

ENTERPRISE NETWORKS

EMEA Product Catalog

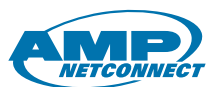

KRONE

FROM TE CONNECTIVITY



HighBand Wall Mount Patching Solution

The highest performing cross-connect system in the world

MAXIMUM NETWORK THROUGHPUT

TE Connectivity's HighBand cross connect solution allows for maximum network throughput and a convenient, secure network termination point.



The solution is comprised of high performance disconnection modules, user friendly cable management and innovative antisnag patch cords. It is the ideal cabling solution for companies who require efficiency, guaranteed performance and appealing aesthetics.

The HighBand range is based on Patch-by-Exception, which is a unique termination technology that offers material, installation and operational cost savings, making it a compelling alternative to traditional RJ45 products. The beauty of a patch-by-exception solution is that the connections are hard wired so no patch cords or jumper cables are visible at the front. The system is totally hard wired from network equipment to work area, providing a secure, reliable, high performance infrastructure from switch to work area, or PABX to telephone. Patch cords can be used to route 'exceptions' or changes to the original configuration. The disconnection modules can be either patched or jumpered and used in a Patch-by-Exception structured cabling solution.

HighBand utilizes the silver plated, world renowned LSA-PLUS contact principle. This TE Connectivity technology has become the industry standard in over 140 countries. The gas-tight contacts ensure a reliable and long lasting connection.

The frequent moves, adds and changes that occur in today's cabling systems can quickly degrade the quality of wire termination. TE Connectivity products maintain superior connectivity during hundreds of re-terminations and deliver the best electrical performance in the industry.

RELIABLE, SECURE AND COST EFFECTIVE



For further information on the HighBand System please contact your local Enterprise Networks sales representative

Table of Contents

Systems by Name:

1. MPO/MPOptimate System.....	1
2. MRJ21 System.....	25
3. Sigma-Link System.....	35
4. Mixed Media Platform.....	41
5. FiberGuide System.....	51
6. Storage Area Management (SAM).....	83
7. Core VSM System	89
8. Managed Connectivity	95
9. Optical LAN Solutions.....	117
10. AMP CO System	123

Systems by Technology:

11. Fiber Optic Cabling.....	139
12. Modular Twisted Pair Cabling.....	197
13. Home Net-works Residential Cabling.....	269
14. Commercial and Industrial Ethernet LAN.....	275
15. Administration & Labeling.....	283
Part Number Index.....	287

What's New?

Introducing the first TE Enterprise Networks Catalog with the combined AMP NETCONNECT and KRONE portfolios for the EMEA and AU/NZ regions

This edition of the Enterprise Networks Product Catalog is the first catalog for our EMEA based customers that features products from both the AMP NETCONNECT and KRONE portfolios.

This means that TE Connectivity can now offer you a choice from the best of both worlds to address all of your cabling infrastructure needs, no matter if it's a Data Center, an Office Complex or a Campus environment.

In addition to the existing products from these two world class brands, you'll find many exciting, new products as featured on this double page.

The catalog is split into two main sections: the first (chapters 1-10) contains our products organised by the name of the system, and the second (chapters 11-15) makes it easy to find products by technology for example, Twisted Pair or Fiber Optic.

You'll also find useful cross-references in each section to make sure you don't miss the product you are looking for that may be listed in a different section.



KRONE

FROM TE CONNECTIVITY

MRJ21 XG System - A Pre-Connectorized Plug & Play 10 GbE Copper System

The MRJ21 XG System supports 10 Gigabit Ethernet throughput in all architectures where copper cabling is required. This pre-terminated Plug & Play system enables the data center manager to quickly add additional capacity or services whilst guaranteeing data throughput performance 100% of the time. Also, the lower cable volume deployed in the data center can reduce containment costs, and present less of an obstruction to the airflow entering and exiting the servers and switches.



Learn more about the MRJ21 XG System from page 26.

Sigma-Link Quick-Fit System - A pre-terminated bundled Copper Cabling Solution

The Sigma-Link Quick-Fit System can be deployed in any application that requires copper twisted pair cabling as the medium of transport. It can be used to connect Users to Switches, Switches to other Switches, or Switches to Servers. Ranging from Category 6 to Category 7A, Sigma-Link supports up to 10 Gigabit Ethernet transmission, and beyond, allowing very high bandwidth applications and protocols to be supported in the future. As a Housing-to-Housing solution it can be quickly located into our UCP panels, taking minimal time to deploy and configure a new channel in the network.



Learn more about the Sigma-Link Quick-Fit System from page 36.

Storage Area Management - Simplify your Optical Cable Management

TE's Storage Area Management (SAM) Solution for SAN infrastructures is designed to reduce the bulkiness of cabling and connectors in the data center by up to 80% and enable high-density deployment with fewer costly cabinet or infrastructure upgrades. SAM can help you save time, reduce costs, maximize efficiency, and free up much needed space in your data center. It takes the complexity out of cable management, and optimizes the performance of your data center floor space, racks and electronics.

De-clutter your racks for a highly organized, eco-friendly network infrastructure and deliver operational efficiency to your SAN cabling.

Learn more about the SAM Solution from page 84.



What's New?

Core Vertical Switch Management – Deliver Efficiency to the Core of Your DC

The Core Vertical Switch Management platform (Core VSM) is an innovative solution to the challenges posed in the data center by high-density core switches with a vertical blade configuration.

The platform consists of a cable management guide that fits above the switch and copper or fiber modules that provide connections for blades of either media. The complete Core VSM platform can be installed within an 800 mm wide cabinet, saving valuable white space in the data center.

Within the Core VSM platform, all patch cables, whether fiber or copper, are managed vertically with only one length of patch cord being required to patch within a frame which simplifies the build process and ongoing logistics.

Learn more about the Core VSM Solution from page 90.



Infrastructure Configuration Manager - Know Your Network!

The Infrastructure Configuration Manager (ICM) is software specifically designed to operate as part of TE's Managed Connectivity solution. ICM can be used by a full range of companies – small, medium and enterprise customers can utilize the software to accurately document the physical infrastructure that their business relies on. This software engine enables the automated, accurate, real-time physical layer management of TE's two hardware platforms: AMPTRAC 9th wire system and QUAREO connection point identification technology, providing customers with a single software for both solutions. ICM provides a live graphical view of the physical layer topology, including Layer 2 and Layer 3 devices. The latest addition to this software solution is a mobile app for smartphones (ICM Mobile) which allows a technician to access the ICM desktop functionalities like Work Orders, Events and several settings from a mobile device.



Learn more about ICM on pages 96 and 104.

Optical LAN Solutions – New Ways of Delivering High-Bandwidth to Each Desktop

TE Connectivity offers a complete, end-to-end PON infrastructure solution called Optical LAN Solution (OLS). From the data center to the desktop, our customers have tapped the experience and innovation of TE to build their PON networks. TE's suite of end-to-end connectivity is truly comprehensive and takes a single strand of singlemode fiber from the Data Center all the way to the individual desk or end device location.

Learn more about OLS from page 118.

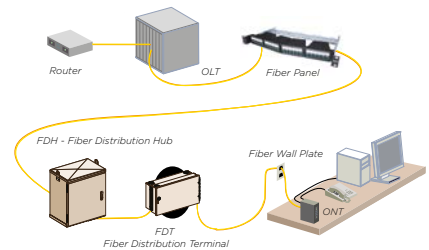

TE Enterprise Networks 25 Year Warranty

WARRANTY SUPPORT FOR THE NEXT 25 YEARS

There are many structured cabling warranties available on the market today but only the TE25 Warranty provides all of this in one package, backed by a multi-billion dollar company with connector technology at the heart of its strategy.



TE Connectivity is committed to being the world's leading provider of enterprise networks infrastructure solutions. With connector technology as the prime focus of our business and a track record in the structured cabling industry through our AMP NETCONNECT and KRONE brands, a TE25 warranty provides the added assurance of a warranty backed by a company with long-term industry stability.

THE TE 25 YEAR SYSTEM WARRANTY PROVIDES COVER ON THE COMPLETE CABLING SYSTEM

- Comprises cable, connectors, connecting hardware and patch cords
- Covers defects in either materials or workmanship for the full 25 years
- Ensures that all signal carrying components meet the prescribed mechanical and transmission specifications for these products
- Includes repair or replacement of defective products— at our cost
- Includes the labor cost

DIRECT TO END USER

The TE25 Warranty is a contract made directly between TE Connectivity and the customer.

How It Works:

1. End user selects TE Connectivity Cabling system
2. End user selects ND&I program installer
3. ND&I installs, tests and documents the cabling system
4. ND&I provides defined project documentation and test results to TE Connectivity
5. TE grants warranty to end user

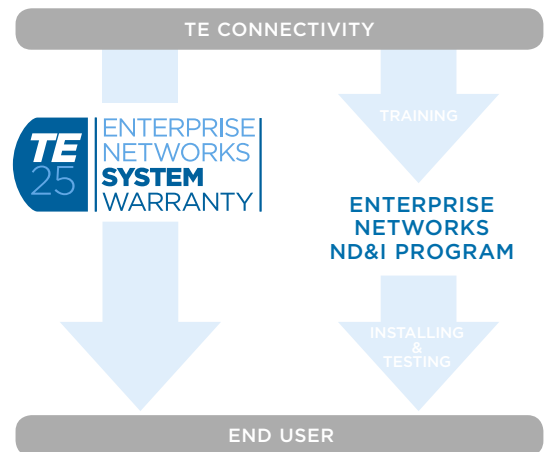

THE TE25 COMPONENT WARRANTY

For those occasions when a full system warranty is not appropriate, for example where confidentiality or security issues prevent full details of the system being shared with TE, a component warranty is available. Less stringent in terms of the registration requirements and not as comprehensive as the system warranty, it still provides 25 year cover for all TE components to the latest international standards.



1. MPO/MPOptimate System

MPO/MPOptimate Installation and Polarity	02
12 Fiber MPOptimate System.....	03
12 Fiber MPO System.....	07
24 Fiber MPOptimate System.....	13
MPO/MPOptimate Panels & Accessories.....	19
Q3000 Series MPO Fiber Panels	22
MPO/MPOptimate Cleaning Tools.....	24

MPO/MPOOptimate System

MPO/MPOOptimate Installation and Polarity

MPO/MPOOptimate installation and polarity

In each fiber optic system, the link from source (Tx) to receiver (Rx) needs to be flipped once.

In a complete MPO/MPOOptimate link this flipping is provided by one flipped cassette, while all other components in this link shall be installed as straight version.

MPOOptimate ready for 10, 40 and 100 Gb/s

The MPOOptimate system is designed to support 10G Ethernet and 4/8/16G Fiber Channel applications through the complete structure of a Data Center, as specified in ISO/IEC 24764, EN 50173-5 and TIA/EIA 942. The MPOOptimate system is designed to have 6 cassettes per link for 10 Gb/s with a full 300 meter support on OM3 fibers and 550 meter on OM4 fibers.

It offers one passive channel from the end equipment to the core switch without the need of repeating signals for amplifying reasons. When using the MPOOptimate cabling system, the owner can replace aggregation switches by a patch cord without changing the passive infrastructure.

The system offers already today a fully 40 and 100 Gb/s capability and seamless migration.

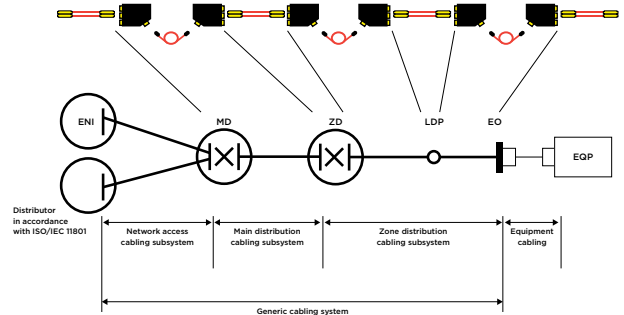
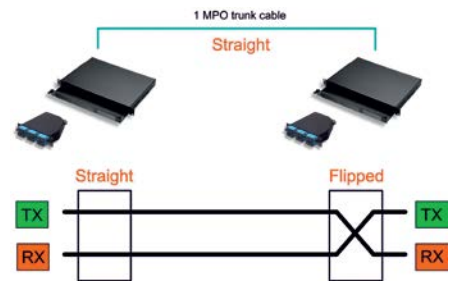

Length tables for MPO/MPOOptimate trunks and fan-out assemblies

LENGTH TABLE A:

Y-X	Length	Y-X	Length	Y-X	Length	Y-X	Length	Y-X	Length	Y-X	Length	Y-X	Length	Y-X	Length
0-2	2 m	1-3	13 m	2-4	24 m	3-5	35 m	4-6	46 m	5-7	57 m	6-8	68 m	7-9	79 m
0-3	3 m	1-4	14 m	2-5	25 m	3-6	36 m	4-7	47 m	5-8	58 m	6-9	69 m	8-0	80 m
0-4	4 m	1-5	15 m	2-6	26 m	3-7	37 m	4-8	48 m	5-9	59 m	7-0	70 m	8-1	81 m
0-5	5 m	1-6	16 m	2-7	27 m	3-8	38 m	4-9	49 m	6-0	60 m	7-1	71 m	8-2	82 m
0-6	6 m	1-7	17 m	2-8	28 m	3-9	39 m	5-0	50 m	6-1	61 m	7-2	72 m	8-3	83 m
0-7	7 m	1-8	18 m	2-9	29 m	4-0	40 m	5-1	51 m	6-2	62 m	7-3	73 m	8-4	84 m
0-8	8 m	1-9	19 m	3-0	30 m	4-1	41 m	5-2	52 m	6-3	63 m	7-4	74 m	8-5	85 m
0-9	9 m	2-0	20 m	3-1	31 m	4-2	42 m	5-3	53 m	6-4	64 m	7-5	75 m	8-6	86 m
1-0	10 m	2-1	21 m	3-2	32 m	4-3	43 m	5-4	54 m	6-5	65 m	7-6	76 m	8-7	87 m
1-1	11 m	2-2	22 m	3-3	33 m	4-4	44 m	5-5	55 m	6-6	66 m	7-7	77 m	8-8	88 m
1-2	12 m	2-3	23 m	3-4	34 m	4-5	45 m	5-6	56 m	6-7	67 m	7-8	78 m	8-9	89 m

LENGTH TABLE B:

Y-X	Length	Y-X	Length	Y-X	Length	Y-X	Length	Y-X	Length	Y-X	Length	Y-X	Length	Y-X	Length
9-9	100 m	1-1	111 m	2-2	122 m	3-3	133 m	4-4	148 m	5-5	170 m	6-6	192 m	7-7	270 m
0-1	101 m	1-2	112 m	2-3	123 m	3-4	134 m	4-5	150 m	5-6	172 m	6-7	194 m	7-8	280 m
0-2	102 m	1-3	113 m	2-4	124 m	3-5	135 m	4-6	152 m	5-7	174 m	6-8	196 m	7-9	290 m
0-3	103 m	1-4	114 m	2-5	125 m	3-6	136 m	4-7	154 m	5-8	176 m	6-9	198 m	8-0	300 m
0-4	104 m	1-5	115 m	2-6	126 m	3-7	137 m	4-8	156 m	5-9	178 m	7-0	200 m	8-1	320 m
0-5	105 m	1-6	116 m	2-7	127 m	3-8	138 m	4-9	158 m	6-0	180 m	7-1	210 m	8-2	340 m
0-6	106 m	1-7	117 m	2-8	128 m	3-9	139 m	5-0	160 m	6-1	182 m	7-2	220 m	8-3	360 m
0-7	107 m	1-8	118 m	2-9	129 m	4-0	140 m	5-1	162 m	6-2	184 m	7-3	230 m	8-4	380 m
0-8	108 m	1-9	119 m	3-0	130 m	4-1	142 m	5-2	164 m	6-3	186 m	7-4	240 m	8-5	400 m
0-9	109 m	2-0	120 m	3-1	131 m	4-2	144 m	5-3	166 m	6-4	188 m	7-5	250 m	8-6	420 m
1-0	110 m	2-1	121 m	3-2	132 m	4-3	146 m	5-4	168 m	6-5	190 m	7-6	260 m	8-7	440 m

MPO/MPOptimate System

12 Fiber MPOptimate System

MPOptimate pre-terminated trunks

FEATURES

- Cable terminated with low loss 12 fiber MPOptimate connectors
- Terminated with female MPO connectors (male versions on request)
- OM3 or OM4 cable performance, LSZH construction
- Connector performance: Attenuation \leq 0.35 dB (max); RL \geq 28 dB (min)
- The trunks are equipped with midi fan-out and 3.2mm round cable MPO tails
- All tails are protected with transparent protection sleeve
- Available in 12, 24 and 48 fiber (other fiber counts on request)
- Factory pre-terminated assemblies
- All products with protocol, for constant and reliable quality
- Available in 12, 24 and 48 fiber (other fiber counts on request)
- Packaging: \leq 50 m in box, $>$ 50 m on reel
- Re-usable pulling socks can be ordered separately.
12 - 24 fiber trunks Part Number 2055567-1
48 fiber trunks Part Number 2055567-2



ORDERING INFORMATION

Description	Part Number	Part Number
	2-99 m - table A	100-500 m - table B
12 fiber; OM4 XGA 10 Gb/s; Straight; A wiring	Y-2055576-X	Y-2055577-X
24 fiber; OM4 XGA 10 Gb/s; Straight; A wiring	Y-2055578-X	Y-2055579-X
48 fiber; OM4 XGA 10 Gb/s; Straight; A wiring	Y-2160075-X	Y-2160076-X
12 fiber; OM3 XG 10 Gb/s; A wiring	Y-2055611-X	Y-2055612-X
24 fiber; OM3 XG 10 Gb/s; A wiring	Y-2055715-X	Y-2055716-X
48 fiber; OM3 XG 10 Gb/s; A wiring	Y-2160073-X	Y-2160074-X

For available lengths: see page 02

MPO/MPOptimate System

12 Fiber MPOptimate System

MPOptimate to LC Quick-Fit cassettes

FEATURES

- Pre-terminated low loss cassettes
- Front: 6 x optimized LC Duplex or 6 x optimized LC Quad
- Back: 1 or 2 low loss MPOptimate connector(s)
- Available in straight or flipped pair version
- Optical cassette performance in OM3 and OM4:
Attenuation \leq 0.35 dB/cassette (max.)
RL \geq 27 dB (min)
- All products with protocol, for constant and reliable quality
- Fits in AMP NETCONNECT Quick-Fit patch panels with maximum density of 4 cassettes per 1U
- Port number labeling and additional label strip included



ORDERING INFORMATION

Description	Pairs straight Part Number	Pairs flipped Part Number
1 x MPOptimate to 6 x LC Duplex (12 fiber); OM3 XG 10 Gb/s	1671226-3	1-1671226-3
1 x MPOptimate to 6 x LC Duplex (12 fiber); OM4 XG _A 10 Gb/s	1671226-5	1-1671226-5
2 x MPOptimate to 6 x LC Quad (24 fiber); OM3 XG 10 Gb/s	1671227-3	1-1671227-3
2 x MPOptimate to 6 x LC Quad (24 fiber); OM4 XG _A 10 Gb/s	1671227-5	1-1671227-5

MPOptimate to SC Quick-Fit cassettes

FEATURES

- Pre-terminated low loss cassettes
- Front: 6 x optimized SC Duplex
- Back: 1 x low loss MPOptimate connector
- Available in straight or flipped pair version
- Optical cassette performance in OM3:
Attenuation \leq 0.35 dB (max.)
RL \geq 27 dB (min)
- All products with protocol, for constant and reliable quality
- Fits in AMP NETCONNECT Quick-Fit patch panels with maximum density of 4 cassettes per 1U

Port number labeling and additional label strip included



ORDERING INFORMATION

Description	Pairs straight Part Number	Pairs flipped Part Number
1 x MPOptimate to 6 x SC Duplex; (12 fiber): OM3 XG 10 Gb/s	1671228-3	1-1671228-3

MPO/MPOptimate System

12 Fiber MPOptimate System

MPOptimate to LC pre-assembled panel

FEATURES

- Pre-terminated panel with 4 or 8 MPOptimate 12 fiber trunk connections at rear and 12 or 24 optimized LC Quad at the front side
- Flush mount LC couplers in front and integrated management on the rear side
- Optical panel performance: Attenuation \leq 0.35 dB (max); RL \geq 27 dB (min)
- All products with protocol, for constant and reliable quality



ORDERING INFORMATION

Description	Pairs straight Part Number	Pairs flipped Part Number
Fiber type: OM3 XG 10 Gb/s; Fiber count: 96 fiber	1966328-5	2-1966328-5
Fiber type: OM3 XG 10 Gb/s; Fiber count: 48 fiber	1966328-6	2-1966328-6
Fiber type: OM4 XGA 10 Gb/s; Fiber count: 96 fiber	1966328-8	2-1966328-8
Fiber type: OM4 XGA 10 Gb/s; Fiber count: 48 fiber	1966328-7	2-1966328-7

MPOptimate patch cords

FEATURES

- Low loss MPOptimate 12 fiber MPO round cable patch cord
- Terminated with male and/or female MPOptimate connectors
- Cable performance: OM4; OM3 XG 10 Gb/s; LSZH construction
- Connector performance: Attenuation \leq 0.35 dB (max.); RL \geq 28 dB (min)
- All products with protocol, for constant and reliable quality
- Available in female/female and male/female version in straight "A" wiring and total flipped "B" wiring



Color: aqua

LENGTH TABLE:

Y-X	Length	Y-X	Length	Y-X	Length	Y-X	Length	Y-X	Length	Y-X	Length	Y-X	Length	Y-X	Length		
9-0	0,5	9-5	5,5	1--1	11	2--1	21	3--1	31	4--1	41	5--1	51	6--1	61	7--1	71
0-1	1,0	0-6	6,0	1--2	12	2--2	22	3--2	32	4--2	42	5--2	52	6--2	62	7--2	72
9-1	1,5	9-6	6,5	1--3	13	2--3	23	3--3	33	4--3	43	5--3	53	6--3	63	7--3	73
0-2	2,0	0-7	7,0	1--4	14	2--4	24	3--4	34	4--4	44	5--4	54	6--4	64	7--4	74
9-2	2,5	9-7	7,5	1--5	15	2--5	25	3--5	35	4--5	45	5--5	55	6--5	65	7--5	75
0-3	3,0	0-8	8,0	1--6	16	2--6	26	3--6	36	4--6	46	5--6	56	6--6	66	7--6	76
9-3	3,5	9-8	8,5	1--7	17	2--7	27	3--7	37	4--7	47	5--7	57	6--7	67	7--7	77
0-4	4,0	0-9	9,0	1--8	18	2--8	28	3--8	38	4--8	48	5--8	58	6--8	68	7--8	78
9-4	4,5	9-9	9,5	1--9	19	2--9	29	3--9	39	4--9	49	5--9	59	6--9	69	7--9	79
0-5	5,0	1-0	10	2-0	20	3-0	30	4-0	40	5-0	50	6-0	60	7-0	70	8-0	80

ORDERING INFORMATION

Description	Pairs straight Part Number	Pairs total flipped Part Number
MPOptimate female - MPOptimate female patch cord; OM3 XG 10 Gb/s	Y-2160135-X	Y-2160193-X
MPOptimate female - MPOptimate female patch cord; OM4 XGA 10 Gb/s	Y-2160136-X	Y-2160194-X
MPOptimate female - MPOptimate male patch cord; OM3 XG 10 Gb/s	Y-2160139-X	Y-2160197-X
MPOptimate female - MPOptimate male patch cord; OM4 XGA 10 Gb/s	Y-2160140-X	Y-2160198-X

MPO/MPOptimate System

12 Fiber MPOptimate System

MPOptimate Fan-Out cable assemblies

FEATURES

- Low loss transition from MPO to LC or SC tails 2 mm
- Terminated with female or male MPOptimate connectors
- Cable performance: OM4 or OM3 XG 10 Gb/s; LSZH construction
- Optical performance:
 - MPO connector: Attenuation \leq 0.35 dB (max.); RL \geq 28 dB (min)
 - LC/SC connector: Attenuation \leq 0.15 dB (max); RL \geq 35 dB(min)
- All products with protocol, for constant and reliable quality
- Tail lengths: 4 x 40 cm, 4 x 50 cm, 4 x 60 cm.
Other tail lengths available on request
- The trunks are equipped with midi fan-out; 3.2 round cable MPO tails and 2.0mm
- All tails are protected with transparent protection sleeve
- Packaging: \leq 50 m in box, >50 m on reel
- Re-usable pulling socks can be ordered separately. Part Number 2055567-1

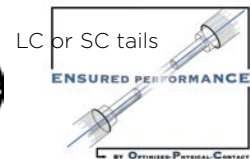

ORDERING INFORMATION

Description	Part Number	Part Number
	2-99 m - table A	100-500 m - table B
1 x MPOptimate female to 12 x LC Simplex; OM4 XGA 10 Gb/s	Y-2055580-X	Y-2055581-X
1 x MPOptimate female to 12 x SC Simplex; OM4 XGA 10 Gb/s	Y-2160114-X	Y-2160115-X
1 x MPOptimate female to 12 x LC Simplex; OM3 XG 10 Gb/s	Y-2055623-X	Y-2055624-X
1 x MPOptimate female to 12 x SC Simplex; OM3 XG 10 Gb/s	Y-2160112-X	Y-2160113-X
1 x MPOptimate male to 12 x LC Simplex; OM4 XGA 10 Gb/s	Y-2160146-X	Y-2160147-X
1 x MPOptimate male to 12 x SC Simplex; OM4 XGA 10 Gb/s	Y-2160126-X	Y-2160127-X
1 x MPOptimate male to 12 x LC Simplex; OM3 XG 10 Gb/s	Y-2055600-X	Y-2055704-X

For available lengths: see 02

MPOptimate System LC and SC patch cords

FEATURES

- Patch cords with optimized LC and SC connectors
- Cable performance: OM4 or OM3 XG 10 Gb/s; LSZH construction
- Optical performance:
 - LC connector: Attenuation \leq 0.15 dB (max); RL \geq 35 dB(min)
 - SC connector: Attenuation \leq 0.15 dB (max); RL \geq 35 dB(min)
- All products with protocol, for constant and reliable quality



Y- -X	Length
0- -1	1 m
0- -3	3 m
0- -5	5 m
1- -0	10 m

ORDERING INFORMATION

Description	Part Number
Patch cord LC Duplex - LC Duplex; OM3 XG 10 Gb/s	Y-1920743-X
Patch cord SC Duplex - SC Duplex; OM3 XG 10 Gb/s	Y-2055108-X
Patch cord LC Duplex - SC Duplex; OM3 XG 10 Gb/s	Y-2055109-X
Patch cord LC Duplex - LC Duplex; OM4 XGA 10 Gb/s	Y-2160046-X
Patch cord SC Duplex - SC Duplex; OM4 XGA 10 Gb/s	Y-2160047-X
Patch cord LC Duplex - SC Duplex; OM4 XGA 10 Gb/s	Y-2160048-X

MPO/MPOptimate System

12 Fiber MPO System

Pre-terminated MPO trunk cable, 12/24/48 fiber

FEATURES

- Factory pre-terminated assemblies
- Cables terminated with high density MPO connectors
- All products with protocol, for constant and reliable quality
- In OM3 and OS2 design with LSZH sheath
- Available in lengths from 2 up to 500 m
- The trunks are equipped with midi fan-out and 3.2mm round cable MPO tails
- All tails are protected with transparent protection sleeve
- Available in 12, 24 and 48 fiber (other fiber counts on request)
- Packaging: ≤50 m in box, >50 m on reel
- Re-usable pulling socks can be ordered separately.
12 and 24 fibre trunks Part number 2055567-1
48 fibre trunks Part number 2055567-2



ORDERING INFORMATION

Description	Part Number	Part Number
	2-99 m - table A	100-500 m - table B
12 Fiber; OM3 XG 10 Gb/s; Straight "A" wiring	Y-2055707-X	Y-2055708-X
24 Fiber; OM3 XG 10 Gb/s; Straight "A" wiring	Y-2055709-X	Y-2055710-X
48 Fiber; OM3 XG 10 Gb/s; Straight "A" wiring	Y-2160071-X	Y-2160072-X
12 Fiber; SM; Straight "A" wiring	Y-2055711-X	Y-2055712-X
24 Fiber; SM; Straight "A" wiring	Y-2055713-X	Y-2055714-X
48 Fiber; SM; Straight "A" wiring	Y-2160077-X	Y-2160078-X

For available lengths: see page 02

MPO/MPOptimate System

12 Fiber MPO System

MPO to LC Quick-Fit cassettes

FEATURES

- Simple and flexible premises fiber cabling
- Pre-terminated cassettes with either 1 or 2 MPO trunk connections (1 x 12 or 2 x 12 fibers) at rear
- 6 x LC Duplex (12 fibers) or 6 x LC Quad (24 fibers) connection in the front
- All products with protocol, for constant and reliable quality
- Easy installation, moves, adds and changes
- Fits in all AMP NETCONNECT Patch Panels for Quick-Fit Modules
- Panels accept up to 4 cassettes achieving up to 96 fiber connections on 1U

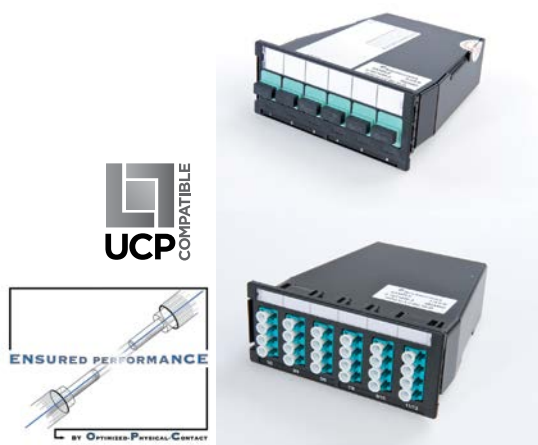

ORDERING INFORMATION

Description	Pairs straight Part Number	Pairs flipped Part Number
1 x MPO to 6 x LC Duplex; OM3 XG 10 Gb/s	1671205-3	1-1671205-3
2 x MPO to 6 x LC Quad; OM3 XG 10 Gb/s	1671206-3	1-1671206-3
1 x MPO to 6 x LC Duplex; SM	1671205-4	1-1671205-4
1 x MPO to 6 x LC APC Duplex; SM	1671205-6	1-1671205-6
2 x MPO to 6 x LC Quad; SM	1671206-4	1-1671206-4
2 x MPO to 6 x LC APC Quad; SM	1671206-6	1-1671206-6

MPO to SC Quick-Fit cassettes

FEATURES

- Simple and flexible premises fiber cabling
- Pre-terminated cassettes with 1 MPO trunk connection (1 x 12 fibers) at rear
- 6 x SC Duplex (12 fibers) connections in the front
- All products with protocol, for constant and reliable quality
- Easy installation, moves, adds and changes
- Fits in all AMP NETCONNECT Patch Panels for Quick-Fit Modules
- Panels accept up to 4 cassettes on 1U



ORDERING INFORMATION

Description	Pairs straight Part Number	Pairs flipped Part Number
1 x MPO to 6 x SC Duplex; OM3 XG 10 Gb/s	1671207-3	1-1671207-3
1 x MPO to 6 x SC Duplex; SM	1671207-4	1-1671207-4
1 x MPO to 6 x SC APC Duplex; SM	1671207-6	1-1671207-6

MPO/MPOptimate System

12 Fiber MPO System

MPO to LC pre-assembled panel

FEATURES

- Simple and flexible premises fiber cabling
- High Density Compact designed fix style 19" panel 1U
- Pre-terminated panel with 4 or 8 MPO 12 fiber trunk connections at rear and 12 or 24 LC Quad at the front side
- All products with protocol, for constant and reliable quality
- Flush mount LC couplers in front and integrated management on the rear side



ORDERING INFORMATION

Description	Pairs Straight Part Number	Pairs Flipped Part Number
Fiber Type: OM3 XG 10 Gb/s; Fiber count: 96 fibers	1966328-1	2-1966328-1
Fiber Type: OM3 XG 10 Gb/s; Fiber count: 48 fibers	1966328-2	2-1966328-2
Fiber Type: SM; Fiber count: 96 fibers	1966328-3	2-1966328-3

MPO patch cords

FEATURES

- MPO patch cord
- Cable performance: OM3 or OS2; LSZH 3.2mm round cable construction
- All products with protocol, for constant and reliable quality
- Available in female/female and male/female version in straight "A" wiring and total flipped wiring "B" wiring



Color: aqua

LENGTH TABLE:

Y- -X	Length	Y- -X	Length	Y- -X	Length	Y- -X	Length	Y- -X	Length	Y- -X	Length	Y- -X	Length	Y- -X	Length		
9- -0	0,5	9- -5	5,5	1- -1	11	2- -1	21	3- -1	31	4- -1	41	5- -1	51	6- -1	61	7- -1	71
0- -1	1,0	0- -6	6,0	1- -2	12	2- -2	22	3- -2	32	4- -2	42	5- -2	52	6- -2	62	7- -2	72
9- -1	1,5	9- -6	6,5	1- -3	13	2- -3	23	3- -3	33	4- -3	43	5- -3	53	6- -3	63	7- -3	73
0- -2	2,0	0- -7	7,0	1- -4	14	2- -4	24	3- -4	34	4- -4	44	5- -4	54	6- -4	64	7- -4	74
9- -2	2,5	9- -7	7,5	1- -5	15	2- -5	25	3- -5	35	4- -5	45	5- -5	55	6- -5	65	7- -5	75
0- -3	3,0	0- -8	8,0	1- -6	16	2- -6	26	3- -6	36	4- -6	46	5- -6	56	6- -6	66	7- -6	76
9- -3	3,5	9- -8	8,5	1- -7	17	2- -7	27	3- -7	37	4- -7	47	5- -7	57	6- -7	67	7- -7	77
0- -4	4,0	0- -9	9,0	1- -8	18	2- -8	28	3- -8	38	4- -8	48	5- -8	58	6- -8	68	7- -8	78
9- -4	4,5	9- -9	9,5	1- -9	19	2- -9	29	3- -9	39	4- -9	49	5- -9	59	6- -9	69	7- -9	79
0- -5	5,0	1- -0	10	2- -0	20	3- -0	30	4- -0	40	5- -0	50	6- -0	60	7- -0	70	8- -0	80

ORDERING INFORMATION

Description	Pairs straight Part Number	Pairs total flipped Part Number
MPO female - MPO female Patch Cord; OM3 XG 10 Gb/s	Y-2160134-X	Y-2160192-X
MPO female - MPO female Patch Cord; SM	Y-2160137-X	Y-2160195-X
MPO male - MPO female Patch Cord; OM3 XG 10 Gb/s	Y-2160138-X	Y-2160196-X
MPO male - MPO female Patch Cord; SM	Y-2160141-X	Y-2160199-X

MPO/MPOptimate System

12 Fiber MPO System

MPO Fan-Out cable assemblies

FEATURES

- MPO round cable to LC or SC 12 x 2 mm tails
- Terminated with female or male MPO connectors
- Cable performance: OM3 and OS2 in LSZH construction
- All products with protocol, for constant and reliable quality
- Tail lengths: 4 x 40cm, 4 x 50cm, 4 x 60cm (other tail lengths available on request).
- The trunks are equipped with midi fan-out; 3.2 round cable MPO tails and 2.0mm LC or SC tails
- All tails are protected with transparent protection sleeve
- Packaging: ≤50 m in box, >50 m on reel
- Re-usable pulling socks can be ordered separately. Part Number 2055567-1



ORDERING INFORMATION

Description	Part Number	Part Number
	2-99 m - table A	100-500 m - table B
1 x MPO female to 12 x LC Simplex; OM3 XG 10 Gb/s	Y-2160106-X	Y-2160107-X
1 x MPO female to 12 x LC Simplex; SM	Y-2160108-X	Y-2160109-X
1 x MPO female to 12 x SC Simplex; OM3 XG 10 Gb/s	Y-2160110-X	Y-2160111-X
1 x MPO female to 12 x SC Simplex; SM	Y-2160116-X	Y-2160117-X
1 x MPO male to 12 x LC Simplex; OM3 XG 10 Gb/s	Y-2160012-X	Y-2160013-X
1 x MPO male to 12 x LC Simplex; SM	Y-2160122-X	Y-2160123-X
1 x MPO male to 12 x SC Simplex; OM3 XG 10 Gb/s	Y-2160124-X	Y-2160125-X
1 x MPO male to 12 x SC Simplex; SM	Y-2160128-X	Y-2160129-X

For available lengths: see page 02

MPO/MPOptimate System

12 Fiber MPO System

Patch Leads – Technical Data

SC Assemblies

Cable sheath:	LSZH
Cable diameter:	2.5 mm Twin Zip
Ferrule	Ceramic

LC Assemblies

Cable sheath:	LSZH
Cable diameter:	1.8 mm Mini Twin Zip
Ferrule	Ceramic

All assemblies are machine polished providing highest quality.

Multimode OM3 and singlemode OS2 assemblies have an ensured performance by Optimized-Physical-Contact (OPC).

All assemblies are factory tested and come with a test protocol.

Insertion Loss and Return Loss values specified against reference connectors.

Singlemode Patch Cords

Connector Type	Attenuation max.	Return loss. min.	Temp. Range
SC, PC	0,3 dB	> 45 dB	-10°C / +60°C
LC, PC	0,3 dB	> 45 dB	-10°C / +60°C

Multimode Patch Cords

Connector Type	Attenuation max.	Return loss. min.	Temp. Range
SC, PC	0,3 dB	> 20 dB	-10°C / +60°C
LC, PC	0,3 dB	> 20 dB	-10°C / +60°C

LC Duplex / LC Duplex patch cords

FEATURES

- All assemblies are machine polished providing highest quality.
- Multimode OM3 and singlemode OS2 assemblies have an ensured performance by Optimized-Physical-Contact (OPC).
- All assemblies are factory tested and come with a test protocol



ORDERING INFORMATION

Description	Part Number	Y- X	Length
OS2	Y-6536501-X	0- -1	1 m
OM3 XG 10 Gb/s	Y-6536969-X	0- -2	2 m
		0- -3	3 m
		0- -5	5 m
		1- -0	10 m

MPO/MPOptimate System

12 Fiber MPO System

LC Duplex / SC Duplex patch cords

FEATURES

- All assemblies are machine polished providing highest quality.
- Multimode OM3 and singlemode OS2 assemblies have an ensured performance by Optimized-Physical-Contact (OPC).
- All assemblies are factory tested and come with a test protocol



Y- -X	Length
0- -1	1 m
0- -2	2 m
0- -3	3 m
0- -5	5 m
1- -0	10 m

ORDERING INFORMATION

Description	Part Number
OS2	Y-6536508-X
OM3 XG 10 Gb/s	Y-6536967-X

SC Duplex / SC Duplex patch cords

FEATURES

- All assemblies are machine polished providing highest quality.
- Multimode OM3 and singlemode OS2 assemblies have an ensured performance by Optimized Physical Contact (OPC).
- All assemblies are factory tested and come with a test protocol

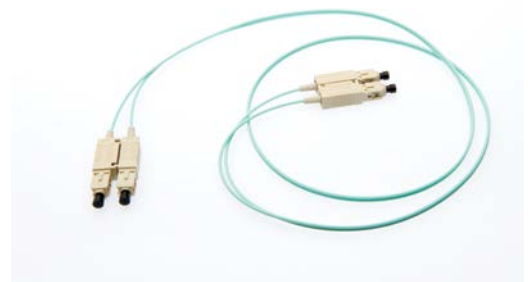

Y- -X	Length
0- -1	1 m
0- -2	2 m
0- -3	3 m
0- -5	5 m
1- -0	10 m

ORDERING INFORMATION

Description	Part Number
OS2	Y-6348260-X
OM3 XG 10 Gb/s	Y-6536464-X

MPO/MPOptimate System

24 Fiber MPOptimate System

24 Fiber MPOptimate System

Demand for bandwidth and storage is expanding at a breathtaking rate within the data center, which means that the environment is rapidly evolving, making the impact on data center design and management profound.

Networks will need to be ready to migrate from 10 to 40 to 100 GbE speeds dynamically, whilst data center managers and designers need to be able to manage this migration to maximize efficiency and responsiveness while minimizing cost.

Preparing for this trend demands a simple yet robust migration pathway.

As part of TE Connectivity's data center solution, the 24 Fiber MPOptimate system enables such a plan, supporting the migration of increasing data speeds required to support the next generation of servers, storage and switching platforms.



SYSTEM FEATURES:

- Low-loss 24 fiber MPOptimate modules
- Fast interfacing, "trouble free" of gender and polarity issues
- Low loss 24 fiber MPOptimate trunks
- Supporting 10/40/100GbE throughput
- A single trunking format that can be replicated and upgraded simply and flexibly
- Pre-engineered paths and polarity
- 24 Fiber trunk systems offer higher fiber utilization versus 12 fiber trunk systems
- Fewer trunks: less containment space needed leading to lower initial build costs.
- Fewer connections: faster time to turn up circuits
- Fewer components
- Standardized practices for design, installation, documentation and troubleshooting polarity
- Each product is individually tested to ensure that its performance meets or exceeds the required standard. The test results are supplied with each product.

MPO/MPOOptimate System

24 Fiber MPOOptimate System

MPOOptimate 24f pre-terminated trunks

FEATURES

- Loose tube cable construction, ideal for routing through cable tray or raceway
- Cable terminated with low loss 24 fiber MPOOptimate connectors
- Terminated with female MPO connectors (male versions on request)
- OM3, OM4 cable performance, LSZH construction
- Connector performance for OM3/OM4:
Attenuation \leq 0.25 dB (max.);
RL \geq 28 dB (min)
- The trunks are equipped with midi fan-out and 3.8mm round cable MPO tails (80cm)
- All tails are protected with transparent protection sleeve
- Factory pre-terminated assemblies
- All products with protocol, for constant and reliable quality
- Packaging: \leq 50 m in box, $>$ 50 m on reel
- Re-usable pulling socks can be ordered separately. Part Number 2055567-1



Color: aqua

ORDERING INFORMATION

Description	Part Number	Part Number
	2-99 m - table A	100-500 m - table B
24 fiber; OM3; Straight A wiring;	Y-2160663-X	Y-2160664-X
24 fiber; OM4; Straight A wiring;	Y-2160608-X	Y-2160609-X

For available lengths: see 02

MPO/MPOptimate System

24 Fiber MPOptimate System

10Gb/s Cassettes – 1x24 fiber MPO to 6 LC Quad connectors



FEATURES

- Pre-terminated low loss cassettes
- Front: 6 x optimized LC Quad
- Back: 1 x 24 fiber low loss MPOptimate connector
- Optical cassette performance for OM3/OM4:
Attenuation \leq 0.35 dB(max.) RL \geq 27 dB(min)
- All products with protocol, for constant and reliable quality
- Port number labelling and additional label strip included



ORDERING INFORMATION

Description	Part Number straight	Part Number flipped
1x24 fiber MPO to 6x LC Quad OM4	2160266-5	1-2160266-5
1x24 fiber MPO to 6x LC Quad OM3	2160266-3	1-2160266-3

40GbE (4 x 10GbE) Cassette – 1x24 fiber MPO to 6 LC Quad connectors



FEATURES:

- Quick-Fit design, fits in all UCP products
- OM4 bend insensitive fiber
- For channel with 40G MPO cassettes connected to 40G (4x10G) transceiver
- Cassette attenuation: typical 0.25dB/max. 0.35dB
- Cassette Return Loss: 27dB min



ORDERING INFORMATION

Description	Wire map	Part Number
1x24 fiber MPO to 6x LC Quad	Special 40/10G	2160640-5

40Gb/s Cassette – 1x24 fiber MPO to 3x12 (8) fiber MPO connectors



FEATURES:

- Quick-Fit design, fits in all UCP products
- OM4 bend insensitive fiber
- Cassette attenuation: typical 0.36dB/max. 0.5dB
- Cassette Return Loss: 27dB min

ORDERING INFORMATION

Description	Wire map	Part Number
1x24 fiber MPO to 3x12(8) fiber MPO	Universal	2160639-5



MPO/MPOptimate System

24 Fiber MPOptimate System

40Gb/s Cassette - 2x24 fiber MPO to 6x12 (8) fiber MPO connectors



FEATURES:

- Quick-Fit design, fits in all UCP products
- OM4 bend insensitive fiber
- Cassette attenuation: typical 0.36dB/max. 0.5dB
- Cassette Return Loss: 27dB min

ORDERING INFORMATION

Description	Wire map	Part Number
2x24 fiber MPO to 6x12(8) fiber MPO	Universal	2160649-5



100Gb/s Cassette - 1x24 fiber MPO to 1x24 fiber MPO connector



FEATURES:

- Quick-Fit design, Fits in all UCP products
- OM4 bend insensitive fiber
- Cassette attenuation: typical 0.36dB/max. 0.5dB
- Cassette Return Loss: 27dB min

ORDERING INFORMATION

Description	Wire map	Part Number
1x24 fiber MPO to 1x24 fiber MPO	Polarity A	2160650-5
1x24 fiber MPO to 1x24 fiber MPO	Polarity B	1-2160650-5



100Gb/s Cassette - 2x24 fiber MPO to 2x24 fiber MPO connectors



FEATURES:

- Quick-Fit design, fits in all UCP products
- OM4 bend insensitive fiber
- Cassette attenuation: typical 0.36dB/max. 0.5dB
- Cassette Return Loss: 27dB min

ORDERING INFORMATION

Description	Wire map	Part Number
2x24 fiber MPO to 2x24 fiber MPO	Polarity A	2160651-5
2x24 fiber MPO to 2x24 fiber MPO	Polarity B	1-2160651-5



MPO/MPOOptimate System

24 Fiber MPOOptimate System

MPOOptimate 24f patch cords

FEATURES

- For direct connection of 100G transceivers
- Construction suited to inter-cabinet patching
- Low loss MPOOptimate 24 fiber
MPO round 3.8mm cable patch cord
- OM3 and OM4 cable performance, LSZH construction
- Connector performance for OM3/OM4:
Attenuation \leq 0.25 dB (max.); RL \geq 28 dB (min)
- All products with protocol, for constant and reliable quality
- Available in female/female type A (straight) wiring

Color: aqua



LENGTH TABLE:

Y- X	Length	Y- -X	Length	Y- -X	Length	Y- -X	Length	Y- -X	Length	Y- -X	Length	Y- -X	Length	Y- -X	Length		
9- 0	0,5	9- -5	5,5	1- -1	11	2- -1	21	3- -1	31	4- -1	41	5- -1	51	6- -1	61	7- -1	71
0- -1	1,0	0- -6	6,0	1- -2	12	2- -2	22	3- -2	32	4- -2	42	5- -2	52	6- -2	62	7- -2	72
9- -1	1,5	9- -6	6,5	1- -3	13	2- -3	23	3- -3	33	4- -3	43	5- -3	53	6- -3	63	7- -3	73
0- -2	2,0	0- -7	7,0	1- -4	14	2- -4	24	3- -4	34	4- -4	44	5- -4	54	6- -4	64	7- -4	74
9- -2	2,5	9- -7	7,5	1- -5	15	2- -5	25	3- -5	35	4- -5	45	5- -5	55	6- -5	65	7- -5	75
0- -3	3,0	0- -8	8,0	1- -6	16	2- -6	26	3- -6	36	4- -6	46	5- -6	56	6- -6	66	7- -6	76
9- -3	3,5	9- -8	8,5	1- -7	17	2- -7	27	3- -7	37	4- -7	47	5- -7	57	6- -7	67	7- -7	77
0- -4	4,0	0- -9	9,0	1- -8	18	2- -8	28	3- -8	38	4- -8	48	5- -8	58	6- -8	68	7- -8	78
9- -4	4,5	9- -9	9,5	1- -9	19	2- -9	29	3- -9	39	4- -9	49	5- -9	59	6- -9	69	7- -9	79
0- -5	5,0	1- -0	10	2- -0	20	3- -0	30	4- -0	40	5- -0	50	6- -0	60	7- -0	70	8- -0	80

ORDERING INFORMATION

Description	Part Number
24 fiber; OM4; Straight A wiring;	Y-2160304-X
24 fiber; OM3; Straight A wiring;	Y-2160305-X

MPO/MPOOptimate System

24 Fiber MPOOptimate System

40GbE to 10GbE Fan-Out cords - 12 fiber MPO to 4xLC duplex (Fan-Out)



FEATURES:

- MPO side connects to 40G QSFP transceiver, LC side connects to 10G SPF+ (channel)
- Wire map: LC 1-MPO fiber 1-12, LC2-MPO fiber 2-11, LC3-MPO fiber 3-10, LC4-MPO fiber 4-9
- 8 fiber 3,2/2,0mm diameter
- OM4 bend insensitive fiber LSZH cable
- Flammability IEC 60332 Parts 1 & 3

Color: Aqua



LENGTH TABLE:

Y- X	Length	Y- X	Length	Y- X	Length	Y- X	Length	Y- X	Length	Y- X	Length	Y- X	Length	Y- X	Length	Y- X	Length	Y- X	Length	Y- X	Length	
9- 0	0,5	9- 5	5,5	1- -1	11	2- -1	21	3- -1	31	4- -1	41	5- -1	51	6- -1	61	7- -1	71					
0- -1	1,0	0- -6	6,0	1- -2	12	2- -2	22	3- -2	32	4- -2	42	5- -2	52	6- -2	62	7- -2	72					
9- -1	1,5	9- -6	6,5	1- -3	13	2- -3	23	3- -3	33	4- -3	43	5- -3	53	6- -3	63	7- -3	73					
0- -2	2,0	0- -7	7,0	1- -4	14	2- -4	24	3- -4	34	4- -4	44	5- -4	54	6- -4	64	7- -4	74					
9- -2	2,5	9- -7	7,5	1- -5	15	2- -5	25	3- -5	35	4- -5	45	5- -5	55	6- -5	65	7- -5	75					
0- -3	3,0	0- -8	8,0	1- -6	16	2- -6	26	3- -6	36	4- -6	46	5- -6	56	6- -6	66	7- -6	76					
9- -3	3,5	9- -8	8,5	1- -7	17	2- -7	27	3- -7	37	4- -7	47	5- -7	57	6- -7	67	7- -7	77					
0- -4	4,0	0- -9	9,0	1- -8	18	2- -8	28	3- -8	38	4- -8	48	5- -8	58	6- -8	68	7- -8	78					
9- -4	4,5	9- -9	9,5	1- -9	19	2- -9	29	3- -9	39	4- -9	49	5- -9	59	6- -9	69	7- -9	79					
0- -5	5,0	1- -0	10	2- -0	20	3- -0	30	4- -0	40	5- -0	50	6- -0	60	7- -0	70	8- -0	80					

ORDERING INFORMATION

Description	Wire map	Part Number
12 fiber MPO to 4x LC duplex cable.	Special 40/10G	Y-2160510-X

MPO/MPOptimate System

MPO/MPOptimate Panels & Accessories

UCP Patch Panel Angled and Flushmount

Please refer to Chapter 4, page 48

Note: For angled modular drawer panels see page 148



Angled Quick-Fit MPO/MPOptimate drawer panel

FEATURES

- Accommodates up to 4 MPO/MPOptimate Quick-Fit cassettes
- High-End solution
- Fully integrated and retractable cable management bracket
- Allows for easy Move, Adds and Changes
- Angled style of panels provides additional cable management towards side area

Color: black (RAL 9005)



ORDERING INFORMATION

Description	Part Number
Modular MPO/MPOptimate drawer panel for 4 Quick-Fit cassettes, angled	1-1671436-1

Flush Quick-Fit MPO/MPOptimate drawer panel

FEATURES

- Accommodates up to 4 MPO/MPOptimate Quick-Fit cassettes
- High-End solution
- Fully integrated and retractable cable management bracket
- Allows for easy Move, Adds and Changes
- Flushmount

Color: black (RAL 9005)



ORDERING INFORMATION

Description	Part Number
Modular MPO/MPOptimate drawer panel for 4 Quick-Fit cassettes, flush	1-1671437-1

MPO/MPOptimate System

MPO/MPOptimate Panels & Accessories

Modular MPO/MPOptimate front plate for Quick-Fit cassettes

FEATURES

- Low cost solution
- Flush mount
- Front plate with no additional cable management
- Does accept copper and fiber in one panel

Color: black (RAL 9005)



ORDERING INFORMATION

Description	Part Number
Modular MPO/MPOptimate front plate	1-1671373-1

MPO/MPOptimate coupler Quick-Fit module

FEATURES

- Quick-Fit module with 6 x or 12 x MPO coupler
- Port number labeling and additional label strip included
- MPO coupler always used with on one side MPO male and other side MPO female connector

Color: black (RAL 9005)



ORDERING INFORMATION

Description	Part Number
6 x MPO coupler module	1671200-1
12 x MPO coupler module	1711987-1

MPO/MPOptimate back cable manager

FEATURES

- 19", 1 U rear cable management bar
- Used for MPO front panels
- 3 depths available
- Applications include new installation and retrofit
- Rear or front of rack or cabinet mount

Color: black (RAL 9005)

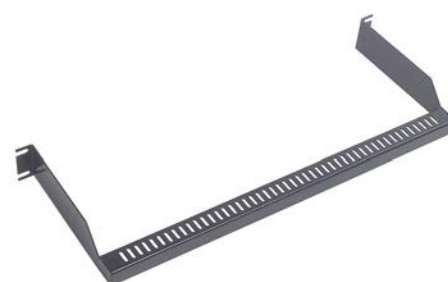

ORDERING INFORMATION

Description	Part Number
Cable management bar 100 mm depth	1711314-1
Cable management bar 175 mm depth	1711314-2
Cable management bar 275 mm depth	1711314-3

MPO/MPOptimate System

MPO/MPOptimate Panels & Accessories

MPO/MPOptimate pull protection sleeve

FEATURES

- Re-usable installation pull and protection kit
- IP 67 protection
- Must be ordered separately
- One part number contains 1 x installation sleeve with end cap and 1 x pull sleeve with pull eye
- Does fit to:
 - 12 fiber MPO and MPOptimate trunks with midi fan-out
 - 24 fiber MPO and MPOptimate trunks with midi fan-out
 - 12 x MPO to LC or SC MPO and MPOptimate trunk with midi fan-out
 - 48 fiber MPO and MPOptimate trunks with midi fan-out (use 2055567-2)



Color: black (RAL 9005)

ORDERING INFORMATION

Description	Part Number
Protection sleeve kit for 12 and 24 fiber cables	2055567-1
Protection sleeve kit for 48 fiber cables	2055567-2

Velcro Cable Ties

FEATURES

- Hook and loop ties
- No risk of damaging cables
- Releasable and reusable
- An order quantity of one equals one roll of 10 ties



ORDERING INFORMATION

Description	Part Number
Velcro Tie 1" x 8" (10pcs.)	1375253-2
Velcro Tie 1" x 12" (10pcs.)	1375254-2

MPO/MPOptimate System

Q3000 Series MPO Fiber Panels

Q3000 Series Fiber Panels are the latest innovation in our High Fiber Count suite of products. The Q3000 Series provides a traditional fiber enclosure to accommodate applications with high density fiber terminations that require easy access to individual connectors and cable management within the panel. The Q3000 series can accommodate LC or MPO applications in singlemode and multimode fiber types

FEATURES

- Support IEEE 802.3ae, IEEE 802.3ba, IEEE 802.3z
- Exceed ANSI/TIA-568-C.3 and ISO 11801 Edition 2 cabling system requirements
- OM3, OM4, OS1 and OS2
- 19-Inch rack mountable
- Available in 1, 2, and 4U Chassis
- 48 Fiber (24 Duplex LC) LC-to-MPO Blade
- 192 Fiber (16 Port) MPO-to-MPO Blade

DIMENSIONS

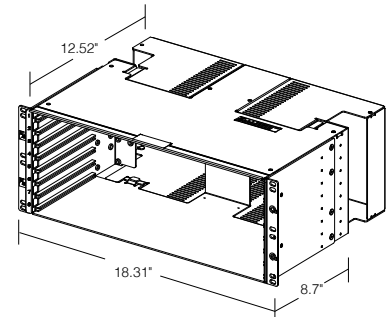
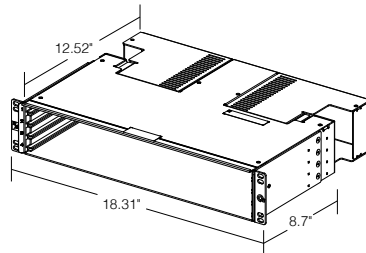
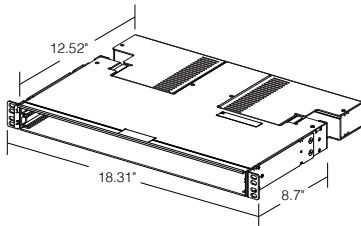

MPO/MPOptimate System

Q3000 Series MPO Fiber Panels

Q3200, Q3400 and Q3800 Chassis (unloaded)

Q3000 Series base chassis fit in any EIA/TIA 19-inch rack or cabinet. They can be loaded with any of the Q3000 or Q4000 series blades based on the application required. An optional door kit can be purchased to provide additional protection to the fiber patch cords exiting the panel.



ORDERING INFORMATION

Product Description		Part Number
Q3000 series chassis	Q3200; 1U (1.75" x 19" x 15"), accommodates 2 blades	QUCH-1RU
	Q3400; 2U (3.5" x 19" x 15"), accommodates 4 blades	QUCH-2RU
	Q3800; 4U (7" x 19" x 15"), accommodates 8 blades	QUCH-4RU
Front door kits	Q3200; 1U	QDR-1RU
	Q3400; 2U	QDR-2RU
	Q3800; 4U	QDR-4RU

Q3000 Blades

Q3000 Series blades are offered in LC-MPO, and MPO/MPO adapter only in singlemode, OM3 and OM4. These blades mount in either the Q4000 managed chassis to provide the end-user to upgrade the blade to Q4000 at a later date or into the standard Q3000 base chassis. Each blade is 1/2U in height (0.875 inches).



LC-MPO Blade



MPO-MPO Blade

ORDERING INFORMATION

Product Description		Part Number
LC to MPO; 24 Duplex LC ports (48 Fibers) distributed from 2 each 12 fiber MPO connectors	Singlemode ultra polish LC-MPO blade	QUFB-48FDLCMSMHR
	OM3 Multimode LC-MPO blade	QUFB-48FDLCMM3HR
MPO to MPO; 16 MPO ports with 12 Fibers each (192 fibers)	Singlemode MPO-MPO blade	QUFB-192FMPMSMHR
	OM3/OM4 Multimode MPO-MPO blade	QUFB-192FMPOMMHR

MPO/MPOptimate System

MPO/MPOptimate Cleaning Tools

MPO/LC/SC/MT-RJ Cassette Cleaners



ORDERING INFORMATION

Description	Part Number
MTP/MPO with pins; Packaging: 1	1918802-1
1 Slot Reel Cleaner for MPO/LC/SC and MT-RJ; Packaging: 1	1918803-1
2 Slot reel cleaner for LC and SC; Packaging: 1	1918805-1
Cleaner Refill; Packaging: 6 rolls	1918806-1

MPO Coupler Cleaner



ORDERING INFORMATION

Description	Part Number
MPO IBC; Packaging: 1	1918809-1

LC/SC bulkhead cleaner



ORDERING INFORMATION

Description	Part Number
SC IBC (In Bulkhead Cleaner)	2064499-1
LC IBC (In Bulkhead Cleaner)	2064500-1
LC duplex IBC (In Bulkhead Cleaner)	2111664-1

2. MRJ21 System

MRJ21 XG Cassettes & Panels.....	26
MRJ21 XG Trunks & Fan-Outs.....	27
MRJ21 Cassettes & Panels.....	28
MRJ21 Trunks.....	30
MRJ21 Fan-Outs.....	32
MRJ21 Accessories	33

MRJ21 System

MRJ21 XG Cassettes & Panels

MRJ21 XG Quick-Fit Cassette 8 Port (10 Gb/s)

FEATURES

- Optimal for use in combination with UCP patch panels: plug & play deployment
- Compatible with MRJ21 XG cable assemblies for 10GbE performance
- Front side: 8 x RJ45 jack (2 rows of 4 jacks)
- Rear side: 2 x MRJ21 receptacle
- Factory terminated and tested solution
- For AMPTRAC version of MRJ21 XG Quick-Fit cassette please see page 109 in Chapter 8 Managed Connectivity

Color: black (RAL 9005)



ORDERING INFORMATION

Description	Part Number
MRJ21 XG Quick-Fit cassette for 10GBase-T	2153115-1

MRJ21 XG 19" Patch Panel, 1U, straight

FEATURES

- Optimal for use in environments where high density is required
- Factory terminated and tested solution
- Compatible with MRJ21 XG cable assemblies for 10GbE performance
- Straight panel with either 24 or 48 ports on 1U
- For AMPTRAC version of MRJ21 XG 19" panel please see page 109 in Chapter 8 Managed Connectivity

Color: black (RAL 9005)



ORDERING INFORMATION

Description	Part Number
Straight panel 1U for 10GbE; MRJ21 Plugs: 6; RJ-45 Ports: 24	2153041-1
Straight panel 1U for 10GbE; MRJ21 Plugs: 12; RJ-45 Ports: 48	2153046-1

MRJ21 System

MRJ21 XG Trunks & Fan-Outs

MRJ21 XG to MRJ21 XG trunks



FEATURES

- Friendly field installable 10 GbE solution
- Factory terminated and 100% tested solution
- Dense double blade connector with offset jackscrews for latching
- 16 pair shielded cable with AWG 26 solid conductors
- Available with LSZH or CMR sheath

Color: white

ORDERING INFORMATION

Description	Part Number
MRJ21 XG to MRJ21 XG, 10 Gb/s, 180°-180° back shell; LSZH sheath	Y-2153052-X
MRJ21 XG to MRJ21 XG, 10 Gb/s, 180°-45° back shell; LSZH sheath	Y-2153078-X
MRJ21 XG to MRJ21 XG, 10 Gb/s, 180°-180° back shell; CMR sheath	Y-2111521-X
MRJ21 XG to MRJ21 XG, 10 Gb/s, 180°-45° back shell; CMR sheath	Y-2111522-X

Y- -X	Length
0- -3	3 m
0- -5	5 m
1- -0	10 m
1- -5	15 m
2- -0	20 m
2- -5	25 m
3- -0	30 m
3- -5	35 m
4- -0	40 m

MRJ21 XG Fan-Out cable to multiple RJ-45 plugs (shielded)



FEATURES

- Friendly field installable 10 GbE solution
- Suitable for use in 3-connector models where 10 GbE application is required
- Factory terminated, 100% tested and serialized
- 16 pair, shielded, AWG 26 solid conductors
- MRJ21 to 4xRJ45 fan-out

ORDERING INFORMATION

Description	Part Number
MRJ21 to 4 RJ-45. 180° back shell; LSZH sheath	Y-2153230-X

Y- -X	Length
0- -3	3 m
0- -5	5 m
1- -0	10 m
1- -5	15 m
2- -0	20 m
2- -5	25 m
3- -0	30 m
3- -5	35 m
4- -0	40 m

MRJ21 System

MRJ21 Cassettes & Panels

MRJ21 Quick-Fit Cassette 12 port (1 Gb/s)

FEATURES

- Pre-terminated Quick-Fit cassette
- High Performance TP Cabling for guaranteed application performance
- High-density, small form factor connectivity
- Modular pluggable solution
- Automatic bonding by design



ORDERING INFORMATION

Description	Part Number
MRJ21 Quick-Fit cassette for 1000Base-T	1711970-1

MRJ21 angled patch panel (shielded and unshielded)

FEATURES

- High-performance TP cabling for guaranteed application performance
- High-density, small form factor copper connector interface
- Angled panel with 48 ports on 1U
- Factory terminated and tested solution
- Modular, pluggable solution
- Including grounding bolt

Color: black (RAL 9005)



ORDERING INFORMATION

Description	Part Number
Angled MRJ21 panel for 1000Base-T; MRJ21 Plugs: 8; RJ-45 Ports: 48	1-1671143-1

MRJ21 System

MRJ21 Cassettes & Panels

MRJ21 patch panel, 1U, straight (shielded)

FEATURES

- High performance TP cabling for guaranteed application performance
- High-density, small form factor copper connector interface
- Factory terminated and tested solution
- Straight panel with 24 or 48 ports on 1U
- Modular pluggable solution

Color: black (RAL 9005)



ORDERING INFORMATION

Description	Part Number
Standard straight panel for 1000Base-T; MRJ21 Plugs: 4; RJ-45 Ports: 24	1711944-1
Standard straight panel for 1000Base-T; MRJ21 Plugs: 8; RJ-45 Ports: 48	1777098-1

MRJ21 patch panel, 1U, straight (unshielded)

FEATURES

- High-performance TP cabling for guaranteed application performance
- High-density, small form factor copper connector interface
- Straight panel with 24 or 48 ports on 1U
- Factory terminated and tested solution
- Modular, pluggable solution

Color: black (RAL 9005)



ORDERING INFORMATION

Description	Part Number
Standard straight panel for 100Base-T; MRJ21 Plugs: 4; RJ-45 Ports: 48	1435965-1
Standard straight panel for 1000Base-T; MRJ21 Plugs: 8; RJ-45 Ports: 48	1435971-1
Standard straight panel for 1000Base-T; MRJ21 Plugs: 4; RJ-45 Ports: 24	1777029-1

MRJ21 System

MRJ21 Trunks

MRJ21 to MRJ21 cable assemblies (shielded)

FEATURES

- Friendly field installable 1 Gbs solution
- Enhanced screening and improved EMC
- Factory terminated and 100 % tested solution
- Dense double blade connector with offset jackscrews for latching
- 1.5 to 4 times the port density of 2 x 6 Stacked Mod Jack (RJ-45)
- 24 pair shielded cable with AWG 24 solid conductors

Color: white



Y- -X	Length
0- -5	5 m
1- -0	10 m
1- -5	15 m
2- -0	20 m
2- -5	25 m
3- -0	30 m
3- -5	35 m
4- -0	40 m
5- -0	50 m

ORDERING INFORMATION

Description	Part Number
MRJ21 to MRJ21, 180°-180° back shell; LSZH sheath	Y-1711758-X
MRJ21 to MRJ21, 180°-45° back shell; LSZH sheath	Y-1711774-X

MRJ21 to MRJ21 cable assemblies (unshielded)

FEATURES

- Factory terminated and tested solution
- Modular, pluggable solution
- Dense CHAMP style double blade design with offset jackscrew
- Contact layout and footprint for differential pairs creates reduced crosstalk and built-in compensation
- 1.5 to 4 times the port density of 2 x 6 Stacked Mod Jack (RJ-45)
- 3 times the port density of an RJ-21
- Jackscrew for positive latching and secure cable retention

Color: gray



Y- -X	Length
0- -5	5 m
1- -0	10 m
1- -5	15 m
2- -0	20 m
2- -5	25 m
3- -0	30 m
3- -5	35 m
4- -0	40 m
5- -0	50 m

ORDERING INFORMATION

Description	Part Number
MRJ-21 to MRJ-21, 180° back shell; CMR sheath	Y-2111366-X
MRJ-21 to MRJ-21, 180°-45° back shell; CMR sheath	Y-2111371-X

MRJ21 System

MRJ21 Trunks

MRJ21 to MRJ21 ultra slim cable assemblies (unshielded)

FEATURES

- Factory terminated and tested solution
- Modular, pluggable solution
- Dense CHAMP style double blade design with offset screw fixing
- Improves uptime and space efficiency on site
- 9,2mm cable OD
- 50-60% less cable mass in pathways and spaces than comparable 4-pair cabling
- 40% less weight than comparable 4-pair cabling
- Gigabit Ethernet Channel performance
- Jackscrews for positive latching and secure cable retention

Color: gray



Y- -X	Length
0- -2	2 m
0- -5	5 m
1- -0	10 m
1- -5	15 m
2- -0	20 m
2- -5	25 m
3- -0	30 m

ORDERING INFORMATION

Description	Part Number
MRJ21 to MRJ21 , Ultra slim, 180° back shell; CMR sheath	Y-2111367-X

* 30 meters application length restrictions apply

MRJ21 System

MRJ21 Fan-Outs

MRJ21 Fan-Out cable to multiple RJ-45 plugs (shielded)

FEATURES

- Friendly field installable 1 Gbs solution
- Enhanced screening and improved EMC
- Factory terminated and 100 % tested solution
- Dense double blade connector with offset jackscrews for latching
- 1.5 to 4 times the port density of 2 x 6 Stacked Mod Jack (RJ-45)
- 24 pair shielded cable with AWG 24 solid conductors

Color: white



Y- -X	Length
0- -5	5 m
1- -0	10 m
1- -5	15 m
2- -0	20 m
2- -5	25 m
3- -0	30 m
3- -5	35 m
4- -0	40 m
5- -0	50 m

ORDERING INFORMATION

Description	Part Number
MRJ21 to 6 RJ-45, 180° back shell; LSZH sheath	Y-1711789-X

MRJ21 Fan-Out cable to multiple RJ-45 plugs (unshielded)

FEATURES

- Factory terminated and tested solution
- MRJ21 to RJ45 hydra cable assemblies are wired so that all 4-pairs of the RJ45 are active for Gigabit Ethernet
- New ergonomic features for easier handling
- Modular, pluggable solution
- Dense CHAMP style double blade design with offset screw fixing
- Contact layout and footprint for differential pairs creates reduced crosstalk and built-in compensation
- 3 times the port density of an RJ-21
- Jackscrews for positive latching and secure cable retention
- Other lengths on request

Color: gray



Y- -X	Length
0- -5	5 m
1- -0	10 m
1- -5	15 m
2- -0	20 m
2- -5	25 m
3- -0	30 m
3- -5	35 m
4- -0	40 m
5- -0	50 m

ORDERING INFORMATION

Description	Part Number
MRJ-21 to 6 RJ-45 for 1000Base-T, 180° back shell; CMR sheath	Y-2111370-X

MRJ21 System

MRJ21 Accessories

UCP Patch Panel Angled and Flushmount

Please refer to Chapter 4, page 48



MRJ21 cable guiding shelf

FEATURES

- 19" 4U shelf with 16 vertical slots
- Each slot accepts max. 8 stacks of MRJ21 cable assemblies
- Tie down capability at the back of the shelf

Color: black (RAL 9005)



ORDERING INFORMATION

Description	Part Number
MRJ21 cable guiding shelf	1671175-1

MRJ21 System

MRJ21 Accessories

MRJ21 Back cable manager

FEATURES

- 19", 1U rear cable management bar
- Used for MRJ21 or other high density copper or fiber optic panels
- Simple on site assembly
- Applications include new installation and retrofit
- Rear or front of rack or cabinet mount
- 4 depths available
- Tie-down capability on side brackets and back tie-down bar
- Tie-down bar is adjustable for horizontal or vertical cable strain relief

Color: black (RAL 9005)



ORDERING INFORMATION

Description	Part Number
Back cable manager 6" (150 mm) depth	1933352-1
Back cable manager 9" (230 mm) depth	1933352-2
Back cable manager 12" (300 mm) depth	1933352-3
Back cable manager 16" (400 mm) depth	1933352-4

3. Sigma-Link System

Sigma-Link Quick-Fit Class F _A	36
Sigma-Link Quick-Fit Class E _A	37
Sigma-Link Quick-Fit Class E.....	38
Sigma-Link Quick-Fit Panel.....	39
Sigma-Link Quick-Fit Accessories.....	40

Sigma-Link Quick-Fit System

Sigma-Link Quick-Fit Class F_A

Σ-Link Quick-Fit Cable Assemblies Class F_A - PL

FEATURES

- 24 ports per 1U, 6 port links
- Lengths 2-90m
- Factory assembled and 100% tested
- Bundle of 6 x 4 pair solid Category 7_A S/FTP cable (compliant to IEC 61156-5)
- LSFRZH sheath
- Three different types of far end termination available (housing, loose jacks, open cable ends)
- Housing-to-Housing version features integrated Plastic Optical Fiber (POF) for easy tracing of far end



Termination guidelines for Σ-Link Housing-to-Open end:

Install jacks with tool (AMP PN 1725150-1) according to instruction sheet 411-93013.
Use following jacks: AMP-TWIST 7_{AS}
(AMP PN 1711437-1 without dustcover or 1711441-1 with dustcover)

Note:

To achieve PL performance cable length should be > 2 m (2 connector model) according to ISO 11801 spec.

Y- -X	Length
0- -2	2 m
0- -5	5 m
1- -0	10 m
1- -5	15 m
2- -0	20 m
2- -5	25 m
3- -0	30 m
3- -5	35 m
4- -0	40 m
5- -0	50 m
6- -0	60 m
7- -0	70 m
8- -0	80 m
9- -0	90 m

ORDERING INFORMATION

Description	Part Number
Sigma-Link Cable Assembly Housing-to-Housing with POF Class F _A STP	Y-2153150-X
Sigma-Link Cable Assembly Housing-to-Jacks Class F _A STP	Y-2153151-X
Sigma-Link Cable Assembly Housing-to-Open End Class F _A STP	Y-2153152-X

Sigma-Link Quick-Fit System

Sigma-Link Quick-Fit Class E_A

Σ-Link Quick-Fit Cable Assemblies Class E_A - PL

FEATURES

- 24 ports per 1U, 6 port links
- Lengths 2-90m
- Factory assembled and 100% tested
- Bundle of 6 x 4 pair solid Category 7 F/FTP cable
- LSZH sheath
- Four different types of far end termination available (housing, loose jacks, open cable ends, loose plugs)
- Housing-to-Housing version features integrated Plastic Optical Fiber (POF) for easy tracing of far end
- Housing-to-Plugs version for service presentation in mobile Data Centers



Termination guidelines for Σ-Link Housing-to-Open end:

Install jacks with tool (AMP PN 1725150-1) according to instruction sheet 411-93016.

Use following jacks: AMP-TWIST 6_AS

(AMP PN 1711716-1 without dustcover or 1711592-1 with dustcover).

Note:

To achieve PL performance cable length should be > 2 m (2 connector model) according to ISO 11801 spec.

Y-	-X	Length
0-	-2	2 m
0-	-5	5 m
1-	-0	10 m
1-	-5	15 m
2-	-0*	20 m
2-	-5*	25 m
3-	-0*	30 m
3-	-5*	35 m
4-	-0*	40 m
5-	-0*	50 m
6-	-0*	60 m
7-	-0*	70 m
8-	-0*	80 m
9-	-0*	90 m

* not applicable for Housing-to-Plugs version

ORDERING INFORMATION

Description	Part Number
Sigma-Link Cable Assembly Housing-to-Housing with PoF Class E _A STP	Y-2153146-X
Sigma-Link Cable Assembly Housing-to-Jacks Class E _A STP	Y-2153147-X
Sigma-Link Cable Assembly Housing-to-Open End Class E _A STP	Y-2153148-X
Sigma-Link Cable Assembly Housing-to-Plugs Class E _A STP (Only available up to 15 m! Shorter lengths between increments on request.)	Y-2153149-X

Sigma-Link Quick-Fit System

Sigma-Link Quick-Fit Class E

Σ-Link Quick-Fit Cable Assemblies Class E - PL

FEATURES

- 24 ports per 1U, 6 port links
- Lengths 2-90m
- Factory assembled and 100% tested
- Bundle of 6 x 4 pair solid Category 6 U/UTP Cable
- LSZH Sheath
- Three different types of far end termination available (housing, loose jacks, open cable ends)
- Housing-to-Housing version features integrated Plastic Optical Fiber (POF) for easy tracing of far end



Termination guidelines for Σ-Link Housing-to-Open end:

Install jacks with tool (AMP PN 0-1725150-1) according to instruction sheet 408-8858
Use following jacks: Cat 6 RJ45 SL 110 connect
(AMP PN 0-1375055-X without dustcover or 0-1375187-X with dustcover)

Note:

To achieve PL performance cable length should be > 2 m (2 connector model) according to ISO 11801 spec.

Y- -X	Length
0- -2	2 m
0- -5	5 m
1- -0	10 m
1- -5	15 m
2- -0	20 m
2- -5	25 m
3- -0	30 m
3- -5	35 m
4- -0	40 m
5- -0	50 m
6- -0	60 m
7- -0	70 m
8- -0	80 m
9- -0	90 m

ORDERING INFORMATION

Description	Part Number
Sigma-Link Cable Assembly Housing-to-Housing with POF Class E UTP	Y-2153140-X
Sigma-Link Cable Assembly Housing-to-Jacks Class E UTP	Y-2153141-X
Sigma-Link Cable Assembly Housing-to-Open End Class E UTP	Y-2153142-X

Sigma-Link Quick-Fit System

Sigma-Link Quick-Fit Panel

UCP Patch Panel Angled and Flushmount

Please refer to Chapter 4, page 48



Sigma-Link Quick-Fit System

Sigma-Link Quick-Fit Accessories

Σ-Link identifier lamp

FEATURES

- Identifies the far end of the installed link
- Easy mounting on the housings



ORDERING INFORMATION

Description	Part Number
Sigma-Link identifier lamp; blue LED	1-1671330-1

4. Mixed Media Platform

NETpodium

Rack & Doors.....	42
Panels & Covers.....	43
Accessories.....	44

In-cabinet Management

Accessories.....	46
------------------	----

Universal Connectivity Platform

Patch Panels.....	48
Mounting Accessories.....	49
FiberGuide Mounting Accessories.....	50

Mixed Media Platform

NETpodium - Rack & Doors

NETpodium Rack

FEATURES

- Dimensions W x D x H = 1000 x 600 x 2200mm
- 45U
- 2 x 45U Cable managers included
- 2 large vertical cable ducts included
- Universal 19" Mounting rails according EIA 310

Color: black (RAL 9005)

ORDERING INFORMATION

Description	Part Number
NETpodium Cross-Connect Rack 1000x600	1-1671405-1



Front Doors

FEATURES

- Pair of standard solid doors (left and right)
- Bi-directional doors open to the left and right for maximum freedom during handling
- Comes with integrated locks (one per door panel)

Color: black (RAL 9005)

ORDERING INFORMATION

Description	Part Number
Front Door	1-1671545-1



Mixed Media Platform

NETpodium - Panels & Covers

Side Panel

FEATURES

- Solid aluminum side panel to cover the sides of the cabinet
- Easy to add and remove

Color: black (RAL 9005)

ORDERING INFORMATION

Description	Part Number
Side Panel Left	1-1671578-1
Side Panel Right	1-1671578-2

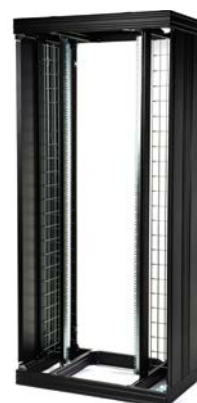

Back Panel

FEATURES

- Solid aluminum back panel to cover the backside of the cabinet
- Easy to remove

Color: black (RAL 9005)

ORDERING INFORMATION

Description	Part Number
Back Panel	1-1671579-1
Back Panel with backstrip	1-1671579-2



Top Cover

FEATURES

- Aluminum top panel with 4 knock-out access ports for optimal cabling access

Color: black (RAL 9005)

ORDERING INFORMATION

Description	Part Number
Top Cover	1-1671555-1



Bottom Cover

FEATURES

- Aluminum bottom panel to block airflow

Color: black (RAL 9005)

ORDERING INFORMATION

Description	Part Number
Bottom Cover	1-1671554-1



Mixed Media Platform

NETpodium - Accessories

Baying Kit

FEATURES

- Kit to be used to attach and secure two NETpodium racks side-by-side or back-to-back

Color: galvanized

ORDERING INFORMATION

Description	Part Number
Baying Kit (12 pcs)	1-1671587-1



Overhead Cabling Pathway

FEATURES

- Overhead cabling pathway, including bend radius control for both balanced copper cabling and fiber optic cabling
- A cost effective way of routing cords from one cabinet to an adjacent cabinet
- Dim holes: 185 x 175mm
- Max capacity = +/- 120 cables with 9mm OD

Color: black (RAL 9005)

ORDERING INFORMATION

Description	Part Number
Overhead Cabling Pathway	1-1671508-1



4U Pass Through Channel

FEATURES

- 4U pass through channel designed to fit at the bottom of a NETpodium rack
- Allows intra-cabinet patching inside the NETpodium rack
- Only fits in NETpodium rack

Color: black (RAL 9005)

ORDERING INFORMATION

Description	Part Number
Pass Through Channel	1671614-1



Mixed Media Platform

NETpodium - Accessories

FO Slack Storage Spools

FEATURES

- Provides overlength capacity for FO cords
- Enables the use of 1 length FO cords in a rack

Color: black (RAL 9005)



ORDERING INFORMATION

Description	Part Number
FO Slack Storage Spools (Left + Right)	1-1671610-1

NETpodium Copper Cable Dividing plate

FEATURES

- Designed for X-Connect patching to divide 2 and 4m length of copper cords

Color: black (RAL 9005)

ORDERING INFORMATION

Description	Part Number
NETpodium Copper Cable Dividing plate	1671933-1



NETpodium bracket for wire basket

FEATURES

- Bracket to be used onto the wire basket
- Accepts additional accessories

Color: galvanized

ORDERING INFORMATION

Description	Part Number
NETpodium bracket for wire basket (4pcs)	1671938-2



End Caps

FEATURES

- Cap to cover the aluminum profile

Color: black (RAL 9005)

ORDERING INFORMATION

Description	Part Number
End Cap (8pcs)	1-1671609-1



High-Density Front-Loading Cable Managers for Cabinets

FEATURES

- Offers bend radius (according to ISO/IES 11801:2002 table 25) and mechanical protection
- Rubber entry/exit retainers ensure cable captivity preventing accidental disturbance of patch cords
- Suitable for Twisted Pair & Fiber Optic patch cords
- Note: To get a left/right pair order the respective part number twice (higher MOQs may apply)!

Color: black (RAL 9005)

ORDERING INFORMATION

Description	Part Number
High-Density Front-Loading Cable Managers 1U	1671495-1
High-Density Front-Loading Cable Managers 2U	1671495-2
High-Density Front-Loading Cable Managers 4U	1671495-4
High-Density Front-Loading Cable Managers 6U	1671495-6
High-Density Front-Loading Cable Managers 15U	1-1671495-5



Horizontal Slack Storage Panel

FEATURES

- 4U storage panel to store copper overlength in a copper X-connect configuration
- Allows left or right cable entry
- Hinged access cover ensures accessibility and security of installed patch cords

Color: black (RAL 9005)

ORDERING INFORMATION

Description	Part Number
Horizontal Slack Storage Panel	1671711-1



2U Pass Through Duct

FEATURES

- 2U pass through duct
- Allows left to right side patching as well as front to back patching and intra-cabinet patching
- Hinged access cover ensures accessibility of installed Patch Cords

Color: black (RAL 9005)

ORDERING INFORMATION

Description	Part Number
2U pass through duct	1-1671080-2



Mixed Media Platform

In-Cabinet Management - Accessories

1U Blanking Plates

FEATURES

- 1U blind panels
- Angled version to fill gaps between angled panels
- Straight version to fill gaps between straight panels or active equipment

Color: black (RAL 9005)



ORDERING INFORMATION

Description	Part Number
1 U blind panel angled	1671113-1
1 U blind panel straight	1671113-2

1 U Cable Management Panels 19"

FEATURES

- Panels mount to the front of 19" racks and provide for the orderly dressing and routing of cable assemblies
- Various ring lengths available
- 1 U high

Note: PN 1859160-1 is optimized to be used with panels incl. Quick-Fit modules



ORDERING INFORMATION

Description	Part Number
4 rings; light gray (RAL 7035); Height: 1 U; Ring length: 60 mm	9-101019-0
5 rings; black (RAL 9005); Height: 1 U; Ring length: 95 mm	558329-1
5 rings black (RAL 9005)	1859160-1

Mounting Hardware

FEATURES

- Hardware to attach panels and equipment to racks and cabinets
- Packaging quantity: 50 and 500

ORDERING INFORMATION

Description	Part Number
Screw set (50 pcs) M6	1671147-1
Screw set (500 pcs) M6	1671147-2
Screw set (500 pcs) M6 + cage nuts	1671147-4
Screw set (50 pcs) M6 + cage nuts	1671147-3



M6



M6 + Cage Nuts

Mixed Media Platform

Universal Connectivity Platform - Patch Panels

UCP Patch Panel Angled and Flushmount

FEATURES

- 19" 1U unloaded modular patch panel with support for 4 Quick-Fit Modules
- Angled and flush style panels available
- Modular, rear cable management for both horizontal Copper and Fiber cables
- Accepts Pre-terminated Cu or FO cassettes or Field-terminated Copper modules
- Including grounding bolt



Color: black (RAL 9005)

ORDERING INFORMATION

Description	Part Number
UCP Patch Panel 1U Angled	1-1671590-1
UCP Patch Panel 1U Flush	1-1671594-1

Xtra-U Fiber Panel with Cable Management

FEATURES

- 3U Bracket to support a single MPOptimate Quick-Fit cassette
- Management rings to store and protect excess MPOptimate trunk cables
- Including grounding bolt

Color: black (RAL 9005)



ORDERING INFORMATION

Description	Part Number
Xtra-U Fiber Panel with Cable Management (for standard racks)	1-1671547-1
Xtra-U Fiber Panel with Cable Management (for NETpodium rack)	1-1671550-1

Xtra-U Copper Panel without Cable Management

FEATURES

- 3U Bracket to support a single Copper Quick-Fit cassette or module
- Including grounding bolt

Color: black (RAL 9005)

ORDERING INFORMATION

Description	Part Number
Xtra-U Copper Panel without Cable Management (for standard racks)	1-1671548-1
Xtra-U Copper Panel without Cable Management (for NETpodium rack)	1-1671551-1



Mixed Media Platform

Universal Connectivity Platform - Mounting Accessories

Xtra-U Vertical Panel Mounting Brackets

FEATURES

- Bracket set to install a 1U 19" panel vertically outside of the 19" area of a cabinet/rack
- Available for 1U

Color: galvanized



ORDERING INFORMATION

Description	Part Number
Xtra-U Vertical Panel Mounting Brackets (2 pcs) (for standard racks)	1-1671549-1
Xtra-U Vertical Panel Mounting Brackets (2 pcs) (for NETpodium rack)	1-1671552-1



Xtra-U Subfloor Panel Holder Kit

FEATURES

- Bracket set to install 19" panels in the false floor area underneath cabinets/racks
- Suitable for Copper and Fiber installations
- Allows up to 630mm gap between support pillars
- Attachable to support pillars with round or square cross-section (diameters from 14 to 30mm)
- Available for 1, 2 or 4U

Color: galvanized



ORDERING INFORMATION

Description	Part Number
Xtra-U Subfloor Panel Holder Kit 1U	1671189-1
Xtra-U Subfloor Panel Holder Kit 2U	1671189-2
Xtra-U Subfloor Panel Holder Kit 4U	1671189-4



Xtra-U Aerial Panel Holder Kit for Wire Mesh Cable Trays

FEATURES

- Universal bracket for installing 19" patch panels above cabinets /racks
- Can be attached to wire mesh cable trays
- 2U and 4U version available

Color: galvanized



ORDERING INFORMATION

Description	Part Number
Xtra-U Aerial Panel Holder Kit (2U) for Wire Mesh Trays	1-1671603-1
Xtra-U Aerial Panel Holder Kit (4U) for Wire Mesh Trays	1-1671603-2



Mixed Media Platform

Universal Connectivity Platform - FiberGuide Mounting Accessories

Xtra-U FiberGuide System Quick-Fit adaptor

FEATURES:

- Fits to FGS products, s.a. 4" Express Exits, 4 x 4 Downspouts
- Can accommodate up to 2 Quick-Fit MPO cassettes or modules
- Integrated strain relief feature
- Including grounding bolt

Color: galvanized



ORDERING INFORMATION

Description	Part Number
Xtra-U FGS Quick-Fit adaptor	1-1671618-1

Xtra-U Aerial Panel Holder Kit for FiberGuide System

FEATURES

- Universal bracket for installing 19" patch panels above cabinets /racks
- Can be attached to FGS channels (4 x 4, 4 x 6 and 4 x 12)
- 2U and 4U version available

Color: galvanized



ORDERING INFORMATION

Description	Part Number
Xtra-U Aerial Panel Holder Kit (2U) for FGS	1-1671603-3
Xtra-U Aerial Panel Holder Kit (4U) for FGS	1-1671603-4

5. FiberGuide System

2x2 System	52
4x4 System.....	55
2x6 System.....	60
4x6 System.....	63
4x12 System	68
4x24 System.....	74
LighTrax to FGS adaptors.....	77
Express Exit™ Family.....	78
System Support Kits	80

FiberGuide System

2" H x 2" W - Fittings

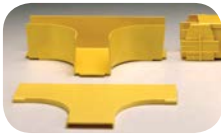

Horizontal T
(FGS-MHTA-C)



Horizontal Cross
(FGS-MHXP-C)

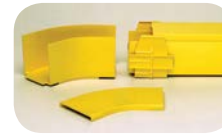

45° Horizontal Elbow
(FGS-MH4A-C)

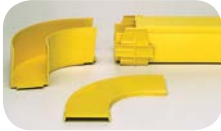

90° Horizontal Elbow
(FGS-MH9A-C)

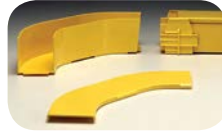

90° Extended
Horizontal Elbow
(FGS-MH9A-C-45/2)



45° Up Elbow
(FGS-MU4A-C)

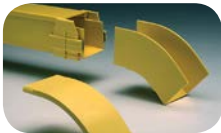

45° Down Elbow
(FGS-MD4A-C)



2x2 to 4x4
Straight Adapter
(FGS-MDSA-AC)



End Cap
(FGS-HMEC-C)

ORDERING INFORMATION

Description	Number of Junctions	Catalog Number	
		Yellow System	Black System
2x2 fittings			
Horizontal T; <i>cover included</i>	3	FGS-MHTA-C	FGSB-MHTA-C
Horizontal cross; <i>cover and two 2x2 junctions included; two additional 2x2 junctions required (see p. 22)</i>	2+2	FGS-MHXP-C	FGSB-MHXP-C
45° horizontal elbow; <i>cover included</i>	2	FGS-MH4A-C	FGSB-MH4A-C
90° horizontal elbow; <i>cover included</i>	2	FGS-MH9A-C	FGSB-MH9A-C
90° extended horizontal elbow; <i>cover included; similar to two 45° horizontal elbows joined</i>	2	FGS-MH9A-C-45/2	FGSB-MH9A-C-45/2
45° up elbow; <i>cover included</i>	2	FGS-MU4A-C	FGSB-MU4A-C
90° up elbow; <i>cover included</i>	2	FGS-MU9A-C	FGSB-MU9A-C
45° down elbow; <i>cover included</i>	2	FGS-MD4A-C	FGSB-MD4A-C
90° down elbow; <i>cover included</i>	2	FGS-MD9A-C	FGSB-MD9A-C
2x2 conversions			
2x2 to 4x4 straight adapter; <i>cover included</i>	(1) 2x2, (1) 4x4	FGS-MDSA-AC	FGSB-MDSA-AC
2x2 end cap			
End cap; <i>junction included</i>	--	FGS-HMEC-C	FGSB-HMEC-C

FiberGuide System

2" H x 2" W - Downspouts and Attachments



2x2 Standard Downspout
(FGS-MSDS-C)



2x2 Extended Downspout
(FGS-MDSP-C)



Extended Downspout
(FGS-KDH2-C shown attached to 2x2 FiberGuide system)



Dual 7/8" Flex Tube Attachment
(FGS-KT03-C)



Dual 7/8" Flex Tube Attachment
(FGS-KT03-C shown attached to downspout)

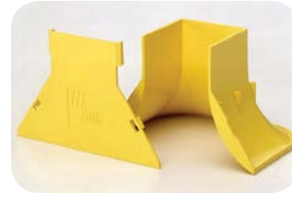

2x2 Trumpet Flare
(FGS-MTRM-C)

ORDERING INFORMATION

Description	Number of Junctions	Catalog Number	
		Yellow System	Black System
2x2 downspouts			
Standard downspout; <i>cover included</i>	2	FGS-MSDS-C	FGSB-MSDS-C
Extended downspout; <i>cover included</i>	1	FGS-MDSP-C	FGSB-MDSP-C
Extended downspout; <i>cover and 2" flex tube, 2' long, included</i>	1	FGS-KDH2-C	FGSB-KDH2-C
Trumpet flare; <i>2x2 junction included</i>	-	FGS-MTRM-C	FGSB-MTRM-C
2x2 attachments			
2x2 flex tube attachment - 2" flex tube and a 2x2 junction included			
5' length	-	FGS-MEX1-C-5F	FGSB-MEX1-C-5F
10' length	-	FGS-MEX1-C-10F	FGSB-MEX1-C-10F
15' length	-	FGS-MEX1-C-15F	FGSB-MEX1-C-15F
Dual 7/8" flex tube attachment - <i>two lengths of 7/8" flex tube and a 2x2 junction included</i>			
(2) 5' length	-	FGS-KT03-C	FGSB-KT03-C
(2) 10' length	-	FGS-KT03-C-10F	FGSB-KT03-C-10F
(2) 15' length	-	FGS-KT03-C-15F	FGSB-KT03-C-15F
Flex tube clamp kit of 10; attaches 7/8" flex tube to rack	-	FGS-HSHC-10	FGS-HSHC-10

FiberGuide System

2" H x 2" W - Straight Section and Junction

Straight Section

The 2x2 straight section is a U-shaped trough that provides a protective raceway for optical fibers. Available in 6-foot lengths, the straight section carries fibers horizontally throughout the system. It can also be installed vertically when routing around obstructions. A warning label indicating caution around fiber optic cable is included with each junction kit.



Horizontal Straight Section

ORDERING INFORMATION

Description	Catalog Number	
	Yellow System	Black System
2x2 straight section; horizontal straight section; 6' long, cover included	FGS-MSHA-C	FGSB-MSHA-C

Junction

The 2x2 junction is used for mechanically joining FiberGuide® sections. No tools are required for assembly.



Junction
(FGS-MJWR-C)

ORDERING INFORMATION

Description	Catalog Number	
	Yellow System	Black System
2x2 junction	FGS-MJWR-C	FGSB-MJWR-C

FiberGuide System

4" H x 4" W - Fittings



Horizontal T
(FGS-MHRT-A)



Horizontal Cross
(FGS-MHXP-A)



90° Horizontal Elbow
(FGS-MH9E-A)



90° Up Elbow
Metal Cover Included
(FGS-MU9E-A)



90° Down Elbow
(FGS-MD9E-A)



45° Horizontal Elbow
(FGS-MH4E-A)



45° Up Elbow
Metal Cover Included
(FGS-MU4E-A)



45° Down Elbow
(FGS-MD4E-A)



4x4 to 4x6 Straight Adapter
(FGS-MDSA-AB)



Expandable Straight Section
(FGS-MVAR-A)



Cut-in T
(FGS-MHIS-A)



Cut-in T Fixture
shown on straight section
(FGS-MHIS-JIG-A/B/F)



End Cap
(FGS-HMEC-A)



Snap-on Plastic Cover
(FGS-SH4E-A shown attached to 45°
horizontal elbow with junctions)

FiberGuide System

4" H x 4" W - Fittings

ORDERING INFORMATION

Description	Number of Junctions	Part Number			
		Yellow System	Yellow System Snap-on Cover	Black System	Black System Snap-on Cover
4x4 fittings					
Horizontal T	3	FGS-MHRT-A	FGS-SHRT-A	FGSB-MHRT-A	FGSB-SHRT-A
Horizontal cross	4	FGS-MHXP-A	FGS-SHXP-A	FGSB-MHXP-A	FGSB-SHXP-A
90° horizontal elbow	2	FGS-MH9E-A	FGS-SH9E-A	FGSB-MH9E-A	FGSB-SH9E-A
90° up elbow metal cover included	2	FGS-MU9E-A	FGS-SU9E-A	FGSB-MU9E-A	FGSB-SU9E-A
90° down elbow	2	FGS-MD9E-A	FGS-SD9E-A	FGSB-MD9E-A	FGSB-SD9E-A
45° horizontal elbow	2	FGS-MH4E-A	FGS-SH4E-A	FGSB-MH4E-A	FGSB-SH4E-A
45° up elbow metal cover included	2	FGS-MU4E-A	FGS-SU4E-A	FGSB-MU4E-A	FGSB-SU4E-A
45° down elbow	2	FGS-MD4E-A	FGS-SD4E-A	FGSB-MD4E-A	FGSB-SD4E-A
4x4 conversions					
4x4 to 4x6 straight adapter	(1) 4x4, (1) 4x6	FGS-MDSA-AB	FGS-SDSA-AB	FGSB-MDSA-AB	FGSB-SDSA-AB
4x4 expandable straight section	2	FGS-MVAR-A	-	FGSB-MVAR-A	-
4" Cut-in T assembly hardware included	-	FGS-MHIS-A	-	FGSB-MHIS-A	-
6" Cut-in T assembly hardware included	-	FGS-MHIS-B	-	FGSB-MHIS-B	-
12" Cut-in T assembly hardware included	-	FGS-MHIS-F	-	FGSB-MHIS-F	-
Cut-in T fixture	-	FGS-MHIS-JIG-A/B/F	-	FGS-MHIS-JIG-A/B/F	-
4x4 end cap	-	FGS-HMEC-A	-	FGS-HMEC-A	-

FiberGuide System

4" H x 4" W - Downspouts and Attachments



Downspout
(FGS-MDSP-A)



Cover for 4x4 Downspout
(FGS-MCDS-AB)



Extended Downspout
(FGS-MDSP-EX-A)
shown with and without cover)

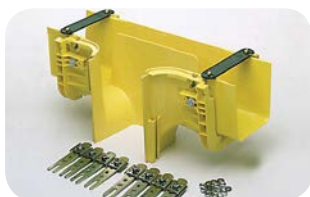

Insertable Downspout
(FGS-MDSP-A/I)



Trumpet Flare
(FGS-MTRM-A)



**Downspout Exit
Junction Kit**
(FGS-MJWR-A)



4x4/4x6 Downspout Insert
(FGS-HDSI-AB)



**4" Square to 2" Round Adapter
with Flex Tube**
(FGS-ASRI)
requires FGS-MJWR-A
Junction Kit)



Dual 2" Flex Tube Attachment
(FGS-KT03-A)



Single 2" Flex Tube Attachment
(FGS-KT03-A1)



2" Quad Flex Tube Attachment
(FGS-KT03-A4)

FiberGuide System

4" H x 4" W - Downspouts and Attachments

An array of 4x4 downspout options are available to feed fiber from overhead straight sections into fiber optic equipment below.

ORDERING INFORMATION

Description	Number of Junctions	Part Number	
		Yellow System	Black System
4x4 downspouts			
Downspout	2**	FGS-MDSP-A	FGSB-MDSP-A
Cover for 4x4 downspout	-	FGS-MCDS-AB	FGSB-MCDS-AB
Extended downspout	2*	FGS-MDSP-EX-A	FGSB-MDSP-EX-A
Cover for 4x4 extended downspout	-	FGS-MCDS-EX-AB	FGSB-MCDS-EX-AB
Insertable downspout	-	FGS-MDSP-A/I	FGSB-MDSP-A/I
Trumpet flare used on both 4x4 and 4x6 downspouts; no 4" junction kit required	-	FGS-MTRM-A	FGSB-MTRM-A
Downspout exit junction kit	-	FGS-MJWR-A	FGSB-MJWR-A
4x4/4x6 downspout; insert converts bottom of downspout to 2x2" without using 2" to 4" adapter, saving vertical space	-	FGS-HDSI-AB	FGS-HDSI-AB
4x4 attachments			
Square to 2" round adapter with flex tube; one 4x4 junction kit (FGS-MJWR-A) required to attach to a downspout drop			
5' length	1	FGS-ASRI-5F	FGSB-ASRI-5F
10' length	1	FGS-ASRI-10F	FGSB-ASRI-10F
15' length	1	FGS-ASRI-15F	FGSB-ASRI-15F
Dual 2" flex tube attachment; no 4x4 junction kit required			
(2) 5' length	-	FGS-KT03-A	FGSB-KT03-A
(2) 10' length	-	FGS-KT03-A10F	FGSB-KT03-A10F
(2) 15' length	-	FGS-KT03-A15F	FGSB-KT03-A15F
Single 2" flex tube attachment; no 4x4 junction kit required			
5' length	-	FGS-KT03-A1	FGSB-KT03-A1
10' length	-	FGS-KT03-A1-10F	FGSB-KT03-A1-10F
15' length	-	FGS-KT03-A1-15F	FGSB-KT03-A1-15F
Quad 2" flex tube attachment; no 4x4 junction kit required			
(4) 5' length	-	FGS-KT03-A4-5F	FGSB-KT03-A4-5F
(4) 10' length	-	FGS-KT03-A4-10F	FGSB-KT03-A4-10F
(4) 15' length	-	FGS-KT03-A4-15F	FGSB-KT03-A4-15F
4x4 quad 7/8" flex tube attachment; no 4x4 junction kit required			
(4) 5' length	-	FGS-KT07-A4-5F	FGSB-KT07-A4-5F
(4) 10' length	-	FGS-KT07-A4-10F	FGSB-KT07-A4-10F
(4) 15' length	-	FGS-KT07-A4-15F	FGSB-KT07-A4-15F

*A third junction is needed if drop is to a fitting or straight section.

**This drop junction must be a junction type FGS-MJWR-A, FGSB-MJWR-A.

FiberGuide System

4" H x 4" W - Straight Section and Snap-Fit™ Junction

Straight Section

The unique four-channel design of the 4x4 FiberGuide straight section allows the standard system to be attached to the support structure without the need to cut or drill any holes within the trough. This ensures that the patch cords will not come in contact with any screw heads or bolts, an important consideration in 4x4 systems where higher cable counts apply increased pressure on patch cords at the bottom of the trough.



Horizontal
Straight Section
(FGS-MSHS-A)



Expandable
Straight Section
(FGS-MVAR-A)



Hinged Cover for
Horizontal Straight Section
(FGS-MSNC-A)

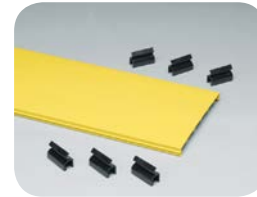

Snap-On
Cover for Horizontal
Straight Section
(FGS-MSSC-A)

ORDERING INFORMATION

Description	Part Number	
	Yellow System	Black System
4x4 straight section		
Horizontal straight section; 6' long, cover sold separately	FGS-MSHS-A	FGSB-MSHS-A
Expandable straight section	FGS-MVAR-A	FGSB-MVAR-A
4x4 accessories		
Hinged cover kit for horizontal straight section; includes three mounting hinges and three clips	FGS-MSNC-A	FGSB-MSNC-A
Snap-on cover kit for horizontal straight section; includes six capture clips with mounting clasps	FGS-MSSC-A	FGSB-MSSC-A
Kit - 10 black capture clips	FGS-DHCP	FGS-DHCP
Kit - 10 black capture clips and 10 hinges	FGS-DHHC (Yellow Hinge)	FGSB-DHHC (Black Hinge)

Snap-Fit™ Junction

The Snap-Fit™ junction assembly is available for the 4-inch FiberGuide system. The Snap-Fit junction is a completely tool-less junction. No additional tools are required for installation or removal. The junction exhibits superior holding force and accommodates support brackets. A warning label indicating caution around fiber optic cable is included with each junction kit.



Snap-Fit Junction
(FGS-MFAW-A)

ORDERING INFORMATION

Description	Part Number	
	Yellow System	Black System
4x4 Snap-Fit™ junction	FGS-MFAW-A	FGSB-MFAW-A

FiberGuide System

2" H x 6" W - Fittings, Downspouts and Attachments



2x6 to 2x2 Downspout
(FGS-MDSP-G)



Horizontal T
(FGS-MHRT-G)



Horizontal Cross
(FGS-MHXP-G)



90° Horizontal Elbow
(FGS-MH9E-G)



90° Down Elbow
(FGS-MD9E-G)



45° Horizontal Elbow
(FGS-MH4E-G)



45° Up Elbow
(FGS-MU4E-G)
(Metal Cover Included)



45° Down Elbow
(FGS-MD4E-G)



2x6 to 4x4 Adapter
(FGS-MDSA-GA)



2x6 to 4x6 Adapter
(FGS-MDSA-GB)



Trumpet Flare
(FGS-MTRM-G)

FiberGuide System

2" H x 6" W – Fittings, Downspouts and Attachments

ORDERING INFORMATION

Description	Number of Junctions	Part Number	
		Yellow System	Black System
2x6 fittings			
Horizontal T	3	FGS-MHRT-G	FGSB-MHRT-G
Horizontal cross	4	FGS-MHXP-G	FGSB-MHXP-G
90° horizontal elbow	2	FGS-MH9E-G	FGSB-MH9E-G
90° down elbow	2	FGS-MD9E-G	FGSB-MD9E-G
45° horizontal elbow	2	FGS-MH4E-G	FGSB-MH4E-G
45° up elbow, metal cover included	2	FGS-MU4E-G	FGSB-MU4E-G
45° down elbow	2	FGS-MD4E-G	FGSB-MD4E-G
2x6 conversions			
2x6 to 4x4 adapter	(1) 2x6, (1) 4x4	FGS-MDSA-GA	FGSB-MDSA-GA
2x6 to 4x6 adapter	(1) 2x6, (1) 4x6	FGS-MDSA-GB	FGSB-MDSA-GB
2x6 downspouts			
2x6 to 2x2 downspout	2	FGS-MDSP-G	FGSB-MDSP-G
Trumpet flare	-	FGS-MTRM-G	FGSB-MTRM-G
2x6 attachments			
Dual 2" flex tube attachment	-	FGS-KT03-G-5F	FGSB-KT03-G-5F
2x6 end cap	-	FGS-HMEC-G	FGS-HMEC-G

Low-Profile Express Exit™

Designed for low-ceiling or height restricted environments, the Express Exit™ for the 2x6 FiberGuide system extends only two inches above the straight section sidewall. The Express Exit accommodates up to 150 (3 mm) patch cords, includes removable rear cable guides for additional cable management, and features a 2x2 exit opening. It is designed specifically for the 2x6 FiberGuide system and should not be used on any other FiberGuide system.



Express Exit
(FGS-MEXP-LP-G)

ORDERING INFORMATION

Description	Part Number	
	Yellow System	Black System
Low-Profile Express Exit™ (designed exclusively for the 2x6 system) <i>Base, cover, mounting hardware, and support bracket included</i>	FGS-MEXP-LP-G	FGSB-MEXP-LP-G

FiberGuide System

2" H x 6" W – Straight Section and Junction

Straight Section

The unique four-channel design of the 2x6 FiberGuide straight section allows the standard system to be attached to the support structure without the need to cut or drill any holes within the trough. This ensures that the patch cords will not come in contact with any screw heads or bolts.



Straight Section
(FGS-MSHS-G)



Hinged Cover Kit for Horizontal Straight Section
(FGS-MSNC-B/G)

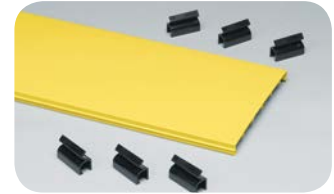

6-inch Snap-on Cover
(FGS-MSSC-B/G)

ORDERING INFORMATION

Description	Part Number	
	Yellow System	Black System
2x6 straight section; horizontal straight section; 6' long, cover sold separately	FGS-MSHS-G	FGSB-MSHS-G
2x6 accessories		
2x6 hinged cover kit for horizontal straight section; three mounting hinges and three clips included	FGS-MSNC-B/G	FGSB-MSNC-B/G
6-inch snap-on cover kit for horizontal straight section; six capture clips with mounting clasps included	FGS-MSSC-B/G	FGSB-MSSC-B/G
Kit-10 black capture clips	FGS-DHCP	FGS-DHCP

Junction

The one-piece junction employs factory-installed set screws to assure strength and durability. No cutting or drilling of the components is required for assembly. A warning label indicating caution around fiber optic cable is included with each junction kit.



2x6 Junction
(FGS-JUNC-G)

ORDERING INFORMATION

Description	Part Number	
	Yellow System	Black System
2x6 junction	FGS-JUNC-G	FGSB-JUNC-G

FiberGuide System

4" H x 6" W - Fittings



Horizontal T
(FGS-MHRT-B)



Horizontal Cross
(FGS-MHXP-B)



90° Horizontal Elbow
(FGS-MH9E-B)



90° Up Elbow
Cover Included
(FGS-MU9E-B)



90° Down Elbow
(FGS-MD9E-B)



45° Horizontal Elbow
(FGS-MH4E-B)



45° Up Elbow
Cover Included
(FGS-MU4E-B)



45° Down Elbow
(FGS-MD4E-B)



4x4 to 4x6 Straight Adapter
(FGS-MDSA-AB)



Expandable
Straight Section
(FGS-MVAR-B)



6" Cut-in T
(FGS-MHIS-B)



Cut-in T Fixture
(FGS-MHIS-JIG-A/B/F shown on
a straight section)



4x12 to Single 4x6 Adapter
(FGS-MDSA-FB)
(Cover: FGS-SDSA-FB)



End Cap
(FGS-HMEC-B)



Snap-on Plastic Cover
(FGS-SH4E-B shown attached
to 45° horizontal elbow
with junctions)

FiberGuide System

4" H x 6" W - Fittings

ORDERING INFORMATION

Description	Number of Junctions	Part Number			
		Yellow System	Yellow System Snap-on Cover	Black System	Black System Snap-on Cover
4x6 fittings					
Horizontal T	3	FGS-MHRT-B	FGS-SHRT-B	FGSB-MHRT-B	FGSB-SHRT-B
Horizontal cross	4	FGS-MHXP-B	FGS-SHXP-B	FGSB-MHXP-B	FGSB-SHXP-B
90° horizontal elbow	2	FGS-MH9E-B	FGS-SH9E-B	FGSB-MH9E-B	FGSB-SH9E-B
90° up elbow metal cover included	2	FGS-MU9E-B	-	FGSB-MU9E-B	-
90° down elbow	2	FGS-MD9E-B	FGS-SD9E-B	FGSB-MD9E-B	FGSB-SD9E-B
45° horizontal elbow	2	FGS-MH4E-B	FGS-SH4E-B	FGSB-MH4E-B	FGSB-SH4E-B
45° up elbow metal cover included	2	FGS-MU4E-B	FGS-SU4E-B	FGSB-MU4E-B	FGSB-SU4E-B
45° down elbow	2	FGS-MD4E-B	FGS-SD4E-B	FGSB-MD4E-B	FGSB-SD4E-B
4x6 conversions					
4x4 to 4x6 straight adapter	(1) 4x4, (1) 4x6	FGS-MDSA-AB	FGS-SDSA-AB	FGSB-MDSA-AB	FGSB-SDSA-AB
4x12 to single 4x6 adapter	-	FGS-MDSA-FB	FGS-SDSA-FB	FGSB-MDSA-FB	FGSB-SDSA-FB
4x6 expandable straight section	2	FGS-MVAR-B	-	FGSB-MVAR-B	-
4" Cut-in T; assembly hardware included	-	FGS-MHIS-A	-	FGSB-MHIS-A	-
6" Cut-in T; assembly hardware included	-	FGS-MHIS-B	-	FGSB-MHIS-B	-
12" Cut-in T; assembly hardware included	-	FGS-MHIS-F	-	FGSB-MHIS-F	-
Cut-in T fixture	-	FGS-MHIS-JIG-A/B/F	-	FGS-MHIS-JIG-A/B/F	-
4x6 end cap	-	FGS-HMEC-B	-	FGS-HMEC-B	-

FiberGuide System

4" H x 6" W - Downspouts and Attachments



Downspout
(FGS-MDSP-B)



Cover for 4x6 Downspout
(FGS-MCDS-AB)



Extended Downspout
(FGS-MDSP-EX-B shown with
and without cover)



Insertable Downspout
(FGS-MDSP-B/I)



Dual Downspout
(FGS-MDSP-2B)



Dual Downspout with Divider
(FGS-MDSP-2B-IMP)



**Trumpet Flare Kit for 4x6
Dual Downspout**
(FGS-MTRM-2B)



**Trumpet Flare Kit for Dual
Downspout with Divider**
(FGS-MTRM-2B-IMP)



**Single 2" Flex Tube
Attachment**
(FGS-KT03-A1)



Trumpet Flare Kit
(FGS-MTRM-A shown attached
to downspout)



4x4/4x6 Downspout Insert
(FGS-HDSI-AB)



Downspout Exit Junction Kit
(FGS-MJWR-A)



**4" Square to 2" Round
Adapter with Flex Tube**
(FGS-ASRI requires
FGS-MJWR-A junction kit)



Dual 2" Flex Tube Attachment
(FGS-KT03-A)



**2" Quad Flex
Flex Tube Attachment**
(FGS-KT03-A4)

FiberGuide System

4" H x 6" W - Downspouts and Attachments

4x6 downspouts and attachments feed fiber from overhead straight sections into fiber optic equipment below. All 4x6 downspouts feature 4-inch exits and attach to the 4-inch x 4-inch attachments listed below.

ORDERING INFORMATION

Description	Number of Junctions	Part Number	
		Yellow System	Black System
4x6 downspouts			
Downspout Note: <i>If a trumpet flare is required use a 4x4 flare (FGS-MTRM-A)</i>	2*	FGS-MDSP-B	FGSB-MDSP-B
Cover for 4x6 downspout and dual downspout	-	FGS-MCDS-AB**	FGSB-MCDS-AB**
Extended downspout	2	FGS-MDSP-EX-B	FGSB-MDSP-EX-B
Cover for 4x6 extended downspout	-	FGS-MCDS-EX-AB	FGSB-MCDS-EX-AB
Insertable downspout	-	FGS-MDSP-B/I	FGSB-MDSP-B/I
Dual drop downspout	2*	FGS-MDSP-2B	FGSB-MDSP-2B
Trumpet flare for dual drop downspout (kit of 2 FGS-MTRM-A)	-	FGS-MTRM-2B	FGSB-MTRM-2B
Dual drop downspout with divider	2	FGS-MDSP-2B-IMP	FGSB-MDSP-2B-IMP
Trumpet flare for dual drop downspout with divider (kit of 2)		FGS-MTRM-2B-IMP	FGSB-MTRM-2B-IMP
Junction for downspout exit		FGS-MJWR-A	FGSB-MJWR-A
4x4/4x6 downspout insert; <i>converts bottom of downspout to 2x2 without using 2" to 4" adapter, saving vertical space</i>		FGS-HDSI-AB	FGSB-HDSI-AB
4x4 Trumpet flare; used on exits of 4x4 and 4x6 downspouts — <i>no 4" junction kit required</i>		FGS-MTRM-A	FGSB-MTRM-A
4x6 Trumpet flare		FGS-MTRM-B	FGSB-MTRM-B
4x6 attachments			
4x4 square to 2" round adapter with flex tube; <i>one 4x4 junction kit (FGS-MJWR-A) required to attach to a downspout drop</i>			
5' length	1	FGS-ASRI-5F	FGSB-ASRI-5F
10' length	1	FGS-ASRI-10F	FGSB-ASRI-10F
15' length	1	FGS-ASRI-15F	FGSB-ASRI-15F
4x4 dual 2" flex tube attachment; <i>no 4x4 junction kit required</i>			
(2) 5' length	-	FGS-KT03-A	FGSB-KT03-A
(2) 10' length	-	FGS-KT03-A10F	FGSB-KT03-A10F
(2) 15' length	-	FGS-KT03-A15F	FGSB-KT03-A15F
4x4 single 2" flex tube attachment; <i>no 4x4 junction kit required</i>			
5' length	-	FGS-KT03-A1	FGSB-KT03-A1
10' length	-	FGS-KT03-A1-10F	FGSB-KT03-A1-10F
15' length	-	FGS-KT03-A1-15F	FGSB-KT03-A1-15F
4x4 quad 2" flex tube attachment; <i>no 4x4 junction kit required</i>			
(4) 5' length	-	FGS-KT03-A4-5F	FGSB-KT03-A4-5F
(4) 10' length	-	FGS-KT03-A4-10F	FGSB-KT03-A4-10F
(4) 15' length	-	FGS-KT03-A4-15F	FGSB-KT03-A4-15F
4x4 quad 7/8" flex tube attachment; <i>no 4x4 junction kit required</i>			
(4) 5' length	-	FGS-KT07-A4-5F	FGSB-KT07-A4-5F
(4) 10' length	-	FGS-KT07-A4-10F	FGSB-KT07-A4-10F
(4) 15' length	-	FGS-KT07-A4-15F	FGSB-KT07-A4-15F

*A 4x4 junction is needed to drop to a fitting or a straight section.
This drop junction must be a junction type FGS-MJWR-A or FGSB-MJWR-A.

**Dual downspout requires two covers.

FiberGuide System

4" H x 6" W – Straight Section and Junction

Straight Section

The unique four-channel design of the 4x6 FiberGuide straight section allows the standard system to be attached to the support structure without the need to cut or drill any holes within the trough. This ensures that the patch cords will not come in contact with any screw heads or bolts, an important consideration in 4x6 systems where higher cable counts apply increased pressure on patch cords at the bottom of the trough.



Horizontal Straight Section
(FGS-MSHS-B)



Expandable Straight Section
(FGS-MVAR-B)



Hinged Cover Kit
for Horizontal Straight Section
(FGS-MSNC-B/G)

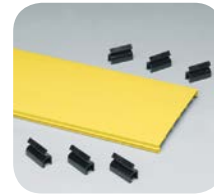

6" Snap-on Cover
for Horizontal Straight Section
(FGS-MSSC-B/G)

ORDERING INFORMATION

Description	Part Number	
	Yellow System	Black System
4x6 straight sections		
Horizontal straight section; 6' long, cover sold separately	FGS-MSHS-B	FGSB-MSHS-B
Expandable straight section	FGS-MVAR-B	FGSB-MVAR-B
Slack storage straight section	FGS-MSHS-STOR-B	FGSB-MSHS-STOR-B
4x6 accessories		
Hinged cover kit for horizontal straight section; includes three mounting hinges and three clips	FGS-MSNC-B/G	FGSB-MSNC-B/G
6" snap-on cover kit for horizontal straight section; includes six capture clips with mounting clasps	FGS-MSSC-B/G	FGSB-MSSC-B/G
Kit - 10 black capture clips	FGS-DHCP	FGS-DHCP
Kit - 10 black capture clips and 10 hinges	FGS-DHHC (Yellow Hinge)	FGSB-DHHC (Black Hinge)

Snap-Fit™ Junction

The Snap-Fit™ junction assembly is available for the 6-inch FiberGuide system. The new junction is a completely tool-less junction. No additional tools are required for installation or removal. The Snap-Fit Junction exhibits superior holding force and accommodates support brackets. A warning label indicating caution around fiber optic cable is included with each junction kit.



Snap-Fit Junction
(FGS-MFAW-B)

ORDERING INFORMATION

Description	Part Number	
	Yellow System	Black System
4x6 Snap-fit junction	FGS-MFAW-B	FGSB-MFAW-B

FiberGuide System

4" H x 12" W - Fittings



Horizontal T
(FGS-MHRT-F)



Horizontal Cross
(FGS-MHXP-F)



90° Horizontal Elbow
(FGS-MH9E-F)



90° Down Elbow
(FGS-MD9E-F)



45° Horizontal Elbow
(FGS-MH4E-F)



45° Up Elbow
(FGS-MU4E-F)



45° Down Elbow
(FGS-MD4E-F)



Horizontal T with Single 6" Exit
(FGS-MHRT-F/B)



Horizontal Cross with Two 6" Exits
(FGS-MHXP-B/F)



4x12 to Dual 4x6 Adapter
(FGS-MDSA-F2B)



4x12 to Single 4x6 Adapter
(FGS-MDSA-FB)



4x12 to 4x6 Adapter - Right
(FGS-MDSA-FB-R)



4x12 to 4x6 Adapter - Left
(FGS-MDSA-FB-L)



End Cap
(FGS-HMEC-F)



Expandable Straight Section
(FGS-MVAR-F)



12" Cut-in T
(FGS-MHIS-F)



Cut-in T Fixture
(FGS-MHIS-JIG-A/B/F shown on a straight section)



Snap-on Cover
(FGS-SH4E-F shown separate)



Snap-on Cover Installation



Snap-on Cover
(FGS-SH4E-F shown installed)

FiberGuide System

4" H x 12" W – Fittings

ORDERING INFORMATION

Description	Number of Junctions	Part Number			
		Yellow System	Yellow System Snap-on Cover	Black System	Black System Snap-on Cover
4x12 fittings					
Horizontal T	3	FGS-MHRT-F	FGS-SHRT-F	FGSB-MHRT-F	FGSB-SHRT-F
Horizontal cross	4	FGS-MHXP-F	FGS-SHXP-F	FGSB-MHXP-F	FGSB-SHXP-F
90° horizontal elbow	2	FGS-MH9E-F	FGS-SH9E-F	FGSB-MH9E-F	FGSB-SH9E-F
90° down elbow	2	FGS-MD9E-F	FGS-SD9E-F	FGSB-MD9E-F	FGSB-SD9E-F
45° horizontal elbow	2	FGS-MH4E-F	FGS-SH4E-F	FGSB-MH4E-F	FGSB-SH4E-F
45° up elbow, metal cover included	2	FGS-MU4E-F	FGS-SU4E-F	FGSB-MU4E-F	FGSB-SU4E-F
45° down elbow	2	FGS-MD4E-F	FGS-SD4E-F	FGSB-MD4E-F	FGSB-SD4E-F
Horizontal T with single 6" exit	(2) 4x12, (1) 4x6	FGS-MHRT-F/B	FGS-SHRT-F/B	FGSB-MHRT-F/B	FGSB-SHRT-F/B
Horizontal cross with two 6" exits	(2) 4x12, (2) 4x6	FGS-MHXP-B/F	FGS-SHXP-B/F	FGSB-MHXP-B/F	FGSB-SHXP-B/F
4x12 conversions					
4x12 to dual 4x6 adapter	(1) 4x12, (2) 4x6	FGS-MDSA-F2B	FGS-SDSA-F2B	FGSB-MDSA-F2B	FGSB-SDSA-F2B
4x12 to single 4x6 adapter	(1) 4x12, (1) 4x6	FGS-MDSA-FB	FGS-SDSA-FB	FGSB-MDSA-FB	FGSB-SDSA-FB
4x12 to 4x6 right adapter; <i>includes fastening hardware</i>		FGS-MDSA-FB-R		FGS-MDSA-FB-R	
Fixed metal cover for right adapter		FGS-VDSA-FB-R		FGS-VDSA-FB-R	
4x12 to 4x6 left adapter; <i>includes fastening hardware</i>		FGS-MDSA-FB-L		FGS-MDSA-FB-L	
Fixed metal cover for left adapter		FGS-VDSA-FB-L		FGS-VDSA-FB-L	
Expandable straight section	2	FGS-MVAR-F	-	FGSB-MVAR-F	-
4" Cut-in T; <i>assembly hardware included</i>	-	FGS-MHIS-A	-	FGSB-MHIS-A	-
6" Cut-in T; <i>assembly hardware included</i>	-	FGS-MHIS-B	-	FGSB-MHIS-B	-
12" Cut-in T; <i>assembly hardware included</i>	-	FGS-MHIS-F	-	FGSB-MHIS-F	-
Cut-in T fixture	-	FGS-MHIS-JIG-A/B/F	-	FGS-MHIS-JIG-A/B/F	-
4x12 end cap		FGS-HMEC-F		FGS-HMEC-F	
4x12 variable support locator kits for; <i>Each kit contains all necessary mounting hardware. Fitting sold separately.</i>					
FGS-MDSP-F (downspout)		FGS-MDSP-F-VS		FGS-MDSP-F-VS	
FGS-MHRT-F (horizontal T)		FGS-MHRT-F-VS		FGS-MHRT-F-VS	
FGS-MHXP-F (horizontal cross)		FGS-MHXP-F-VS		FGS-MHXP-F-VS	
FGS-MH9E-F (90° horizontal elbow)		FGS-MH9E-F-VS		FGS-MH9E-F-VS	
FGS-MHRT-F/B (horizontal T - 6"/12")		FGS-MHRT-F/B-VS		FGS-MHRT-F/B-VS	
FGS-MHXP-B/F (horizontal cross- 6"/12")		FGS-MHXP-B/F-VS		FGS-MHXP-B/F-VS	

FiberGuide System

4" H x 12" W – Downspouts and Attachments



Downspout
(FGS-MDSP-F)



Cover for 4x12 Downspout
(FGS-SDSP-F)



Trumpet Flare
(FGS-MTRM-F)



Downspout with Rear T
(FGS-MDRT-F)



Island T
(FGS-ISLAND-F)



Island T with Recessed Dividing Spool
(FGS-ISLAND3-F shown with 12" Junction, 90° Down Elbow and Trumpet Flare)



4x6 Dual 2" Flex Tube Attachment
(FGS-KT03-B)



4x6 Trumpet Flare Kit
(FGS-MTRM-B shown alone and attached to 4x12 Downspout)



4x12 to 4x4 Downspout Converter
(FGS-HDSI-F/D)



The FGS-HDSI-F/D attached to both the 4x12 downspout and the 4x4 slotted duct without the use of hardware

FiberGuide System

4" H x 12" W – Downspouts and Attachments

An array of 4x12 downspouts and attachments are available to feed fiber from overhead straight sections into fiber optic equipment below. The 4x12 downspout features a 4x6 exit and accepts the 4x6 exit attachments listed below.

ORDERING INFORMATION

Description	Number of Junctions	Yellow System Part Number	Black System Part Number
4x12 downspouts			
Downspout	2*	FGS-MDSP-F	FGSB-MDSP-F
Cover for 4x12 downspout	-	FGS-SDSP-F	FGSB-SDSP-F
Insertable downspout	-	FGS-MDSP-F/I	FGSB-MDSP-F/I
Trumpet flare	-	FGS-MTRM-F	FGSB-MTRM-F
Downspout with rear T	3*	FGS-MDRT-F	FGSB-MDRT-F
Island T with spool and factory installed trumpet flare	2	FGS-ISLAND-F	FGSB-ISLAND-F
Island T with trumpet and dividing spool; <i>Variable Support Locator Kit included</i>	2	FGS-ISLAND-F-513	FGSB-ISLAND-F-513
Island T with recessed dividing spool	3	FGS-ISLAND3-F	FGSB-ISLAND3-F
4x12 attachments			
4x6 dual 2" flex tube attachment			
5' length	-	FGS-KT03-B	FGSB-KT03-B
10' length	-	FGS-KT03-B-10F	FGSB-KT03-B-10F
15' length	-	FGS-KT03-B-15F	FGSB-KT03-B-15F
4x6 trumpet flare kit; <i>used on 4x12 downspouts</i>		FGS-MTRM-B	FGSB-MTRM-B
4x12 to 4x4 downspout converter; <i>converts downspout opening to accept 4x4 slotted duct</i>	-	FGS-HDSI-F/D	FGS-HDSI-F/D
4x12 to 2x2 downspout converter	-	FGS-HDSI-F/C	FGS-HDSI-F/C

*An additional junction is needed if drop is to fitting or straight section.
This 4x6 junction must be a junction type FGS-MFAW-B, FGSB-MFAW-B.

FiberGuide System

4" H x 12" W – Straight Section

The unique nine-channel design of the 4x12 FiberGuide straight section provides unmatched strength and allows the attachment of support structure without the need to cut or drill holes within the raceway. This ensures that the patch cords will not come in contact with any screw heads or bolts, an important consideration in 4x4, 4x6, and 4x12 systems where higher cable counts apply increased pressure on the patch cords at the bottom of the raceway.

The 4x12 system covers feature a snap-on design. This allows the cover to be used in environments with limited headroom. Two 3-foot cover sections come with each order, making it easy for one person to remove the covers. Each cover kit includes a tether kit. The straight section covers are designed to be placed over the 4x12 downspouts, speeding installation time by reducing the number of measurements and cuts that need to be made.



Horizontal Straight Section
(FGS-MSHS-F)

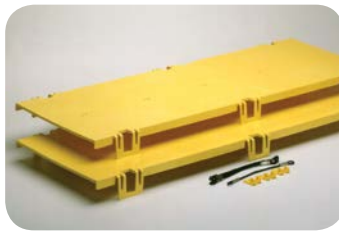

Horizontal Straight Section Cover
(FGS-MSSC-F includes two 3' Lengths and Tethering Hardware)



Expandable Straight Section
(FGS-MVAR-F)



12" Hinged Cover for Horizontal Straight Section
(FGS-MSNC-F)



Straight Section Cover in Tethered Position



Straight Section Cover Attached to Straight Section

ORDERING INFORMATION

Description	Part Number	
	Yellow System	Black System
4x12 straight section		
Horizontal straight section; 6' long, cover sold separately	FGS-MSHS-F	FGSB-MSHS-F
Expandable straight section	FGS-MVAR-F	FGSB-MVAR-F
Slack storage straight section	FGS-MSHS-STOR-F	FGSB-MSHS-STOR-F
4x12 accessories		
Hinged cover kit for horizontal straight section; includes five mounting hinges and three clips	FGS-MSNC-F	FGSB-MSNC-F
Snap-on cover kit for horizontal straight section; includes 3' covers, optional tethering kit	FGS-MSSC-F	FGSB-MSSC-F
Kit - 10 black capture clips	FGS-DHCP	FGS-DHCP
Kit - 10 black capture clips and 10 hinges	FGS-DHHC	FGSB-DHHC

FiberGuide System

4" H x 12" W – Snap-Fit™ Junction

The new Snap-Fit™ junction is available for the 12-inch FiberGuide system. The Snap-Fit junction is a completely tool-less junction. No additional tools are required for installation or removal. The Snap-Fit junction exhibits superior holding force and accommodates support brackets.

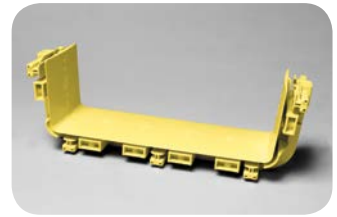

4x12 Snap-Fit Junction
(FGS-MFAW-F)

ORDERING INFORMATION

Description	Part Number	
	Yellow System	Black System
4x12 Snap-Fit™ junction	FGS-MFAW-F	FGSB-MFAW-F

FiberGuide System

4" H x 24" W - Fittings



End Cap
(FGS-HMEC-H)



Horizontal Cross with Dual 12" Exits
(FGS-MHXP-F/H)



Horizontal Cross
(FGS-MHXP-H)



45° Horizontal Elbow
(FGS-MH4E-H)



Horizontal T with Single 12" Exit
(FGS-MHRT-H/F)



12" Cut-in T
(FGS-MHIS-F/H)



45° Down Elbow
(FGS-MD4E-H)



4x24 to 4x12 Adapter
(FGS-MDSA-HF)



45° Up Elbow
(FGS-MU4E-H)

ORDERING INFORMATION

Description	Part Number	
	Yellow System	Black System
4x24 fittings		
45° horizontal elbow	FGS-MH4E-H	FGSB-MH4E-H
Horizontal T with single 12" exit	FGS-MHRT-H/F	FGSB-MHRT-H/F
Horizontal T with three 24" exits	FGS-MHRT-H	FGSB-MHRT-H
Horizontal cross	FGS-MHXP-H	FGSB-MHXP-H
Horizontal cross with dual 12" exits	FGS-MHXP-F/H	FGSB-MHXP-F/H
45° up elbow	FGS-MU4E-H	FGSB-MU4E-H
45° down elbow	FGS-MD4E-H	FGSB-MD4E-H
4x24 conversions		
12" cut-in T for 4x24*	FGS-MHIS-F/H	FGSB-MHIS-F/H
6" cut-in T for 4x24*	FGS-MHIS-B/H	FGSB-MHIS-B/H
4" cut-in T for 4x24*	FGS-MHIS-A/H	FGSB-MHIS-A/H
4x24 to 4x12 adapter	FGS-MDSA-HF	FGSB-MDSA-HF
4x24 end cap	FGS-HMEC-H	FGS-HMEC-H

*Designed exclusively for the 4x24" system.

FiberGuide System

4" H x 24" W - Downspouts

4x24 downspouts and attachments feed fiber from overhead straight sections into fiber optic equipment below.

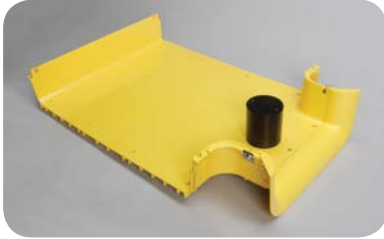

Island T with Single 12" Exit
(FGS-ISLAND-H/F)



Trumpet Flare
(FGS-MTRM-H)

ORDERING INFORMATION

Description	Part Number	
	Yellow System	Black System
Island T with single 12" exit	FGS-ISLAND-H/F	FGSB-ISLAND-H/F
Trumpet flare	FGS-MTRM-H	FGS-MTRM-H

FiberGuide System

4" H x 24" W - Straight Section, Snap-Fit™ Junctions and covers

Straight Section

The unique double wall channel design of the 4x24 straight section provides exceptional strength and durability for high fiber count applications and allows the standard system to be attached to the support structure without the need to cut or drill any holes within the trough. The six channel design ensures that the patch cords will not come in contact with any screw heads or bolts, an important consideration in 4x24 systems where higher cable counts apply increased pressure on patch cords at the bottom of the trough.

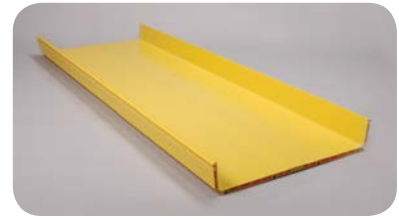

Straight Section
(FGS-MSHS-H)

ORDERING INFORMATION

Description	Part Number	
	Yellow System	Black System
4x24 straight section; horizontal straight section, 6' long	FGS-MSHS-H	FGSB-MSHS-H

Snap-Fit Junction

The Snap-Fit™ Junction assembly is available for the 24-inch FiberGuide System. The Snap-Fit junction is a completely tool-less junction. No additional tools are required for installation or removal. The junction exhibits superior holding force and accommodates support brackets. A warning label is included with each junction kit.



Snap-Fit Junction
(FGS-MFAW-H)

ORDERING INFORMATION

Description	Part Number	
	Yellow System	Black System
4x24 Snap-Fit™ junction	FGS-MFAW-H	FGSB-MFAW-H

Cover Kits

ORDERING INFORMATION

Description	Part Number
Cover for 4"x24"x6' straight section - FGS-MSHS-H	FGS-FSFC-H
Cover for 4"x24"horizontal tee with single 12" Exit - FGS-MHRT-H/F	FGS-FHRT-H/F
Cover for 4"x24"horizontal cross with dual 12" Exits - FGS-MHXP-F/H	FGS-FHXP-F/H
Cover for 4"x24"horizontal cross - FGS-MHXP-H	FGS-FHXP-H
Cover for 4"x24" 45° horizontal elbow - FGS-MH4E-H	FGS-FH4E-H
Cover for 4"x24"horizontal tee - FGS-MHRT-H	FGS-FHRT-H
Cover for 4"x24" 4° down elbow - FGS-MD4E-H	FGS-FD4E-H
Cover for 4"x24" to 4"x12" reducer - FGS-MDSA-HF	FGS-FDSA-HF

FiberGuide System

LighTrax to FGS adaptors

FiberGuide Adaptation kits

Adaptation kits make it possible to easily migrate from Lightrax to FiberGuide. They are easy to install and offer the opportunity to seamlessly expand your current raceway system.

Adaptation kits are available for the following sizes: 4x4", 4x6/4x8", 4x12/4x8" and 4x12".

ORDERING INFORMATION

Description	Part Number
Adapter Kit 4" to 4" (100 to 100mm)	FGS-FRH-4/4ADP
Adapter Kit FGS 4x6" to Lightrax 4x8" (150 to 200mm)	FGS-FRH-6/8ADP
Adapter Kit FGS 4x12" to Lightrax 4x8" (300 to 200mm)	FGS-FRH-12/8ADP
Adapter Kit 12" to 12" (300 to 300mm)	FGS-FRH-12/12ADP



Adapter Kit 4" to 4"



Adapter Kit FGS 4x6" to Lightrax 4x8"



Adapter Kit FGS 4x12" to Lightrax 4x8"



Adapter Kit 12" to 12"

FiberGuide System

Express Exit™ Family for 4x4, 4x6 and 4x12 Systems

ADC's patented* Express Exit™ family accommodates various raceway environments and applications. By simply securing an Express Exit to the sidewall of any 4x4, 4x6, 4x12, or 4x24 FiberGuide straight section, jumpers can be permanently or temporarily routed to fiber optic terminal (FOT) equipment below. No cutting of the FiberGuide system is required. Positioning a drop with a member of the Express Exit family greatly simplifies installation, protects the integrity of fibers already present in the raceway, and increases overall flexibility of the raceway system. All Express Exits guarantee 2-inch bend radius protection.



Express Exit Family

Express Exit Style	Height Above Sidewall	Exit Opening	3 mm Patch Cord Capacity	2 mm Patch Cord Capacity	Hinged Rear Cover	Exit Fin Inserts
2-Inch Express Exit	4"	2" x 2" ¹	150	350	No	No
Low-Profile Express Exit	2"	2" x 2" ¹	150	350	No	No
4-Inch Express Exit	4"	4" x 4" ²	300	700	Yes	Yes

¹Accepts all standard 2x2" attachments.

²Accepts all standard 4x4" attachments.

4-Inch Express Exit™

The 4-Inch Express Exit is designed to distribute and manage medium cable counts to FOT or ODF equipment. It features a 4-inch by 4-inch exit opening to accept all standard 4x4 downspout attachments and includes insertable exit fins and removable rear cable guides for additional cable management.



4-Inch Express Exit

ORDERING INFORMATION

Description	Part Number	
	Yellow System	Black System
4-inch Express Exit™		
Express Exit; base, base cover, mounting hardware, support bracket, and exit inserts included	FGS-MEXP-E-A/B/F	FGSB-MEXP-E-A/B/F
4-inch accessories		
Express Exit rear hinged cover kit; one 4x4, 4x6, 4x12 rear hinged cover	FGS-MEXC-E-A/B/F	FGSB-MEXC-E-A/B/F
Express Exit rear hinged cover for 4x4 raceway	FGS-MEXC-E-A	FGSB-MEXC-E-A
Express Exit rear hinged cover for 4x6 raceway	FGS-MEXC-E-B	FGSB-MEXC-E-B
Express Exit rear hinged cover for 4x12 raceway	FGS-MEXC-E-F	FGSB-MEXC-E-F

*Other patents pending.

FiberGuide System

Express Exit™ Family for 4x4, 4x6 and 4x12 Systems

2-Inch Express Exit™

The 2-Inch Express Exit, ADC's initial offering in the Express Exit product family, accommodates up to 350, 2 mm patch cords. The patch cords are routed from a 4x4, 4x6, 4x12 or 4x24 straight section to FOT equipment below the raceway.



2-Inch Express Exit

ORDERING INFORMATION

Description	Part Number	
	Yellow System	Black System
2-Inch Express Exit™ ; base, base cover, mounting hardware and support bracket included	FGS-MEXP-A/B/F	FGSB-MEXP-A/B/F

Low-Profile Express Exit™

Designed for low-ceiling or height-restricted environments, the Low-Profile Express Exit features a front-removable cover and extends only 2 inches above the FiberGuide straight section sidewall. It also includes removable rear cable guides for additional cable management.



Low-Profile Express Exit

ORDERING INFORMATION

Description	Part Number	
	Yellow System	Black System
Low-Profile Express Exit™ ; base, base cover, mounting hardware and support bracket included	FGS-MEXP-LP-A/B/F	FGSB-MEXP-LP-A/B/F

Attachments for 2-Inch Express Exit™ and Low-Profile Express Exit™

ORDERING INFORMATION

Description	Part Number	
	Yellow System	Black System
2x2 trumpet flare ; junction included	FGS-MTRM-C	FGSB-MTRM-C
Single 2" flex tube attachment ; 2" flex tube and a 2x2 junction to attach to Express Exit unit included		
5' length	FGS-MEX1-C-5F	FGSB-MEX1-C-5F
10' length	FGS-MEX1-C-10F	FGSB-MEX1-C-10F
15' length	FGS-MEX1-C-15F	FGSB-MEX1-C-15F
Dual 7/8" flex tube attachment ; two lengths of 7/8" flex tube and a 2" junction to attach to Express Exit unit included		
(2) 5' lengths	FGS-KT03-C	FGSB-KT03-C
(2) 10' lengths	FGS-KT03-C-10F	FGSB-KT03-C-10F
(3) 15' lengths	FGS-KT03-C-15F	FGSB-KT03-C-15F

FiberGuide System

System Support Kits for 2x6, 4x4 and 4x6 Systems



Ladder Rack Cantilever Support Bracket Kit
(FGS-HDLB-4)



L Bay Support Bracket Kit
(FGS-HLBK shown alone and attached to 4x4 FiberGuide)



New Threaded Rod Bracket kit
(FGS-HNTR-XX shown alone and attached to threaded rod)



Existing Threaded Rod Bracket Kit
(FGS-HETR-XX shown alone and attached to threaded rod)



Modified New Threaded Rod Bracket Kit (FGS-HNTR-5/8-A shown alone and attached to threaded rod)



Top Support Low Profile C-bracket Kit
(FGS-HNTS-XX-LP)



Top Support C-Bracket Kit
(FGS-HNTS-XX)



Modified Existing Threaded Rod Bracket Kit
(FGS-HETR-5/8-A shown alone and attached to threaded rod)



Center Support Bracket Kit
(FGS-HTUB-XX)

ORDERING INFORMATION

Description	Part Number
2x6, 4x4, 4x6 system support kits	
Ladder rack cantilever support bracket kit	FGS-HDLB-3
L bay support bracket kit	FGS-HLBK
New threaded rod bracket kit; (XX = size: 1/2", 5/8", 12 mm, 14 mm, 16 mm, 18 mm)	FGS-HNTR-XX
Existing threaded rod bracket kit; (XX = size: 1/2", 5/8", 12 mm, 14 mm, 16 mm)	FGS-HETR-XX
Modified new threaded rod bracket kit; 5/8"	FGS-HNTR-5/8-A
Top support low-profile C-bracket kit; (XX = size: 1/2", 5/8", 12 mm, 14 mm, 16 mm)	FGS-HNTS-XX-LP
Top support C-bracket kit; (XX = size: 1/2", 5/8", 12 mm, 14 mm, 16 mm)	FGS-HNTS-XX
Modified existing threaded rod bracket kit; 5/8"	FGS-HETR-5/8-A
Center support bracket kit; (XX = size: 1/2", 5/8", 12 mm, 14 mm, 16 mm, 20 mm)	FGS-HTUB-XX
Digital cableway bracket kit; 305 mm (12")	FGS-HCBL-12
Digital cableway bracket kit; 381 mm (15")	FGS-HCBL-15
Ladder rack center support bracket kit	FGS-HNLR-AB
OMX frame center support bracket kit; 16 mm (.63")	FGS-HOMX-16MM
Under floor support bracket kit	FGS-HUFB-A

For custom brackets please contact your local Sales Representative

FiberGuide System

System Support Kits for 4x12 Systems



Existing Ladder Rack Center Support Bracket Kit
(FGS-HETP-F-XX)



Trapeze Bracket Kit
(FGS-HNTP-F-XX)



Center Support Threaded Rod Bracket Kit
(FGS-HTUB-F-XX shown alone and attached to threaded rod)



Top Support Low-Profile Threaded Rod Bracket Kit
(FGS-HNTS-F-XX-LP shown alone and attached to threaded rod)



Top Support Threaded Rod Bracket Kit
(FGS-HNTS-F-XX)



New Threaded Rod Bracket Kit
(FGS-HNTR-F-XX)



Existing Threaded Rod Bracket Kit
(FGS-HETR-F-XX)

ORDERING INFORMATION

Description	Part Number
4x12 system support kits	
New ladder rack center support bracket kit	FGS-HNLR-F
Existing ladder rack center support bracket kit; (XX = size: 1/2", 5/8", 12 mm, 14 mm, 16 mm)	FGS-HETP-F-XX
Trapeze bracket kit; (XX = size: 1/2", 5/8", 12 mm, 14 mm, 16 mm)	FGS-HNTP-F-XX
Center support threaded rod bracket kit; (XX = size: 1/2", 5/8", 12 mm, 14 mm, 16 mm, 20 mm)	FGS-HTUB-F-XX
Top support low-profile threaded rod C-bracket kit; (XX = size: 1/2", 5/8", 12 mm, 14 mm, 16 mm)	FGS-HNTS-F-XX-LP
Top support threaded rod C-bracket kit; (XX = size: 1/2", 5/8", 12 mm, 14 mm, 16 mm)	FGS-HNTS-F-XX
New threaded rod bracket kit; (XX = size: 5/8", 14 mm, 16 mm, 18 mm)	FGS-HNTR-F-XX
Existing threaded rod bracket kit; (XX = size: 5/8", 14 mm, 16 mm)	FGS-HETR-F-XX

FiberGuide System

System Support Kits for 4x24 Systems



Variable Fitting Support Locator Kit - Horizontal Elbow
(FGS-MH4E-H-VS)

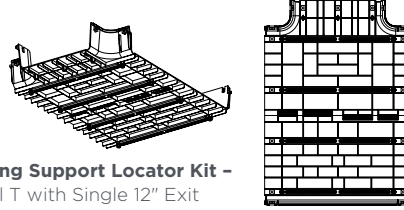

Variable Fitting Support Locator Kit - Horizontal T with Single 12" Exit
(FGS-MHRT-H/F-VS)

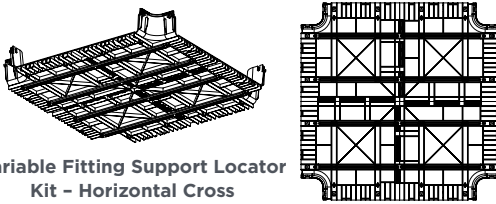

Variable Fitting Support Locator Kit - Horizontal Cross
(FGS-MHXP-H-VS)

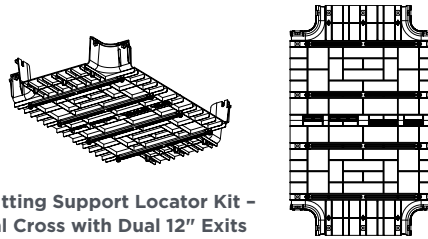

Variable Fitting Support Locator Kit - Horizontal Cross with Dual 12" Exits
(FGS-MHXP-F/H-VS)

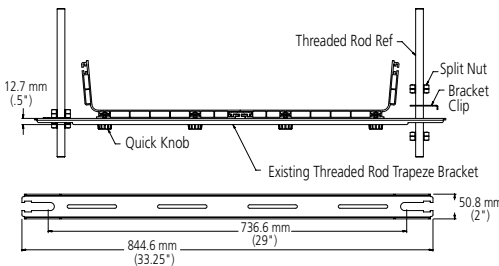

Existing 5/8" Threaded Rod Trapeze Bracket Kit
(FGS-HETP-H-5/8)

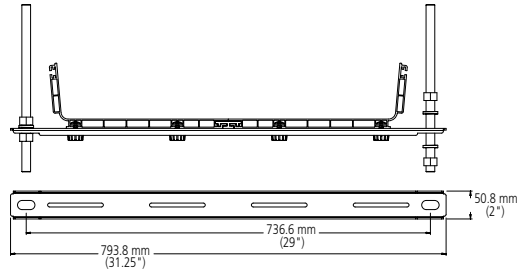

New 5/8" Threaded Rod Trapeze Bracket Kit
(FGS-HNTP-H-5/8)

ORDERING INFORMATION

Description	Part Number
4x24 System Support Kits	
Variable fitting support Locator kit for;	
Horizontal elbow	FGS-MH4E-H-VS
Horizontal T with single 12" exit	FGS-MHRT-H/F-VS
Horizontal cross	FGS-MHXP-H-VS
Horizontal cross with dual 12" exits	FGS-MHXP-F/H-VS
Threaded rod trapeze bracket kit for;	
Existing; 5/8"	FGS-HETP-H-5/8
New; 5/8"	FGS-HNTP-H-5/8

6. Storage Area Management (SAM)

Optical Cable Management, Simplified!	84
Under-chassis Enclosure & Adaptor Plates	85
Hydra Cable Assemblies	86
Far-end Panel Equipment	87
Trunk Cable Assemblies	88

Storage Area Management (SAM)

Optical Cable Management, Simplified!

Your data center is managing more information than ever. This is the driving force behind the need for more efficient and effective storage solutions. The increasing complexity of managing a large quantity of devices and data is escalating the cost of software and services, and is drawing most of the IT community's attention. The physical layer drives much of the complexity associated with installing SAN systems, and many of the impediments associated with these implementations.

There are a number of challenges with SAN cabling at the physical layer. High-density port groupings, the sheer volume of patch cords, moves, adds, and changes, and the ports themselves—installing and tracking the actual devices and cables connecting them, can all prove to be difficult. Plus, space is at a premium in most data centers; many have narrow cabinets or four post racks with inadequate cable management space.

TE's Storage Area Management (SAM) Solution for network infrastructures is designed to reduce the bulkiness of cabling and connectors in the data center by up to 80% and enable high-density deployment with fewer costly cabinet or infrastructure upgrades. SAM can help you save time, reduce costs, maximize efficiency, and open up much needed space in your data center. It takes the complexity out of cable management, and optimizes the performance of your data center floor space, racks and electronics.

De-clutter your racks for a highly organized, eco-friendly network infrastructure. SAM delivers operational efficiency to Storage Area Network (SAN) cabling and can help customers:

- Reduce SAN switch cabling volume by up to 80%
- Implement high-density deployment with fewer cabinet or infrastructure upgrades
- Reduce space requirements by managing up to 768 fiber ports within 2 rack units
- Minimize footprint—no additional front vertical, side, or horizontal cable management devices
- Deploy in narrow cabinets or racks and limited space environments
- Minimize cable mass and slack management using linecard-optimized hydra assemblies
- Easily access ports
- Maintain unobstructed linecard maintenance
- Achieve simplified scalability
- Organize with pre-labeled ports
- Speed up deployment and reduce connection errors with color-coded and keyed connections
- Simplify installation, upgrades and migration with dedicated linecard kits
- Improve operational response time
- Remove and redeploy linecards in several quick "clicks"
- Leverage the high density UCP cable management system with MPOptimate Quick-Fit cassettes
- Can be combined with other MPOptimate products in the channel within budget limits of the application



Storage Area Management (SAM)

Under-chassis Enclosure & Adaptor Plates

SAM Rack Mount Optical Fiber Enclosure

FEATURES

- Accepts 12 SAM adaptor plates
- Angled front face for improved visibility and cable management
- Rugged aluminum construction
- Internal guides to ease installation of trunk assemblies
- Adjustable front and rear mounting brackets included
- Panel labelling on rear to simplify location and documentation
- Pre-loaded with 12 blank plates



ORDERING INFORMATION

Description	Part Number
Rack Mount Patch Enclosure, 2U MPO SECURE	1553761-1

SAM MPO Adaptor Plates

FEATURES

- Adaptor counts match 16, 32, 48 and 64-port blades
- Color-coded keying on adaptors minimize risk of improper mating (keying on hydra side only—trunk side is not keyed)
- Port numbering matches blades
- Robust screw-in mounting system
- Accepts Multi Mode and Single Mode assemblies



ORDERING INFORMATION

Description	Part Number
16-Port blade (2 x MPO secure coupler)	2193050-1
32-Port blade (4 x MPO secure coupler)	2193051-1
48-Port blade (6 x MPO secure coupler)	2193052-1
64-Port blade (8 x MPO secure coupler)	2193016-1
Adaptor Plate Blank with 2 Cable Management rings	2111481-1

Storage Area Management (SAM)

Hydra Cable Assemblies

SAM Hydra Cable Assemblies

FEATURES

- 8-Port/16-fiber assemblies
- Length optimized for minimum slack
- SECURE MPO or MPOptimate connectors feature color coded keying for proper mating
- Overmolded LSZH cables
- Uniboot universal pitch LC connectors
- Individually labelled legs



ORDERING INFORMATION

Description	Port Label	MPO Color	Part Number MPO OS2	Part Number MPOptimate OM4
Hydra Cable Assembly for 16-Port & 32-Port blade	0-7	green	2160323-1	2160322-1
Hydra Cable Assembly for 16-Port & 32-Port blade	8-15	orange	2160325-1	2160324-1
Hydra Cable Assembly for 32-Port blade	16-23	green	2160323-2	2160322-2
Hydra Cable Assembly for 32-Port blade	24-31	orange	2160325-2	2160324-2
Hydra Cable Assembly for 48-Port blade	0-7	red	2160317-1	2160503-1
Hydra Cable Assembly for 48-Port blade	8-15	yellow	2160319-1	2160318-1
Hydra Cable Assembly for 48-Port blade	16-23	blue	2160321-1	2160320-1
Hydra Cable Assembly for 48-Port blade	24-31	red	2160317-2	2160503-2
Hydra Cable Assembly for 48-Port blade	32-39	yellow	2160319-2	2160318-2
Hydra Cable Assembly for 48-Port blade	40-47	blue	2160321-2	2160320-2
Hydra Cable Assembly for 64-Port blade	0-7	orange	2160386-1	2160385-1
Hydra Cable Assembly for 64-Port blade	8-15	slate	2160388-1	2160387-1
Hydra Cable Assembly for 64-Port blade	16-23	aqua	2160390-1	2160389-1
Hydra Cable Assembly for 64-Port blade	24-31	violet	2160392-1	2160391-1
Hydra Cable Assembly for 64-Port blade	32-39	orange	2160386-2	2160385-2
Hydra Cable Assembly for 64-Port blade	40-47	slate	2160388-2	2160387-2
Hydra Cable Assembly for 64-Port blade	48-55	aqua	2160390-2	2160389-2
Hydra Cable Assembly for 64-Port blade	56-63	violet	2160392-2	2160391-2

Storage Area Management (SAM)

Far-End Panel Equipment

SAM Far-End MPO/MPOptimate Quick-Fit cassettes

FEATURES

- 8 port (16 fiber) cassette to replicate 8 SFP ports on director blade
- Rear side: 1 x MPO (to accept one MPO trunk assembly)
Front side: 4 x LC Quad (to accept eight standard LC duplex assemblies)
- Maintains same port identity and labelling scheme as the hydra assemblies (including 8 pre-numbered port labels)
- To be used in UCP panels



ORDERING INFORMATION

Description	Part Number
MPOptimate OM4 Quick-Fit cassette	2160270-3
MPO OS2 Quick-Fit cassette	2160270-2

UCP Patch Panel Angled and Flushmount

Please refer to Chapter 4, page 48



Storage Area Management (SAM)

Trunk Cable Assemblies

SAM MPO/MPOptimate Trunk Cable Assemblies

FEATURES

- 24-fiber assemblies (16 active when mated to hydras) provide an upgrade path to 40 and 100 GbE
- Mate with SAM adaptor plates and SAM Quick-Fit cassettes
- Non-keyed MPO interface
- LSZH rated, indoor outdoor loose tube cable
- Pre-tested and ready to install
- The trunks are equipped with midi fan-out and 3.8mm round cable MPO tails (1.4mtr)
- All tails are protected with transparent protection sleeve



ORDERING INFORMATION

Description	Part Number
MPOptimate OM4	Y-2160301-X
MPO OS2	Y-2160302-X

Y- X	Length	Y- X	Length	Y- X	Length	Y- X	Length	Y- X	Length	Y- X	Length	Y- X	Length	Y- X	Length
0- -2	2 m	1- -3	13 m	2- -4	24 m	3- -5	35 m	4- -6	46 m	5- -7	57 m	6- -8	68 m	7- -9	79 m
0- -3	3 m	1- -4	14 m	2- -5	25 m	3- -6	36 m	4- -7	47 m	5- -8	58 m	6- -9	69 m	8- -0	80 m
0- -4	4 m	1- -5	15 m	2- -6	26 m	3- -7	37 m	4- -8	48 m	5- -9	59 m	7- -0	70 m	8- -1	81 m
0- -5	5 m	1- -6	16 m	2- -7	27 m	3- -8	38 m	4- -9	49 m	6- -0	60 m	7- -1	71 m	8- -2	82 m
0- -6	6 m	1- -7	17 m	2- -8	28 m	3- -9	39 m	5- -0	50 m	6- -1	61 m	7- -2	72 m	8- -3	83 m
0- -7	7 m	1- -8	18 m	2- -9	29 m	4- -0	40 m	5- -1	51 m	6- -2	62 m	7- -3	73 m	8- -4	84 m
0- -8	8 m	1- -9	19 m	3- -0	30 m	4- -1	41 m	5- -2	52 m	6- -3	63 m	7- -4	74 m	8- -5	85 m
0- -9	9 m	2- -0	20 m	3- -1	31 m	4- -2	42 m	5- -3	53 m	6- -4	64 m	7- -5	75 m	8- -6	86 m
1- -0	10 m	2- -1	21 m	3- -2	32 m	4- -3	43 m	5- -4	54 m	6- -5	65 m	7- -6	76 m	8- -7	87 m
1- -1	11 m	2- -2	22 m	3- -3	33 m	4- -4	44 m	5- -5	55 m	6- -6	66 m	7- -7	77 m	8- -8	88 m
1- -2	12 m	2- -3	23 m	3- -4	34 m	4- -5	45 m	5- -6	56 m	6- -7	67 m	7- -8	78 m	8- -9	89 m

7. Core VSM System

Management Panels	90
Copper Solution.....	91
Fiber Solution.....	93

Core VSM

Management Panels

Rack Mount Quick-Fit Panel

FEATURES

- Accepts up to 9 Quick-Fit modules
- 3U
- Including cable support bars with tie down options and Fiber Optic tail over length

Color: Black (RAL 9005) and galvanised finish

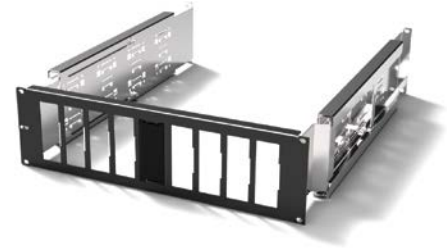

ORDERING INFORMATION

Description	Part Number
Rack Mount Quick-Fit Panel	1671907-1

Cable Management Tray

FEATURES

- Optimized to replace Cisco Nexus 7010 switch cable manager
- Provides vertical patch cord guiding

Color: Black (RAL 9005)



ORDERING INFORMATION

Description	Part Number
Cable Management Tray for Cisco Nexus 7010	1671633-1

RJ-45 to MRJ21 Quick-Fit Cassettes (1 or 10 Gb/s)

For RJ-45 copper management please use our MRJ21 Quick-Fit cassettes:

- for 10 GbE (XG) see page 26



- for 1 GbE see page 28



MRJ21 to MRJ21 shielded cable assemblies (1 or 10 Gb/s)

For RJ-45 copper management please use our MRJ21 trunk cable assemblies:

- for 10 GbE (XG) see page 27



- for 1 GbE see page 30



Category 6_A S/FTP Patch Cord RJ-45

FEATURES

- Exceeds Category 6_A performance suitable for 10 Gb/s data transmission
- Category 7 S/FTP stranded cable
- LSZH sheath
- Color-matched snagless boots
- Universal B-wiring
- Specially engineered patch cord length allows one length for all patch cords in a rack, reducing inventory holding costs and increasing flexibility for MACs



ORDERING INFORMATION

Description	Part Number
Patch Cord RJ45 Cat. 6 _A S/FTP, White	2153188-1

Category 5e F/UTP Patch Cord RJ-45

FEATURES

- Category 5e according to ISO/IEC 11801 and EN-50173-1
- 4 Pair stranded F/UTP cable
- LSZH sheath
- Color-matched snagless boots
- Universal wiring
- Specially engineered patch cord length allows one length for all patch cords in a rack, reducing inventory holding costs and increasing flexibility for MACs



ORDERING INFORMATION

Description	Part Number
Patch Cord RJ45 Cat 5E F/UTP, White	2153190-1

LC to MPO Quick-Fit cassettes or MPO to MPO modules

For LC or MPO fiber management please use our MPOptimate Quick-Fit cassettes and modules

- for MPO to LC Quick-Fit cassettes see page 4



- for MPO Coupler Quick-Fit modules see page 20



MPOptimate pre-terminated trunks

For LC or MPO fiber management please use our MPOptimate pre-terminated trunks on page 3



MPOptimate patch cords

For LC or MPO fiber management please use our MPOptimate pre-terminated patch cords on page 5



MPOptimate System LC patch cords

FEATURES

- Patch cords with optimized LC connectors
- Cable performance: OM4 XG_A or OM3 XG 10 Gb/s; LSZH construction
Optical performance: Attenuation ≤ 0.15 dB; RL ≥ 35 dB
- Specially engineered patch cord length allows one length for all patch cords in a rack, reducing inventory holding costs and increasing flexibility for MACs



ORDERING INFORMATION

Description	Part Number
Patch cord LC Duplex - LC Duplex; OM3 XG 10 Gb/s	2160506-1
Patch cord LC Duplex - LC Duplex; OM4 XG _A 10 Gb/s	2160506-2

MPOptimate Fan-Out cable assemblies

FEATURES

- Low loss transition from MPO to LC tails 2 mm
- Terminated with male MPOptimate connectors
- OM4 cable performance, LSZH construction
- Specially engineered fan-out cable length allows one length for all cable assemblies in a rack, reducing inventory holding costs and increasing flexibility for MACs

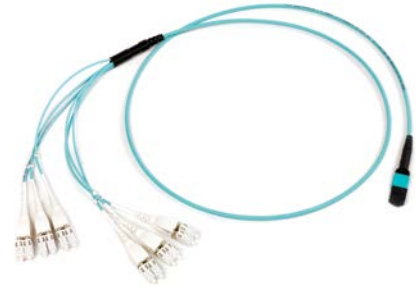

ORDERING INFORMATION

Description	Part Number
MPO male - LC Fan-out OM4 XG _A 10 Gb/s for 48 port blade	2160537-1
MPO male - LC Fan-out OM4 XG _A 10 Gb/s for 32 port blade	2160538-1

8. Managed Connectivity

ICM for Quareo Technology	96
Q4000 Managed Fiber Platform	97
Quareo Managed Fiber Trunk Cables and Patch Cords.....	100
Q2000 Managed Copper Platform.....	101
Quareo Managed Copper Patch Cords	103
ICM for AMPTRAC Technology	104
AMPTRAC Analyzer.....	105
AMPTRAC Scanning Module Cables.....	106
AMPTRAC Fiber Platform	107
AMPTRAC Fiber Patch Cords	108
AMPTRAC Copper Platform	109
AMPTRAC Copper Patch Cords.....	114
AMPTRAC Sensor Strips.....	115
Accessories.....	116

Managed Connectivity

ICM for Quareo Technology

Quareo Infrastructure Configuration Manager Software

The TE Managed Connectivity software (ICM) supports both AMPTRAC and Quareo technologies.

Quareo ICM can be used either as a 'stand alone' application or as a tool for integrating valuable Quareo information into third party / custom applications.

As a stand alone retail application ICM provides the following features:

FEATURES

- Fully automated documentation system
- Real time monitoring
- Automatic database update on changes
- Self-discovers Patch Cords
- Event logs and data base reports
- Programmable alerts
- Automated work order processing
- Auto-discovers IP devices
- Automatic re-synchronization on power outages
- User management
- Supports ITIL best practices
- ISO 20000 and BS 15000 compliant
- CSV data import
- Easy to use and intuitive menu structure

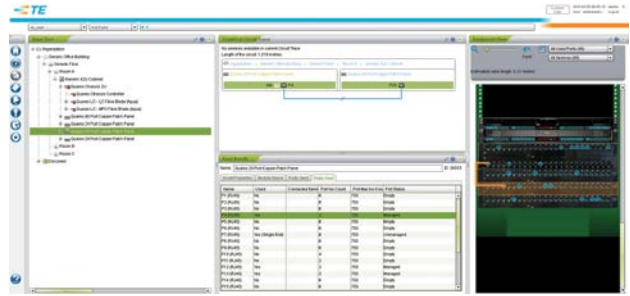

ORDERING INFORMATION

Description	Part Number
ICM Software; 480 Port License	1591369-1
ICM Software; 2400 Port License	1591369-2
ICM Software; 4800 Port License	1591369-3
ICM Software; 9600 Port License	1591369-4
ICM Software; 24,000 Port License	1591369-5
ICM Software; 48,000 Port License	1591369-6
ICM Software; 96,000 Port License	1591369-7

Alternative port and service packages also available.

Managed Connectivity

Q4000 Managed Fiber Platform

Quareo forms one of the two hardware base technologies within TE's Managed Connectivity Solution.

The Fiber solution comprises of fiber network Chassis (1, 2 and 4U), which accommodate 0.5U blades (2, 4 and 8 respectively). Fiber blades support MPO-MPO and MPO-LC configurations. The portfolio is supported by a range of managed trunks and patch cords.

Q4000 Network Chassis: Q4200, Q4400, Q4800

Q4000 Series Network Chassis featuring Quareo™ Technology allow network personnel to view, manage and audit the physical layer. This means, for the first time, the physical layer is now subject to the same compliance policy as higher layers of the network. With 70% of network outages attributed to errors made in the physical layer, TE introduces a new category of products. Simply put, Quareo enables Managed Connectivity using connection point identification (CPID).



The Quareo Q4000 Series chassis are designed to accommodate the Q3000 blades for an unmanaged solution or the Q4000 blades for a managed solution utilizing CPID.

FEATURES

- Supports a Q4000 Series Chassis Controller
- User Indicators
 - Power: Green
 - Alert: Yellow
 - Status: Green/Red
- Reset Button
- Trunk and Fan-out brackets supplied for rear cable management
- Maintenance Services available on this product

SPECIFICATIONS

PHYSICAL:

Rack Mounting:	EIA/ETSI/WECO/IEC 60297 19" equipment racks
Grounding:	2-screw grounding location for standard grounding lug
Dimensions (HxWxD):	Q4200: 1U, 44.5 mm x 483 mm x 338 mm (1.75" x 19" x 13.3")
	Q4400: 2U, 88.9 mm x 483 mm x 338 mm (3.5" x 19" x 13.3")
	Q4800: 4U, 177.8 mm x 483 mm x 338 mm (7" x 19" x 13.3")

ENVIRONMENTAL:

Operating Temperature:	-10 °C to +60° C (+14 °F to +140° F)
Storage Temperature:	-40 °C to +85° C (-40°F to +185° F)
Humidity:	5% to 95% non-condensing RoHS Compliant

Safety:	(UL), c(UL), CE, A-TICK
Flammability:	(UL) 94 V-0 UL 1863

EMC:	EMC Directive, 2004/108/EEC
-------------	-----------------------------

ORDERING INFORMATION

Description	Part Number
Q4200 (2 blades); 1U Network Chassis, accommodates 2 each Q4000 series blades	QCH-1RU
Q4400 (4 blades); 2U Network Chassis, accommodates 4 each Q4000 series blades	QCH-2RU
Q4800 (8 blades); 4U Network Chassis, accommodates 8 each Q4000 series blades	QCH-4RU

Managed Connectivity

Q4000 Managed Fiber Platform

Q4000 Network Chassis: QCC-4 Chassis Controller

The QCC-4 Chassis Controller is compatible with Q4000 Series Chassis.



FEATURES

- Supports a Q4000 Series Chassis
- User Indicators
 - Ethernet Link: Green
 - Ethernet Activity: Yellow
- Maintenance Services available on this product

SPECIFICATIONS

PHYSICAL:

Dimensions (HxWxD): 25.2 mm x 87.9 mm x 124.7 mm
(0.99" x 3.46" x 4.91")

Electrical I/F: RJ45

Electrical Aux. I/F: 2-Pin Micro-Fit 3.0™

ENVIRONMENTAL:

Operating Temperature: -10° C to +60° C (+14° F to +140° F)

Storage Temperature: -40° C to +85° C (-40° F to +185° F)

Humidity: 5% to 95% non-condensing
RoHS Compliant

ELECTRICAL:

PoE Power: IEEE 802.3af Class 0

Auxiliary input Power: +48VDC @ 270mA

Safety: (UL), c(UL), CE, A-TICK
UL 1863

EMC: EMC Directive, 2004/108/EEC

Network: Supports 10Base-T and 100Base-TX

ORDERING INFORMATION

Description	Part Number
QCC-4; Chassis Controller for Q4000 Network Chassis	QCPU-MCBM

Managed Connectivity

Q4000 Managed Fiber Platform

Q4000 Blades

COMMON FEATURES

- Available in multimode and singlemode
- Blade Controller is hot swappable in blade
- Front cable management with removable designation labels
- Rear cable management tie down points to work with Q4000 Series Network Chassis Rear Cable Management
- Blade remains powered when extended to the first position
- User Indicators Blade Controller (LED)
Power: Green Alert: Yellow/Green
- User Indicators Blade (LED) Duplex Ports: Yellow/Green
- Maintenance services are available

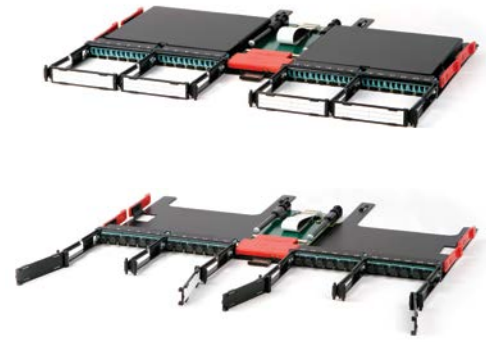

FEATURES

- 0.5U blade
- 16 MPO ports on MPO-to-MPO blade
- 24 Duplex LC ports distributed from 2EA 12 fiber MPO cables on LC-to-MPO blade
- Supports Quareo enabled and standard 12 fiber MPO cables
- Supports Quareo enabled and standard LC-LC duplex patch cords
- Requires 1EA QBC-4 Blade Controller (ships with Blade)

SPECIFICATIONS

PHYSICAL

Dimensions (HxWxD): 19.3 mm x 438.4 mm x 373.1 mm (0.76" x 17.26" x 14.69")

ENVIRONMENTAL

Operating Temperature: -10° C to +60° C (+14° F to +140° F)
Storage Temperature: -40° C to +85° C (-40° F to +185° F)
Humidity: 5% to 95% non-condensing

ELECTRICAL

Input Power: 1.0 W Max.
Optical Interface
MPO-to-MPO: 12 Fiber MPO
LC-to-MPO: Duplex LC (front), 12 Fiber MPO (rear)

COMPLIANCE

Safety: RoHS Compliant
(UL), c(UL), CE, A-TICK
Flammability: (UL) 94 V-0
UL 1863
EMC: EMC Directive, 2004/108/EEC

ORDERING INFORMATION

Description	Part Number
Chassis Blade Fiber; 16 Port (192 Fiber), MPO-to-MPO	
Multimode	QFB-192FMPOMMHR
Singlemode	QFB-192FMPOS MHR
Chassis Blade Fiber; 24 Port (48 Fiber), LC-to-MPO	
Multimode	QFB-48FDLCMM MHR
Singlemode	QFB-48FDLCMS MHR
Blank Blade Cover for Empty Blade Position Q4000/Q3000	QBCB-HR

Managed Connectivity

Quareo Managed Fiber Trunk Cables and Patch Cords

Quareo MPO-to-MPO Trunk Cables

FEATURES

- Plug-and-Play Cables to connect active equipment into the network
- Round design eliminates preferential bend issues which results in increased density and greater manageability
- Performance Specifications: OM3/OM4: Attenuation \leq 0.7 dB (max); RL \geq 20 dB (min)
OS2: Attenuation \leq 1.0 dB (max); RL \geq 55 dB (min)



ORDERING INFORMATION

Product Description	Fiber Type				Part Number
12 Fiber LSZH	Singlemode	OS2	Trunk	MPO-to-MPO	QFA-1WWSMZNXXXMAA
	Multimode	OM3	Trunk	MPO-to-MPO	QFA-1FFM3ZNXXXMAA
		OM4	Trunk	MPO-to-MPO	QFA-1FFM4ZNXXXMAA
24 Fiber LSZH	Singlemode	OS2	Trunk	MPO-to-MPO	QFA-2WWSMZNXXXMAA
	Multimode	OM3	Trunk	MPO-to-MPO	QFA-2FFM3ZNXXXMAA
		OM4	Trunk	MPO-to-MPO	QFA-2FFM4ZNXXXMAA
48 Fiber LSZH	Singlemode	OS2	Trunk	MPO-to-MPO	QFA-4WWSMZNXXXMAA
	Multimode	OM3	Trunk	MPO-to-MPO	QFA-4FFM3ZNXXXMAA
		OM4	Trunk	MPO-to-MPO	QFA-4FFM4ZNXXXMAA
96 Fiber LSZH	Singlemode	OS2	Trunk	MPO-to-MPO	QFA-8WWSMZNXXXMAA
	Multimode	OM3	Trunk	MPO-to-MPO	QFA-8FFM3ZNXXXMAA
		OM4	Trunk	MPO-to-MPO	QFA-8FFM4ZNXXXMAA

Replace XXX with desired length in Meters. Example 001 for 1 m, 010 for 10 m. Additional configurations available upon request

Quareo Fiber Patch Cords

FEATURES

- Managed Fiber cables feature Quareo Technology with connection point identification
- Can be used in cross-connect, test, or equipment areas
- Standard Lengths: 1, 2, 3, 5 and 10 m
- Standard Colors: Aqua for multimode, Yellow for Singlemode
- Standard Materials: LSZH (plenum also available)
- Performance Specifications: OM3/OM4: Attenuation \leq 0.3 dB (max); RL \geq 20 dB (min)
OS2: Attenuation \leq 0.3 dB (max); RL \geq 55 dB (min)



ORDERING INFORMATION

Product Description	Fiber Type		Polarity	Part Number
LC-LC LSZH	Multimode	OM3	A-to-A	QFPC-MPPM3ZAXXXM
			A-to-B	QFPC-MPPM3ZBXXXM
		OM4	A-to-A	QFPC-MPPM4ZAXXXM
			A-to-B	QFPC-MPPM4ZBXXXM
	Singlemode	OS2	A-to-A	QFPC-MKKSMZAXXXM
			A-to-B	QFPC-MKKSMZBXXXM

Replace XXX with desired length in meters E.G 001 for 1m. Other materials available upon request.

Managed Connectivity

Q2000 Managed Copper Platform

Quareo forms one of the two hardware base technologies within TE's Managed Connectivity Solution. The Copper solution comprises of patch panel (1 and 2U) in shielded and unshielded variants and is supported by a range of managed network cables.

Patch Panels: Q2324 and Q2348

Q2000 Series Patch Panels featuring Quareo Technology allow network personnel to view, manage and audit the physical layer. This means, for the first time, the physical layer is now subject to the same compliance policy as higher layers of the network. With 70% of network outages attributed to errors made in the physical layer, TE introduces a new category of products. Simply put, Quareo enables managed connectivity using connection point identification (CPID).

FEATURES

- Quareo enabled functionality with dual color port illumination via LEDs
- Integral cable management bar
- 45° IDC contacts providing secure, gas-tight connections
- Accepts 110 style termination tools
- Universal 568A/B wiring
- Discrete labeling system
- Maintenance services available on this product

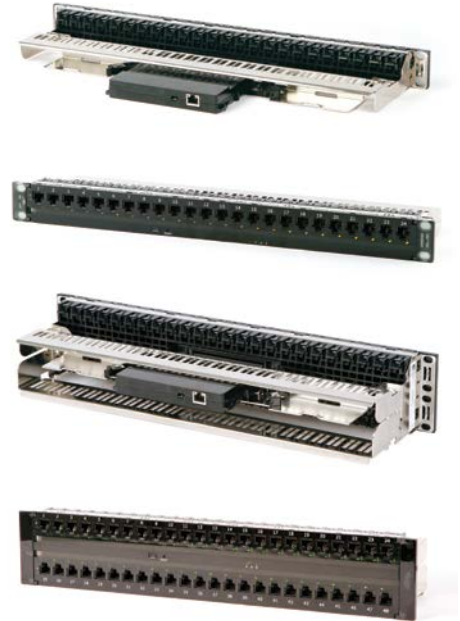

SPECIFICATIONS

PHYSICAL:

Rack Mounting:

EIA/ETSI/WECO/IEC 60297 19" equipment racks

Dimensions (HxWxD):

Q2324, 1U: 44.5 mm x 483 mm x 120 mm (1.75" x 19" x 4.75")

Q2348, 2U: 88.9 mm x 483 mm x 120 mm (3.50" x 19" x 4.75")

ENVIRONMENTAL

Operating temperature:

-40° to 70° C (104 to 158° F)

Number of plug insertions:

≥750 (IEC/EN 60603-7)

Diameter range:

solid and stranded copper conductors: 26AWG to 22 AWG (0.4 mm dia to 0.6 mm dia) solid core cable and 24AWG stranded cable.

Wire insulation diameter range: 1.04 mm to 1.60 mm (0.041" x 0.063")

Insulation resistance:

at 40°C and 93% RH ≥500 MΩ

Contact resistance:

≤1 mΩ typical

Contact re-terminations:

≥200

COMPLIANCE

UL/CSA Approved, CE, A-TICK

UL 94 V-0

UL1863

RoHS compliant

Performance to ANSI/TIA-568-C.2 and ISO 11801, Edition 2 for Category 6/Class E and Category 6_A/Class E_A.

Independently certified.

RJ socket, 8 positions FCC Part (IEC 60603-7)

ORDERING INFORMATION

Description	Part Number
Q2324 ; 24 Port Patch panel WITH jacks, Cat. 6 _A , UTP	QCPP-24MC6AU
Q2348 ; 48 Port Patch Panel WITH jacks, Cat. 6 _A , UTP	QCPP-48MC6AU
Q2324 ; 24 Port Patch Panel WITH jacks, Cat. 6 _A , STP	QCPP-24MC6AS
Q2348 ; 48 Port Patch Panel WITH jacks, Cat. 6 _A , STP	QCPP-48MC6AS

Managed Connectivity

Q2000 Managed Copper Platform

QPC-2 Panel Controller Compatible with Q2000 Patch Panels



FEATURES

- Panel controller operates with the Q2000 family of Network Patch Panels
- Designed to fit inside the rear cable manager without interfering with panel connectivity, does not require additional rack space
- Power can be supplied through IEEE 802.3af compliant switch port or additional auxiliary power supply (can be simultaneous)
- Link and activity status LEDs at the rear of unit
- Seamless power transition from PoE to aux supply
- Maintenance services available on this product

SPECIFICATIONS

Product Dimensions (HxWxD):	21 mm x 143 mm x 105 mm (0.82" x 5.62" x 4.142")
Environmental:	
Operating Temperature:	-10° C to +60° C (+14° F to +140° F)
Compliance	
Flammability:	(UL) 94 V-0 RoHS Compliant UL/CSA Approved, CE, C-TICK Conformance with 8 way modular (RJ45) jack requirements according to IEC-60603-7 series and TIA/EIA-968-A (FCC 68.500)
Alternate Input Power: Minimum requirements:	Alternate power source to comply with AC/DC desktop power supply brick.
Input Voltage:	100-240VAC, 50-60Hz, 0.5A
Output Voltage:	48VDC, 0.4A

ORDERING INFORMATION

Description	Part Number
QPC-2; Panel Controller for Q2000 Patch Panels	QCPU-MPPM-1

Managed Connectivity

Quareo Managed Copper Patch Cords

Category 6_A U/UTP and S/FTP

These managed cables exceed all performance requirements for Augmented Category 6 (Cat 6_A). The plug is designed with integrated strain relievers that prevent the cable from moving at the termination point when the cable is flexed, safeguarding circuit integrity and guaranteeing maximum performance. The strain relievers also ensure that proper bend radii are maintained throughout the network.



FEATURES

- Quareo Technology with connection point identification
- Connector Interface: Plug type RJ45 shielded/unshielded that conforms to 8 way modular RJ45 Jack according with IEC 60603-7 series and TIA/EIA-968-A.
- Latch Type: Snag-less
- Boot: Flexible with built in strain relief to maintain proper bend radius
- Wiring Configuration: T568A, T568B and Cross-over

SPECIFICATIONS

ELECTRICAL

ANSI/TIA-568-C.2 and ISO 11801, Edition 2 Category 6_A/Class E_A
Category 6, 5e, 5 and 3 backward compatible

ENVIRONMENTAL

Controlled Environment
GR-63, Section 4.1.2

Operating Temperature: -10° C to +60° C
Storage Temperature: -0° C to +50° C
Relative Humidity: 5% to 90% non-condensing
Relative Humidity: 5% to 95% non-condensing

COMPLIANCE

UL 94 V-0
TICK N355
C(UL)us 49S3
CE
RoHS and WEEE 2002/95/EC Directive on the restriction of the use of certain hazardous substances in electrical and electronic equipment

ORDERING INFORMATION

Description	Available Colors Replace XX	Available Lengths Replace YY	Part Number		
			LSZH	T568B	QCPC-6ARUZZB-XXYYM
Category 6 _A U/UTP Managed Copper Cable	BL = Blue RD = Red OR = Orange GY = Grey GN = Green WT = White YL = Yellow	01 = 1 m 02 = 2 m 03 = 3 m 05 = 5 m 07.5 = 7.5 m 10 = 10 m	LSZH	T568B	QCPC-6ARUZZB-XXYYM
Category 6 _A S/FTP Managed Copper Cable			LSZH	T568B	QCPC-6ARSZB-XXYYM

Note: Not all S/FTP types available in all colors. Please check with Customer Services.

Additional lengths, wiring schemes and shielding types available upon request.

Managed Connectivity

ICM for AMPTRAC Technology

AMPTRAC Infrastructure Configuration Manager Software

FEATURES

- Fully automated documentation system
- Real time monitoring
- Automatic database update on changes
- Self-discovers Patch Cords
- Event logs and data base reports
- Programmable alerts
- Automated work order processing
- Auto-discovers IP devices
- Automatic re-synchronization on power outages
- User management
- Supports ITIL best practices
- ISO 20000 and BS 15000 compliant
- CSV data import
- Easy to use and intuitive menu structure

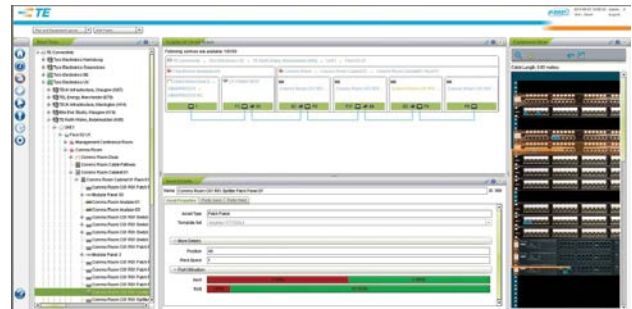

ORDERING INFORMATION

Description	Part Number
ICM Software License	Sold with Analyzer

Managed Connectivity

AMPTRAC Analyzer

AMPTRAC Analyzers

FEATURES

- Adds the physical layer to your network documentation system
- Universal analyzer design
 - Analyzer can be configured as a master or slave unit
 - Any unit can directly communicate to database server or through another analyzer
 - Virtually unlimited in number of ports/drops which can be monitored
- Very flexible design and implementation allowing for use in office buildings, data centers and remote/branch offices
- Analyzers sold with AMPTRAC ICM Software license
- Available in 384 port, 768 port or 1152 port versions (19", 1U)
- Shallow depth at 6.25" (160 mm)
- Suitable for shelve or 19" rack or cabinet mounting
- Large 4 line LCD display providing interactive communications with the database
- Use of latest and current circuitry design
- Minimum heat dissipation - no concerns over heat management in rack or cabinet
- Low power consumption and long lifetime
- Dual external PSUs supported



Remote Scanning module required

ORDERING INFORMATION

Description	Part Number
AMPTRAC ANALYZER HD 1152 (ICM Included)	1-1591360-1
AMPTRAC ANALYZER HD 768 (ICM Included)	2-1591360-3
AMPTRAC ANALYZER HD 384 (ICM Included)	3-1591360-1
Additional External PSU	1-1591364-0
Scanning Module	1-1591363-0

ICM also available without analyzer. Ask TE for more details

Managed Connectivity

AMPTRAC Scanning Module Cables

AMPTRAC Scanning Module Cable Assemblies

Every patch panel or switch port has a copper sensor pad associated with it. All sensor pads are connected to the AMPTRAC analyzer via a scanning module and scanning module cable. The scanning module has two types of connector, an RJ45 connector, which is used to connect the module to the analyzer via a standard Category 5 or Category 6 patch cable and a 2.0mm AMPMODU connector, which connects the module to the switch or patch panel via the scanning module cable. For monitored devices of less than 24 ports, multiple cables can be inserted into the AMPMODU connector equal to the 24 port total. Each scanning module cable is between 2-4 feet long allowing the scanning module to be located on the left or the right and be secured on the cable support management bar or onto the rack/cabinet.

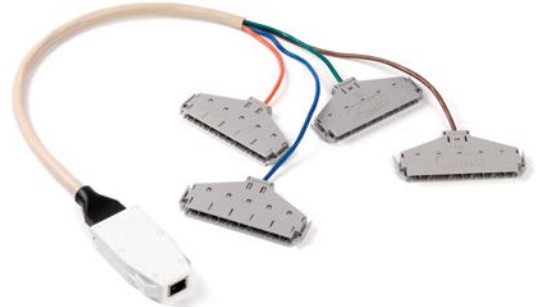

ORDERING INFORMATION

Description	# Positions	Length (ft)	Part Number
AMPTRAC patch panels utilizing the 6-position SL Interface Module, i.e. SL panels, HD Panels, Quick-Fit Panels; 110 Plug-n-Play to 2.0mm MODU Latching	24	2	2111440-2
24-port Sensor Strips for electronics, EMEA AMPTRAC Ready and EMEA 7AS Panels (rear attachment); 2.0 mm MODU to 2.0mm MODU Latching	24	2	2111441-2
	24	4	2111441-4
AMPTRAC MRJ-21 patch panels, EMEA AMPTRAC Ready patch panels (front attachment), ACO; HD-22 to 2.0mm MODU Latching	24	2	2111442-2
AMPTRAC Fiber Optic MPO Cassettes; RJ-11 to 2.0mm MODU Non-Latching	6	1.5	2111443-1
AMPTRAC MRJ21 XG quick fit Cassette	8	2	2153175-2
	2	4	2111444-4
	6	4	2111445-4
	8	4	2111446-4
	12	4	2111447-4
	16	4	2111448-4

Managed Connectivity

AMPTRAC Fiber Platform

AMPTRAC Optical Fiber Patch Panels

FEATURES

- Available for LC Duplex and SC Duplex systems
- Available in OM3, OM4 and singlemode
- Support field termination or use with MPO cassettes
- Duplex LC SL Series inserts sold separately.

ORDERING INFORMATION

Description	Part Number
Snap-In SC Adaptor Plate, 6 ports (12 fibers); Fiber Type: Multimode (beige)	1435657-1
Snap-In SC Adaptor Plate, 6 ports (12 fibers); Fiber Type: Singlemode (blue)	1435657-2
Snap-In SC Adaptor Plate, 6 ports (12 fibers); Fiber Type: Singlemode APC (green)	1435657-3
MPO/SC Snap-In Cassette, 6 ports (12 fibers); Pairs: straight; Fiber Type: OM3 XG 10 Gb/s	1435688-1
MPO/SC Snap-In Cassette, 6 ports (12 fibers); Pairs: flipped; Fiber Type: OM3 XG 10 Gb/s	1435688-2
MPO/SC Snap-In Cassette, 6 ports (12 fibers); Pairs: straight; Fiber Type: Singlemode	1435689-1
MPO/SC Snap-In Cassette, 6 ports (12 fibers); Pairs: flipped; Fiber Type: Singlemode	1435689-2
MPO/LC Quick-Fit Cassette, 6 ports (12 fibers); Pairs: straight; Fiber Type: OM3 XG 10 Gb/s	1671209-3
MPO/LC Quick-Fit Cassette, 6 ports (12 fibers); Pairs: flipped; Fiber Type: OM3 XG 10 Gb/s	1-1671209-3
MPO/LC Quick-Fit Cassette, 6 ports (12 fibers); Pairs: straight; Fiber Type: Singlemode	1671209-4
MPO/LC Quick-Fit Cassette, 6 ports (12 fibers); Pairs: flipped; Fiber Type: Singlemode	1-1671209-4
MPOOptimate/LC Quick-Fit Cassette, 6 ports (12 fibers); Pairs: straight; Fiber Type: OM4	1671229-5
MPOOptimate/LC Quick-Fit Cassette, 6 ports (12 fibers); Pairs: flipped; Fiber Type: OM4	1-1671229-5
LC AMPTRAC Quick-Fit Module, 6 ports (12 fibers); Fiber Type: OM3 XG 10 Gb/s	1933420-2
LC AMPTRAC Quick-Fit Module, 6 ports (12 fibers); Fiber Type: SM	1933420-3
1U drawer loaded with 24 LC Duplex AMPTRAC Inserts (48 fibers); Fiber Type: Singlemode	1671149-1
1U drawer for loaded with 24 LC Duplex AMPTRAC Inserts (48 fibers); Fiber Type: OM3 XG 10 Gb/s	1671149-3
1U Drawer for 4 MPO AMPTRAC Quick-Fit Cassettes or Quick-Fit modules	1671149-5

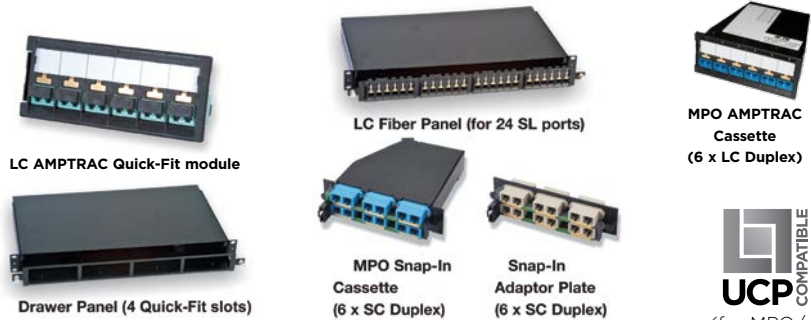

Managed Connectivity

AMPTRAC Fiber Patch Cords

AMPTRAC Fiber Optic Patch Cords

FEATURES

- Exceeds optical performance specifications for OM3, OM4 and single mode
- Patch Cord assemblies contain copper conductor connected to external pin
- External pin makes contact with sensor pad on Patch Panel or switch
- Cable is a mini-tri-zip design for flexibility and small size
- Available for LC Duplex and SC Duplex assemblies
- MPOptimate Optical performance:
Attenuation :IL ≤ 0.15dB, Return Loss: RL ≥ 35dB
- SM Optical performance:
Attenuation: IL ≤0.5 dB, return Loss: RL ≥20dB



LC DUPLEX



SC DUPLEX

ORDERING INFORMATION

Description	Part Number	Y- -X	Length
LC Duplex to LC Duplex; MPOptimate OM4	Y-2160052-X	0- -1	1 m
LC Duplex to LC Duplex; OM3 XG 10 Gb/s	Y-2055438-X	0- -2	2 m
LC Duplex to LC Duplex; Singlemode	Y-1435791-X	0- -3	3 m
LC Duplex to SC Duplex; OM3 XG 10 Gb/s	Y-1435796-X	0- -5	5 m
LC Duplex to SC Duplex; Singlemode	Y-1435797-X	0- -7	7 m
SC Duplex to SC Duplex; OM3 XG 10 Gb/s	Y-1435725-X	1- -0	10 m
SC Duplex to SC Duplex; Singlemode	Y-1435726-X		

Managed Connectivity

AMPTRAC Copper Platform

MRJ21 XG Quick-Fit AMPTRAC Cassette 8 Port (10 Gb/s)

FEATURES

- Adds AMPTRAC functionality to MRJ21 XG cabling
- Compatible to MRJ21 XG cable assemblies for 10GbE performance

Color: black (RAL 9005)

ORDERING INFORMATION



Description	Part Number
MRJ21 XG Quick-Fit AMPTRAC cassette for 10GBase-T	2153091-1

MRJ21 XG 19" AMPTRAC Patch Panel, 1U, straight

FEATURES

- Adds AMPTRAC functionality to MRJ21 XG cabling
- Factory terminated and tested solution
- Compatible with MRJ21 XG cable assemblies for 10GbE performance
- Straight panel with either 24 or 48 ports on 1U

Color: black (RAL 9005)

ORDERING INFORMATION



Description	Part Number
Straight AMPTRAC panel 1U for 10GbE; MRJ21 Plugs: 6; RJ-45 Ports: 24	2153040-1
Straight AMPTRAC panel 1U for 10GbE; MRJ21 Plugs: 12; RJ-45 Ports: 48	2153049-1

MRJ21 AMPTRAC Patch Panels

FEATURES

- High-density, small form factor connectivity
- Factory terminated and tested
- Modular, pluggable design
- 4 pair MRJ21 Patch Panels for 10Base, 100Base-T and 1000Base-T
- 2 pair MRJ21 Patch Panels for 10Base and 100Base-T

ORDERING INFORMATION

Description	Part Number
Shielded 24 port straight Patch Panel; 4 pair (10/100/1000Base-T)	1711944-2
Unshielded 24 port straight Patch Panel; 4 pair (10/100/1000Base-T)	1777029-2
Unshielded 48 port straight Patch Panel; 4 pair (10/100/1000Base-T)	1777041-1
Unshielded 48 port straight Patch Panel; 2 pair (10/100Base-T)	1777042-1
Unshielded 48 port angled Patch Panel; 4 pair (10/100/1000Base-T)	1777053-1



Managed Connectivity

AMPTRAC Copper Platform

Category 6 - AMPTRAC PCB Patch Panel (STP)

FEATURES

- 19", 1U, RJ-45 Patch Panel with 24 ports
- Category 6 Pyramid tested
- LSA-Plus® tool compatible enhanced 110 IDC blocks
- 10 Gigabit Ethernet ready
- Rear cable management
- Cover adapts to different cable diameters via variable snap-in position
- Shield connection separated from strain relief
- Including grounding bolt
- Universal wiring - T568 A or B wiring pattern
- Protected PCB

Color: black (RAL 9005)



ORDERING INFORMATION

Description	Part Number
Shielded Cat. 6 Full AMPTRAC 24 port Patch Panel, Color: black	1644042-1

Category 6 - AMPTRAC PCB Patch Panel (UTP)

FEATURES

- 19", 1U, RJ-45 Patch Panel with 24 ports
- Category 6 Pyramid tested
- LSA-Plus® tool compatible enhanced 110 IDC blocks
- 10 Gigabit Ethernet ready
- Rear cable management
- Including grounding bolt
- Universal wiring - T568 A or B wiring pattern
- Protected PCB

Color: black (RAL 9005)



ORDERING INFORMATION

Description	Part Number
Unshielded Cat. 6 Full AMPTRAC 24 port Patch Panel, Color: black	1711147-1

Managed Connectivity

AMPTRAC Copper Platform

STP/UTP SL 110C Jack Patch Panels (w/o Rear Cable Management)

FEATURES

- Available in standard straight version or in angled version for improved cable and space management
- Uses AMP NETCONNECT high-performance SL Series 110C Modular Jacks
- I/O connection made with 110C PlugnPlay Cable Assembly
- Cost-effective AMPTRAC *Ready!* solution: install AMPTRAC Patch Panels now and analyzer and software later
- Category 6 Patch Panels come with Modular Jacks bagged separately (unloaded) for field termination with SL Series Modular Jack Termination Tool.



ORDERING INFORMATION

Description	Part Number
Unshielded Cat. 6, 24 port panel; Type: Straight; Height: 1U	1933327-1
Unshielded Cat. 6, 48 port panel; Type: Straight; Height: 2U	1933328-1
Unshielded Cat. 6, 24 port panel; Type: Angled; Height: 1U	1933329-1
Unshielded Cat. 6, 48 port panel; Type: Angled; Height: 2U	1933330-1
Shielded XG 24 Port Panel; Type: Straight; Height: 1U	1933331-1
Shielded XG 48 Port Panel; Type: Straight; Height: 2U	1933332-1
Shielded XG 24 Port Panel; Type: Angled; Height: 1U	1933333-1
Shielded XG 48 Port Panel; Type: Angled; Height: 2U	1933334-1

Category 3 - AMPTRAC *Ready!* 50 Port Telephone Patch Panel

FEATURES

- 19", 1U, Telephone Panel with 50 ports
- AMPTRAC *Ready!* high-end version
- Active Pin-out: 36,45
- Conductor diameter range from AWG 26-22 (0.4-0.65 mm)
- Easy upgrade to AMPTRAC Infrastructure Management
- Rear cable management for multipair cables
- 110Connect blocks for conductor insulation diameters up to 1.28 mm



ORDERING INFORMATION

Description	Part Number
AMPTRAC <i>Ready!</i> 50 port panel; Color: light gray (RAL 7035)	1394060-1
AMPTRAC <i>Ready!</i> 50 port panel; Color: black (RAL 9005)	1394060-2
I/O upgrade kit to full AMPTRAC	1435954-1

Managed Connectivity

AMPTRAC Copper Platform

STP & UTP Quick-Fit Modules

FEATURES

- Used to add AMPTRAC functionality to AMP-TWIST SL Jack cabling
- STP version has automatic bonding by design
- Labels included
- Set of 4 modules



ORDERING INFORMATION

Description	Part Number
STP AMPTRAC ready Quick-Fit module (4 pcs)	1933196-1
UTP AMPTRAC ready Quick-Fit module (4 pcs)	1933197-1

Angled AMPTRAC Modular Quick-Fit Panel (unloaded)

FEATURES

- 19" 1U angled modular Patch Panel to be equipped with different SlimLine jacks without dust cover
- Adjustable & removable rear cable bracket incl. easy to use cable organizing CaRe-clips
- Including grounding bolt



Color: black (RAL 9005)

ORDERING INFORMATION

Description	Part Number
Angled Full AMPTRAC Modular panel for UTP SL Jacks	1-1671136-3
Angled Full AMPTRAC Modular panel for STP SL Jacks	1-1671136-4

Flushmount AMPTRAC Modular Quick-Fit Panel (unloaded)

FEATURES

- 19" 1U unloaded flushmount panel to be equipped with different SlimLine jacks
- Suitable for UTP and STP jacks
- Including grounding bolt

Color: black (RAL 9005)



ORDERING INFORMATION

Description	Part Number
Flushmount Full AMPTRAC Modular Panel	1-1671187-1

Flushmount AMPTRAC Standard Patch Panel (unloaded)

FEATURES

- 19" unloaded flushmount Patch Panel to be equipped with different SlimLine jacks
- Full AMPTRAC
- Accepts up to 24 SL Jacks without dust cover
- Including grounding bolt



ORDERING INFORMATION

Description	Part Number
Full AMPTRAC unloaded Panel for AMP-TWIST 6 jacks; Color: black (RAL 9005)	1711685-4
Full AMPTRAC unloaded Panel for AMP-TWIST 7 jacks; Color: black (RAL 9005)	1711742-1

AMPTRAC Scanning Module Upgrade Kit for 1U Patch Panels

FEATURES

- Brings AMPTRAC functionality to AMPTRAC *Ready!* Patch Panels
- Front and rear Scanning Module cable connection



ORDERING INFORMATION

Description	Part Number
AMPTRAC Upgrade Kit with front Scanning Module port, Color: black	1711148-1
AMPTRAC Upgrade Kit with rear Scanning Module port, Color: black	1711148-4
AMPTRAC Cat. 7 Δ S Upgrade Kit with rear Scanning Module port; Color: black	1711749-1

Managed Connectivity

AMPTRAC Copper Patch Cords

Twisted Pair Patch Cords Assemblies

FEATURES

- Patch Cord assemblies contain 9th conductor that is connected to external probe molded into the modular plug boot
- External probe makes contact with sensor pad on Patch Panel or switch
- Off-center probe designed to accommodate stacked-jack LAN switch configurations
- LSZH jacket
- Over-molded snagless boots

Color: white



ORDERING INFORMATION

Description	Performance	Part Number
4pr AMPTRAC: AMP-TWIST 7 _A S to AMP-TWIST 7 _A S; LSZH S/FTP	Cat. 7 _A / Class F _A	Y-1711755-X
4pr AMPTRAC: AMP-TWIST 7 _A S to RJ-45; LSZH S/FTP	Cat. 6 _A / Class E _A	Y-1711756-X
4pr AMPTRAC: RJ-45 to RJ-45; LSZH S/FTP	Cat. 6/ Class E _A	Y-1711548-X
2pr AMPTRAC: AMP-TWIST 7 _A S to RJ-45, Ethernet pinout 1236; LSZH S/FTP	Cat. 5E/ Class D	Y-1711757-X
2pr AMPTRAC: AMP-TWIST 7 _A S to RJ-45, ISDN pinout 3645; LSZH S/FTP	Cat. 5E/ Class D	Y-1711760-X
4pr AMPTRAC: RJ-45 to RJ-45; LSZH UTP, 1 m	Cat. 6/ Class E _A	1711351-5
4pr AMPTRAC: RJ-45 to RJ-45; LSZH UTP, 2 m	Cat. 6/ Class E _A	1711351-6
4pr AMPTRAC: RJ-45 to RJ-45; LSZH UTP, 3 m	Cat. 6/ Class E _A	1711351-7
4pr AMPTRAC: RJ-45 to RJ-45; LSZH UTP, 5 m	Cat. 6/ Class E _A	1711351-8

Y- X	Length
0- -1	1 m
0- -2	2 m
0- -3	3 m
0- -5	5 m

Managed Connectivity

AMPTRAC Sensor Strips

Sensor Strips for LAN Electronics

FEATURES

- Sensor strips are readily available for a number of LAN electronic equipment types
- Easy mounting and installation
- The below Product Parts shows a selection of commonly used switch models
- Custom sensor strips can be designed on request to work with other LAN electronic equipment (LAN equipment manufacturer, model number, and model revision are required in determining the selection of the proper sensor strip)

Important note: Port footprint of LAN electronic model may be changed by manufacturer without notification! To prevent sensor pad mismatch, always double-check your actual LAN electronics model with scaled sensor strip template (PDF). For switch models not listed or additional information ask your local AMP NETCONNECT sales contact.



ORDERING INFORMATION

Description	Part Number
Ports per Strip: 24; Typical Switch: CISCO 4000 and 6000, 48-Port Blades	1435346-1
Ports per Strip: 24; Typical Switch: CISCO 3500 and 4548, 48-Port	1435346-4
Ports per Strip: 24; Typical Switch: CISCO 2950, 3500, 3750, 24-Port	1435346-5
Ports per Strip: 2; Typical Switch: CISCO 3500 Fiber Uplink Ports	1435818-1
Ports per Strip: 16; Typical Switch: CISCO GBIC, 16-Port Blade	1435820-1
Ports per Strip: 26; Typical Switch: CISCO 2950, 24-Port + 2 Uplink Ports	1435827-1
Ports per Strip: 16; Typical Switch: EXTREME Summit 48i	1435927-1
Ports per Strip: 24; Typical Switch: NORTEL BAYSTACK 450-24T, 24-Port	1435933-1
Ports per Strip: 24; Typical Switch: CISCO MT-RJ 6000, 24-Port Blade	1435937-1
Ports per Strip: 24; Typical Switch: NORTEL BAYSTACK 470-48T, 48-Port	1435939-1
Ports per Strip: 2; Typical Switch: Generic Fiber Uplink Ports	1435950-1
Ports per Strip: 12; Typical Switch: EXTREME Summit 1i & 5i and Alpine 3808	1435952-1
Ports per Strip: 2; Typical Switch: ALCATEL 6648 Fiber Uplink Ports	1479890-1
Ports per Strip: 48; Typical Switch: CISCO 6148, 48 ports	1499651-1
Ports per Strip: 48; Typical Switch: NORTEL BAYSTACK 5520	1499660-1
Ports per Strip: 24; Typical Switch: ALCATEL OmniSwitch OS6624, 24-Port	1777005-1
Ports per Strip: 24; Typical Switch: NORTEL PASSPORT 8648, 24-Port	1777014-1
Ports per Strip: 12; Typical Switch: Generic Stacked, 14 mm Spacing, 12-Port	1777019-1
Ports per Strip: 8; Typical Switch: HP Procurve J4111A	1933098-1
Ports per Strip: 24; Typical Switch: HP Procurve J8702A & 3500yl	1933899-1

Managed Connectivity

Accessories

Cable Management Brackets and Bars

FEATURES

- Brackets and bars provide support for Scanning Module cables or Patch Cords
- Front mount to monitored Patch Panels and switches
- Adjustable universal brackets for use at left or right panel edge



ORDERING INFORMATION

Description	Part Number
Scanning Module cable retainer bracket for CISCO 3500, 48 port switch	1435779-1
Universal Scanning Module cable bracket 40 mm, single-side-mount	1499659-1
Universal Scanning Module cable bracket 100 mm, single-side-mount	1499659-2
Universal Scanning Module cable bracket 448 mm, double-side-mount	1499659-3
1U Cable Management Bar Rack Mounting	1557548-1
Patch Cord management bar	1711344-1
1U Cable Management Bar Patch Panel Mounting	1933425-1

9. Optical LAN Solutions

Introduction.....	118
Rapid Fiber Distribution Hub (iFDH)	119
Splitter Modules & Fiber Distribution Terminal.....	120
Wall Boxes.....	121
Fiber Panels and Connectivity.....	122

Optical LAN Solution

Introduction

As optical fiber moves closer to end users, rapid changes are underway in both the data center and the equipment closet. As a result, new installation and maintenance techniques are being employed within enterprise applications. Passive Optical Network (PON) applications are now being deployed. Fiber is no longer limited to just access equipment. Fiber connectivity to a single user is a reality.

TE Connectivity offers a complete, end-to-end PON infrastructure solution called Optical LAN Solutions (OLS). From the data center to the desktop, our customers have tapped the experience and innovation of TE to build their PON networks. TE's suite of end-to-end connectivity solutions is truly comprehensive. This ordering guide highlights the most commonly used components that feature field-proven attributes that save time, money, and can help improve customer satisfaction.

The diagram below highlights a PON deployment using the TE OLS solution. Each number corresponds to a specific innovative TE solution which is described in more detail in this ordering guide.

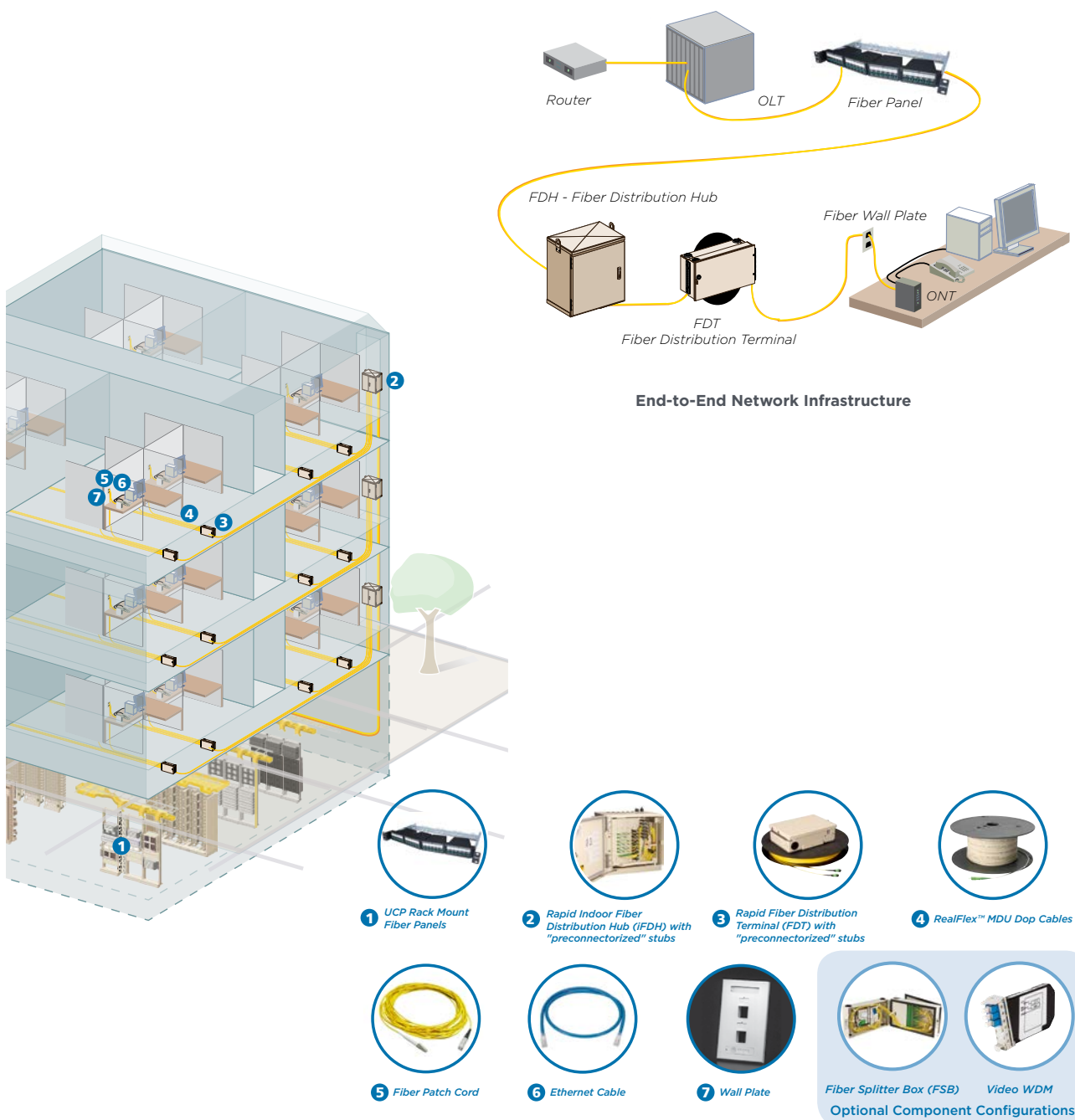

Optical LAN Solution

Rapid Fiber Distribution Hub (iFDH)

Rapid Fiber Distribution Hub (iFDH)

TE's Rapid Fiber Distribution Hub organizes and administers optical fiber cables and passive optical splitters for enterprise PON applications. The enclosures support plug-and-play termination with a cross-connect/interconnect interface that makes installation, maintenance, and changes faster and easier. The RapidReel™ feeder cable speeds up installation time and conveniently stores slack inside the iFDH.

FEATURES

- Support plug-and-play termination
- Can be either wall or rack mounted with the hardware provided
- Traditional swing-frame design allows superior rear access
- Includes RapidReel™ feeder cable
- Designed to meet NEMA-12 requirements
- UL 1863 Listed

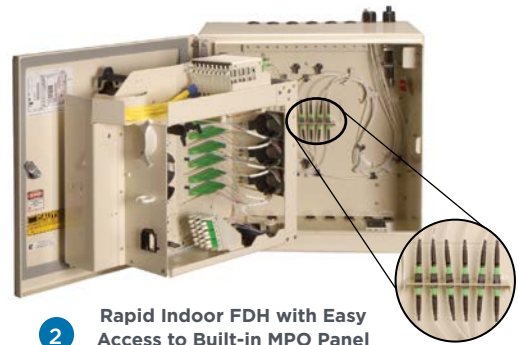

2 Rapid Indoor FDH with Easy Access to Built-in MPO Panel

ORDERING INFORMATION

Description	Feeder Cable Type	Distribution Type	Feeder Stub Length	Part Number
72-Port for up to 9 splitters	12-fiber plenum	6 MPO adapters	100'	OLH-MK072J00M0MKCA
			250'	OLH-MK072J00M0MKEA
			500'	OLH-MK072J00M0MKBA
288-Port for up to 18 splitters	24-fiber plenum	24 MPO adapters	100'	OLH-MM288J00M0MKCB
			250'	OLH-MM288J00M0MKEB
			500'	OLH-MM288J00M0MKBB
432-Port for up to 22 splitters		36 MPO adapters	100'	OLH-MN432J00M0MKCB
			250'	OLH-MN432J00M0MKEB
			500'	OLH-MN432J00M0MKBB

*Note: Splitters are purchased separately; ordering information on the following page.

Optical LAN Solution

Splitter Modules & Fiber Distribution Terminal

Mini Plug & Play Splitter Modules

TE's Mini Plug & Play Splitter Modules support centralized splitting architectures. The modules are available in a wide range of split ratios and are used in TE's iFDH OLH series cabinets. The rugged packaging is built for high performance, while the true plug & play design reduces installation time.

FEATURES

- Bend-optimized fiber and ruggedized extreme temperature cabling
- Operating temperature range -55° to +85° C
- Superior loss performance at 1490 and 1550 wavelengths
- Easy to insert and remove without affecting adjacent splitters
- Allows pass-through of up to 2 fibers per splitter
- UL 1863 Listed



ORDERING INFORMATION

Description		Part Number
Optical Splitter Module Angled SC Pigtails	1 x 32 splitter	OLS-MPP13266
	1 x 16 splitter	OLS-MPP11666
	1 x 8 splitter	OLS-MPP10866
	2 x 32 splitter	OLS-MPP12A66

Rapid Fiber Distribution Terminal

TE's Rapid Fiber Distribution Terminal (FDT) provides a compact, NEMA-12 rated solution for connecting optical fiber cables within enterprise environments and serve as the distribution point between the Rapid iFDH and the user area. It eliminates the need for splice cases and separate cable assemblies by integrating the RapidReel cable payout system. Use of factory terminated and tested MPO connectors instead of splicing provide a plug-and-play environment that reduces labor costs and speeds project completion. The Rapid FDT provide a lockable consolidation point and localized patch field, allowing for precise cable length customization in the field, while reducing overall cable volume and simplifying routing from the FDH to the user area. The iFDT's compact footprint enables it to be placed under raised floors or wall mounted.

FEATURES

- Built-in RapidReel technology allows for easy payoff of MPO stub
- Patented break-away spool flanges reduce slack storage size to within the enclosures footprint
- Utilizes Reduced Bend Radius Fiber
- UL 1863 Listed

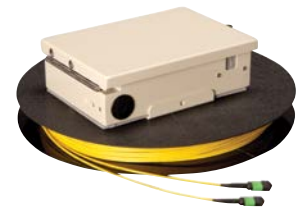

3 Rapid FDT
(using slider adapter packs)

ORDERING INFORMATION

Description	Stub	Feeder Stub Length	Part Number
12-fiber Loose tube plenum cable	MPO	100'	OLR-SJ12J00D1002A
		200'	OLR-SJ12J00D2002A
		300'	OLR-SJ12J00D3002A
24-fiber Loose tube plenum cable		100'	OLR-SJ24J00D1002A
		200'	OLR-SJ24J00D2002A
		300'	OLR-SJ24J00D3002A

Optical LAN Solution

Wall Boxes

Wall Boxes

TE's Fiber Splitter Boxes (FSB) are mini Fiber Distribution Hubs that can be used for plug and play (PNP) or fusion splice applications.

When used as a plug and play box, they are ideal for uses such as lower count floors or buildings, extra capacity requirements beyond the standard Fiber Distribution Hub (FDH), and when localized splitting or physical path redundancy (using a 2 x 32 split) is desired.

The same box can also be used to extend services beyond the primary building to other smaller buildings with limited users on the campus. In this type of application, the FSB is typically spliced to the OSP fiber cable connecting the buildings and would offer the optical splitting required to provide PON services to the second building.

These wall boxes provide a small footprint for splitting, terminating, and splicing. FSBs accept standard plug and play splitters and can be easily added after the wall box has been installed. FSBs accommodate 1 x 8, 1 x 16, 1 x 32, and 2 x 32 splitters. Wall mounting provides significant space savings and the unique swing frame design allows for easy access to the back section of the wall box.



FSB-32 Indoor Enclosure

FEATURES AND BENEFITS

- Dual hinge design creates separation between rear splitter section and front customer side access
- Splitters can be easily installed after wall box installation allowing for separate purchase
- Provides up to 32 customer access ports per splitter
- Dual hinge provides small footprint on the wall while maintaining excellent hand access to connectors
- Accepts standard PNP splitter modules (same as iFDH)
- UL 1863 Listed

ORDERING INFORMATION

Description	Part Number	
FSB-32 Indoor Enclosure; with SC/APC adapters, 32-fiber distribution	No splitters, no splice trays	OSB-SBJ032000000
	No splitters, with heat shrink splice trays	OSB-SBJ232000000
	1 x 32 splitter installed, no splice trays	OSB-SBJ032A10000
	1 x 32 splitter installed, with heat shrink splice trays	OSB-SBJ232A10000
	2 x 32 splitter installed, no splice trays	OSB-SBJ032G10000
	2 x 32 splitter installed, with heat shrink splice trays	OSB-SBJ232G10000
Optical Splitter Module - Angled SC Pigtails	1 x 32 splitter	OLS-MPP13266
	1 x 16 splitter	OLS-MPP11666
	1 x 8 splitter	OLS-MPP10866
	2 x 32 splitter	OLS-MPP12A66

Optical LAN Solution

Fiber Connectivity

SC Simplex Drop Cable

ORDERING INFORMATION

Description	Part Number
SC/APC-SC/APC Simplex Drop Cable G.657-A.2, yellow	Y-2160593-X
SC/APC-SC/UPC Simplex Drop Cable G.657-A.2, yellow	Y-2160594-X



Y- -X	Length	Y- -X	Length	Y- -X	Length	Y- -X	Length	Y- -X	Length	Y- -X	Length
0- -1	1 m	0- -5	5 m	2- -5	25 m	4- -5	45 m	6- -5	65 m	8- -5	85 m
0- -2	2 m	1- -0	10 m	3- -0	30 m	5- -0	50 m	7- -0	70 m	9- -0	90 m
0- -3	3 m	1- -5	15 m	3- -5	35 m	5- -5	55 m	7- -5	75 m	9- -5	95 m
0- -4	4 m	2- -0	20 m	4- -0	40 m	6- -0	60 m	8- -0	80 m		

LC to MPO Quick-Fit cassettes or MPO to MPO modules

For SC and MPO fiber management please use our MPOptimate Quick-Fit cassettes and modules

- for MPO to SC Quick-Fit cassettes please see Chapter 1 - MPO/MPOptimate System

- for MPO Coupler Quick-Fit modules please see Chapter 1 - MPO/MPOptimate System



10. AMP CO System

AMP CO Ultra Panels	124
AMP CO Ultra Outlets	127
AMP CO Inserts.....	131
AMP CO Tools & Accessories.....	138

AMP CO Ultra Quick-Fit 8 Port Patch Panel

FEATURES

- 19" 1U patch panel for 8 AMP CO Ultra Inserts
- Fast termination and easy assembly
- Shielded housing with patented automatic shielding clamp
- Straight cable exit plus management bar
- Kit includes 4 AMP CO Ultra Quick-Fit Kits, mounting material and grounding bolt
- Performance up to 2.0 GHz



ORDERING INFORMATION

Description	Color	Part Number
AMP CO Ultra Quick-Fit 8 Port Patch Panel	Light grey (RAL 7035)	2153112-1
	Black (RAL 9005)	2153112-3

AMP CO Ultra Quick-Fit 16 Port Patch Panel

FEATURES

- 19" 2U patch panel for 16 AMP CO Ultra Inserts
- Fast termination and easy assembly
- Shielded housing with patented automatic shielding clamp
- Straight cable exit plus management bar
- Kit includes 8 AMP CO Ultra Quick-Fit Kits, mounting material and grounding bolt
- Performance up to 2.0 GHz



ORDERING INFORMATION

Description	Color	Part Number
AMP CO Ultra Quick-Fit 16 Port Patch Panel	Light Grey (RAL 7035)	2153113-1
	Black (RAL 9005)	2153113-3

AMP CO Ultra 24 Port High Density Patch Panel

FEATURES

- 19" 2U patch panel for 24 AMP CO Ultra Inserts
- Fast termination and easy assembly
- Shielded housing with patented automatic shielding clamp
- Straight cable exit plus management bar
- Kit includes 24 die cast housings, 24 AMP CO Plus Edge Connectors, frames, mounting material and grounding bolt
- Performance up to 2.0 GHz



ORDERING INFORMATION

Description	Color	Part Number
AMP CO Ultra 24 Port High Density Patch Panel	Light Grey (RAL 7035)	1711686-1
	Black (RAL 9005)	1711686-3

UCP Patch Panel Angled and Flushmount

Please refer to Chapter 4, page 48



AMP CO Ultra Quick-Fit Kit

FEATURES

- Fits in UCP Patch Panel angled and flush mount as well as consolidation point boxes
- Fast termination and easy assembly
- Shielded housing with patented automatic shielding clamp
- Kit includes 2 die-cast housings, 2 shielded edge connectors and frame for labelling
- Performance up to 2.0 GHz



ORDERING INFORMATION

Description	Color	Part Number
AMP CO Ultra Quick-Fit Kit	Black (RAL 9005)	2153014-1

CP Box for Quick-Fit Cassettes & Modules

FEATURES

- Consolidation point box ready for 1 AMP CO Ultra Quick-Fit Kits
- Robust sheet metal construction
- Two separate zones; installation zone and user zone
- Hinged cover with knurled screw
- Dust protection for the full connection
- Grounding bolt included



ORDERING INFORMATION

Description	Color	Part Number
CP Box for Quick-Fit Cassettes & Modules	Black (RAL 9005)	1-1671414-1

AMP CO Ultra Distribution Box

FEATURES

- 1U distribution box for surface mount or raised floor use for 8 AMP CO Ultra Inserts
- Robust sheet metal construction
- Fast termination and easy assembly
- Shielded housing with patented automatic shielding clamp
- Kit includes 4 AMP CO Ultra Quick-Fit Kits, mounting material and grounding bolt
- Performance up to 2.0 GHz



ORDERING INFORMATION

Description	Color	Part Number
AMP CO Ultra Distribution Box	Black (RAL 9005)	2153173-3

AMP CO System

AMP CO Ultra Outlets

AMP CO Ultra Installation Kit DIN 50x50

FEATURES

- Fast termination and easy assembly
- Shielded installation kit flush mount
- DIN faceplate 50 x 50 mm
- Compatible with standard and designer frame series
- Metal frame ready for different footprint or fixation configurations
- Shielded edge connector for AWG 22-24 twisted pair cables
- Shielded housing with tangible screen termination
- Strain relief by cable tie
- Top, left or right cable entry
- 2.0 GHz performance

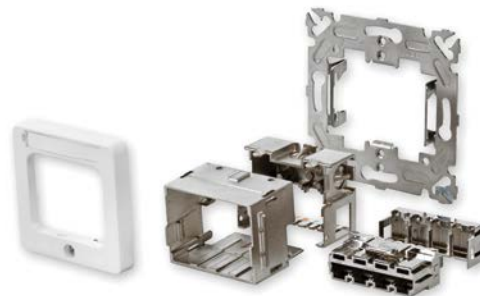

ORDERING INFORMATION

Description	Color	Part Number
AMP CO Ultra Installation Kit DIN 50x50	Almond (RAL 1013)	1711655-1
	Black (RAL 9005)	1711655-3
	Pure White (RAL 9010)	2-1711655-1

AMP CO Ultra Installation Kits DIN 68x68

FEATURES

- Fast termination and easy assembly
- Shielded installation kit flush mount
- Straight or angled versions
- DIN faceplate 68 x 68 mm
- Metal frame ready for different footprint or fixation configurations
- Shielded edge connector for AWG 2-24 twisted pair cables
- Shielded housing with tangible screen termination
- Strain relief by cable tie
- Top, left or right cable entry
- 2.0 GHz performance

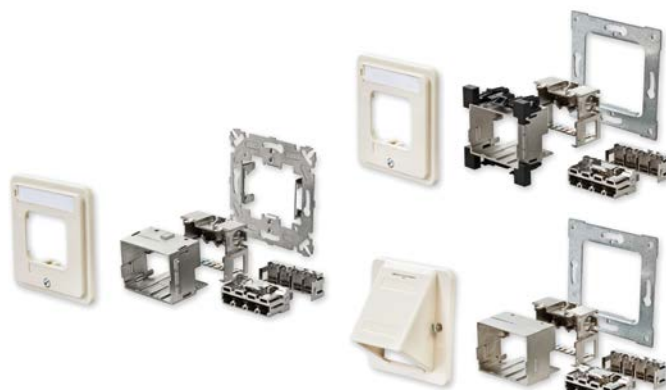

ORDERING INFORMATION

Description	Color	Part Number
AMP CO Ultra Installation Kit DIN 68x68	Almond (RAL 1013)	1711856-1
AMP CO Ultra Installation Kit DIN 68x68	Pure White (RAL 90100)	2-1711856-1
AMP CO Ultra Installation Kit DIN 68x68 Top	Almond (RAL 1013)	1711870-1
AMP CO Ultra Installation Kit DIN 68x68 Top	Pure White (RAL 9010)	2-1711870-1
AMP CO Ultra Installation Kit DIN 68x68 Angled	Almond (RAL 1013)	1711875-1
AMP CO Ultra Installation Kit DIN 68x68 Angled	Pure White (RAL 9010)	2-1711875-1

AMP CO Ultra Installation Kit DIN Floor Box

FEATURES

- Fast termination and easy assembly
- Shielded installation kit floor box
- Shielded edge connector for AWG 22-24 twisted pair cables
- Shielded housing with tangible screen termination
- Strain relief by cable tie
- Bottom cable entry
- 2.0 GHz performance



ORDERING INFORMATION

Description	Color	Part Number
AMP CO Ultra Installation Kit DIN 50x50 Floor Box	Almond (RAL 1013)	1711876-1
AMP CO Ultra Installation Kit DIN 70x58 Floor Box	Almond (RAL 1013)	1711855-1

AMP CO Ultra Installation Kit Swiss “EDIZIOdue Compatible”

FEATURES

- Fast termination and easy assembly
- Shielded installation kit flush mount and surface mount
- Faceplate applicable to “EDIZIOdues Compatible” systems
- Shielded edge connector for AWG 22-24 twisted pair cables
- Shielded housing with tangible screen termination
- Strain relief by cable tie
- Top, left or right cable entry
- 2.0 GHz performance



ORDERING INFORMATION

Description	Color	Part Number
AMP CO Ultra Installation Kit Swiss EDIZIOdue Compatible AP	Pure White (RAL 9010)	1711869-1
AMP CO Ultra Installation Kit Swiss EDIZIOdue Compatible UP	Pure White (RAL 9010)	1711859-1
AMP CO Ultra Installation Kit Swiss EDIZIOdue Compatible UP	Black (RAL 9005)	1711859-2
AMP CO Ultra Installation Kit Swiss EDIZIOdue Compatible KNL	Light Gray	1711858-1
AMP CO Ultra Installation Kit Swiss EDIZIOdue Compatible KNL	Dark Gray	1711858-2
AMP CO Ultra Installation Kit Swiss EDIZIOdue Compatible KNL	Black (RAL 9005)	1711858-3
AMP CO Ultra Installation Kit Swiss EDIZIOdue Compatible KNL	Pure White (RAL 9010)	1711858-4

AMP CO Ultra Installation Kit Swiss “Standard”

FEATURES

- Fast termination and easy assembly
- Shielded installation kit flush mount and surface mount
- Faceplate applicable to “Standard” systems
- Shielded edge connector for AWG 22-24 twisted pair cables
- Shielded housing with tangible screen termination
- Strain relief by cable tie
- Top, left or right cable entry
- 2.0 GHz performance



ORDERING INFORMATION

Description	Color	Part Number
AMP CO Ultra Installation Kit Swiss UP	Pure White (RAL 9010)	1711861-1
AMP CO Ultra Installation Kit Swiss AP	Pure White (RAL 9010)	1711862-1
AMP CO Ultra Installation Kit Swiss KNL	Pure White (RAL 9010)	1711864-1

AMP CO Ultra Installation Kit Swiss “FLF”

FEATURES

- Fast termination and easy assembly
- Shielded installation kit flush mount and surface mount
- Faceplate applicable to “FLF” systems
- Shielded edge connector for AWG 22-24 twisted pair cables
- Shielded housing with tangible screen termination
- Top, left or right cable entry (90°) and rear cable exit (180°)
- 2.0 GHz performance



ORDERING INFORMATION

Description	Color	Part Number
AMP CO Ultra Installation Kit Swiss FLF, Cable exit 90°	Pure White (RAL 9010)	1711865-1
AMP CO Ultra Installation Kit Swiss FLF AP, Cable exit 90°	Pure White (RAL 9010)	1711866-1
AMP CO Ultra Installation Kit Swiss FLF, Cable exit 180°	Pure White (RAL 9010)	2153074-1
AMP CO Ultra Installation Kit Swiss FLF AP, Cable exit 180°	Pure White (RAL 9010)	2153075-1

AMP CO Ultra Installation Kit 45 x 45

FEATURES

- Fast termination and easy assembly
- Shielded installation kit flush mount
- Faceplate 45 x 45 mm
- Shielded edge connector for AWG 22-24 twisted pair cables
- Shielded housing with tangible screen termination
- Strain relief by cable tie
- Top, left or right cable entry
- 2.0 GHz performance



ORDERING INFORMATION

Description	Color	Part Number
AMP CO Ultra Installation Kit 45x45	Almond (RAL 1013)	1711860-1
AMP CO Ultra Installation Kit 45x45	Pure White (RAL 9010)	1711860-2
Adaptor Frame to 50 x 50 mm	Almond (RAL 1013)	1379156-1

AMP CO System

AMP CO Inserts

AMP CO Plus Category 7_A AMP-TWIST 7_{AS} Style Insert

FEATURES

- Exchangeable system insert for 1 x ISO Category 7_A (acc. IEC 61076-3-104)
- Class F_A, supports 1 GHz bandwidth
- Application: All services incl. 10 Gigabit Ethernet (10GBASE-T)

Pin out: EIA/TIA 568A; 8 pins, shielded

ORDERING INFORMATION

Description	Color	Part Number
Insert Cat. 7 _A AMP-TWIST 7 _{AS} Style	Almond (RAL 1013)	1711409-1
	Black (RAL 9005)	1711409-3
	Pure White (RAL 9010)	1711409-5

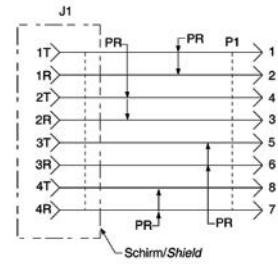

AMP CO Plus Category 7_A ARJ-45 Insert

FEATURES

- Exchangeable system insert for 1 x ISO Category 7_A (compatible with IEC 60603-7-7)
- Class F_A, supports 1 GHz bandwidth
- Application: All Ethernet services incl. 10 Gigabit Ethernet (10GBASE-T)

Pin out: EIA/TIA 568A; 8 pins, shielded

ORDERING INFORMATION

Description	Color	Part Number
Insert Cat. 7 _A ARJ-45	Almond (RAL 1013)	1711609-1
	Black (RAL 9005)	1711609-3
	Pure White (RAL 9010)	1711609-5



AMP CO Plus Category 7 Dual RJ-45 Insert for ATM

FEATURES

- Exchangeable system insert 2 x RJ-45
- Category 7 / Class F
- Application: 2 x ATM 622 MBit/s

Pin out: 12.78 + 12.78; 2 x 4 pins, shielded

ORDERING INFORMATION

Description	Color	Part Number
Insert 2 x RJ-45 Cat. 7	Almond (RAL 1013)	336556-1
	Black (RAL 9005)	336556-3
	Pure White (RAL 9010)	336556-5

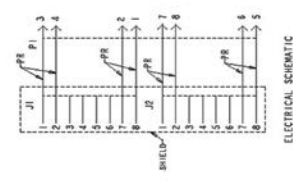

AMP CO System

AMP CO Inserts

AMP CO Plus Broadband Inserts for “Triple Play”

FEATURES

- Exchangeable system insert with F-series connector and 2 x RJ-45
- Application: 1 x CATV + 1 x Fast Ethernet (100BASE-TX) + 1x ISDN

Pin out: Balun 75Ω + 12.36 + 45; shielded



ORDERING INFORMATION

Description	Color	Part Number
Insert F-Series + 2 x RJ-45	Almond (RAL 1013)	1711336-1
	Black (RAL 9005)	1711336-3
	Pure White (RAL 9010)	1711336-5

AMP CO Plus Splitter Insert for Gigabit Ethernet and ISDN

FEATURES

- Exchangeable system insert 2 x RJ-45
- Application: 1 x Gigabit Ethernet (1000BASE-T) + 1x ISDN
- ITU I.430 services
- ISDN port is a 4 wire s-bus basic rate interface (BRI) including power feeding
- Two splitters required for system operation

Pin out: EIA/TIA 568 A: 8 pins, shielded



ORDERING INFORMATION

Description	Color	Part Number
Insert 2 x RJ-45 mixed	Almond (RAL 1013)	1591721-1
	Black (RAL 9005)	1591721-3
	Pure White (RAL 9010)	1591721-5

AMP CO Plus Category 6_A RJ-45 Insert for 10 Gigabit Ethernet

FEATURES

- Exchangeable system insert 1 x RJ-45
- Category 6_A / Class E_A
- Application: All Ethernet services incl. 10 Gigabit Ethernet (10GBASE-T) or ATM 1.2 GBit/s

Pin out: EIA/TIA 568A; 8 pins, shielded



ORDERING INFORMATION

Description	Color	Part Number
Insert 1 x RJ-45 Cat. 6 _A	Almond (RAL 1013)	1711796-1
	Black (RAL 9005)	1711796-3
	Pure White (RAL 9010)	1711796-5

AMP CO System

AMP CO Inserts

AMP CO Plus Category 6_A Dual RJ-45 Insert for Fast Ethernet

FEATURES

- Exchangeable system insert 2 x RJ-45
- Category 6_A / Class E_A
- Application: 2 x Fast Ethernet (100BASE-TX)

Pin out: 12.36 + 12.36; 2 x 4 pins, shielded

ORDERING INFORMATION

Description	Color	Part Number
Insert 2 x RJ-45 Cat. 6 _A Ethernet	Almond (RAL 1013)	1711801-1
	Black (RAL 9005)	1711801-3
	Pure White (RAL 9010)	1711801-5

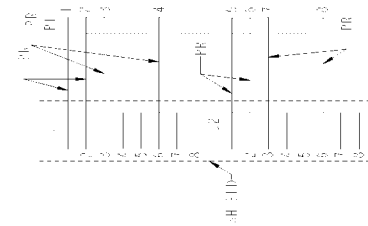

AMP CO Plus Category 6_A Dual RJ-45 Insert for Fast Ethernet + Voice/Data

FEATURES

- Exchangeable system insert 2 x RJ-45
- Category 6_A / Class E_A
- Application: 1 x Fast Ethernet (100BASE-TX) + 1 x ISDN, xDSL or Token Ring

Pin out: 36.45 + 12.36; 2 x 4 pins, shielded

ORDERING INFORMATION

Description	Color	Part Number
Insert 2 x RJ-45 Cat. 6 _A mixed	Almond (RAL 1013)	1711804-1
	Black (RAL 9005)	1711804-3
	Pure White (RAL 9010)	1711804-5

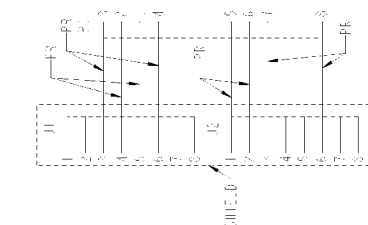

AMP CO Plus Category 6_A Dual RJ-45 Insert for Voice/Data

FEATURES

- Exchangeable system insert 2 x RJ-45
- Category 6_A / Class E_A
- Application: 2 x ISDN, xDSL or Token Ring

Pin out: 36.45 + 36.45; 2 x 4 pins, shielded

ORDERING INFORMATION

Description	Color	Part Number
Insert 2 x RJ-45 Cat. 6 _A ISDN	Almond (RAL 1013)	1711807-1
	Black (RAL 9005)	1711807-3
	Pure White (RAL 9010)	1711807-5

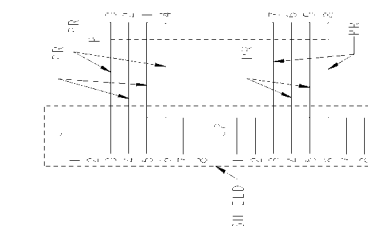

AMP CO System

AMP CO Inserts

AMP CO Plus Category 6 RJ-45 Insert for 1 Gigabit Ethernet

FEATURES

- Exchangeable system insert 1 x RJ-45
- Category 6 / Class E
- Application: 1x Gigabit Ethernet (1000BASE-T), 1 x Fast Ethernet (100BASE-TX) or ATM 1.2 GBit/s

Pin out: EIA/TIA 568A; 8 pins, shielded

ORDERING INFORMATION

Description	Color	Part Number
Insert 1 x RJ-45 Cat. 6	Almond (RAL 1013)	336548-1
	Black (RAL 9005)	336548-3
	Pure White (RAL 9010)	336548-5

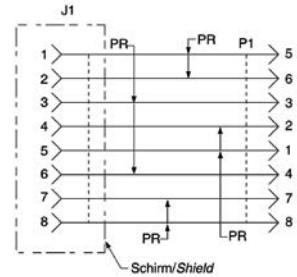

AMP CO Plus Category 5e RJ-45 Insert for Gigabit Ethernet

FEATURES

- Exchangeable system insert 1 x RJ-45
- Category 5e / Class D
- Application: 1x Gigabit Ethernet (1000BASE-T) or 1 x Fast Ethernet (100BASE-TX)

Pin out: EIA/TIA 568 A; 8 pins, shielded

ORDERING INFORMATION

Description	Color	Part Number
Insert 1 x RJ-45 Cat. 5e	Almond (RAL 1013)	284584-1
	Black (RAL 9005)	284584-3
	Pure White (RAL 9010)	284584-5

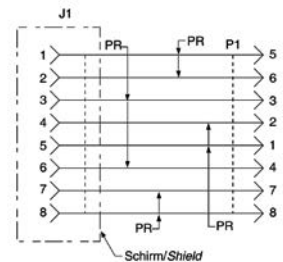

AMP CO Plus Category 5e Dual RJ-45 Insert for Fast Ethernet

FEATURES

- Exchangeable system insert 2 x RJ-45
- Category 5e / Class D
- Application: 2 x Fast Ethernet (100 Base-TX)

Pin out: 12.36 + 12.36; 2 x 4 pins, shielded

ORDERING INFORMATION

Description	Color	Part Number
Insert 2 x RJ-45 Cat. 5e Ethernet	Almond (RAL 1013)	183636-1
	Black (RAL 9005)	183636-3
	Pure White (RAL 9010)	183636-5

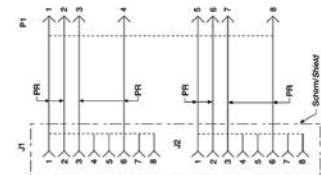

AMP CO System

AMP CO Inserts

AMP CO Plus Category 5e Dual RJ-45 Insert for Fast Ethernet + Voice/Data

FEATURES

- Exchangeable system insert 2 x RJ-45
- Category 5e / Class D
- Application: 1 x Fast Ethernet (100BASE-TX) + 1 x ISDN, xDSL or Token Ring

Pin out: 36.45 + 12.36; 2 x 4 pins, shielded

ORDERING INFORMATION

Description	Color	Part Number
Insert 2 x RJ-45 Cat. 5e mixed	Almond (RAL 1013)	183641-1
	Black (RAL 9005)	183641-3
	Pure White (RAL 9010)	183641-5

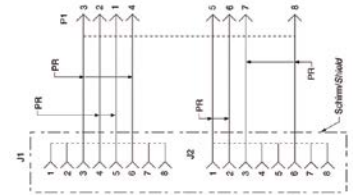

AMP CO Plus Category 5e Dual RJ-45 Insert for Voice/Data

FEATURES

- Exchangeable system insert 2 x RJ-45
- Category 5e / Class D
- Application: 2 x ISDN, xDSL or Token Ring

Pin out: 36.45 + 36.45; 2 x 4 pins, shielded

ORDERING INFORMATION

Description	Color	Part Number
Insert 2 x RJ-45 Cat. 5e ISDN	Almond (RAL 1013)	183635-1
	Black (RAL 9005)	183635-3
	Pure White (RAL 9010)	183635-5

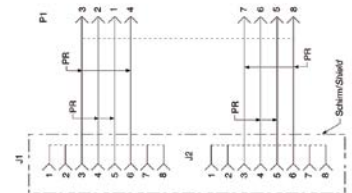

AMP CO Plus Dual Patch Panel Insert PoE Power Conversion

FEATURES

- Exchangeable system insert 2 x RJ-45
- Converts IEEE 802.3af mode B input to mode A output
- Uses Power Mux/Demux Technology
- For use with midspan units providing power over unused pairs
- Application: 2 x PoE (input mode independent), e.g. VoIP, over a 4 pair cable (sheath sharing)

ORDERING INFORMATION

Description	Color	Part Number
Insert 2 x PoE Power Conversion	Almond (RAL 1013)	1711125-1
	Black (RAL 9005)	1711125-3
	Pure White (RAL 9010)	1711125-5

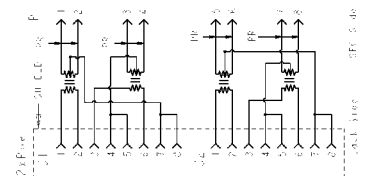

AMP CO System

AMP CO Inserts

AMP CO Plus Dual Insert PoE Mode A

FEATURES

- Exchangeable system insert 2 x RJ-45
- 2 x PoE IEEE 802.3af Mode A
- For use in outlet or with phantom power midspan units
- Application: 2 x PoE, e.g. VoIP, over a 4 pair cable (sheath sharing)

Pin out: 12.36 + 12.36; 2 x 4 pins; shielded

ORDERING INFORMATION

Description	Color	Part Number
Insert 2 x PoE Mode A	Almond (RAL 1013)	1711135-1
	Black (RAL 9005)	1711135-3
	Pure White (RAL 9010)	1711135-5

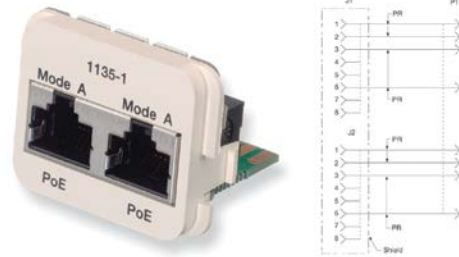

AMP CO Plus 3-Port Insert Standard Phones

FEATURES

- Exchangeable system insert 3 x RJ-45
- 1 x Category 6 / Class E + 2 x Category 3 / Class C
- Application: 1 x Fast Ethernet (100BASE-TX) + 2 x Phones (2 wire use)

Pin out: 12.36 + 45 + 45; 1 x 4 pins shielded and 2 x 2 pins unshielded

ORDERING INFORMATION

Description	Color	Part Number
Insert 3 x RJ-45 for Standard phone	Almond (RAL 1013)	1711100-1
	Black (RAL 9005)	1711100-3
	Pure White (RAL 9010)	1711100-5

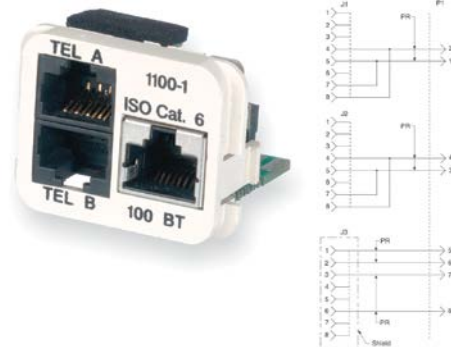

AMP CO Plus 3-Port Insert Shunt Phones

FEATURES

- Exchangeable system insert 3 x RJ-45
- 1 x Category 6 / Class E + 2 x Category 3 / Class C
- Application: 1 x Fast Ethernet (100BASE-TX) + 2 x Phones (parallel use)

Pin out: 12.36 + 36.45 + 36.45; 1 x 4 pins shielded and 2 x 4 pins unshielded

ORDERING INFORMATION

Description	Color	Part Number
Insert 3 x RJ-45 for Shunt phone	Almond (RAL 1013)	1711450-1
	Black (RAL 9005)	1711450-3
	Pure White (RAL 9010)	1711450-5

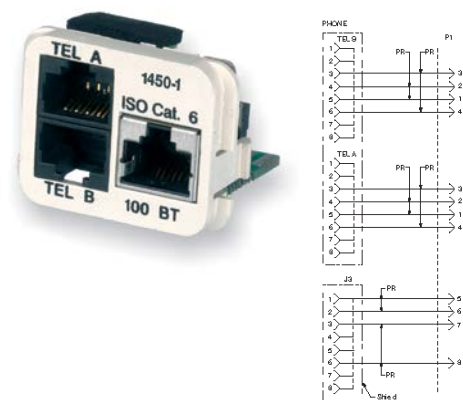

AMP CO System

AMP CO Inserts

AMP CO Plus 4 Pair Sub-D 9pos Insert

FEATURES

- Exchangeable system insert 1 x Sub-D 9pos
- Includes M3 nuts for locking

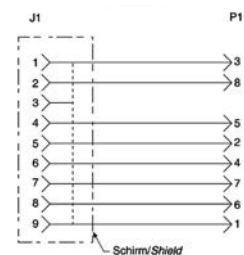

ORDERING INFORMATION

Description	Color	Part Number
Insert Sub-D 9pos	Almond (RAL 1013)	183553-1

AMP CO Inserts for Voice Applications

FEATURES

- Exchangeable system insert 2 x or 4 x RJ-11 or RJ-45
- 2 x or 4 x Category 3 / Class C
- Application: ISDN, So or UpN



ORDERING INFORMATION

Description	Shielded	Terminated	Part Number	-X	Color
Insert 2 x RJ-45; Use at: outlet/panel; Note: French version	Yes	No	183578-1	-1	Almond (RAL 1013)
Insert 2 x RJ11; Use at: outlet; Note: panel side 284584-X	No	No	555614-1	-3	Black (RAL 9005)
Insert 4 x RJ-45; Use at: outlet/panel; Note: French version	No	No	1644016-X	-5	Pure White (RAL 9010)
Insert 4 x RJ-45; Use at: outlet/panel; Note: panel + outlet	No	No	1711000-X		
Insert 4 x RJ-45; Use at: outlet; Note: panel side 183635-X	No	100Ω	1711001-X		
Insert 2 x RJ-45 parallel; Use at: outlet; Note: panel side 284584-X	No	No	1711339-1		

AMP CO Plus Blank Insert

FEATURES

- Blank insert
- Dust protection for unused ports



ORDERING INFORMATION

Description	Color	Part Number
Blank Insert	Almond (RAL 1013)	555644-1
	Black (RAL 9005)	555644-3
	Grey (RAL 7035)	555644-5
	Pure White (RAL 9010)	555644-9

AMP CO System

AMP CO Tools & Accessories

AMP CO Ultra Pistol-Grip Tool

FEATURES

- Pistol grip tool for fast and easy termination of AMP CO Ultra modules
- Ensures repeatable high termination quality
- Considerable reduction of termination time
- Including adapter piece for termination of AMP CO Ultra modules
- AMP CO Ultra Tool Adapter-Gauge and Blade are also available as spare parts



ORDERING INFORMATION

Description	Part Number
AMP CO Ultra Pistol-Grip Tool	1711500-1
AMP CO Ultra Tool Adapter-Gauge	2153264-1
AMP CO Ultra Tool Blade	2153117-1

AMP CO Plus Edge Connector

FEATURES

- Shielded edge connector for AWG 22-24 twisted pair cables
- 2.0 GHz performance
- 110C compatible IDC block
- Universal color code
- Fully shielded



ORDERING INFORMATION

Description	Quantity	Part Number
AMP CO Plus Edge Connector	100 pieces	336455-1
	8 pieces	336455-2
	10 pieces	336455-3

Printer Labels for AMP CO Installation Kits

FEATURES

- Self-adhesive A4 sheets with printer labels for AMP CO Installation Kits
- Uses standard MS Excel sheet

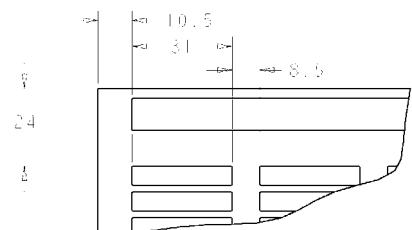

ORDERING INFORMATION

Description	Part Number
Labels (6 x 32 mm, 170 pcs per sheet); Packaging 10 sheets	969704-1

11. Fiber Optic Cabling

System Cable	140
Patch Panels	148
Accessories for Patch Panels	152
Quick-Fit Modules.....	154
Wall Mount Enclosures.....	155
Snap-In Modules.....	157
Pre-assembled LC & SC Trunks.....	159
Patch Cords and Pigtails.....	160
Outlets.....	168
Adaptors	171
LightCrimp and LightCrimp Plus	174
Epoxy Connectors	178
Splicing Products.....	181
Fiber Optic Tools.....	184
Fiber Cleaning and Inspection.....	192

Fiber Optic Cabling

System Cable

Technical Data

FIRE PERFORMANCE

Sheathing materials for internal cables comply fully with the following standards:

ASPECT

NORM

- Flammability
- Smoke emission
- Acid gas emission
- Toxicity
- IEC 60332 Parts 1 and 3
- IEC 61034 Parts 1 and 2
- IEC 60754 Parts 1 and 2
- NES 713

Drum Ref	Barrel (mm)	Flange (mm)	Traverse (mm)	Weight (kg)
P5	300	500	400	5.5
P6	300	600	400	7
P8	400	800	400	12.5
P10	400	1000	500	20
P12	400	1200	500	32
P14	700	1400	700	65
L (P17)	1000	1700	800	180
M (P20)	1200	2000	800	250
N (P22)	1200	2200	800	420

MULTIMODE FIBERS

ISO/IEC 11801 and EN 50173	Overfill Bandwidth (MHz x km)		Max. Link Length for 1 GBit/s (m)		Max. Link Length for 10 GBit/s (m)		Fiber Attenuation (dB/km)		
	850 nm	1300 nm	850 nm (1000Base-SX)	1300 nm (1000 Base-LX)	850 nm (10GBase-SR) (10GBase-SW)	1300 nm (10GBase-LX4)	850 nm	1300 nm	
OM1	62.5 μm	≥ 200	≥ 600	275	550*	33	360*	≤ 2.9	≤ 0.7
OM1 <i>Plus</i>	62.5 μm	≥ 250	≥ 800	400	1000*	65	450*	≤ 2.9	≤ 0.7
OM2	50 μm	≥ 500	≥ 500	550	550*	83	300*	≤ 2.4	≤ 0.6
OM2 <i>Plus</i>	50 μm	≥ 600	≥ 1200	750	2000*	150	1000*	≤ 2.4	≤ 0.6
OM3 (XG)	50 μm	≥ 1500	≥ 500	1000	600	300	300	≤ 2.4	≤ 0.6
OM4 (XG _A)	50 μm	≥ 3500	≥ 500	1040	600	550**	300	≤ 2.4	≤ 0.6

* Mode conditioning patchcords required

** According to the IEEE 10Gb Ethernet model

SINGLEMODE FIBERS

ISO/IEC 11801 and EN 50173	Chromatic Dispersion (ps/nm x km)		Cut-off Wavelength, cabled	Point Discontinuity	Fiber Attenuation (dB/km)		
	1310 nm	1550 nm	(nm)	(dB)	1310 nm	1380-1386 nm	1550 nm
OS2 (ITU-T G.652D)	≤ 3.5	≤ 18,0	≤ 1260	≤ 0.05	≤ 0.34	≤ 0.34	≤ 0.22

GEOMETRICAL FIBER PROPERTIES

Fiber Type	Core/Mode-field (nm)	Cladding (nm)	Coating (nm)
OM1, OM1 <i>Plus</i>	62.5 ± 3	125 ± 2	245 ± 10
OM2, OM2 <i>Plus</i> , OM3(XG), OM4(XG _A)	50 ± 2.5	125 ± 2	245 ± 5
OS2	9.2 ± 0.4	125 ± 1	245 ± 5



For all OM4 XG_A System Cables

OPTICAL CABLE SPECIFICATIONS

Maximum Attenuation (dB/km)

	Loose Tube/Dry Tube		Tight Buffered	
	850 nm	1300 nm	850 nm	1300 nm
Multimode				
50/125	2.5	0.7	2.5	0.7
62.5/125	2.9	0.9	2.7	0.9
Singlemode				
	1310 nm	1550 nm	1310 nm	1550 nm
OS2	0.4	0.25	0.4	0.25

NOTE: For higher fiber performance please contact our local sales teams.

Fiber Optic Cabling

System Cable

Zip Twin and Mini Zip Twin Cable

FEATURES

- Low Smoke Zero Halogen (LSZH)
- Available buffer designs:
 - Zip Twin: Tight-Buffer (900µm)
 - Mini Zip Twin: Tight-Buffer (600µm)
- Fiber categories: OM1, OM1 **Plus**, OM2, OM2 **Plus**, OM3 **XG**, OM4 **XG_A**, OS2
- Tight buffer versions suitable for TE CONNECTIVITY Quick Termination Products (i.e. LightCrimp or LightCrimp Plus)

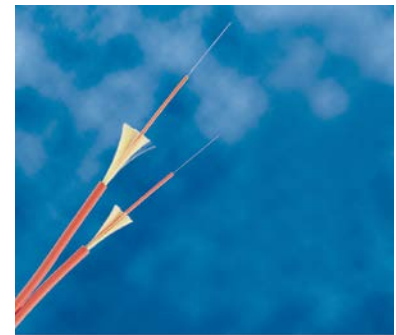
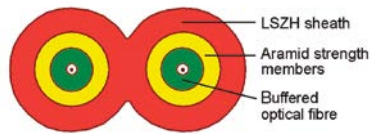

Y-	Reel size	-X	Fiber category
1-	1 Kilometer	-2	OM4 XG_A
2-	2 Kilometer	-3	OM3 XG
3-	3 Kilometer	-4	OS2
4-	4 Kilometer	-5	OM1
		-6	OM2 Plus
		-7	OM2
		-9	OM1 Plus

ORDERING INFORMATION

Description	Part Number
Fiber count: 2; Cable type: Zip Twin TB (Tight Buffered Construction)	Y-599142-X
Fiber count: 2; Cable type: Mini Zip Twin TB (Tight Buffered Construction)	Y-6206650-X

MECHANICAL PERFORMANCE

Fiber count	Overall Ø (mm)	Weight (kg/km)	Installation tension max. during installation (N)	Crush resistance (N)	Minimum bend radius during installation (mm)
ZipTwin	2.5 x 5.0	14	300	1000	40
Mini Zip Twin	1.8 x 3.75	6.6	220	2000	25

TEMPERATURE RANGE

Cable type	Transport/Storage	Installation	Operation
Zip Twin, Mini Zip Twin	- 10 to + 70 °C	- 5 to + 70 °C	- 10 to + 70 °C

PACKAGING

For drum size see page 140

Cable Type	1km	2km	3km	4km
Zip Twin	P5	P5	P6	P6
Mini Zip Twin	P5	P5	P5	P5

Fiber Optic Cabling

System Cable

Internal/External Office Distribution Cable

FEATURES

- Universal Low Smoke Zero Halogen (ULSZH)
- For indoor and outdoor applications
- Suitable for backbone and Fiber-to-the-Desk
- Increased strength and durability
- Tight-Buffer construction
- Suitable for all termination techniques
- Fiber categories: OM1, OM1 **Plus**, OM2, OM2 **Plus**, OM3 **XG**, OM4 **XG_A**, OS2
- Aramid strength members

ORDERING INFORMATION

Description	Part Number	Y-	Reel size	-X	Fiber category
Fiber count: 4	Y-599144-X	1-	1 Kilometer	-2	OM4 XG _A
Fiber count: 6	Y-599145-X	2-	2 Kilometers	-3	OM3 XG
Fiber count: 8	Y-599146-X	3-	3 Kilometers	-4	OS2
Fiber count: 12	Y-599148-X	4-	4 Kilometers	-5	OM1
Fiber count: 16	Y-599149-X			-6	OM2 Plus
Fiber count: 24	Y-1716029-X			-7	OM2
Fiber count: 36	Y-599602-X			-9	OM1 Plus
Fiber count: 48	Y-599603-X				

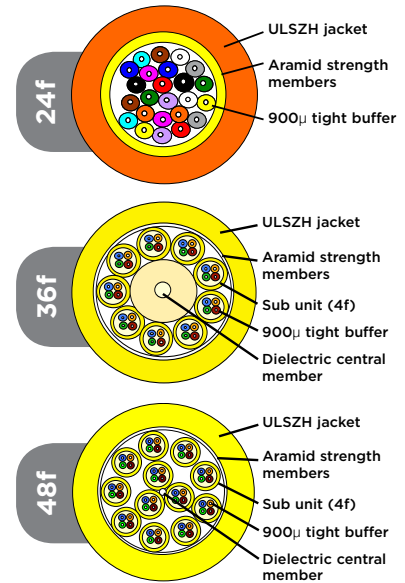

MECHANICAL PERFORMANCE

Fiber count	Overall Ø (mm)	Weight (kg/km)	Installation tension max. during installation (N)	Crush resistance (N)	Combustion Energy (MJ/m)	Minimum bend radius during installation (mm)
4	5	27	650	2000	0.424	75
6	6	33	1000	2000	0.714	90
8	6	35	1000	2000	0.742	90
12	7.5	56	1000	2000	0.953	115
16	8	61	1000	2000	1.175	120
24	9.5	80	1000	2000	1.513	240
36	17	280	2000	2000	6.199	430
48	17.3	230	2000	2000	6.018	430

TEMPERATURE RANGE

Cable type	Transport/Storage	Installation	Operation
Office Distribution Cable	- 20 to + 70 °C	- 5 to + 50 °C	- 10 to + 70 °C

PACKAGING

For drum size see page 140

Fiber count	1km	2km	3km	4km
4	P5	P6	P8	P8
6,8	P6	P8	P8	P10
12	P8	P10	P10	P10
16	P8	P10	P10	P10
24	P10	P10	P12	P12
36,48	P12	P14	P17	P20

Fiber Optic Cabling

System Cable

Internal/External Loose Tube Cable

FEATURES

- Universal Low Smoke Zero Halogen (ULSZH)
- For indoor and outdoor applications
- Loose tube construction
- Dry tube construction also available
- Suitable for all termination techniques
- Fiber categories: OM1, OM1 *Plus*, OM2, OM2 *Plus*, OM3 *XG*, OM4 *XG_A*, OS2
- Aramid strength members

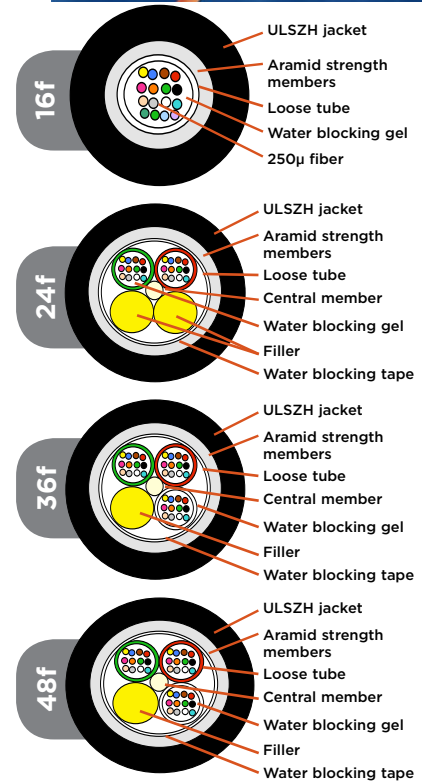
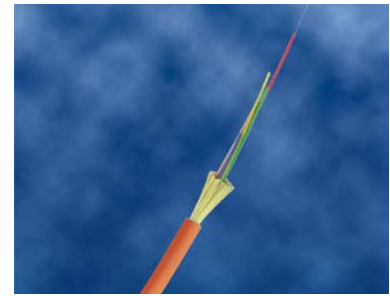

ORDERING INFORMATION

Description	Gel filled tube version Part Number	Dry tube version Part Number	Y-	Reel size
Fiber count: 4	Y-599160-X	Y-599152-X	1-	1 Kilometer
Fiber count: 6	Y-599161-X	Y-599153-X	2-	2 Kilometer
Fiber count: 8	Y-599162-X	Y-599154-X	3-	3 Kilometer
Fiber count: 12	Y-599164-X	Y-599156-X	4-	4 Kilometer
Fiber count: 16	Y-599165-X	Y-599157-X		
Fiber count: 24 (multi-tube)	Y-599167-X	Y-599159-X	-X	Fiber category
Fiber count: 24 (uni-tube)	Y-1716000-X	-	-2	OM4 <i>XG_A</i>
Fiber count: 48	Y-599609-X	Y-599605-X	-3	OM3 <i>XG</i>
Fiber count: 72	Y-599610-X	Y-599606-X	-4	OS2
Fiber count: 96	Y-599611-X	Y-599607-X	-5	OM1
			-6	OM2 <i>Plus</i>
			-7	OM2
			-9	OM1 <i>Plus</i>

MECHANICAL PERFORMANCE

Fiber count	No. of tubes/fillers	Overall Ø (mm)	Weight (kg/km)	Installation tension max. during installation (N)	Crush resistance (N)	Combustion Energy (MJ/m)	Minimum bend radius during installation (mm)
4, 6, 8, 12	1	6.4	33	500	2000	0.886	140
16, 24	1	7.5	44	500	2000	1.65	150
24, 48	4	11.5	125	1000	2000	3.35	170
72	6	12.7	155	2700	2000	4.302	250
96	8	15	210	2700	2000	6.076	300

TEMPERATURE RANGE

Cable type	Transport/Storage	Installation	Operation
Dry, loose tube	- 10 to + 60 °C	- 5 to + 50 °C	- 10 to + 60 °C
Gel filled, loose tube	- 20 to + 60 °C	- 5 to + 50 °C	- 20 to + 60 °C

PACKAGING

For drum size see page 140

Fiber count	1km	2km	3km	3km
4,6,8,12	P8	P8	P10	P10
16, 24 uni	P8	P10	P10	P10
24 multi, 48	P12	P12	P12	P14
72	P12	P12	P14	P17
96	P12	P14	P17	P17

Fiber Optic Cabling

System Cable

Internal/External Loose Tube System Cable with non-metallic rodent resistance

FEATURES

- Universal Low Smoke Zero Halogen (ULSZH)
- LLDPE (Linear Low Density Polyethylene) sheath
- For indoor and outdoor applications
- For use in ducts and direct burial applications
- Non-metallic rodent resistant with peripheral strength members
- Water blocking E-glass yarn (moisture protection)
- Loose tube construction
- Dry tube construction also available
- Suitable for all termination techniques
- Fiber categories:
 - OM1, OM1 Plus, OM2, OM2 Plus, OM3 XG, OM4 XGA, OS2

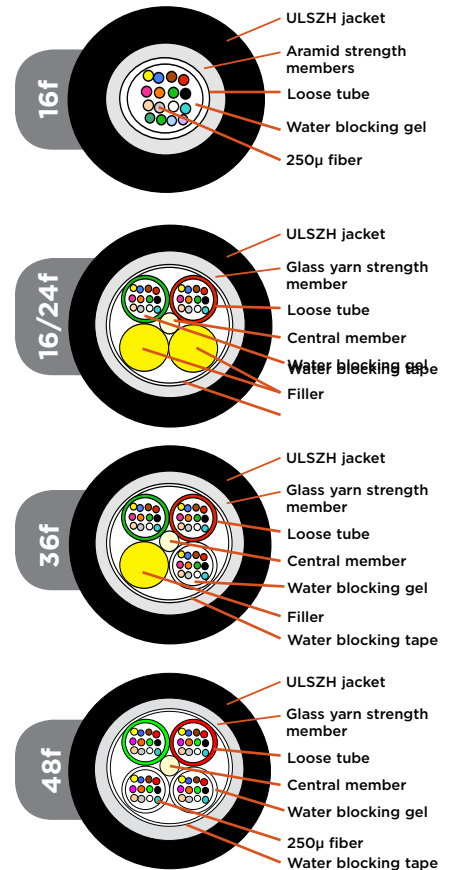

ORDERING INFORMATION

Description	Gel filled tube version Part Number	Dry tube version Part Number
Fiber count: 4	Y-599622-X	Y-599614-X
Fiber count: 6	Y-599623-X	Y-599615-X
Fiber count: 8	Y-599624-X	Y-599616-X
Fiber count: 12	Y-599625-X	Y-599617-X
Fiber count: 16	Y-599626-X	Y-599618-X
Fiber count: 24 (multi-tube)	Y-599627-X	Y-599619-X
Fiber count: 24 (uni-tube)	Y-1716001-X	-
Fiber count: 36	Y-599628-X	Y-599620-X
Fiber count: 48	Y-599629-X	Y-599621-X

Y-	Reel size
1-	1 Kilometer
2-	2 Kilometer
3-	3 Kilometer
4-	4 Kilometer

-X	Fiber category
-2	OM4 XG _A
-3	OM3 XG
-4	OS2
-5	OM1
-6	OM2 Plus
-7	OM2
-9	OM1 Plus

MECHANICAL PERFORMANCE

Fiber count	No. of tubes/fillers	Overall Ø (mm)	Weight (kg/km)	Installation tension max. during installation (N)	Crush resistance (N)	Combustion Energy (MJ/m)	Minimum bend radius during installation (mm)
4, 6, 8, 12	1	6.4	48	1250	1000	0.677	140
16, 24	1	8	74	1250	1000	1.271	160
24, 36, 48	4	11.5	105	2000	2000	3.171	230

TEMPERATURE RANGE

Cable type	Transport/Storage	Installation	Operation
Dry, loose tube	- 10 to + 70 °C	- 5 to + 50 °C	- 10 to + 70 °C
Gel filled, loose tube	- 20 to + 70 °C	- 5 to + 50 °C	- 20 to + 70 °C

PACKAGING

For drum size see page 140

Fiber count	1km	2km	3km	4km
4, 6, 8, 12	P8	P8	P10	P10
16, 24 uni	P8	P10	P10	P10
24 multi, 36, 48	P12	P12	P12	P14

Fiber Optic Cabling

System Cable

External Rodent Resistant Loose Tube System Cable with Non-Metallic Armour

FEATURES

- Universal Low Smoke Zero Halogen (ULSZH)
- LDPE sheath upon request
- For external applications where increased resistance to rodent attack is required
- For use in ducts and direct burial applications
- Longitudinal and lateral water resistance
- High crush resistance and high tensile strength
- Non-metallic rodent resistant Glass Reinforced Plastic armouring
- Gel filled loose tube construction
- Suitable for all termination techniques
- Fiber categories: OM1, OM1 Plus, OM2, OM2 Plus, OM3 XG, OM4 XGA, OS2

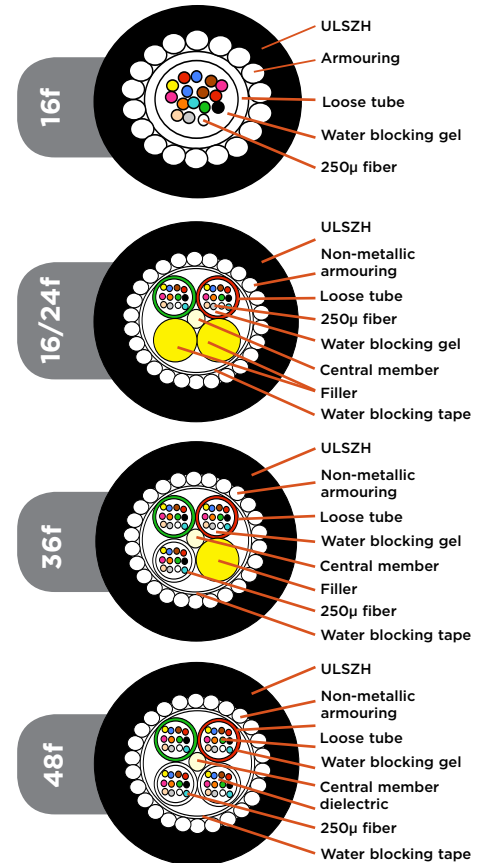
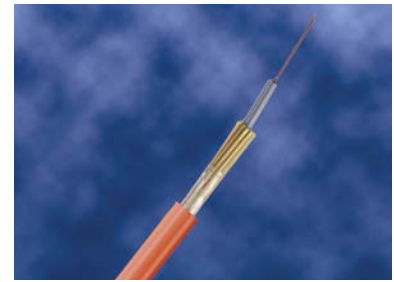

ORDERING INFORMATION

Description	Part Number
Fiber count: 4	Y-599168-X
Fiber count: 6	Y-599169-X
Fiber count: 8	Y-599170-X
Fiber count: 12	Y-599172-X
Fiber count: 16	Y-599173-X
Fiber count: 24	Y-599175-X
Fiber count: 36	Y-599612-X
Fiber count: 48	Y-599613-X

Y-	Reel size
1-	1 Kilometer
2-	2 Kilometer
3-	3 Kilometer
4-	4 Kilometer
-X	Fiber category
-2	OM4 XG_A
-3	OM3 XG
-4	OS2
-5	OM1
-6	OM2 Plus
-7	OM2
-9	OM1 Plus

MECHANICAL PERFORMANCE

Fiber count	No of tubes/fillers	Overall Ø (mm)	Weight (kg/km)	Installation tension max. during installation (N)	Crush resistance (N)	Combustion Energy (MJ/m)	Minimum bend radius during installation (mm)
4, 6, 8, 12	1	9	94	2000	3000	1.973	230
16	1	11	143	3000	3000	3.038	280
24, 36, 48	4	15	236	6000	4000	4.671	465

TEMPERATURE RANGE

Cable type	Transport/Storage	Installation	Operation
Single tube	- 20 to + 70 °C	- 5 to + 50 °C	- 20 to + 70 °C
Multi tube	- 30 to + 70 °C	- 5 to + 50 °C	- 30 to + 70 °C

PACKAGING

For drum size see page 140

Fiber count	1km	2km	3km	4km
4, 6, 8, 12	P8	P10	P10	P12
16	P10	P12	P12	P14
24, 36, 48	P12	P14	P17	P17

Fiber Optic Cabling

System Cable

External Rodent Resistant Loose Tube System Cable with corrugated steel armour

FEATURES

- LLDPE (Linear Low Density Polyethylene)
- Metallic rodent resistant (corrugated steel)
- For use in ducts and in direct burial applications
- Longitudinal and lateral water resistance
- Central gel-filled loose tube construction
- Excellent crush and impact resistance
- Suitable for all termination techniques
- Fiber categories: OM1, OM1 Plus, OM2, OM2 Plus, OM3 XG, OM4 XGA, OS2
- Option: ULSZH sheath for internal and external applications

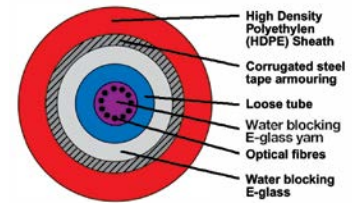

ORDERING INFORMATION

Description	Part Number
Fiber count: 4	Y-599681-X
Fiber count: 6	Y-599682-X
Fiber count: 8	Y-599692-X
Fiber count: 12	Y-599683-X
Fiber count: 24	Y-599690-X

Y-	Reel size	-X	Fiber category
1-	1 Kilometer	-2	OM4 XG _A
2-	2 Kilometer	-3	OM3 XG
3-	3 Kilometer	-4	OS2
4-	4 Kilometer	-5	OM1
		-6	OM2 <i>Plus</i>
		-7	OM2
		-9	OM1 <i>Plus</i>

MECHANICAL PERFORMANCE

Fiber count	No. of tubes/fillers	Overall Ø (mm)	Weight (kg/km)	Installation tension max. during installation (N)	Crush resistance (N)	Minimum bend radius during installation (mm)
4, 6, 8, 12	1	10	104	1250	3000	200
24	1	10.5	120	1250	3000	200

TEMPERATURE RANGE

Cable type	Transport/Storage	Installation	Operation
Gel filled, loose tube	- 20 to + 70 °C	- 5 to + 50 °C	- 20 to + 70 °C

PACKAGING

For drum size see page 140

Fiber count	1km	2km	3km	4km
4, 6, 8, 12	P10	P10	P12	P12
24	P10	P12	P12	P14

Fiber Optic Cabling

System Cable

Internal/External Fire Survival Loose Tube Cable

FEATURES

- Circuit Integrity for 90 minutes at 750°C (following IEC 60331-25)
- Low Smoke Zero Halogen (LSZH)
- For use in ducts and direct burial applications
- Longitudinal and lateral water resistance
- Metallic CST armour between 2 jackets provides excellent crush resistance
- Gel filled loose tube construction
- Suitable for all termination techniques
- Fiber categories: OM1, OM1 Plus, OM2, OM2 Plus, OM3 XG, OM4 XGA, OS2

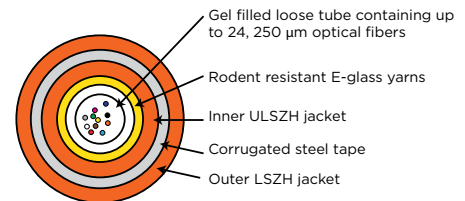

ORDERING INFORMATION

Description	Part Number
Fiber count: 4	Y-1716219-X
Fiber count: 6	Y-1716218-X
Fiber count: 8	Y-1716217-X
Fiber count: 12	Y-1716211-X
Fiber count: 16	Y-1716220-X
Fiber count: 24	Y-1716216-X

Y-	Reel size	-X	Fiber category
1-	1 Kilometer	-2	OM4 XG_A
2-	2 Kilometer	-3	OM3 XG
3-	3 Kilometer	-4	OS2
4-	4 Kilometer	-5	OM1
		-6	OM2 Plus
		-7	OM2
		-9	OM1 Plus

MECHANICAL PERFORMANCE

Fiber count	Overall Ø (mm)	Weight (kg/km)	Installation tension max. during installation (N)	Crush resistance (N)	Combustion Energy (MJ/m)	Minimum bend radius during installation (mm)
4, 6, 8, 12, 16, 24	12.7	216	1400	3000	6.2	255

TEMPERATURE RANGE

Cable type	Transport/Storage	Installation	Operation
Fire Survival Cable	-20 to +70 C	-5 to +50 C	-20 to +70C

PACKAGING

For drum size see page 140

Fiber count	1km	2km	3km	4km
4, 6, 8, 12, 16, 24	P12	P10	P14	P17

Fiber Optic Cabling

Patch Panels

Angled modular fiber optic panel

FEATURES

- Drawer style, 1U, 19"
- Plexi transparent cover
- 4 Quick-Fit cutouts
- One pin splice tray fixation (splice tray NOT included)

Color: black (RAL 9005)



ORDERING INFORMATION

Description	Part Number
Angled modular FO panel	1-1671260-1

1U Modular fiber optic panel flushmount style

FEATURES

- Drawer style, 1U, 19"
- Exchangeable adaptor panels (to be ordered separately)
- Unloaded and half-loaded (12 adaptors) panels available on request
- ST-style loaded adaptor panels available on request
- Plexi transparent cover
- Pull-out labeling strip
- Cable entrance by means of cable termination kit with glands (PN 1671273-1) or cable termination kit with flex tube (PN 1671274-1) in case of limited space in the back see accessories page 152
- Maximum 2 Splice Trays can be stored in the panel (2 x 24 = 48 splices)
- One pin Splice Tray fixation (splice tray NOT included)
- For splicing accessories see page 181
for cable management see page 152



ORDERING INFORMATION

Description	Part Number
Modular fiber panel - drawer; Color: black (RAL 9005)	1-1671262-1
Modular fiber panel - drawer with pre-installed adaptor panel for 4 Quick-Fit modules; color: black (RAL 9005)	1-1671365-1
Adaptor panel with 24 x SC duplex; Color: black (RAL 9005)	2-1671268-X
Adaptor panel with 24 x LC duplex; Color: black (RAL 9005)	2-1671271-X
Adaptor panel for 4 Quick-Fit modules; Color: black (RAL 9005)	1671263-1
Modular fiber panel - drawer; Color: grey (RAL 7035)	1-1671262-2
Adaptor panel with 24 x SC duplex; Color: grey (RAL 7035)	2-1671269-X
Adaptor panel with 24 x LC duplex; Color: grey (RAL 7035)	2-1671272-X
Adaptor panel for 4 Quick-Fit modules; Color: grey (RAL 7035)	1671263-2

-X	Fiber type	Color
-1	OM1	beige
-2	OM2	black
-3	OM3	aqua
-4	OS2	blue

Fiber Optic Cabling

Patch Panels

1U - LC, SC, ST-Style patch panel, international version

FEATURES

- Drawer style, 1U, 19"
- Preinstalled dust covers on unpopulated ports
- Incl. management rings and metric glands
- Available in 300 mm and 220 mm depth
- Available in ST-Style, SC and LC
- Supplied without splicing tray

Color: black (RAL 9005)



ORDERING INFORMATION

Description	220 mm Part Number	300 mm Part Number
24 x ST-Style, Multimode and Singlemode; Unpopulated	1206480-8	206114-8
24 x ST-Style, Multimode; With 12 adapters	2-1206480-4	2-1206114-4
24 x ST-Style, Multimode; With 24 adapters and pigtails (OM2)	-	4-1206114-0
24 x ST-Style, Multimode; With 24 adapters	4-1206480-4	4-1206114-4
12 x SC Duplex, Multimode and Singlemode; unpopulated	1206505-8	1206138-8
12 x SC Duplex, Multimode; With 6 adapters	2-1206505-4	2-1206138-4
12 x SC Duplex, Multimode; With 12 adapters and 24 pigtails (OM3)	-	4-1206138-0
12 x SC Duplex, Multimode; With 12 adapters	4-1206505-4	4-1206138-4
24 x SC Duplex, Multimode and Singlemode; Unpopulated	-	1206343-4
24 x SC Duplex, Multimode; with 24 adapters	-	4-1206343-4
24 x SC Duplex, Singlemode; with 24 adapters	-	4-1671002-4
12 x SC Duplex, Singlemode; With 6 adapters	2-1671017-4	2-1348960-4
12 x SC Duplex, Singlemode; With 12 adapters and 24 pigtails (OS2)	-	4-1348960-0
12 x SC Duplex, Singlemode; With 12 adapters	4-1671017-4	4-1348960-4
24 x LC Duplex, Multimode and Singlemode; unpopulated	-	1671000-8
24 x LC Duplex, Singlemode; With 12 adapters	-	2-1671000-4
24 x LC Duplex, Multimode; With 12 adapters	-	2-1671000-8
24 x LC Duplex, Singlemode; with 24 adapters	-	4-1671000-4
24 x LC duplex, Multimode, with 12 adaptors AQUA	-	2-1671000-2
24 x LC Duplex, Multimode; With 24 adapters	-	4-1671000-8
24 x LC duplex, Multimode; with 24 adaptors AQUA	-	4-1671000-2

Fiber Optic Cabling

Patch Panels

1U - LC, SC, ST-Style patch panel, German version

FEATURES

- 1U, 19", metal, Supplied with ANT splicing trays
- Pre-installed adapters
- Pre-installed dust covers on unpopulated ports
- Alignment sleeve material: Multimode = Metal;
Singlemode = Ceramic
- 2 rear cable entries
- Incl. 1 blindcover and 1 metric pre-installed cable entry plate (German version)
- Populated fix style versions comes with cable management rings

Color: light grey (RAL 7035)

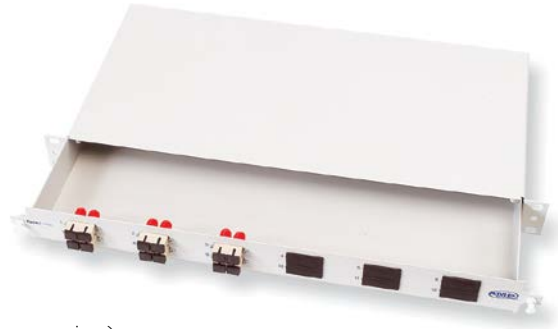

ORDERING INFORMATION

Description	Fix style Part Number	Drawer style Part Number
24 x LC Duplex/LC Duplex, unpopulated	1671121-8	1671130-8
24 x LC Duplex/LC Duplex, Multimode; With 24 adapters	4-1671121-8	4-1671130-8
24 x LC Duplex/LC Duplex, Multimode; With 12 adapters	2-1671121-4	2-1671130-8
24 x LC Duplex/LC Duplex, Singlemode; With 24 adapters	4-1671121-4	4-1671130-4
24 x LC Duplex/LC Duplex, Singlemode; With 12 adapters	2-1671121-4	2-1671130-4
24 x SC Duplex/SC Duplex; Unpopulated	1418734-1	1418735-1
12 x SC Duplex/SC Duplex; Unpopulated	969615-1	969994-1
12 x SC Duplex/SC Duplex, Multimode; With 12 adapters	1-969619-1	969631-1
12 x SC Duplex/SC Duplex, Multimode; With 6 adapters	1-969617-1	969629-1
12 x SC Duplex/SC Duplex, Singlemode; With 12 adapters	1418731-1	1418733-1
12 x SC Duplex/SC Duplex, Singlemode; With 6 adapters	1418730-1	1418732-1
24 x ST Style; Unpopulated	969614-1	969993-1
24 x ST Style Multimode; With 24 adapters	1-969618-1	969630-1
24 x ST Style Multimode; With 12 adapters	1-969616-1	969628-1

1U MT-RJ patch panel, international version

FEATURES

- MT-RJ panel, 1U, 19"
- Holds up to 24 MT-RJ Jacks or up to 24 MT-RJ pigtails
- Drawer style, slide and tilt
- Incl. management rings
- Splice tray not included

Color: black (RAL 9005)



ORDERING INFORMATION

Description	Part Number
24 positions for MT-RJ jacks accepts: MT-RJ panel jack or MT-RJ pigtails with 6 cable entries, incl. 2 metric glands	1206704-4

Fiber Optic Cabling

Patch Panels

Fiber Optic 1U Plastic Fiber Patch Panel

FEATURES

- 1U sliding panel for ease of access and standard deployment into 19 inch racks
- Internal cable management protects splices and pigtails and maintains bend radius
- A PC-ABS construction means that the tray is both lightweight whilst retaining mechanical strength
- UL94V -0 flammability rating, allows usage within a building



ORDERING INFORMATION

Description	Color	Adaptor	Fiber type	Part Number
Fiber patch panel 12 port	grey	6 x SC Duplex	multimode	7033 1 080-12
Fiber patch panel 24 port	grey	12 x SC Duplex	multimode	7033 1 080-24
Fiber Patch Panel 12 Port	black	6 x SC Duplex	multimode	7033 1 180-12
Fiber Patch Panel 24 Port	black	12 x SC duplex	multimode	7033 1 180-24
Fiber Patch Panel 12 Port	grey	12 x ST	multimode	7033 1 082-12
Fiber Patch Panel 24 Port	grey	24 x ST	multimode	7033 1 082-24
Fiber Patch Panel 12 Port	black	12 x ST	multimode	7033 1 182-12
Fiber Patch Panel 24 Port	black	24 x ST	multimode	7034 1 182-24
Fiber patch panel 24 port	grey	12x LC Duplex	multimode	7033 1 103-12
Fiber patch panel 48 port	grey	24 x LC Duplex	multimode	7034 1 103-24
Fiber patch panel 12 port	grey	6 x SC Duplex	singlemode	7033 1 101-12
Fiber patch panel 24 port	grey	12 x SC Duplex	singlemode	7033 1 101-24
Fiber patch panel 24 port	grey	12 x LC Duplex	singlemode	7033 1 084-12
Fiber patch panel 48 port	grey	24 x LC Duplex	singlemode	7034 1 084-24

Fiber Optic Cabling

Accessories for Patch Panels

Accessories for Patch Panels, 1U Modular Fiber Optic Panel Flushmount Style

ORDERING INFORMATION

Description	Part Number
Cable management kit with glands; Packaging: 1; For 1U - Modular Fiber Optic Panel - Flushmount style	1671273-1
Cable termination kit with flex tube; Packaging: 1; For 1U - Modular Fiber Optic Panel - Flushmount style	1671274-1



Accessories for Patch Panels, German Version

ORDERING INFORMATION

Description	Part Number
45° cable entry plate for metric glands (german style panels only); Packing: 1	1418770-1



Fiber Optic Cabling

Accessories for Patch Panels

Accessories for all Patch Panels



ORDERING INFORMATION

Description	Part Number
Dust cover for SC Duplex Cut-Out; Packaging: 100	1206121-2
Dust cover for ST-Style Cut-Out; Packaging: 100	1206134-1
PG 9 Gland (3.5-8 mm); Packaging: 50	1206144-1
PG 16 Gland (9-14 mm); Packaging: 50	1206145-1
Cable management ring kit (2 rings); Packaging: 1	1206146-1
Dust cover for SC Simplex/LC Simplex Cut-Out; Packaging: 100	1418800-1
M 20; Packaging: 50	1671054-1
M 25; Packaging: 50	1671054-2

Fiber Optic Cabling

Quick-Fit Modules

Quick-Fit Fiber Modules

FEATURES

- Universal Modules with Quick-Fit footprint
- Fit in all TE CONNECTIVITY Patch Panels with Quick-Fit footprint
- Not interchangeable with push pin fixation

Color: black (RAL 9005)

Note: MT-RJ panel jacks NOT include



ORDERING INFORMATION

Description	Color	Part Number
6 x LC duplex; Fiber Type: OM2; Ferrule: Ceramic	Black	1671196-2
6 x LC duplex; Fiber Type: OM3 XG 10 Gb/s; Ferrule: Ceramic	Aqua	1671196-3
6 x LC duplex; Fiber Type: OS2; Ferrule: Ceramic	Blue	1671196-1
6 x LC/APC duplex; Fiber Type: OS2; Ferrule: Ceramic	Green	1671196-4
6 x LC quad; Fiber Type: OM2; Ferrule: Composite	Beige	1671202-2
6 x LC quad; Fiber Type: OM3 XG 10 Gb/s; Ferrule: Ceramic	Aqua	1671202-3
6 x LC quad; Fiber Type: OS2; Ferrule: Ceramic	Blue	1671202-1
6 x LC/APC quad; Fiber Type: OS2; Ferrule: Ceramic	Green	1671202-4
6 x MT-RJ*; Fiber Type: OM2; Ferrule: Composite	Black	1671197-2
6 x MT-RJ*; Fiber Type: OM3 XG 10 Gb/s; Ferrule: Ceramic	Aqua	1671197-3
6 x MT-RJ*; Fiber Type: OS2; Ferrule: Ceramic	Blue	1671197-1
6 x SC duplex; Fiber Type: OM2; Ferrule: Ceramic	Beige	1671201-2
6 x SC duplex; Fiber Type: OM3 XG 10 Gb/s; Ferrule: Ceramic	Aqua	1671201-3
6 x SC duplex; Fiber Type: OS2; Ferrule: Ceramic	Blue	1671201-1
6x SC/APC duplex; Fiber Type: OS2; Ferrule: Ceramic	Green	1671201-4
6 x ST; Fiber Type: Multimode; metallic body; Ferrule: Composite		1671195-2
6 x ST; Fiber Type: Singlemode; metallic body; Ferrule: Ceramic		1671195-1
Blank module		1479698-1

MPO/MPOptimate coupler Quick-Fit module

FEATURES

- Quick-Fit module with 6 x MPO coupler
- Port number labeling and additional label strip included
- MPO coupler always used with on one side MPO male and other side MPO female connector

Color: black (RAL 9005)

ORDERING INFORMATION

Description	Part Number
6 x MPO coupler module	1671200-1
12 x MPO coupler module	1711987-1



Fiber Optic Cabling

Wall Mount Enclosures

Wall Mount Enclosure for 6 Modules, Unloaded, with Side Door

FEATURES

- Accepts 6 Snap-In-Modules (Snap-In Modules)
- Optional lock available (559501-2)
- Optional grommets available
- Splice tray holder available
- Designed for intrabuilding or campus backbone applications
- Reversible cable strain relief bracket
- Recessed, easy-to-use door latches
- Dimensions (for exact dimensions consult customer drawing):
16.5" (40 cm) H x 14" (35.5 cm) D x 5" (13 cm) W

Color: black (RAL 9005)



ORDERING INFORMATION

Description	Part Number
With grommets, cable glands and splice tray holder	1278755-4
Splice tray holder kit	1374526-1
Grommets	559496-2
Lock	559501-2

Wall Mount Enclosure 2F/4F (Plastic)

FEATURES

- Pre-installed adapter
- Size: 125 x 150 x 65 mm (W x H x D)
- IP 53 rated

ORDERING INFORMATION

Description	Part Number
Wall Mount Enclosure 2F, 1 x SC Duplex, MM	1671116-1
Wall Mount Enclosure 2F, 1 x SC Duplex, SM	1671116-2
Wall mount enclosure 4F, 1 x LC quad, MM	1671116-3
Wall mount enclosure 4F, 1 x LC quad, SM	1671116-4



Fiber Optic Cabling

Wall Mount Enclosures

Wall Mount Enclosure 6F/12F (Plastic)

FEATURES

- Pre-installed adapters
- Incl. management ring
- Size: 225 x 280 x 85 mm (W x H x D)
- IP 53 rated

ORDERING INFORMATION

Description	Part Number
Wall Mount Enclosure 6F, 1 x SC Duplex, MM	1671117-1
Wall Mount Enclosure 6F, 1 x SC Duplex, SM	1671117-2
Wall Mount Enclosure 12F, 3 x LC quad, MM	1671117-3
Wall Mount Enclosure 12F, 3 x LC quad, SM	1671117-4



Wall Mount Enclosure 12/24F (Plastic)

FEATURES

- Pre-installed adapters
- Incl. management ring
- Supplied without splicing tray
- Size: 220 x 325 x 110 mm (W x H x D)
- IP 53 rated

ORDERING INFORMATION

Description	Part Number
Wall Mount Enclosure 12F, 1 x SC Duplex, MM	1671118-1
Wall Mount Enclosure 12F, 1 x SC Duplex, SM	1671118-2
Wall Mount Enclosure 24F, 1 x SC Duplex, MM	1-1671118-1
Wall Mount Enclosure 24F, 1 x SC Duplex, SM	1-1671118-2
Wall Mount Enclosure 24F, 6 x LC quad, MM	1671118-3
Wall Mount Enclosure 24F, 6 x LC quad, SM	1671118-4



Fiber Optic Cabling

Snap-In Modules

MPO/MPOptimate Snap-In module

FEATURES

- Fits in all TE CONNECTIVITY patch panels for Snap-In modules

Color: black (RAL 9005)



ORDERING INFORMATION

Description	Part Number
MPO coupler 6 x 12 fibers (multimode + singlemode); Packaging: 1	1374598-1

LC Snap-In-Modules

FEATURES

- Fits in all TE CONNECTIVITY patch panels for Snap-In modules

ORDERING INFORMATION

Description	Part Number
LC Duplex, 12 fibers (Singlemode), Packaging: 1	1374463-1
LC Duplex, 12 fibers (Multimode), Packaging: 1	1374463-2



SC Snap-In-Modules

FEATURES

- Fits in all TE CONNECTIVITY Patch Panels for Snap-In-Modules

ORDERING INFORMATION

Description	Part Number
Duplex SC, 6 fibers; Packaging: 1; Fiber type: Multimode	559558-1
Duplex SC, 6 fibers; Packaging: 1; Fiber type: Singlemode	559558-2
Duplex SC, 12 fibers; Packaging: 1; Fiber type: Multimode	559596-1
Duplex SC, 12 fibers; Packaging: 1; Fiber type: Singlemode	559596-2

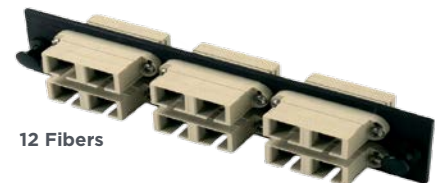

SC to ST-Style Snap-In-Modules

FEATURES

- Fits in all TE CONNECTIVITY Patch Panels for Snap-In-Modules

ORDERING INFORMATION

Description	Part Number
Duplex SC to ST-Style, 12 fibers (Multimode), Packaging: 1	1278368-1
Duplex SC to ST-Style, 6 fibers (Multimode), Packaging: 1	559601-1



Fiber Optic Cabling

Snap-In Modules

ST-Style Snap-In-Modules

FEATURES

- Fits in all TE CONNECTIVITY Patch Panels for Snap-In-Modules

ORDERING INFORMATION

Description	Part Number
ST-Style, 12 fibers (Multimode); Packaging: 1	1278567-1
ST-Style, 12 fibers (Singlemode); Packaging: 1	1278567-2
ST-Style, 6 fibers (Singlemode); Packaging: 1	559515-2
ST-Style, 6 fibers (Multimode); Packaging: 1	559557-1



12 Fibers



6 Fibers

MT-RJ Snap-In-Modules

FEATURES

- Holds up to six MT-RJ Jacks or MT-RJ Jack pigtails
- Fits in TE CONNECTIVITY Patch Panels for Snap-In-Modules
- Individual ports icon-able

ORDERING INFORMATION

Description	Part Number
Snap-In-Module for 6 MT-RJ Jacks or Jack Pigtails	1278328-3



SL Snap-In-Modules

FEATURES

- Fits in all TE CONNECTIVITY Patch Panels for Snap-In modules

ORDERING INFORMATION

Description	Part Number
6 port SL, black	1479506-1
6 port SL, not painted	1671168-1

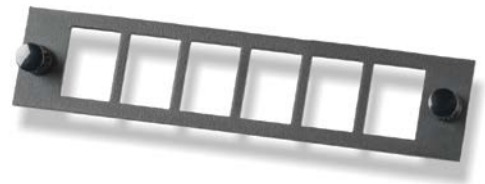

Snap-In blank modules

ORDERING INFORMATION

Description	Part Number
Blank module for panel \geq 2 U and wall mount box; Packaging: 1	559523-1
Blank module, Packaging: 1	1671146-1



Fiber Optic Cabling

Pre-assembled LC & SC Trunks

Multi fiber pre-assembled trunk cables

FEATURES:

- Factory pre-assembled 6 or 12 fiber trunks
- Simplex connectors at each end (LC/LC, SC/SC or LC/SC)
- LSZH cable loose tube indoor/outdoor cable
- Staggered tails provide easy cable management
- Tail lengths: 4x40+4x50+4x60 (6x50 for 6 fiber cables)
- Other cable constructions/configurations available on request
- The trunks are equipped with midi fan-out and 2mm round tails protected with transparent protection sleeve
- All cords with protocol, for constant and reliable quality
- Packaging: ≤50 m in box, >50 m on reel
- Re-usable pulling socks can be ordered separately (Part Number 2055567-1, see page 21)



ORDERING INFORMATION

		Fiber type	Part Number	Part Number
			2-99 m table A*	100-500m table B*
12 fiber assembly	SC/SC	OM3	Y-2055665-X	Y-2055666-X
	SC/SC	OM4	Y-2055613-X	Y-2055614-X
	SC/SC	SM	Y-2055687-X	Y-2055688-X
	LC/LC	OM3	Y-2055725-X	Y-2055726-X
	LC/LC	OM4	Y-2055583-X	Y-2055584-X
	LC/LC	SM	Y-2055727-X	Y-2055728-X
	LC/SC	OM3	Y-2055667-X	Y-2055668-X
	LC/SC	SM	Y-2255669-X	Y-2055670-X
6 fiber assembly	LC/LC	OM3	Y-2160142-X	Y-2160143-X
	LC/LC	OM4	Y-2160144-X	Y-2160145-X
	LC/LC	SM	Y-2055740-X	Y-2055741-X

* For length tables A and B please refer to page 2 in the MPO/MPOptimate Chapter.

Fiber Optic Cabling

Patch Cords and Pigtails/Technical Data

Technical Data for Patch Cords & Pigtails

- All assemblies are machine polished providing highest quality.
- Multimode OM3, OM4 and singlemode OS2 assemblies have an ensured performance by Optimized-Physical-Contact (OPC).
- All assemblies are factory tested and come with a test protocol.
- Attenuation and Return Loss values specified against reference connectors.



For all OM4 assemblies



For all OM3, OM4 & OS2 assemblies

PATCH CORDS

Fiber Cable		Connector Ferrule Material		
Cable sheath material	LSZH		LC, SC, ST	ceramic
LC	mini twinzip 1.8mm		MT-RJ, MPO	thermoplastic
SC, ST	twinzip 2.5mm			
LC duplex uniboot	dualan round 2mm			
MT-RJ	mini twinzip 1.8mm			

MULTIMODE	FIBER TYPE	MAX. ATTENUATION [dB]*	MIN. RETURN LOSS [dB]*	TEMP RANGE
LC/PC & SC/PC & ST/PC	OM1, OM2	0.3	20	-10°C / +60°C
LC/PC & SC/PC	OM3	0.3	25	-10°C / +60°C
LC/PC & SC/PC (LOW LOSS)	OM3, OM4	0.15	35	-10°C / +60°C
MT-RJ	OM1, OM2	0.5	20	-10°C / +60°C
MT-RJ	OM3	0.5	25	-10°C / +60°C
MPO	OM1, OM2	0.75	20	-10°C / +60°C
MPO	OM3	0.5	25	-10°C / +60°C
MPOptimate	OM3, OM4	0.35	28	-10°C / +60°C

SINGLEMODE

LC/PC & SC/PC & ST/PC	OS2	0.3	45	-10°C / +60°C
LC/APC & SC/APC	OS2	0.3	65	-10°C / +60°C
MT-RJ	OS2	0.75	35	-10°C / +60°C
MPO, MPO/APC	OS2	0.6	35	-10°C / +60°C

* Attenuation and return loss values against reference connector

PIGTAILS

Fiber Cable	Connector Ferrule Material		
Tight buffer or semi-tight		LC, SC, ST	ceramic
(specified per part number)		MT-RJ	thermoplastic

MULTIMODE	FIBER TYPE	MAX. ATTENUATION [dB]*	MIN. RETURN LOSS [dB]*	TEMP RANGE
LC/PC & SC/PC & ST/PC	OM1, OM2	0.3	20	-10°C / +60°C
LC/PC & SC/PC	OM3	0.3	25	-10°C / +60°C
LC/PC & SC/PC (LOW LOSS)	OM3, OM4	0.15	35	-10°C / +60°C
MT-RJ	OM1, OM2	0.5	20	-10°C / +60°C
MT-RJ	OM3	0.5	25	-10°C / +60°C

SINGLEMODE

LC/PC & SC/PC & ST/PC	OS2	0.3	45	-10°C / +60°C
LC/APC & SC/APC	OS2	0.3	65	-10°C / +60°C
MT-RJ	OS2	0.75	35	-10°C / +60°C

* Attenuation and return loss values against reference connector

Fiber Optic Cabling

Patch Cords and Pigtails

LC Duplex Uniboot - LC Duplex Uniboot

FEATURES

- All assemblies are machine polished providing the highest quality
- Multimode OM3, OM4 and singlemode assemblies have an ensured performance by Optimized-Physical-Contact (OPC)
- All assemblies are factory tested and come with a test protocol

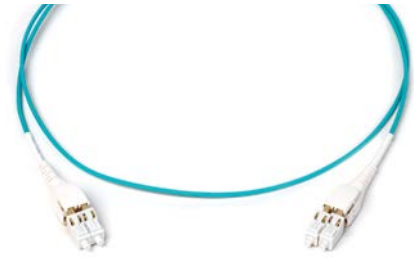

ORDERING INFORMATION

Description	Part Number
OM2	Y-2160404-X
OM3	Y-2160349-X
OM4	Y-2160588-X

Y- -X	Length
0- -1	1 m
0- -2	2 m
0- -3	3 m
0- -5	5 m
1- -0	10 m

LC Duplex / LC Duplex Patch Cords

FEATURES

- All assemblies are machine polished providing highest quality.
- Multimode OM3, OM4 and singlemode OS2 assemblies have an ensured performance by Optimized-Physical-Contact (OPC).
- All assemblies are factory tested and come with a test protocol.

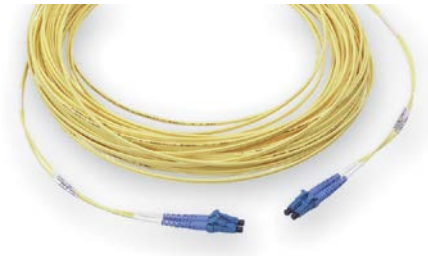

ORDERING INFORMATION

Description	Part Number
OS2	Y-6536501-X
OS2/APC	Y-2160008-X
OM2	Y-6536502-X
OM1	Y-6536503-X
OM3 XG 10 Gb/s	Y-6536969-X
OM4	Y-2160046-X

Y- -X	Length
0- -1	1 m
0- -2	2 m
0- -3	3 m
0- -5	5 m
1- -0	10 m

Fiber Optic Cabling

Patch Cords and Pigtails

LC Duplex / SC Duplex Patch Cords

FEATURES

- All assemblies are machine polished providing highest quality.
- Multimode OM3, OM4 and singlemode OS2 assemblies have an ensured performance by Optimized-Physical-Contact (OPC).
- All assemblies are factory tested and come with a test protocol.

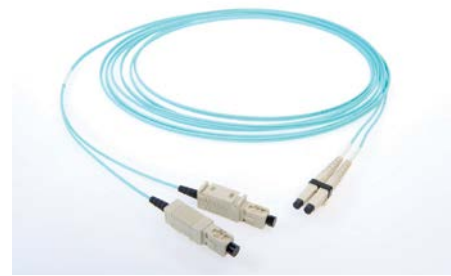

ORDERING INFORMATION

Description	Part Number	Y- -X	Length
OS2	Y-6536508-X	0- -1	1 m
OM2	Y-6536509-X	0- -2	2 m
OM1	Y-6536510-X	0- -3	3 m
OM3 XG 10 Gb/s	Y-6536967-X	0- -5	5 m
OM4	Y-2160048-X	1- -0	10 m

LC Duplex / ST-Style Patch Cords

FEATURES

- All assemblies are machine polished providing highest quality.
- Multimode OM3 and singlemode OS2 assemblies have an ensured performance by Optimized-Physical-Contact (OPC).
- All assemblies are factory tested and come with a test protocol.



ORDERING INFORMATION

Description	Part Number	Y- -X	Length
OS2	Y-6695657-X	0- -1	1 m
OM2	Y-1568757-X	0- -2	2 m
OM1	Y-6695121-X	0- -3	3 m
OM3 XG 10 Gb/s	Y-6695697-X	0- -5	5 m
		1- -0	10 m

Fiber Optic Cabling

Patch Cords and Pigtails

SC Duplex / SC Duplex Patch Cords

FEATURES

- All assemblies are machine polished providing highest quality.
- Multimode OM3, OM4 and singlemode OS2 assemblies have an ensured performance by Optimized-Physical-Contact (OPC).
- All assemblies are factory tested and come with a test protocol.



ORDERING INFORMATION

Description	Part Number	Y- -X	Length
OS2	Y-6348260-X	0- -1	1 m
OS2/APC	Y-6536767-X	0- -2	2 m
OM2	Y-5349565-X	0- -3	3 m
OM1	Y-5349578-X	0- -5	5 m
OM3 XG 10 Gb/s	Y-6536464-X	1- -0	10 m
OM4	Y-2160047-X		

SC Duplex / ST-Style Duplex Patch Cords

FEATURES

- All assemblies are machine polished providing highest quality.
- All assemblies are factory tested and come with a test protocol.

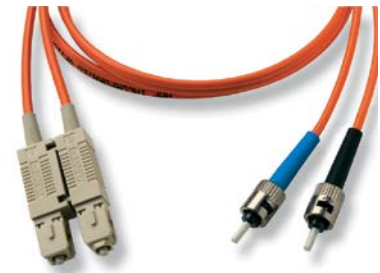

ORDERING INFORMATION

Description	Part Number	Y- -X	Length
OM2	Y-5349567-X	0- -1	1 m
OM1	Y-5349580-X	0- -2	2 m
		0- -3	3 m
		0- -5	5 m
		1- -0	10 m

ST-Style Duplex / ST-Style Duplex Patch Cords

FEATURES

- All assemblies are machine polished providing highest quality.
- Singlemode OS2 assemblies have an ensured performance by Optimized-Physical-Contact (OPC).
- All assemblies are factory tested and come with a test protocol.



ORDERING INFORMATION

Description	Part Number	Y- -X	Length
OS2	Y-6206158-X	0- -1	1 m
OM2	Y-5349561-X	0- -2	2 m
OM1	Y-5349574-X	0- -3	3 m
		0- -5	5 m
		1- -0	10 m

Fiber Optic Cabling

Patch Cords and Pigtails

MT-RJ/MT-RJ Patch Cords

FEATURES

- All assemblies are machine polished providing highest quality.
- Multimode OM3 and singlemode OS2 assemblies have an ensured performance by Optimized-Physical-Contact (OPC).
- All assemblies are factory tested and come with a test protocol.



ORDERING INFORMATION

Description	Part Number	Y- -X	Length
OS2	Y-6206621-X	0- -1	1 m
OM2	Y-6206617-X	0- -2	2 m
OM1	Y-6206613-X	0- -5	5 m
OM3 XG 10 Gb/s	Y-6536462-X	1- -0	10 m

MT-RJ/LC Duplex Patch Cords

FEATURES

- All assemblies are machine polished providing highest quality.
- Multimode OM3 and singlemode OS2 assemblies have an ensured performance by Optimized-Physical-Contact (OPC).
- All assemblies are factory tested and come with a test protocol.



ORDERING INFORMATION

Description	Part Number	Y- -X	Length
OS2	Y-6536511-X	0- -1	1 m
OM2	Y-6536512-X	0- -2	2 m
OM1	Y-6536513-X	0- -3	3 m
OM3 XG 10 Gb/s	Y-6536968-X	0- -5	5 m
		1- -0	10 m

MT-RJ/SC Duplex Patch Cords

FEATURES

- All assemblies are machine polished providing highest quality.
- Multimode OM3 and singlemode OS2 assemblies have an ensured performance by Optimized-Physical-Contact (OPC).
- All assemblies are factory tested and come with a test protocol.



ORDERING INFORMATION

Description	Part Number	Y- -X	Length
OS2	Y-6206623-X	0- -1	1 m
OM2	Y-6206619-X	0- -2	2 m
OM1	Y-6206615-X	0- -3	3 m
OM3 XG 10 Gb/s	Y-6536463-X	0- -5	5 m
		1- -0	10 m

Fiber Optic Cabling

Patch Cords and Pigtails

MT-RJ/ST-Style Duplex Patch Cords

FEATURES

- All assemblies are machine polished providing highest quality.
- Multimode OM3 and singlemode OS2 assemblies have an ensured performance by Optimized-Physical-Contact (OPC).
- All assemblies are factory tested and come with a test protocol.



Y- -X	Length
0- -1	1 m
0- -2	2 m
0- -3	3 m
0- -5	5 m
1- -0	10 m

ORDERING INFORMATION

Description	Part Number
OM2	Y-6206620-X
OM1	Y-6206616-X

Mode Conditioning Patch Cords

FEATURES

- Used for the implementation of Gigabit and 10 Gigabit Ethernet laser based transmissions over multimode fiber (MMF)
- For 50 μm and 62,5 μm fibers
- LSZH sheath
- Standard length 3 m

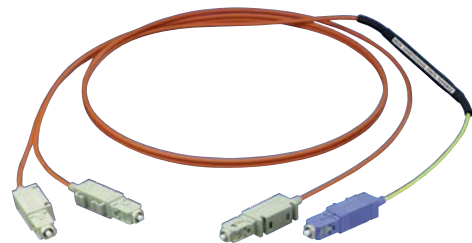

ORDERING INFORMATION

Description	Part Number
LC Duplex (SM) to LC Duplex, OM2; Length: 3 m	6536803-3
LC Duplex (SM) to SC Duplex, OM2; Length: 3 m	6536810-3
LC Duplex (SM) to SC Duplex, OM1; Length: 3 m	6536811-3
LC Duplex (SM) to ST-Style Duplex, OM1; Length: 3 m	6695313-3
SC Duplex to SC Duplex; OM2; Length: 3 m	6206820-3
SC Duplex to SC Duplex; OM2; Length: 3 m	6206821-3
SC Duplex (SM) to ST-Style Duplex; OM2; Length: 3 m	6348269-3
SC Duplex to ST-Style Duplex; OM1; Length: 3 m	6348271-3
SC Duplex (SM) to MT-RJ; OM2; Length: 3 m	6536769-3
SC Duplex (SM) to MT-RJ; OM1; Length: 3 m	6536770-3
MT-RJ (SM) to SC Duplex; OM2; Length: 3 m	6536447-3
MT-RJ (SM) to SC Duplex; OM; Length: 3 m	6536446-3
MT-RJ (SM) to ST-Style Duplex; OM2; Length: 3 m	6536445-3
MT-RJ (SM) to ST-Style Duplex; OM1; Length: 3 m	6536444-3

Fiber Optic Cabling

Patch Cords and Pigtails

LC Pigtails

FEATURES

- All assemblies are machine polished providing highest quality.
- Multimode OM3, OM4 and singlemode OS2 assemblies have an ensured performance by Optimized-Physical-Contact (OPC).
- All assemblies are factory tested and come with a test protocol.

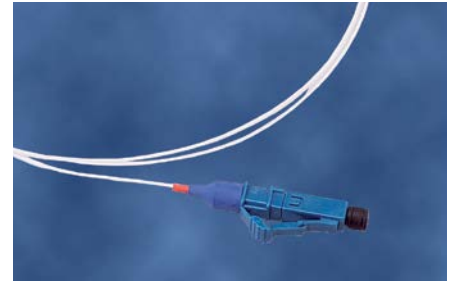

ORDERING INFORMATION

Description	Part Number
LC tuned; OS2; Strip: semi-tight; Length: 2 m	6536880-2
LC tuned; OS2; Strip: tight; Length: 2 m	6695512-2
LC/APC; OS2; Strip: semi-tight; Length: 2 m	2055425-2
LC; OM1; Strip: semi-tight; Length: 2 m	6536974-2
LC; OM1; Strip: tight; Length: 2 m	6695510-2
LC; OM2; Strip: semi-tight; Length: 2 m	6536975-2
LC; OM2; Strip: tight; Length: 2 m	6695509-2
LC; OM3 XG 10 Gb/s; Strip: semi-tight; Length: 2 m	6536966-2
LC; OM3 XG 10 Gb/s; Strip: tight; Length: 2 m	6695511-2
LC; OM4; Strip: semi-tight buffer; Length: 2 m	2160042-2
LC; OM4; Strip: tight buffer; Length: 2 m	2160040-2

SC Pigtails

FEATURES

- All assemblies are machine polished providing highest quality.
- Multimode OM3, OM4 and singlemode OS2 assemblies have an ensured performance by Optimized-Physical-Contact (OPC).
- All assemblies are factory tested and come with a test protocol.



ORDERING INFORMATION

Description	Part Number
SC/PC tuned; OS2; Strip: semi-tight; Length: 2 m	5233582-2
SC/PC tuned; OS2; Strip: tight; Length: 2 m	6695508-2
SC/APC; OS2; Strip: semi-tight; Length: 2 m	5233103-2
SC; OM1; Strip: semi-tight; Length: 2 m	5349584-4
SC; OM1; Strip: tight buffer; Length: 2 m	6695506-2
SC; OM2; Strip: semi-tight; Length: 2 m	5349568-4
SC; OM2; Strip: tight buffer; Length: 2 m	6695505-2
SC OM3 XG 10 Gb/s (Strip length ca. 0.8 m); Strip: semi-tight; Length: 2 m	6536555-2
SC OM3 XG 10 Gb/s; Strip: tight; Length: 2 m	6695507-2
SC; OM4; Strip: semi-tight buffer; Length: 2 m	2160043-2
SC; OM4; Strip: tight buffer; Length: 2 m	2160041-2

Fiber Optic Cabling

Patch Cords and Pigtails

ST-Style Pigtails

FEATURES

- All assemblies are machine polished providing highest quality.
- All assemblies are factory tested and come with a test protocol.

ORDERING INFORMATION

Description	Part Number
ST-Style; OM2; Length: 2 m	5349569-4
ST-Style; OM1; Length: 2 m	5349582-4



MT-RJ Pigtails

FEATURES

- Fits in all TE CONNECTIVITY MT-RJ Patch Panels
- Multimode OM3 and singlemode OS2 assemblies have an ensured performance by Optimized-Physical-Contact (OPC).
- Colored housing optional available

ORDERING INFORMATION

Description	Part Number
MT-RJ SL Series Housing; Color: almond	1374416-1
MT-RJ SL Series Housing; Color: black	1374416-2
MT-RJ SL Series Housing; Color: white	1374416-3
MT-RJ SL Series Housing; Color: grey	1374416-4
MT-RJ SL Series Housing; Color: electrical ivory	1-1374416-1
MT-RJ Jack Pigtail; OM1; Color: black; Length: 3 m;	6348941-1
MT-RJ Jack Pigtail; OM2; Color: black; Length: 3 m;	6348942-1
MT-RJ Jack Pigtail; OS2; Color: blue; Length: 3 m;	6391366-1
MT-RJ Jack Pigtail; OM3 10GBit XG; Color: black; Length: 3 m;	6536556-1

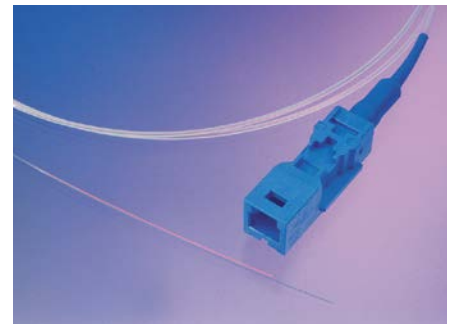

Fiber Optic Cabling

Outlets

Universal Fiber Optic wall outlets

FEATURES

- Unpopulated wall outlets for all Fiber-to-the-Desk applications (Inserts to be ordered separately)

Color: pure white (RAL 9010)



ORDERING INFORMATION

Description	Part Number
"45x45" Outlet 45 x 45 mm for SC-Duplex, ST-Style, SL adaptor or MT-RJ jack; Color: white (RAL 9010)	183931-1
DIN Outlet for SC Duplex or SC/ST-Style Duplex Adaptor; Frame: No; Color: almond (RAL 1013)	966936-2
DIN Outlet for SC Duplex or SC/ST-Style Duplex Adaptor; Frame: No; Color: white (RAL 9010)	2-966936-2

DIN Dual Angled Outlet

FEATURES

- Dual outlet to accept either up to 2 SL Series Jacks
- To be used with single or multiple gang DIN faceplates
- Supplied complete with back plate, adapter plate and shutters
- Individual ports are icon-able



ORDERING INFORMATION

Description	Part Number
DIN Dual Angled Outlet, for 2x Slim Line Jack; Color: almond (RAL 1013)	966936-5
DIN Dual Angled Outlet, for 2x Slim Line Jack; Color: pure white (RAL 9010)	2-966936-5

Fiber Optic Cabling

Outlets

DIN Surface Mount Outlet Back Box

FEATURES

- Back Box for Surface Mounting
- Available individually or as a complete kit with a single faceplate
- Not suitable for use with multiple faceplates



ORDERING INFORMATION

Description	Part Number
Surface Mount Outlet Back Box; almond (RAL 1013); Back box only	966740-1
Surface Mount Outlet Back Box; almond (RAL 1013); Back box + faceplate	966740-2
Surface Mount Outlet Back Box; pure white (RAL 9010); Back box only	2-966740-1
Surface Mount Outlet Back Box; pure white (RAL 9010); Back box + faceplate	2-966740-2
Adaptor DIN RAIL to DIN Surface Mount Outlet Back Box	1671164-1

Cable Management for 2 Port Wall Outlets

FEATURES

- Cable management with strain relief for the cable
- For all DIN style wall outlets

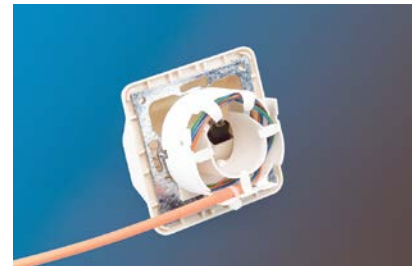

ORDERING INFORMATION

Description	Part Number
Cable management	1534332-1

Fiber Optic Cabling

Outlets

Fiber Optic Wall Outlet

FEATURES

- Designed for modern small-form-factor deployments and into legacy Gigabit Ethernet deployments.
- MT-RJ offers both singlemode and multimode solutions, whilst LC, SC, and ST are available as a multimode solution.
- Integrated cable management allows diverse routing for excess spool management and maintenance of bend radius whilst the Fiber optic cable is housed in the solution.
- The footprint suits standard (BS4660) electrical wall back boxes for deployment in trunking and walls.
- Designed to allow the insertion of heat shrink splice protection holders giving the flexibility to choose between direct termination and splicing.
- Anchor points allow the Fiber optic cable to be tied-off at the point of entry into the base which prevents the cable from slipping back into a wall recess during installation.
- Per port labelling provides easy identification of each subscriber network link.



ORDERING INFORMATION

Description	Part Number
1 x SC duplex outlet	7033106902
2 x SC duplex outlet	7033106904
2 x ST outlet	7033107102
4 x ST outlet	7033107104
1 x LC quad outlet	1350376
2 x LC quad outlet	1350377

Fiber Optic Cabling

Adaptors

LC Duplex/LC Duplex Adaptors

FEATURES

- Suitable for any LC Duplex connector
- Fits in any SC Simplex cut-out
- Available for singlemode and multimode



ORDERING INFORMATION

Description	Part Number
Housing: Plastic; Sleeve: Ceramic; Color: blue; Mounting: Clip/Screw; Application: SM	6457567-4
Housing: Plastic; Sleeve: Ceramic; Color: almond; Mounting: Clip/Screw; Application MM	6457567-5
Housing: Plastic; Sleeve: Ceramic; Color: green; Mounting: Clip/Screw; Application: SM	2125019-2
Housing: Plastic; Sleeve: Metal; Color: almond; Mounting: Clip/Screw; Application: MM	6457567-8
Housing: Plastic; Sleeve: Ceramic; Color: aqua; Mounting: Clip/Screw; Application: OM3 XG 10Gb/s	1-6457567-6

LC Quad/LC Quad Adaptors

FEATURES

- Suitable for any LC Duplex connector
- Fits in any SC Duplex cut-out
- Available for singlemode and multimode



ORDERING INFORMATION

Description	Part Number
Housing: Plastic; Sleeve: Ceramic; Color: blue; Mounting: Clip/Screw; Application: SM	1695790-4
Housing: Plastic; Sleeve: Metal; Color: beige; Mounting: Clip/Screw; Application: MM	1695790-5
Housing: Plastic; Sleeve: Ceramic; Color: aqua; Mounting: Clip/Screw; Application: OM3 XG 10Gb/s	1-1695790-0
Housing: Plastic; Sleeve: Ceramic; Color: green; Mounting: Clip/Screw; Application : SM	1695790-6

SC Duplex/SC Duplex Adaptors

FEATURES

- Suitable for any SC duplex connector
- Available for singlemode and multimode



ORDERING INFORMATION

Description	Part Number
Housing: Plastic; Sleeve: Ceramic; Color: blue; Mounting: Clip/Screw; Application: SM	1-5502776-1
Housing: Plastic; Sleeve: Ceramic; Color: almond; Mounting: Clip/Screw; Application: MM	1-5502776-2
Housing: Plastic; Sleeve: Ceramic; aqua; Mounting: Clip/Screw; Application: OM3 XG 10 Gb/s	2-5502776-6
Housing: Plastic; Sleeve: Metal; Color: almond; Mounting: Clip/Screw; Application: MM	5504640-1
Housing: Plastic; Sleeve: Ceramic; Color: green; Mounting: Clip/Screw; Application SM	2-5502776-3
Housing: Plastic; Sleeve: Ceramic; Color: nickel; Mounting: Clip/Screw; Application: SM/MM	6278049-3

Fiber Optic Cabling

Adaptors

SC Simplex/SC Simplex Adaptors

FEATURES

- Suitable for any SC Simplex connector
- Available for singlemode and multimode

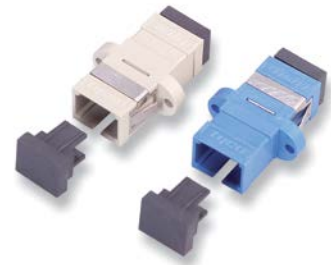

ORDERING INFORMATION

Description	Part Number
Housing: Plastic; Sleeve: Ceramic; Color: blue; Mounting: Clip/Screw; Application: SM	1-5502632-1
Housing: Plastic; Sleeve: Ceramic; Color: almond; Mounting: Clip/Screw; Application: MM	1-5502632-2
Housing: Plastic; Sleeve: Ceramic; Color: aqua; Mounting: Clip/Screw; Application: OM3 XG 10Gb/s	2-5502632-4
Housing: Plastic; Sleeve: Metal; Color: almond; Mounting: Clip/Screw; Application: MM	5504614-1

SC-APC/SC-APC Adaptors

FEATURES

- Suitable for any SC-APC connector



ORDERING INFORMATION

Description	Part Number
Simplex: Housing: Plastic; Sleeve: Ceramic; Color: green/without strap; Mounting: Clip/Screw; Application: SM	2-106901-6
Simplex: Housing: Plastic; Sleeve: Ceramic; Color: green/with strap; Mounting: Clip/Screw; Application: SM	4-106901-4
Duplex: Housing: Plastic; Sleeve: Ceramic; Color: green; Mounting: Clip/Screw; Application: SM	2-5502776-3

ST-Style Simplex/ST-Style Simplex 2.5 mm Bayonet Adaptors

FEATURES

- Suitable for any ST-style simplex connector
- Available for singlemode and multimode



ORDERING INFORMATION

Description	Part Number
Housing: Metal; Sleeve: Polymer; Application: MM	501381-1
Housing: Metal; Sleeve: Ceramic; Application: SM	502750-1
Housing: Metal; Sleeve: Metal; Application: MM	504021-1
Housing: Metal; Sleeve: Metal; Application: MM	504021-2

Fiber Optic Cabling

Adaptors

SC Duplex/ST-Style Duplex Adaptors

FEATURES

- Available for singlemode and multimode
- Suitable for any ST-Style and SC connector



ORDERING INFORMATION

Description	Part Number
Housing: Plastic; Sleeve: Ceramic; Color: blue; Mounting: Clip/Screw; Application: SM; Packaging: 10	5503137-5
Housing: Plastic; Sleeve: Ceramic; Color: almond; Mounting: Clip/Screw; Application: MM Standard; Packaging: 10	5503137-6
Housing: Plastic; Sleeve: Metal; Color: almond; Mounting: Clip/Screw; Application: MM Standard; Packaging: 10	5504663-4

SC Simplex/ST-Style Simplex Adaptors

FEATURES

- Suitable for any ST and SC Simplex connector
- Available for singlemode and multimode



ORDERING INFORMATION

Description	Part Number
Housing: Plastic; Sleeve: Metal; Color: almond; Mounting: Clip/Screw; Application: MM;	5502780-3
Housing: Plastic; Sleeve: Ceramic; Color: blue; Mounting: Clip/Screw; Application: SM;	5502780-5
Housing: Plastic; Sleeve: Ceramic; Color: almond; Mounting: Clip/Screw; Application: MM	5502780-6

MT-RJ/MT-RJ Adaptors

FEATURES

- Suitable for MT-RJ connectors
(1 connector with guide pins, the other without pins)
- Simplex coupler fits in SC simplex cut-out
- Duplex coupler fits in SC duplex cut out
- Available for singlemode and multimode



ORDERING INFORMATION

Description	Part Number
Simplex; Housing: Plastic; Color: almond; Mounting: Clip/Screw; Application: MM/SM	1278017-1
Duplex; Housing: Plastic; Color: almond; Mounting: Clip/Screw; Application: MM	6374906-1
Duplex; Housing: Plastic; Color: blue; Mounting: Clip/Screw; Application: SM	6374906-5

Fiber Optic Cabling

LightCrimp and LightCrimp Plus

AMP LightCrimp Plus Connectors

FEATURES

- Easiest and quickest fiber termination (less than one minute)
- Factory polished for consistent high quality and finish (no paper required)
- No epoxy, curing or UV-light required
- Available for ST-Style, SC and LC
- Complies with the relevant TIA/EIA, IEC, CECC und EN/IS standards
- Durability: 500 cycles



TECHNICAL DATA

- Ferrule: Ceramic
 - Attenuation typical (dB): 0.3 (MM/SM)
 - Temperature range: -10°C to +60°C
- LightCrimp Plus ST-Style; English; Part Number: 408-4457

INSTRUCTION SHEET LIGHTCRIMP PLUS

LightCrimp Plus LC; English; Part Number: 408-8925
 LightCrimp Plus SC; English; Part Number: 408-4471

LightCrimp Plus LC Connectors

FEATURES

- LC connector (simplex or duplex)
- Ceramic ferrule
- With pre-installed and pre-polished fiber



ORDERING INFORMATION

Description	Part Number
Simplex LC OS2 (1.6 to 2.0 mm Jacketed Cable); Housing: Blue; Boot: Blue; Packaging: 10	1918626-1
Simplex LC OM1 (1.6 to 2.0 mm Jacketed Cable); Housing: Beige; Boot: Beige; Packaging: 10	1918627-1
Simplex LC OM2 (1.6 to 2.0 mm Jacketed Cable); Housing: Beige; Boot: Black; Packaging: 10	1918627-2
Simplex LC OM3 XG/OM4 XG _A (1.6 to 2.0 mm Jacketed Cable); Housing: Beige; Boot: Aqua; Packaging: 10	1918627-3
Simplex LC OS2 APC (250 μm + 900 μm only); Housing: green; Boot: blue; Packaging: 10	2064181-1
Simplex LC OS2 (250 μm + 900 μm only); Housing: blue; Boot: blue; Packaging: 10	6754482-1
Simplex LC OM1 (250 μm + 900 μm only); Housing: Beige; Boot: Beige; Packaging: 10	6754483-1
Simplex LC OM2 (250 μm + 900 μm only); Housing: Beige; Boot: black; Packaging: 10	6754483-2
Simplex LC OM3 XG/OM4 XG _A (250 μm + 900 μm only); Housing: Beige; Boot: Aqua; Packaging: 10	6754483-4
Clip to connect two LC simplex to one LC duplex connector; Black (6pc per bag)	1754371-2
Clip to connect two LC simplex to one LC duplex connector; Blue	1754371-4
Clip to connect two LC simplex to one LC duplex connector; Beige	1754371-5

Fiber Optic Cabling

LightCrimp and LightCrimp Plus

LightCrimp Plus SC Connectors

FEATURES

- SC connector (simplex)
- Ceramic ferrule
- With pre-installed and pre-polished fiber

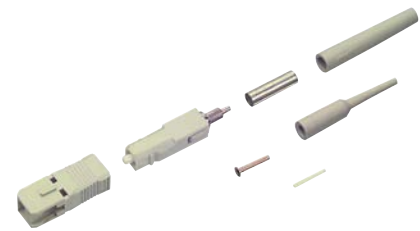

ORDERING INFORMATION

Description	Part Number
Simplex SC OS2 APC; (250 μm + 900 μm only); Body: green; Boot: Blue; Packaging: 10	2064184-1
Simplex SC OM1 (250 μm + 900 μm + 3 mm jacketed cable); Body: Beige; Boot: Beige; Packaging: 10;	5492643-1
Simplex SC OM2 (250 μm + 900 μm + 3 mm jacketed cable); Body: Beige; Boot: black; Packaging: 10;	6278079-2
Simplex SC OM3 XG/OM4 XG _A 10 Gb/s (250 μm + 900 μm + 3 mm jacketed cable); Body: Beige; Boot: Aqua; Packaging: 10;	6588291-2
Simplex SC OS2 (250 μm + 900 μm + 3 mm jacketed cable); Body: blue; Boot: blue; Packaging: 10	6693276-1
Clips to connect two SC simplex connectors to one SC duplex connector (2 clips needed); black	6348522-1
Clips to connect two SC simplex connectors to one SC duplex connector (2 clips needed); green	6348522-2
Clips to connect two SC simplex connectors to one SC duplex connector (2 clips needed); blue	6348522-3
Clips to connect two SC simplex connectors to one SC duplex connector (2 clips needed); beige	6348522-4



LightCrimp Plus ST-Style Connectors

FEATURES

- ST-Style Connectors
- Ceramic ferrule
- With pre-installed and pre-polished fiber



ORDERING INFORMATION

Description	Part Number
Simplex ST OS2 (250 μm + 900 μm + 3 mm jacketed cable); Boot: black; Packaging: 10	1828953-3
Simplex ST OM1 (250 μm + 900 μm + 3 mm jacketed cable); Boot: Beige; Packaging: 10	5492642-2
Simplex ST OM2 (250 μm + 900 μm + 3 mm jacketed cable); Boot: black; Packaging: 10	6278082-1
Simplex ST OM3 XG/OM4 XG _A (250 μm + 900 μm + 3 mm jacketed cable); Boot: Aqua; Packaging: 10	6278082-2



Fiber Optic Cabling

LightCrimp and LightCrimp Plus

LightCrimp Splice

FEATURES

- Terminates 250 micron coated and 900 micron tight buffered and 2.0 mm jacketed fibers
- Use with MM and SM 125 micron fibers
- Use with termination toolkit Part Number 1553212-1
- Typical attenuation 0.1 dB
- Typical return loss >20 dB MM and >35 dB SM
- Instruction sheets LightCrimp Splice: Part Number 408-10193



ORDERING INFORMATION

Description	Part Number
LightCrimp Splice for 250 micron coated and 900 micron tight buffered fibers	1985374-1
LightCrimp Splice for 2.0 mm jacketed fiber cable	1985805-1

AMP LightCrimp Connector

FEATURES

- Cleave, crimp, polish and connect
- High performance pre-radiussed ferrules
- Reduced polishing time
- Durability: 500 cycles
- Each connector comes in a kit containing accessories needed to terminate to 900 µm buffer, 250 µm coating and 3 mm cable
- Compliant with TIA/EIA, IEC, CECC and EN standards
- No epoxy - just polish



TECHNICAL DATA

- Ferrule: Ceramic or stainless steel
- Attenuation (dB): 0.3
- Temperature range: -40 °C (ceramic) or -25 °C (stainless steel) to +65 °C

INSTRUCTION SHEET LIGHTCRIMP

LightCrimp ST-Style; English: Part Number: 408-9860

LightCrimp SC; English; Part Number: 408-4066

Fiber Optic Cabling

LightCrimp and LightCrimp Plus

LightCrimp SC Connector

FEATURES

- SC connector (simplex or duplex)
- Ceramic ferrule
- With strain relief and crimp eyelet



ORDERING INFORMATION

Description	Part Number
Simplex SC MM; Ferrule: Ceramic; Packaging: 10	5503692-1
Duplex SC MM; Ferrule: Ceramic; Packaging: 10	5503693-1
Clip to connect two SC simplex connectors to one SC duplex connector (2 clips needed); black	6348522-1
Clip to connect two SC simplex connectors to one SC duplex connector (2 clips needed); green	6348522-2
Clip to connect two SC simplex connectors to one SC duplex connector (2 clips needed); blue	6348522-3
Clip to connect two SC simplex connectors to one SC duplex connector (2 clips needed); beige	6348522-4

LightCrimp ST-Style Connector

FEATURES

- ST-Style connector
- Multimode and singlemode
- With strain relief and crimp eyelet



ORDERING INFORMATION

Description	Part Number
Singlemode ST-Style; Ferrule: Ceramic; Packaging: 1	5504000-1
Multimode ST-Style; Ferrule: Stainless steel; Packaging: 100	5504034-1
Multimode ST-Style; Ferrule: Ceramic; Packaging: 100	5504600-1

Fiber Optic Cabling

Epoxy Connectors

LC Connector Kits

FEATURES

- Multimode and singlemode (Telcordia GR-326 tested and TIA/EIA 568-B.3 qualified)
- Universal connector body:
 - common body for simplex or duplex
 - common body for jumper or buffer applications
- Field installable duplex clip
- Improved side load strength
- Attenuation typ. < 0.2 dB
- Temperature range -40 °C to +85 °C
- Durability: 0.2 dB change after 500 cycles (MM)

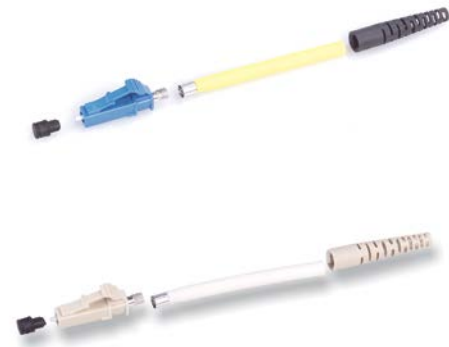

ORDERING INFORMATION

Description	Part Number
Type: Simplex; Ferrule: Ceramic; Boot: 1.6-2.0 mm; Fiber type: SM	1918266-1
Type: Simplex; Ferrule: Ceramic; Boot: 1.6-2.0 mm; Fiber type: MM	1918267-1
Type: Duplex; Ferrule: Ceramic; Boot: 1.6-2.0 mm; Fiber type: SM	1918372-1
Type: Duplex; Ferrule: Ceramic; Boot: 1.6-2.0 mm; Fiber type: MM	1918373-1
Type: Simplex; Ferrule: Ceramic; Boot: 3.0 mm; Fiber type: SM	1918374-1
Type: Simplex; Ferrule: Ceramic; Boot: 3.0 mm; Fiber type: MM	1918375-1
Type: Duplex; Ferrule: Ceramic; Boot: 3.0 mm; Fiber type: SM	1918376-1
Type: Duplex; Ferrule: Ceramic; Boot: 3.0 mm; Fiber type: MM	1918377-1
Type: Simplex; Ferrule: Ceramic; Boot: 0.9 mm; Fiber type: SM	1918384-1
Type: Simplex; Ferrule: Ceramic; Boot: 0.9 mm; Fiber type: MM	1918385-1
Type: Duplex; Ferrule: Ceramic; Boot: 0.9 mm; Fiber type: MM	1918388-1
Clip to connect two LC simplex to one LC duplex connector, Black	1754371-1
Clip to connect two LC simplex to one LC duplex connector, Black (6pc per bag)	1754371-2
Clip to connect two LC simplex to one LC duplex connector, Black (72 pc per bag)	1754371-3
Clip to connect two LC simplex to one LC duplex connector, Blue	1754371-4

Fiber Optic Cabling

Epoxy Connectors

SC Connector Kits

FEATURES

- High performance pre-radiussed ferrules
- SC compatible JIS C-5973
- Multimode or singlemode
- Durability: 0.2 dB change after 1000 cycles (MM)
- Temperature range: -40°C to +85°C
- Attenuation typ. < 0.2 dB
- Available in simplex and duplex



ORDERING INFORMATION

Description	Part Number
Bend limiting buffer boots (100 pcs); 0.9 mm; beige	6457493-9
Bend limiting buffer boots (100 pcs); 0.9 mm; black	6457493-3
Bend limiting cable boots (100 pcs); short; 3 mm; beige	5503971-1
Bend limiting cable boots (100 pcs); short; 3 mm; black	1-5503971-0
Bend limiting cable boots (100 pcs); short; 3 mm; red	1-5503971-1
Duplex; Ferrule: Ceramic; Boot: 3 mm; Crimp eyelet: yes; Fiber type: MM	5504657-1
Duplex; Ferrule: Ceramic; Boot: 3 mm; Crimp eyelet: yes; Fiber type: SM	5504655-1
Simplex; Ferrule: Ceramic; Boot: 0.9 mm; Crimp eyelet: no; Fiber type: MM	5504932-1
Simplex; Ferrule: Ceramic; Boot: 0.9 mm; Crimp eyelet: no; Fiber type: SM	5492123-1
Simplex; Ferrule: Ceramic; Boot: 3 mm; Crimp eyelet: yes; Fiber type: MM	5503948-1
Simplex; Ferrule: Ceramic; Boot: 3 mm; Crimp eyelet: yes; Fiber type: SM	5504646-1
Clip to connect two SC simplex- to one SC duplex connector; black.	6348522-1
Clip to connect two SC simplex- to one SC duplex connector; green.	6348522-2
Clip to connect two SC simplex- to one SC duplex connector; blue.	6348522-3
Clip to connect two SC simplex- to one SC duplex connector; beige.	6348522-4

Fiber Optic Cabling

Epoxy Connectors

ST-Style Connector Kits

FEATURES

- High performance pre-radiussed ferrules
- ST-Style compatible bayonet coupling
- Multimode or singlemode
- Durability: 0,2 dB change after 1000 cycles (MM)
- Temperature range: -20°C to +75°C
- Attenuation typ. < 0,3 dB
- Available in DieCast and overmolded (OVM) version



ORDERING INFORMATION

Description	Part Number
Bend limiting buffer boots (100 pcs); 0.9 mm; black	5503628-2
Bend limiting cable boots (100 pcs); short; 3 mm; black	501457-1
Bend limiting cable boots (100 pcs); short; 3 mm; red	501457-3
Ferrule: Ceramic; Connector body/bayonet: DieCast/Metal; 3 mm boot: no; 0.9 mm boot: yes; Crimp eyelet: yes; Fiber type: SM	502613-2
Ferrule: Ceramic; Connector body/bayonet: DieCast/Metal; 3 mm boot: yes; 0.9 mm boot: no; Crimp eyelet: yes; Fiber type: SM	5502580-2
Ferrule: Ceramic; Connector body/bayonet: OVM/Metal; 3 mm boot: no; 0.9 mm boot: no; Crimp eyelet: yes; Fiber type: MM	503676-1
Ferrule: Ceramic; Connector body/bayonet: OVM/Metal; 3 mm boot: yes; 0.9 mm boot: no; Crimp eyelet: yes; Fiber type: MM	503677-1

Fiber Optic Cabling

Splicing Products

Splice Trays

FEATURES

- Splice trays delivered with cover
- Splice protectors not included in tray

ORDERING INFORMATION

Description	Part Number
For 24 SMOUV (62 mm) splice protectors, picture A	1671281-1
For 24 ANT splice protectors, picture B	1671281-2
For 24 RECORDsplice splices, picture C	1671281-3
ANT splice protector; Packaging: 150	182398-000
SMOUV splice protector (62 mm); Packaging: 100	657054-000

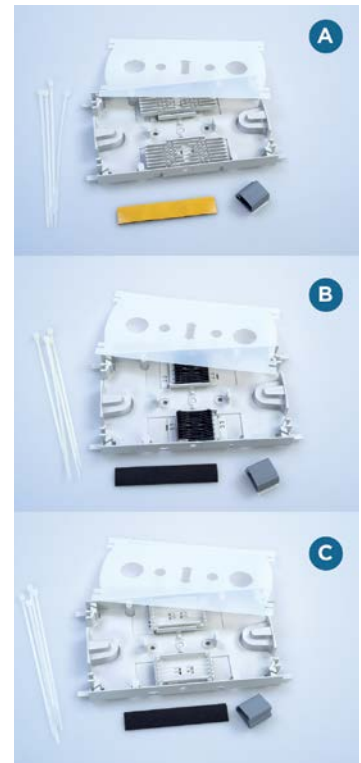

Fiber Optic Cabling

Splicing Products

AMP CORELINK Mechanical Splice

Mechanical Quick Termination

The CORELINK splice is easy to use, high performance mechanical splice for 125 μm singlemode and multimode fibers. Its unique clamping mechanism is activated with a simple key, no other tool is required. The splice is remateable - either fiber can be removed and replaced in the splice at any time.



FEATURES

- No fusion splice necessary
- Torsion resistant
- Bellcore TR-765 tested
- For multimode and singlemode
- For tight buffer, semi-tight and loose tube
- For 250 μm coating and 900 μm buffer
- Cleaning Tools
- Light Crimp Universal Cleave Tool
- Fiber Optic Cleave Tool for Field Installations

TECHNICAL DATA:

Singlemode

- Color: transparent
- Attenuation typical (dB): ≤ 0.3
- Return loss typical (dB): -35 dB (min)
- Application: SM
- Temperature range: -10°C to +60°C
- Dimensions: 51 x 7.6 x 3.3 mm

Multimode

- Color: transparent blue
- Attenuation typical (dB): ≤ 0.3
- Return loss typical (dB): -20 dB (min)
- Application: MM
- Temperature range: -10°C to +60°C
- Dimensions: 51 x 7.6 x 3.3 mm

CORELINK Splices

FEATURES

- Mechanical splice
- Re-usable



ORDERING INFORMATION

Description	Part Number
12 CORELINK Splices for single- and multimode	503577-1
2 Replacement keys in key holder	503681-1

Fiber Optic Cabling

Splicing Products

Splice Holder for CORELINK Splices

FEATURES

- 31.8 x 61.0 mm Elastomer holder for 6 or 12 CORELINK splices
- For mount in splice boxes or in distribution boxes

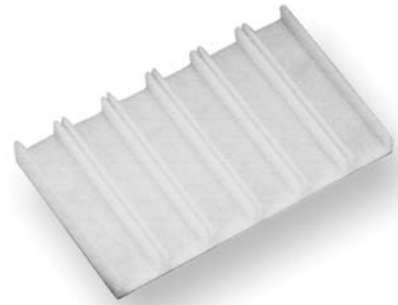

ORDERING INFORMATION

Description	Part Number
Splice holder for 6 CORELINK splices	559066-1
Splice holder for 12 CORELINK splices	559087-1

Workstation for CORELINK Splices

FEATURES

- For easy and safe installation of the CORELINK splices



ORDERING INFORMATION

Description	Part Number
CORELINK Cleave tool	1871696-1
CORELINK Workstation	503605-1

Fiber Optic Cabling

Fiber Optic Tools

LightCrimp Plus Termination Tool Kits

FEATURES

- Termination Tool kit includes:
 - Pro-Crimper II Hand Tool and appropriate die set
 - Stripper tools
 - Kevlar scissor
 - Cable holder
 - Cleave tool



ORDERING INFORMATION

Description	Part Number
LightCrimp Plus ST-Style Connector Termination Tool Kit without microscope	492697-1
LightCrimp Plus ST-Style Connector Termination Tool Kit with microscope	492697-2
LightCrimp Plus ST-Style, SC, LC Connectors and MT-RJ Jack Termination Tool Kit without microscope	1278118-4
LightCrimp Plus ST-Style, SC, LC Connectors and MT-RJ Jack Termination Tool Kit with microscope	1278118-5
LightCrimp Plus LC/SC and LightCrimp Splice Termination Tool Kit without microscope	1553212-1
LightCrimp Plus LC + SC Connector Termination Tool Kit without microscope	1754845-1
LightCrimp Plus LC + SC Connector Termination Tool Kit with microscope	1754845-2

LightCrimp Termination Tool Kit

FEATURES

- Termination tool kit includes:
 - PRO-CRIMPER II Hand Tool and appropriate die set
 - Stripper tools
 - Kevlar scissor
 - Template strip
 - Cleave tool
 - Polishing bushings
 - Polishing films
 - Polishing plate
 - Microscope as listed
- Microscope separately available



ORDERING INFORMATION

Description	Part Number
LightCrimp SC and ST-Style; Type: Mini Tool Kit; Microscope: No Microscope	492543-1
LightCrimp ST-Style; Type: Termination Kit; Microscope: No Microscope	503330-1
LightCrimp SC and ST-Style; Type: Termination Kit; Microscope: No Microscope	503957-1
LightCrimp SC and ST-Style; Type: Termination Kit; Microscope: Premium Microscope	503957-2

Fiber Optic Cabling

Fiber Optic Tools

MT-RJ Jack Termination Tool Kit

FEATURES

- Termination tool kit includes:
 - Soft case
 - Kevlar scissors
 - MT-RJ strip length template
 - Miller strip tool
 - Actuator key
 - Cable stripper
 - Alcohol wipes
 - Micro stripper



ORDERING INFORMATION

Description	Part Number
MT-RJ Tool Kit without microscope	1278346-1
MT-RJ Tool Kit with microscope	1278346-2

Pro-Installer Epoxy/Polish Type Connector Termination Tool Kit

FEATURES

- Includes all tools necessary to install the following connectors:
 - ST-Style, TE CONNECTIVITY SC, FSD, FC, D4, FSMA (Epoxy sold separately)
- Tool kits include (except otherwise specified):
 - PRO-CRIMPER II Hand Tool and crimping dies
 - Polishing bushings
 - Polishing film
 - Cable and fiber strippers
 - Scissors
 - Scribe tool
 - Microscope with tripod and power source
 - Epoxy curing oven



ORDERING INFORMATION

Description	Part Number
Tool kit with 240V curing oven and with microscope	501258-8
LC Upgrade Kit	1754462-1

Fiber Optic Cabling

Fiber Optic Tools

Epoxy/Polish Type Connector Termination Tool Kit

FEATURES

- Tool kits include:
 - Carrying case
 - PRO-CRIMPER II Hand Tool and crimping dies
 - Polishing bushings
 - Polishing film
 - Cable and fiber strippers
 - Scissors
 - Scribe tool
- Kits contain polishing materials for approximately 60 connectors (consumables can be purchased separately)
- SC tool kit can also be used to install FC Connectors



ORDERING INFORMATION

Description	Part Number
LC Upgrade Kit	1754603-1
ST-Style	503746-1
SC/FC	503746-7

Universal No Epoxy Termination Tool Kit

FEATURES

- Includes all tools necessary for installing:
 - MT-RJ jacks and MT-RJ Secure jacks
 - LightCrimp Plus ST-Style, SC and LC connectors
 - LightCrimp ST-Style and SC connectors
- Termination Tool kit includes:
 - PRO-CRIMPER II Hand Tool and appropriate die set
 - Stripper tools
 - Kevlar scissor
 - Cable holder
 - Cleave tool
 - LightCrimp Plus Termination Video CD-Rom



ORDERING INFORMATION

Description	Part Number
Universal no epoxy termination tool kit without microscope	1278949-2
Universal no epoxy termination tool kit with microscope	1278949-3

Fiber Optic Cabling

Fiber Optic Tools

LightCrimp Universal Cleave Tool

FEATURES

- Used in both SC and ST-Style LightCrimp connector terminations
- Included in all LightCrimp tool kits



ORDERING INFORMATION

Description	Part Number
LightCrimp Universal Cleave Tool	503705-1

LightCrimp Plus Cable Holder

FEATURES

- Stripping template and cable holder for LightCrimp Plus terminations
- Included in the LightCrimp Plus tool kit



ORDERING INFORMATION

Description	Part Number
LightCrimp splice cable holder	1985771-1
LC and SC	2064540-1
ST-Style	492703-1

Fiber Optic Cleave Tool for Field Installations

FEATURES

- Applicable to LightCrimp Plus Connector, MT-RJ and CORELINK termination:
- Lifespan of blade is approximately 10000 cycles
- Cleaving length: 4, 6, 8, 10, 16 mm
- For 900 μ m and 250 μ m fiber



ORDERING INFORMATION

Description	Part Number
Fiber Optic Cleave Tool	1871696-1

Fiber Optic Cabling

Fiber Optic Tools

Separate Tools

FEATURES

- Stripping tools, Micro-Stripper and Kevlar scissor for easy and save fiber preparation



ORDERING INFORMATION

Description	Part Number
Solid Steel Kevlar Scissor	501014-1
Stripping tool for cable jackets (red handles)	1278531-1
Cable Jacket Clamp	1278625-1
Kevlar shears (blue handle)	1278637-1
Miller Stripping tool for buffer, fiber coating and 2-3 mm jackets (yellow handles)	1754708-1
Micro-Strip 2 mm Cable Jacket Splitter	2064453-2
Micro-Stripper for 900 μ m buffer (mandatory for MT-RJ jack termination)	492109-2
Jacket stripper	501198-1

Pro Crimper II Hand Tool and Fiber Optic Die Sets

FEATURES

- Hand tool and die sets for fiber optic connectors



ORDERING INFORMATION

Description	Part Number
Die Set: LC Epoxy; Cable Jacket Diameter: 1.6-2.0 & 2.4 & 3.0 mm	1588175-1
Die Set: LightCrimp Plus and LightCrimp ST-Style; Cable Jacket Diameter: 2.0, 2.5 & 3.0 mm	492622-1
Die Set: LightCrimp Plus and LightCrimp SC; Cable Jacket Diameter: 2.5 & 3.0 mm	492783-1
Die Set: LightCrimp Plus LC and SC and LightCrimp Splice; Cable Diameter: 2.0 mm	1985766-1
Die Set: SC; Cable Jacket Diameter: 2.0&2.4 / 2.5 & 3.0 mm	492025-1
Die Set: SC; Cable Jacket Diameter: 3.0 mm	503910-1
Die Set: ST-Style; Cable Jacket Diameter: 3.0 mm	58424-1
Hand Tool and Die Set: LC Epoxy; Cable Jacket Diameter: 1.6 - 2.0 & 2.4 & 3.0 mm	1588176-1
Hand Tool and Die Set: LightCrimp Plus and LightCrimp SC; Cable Jacket Diameter: 2.5 & 3.0 mm	492782-1
Hand Tool and Die Set: LightCrimp Plus and LightCrimp ST-Style; Cable Jacket Diameter: 2.0, 2.5 & 3.0 mm	492623-1
Hand Tool and Die Set: LightCrimp Plus LC and SC and LightCrimp Splice; Cable Jacket Diameter: 2.0 mm	2064603-1
Hand Tool and Die Set: LightCrimp Plus LC; Cable Jacket Diameter: 1.6-2.0 mm	1754137-1
Hand Tool and Die Set: SC; Cable Jacket Diameter: 2.0&2.4/2.5&3.0 mm	492026-1
Hand Tool and Die Set: SC; Cable Jacket Diameter: 3.0 mm	503911-1
Hand Tool and Die Set: ST-Style; Cable Jacket Diameter: 3.0 mm	58433-4
PRO-CRIMPER II Hand Tool only	2064431-1

Fiber Optic Cabling

Fiber Optic Tools

Sapphire Tipped Scribe Tool and Accessories

FEATURES

- Long-lasting sapphire blade
- Pen-type casing
- For epoxy style connectors only



ORDERING INFORMATION

Description	Part Number
Sapphire tipped Scribe Tool	504064-1
Replacement Blades	504290-1

Polishing Bushings, Curing Sleeves and Strip Card Kit

FEATURES

- Polishing bushings for all polishing processes
- Curing sleeves for safe oven application



Polishing Bushing 2.5 mm

ORDERING INFORMATION

Description	Part Number
Curing sleeve; Used with: LC 900 µm; Notes: 12 pcs	1457630-1
Curing sleeve; Used with: LC jacketed cable; Notes: 12 pcs	1457630-2
Strip Card Kit; Used with: LC Connectors; Notes: -	1588756-1
Polishing bushing; Used with: Ceramic LC Connectors; Notes: -	1754074-1
Strip Card Kit; Used with: ST-Style and SC Connectors	501818-1
Alcohol Wipes 200 packet/box	501857-2
Curing sleeve; Used with: Ceramic, stainless steel and Polymer composite ST-Style connectors; Notes: 12 pcs.	502259-1
Polishing bushing; Used with: SC Connectors; Notes: black Polymer	502631-1
Curing sleeve; Used with: SC Connectors; Notes: 1 pc.	502656-1
Polishing bushing; Used with: Ceramic, stainless steel and Polymer composite ST-Style connectors; Notes: black Polymer	503304-1
Polishing bushing; Used with: Ceramic and stainless steel ST-Style connectors; Notes: Metal	503337-1
Polishing bushing; Used with: SC Connectors; Notes: Metal	503787-1



Polishing Bushing SC



SC Curing Sleeve

ST-Style Curing Sleeve
2.5 mm bayonette

Fiber Optic Cabling

Fiber Optic Tools

Polish Pads

FEATURES

- Acryl polishing plate
- Self-adhesive polishing pad

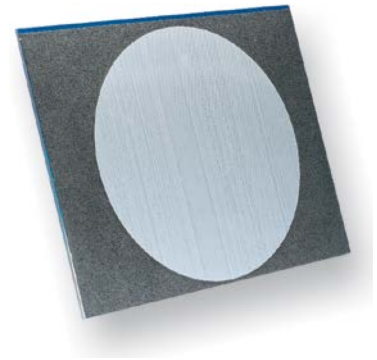

ORDERING INFORMATION

Description	Part Number
Polishing plate 8.5x11 inch	501197-1
Polishing pad for polymer ferrules 21 cm diameter, white, self-adhesive	501523-1
Polishing pad for ceramic ferrules 21 cm diameter, white, self-adhesive	501858-1

Epoxy Curing Oven

FEATURES

- Reduces time required to cure epoxy in fiber optic connectors
- Accepts all TE CONNECTIVITY Fiber Optic Connectors that require epoxy
- Comes equipped to cure up to four duplex connectors and 12 simplex connectors at once
- Optional blocks to allow up to 8 duplex and 24 simplex connectors available
- Variable temperature control (60°C to 125°C)
- Includes thermometer and cable support bracket



ORDERING INFORMATION

Description	Part Number
Adapter block for 1.6, 2.0 and 2.4 mm SC and LC connectors	1457628-1
Adapter block for 24 single connectors	502129-1
Curing oven (220 Volt) incl. adapter block for 16 connectors	502134-2
Adapter block for 8 duplex connectors	502222-1

EPO-TEK 353ND epoxy

FEATURES

- Pre-measured bi-packs for consistent results
- Ideal for bonding fibers and optical components
- Long pot life
- Heat-cured and room-temperature epoxy
- High service temperature
- Supplied in 4-gram packs



ORDERING INFORMATION

Description	Part Number
EPO-TEK 353ND; Cure time/Temp.: 10min @ 115°C; Pot life: +/- 30 min; Color after Curing: red; Viscosity (cps): 2000; Max. Temp.: 200°C; Glass transition-temp: 124°C	504035-1

Fiber Optic Cabling

Fiber Optic Tools

TRA-CON (R) and Hysol (R) Epoxy

FEATURES

- General purpose epoxy for SC and ST-Style epoxy polish connectors
- Long pot life
- Heat-cured and room-temperature epoxy
- High service temperature



ORDERING INFORMATION

Description	Part Number
Application: For manufacturing and field use; Connectors: FDDI, ESCON, ST-Style, FSMA; Cure time and temperature: 24 hr @ 25°C, 2 hr @ 65°C; Pot life: 30 mins; Color: blue; Packaging: 25 x 2 g; Connectors pro package: 250	1918652-1
Application: For manufacturing and field-use; Connectors: all; Cure time and temperature: 30 mins @ 100°C; Pot life: 30 mins; Color: blue; Packaging: 1 x 70.8 g + 1 x 22.6 g; Connectors pro package: 400	502418-1



Adhesive Applicator Syringe and Polishing Films

FEATURES

- 3 ccl capacity
- Ideal for epoxy



ORDERING INFORMATION

Description	Part Number
Hand Polishing Film (Packet of 15); Connector Type: Epoxy-Polish LC; Grit Grade: 0.9 µm	1374484-1
Polishing Consumables; Hand Polishing Film (Packet of 10); Connector Type: Epoxi-Polish SC, Epoxi-Polish Singlemode ST-Style, Epoxi-Polish Multimode ST-Style, LightCrimp SC and ST-Style; Grit Grade: 0.3 µm	228433-5
Polishing Consumables; Hand Polishing Film (Packet of 10); Connector Type: Epoxi-Polish Multimode ST-Style, LightCrimp SC and ST-Style; Grit Grade: 1 µm	228433-7
Polishing Consumables; Hand Polishing Film (Packet of 10); Connector Type: Epoxi-Polish SC, Epoxi-Polish Singlemode ST-Style, Epoxi-Polish Multimode ST-Style, LightCrimp SC and ST-Style; Grit Grade: 5 µm	228433-8
Polishing Consumables; Hand Polishing Film (Packet of 10); Connector Type: LightCrimp SC and ST-Style; Grit Grade: 15 µm	228433-9
Adhesive applicator syringe	501473-3
Mixing cup	502282-2
Polishing Consumables; Hand Polishing Film (Packet of 5); Connector Type: Epoxi-Polish SC, Epoxi-Polish Singlemode ST-Style	502748-2

Fiber Optic Cabling

Fiber Cleaning and Inspection

Optical Fiber Inspection and Cleaning Kits

FEATURES

- Densely woven micro-fiber cloth cleans fiber optic connector tips and reduces static charge
- Reel cleaners that work with FC, SC, ST and MT-RJ connectors, as well as PARA-OPTIX products
- Stick cleaners with perforated handles for customizing length and angle
- High resolution, 200x microscope to visual inspect connectors before mating



ORDERING INFORMATION

Description	Part Number
Optical Fiber and Cleaning Kit A 1x Visual Fault Locator (VFL) with 1.25 mm Adapter 1x 200x Microscope with 2.5 mm Adapter 1x 1.25 mm (LC) Microscope Adapter 1x MT-RJ Microscope Adapter 1x MPOA Microscope Adapter 1x MPO Microscope Adapter 1x Termination Training, CD-ROM 5x 2.5 mm Stick Cleaners (10/Package) 5x 1.25 mm Stick Cleaners (10/Package) 1x One Slot Reel Cleaner 1x MT-RJ w/pins Reel Cleaner 1x SC in Bulkhead Cleaner (IBC) 1x LC IBC 1x MPO IBC 1x Premium Hardcase	2064651-1
Optical Fiber and Cleaning Kit B 1x Visual Fault Locator (VFL) with 1.25 mm Adapter 1x 200x Microscope with 2.5 mm Adapter 1x 1.25 mm (LC) Microscope Adapter 1x MT-RJ Microscope Adapter 1x Termination Training, CD-ROM 5x 2.5 mm Stick Cleaners (10/Package) 5x 1.25 mm Stick Cleaners (10/Package) 1x One Slot Reel Cleaner 1x MT-RJ w/pins Reel Cleaner 1x SC in Bulkhead Cleaner (IBC) 1x LC IBC 1x Premium Hardcase	2064651-2
Optical Fiber and Cleaning Kit C 1x Visual Fault Locator (VFL) with 1.25 mm Adapter 1x 200x Microscope with 2.5 mm Adapter 1x 1.25 mm (LC) Microscope Adapter 1x Termination Training, CD-ROM 5x 2.5 mm Stick Cleaners (10/Package) 5x 1.25 mm Stick Cleaners (10/Package) 1x One Slot Reel Cleaner 1x SC in Bulkhead Cleaner (IBC) 1x LC IBC 1x Premium Hardcase	2064651-3

Fiber Optic Cabling

Fiber Cleaning and Inspection

MPO/LC/SC/MT-RJ Cassette Cleaners

ORDERING INFORMATION

Description	Part Number
MTP/MPO with pins; Packaging: 1	1918802-1
1 Slot Reel Cleaner for MPO/LC/SC and MT-RJ; Packaging: 1	1918803-1
MT-RJ with pins Reel Cleaner; Packaging: 1	1918804-1
2 Slot reel cleaner for LC and SC; Packaging: 1	1918805-1
Cleaner Refill; Packaging: 6 rolls	1918806-1



MPO Coupler Cleaner

ORDERING INFORMATION

Description	Part Number
MPO IBC; Packaging: 1	1918809-1



Card Cleaner

ORDERING INFORMATION

Description	Part Number
Card Cleaner; Packaging: 1	1918810-1
Card Cleaner Refill; Packaging: 100 sheets	1918811-1



Cleaning Sticks for Single Fiber Couplers

ORDERING INFORMATION

Description	Part Number
2.5 mm stick cleaner; Packaging: 25 x 10	1918807-1
1.25 mm stick cleaner; Packaging: 25 x 10	1918808-1



LC/SC bulkhead cleaner

ORDERING INFORMATION

Description	Part Number
SC IBC (In Bulkhead Cleaner)	2064499-1
LC IBC (In Bulkhead Cleaner)	2064500-1



Fiber Optic Cabling

Fiber Cleaning and Inspection

Inspection Microscope

FEATURES

- Optimal visual examination of terminated ends
- 500 µm field of view
- Dual illumination
- Coaxial for inspecting polish quality
- Oblique for general conditions
- Field and laboratory examination for multimode and singlemode fibers
- Portable
- Integral infrared filters for safety
- Do NOT use any microscope to view active fiber signals
- Disposable, Type LR44 batteries
- Long-life LED (appr. 100.000 hours of operation)

- Each kit contains:
 - 10-power objective microscope with an impact resistant ergonomic rubber shell and high quality glass optics
 - 20-power eyepiece
 - Padded carrying case with an integrated belt loop and internal adapter storage pocket
 - Neck lanyard with safety breakaway feature
 - Universal 2.5 mm ferrule adapter (for SC, ST and FC)



ORDERING INFORMATION

Description	Part Number
1.25 mm universal (LC and MU)	1754765-1
2.50 mm universal (SC, ST-Style and FC)	1754766-1
Inspection Microscope Kit	1754767-1
MT-RJ	1754768-1
SC/APC	1828833-1
MPO Microscope Adapter	1828836-1
MPOA Microscope Adapter	1828837-1
1.25 mm universal LC duplex adapter	2123273-1
1.25 mm LC APC adapter	1553785-1

Fiber Optic Cabling

Fiber Cleaning and Inspection

Visual Fault Locator

FEATURES

- 650 µm (visible) Class 2 1.0 mW max. Diode Laser
- Continuous and flashing (2-3 Hz pulsed) modes
- Uses 1 “AA” style battery for >30 hours of continuous use
- Standard 2.5 mm adaptor for SC, ST, and FC connectors
- Optional 1.25 mm adaptor for LC and MU connectors



ORDERING INFORMATION

Description	Part Number
Hand Held Visual Fault Locator incl. 2.5 mm adaptor	1828352-1
Hand Held Visual Fault Locator incl. 2.5 + 1.25 mm adaptor	1828352-2
Adaptor for Hand Held VFL 1.25 mm	1828353-1

OTDR Launch Lead Kits for Optical Testing and Certification

FEATURES

- Each kit contains:
 - Launch and tail lead
 - Length 400 m (MM) and 500 m (SM)
 - Data sheet of end face geometry
 - Coupling bushings
 - Cleaning aides
 - Instruction manual



Y- -X	Connector Type	Y- -X	Connector Type	Y- -X	Connector Type	Y- -X	Connector Type
0- -1	SC/PC to SC/PC	0- -6	ST/PC to SC/PC	1- -1	LC/PC to SC/PC	1- -6	FC/PC to SC/PC
0- -2	SC/PC to ST/PC	0- -7	ST/PC to ST/PC	1- -2	LC/PC to ST/PC	1- -7	FC/PC to ST/PC
0- -3	SC/PC to LC/PC	0- -8	ST/PC to LC/PC	1- -3	LC/PC to LC/PC	1- -8	FC/PC to LC/PC
0- -4	SC/PC to PC/PC	0- -9	ST/PC to PC/PC	1- -4	LC/PC to PC/PC	1- -9	FC/PC to PC/PC
0- -5	SC/PC to MT-RJ	1- -0	ST/PC to MT-RJ	1- -5	LC/PC to MT-RJ	2- -0	FC/PC to MT-RJ

ORDERING INFORMATION

Description	Part Number
OM2-OM3 and OM4 Launch Lead	Y-6695240-X
OM1 Launch Lead	Y-6695242-X
OS2 Launch Lead	Y-6695244-X

Fiber Optic Cabling

Fiber Cleaning and Inspection

Power meter testlead Kits for Optical Testing and Certification

FEATURES:

- Simplex Test leads
- LSZH cable, Length 3 meter
- Data sheet of end face geometry packed per assembly
- MOQ: 6 per item

ORDERING INFORMATION



Description	Part Number
50 micron test lead for OM2-OM3 and OM4 Attenuation test	
SC/PC to SC/PC	2160547-3
SC/PC to LC/PC	2160548-3
LC/PC to LC/PC	2160549-3
9 micron test lead for SM OS1 and SM OS2 Attenuation test	
SC/PC to SC/PC	2160550-3
SC/PC to LC/PC	2160551-3
LC/PC to LC/PC	2160552-3

12. Modular Twisted Pair Cabling

Category 7_A

Cable	198
Jacks.....	199
Consolidation Point.....	200
Patch Cords.....	201

Category 6_A

Cable	205
Jacks.....	207
Consolidation Point.....	209
Patch Cords.....	210

Category 6

Cable	211
Jacks.....	212
Outlets.....	215
Patch Panels.....	216
Consolidation Point.....	218
Patch Cords.....	219

Category 5e

Cable	222
Jacks.....	224
Patch Panels.....	226
Consolidation Point.....	229
Patch Cords.....	230

Voice

Backbone Cable.....	233
Jacks	234
LSA-PLUS.....	237
Indoor Boxes.....	242

Unloaded Hardware

Patch Panels.....	245
Consolidation Point.....	248
Mini Pods.....	249
Outlets.....	250
Surface Mount Boxes.....	264

Twisted Pair Tools	266
---------------------------------	-----

Modular Twisted Pair

Category 7_A - Cable

Category 7_A S/FTP Cable AWG 22

FEATURES

- High performance S/FTP cable
- Enables broadband applications like CATV, multimedia etc.
- Qualified against IEC 61156-7 and tested up to 1500MHz
- Individually foiled pairs plus overall copper braid
- AWG 22 solid conductor
- Fire retardant LSZH sheath

Color: white

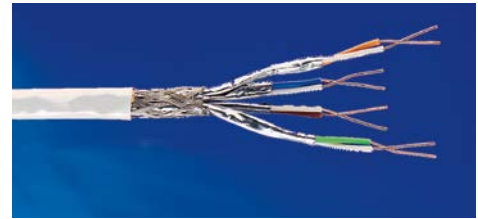

ORDERING INFORMATION

Description	Part Number
AWG 22; Type: Simplex; OD 8.1 mm; Packaging: 1000 m/Reel	1499101-1
AWG 22; Type: Duplex; OD 8.1 x 16.5 mm; Packaging: 500 m/Reel	1711003-1

Category 7_A S/FTP Cable AWG 23

FEATURES

- High performance S/FTP cable
- Qualified against IEC 61156-5 Category 7_A and tested up to 1200MHz
- Individually foiled pairs plus overall copper braid
- AWG 23 solid conductor
- Fire retardant LSZH sheath

Color: white

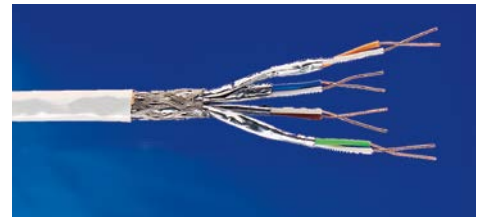

ORDERING INFORMATION

Description	Part Number
AWG 23; Type: Simplex; OD 7.9 mm; Packaging: 1000 m/Reel	1711910-1
AWG 23; Type: Duplex; OD 7.9 x 16.0 mm; Packaging: 500 m/Reel	1711913-1

Modular Twisted Pair

Category 7_A - Jacks

AMP-TWIST 7_AS SL Jack

FEATURES

- 4 chamber connector, fully compatible to IEC 61076-3-104 Ed. 2, 1000 MHz
- Class F_A / Category 7_A as per ISO/IEC 11801 Ed.2 Amd.2
- Termination time less than 1.5 minutes using TE's AWC technique
- Easiest installation with only 2 parts
- Patented shield clamp with integrated strain relief
- Available with or without dust cover
- Optional colored dust covers available



ORDERING INFORMATION

Description	Part Number
Cat. 7 _A die-cast Jack without dust cover, 180° cable exit	1711437-1
Cat. 7 _A die-cast Jack with dust cover, 180° cable exit	1711441-1
Colored dust cover (in bag of 50 pieces); Color: blue	1-1711481-6
Colored dust cover (in bag of 50 pieces); Color: red	1-1711481-7
Colored dust cover (in bag of 50 pieces); Color: yellow	1-1711481-8
Colored dust cover (in bag of 50 pieces); Color: green	1-1711481-9

Modular Twisted Pair

Category 7_A - Consolidation Point

AMP-TWIST 7_AS Consolidation Point Transition Cable Assemblies

FEATURES

- Assembly to connect the work area outlet with the consolidation or transition point
- Saves time and money on moves, adds and changes
- Slim line design for High-Density solutions
- According to ISO/IEC 11801
- Cat. 7_A S/FTP solid cable acc. to IEC 61156-7
- LSFRZH sheath



Color: white

ORDERING INFORMATION

Description	Part Number
AMP-TWIST 7 _A S SL jack w/o dust cover to AMP-TWIST 7 _A S plug; Class F _A	Y-1711579-X
AMP-TWIST 7 _A S SL jack with dust cover to AMP-TWIST 7 _A S plug; Class F _A	Y-1711776-X

Y- -X	Length
0- -5	5.0 m
1- -4	7.5 m
1- -0	10.0 m
1- -5	15.0 m
2- -0	20.0 m
3- -0	30.0 m

Other lengths on request.

Modular Twisted Pair

Category 7_A - Patch Cords

AMP-TWIST 7_AS to AMP-TWIST 7_AS Patch Cord

FEATURES

- Slim line design for High-Density solutions
- Category 7_A S/FTP stranded cable
- LSZH sheath
- Black boot on AMP-TWIST 7_AS plug

Color: white

ORDERING INFORMATION

Description	Part Number
Pairs: 4; Cat. 7 _A	Y-1711637-X

Other lengths on request.



Y- -X	Length
1- -1	0.5 m
0- -1	1.0 m
0- -2	2.0 m
0- -3	3.0 m
0- -5	5.0 m
1- -0	10.0 m

AMP-TWIST 7_AS to RJ-45 Patch Cord

FEATURES

- Slim line design for High-Density solutions
- Category 7 S/FTP stranded cable
- LSZH sheath
- Black boot on AMP-TWIST 7_AS plug

Color: white

ORDERING INFORMATION

Description	Part Number
Pairs: 4; Cat. 6 _A	Y-336488-X

Other lengths on request.



Y- -X	Length
1- -1	0.5 m
0- -1	1.0 m
0- -2	2.0 m
0- -3	3.0 m
0- -5	5.0 m
1- -0	10.0 m

Modular Twisted Pair

Category 7_A - Patch Cords

AMP-TWIST 7_AS (2 Pair) to RJ-45 Patch Cord

FEATURES

- Slim line design for High-Density solutions
- Stranded shielded cable
- LSZH sheath
- Black boot on AMP-TWIST 7_AS plug

Color: white



ORDERING INFORMATION

Description	Part Number
Pairs: 2 (Ethernet 12/36); Cat. 5E	Y-1711613-X
Pairs: 2 (ISDN 36/45); Cat. 5E	Y-1711618-X

Y- -X	Length
1- -1	0.5 m
0- -1	1.0 m
0- -2	2.0 m
0- -3	3.0 m
0- -5	5.0 m
1- -0	10.0 m

Other lengths on request.

AMP-TWIST 7_AS Telephone Patch Cord (1 Pair)

FEATURES

- Slim line design for High-Density solutions
- RJ-11 to 1pair plug acc. to IEC 61076-3-104
- LSZH sheath
- Black boot

Color: black



ORDERING INFORMATION

Description	Part Number
Pairs: 1 (Voice Application); Cat. 3	Y-1711623-X

Y- -X	Length
1- -1	0.5 m
0- -1	1.0 m
0- -2	2.0 m
0- -3	3.0 m
0- -5	5.0 m
1- -0	10.0 m

Other lengths on request.

Modular Twisted Pair

Category 7_A - Patch Cords

AMP-TWIST 7_AS CATV Patch Cord (1 Pair)

FEATURES

- Slim line design for High-Density solutions
- PAL or male F-Series connector with integrated balun to 1 pair plug acc. to IEC 61076-3-104
- Category 7_A S/FTP stranded cable
- LSZH sheath
- Black boot

Color: green

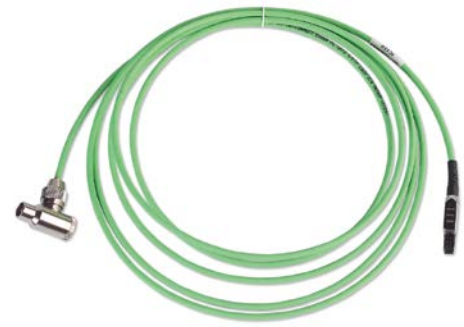

ORDERING INFORMATION

Description	Part Number
Pairs: 1 (F-conn with Balun); CATV	Y-1711624-X
Pairs: 1 (Coax with Balun); CATV	Y-1711659-X

Y- -X	Length
1- -1	0.5 m
0- -1	1.0 m
0- -2	2.0 m
0- -3	3.0 m
0- -5	5.0 m
1- -0	10.0 m

Other lengths on request.

AMP-TWIST 7_AS Single End Patch Cord

FEATURES

- Slim line design for High-Density solutions
- Category 7_A S/FTP cable
- LSZH sheath
- Black boot on AMP-TWIST 7_AS plug

Color: white



ORDERING INFORMATION

Description	Part Number
Pairs: 4; Cat. 7 _A ; Construction: Stranded	Y-1711580-X
Pairs: 4; Cat. 7 _A ; Construction: Solid	Y-1711787-X

Y- -X	Length
0- -5	5.0 m
1- -4	7.5 m
1- -0	10.0 m
1- -5	15.0 m
2- -0	20.0 m
3- -0	30.0 m

Other lengths on request.

Modular Twisted Pair

Category 7_A - Patch Cords

Category 7_A ARJ-45 Patch Cord

FEATURES

- Ideal for installations in combination with AMP CO Plus ARJ-45 Cat. 7_A
- Category 7_A S/FTP stranded cable
- ARJ-45 plug acc. to IEC 60603-7-7
- LSZH sheath

Color: white



ORDERING INFORMATION

Description	Part Number
ARJ-45 to ARJ-45; Cat. 7 _A	Y-1711563-X
ARJ-45 to RJ-45; Cat. 6 _A	Y-1711564-X

Y- -X	Length
0- -1	1.0 m
0- -2	2.0 m
0- -3	3.0 m
0- -5	5.0 m
1- -0	10.0 m

Modular Twisted Pair

Category 6_A - Cable

Category 7 S/FTP Cable

FEATURES

- Qualified against IEC 61156-5 Category 7 and EN 50288-4-1
- Individually foiled pairs plus overall copper braid
- AWG 23 solid conductor
- Fire retardant LSZH sheath

Color: white

ORDERING INFORMATION

Description	Part Number
AWG 23; Type: Simplex; OD: 7.3 mm; Packaging: 1000 m/Reel	57893-1
AWG 23; Type: Duplex; OD: 7.6 x 16.0 mm; Packaging: 500 m/Reel	1711005-1

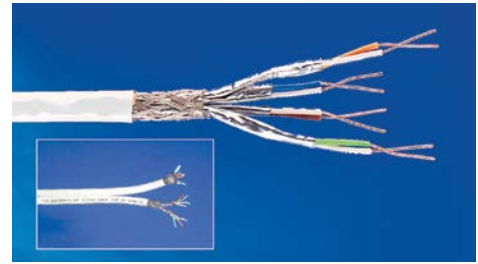

Category 7 F/FTP Cable

FEATURES

- Qualified against IEC 61156-5 Category 7 and EN 50288-4-1
- Individually foiled pairs plus overall foil shield and drain wire
- AWG 23 solid conductor
- LSZH sheath

Color: white

ORDERING INFORMATION

Description	Part Number
AWG 23; Type: Simplex; OD: 7.4 mm; Packaging: 500 m/Reel	1711163-1
AWG 23; Type: Duplex; OD: 7.2 x 15.0 mm; Packaging: 500 m/Reel	1711195-1



Category 7 S/FTP Outdoor Cable

FEATURES

- Qualified against IEC 61156-5 Category 7 and EN 50288-4-1 and tested up to 600MHz
- Suitable for 10GBase-T applications
- Can be used for direct burial and cable duct installation
- Individually foiled pairs plus overall copper braid
- Double jacketed:
 - Inner jacket material: LSZH
 - Outer jacket material: PE black, UV resistant
- Moisture barrier (plastic coated aluminum tape) in between jackets
- AWG 23 solid conductor

Color: black

ORDERING INFORMATION

Description	Part Number
AWG 23; Type: Simplex; OD 11.7 mm; Packaging: 1000 m/Reel	2153161-1



Modular Twisted Pair

Category 6_A - Cable

Category 6_A F/UTP Cable AWG 24

FEATURES

- Qualified against IEC 61156-5 Category 6_A and EN 50288-10-1
- Suitable for 10GBase-T applications
- Overall foil shield, embedded in between synthetic tapes, with drain wire
- AWG 24 solid conductor
- LSZH sheath according to IEC 60332-1 fire rating

Color: white



ORDERING INFORMATION

Description	Part Number
AWG 24; Type: Simplex; OD 7.1mm; Packaging: 500 m/Reel	2153022-3

Category 6_A U/UTP Cable AWG 23

FEATURES

- Supports 10Gigabit Ethernet to a full 100m up to 500MHz
- UTP cable, qualified against IEC 61156-5 Category 6_A
- Patented technology with oblique elliptical offset filler to minimise the effect of alien crosstalk and insertion loss
- AWG 23 solid conductor
- LSZH sheath acc. to IEC 60332-1 fire rating

Color: blue



ORDERING INFORMATION

Description	Part Number
AWG 23; Type: Simplex; OD: 7.62mm - 6.5mm x 8.4mm; Packaging: 305m/Reel	2171014-1

Modular Twisted Pair

Category 6_A - Jacks

AMP-TWIST 6_A S SL Jack

FEATURES

- Class E_A / Category 6_A as per ISO/IEC 11801 Ed.2 Amd.2
- Termination time less than 1 minute using TE's AWC technique
- Easiest installation with only 2 parts
- Patented shield clamp with integrated strain relief
- Available with or without dust cover
- Optional colored dust covers available



ORDERING INFORMATION

Description	Part Number
Cat. 6 _A RJ-45 die-cast Jack without dust cover, 180° cable exit	1711716-1
Cat. 6 _A RJ-45 die-cast Jack with dust cover, 180° cable exit	1711592-1
Colored dust cover (bag of 50 pieces); Color: blue	1-1711691-6
Colored dust cover (bag of 50 pieces); Color: red	1-1711691-7
Colored dust cover (bag of 50 pieces); Color: yellow	1-1711691-8
Colored dust cover (bag of 50 pieces); Color: green	1-1711691-9

Q- Jack (STP)

FEATURES

- Class E_A / Category 6_A as per ISO/IEC 11801 Ed.2 Amd.2
- Suitable for Q-Jack Patch Panels (Page 247)
- Punch down termination onto LSA-PLUS contacts to ensure swift installation
- Shielded cap ensures full 360° bonding and grounding
- Universal wiring - T568 A or B wiring pattern



ORDERING INFORMATION

Description	Part Number
Cat. 6 _A RJ-45 shielded Jack without dust cover (blister pack of 12 units); Color: black (RAL 9005)	300001743975

RJ45 STP KM8 Modular Jacks

FEATURES

- Class E_A / Category 6_A as per ISO/IEC 11801 Ed.2 Amd.2
- Keystone design ensures compatibility with a range of faceplates and adaptors
- KM8 design provide built-in conductor management
- LSA-PLUS quick connection technique with highly reliable wire termination method
- Shielding clamp ensures full 360° bonding and grounding
- Universal wiring - T568 A or B wiring pattern



ORDERING INFORMATION

Description	Part Number
Cat. 6 _A RJ-45 shielded Jack without dust cover; Color: white (RAL 9010)	6830 1 811-01
Cat. 6 _A RJ-45 shielded Jack without dust cover; Color: black (RAL 9005)	6830 1 811-04

Modular Twisted Pair

Category 6_A - Jacks

AMP-TWIST 6_AU SL Jack

FEATURES

- Class E_A as per ISO/IEC 11801 Ed.2 Amd.2
- Termination time less than 1 minute using TE's AWC technique
- Easiest installation with only 2 parts
- Superior technology to reduce alien crosstalk
- Available with or without dust cover
- UL listed
- Universal wiring - T568 A or B wiring pattern
- Several colors available on demand



X	Color
-1	Almond
-2	Black
-4	Gray
-5	Orange
-6	Blue
-7	Red
-8	Yellow
-9	Green

ORDERING INFORMATION

Description	Part Number
Cat. 6 _A RJ-45 unshielded Jack without dust cover, 180° cable exit	1933476-X
Cat. 6 _A RJ-45 unshielded Jack with dust cover, 180° cable exit	2111676-X

Q- Jack (UTP)

FEATURES

- Class E_A / Category 6_A as per ISO/IEC 11801 Ed.2 Amd.2
- Suitable for Q-Jack Patch Panels (Page 247)
- Punch down termination onto LSA-PLUS contacts to ensure swift installation
- Universal wiring - T568 A or B wiring pattern



ORDERING INFORMATION

Description	Part Number
Cat. 6 _A RJ-45 unshielded Jack without dust cover (blister pack of 12 units); Color: black (RAL 9005)	300001743978

RJ45 UTP Modular Jack

FEATURES

- Class E_A / Category 6_A as per ISO/IEC 11801 Ed.2 Amd.2
- Keystone design ensures compatibility with a range of faceplates and adaptors
- Punch down termination onto LSA-PLUS contacts to ensure swift installation
- Cap with metallic particles to mitigate alien crosstalk
- Universal wiring - T568 A or B wiring pattern

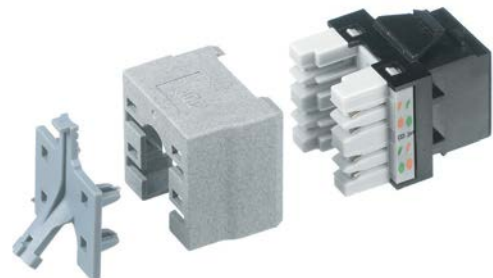

ORDERING INFORMATION

Description	Part Number
Cat. 6 _A RJ-45 unshielded Jack without dust cover; Color: white (RAL 9010)	6830 1 885-01
Cat. 6 _A RJ-45 unshielded Jack without dust cover; Color: black (RAL 9005)	6830 1 885-04

Modular Twisted Pair

Category 6_A - Consolidation Point

AMP-TWIST 6_AS Consolidation Point Transition Cable Assemblies

FEATURES

- Assembly to connect the work area outlet with the consolidation or transition point
- Saves time and money on moves, adds and changes
- According to ISO/IEC 11801
- Category 7 F/FTP solid cable according to IEC 61156-5 and EN 50288-4-1
- LSZH sheath
- Universal wiring



Color: white



ORDERING INFORMATION

Description	Part Number
AMP-TWIST 6 _A S SL jack w/o dust cover to RJ-45 plug; Class E _A	Y-1711825-X
AMP-TWIST 6 _A S SL jack with dust cover to RJ-45 plug; Class E _A	Y-1711851-X

Y- -X	Length
0- -5	5.0 m
1- -4	7.5 m
1- -0	10.0 m
1- -5	15.0 m
2- -0	20.0 m
3- -0	30.0 m

Modular Twisted Pair

Category 6_A - Patch Cords

Category 6_A LSZH UTP and S/FTP Patch Cords

FEATURES

- Supports 10 Gigabit Ethernet to a full 100m
- Exceeds the requirements of IEEE 802.3an (10GBASE-T) and ISO/IEC 11801:2002 amendment/channel requirements
- Superior cable flexibility from stranded cores
- Boot maintains correct bend radius to ensure maximum performance



ORDERING INFORMATION

Description	Cable Color	Cable Type	Part Number	-XX	Length
Augmented Category 6 LSZH Patch Cord RJ45 plug to RJ45 plug, T568B	Blue	LSZH UTP	6645 2 827-XX	-04	1.0 m
	Blue	LSZH S/FTP	6830 2 881-XX	-07	2.0 m
	Red	LSZH S/FTP	6830 2 882-XX	-10	3.0 m
	Yellow	LSZH S/FTP	6830 2 883-XX	-15	5.0 m
	Green	LSZH S/FTP	6830 2 884-XX	-25	7.5 m
	Orange	LSZH S/FTP	6830 2 885-XX	-33	10 m
	Grey	LSZH S/FTP	6830 2 887-XX		

Other colors and lengths are available upon request.

Category 6_A S/FTP Patch Cord RJ-45 LSZH

FEATURES

- Category 7 S/FTP stranded cable
- LSZH sheath
- Color-matched snagless boots



ORDERING INFORMATION

Description	Part Number	Y- -X	Length
Color: white	Y-1711815-X	1- -1	0.5 m
Color: blue	Y-1711816-X	0- -1	1.0 m
Color: gray	Y-1711817-X	0- -2	2.0 m
Color: yellow	Y-1711818-X	0- -3	3.0 m
Color: red	Y-1711819-X	0- -5	5.0 m
Color: green	Y-1711820-X	1- -0	10.0 m

Other colors and lengths are available upon request.

Modular Twisted Pair

Category 6 - Cable

Category 6 F/FTP Cable

FEATURES

- Qualified against IEC 61156-5 Category 6 and EN 50288-5-1
- Individually foiled pairs plus overall foil shield
- AWG 23 solid conductor
- LSZH sheath

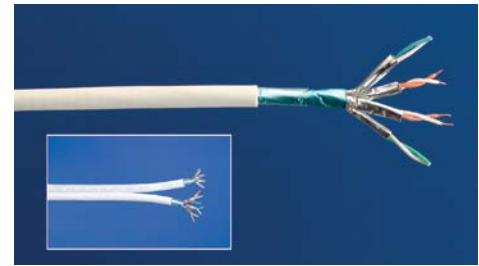

ORDERING INFORMATION

Description	Color	Part Number
AWG 23; Type: Simplex; OD: 7.3 mm; Packaging: 500 m/Reel	White	1711007-1
AWG 23; Type: Duplex; OD: 7.6 x 15.5 mm; Packaging: 500 m/Reel	White	1711008-1

Category 6 U/UTP Cable

FEATURES

- 250 MHz Category 6 U/UTP Cable
- Qualified against IEC 61156-5 Category 6 and EN 50288-6-1
- Cross web filler to separate the pairs

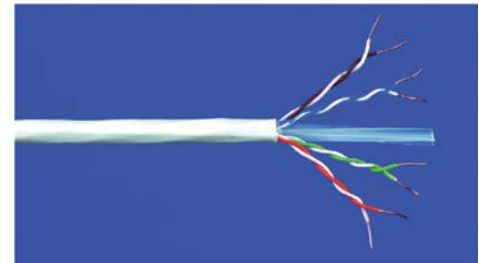

ORDERING INFORMATION

Description	Color	Part Number
Sheathing: PVC; Type: Simplex; OD 6.0 mm; Packaging: 305 m/Reel-In-A-Box	White	219584-2
Sheathing: PVC; Type: Simplex; OD 6.0 mm; Packaging: 1000 m/Reel	White	219584-3
Sheathing: LSZH; Type: Simplex; OD 6.0 mm; Packaging: 305 m/Reel-In-A-Box	White	219585-2
Sheathing: LSZH; Type: Simplex; OD 6.0 mm; Packaging: 1000 m/Reel	White	219585-3
Sheathing: LSZH; Type: Duplex; OD 6.2 x 13.0 mm; Packaging: 500 m/Reel	White	1711053-1
Sheathing: LSFRZH; Type: Simplex; OD: 6.3 mm; Packaging: 500 m/Reel; Color: Black	White	1-1711166-7

Category 6 U/UTP Outdoor Cable

FEATURES

- 250 MHz Category. 6 U/UTP Cable
- Double jacketed:
 - inner jacket material: PE
 - outer jacket material: LSZH
- AWG 24
- For aerial use
- Suitable in an IP65 environment

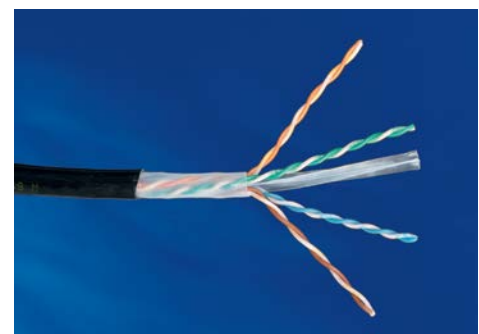

ORDERING INFORMATION

Description	Part Number
Sheathing: LSZH; OD: 7.2 mm; Packaging: 500 m/Reel	1711006-1

Modular Twisted Pair

Category 6 - Jacks

AMP-TWIST 6S SL Jack

FEATURES

- Category 6 as per ISO/IEC 11801 Ed.2 Amd.2
- Class E_A as per ISO/IEC 11801 Ed.2 Amd.1
- Termination time less than 1 minute using TE's AWC technique
- Easiest installation with only 2 parts
- Patented shield clamp with integrated strain relief
- Available with or without dust cover
- Available with rear (180°) or side (90°) cable exit
- Available DIN Rail Kit
- Optional colored dust covers available

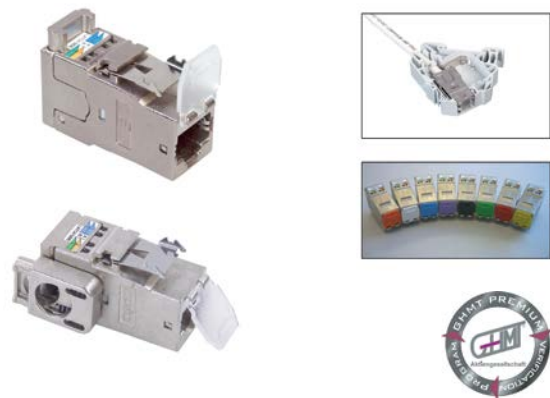

ORDERING INFORMATION

Description	Part Number
Cat. 6 RJ-45 die-cast Jack without dust cover, 180° cable exit	1711342-1
Cat. 6 RJ-45 die-cast Jack without dust cover, 90° cable exit	1711343-1
Cat. 6 RJ-45 die-cast Jack with dust cover, 180° cable exit	1711160-1
Cat. 6 RJ-45 die-cast Jack with dust cover, 90° cable exit	1711295-1
Colored dust cover (bag of 50 pieces); Color: blue	1-1711691-6
Colored dust cover (bag of 50 pieces); Color: red	1-1711691-7
Colored dust cover (bag of 50 pieces); Color: yellow	1-1711691-8
Colored dust cover (bag of 50 pieces); Color: green	1-1711691-9

RJ45 STP KM8 Modular Jack

FEATURES

- Class E / Category 6 as per ISO/IEC 11801 Ed.2 Amd.2
- Keystone design ensures compatibility with a range of faceplates and adaptors
- KM8 design provide built-in conductor management
- LSA-PLUS quick connection technique with highly reliable wire termination method
- Shielding clamp ensures full 360° bonding and grounding
- Universal wiring - T568 A or B wiring pattern



ORDERING INFORMATION

Description	Part Number
Cat. 6 RJ-45 Shielded Jack without dust cover; Color: white (RAL 9010)	6830 1 810-01
Cat. 6 RJ-45 Shielded Jack without dust cover; Color: black (RAL 9005)	6830 1 810-04

Modular Twisted Pair

Category 6 - Jacks

SL Series 110Connect Jacks (STP)

FEATURES

- Category 6 Pyramid Tested
- Universal wiring - T568 A or B wiring pattern



ORDERING INFORMATION

Description	Part Number
Cat. 6 RJ-45 shielded Jack without dust cover, 180° cable exit	1375188-1

SL Series 110Connect Jacks (UTP)

FEATURES

- SlimLine (SL) Series: Thin profile improves outlet density
- Category 6 Pyramid Tested
- Available with or without dust cover
- 90° or 180° cable dress for easy termination
- Bend-limiting strain relief included
- UL listed
- Universal wiring - T568 A or B wiring pattern
- Several colors available on demand

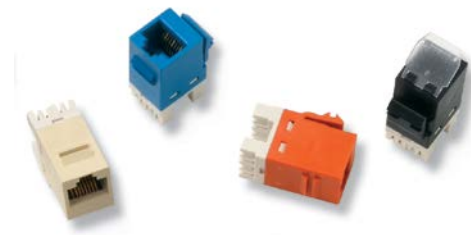

ORDERING INFORMATION

Description	Part Number
Cat. 6 RJ-45 unshielded Jack without dust cover	Y-1375055-X
Cat. 6 RJ-45 unshielded Jack with dust cover	Y-1375187-X

Y- -X	Color
0- -1	Beige
0- -2	Black
0- -3	White
0- -6	Blue
0- -7	Red

Modular Twisted Pair

Category 6 - Jacks

RJ45 UTP KM8 Modular Jack

FEATURES

- Class E / Category 6 as per ISO/IEC 11801 Ed.2 Amd.2
- Keystone design ensures compatibility with a range of faceplates and adaptors
- KM8 design provide built-in conductor management
- LSA-PLUS quick connection technique with highly reliable wire termination method
- Universal wiring - T568 A or B wiring pattern
- Several colors available on demand



ORDERING INFORMATION

Description	Part Number
Cat. 6 RJ-45 Unshielded Jack without dust cover; Color: white (RAL 9010)	6830 1 800-01
Cat. 6 RJ-45 Unshielded Jack without dust cover; Color: black (RAL 9005)	6830 1 800-04

SL Series Modular Coupler

FEATURES

- Straight Category 6 coupler
- Compact coupler for two modular plugs
- SL Series: Thin profile improves outlet density



ORDERING INFORMATION

Description	Part Number
Cat. 6 RJ-45 unshielded Coupler	2111123-1
Cat. 6 RJ-45 shielded Coupler	2111124-1

Modular Twisted Pair

Category 6 - Outlets

Category 6 DIN Dual Floor Outlet

FEATURES

- Category 6 Pyramid Tested
- Flat die-cast design for easy floor box mounting
- 50 x 50 mm faceplate universal fit
- LSA-PLUS tool compatible enhanced 110 IDC blocks
- Universal label for TIA 568A or TIA 568B wiring
- Protected PCB



ORDERING INFORMATION

Description	Part Number
Floor outlet; Ports: 2; Color: almond (RAL 1013)	336539-1
Floor outlet; Ports: 2; Color: pure white (RAL 9010)	2-336539-1

Modular Twisted Pair

Category 6 - Patch Panels

Category 6 24 Ports Shielded Patch Panel

FEATURES

- 19", 1U, RJ-45 Patch Panel with 24 ports
- Class E_A Permanent Link and Category 6 Pyramid Tested
- Prepared for AMPTRAC upgrade
- Enhanced 110 IDC blocks compatible with 110C Impact or LSA-PLUS Insertion tool
- Rear cable management
- Cover adapts to different cable diameters via variable snap-in position
- Shield connection separated from strain relief
- Universal wiring - T568 A or B wiring pattern
- Including grounding bolt
- Protected PCB



ORDERING INFORMATION

Description	Part Number
Cat. 6 24 Ports Shielded Patch Panel; Color: black (RAL 9005)	1644042-2
Cat. 6 24 Ports Shielded Patch Panel; Color: light grey (RAL 7035)	1644042-3

Category 6 24 Ports Unshielded Patch Panel

FEATURES

- 19", 1U, RJ-45 Patch Panel with 24 ports
- Category 6 Pyramid Tested
- Prepared for AMPTRAC upgrade
- Enhanced 110 IDC blocks compatible with 110C Impact or LSA-PLUS Insertion tool
- Rear cable management
- Universal wiring - T568 A or B wiring pattern
- Including grounding bolt
- Protected PCB

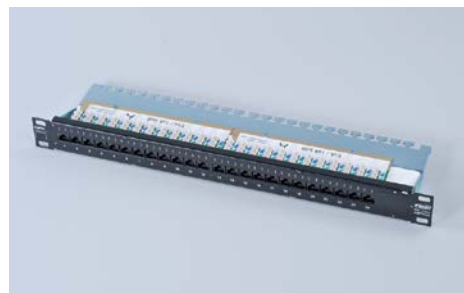

ORDERING INFORMATION

Description	Part Number
Cat. 6 24 Ports Unshielded Patch Panel; Color: black (RAL 9005)	1711147-2

Modular Twisted Pair

Category 6 - Patch Panels

MiniPods

FEATURES

- External mounting points
- Can be passed through standard floor grommets
- Incorporated dust protection on each port
- Pre-loaded with modular connectivity (including CL jacks)
- 3, 4 and 6 port versions available



ORDERING INFORMATION

Description	Part Number
MiniPod Cat. 6 CL UTP 3 port	6540 1 684-03
MiniPod Cat. 6 CL UTP 4port	6540 1 678-04
MiniPod Cat. 6 CL UTP 6 port	6540 1 678-06



Modular Twisted Pair

Category 6 - Consolidation Point

AMP-TWIST 6S to AMP-TWIST 7_AS Consolidation Point Transition Cable Assembly

FEATURES

- Assembly to connect the work area outlet with the consolidation or transition point
- Saves time and money on moves, adds and changes
- According to ISO/IEC 11801
- Category 7 S/FTP solid cable acc. to IEC 61156-5 and EN 50288-4-1
- LSFRZH sheath
- Universal wiring

Color: white

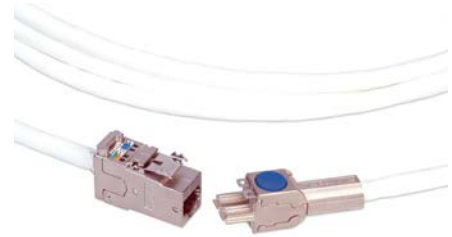

ORDERING INFORMATION

Description	Part Number
AMP-TWIST 6S SL jack w/o dust cover to AMP-TWIST 7 _A S plug; Class E _A	Y-1711666-X
AMP-TWIST 6S SL jack with dust cover to AMP-TWIST 7 _A S plug; Class E _A	Y-1711777-X

Y- -X	Length
0- -5	5.0 m
1- -4	7.5 m
1- -0	10.0 m
1- -5	15.0 m
2- -0	20.0 m
3- -0	30.0 m

Unshielded Consolidation Point Transition Cable Assemblies

FEATURES

- Assembly to connect the work area outlet with the consolidation or transition point (SL 110C Jack to modular plug)
- Meets ISO/IEC 11801 and EN 50173-1
- 4 pair solid U/UTP cable
- LSZH sheath
- Universal wiring

Color: white



ORDERING INFORMATION

Description	Part Number
Cat. 6; Class E	Y-1711027-X

Y- -X	Length
0- -5	5.0 m
1- -4	7.5 m
1- -0	10.0 m
1- -5	15.0 m
2- -0	20.0 m

Modular Twisted Pair

Category 6 - Patch Cords

Modular and Overmolded Solid Core Patch Cords

FEATURES

- Performance exceeding Category 6 specifications up to 250MHz
- Wired to T568-B
- Complete with integrated strain relief to protect terminations within the plug
- Fully interoperable and backwards compatible
- Maximum throughput, reliability and performance in your IT network
- Covered by the System Warranty



ORDERING INFORMATION

Description	Length	Part Number
Patch Cord, Solid Core, Category 6 RJ45 plug to RJ45 plug, T568B; Orange LSZH UTP	20m	6529 1 225-20
	30m	6529 1 225-30
	40m	6529 1 225-40
	50m	6529 1 225-50
Modular White LSZH UTP	20m	2-1711171-0
	30m	3-1711171-0
	40m	4-1711171-0
	50m	5-1711171-0

Other colors and lengths are available upon request

Modular Twisted Pair

Category 6 - Patch Cords

Category 6 UTP and S/FTP Patch Cord

FEATURES

- Performance exceeding Category 6 specifications up to 250MHz
- Range of sheath and length variants
- Fully interoperable and backwards compatible
- Maximum throughput, reliability and performance in your IT network
- Superior cable flexibility from stranded cores
- Boot maintains correct bend radius to ensure maximum performance
- Third party certification to offer complete peace of mind and guarantee quality
- Covered by the System Warranty



ORDERING INFORMATION

Description	Cable Color	Cable Type	Part Number
Cat. 6 overmolded Patch Cord; RJ45 plug to RJ45 plug, T568B	Blue	LSZH, UTP or S/FTP*	6830 2 8Y1-XX
	Red	LSZH, UTP or S/FTP*	6830 2 8Y2-XX
	Yellow	LSZH, UTP or S/FTP*	6830 2 8Y3-XX
	Green	LSZH, UTP or S/FTP*	6830 2 8Y4-XX
	Orange	LSZH, UTP or S/FTP*	6830 2 8Y5-XX
	Grey	LSZH, UTP or S/FTP*	6830 2 8Y7-XX
Cat. 6 Patch Cord; RJ45 plug to RJ45 plug, crossover wired	Blue	LSZH UTP	6830 2 911-XX
	Red	LSZH UTP	6830 2 912-XX
	Yellow	LSZH UTP	6830 2 913-XX
	Green	LSZH UTP	6830 2 914-XX
	Orange	LSZH UTP	6830 2 915-XX
	Grey	LSZH UTP	6830 2 917-XX

Test Specification

Exceeds specifications according to ISO/IEC 11801:2002, EN 50173-1:2002 and TIA/EIA 568-B

Fire rating IEC 60332-1 (UTP), IEC 60332-3 (S/FTP)

-XX	Length
-04	1.0 m
-07	2.0 m
-10	3.0 m
-15	5.0 m
-25	7.5 m
-33	10 m

*For UTP Cable Y = 2, for S/FTP Cable Y = 6.

Modular Twisted Pair

Category 6 - Patch Cords

Category 6 S/FTP Patch Cord RJ-45 LSZH

FEATURES

- Category 7 S/FTP stranded cable
- LSZH sheath
- Color-matched snagless boots
- Universal B-wiring



ORDERING INFORMATION

Description	Part Number
Color: white	Y-959385-X
Color: gray	Y-1711076-X
Color: green	Y-1711077-X
Color: yellow	Y-1711078-X
Color: blue	Y-1711079-X

Other colors and lengths are available upon request.

Category 6 U/UTP Patch Cord RJ-45 LSZH

FEATURES

- Category 6 according to ISO/IEC 11801 and EN-50173-1
- 4 Pair stranded U/UTP cable
- LSZH sheath
- Color-matched snagless boots
- Universal wiring



ORDERING INFORMATION

Description	Part Number	Y- -X	Length
Color: white	Y-1711091-X	1- -1	0.5 m
Color: gray	Y-1711093-X	0- -1	1.0 m
Color: blue	Y-1711094-X	0- -2	2.0 m
Color: green	Y-1711095-X	0- -3	3.0 m
Color: red	Y-1711096-X	0- -5	5.0 m
		1- -0	10.0 m

Other colors and lengths are available upon request.

Modular Twisted Pair

Category 5e - Cables

Category 5e SF/UTP Cable

FEATURES

- Qualified against IEC 61156-5 Category 5e and EN 50288-2-1
- Overall copper braid plus foil shield
- Very low delay skew, suitable for 1000Base-T
- AWG 24 solid conductor

Color: white

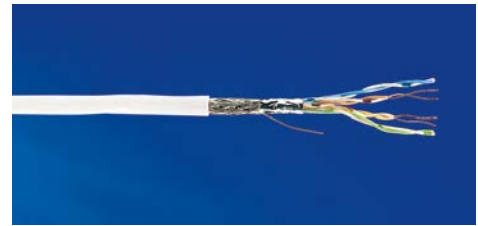

ORDERING INFORMATION

Description	Part Number
Sheathing: LSZH; Type: Simplex; OD 6.5 mm; Packaging: 500 m/Reel	219484-2

Category 5e F/UTP Cable

FEATURES

- Qualified against IEC 61156-5 Category 5e and EN 50288-2-1
- Overall foil shield with drain wire
- Very low delay skew, suitable for 1000Base-T
- AWG 24 solid conductor

Color: white

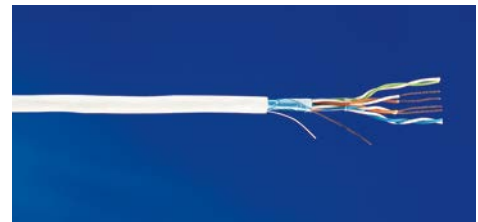

ORDERING INFORMATION

Description	Part Number
Sheathing: PVC; Type: Simplex; OD 6.2 mm; Packaging: 305 m, Pull-box	219413-2
Sheathing: PVC; Type: Simplex; OD 6.2 mm; Packaging: 1000 m/Reel	219413-3
Sheathing: LSZH; Type: Simplex; OD 6.2 mm; Packaging: 305 m, Pull-box	219420-2
Sheathing: LSZH; Type: Simplex; OD 6.2 mm; Packaging: 1000 m/Reel	219420-3
Sheathing: LSZH; Type: Duplex; OD 5.9 x 12.2 mm; Packaging: 500 m/Reel	136816-1

Modular Twisted Pair

Category 5e - Cables

Category 5e U/UTP Cable

FEATURES

- 100 MHz Category 5e UTP Cable
- AWG 24

Color: white

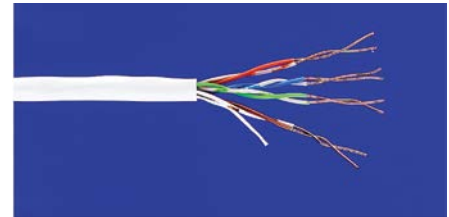

ORDERING INFORMATION

Description	Part Number
Sheathing: PVC; Type: Simplex; OD 5.1 mm; Packaging: 305 m, Pull-Box	57535-2
Sheathing: PVC; Type: Simplex; OD 5.1 mm; Packaging: 1000 m/Reel	57535-3
Sheathing: LSZH; Type: Simplex; OD 5.1 mm; Packaging: 305 m, Pull-Box	57538-2
Sheathing: LSZH; Type: Simplex; OD 5.1 mm; Packaging: 1000 m/Reel	57538-3
Sheathing: LSZH; Type: Duplex; OD 5.5 x 11.5 mm; Packaging: 500 m/Reel	1711043-1

25 Pair Category 5e PowerSum Backbone Cable

FEATURES

- Category 5e UTP Backbone Cable
- 25 Pair Construction
- AWG 24
- UL listed

Color: white



ORDERING INFORMATION

Description	Part Number
Sheathing: CMR; OD: 13.0 mm; Packaging: 305 m/Reel	1499418-1

Modular Twisted Pair

Category 5e - Jacks

SL Series 110Connect Jacks (STP)

FEATURES

- Universal wiring-T568 A or B wiring pattern
- Category 5e

ORDERING INFORMATION

Description	Part Number
Cat. 5e RJ-45 shielded Jack without dust cover, 180° cable exit	1375189-1



SL Series 110Connect Jacks (UTP)

FEATURES

- SlimLine (SL) Series: Thin profile improves outlet density
- Category 5e
- Available with or without dust cover
- 90° or 180° cable dress for easy termination
- Bend-limiting strain relief included
- UL listed
- Universal wiring - T568 A or B wiring pattern
- Several colors available on demand

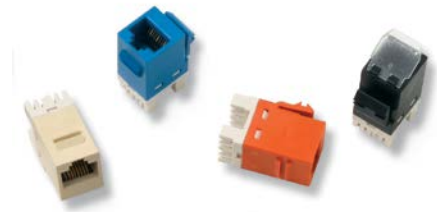

ORDERING INFORMATION

Description	Part Number
Cat. 5e RJ-45 unshielded Jack without dust cover	Y-1375191-X
Cat. 5e RJ-45 unshielded Jack with dust cover	Y-1375190-X

Y- -X	Color
0- -1	Beige
0- -2	Black
0- -3	White
0- -6	Blue
0- -7	Red

Modular Twisted Pair

Category 5e - Jacks

Standard 110Connect Jacks (UTP)

FEATURES

- Category 5e
- UL listed
- Universal wiring - T568 A or B wiring pattern
- Several colors available on demand

Y- -X	Color
0- -1	Beige
0- -2	Black
0- -3	White
0- -6	Blue
0- -7	Red



ORDERING INFORMATION

Description	Part Number
Cat. 5e RJ-45 unshielded Jack without dust cover	Y-406372-X

SL Series Modular Coupler

FEATURES

- Straight Category 5e coupler
- Compact coupler for two modular plugs
- SL Series: Thin profile improves outlet density



ORDERING INFORMATION

Description	Part Number
Cat. 5e RJ-45 unshielded Coupler	2111121-1
Cat. 5e RJ-45 shielded Coupler	2111122-1

Modular Twisted Pair

Category 5e - Patch Panels

Category 5e 24 Ports Shielded Patch Panel

FEATURES

- 19", 1U, RJ-45 Patch Panel with 24 ports
- Category 5e
- Available as LSA-PLUS and 110Connect Version
 - LSA-PLUS Version: Enhanced LSA-PLUS IDC blocks compatible with LSA-PLUS Insertion tool
 - 110Connect Version: Enhanced 110C IDC blocks compatible with 110C Impact tool and LSA-PLUS Insertion tool
- Rear cable management
- Shield connection separated from strain relief
- Universal wiring - T568 A or B wiring pattern
- Including grounding bolt
- Protected PCB

Color: black (RAL 9005)



ORDERING INFORMATION

Description	Part Number
Cat. 5e 24 Ports Shielded Patch Panel with 110C IDC blocks	336671-2
Cat. 5e 24 Ports Shielded Patch Panel with LSA-PLUS IDC blocks	7022 1 015-24

Modular Twisted Pair

Category 5e - Patch Panels

Category 5e 6Block Unshielded Patch Panel

FEATURES

- 19", RJ-45 Patch Panel with 24 (1U) or 48 (2U) ports
- Category 5e
- Enhanced 110 IDC blocks compatible with 110C Impact or LSA-PLUS Insertion tool
- Universal wiring - T568 A or B wiring pattern

Color: black (RAL 9005)



ORDERING INFORMATION

Description	Part Number
Cat. 5e 6Block Unshielded Patch Panel; N° of Ports: 24	406330-1
Cat. 5e 6Block Unshielded Patch Panel; N° of Ports: 48	406331-1

Category 5e 24 Ports Unshielded Patch Panel

FEATURES

- 19", 1U, RJ-45 Patch Panel with 24 ports
- Category 5e
- Enhanced LSA-PLUS IDC blocks compatible with LSA-PLUS Insertion tool
- Rear cable management
- Universal wiring - T568 A or B wiring pattern
- Including grounding bolt
- Protected PCB

Color: black (RAL 9005)

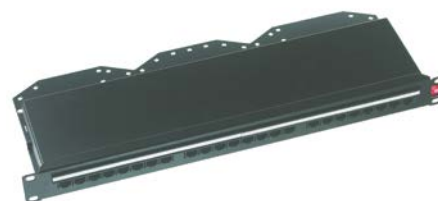

ORDERING INFORMATION

Description	Part Number
Cat. 5e 24 Ports Unshielded Patch Panel	6527 1 607-24

Modular Twisted Pair

Category 5e - Patch Panels

MiniPods

FEATURES

- External mounting points
- Can be passed through standard floor grommets
- Incorporated dust protection on each port
- Pre-loaded with modular connectivity (including CL jacks)
- 4 and 6 port versions available



ORDERING INFORMATION

Description	Part Number
MiniPod Cat. 5e CL UTP 4 port	6540 1 677-04
MiniPod Cat. 5e CL UTP 6 port	6540 1 677-06

Modular Twisted Pair

Category 5e - Consolidation Point

Unshielded Consolidation Point Transition Cable Assemblies

FEATURES

- Assembly to connect the work area outlet with the consolidation or transition point (SL 110C Jack to modular plug)
- Meets ISO/IEC 11801 and EN 50173-1
- 4 pair solid U/UTP cable
- LSZH sheath
- Universal wiring



Color: white

ORDERING INFORMATION

Description	Part Number
Cat. 5e; Class D	Y-1711040-X

Y- -X	Length
0- -5	5.0 m
1- -4	7.5 m
1- -0	10.0 m
1- -5	15.0 m
2- -0	20.0 m

Modular Twisted Pair

Category 5e - Patch Cords

Category 5e Overmolded UTP Patch Cords

Category 5e overmolded patch cords with integrated strain relief available in standard T568B and crossover configurations, LSZH and PVC.

Before ordering patch cords, check the transmit and receive orientation of the hub and network interface card. Some manufacturers require a crossover of transmit and receive pairs; others have either the hub port or NIC card reversed in advance. Some can switch between the two.

TEST SPECIFICATION

Exceeds specifications according to ISO/IEC 11801:2002, EN 50173-1:2002 and TIA/EIA 568-B

Fire rating IEC 60332-1

FEATURES

- Performance exceeding Category 5e specifications up to 100MHz
- Range of sheath and length variants
- Fully interoperable and backwards compatible
- Third party certification at a component level
- Superior cable flexibility from stranded cores
- Boot maintains correct bend radius to ensure maximum performance
- Flammability rating for PVC and LSZH cords: IEC 60332-1



ORDERING INFORMATION

Description	Color	Part Number	-YY	Length
Category 5e Overmolded Patch Cord RJ45 plug to RJ45 plug, T568B PVC	Blue UTP	7063 7 611-YY	-04	1.0 m
	Red UTP	7063 7 612-YY	-07	2.0 m
	Yellow UTP	7063 7 613-YY	-10	3.0 m
	Green UTP	7063 7 614-YY	-15	5.0 m
	Grey UTP	7063 7 617-YY	-25	7.5 m
			-33	10 m

Other colors and lengths are available upon request

Modular Twisted Pair

Category 5e - Patch Cords

Solid Core Patch Cords

For use in data centres and communications rooms to enable 'hard-wired' connections between patch panels and active networking equipment.

Wired to T568-B and complete with terminated plugs at both ends, patch cords are 100% tested and warranted to exceed specification requirements.

TEST SPECIFICATION

Exceeds specifications according to ISO/IEC 11801:2002, EN 50173-1:2002 and TIA/EIA 568-B

Fire rating is IEC 60332-1

FEATURES

- Performance exceeding Category 5e specifications up to 100MHz
- Wired to T568-B
- Complete with integrated strain relief to protect terminations within the plug
- Fully interoperable and backwards compatible



ORDERING INFORMATION

Description	Part Number	-XX	Length
		Patch Cord, Solid, Category 5e U/UTP, LSZH, Blue	6529 1 202-XX
Patch Cord, Solid, Category 5e U/UTP, LSZH, White	6529 1 203-XX	-20	20 m
Patch Cord, Solid, Category 5e U/UTP, LSZH, Orange	6529 1 205-XX	-30	30 m
		-40	40 m
		-50	50 m

Other colors and lengths are available upon request

Modular Twisted Pair

Category 5e - Patch Cords

Category 5e F/UTP Patch Cord

FEATURES

- Category 5e according to ISO/IEC 11801 and EN-50173-1
- 4 Pair stranded F/UTP cable
- LSZH sheath
- Color-matched snagless boots
- Universal wiring

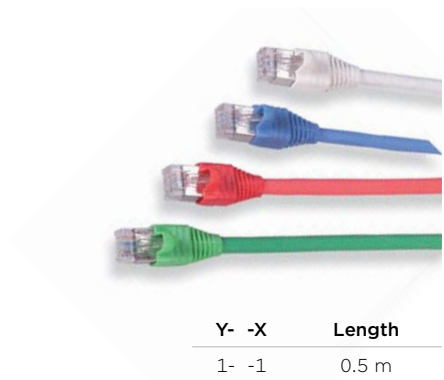

Y- -X	Length
1- -1	0.5 m
0- -1	1.0 m
0- -2	2.0 m
0- -3	3.0 m
0- -5	5.0 m
1- -0	10.0 m

ORDERING INFORMATION

Description	Part Number
F/UTP; Color: gray	Y-959305-X
F/UTP; Color: green	Y-959306-X
F/UTP; Color: yellow	Y-959307-X
F/UTP; Color: blue	Y-959308-X
F/UTP; Color: red	Y-959309-X
F/UTP; Color: white	Y-1644077-X

Other colors and lengths are available upon request

Category 5e U/UTP Patch Cord RJ-45 LSZH

FEATURES

- Category 5e according to ISO/IEC 11801 and EN-50173-1
- 4 Pair stranded U/UTP cable
- LSZH sheath
- Color-matched snagless boots
- Universal wiring



ORDERING INFORMATION

Description	Part Number	Y- -X	Length
Color: white	Y-1644076-X	1- -1	0.5 m
Color: red	Y-1711028-X	0- -1	1.0 m
Color: green	Y-1711034-X	0- -2	2.0 m
Color: blue	Y-1711035-X	0- -3	3.0 m
Color: gray	Y-1711038-X	0- -5	5.0 m
		1- -0	10.0 m

Other colors and lengths are available upon request

Modular Twisted Pair

Voice - Backbone Cable

25 Pair Category 5E PowerSum Backbone Cable

FEATURES

- Category 5E UTP Backbone Cable
- 25 Pair Construction
- AWG 24
- UL listed

Color: white



ORDERING INFORMATION

Description	Part Number
Sheathing: CMR; OD: 13.0 mm; Packaging: 305 m/Reel	1499418-1

Multi-Pair Category 3 Backbone Cable

FEATURES

- Category 3 Telephone Backbone Cable
- AWG 24
- LSZH Jacket

Color: white



ORDERING INFORMATION

Description	Part Number
25 Pairs; OD: 13.0 mm; Packaging: 500 m/Reel	1711494-1
50 Pairs; OD: 16.0 x 29.0 mm; Packaging: 500 m/Reel	1711495-1
100 Pairs; OD: 35.0 mm; Packaging: 500 m/Reel	1711496-1

Modular Twisted Pair

Voice - Jacks

SL Series Modular Jack (UTP)

FEATURES

- SlimLine (SL) Series: Thin profile improves outlet density
- Category 3
- 90° or 180° cable dress for easy termination
- Bend-limiting strain relief included
- UL listed
- Universal wiring - T568 A or B wiring pattern
- Several colors available on demand

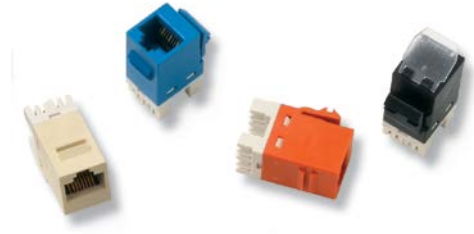

ORDERING INFORMATION

Description	Part Number
Cat. 3 RJ-11 unshielded Jack without dust cover	Y-1375192-X

Y- -X	Color
0- -1	Beige
0- -2	Black
0- -6	Blue
1- -3	Alpine White

SL Series Modular Coupler

FEATURES

- Straight Category 3 telephone coupler
- Compact coupler for two modular plugs
- SL Series: Thin profile improves outlet density



ORDERING INFORMATION

Description	Part Number
Cat. 3 RJ-11 (6 pos) unshielded Coupler	555050-1
Cat. 3 RJ-45 (8 pos) unshielded Coupler	555052-1

Modular Twisted Pair

Voice - Jacks

SL Series Multimedia Inserts

Y- -X	Color
0- -1	Light Almond
0- -2	Black
1- -3	Alpine White

FEATURES

- The inserts offer flexibility and density at the work area outlet
- Can be installed in any faceplate or outlet designed to the SL series jack footprint
- Some couplers may not be available in all colors

ORDERING INFORMATION

Description	Part Number
ST Coupler; Fiber Type: Multimode	Y-1339123-X
ST Coupler; Fiber Type: Singlemode	Y-1479181-X
BNC Coupler Insert; Figure B	Y-2111615-X
MT-RJ SL Series Housing	Y-1374416-X
RCA Coupler, Red Dielectric	Y-1375361-X
RCA Coupler, White Dielectric	Y-1375362-X
RCA Coupler, Yellow Dielectric	Y-1375363-X
RCA Solder Termination, Red Dielectric	Y-1375364-X
RCA Solder Termination, White Dielectric	Y-1375365-X
RCA Solder Termination, Yellow Dielectric	Y-1375366-X
RCA Coupler, Green Dielectric	Y-1933192-X
RCA Coupler, Blue Dielectric	Y-1933193-X
RCA Coupler, Orange Dielectric	Y-1933194-X
RCA to F-Connector; Figure I	Y-1933096-X
F-Connector Coupler, 2 GHz; Figure E	Y-1499855-X
3.5 mm Stereo Mini-Headphone, Screw Terminal, Figure F	Y-1933582-X
Speaker Post, Black Stripe	Y-1479190-X
Speaker Post, Red Stripe; Figure G	Y-1479191-X
SC Simplex Coupler; Fiber Type: Multimode or Singlemode	Y-1499836-X
LC Coupler; Fiber Type: Singlemode APC; LC Coupler and Housing, Green	1933286-3
LC Coupler; Fiber Type: Singlemode; LC Coupler and Housing, Blue	1933286-4
LC Coupler; Fiber Type: XG LO 850 nm 50/125µm; LC Coupler and Housing, Aqua, OM3 & OM4	1933286-6
LC Coupler; Fiber Type: 50/125µm; LC Coupler and Housing, Black, OM2	1-1933286-1
LC Coupler; Fiber Type: 62.5/125µm; LC Coupler and Housing, Beige, OM1	1-1933286-2
USB A-A Coupler; Figure J	Y-1933659-X
USB B-A Coupler; Figure K	Y-1933661-X
HDMI Coupler Figure H	2111500-2
Blank Insert Figure A	Y-1116412-X

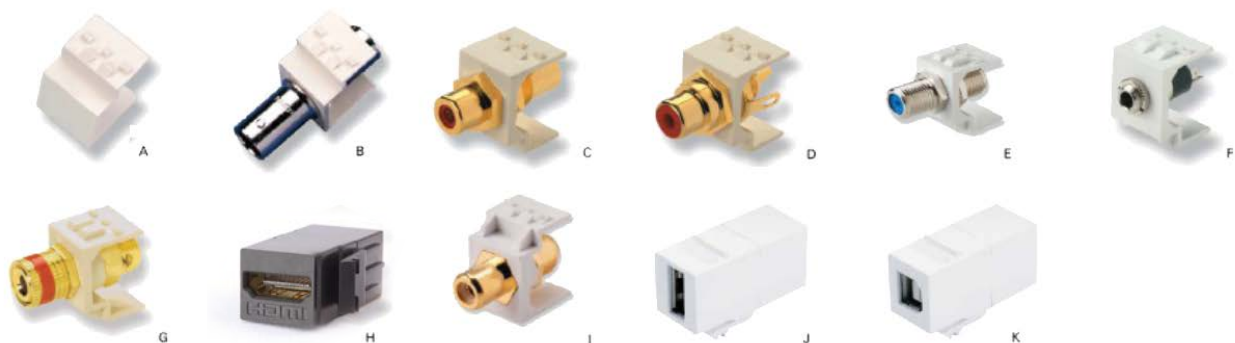

Modular Twisted Pair

Voice - Patch Panels

Category 3 Telephone Patch Panel - fixed

FEATURES

- 19", 1U, Telephone Panel with 50 ports
- Prepared for AMPTRAC upgrade
- Active Pin-out: 36,45
- Enhanced 110 IDC blocks compatible with 110C Impact or LSA-PLUS Insertion tool
- Conductor diameter range from AWG 26-22 (0.4-0.65 mm)
- Rear cable management for multipair cables
- 110 IDC blocks for conductor insulation diameters up to 1.28 mm

Color: black (RAL 9005)



ORDERING INFORMATION

Description	Part Number
Cat. 3; 50 Ports Telephone Patch Panel - fixed; 110C IDC blocks	1394060-2

Category 3 Telephone Patch Panel - sliding

FEATURES

- 19", 1U, Telephone Panel with 25 or 50 ports
- Active Pin-out: 36,45
- Enhanced LSA-PLUS IDC blocks compatible with LSA-PLUS Insertion tool
- Expansive cable management for maximum cable protection
- Innovative sliding panel mechanism for improved ease of installation

Color: black (RAL 9005)



ORDERING INFORMATION

Description	Part Number
Cat. 3; 25 Ports Telephone Patch Panel - sliding; LSA-PLUS blocks	7022 4 001-25
Cat. 3; 50 Ports Telephone Patch Panel - sliding; LSA-PLUS blocks	7022 4 001-50

Modular Twisted Pair

Voice - LSA-PLUS Modules

LSA-PLUS Series 2 Backmount Disconnection Module

10 pair LSA-PLUS modules which contain two piece contacts normally closed. Has advantage of individual pair disconnection and four wire test access.



ORDERING INFORMATION

Description	Part Number
LSA-PLUS Backmount Disconnection Module, White, Pack of 10	6089 1 102-02
LSA-PLUS Backmount Disconnection Module, Cream, Pack of 10	6089 1 810-00

LSA-PLUS PROFIL NT Disconnection Module

Disconnection module for 10 pairs, with right-angled arrangement of the contact rows for distributor systems ensuring enhanced access security. The mounting pitch is only 17.5mm. For installation in PROFIL rack systems with rod spacing 95mm for 10 pairs.

Small jumper guides left and right with built-in earth contact clips.

Housing colour: cream white

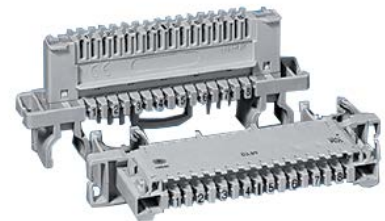

ORDERING INFORMATION

Description	Part Number
LSA-PLUS PROFIL NT Disconnection Module, 10 Pairs	7014 1 601-00

LSA-PLUS PROFIL NT Earth Module

For connecting drain wires to an earth contact without soldering, wire-stripping or the use of screws.

Designed for universal use with:

- Up to 20 drain wires
- For clicking onto PROFIL frames

Housing colour: red

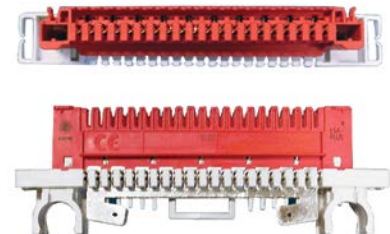

ORDERING INFORMATION

Description	Part Number
LSA-PLUS PROFIL NT Earth Module	7014 2 152-00

Modular Twisted Pair

Voice - LSA-PLUS Label Holders

10 Pair Label Holder and Labels

Easy identification of terminations and groups of modules. Label holders are available for mounting on 10 pair LSA-PLUS modules and for mounting directly onto the backmount frame. Labels can be ordered separately.



ORDERING INFORMATION

Description	Quantity	Part Number
Double Sided Hinged Label Holder Grey	Pack of 10	6092 1 810-00
Label Holder Complete with Label, fits on one position on backmount frame	Pack of 10 Strips	6092 1 820-00
Blank white labels for use with label holders 6092 1 810-00 & 6092 1 840-00	Pack of 100	6534 1 001-00

PROFIL Module Label Holder

Designed for universal use with backmount frame and PROFIL rod systems. For vertical identification

Label size: 95 x 18 mm for 2/10

Requires the space of one connection module in the backmount frame / PROFIL rod system.



ORDERING INFORMATION

Description	Part Number
PROFIL Module Label Holder	6753 2 009-00

LSA-PLUS NT Hinged Label Holder

Hinged label holder for LSA-PLUS NT. Can be inserted directly onto LSA-PLUS NT/PROFIL NT modules for 10 pairs. Comes with paper label and transparent cover. The flammability class of the grey label holder is UL94 V-0



ORDERING INFORMATION

Description	Part Number
Hinged Label Holder	7014 2 007-00

Modular Twisted Pair Voice - LSA-PLUS Frames

Backmount Frames

Backmount frames in a variety of sizes, suitable for LSA-PLUS Series 2 Modules.

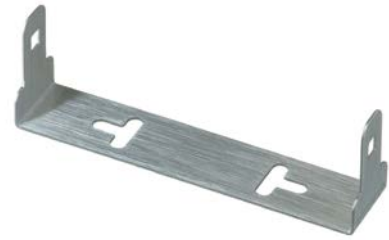

ORDERING INFORMATION

Description	Quantity	Part Number
11mm Deep, 1 Module	1	6424 3 005-01
11mm Deep, 2 Modules	1	6424 3 005-02
11mm Deep, 7 Modules	1	6424 3 005-07
30mm Deep, 10 Modules	1	6424 3 007-10
50mm Deep, 30 Modules	1	6424 3 009-30
60mm Deep, 34 Modules	1	6424 3 010-34

PROFIL Frame 95/46

For installation in already set-up distribution frames and distribution cabinets.

- The frame consists of:
 - 2 PROFIL rods, 12mm in diameter (stainless steel)
 - An adequate number of PROFIL holders with a depth of 46mm
- Completely assembled PROFIL frame:
 - PROFIL frame 95 for accommodation of LSA PROFIL modules 2/10, 2/8-95, LS 10 pairs and HighBand*

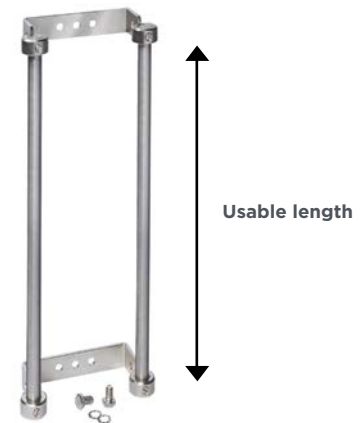

ORDERING INFORMATION

Description	Part Number
PROFIL Frame 95/46, length of rods 299mm	6577 2 812-01
PROFIL Frame 95/46, length of rods 574mm	6577 2 812-02
PROFIL Frame 95/46, length of rods 861mm	6577 2 812-03
PROFIL Frame 95/46, length of rods 1136mm	6577 2 812-04
PROFIL Frame 95/46, length of rods 1423mm	6577 2 812-05
PROFIL Frame 95/46, length of rods 1698mm	6577 2 812-06

Modular Twisted Pair

Voice - LSA-PLUS Connection Cords

LSA-PLUS Series 2 Connection Cord

Equipped with a plug at each end of the cord. Primarily used for interconnecting separate circuits either on the same or between different LSA-PLUS modules.



ORDERING INFORMATION

Description	Quantity	Part Number
2 Pole. For use with LSA-PLUS connection and disconnection modules, cord length 1.5m	Pack of 10	6529 1 022-01
4 Pole. For use with LSA-PLUS switching and disconnection modules, cord length 1.5m	Pack of 10	6529 1 042-01

LSA-PLUS NT Connection Cord, 1 Pair

Connection cord with 2 NT plugs. Thanks to the extended length, the plug can be easily gripped even when there are adjacent protection magazines. Designed for LSA-PLUS NT/LSA PROFIL NT disconnection and switching modules; 2-pole connection on the cable side (a to a and b to b).



ORDERING INFORMATION

Description	Part Number
LSA-PLUS NT connection cord, 1 pair 2m	7014 2 040-00

Modular Twisted Pair

Voice - LSA-PLUS Protection Plugs

ComProtect Series B

Compact plug-in single pair overvoltage protection for LSA-PLUS series. ComProtect Series B protects from damage caused by overvoltage with a 3-pole GDT with failsafe (primary circuit) and transient secondary elements (Diodes) for quick responding fine protection. Additional overcurrent protection is realised with reversible thermistors (PTCs) that complete the 5 point protective circuitry. These devices are designed for use in exchanges and terminal equipment in both analogue and ISDN (<2MBps) systems. All include earthing rail.



ORDERING INFORMATION

Description	Quantity	Part Number
CP BI12A1 - 5 point and transient protection, max. operating voltage is 12V, GDT with failsafe	10	5909 1 084-00
CP BI24A1 - as above, max. operating voltage is 24V	10	5909 1 083-00
CP BI70A1 - as above, max. operating voltage is 70V	10	5909 1 082-00
CP BI180A1 - as above, max. operating voltage is 180V	10	5909 1 076-00
CP BOD180A2 - high GDT clamping voltage (>250V)	10	5909 1 078-10

NTP OD180A2

Recommended for protection of distribution and terminal equipment in analog, ISDN, HDSL and ADSL telecommunication systems. Designed for the partial or complete equipping of LSA-PLUS NT or LSA PROFIL NT disconnection or switching modules in conjunction with a 10-pair earth bar (Order No.: 7019 3 037-00).

The protection circuit consists of a 3-pole overvoltage arrester, fail-safe contact, reversible overcurrent protection components and diodes for secondary overvoltage protection. The overcurrent protection functions as a reversible line fuse.



ORDERING INFORMATION

Description	Part Number
NTP OD180A2	7019 1 014-00

Modular Twisted Pair

Voice - Indoor Boxes

Connection Box 201D

Low profile plastic box accommodates up to 20 pairs or 2 LSA-PLUS modules.

Dimensions: 170(H) x 120(W) x 43(D)mm



ORDERING INFORMATION

Description	Part Number
Connection Box 201D, 20 Pair	6429 1 076-00
Connection Box 201D, 10 Pair	6429 1 078-00

Connection Box 301A

Plastic modular box, for 100 pairs designed to accommodate 10 LSA-PLUS 10 pair modules.

Dimensions: 320(H) x 210(W) x 120(D)mm

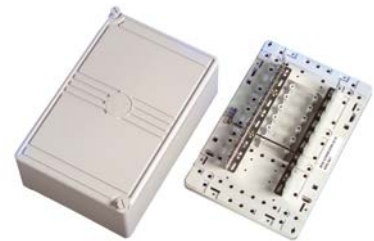

ORDERING INFORMATION

Description	Part Number
Connection Box 301A (Includes 1 backmount frame 5/30/10A equivalent and earthing)	6530 1 017-00

Modular Twisted Pair

Voice - Indoor Boxes

KRONECTION Boxes

FEATURES

- Plastic Distribution Box for Surface- and flush-mounted applications
- All KRONECTION boxes (empty housing) can be fitted with LSA-PLUS NT back-mount frames
- KRONECTION boxes with back-mount frames are designed for installation of overvoltage protection elements (additional wall attachment frame required)
- Protection class: IP 30 according to DIN 40050. These distribution boxes are designed for indoor use.
- Flammability class: UL 94V-0

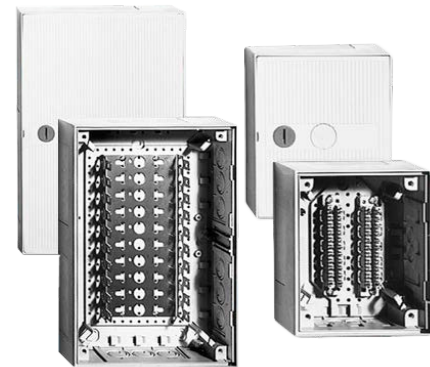

Color: RAL 7035 (polystyrene-compatible paintings possible).

ORDERING INFORMATION

Description	H x W x D (mm)	Part Number
KRONECTION-Box I (empty)	170 x 140 x 75	6436 1 001-xx
KRONECTION-Box I (outfitted with 1 back-mount frame for 3 LSA-PLUS modules 2/10)	170 x 140 x 75	6436 1 013-xx
Back-mount frame NT for Box I (30 pairs, without label holder)		7014 3 046-13
KRONECTION-Box II (empty)	215 x 215 x 75	6406 1 001-xx
KRONECTION-Box II (outfitted with 1 back-mount frame for 3 LSA-PLUS modules 2/10)	215 x 215 x 75	6406 1 015-xx
Back-mount frame NT for Box II (70 pairs, without label holder)		7014 3 046-12
KRONECTION-Box III (empty)	320 x 215 x 75	6437 1 001-xx
KRONECTION-Box III (outfitted with 1 back-mount frame for 3 LSA-PLUS modules 2/10)	320 x 215 x 75	6437 1 020-xx
Back-mount frame NT for Box III (120 pairs, without label holder)		7014 3 046-11

xx = 20 for door with turnbuckle

xx = 21 for door with cylinder lock and one key

Accessories for KRONECTION-Box I, II, III

FEATURES

- Mounting frames available as flush-mount or for attachment
- Attachment frames for increasing the installation depth by 37 mm for overvoltage protection applications



Flush-mounting frame

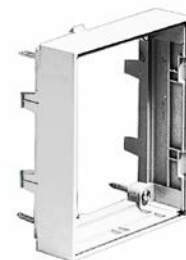

Attachment frame

ORDERING INFORMATION

Description	Part Number
Flush-mounting frame for KRONECTION-Box I	6436 2 004-20
Attachment frame for KRONECTION-Box I	6436 3 003-20
Flush-mounting frame for KRONECTION-Box II	6406 2 004-20
Attachment frame for KRONECTION-Box II	6406 3 003-20
Flush-mounting frame for KRONECTION-Box III	6437 2 004-20
Attachment frame for for KRONECTION-Box III	6437 3 003-20
Cylinder lock for replacing the turnbuckle incl. one key	6437 2 010-00
Jumper pin as wire guide (6 pieces)	6406 2 013-00

Modular Twisted Pair Voice - Indoor Boxes

LSA Connection Boxes

FEATURES

- Manufactured from lightweight 1mm mild steel
- Removable top and bottom gland plates and internal jumper rings
- Quick release hinges
- Doors can be hinged either left or right
- Strong, robust and durable solution
- Tidy cable management
- Quick release hinges aid and simplify installations
- Increased flexibility



ORDERING INFORMATION

Description	Pairs Capacity	Backmount Frames	Dimensions (mm) WxHxD	Weight (Kg)	Jumper rings	Pack Qty	Part Number.
Connection Box 500 Series	100	1 x 10 way	235x350x115	3.2	4	1	6428 2 421-00
Connection Box 500 Series	200	1 x 20 way	235x700x115	5.2	6	1	6428 2 420-00
Connection Box 500 Series	200	2 x 10 way	425x350x115	5.4	6	1	6428 2 418-00
Connection Box 500 Series	400	2 x 20 way	425x700x115	8.6	9	1	6428 2 419-00
Connection Box 510	340	1 x 34 way	300x1000x140	11	8	1	6428 2 423-00
Connection Box 520	680	2 x 34 way	500x1000x140	17	12	1	6428 2 424-00
Connection Box 530	1020	3 x 34 way	750x1000x140	25	16	1	6428 2 425-00
Connection Box 540	1340	4 x 34 way	1000x1000x140	32	20	1	6428 2 422-00

Modular Twisted Pair

Unloaded Hardware - Patch Panels

UCP Patch Panel Angled and Flushmount

FEATURES

- 19" 1U unloaded modular patch panel with support for 4 Quick-Fit Modules
- Angled and flush style panels available
- Modular, rear cable management for both horizontal Copper and Fiber cables
- Accepts Pre-terminated Cu or FO cassettes or Field-terminated Copper modules
- Including grounding bolt



Color: black (RAL 9005)

ORDERING INFORMATION

Description	Part Number
UCP Patch Panel 1U Angled	1-1671590-1
UCP Patch Panel 1U Flush	1-1671594-1

Angled 1U Modular Panel (unloaded)

FEATURES

- 19" 1U angled modular Patch Panel to be equipped with different Slim Line jacks
- Adjustable & removable rear cable bracket incl. easy to use cable organizing CaRe-clips
- Including grounding bolt



Color: black (RAL 9005)

ORDERING INFORMATION

Description	Part Number
Angled modular panel UTP	1-1671157-1
Angled modular panel STP	1-1671157-2

Modular Twisted Pair

Unloaded Hardware - Patch Panels

Flushmount AMPTRAC *Ready!* Patch Panel (unloaded)

FEATURES

- 19" 1U unloaded flushmount panel to be equipped with different SlimLine jacks
- AMPTRAC *Ready!* version: prepared for AMPTRAC upgrade
- Holds up to 24 SL jacks

Color: black (RAL 9005)

ORDERING INFORMATION

Description	Part Number
AMPTRAC <i>Ready!</i> unloaded panels for all SL jacks; Color: black (RAL 9005)	1711685-1
AMPTRAC <i>Ready!</i> unloaded panels for all SL jacks; Color: light gray (RAL 7035)	1711685-2



Flushmount Modular Patch Panel (unloaded)

FEATURES

- 19" 1U unloaded flushmount panel to be equipped with different SlimLine jacks
- Suitable for UTP and STP SL Series jacks
- Including grounding bolt

Color: black (RAL 9005)

ORDERING INFORMATION

Description	Part Number
Flushmount Modular Panel	1-1671183-1



Flushmount Standard Patch Panels (unloaded)

FEATURES

- 19" Standard unloaded flushmount panel to be equipped with different SlimLine jacks
- Accepts up to 24 SL jacks
- Including grounding bolt

ORDERING INFORMATION

Description	Part Number
24 port panel; Height: 1U; Color: black (RAL 9005)	336526-1
24 port panel; Height: 1U; Color: light gray (RAL 7035)	336526-4



Modular Twisted Pair

Unloaded Hardware - Patch Panels

Modular Q-Jack Patch Panel (unloaded)

FEATURES

- 19" unloaded 1U flushmount patch panel to be used with Q-Jacks (see page 208)
- UTP and STP configuration possible
- Integral cable management bar
- 45° IDC contacts providing secure, gas-tight connections
- Accepts 110 style termination tools
- Universal 568A/B wiring
- Discrete labelling system



ORDERING INFORMATION

Description	Part Number
24 port Q-Jack Patch Panel (unloaded)	300001739943
48 port Q-Jack Patch Panel (unloaded)	300001739995
Blank plugs 12 per pack	300001741753

Modular KM8 Jack Patch Panel (unloaded)

FEATURES

- 19" unloaded 1U flushmount patch panel to be used with KM8 Jacks (see pages 207, 212 and 214)
- UTP and STP configuration possible
- Integral cable management bar
- KM8 termination tool
- Discrete labelling system



ORDERING INFORMATION

Description	Part Number
24 port KM8 Patch Panel (unloaded)	7022 2 155-24
32 port KM8 Patch Panel (unloaded)	7022 2 155-32

Modular Twisted Pair

Unloaded Hardware - Consolidation Box

Quick-Fit Consolidation Point Box

FEATURES

- Wall mount or raised floor use
- Hinged cover with knurled screw
- Low profile (H = 56mm)
- High flexibility, accepts copper and fiber Quick-Fit modules and/or cassettes
- Installer friendly
- Dust resistant
- Easy access for cleaning fiber optic connectors
- Robust construction
- Integrated strain relief feature
- Including grounding bolt

Color: Black (RAL 9005)



ORDERING INFORMATION

Description	Part Number
Quick-Fit Consolidation Point Box	1-1671414-1

Unloaded Copper Quick-Fit Modules

- To be equipped with six SL Jacks
- Available for STP and UTP
- Automatic bonding by design
- Labels included



ORDERING INFORMATION

Description	Part Number
STP Quick-Fit module	2111093-1
UTP Quick-Fit module	2111117-1
Blank Quick-Fit module	1479698-1



Modular Twisted Pair

Unloaded Hardware - Mini-Pods

MiniPods

FEATURES

- External mounting points
- Can be passed through standard floor grommets
- Incorporated dust protection on each port
- 3, 4 and 6 port versions available
- Unloaded version for AMP TWIST 6_AS jack

ORDERING INFORMATION

Description	Part Number
MiniPod Unloaded 3 port w/angled adaptor for AT 6 _A S	2153216-3
MiniPod Unloaded 4 port w/angled adaptor for AT 6 _A S	2153216-4
MiniPod Unloaded 6 port w/angled adaptor for AT 6 _A S	2153216-6



Modular Twisted Pair

Unloaded Hardware - Outlets 80 x 80 mm (DIN)

DIN Flushmount 3 Port Angled Outlet

FEATURES

- 3 port outlet to accept up to 3 SL Series Jacks
- Compatible with standard and designer 50 x 50 faceplates and 80 x 80 frames
- Ports are iconable Links to labeling in by name



ORDERING INFORMATION

Description	Part Number
DIN flushmount 3 port angled outlet (incl. 50 x 50 faceplate); Color: almond (RAL 1013)	1711485-1
DIN flushmount 3 port angled outlet (incl. 50 x 50 faceplate); Color: pure white (RAL 9010)	1711485-2
DIN flushmount 3 port angled outlet UPO (mounting frame only)	1711490-1
DIN flushmount 3 port angled outlet (incl. 50 x 50 faceplate & 80 x 80 frame); Color: almond (RAL 1013)	1711537-1
DIN flushmount 3 port angled outlet (incl. 50 x 50 faceplate & 80 x 80 frame); Color: pure white (RAL 9010)	1711537-2

DIN 3 Port Angled Outlet

FEATURES

- 3 Port outlet to accept up to 3 SL Series Jacks
- 50 x 50 mm footprint
- Supplied complete with 2 removable / replaceable blanking plates



ORDERING INFORMATION

Description	Part Number
50 x 50 mm DIN 3 port angled outlet without plastic frame; Color: almond (RAL 1013)	336613-1
50 x 50 mm DIN 3 port angled outlet without plastic frame; Color: pure white (RAL 9010)	2-336613-1
50 x 50 mm DIN 3 port angled outlet with 80 x 80 mm plastic frame; Color: almond (RAL 1013)	336614-1
50 x 50 mm DIN 3 port angled outlet with 80 x 80 mm plastic frame; Color: pure white (RAL 9010)	2-336614-1

Modular Twisted Pair

Unloaded Hardware - Outlets 80 x 80 mm (DIN)

DIN Dual Angled Outlet

FEATURES

- Dual outlet to accept either up to 2 SL Series Jacks
- To be used with single or multiple gang DIN faceplates
- Supplied complete with back plate, adapter plate and shutters
- Individual ports are icon-able



ORDERING INFORMATION

Description	Part Number
DIN Dual Angled Outlet, for 2x Slim Line Jack; Color: almond (RAL 1013)	966936-5
DIN Dual Angled Outlet, for 2x Slim Line Jack; Color: pure white (RAL 9010)	2-966936-5

DIN Standard Outlet for Recessed Mounting

FEATURES

- Outlet for recessed mounting
- To be used with single or multiple gang DIN faceplates
- Supplied complete with spring loaded shutter

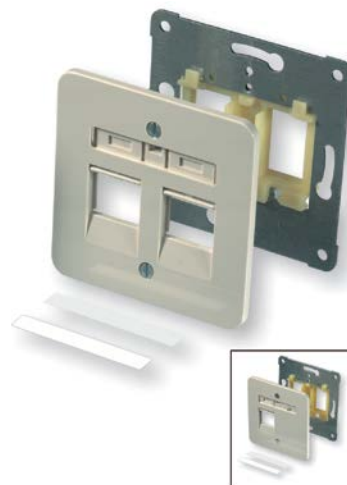

ORDERING INFORMATION

Description	Part Number
DIN standard outlet; almond (RAL 1013)	966223-1
DIN standard outlet; pure white (RAL 9010)	2-966223-1
DIN dual straight outlet; almond (RAL 1013)	966224-1
DIN dual straight outlet; pure white (RAL 9010)	2-966224-1

European Keystone Faceplate for HK and KM8

FEATURES

- Two port faceplate, 50x50
- For use with Cat5e HK and Cat6 KM8 jacks
- Complete with integrated dust protection
- Removable corners for installation in areas with restricted space



ORDERING INFORMATION

Description	Part Number
Unloaded Keystone Faceplate, 50x50, White	6690 2 675-01
Faceplate, 80x80, White	6690 3 725-05

Note: Unloaded faceplates compatible with HK jacks:

Cat 5e HK UTP Pure White (6540 1 130-01)

Cat 5e HK UTP Black (6540 1 130-04)

Cat 5e HK STP Metal (6540 1 154-02)

Modular Twisted Pair

Unloaded Hardware - Outlets 80 x 80 mm (DIN)

DIN 50 x 50 mm Faceplate Frame

FEATURES

- Faceplate suitable for all outlets with a 50 x 50 mm footprint
- External Dimensions 80 x 80 mm

ORDERING INFORMATION

Description	Part Number
80 x 80 mm Faceplate Frame for 50 x 50 mm outlets; pure white (RAL 9010)	5-336608-1
80 x 80 mm Faceplate Frame for 50 x 50 mm outlets; Color: almond (RAL 1013)	5-336608-2
80 x 80 mm Faceplate Frame for 50 x 50 mm outlets; Color: black (RAL 9005)	5-336608-3



Single and Multiple DIN Faceplate Frames

FEATURES

- Faceplate for suitable for all outlets with a 75 x 75 mm footprint
- External Dimensions 80 x 80 mm

ORDERING INFORMATION

Description	Part Number
Single Faceplate Frame; almond (RAL 1013)	964830-1
Single Faceplate Frame; pure white (RAL 9010)	2-964830-1
Dual Faceplate Frame; almond (RAL 1013)	964361-2
Dual Faceplate Frame; pure white (RAL 9010)	2-964361-2
Triple Faceplate Frame; almond (RAL 1013)	964361-3
Triple Faceplate Frame; pure white (RAL 9010)	2-964361-3

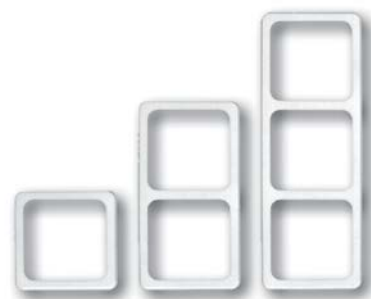

DIN Surface Mount Outlet Back Box

FEATURES

- Back Box for Surface Mounting
- Available individually or as a complete kit with a single faceplate
- Not suitable for use with multiple faceplates

ORDERING INFORMATION

Description	Part Number
Surface Mount Outlet Back Box; almond (RAL 1013); Back box only	966740-1
Surface Mount Outlet Back Box; almond (RAL 1013); Back box + faceplate	966740-2
Surface Mount Outlet Back Box; pure white (RAL 9010); Back box only	2-966740-1
Surface Mount Outlet Back Box; pure white (RAL 9010); Back box + faceplate	2-966740-2
Adaptor DIN RAIL to DIN Surface Mount Outlet Back Box;	1671164-1



Modular Twisted Pair

Unloaded Hardware - Outlets 80 x 80 mm (DIN)

Universal Mounting Bracket

FEATURES

- Universal Mounting Bracket for installations into trunking
- Available in two sizes:
 - for installation into trunking with a small "C-Profile"
 - for installation into trunking with a big "C-Profile"

ORDERING INFORMATION

Description	Part Number
Universal Mounting Bracket for small C-profile	966498-1
Universal mounting bracket for big C-profile	1671925-1



Modular Twisted Pair

Unloaded Hardware - Outlets 80 x 80 mm (DIN)

Floor box Bracket for OBO Bettermann GESR 7/10

FEATURES

- Mounting Bracket for installations into Ackerman floor boxes
- Supplied complete with fixing screws
- Stainless Steel bracket
- Complete with strain relief handle
- 2 lengths available - with or without cable management
- Blanking Plate available separately



ORDERING INFORMATION

Description	Part Number
Blanking Plate (Pearl white)	964719-1
Floor box Bracket; 3 Gang without Management	1394294-1
Floor box Bracket; 2 Gang without Management	1394294-3

SL Jack Mounting Frame for Bettermann Floor Boxes

FEATURES

- High density SL applications in floor box environments
- Angled geometry for easy cable management
- Frame is iconable and provides labeling space
- May be modified to suit almost any floor box application
- SL Jacks with dust covers recommended for use within these frames
- Patent pending
- Available unpainted or in black
- Unpainted parts are equipped with VDE grounding bolt



Color: black

ORDERING INFORMATION

Description	Part Number
SL Jack mounting frame; 6 Ports black (short version)	1711255-1
SL Jack mounting frame; 9 Ports black (long version)	1711255-2
SL Jack mounting frame; 6 Ports unpainted (short version)	1711255-3
SL Jack mounting frame; 9 Ports unpainted (long version)	1711255-4

Modular Twisted Pair

Unloaded Hardware - Outlets Swiss Installation

“EDIZIOdue” 2 Port Straight

FEATURES

- “EDIZIOdue” 2 port faceplates suitable for trunking, recessed or surface mounting
- Accepts all SL Series Jacks
- Individual ports are icon-able



ORDERING INFORMATION

Description	Part Number
AP; Color: pure white (RAL 9010)	5-101016-7
UP; Color: pure white (RAL 9010)	1711168-1
UP; Color: black (RAL 9005)	1711168-4
KNL; Color: pure white (RAL 9010)	1711169-1
KNL; Color: black (RAL 9005)	1711169-4

Kallysto 2 Port Angled with Adaptor Plate

FEATURES

- Kallysto 2 port angled faceplate suitable for trunking, recessed or surfaced mounting
- Accepts all SL Series Jacks
- Large labeling field



ORDERING INFORMATION

Description	Part Number
UP; Color: pure white (RAL 9010)	1711604-1
UP; Color: black (RAL 9005)	1711604-4
KNL; Color: pure white (RAL 9010)	1711632-1
KNL; Color: black (RAL 9005)	1711632-4
AP; Color: pure white (RAL 9010)	1711633-1
AP; Color: black (RAL 9005)	1711633-4

“FLF” 2 Port with Adaptor Plate

FEATURES

- Dual faceplate suitable for floor box mounting
- Accepts all SL Series Jacks

ORDERING INFORMATION

Description	Part Number
FLF; Color: pure white	1711606-1
FLF; Color: black	1711606-2



Modular Twisted Pair

Unloaded Hardware - Outlets Swiss Installation

“EDIZIOdue Compatible” 3 Port DIN Flushmount Angled

FEATURES

- “EDIZIOdue compatible” 3 port angled faceplates suitable for trunking or recessed mounting
- Accepts all SL Series Jacks (except AMP-TWIST 7_AS)
- Self-adhesive labels are available
- Individual ports are icon-able



ORDERING INFORMATION

Description	Part Number
UP, 3 port; Color: pure white (RAL 9010)	1711625-1
KNL, 3 port; Color: pure white (RAL 9010)	1711626-1

“EDIZIOdue Compatible” 3 Port DIN Angled

FEATURES

- “EDIZIOdue compatible” 3 port DIN angled faceplates suitable for trunking or recessed mounting
- Accepts all SL Series Jacks
- Self-adhesive labels are available
- Individual ports are icon-able



ORDERING INFORMATION

Description	Part Number
UP, 3 port; Color: pure white (RAL 9010)	1711082-1
KNL, 3 port; Color: pure white (RAL 9010)	1711083-1

“EDIZIOdue Compatible” 4 Port Straight

FEATURES

- “EDIZIOdue compatible” 4 port straight faceplates
- Accepts all SL Series Jacks
- Self-adhesive labels are available
- Individual ports are icon-able



ORDERING INFORMATION

Description	Part Number
KNL, 4 Port; Color: pure white	1711282-1
KNL, 4 port; Color: black	1711282-2

Modular Twisted Pair

Unloaded Hardware - Outlets Swiss Installation

“Standard” 2 Port Straight

FEATURES

- “Standard” Style 2 port faceplates suitable for trunking or recessed mounting
- Accepts all SL Series Jacks
- Individual ports are icon-able



ORDERING INFORMATION

Description	Part Number
UP; Color: pure white (RAL 9010)	7-101016-3
KNL; Color: pure white (RAL 9010)	7-101016-5

Basico 2 Port Angled with Adaptor Plate

FEATURES

- Basico 2 port angled faceplates suitable for trunking, recessed or surface mounting
- Accepts all SL series jacks
- Large labeling field



ORDERING INFORMATION

Description	Part Number
UP; Color: pure white (RAL 9010)	1711605-1
AP; Color: pure white (RAL 9010)	1711634-1
KNL; Color: pure white (RAL 9010)	1711644-1

Blanking plate

FEATURES

- Blanking plate to be inserted from frontside



ORDERING INFORMATION

Description	Part Number
Blanking Plate for EDIZIOdue 2port + 4port and Standard Outlets; Color: pure white	1711283-1
Blanking Plate for EDIZIOdue 2port + 4port and Standard Outlets; Color: black	1711283-2
Blanking Plate for Kallysto, Basico and FLF; Color: pure white	1711937-1
Blanking Plate for Kallysto, Basico and FLF; Color: black	1711937-2

Modular Twisted Pair

Unloaded Hardware - Outlets UK Style (BS)

BS 50 mm Unloaded Faceplates and Shuttered Modules

FEATURES

- Unloaded faceplate accepts either 2 or 4 BS 50 mm shuttered modules
- Single shuttered 50 mm module (spring loaded shutter)
- Dimensions module: 25 x 50 mm

Color: signal white (RAL 9003)



ORDERING INFORMATION

Description	Part Number
Single shuttered 25 x 50 mm angled module	1711275-1
Single gang faceplate (for 2 shuttered modules)	1711399-1
Dual gang faceplates (for 4 shuttered modules)	1711400-1
Triple gang faceplate (for 3 shuttered modules)	1711963-1
Blanking plate 25 x 50 mm	1711403-1
Blanking plate 12.5 x 50 mm	1711404-1

UK Style Faceplates & Adaptors

FEATURES

- For use with CL keystone jacks
- In-line and angled options available
- Single and Double gang faceplates



ORDERING INFORMATION

Description	Part Number
RJ-K CL Standard 25x50 adaptor white (pack of 20)	6540 1 801-00
RJ-K CL Angled 25x50 adaptor white (pack of 20)	6540 1 802-00
Keystone Angled 25x50 adaptor white (pack of 1)	6538 4 111-05
Unloaded Deep Faceplate, UK style, 50x50 (single-gang), White (Pack of 10)	6540 1 812-04
Unloaded Deep Faceplate, UK style, 50x100 (double-gang), White (Pack of 10)	6540 1 812-05

Note: Unloaded adaptors compatible with jacks:
 Cat 5e CL UTP White shutter RJ45 (6540 1 200-01)
 Cat 6 CL UTP White RJ45 (6537 1 010-00)

Modular Twisted Pair

Unloaded Hardware - Outlets UK Style (BS)

BS LJ6C Unloaded Faceplates and Shuttered Modules

FEATURES

- Unloaded faceplate accepts either 1 or 2 LJ6C shuttered modules
- Dimensions faceplate: 86 x 86 mm (single and dual port)
- Single shuttered LJ6C module (spring loaded shutter)
- Dimensions module 25 x 39 mm

Color: signal white (RAL 9003)



ORDERING INFORMATION

Description	Part Number
Single port LJ6C unloaded faceplate	1711301-1
Dual port LJ6C unloaded faceplate	1711302-1
Quad port LJ6C unloaded faceplate	2153004-1
Single shuttered LJ6C module	1711348-1
Blanking plate	1711491-1
Single unshuttered angled LJ6C module	1711775-1
Single shuttered angled LJ6C module	1859096-1



LJ6C UK Style Faceplates & Adaptors

FEATURES

- Adaptors for use with CL keystone jacks
- In-line and angled options available

ORDERING INFORMATION

Description	Part Number
CL Standard LJ6C Adaptor (pack of 20)	6540 1 810-00
CL Angled LJ6C Adaptor (pack of 20)	6540 1 813-00
Keystone Standard LJ6C Adaptor (pack of 1)	6830 2 402-00
Keystone Angled LJ6C Adaptor (pack of 1)	6540 1 814-01

Note: Unloaded adaptors compatible with jacks:
 Cat 5e CL UTP White shutter RJ45 (6540 1 200-01)
 Cat 6 CL UTP White RJ45 (6537 1 010-00)



Modular Twisted Pair

Unloaded Hardware - Outlets UK Style (BS)

Keystone UK Style Faceplate

FEATURES

- UK style faceplate with integrated dust protection
- For accommodating Category 5e HK and Category 6 KM8 and keystone jacks
- Dimensions: 85 x 85mm



ORDERING INFORMATION

Description	Part Number
Unloaded Faceplate, Keystone, UK Style, White, Single	6538 3 111-03
Unloaded Faceplate, Keystone, UK Style, White, Double	6538 3 111-04

Note: Unloaded faceplates compatible with HK jacks:
Cat 5e HK UTP Pure White (6540 1 130-01)
Cat 5e HK UTP Black (6540 1 130-04)
Cat 5e HK STP Metal (6540 1 154-02)

Back Boxes for UK Style Outlets

FEATURES

- Designed for surface installations
- Dimensions: 86 x 86 x 27mm



ORDERING INFORMATION

Description	Part Number
Back Box, Single Gang White	6536 1 005-00
Back Box, Double Gang White	6536 3 044-00

Modular Twisted Pair

Unloaded Hardware - Outlets 45 x 45 mm ("Mosaic")

Single and Dual Outlets 45 x 45 mm in Angled and Flat versions

FEATURES

- Unloaded Single Port half width shuttered module (spring loaded) with 22.5 x 45 mm footprint
- Unloaded Dual and Single Port full width shuttered module (spring loaded) with 45 x 45 mm footprint
- Frame outer dimension 86 x 86 mm
- Frame mounting dimension 60 mm

Color: pure white (RAL 9010)

ORDERING INFORMATION

Description	Part Number
Dual/Single Port angled outlet for 2 SL jacks or 1 AMP-TWIST Jack; Size: 45 x 45 mm; Picture: A	336793-1
Dual Port shuttered angled outlet for 2 AMP-TWIST Jacks; Size: 45 x 45 mm; Picture: B	1711797-1
Single Port shuttered angled outlet for 1 SL jack or 1 AMP-TWIST Jack; Size: 22.5 x 45 mm; Picture: C	1711664-1
Single Port shuttered angled outlet for 2 AMP-TWIST Jacks; Size: 45 x 45 mm;	1711653-1
Single Port shuttered flat outlet for 1 SL jack or 1 AMP-TWIST Jack; Size: 22.5 x 45 mm, Picture: D	1711349-1
Single Port shuttered flat outlet for 1 SL jack or 1 AMP-TWIST Jack; Size: 45 x 45 mm; Picture: E	1711277-1
Dual Port shuttered flat outlet 2 SL jacks; Size: 45 x 45 mm	1711276-1
"45x45" Outlet 45 x 45 mm for SC-Duplex, ST-Style, SL adaptor or MT-RJ jack; Picture: F	183931-1
Frame for 1x 45 x45 module or 2x 22.5x45 modules; Size: 45 x 45 mm; Picture: G	1-1711307-1
Blind cover; Size: 22.5 x 45 mm	1711306-1
Adapter Frame to 50 x 50 mm; Color: almond (RAL 1013); Picture: H	1379156-1
Adapter Frame 50 x 50 mm to Legrand Valena™ frames	1859130-1
85 x 85 Surface mount box; accepts frame 1-1711307-1; 45 mm deep	185705-1



Modular Twisted Pair

Unloaded Hardware - Outlets 45 x 45 mm (“Mosaic”)

45x45 Adaptors and Faceplate

FEATURES

- For use with Category 5e HK and Category 6 RJ45 Keystone jacks
- Adaptors come complete with integrated dust protection

ORDERING INFORMATION

Description	Part Number
Adaptor 22,5x45mm, Single, White	6690 1 825-10
Adaptor 45x45mm, Single,White	6690 1 825-00
Unloaded Faceplate,45x45mm, White	6690 3 745-01

Note: Unloaded adaptors compatible with HK jacks:
Cat 5e HK UTP Pure White (6540 1 130-01)
Cat 5e HK UTP Black (6540 1 130-04)
Cat 5e HK STP Metal (6540 1 154-02)



Modular Twisted Pair

Unloaded Hardware - Outlets Single/Double Gang (US Installation)

Standard USA Faceplates

FEATURES

- Accepts all AMP-TWIST jacks, SL Series jacks, MT-RJ outlet jacks and SL Series inserts
- Faceplate dimensions:
2.75 in (69.85 mm) x 4.5 in (114.30 mm) x 0.22 in (5.59 mm)
- Label viewing area with
integrated label covers that flip down and Snap-in place
- Extender kits are used to add 0.5 inches of space between the mounting surface and the faceplate

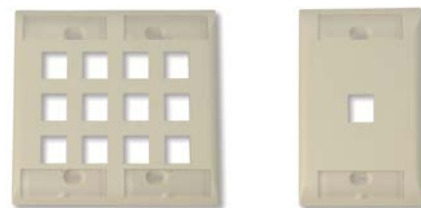

ORDERING INFORMATION

Description	Part Number
Port Count: 1; Single Gang; Orientation: Vertical	2111008-1
Port Count: 2; Single Gang; Orientation: Vertical	2111009-1
Port Count: 3; Single Gang; Orientation: Vertical	2111010-1
Port Count: 4; Single Gang; Orientation: Vertical	2111011-1
Port Count: 6; Single Gang; Orientation: Vertical	2111012-1
Port Count: 6; Double Gang; Orientation: Vertical	2111013-1
Port Count: 8; Double Gang; Orientation: Vertical	2111014-1
Port Count: 12; Double Gang; Orientation: Vertical	2111015-1
Extender Kit	2111201-1
Port Count: 4; Single Gang; Orientation: Horizontal	2111203-1

Y- -X	Color
0- -1	Almond
0- -2	Black
0- -3	White
0- -4	Gray
1- -1	Electrical Ivory

Surface Boxes

FEATURES

- Back Box for Surface Mounting
- 44.5 mm depth and one piece construction simplifies installation

ORDERING INFORMATION

Description	Part Number
Single Gang; almond	558251-1
Single Gang; pure white	558251-3



Modular Twisted Pair

Unloaded Hardware - Surface Mount Boxes

Surface Mount Modules and Accessories

FEATURES

- Accept AMP-TWIST modular jacks and all SL Series modular jacks and inserts
- Can accommodate fiber cable and connectors (MT-RJ, LC, simplex SC, and ST) and includes fiber loop management
- Allows access to jacks and inserts while module is mounted
- Cable exits located on rear, bottom and both sides of modules Features cable entry strain relief
- Provided with label and clear label cover, squares of double-sided foam tape, self-tapping screws, and cable ties

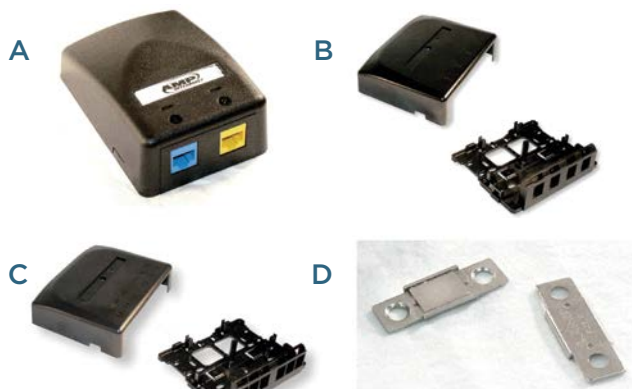

Y-	-X	Color
0-	-1	Almond
0-	-2	Black
0-	-3	White
0-	-4	Gray
1-	-1	Electrical Ivory

ORDERING INFORMATION

Description	Part Number
Surface Mount Module; 2-Port; Figure A	Y-1933668-X
Surface Mount Module; 4-Port; Figure B	Y-1933671-X
Surface Mount Module; 6-Port; Figure C	Y-1933674-X
Magnet for Metal Surface Mounting; Figure D	1933677-1

Modular Jack Boxes

FEATURES

- Accepts unshielded Standard 110Connect, any SL Series Jacks and MT-RJ
- Very compact
- Individual outlets are icon-able
- Patented invisible icon holes remain invisible when not used

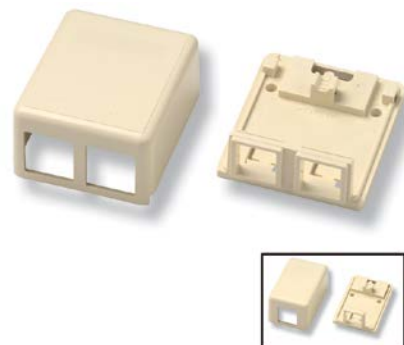

ORDERING INFORMATION

Description	Part Number
1 Port; almond	1116697-1
1 Port; pure white	1116697-3
2 Port; almond	1116698-1
2 Port; pure white	1116698-3

Modular Twisted Pair

Unloaded Hardware - Surface Mount Boxes

AMP-TWIST SL Jack Office Boxes

FEATURES

- Accepts AMP-TWIST jacks and all SL series jacks
- Compatible with most trunking
- High density
- Individual outlets are icon-able
- Patented invisible icon holes remain invisible when not used



ORDERING INFORMATION

Description	Part Number
2 Port; Color: almond	1933287-1
2 Port; Color: black	1933287-2
2 Port; Color: pure white	1933287-3
4 Port; Color: almond	1933288-1
4 Port; Color: black	1933288-2
4 Port; Color: pure white	1933288-3

Surface Mount Boxes

FEATURES

- Dimensions enable it to be used in restricted spaces
- Flammability class: UL94 V0



ORDERING INFORMATION

Description	Part Number
Surface Mount, unloaded for KM8, 1port	7080 2 064-10
Surface Mount, unloaded for KM8, 2port	7080 2 065-10



RJ-45 Dust Cap

FEATURES

- Re-usable rubber dust caps
- Fits in all RJ 45 Jacks
- Available in 7 colors



ORDERING INFORMATION

Description	Part Number
RJ-45 dust cap	Y-969556-X

Y- -X	Color
0- -1	Red
0- -2	Yellow
0- -3	Green
0- -4	Blue
0- -5	Black
0- -6	Gray
0- -7	White

Modular Twisted Pair

Twisted Pair Tools

AMP-TWIST & SL Series Modular Jack Termination Tool Kit

FEATURES

- Terminates all AMP-TWIST and SL Series Modular Jacks
- Strips cable, marks foil, terminates and cuts 8 conductors at once
- Maintains twisted pair integrity
- Reliable connections every time
- Time and cost saving simplifying lacing process and speeding up the termination
- Lacing fixture assures simple and efficient use (not used for AMP-TWIST Jacks)



ORDERING INFORMATION

Description	Part Number
Handheld termination tool kit with lacing fixture	1725150-1
Handheld termination tool kit without lacing fixture (for AMP-TWIST jacks)	1725150-3
Lacing fixture - Spare Part	1673956-1

110C Impact Tools

FEATURES

- Industry standard termination tools for SL Modular, 110Connect, AMP CO Ultra and other LSA-PLUS compatible IDC blocks
- Available as impact tool (premium or standard version) or as non-impact tool
- Tools are delivered with blade
- Extended-life blades have a lifetime three times longer than standard blades

ORDERING INFORMATION

Description	Part Number
Premium Impact Tool with Extended-Life Blade	1375308-1
Standard Impact Tool with Standard Blade	1583608-1
Non-Impact Tool with Standard Blade	1583236-1
Replacement Blade (Extended-Life)	1375309-1
Replacement Blade (Standard)	1375310-1



Modular Twisted Pair

Twisted Pair Tools

Cable Preparation Tools

FEATURES

- Easy, safe and fast cable preparation
- Diagonal Cutter for precise cutting of wire
- JackKnack cuts the cable sheath
- LightKnack is designed to provide light anywhere



ORDERING INFORMATION

Description	Part Number
Diagonal Cutter	1116571-1
JackKnack	2119000-1
LightKnack	2119700-1



Q-Jack Punchdown Pad

FEATURES

- Q-Jack Punchdown Pad helps the termination process
- Q-Jack Punchdown Pad also support RJ45 UTP Modular Jacks

ORDERING INFORMATION

Description	Part Number
Q-Jack Punchdown Pad (Pack of 10)	6537 1 610-00



LSA-PLUS Insertion Tool

FEATURES

- For termination of wires with the conductor diameter range 0.35 - 0.9mm and overall diameter range 0.7 - 2.6mm
- Insert and cut wires simultaneously
- Insertion sensor ensures the conductor is fully inserted into the block contacts before allowing any excess wire to be cut off
- An inhibitor lock prevents the scissors from operating, particularly useful in applications in which conductors are daisy-chained through several contacts
- Specially designed wire hook removes terminated conductors
- Blade helps to remove blocks easily from back mount frames



ORDERING INFORMATION

Description	Part Number
LSA-PLUS Insertion Tool	6417 2 055-01

Modular Twisted Pair

Twisted Pair Tools

KM8 Termination Tool

FEATURES

- Tool for swift terminating KM8 style jacks
- Hundreds of KM8 jack terminations from one tool



ORDERING INFORMATION

Description	Part Number
KM8 Termination Tool	6830 1 490-00

Multimate termination Tool

FEATURES

- Terminates RJ45 UTP Modular Jack ensuring a significant saving of installation time
- Inserts and crops wire simultaneously in one single handed easy action
- Replacement blade units can be purchased and replaced without the need for special tooling
- Carry pouch with belt loop helps conveniently store and protect the tool and its contents



ORDERING INFORMATION

Description	Part Number
Multimate Termination Tool Pack	6467 1 140-00
Replacement Head, C6A Keystone (White)	6467 2 142-00
Replacement Blade Unit	6467 2 149-00

13. Home Net-works Residential Cabling

Enclosures & Panels.....	270
Modules.....	271
Connectivity.....	272
Accessories.....	274

Home Net-Works Residential Cabling

Enclosures & Panels

Home Net-Works Enclosures Surface Mount

FEATURES

- Aesthetic surface mount enclosure
- Solid steel construction with hingeable cover
- Knockout ports for cable entry on top and bottom
- 1" x 1" mounting grid for maximum versatility
- Accommodates multiple 18-Port connectivity panels
- Including grounding bolt



ORDERING INFORMATION

Description	Color	Part Number
Home Net-Works Enclosure Small	White (RAL 9003)	1-1671331-1
Home Net-Works Enclosure Large	White (RAL 9003)	1-1671331-2

Home Net-Works Enclosures Flush Mount

FEATURES

- Aesthetic flush mount enclosure with cover (all AWG 20 steel)
- Multiple double knockouts for cable entry on all surfaces
- Multiple cable tie tabs for cable management
- 1" x 1" mounting grid for maximum versatility
- Recess or surface option
- Dual knockouts for electrical j-box
- Accommodates multiple 18-Port connectivity panels

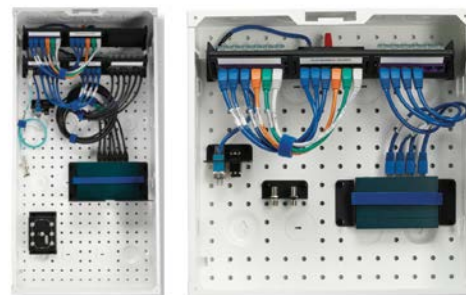

ORDERING INFORMATION

Description	Color	Part Number
14" Enclosure with Cover	White	1933691-1
28" Enclosure with Cover	White	1933692-1

Connectivity Panels

FEATURES

- Inclined panel accepting up to 3 x 6-port modules
- Available for UTP and STP
- STP version including a PEC and grounding point



ORDERING INFORMATION

Description	Color	Part Number
Angled Bracket STP	Black (RAL 9005)	1933776-1
Angled Bracket UTP	Black (RAL 9005)	1933693-1

Home Net-Works Residential Cabling

Modules

AMP CO Ultra Quick-Fit Kit

FEATURES

- Fast termination and easy assembly
- Shielded housing with patented automatic shielding clamp
- Kit includes 2 die-cast housings, 2 AMP CO Plus Edge Connectors and frame for labeling. (AMP CO Inserts to be ordered separately)
- Performance up to 2.0 GHz



ORDERING INFORMATION

Description	Color	Part Number
AMP CO Ultra Quick-Fit Kit; (RAL 9005)	Black	2153014-1

Standard Telecom Bridge

FEATURES

- 6 Ports - 4 lines per port
- For basic telephone, fax and dial-op modem service
- Bridge for incoming lines to six output ports



ORDERING INFORMATION

Description	Part Number
Front-Loadable Standard Telecom Bridge	1479701-1

Unloaded Connectivity Module

FEATURES

- 6 port module, accepts all SL series jacks
- Available for UTP and STP



ORDERING INFORMATION

Description	Part Number
Connectivity Module STP	2111093-1
Connectivity Module UTP	2111117-1
Blank module	1479698-1

Home Net-Works Residential Cabling

Connectivity

SL Series Multimedia Inserts

FEATURES

- The inserts offer flexibility and density at the work area outlet
- Can be installed in any faceplate or outlet designed to the SL series jack footprint
- Some couplers may not be available in all colors

Y- -X	Color
0- -1	Light Almond
0- -2	Black
1- -3	Alpine White

ORDERING INFORMATION

Description	Part Number
ST Coupler; Fiber Type: Multimode	Y-1339123-X
ST Coupler; Fiber Type: Singlemode	Y-1479181-X
BNC Coupler Insert; Figure B	Y-2111615-X
MT-RJ SL Series Housing	Y-1374416-X
RCA Coupler, Red Dielectric	Y-1375361-X
RCA Coupler, White Dielectric	Y-1375362-X
RCA Coupler, Yellow Dielectric	Y-1375363-X
RCA Solder Termination, Red Dielectric	Y-1375364-X
RCA Solder Termination, White Dielectric	Y-1375365-X
RCA Solder Termination, Yellow Dielectric	Y-1375366-X
RCA Coupler, Green Dielectric	Y-1933192-X
RCA Coupler, Blue Dielectric	Y-1933193-X
RCA Coupler, Orange Dielectric	Y-1933194-X
RCA to F-Connector; Figure I	Y-1933096-X
F-Connector Coupler, 2 GHz; Figure E	Y-1499855-X
3.5 mm Stereo Mini-Headphone, Screw Terminal, Figure F	Y-1933582-X
Speaker Post, Black Stripe	Y-1479190-X
Speaker Post, Red Stripe; Figure G	Y-1479191-X
SC Simplex Coupler; Fiber Type: Multimode or Singlemode	Y-1499836-X
LC Coupler; Fiber Type: Singlemode APC; LC Coupler and Housing, Green	1933286-3
LC Coupler; Fiber Type: Singlemode; LC Coupler and Housing, Blue	1933286-4
LC Coupler; Fiber Type: XG LO 850 nm 50/125µm; LC Coupler and Housing, Aqua, OM3 & OM4	1933286-6
LC Coupler; Fiber Type: 50/125µm; LC Coupler and Housing, Black, OM2	1-1933286-1
LC Coupler; Fiber Type: 62.5/125µm; LC Coupler and Housing, Beige, OM1	1-1933286-2
USB A-A Coupler; Figure J	Y-1933659-X
USB B-A Coupler; Figure K	Y-1933661-X
HDMI Coupler Figure H	2111500-2
Blank Insert Figure A	Y-1116412-X

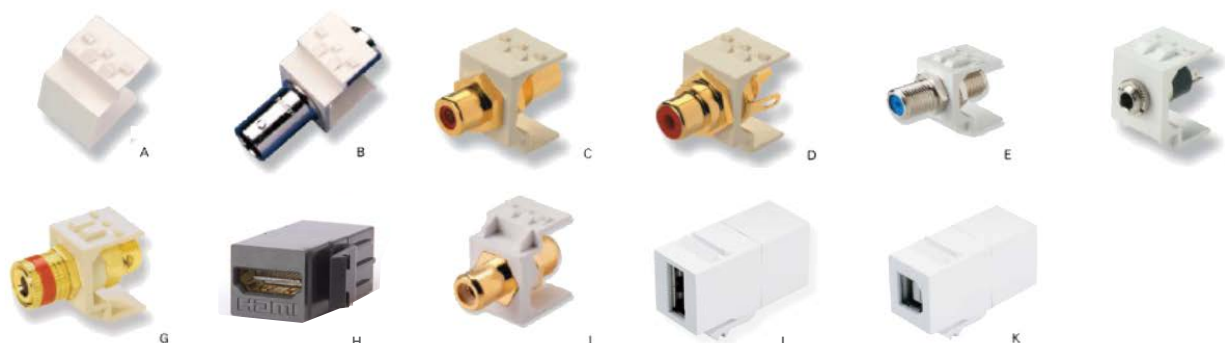

Home Net-Works Residential Cabling

Connectivity

SL Series Multimedia Jacks

FEATURES

- For use when distances are less than 130 ft.
- Uses Standard 110 Termination and will accept 26-22 AWG conductors
- RCA Multimedia Jack
 - For audio and visual signals
 - Uses one pair of twisted-pair-cable white,red or yellow dielectrics to match home theater equipment
- S-Video Multimedia Jack
 - For S-Video Y/C (Luminance/Chrominance black and white/Color) signals
 - Uses two pairs of a standard twisted-pair cable



ORDERING INFORMATION

Description	Part Number
S-Video	1375149-2
RCA to 110 Punch Down, Red Dielectric	Y-1479230-X
RCA to 110 Punch Down, White Dielectric	Y-1479231-X
RCA to 110 Punch Down, Yellow Dielectric	Y-1479232-X

Y- -X	Color
0- -1	Light Almond
1- -3	Alpine White

Home Net-Works Residential Cabling

Accessories

Velcro Cable Ties

FEATURES

- Hook and loop ties
- No risk of damaging cables
- Releasable and reusable
- An order quantity of one equals one roll of 10 ties



ORDERING INFORMATION

Description	Part Number
Velcro Tie 1" x 8" (10pcs.)	1375253-2
Velcro Tie 1" x 12" (10pcs.)	1375254-2

Accessories

FEATURES

- Demarcation bracket: SL Series bracket accepts 2 SL Series jacks for incoming data service demarcation
- Velcro Hold-Down Bracket: Used to secure network electronics such as cable/DSL routers
- Network Shelf: Accommodates network electronics such as DSL modems, routers and switches



ORDERING INFORMATION

Description	Part Number
Dual Demarcation Bracket	1479441-1
Velcro Hold-Down Bracket	1479440-1
Network Shelf	1479437-1

14. Commercial and Industrial Ethernet LAN

Power-over-Ethernet	276
LAN Media Converters.....	277
Industrial Media Converters.....	279
Industrial Switches	280
SFP Transceiver.....	282

Commercial and Industrial Ethernet LAN

Power-over-Ethernet

8 Port Modular PoE Gigabit Midspan Unit

FEATURES

- 8 Port PoE Midspan Unit
- 19" rack mountable (with mounting frame)
- Universal 110/220V (50/60Hz) power supply
- Full power on every port (15.4 W)
- Up to 3 devices can be mounted into a 19", 1U mounting frame



ORDERING INFORMATION

Description	Part Number
19", mounting frame 1U for 3 Midspans units	1591185-0
8 Port PoE Midspan unit; Power Cord for Europe	1591188-2
8 Port PoE Midspan unit; Power Cord for UK/Ireland	1591188-7

Commercial and Industrial Ethernet LAN

LAN Media Converters

Ethernet Media Converter

FEATURES

- 10 Slot 19" Rack Mount Chassis System
- Supports up to 10 Media Converters
- Different Media Converter types can be mixed
- Hot-Swappable Converters
- A second power supply can be fitted
- Exceptionally reliable dual redundant power system can be Hot-Swapped
- Dimensions: 440 x 226 x 133 mm (W x D x H)
- Internal cooling fan
- Includes kit for mounting in 19" racking



ORDERING INFORMATION

Description	Part Number
10 Slot Chassis System with 1 Power Unit; Europe	1591032-2
10 Slot Chassis System with 1 Power Unit; UK/Ireland	1591032-7
Spare/Redundant AC Power Unit for Chassis	1591034-0

10/100 MBit/s Ethernet Media Converter

FEATURES

- 10/100 MBit/s RJ-45 Copper port
- Auto-MDI/MDI-X detection
- 100Base-FX fiber port
- Dimensions: 85 x 120 x 26 mm (W x D x H)



ORDERING INFORMATION

Description	Part Number
10/100M Multimode SC Media Converter; Europe	1591024-2
10/100M Multimode SC Media Converter; UK/Ireland	1591024-7
10/100M Multimode ST-Style Media Converter; Europe	1591026-2
10/100M Multimode ST-Style Media Converter; UK/Ireland	1591026-7
10/100M Singlemode - Single Fiber WDM 1550 nm Converter; Europe	1591029-2
10/100M Singlemode - Single Fiber WDM 1550 nm Converter;UK/Ireland	1591029-7
10/100M Singlemode SC Media Converter; Europe	1591030-2
10/100M Singlemode SC Media Converter; UK/Ireland	1591030-7
10/100M Singlemode - Single Fiber WDM 1310 nm Converter; Europe	1591031-2
10/100M Singlemode - Single Fiber WDM 1310 nm Converter; UK/Ireland	1591031-7

Commercial and Industrial Ethernet LAN

LAN Media Converters

Gigabit Ethernet Media Converter

FEATURES

- 10/100/1000 MBit/s RJ-45 Copper port
- Auto-MDI/MDI-X detection
- 1000Base-SX or 1000Base-LX fiber port
- Dimensions: 85 x 120 x 26 mm (W x D x H)



ORDERING INFORMATION

Description	Part Number
1000Base-SX (multimode) Media Converter; Europe	1591020-2
1000Base-SX (multimode) Media Converter; UK/Ireland	1591020-7
1000Base-LX (singlemode) Media Converter; Europe	1591022-2
1000Base-LX (singlemode) Media Converter; UK/Ireland	1591022-7

Commercial and Industrial Ethernet LAN

Industrial Media Converters

Industrial Copper-to-Fibre Media Converter

FEATURES

- Suitable for plant rooms, factory floor, oil and gas terminal rail and marine and many more harsh environments
- Provides High / low temperature range with rugged construction Compact housing, 140 x 30 x 95 mm
- IP30 protection
- Store-and-Forward Switching Architecture
- RJ-45 port support MDI/MDI-X auto-crossover
- Autonegotiation Speed, Half/Full Duplex
- Signal indicating LEDs
- Built-In Link Lose Forwarding (LLF) & Link Fault Pass-Through (LFP) Technology
- Redundant wide range power input +12 to +48 V DC
- Flexible mounting: DIN-rail and panel mounting
- Operating Temperatures -40°C up to +75 °C



ORDERING INFORMATION

Description	Part Number
10/100 Multimode Ethernet Media converter- TEC-100-MM-XE	1987152-2

Commercial and Industrial Ethernet LAN

Industrial Switches

Fast Ethernet Industrial Switches (Unmanaged)

FEATURES

- Suitable for factories, rail and road side deployment
- Compact housing, 140 x 30 x 95 mm
- IP30 protection
- Relay output
- Store-and-Forward Switching Architecture
- RJ-45 port support MDI/MDI-X
- Broadcast storm protection
- Embedded switch controller
- supports auto negotiation
- Signal indicating LEDs
- Network Cable Redundant wide range power input +12 to +48 V DC
- Flexible mounting: DIN-rail and panel mounting
- Operating Temperatures -40°C up to +75 °C



ORDERING INFORMATION

Description	Part Number
4 Port 10/100 Ethernet Switch with single MM SC Uplink Port - TES-401-MM-XE	1987033-2
5 Port 10/100 Ethernet Switch --TES-500-XE	1987031-2
8 Port 10/100 Ethernet Switch - TES 800-XE	1987032-2

Gigabit Ethernet Industrial Switches (Unmanaged)

FEATURES

- Suitable for factories, rail and road side deployment
- Compact housing, 140 x 30 x 95 mm
- IP30 protection
- Relay output
- Store-and-Forward Switching Architecture
- RJ-45 port support MDI/MDI-X
- Broadcast storm protection
- Embedded switch controller
- Supports auto negotiation
- Signal indicating LEDs
- Network Cable Redundant wide range power input +12 to +48 V DC
- Flexible mounting: DIN-rail and panel mounting
- Operating Temperatures -40°C up to +75 °C



ORDERING INFORMATION

Description	Part Number
4 Port 10/100/1000 Ethernet Switch with single SFP Uplink Port - TES-4001-SFP-XE	1987155-2
8 Port 10/100/1000 Ethernet Switch - TES 8000-XE	1987154-2

Commercial and Industrial Ethernet LAN

Industrial Switches

10/100 Managed Industrial Switches (with Gigabit Uplink)

FEATURES

- Layer 2
- Gigabit Uplink: 2 Ports RJ-45 / SFP fiber
- Combo function (SFP or Gigabit Copper)
- Robust housing, 152 x 72 x 106 mm
- IP30 protection
- Relay output
- Store-and-Forward Switching Architecture
- RJ-45 port support MDI/MDI-X
- Signal indicating LEDs



ORDERING INFORMATION

Description	Part Number
16 Port Unmanaged 10/100 Ethernet With Dual SFP Uplink Combo ports - TES 162M-GU-SFP-COMBO	1987256-2
8 Port 10/100 Ethernet Switch with Dual SFP Uplink Combo ports - TES-802M-GU-SFP-CO	1987257-2

Commercial and Industrial Ethernet LAN

SFP Transceivers

SFP (Small Form Factor Pluggable) Transceiver



ORDERING INFORMATION

Description	Part Number
SFP Transceiver SFP-100-FX-MM	1987195-1
SFP Transceiver SFP-1000-SX-MM	3-1987195-3
SFP Transceiver SFP-100-FX-SM	1591530-1
SFP Transceiver SFP-1000-LX-SM	1591313-1

15. Administration & Labeling

Icons.....	284
Printer Labels.....	285
Quick-Fit Port Labels.....	286

Administration & Labeling

Icons

Icons

FEATURES

- Icons for port identification applicable to various faceplates of 110Connect and AMP CO series
- Different colors and different symbols available



Y- X	Color
0- -1	Almond
0- -2	Red
0- -3	Green
0- -4	Blue
0- -5	Yellow
0- -6	Black
0- -7	Orange
0- -8	White
0- -9	Violet
1- -0	Gray

ORDERING INFORMATION

Description	Part Number
16 x data	Y-558198-X
16 x phone	Y-558199-X
16x neutral; available in -1, -6, -8 and 1- -0	Y-558821-X
4x neutral, 2x Cat. 5E, 2x Cat. 6 and 1x V1, V2, V3, V4, D1, D2, D3, D4	Y-1375092-X

Printer Labels for AMP CO Installation Kits

FEATURES

- Self-adhesive A4 sheets with printer labels for AMP CO Installation Kits
- Uses standard MS Excel sheet

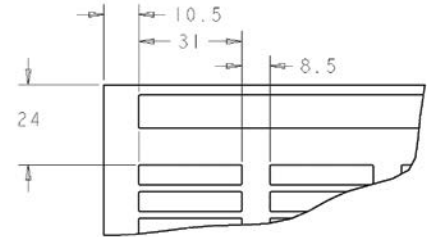

ORDERING INFORMATION

Description	Part Number
Labels (6 x 32 mm, 170 pcs per sheet); Packaging 10 sheets	969704-1

Administration & Labeling

Printer Labels

Patch Panel Labels

FEATURES

- Labels are designed to fit AMP NETCONNECT and similar patch panels
- Card stock labels are perforated and compatible with inkjet and laser printers
- Self-adhesive polyester labels are pre-cut and compatible with laser printers
- Labels are supplied on 8.5" x 11" (21,6 x 27,9 cm) sheets
- Special 0.25" (6,4 mm) high label is provided for use when icons are also desired
- For use with 110Connect and SL-style panels

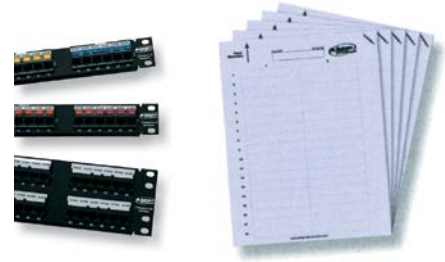

ORDERING INFORMATION

Description	Part Number
Self-adhesive Polyester; Label Size (w x h): 3.10" x 0.50" (7.9 x 1.3 cm); Labels per Sheet: 36; Standard Package: 5 sheets (180 labels)	1375352-1
Self-adhesive Polyester (also for use with 110Connect Office Box, 2 Port und 4 Port); Label Size (w x h): 3.30" x 0.25" (8.4 x 0.6 cm); Labels per Sheet: 72; 5 Sheets (360 labels)	1375353-1

Labels for Cable and Cable-Assemblies

FEATURES

- Labels are designed for use on cable and cable assemblies
- Labels are pre-cut and compatible with laser printers



ORDERING INFORMATION

Description	Part Number
4-Pair Cable; Label size (w x h): 0.984" x 1.496" (2.5 x 3.8 cm); Labels per Sheet: 48; Standard Package: 5 sheets (240 labels)	1479002-1
Self-adhesive Polyester 25-Pair Cable; Label size (w x h): 0.984" x 2.480" (2.5 x 6.3 cm); Labels per Sheet: 24; Standard Package: 5 sheets (120 labels)	1479003-1

Administration & Labeling

Quick-Fit Port Labels

Port ID labels for Quick-Fit modules and cassettes

FEATURES

- Number identification of ports
- MOQ = 100 pcs



ORDERING INFORMATION

Description	Part number
Port ID label 1...6	1933140-1
Port ID label 7...12	1933140-2
Port ID label 13...18	1933140-3
Port ID label 19...24	1933140-4
Port ID label 1/2...11/12	1671415-1
Port ID label 13/14...23/24	1671415-2
Port ID label 25/26...35/36	1671415-3
Port ID label 37/38...47/48	1671415-4

Index

Part Number Index.....	288
Reliable Performance.....	298

Index

Part Number Index

Part Number	Page	Part Number	Page	Part Number	Page
1		1375353	285	1479701	271
101016	255, 257	1375361	235, 272	1479890	115
101019	47	1375362	235, 272	1499101	198
106901	172	1375363	235, 272	1499418	223, 233
1116412	235, 272	1375364	235, 272	1499651	115
1116571	267	1375365	235, 272	1499659	116
1116697	264	1375366	235, 272	1499660	115
1116698	264	1379156	130, 261	1499836	235, 272
1206114	149	1394060	111, 236	1499855	235, 272
1206121	153	1394294	254	1534332	169
1206134	153	1418730	150	1553212	184
1206138	149	1418731	150	1553761	85
1206144	153	1418732	150	1553785	194
1206145	153	1418733	150	1557548	116
1206146	153	1418734	150	1568757	162
1206343	149	1418735	150	1583236	266
1206480	149	1418770	152	1583608	266
1206505	149	1418800	153	1588175	188
1206704	150	1435346	115	1588176	188
1278017	173	1435657	107	1588756	189
1278118	184	1435688	107	1591020	278
1278328	158	1435689	107	1591022	278
1278346	185	1435725	108	1591024	277
1278368	157	1435726	108	1591026	277
1278531	188	1435779	116	1591029	277
1278567	158	1435791	108	1591030	277
1278625	188	1435796	108	1591031	277
1278637	188	1435797	108	1591032	277
1278755	155	1435818	115	1591034	277
1278949	186	1435820	115	1591185	276
1339123	235, 272	1435827	115	1591188	276
1348960	149	1435927	115	1591313	282
1350376	170	1435933	115	1591360	105
1350377	170	1435937	115	1591363	105
136816	222	1435939	115	1591364	105
1374416	167, 235, 272	1435950	115	1591369	96
1374463	157	1435952	115	1591530	282
1374484	191	1435954	111	1591721	132
1374526	155	1435965	29	1644016	137
1374598	157	1435971	29	1644042	110, 216
1375055	213	1457628	190	1644076	232
1375092	284	1457630	189	1644077	232
1375149	273	1479002	285	1671000	149
1375187	213	1479003	285	1671002	149
1375188	213	1479181	235, 272	1671017	149
1375189	224	1479190	235, 272	1671054	153
1375190	224	1479191	235, 272	1671080	46
1375191	224	1479230	273	1671113	47
1375192	234	1479231	273	1671116	155
1375253	21, 274	1479232	273	1671117	156
1375254	21, 274	1479437	274	1671118	156
1375308	266	1479440	274	1671121	150
1375309	266	1479441	274	1671130	150
1375310	266	1479506	158	1671136	112
1375352	285	1479698	154, 248, 271	1671143	28

Index

Part Number Index

Part Number	Page	Part Number	Page	Part Number	Page
1671146	158	1671579	43	1711255	254
1671147	47	1671587	44	1711275	258
1671149	107	1671590	48, 245	1711276	261
1671157	245	1671594	48, 245	1711277	261
1671164	169, 253	1671603	49, 46	1711282	257
1671168	158	1671609	45	1711295	212
1671175	33	1671610	45	1711301	259
1671183	246	1671614	44	1711302	259
1671187	112	1671618	50	1711306	261
1671189	49	1671633	90	1711307	261
1671195	154	1671711	46	1711314	20
1671196	154	1671907	90	1711336	132
1671197	154	1671925	253	1711339	137
1671200	20, 154	1671933	45	1711342	212
1671201	154	1671938	45	1711343	212
1671202	154	1673956	266	1711344	116
1671205	8	1695790	171	1711348	259
1671206	8	1711000	137	1711349	261
1671207	8	1711001	137	1711351	114
1671209	103	1711003	198	1711399	258
1671226	4	1711005	205	1711400	258
1671227	4	1711006	211	1711403	258
1671228	4	1711007	211	1711404	258
1671229	107	1711008	211	1711409	131
1671260	148	1711027	218	1711437	199
1671262	148	1711028	232	1711441	199
1671263	148	1711034	232	1711450	136
1671268	148	1711035	232	1711481	199
1671269	148	1711038	232	1711485	250
1671271	148	1711040	229	1711490	250
1671272	148	1711043	223	1711491	259
1671273	152	1711053	211	1711494	233
1671274	152	1711076	221	1711495	233
1671281	181	1711077	221	1711496	233
1671330	40	1711078	221	1711500	136
1671331	270	1711079	221	1711537	250
1671365	148	1711082	256	1711548	114
1671373	20	1711083	256	1711563	204
1671405	42	1711091	221	1711564	204
1671414	126, 248	1711093	221	1711579	200
1671415	286	1711094	221	1711580	203
1671436	19	1711095	221	1711592	207
1671437	19	1711096	221	1711604	255
1671495	46	1711100	136	1711605	257
1671508	44	1711125	135	1711606	255
1671545	42	1711135	136	1711609	131
1671547	48	1711147	110, 216	1711613	202
1671548	48	1711148	113	1711618	202
1671549	49	1711160	212	1711623	202
1671550	48	1711163	205	1711624	203
1671551	48	1711166	211	1711625	256
1671552	49	1711168	255	1711626	256
1671554	43	1711169	255	1711632	255
1671555	43	1711171	219	1711633	255
1671578	43	1711195	205	1711634	257

Index

Part Number Index

Part Number	Page	Part Number	Page	Part Number	Page
1711637	201	1711987	20, 154	1918377	178
1711644	257	1716000	143	1918384	178
1711653	261	1716001	144	1918385	178
1711655	127	1716029	142	1918388	178
1711659	203	1716211	147	1918626	174
1711664	261	1716216	147	1918627	174
1711666	218	1716217	147	1918652	191
1711685	113, 246	1716218	147	1918802	24, 193
1711686	125	1716219	147	1918803	24, 193
1711691	207, 212	1716220	147	1918804	193
1711716	207	1725150	266	1918805	24, 193
1711742	113	1754074	189	1918806	24, 193
1711749	113	1754137	188	1918807	193
1711755	114	1754371	174, 178	1918808	193
1711756	114	1754462	185	1918809	24, 193
1711757	114	1754603	186	1918810	193
1711758	30	1754708	188	1918811	193
1711760	114	1754765	194	1920743	6
1711774	30	1754766	194	1933096	235, 272
1711775	259	1754767	194	1933098	115
1711776	200	1754768	194	1933140	286
1711777	218	1754845	184	1933192	235, 272
1711787	203	1777005	115	1933193	235, 272
1711789	32	1777014	115	1933194	235, 272
1711796	132	1777019	115	1933196	112
1711797	261	1777029	29, 109	1933197	112
1711801	133	1777041	109	1933286	235, 272
1711804	133	1777042	109	1933287	265
1711807	133	1777053	109	1933288	265
1711815	210	1777098	29	1933327	111
1711816	210	182398-	181	1933328	111
1711817	210	1828352	195	1933329	111
1711818	210	1828353	195	1933330	111
1711820	210	1828833	194	1933331	111
1711825	209	1828836	194	1933332	111
1711851	209	1828837	194	1933333	111
1711855	128	1828953	175	1933334	111
1711856	127	183553	137	1933352	34
1711858	128	183578	137	1933420	107
1711859	128	183635	135	1933425	116
1711860	130	183636	134	1933476	208
1711861	129	183641	135	1933582	235, 272
1711862	129	183931	168, 261	1933659	235, 272
1711864	129	185705	261	1933661	235, 272
1711865	129	1859096	259	1933668	264
1711866	129	1859130	261	1933671	264
1711869	128	1859160	51	1933674	264
1711870	127	1871696	183, 187	1933677	264
1711875	127	1918266	178	1933691	270
1711876	128	1918267	178	1933692	270
1711910	198	1918372	178	1933693	270
1711913	198	1918373	178	1933776	270
1711944	29, 109	1918374	178	1933899	115
1711963	258	1918375	178	1966328	5, 9
1711970	28	1918376	178	1985374	176

Index

Part Number Index

Part Number	Page	Part Number	Page	Part Number	Page
1985766	188	2055740	159	2153041	26
1985771	187	2055741	159	2153046	26
1985805	176	2064181	174	2153049	109
1987031	280	2064184	175	2153052	27
1987033	280	2064431	188	2153074	129
1987152	279	2064453	188	2153075	129
1987154	280	2064499	24, 193	2153078	27
1987155	280	2064500	24, 193	2153091	109
1987195	282	2064540	187	2153112	124
1987256	281	2064603	188	2153113	124
1987257	281	2064651	192	2153115	26
2		2111008	263	2153117	138
2055108	6	2111009	263	2153140	38
2055109	6	2111010	263	2153141	38
2055425	166	2111011	263	2153142	38
2055438	108	2111012	263	2153146	37
2055567	21	2111013	263	2153147	37
2055576	3	2111014	263	2153148	37
2055577	3	2111015	263	2153149	37
2055578	3	2111093	248, 271	2153150	36
2055579	3	2111117	248, 271	2153151	36
2055580	6	2111121	225	2153152	36
2055581	6	2111122	225	2153161	205
2055583	159	2111123	214	2153173	126
2055584	159	2111124	214	2153175	106
2055600	6	2111201	263	2153188	92
2055611	3	2111203	263	2153190	92
2055612	3	2111366	30	2153216	249
2055613	159	2111367	31	2153230	27
2055614	159	2111370	32	2153264	138
2055623	6	2111371	30	2160008	161
2055624	6	2111440	106	2160012	16
2055665	159	2111441	106	2160013	16
2055666	159	2111442	106	2160040	166
2055667	159	2111443	106	2160041	166
2055668	159	2111444	106	2160042	166
2055670	159	2111445	106	2160043	166
2055677	159	2111446	106	2160046	6, 161
2055687	159	2111447	106	2160047	6, 163
2055688	159	2111448	106	2160048	6, 162
2055704	6	2111481	85	2160052	108
2055707	7	2111500	235, 272	2160071	7
2055708	7	2111521	27	2160072	7
2055709	7	2111522	27	2160073	3
2055710	7	2111615	235, 272	2160074	3
2055711	7	2111664	24, 193	2160075	3
2055712	7	2111676	208	2160076	3
2055713	7	2119000	267	2160077	7
2055714	7	2119700	267	2160078	7
2055715	3	2123273	194	2160106	10
2055716	3	2125019	171	2160107	10
2055725	159	2153004	259	2160108	10
2055726	159	2153014	126, 271	2160109	10
2055727	159	2153022	206	2160110	10
2055728	159	2153040	109	2160111	10

Index

Part Number Index

Part Number	Page	Part Number	Page	Part Number	Page
2160112	6	2160389	86	336613	250
2160113	6	2160390	86	336614	250
2160114	6	2160391	86	336671	226
2160115	6	2160392	86	336793	261
2160116	10	2160404	161		
2160117	10	2160503	86	4	
2160122	10	2160506	94	406330	227
2160123	10	2160510	22	406331	227
2160124	10	2160537	94	406372	225
2160125	10	2160538	94	492025	188
2160126	6	2160547	196	492026	188
2160127	6	2160548	196	492109	188
2160128	10	2160549	196	492543	184
2160129	10	2160550	196	492622	188
2160134	9	2160551	196	492623	188
2160135	5	2160552	196	492697	184
2160136	5	2160588	161	492703	187
2160137	9	2160593	122	492782	188
2160138	9	2160594	122	492783	188
2160139	5	2160608	12		
2160140	5	2160609	12	5	
2160141	9	2160639	19	501014	188
2160142	159	2160640	19	501197	190
2160143	159	2160649	20	501198	188
2160144	159	2160650	20	501258	185
2160145	159	2160651	20	501381	172
2160146	6	2160663	18	501457	180
2160147	6	2160664	18	501473	191
2160192	9	2171014	206	501523	190
2160193	5	2193016	85	501818	189
2160194	5	2193050	85	501857	189
2160195	9	2193051	85	501858	190
2160196	9	2193052	85	502129	190
2160197	5	219413	222	502134	190
2160198	5	219420	222	502222	190
2160199	11	219484	222	502259	189
2160270	87	219584	211	502282	191
2160301	88	219585	211	502418	191
2160302	88	2255669	159	502613	180
2160304	21	228433	191	502631	189
2160305	21	284584	134	502656	189
2160317	86			502748	191
2160318	86	3		502750	172
2160319	86	300001739943	247	503304	189
2160320	86	300001739995	247	503330	184
2160321	86	300001741753	247	503337	189
2160322	86	300001743975	207	503577	182
2160323	86	300001743978	208	503605	183
2160324	86	336455	138	503676	180
2160325	86	336488	201	503677	180
2160349	161	336526	246	503681	182
2160385	90	336539	215	503705	187
2160386	90	336548	134	503746	186
2160387	90	336556	131	503787	189
2160388	90	336608	252	503910	188

Index

Part Number Index

Part Number	Page	Part Number	Page	Part Number	Page
503911	188	559515	158	599620	144
503957	184	559523	158	599621	144
504021	172	559557	158	599622	144
504035	190	559558	157	599623	144
504064	189	559596	157	599624	144
504290	189	559601	157	599625	144
5233103	166	57535	223	599626	144
5233582	166	57538	223	599627	144
5349561	163	57893	205	599628	144
5349565	163	58424	188	599629	144
5349567	163	58433	188	599681	146
5349568	166	5909 1 076-	241	599682	146
5349569	167	5909 1 078-	241	599683	146
5349574	163	5909 1 082-	241	599690	146
5349578	163	5909 1 083-	241	599692	146
5349580	163	5909 1 084-	241		
5349582	167	599144	142	6	
5349584	166	599145	142	6089 1 102-	237
5492123	179	599146	142	6089 1 810-	237
5492642	175	599148	142	6092 1 810-	238
5492643	175	599149	142	6092 1 820-	238
5502580	180	599152	143	6092 1 840-	238
5502632	172	599153	143	6206158	163
5502776	171, 172	599154	143	6206613	164
5502780	173	599156	143	6206615	164
5503137	173	599157	143	6206616	165
5503628	180	599159	143	6206617	164
5503692	177	599160	143	6206619	164
5503693	177	599161	143	6206620	165
5503948	179	599162	143	6206621	164
5503971	179	599164	143	6206623	164
5504000	177	599165	143	6206650	141
5504034	177	599167	143	6206820	165
5504600	177	599168	145	6206821	165
5504614	172	599169	145	6278049	171
5504640	171	599170	145	6278079	175
5504646	179	599172	145	6278082	175
5504655	179	599173	145	6348260	12, 163
5504657	179	599175	145	6348269	165
5504663	173	599602	142	6348271	165
5504932	179	599603	142	6348522	175, 177, 179
555050	234	599605	143	6348941	167
555052	234	599606	143	6348942	167
555614	137	599607	143	6357 1 610-	267
555644	137	599609	143	6374906	173
558176	284	599610	143	6391366	167
558198	284	599611	143	6406 1 001-	243
558199	284	599612	145	6406 1 015-	243
558251	263	599613	145	6406 2 004-	243
558329	47	599614	144	6406 2 013-	243
558821	284	599615	144	6406 3 003-	243
559066	183	599616	144	6417 2 055-	267
559087	183	599617	144	6424 3 005-	239
559496	155	599618	144	6424 3 007-	239
559501	155	599619	144	6424 3 009-	239

Index

Part Number Index

Part Number	Page	Part Number	Page	Part Number	Page
6424 3 010-	239	6536769	165	6830 2 402-	259
6428 2 418-	244	6536770	165	6830 2 881-	210
6428 2 419-	244	6536803	165	6830 2 882-	210
6428 2 420-	244	6536810	165	6830 2 883-	210
6428 2 421-	244	6536811	165	6830 2 884-	210
6428 2 422-	244	6536880	166	6830 2 885-	210
6428 2 423-	244	6536966	166	6830 2 887-	210
6428 2 424-	244	6536967	12, 162	6830 2 8Y1-	220
6428 2 425-	244	6536968	164	6830 2 8Y2-	220
6429 1 076-	242	6536969	11, 161	6830 2 8Y3-	220
6429 1 078-	242	6536974	166	6830 2 8Y4-	220
6436 1 001-	243	6536975	166	6830 2 8Y5-	220
6436 1 013-	243	6538 3 111-	260	6830 2 8Y7-	220
6436 2 004-	243	6538 4 111-	258	6830 2 911-	220
6436 3 003-	243	6540 1 677-	228	6830 2 912-	220
6437 1 001-	243	6540 1 678-	217	6830 2 913-	220
6437 1 020-	243	6540 1 684-	217	6830 2 914-	220
6437 2 004-	243	6540 1 801-	258	6830 2 915-	220
6437 2 010-	243	6540 1 802-	258	6830 2 917-	220
6437 3 003-	243	6540 1 810-	259		
6457493	179	6540 1 812-	258	7	
6457567	171	6540 1 813-	259	7014 1 601-	237
6467 1 140-	268	6540 1 814-	259	7014 2 007-	238
6467 2 142-	268	657054-	181	7014 2 040-	240
6467 2 149-	268	6577 2 812-	239	7014 2 152-	237
6527 1 607-	227	6588291	175	7014 3 046-	243
6529 1 022-	240	6645 2 827-	210	7019 1 014-	241
6529 1 042-	240	6690 1 825-	262	7022 1 015-	226
6529 1 202-	231	6690 2 675-	251	7022 2 155-	247
6529 1 203-	231	6690 3 725-	251	7022 4 001-	236
6529 1 205-	231	6690 3 745-	262	7033 1 080-	151
6529 1 225-	219	6693276	175	7033 1 082-	151
6530 1 017-	242	6695121	162	7033 1 084-	151
6534 1 001-	238	6695240	195	7033 1 101-	151
6536 1 005-	260	6695242	195	7033 1 103-	151
6536 3 044-	260	6695244	195	7033 1 180-	151
6536444	165	6695313	165	7033 1 182-	151
6536445	165	6695505	166	7033106902	170
6536446	165	6695506	166	7033106904	170
6536447	165	6695507	166	7033107102	170
6536462	164	6695508	166	7033107104	170
6536463	164	6695509	166	7034 1 084-	151
6536464	12, 163	6695510	166	7034 1 103-	151
6536501	11, 161	6695511	166	7034 1 182-	151
6536502	161	6695512	166	7063 7 611-	230
6536503	161	6695657	162	7063 7 612-	230
6536508	12, 162	6695697	162	7063 7 613-	230
6536509	162	6753 2 009-	238	7063 7 614-	230
6536510	162	6754482	174	7063 7 617-	230
6536511	164	6754483	174	7080 2 064-	265
6536512	164	6830 1 490-	268	7080 2 065-	265
6536513	164	6830 1 800-	214		
6536555	166	6830 1 810-	212	9	
6536556	167	6830 1 811-	207	959305	232
6536767	163	6830 1 885-	208	959306	232

Index

Part Number Index

Part Number	Page	Part Number	Page	Part Number	Page
FGS-MHRT-H/F	74, 76	FGS-SD9E-A	56	FGSB-MD9E-G	61
FGS-MHRT-H/F-VS	82	FGS-SD9E-B	64	FGSB-MDRT-F	71
FGS-MHTA-C	52	FGS-SD9E-F	69	FGSB-MDSA-AB	56, 64
FGS-MHXP-A	56	FGS-SDSA-AB	56, 64	FGSB-MDSA-AC	52
FGS-MHXP-B	64	FGS-SDSA-F2B	69	FGSB-MDSA-F2B	69
FGS-MHXP-B/F	69	FGS-SDSA-FB	64, 69	FGSB-MDSA-FB	64, 69
FGS-MHXP-B/F-VS	69	FGS-SDSP-F	71	FGSB-MDSA-GA	61
FGS-MHXP-C	52	FGS-SH4E-A	56	FGSB-MDSA-GB	61
FGS-MHXP-F	69	FGS-SH4E-B	64	FGSB-MDSA-HF	74
FGS-MHXP-F/H	74, 76	FGS-SH4E-F	69	FGSB-MDSP-2B	66
FGS-MHXP-F/H-VS	82	FGS-SH9E-A	56	FGSB-MDSP-2B-IMP	66
FGS-MHXP-F-VS	69	FGS-SH9E-B	64	FGSB-MDSP-A	58
FGS-MHXP-G	61	FGS-SH9E-F	69	FGSB-MDSP-A/I	58
FGS-MHXP-H	74, 76	FGS-SHRT-A	56	FGSB-MDSP-B	66
FGS-MHXP-H-VS	82	FGS-SHRT-B	64	FGSB-MDSP-B/I	66
FGS-MJWR-A	58, 66	FGS-SHRT-F	69	FGSB-MDSP-C	53
FGS-MJWR-C	54	FGS-SHRT-F/B	69	FGSB-MDSP-EX-A	58
FGS-MSDS-C	53	FGS-SHXP-A	56	FGSB-MDSP-EX-B	66
FGS-MSHA-C	54	FGS-SHXP-B	62	FGSB-MDSP-F	71
FGS-MSHS-A	59	FGS-SHXP-B/F	69	FGSB-MDSP-F/I	71
FGS-MSHS-B	67	FGS-SHXP-F	69	FGSB-MDSP-G	61
FGS-MSHS-F	72	FGS-SU4E-A	56	FGSB-MEX1-C-	53, 79
FGS-MSHS-G	62	FGS-SU4E-B	64	FGSB-MEXC-E-A	78
FGS-MSHS-H	76	FGS-SU4E-F	69	FGSB-MEXC-E-A/B/F	78
FGS-MSHS-STOR-B	67	FGS-SU9E-A	56	FGSB-MEXC-E-B	78
FGS-MSHS-STOR-F	72	FGS-VDSA-FB-L	69	FGSB-MEXC-E-F	78
FGS-MSNC-A	59	FGS-VDSA-FB-R	69	FGSB-MEXP-A/B/F	79
FGS-MSNC-B/G	62, 67	FGSB-ASRI-	58, 66	FGSB-MEXP-E-A/B/F	78
FGS-MSNC-F	72	FGSB-DHHC	59, 67, 72	FGSB-MEXP-LP-A/B/F	79
FGS-MSSC-A	59	FGSB-HMEC-C	52	FGSB-MEXP-LP-G	61
FGS-MSSC-B/G	62, 67	FGSB-ISLAND3-F	71	FGSB-MFAW-A	59
FGS-MSSC-F	72	FGSB-ISLAND-F	71	FGSB-MFAW-B	67
FGS-MTRM-2B	66	FGSB-ISLAND-F-513	71	FGSB-MFAW-F	73
FGS-MTRM-2B-IMP	66	FGSB-ISLAND-H/F	75	FGSB-MFAW-H	76
FGS-MTRM-A	58, 66	FGSB-JUNC-G	62	FGSB-MH4A-C	52
FGS-MTRM-B	71	FGSB-KDH2-C	53	FGSB-MH4E-A	56
FGS-MTRM-C	53, 79	FGSB-KT03-A	58, 66	FGSB-MH4E-B	64
FGS-MTRM-F	71	FGSB-KT03-A1-	58, 66	FGSB-MH4E-F	69
FGS-MTRM-G	61	FGSB-KT03-A4-	58, 66	FGSB-MH4E-G	61
FGS-MTRM-H	75	FGSB-KT03-B-	71	FGSB-MH4E-H	74
FGS-MU4A-C	52	FGSB-KT03-C-	53, 79	FGSB-MH9A-C	52
FGS-MU4E-A	56	FGSB-KT03-G-	61	FGSB-MH9A-C-45/2	52
FGS-MU4E-B	64	FGSB-KT07-A4-	58, 66	FGSB-MH9E-A	56
FGS-MU4E-F	69	FGSB-MCDS-AB	58, 66	FGSB-MH9E-B	64
FGS-MU4E-G	61	FGSB-MCDS-EX-AB	58, 66	FGSB-MH9E-F	69
FGS-MU4E-H	74	FGSB-MD4A-C	52	FGSB-MH9E-G	61
FGS-MU9A-C	52	FGSB-MD4E-A	56	FGSB-MHIS-A	56, 64, 69
FGS-MU9E-A	56	FGSB-MD4E-B	64	FGSB-MHIS-A/H	74
FGS-MU9E-B	64	FGSB-MD4E-F	69	FGSB-MHIS-B	56, 64, 69
FGS-MVAR-A	56, 59	FGSB-MD4E-G	61	FGSB-MHIS-B/H	74
FGS-MVAR-B	64, 67	FGSB-MD4E-H	74	FGSB-MHIS-F	56, 64, 69
FGS-MVAR-F	69, 72	FGSB-MD9A-C	52	FGSB-MHIS-F/H	74
FGS-SD4E-A	56	FGSB-MD9E-A	56	FGSB-MHRT-A	56
FGS-SD4E-B	64	FGSB-MD9E-B	64	FGSB-MHRT-B	64
FGS-SD4E-F	69	FGSB-MD9E-F	69	FGSB-MHRT-F	69

Index

Part Number Index

Part Number	Page	Part Number	Page	Part Number	Page
FGSB-MHRT-F/B	69	FGSB-SD9E-F	69	QBCB-HR	99
FGSB-MHRT-G	61	FGSB-SDSA-AB	56, 64	QCH-	97
FGSB-MHRT-H	74	FGSB-SDSA-F2B	69	QCPC-6ARSZB-	103
FGSB-MHRT-H/F	74	FGSB-SDSA-FB	64, 69	QCPC-6ARUZB-	103
FGSB-MHTA-C	52	FGSB-SDSP-F	71	QCPP-24MC6AS	101
FGSB-MHXP-A	56	FGSB-SH4E-A	56	QCPP-24MC6AU	101
FGSB-MHXP-B	64	FGSB-SH4E-B	64	QCPP-48MC6AS	101
FGSB-MHXP-B/F	69	FGSB-SH4E-F	69	QCPP-48MC6AU	101
FGSB-MHXP-C	52	FGSB-SH9E-A	56	QCPU-MCBM	98
FGSB-MHXP-F	69	FGSB-SH9E-B	64	QCPU-MPPM-1	102
FGSB-MHXP-F/H	74	FGSB-SH9E-F	69	QDR-	23
FGSB-MHXP-G	61	FGSB-SHRT-A	56	QFA-1WWSMZNXMAA	100
FGSB-MHXP-H	74	FGSB-SHRT-B	64	QFA-1FFM3ZNXMAA	100
FGSB-MJWR-A	58, 66	FGSB-SHRT-F	69	QFA-1FFM4ZNXMAA	100
FGSB-MJWR-C	54	FGSB-SHRT-F/B	69	QFA-2WWSMZNXMAA	100
FGSB-MSDS-C	53	FGSB-SHXP-A	56	QFA-2FFM3ZNXMAA	100
FGSB-MSHA-C	54	FGSB-SHXP-B	64	QFA-2FFM4ZNXMAA	100
FGSB-MSHS-A	59	FGSB-SHXP-B/F	69	QFA-4WWSMZNXMAA	100
FGSB-MSHS-B	67	FGSB-SHXP-F	69	QFA-4FFM3ZNXMAA	100
FGSB-MSHS-F	72	FGSB-SU4E-A	56	QFA-4FFM4ZNXMAA	100
FGSB-MSHS-G	62	FGSB-SU4E-B	64	QFA-8WWSMZNXMAA	100
FGSB-MSHS-H	76	FGSB-SU4E-F	69	QFA-8FFM3ZNXMAA	100
FGSB-MSHS-STOR-B	67	FGSB-SU9E-A	56	QFA-8FFM4ZNXMAA	100
FGSB-MSHS-STOR-F	72			QFB-192FMPOMMHR	99
FGSB-MSNC-A	59	N		QFB-192FMPOSMHR	99
FGSB-MSNC-B/G	62, 67	NTP OD180A2	241	QFB-48FDLCMMHR	99
FGSB-MSNC-F	72			QFB-48FDLCMSHR	99
FGSB-MSSC-A	59	O		QFPC-MKKSMAZAXXM	100
FGSB-MSSC-B/G	62, 67	OLH-MK072J00M0MKBA	119	QFPC-MKKSMBBAXXM	100
FGSB-MSSC-F	72	OLH-MK072J00M0MKCA	119	QFPC-MPPM3ZAXXM	100
FGSB-MTRM-2B	66	OLH-MK072J00M0MKEA	119	QFPC-MPPM3ZBAXXM	100
FGSB-MTRM-2B-IMP	66	OLH-MM288J00M0MKBB	119	QFPC-MPPM4ZAXXM	100
FGSB-MTRM-A	58, 66	OLH-MM288J00M0MKCB	119	QFPC-MPPM4ZBAXXM	100
FGSB-MTRM-B	71	OLH-MM288J00M0MKEB	119	QUCH-	23
FGSB-MTRM-C	53, 79	OLH-MN432J00M0MKBB	119	QUFB-192FMPOMMHR	23
FGSB-MTRM-F	71	OLH-MN432J00M0MKCB	119	QUFB-192FMPOSMHR	23
FGSB-MTRM-G	61	OLH-MN432J00M0MKEB	119	QUFB-48FDLCMM3HR	23
FGSB-MU4A-C	52	OLR-SJ12J00D1002A	120	QUFB-48FDLCMSHR	23
FGSB-MU4E-A	56	OLR-SJ12J00D2002A	120		
FGSB-MU4E-B	64	OLR-SJ12J00D3002A	120		
FGSB-MU4E-F	69	OLR-SJ24J00D1002A	120		
FGSB-MU4E-G	61	OLR-SJ24J00D2002A	120		
FGSB-MU4E-H	74	OLR-SJ24J00D3002A	120		
FGSB-MU9A-C	52	OLS-MPP10866	120, 121		
FGSB-MU9E-A	56	OLS-MPP11666	120, 121		
FGSB-MU9E-B	64	OLS-MPP12A66	120, 121		
FGSB-MVAR-A	56	OLS-MPP13266	120, 121		
FGSB-MVAR-A	59, 64	OSB-SBJ032000000	121		
FGSB-MVAR-B	67	OSB-SBJ032A10000	121		
FGSB-MVAR-F	69, 72	OSB-SBJ032G10000	121		
FGSB-SD4E-A	56	OSB-SBJ232000000	121		
FGSB-SD4E-B	64	OSB-SBJ232A10000	121		
FGSB-SD4E-F	69	OSB-SBJ232G10000	121		
FGSB-SD9E-A	56				
FGSB-SD9E-B	64				

XG_A 10 Gb/s Approved

High-speed 10 Gigabit Ethernet over Twisted Pair and Fiber Optic Cabling

The AMP NETCONNECT XG Systems, comprising Cat. 6 Copper and OM3 Fiber products have become firmly established industry-leading portfolios with excellent 10 Gb/s performance.

As transmission and connectivity technologies have progressed, TE has developed products which exploit these technological advantages: our AMP NETCONNECT XG_A Systems include our Cat. 6_A Copper and OM4 Fiber portfolios to become an end-to-end 10 Gb/s infrastructure solutions. They are fully compliant with the latest ISO/IEC 11801 Amendment 2 specifications.

The **XG_A 10 Gb/s approved** seal is an indicator for all products of the XG_A family.



ISO Cat. 6_A

An augmented Category 6 specification

All products in this catalog that feature the **ISO Cat. 6_A** seal are compliant with the global cabling standard ISO/IEC 11801 Amendment 2.

This amendment defines specifications for Cat. 6_A components and Class E_A permanent links. These global Cat. 6_A / Class E_A specifications require a generation of connecting hardware offering far superior performance compared to the existing products which are based on the American TIA standard.

Benefits of this higher standard include more headroom, "mix & match" capability, enabling short links, and removing the requirement for ANEXT testing.



Ensured Performance

Optimized Physical Contact (OPC) enhances your link parameters

Why do you require a controlled ferrule end face? Enhanced services such as Gigabit, 10 Gigabit and soon 40/100 Gigabit Ethernet require a high quality cabling system. Therefore, IEC 608749 specifies the dimensional details of fiber optic connectors in order to ensure interoperability and performance within an ISO 11801 specified application. These dimensional requirements are directly related to the endface characteristics of a polished ferrule, namely its **radius, dome offset** and **fiber position**.

If these ferrule characteristics are optimal, an **Optimized Physical Contact (OPC)** between the two connectors is guaranteed. This will enhance data transmission parameters like **optical performance, Attenuation, Return Loss** and **data link stability**.

Also, the optical **interoperability** between connectors of different suppliers can be ensured by controlled endfaces. As a result of **OPC** a stable physical contact between the endfaces is achieved. This provides a very low Insertion Loss as well as a high Return Loss in order to run high speed applications like 10/40/100 Gigabit Ethernet. All products in this catalog that feature the **Ensured Performance** logo provide **OPC** at all time. AMP NETCONNECT guarantees a controlled endface for all OM3, OM4 and OS2 assemblies and field installable products (MT-RJ and LightCrimp Plus).

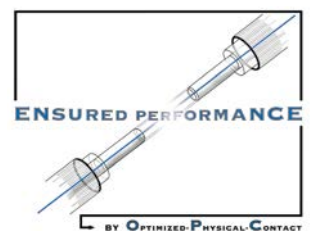

Universal Connectivity Platform

Rack efficiency and multiple media deployment

The Universal Connectivity Platform (UCP) is designed to deliver rack efficiency and multiple media deployment. It comprises a versatile range of components that include patch panels, subfloor panel and overhead panel mounts, pre-terminated links and adaptor modules. One common patch panel, either angled or flat, is used to accommodate both copper and fiber, and the units can be installed within or outside the 19-inch envelope. Side mounting brackets maximize usable space along the vertical posts of the rack system, while adaptive mounting brackets can be used strategically above and below the racks.

The UCP accepts pre-terminated copper assemblies, fiber cassettes and MRJ21 high density copper connectivity cassettes, for faster deployment and high reliability. It is also fully compatible with TE Connectivity's AMPTRAC managed connectivity solution.

Products which can be used inside the Universal Connectivity Platform are marked with the **UCP Compatible** seal.



RoHS Ready

Restriction on the Use of Hazardous Substances

TE Connectivity will support your RoHS requirements. We've assessed more than 1.5 million end items/components for RoHS compliance, and issued new part numbers where required in the process of eliminating the restricted materials. All part numbers in this catalog are RoHS compliant. These products comply with European Union Directive 2002/95/EC as amended 1 January 2006 that restricts the use of lead, mercury, cadmium, hexavalent chromium, PBB, and PBDE in certain electrical and electronic products sold into the EU as of 1 July 2006.

NOTE: For purposes of this catalog, included within the definition of RoHS Compliant are:

- Products that are clearly "Out of Scope" of the RoHS Directive such as hand tools and other non-electrical accessories.
- Products that contain lead in solderable interfaces (they do not contain any of the other five restricted substances above allowable limits). However, these products are covered by an application-based exception for lead in solders, such as the server, storage, or networking infrastructure exemption of the same directive.

NOTE: Information regarding RoHS compliance is provided based on reasonable inquiry of our suppliers and represents our current actual knowledge based on the information provided by our suppliers. This information is subject to change.



Wiring Diagrams for Modular Plugs and Jacks

T568A Wiring

T568B Wiring

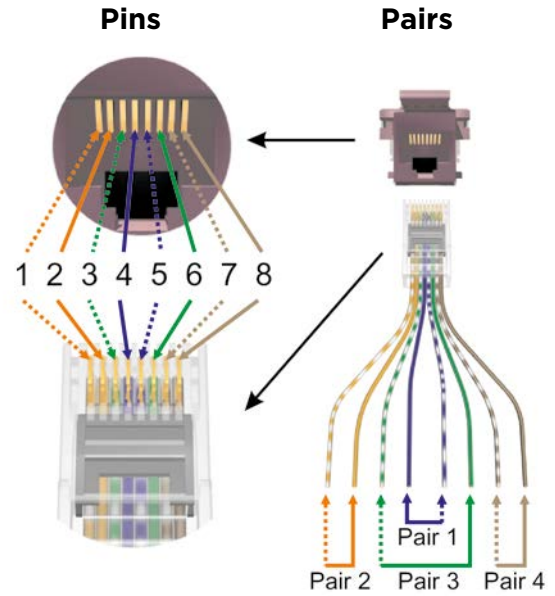
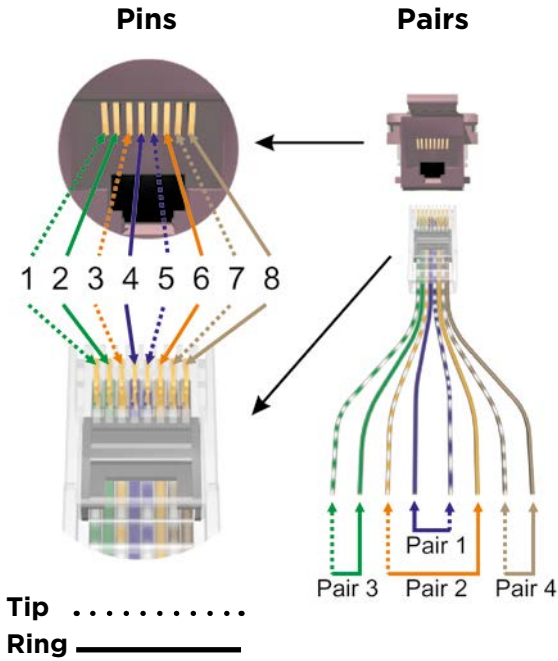

Application Wiring Diagrams for Modular Jacks

- 10Base-T
- 100Base-TX

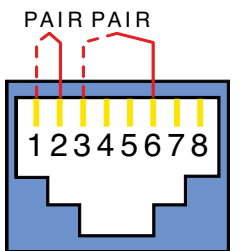

Tip
Ring _____

- 1000Base-T
- 10GBase-T

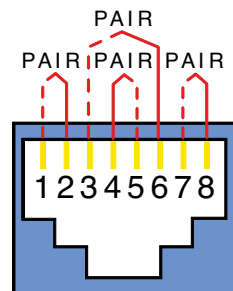

- Token Ring
- ISDN, xDSL

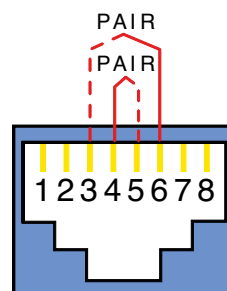

- ATM/TP-PMD
- 1000Base-TX2

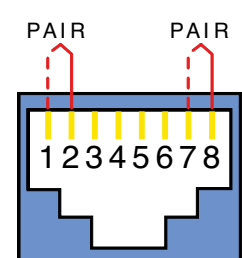

Note: All of the applications listed above (as well as most other communications applications) can be implemented on both T568A and T568B jacks.

THE FOUNDATION OF YOUR AGILE DATA CENTER EVERY CONNECTION COUNTS



2013 THOMSON REUTERS
TOP 100
GLOBAL INNOVATORS



KRONE

FROM TE CONNECTIVITY



EVERY CONNECTION COUNTS

te.com/enterprise-eu

TE ENTERPRISE NETWORKS REGIONAL SALES HEADQUARTERS:

North America

Greensboro, NC, USA
Ph: +1-800-553-0938
Fx: +1-717-986-7406

Latin America

Buenos Aires, Argentina
Ph: +54-11-4733-2200
Fx: +54-11-4733-2282

EMEA

Kessel-Lo, Belgium
Ph: +32-16-35-1321
Fx: +32-16-35-2188

SAARC

Bangalore, India
Ph: +91-80-4011-5000
Fx: +91-80-4011-5030

Asia

Hong Kong, China
Ph: +852-2735-1628
Fx: +852-2735-1625

Pacific

Sydney, Australia
Ph: +61-2-8748-9500
Fx: +61-2-9748-8487

TE ENTERPRISE NETWORKS IN EUROPE, MIDDLE EAST AND NORTH AFRICA:

Austria

Vienna
Ph: +43-1-90560-1204
Fx: +43-1-90560-1270

Denmark

Glostrup
Ph: +45-70-15-52-00
Fx: +45-43-44-14-14

Hungary

Budapest
Ph: +36-1-289-1007
Fx: +36-1-289-1010

Norway

Nesbru
Ph: +47-99-66-77-50
Fx: +47-66-77-88-98

Spain

Montcada (Barcelona)
Ph: +34-93-291-0330
Fx: +34-93-291-0608

UK

Tewkesbury, Glos
Ph: +44-1684-857966
Fx: +44-1684-857988

Belarus

Minsk
Ph: +375-17-237-47-94
Fx: +375-17-237-47-94

Egypt

Cairo
Ph: +20-2-2419-2334
Fx: +20-2-2417-7647

Italy

Collegno (Torino)
Ph: +39-011-4012-111
Fx: +39-011-4012-268

Poland

Warsaw
Ph: +48-22-4576-700
Fx: +48-22-4576-720

Sweden

Upplands Väsby
Ph: +46-8-5072-5000
Fx: +46-8-5072-5001

Ukraine

Kiev
Ph: +380-44-206-2265
Fx: +380-44-206-2264

Belgium

Kessel-Lo
Ph: +32-16-35-2326
Fx: +32-16-35-2353

Finland

Helsinki
Ph: +358-95-12-34-20
Fx: +358-95-12-34-250

Kazakhstan

Almaty
Ph: +7-327-244-5875
Fx: +7-327-244-5877

Portugal

Evora
Ph: +351-961-377-331
Fx: +351-211-454-506

Switzerland

Steinach
Ph: +41-71-447-0-447
Fx: +41-71-447-0-423

Bulgaria

Sofia
Ph: +359-2-971-2152
Fx: +359-2-971-2153

France

Cergy-Pontoise
Ph: +33-1-3420-2122
Fx: +33-1-3420-2268

Lithuania

Vilnius
Ph: +370-5-213-1402
Fx: +370-5-213-1403

Romania

Bucharest
Ph: +40-31-860-2113

Turkey

Istanbul
Ph: +90-212-339-92-00
Fx: +90-212-339-92-02

Czech Rep. & Slovakia

Brno
Ph: +420-541-162-112
Fx: +420-541-162-223

Germany

Darmstadt
Ph: +49-6151-607-1547
Fx: +49-6151-607-1219

Netherlands

Den Bosch
Ph: +31-73-6246-246
Fx: +31-73-6246-958

Russia

Moscow
Ph: +7-495-790-7902
Fx: +7-495-721-1894

U.A.E.

Dubai
Ph: +971-4-3466511
Fx: +971-4-3466513

TE ENTERPRISE NETWORKS

EMEA Product Catalog



Contact us:

Please contact us at one of the regional offices shown above.

TE Enterprise Networks:
www.te.com/enterprise-eu

TE Connectivity:
www.te.com

TE Connectivity, TE connectivity (logo), Tyco Electronics, and TE (logo) are trademarks of the TE Connectivity Ltd. family of companies and its licensors.

While TE Connectivity has made every reasonable effort to ensure the accuracy of the information in this document, TE Connectivity does not guarantee that it is error-free, nor does TE Connectivity make any other representation, warranty or guarantee that the information is accurate, correct, reliable or current. TE Connectivity reserves the right to make any adjustments to the information contained herein at any time without notice. TE Connectivity expressly disclaims all implied warranties regarding the information contained herein, including, but not limited to, any implied warranties of merchantability or fitness for a particular purpose. The dimensions in this document are for reference purposes only and are subject to change without notice. Specifications are subject to change without notice. Consult TE Connectivity for the latest dimensions and design specifications.

Tyco Electronics Corporation, a TE Connectivity Ltd. Company. All Rights Reserved.

313956AE 11/13 Revision 2 © 2013