

EN - For pricing and availability in your local country please visit one of the below links:

DE - Informationen zu Preisen und Verfügbarkeit in Ihrem Land erhalten Sie über die unten aufgeführten Links:

FR - Pour connaître les tarifs et la disponibilité dans votre pays, cliquez sur l'un des liens suivants:

[D23BCN](#)

[D7BCT](#)

[D7EST](#)

EN
This Datasheet is presented by
the manufacturer

DE
Dieses Datenblatt wird vom
Hersteller bereitgestellt

FR
Cette fiche technique est
présentée par le fabricant



OSRAM DULUX® EL electronic energy saving lamps

Economical alternatives
to ordinary light bulbs
Technical Guide

SEE THE WORLD IN A NEW LIGHT

OSRAM



1 General	3
1.1 OSRAM DULUX® EL – Electronic energy saving lamps	3
1.2 International standards	3
1.3 Range of lamps	4
1.3.1 Overview	4
1.3.2 OSRAM DULUX® EL LONGLIFE E14	5
1.3.3 OSRAM DULUX® EL LONGLIFE E27	6
1.3.4 OSRAM DULUX® EL ECONOMY	8
1.3.5 OSRAM DULUX® EL LONGLIFE CLASSIC	10
1.3.6 OSRAM DULUX® EL ECONOMY CLASSIC	12
1.3.7 OSRAM DULUX® EL GLOBE LONGLIFE and ECONOMY	14
1.3.8 OSRAM DULUX® EL LONGLIFE REFLECTOR	15
1.3.9 OSRAM DULUX® EL FACILITY	16
1.3.10 OSRAM DULUX® EL VARIO	18
1.3.11 OSRAM DULUX® EL SENSOR Plus	19
1.3.12 OSRAM CIRCOLUX® EL	21
1.4 Economy	22
1.4.1 Comparison of operating costs	22
1.4.2 Typical replacement intervals	23
2 Function and technical design	24
2.1 Generation of light	24
2.2 Electronic control gear	25
2.2.1 Operation	25
2.2.2 Energy savings thanks to electronic control gear	26
2.2.3 Visual comfort	27
3 Lamp data and lamp properties	28
3.1 Ignition properties, start-up, switching behaviour	28
3.2 Start-up current	29
3.3 Photometric data	29
3.3.1 Spectral distributions	29
3.3.2 Luminance	30
3.3.3 Luminous intensity distribution	30
3.4 Temperature influences	32
3.4.1 Dependence on burning positions and temperature	32
3.4.2 Lamp temperatures	34
3.4.3 Notes on luminaire design	35
3.5 Power supply	35
3.5.1 Dependence on mains voltage and mains frequency	35
3.5.2 Operation on dc voltage, emergency lighting	36
3.5.2.1 OSRAM DULUX® EL LONGLIFE 5W and 7W	36
3.5.2.2 OSRAM DULUX® EL FACILITY	37
3.5.3 Dimmer operation	38
3.5.4 Operation on electronic switches	38
3.5.5 Operation on switches with load relief, spark suppression or neon lamps parallel to the switch path	39
3.5.6 Operation on motion detectors	39

3.5.7	Parallel operation with CCG without power factor correction	39
3.5.8	Operation on BUS systems	40
3.5.9	Operation on non-sinusoidal voltage sources	40
3.5.10	Phase shift, power factor, pf correction	40
3.5.11	Mains current harmonic content	41
3.5.12	RFI suppression	41
3.5.13	Resistance to electro-magnetic interference and transient overvoltages	41
3.5.14	Interference from IR remote controls	41
3.5.15	Bases, holders	41
3.6	Reduction in luminous flux over time	42
3.7	Lamp life	43
3.8	Suitability for outdoor applications	44
3.9	Suitability for explosion-proof luminaires	44
3.10	Additional information on OSRAM DULUX® EL SENSOR Plus	45
3.11	Possible malfunctions of OSRAM DULUX® EL SENSOR Plus	46
4	OSRAM DULUX® EL and the environment	47
4.1	Energy balance	47
4.2	Substances	47
4.3	Disposal	48
4.4	Energy Efficiency Index (EEI)	48
4.5	OSRAM contacts	50

1 General

1.1 OSRAM DULUX® EL electronic energy-saving lamps

OSRAM DULUX® EL lamps are compact fluorescent lamps with integrated electronic control gear for mains voltage from 220 to 240 V. The lamps are available with E14 or E27 screw bases or B22d bayonet bases, which means they are quick and simple direct replacements for ordinary light bulbs. They offer the dual benefits of the comfort of a ordinary light bulb and the economy of a fluorescent lamp.

OSRAM DULUX® EL lamps are particular economical. They have a reputation as „long-distance runners“ because they consume very little electricity.

At 0.13 €/kWh, none cost **more than 1/3 € Cent** per hour to run.

OSRAM DULUX® EL is available in **LONGLIFE** and **ECONOMY** versions with the following characteristics:

	OSRAM DULUX® EL LONGLIFE	OSRAM DULUX® EL ECONOMY
Electricity savings compared with ordinary light bulbs of nearest light output	80 %	up to 80 %
Lamp life (at 3 h/day)*	about 12 years	about 6 years
Average lamp life*	15000 h	8000 h
Flicker-free starting	Yes, warm start ¹⁾	Yes, cold start ²⁾
Flicker-free light	Yes	Yes
Optimised lamp dimensions	1,2,3 turn tubes	2,3 turn tubes
Low weight	35 g to 165 g	63 g to 165 g
Thermal output	only 20% of input power	only 20% of input power
Reliable starting (see also Section 3.1)	down to -30°C	down to -15°C
Incandescent like light	Yes	Yes
On/off switching with no reduction in life	Yes ^{*1)} 500000 on/off switching operations	Yes ^{*2)} 5000 on/off switching operations

* All lifespan claims relate to a cycle of 165 minutes on, 15 minutes off as per current IEC regulations. The following switching operations should not be exceeded:

For OSRAM DULUX® EL LONGLIFE: 500000 on/off operations

For OSRAM DULUX® EL ECONOMY: 5000 on/off operations

1) Start with cathode preheating, cycle 30 s on, 150 s off

2) Start without cathode preheating, cycle 30 s on, 30 s off

Main areas of application for OSRAM DULUX® compact fluorescent lamps are as follows:

1. In the commercial sector: e. g. restaurants, hotels, ticket offices, foyers, corridors, offices

In view of the enormous savings in electricity and replacement costs, these lamps are ideal for areas where continuous lighting is needed.

2. In the domestic sector: e. g. in living rooms and the kitchen.

OSRAM DULUX® EL LONGLIFE are needed if there are high demands to be met in terms of lamp life and frequent on/off switching.

1.2 International standards

OSRAM DULUX® EL compact fluorescent lamps carry the CE symbol of the EU and comply with all the relevant European standards, in particular the following:

- EN 60968 (safety requirements)
- EN 60969 (performance requirements)
- EN 61000-3-2 (mains current harmonics)
- EN 55015 (RFI suppression)
- EN 61547 (EMC Immunity Requirements)



1.3 Range of lamps

1.3.1 Overview

OSRAM DULUX® EL LONGLIFE									
	Standard	Specials							
Wattage	Tube version	Classic A	Classic Candle B	GLOBE	FACILITY	VARIO	SENSOR Plus	CIRCOLUX	REFLECTOR
	1.3.2/1.3.3	1.3.5	1.3.5	1.3.7	1.3.9	1.3.10	1.3.11	1.3.12	1.3.8
Wattage	lm								cd
3	100								
5	240	140	150						
7	400	320	280						
8									
9									
10		500			500				
11	630	450							
12									
14					800				
15	900	800		700			900		335
16									
18									
20	1200	1155		1100					450
21									
23	1500					1500/350			
24								1700	
30									

OSRAM DULUX® EL ECONOMY				
	Standard	Specials		
Wattage	Tube version	Classic A	Classic Candle B	GLOBE
	1.3.4	1.3.6	1.3.6	1.3.7
Wattage	lm			
3				
5		200	160	
7		350	280	
8	400			
9			340	
10		500		
11				
12	550			
14				
15		800		
16	900			700
18				
20				
21	1200			1100
23				
24	1500			



**1.3.2 OSRAM DULUX® EL
 LONGLIFE
 E 14**

The high quality brand name compact fluorescent lamp with E14 base.

- About 12 years life (if used for around 3 hours a day)
- Very low weight and suitable for small luminaires
- On/off switching as for ordinary light bulbs with no reduction in life (more than 500000 switching operations possible in a 30 s on/150 s off cycle)
- A total of four wattages for the large range of E14 applications
- Luminaires restricted to 40 W incandescent lamps can be made brighter with OSRAM DULUX® EL LONGLIFE E14 11 W lamps (60 W equivalent)
- The OSRAM DULUX® EL 3 W is the most compact and economical energy saving lamp with a screw base
- OSRAM DULUX® EL LONGLIFE 5 W and 7 W with E14 bases are suitable for continuous operation on DC power supplies with restrictions (see also 3.5.2)
- Not suitable for use with dimmers, electronic switches or motion detectors

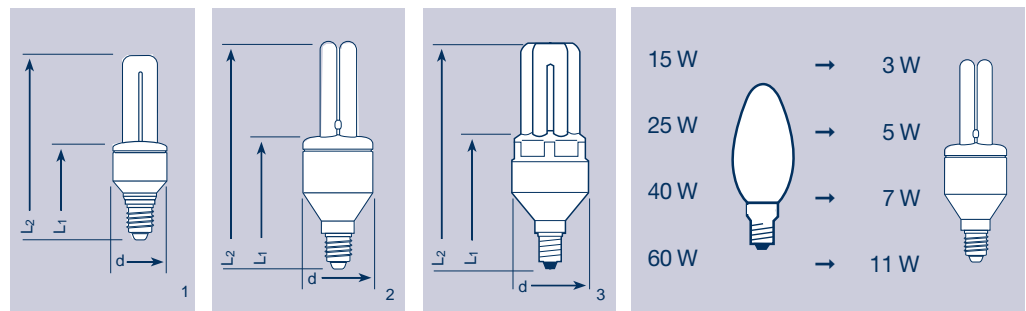

LONGLIFE

NEW

Reference	DEL	DEL	DEL	DEL	DEL
	LL	LL	LL	LL***	LL**
	3 W E14	5 W E14	7 W E14	11 W E14	11 W E14
Fig.	1	2	2	2	3
Warm start (start with cathode preheating)	Yes	Yes	Yes	Yes	Yes
Power input (W)	3	5	7	11	11
Lamp current rms value (mA)	30	40	55	90	90
Peak value (mA)	75	150	180	270	270
Luminous flux (lm)	100	240	400	600	630
Luminous efficacy (lm/W)	33	48	57	55	57
Colour appearance	827	827	827	827	827
Colour rendering group	1B	1B	1B	1B	1B
Energy Label classification	A	A	A	A	A
Length L ₁ (mm)	58,5	64	78	78	72
Length L ₂ (mm)	115±2	122±2	136±3	148±3	126±3
Diameter d (mm)	30	36	45	45	45
Weight (g)	35	43	59	64	61
Suitable for DC operation	No	Yes*)	Yes*)	No	No
Rated average life (h)	12000	15000	15000	15000	15000

* see 3.5.2
 ** From January 2004
 *** Will be withdrawn by the end of 2003



**1.3.3 OSRAM DULUX® EL
LONGLIFE
E27**

The high quality brand name compact fluorescent lamp for standard E27 and B22d light bulb holders.

- About 12 years life (if used for around 3 hours a day)
- Wide range from 5 W to 23 W and up to four different colour appearances
- OSRAM DULUX® EL LONGLIFE E27 lamps are suitable for most light bulb fittings because of their compact dimensions
- Ideal for all applications that require long life and an ability to withstand frequent on/off switching
- On/off switching as for ordinary light bulbs with no reduction in life (500.000 switching operations possible in a 30 s on/150 s off cycle)
- OSRAM DULUX® EL LONGLIFE 5 W and 7 W are suitable for continuous operation on DC power supplies with restrictions (see also 3.5.2.1)
- Some OSRAM DULUX® EL lamps are also available for other mains voltages (e. g. 120 V) and other bases (with different technical data)
- Not suitable for use with dimmers, electronic switches or motion detectors

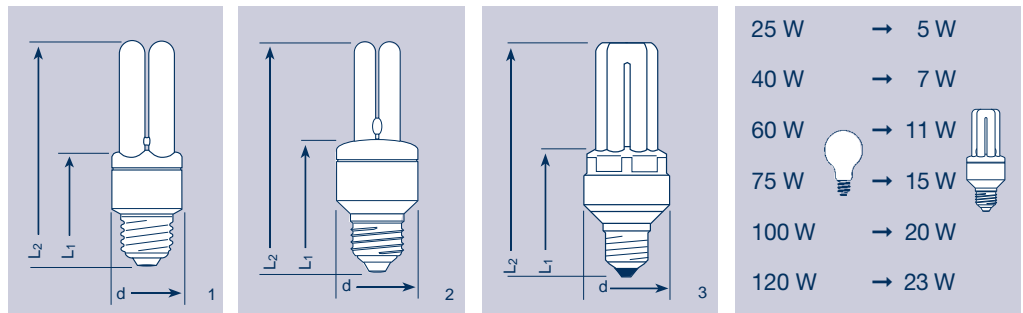

LONGLIFE

NEW

Reference	DEL LL 5 W	DEL LL 7 W	DEL LL*** 11 W	DEL LL** 11 W
Fig.	1	2	2	3
Warm start (start with cathode preheating)	Yes	Yes	Yes	Yes
Power input (W)	5	7	11	11
Lamp current rms value (mA)	40	55	90	90
Peak value (mA)	150	180	270	270
Luminous flux (lm)	240	400	600 ¹⁾	630 ¹⁾
Luminous efficacy (lm/W)	48	57	55	57
Colour appearance	827	827	827	827
	-	840	840	840
	-	-	860 ¹⁾	860 ¹⁾
Colour rendering group	1B	1B	1B	1B
Energy Label classification	A	A	A ²⁾	A ²⁾
Length L ₁ (mm)	62	73	73	68
Length L ₂ (mm)	121±2	131±3	143±3	117±3
Diameter d (mm)	36	45	45	45
Weight (g)	46	67	73	62
Suitable for DC operation	Yes*	Yes*	No	No
Rated average life (h)	15000	15000	15000	15000

¹⁾ 5 % less luminous flux for colour 860

²⁾ Colour 860, Energy Label B

* see 3.5.2.1

** From January 2004

*** Will be withdrawn by the end of 2003



**1.3.3 OSRAM DULUX® EL
 LONGLIFE
 E27
 (Continued)**

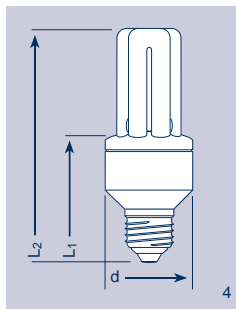
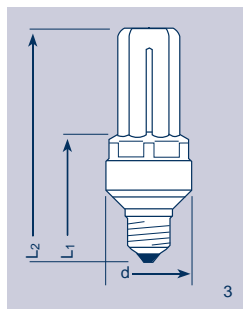

25 W	→	5 W
40 W	→	7 W
60 W	→	11 W
75 W	→	15 W
100 W	→	20 W
120 W	→	23 W

LONGLIFE

Reference	<u>NEW</u>		<u>NEW</u>		
	DUL EL LL 15 W	DEL LL** 15 W	DUL EL LL 20 W	DUL EL LL** 20 W	DUL EL LL 23 W
Fig.	4	3	4	3	4
Warm start (start with cathode preheating)	Yes	Yes	Yes	Yes	Yes
Power input (W)	15	15	20	20	23
Lamp current rms value (mA)	120	120	160	160	185
Peak value (mA)	360	360	480	480	560
Luminous flux (lm)	900 ¹⁾	900 ¹⁾	1200 ¹⁾	1200 ¹⁾	1500 ¹⁾
Luminous efficacy (lm/W)	60	60	60	60	65
Colour appearance	827	827	827	827	827
	840	840	840	840	840
	860 ¹⁾	860 ¹⁾	860 ¹⁾	860 ¹⁾	860 ¹⁾
Colour rendering group	1B	1B	1B	1B	1B
Energy Label classification	A ²⁾	A ²⁾	A ²⁾	A ²⁾	A ²⁾
Length L ₁ (mm)	81,5	73	81,5	73	83
Length L ₂ (mm)	140±3	128±3	153,5±3	141±3	173±3
Diameter d (mm)	52	45	52	45	58
Weight (g)	92	65	95	73	100
Suitable for DC operation	No	No	No	No	No
Rated average life (h)	15000	15000	15000	15000	15000

¹⁾ 5 % less luminous flux for light colour 860

²⁾ Colour 860, Energy Label B

* see 3.5.2

** From January 2004

1.3.4 OSRAM DULUX® EL ECONOMY

The low-cost brand name compact fluorescent lamp for standard lamp fittings.

- The quality standard for normal household use, ideal for continuous economical lighting
- About 6 years life (if used for around 3 hours a day)
- Instant flicker-free starting as for an ordinary light bulb
- Straightforward range with two E14 wattages and five E27/B22d wattages
- Cold start (no filament preheating, up to 5000 switching operations for a 30 s on, 30 s off cycle)
- Not suitable for DC operation, emergency lighting systems, dimmers, electronic switches or motion detectors

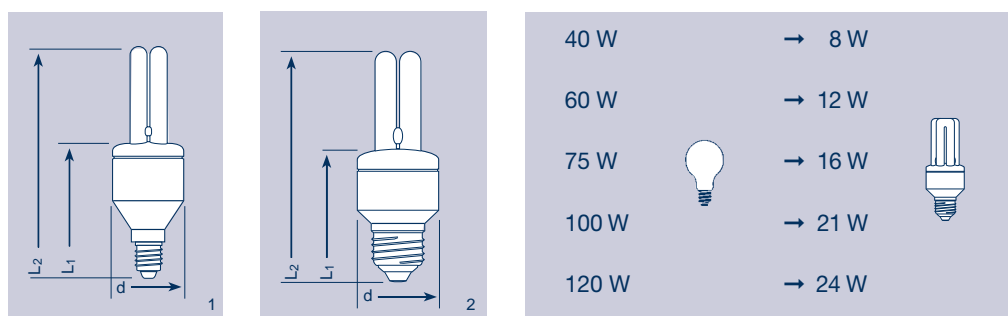

ECONOMY

Reference	DEL ECO 8 W E14	DEL ECO 12 W E14	DEL ECO 8 W	DEL ECO 12 W
Fig.	1	1	2	2
Cold start (start without cathode preheating)	Yes	Yes	Yes	Yes
Power input (W)	8	12	8	12
Lamp current rms value (mA)	75	120	75	120
Peak value (mA)	200	300	200	300
Luminous flux (lm)	400	550	400	550 ¹⁾
Luminous efficacy (lm/W)	50	50	50	50
Colour appearance	827	827	827	827
	-	-	840	840
	-	860 ¹⁾	-	860 ¹⁾
Colour rendering group	1B	1B	1B	1B
Energy Label classification	A	A ²⁾	A	A ²⁾
Length L ₁ (mm)	78	78	73	73
Length L ₂ (mm)	134±3	142±3	129±3	138±3
Diameter d (mm)	45	45	45	45
Weight (g)	59	60	55	60
Available with base	E14	E14	E27 B22d	E27 B22d
Suitable for DC operation	No	No	No	No
Rated average life (h)	8000	8000	8000	8000

¹⁾ 5 % less luminous flux for colour 860

²⁾ Colour 860, Energy Label B

**1.3.4 OSRAM DULUX® EL
ECONOMY
(Continued)**

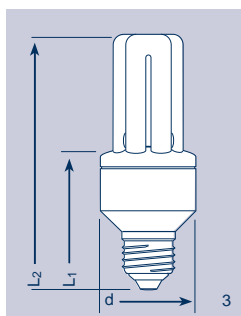

40 W	→	8 W
60 W	→	12 W
75 W	→	16 W
100 W	→	21 W
120 W	→	24 W

ECONOMY

NEW

Reference	DEL ECO 16 W	DEL ECO 21 W	DEL ECO 24 W
Fig.	3	3	3
Cold start (start without cathode preheating)	Yes	Yes	Yes
Power input (W)	16	21	24
Lamp current rms value (mA)	125	160	185
Peak value (mA)	390	510	560
Luminous flux (lm)	900 ¹⁾	1200 ¹⁾	1500 ¹⁾
Luminous efficacy (lm/W)	56	57	62,5
Colour appearance	827 840 860 ¹⁾	827 840 860 ¹⁾	827 840 860 ¹⁾
Colour rendering group	1B	1B	1B
Energy Label classification	A ²⁾	B	A
Length L ₁ (mm)	81,5	81,5	81,5
Length L ₂ (mm)	140±3	153,5±3	173±3
Diameter d (mm)	52	52	52
Weight (g)	85	88	92
Available with base	E27 B22d	E27 B22d	E27 B22d
Suitable for DC operation	No	No	No
Rated average life (h)	8000	8000	8000

¹⁾ 5 % less luminous flux for colour 860

²⁾ Colour 860, Energy Label B

**1.3.5 OSRAM DULUX® EL
LONGLIFE
CLASSIC**

The high quality brand name compact fluorescent lamp with the classic light bulb shape combines the benefits of the incandescent lamp with those of the compact fluorescent lamp

- About 12 years life (if used for around 3 hours a day), based on the same specifications and requirements for life and on/off switching frequency as for OSRAM DULUX® EL LONGLIFE
- Ideal for decorative and free-burning applications
- Special finish outer bulb for particularly soft light
- LONGLIFE versions are particularly suitable for use in enclosed and ventilated outdoor luminaires at low ambient temperatures
- LONGLIFE versions are available in six wattages with E14 or E27/B22d bases
- OSRAM DULUX® EL CLASSIC lamps are not suitable for use with dimmers or electronic switches or motion detectors

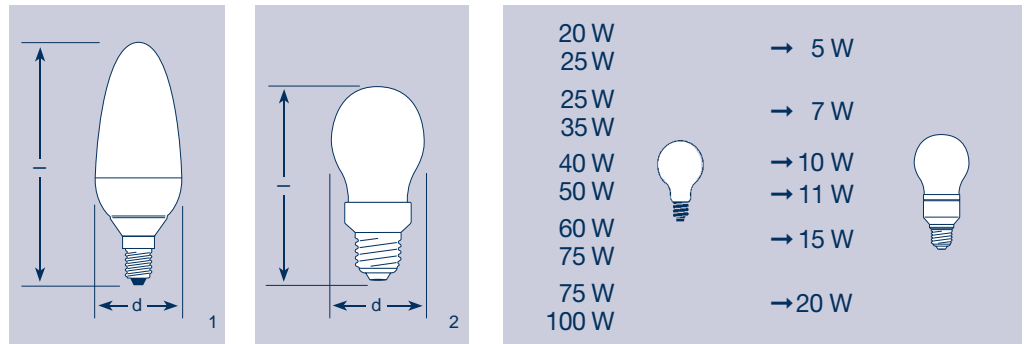

LONGLIFE



NEW

Reference	DEL CL A 5 W	DEL CL B 5 W E14	DEL CL A 7 W	DEL CL B 7 W E14	DEL CL A 10 W
Fig.	2	1	2	1	2
Warm start (start with cathode preheating)	Yes	Yes	Yes	Yes	Yes
Power input (W)	5	5	7	7	10
Lamp current rms value (mA)	40	40	55	55	80
Peak value (mA)	150	150	180	180	240
Luminous flux (lm)	140	150	320	280	500
Luminous efficacy (lm/W)	30	30	45	40	50
Colour appearance	827	827	827	827	827
Colour rendering group	1B	1B	1B	1B	1B
Energy Label classification	B	B	A	B	A
Length l (mm)	109±2	131±2	111±2	131±2	123,5±2
Diameter d (mm)	60	46	60	46	60
Weight (g)	65	65	60	65	80
Base	E27 B22d	E14	E27 B22d	E14	E27 B22d
Suitable for DC operation	No	No	No	No	No
Rated average life (h)	12000	12000	12000	12000	10000

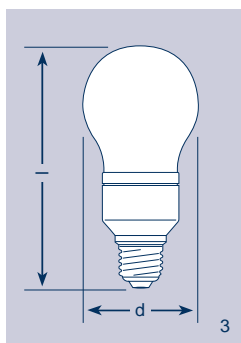

**1.3.5 OSRAM DULUX® EL
LONGLIFE
CLASSIC
(Continued)**



20 W		→ 5 W	
25 W		→ 7 W	
40 W		→ 10 W → 11 W	
60 W		→ 15 W	
75 W		→ 20 W	

LONGLIFE

Reference			<u>NEW</u>	<u>NEW</u>
	DEL CL A 11 W*	DEL CL A 15 W	DEL CL A 15 W	DEL CL A** 20 W
Fig.	3	3	3	3
Warm start (start with cathode preheating)	Yes	Yes	Yes	Yes
Power input (W)	11	15	15	20
Lamp current rms value (mA)	90	120	120	160
Peak value (mA)	270	360	360	480
Luminous flux (lm)	450	800	800	1155
Luminous efficacy (lm/W)	45	53	53	55
Colour appearance	827	827	827	827
Colour rendering group	1B	1B	1B	1B
Energy Label classification	B	A	A	A
Length l (mm)	147±2	149,5±2	142±2	152±2
Diameter d (mm)	70	70	65	70
Weight (g)	88	146	105	112
Base	E27	E27	E27	E27
	B22d	B22d	B22d	B22d
Suitable for DC operation	No	No	No	No
Rated average life (h)	12000	12000	10000	10000

* Will be withdrawn from 01/2004

** From September 2003

1.3.6 OSRAM DULUX® EL ECONOMY CLASSIC

The high quality brand name compact fluorescent lamp with the classic light bulb shape combines the benefits of the incandescent lamp with those of the compact fluorescent lamp.

- The new generation is more compact and attractive
- About 6 years life (if used for around 3 hours a day), based on the same specifications and requirements for life and on/off switching frequency as for OSRAM DULUX® EL ECONOMY
- Ideal for decorative and free-burning applications
- Special finish outer bulb for particularly soft light
- ECONOMY versions are available in five wattages with E27/B22d bases
- OSRAM DULUX® EL CLASSIC lamps are not suitable for use with dimmers or electronic switches or motion detectors

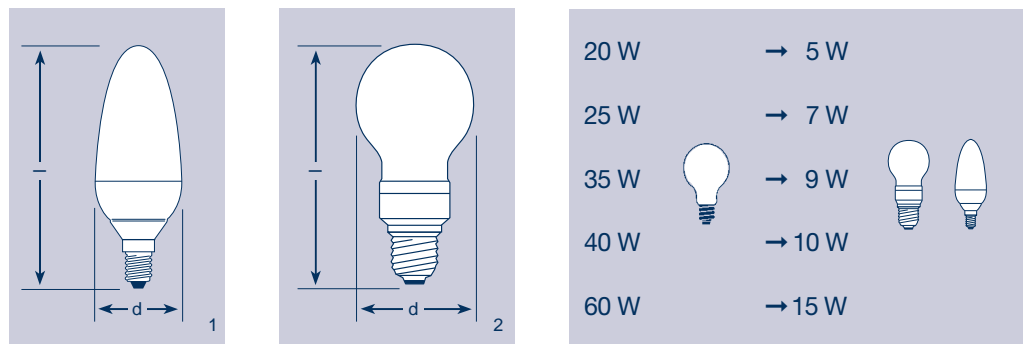

ECONOMY

	<u>NEW</u>	<u>NEW</u>	<u>NEW</u>	<u>NEW</u>
Reference	DEL CL A ECO 5 W	DEL CL B ECO 5 W	DEL CL A ECO 7 W	DEL CL B ECO 7 W
Fig.	2	1	2	1
Warm start (start with cathode preheating)	Yes	Yes	Yes	Yes
Power input (W)	5	5	7	7
Lamps current rms value (mA)	40	40	55	55
Peak value (mA)	120	120	165	165
Luminous flux (lm)	200	160	350	280
Luminous efficacy (lm/W)	40	32	50	40
Colour appearance	827	827	827	827
Colour rendering group	1B	1B	1B	1B
Energy Label classification	A	B	A	B
Length l (mm)	106,5±2	116,5±2	116,5±2	123,5±2
Diameter d (mm)	52	42	56	43
Weight (g)	65	65	65	65
Base	E27 B22d	E14	E27 B22d	E14
Suitable for DC operation	No	No	No	No
Rated average life (h)	6000	6000	6000	6000



**1.3.6 OSRAM DULUX® EL
ECONOMY
CLASSIC
(Continued)**

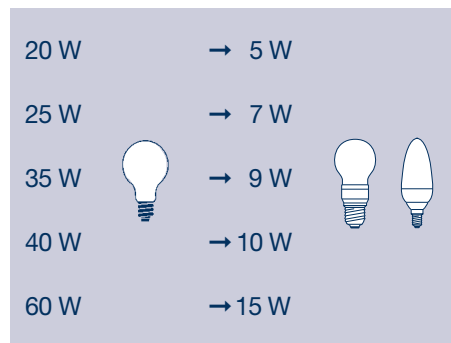
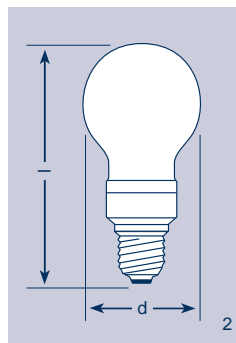
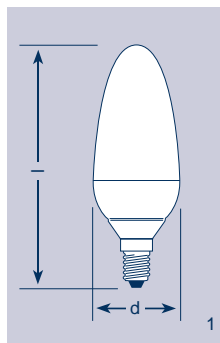

ECONOMY

Reference	<u>NEW</u>	<u>NEW</u>	<u>NEW</u>
	DEL CL B ECO 9 W	DEL CL A ECO 10 W	DEL CL A ECO 15 W
Fig.	1	2	2
Warm start (start with cathode preheating)	Yes	Yes	Yes
Power input (W)	9	10	15
Lamp current rms value (mA)	70	80	120
Peak value (mA)	225	240	360
Luminous flux (lm)	340	500	800
Luminous efficacy (lm/W)	38	50	53
Colour appearance	827	827	827
Colour rendering group	1B	1B	1B
Energy Label classification	B	A	B
Length l (mm)	131±2	126,5±2	142,7±2
Diameter d (mm)	46	60	65
Weight (g)	70	80	100
Base	E14	E27 B22d	E27 B22d
Suitable for DC operation	No	No	No
Rated average life (h)	6000	6000	6000

**1.3.7 OSRAM DULUX® EL
LONGLIFE
GLOBE**

**OSRAM DULUX® EL
ECONOMY
GLOBE**

The high quality brand name compact fluorescent lamp with new, more decorative large bulb.

- OSRAM DULUX® EL GLOBE has the same comfort and economy features as the OSRAM DULUX® EL LONGLIFE and OSRAM DULUX® EL ECONOMY lamps with 6 or 12-years lamp life (at 3 h/day based on their specifications and requirements for lamp life and on/off switching frequency)
- OSRAM DULUX® EL GLOBE offers pleasant glare-free light, uniform distribution of the light and improved impact resistance (splinter protection) thanks to its plastic bulb with locking feature (NEW)
- OSRAM DULUX® EL LONGLIFE GLOBE lamps are particularly suitable for use in enclosed, ventilated and semi-open outdoor luminaires at low ambient temperatures
- Suitable, with restrictions, for use in open luminaires outdoors, provided there is no possibility of moisture ingress (rain, splashwater, dew, etc.). Condensate can lead to premature lamp failure; this is minimised by the new bulb locking feature
- Not suitable for DC operation, emergency lighting systems, dimmers, electronic switches or motion detectors.

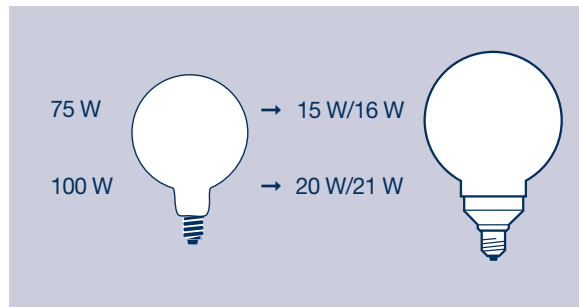
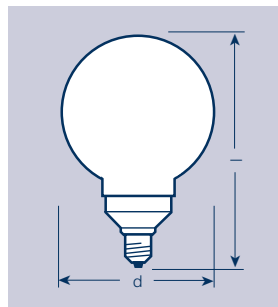

LONGLIFE

ECONOMY

Reference	DEL	DEL	DEL	DEL
	LL	LL	ECO	ECO
	GL 15 W	GL 20 W	GL 16 W	GL 21 W
Warm start (start with cathode preheating)	Yes	Yes	No	No
Power input (W)	15	20	16	21
Lamp current rms value (mA)	120	160	125	170
Peak value (mA)	360	480	390	510
Luminous flux (lm)	700 ¹⁾	1100 ¹⁾	700	1100
Luminous efficacy (lm/W)	47	55	44	52
Colour appearance	827	827	827	827
	860 ¹⁾	860 ¹⁾	–	–
Colour rendering group	1B	1B	1B	1B
Energy Label classification	B	B	B	B
Length l (mm)	169±2	190±2	169±2	190±2
Diameter d (mm)	97	117	97	117
Weight (g)	150	155	150	155
Available with base	E27	E27	E27	E27
	B22d	B22d	B22d	B22d
Suitable for DC operation	No	No	No	No
Rated average life (h)	15000	15000	8000	8000

¹⁾ 5 % less for colour 860



**1.3.8 OSRAM DULUX® EL
LONGLIFE
REFLECTOR**

The high quality brand name compact fluorescent lamp with new, more decorative integrated reflector.

- OSRAM DULUX® EL LONGLIFE REFLECTOR offers the same comfort and economy as OSRAM DULUX® EL LONGLIFE with a lamp life of about 12 years (at around 3 hours a day).
- Ideal for applications that require long life and an ability to withstand frequent on/off switching as for ordinary light bulbs with no reduction in life (more than 500000 switching operations possible in a 30 s on/150 s off cycle)
- OSRAM DULUX® EL LONGLIFE REFLECTOR is ideal in spotlights and downlights and can replace conventional incandescent reflector lamps; the heat on illuminated objects is greatly reduced as a result
- The contoured wipe-clean reflector and the lamp form an optimum directional light source
- Not suitable for DC operations, emergency lighting systems, dimmers, electronic switches or motion detectors

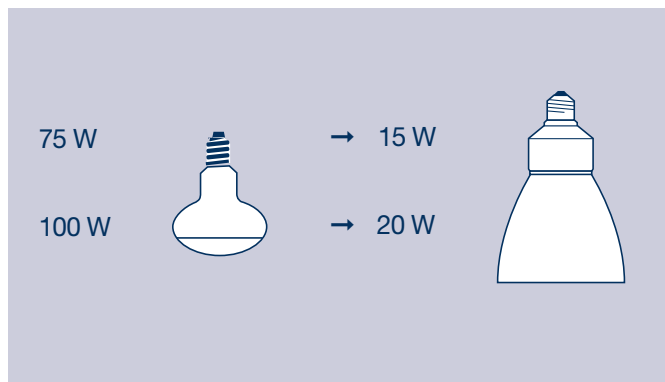
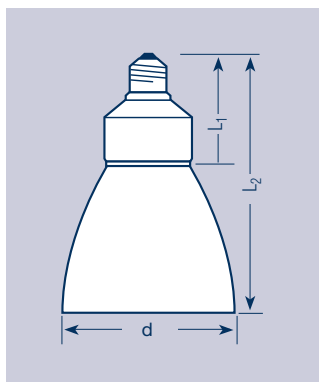

LONGLIFE

Reference	DEL	DEL
	LL	LL
	REFL 15 W	REFL 20 W
Warm start (start with cathode preheating)	Yes	Yes
Power input (W)	15	20
Lamp current rms value (mA)	120	160
Peak value (mA)	360	480
Luminous intensity (cd)	335	450
Half-peak angle (50 % I ₀) (°)	80	80
Colour appearance	827	827
Colour rendering group	1B	1B
Length l ₁ (mm)	92,5	101
Length l ₂ (mm)	143±2	161±2
Diameter d (mm)	102	117,5
Weight (g)	145	170
Base	E27	E27
	B22d	B22d
Suitable for DC operation	No	No
Rated average life (h)	15000	15000

**1.3.9 OSRAM DULUX® EL
 LONGLIFE
 FACILITY**

The electronic brand name compact fluorescent lamp for professional applications, based on Longlife technology.

- OSRAM DULUX® EL FACILITY can be switched on and off any number of times within its average life of 15000 h in accordance with IEC regulations and has the same comfort and economy features as the OSRAM DULUX® EL LONGLIFE
- Power-Boost facility so it reaches its rated luminous flux more quickly (90 % in 100 s)
- Short ignition times of less than 0.5 s
- Suitable for operation at temperatures from -30°C to +50°C; reliable starting as low as -30°C
- No need to leave the lamp off for a certain time before switching it on again
- Suitable for 220–240 V DC systems
- Not suitable for use with dimmers, electronic switches or systems that warn of imminent disconnection by dimming the light

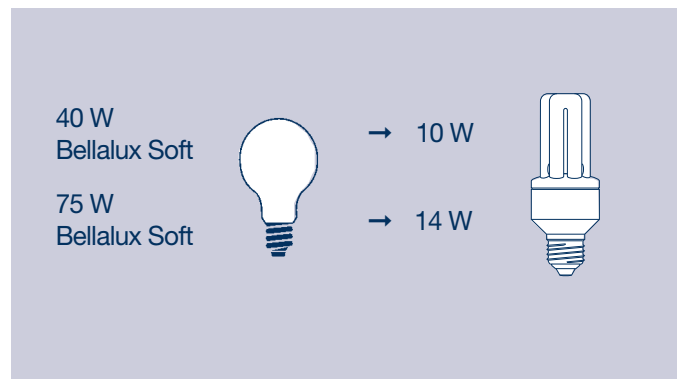
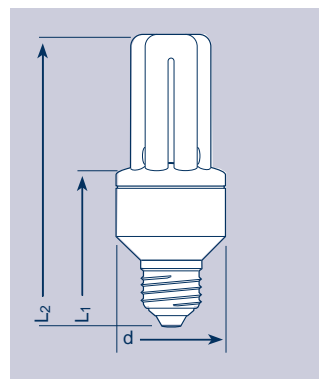

LONGLIFE

	<u>NEW</u>	<u>NEW</u>
Reference	DEL FCY 10 W	DEL FCY 14 W
Warm start (start with cathode preheating)	Yes	Yes
Power input (W)	10	14
Lamp current rms value (mA)	80	110
Peak value (mA)	240	380
Luminous flux (lm)	500	800
Luminous efficacy (lm/W)	50	57
Colour appearance	827	827
Colour rendering group	1B	1B
Energy Label classification	A	A
Length l ₁ (mm) E27 and B22d bases	64±3	72,5±3
E14 base	69±3	–
Length l ₂ (mm) E27 and B22d bases	129±3	131±3
E14 base	134±3	–
Diameter d (mm)	45	52
Weight (g)	55	80
Available with base	E27/E14 B22d	E27 B22d
Suitable for DC operation	Yes	Yes
Rated average life (h)	15000	15000

1.3.9 OSRAM DULUX® EL Use with stairwell lighting time switches:**LONGLIFE
FACILITY**

The total power input of multiple OSRAM DULUX® EL FACILITY lamps should not exceed 1/8 of the permitted incandescent lamp load. This value depends on the switch design and cannot be applied to other types of energy saving lamp. In addition to the switching load, the provisions of DIN 18015-2 must also be noted: „...in the case of lighting systems in stairwells of multi-family residences, automatic disconnection circuits must be equipped with a warning function (such as dimming of the lights) to avoid sudden darkness“. The type and design of this warning function have not been standardised.

Known designs:

- Warning function with reduced brightness (dimming): The dimming function is generally achieved by half-wave rectification of the mains voltage. DEL FACILITY is not suitable for this mode of operation.
- Warning signal provided by multiple (double) flashing (interruptions of the current) before disconnection: The lamp is not likely to suffer damage. The warning signal is noticeably changed by the preheating phase of the DEL FACILITY (approx. 0.4 s). If there is an unsuitable pulse sequence the lamp may go off (at least 0.4 s for each switching operation).

ON time:

For the benefit of the lamp, the ON time should not be less than 3 minutes.

Examples:

- a) Incandescent lamp load for 2300 W cutout, the following can be connected:
OSRAM DULUX® EL FACILITY 28 x 10 W or 20 x 14 W
- b) Incandescent lamp load for 1000 W cutout, the following can be connected:
OSRAM DULUX® EL FACILITY 13 x 10 W or 9 x 14 W

1.3.10 OSRAM DULUX® EL LONGLIFE VARIO The high quality brand name compact fluorescent lamp with integrated option for varying the light.

- The lighting level can be varied by simply switching the lamp off and on again. Within 3 seconds the luminous flux is reduced to about 25 % of the rated value. Switching the lamp off and on again takes the lamp back up to 100 % luminous flux, irrespective of how long it is switched off. Recommendation: allow the lamps to burn in at full load for at least 1 minute each time before „dimming to around 25 %“ to achieve stable operation
- Additional energy savings from reducing power consumption to 40 %. For more information see Section 3.5.3 Dimmer operation
- In accordance with IEC regulations, OSRAM DULUX® EL LONGLIFE VARIO can be switched on and off any number of times within its average life of 15000 hours and within its permitted temperature range of +15°C to +50°C without having to be switched off for a certain amount of time before being switched on again
- Not suitable for use with existing dimmer systems, DC power, emergency lighting systems or electronic switches

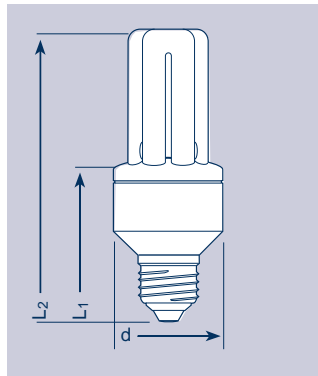

LONGLIFE

NEW

Reference	DEL VAR 23 W		
Warm start (start with cathode preheating)	Yes		
Technical characteristics	Full load	Power-Boost	Vario function
Power input (W)	23	24,5	9
Lamp current rms value (mA _{rms})	185	170	70
Peak value (mA)	560	650	225
Luminous flux (lm)	1500	–	350
Luminous efficacy (lm/W)	65	–	39
Colour appearance	827		
Colour rendering group	1B		
Energy Label classification	A		
Length l ₁ (mm)	83		
Length l ₂ (mm)	173±3		
Diameter d (mm)	58		
Weight (g)	110		
Available with base	E27 B22d		
Suitable for DC operation	No		
Rated average life (h)	15000		



**1.3.11 OSRAM DULUX® EL
 LONGLIFE
 SENSOR Plus**

The high quality brand name compact fluorescent lamp with microprocessor technology and control based on ambient light.

Operating principle:

OSRAM DULUX® EL SENSOR Plus automatically switches on at dusk and off again at dawn. Two light sensors at the side continually measure the ambient light and determine the infra-red content of its spectral distribution; in this way the lamp is controlled according to available daylight (for details see how it works on page 20).

- OSRAM DULUX® EL SENSOR Plus is not affected by its own light; the lamp offers all the comfort and economy features of OSRAM DULUX® EL LONGLIFE technology; the OSRAM DULUX IC (integrated circuit) ensures optimum operation
- Simple „plug & play“ installation for use in all standard fittings for incandescent lamps; may only be used outdoors in enclosed and ventilated luminaires
- Automatic adjustment to ambient lighting conditions A setting controller, as on the predecessor model OSRAM DULUX® EL SENSOR, is not needed
- The lamp indicates it is ready each time power is applied
- Not suitable for DC operation, emergency lighting systems, dimmers or electronic switches

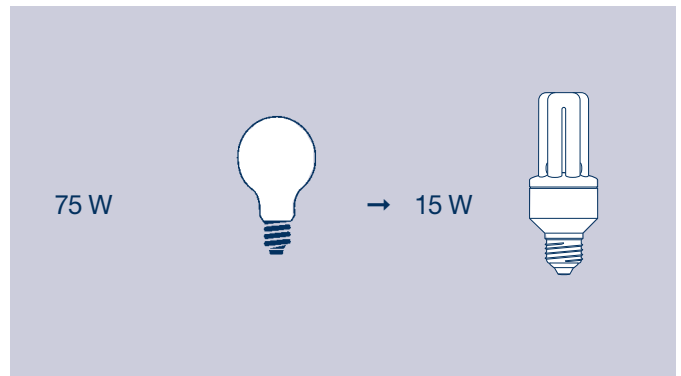
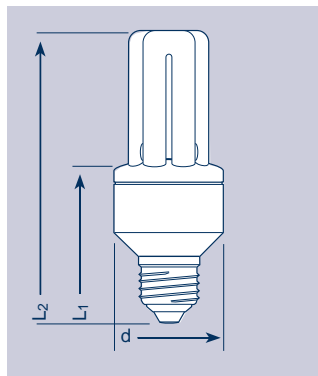

LONGLIFE

NEW

Reference	DEL 15 W SENSOR Plus
Warm start (start with cathode preheating)	Yes
Power input (W)	15
Lamp current rms value (mA)	120
Peak value (mA)	360
Luminous flux (lm)	900
Luminous efficacy (lm/W)	60
Colour appearance	827
Colour rendering group	1B
Energy Label classification	A
Length l ₁ (mm)	81,5
Length l ₂ (mm)	140±3
Diameter d (mm)	52
Weight (g)	95
Available with base	E27, B22d
Suitable for DC operation	No
Rated average life (h)	15000



**1.3.11 OSRAM DULUX® EL
LONGLIFE
SENSOR Plus**

How it works:

The lamp is controlled by infra-red (IR) radiation. Infra-red radiation is emitted by the sun, remote controls and artificial light sources such as incandescent and halogen lamps. By contrast, fluorescent lamps emit very little IR radiation once they have reached their normal operation state. The light from such lamps does not interfere the IR sensor which could make the lamps flicker or go off.

In the case of sunlight, it can be assumed that the brightness of the visible light is proportional to the intensity of the infra-red radiation. The two sensors on the lamp (behind the red covers) detect the IR radiation in the vicinity of the lamp. A measurement signal is derived from this, and this signal is then evaluated by the electronic circuitry in the lamp:

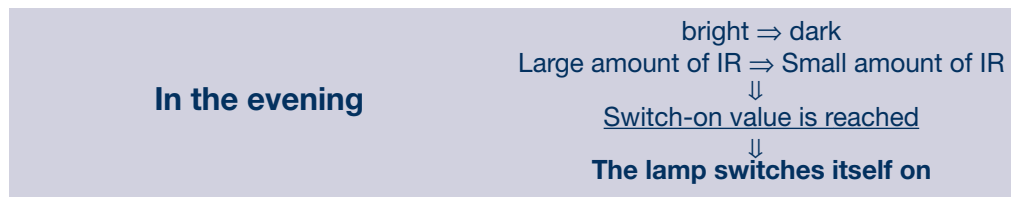

After a maximum of 30 minutes the translucence of the luminaire is measured.

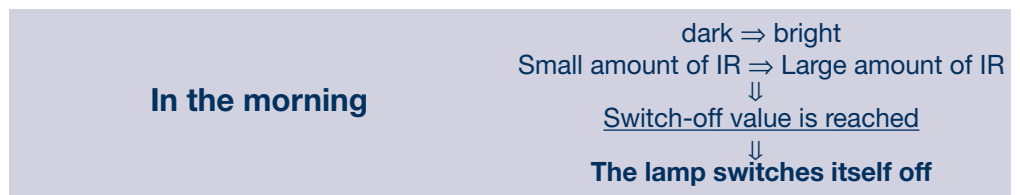

Self-test each time power is applied.

A complete lamp test is performed. All the components of the lamp are checked for correct operation. The lamp will light after about two seconds to indicate that the test has been successfully completed.

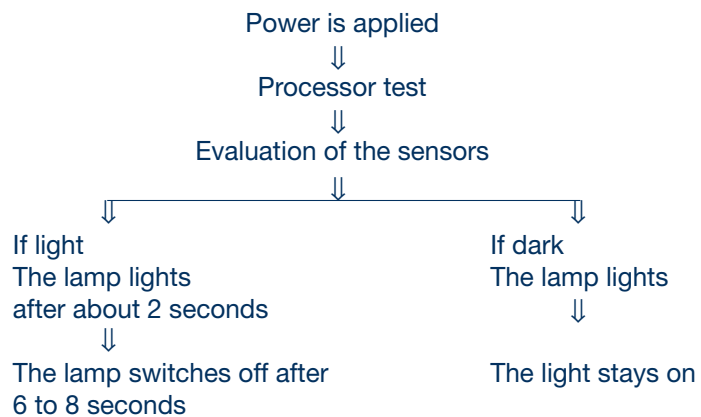

1.3.12 OSRAM CIRCOLUX® EL LONGLIFE

The brightest circular brand name compact fluorescent lamp.

- OSRAM CIRCOLUX® EL offers the same comfort and economy as OSRAM DULUX® EL LONGLIFE with a lamp life of up to 12 years (at around 3 hours a day).
- Thanks to its slim circular shape, OSRAM CIRCOLUX® EL is ideal for pendant luminaires and offers uniform light distribution for general lighting applications
- Not suitable for DC operation, emergency lighting systems, dimmers, electronic switches or motion detectors

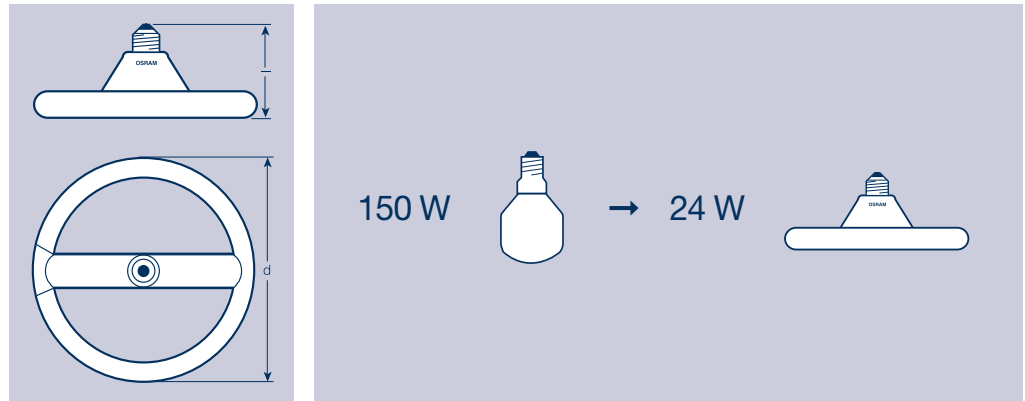

LONGLIFE

Reference	CIRCO EL 24 T5
Power input (W)	24
Warm start (start with cathode preheating)	Yes
Lamp current rms value (mA)	190
Peak value (mA)	570
Luminous flux (lm)	1700
Luminous efficacy (lm/W)	71
Colour appearance	827
	840
Colour rendering group	1B
Energy Label classification	A
Length (mm)	99
Diameter d-max. (mm)	225
Tube diameter	T5 (16 mm)
Weight (g)	170
Available with base	E27
Suitable for DC operation	No
Rated average life (h)	15000

1.4 Economy

1.4.1 Comparison of operating costs

OSRAM DULUX® EL consumes only about one fifth of the electricity of ordinary light bulbs of comparable light output. These savings from low energy consumption is an important aspect in cost/benefit analyses. In commercial applications, the price of the lamps and their maintenance costs also play a role. A comparison between the operating costs of incandescent lamps and those of the OSRAM DULUX® EL range shows that because of the lower electricity costs and longer life of OSRAM DULUX® EL lamps there are considerable benefits despite the higher purchase price. What's more, there are savings in maintenance costs (labour costs for replacing lamps), which are much higher for incandescent lamps because of their shorter life, and possible savings in air-conditioning costs.

Table 1: Savings in operating costs with an OSRAM DULUX® EL LONGLIFE 15 W compared with a 75 W light bulb

Lamp	OSRAM DULUX® EL LONGLIFE	Incandescent lamp
Power input	15 W	75 W
Quantity	1	15
Hours burned	15000 h	15000 h
Life/lamp	15000 h	1000 h
Electricity consumption over 15000 h	225 kWh	1125 kWh
Electricity costs at € 0.13/kWh	29.25 €	146.25 €
+ lamp price ¹⁾	9.95 € (1 x 9.95 €)	13.05 € (15 x 0.87 €)
= Total costs	39.20 €	159.30 €
Savings per OSRAM DULUX® EL LONGLIFE	120.10 €	–

¹⁾ Recommended retail price in Germany

Fig. 1: Comparison of operating costs, price of electricity: € 0.13

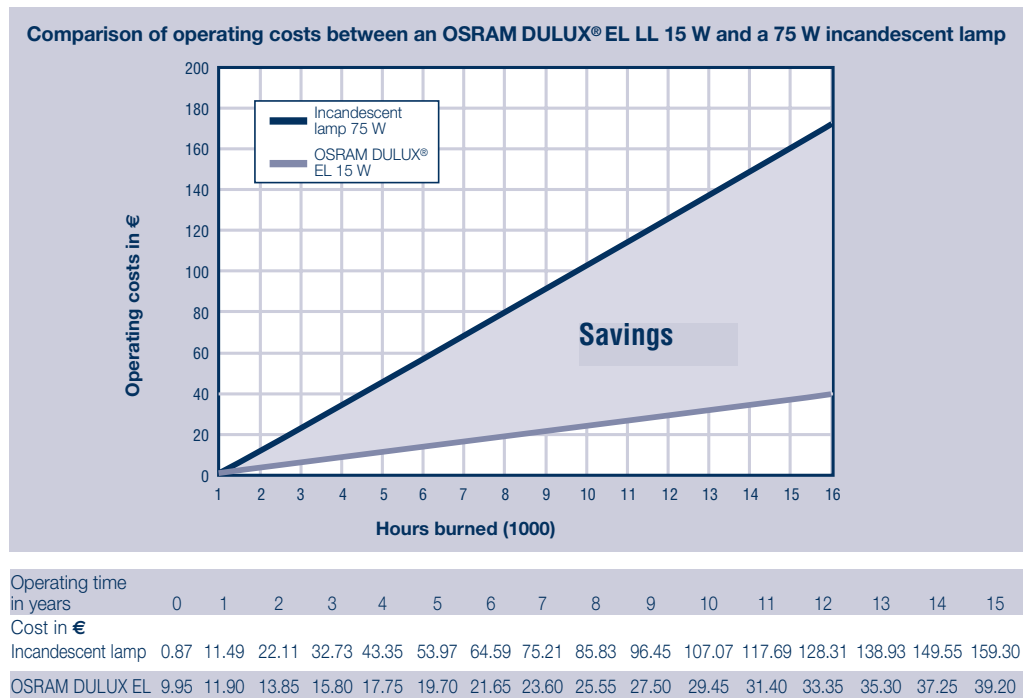

1.4.2 Typical replacement intervals

Examples of replacement intervals for OSRAM DULUX® EL LONGLIFE compared with incandescent lamps in domestic and commercial applications:

Application	Operating time in hours daily = approx. annually	Replacement intervals for OSRAM DULUX® EL LONGLIFE Incandescent lamp	
Private household	3 h/day = 1100 h/year	about 12 years	11 to 12 months
Commercial use	10 h/day = 3650 h/year	about 4 years	2 to 3 months

2. Function and technical design

2.1 Generation of light

As with all fluorescent lamps, light is generated in an OSRAM DULUX® EL lamp by low pressure gas discharge. Electrical current is passed between the two electrodes in the tube which is filled with partially ionised gas. The electrons excite mercury atoms to emit short-wave ultra-violet light, which is converted into visible light in the phosphor layer on the inside of the tube (Fig. 2). Different light colours are produced depending on the phosphor mix.

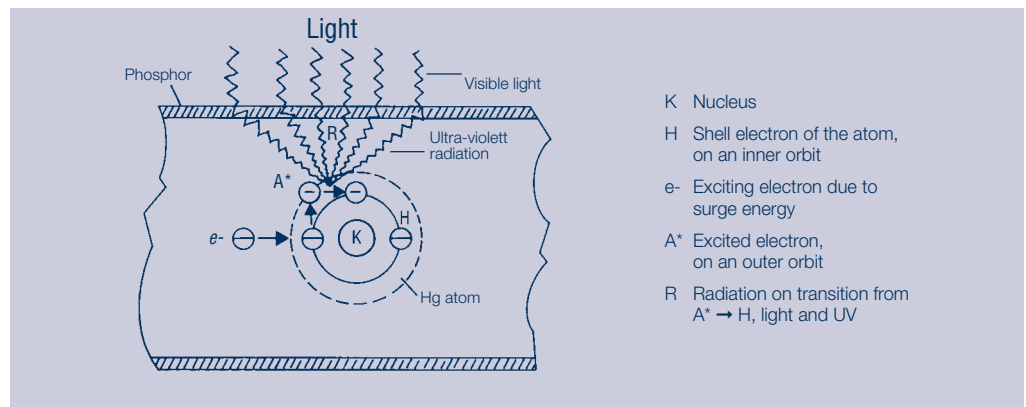

Fig. 2: Generation of light in a fluorescent lamp

Compared with an incandescent lamp, the process described for generating light needs only around 1/4 of the electrical energy (1/5 if electronic control gear is used). The presence of mercury in the filler gas is crucial for optimum energy conversion in the light generation process.

OSRAM DULUX® EL lamps are designed so that the optimum mercury pressure is achieved in the base-up position at an ambient temperature of 25°C.

2.2 Electronic control gear

Fluorescent lamps need a voltage pulse of several hundred volts in order to start, and need the current to be limited to several hundred mA in order to continue operating properly. In conventional control gear (CCG operation), these two functions are provided by an inductive resistor (choke) and starter. Chokes for a mains frequency of 50 Hz are large and heavy and cause power losses that in the case of compact lamps may be as much as 40 % of the total power input.

Instead of conventional control gear, an OSRAM DULUX® EL lamp has integrated electronic control gear for starting and current limitation. The electronic circuitry is small and lightweight. The lamp starts quickly and without flickering. The power losses are only one third of those of conventional control gear.

2.2.1 Operation

Electronic control gear contains a number of functional elements:

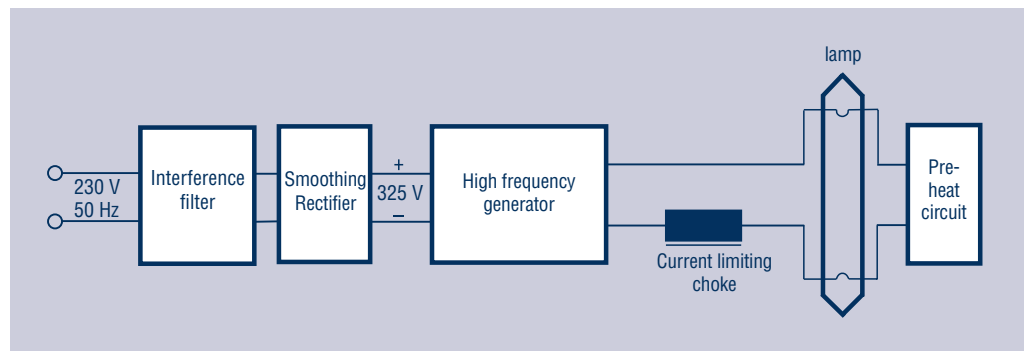

Fig. 3: Block diagram of electronic control gear

First, a DC voltage of about 280 V is produced from the 50 Hz mains voltage by a rectifier with a smoothing capacitor. This voltage is converted into a square-wave AC voltage with a frequency of more than 40 kHz in the high frequency generator (oscillator), in which two transistors operate as fast acting switches. Even if electronic control gear is used, current limitation and power setting are still handled by chokes. Because of the high operating frequency, however, they have a very much smaller inductance (owing to impedance $Z = H \times \omega$) and smaller dimensions than the ones used with conventional control gear.

For the lamp to start properly, a voltage of several hundred volts must be applied. In OSRAM DULUX® EL LONGLIFE lamps the lamp electrodes are heated up to the electrode emission temperature (warm start) prior to starting to achieve long life and tolerance to frequent on/off switching.

With the electronic control gear used, these two conditions are met by a series resonance circuit, whose resonating for OSRAM DULUX® EL LONGLIFE lamps is deliberately delayed by a PTC thermistor (preheat phase).

In the case of OSRAM DULUX® EL VARIO, OSRAM DULUX® EL FACILITY and OSRAM DULUX® EL SENSOR Plus, preheating of the filament and starting of the lamp are closely controlled by an integrated circuit (OSRAM DULUX® IC).

A radio interference filter prevents the generator frequency and its harmonics from affecting the supply cables.

Thanks to the electronic control gear, an OSRAM DULUX® EL can be operated on any standard mains frequency and is not affected by fluctuations in the mains frequency. Certain lamp types can also be operated on DC voltage (see 3.5.2).

2.2.2 Energy savings thanks to electronic control gear

Compared with fluorescent lamps with conventional control gear, there are further energy savings of around 20 % with electronic control gear.

This is due essentially to two effects:

- The losses with electronic control gear are only about one third of the losses with conventional control gear.
- The luminous efficacy of a fluorescent lamp shows a significant improvement of around 20 % at high frequencies, with saturation setting it at around 50 kHz.

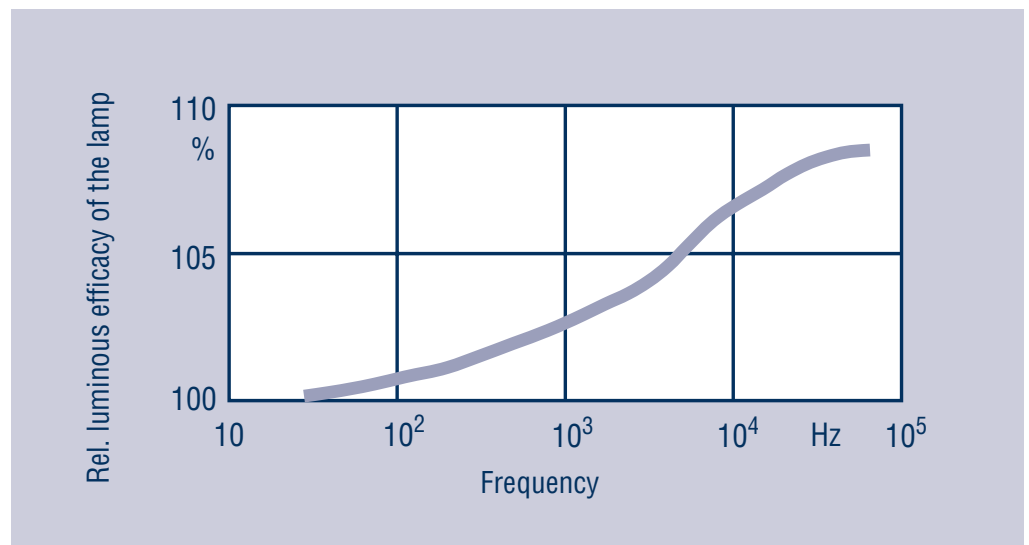
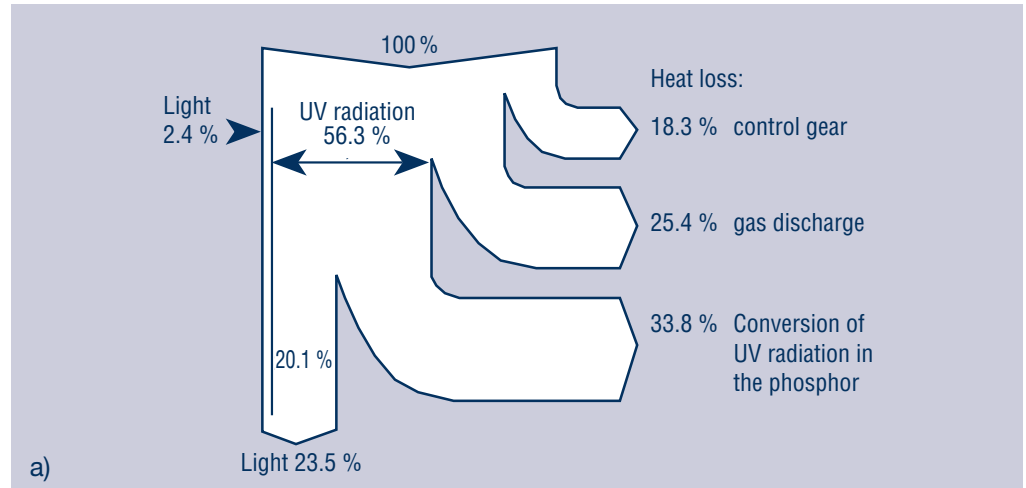

Fig. 4: Luminous efficacy of a fluorescent lamp as a function of the operating frequency

2.2.2 Energy savings thanks to electronic control gear (Continued)

Overall the power balance of fluorescent lamps with conventional control gear and electronic control gear is as follows:

Conventional control gear



Electronic control gear

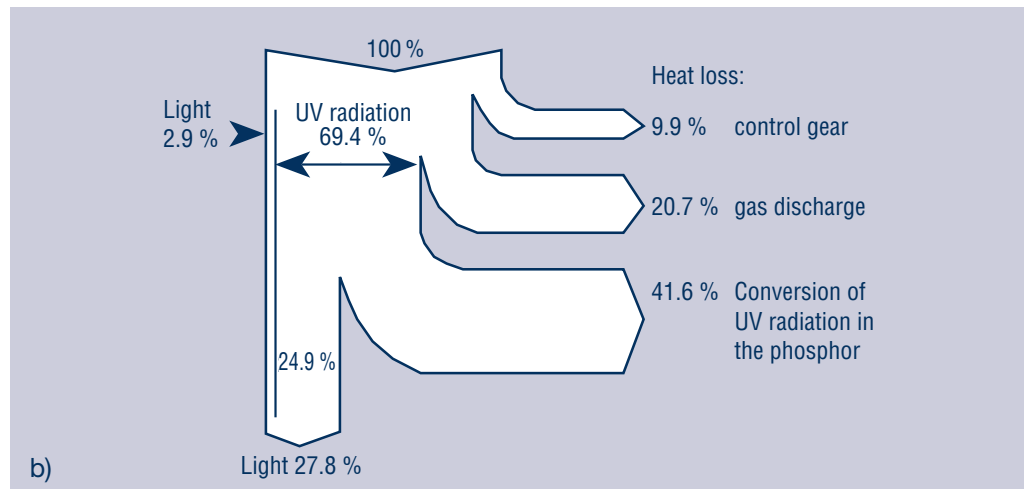

Fig. 5: Power balance of a fluorescent lamp with a) conventional and b) electronic control gear

2.2.3 Visual comfort

The use of electronic control gear also brings photometric benefits that considerably improve visual comfort.

Electrode flickering and luminous ripple, which are normal with conventional control gear, cannot be perceived by the human eye at these high frequencies at which the lamp is operated. The eye therefore does not tire as quickly and the light is more comfortable.

3. Lamp data and lamp properties

Unless otherwise indicated, the following test conditions apply to all the technical data specified in this document:

- Supply voltage 230 V/50 Hz
- Lamp installed (Base up), free burning
- Ambient temperature 25°C ± 1°C

3.1 Ignition properties/ start-up/ switching behaviour

For OSRAM DULUX® EL lamps, reliable starting is assured in the mains voltage range from 198 V to 254 V and at temperatures from -30°C to +50°C, with the following exceptions:

- | | |
|-----------------------------------|---------------------|
| – OSRAM DULUX® EL LONGLIFE 3 W | from +5°C to +50°C |
| – OSRAM DULUX® EL LONGLIFE 5 W | from -20°C to +50°C |
| – OSRAM DULUX® EL VARIO | from +15°C to +50°C |
| – OSRAM DULUX® EL ECONOMY | from -15°C to +40°C |
| – OSRAM DULUX® EL ECONOMY CLASSIC | from -15°C to +40°C |
| – OSRAM DULUX® EL ECONOMY GLOBE | from -15°C to +40°C |
| – OSRAM CIRCOLUX® EL 24 W T5 | from -10°C to +50°C |

In contrast to fluorescent lamps with conventional control gear, OSRAM DULUX® EL LONGLIFE lamps start without flickering in less than 1.5 s. This time is needed for preheating the cathodes; at low temperatures this may take up to 2 s. Immediately after starting, the lamp produces around 40 % of its rated luminous flux. At room temperature (25°C) it then takes about 2 minutes for the lamp to reach 90 % of its maximum luminous flux.

Thanks to this precise cathode preheating, controlled by the electronic circuitry, the life of OSRAM DULUX® EL LONGLIFE lamps is not significantly affected by frequent on/off switching. For a switching cycle of 30 s on/150 s off, an OSRAM DULUX® EL LONGLIFE can handle more than 500000 switching operations in its lifetime.

The requirement here is that the lamp should remain off for at least two minutes before being switched on again so that the PTC thermistor, which controls the starting process in electronic control gear and which is hot while the lamp is in operation, can cool down.

There will be a significant reduction in lamp life if this off time is consistently less than two minutes.

This does not apply to OSRAM DULUX® EL VARIO, OSRAM DULUX® EL SENSOR Plus or OSRAM DULUX® EL FACILITY. These lamps can be switched on and off without restriction. This makes the OSRAM DULUX® EL FACILITY ideal, for example, for stairwell lighting with automatic switch off. If normal OSRAM DULUX® EL LONGLIFE lamps are to be used for this purpose, we recommend switching over to continuous light during the busy times morning and evening.

Because of their design (cold start within 0.2 s without cathode preheating), OSRAM DULUX® EL ECONOMY lamps should not be used in lighting systems in which the lamps are frequently switched on and off (e. g. stairwell lighting or motion detection systems). For a switching cycle of 30 s on/30 s off, OSRAM DULUX® EL ECONOMY lamps can handle more than 5000 switching operations; the average life is 8000 h for a switching cycle of 165 s on/15 s off.

3.2 Start-up current

Contrary to popular belief, frequent switching does **not** increase energy consumption. At the moment of starting there is a short high surge of current of up to 25 A (approx. 80µs half-value width, to charge the internal smoothing capacitor, VARIO: 48 A). This small amount of energy is not lost, however, but is converted into light.

3.3 Photometric data

3.3.1 Spectral distributions

The relative spectral distribution is determined mainly by the colour appearance. Various types and wattages have little effect on this curve.

The spectral distributions shown are therefore typical of all OSRAM DULUX® lamps of the relevant colour appearance.

x axis: mW/(m² x 5 nm x 1000 lx)

y axis: Wavelength in nanometres.

Notes on the diagrams:

The spectral radiant intensity distributions relate to an illuminance of 1000 lx. This has the advantage that the absolute values of any illuminance can be determined simply from the following quotient:

$$\frac{\text{Illuminance E (measured) x(y axis value)}}{1000 \text{ lx}}$$

The spectral intensities are grouped in wavelength ranges of 5 nanometres. The values integrated across 5 nm are specified, irrespective of actual distributions. This corresponds to the standard that is the basis for all calculations of subsequent results (e. g. colour, colour rendering).

Fig. 6: LUMILUX® colour appearances

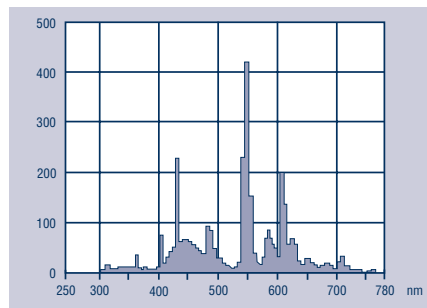

Colour 860 (6000 Kelvin)
 LUMILUX® Daylight

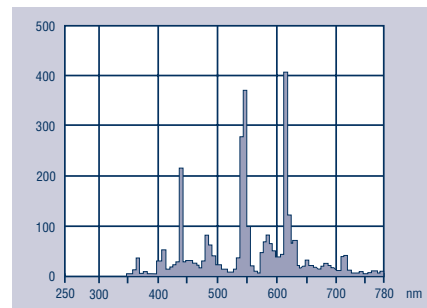

Colour 840 (4000 Kelvin)
 LUMILUX® Cool White

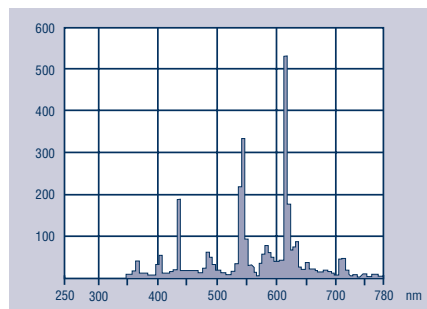

Colour 827 (2700 Kelvin)
 LUMILUX INTERNA®



3.3.2 Luminance

The luminance of OSRAM DULUX® EL lamps is 2.5 cd/cm² (0.5 cd/cm² for opal CLASSIC and GLOBE lamps)

3.3.3 Luminous intensity distribution

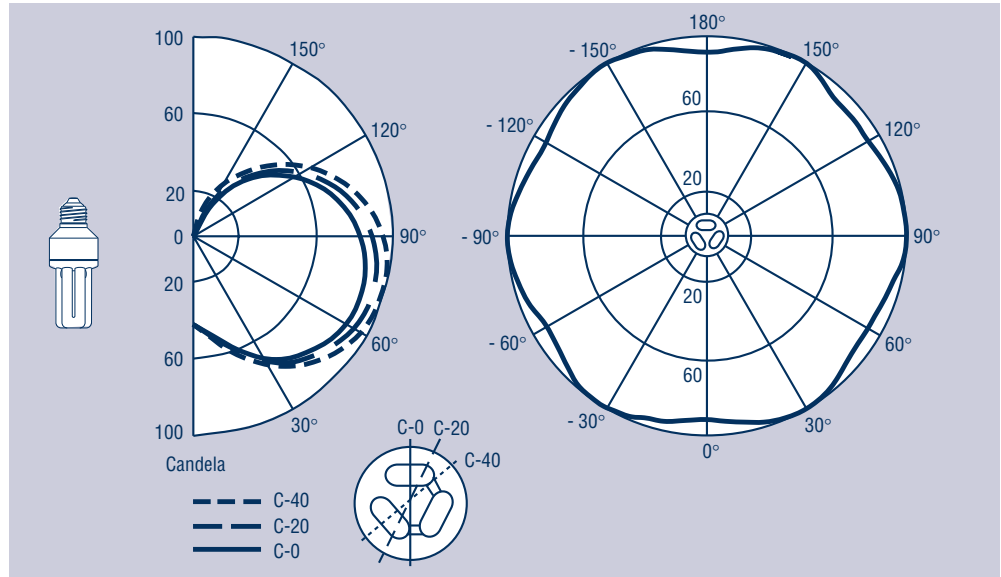

Fig. 8a: OSRAM DULUX® EL LONGLIFE 11 W, 15W, 20W, 23 W
 OSRAM DULUX® EL ECONOMY 16 W, 21 W and 24 W
 OSRAM DULUX® EL FACILITY 10W, 14 W
 OSRAM DULUX® EL SENSOR Plus 15 W
 OSRAM DULUX® EL VARIO 23 W

Axial and radial luminous intensity distribution curves, referred to 1000 lm

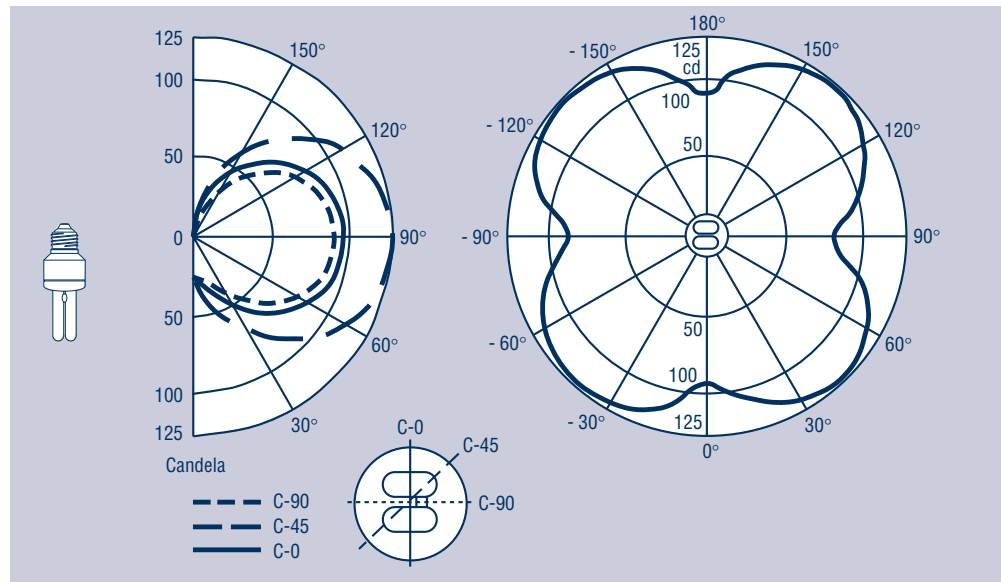

Fig. 8b: OSRAM DULUX® EL LONGLIFE 3W, 5W and 7W
 OSRAM DULUX® EL ECONOMY 8W and 12W

Axial and radial luminous intensity distribution curves, referred to 1000 lm

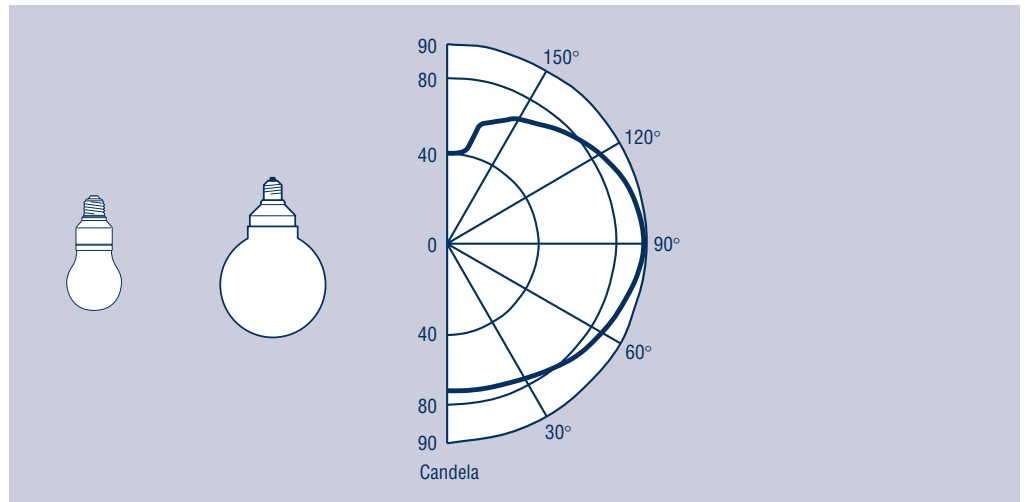

Fig. 9: OSRAM DULUX® EL LONGLIFE CLASSIC 5W, 7W, 10W, 11W, 15W and 20W
 OSRAM DULUX® EL ECONOMY CLASSIC 5W, 7W, 9W, 10W and 15W
 OSRAM DULUX® EL LONGLIFE GLOBE 15W, 20W
 OSRAM DULUX® EL ECONOMY GLOBE 16W and 21W
 Axial and radial luminous intensity distribution curves, referred to 1000 lm

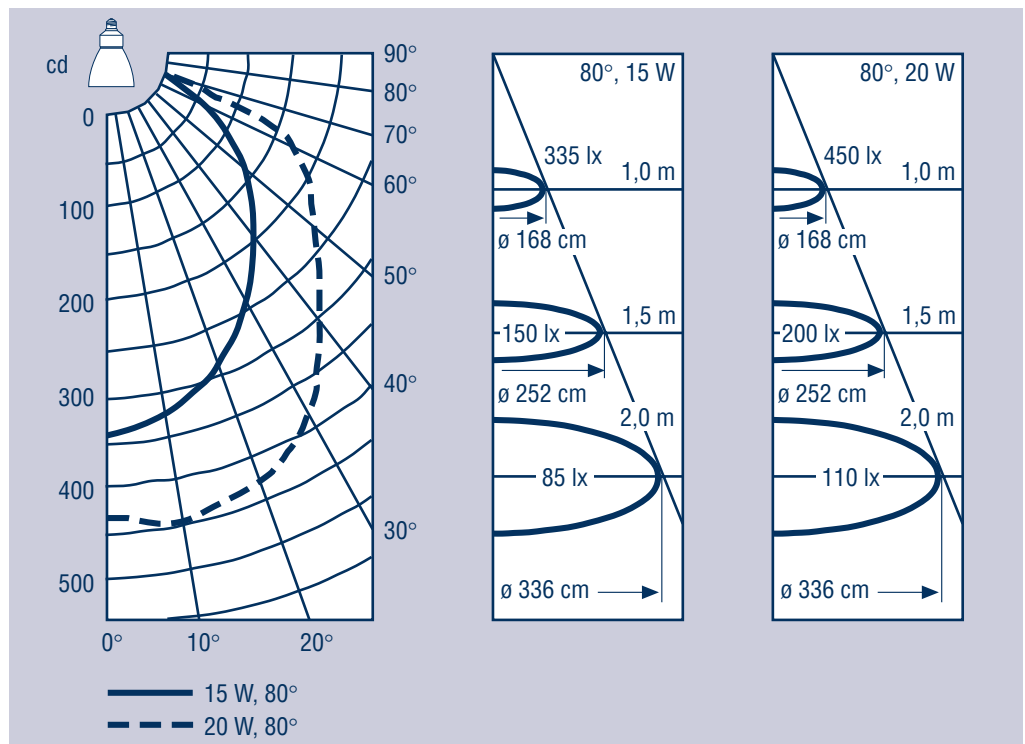

Fig. 10 OSRAM DULUX® EL LONGLIFE REFLEKTOR 15W, 20W
 Luminous intensity distribution curves in candela (cd), illuminance in lx

3.4 Temperature influences

OSRAM DULUX® EL LONGLIFE, OSRAM DULUX® EL FACILITY and OSRAM DULUX® EL SENSOR Plus can be used in a temperature range from **-30°C to +50°C**.

Exceptions:

OSRAM DULUX® EL LONGLIFE 3 W	from +5°C to +50°C
OSRAM DULUX® EL LONGLIFE 5 W	from -20°C to +50°C
OSRAM DULUX® EL VARIO	from +15°C to +50°C
OSRAM DULUX® EL ECONOMY	from -15°C to +40°C
OSRAM DULUX® EL ECONOMY CLASSIC	from -15°C to +40°C
OSRAM DULUX® EL ECONOMY GLOBE	from -15°C to +40°C
OSRAM CIRCOLUX® EL 24 W T5	from -10°C to +50°C

At lower temperatures than those specified the high starting voltage may destroy the lamp. The thermal load on the components at temperatures above 50°C may lead to the premature failure on the integrated electronic control gear.

3.4.1 Dependence on burning positions and temperatures

The luminous flux of Hg low pressure discharge lamps such as the OSRAM DULUX® EL is dependent on the mercury vapour pressure in the lamp and therefore on the temperature at the coolest point (cf. 2.1).

When OSRAM DULUX® EL lamps are used in the base up position, the bends in the tubes act as cold spots. Optimum luminous flux is reached when these bends have a temperature of 45°C. This is the case for base up and horizontal positions at an ambient temperature of 20 to 25°C. In the base down position, the rising heat causes cold spots (controlling the Hg vapour pressure) to form in the cylindrical part of the discharge tube; the highest luminous flux in the base down position is reached when the ambient temperature is around -5°C.

For free-burning lamps the ambient temperature corresponds to the room temperature. If the lamps are operated in luminaires, the temperature in the immediate vicinity of the lamp is crucial for the luminous flux.

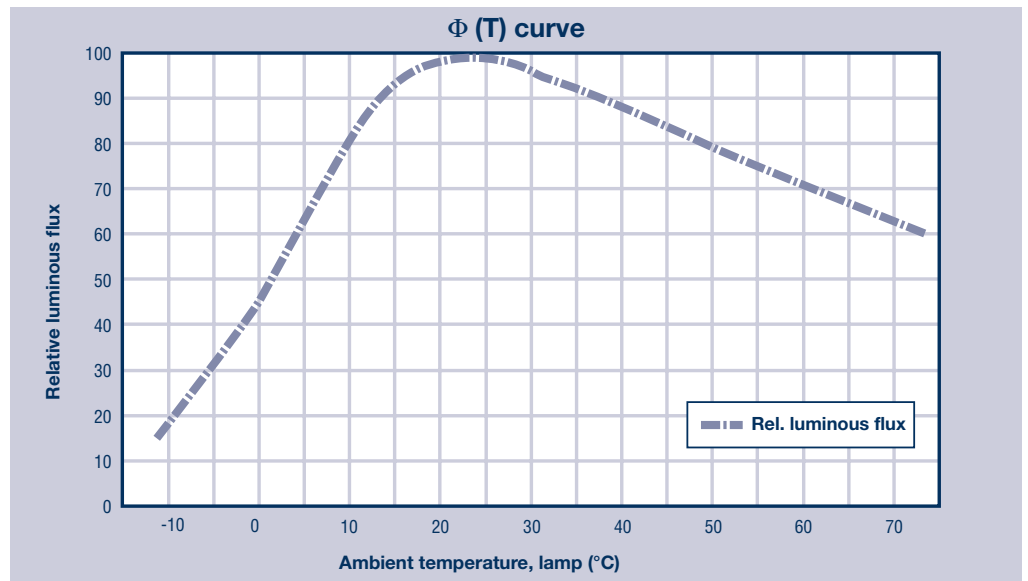

Fig. 11a: Typical luminous flux/temperature curve for OSRAM DULUX® EL LONGLIFE 15 W in base up and horizontal burning positions

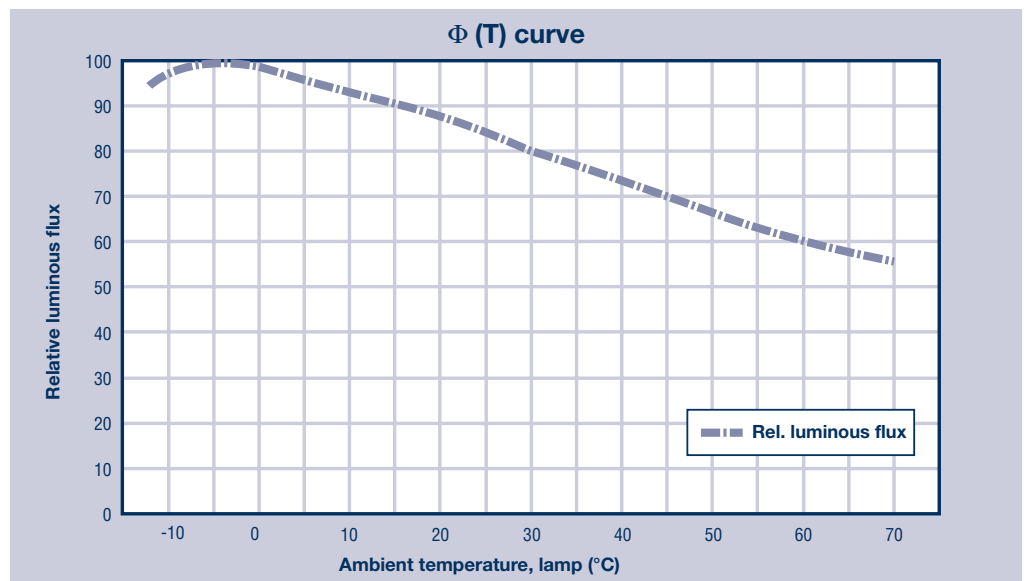

Fig. 11b: Typical luminous flux/temperature curve for OSRAM DULUX® EL LONGLIFE 15 W in the base down burning position

3.4.2 Lamp temperatures

The VDE (Association of German Engineers) recommends maximum temperatures at certain critical locations in luminaires to ensure safe operation. Compared with incandescent lamps, the temperatures that occur when OSRAM DULUX® EL are in operation are much lower on the glass itself and on the casing, and therefore in the luminaire. This means that OSRAM DULUX® EL lamps with higher luminous fluxes can be used in luminaires that have been approved for incandescent lamps up to a certain wattage.

Temperatures in °C at different places on OSRAM DULUX® EL LONGLIFE lamps and incandescent lamps (230 V, free-burning, base up):

Temperature measurement point	1*)	2	3
OSRAM DULUX® EL LONGLIFE 5 W	30	50	37
OSRAM DULUX® EL LONGLIFE 7 W	20	60	44
OSRAM DULUX® EL LONGLIFE 7 W	22	60	44
OSRAM DULUX® EL LONGLIFE 11 W	28	65	47
OSRAM DULUX® EL LONGLIFE 15 W	30	70	48
OSRAM DULUX® EL LONGLIFE 20 W	35	70	51
OSRAM DULUX® EL LONGLIFE 23 W	30	65	49
Incandescent lamp 40 W	70	130	65
Incandescent lamp 60 W	90	150	75
Incandescent lamp 75 W	105	175	85
Incandescent lamp 100 W	130	220	100

*) Base edge overtemperature to EN 60 360 (permitted limit values: IEC 60432-1)

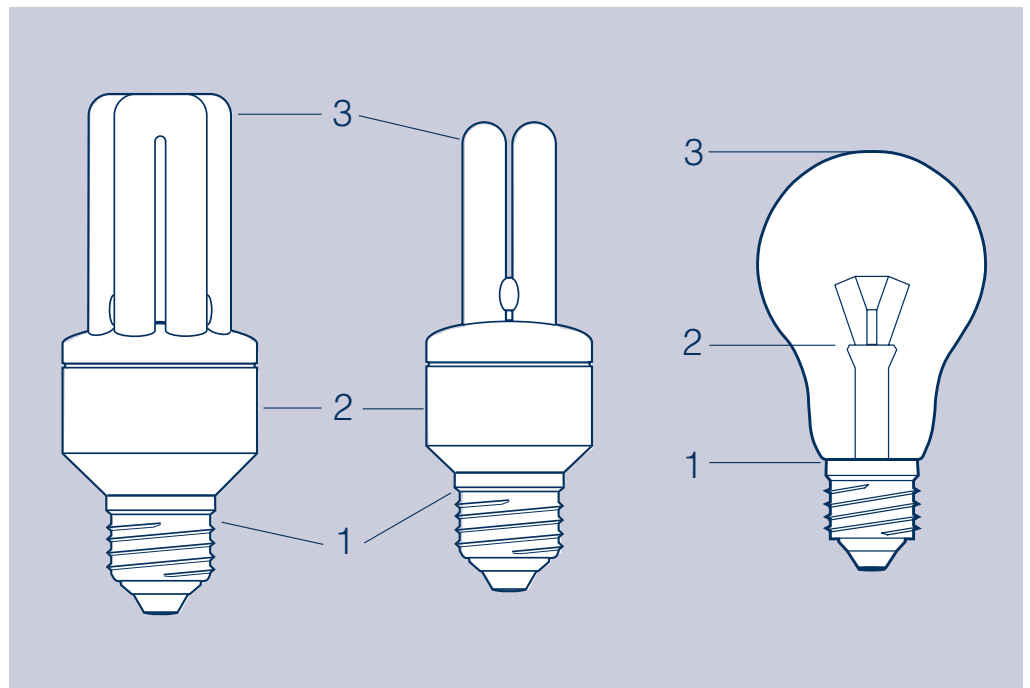

Fig. 12: Temperature measurement points on OSRAM DULUX® EL lamps and Incandescent lamps

3.4.3 Notes on luminaire design

Burning position

Because of the thermal conditions on the lamp there are significant differences in the luminous flux/temperature curve for base down, base up and horizontal burning positions (see 3.4.1). The base down position is recommended for all applications in which low ambient temperatures are expected.

If lamps are to be installed in the base down position in outdoor luminaires it is important to ensure that no water (e. g. condensate in the luminaire) can penetrate into the electronic circuitry between the glass and the base casing. (cf. 3.8/Suitability for outdoor applications)

3.5 Power supply

OSRAM DULUX® EL lamps operate ideally on AC voltage in the range from 198 V to 254 V (according to DIN IEC 38).

3.5.1 Dependence on mains voltage and mains frequency

The electrical data of lamps differs according to the mains voltage. The changes are substantial in the case of an incandescent lamp, but minimal in the case of OSRAM DULUX® EL.

As the voltage increases, the output and the luminous flux change very little (Fig. 14). This behaviour is welcome in view of the frequent overvoltages in the mains supply. Voltages up to 254 V have virtually no effect on the life of an OSRAM DULUX® EL lamp, in contrast to the situation with incandescent lamps. The luminous efficacy of OSRAM DULUX® EL lamps as a measure of the efficiency with which electrical power is used is virtually unaffected by changes in the mains voltage in the range of - 10 % to +10 %.

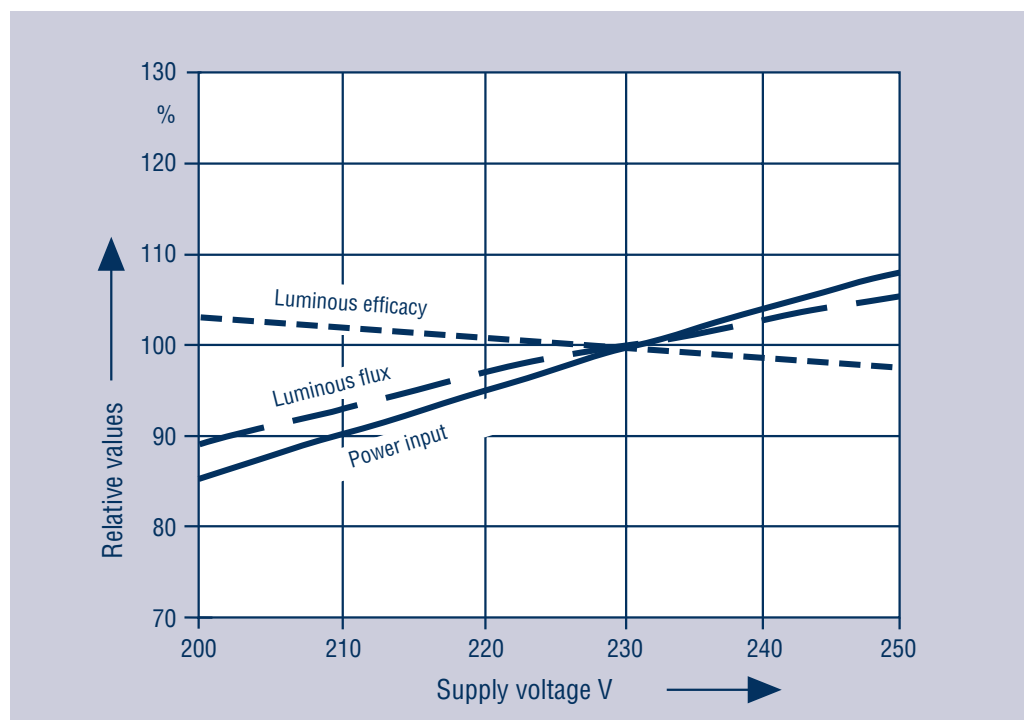

Fig. 14: Electrical data as a function of the supply voltage

OSRAM DULUX® EL lamps can be operated at any standard mains frequency and are largely unaffected by fluctuations in the mains frequency.

3.5.2 Operation on DC voltage/emergency lighting

OSRAM DULUX® EL LONGLIFE 5 W and 7 W E27/B22d/E14 can be operated in the usual AC voltage range and also on DC voltage in the 176 V DC to 310 V DC range and on battery powered 220/240 V systems.

3.5.2.1 OSRAM DULUX® EL LONGLIFE 5 W and 7 W

At a lower threshold voltage of 176 V DC the lamps will start reliably from 5°C to 50°C and are insensitive to overvoltages in the DC system up to 310 V DC.

OSRAM DULUX® EL LONGLIFE lamps achieve their rated values in DC operation at around 280 V DC. For other DC voltages the differences are as follows:

Table 3: Electrical and photometric data in dc operation

Supply voltage:	Power input ¹⁾	Luminous flux ¹⁾	System or battery current ²⁾
310 V DC	110 %	110 %	48 %
280 V DC	100 %	100 %	49 %
220 V DC	80 %	78 %	50 %
180 V DC	65 %	60 %	50 %

1) As a percentage of the rated value

2) As a percentage of the rms value for AC voltage

Emergency lighting:

OSRAM DULUX® EL LONGLIFE 5W and 7 W are suitable for use in emergency lighting systems. For most emergency lighting systems, VDE 0108 calls for a starting time of less than one second. Since the requirements for restart time with DC voltage are met only if the lamp is at operating temperature, they can only be used for maintained emergency lighting.

Table 4: Typical starting times for OSRAM DULUX® EL LONGLIFE 5 W and 7 W (in seconds, cold lamp) in DC operation at different temperatures

Ambient temperature:	176 V DC	198 V DC	220 V DC	280 V DC
0°C	7	5	4	2
10°C	6	4	3	2
23°C	5	4	3	< 2
50°C	4	3	2	1

The requirements for luminous flux, luminance and so on in areas such as corridors and stairwells must be met by the system in which lighting designers use OSRAM DULUX® EL LONGLIFE lamps.

3.5.2.2 OSRAM DULUX® EL LONGLIFE FACILITY OSRAM DULUX® EL FACILITY 10 W and 14 W E27/B22d/E14 can be operated indoors on AC voltage and also on DC voltage in the 176 V DC to 310 V DC range and on battery powered 220/240 V systems.

At a lower threshold voltage of 176 V DC the OSRAM DULUX® EL FACILITY will start reliably at temperatures from -30°C to 50°C. They can handle overvoltages in the DC system up to 310 V DC. The lamps reach their rated values in DC operation at around 280 V DC. For other DC voltage values the differences are typically as follows:

Electrical and photometric data in DC operation

Supply voltage:	Power input ¹⁾	Luminous flux ¹⁾	System or battery-current ²⁾
310 V DC	110 %	110 %	48 %
280 V DC	100 %	100 %	49 %
220 V DC	80 %	78 %	50 %
180 V DC	65 %	60 %	50 %

1) As a percentage of the rated value

2) As a percentage of the rms value for ac voltage

Emergency lighting:

With a starting time of less than 0.5 s, OSRAM DULUX® EL FACILITY lamps are suitable in accordance with VDE 0108 for use in emergency lighting systems in a DC voltage range from 176 V DC to 310 V DC. This applies to both maintained and non-maintained emergency lighting.

With due regard to the properties of the lamps, the requirements for luminous flux and illuminance in areas such as corridors and stairwells must be met by the system in which lighting designers use OSRAM DULUX® EL FACILITY lamps.

3.5.3 Dimmer operation

Brightness control with standard dimmers is **not possible** with OSRAM DULUX® EL lamps.

The electronic control gear of the lamp contains a rectifier and smoothing capacitor (electrolytic capacitor) in the input circuit. This electrolytic capacitor is always charged to the peak value of the AC voltage; mains current flows only briefly and up to the maximum mains voltage.

This design prohibits operation with standard dimmers since leading-edge and trailing-edge dimmers would damage the electrolytic capacitor with their steep voltage rises and associated high peak currents.

In addition, most dimmers require a minimum load of many times that of an OSRAM DULUX® EL lamp so that even with the dimmer fully turned up, its switching element would not find an adequate holding current, with the result that the lamp would be continually switched on and off. This would not only damage the OSRAM DULUX® EL lamp, it may also destroy the dimmer.

As an alternative to external dimmer systems, OSRAM therefore offers the OSRAM DULUX® EL VARIO, the lamp with integrated two-stage brightness control (cf. 1.3.10).

3.5.4 Operation on electronic switches

This mode of operation is possible only if certain conditions are met.

Because of the design of the input circuit, current flows only for about 4 ms per mains half-wave (cf. 3.5.3). The peak value of this current is three times the rms value. This high crest factor must be taken into account when operating the lamp with electronic switches. Simple thyristor or triac switches that are triggered only once after zero crossing are not suitable because the OSRAM DULUX® EL does not draw holding current at this point. An ohmic load (such as an incandescent lamp) would have to be operated in parallel with the OSRAM DULUX® EL. This would then ensure the holding current for the electronic switch.

More suitable are electronic switches that do not need a holding current (for example those with a MOSFET as the active switching element), or a relay and contactor.

Note the maximum switch-on current of 25 A for approx 80 µs half-value width (except VARIO: 48 A). A reduction to less than 1 A per OSRAM DULUX® EL is possible if, with appropriate control of the electronic switch, the lamp is only switched on at zero crossing.

The maximum charge taken up in the switch-on current surge is between 0.4 and 3 mAs (depending on the wattage); the maximum energy taken from the source per switch-on current surge is 1 Ws (2 Ws if switch-on takes place at maximum mains value). This applies to OSRAM DULUX® EL LONGLIFE, OSRAM DULUX® EL ECONOMY, OSRAM DULUX® EL FACILITY, OSRAM DULUX® EL SENSOR Plus and OSRAM DULUX® EL VARIO.

3.5.5 Operation on switches with load relief, spark suppression or glow lamps parallel to the switch path

OSRAM DULUX® EL lamps cannot be operated on jumpered switches (even at high resistance).

Because of the parallel path to the switch the OFF setting is never fully at high resistance. If incandescent lamps are used this is of no importance. If however all the incandescent lamps are replaced by OSRAM DULUX® EL lamps, then even small currents with the switch in the OFF setting will cause the high-impedance input circuit of the OSRAM DULUX® EL to charge up until the threshold voltage at the electrolytic capacitor for starting the HF generator is reached and the lamp consumes the energy stored in the electrolytic capacitor in repeated attempts to start.

This leads to premature ageing and the brief weak flashes of light are irritating.

Necessary load relief elements have to be wired parallel to the load, and neon lamps for illuminating the switches need to be connected parallel to the mains as permanent lights or parallel to the load as signal lights.

3.5.6 Operation on motion detectors

OSRAM DULUX® EL lamps can be operated with motion detectors provided the provisions of Section 3.5.4 (for the switching element of the motion detector) and Section 3.5.5 (for any switch load relief elements parallel to the switch) are met.

If motion detectors are used in highly frequented areas, we recommend either setting the ON time as long as possible to avoid unnecessary on/off switching or installing OSRAM DULUX® EL FACILITY lamps.

For these applications the base down burning position is better than the base up position because the ECG stays cooler and the PTC thermistor cools down faster ready for the next gentle start (cf. Section 3.1).

If the lamps are used outdoors in conjunction with motion detectors, note that at low temperatures low levels of luminous flux will be available immediately after the lamp is switched on.

Again, the base down position is better (cf. 3.4.1).

3.5.7 Operation parallel to uncorrected CCG lamps

If uncorrected conventional control gear is used (or highly inductive loads) a large voltage surge may be generated when the control gear is switched off at maximum current.

If an OSRAM DULUX® EL is connected in parallel on the same circuit it will be exposed to a large voltage surge which may destroy it (see also Section 3.5.13).

-
- 3.5.8 Operation on BUS systems**
- If the OSRAM DULUX® EL lamp is controlled by a BUS system, the requirements of Sections 3.5.4 and 3.5.5 must be met.
- 3.5.9 Operation on non-sinusoidal voltage sources**
- Operation of OSRAM DULUX® EL lamps on non-sinusoidal voltage sources (e. g. square wave and trapezoidal inverters) is not straightforward.
- It should be remembered that steep signal edges with square-wave inverters mean additional reverse recovery losses for the rectifier and that frequently observed overshoots by powerful inverters may lead to increased charging currents in the electrolytic capacitor (increased crest factor) and, in the worst case scenario, to significant over-voltages. In the event of a high energy overshoot, the electrolytic capacitor charges up to its peak value.
- The rms currents should under no circumstances exceed the values for sinusoidal supply and there should be no overshoots. In selecting the inverter, bear in mind that at the moment its is started an OSRAM DULUX® EL lamp has four times the current draw for less than 100 ms (or up to several seconds if the lamp is started at a low temperature) (temporary overload capacity of the inverter). It must be possible for the electrolytic capacitor (typically 1 to 6,8 μ F) to be charged by the inverter (start-up current, stability of the control loop).
- 3.5.10 Phase shift Power factor PF correction**
- The phase shift factor $\cos \varphi$ indicates the phase shift between mains current and mains voltage and relates exclusively to the fundamental harmonic (50 Hz). The phase shift of harmonics that occur because of non-sinusoidal current draw is not considered here.
- OSRAM DULUX® EL lamps have a phase shift factor $\cos \varphi$ of $\approx 0,95$ (capacitive).
- The power factor (λ) is defined as:
 $\lambda = \text{active power } N / (\text{rms current } I_{\text{rms}} \times \text{rms voltage } U_{\text{rms}})$.
- For OSRAM DULUX® EL LONGLIFE and ECONOMY it is approximately 0.6. This value results from the distorted non-sinusoidal draw (mains current harmonic content) of OSRAM DULUX® EL LONGLIFE and ECONOMY and to a lesser extent from a current/voltage phase shift of the 50 Hz component. For this reason, correction of the power factor by capacitors, which is usual with fluorescent lamps in CCG mode, is not possible.
- The actual energy consumption of OSRAM DULUX® EL LONGLIFE and ECONOMY lamps is only 20 % of that of an incandescent lamp of similar light output. It is independent of the power factor and is determine only by the active power, which can be measured by a standard ammeter. The savings of 80 % have a direct impact on fuel consumption (coal, oil, gas) and on emissions from power stations.
- Because of the lower power factor of around 0.6, the power consumption of OSRAM DULUX® EL LONGLIFE and ECONOMY lamps is not reduced to 20 % but to around 33 %. This causes an appropriate reduction in current draw and not an increase in the losses between the generator and load, and therefore additional energy savings.

-
- 3.5.11 Mains current harmonic content** Since January 1, 2001 EN 61000-3-2 „Electromagnetic Compatibility (EMC)...“ is the general standard for harmonic currents.
- All OSRAM DULUX® EL and OSRAM CIRCOLUX® EL lamps comply with the provisions of EN 61000-3-2.
- 3.5.12 RFI suppression** All OSRAM DULUX® EL and OSRAM CIRCOLUX® EL lamps are RFI suppressed to EN 55015 (identical to CISPR 15). Interference on the mains supply is prevented by the interference suppression filter connected on the incoming side of the electronics.
- 3.5.13 Resistance to electro-magnetic interference and transient overvoltages** All OSRAM DULUX® EL and OSRAM CIRCOLUX® EL lamps comply with the immunity requirements defined in EN 61547 relating to external electromagnetic interference.
- 3.5.14 Interference from IR remote controls** The discharge characteristics of fluorescent lamps means that a small amount of infra-red radiation cannot be avoided. If conditions are less than ideal, particularly if the lamps and the IR receiver are arranged too close to one another, this may lead to interference with IR remote controls. This also depends on the modulation of the radiation emitted by the lamp (operating frequency of the ECG), the modulation frequency and the coding of the signals used for IR signal transmission. The signal-to-noise ratio also plays a role.
- If interference occurs, we recommend moving the IR receiver out of the radiation range of the lamp or by making sure it is not exposed to direct light.
- The IEC has produced recommendations for avoiding such interference on IR signal transmission equipment. Unfortunately, some old IR signal transmitters operated in the same frequency range as the lamps (about 35 kHz).
- OSRAM therefore increased the operating frequency of all OSRAM DULUX® EL and OSRAM CIRCOLUX® EL lamps to more than 40 kHz to minimise the risk of interference.
- The latest generation of IR controlled equipment is now making use of „intelligent“ IR receivers that continue to operate correctly even if they receive IR interference.
- 3.5.15 Bases/holders** OSRAM DULUX® EL LONGLIFE, OSRAM DULUX® EL ECONOMY and OSRAM CIRCOLUX® EL lamps are equipped with E14 or E27 screw bases or with B22d bayonet bases on request and will therefore fit in any standard incandescent lamp fittings.

3.6 Reduction in luminous flux over time

Because of chemical changes in the phosphor and the glass the luminous flux of an energy saving lamp will decrease with age. This reduced is around 30 % with conventional phosphors and only around 25 to 27 % with the LUMILUX® tri-phosphors used in all OSRAM DULUX® EL and OSRAM CIRCOLUX® EL lamps.

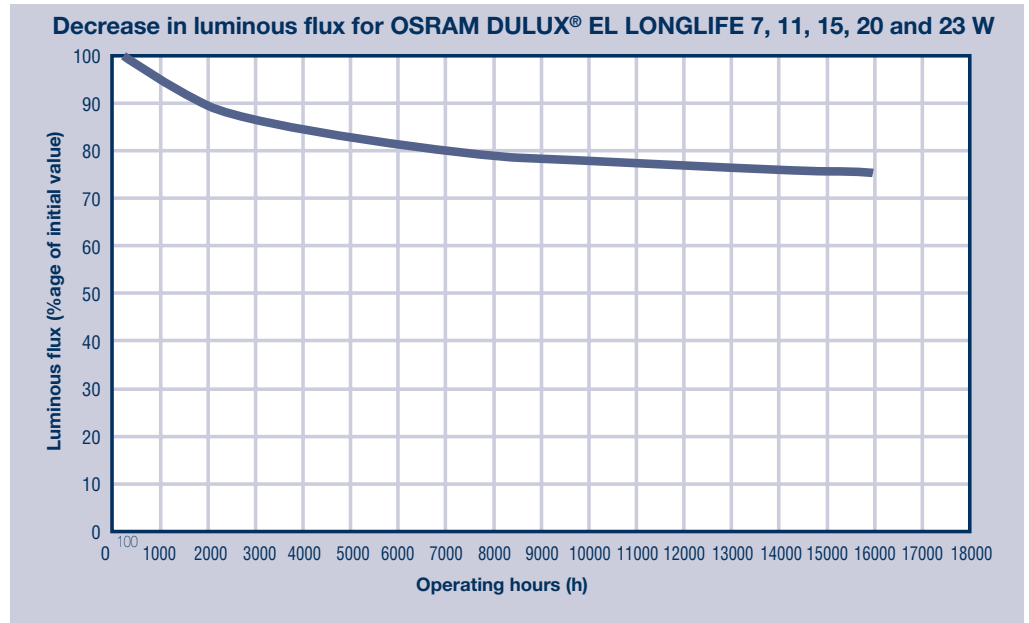

Fig. 15a: Typical relationship between luminous flux and hours of operation for OSRAM DULUX® EL LONGLIFE

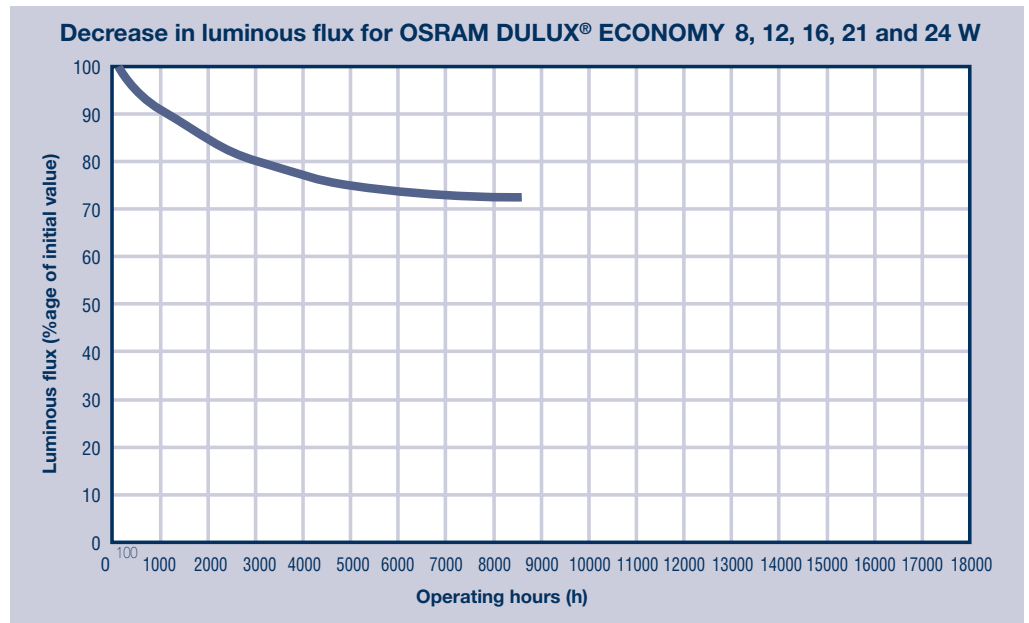

Fig. 15b: Typical relationship between luminous flux and hours of operation for OSRAM DULUX® EL ECONOMY



3.7 Lamp life

The life of fluorescent lamps is determined essentially by the consumption of the emitter on the lamp cathodes. The average life of OSRAM DULUX® EL LONGLIFE lamps is 15000 hours; that of OSRAM DULUX® EL ECONOMY lamps is 8000 hours. Half of any number of lamps may fail up to this time (50 % mortality).

Mortality curve for OSRAM DULUX® LONGLIFE 7, 11, 15, 20 and 23 W

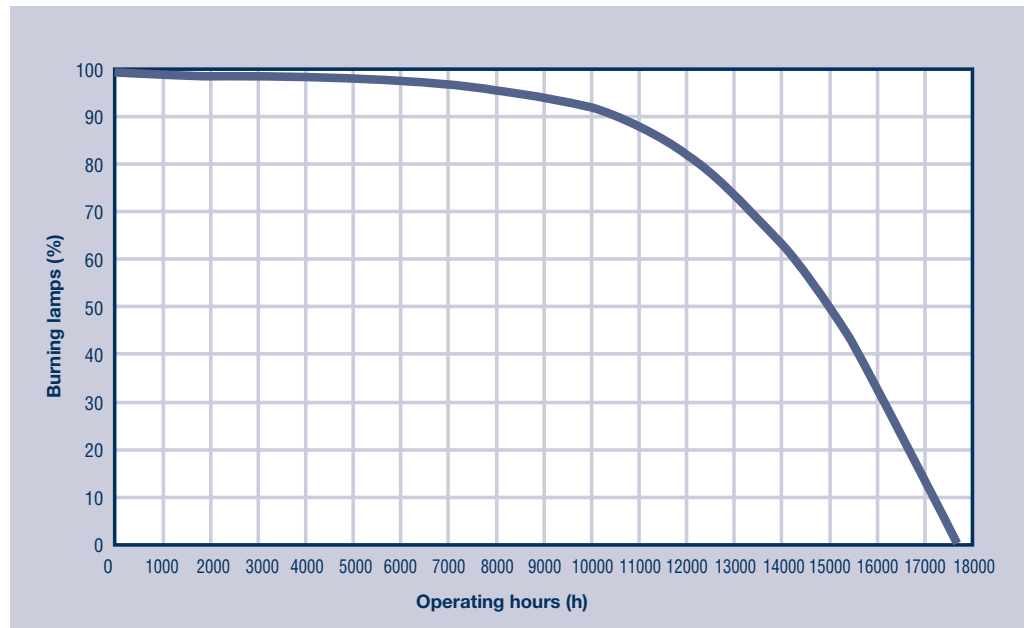

Mortality curve for OSRAM DULUX® ECONOMY 8, 12, 16, 21 and 24 W

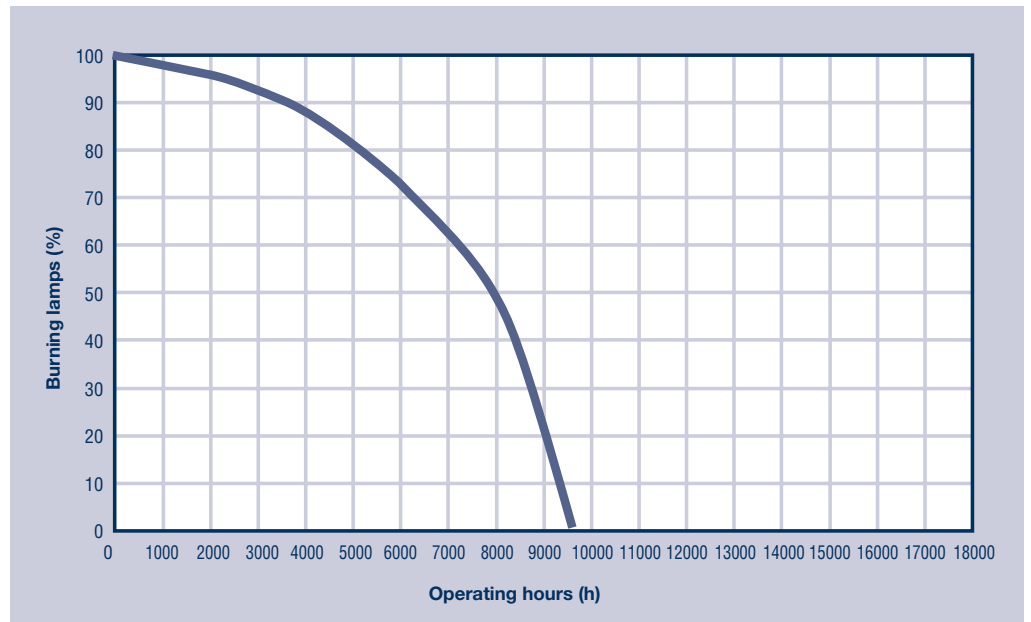

Fig. 16: Typical mortality curve for OSRAM DULUX® EL LONGLIFE and ECONOMY lamps

**3.7 Life
(Continued)**

The following may shorten the life of a lamp:

- Overloading of the lamp at excessive supply voltage (see 3.5)
- Failure of electronic components at excessively high/low ambient temperatures (see 3.4)
- Operation on standard leading-edge or trailing-edge dimmers (see 3.5.3)
- Operation on electronic switches (see 3.5.4)
- Operation on switches with load relief, spark suppression or neon lamps parallel to the switch path (see 3.5.5)
- Operation parallel to non-pfc CCG lamps (see 3.5.7)
- Operation on non-sinusoidal voltage sources (see 3.5.9)
- Frequent switching – e. g. in stairwell lighting (see 3.1, exceptions: OSRAM DULUX® EL VARIO, OSRAM DULUX® EL SENSOR Plus and OSRAM DULUX® EL FACILITY)
- Excessively short OFF times (PTC thermistor) for OSRAM DULUX® EL LONGLIFE and OSRAM CIRCOLUX® EL

When lamp comes to the end of its life the lamp circuit is broken; the flickering typical of fluorescent lamps operated on chokes and starters does not occur with electronic energy saving lamps.

**3.8 Suitability for
outdoor applications**

OSRAM DULUX® EL LONGLIFE and ECONOMY lamps are suitable for outdoor use. However, to protect them from moisture they must be used in enclosed ventilated luminaires that have a drain hole where condensate can escape.

If the lamps are used outdoors in winter the luminous flux may be reduced by the low temperatures (see Section 3.4.1).

OSRAM DULUX® EL CLASSIC and OSRAM DULUX® EL GLOBE (LONGLIFE and ECONOMY) in enclosed ventilated luminaires (with drain holes) or semi-enclosed luminaires are ideal for outdoor use in the base down burning position. If low temperatures are expected, OSRAM DULUX® EL LONGLIFE CLASSIC (1.3.5) or GLOBE (1.3.7) should be used.

**3.9 Suitability for
explosion-proof
luminaires**

OSRAM DULUX® EL LONGLIFE and ECONOMY lamps can also be used in areas where there is a heightened risk of fire or explosions. The requirement here is that they should be used in luminaires that comply with type of protection „flameproof enclosure“ to EN 50018. The fact that these lamps produce much less heat than incandescent lamps is advantageous here.

3.10 Additional information on OSRAM DULUX® EL SENSOR Plus

1. Why doesn't the lamp come on immediately in a darkened room?
 - IR (= infra red) radiation from the sun may still be getting into the room
 - There is an IR source in the room (such as a light bulb switched on)
 - Depending on the IR level it may take up to 45 seconds for the lamp to switch on
2. Can I have several lamps in one luminaire or in neighbouring luminaires?
 - Yes, provided the sensors are not pointing directly at the other lamps.
3. How can I test a lamp in a luminaire?
 - You can do this by simply applying mains voltage (see Self-test)
 - Further testing can only be carried out at considerable cost. Covering the sensors may cause the lamp to go out after 45 seconds. If the sensors are then uncovered again the lamp will switch on again only after a lengthy period of time and will switch off as the ambient brightness increases.
4. In one luminaire the lamp switches on too early in the evening.
 - Cause: The luminaire or lamp is pointing east-north-east. In the evening very little light (and therefore IR radiation) falls on the lamp.
 - Remedy: Change the position of the luminaire, change the shade over the luminaire, turn the sensor towards the source of light.
5. In one luminaire the lamp switches on too late in the morning.
 - Cause: The luminaire or lamp is pointing west-north-west. In the morning very little light (and therefore IR radiation) falls on the lamp. The problem may rest with the design of the luminaire – the sensors may not be „seeing“ and IR radiation.
 - Remedy: Change the position of the luminaire, change the shade over the luminaire, turn the sensor towards the source of light.
6. The lamp flashes at night in the luminaire.
 - Cause: An external light source (IR) is interfering with the normal operation of the lamp or the luminaire cover is the problem.
 - Remedy: Change the luminaire cover, turn the sensors towards daylight (IR).

As an OSRAM DULUX IC is used to control the lamp, the life of the lamp will not be significantly affected by frequent on/off switching.

3.11 Possible malfunctions OSRAM DULUX® EL SENSOR Plus	Fault	Possible reason	Remedy
	The lamp does not switch itself on	No power supply to the lamp because <ul style="list-style-type: none"> ▶ the lamp is not screwed in far enough ▶ Luminaire incorrectly connected ▶ Contacts out of alignment ▶ Lamp faulty 	<ul style="list-style-type: none"> ▶ Screw in properly ▶ Check contacts ▶ Position contacts correctly ▶ Consult dealer
	The lamp does not switch off in daylight	The luminaire is in too much shade	Change the position of the luminaire

4. OSRAM DULUX® EL and the environment

4.1 Energy balance

Whenever energy is used there is an impact on the environment. This impact principally takes the form of the release of carbon dioxide (CO₂) when electricity is generated in fossil fueled power stations (1 kWh of electricity = 1 kg of CO₂ emissions*). The CO₂ contributes significantly to the „greenhouse effect“, or global warming.

Saving energy is therefore of utmost importance for environmental protection and for **OSRAM**.

Compared with ordinary light bulbs, all OSRAM DULUX® EL LONGLIFE and ECONOMY lamps not only save energy during their lives, they need less energy for their manufacture.

* For an assumed efficiency of 37 % (power station + power distribution), a molecular weight for CO₂ of 44 and a thermal value of 10 kWh per 1 kg of coal (carbon), **1 kg CO₂ is produced per 1 kWh of generated energy**.

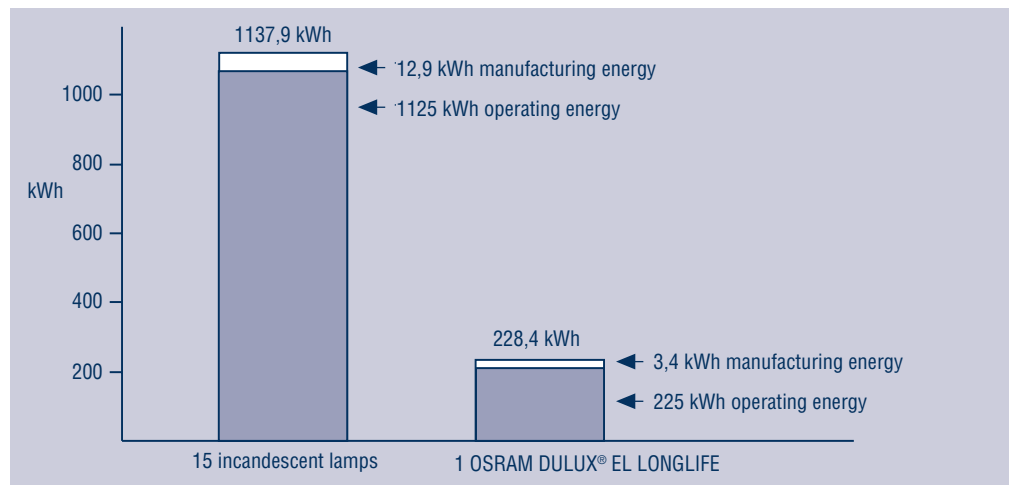

Fig. 19: Cumulative energy consumption (kWh) for the manufacture (incl. materials) and operation of 75 W incandescent lamps and comparable 15 W OSRAM DULUX® EL lamps

What’s more, mercury is released when energy is generated from fossil fuels, which means that in this respect the environmental impact of incandescent lamps is much greater than that of compact fluorescent lamps even allowing for the mercury in the compact fluorescent lamp.

All OSRAM DULUX® EL LONGLIFE and ECONOMY lamps are environmentally friendly products because of their energy savings and the associated reduced environment impact (carbon dioxide and mercury).

4.2 Substances

Like all discharge lamps, OSRAM DULUX® EL LONGLIFE and ECONOMY lamps are enclosed systems in normal use. Apart from emitting light, they therefore can have no impact on the environment.

A major substance in discharge lamps that is potentially harmful to the environment is mercury. Without it, however, the lamps would not work. Thanks to a patented dosing procedure, OSRAM has succeeded in reducing the mercury content to less than 3 mg per lamp.

OSRAM DULUX® EL LONGLIFE and ECONOMY lamps contain **no radioactive substances**.



4.3 Disposal

In Germany, discharge lamps that contain mercury are classified as waste requiring special supervision (special waste) under the Closed Substance Cycle and Management Act (Kreislaufwirtschaftsgesetz) and its provisions. This means that these lamps have to be disposed of as special waste (EEC Code 060404 Waste containing mercury), apart from small volumes in private households.

Private users should still dispose of their old fluorescent lamps (OSRAM DULUX®) at local recycling centres or collection points.

4.4 Energy Efficiency Index EEI

European Directive 98/11/EC, Energy labelling of mains voltage household lamps: The EEI (Energy Efficiency Index, e. g. EEI = A), also known as the „Energy Label“, classifies lamps according to their energy efficiency (it does not relate to luminaires however).

The seven classes are defined by certain limit values in light output relative to wattage. Lamps in class A are the most efficient at converting electrical energy into light.

Type	3W	5W	7W	8W	9W	10W	11W	12W	14W	15W	16W	20W	21W	23W	24W
OSRAM DULUX®EL LONGLIFE E14	A	A	A				A								
OSRAM DULUX®EL LONGLIFE E27/B22d		A	A				A			A		A		A	
OSRAM DULUX®EL LONGLIFE CLASSIC A		B	A B'			A	B			A		A			
OSRAM DULUX®EL LONGLIFE GLOBE										B		B			
OSRAM DULUX®EL LONGLIFE REFLEKTOR										*		*			
OSRAM DULUX®EL LONGLIFE FACILITY						A			A						
OSRAM DULUX®EL LONGLIFE VARIO														A	
OSRAM DULUX®EL LONGLIFE SENSOR Plus										A					
OSRAM DULUX®EL ECONOMY E14				A				A							
OSRAM DULUX®EL ECONOMY E27/B22d				A				A			A		B		A
OSRAM DULUX®EL ECONOMY CLASSIC A	A B'	A B'		B'	A					A					
OSRAM DULUX®EL ECONOMY GLOBE											B		B		
OSRAM CIRCULUX®EL															A

* Reflector lamps are excluded from the Energy Label.

B' Candle version

Formula for compact fluorescent lamps with integrated control gear:

Conditions for Class A: $W \leq (0.24 \times \sqrt{\text{luminous flux}}) + (0.0103 \times \text{luminous flux})$

Conditions for Class B: $E_i < 60 \%$

$E_i = W/W_R \%$

$W_R = (0.88 \times \sqrt{\text{luminous flux}}) + (0.049 \times \text{luminous flux})$

W stands for rated power

W_R stands for reference power input

E_i stands for % Energy Efficiency Index

German standard DIN EN 50285: 1999 „Energy efficiency of electric lamps for household use – measuring methods“

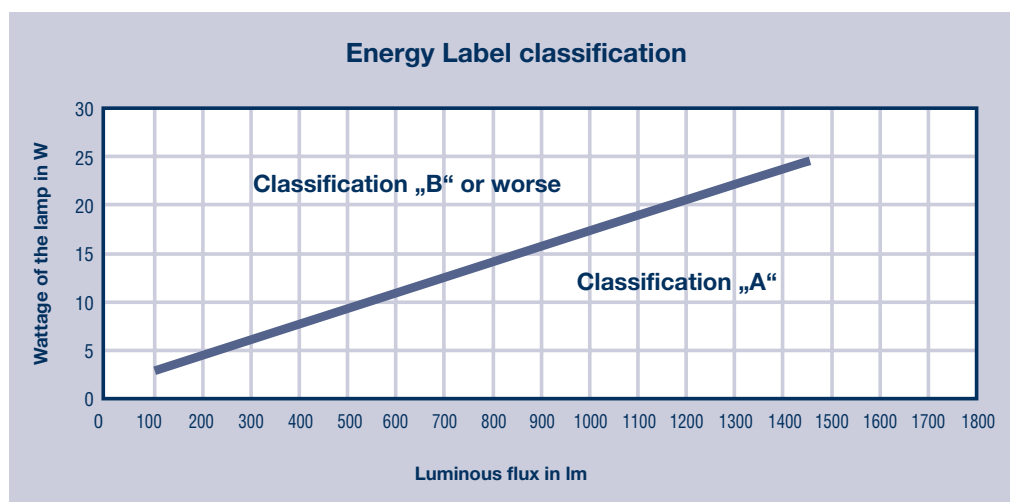

Your contacts

Alfred Haas
Head of Business Unit CFL
OSRAM GmbH
CFL M-M
Hellabrunner Str. 1
D-81543 Munich

Tel. (+49 89) 62 13-22 08
Fax (+49 89) 62 13-40 52
E-Mail: a.haas@osram.de

Thomas Heider
Product Manager
OSRAM GmbH
CFL M-M
Hellabrunner Str. 1
D-81543 Munich

Tel. (+49 89) 62 13-24 23
Fax (+49 89) 62 13-40 52
E-Mail: t.heider@osram.de

Christian Daelman
Application Engineer
OSRAM GmbH
CFL M-M
Hellabrunner Str. 1
D-81543 Munich

Tel. (+49 89) 62 13-26 04
Fax (+49 89) 62 13-40 52
E-Mail: c.daelman@osram.de

For further product information on compact fluorescent lamps go to:
<http://www.osram.de/produkte/allgemein/kompakt/index.html>

www.OSRAM.com

Head office Germany

OSRAM GmbH
Hellabrunner Strasse 1
81536 München
Tel.: +49-89-62 13-0
Fax: +49-89-62 13-20 20

International addresses

Albania

(supported by OSRAM Greece)

Argentina

OSRAM Argentina S.A.C.I.
Ramos Mejia 2456
B 1643 ADN Beccar
Pcia. de Buenos Aires
Tel.: +54-11-6333-8000
Fax: +54-11-4737-0222

Australia

OSRAM Australia Pty. Limited
Building 1, 11th Floor
P.O. Box 673
423 Pennant Hills Road
Pennant Hills
2120 New South Wales
Tel.: +61-29-4 81-83 99
Fax: +61-29-4 81-94 68

Austria

OSRAM GmbH
Lemböckgasse 49/C/5
1230 Wien
Postfach 1 62
1231 Wien
Tel.: +43-1-6 80 68-0
Fax: +43-1-6 80 68-7

Baltic states:

Estonia, Latvia, Lithuania

(supported by OSRAM Finland)

Belgium

N.V. OSRAM S.A.
Mercuriusstraat 28
1930 Zaventem Zuid 7
Tel.: +32-2-7 19 29 11
Fax: +32-2-7 20 99 75

Bosnia-Herzegovina

(supported by OSRAM Croatia)

Brazil

OSRAM do Brasil Lâmpadas Elétricas Ltda.
Av. dos Autonomistas, 4229
06090-901 Osasco-SP
Tel.: +55-11-36 84 74 08
Fax: +55-11-36 85 94 95

Bulgaria

OSRAM OOOD
Nikola Obreschkov 1, Wh. A., App. 1
1113 Sofia / Bulgaria
Tel.: +359-2-9 71 22 62
Fax: +359-2-9 71 45 46

Canada

OSRAM SYLVANIA Ltd.
2001 Drew Road
Mississauga
Ontario L5S 1S4
Tel.: +1-905-6 73 61 71
Fax: +1-905-6 73 62 90

Chile

OSRAM Chile Ltda.
Santa Elena de Huechuraba
1135 B Huechuraba
Santiago-Chile
Tel.: +56-2-7 40-09 39
Fax: +56-2-7 40-04 66

China

OSRAM Foshan Lighting Co. Ltd.
No.1 North Industrial Road,
Postal code 528000
Foshan, Guangdong, P.R. China
Tel.: +86-757-64 82-111
Fax: +86-757-64 82-222

OSRAM Shanghai Rep. Office

Harbour Ring Plaza No. 18
Xi Zang Middle Road
Room 2802, 2803 A
Shanghai, 200001 P.R.C.
Tel.: +86-21-53 85 28-48
Fax: +86-21-64 82 12-19

OSRAM Sylvania Inc.

PMC Shanghai Rep. Office
2805A 28/F Harbour Ring Plaza
No. 18 Xi Zang Rd. M. Shanghai
Shanghai, 200001 P.R.C.
Tel.: +86-21-53 85 28-48
Fax: +86-21-53 85 20 22

Colombia

OSRAM de Colombia
Diagonal 109 No. 21-05
Oficina 607, 608
Bogotá
Tel.: +57-1-6 19 24 07
Fax: +57-1-6 37 18 55

Croatia

OSRAM d.o.o.
Ozaljska 93
10000 Zagreb
Tel.: +385-1-303-20 00
Fax: +385-1-303-20 01

Czech Republic

OSRAM spol. s.r.o. Praha
Tylovo náměstí 3/15
12000 Praha 2
Tel.: +420-2-2 19 87-100
Fax: +420-2-2 19 87-120

Denmark

OSRAM A/S
Dybendalsvaenget 3
Postboks 259
2630 Tåstrup
Tel.: +45-44-77 50-00
Fax: +45-44-77 50-55

Egypt

OSRAM Cairo
Rep. Office OSRAM GmbH
5th Floor, Unit No. 507
57 Giza Street
Cairo, Giza
Tel.: +20-2-7 48 66 46
Fax: +20-2-7 48 66 46

Ecuador

OSRAM del Ecuador S.A.
Casilla 09-01-8410
Guayaquil
Tel.: +593-4-2 89 36 09
Fax: +593-4-2 89 35 58

Finland

OSRAM Oy
Vanha Porvoontie 229
01380 Vantaa
Box 91
01301 Vantaa
Tel.: +358-9-74 22 33 00
Fax: +358-9-74 22 33 74

France

OSRAM SASU
5, Rue d'Altorf
67124 Molsheim
BP 1 09
67124 Molsheim Cedex
Tel.: +33-388-49 75 99
Fax: +33-388-49 75 97

Great Britain

OSRAM Ltd.
OSRAM House
Waterside Drive
Langley, Berkshire
SL3 6EZ
Tel.: +44-17 44-81 22 21
Fax: +44-17 44-83 19 00

Greece

OSRAM A.E.
Athinon Av. 56
10441 Athen
Tel.: +30-2 10-5 20 18 00
Fax: +30-2 10-5 22 72 00

Hong Kong

OSRAM Prosperity Co. Ltd.
Rm 4007-09 Office Tower, Convention Plaza
1 Harbour Road, Wanchai
Hong Kong
Tel.: +852-25 11 22 68
Fax: +852-25 11 20 38

Hungary

OSRAM KFT.
Alkotás utca 41.
1123 Budapest
Pf.: 700/61
1535 Budapest
Tel.: +36-1-2 25-30 55
Fax: +36-1-2 25-30 54

Iceland

Jóhann Olafsson & Co. h/f
43 Sundaborg 13
104 Reykjavik
Tel.: +354-533 19 00
Fax: +354-533 19 30

India

OSRAM India Ltd.
Signature Towers, 11th Floor,
Tower-B South City-I
122001 Gurgaon Haryana/India
Tel.: +91-124-238 31-80
Fax: +91-124-238 31-82

Indonesia

PT OSRAM Indonesia
Jalan Siliwangi KM 1
Desa Keroncong
Jatuiwang
15134 Tangerang
Tel.: +62-21-5 90 01 27-00
Fax: +62-21-5 90 05 59

Iran

OSRAM Lamp Private Joint Stock Company
(OSRAM PJS Co.)
Bokharest Ave, Str. 6, No. 13
Tehran
Iran
Tel.: +98-21-8 73 84 76
Fax: +98-21-8 73 24 13

Italy

OSRAM Società Riunite
OSRAM Edison-Clerici S.p.A.
Via Savona 105
Casella Postale 1 41 06
20144 Milano
Tel.: +39-02-42 49-1
Fax: +39-02-42 49-380

Japan

OSRAM-MELCO Ltd.
Tobu Yokohama Bldg.No. 3 (4F) 8-29,
Kitasaiwai 2-chome, Nishi-Ku
220-0004 Yokohama
Tel.: +81-45-3 23 51-20
Fax: +81-45-3 23 51-55

OSRAM Ltd.

Tobu Yokohama Bldg.No. 3 (6F) 8-29,
Kitasaiwai 2-chome, Nishi-Ku
220-0004 Yokohama
Tel.: +81-45-3 23 51-00
Fax: +81-45-3 23 51-10

Korea

OSRAM Korea Co., Ltd.
3rd. Fl. Ye-Sung Bldg. 150-30
Samsung-dong, Kangnam-Ku
Seoul 135-090
Tel.: +82-2-5 54 41 12
Fax: +82-2-5 56 16 44

Macedonia

(supported by OSRAM Greece)

Malaysia

OSRAM (Malaysia) Sdn Bhd
7.05-7.06 Amoda Building
22, Jalan Imbi
55100 Kuala Lumpur
Tel.: +60-3-21 45 95-33
Fax: +60-3-21 45 95-35

Mexico

OSRAM de México, S.A. de C.V.
Camino a Tepalcapa No. 8
54900 Tultitlán/Edo. de México
Tel.: +52-5-58 99-18 00
Fax: +52-5-58 99-65 60

Netherlands

OSRAM Nederland B.V.
Vennootsweg 15
2404 CG Alphen a/d Rijn
Postbus 3 32
2400 Alphen a/d Rijn
Tel.: +31-172-48 38 38
Fax: +31-172-44 30 25

Norway

OSRAM Oslo
OSRAM AS
Strandveien 50
N-1366 Lysaker
Tel.: +47-67 83 67-00
Fax: +47-67 83 67-40

Philippines

OSRAM Philippines
Unit 2002-2003
Antel Global Corporate Center
Julia Vargas Avenue
Ortigas Center
Pasig City
Tel.: +632-687 60 48-50
Fax: +632-687 60 57

Poland

OSRAM Sp. z o.o.
ul. Wiertnicza 117
PL 02292 Warszawa
Tel.: +48-22-6 51 78 69
Fax: +48-22-6 42 14 18

Portugal

OSRAM Empresa de
Aparelhagem Eléctrica Lda.
Rua Alto do Montijo
Nr. 15-4 andar
2795-619 Carnaxide
Tel.: +351-2 14 16 58 60
Fax: +351-2 14 17 12 59

Romania

OSRAM Romania S.R.L.
Sos. Pipera Nr. 41 Sector 2
7000 Romania/Bucaresti
Tel.: +40-21-2 33 02-12
Fax: +40-21-2 33 02-14

Russia

OSRAM RUS
Rep. Office OSRAM GmbH
Ul. Malaja Kaluschskaja 15/4
119071 Moscow
Tel.: +7-095-9 35 70-70
Fax: +7-095-9 35 70-76

Singapore

OSRAM Singapore (Pte.) Ltd.
159 Sin Ming Road
#05-04 Amtech Building
575625 Singapore
Tel.: +65-65 52 01 10
Fax: +65-65 52 71 17

Slovak Republic

OSRAM Slovakia a.s.
Komárnanská cesta 7
94093 Nové Zámky
Tel.: +42-1-35 64 64-409
Fax: +42-1-35 64 64-893

Slovenia

(supported by OSRAM Austria)

South Africa

OSRAM (Pty.) Ltd.,
260, 15th Road
1683 Randjespark/Midrand
Private BAG X 206
1685 Halfway House/Midrand
Tel.: +27-11-2 07 56 00
Fax: +27-11-8 05 17 11

Spain

OSRAM, S.A.
Calle de la Solana, 47
28850 Torrejón de Ardoz (Madrid)
Tel.: +34-91-6 55 52 00
Fax: +34-91-6 77 92 40

Sweden

OSRAM AB
Rudanvägen 1
Box 5 04
13625 Haninge
Tel.: +46-8-7 07 44-00
Fax: +46-8-7 07 44-40

Switzerland

OSRAM AG
In der Au 6
Postfach 2179
8401 Winterthur/Töss
Tel.: +41-52-2 09 91 91
Fax: +41-52-2 09 99 99

Taiwan

OSRAM Taiwan Company Ltd.
Sung Chiang Road, 7th Floor
Empire Building No. 87
P.O. Box 46304
Taipei
Tel.: +886-2-25 08 35 02
Fax: +886-2-25 09 67 82

Thailand

OSRAM Thailand Co., Ltd.
100/45, 24th Floor
Sathorn Nakorn Tower
North Sathorn Road
Khwaeang Silom
Khet Bangrak, Bangkok 10500
Tel.: +66-2-6 36 74 75
Fax: +66-2-6 36 74 77

Turkey

OSRAM AMPUL TIC. A.S.
Meclisi Mebusan Caddesi 125
80400 Findikli Istanbul
Tel.: +90-212-334-1334
Fax: +90-212-334-1142

Ukraine

OSRAM Kiev
Rep. Office OSRAM GmbH
Ul. Vorovskogo, 36
01054 Kiev
Tel.: +380-44-2 46 93 14
Fax: +380-44-2 46 99 91

United Arab Emirates

OSRAM Middle East FZE
4th Floor, New High Rise Building
LOB 14
P.O. Box 17476
Jebel Ali, Dubai
Tel.: +971-4-88 13-767
Fax: +971-4-88 13-769

USA

OSRAM SYLVANIA INC.
100 Endicott Street
Danvers, MA 01923
Tel.: +1-978-777-19 00
Fax: +1-978-777-12 47

Vietnam

OSRAM Singapore Pte. Ltd.
Rep. Office Vietnam
59A Ly Thai To Street, Hanoi Press Club
Hoan Kiem District
Hanoi - Vietnam
Tel.: +84-4-93 49-801
Fax: +84-4-93 49-803

Yugoslavia

OSRAM Belgrad
Rep. Office of OSRAM GmbH
Predstavništvo OSRAM GmbH
Cika Ljubina 15/V
11000 Beograd
Tel.: +381-11-30 30-860
Fax: +381-11-30 30-853

Internet

<http://www.osram.de>
<http://www.osram.com>
<http://www.osram.de/lightatwork/>
<http://www.osram.com/lightatwork/>

EN - For pricing and availability in your local country please visit one of the below links:

DE - Informationen zu Preisen und Verfügbarkeit in Ihrem Land erhalten Sie über die unten aufgeführten Links:

FR - Pour connaître les tarifs et la disponibilité dans votre pays, cliquez sur l'un des liens suivants:

[D23BCN](#)

[D7BCT](#)

[D7EST](#)

EN
This Datasheet is presented by
the manufacturer

DE
Dieses Datenblatt wird vom
Hersteller bereitgestellt

FR
Cette fiche technique est
présentée par le fabricant