

Jon Fauer, ASC

www.fdtimes.com

November 2022

Issue 117

# FILM AND DIGITAL TIMES

Art, Technique and Technology in Motion Picture Production Worldwide



# FILM AND DIGITAL TIMES

Art, Technique and Technology

*Film and Digital Times* is the guide to technique and technology, tools and how-tos for Cinematographers, Photographers, Directors, Producers, Studio Executives, Camera Assistants, Camera Operators, Grips, Gaffers, Crews, Rental Houses, and Manufacturers.

It's written, edited, and published by Jon Fauer, ASC, an award-winning Cinematographer and Director. He is the author of 14 bestselling books—over 120,000 in print—famous for their user-friendly way of explaining things. With inside-the-industry “secrets-of-the-pros” information, *Film and Digital Times* is delivered to you by subscription or invitation, online or on paper. We don't take ads and are supported by readers and sponsors.

© 2022 Film and Digital Times, Inc. by Jon Fauer

## subscribe

# www.fdtimes.com

Subscribe online, call, mail or fax:

Direct Phone: 1-570-567-1224

Toll-Free (USA): 1-800-796-7431

Fax: 1-724-510-0172

## Film and Digital Times On Paper, Online, and On iPad

### Print + Digital Subscriptions

Film and Digital Times Print + Digital subscriptions continue to include digital (PDF) access to current and all back issues online.

### iPad and iPhone

Get Film and Digital Times for iPad and iPhone on the Apple Newsstand. Download our free app in the iTunes Store (search: Film and Digital Times). Get individual issues, back issues, or an annual subscription.

### Digital (PDF) subscriptions

Digital (PDF) subscriptions include unlimited access to the current and all back issues. [www.fdtimes.com/issues](http://www.fdtimes.com/issues)

### FDTimes Customer Service

For subscription or account questions, please contact us by phone Monday–Friday, 9 am–5:30 pm EST.

Phone: 1-570-567-1224

Toll-Free (USA): 1-800-796-7431

Fax: 1-724-510-0172

Email via website: [fdtimes.com/contact](http://fdtimes.com/contact)

Mailing address: Film and Digital Times Subscriptions  
PO Box 922  
Williamsport, PA 17703 USA

Editorial offices in New York City

# www.fdtimes.com

On Paper, Online, and now on iPad

## Subscribe Online:

[www.fdtimes.com/subscribe](http://www.fdtimes.com/subscribe)

## Call, Mail or Fax:

Direct Phone: 1-570-567-1224

Toll-Free (USA): 1-800-796-7431

Fax: 1-724-510-0172

Film and Digital Times Subscriptions  
PO Box 922  
Williamsport, PA 17703  
USA

- |                          |   |          |           |
|--------------------------|---|----------|-----------|
| <input type="checkbox"/> | 1 Year Print and Digital, USA   | 6 issues | \$ 49.95  |
| <input type="checkbox"/> | 1 Year Print and Digital, Canada  | 6 issues | \$ 59.95  |
| <input type="checkbox"/> | 1 Year Print and Digital, Worldwide   | 6 issues | \$ 69.95  |
| <input type="checkbox"/> | 1 Year Digital (PDF)  |          | \$ 29.95  |
| <input type="checkbox"/> | 1 year iPad/iPhone App upgrade<br>(normally 29.99) <i>Get FDTimes on Apple<br/>Newsstand with iPad App when you order<br/>a Print or Digital Subscription (above)</i> |          | + \$ 9.99 |

Total \$ \_\_\_\_\_

Payment Method (please check one):

- VISA    Mastercard    American Express  
 Check Enclosed (payable to Film and Digital Times)

Credit Card # \_\_\_\_\_

3 or 4 digit security code \_\_\_\_\_

Expiration Date \_\_\_\_\_

Signature \_\_\_\_\_

Name \_\_\_\_\_

Company \_\_\_\_\_

Title \_\_\_\_\_

Address \_\_\_\_\_

City \_\_\_\_\_

State or Province \_\_\_\_\_

Country \_\_\_\_\_

Zip or Postal Code \_\_\_\_\_

Phone \_\_\_\_\_

Fax \_\_\_\_\_

Email \_\_\_\_\_



# Contents: November 2022 Issue 117

Leitz Park .....	4-5
Leitz Cine Confab .....	6-8
Assembling Hugo .....	9
Leitz Cine Lens Lines .....	10-11
Leitz Cine Lenses: Comparison Chart .....	12
Mounts and Adapters .....	13
Leitz LPL Mount for Sony VENICE 1 and 2.....	14
Leitz Elsie .....	15
Leitz Hugo .....	16
“Shoot wide open, no excuses” .....	17
HUGO 75mm and 90mm: Eyes Wide Open at T1.5.....	18
As seen with Hugo at T1.5.....	19-27
SLATE from Tribe7 .....	28-29
Cooke Varotal/i FF T2.9 Full Frame Spherical Zoom Lenses ....	30
Cooke Varotal/i FF T2.9 Full Frame Spherical Zooms .....	31-33
Cooke Varotal/i FF Focal Lengths: 19-40, 30-95, 80-215 .....	34
Cooke S8/i and Varotal/i FF Size Comparisons .....	34
We took a Look at Cooke Varotal/i FF in Industry City.....	35
BTS: Cooke Looks at Industry City .....	36
Framegrabs: Cooke Looks at Industry City .....	37
Cooke Looks at Industry City.....	38-41
Cooke Super35 Varotal Zoom Lens History .....	42-43
Fabian Weston, Protists and Pocket Cinema Cameras .....	44-47
Top Chef 2022 Winner Buddha Lo of HUSA in New York. ....	48
Top Chef Buddha Lo seen through a Nikon Z 9 .....	49
Nikon Z 9 for Cine.....	50
Nikon Z 9: Some Cine Menu Settings .....	51
Nikon Z 9 Cine 8.3K N-RAW 12-bit Framegrabs .....	52-53
Michael Cioni on Frame.io C2C and Partners .....	54-55
Fujifilm X-H2S + FT-XH + C2C with Frame.io .....	56
Fujifilm File Transmitter FT-XH.....	56
Fujifilm X-H2S.....	57
Fujifilm X-H2S Zooms.....	58
Chrosziel Meta Mount (E to PL with Metadata) .....	59
FUJINON 25-1000 F2.8-5.0 PL Mount Zoom .....	60-62
Mike Prickett on <i>100 Foot Wave</i> , 50-1000mm Zooms.....	63
<i>100 Foot Wave</i> , 50-1000mm Zooms .....	64
Mike Prickett on <i>100 Foot Wave</i> , 50-1000mm Zooms.....	65
Mike Prickett on <i>100 Foot Wave</i> .....	66
<i>100 Foot Wave</i> , 50-1000mm Zooms .....	67
Naomi Kawase, Director of <i>TOKYO 2020</i> .....	68-72
Masaya Suzuki, Principal DP of <i>TOKYO 2020</i> .....	73-75
Live Under Covid.....	76-79
Ji-Sun Yoo, DP of <i>D.P.</i> .....	80
SIGMA Classics on <i>D.P.</i> .....	81
Francisco Campos-Lopez on <i>DamBusters</i> .....	82
<i>DamBusters</i> .....	83-87
Darren Lew on <i>Carstage</i> .....	88-89
New ARRI Rental North America HQ in LIC .....	90-91
Angénieux Optimo Ultra Compact FF & U35 Full Pack.....	92
Aymeric Colas, Steadicam on <i>Athena</i> .....	93
Sponsors and Educational Partners .....	95

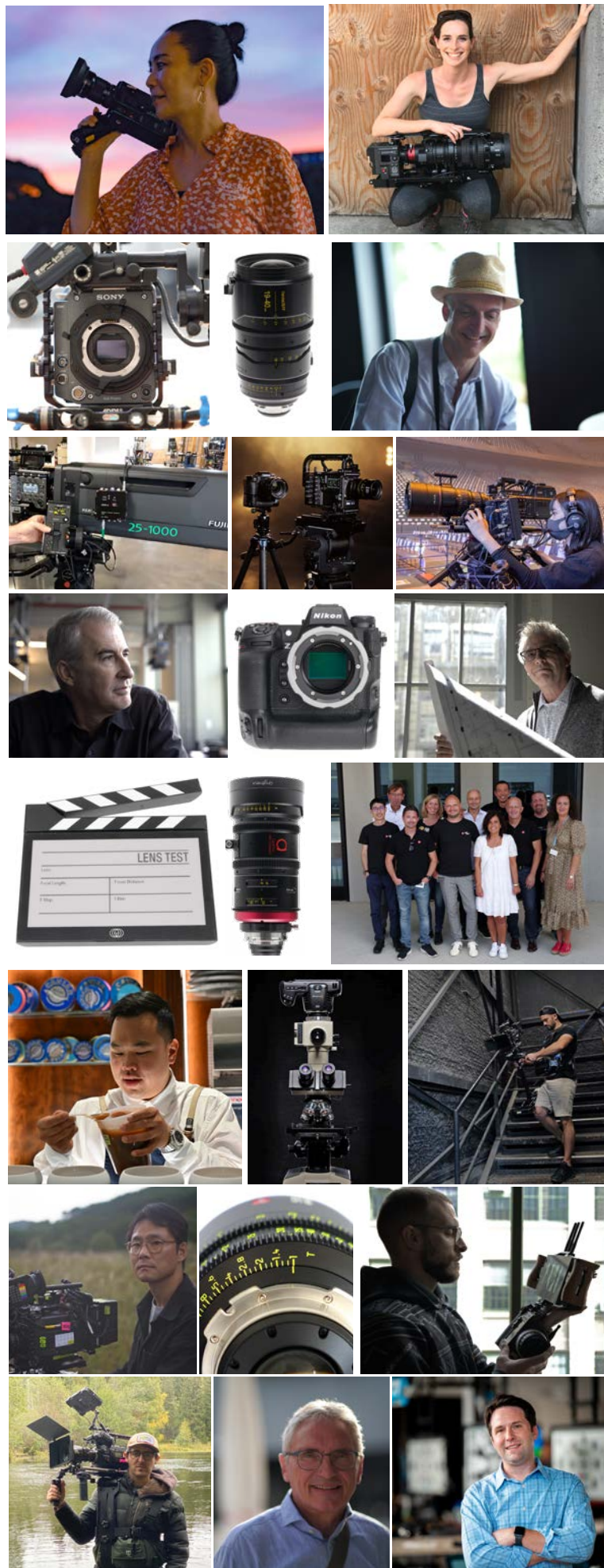





Leica Camera AG headquarters in Leitz Park resembles camera lenses. Designed by Gruber + Kleine-Kraneburg Architekten, the building has a 5-meter tall Guardian SunGuard SuperNeutral 70/41 curved glass facade that balances solar control, light transmission and thermal insulation.

1772. Goethe slept here. Well, actually, he stayed a couple of kilometers down the road, in lodgings less lavish than you'll find today at the Ernst Leitz Hotel in Leitz Park, Wetzlar.

September 5 – 8, 2022. Camera crews from around the world stayed here. The team at Ernst Leitz Wetzlar invited a group of cinematographers and camera assistants to visit, with eyes-to-eyepiece and hands-on-lens time with Hugo, Elsie and six other lines of Leitz lenses. There were lectures, factory tours, Sattmacher's Airstream barbecue, fine food and refreshments.

It was a like a wizarding confabulation. We sat transfixed during a lecture by the grandmaster of Leica optical design Peter Karbe, watched lenses being assembled and gathered in the lens projection room. Rainer Hercher, Raimund Bayer, Laura Kaufmann and their worldwide Leitz emissaries hosted the festivities and events in Wetzlar.

Meanwhile, back at young Goethe. With themes reminiscent of *Shakespeare in Love* (1998), *Young Goethe in Love* is a 2010 German film, loosely historical, "about a tempestuous aspiring writer, who, having failed his law exams, is sent by his father to

the provincial town of Wetzlar to mend his ways. Goethe predictably falls in love with Lotte who is otherwise engaged."

The novel behind the film is *The Sorrows of Young Werther*, written by Goethe in 1774, based on his unrequited love of Charlotte (Lotte) Buff. It was an 18th century blockbuster.

Few poets have written more about wandering than love-lorn, long-suffering Johann Wolfgang von Goethe. "I am a poor, wretched, lovelorn creature," Goethe wrote in his second novel, *Wilhelm Meister's Apprenticeship*. The author clearly had issues. He possessed a depressing habit of falling in love with women who were married or unavailable, and then writing poetry to drown his sorrows on long journeys.

If your long journey has been unrequited in the search for a decisive look, you may have missed Ernst Leitz Wetzlar's burgeoning portfolio of diverse cine lenses. Leitz now offers an eclectic choice of 8 lines of cine lenses—with different qualities and styles—that appeal to the cinematographer's quest for the right lens with the right look for the right story. While some brands strive for uniform looks across the lines, Leitz has been



# Leitz Park



The architectural concept Leitz-Park III is a counterpoint to the round shapes across the street. Andreas Kaufmann described it as “reminiscent of Montalcino or Sienna. The buildings are related, but look different, and surround a square or marketplace. Leitz (Cine) is at right.

introducing a steady stream of impeccably crafted lenses that possess different looks, with different styles, different tastes and different approaches.

Leitz Park is like Legoland, a Leica Land destination for Leica lovers, aficionados and professionals worldwide. The architecture is unique. Leitz Park II, where Leica cameras are built, has the curved shapes of lens barrels or analog Leica cameras' film cassette chambers. To the right of the bright white lobby are galleries of photographs. Book a tour to see the latest cameras being assembled in a vast clean room and to see an exhibition of Leica history and products from the past hundred years. Café Leitz is strategically placed in the center of the campus. Try the Zwetschgenkuchen (plum cake) and fresh fruit smoothies.

Across the street is the architectural counterpoint to the curves of Leica Camera AG. The cubist buildings here contain the headquarters of Ernst Leitz Wetzlar (Cine), the Ernest Leitz Museum and Shop, Leica Welt (World), Archives, Leica Store, corporate office tower, the Ernst Leitz Hotel and OSKARS (as in Oskar Barnack) Restaurant.



Gavin Finney, BSC, looking at Hugo on VENICE 2, in focus at T1.5 with a Leitz Hugo on a Leica SL2-S and L to LPL mount. Gavin has shot at least 3 major productions with Leitz cine lenses.

# Leitz Cine Confab





# Leitz Cine Confab



Left to right:  
Po Liu,  
Raimund Bayer,  
Ben Ross,  
Lena Altintop,  
Robert Höft,  
Rainer Hercher,  
Lisa de Carvalho,  
Osamu Tsukada,  
Kevan Parker,  
Seth Emmons,  
Laura Kaufmann.







Above: Osamu Tsukada with Leitz SL2-S, Leitz L to LPL Mount, and an L-Mount Hugo 24mm T1.5.

Below Left: Taken with Leitz Hugo 90mm at T1.5, writer, photographer, filmmaker Ariane Damain Vergallo taking a close-up of Christine A. Maier, BVK, AAC with a Leitz Q. The Leitz Q has a dedicated 28mm Summilux f/1.7 that focuses to 30 cm (11.8") and 17 cm (6.7") in Macro.



Leitz Henri DP/  
Directors Finder  
with SL2-S and  
an L-Mount Hugo  
24mm.



# Assembling Hugo

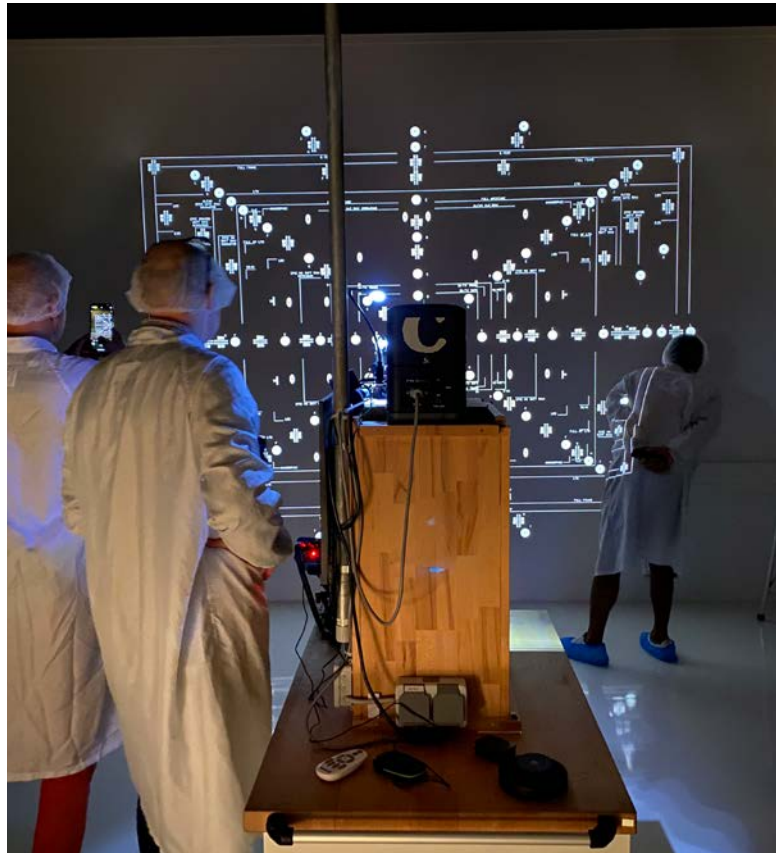
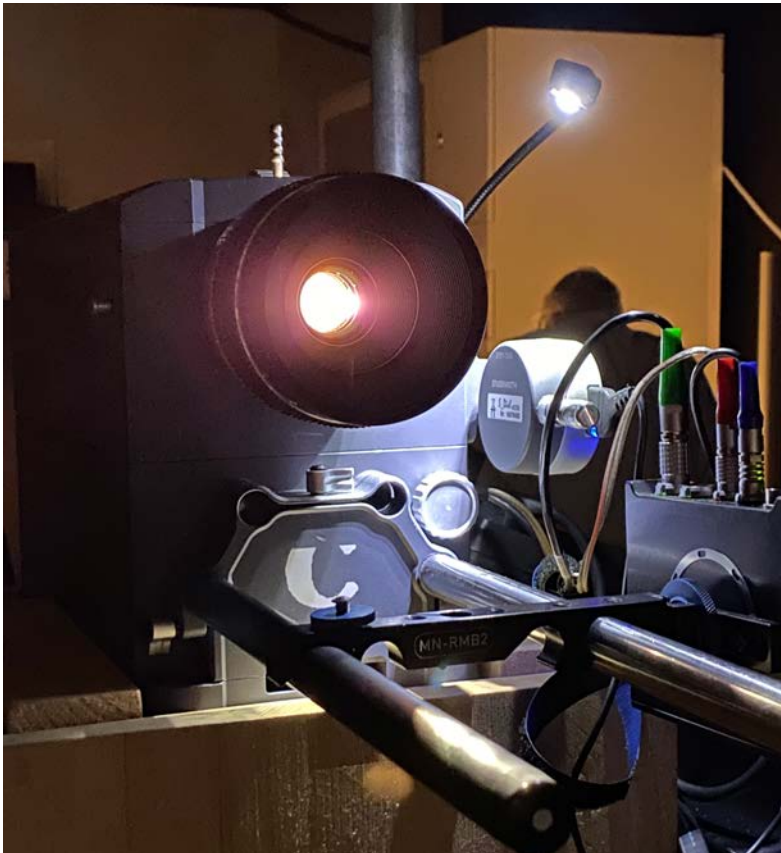

# Leitz Cine Lens Lines



Summilux-C  
Super35



Summicron-C  
Super35



Leitz PRIME  
Full Frame



Leitz ZOOM  
Full Frame

by Seth Emmons

There are now eight sets in the Leitz Cine Lens lineup. Each set has its unique characteristics. To help simplify what they do and how they look, we can assign them to three categories.

- Performance: Leitz PRIME, Leitz ZOOM, Summilux-C
- Character: Elsie, Summicron-C
- Legacy: Hugo, M 0.8, Thalia

## Performance

### Leitz PRIME, Leitz ZOOM, Summilux-C

- An accurate image on which to build your individual look.
- Fast, consistent aperture.
- Uniform high resolution and illumination across the entire frame.
- Almost no distortion or aberrations.

Cinematographers and lens designers historically have valued lenses with optimally corrected optics that perform equally well across the entire image field and are as fast as possible. Leitz Cine continues the tradition of outstanding Leica optical and mechanical innovation with its Leitz Performance lens family.

Leitz Summilux-C Super35 format primes were the first cine lenses by the company founded as CW Sonderoptic, now Ernst Leitz Wetzlar. Leitz PRIME and Leitz ZOOM are the Full Frame members of the Performance family. They exhibit even field illumination, negligible loss of resolution towards the edges of the frame, preservation of detail in low light and low contrast scenes, almost imperceptible chromatic aberrations through the entire aperture range. They represent the technical best that Leitz Cine lenses can achieve while remaining humane, gentle,

and never clinical or mechanical in image look and feel.

The bokeh of the Performance lens family maintain clarity, separation and depth. Well-controlled flaring enables strong in-frame light sources with minimal image degradation. These lenses provide cinematographers a naturally beautiful, clean canvas on which to build their images with composition, lighting, filtration, set design and wardrobe without worrying about the lenses shouting out the rest of their efforts. The clean, undistorted image also aids in VFX, compositing, virtual production, and post production work.

Leitz ZOOM lenses cut beautifully with Leitz PRIME and Summilux-C lenses—color matched, with no ramping, breathing or distortion. These parfocal zoom lenses can closely replicate the images of most prime lenses in performance while maintaining the skin tones and color rendition that Leitz is known for.

## Character

### Elsie, Summicron-C

- Dimensional field with fall off toward the corners.
- Unique bokeh.
- More flaring.
- Smaller, lighter and budget-friendly.

The lenses in the Leitz Character family introduce more of their own look to the image by fashioning imperfections into elegant characteristics. They build off the technology of the Performance series to offer a “rounded” image where resolution and illumination can fall off gradually toward the corners to help center the audience’s attention. Combined with a soft and smooth focus roll off, these lenses provide a point of view that can be further accentuated with lighting and framing.



# Leitz Cine Lens Lines



Thalia  
65mm Format



Elsie  
Full Frame



M 0.8  
Full Frame



Hugo  
Full Frame

Both lens sets in the Character series offer their own unique mix of minimal distortion, barely perceptible aberrations, and special bokeh that give them a life of their own. The Full Frame Elsie lenses closely resemble the bokeh of traditional Leica still lenses.

Elsie lenses were designed for Full Frame but illuminate well beyond that image circle and may be useable in certain formats on the Alexa 65, although further testing is needed.

The Super35 Summicron-C lenses offer a more classic, traditional cine lens bokeh.

Each of these sets feature their own flare characteristics to give cinematographers more to work with when directing light into the lens. These Character lenses are generally smaller and lighter than the Performance lenses in the same format category and cater to a larger range of budgets and projects without compromise.

## Legacy

### Hugo, M 0.8, Thalia

- Interesting and unique among other cine lenses.
- Hugo and M 0.8: center-weighted, iconic Leica look.
- Thalia: Medium Format portrait look.
- The most compact and lightweight Leitz lenses.
- Based on classic Leica glass.

Leica lenses have created many of the most memorable images of the past century. The Leitz Legacy lens family applies this ethos to some of the most stunning and coveted still photography lenses ever developed: the Leica M Leica Format (Full Frame) series and the Leica S Medium Format series.

Many cinematographers have dreamt of using these lenses to

create moving pictures. Now the iconic look of these lenses can be used to tell their stories.

Leica M glass sits at the heart of both the Hugo and M 0.8 series. Their intention is to preserve not only the iconic M image characteristics but also the small size and weight that have made them the choice of photographers intent on capturing decisive moments. The optical elements are hand-selected from Leica's photography lens production line for optimal performance.

M 0.8 lenses are modified for a traditional cine camera configuration with lens gears, stepless irises and minimal adjustment.

As with Leitz M 0.8, the new line of Leitz Hugo lenses also have Leica optical elements. But, their housings are built from scratch with a completely new cine lens mechanical design. Focus and iris travel are expanded and have smooth cam mechanisms. Furthermore, Hugo lenses focus much closer than M 0.8.

Hugo lenses have a robust cine-style housing just like other Leitz lenses, while the M 0.8 lenses retain the compact size of the Leica M lenses with the addition of properly pitched gear rings and uniform 80 mm front diameters.

The look of Hugo and M 0.8 consists of dynamic bokeh that combine with center-weighted performance to create a dimensional image that seems to pop off the screen and stands out as being something truly special.

Leitz Thalia lenses reimagine Leica's S lenses in familiar, compact and lightweight cine lens housings. They maintain an enormous 60 mm image circle that covers through ALEXA 65 format and beyond. These lenses present a fair amount of fall-off toward the corners reminiscent of Medium format portraiture to create an intimacy that feels natural and special. They combine flare-friendly coatings with sensational bokeh.

# Leitz Cine Lenses: Comparison Chart

	Leitz PRIME	Leitz ZOOM	Summilux-C	Elsie	Summicron-C	Hugo	M 0.8	Thalia
<b>Classification</b>	Performance	Performance	Performance	Character	Character	Legacy	Legacy	Legacy
<b>Image circle (mm)</b>	46.5 mm	46.5 mm	33 mm	46.5 mm	36 mm	43.3 mm	43.3 mm	60 mm
<b>Format coverage</b>	Super35	Super35	Super35	Super35	Super35	Super35	Super35	Super35
	Full Frame	Full Frame		Full Frame		Full Frame	Full Frame	Full Frame
								ALEXA 65
<b>Field Curvature / Illumination, Resolution Fall-Off:</b>								
- on S35	Flat	Flat	Flat	Very Mild (Illumination)	Very mild	Mild	Mild	Very Mild
- on FF	Flat	Very Mild		Mild (Illumination)		Moderate	Moderate	Mild
- on A65								Moderate
<b>Aperture / T-stop</b>	1.8	2.8	1.4	2.1	2	1.5	f/1.4 & f/2	2.2 - 3.6
<b>Focal lengths in set</b>	13	2	12	12	11	10	8	10
<b>Focal lengths (mm)</b>	18, 21, 25, 29, 35, 40, 50, 65, 75, 100, 135, 180, 350	25-75 / 55-125	16, 18, 21, 25, 29, 35, 40, 50, 65, 75, 100, 135	15, 18, 21, 25, 29, 35, 40, 50, 65, 75, 100, 125	15, 18, 21, 25, 29, 35, 40, 50, 75, 100, 135	18, 21, 24, 28, 35, 50, 50-N, 70, 90, 135	21, 24, 28, 35, 50, 50-N, 75, 90	24, 30, 35, 45, 55, 75, 90, 100, 120, 180
<b>Lens mounts</b>	PL	PL	PL		PL			PL
	LPL	LPL		LPL		LPL		LPL
						M	M	
						L		
<b>Close focus (ft / m)</b>								
at 18mm (or nearest)	1'2" / .35	on 25-75: 3' / .91	1'6" / .45	1'2" / .35	1' / .3	(21mm) 1' / .3	(21mm) 2'3" / .7	(24mm) 7.8" / .2
at 35mm	1'6" / .45		1'6" / .45	1'2" / .35	1'2" / .36	1'2" / .36	2'3" / .7	1'8" / .5
at 75mm (or nearest)	2'2" / .75	on 55-125: 3'5" / 1.05	2'6" / .79	2'6" / .75	2'7" / .8	2'6" / .75	3'3" / 1	(70mm) 1'8" / .5
<b>Metadata</b>	/i	/i	—	/i	—	—	—	/i
<b>Weight (lb / kg)</b>								
at 18mm (or nearest)	7.1 / 3.2	on 25-75: 8.2 / 3.7	3.6 / 1.6	5.3 / 2.4	2.9 / 1.3	(21mm) 1.85 / .84	(21) 1.1 / .51	(24mm) 3.1 / 1.4
at 35mm	6.3 / 2.87		3.6 / 1.6	4.4 / 2.0	2.9 / 1.3	1.78 / .81	.8 / .38	3.1 / 1.4
at 75mm (or nearest)	6.2 / 2.83	on 55-125: 9.7 / 4.4	3.5 / 1.6	4.4 / 2.0	2.7 / 1.2	3.09 / 1.40	1.3 / .57	(70mm) 2.3 / 1.0
<b>Made in</b>	Germany	Germany	Germany	Germany	Japan	Germany	Germany	Germany
<b>Front diameter</b>	114 mm	114 mm	95 mm	95 mm (most)	95 mm	95 mm	80 mm	95 mm
<b>Breathing</b>	None	None	None	Very Little	Very Little	Some	Some	Some
<b>Iris shape</b>	Round	Round	Traditional	Round	Traditional	Round	Scalloped	Round
<b>Flaring</b>	Controlled	Controlled	Controlled	Dynamic	Moderate	Moderate	Moderate	Dynamic



# Mounts and Adapters

## Lens Mounts

*Seth Emmons continues:*

Several Leitz cine lenses have user-swappable mounts. As cameras and formats continue to evolve, so do the design parameters and options for mounting Leitz lenses. We see a growing use of LPL mounts not only on ARRI cameras, but on Sony, RED and others. Leitz has embraced the creation of the LPL mount standard by ARRI. The shallower, wider LPL mount made the cine housing of the Hugo lenses possible and was used as the basis for the Elsie lenses design, saving size and weight while maintaining optical performance. Offering Leica's M mount and L mount for Hugo, and M mount on M 0.8, allow these already compact lenses to fit on even more compact cameras—giving productions more creative options for camera mounting and movement.

Format	Lens	PL	LPL	M	L
65mm	Thalia	X	X		
Full Frame	Leitz PRIME	X	X		
	Leitz ZOOM	X	X		
	Elsie		X		
	Hugo		X	X	X
	M 0.8			X	
Super35	Summilux-C	X			
	Summicron-C	X			

## Camera Mounts

Many professional cine cameras and almost all the smaller production-capable hybrid mirrorless cameras in the market today come with either user-swappable mounts or very shallow flange focal distances that allow almost any lens to be used with adapters.

Leitz has created a series of mounts and adapters to make it easier for crews to use Leitz cine lenses in different mounts on a variety of camera systems.

## Leitz Camera Mounts

<b>LPL Mount for Sony</b>	with /i metadata: VENICE, VENICE 2
<b>M Mount for ARRI</b>	ALEXA 35, ALEXA Mini LF, ALEXA Mini, AMIRA
<b>M Mount for Sony</b>	VENICE, VENICE 2

## Leitz Lens Mount Adapters

<b>LPL to PL Adapter</b>	with /i metadata
<b>L to PL Adapter</b>	for L Mount cameras: Leica SL2 / SL2-S,
<b>L to LPL Adapter</b>	SIGMA fp L, Panasonic S1H



Leitz Prime  
PL Mount  
also available in LPL



Elsie  
LPL Mount



Hugo  
LPL Mount  
also available in M or L

# Leitz LPL Mount for Sony VENICE 1 and 2



Sony VENICE 2 with Leitz LPL Mount attached (instead of the PL Mount that comes with VENICE)



Front view of Sony VENICE LPL Mount with LPL to PL Adapter, available from Leitz. Electrical contacts for *i* lens data are at 12 o'clock position, both for LPL and PL mount lenses.

Rear view of Leitz VENICE LPL Mount (this side attaches to Sony VENICE with six screws. Lens data contacts are at the 6 o'clock position.) Above right: rear of LPL to PL Adapter, showing PL lens data pass-through.



At left and right: side views of Sony VENICE LPL Mount and LPL to PL Adapter by Leitz.

If you are working with both LPL and PL mount lenses on Sony VENICE cameras, this combination is a big time-saver. The mounts are rock-solid. Your flange focal depths will not vary.





# Leitz Elsie



Leitz Elsie Lens	15mm	18mm	21mm	25mm	29mm	35mm	40mm	50mm	65mm	75mm	100mm	125mm	150mm
Aperture	T2.1	T2.1	T2.1	T2.1	T2.1	T2.1	T2.1	T2.1	T2.1	T2.1	T2.1	T2.1	
Close Focus (ft)	1'2"	1'2"	1'2"	1'2"	1'2"	1'2"	1'2"	1'8"	2'2"	2'6"	2'10"	4'2"	5'
Close Focus (m)	0.35	0.35	0.35	0.35	0.35	0.35	0.35	0.5	0.65	0.75	0.85	1.25	1.5
Horizontal angle of view, Full Frame, 36 x 24 mm	100.4°	90.0°	81.2°	71.5°	63.7°	54.4°	48.5°	39.6°	31.0°	27.0°	20.4°	16.4°	
Horizontal angle of view, Super35, 24.9 x 18.7 mm	79.4°	69.3°	61.3°	52.9°	46.5°	39.1°	34.6°	28.0°	21.7°	18.8°	14.2°	11.4°	
Weight (lb), approx		5.3	5.3	4.4	4.4	4.4	4.4	4.4	4.4	4.6	4.6	5.5	
Weight (kg), approx		2.4	2.4	2	2	2	2	2	2	2.1	2.1	2.5	
Front Diameter (mm)		114	114	95	95	95	95	95	95	95	95	114	
Length (in / mm)		6.3" / 160 mm											
Image Circle Diagonal	46.5 mm												
Lens Mount	LPL Mount (44 mm flange focal depth) with /i Technology and LDS-2 lens data												
Barrel Rotation	Focus: 270° / Iris: 51.45°												
Focus and Iris Gears	Matched locations for all focal lengths / 0.8 M gears												
Front Filter / Rear	M 92 mm x 1 mm screw-in: 25 mm - 100 mm; M 112 x 1.5 mm screw-in: 125 mm / Rear Net holder												
Focus scales	Quick change from Imperial to Metric—just flip the focus ring												
Iris Blades / Shape	The number of blades varies to match the look through all focal lengths   Circular through all stops												



# Leitz Hugo



Leitz Hugo Lens	21	24	28	35	50	75	90	50-N
Focal Length	21mm	24mm	28mm	35mm	50mm	75mm	90mm	50mm
Aperture	T1.5	T1.5	T1.5	T1.5	T1.5	T1.5	T1.5	T1.0
Close Focus (ft)	1'	1'	1'2"	1'2"	1'8"	2'6"	2'10"	1'8"
Close Focus (m)	0.3	0.3	0.35	0.36	0.5	0.75	0.85	0.5
Weight (lb)	1.85	1.9	1.83	1.78	1.9	3.02	3.04	2.45
Weight (kg)	0.84	0.86	0.83	0.81	0.86	1.37	1.38	1.11
Length (in / mm)	2.7"	2.7"	2.7"	2.7"	2.7"	4.4"	4.4"	3.2"
Length (mm)	68	68	68	68	68	112	112	82

Image Circle:	43.3 mm
Lens Mount:	LPL, Leica M, Leica L Mounts
Front Diameter:	95 mm
Front Filter:	M 92 mm x 1 screw-in
Gear Rings:	Matched locations for all focal lengths
Focus Rotation:	270°
Iris Rotation:	70.5° (except 50-N rotates 81°)
Focus Scales:	Imperial or Metric, easily swapped
Iris:	11 Blades, Circular Shape



Hugo 50mm T1.5 and 50-N T1.0



## “Shoot wide open, no excuses”



Peter Karbe, Leica Camera AG Senior Managing Expert Optics and Platform/ taken with Leitz Hugo wide open at T1.5, no excuses.

Leica optical designer Peter Karbe presented a lecture on optics.

“The properties of the Leica M-Lenses are compactness, light intensity, imaging performance and robustness. Each of these aspects has specific design requirements. We also try to design for the best performance with the fewest number of optical elements possible. We try to minimize aberrations and avoid ‘nervous backgrounds’ that accumulate as you add more elements. The backgrounds have pleasing bokeh.”

Peter Karbe trained as a photographer before studying physics and optics at university. When he started work at Leica Camera, he studied old designs. “The design process is evolutionary, not revolutionary,” he said. “Along the way, we implemented floating elements, aspheres and new ideas.”

Peter’s comments at the Leitz barbecue, during several lectures and an interview on the Leica Camera Blog are summarized here:

“Sometimes [there are] contradicting design requirements. Lens speed and compactness, for example, are opposing concepts. To design faster lenses, you need more lens elements, but more lens elements means larger optical systems. Such challenges force us to look for solutions that didn’t exist before.

“The performance must not only be there theoretically, but the M-Lens has to deliver it in practice. A lot of manual work is

necessary for that, and a lot of know-how considering lenses and lens production. This is how we ensure the high level of performance, the tolerances and, above all, the durability of the M-Lenses. It is a fact that you can still use lenses easily that were on the market 65 years ago. We also have special production processes for the glass as it requires special care to manufacture these lens elements. The glass elements that are processed are very sensitive and must be handled with particular care. And this degree of care is simply not possible under time pressure.

“My inspiration partly comes from the fact that I take a lot of photos myself. Not in order to exhibit my images, but to try out where the strengths and weaknesses of our optical systems are. A lot of inspiration also comes from the feedback of our customers. We are always looking for answers that enable us to meet their wishes and at the same time correspond to our values.”

“Shoot wide open, no excuses,” Peter said. And so I did, all wide open “with a wrench” at T1.5 on the Leitz Hugo lenses.

To see how Hugo lenses look, here are some portraits, on the following pages, taken with 90mm and 75mm Hugo primes on a Leica SL2-S and SIGMA fp L with the Leitz L to LPL Mount Adapter. Hugo Primes have a familiar look—from 100 years of Leica photography and 70 years of M lenses. I hope my enthusiasm shines through.

## HUGO 75mm and 90mm: Eyes Wide Open at T1.5



Laurie Rose, BSC (above). Tom Stern, ASC, AFC (below)







Salomé Rapinat, Cinematographer (above). Gavin Finney, BSC (below).



## As seen with Hugo at T1.5



Rainer Hercher, Leitz Managing Director and Lena Krause, Cinematographer (above). Tommaso Vergallo, Key Account Manager, Leitz (below).







Laura Kaufmann, Leitz Marketing Manager (above). Balazs Bolygo, BSC (below).





Stephan Schultz, Head of Product Management, Leica Camera (above). Christine A. Maier, BVK, AAC (below).







Peter Karbe, Senior Managing Expert Optics and Platform, with Leitz Managing Director Raimund Bayer (above). Jean-Noël Ferragut, AFC (below).



As seen with Hugo at T1.5



Seth Emmons, Leitz Director of Communications (above). Florian Bode, Development, Leitz (below).







Po Liu, Leitz Regional Sales Manager Greater China (above). Robert Höft, Leitz Customer Care (below).





Lisa de Carvalho, Leitz Customer Care (above). Uli Schröder, Leitz Process Planning/Technology (below).







Kevan Parker, Leitz Regional Sales Manager EMEA, India (above). Ben Ross, Leitz Regional Sales Manager Americas (below).



# SLATE from Tribe7



Alfred Hitchcock holding up a clapperboard on the set of *Psycho*, January 29, 1960. Photo by Hulton Archive/Getty Images.

Clapperboards haven't changed much since *Psycho*.

Call it a clapperboard, clap sticks or slate — filmmakers always had to identify scenes, takes and tests. Like a school blackboard, you used chalk to mark it up. Mischievous clapper-loaders could annoy with the same “grima” screeching of fingernails.

Acrylic and Dry Erase markers came next. The resounding mechanical clap was the definitive call to action that has endured as an unflinching start mark when timecode failed or clocks drifted.

Leave it to the team at Tribe7, innovators of Blackwing7 lenses, to come up with a new, exciting and innovative SLATE. It has familiar sticks that clap (heads or tails) and a board to mark with Dry Erase pens. But this is no ordinary writing surface.

SLATE has an e-paper display similar to a Kindle. Instead of a board with pre-engraved lettering or custom graphics that have to be ordered in advance, graphics and template text on SLATE can be changed immediately.

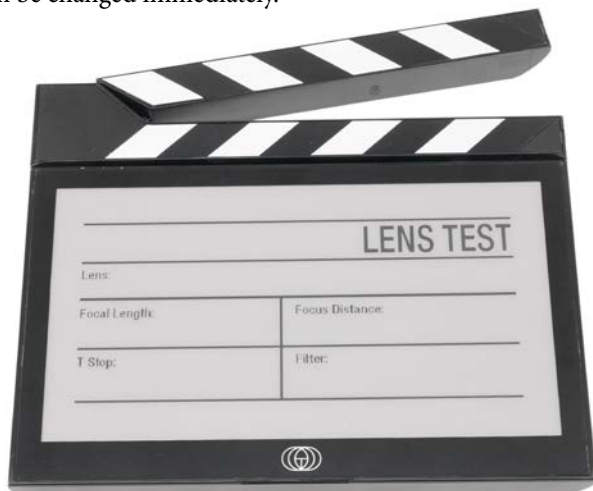

It works like this:

1. Load the SLATE app (iOS or Android) onto your smartphone. I have an iPhone, so we'll use it as the example.

2. Design your SLATE layout with any graphics app (e.g. Photoshop, Illustrator) or sketch it out on paper and shoot it with your smartphone. Save it as a .jpg file.

Load the image into Mac Photos or your Android collection.

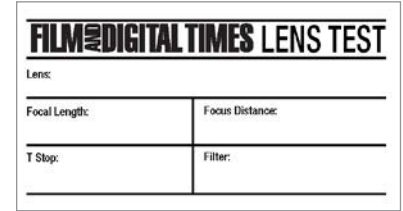

3. Open the SLATE app on your smartphone and select an image or one of the default, pre-loaded templates.

To load a new image, tap the + icon at the lower right side of the screen.



4. Now, select an image or graphic from your photo library.



5. An edit screen opens in the app. You can resize, rotate, crop or zoom. Click DONE when happy.





# SLATE from Tribe7



6. That takes you to the next screen where you can adjust dithering and contrast (black/white threshold).

Be sure to give the image a name; otherwise it will not be saved. Click the SHARE icon at the upper right of the screen to save it to the SLATE app's library of images.



Photo of SLATE by Tribe7 taken with Blackwing7

12. Each compact, programmable, 7.5" SLATE with black & white sticks and carry pouch comes in a thoughtfully designed box and starts shipping around the end of November.

You can order online at [blackslate7.com](http://blackslate7.com)

Distributors will be announced in the coming months.



7. Your phone's built-in NFC (near-field communication) will transfer the image from phone to SLATE.

This is the same technology used in Apple Pay and other contactless payments. The NFC antenna of recent iPhones is at the top right edge.

Hold your iPhone on the front or back of SLATE's center area.



8. If you don't get a 100% DONE confirmation, move the phone around for a better NFC connection.

Now your SLATE is ready to go.



9. Write the scene, take and camera settings directly on SLATE with a Dry Erase marker. As with any clapperboard, do NOT use an indelible Sharpie unless you are ready to keep these notes forever. Upload SLATE with new images or templates whenever you like.

10. SLATE is built with tough ABS polymer and a hard-coated anti-glare screen. It is self-powered. There are no on-off switches, batteries or cables. SLATE is always on and never requires charging. Its internal lithium battery should last 7 years.

11. SLATE offers self-adhesive color-chart-accurate labels that stick to the sticks as well as replacement black & white ones.



# Cooke Varotal/i FF T2.9 Full Frame Spherical Zoom Lenses





# Cooke Varotal/i FF T2.9 Full Frame Spherical Zooms



Cooke is back with more zoom lenses.

Two new Cooke Varotal/i FF Full Frame zoom lenses were introduced in November 2021 and released earlier this year: 30-95 mm T2.9 and 85-215 mm T2.9.

And now, the duo becomes a trio. Please welcome the Cooke Varotal/i FF 19-40 mm T2.9.

They all have:

- PL or LPL mounts.
- Aperture range: T2.9 – T22.
- 114mm front diameters.
- 112mm front screw-in filter threads.
- Maximum image diagonal coverage of 46.3mm Ø.
- 280 degree rotation of focus scales.
- 48 degree rotation of iris scales.
- Industry standard M0.8 lens gears.
- Cooke /i Technology lens data contacts in lens mount and 4-pin connector.
- Familiar Cooke barrel, gearing and style.

They look like Cooke, not only the images captured, but also the familiar hardened, shiny black anodized barrel, with uniform gearing and style.

Skin tones appear smooth and cosmetically gentle. They are compact, rugged and convenient for the current crop of smaller Full Frame cameras. These latest Varotals complement Cooke S7/i T2 and Cooke S8/i T1.4 Full Frame primes.

These things seem to go in cycles. Horace W. Lee designed the legendary Cooke Speed Panchros a century ago, in 1921.

Fifty years later, in 1971, Cooke introduced the 20-100 mm T3.1 Varotal zoom, designed by Gordon H. Cook.

Primes returned in 1998 with Cooke S4.

Cooke's 16mm format CXX 15-40mm T2.0 came in 2006.

More primes followed.

And now, there are new Cooke Varotal/i FF zooms.

Then why would you want a new zoom when you have primes?

It might be a creative reason—you might want to do a gentle push in as the actor reaches a dramatic moment, as we have done, using a Preston Microforce attached to the fluid head handle.

You might want to hide a dolly move with an elegant widening of focal length.

You may be on a screaming streaming series with forty setups a day and even quick lens changes add up to an extra hour of time that could be saved by zooms that make you the hero of the day.

If you hear someone on set muttering that modern zooms are not as sharp as primes, just ask them to imagine the Varotal/i FF series as Zoomable Primes.

## Zoomable Primes

The original Cooke Varo-Panchro 20-60 T3.1 introduced in 1981 may remind you of the new Cooke Varotal/i FF 30-90 T2.9. (Divide focal lengths by approximately 1.4 for the FF-to-S35 conversion.) The 35mm format Varo-Panchro was heralded as having the optical performance similar to a prime. And it didn't breathe.

The new Cooke Varotal/i FF Zooms can work as "Zoomable Primes" when you don't have time for lens changes.

And, you get the advantage of more focal lengths than ever could fit into a single lens case.

# Cooke Varotal/i FF T2.9 Full Frame Spherical Zooms



left side



top



right side



# Cooke Varotal/i FF T2.9 Full Frame Spherical Zooms



Cooke Varotal/i FF Spherical Zoom	19-40mm	30-95mm	85-215mm
T-Stop range	T2.9 - T22	T2.9 - T22	T2.9 - T22
Angular rotation of iris scale	48°	48°	48°
Min. marked object distance	0.6 m 2 ft	0.8 m 2 ft 8 in	1.5 m 5 ft
Close focus from lens front	320 mm 1 ft 1 in	500 mm 1 ft 7 in	1,000 mm 3 ft 3 in
Angular rotation to MOD endstop	280°	280°	280°
Angular rotation of zoom	103°	112°	100°
Length from front of lens to lens mount	228 mm 9 in	255 mm 10 in	255 mm 10 in
Maximum front diameter	114 mm 4.5 in	114 mm 4.5 in	114 mm 4.5 in
Total weight (with lens mount)	3.5 kg 7.7 lbs	4 kg 8.8 lbs	4 kg 8.8 lbs
Front sScrew-in filter	M112.5 x 0.5	M112.5 x 0.5	M112.5 x 0.5
Maximum format coverage	46.3mm Ø (Full Frame, VV and beyond)		
Focus scales	Imperial or Metric scales marked from infinity to MOD. 19-40 focus scale 0.6m/2' to infinity 30-95 focus scale 0.8m/2'8" to infinity 85-215 focus scale 1.5m/5' to infinity		
Focus, iris, and zoom drive gear	0.8 metric module		
Iris scales	Two opposing linear T scales - whole and third stops marked		
Lens mount	PL or LPL		



19-40



30-95



85-215

## Cooke Varotal/i FF Focal Lengths: 19-40, 30-95, 80-215 mm



19-40 at 19mm

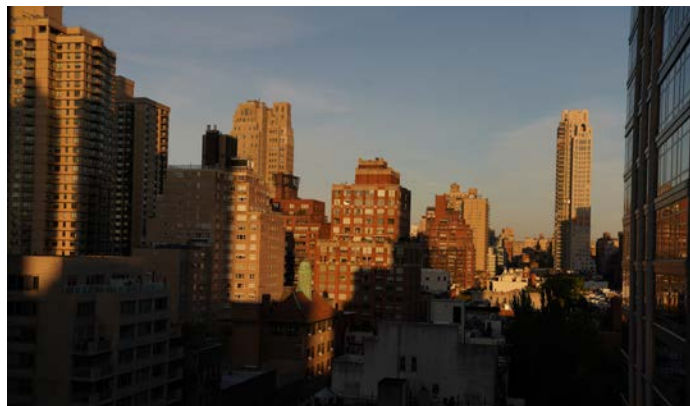

19-40 at 40mm

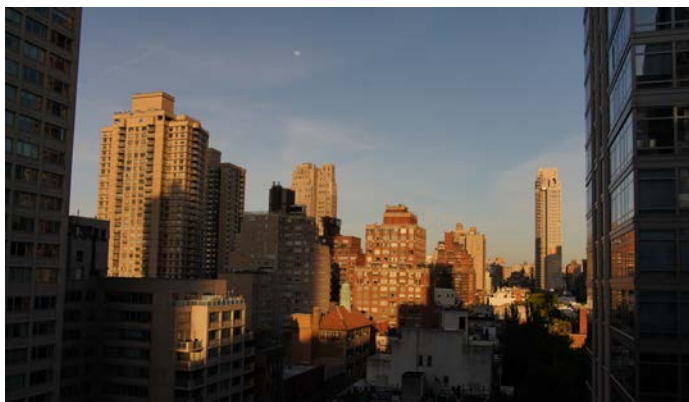

30-95 at 30mm

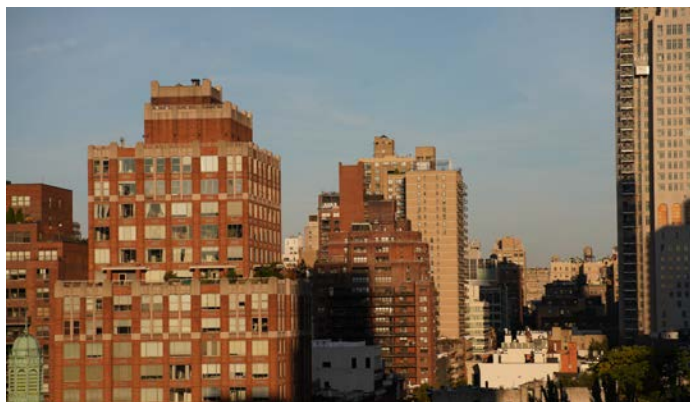

30-95 at 95mm

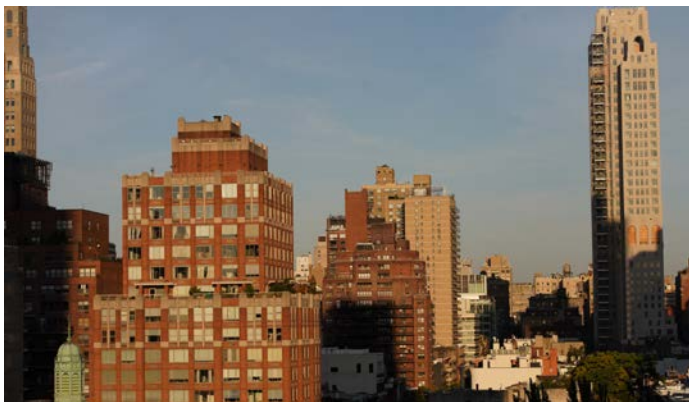

85-215 at 85mm



85-215 at 215mm

## Cooke S8/i and Varotal/i FF Size Comparisons





# We took a Look at Cooke Varotal/i FF in Industry City



Geoff Smith grading at FDTimes on DaVinci Resolve Studio.

Cooke's Chief Marketing Officer Danny Haikin was nattering on the dog 'n bone (phone): "Under your eternal NDA, we're introducing the new Cooke 19-40 Varotal/i FF. Could you have a look?" A few days later, the lens arrived. It came, I saw, I commented. "Danny," I said. "It's vibrant. Vivacious. Images are almost three-dimensional."

Danny said, "Vivacious? That's a new one. You wouldn't let me use the word 'organic' in the FDTimes write-up of our S8/i. You insisted on 'film-like.' But now, 'vivacious?'"

"Well, well, well," I sputtered. "We may be running low on words, art galleries, wine tastings or food allusions to describe these vivacious, vibrant Varotal/i zooms."

Danny replied, "I like the alliterative V. But if a picture is worth more than all the V letters you can muster, how about a video with all three Varotal/i zooms? But please, no models with bad makeup. No fairy lights bokehing in the background or flash-lights flaring from the front. Something serious. Not the hilarious spoof Cine Lens Test directed by Ben Siow and Kelvin Chew. And spare us a remake of the Omar Sharif riding toward camera shot in *Lawrence of Arabia*."

Faster than you could say "The Hunting of the Snark," with apologies to Lewis Carroll:

The crew was complete, it included an AC—  
A Gaffer mainly for negative fill—  
An AD, brought to arrange their disputes—  
And a Broker to insure their goods.

## Took a Look at Cooke Varotal/i FF Zooms

FDTimes looked at Cooke Varotal/i FF Zooms on VENICE 2 at Industry City, in Brooklyn, NY. You can see the 4K video at:

[youtu.be/zF-5mThr0j0](https://youtu.be/zF-5mThr0j0)  
[vimeo.com/766754992](https://vimeo.com/766754992)

## Full Frame Faces

The idea was to focus on faces, since so much of what we do is all about the faces of actors and actresses and real people. These are Full Frame lenses—so that meant a Full Frame camera with the widest range of internal NDs because I love to shoot wide open. We wanted the lenses unadorned, without filters. Skin tones appeared beautifully smooth and gentle when captured on the latest 8K sensor and delivered in 4K.

We looked at 19-40, 30-95 and 85-215 Cooke Varotal/i zooms on the latest Sony VENICE 2, recording 8.2K 17:9 DCI at 24 fps. I assembled the rough cut with music on DaVinci Resolve Studio. Corey Abel did the final cut on Adobe Premiere, which made the round trip back to DaVinci Resolve Studio for grading and delivery.

AbelCine Camera Technology Specialist, DIT and colorist Geoff Smith notes: "For grading, we only used native tools in the Studio version of Resolve 18.0.4 – lift, gamma, gain, offset, curves, color temperature, etc. Color management was performed 'manually' with Resolve FX Color Space Transforms applied pre- and post- the clips in a group (a 'CST sandwich'). The first CST node (in 'Group Pre-Clip') converts from Sony S-Log3/S-Gamut3.Cine to DaVinci Intermediate/DaVinci Wide Gamut and the second CST converts from DaVinci Intermediate/DaVinci Wide Gamut to RecC709 (i.e. an output transform). The idea is that one should be able to change the output target in the second CST to another OETF (e.g. ST.2084 PQ/P3-D65) and observe/trim the grade on an appropriate display (such as a BVM-X300 or BVM-HX310) without re-grading from scratch. The Color Management tab in Project Settings should be set to DaVinci YRGB (the default) rather than either DaVinci YRGB Color Managed or an ACES flavor."

## The List of Thanks is Long:

AbelCine for production services, equipment and locations. Pete Abel for his enthusiasm and generous support of this production. Pete and Rich Abel for starring roles in the film. Eric Johnston, Cooke Director of Business Development for organizing the Varotals and taking the BTS photos. Tanya Lyon, Sony Marketing Communications Manager—Cinema Division, and Paul Healy, Business Development at Sony, for diverting a VENICE 2 to our 1-day prep / 1-day shoot.

Locations were all within Industry City, a vibrant, creative community with more than 500 businesses, including media and technology companies, art studios, sports facilities, restaurants, bars, and shopping in 16 massive buildings on the Brooklyn waterfront.

AbelCine's huge windows provided beautiful available light for a large cast of AbelCine staff who patiently endured available props, butterflies on their noses, and bad jokes to make them grin. Moore Brothers Wine Company is across the street from AbelCine. The store is chilled to wine-cellar 55 degrees, so wear a jacket while you browse their vast selection of wines from small-family estates in France, Italy, Germany, Spain, Argentina, and the United States. Christophe Pourny Studio is one flight upstairs, with *Travaux En Cours* woven hats and all manner of French furnishings, home goods, soaps, chefs aprons, books and designer tote bags.

## Crew:

Director/Cameraman	Jon Fauer, ASC
Focus Puller/AC	Tom Kane
DIT:	Geoff Smith
Tech Services Supervisor	Avery Venable-Turner
Gaffer	Ross Faccio
Production Coordinator	Nastasia Avrutin
Production Services	Megan Donnelly

# BTS: Cooke Looks at Industry City

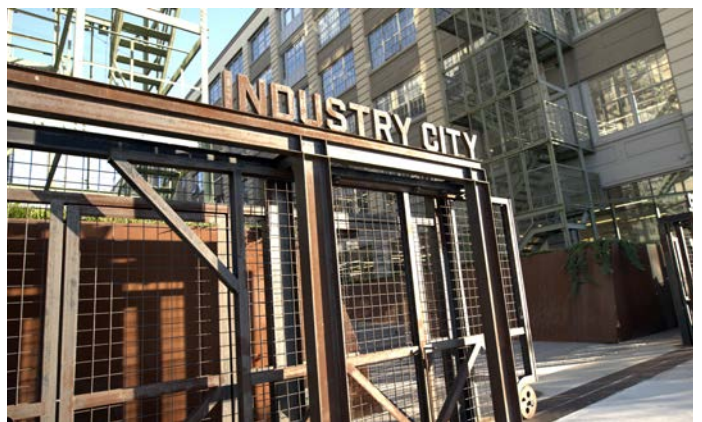

BTS Photos by Eric Johnston taken with 32mm & 40mm S8/i on a7S II with PL mount



## Framegrabs: Cooke Looks at Industry City



# Cooke Looks at Industry City





## Cooke Looks at Industry City



# Cooke Looks at Industry City





# Cooke Looks at Industry City



# Cooke Super35 Varotal Zoom Lens History



## 1932. Cooke Varo 40-120mm Variable Focal (Zoom) Lens.

Arthur Warmisham was the optical designer (British patent 398,307) of one of the first commercially manufactured variable focal (zoom) lenses for cinematography. The Cooke Varo 40-120mm cine lens for 35mm format was assembled and sold by Bell & Howell. It came equipped with a special cradle that held the Varo lens and the camera together to ensure correct alignment. Focal length was changed by rotating a crank.



Cooke Varotal 20-100 T3.1 Photo by Contrast Cine.

## 1971. Cooke Varotal 20-100mm, f2.8 / T3.1 Zoom.

Designed by Gordon H. Cook, this was Cooke's first high-quality zoom lens for 35mm motion picture cameras. Its design remained central to the concept for Cooke zooms produced through the 1990s. It had a sealed front focus unit and fixed front element that eliminated the risk of dirt and moisture being drawn into the lens, did not rotate or trombone in and out, and allowed for convenient fitting of a mattebox. It had anti-reflective wide-band Varomag high-performance coatings. This increased shadow area definition, light transmission, durability, and reduced ghosting and flares. Originally fitted with an ARRI bayonet mount, most now have a retrofit PL mount (developed by ARRI in 1982).

**The Cooke Varotal is the first motion picture zoom lens not to be designed on the principle of a bicycle pump.**

Cooke ad courtesy of ASC Magazine and Cooke Optics.

## 1975. Cooke Cine Varotal 25-250mm f2.8 / T3.1 Zoom.

Cooke's first 10:1 long range zoom lens for 35mm.

The print magazine headline by Alastair Riach, Cooke's great ad-man at the time, was, "The Cooke Varotal is the first motion picture zoom lens not to be designed on the principle of a bicycle pump."



Cooke Varopanchro 20-60 T3.1. Photo by Cine Lens Manual.

## 1981. Cooke Varo-Panchro 20-60mm T3.1 Zoom.

The concept was optical performance comparable to prime lenses. This was my first Varotal on a brand-new Arriflex 35-BL3, a young Jon Fauer and a young Tom Cruise on *All the Right Moves* in 1983. Mud, rain, night exterior, and lots of low angles in the mud. Tom Stern, ASC, was the gaffer, ringing the stadium in Johnstown, PA with lots of Musco lights but we were still wide open with a wrench at T3.1.

The Varo-Panchro was unique. It was the first zoom I had ever seen that didn't breathe. You could rack focus from a close-up low angle to the far-away crowd and the image did not shift. And because of all the mud and rain, changing prime lenses was not practical. Its 3x zoom range covered wide to mid-range. And so, the Varotal worked as a zoomable prime, not because we didn't want to zoom but because we didn't have time to use primes.



# Cooke Super35 Varotal Zoom Lens History



**1983. Cooke Cine Varotal 25-250mm T3.9 Mark II Zoom.**

There were 2 versions of the Mk II 25-250: focus barrel in front, and zoom in front with focus at the rear (early Panavision style).

**1986. Cooke Wide Angle Varotal, 14-70mm T3.1 Zoom.**

During the development stage in the mid-1980s, customers' input prompted the company to incorporate a curved front cover glass and a noise isolator. This lens was unique in the zoom series because it included a wide angle aspheric element.



**1987. Cooke Varotal 18-100mm T3 Zoom.**

Design was initiated at the beginning of 1987 and the lens was exhibited for the first time at Photokina in 1988. It included refinements prompted by suggestions from cinematographers and camera operators. It became very popular.



**1992. Cooke Cinetal 25-250mm T3.7 Mark III Zoom**

**1998 - 2021. Zoom Time Out.**

Cooke stopped building 35mm cine zooms by around 1998 (with the exception of the short and fast 15-40mm T2.0 CXX S4i in 2006 and a video camera version of the 18-100).

**2021. Cooke Varotal/i Full Frame 30-95 and 85-215 T2.9 Zooms.**

Cooke introduced Full Frame 30-95mm T2.9 and 85-215mm T2.9 Varotal/i FF Zooms in November 2021.

**2022. Cooke Varotal/i FF 30-95 T2.9 and 85-215 T2.9 Zooms.**

Cooke introduces Full Frame 19-40mm T2.9 Varotal/i.

Cooke Varotal Zoom Lens	Aperture	Minimum Focus	Front Diameter	Length from image plane	Weight kg (lb)
Cooke 14-70 Varotal	T 3.1-22	2'3" (.7 m)	191 mm	16" (406 mm)	12.75 lb (5.8 kg)
Cooke 18-100 Varotal	T 3-22	2'3" (.7 m)	150 mm	14½" (370 mm)	13.5 lb (6.1 kg)
Cooke 20-60 Varopanchro	T 3.1-22	2'1" (.63 m)	116 mm	11" (280 mm)	4.8 lb (2.2 kg)
Cooke 20-100 Varotal	T 3-22	2'3" (.7 m)	144 mm	14½" (370 mm)	9 lb (4 kg)
Cooke 25-250 Mk I Cine Varotal	T4 - 22	5'6" (1.7 m)	124 mm		11.5 lb (5.2 kg)
Cooke 25-250 Mk II Cine Varotal	T 3.9-22	5'3" (1.6 m)	121 mm	13¾" (350 mm)	9.2 lb (4.2 kg)
Cooke 25-250 Mk III Cinetal	T 3.7 - 22	5'6" (1.7 m)	150 mm		10.5 lb (4.8 kg)

## Fabian Weston, Protists and Pocket Cinema Cameras

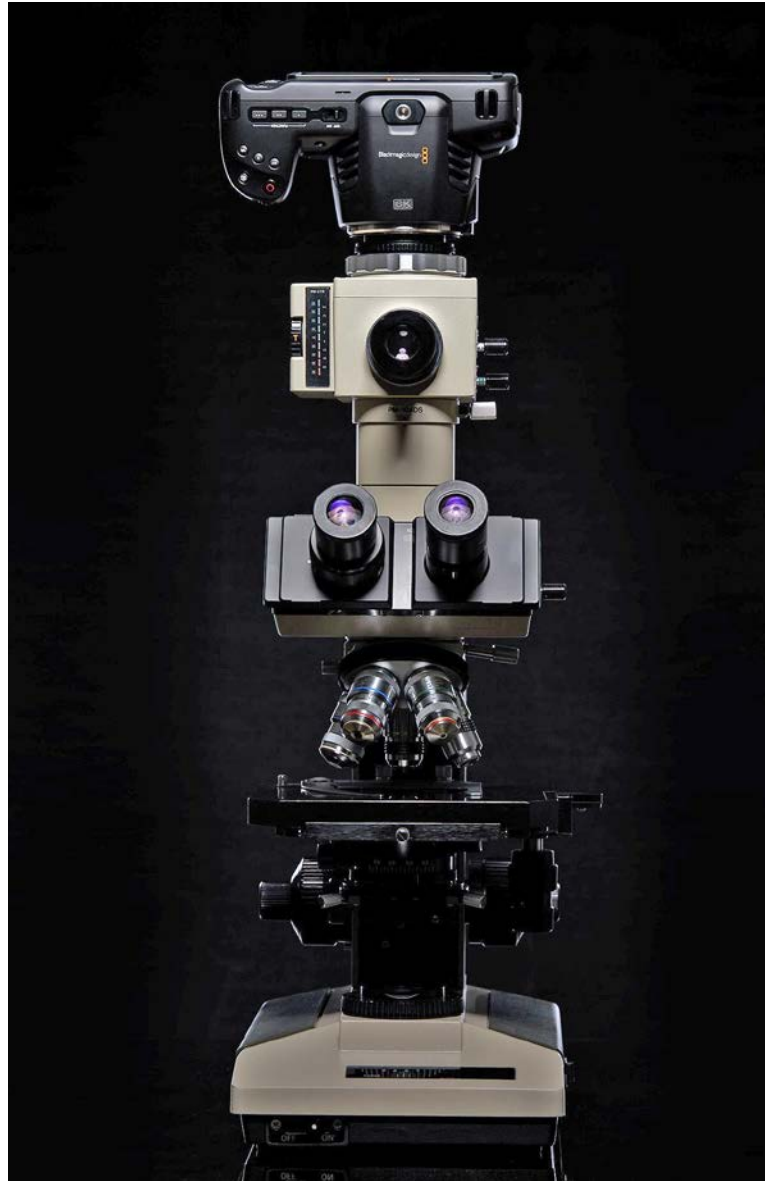

Meet Fabian Weston and Protist Lab Films. This story began with an email from Blackmagic Design's Stephanie Hueter. It got my attention:

*Protists are single-celled eukaryotic organisms that are not animal, plant, fungus, bacteria or virus. Most people know them as algae and protozoa.*

*The founder of Protist Lab Films, Fabian Weston from Australia, built an innovative 6K camera setup mounted to a microscope using a Blackmagic Pocket Cinema Camera 6K to capture microscopic single celled Protists, some of the Earth's smallest and most ancient creatures. The videos are edited and graded using DaVinci Resolve editing, color grading, visual effects (VFX) and audio post production software. The end goal of Protist Lab Films is to generate awareness of the little-known Protist kingdom.*

*Protist Lab Films is run by former lab technician and sound engineer Fabian Weston. After 25 years as a sound engineer and music producer working with some of Australia's best musicians, engineers and producers, including the famous Albert Studios, Weston returned to his passion for microscopy and the fascinating*

*creatures that microscopes reveal.*

*Weston started Protist Lab Films a few years ago with an old microscope and his smartphone camera. He was familiar with Blackmagic Design from his years in the music and entertainment industry. After an industry friend recommended Blackmagic Design, Weston began looking at its extensive catalog of options. He soon discovered the extent to which both hardware and software from the Melbourne based company could assist him in his work at the microscope.*

*Since the beginning of 2022, Fabian has been using the Pocket Cinema Camera 6K to capture the amazing world of these tiny creatures. He created a unique custom setup to connect his microscope directly to the Pocket Cinema Camera 6K. After capturing the images in Blackmagic RAW, footage is edited and then graded using DaVinci Resolve. For the final touch, drawing on his talent as a musician and music producer, he adds a custom soundtrack to some of the films before publishing the videos on the Protist Lab Films YouTube channel.*

*[youtube.com/channel/UCShLhIReMWZSe1xZI2E2pWQ/videos](https://youtube.com/channel/UCShLhIReMWZSe1xZI2E2pWQ/videos)*



# Fabian Weston, Protists and Pocket Cinema Cameras

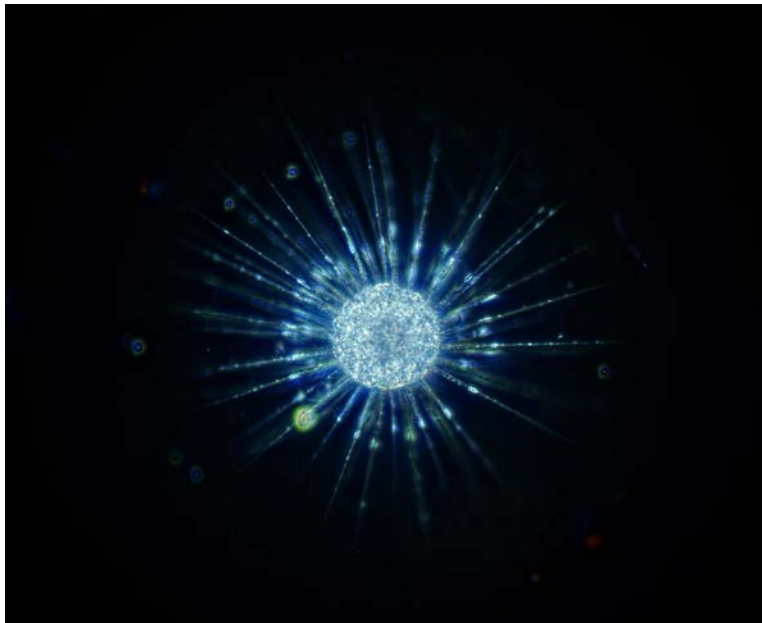

*Actinophrys*—a Heliozoan Amoeba. Framegrabs by Protist Lab Films.

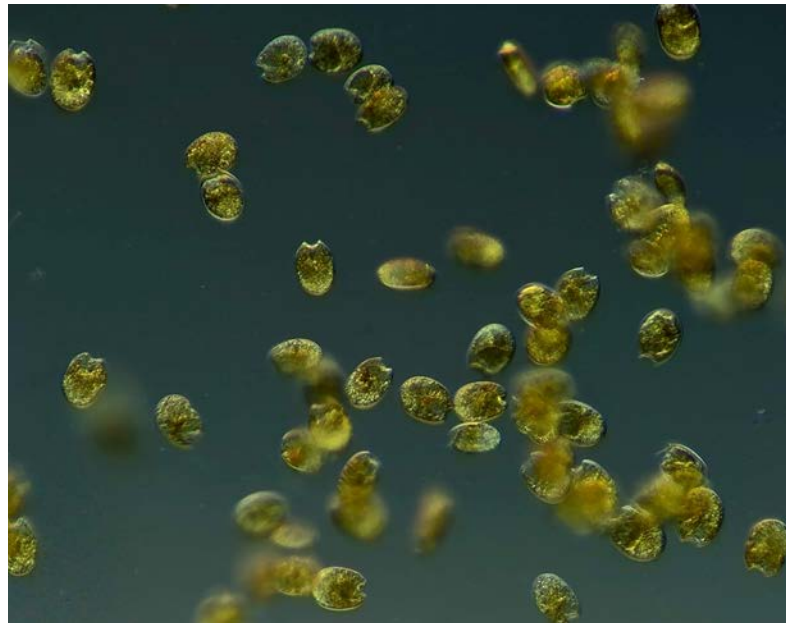

*Prorocentrum* — a Toxin Producing Dinoflagellate.

*“It’s an unbroken end-to-end process, and it’s just great to work within the single domain. Plus, the tech support is lightning fast. Blackmagic Design has definitely made the whole workflow very easy and smooth,”* Weston said.

*He was awarded first place in Nikon’s 2021 Small World in Motion Competition for a film documenting Protists living in the guts of common Australian termites.*

*“Very few people are making music from scratch and putting it to footage of microscopic organisms, so what I’ve been able to achieve so far is something that is both unique and engaging. I’m a big fan of Blackmagic Design’s philosophy and industry focus, and I’m sure people like me will continue to use its gear for new and wonderful projects in the future too,”* Weston concluded.

I wanted to learn more. We connected on Zoom.

## **Jon Fauer: Wasn’t it Antonie Van Leeuwenhoek who called microscopic creatures ‘wee beasties’?**

Fabian Weston: Yes, though he was referring to something else and not these particular creatures. He is credited with being the first person to make us aware of microscopic organisms. He had a crude little microscope and started the whole thing of microscopy into the 17th century.

It would have been the equivalent of having landed on an alien planet about 400 years ago and trying to figure out all the alien creatures. There’s so much still to learned about life of Earth at that level, and much we still don’t know. We’ve learned a lot but there’s a planet full of creatures waiting to be discovered.

## **Especially in Australia where you have all kinds of weird and scary creatures?**

Australia is raw with a unique biology for sure. Not the case with microbes. They are spread across the whole world, and what I find here, you’ll find anywhere in the world. They’re everywhere in all water. This is the difference with microbes, compared with larger macro creatures. There are a few rare endemic protists, but

generally these creatures are considered to be cosmopolitan. I did find a rarely seen Australian endemic protist recently, *Neotessella volvocina*. An exciting find. Discovered in 1917, then not seen again until 1985 and by myself in 2021 and 2022, capturing wonderful video documentation with the camera.

## **How did you start in the world of microorganisms?**

I grew up north of Sydney, Australia. Beach and cows, bush and horses. When I was a boy of 11, I got a microscope for Christmas and it all started there. Earlier, I was an astronomy fanatic. I had a telescope and binoculars. I’d sneak out in the middle of the night and just stare at the stars. But when I got a microscope, I went the other way, looking downwards. I was fascinated by the macrocosm and then the microcosm took over. My other growing passion was music and audio technology.

## **How did Protist Film Labs begin?**

With passion and a vision. I had my iPhone clamped to a microphone stand pointed down the microscope eyepiece when I started. I’m very particular and I like things to be just right. That drove me to get a better microscope. I sold some of my audio gear and reinvested in optics. At the moment, I use Olympus BH and BH2 series microscopes. I like the BH series in particular; it is solid and as old as me. Used with a range of high quality Zeiss and Olympus objective lenses.

## **How did you attach the Blackmagic Pocket Cinema Camera 6K to the microscope?**

My microscopes are from the ’70s and ’80s. They have a series of photographic attachments for old Olympus 35mm still film camera with an Olympus OM mount. My issue, of course, was that it needed to fit the EF Mount of the Pocket Cinema Camera. I DIY converted an old 35mm camera adapter with an EF mount, a helicoidal ring and epoxy. There’s a photo projection lens inside the tube that projects a focused image from the objective to the sensor. It has a 1.67x magnification factor to fit the image circle around the border of the sensor neatly.

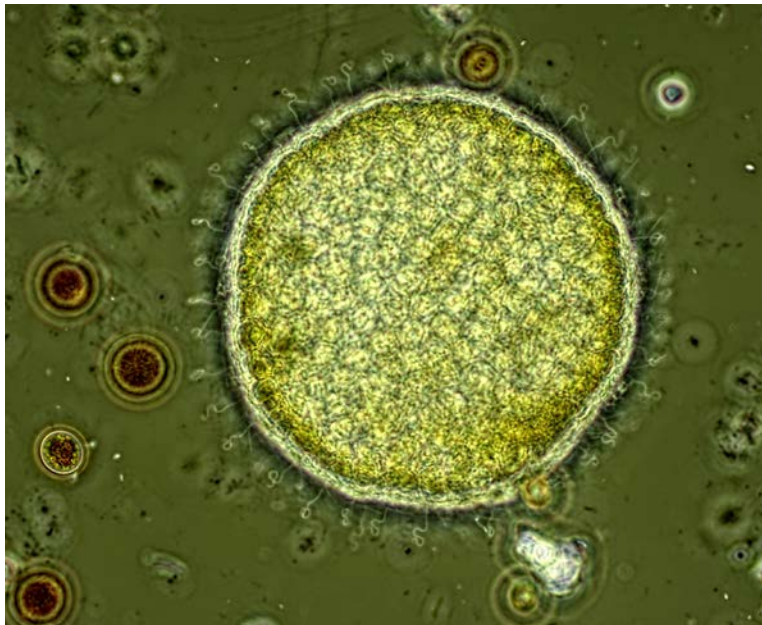

An extremely rare colony of *Neotessella volvocina*.



*Frontonia* — a Ciliate Protozoan.

## Is there a beam splitter?

There is a push/pull lever system. I can pull it out halfway and it'll send 80% of the image to the camera and 20% to the eyepieces. Or, I pull it all the way out and it's 100% to the camera, nothing to the eyepieces. This is the filming setting.

## How do you achieve the beautiful, dark backgrounds in your shots?

It's an illumination technique called dark field. Instead of shooting light straight up through the specimen and into the objective, it's being bounced off a mirror to light the specimen from an angle. The effect is that the light from the lamp doesn't enter the objective lens, thus giving a black background and filling the objective lens with scattered light from the specimen only.

## Is this scattered light like a flare?

No. That's the actual creature. All the light you see there is scattered light from the *Actinophrys*.

## What magnification do you typically use?

Magnification choice depends on the subject being filmed. What matters is the resolution and the objectives' ability to resolve one point from another. You may see a single speck but can the objective reveal that it's a single speck or is it really two points that are so close together that the objective only sees one? That's where the objective's numerical aperture and the resolving power of the microscope come into play.

There's two aspects to the objective, it's magnification and it's numerical aperture (NA). NA is its ability to resolve visibly separate points from each other. Resolution is crucial because light microscopes by nature approach the limit of resolution using light waves.

**I'm trying to remember microscopes in biology class. You don't talk in terms, as in macro photography, such as 2 times the actual image size?**

If I use a 10 times objective and my eyepiece is magnifying 10 times, then 10 times 10 is 100. Yes you're magnifying 100 times, but that's only relevant to human eye observation. This means it's relative to the object being 100 times closer to your eye but in focus and resolved. But when it comes to a camera, that's all thrown out the window. No longer are we dealing with projection to the eyes. It is a recorded medium that can be displayed on any size screen, therefore magnification depends on viewing display size.

In photomicrography it's about a sensor or film. What's relevant is the NA of the objective used, what projection lens you project the image with and Nyquist considerations. The best thing is to actually put a measure bar on the video so that you can get an idea of size.

## How do you control exposure in the camera?

I set the ISO as low as possible, starting at 100 if I can get away with that because I just don't want any noise and use as bright a light source as possible. The microscope has a 100 Watt halogen light source that gets quite hot. Prior to the light hitting the specimen, there's an IR/UV filter fitted.

## So exposure depends on light intensity. You have a dimmer?

Using the dimmer on a halogen lamp causes color change. I use ND filters instead if needed. It's different from what would normally be done. As a cinematographer, you'd put the ND on the lens, but microscopists use ND filters in a different way—it's the light source that gets the filter, not the lens.

When I'm using polarized light, there's quite a bit of light extinction. I might have to crank the ISO up at the expensive of noise. I can deal with the noise effectively in DaVinci Resolve in post but the Pocket Cinema Camera is fabulous; there is very little noise in the signal. The dual ISO is a real winner for me at the microscope.

## Why did you choose the Blackmagic Pocket Cinema Camera?



# Fabian Weston, Protists and Pocket Cinema Cameras



Fabian Weston collecting samples.



Grading with DaVinci Resolve.

I was doing some work with a colleague at The Basement Studios in Sydney a few years ago and they had a lot of Blackmagic equipment. It was the first time I heard of Blackmagic. There were Blackmagic things all around me. I was actually quite amazed when my colleague said, “See this box. It feeds into that. And that goes to the Internet”

That was my first exposure to Blackmagic. Then the microscopes came along. I had my frustrations with using a smartphone even though DaVinci Resolve was a godsend to improve the shortcomings. I looked around, asked lots of questions. But the more I looked, Blackmagic stood out. You can't go past the name to start with. It has an allure of its own, but being an Australian company was definitely an influencing factor. I came to know about the company, loved Grant Petty's philosophy and how it all started.

It's not just about the camera; there's more to it. I got it because I come from a similar background. Changes in the recording industry paralleled what happened in the movie and TV industry as well. I thought, wow, that's a guy with a vision and philosophy and he actually did it and good on him. And the bonus is that Blackmagic also acquired Fairlight, more Aussie stuff. Fairlight is named after a suburb here in Sydney.

*Kim Ryrie and his classmate Peter Vogel built the Fairlight CMI (Computer Musical Instrument) in 1979 with a license from Tony Furse of Creative Strategies, another Sydney company. It was a digital synthesizer, sampler, and digital audio workstation at a time when audio was mostly tape-based. Peter Gabriel, Hans Zimmer, Herbie Hancock, Stevie Wonder and Bad Company all bought Fairlights. Blackmagic Design acquired Fairlight in 2016 and continues the line with high-end audio mixers (1000 tracks), control surfaces, workstations and integration with DaVinci Resolve.*

Fairlight was a legendary thing to come into the music industry. A game changer. I couldn't be happier than to be within the Blackmagic domain. I come from the same world and totally get

where they are coming from, admire their history and like the down-to-earth, service focused approach to their customer base. Looking forward to cloud collaborating with colleagues in other countries.

## **Which camera model do you have now? The Pocket Cinema Camera 6K Pro with ND filters?**

No, as I mentioned, microscopes use ND filters on the light source; I needed a camera without. I'm currently using the latest Blackmagic Pocket Cinema Camera 6K G2. (It has all the features of the 6K Pro, tiltable LCD monitor, accessory EVF, but without the internal NDs.)

## **What are your camera settings?**

I shoot 6K BRAV, usually at Q3 variable bit-rate and at 25 or 50 fps to match our 50Hz AC power cycle. If I go chasing a microbe across the slide, I'd use a faster shutter. For motionless things slow shutters are fine. Sometimes it's like filming a race car with everything else is whizzing past as you.

## **Do you shoot slow motion or timelapse as well?**

Sometimes time lapse, definitely. Many interesting microscopic processes are quite slow. It can take hours to film a single process. For slow-motion; I'll use a high frame rate for very fast things. They're so fast I need to avoid frame blur as much as possible.

## **You do your post work in DaVinci Resolve?**

Yes, I do the editing and color grading exclusively in DaVinci Resolve. With microbes, there's a certain amount of artistic license when it comes to grading. So, when I color things, a lot of it is aesthetics. But still trying to be true to what the colors are, there are definitely very specific colors to some of these creatures. Making sure they're brown, green or red where and when they're supposed to be. But as far as the overall look there's plenty of room for creativity.



Top Chef 2022 Winner Buddha Lo of HUSO in New York.  
Photo: Jon Fauer. Nikon Z 9. NIKKOR Z 50mm f/1.2 S.





## Top Chef Buddha Lo seen through a Nikon Z 9



Keep your camera focused on Chef Buddha Lo. He is a rapidly rising rock star of the restaurant world and winner of this year's Top Chef Award. The camera in focus today at HUSO restaurant is a stellar Nikon Z 9 and the lens is a NIKKOR Z 50mm f/1.2 S.

In cine and still mode, what better place to try a new camera and lens than a restaurant where the light is low, the bokeh bright, and food so spectacular that it takes the breath away within caviar egg depth of focus. And truffles. Who else would have deconstructed a Parker House Roll into a puffy concoction drizzled with honey and topped with freshly shaved white truffles?

Chef Buddha Lo grew up in Port Douglas, Australia, gateway to the Great Barrier Reef and a town famous for resorts and restaurants. He started cooking at an early age. His father ran a successful Hong Kong style restaurant. The nickname Buddha came from being a chubby kid: after school, he cooked at the family restaurant and by age 14, was working weekends at a 5-star hotel in Port Douglas. Upon graduating high school, Buddha moved to Melbourne and attended the William Angliss Institute culinary school. He won a scholarship for a 2-month stage at the 2 Michelin star Château Cordeillan-Bages in Pauillac, France. Returning to Australia, he went to work for Raymond Capaldi and became the head chef at age 19.

Buddha Lo then moved to London and landed a position at 3-Michelin star Restaurant Gordon Ramsay, where he won an excellence award. He went on to stage all over Europe at Michelin star kitchens in Sweden, Copenhagen, London and France. After 3 more years back in Melbourne, he got a job at the number 1 restaurant in the world at the time, Eleven Madison Park in New York. Buddha worked his way through the kitchen and won the Eleven Madison Park cook battle.

Buddha is now the Executive chef of Marky's and HUSO at 81st Street and Madison Avenue in New York City. We met by accident, on May 3, 2019. Thirsty after a daily run in Central Park, I saw what looked like a fancy grocery store and entered Marky's in search of Gatorade or bottled water. But this was not your average store. The shelves were lined with caviar and marrons glacés. Showcases displayed Jamon Iberico and white truffles.

A gentleman with an Australian accent and chef's apron kindly informed me that Gatorade was not an option. He explained how Marky's manages their own sustainable aquaculture facility in North Florida, Sturgeon Aquafarms. We chatted about Australia;



I asked if he knew any of our friends at Blackmagic in Melbourne. And then Buddha said, "Why not come back here this evening? It is the opening night of our new restaurant, HUSO." We did—not yet knowing about Chef Buddha's wanderings and education at some of the world's temples of gastronomy. An incredible dinner that evening demonstrated his genius.

Cut to October 2022. I ran into Chef Buddha riding his electric scooter up Madison Avenue. "Have you seen *Top Chef*, by any chance?" he asked. No, I had not. "Come to dinner next week. We're totally booked, but we can add a table. Dinner will be based on *Top Chef Houston Season 19*."

Chef Buddha was so modest. We bit our fingernails and cheered him on, on screen, as he navigated the competition and we binged the entire season. He received rare praise from tough judges, the admiration of culinary icons Eric Ripert and Daniel Boulud, and went on to win the title of Top Chef with his artistic, delicious, innovative, skillful creations.

And so, we're here for an 8-course tasting menu at HUSO with Nikon Z 9 and 50mm f/1.2 lens discreetly tucked under the table in a business-like briefcase. The camera didn't stay hidden long. Every course, visual and gustatory masterpieces, called out for coverage as stills and video. Other diners were accommodating as they eyed the close-focus antics. Chef Buddha and the super helpful staff were generous in their patience. The menu through December is episodic and derived from Buddha's winning creations on *Top Chef 2022*. You can watch the series on Bravo or Peacock, or experience it first hand at HUSO.



# Nikon Z 9 for Cine



Nikon Z 9 with NIKKOR Z 24-70mm f/2.8 S

Whether you are working with Top Chefs or top models, doing sports, drama, documentary, events, tabletop or high fashion, try the new Z 9, Nikon's flagship, top-of-the-line hybrid, mirrorless digital still and cine camera. It is a magnificent camera, adept at both stills and video. Its 8K 12-bit video images are as spectacular as its stills. It feels like a longtime friend the moment you grab it.

With the Z 9, Nikon unquestionably raised the bar on image quality, ergonomics and versatility for filming on location and in studios. Images from the 45.7MP Full Frame Stacked sensor are gorgeous. The camera's tactile, ergonomic heft is familiar. It may remind you of a Nikon F4 from analog film days. Every button is familiar and intuitive. The OLED EVF appears sharper than any previous Nikon optical or electronic viewfinder. Its 3.69m-dot OLED panel adjusts luminance up to an eye-popping 3000 nits.

The Z 9 records internal 8.3K 12-bit N-RAW up to 60 fps or 4.1K 12-bit N-RAW up to 120 fps or 4.1K ProRes RAW up to 60 fps. Dual CFexpress Type B card slots provide internal video recording up to 2 hours and 5 minutes. Image transfers are supported via 1000BASE-T wired LAN with an RJ-49 port and built-in wireless LAN (IEEE 802.11b/g/n/a/ac).

DaVinci Resolve seamlessly ingested and played back Z 9 8.3K 12-bit internally recorded NEV N-RAW files. The color and contrast was so good, tweaking almost seemed superfluous.



Nikon Z 9 with native Z mount, 16 mm flange focal depth, 55 mm ID.



Nikon Z 9 with NIKKOR Z 50mm f/1.2 S.



Nikon Z 9 with Z to PL mount, 52 mm flange focal depth, 54 mm ID.



Nikon Z 9 with Wooden Camera Z to PL mount adapter and Cooke S8/i 40mm T1.4 prime lens.



# Nikon Z 9: Some Cine Menu Settings

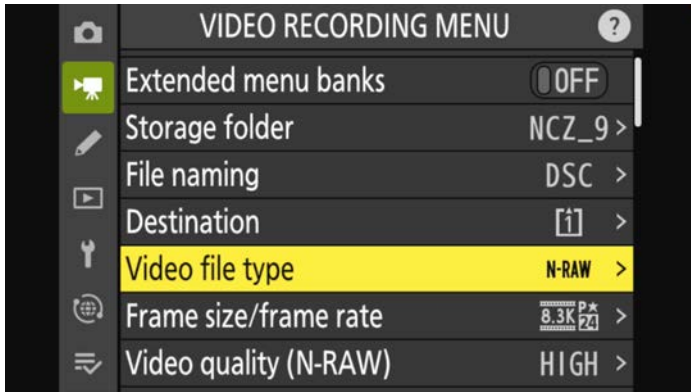

Select Video File Type (N-RAW is shown here).

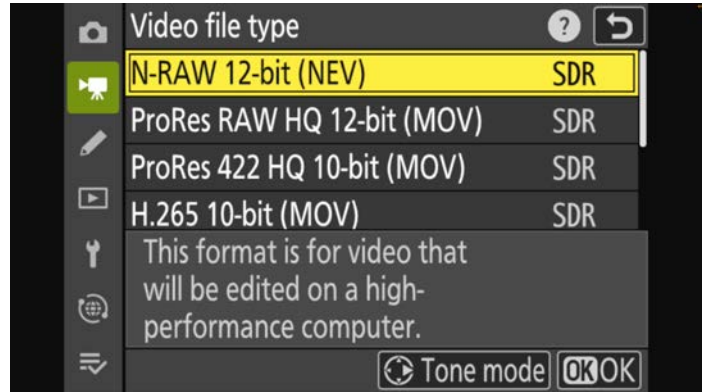

Internal Video recording includes N-RAW 12-bit (NEV), ProRes RAW HQ 12-bit (MOV), ProRes 422 HQ 10-bit, H.265 10-bit (also with N-Log), etc.

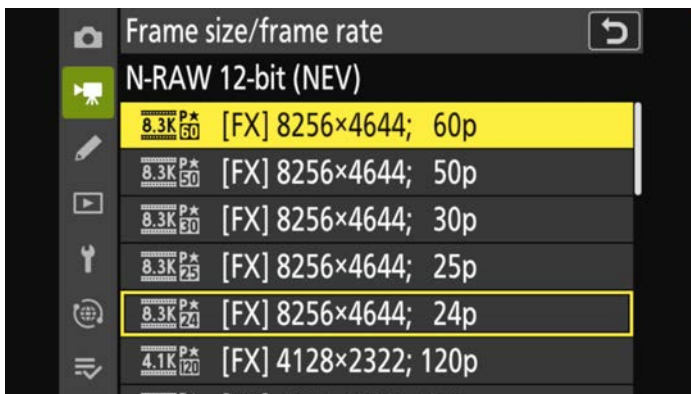

N-RAW 8.3K up to 60 fps. FX is Full Frame. DX is APS-C / S35

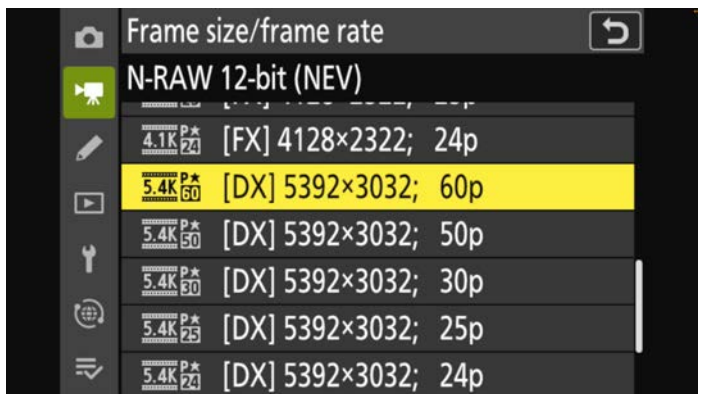

N-RAW 12-bit DX (S35) 5.3K up to 60 fps.

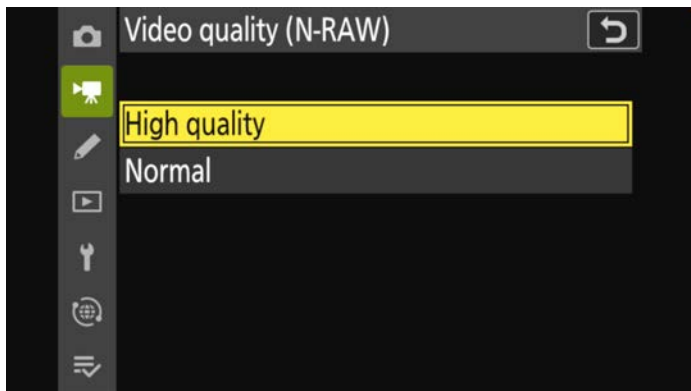

N-RAW has two compression ratios: High Quality and Normal.



20 Picture Controls (LUTs) with nice names: silence, somber, pop, etc.

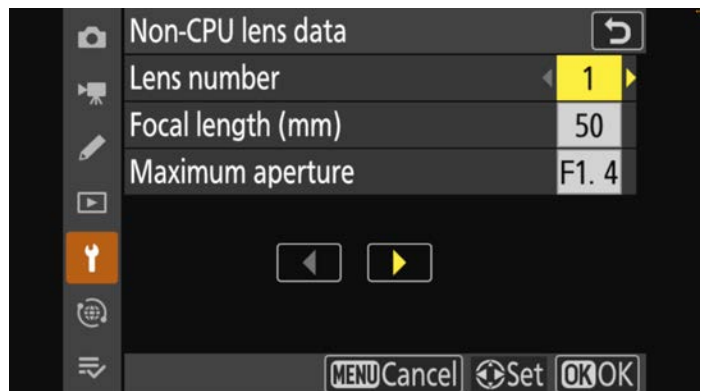
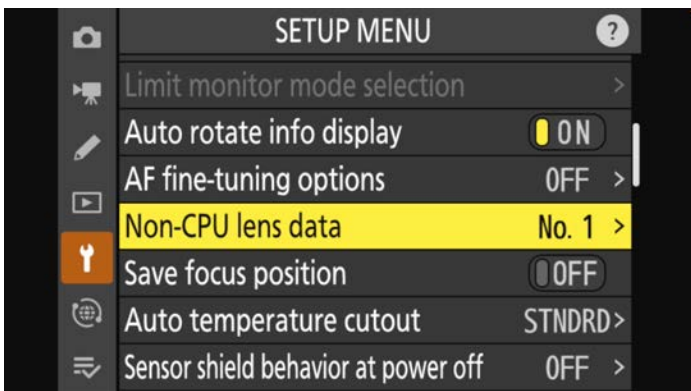

The camera and menu are intuitive except for Z Mount lens adapters like the PL mount on the opposite page. The camera will not shoot unless you assign an arbitrary Non-CPU (non NIKKOR S) lens in the menu. In this example, we just call it a 50mm F1.4 lens and assign it as Lens Number 1.

# Nikon Z 9 Cine 8.3K N-RAW 12-bit Framegrabs



Above: Nikon Z 9 EVF display. We're recording 8.3K video at 24 fps to an internal CFexpress Type B card 1 with a NIKKOR Z 50mm f/1.2 S.  
Below: Sunshade removed and sunlight down the barrel, beautiful flares and bokeh emerge with the NIKKOR Z 50mm f/1.2 S.





## Nikon Z 9 Cine 8.3K N-RAW 12-bit Framegrabs



DaVinci Resolve opens N-RAW (.NEV) files seamlessly. All of these 8K grab-stills were exported by DaVinci Resolve directly from the original footage. The shot below was a manual rack focus with the NIKKOR Z 50mm f/1.2 S — so smooth, it was as good as the smoothest of dedicated cine primes.

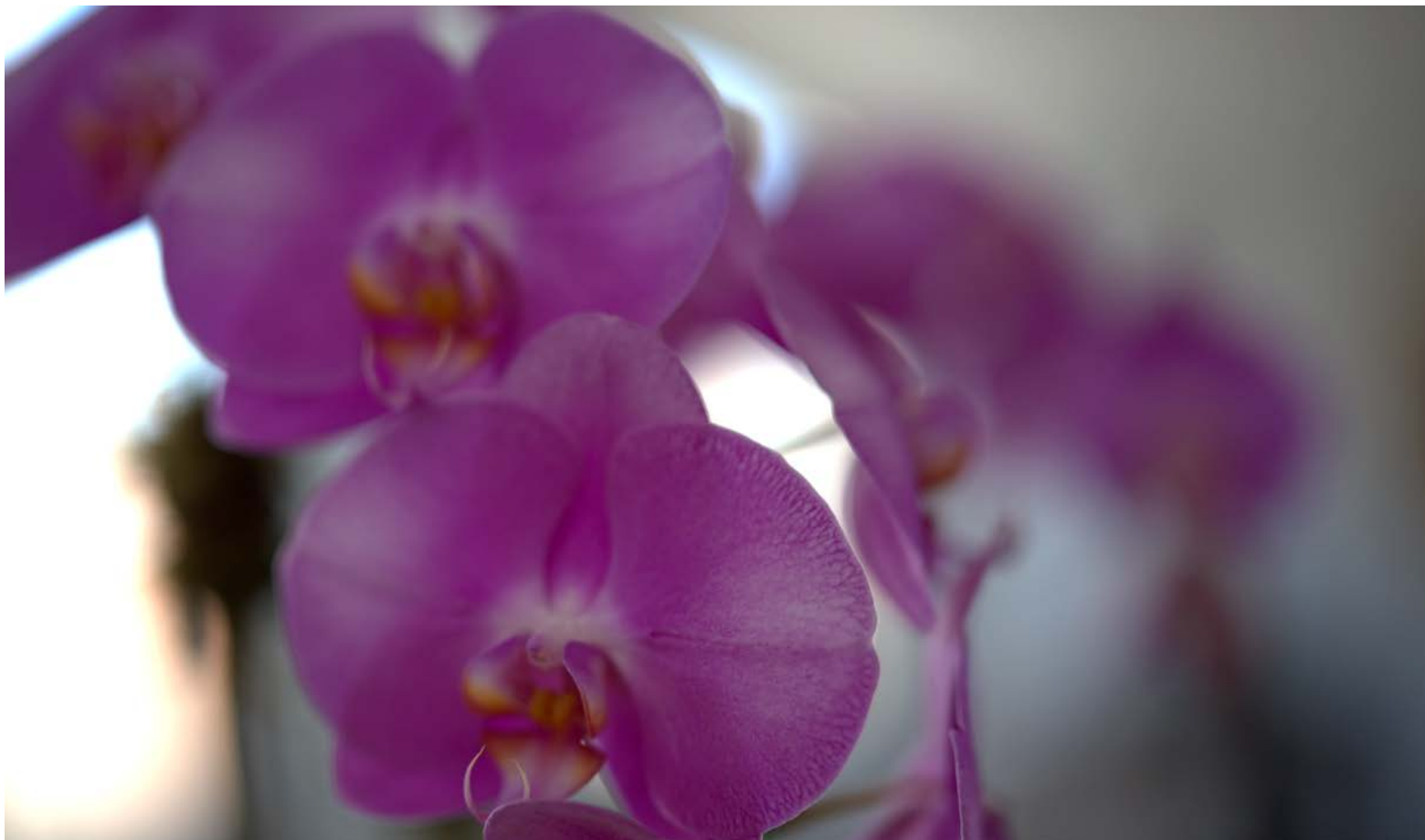



Michael Cioni was like an orchestra conductor in a candy store at Cine Gear LA this past June. The Adobe Frame.io booth was festooned with partners whose cameras, audio recorders and post production apps played nicely with Frame.io's Camera to Cloud and Adobe's Creative Cloud services.

A couple of weeks ago, Michael and Charlie Anderson were on the phone with more exciting updates. Our discussion was so long and so interesting, we'll save it for the next episodic edition of FDTimes. Here's a teaser. Ask these guys one question and that will elicit a workflow —WORDFLOW! — that requires no additional prompting.

Michael began, "I joined Frame.io a little over three years ago, and you were one of the first people I talked to. I still remember where I was standing. You were under NDA. And what wasn't clear, what wasn't known at the time, was that when we talked back in the late summer of 2019, I had already met with Jarred Land and David Fincher, talking about the C2C concept. It was just a whiteboard, 'What if? Wouldn't it be great?' kind of a thing. RED had not yet built RAPTOR or KOMODO, but they had started moving towards their DSMC3 line, and they wanted to ensure that the next set of products unlocked certain attributes that weren't previously possible anywhere.

"What's fun is that this has actually been a long time coming. Even though we've had great success with Camera to Cloud thus far, adding the RED V-RAPTOR and the Fujifilm X-H2S took quite some time. There's an old phrase that I love: "The best time to plant a tree is 20 years ago."

"Many of our friends fall in a zone where they're like, 'All right, call me when it's really mature.' But you and I are people who

buy Android and iPhones the day they come out. Other friends of ours are running phones four or five years old, and they're happy. It's just a different approach.

"By the end of the decade, as we get into the 2030s, that's when cameras will stop having removable media, and they'll just cache their files internally and publish those caches to the Cloud. I think cameras a decade from now will be like cell phones, in that they won't have a slot for media cards. The best way to get media off your phone today is the Cloud. And the best way to get media off a cinema camera in 10 years will be the Cloud. So this is where we're headed, and this is our path to a Cloud-first workflow. Even though we are planning for internal raw uploading by 2028, we're actually delivering it working today."

So, that's the teaser with some spoiler alerts for the next FDTimes edition. But first, here's the prequel, a sort of white paper statement of purpose and state of the current art.

### *by Michael Cioni, Senior Director, Global Innovation Creative Product, Adobe*

When I joined Frame.io three years ago, we announced our intention to embark on a new path to connect the production community to the cloud. Why? Because for the past 100 years of film and video production, we lived with the inconvenient disruption of needing to download or ship some sort of physical media in order to edit or share it.

Eighteen months later, we officially launched Frame.io Camera to Cloud (C2C) with two hardware partners—Teradek for video, and Sound Devices for audio. Since then, more than 5,000 productions have used Camera to Cloud, and we've heard from directors and producers—for series like *WeCrashed*, live sports



# Michael Cioni on Frame.io C2C and Partners

events for the Golden State Warriors, and location shoots for Red Bull Media—that it's changed the way they work by dramatically increasing the speed of creative collaboration and the flexibility of their workflows.

In that time, our C2C Connections community has also expanded with dozens of new partnerships. The number of cameras with C2C compatibility has increased exponentially. Integrations with Teradek, Atomos, and FiLMiC Pro have made it possible to shoot almost any kind of project and have immediate viewing and editing access from anywhere in the world.

At Adobe MAX, we announced the next leap forward in connecting cameras to the cloud. New partnerships with RED and Fujifilm are now removing the barrier of needing to physically move media. With the Camera to Cloud integration now built directly into these cameras, we've taken the next step toward the cloud-based workflow we've been envisioning—no additional hardware, and no hard drives required. This is more than just a technological first—it's a snapshot of the way every creative will work in the future.

## RED V-RAPTOR and V-RAPTOR XL

Since day one, RED cameras have been C2C enabled through the use of the Teradek CUBE 655. But with this new innovation (available in late 2022), the RED V-RAPTOR and V-RAPTOR XL are able to upload 8K REDCODE RAW files directly to the cloud from the camera.

While this currently requires access to high-bandwidth networking (wireless or ethernet), it represents the next tangible step toward the future of cloud-based RAW workflows. Camera to Cloud with RED V-RAPTOR and V-RAPTOR XL unlock the biggest workflow improvements in more than a decade and begins to remove the delays that creative teams have been accustomed to when shipping drives.

Think about it: productions that shoot on stages can deliver original camera files (OCF) directly to the post house as they're being shot. Virtual productions or complex visual effects can send OCF directly to the VFX house. ProRes files can be automatically delivered right to production offices and cutting rooms for immediate editing. And for productions that want the highest quality dailies, RAW video and audio files can be synced, color corrected, and transcoded in the cloud through our integration with Colorfront.

But what's even more significant about this integration in the immediate future is that it enables a native ProRes proxy workflow that contains every ounce of asset metadata available in the camera. It's a workflow designed to support our commitment to high-end, professional cinema workflows by providing many of the same benefits of an OCF-to-cloud workflow, but requiring less network and processing infrastructure. ProRes files are supported for playback on Frame.io, so these high-quality files are available to view, share, and edit without requiring additional transcoding. This means you'll be able to shoot 8K RAW with a frame-accurate ProRes proxy and upload the 8K RAW, the proxy (or both) as fast as your internet allows. And on top of that, it accurately captures off-speed recordings, which is something a lot of you have been asking about.

If you watch our video demo, you'll see how easy it is to securely

authenticate the camera to Frame.io, and how quickly we sent the first-ever automatic transmission of an 8K RAW R3D file, a log file, a CDL, a ProRes proxy file, a WAV, and a custom LUT—all associated with each take.

Until now, most workflows required the tracking and tracing of numerous sidecars. With Camera to Cloud, our centralization and automation accelerates the transition from production to post and better connects creatives with their collaborators. This is the foundation of an entirely new workflow that will eventually become the industry standard.

## Fujifilm X-H2S

When we first launched Camera to Cloud, we talked a lot about how it enabled the professional video industry to work more like the way social media influencers have shared images for years, shooting stills on mobile devices and sharing them directly on platforms like Instagram.

Now, we have announced an integration designed especially for professional still photographers and filmmakers. Fujifilm X-H2S is the world's first digital hybrid stills and video camera to natively integrate with Frame.io Camera to Cloud. When paired with the FT-XH file transfer attachment to establish an internet connection, workflows will be fully cloud-based, with Frame.io supporting high-resolution RAW video files and still files with loupe, navigation and annotation tools.

This integration will be especially useful for multidisciplinary creative teams, so that related assets like stills and graphics can be easily organized in the same Frame.io project along with video. What's also notable is that the X-H2S can upload ProRes and proxy video files, which unlocks a whole new way of working. You can shoot anything—from a wedding to a sporting event or live concert—send your photos (or video) to someone on your team so they can retouch the asset, and share it or post it without ever having to exchange a drive or camera card or any kind of physical media.

## Camera to Cloud (C2C)

While shooting to the cloud certainly speeds up your workflow, there's more to it than just that. It also increases the flexibility and control you have over the way you work. Imagine your raw camera footage being instantly backed up and accessible to anyone without downloading or shipping a drive. That's what we're doing, and the Camera to Cloud ecosystem we're building is the key.

As bandwidth improves, the expectation for immediate access to footage will become the most vital component to an efficient workflow. By evolving the technology to include in-camera automatic file transmission, we're making enormous strides toward accomplishing this goal for productions of all types, sizes, and budgets. Looking back on more than 20 years of working in media and entertainment, I realize that what has consistently inspired me throughout my entire career is the desire to use technology to improve creative control. That's what's so exciting about these new innovations.

But what's most exciting for us is seeing how you decide to use them, and how they enable you to do more groundbreaking work. This is the next leg of the journey and we can't wait to see what lies ahead.

# Fujifilm X-H2S + FT-XH + C2C with Frame.io



October 18, 2022. Fujifilm announced new firmware for their X-H2S digital camera with Fujifilm FT-XH file transmitter battery grip “that will provide the world’s first native Camera-to-Cloud (C2C) integration capability for digital still cameras,” in partnership with Frame.io. The firmware, expected in spring 2023, will enable users to send still or video files directly from the camera to Frame.io cloud servers.

“Getting image and video files from your digital camera into post-production is a time-consuming process that can often require creating backups, transferring to hard drives, and then forwarding to the next step in the production workflow. C2C eliminates these tedious steps altogether,” said Victor Ha, Vice President of Electronic Imaging and Optical Devices divisions, Fujifilm North America Corporation. “From the first press of the shutter, or the end of the first take, with this firmware and using FT-XH, files will automatically upload to a user’s Frame.io account directly from X-H2S and be ready for use within seconds.”

## Fujifilm File Transmitter FT-XH

The gateway for your camera to cloud connection via Frame.io with a FUJIFILM X-H2S is the FT-XH file transmitter that attaches to the bottom of the camera. It connects to the Internet via an RJ45 Ethernet plug or wireless LAN (IEEE 802.11a/b/g/n/ac WiFi).

FT-XH looks like a familiar battery grip. Two high capacity NP-W235 batteries slide inside. It’s also a good vertical grip.

With the X-H2S, the following communication specifications are enabled:

- FTP transfer by wired LAN / wireless LAN / USB Smartphone tethering.
- Tethered shooting by wired LAN / wireless LAN
- Remote recording by wired LAN / wireless LAN
- Capable of controlling up to four X-H2S / X-H2 cameras from a browser at the same time.

## Share it Now, Deliver Later

Using FT-XH, configure X-H2S to deliver Apple ProRes proxy files and get bandwidth-efficient, high-quality files in Frame.io that are small enough to be easily shared on social media and to start the editing process until they can be swapped with original camera files for finishing and final delivery of images and video.

## Send What You Want, When You Want

Deliver Apple ProRes proxy files to Frame.io as they are being recorded or choose from a variety of other still and video file types for access, in near real-time, once the files are recorded and transferred to Frame.io. Files can be transmitted automatically, individually sent, or prioritized directly on the X-H2S to send from the camera to your team anywhere in the world upon completion of the shot.

## Connected and Secure Files

Trusted Partner Network (TPN) and Security Operations Center (SOC) 2 Type 2 compliance is implemented when X-H2S, with an attached FT-XH, is authenticated and paired with a Frame.io account. Created by the Motion Picture Association (MPA) and Content Delivery and Security Association (CDSA), TPN is the global, industry-wide initiative that defines requirements and best practices for protecting digital content.

Victor Ha continued, “These are exciting possibilities for collaborating with off-site art directors, on-set and near-set DITs and editors, colorists, off-set editors, or anyone else involved in production. From downloading still images, remotely processing in Lightroom or Photoshop, quickly reviewing and choosing video clips, to creating a rough cut, production work can finally start before the waiting even begins.”

## Pricing and Availability

Built-in C2C functionality is included in Fujifilm’s firmware update which is expected to be available for free download by X-H2S customers with FT-XH and a paid Adobe Creative Cloud subscription in spring 2023. For more information please visit: [frame.io/creative-cloud/](https://frame.io/creative-cloud/)



FT-XH battery grip file transmitter.



# Fujifilm X-H2S

## X-H2S Connection to Frame.io

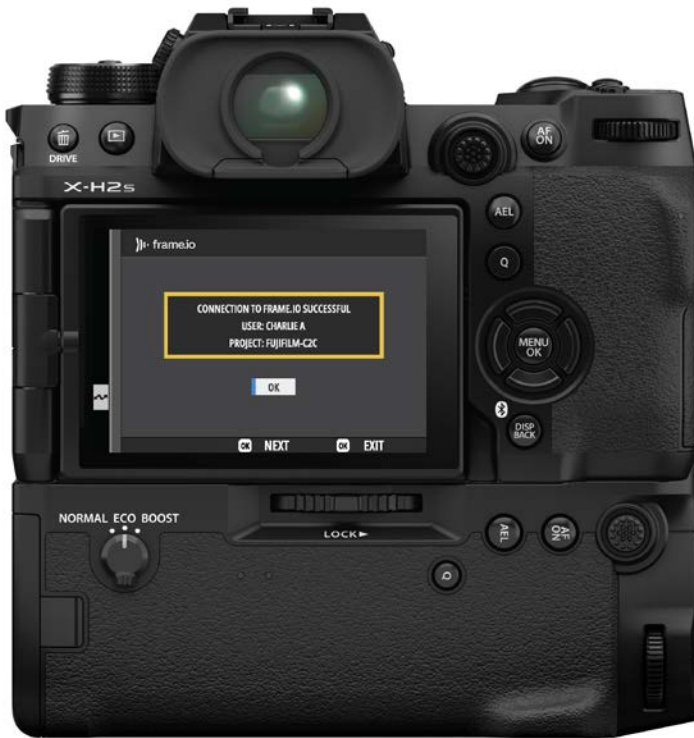

Connect to Frame.io from the NETWORK/USB Setting Menu of the X-H2S camera with FT-XH attached.

Note: The Adobe C2C interface for Fujifilm X-H2S is still under development and subject to change.

## X-H2S Important Menu Settings

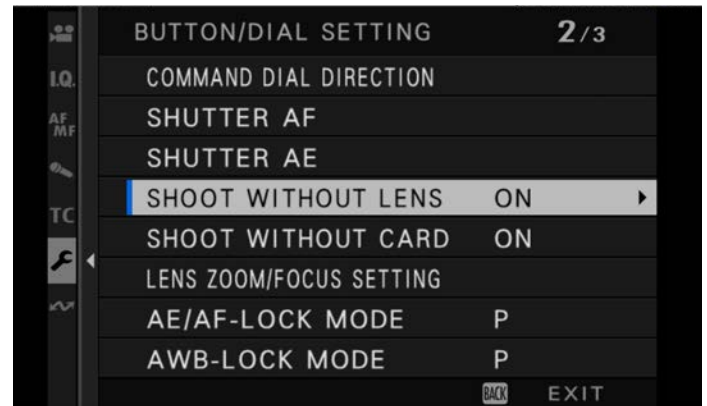

If you're shooting with an X Mount to PL Adapter, be sure to set the Menu to SHOOT WITHOUT LENS > ON.

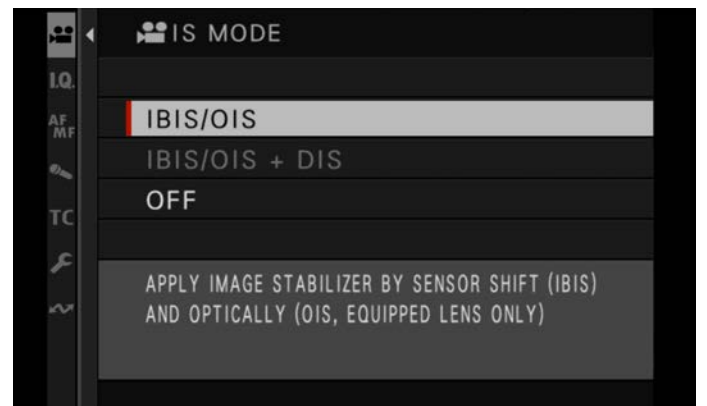

IBIS In Body Image Stabilization is helpful especially for non-OIS lenses.

## Fujifilm X-H2S Lens Mounts



Fujifilm X-H2S with native X Mount (17.7 mm Flange Focal Depth)



Fujifilm X-H2S with X Mount to PL Mount Adapter (52 mm Flange Focal Depth)

# Fujifilm X-H2S Zooms

FUJINON MKX  
50-135mm T2.9  
Zoom Lens



Fujifilm F18-120mm F4 LM PZ WR  
Zoom Lens



If you were packing for an expedition to a desert island and the mandate was one camera, one lens, and only one data card, you might pick the Fujifilm X-H2S camera with a Fujifilm XF18-120mm F4 LM PZ WR Zoom lens.

You will also want to attach the new Fujifilm FT-XH file transmitter battery grip. It sends files from camera to cloud via Frame.io, as described on the previous pages.

The XF18-120 zoom lens was built with the cooperation of FUJINON cine and broadcast lens designers. It has an X Mount and a built-in rocker-controlled variable speed power zoom with smooth manual override. You can switch seamlessly from auto to manual focus. Close focus is 60 cm / 23.6". The aperture is constant at F4.



The Fujifilm X-H2S pairs nicely with a FUJINON MKX 50-135mm T2.9 zoom. The MKX zoom has a Fujifilm X Mount, so you don't need a PL adapter.

This is an affordable, manual, cine-style Super35 / APS-C zoom lens. Compact, weighing a mere 980 g / 2.2 lb, it has an 82 mm front diameter.

Focus, zoom, and iris rings have an industry-standard 0.8M gear pitch and a 200° focus rotation.



FG-XH battery grip →  
but not a file transmitter



# Chrosziel Meta Mount (E to PL with Metadata)

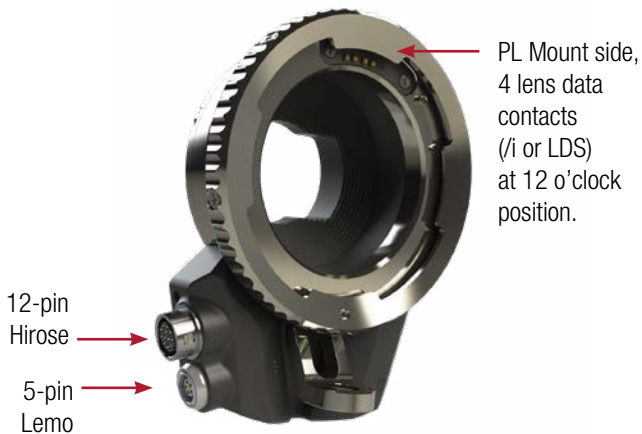

Picture this. You have a Sony FX3, FX6 or FX9 camera. It has an E-mount. And you have one of the many available E-mount to PL adapters to attach PL Mount lenses. But don't you want to see the focus, iris and zoom settings in your viewfinder or on a monitor?

Now you can, with the new Chrosziel Meta Mount. When the Meta Mount is attached to a Sony E-mount camera, PL lenses with /i or LDS contacts send their focus, iris and zoom lens data through the adapter to the camera and appear in the viewfinder on monitor, and are recorded in the video metadata file for use in post production. Furthermore, Meta Mount enables Auto-Iris: the camera can control the lens aperture on Auto-Iris equipped and enabled lenses.

Picture another scenario. You want to use the new FUJINON 25-1000mm PL Mount zoom on your Sony FX9. Read on:

The Chrosziel Meta Mount is a "hot mount" adapter with the required E-mount contacts to provide Servo or ENG lens control through its 12-pin Hirose connector.

When the Meta Mount is used with a servo motor-controlled lens (Cine or ENG), the focus, iris and zoom servo motors of the lens can be controlled through the camera and are compatible with handgrips on Sony FX9, FX6, FX3 cameras, a Sony RCP (Remote Control Panel) or the camera's web GUI.

## Spec Chrosziel Meta Mount (MA-EPL-HR12) Specs

- E-mount camera to PL mount lens adapter
- Contacts and electronics for metadata communication
- 12-pin Hirose for ENG lens control
- 3/8-16 lens support socket
- USB Mini-B connector for firmware updates
- Lemo compatible 0B 5-pin for 10-16 V DC power, e.g. for servo lens control power.
- Power consumption max. approx. 350 mAh @ 12V

In the box:

- Chrosziel Meta Mount E-mount to-PL Mount Adapter
- MN-AB cable: 12 Volt A/B D-Tap to 0B 5-pin Lemo
- F55-A2-P-CAM cable
- Shim Set, E-Mount side
- USB Mini Cable

[www.chrosziel.com](http://www.chrosziel.com)



# FUJINON 25-1000 F2.8-5.0 PL Mount Zoom



Fujifilm announced the development of its new FUJINON HZK 25-1000 mm zoom lens. The official name is HZK25-1000mm F2.8-F5.0 PL Mount Box Lens. But it's much more than just a 40x box lens for multi-camera concerts, events, broadcast and sports.

It has:

- PL Mount.
- 1.5x Internal Expander to cover Full Frame.
- Automatic Restoration of Illumination Attenuation (ARIA)—in other words, as you zoom in, automatic ISO correction corrects for aperture ramping. \*
- Automatic Lens Chromatic Aberration Correction. \*
- Remote Back-Focus. \*

\*Currently only works with SONY HDC-F5500.

The native PL mount beckons to be used on cine cameras: on commercials, sports, stunts, car spots, and features. Imagine a 120 fps slow motion shot of an Olympic hurdler racing toward camera, from full figure to extreme close-up.

This FUJINON 25-1000 covers Super35 sensors (image diagonal 28.55mm). With its built-in 1.5x dual format expander, it covers Full Frame sensors (41.3mmØ image diagonal) and the focal

length range becomes 37.5-1500 mm. Since an expander is effectively a high-quality extender, certainly it works as a 27.5-15000 mm zoom in Super35 as well.

Super35 and Full Frame digital cine cameras have been increasingly used in broadcasting, sports and live events. Large sensor cameras offer immersive images, exciting separation of subject from background, and high dynamic range compared to traditional B4 video cameras.

The new FUJINON HZK 25-1000 offers an amazingly long zoom range and very wide aperture, with the quality and optical performance familiar to users of the highly respected FUJINON Premier Series. (The longest Premier zoom thus far is the HK 75-400mm T2.8-3.8.)

The F2.8 at the wide end of the 25-1000 lens enables filming in low-light locations such as indoor concerts or nighttime events, with beautiful bokeh and a cinematic look. Fujifilm's optical technology suppresses aberrations by using large aspherical and fluorite lens elements that eliminate ghosting, flares, and color fringing. Highly advanced polishing methods prevent undesirable "onion ring" effects in the out-of-focus bokeh.



# FUJINON 25-1000 F2.8-5.0 PL Mount Zoom



Optical quality is controlled through repeated simulations using Fujifilm's proprietary FOCUS (Fujifilm Optical Class Library and Utilities System) optical design application, which helps determine the selection of glass materials from a vast permutation of possibilities. Coatings are optimized and mechanical design is tweaked to minimize internal barrel flare. The FOCUS application simulates the lens characteristics during the design process.

Why is the FUJINON 25-1000 shaped like a box when typical cine lenses have barrels? Of course, part of the heritage comes from the broadcast world of box lenses. But there's a practical explanation. The main reason for this is the ability to use optical elements with a large diameter. While a barrel-type body limits the use of optical elements to a diameter up to about 130 mm, this lens uses glass with diameters larger than 220 mm.

The area of the lens is about 3 times larger, which is especially advantageous in terms of brightness, and the lens maintains F2.8 without ramping up to focal lengths of 465mm and F5.0 at 1,000mm at the telephoto end.

In addition to the size of the lens, it has the advantages of a flexible layout and a large number of usable lens elements, which are advantageous for achieving high zoom magnification, improved performance and various specifications.

Second is its ease of operation. Especially in sports photography,

it is essential to have a fast response time and high-speed zoom movements that are directly related to the camera operator's sensitivity. This is achieved by directly connecting the zoom and focus cams with a belt drive, rather than with a gear drive, where backlash can be physically unavoidable.

This lens is the first commercially available box-type zoom lens for large sensor cameras equipped that has optical image stabilization. This enables stable shooting while precisely compensating for vibrations in the venue. The latest anti-vibration mechanism and firmware utilizes Fujifilm's ceramic ball roller system. Not only does this mechanism provide a high level of anti-vibration performance against shaking caused by footsteps and wind, but it also suppresses shaking of the hands to ensure stable image capture. Not that any camera operator would have shaking hands!

Camera operators can work with the lens in a live broadcasting setup since existing FUJINON box lens accessories can be used in support of multi-camera operation. And for camera crews of cine productions, wireless FIZ lens controllers from Preston Cinema Systems and ARRI are compatible and can be connected to the HZK25-1000.

The FUJINON HZK25-1,000mm F2.8-F5.0 is expected to be available in Spring 2023. For more information, visit: [www.fujinon.com](http://www.fujinon.com)



# FUJINON 25-1000 F2.8-5.0 PL



Mockup of FUJINON 25-1000 with Preston MDR (Motor Driver) and FIZ Hand Unit.

## 25-1000 Specs

Zoom Range: 25-1000 mm in Super35  
with internal extender: 37-1500 mm in Super35  
with internal expander: 37.5-1500 in Full Frame

*Note, the internal expander and extender in this lens are the same device. Expanders and extenders increase the focal length by their designated ratio (e.g. 15x). Expanders generally pay greater attention to maintaining optical quality towards the edges, which is important in Full Frame. Extenders basically "worry" about the center Super35 area.*

Maximum Aperture in Super35: F2.8 at 25mm  
F3.9 at 700mm  
F5.0 at 1000mm

Maximum Aperture in Full Frame  
with internal 1.5x expander: F4.2 at 37.5mm  
F5.3 at 1050mm  
F7.5 at 1500mm

Image Diagonal in Super35: Ø 28.2mm  
Image Diagonal in Full Frame: Ø 41mm

Close Focus (M.O.D.) 3.5m / 11'5"  
Length 669mm / 26.3"  
Weight 28.8 kg / 63.5 lb

- ALAC - Automatic Chromatic Aberration Correction
- ARIA - Automatic Restoration of Illumination Attenuation corrects for aperture ramping.
- Remote Back-Focus



# Mike Prickett on *100 Foot Wave*, 50-1000mm Zooms



Foreground: Cinematographer Mike Prickett.  
Filming in background: Engineer Josh Quick.

*Michael Prickett, DP on the HBO documentary series 100 Foot Wave, won a 2022 Emmy for Outstanding Cinematography. The 6-part series centers on big wave surfer Garrett McNamara and giant waves at Nazaré, Portugal. Season 2 is coming soon. Season 1 is on HBO Max: [hbo.com/100-foot-wave](https://hbo.com/100-foot-wave)*

## **Jon: How did you get into this business?**

Mike: I was a surfer when I was in high school on Oahu and I started taking pictures of my friends surfing. I was a still photographer originally and then started shooting 8mm, 16mm film. I loved it so much I ended up not surfing as much and kept shooting more and more. Then I fell in love with the Arriflex 16SR2. I think you wrote a book on that.

## **Good memory. Yes, I did. That was a great camera.**

I still have it. I made a water housing and there's never been one so well balanced. I made it out of fiberglass and plexi.

## **Cut to the present day. How did *100 Foot Wave* begin and how did you manage logistics, camera packages and crew?**

I made a movie called *Chasing Mavericks* with Gerard Butler. The *100 Foot Wave* director and producers liked it and contacted me. Also I grew up with Garrett McNamara, the star of *100 Foot Wave* so I actually had a bunch of archival footage of him.

## **What cameras did you have on the show?**

We shot with Canon EOS C500 MkII cameras for the interviews, run-n-gun shots and for some long lens scenes. We sometimes had a dozen cameras running: RED MONSTRO 8K as our main cameras, V-RAPTOR, and a Phantom 4K Flex.

## **What did you have for underwater and splash housings?**

Gates. I like Gates housings. We have these underwater SEA-BOBs that can go really fast underwater, I think 20 knots. It's as if you're a dolphin. So we put that Gates camera in front and you can zip around. It's like a jet ski underwater. You hold it like a little dive scooter, but it's on steroids. It looks like the James Bond of dive scooters. The camera's right in front of the SEABOB. We also have different mounts. If you were on the surface, you could put the camera on top of it facing, sideways, and essentially you could do a dolly tracking move at water level.

We use scuba tanks sometimes, but mostly you just hold your breath, because that way you can go up and down fast. If you were on scuba tanks, going under waves would be really hard.

So the camera's mounted right in front of the SEABOB. That way, wherever you're going, it's in the front.

## **What kind of cameras went onto the gimbals?**

We had a RED MONSTRO 8K in there with a Canon CINE-SERVO 50-1000mm T5.0-8.9 50-1000mm zoom lens in a Shotover F1 Gimbal housing. We had at least three of those 50-1000mm on the job.

We love that lens. We use Shotover gimbals on the helicopter a lot. And then we put the Shotover on sticks in the back of a boat and then we can use that gimbal with the 50-1000mm. The boat can be moving really fast, in and out of the wave, and you can zoom into someone's eyes. It's amazing: the gimbal is so steady even when the lens is zoomed in to 1000mm. It's awesome.

## **You can go all the way to 1000mm and it stays steady?**

No problem. It actually has a built-in 1.4x extender so you can go to 1500mm and it's still steady.

We also put a gimbal on the back of a jet ski. This is something that we kind of invented. It's a little gimbal and we put a small compact zoom in it and we can control it from two miles away up on the cliff. We just have a driver of the jet ski and they can drop down the wave. If you watch episode five of *100 Foot Wave*, you can see that gimbal and you can see us using it. You basically can tow the surfers in with the same jet ski that you're filming with and then you can be in front of them, zooming and following them. We didn't put the 50-1000mm in there though because it is obviously too big.

## **What kind of gimbal is on the jet ski?**

That was a prototype. It was a B1 SHOTOVER gimbal, but now we use a GSS. GSS has a new gimbal that we put on the back of the ski. In the gimbal, we have a RED V-RAPTOR, so we can do higher frame rates, and a Canon CN-E 25-250mm T2.95 Zoom Lens. Of course, the V-RAPTOR is Full Frame, so we're shooting in Super35 format. But the 25-250 covers full frame with its built-in 1.5x Teleconverter (Extender/Expander) engaged.

## 100 Foot Wave, 50-1000mm Zooms



### **You're mixing Full Frame and Super35 on this production?**

Depending on the lenses and where the camera is mounted.

### **How do you keep spray off gimbal and camera on the jet ski?**

We have a rain spinner that goes in front of the housing. You can hit it with a water hose and it remains clear.

### **Do you own all this equipment?**

Yes. I think if I rented the equipment, the rental house people would probably say, "Oh my god, what are you doing with our stuff?" So we ended up buying everything that we use.

### **In Nazaré, where is the wave and the shore break in relation to that big giant cliff? It looks awfully close.**

It's right there. If you fall in the wave, you're pretty much going to be into that cliff in 20 seconds or so. You really can't fall. It's pretty scary. Just a little to the right is the big shore break which is even more scary because that shore break is just crazy.

### **Is that big wave there all year round?**

No, just a few times a year. It starts mid October and goes to the end of February or beginning of March. Kind of like the North Shore season out here in Hawaii.

### **Tell us about the crew. How did you round up all the usual surfing camera suspects?**

We had a really good crew. Josh Quick is our main guy. He shoots, is like a master AC, and he helped me pick out the crew that we work with a lot. In our field of chasing big waves, it gets big in Hawaii and then we get on a plane and race to Mavericks in California to catch that same swell before it gets there. I picked the same group of people that we usually work with

so everybody knew what to do. I can't monitor each camera, because we had 15 cameras. So I had to trust their wisdom in getting good shots. Surfing's such a different sport. I try to have crew who are used to shooting surfing.

We did monitor some stuff but it's all line of sight. When the camera on a jet ski would go behind a 100 or an 80 foot wave, the water would block the signal. Even when the wave went by, the camera operators were on their own. They had to adjust the aperture or whatever on their own and make sure they had good framing. We had a lot of meetings in advance to explain what we were looking for. Then we had different LUTs for different times of day, in the fog and different kinds of conditions. Josh Quick set everybody up depending on what camera system they had.

### **Which camera were you operating?**

The RED MONSTRO. We would move around depending on the day. Sometimes in the morning it was really foggy and so we'd have to get closer so you weren't shooting through as much fog, and then later in the day, we'd move around by the light-house on top of the cliff.

### **That was probably a good vantage point for the 50-1000mm?**

You can cover almost everything with that fantastic Canon 50-1000mm lens. We also do a lot of work for the BBC and I think that's a go-to camera as well for their nature shows.

### **You probably used Canon's earlier go-to long zoom, the 150-600mm, a still lens modified for cine shooting.**

I have that lens. I used one of those in Nazaré, rehoused by Otto Nemenz. I still have the Century Optics modified one too. I do have quite a few 150-600s. But my main lens is the 50-1000mm.



## Mike Prickett on *100 Foot Wave*, 50-1000mm Zooms



Canon CINE-SERVO 50-1000mm T5.0-8.9 50-1000mm.



Seabob with underwater camera housing in front.



### Did you have camera assistants pulling focus?

Yes. Even on the remote control jet ski camera, we had a focus puller because I was so busy framing the camera. We used an ABonAir system. It's a long range, low latency wireless video transmitter and receiver. I could operate and frame up the camera with that system. The focus puller was watching on the monitor and was using a Preston Hand Unit. This was essential, especially when I punched in tight at 1000mm to get the surfer's face. We do the same thing in the helicopter. When I use the 50-1000mm in a helicopter we use a Preston as well.

*Josh Quick added: The ABonAir model was the AB512 portable version. I rigged the Preston wireless control through the Shotover interface using a 900Mhz transmitter. Run/Start, focus, iris, zoom, pan, tilt, and roll were all controlled over that transmission. The AB512 units were used for microwave HD video transmission due*

*to their extremely low latency with sub-frame delays.*

### How do the jet skis towing and launching the surfers avoid getting knocked over by the actual wave?

It takes a lot of practice. Basically, the jet ski tows the surfer. Because in waves that big, it's moving so fast that you can't paddle in. They tow the surfer into the wave on a rope, and jet ski that tows them in is already in front of the wave. You just keep going in front of the wave, or it can go off the shoulder depending on what's happening with that wave. And then there's usually two other skis right behind that one that come in to do the pickup for that surfer.

Sometimes that same driver can pick them up, but they have to have a lot of safety, especially out there. There's plastic and fishing nets and stuff in the water. If your jet ski sucks those up, it stalls. You can get caught inside and get in a lot of trouble real quick.



## Mike Prickett on *100 Foot Wave*



Jet Ski with gimbal remote operated by Mike Prickett.



Mike Prickett operating gimbal camera with joystick.



There are lot of safety skis. Just safety for the safety for the safety.

### **How did you wrangle all the data from 15 cameras?**

Basically everyone had a hand in it. We had a DIT, who wasn't like a separate DIT, because he was shooting and everyone wore lots of hats. All of us were downloading our cards at the end of each day. We had 1 TB RED cards for the RED cameras and CFast cards for the Canon cameras. I'd say each camera shot about 2 TB per day. The interviews would take up quite a bit more because they're constantly running.

### **Where did you position the cameras?**

We had two in the water. Laurent Pujol, who also won an Emmy, was handheld in a housing on the back of a jet ski. I operated a remote control jet ski gimbal from up on the mountain. Two cameras were by the lighthouse, a wide and a tight. One at the

harbor. Then, along the cliff, we had a 5 cameras every 50 or 75 yards. We had cameras on the beach and another gimbal camera on a little dune buggy that would go up and down so we could do tracking moves of the surfers, like a dolly. We had a FUJINON 20-120 T3.5 Super35 Cabrio in that gimbal.

### **How did you clean the salt water off the equipment each day?**

That was a daily cleanup of everything. Windex on all the surfaces. Lens cleaner on the lenses. And Salt-Away on some of the bigger areas.

### **How do you clear the spray from the cameras while shooting?**

If your camera is without a rain spinner, you're constantly cleaning, often with a small squeegee or spitting on the lens. A raw potato works well. You cut it in half, put it in your pocket, rub it on the lens and the water just sheets off the lens really nicely.



## 100 Foot Wave, 50-1000mm Zooms



Dr. Raina Heaton PhD, Camera Assistant and Assistant Professor at the University of Oklahoma, with RED MONSTRO 8K and Canon CINE-SERVO 50-1000mm T5.0-8.9 PL.



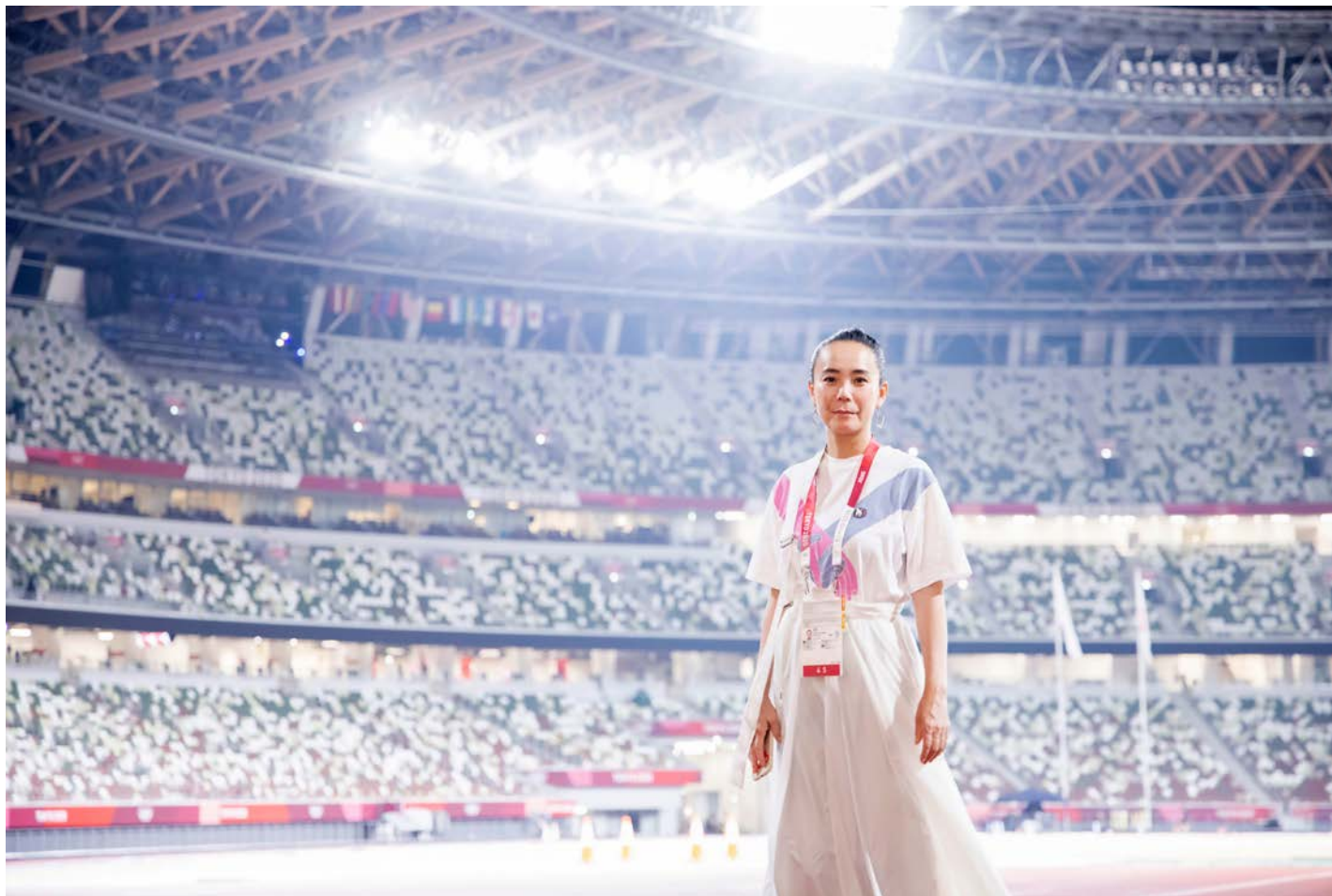

Naomi Kawase, Director of TOKYO 2020. Photo ©2022 International Olympic Committee. All Rights Reserved.

*The Official Tokyo 2020 Olympic Film by Naomi Kawase was produced in two parts: one showing the Games from the point of view of the athletes (Side A), and the other of the staff and volunteers (Side B). Side A premiered at the Cannes Film Festival on May 25, 2022.*

*The film was produced by the Kinoshita Group and the Tokyo 2020 Organizing Committee, in collaboration with the International Olympic Committee (IOC). Naomi Kawase was the youngest filmmaker to win the Caméra d'Or award for best debut director at the Festival de Cannes with her first feature, Suzaku, released in 1997. She is the first Japanese woman to be appointed a UNESCO goodwill ambassador in recognition of her film work, which focuses on the stories of women across generations.*

***Yas Mitsuwa arranged this interview and did simultaneous translation during our video conference.***

**Jon Fauer: When and how did the concept of TOKYO 2020 begin and evolve?**

Naomi Kawase: It was in the spring or early summer of 2018. The Olympic Organizing Committee got in touch with me. They said, "You are one of the nominees to direct the official Tokyo 2020 Olympic film. How would you make it if you are selected?" I submitted some proposals and was selected in early fall of 2018. We started shooting the pre-events in 2019; the pandemic began during shooting, and then the Olympic games were

postponed for one year.

**Did your concept change as a result?**

Yes. Originally, I wanted to focus on the volunteers in 2020. When Tokyo was selected to host the Olympics, they promoted "Omotenashi," the hospitality of the Japanese. I thought the Olympics would be a great opportunity for us to demonstrate our hospitality to athletes and visitors. I wanted to introduce the delicate care and the Japanese spirit, characteristics, and virtue through the volunteers.

I was also interested in how Tokyo would be changed. I planned to record how the athletes' village was constructed and how the bay area of Tokyo would be developed. Of course, I wanted to shoot the competitions of top athletes and convey stories beyond the competition. In that sense, I imagined something like a normal official film should be.

In addition to that, we had the Great East Japan Earthquake in 2011 and the tragic accident of the nuclear power plant in Fukushima. During the campaign to host the Olympics, one of the themes was the Recovery Olympics and they wanted to get rid of the negative impression of the name "Fukushima." So I wanted to take what happened in Fukushima when the Olympics came and how cities and villages were changed.

I had all these plans for the film, but the situation changed because of COVID-19. For example, there were rules of social





Naomi Kawase with her 8mm camera. ©2022 International Olympic Committee. All Rights Reserved.

distancing and we could not get close to the athletes. We could not place our camera at the positions we wished. To avoid any chance of infecting the athletes, we could not even interview them during the postponement. To be honest, I wish I could interview athletes without limitations, so that we could see better what they were really thinking and feeling in their hearts.

**Was the style of TOKYO 2020 (both sides) planned from the beginning—for example, the extreme close-ups in interviews and the cutaways of nature showing the changing seasons?**

I usually interview a person with the minimum number of crew members: a cinematographer, a sound recordist, and me, in order not to put pressure on the interviewee. It is my style to do extreme close-ups of the interviewees, so that we can capture subtle changes in their facial expressions. I consciously shot these interviews with that point of view.

The cutaways of nature show the changing seasons as you mentioned. They show not only the four seasons of Japan but also the fact that one year had passed due to the postponement of the games because of the pandemic. This is also one of styles that I like to employ.

**I saw production stills of you with a Canon 1014XL-S 8mm film camera. That reminded me of Jean-Luc Godard.**

I shot nature scenes with Super 8 and 16mm film cameras. The

16mm film camera was my Canon Scoopic. The Scoopic was my very first film camera. It is a good camera. (*We are on Zoom and Ms. Kawase holds up her Scoopic.*)

**There's a picture of you interviewing IOC President Thomas Bach, right up close to his face. What camera was that?**

That was shot with an off-the-shelf handheld video camcorder. It was small and the only thing I needed to do was press a REC button. An autofocus lens is built in. It helped me to get closer to the interviewees. Physical distance is sometimes proportional to psychological distance. I was the only one allowed to go close to Mr. Bach, so I had to be the Director/DP. But I did not want to make a rattling noise with my 8mm film camera during the interview, so I used the small consumer video camcorder. It worked really well and he was not self-conscious. You could not do that with a regular crew.

**The sound design was very quiet. That was interesting. When we watched the Tokyo Olympics on TV, it seemed very noisy. Maybe the networks added noise?**

Actually, I invited a sound designer from France who always works on my feature films to do the final mixing. We had a dozen sound recordists on the Olympic locations and recorded the sound there. As you mentioned, it was a bit noisy at the venue. Music was also being played there and we also heard



Photo ©2022 International Olympic Committee. All Rights Reserved.

announcements over the public address system. In other words, sound composition for the venue was mostly recorded in post.

**Please talk about the logistics in terms of production schedule, planning, shot lists, picking crews and all the details. I expect they were daunting.**

We had to submit all the camera positions by March 2020. But in reality, there were so many things to think about. For example, we had to imagine where the badminton courts were located and what images could be shot by looking at the floorplans. The deadline to submit the camera positions was very strict and we could not place our cameras without this process. It was not a situation where cinematographers could come and go as they wanted, as was the case with Kon Ichikawa's 1965 *Tokyo Olympiad*. Now broadcasting is important and OBS (Olympic Broadcasting Services) kept all the best positions for their cameras. There was a rule that we could not appear in frame in the images of OBS and if we were, we would be penalized and could not film the game any further. We could use anything shot by OBS but did not have a freedom of placing cameras. All these processes and negotiations to apply for the camera positions was troublesome.

**You got some great shots that I have never seen before. Especially a super long lens shot of Naomi Osaka at the Opening Ceremony. I did not see that on TV.**

We also applied for these unique camera positions in advance and OBS granted permission for that setup.

**How did you coordinate with the main DP Masaya Suzuki and the rest of the crew?**

Masaya was the DP of the film I shot before *Tokyo 2020*. I decided to go with cinematographers who had experience in documentary projects. Masaya also has many friends and brains in the film industry, and he helped us to coordinate the best crew members. We also asked the documentary specialists from Yutaka Yamazaki's team, with whom I often work together, especially on documentary projects.

**Are you interested in technical things? If so, would you care to discuss how the cameras and lenses were picked?**

I have some film cameras and have been shooting by myself since I was in my 20s. But I asked Masaya to select all the cameras and the lenses for this project.

**But I guess you were also shooting a lot of scenes by yourself as well as directing?**

That's right. (*Ms. Kawase holds up a number of cameras.*) Here is my Elmo Super 8. And this my Fujica ZC1000 Single-8. It is almost like a decoration at the office now. My treasure.

**Were you influenced by Kon Ichikawa's *Tokyo 1964* film?**

I think I was influenced by Kon Ichikawa's film and we shared a



# Naomi Kawase, Director of *TOKYO 2020*



Above: ©2022 International Olympic Committee. All Rights Reserved.



common understanding of what we were shooting. This is not a pure documentary film. It is a film that contains narrative and storytelling. I think TV can take care of accurately recording the facts. I wanted to make a work of filmmaker Naomi Kawase.

## How could you get so close to many key people and athletes?

I think we were able to get close to these athletes and key people because of the amount of time we put into it. We started the project in 2018, kept shooting for 3 years, and spent almost 4 years to complete these official Olympic films. So I was confident and happy to make two films: *Side: A* and *Side: B*. *Side: A* focuses on the athletes. And *Side: B* focuses on the COVID-19 situation, people of the Organizing Committee, and other staff behind the Olympics. This shows how Japanese people arranged and held the Olympic Games.

Unfortunately, rumors about the Olympics were severe. Although it was an honor for Japan to be awarded a world-class sports event, many people in Japan also had negative feelings due to fear of COVID-19. Almost 80% of the population objected to holding it. So I shot the events as well as the demonstrations. But I also wanted to show how the future is entrusted to the children. That is true and real. I myself was not biased in any direction in these films and I tried to look at what was happening objectively.

**That was a debate held around the world. Were you worried about your health and that of your crew?**

Japan is an island country. At first, we subconsciously tended to feel that we were protected. But the world is connected. I felt anxious about the possible collapse of medical care and the chaos of society, but I think it was a good opportunity for us to think about these potential problems.

We are ones who express ourselves. I believe we should not be influenced by the moods that are generated from news.

**At that time, March-April 2020 was pretty scary in New York. All productions had shut down. Offices were closed. People were terrified. The government was in denial.**

Do you remember the scene at the beginning of the film? New York, Los Angeles and other cities in the world. Times Square was empty. Everywhere on this planet had more or less the similar situation. Thankfully I have friends all over the world and they filmed the places where they were. In a sense, we have to tell the truth with motion pictures. We have to show what is happening at that time. However this is not enough. As Kon Ichikawa said, we have to tell the story. It would be great if people learn something from films. In the future, people who watch the film may think about the situation in Japan and the world at that time.

**Did you approach the film with a neutral or subjective point of view?**

Both. First of all, my position was neutral. But of course, there was another Naomi Kawase's point of view. She was always





©2022 International Olympic Committee. All Rights Reserved.



thinking about the film objectively. It is difficult to tell... one is Naomi Kawase myself and the other is Director Naomi Kawase.

### **Would you like to discuss your personal point of view?**

I love mathematics. I usually try to be neutral, as I calculate too much. Many people have the opposite image of Naomi Kawase. I am considered to be natural, as my films have many scenes of nature and kind people, and I always try to express human emotions. But I have to be a calculating woman to realize them as a feature film.

**So should I dare to say what I thought the theme was—from my point of view in the audience? I have been to Japan many times. I thought you presented a very interesting view of Japanese society. The way you focused on women athletes and their babies was something that no Olympic film had done before. It is a human story. With a humanistic point of view. The event itself was politicized and sometimes nationalistic. But you went above those things to show a lot of human emotions.**

Thank you. Because I am a woman. As a director, it has been very hard to make films in the last 30 years. It was very hard because I am a woman and Japanese. Maybe women athletes are in a similar situation.

Do you remember the marathon runner in the film, Aliphine Tuliamuk from the USA? She is a mother and came to the Olympics with her husband. He took care of their baby at the hotel in Tokyo. That was very touching. Her husband said she is an athlete but is also a human being. This is not only an issue of gender equality. It reminds me of the song *We are the World*.

**How did you get into the film business and why did you want to be a film director? Especially if it is so difficult in Japan.**

I live in Nara. Here, it is mostly countryside, far from Tokyo. The situation here is also different from Tokyo. In my generation, my friends got married at around 20 years old and had children. I was different as I wanted to make films.

I did not have my parents. When I was born, my parents divorced. I was adopted by an elderly couple who were distant relatives in their 60s and did not have children. Since I was small, I have been thinking, why was I born? Who am I? I was

very confused when I was a child. My life suddenly changed when I was 18 years old. I met a Super 8 camera at that time. I shot a scene of ordinary life in the real world. When I projected the developed film in a dark room, I was surprised to see that I could see images from time that had already passed. I thought it was a miracle. I could not be positive in my life, as I did not have my parents and I was poor; however film changed my life.

**You remind me of François Truffaut and the Antoine Doinel cycle.**

Film is my other life. I never really thought of it, because we've already done it. Film offers a way of expressing ourselves and explanations of why we do things, sorting out our dreams and emotions.

**You said that there was a competition to get the Olympic film job. How was the selection process done?**

I do not know the details but I heard there were 4 candidates for director. There were several parameters: first, the director should be known worldwide. Second, the director should be from the host country. And third, the director should be unique.

**Well deserved. Congratulations. What are you working on now? What's next?**

We recently had the Nara international Film Festival. I am the executive director of the festival. Since *Mogari no Mori (The Mourning Forest)* that won the Grand Prix at Cannes in 2007, many people took an interest in Nara, which is the location of the film and my hometown. However, Nara's economy is not that good. I felt that its good culture is disappearing here and decided to hold a film festival. I have been working on it since the Olympic project. Actually, Nara is a nice place. Please visit Nara when you come to Japan. You are always welcome.

I also want to shoot another film but my next project is Expo 2025 Osaka. I am the producer of the event and will have a pavilion Naomi Kawase. There are fewer than 1000 days until the event. I have to start preparing for it in earnest. There will be a new style of theater. A representative of audience will talk to a person on the screen, but they do not know if it is real or fiction.

**I look forward to visiting both Nara and your Osaka pavilion. Thank you.**



# Masaya Suzuki, Principal DP of TOKYO 2020

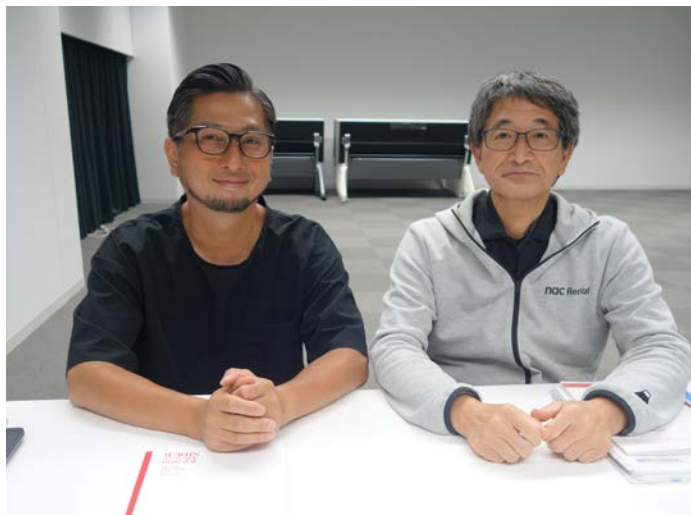

DP Masaya Suzuki with Hiromi Shindome of NAC (L-R).

*Cinematographer Masaya Suzuki was one of the directors of photography for Naomi Kawase's official film of the 2020 Olympic Games. He was also head of the 51 Team Kawase cinematographers for the production. This interview took place at NAC Rental located in Akasaka, downtown Tokyo. NAC Rental (also known as nac and formerly known as nac camera service) supplied gear and service not only for the Tokyo 2020 official film but also for Tokyo 1964 directed by Kon Ichikawa. Hiromi Shindome of NAC Rental also joined the interview.*

**Interview by Yasuaki Mitsuwa**

**FDTimes: The Tokyo 2020 Olympic Games were held last year, between July 23 and August 8, 2022. When did you start shooting the official film?**

Masaya Suzuki: Yamazaki-san (DP Yutaka Yamazaki) started shooting the documentary part in 2019. I joined the team on March 18, 2020 when the ceremony was held at Haneda Airport. That was the day an airplane departed from the airport to go to Greece to receive the Olympic Torch. Then, just before the Olympic Torch relay start at Fukushima on March 24, 2020, the Olympic Games were postponed due to the global pandemic of COVID-19. On that day, I filmed local staff clearing away the venue as the ceremony was cancelled. I remember that they looked quite disappointed. Nobody knew whether the Olympic Games would actually be held in 2021. It was unclear and gloomy at that time.

**A total of 51 cinematographers are listed in the credits. When the postponement was decided, did the film crew disband?**

Suzuki: Yes and no. All the crew members had to have a pass called AD (Accreditation Card). This is like an ID card with a picture, and it was necessary to enter the main stadium and each venue without exception. As of March 2021, all the crew members were fixed in order to apply for the AD in advance. After the decision of postponement was made, I made phone calls to every member and asked them for help if the Olympic Games were to be held the next year. During 2020, some members, including me, filmed the documentary part, like interviews with the national team members in training, medical workers fighting against COVID-19, officials preparing the event, and others.

**You worked with Director Naomi Kawase before this project?**

I worked on one of her feature films as 1st AC before. It was originally intended for me to join this project as an assistant. If the Olympic Games were not postponed a year, I probably would not have been hired as a DP. I had some opportunities to work with Director Kawase as a DP in 2020 and that is how it happened. For example, I shot a documentary film of *Omizutori*, a Buddhism event at Todai-ji Temple in Nara that has continued for more than 1200 years. I also shot *Miwa Somen*, a commercial of Japanese noodles in Nara. During 2020, I asked other DPs to support these projects and introduced them to Director Kawase.

**What type of cinematographers did you ask to join the team?**

The Olympic Games were held in mid-summer, so I called young cinematographers who could work by themselves flexibly for the outdoor shooting under the scorching sun. About one third of them were experienced documentary cinematographers usually working with DP Yamazaki. Others were young cinematographers who also had experience as camera assistants on feature films.

**What style and look did you share with the other cinematographers? Did you have any requests from Ms. Kawase?**

Director Kawase had two clear requests. First, she wanted us to shoot close-ups of subjects' faces for interviews as much as possible. Sometimes their heads and chins could be out of frame. She wanted to capture subtle changes in the facial expressions of the interviewees to see the truth behind. The second request was to be the eyes of the audience. The games were held without any audiences because of the pandemic. She asked us to substitute the eyes of people who were supposed to come to see the games but couldn't. And also, she said, "I am looking forward to your work."

**She relied on you and the imagination of cinematographers?**

I think so. She wanted us to think and shoot the film by ourselves and was looking forward to seeing the results. The film is a double feature. *SIDE: A* focuses on the athletes and *SIDE: B* is behind-the-scenes. However, this was originally planned to be one feature of 120 minutes. But 120 minutes are not that long, so everyone on the film crew wanted to take great shots to be used in the film. I remember that we showed each other what we had shot that day after we returned to the NAC equipment room in Akasaka until late every night.

**During the Olympics, different games take place on the same day. Did you organize smaller teams depending on the event?**

Yes. We shot a total of 24 different sports events. Each team consisted of 2-6 cinematographers and 1-4 other crew like director and sound engineer. Most of them were teams of 10 crew members at the maximum. All the cinematographers had to operate the cameras by themselves. No assistants, no focus pullers.

**Tell me about the equipment. What cameras did you use for the project and how many?**

We used 67 cameras in total. Panasonic EVA1 and Canon C300 were the main cameras.

**How did you select cameras for each event?**

Suzuki: We had a time-consuming process. First, we had to

# Masaya Suzuki, Principal DP of TOKYO 2020

apply for quantity of cameras and preferred positions in each venue with OBS (Olympic Broadcasting Services). After receipt of their approval, we went location scouting and selected appropriate cameras and lenses. It took more than 1 year for this process. We chose EVA1 for indoor sports, high-speed shots (120 fps), and scenes that needed telephoto lenses, because we made good use of its Dual Native ISO (ISO 800 and 2500). For sports where the athletes come toward the camera and focus-pulling is difficult, we used the C300 with its autofocus function. In other words, we chose the cameras depending on the characteristics of the sport, venue and shooting conditions. It was like solving a puzzle of equipment.

Director Kawase shot many scenes by herself, and these clips are in the opening and ending of the films. The impressive scenes of children were done with a Canon 16mm Scoopic film camera. She has much experience in documentary filmmaking and always carried a consumer camcorder as well. For example, she did a very private scene with Thomas Bach (president of IOC) and Yoshiro Mori (former prime minister and president of the Organizing Committee) chatting in the elevator. It only could have been shot by Director Kawase.

Director Kawase's energy and ability was amazing. I was surprised to witness such scenes next to her as the interviewees talked openly and honestly.

## What was the recording format?

We recorded Log format with the EVA1 and C300. I made a kind of shooting guide and handed it out to all the cinematographers at the first meeting. They could refer to the guidebook for the camera settings and recording formats. By the way, I had to create various documents and managed the equipment and media in an Excel file in the cloud. As a result, my Excel skills improved a lot.

## What lenses did you use?

We used zoom lenses for still cameras because of their mobility for single-person operation. I used a SIGMA 60-600mm for the opening ceremony. Director Kawase asked me to get a tight close-up shot of Naomi Osaka for her torch-lighting scene. I also used the lens with an extender to film the Emperor's speech declaring the opening of the Olympic Games. F-value of the 60-600mm lens is 6.3. And with a extender, it was like F8 and F11. So I used the base ISO 2500 with the EVA1. Dual Native ISO was very helpful for night games and high-speed shots.

## I guess you also needed a lot of media.

Suzuki: We needed many SD cards for the EVA1 and many CF Express Type B cards for the C300 cameras. We used more than 200 cards in total. I was very nervous about whether we had enough media every day during the Olympic Games.

## What was the daily schedule during the Olympic Games?

During the games, the equipment room on the B1 floor of NAC Rental was open 24 hours a day. Nagata-san and Shindome-san of NAC stayed here during the daytime. Each cinematographer came to the equipment room, took a PCR Covid test, picked up the equipment, and then went to the venue for shooting. At the end of the day, we came back here, returned the equipment, and submitted the recorded media. That was our daily routine. It was very hot and humid in Tokyo but all the crew members

## Partial Equipment List

	Brand	Model	Quantity
<b>Cameras</b>	<b>Panasonic</b>	EVA1	19
		AG-CX350	5
		HC-X2000	2
		Varicam LT	1
		LUMIX S1H	2
	<b>Canon</b>	EOS C300 MkIII	10
		EOS C500 MkII	1
		EOS C70	3
		XF405	7
		XF705	6
		XA40	8
		<b>Total</b>	<b>67</b>
<b>Lenses</b>	<b>Canon</b>	24-105mm	22
		24-70mm	3
		70-200mm	13
		16-35mm	22
		28-300mm	12
		100-400mm	22
		11-24mm	2
		20mm	1
		1.4x Extender	12
	2x Extender	23	
	<b>SIGMA</b>	60-600mm	8
		<b>Total</b>	<b>105</b>

were OK. Most importantly, I am glad that nobody was infected during the period. Our COVID task team worked hard without sleeping at night.

## Did you watch Tokyo Olympiad by Kon Ichikawa?

Yes. I like that it does not focus on the results of each competition, like who won and who lost. I think it is a unique viewpoint of Kon Ichikawa who shot many feature films. I was surprised to see that his documentary film was shot with anamorphic lenses.

*Hiroshi Shindome of NAC added: In the 1950s, TV was not as widespread as it is now in Japan. Almost everybody watched news films in movie theaters. Many were shot with anamorphic lenses. NAC used to manufacture and sell anamorphic lenses called HM lenses for news films and we also built some custom telephoto anamorphic lenses for Director Ichikawa's Tokyo Olympiad project.*

**There were many things happening before the Olympic Games, and there were strong headwinds. President Mori resigned because of his comments demeaning women.**

Some people said that the impact of Mori's resignation on Japa-





nese society was greater than the postponement of the Olympics. It may be true. After Mori resigned, a number of women joined the Organization Committee including the president succeeding him. I think this was an opportunity for Japan to change. 50 or 100 years later, when people watch the films, they may think the Olympics triggered the change of Japan in 2021. These are documentary films that captured the real Japan in 2021.

### **What else was impressive to you?**

I was moved and wept watching the women's skateboard competitions. Even if they tried difficult tricks and failed, they were praised by their rivals. They were also happy to see the success of their rivals as if it was their own success. It shows how they purely enjoyed the sport. It was very different from my teenage memories. I was a member of a baseball team in high school. In Japan, we used to play sports, because "there is something beyond effort and suffering." The scene I saw was like "there is something beyond fun." I felt like Japan will be changed by these young people.

### **The Olympics were held without spectators. Was this good or bad for filming?**

The good thing was that we could enter the venues smoothly from an aspect of security. We did not have to stay with the camera all the time at each venue. On the other hand, if there had been spectators, I think the expressions of the athletes might have been different. I felt a bit strange when I filmed a badminton match. It was quiet and I could only hear the sound of rackets, shuttle, and players. I heard many athletes say that the cheering pushed them on and I understood it at that time. For example, there is a customary clapping of spectators for the running long jump. The result might be different with the clapping, even if the difference was a few centimeters or so.

We thought many people would come to Japan for the Olympics

and we were expecting Japan would be active and lively. We were looking forward to see that. When it was postponed, we were wondering if it would really take place in 2021. Japanese society was something like in depression. I interviewed people in empty downtown Tokyo and medical workers at hospitals in 2020 and I did not know whether we were chasing the Olympics or COVID-19. To be honest, we shot many scenes that we could make into a great film, even if the Olympics were not held.

*Hiromi Shindome asked, "Do you mind if we mention your jinx?"*

I don't know but some Japanese athletes and national teams lost when I went to shoot the venues like the 400m relay and the Judo team competition. Other crew members asked me not to go to the venue, please.

### **You were in Fukushima, and not at the venue, for the mixed doubles badminton tournament?**

That may be why they won!

### **Wrap shot comments?**

I would like to say that this is a work made by all the crew members. Many people worked hard and supported us very much. I would like to get together with all crew members and have a viewing party to hear what else happened behind the scenes, and before and after the clips shown in the film. I want to hear what others did, saw, and thought while we were looking through our viewfinders.

Personally, I was luckily able to witness and experience this event that I would normally only see on TV or a movie screen if I lived a normal life. It was also a great experience for me to work with people from different professions, whom I would not even know if I had not been involved in this film—members of the organizing committee from various governmental agencies and sponsor companies, politicians and others.





by *Yasuhiko Mikami*

What makes Japan different? 120 million people live on this small island with the world's 3rd largest economy, while they are constantly reminded of natural hazards on a daily basis. Earthquakes, volcanos, tsunamis, typhoons, extreme rain and snowfall, the list goes on. Lately, the country faced a new challenge named Covid, just like the rest of the world.

Against this backstory, please meet Mr. Yuji Morihara who runs the production company Gonshiro in Tokyo. It was established in 1989, specializing in live event production, primarily pop-rock concerts of Japanese artists. What makes Gonshiro different from other live video production companies is the way they mix Super35 digital cinema cameras with standard broadcast cameras.

In late December 2020, the FDTJ team was invited to watch their production of a live concert at the Saitama Super Arena, located 30 km north of Tokyo. The stadium has a maximum capacity of 37,000, although ticket sales were cut to half to keep appropriate

social distancing for the audience.

A total of 24 cameras were used, which is the maximum number of inputs on the video switcher. There were effectively 3 camera categories:

2/3" broadcast: Sony HDC-4300 with Fujinon high zoom ratio box zoom lenses.

POV: Panasonic AW-EU150K and GoPros. The small camera profile makes them a favorite choice on stage. The cameras can be placed between drum sets and fairly close to the performers without disturbing them.

Super35: Three Sony F55 cameras were configured in broadcast mode via HDC-4000 adapters. All three cameras were attached to Angénieux zoom lenses: Optimo 28-340, 24-290, and a compact Optimo Style 16-40.

Two ARRI Amiras were used handheld style with Canon EF 70-200mm photo zooms.

Two ALEXA Minis were placed in front of the stage, one on a





tracking dolly, and another on a crane. What made these two cameras unique was the choice of lenses, as the camera operators had the liberty to choose different lenses, including primes, during the show. They even exchanged lenses while the performance was underway. A set of ARRI shift lenses (rehoused Canon EF glass), a vintage Cooke 25-250 zoom, and a set (6 focal lengths) of Angénieux Optimo Prime lenses were prepared. Why prime lenses for a live event production, and why even dare to change lenses during the show? We asked these questions to DP and CEO of Gonshiro, Mr. Yuji Morihara.

## **Tell us why you mix broadcast cameras with S35 cameras in a live production environment.**

If we were living in a perfect world, I would love to see cine quality lenses on all of my cameras. There is such a big difference between most TV broadcast zoom lenses and cinema lenses: the look, gentle contrast, depth of field control, and the list goes on. There are a few reasons why we have to mix non-cine style cameras for a live production. These cameras are assigned to restricted camera positions. When ticket sales begin, the audi-

ence seat positions are fixed, which also means the locations for cameras are pre-determined. That is where high-zoom ratio box type TV zooms are necessary for the reach. We cannot place cameras in front of the dead center of the stage as it disturbs the audience. In many cases, there is not enough space to place a large camera and lens. Compact cameras like GoPros and PTZ cameras with integrated camera pan-tilt control come in handy to place cameras in tight spaces.

## **Perhaps zoom lenses are better suited to shoot live events? Then, why prime lenses?**

We have been using prime lenses for a while, and it started off by using shift lenses. One day we had a camera with a shift lens on a Spidercam and flew it over the audience at Tokyo dome. Using shift lenses and controlling the focus area creates a pseudo “miniature photography” look, and both the artist and the audience loved it. Then we took it a step further and used shift lens in a more orthodox manner shooting close ups of the main talent. It certainly gives a unique look. Of course, we have to be careful when to use such specialty lens. It works very well when the



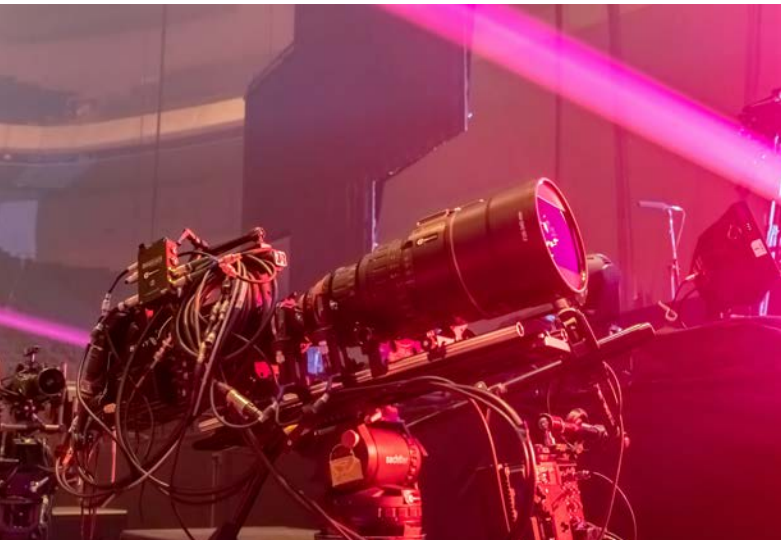

artist is not moving and during moments when the artists want the audience to concentrate on listening to the song. We do not use shots from the Shift lens camera all the time. The standard shots are covered by more regular cameras equipped with zoom lenses, whether Cine zooms or TV zooms. However, the S35 cameras with prime lenses play a fundamental role to spice up the show.

## **How /when /who decides which prime lens to use?**

The camera operator needs to know the songs and the order. There are certain moments that you cannot miss, and the operators know when that is. They have the liberty to select which lens to use. Just in case there is a risk of missing that moment, I talk over the radio asking for a lens change. It doesn't matter if the lens change happens in the middle of a song, as we have the rest of the cameras covering the whole show.

## **What was your impression on the new Optimo Prime lenses?**

Unmistakably Angénieux: the gentle contrast, nice rainbow flair, all packed in such a small form factor makes these lenses extremely attractive. They match beautifully with the zoom lenses we have. The longest lens was the 135mm Optimo Prime. On certain shots we wanted a longer reach and I understand a 200mm lens is coming soon.

## **We noticed that your lenses had neither matte boxes nor lens shades.**

There are two reasons. First, we have to keep the camera profile as small as possible so as not to disturb the show and to keep the camera package weight as low as possible to use smaller camera support gear. Second, we cannot prevent the stage lights from hitting the lenses, but that is a very important artistic factor. Actually, we love occasional flares as they enhance the ambiance. We are always looking for ways to create beautiful flares, and that is one major reason I like using Angénieux lenses since they create a natural rainbow-colored flare. Perhaps we are obsessed (in a positive way). In order to enhance the flare, we often put a small reflective piece of plastic in front of the lens to induce more light reflections into the lens.

## **How do you decide on the camera movements and when to switch cameras? Is there a full rehearsal with the musicians?**

We rarely have the chance for a full rehearsal. The standard practice is to have a pre-production meeting with the director, artist's office, lighting department and set designers. Usually, the meeting happens two months ahead of the show, but it could be close as 10 days before. We go through the set list, define camera positions, exchange other requests.

A major difference between drama/feature production vs. live production is "whom do we light for?" In drama/features the director and cinematographer determine the shot. In live production, the live audience takes precedence. We cannot place or move cameras that disturb their experience of the concert or event. The good camera positions are very precious, and sometimes we have to work with a second camera crew who is in charge of the video that is projected on the large venue screens.

So, negotiating and agreeing on camera positions requires some negotiation skills, and getting the lighting condition that I want is yet another story. Interesting enough, things have gradually changed because of COVID. Since we have to limit the audience size, there is a bit more freedom in choosing camera spots. More concerts are being streamed live over the internet, meaning paid viewers are participating in the concerts through my lenses and cameras. I feel the stage lighting team members are getting a bit more cooperative and listening to my requests.

Instead of having a full camera rehearsal, what happens is I sit through the whole concert at the start of the tour. I carefully watch the show, decide the shot list. In a busy year, I would attend 250 concerts within 12 months, either for preparation or live production. For large scale shows that involve many dancers, I myself create a camera script that shows the camera movement and where the lead artists are. It is something like what you do in football, you analyze the action and formation, and then define how to move the cameras around. Needless to say, the camera operators should not collide with the dancers, nor should they obscure the view of the audience. On a big show the camera script can be as long as 200 pages for one night. The camera operators check the camera script on their iPads all the time.

As the DP of the show, I sit with the director and switcher, and support them in monitoring all the incoming camera signals. It is like staring at 24 pieces of a puzzle all the time, making sure





each piece (each camera angle) fits the song. Which camera to pick is decided between the program director and the switcher. I rarely check which camera is selected for the main program output. My mission is to keep feeding pictures that match the song and satisfy the creative intent of the director.

### **How do you match the look between so many different cameras and lenses?**

I have to confess there is no perfect scenario, but we do our best to match the cameras as much as possible during camera prep. Usually the smaller format cameras are more difficult to match with the rest of the group.

### **I noticed you had photo zoom lenses attached to the two ARRI Amiras—why was that?**

I am looking for a fast and long tele zoom that is compact and light enough for handheld shooting. At the moment, the Canon 70-200mm F2.8 photo zoom is one of the viable options, and they are very affordable as well.

### **Have you considered using Full Frame cameras?**

When you compare S35 vs FF/VV, the most meaningful advantage is offering enhanced depth of field control at wider angles. Sure there is a benefit in using say a 24mm T1.5 lens, but I am not sure how we can benefit from such camera/lens combination when shooting live concerts. I also need high quality 1080/24P live output from those FF cameras, as recording large RAW files is not an option. Before stepping up to Full Frame cameras/lenses, I would like to try S35 anamorphic.

One important advantage of using S35 cameras compared to smaller sensor cameras is the selective depth of field. They make the artist stand out from the background, where in many cases the stage screen/panels occupy a large portion within the picture frame. When using smaller format cameras, the pixels of those screens can be very annoying. The selective depth of field on S35 cameras help to smooth out those pixels, and that is the reason why we always try to shoot at full open T-stop on our S35 cameras.

### **Have you considered adopting cutting edge technology like AR and 5G connections to enhance your production value?**

We frequently receive requests from telecom companies to provide raw camera footage for 5G technology experiments. Their agenda is to promote 5G to each individual audience, allowing them to watch their favorite dancer or singer on their cell phones. In fact it is the exact opposite approach to what we do. We carefully design each shot by selecting the right lens, right framing, add the most effective camera movement, and switch between multiple cameras to enhance the concert experience. We want the audience to enjoy the sound and image in a decent environment with larger screens and better speakers. The 5G approach is to bypass all the added value and let the audience just monitor their favorite actor/singer/musician on a tiny screen, as if they had their own surveillance camera. Perhaps the 5G approach would work for sports events, but I am not sure if it is a good thing for live music events.

### **What was the most troublesome aspect in shooting a live concert under COVID?**

The first and foremost concern was “is the concert going to take place or not,” followed by the next question, “are we going to have the audience or not?” Having the audience or not has a big impact on stage lighting and camera positions. It mentally affects the artists and performers, as they are not used to performing in a vacant stadium. On New Year’s Eve, we shot a rock concert in a totally empty Yokohama Arena that can accommodate 17,000 people. We got a shot of the lead vocalist from behind the stage, and he was constantly waving to the vacant stadium as if it was full of fans. That was a very emotional moment. I honestly respect his showmanship and cannot wait for the day when things return to normal.

There is a concern in this industry about the future of live events; what will be the “new normal”. Once Covid has happened, would tens and thousands of people still gather in a crowded stadium again to attend an event? Would the artist go through a rigorous nationwide road tour for weeks and months? It seems live streaming is here to stay, and many artists are exploring different ways to make the most out of this new distribution scheme. The show must go on.



Above: Photo of DP Ji-Sun Yoo courtesy of SAEKI P&C. Opposite: Production stills courtesy of Netflix Korea.

*I had been bingeing on the Netflix Korea series D.P. The title was intriguing enough. D.P. as in Deserter Pursuit, not Director of Photography. Set in 2014, D.P. is the story of a team of Korean military police and their heartbreaking job of catching deserters.*

*But even more interesting was the artistic use of SIGMA Classic Prime lenses. Kazuto Yamaki, CEO of SIGMA Corporation, introduced Ms. Courtney Lee, Vice President of Saeki P&C and distributor of SIGMA in Korea.*

*The DP of D.P. worked with SIGMA Classics in a careful and controlled way. It was quite unlike anything else I had seen with these lenses. SIGMA Classics are uncoated and can achieve a painterly quality with beautiful flares and bokeh. Used without restraint, the image can wash out. But of course, cinematographer Ji-Sun Yoo had worked as a gaffer and knew these things.*

*Courtney Lee graciously translated my questions and Ji-Sun Yoo's replies.*

**Jon Fauer: Congratulations. *D.P.* looks amazing. I watched the entire season. Your cinematography was the best use of SIGMA Classic Primes that I have seen so far.**

Ji-Sun Yoo: Thank you.

**Why did you choose Classic Primes?**

*D.P. is a Netflix Original series and, to my knowledge, it required a different cinematic expression. Though it is a Full Frame 4K production, I wanted to recall the atmosphere of rough/rugged classic film look but with unique characteristics. I found SIGMA Classic Primes addressed those needs perfectly: something uncommon and with an unusual look.*

**Usually we think of uncoated lenses for period pieces or romantic dramas. *D.P.* was neither. Please discuss.**

*The series presents the story of Private Ahn Joon-ho as he begins his military career in an army dominated by rules and rank. To express how he endures and copes with such an environment and circumstances, I wanted to create an "ironic" look where both brightness and darkness of light coexist in soft texture.*

Light has a dual function: it accommodates brightness and desire, but it also embodies discomfort and tension. Soldiers in the higher echelons of hierarchy usually stand against the light and are less affected by it, while low-ranking soldiers are placed in a position where they can't avoid the light. In order for this use of light to be expressed throughout the series, uncoated lenses would be an excellent choice, I assumed.

**A very fine assumption. How did you and the director arrive at the style and look for *D.P.*? And the choice of lenses?**

During tests for *D.P.*, Jun-hee Han, the director, had mentioned the look of 16mm film. It sounded interesting, but I didn't want *D.P.* to have the ordinary "vintage look." To distinguish the look, we decide to go for lenses and filters that are rather more responsive to the light.

**Were you wide open on most of interiors and night exteriors?**

Most of the times, yes. From episode 1 to 4, I used wide angle lenses to capture the emotions of the characters as dimensionally as possible by locating the camera very close to them. From episode 5 to 6, the complicated and twisted situations were shot with telephoto lenses to create a very flat and frustrating atmosphere.

**How did you keep the lenses from flaring too much and looking "foggy?" (Many flags and careful placement of lights?)**

The flare of SIGMA Classic Prime is distinctive compared to any other lenses. Frankly speaking, the lens gave me a bit of a surprise in the beginning, but its characteristics had become a solid impression in the cinematography. So, I intentionally overexposed the soft blur of the highlights in the beginning. However, as the story became more serious towards the second half, the exposure of highlights was reduced intentionally to focus on the story and emotions, rather than the image. Of course, it was time-consuming and laborious. However, I was able to create a new look by embracing such characteristics.

**Favorite focal lengths?**

No single ones, really. I am always looking for an angle of view that suits the situation.





## Any other lenses—zooms?

SIGMA Classic Primes were used for almost all of my shots while shooting *D.P.*, except for some CG background compositing scenes.

## Filters?

DREAM FX filter. This filter is a lot of fun to use since it is also very sensitive to light with a strong personality, like SIGMA Classic Primes.

## Your focus puller did a good job. Wide open, Full Frame. Please explain.

We were shooting in Full Frame and a majority of the scenes were shot wide open. It was necessary to plan the movement of the actors and the positions of the camera(s) exactly before the shoot. Despite the challenges and circumstances, my focus puller Yoon-Sung Lee did an amazing job.

## What cameras did you use?

ARRI ALEXA Mini LF and Panasonic S1H.

## Please discuss camera moves and composition. Handheld? Steadicam?

I always worry about spatial expression: how to signify the space and how to represent the actors and their behavior properly. *D.P.* takes place in a confined space of the military unlike the rest of society. To highlight the distinction, it was necessary to construct how the characters would behave and act in a given space.

For example, camera moves in early episodes when Private Ahn Junho joined the army had to be very minimal. This was to reveal his submissive attitude to higher ranking soldiers, physically and emotionally. As he slowly adjusted to military life, the scenes were composed to be led by the movement of Private Ahn Junho—with the camera following him to express the change of his behavior.

To indicate different stages of emotion, we used a dolly to illustrate the soft atmosphere, and, in some sequences, we shot handheld to indicate his dynamic emotions.

## How large was your camera crew?

Aside from me, 7 crew members were working with two ALEXA Mini LF cameras and the sub cameras.

## How many days for each episode?

It wasn't exactly scheduled for each episode, but it took us about 5 months to film 6 episodes.

## When did principal photography begin and end?

I participated in pre-production from May 2020, began principal photography in September 2020 and finished filming at the end of January 2021. And the DI took about three months for me.

## Rental house or do you own your equipment?

We used equipment from a rental house. Special thanks to Digital Factory for their great support in many ways.

## Please discuss your lighting package.

We tried to limit the use of LED light as much as possible. Instead, we used tungsten and HMIs to create an old-fashioned lighting experience.

## How did you begin your career in film? Film school?

I majored in business administration. But ever since I was young, I loved watching feature films—especially the ones directed by Chang-Dong Lee. That is when I realized I wanted to make my own movies and decided to learn about cinematography by working on film sets.

Watching a movie is still my favorite thing to do. When I am off, I try to watch as many movies as possible.

## Congratulations. *D.P.* is a big success worldwide.

From the very beginning to the end, the look of *D.P.* was rather unfamiliar to many people. There were a lot of concerns and expectations at the same time because of that. Fortunately, many people from all around the globe have enjoyed *D.P.* and I am very grateful.

*D.P.* means a lot to me, and it encouraged me to take on new challenges in my career. I would like to express my gratitude to those who always trusted me no matter what.



## Francisco Campos-Lopez on *DamBusters*



Francisco (Franco) Campos-Lopez handheld with Blackmagic URSA Mini Pro 12K.

*Francisco (Franco) Campos-Lopez zoomed in from Brussels where he was preparing for the world premiere of his film *DamBusters*. He also presented a special version of the film for the European Parliament.*

*Franco was born in Chile. He is an award-winning filmmaker, having attended the Chilean Film School (Escuela de Cine de Chile) in Santiago. After a number of years in LA, he moved to Alexandria, Virginia, near Washington, DC, National Geographic and Discovery.*

*Watch the film here: [www.dambusters.net](http://www.dambusters.net)*

**Jon: tell us about the background to *DamBusters*.**

*Franco: *DamBusters* had been on my mind since I was kid in 1995 and watched as one of the most beautiful rivers in the world, the Biobío, was lost to a mega dam that we didn't really need. Biobío is in the south of Chile, where I was born. It created such an impact on me that I vowed, no matter what, I would set aside some time in my career to do things for rivers and the en-*

*vironment. A few ago later, I started learning about dam removal to better set up river restoration and it became a thing to me.*

*Of course, many dams are necessary for hydro power, flood control, irrigation and reservoirs. But many dams are obsolete obstacles that can be demolished to restore nature. I strongly believe that nowadays, in the state that our planet is in, we need instances where we can bring nature back.*

*The film was commissioned and co-produced by the World Fish Migration Foundation, WWF, and Magen Entertainment, with the support of Wetlands International, The Nature Conservancy, the European Anglers Alliance, Nationale Postcode Loterij, the Life Programme of the European Union, Mulago, Biohabitats and the ForestPeace Foundation.*

*Initially, my company partnered with the World Wildlife Fund (WWF). We started filming last year and now we have the culmination of those efforts with the EU screening and world premiere. The concept is not really a natural history film but*





In the estuary at Mont Saint-Michel, France.

more about following the journey of inspiring individuals.

### **How did you get funding for the film?**

I got some seed money from the Dutch lottery and from the EU. Then the WWF came into the picture by providing completion bond funds. A lot is being absorbed by my company. We made it work, but mainly it was an entity from the Netherlands.

### **Why was the US not involved?**

The US did not get involved because here, the US is way ahead of every other country in terms of dam removal. It started in California in the '80s. So the US has been an inspiration for dam removal.

### **Why were these dams built in the first place?**

If we start with France, which is where the film begins, the typical scenario was that these dams were established to provide some electricity—not even providing an entire regional or town, but just some electricity. The dams that we feature in the film are

close to the Atlantic Ocean. One is in a famous spot, near Mont Saint-Michel, in Normandy. There are two dams preventing the river's natural flow. The people there got very little energy from it, but they were attached to the lake forming a reservoir. It was a recreational area for them. But these rivers flow into an estuary and then the ocean. From an ecosystem point of view, it is complicated because you are cutting the flow between rivers and estuaries.

And then, in Spain, the dam was built in 1899 with a very minimal hydroelectric operation that actually expired about five years ago. It was not even producing electricity. But no one had the money to maintain it, and they do require maintenance. And then in Lithuania, there was more like a Soviet era dam controlling the flow of the river, not producing any electricity.

Estonia was very similar to what you see in the northeast of the US. All these dams were built for mills, long gone, not having a practical use anymore. Finland was a ground-breaking case





Blackmagic URSA Mini Pro 12K, fully rigged.

because they were producing a very minimal amount of electricity, and then the government and some entities negotiated for restoration of the river, which will be better economically for the entire region.

### **Where does that leave hydropower that requires dams?**

Great question. We're discussing that all the time and the crisis is real. We were reading the paper today about Nord Stream. Europeans are worried and some countries, especially in Scandinavia, are not promoting a dam removal agenda right now.

They're in a tough spot for energy. But, when you say dam removal, you might believe that we are thinking about all the dams. But, the dams that are most likely to be scheduled for removal by the EU are mostly obsolete, don't provide any fish passages, and are not producing electricity.

The large dams that exist all over Europe are not going anywhere. They're needed. The big challenge also is that many Europeans are very wired in terms of being familiar with their dams because it has a recreational value. They have the lake, they have some electricity.

On the other hand, many countries in Europe are producing a lot of energy from wind farms and solar. Spain a leader in the effort of dam removal in the world and they have an entire region in the south that is all solar farms.

The EU is fully committed to remove a lot of dams on the entire continent and a lot of money is going to restore rivers. But the distinction here is to make sure that they're obsolete dams and are a burden for the public. That they represent a hazard.

### **What do you tell people who say, "Oh we're going to miss our lake"? What do they get in return?**

It happened to us in Normandy. We experience all those things. It has to be fair, it has to be balanced. I was very moved by all the people in France. They seemed to have protesting in their DNA. So they go around with billboards. You see all the grannies there: it's really cool and they're very reasonable. Others said they were sad because they learned how to swim there and learned how to fish. They believed, which is one of the biggest misconceptions of dams, that their towns could be flooded because they provided flood control, which is not true in this case.





Like Excalibur rising from the waters, a Blackmagic Pocket Cinema Camera 6K Pro.

So now they see the river is restored, they're getting salmon back after 100 years. They're excited. They finally see that nature is very quick in coming back. We covered the process. Now the area is beautiful—everyone could see a tangible process of their nature coming back, bringing fish back. They don't have the lake, but they have a beautiful river now.

It was a hard way because they felt the decision was made in Paris. But then you see the beauty of nature coming back. In the moment you open up a river and you get the banks back, it's amazing how quickly nature comes back. Now they're enjoying the results. They created kayaking centers and swim areas to enjoy the river. Some countries are creating man-made rapids, so they can have white water for kayaking, canoeing and rafting.

#### **Let's get to the equipment. Tell us about cameras.**

We had up to four cameras running. The main camera was a Blackmagic URSA Mini Pro 12K PL. That camera is an interesting combination of high resolution and images that do not look unnaturally sharp. It's very pleasing and I never wanted this film to have a super crisp natural history look, although they cer-

tainly have a place and I watch them all the time. But, I wanted to show nature with more of a filmic view.

And that camera is very versatile because I can do a very sharp landscape if I want to, and just use down sampling of the sensor, and get a very sharp image that the colorist can work with. But at the same time, it provides a very beautiful image. My favorite shots are recorded with this camera because it provided the cinematic look in a film about nature.

The camera's very rugged and has taken a beating in many conditions. I used this camera in deserts, in snow, in glaciers and it never failed. For example, we were in an area of northern Finland where the weather could be really complicated and suddenly change to a misty day, which is not good for cameras. I needed something reliable and that camera was my choice there. I own the camera, of course. I used it for many scenes of this documentary. But in Finland, I put it to work like crazy — carrying the camera and all the accessories in a lot of clothing pockets.

And then, the Blackmagic Gen Five color science of this camera is absolutely beautiful, and it makes things easier post when you





are using multiple cameras.

### What were your recording settings?

Mostly 8K, sometimes 12K, always B-RAW, Q3 Constant Quality, Extended Video LUT. I shot everything in 8K on the A camera. The B cameras were the original Pocket Cinema Camera 6K and the Pocket Cinema Camera 6K Pro. Those were at 5.7K. I have the Pro version because it has the ND filters built in, which are helpful when I need to be fast.

### Who operated your other cameras?

We hired local DPs and crews in each country.

### Did you have a focus puller on the A camera?

No, I was operating, doing zooms and focusing myself. I had Tilta handgrips with lens controls for focus and zoom. They never failed me and proved to be reliable. The right handle was for focus and the left one was doing the zoom.

It was good for me to be fast, but I had to stay safe in the water and rugged conditions.

### When you were running around all over Europe and everywhere else, how did you handle your data at day's end?

By not sleeping much. Basically, I had two jobs. I was directing, shooting this whole thing every day for a year or two. At night, it would be my second shift to make sure everything was fine.

### What kind of SSDs do you use for file copying?

I use SanDisk 4 TB SSDs. They are worth it. They never fail. You

can beat them up. They are water resistant.

### Do you record from the URSA 12K directly to those SSDs?

Sometimes, but the URSA Mini Pro 12K has an accessory URSA Mini Recorder SSD module. It attaches directly to the back of the camera and lets you record Blackmagic RAW files onto 2.5 inch NVMe 7mm U.2 SSDs or standard 2.5 inch SSD Media. I actually shot on this thing every time I could.

### What handles, rods and support did you have for the camera?

Even though I was running around a lot, I had the URSA Mini Pro 12K basically in studio mode because I like 19 millimeter rods. I'm in the 19mm world with all my Wooden Camera accessories. The reason I use this system, as you can see in the photos, is that I'm not using any shoulder pad because I was using an Ergorig handheld camera support with dovetail combo. I have Bright Tangerine matteboxes, including the clip-on Misfit Atom. It's light; it doesn't fall off when you bounce the camera.

### Please discuss look and grading.

It's good to talk about this, because we spent most of the time doing the grading and getting the look that we need. So the colorist set me up in advance and created 3D LUTs to load into the cameras to have a cohesive monitoring experience. This worked throughout, with all the cameras, even when we had to go fast, as well as when we were watching dailies. He worked on ACES, so the whole film was done in ACES. The LUT was similar to the camera's extended video setting. I asked him to be a bit more





contrasty so I could protect the shadows and blacks.

But the video codec is so good, especially when you do everything in DaVinci Resolve, you don't need any plugins or third party software. If you stay in DaVinci Resolve, you can really unleash the codec. The highlights were beautiful in areas where we had hard sunlight. The color was good, and it was such a great baseline from all the cameras. I would like to praise our colorist, Gonzalo Greco. We have been a team for a long time. He's my right hand in terms of the look. We usually work beforehand creating tests, then I go on set with his LUTs, and we tweak again.

One of the challenges that we had in this film was the amount of additional footage and stock footage that we received. In that regard, it was good to standardize everything on ACES to deal with drone footage, explosion scenes, and archival material and still have a look that was cohesive.

The whole project had, I believe, about 35 TB of data and we did proper media management sending the RAW files on DaVinci Resolve with the trim option so you still retain all the RAW metadata. It was a very complicated process and probably where we spent most time.

### **Please tell us more about trim process.**

You have a couple options. When you are going to hand off the online process and want to have someone doing the color correcting and finishing, you can probably copy all the project files to a drive, which is inconvenient because it's a huge drive with all the assets and it takes forever. But DaVinci Resolve has an op-

tion for a third party as a confirming process with all the media management. So DaVinci Resolve will create the media management and you can select an option to output the selected RAW files, with handles (extra time) if you like.

Since this film relies on a lot of sit-down interviews, you might have used, for example, 30 seconds from a 20 minute interview. It would be very inefficient and a waste of time to send a colorist the entire uncut RAW scene that could be many terabytes of data. So instead, this process of outputting media management with the trim option actually groups the splices from each RAW file. The whole film with the metadata came to around 600 GB when prepared with media management for the colorist.

The colorist can take that drive, relink everything on the DaVinci Resolve project with the proper color administration, do the work, send it back to me as a DRT (DaVinci Resolve Timeline) on my project, and I can just see everything is fine. A third person will log into the computer from a server to do the conforming, make sure that everything's fine and eventually do the mastering and deliver the DCP.

People in three different countries were preparing things like that. It was a pretty seamless way of working. I think it was a good decision to have a consistent Blackmagic Design workflow from cameras to post. We were in a DaVinci DaVinci Resolve environment and it was pretty flawless and easy to do. We were able to retain maximum quality and have the colorist deliver the UltraHD 4K master. So, I'm pretty excited by the way it worked out.





Eight-foot tubes in the shot are removed by compositing with a clean motion control pass.

*There's an interesting Chevrolet Equinox EV commercial. Instead of the usual running footage against a virtual background, this one is like a cubist deconstruction that clearly helps demonstrate how the process works. You can see the individual panels surrounding a turntable on which the hero electric SUV revolves. Darren Lew was the cinematographer. His discussion is like a short tutorial on working with active backgrounds at Carstage in New York.*

*You can see the spot at: [youtu.be/S-IcGVD-94w](https://youtu.be/S-IcGVD-94w)*

Darren Lew: This is actually a testament to how well the active LED background panels can be used as lighting sources. I could write down my entire lighting order on a cocktail napkin and recite it from memory. Now that's unusual for a car job.

### **How bright were the LED sources?**

I was at ISO 2500. We had plenty of light and exposure.

### **What camera were you using?**

We were shooting Full Frame. I used the Sony VENICE camera and Cooke S7/i lenses.

One of the things that is so good about the stage is that the screens can be moved very close to the object. As you well know, what can make the difference in lighting sometimes is the distance of the source to the subjects. The quality becomes totally different. In their system you can bring it quite close.

**That's interesting because often in volumes and active background stages, the screens are fixed or require quite some time to move.**

Exactly. Sometimes, there's no way you're going to be able to change the positions of the screen. In Carstage, I might want the light to fall off more. I want to change the reflections. I want to change the catch lights. More than anything, I want a different kind of look. There was an advantage of working at Carstage and yes, we used it as an art installation. But also we brought the sources in quite close to the car.

I'm talking mostly about the top three panels above and the side panels that we could bring in quite close to the subject.

So needless to say, they're lighting sources. They're not only giving reflections. They're lighting the object.

### **Where does the footage for the backgrounds come from?**

They were licensed from stock footage companies.

### **How do you control the intensity and the colors of the backgrounds?**

There is an operator who can change whatever is on each of the panels, and there's a separate operator who is like a DIT and can change the color or change the intensity. They work in conjunction with each other. I typically work like many DPs do now with HME intercom headsets. That means I can be standing at my own DIT station, and we can have a full discussion about what's working and what's not and everybody hears it at once. If the perspective doesn't quite look right, let's slide that down about eight inches, move it about a foot to the left, and let's make those highlights in the sky come down a little bit. We make the adjustments.

### **Is the team controlling the panels from Carstage?**





Darren explained: "The advantage of the colored panels while setting up and lighting is that you can identify which panel is throwing which reflection.

Yes. Joe White provided those people because they know the systems intimately.

### How do you sync up the camera to the backgrounds?

It has to be genlocked. We brought the camera in a day early to do a genlock test. We also genlocked a motion control Technodolly 15. It was motion control because we needed to add separate elements to the image. For example, a lot of lights and mylar mirrors were in frame and had to be removed. I would shoot passes with the lights in shot. Then we removed the light for a pass with the lights out of the shot.

### How did you get those nice highlights on the car?

We had some eight-foot tubes all around and on the deck, giving us the highlights off the car and the wheels.

### Do your additional lights have to be synced up as well?

Very good question. Sometimes they do, especially when there are transitions. But for this spot, we didn't do anything as technical. Here's the thing: when shooting a car, the car is like a mirror. But in this case, we have the camera moving and the car moving on a turntable. So there are a lot of chances for bad reflections.

Fortunately the side panels and walls in Carstage can go up and down. That was really helpful.

### How did you get started in this business?

I started as a photographer's assistant in New York. I worked for Annie Leibovitz, Kurt Markus and fashion photographer Steven Meisel. I was Steven's first assistant for 12 years. He was very generous and let me start shooting his commercials. My first time shooting 35mm film was a union commercial on two stages at Silvercup. It was a good way to get started. But I didn't go to film school, so I'll put it this way: I learned by making a lot of mistakes along the way and working with great crews.

### Credits

Director: Ben Tricklebank  
1st AC: John Clemens  
DIT: Jeff Flohr  
Gaffer: Greg Addison  
Key Grip: Dave Araki

Producer: Josh Porter  
Production Company: Furlined  
Studio: Carstage  
[www.thecarstage.com](http://www.thecarstage.com)



# New ARRI Rental North America HQ in LIC



Oct. 22, 2022. ARRI Rental hosted a full-house open house grand opening of their beautiful new facility in Long Island City. The party was so good, catching up with colleagues, conversations non-stop, there was no time for photos. Instead, here are pre-party pictures by ARRI Rental.

Andy Shippersides, above, President of ARRI Rental North America, said, "Our new North American HQ serves as another example of our dedication to supporting filmmakers in the hub of New York's production scene. We look forward to this new facility as a resource for the community, with improved access to our products and services."

Access is easy. Five subway stops from Grand Central on the #7 Flushing Line, get off at Rawson Street and walk 3 blocks. By car, ARRI Rental is conveniently located in the golden triangle

between the 59th Street Bridge, the Midtown Tunnel and the Greenpoint Avenue exit of the LIE or BQE.

The 3-story, 42,000 square-foot, modern, pristine space is bright and spacious. The ground floor has a studio for shooting tests and equipment demos, machine shop and loading dock. The second floor is a vast check-out space with lots of daylight, 10 prep bays and 4 feature checkout rooms. The top floor's wall-to-wall windows offer amazing views of the Manhattan skyline. There's a large customer lounge and outdoor roof patio deck, which is where the grand opening party spilled out for drinks, music, food and fireworks.

ARRI Rental has come a long way since its evolution from Ferco to CSC to ARRI/CSC to ARRI Secaucus to ARRI Brooklyn. And what a great place it is.



# New ARRI Rental North America HQ in LIC





# Angénieux Optimo Ultra Compact FF & U35 Full Pack



Angénieux IRO rear group transforms the 21-56mm T2.9 Full Frame Ultra Compact to a 16-42mm T2.2 U35 format zoom lens.

Angénieux 21-56mm T2.9 Full Frame. 46.3mm image coverage Ø.

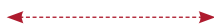

Angénieux IRO rear group transforms the 37-102mm T2.9 Full Frame Ultra Compact to a 28-76mm T2.2 U35 format zoom lens.

Angénieux 37-102 T2.9 Full Frame. 46.3mm image coverage Ø.

Nov 10, 2022. Stop the presses. Angénieux announces a “Full Pack” version of their Optimo Ultra Compact 37-102 and 21-56 Full Frame zoom lenses. The Full Pack includes each lens with both a Full Frame and an Ultra35 (U35) rear. That can be changed easily to cover the entire sensor area of Full Frame cameras or the U35 (Open Gate) area of the ARRI ALEXA 35.

This is made possible by Angénieux’s Interchangeable Rear Optics (IRO) technology. It is important to note that these are not speed boosters or reducers—IRO is a dedicated rear optical group.

Angénieux Ultra Compact 37-102 T1.9 and 21-56 T2.9 Zooms were introduced at Cannes on July 15, 2021. Both lenses cover Full Frame/VV, with an image diagonal of 46.3 mm Ø.

When equipped with the new IRO group, these lenses cover U35 (a.k.a. Ultra35 or Open Gate) with an image diagonal of 34.6 mm Ø and a gain in maximum aperture to T2.2. And so, Ultra Compacts with the U35 back become, respectively, a 28-76 T 2.2 and a 16-42 T 2.2.

I guess this was inevitable. Angénieux’s estimable Optimo Ultra 12x Zoom can be configured three ways: FF/VV, S35 or U35.

Angénieux Type EZ Zooms configure as FF/VV or S35.

There was a hidden clue to convertibility as early as September 2021 when pre-production Ultra Compact Zooms were hand-carried from Saint-Héand to Band Pro’s rooftop premiere launch in New York. If you looked closely, and that was decidedly difficult considering the dimming New York evening sky and the copious quantities of cocktails and champagne that flowed, you might have noticed a small oval window above the iris and zoom rings that proclaimed the lens was FF/VV. Why would it be in a window and not permanently proclaimed and engraved on



the lens barrel itself below the logo and name? And how do you change iris and zoom rings?

Severine Serrano, Managing Director, Angénieux International Sales, explained:

- The Full Pack version of the Ultra Compact Zoom comes with 2 IRO rear modules: one Full Frame and one U35 (Open-Gate).
- There is only one iris ring. It is engraved with T-Stops for both FF and U35.
- And there is only one zoom ring, engraved with focal lengths for both FF and U35 formats.
- To change between FF and U35, a lens technician just needs to flip the ring around (a quick and easy procedure).
- The focus ring is untouched. Focus distances remain the same.
- As with the Optimo Ultra 12x, you must match its lens serial number with its FF and U35 IRO rears.
- And yes, existing owners can upgrade their original Ultra Compact zooms to Full Pack versions.



## Aymeric Colas, Steadicamer on *Athena*

In France, the credit for Steadicam Operator is “Steadicamer.” That word is nice and concise: four syllables rather than seven.

Aymeric Colas flew an ALEXA 65 on his Steadicam M-2 for hours on end, day after day, on *Athena*. You can watch it on Netflix. Directed by Romain Gavras, *Athena* could be pitched as his father's 1969 film *Z* meets Pontecorvo's 1966 *The Battle of Algiers* meets the January 6, 2021 insurrection. The 11-minute opening sequence is unforgettable and the film is a masterclass in camera moves: Steadicam, gimbal, handheld, scooters, drones, lifts and more.

Aymeric used his Steadicam M-2 with its integrated Volt that held a perfectly level horizon, as he navigated through the mayhem of riots, complete with live flash-bangs and fireworks. Lenses were Tribe7 Blackwing7 and Leitz Thalia. Monitor was SmallHD 7-inch. His focus puller was the talented Lara Perrotte. Matthias Boucard, AFC was the DP. They all had worked together previously on *Eiffel*.

Aymeric's in-depth interview will be in the next edition of *FDTimes*, as well as an article about visiting the headquarters of SmallHD.

Photo by Ariane Damain Vergallo.



# www.fdtimes.com

On Paper, Online, and now on iPad

© 2022 Film and Digital Times, Inc. by Jon Fauer

## Subscribe Online:

www.fdtimes.com/subscribe

## Call, Mail or Fax:

Direct Phone: 1-570-567-1224

Toll-Free (USA): 1-800-796-7431

Fax: 1-724-510-0172

Film and Digital Times Subscriptions  
PO Box 922  
Williamsport, PA 17703  
USA

- |                          |   |           |          |
|--------------------------|---|-----------|----------|
| <input type="checkbox"/> | 1 Year Print and Digital, USA   | 6 issues  | \$ 49.95 |
| <input type="checkbox"/> | 1 Year Print and Digital, Canada  | 6 issues  | \$ 59.95 |
| <input type="checkbox"/> | 1 Year Print and Digital, Worldwide   | 6 issues  | \$ 69.95 |
| <input type="checkbox"/> | 1 Year Digital (PDF)  |           | \$ 29.95 |
| <input type="checkbox"/> | 1 year iPad/iPhone App upgrade<br>(normally 29.99) <i>Get FDTimes on Apple<br/>Newsstand with iPad App when you order<br/>a Print or Digital Subscription (above)</i> | + \$ 9.99 |          |

Total \$ \_\_\_\_\_

Payment Method (please check one):

- VISA    Mastercard    American Express  
 Check Enclosed (payable to Film and Digital Times)

Credit Card # \_\_\_\_\_

3 or 4 digit security code \_\_\_\_\_

Expiration Date \_\_\_\_\_

Signature \_\_\_\_\_

Name \_\_\_\_\_

Company \_\_\_\_\_

Title \_\_\_\_\_

Address \_\_\_\_\_

City \_\_\_\_\_

State or Province \_\_\_\_\_

Country \_\_\_\_\_

Zip or Postal Code \_\_\_\_\_

Phone \_\_\_\_\_

Fax \_\_\_\_\_

Email \_\_\_\_\_

## Sponsors and Educational Partners

### Titans of the Industry

adobe.com  
arri.com  
blackmagicdesign.com  
canonusa.com  
cookeoptics.com  
creativesolutions.io  
leica-camera.com  
sony.com/professional  
tiffen.com

### Moguls

abelcine.com  
aja.com  
angenieux.com  
bandpro.com  
cyp.com  
frame.io  
fujifilm.com  
leitz-cine.com  
prestoncinema.com  
red.com  
sigma-global.com  
teradek.com  
zeiss.com/cine

### Executive Producers

emit.fr  
lowel.com  
litepanels.com  
ocon.com  
panavision.com  
servicevision.es  
smallhd.com  
woodencamera.com

### Producers

antonbauer.com  
atlaslensco.com  
cartoni.com  
cinemaelec.com  
ibe-optics.com  
ottonemenz.com  
photocineshop.com  
C&L Studio: camarasyuces.com  
tokinacinemausa.com  
transvideo.eu

### Co-Producers

aatondigital.com  
BandH.com  
chrosziel.com  
www.cinepads.com  
manfrotto.us  
mole.com  
msegrip.com  
orcabags.com  
pstechnik.de  
sachtler.com  
steadicam.com

### Associate Producers

16x9inc.com  
brighttangerine.com  
bromptontech.com  
carstage.com  
chengseng.com  
chrosziel.com  
cinetech.it  
cmotion.eu  
dmglumiere.com  
denz-denz.com  
easyrig.se  
filmtools.com  
hd-systems.biz  
idxtek.com  
inovativ.com  
jfisher.com  
loumasystems.biz  
mytworks.com  
nanliteus.com  
panasonic.com  
pat-acc.com  
raid-japan.com  
ronfordbaker.co.uk  
rosco.com  
sekonik.com  
shapewlb.com  
vocas.com

### Rental Houses

abelcine.com  
arri-rental.com  
bertonevisuals.com  
camalot.com  
camarasyluces.com  
cinediving.com  
www.hd-systems.biz  
jpfocine.cl  
kofilmrental.com  
koernercamera.com  
lemac.com.au  
lensrentals.com  
lites.be  
ljud-bildmedia.se  
lvusa.com  
musitelli.com  
nacinc.com  
panalight.it  
photocinerent.com  
rawcamera.com  
rvz.fr  
sanwa-group.com  
servicevision.es  
storyline.no

### Media Partners

afcinema.com  
airstar-light.us/film  
bscexpo.com  
camerimage.com  
cinec.de  
cinegearexpo.com  
eurocineexpo.com  
fsfsweden.se  
ibc.org  
icgmagazine.com  
imago.org  
inter-bee.com  
nabshow.com  
soc.org



# Sponsors and Educational Partners

## Associate Producers



## Rental Houses

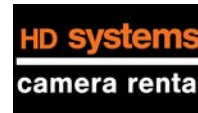

## Media and Production Partners



Titans of the Industry



Moguls



Executive Producers



Producers



Co-Producers

