

Forgotten Books

— www.forgottenbooks.com —

Copyright © 2016 FB &c Ltd.

All rights reserved. No part of this publication may be reproduced, distributed, or transmitted in any form or by any means, including photocopying, recording, or other electronic or mechanical methods, without the prior written permission of the publisher, except in the case of brief quotations embodied in critical reviews and certain other noncommercial uses permitted by copyright law.

SMITHSONIAN INSTITUTION
UNITED STATES NATIONAL MUSEUM
Bulletin 123

REVISION OF THE NORTH AMERICAN MOTHS
OF THE SUBFAMILY EUCOSMINAE OF
THE FAMILY OLETHREUTIDAE

BY

CARL HEINRICH

Of the Bureau of Entomology, United States Department of Agriculture



WASHINGTON
GOVERNMENT PRINTING OFFICE

1923

ADVERTISEMENT.

The scientific publications of the United States National Museum consist of two series, the *Proceedings* and the *Bulletins*.

The *Proceedings*, the first volume of which was issued in 1878, are intended primarily as a medium for the publication of original, and usually brief, papers based on the collections of the National Museum, presenting newly acquired facts in zoology, geology, and anthropology, including descriptions of new forms of animals, and revisions of limited groups. One or two volumes are issued annually and distributed to libraries and scientific organizations. A limited number of copies of each paper in pamphlet form is distributed to specialists and others interested in the different subjects as soon as printed. The date of publication is printed on each paper, and these dates are also recorded in the tables of contents of the volumes.

The *Bulletins*, the first of which was issued in 1875, consist of a series of separate publications comprising chiefly monographs of large zoological groups and other general systematic treatises (occasionally in several volumes), faunal works, reports of expeditions, and catalogues of type specimens, special collections, etc. The majority of the volumes are octavos, but a quarto size has been adopted in a few instances in which large plates were regarded as indispensable.

Since 1902 a series of octavo volumes containing papers relating to the botanical collections of the Museum, and known as the *Contributions from the National Herbarium*, has been published as bulletins.

The present work forms No. 123 of the *Bulletin* series.

WILLIAM DEC. RAVENEL,
Administrative Assistant to the Secretary,
in charge of the United States National Museum.

WASHINGTON, D. C., JANUARY 31, 1923.

CONTENTS.

	Page.
Introduction-----	1
Historical review-----	2
Phylogeny and classification-----	4
Comparative table of structural characters-----	6
Description of family Olethreutidae-----	9
Key to the subfamilies-----	10
Larval habits and economic importance-----	10
Key to the genera of Eucosminae-----	11
GENUS 1. Pseudogalleria-----	12
2. Rhyacionia-----	13
3. Petrova-----	21
4. Barbara-----	27
5. Spilonota-----	30
6. Strepsicrates-----	31
7. Thiodia-----	32
8. Eucosma-----	71
9. Epiblema-----	136
10. Suleima-----	155
11. Sonia-----	160
12. Gypsonoma-----	162
13. Proteoteras-----	165
14. Zeiraphera-----	169
15. Exentera-----	172
16. Gretchena-----	179
17. Griselda-----	186
18. Gwendolina-----	188
19. Crocidosema-----	189
20. Norma-----	191
21. Kundrya-----	192
22. Rhopobota-----	193
23. Epinotia-----	194
24. Anchylopera-----	233
25. Ancylis-----	243
26. Hystriophora-----	253
Species referable elsewhere-----	259
Species omitted-----	260
Appendix-----	263
Explanation of plates-----	273
Index-----	287

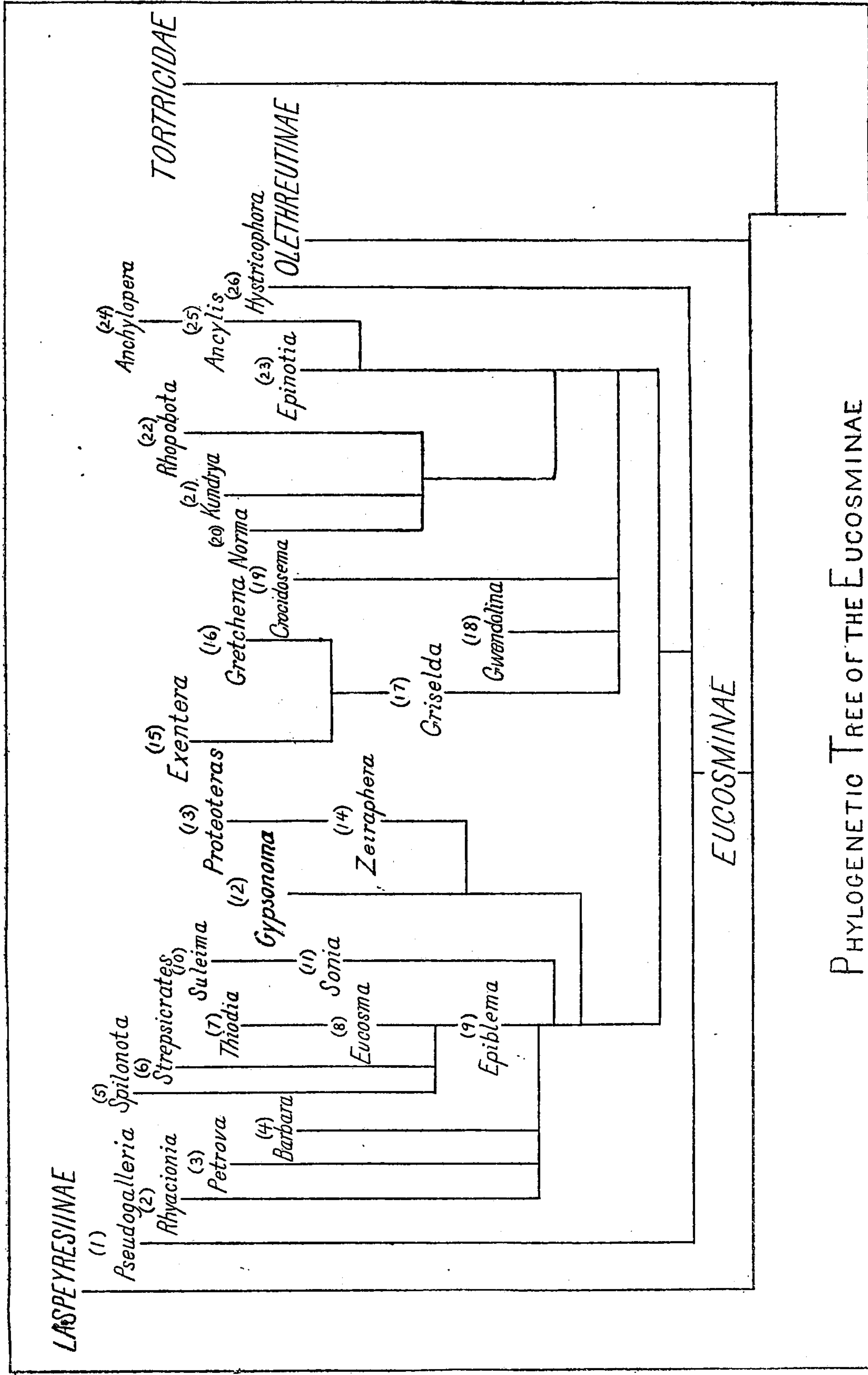

PHYLOGENETIC TREE OF THE EUCOSMINAE

REVISION OF THE NORTH AMERICAN MOTHS OF THE SUB-FAMILY EUCOSMINAE OF THE FAMILY OLETHREUTIDAE.

By CARL HEINRICH,

Of the Bureau of Entomology, United States Department of Agriculture.

INTRODUCTION.

The present paper is the result of several years' study of the family Olethreutidae. It is based chiefly on the collections of the United States National Museum, the American Museum of Natural History, and of Dr. William Barnes, of Decatur, Illinois. Through the courtesy of the American Museum I have been able to study and arrange the Kearfott material and to make genitalia slides of such species as were not represented by authentically determined specimens in the United States National Museum. Wherever possible the genitalia of the type specimen—where the latter was a male and available—were examined and mounted on slides. Genitalia slides were made of every species represented by males in the National Collection, and in many cases several slides were made of a species, especially of doubtful or variable forms. Doctor Barnes has loaned the National Museum the whole of his unworked material, and both he and the American Museum have contributed liberally to the National Collection. The three collections are being arranged to conform to the system herein proposed, and at present represent, with the exceptions noted in the text, the complete described North American fauna in this group. I have also examined the Zeller types in the Museum of Comparative Zoölogy and the Clemens types in Philadelphia, and Dr. Henry Fernald has kindly allowed me to study the collection of his father at Amherst, Massachusetts.

I am also indebted to Dr. W. T. M. Forbes for some valuable suggestions. Mr. August Busck, at whose suggestion I undertook the revision of the Olethreutidae, has given me his notes on the Walsingham types in the British Museum and has helped at every stage by criticism and suggestion. Indeed, without the support of his mature and comprehensive knowledge it would have been impossible to have accomplished anything with this most difficult group. The present preliminary paper is a complement to his revision of the Tortricidae

proper and is in reality only a division of labor preparatory to a monograph of the entire North American Microlepidoptera on which he and I are now engaged. Inasmuch as the latter work will deal fully with each species, it has been deemed advisable to confine the present paper within the limits of a mere revision, omitting descriptions of already named species, except in so far as these are covered by specific keys and photographs of the male genitalia. Only the more important references are cited, and for those species common to both Europe and North America purely European synonymy has been omitted. The accepted North American synonymy has in each case been reexamined and corrected or verified by comparison with types or other authentic specimens. In a few instances where this could not be done (for example, some of the Walker species whose types are in the British Museum) the fact has been noted in the text and the synonymy of older authors followed. Citations to the Dyar catalogue (Catalogue of North American Lepidoptera, 1903) refer to the United States National Museum Bulletin No. 52.

Twenty-six genera are recognized as belonging to the subfamily. Of these, nine are described as new. It is unfortunate that additional generic names had to be made, as the synonymy is already heavily burdened, but I have only done so where no older names could be applied. The generic synonymy itself is not complete, as only those genera are treated of which the genitalia of the genotype could be studied. Three hundred and eighty-two species and twenty-nine varieties are recognized. Of these, sixty-nine species and nine varieties are described as new. Six species which I have been unable to recognize or place properly from the published descriptions, with three others which must be referred to other groups, are briefly treated at the end of the paper.

HISTORICAL REVIEW.

Until recently the Heinemann system has been the base of classification in the Tortricidae, and while nearly all workers felt it to be unsatisfactory there has been no radical departure until 1915, when Walsingham and Durrant¹, largely at the suggestion of Busck, threw out all genera based on secondary sexual characters, placing under the genus *Eucosma* alone some twenty-seven as synonyms. The list is not complete, for the authors made no attempt to place those genera whose genotypes were not before them at the time. Their genus *Eucosma* corresponds roughly—this is, with the inclusion of a few generic groups that they still tentatively retained such as *Ancylis*, *Rhyacionia* (*Evetria* Authors not Hübner), *Hendecaneura*—to the subfamily Eucosminae as here defined. Meyrick in 1910 in his classi-

¹ Biol. Cent. Amer. Lepid. Heter., vol. 4.

fication of the Australian Tortricina² discarded the male costal fold as a valid character, retaining, however, other secondary characters, particularly those of the male antennae, though Busck has previously³ pointed out the weakness of all such characters. As early as 1876 Peyerimhoff⁴ and again in 1885 Barrett⁵ had pointed out the worthlessness of the costal fold. Peyerimhoff's paper is a fine critical study of the various external characters of the Tortricoidea. He saw much more than any of his contemporaries or successors their weaknesses, but unfortunately he was unable to suggest a better arrangement. Dampf in 1908,⁶ in a very careful morphological study of the genitalia of *Rhopobota naevana*, calls attention to the taxonomic value of these organs, pointing out what he believes to be generic differences in several European species and defining the subfamilies Tortricinae and Olethreutinae on genitalic characters.⁷ No other author, as far as I know, has ever attempted to use genitalia in classifying the moths of this group, and Dampf's paper is naturally confined to the study in hand, suggesting rather than carrying out the larger application. Kearfott's work with the Tortricid families was confined to specific descriptions. Fernald's long-expected revisions never appeared. His Synonymical Catalogue⁸ is merely the application of the Heinemann system to the North American fauna. He did, however, a valuable and lasting work in fixing the types of the various Tortricid genera (The Genera of the Tortricidae and Their Types, 1908) and clearing the field of vexatious nomenclatorial problems. Walsingham and Durrant's later work in the *Biologia* has changed the terminology very little from Fernald except by additions to the synonymy. Their few radical changes, such as the substitutions of *Cydia* Hübner for *Carpocapsa* Treitschke (with *pomonella* Linnaeus as type) and the relegation of *Laspeyresia* Hübner to synonymy, are the result of the acceptance of Stephens Catalogue in the matter of type fixation. On such questions the writer prefers to follow the American authors, accepting the types as fixed by Fernald.

In lumping all genera that could not be maintained on venational or other structural characters common to both sexes, the authors of the *Biologia* took a long step in advance toward a natural classification. This is evidenced by the fact that the generic divisions here

² Proc. Linn. Soc. New South Wales, vol. 36, pt. 2.

³ Proc. Biol. Soc. Wash., vol. 19, 1906, p. 174.

⁴ Ann. Soc. Ent. France, vol. 6, ser. 5, pp. 523-546.

⁵ Ent. Mo. Mag., vol. 22, pp. 1-6.

⁶ Iris, vol. 21, pp. 304-329.

⁷ In 1917 I gave a short paper before the Washington Entomological Society (Proc. Ent. Soc. Wash., vol. 19, pp. 137-138), in which I separated the Olethreutidae and Tortricidae on genitalic structure and criticised Meyrick's use of the uncus for that purpose. I regret that at the time I was unacquainted with Doctor Dampf's paper, which had already covered much of the same ground.

⁸ Trans. Amer. Ent. Soc., vol. 10, 1882, pp. 1-72.

made after consideration of both primary and secondary characters in the light of the added information derived from a study of the male genitalia and to a limited extent of the larvae, only split within, and not across, the limits of their genera. The only weakness of their system lay in the equal value they attached to differences in fore and hind wing variation. The erection of the family Sparganothidae is untenable on the character given (7 and 8 of fore wing stalked) for the stalking of veins 7 and 8 of the fore wing does occur in several genera in the Olethreutidae, and these can in no way be united with *Sparganothis*, in spite of the pectinate hind wing.

PHYLOGENY AND CLASSIFICATION.

It is the author's conviction that in the Olethreutidae venational changes of the hind wings are the characters of most fundamental import. On these characters—with the exceptions of a stalked 6–7, easily and at different places derived from the normal approximate condition of these veins, and the united 3–4 derived equally readily from a stalking of 3–4—the genera fall into larger natural groups to which, for convenience of handling, subfamily names are given.

In separating the genera of the Eucosminae I have considered as nearly as possible all the external structural characters of the moth, including secondary sexual modifications. My purpose has been to arrange the species in their natural order, putting together those most alike in genitalic structure and general habitus and separating them into groups according to their development from the generalized type. These groups I have designated as genera, defining them on any characters that would serve to identify them. In this family, strange as it may seem, it is necessary to know what species constitute a group before the taxonomic value of any single character can be established. Once we know what species constitute a group, any character or combination of characters will serve to identify it, even though such a character unsupported may not of itself justify generic separation. This applies to venational almost as strongly as it does to secondary sexual characters. Of the latter I have been able to use the male antennal notch (figs. 3a, 4a) and certain male sex scalings on the hind wings (*Proteoteras*, *Crocidosema*, *Rhopobota*, figs. 6, 7). These characters, though independently acquired in different places, indicate an advance from the primitive type and correspond with other progressive characters in the genitalia. This, of course, does not mean that all the species having an antennal notch, for example, belong together, any more than that all the species having veins 7 and 8 of fore wing stalked belong together, but I think it does mean that they have developed further than those without the notch and should be separated from them, particularly as such a character when once acquired would not be easily lost.

The male costal fold, on the other hand, is thoroughly unreliable. I have used it only in one place (*Thiodia*), and there simply for convenience, to separate an unwieldy genus and there again only because the species which would fall under *Thiodia* are closely related otherwise and in venation average a considerable advance over those with the fold (3-4 of hind wing are very frequently long stalked or united in *Thiodia*, seldom so in *Eucosma* proper). Since the generic name already exists, nothing is added to the synonymy by the separation. I believe that the Eucosminae as a group originated from a form possessing the fold, and that its loss is part of the general progress, but it is too easily and frequently lost in any of the groups for the loss to be significant here. Neither have I been able to use differences in pectination of the male antennae or vestiture of the palpi. The differences are too gradual and slight and as marked between species within a given group as between the groups themselves.

In the Olethreutidae, generic divisions have not the same significance as in groups where natural limitations are sharply defined by consistent structural differences. This is particularly true of the Eucosminae, which is in reality one large composite genus with few or no distinct gaps between the species, and with exasperating specific fluidity. In fact, because of the tendency to modify under local and food-plant conditions, to split off into local races and varieties differing in structure, color, and size, the fixing of specific limits is often a difficult matter. With the genera the limits are even more obscure. Fundamental structural differences between the subfamilies are none too rigidly fixed. The transition, for example, from a hind wing with vein 5 bent and closely approximate to 4 at the base to one with 5 straight and parallel with 4 (the Laspeyresian character) is not sudden. Indeed, several of the Eucosminae have vein 5 well separated from 4, and, in some cases, were it not for habitus and genitalic characters there would be considerable doubt of their position. With all other characters it is the same. Nothing holds rigidly. There are, however, within the family several definite tendencies at work indicating diverging lines of development. Not all the species are tending the same way. Groups here and there show markedly opposite tendencies, and in the farthest advanced species the result is striking. But the difficulty is that not one or two but many tendencies are manifest, and in no two groups is the same proportion or rate of change among the various structures maintained. Some, for example, will retain a developed uncus while exhibiting an advanced type of neuration. Others again in losing the uncus exhibit a tendency to narrow and split the organ, while still others reduce it in an entirely different way. Such tendencies are significant, as they show the influence of heredity, different in the descendants of different

individuals who in remote or recent time diverged in method to a common end (in the case in point to a form without uncus). To lump all such groups of species into a single genus because no one single consistent and inflexible character can be found to separate each of them from all the others is to beg the issue. Not only convenience but fidelity to the truth, as we know it, demands some arrangement and separation of the specific groups that will link the species in their natural order and separate them according to their different lines of development. These groupings we call genera, Their definitions we must frame in a synthesis of characters so as to include within the genus those species which are obviously close and to exclude all obviously different.

On the other hand, to unite forms that agree on one or two structural details—whatever they may be—or to classify upon one set of characters, venational, genitalic, vestigial, or secondary sexual, is to commit the absurd, bringing together species of widely different origin and separating others that by their very habitus must be specifically close. For example, the stalking or fusion of veins 7 and 8 of the fore wing, the uniting of 3 and 4 of hind wing, the loss of uncus or socii from the genitalia, the presence of raised scales or an antennal notch may and do occur each in several places. It is that synthesis of several characters considered in the manner of their development which must be considered significant.

The comparative chart will illustrate more clearly than any possible description the tendencies working to separate groups and how far each has progressed in the several groups, and should show at once the necessity of some arrangements expressing this progression and the difficulty of defining it in terms of "yes or no," "with or without," since its real significance is the total of results plus direction.

The general tendencies in the Eucosminae may be enumerated as follows:

1. In wing shape: from a form with rather broad forewings with a costal fold and convex termen tending to narrower winged forms, with termen straight and slanting, evenly concave with apex rounded or distinctly falcate, or with termen deeply notched between veins 4 and 5, the costal fold disappearing and frequently lost.

2. In forewing venation: from a primitive form with 2 straight, 3, 4, and 5 well separated at termen, 11 arising from cell well before middle, with upper internal vein of cell branching off between 10 and 11 and with apical end of cell unconstricted; the tendencies are for the apical end of the cell to become constricted, for the internal vein to move forward till it branches off between 9 and 10, for 11 to move forward till it arises from the middle or somewhat beyond the middle of the cell, for 3, 4, and 5 to crowd together at the termen

No.	Genus.	Antenna.	Socii.					Uncus.			Eighth abdominal segment.	Remarks.
		With notch.	Veins 3 and 4 connate.	Veins 3 and 4 stalked.	More or less spined but without long hair tufts.	With long hair tufts.	Absent.	Developed simple or bifid.	Developed bifurcate.	Rudimentary or absent.	Appreciably modified.	
1	Pseudogalleria.....	X	X	X	X	Gnathos nearly obsolete.
2	Rhyacionia.....	X	X	X	Socii sometimes faintly indicated (rudimentary).
3	Petrova.....	X	X	X	
4	Barbara.....	X	X	X	
5	Spilonota.....	X	X	X	X	
6	Strepsicrates....	X	X	X	X	
7	Thiodia.....	X	X	X	Veins 3 and 4 of hind wing very rarely long stalked or united.
8	Eucosma.....	X	X	X	
9	Epiblema.....	X	X	X	
10	Suleima.....	X	X	X	
11	Sonia.....	X	X	X	Veins 6 and 7 of hind wing approximate towards base or anastomosing beyond cell.
12	Gypsonoma.....	X	X	X	Socii heavily haired.
13	Proteoteras.....	X	X	X	X	
14	Zeiraphera.....	X	X	X	
15	Exentera.....	X	X	X	
16	Gretchena.....	X	X	X	
17	Griselda.....	X	X	X	
18	Gwendolina.....	X	X	X	Socii as broad as long, almost round.
19	Crociosema.....	X	X	X	
20	Norma.....	X	X	X	
21	Kundrya.....	X	X	X	
22	Rhopobota.....	X	X	X	Socii peculiarly modified
23	Epinotia.....	X	X	X	Socii often heavily haired.
24	Anchylopera.....	X	X	X	X	Socii usually heavily haired.
25	Ancylis.....	X	X	X	X	Do.
26	Hystriophora.....	X	X	X	X	

Symbols: X=Character present.

1 Rarely.

2 See remarks.

3 Often.



(in extreme cases 3 and 4 fusing well before the termen), and for vein 2 to become sharply bent upward before reaching termen.

3. In hind wing venation: from a form with 6-7 approximate toward base ("tortriciform"), with 3-4 short stalked, and with 5 bent at base and closely approximate to the stalk of 3 and 4; to forms with 6-7 distinctly stalked, with 3 and 4 united, and with 5 tending to become straight and moving away from 3 and 4 at the base.

4. In secondary characters: from a smooth winged form with simple antennae and possessing the male costal fold but without the other secondary sexual modifications; to forms with raised scales on forewings, notched antennae or male sex scalings on the hind wings.

5. In genitalic development showing modification in several directions, all tending, however, to the following results: a loss of uncus, socii, clasper, and costal hook of harpe (element of a divided, reduced, and modified transtilla) and a general simplifying of the tegumen and harpes. The uncus disappears in three distinct ways: (a) by gradual weakening and reduction without narrowing (*Eucosma-Epiblema* group); (b) by narrowing, splitting to a bifid hook and gradually becoming shorter and shorter till it disappears but without becoming more weakly chitinized (*Epinotia-Ancylis* group); (c) by bifurcation and reduction becoming in advanced types (*Rhopobota*, *Norma*, *Kundrya*) two short widely separated, weakly chitinized projections from the posterior end of the tegumen.

The socii disappear (or lose their identity) in two ways, either by gradual reduction (*Rhyacionia*) or by fusion with gnathos (*Gypsonoma*, *Gretchena*, *Epinotia*). In the latter case, however, it does not appear to be the socii which are disappearing. In fact, they become broader, more triangular (*Gypsonoma*) or more strongly chitinized (*Epinotia*). The gnathos becomes correspondingly smaller and more restricted but in the close association and final fusion of the two parts the identity of the socii is obscured. The most extreme development is reached in *Rhopobota* where there is an almost complete fusion of the two parts into a hairy, knobbed, porrected organ, only the apices of which can be differentiated as socii and only a narrow connecting band between the two porrected arms identified as the free element of a gnathos. All the rest is a fusion of the two parts. The gnathos itself is entirely lost only in *Hystriophora*. The harpes undergo various developments, in some forms acquiring spines on the outer surface (*Rhopobota*, *Crociosema*), but on the whole tending to lose the heavy spining from sacculus and the region bordering the neck. These organs have a wide specific range of shape but the general tendency is to a simple form with rather broad battledore

shaped and evenly spined cucullus. This type is best exemplified in the Laspeyresiinae which from the standpoint of genitalia exhibits the highest development of the Olethreutidae.

In the subfamily Eucosminae there are apparently three main lines of development, three group complexes as it were. The first and largest is the *Epiblema-Eucosma-Thiodia* line with its several off-shoots; the second and in some respects more primitive (as to uncus and harpes structure) but otherwise more advanced type (on wing form) is the *Epinotia-Ancylis* line with its laterals. Most of the genera trace either to one or the other of these two stems. A few (*Rhopobota*, *Kundrya*, *Norma*) show affinities to both lines and are of doubtful origin, but on the whole seem more closely related to the *Epinotia* than the *Eucosma* group. The third distinct line is represented by a single genus, *Hystriophora*, a highly specialized type with its divided harpes and lost gnathos, but on other genitalia structures a primitive form not linked up with any other Olethreutid group or genus that I know. The modified eighth abdominal segment so prominently developed in this genus and *Pseudogalleria* is also somewhat similarly developed in *Proteoteras*. Venation places *Hystriophora* in Eucosminae, but the genitalia while distinctly Olethreutid show many resemblances to the Tortricid type. It has no derivatives and probably is an advanced specialization from the most primitive type. At any rate, it forms a line by itself. *Pseudogalleria*, the most advanced of the Eucosminae and what may be considered to represent a possible fourth line, shows more affinity to the *Eucosma* than to the *Epinotia* groups. In structure it has much in common with *Rhyacionia* and forms the connecting link between the Eucosminae and Laspeyresiinae. If genitalia alone were considered, it would easily go into the latter subfamily.

At this point it might be well to consider for a moment the relative position of the two families Tortricidae and Olethreutidae. Our distinguished authority on dogmatic evolution, Mr. Edward Meyrick, derives the former from the latter. To quote his own words,⁹ "the external relationship of the family (Tortricidae) appears to be clear; it is a development from the *Argyroplote* group of the Eucosmidae (Olethreutidae) the transitional connection (through *Mictoneura* in the Tortricidae and *Articolla* in the Eucosmidae) being almost complete. As the *Argyroplote* group exhibits a not inconsiderable degree of modification relatively to the *Laspeyresia* group, which is the primitive form of the Eucosmidae, the origin of the Tortricidae must be regarded as markedly later than that of the Eucosmidae." With these conclusions and their premises we are compelled to disagree. The family Olethreutidae is sharply distinguished from the Tortri-

⁹ Genera Insectorum: Tortricidae, Fasc. 149, 1913, p. 2.



THIS PAGE IS LOCKED TO FREE MEMBERS

Purchase full membership to immediately unlock this page



Never be without a book!

Forgotten Books Full Membership gives universal access to 797,885 books from our apps and website, across all your devices: tablet, phone, e-reader, laptop and desktop computer

A library in your pocket for \$8.99/month

Continue

*Fair usage policy applies

margin of harpe, leaving a more or less restricted opening at base of harpe; cucullus well defined; transtilla absent or represented only in its reduced elements by a short hook on costa of harpe near base; anellus developed, consisting of a triangular plate with extended central arm supporting aedoeagus.

Larva.—Prothorax with three setae on prespiracular shield; IIa as high or higher than Ia. Proleg-bearing abdominal segments with IV and V approximate under the spiracle. Ninth abdominal segments with paired setae II closer together than paired I on dorsum of eighth abdominal segment, usually on a single chitinization; I and III approximate, normally on a single chitinization. No secondary hairs, except an occasional fourth seta in Group VII on proleg-bearing abdominal segments.

Pupa.—Two rows of spines on dorsum of most abdominal segments; wings broad at tip (not sharply tapering); antennae not reaching to tips of wings.

KEY TO THE SUBFAMILIES OF OLETHREUTIDAE.

1. Hind wing with 5 straight, almost parallel with 4 (fig. 2) ---Laspeyresiinae.
Hind wing with 5 bent at base, approximate to 4-----2
2. Hind wing with 3-4 separate or connate (fig. 1)-----Olethreutinae.
Hind wing with 3-4 stalked or united (fig. 6)-----Eucosminae.¹⁰

Dichrorampha belongs in the Laspeyresiinae. It is obviously close to *Laspeyresia* and a derivative from it. The separate condition of veins 6-7 in the hind wing may be interpreted as a later development rather than the primitive venational type. *Bactra* and *Polychrosis* fall naturally in the Olethreutinae.

All the characters defining the subfamily are given in the above key. The larvae of so few species are available that no definition can be drawn on larval characters.

LARVAL HABITS AND ECONOMIC IMPORTANCE.

Nearly every type of larval activity is represented in this subfamily. The greater number of species whose life histories are known are borers in the roots, stems, bark, buds or fruits of trees, shrubs, or low growing plants. Several are leaf-tiers and a few feed exposed upon the leaves or flowers. In the genus *Epinotia* we have at least two species (*E. heucherana* and *E. ruidosana*) whose larvae are true leaf miners for the entire feeding period. A number of

¹⁰ This character seems to share the fate of nearly all others and to fall down in one place (*Gwendolina concitatricana* Heinrich). Here in most specimens veins 3 and 4 are distinctly connate. In a couple, however, they appear very short stalked and as the genitalia is distinctly Eucosmin, it must be included in the Eucosminae. *Gwendolina* is also distinguished from the Olethreutinae by having a distinct notch in termen of fore wing.

species are of prime economic importance and four of our common introduced pests (*Spilonota ocellana*, *Crociosema plebeiana*, *Rhopobota naevana*, and *Rhyacionia buoliana*) are members of the subfamily. In fact the species constituting the genera *Rhyacionia*, *Petrova*, and *Barbara* (the old genus *Evetria* of authors) are the most important lepidopterous enemies of our coniferous trees. Nearly every plant family finds an enemy somewhere in the Eucosminae and its range of food plants covers most of the genera of our flora. All authentic food plant records are given under each species. It is hoped that the too frequent phrase, "food plant unknown", will stimulate more extensive biological activities; for only when the larvae of our species are known will it be possible to construct a truly satisfactory taxonomy.

KEY TO THE GENERA OF EUCOSMINAE.

The genus *Hendecaneura* Walsingham, treated in the appendix, is not included in this key. It would fall under No. 24 and be differentiated from *Zeiraphera* by the stalked rather than approximate condition of veins 6-7 in the hind wing.

1. Fore wing with a distinct notch in termen; hind wing with veins 3 and 4 connate..... (18) **Gwendolina**.
Fore wing with or without a notch; but if notch is present veins 3 and 4 of hind wings never connate.....2
2. Fore wing with apex falcate.....3
Fore wing with apex pointed or rounded but not distinctly falcate.....4
3. Veins 3 and 4 of hind wings stalked..... (25) **Ancylis**.
Veins 3 and 4 of hind wings united..... (24) **Anchylopera**.
4. Fore wing with 4-5 connate.....5
Fore wing with 4-5 separate or approximate; not connate.....7
5. Costal hook of harpe absent; socii rudimentary or absent... (2) **Rhyacionia**.
Costal hook of harpe present; socii developed, long.....6
6. Harpe with rudimentary clasper..... (3) **Petrova**.
Harpe without such clasper..... (4) **Barbara**.
7. Fore wing with 7 and 8 united.....8
Fore wing with 7 and 8 approximate connate or stalked.....10
8. Uncus absent; if rudimentary not bifurcate.....9
Uncus weak but developed, bifurcate..... (21) **Kundrya**.
9. Veins 3 and 4 of hind wing stalked..... (11) **Sonia**.
Veins 3 and 4 of hind wing united..... (10) **Suleima**.
10. Antenna of male with notch above basal joint.....11
Antenna of male without notch above basal joint.....12
11. Fore wing smooth..... (5) **Spilonota**.
Fore wing with tufts of raised scales above dorsum..... (6) **Stepsicrates**.
12. Harpe with heavy spines from outer surface.....13
Harpe without heavy spines from outer surface.....15
13. Gnathos and socii fused; socii caudally projected..... (22) **Rhopobota**.
Gnathos and socii separate; socii drooping.....14
14. Fore wing with tufts of raised scales above dorsum..... (13) **Proteoteras**.
Fore wing smooth..... (19) **Crociosema**.
15. Eighth abdominal segment modified and included in genitalia.....16
Eighth abdominal segment not so modified.....17

16. Harpes divided.....(26) **Hystriophora.**
 Harpes simple.....(1) **Pseudogalleria.**
17. Harpe with rudimentary clasper.....18
 Harpe without rudimentary clasper.....19
18. Veins 6 and 7 of hind wing stalked.....(12) **Gypsonoma.**
 Veins 6 and 7 of hind wing approximate towards base.....(9) **Epiblema.**
19. Uncus normally strong; if reduced bifurcate or narrow and bifid.....20
 Uncus rudimentary or absent; not bifurcate or narrow and bifid.....22
20. Uncus bifurcate; arms widely separated.....21
 Uncus simple or bifid (narrow).....(23) **Epinotia.**
21. Socii broadly triangular.....(17) **Griselda.**
 Socii ribbon like.....(20) **Norma.**
22. Socii and gnathos fused beyond base; gnathos reduced.....23
 Socii and gnathos free beyond base; gnathos not reduced.....24
23. Fore wing with slight tufts of raised scales above dorsum....(16) **Gretchena.**
 Fore wing smooth.....(15) **Exentera.**
24. Socii short and broad (triangular); harpes sickle shaped with neck densely
 densely spined.....(14) **Zeiraphera.**
 Socii finger like; harpse otherwise.....25
25. Fore wing of male with costal fold.....(8) **Eucosma.**
 Fore wing of male without costal fold.....(7) **Thiodia.**

1. Genus PSEUDOGALLERIA Ragonot.

(Figs. 39, 40, 413.)

Genotype.—*Galleria inimicella* Zeller.

Thorax with slight posterior tuft.

Fore wing smooth; termen concave between 4 and 7; 12 veins; 7 and 8 separate; 10 from cell midway between 9 and 11; 9 approximate to 8; 11 from near middle of cell; upper internal vein of cell from between 9 and 10; 3, 4, and 5 not approximate at termen; 2 straight; no costal fold in male.

Hind wing with 8 veins; 6 and 7 approximate towards base; 3 and 4 stalked.

Male genitalia with harpe simple; cucullus weakly spined, with only a few scattered strong spines in corona; sacculus weakly haired. Uncus and socii absent. Gnathos weak, almost obsolete. Posterior of tegumen forming a hood over anal opening. Vinculum rather broadly triangular. Aedoeagus slightly curved; long; tapering; moderately stout; cornati a cluster of a half dozen slender moderately long spines. Eighth abdominal segment distinctly modified.

On genitalic structure this genus would go into the Laspeyresiinae. Its hind wing venation, however, is typically Eucosmid and it will have to go here as the highest development of the Eucosminae, linking that subfamily and the Laspeyresiinae.

It contains only one species.

PSEUDOGALLERIA INIMICELLA (Zeller).

(Figs. 39, 40, 413.)

Galleria inimicella ZELLER, Verh. Zool.-bot. Ges. Wien., vol. 22, 1872, p. 559.*Pseudogalleria inimicella* RAGONOT, Ann. Soc. Ent. France, vol. 4, ser. 6, Bull. pp. L-LI.—FERNALD, in Dyar List N. Amer. Lepid., no. 5078, 1903.—KEARFOTT, Proc. U. S. Nat. Mus., vol. 28, 1905, p. 350; Can. Ent., vol. 37, 1905, p. 209; Ins. N. J., 1909, p. 541.—BARNES and MCDUNNOUGH, Check List Lepid. Bor. Amer., no. 6878, 1917.

Male genitalia figured from reared specimen in National Collection from Washington, District of Columbia ("Jan. 11, 1900, August Busck").

Larva bores subterraneously in the stem of *Smilax*.

Distribution according to specimens in National Collection, American Museum, and collection Barnes: District of Columbia, New York, New Jersey, Connecticut, North Carolina, Texas, Indiana, Manitoba.

Alar expanse.—16.5–23 mm.

Type.—In collection, Museum Comparative Zoology.

Type locality.—Dallas, Texas.

Food plant.—*Smilax* (cat briar).

2. Genus RHYACIONIA Hübner.

(Figs. 9, 15, 45.)

Genotype.—*Tortrix buoliana* Denis and Schiffermüller.

Synonyms.—*Retinia* Guenée. *Genotype*.—*Tortrix buoliana* Denis and Schiffermüller. *Evetria* Authors (not Hübner) (part).

Fore wing smooth; termen straight or very slightly convex; 12 veins; 7 and 8 separate; 4 and 5 connate; 10 remote from 9 but further from 11 than from 9; 11 from middle or near middle of cell; upper internal vein from between 10–11; 3, 4 and 5 remote at termen; 2 straight; no costal fold in male.

Hind wing with 12 veins; 6 and 7 approximate toward base; 3 and 4 stalked.

Male genitalia with harpes simple; cucullus sharply defined but somewhat narrower than middle of harpe; pollex present (very short in genotype but normally well developed); no strong anal spines; neck smooth; sacculus without heavy spine or hair clusters; *costal hook absent*, its place taken by a small triangular membrane connecting costa of harpe and vinculum. Uncus absent. Socii rudimentary (mere clusters of hairs in type) or absent. Gnathos not distinguishable (in genotype represented by a weakly chitinized ventral plate on underside of anal tube. In other species even this is absent). Aedoeagus straight or very slightly curved; slender, or if stout, tapering; moderately long; cornuti, when distinguishable, consisting of a cluster of two or more of slender, elongate spines.

The genus as here defined represents one group of those species which formerly constituted the genus *Retinia* or what we in recent years have been wrongly calling *Evetria*. The type of the latter (*tedella* Clerck) is nowise related to any of the species that have been cited as *Evetria*, and is congeneric with *similana* Hübner the type of *Epinotia*. *Evetria* must fall therefore as a synonym of the latter. A study of the different coniferous bud, shoot and cone moths showed that among those Olethreutids without the costal fold there were three distinct groups, each with its own peculiar type of genitalia and a correlating specialization of larval habit, and representing what I believe to be three closely related but distinct genera. They have been till now considered as one genus (*Evetria* of authors not Hübner) which was retained on the connate character of veins 4 and 5 of the fore wing, a lumping that can not be maintained unless we are willing to ignore genitalic characters altogether. In that case, everything in the subfamily might as well go into *Eucosma* for, unsupported, the venational character is no better than any other. On the whole it holds, but in several *Eucosma* 4 and 5 are so closely approximate that it requires an effort of the imagination to distinguish them as not connate. I have been compelled to use the character in my generic key; but I should hate to rest a genus on it alone. Furthermore, the larval habits and structure indicate the same lines of generic cleavage as the genitalia.

In *Rhyacionia* the larvae feed only on pines, boring into the buds and from them into the new growth of the stems. Their presence is usually indicated by a resinous exudation about the buds; but none of them cause pitch nodules to form on the stems.

In *Petrova* the larvae bore into the stems, branches, and bark of both pines and spruces, some species favoring the new and others the older growth. None of them attack the buds and all cause a nodule like exudation of pitch to gather on the part of the tree attacked. This nodule is quite characteristic, being a round dirty lump of pitch and frass. Within it they rest when not feeding and within it they pupate. The larvae themselves have an extra seta on the abdominal prolegs. In every other genus in the Olethreutidae as far as I know there are only three setae in Group VII on the prolegs. In *Petrova* there are four.

In *Barbara* the larvae all feed in the cones of spruce. None of them attack the buds, stems, bark, or other parts of the tree.

KEY TO THE SPECIES OF RHYACIONIA.

1. Fore wing silvery white, transversely lined and blotched with pale faun color ----- (10) *subcervinana*.
- Fore wing otherwise ----- 2

2. Entire fore wing ferruginous orange; transverse markings in the form of irregular, sharply contrasting silver white bars----- (1) *buoliana*.
Ground color of fore wings red-brown; if ferruginous orange only so in apical area and with basal part of wing grayish, faintly cross lined with whitish or silvery gray----- 3
3. Basal area of wing grayish----- 4
Basal area of wing reddish brown----- 8
4. A narrow, longitudinal black streak or two in fore wing from middle of termen----- (2) *neomexicana*.
No such longitudinal black streak from middle of termen----- 5
5. Outer sides of palpi distinctly ferruginous----- 6
Outer sides of palpi grayish or grayish fuscous----- 7
6. Grayish part of wing heavily dusted with blackish; termen finely edged with very dark ferruginous brown----- (6) *montana*.
Grayish part of fore wings without such black dusting; termen edged with bright brownish red----- (3) *pasadenana*.
7. Grayish basal shade extending as far out toward outer margin on dorsum as on costa; male antennae coarsely ciliate----- (4) *busckana*.
Grayish basal shade extending further out toward outer margin on costa than on dorsum; male antenna very finely ciliate, almost smooth.
(5) *adana*.
8. Basal ferruginous patch following by a broad median whitish fascia frosted with silver scales----- (7) *rigidana*.
Basal ferruginous patch following by a narrow antimedial yellowish white fascia----- 9
9. Specimens averaging under 15 mm. alar expanse----- (8) *frustrana*.
Specimens averaging over 15 mm. alar expanse----- (9) *var. bushnelli*.

1. *RHYACIONIA BUOLIANA* (Schifferrmüller).

(Figs. 9, 15, 45.)

Tortrix buoliana SCHIFFERMÜLLER, Syst. Verz. der Schmett., 1776, p. 128.

Rhyacionia buoliana HÜBNER, Verz., 1818, p. 379.

Retinia buoliana GUENÉE, Index. Microlep., 1845, p. 46.

Evetria buoliana MEYRICK, Handbk. Brit. Lepid., 1895, p. 470.—STAUDINGER and REBEL, Cat. Lepid., vol. 2, no. 1851, 1901.—BUSCK, Journ. Econ. Ent., vol. 7, 1914, p. 340; Bull. U. S. Dep. Agr., no. 170, 1915, pp. 1-11.

This dangerous pest has been repeatedly introduced into this country on European pine seedlings and has been discovered in several of our nurseries. At present writing it seems to be well established only on Long Island. Busck's bulletin gives the life history and a comprehensive bibliography.

Male genitalia figured from specimen in National Collection from Westbury, Long Island (New York) reared under Hopk. U. S. no. 13905a from *Pinus sylvestris* (Heinrich, 12 June, 1915).

Specimens in National Collection, American Museum, and collection Barnes from New York.

Alar expanse.—16-24 mm.

Type.—Location unknown.

Type locality.—Austria.

Food plant.—*Pinus* (various species).

2. RHYACIONIA NEOMEXICANA (Dyar).

(Fig. 46.)

Evetria neomexicana DYAR, Proc. Ent. Soc. Wash., vol. 5, 1903, p. 286.—BARNES and McDUNNOUGH, Check List Lepid. Bor. Amer., no. 6764, 1917.

Semasia effectalis COCKERELL (not Hulst), Ent. News, vol. 12, 1901, p. 317.

This is the principal native bud moth on the western yellow pines in the Southwest. It is of great economic importance and in New Mexico and Arizona does great damage to the trees. The life history has been worked out by Mr. J. H. Pollock, of the United States Bureau of Entomology. According to his notes the species has one generation a year, the adults emerging from April 12 to 23, laying their eggs on the inner side near the base of the needles. In from thirty-nine to forty-six days the eggs hatch, the larvae bore into the buds down into the stems of the new shoots, killing them, and when they have exhausted the food in one, passing to another and repeating the process. Larval development is completed by July 15, at which time the caterpillars leave the twigs and enter the ground, at the base of the tree, spin a thin cocoon and pupate. By August 1 all the brood have pupated and in this stage they overwinter.

Male genitalia figured from specimen in National Collection from Flagstaff, Arizona (Hopk. U. S. no. 13962*b*, C. F. Kostian, collector, June 29, 1916).

Distribution according to specimens in National Collection, American Museum and collection Barnes: New Mexico, Arizona, southern Colorado.

Alar expanse.—19–28 mm.

Type.—In National Collection.

Type locality.—Las Vegas, New Mexico.

Food plant.—*Pinus ponderosa*, *P. scopulorum*.

3. RHYACIONIA PASADENANA (Kearfott).

(Fig. 50.)

Evetria pasadenana KEARFOTT, Trans. Amer. Ent. Soc., vol. 33, 1907, p. 3.

BARNES and McDUNNOUGH, Check List Lepid. Bor. Amer., no. 6771, 1917.

This is the species that has been recorded by Walsingham and others as the European *R. duplana* Hübner. The true *dupleana* does not occur in our fauna. We have two specimens in the United States National Museum reared from buds of pine (species not specified), one of which had been seen by Walsingham and labeled “*dupleana* Hübner.”

Male genitalia figured from reared specimen in national collection from California (exact locality not specified).



THIS PAGE IS LOCKED TO FREE MEMBERS

Purchase full membership to immediately unlock this page



HISTORY

Tens of thousands of important historical sources, many previously unobtainable, are now available for the first time with a Forgotten Books Full Membership.

Unlimited Access
\$8.99/month

Continue

*Fair usage policy applies

from both *adana* and *busckana* by the number and size of its cornuti, having a dozen or more short ones in a cluster while the other two species have only three each and these rather long.

Named in honor of my friend, August Busck.

5. *RHYACIONIA ADANA*, new species.

(Fig. 52.)

Like *R. busckana*, from which it differs in having very finely ciliate (almost smooth) antennae in the male; darker palpi; a touch of red on the tegulae; and an invasion of the outer ferruginous shade into the gray ground color on dorsum. In other words, the grayish basal shade extends further out into the wing on costal than on dorsal half of fore wing, not extending beyond the middle of the wing on latter. In this respect the pattern is that of *neomexicana* without the longitudinal black streak from middle of termen. It is distinguished also by its aedoeagus which is smooth and tapers to a long curved pointed tip.

Male genitalia of type figured.

Alar expanse.—16–17.5 mm.

Type.—Cat. No. 24786, U.S.N.M.

Paratypes.—In National Collection, American Museum, and collection Barnes.

Type locality.—Forest Hills, Massachusetts.

Food plant.—Unknown.

Described from male type from Forest Hills, Massachusetts ("Wm. Raff, 5-IV-1910"); two male paratypes from Falls Church, Virginia (A. F. Kneale, March 21, 1919, and March 31, 1920); one male paratype from Bluemont, Virginia (A. F. Kneale, March 30, 1920); and one male paratype from Hazleton, Pennsylvania ("Dietz, IV-16-87").

Named in honor of Miss Ada F. Kneale, to whom I am indebted for the very careful genitalia drawings accompanying this paper.

Superficially this species is uncomfortably close to *busckana*, but on male antenna and genitalia characters must be kept separate. Neither have as yet been bred and the larvae of both are unknown.

6. *RHYACIONIA MONTANA* (Busck).

(Fig. 47.)

Evetria montana BUSCK, Proc. Ent. Soc. Wash., vol. 16, 1914, p. 147.—BARNES and McDUNNOUGH, Check List Lepid., Bor. Amer., no. 6777, 1917.

I have seen only the type of this species. It differs from the others of this immediate group (*neomexicana*, *pasadenana*, *busckana*, *adana*) chiefly in the number and character of the cornuti of the

penis. In *montana* these are very short and stout and form a cluster of a dozen or more set very close together.

Male genitalia figured from type.

Alar expanse.—19 mm.

Type.—In National Collection.

Type locality.—Elliston, Montana.

Food plant.—*Pinus contorta*.

7. RHYACIONIA RIGIDANA (Fernald).

(Fig. 49.)

Retinia rigidana FERNALD, Rept. U. S. Dept. Agr. for 1879, 1880, p. 237.—

PACKARD, Fifth Rept., U. S. Ent. Com., 1890, p. 754.

Exetria rigidana FERNALD, in Dyar List N. Amer. Lepid., no. 4999, 1903.—

BARNES and MCDUNNOUGH, Check List Lepid. Bor. Amer., no. 6761, 1917.

For many years this species had not been represented in our collections, and as far as I know has not been recorded in our economic literature since Packard's citation of the original description and notes of Fernald and Comstock. I have several times in recent years reared the moth from larvae feeding in the buds of various pines also infested with the larvae of the Nantucket pine moth, *R. frustrana* Comstock. The two species occur together, have the same habits, and are probably confused in the economic references to *frustrana*. Fernald's species, however, seems to be more local. While its distribution in the East probably corresponds roughly to that of *frustrana*, it is to be found only in localities here and there and does not seem to be very common anywhere. The larvae of the two have never been satisfactorily differentiated and the complete life history of *rigidana* remains to be worked out. It has two generations a year (like *frustrana*), the moths issuing in March and April and again in late June and early July. It overwinters in the buds as pupa.

Male genitalia figured from specimen in National Collection from Staunton, Virginia (reared April 7, 1917 under Hopk. U. S. no. 13975a from larva in bud of *Pinus taeda*, J. J. de Gryse, collector.)

Distribution according to specimens in National Collection, American Museum, and collection Barnes: Virginia, West Virginia, North Carolina, New York.

Alar expanse.—14–18 mm.

Type.—In collection Fernald.

Type locality.—Ithaca, New York.

Food plants.—*Pinus rigida*, *P. virginiana*, *P. taeda*, *P. laricio*, *P. sylvestris*.

8. RHYACIONIA FRUSTRANA (Comstock).

(Fig. 53)

Retinia frustrana COMSTOCK, Rept. U. S. Dept. Agr. for 1879, 1880, p. 236.—

PACKARD, Fifth Report U. S. Ent. Com., 1890, p. 745.

Evetria frustrana FERNALD, in Dyar's List N. Amer. Lepid., no. 4998, 1903.—

BARNES and McDUNNOUGH, Check List Lepid. Bor. Amer., no. 6760, 1917.

This species is known in economic literature as the "Nantucket pine moth." It is our commonest and on the whole the most destructive pine moth we have—on account, chiefly, of its abundance and wide distribution. It occurs nearly everywhere east of the Rockies where pines grow. It has two generations a year (moths issuing during March and early April and again during June and July) and its life history corresponds to that of *rigidana* as far as we know the latter. Its favored food plant in the east is the common scrub pine (*Pinus virginiana*), but it attacks and thrives on all species except the white pines. For some reason these seem to be immune.

Male genitalia figured from specimen in National Collection from Morristown, Pennsylvania (reared from *Pinus taeda*, April, 1915, under Hopk. U. S. no. 12169c, Heinrich, collector).

Distribution according to specimens in National Collection, American Museum, and collection Barnes: Florida, Texas, Georgia, Alabama, South Carolina, West Virginia, Virginia, Pennsylvania, District of Columbia, New Jersey, Massachusetts.

Alar expanse.—9–15 mm.*Type*.—In collection Cornell University.*Type locality*.—Massachusetts.*Food plant*.—*Pinus*, spp.

9. RHYACIONIA FRUSTRANA BUSHNELLI (Busck).

(Fig. 48.)

Evetria bushnelli BUSCK, Proc. Ent. Soc. Wash., vol. 16, 1914, p. 144.—BARNES

and McDUNNOUGH, Check List Lepid. Bor. Amer., no. 6773, 1917.

Busck described this as a separate western species distinct from the eastern *frustrana*. After several years' rearings of both forms, during which I have succeeded in producing a typical *bushnelli* artificially by inducing our smaller native *frustrana* to oviposit on western yellow pine (*P. ponderosa*) and rearing through on that tree, and after comparison of the genitalia of several specimens, I am convinced that it is nothing more than a local food plant race. There are, in fact, no consistent characters upon which to separate the two. On account of its great economic importance in the sections of the West where it occurs, I am retaining Busck's name as a racial designation. I have seen it in the West only in places where

reforestation has been undertaken, and in such places its origin can be traced to trees introduced from eastern nurseries. At Halsey, Nebraska, the infestation is especially severe, nearly every bud of nearly every pine tree containing one or more larvae.

Male genitalia figured from specimen in National Collection from Fort Bayard, New Mexico (reared from *Pinus ponderosa*, March 17, 1916, under Hopk. U. S. no. 13955, A. J. Jaenicke, collector).

Distribution according to specimens in National Collection, American Museum, and collection Barnes: Arizona, New Mexico, Nebraska.

Alar expanse.—12–19 mm.

Type.—In National Collection.

Type locality.—Fort Bayard, New Mexico.

Food plant.—*Pinus ponderosa* and other species.

10. RHYACIONIA SUBCERVINANA (Walsingham).

Retinia subcervinana WALSINGHAM, Illus. Lepid. Heter. Brit. Mus., vol. 4, 1879, p. 25.

Evetria subcervinana FERNALD, in Dyar List N. Amer. Lepid., no. 5004, 1903.—BARNES and McDUNNOUGH, Check List Lepid. Bor. Amer., no. 6763, 1917.

This species is placed here only tentatively, as I have never seen a specimen that could be assigned to Walsingham's name. The distinguishing characters given in the key are taken from the original description and figure.

Alar expanse.—14 mm.

Type.—In British Museum.

Type locality.—Rouge River, Oregon.

Food plant.—Unknown.

3. PETROVA, new genus.

Genotype.—*Retinia comstockiana* Fernald.

Synonym.—*Evetria* Authors (not Hübner) (part).

Characters as in *Rhycionia*, except as follows:

Fore wing with termen straight or very slightly concave.

Male genitalia with harpes battledore shaped; cucullus very large; neck incurvation¹¹ deep; sacculus with clasper spur projecting into incurvation of neck; costal hook present. Socii developed; finger like; very long, more than half the length of tegumen. Gnathos free; weakly chitinized. Aedoeagus straight; short; stout; cornuti a cluster of several elongate spines. Larva with four setae in group VII on proleg-bearing abdominal segments.

The larvae of this genus feed on various pines and spruces, boring into bark or stems and forming a characteristic nodule of pitch and frass over the part attacked.

¹¹ Wrongly called "anal angle" by me in Proc. U. S. Nat. Mus., vol. 57, 1920, p. 92.

KEY TO THE SPECIES OF PETROVA.

1. Ground color of fore wing from base to apex orange yellow or ferruginous brown..... 2
Ground color of fore wing gray or brown heavily dusted with black; if ferruginous or yellowish with at least a grayish basal area..... 6
2. Fore wing orange yellow with two white fascia..... (7) *sabiniana*.
Fore wing ferruginous abundantly streaked with white..... 3
3. Head snow white; thorax and extreme base of fore wing heavily marked with white; a broad median fascia of silver white..... (1) *comstockiana*.
Head cream white or ferruginous; thorax and extreme base of fore wing showing more of the ferruginous ground color than of white scaling; median whitish cross markings interspaced with ground color..... 4
4. Fore wing with no black scaling on disk; basal line of cilia ferruginous; hind wing whitish shading to pale ochreous..... (2) *virginiana*.
Fore wing with scattered dustings of black scales on disk; basal line of cilia black; hind wing dark smoky fuscous..... 5
5. Head cream white..... (3) *albicapitana*.
Head ferruginous ochreous..... (4) var. *arizonensis*.
6. Apical area of wing reddish or ferruginous ochreous..... 7
Apical area of wing grayish, blackish, or brown dusted with black..... 9
7. Termen of fore wing edged with a fine black line at base of cilia.
(8) *edemoidana*.
Termen not so margined..... 8
8. Fore wing with distinct grayish median fascia slanting outwardly from dorsum to costa; termen broadly margined with dark brick red... (9) *zozana*.
Fore wing with no such median fascia; termen with a narrow red marginal line (10) *monophylliana*.
9. Ground color of fore wing brown dusted with black and with pale markings more or less overlaid with metallic scales..... 10
Ground color gray or grayish white; no metallic scaling on fore wing.... 11
10. Thorax sordid white dusted with grayish fuscous..... (5) *metallica*.
Thorax pure white..... (6) *luculentana*.
11. Head ferruginous ochreous; fore wing with a distinct black spot on dorsum before anal angle and a large black half moon spot on termen near apex; also several faint scattered blotches of greenish scales.... (13) *picicolana*.
Head dark grayish fuscous; fore wing blotched with white or irregularly barred with grayish white..... 12
12. Pale markings on fore wing pure white and fused into two irregular blotches forming tortuous anti-median and post median fasciae.
(12) *burkeana*.
Pale markings sordid gray white, barring wing from base to termen and interlined and spaced with the grayish fuscous ground color; not fusing in conspicuous blotches..... (11) *gemistrigulana*.

1. PETROVA COMSTOCKIANA (Fernald).

(Figs. 20, 54.)

Retinia ? comstockiana FERNALD, Can. Ent., vol. 11, 1879, p. 157.—COMSTOCK, Rept. Dept. Agr. for 1879, 1880, p. 235.—PACKARD, Fifth Report U. S. Ent. Com., 1890, p. 742.

Evetria constockiana FERNALD, in Dyar List N. Amer. Lepid., no. 5000, 1903.—BARNES and McDUNNOUGH, Check List Lepid. Bor. Amer., no. 6762, 1917.

This and *virginiana* are our common nodule makers in the eastern United States. They differ in habit chiefly in that *comstockiana* bores only in stems of the same year's growth, while *virginiana* normally attacks the bark of older twigs and branches. The work can be easily recognized by the large hard nodules of frass-stained pitch found at the exit holes of the galleries.

Male genitalia figured from specimen in National Collection from Veitch, Virginia (reared from *Pinus taeda* June 1, 1914, under Hopk. U. S. no. 12128c, Heinrich).

Distribution according to specimens in National Collection, American Museum, and collection Barnes: Virginia, Maryland, New Jersey, New York, Massachusetts.

Alar expanse.—14–20 mm.

Type.—In collection Fernald.

Type locality.—Ithaca, New York.

Food plants.—*Pinus taeda*, *P. rigida*, *P. sylvestria*.

2. PETROVA VIRGINIANA (Busck).

(Fig. 55.)

Evetria virginiana BUSCK, Proc. Ent. Soc. Wash., vol. 16, 1914, p. 145.—
BARNES and MCDUNNOUGH, Check List Lepid. Bor. Amer., no. 6774, 1917.

This is the species referred to by Kearfott (Ins. N. J., 1910, p. 538) as *Rhyacionia wenzeli* Kearfott, but never described by him.

Male genitalia figured from specimen in National Collection from Falls Church, Virginia (reared from *Pinus virginiana*, 26 April, 1915, Heinrich).

Distribution according to specimens in National Collection, American Museum, and collection Barnes: Virginia, Pennsylvania, New Jersey.

Alar expanse.—17.5–23 mm.

Type.—In National Collection.

Type locality.—Falls Church, Virginia.

Food plant.—*Pinus virginiana*.

3. PETROVA ALBICAPITANA (Busck).

(Fig. 56.)

Evetria albicapitana BUSCK, Proc. Ent. Soc. Wash., vol. 16, 1914, p. 147.—
BARNES and MCDUNNOUGH, Check List Lepid. Bor. Amer., no. 6778, 1917.—
HEINRICH, Proc. U. S. Nat. Mus., vol. 57, 1920, p. 57.

This species replaces *virginiana* in the West. It is the one that has appeared in our lists as the European *pinivorana*. The latter, however, is quite different in genitalia and does not occur in our fauna.

Male genitalia figured from specimen in United States National Museum from Boulder Point, Wisconsin (reared from *Pinus divaricata*, 19 May, 1914, under Hopk. U. S. no. 11199*b*, Rohwer and Christensen).

Distribution according to specimens in National Collection, American Museum, and collection Barnes: Saskatchewan, Idaho, Montana, Wisconsin, Ontario.

Alar expanse.—16–23 mm.

Type.—In National Collection.

Type locality.—Prince Albert, Saskatchewan.

Food plants.—*Pinus divaricata*, *P. contorta*.

4. PETROVA ALBICAPITANA ARIZONENSIS (Heinrich).

(Fig. 57.)

Evetria albicapitana arizonensis HEINRICH, Proc. U. S. Nat. Mus., vol. 57, 1920, p. 57.

A paler Arizona race of *albicapitana*. Represented in our collections as far as I know only by the type and paratype at Washington.

Male genitalia figured from type.

Alar expanse.—11–14.5 mm.

Type.—In National Collection.

Type locality.—Santa Catalina Mountains, Arizona.

Food plant.—*Pinus cembroides*.

5. PETROVA METALLICA (Busck).

(Fig. 58.)

Evetria metallica BUSCK, Proc. Ent. Soc. Wash., vol. 16, 1914, p. 146.—BARNES and McDUNNOUGH, Check List Lepid. Bor. Amer., no. 6776, 1917.

A purplish brown metallic species having larval habits and life history similar to those of *albicapitana*.

Male genitalia figured from specimen in National Collection from Potomac, Montana (reared from *Pinus ponderosa*, 25 March, 1916, under Hopk. U. S. no. 13959*a*, Joseph Brunner).

Distribution according to specimen in National Collection, American Museum, and collection Barnes: Montana and California (Lake Tenaya).

Alar expanse.—16–19 mm.

Type.—In National Collection.

Type locality.—Missoula, Montana.

Food plants.—*Pinus ponderosa*, *P. contorta*, *P. murrayana*.



THIS PAGE IS LOCKED TO FREE MEMBERS
Purchase full membership to immediately unlock this page



Never be without a book!

Forgotten Books Full Membership gives universal access to 797,885 books from our apps and website, across all your devices: tablet, phone, e-reader, laptop and desktop computer

A library in your pocket for \$8.99/month

Continue

*Fair usage policy applies

9. PETROVA ZOZANA (Kearfott).

Evetria zozana KEARFOTT, Trans. Amer. Ent. Soc., vol. 33, 1907, p. 2.—BARNES and McDUNNOUGH, Check List Lepid. Bor. Amer., no 6769, 1917.
Evetria matutina MEYRICK, Ent. Mo. Mag., vol. 48, 1912, p. 35.

I have seen only the type (a female) of this species. It is close to *edimoidana* in pattern and markings, but appears distinct.

Alar expanse.—20 mm.

Type.—In American Museum.

Type locality.—Placer County, California.

Food plant.—Unknown.

10. PETROVA MONOPHYLLIANA (Kearfott).

Evetria monophylliana KEARFOTT, Trans. Amer. Ent. Soc., vol. 33, 1907, p. 1.—BARNES and McDUNNOUGH, Check List Lepid. Bor. Amer., no. 6767, 1917.

None of Kearfott's male cotypes in the National Collection or the American Museum has an abdomen, so genitalia could not be studied. I have little hesitation, however, in placing his species in this genus.

Alar expanse.—15–19 mm.

Type.—In American Museum.

Type locality.—Corso Valley, Kern County, California.

Food plant.—*Pinus monophylla*.

11. PETROVA GEMISTRIGULANA (Kearfott).

(Fig. 63.)

Evetria gemistrigulana KEARFOTT, Proc. U. S. Nat. Mus., vol. 28, 1905, p. 349.—BARNES and McDUNNOUGH, Check List Lepid. Bor. Amer., no. 6765, 1917.

This species is superficially much like the European *P. resinella* Linneus. The two are quite distinct in genitalia, however, and the latter does not occur in our fauna.

Male genitalia figured from cotype in United States National Museum from Tryon, North Carolina (Fiske, "5-20").

Distribution according to specimens in National Collection and American Museum: North Carolina and Florida.

Alar expanse.—19–21 mm.

Type.—In American Museum.

Type locality.—Tryon, North Carolina.

Food plant.—Unknown.

12. PETROVA BURKEANA (Kearfott).

(Fig. 60.)

Evetria burkeana KEARFOTT, Trans. Amer. Ent. Soc., vol. 33, 1907, p. 4.—BARNES and McDUNNOUGH, Check List Lepid. Bor. Amer., no. 6772, 1917.

This and the following species are spruce feeders as distinguished from all the others in this genus (with the possible exception of *gemistrigulana*) which are confined to the pines.

Male genitalia figured from specimen in National Collection from Missoula, Montana (reared from *Picea engelmanni*, June 15, 1915, under Hopk. U. S. no. 11083, B. T. Harvey).

Distribution according to specimens in National Collection, American Museum and collection Barnes: Washington and Montana.

Alar expanse.—26–28 mm.

Type.—In American Museum.

Type locality.—Hoquian, Washington.

Food plants.—*Picea stichensis*, *P. engelmanni*.

13. PETROVA PICICOLANA (Dyar).

(Fig. 62.)

Eucosma picicolana DYAR, Journ. N. Y. Ent. Soc., vol. 14, 1906, p. 108.—BARNES and McDUNNOUGH, Check List Lepid Bor. Amer., no. 7008, 1917.

Described in *Eucosma* but belongs here. A striking easily recognized species and the largest in the genus.

Male genitalia figured from specimen in American Museum from Plain County, California.

Distribution according to specimens in National Collection, American Museum, and collection Barnes: Washington, Idaho, California, British Columbia.

Alar expanse.—27–32 mm.

Type.—In National Collection.

Type locality.—Paradise Valley, Washington.

Food plants.—*Abies lasiocarpa*, *A. grandis*.

4. BARBARA, new genus.

Genotype.—*Evetriā colfaxiana* Kearfott.

Synonym.—*Evetria* Authors (not Hübner) (part).

Characters as in *Petrova* except as follows:

Cucullus of harpes trigonate; rudimentary clasper—spur of sacculus absent.

Larva with only the *three* normal setae in Group VII on proleg-bearing abdominal segments. Larvae feed in cones of various spruces.

KEY TO THE SPECIES OF BARBARA.

1. Hind wing very dark brown; almost black, concolorous with dark areas of fore wing; pale markings on fore wing iridescent lead gray
(5) *ulteriorana*.
- Hind wing pale or dark smoky fuscous, not blackish; paler than dark areas of fore wing; pale markings on fore wing gray, suffused with whitish, ochreous or pale greenish scales..... 2
2. Head ferruginous ochreous..... 3
- Head blackish or fuscous, more or less dusted with white..... 4

3. White geminations on outer half of costa repeated on underside of fore wing as short, very thin dashes----- (1) *colfaxiana* (typical).
 White costal geminations repeated on underside of fore wing as spots about as broad as long----- (3) var. *coloradensis* (part).
4. Pale areas of fore wing partially suffused with ochreous-- (4) var. *taxifoliella*.
 Pale areas of fore wing tinted with pale greenish-----5
5. Cilia of hind wing whitish; hind wing very pale ochreous fuscous.
 (3) var. *coloradensis* (part).
 Cilia of hind wing dark smoky fuscous; hind wing dark brownish fuscous.
 (2) var. *siskiyouana*.

1. **BARBARA COLFAXIANA** (Kearfott).

(Figs. 24, 69.)

Evetria colfaxiana KEARFOOT, Trans. Amer. Ent. Soc., vol. 33, 1907, p. 3.—
 BARNES and McDUNNOUGH, Check List Lepid. Bor. Amer., no. 6770, 1917.—
 HEINRICH, Proc. U. S. Nat. Mus., vol. 57, 1920, pp. 53-55.

The reasons for considering this and the following three forms but local and food plant races of a single species are covered in my paper in the Proceedings of the National Museum. As yet I have no reason to doubt the correctness of the conclusion.

Male genitalia figured from specimen in National Collection from Ashland, Oregon (reared from cones of *Pseudotsuga taxifolia*, April 12, 1915, under Hopk. U. S. no. 12536a¹, J. M. Miller).

Distribution according to specimens in National Collection, American Museum and collection Barnes: California, Oregon, Washington, British Columbia.

Alar expanse.—15-21 mm.

Type.—In American Museum.

Type locality.—Colfax, Placer County, California.

Food plant.—*Pseudotsuga taxifolia*.

2. **BARBARA COLFAXIANA SISKIYOUANA** (Kearfott).

(Fig. 70.)

Evetria siskiyouana KEARFOOT, Can. Ent., vol. 39, 1907, p. 77.—BARNES and
 McDUNNOUGH, Check List Lepid. Bor. Amer., no. 6766, 1917.

Evetria colfaxiana siskiyouana HEINRICH, Proc. U. S. Nat. Mus., vol. 57, 1920,
 pp. 53-55.

Male genitalia figured from specimen in National Collection from Ashland, Oregon (reared from *Abies concolor*, April 1, 1915, under Hopk. U. S. no. 12560a, F. P. Kean).

Distribution according to specimens in National Collection, American Museum, and collection Barnes: California and Oregon.

Alar expanse.—21-24 mm.

Type.—In American Museum.

Type locality.—Siskiyou County, California.

Food plants.—*Abies concolor*, *A. shastensis*, *A. magnifica*.

3. BARBARA COLFAXIANA COLORADENSIS (Heinrich).

(Figs. 71, 72.)

Evetria colfaxiana coloradensis HEINRICH, Proc. U. S. Nat. Mus., vol. 57, 1920, pp. 53-55.

Male genitalia figured from type (reared under Hopk. U. S. no. 14212a from *Abies concolor*, Oct. 6, 1915, J. H. Pollock) and from paratype (reared under Hopk. U. S. no. 12567a from *Pseudotsuga taxifolia*, Sept. 11, 1914, Garden of the Gods, Colorado, G. Hofer); both from National Collection.

Distribution according to specimens in National Collection, American Museum, and collection Barnes: Colorado.

Alar expanse.—19-22 mm.

Type.—In National Collection.

Type locality.—Mount Manitou, Colorado.

Food plants.—*Abies* and *Pseudotsuga*.

4. BARBARA COLFAXIANA TAXIFOLIELLA (Busck).

(Fig. 73.)

Evetria taxifoliella BUSCK, Proc. Ent. Soc. Wash., vol. 16, 1914, p. 146.—BARNES and McDUNNOUGH, Check List Lepid. Bor. Amer., no. 6775, 1917.

Evetria colfaxiana taxifoliella HEINRICH, Proc. U. S. Nat. Mus., vol. 57, 1920, pp. 53-55.

Male genitalia figured from paratype in National Collection from Missoula, Montana (reared under Hopk. U. S. no. 11509, March, 1913, J. Brunner).

Distribution according to specimens in National Collection, American Museum, and collection Barnes: Montana.

Alar expanse.—13-15 mm.

Type.—In National Collection.

Type locality.—Missoula, Montana.

Food plant.—*Pseudotsuga taxifolia*.

5. BARBARA ULTERIORANA (Heinrich).

(Fig. 74.)

Evetria ulteriorana HEINRICH, Proc. U. S. Nat. Mus., vol. 57, 1920, p. 55.

I am still strongly of the opinion that this is nothing but a very aberrant form of *colfaxiana*; but as further rearings have added nothing to our knowledge and as it is represented by a large series, all uniform, I feel constrained to keep it for the time being under a separate specific name.

Male genitalia figured from type.

Distribution according to specimens in National Collection, American Museum, and collection Barnes: Oregon.

Alar expanse.—13–14 mm.

Type.—In National Collection.

Type locality.—Waldo, Oregon.

Food plant.—*Pseudotsuga taxifolia*.

5. Genus SPILONOTA Stephens.

(Figs. 4, 4a, 18, 307.)

Genotype.—*Tortrix ocellana* Denis and Schiffermüller.

Synonym.—*Tmetocera* Lederer. *Genotype*—*Tortrix ocellana* Denis and Schiffermüller.

Antenna of male with a notch slightly beyond basal joint (fig. 4a).

Fore wing smooth; termen nearly straight, very slightly concave between veins 3 and 6; 12 veins; 7 and 8 connate; 9 closely approximate to 7 and 8; 10 remote from 9 but not nearer 11 than 9; 11 from before middle of cell; upper internal vein of cell from between 10 and 11; 3, 4 and 5 *not* approximate at termen; no costal fold in male.

Hind wing with 8 veins; 6 and 7 approximate at base; 3 and 4 stalked.

Male genitalia with harpes greatly elongate and narrow; cucullus reduced and armed with large spine at anal angle; neck smooth. Uncus absent. Socii short; moderately broad. Gnathos free; weak. Aedoeagus short; rather slender; supporting arm of annellus and articulation with aedoeagus very stout; cornuti a cluster of slender elongate spines.

A derivative of *Eucosma*.

SPILONOTA OCELLANA (Denis and Schiffermüller).

(Figs. 4, 4a, 18, 307.)

Tortrix ocellana DENIS and SCHIFFERMÜLLER, Syst. Verz. Wien, 1776, p. 130.

Spilonota ocellana STEPHENS, Cat. Brit. Ins., vol. 2, no. 6901, 1829, p. 173.—

WALSINGHAM, Biol. Cent. Amer. Heter., vol. 4, 1914, p. 228.

Tmetocera ocellana LEDERER, Wien. Ent. Monat., vol. 3, 1859, pp. 124, 367–8.—

ZELLER, Verh. Zool-bot. Ges. Wien., vol. 25, 1875, p. 267.—SLINGERLAND, Bull.

no. 107, Cornell Agr. Expr. Stät., 1896, pp. 57–66.—STAUDINGER and REBEL,

Cat. Lepid., vol. 2, no. 2255, 1901.—FERNALD, in Dyar List, N. Amer. Lepid.,

no. 5237, 1903.—BARNES and McDUNNOUGH, Check List Lepid. Bor. Amer.,

no. 7170, 1917.—SANDERS and DUSTAN, Bull. no. 16, Dept. Agr., Ottawa,

1919, pp. 25–33.

Hedya pyrifoliana CLEMENS, Proc. Acad. Nat. Sci., Phila., 1860, p. 357.

Penthina oculana HARRIS, Inj. Ins., 1862, p. 482.

Grapholitha ocellana lariciana HEINEMANN, Schmet, Deutsch., vol. 1, 1863, p. 206.

Grapholitha oculana SAUNDERS, Can. Ent., vol. 3, 1871, p. 13.

This well-known imported fruit-tree insect figures extensively in the economic literature of this country and Europe. Only a few of

the more important references are given above. The purely European synonymy is also omitted. It is of chief economic concern as an apple pest.

Male genitalia figured from specimen in National Collection, reared from apple (New York).

Distribution according to specimens in National Collection, American Museum, and collection Barnes: New York, Massachusetts, Connecticut, New Hampshire, New Jersey, Pennsylvania, Ohio, Washington, British Columbia.

The variety *lariciana* Heinemann is only a color form without the characteristic white median shading on fore wing. It does not appear to be in any sense a local race and shows no variation in genitalia from the typical *ocellana*. I have seen specimens from New York, New Hampshire, and British Columbia. Heinemann described it as a larch feeder. Our reared specimen, however, was from apple.

Alar expanse.—12–16 mm.

Types.—Locations unknown (*ocellana*, *pyrifoliana*, *lariciana*); lost (*oculana*).

Type localities.—Germany (*ocellana* and *lariciana*); Pennsylvania? (*pyrifoliana*); New York (*oculana*).

Food plants.—Oak, apple, blackberry, laurel, pear, plum, *Crataegus* (var. *lariciana* from "*Pinus larix*" in Europe, according to Heinemann).

6. Genus STREPSICRATES Meyrick.

(Figs. 3, 3a, 23, 306.)

Genotype.—*Sciaphila ejectana* Walker.

Synonym.—*Phthinolophus* Dyar. *Genotype*.—*Phthinolophus identanus* Dyar.

Antenna of male with notch above basal joint (fig. 3a).

Fore wing with a prominent scale tuft over middle of vein 1b; termen straight, hardly concave; 12 veins, 7 and 8 separate; 10 from cell halfway between 9 and 11; 11 from near middle of cell; upper internal vein of cell from between 10 and 11; 3, 4, and 5 not approximate at termen; 2 nearly straight; costal fold of male present.

Hind wing with 8 veins; 6 and 7 approximate at base; 3 and 4 stalked.

Male genitalia as in *Spilonota* except:

Harpe with pollex developed; neck well clothed with hair like spines; cucullus with several slender spines on outer surface along lower and outer margins; socii very small, fingerlike. Supporting arm of annellus slender.

Close to *Spilonota* but separately derived from *Eucosma*. Contains only one North American species.

STREPSICRATES INDENTANA (Dyar).

(Figs. 3, 3a, 23, 306.)

Phthinolophus indentanus DYAR, Proc. Ent. Soc. Wash., vol. 5, 1903, p. 306.—
BARNES and McDUNNOUGH, Check List Lepid. Bor. Amer., no. 7171, 1917.

I have not seen a specimen of Walker's *ejectana* the type of *Strepsicrates*, but have before me specimens of the congeneric West Indian *S. smithiana* Walsingham, which in structure is no different from *indentana* Dyar. The genitalia of the two are identical and the only difference is in color, and that but slight. Inasmuch as our species is variable and all three (*ejectana*, *smithiana*, and *indentana*) are feeders on Myrtaceae (or Myricaceae), it would appear that we are dealing with one rather variable, widely distributed species, and such I believe is the case. I am not making the synonymy now in absence of a male of *ejectana* for genitalia comparison. If all three should prove to be the same species, they could in all likelihood be distinguished as separate races. At any rate, the genus *Phthinolophus* Dyar must fall before *Strepsicrates* Meyrick. It is in no sense equivalent to *Crocidosema* Zeller, as suggested by Busck.¹²

Male genitalia figured from paratype in the National Collection from Fortress Monroe, Virginia (reared from Myrtle, Dept. Agr. no. 3422, "2/7/84").

Distribution according to specimens in National Collection, American Museum, and collection Barnes: Florida, Virginia, District of Columbia, Pennsylvania, New Jersey.

Alar expanse.—12–15 mm.

Type.—In National Collection.

Type locality.—Fortress Monroe, Virginia.

Food plants.—*Myrica cerifera*, *Eugenia*.

7. Genus THIODIA Hübner.

(Fig. 16.)

Genotype.—*Tortrix citrana* Hübner.

Synonyms.—1. *Eriopsela* Guenée. *Genotype*.—*Tortrix quadrana* Guenée.

2. *Calosetia* Stainton. *Genotype*.—*Tortrix nigromaculana* Haworth.

3. *Cydia* Hübner. *Genotype*.—*Tortrix orspidiscana* Hübner.

4. *Semasia* Authors (not Stephens).

5. *Ioplocama* Clemens. *Genotype*.—*Ioplocama formosana* Clemens.
(Figs. 17, 88.)

¹² Proc. Ent. Soc. Wash., vol. 12, 1910, p. 132.



THIS PAGE IS LOCKED TO FREE MEMBERS

Purchase full membership to immediately unlock this page



HISTORY

Tens of thousands of important historical sources, many previously unobtainable, are now available for the first time with a Forgotten Books Full Membership.

Unlimited Access
\$8.99/month

Continue

*Fair usage policy applies

8. Hind wing with veins 3 and 4 stalked----- (39) *argenticostana*.
 Hind wing with veins 3 and 4 united----- (40) *spiculana*.
9. A series of fuscous dots along dorsal margin of fore wing.
 (41) *dorsiatomana*.
 No such series of fuscous dots on dorsal margin-----10
10. Dorsal area of fore wing below the fold white----- (45) *pallidarcis*.
 Dorsal area below the fold ochreous-----11
11. Fore wing with vein 2 indicated by a streak of blackish fuscous scaling;
 veins 3 and 4 of hind wing stalked----- (42) *striatana*.
 Fore wing without such blackish streak over vein 2; veins 3 and 4 of hind
 wing united----- (43) var. *occidentalis*.
12. Fore wing heavily dusted and marked with dark ashy gray; no ochreous
 suffusion----- (35) *misturana*.
 Fore wing cream or dirty white, slightly dusted with gray; if heavily
 dusted with gray, then subcostal area bordering median streak toward
 base strongly ochreous-----13
13. Head snow white -----14
 Head dusted with ashy gray or fuscous-----15
14. Median white streak of fore wing with a narrow wedge shaped brown mark
 on lower margin just beyond base----- (38) *indagatricana*.
 Median white streak without such mark on lower margin. (44) *delphinoides*.
15. Median white streak strongly contrasted against ground color; hind wing
 smoky fuscous----- (37) *clavana*.
 Median white streak faint, fading into ground color; hind wing whitish.
 (36) *parvana*.
16. Fore wing blackish fuscous (or very dark grayish fuscous) with sharply
 contrasting white ocelloid patch and white patch on mid dorsum-----17
 Fore wing not so marked-----20
17. Ground color of fore wing at apex light ochreous brown-- (22) *marmontana*.
 Ground color of fore wing at apex blackish fuscous-----18
18. White apical costal dash on fore wing triangular, as broad as long; ocellus
 containing three black lines, the lowest strongly arched.
 (23) *oregonensis*.
 White apical costal dash short and narrow, longer than broad; ocellus with
 black markings somewhat irregular but not as above-----19
19. Median dorsal white patch on fore wing well separated from ocellus by a
 broad patch of the ground color----- (20) *crispana*.
 Median dorsal white patch but narrowly separated from the ocellus.
 (21) *alterana*.
20. Fore wing light ochreous salmon color----- (49) *salmicolorana*.
 Fore wing not ochreous salmon color-----21
21. Fore wing gray, unicolorous and unmarked-----22
 Fore wing otherwise; if gray distinctly marked; if unicolorous not gray--23
22. Antenna of male nearly smooth----- (27) *lapidana*.
 Antenna of male strongly pubescent----- (28) *sublapidana*.
23. Ocelloid patch of fore wing well marked, with a median silver bar dividing
 a cluster of six or more black spots-----24
 Ocellus not clearly defined; or if so, marked otherwise than as above---27
24. Ground color of fore wing lemon or golden yellow-----25
 Ground color of fore wing brownish ochreous partially suffused with gray-
 ish or whitish scaling-----26
25. Fore wing with an outer fuscous and metallic fascia and a strong fuscous
 shading over ocellus----- (14) *annetteana*.
 Fore wing without such----- (15) *refusana*.

26. Ocellus with black dots, ten in number and arranged in two longitudinal lines ----- (16) *decempunctana*.
 Ocellus with black dots, twelve or more in number and arranged in three longitudinal lines ----- (13) *amphorana*.
27. Fore and hind wings ferruginous brown ----- 28
 Fore and hind wings sometimes concolorous; but if so, not ferruginous brown ----- 32
28. Outer third of fore wing appreciably darker than basal area ----- 29
 Outer third of fore wing not appreciably darker than basal area.
 (1) *radiatana* (female).
29. Cilia of fore wing fuscous, heavily dusted with grayish white.
 (3) *essexana* (female).
 Cilia of fore wing ferruginous, if somewhat fuscous not heavily dusted with white ----- 30
30. Ocellus of fore wing obsolete ----- 31
 Ocellus indicated by a couple of faint vertical silvery bars and two longitudinal black streaks ----- (5) *umbrastriana* (female).
31. Hind wing darker, and more fuscous than darkest shading on fore wing.
 (4) *roseotermianana* (female).
 Hind wing no darker than darkest shading on fore wing; more ferruginous than fuscous ----- (7) *ferruginana*.
32. Fore wing distinctly ferruginous, dull ochreous, dark gray brown or blackish fuscous; if sometimes pale gray brown or pale ochreous not over 20 mm. alar expanse ----- 33
 Fore wing otherwise ----- 40
33. Fore and hind wings both blackish fuscous ----- (9) *perfuscana*.
 Fore and hind wings not both blackish fuscous ----- 34
34. Entire fore wing pale-rust red or dull ochreous ----- 35
 Entire fore wing not so colored ----- 36
35. Fore wing rust color; alar expanse over 20 mm ----- (56) *benjamini*.
 Fore wing ochreous; alar expanse less than 15 mm ----- (18) *mormonensis*.
36. Entire fore wing except yellowish ocelloid patch and extreme sub-apical area, blackish fuscous; hind wings pale smoky fuscous.
 (8) *ochroterminana*.
 Entire fore wing not blackish fuscous; or if so hind wings very dark brown ----- 37
37. Hind wing dark brown or dark smoky fuscous with white cilia.
 { (6) *formosana*.
 { (2) *awemeana* (female).
 Hind wing pale smoky fuscous; if dark with but slightly paler cilia ----- 38
38. Fore wing dark reddish ochreous; head white ----- (10) *raracana*.
 Fore wing brownish ochreous or brown dusted with blackish; if sometimes red, head not white ----- 39
39. Fore wing fawn brown, shading to whitish ochreous on outer fourth and above cell; head whitish ochreous ----- (12) *ochrocephala*.
 Fore wing gray brown, brownish ochreous, brown dusted with blackish or red-brown; but not shading to whitish ochreous; head ferruginous or gray ----- (11) *corculana*.
40. Ground color of fore wing cream color, pale lemon yellow, ochreous or olivaceous ----- 41
 Ground color grayish fuscous, ashy gray or white ----- 58
41. Ground color of fore wing pale lemon yellow ----- 42
 Ground color of fore wing ochreous, cream color or olivaceous ----- 43

42. Alar expanse over 16 mm----- (63) *grindeliana*.
 Alar expanse under 16 mm----- (64) *stramineana*.
43. Ground color of fore wing olivaceous----- 44
 Ground color not olivaceous----- 49
44. Olivaceous tint more green than ochreous----- 45
 Olivaceous tint more ochreous than green----- 47
45. Dark markings on fore wing an evenly distributed spotting of blackish
 fuscous ----- (62) *granulatana*.
 Dark markings on fore wing more concentrated; forming a faint fuscous
 basal patch, a median longitudinal fuscous shading, a faint fuscous spot
 on dorsum near tornus and a transverse band from mid costa to a
 darkened subapical area----- 46
46. Costa of fore wing distinctly marked from base to apex with short fuscous
 dashes; alar expanse under 15 mm----- (60) *verniochreana*.
 Costa appreciably marked with fuscous only on outer half; alar expanse
 over 15 mm----- (59) *olivaceana*.
47. Fore wing with an appreciable outer fascia or with a heavy clouding of
 purplish brown suffusing much of basal two-thirds; head pale olivaceous
 ochreous----- 48
 Fore wing not so marked; head grayish ochreous----- (58) *perangustana*.
48. Dark scaling of fore wing blackish fuscous; cilia with a narrow blackish me-
 dian band----- (55) *montanana*.
 Dark scaling of fore wing purplish brown; cilia without blackish median
 band ----- (61) *imbridana*.
49. Fore wing with a strongly ferruginous suffusion on terminal fifth; alar
 expanse over 25 mm----- (67) *bucephaloides*.
 Fore wing without such; or if with a contrasting ferruginous suffusion on
 outer fifth, then alar expanse less than 25 mm----- 50
50. Fore wing with a white or bluish white suffusion along entire dorsum; or
 with a broad whitish patch on mid dorsal margin, paler than the ground
 color ----- 51
 Fore wing without such; mid dorsal pale area of the ground color----- 52
51. Alar expanse 19 to 31 mm----- (66) *offectalis* (in part).
 Alar expanse not over 13 mm----- (48) *kiscana*.
52. Head white or cream colored without any gray or fuscous dustings----- 53
 Head strongly dusted with grayish fuscous----- 54
53. Fore wing with a pale brownish ochreous half basal patch, several fine cos-
 tal dashes and an irregular patch of the same color on outer dorsal mar-
 gin before tornus; ochreous markings largely suffusing the white ground
 color; alar expanse less than 20 mm----- (57) *griseocapitana*.
 Fore wing milk or cream white; dark markings obsolete or nearly so, not
 as above, gray; alar expanse over 20 mm----- (66) *offectalis* (part).
54. Cilia of fore wing ochreous with no blackish or fuscous dusting.
 (4) *roseotermiana* (male).
 Cilia white or brown shaded with black, to the naked eye distinctly gray-- 55
55. Fore wing with an appreciable median longitudinal brownish ochreous
 streak ----- 56
 Fore wing without such----- (5) *umbrastriana* (male).
56. Median streak not reaching end of cell----- (2) *awemeana* (male).
 Median streak reaching to or beyond end of cell----- 57
57. Fore wing with veins beyond cell outlined with brownish ochreous; ocelloid
 patch not defined----- (1) *radiatana* (male).
 Veins beyond cell not distinctly outlined with brownish ochreous; ocellus de-
 fined by two vertical silvery bars----- (3) *essexana* (male).

58. Alar expanse over 20 mm----- 59
 Alar expanse under 20 mm----- 62
59. Basal two-thirds of fore wing above fold darker than rest of wing.
 (65) *umbraticana*.
 Basal area above fold not darker than rest of wing----- 60
60. Cilia of fore wing white with a moderately broad median fuscous band.
 (31) *tarandana*.
 Cilia of fore wing fuscous with a fine white sub-basal line and the tips of
 the scales white----- 61
61. Fore wing with outer fascia and basal patch distinct----- (30) *transversa*.
 Fore wing with fascia and basal patch obsolete or nearly so----- (29) *elongana*.
62. Ground color of fore wing dark ashy gray----- 63
 Ground color of fore wing white or whitish----- 64
63. Fore wing with two large well defined black spots on dorsum.
 (24) *tomonana*.
 Fore wing without such----- (32) *cinereolineana*.
64. Fore wing with a complete, outwardly angulate basal patch----- (17) *columbiana*.
 Basal patch disappearing above fold or altogether absent ----- 65
65. A strongly marked outwardly curved dark spot on dorsal margin of fore
 wing near base ----- 66
 No such strongly marked spot on dorsal margin near base ----- 67
66. Inner dark spot on dorsal margin of fore wing reddish brown.
 (25) *apacheana*.
 Inner dark dorsal spot dark gray-brown----- (26) *influana*.
67. Basal half of costa shining white, unmarked----- (50) *pallidicostana*.
 Costa finely marked from base with fuscous dashes ----- 68
68. Hind wing uniformly pale smoky fuscous----- (19) *delphinus*.
 Hind wing whitish, shaded with fuscous only toward apex and outer
 margin----- 69
69. Alar expanse 14 to 18 mm; hind wing with veins 3 and 4 stalked----- 70
 Alar expanse 12 mm. or less; hind wing with veins 3 and 4 united----- 71
70. Palpi projecting nearly twice the length of the head beyond it.
 (34) *tenuiana*.
 Palpi projecting no more than the length of the head beyond it.
 (33) *migratana*.
71. Ground color of fore wing much obscured by fuscous markings giving wing
 a grayish white appearance----- (47) *subminimana*.
 White ground color but little obscured by fuscous markings; general color
 much more white than gray----- (46) *minimana*.

1. *THIODIA RADIATANA* (Walsingham).

(Fig. 75.)

Semasia radiatana WALSINGHAM, Illus. Lepid. Heter. Brit. Mus., vol. 4, 1879,
 p. 55.

Thiodia radiatana FERNALD, in Dyar List N. Amer. Lepid., no. 5163, 1903.—
 KEARFOTT, Proc. U. S. Nat. Mus., vol. 28, 1905, p. 359; Trans. Amer. Ent.
 Soc., vol. 33, 1907, pp. 37, 38.

Eucosma radiatana BARNES and McDUNNOUGH, Check List Lepid. Bor. Amer.,
 no. 7048, 1917.

How many good species are represented by this and the following
 six names can be ascertained only by careful and extensive rearings.
 It is very doubtful if we have more than three or four, the others
 being at best but local races or color varieties. For the present,

however, they must all stand as distinct species. The larvae of all, so far as known, are stem borers.

Male genitalia figured from typical specimen in National Collection from Brighton, Pennsylvania ("H. D. Merrick, 5-21-02").

Distribution according to specimens in National Collection, American Museum, and collection Barnes: New Jersey, New York, North Carolina, Maryland, Kansas, Virginia, Pennsylvania.

Alar expanse.—17-25 mm.

Type.—In British Museum.

Type locality.—"Eastern United States."

Food plant.—*Solidago*.

2. THIODIA AWEMEANA Kearfott.

(Fig. 76.)

Thiodia awemeana KEARFOTT, Trans. Amer. Ent. Soc., vol. 33, 1907, pp. 38, 39, 41.

Eucosma awemeana BARNES and McDUNNOUGH, Check List Lepid. Bor. Amer., no. 7052, 1917.

Male genitalia figured from specimen in National Collection from Cartwright, Manitoba (E. F. Heath).

Distribution according to specimens in National Collection, American Museum, and collection Barnes: Manitoba and Ontario.

Alar expanse.—17-20 mm.

Type.—In American Museum.

Type locality.—Aweme, Manitoba.

Food plant.—Unknown.

3. THIODIA ESSEXANA Kearfott.

(Fig. 83.)

Thiodia essexana KEARFOTT, Trans. Amer. Ent. Soc., vol. 33, 1907, pp. 38, 39.

Eucosma essexana BARNES and McDUNNOUGH, Check List Lepid. Bor. Amer., no. 7049, 1917.

Male genitalia figured from cotype in National Collection ("Caldwell, N. J., May 22, 04, W. D. Kearfott").

Specimens in National Collection, American Museum, and collection Barnes all from New Jersey.

Alar expanse.—17-24 mm.

Type.—In American Museum.

Type locality.—Caldwell, New Jersey.

Food plant.—*Aster patens*.

4. THIODIA ROSEOTERMINANA Kearfott.

(Fig. 77.)

Thiodia roseotermi nana KEARFOTT, Trans. Amer. Ent. Soc., vol. 33, 1907, pp. 38, 39, 40.

Eucosma roseotermi nana BARNES and McDUNNOUGH, Check List Lepid. Bor. Amer., no. 7051, 1917.

Male genitalia figured from cotype in National Collection, from Wisconsin.

Distribution according to specimens in National Collection, American Museum, and collection Barnes: Ohio, Pennsylvania, Wisconsin, New Hampshire.

Alar expanse.—16–21 mm.

Type.—In American Museum.

Type locality.—Cincinnati, Ohio.

Food plant.—Unknown.

5. THIODIA UMBRASTRIANA Kearfott.

(Fig. 87.)

Thiodia umbrastriana KEARFOTT, Trans. Amer. Ent. Soc., vol. 33, 1907, pp. 38, 39, 40.

Eucosma umbrastriana BARNES and McDUNNOUGH, Check List Lepid. Bor. Amer., no. 7050, 1917.

Male genitalia figured from cotype in National Collection from Cincinnati, Ohio (5-17-03).

Distribution according to specimens in National Collection, American Museum, and collection Barnes: Ohio, Colorado, Wisconsin, New Hampshire, Massachusetts, Pennsylvania, New Jersey, Illinois, Manitoba.

Alar expanse.—16–20 mm.

Type.—In American Museum.

Type locality.—Cincinnati, Ohio.

Food plant.—Unknown.

6. THIODIA FORMOSANA (Clemens).

(Figs. 17, 88.)

Ioplocama formosana CLEMENS, Proc. Acad. Nat. Sci. Phila., 1860, p. 360.

Grapholita sagittana WALKER, Cat. Lepid. Heter. Brit. Mus., vol. 28, 1863, p. 386.

Grapholitha stercoreana ZELLER, Verh. Zool.-bot. Ges. Wien., vol. 25, 1875, p. 290.

Thiodia formosana FERNALD, in Dyar List N. Amer. Lepid., no. 5165, 1903.—KEARFOTT, Trans. Amer. Ent. Soc., vol. 33, 1907, pp. 38, 39.

Eucosma formosana BARNES and McDUNNOUGH, Check List Lepid. Bor. Amer., no. 7054, 1917.

Male genitalia figured from typical specimen in National Collection from Quebec, Canada (A. W. Hanham).

Distribution according to specimens in the National Collection, American Museum, and collection Barnes: Virginia, Pennsylvania, New Jersey, New York, Massachusetts, Maine, Ontario, Quebec.

Alar expanse.—18–20 mm.

Types.—In Academy Natural Science Philadelphia (*formosana*); British Museum (*sagittana*); British Museum? (*stercoreana*).

Type localities.—Illinois (*formosana*); Nova Scotia (*sagittana*); "Maine or Massachusetts" (*stercoreana*).

Food plant.—*Solidago*.

7. *THIODIA FERRUGINANA* (Fernald).

(Fig. 89.)

Semasia ferruginana FERNALD, Trans. Amer. Ent. Soc., vol. 10, 1882, p. 72.*Thiodia ferruginana* FERNALD, in Dyar List N. Amer. Lepid., no. 5168, 1903.—

KEARFOTT, Trans. Amer. Ent. Soc., vol. 33, 1907, pp. 38, 39.

Eucosma ferruginana BARNES and MCDUNNOUGH, Check List Lepid. Bor. Amer., no. 7053, 1917.

Male genitalia figured from specimen in the National Collection collected at Falls Church, Virginia (May 2, 1914, August Busck).

Distribution according to specimens in National Collection, American Museum, and collection Barnes: Virginia, New Jersey, Pennsylvania, Ontario.

Alar expanse.—13–19 mm.*Type*.—In collection Fernald.*Type locality*.—New Hampshire.*Food plant*.—Unknown.8. *THIODIA OCHROTERMINANA* Kearfott.

(Fig. 98.)

Thiodia ochroterminana KEARFOTT, Can. Ent., vol. 39, 1907, p. 57.*Eucosma ochroterminana* BARNES and McDONNOUGH, Check List Lepid. Bor. Amer., no 7063, 1917.

Male genitalia figured from cotype in National Collection, from Plummers' Island, Maryland (Aug. 1900, A. Busck).

Distribution according to specimens in National Collection, American Museum, and collection Barnes: New Jersey, Pennsylvania, Maryland, New Hampshire, Massachusetts, Illinois, Montreal, Manitoba.

Alar expanse.—11–15.5 mm.*Type*.—In American Museum.*Type locality*.—Montclair, New Jersey.*Food plant*.—Unknown.9. *THIODIA PERFUSCANA*, new species.

(Fig. 99.)

Entire insect a dull dark fuscous. Palpi towards base and on inner sides somewhat greyish or dirty white. Fore wing with a few semimetallic streaks from costa especially toward apex but these very obscure; ocellus defined by two semimetallic vertical bars and containing four or five short, faint, horizontal black lines; the ground color of the ocellar patch somewhat paler than that of rest of fore wing. Hind wing concolorous with fore wing; cilia not appreciably paler.

Male genitalia of type figured.

Alar expanse.—11–13 mm.*Type*.—In American Museum.



THIS PAGE IS LOCKED TO FREE MEMBERS
Purchase full membership to immediately unlock this page



Never be without a book!

Forgotten Books Full Membership gives universal access to 797,885 books from our apps and website, across all your devices: tablet, phone, e-reader, laptop and desktop computer

A library in your pocket for \$8.99/month

Continue

*Fair usage policy applies

terminated are mostly referable to *corculana* Zeller. The latter is a variable species so far as color is concerned; some Colorado specimens shading into a bright brownish red. The usual brown color is however decidedly more fuscous than ferruginous.

Male genitalia figured from specimen in National Collection from Verdi, Nevada (A. H. Vachell, "June 1-10").

Distribution according to specimens in National Collection, American Museum and collection Barnes: Nevada, Oregon, Colorado, California, British Columbia.

Alar expanse.—14-18 mm.

Type.—In British Museum.

Type locality.—Vancouver Island.

Food plant.—Unknown.

12. THIODIA OCHROCEPHALA (Walsingham).

Semasia ochrocephala WALSINGHAM, Trans. Ent. Soc. Lond., 1895, p. 513.

Thiodia ochrocephala FERNALD, in Dyar List N. Amer. Lepid., no. 5203, 1903.

Eucosma ochrocephala BARNES and McDUNNOUGH, Check List Lepid. Bor. Amer., no. 7078, 1917.

I have seen nothing that absolutely fits Walsingham's description of this species except a new species of *Suleïma* which I describe elsewhere in this paper as *S. skinnerana*. I have hesitated to identify the latter as *ochracephala* because of its reduced venation. Walsingham would hardly have overlooked such a character nor would he have been apt to describe a species having veins 7 and 8 of fore wing united as a *Semasia*.

Alar expanse.—18 mm.

Type.—In British Museum.

Type locality.—Loveland, Colorado.

Food plant.—Unknown.

13. THIODIA AMPHORANA (Walsingham).

(Fig. 86.)

Semasia amphorana WALSINGHAM, Illus. Lepid. Heter. Brit. Mus., vol. 4, 1879, p. 63.

Thiodia amphorana FERNALD, in Dyar List N. Amer. Lepid., no. 5184, 1913.

Eucosma amphorana BARNES and McDUNNOUGH, Check List Lepid. Bor. Amer., no. 7060, 1917.

A striking species not easily confused with anything else in the genus. The hind wing venation varies somewhat in different specimens, some having veins 3 and 4 united while others have them stalked.

Male genitalia figured from specimen in National Collection from Alameda County, California ("April").

Specimens in National Collection, American Museum, and collection Barnes from California.

Alar expanse.—15–21 mm.

Type.—In British Museum.

Type locality.—"Camp Watson on John Day's River," Oregon.

Food plant.—Unknown.

14. *THIODIA ANNETTEANA* Kearfott.

(Fig. 90.)

Thiodia annetteana KEARFOTT, Trans. Amer. Ent. Soc., vol. 33, 1907, p. 42.

Eucosma annetteana BARNES and McDUNNOUGH, Check List Lepid. Bor. Amer., no. 7058, 1917.

Male genitalia figured from cotype in National Collection from Cincinnati, Ohio ("Annette F. Braun, IV-10-06").

Distribution according to specimens in National Collection American Museum and collection Barnes: Ohio, Rhode Island, Texas.

Alar expanse.—13–15 m.

Type.—In American Museum.

Type locality.—Cincinnati, Ohio.

Food plant.—Unknown.

15. *THIODIA REFUSANA* (Walker).

(Fig. 119.)

Grapholita refusana WALKER, Cat. Lepid. Heter. Brit. Mus., vol. 28, 1863, p. 382.

Semasia refusana WALSINGHAM, Illus. Lepid. Heter. Brit. Mus., vol. 4, 1879, p. 63.

Thiodia refusana FERNALD, in Dyar List N. Amer. Lepid., no. 5196, 1903.—KEARFOTT, Can. Ent., vol. 37, 1905, pp. 46, 209.

Eucosma refusana BARNES and McDUNNOUGH, Check List Lepid. Bor. Amer., no. 7059, 1917.

Male genitalia figured from specimen in National Collection from Oak Station, Pennsylvania ("Fred Marloff, May 18-08").

Distribution according to specimens in National Collection, American Museum and collection Barnes: Pennsylvania, Virginia, Wisconsin, Manitoba, Massachusetts.

Alar expanse.—15–18 mm.

Type.—In British Museum.

Type locality.—St. Martin's Falls, Albany River, Hudson Bay.

Food plant.—Unknown.

16. *THIODIA DECEMPUNCTANA* (Walsingham).

(Fig. 120.)

Semasia decempunctana WALSINGHAM, Illus. Lepid. Heter. Brit. Mus., vol. 4, 1879, p. 58.

Thiodia decempunctana FERNALD, in Dyar List N. Amer. Lepid., no. 5185, 1903.

Eucosma decempunctana BARNES and McDUNNOUGH, Check List Lepid. Bor. Amer., no. 7980, 1917.

Male genitalia figured from cotype in National Collection.

There is one other specimen without locality label in the Kearfott collection at the American Museum.

Alar expanse.—13–18 mm.

Type.—In British Museum.

Type locality.—The Dalles, Oregon.

Food plant.—Unknown.

17. *THIODIA COLUMBIANA* (Walsingham).

(Fig. 121.)

Semasia columbiana WALSINGHAM, Illus. Lepid. Heter. Brit. Mus., vol. 4, 1879, p. 57.

Thiodia columbiana FERNALD, in Dyar List N. Amer. Lepid., no. 5187, 1903.

Eucosma columbiana BARNES and McDUNNOUGH, Check List Lepid. Bor. Amer., no. 7082, 1917.

Male genitalia figured from cotype in National Collection.

The only authentic specimens of this species I have seen aside from the cotype are a few from Doctor Barnes' unworked material collected at Vineyard, Utah, by Tom Spaulding. Examples of those are now in National Collection, American Museum and collection Barnes.

Alar expanse.—13–17 mm.

Type.—British Museum.

Type locality.—North Oregon, near Columbia River.

Food plant.—Unknown.

18. *THIODIA MORMONENSIS*, new species.

(Fig. 129.)

Antenna pale grayish ochreous; basal joint cream colored. Palpus pale ochreous white; terminal joint fuscous. Face pale ochreous white. Head and thorax ochreous. Fore wing ochreous but shading a trifle darker than head and thorax except at extreme base of wing, along basal half of costa and on middle of dorsal margin where there is a large obscure triangular spot reaching into cell, this last and the base of wing and basal half of costa are the same light ochreous shade as the head and thorax; costa with a dozen or so faint fuscous dashes between base and apex, towards apex these are

faintly interspaced with white; on costa beyond middle a fine line of whitish semi-metallic scales extending transversely almost to inner vertical bar of ocellus; a similar line from apical fourth of costa extending nearly to top of outer vertical bar of ocellus and there joining a short inwardly curved, metallic streak from costa just before apex; ocellus consisting of two distinct and one very faint horizontal black lines bounded before and behind by vertical semi-metallic whitish bars; cilia ochreous-fuscous heavily dusted with blackish fuscous towards base. Hind wing dull dark fuscous, rather coarsely scaled; cilia pale ochreous-fuscous with a dark basal band. Legs very pale ochreous; tarsi faintly annulated with ochreous-fuscous.

Male genitalia of type figured.

Alar expanse.—13.5 mm.

Type.—Cat. No. 24788, U.S.N.M.

Paratypes.—In National Collection, American Museum, and collection Barnes.

Type locality.—Salt Lake City, Utah.

Food plant.—Unknown.

Described from male type collected by C. N. Ainslie, one male paratype from Alamosa, Colorado (Oslar), and three male and one female paratypes from Denver, Colorado (Oslar). This species is quite distinct in appearance and easily recognized by the decided ochreous color of its head, thorax and fore wings coupled with its dark dull fuscous hind wings. Veins 3 and 4 of the hind wing are united.

19. *THIODIA DELPHINUS*, new species.

(Fig. 134.)

Antennae, palpi, face, head, and thorax ashy gray white. Fore wing whitish tinged with ochreous making the ground color a dirty yellowish white; a few fuscous scales at middle near base outwardly marking a faint and partially completed basal patch; from middle of costa a faint rather broad ochreous band extending outwardly to end of cell and thence downward to dorsal margin behind the ocellar patch, forming an obscure but complete angulate fascia on outer half of wing; the costal edge of this fascia fuscous; a few short faint scattered fuscous dashes on costa before middle; on outer half of costa beyond the fascia four outwardly curved pure white gminate marks, each divided by a thin fuscous line; alternating with these three triangular fuscous spots, the white gemination fusing somewhat below costa, giving the outer third of costa the appearance to the naked eye of a narrow white strip marked with fuscous spots; these white costal geminations repeated on underside of fore wing; extreme apex, termen and area immediately above ocellar patch fuscous;

ocellus a pure white patch containing two longitudinal blackish fuscous streaks well separated and sometimes rather poorly defined; cilia heavily dusted with fuscous. Hind wing with veins 3 and 4 stalked; smoke color, somewhat darker towards apex; cilia concolorous with a darker basal band, extreme tips of hairs white.

Male genitalia of type figured.

Alar expanse.—17–19 mm.

Type.—In collection Barnes.

Paratypes.—Cat. No. 24789, U.S.N.M. Also in American Museum, and collection Barnes.

Type locality.—Deer Park Springs, Lake Tahoe, California.

Food plant.—Unknown.

Described from male type and seven male paratypes from Doctor Barnes' collection, all labeled "Deer Park Springs, Lake Tahoe, California." Five of the specimens including the type bear a second label, "July 1-7." Two are labeled "July 8-15." The seventh bears no date.

This species can be recognized at once by its striking genitalia, quite different from anything else in the genus or subfamily except *delphinoides*. The latter, however, has quite another wing pattern and its genitalia are sufficiently different to prevent confusion of the two species.

20. THIODIA CRISPANA (Clemens).

(Fig. 101.)

Steganoptycha crispata CLEMENS, Proc. Ent. Soc. Phila., vol. 5, 1865, p. 137.

Epinotia crispata FERNALD, in Dyar List N. Amer. Lepid., no. 5227, 1903.

Enarmonia crispata BARNES and McDUNNOUGH, Check List Lepid. Bor. Amer., no. 7152, 1917.

Male genitalia figured from specimen in National Collection from Pemberton, New Jersey ("8-25-14, H. B. Scammell").

Distribution according to specimens in National Collection, American Museum and collection Barnes: Missouri, District of Columbia, New Jersey, Pennsylvania, New York, Ohio, Illinois.

Alar expanse.—11.5–13.5 mm.

Type.—In Academy Natural Science, Philadelphia.

Type locality.—Virginia?

Food plant.—Unknown.

21. THIODIA ALTERANA, new species.

(Fig. 102.)

Very close to *crispata* Clemens and probably included under that name in most collections. Superficially it can be differentiated only by the more diffused central white dorsal spot on the fore wing. In *crispata* this spot is separated from the white ocelloid patch by con-

siderable of the ground color, while in *alterana* it is broad and encroaches upon this dark area. The genitalia of the two forms differ enough in the shape, set, and curve of the harpe to forbid us keeping them under one name. Veins 8 and 4 of hind wing are stalked in both species.

Male genitalia of type figured.

Alar expanse.—9–12 mm.

Type.—Cat. No. 24790, U.S.N.M.

Paratypes.—In National Collection, American Museum, and collection Barnes.

Type locality.—Plummer Island, Maryland.

Food plant.—Unknown.

Described from male type and six male paratypes collected at Plummer Island, Maryland, during August, 1903, by August Busck.

22. THIODIA MARMONTANA (Kearfott).

(Fig. 103.)

Proteopteryx marmontana KEARFOTT, Can. Ent., vol. 39, 1907, p. 155.—BARNES and McDUNNOUGH, Check List Lepid. Bor. Amer., no. 7128, 1917.

A somewhat larger species but closely resembling both *crispata* Clemens and *alterana* Heinrich, differing from the latter in genitalia and from the former in the greater diffusion of the median white dorsal spot on fore wing and from both in its more ochreous-fuscous ground color at extreme apex and along termen of fore wing.

Male genitalia figured from cotype in National Collection, from Prince Albert, Alberta, Canada ("19 July"). The asymmetry shown in the figure is unusual and not characteristic of the species. In this particular specimen the harpe happens to be deformed. The right harpe shows the normal shape.

Distribution according to specimens in National Collection, American Museum, and collection Barnes: Manitoba, Assiniboine, Alberta, New Hampshire.

Alar expanse.—12.5–18 mm.

Type.—In American Museum.

Type locality.—Rounthwaite, Manitoba.

Food plant.—Unknown.

23. THIODIA OREGONENSIS, new species.

(Fig. 104.)

A rather large fuscous species with white ocelloid patch and a median white dorsal patch on fore wing. Very like *marmontana* Kearfott, except that in the apex and along termen of fore wing the general dark fuscous ground color prevails and does not shade into

ochreous-fuscous. It is distinguished from all the *Thiodia* having a mid dorsal white patch and a white ocelloid patch on fore wing by the character of the black lines in the ocellus; the latter are three, the middle one very short and the lower one extending downward on each side of the vertical pale bars, forming a thin black half circle like a very much arched eyebrow. The cuculli of the harpes of the genitalia are also broader in proportion to their length than are those in any of the three preceding species. Hind wing dark fuscous; veins 3 and 4 long stalked.

Male genitalia of type figured.

Alar expanse.—17 mm.

Type.—In collection Barnes.

Paratypes.—Cat. No. 24791, U.S.N.M. Also in American Museum and collection Barnes.

Type locality.—Crater Lake, Oregon.

Food plant.—Unknown.

Described from male type and one male and two female paratypes labeled "July 24–31, Crater Lake, Oregon," all from Doctor Barnes' collection.

24. *THIODIA TOMONANA* (Kearfott).

(Fig. 105.)

Eucosma tomonana KEARFOTT, Can. Ent., vol. 39, 1907, p. 78.—BARNES and McDUNNOUGH, Check List Lepid. Bor. Amer., no. 6976, 1917.

Eucosma limigena MEYRICK, Ent. Mo. Mag., vol. 48, 1912, p. 36.

Male genitalia figured from cotype in National Collection from Montreal, Canada ("12-VIII-05").

Distribution according to specimens in National Collection, American Museum, and collection Barnes: New Jersey, Pennsylvania, Connecticut, Quebec.

Alar expanse.—12–15 mm.

Type.—In American Museum.

Type locality.—Essex County Park, New Jersey.

Food plant.—Unknown.

25. *THIODIA APACHEANA* (Walsingham).

(Fig. 130.)

Semasia apacheana WALSINGHAM, Trans. Ent. Soc. Lond., 1884, p. 143.

Thiodia apacheana FERNALD, in Dyar List N. Amer. Lepid., no. 5199, 1903.

Eucosma apacheana BARNES and McDUNNOUGH, Check List Lepid. Bor. Amer., no. 7099, 1917.

Veins 3 and 4 of hind wing united.

Male genitalia figured from specimen in National Collection from Kaslo, British Columbia ("H. G. Dyar, Coll., no. 19945").



THIS PAGE IS LOCKED TO FREE MEMBERS

Purchase full membership to immediately unlock this page



HISTORY

Tens of thousands of important historical sources, many previously unobtainable, are now available for the first time with a Forgotten Books Full Membership.

Unlimited Access
\$8.99/month

Continue

*Fair usage policy applies

whiter heads and palpi, and the closer approximation of veins 3 and 4 of fore wing. In many specimens of *influana* these veins fuse before termen.

The Regina specimen in the American Museum determined by Kearfott as *parvana* Walsingham is also referable to *influana*.

27. **THIODIA LAPIDANA** (Walsingham).

Semasia lapidana WALSINGHAM, Illus. Lepid. Heter. Brit. Mus., vol. 4, 1879, p. 58.

Thiodia lapidana FERNALD, in Dyar List N. Amer. Lepid., no. 5190, 1903.

Eucosma lapidana BARNES and McDUNNOUGH, Check List Lepid. Bor. Amer., no. 7085, 1917.

I have seen no specimens of this species, but it is obviously very close to *sublapidana* Walsingham and must therefore be placed in *Thiodia*. According to Walsingham veins 3 and 4 of hind wing are either long stalked or united.

Alar expanse.—15 mm.

Type.—In British Museum.

Type locality.—Crooked River, Klamath River, Southern Oregon.

Food plant.—Unknown.

28. **THIODIA SUBLAPIDANA** (Walsingham).

(Fig. 122.)

Semasia sublapidana WALSINGHAM, Illus. Lepid. Heter. Brit. Mus., vol. 4, 1879, p. 59.

Thiodia sublapidana FERNALD, in Dyar List N. Amer. Lepid., no. 5191, 1903.

Eucosma sublapidana BARNES and McDUNNOUGH, Check List Lepid. Bor. Amer., no. 7086, 1917.

The specimens in our collections determined by Kearfott as this species were incorrectly so named. I have described them as *Eucosma excerptionana*. They have the costal fold and differ in genitalia from the true *sublapidana*, a cotype of which is in the National Collection. The latter has no costal fold. It also has veins 3 and 4 of hind wing united.

Male genitalia figured from cotype in National Collection.

Alar expanse.—16 mm.

Type.—In British Museum.

Type locality.—Klamath Lakes, Southern Oregon.

Food plant.—Unknown.

29. *THIODIA ELONGANA* (Walsingham).

(Fig. 128.)

Semasia ? elongana WALSINGHAM, Illus. Lepid. Heter. Brit. Mus., vol. 4, 1879, p. 56.

Thiodia elongana FERNALD, in Dyar List. N. Amer. Lepid., no. 5172, 1903.—
DYAR, Proc. U. S. Nat. Mus., vol. 27, 1904, p. 927.

Eucosma elongana BARNES and McDUNNOUGH, Check List Lepid. Bor. Amer., no. 7092, 1917.

Superficially close to the following species (*transversa* Walsingham) but quite different in genitalia. The markings on fore wing are also much more obscure in *elongana* than in *transversa*. Veins 3 and 4 of hind wing are very long stalked or united.

Male genitalia figured from specimen in National Collection from Kaslo, British Columbia ("H. G. Dyar no. 19084").

Distribution according to specimens in National Collection, American Museum and collection Barnes: British Columbia and Colorado.

Alar expanse.—25–30 mm.

Type.—In British Museum.

Type locality.—Northern Oregon.

Food plant.—Unknown.

30. *THIODIA TRANSVERSA* (Walsingham).

(Fig. 111.)

Semasia transversa WALSINGHAM, Trans. Ent. Soc. Lond., 1895, p. 514.

Thiodia transversa FERNALD, in Dyar List N. Amer. Lepid., no. 5205, 1903.

Thiodia elongana transversa DYAR, Proc. U. S. Nat. Mus., vol. 27, 1904, p. 927.

Eucosma transversa BARNES and McDUNNOUGH, Check List Lepid. Bor. Amer., no. 7103, 1917.

Is a very distinct species from *elongana* as shown by the genitalia. It may possibly prove to be a southern race of *tarandana* Möscher, as suggested by Walsingham, but seems distinct enough from the specimens I have been able to recognize as the latter species. From *elongana* it is chiefly separable (superficially) by the distinctly defined outer fascia and the distinct basal patch reaching almost to costa on fore wing. Veins 3 and 4 of hind wing are either stalked or united.

Male genitalia from specimen in National Collection from Estes Park, Colorado ("H. G. Dyar, Aug., 1912").

Distribution according to specimens in National Collection, American Museum and collection Barnes: British Columbia (Kaslo) and Colorado.

Alar expanse.—23–28 mm.

Type.—In British Museum.

Type locality.—Loveland, Colorado.

Food plant.—Unknown.

31. THIODIA TARANDANA (Möschler).

(Fig. 112.)

Grapholitha tarandana MÖSCHLER, Stett. Ent. Zeit., vol. 35, 1874, p. 165.*Semasia tarandana* WALSNHAM, Trans. Ent. Soc. Lond., 1895, p. 514.*Thiodia tarandana* FERNALD, in Dyar List. N. Amer. Lepid., no. 5173, 1903.*Eucosma tarandana* BARNES and McDUNNOUGH, Check List Lepid. Bor. Amer., no. 7093, 1917.

In the National Collection are two males from Aweme, Manitoba, collected by N. Criddle ("II-VIII-1915," and "2-VIII-1915"), which I recognize as this species. They answer very well to Möschler's description and agree with the specimen from Labrador in the Fernald collection. This latter bears Möschler's label and is very likely the actual type. From *transversa* these specimens are separable by the paler cilia of their hind wings and the peculiarly marked cilia of the fore wings. In both *elongana* and *transversa* the fore wing cilia are fuscous with a thin sub-basal white line and the tips of the hairs white, while in *tarandana* the cilia are distinctly white with a moderately broad median fuscous band. Veins 3 and 4 of hind wings are stalked.

Male genitalia figured from specimen in National Collection.

Specimens in National Collection, American Museum, and collection Barnes from Manitoba.

Alar expanse.—21-27 mm.

Type.—In collection Fernald ?.

Type locality.—Labrador.

Food plant.—Unknown.

32. THIODIA CINEREOLINEANA, new species.

(Fig. 132.)

Dark grayish fuscous, the ends of many scales tipped with white. Fore wing with vein 2 straight; termen slanting and concave; veins 3, 4, and 5 somewhat approximate at termen; costa strigulated with fine blackish fuscous and white geminations; along the fold and on several of the veins longitudinal streaks of blackish fuscous scaling, between which the dark scales are more evenly tipped with white, giving the fore wing the appearance of being finely streaked longitudinally with ashy white and dark gray; ocelloid patch white with two longitudinal black streaks; cilia white with a fine subbasal and a somewhat broader subterminal fuscous line. Hind wing with veins 3 and 4 united; pale smoky fuscous, darkening toward apex and along termen; cilia whitish with a fuscous basal line.

Male genitalia of type figured.

Alar expanse.—14 mm.

Type.—Cat. No. 24793, U.S.N.M.

Type locality.—Eureka, Utah.

Food plant.—Unknown.

Described from a single male collected at Eureka, Utah, by Tom Spalding ("IV-21-10"). Very near in appearance to *misturana* Heinrich but distinct on genitalia and lacking any of the dark patches on fore wing so noticeable in the latter species.

33. *THIODIA MIGRATANA*, new species.

(Fig. 116.)

Palpi short, not projecting more than the length of the head beyond it; white; tuft on second joint faintly spotted with fuscous. Head and thorax creamy white. Fore wing with vein 2 straight; termen slanting and slightly concave; veins 3, 4, and 5 closely approximate at termen; creamy white faintly dusted and marked with pale grayish fuscous; from just beyond middle of costa a narrow shading of gray extending outwardly and joining, above upper inner angle of ocelloid patch, a similar curved band arising from dorsal margin and bordering the inner side of the ocelloid patch; on costa between this obscure fascia and apex four small short fuscous dashes interspaced by white geminate marks; above ocellus a faint clouding of grayish fuscous; on dorsal margin, just behind ocellus, and fusing with the vertical part of the fascia, a thin arc of fuscous scales; along fold for a short distance from near base of wing a dash of fuscous scales; ocellus white with one distinct longitudinal black streak; cilia white dusted with fuscous. Hind wing whitish, shading to pale smoky fuscous at apex and termen; cilia white with but a very faint basal fuscous band; veins 3 and 4 stalked.

Male genitalia of type figured.

Alar expanse.—17-18 mm.

Type.—In collection Barnes.

Paratype.—Cat. No. 24794, U.S.N.M.

Type locality.—Olanche, Inyo County, California ("Apr. 24-30").

Food plant.—Unknown.

Described from male type and female paratype bearing similar labels and both from Doctor Barnes's collection.

It is closest to *tenuiana* Walshingham but distinguished from the latter by its much larger genitalia, fainter markings and shorter palpi.

34. *THIODIA TENUIANA* (Walsingham).

(Fig. 96.)

Semasia tenuiana WALSINGHAM, Illus. Lepid. Heter. Brit. Mus., vol. 4, 1879, p. 59; Trans. Ent. Soc. Lond., 1884, p. 143.

Thiodia tenuiana FERNALD, in Dyar List N. Amer. Lepid., no. 5178, 1903.—Not KEARFOTT, Can. Ent., vol. 37, 1905, pp. 46, 209.

Eucosma tenuiana BARNES and McDUNNOUGH, Check List Lepid. Bor. Amer. no. 7066, 1917.

Kearfott has wrongly determined this species, most of his specimens being referable to *misturana* Heinrich. The two species are quite different as venation and genitalia show. There are two males of the true *tenuiana* in the National Collection from Nevada County, California ("Sept.") determined by Walsingham in 1886. I have also found two like males among Kearfott's unworked specimens from Stockton, Utah ("Tom Spalding," "IX-4-4," and "IX-11-4"). In all four, veins 3 and 4 of hind wing are long stalked.

Male genitalia figured from specimen in National Collection from Nevada County, California.

Alar expanse.—14–18 mm.

Type.—In British Museum.

Type locality.—Siskiyou County, California.

Food plant.—Unknown.

35. *THIODIA MISTURANA*, new species.

(Fig. 106.)

Palpi extending one and one-half times the length of the head beyond it; white dusted with gray, sometimes entirely gray. *Face*, head and thorax white dusted with gray or entirely gray. *Fore wing* white or whitish, dusted and marked with gray or grayish fuscous; along fold from base to near middle of wing a dark grayish fuscous dash, more or less distinctly margined above by a streak of the white ground color; a faint outwardly angulate fascia extending from middle of costa to dorsal margin just behind ocelloid patch and fusing more or less completely with a dark shading above ocelloid patch; on costa between fascia and apex three or four narrow, short, dark dashes interspaced with white streaks, the latter fusing more or less below costa, and the last just before apex forming a quite conspicuous white triangular spot; extreme apex dark; ocellus white, containing two longitudinal and parallel black streaks; cilia white rather heavily dusted with dark gray. *Hind wing* with veins 3 and 4 united; pale smoky fuscous; cilia paler.

Male genitalia of type figured.

Alar expanse.—12–15 mm.

Type.—Cat. No. 24795, U.S.N.M.

Paratypes.—In American Museum and collection Barnes.

Type locality.—Oxbow, Saskatchewan.

Food plant.—Unknown.

Described from male type and two female paratypes from Oxbow, Saskatchewan, collected by Frederick Knab ("9-VI-07" and "5-VI-07").

In addition to the above I have before me specimens from the following localities: White Pass, Alaska; Aweme, Manitoba; San Luis Obispo, Los Angeles, and Inyo Counties, California. In size these average about the same as the Saskatchewan and Manitoba specimens although some are larger (as much as 18 mm. alar expanse).

It is closest to *parvana* Walsingham with which it agrees very closely in palpi and venation structure; but it lacks the ochreous scaling which, according to Walsingham, is characteristic of his species. Kearfott has determined specimens of *misturana* as *parvana*, *tenuiana*, and *minimana*.

36. THIODIA PARVANA (Walsingham).

Semasia parvana WALSINGHAM, Illus. Lepid. Heter. Brit. Mus., vol. 4, 1879, p. 60.

Thiodia parvana FERNALD, in Dyar List N. Amer. Lepid., no. 5192, 1903.—Not KEARFOTT, Can. Ent., vol. 37, 1905, p. 46.

Eucosma parvana BARNES and McDUNNOUGH, Check List Lepid. Bor. Amer., no. 7067, 1917.

I have seen no specimen answering fully to Walsingham's description and figure. The specimens I have seen so determined by Kearfott are referable to *misturana* Heinrich or *influana* Heinrich.

Alar expanse—11.5 mm.

Type.—In British Museum.

Type locality.—North Oregon.

Food plant.—Unknown.

37. THIODIA CLAVANA (Fernald).

(Fig. 78.)

Semasia clavana FERNALD, Trans. Amer. Ent. Soc., vol. 10, 1882, p. 72.

Thiodia clavana FERNALD, in Dyar List N. Amer. Lepid., no. 5179, 1903.

Eucosma clavana BARNES and McDUNNOUGH, Check List Lepid. Bor. Amer., no. 7067, 1917.

In this species veins 3 and 4 of hind wing are either very long stalked or united.

Male genitalia figured from specimen in American Museum, from Winchendon, Massachusetts ("V-26-02").

Distribution according to specimens in National Collection, American Museum, and collection Barnes: New York, New Hampshire, Massachusetts.

Alar expanse.—14 mm.

Type.—In collection Fernald.

Type locality.—Truro, Massachusetts.

Food plant.—Unknown.

38. *THIODIA INDAGATRICANA*, new species.

(Fig. 107.)

Palpus projecting the length of the head beyond it; white with a faint grayish spot on outer side of second joint and a more or less perceptible grayish shading towards ends of scales on underside of tuft of second joint. Face and head white. Thorax white somewhat dusted with ochreous or pale gray. Fore wing with termen oblique and concave; veins 3, 4, and 5 closely approximate at termen; whitish shaded with pale ochreous or very pale gray; a somewhat indistinct but appreciable median white longitudinal stripe extending from base to top of ocelloid patch; bordering this above and below from base to about middle of cell a broader shading of pale ochreous; rest of wing including dorsal margin to base suffused with very pale gray, except for the upper half of the ocelloid patch and a narrow border along costa at outer third and extreme costal edge to base; these are white; costa finely strigulate with fuscous from base to apex, the strigulations growing stronger and longer toward apex; extreme apex pale gray; ocellus narrow containing a single rather short blackish dash and sometimes two or three black or fuscous dots; in some specimens there is a line of blackish scales along fold from base to middle, the line widening out somewhat towards its tip; cilia white dusted with pale gray. Hind wing with veins 3 and 4 united; pale smoky fuscous; cilia white with a pale fuscous basal line.

Male genitalia of type figured.

Alar expanse.—14–16 mm.

Type.—Cat. No. 24796, U.S.N.M.

Paratypes.—In National Collection, American Museum, and collection Barnes.

Type locality.—Provo, Utah.

Food plant.—Unknown.

Described from male type, four male and three female paratypes from Provo, Utah, Tom Spalding, collector (dated as follows: Type and 3 males and 2 females, "VIII-26-8"; 1 male and 1 female, "VIII-21-8"); 9 male paratypes from Eureka, Utah, Tom Spalding, collector (dated as follows: 1 male, "VIII-6-10"; 3 males, "VIII-9-11"; 1 male, "VIII-10-11"; 1 male, "VIII-14-11"; 2 males, "VIII-15-11"; 1 male, "VII-17-11"); 1 female paratype from Glenwood Springs, Colorado (W. Barnes, August, 1892); 5 male and 1 female paratypes from Denver, Colorado (Oslar); and 1 female paratype from Elk Point, South Dakota (C. N. Ainslie, Aug., 1913).

Apparently close to both *parvana* Walsingham and *clavana* Fernald. Distinguished from the latter by genitalia, the generally paler color and its white rather than grey head; and from *parvana* by its white head.



THIS PAGE IS LOCKED TO FREE MEMBERS
Purchase full membership to immediately unlock this page



Never be without a book!

Forgotten Books Full Membership gives universal access to 797,885 books from our apps and website, across all your devices: tablet, phone, e-reader, laptop and desktop computer

A library in your pocket for \$8.99/month

Continue

*Fair usage policy applies

Distribution according to specimens in National Collection, American Museum, and collection Barnes: Alberta, Saskatchewan, Manitoba.

Alar expanse.—20–21 mm.

Type.—In American Museum.

Type locality.—Regina.

Food plant.—Unknown.

42. *THIODIA STRIATANA* (Clemens).

(Fig. 80.)

Anchylopera striatana CLEMENS, Proc. Acad. Nat. Sci. Phila., 1860, p. 349.

Paedisca albicepsana WALKER, Cat. Lepid. Heter. Brit. Mus., vol. 28, 1863, p. 379.

Grapholitha trivittana ZELLER, Vehr. Zool.-bot. Ges. Wien., vol. 25, 1875, p. 287.

Thiodia stratana FERNALD, in Dyar List N. Amer. Lepid., no. 5177, 1903.—KEARFOTT, Can. Ent., vol. 37, 1905, pp. 45, 209.

Fucosma striatana BARNES and McDUNNOUGH, Check List Lepid. Bor. Amer., no. 7065, 1917.

A common species found all over the United States east of the Sierras. It has veins 3 and 4 of hind wing stalked.

Male genitalia figured from specimen in National Collection from Pittsburgh, Pennsylvania (Henry Engel, "VI-3-05").

Distribution according to specimens in National Collection, American Museum and collection Barnes: Missouri, Minnesota, Wisconsin, Illinois, Iowa, North Dakota, Colorado, Utah, Pennsylvania, District of Columbia, New York, New Jersey, Maine, Massachusetts, Ontario, Alberta.

Alar expanse.—13–18 mm.

Types.—In Academy of Natural Science, Philadelphia (*striatana*); British Museum (*albicepsana*, *trivittana*?).

Type localities.—Baltimore, Maryland (*striatana*); "North America" (*albicepsana*); Texas (*trivittana*).

Food plant.—Unknown.

43. *THIODIA STRIATANA OCCIDENTALIS*, new variety.

(Fig. 79.)

In color and markings like *striatana* Clemens; differing in genitalia and in having veins 3 and 4 of hind wing united; the white median stripe of fore wing is also shorter, not reaching to ocellar patch and tapering to a point towards extremity. In this respect resembles *spiculana* Zeller. The latter however has a different style of costal marking.

Male genitalia of type figured.

Alar expanse.—16–19 mm.

Type.—In collection Barnes.

Paratypes.—Cat. No. 24797, U.S.N.M., also in American Museum and collection Barnes.

Type locality.—Shasta Retreat, Siskiyou County, California.

Food plant.—Unknown.

Described from male type and five female paratypes from Dr. Barnes' material all collected at Shasta Retreat and dated as follows: type, "July 16-22"; 3 paratypes, "June 16-23," two paratypes, "June 24-30."

This form so closely resembles *striatana* that I hesitate to describe it as anything but a Pacific coast race of *striatana*. The differences in shape and size of the harpes of the genitalia would however suggest two distinct species.

44. THIODIA DELPHINOIDES, new species.

(Fig. 135.)

Palpus projecting the length of the head beyond it; white with the tuft on second joint shading to gray beneath; also a round grayish spot on outer side of second joint. Head and thorax white. Fore wing faintly dusted with pale gray giving the insect a pearly grayish white appearance to the naked eye; the snow white ground color chiefly distinguished on outer third of costa, in the narrow ocelloid patch and in a faint median streak from base to end of cell; on costa just before apex the white forms a rather conspicuous triangular spot; in ocellus one or two short black dashes faintly indicated; costa marked with short fuscous dashes, the latter more appreciable on outer half of wing; cilia white faintly dusted with grayish fuscous. Hind wing with veins 3 and 4 stalked; very pale smoky gray shading to fuscous at apex and termen; cilia white with a pale fuscous basal line and a more or less extended, paler fuscous median shading. Anal tuft stout, white. Male genitalia similar to those of *delphinus* Heinrich but with neck of harpe more slender and costal angle of cucullus differently produced.

Male genitalia of type figured.

Alar expanse.—12.5-16.5 mm.

Type.—Cat. No. 24798, U.S.N.M.

Paratypes.—In National Collection, American Museum, and collection Barnes.

Type locality.—Eureka, Utah.

Food plant.—Unknown.

Described from a large series in the National Collection and Barnes' collection all from Eureka, Utah, collected by Tom Spalding and bearing various August dates. Of these I have selected one male as type and thirty male paratypes.

45. *THIODIA PALLIDARCIS*, new species.

(Fig. 97.)

Palpi projecting about one and one-half times the length of the head beyond it; white somewhat dusted with gray on the outer sides. Face and head snow white. Thorax white very faintly dusted with pale ochreous on the sides. Ground color of fore wing white largely obscured by pale ochreous-fuscous; the white ground color chiefly indicated as a median horizontal streak (*above* the fold) extending from base to end of cell and somewhat attenuated at its apex, a white margin along basal half of costa, six outwardly curved, narrow, rather long white dashes on outer half of costa and a more or less distinct white shading along dorsal margin below the fold; the white costal geminations are interspaced with pale fuscous streaks; ocellus indicated only by the obscure semi-metallic inner and outer bars and two or three black scales; cilia white faintly dusted with blackish fuscous scales. Hind wing with veins 3 and 4 long stalked; very pale smoky fuscous; cilia white.

Male genitalia of type figured.

Alar expanse.—13–14 mm.

Type.—In American Museum.

Paratypes.—Cat. No. 24799, U.S.N.M., also in American Museum and collection Barnes.

Type locality.—San Diego, California.

Food plant.—*Artemisia californica*.

Among Kearfott's duplicates in the American Museum, I found four specimens (three males and one female) from San Diego, California (W. S. Wright, Collector) dated as follows: 2 males, "V-10-08"; 1 male, and 1 female, "VI-9-08" These had been designated by Kearfott as cotypes of a new species with the name "*Thiodia pallidarcis*." The description and name, however, were never published. I have, therefore, adopted the Kearfott manuscript name and make one male the type and the other three specimens paratypes. Six additional male paratypes are also included from a series out of Doctor Barnes' collection also from San Diego, California. A female in the National Collection from Los Angeles County, California, and labeled in Koebel's handwriting, "from larva in *Artemisia californica*, no. 180" is also included as a paratype.

The species very closely resembles *indagatrica* Heinrich but differs in genitalia. It also has fore wings somewhat broader in proportion to their length and there is no indication of the dark scaling on the fold normally to be found in *indagatrica*.

46. *THIODIA MINIMANA* (Walsingham).

(Fig. 131.)

Semasia minimana WALSINGHAM, Illus. Lepid. Heter. Brit. Mus., vol. 4, 1879, p. 60.

Thiodia minimana FERNALD, in Dyar List N. Amer. Lepid., no 5194, 1903.

Eucosma minimana BARNES and McDUNNOUGH, Check List Lepid. Bor. Amer., no. 7073, 1917.

I have seen no specimens from the type locality that answer to Walsingham's description and figure and nothing that could with certainty be referred to his name. The only specimens I have seen that seem to fit both description and figure are a male from Los Angeles County, California ("Apr.") and two specimens from Olancho, Inyo County, California. One of the latter is in the Barnes collection. The other and the specimen from Los Angeles County are in the National Collection. Pending examination of the actual type I am referring them here.

The male genitalia is figured from the Olancho specimen in the National Collection.

Alar expanse.—10–12 mm.

Type.—In British Museum.

Type locality.—Siskiyou County, California.

Food plant.—Unknown.

47. *THIODIA SUBMINIMANA*, new species.

(Fig. 133.)

Very like *minimana* but with fuscous irrorations more completely diffused over the ground color giving the fore wing a whitish gray rather than a predominantly white appearance. Hind wing also more suffused with pale smoky fuscous toward apex and outward margin; veins 3 and 4 united. Legs with tarsi conspicuously banded with black. The species is easily recognized by its peculiar genitalia.

Male genitalia of type figured.

Alar expanse.—10–12 mm.

Type.—In collection Barnes.

Paratypes.—Cat. No. 24800, U.S.N.M. Also in American Museum and collection Barnes.

Type locality.—San Diego, California.

Food plant.—Unknown.

Described from male type and 10 male paratypes from Doctor Barnes' collection labeled San Diego, California, "Aug. 1–7" and "Aug. 16–23" and three male paratypes from Kearfott's duplicate collection in the American Museum labeled San Diego, California, W. S. Wright, "VII-22-08" and "VIII-8-08." One of these latter is also labeled in Kearfott's handwriting, "*Thiodia minimana*

Walsingham." It is possible that this may be the true *minimana*; but if so it does not match the description. The locality also suggests a different form. At any rate it is quite distinct from what I take to be *minimana*. Kearfott's determination means nothing as he put at least three different species under Walsingham's name.

48. *THIODIA KISCANA* Kearfott.

(Fig. 81.)

Thiodia kiscana KEARFOTT, Trans. Amer. Ent. Soc., vol. 33, 1907, p. 92.

Thiodia speculigera MEYBICK, Ent. Mo. Mag., vol. 48, 1912, p. 35.

Eucosma kiscana BARNES and MCDUNNOUGH, Check List Lepid. Bor. Amer., no. 7074, 1917.

Male genitalia figured from cotype in National Collection from Cincinnati, Ohio (A. F. Braun, "VI-18-04").

Distribution according to specimens in National Collection, American Museum, and collection Barnes: Ohio, Pennsylvania, Virginia, New Jersey.

Alar expanse.—11–13 mm.

Type.—In American Museum.

Type locality.—Greenwood Lake, New Jersey.

Food plant.—Unknown.

49. *THIODIA SALMICOLORANA*, new species.

(Fig. 123.)

Palpus white with a very faint gray shading on under side of second joint. Head and thorax white. Fore wing white with a light ochreous salmon suffusion; in unrubbed specimens outer fourth very faintly shaded with grayish; a faint indication of a median white streak on basal half of wing; also a few indistinct dark streaks interspaced with white geminations on the outer half of costa, not easily seen by the naked eye; ocelloid patch not clearly defined, indicated only by two obscure, vertical semilustrous bars and one or two fuscous scales; cilia white, faintly dusted with blackish fuscous. Hind wing with veins 3 and 4 stalked; whitish with a faint fuscous shading along termen; cilia white.

Male genitalia of type figured.

Alar expanse.—13–15 mm.

Type.—In collection Barnes.

Paratypes.—Cat. No. 24801, U.S.N.M. Also in American Museum, and collection Barnes.

Type locality.—Stockton, Utah.

Food plant.—Unknown.

Described from male type from Stockton, Utah ("VII-30-13"); ten males and two female paratypes from Eureka, Utah; five male

paratypes from Deer Creek, Provo Canyon, Utah, all collected by Tom Spalding (July–August), selected out of a series of over fifty specimens from Doctor Barnes collection; and eight male paratypes from Stockton, Utah (Tom Spalding), out of the Kearfott collection.

A distinct and easily recognized species, at once distinguished by its genitalia and the light ochreous salmon colored and practically unmarked fore wing.

50. *THIODIA PALLIDICOSTANA* (Walsingham).

(Fig. 82.)

Semasia pallidicostana WALSINGHAM, Illus. Lepid. Heter. Brit. Mus., vol. 4, 1879, p. 62.

Thiodia pallidicostana FERNALD, in Dyar List N. Amer. Lepid., no. 5180, 1903.—KEARFOTT, Can. Ent., vol. 37, 1905, p. 209.

Eucosma pallidicostana BARNES and McDUNNOUGH, Check List Lepid. Bor. Amer., no. 7068, 1917.

Male genitalia figured from specimen in National Collection from Cartwright, Manitoba (E. F. Heath).

Specimens in National Collection and American Museum from Manitoba.

Veins 3 and 4 of hind wing stalked.

Alar expanse.—16–18 mm.

Type.—In British Museum.

Type locality.—"Sonoma and Lake Counties, California."

Food plant.—Unknown.

51. *THIODIA ARTEMISIANA* (Walsingham).

(Fig. 127.)

Semasia artemisiana WALSINGHAM, Illus. Lepid. Heter. Brit. Mus., vol. 4, 1879, p. 56.

Thiodia artemisiana FERNALD, in Dyar List N. Amer. Lepid., no. 5174, 1903.

Eucosma artemisiana BARNES and McDUNNOUGH, Check List Lepid. Bor. Amer., no. 7097, 1917.

Male genitalia from specimen in National Collection from Pullman, Washington ("19 Aug. 98," C. V. Piper).

Distribution according to specimens in National Collection, American Museum, and collection Barnes: Washington and California.

Veins 3 and 4 of hind wing united.

Alar expanse.—20–22 mm.

Type.—In British Museum.

Type locality.—Mount Shasta, California.

Food plant.—Artemisia.

52. *THIODIA INFIMBRIANA* Dyar.

(Fig. 125.)

Thiodia artemisiana infimbriana DYAR, Proc. U. S. Nat. Mus., vol. 27, 1904, p. 927.—KEARFOTT, Can. Ent., vol. 37, 1905, p. 209.

Eucosma artemisiana infimbriana BARNES and McDUNNOUGH, Check List Lepid. Bor. Amer., no. 7097, 1917.

Dyar described this originally as a variety of *artemisiana* Walsingham, but it is enough different in genitalia to justify specific separation. The chief color differences between the two species are in the cilia of the fore wings. In *artemisiana* they are red-brown, while in *infimbriana* they are olivaceous, faintly dusted with blackish fuscous. Veins 3 and 4 of hind wings are united in both species.

Male genitalia figured from cotype in National Collection (Kaslo, British Columbia, H. G. Dyar, "no. 19938").

Distribution according to specimens in National Collection, American Museum, and collection Barnes: Washington, British Columbia, Manitoba.

Alar expanse.—17–19 mm.

Type.—In National Collection.

Type locality.—Kaslo, British Columbia.

Food plant.—"Artemesia ludovicana."

53. *THIODIA OCTOPUNCTANA* (Walsingham).

(Fig. 126.)

Semasia octopunctana WALSHINGHAM, Trans. Ent. Soc. Lond., 1895, p. 512.

Thiodia octopunctana FERNALD, in Dyar List N. Amer. Lepid., no. 5204, 1903.

Eucosma octopunctana BARNES and McDUNNOUGH, Check List Lepid. Bor. Amer., no. 7102, 1917.

This is a somewhat variable species. In some of the Utah specimens the black spots in the ocelloid patch are obsolete and in all the cilia of the hind wing have a dark basal band which is not found in the California specimen. The genitalia vary somewhat in Utah specimens but not to any significant degree and in some are identical with those of the California specimen. The two forms probably represent distinct races; but I have seen no specimen from the type locality (Colorado) and therefore hesitate to so distinguish them.

Male genitalia from specimen in National Collection from San Bernardino Mountains, California (T. Grinnell, July 1, 1907).

Distribution according to specimens in National Collection, American Museum, and collection Barnes: California and Utah.

Alar expanse.—15–18 mm.

Type.—In British Museum.

Type locality.—Larima County, Colorado.

Food plant.—Unknown.



THIS PAGE IS LOCKED TO FREE MEMBERS

Purchase full membership to immediately unlock this page



HISTORY

Tens of thousands of important historical sources, many previously unobtainable, are now available for the first time with a Forgotten Books Full Membership.

Unlimited Access
\$8.99/month

Continue

*Fair usage policy applies

56. *THIODIA BENJAMINI*, new species.

(Fig. 114.)

Close to *montanana* Walsingham with which it agrees in genitalia but strikingly different in color. Outer sides of palpi, thorax and fore wings rust red strongly inclining to yellowish. Head, face and inner sides of palpi somewhat paler. Fore wings nearly unicolorous; pattern in paler specimens as in *montanana* (with a slightly darker, angulate, outer fascia and a basal half patch at inner dorsal angle) but nearly obsolete, completely so in darker specimens; cilia rust red. Hind wings with veins 3 and 4 stalked; pale smoky fuscous; cilia slightly paler.

Male genitalia of type figured.

Alar expanse.—22.5–26 mm.

Type.—In collection Barnes.

Paratypes.—Cat. No. 24802, U.S.N.M. Also in American Museum and collection Barnes.

Type locality.—Vineyard, Utah.

Food plant.—Unknown.

Described from male type and ten male paratypes collected at Vineyard, Utah, by Tom Spalding and dated as follows: Type, "IX-12-11"; 1 specimen, "IX-6-11"; 8 specimens, "IX-11-11"; specimen, "IX-13-11"; all from Doctor Barnes' collection.

It is possible that this may prove to be a variety of *montanana*. The color, however, is very different and it will at least require varietal separation. It is a striking and easily recognized form.

I take pleasure in naming it after Dr. Marcus Benjamin, as a slight acknowledgment of many courtesies.

57. *THIODIA GRISEOCAPITANA* (Walsingham).

(Fig. 92.)

Semasia griseocapitana WALSINGHAM, Illus. Lepid. Heter. Brit. Mus., vol. 4, 1879, p. 61.

Thiodia griseocapitana FERNALD, in Dyar List N. Amer. Lepid., no. 5181, 1903.

Eucosma griseocapitana BARNES and McCUNNOUGH, Check List Lepid. Bor. Amer., no. 7069, 1917.

There is a female cotype of this species in the National Collection. Male genitalia figured from specimen in National Collection from Denver, Colorado.

Distribution according to specimens in National Collection, American Museum, and collection Barnes: California, Colorado, Utah.

All have veins 3 and 4 of hind wings stalked.

Alar expanse.—16–18 mm.

Type.—In British Museum.

Type locality.—Mount Shasta, California.

Food plant.—Unknown.

58. *THIODIA PERANGUSTANA* (Walsingham).

Semasia perangustana WALSINGHAM, Illus. Lepid. Heter. Brit. Mus., vol. 4, 1879, p. 58.

Thiodia perangustana FERNALD, in Dyar List N. Amer. Lepid., no. 5183, 1903.

Eucosma perangustana BARNES and McDUNNOUGH, Check List Lepid. Bor. Amer., no. 7072, 1917.

I have seen nothing that answers satisfactorily to Walsingham's description and figure. The species is keyed and placed on characters given in his description.

Veins 3 and 4 of hind wing are united.

Alar expanse.—15 mm.

Type.—In British Museum.

Type locality.—Siskiyou Mountains, North California.

Food plant.—Unknown.

59. *THIODIA OLIVACEANA* (Riley).

(Fig. 91.)

Grapholitha olivaceana RILEY, Trans. St. Louis Acad. Sci., vol. 4, 1881, p. 320.

Thiodia olivaceana FERNALD, in Dyar List N. Amer. Lepid., no. 5164, 1903.

Eucosma olivaceana BARNES and McDUNNOUGH, Check List Lepid. Bor. Amer., no. 7061, 1917.

Male genitalia figured from specimen in National Collection from Plummer Island, Maryland (A. Busck, July, 1903).

Distribution according to specimens in National Collection, American Museum and collection Barnes: Illinois, New Hampshire, New York, New Jersey, Rhode Island, Massachusetts, Maryland, District of Columbia.

Veins 3 and 4 of hind wing stalked.

Alar expanse.—15–18 mm.

Type.—In National Collection.

Type locality.—Illinois.

Food plant.—*Solidago*.

60. *THIODIA VERNIOCHREANA*, new species.

(Fig. 95.)

In color and pattern like *olivaceana* but smaller and different in genitalia. It differs also in that the fuscous dashes on costa of fore wing are continuous from base to apex while in *olivaceana* they are only well distinguished on outer half. On the outer side of second joint of the palpus there is a distinct circular fuscous spot which is lacking or but faintly indicated in *olivaceana*. In both species veins 3 and 4 of hind wing are stalked.

Male genitalia of type figured.

Alar expanse.—10–13 mm.

Type.—In American Museum.

Paratypes.—Cat. No. 24803, U.S.N.M.; also in American Museum and collection Barnes.

Type locality.—Mount Holly, New Jersey.

Food plant.—Unknown.

Described from male type, four male and one female paratypes from Mount Holly, New Jersey (dated "VIII-19-1906") and one male paratype from Hyde Park, Massachusetts (F. Heimbach, "8-21-1907") all from the Kearfott collection.

61. *THIODIA IMBRIDANA* (Fernald).

(Fig. 108.)

Cydia imbridana FERNALD, Can. Ent., vol. 37, 1905, p. 400.—KEARFOTT, Can. Ent., vol. 37, 1905, p. 253.

Eucosma imbridana BARNES and McDUNNOUGH, Check List Lepid. Bor. Amer., no. 7062, 1917.

Male genitalia figured from specimen in National Collection from Oak Station, Pennsylvania (F. Marloff, "VIII-16-16").

Distribution according to specimens in National Collection, American Museum, and collection Barnes: Pennsylvania, Connecticut, New Jersey, New York, District of Columbia, Manitoba, Colorado (Denver).

Veins 3 and 4 of hind wing stalked.

Alar expanse.—11-19 mm.

Type.—In collection Fernald.

Type locality.—Sandy Hook, New Jersey.

Food plant.—Unknown.

62. *THIODIA GRANULATANA* (Kearfott).

(Fig. 94.)

Cydia granulata KEARFOTT, Journ. N. Y. Ent. Soc., vol. 16, 1908, p. 173.

Eucosma granulata BARNES and McDUNNOUGH, Check List Lepid. Bor. Amer., no. 7106, 1917.

Male genitalia figured from type.

Distribution according to specimens in National Collection, American Museum, and collection Barnes: Boulder, Platte Canon, and Denver, Colorado.

Veins 3 and 4 of hind wing stalked.

Alar expanse.—15-18 mm.

Type.—In American Museum.

Type locality.—Denver, Colorado.

Food plant.—Unknown.

63. *THIODIA GRINDELIANA* (Busck).

(Fig. 117.)

Cydia grindeliana BUSCK, Can. Ent., vol. 38, 1906, p. 211.*Eucosma grindeliana* BARNES and McDUNNOUGH, Check List Lepid. Bor. Amer., no. 7070, 1917.

This species is very close to *stramineana* Walsingham. It differs chiefly in its larger size and larger genitalia. Also in many specimens of *grindeliana* there is more or less longitudinal dusting of fuscous on the fold and along the cell. This character is not constant, however, and some of the paratypes are as clear yellow as *stramineana*, without any such fuscous streaking. It may prove to be a large race of *stramineana* but for the present will have to be kept separate.

Veins 3 and 4 of hind wing are stalked.

Male genitalia figured from paratype in National Collection.

Specimens in National Collection and American Museum from Clarendon, Texas.

Alar expanse.—17–19 mm.*Type*.—In National Collection.*Type locality*.—Clarendon, Texas.*Food plant*.—*Grindelia squarrosa*, variety *nuda*.64. *THIODIA STRAMINEANA* (Walsingham).

(Fig. 118.)

Semasia stramineana WALSINGHAM, Illus. Lepid. Heter. Brit. Mus., vol. 4, 1879, p. 60.*Thiodia stramineana* FERNALD, in Dyar List N. Amer. Lepid., no. 5193, 1903.*Eucosma stramineana* BARNES and McDUNNOUGH, Check List Lepid. Bor. Amer., no. 7076, 1917.

According to Walsingham's description veins 3 and 4 of hind wing are united. His specimens were from Colorado and very small. Those that I have seen in the collections as *stramineana* show veins 3 and 4 stalked and they average a little larger except some from California. These latter have the stalk of veins 3 and 4 very long and in some cases the fork is only visible at termen. It is possible therefore that the venation varies as in a number of other *Thiodia* and the species has 3 and 4 both stalked and united. In pattern and color the specimens we have been calling *stramineana* match Walsingham's description and figure. Should it eventually prove that the true *stramineana* has veins 3 and 4 always united the specimens we are now calling that species will need a new name.

Male genitalia figured from specimen in National Collection from Mesilla, New Mexico.

Distribution according to specimens in National Collection, American Museum, and collection Barnes: Arizona, New Mexico, California (LaPuerta).

Alar expanse.—11.5–15 mm.

Type.—In British Museum.

Type locality.—Denver, Colorado.

Food plant.—Unknown.

65. *THIODIA UMBRATICANA*, new species.

(Fig. 84.)

Palpi, head and thorax dark fuscous gray sparsely dusted with whitish. Palpi projecting over twice the length of the head beyond it. Fore wing with termen distinctly slanting, not concave; veins 3, 4, and 5 not appreciably approximate at termen; the outer third and dorsal margin below fold ashy gray, obscurely dusted and spotted with fuscous scales; above fold from base to end of cell a patch or suffusion of fuscous shading the color of dirty bronze; on outer third of costa two obscure spots of similar color; another at apex; ocelloid patch not defined, indicated only by a few scattered black scales; cilia fuscous gray. Hind wing smoky fuscous; cilia somewhat paler with a dark basal line.

Male genitalia of type figured.

Alar expanse.—22mm.

Type.—Cat. No. 24804, U.S.N.M.

Type locality.—Golden, Colorado.

Food plant.—Unknown.

Described from a single male collected in the foot hills above Golden, Colorado, March 13, 1901 (Dyar and Caudell) and bearing Dyar's number, 16254. This specimen had been placed under *elongana* Walsingham, which it resembles somewhat. It differs strikingly in genitalia and is in fact close to *effectalis* Hulst, from which it is distinguished superficially by its darker color.

66. *THIODIA EFFECTALIS* (Hulst).

(Fig. 85.)

Crambus effectalis HULST, Amer. Ent. Soc., vol. 33, 1886, p. 166.

Semasia obliterana WALSINGHAM, Trans. Ent. Soc. Lond., 1895, p. 513.

Thiodia effectalis FERNALD, in Dyar List N. Amer. Lepid., no. 5198, 1903.

Thiodia obliterana FERNALD, in Dyar List N. Amer. Lepid., no. 5201, 1903.

Eucosma effectalis BARNES and MCDUNNOUGH, Check List Lepid. Bor. Amer., no. 7095, 1917.

Eucosma obliterana BARNES and MCDUNNOUGH, Check List Lepid. Bor. Amer., no. 7101, 1917.

This is an extremely variable species and very difficult to key. The Arizona specimens run to a paler form than those from Colorado,

but they are hardly a good race as both forms occur and intergrade in Utah making separation and definition impossible. I have, therefore, sunk Walsingham's *obliterana* as a synonym. At most it designates only a color variety.

Male genitalia figured from typical specimen in the National Collection from Florissant, Colorado (S. A. Rohwer, July 7, 1907).

Distribution according to specimens in National Collection, American Museum and collection Barnes: Colorado, Arizona, Utah, Florida.

Veins 3 and 4 of hind wing normally united, occasionally stalked.

Alar expanse.—19–31 mm.

Types.—Location unknown (*effectalis*); British Museum (*obliterana*).

Type localities.—Colorado (*effectalis*); Arizona (*obliterana*).

Food plant.—"Artemisia."

67. THIODIA BUCEPHALOIDES (Walsingham).

Semasia bucephaloides WALSINGHAM, Ins. Life, vol. 3, 1891, p. 465; Trans. Ent. Soc. Lond., 1895, p. 512.

Thiodia effectalis FERNALD, in Dyar List N. Amer. Lepid., no. 5198, 1903.—DYAR, Proc. Ent. Soc. Wash., vol. 5, 1905, p. 285.

Eucosma effectalis BARNES and MCDUNNOUGH, Check List Lepid. Bor. Amer., no. 7095, 1917.

This may be as indicated by the above synonymy nothing but a color variety of *effectalis*. I have seen no male specimens from the type locality. In the Kearfott collection of the American Museum there is a female from Colorado which matches Walsingham's figure and description except that it has veins 3 and 4 united while Walsingham's figure shows them as stalked. This, however, may not be significant as *effectalis* has them both ways. Kearfott's specimen looks like a good species.

Alar expanse.—30 mm.

Type.—In British Museum.

Type locality.—Little Shasta, Siskiyou County, California.

Food plant.—Unknown.

8. Genus EUCOSMA Hübner.

For the following new species, *serapicana*, *palabundana*, not included in key, see Appendix.

(Figs. 21, 148.)

Genotype.—*Eucosma circulana* Hübner.

Synonyms.—1. *Grapholitha* Treitschke in part (*Pelochrista* Lederer). *Genotype*.—*Paedisca mancipiana* Mann.

2. *Pygolopha* Lederer. *Genotype*.—*Penthina lugubrana* Treitschke.

3. *Catoptria* Guenee. *Genotype*.—*Tortrix cana* Haworth.

4. *Affa* Walker. *Genotype*.—*Affa bipunctella* Walker.

5. *Callimosema* Clemens. Genotype.—*Callimosema scintillana* Clemens.

Fore wing smooth; termen straight or slightly concave between veins 3 and 6; 12 veins; 7 and 8 separate; 4 and 5 separate; 10 much nearer to 9 than to 11; 11 from middle or just before middle of cell; upper internal vein of cell from between 10 and 11; 3, 4 and 5 remote or approximate at termen but not the former when termen is appreciably concave; 2 straight or very slightly bent up near termen; 3 and 4 rarely fusing before termen (fig. 5); male with costal fold.

Hind wing with 7 or 8 veins; 3 and 4 stalked, rarely united; 6 and 7 approximate toward base.

Male genitalia with harpes simple; cucullus variously shaped, sharply defined, usually with strong anal spine or spines; neck incurvation usually pronounced; neck not heavily spined or haired; sacculus without heavy spine or hair clusters; costal hook present; no rudimentary clasper. Socii developed; finger like; short or moderate. Gnathos free to near base; weakly chitinized but not reduced. Uncus rudimentary; never more than a rounded or pointed projection at end of tegumen; basally broader than long. Aedoeagus straight; short or moderate; normally stout, not needle like; cornuti a cluster of three or more elongate spines.

The largest genus in the subfamily. It is still considerable of a lump. The different types of cuculli seem to suggest the possibility of further division but an attempt along these lines would separate species that on pattern and general habitus seem extremely close. Very likely the larvae will give us characters on which to divide the genus; but as yet too small a percentage is known. As it stands *Eucosma* represents a group of species intermediate between *Epi-blema* and *Thiodia* and with them constituting one of the two main stems of the Eucosminae.

KEY TO THE SPECIES OF EUCOSMA.

1. Fore wing unicolorous; sometimes finely dusted, finely and evenly spotted, or with a single small spot at end of cell, but with no large dark spots or perceptibly clouded areas nor appreciable white lines nor ocelloid patch nor other conspicuous markings-----2
Fore wing otherwise-----17
2. Ground color of fore wing white-----3
Ground color of fore wing not white-----4
3. Fore wing evenly and conspicuously spotted with black.
(79) *hyponomeutana*.
Fore wing with only a few scattered black scales----- (70) *larana*.
4. Fore wing bright yellow or golden-----5
Fore wing otherwise colored, often ochreous but not bright yellow or golden -----7
5. Fore wing yellow-----6
Fore wing golden evenly spotted with darker iridescent patches.
(78) *grandiflavana*.



THIS PAGE IS LOCKED TO FREE MEMBERS
Purchase full membership to immediately unlock this page



Never be without a book!

Forgotten Books Full Membership gives universal access to 797,885 books from our apps and website, across all your devices: tablet, phone, e-reader, laptop and desktop computer

A library in your pocket for \$8.99/month

Continue

*Fair usage policy applies

27. Median bar unbroken from base to margin----- (3) *crambitana*.
 Median bar not unbroken from base to margin----- 28
28. Median bar absent; white markings oblique----- (20) *ragonoti*.
 Median bar present; white markings longitudinal----- 29
29. Median bar reaching from base to middle of wing----- 30
 Median bar not reaching from base to middle of wing----- (13) *sandiego*.
30. An unbroken silver band along costa from base to just before apex.
 (5) *canariana*.
 No such unbroken costal band----- 31
31. Ground color of fore wing golden ochreous----- (6) *ridingsana*.
 Ground color of fore wing pink or red----- 32
32. Median bar and spots narrow; ground color pinkish----- (7) *fernaldana*.
 Median bar and spots broad; ground color rust red----- (8) *magnidicana*.
33. Serpentine white bar on disk near center of wing----- 34
 Serpentine white bar on lower median field, forming a line along fold to
 tornus, thence upward along termen to apex----- (15) *optimana*.
34. A long silver stripe along dorsal margin of fore wing----- (14) *gilletteana*.
 A single white spot on dorsal margin near middle----- 35
35. Serpentine white bar continued to base of fore wing----- (16) *agassizii*.
 Serpentine white bar not continued to base of fore wing but often joining
 dorsal margin near base----- (17) *bolanderana*.
36. Fore wing ochreous white or pale ochreous, lined with white; the white
 markings often obscure; if distinct, not silvery; no ocellus; no dark
 patches on dorsal margin----- 37
 Fore wing otherwise----- 41
37. White markings rather sharply contrasted against ground color----- 38
 White markings fine and obscure or poorly contrasted against ground
 color----- 39
38. With a white serpentine bar on lower median field curving upward from
 dorsal margin near base and returning to dorsal margin near tornus.
 (21) *serpentana*.
 No such serpentine bar; but with strong median white bar extending from
 base to just beyond middle of wing----- (24) *morrisoni*.
39. Ground color pale dull ochreous; white lines very fine; no marked median
 streak----- (27) *agricolana*.
 Ground color whitish ochreous; white lines often blending into ground
 color; but rather coarse than fine; median white streak distinguish-
 able----- 40
40. White areas predominating over dark, giving a generally white appearance
 to wing----- (23) *argentialbana*.
 Dark areas somewhat more predominate than the white, giving wing a
 rather dirty white appearance----- { (25) *pergandeanana*.
 (26) var. *flavana*.
41. Fore wing cream white, whitish-ochreous, ochreous, golden, reddish, or
 grayish-fuscous; with ocellus usually strongly marked, consisting of one
 or more short horizontal black lines or a series of black dots between
 two or three vertical white or metallic bars; costa usually finely strig-
 ulated with white; often with scattered spots or curved lines of semi-
 metallic scales; if ocellus is poorly defined, a clouding of fuscous scales
 forming a blotch of dark scaling somewhere in cell; no distinct dark
 patches on dorsal margin; no definable dark basal patch----- 42
 Fore wing otherwise----- 61

42. Apex of fore wing acutely pointed; termen deeply concave; ground color ochreous with a somewhat coppery hue-----43
 Apex of fore wing bluntly pointed or rounded; termen rounded, straight, or but slightly concave-----45
43. Veins 3-4 of fore wing fusing before termen-----44
 Veins 3-4 of fore wing closely approximated but not fusing before termen.
 (126) *conspiciendana*.
44. Head reddish ochreous----- (125) *cataclystiana*,
 Head white ----- (127) *floridana*,
45. Fore wing with blotch of fuscous scaling in cell-----46
 Fore wing without such blotch-----47
46. Ground color dirty whitish ochreous; alar expanse over 15 mm.
 (29) *comatulana*.
 Ground color clay-yellow; alar expanse under 14 mm--- (43) *pallidipalpana*.
47. Fore wing cream white or whitish ochreous with a distinctly grayish cast-----48
 Fore wing ochreous, golden, reddish, or grayish fuscous-----49
48. Ocellus with one black longitudinal line----- (33) *monogrammana*.
 Ocellus with three black longitudinal lines----- (34) *atomosana*.
49. Ground color of fore wing grayish fuscous-----50
 Ground color of fore wing not grayish fuscous-----51
50. Head brown irrorated with white----- (35) *glomarana*.
 Head putty color----- (36) *sandana*.
51. Fore wing with scattered spots or curved lines of semimetallic scales---53
 Fore wing not so marked-----52
52. Underside of fore wing dusted with fuscous especially toward extremity.
 (44) *perdricana*.
 Underside of fore wing not so dusted----- (28) *costastrigulana*.
53. Semimetallic markings in scattered spots-----54
 Semimetallic markings in thin curved lines-----56
54. Alar expanse 12 mm. or less----- (30) *albiguttana*.
 Alar expanse over 16 mm-----55
55. Metallic spots bordered with white----- (31) *graciliana*.
 Metallic spots not bordered with white ----- (32) *galenapunctana*.
56. Area near termen of fore wing, above ocellus, white dusted with faint fuscous streaks-----58
 Area above ocellus of the yellowish ground color; not so dusted-----57
57. Costa from base to beyond middle shaded with fuscous----- (37) *circulana*.
 Costa from base to beyond middle putty colored and somewhat paler than ground color of fore wing----- (38) var. *gemellana*.
58. Fore wing at least twice as long as broad-----59
 Fore wing not over one and one-half times as long as broad-----60
59. Distribution Atlantic States to Rocky Mountains----- (39) *scintillana*.
 Distribution Rocky Mountain region and westward----- (40) var. *randana*.
60. Ground color of fore wing indian red----- (41) *fratrueis*.
 Ground color of fore wing buckskin yellow----- (42) *fraudabilis*.
61. Fore wing with a dark basal patch extending from inner angle or near inner angle of dorsal margin or with at least one dark band, or spot on dorsal margin-----68
 Fore wing without such marking-----62
62. Fore wing with a few longitudinal streaks of black or white; otherwise unmarked -----63
 Fore wing otherwise-----64

63. Longitudinal streaks black----- (82) *bilineana*.
 Longitudinal streaks white----- (85) *mediostriata*.
64. Fore wing ashy-gray, whitish or pale golden-----66
 Fore wing dark brown; or ochreous partially clouded with blackish fuscous.
 65
65. Fore wing dark brown; costa finely strigulated with white.
 (103) *fulminana*.
 Fore wing pale ochreous shading into blackish fuscous toward dorsum.
 (104) *rusticana*.
66. With a brown spot or dash at apex of fore wing-----67
 Without such spot----- (88) *biplagata*.
67. A distinct brown streak from costa beyond middle slanting outwardly to
 near tornus, but not touching dorsal margin; alar expanse under 20 mm.
 (89) *primulana*.
 A faint brownish dusting extending in an arc from costa beyond middle to
 apex, joining apical dot; alar expanse 26 mm. and over---- (87) *baetrana*.
68. Fore wing with a single dark dash from middle of dorsal margin extending
 to middle of wing; or with a single dark patch covering most of dorsal
 margin -----69
 Markings on dorsal margin otherwise-----70
69. Dark patch extending from mid-dorsal margin, finger like, slanting out-
 wardly and extending to middle of wing----- (51) *maculatana*.
 Dark patch covering most of dorsal margin----- (22) *heathiana*.
70. Male costal fold narrow, not flatly appressed, extending to middle of
 costa -----71
 Male costal fold rather broad, flatly appressed, not extending beyond basal
 third of costa-----77
71. Alar expanse 8 to 11 mm.----- (90) *gomonana*.
 Alar expanse 13 mm. or over-----72
72. Head snow white; fore wing without any short germinate spots on apical
 third of costa----- (52) *sonomana*.
 Head cream yellow or ochreous; two or more short geminate spots on
 apical third of costa-----73
73. Pale portions of fore wing whitish, semi-metallic----- (56) *monitorana*.
 Pale portions of fore wing yellow-----74
74. Dark portions of fore wing dark brick red-----75
 Dark portions of fore wing pale rust red or brown-----76
75. Posterior part of thorax heavily dusted with silver gray scales; outer costal
 spots of fore wing yellow----- (55) *rescissoriana*.
 Posterior part of thorax but faintly dusted with gray scales; outer costal
 spots of fore wing brick red----- (54) *cocana*.
76. Dark markings of fore wing rust red----- (53) *bobana*.
 Dark markings of fore wing brown----- (57) *tocullionana*.
77. Fore wing with a dark basal patch, broader on costal than dorsal margin,
 not angulate; sometimes with a transverse white line extending across
 wing parallel with this from middle, or just beyond middle of dorsal mar-
 gin, toward costa; or with an outer dark patch on dorsal margin not ex-
 tending to costa but running parallel with such a basal patch-----78
 Basal patch obscure, represented only by dusting on paler background; if
 present and distinct, straight or outwardly angulate, not appreciably
 wider on costal than dorsal margins; often broken and vanishing toward
 costa; sometimes only represented by a dark angulate spot on dorsal mar-
 gin just beyond base; sometimes an outer transverse dark band on wing,
 but latter, if present, not running parallel with basal patch-----80

78. Two transverse parallel white lines on fore wing-----79
 No such transverse white lines----- (92) *nandana*.
79. A distinct dark spot at apex----- (112) *aspidana*.
 No such apical spot----- (91) *dilatana*.
80. Hind wing rust red----- (98) *graduatana*.
 Hind wing not rust red-----81
81. Fore wing red-brown, chocolate brown, or terra cotta with darker markings-----82
 Fore wing white, whitish ochreous, grayish white, or dark ashy fuscous with darker markings-----89
82. An obscure dark basal patch on fore wing; no dark spot on dorsal margin darker than extreme base of wing; an obscure transverse dark shade across wing from dorsal margin near tornus to costa-----86
 One or two dark spots on dorsal margin; inner dark spot darker than extreme base of wing-----83
83. A distinct dark spot on dorsal margin of fore wing near base and one from costa near middle (sometimes reaching dorsal margin); the two spots not fusing----- (94) *dorsisignatana*.
 Dark markings not so placed; or if so, fused into one mark-----84
84. Dorsal and costal dark spots on fore wing fused into a single gourd shaped mark-----85
 Two dark spots on dorsal margin of fore wing; neither reaching to costa. (97) *engelana*.
85. Ground color of fore wing dark brown----- (95) *diffusana*.
 Ground color of fore wing red-brown----- (96) *similana*.
86. Outer transverse dark shade of fore wing outwardly edged with white---87
 No such white margin on transverse band-----88
87. Palpi and head ochreous fuscous sometimes slightly ferruginous but not purplish red----- (99) *juncticiliana*.
 Palpi and head purplish red----- (100) *excusabilis*.
88. Scales on head and thorax brown tipped with white; hind wing dark brown----- (106) *sombreana*.
 Scales on head and thorax reddish brown; not tipped with white; hind wing pale smoky fuscous----- (102) *mandana*.
89. Fore wing dark ashy fuscous; darker markings indicated, but obscure, not contrasted with ground color-----90
 Ground color of fore wing white or whitish; if ashy gray, darker markings sharply contrasted-----92
90. Vertical metallic bars of ocellus of fore wing narrow----- (101) *eumaea*.
 Vertical metallic bars of ocellus of fore wing broad-----91
91. A narrow whitish patch on mid-dorsum of fore wing----- (123) *womonana*.
 No such whitish patch on dorsal margin of fore wing----- (124) *vandana*.
92. An outwardly slanting fuscous band from middle of costa extending to and fusing with outer dorsal patch before tornus, forming a complete fascia---93
 No such complete fascia; if indicated broken at or below middle by at least a line or shade of the pale ground color-----101
93. Ground color suffused with dark scales giving fore wing a decidedly grayish appearance-----94
 Ground color distinctly white; or somewhat dusted, giving fore wing a pale bluish white rather than a distinct gray tint-----95

94. Basal patch not complete, indicated only by an outwardly oblique dark dash on dorsal margin near base; fascia outwardly margined by a thin white line ----- (109) *corosana*.
 Basal patch complete, outwardly angulate; fascia not so outwardly margined ----- (107) *pandana*.
95. Alar expanse over 25 mm ----- 96
 Alar expanse less than 25 mm ----- 98
96. Head reddish ----- (63) *invicta*.
 Head white ----- 97
97. Ground color of fore wing pearly gray white ----- (65) *snyderana*.
 Ground color of fore wing pure white ----- (64) *subinvicta*.
98. Hind wing dark brown, as dark as dark markings on forewing, or darker ----- 99
 Hind wing smoky fuscous; paler than dark markings on fore wing ----- 100
99. Outer fourth of fore wing, beyond fascia, mostly white ----- (59) *momana*.
 Outer fourth of fore wing, beyond fascia, largely occupied by a brown terminal blotch ----- (58) *lolana*.
100. Head ochreous; terminal joint of labial palpus black ----- (119) *rorana*.
 Head white; terminal joint of labial palpus white ----- (60) *grotiana*.
101. Outer dark spot on dorsal margin a large quadrangular fuscous blotch covering entire terminal third of wing (including ocellar area) except a narrow part below apical third of costa, touching costa only at extreme apex ----- (80) *giganteana*.
 Outer dark spot otherwise ----- 102
102. Vein 3 of fore wing not bent upward, reaching termen just above anal angle; termen slanting and rounded, slightly convex ----- 103
 Vein 3 of fore wing bent upward, reaching termen well above anal angle; termen nearly vertical and slightly concave; if slanting, straight or a trifle concave, not convex ----- 105
103. Dark markings of fore wing blackish brown ----- 104
 Dark markings of fore wing pale grayish fuscous ----- (113) *hohana*.
104. Median fascia rather broad and outer dark patch near termen conspicuous. ----- (61) *dodana*.
 Median fascia narrow; outer dark patch obscure ----- (62) *fofana*.
105. Outer dorsal patch on fore wing narrowest at base, inwardly oblique. ----- (122) *zomonana*.
 Outer dorsal patch on fore wing wide at base, vertical or outwardly oblique ----- 106
106. A distinct outwardly oblique half fascia from middle of costa, extending nearly to outer dorsal patch, as wide as outer dorsal patch and separated from it by only a narrow strip of the pale ground color of the fore wing ----- 107
 No such half fascia ----- 108
107. Head white; alar expanse not over 15 mm ----- (69) *matutina*.
 Head not white; alar expanse over 20 mm ----- (108) *fiskeana*.
108. A distinct and isolated fuscous patch or mark at end of cell ----- 109
 No such patch; or, if present fusing with dark patch above ocellus or with outer dorsal patch, not isolated ----- 115
109. Ground color of fore wing white ----- 110
 Ground color of fore wing whitish ochreous ----- 112
110. From costa beyond apical third, a sinuous, irregularly dilated fuscous band or line running around outer margin of ocellus to tornus ----- (116) *suadana*.
 No such marking ----- 111

111. Apical spot curved inward from apex of fore wing and decidedly fawn brown ----- (66) *emaciatana*,
 Apical spot outwardly curved and ashy fuscous ----- (67) *totana*.
112. Head pure white; a distinct white spot in cilia of fore wing just below apex ----- (74) *reversana*,
 Head ochreous or ochreous white; no such white spot in cilia of fore wing ----- 113
113. Termen of fore wing nearly vertical; veins 3, 4 and 5 decidedly approximate at termen ----- (71) *exclusoriana*,
 Termen of fore wing slanting; veins 3, 4 and 5 not approximate at termen ----- 114
114. Dark markings obscure; veins 3 and 4 of hind wing long stalked or united. (73) *occipitana*.
 Dark markings distinct; veins 3 and 4 of hind wing short stalked. (72) *daemonicana*.
115. Fore wing with a smeared appearance, the ground color encroaching on the dark markings ----- 116
 Dark markings of fore wing definitely defined against ground color ----- 117
116. Ground color dirty white ----- (118) *expolitana*,
 Ground color ochreous white ----- (115) *palousana*,
117. Head pure white ----- 118
 Head ochreous-white, ashy white or grayish-brown ----- 119
118. Termen of fore wing nearly vertical ----- (120) *metariana*,
 Termen of fore wing decidedly slanting ----- (68) *popana*.
119. Head ochreous-white ----- 120
 Head ashy white or grayish-brown ----- 123
120. Cilia of fore wing pure white ----- (117) *canana*,
 Cilia of fore wing dusted or streaked with fuscous ----- 121
121. Alar expanse under 20 mm ----- 122
 Alar expanse over 20 mm ----- (76) *shastana*.
122. Dark markings of fore wing contrasted against pale (whitish) ground color; hind wing pale smoky fuscous ----- (75) *tahoensis*.
 Dark markings faintly defined, these and ground color suffused with ochreous; hind wing very dark full fuscous ----- (77) *palpana*.
123. Dorsal patches and apical spot on fore wing ferruginous brown. (114) *biquadrana*.
 Dorsal patches and apical spot blackish fuscous ----- 124
124. Outer dorsal spot of fore wing triangular, sharply defined and faintly edged with white scales ----- 125
 Outer dorsal spot irregularly square; not edged with white scales and less clearly defined ----- (121) *passerana*.
125. Fore wing of male with termen not concave; veins 3, 4, and 5 not appreciably approximate at termen ----- (110) *pulveratana*,
 Fore wing of male with termen very slightly concave; veins 3, 4, and 5 somewhat approximate at termen ----- (111) *consobrinana*.

1. *EUCOSMA QUINQUEMACULANA* (Robinson).

(Fig. 231.)

Conchylis quinquemaculana ROBINSON, Trans. Amer. Ent. Soc., vol. 2, 1869, p. 284.

Eucosma quinquemaculana FERNALD, in Dyar List N. Amer. Lepid. no. 5080, 1903.—DYAR, Proc. Ent. Soc. Wash., vol. 5, 1903, p. 179.—KEARFOTT, Proc. U. S. Nat. Mus., vol. 128, 1905, p. 350.—BARNES and McDUNNOUGH, Check List Lepid. Bor. Amer., no. 6879, 1917.

Male genitalia figured from typical specimen in National Collection taken at Tryon, North Carolina (Fiske).

Distribution according to specimens in National Collection, American Museum, and collection Barnes: North Carolina, Florida, Long Island, New York, Georgia.

Alar expanse.—14.5–20 mm.

Type.—In American Museum.

Type locality.—Pennsylvania.

Food plant.—Unknown.

2. EUCOSMA ROBINSONANA (Grote).

(Fig. 214.)

Conchylis robinsonana GROTE, Can. Ent., vol. 4, 1872, p. 101.

Paedisca quintana ZELLER, Verb. Zool. bot. Ges. Wien., vol. 25, 1875, p. 304.

Paedisca robinsonana WALSINGHAM, Trans. Ent. Soc. Lond., 1884, p. 136.

Eucosma quinquemaculana FERNALD, in Dyar List N. Amer. Lepid., no. 5080, 1903.

Eucosma robinsonana DYAR, Proc. Ent. Soc. Wash., vol. 5, 1903, p. 179.—BARNES and McDUNNOUGH, Check List Lepid. Bor. Amer., no. 6880, 1917.

Eucosma robinsoniana tryonana KEARFOTT, Proc. U. S. Nat. Mus., vol. 28, 1905, p. 350.

Eucosma robinsoniana KEARFOTT, Proc. U. S. Nat. Mus., vol. 28, 1905, p. 351.

Dyar and Kearfott removed this species from the synonymy of *quinquemaculana* Robinson. The genitalia shows this to be correct. Kearfott's supposed variety *tryonana*, however, must fall as a synonym since the character he gives (whether the white mark at tornus of fore wing is a single spot or cluster of three or four spots) does not hold and there is nothing in the genitalia to indicate either a specific or distinct racial difference.

Male genitalia figured from typical specimen in National Collection taken at Washington, District of Columbia (Busck).

Distribution according to specimens in National Collection, American Museum, and collection Barnes: Florida, North Carolina, District of Columbia, New Jersey, Iowa, Alabama.

Alar expanse.—10–17.5 mm.

Types.—In Academy Natural Science Philadelphia (*robinsonana*); Museum Comparative Zoology (*quintana*); American Museum (*tryonana*).

Type localities.—Alabama (*robinsonana*); Dallas, Texas (*quintana*); Tryon, North Carolina (*tryonana*).

Food plant.—Unknown.



THIS PAGE IS LOCKED TO FREE MEMBERS

Purchase full membership to immediately unlock this page



HISTORY

Tens of thousands of important historical sources, many previously unobtainable, are now available for the first time with a Forgotten Books Full Membership.

Unlimited Access
\$8.99/month

Continue

*Fair usage policy applies

Conchylis hipeana GROTE, Can. Ent., vol. 8, 1876, p. 207.

Eucosma ridingsana FERNALD, in Dyar List N. Amer. Lepid., no. 5083, 1903.—KEARFOTT, Can. Ent., vol. 37, 1905, p. 208.—BARNES and McDUNNOUGH, Check List Lepid. Bor. Amer., no. 6894, 1917.

A distinct species but somewhat variable both in markings and genitalia. The difference in the latter are however slight and confined to small variations in the size and shape of the cucullus of the harpe. Four moths were reared by the writer August 3-4, 1915, from larvae taken feeding in the roots of "greasewood?" at Garden of the Gods, Colorado (Hopk. U. S. no. 12197, A. B. Champlain, Coll.). They will probably be found to feed in other species of the Chenopodiaceae.

Grote's two species are at present listed as varieties. I have seen no specimens answering his descriptions from eastern Canada and it is very possible that his names may represent either a distinct eastern species or a local race of *ridingsana*. For the present I am retaining them in the synonymy.

Male genitalia figured from typical specimen in the National Collection taken at Pullman, Washington (C. V. Piper).

Distribution according to specimens in National Collection, American Museum, and collection Barnes: Washington, Colorado, Utah, Arizona, New Mexico, California, Texas, Manitoba, Illinois.

Alar expanse.—18-26 mm.

Types.—Lost? (*ridingsana*); In British Museum? (*argentifurcatana* and *hipeana*).

Type localities.—Colorado (*ridingsana*); Port Stanley, Ontario (*argentifurcatana* and *hipeana*).

Food plant.—Roots of "greasewood?" (*Sarcobatus vermiculatus*?).

7. EUCOSMA FERNALDANA (Grote).

(Fig. 209.)

Paedisca fernaldana GROTE, N. Amer. Ent., 1880, p. 98.

Eucosma fernaldana FERNALD, in Dyar List N. Amer. Lepid., no. 5084, 1903.—DYAR, Proc. Ent. Soc. Wash., vol. 5, 1903, pp. 179, 180.—BARNES and McDUNNOUGH, Check List Lepid. Bor. Amer., no. 6895, 1917.

Extremely close to *ridingsana* Robinson but distinguished by the reddish rather than yellow ground color.

Male genitalia figured from typical specimen in National Collection taken at Aweme, Manitoba (Criddle).

Distribution according to specimens in National Collection, American Museum, and collection Barnes: Manitoba, New Mexico, Utah, Colorado.

Alar expanse.—15-25 mm.

Type.—In British Museum?

Type locality.—Colorado.

Food plant.—Unknown.

8. *EUCOSMA MAGNIDICANA*, new species.

(Fig. 208.)

Dull rust red with silver markings on fore wing as in *fernaldana* Grote but considerably broader; median silver bar broad, broken in middle by a rather wide space of the red ground color; a broadly triangular silver spot on costa near middle; almost touching this and separated only by a thin line of the ground color a similar large oval silver spot on costa near apex; along dorsum a broad silver band extending from base of wing almost to tornus; the silver markings not so sharply edged as in *fernaldana*. Hind wings dull grayish fuscous.

Male genitalia of type figured.

Alar expanse.—28 mm.

Type.—In American Museum.

Type locality.—Southwest Colorado.

Food plant.—Unknown.

Described from a single male from the Kearfott collection in the American Museum of Natural History ("Dietz, 1899"). A striking and easily recognized species, nearest to *E. fernaldana* Grote, but distinguished from the latter by the width of the silver markings. The genitalia are very much alike in the two species.

9. *EUCOSMA CANICEPS* (Walsingham).

(Fig. 185.)

Paedisca caniceps WALSINGHAM, Trans. Ent. Soc. Lond., 1884, p. 137.

Eucosma caniceps FERNALD, in Dyar List N. Amer. Lepid., no. 5149, 1903.—

BARNES and McDUNNOUGH, Check List Lepid. Bor. Amer., no. 6899, 1917.

Male genitalia figured from typical specimen in National Collection taken at Stockton, Utah (Tom Spalding).

Specimens in National Collections, American Museum and collection Barnes from Utah.

Alar expanse.—26–30 mm.

Type.—In British Museum.

Type locality.—Montana.

Food plant.—Unknown.

10. *EUCOSMA GANDANA* Kearfott.

Eucosma gandana KEARFOTT, Trans. Amer. Ent. Soc., vol. 33, 1907, p. 20.—

BARNES and McDUNNOUGH, Check List Lepid. Bor. Amer., no. 6897, 1917.

Eucosma chloroleuca MEYRICK, Ent. Mo. Mag., vol. 48, 1912, p. 34.

Known only from the single female type. Is closest in appearance to *caniceps* Walsingham from which it is distinguished by its lemon yellow color.

Alar expanse.—33 mm.

Type.—In American Museum.

Type locality.—Denver, Colorado.

Food plant.—Unknown.

11. *EUCOSMA ADAMANTANA* (Guenée).

(Fig. 215.)

Argyroptera adamantana GUENÉE, Ann. Soc. Ent. France, ser. 2, vol. 3, 1845, p. 303.

Paedisca adamantana WALSINGHAM, Trans. Ent. Soc. Lond., 1895, p. 505.

Eucosma adamantana FERNALD, in Dyar List N. Amer. Lepid., no. 5145, 1903.—

KEARFOTT, Proc. U. S. Nat. Mus., vol. 28, 1905, p. 351.—BARNES and McDUNNOUGH, Check List Lepid. Bor. Amer., no. 6884, 1917.

Male genitalia figured from typical specimen in National Collection taken at Tryon, North Carolina (*Fiske*).

Distribution according to specimens in National Collection, American Museum, and collection Barnes: North Carolina, New Jersey, Florida.

Alar expanse.—15–20 mm.

Type.—In collection Oberthür.

Type locality.—"Lapland?" "North America."

Food plant.—Unknown.

12. *EUCOSMA SPALDINGANA* Kearfott.

(Fig. 184.)

Eucosma spaldingana KEARFOTT, Trans. Amer. Ent. Soc., vol. 33, 1907, p. 19.—

BARNES and McDUNNOUGH, Check List Lepid. Bor. Amer., no. 6893, 1917.

Male genitalia figured from cotype in National Collection (Stockton, Utah).

Distribution according to specimens in National Collection, American Museum and collection Barnes: Stockton, Utah, and Eureka, Utah.

Alar expanse.—14–26 mm.

Type.—In American Museum.

Type locality.—Stockton, Utah.

Food plant.—Unknown.

13. *EUCOSMA SANDIEGO* Kearfott.

(Fig. 181.)

Eucosma sandiego KEARFOTT, Journ. New York Ent. Soc., vol. 16, 1908, p. 172.—

BARNES and McDUNNOUGH, Check List Lepid. Bor. Amer., no. 6898, 1917.

Male genitalia figured from cotype in National Collection.

Distribution according to specimen in National Collection, American Museum and collection Barnes: San Diego, California, and Loma Linda, California.

Alar expanse.—18.5–28 mm.

Type—In American Museum.

Type locality.—San Diego, California.

Food plant.—Unknown.

14. *EUCOSMA GILLETTEANA* Dyar.

(Fig. 194.)

Eucosma gilletteana DYAR, Proc. Ent. Soc. Wash., vol. 5, 1903, pp. 180, 229.—

BARNES and McDUNNOUGH, Check List Lepid. Bor. Amer., no. 6883, 1917.

Male genitalia figured from cotype in National Collection from Colorado (" #2471 ").

Distribution according to specimens in National Collection, American Museum, and collection Barnes: Arizona, Colorado, Texas, Utah.

Alar expanse.—16–25 mm.

Type.—In National Collection.

Type locality.—Williams, Arizona.

Food plant.—Unknown.

15. *EUCOSMA OPTIMANA* Dyar.

(Fig. 196.)

Eucosma optimana DYAR, Proc. Ent. Soc. Wash., vol. 5, 1893, p. 180.—BARNES

and McDUNNOUGH, Check List Lepid. Bor. Amer., no. 6891, 1917.

Male genitalia figured from type.

Distribution according to specimens in National Collection, American Museum, and collection Barnes: Colorado, Utah.

Alar expanse.—27–33 mm.

Type.—In National Collection.

Type locality.—Glenwood Springs, Colorado.

Food plant.—Unknown.

16. *EUCOSMA AGASSIZII* (Robinson).

(Fig. 200.)

Conchylis agassizii ROBINSON, Trans. Amer. Ent. Soc., vol. 2, 1869, p. 284.

Eucosma agassizii FERNALD, in Dyar List N. Amer. Lepid., no. 5082, 1903.—

DYAR, Proc. Ent. Soc. Wash., vol. 5, 1908, p. 180.—BARNES and McDUNNOUGH, Check List Lepid. Bor. Amer., no. 6882, 1917.

Male genitalia figured from specimen in American Museum taken at Stockton, Utah (Tom Spalding).

Specimens in American Museum and collection Barnes from Utah.

Alar expanse.—23 mm.

Type.—Lost.

Type locality.—Waco County, Texas.

Food plant.—Unknown.

17. *EUCOSMA BOLANDERANA* (Walsingham).

(Fig. 201.)

Paeidisca bolanderana WALSINGHAM, Illus. Lepid. Heter. Brit. Mus., vol. 4, 1879, p. 42; Trans. Ent. Soc. Lond., 1884, p. 136.

Eucosma bolanderana FERNALD, in Dyar List N. Amer. Lepid., no. 5081, 1903.—
DYAR, Proc. Ent. Soc. Wash., vol. 5, 1903, p. 179.—BARNES and McDUN-
NOUGH, Check List Lepid. Bor. Amer., no. 6881, 1917.

Male genitalia figured from cotype in National Collection taken at type locality.

Distribution according to specimens in National Collection, American Museum and collection Barnes: California, Utah, Colorado, Arizona, New Mexico.

Alar expanse.—17–20 mm.

Type.—In British Museum.

Type locality.—Mount Shasta, California.

Food plant.—Unknown.

18. *EUCOSMA ARGENTEANA* (Walsingham).

(Fig. 216.)

Paedisca argenteana WALSINGHAM, Trans. Ent. Soc. Lond., 1895, p. 504.

Eucosma argenteana FERNALD, in Dyar List N. Amer. Lepid., no. 5146, 1903.—
DYAR, Proc. Ent. Soc. Wash., vol. 5, 1903, p. 179.—BARNES and McDUN-
NOUGH, Check List Lepid. Bor. Amer., no. 6885, 1917.

This species has veins of 3, 4 of hind wing long stalked and sometimes united; some specimens exhibiting both venations on the hind wings.

Male genitalia from specimen in National Collection taken in Colorado (“#2578”).

Distribution according to specimens in National Collection American Museum and collection Barnes: Colorado, Montana.

Alar expanse.—18–20 mm.

Type.—In British Museum.

Type locality.—Loveland, Colorado.

Food plant.—Unknown.

19. *EUCOSMA IDAHOANA* Kearfott.

(Fig. 217.)

Eucosma idahoana KEARFOTT, Trans. Amer. Ent. Soc., vol. 33, 1907, p. 90.—
BARNES and McDUNNOUGH, Check List Lepid. Bor. Amer., no. 6892, 1917.

In pattern like *argenteana* Walsingham but distinguished by the olivaceous ground color of the fore wings. The genitalia of the two species are quite different. Appears to be known only from the type.

Male genitalia of type figured.

Alar expanse.—21 mm.

Type.—In American Museum.

Type locality.—Blackfoot, Idaho.

Food plant.—Unknown.

20. *EUCOSMA RAGONOTI* (Walsingham).

(Fig. 202.)

Paedisca ragonoti WALSINGHAM, Trans. Ent. Soc. Lond., 1895, p. 503.*Eucosma ragonoti* FERNALD, in Dyar List N. Amer. Lepid., no. 5160, 1903.—DYAR, Proc. Ent. Soc. Wash., vol. 5, 1903, p. 180.—BARNES and McDUNNOUGH, Check List Lepid. Bor. Amer., no. 6887, 1917.*Eucosma ragonoti barnesiana* DYAR, Proc. Ent. Soc. Wash., vol. 5, 1903, p. 180.

Dyar's varietal name falls into the synonymy since it identifies only an aberration. We are limiting such names to distinct local races and food plant varieties and applying them even then rarely and only when there is a distinct necessity for a designation. Were we to begin naming all aberrations and color varieties in this group where species are so subject to variation there would result only a multiplication and confusion of names which could serve no useful purpose. In *ragonoti* the dorsal spots vary greatly, are more often fused than not and when fused make a fascia of variable form. Two specimens from the same locality and taken at the same time frequently show both extremes; that is, with the dorsal spots distinctly separate or completely fused.

Male genitalia figured from paratype in National Collection.

Specimens in National Collection, American Museum and collection Barnes from various Colorado localities.

Alar expanse.—20–25 mm.*Type*.—In British Museum.*Type locality*.—Loveland, Colorado.*Food plant*.—Unknown.21. *EUCOSMA SERPENTANA* (Walsingham).

(Figs. 206, 207.)

Paedisca serpentana WALSINGHAM, Trans. Ent. Soc., London, 1895, p. 504.*Eucosma serpentana* FERNALD, in Dyar List, N. Amer. Lepid., no. 5161, 1903.—DYAR, Proc. Ent. Soc. Wash., vol. 5, 1903, p. 180.—BARNES and McDUNNOUGH, Check List Lepid. Bor. Amer., no. 6888, 1917.

A species easily recognized on pattern. The structural characters, however, like those of many species in this subfamily show rather marked differences in specimens from Pacific coast as compared with those from east of the Sierras. Differences such as those shown in the harpes of the two specimens here figured (figs. 206, 207) would normally indicate two species; but as between specimens from the Pacific coast region and Rocky Mountain or eastern localities they often signify no more than racial differences.

Male genitalia figured from specimens in National Collection taken at Pullman, Washington (C. V. Piper) and Mesilla, New Mexico (C. N. Ainslie).

Distribution according to specimens in National Collection, American Museum, and collection Barnes: Washington, Montana, New Mexico, Iowa.

Alar expanse.—16–20 mm.

Type.—In British Museum.

Type locality.—Loveland, Colorado.

Food plant.—Unknown.

22. EUCOSMA HEATHIANA Kearfott.

(Fig. 235.)

Eucosma heathiana KEARFOTT, Can. Ent., vol. 39, 1907, p. 56.—BARNES and McDUNNOUGH, Check List Lepid. Bor. Amer., no. 6930, 1917.

Male genitalia figured from cotype in National Collection from Washington County, Arkansas.

Distribution according to specimens in National Collection, American Museum, and collection Barnes: Manitoba, Arkansas, South Dakota, Iowa, Kansas, New Mexico.

Alar expanse.—14–18.5 mm.

Type.—In American Museum.

Type locality.—Cartwright, Manitoba.

Food plant.—Unknown.

23. EUCOSMA ARGENTIALBANA (Walsingham).

(Fig. 234.)

Paedisca argentialbana WALSINGHAM, Illus. Lepid. Heter. Brit. Mus., vol. 4, 1879, p. 44.

Paedisca smithiana WALSINGHAM, Trans. Ent. Soc. Lond., 1895, p. 506.

Eucosma argentialbana FERNALD, in Dyar List N. Amer. Lepid., no. 5089, 1903.—KEARFOTT, Can. Ent., vol. 37, 1905, p. 44.—BARNES and McDUNNOUGH, Check List Lepid. Bor. Amer., no. 6918, 1917.

Eucosma smithiana FERNALD, in Dyar List N. Amer. Lepid., no. 5162, 1903.—KEARFOTT, Can. Ent., vol. 37, 1905, p. 44.—BARNES and McDUNNOUGH, Check List Lepid. Bor. Amer., no. 7047, 1917.

My conception of this species agrees with Kearfott's, except that I would include *smithiana* Walsingham as a synonym, as there is nothing in the description of the two species on which to separate them. The specimens in the American Museum determined by Kearfott as *smithiana* are *Thiodias* and obviously not Walsingham's species.

I have seen no specimens from the type locality of *argentialbana* (Texas) but specimens from Colorado, New Mexico, Utah and Manitoba agreeing with the descriptions of both *argentialbana* and *smithiana* agree on all genitalia characters. In the National Collection there is also a series of specimens from Sioux City, Iowa ("IX,



THIS PAGE IS LOCKED TO FREE MEMBERS
Purchase full membership to immediately unlock this page



Never be without a book!

Forgotten Books Full Membership gives universal access to 797,885 books from our apps and website, across all your devices: tablet, phone, e-reader, laptop and desktop computer

A library in your pocket for \$8.99/month

Continue

*Fair usage policy applies

Alar expanse.—14–22 mm.

Types.—In British Museum.

Type localities.—Texas (*argentialbana*); Loveland, Colorado (*smithiana*).

Food plant.—Unknown.

24. *EUCOSMA MORRISONI* (Walsingham).

(Fig. 229.)

Paedisca morrisoni WALSINGHAM, Trans. Ent. Soc. Lond., 1884, p. 138.

Eucosma morrisoni FERNALD, in Dyar List N. Amer. Lepid., no. 5159, 1903.—

DYAR, Proc. Ent. Soc. Wash., vol. 5, 1903, p. 179.—KEARFOTT, Can. Ent., vol. 37, 1905, pp. 44, 208.—BARNES and McDUNNOUGH, Check List Lepid. Bor. Amer., no. 6886, 1917.

Male genitalia figured from specimen in National Collection taken at Vineyard, Utah ("VIII, 9–13, Tom Spalding").

Distribution according to specimens in National Collection American Museum and collection Barnes: Utah, Colorado, Montana, Manitoba, New Mexico, California.

Alar expanse.—16–23 mm.

Type.—In British Museum.

Type locality.—Montana.

Food plant.—Unknown.

25. *EUCOSMA PERGANDEANA* Fernald.

(Fig. 240.)

Eucosma pergandiana FERNALD, Can. Ent., vol. 37, 1905, p. 399.—KEARFOTT,

Proc. U. S. Nat. Mus., vol. 28, 1905, p. 352.—BARNES and McDUNNOUGH, Check List Lepid. Bor. Amer., no. 6917, 1917.

Paedisca pergandiana WALSINGHAM, Trans. Ent. Soc. Lond., 1895, p. 506.

This species with its western variety *flavana* Fernald comes between *morrisoni* Walsingham and *agricolana* Walsingham and grades into both species in pattern. It is variable also in structure having veins 3–4 of hind wing frequently long stalked and occasionally even united. The genitalia also are somewhat variable. I would limit the name *pergandiana* to the eastern form.

Male genitalia figured from a typical specimen in National Collection taken at East River, Connecticut ("July—C. R. Ely").

Distribution according to specimens in National Collection, American Museum and collection Barnes: North Carolina, Pennsylvania, District of Columbia, Connecticut, New Hampshire, New Jersey, New York, Ohio, Massachusetts.

Alar expanse.—13.5–18 mm.

Type.—In collection Fernald.

Type locality.—Virginia. (Male type labeled "Pergande, Washington").

Food plant.—Unknown.

26. EUCOSMA PERGANDEANA FLAVANA Fernald.

(Fig. 236.)

Eucosma pergandean flavana FERNALD, Can. Ent., vol. 37, 1905, p. 399.—
BARNES and McDONNOUGH, Check List Lepid. Bor. Amer., no. 6917, 1917.

The name *flavana* is merely a varietal designation for the western specimens of *pergandean* Fernald and probably should be relegated to the synonymy as it does not seem to apply to any definite race. I am holding it for the present as the specimens to which it has been applied run into *agricolana* Walsingham. The two species (if there are two) are mixed in all the collection. The genitalia does not help us for the same variations occur in both the Rocky Mountains and Pacific coast specimens and do not correspond with the patterns which are also equally variable.

I have figured the genitalia of what I take to be a typical specimen from Pullman, Washington (C. V. Piper).

Alar expanse.—15–18 mm.

Type.—In collection Fernald.

Type locality.—Texas.

Food plant.—Unknown.

27. EUCOSMA AGRICOLANA (Walsingham).

(Figs. 228, 233.)

Paedisca agricolana WALSINGHAM, Illus. Lepid. Heter. Brit. Mus., vol. 4, 1879, p. 42; Trans. Ent. Soc. Lond., 1884, p. 139.

Eucosma agricolana FERNALD, in Dyar List N. Amer. Lepid., no. 5092, 1903.—
BARNES and McDONNOUGH, Check List Lepid. Bor. Amer., no. 6922, 1917.

A variable and difficult species. Some of the Colorado specimens show so little of the white ground color emphasized by Walsingham in his description that they could be referred to more properly as pale dull ochreous. In the American Museum of Natural History there is a typical specimen from Yellowstone Park, Wyoming, corresponding closely to Utah specimens in the National Collection and agreeing perfectly in genitalia with one of the Colorado forms figured here (fig. 228). I have seen no specimens from either of the type localities (California or Oregon). In the Kearfott collection there are three specimens named by Walsingham. One of these is labeled "cotype" but none bear locality labels.

Male genitalia figured from two Colorado forms in the National Collection.

Distribution according to specimen in National Collection, American Museum and Collection Barnes: Colorado, Arizona, Utah, Wyoming, British Columbia (Kaslo).

Alar expanse.—13–23 mm.

Type.—In British Museum.

Type localities.—"California, Oregon."

Food plant.—Unknown.

28. *EUCOSMA COSTASTRIGULANA* Kearfott.

(Fig. 163.)

Eucosma costastrigulana KEARFOTT, Journ. N. Y. Ent. Soc., vol. 16, 1907, p. 171.—BARNES and MCDUNNOUGH, Check List Lepid. Bor. Amer., no. 6910, 1917.

A variable species in genitalia, not to be distinguished from *comatulana* Zeller except by the darker dusting on the fore wing of the latter. I think the two are one species. From the same localities in Colorado we get both forms and nearly all the possible genitalia variations. I am retaining Kearfott's name however until something is known of their life history.

Male genitalia figured from cotype in National Collection from San Diego, California.

Distribution according to specimens in National Collection, American Museum, and Collection Barnes: California, Colorado, Utah.

Alar expanse.—13–18 mm.

Type.—In American Museum.

Type locality.—San Diego, California.

Food plant.—Unknown.

29. *EUCOSMA COMATULANA* (Zeller).

(Fig. 164.)

Paedisca comatulana ZELLER, Verh. Zool-bot. Ges. Wien, vol. 25, 1875, p. 316.

Eucosma comatulana FERNALD, in Dyar List N. Amer. Lepid., no. 5098, 1903.—BARNES and MCDUNNOUGH, Check List Lepid. Bor. Amer., no. 6926, 1917.

This species has been badly mixed in the collections. Should *costastrigulana* Kearfott prove to be a distinct species, *comatulana* must be limited to the form in which the fore wing shows appreciable shading of dull fuscous, and has the incurvation of the neck of the harpe wide as in figure 164. In that event it will be necessary to erect at least two more species for the forms diverging on genitalia from typical *comatulana* and *costastrigulana* but intergrading with them on pattern and color. The females of both species have an appreciable admixture of black scales in the anal tuft, somewhat more pronounced in the darker specimens of *comatulana*.

Male genitalia figured from typical specimen in National Collection from Clear Creek, Colorado.

Distribution according to specimens in National Collection, American Museum, and collection Barnes: Texas, Colorado, Arizona, New



THIS PAGE IS LOCKED TO FREE MEMBERS

Purchase full membership to immediately unlock this page



HISTORY

Tens of thousands of important historical sources, many previously unobtainable, are now available for the first time with a Forgotten Books Full Membership.

Unlimited Access
\$8.99/month

Continue

*Fair usage policy applies

32. *EUCOSMA GALENAPUNCTANA* Kearfott.

(Fig. 166.)

Eucosma galenapunctana KEARFOTT, Journ. New York Ent. Soc., vol. 16, 1908, p. 169.—BARNES and McDUNNOUGH, Check List Lepid. Bor. Amer., no. 6909, 1917.

A rocky Mountain species very close to *graciliana* Kearfott, but distinguished by male genitalia and the absence of any white scaling about the silver spots on fore wing. The ocellar markings are somewhat variable, in some specimens being almost obsolete.

Male genitalia figured from cotype in National Collection from Clear Creek, Colorado.

Specimens in National Collection, American Museum, and collection Barnes from various Colorado localities.

Alar expanse.—17–25.5 mm.

Type.—In American Museum.

Type locality.—Colorado.

Food plant.—Unknown.

33. *EUCOSMA MONOGRAMMANA* (Zeller).

Paedisca monogrammana ZELLER, Verh. Zool.-bot. Ges. Wien., vol. 25, 1875, p. 313.

Eucosma monogrammana FERNALD, in Dyar List N. Amer. Lepid., no. 5086, 1903.—KEARFOTT, Proc. U. S. Nat. Mus., vol. 28, 1905, p. 353.—BARNES and McDUNNOUGH, Check List Lepid. Bor. Amer., no. 6908, 1917.

This species is not represented by authentic specimens in the National Museum, the American Museum, or the Barnes collections. There are four specimens in the Fernald collection at Amherst, Massachusetts, from Dallas Texas, but none of these bears Zeller's green label. The species strongly resembles *atomosana* Walsingham, which I am inclined to believe will prove to be only a western race of Zeller's species.

Alar expanse.—20 mm.

Type.—In British Museum?

Type locality.—Dallas, Texas.

Food plant.—Unknown.

34. *EUCOSMA ATOMOSANA* (Walsingham).

(Fig. 165.)

Paedisca atomosana WALSINGHAM, Illus. Lepid. Heter., vol. 4, 1879, p. 42.

Eucosma atomosana FERNALD, in Dyar List N. Amer. Lepid., no. 5091, 1903.—KEARFOTT, Proc. U. S. Nat. Mus., vol. 28, 1905, p. 353.—BARNES and McDUNNOUGH, Check List Lepid. Bor. Amer., no. 6921, 1917.

Male genitalia figured from specimen in National Collection taken at Claremont, California.

Distribution according to specimens in National Collection, American Museum, and collection Barnes: California, Arizona, New Mexico.

Alar expanse.—20–23.5 mm.

Type.—In British Museum.

Type locality.—San Francisco, California.

Food plant.—Unknown.

35. EUCOSMA GLOMERANA (Walsingham).

(Fig. 146.)

Paedisca glomerana WALSINGHAM, Illus. Lepid. Heter., vol. 4, 1879, p. 49.

Eucosma glomarana FERNALD, in Dyar List N. Amer. Lepid., no. 5103, 1903.

Eucosma glomerana KEARFOTT, Can. Ent., vol. 37, 1905, p. 209.—BARNES and McDUNNOUGH, Check List Lepid. Bor. Amer., no. 6936, 1917.

Male genitalia figured from specimen in National Collection from Kansas.

Distribution according to specimens in National Collection, American Museum, and collection Barnes: Kansas, Iowa, Manitoba.

Alar expanse.—20–26 mm.

Type.—In British Museum.

Type locality.—Texas.

Food plant.—Unknown.

36. EUCOSMA SANDANA Kearfott.

(Fig. 144.)

Eucosma sandana KEARFOTT, Trans. Amer. Ent. Soc., vol. 33, 1907, p. 22.—

BARNES and McDUNNOUGH, Check List Lepid. Bor. Amer., no. 6904, 1917.

Eucosma griphodes MEYRICK, Ent. Mo. Mag., vol. 48, 1913, p. 34.

Very close to *glomerana* Walsingham, if not merely a variety of that species. From the specimens determined as the latter, Kearfott's species differs chiefly in its proportionally larger male genitalia. The structure of these organs in the two species is otherwise the same.

Male genitalia figured from type.

Distribution according to specimens in National Collection, American Museum and Collection Barnes: Kansas, South Dakota, Colorado.

Alar expanse.—19–24 mm.

Type.—In American Museum.

Type locality.—Chimney Gulch, Colorado.

Food plant.—Unknown.

37. EUCOSMA CIRCULANA Hübner.

(Figs. 21, 148.)

Eucosma circulana HÜBNER, Zutr. Exot. Schmett., vol. 2, 1823, figs. 363, 364.—

FERNALD, in Dyar List N. Amer. Lepid., no. 5079, 1903.—KEARFOTT, Proc. U. S. Nat. Mus., vol. 28, 1905, p. 352 (not Kearfott. Can. Ent., vol. 37, 1905, p. 44).—BARNES and McDUNNOUGH, Check List Lepid. Bor. Amer., no. 6901, 1917.

?*Paedisca circulana* WALSINGHAM, Trans. Ent. Soc. Lond., 1884, p. 136.

The specimens under this name in the collections have been very badly mixed and the conception of the species itself somewhat confused in spite of Hübner's very accurate figure. His name applies obviously to a form which has the ground color above the ocellus in the fore wing yellow and unmarked by white or fuscous scales. *Eucosma scintillana* Clemens which has been listed as a variety or synonym of *circulana* is an entirely different species as the genitalia show.

Hübner described *circulana* as from Pennsylvania, but I have seen specimens only from Florida and Louisiana. It is not common and the usual references to it in literature apply to *scintillana* Clemens. In Florida itself there appear to be two species or at least two distinct races on the east and west coast, hardly to be distinguished in color or pattern but with so much difference in the genitalia that I do not feel justified in including them under the same name. The name *gemellana* is proposed for the west coast specimens.

Male genitalia of *E. circulana* figured from typical specimen in National Collection taken at Hastings, Florida.

Distribution according to specimens in National Collection, American Museum and Collection Barnes: Florida, Louisiana.

Alar expanse.—16 mm.

Type.—Location unknown.

Type locality.—"Pennsylvania."

Food plant.—Unknown.

38. EUCOSMA CIRCULANA GEMELLANA, new variety.

(Fig. 150.)

Like *circulana* Hübner from which it differs only in male genitalia and in the pale putty colored shading on costa of fore wing from base to beyond middle. In *circulana* this part of the costa is more or less dusted with fuscous scales. The neck of the harpe of the male genitalia is narrower while the harpe itself is larger than in *circulana*.

Male genitalia of type figured.

Alar expanse.—19–24 mm.

Type.—Cat. No. 24805 U.S.N.M.

Paratype.—In collection Barnes.

Type locality.—St. Petersburg, Florida.

Food plant.—Unknown.

Described from male type and two male paratypes. The type and one paratype are from St. Petersburg, Florida (the latter from Doctor Barnes' collection collected by R. Ludwig ("4-11-14")). The other specimen is a large male without abdomen from the Walsingham collection, labeled "Florida, Morrison, 1884" and with the name "*Paedisca circulana*" in Walsingham's handwriting.



THIS PAGE IS LOCKED TO FREE MEMBERS
Purchase full membership to immediately unlock this page



Never be without a book!

Forgotten Books Full Membership gives universal access to 797,885 books from our apps and website, across all your devices: tablet, phone, e-reader, laptop and desktop computer

A library in your pocket for \$8.99/month

Continue

*Fair usage policy applies

Male genitalia figured from cotype in National Collection from Denver, Colorado.

Distribution according to specimens in National Collection, American Museum and collection Barnes: Colorado, New Mexico, Arizona, California (Havilah).

Alar expanse.—11–26 mm.

Type.—In American Museum.

Type locality.—Denver, Colorado.

Food plant.—Unknown.

41. *EUCOSMA FRATRUELIS*, new species.

(Fig. 232.)

Superficially like *scintillana* Clemens except that the wings are much broader in proportion to their length, a little more than half as long as broad; their ground color is an Indian red with the ocellus and its surrounding grayish and fuscous dusting occupying a large portion of the outer half of the wing, the grayish and fuscous in this part extending to costa; a straight rather narrow dull silver fascia at middle of wing; a spot of similar metallic scales on costa just beyond middle; a similar curved band of the same silver scaling on the reddish ground color from costa near apex to middle of termen; base of wing, thorax, and head mixed gray and fuscous; costal fold of male extending over one-third the wing length; hind wings dark brown; cilia paler. Male genitalia differs from all the forms of *scintillana* in the much narrower emargination between cucullus and sacculus of harpe.

Male genitalia of type figured.

Alar expanse.—12–14 mm.

Type.—In collection Barnes.

Paratypes.—Cat. No. 24806 U.S.N.M., also in American Museum and collection Barnes.

Type locality.—Southern Pines, North Carolina.

Food plant.—Unknown.

Described from male type and 10 male and 3 female paratypes from Doctor Barnes's collection. Collected at Southern Pines, North Carolina (July 8 to Sept. 15).

42. *EUCOSMA FRAUDABILIS*, new species.

(Fig. 161.)

Like *fratrueis* Heinrich in size and general appearance, but much paler. Ground color of fore wing buckskin yellow, with straight narrow antimedial and a similar median fascia; fuscous dusting in fore wing limited to area about ocellus and bordering median fascia. Head and thorax concolorous with fore wing. Hind wing pale ochreous fuscous.

Male genitalia of type figured.

Alar expanse.—13–16 mm.

Type.—In collection Barnes.

Paratypes.—Cat. No. 24807 U.S.N.M. Also in American Museum and collection Barnes.

Type locality.—Southern Pines, North Carolina.

Food plant.—Unknown.

Described from male type and 13 male and 4 female paratypes, all from Doctor Barnes's collection, collected at Southern Pines (June 1 to July 23). There is also in the National Museum a small (11 mm.) rubbed male of this species collected by Doctor Dyar at Skyland, Virginia, July 15, 1911.

43. *EUCOSMA PALLIDIPALPANA* Kearfott.

(Fig. 227.)

Eucosma pallidipalpata KEARFOTT, Proc. U. S. Nat. Mus., vol. 28, 1905, p. 353.—

BARNES and MCDUNNOUGH, Check List Lepid. Bor. Amer., no. 6920, 1917.

Male genitalia figured from typical specimen in National Collection collected at Washington, District of Columbia, July, 1901 (Busck).

Distribution according to specimens in National Collection, American Museum; and collection Barnes: Virginia, District of Columbia, North Carolina, Connecticut, Iowa.

Alar expanse.—9–13.5 mm.

Type.—In American Museum.

Type locality.—Washington, District of Columbia.

Food plant.—Unknown.

44. *EUCOSMA PERDRICANA* (Walsingham).

(Fig. 205.)

Paedisca perdricana WALSINGHAM, Illus. Lepid. Heter. Brit. Mus., vol. 4, 1879, p. 49.

Eucosma perdricana FERNALD, in Dyar List N. Amer. Lepid., no. 5102, 1903.—

BARNES and MCDUNNOUGH, Check List Lepid. Bor. Amer., no. 6934, 1917.

Eucosma kandana KEARFOTT, Trans. Amer. Ent. Soc., vol. 33, 1907, p. 20.—

BARNES and MCDUNNOUGH, Check List Lepid. Bor. Amer., no. 6911, 1917.

Eucosma argillacea MEYRICK, Ent. Mo. Mag., vol. 48, 1912, p. 34.

Kearfott's type and cotypes of *kandana* answer in every detail Walsingham's description of *perdricana*, and I have no hesitation in listing it as a synonym. Aside from the specimens determined as *kandana*, there are no specimens that could be applied to Walsingham's name in the National Collection or either of the two other collections. The specimen in the American Museum determined by Kearfott as *perdricana* Walsingham is much too large for that species.

Male genitalia figured from cotype of *kandana* Kearfott in National Collection.

Distribution according to specimens in National Collection, American Museum, and collection Barnes: Utah, Colorado.

Alar expanse.—18–20 mm.

Types.—In British Museum (*perdricana*); in American Museum (*kandana*).

Type localities.—Burney Falls, Shasta County, California (*perdricana*); Stockton, Utah (*kandana*).

Food plant.—Unknown.

45. EUCOSMA LURIDANA (Walsingham).

(Fig. 204.)

Paedisca luridana WALSINGHAM, Illus. Lepid. Heter. Brit. Mus., vol. 4, 1879, p. 44.

Eucosma luridana FERNALD, in Dyar List N. Amer. Lepid., no. 5088, 1903.—

BARNES and MCDUNNOUGH, Check List Lepid. Bor. Amer., no. 6916, 1917.

Walsingham's cotype from North Carolina is in the National Collection: It is a unicolorous, pale, fawn colored specimen without the markings shown in his figure.¹³ Under this name we have also had a series of some twenty-two males collected at Pullman, Washington, during July and August by C. V. Piper. These Kearfott has determined as Walsingham's species. Some specimens show a distinct, though pale, fawn-colored basal spot and a similar small spot on dorsum before tornus. In others the entire wing is suffused with very pale fawn color showing no traces of the above-mentioned spots. The genitalia of the various specimens show considerable variation but none quite agree with the cotype of *luridana*. It is possible that *luridana* is an unusually variable species and may include all these extremes. I am inclined to think however that our specimens represent two species. Rearing alone will decide. For the present I am able to determine as *luridana* only four specimens from Eureka, Utah (Tom Spalding), from Doctor Barnes's material. Two of these are in the National Collection and two in his collection. These agree with Walsingham's cotype in structure and color except that the fore wings are a trifle more pinkish, possibly due to the age of the Walsingham specimen.

Male genitalia figured from cotype.

Alar expanse.—18–19 mm.

Type.—In British Museum.

Type locality.—"North California."

Food plant.—Unknown.

¹³ Fig. 3, Pl. 70, Illus. Lepid. Heter. Brit. Mus., vol. 4.



THIS PAGE IS LOCKED TO FREE MEMBERS

Purchase full membership to immediately unlock this page



HISTORY

Tens of thousands of important historical sources, many previously unobtainable, are now available for the first time with a Forgotten Books Full Membership.

Unlimited Access
\$8.99/month

Continue

*Fair usage policy applies

Distribution according to specimens in National Collection, American Museum, and Collection Barnes: Washington, Wyoming (Yellowstone Park), Oregon, California.

Alar expanse.—27–32.5 mm.

Type.—In British Museum.

Type locality.—Rouge River, Oregon.

Food plant.—Unknown.

49. *EUCOSMA HANDANA* Kearfott.

(Fig. 188.)

Eucosma handana KEARFOTT, Trans. Amer. Ent. Soc., vol. 33, 1907, p. 20.—

BARNES and McDUNNOUGH, Check List Lepid. Bor. Amer., no. 5905, 1917.

Eucosma caramitis MEYRICK, Ent. Mo. Mag., vol. 48, 1912, p. 34.

A large unicolorous species close to *subflavana* Walsingham but distinguished by male genitalia and the absence of any sublustrous scales on the fore wing. In rubbed specimens it is very difficult to tell the two species apart without examining the genitalia.

Male genitalia figured from cotype in National Collection.

Specimens in National Collection, American Museum, and Collection Barnes from Stockton, Utah.

Alar expanse.—25–30 mm.

Type.—In American Museum.

Type locality.—Stockton, Utah.

Food plant.—Unknown.

50. *EUCOSMA IMMACULANA* Kearfott.

(Fig. 179.)

Eucosma immaculana KEARFOTT, Trans. Amer. Ent. Soc., vol. 33, 1907, p. 35.—

BARNES and McDUNNOUGH, Check List Lepid. Bor. Amer., no. 6900, 1917.

A large unicolorous species easily distinguished by the pinkish ochreous color of the fore wings.

Male genitalia figured from cotype in National Collection.

Represented by cotypes only in National Collection, American Museum and Collection Barnes, all from Pullman, Washington.

Alar expanse.—25–28 mm.

Type.—In American Museum.

Type locality.—Pullman, Washington.

Food plant.—Unknown.

51. *EUCOSMA MACULATANA* (Walsingham).

(Fig. 190.)

Paedisca maculatana WALSINGHAM, Illus. Lepid. Heter. Brit. Mus., vol. 4, 1879' p. 48.

Eucosma maculatana FERNALD, in Dyar List N. Amer. Lepid., no 5111, 1903.—

BARNES and McDUNNOUGH, Check List Lepid. Bor. Amer., no. 7033, 1917.

A very distinct and strikingly marked species. Specimens in Collection Barnes and National Collection from Shasta Retreat (Siskiyou County) California are grayish fuscous, considerably paler than the type but agreeing in all details of pattern and genitalia.

Male genitalia figured from cotype in National Collection.

Distribution according to specimens in National Collection, American Museum, and Collection Barnes: Lake, Mendocino, Placer and Siskiyou Counties, California; Yellowstone Park, Wyoming.

Alar expanse.—16–23 mm.

Type.—In British Museum.

Type locality.—Lake County, California.

Food plant.—Unknown.

52. EUCOSMA SONOMANA Kearfott.

(Fig. 141.)

Eucosma sonomana KEARFOOT, Trans. Amer. Ent. Soc., vol. 33, 1907, p. 27.—

BARNES and McDUNNOUGH, Check List Lepid. Bor. Amer., no. 7002, 1917.

The most beautiful species in the genus and like the following five species closely resembling the bud, cone, and shoot moths formerly listed under the old genus *Retinia* (*Evetria* Authors) and superficially distinguishable from them only by the presence of a costal fold in the fore wing of the male. They are all feeders in coniferous trees.

In the National Collection we have five specimens reared from *Pinus ponderosa* and *Picea engelmanni*, March 5, 1915, and April 4 and 5, 1916, at Missoula, Montana, by Joseph Brunner (reared in connection with the forest insect investigations of the U. S. Bureau of Entomology under Hopk. U. S. nos. 12350, 12369, and 12370).

Male genitalia figured from one of the above reared specimens.

Distribution according to specimens in National Collection, American Museum and Collection Barnes: Montana, California.

Alar expanse.—18–21 mm.

Type.—In American Museum.

Type locality.—Sonoma County, California.

Food plants.—*Pinus ponderosa*, *Picea engelmanni* (larvae boring in the pith of terminal branches).

53. EUCOSMA BOBANA Kearfott.

(Fig. 140.)

Eucosma bobana KEARFOTT, Trans. Amer. Ent. Soc., vol. 33, 1907, p. 26.—

BARNES and McDUNNOUGH, Check List Lepid. Bor. Amer., no. 7000, 1917.

Eucosma antichroma MEYRICK, Ent. Mo. Mag., vol. 48, 1912, p. 35.

This is a species of economic importance as the larva bores into the cones and feeds on the seeds of the western yellow pines. Several moths have been reared in connection with the forest insect

investigations of the U. S. Bureau of Entomology from cones of *Pinus ponderosa* and *P. jeffreyi* collected at Silver Lake, Oregon (Hopk. U. S. no. 13251^b, P. D. Sargent, Coll.), Pine Valley, California (Hopk. U. S. no. 13276^a, F. P. Keen, Coll.). According to J. M. Miller, of the Bureau of Entomology, who has investigated the life history, the species has only one generation a year, the larvae feeding during June, July, and August, pupating in October, and overwintering in cocoon as pupa within the cones, moths issuing the following May and June.

Male genitalia figured from reared specimens in National Collection. (Silver Lake, Oregon. Hopk. U. S. no. 13251^b.)

Distribution according to specimens in National Collection, American Museum and Collection Barnes: Colorado, Oregon, California, Utah, Arizona, Texas.

Alar expanse.—17–28 mm.

Type.—In American Museum.

Type locality.—Salida, Colorado.

Food plants.—*Pinus ponderosa*, *Pinus jeffreyi*.

54. EUCOSMA COCANA Kearfott.

(Fig. 139.)

Eucosma cocana KEARFOTT, Trans. Amer. Ent. Soc., vol. 33, 1907, p. 26.—

BARNES and McDUNNOUGH, Check List Lepid. Bor. Amer., no. 7001, 1917.

Eucosma rhodophaea MEYRICK, Ent. Mo. Mag., vol. 48, 1912, p. 35.

Known only from the types. In general appearance closest to *bobana* Kearfott and *rescissoriana* Heinrich, but in genitalia more like *monitorana* Heinrich. Apparently a distinct species and obviously of this immediate group. Will be found to be a coniferous feeder when bred.

Male genitalia of type figured.

Alar expanse.—19 mm.

Type.—In American Museum.

Type locality.—Tryon, North Carolina.

Food plant.—Unknown.

55. EUCOSMA RESCISSORIANA Heinrich.

(Fig. 138.)

Eucosma rescissoriana HEINRICH, Proc. U. S. Nat. Mus., vol. 57, 1920, p. 58.

Known only from the type.

Male genitalia of type figured.

Alar expanse.—23 mm.

Type.—In National Collection.

Type locality.—Sprague River, Oregon.

Food plant.—*Pinus murrayana* (larvae feeding in cones on scales and seeds).



THIS PAGE IS LOCKED TO FREE MEMBERS
Purchase full membership to immediately unlock this page



Never be without a book!

Forgotten Books Full Membership gives universal access to 797,885 books from our apps and website, across all your devices: tablet, phone, e-reader, laptop and desktop computer

A library in your pocket for \$8.99/month

Continue

*Fair usage policy applies

Distribution according to specimens in National Collection, American Museum, and collection Barnes: Yuma County, Redington, Prescott, Arizona.

Alar expanse.—32 mm.

Type.—In American Museum.

Type locality.—Yuma County, Arizona.

Food plant.—Unknown.

60. *EUCOSMA GROTIANA* Kearfott.

(Fig. 154.)

Eucosma grotiana KEARFOTT, Journ. New York Ent. Soc., vol. 16, 1908, p. 170.—

BARNES and McDUNNOUGH, Check List Lepid. Bor. Amer., No. 6958, 1917.

Male genitalia figured from cotype in National Collection ("Colorado #2620").

Distribution according to specimens in National Collection, American Museum and collection Barnes: Illinois, Iowa, Colorado, New Mexico, Texas.

Alar expanse.—15–22 mm.

Type.—In American Museum.

Type locality.—Iowa.

Food plant.—Unknown.

61. *EUCOSMA DODANA* Kearfott.

(Fig. 177.)

Eucosma dodana KEARFOTT, Trans. Amer. Ent. Soc., vol. 33, 1907, p. 27.—BARNES

and McDUNNOUGH Check List Lepid. Bor. Amer., no. 7003, 1917.

Eucosma spilophora MEYRICK, Ent. Mo. Mag., vol. 48, 1912, p. 35.

Male genitalia figured from specimen in National Collection collected at Mount Pirau, Alberta.

Distribution according to specimens in National Collection, American Museum and collection Barnes: Colorado, Alberta.

Alar expanse.—16.5–24 mm.

Type.—In American Museum.

Type locality.—Southwest Colorado.

Food plant.—Unknown.

62. *EUCOSMA FOFANA* Kearfott.

(Fig. 178.)

Eucosma fofana KEARFOTT, Trans. Amer. Ent. Soc., vol. 33, 1907, p. 28.—BARNES

and McDUNNOUGH Check List Lepid. Bor. Amer., no. 7004, 1917.

Eucosma annulata MEYRICK, Ent. Mo. Mag., vol. 48, 1912, p. 35.

Known only from the type. Very close to *dodana* Kearfott, if not merely an aberration of that species. The two forms are hardly separable.

Male genitalia figured from type.

Alar expanse.—21 mm.

Type.—In American Museum.

Type locality.—Berthoud Pass, Colorado.

Food plant.—Unknown.

63. *EUCOSMA INVICTA* (Walsingham).

(Fig. 192.)

Paedisca invicta WALSINGHAM, Trans. Ent. Soc. Lond., 1895, p. 509.

Eucosma invicta FERNALD, in Dyar List N. Amer. Lepid., no. 5157, 1903.—KEARFOTT, Trans. Amer. Ent. Soc., vol. 33, 1907, p. 33.—BARNES and McDUNNOUGH, Check List. Lepid. Bor. Amer., no. 7018, 1917.

Male genitalia figured from specimen in National Collection labeled "Colorado, Collection, Wm. Schaus."

Specimens in National Collection, American Museum, and collection Barnes from Colorado.

Alar expanse.—26–34 mm.

Type.—In British Museum.

Type locality.—Larima County, Colorado.

Food plant.—Unknown.

64. *EUCOSMA SUBINVICTA* Kearfott.

Eucosma subinvicta KEARFOTT, Trans. Amer. Ent. Soc., vol. 33, 1907, p. 33.—BARNES and McDUNNOUGH, Check List Lepid. Bor. Amer., no. 7019, 1917.

I believe this is only a race of *invicta*, but have seen no males. The type and the two specimens in the National Museum (all from Williams, Arizona) are females.

Alar expanse.—26–30 mm.

Type.—In American Museum.

Type locality.—Williams, Arizona.

Food plant.—Unknown.

65. *EUCOSMA SNYDERANA* Kearfott.

(Fig. 195.)

Eucosma snyderana KEARFOTT, Trans. Amer. Ent. Soc., vol. 33, 1907, p. 89.—BARNES and McDUNNOUGH, Check List Lepid. Bor. Amer., no. 7034, 1917.

Known only from the type.

Male genitalia of type figured.

Alar expanse.—28 mm.

Type.—In American Museum.

Type locality.—Blackfoot, Idaho.

Food plant.—Unknown.

66. *EUCOSMA EMACIATANA* (Walsingham).

(Fig. 193.)

Paedisca emaciatana WALSINGHAM, Trans. Ent. Soc. Lond., 1884, ^p. 137.*Eucosma emaciatana* FERNALD, in Dyar List N. Amer. Lepid., no. 5154, 1903.—

BARNES and McDUNNOUGH, Check List Lepid. Bor. Amer., no. 7042, 1917.

This species is one of a number in the genus that have very similar genitalia; but those with the same wing shape and similar pattern differ in genitalia structure. The termen of the fore wing in *emaciatana* is straight and decidedly slanting. There are two specimens in the National Museum from the material submitted by Doctor Barnes and other specimens in his collection which I determine as this species. Kearfott's specimen in the American Museum is not the same and I do not believe can be Walsingham's species, although Kearfott's specimen is from Arizona. In most cases, where there are any chances of mistake or where the species are at all obscure, his determinations of Walsingham's species are not to be relied on.

Male genitalia figured from specimen in National Collection collected at Eureka, Utah., by Tom Spalding ("vii-27-11").

Distribution according to specimens in National Collection and Collection Barnes: Eureka and Vineyard, Utah.

Alar expanse.—22 mm.

Type.—In British Museum.

Type locality.—Arizona.

Food plant.—Unknown.

67. *EUCOSMA TOTANA* Kearfott.

(Fig. 198.)

Eucosma totana KEARFOTT, Trans. Amer. Ent. Soc., vol. 33, 1907, p. 32.—BARNES and McDUNNOUGH, Check List Lepid. Bor. Amer., no. 6928, 1917.

Eucosma spodias MEYRICK, Ent. Mo. Mag., vol. 48, 1912, p. 35.

Very close to *emaciatana* Walsingham and with similar genitalia and markings, but obviously a distinct species. It differs in the following:

The palpi are much longer; the dustings and markings on fore wing are more distinct and ashy fuscous rather than faun brown; the apical costal dash is oppositely curved (in *emaciatana* it curves inward slightly from the apex and is distinctly faun brown). There is also a distinct cloud of dark scales over ocellus and a dusting of dark scales along vein 1c which are lacking in *emaciatana*. The termen of fore wing is slanting as in *emaciatana* but veins 3 and 4 are somewhat more bent and slightly more approximate at termen.

Kearfott's cotypes represent at least two different species, none of the paratypes apparently agreeing with the type. I have been able to match the latter with three males from Eureka, Utah. There is



THIS PAGE IS LOCKED TO FREE MEMBERS

Purchase full membership to immediately unlock this page



HISTORY

Tens of thousands of important historical sources, many previously unobtainable, are now available for the first time with a Forgotten Books Full Membership.

Unlimited Access
\$8.99/month

Continue

*Fair usage policy applies

Alar expanse.—12–14 mm.

Type.—In British Museum.

Type locality.—Texas.

Food plant.—Unknown.

70. *EUCOSMA LARANA* (Walsingham).

(Fig. 197.)

Paedisca larana WALSINGHAM, Illus. Lepid. Heter. Brit. Mus., vol. 4, 1879, p. 43.

Eucosma larana FERNALD, in Dyar List N. Amer. Lepid., no. 5087, 1903.—
BARNES and McDUNNOUGH, Check List Lepid. Bor. Amer., no. 6915, 1917.

Male genitalia figured from cotype in National Collection.

Specimens from Doctor Barnes' material in the National Collection and Collection Barnes I have also identified as this species. They are a trifle larger and the male genitalia are also somewhat larger. They may prove to be a different but very close species. For the present I am inclined to regard them as only a variety or race; collected at Vineyard, Utah ("Aug., 1912") by Tom Spalding. This species is chiefly distinguished from *emaciatana* and those that immediately follow it in this arrangement by the termen of the fore wing, which in *larana* is almost vertical rather than decidedly slanting.

Kearfott's specimens in the American Museum were not correctly determined.

Alar expanse—19–24 mm.

Type.—In British Museum.

Type locality.—Siskiyou County, California.

Food plant.—Unknown.

71. *EUCOSMA EXCLUSORIANA*, new species.

(Fig. 160.)

Sordid whitish overlaid with ochreous and ashy fuscous scales. Palpi white dusted with fuscous. Face clear white. Head yellowish. Fore wing with termen somewhat slanting, slightly concave; veins 3, 4 and 5 approximate at termen; in general appearance yellowish white, spotted and marked with ashy fuscous; the fuscous dustings forming a distinct spot in cell near base (indicating a basal patch in part), at end of cell a larger, more conspicuous spot, another in apical area over ocellus and a small triangular spot or dorsum before tornus, the latter rather obscure; costa strigulated with white and fuscous; two black streaks in ocellus; cilia heavily dusted with blackish fuscous. Hind wing pale, smoky fuscous, somewhat darker along outer margin; cilia white with a fuscous basal line. Legs white, dusted on outer sides

with fuscous; tibiae and tarsi strongly banded with fuscous. Anal tuft of female black.

Male genitalia of type figured.

Alar expanse.—14.5–16 mm.

Type.—Cat. No. 24809, U.S.N.M.

Paratypes in National Collection, American Museum and collection Barnes.

Type locality.—Cotulla, Texas.

Food plant.—Unknown.

Described from male type and three male paratypes from Cotulla, Texas, in the National Collection, and from one male and four female paratypes from San Antonio, Texas, in Kearfott's unworked material at the American Museum. The latter were set aside by Kearfott as a new species under the manuscript name "*atomosana* Fernald" and so mentioned in Transactions of the American Entomological Society (vol. 33, 1907, p. 23). In general appearance this and the following four species closely resemble each other. It is distinct, however, and easily recognized by its characteristic genitalia.

72. *EUCOSMA DAEMONICANA*, new species.

(Fig. 220.)

Like *exclusoriana* in color and markings, but termen of fore wing decidedly slanting with veins 3, 4, and 5 not approximate at termen, and face and palpi are whitish ochreous rather than distinctly white. The entire insect has a pale yellowish ochreous color and the white ground color is completely obscured except for a few costal dashes. From *occipitana* Zeller it is distinguished by its more pronounced spots of fuscous scales and from all the species of this immediate group by the male genitalia.

Male genitalia of type figured.

Alar expanse.—17 mm.

Type.—Cat. No. 24810 U.S.N.M.

Type locality.—Hell Canyon, New Mexico.

Food plant.—Unknown.

Described from a single male collected by the writer September 14, 1916, in Hell Canyon, Manzano National Forest, New Mexico.

73. *EUCOSMA OCCIPITANA* (Zeller).

(Fig. 226.)

Paedisca occipitana ZELLER, Verh. Zool.-bot. Ges. Wien., vol. 25, 1875, p. 315.

Eucosma occipitana FERNALD, in Dyar List N. Amer. Lepid., no. 5099, 1903.—

Not KEARFOTT, Can. Ent., vol. 37, 1905, p. 208.—BARNES and McDUNNOUGH, Check List Lepid. Bor. Amer., no. 6927, 1917.

This species is less distinctly marked than any of the others in this immediate group although the pattern is much the same. In the hind wing veins 3-4 are long stalked and occasionally united.

Male genitalia figured from specimen in National Collection from Mesilla, New Mexico (C. N. Ainslie).

Distribution according to specimens in National Collection, American Museum and Collection Barnes: Colorado, New Mexico (Mesilla), Kearfott's record from Manitoba¹⁴ is based on a misidentification. His specimens under this name being *Thiodia griseocapitana* Walsingham.

Alar expanse.—14-18 mm.

Type.—In British Museum.

Type locality.—Texas.

Food plant.—Unknown.

74. EUCOSMA REVERSANA Kearfott.

(Fig. 223.)

Eucosma reversana KEARFOTT, Trans. Amer. Ent. Soc., vol 33, 1907, p. 22.—
BARNES and McDUNNOUGH, Check List Lepid. Bor. Amer., no. 6942, 1917.

Very close to *shastana* Walsingham and *tahoensis* Heinrich but distinguished by characteristic genitalia and the distinct white spot in the cilia of the fore wing just below the apex. In this case also Kearfott's types are mixed. The paratype in the American Museum is my *exclusoriana*.

Male genitalia of type figured.

Distribution according to specimens in National Collection, American Museum, and collection Barnes: Texas, Arizona (Mohave County.)

Alar expanse.—17-20 mm.

Type.—In American Museum.

Type locality.—San Antonio, Texas.

Food plant.—Unknown.

75. EUCOSMA TAHOENSIS, new species.

(Fig. 230.)

Palpi, face and head ochreous-fuscous; palpi and head darker than face. Thorax fuscous with scattered whitish scales. Fore wing with termen slanting, not appreciably concave and with veins 3, 4, and 5, at most, only slightly approximate at termen; whitish marked with fuscous; a fuscous angulate basal patch, obscure towards costa; on dorsum before tornus another conspicuous fuscous patch extending into cell; over ocellus a cloud of fuscous scaling; along costa several narrow, short fuscous dashes interspaced with

¹⁴ Can. Ent., vol. 37, 1905, p. 208.



THIS PAGE IS LOCKED TO FREE MEMBERS
Purchase full membership to immediately unlock this page



Never be without a book!

Forgotten Books Full Membership gives universal access to 797,885 books from our apps and website, across all your devices: tablet, phone, e-reader, laptop and desktop computer

A library in your pocket for \$8.99/month

Continue

*Fair usage policy applies

78. *EUCOSMA GRANDIFLAVANA* (Walsingham).

(Fig. 191.)

Paedisca grandiflavana WALSINGHAM, Illus. Lepid. Heter. Brit. Mus., vol. 4, 1879, p. 47.

Eucosma grandiflavana FERNALD, in Dyar List N. Amer. Lepid., no. 5107, 1903.—
BARNES and McDUNNOUGH, Check List Lepid. Bor. Amer., no. 6907, 1917.

Male genitalia figured from specimen in National Collection from Deer Park Springs Lake, California.

Distribution according to specimens in National Collection, American Museum and collection Barnes: California, Nevada.

Alar expanse.—30–34 mm.

Type.—In British Museum.

Type locality.—Lake County, California.

Food plant.—Unknown.

79. *EUCOSMA HYPONOMEUTANA* (Walsingham).

Paedisca hyponomeutana WALSINGHAM, Trans. Ent. Soc. Lond., 1895, p. 502.

Eucosma hyponomeutana FERNALD, in Dyar List N. Amer. Lepid., no. 5156, 1903.—BARNES and McDUNNOUGH, Check List Lepid. Bor. Amer., no. 7044, 1917.

A striking species unlike anything else in the Olethreutidae. I have not been able to examine the genitalia but have little doubt of the generic position. The species appears to be rare. There is a single male (without abdomen) from Colorado in the American Museum and a female from Colorado ("Dyar and Caudell, Coll. no. 17883") in the National Collection.

Alar expanse.—26–30 mm.

Type.—In British Museum.

Type locality.—Loveland, Colorado.

Food plant.—Unknown.

80. *EUCOSMA GIGANTEANA* (Riley).

(Fig. 143.)

Paedisca giganteana RILEY, Trans. St. Louis Acad. Sci., vol. 4, 1881, p. 318.—
WALSINGHAM, Trans. Ent. Soc. Lond., 1884, p. 139.

Eucosma giganteana FERNALD, in Dyar List N. Amer. Lepid., no. 5101, 1903.—
KEARFOTT, Proc. U. S. Nat. Mus., vol. 28, 1905, p. 354.—BARNES and McDUNNOUGH, Check List Lepid. Bor. Amer., no. 7021, 1917.

Riley's type material is in the National Collection and consists of three females rather than two as stated in his description. One of these from Wisconsin (Barlow) and not mentioned in his description is labeled in his own handwriting "*Paedisca giganteana* Riley, Type."

Male genitalia figured from specimen in National Collection from Tryon, North Carolina (Fiske, Coll.)

Distribution according to specimens in National Collection, American Museum and collection Barnes: Missouri, Kansas, Arkansas, Illinois, North Carolina, Florida.

The National Collection has also received larvae from Mr. A. K. Wyatt, of Chicago, Illinois, who informs us that the species feeds in the roots of *Silphium perfoliatum*.

Alar expanse.—25–40 mm.

Type.—In National Collection.

Type locality.—Missouri.

Food plant.—*Silphium perfoliatum*.

81. EUCOSMA BIPUNCTELLA (Walker).

(Fig. 142.)

Affa bipunctella WALKER, Cat. Lepid. Heter. Brit. Mus., vol. 27, 1863, p. 202.

Paedisca worthingtoniana FERNALD, Can. Ent., vol. 10, 1878, p. 83.

Paedisca bipunctella WALSINGHAM, Illus. Lepid. Heter. Brit. Mus., vol. 4, 1879, p. 47.

Eucosma bipunctella FERNALD, in Dyar List N. Amer. Lepid., no. 5106, 1903.—

BARNES and McDUNNOUGH, Check List Lepid. Bor. Amer., no. 7022, 1917.

Male genitalia figured from specimens in National Collection from Chicago, Illinois, reared by A. K. Wyatt, "VIII-8-14," from larvae feeding in the roots of *Silphium laciniata*.

Distribution according to specimens in National Collection, American Museum, and collection Barnes: Kansas, Illinois.

Alar expanse.—32–43 mm.

Types.—In British Museum (*bipunctella*); in collection Fernald (*worthingtoniana*).

Type localities.—"———" (*bipunctella*); north Illinois (*worthingtoniana*).

Food plant.—*Silphium laciniata*.

82. EUCOSMA BILINEANA Kearfott.

(Fig. 145.)

Eucosma bilineana KEARFOTT, Can. Ent., vol. 39, 1907, p. 54.—BARNES and McDUNNOUGH, Check List Lepid. Bor. Amer., no. 7039, 1917.

This is a rather variable species, some of the specimens showing little or nothing of the longitudinal black streaks so characteristic of normal specimens.

Male genitalia figured from cotype in National Collection from west Manitoba ("Hanham, July").

Distribution according to specimens in National Collection, American Museum, and collection Barnes: Manitoba, Utah, Colorado, Iowa, Illinois.

Alar expanse.—24–32 mm.

Type.—In American Museum.

Type locality.—Illinois.

Food plant.—Unknown.

83. *EUCOSMA DENVERANA* Kearfott.

(Fig. 183.)

Eucosma denverana KEARFOTT, Can. Ent., vol. 39, 1907, p. 77.—BARNES and McDUNNOUGH, Check List Lepid. Bor. Amer., no. 6935, 1917.

Male genitalia figured from cotype in National Collection.

Specimens in National Collection, American Museum, and collection Barnes all from Denver, Colorado.

Alar expanse.—24–28 mm.

Type.—In American Museum.

Type locality.—Denver, Colorado.

Food plant.—Unknown.

84. *EUCOSMA FUSCOPARSA* (Walsingham).

(Fig. 218.)

Paedisca fuscosparsa WALSINGHAM, Trans. Ent. Soc. Lond., 1895, p. 507.

Eucosma fuscosparsa FERNALD, in Dyar List N. Amer. Lepid., no. 5155, 1903.—BARNES and McDUNNOUGH, Check List Lepid. Bor. Amer., no. 7043, 1917.

Male genitalia figured from specimen in National Collection from Colorado.

Specimens from Colorado in National Collection, American Museum, and collection Barnes.

Alar expanse.—20–28 mm.

Type.—In British Museum.

Type locality.—Loveland, Colorado.

Food plant.—Unknown.

85. *EUCOSMA MEDIOSTRIATA* (Walsingham).

(Fig. 245.)

Paedisca mediotriata WALSINGHAM, Trans. Ent. Soc. Lond., 1895, p. 508.

Eucosma mediotriata FERNALD, in Dyar List N. Amer. Lepid., no. 5158, 1917.—BARNES and McDUNNOUGH, Check List Lepid. Bor. Amer., no. 7046, 1917.

A variable species in color and markings, ranging from a form in which the fore wings are a dull brown marked along the veins with white to a form with the fore wings a clear pale buckskin yellow practically without markings. The genitalia of these, however, show no significant variations.

Male genitalia figured from typical specimen in National Collection from Colorado ("2576").

Distribution according to specimens in National Collection, American Museum, and collection Barnes: Colorado, Utah, Idaho, Nevada.

Alar expanse.—17–26 mm.

Type.—In British Museum.

Type locality.—Loveland, Colorado.

Food plant.—Unknown.



THIS PAGE IS LOCKED TO FREE MEMBERS

Purchase full membership to immediately unlock this page



HISTORY

Tens of thousands of important historical sources, many previously unobtainable, are now available for the first time with a Forgotten Books Full Membership.

Unlimited Access
\$8.99/month

Continue

*Fair usage policy applies

Alar expanse.—26–30 mm.

Type.—In collection Barnes.

Paratypes.—Cat. No. 24813, U.S.N.M.; also in American Museum and collection Barnes.

Type locality.—Silverton, Colorado.

Food plant.—Unknown.

Described from male type and three male paratypes from Doctor Barnes' collection labeled "Silverton, Colorado," "July 16–23" (type and paratype), "July 24–31" (one paratype), and "Aug. 1–7" (one paratype); and from one male paratype from the American Museum collection labeled "Durango, Colorado."

An easily recognized species, in superficial appearance somewhat resembling a *Bactra*.

88. *EUCOSMA BIPLAGATA* (Walsingham).

(Fig. 174.)

Paedisca biplagata WALSINGHAM, Trans. Ent. Soc. Lond., 1895, p. 507.

Eucosma biplagata FERNALD, in Dyar List N. Amer. Lepid., no. 5148, 1903.—

BARNES and McDUNNOUGH, Check List Lepid. Bor. Amer., no. 7023, 1917.

Male genitalia figured from specimen in National Collection from Pullman, Washington ("23–July–98, C. V. Piper").

Distribution according to specimens in National Collection, American Museum and collection Barnes: Washington, Colorado.

Alar expanse.—24–26 mm.

Type.—In British Museum.

Type locality.—Loveland, Colorado.

Food plant.—Unknown.

89. *EUCOSMA PRIMULANA* (Walsingham).

(Fig. 171.)

Paedisca primulana WALSINGHAM, Illus. Lepid. Heter. Brit Mus., vol. 4, 1879, p. 45.

Eucosma primulana FERNALD, in Dyar List N. Amer. Lepid., no. 5095, 1903.—

BARNES and McDUNNOUGH, Check List Lepid. Bor. Amer., no. 7024, 1917.

Male genitalia figured from specimens in National Collection from Sonoma County, California ("A. H. Vachell, May 10–25").

Specimens in National Collection, American Museum and Collection Barnes from Sonoma County, California.

Alar expanse.—15–20 mm.

Type.—In British Museum.

Type locality.—Mendocino County, California.

Food plant.—Unknown.

90. EUCOSMA GOMONANA Kearfott.

(Fig. 149.)

Eucosma gomonana KEARFOTT, Can. Ent., vol. 39, 1907, p. 78.—BARNES and McDUNNOUGH, Check List Lepid. Bor. Amer., no. 6998, 1917.

Eucosma discipula MEYRICK, Ent. Mo. Mag., vol. 48, 1912, p. 35.

A small species different from anything else in the genus.

Male genitalia figured from specimen in National Collection from Plummer Island, Maryland ("Apr., 1909, August Busck").

Distribution according to specimens in National Collection, American Museum and Collection Barnes: New Jersey, Maryland, Virginia, District of Columbia.

Alar expanse.—8–11 mm.

Type.—In American Museum.

Type locality.—Essex County Park, New Jersey.

Food plant.—Unknown.

91. EUCOSMA DILATANA (Walsingham).

Paedisca dilatana WALSINGHAM, Trans. Ent. Soc. Lond., 1895, p. 510.

Eucosma dilatana FERNALD, in Dyar List N. Amer. Lepid., no. 5153, 1903.—

BARNES and McDUNNOUGH, Check List Lepid. Bor. Amer., no. 7041, 1917.

I have seen only two specimens of this species, a female in Doctor Barnes's collection labeled "Wilgus, Cochise County, Arizona," and a female in the Kearfott collection at the American Museum from the Baboquavaria Mountains, Arizona.

It is very like *nandana* Kearfott but much paler.

Alar expanse.—26 mm.

Type.—In British Museum.

Type locality.—Arizona.

Food plant.—Unknown.

92. EUCOSMA NANDANA Kearfott.

(Fig. 211.)

Eucosma nandana KEARFOTT, Trans. Amer. Ent. Soc., vol. 33, 1907, p. 17.—

BARNES and McDUNNOUGH, Check List Lepid. Bor. Amer., no. 6944, 1917.

Eucosma chersaea MEYRICK, Ent. Mo. Mag., vol. 48, 1912, p. 34.

Close to *dilatana* Walsingham.

Male genitalia figured from specimen in National Collection from Chicago, Illinois ("IX, 8–16, A. K. Wiatt").

Distribution according to specimens in National Collection, American Museum, and collection Barnes: Manitoba, Illinois, Iowa, North Carolina.

Alar expanse.—25–30 mm.

Type.—In American Museum.

Type locality.—Rounthwaite, Manitoba.

Food plant.—Unknown.

93. *EUCOSMA LANDANA* Kearfott.

Eucosma landana KEARFOTT, Trans. Amer. Ent. Soc., vol. 33, 1907, p. 18.—

BARNES and MCDUNNOUGH, Check List Lepid. Bor. Amer., no. 7007, 1917.

Eucosma isospora MEYRICK, Ent. Mo. Mag., vol. 48, 1912, p. 34.

This species is represented in the collections only by females, so the generic reference can not be made with absolute certainty. I have little doubt, however, that it belongs in *Eucosma*. It is unique and not easily confused with any other species.

Distribution according to specimens in National Collection, American Museum and collection Barnes: Manitoba, Saskatchewan, Iowa.

Alar expanse.—23–27 mm.

Type.—In American Museum.

Type locality.—Rounthwaite, Manitoba.

Food plant.—Unknown.

94. *EUCOSMA DORSISIGNATANA* (Clemens).

(Fig. 180.)

Poecilochroma ? dorsisignatana CLEMENS, Proc. Acad. Nat. Sci. Phila., 1860, p. 353.

Carpocapsa distigmata WALKER, Cat. Lepid. Heter. Brit. Mus., vol. 28, 1863, p. 394.

Paedisca clavata ZELLER, Verh. Zool.-bot. Ges. Wien., vol. 25, 1875, p. 303.

Paedisca dorsisignatana FERNALD, Syn. Cat. Tort. N. Amer. (Trans. Amer. Ent. Soc., vol. 10, 1882), no. 290, 1882.—WALSINGHAM, Trans. Ent. Soc. Lond., 1884, p. 140.

Eucosma dorsisignatana FERNALD, in Dyar List N. Amer. Lepid., no. 5144, 1903.—KEARFOTT, Proc. U. S. Nat. Mus., vol. 28, 1905, p. 355; Can. Ent., vol. 37, 1905, p. 208; Journ. New York Ent. Soc., vol. 16, 1908, p. 169.—BARNES and MCDUNNOUGH, Check List Lepid. Bor. Amer., no. 7029, 1917.

If *similana* Clemens (*confluana* Kearfott), *diffusana* Kearfott, and *engelana* Kearfott can be retained as good species or even varieties, which I doubt, the synonymy will be restricted as above.

Male genitalia figured from typical specimen in National Collection.

Distribution according to specimens in National Collection, American Museum, and collection Barnes: Manitoba, British Columbia, Kansas, Maryland, Virginia, District of Columbia, North Carolina, Quebec, New Hampshire, New York, New Jersey, Colorado.

Alar expanse.—17–22 mm.

Types.—Lost ? (*dorsisignatana*); British Museum (*distigmata*); British Museum ? (*clavata*).

Type localities.—Pennsylvania ? (*dorsisignatana*); "North America" (*distigmata*); Ohio (*clavata*).

Food plant.—*Solidago* (larva a root borer according to Kellicott).



THIS PAGE IS LOCKED TO FREE MEMBERS

Purchase full membership to immediately unlock this page



Never be without a book!

Forgotten Books Full Membership gives universal access to 797,885 books from our apps and website, across all your devices: tablet, phone, e-reader, laptop and desktop computer

A library in your pocket for \$8.99/month

Continue

*Fair usage policy applies

Alar expanse.—18–21 mm.

Types.—Lost ? (*similana*); in American Museum (*confluana*).

Type localities.—Pennsylvania ? (*similana*); Montclair, New Jersey (*confluana*).

Food plant.—Unknown.

97. *EUCOSMA DORSISIGNATANA ENGELANA* Kearfott.

(Fig. 170.)

Eucosma engelana KEARFOTT, Journ. New York Ent. Soc., vol. 16, 1908, p. 169.—

BARNES and McDUNNOUGH, Check List Lepid. Bor. Amer., no. 6978, 1917.

I have seen only the type in New York. The latter is so rubbed that no markings are left. It appears to be only a pale, runted specimen of *similana* Clemens.

Male genitalia figured from type.

Alar expanse.—14–17 mm.

Type.—In American Museum.

Type locality.—Pittsburgh, Pennsylvania.

Food plant.—Unknown.

98. *EUCOSMA GRADUATANA* (Walsingham).

Paedisca graduatana WALSINGHAM, Illus. Lepid. Heter. Brit. Mus., vol. 4, 1879, p. 54.

Paedisca dorsisignatana FERNALD, Syn. Cat. Tort. N. Amer., no. 290, 1882.

Eucosma dorsisignatana FERNALD, in Dyar List N. Amer. Lepid., no. 5144, 1903.—BARNES and McDUNNOUGH, Check List Lepid. Bor. Amer., no. 7029, 1917.

Eucosma graduatana KEARFOTT, Can. Ent., vol. 37, 1905, p. 208.

Kearfott is very likely correct in removing this species from the synonymy. His two specimens in the American Museum of Natural History (a male without abdomen and a female) agree with Walsingham's figure and are easily separable from *dorsisignatana* and its varieties by the rust-red color of the hind wings.

I have seen no other representatives of this species. Kearfott's specimens are from Aweme, Manitoba.

Alar expanse.—17 mm.

Type.—In British Museum.

Type locality.—Texas.

Food plant.—Unknown.

99. *EUCOSMA JUNCTICILIANA* (Walsingham).

(Fig. 155.)

Rhyacionia juncticiliana WALSINGHAM, Illus. Lepid. Heter. Brit. Mus., vol. 4, 1879, p. 75.

Eucosma juncticiliana FERNALD, in Dyar List N. Amer. Lepid., no. 5121, 1903.—KEARFOTT, Proc. U. S. Nat. Mus., vol. 28, 1905, p. 354; Can. Ent., vol. 37, 1905, p. 209.—BARNES and McDUNNOUGH, Check List Lepid. Bor. Amer., no. 6967, 1917.

I have seen no specimens of this species from the Shasta region or any other California locality. In the Kearfott collection there is a male labeled "Named by Walsingham," but it bears no locality label. It differs in a number of slight details of genitalia structure from what we have been calling *juncticiliana*, and if the specimen is from the type locality, the Rocky Mountain and eastern form should be differentiated as a local race. For the present we may assume that the common form represented in our collections is the true *juncticiliana*.

Male genitalia figured from specimen in National Collection from Tryon, North Carolina ("Fiske, 8-13-14").

Distribution according to specimens in National Collection, American Museum, and collection Barnes: Massachusetts, Maryland, Pennsylvania, New Jersey, North Carolina, Florida, Colorado, Washington, Manitoba, Ontario.

Alar expanse.—14–20 mm.

Type.—In British Museum.

Type locality.—Shasta County, California.

Food plant.—*Solidago*.

100. *EUCOSMA EXCUSABILIS*, new species.

(Fig. 158.)

Very like *juncticiliana* Walsingham, from which it only differs in genitalia structure and the color of its palpi and head. The differences in the shape of the harpes are easily seen in the figures. Walsingham's species has the cucullus much narrower and the costal angle of the cucullus much sharper than *excusabilis*. The latter also has a more rounded, more constricted incurvation of the neck of the harpe and a finer tufting of spines in the arch of the neck of harpe than *juncticiliana*. Both species have the same pattern and, except for the difference noted, the same color scheme. If anything, *excusabilis* is a trifle the darker of the two.

Male genitalia of type figured.

Alar expanse.—20 mm.

Type.—In collection Barnes.

Paratypes.—Cat. No. 24814 U.S.N.M., also in American Museum.

Type locality.—Deer Park Springs, Lake Tahoe, California.

Food plant.—Unknown.

Described from three males from the Barnes collection, all from the type locality. At first I took them to be only a form of *juncticiliana*, but the genitalia show that they represent a distinct species.

101. EUCOSMA EUMAEA Meyrick.

(Fig. 159.)

Eucosma wandana KEARFOTT, Trans. Amer. Ent. Soc., vol. 33, 1907 p. 24.—

BARNES and McDUNNOUGH, Check List Lepid. Bor. Amer., no. 6950, 1917.

Eucosma eumaea MEYRICK, Ent. Mo. Mag., vol. 48, 1912, p. 34.

In this instance we are able to use one of Meyrick's substitutes for the Kearfott "nonsense names," as *wandana* is a homonym of *vandana* Kearfott, the only difference in the two being a substitution of the letter *w* for *v*. In Latin or Latinized words these represent the same symbol.

Male genitalia figured from type which is the only authentic specimen of the species I have seen.

Alar expanse.—17 mm.*Type*.—In American Museum.*Type locality*.—Cincinnati, Ohio.*Food plant*.—Unknown.

102. EUCOSMA MANDANA Kearfott.

(Fig. 168.)

Eucosma mandana KEARFOTT, Trans. Amer. Ent. Soc., vol. 33, 1907, p. 17.—

BARNES and McDUNNOUGH, Check List Lepid. Bor. Amer., no. 6914, 1917.

Eucosma amanda MEYRICK, Ent. Mo. Mag., vol. 48, 1912, p. 34.

Male genitalia figured from cotype in National Collection from Plummers' Island, Maryland (August Busck, July, 1903).

Distribution according to specimens in National Collection, American Museum, and collection Barnes: New Jersey, Maryland, District of Columbia, Texas.

Alar expanse.—17–19 mm.*Type*.—In American Museum.*Type locality*.—Washington, District of Columbia.*Food plant*.—Unknown.

103. EUCOSMA FULMINANA (Walsingham).

(Fig. 176.)

Paedisca fulminana WALSINGHAM, Illus. Lepid. Heter. Brit. Mus., vol. 4, 1879, p. 50.*Eucosma fulminana* FERNALD, in Dyar List N. Amer. Lepid., no. 5104, 1903.—

BARNES and McDUNNOUGH, Check List Lepid. Bor. Amer., no. 6937, 1917.

Male genitalia figured from specimen in National Collection from Iowa.

Distribution according to specimens in National collection, American Museum, and collection Barnes: Iowa, Illinois, Wisconsin, Kansas.



THIS PAGE IS LOCKED TO FREE MEMBERS

Purchase full membership to immediately unlock this page



HISTORY

Tens of thousands of important historical sources, many previously unobtainable, are now available for the first time with a Forgotten Books Full Membership.

Unlimited Access
\$8.99/month

Continue

*Fair usage policy applies

Type.—Cat. No. 24815, U.S.N.M.

Type locality.—Eastern shore of Mobile Bay, Alabama.

Food plant.—*Chrysoma pauciflosculosa*.

Described from male type and female paratype reared October 3, 1920, by George P. Englehardt at Brooklyn, N. Y., "from root cuttings of *Chrysoma (Solidago) pauciflosculosa* collected by Dr. Thomas van Aller, of Mobile, Alabama, during September (1920) near Daphne, Baldwin County, Alabama, along the eastern shore of Mobile Bay in sand along the beach. The larvae attacks the rootstock, boring in tortuous channels from the base of the plantstalk downwards. The galleries are packed tightly with powdery frass. At time of pupation it constructs a circular tube one or two inches long, out of minute plant chips and silk, either within the gallery or adjacent thereto along the rootstalk. When received during September the rootstocks contained two pupae and a number of larvae in various stages of growth."

To Mr. Englehardt we are indebted for the above note.

106. *EUCOSMA SOMBREANA* Kearfott.

(Fig. 151.)

Eucosma sombreana KEARFOTT, Proc. U. S. Nat. Mus., vol. 28, 1905, p. 357.—

BARNES and MCDUNNOUGH, Check List Lepid Bor. Amer., no. 7036, 1917.

Eucosma phlaeodes MEYRICK, Exot. Microlepid. vol. 2, pt. 2, 1920, p. 344.

This species is slightly variable in color, but at that Kearfott has mixed two species among his cotypes. Two females in the National Museum and one in the American Museum are quite different from his type.

Mr. George P. Englehardt who has reared the species has furnished the following note on its habits: "Adults, July–August. Larvae, September–November, borers, in *Helianthus giganteus* and *H. tuberosus*, beginning at basal part of plant stalk, downward into rootstock and later into the tubers. Frass and slimy exudence indicate places of attack. At maturity, late October or early November, the larvae leave foodplant, tunnel through the soil to within about one inch below surface and hibernate within a tough, oval cocoon, flattened at the upper end to seal a horizontal slit. Pupation does not take place until late June or early July. Pupal state about two weeks."

Male genitalia from typical specimen in National Collection from Ocone, Illinois ("Aug. 16").

Distribution: North Carolina, New York, Maryland, Pennsylvania, Illinois, Missouri, Ohio, New Jersey, Connecticut, Arkansas, Manitoba.

Alar expanse.—19–27 mm.

Type.—In American Museum.

Type locality.—Tryon, North Carolina.

Food plants.—*Helianthus giganteus* and *H. tuberosus*.

107. EUCOSMA PANDANA Kearfott.

(Fig. 153.)

Eucosma pandana KEARFOTT, Trans. Amer. Ent. Soc., vol. 33, 1907, p. 17.—

BARNES and McDUNNOUGH, Check List Lepid. Bor. Amer., no. 6943, 1917.

Eucosma sardiopa MEYRICK, Ent. Mo. Mag., vol. 48, 1912, p. 34.

Among his cotypes Kearfott has two distinct species. Only the Texan specimens are the true *pandana*. The cotypes from Wilgus, Arizona (a female in the American Museum and a male in the National Collection) are only a grey variety of *corosana* Walsingham.

Male genitalia figured from typical specimen in National Collection from Kerrville, Texas.

Specimens in National Collection, American Museum and collection Barnes from Texas.

Alar expanse.—23–28 mm.

Type.—In American Museum.

Type locality.—Kerrville, Texas.

Food plant.—Unknown.

108. EUCOSMA FISKEANA Kearfott.

(Fig. 152.)

Eucosma fiskeana KEARFOTT, Proc. U. S. Nat. Mus., vol. 28, 1905, p. 358.—BARNES and McDUNNOUGH, Check List Lepid. Bor. Amer., no. 7035, 1917.

Male genitalia figured from cotype in National Collection from Tryon, North Carolina.

Distribution according to specimens in National Collection, American Museum and collection Barnes: North Carolina, Virginia, Illinois.

Alar expanse.—20–29 mm.

Type.—In American Museum.

Type locality.—Tryon, North Carolina.

Food plant.—Unknown.

109. EUCOSMA COROSANA (Walsingham).

(Fig. 219.)

Paedisca corosana WALSINGHAM, Trans. Ent. Soc. Lond., 1884, p. 139.

Eucosma corosana FERNALD, in Dyar List N. Amer. Lepid., no. 5152, 1903.—

KEARFOTT, Can. Ent., vol. 37, 1905, p. 209.—BARNES and McDUNNOUGH, Check List Lepid. Bor. Amer., no. 7040, 1917.

Male genitalia figured from specimen in National Collection from Colorado ("Dyar and Caudell, 17882").

Distribution according to specimens in National Collection, American Museum and collection Barnes: Arizona, Colorado, Utah. The

National Collection also contains specimens from Venadio, Sinaloa, Mexico.

Alar expanse.—18–21 mm.

Type.—In British Museum.

Type locality.—Montana.

Food plant.—Unknown.

110. *EUCOSMA PULVERATANA* (Walsingham).

(Fig. 238.)

Paedisca pulveratana WALSINGHAM, Illus. Lepid. Heter. Brit. Mus., vol. 4, 1879, p. 45; Trans. Ent. Soc. Lond., 1884, p. 140.

Eucosma pulveratana FERNALD, in Dyar List N. Amer. Lepid., no. 5122, 1903.—BARNES and MCDUNNOUGH, Check List Lepid. Bor. Amer., no. 6968, 1917.

Appears to be a somewhat variable species.

Cotype in National Collection.

Male genitalia figured from typical specimen from San Diego, California ("7-31-07, W. S. Wright").

Distributed according to specimens in National Collection, American Museum and collection Barnes: Claremont, San Diego, San Francisco, Los Angeles, and Loma Linda, California. In the National Museum we also have a few specimens from Mexico City, Mexico, recently received from Señor Roberto Müller. This species until now has not been recorded from Mexico.

Alar expanse.—15–19 mm.

Type.—In British Museum.

Type locality.—San Francisco, California.

Food plant.—Unknown.

111. *EUCOSMA CONSOBRINANA*, new species.

(Fig. 242.)

Like *pulveratana* Walsingham, of which it may prove to be a variety. It is smaller, however, and has considerably smaller genitalia. The termen of fore wing is slightly concave, not so slanting as in *pulveratana* and veins 3, 4, and 5 are appreciably approximate at termen. In *pulveratana* (especially in the male) veins 3, 4, and 5 are more nearly parallel and the termen of fore wing is not concave. The markings are the same in both species except that to the naked eye *consobrinana* has a cloud of fuscous scaling near termen below apex, which is not so noticeable in *pulveratana*. Color dirty grayish white with grayish fuscous markings.

Male genitalia of type figured.

Alar expanse.—11–14 mm.

Type.—Cat. No. 24816, U.S.N.M.

Paratypes.—In National Collection, American Museum, and collection Barnes.



THIS PAGE IS LOCKED TO FREE MEMBERS
Purchase full membership to immediately unlock this page



Never be without a book!

Forgotten Books Full Membership gives universal access to 797,885 books from our apps and website, across all your devices: tablet, phone, e-reader, laptop and desktop computer

A library in your pocket for \$8.99/month

Continue

*Fair usage policy applies

Alar expanse.—22 mm.

Type.—In British Museum.

Type locality.—Pitt River, Shasta County, California.

Food plant.—Unknown.

115. *EUCOSMA PALOUSANA* Kearfott.

(Fig. 222.)

Eucosma palousana KEARFOTT, Trans. Amer. Ent. Soc., vol. 33, 1907, p. 34.—
BARNES and MCDUNNOUGH, Check List Lepid. Bor. Amer., no. 6940, 1917.

Kearfott has two species among his cotypes representing two different genera. The California specimens are the same as *Sonia filiana* Busck, as are also the specimens determined by Kearfott as *Eucosma shastana* Walsingham. The type of *palousana*, however, (a male from Pullman, Washington) is a true *Eucosma* with veins 7 and 8 of fore wing both present and separate. One of his cotypes ("Pullman, Washington, 10 Aug., '98, Wash. Exp. Sta. #533, C. V. Piper") in the National Collection is conspecific with the type.

There are also in the National Collection two other female specimens from Pullman, Washington.

It is possible that *palousana* may be a synonym or local race of *biquadrana* Walsingham, but this can not be ascertained in the absence of an authentic male of Walsingham's species.

Male genitalia of type figured.

Alar expanse.—20 mm.

Type.—In American Museum.

Type locality.—Pullman, Washington.

Food plant.—Unknown.

116. *EUCOSMA SUADANA*, new species.

(Fig. 243.)

Palpus white, slightly clouded with fuscous on tuft of second joint. Face and head white. Thorax white somewhat marked with fuscous. Fore wing with a short appressed fold in the male; termen slanting, not concave; veins 3, 4, and 5 not appreciably approximate at termen; white marked with dark fuscous; on dorsum beyond base and before middle a conspicuous outwardly curved fuscous patch reaching to top of cell; another broadly triangular fuscous spot on dorsum beyond middle; along costa several five geminate fuscous dashes; also near middle of costa a square fuscous patch; from costa just beyond apical third a more or less triangular spot extending in a curved, somewhat irregular and variously expanded fuscous band running to tornus around outer margin of ocellus; between this and apex a small but rather conspicuous triangular fuscous spot; another somewhat larger spot at apex; at end of cell an obscure fuscous spot; white areas somewhat streaked and spotted with

fuscous, but the white ground color nowise obscured thereby; ocellus only faintly marked with scattered fuscous or blackish scales; cilia fuscous, the tips of the scales white; hind wing smoky fuscous; cilia pale fuscous, with a darker basal line and the tips of the scales white. Fore and middle legs fuscous with scaling at ends of joints whitish; hind legs dirty white *not* appreciably banded or shaded with fuscous.

Male genitalia of type figured.

Alar expanse.—18–22 mm.

Type.—Cat. No. 24817, U.S.N.M.

Paratypes.—In National Collection, American Museum, and collection Barnes.

Type locality.—Vineyard, Utah.

Food plant.—Unknown.

Described from male type and two male and four female paratypes all from Vineyard, Utah, Tom Spalding, collector (one specimen dated "VII-6-12"; two dated "VII-8-12"; three, "VII-10-12"; and one, "VII-14-12"). Part of these were from the unplaced material in the National Museum and the rest from Doctor Barnes' collection.

I have described this species with considerable hesitation and some doubt. It may prove to be a local race of *palousana* Kearfott. All the specimens of *palousana* I have seen are old and more ochreous than fuscous colored in the dark areas. The whitish parts of fore wing also have a yellowish tint entirely lacking in *suadana*. The white head and the dark fuscous rather than ferruginous spots on fore wing exclude *suadana* from *biquadrana* Walsingham which it also approaches closely.

117. EUCOSMA CANANA (Walsingham).

Paedisca canana WALSINGHAM, Illus. Lepid. Heter. Brit. Mus., vol. 4, 1879, p. 50; Trans. Ent. Soc. Lond., 1884, p. 139.

Eucosma canana FERNALD, in Dyar List N. Amer. Lepid., no. 5115, 1903.—
BARNES and MCDUNNOUGH, Check List Lepid. Bor. Amer., no. 6951, 1917.

There is a female paratype in the National Collection. I have seen no other specimens. It is distinguished from the other species in this immediate group by the pure white cilia of the fore wing. Walsingham described it from California, but also records a specimen from Arizona.¹⁵

Alar expanse.—19 mm.

Type.—In British Museum.

Type localities.—"Mendocino and Lake Counties, California.

Food plant.—Unknown.

¹⁵ Trans. Ent. Soc. Lond., 1884, p. 139.

118. *EUCOSMA EXPOLITANA*, new species.

(Fig. 249.)

In pattern like *suadana* Heinrich but with a more washed-out appearance, the white areas of fore wing more sordid and the fuscous spots and markings paler and less sharply defined. The entire insect has a rubbed over appearance as if the pattern had been partially erased. The curved fuscous line from beyond outer third of costa to tornus so prominent in *suadana* is either broken in *expolitana* or else narrow and obscure. In genitalia it equals *rorana* Kearfott, but differs in lacking a completed fascia on fore wing beyond middle, the head is more whitish and the insect generally lacks the rusty appearance of Kearfott's species. The last joint of the labial palpus is black in both forms.

Male genitalia of type figured.

Alar expanse.—16–20 mm.

Type.—Cat. No. 24818 U.S.N.M.

Paratypes.—In National Collection, American Museum, and collection Barnes.

Type locality.—Provo, Utah.

Food plant.—Unknown.

Described from male type ("labeled, Provo, Utah, Tom Spalding, VIII-11-8") and four male and two female paratypes from Provo, Utah (Aug. 4 to 20), and two male and one female paratypes from Eureka, Utah ("VII-8-11," "VII-24-11," "VIII-15-11"), all collected by Tom Spalding.

These paratypes have been selected from a large series in the National Museum and Barnes's collections. There is also a specimen of the same species in the National Collection from Arizona.

This species may prove on rearing to be nothing but a variety of *rorana*. The genitalia are the same in both. In large series of *expolitana*, however, there is so little variety in pattern that I do not feel justified in lumping them with *rorana*. In general appearance the two appear quite distinct.

119. *EUCOSMA RORANA* Kearfott.

(Fig. 252.)

Eucosma rorana KEARFOTT, Trans. Amer. Ent. Soc., vol. 33, 1907, p. 31.—BARNES and McDUNNOUGH, Check List Lepid. Bor. Amer., no. 6931, 1917.

Eucosma sceletopa MEYRICK, Ent. Mo. Mag., vol. 48, 1912, p. 35.

Male genitalia figured from cotype in National Collection from the type locality.

Distribution according to specimens in National Collection, American Museum, and collection Barnes: Stockton and Vineyard, Utah.



THIS PAGE IS LOCKED TO FREE MEMBERS

Purchase full membership to immediately unlock this page



HISTORY

Tens of thousands of important historical sources, many previously unobtainable, are now available for the first time with a Forgotten Books Full Membership.

Unlimited Access
\$8.99/month

Continue

*Fair usage policy applies

122. *EUCOSMA ZOMONANA* Kearfott.

(Fig. 250.)

Eucosma zomonana KEARFOTT, Can. Ent., vol. 39, 1907, p. 80.—BARNES and MCDONNOUGH, Check List Lepid. Bor. Amer., no. 6973, 1917.

Eucosma explosa MEYBICK, Ent. Mo. Mag., vol. 48, 1912, p. 36.

Looks like an eastern form of *passerana*. Has the head ashy gray, the dorsal marks on fore wing blackish brown and the outer dorsal mark slanting decidedly toward cell.

Male genitalia figured from specimen in National Collection from Plummer Island, Maryland (June, 1906, August Busck, collector).

Distribution according to specimens in National Collection, American Museum, and collection Barnes: Missouri, Illinois, Tennessee, Pennsylvania, Maryland, District of Columbia.

Alar expanse.—11–15 mm.

Type.—In American Museum.

Type locality.—New Brighton, Pennsylvania.

Food plant.—Unknown.

123. *EUCOSMA WOMONANA* Kearfott.

(Fig. 244.)

Eucosma womonana KEARFOTT, Trans. Amer. Ent. Soc., vol. 33, 1907, p. 88.—

BARNES and MCDONNOUGH, Check List Lepid. Bor. Amer., no. 6941, 1917.

Eucosma semnitis MEYRICK, Ent. Mo. Mag., vol. 48, 1912, p. 35.

Another eastern representative of the *passerana* group. Closest to *vandana* and probably only a more northern variety of that species.

Male genitalia figured from type.

Distribution according to specimens in National Collection and American Museum: Ohio, Maryland, Texas.

Alar expanse.—15 mm.

Type.—In American Museum.

Type locality.—Cincinnati, Ohio.

Food plant.—Unknown.

124. *EUCOSMA VANDANA* Kearfott.

(Fig. 246.)

Eucosma vandana KEARFOTT, Trans. Amer. Soc., vol. 33, 1907, p. 24.—BARNES and MCDONNOUGH, Check List Lepid. Bor. Amer., no. 6946, 1917.

Eucosma pholas MEYBICK, Ent. Mo. Mag., vol. 48, 1912, p. 34.

A Florida species like *passerana*, but with white areas of fore wing entirely obscured by dark fuscous markings, the only pale part being in the ocellar area. The characteristic dorsal patches are also obscured in the general brown color. Head ashy fuscous.

Male genitalia figured from typical specimen in National Collection.

All specimens in National Collection, American Museum, and collection Barnes from Hastings, Florida.

Alar expanse.—12–16 mm.

Type.—In American Museum.

Type locality.—Hastings, Florida.

Food plant.—Unknown.

125. *EUCOSMA CATACLYSTIANA* (Walker).

(Figs. 5, 156.)

Paedisca cataclystiana WALKER, Cat. Lepid. Heter. Brit. Mus., vol. 28, 1863, p. 378.—WALSINGHAM, Illus. Lepid. Heter. Brit. Mus., vol. 4, 1879, p. 46.

Steganoptycha ? ochreana CLEMENS, Proc. Ent. Soc. Phila., vol. 3, 1864, p. 520.

Eucosma cataclystiana FERNALD, in Dyar List N. Amer. Lepid., no. 5096, 1903.—KEARFOTT, Proc. U. S. Nat. Mus., vol. 28, 1905, p. 353.—BARNES and McDUNNOUGH, Check List Lepid. Bor. Amer., no. 6924, 1917.

A common and well-known species in the eastern United States, readily recognized by its reddish ochreous color and peculiar venation. It is the only species in the country with reddish ochreous head, thorax, antenna, and fore wing, in which veins 3 and 4 of fore wing fuse before reaching termen. The apex of the fore wing is acutely produced and the termen distinctly concave.

Male genitalia figured from specimen in National Collection from Kentucky ("August Busck, Aug.").

Distribution according to specimens in National Collection, American Museum and collection Barnes: Kentucky, Kansas, Colorado, Manitoba, New Mexico, North Carolina, Virginia, Maryland, District of Columbia, New Jersey, Illinois, New York, Massachusetts, Pennsylvania. The National Collection also contains a single specimen (male) from Mexico City, Mexico, collected by Senor Roberto Müller. This Mexican record is new.

Alar expanse.—12–19 mm.

Types.—In British Museum (*cataclystiana*); Academy Natural Science, Philadelphia (*ochreana*).

Type localities.—"North America" (*cataclystiana*); Virginia (*ochreana*).

Food plant.—Unknown.

126. *EUCOSMA CONSPICIENDANA*, new species.

(Fig. 157.)

Antennae, head, thorax, and fore wings reddish ochreous. Wing pattern and markings as in *cataclystiana*, except that the lines from costa near apex are finer, and white rather than silvery. The apex of fore wing is acutely produced and termen is concave, but appreci-

ably less so than in *cataclystiana*; also veins 3 and 4 are approximate at termen and not fused as in *cataclystiana*.

Male genitalia of type figured.

Alar expanse.—17–18 mm.

Type.—In American Museum.

Paratypes.—Cat. No. 24820 U.S.N.M.; also in American Museum and Collection Barnes.

Type locality.—Stockton, Utah.

Food plant.—Unknown.

Described from male type and female paratype from Stockton, Utah (Tom Spalding, Collector, "VII-4-4" and "VI-27-4"), one male paratype from Loma Linda, San Bernardino County, California, one male paratype from Eureka, Utah ("Tom Spalding, V-31-10"), and one male paratype from St. Ignatius, Montana.

A very distinct species, as shown by the male genitalia.

127. EUCOSMA FLORIDANA Kearfott.

(Fig. 147.)

Eucosma floridana KEARFOTT, Trans. Amer. Ent. Soc., vol. 33, 1907, p. 21.—
BARNES and MCDUNNOUGH, Check List Lepid. Bor. Amer., no. 6912, 1917.

This species also has veins 3 and 4 of fore wing fusing before termen; but is distinguished by its white head and pale clay colored thorax. There are also a few scattered silver spots on the reddish yellow fore wings.

Male genitalia figured from cotype in National Collection.

Cotypes in National Collection, American Museum, and collection Barnes, all from Hastings, Florida.

Alar expanse.—18–22 mm.

Type.—In American Museum.

Type locality.—Hastings, Florida.

Food plant.—Unknown.

9. Genus EPIBLEMA Hübner.

Genotype.—*Phalæna Tinea foenella* Linnaeus (fig. 19).

Synonyms.—1. *Apotomis* Hübner. *Genotype*.—*Apotomis turbidana* Hübner.

2. *Pardia* Guenée. *Genotype*.—*Tortrix tripunctana* Denis and Schiffmüller.

3. *Notocebia* Hübner. *Genotype*.—*Phalaena Tortrix uddmanniana* Linnaeus.

4. *Grapholitha* Treitschke, part (*Cocochroea* Lederer). *Genotype*.—*Paedisca grandaevana* Zeller.

5. *Monosphragis* Clemens. *Genotype*.—*Monosphragis otiosana* Clemens.



THIS PAGE IS LOCKED TO FREE MEMBERS
Purchase full membership to immediately unlock this page



Never be without a book!

Forgotten Books Full Membership gives universal access to 797,885 books from our apps and website, across all your devices: tablet, phone, e-reader, laptop and desktop computer

A library in your pocket for \$8.99/month

Continue

*Fair usage policy applies

13. Second joint of palpus clothed with long scales which extend far beyond and cover terminal joint----- (21) *hirsutana*.
Second joint of palpus not so clothed; terminal joint exposed.
(22) *purpurissatana*.
14. Male with costal fold extending more than half the length of the wing---15
Male with fold not extending beyond middle of costa-----16
15. Fore wing sordid pinkish white with bluish fuscous markings; termen and cilia of same from apex to above tornus blue black; dark basal patch outwardly angulate----- (18) *obfusca*.
Fore wing white marked and mottled with black, red-brown and leaden scales; termen from apex to above tornus margined with red-brown; dark basal patch with outer margin crenulate----- (20) *carolinana*.
16. Fore wing unicolorous, bright ochreous----- (10) *ochraceana*.
Fore wing not unicolorous; if so, not bright ochreous-----17
17. Fore wing with a white median area, blackish fuscous basal patch, a grayish fuscous suffusion over outer third and a distinct round black spot at lower outer angle of cell----- (15) *scudderiana*.
Fore wing pattern otherwise-----18
18. Fore wing with ground color ashy gray-white suffused with darker gray and with definite dark fuscous-gray basal and outer dorsal patches but these not well contrasted against ground color----- (13) *exacerbaticana*.
Fore wing with ground color other than ashy-gray white; or if so colored, without basal and outer dorsal patches or with these strongly contrasted against ground color-----19
19. Fore wing with pale ground color and well contrasted dark basal patch and dark patch on outer dorsal margin; head black, dark fuscous, or ochreous fuscous-----20
No such basal and dorsal patches on fore wing; or, if latter are present, head white or whitish ochreous-----24
20. Basal patch and dark markings on fore wings dark slate gray or bluish fuscous-----22
Dark markings pale brown or ferruginous-----21
21. Dark markings on fore wing pale brown, spotted with black scaling; pale areas mottled with lead-colored scales giving a marbled appearance to the fore wing----- (25) *suffusana*.
Dark markings on fore wing ferruginous, at least toward termen where there is a well defined, inwardly curved ferruginous band_ (28) *culminana*.
22. Hind wing whitish----- (27) *illotana*.
Hind wing brown or smoky fuscous-----23
23. Pale areas of fore wing somewhat pinkish----- (19) *desertana*.
Pale areas of fore wing pale whitish gray----- (17) *discretivana*.
24. Terminal joint of palpus black and antenna with a sharply contrasted black spot on second joint-----27
Terminal joint of palpus not black and antenna without such black spot on second joint-----25
25. Ground color of fore wing whitish or pale yellow; distinct basal and outer dorsal dark patches-----26
Ground color of fore wing ochreous-fuscous or brownish gray; ocelloid patch white and a white germinate dash on costa near apex; no other contrasted markings----- (3) *strenuana*.
26. Ocelloid patch and median pale area of fore wing yellowish---- (11) *sosana*.
Ocelloid patch and median pale area of fore wing whitish-- (12) *insidiosana*.

27. Ground color of fore wing pale sordid ochreous or ochreous fuscous.....28
 Ground color grayish white or ashy gray.....29
28. Ground color ochreous fuscous.....(4) *abruptana*.
 Ground color pale sordid ochreous somewhat clouded with grayish fuscous
 and with a grayish fuscous patch in cell near base.....(5) *numerosana*.
29. Basal patch on fore wing indicated by its outer blackish fuscous margin.
 (6) *grossbecki*.
 Fore wing without any such indication of a basal patch.....30
30. Ground color of fore wing ashy gray, rather dark.....(9) *deflexana*.
 Ground color of fore wing grayish white, very pale.....31
31. A conspicuous dot on fore wing over vein 1c, one-third from base.
 (7) *praesumptiosa*.
 No such brown dot on fore wing.....(8) var. *separationis*.

1. *EPIBLEMA BOXCANA* (Kearfott).

(Fig. 254.)

Eucosma boxcana KEARFOTT, Trans. Amer. Ent. Soc., vol. 33, 1907, p. 87.—

BARNES and McDUNNOUGH, Check List Lepid. Bor. Amer., no. 6975, 1917.

Eucosma aspista MEYRICK, Ent. Mo. Mag., vol. 48, 1912, p. 35.

There appear to be two species or at least two distinct forms among the cotypes of this species. The typical *boxcana* has a distinct black patch on dorsum of fore wing just before tornus and bordering the mid-dorsal white spot, also a blackish shade to basal patch. It belongs in the *strenuana* group and is very close to that species but distinct.

Male genitalia figured from cotype in National Collection, from Kerrville, Texas.

Distribution according to specimens (typical) in National Collection, American Museum, and collection Barnes; Ohio, Texas, Illinois, New Jersey.

Alar expanse.—14–18 mm.*Type*.—In American Museum.*Type locality*.—Cincinnati, Ohio.*Food plant*.—Unknown.2. *EPIBLEMA SERANGIAS* (Meyrick).

(Fig. 256.)

Eucosma vomonana KEARFOTT, Trans. Amer. Ent. Soc., vol. 33, 1907, p. 90.—

BARNES and McDUNNOUGH, Check List Lepid. Bor. Amer., no. 6997, 1917.

Eucosma serangias MEYRICK, Ent. Mo. Mag., vol. 48, 1912, p. 35.

In this case we are again able to use a Meyrick substitute for one of Kearfott's "nonsense" names, as *vomonana* is preoccupied by *womonana* Kearfott, the synonymous letters *v* and *w* being the only difference between the two.

This species is distinguished from the others of the *strenuana* group by the lack of any ocellus in the fore wing.

Male genitalia figured from type.

Specimens in National Collection, American Museum, and collection Barnes from Placer County, California.

Alar expanse.—15–17 mm.

Type.—In American Museum.

Type locality.—Cisco, Placer County, California.

Food plant.—Unknown.

3. EPIBLEMA STRENUANA (Walker).

(Figs. 257, 258.)

Grapholita strenuana WALKER, Cat. Lepid. Heter. Brit. Mus., vol. 28, 1863, p. 383.

Grapholita exvagana WALKER, Cat. Lepid. Heter. Brit. Mus., vol. 28, 1863, p. 383.

Steganoptycha flavocellana CLEMENS, Proc. Ent. Soc. Phila., vol. 5, 1865, p. 138.

Grapholitha subversana ZELLER, Verh. Zool.-bot. Ges. Wien, vol. 25, 1875, p. 318.

Paedisca strenuana WALSINGHAM, Illus. Lepid. Heter. Brit. Mus., vol. 4, 1879, p. 52; Trans. Ent. Soc. Lond., 1884, p. 140.

Eucosma strenuana FERNALD, in Dyar List N. Amer. Lepid., no. 5129, 1903.—

BARNES and McDUNNOUGH, Check List Lepid. Bor. Amer., no. 6981, 1917.

Eucosma minutana KEARFOTT, Proc. U. S. Nat. Mus., vol. 28, 1905, p. 356.—

BARNES and McDUNNOUGH, Check List Lepid. Bor. Amer., no. 6982, 1917.

Eucosma antaxia MEYRICK, Exot. Microlepid., vol. 2, pt. 2, 1920, p. 344.

This is the most variable species of the genus both in color and structure. On the differences in shape and size of the harpes one would be inclined to divide it into at least six species. None of the forms can be maintained, however, even as a race, as all possible variations are to be found in any rearing from a given locality. Kearfott's *minutana* is the most distinct on color; but it is not constant and in color and structure grades into the typical dark *strenuana* form. In all specimens the chitinization of the subanal plate of the gnathos is the same and a constant character. The size and minor differences of the harpes, however, can not be used to separate this species even from those of the *numerosana* group. The latter also have a constant character in the subanal plate of the gnathos. This structure is nearly square in *numerosana*, and its allies while in *strenuana* it approaches the hour-glass shape.

Male genitalia figured from specimens in National Collection from San Diego, California (fig. 257) and Palm Beach, Florida (fig. 258). These show the two extremes in genitalia structure. The former is the more nearly typical.

Distribution according to specimens in National Collection, American Museum and collection Barnes: California, Utah, Colorado, Missouri, Texas, Arkansas, Tennessee, Ohio, West Virginia, Florida, North Carolina, Virginia, Maryland, District of Columbia, Pennsylvania, New York, New Jersey, Connecticut, Illinois.

Alar expanse.—10–19 mm.



THIS PAGE IS LOCKED TO FREE MEMBERS

Purchase full membership to immediately unlock this page



HISTORY

Tens of thousands of important historical sources, many previously unobtainable, are now available for the first time with a Forgotten Books Full Membership.

Unlimited Access
\$8.99/month

Continue

*Fair usage policy applies

the same stout, broad, almost triangular aedoeagus, the same well separated socii, the same hood like, round, reduced uncus and the same squarish chitinization of the subanal plate of the gnathos; in color marking they agree in all having a blue black second antennal joint, a black terminal joint of palpus and a round black spot on the outer side of second joint of palpus. They vary greatly in the ground color and pattern of fore wings and in size and shape of the harpes.

I have split the complex and grouped the forms under district names upon the same logic that prompted the lumpings under *strenuana*, namely to prevent confusion. The *strenuana* and *numerosana* groups are very close but have constant and obvious characters to separate them. Now with the *strenuana* forms we know they are all one species for all their varieties have been produced from a single rearing from a single locality (District of Columbia). With the *numerosana* complex on the other hand we have only a strong suspicion of specific identity. They have not been reared. When they are I expect we shall find them all one species. Until then however, I think it best to keep the different forms under separate names. They can always be lumped and in the mean time no harm is done by the synonymy.

Male genitalia figured from specimen in National Collection from Kerrville, Texas.

Distribution according to specimens in National Collection, American Museum, and collection Barnes: Texas, Arkansas, and Louisiana.

Alar expanse.—15–19 mm.

Type.—In Museum Comparative Zoology.

Type locality.—Dallas, Texas.

Food plant.—Unknown.

6. *EPIBLEMA GROSSBECKI*, new species.

(Fig. 261.)

Like *numerosana* except: Head and thorax more whitish. Fore wing very pale gray; costa of the gray ground color finely and evenly strigulated from base to apex with fuscous; an outwardly angulate basal patch indicated only by a narrow fascia of blackish fuscous scales on its outer margin; on dorsum bordering the inner margin of ocellus a narrow band of blackish fuscous scaling; joining this a faint, narrow, more or less continuous line of blackish fuscous scales from middle of costa; a distinct blackish fuscous spot at apex; above and at outer margin of white ocellar spot some streaking of blackish scales; cilia white dusted with pale fuscous giving an even light gray color to the fringe.

Male genitalia of type figured.

Alar expanse.—13–20 mm.

Type.—In American Museum.

Paratypes.—Cat. No. 24821 U.S.N.M.; also in American Museum and collection Barnes.

Type locality.—Everglades, Florida (April, 1912).

Food plant.—Unknown.

Described from male type and 9 male and 4 female paratypes from Everglades, Florida, and five male paratypes from Fort Myer, Florida, all from the Kearfott collection in the American Museum. Kearfott had set this aside as a new species and given it the manuscript name *grossbecki*, which I take pleasure in validating. I believe that it will eventually prove to be a synonym or at most a Florida race of *numerosana*, but for the present it is better to name it as a distinct species.

7. *EPIBLEMA PRAESUMPTIOSA*, new species.

(Fig. 262.)

Palpi, face, head, and antennae white; third joint of palpus and second joint of antenna black; a spot of bluish fuscous scaling on outer side of second joint of palpus. Thorax and fore wing white faintly and evenly dusted with pale fuscous giving the entire insect a uniformly grayish white appearance; costa of fore wing evenly strigulated with pale fuscous; near apex a short but conspicuous triangular white dash; at apex a pale fuscous spot; over vein 1c, one-third from base, a conspicuous brown spot; a smaller fainter brown spot on inner margin of ocellus; ocellus white with a central black dot and a similar black dot at upper margin; cilia concolorous with wing. Hind wings concolorous with fore wings; cilia slightly paler. Legs white dusted with pale fuscous on outer sides.

Male genitalia of type figured.

Alar expanse.—14–17 mm.

Type.—Cat. No. 24822 U.S.N.M.

Paratypes.—In National Collection, American Museum, and collection Barnes.

Type locality.—Brownsville, Texas.

Food plant.—Unknown.

Described from male type and five female paratypes collected at Brownsville, Texas, by August Busck ("5-27-17").

On genitalia hardly distinguishable from *numeroana* and *abruptana*, but superficially quite distinct.

8. *EPIBLEMA PRAESUMPTIOSA SEPARATIONIS*, new variety.

(Fig. 265.)

Like *praesumptiosa*, except much smaller and without the brown spots on vein 1c and at inner margin of ocellus. The genitalia also differs in having the cucullus of the harpe more rounded.

Male genitalia of type figured.

Alar expanse.—9–11 mm.

Type.—Cat. No. 24823 U.S.N.M.

Paratypes.—National Collection, American Museum, and collection Barnes.

Type locality.—Brownsville, Texas.

Food plant.—Unknown.

Described from male type and two male and two female paratypes from Brownsville, Texas, collected by August Busck ("5-27-17").

Looks like a runted *praesumptiosa*, except for the harpes of the male genitalia.

9. *EPIBLEMA DEFLEXANA*, new species.

(Fig. 266.)

A pale grayish fuscous (or ashy gray) form like the paler *strenuana* specimens (*minutana* Kearfott), except for black terminal joint of palpus and black second joint of antenna. Head and face sordid white. Hind wings pale smoky fuscous. Tarsi of legs strongly marked with dark fuscous on outer sides. Male genitalia as in *abruptana* Walsingham, but with cucullus of harpe much reduced.

Male genitalia of type figured.

Alar expanse.—12.5 mm.

Type.—Cat. No. 24824 U.S.N.M.

Type locality.—Brownsville, Texas.

Food plant.—Unknown.

Described from male type and male paratype from Brownsville, Texas, collected by August Busck ("5-27-17").

Probably an extreme form of *abruptana* Walsingham and like that and the three other new forms here described, but a variation of *numerosana* Zeller. If any are to be kept distinct, however, this form also requires separation.

10. *EPIBLEMA OCHRACEANA* Fernald.

(Fig. 268.)

Epiblema ochraceana FERNALD Journ. New York Ent. Soc., vol. 9, 1901, p. 51.

Eucosma ochraceana FERNALD, in Dyar List N. Amer. Lepid., no. 5097, 1903.—

BARNES and McDONNOUGH, Check List Lepid. Bor. Amer. no. 6925, 1917.

A distinct species, like *strenuana* in genitalia, but easily distinguished by its uniformly bright ochreous color.

Male genitalia from specimen in National Collection, from Palm Beach, Florida.

Specimens in National Collection, from Palm Beach, Florida.

Alar expanse.—12 mm.

Type.—In National Collection.

Type locality.—Palm Beach, Florida.

Food plant.—Unknown.



THIS PAGE IS LOCKED TO FREE MEMBERS
Purchase full membership to immediately unlock this page



Never be without a book!

Forgotten Books Full Membership gives universal access to 797,885 books from our apps and website, across all your devices: tablet, phone, e-reader, laptop and desktop computer

A library in your pocket for \$8.99/month

Continue

*Fair usage policy applies

13. *EPIBLEMA EXACERBATRICANA*, new species.

(Fig. 264.)

Like *insidiosana* Heinrich except darker and with fore wings narrower in proportion to their length. Palpi, face, and head sordid grayish white tinged with ochreous; third joint of palpus black. Fore wing ashy gray white with darker fuscous gray basal patch, outer dorsal patch, costal strigulae and clouding above ocelloid patch; ocellus consisting of two vertical bars of whitish semi-metallic scaling (sometimes faintly tinted with pink) and a median dark spot or streak breaking into the outer bar; cilia whitish, heavily dusted with fuscous gray. Hind wing dark smoky fuscous; cilia a trifle paler with dark basal band. Legs ashy fuscous on outer sides faintly ringed on tibiae and tarsi with ochreous white; sordid ochreous white on inner sides.

Male genitalia of type figured.

Alar expanse.—11–13 mm.

Type.—In collection Barnes.

Paratypes.—Cat. No. 24826, U.S.N.M. Also in American Museum and collection Barnes.

Type locality.—Southern Pines, North Carolina.

Food plant.—Unknown.

Described from male type and 14 male and 4 female paratypes from Southern Pines, North Carolina ("Aug. 16–23" to "Sept. 16–23"), all from Doctor Barnes's collection. On genitalia and pattern appears to be a distinct species close to *insidiosana*.

14. *EPIBLEMA TRIPARTITANA* (Zeller).

(Fig. 270.)

Paedisca tripartitana ZELLER, Verh. Zool-bot. Ges. Wien., vol. 25, 1875, p. 308.

Eucosma tripartitana FERNALD, in Dyar List N. Amer. Lepid., no. 5141, 1903.—

BARNES and McDUNNOUGH, Check List Lepid. Bor. Amer., no. 7025, 1917.

A distinct species, easily recognized by the characters given in the key.

Male genitalia figured from specimen in National Collection from Cocoanut Grove, Florida (E. A. Schwarz).

Distribution according to specimens in National Collection, American Museum and collection Barnes: Florida and Texas. One specimen in the American Museum from Brownsville, Texas, labeled as reared from *Rudbeckia*; presumably this species but too badly rubbed to allow of certain identification.

Alar expanse.—14–21 mm.

Type.—In Museum Comparative Zoology.

Type locality.—Dallas, Texas.

Food plant.—"Gutierrezia microcephala" (Zeller); *Rudbeckia*, larva an inquilin in Cecidomyid galls (Wm. T. Davis).

15. *EPIBLEMA SCUDDERIANA* (Clemens).

(Fig. 271.)

Hedya scudderiana CLEMENS, Proc. Acad. Nat. Sci. Phila., 1860, p. 358.*Euryptychia saligneana* CLEMENS, Proc. Ent. Soc. Phila., vol. 5, 1865, p. 141.*Paedisca affusana* ZELLER, Verh. Zool-bot. Ges. Wien, vol. 25, 1875, p. 307.*Paedisca scudderiana* KELLICOTT, Can. Ent., vol. 14, 1882, p. 161.—WALSINGHAM, Trans. Ent. Soc. Lond., 1884, p. 140.*Eucosma scudderiana* FERNALD, in Dyar List N. Amer. Lepid., no. 5139, 1903.—KEARFOTT, Proc. U. S. Nat. Mus., vol. 28, 1905, p. 354; Can. Ent., vol. 37, 1905, p. 208.—BARNES and McDUNNOUGH, Check List Lepid. Bor. Amer., no. 7014, 1917.

A common and well known species. The larva is a stem borer and gall maker in golden rod.

Male genitalia figure from reared specimen in National Collection from Boston, Massachusetts ("May, 1908").

Distribution according to specimens in National Collection, American Museum, and collection Barnes: Massachusetts, New York, New Jersey, Pennsylvania, Ohio, Illinois, Wisconsin, North Carolina, Indiana, Iowa, Manitoba, Ontario.

Alar expanse.—15–21 mm.

Types.—In Academy National Science, Philadelphia (*scudderiana*); ———? (*saligneana*); ———? (*affusana*).

Type localities.—Massachusetts (*scudderiana*); Rock Island, Illinois (*scudderiana*) "North America" (*affusana*).

Food plant.—*Solidago*.

16. *EPIBLEMA KENNEBECANA* (Kearfott).

(Fig. 272.)

Epinotia kennebecana KEARFOTT, Can. Ent., vol. 39, 1907, p. 157.*Enarmonia kennebecana* BARNES and McDUNNOUGH, Check List Lepid. Bor. Amer., no. 7164, 1917.

A small apparently distinct species, known to me only from the type. It looks like a small *scudderiana* except that the basal patch of fore wing is outwardly angulate and that neither the mid dorsal nor the ocelloid white patches extend to costa.

Male genitalia figured from type.

Alar expanse.—13 mm.

Type.—In American Museum.

Type locality.—Kennebunk Port, Maine.

Food plant.—Unknown.

17. *EPIBLEMA DISCRETIVANA* (Heinrich).

(Fig. 273.)

Eucosma discretivana HEINRICH, Journ. Agr. Res., vol. 20, 1921, p. 823.

Male genitalia figured from type.

A reared series (type and paratypes) in National Collection from Texas.

Alar expanse.—13–16 mm.

Type.—In National Collection.

Type locality.—Sheldon, Texas.

Food plant.—"Wild myrtle."

18. *EPIBLEMA OBFUSCANA* (Dyar).

(Fig. 274.)

Paedisca obfuscata RILEY, Proc. Ent. Soc. Wash., vol. 1, 1888, p. 33.

Eucosma obfuscana DYAR, List N. Amer. Lepid., nos. 5140–1, 1903.—KEARFOTT, Bull. Amer. Mus. Nat. Hist., vol. 23, 1907, p. 157.—BARNES and McDUNNOUGH, Check List Lepid. Bor. Amer., no. 7016, 1917.

The naming of this species will have to be credited to Dyar, as the few remarks of Riley's in the Proceedings of the Washington Entomologist Society can not possibly be construed as a description. The species is quite distinct from both *scudderiana* and *desertana*. From the latter, which it most closely resembles, it is at once separated by the uncus of the male genitalia as well as the less obvious color character given in our key.

The larva is a stem borer in golden-rod.

Male genitalia figured from specimen in National Collection from Ames, Iowa ("Osborn, 5-30-81").

Distribution according to specimens in National Collection, American Museum, and collection Barnes: Iowa, District of Columbia, Wisconsin, Pennsylvania, Virginia, North Carolina, New York.

Alar expanse.—15–21 mm.

Type.—In National Collection.

Type locality.—District of Columbia.

Food plant.—*Solidago*.

19. *EPIBLEMA DESERTANA* (Zeller).

(Fig. 275.)

Paedisca desertana ZELLER, Verh. Zool-bot. Ges. Wien, vol. 25, 1875, p. 306.

Eucosma desertana FERNALD, in Dyar List. N. Amer. Lepid., no. 5140, 1903.—BARNES and McDUNNOUGH, Check List Lepid. Bor. Amer., no. 7015, 1917.

The larva of this species is also a stem gall maker in golden-rod. Male genitalia figured from specimen in National Collection from Wellington, Kansas.

Distribution according to specimens in National Collection, American Museum, and collection Barnes: New York, New Jersey, Pennsylvania, Maryland, Virginia, Texas, Florida, Kansas.

Alar expanse.—11–18 mm.

Type.—In Museum Comparative Zoology.

Type locality.—Dallas, Texas.

Food plant.—*Solidago*.



THIS PAGE IS LOCKED TO FREE MEMBERS

Purchase full membership to immediately unlock this page



HISTORY

Tens of thousands of important historical sources, many previously unobtainable, are now available for the first time with a Forgotten Books Full Membership.

Unlimited Access
\$8.99/month

Continue

*Fair usage policy applies

outer angle of the mid dorsal white patch a streak of white extending to end of cell and ending in an upcurved white dash; three or four obscure dirty white dashes on apical third of costa; ocellus consisting of a shining broad bluish metallic inner bar and a narrower outer bar of the same color enclosing three more or less coalescing black streaks; areas bordering ocellus above and behind heavily dusted with black; a fine black line along terminal margin; cilia dirty ochreous white shading to blackish fuscous at tips. Hind wing dark smoky brown; cilia pale with a dark basal band.

Male genitalia of type figured.

Alar expanse.—10.5–11.5 mm.

Type.—In Canadian National Collection.

Paratype.—Cat. No. 24827, U.S.N.M.

Type locality.—Vernon, British Columbia.

Food plant.—Wild rose.

Described from male type and female paratype received from Dr. J. M. McDunnough and labeled: "Vernon, B. C., from wild roses, V-20."

This species is apparently very close to *hirsutana* Walsingham. I suspected it of being that form; but Walsingham states clearly that *hirsutana* has the second joint of palpus clothed with long scales which project far beyond the apical joint. In *purpurissatana* the scales are rather short and the third joint exposed. Superficially it most resembles *Epinothia heucherana* Heinrich, with which it might easily be confused. Its genitalia are, however, typically Epiblemid.

23. EPIBLEMA WALSHINGAMI (Kearfott).

(Fig. 278.)

Enarmonia walsinghami KEARFOTT, Trans. Amer. Ent. Soc., vol. 33, 1907, p. 57.

Laspeyresia walsinghami BARNES and MCDUNNOUGH, Check List Lepid. Bor. Amer., no. 7245, 1917.

Kearfott's cotypes represent two species of *Epiblema*. The true *walsinghami* is a broad winged dark form with a triangular mid-dorsal white patch on fore wing and superficially looks like a *Laspeyresia* resembling *L. americana* Walsingham from which Kearfott distinguished it. The Tryon, North Carolina, specimens from the National Museum were divided by Kearfott, one of those he labelled (incorrectly) *L. americana*, and two he included among his cotypes of *walsinghami*. They are true *Epiblema*, but quite distinct on genitalia and other characters from *walsinghami*, and of course do not at all answer to *americana*, which is a true *Laspeyresia*.

Male genitalia figured from typical specimen in National Collection from Oak Station, Pennsylvania ("V-13-16").

Distinction according to specimens in National Collection, American Museum, and Collection Barnes: New Jersey, Pennsylvania, Florida.

Alar expanse.—14.5–16 mm.

Type.—In American Museum.

Type locality.—Essex County, New Jersey.

Food plant.—Unknown.

24. *EPIBLEMA INFELIX*, new species.

(Fig. 276.)

Head, thorax and fore wings brownish ochreous. Fore wing with termen slightly concave; veins 3, 4, and 5 somewhat approximate at termen; a rather large irregularly square white patch on mid dorsum marked with one or two short fuscous dashes or dots on dorsal margin; outer half of costa marked with four pair of short white dashes which are continued in bluish metallic scales, the metallic scaling shading a large part of outer third of wing; ocellus consisting of two vertical bars of bluish metallic scales, the inner one very broad, and a vertical central line of black scales, which broadens into an outwardly pointed pot hook above; a patch or two of black scales on inner margin of ocellus; termen brown; cilia brownish fuscous with a darker basal line. Hind wing dark brown; cilia but slightly paler.

Male genitalia of type figured.

Alar expanse.—18–21 mm.

Type.—Cat. No. 24828, U.S.N.M.

Paratypes.—In National Collection, American Museum, and collection Barnes.

Type locality.—Tryon, North Carolina.

Food plant.—Unknown

Described from male type and one male and one female paratype from Tryon, North Carolina (the type dated "5-25-'04" and the paratypes dated "7-5-04"), Fiske, collector.

The type had been labeled *Enarmonia americana* Walsingham by Kearfott and the female paratype had been made a cotype of (*Enarmonia*) *Epiblema walsinghami* Kearfott. The cotype of *walsinghami* from Tryon, North Carolina, in the American Museum is also this species, but as it is somewhat aberrant I do not include it among my paratypes. The mid dorsal white spot on fore wing is sharply triangular, as in *walsinghami*, and the dark color approaches that of *walsinghami* a little more than it does *infelix*. Its genitalia and venation, however, are those of the latter, and I have no doubt it is that species. It is not *walsinghami*.

The distinguishing characters separating the two species, in addition to genitalia differences, are as follows:

In *walsinghami* the head and thorax is blue black, the apical third of fore wing is much darker and the metallic markings less obvious; vein 2 of fore wing is not bent upward, and vein 3, 4, and 5 are well separated at termen; in the hind wing vein 5 is rather well separated from 4 at base, not far enough, however, to justify its being confused with the *Laspeyresiinae*. In *infelix* vein 5 of hind wing is closely approximate to 4 at base; 3 and 4 are longer stalked; vein 2 of fore wing is bent up; the termen is more concave; 3, 4, and 5 are slightly approximate at termen; the apical third of fore wing is browner, the metallic scaling more obvious, and the head brown. In all specimens, except the somewhat aberrant one in New York, the face is too rubbed to be sure of its color. The latter has a white face. In *walsinghami* the face is blackish fuscous. The two species must be very close to *hirsutana* Walsingham.

25. *EPIBLEMA SUFFUSANA* (Zeller).

(Fig. 279.)

Penthina suffusana ZELLER, Isis, 1846, p. 211.

Notocelia suffusana STAUDINGER and REBEL, Cat. Lepid., vol. 2, no. 2060, 1901.

Eucosma suffusana KEARFOOT, Ins. of N. J., 1910, p. 541.—BARNES and McDUNNOUGH, Check List Lepid. Bor. Amer., no. 6957, 1919.

This introduced European insect is to be found in a few of our Eastern localities. Its only known food plant in this country is Rose, the larva attacking the buds and young leaves. In Europe it is recorded from *Prunus*, *Pyrus*, and *Crataegus*.

Male genitalia figured from specimen in National Collection from Oak Station, Pennsylvania ("Fred Marloff, vii-1-12").

Distribution according to specimens in National Collection, American Museum, and collection Barnes: New Jersey, Pennsylvania, Maryland.

Alar expanse.—16–19 mm.

Type in collection.—Unknown.

Type locality.—North Germany.

Food plant.—Rose.

26. *EPIBLEMA DORSISUFFUSANA* (Kearfott).

(Fig. 280.)

Eucosma dorsisuffusana KEARFOTT, Jour. New York Ent. Soc., vol. 16, 1908, p. 167.—BARNES and McDUNNOUGH, Check List Lepid. Bor. Amer., no. 7017, 1917.

This species is easily recognized by the dark fuscous ground color and the white dorsal area of fore wing, the latter formed by the confluence of the median dorsal and ocelloid patches.

Male genitalia figured from type.



THIS PAGE IS LOCKED TO FREE MEMBERS
Purchase full membership to immediately unlock this page



Never be without a book!

Forgotten Books Full Membership gives universal access to 797,885 books from our apps and website, across all your devices: tablet, phone, e-reader, laptop and desktop computer

A library in your pocket for \$8.99/month

Continue

*Fair usage policy applies

29. EPIBLEMA OTIOSANA (Clemens).

(Fig. 283.)

Monosphragis otiosana CLEMENS, Proc. Acad. Nat. Sci. Phila., 1860, p. 354.*Paedisca inclinana* ZELLER, Verh. Zool.-bot. Ges. Wien., vol. 25, 1875, p. 301.*Paedisca otiosana* WALSINGHAM, Trans. Ent. Soc. Lond., 1884, p. 140.*Eucosma otiosana* FERNALD, in Dyar List N. Amer. Lepid., no. 5142, 1903.—

KEARFOTT, Proc. U. S. Nat. Mus., vol. 28, 1905, p. 355.—BARNES and McDUNNOUGH, Check List Lepid. Bor. Amer., no. 7062, 1917.

A very variable species as to size of individual specimens but rather constant in pattern. It has been confused somewhat with *constrictana* Zeller, but the latter is generically distinct. The larva is a stem borer in various weeds.

Male genitalia figured from specimen in National Collection from Tryon, North Carolina ("Fiske, 6-30-'04").

Distribution according to specimens in National Collection, American Museum, and collection Barnes: Missouri, Kansas, Ohio, Illinois, Arkansas, Florida, Maryland, North Carolina, Tennessee, District of Columbia, Pennsylvania, New Jersey, New York, Massachusetts.

Alar expanse.—12–20 mm.

Types.—In Academy Natural Science Philadelphia (*otiosana*); Museum Comparative Zoology (*inclinana*).

Type localities.—Pennsylvania (*otiosana*); Dallas, Texas (*inclinana*).

Food plants.—*Bidens frondosa*, *Polygonum*, *Ambrosia*.

30. EPIBLEMA BRIGHTONANA (Kearfott).

(Fig. 284.)

Eucosma brightonana KEARFOTT, Trans. Amer. Ent. Soc., vol. 33, 1907, p. 23.—

BARNES and McDUNNOUGH, Check List Lepid. Bor. Amer., no. 6977, 1917.

Male genitalia figured from cotype in National Collection.

Specimens in National Collection, American Museum, and collection Barnes from Pennsylvania.

Alar expanse.—13–16 mm.

Type.—In American Museum.

Type locality.—New Brighton, Pennsylvania.

Food plant.—Unknown.

31. EPIBLEMA TANDANA (Kearfott).

(Fig. 289.)

Eucosma tandana KEARFOTT, Trans. Amer. Ent. Soc., vol. 33, 1907, p. 23.—

BARNES and McDUNNOUGH, Check List Lepid. Bor. Amer., no. 7032, 1917.

Eucosma trapezitis MEYRICK, Ent. Mo. Mag., vol. 48, 1912, p. 34.

Male genitalia figured from specimen in American Museum from Montclair, New Jersey (Kearfott).

Distribution according to specimens in National Collection, American Museum, and collection Barnes: Illinois, Pennsylvania, New Jersey, Iowa.

Alar expanse.—20–22 mm.

Type.—In American Museum.

Type locality.—New Brighton, Pennsylvania.

Food plant.—Unknown.

32. *EPIBLEMA ABBREVIATANA* (Walsingham):—

(Fig. 255.)

Paedisca abbreviatana WALSINGHAM, Illus. Lepid. Heter. Brit. Mus., vol. 4, 1879, p. 54.

Eucosma abbreviatana FERNALD, in Dyar List N. Amer. Lepid., no. 5124, 1903.—KEARFOTT, Can. Ent., vol. 37, 1905, p. 208.—BARNES and McDUNNOUGH, Check List Lepid. Bor. Amer., no. 6970, 1917.

Male genitalia figured from specimen in National Collection from New Haven, Connecticut (“W. E. Britton, 24 May, 1905”).

Distribution according to specimens in National Collection, American Museum, and collection Barnes: Connecticut, New Jersey, Illinois, Ontario, Saskatchewan. One specimen from Riley collection in U.S.N.M. without locality, but labeled “*Solidago* ? 20–5.85.”

Alar expanse.—10–12 mm.

Type.—In British Museum.

Type locality.—Washington, District of Columbia.

Food plant.—*Solidago*?

EPIBLEMA TRIGEMINANA (Stephens).

This European species has been recorded from our fauna.¹⁶ To the best of my knowledge we do not have the true *trigeminana* and the name should be dropped from our lists. None of the American specimens I have seen labeled as *trigeminana* were even congeneric with Stephens's species.

10. *SULEIMA*, new genus.

(Figs. 26, 292.)

Genotype.—*Semasia helianthana* Riley.

Characters as in *Sonia* except:

Hind wing with 7 veins; 6 and 7 stalked; 3 and 4 united. 3 and 5; vein 11 from middle or slightly beyond middle of cell; male without costal fold.

Hind wing with 7 veins; 6 and 7 stalked; 3 and 4 united.

Male genitalia with no rudimentary clasper on harpe. Socii short; finger-like.

¹⁶ Walsingham, Illus. Lepid. Heter. Brit. Mus., vol. 4, 1879, pp. 51, 77.

Derived from *Sonia*. In venation the most advanced of the Eucosmine genera.

KEY TO THE SPECIES OF SULEIMA.

1. Fore wing with entire dorsum white, dotted along margin with fuscous. (6) *cinerodorsana*.
Fore wing with entire dorsum not white.----- 2
2. Fore wing white with dark basal patch and dark patch on outer dorsal margin before ocellus.----- 3
Fore wing gray or fuscous----- 4
3. Head cream white; subcostal area of fore wing beyond middle nearly pure white.----- (4) *lagopana*.
Head pale ochreous; subcostal area of fore wing beyond middle clouded with fuscous.----- (5) *baracana*.
4. Fore wing pale ashy gray with strong outwardly curved antimedial blackish fuscous patch on dorsal margin and similar smaller patch on dorsum before ocellus.----- (1) *helianthana*.
Fore wing dark and not so marked.----- 5
5. Fore wing dark gray with darker basal and outer dorsal patches but faintly indicated.----- (2) *daracana*.
Fore wing with area beyond end of cell pale ochreous.----- (3) *skinnerana*.

1. SULEIMA HELIANTHANA (Riley).

(Figs. 26, 292.)

Semasia helianthana RILEY, Trans. St. Louis Acad. Sci., vol. 4, 1881, p. 319.

Thiodia helianthana FERNALD, in Dyar List N. Amer. Lepid., no. 5186, 1903. no. 7081, 1917.—HEINBICH, Journ. Agr. Res., vol. 20, 1921, p. 824.

This is an easily recognized species and its food plant is known; but it is often misidentified. In collections it frequently appears as *lagopana* Walsingham. The larva feeds in the stems and on the seeds of the common garden sunflower.

Male genitalia figured from type.

Distribution according to specimens in National Collection, American Museum, and collection Barnes: Texas, California, Illinois.

Alar expanse.—15–20 mm.

Type.—In National Collection.

Type locality.—Texas.

Food plant.—*Helianthus*.

2. SULEIMA DARACANA (Kearfott).

(Fig. 293.)

Thiodia daracana KEARFOTT, Trans. Amer. Ent. Soc., vol. 33, 1907, p. 44.

Eucosma daracana BARNES and McDUNNOUGH, Check List Lepid. Bor. Amer., no. 7077, 1917.

Thiodia profana MEYBICK, Ent. Mo. Mag., vol. 48, 1912, p. 34.

A dark gray species, quite distinct from anything in the genus.

Male genitalia figured from cotype in National Collection from Placer County, California.



THIS PAGE IS LOCKED TO FREE MEMBERS

Purchase full membership to immediately unlock this page



HISTORY

Tens of thousands of important historical sources, many previously unobtainable, are now available for the first time with a Forgotten Books Full Membership.

Unlimited Access
\$8.99/month

Continue

*Fair usage policy applies

4. SULEIMA LAGOPANA (Walsingham).

(Fig. 296.)

Steganoptycha lagopana WALSINGHAM, Illus. Lepid. Heter. Brit. Mus., vol. 4, 1879, p. 71; Trans. Ent. Soc. Lond., 1884, p. 145.

Epinotia lagopana FERNALD, in Dyar List N. Amer. Lepid., no. 5222, 1903.

Enarmonia lagopana BARNES and McDUNNOUGH, Check List Lepid. Bor. Amer., no. 7149, 1917.

Various things have been confused under this name and specimens of *helianthana* Riley have more often than not been labeled *lagopana*. In the Kearfott collection there is a specimen of the true *lagopana* without locality label, but bearing Walsingham's name label. I have also seen three authentic specimens in the Fernald collection at Amherst from California, which had probably been submitted to Walsingham. Kearfott also had a specimen of *lagopana* from Phoenix, Arizona, under the name *Eucosma canana* Walsingham. Superficially it resembles the *Eucosma canana* group, but is easily separable on venation and it is quite distinct from all *Suleima* except *baracana* Kearfott.

Male genitalia figured from specimen in National Collection from Southern Arizona ("Poling, Sept. 1900").

Distribution according to specimens in National Collection, American Museum and collection Barnes: California (?) and Arizona.

Alar expanse.—15–22 mm.

Type.—In British Museum.

Type of locality.—Colusa County, California.

Food plant.—Unknown.

5. SULEIMA BARACANA (Kearfott).

(Fig. 297.)

Thiodia baracana KEARFOTT, Trans. Amer. Ent. Soc., vol. 33, 1907, p. 43.

Thiodia caracana KEARFOTT, Trans. Amer. Ent. Soc., vol. 33, 1907, p. 43.

Thiodia oxyleuca MEYBICK, Ent. Mo. Mag., vol. 48, 1912, p. 34.

Thiodia famosa MEYRICK, Ent. Mo. Mag., vol. 48, 1912, p. 34.

Eucosma baracana BARNES and McDUNNOUGH, Check List Lepid. Bor. Amer., no. 7107, 1917.

Eucosma caracana BARNES and McDUNNOUGH, Check List Lepid. Bor. Amer., no. 7108, 1917.

Here Kearfott has copied Walker and described the same insect under two different names on the same page. We thus get rid of one of his "nonsense names." Eventually we shall probably be rid of both, as well as Mr. Meyrick's more elegant substitutes, for *baracana* is probably nothing but a color variety of *lagopana* Walsingham. It differs only in that the head is a trifle more ochreous, the dark costal strigulae of fore wings a trifle narrower, the dark areas more suffused and the white less prominent than in Walsingham's

species. They are variable forms, however, and in genitalia there is nothing to distinguish the two apart. I retain them as separate species for the present, pending some knowledge of their life history, but have little doubt but that they will eventually prove the same.

Male genitalia figured from cotype in National Collection (Colorado "2133").

Distribution according to specimens in National Collection, American Museum, and collection Barnes: Colorado, Utah, California.

Alar expanse.—15–22 mm.

Types.—In American Museum.

Type localities.—Stockton, Utah (*baracana*); Denver, Colorado (*caracana*).

Food plant.—Unknown.

6. SULEIMA CINERODORSANA, new species.

(Fig. 294.)

Palpi, face and head white; the outer sides of palpi faintly dusted with fuscous. Thorax dark brownish fuscous; tegulae shaded with white. Fore wing dark brownish fuscous with entire dorsal margin and ocelloid patch white and a few short white dashes on costa near apex; along the entire length of dorsal edge of white dorsal strip, a series of small fuscous dots; ocellus with one or two longitudinal black streaks; cilia whitish heavily dusted with blackish fuscous especially above tornus.—Hind wing pale smoky fuscous, darker towards outer margin and apex; cilia whitish with dark basal and subterminal bands.

Genitalia of type figured.

Alar expanse.—11.5–16 mm.

Type.—In American Museum.

Paratypes.—Cat. No. 24830 U.S.N.M.; also in American Museum and collection Barnes.

Type locality.—Oak Station, Pennsylvania.

Food plant.—Unknown.

Described from male type, nine male and four female paratypes collected at Oak Station, Pennsylvania, by Fred Marloff and bearing various dates from July 26 to Aug. 15, one male paratype from Pittsburgh, Pennsylvania ("Henry Engel, VII-17-05"), and one male paratype from Cabin John Bridge, Maryland ("August Busck, Aug."), all from the Kearfott collection in the American Museum.

A distinct easily recognized species which Kearfott recognized as new and had given the manuscript name "*cinereadorsana*," but which he never described.

11. SONIA, new genus.

(Figs. 22, 291.)

Genotype—*Paedisca constrictana* Zeller.

Fore wing smooth; termen markedly concave between 3 and 6; 11 veins; 7 and 8 united; 10 much nearer to 9 than to 11; 11 from well before middle of cell; upper internal vein of cell from between 10 and 11; 3, 4, and 5 approximate at termen; 2 straight; costal fold present in male.

Hind wing with 8 veins; 6 and 7 approximate at base, often anastomosing beyond cell; 3 and 4 stalked.

Male genitalia as in *Eucosma* except:

Rudimentary clasper present on harpe (as in *Epiblema*); socii short, rather broad in proportion to length (but not broadly triangular).

A derivative of *Epiblema*.

KEY TO THE SPECIES OF SONIA.

1. Fore wing chocolate brown with gray or grayish white markings; hind wing brown with dark cilia.....(1) *constrictana*.
Fore wing ochreous with ochreous fuscous, or white with dark grayish fuscous markings; hind wing smoky fuscous with pale cilia.....2
2. Paler areas of fore wing white.....(2) *vovana*.
Paler areas of fore wing ochreous.....(3) *filiana*.

1. SONIA CONSTRICTANA (Zeller).

(Figs. 22, 291.)

Paedisca (?) *constrictana* ZELLER, Vehr. Zool. bot. Ges. Wien, vol. 25, 1875, p. 305.—WALSINGHAM, Trans. Ent. Soc. Lond., 1884, p. 140.

Eucosma constrictana FERNALD, in Dyar List N. Amer. Lepid., no. 5125, 1903.—KEARFOTT, Proc. U. S. Nat. Mus., vol. 28, 1905, p. 359.—BARNES and McDUNNOUGH, Check List Lepid. Bor. Amer., no. 6971, 1917.

There is considerable variation in this species both in color and genitalia structure, the head varying from dull dark fuscous to pinkish, the paler areas of fore wing from pale grayish fuscous to almost white. There is also considerable difference in the shape of the cucullus of the harpe in different specimens. The differences do not seem constant enough, however, to enable specific or even distinct racial separation.

In the hind wing veins 6 and 7 are normally closely approximate toward base, but some specimens show a slight anastomosing beyond the cell, and in a few the veins appear to be truly stalked. These venational differences do not correspond with differences in either genitalia or color.

Zeller's species has been sometimes confused with *Epiblema otiosana* Clemens and more often with *Epinotia perplexana* Fernald. There is no occasion for this, as its fore wing venation readily sepa-



THIS PAGE IS LOCKED TO FREE MEMBERS
Purchase full membership to immediately unlock this page



Never be without a book!

Forgotten Books Full Membership gives universal access to 797,885 books from our apps and website, across all your devices: tablet, phone, e-reader, laptop and desktop computer

A library in your pocket for \$8.99/month

Continue

*Fair usage policy applies

terminated a large series of *filiana* from San Diego, California, as *Eucosma shastana* Walsingham. In *filiana* veins 6 and 7 of hind wings are normally closely approximate towards base. In a very few specimens they anastomose for a very short distance just beyond the cell.

Male genitalia figured from type.

Distribution according to specimens in National Collection, American Museum, and collection Barnes: Los Angeles, San Diego, and West Riverside, California.

Alar expanse.—20–25 mm.

Type.—In National Collection.

Type locality.—West Riverside, California.

Food plant.—Unknown.

12. GENUS GYPSONOMA Meyrick.

(Figs. 27, 27a, 64.)

Genotype.—(*Tortrix dealbana* Frölich) *Tortrix incarnana* Har-
worth.

Fore wing smooth; termen slightly concave between veins 3 and 6; 12 veins; 7 and 8 approximate; 10 from cell midway between 9 and 11; 11 from cell at or near middle; upper internal vein of cell from between 9 and 10; 3, 4, and 5 separate or but slightly approximate at termen; 2 straight; no costal fold in male.

Hind wing with 8 veins; 6 and 7 stalked, 3 and 4 stalked.

Male genitalia with harpes club shaped; normally with a pair of strong hair tufts from intersegmental area at base of tegumen; cucullus moderate; rudimentary clasper present; neck smooth; sacculus sparsely clothed with fine hairlike spines. Uncus absent. Socii broad, roughly triangular; densely haired but without the beard-like tufts of *Proteoteras*. Gnathos greatly restricted and partially fused with socii. Aedoeagus moderately long; stout; cornuti a cluster of elongate spines.

An offshoot from *Epiblema*. Closely related to *Zeiraphera* and *Proteoteras*.

KEY TO THE SPECIES OF GYPSONOMA.

1. Fore wing with no white or whitish areas beyond dark basal patch.

(4) *salicicolana*.

Fore wing with ground color beyond basal patch, white or whitish; or at least with a broad white fascia bordering the basal patch-----2

2. White on fore wing confined to a broad fascia bordering the dark basal patch.

(3) *substitutionis*.

Apical third of fore wing whitish or heavily dusted with white-----3

3. A well-defined and complete post median dark fascia on fore wing.

(1) *fasciolana*.

No well-defined post median dark fascia----- (2) *haimbachiana*.

1. GYPSONOMA FASCIOLANA (Clemens).

(Fig. 68.)

- Anchylopera fasciolana* CLEMENS, Proc. Ent. Soc., Phila., vol. 3, 1864, p. 511.
Penthina blakeana GROTE, Bull. Buffalo Soc. Nat. Sci., vol. 1, 1873, p. 91.
Steganoptycha fasciolana WALSINGHAM, Trans. Ent. Soc. Lond., 1884, p. 145.
Epinotia fasciolana FERNALD, in Dyar List N. Amer. Lepid., no. 5221, 1903.
 KEARFOTT, Can. Ent., vol. 37, 1905, p. 253.
Enarmonia fasciolana BARNES and McDUNNOUGH, Check List Lepid. Bor. Amer., no. 7146, 1917.

I am placing this species here with some hesitation, as the rudimentary clasper on the harpe is nearly obsolete and somewhat differently placed than in the other species. Otherwise, however, the structures agree, and there is no genus in which it fits as well as it does here.

Male genitalia figured from specimen in National Collection from White Horse, Alaska (P. B. Clark).

Distribution according to specimens in National Collection, American Museum, and collection Barnes: Pennsylvania, New Hampshire, Indiana, Ontario, Quebec, Manitoba, British Columbia, Alaska.

Alar expanse.—13–18 mm.

Types.—Lost ? (*fasciolana*); in British Museum (*blakeana*).

Type localities.—New Brunswick, Maine (*fasciolana*); Pennsylvania (*blakeana*).

Food plant.—Unknown.

2. GYPSONOMA HAIMBACHIANA (Kearfott).

(Figs. 27, 27a, 64.)

- Epinotia haimbachiana* KEARFOTT, Trans. Amer. Ent. Soc., vol. 33, 1907, p. 51.
Enarmonia haimbachiana BARNES and McDUNNOUGH, Check List Lepid. Bor. Amer., no 7148, 1917.

Male genitalia figured from cotype in National Collection from Philadelphia, Pennsylvania.

Distribution according to specimens in National Collection, American Museum, and collection Barnes: Pennsylvania, Ohio, Illinois, Wisconsin, New Jersey.

Alar expanse.—13–15 mm.

Type.—In American Museum.

Type locality.—Philadelphia, Pennsylvania.

Food plant.—Unknown.

3. GYPSONOMA SUBSTITUTIONIS, new species.

(Fig. 67.)

Palpi, face and head grayish fuscous. Fore wing dark brown with a moderately broad anti-median white fascia, the outer margin of which is somewhat irregular, projecting as a slight spur just above

dorsum; ocellus consisting of two vertical bars of leaden scales inclosing three or four short black streaks or dots; from outer third of costa a narrow oblique band of lead colored scales extending to and joining the inner bar of the ocellus; a few faint whitish strigulae on outer third of costa; at apex a small round black dot; cilia fuscous brown with a darker basal line. Hind wing smoky fuscous; cilia concolorous with a very fine whitish basal line.

Male genitalia of type figured.

Alar expanse.—12 mm.

Type.—Cat. No. 24831, U.S.N.M.

Type locality.—Aweme, Manitoba.

Food plant.—Unknown.

Described from male type from Aweme, Manitoba ("Criddle, 27-VII-05"—in National Collection.

This is the species that has figured in our lists and been determined in our collections as the European *incarnana* Haworth. It differs in genitalia (compare figs. 66, 67) as well as in pattern. The true *incarnana* has a distinct black spot on the disk and considerable whitish scaling on outer fourth of fore wing both of which are lacking in *substitutionis*. Moreover the latter has a black dot at apex which is entirely absent in the European species. The true *incarnana* probably does not occur in this country and should be dropped from our lists.

4. GYPSONOMA SALICICOLANA (Clemens).

(Fig. 65.)

Hedya salicicolana CLEMENS, Proc. Ent. Soc. Phila., vol. 3, 1864, p. 514.

Hedya saliciana CLEMENS, Proc. Ent. Soc. Phila., vol. 3, 1864, p. 515.

Epinotia salicicolana FERNALD, in Dyar List N. Amer. Lepid., no. 5225, 1903.

Epinotia saliciana FERNALD, in Dyar List N. Amer. Lepid., no. 5226, 1903.

Enarmonia salicicolana BARNES and McDUNNOUGH, Check List Lepid. Bor. Amer., no. 7159, 1917.

Enarmonia saliciana BARNES and McDUNNOUGH, Check List Lepid. Bor. Amer., no. 7160, 1917.

The genitalia of Clemens two species are alike in all details. There is some slight color differences, but they grade into each other through several specimens, and both have the same larval habit and food plants, being inquilin feeders in galls on *Salix*. They have also been reared, according to Kearfott,¹⁷ from larvae crumpling the young leaves. I have compared our specimens carefully with the types and have no hesitation in making the synonymy.

Male genitalia figured from reared specimen (*saliciana*) in National Collection from Pleasantville, Indiana ("on willow," I. W. Spencer).

¹⁷ Insects of New Jersey, 1909, p. 544.



THIS PAGE IS LOCKED TO FREE MEMBERS

Purchase full membership to immediately unlock this page



HISTORY

Tens of thousands of important historical sources, many previously unobtainable, are now available for the first time with a Forgotten Books Full Membership.

Unlimited Access
\$8.99/month

Continue

*Fair usage policy applies

5. Fore wing with a broad white band along costa and with white ocelloid patch----- (4) *naracana*.
 Fore wing without such-----6
6. Ground color of fore wing bright verdegris green----- (5) *moffatiana*.
 Ground color of fore wing olivaceous green----- (1) *aesculana*.

KEY TO THE SPECIES ACCORDING TO SEX SCALING OF THE MALES.

1. No black sex scaling on either fore or hind wings----- (2) *crescentana*.
 More or less black scaling present, at least on hind wing-----2
2. Sex scaling on underside of wings only-----4
 Sex scaling also present on upper side of hind wings-----3
3. Sex scaling along costal edge and covering outer half of fore wing on underside; outer two-thirds of underside of hind wing so scaled, except costal area above vein 8; entire upper surface of hind wing below vein 8 except extreme base heavily dusted with blackish fuscous----- { (6) *arizonae*.
 (7) *obnigrana*.
 Sex scaling limited to a heavy streak below costa on underside of fore wing and a black costal margin on upper and under side of hind wing.
 (1) *aesculana*.
 (2) *willingana*.
4. A thin streak of black scaling along basal two-thirds of costal edge on underside of hind wing; on underside of fore wing a faint longitudinal subcostal streak near middle----- (4) *naracana*.
 Hind wings as above but no such scaling on fore wing----- (5) *moffatiana*.

1. *PROTEOTERAS AESCULANA* Riley.

(Figs. 7, 25, 299.)

Proteoteras aesculana RILEY, Trans. St. Louis Acad. Sci., vol. 4, 1881, p. 321.—
 BARNES and MCDUNNOUGH, Check List Lepid. Bor. Amer., no. 7130, 1917.
Proteoteras aesculanum PACKARD, Fifth Report U. S. Ent. Com., 1890, p. 655.—
 FERNALD, in Dyar List N. Amer. Lepid., no. 5219, 1903.

The commonest and most widely distributed species in the genus, somewhat variable in size and color but easily distinguished by the characters given in the key. The larva bores in seeds, leaf stalks, and terminal twigs of horse chestnut and maple. In the National Collection we have series reared from both food plants.

Male genitalia figured from reared specimens in National Collection from Missouri (Murtfeldt, "73 1," July 23, 1883).

Distribution according to specimens in National Collection, American Museum, and collection Barnes: Missouri, Kansas, Iowa, Illinois, Ohio, Pennsylvania, New Jersey, District of Columbia, Maryland, West Virginia, Oregon, California, Ontario, Vancouver Island, Manitoba.

Alar expanse.—11–18 mm.

Type.—In National Collection.

Type locality.—Missouri.

Food plants.—*Acer*, *Aesculus*.

2. *PROTEOTERAS WILLINGANA* (Kearfott).

(Fig. 302.)

Proteopteryx willingana KEARFOTT, Can. Ent., vol. 36, 1904, p. 306; Can. Ent., vol. 37, 1905, p. 89.—BARNES and MCDUNNOUGH, Check List Lepid. Bor. Amer., no. 7125, 1917.

This is a true *Proteoteras* with the same sex scaling as *aesculana* and like that species in color except that the fore wings are gray without the distinctly greenish olivaceous cast of *aesculana*. One would naturally take it for a form or variety of Riley's species were it not for its different genitalia.

The larva is a gall maker in terminal twigs and leaf steams of box elder.

Male genitalia from specimen in National Collection from Cincinnati, Ohio ("A. F. Braun, VI-1-05").

Distribution according to specimens in National Collection, American Museum, and collection Barnes: British Columbia, Saskatchewan, North Dakota, Kansas, Missouri, Illinois, Ohio, Maryland, District of Columbia.

Alar expanse.—15–20 mm.

Type.—In American Museum.

Type locality.—Regina, Saskatchewan.

Food plant.—*Negundo aceroides*.

3. *PROTEOTERAS CRESCENTANA* Kearfott.

(Fig. 301.)

Proteoteras crescentana KEARFOTT, Trans. Amer. Ent. Soc., vol. 33, 1907, p. 49.—BARNES and MCDUNNOUGH, Check List Lepid. Bor. Amer., no. 7132, 1917.

Easily distinguished by the heavy black crescent shaped band from mid costa to apex of fore wing and the distinctly ochreous color of the costal patch enclosed within the crescent. There is considerable variation in the genitalia between eastern and northwestern specimens suggesting two possible races but no corresponding color or pattern differences. In the National Collection we have a specimen from Manhattan, Kansas, reared from box elder, and in the American Museum there is one from Regina, Saskatchewan, labeled "ex. pupa, in maple stem."

Male genitalia figured from type.

Distribution according to specimens in National Collection, American Museum, and collection Barnes: Maryland, Ohio, Kansas, Iowa, Illinois, South Dakota, Manitoba, Saskatchewan.

Alar expanse.—16–19 mm.

Type.—In American Museum.

Type locality.—Plummer Island, Maryland.

Food plants.—*Acer* and *Negundo*.

4. *PROTEOTERAS NARACANA* Kearfott.

(Fig. 304.)

Proteoteras naracana KEARFOTT, Trans. Amer. Ent. Soc., vol. 33, 1907, p. 50.—

BARNES and McDUNNOUGH, Check List Lepid. Bor. Amer., no. 7134, 1917.

Proteoteras praesinospila MEYRICK, Ent. Mo. Mag., vol. 48, 1912, p. 34.

A species easily distinguished by its olivaceous green fore wing, with white ocelloid patch, broad white band along upper third of wing, distinct black spot on upper margin of ocellus and the sharply pointed rudimentary uncus of its genitalia.

Male genitalia figured from specimens in National Collection from Oak Station, Pennsylvania (F. Marloff, "V-25-1912").

Distribution according to specimens in National Collection, American Museum, and collection Barnes: Pennsylvania, Ohio, Wisconsin.

Alar expanse.—16–22 mm.

Type.—In American Museum.

Type locality.—New Brighton, Pennsylvania.

Food plant.—Unknown.

5. *PROTEOTERAS MOFFATIANA* Fernald.

(Fig. 303.)

Proteoteras moffatiana FERNALD, Can. Ent., vol. 37, 1905, p. 16.—BARNES and

McDUNNOUGH, Check List Lepid. Bor. Amer., no. 7135, 1917.

A striking species at once to be recognized by the bright verdegris green of its fore wings.

Male genitalia from specimen in National Collection from Poughkeepsie, New York (H. G. Dyar, "no. 2182").

Distribution according to specimens in National Collection, American Museum, and collection Barnes: New York, Pennsylvania, New Jersey, Wisconsin.

Alar expanse.—14–20 mm.

Type.—In collection Fernald.

Type locality.—London, Ontario.

Food plant.—Unknown.

6. *PROTEOTERAS ARIZONAE* Kearfott.

(Fig. 300.)

Proteoteras arizonae KEARFOTT, Trans. Amer. Ent. Soc., vol. 33, 1907, p. 48.—

BARNES and McDUNNOUGH, Check List Lepid. Bor. Amer., no. 7131, 1917.

This is a grayish western form, the males of which can be recognized by the diffused dark sex scaling on underside of both fore and hind wings. The only thing like it is the following species, which may be but an extreme eastern variety.

Male genitalia figured from specimen in National Collection from Mesilla, New Mexico (Cockerell).



THIS PAGE IS LOCKED TO FREE MEMBERS

Purchase full membership to immediately unlock this page



Never be without a book!

Forgotten Books Full Membership gives universal access to 797,885 books from our apps and website, across all your devices: tablet, phone, e-reader, laptop and desktop computer

A library in your pocket for \$8.99/month

Continue

*Fair usage policy applies

Hind wing with 8 veins; 6 and 7 closely approximate at base; 3 and 4 stalked.

Male genitalia with harpe sickle shaped; neck densely spined; cucullus large; sacculus reduced, not strongly spined. Uncus rudimentary. Socii developed; broad in proportion to their length; roughly triangular. Gnathos free; weak. Aedoeagus short; straight; moderately stout; cornuti a cluster of elongate spines.

A small genus, most of the species of which are feeders on coniferous trees. The spining on the neck of the harpe is appreciable in all the species, but in the genotype and in *ratzeburgiana* it is less dense and more hair like than in the other species.

KEY TO THE SPECIES OF ZEIRAPHERA.

1. Termen of fore wing vertical, slightly concave; dark markings shaded with greenish olivaceous.....(1) *claypoleana*.
Termen of fore wing slanting and straight, not concave; no shading of greenish olivaceous on fore wing.....2
2. Lighter area of fore wing ferruginous ochreous.....(2) *ratzeburgiana*.
Lighter area of fore wing gray or grayish white.....3
3. Median pale area of fore wing narrow, and no wider on dorsum than costa.
(4) *fortunana*.
Median pale area of fore wing wide, and wider on dorsum than costa.
(3) *diniana*.

1. ZEIRAPHERA CLAYPOLEANA (Riley).

(Fig. 285.)

Proteoteras (?) *claypoleana* RILEY, Amer. Nat., 1882, p. 913.

Steganoptycha claypoleana CLAYPOLE, Psyche, vol. 3, 1882, p. 364.—RILEY, Papilio, vol. 3, 1883, p. 191.—PACKARD, Fifth Report U. S. Ent. Com., 1890, p. 654.—LINTNER, Rept. N. Y. State Ent, vol. 12, 1897, p. 214.

Sericoris instrutana CLAYPOLE (Not CLEMENS), Proc. Amer. Assn. Adv. Sci., vol. 30, 1881, p. 269; Amer. Nat., vol. 15, 1881, p. 1009.

Epinotia claypoleana FERNALD, in Dyar List N. Amer. Lepid., no. 5232, 1903.

Enarmonia claypoleana BARNES and McDUNNOUGH, Check List Lepid. Bor. Amer., no. 7156, 1917.

This species is placed here provisionally. In genitalia structure it is true *Zeiraphera* while in wing shape, pattern, color and larval habit it would go better with *Proteoteras* than with the coniferous feeders that constitute the typical *Zeiraphera*. It is in fact a primitive *Proteoteras* that has not yet developed the advanced genitalia or secondary sexual characters and forms the link between *Zeiraphera* and *Proteoteras*. It should rightly have a separate generic designation; but I have been unable to find a character to separate and distinguish it. For the present it may remain in *Zeiraphera* with which it has many affinities. It certainly can not be included in *Proteoteras* as it possesses none of the structural characters that definitely characterize that group.

The larva bores in the leaf-stalks and feeds on the leaves and flowers of the common buckeye. We have also in the National Collection a couple of specimens labeled as reared from chestnut (E. A. Schwarz, Victoria, Texas).

Male genitalia figured from reared specimen in the National Collection from Riley's type series ("360L").

Distribution according to specimens in the National Collection, American Museum, and collection Barnes: Ohio, Missouri, Texas.

Alar expanse.—14–17 mm.

Type.—In National Collection.

Type locality.—Ohio.

Food plant.—*Aesculus glabra*.

2. ZEIRAPHERA RATZEBURGIANA (Ratzeburg).

(Fig. 286.)

Tortrix ratzeburgiana RATZEBURG, Forst, Ins., vol. 2, 1840, p. 217.

Steganoptycha ratzburgiana FERNALD, Rept. U. S. Dept. Agr., 1884, p. 378.—

PACKARD, Fifth Report, U. S. Ent. Com., 1890, p. 845.—STAUDINGER and REBEL, Cat. Lepid., vol. 2, no. 1983, 1901.

Epinotia ratzenburgiana FERNALD, in Dyar List N. Amer. Lepid., no 5233, 1903.

Enarmonia ratzeburgiana BARNES and MCDUNNOUGH, Check List Lepid. Bor. Amer., no. 7157, 1917.

Ratzeburg, not Saxesen, is really the author of this name, and it should be credited to him as is done by Staudinger and Rebel. The species is an introduced one in this country, but is apparently well distributed through the spruce regions of the Northern States and Canada. The larva is an external feeder on the leaves.

Male genitalia figured from reared specimens in the National Collection from Hoquiam, Washington (on *Picea stichensis*, Burke, collector, Hopk. U. S. no. 4026a).

Distribution according to specimens in the National Collection, American Museum, and collection Barnes: Maine, Washington, Ontario.

Alar expanse.—12–15 mm.

Type.—Unknown.

Type locality.—Germany.

Food plants.—*Abies*, *Picea*.

3. ZEIRAPHERA DINIANA (Guenée).

(Fig. 287.)

Sphaleroptera diniana GUENÉE, Ind. Microlep., 1845, p. 33.

Grapholitha pinicolana ZELLER, Isis, 1846, p. 242.

Steganoptycha diniana STAUDINGER and REBEL, Cat. Lepid., vol. 2, no. 1977, 1901.

Epinotia pinicolana FERNALD, in Dyar List N. Amer. Lepid., no. 5229, 1903.—

KEARFOTT, Can. Ent., vol. 37, 1905, p. 89.

Cydia pseudotsugana KEARFOTT, Can. Ent., vol. 36, 1904, p. 110.

Thiodia pseudotsugana DYAR, Proc. U. S. Nat. Mus., vol. 27, 1904, p. 927.

Epinotia pseudotsugana KEARFOTT, Can. Ent., vol. 37, 1905, pp. 89, 253.

Enarmonia pseudotsugana BARNES and MCDUNNOUGH, Check List Lepid. Bor. Amer., no. 7143, 1917.

Enarmonia pinicolana BARNES and MCDUNNOUGH, Check List Lepid. Bor. Amer., no. 7144, 1917.

Kearfott's *pseudotsugana* is plainly a synonym of *pinicolana* Zeller. The character he gives for separating the two (that is, whether the dark markings incline to lead gray or brown) is by no means constant. Authentic European specimens of *pinicolana* show considerable variation and the typical *pseudotsugana* is included in its forms. There are no appreciable genitalia differences in the two. The reference of *pinicolana* as a synonym of *diniana* Guenee I have accepted on the authority of the European lists.

Male genitalia figured from specimens of *pseudotsugana* in National Collection from Kaslo, British Columbia (Dyar "Coll. no. 30964.")

Distribution according to specimens in National Collection, American Museum, and collection Barnes: British Columbia, Manitoba, Ontario, Quebec, Montana, New York, New Hampshire (Mt. Washington.)

Alar expanse.—15–21 mm.

Types.—In collection Oberthür ? (*diniana*); In British Museum ? (*pinicolana*); In American Museum (*pseudotsugana*).

Type localities.—The Alps (*diniana*); Germany (*pinicolana*); Kaslo, British Columbia (*pseudotsugana*).

Food plants.—*Pseudotsuga*; (in Europe on *Larix* and *Abies*).

4. ZEIRAPHERA FORTUNANA (Kearfott).

(Fig. 288.)

Epinotia fortunana KEARFOTT, Can. Ent., vol. 39, 1907, p. 126.

Enarmonia fortunana BARNES and MCDUNNOUGH, Check List Lepid. Bor. Amer., no. 7168, 1917.

Male genitalia figured from cotype in National Collection.

Specimens in National Collection, American Museum, and collection Barnes from Ontario, Canada.

Alar expanse.—12–15 mm.

Type.—In American Museum.

Type locality.—Ottawa, Canada.

Food plant.—Unknown.

15. Genus EXENTERA Grote.

(Figs. 30, 30a, 308.)

Genotype.—(*Exentera apriliana* Grote) = *Sciaphila improbana* WALKER.



THIS PAGE IS LOCKED TO FREE MEMBERS

Purchase full membership to immediately unlock this page



HISTORY

Tens of thousands of important historical sources, many previously unobtainable, are now available for the first time with a Forgotten Books Full Membership.

Unlimited Access
\$8.99/month

Continue

*Fair usage policy applies

1. EXENTERA IMPROBANA (Walker).

- (Figs. 30, 30a, 308.)

Sciaphila improbana WALKER, Cat. Lepid. Brit. Mus., vol. 28, 1863, p. 337.*Paedisca diffinana* WALKER, Cat. Lepid. Brit. Mus., vol. 28, 1863, p. 378.*Hedya cressoniana* CLEMENS, Proc. Ent. Soc. Phila., vol. 3, 1864, p. 514.*Exentera apriliana* GROTE, Can. Ent., vol. 9, 1877, p. 227.—FERNALD, in Dyar List N. Amer. Lepid., no. 5208, 1903.—BARNES and MCDUNNOUGH, Check List Lepid. Bor. Amer., no. 7111, 1917.*Paedisca improbana* WALSINGHAM, Illus. Lepid. Heter. Brit. Mus., vol. 4, 1879, p. 51.*Eucosma improbana* FERNALD, in Dyar List N. Amer. Lepid., no. 5133, 1903.—BARNES and MCDUNNOUGH, Check List Lepid. Bor. Amer., no. 6992, 1917.*Proteopteryx cressoniana* FERNALD, in Dyar List N. Amer. Lepid., no. 5212, 1903.—BARNES and MCDUNNOUGH, Check List Lepid. Bor. Amer., no. 7115, 1917.

Specimens of both *cressoniana* Clemens and *spoliata* Clemens have been indiscriminately determined by Kearfott and others as *improbana* Walker. I have compared our material with Clemens's types and find no great difficulty in separating his two species. Both are variable and in genitalia structure very similar but there are consistent differences in pattern and color which will separate them. Clemens's type of *cressoniana* answering as it does in every detail to the descriptions of *improbana* as given by Walker and Walsingham, can hardly be anything but that species and I have no hesitation in making the synonymy. Under the name *apriliana* Grote two different species have been confused. The greater number so determined are *improbana* Walker. A few of the smaller specimens are referable to the genus *Epinotia*. I am describing them elsewhere in this paper under the name *Epinotia bicordana*.

The life history of *improbana* has not been worked out. We have in the National Museum two specimens reared by Doctor Dyar from larvae taken on oak (Bellport, Long Island) and it is very likely that that is its natural food plant and that its life history and habits are much the same as those of *spoliata*. The moths of both species are commonly taken together in early spring, appearing before the trees leaf out or just as the buds are opening.

Male genitalia figured from specimen in National Collection from New York ("Comstock No. 177, Sub 1").

Distribution according to specimens in National Collection, American Museum, and collection Barnes: Massachusetts, New Hampshire, New York, Pennsylvania, New Jersey, Illinois, Missouri.

Alar expanse.—15–21 mm.

Types.—In British Museum (*improbana*, *diffinana*, *apriliana*); in Academy Natural Science, Philadelphia (*cressoniana*).

Type localities.—St. Martin's Falls, Albany River, Hudson Bay (*improbana* and *diffinana*); Virginia (*cressoniana*); Albany, New York (*apriliana*).

Food plant.—Oak.

2. *EXENTERA IMPROBANA OREGONANA* (Walsingham).

(Fig. 309.)

Semasia ? oregonana WALSINGHAM, Illus. Lepid. Heter. Brit. Mus., vol. 4, 1879, p. 62.

Proteopteryx oregonana FERNALD, in Dyar List N. Amer. Lepid., no. 5211, 1903.—BARNES and MCDUNNOUGH, Check List Lepid. Bor. Amer., no. 7114, 1917.

Exentera apriliana KEARFOTT, Can. Ent., vol. 37, 1905, p. 253 (in part).

I am retaining Walsingham's name as a racial designation, though in all probability *oregonana* is nothing but a color variety of *improbana*. On the whole, however, the western specimens are rather uniform. They differ from the eastern forms in that the contrasted markings are almost obsolete and the fore wings to the naked eye at least—practically unicolorous. An occasional specimen from Manitoba is as plainly marked as any eastern *improbana* while not a few New York specimens of the latter grade into typical *oregonana*. The differences in the food plants of our reared specimens and the rather consistent uniformity of far western specimens suggest a distinct race. Veins 7 and 8 of fore wings are either very short stalked or connate—in both forms. Most of the specimens from Manitoba determined by Kearfott as *apriliana* Grote are referable to *oregonana*.

Male genitalia figured from specimen in National Collection from Aweme, Manitoba ("N. Criddle, 30-III-1918, reared from aspen poplar").

Distribution according to specimens in National Collection, American Museum, and collection Barnes: Manitoba, Saskatchewan, Athabasca, British Columbia.

Alar expanse.—19–21 mm.

Type.—In British Columbia.

Type locality.—"Camp Watson, on John Day's River" (near Canyon City), Oregon.

Food plant.—*Populus*.

3. *EXENTERA SPOLIANA* (Clemens).

(Fig. 310.)

Hedya spoliata CLEMENS, Proc. Ent. Soc. Phila., vol. 3, 1864, p. 513.

Proteopteryx spoliata FERNALD, in Dyar List N. Amer. Lepid., no. 5214, 1903.—

BARNES and MCDUNNOUGH, Check List Lepid. Bor. Amer., no. 7121, 1917.

Eucosma haracana BUSCK (not Kearfott), Proc. Ent. Soc. Wash., vol. 16, 1914, p. 150.

In the woods of the District of Columbia and neighboring regions this is our commonest moth in early spring. During late March and early April the adults fly in great numbers wherever chestnut abounds and during May the work of the larvae is quite noticeable. They make a very characteristic roll of the leaf from the tip inward, entering the ground when full fed, pupating in the fall and emerging as moths the following spring. The species is quite variable but apparently distinct from *cressoniana*. Busck, who has worked out the life history, confused it with *haracana* Kearfott; but it does not agree with the type of that species. I have compared reared specimens from chestnut with Clemens's type in Philadelphia and they agree. In both the National Museum and the American Museum there is a considerable series in which the dark marking of fore wings are distinctly ferruginous except for the outer dorsal margin of the basal patch which is blackish fuscous. This would appear to be a distinct species or race except for the fact that there are a few specimens that grade into the typical *spoliana*. The reddish color may in fact be due to the action of the cyanide used in killing the moths. There is no difference in genitalia. While the favorite food plant seems to be chestnut, there is also a specimen in the National Collection from Missouri (coll. C. V. Riley) bred from a larva on maple. The note on the specimen gives a brief description of the larva and the life history and these agree with what we know of the chestnut form.

Male genitalia figured from specimen in the National Collection from Falls Church, Virginia ("Heinrich, Apr. 8-1915").

Distribution according to specimens in National Collection, American Museum, and collection Barnes: Pennsylvania, Virginia, New York, New Jersey, Ohio, Missouri.

Alar expanse.—15-19 mm.

Type.—In Academy of Natural Science, Philadelphia.

Type locality.—Virginia.

Food plant.—Chestnut, maple.

4. EXENTERA HARACANA (Kearfott).

(Fig. 312.)

Proteopteryx haracana KEARFOTT, Trans. Amer. Ent. Soc., vol. 33, 1907, p. 46.—

BARNES and McDUNNOUGH, Check List Lepid. Bor. Amer., no. 7117, 1917.

Proteopteryx resoluta MEYRICK, Ent. Mo. Mag., vol. 48, 1912, p. 34.

This species and *faracana* are distinguished from the others in the genus by the well marked, fine wavy black line on fore wing from apex to middle of costal margin of cell.

In addition to Kearfott's types and paratypes which were the only specimens properly determined by him as *haracana* I find a service from Lakewood, New Jersey, among his unnamed specimens. In all



THIS PAGE IS LOCKED TO FREE MEMBERS

Purchase full membership to immediately unlock this page



Never be without a book!

Forgotten Books Full Membership gives universal access to 797,885 books from our apps and website, across all your devices: tablet, phone, e-reader, laptop and desktop computer

A library in your pocket for \$8.99/month

Continue

*Fair usage policy applies

Distribution according to specimens in National Collection, American Museum, and collection Barnes: Ohio and Pennsylvania.

Alar expanse.—12–15 mm.

Type.—In American Museum.

Type locality.—Cincinnati, Ohio.

Food plant.—Unknown.

7. *EXENTERA HABROSANA*, new species.

(Fig. 314.)

Palpi, face, head, and thorax grayish fuscous with scale ends tipped with white giving them an ashy appearance. Fore wing ashy gray; a brownish-ochreous outwardly curved spot on dorsum near base; a similar smaller, fainter smear of color on dorsum just before tornus, sometimes connected with an indistinct band of the same color from outer third of costa, forming a rather obscure postmedian fascia; but in average specimens this fuses into a dark shade which occupies most of the outer third of wing above the middle; these dark shadings have a semi-lustrous rather bronzy tint especially on outer part of wing; costa with four pairs of short, somewhat obscured, white geminate marks beyond middle; cilia whitish, dusted, lined and spotted with dark fuscous; ocelloid spot pale but not distinctly marked. Hind wing very pale smoky fuscous; shining; cilia white with a dark basal band. Underside of fore wing pale shining fuscous with white geminations on outer half of costa distinct. Underside of hind wing nearly white, slightly smoky, and with a satin sheen.

Male genitalia of type figured.

Alar expanse.—18 mm.

Type.—Cat. no. 24833 U. S. N. M.

Paratypes.—National Collection, American Museum, and collection Barnes.

Type locality.—San Diego, California.

Food plant.—Unknown.

Described from male type and one male paratype from San Diego, California ("W. S. Wright," "3-17-12" and "3-18-12"), one male paratype from San Francisco, California, and one female paratype, without abdomen, labeled "California."

A distinct, easily recognized species with veins 7 and 8 of fore wing connate or very closely approximate at base.

8. *EXENTERA COSTOMACULANA* (Clemens).

(Fig. 315.)

Anchylopera costomaculana CLEMENS, Proc. Acad. Nat. Sci. Phila., 1860, p. 349.

Batodes bipustulana WALKER, Cat. Lepid. Brit. Mus., vol. 28, 1863, p. 316.

Proteopteryx costumaculana FERNALD, in Dyar List N. Amer. Lepid., no. 5217, 1903.

Enarmonia costumaculana BARNES and McDUNNOUGH, Check List Lepid. Bor. Amer., no. 7139, 1917.

Male genitalia figured from specimen in National Collection, from Gowanda, New York ("W. Wild, VI-8-13").

Distribution according to specimens in National Collection, American Museum, and collection Barnes: New York, New Jersey, Pennsylvania, Connecticut, Wisconsin.

Alar expanse.—13–18 mm.

Type.—In Academy Natural Science, Philadelphia.

Type locality.—Pennsylvania.?

Food plant.—Unknown.

9. EXENTERA VIRGINIANA (Clemens).

(Fig. 316.)

Anchylopera virginiana CLEMENS, Proc. Ent. Soc. Phila., vol. 3, 1864, p. 512.

Proteopteryx virginiana FERNALD, in Dyar List N. Amer. Lepid., no 5216, 1903.

Enarmonia virginiana BARNES and McDUNNOUGH, Check List Lepid. Bor. Amer., no. 7138, 1917.

Very close to *costumaculana* Clemens, but apparently distinct. In both species 7 and 8 of fore wing are connate or closely approximate at base.

Male genitalia figured from specimen in National Collection from New Brighton, Pennsylvania. ("H. D. Merrich, 3-19-'02.")

Specimens in National Collection, American Museum, and collection Barnes from Pennsylvania.

Alar expanse.—18–19 mm.

Type.—Lost?

Type locality.—Virginia.

Food plant.—Unknown.

16. GRETCHENA, new genus.

(Figs. 14, 31, 317.)

Genotype.—*Hedya deludana* Clemens.

Fore wing with slight tufts of raised scales above dorsal margin; termen deeply concave between veins 3 and 6 or with a notch between veins 3 and 5; 12 veins; 7 and 8 approximate, connate, or stalked; 10 from cell midway between 9 and 11; 11 from cell at or close to middle; upper internal vein of cell from between 10 and 11; 3, 4, and 5 closely approximate at termen; 2 appreciably bent up toward termen; no costal fold in male.

Hind wing with 8 veins; 6 and 7 closely approximate toward base; 3 and 4 stalked.

Male genitalia with harpe simple; cucullus moderate, with spined area reduced and with strong anal and lower marginal spines; sacculus with a dense clothing of long, hairlike spines, especially toward neck. Uncus absent. Socii developed; set close together near apex of tegumen; strongly chitinized; elongately triangular; porrected (that is, projecting caudally or at right angles from tegumen). Gnathos weak; greatly restricted and partially fused with socii. Aedoeagus long, stout, tapering; supporting arm of annellus slender and long with stout articulation to aedoeagus; cornuti a cluster of elongate spines.

KEY TO THE SPECIES OF GRETCHENA.

1. Fore wing with ocelloid spot white and sharply contrasted against ground color ----- 2
Fore wing without ocellus, or with ocelloid patch not white or sharply contrasted against ground color ----- 3
2. Dark ground color of fore wing shading to ferruginous brown toward apex. (4) *dulciana*.
Dark ground color blackish fuscous without admixture of ferruginous brown ----- (3) *watchungana*.
3. Dark and pale areas of fore wing fusing; no sharply defined black scaling or other markings in apical third; no indication of an ocellus or any whitish streak in cilia below apex ----- (8) *blangulana*.
Fore wing with dark and pale shadings contrasted; ocelloid patch at least indicated; cilia with a whitish dash below apex ----- 4
4. Fore wing with no crescent or blotch of contrasting scaling above ocelloid patch ----- (2) *concupitana*.
Fore wing with crescent or blotch of black scaling above ocelloid patch ----- 5
5. Ground color and major part of fore wing very pale ashy gray ----- 7
Ground color dark gray or, if pale, with the dark scaling occupying major portion of wing ----- 6
6. Subcostal area of fore wing suffused with dark scaling; basal patch complete ----- (6) *amatana*.
Subcostal area pale to base, obliterating basal patch above cell. (7) *delicatana*.
7. Black scaling above ocellus fusing with a black dash at apex and a black streak along upper outer margin of cell, forming a continuous wavy black line ----- (5) *bolliana*.
Black line above ocellus curving down to lower middle of wing, not fusing with the black streak on upper outer margin of cell ----- (1) *deludana*.

1. GRETCHENA DELUDANA (Clemens).

(Figs. 14, 31, 317.)

Hedya deludana CLEMENS, Proc. Ent. Soc. Phila., vol. 3, 1864, p. 513.*Proteopteryx deludana* FERNALD, in Dyar List N. Amer. Lepid., no. 5213.—

BARNES and McDUNNOUGH, Check List Lepid. Bor. Amer., no. 7116, 1917.

Steganoptycha diludana KEARFOTT, Journ. N. Y. Ent. Soc., vol. 16, 1908, p. 173.

In our economic literature this insect has been often recorded as a pecan feeder on account of its confusion with *Gretchena bolliana* Slingerland. Its northern distribution, however, would seem to



THIS PAGE IS LOCKED TO FREE MEMBERS

Purchase full membership to immediately unlock this page



HISTORY

Tens of thousands of important historical sources, many previously unobtainable, are now available for the first time with a Forgotten Books Full Membership.

Unlimited Access
\$8.99/month

Continue

*Fair usage policy applies

15, 1914) and one male and one female paratype from New Brighton, Pennsylvania (H. D. Merrick, "4-27-03" and "5-2-03").

The species is distinct from the others in the genus on both genitalia and slight but constant color characters. In genitalia it most resembles *deludana*, from which it is distinguished by its broad harpes. Unlike all but *biangulana* Walsingham it has no blackish mark or shading on fore wing over the ocellus. From *biangulana* it is distinguished by the greater contrast of its light and dark markings. Veins 7 and 8 of fore wings are stalked.

3. GRETCHENA WATCHUNGANA (Kearfott).

(Fig. 326.)

Epinotia watchungana KEARFOTT, Can. Ent., vol. 39, 1907, p. 81.

Enarmonia watchungana BARNES and MCDUNNOUGH, Check List Lepid. Bor. Amer., no. 7167, 1917.

This and the following species are distinguished from the others in the genus by their whitish ocelloid patches, sharply contrasting with the dark ground color of the fore wings.

The two species (*watchungana* and *dulciana*) are easily separated by genitalia and the characters given in the key. In both species veins 7 and 8 of fore wings are stalked.

Male genitalia figured from cotype in National Collection ("Essex County Park, N. J., Kearfott, 4-21-1900").

Distribution according to specimens in National Collection, American Museum and collection Barnes: New Jersey and Pennsylvania.

Alar expanse.—12-16 mm.

Type.—In American Museum.

Type locality.—Essex County Park, New Jersey.

Food plant.—Unknown.

4. GRETCHENA DULCIANA, new species.

(Fig. 327.)

Palpi, face, head, and thorax brown with a very slight dusting of grayish-white scaling on head and thorax; inner sides of palpi whitish. Fore wing brown with white ocelloid patch, a couple of short, distinct, germinate white dashes on costa near apex, a slight dusting of white and black scaling and a more diffused shading of semi-lustrous lead scales; cilia fuscous dusted with black except at anal angle, where they are white. Hind wing dark, smoky fuscous; cilia paler with a dark basal band. Like *watchungana* Kearfott, except that dark ground color of fore wing is ferruginous brown, especially in apical half, rather than blackish and that it lacks any indication of a whitish, mid-dorsal patch. In *watchungana* also the hind wing is much paler, almost transparent towards base and there is no trace of

leaden scaling on the fore wing. The two species differ markedly in the shape of the harpes of the male genitalia.

Male genitalia of type figured.

Alar expanse.—13–15 mm.

Type.—Cat. No. 24835 U.S.N.M.

Paratypes.—In National Collection, American Museum, and collection Barnes.

Type locality.—Greenwood Lake, New Jersey.

Food plant.—Unknown.

Described from male type and one male paratype from Greenwood Lake, New Jersey (“Kearfott, June”), one female paratype from Plummer Island, Maryland (“Busck, July”), one female paratype from Montclair, New Jersey (“Kearfott, June”), and one female paratype from the Grote and Robinson collection of the American Museum without locality label (“No. 137”). These specimens had been confused by Kearfott with *Epiblema abruptana* Walsingham, and formed part of the series of that species in the National Collection and the American Museum collections. It is quite distinct from the true *abruptana*, however, both on structural and superficial characters.

5. GRETCHENA BOLLIANA (Slingerland.)

(Fig. 322.)

Steganoptycha bolliana SLINGERLAND, Rural New Yorker, June, 1896, p. 401.—

KEARFOTT, Journ. New York Ent. Soc., vol. 16, 1908, p. 173.

Proteopteryx bolliana GILL, Farmers' Bull., no. 843, U. S. Dept. Agr., 1917, p. 25.

This species is known in economic literature as the “Pecan Bud-Moth.” Pecan appears to be its favorite food plant, the larvae feeding upon the buds and leaves and often doing considerable damage to young orchards. It has also been occasionally reared from Hickory, and in the National Collection there are several specimens labeled “from Walnut.” Fore wing with veins 7 and 8 stalked.

Male genitalia from specimen in the National Collection reared from pecan under Quaintance no. 12827 (Lafayette, Louisiana, “X-1-1914”).

Distribution according to specimens in National Collection, American Museum, and collection Barnes: Florida, Texas, Louisiana, North Carolina, South Carolina, Maryland, Pennsylvania, District of Columbia, New Jersey, Illinois.

Alar expanse.—16–18 mm.

Type.—In collection Cornell University.

Type locality.—Ocean Springs, Mississippi.

Food plant.—Pecan, hickory, walnut.

6. GRETCHENA AMATANA, new species.

(Fig. 319.)

A dark grayish fuscous species powdered and marked with ashy gray and blackish scales, the paler areas having a somewhat ochreous tint especially towards costal margin of fore wing. Fore wing with a distinct, outwardly angulate, dark basal patch; on middle of dorsal margin a somewhat irregular pale blotch, in some specimens extending from basal patch almost to ocellus; ocellus pale but not sharply contrasted; above ocellus a crescent of black scales, often fusing with a short black streak on upper outer edge of cell, forming with it what looks like a thin black sickle; cilia gray dusted with blackish fuscous, somewhat paler at anal angle and with one or two pale dashes below apex. Hind wing smoky fuscous; semilustrous; cilia but slightly paler with a faint dark basal band. Harpe of genitalia with a row of 6 or 7 short stiff marginal spines on lower margin near anal angle of cucullus.

Male genitalia of type figured.

Alar expanse.—17–19 mm.

Type.—In American Museum.

Paratypes.—Cat. No. 24836 U.S.N.M.; also in American Museum and collection Barnes.

Type locality.—Oak Station, Pennsylvania.

Food plant.—Unknown.

Described from male type and 3 male and 1 female paratypes from Oak Station, Pennsylvania ("F. Marloff, May"), 2 male and 4 female paratypes from New Brighton, Pennsylvania ("H. D. Merrick, May–June"), 1 male and 1 female paratypes from Hampton, New Hampshire ("S. A. Shaw, June"), 1 male paratype from Pittsburgh, Pennsylvania ("H. Engel, June 8–05"), and 1 male paratype from Jefferson County, West Virginia (Kearfott, "VIII-1") out of a large series from the American Museum collection that had been set aside as a new species by Kearfott under the manuscript name *amatana*, here adopted. Other specimens in the National Collection and American Museum collections from New Jersey and Massachusetts.

This species is at once distinguished from all others in the genus, but *delicatana* Heinrich by the shape of the cucullus of the male genitalia and from the latter by its broader wings, more sordid coloring, and the number of marginal spines before anal angle of cucullus. This latter character seems constant. The color and pattern is somewhat variable.

Veins 7 and 8 of fore wing connate.



THIS PAGE IS LOCKED TO FREE MEMBERS
Purchase full membership to immediately unlock this page



Never be without a book!

Forgotten Books Full Membership gives universal access to 797,885 books from our apps and website, across all your devices: tablet, phone, e-reader, laptop and desktop computer

A library in your pocket for \$8.99/month

Continue

*Fair usage policy applies

is no ocellus. The termen of fore wing is more decidedly slanting than in any other species in the genus and veins 7 and 8 are closely approximate at base, not stalked or connate.

Male genitalia figured from specimen in National Collection from Los Angeles, California.

Specimens in National Collection, American Museum, and collection Barnes from California.

Alar expanse.—17–21 mm.

Type.—In British Museum.

Type locality.—Crooked River, near Klamath Lakes, southern Oregon.

Food plant.—Unknown.

17. GRISELDA, new genus.

(Figs. 36, 329.)

Genotype.—*Paedisca radicana* Walsingham.

Fore wing smooth; termen concave between veins 3 and 5; 12 veins; 7 and 8 approximate; 10 remote from 9 but rather nearer to 9 than to 11; 11 from before middle of cell; upper internal vein of cell from between 10 and 11; 3, 4, and 5 only slightly approximate at termen; 2 very slightly bent up toward termen; costal fold present in male.

Hind wing with 8 veins; 6 and 7 approximate toward base; 3 and 4 stalked.

Male genitalia as in *Epinothia* except:

Uncus bifurcate with arms short and widely separated. Aedoeagus short and stout.

A derivative of *Epinothia*.

KEY TO THE SPECIES OF GRISELDA.

1. Fore wing blackish fuscous with entire dorsal margin white, spotted with black----- (2) *pennsylvaniana*.
Fore wing ochreous fuscous or pale gray; otherwise marked-----2
2. Ground color of fore wing ochreous fuscous; dark markings blackish. (3) *gerulae*.
Ground color pale ashy gray; dark markings ferruginous brown. (1) *radicana*.

1. GRISELDA RADICANA (Walsingham).

(Figs. 36, 329.)

Paedisca radicana WALSINGHAM, Illus. Lepid. Heter. Brit. Mus., vol. 4, 1879, p. 53.

Eucosma radicana FERNALD, in Dyar List N. Amer. Lepid., no. 5113, 1903.—
BARNES and MCDUNNOUGH, Check List Lepid. Bor. Amer., no. 6948, 1917.

This species does not seem to have been known to our Lepidopterists, for the specimens I have seen were either unnamed or wrongly

determined. In the Kearfott collection I found one from Victoria, British Columbia, under the name *scalana* Walsingham and three among the duplicates, labeled as reared from spruce. We have also in the National Collection several collected specimens received from E. H. Blackmore (Victoria, British Columbia) and one specimen from Seaview, Washington, reared from larva feeding on leaves of spruce (Quaintance no. 15564; H. K. Plank, collector; moth issued "VII-3-1918"). All these answer in detail to Walsingham's description and figure.

Male genitalia figured from specimen in National Collection from British Columbia.

Distribution according to specimens in National Collection, American Museum, and collection Barnes: British Columbia and Washington.

Alar expanse.—13–15 mm.

Type.—In British Museum.

Type locality.—Rouge River, Oregon.

Food plant.—Spruce.

2. GRISELDA PENNSYLVANIANA (Kearfott).

(Fig. 328.)

Proteoteras albicapitana pennsylvaniana KEARFOTT, Trans. Amer. Ent. Soc., vol. 33, 1907, p. 48.

Enarmonia pennsylvaniana BARNES and McDUNNOUGH, Check List Lepid. Bor. Amer., no. 7141, 1917.

Kearfott named this as a variety of (*Proteoteras*) *Epinotia albicapitana*, and a specimen in the Fernald collection from Dallas, Texas, is so labeled in his handwriting. Superficially it does look very much like a small race of that species, but in structure is quite different. We have in the National Collection two specimens from Forest Hills, Massachusetts, and one from Missouri. The Fernald collection in addition to the specimen determined by Kearfoot also possesses a male—without label, but presumably from Dallas, Texas.

Male genitalia figured from specimen in National Collection from Forest Hills, Massachusetts ("Wm. Reiff, 14-IV-1910").

Alar expanse.—15.5–17 mm.

Type.—In collection Barnes.

Type locality.—New Brighton, Pennsylvania.

Food plant.—Unknown.

3. GRISELDA GERULAE, new species.

(Fig. 324.)

Antennae, palpi, upper face and head very pale grayish fuscous; antennae faintly barred with black above; lower face white. Fore wing pale dull ochreous fuscous; a white patch on middle of dorsal

margin followed and preceded by a faint shading of blackish fuscous; from middle of costa a somewhat irregular curved line of black scales extending to upper outer angle of cell and thence up to apex; costal area enclosed within this black arc, of the pale ground color marked by three rather conspicuous black dashes; costa otherwise very faintly strigulated with blackish fuscous; ocelloid patch nearly obsolete, indicated only by two very faint, vertical leaden bars; cilia dark brownish fuscous with a darker basal band and a whitish patch at anal angle. Hind wing very pale smoky fuscous; cilia sordid whitish with a smoky basal band.

Male genitals of type figured.

Alar expanse.—17.5–18 mm.

Type.—In American Museum.

Paratype.—Cat. no. 24838 U.S.N.M.

Type locality.—New Brighton, Pennsylvania.

Food plant.—Unknown.

Described from male type and female paratype from the American Museum collection collected by H. D. Merrick ("3-26-02") and labeled "taken in coitu."

In genitalia this species belongs with the foregoing two and all three have the characteristic harpe structure of *Epinothia*, showing their derivation from that genus; but while *peninsylvaniana* and *radicana* also have the *Epinothia* wing pattern, *gerulae* has distinctly that of *Gretchena* or *Eæntera*. It might easily be mistaken for one or the other on superficial appearance were it not for its decided costal fold. There is also a faint indication of raised scaling on the fore wing as in *Gretchena*.

18. GWENDOLINA, new genus.

(Figs. 32, 323.)

Genotype.—*Gwendolina concitatricana*, new species.

Fore wing very slightly rough scaled; termen with a notch at vein 4; 12 veins; 7, 8, 9 approximate at base; 10 from cell midway between 9 and 11; 11 from cell slightly before middle; upper internal vein of cell from between 10 and 11; 3, 4, and 5 closely approximate at termen; 2 appreciably bent at $2/3$; costal fold present in male.

Hind wings with 8 veins; 6 and 7 closely approximate toward base; 3 and 4 connate (in some specimens very short stalked).

Male genitalia as in *Gretchena* except:

Socii not strongly chitinized nor elongately triangular but broad as long, almost circular.

The males also have an additional character in that there is a heavy black sex scaling on the upper surface of the abdomen, on



THIS PAGE IS LOCKED TO FREE MEMBERS

Purchase full membership to immediately unlock this page



HISTORY

Tens of thousands of important historical sources, many previously unobtainable, are now available for the first time with a Forgotten Books Full Membership.

Unlimited Access
\$8.99/month

Continue

*Fair usage policy applies

9 and 11; 11 from cell just before middle; upper internal vein of cell from between 10 and 11; 3, 4 and 5 closely approximate at termen; 2 straight; costal fold of male present.

Hind wing with 8 veins; 6 and 7 closely approximate towards base; 3 and 4 stalked; in the male a conspicuous hair tuft from lower median vein at base of cell.

Male genitalia with a row of long stout spines (2-3) on outer surface of harpe near apex; cucullus irregularly trigonate, large; neck smooth, sacculus densely clothed with long hair-like spines. Uncus present; weak; slender; moderately long. Socii broadly triangular. Gnathos greatly reduced; partially fused with socii.

CROCIDOSEMA PLEBEIANA Zeller.

(Figs. 10, 29, 29a, 325.)

Crocidosema plebeiana ZELLER, Isis, 1847, p. 721.—STAUDINGER and REBEL, Cat. Lepid., vol. 2, no. 1968, 1901.—HEINRICH, Journ. Agr. Res., vol. 20, 1921, p. 822.

Eucosma plebeiana WALSINGHAM, Biol. Cent. Amer. Lepid. Heter., vol. 4, 1914, pp. 231-232.

This widely distributed species is the only one of the genus to be found in our fauna. *Crocidosema marcidellum* Walsingham from Hawaii is congeneric and resembles *plebeiana* very strongly in both pattern and genitalia. Busck's *lantana*, also from Hawaii, and described by him as a *Crocidosema* is, however, an *Epinotia* with the typical *Epinotia* genitalia.

The larva of *plebeiana* is a feeder in the seeds, fruits and flowers of various malvaceae with habits much the same as those of the Pink Bollworm (*Pectinophora gossypiella* Saunders).

There are considerable differences in color and pattern between the males and females. In the latter the fuscous basal patch does not extend to the costa and the greater part of the wing above the fold is ochreous, while in the male the entire wing above the middle is shaded with brownish fuscous.

Male genitalia figured from specimens in National Collection from San Diego, California ("W. S. Wright, 9-30-1911").

Distribution according to specimens in National Collection American Museum, and collection Barnes: California and Texas.

Alar expanse.—12-14 mm.

Type.—Location unknown.

Type locality.—Syracuse, Sicily.

Food plants.—Various *Malvaceae*, *Crataegus*.

20. NORMA, new genus.

(Figs. 33, 414.)

Genotype.—*Epinotia dietziana* Kearfott.

Fore wing smooth; termen deeply concave just below apex (between veins 5 and 6); apex pointed but not falcate; 12 veins; 7 and 8 closely approximate; 10 from cell rather nearer to 9 than to 11; 9 approximate to 8; 11 from middle of cell; upper internal vein of cell from between 9 and 10; 3, 4 and 5 closely approximate at termen; 2 bent up slightly toward termen; no costal fold in male.

Hind wing with 8 veins; 6 and 7 approximate toward base; 3 and 4 stalked.

Male genitalia with harpe simple; several very long spines on cucullus arising near costal margin and neck of harpe; sacculus densely clothed with long hair-like spines. Uncus bifurcate; arms widely separated, weakly chitinized. Socii long; broad; ribbon-like. Aedoeagus straight; moderately long; stout.

A monotypic genus closely related to *Kundrya* and *Rhopobota*. The three are probably derived from the *Epinotia* stem but in the development of the uncus are like nothing except perhaps *Griselda*. The socii and gnathos are more as we find them in *Eucosma*.

NORMA DIETZIANA (Kearfott).

(Figs. 33, 414.)

Epinotia dietziana KEARFOTT, Trans. Amer. Ent. Soc., vol. 33, 1907, p. 92.

Enarmonia dietziana BARNES and McDUNNOUGH, Check List Lepid. Bor. Amer., no. 7141, 1917.

I have reared this species from *Ilex verticillata* along with specimens of both *Rhopobota ilicifoliana* Kearfott and *Kundrya finitimana* Heinrich. The three are apt to be confused but can be easily separated on structural characters, the condition of veins 7 and 8 of fore wing being alone sufficient to distinguish them apart.

Male genitalia figured from cotype in National Collection from Hazleton, Pennsylvania ("5/30").

Distribution according to specimens in National Collection, American Museum, and collection Barnes: Pennsylvania, New Hampshire, Connecticut, Virginia, Indiana, Colorado.

Alar expanse.—10–15 mm.

Type.—In American Museum.

Type locality.—Hazleton, Pennsylvania.

Food plant.—*Ilex verticillata*.

21. KUNDRYA, new genus.

(Figs. 8, 8a, 34, 415.)

Genotype—*Kundrya finitimana*, new species.

Fore wing smooth; termen deeply concave between veins 5 and 6; apex pointed but not falcate; 11 veins; 7 and 8 united; 10 from cell midway between 9 and 11; 9 approximate to 8; 11 from middle of cell; upper internal vein of cell from between 9 and 10; 3, 4, and 5 closely approximate at termen; 2 bent up slightly toward termen; no costal fold in male.

Hind wing with 8 veins; 6 and 7 approximate toward base; 3 and 4 stalked.

Male genitalia as in *Norma* except only one long super spine from cucullus of harpe near costal margin.

Very close to *Norma*, from which it differs chiefly in having veins 7 and 8 of fore wing united, not separate. The difference in the number of super spines on cucullus is probably only a specific character.

KUNDRYA FINITIMANA, new species.

(Figs. 8, 8a, 34, 415.)

Antennae, palpi, upper face, head, and thorax fuscous brown; the terminal fourth of antenna is somewhat paler and the inner sides of palpi and the lower part of face are sordid whitish. Fore wing fuscous brown shading to a more ferruginous brown toward apex and marked with sordid white; the dark scaling forming a distinct basal patch followed by a moderately broad whitish fascia; ocelloid patch whitish, the inner bar suffused with leaden scaling; whitish median fascia and basal patch more or less streaked with lead-colored scales; in fresh specimens a black mark on disk, and in most specimens a round black dot at apex; cilia fuscous, somewhat suffused with whitish at tornus and with a black basal line, the latter most obvious at apex. Hind wing smoky fuscous; cilia slightly paler with a dark basal band.

Male genitalia of type figured.

Alar expanse.—1–10 mm.

Type.—Cat. No. 24840, U.S.N.M.

Paratypes.—National Collection, American Museum, and collection Barnes.

Type locality.—Hampton, New Hampshire.

Food plant.—*Ilex verticillate*.

Described from male type and one male and one female paratype from Hampton, New Hampshire (S. A. Shaw; dated as follows: Type, "VI-11-1909"; male paratype, "VII-12-1909"; female, "VII-15-1913") and three male and one female paratypes from



THIS PAGE IS LOCKED TO FREE MEMBERS
Purchase full membership to immediately unlock this page



Never be without a book!

Forgotten Books Full Membership gives universal access to 797,885 books from our apps and website, across all your devices: tablet, phone, e-reader, laptop and desktop computer

A library in your pocket for \$8.99/month

Continue

*Fair usage policy applies

Vaccinium. In America it is best known as a pest of the cranberry. Plank's bulletin gives the life history and our latest information regarding it.

Male genitalia figured from reared specimens in National Collection from Nova Scotia ("on cranberry, U. S. Dept. no. 7168, issued 17 Aug. 1896").

Distribution according to specimens in National Collection, American Museum, and collection Barnes: Nova Scotia, Washington, New Jersey, Pennsylvania.

Alar expanse.—10–14 mm.

Types.—Location unknown (*naevana*); In British Museum (*luctiferana*); In Museum Comparative Zoology (*vacciniana*).

Type localities.—Europe (*naevana*); St. Martin's Falls, Albany River, Hudson Bay (*luctiferana*); Massachusetts (*vacciniana*).

Food plant.—Cranberry.

2. RHOPOTA NAEVANA ILICIFOLIANA (Kearfott).

Epinotia ilicifoliana KEARFOTT, Bull. Amer. Mus. Nat. Hist., vol 23, 1907, p. 158.

Proteoteryx ilicifoliana BARNES and MCDUNNOUGH, Check List Lepid. Bor. Amer., no. 7129, 1917.

The genitalia of Kearfott's species are identical in all details with those of the true *naevana* and I do not think it is any more than a color variety or at most a food plant race. Eventually we shall probably have to refer it to the synonymy; but until the larva is better known I prefer to hold the name as a racial designation. Kearfott's cotypes average appreciably paler than the general run of typical *naevana*, but there is considerable variation in the latter even among specimens of the same locality reared from cranberry and the differences are by no means constant.

Distribution according to specimens in National Collection, American Museum, and collection Barnes: North Carolina, New Jersey, British Columbia.

Alar expanse.—12–14 mm.

Type.—In American Museum.

Type locality.—Black Mountains, North Carolina.

Food plant.—*Ilex verticillata*.

23. Genus EPINOTIA Hübner.

(Figs. 38, 358.)

Genotype.—*Tortrix similana* Hübner.

Synonyms.—1. *Episagma* Hübner. *Genotype*.—*Phalaena Tortrix solandriana* Linnaeus.

2. *Acalla* Hübner. *Genotype*.—*Tortrix ophthalmicana* Hübner.

3. *Evetria* Hübner. *Genotype*.—*Phalaena Tinea tedella* Clerck.

4. *Panoplia* Hübner. *Genotype*.—*Phalaena Tortrix cruciana* Linnaeus.

5. *Steganoptycha* Stephens. *Genotype*.—*Tinea nisella* Clerck.

6. *Paedisca* Treitschke. *Genotype*.—*Tortrix biluana* Haworth.

7. *Phlaeodes* Guenée. *Genotype*.—*Tortrix tetraquetra* Haworth.

8. *Pamplusia* Guenée. *Genotype*.—*Tortrix mercuriana* Hübner (= *monticolana* Duponchel).

9. *Proteopteryx* Walsingham. *Genotype*.—*Proteopteryx emarginana* Walsingham.

10. *Catastega* Clemens. *Genotype*.—*Catastega timidella* Clemens.

Fore wing smooth (or but slightly rough scaled); termen straight, concave between veins 2 and 6 or with a decided notch between veins 3 and 5; 12 veins; 7 and 8 approximate, rarely connate or short stalked; 10 from about midway between 9 and 11; 11 from before middle of cell; upper internal vein of cell from between 10 and 11; 3, 4, and 5 separate or approximate at termen, closely approximate when termen is notched; 2 straight or slightly bent near termen; apex of wing blunt; costal fold of male present or absent.

Hind wing with 8 veins; 6 and 7 approximate toward base; 3 and 4 stalked.

Male genitalia with harpe simple; cucullus variously shaped, sharply defined; neck incurvation usually narrow and much reduced, when wide, neck not heavily haired or spined; sacculus with dense cluster of heavy short spines near neck incurvation or densely clothed with long slender spines. Uncus usually well developed and strong; simple or bifid; if reduced bifid and no broader than long. Socii greatly developed; if slender, strongly chitinized; normally broadly triangular and densely haired. Gnathos reduced and partially fused with socii. Aedoeagus moderately long; straight; stout or slender but not needle like; cornuti a cluster of elongate spines.

The second large stem of the subfamily. Like *Eucosma*, something of a lump. The costal fold can not be used here except to divide the genus artificially, for its disappearance is so gradual that it is difficult in some cases to say whether it is or is not present. Furthermore there are no correlating characters in the genitalia to justify such a separation. It may be possible to hold *Proteopteryx* on the character of the notched fore wing but here also the genitalia seem to forbid such a splitting. My separation of the genus into two groups is simply a matter of convenience to enable easier placing and identification of the species and does not correspond to any natural division.

KEY TO THE SPECIES OF EPINOTIA.

E. improvisana, new species, described in Appendix, is not included in this key.

Fore wing of Male with Costal Fold-----GROUP A.
Fore wing of Male without Costal Fold-----GROUP B.

GROUP A.

1. Termen of fore wing straight or concave-----2
Termen of fore wing with a decided notch-----38
2. Termen concave; or, if straight, rather vertical than slanting-----3
Termen of fore wing straight and decidedly slanting-----34
3. Male with heavy black sex scaling on inner angle of hind wings.
(7) *perplexana*.
Male with no such sex scaling-----4
4. Fore wing with a distinct white dash in cilia (or on termen) below apex--20
No such white streak in cilia below apex-----5
5. Fore wing with a dark brown basal area, a white spot on mid dorsum and
a roughly triangular blackish fuscous spot on dorsum near tornus; alar
expanse less than 16 mm-----6
Fore wing pattern otherwise; or if as above, then alar expanse over
18 mm-----7
6. Fore wing with a complete, angulate, dark basal patch; ground color along
costa beyond basal third much paler than basal patch, ochreous fuscous.
(27) *walkerana*.
Fore wing without a complete basal patch; ground color of entire costal area
a nearly uniform shade, brownish fuscous----- (28) *momonana* (part).
7. Darker contrasting areas of fore wing orange yellow, brick or madder
red-----8
Darker contrasting areas sometimes ferruginous, but not brick or madder
red, nor orange yellow-----10
8. Fore wings banded with orange yellow----- (8) *castaneana*.
Fore wings with darker areas red-----9
9. Costal and basal areas of fore wing pale brick red; a black line bordering
the lower outer margin of an incomplete basal patch; cilia and terminal
margin from below apex to just above anal angle, black.
(9) *johnsonana*.
No such black markings; a large madder red spot covering apical fifth of
wing----- (10) *madderana*.
10. Termen of fore wing deeply concave; apex somewhat produced and
pointed; ground color pale gray or cream color finely speckled with scat-
tered blackish or fuscous dots-----11
Termen of fore wing straight or but slightly concave; apex not produced;
pattern otherwise-----12
11. Ground color of fore wing gray----- (19) *subplicana*.
Ground color of fore wing cream white----- (20) *basipunctana*.
12. Fore wing greenish or with at least some suffusion of greenish scales-----13
Fore wing without such greenish suffusion-----16
13. Basal patch complete and sharply contrasted----- (6) *medioviridana*.
Basal patch obsolete or but partially defined-----14
14. Fore wing with a prominent, blackish, broken, transverse, outer fascia.
(18) *fumoviridana*.
No such outer fascia on fore wing-----15



THIS PAGE IS LOCKED TO FREE MEMBERS

Purchase full membership to immediately unlock this page



HISTORY

Tens of thousands of important historical sources, many previously unobtainable, are now available for the first time with a Forgotten Books Full Membership.

Unlimited Access
\$8.99/month

Continue

*Fair usage policy applies

28. Basal patch of fore wing slate color; wing beyond basal patch whitish, slightly suffused with blackish fuscous giving a pale bluish white shading to this area----- (25) *var. criddleana*.
Color markings of fore wing various; but not as above----- (24) *nisella*.
29. White area bordering basal patch forming a complete antimedial fascia. (32) *digitana*.
White area bordering basal patch defined as a rather large white spot on dorsal margin; obscured toward costa by fuscous scaling. (33) *transmissana*.
30. Entire costal margin of fore wing from base to near apex white, marked only by fine dark geminations----- (21) *rectiplicana*.
Greater part of costal margin not white; or if so, with at least one conspicuous dark spot near middle----- 31
31. Cilia white at anal angle of fore wing----- (26) *albangulana*.
Cilia at anal angle of fore wing as dark as or darker than cilia toward apex----- 32
32. Fore wing with a complete, transverse, brown fascia extending from outer third of costa to outer fourth of dorsal margin----- (34) *nigralbana*.
No such fascia on fore wing----- 33
33. Median white area of fore wing broad, diffusing to outer fifth below costa. (35) *ruidosana*.
Median white area narrow, defined as an angulate white fascia considerably narrower on costal than on dorsal margin----- (36) *heucherana*.
34. Fore wing blackish fuscous with an irregular white border along entire dorsal margin----- (15) *albicapitana*.
Fore wing grayish white or grayish fuscous----- 35
35. Fore wing unicolorous; markings all but obsolete----- (13) *zandana*.
Fore wing with a fine transverse post median dark shading, with an incomplete dark basal patch, or with a somewhat contrasted white patch on dorsal margin----- 36
36. Fore wing grayish white finely speckled with fuscous and with a fine blackish-fuscous line crossing wing from middle of costa to outer angle of dorsal margin----- (14) *yandana*.
Fore wing much suffused with fuscous, especially on costal half and toward base; a contrasting whitish patch covering greater part of dorsal margin----- 37
37. On fore wing from middle of costa to end of cell a fuscous half fascia heavily dusted with blackish scales----- (11) *laracana*.
Outer half fascia from costa, not dusted with blackish scales, faint or obsolete and fusing into a general fuscous costal suffusion--- (12) *vertumnana*.
38. Neck incurvation of harpe of male genitalia constricted by invasion of cucullus----- (38) *crenana*.
Neck incurvation of harpe not so constricted----- 39
39. *Socii* triangular----- (39) *cercocarpana*.
Socii narrowly elongate----- (37) *emarginana*.

GROUP B.

1. Fore wing unicolorous; or if marked, then only by slightly darker shading or a few dark dots along dorsal margin or a blackish streak on median basal area----- 2
Fore wing not unicolorous; and otherwise marked----- 4
2. Hind wing sordid white----- 3
Hind wing smoky fuscous----- (42) *arctostaphylana*.

3. Fore wing ferruginous brown.....(40) *bigemina*.
 Fore wing fuscous brown.....(41) *Bicordana*.
4. Fore wing longitudinally bicolored, with costal area purplish red or purplish brown and dorsal area whitish.....5
 Fore wing not longitudinally bicolored; or if so, costal area grayish fuscous.....7
5. Costal area of fore wing purplish red.....6
 Costal area of fore wing purplish brown.....(60) *lindana*.
6. Fore wing with whitish dorsal area strongly arched near termen.
 (59) *vagana*.
 Fore wing with whitish dorsal area but slightly arched near termen.
 (58) *septemberana*.
7. Fore wing longitudinally bicolored, but not markedly so; the whitish dorsal area more or less lined with fuscous.....(46) *timidella*,
 Fore wing not longitudinally bicolored.....8
8. Fore wing salmon ochreous with black line along termen, small black dots along dorsal margin and conspicuous black dusting around ocelloid patch.
 (61) *trossulana*.
 Fore wing otherwise colored and marked.....9
9. Fore wing with a conspicuous, blackish, irregular crescent marking on outer half of costa.....(62) *signiferana*.
 Fore wing without such.....10
10. Alar expanse less than 12 mm.....11
 Alar expanse over 12 mm.....13
11. Ground color of fore wing whitish; hind wing very pale smoky fuscous.....12
 Ground color of fore wing bronzy fuscous; hind wing dark smoky fuscous.....(50) *nanana*.
12. Fore wing with distinct transverse dark fascia from mid costa to pretornal dorsal margin; hind wing rather dark smoky fuscous.....(51) *meritana*.
 Outer transverse dark fascia faint or broken, not sharply contracted; hind wing very pale smoke color.....(49) *normanana*.
13. Fore wing with a large triangular dark patch on costa or with a broad transverse dark band or spot extending outwardly from mid costa but not reaching dorsal margin.....14
 Fore wing without such.....19
14. Costal marking a large triangular blackish gray patch.....(53) *lomonana*.
 Costal marking a transverse band.....15
15. Transverse marking chocolate brown or purplish fuscous.....16
 Transverse marking rust or brownish red more or less dusted with black scales.....17
16. Transverse marking chocolate brown, reaching only to lower outer angle of cell.....(52) *medioplagata*.
 Transverse marking purplish fuscous, reaching almost to tornus.
 (54) *purpuriciliana*.
17. Thorax and basal area of wing ochreous.....18
 Thorax and basal area of wing reddish brown... (57) *cruciana*, var. *alaskae*.
18. Underside of fore and hind wings unicolorous.....(55) *cruciana* (typical).
 Underside of fore wing darker than hind wing.
 (56) *cruciana* var. *plumbolineana*.
19. Entire costa of fore wing markedly strigulated with fuscous.....20
 Costa faintly strigulated; appreciably so only toward apex.....22
20. Dark marking of fore wing blackish or grayish fuscous.....21
 Dark markings greenish gray.....(48) *nonana*.

21. Dark areas of fore wing heavily dusted with blackish scales; cilia fuscous with little admixture of white; hind wing dark smoky fuscous.

(45) *marmoreana*.

Dark areas of fore wing grayish fuscous, the fuscous pattern much broken by scaling of the white ground color; cilia white spotted and dusted with fuscous; hind wing pale smoky fuscous..... (47) *aceriella*.

22. Second joint of palpus with two distinct black spots on upper edge; alar expanse less than 15 mm..... (43) *unica*.

Second joint of palpus not so marked; alar expanse over 18 mm.

(44) *infusca*.

GROUP A. MALE WITH COSTAL FOLD. . .

1. EPINOTIA SIMILANA (Hübner).

(Figs. 38, 358.)

Tortrix similana HÜBNER, Vog. and Schmet., 1792, fig. 71.

Tortrix bimaculana DONOVAN, Nat. Hist. Brit. Ins., vol. 13, 1808, pl. 459.

Epinotia similana HÜBNER, Verz. Schmet., 1826, p. 377.—WALSINGHAM, Biol. Cent. Amer. Lepid. Heter., vol. 4, 1914, p. 226.

Paedisca bimaculana ZELLER, Verh. Zool-bot. Ges. Wien, vol. 25, 1875, p. 302.

Epiblema similana STAUDINGER and REBEL, Cat. Lepid., vol. 2, no. 2135, 1901.

Eucosma similana FERNALD, in Dyar List N. Amer. Lepid., no. 5143, 1903.—BARNES and McDUNNOUGH, Check List Lepid. Bor. Amer., no. 7028, 1917.

This species has another European synonym, but I only quote *bimaculana*, as that is the name under which Zeller recorded *similana* from Massachusetts. It is not common in America and is less often taken than *solandriana*.

Male genitalia figured from specimens in National Collection from Medford, Massachusetts ("Sept. 20-1868").

Distribution according to specimens in National Collection, American Museum, and collection Barnes: Massachusetts, Quebec, New Hampshire, British Columbia.

Alar expanse.—18.5-20 mm.

Type.—In collection unknown.

Type locality.—Germany.

Food plants.—Hazel, birch (European records).

2. EPINOTIA SOLANDRIANA (Linnaeus).

(Fig. 354.)

Phalaena Tortrix solandriana LINNAEUS, Syst. Nat., ed. 10, vol. 1, 1758, p. 532.

Episagma solandriana HÜBNER, Verz. Schmet., 1826, p. 383.—WALSINGHAM, Biol. Cent. Amer. Lepid. Heter., vol. 4, 1914, p. 227.

Epiblema solandriana STAUDINGER and REBEL, Cat. Lepid., vol. 2, no. 2125, 1901.

Eucosma solandriana DYAR, Proc. Ent. Soc. Wash., vol. 6, 1904, p. 117.—BARNES and McDUNNOUGH, Check List Lepid. Bor. Amer., no. 7030, 1917.

This and *emarginana* Walsingham are the most variable species in the genus if not in the family, as far as pattern is concerned. It is easily recognized, however, and the genitalia structure is quite uniform in different specimens.



THIS PAGE IS LOCKED TO FREE MEMBERS
Purchase full membership to immediately unlock this page



Never be without a book!

Forgotten Books Full Membership gives universal access to 797,885 books from our apps and website, across all your devices: tablet, phone, e-reader, laptop and desktop computer

A library in your pocket for \$8.99/month

Continue

*Fair usage policy applies

Distribution according to specimens in National Collection, American Museum; and collection Barnes: Colorado and British Columbia.

Alar expanse.—15–17 mm.

Type.—In National Collection.

Type locality.—Boulder, Colorado.

Food plants.—*Pulsatilla hirsutissima*, *Clematis*.

5. *EPINOTIA PULSATILLANA SISKIYOUENSIS*, new variety.

(Fig. 346.)

Like *pulsatillana* except that the whitish dusting on head, thorax, and fore wing is absent. Color dark olivaceous gray, nearly unicolorous; basal patch on fore wing indicated only by a slightly darker shading and a faint outer margin of blackish fuscous scaling; the broken outer fascia of *pulsatillana* obsolete, replaced by very obscure wavy lines of blackish fuscous scaling. Male genitalia as in *pulsatillana* except that uncus is shorter and slightly notched at the tip.

Male genitalia of type figured.

Alar expanse.—18 mm.

Type.—Cat. No. 24842, U.S.N.M.

Type locality.—Shasta Retreat, Siskiyou County, California.

Food plant.—Unknown.

Described from single male type ("Aug. 16–23") easily distinguished from the typical *pulsatillana* by its uniformly dark olivaceous gray color, the absence of contrasted whitish dusting on fore wing beyond basal patch and its short notched uncus.

6. *EPINOTIA MEDIOVIRIDANA* (Kearfott).

(Fig. 347.)

Eucosma medioviridana KEARFOTT, Journ. N. Y. Ent. Soc., vol. 16, 1908, p. 168.—

BARNES and McDUNNOUGH, Check List Lepid. Bor. Amer., no. 6987, 1917.

Very like *pulsatillana* but distinguished by a verdigris green shade bordering basal patch on fore wing and its squarely spatulate uncus.

Male genitalia of type figured.

Distribution according to specimens in National Collection, American Museum, and collection Barnes: Ontario and Pennsylvania.

Alar expanse.—16–17 mm.

Type.—In American Museum.

Type locality.—Ottawa, Canada.

Food plant.—Unknown.

7. *EPINOTIA PERPLEXANA* (Fernald).

(Fig. 375.)

Epiblema perplexana FERNALD, Journ. N. Y. Ent. Soc., vol. 9, 1901, p. 51.

Eucosma perplexana FERNALD, in Dyar List N. Amer. Lepid., no. 5130, 1903.—

BARNES and McDUNNOUGH, Check List Lepid. Bor. Amer., no. 6983, 1917.

This species is distinguished from all other *Epinotia* by the heavy black sex scaling on the upper surface of abdomen and on inner angle of hind wing of the male. A similar secondary character is possessed by *Gwendolina concitaticana* Heinrich. Fernald's species, however, is a true *Epinotia*.

Male genitalia figured from cotype in National Collection (Dyar, Collector).

I have seen only specimens of the type series from the National Collection and Fernald collection.

Alar expanse.—13–15 mm.

Type.—In National Collection.

Type locality.—Palm Beach, Florida.

Food plant.—Unknown.

8. EPINOTIA CASTANEANA (Walsingham).

(Fig. 338.)

Paedisca castaneana WALSINGHAM, Trans. Ent. Soc. Lond, 1895, p. 511.

Eucosma castaneana FERNALD, in Dyar List N. Amer. Lepid., no. 5151, 1903.—

DYAR, Proc. U. S. Nat. Mus., vol. 27, 1904, p. 925.—BARNES and McDUNNOUGH, Check List Lepid. Bor. Amer., no. 7037, 1917.

Male genitalia figured from specimen in National Collection from Kaslo, British Columbia ("Dyar #21057").

Distribution according to specimens in National Collection, American Museum, and collection Barnes: Colorado, Washington, California, British Columbia.

Alar expanse.—12–16 mm.

Type.—In British Museum.

Type locality.—Loveland, Colorado.

Food plant.—Gooseberry (Dyar).

9. EPINOTIA JOHNSONANA (Kearfott).

(Fig. 383.)

Eucosma johnsonana KEARFOTT, Trans. Amer. Ent. Soc., vol. 33, 1907, p. 36.—

BARNES and McDUNNOUGH, Check List Lepid. Bor. Amer., no. 7009, 1917.

A striking species easily recognized by its brick red costal shading, black bordered termen and incomplete, black margined, red basal patch.

Male genitalia figured from specimen in National Collection from Victoria, British Columbia.

Distribution according to specimens in National Collection, American Museum, and collection Barnes: Washington, Nevada, British Columbia.

Alar expanse.—14–16 mm.

Type.—In American Museum.

Type locality.—Nevada.

Food plant.—Unknown.

10. EPINOTIA MADDERANA (Kearfott).

(Fig. 339.)

Eucosma madderana KEARFOOT, Can. Ent., vol. 39, 1907, p. 55.—BARNES and McDUNNOUGH, Check List Lepid. Bor. Amer., no. 7038, 1917.

Male genitalia figured from cotype in National Collection (West Manitoba, A. W. Hanham).

Distribution according to specimens in National Collection, American Museum, and collection Barnes: Manitoba, Saskatchewan, Ontario.

Alar expanse.—13–14 mm.

Type.—In American Museum.

Type locality.—Rounthwaite, Manitoba.

Food plant.—Unknown.

11. EPINOTIA LARACANA (Kearfott).

Proteopteryx laracana KEARFOOT, Trans. Amer. Ent. Soc., vol. 33, 1907, p. 45.—BARNES and McDUNNOUGH, Check List Lepid. Bor. Amer., no. 7118, 1917.

Proteopteryx navalis MEYRICK, Ent. Mag., vol. 48, 1912, p. 34.

I have not figured the genitalia, as the only male I have seen (a cotype from New Brighton, Pennsylvania) is badly rubbed and looks like a different species from the other specimens of the type series. The pattern reminds of an *Exentera*, but the species evidently belongs in *Epinotia* and is probably nothing but a color variety of *vertumnana*. It differs as far as I can see only in the greater intensity of its dark shading; but in the absence of any authentic male I do not feel justified in making the synonymy.

Distribution according to specimens in National Collection, American Museum, and collection Barnes: Ohio, Pennsylvania.

Alar expanse.—15–17 mm.

Type.—In American Museum.

Type locality.—Cincinnati, Ohio.

Food plant.—Unknown.

12. EPINOTIA VERTUMNANA (Zeller).

(Fig. 371.)

Paedisca vertumnana ZELLER, Verh. Zool.-bot. Ges. Wien., vol. 25, 1875, p. 310.

Paedisca celtisana RILEY, Trans. St. Louis Acad. Sci., vol. 4, 1881, p. 319.

Eucosma vertumnana FERNALD, in Dyar List N. Amer. Lepid., no. 5135, 1903.—(not KEARFOOT, Can. Ent., vol. 37, 1905, p. 208).—BARNES and McDUNNOUGH, Check List Lepid. Bor. Amer., no. 6984, 1917.

Eucosma celtisana FERNALD, in Dyar List N. Amer. Lepid., no. 5136, 1903.—BARNES and McDUNNOUGH, Check List Lepid. Bor. Amer., no. 6985, 1917.

Eucosma xandana KEARFOOT, Trans. Amer. Ent. Soc., vol. 33, 1907, p. 24.—

BARNES and McDUNNOUGH, Check List Lepid. Bor. Amer., no. 6995, 1917.

Eucosma atacta MEYRICK, Ent. Mo. Mag., vol. 48, 1912, p. 34.



THIS PAGE IS LOCKED TO FREE MEMBERS

Purchase full membership to immediately unlock this page



HISTORY

Tens of thousands of important historical sources, many previously unobtainable, are now available for the first time with a Forgotten Books Full Membership.

Unlimited Access
\$8.99/month

Continue

*Fair usage policy applies

14. EPINOTIA YANDANA (Kearfott).

(Fig. 369.)

Eucosma yandana KEARFOTT, Trans. Amer. Ent. Soc., vol. 33, 1907, p. 25.—

BARNES and McDUNNOUGH, Check List Lepid. Bor. Amer., no. 6993, 1917.

Eucosma nothroides MEYRICK, Ent. Mo. Mag., vol. 48, 1912, p. 34.

One of the cotypes in the National Collection (a female) has veins 7 and 8 of fore wing stalked. The rest of the specimens have them approximate. This appears to be only an aberration as otherwise the specimen agrees with the other cotypes.

Male genitalia figured from cotype in National Collection from New Brighton, Pennsylvania ("H. D. Merrick, IV-9-04").

All specimens in National Collection, American Museum, and collection Barnes from Pennsylvania.

Alar expanse.—16–17 mm.

Type.—In American Museum.

Type locality.—New Brighton, Pennsylvania.

Food plant.—Unknown.

15. EPINOTIA ALBICAPITANA (Kearfott).

(Fig. 384.)

Proteopteryx albicapitana KEARFOTT, Trans. Amer. Ent. Soc., vol. 33, 1907, p. 47.

Enarmonia albicapitana BARNES and McDUNNOUGH, Check List Lepid. Bor. Amer., no. 7142, 1917.

A striking species easily recognized on both pattern and genitalia. Male genitalia figured from specimen in National Collection from Placer County, California ("Sept.").

Distribution according to specimens in National Collection, American Museum, and collection Barnes: California, Colorado, Utah.

Alar expanse.—17–21 mm.

Type.—In American Museum.

Type locality.—Placer County, California.

Food plant.—Unknown.

16. EPINOTIA HOPKINSANA (Kearfott).

(Fig. 340.)

Eucosma hopkinsana KEARFOTT, Trans. Amer. Ent. Soc., vol. 33, 1907, p. 36.—

BARNES and McDUNNOUGH, Check List Lepid. Bor. Amer., no. 7010, 1917.

A variable species with small tufts of raised scales on fore wing. It probably has two generations a year as moths were reared by Mr. J. M. Miller of the U. S. Bureau of Entomology from January to April and again in October and November. Some of our reared specimens also bear midsummer dates indicating considerable overlapping of broods. The color of the fore wing varies from a pale

apple or verdigris green to a dark absinthe green. The larvae feed in the cones on seeds of Spruce, Pine, and California Cypress. Adults reared from the last are very dark and so different in color from the Spruce and Pine forms that I am giving them a separate varietal designation.

Male genitalia figured from cotype in National Collection from Hoquiam, Washington (Burke, "7-21-04").

Distribution according to specimens in National Collection, American Museum, and collection Barnes: Washington, California, and British Columbia.

Alar expanse.—16–19 mm.

Type.—In American Museum.

Type locality.—Hoquiam, Washington.

Food plants.—*Picea stichensis*, *Pinus radiata*.

17. *EPINOTIA HOPKINSANA CUPRESSI*, new variety.

(Fig. 341.)

Differs from typical *hopkinsana* Kearfott in the much darker green color of thorax and primaries, which are a decided absinthe rather than pale bluish or verdigris green shade; in its dark fuscous cilia on fore wing; and its dark smoky fuscous hind wing. The cilia of the latter are concolorous with the wings and the dark basal band is barely discernable. The genitalia do not differ to any appreciable extent.

Male genitalia figured from type.

Alar expanse.—19–21 mm.

Type.—Cat. No. 24843, U.S.N.M.

Paratypes.—In National Collection, American Museum, and collection Barnes.

Type locality.—Cypress Point, California.

Food plant.—*Cupressus macrocarpa*.

Described from male type (reared under Hopk. U. S. no. 13264 C², Nov. 4, 1915, by J. M. Miller from larva feeding in cones of *Cupressus macrocarpa*); one male and two female paratypes from Pacific Grove, California (reared under Hopk. U. S. no. 12579g, Apr. 15 and 23, 1915, J. M. Miller); two male paratypes from Cypress Point, California (Hopk. no. 13313f, Oct. 26, 1916, J. M. Miller); and two female paratypes from the Kearfott collection taken at Lone Mountain, San Francisco, California (F. X. Williams, "VI-1-09" and "VI-10-09").

A distinct food plant variety of *hopkinsana* easily distinguished by its much darker color.

18. *EPINOTIA FUMOVIRIDANA*, new species.

(Fig. 348.)

Palpi, face and head dark grayish fuscous. Thorax and fore wing dark grayish fuscous dusted with greenish scales giving ground color to the naked eye a smoky gray green appearance; basal patch obsolete; from middle of costa a rather broad transverse black band extending nearly to a black spot on dorsum before tornus, forming with the latter a fascia broken above the dorsal spot by a thin line of the ground color; ocelloid patch faint, a paler greenish shade than the ground color and containing two or three indistinct black streaks; above ocelloid patch a faint shading of black; at apex an inwardly pointed short black dash; on outer half of costa three faint dark fuscous spots; cilia very dark fuscous with a blackish basal shading; termen distinctly concave; veins 3, 4, and 5 approximate at termen; above dorsum a couple of small tufts of raised scales. Hind wing semilustrous; dark smoky fuscous; cilia but slightly paler with a dark basal band and the extreme tips of the hairs white.

Male genitalia of type figured.

Alar. expanse.—19–21 mm.

Type.—In collection Barnes.

Paratypes.—Cat. No. 24844, U.S.N.M.; also in American Museum.

Type locality.—Shasta Retreat, Siskiyou County, California.

Food plant.—Unknown.

Described from male type ("Aug. 16–23") and two female paratypes ("Aug. 16–23," "Sept. 1–7") from Doctor Barnes collection, labeled "Shasta Retreat, Siskiyou County, California."

A distinct species reminding very much of *pulsatillana* Dyar from which it is distinguished by its darker greenish gray color, its black rather than fuscous gray post median fascia, and its more concave termen.

19. *EPINOTIA SUBPLICANA* (Walsingham).

(Fig. 355.)

Paedisca ? subplicana WALSINGHAM, Illus. Lepid. Heter. Brit. Mus., vol. 4, 1879, p. 41.

Eucosma subplicana FERNALD, in Dyar List N. Amer. Lepid., no. 5094, 1903.—
BARNES and MCDUNNOUGH, Check List Lepid. Bor. Amer., no. 6955, 1917.

This species has what amounts to a falcate apex in the fore wing. This character should throw it into *Ancylis*. The genitalia and the large costal fold however clearly show that it belongs where we have placed it. Another example of the difficulties experienced with all characters of this subfamily.

Male genitalia figured from specimen in National Collection from Ashland, Oregon (reared under Hopk. U. S. no. 13208 E,² May 17,



THIS PAGE IS LOCKED TO FREE MEMBERS

Purchase full membership to immediately unlock this page



Never be without a book!

Forgotten Books Full Membership gives universal access to 797,885 books from our apps and website, across all your devices: tablet, phone, e-reader, laptop and desktop computer

A library in your pocket for \$8.99/month

Continue

*Fair usage policy applies

22. EPINOTIA SOLICITANA (Walker).

(Figs. 363, 364.)

Grapholita solicitana WALKER, Cat. Lepid. Heter. Brit. Mus., vol. 28, 1863, p. 387.*Halonota packardiana* CLEMENS, Proc. Ent. Soc. Phila., vol. 2, 1864, p. 417.*Paedisca tephriana* ZELLER, Verh. Zool.-bot. Ges. Wien., vol. 25, 1875, p. 308.*Paedisca solicitana* WALSINGHAM, Illus. Lepid. Heter. Brit. Mus., vol. 5, 1879, p. 55.*Eucosma solicitana* FERNALD, in Dyar List N. Amer. Lepid., no. 5127, 1903.—

BARNES and McDUNNOUGH, Check List Lepid. Bor. Amer., no. 6972, 1917.

One of Zeller's cotypes of *tephriana* (a male) is in the National Collection. It is labeled in Walsingham's handwriting as follows: "*Paedisca solicitana* Wlk.=*tephriana* Zell., Walsm. /86." The male genitalia of this specimen is illustrated (fig. 363). The specimen is in poor condition and the genitalia has been injured. In Figure 364 I show the genitalia of an undamaged specimen from Orono, Maine, reared at the Maine Experiment Station ("Exp. 1337, IV-10-11") from birch.

This is a northern species. The specimens in the Kearfott collection from Pennsylvania, while having the same pattern and coloration as typical *solicitana*, are very doubtfully that species. I have reared from catkins of hazel at Falls Church, Virginia, in company with a number of moths of *Epinotia walkereana*, two specimens which appeared to be *solicitana*. There is no superficial character to separate them, yet the genitalia are different in both the shape of the sacculus and the position of the sacculus spine cluster. I leave them undescribed for the present, awaiting more material and further rearings.

Distribution according to specimens in National Collection, American Museum, and collection Barnes: Maine, New Hampshire, Massachusetts?, Pennsylvania?.

Alar expansè.—13-14 mm.

Types.—In British Museum (*solicitana*), (*tephriana?*); lost: (*packardiana*).

Type localities.—Nova Scotia (*solicitana*); Labrador (*packardiana*); "Massachusetts or Maine" (*tephriana*).

Food plant.—Birch.

23. EPINOTIA HAMPTONANA (Kearfott).

(Fig. 362.)

Eucosma hamptonana KEARFOTT, Can. Ent., vol. 39, 1907, p. 153.—BARNES and McDUNNOUGH Check List Lepid. Bor. Amer., no. 7027, 1917.

Very close to *solicitana* but apparently distinct. The genitalia are the same for the two except that the heavy spine cluster of sacculus is on the dorsal margin in *hamptonana*, while in *solicitana* it is above the margin and nearer the basal orifice of the harpe.

Male genitalia figured from type.

Specimens in National Collection and American Museum from New Hampshire.

Alar expanse.—12.5–14 mm.

Type.—In American Museum.

Type locality.—Hampton, New Hampshire.

Food plant.—Unknown.

24. EPINOTIA NISELLA (Clerck).

(Fig. 356.)

Tinea nisella CLERCK, Icon. Ins., 1759, pl. 12, fig. 6.

Epiblema nisella STAUDINGER and REBEL, Cat. Lepid., vol. 2, no. 2119, 1901.

Eucosma nisella FERNALD, in Dyar List N. Amer. Lepid., no. 5131, 1903.—KEARFOTT, Can. Ent., vol. 37, 1905, p. 208.—BARNES and McDUNNOUGH, Check List Lepid. Bor. Amer., no. 6986, 1917.

A very variable species easily recognized by its peculiar horn like socii. The latter project caudally from the tegumen and look at first glance like the parts of a widely divided uncus.

Male genitalia figured from specimen in National Collection, from Holquiam, Washington (reared from *Salix* under Hopk. U. S. no. 1927a, Burke, Collector).

Distribution according to specimens in National Collection, American Museum, and collection Barnes: Montana, Washington, British Columbia, Manitoba, Ontario.

Alar expanse.—13–16 mm.

Type.—Unknown.

Type locality.—Europe.

Food plants.—*Populus*, *Salix*.

25. EPINOTIA NISELLA CRIDDLEANA (Kearfott).

Proteopteryx criddleana KEARFOTT, Can. Ent., vol. 39, 1907, p. 58.—BARNES and McDUNNOUGH, Check List Lepid. Bor. Amer., no. 7124, 1917.

This is only a rather large and very pale color variety of *nisella*, and should probably not even have a varietal designation. The genitalia agrees in detail with those of typical specimens of *nisella*. I am keeping Kearfott's name for the present on the chance that it may apply to a food plant race.

Specimens in National Collection, American Museum and collection Barnes from Manitoba.

Alar expanse.—16–17 mm.

Type.—In American Museum.

Type locality.—Aweme, Manitoba.

Food plant.—Unknown.

26. EPINOTIA ALBANGULANA (Walsingham).

(Fig. 361.)

Paedisca albangulana WALSINGHAM, Illus. Lepid. Heter. Brit. Mus., vol. 4, 1879, p. 40.

Eucosma albangulana FERNALD, in Dyer List N. Amer. Lepid., no. 5120, 1903.—
BARNES and McDUNNOUGH, Check List Lepid. Bor. Amer., no. 6966, 1917.

Another very variable species, superficially much like *nisella* but radically different in genitalia. It is apparently confined to the far west.

Male genitalia figured from specimen in National Collection from Ashland, Oregon, (reared from larva feeding in catkins of *Alnus oregona*, May 22, 1915, under Hopk. U. S. no. 13200a, by J. M. Miller).

Distribution according to specimens in National Collection, American Museum, and collection Barnes: California, Oregon, Washington, British Columbia, Idaho.

Alar expanse.—14–16 mm.

Type.—British Museum.

Type locality.—Mendocino County, California.

Food plant.—*Alnus*.

27. EPINOTIA WALKERANA (Kearfott).

(Fig. 360.)

Eucosma walkerana KEARFOTT, Trans. Amer. Ent. Soc., vol. 33, 1907, p. 89.—
BARNES and McDUNNOUGH, Check List Lepid. Bor. Amer., no. 6979, 1917.

In the vicinity of Washington, District of Columbia, a common hazel species. The larvae feed in the catkins.

Male genitalia figured from specimen in National Collection from Glencarlyn, Virginia (reared under Hopk. U. S. no. 12105a, May 27, 1914, Heinrich).

Distribution according to specimens in National Collection, American Museum, and collection Barnes: Maryland, Virginia, Pennsylvania, District of Columbia.

Alar expanse.—10–12 mm.

Type.—In American Museum.

Type locality.—District of Columbia.

Food plant.—*Corylus americana*.

28. EPINOTIA MOMONANA (Kearfott).

(Fig. 359.)

Proteopteryx momonana KEARFOTT, Can. Ent., vol. 39, 1907, p. 125.—BARNES and
MCDUNNOUGH, Check List Lepid. Bor. Amer., no. 7127, 1917.

Proteopteryx sanifica MEYRICK, Ent. Mo. Mag., vol. 48, 1912, p. 36.

Very close to *walkerana* Kearfott, but apparently distinct. The socii of the genitalia are broader in proportion to their length in



THIS PAGE IS LOCKED TO FREE MEMBERS

Purchase full membership to immediately unlock this page



HISTORY

Tens of thousands of important historical sources, many previously unobtainable, are now available for the first time with a Forgotten Books Full Membership.

Unlimited Access
\$8.99/month

Continue

*Fair usage policy applies

of their genitalia. They all have the same wing shape and pattern with a strongly marked outwardly angulate basal patch and a complete well-marked outer fascia with a small cup-shaped indentation on its outer margin at upper inner angle of the ocelloid patch. Externally they differ only in color. The articulation and shape of aedoeagus and anellus (especially in *terracoctana* and *miscana*) remind strongly of those organs as they are developed in the genus *Gretchena*.

Male genitalia figured from specimen in National Collection from Cisco, California (A. H. Vachell, "June, 1-05").

Specimens in National Collection, American Museum, and collection Barnes from California.

Alar expanse.—17-19 mm.

Type.—In American Museum.

Type locality.—Cisco, Placer County, California.

Food plant.—Unknown.

31. EPINOTIA SILVERTONIENSIS, new species.

(Fig. 386.)

Like *miscana* except: head sordid grayish or dirty ochreous white; dark basal patch, outer dark fascia, dark shadings above ocelloid patch and at apex and the three outer costal dashes on fore wing, pale semi-lustrous fuscous brown; antimedial area between basal patch and outer fascia, white; a white shading bordering outer margin of fascia and in subcostal area before apex; cup-shaped indentation on outer margin of fascia at upper inner angle of ocelloid patch strongly marked by a small white or metallic spot; vertical bars of ocellus leaden metallic with little or no whitish dusting; hind wings pale smoky fuscous; cilia whitish with dark basal and pale smoky subterminal bands.

Male genitalia of type figured.

Alar expanse.—16-17.5 mm.

Type.—In collection Barnes.

Paratypes.—Cat. No. 24845, U.S.N.M.; also in American Museum Dr. Barnes' collection.

Type locality.—Silverton, Colorado.

Food plant.—Unknown.

Described from male type and 5 male paratypes from Silverton, Colorado ("July 16-23") out of a series of eighteen moths all from Dr. Barnes' collection.

A distinct species easily recognized by its peculiar genitalia. The most characteristic structural difference between it and its nearest ally (*miscana* Kearfott) is found in the shape of the uncus. The organ is bifid in both species, but in *miscana* the forks are long and close together while in *silvertoniensis* they are short and well sepa-

rated. There are also other obvious differences in the shapes of their harpes and aedoeagi. These are clearly indicated in our figures.

32. *EPINOTIA DIGITANA*, new species.

(Fig. 382.)

Very like and close to *nigralbana* Walsingham and *transmissana* Walker. Distinguished from the latter by having a complete anti-median white fascia bordering the brown basal patch on fore wing; this fascia has an indistinct thin median fuscous line but no suffusion of brownish or metallic scaling obscuring the white toward costa as in *transmissana*. From *nigralbana* it differs in having a short white spur projecting out from the middle of the outer margin of the white fascia into the dark postmedian area. In *nigralbana* there is a spur at the same place on the wing, but it is an inward projection from the post median brown area (or fascia) into the white antimedial fascia. From all other American species of *Epino-*
tia, *digitana* differs in having a slender, prominent pollex or finger-like process projecting from the anal angle of the cucullus of the harpe.

Male genitalia of type figured.

Alar expanse.—17–18 mm.

Type.—Cat. No. 24846, U.S.N.M.

Type locality.—Kaslo, British Columbia.

Food plant.—Unknown.

Described from male type from Kaslo, British Columbia (H. G. Dyar, "23588") and 1 male paratype from Pullman, Washington (C. V. Piper). Both are from the National collection and had been determined as *transmissana* Walker. The paratype had been so labeled by Kearfott.

33. *EPINOTIA TRANSMISSANA* (Walker).

(Fig. 357.)

Penthina transmissana WALKER, Cat. Lepid. Heter. Brit. Mus., vol. 28, 1863, p. 375.

Paedisca transmissana WALSINGHAM, Illus. Lepid. Heter. Brit. Mus., vol. 4, 1879, p. 52.

Eucosma transmissana FERNALD, in Dyar List N. Amer. Lepid., no. 5128, 1903.—BARNES and McDUNNOUGH, Check List Lepid. Bor. Amer., no. 6974, 1917.

An eastern and north eastern species closely resembling the western *albangulana* Walsingham, but distinguished by its much stouter genitalia and the evenly angulate basal patch on fore wing, that of *albangulana* having a notch on outer margin below middle which is lacking in *transmissana*. The latter is also a much more uniform

species exhibiting none of the striking color variation so characteristic of *albangulana*. From *nisella* Clerck which also occurs in the north east it is at once distinguished by its broad triangular socii.

Male genitalia figured from specimen in National Collection from New Hampshire (Busck).

Distribution according to specimens in National Collection, American Museum, and collection Barnes: Illinois, Pennsylvania, New Jersey, New Hampshire, Ontario.

Alar expanse.—14–17 mm.

Type.—In British Museum.

Type locality.—Nova Scotia.

Food plant.—*Betula*?

34. *EPINOTIA NIGRALBANA* (Walsingham).

(Fig. 351.)

Paedisca nigralbana WALSINGHAM, Illus. Lepid. Heter. Brit. Mus., vol. 4, 1879, p. 41.

Eucosma nigralbana FERNALD, in Dyar List N. Amer. Lepid., no. 5123, 1903.—
BARNES and McDUNNOUGH, Check List Lepid. Bor. Amer., no. 6956, 1917.

Male genitalia figured from cotype in National Collection.

Distribution according to specimens in National Collection, American Museum, and collection Barnes: California and Colorado.

Alar expanse.—14–16 mm.

Type.—In British Museum.

Type locality.—Mendocino County, California.

Food plant.—Unknown.

35. *EPINOTIA RUIDOSANA*, new species.

(Fig. 380.)

Palpi fuscous gray, white toward base. Face white. Head grayish or ochreous fuscous. Thorax white spotted with bluish fuscous. Ground color of fore wing milky white; an obscure dark angulate basal patch indicated by blotches or dustings of bluish fuscous scales; terminal fourth of wing clouded with black and brown and containing a couple of irregular vertical bars of metallic scales, the black scaling forming two blotches, one above dorsum near tornus and the other below costa before termen; a pale brown streak from mid costa, reaching to or nearly to black patch before tornus; between this brown streak and apex, on costa, three pale brown germinate spots; apex and termen pale brown, the brown color broken by a white dash on termen below apex; extreme margin of termen edged with a fine black line, the latter becoming obsolete towards anal angle; cilia smoky fuscous with a pale shading toward base at apex; underside of fore wing smoky fuscous; under



THIS PAGE IS LOCKED TO FREE MEMBERS
Purchase full membership to immediately unlock this page



Never be without a book!

Forgotten Books Full Membership gives universal access to 797,885 books from our apps and website, across all your devices: tablet, phone, e-reader, laptop and desktop computer

A library in your pocket for \$8.99/month

Continue

*Fair usage policy applies

Alar expanse.—10–13 mm.

Type.—Cat. No. 24848, U.S.N.M.

Paratypes.—In National Collection, American Museum, and collection Barnes.

Type locality.—Rosslyn, Virginia.

Food plant.—*Heuchera americana*.

Described from male type, seven male and two female paratypes all reared from larvaé mining the leaves of our eastern "alum root" (Hopk. U. S. no. 13981, Heinrich, collector).

The habits of the larvae are similar to those of the western *ruidosana* except that they make a digitate rather than a blotch mine (very similar in fact to the mines made by the larvae of the genus *Parectopa*).

They are found fairly abundant in the damp shady spots on the hillsides along the Potomac near Washington, District of Columbia. The larvae were collected in October, 1916, and moths issued during late May and early June of the following year. When full fed, the larvae is a deep uniform red with jet black head and thoracic shield.

The species is close to *ruidosana*, which it replaces in the East; but is quite distinct and easily recognizable.

37. EPINOTIA EMARGINANA (Walsingham).

(Fig. 330.)

Proteopteryx emarginana WALSINGHAM, Illus. Lepid. Heter. Brit. Mus., vol. 4, 1879, p. 68; Trans. Ent. Soc. Lond., 1884, p. 144.—FERNALD, in Dyar List N. Amer. Lepid., no. 5210, 1903; Can. Ent., vol. 36, 1904, p. 120.—BARNES and McDUNNOUGH, Check List Lepid. Bor. Amer., no. 7113, 1917.

This and the following two species would constitute the genus *Proteopteryx* could that group be validly separated from *Epinotia*. It has only one character to distinguish it, namely, the deeply notched termen of fore wing and without some other character either in larval or genitalic structure I would not feel justified in maintaining it.

The three species are quite easily separated on genitalia but in pattern are hardly to be distinguished. Both *emarginana* and *crenana* are extremely variable and many of their varieties have so much the same appearance that without an examination of their genitalia it is practically impossible to determine which is which. Dyar's *cercocarpiana* is if anything the most distinct; but it too, aside from its genitalia, has no key character.

Male genitalia figured from specimen in National Collection from Santa Catalina Mountains, Arizona (reared under Hopk. U. S. no. 12129c from *Quercus agrifolia*, May 28, 1914, M. Chrisman).

Distribution according to specimens in National Collection, American Museum, and collection Barnes: Arizona, California, Oregon, Washington, British Columbia.

Besides a large reared series from oak, we also have in the National Collection a series reared from *Arctostaphylos termentosa* (Hopk. U. S. No. 16186a, June, 1920, Bonnie Doon, California, R. D. Hartman, collector).

Alar expanse.—13–17 mm.

Type.—In British Museum.

Type locality.—Mendocino County, California.

Food plants.—*Quercus* and *Arctostaphylos*.

38. EPINOTIA CRENANA (Hübner).

(Fig. 331.)

Tortrix crenana HÜBNER, Samm. Eur. Schmett. Tort., 1827, fig. 242.

Epiblema crenana STAUDINGER and REBEL, Cat. Lepid., vol. 2, no. 2133, 1901.

Eucosma crenana DYAR, Proc. Ent. Soc. Wash., vol. 6, 1904, p. 117; Proc. U. S. Nat. Mus., vol. 27, 1904, p. 926.—BARNES and McDUNNOUGH, Check List Lepid. Bor. Amer., no. 6996, 1917.

Proteopteryx columbia KEARFOTT, Can. Ent., vol. 36, 1904, p. 112; Can. Ent., vol. 37, 1905, p. 253.—BARNES and McDUNNOUGH, Check List Lepid. Bor. Amer., no. 7123, 1917.

Proteopteryx columbia albidorsana KEARFOTT, Can. Ent., vol. 36, 1904, p. 113.

Proteopteryx columbia mediotriana KEARFOTT, Can. Ent., vol. 36, 1904, p. 114.

Dyar suggested the synonymy of *columbia* and *crenana* in 1904. An examination of the genitalia verifies his contention. The forms *albidorsana* and *mediotriana* are merely color varieties and therefore should be treated as synonyms. There is nothing to be gained to holding such names where they apply only to color varieties of a variable species.

Male genitalia figured from specimen in National Collection from Kaslo, British Columbia (Dyar, "33662").

Distribution according to specimens in National Collection, American Museum, and collection Barnes: Manitoba and British Columbia.

Alar expanse.—14–15 mm.

Types.—In collection, unknown? (*crenana*); in American Museum (*columbia* and varieties).

Type localities.—Europe (*crenana*); Wellington, British Columbia (*columbia* and *mediotriana*); Kaslo, British Columbia (*albidorsana*).

Food plant.—*Salix*.

39. EPINOTIA CERCOARPANA (Dyar).

(Fig. 342.)

Eucosma cercocarpana DYAR, Proc. Ent. Soc. Wash., vol. 5, 1903, p. 297.—BARNES and McDUNNOUGH, Check List Lepid. Bor. Amer., no. 6989, 1917.

Male genitalia figured from paratype in National Collection.

A paratype is in the American Museum. The rest of the types are in the National Collection. I have seen no other specimens.

Alar expanse.—15–18 mm.

Type.—In National Collection.

Type locality.—Platt Canon, Colorado.

Food plant.—*Cercocarpus parvifolius*.

GROUP B. MALE WITHOUT COSTAL FOLD.

40. EPINOTIA BIGEMINA, new species.

(Fig. 374.)

Antennae ferruginous above, whitish gray beneath. Palpus with the third joint long and exposed; ferruginous shading to fuscous at tip; inner side of basal and second joint white. Face, head and thorax ferruginous brown. Fore wing with the termen straight and slanting; veins 3, 4, and 5 not approximate at termen; unicolorous dull ferruginous brown; cilia fuscous. Hind wing white, very faintly mottled with fuscous; cilia white.

Male genitalia of type figured.

Alar expanse.—14–15 mm.

Type.—In American Museum.

Paratypes.—Cat. No. 24849, U.S.N.M.; also in American Museum, and collection Barnes.

Type locality.—Carmel, California.

Food plant.—Unknown.

Described from male type, and 3 male and 3 female paratypes collected by A. H. Vachell at Carmel, California ("Apr."), all from the Kearfott collection of the American Museum.

A distinct species reminding of *arctostaphylana* Kearfott, but distinguished by its genitalia and white hind wings. This and the following species illustrate the difficulty of such a character as the costal fold. I have placed them in the group without fold, but the costa is often partially curled up near base, sometimes for almost half the length of the wing, suggesting a fold; but it is not completely folded over. On wing shape, color and genitalia both species are very close to *vertumnana*, *vandana*, and *zandana* of group A and really belong with them except for the disappearance (or incompleteness) of the fold. As it is, they form a connecting link between the species of *Epinotia* with and without a decided fold.

41. EPINOTIA BICORDANA, new species.

(Fig. 368.)

Antennae, palpi, face, head, thorax, and fore wing dull dark fuscous; cilia paler shading to a dirty white toward anal angle.



THIS PAGE IS LOCKED TO FREE MEMBERS

Purchase full membership to immediately unlock this page



HISTORY

Tens of thousands of important historical sources, many previously unobtainable, are now available for the first time with a Forgotten Books Full Membership.

Unlimited Access
\$8.99/month

Continue

*Fair usage policy applies

surrounding ocelloid patch, pale brown; subcostal area near base and basal patch irregularly spotted with scattered black dots; costa from base finely and weakly strigulated with black, before apex with a few short white dashes, the one just before apex most marked; a similar short white dash on termen below apex, but not extending into the cilia; at apex a round dark-brown dot; some two or three long faint slender metallic streaks from apical third of costa; cilia whitish gray dusted with black. Hind wing smoky fuscous; cilia whitish shading to smoky fuscous at apex and with a dark basal band.

Male genitalia of type figured.

Alar expanse.—13–13.5 mm.

Type.—Cat. No. 24851, U.S.N.M.

Type locality.—Knoxville, Tennessee.

Food plant.—*Bradburya virginiana*.

Described from male type and female paratype from Knoxville, Tennessee, reared by C. N. Ainslie from *Bradburya virginiana* ("Knoxville no. 17295.").

A distinct species easily recognized by its unique genitalia.

44. EPINOTIA INFUSCANA (Walsingham).

(Fig. 352.)

Semasia infusca WALSINGHAM, Illus. Lepid. Heter. Brit. Mus., vol. 4, 1879, p. 62.

Thiodia infusca FERNALD, in Dyar List N. Amer. Lepid., no. 5195, 1903.

Eucosma infusca BARNES and McDUNNOUGH, Check List Lepid. Bor. Amer., no. 7094, 1917.

Several specimens in National Collection, labeled as reared from larvae on *Lupinus arborae*. Male genitalia figured from one such specimen from Alameda County, California.

Distribution according to specimens in National Collection, American Museum, and collection Barnes: California and Arizona.

Alar expanse.—20–21 mm.

Type.—In British Museum.

Type locality.—San Francisco, California.

Food plant.—*Lupinus*.

45. EPINOTIA MARMOREANA, new species.

(Fig. 349.)

Like *infusca* but with the pale areas of fore wing white and with a smaller blackish fuscous spot just above the outer dorsal dark patch.

Palpus with third joint long and exposed; white dusted and clouded with grayish fuscous on outer side. Head and face sordid white somewhat dusted with grayish fuscous on the sides. Thorax grayish

fuscous dusted with white. Fore wing white lined and marked with blackish fuscous; a dark, outwardly angulate basal patch, its blackish ground color somewhat dusted with white scales especially at extreme base and toward costa; on dorsum before tornus a triangulate dark patch; just above this at lower outer angle of cell a small elongate brownish fuscous patch edged with blackish scales; several narrow blackish fuscous streaks on costa, those towards apex more conspicuous than the others and continued towards termen in thin brown lines; a rather conspicuous, inwardly pointed, short blackish apical dash; ocelloid patch nearly obsolete, determined by two semi-metallic silvery bars; margining ocelloid patch on outer and upper sides a curved line of black scales; whitish areas otherwise rather finely streaked and dusted with blackish fuscous scales giving the insect a somewhat marbled appearance; cilia fuscous, dusted with blackish and with a fine white basal line. Hind wing pale smoky fuscous; cilia concolorous, with a fine white basal line.

Male genitalia of type figured.

Alar expanse.—16–18 mm.

Type.—Cat. No. 24852, U.S.N.M.

Paratypes.—In National Collection, American Museum, and collection Barnes.

Type locality.—Stockton, Utah.

Food plant.—Unknown.

Described from male type; 6 male and 5 female paratypes from Stockton, Utah (Tom Spalding, July 16 to 30, 1912, 1913); 1 male and 2 female paratypes from Provo, Utah (Spalding, Aug. 10–11, 1912); 2 female paratypes from Glenwood Springs, Colorado (Wm. Barnes, Aug. 17, 1892); 1 female paratype from Colorado Springs, Colorado; and 1 female paratype from Clear Creek, Colorado (Oslar).

A distinct species, in pattern close to *infusca* Walsingham, but radically different in genitalia.

46. EPINOTIA TIMIDELLA (Clemens).

(Fig. 373.)

Catastega timidella CLEMENS, Proc. Ent. Soc. Phila., vol. 1, 1861, p. 96; Tin.

N. Amer., 1872, p. 177.—DYAR, Proc. Ent. Soc. Wash., vol. 5, 1903, p. 128.—

BARNES and McDUNNOUGH, Check List Lepid. Bor. Amer., no. 7280, 1917.

Gelechia timidella BUSCK, Proc. U. S. Nat. Mus., vol. 25, 1903, p. 852; in Dyar

List N. Amer. Lepid., no. 5830, 1903.

Clemens erected his genus *Catastega* for three species (*timidella*, *aceriella*, *hamameliella*) which he knew and described only as larvae; establishing the genus on the larval habit and separating the species on the differences in food plant.

Dyar (1903) bred *timidella* and thus established the identity of the moth. According to his notes he reared two specimens, both females. I have located one of these and it proves to be a male. We have besides in the National Collection three other males in good condition. Kearfott also had a series of males and females under Clemens's name, all correctly determined and agreeing with Dyar's reared specimen. In 1903 Busck cited *timidella* as the type of *Catastega* and that citation holds; but Clemens's genus falls as a synonym of *Epinotia*.

Male genitalia figured from specimen in National Collection from Hyattsville, Maryland (Busck, 1909).

Distribution according to specimens in National Collection, American Museum, and collection Barnes: New York, Maryland, New Jersey, Manitoba, British Columbia.

Alar expanse.—17–19 mm.

Food plant.—*Quercus*.

Inasmuch as the species was described from the work of its larva it can not be said to have a type, unless we can consider Dyar's reared specimen in the National Collection as such. In that case the citation of the type locality must read Bellport, Long Island, New York. Clemens mentions seeing the work at St. Paul, Minnesota.

47. EPINOTIA ACERIELLA (Clemens).

(Fig. 372.)

Catastega aceriella CLEMENS, Proc. Ent. Soc. Phila., vol. 1, 1861, p. 86; Tin. N. Amer., 1872, p. 178.—FYLES, Ann. Rept. Ent. Soc. Ont., vol. 25, 1894, p. 46.—FERNALD, Gen. Tort., 1908, pp. 39, 56.—WALSINGHAM, Biol. Cent. Amer. Heter., vol. 4, 1914, p. 238.—BARNES and McDUNNOUGH, Check List Lepid. Bor. Amer., no. 7278, 1917.

Hedya signatana CLEMENS, Proc. Ent. Soc. Phila., vol. 3, 1864, p. 514.

Steganoptycha variana CLEMENS, Proc. Ent. Soc. Phila., vol. 3, 1864, p. 514.

Grapholitha subnisana ZELLER, Verh. Zool.-bot. Ges. Wien., vol. 25, 1875, p. 294.

Thiodia signatana FERNALD, in Dyar List N. Amer. Lepid., no. 5189, 1903.

Eucosma sigmatana BARNES and McDUNNOUGH, Check List Lepid. Bor. Amer., no. 7084, 1917.

Fyles' rearing of *aceriella* established the synonymy of *aceriella* and *signatana*, so two of the three species described by Clemens in his genus *Catastega* are accounted for. The third, *hamameliella* yet remains to be reared and identified as adult. Dyar¹⁸ suggests that it is probably a synonym of *Episimus argutanus* Clemens. It may as well rest there for the present.

Both Fernald (1908) and Walsingham (1914) cite *aceriella* as the type of *Catastega*, but as Busck had previously (1903) cited *timidella* as the type their later citations will not hold. At any rate

¹⁸ Proc. Ent. Soc. Wash., vol. 5, 1903, p. 128.



THIS PAGE IS LOCKED TO FREE MEMBERS

Purchase full membership to immediately unlock this page



Never be without a book!

Forgotten Books Full Membership gives universal access to 797,885 books from our apps and website, across all your devices: tablet, phone, e-reader, laptop and desktop computer

A library in your pocket for \$8.99/month

Continue

*Fair usage policy applies

50. EPINOTIA NANANA (Treitschke).

(Fig. 377.)

Coccyx nanana TREITSCHKE, Schmett. Eur., vol. 10, pt. 3, 1835, p. 80.*Steganoptycha nanana* STAUDINGER and REBEL, Cat. Lepid., vol. 2, no. 1894, 1901.*Eucosma domonana* KEARFOTT, Can. Ent., vol. 39, 1907, p. 79.—BARNES and MCDUNNOUGH, Check List Lepid. Bor. Amer., no. 6991, 1917.*Epinotia piceafoliana* KEARFOTT, Journ. N. Y. Ent. Soc., vol. 16, 1908, p. 176.*Eucosma efficax* MEYRICK, Ent. Mo. Mag., vol. 48, 1912, p. 35.*Enarmonia piceafoliana* BARNES and MCDUNNOUGH, Check List, Lepid. Bor. Amer., no. 7163, 1917.

A comparison of the types of *domonana* and *piceafoliana* easily establishes the synonymy. Both the cotypes of *domonana* are females so that Kearfott's reference of it to *Eucosma* (a genus with the costal fold) was a mere guess. His surmise that *piceafoliana* might be the same as the European *nanana* is verified by their genitalia.

Male genitalia from reared specimens in National Collection, from Montclair, New Jersey (Kearfott, "VI-3").

Distribution according to specimens in National Collection, American Museum, and collection Barnes: New Jersey, Massachusetts, Maine.

Alar expanse.—9.5–11 mm.

Type.—In collection unknown? (*nanana*); In American Museum (*domonana* and *piceafoliana*).

Type localities.—Germany (*nanana*); Cunningham, Massachusetts (*domonana*); Essex Park, New Jersey (*piceafoliana*).

Food plant.—*Picea mariana*.

51. EPINOTIA MERITANA, new species.

(Fig. 381.)

Antennae cream white faintly banded above with black. Palpi, face, head and thorax cream color. Fore wing white, banded and cross lined with blackish fuscous; the dark markings forming an outwardly angulate basal patch and a transverse post median fascia; the basal patch is much broken by white scaling especially at extreme base of wing; between basal patch and dark fascia the white shading is most conspicuous, extending from costa to dorsum and containing a very fine median dark line; outer third of wing brown dusted with black, the white scaling limited to costal strigulae and a slight shading along the outer margin of the post median fascia; four pair of white streaks on outer half of costa, the first and second pair fusing below costa and extending nearly to dorsal margin, forming the light shading which borders outer margin of the dark fascia; a fine black line along terminal margin; on termen below apex a small white spot; ocellus nearly obsolete, indicated only by a couple of ob-

scure semimetallic vertical bars; a few other leaden scales scattered over the white markings on outer half of wing; cilia lead gray with a paler shading toward base. Hind wing smoky fuscous; cilia shining lead gray with a somewhat darker basal band.

Male genitalia of type figured.

Alar expanse.—10–11 mm.

Type.—Cat. No. 24853, U.S.N.M.

Paratypes.—National Collection, American Museum, collection Barnes, and collection E. H. Blackmore.

Type locality.—Carbon County, Utah.

Food plant.—*Pinus*.

Described from male type, four male and four female paratypes received from Herbert J. Peck, assistant entomologist of the Utah Agricultural Experiment Station, who states that the moths were reared from larvae mining pine needles (moths issued May and July, 1921); also from one male and three female paratypes collected at Victoria, British Columbia ("18-VII-21," "28-VI-21") by W. R. Carter.

A distinct species close to *nanana* and *normanana*, but distinguished from both by the shape of the cucullus of its harpe. In color and pattern it is most like *normanana* but a trifle darker and with the outer dark fascia of fore wing more clearly defined.

52. EPINOTIA MEDIOPLAGATA (Walsingham).

(Fig. 343.)

Zeiraphera medioplagata WALSINGHAM, Trans. Ent. Soc. Lond., 1895, p. 516.

Epinotia medioplagata FERNALD, in Dyar List N. Amer. Lepid., no. 5236, 1903.—

DYAR, Proc. U. S. Nat. Mus., vol. 27, 1904, p. 928.

Enarmonia medioplagata BARNES and McDUNNOUGH, Check List Lepid. Bor. Amer., no. 7161, 1917.

An easily recognized species.

Male genitalia figured from specimen in National Collection from Kaslo, British Columbia (Dyar, "19700").

Distribution according to specimens in National Collection, American Museum, and collection Barnes: Colorado, British Columbia.

Alar expanse.—14.5–19 mm.

Type.—In British Museum.

Type locality.—Custer County, Colorado.

Food plant.—Unknown.

53. EPINOTIA LOMONANA (Kearfott).

(Fig. 333.)

Tortrix lomonana KEARFOTT, Can. Ent., vol. 39, 1907, p. 82.—BARNES and McDUNNOUGH, Check List Lepid. Bor. Amer., no. 7370, 1917.

Tortrix veneratrix MEYRICK, Ent. Mo. Mag., vol. 48, 1912, p. 36.

In placing this species where he did, Kearfott evidently overlooked the very obvious pectination on the median vein of the hind wing. It is a good Olethreutid and on all characters runs to *Epinotia*.

Male genitalia figured from specimen in National Collection, from Victoria, British Columbia (A. J. Crocker, "12-9-09").

Distribution according to specimens in National Collection, American Museum, and collection Barnes: British Columbia, California, Ontario.

Alar expanse.—14–19 mm.

Type.—In American Museum.

Type locality.—Victoria, British Columbia.

Food plant.—Unknown.

54. *EPINOTIA PURPURICILIANA* (Walsingham).

(Fig. 344.)

Steganoptycha purpuriciliana WALSINGHAM, Illus. Lepid. Heter. Brit. Mus., vol. 4, 1879, p. 72.

Epinotia purpuriciliana FERNALD, in Dyar List N. Amer. Lepid., no. 5224, 1903.

Enarmonia purpuriciliana BARNES and McDUNNOUGH, Check List Lepid. Bor. Amer., no. 7151, 1917.

I have seen only three specimens of this species, all apparently from the region of Mount Shasta, California; a cotype in the National Collection, a specimen named by Walsingham (but without locality label) in the Kearfott collection and a specimen from Shasta Retreat in the Barnes collection.

Male genitalia figured from specimen in American Museum.

Alar expanse.—14 mm.

Type.—In British Museum.

Type locality.—Mount Shasta, California.

Food plant.—Unknown.

55. *EPINOTIA CRUCIANA* (Linnaeus).

Phalaena Tortrix cruciana LINNAEUS, Fauna Svecica, no. 1333, 1761.

Tortrix augustana HÜBNER, Schmet. Europ., 1800, fig. 205.

Steganoptycha cruciana STAUDINGER and REBEL, Cat. Lepid., vol. 2, no. 2003, 1902.

Epinotia augustana FERNALD, In Dyar List No. Amer. Lepid., no. 5228, 1903.

Enarmonia cockleana KEARFOTT, Can. Ent., vol. 36, 1904, p. 137.—DYAR, Proc. U. S. Nat. Mus., vol. 27, 1904, p. 929.

Laspeyresia cockleana BARNES and McDUNNOUGH, Check List Lepid. Bor. Amer., no. 7243, 1917.

Dyar suggested the synonymy of *cockleana* with *cruciana*. An examination of their genitalia proves it. The European species has stood for some time in our lists under the name of its synonym *augustana* Hübner. The genitalia agrees with those of *plumbolin-*



THIS PAGE IS LOCKED TO FREE MEMBERS

Purchase full membership to immediately unlock this page



HISTORY

Tens of thousands of important historical sources, many previously unobtainable, are now available for the first time with a Forgotten Books Full Membership.

Unlimited Access
\$8.99/month

Continue

*Fair usage policy applies

Alar expanse.—13 mm.

Type.—Cat. No. 24854, U.S.N.M.

Type locality.—Yukon, Alaska.

Food plant.—Unknown (probably *Salix*).

Described from a single male type collected by G. I. Huntington, August 3, 1916.

58. EPINOTIA SEPTEMBERANA Kearfott.

(Fig. 353.)

Epinotia septemberana KEARFOTT, Trans. Amer. Ent. Soc., vol. 33, 1907, p. 51.

Enarmonia septemberana BARNES and McDUNNOUGH, Check List Lepid. Bor.

Amer., no. 7136, 1917.

This and the following two species have a similar pattern. The dorsal area of the fore wing is whitish more or less finely spotted with fuscous, and with two projections into the contrasted dark shade on upper half of the wing, a triangular or subtriangular projection near middle and an arched or rounded one above tornus. In *septemberana* the triangular projection is not so sharply defined as in *vagana* and *lindana* and the arched projection above tornus is appreciably flattened.

Male genitalia from cotype in National Collection from Essex County Park, New Jersey (Kearfott, "X-27-03").

Distribution according to specimens in National Collection, American Museum, and collection Barnes: New Jersey, Pennsylvania.

Alar expanse.—16–19 mm.

Type.—In American Museum.

Type locality.—Essex County Park, New Jersey.

Food plant.—Unknown.

59. EPINOTIA VAGANA, new species.

(Fig. 335.)

With the color scheme of *septemberana* and the pattern of *lindana*.

Antennae ferruginous above, grayish beneath. Palpi ferruginous with a somewhat purplish tint; shading to grayish white on inner sides. Head ferruginous on sides, ferruginous-ochreous on top. Thorax ferruginous. Fore wing ferruginous with a purplish bloom over costal half and with the dorsal area white, somewhat speckled with fuscous or ferruginous scales; the whitish dorsal area limited above by a fine white line forming a triangular projection at middle and a rounded arch well above tornus; pale area near tornus somewhat suffused with ferruginous ochreous; cilia ferruginous with a narrow, longitudinal black streak at tornus. Hind wing very pale smoky fuscous; cilia whitish with a dark basal band.

Male genitalia of type figured.

Alar expanse.—17–19 mm.

Type.—Cat. No. 24855, U.S.N.M.

Paratypes.—In National Collection, American Museum, collection Barnes, and collection E. H. Blackmore.

Type locality.—"Liaga, Washington."

Food plant.—*Pyrus rivularis*.

Described from male type; 1 male and three female paratypes from "Liaga, Washington," reared July 20 to 24, 1918; under Quaintance no. 15568 from larvae on "wild crabapple" (larvae collected May 24, 1918, E. S. Heckard); one male and four female paratypes from Victoria, British Columbia (E. H. Blackmore, "13-IX-21"; "1-IX-20"; "24-IX-21"); 1 female paratype from Duncans, Vancouver Island (Hanham); 1 female paratype from Hoquiam, Washington (Burke, "8-30-04").

A distinct species close to and intermediate between *septemberana* and *lindana*. From the former it is distinguished at once by the color of the cilia on fore wing. In *septemberana* these are whitish at anal angle, above anal angle heavily dusted with blackish and with a fine white basal line which reaches nearly to apex. From *lindana* it is at once separated by the rose purple or purplish red rather than purplish brown color of the costal half of the fore wing. It is also easily separated from both species by its genitalia.

60. EPINOTIA LINDANA (Fernald).

(Fig. 334.)

Steganoptycha lindana FERNALD, Can. Ent., vol. 24, 1892, p. 178.

Epinotia lindana FERNALD, in Dyar List N. Amer. Lepid., no. 5235, 1903.—DYAR, Proc. U. S. Nat. Mus., vol. 27, 1904, p. 928.—KEARFOTT, Can. Ent., vol. 37, 1905, p. 253.

Enarmonia lindana BARNES and McDUNNOUGH, Check List Lepid. Bor. Amer., no. 7140, 1917.

Male genitalia figured from specimen in National Collection from St. Johns, Quebec (W. Chagnon, "11-IX-1915").

Distribution according to specimens in National Collection, American Museum, and collection Barnes: Pennsylvania, Quebec, Ontario, Manitoba, British Columbia, California:

Alar expanse.—18–20 mm.

Type.—In collection Fernald.

Type locality.—Hamilton, Ontario.

Food plant.—*Cornus*.

61. EPINOTIA TROSSULANA (Walsingham).

(Fig. 367.)

Grapholitha trossulana WALSINGHAM, Illus. Lepid. Heter. Brit. Mus., vol. 4, 1879, p. 67.

Enarmonia troussulana FERNALD, in Dyar List N. Amer. Lepid., no. 5281, 1903.
Lasperesia troussulana BARNES and McDUNNOUGH, Check List Lepid. Bor.
 Amer., no. 7237, 1917.

In the duplicates of Doctor Barnes's collection were found two specimens of this very striking and beautiful species, one from Plumas County, and the other from Castle Lake, Siskiyou County, California. ("Aug. 8-15.") The latter is now in the National Collection and its genitalia is here figured. We also have a specimen from Victoria, British Columbia, recently received through Mr. E. H. Blackmore.

Alar expanse.—13-14 mm.

Type.—In British Museum.

Type locality.—Hatchet Creek, Siskiyou County, California.

Food plant.—Unknown.

62. *EPINOTIA SIGNIFERANA*, new species.

(Fig. 365.)

Antennae, palpi, face, head, and thorax grayish fuscous, the tips of the scales white, giving the insect a steel gray appearance. In some specimens head and thorax are somewhat ferruginous ochreous. Fore wing steel gray with the faintest indication of a darker basal patch; at extreme inner angle a short dash of blackish scales; from middle of costa, curving down to end of cell and again upward to apex, a moderately broad irregularly crescent-shaped brown marking, more or less suffused with black; along costa several obscure, small fuscous dashes, most noticeable on apical half; cilia concolorous with ground color of wing. Hind wing pale smoky fuscous with faint, wavy, darker mottlings; cilia concolorous with the faintest indication of a dark basal band.

Male genitalia of type figured.

Alar expanse.—14-18 mm.

Type.—Cat. No. 24856, U.S.N.M.

Paratypes.—In National Collection, American Museum, and collection Barnes.

Type locality.—San Diego, California.

Food plant.—Unknown.

Described from male type and 6 male paratypes from San Diego, California (type and 3 of the paratypes labeled "W. S. Wright" and dated "11-14-11," "11-20-11," and "11-21-11"); 1 male and 1 female paratype from Reno, Nevada (H. G. Dyar, Sept. 20 to 25, 1915) and 2 male paratypes from Prescott, Arizona ("Oct. 1-7").

A distinct species easily recognized, as it is the only *Epinoxia* without costal fold, possessing a curved marking on fore wing from mid costa to apex. The termen of fore wing is straight and slanting and veins 3, 4, and 5 are not approximate at termen.



THIS PAGE IS LOCKED TO FREE MEMBERS
Purchase full membership to immediately unlock this page



Never be without a book!

Forgotten Books Full Membership gives universal access to 797,885 books from our apps and website, across all your devices: tablet, phone, e-reader, laptop and desktop computer

A library in your pocket for \$8.99/month

Continue

*Fair usage policy applies

5. Outer transverse stripe from mid costa broadening into a fuscous blotch covering entire lower terminal area----- (6) *semiovana*.
Lower terminal area not suffused with fuscous----- 6
6. Terminal area of fore wing near tornus faintly bluish----- (4) *discigerana*.
Terminal area near tornus not bluish----- (5) *spiraeifoliana*.
7. Basal patch blackish; outer marking and dustings on fore wing a contrasting ferruginous ochreous----- 8
Basal patch red, brownish ochreous, ferruginous brown, or ferruginous ochreous; if sometimes very dark brown then with outer dark marking not a contrasting ferruginous ochreous----- 9
8. Hind wing dark smoky fuscous----- (9) *burgessiana*.
Hind wing whitish----- (10) var. *pruni*.
9. Lower terminal area of fore wing whitish with a single distinct black dot near tornus----- (14) *pulchellana*.
Lower terminal area not so marked----- 10
10. Basal patch strongly marked; if faint then with upper margin shaded with blackish fuscous----- 11
Basal patch nearly obsolete----- (13) *platanana*.
11. Basal patch shaded on upper margin with blackish fuscous-- (8) *maritima*.
Basal patch not so dark margined----- 12
12. Basal patch dark fuscous brown----- (7) *angulifasciana*.
Basal patch ochreous or ferruginous brown----- 13
13. Cilia of fore wing below apex cream white, faintly suffused with ferruginous ochreous----- (11) *laciniana*.
Cilia of fore wing below apex more ferruginous ochreous than whitish.
(12) *fuscociliana*.

1. ANCHYLOPERA NUBECULANA Clemens.

(Fig. 388.)

Anchylopera nubeculana CLEMENS, Proc. Acad. Nat. Sci. Phila., 1860, p. 349.

Phoxopteris nubeculana ZELLER, Verh. Zool.-bot. Ges. Wien, vol. 25, 1875, p. 249.—RILEY, Rept. U. S. Dept Agr., 1878, p. 239.

Ancylis nubeculana FERNALD, in Dyar List N. Amer. Lepid., no. 5240, 1903.—KEARFOTT, Can. Ent., vol. 37, 1905, p. 253.—LEACH, Bull. U. S. Dept. Agr., no. 435, 1916.—BARNES and MCDUNNOUGH, Check List Lepid. Bor. Amer., no. 7174, 1917.

This species is economically the most important of the *Anchylopera* and the best known. It is a common apple pest.

Male genitalia figured from specimen in National Collection from New Brighton, Pennsylvania ("H. D. Merrick, V-27-04").

Distribution according to specimens in National Collection, American Museum, and collection Barnes: Pennsylvania, New Jersey, New Hampshire, Massachusetts, Iowa, Michigan, Manitoba, Ontario.

Alar expanse.—14-16.5 mm.

Type.—In Academy Natural Sciences, Philadelphia.

Type locality.—Pennsylvania?

Food plant.—Apple.

2. ANCHYLOPERA SUBAEQUANA (Zeller).

(Fig. 390.)

Phoxopteris subaequana ZELLER, Verh. Zool.-bot. Ges. Wien, vol. 25, 1875, p. 254.

Ancylis subaequana FERNALD, in Dyar List N. Amer. Lepid., no. 5241, 1903.—
BARNES and McDUNNOUGH, Check List Lepid. Bor. Amer., no. 7175, 1917.

Zeller described this species from three specimens, two males and one female. The males are probably in the British Museum and one of these must be considered the actual type. The female is now in the Fernald Collection. It is much smaller than typical specimens of *subaequana* and is very likely not that species. It has more the size and appearance of one of the *angulifasciana* group. However that may be, it need cause no great difficulty, as the true *subaequana* is quite distinct from other species in this genus. Its extremely long, slender aedoeagus at once identifies it.

Male genitalia figured from specimen in National Collection from Sabec Lake, Maine ("June 25-30").

Distribution according to specimens in National Collection, American Museum, and collect on Barnes: North Carolina, Virginia, Pennsylvania, New Jersey, New Hampshire, Connecticut, Maine, Ontario, Oregon.

Alar expanse.—14-17 mm.

Type.—In British Museum ?

Type locality.—"Maine or Massachusetts."

Food plant.—Unknown.

3. ANCHYLOPERA SUBAEQUANA KINCAIDIANA (Fernald).

Phoxopteris kincaidiana FERNALD, Proc. Wash. Acad. Sci., vol. 2, 1900, p. 500.

Ancylis kincaidiana FERNALD, in Dyar List N. Amer. Lepid., no. 5627, 1903.—
BARNES and McDUNNOUGH, Check List Lepid. Bor. Amer., no. 7204, 1917.

Described as a distinct species but has the same genitalia as *subaequana*. It differs in having a sordid ochreous rather than a cream white head. The costal and outer areas of the wing also have the white ground color more suffused and obscured by grayish dusting than typical specimens of *subaequana*, but these characters are by no means constant. I am holding it therefore as nothing but a northwestern race of Zeller's species.

Distribution according to specimens in National Collection, American Museum, and collection Barnes: Alaska, British Columbia.

Alar expanse.—15-17 mm.

Type.—In National Collection.

Type locality.—Metlakahtla, Alaska.

Food plant.—Unknown.

4. ANCHYLOPERA DISCIGERANA (Walker).

(Fig. 392.)

Grapholita discigerana WALKER, Cat. Lepid. Heter. Brit. Mus., vol. 28, 1863, p. 384.

? *Anchylopera lamiana* CLEMENS, Proc. Ent. Soc. Phila., vol. 3, 1864, p. 513.

Phoxopteryx discigerana WALSINGHAM, Illus. Lepid. Heter. Brit. Mus., vol. 4, 1879, p. 72.

Ancylis discigerana FERNALD, in Dyar List N. Amer. Lepid., no. 5242, 1903.—BARNES and MCDUNNOUGH, Check List Lepid. Bor. Amer., no. 7176, 1917.

Just what this name stands for can not be ascertained without careful comparison with Walker's type. His description would apply to almost any *Anchylopera*. As it is, Walsingham, Fernald, Kearfott, and others have agreed upon a certain California form as Walker's species. This appears to be quite variable, as many specimens have the palpi fuscous, while others from the same localities have them nearly pure white. We have also in the National Collection a series of moths from the Shasta region which, while not distinguishable on external characters from the supposedly typical *discigerana*, exhibit so reduced a cucullus that they appear to represent a distinct species. I believe they are only a local race, but hesitate to describe them under any designation until the identity of the true *discigerana* is established. Pending further information I am determining the form with white palpi as typical. Like *subaequana*, *maritima*, and *angulifasciana*, *discigerana* lacks the uncus. *A. lamiana* Clemens is referred to the synonymy on suspicion. The type is lost; but the description seems to fit.

Male genitalia figured from specimen in National Collection from Placer County, California ("A. H. Vachell, V-1").

Specimens in National Collection, American Museum, and collection Barnes from California.

Alar expanse.—15–19 mm.

Type.—In British Museum (*discigerana*); lost (*lamiana*).

Type locality.—Nova Scotia, (*discigerana*); Brunswick, Maine, (*lamiana*).

Food plant.—Unknown.

5. ANCHYLOPERA SPIRAEIFOLIANA Clemens.

(Fig. 395.)

Anchylopera spiraefoliana CLEMENS, Proc. Acad. Nat. Sci. Phila., 1860, p. 348.

Grapholita metamelana WALKER, Cat. Lepid. Heter. Brit. Mus., vol. 28, 1863, p. 385.

Grapholita discoferana WALKER, Cat. Lepid. Heter. Brit. Mus., vol. 28, 1863, p. 386.

Phoxopteryx spiraefoliana WALSINGHAM, Illus. Lepid. Heter. Brit. Mus., vol. 4, 1879, p. 72.—BEUTENMULLER, Ent. Amer., vol. 5, 1889, p. 39.

Ancylis spiraefoliana FERNALD, in Dyar List N. Amer. Lepid., no. 5246, 1903.—BARNES and MCDUNNOUGH, Check List Lepid. Bor. Amer., no. 7183, 1917.



THIS PAGE IS LOCKED TO FREE MEMBERS

Purchase full membership to immediately unlock this page



HISTORY

Tens of thousands of important historical sources, many previously unobtainable, are now available for the first time with a Forgotten Books Full Membership.

Unlimited Access
\$8.99/month

Continue

*Fair usage policy applies

tifies it. Like *angulifasciana* which it most nearly resembles it has a well developed uncus.

Male genitalia figured from specimen in National Collection from Forest Glen, Maryland ("6-2-14, O. Heidemann").

Distribution according to specimens in National Collection, American Museum, and collection Barnes: Maryland, Pennsylvania, North Carolina, New York, New Jersey, Iowa.

Alar expanse.—15-16mm.

Type.—In British Museum?

Type locality.—New York.

Food plant.—Unknown.

7. ANCHYLOPERA ANGULIFASCIANA (Zeller).

(Fig. 391.)

Phoxopterus angulifasciana ZELLER, Verh. Zool.-bot. Ges. Wien, vol. 25, 1875, p. 256.—FERNALD, Psyche, vol. 3, 1880, p. 88.

Ancylis angulifasciana FERNALD, in Dyar List N. Amer. Lepid., no. 5253.—GROSSARD, Bull. Ohio, Agr. Exp. Sta., no. 297, 1916.—BARNES and McDUNNOUGH, Check List Lepid. Bor. Amer., no. 7180, 1917.

Ancylis intermediana KEARFOTT, Trans. Amer. Ent. Soc., vol. 33, 1907, p. 56.—BARNES and McDUNNOUGH, Check List Lepid. Bor. Amer., no. 7182, 1917.

Zeller's types of this species are probably all in the British Museum. There are, however, in the Fernald collection two specimens labeled "North America" and bearing Zeller's green label. These may or may not be part of the original type material. They are undoubtedly authentic specimens of the true *angulifasciana*. Kearfott's *intermediana* differs in no way from them and must fall as a synonym. I can find no characters on which to separate it even as a local race.

Male genitalia figured from specimen in National Collection from Wooster, Ohio ("5-15-05").

Distribution according to specimens in National Collection, American Museum, and collection Barnes: Ohio, Illinois, Iowa, Massachusetts, New Hampshire, New York, Pennsylvania, Kentucky, Washington, British Columbia, Manitoba, Ontario.

Alar expanse.—9-13 mm.

Types.—In British Museum (*angulifasciana*); in American Museum (*intermediana*).

Type localities.—Ohio (*angulifasciana*); Wellington, British Columbia (*intermediana*).

Food plant.—*Trifolium*.

8. ANCHYLOPERA MARITIMA (Dyar).

(Fig. 394.)

Ancylis maritima DYAR, Proc. Ent. Soc. Wash., vol. 6, 1904, p. 221.—BARNES and McDUNNOUGH, Check List Lepid. Bor. Amer., no. 7184, 1917.

In size, structure, and general appearance very close to *angulifasciana*. Like the latter, it lacks an uncus, but it is at once distinguished by the more elongate cucullus of its harpe.

Male genitalia figured from paratype in National Collection from the type locality.

Distribution according to specimens in National Collection, American Museum, and collection Barnes: Rhode Island and Maine.

Alar expanse.—11–13 mm.

Types.—In National Collection.

Type locality.—Weekapaugh, Rhode Island.

Food plant.—*Lathyrus maritima*.

9. ANCHYLOPERA BURGESSIANA (Zeller).

(Fig. 396.)

Phoxopteris burgessiana ZELLER, Verh. Zool.-bot. Ges. Wien, vol. 25, 1875, p. 252.

Phoxopteris murtfeldtiana RILEY, Trans. St. Louis Acad. Sci., vol. 4, 1881, p. 323.

Ancylis burgessiana FERNALD, in Dyar List N. Amer. Lepid., no. 5248, 1903.—BARNES and MCDUNNOUGH, Check List Lepid. Bor. Amer., no. 7186, 1917.

Ancylis murtfeldtiana FERNALD, in Dyar List N. Amer. Lepid., no. 5244, 1903.—BARNES and MCDUNNOUGH, Check List Lepid. Bor. Amer., no. 7179, 1917.

A comparison of the types of *burgessiana* and *murtfeldtiana* shows them to be the same species. The work of the larvae is fairly common in the vicinity of Washington, District of Columbia, on the chestnut and chinquapin, as well as several of the oaks, and I have reared the typical form from chestnut.

Male genitalia figured from specimen in National Collection from Wyoming County, Pennsylvania ("VI-17-06, W. D. Kearfott").

Distribution according to specimens in National Collection, American Museum, and collection Barnes: Missouri, Pennsylvania, Massachusetts, North Carolina, New Jersey.

Alar expanse.—11–15 mm.

Types.—In collection Fernald (*burgessiana*); in National Collection (*murtfeldtiana*).

Type localities.—Beverly, Massachusetts (*burgessiana*); Missouri, (*murtfeldtiana*).

Food plants.—Oak, chestnut, chinquapin.

10. ANCHYLOPERA BURGESSIANA PRUNI, new variety.

Like *burgessiana* Zeller from which it differs only in the color of the hind wing, which is a very pale smoky fuscous, almost white, with a slight yellowish shade toward apex.

Alar expanse.—10–15 mm.

Type.—Cat. No. 24857, U.S.N.M.

Paratypes.—In National Collection, American Museum, and collection Barnes.

Type locality.—Caldwell, New Jersey.

Food plant.—*Prunus*.

Described from male type from Caldwell, New Jersey ("May 17-03, W. D. Kearfott"), 3 male paratypes from Oak Station, Pennsylvania ("May 22-08," and "V-22-10," "Fred Marloff"), 2 male paratype from St. Louis, Missouri ("V-14-05, McElhose"), 1 male paratype labeled, "from cultivated cherry, 5-22-85" and 1 male paratype labeled "273 M, on wild cherry, 4-29-85." The last two specimens have been for many years in the National Collection under the name *burgessiana* Zeller.

In view of the confusion and uncertainty that prevails in regard to several species in this genus (namely, *laciniana*, *spiraeifoliana*, *dubiana*, and *pulchellana*) I dislike to add a further name to the list.

It is advisable, however, to have names to distinguish the oak and *Prunus* feeding forms. I think they are one species; but there is always the possibility that they are not, and since they are at least distinguishable as food plant races on the color of the hindwings it seems but the wisdom of caution to so separate them. A too fine splitting can always be corrected, but a false lumping is not as easily remedied and is fruitful of nothing but confusion.

11. ANCHYLOPERA LACINIANA (Zeller).

(Fig. 397.)

Phoxopterus laciniana ZELLER, Verh: Zool.-bot. Ges. Wien, vol. 25, 1875, p. 253.

Ancyliis laciniana FERNALD, in Dyar List N. Amer. Lepid., no. 5247, 1903.—

KEARFOTT, Can. Ent., vol. 37, 1905, p. 253.—BARNES and McDUNNOUGH, Check List Lepid. Bor. Amer., no. 7190, 1917.

This species has also been badly juggled. Zeller's description is plain enough and can hardly refer to anything else than the form here determined. There is, however, in the Fernald collection a specimen from Massachusetts, labeled in Zeller's handwriting and possibly one of his cotypes, which agrees better with what I am calling *spiraeifoliana* than with any of our conceptions of *laciniana*; but then it does not agree with Zeller's description either and as there is little likelihood of its being the actual type we need not appeal to it against the description.

Male genitalia figured from specimen in National Collection from Mountain Lake, Virginia ("14-21, June, 1907, A. F. Braun").

Distribution according to specimens in National Collection, American Museum, and collection Barnes: North Carolina, Virginia, Pennsylvania, New Jersey, New Hampshire, Massachusetts.

Alar expanse.—13.5-16 mm.



THIS PAGE IS LOCKED TO FREE MEMBERS
Purchase full membership to immediately unlock this page



Never be without a book!

Forgotten Books Full Membership gives universal access to 797,885 books from our apps and website, across all your devices: tablet, phone, e-reader, laptop and desktop computer

A library in your pocket for \$8.99/month

Continue

*Fair usage policy applies

Ancylis platanana FERNALD, in Dyar List N. Amer. Lepid., no. 5254, 1903.—

BARNES and McDUNNOUGH, Check List Lepid. Bor. Amer., no. 7191, 1917.

This is the well known sycamore feeder. In addition to typical pale specimens with the basal patch nearly obsolete I have before me what I take to be a darker variety with well defined faun brown basal patch and a well defined reddish outer bar on fore wing. Most of these specimens are from Colorado and may represent a distinct species. I hesitate to describe them or to include them under *platanana*, as none of them have been reared.

Male genitalia figured from specimen in National Collection from Oak Station, Pennsylvania ("Fred Marloff, 19 May, 1900").

Distribution according to specimens in National Collection, American Museum, and collection Barnes: District of Columbia, Maryland, Pennsylvania, New Jersey, New York, West Virginia, Ohio, Illinois, Missouri, Arkansas.

Alar expanse.—10–16 mm.

Types.—In Academy Natural Sciences, Philadelphia (*platanana*); Museum Comparative Zoology (*marcidana*).

Type localities.—Pennsylvania (*platanana*); Dallas, Texas (*marcidana*).

Food plant.—*Platanus*.

14. ANCHYLOPERA PULCHELLANA Clemens.

(Fig. 389.)

Anchylopera pulchellana CLEMENS, Proc. Ent. Soc. Phila., vol. 3, 1864, p. 511.

Proteopteryx pulchellana FERNALD, in Dyar List N. Amer. Lepid., no. 5218, 1903.

Ancylis pulchellana KEARFOTT, Bull. Amer. Mus. Nat. Hist., vol. 23, 1907, p. 159.—

BARNES and McDUNNOUGH, Check List Lepid. Bor. Amer., no. 7181, 1917.

This species is distinguishable by the red-brown basal patch and the small but conspicuous black dot on the whitish tornal area of the fore wing. These characters are given in Clemens description. They are not present however in the specimen in Philadelphia which Fernald selected as the probable type. This latter is referable to *laciniaria* as are many of the specimens which have been determined as *pulchellana*. The actual type of *pulchellana* is probably nonexistent.

Male genitalia figured from specimen in National Collection from Merchantville, New Jersey ("V-26-1904").

Specimens in National Collection, American Museum, and collection Barnes from New Jersey.

Alar expanse.—13–16 mm.

Type.—Lost?

Type locality.—Virginia.

Food plant.—Unknown.

ANCHYLOPERA LUNDANA (Fabricius).

This European species was recorded from Oregon by Walsingham and still appears in our lists. I have never seen an American moth, however, that agreed with European specimens of *lundana* and am inclined to the belief that it does not occur here and should be dropped from our lists.

25. Genus ANCYLIS Hübner.

(Figs. 13, 35.)

Genotype.—*Pyralis laetana* Fabricius.

Fore wing smooth; termen concave between veins 3 and 6; apex distinctly falcate; 12 veins, 7 and 8 separate; 10 from about midway between 9 and 11; 9 not closely approximate to 8; 11 from cell at, or just before middle of cell; upper internal vein of cell from between 10 and 11; 3, 4, and 5 more or less approximate at termen; 2 straight or very slightly bent up toward termen; no costal fold in male.

Hind wing with 8 veins; 6 and 7 approximate toward base; 3 and 4 stalked.

Male genitalia with harpe narrowly elongate; cucullus sharply defined, long and narrow; neck incurvation normally pronounced and broad; neck smooth; sacculus without spine clusters and very sparsely clothed with hair like spines; costal hook weak, frequently absent and replaced by membrane as in *Rhyacionia*. Uncus present or absent; if present, bifid and hook like. Socii greatly developed, very broad and densely haired. Gnathos greatly reduced almost completely fused with socii. Aedoeagus slender; straight or slightly curved; moderately long to very long.

A direct derivative from *Epinothia*. To be distinguished chiefly by its falcate fore wing (fig. 13). The genitalia are not structurally different from those of *Epinothia*.

KEY TO THE SPECIES OF ANCYLIS.

1. Fore wing bronzy brown with a metallic luster.....(18) *loricana*.
Fore wing not bronzy brown nor with a metallic luster.....2
2. Fore wing with an outer dark transverse fascia or a dark crescent on outer half of costa.....3
Fore wing without such.....7
3. Fore wing with dark crescent from mid costa to apex.....(15) *torontana*.
Fore wing with a dark transverse outer fascia.....4
4. Costa of fore wing broadly margined with pure white, finely strigulated with black and interrupted at middle by the dark fascia... (14) *mediofasciana*.
Costa of fore wing sometimes pale but not pure white.....5
5. Fore wing with an obscure whitish gray triangular patch on mid-dorsal margin and a grayish white patch at tornus.....(9) *carbonana*.
Fore wing without such.....6

6. Ground color of fore wing much broken by wavy blackish vertical lines. (12) *unguicella*.
 Ground color of fore wing little broken by vertical blackish lines. (13) *pacificana*.
7. Fore wing with a sinuate whitish longitudinal line..... 8
 Fore wing without such line..... 9
8. Veins 3 and 4 of hind wing very short stalked, often nearly connate. (11) *goodelliana*.
 Veins 3 and 4 of hind wing moderately long stalked..... (10) *diminutana*.
9. Fore wing with a defined basal patch..... 11
 Fore wing without defined basal patch..... 10
10. Fore wing with costa from base almost to apex broadly margined with pure unmarked white..... (17) *albacostana*.
 Fore wing with costa of the brownish ground color, faintly strigulated, from base with blackish and toward apex with white..... (16) *tineana*.
11. Basal patch of fore wing continuing to costa; if obscured toward costa, then costa at base broadly smeared with semilustrous leaden purple or steel blue scales..... 12
 Basal patch not continued to costa; costa at base whitish ochreous or gray strigulated with brown or black..... 14
12. Head white or whitish..... (5) *divisana*.
 Head decidedly ochreous..... 13
13. Basal patch of fore wing dark purplish..... { (7) *muricana*.
 Basal patch ferruginous ochreous..... (6) *apicana*.
 Basal patch and outer dark shading of fore wing brown or brownish red..... 15
 Basal patch and outer dark shading of fore wing ferruginous orange. (3) var. *fragariae*.
15. Dark shadings of fore wing distinctly brown..... { (1) *comptana*.
 Dark shadings of fore wing brownish red..... (2) var. *cometana*.
 (4) var. *floridana*.

1. ANCYLIS COMPTANA (Fröhlich).

Tortrix comptana FRÖHLICH, Enumer. Tort. Wurt., 1828, p. 99.

Grapholita conflexana WALKER, Cat. Lepid. Heter. Brit. Mus., vol. 28, 1863, p. 384.

Phoxopterus comptana ZELLER, Verh. Zool.-bot. Ges. Wien, vol. 24, 1875, p. 257.

Ancylis comptana FERNALD, In Dyar List N. Amer. Lepid., no. 5252, 1903.—

BARNES and McDUNNOUGH, Check List Lepid. Bor. Amer., no. 7185, 1917.

This is the species known to our economic literature as the "strawberry leaf roller." In Europe it has a number of food plants of the rose and mint families. Here it is most commonly found on strawberries, blackberries, and raspberries. I was inclined to regard Zeller's species *amblygona* and *floridana* as mere color varieties which should be treated as synonyms. Dr. W. T. M. Forbes, however, thinks that they can be held as local races; the typical *comptana* as the dark form ranging from northern New Jersey northward, *fragariae* (*amblygona*) as the pale form from southern New Jersey, Ohio, and Missouri westward and southward; and *floridana* as the dark form ranging from southern New Jersey southward. The



THIS PAGE IS LOCKED TO FREE MEMBERS

Purchase full membership to immediately unlock this page



HISTORY

Tens of thousands of important historical sources, many previously unobtainable, are now available for the first time with a Forgotten Books Full Membership.

Unlimited Access
\$8.99/month

Continue

*Fair usage policy applies

3. ANCYLIS COMPTANA FRAGARIAE (Walsh and Riley).

(Fig. 406.)

Achylopera fragariae WALSH and RILEY, Amer. Ent., vol. 1, 1869, p. 89; Ins. Mo., vol. 1, 1869, p. 142.

Phoxopterus amblygona ZELLER, Vehr. Zool.-bot. Ges., vol. 25, 1875, p. 259.

Ancylis amblygona FERNALD, in Dyar List N. Amer. Lepid., no. 5251, 1903.—

BARNES and MCDUNNOUGH, Check List Lepid. Bor. Amer., no. 7188, 1917.

Ancylis comptana FERNALD, in Dyar List N. Amer. Lepid., no. 5252, 1903.—

BARNES and MCDUNNOUGH, Check List Lepid. Bor. Amer., no. 7185, 1917.

All our reared specimens from strawberry, blackberry, and raspberry in the National Collection are of this variety. We also have a single specimen labeled "on Solidago, iss. May 25-84."

Male genitalia figured from reared specimen in National Collection from Vineland, New York ("#6687, on blackberry, 9-July-95")^f.

Distribution according to specimens in National Collection, American Museum, and collection Barnes: Illinois, New York, Missouri, District of Columbia, Maryland, Pennsylvania, North Carolina, Louisiana, Colorado, South Dakota.

Alar expanse.—9-13 mm.

Types.—In National Museum (*fragariae*); in British Museum? (*amblygona*).

Type localities.—Illinois (*fragariae*); Washington, District of Columbia (*amblygona*).

Food plants.—Strawberry, raspberry, blackberry, *Solidago*?

4. ANCYLIS COMPTANA FLORIDANA (Zeller).

Phoxopterus floridana ZELLER, Verh. Zool.-bot. Ges. Wien, vol. 25, 1875, p. 258.

Ancylis floridana FERNALD, in Dyar List N. Amer. Lepid., no. 5250, 1903.—

BARNES and MCDUNNOUGH, Check List Lepid. Bor. Amer., no. 7189, 1917.

The only reared specimens I have seen answering to this supposed race are a series in the National Collection from Whiting, New Jersey, reared from bearberry. They are more distinctly reddish than typical eastern *comptana* and much darker than the usual run of *fragariae*.

Alar expanse.—11-12 mm.

Type.—In British Museum?

Type locality.—Ohio.

Food plant.—*Arctostaphylos*.

5. ANCYLIS DIVISANA (Walker).

(Fig. 400.)

Grapholita divisana WALKER, Cat. Lepid. Heter. Brit. Mus., vol. 28, 1863, p. 385.

Phoxopteryx divisana WALSINGHAM, Illus. Lepid. Heter. Brit. Mus., vol. 4, 1879, p. 74.

Ancylis divisana FERNALD, in Dyar List N. Amer. Lepid., no. 5255, 1903.—BARNES and McDUNNOUGH, Check List Lepid. Bor. Amer. no. 7192, 1917.

The well-known oak *Ancylis*.

Male genitalia figured from specimen in National Collection from Hampton, New Hampshire ("V-30-1906, S. A. Shaw").

Distribution according to specimens in National Collection, American Museum, and collection Barnes: District of Columbia, Maryland, Virginia, Pennsylvania, New Jersey, New Hampshire, Massachusetts, Maine, Missouri, Illinois.

Alar expanse.—10-14 mm.

Type.—In British Museum.

Type locality.—Nova Scotia.

Food plant.—*Quercus*.

6. ANCYLIS APICANA (Walker).

(Fig. 402.)

Grapholita apicana WALKER, Cat. Lepid. Heter. Brit. Mus., vol. 35, 1866, p. 1795.

Phoxopteryx apicana WALSINGHAM, Illus. Lepid. Heter. Brit. Mus., vol. 4, 1879, p. 73.

Ancylis apicana FERNALD, in Dyar List N. Amer. Lepid., no. 5256, 1903.—BARNES and McDUNNOUGH, Check List Lepid. Bor. Amer., no. 7193, 1917.

Very close to *divisana* in color and genitalia, but apparently distinct.

Male genitalia figured from specimen in National Collection from Hampton, New Hampshire ("VI-6-1908, S. A. Shaw").

Distribution according to specimens in National Collection, American Museum and collection Barnes: Pennsylvania, New Hampshire, Maine, Minnesota, Ontario, Manitoba, British Columbia.

Alar expanse.—11-13 mm.

Type.—In British Museum.

Type locality.—Nova Scotia.

Food plant.—Unknown.

7. ANCYLIS MURICANA (Walsingham).

(Fig. 401.)

Phoxopteryx muricana WALSINGHAM, Illus. Lepid. Heter. Brit. Mus., vol. 4, 1879, p. 74.

Ancylis muricana FERNALD, in Dyar List N. Amer. Lepid., no. 5258.—KEARFOTT, Ins. N. J., 1909, p. 545.—BARNES and McDUNNOUGH, Check List Lepid. Bor. Amer., no. 7195, 1917.

Male genitalia figured from specimen in National Collection from Washington, District of Columbia ("Jan. 1900, Busck").

Distribution according to specimens in National Collection, American Museum, and collection Barnes: District of Columbia, Virginia, Pennsylvania, New Jersey, New York.

Alar expanse.—10–12 mm.

Type.—In British Museum.

Type locality.—District of Columbia.

Food plant.—*Rubus* (blackberry).

8. *ANCYLIS MURICANA CORNIFOLIANA* (Riley).

(Fig. 403.)

Phoxopterus cornifoliana RILEY, Trans. St. Louis Acad. Sci., vol. 4, 1881, p. 324.

Ancylis cornifoliana FERNALD, in Dyar List N. Amer. Lepid., no. 5257, 1903.—

BARNES and MCDUNNOUGH, Check List Lepid. Bor. Amer., no. 7194, 1917.

I can see no difference between Riley's type and typical specimens of *muricana* and only hold *cornifoliana* on the suspicion that there may possibly be a larval difference. The genitalia offer no help as these organs are alike in all four of the forms in this group (*divisana*, *apicana*, *muricana*, and *cornifoliana*).

Male genitalia figured from type.

This is the only specimen reared from *Cornus* that I have seen. In the Fernald collection there is one labeled, "*cornifoliana* on black birch."

Alar expanse.—10 mm.

Type.—In National Collection.

Type locality.—Manhattan, Kansas.

Food plants.—*Cornus*, *Betula*.

9. *ANCYLIS CARBONANA*, new species.

(Fig. 407.)

Palpi and face gray. Head and thorax ferruginous dusted with gray. Fore wing dark ferruginous brown, somewhat dusted with blackish; basal half of costa suffused with pale gray; from middle of costa a somewhat darker shade of the ground color forms a faint oblique fascia to dorsum before tornus; over ocelloid patch and fusing with this fascia a similar dark shading; costa strigulated throughout with black and on outer half with white; on dorsum just beyond middle a very obscure, roughly triangular grayish white patch and on tornus an irregular somewhat variable, grayish white ocelloid patch, often markedly indented on its inner margin; cilia dark ferruginous fuscous at apex, with a strong white patch divided by a narrow black line just below apex, from thence around tornus fuscous with a broad white or whitish basal band. Hind wing dark smoky fuscous; cilia slightly paler with a dark basal band.

Male genitalia of type figured.

Alar expanse.—12.5–16.5 mm.

Type.—In American Museum.

Paratypes.—Cat. No. 24858, U.S.N.M., also in American Museum and collection Barnes.



THIS PAGE IS LOCKED TO FREE MEMBERS
Purchase full membership to immediately unlock this page



Never be without a book!

Forgotten Books Full Membership gives universal access to 797,885 books from our apps and website, across all your devices: tablet, phone, e-reader, laptop and desktop computer

A library in your pocket for \$8.99/month

Continue

*Fair usage policy applies

Types.—In collection unknown (*diminutana*); in American Museum (*diminuatana*).

Type localities.—England (*diminutana*); Caldwell, New Jersey (*diminuatana*).

Food plant.—*Salix*.

11. ANCYLIS GOODELLIANA (Fernald).

(Fig. 411.)

Phoxopterus goodelliana FERNALD, Trans. Amer. Ent. Soc., vol. 10, 1882, p. 69.

Ancylis goodelliana FERNALD, in Dyar List N. Amer. Lepid., no. 5261, 1903.—

KEARFOTT, Proc. U. S. Nat. Mus., vol. 28, 1905, pp. 361, 362.—BARNES and MCDUNNOUGH, Check List Lepid. Bor. Amer., no. 7198, 1917.

Distinguished from *diminutana* by its genitalia, the more whitish costa of its fore wing, and a longer stalking of veins 3 and 4 of hind wing.

Male genitalia figured from specimen in National Collection from Framingham, Massachusetts ("VI-5-1906, C. A. Frost").

Distribution according to specimens in National Collection, American Museum, and collection Barnes: Maine, Massachusetts, New Hampshire, New York, North Carolina, New Jersey, Florida, Wisconsin, Colorado, Manitoba.

Alar expanse.—15–18 mm.

Type.—In collection; Fernald.

Type locality.—Maine.

Food plant.—Unknown.

12. ANCYLIS UNGUICELLA (Linnaeus).

(Fig. 409.)

Phalaena Tinea unguicella LINNAEUS, Syst. Nat., ed. 10, 1760, p. 536.

Anchylopera plagosana CLEMENS, Proc. Ent. Soc. Phila., vol. 2, 1846, p. 417.

Ancylis unguisella STAUDINGER and REBEL, Cat. Lepid., vol. 2, no. 2271, 1901.

Ancylis plagosana FERNALD, in Dyar List N. Amer. Lepid., no. 5262, 1903.—

KEARFOTT, Can. Ent., vol. 37, 1905, p. 254.—BARNES and MCDUNNOUGH, Check List Lepid. Bor. Amer., no. 7199, 1917.

There are no pattern or genitalia differences between *plagosana* and *unguicella*. At most they could be but racially distinguished and I do not believe even such a splitting would be valid. There seems to be a little more intensity in the black dusting in American specimens, but they are somewhat variable and the character is not constant.

Male genitalia figured from specimen in National Collection from Aweme, Manitoba ("18-V-05; Criddle").

Distribution according to specimens in National Collection, American Museum, and collection Barnes: British Columbia, Manitoba, Alaska.

Alar expanse.—15–18 mm.

Types.—In collection unknown (*unguicella*); Academy Natural Science, Philadelphia (*plagosana*).

Type localities.—Europe (*unguicella*); Labrador (*plagosana*).

Food plant.—*Erica* (European record).

ANCYLIS PACIFICANA (Walsingham).

(Fig. 410.)

Phoxopteryx pacificana WALSINGHAM, Illus. Lepid. Heter. Brit. Mus., vol. 4, 1879, p. 73.

Ancylis pacificana FERNALD, in Dyar List N. Amer. Lepid., no. 5263, 1903.—DYAR, Proc. U. S. Nat. Mus., vol. 27, 1904, p. 928.—BARNES and McDUNNOUGH, Check List Lepid. Bor. Amer., no. 7200, 1917.

Very close to *unguicella* and often confused with that species. Most of the British Columbia specimens that have gone under the name *pacificana* are *unguicella*. Walsingham's species averages larger and has the whitish gray areas more evenly colored and less marked with blackish than *unguicella*. It also has a shorter aedoeagus.

Male genitalia figured from specimen in National Collection (from Placer County, California "VI-A. H. V.").

Distribution according to specimens in National Collection, American Museum, and collection Barnes: California, British Columbia, Colorado.

Alar expanse.—18–22 mm.

Type.—British Museum.

Type locality.—Mendocino County, California.

Food plant.—Unknown.

14. ANCYLIS MEDIOFASCIANA (Clemens).

(Fig. 412.)

Anchylopera mediofasciana CLEMENS, Proc. Ent. Soc. Phila., vol. 3, 1864, p. 511.

Phoxopteris mediofasciana ZELLER, Verh. Zool.-bot. Ges. Wien, vol. 25, 1875, p. 248.

Ancylis mediofasciana FERNALD, in Dyar List N. Amer. Lepid., no. 5239.—DYAR, Proc. U. S. Nat. Mus., vol. 27, 1904, p. 928.—KEARFOTT, Can. Ent., vol. 37, 1905, pp. 89, 253.—BARNES and McDUNNOUGH, Check List Lepid. Bor. Amer., no. 7173, 1917.

A striking species not easily confusable with anything else.

Male genitalia figured from specimen in National Collection from San Diego, California ("3-12-10, W. S. Wright").

Distribution according to specimens National Collection, American Museum, and collection Barnes: California, Manitoba, Maine, Ontario.

Alar expanse.—15–20 mm.

Type.—Lost?

Type locality.—Maine.

Food plant.—Unknown.

15. ANCYLIS TORONTANA (Kearfott).

Proteoteras torontana KEARFOTT, Trans. Amer. Ent. Soc., vol. 33, 1907, p. 50.—

BARNES and McDUNNOUGH, Check List Lepid. Bor. Amer., no. 7133, 1917.

The type is a male in very poor condition, without abdomen and much stained, which probably accounts for the yellowish tint of the ground color mentioned by Kearfott in his description. Except for the brown crescent from midcosta to apex, the type is like *mediofasciana*. In some specimens of the latter there is a suggestion of a dark shade connecting the fascia and the dark apical spot, but I have seen no true *mediofasciana* which had an unbroken brown crescent on the outer half of costa. With more material from the type locality *torontana* may prove to be but an aberration of Clemens' species; but for the present it must be kept separate.

Alar expanse.—20 mm.

Type.—In American Museum.

Type locality.—Toronto, Canada..

Food plant.—Unknown.

16. ANCYLIS TINEANA (Hübner).

(Fig. 405.)

Tortrix tineana HÜBNER, Schmet. Eur., Tort., 1800, fig. 81.

Anchylopera ocellana CLEMENS, Proc. Ent. Soc. Phila., vol. 3, 1864, p. 510.

Pandemis leucophaleratana PACKARD, Proc. Boston, Soc. Nat. Hist., vol. 11, 1866, p. 56.

Ancylis tineana STAUDINGER and REBEL, Cat. Lepid., vol. 2, no. 2268, 1901.—
FERNALD, in Dyar List N. Amer. Lepid., no. 5266, 1903.—BARNES and
MCDUNNOUGH, Check List Lepid. Bor. Amer., no. 7203, 1917.

A striking species easily recognized by its unique genitalia.

Male genitalia figured from European specimen in National Collection.

Distribution according to specimens in National Collection, American Museum, and collection Barnes: Massachusetts, New Hampshire, Manitoba.

Alar expanse.—14–16 mm.

Types.—In collection unknown (*tineana*); lost? (*ocellana*); Museum Comparative Zoology (*leucophaleratana*).

Type localities.—Europe (*tineana*); New Brunswick, Maine (*ocellana*); Hopedale, Labrador (*leucophaleratana*).

Food plant.—*Populus*.



THIS PAGE IS LOCKED TO FREE MEMBERS

Purchase full membership to immediately unlock this page



HISTORY

Tens of thousands of important historical sources, many previously unobtainable, are now available for the first time with a Forgotten Books Full Membership.

Unlimited Access
\$8.99/month

Continue

*Fair usage policy applies

9 not closely approximate to 8; 11 from middle of cell; upper internal vein of cell from between 10 and 11; 3, 4, and 5 *not* closely approximate at termen; 2 straight or very nearly so; no costal fold in male.

Hind wing with 8 veins; 6 and 7 approximate toward base; 3 and 4 stalked.

Male genitalia with harpes divided and often assymetrical, costa free nearly to base; cucullus and sacculus not differentiated. Uncus developed; triangular; long; strong; bifid. Socii and gnathos absent. Aedoeagus decidedly curved; long; stout; cornuti a longitudinal series of short, heavy, curved, thornlike spines. Eighth abdominal segment distinctly modified.

In addition to its peculiar genitalia which are like those of no other genus in the Olethreutidae, *Hystriophora* has a wing character that will also serve to identify it. The termen is decidedly concave and veins 3, 4, and 5 are not approximate at termen (fig. 12). In other genera whenever the termen is appreciably concave, these veins are always approximate at termen.

The genitalia are very heavy and so constructed that it is difficult to secure good mounts without dissecting the parts. For this reason it is nearly impossible to take a satisfactory photograph from slides.

KEY TO THE SPECIES OF HYSTRICOPHORA.

H. ostentatrix, new species, described in the appendix is not included in this key.

1. Fore and hind wings both white----- (11) *vestaliana*.
Fore and hind wings not both white; if fore wing white, hind wing dark brown----- 2
2. Fore wing white, whitish gray, or whitish ochreous----- 3
Fore wing ochreous brown or dull golden ochreous----- 6
3. Fore wing with a narrow evenly concave black line within termen.
----- (10) *kokana*.
Fore wing without such; if with black terminal line, latter sinuate, following terminal margin, not evenly concave----- 4
4. Ground color of fore wing sordid whitish ochreous----- (6) *roessleri*.
Ground color of fore wing white or whitish gray----- 5
5. Fore wing grayish white blotched on dorsal half with brownish; cilia of hind wing with a dark basal band----- (7) *asphodelana*.
Fore wing nearly pure white; cilia of hind wing without dark basal band.
----- (8) var. *seraphicana*.
6. Outer half of costa and terminal area of fore wing strongly marked and shaded with orange yellow----- (9) *ochreicostana*.
Outer half of costa and terminal area not so marked----- 7
7. Ground color of fore wing ochreous brown, more brown than yellow, nowise golden----- 8
Ground color of fore wing more golden than brown----- 9
8. Fore wing without ocelloid markings above tornus----- (4) *stygiانا*.
Fore wing with two or three short fine black dashes above tornus.
----- (5) var. *californiae*.

9. Costa of fore wing straight from before middle to apex----- (3) *paradisiae*.
 Costa of fore wing slightly arched before apex-----10
 10. Fore wing a dull golden faun color----- (1) *leonana*.
 Fore wing a pale golden saffron color----- (2) var. *aurantiana*.

1. **HYSTRICOPHORA LEONANA** Walsingham.

(Figs. 41, 42, 43, 44, 417.)

Hystricophora leonana WALSINGHAM, Illus. Lepid. Heter. Brit. Mus., vol. 4, 1879, p. 65.—FERNALD, in Dyar List N. Amer. Lepid., no. 5209, 1903.—BARNES and McDUNNOUGH, Check List Lepid. Bor. Amer., no. 7112, 1917.

A co-type of this species is in the National Collection. It is distinguished from other species of *Hystricophora* by its slender harpes and the shape of its fore wings. The latter are a trifle broader in proportion to their length in *leonana* than in the others, and it also has the costa somewhat arched. In the other species it is straight.

Male genitalia figured from specimen in National Collection from middle California.

Specimens from California in National Collection, American Museum, and collection Barnes.

Alar expanse.—19–20 mm.

Type.—In British Museum.

Type locality.—"Sonoma, Lake, and Mendocino Counties," California.

Food plant.—Unknown.

2. **HYSTRICOPHORA LEONANA AURANTIANA** Walsingham.

Hystricophora leonana aurantiana WALSINGHAM, Illus. Lepid. Heter. Brit. Mus., vol. 4, 1879, p. 65.—FERNALD, in Dyar List N. Amer. Lepid., no. 5209.^a—BARNES and McDUNNOUGH, Check List Lepid. Bor. Amer., no. 7112^a, 1917.

This, as Walsingham suggests, is probably nothing but a brighter, more golden color variety of *leonana*. On the suspicion that it may represent a local race I am holding the name. A specimen in the Kearfott collection labeled "Co-type" looks like a typical *leonana*.

Alar expanse.—19 mm.

Type.—In British Museum.

Type locality.—Shasta County, California.

Food plant.—Unknown.

3. **HYSTRICOPHORA PARADISIAE**, new species.

Palpus gray; whitish toward base. Head grayish ochreous. Thorax and fore wing dull grayish golden. Fore wing practically unmarked, sometimes faintly clouded with a darker shade toward base, but with costal and ocelloid markings obsolete or extremely faint; cilia ochreous with a faint brown shade just beyond base; extreme base of cilia whitish. Hind wing a trifle darker and more brownish

than fore wing, but nearly the same general color; cilia whitish with a dark basal band.

Alar expanse.—24–25 mm.

Type.—In collection Barnes.

Paratype.—Cat. No. 24859 U.S.N.M.; also in American Museum and collection Barnes.

Type locality.—Paradise Valley, Mount Rainier, Washington.

Food plant.—*Lupinus polyphyllus*.²⁰

Described from male type and three male paratypes, all from the type locality and labeled, "July 24–31." Much like *leonana*, but darker, with darker hind wings, straighter costa, and without the distinct markings of Walsingham's species. Closest to *stygiانا* Dyar, but distinguished from the latter by its more golden color. In genitalia *paradisiae*, *stygiانا*, *roessleri*, and *asphodelana* are so much alike that it is practically impossible to separate them on structural characters. In all the eighth abdominal segment is less highly modified than in *leonana*, *vestaliana*, or *ochreicostana*, the projections of the tergite being mere rounded stubs, very short, and not as long fingered processes in the other three species.

4. HYSTRICOPHORA STYGIANA (Dyar).

(Fig. 12.)

Thiodia stygiانا DYAR, Proc. Ent. Soc. Wash., vol. 5, 1903, p. 230.

Eucosma stygiانا BARNES and McDUNNOUGH, Check List Lepid. Bor. Amer., no. 7090, 1917.

I have succeeded in rearing a couple of moths of this interesting species from larvae boring in the roots of a plant resembling lupine, collected at Colorado Springs, Colorado, by A. B. Champlain. Full-grown larvae were collected in early March, 1915, and moths issued April 7 and 15 of the same year.

Male genitalia as in *roessleri*.

Distribution according to specimens in National Collection, American Museum, and collection Barnes: Arizona, Colorado, Utah, Wyoming, British Columbia.

Alar expanse.—25–28 mm.

Type.—In National Collection.

Type locality.—Williams, Arizona.

Food plant.—*Lupinus*?

5. HYSTRICOPHORA STYGIANA CALIFORNIAE, new variety.

Like the typical *stygiانا* but differing in its darker, more distinct costal markings and the presence of two or three short black longitudinal streaks above tornus. In *stygiانا* proper there is no indication whatever of an ocelloid patch.

²⁰ After this species had been described several specimens were received reared from roots of *Lupinus* at Forest Grove, Oregon, by L. P. Rockwood ("Webster No. 20585").



THIS PAGE IS LOCKED TO FREE MEMBERS
Purchase full membership to immediately unlock this page



Never be without a book!

Forgotten Books Full Membership gives universal access to 797,885 books from our apps and website, across all your devices: tablet, phone, e-reader, laptop and desktop computer

A library in your pocket for \$8.99/month

Continue

*Fair usage policy applies

unable to separate all of them satisfactorily on any geographical basis.

Male genitalia as in *roessleri*.

Distribution according to specimens in National Collection, American Museum, and collection Barnes: Colorado, Oregon, Utah, British Columbia, Alberta, Alaska.

Alar expanse.—23–30 mm.

Type.—In American Museum.

Type locality.—Head of Pine Creek, Calgary, Alberta, Canada.

Food plant.—Unknown.

8. HYSTRICOPHORA ASPHODELANA SERAPHICANA, new variety.

Paler than *asphodelana*. Fore wing nearly pure white with markings almost obsolete and little or no trace of dark shading on dorsum; cilia snowy white with a faint broken dark anti-basal line above tornus. Hind wing dark brown; cilia snow white without dark basal line. Underside of fore wing dark fuscous; termen and costa white. Underside of hind wing white.

Alar expanse.—30–31 mm.

Type.—Cat. No. 24861, U.S.N.M.

Paratypes.—In National Collection, American Museum, and collection Barnes.

Type locality.—Pullman, Washington.

Food plant.—Unknown.

Described from male type and two male paratypes from the type locality ("C. V. Piper, 13 May, 98") and four male and one female paratypes from Glacier National Park, Montana ("H. G. Dyar, June 29, 1921;" "July 24–31").

A distinct variety easily distinguished by the snow-white unshaded cilia of its dark hind wings.

9. HYSTRICOPHORA OCHREICOSTANA (Walsingham).

(Fig. 419.)

Semasia ochreicostana WALSINGHAM, Trans. Ent. Soc. Lond., 1884, p. 141.

Thiodia ochreicostana FERNALD, in Dyar List N. Amer. Lepid., no. 5202, 1903.

Eucosma ochreicostana BARNES and McDUNNOUGH, Check List Lepid. Bor. Amer., no. 7057, 1917.

A distinct species easily recognized by its strongly marked ocellus and the strong orange yellow markings and shadings on terminal area of fore wing.

Male genitalia figured from specimen in National Collection from Denver, Colorado ("Oslar").

Distribution according to specimens in National Collection, American Museum, and collection Barnes: Colorado, Utah, Kansas, Iowa.

Alar expanse.—16–19 mm.

Type.—In British Museum.

Type locality.—Montana.

Food plant.—Unknown.

10. *HYSTRICOPHORA KOKANA* (Kearfott).

Eucosma kokana KEARFOTT, Trans Amer. Ent. Soc., vol. 33, 1907, p. 29.—BARNES and McDUNNOUGH, Check List Lepid. Bor. Amer., no. 7006, 1917.

Eucosma chortaea MEYRICK, Ent. Mo. Mag., vol. 48, 1912, p. 35.

I refer this species here only provisionally, as I have seen no specimens other than the type, and that is a female. It is distinguished from other species in this genus by the evenly concave dark line along inside of termen of fore wing.

Alar expanse.—20 mm.

Type.—In American Museum.

Type locality.—Cincinnati, Ohio.

Food plant.—Unknown.

11. *HYSTRICOPHORA VESTALIANA* (Zeller).

(Fig. 420.)

Grapholitha vestaliana ZELLER, Verh. Zool.-bot. Ges. Wien, vol. 25, 1875, p. 286.

Thiodia vestaliana FERNALD, in Dyar List N. Amer. Lepid., no. 5171, 1903.

Eucosma vestaliana BARNES and McDUNNOUGH, Check List Lepid. Bor. Amer., no. 7091, 1917.

A striking species easily recognized by its white fore and hind wings, the black strigulae on outer half of costa, the fine black line bordering the termen of fore wing and the symmetrical harpes of its genitalia.

Male genitalia figured from specimen in National Collection from Boulder, Colorado ("T. D. A. Cockerell, July 29").

Distribution according to specimens in National Collection, American Museum, and collection Barnes: Colorado, Wyoming, Kansas, Iowa, Florida.

Alar expanse.—19–25 mm.

Type.—In Museum of Comparative Zoology.

Type locality.—Dallas, Texas.

Food plant.—Unknown.

SPECIES REFERABLE ELSEWHERE.

The following species now listed with the Eucosminae are referable to other groups. The numbers before each are those of the Barnes and McDunnough List and the Dyar Catalogue in the order given. Where only one number is given it is that of the Barnes and McDunnough List.

6952-5116. *Eucosma lineana* FERNALD, Journ. N. Y. Ent. Soc., vol. 9, 1901, p. 50.

Goes in *Olethreutes*.

7088-5169. *Tortrix succedana* DENIS and SCHIFFERMÜLLER, Syst. Verz. Wien., 1776, p. 129.

Goes in *Laspeyresia*. Is a European species probably wrongly credited to our fauna.

7158-5234. *Steganoptycha pyricolana* MURTFELDT, Bull., no. 23, U. S. Dept. Agr., 1891, p. 52.

Is a *Laspeyresia*.

7165. *Epinotia favillana* DYAR, Proc. Ent. Soc. Wash., vol. 5, 1903, p. 230.

Goes in *Olethreutes*.

7166. *Epinotia ? cornutana* DYAR, Proc. Ent. Soc. Wash., vol. 5, 1903, p. 231.

Referable to *Laspeyresia*.

SPECIES OMITTED.

The following species I have been unable to recognize or place from their descriptions:

Eucosma fuscana KEARFOTT, Can. Ent., vol. 39, 1907, p. 53.—BARNES and McDUNNOUGH, Check List Lepid. Bor. Amer., no. 7011, 1917.

In his description Kearfott states that the species was described from four specimens which were distributed as cotypes in his and Fernald's collections and the collection of the National Museum. I am unable to find any specimens in these collections so labeled. Kearfott either must have mislaid or forgot to label his types. At any rate they have disappeared.

Alar expanse.—23-30 mm.

Type.—Lost.

Type localities.—"Rounthwaite, Manitoba; Iowa; Chicago; Illinois."

Food plant.—Unknown.

Grapholitha taleana GROTE, Can. Ent., vol. 10, 1878, p. 54.—FERNALD, in Dyar List. N. Amer. Lepid., no. 5182, 1903 (*Thiodia*).—BARNES and McDUNNOUGH, Check List Lepid. Bor. Amer., no. 7071, 1917 (*Eucosma*).

Impossible to recognize from the description.

Alar expanse.—18 mm.

Type.—In British Museum.

Type locality.—Illinois.

Food plant.—Unknown.

Sciaphila perstructana WALKER, Cat. Lepid. Heter. Brit. Mus., vol. 28, 1863, p. 343.—WALSINGHAM, Illus. Lepid. Heter. Brit. Mus., vol. 4, 1879, p. 64 (*Semasia*).—FERNALD, in Dyar List N. Amer. Lepid., no. 5197, 1903 (*Thiodia*).—BARNES and McDUNNOUGH, Check List Lepid. Bor. Amer., no. 7096, 1917 (*Eucosma*).



THIS PAGE IS LOCKED TO FREE MEMBERS

Purchase full membership to immediately unlock this page



HISTORY

Tens of thousands of important historical sources, many previously unobtainable, are now available for the first time with a Forgotten Books Full Membership.

Unlimited Access
\$8.99/month

Continue

*Fair usage policy applies

APPENDIX.

The following new species and the information regarding *Hendecaneura shawiana* came to hand after the revision had gone to press and too late to allow them to be properly incorporated into the body of the manuscript. As names were required for the new forms, it was thought better to give them in an appendix rather than a later separate publication.

THIODIA SORORIANA, new species.

(Fig. 421.)

A unicolorous gray species. Palpi, face, head, thorax, and fore wing very dark grayish fuscous, finely powdered with white, giving the entire insect a uniformly dark ashy gray appearance; bordering termen a narrow straight faint blackish band; termen straight, decidedly slanting; veins 3, 4, and 5 well separated toward termen. Hind wing dark smoky gray; cilia slightly paler with a dark basal band; veins 3 and 4 stalked.

Right harpe of male genitalia of type figured.

Alar expanse.—17.5–18 mm.

Type.—In Canadian National Collection.

Paratype.—Cat. No. 25613 U.S.N.M.

Type locality.—Aweme, Manitoba.

Food plant.—Unknown.

Described from male type and paratype from the type locality ("N. Criddle, 24-IX-1921" and "22-IX-1921"), received through Doctor McDunnough. I have also seen specimens of the same species in the Fernald collection at Amherst, from Ontario, Canada, bearing the manuscript name "*cinerea* Fernald." In the key given it would run down to *lapidana* Walsingham, from which it can be separated by the dark band bordering termen of fore wing. It most closely resembles *Hystriophora* (?) *kokana* Kearfott, but I do not think it can be that species.

THIODIA NEPOTINANA, new species.

(Fig. 422.)

White heavily dusted with dark gray (or gray dusted with white). Palpi, face and head more white than gray. Fore wing with the

gray areas most distinctly defined as a dark basal patch which becomes obsolete toward costa and a dark fascia from mid costa to dorsum before tornus and two or three triangular spots on outer half of costa, the latter interspaced with pairs of rather long, fine, white lines; the white dusting in fresh specimens is pretty well scattered over the whole wing but is most obvious on mid dorsum (as a faint square patch), in tornal area and along costa toward apex; ocelloid patch white with two short black streaks; cilia white, with a fine black subbasal line and an outer dusting of blackish fuscous scaling. Hind wing whitish with a fuscous shading along termen and toward apex; cilia white with a dark basal band and toward apex with a median dark shading; veins 3 and 4 united.

Right harpe of male genitalia figured.

Alar expanse.—11–15 mm.

Type.—In collection Barnes.

Paratypes.—Cat. No. 25614 U.S.N.M. Also in American Museum and collection Barnes.

Type locality.—Eureka, Utah.

Food plant.—Unknown.

Described from male type, five male and two female paratypes from the type locality ("Tom Spalding, V—30—11"), one male paratype from Stockton, Utah ("Tom Spalding, V—24—04"), one male paratype from Olancho, California ("June 16—23"), and five male and one female paratypes from Verdi, Nevada ("A. H. Vachell, June 1—10"). The paratypes from Nevada average smaller than the others and may possibly represent a local race. At present, however, there seems to be no reason for distinguishing it by a separate name.

In our key the species would run down to alternative 69. It is nearest *tenuiana* and *migratana* in pattern and markings but distinct from anything in the genus in the shape of its harpes.

THIODIA FERTORIANA, new species.

(Fig. 423.)

In pattern much alike *misturana* Heinrich but quite different in genitalia. The ground color of the fore wing is dark gray rather than white, the white geminations on outer half of costa are longer and the median white streak is both longer and more obscure than in *misturana*, being interrupted longitudinally by a streak of blackish dusting. The coloring of the cilia of fore wings is also different. In *fertoriana* at extreme base, edging the termen, there is a narrow black line outwardly bordered by a narrow white band; beyond this the cilia are dark grayish fuscous. In *misturana* on the other hand there are no such contrasting white and black lines, the cilia being



THIS PAGE IS LOCKED TO FREE MEMBERS
Purchase full membership to immediately unlock this page



Never be without a book!

Forgotten Books Full Membership gives universal access to 797,885 books from our apps and website, across all your devices: tablet, phone, e-reader, laptop and desktop computer

A library in your pocket for \$8.99/month

Continue

*Fair usage policy applies

fascia; basal patch slightly angulate but broader on dorsum than costa, dusted toward base with grayish white; outer fascia slanting from mid costa to dorsum before tornus, nearly straight; ocelloid patch consisting of three vertical silvery bars inclosing 9 or 10 black dots, 3 or 4 between inner and median bars and 6 between median and outer bars; above and below ocellus a clouding of grayish fuscous; apex shaded with yellow-brown; costa between fascia and apex, white, marked with three or four obscure brownish spots; white areas somewhat clouded with fuscous, giving them a grayish white appearance; cilia white dusted with fuscous. Hind wing rather pale smoky fuscous; cilia white with a dark basal band; veins 3 and 4 united.

Right harpe of male genitalia of type figured.

Alar expanse.—11.5–13.5 mm.

Type.—In American Museum.

Paratype.—Cat. No. 25617, U.S.N.M. Paratypes also in Canadian National Collection.

Type locality.—Aweme, Manitoba.

Food plant.—Unknown.

Described from male type, two male and one female paratypes all from the type locality (Norman Criddle, collector), and dated as follows: Type ("22-VI-05"), two male paratypes ("4-VI-1921," and "12-VI-1921"); female paratype ("7-VI-1921"). The type is from the collection of the American Museum. The paratypes were received through Dr. J. McDunnough.

A very pretty little species resembling *octopunctana* and *scalana*, but distinguished from both on genitalia and color. In *octopunctana* the basal patch and fascia are golden yellow. In *scalana* they are dark grayish fuscous. The harpe of *festivana* has the anal angle of cucullus more sharply pointed than that of *octopunctana* and less produced than that of *scalana*. The new species also has fewer cornuti on the penis than either of Walsingham's species. In the key it would run down to *scalana*, and according to the arrangement given should be placed between it and *octopunctana*.

EUCOSMA SERAPICANA, new species.

(Fig. 426.)

Antennae, palpi, face, head, and thorax cream (or ivory) white. Fore wing cream white with a few obscure scattered dustings of blackish scales; a peppering of black on the cilia; and an ocelloid patch consisting of two faint vertical silvery bars inclosing three fine, longitudinal, black streaks; otherwise unmarked; no trace of strigulae on costa. Hind wing smoky fuscous; cilia white with a dark basal band.

Harpe of male genitalia of type figured.

Alar expanse.—23 mm.

Type.—Cat. No. 25618 U.S.N.M.

Type locality.—Great Falls, Montana.

Food plant.—Unknown.

Described from unique type collected by Dr. H. G. Dyar, July 8, 1921. Closest to *atomosana* Walsingham. In the key would run to *atomosana* and *monogrammana*, but is easily separated from both by the unmarked costa of its fore wing.

EUCOSMA PALABUNDANA, new species.

(Fig. 427.)

Antennæ dark fuscous, paler beneath. Palpus dark grayish fuscous; inner side paler, somewhat ochreous; terminal joint black. Head dull sordid ochreous. Thorax blackish fuscous dusted with white. Fore wing grayish white, marked and dusted with blackish fuscous; an outwardly angulate blackish fuscous basal patch broken near inner angle by whitish scaling; from middle of costa an outwardly slanting dark band which fuses with a similar dark outer dorsal patch just before tornus, forming a complete angulate fascia; costa beyond basal patch finely strigulated with white and blackish fuscous; ocelloid patch consisting of two vertical pinkish bars inclosing two or three narrow longitudinal black streaks, the outer pinkish vertical bar broken below middle and bordered outwardly by a blackish fuscous shade which curves inward over the ocellus; cilia dark fuscous peppered with white and becoming paler at outer margin. Hind wing dark smoky fuscous; cilia paler with a dark basal band and the outer scales tipped with white.

Harpe of male genitalia of type figured.

Alar expanse.—14–16.5 mm.

Type.—In Canadian National Collection.

Paratypes.—Cat. No. 25619 U.S.N.M.

Type locality.—Aweme, Manitoba.

Food plant.—Unknown.

Described from male type and one male paratype from Aweme, Manitoba, dated, respectively, "2-VII-1921," and "25-VIII-1921," Norman Criddle, collector, and one male paratype from Hessville, Ind. ("A. K. Wyatt, VII-4-14").

A distinct species superficially most like *Gypsonoma fasciolana* Clemens but easily separated from that species on structure. In the key it would run down to *rorana* Kearfott, from which it is at once distinguished by its very different harpes and the pinkish color of the vertical bars of the ocelloid patch. In the arrangement given it should be placed after *grotiana* Kearfott.

EPIBLEMA GRATUITANA, new species.

(Fig. 431.)

Like *purpurissatana* Heinrich except for somewhat larger size, paler palpi, face, and thorax, a broader suffusion of the white on forewing (especially toward base), and its differently shaped harpes. It would run to *purpurissatana* in the key and would be separated most readily by the whitish ochreous rather than dirty gray white palpi. There is none of the lead-colored shading on the palpi such as we have in *purpurissatana*. The cilia of the hind wing are paler and the blackish dusting on forewing is less pronounced. Otherwise the two species are alike in color and markings. The only genitalia difference is in the shape of the harpes, but this is quite obvious, as the figures will show.

Right harpe of male genitalia of type figured.

Alar expanse.—15–16 mm.

Type.—Cat. No. 25850 U.S.N.M.

Type locality.—East Sound, Washington.

Food plant.—Unknown.

Described from male type from the type locality dated, "7-11-01," and one female paratype from Whidby Island, Washington ("8-6-99, T. Kincaid"). These two specimens were in the National Collection under *Laspeyresia fletcherana* Kearfott, where they had been placed by Kearfott. The male, in fact, bears a name label in his handwriting, "*Enarmonia fletcherana* K. Metatype." The true *fletcherana* is a *Laspeyresia* and of course something quite different.

EPIBLEMA PERICULOSANA, new species.

(Fig. 428.)

Antennae dark gray above, whitish ochreous beneath. Palpi whitish ochreous dusted with dark gray on outer sides. Face gray. Head ochreous with more or less admixture of gray. Thorax dark grayish fuscous. Fore wing with short appressed costal fold in male; termen slanting, straight, not concave; veins 3 and 4 parallel from beyond base; vein 11 from cell near base; vein 12 very short; color dark grayish (or blackish) fuscous with a square white patch near middle of dorsum and a whitish shading below costa beyond middle; dorsal white patch square, divided by a fine central dark line and not extending above middle of wing; no defined ocelloid patch; at middle of subterminal area a smudge of black scaling; rest of terminal area somewhat dusted with brownish ochreous; costal markings faint; an obscure black spot at apex and scattered black scales on dark areas bordering the white dorsal patch; cilia grayish fuscous, somewhat dusted with dirty white. Hind wing with veins 3 and 4 very short stalked, in type actually separate; color pale smoky fuscous; cilia somewhat paler with a dark basal band.



THIS PAGE IS LOCKED TO FREE MEMBERS

Purchase full membership to immediately unlock this page



HISTORY

Tens of thousands of important historical sources, many previously unobtainable, are now available for the first time with a Forgotten Books Full Membership.

Unlimited Access
\$8.99/month

Continue

*Fair usage policy applies

Very close to *subplicana* Walsingham and possibly a local race of that species; but quite different in color and easily distinguished. Until we know more about them the two had better be regarded as separate species.

ANCHYLOPERA DEFINITIVANA, new species.

(Fig. 432.)

Fore wing whitish ochreous with a black smudge at end of cell, a shading of ochreous beyond, broken by a pair of indistinct longitudinal black streaks, some blackish dusting toward tornus and an argus brown basal patch; outer margin of basal patch straight, decidedly slanting, and outwardly margined by a few black scales; costa marked with fine black geminations; around apex and along termen nearly to tornus, a fine black line; cilia whitish ochreous. Hind wing very pale smoky fuscous, inclining to whitish ochreous.

Male genitalia of type figured.

Alar expanse.—14.5 mm.

Type.—Cat. No. 25622, U.S.N.M.

Type locality.—Nevada.

Food plant.—Unknown.

Described from single male labeled "Nevada, July 16-23." A distinct species easily recognized on pattern and genitalia. It is the only one with a black smudge at the end of the cell on fore wing, and the only one having at once an uncus and so long and slender an aedoeagus.

HYSTRICOPHORA OSTENTATRIX, new species.

Antennae, palpi, head, and thorax brownish gray; face, underside of antennae, and inner sides of palpi paler, more whitish ochreous. Fore wing brownish-fuscous-gray dusted with scattered white and some few black scales; from slightly beyond middle of dorsum to middle of costa a faint, biangulate, darker gray fascia; a similar dark shade on dorsum before ocelloid patch; ocellus an obscure vertical metallic bar inwardly bordered by three black streaks and outwardly by three black dots and a white or whitish-ochreous elongate patch near termen above tornus; ground color near apex also more ochreous than gray; costa between fascia and apex marked with four black spots alternating with narrow white streaks; dorsal margin faintly dotted with black; cilia whitish ochreous, blotched with smoky blackish fuscous above tornus. Hind wing brown; cilia only slightly paler.

Male genitalia as in *roessleri* Zeller, except with fewer cornuti.

Alar expanse.—28.5-29 mm.

Type.—In collection Barnes.

Paratype.—Cat. No. 25623, U.S.N.M.

Type locality.—Mineral King, Tulare County, California.

Food plant.—Unknown.

Described from type and male paratype both from the type locality and labeled "Aug. 1-7" and "July 16-23." Nearest to *roessleri* Zeller; but distinguished from it by the lack of any white shading on basal costal area, by the distinguishable median fascia of fore wing, the darker cilia of hind wings, and the fewer cornuti (10) on penis. In our key it would fall between *roessleri* and *asphodelana*. From the latter it is distinguished by the contrasted pale markings on fore wing near tornus. It also has fewer cornuti than *asphodelana*, which in this character agrees with *roessleri*.

Genus HENDECANEURA Walsingham.

(Figs. 429, 430.)

Genotype.—*Hendecaneura impar* Walsingham.

In working up the *Laspeyresinae* I find that one of the species at present listed under *Laspeyresia* (*shawiana* Kearfott) is a true Eucosmine and referable to Walsingham's *Hendecaneura*. This genus, though somewhat incorrectly defined by its author, is easily identified on venation. I have seen no males of the type species; but there is in the national collection a female cotype of *H. impar* and both males and females of *shawiana*. There can be no doubt that the two species are congeneric. The following description is based upon the male of *shawiana* and females of both *shawiana* and *impar*:

Fore wing smooth; termen very slightly concave between veins 3 and 6; male with 11 veins; 12 absent; 11 from cell near base; 7 and 8 separate; female with 12 veins, all separate; 11 from cell at or a trifle before middle; in both sexes, 3, 4, and 5 are but slightly approximate at termen, 2 is straight and the upper internal vein of cell is absent; male with a short appressed costal fold.

Hind wing with 8 veins; 3 and 4 stalked; 5 decidedly bent toward base, approximate to 4; 6 and 7 stalked.

Male genitalia as in *Zeiraphera* except that neck of harpe is longer and neck incurvation more pronounced.

Walsingham is obviously in error in interpreting the absent costal vein in fore wing of the male as 9. Vein 12 is much reduced in a number of species of *Epiblema* and *Eucosma* and is often entirely hidden under the fold. This together with the fact that all the remaining costal veins in *Hendecaneura* spring from cell shows that it must be 12 which is absent. Walsingham is also wrong in stating that 6 and 7 of hind wing are "nearly coincident along their base." In the

cotype of *impar* before me as well as in the specimens of *shawiana* they are distinctly stalked.

Hendecaneura is closest to *Zeiraphera* Treitschke from which it is distinguished by its more advanced venation and the possession of a costal fold. The genitalia of the two are very close. As far as known there is only one North American species.

HENDECANEURA SHAWIANA (Kearfott).

(Figs. 429, 430.)

Enarmonia shawiana KEARFOTT, Can. Ent., vol. 39, 1907, p. 154.

Laspeyresia shawiana BARNES and McDUNNOUGH, Check List Lepid. Bor. Amer., no. 7209, 1917.

In the male of this species there is a peculiar character which may or may not be of generic value. The fore wing has a circular pit or depression on the underside near the base of vein 1*b*, destroying the upper branch of the fork. This pit is entirely lacking in the female, and 1*b* is normal.

Male genitalia figured from specimen in the National Collection from the type locality.

Distribution according to specimens in National Collection, American Museum, and collection Barnes: New Hampshire and New Jersey.

Alar expanse.—9–14 mm.

Type.—In American Museum.

Type locality.—Hampton, New Hampshire.

Food plant.—Unknown.



THIS PAGE IS LOCKED TO FREE MEMBERS

Purchase full membership to immediately unlock this page



Never be without a book!

Forgotten Books Full Membership gives universal access to 797,885 books from our apps and website, across all your devices: tablet, phone, e-reader, laptop and desktop computer

A library in your pocket for \$8.99/month

Continue

*Fair usage policy applies

FIG. 3a. Basal joints of male antenna of *S. indentana*, much enlarged, showing notch.

4. Male antenna of *Spilonota ocellana* (Denis and Schiffermüller).
- 4a. Basal joints of male antenna of *S. ocellana*, much enlarged, showing notch.
5. Fore wing venation of *Eucosma cataclystiana* (Walker).
6. Hind wing of *Rhopobota naevana* (Hübner) showing venation and male sex scaling.
7. Hind wing of *Proteoteras aesculana* Riley, showing venation and male sex scaling.
8. Denuded hind wing of *Kundrya finitimana* Heinrich (male).
- 8a. Denuded fore wing of *Kundrya finitimana*.
9. Fore wing venation of *Rhyacionia buoliana* (Schiffermüller).
10. Hind wing of *Crociosema plebeiana* Zeller (male), showing enlarged hair tuft on lower median vein.
11. Fore wing venation of *Sonia filiana* (Busck).
12. Fore wing venation of *Hystriophora stygiana* (Dyar).
13. Denuded fore wing of *Ancylis laetana* (Fabricius).
14. Denuded fore wing of *Gretchena deludana* (Clemens).

PLATE 2.

Male genitalia (Eucosminae).

- FIG. 15. *Rhyacionia buoliana* (Schiffermüller).
 16. *Thiodia citrana* Hübner.
 17. (*Ioplocama*) *Thiodia formosana* (Clemens).

PLATE 3.

Male genitalia (Eucosminae).

- FIG. 18. *Spilonota ocellana* (Denis and Schiffermüller).
 19. *Epiblema foenella* (Linnaeus).
 20. *Petrova comstockiana* (Fernald).

PLATE 4.

Male genitalia (Eucosminae).

- FIG. 21. *Eucosma circulana* Hübner.
 22. *Sonia constrictana* (Zeller).
 23. (*Phthinolophus*) *Strepsicrates indentana* (Dyar).
 24. *Barbara colfaxiana* (Kearfott).
 25. *Proteoteras aesculana* Riley.

PLATE 5.

Male genitalia (Eucosminae).

- FIG. 26. *Suleima helianthana* (Riley).
 27. *Gypsonoma haimbachiana* (Kearfott) (ventral view of organs spread, with aedoeagus and anellus omitted).
 27a. *Gypsonoma haimbachiana* (Kearfott) (anellus and aedoeagus).
 28. *Zeiraphera corticana* (Hübner).
 29. *Crociosema plebeiana* Zeller.
 29a. *Crociosema plebeiana* Zeller (detail showing articulations of uncus, gnathos, and socii).

PLATE 6.

Male genitalia (Eucosminae).

- FIG. 30. *Exentera improbana* (Walker).
 30a. *Exentera improbana* (Walker) (detail showing articulations of socii and gnathos).
 31. *Gretchena deludana* (Clemens).
 32. *Gwendolina concitatricana* Heinrich.

PLATE 7.

Male genitalia (Eucosminae).

- FIG. 33. *Norma dietziana* (Kearfott).
 34. *Kundrya finitimana* Heinrich.
 35. *Ancylis laetana* (Fabricius).
 36. *Griselda radicana* (Walsingham).
 37. *Rhopobota naevana* (Hübner).
 38. *Epinotia similana* (Hübner).

PLATE 8.

Male genitalia (Eucosminae).

- FIG. 39. *Pseudogalleria inimicella* (Zeller).
 40. *Pseudogalleria inimicella* (Zeller) (posterior view of eighth abdominal segment showing modifications of tergite and sternite).
 41. *Hystriophora leonana* Walsingham (ventral view of organs with harpes spread and aedoeagus omitted. The uncus has been bent downward by pressure on the slide. Its normal position in relation to the tegumen is as in fig. 44).
 42. *Hystriophora leonana* Walsingham (lateral view of eighth abdominal segment showing modifications of tergite and sternite).
 43. *Hystriophora leonana* Walsingham (detail: aedoeagus and anellus).
 44. *Hystriophora leonana* Walsingham (detail: tegumen and uncus).

PLATE 9.

Male genitalia (*Rhyacionia*).

- FIG. 45. *Rhyacionia buoliana* (Schiffermüller).
 46. *Rhyacionia neomexicana* (Dyar).
 47. *Rhyacionia montana* (Busck).
 48. *Rhyacionia frustrana bushnelli* (Busck).
 49. *Rhyacionia rigidana* (Fernald).
 50. *Rhyacionia pasadenana* (Kearfott).
 51. *Rhyacionia busckana* Heinrich.
 52. *Rhyacionia adana* Heinrich.
 53. *Rhyacionia frustrana* (Comstock).

PLATE 10.

Male genitalia (*Petrova*).

- FIG. 54. *Petrova comstockiana* (Fernald).
 55. *Petrova virginiana* (Busck).
 56. *Petrova albicapitana* (Busck).
 57. *Petrova albicapitana arizonensis* (Heinrich).
 58. *Petrova metallica* (Busck).
 59. *Petrova luculentana* (Heinrich).

PLATE 11.

Male genitalia (*Petrova*).

- FIG. 60. *Petrova burkeana* (Kearfott).
 61. *Petrova sabiniana* (Kearfott).
 62. *Petrova picicolana* (Dyar).
 63. *Petrova gemistrigulana* (Kearfott).

PLATE 12.

Male genitalia (*Gypsonoma*, *Barbara*).

- FIG. 64. *Gypsonoma haimbachiana* (Kearfott).
 65. *Gypsonoma salicicolana* (Clemens) (= *saliciana* Clemens).
 66. *Gypsonoma incarnana* (Haworth) (European specimen).
 67. *Gypsonoma substitutionis* Heinrich.
 68. *Gypsonoma fasciolana* (Clemens).
 69. *Barbara colfaxiana* (Kearfott).
 70. *Barbara colfaxiana siskiyouana* (Kearfott).
 71. *Barbara colfaxiana coloradensis* (Heinrich), male genitalia of type, reared from *Abies*.
 72. *Barbara colfaxiana coloradensis* (Heinrich), male genitalia of paratype, reared from *Pseudotsuga*.
 73. *Barbara colfaxiana taxifoliella* (Busck).
 74. *Barbara ulteriorana* (Heinrich).

PLATE 13.

Male genitalia (*Thiodia*).

- FIG. 75. *Thiodia radiatana* (Walsingham).
 76. *Thiodia awemeana* Kearfott.
 77. *Thiodia roseotermiana* Kearfott.
 78. *Thiodia clavata* (Fernald).
 79. *Thiodia striatana occidentalis* Heinrich.
 80. *Thiodia striatana* (Clemens).
 81. *Thiodia kiscana* Kearfott.
 82. *Thiodia pallidicostana* (Walsingham).
 83. *Thiodia essexana* Kearfott.
 84. *Thiodia umbraticana* Heinrich.



THIS PAGE IS LOCKED TO FREE MEMBERS

Purchase full membership to immediately unlock this page



HISTORY

Tens of thousands of important historical sources, many previously unobtainable, are now available for the first time with a Forgotten Books Full Membership.

Unlimited Access
\$8.99/month

Continue

*Fair usage policy applies

- FIG. 123. *Thiodia salmicolorana* Heinrich.
 124. *Thiodia scalana* (Walsingham).
 125. *Thiodia infimbriana* Dyar.
 126. *Thiodia octopunctana* (Walsingham).
 127. *Thiodia artemisiana* (Walsingham).
 128. *Thiodia elongana* (Walsingham).
 129. *Thiodia mormonensis* Heinrich.
 130. *Thiodia apacheana* (Walsingham).

PLATE 18.

Male genitalia (*Thiodia*).

- FIG. 131. *Thiodia minimana* (Walsingham).
 132. *Thiodia cinereolineana* Heinrich.
 133. *Thiodia subminimana* Heinrich.
 134. *Thiodia delphinus* Heinrich.
 135. *Thiodia delphinoides* Heinrich.

PLATE 19.

Male genitalia (*Eucosma*).

- FIG. 136. *Eucosma tocullionana* Heinrich.
 137. *Eucosma monitorana* Heinrich.
 138. *Eucosma rescissoriana* Heinrich.
 139. *Eucosma cocana* Kearfott.
 140. *Eucosma bobana* Kearfott.
 141. *Eucosma sonomana* Kearfott.
 142. *Eucosma bipunctella* (Walker).

PLATE 20.

Male genitalia (*Eucosma*).

- FIG. 143. *Eucosma giganteana* (Riley).
 144. *Eucosma sandana* Kearfott.
 145. *Eucosma bilineana* Kearfott.
 146. *Eucosma glomerana* (Walsingham).
 147. *Eucosma floridana* Kearfott.
 148. *Eucosma circulana* Hübner.
 149. *Eucosma gomonana* Kearfott.
 150. *Eucosma circulana gemellana* Heinrich.
 151. *Eucosma sombreana* Kearfott.

PLATE 21.

Male genitalia (*Eucosma*).

- FIG. 152. *Eucosma fiskeana* Kearfott.
 153. *Eucosma pandana* Kearfott.
 154. *Eucosma grotiana* Kearfott.
 155. *Eucosma juncticiliana* (Walsingham).
 156. *Eucosma cataclystiana* (Walker).
 157. *Eucosma conspiciendana* Heinrich.
 158. *Eucosma excusabilis* Heinrich.
 159. *Eucosma eumaea* Meyrick.
 160. *Eucosma exclusoriana* Heinrich.
 161. *Eucosma fraudabilis* Heinrich.

PLATE 22.

Male genitalia (*Eucosma*).

- FIG. 162. *Eucosma rusticana* Kearfott.
 163. *Eucosma costastrigulana* Kearfott.
 164. *Eucosma comatulana* (Zeller).
 165. *Eucosma atomosana* (Walsingham).
 166. *Eucosma galenapunctana* Kearfott.
 167. *Eucosma graciliana* Kearfott.
 168. *Eucosma mandana* Kearfott.
 169. *Eucosma albiguttana* (Zeller).

PLATE 23.

Male genitalia (*Eucosma*).

- FIG. 170. *Eucosma dorsisignatana engelana* Kearfott.
 171. *Eucosma primulana* (Walsingham).
 172. *Eucosma dorsisignatana similana* (Clemens).
 173. *Eucosma dorsisignatana diffusana* Kearfott.
 174. *Eucosma biplagata* (Walsingham).
 175. *Eucosma lolana* Kearfott.
 176. *Eucosma fulminana* (Walsingham).

PLATE 24.

Male genitalia (*Eucosma*).

- FIG. 177. *Eucosma dodana* Kearfott.
 178. *Eucosma fofana* Kearfott.
 179. *Eucosma immaculana* Kearfott.
 180. *Eucosma dorsisignatana* (Clemens).

PLATE 25.

Male genitalia (*Eucosma*).

- FIG. 181. *Eucosma sandiego* Kearfott.
 182. *Eucosma canariana* Kearfott.
 183. *Eucosma denverana* Kearfott.

PLATE 26.

Male genitalia (*Eucosma*).

- FIG. 184. *Eucosma spaldingana* Kearfott.
 185. *Eucosma caniceps* (Walsingham).
 186. *Eucosma subflavana* (Walsingham).

PLATE 27.

Male genitalia (*Eucosma*).

- FIG. 187. *Eucosma consociana* Heinrich.
 188. *Eucosma handana* Kearfott.
 189. *Eucosma irroratana* (Walsingham).
 190. *Eucosma maculatana* (Walsingham).

PLATE 28.

Male genitalia (*Eucosma*).

- FIG. 191. *Eucosma grandiflavana* (Walsingham).
 192. *Eucosma invicta* (Walsingham).
 193. *Eucosma emaciatana* (Walsingham).
 194. *Eucosma gilletteana* Dyar.

PLATE 29.

Male genitalia (*Eucosma*).

- FIG. 195. *Eucosma snyderana* Kearfott.
 196. *Eucosma optimana* Dyar.
 197. *Eucosma larana* (Walsingham).
 198. *Eucosma totana* Kearfott.

PLATE 30.

Male genitalia (*Eucosma*).

- FIG. 199. *Eucosma matutina* (Grote).
 200. *Eucosma agassizii* (Robinson).
 201. *Eucosma bolanderana* (Walsingham).
 202. *Eucosma ragonoti* (Walsingham).

PLATE 31.

Male genitalia (*Eucosma*).

- FIG. 203. *Eucosma momana* Kearfott.
 204. *Eucosma luridana* (Walsingham).
 205. *Eucosma perdricana* (Walsingham).
 206. *Eucosma serpentana* (Walsingham) (Pullman, Washington, specimen).
 207. *Eucosma serpentana* (Walsingham) (Mesilla, New Mexico, specimen).

PLATE 32.

Male genitalia (*Eucosma*).

- FIG. 208. *Eucosma magnidicana* Heinrich.
 209. *Eucosma fernaldana* (Grote).
 210. *Eucosma ridingsana* (Robinson).

PLATE 33.

Male genitalia (*Eucosma*).

- FIG. 211. *Eucosma nandana* Kearfott.
 212. *Eucosma mobilensis* Heinrich.
 213. *Eucosma crambitana* (Walsingham).

PLATE 34.

Male genitalia (*Eucosma*).

- FIG. 214. *Eucosma robinsonana* (Grote).
 215. *Eucosma adamantana* (Guenée).
 216. *Eucosma argenteana* (Walsingham).
 217. *Eucosma idahoana* Kearfott.



THIS PAGE IS LOCKED TO FREE MEMBERS
Purchase full membership to immediately unlock this page



Never be without a book!

Forgotten Books Full Membership gives universal access to 797,885 books from our apps and website, across all your devices: tablet, phone, e-reader, laptop and desktop computer

A library in your pocket for \$8.99/month

Continue

*Fair usage policy applies

PLATE 40.

Male genitalia (*Epiblema*):

- FIG. 254. *Epiblema boxcana* (Kearfott).
 255. *Epiblema abbreviatana* (Walsingham).
 256. *Epiblema serangias* (Meyrick).
 257. *Epiblema strenuana* (Walker).
 258. *Epiblema strenuana* (Walker).
 259. *Epiblema abruptana* (Walsingham).
 260. *Epiblema numerosana* (Zeller).
 261. *Epiblema grossbecki* Heinrich.
 262. *Epiblema praesumptiosa* Heinrich.
 263. *Epiblema insidiosana* Heinrich.

PLATE 41.

Male genitalia (*Epiblema*).

- FIG. 264. *Epiblema exacerbatricana* Heinrich.
 265. *Epiblema praesumptiosa separationis* Heinrich.
 266. *Epiblema deflexana* Heinrich.
 267. *Epiblema purpurissatana* Heinrich.
 268. *Epiblema ochraceana* Fernald.
 269. *Epiblema sosana* (Kearfott).
 270. *Epiblema tripartitana* (Zeller).
 271. *Epiblema scudderiana* (Clemens).
 272. *Epiblema kennebecana* (Kearfott).
 273. *Epiblema discretivana* (Heinrich).

PLATE 42.

Male genitalia (*Epiblema*).

- FIG. 274.] *Epiblema obfusca* (Dyar).
 275. *Epiblema desertana* (Zeller).
 276. *Epiblema infelix* Heinrich.
 277. *Epiblema carolinana* (Walsingham).
 278. *Epiblema walsinghamsi* (Kearfott).
 279. *Epiblema suffusana* (Zeller).
 280. *Epiblema dorsisuffusana* (Kearfott).
 281. *Epiblema illotana* (Walsingham).

PLATE 43.

Male genitalia (*Epiblema*, *Zeiraphera*).

- FIG. 282. *Epiblema culminana* (Walsingham).
 283. *Epiblema otiosana* (Clemens).
 284. *Epiblema brightonana* (Kearfott).
 285. *Zeiraphera claypoleana* (Riley).
 286. *Zeiraphera ratzeburgiana* (Ratzeburg).
 287. *Zeiraphera diniana* (Guenée).
 288. *Zeiraphera fortunana* (Kearfott).
 289. *Epiblema tandana* (Kearfott).

PLATE 44.

Male genitalia (*Sonia*, *Suleima*).

- FIG. 290. *Sonia vovana* (Kearfott).
 291. *Sonia constrictana* (Zeller).
 292. *Suleima helianthana* (Riley).
 293. *Suleima daracana* (Kearfott).
 294. *Suleima cinerodorsana* Heinrich.
 295. *Sonia filiana* (Busck).
 296. *Suleima lagopana* (Walsingham).
 297. *Suleima baracana* (Kearfott).
 298. *Suleima skinnerana* Heinrich.

PLATE 45.

Male genitalia (*Proteoteras*, *Strepsicrates*, *Spilonota*).

- FIG. 299. *Proteoteras aesculana* Riley.
 300. *Proteoteras arizonae* Kearfott.
 301. *Proteoteras crescentana* Kearfott.
 302. *Proteoteras willingana* (Kearfott).
 303. *Proteoteras moffatiana* Fernald.
 304. *Proteoteras naracana* Kearfott.
 305. *Proteoteras obnigrana* Heinrich.
 306. *Strepsicrates indentana* (Dyar).
 307. *Spilonota ocellana* (Denis and Schiffermüller).

PLATE 46.

Male genitalia (*Exentera*).

- FIG. 308. *Exentera improbana* (Walker).
 309. *Exentera improbana oregonana* (Walsingham).
 310. *Exentera spoliata* (Clemens).
 311. *Exentera faracana* (Kearfott).

PLATE 47.

Male genitalia (*Exentera*).

- FIG. 312. *Exentera haracana* (Kearfott).
 313. *Exentera maracana* (Kearfott).
 314. *Exentera habrosana* Heinrich.
 315. *Exentera costumaculana* (Clemens).
 316. *Exentera virginiana* (Clemens).

PLATE 48.

Male genitalia (*Gretchena*).

- FIG. 317. *Gretchena deludana* (Clemens).
 318. *Gretchena concubitana* Heinrich.
 319. *Gretchena amatana* Heinrich.
 320. *Gretchena delicatana* Heinrich.
 321. *Gretchena biangulana* (Walsingham).

PLATE 49.

Male genitalia (*Gretchena*, *Gwendolina*, *Griselda*, *Crocidosema*).

- FIG. 322. *Gretchena bolliana* (Slingerland).
 323. *Gwendolina concitaticana* Heinrich.
 324. *Griselda gerulae* Heinrich.
 325. *Crocidosema plebeiana* Zeller.
 326. *Gretchena watchungana* (Kearfott).
 327. *Gretchena dulciana* Heinrich.
 328. *Griselda pennsylvaniana* (Kearfott).
 329. *Griselda radicana* (Walsingham).

PLATE 50.

Male genitalia (*Epinotia*).

- FIG. 330. *Epinotia emarginana* (Walsingham).
 331. *Epinotia crenana* (Hübner).
 332. *Epinotia ethnica* Heinrich.
 333. *Epinotia lomonana* (Kearfott).
 334. *Epinotia lindana* (Fernald).
 335. *Epinotia vagana* Heinrich.
 336. *Epinotia cruciana alaskae* Heinrich.
 337. *Epinotia cruciana plumbolineana* (Kearfott)
 338. *Epinotia castaneana* (Walsingham).
 339. *Epinotia madderana* (Kearfott).

PLATE 51.

Male genitalia (*Epinotia*).

- FIG. 340. *Epinotia hopkinsana* (Kearfott).
 341. *Epinotia hopkinsana cupressi* Heinrich.
 342. *Epinotia cercocarpana* (Dyar).
 343. *Epinotia medioplaga* (Walsingham).
 344. *Epinotia purpuriciliana* (Walsingham).
 345. *Epinotia pulsatillana* (Dyar).
 346. *Epinotia pulsatillana siskiyouensis* Heinrich
 347. *Epinotia medioviridana* (Kearfott).
 348. *Epinotia fumoviridana* Heinrich.
 349. *Epinotia marmoreana* Heinrich.

PLATE 52.

Male genitalia (*Epinotia*).

- FIG. 350. *Epinotia arctostaphylana* (Kearfott).
 351. *Epinotia nigralbana* (Walsingham).
 352. *Epinotia infusca* (Walsingham).
 353. *Epinotia septemberana* Kearfott.
 354. *Epinotia solandriana* (Linnaeus).
 355. *Epinotia subplicana* (Walsingham).
 356. *Epinotia nisella* (Clerck).
 357. *Epinotia transmissana* (Walker).
 358. *Epinotia similana* (Hübner).
 359. *Epinotia momonana* (Kearfott).



THIS PAGE IS LOCKED TO FREE MEMBERS

Purchase full membership to immediately unlock this page



HISTORY

Tens of thousands of important historical sources, many previously unobtainable, are now available for the first time with a Forgotten Books Full Membership.

Unlimited Access
\$8.99/month

Continue

*Fair usage policy applies

- FIG. 397. *Anchylopera laciniana* (Zeller).
 398. *Anchylopera platanana* Clemens.
 399. *Anchylopera fuscociliana* Clemens.

PLATE 57.

Male genitalia (*Ancylis*).

- FIG. 400. *Ancylis divisana* (Walker).
 401. *Ancylis muricana* (Walsingham).
 402. *Ancylis apicana* (Walker).
 403. *Ancylis muricana cornifoliana* (Riley).
 404. *Ancylis diminutana* (Haworth).
 405. *Ancylis tineana* (Hübner).
 406. *Ancylis comptana fragariae* (Walsh and Riley).
 407. *Ancylis carbonana* Heinrich.
 408. *Ancylis albacostana* Kearfott.
 409. *Ancylis unguicella* (Linnaeus).
 410. *Ancylis pacificana* (Walsingham).
 411. *Ancylis goodelliana* (Fernald).
 412. *Ancylis mediofasciana* (Clemens).

PLATE 58.

(Male genitalia (*Pseudogalleria*, *Norma*, *Kundrya*, *Rhopobota*, *Hystricophora*).

- FIG. 413. *Pseudogalleria inimicella* (Zeller).
 414. *Norma dietziana* (Kearfott).
 415. *Kundrya finitimana* Heinrich.
 416. *Rhopobota naevana* (Hübner).
 417. *Hystricophora leonana* Walsingham. (In this preparation the uncus is bent downward and the aedoeagus, dissected out, lies above and against the uncus.)
 418. *Hystricophora roessleri* (Zeller).
 419. *Hystricophora ochreicostana* (Walsingham).
 420. *Hystricophora vestaliana* (Zeller).

PLATE 59.

Male Genitalia and Wing Characters (*Eucosminae*).

- FIG. 421. *Thiodia sororiana* Heinrich (right harpe of male genitalia).
 422. *Thiodia nepotinana* Heinrich (right harpe of male genitalia).
 423. *Thiodia fertoriana* Heinrich (right harpe of male genitalia).
 424. *Thiodia modicellana* Heinrich (right harpe of male genitalia).
 425. *Thiodia festivana* Heinrich (right harpe of male genitalia).
 426. *Eucosma serapicana* Heinrich (right harpe of male genitalia).
 427. *Eucosma palabundana* Heinrich (right harpe of male genitalia).
 428. *Epiblema periculosana* Heinrich (right harpe of male genitalia).
 429. *Hendecaneura shawiana* (Kearfott) (male genitalia with left harpe omitted).
 430. *Hendecaneura shawiana* (Kearfott) (denuded fore and hind wings of male and denuded fore wing of female).
 431. *Epiblema gratuitana* Heinrich (male genitalia with left harpe omitted).
 432. *Anchylopera definitivana* Heinrich (male genitalia).

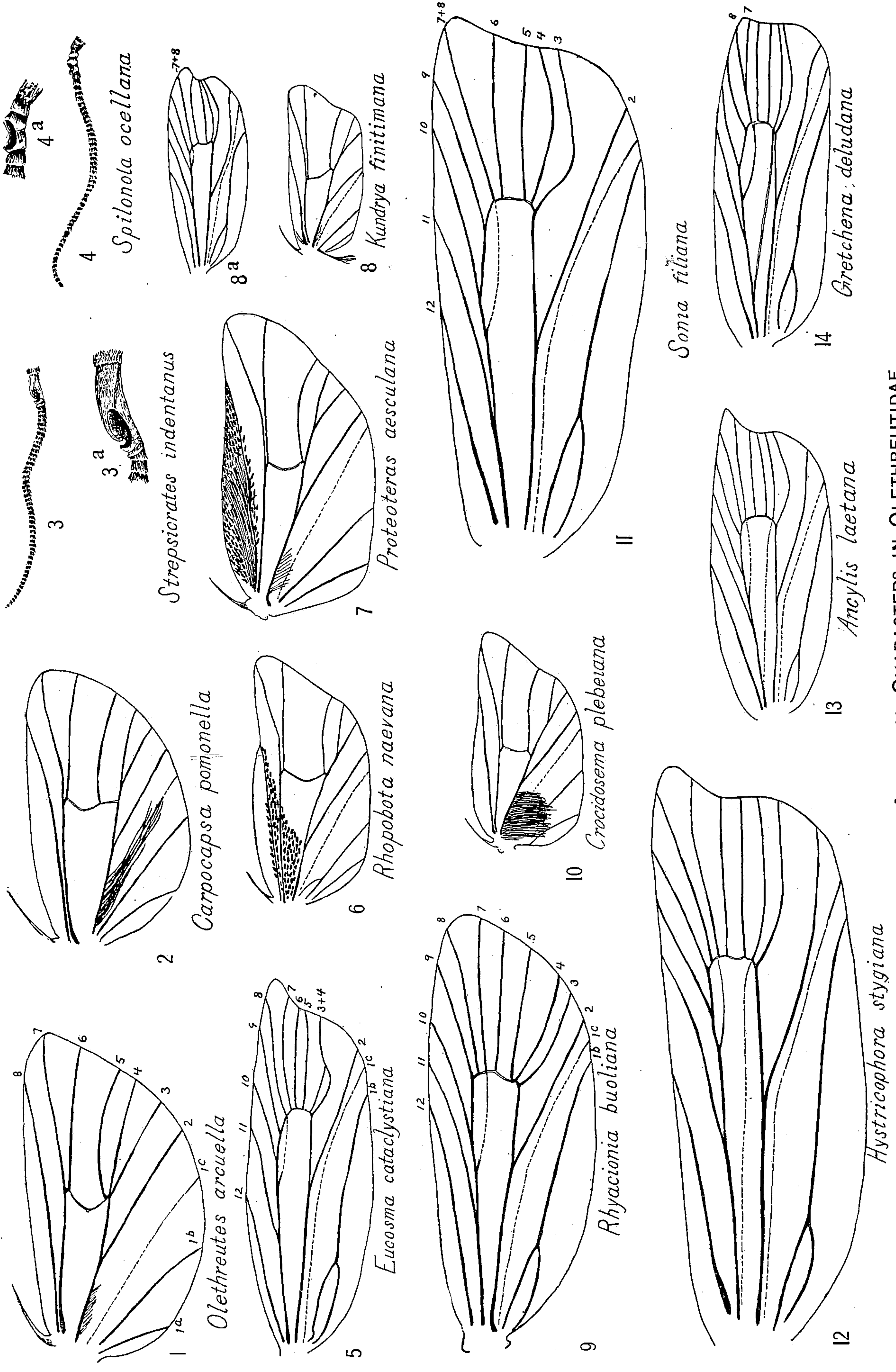

WING AND ANTENNAL CHARACTERS IN OLETHREUTIDAE.

FOR EXPLANATION OF PLATE SEE PAGES 273 AND 274.

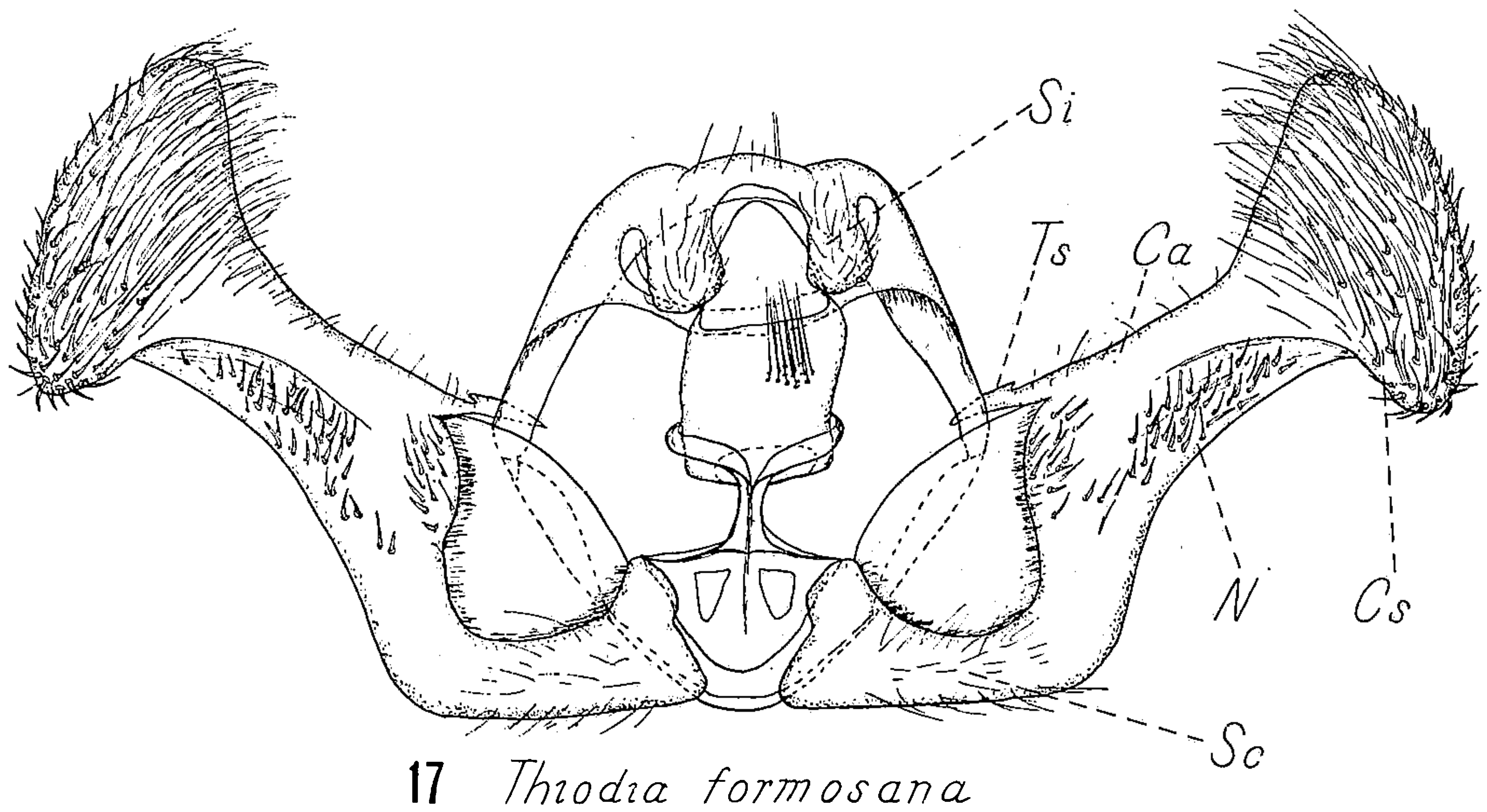
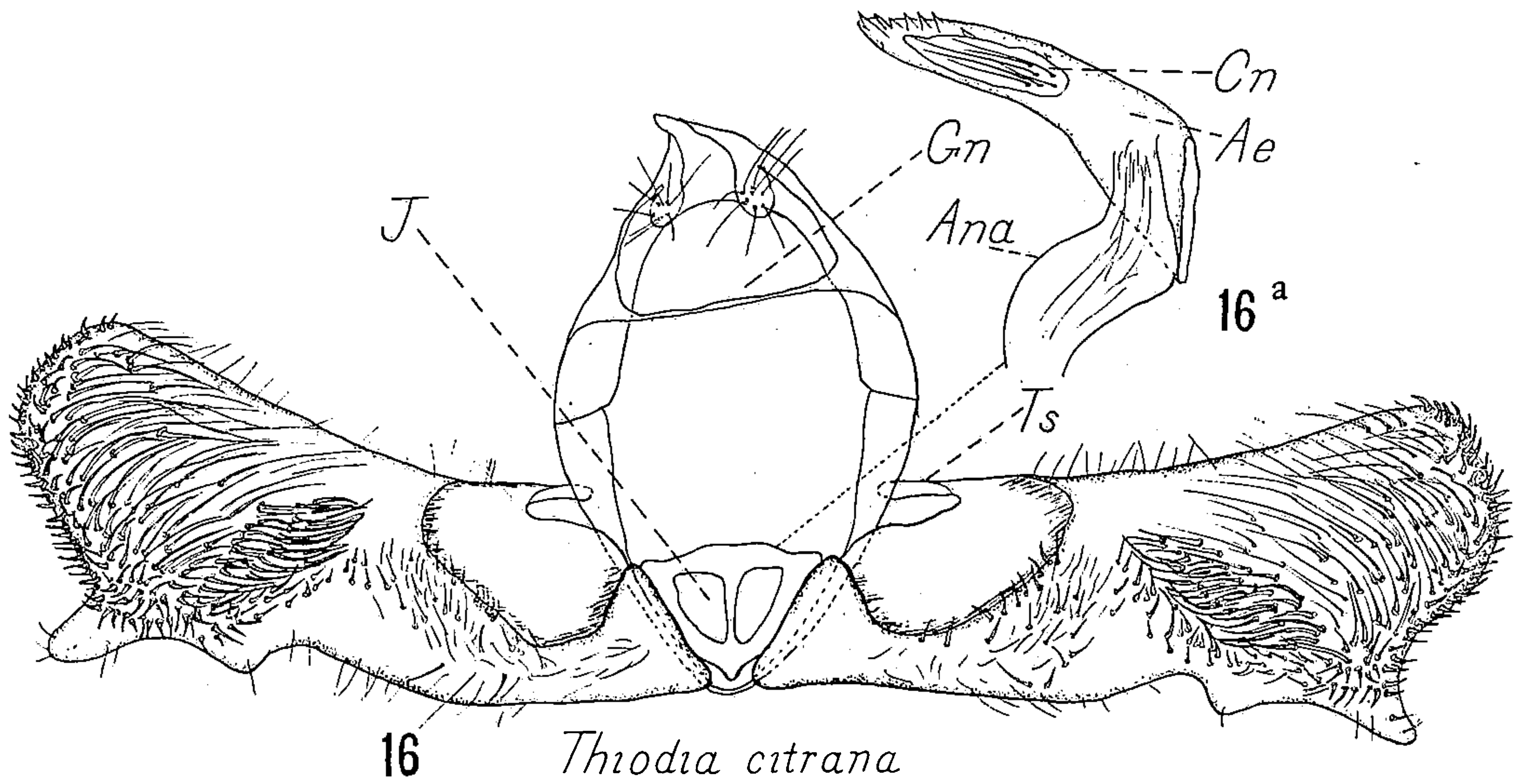
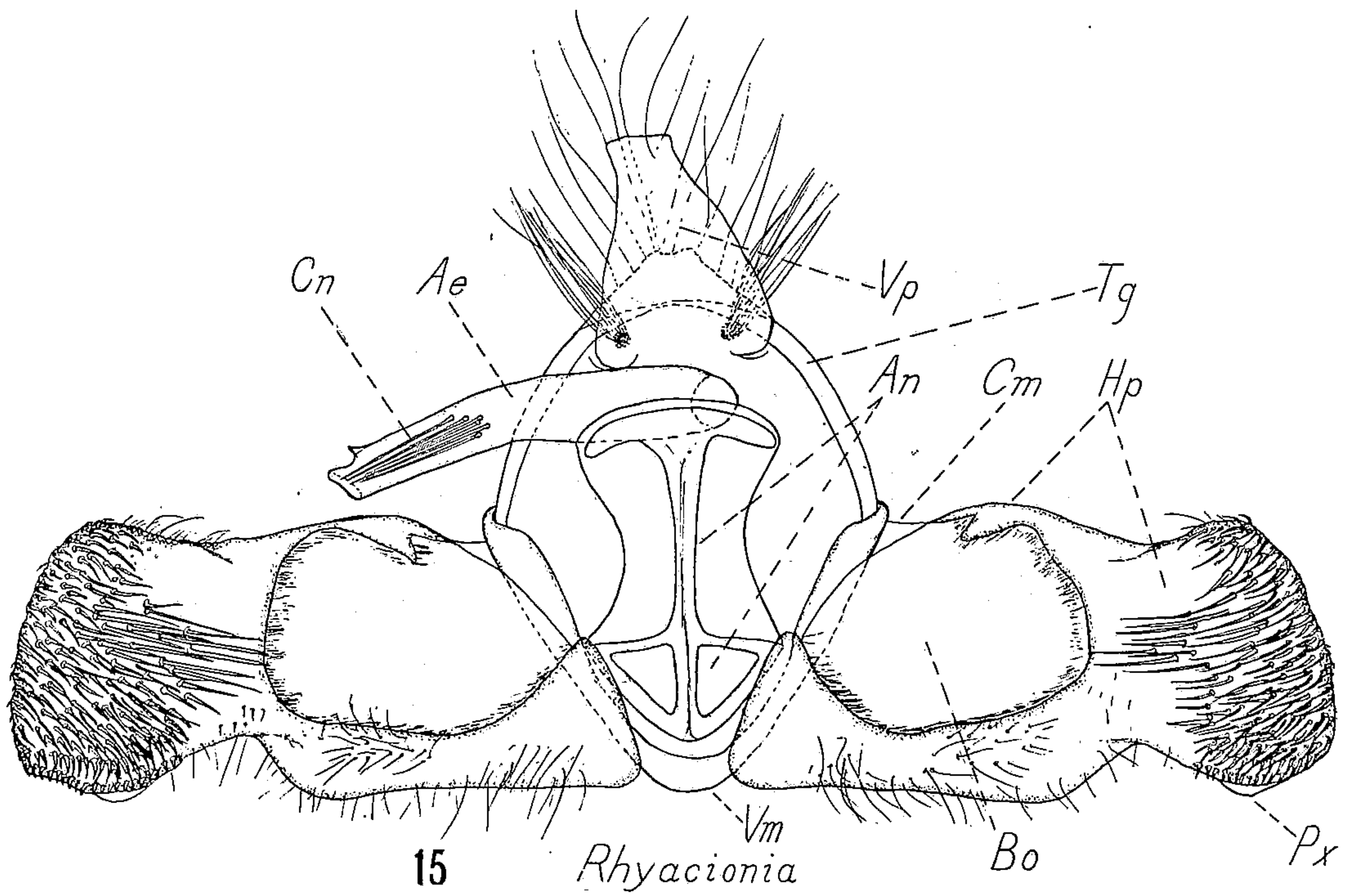

MALE GENITALIA OF GENOTYPES OF EUCOSMINAE.

FOR EXPLANATION OF PLATE SEE PAGE 274



THIS PAGE IS LOCKED TO FREE MEMBERS
Purchase full membership to immediately unlock this page



Never be without a book!

Forgotten Books Full Membership gives universal access to 797,885 books from our apps and website, across all your devices: tablet, phone, e-reader, laptop and desktop computer

A library in your pocket for \$8.99/month

Continue

*Fair usage policy applies

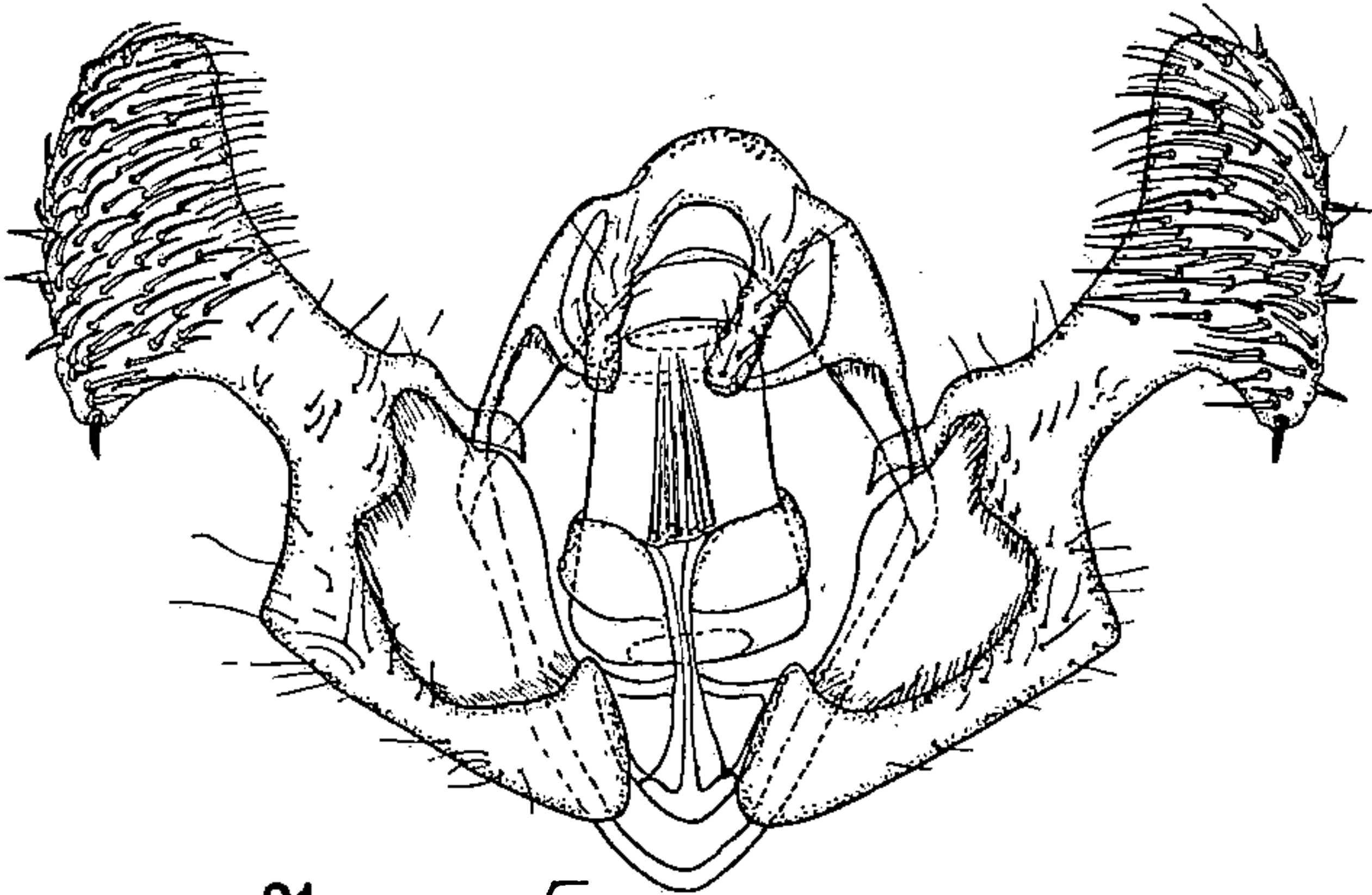

21 *Eucosma*

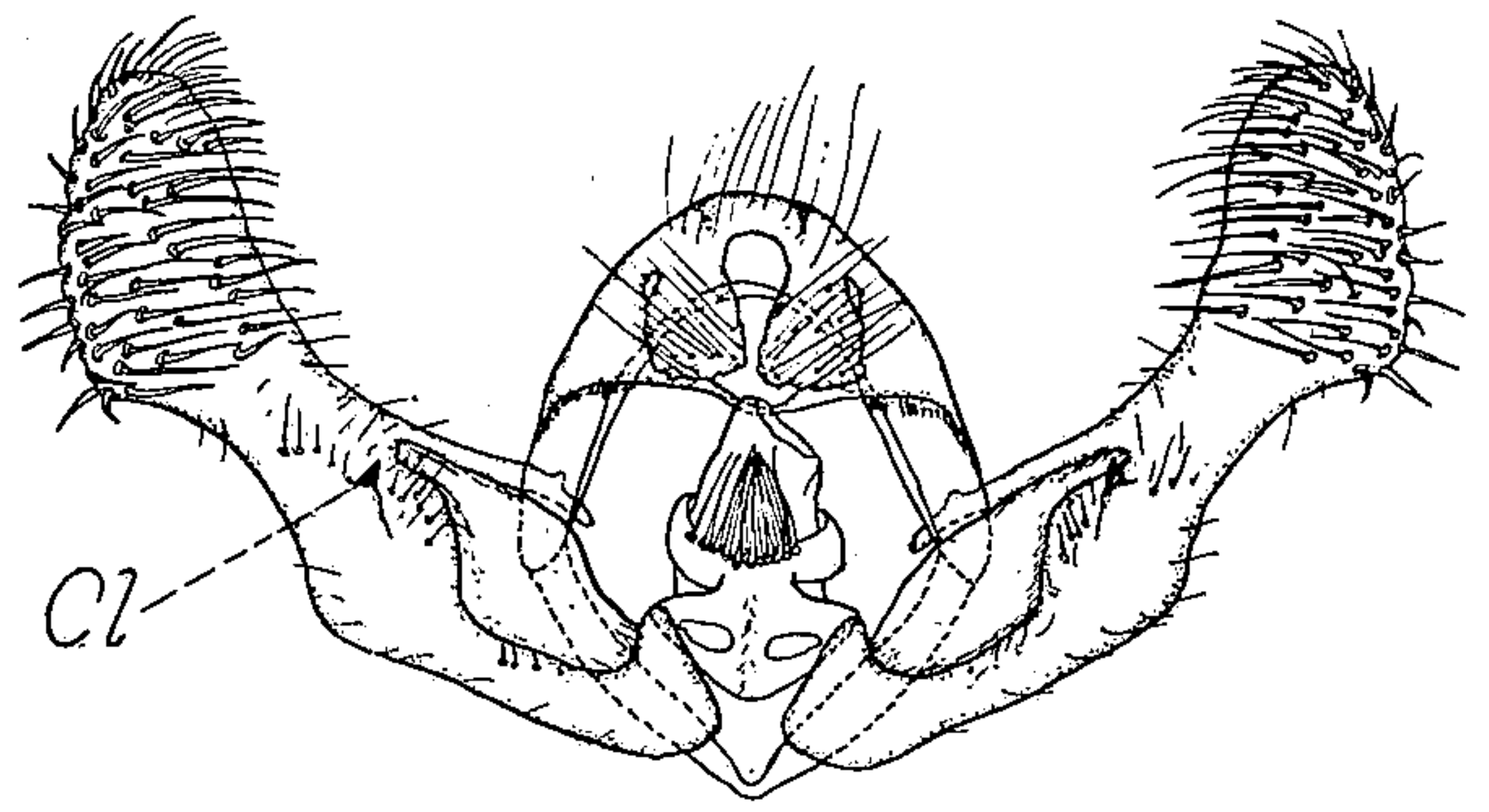

22 *Sonia*

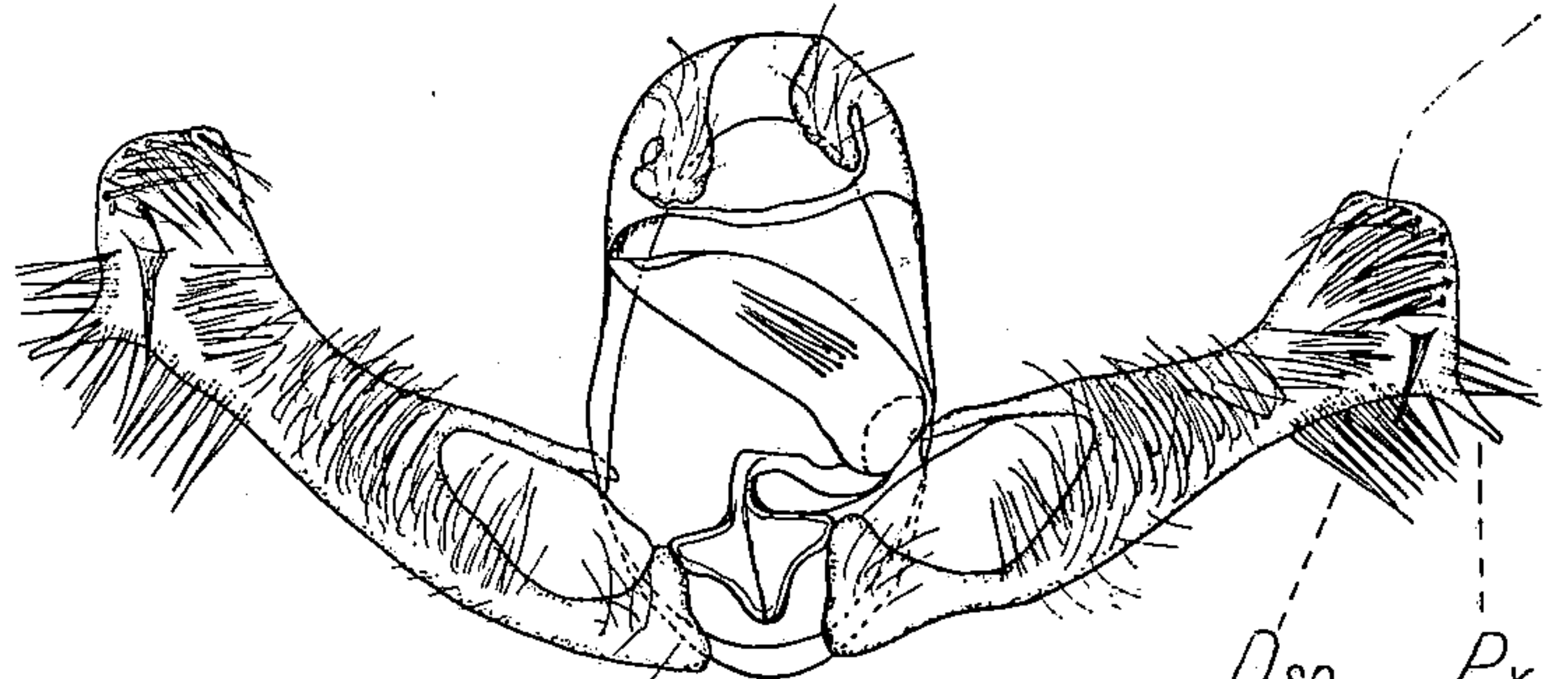

23 *Strepsicrates*

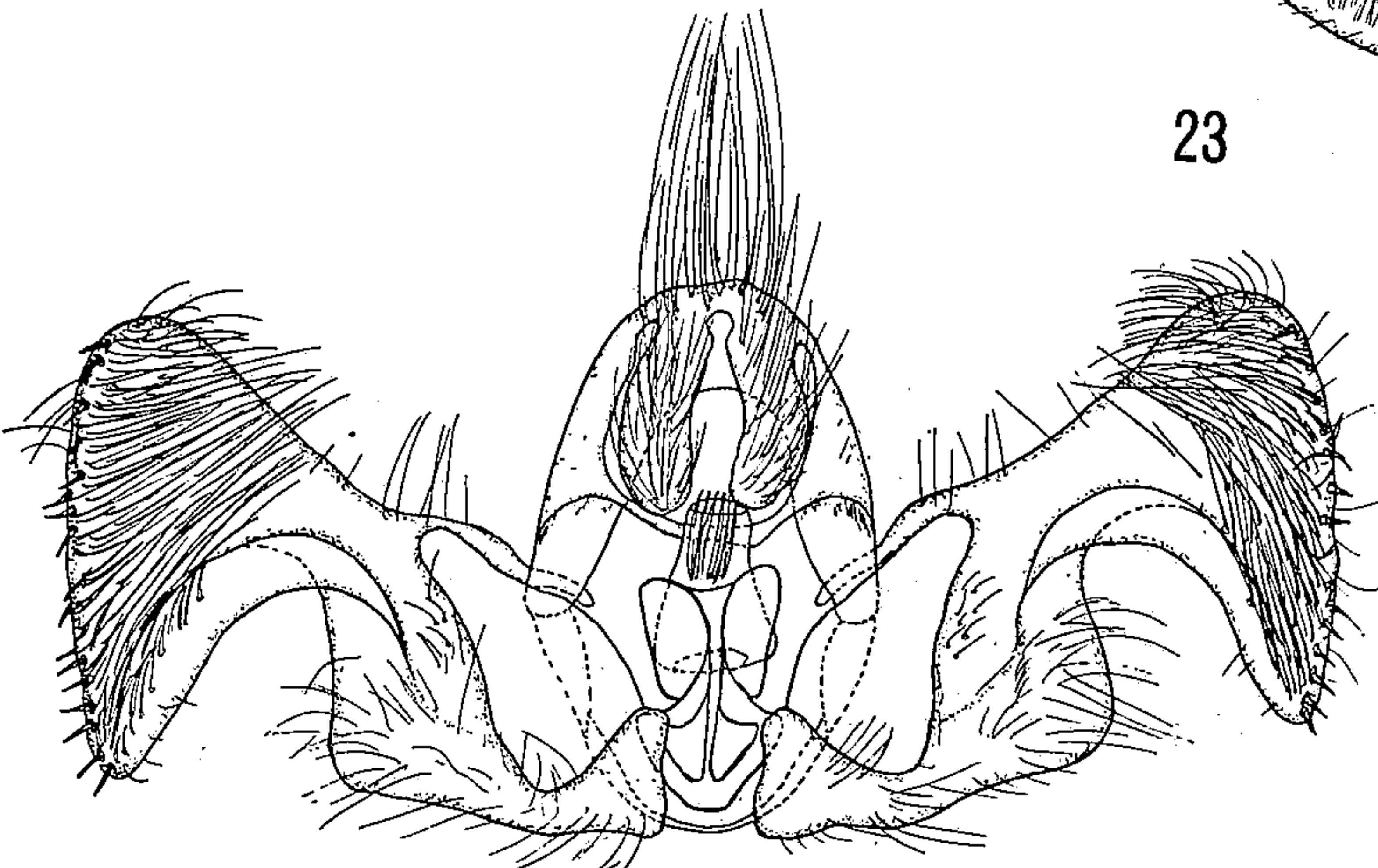

24 *Barbara*

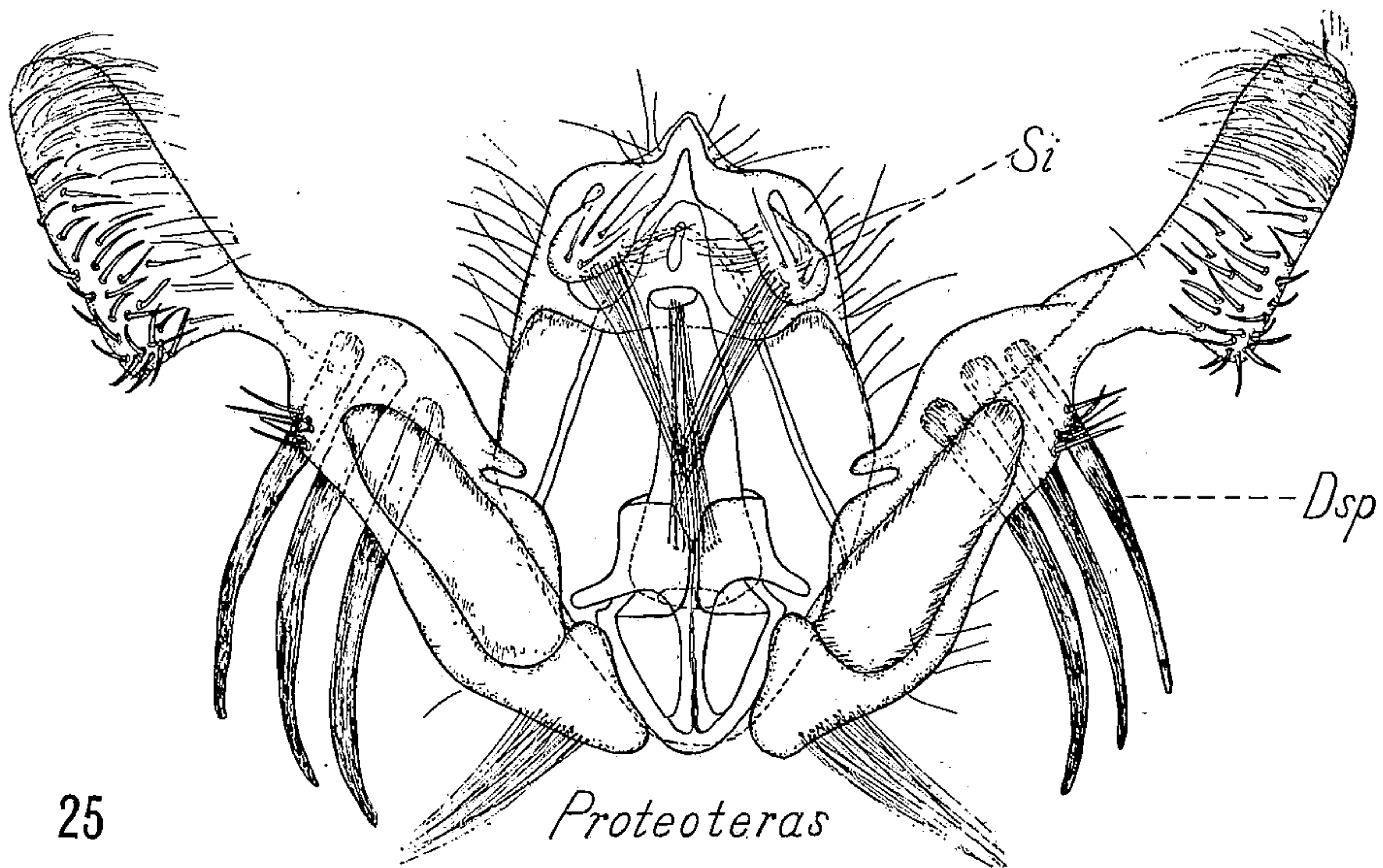

25 *Proteoteras*

MALE GENITALIA OF GENOTYPES OF EUCOSMINAE.

FOR EXPLANATION OF PLATE SEE PAGE 274.

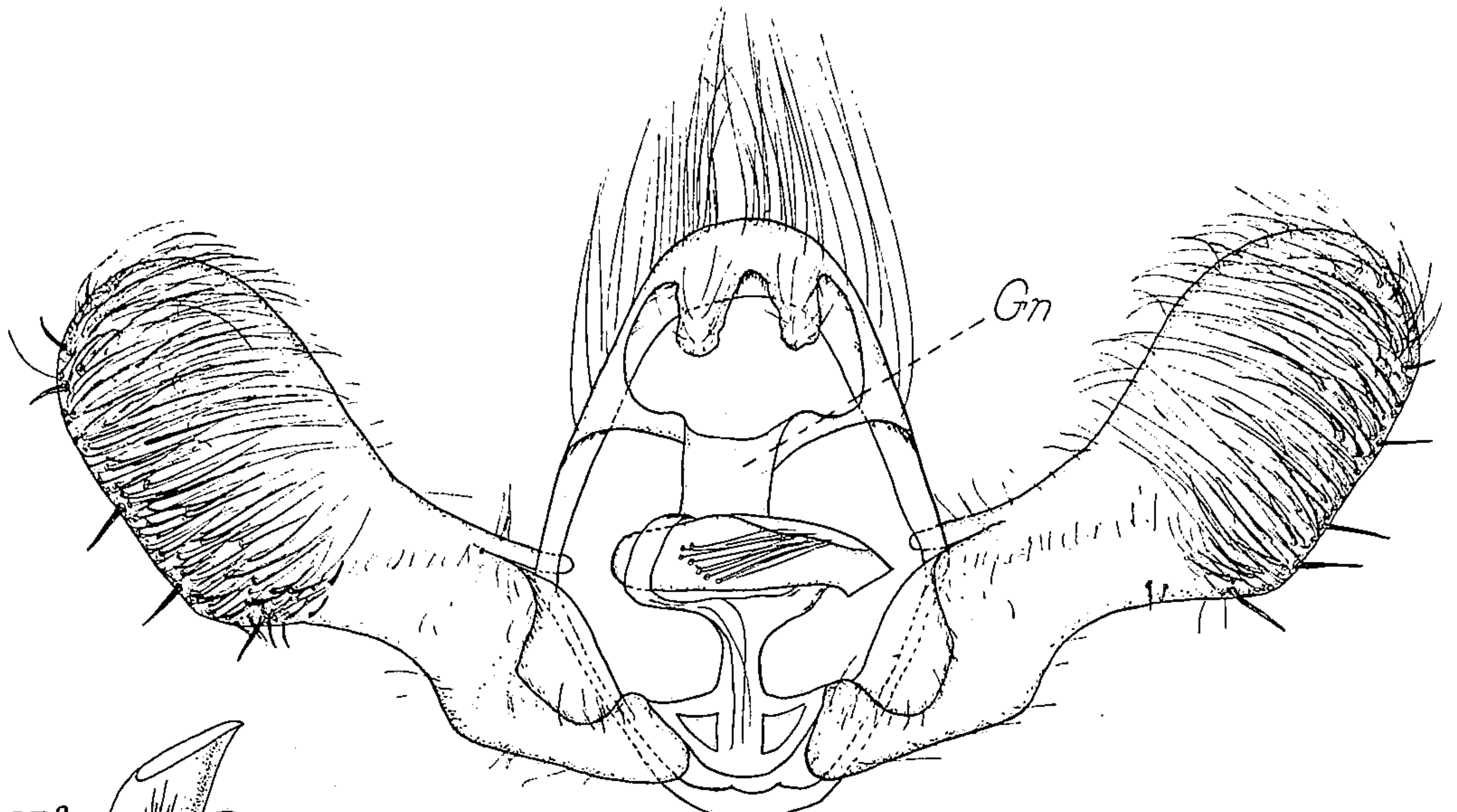

26 *Suleima*

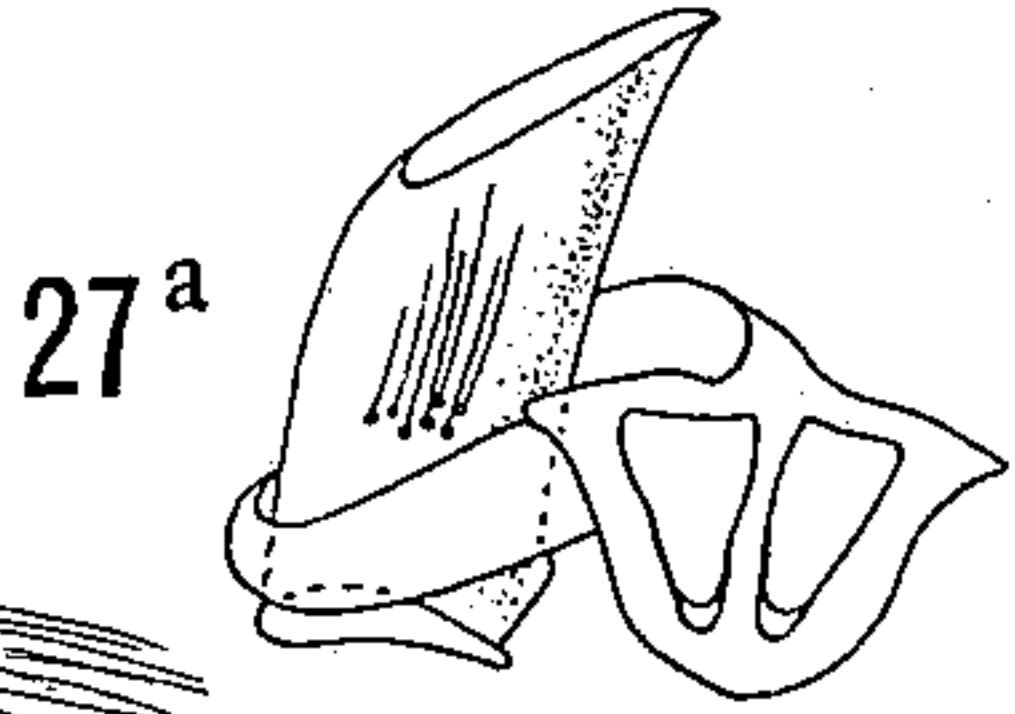

27^a

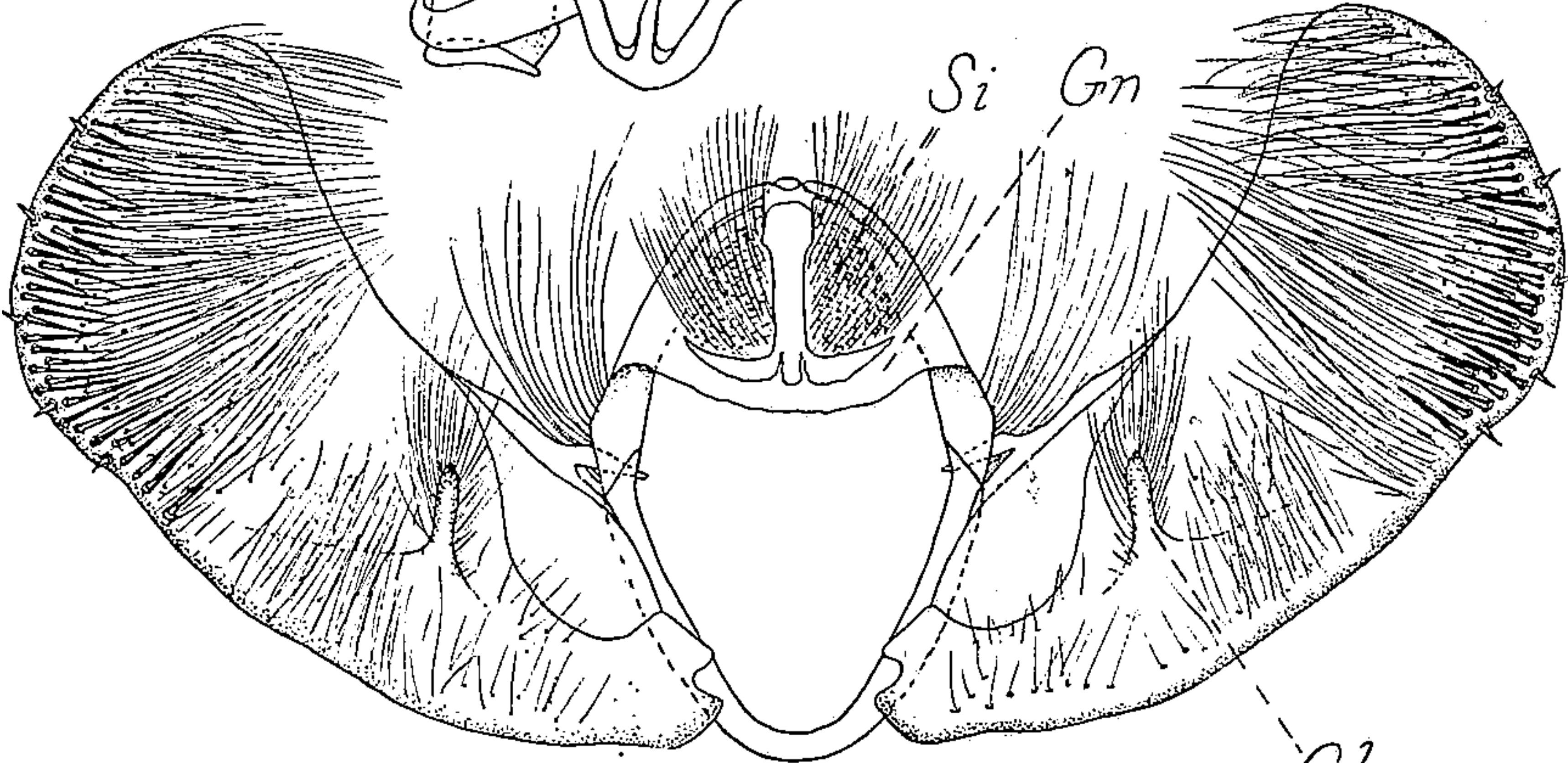

27 *Gypsoroma*



28 *Zeiraphera*

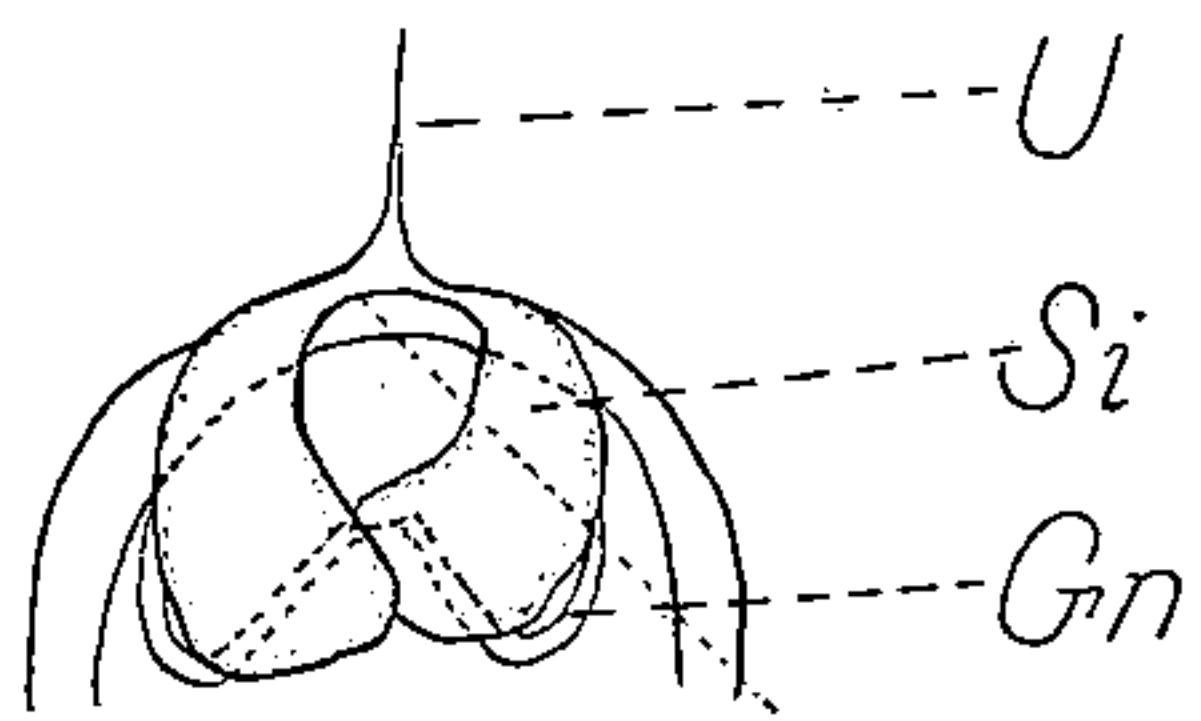

29^a

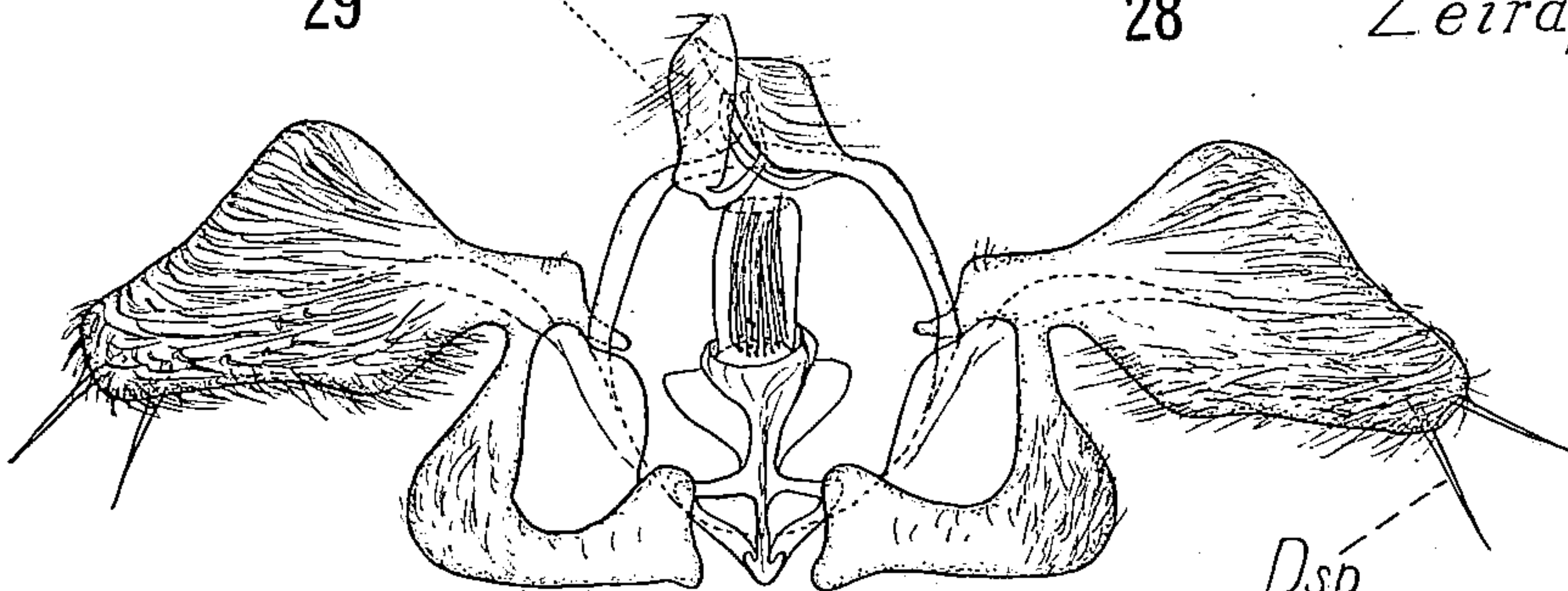

29 *Crocidosema*

MALE GENITALIA OF GENOTYPES OF EUCOSMINAE

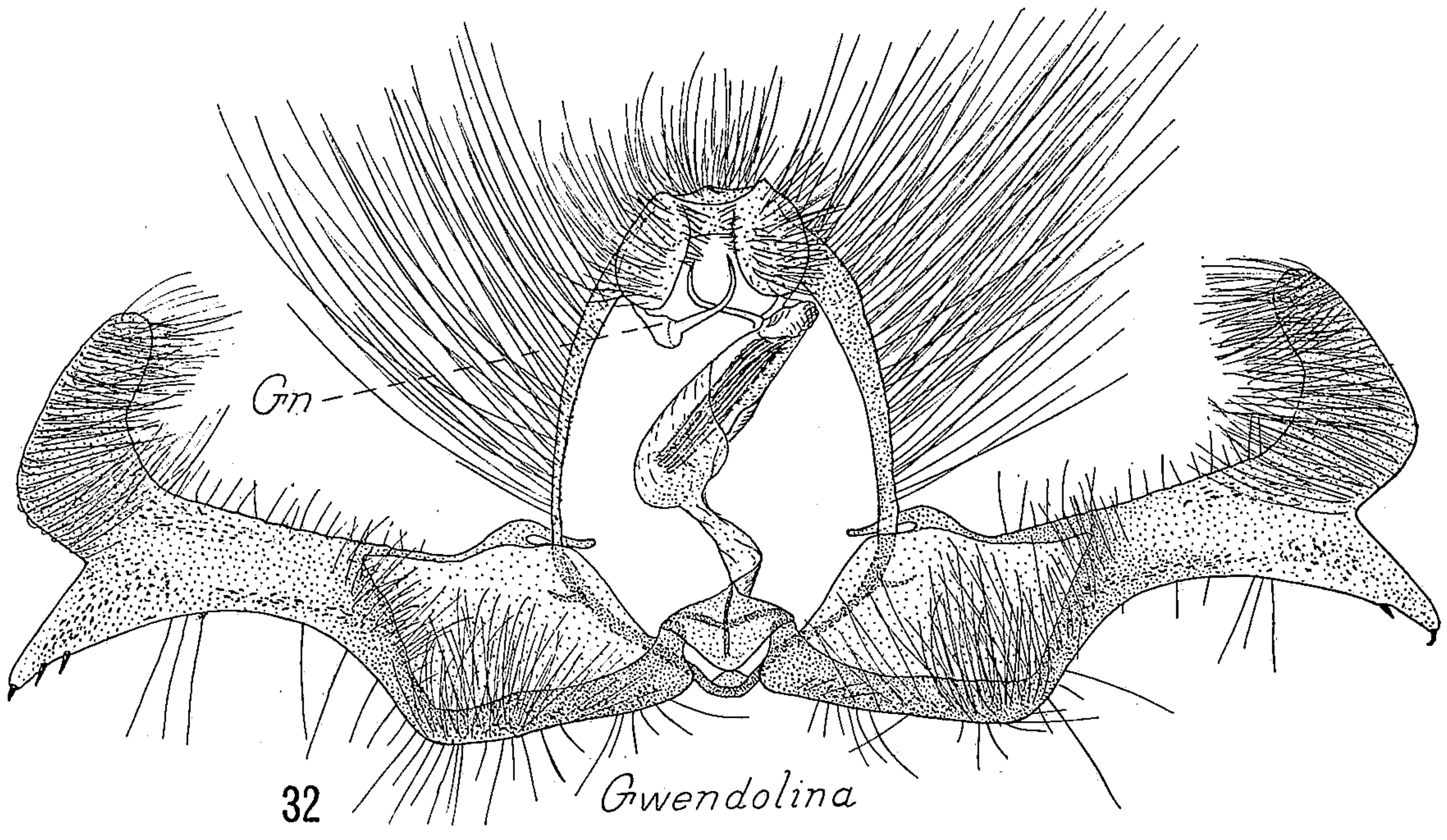
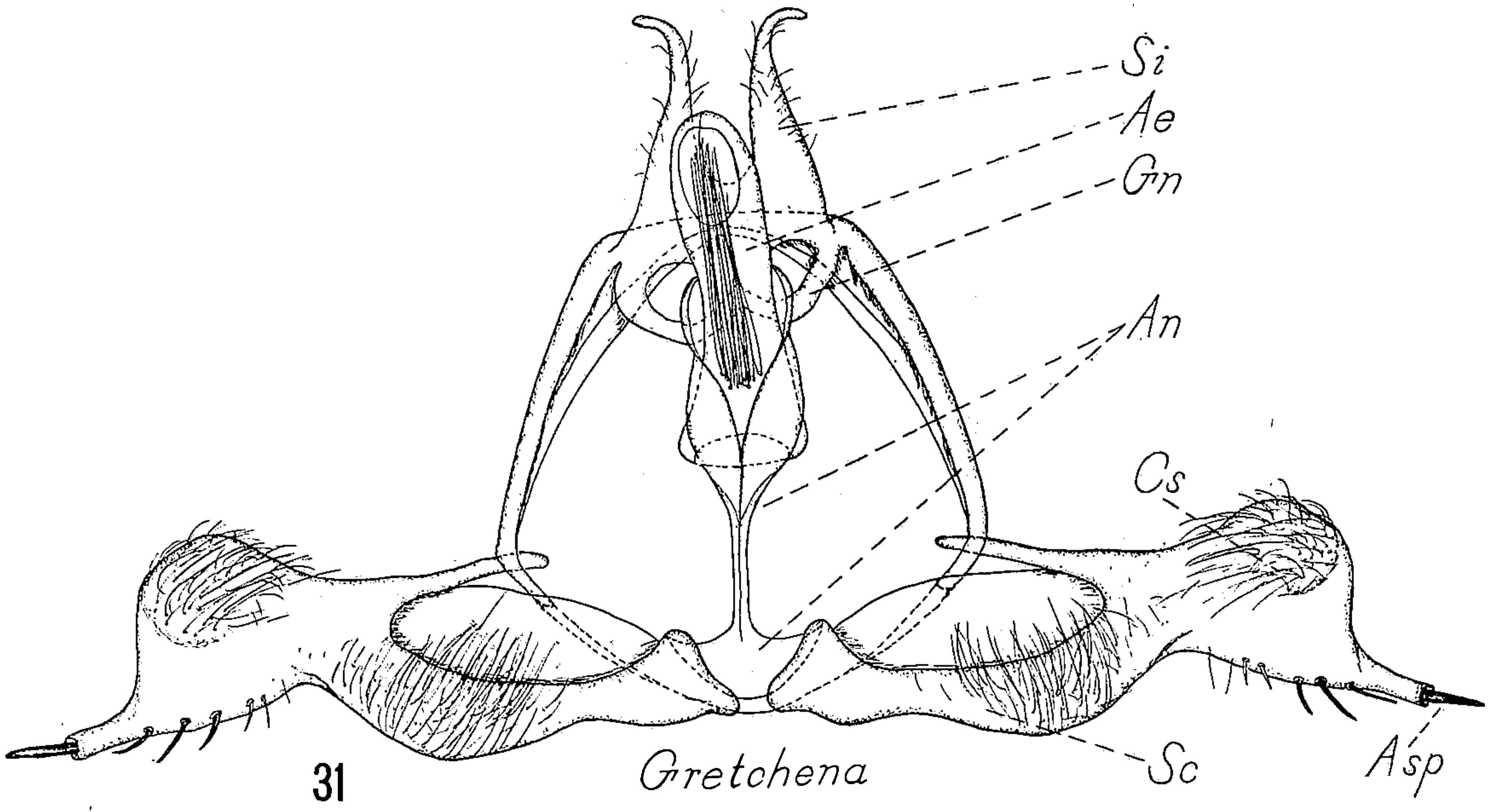
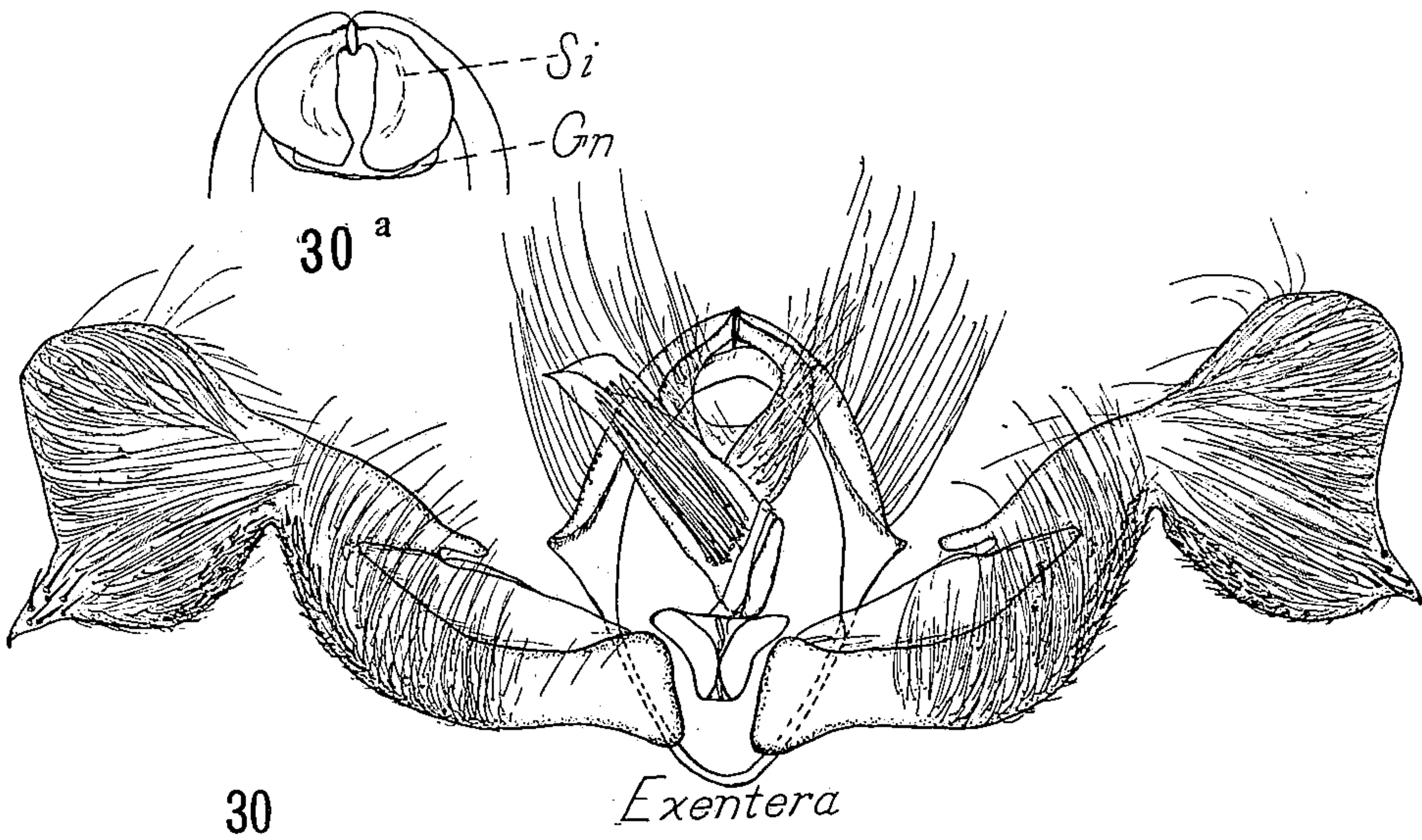

MALE GENITALIA OF GENOTYPES OF EUCOSMINAE.



THIS PAGE IS LOCKED TO FREE MEMBERS

Purchase full membership to immediately unlock this page



HISTORY

Tens of thousands of important historical sources, many previously unobtainable, are now available for the first time with a Forgotten Books Full Membership.

Unlimited Access
\$8.99/month

Continue

*Fair usage policy applies

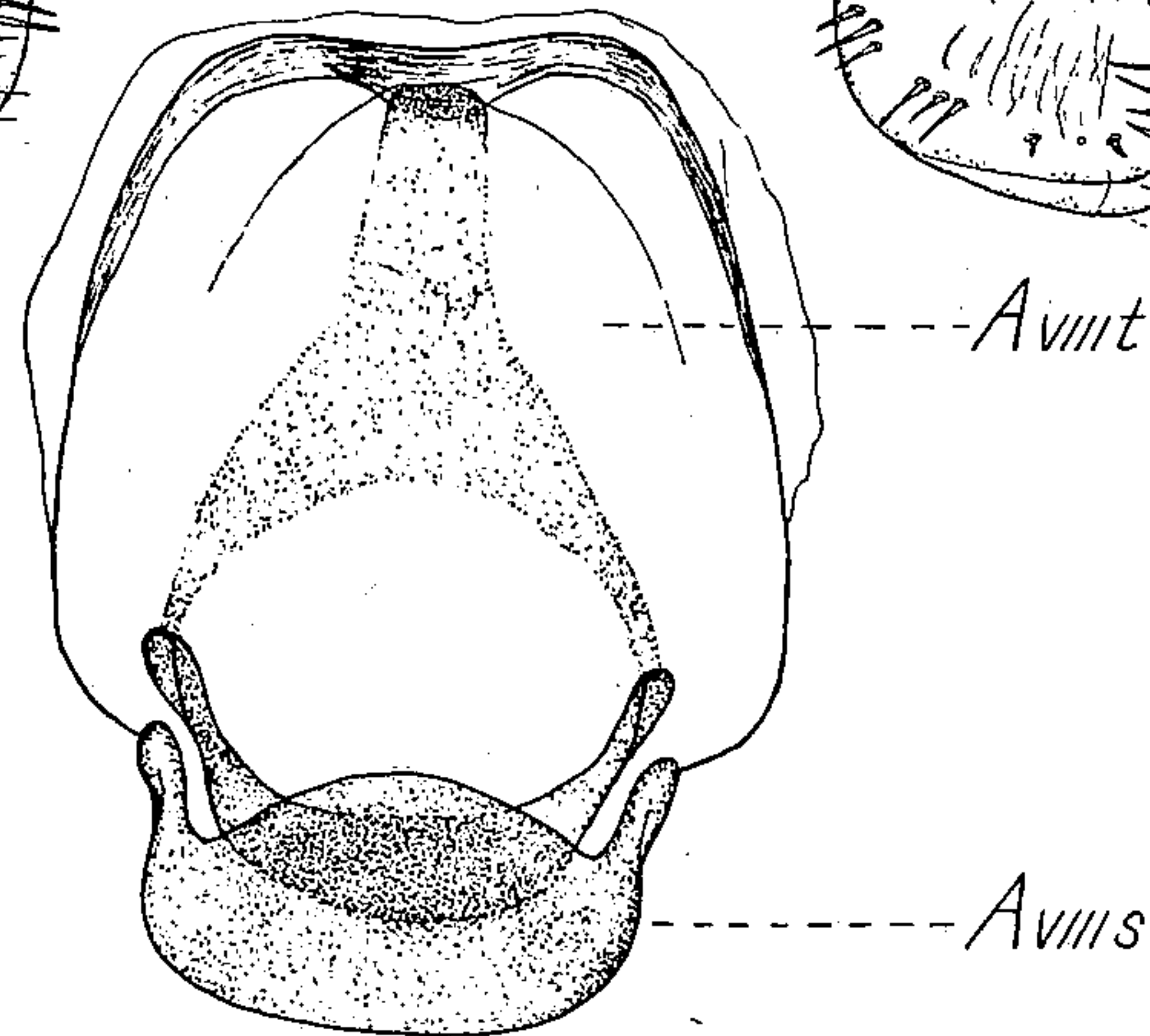
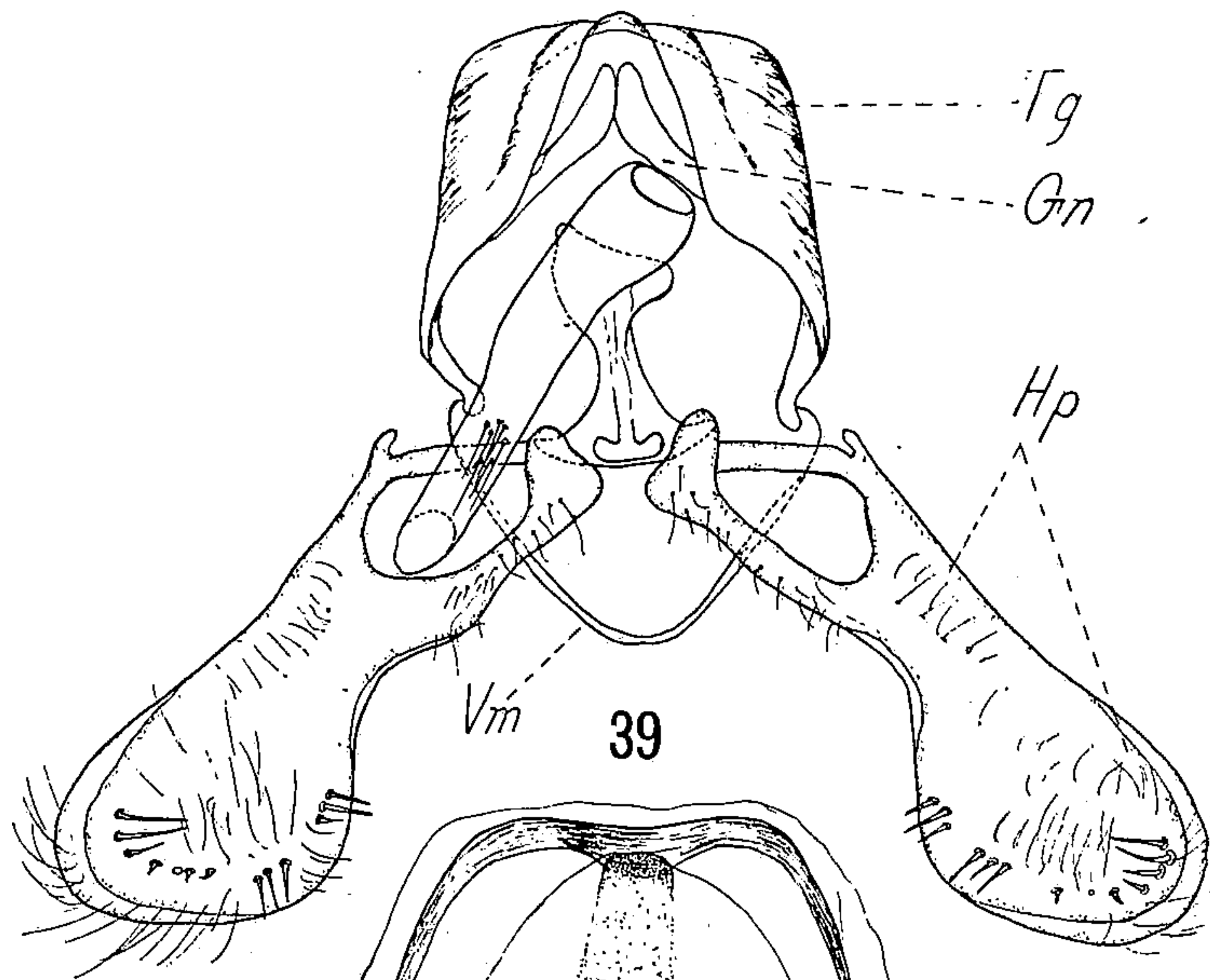

Pseudogalleria

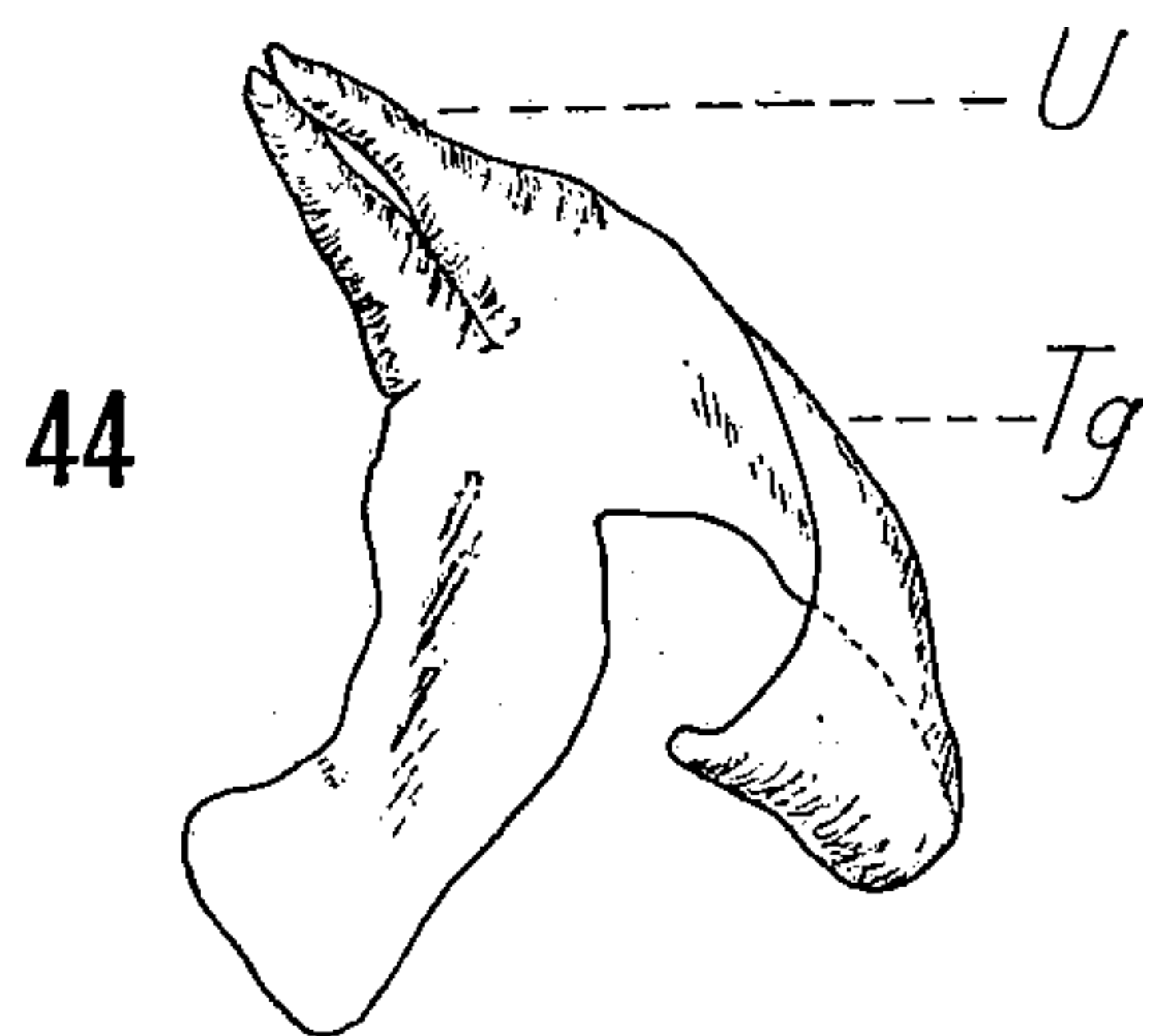
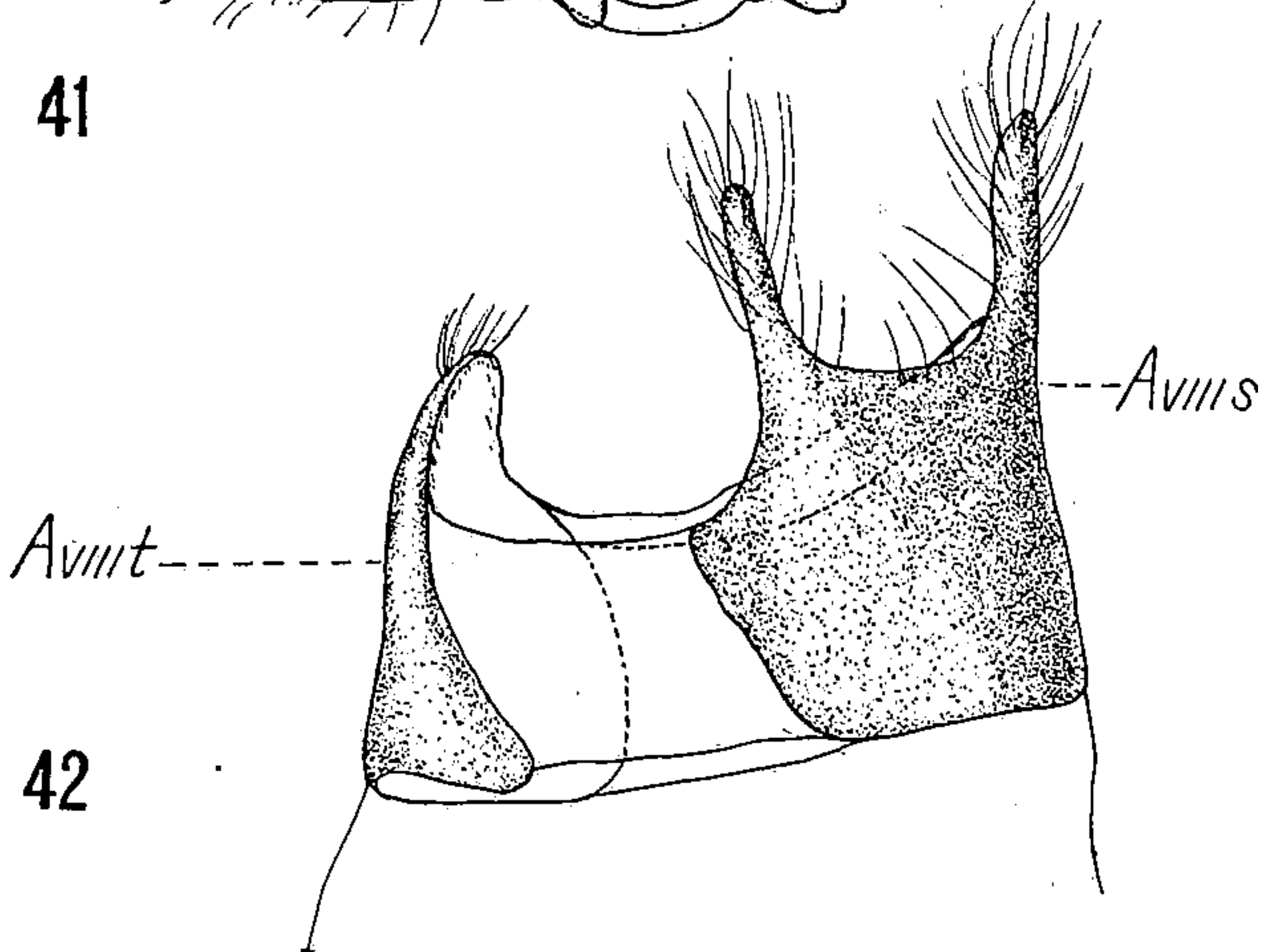
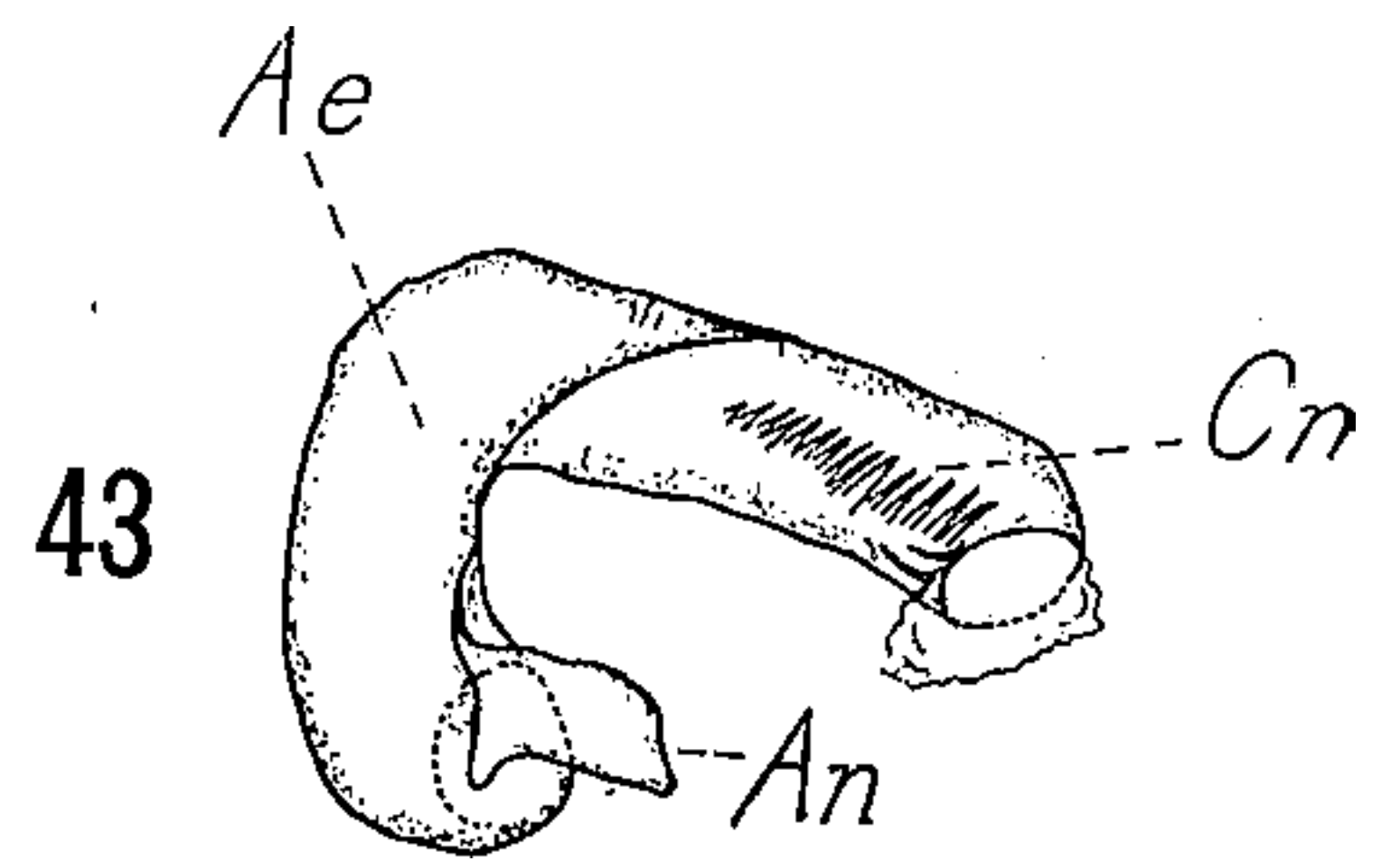
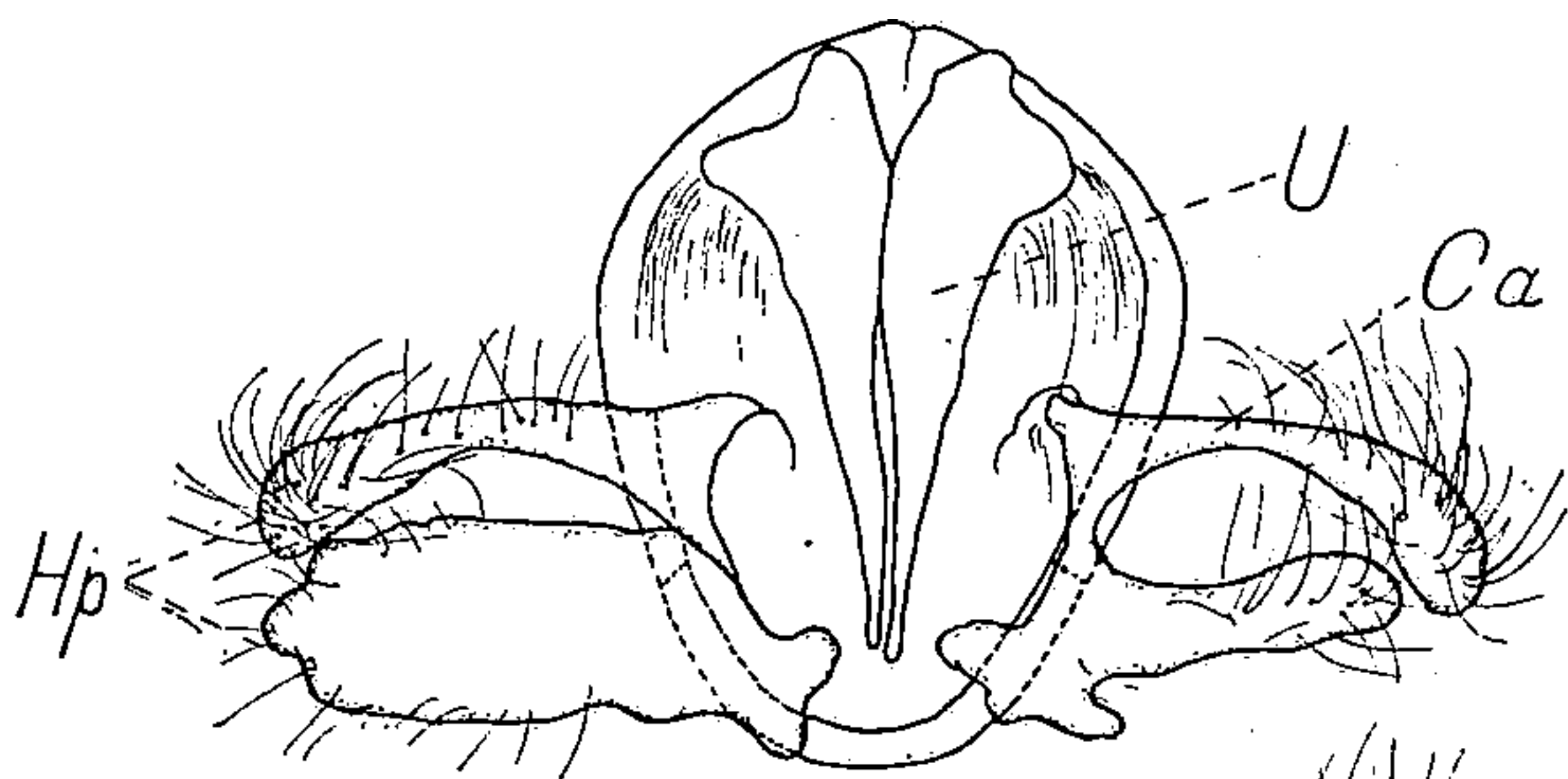

Hystriophora

MALE GENITALIA OF GENOTYPES OF EUCOSMINAE.

FOR EXPLANATION OF PLATE SEE PAGE 275.

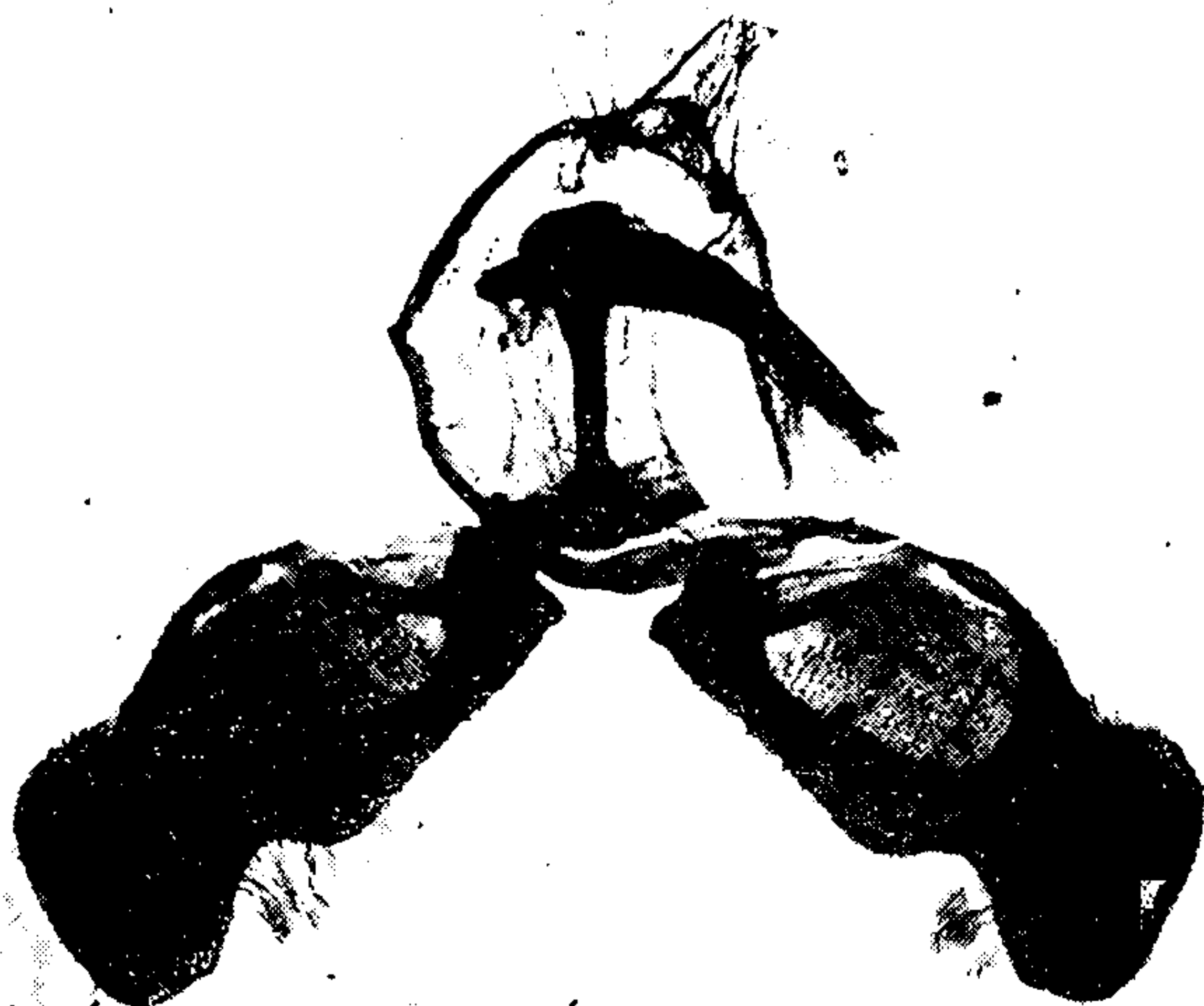

45 *buoliana*



49 *rigidana*

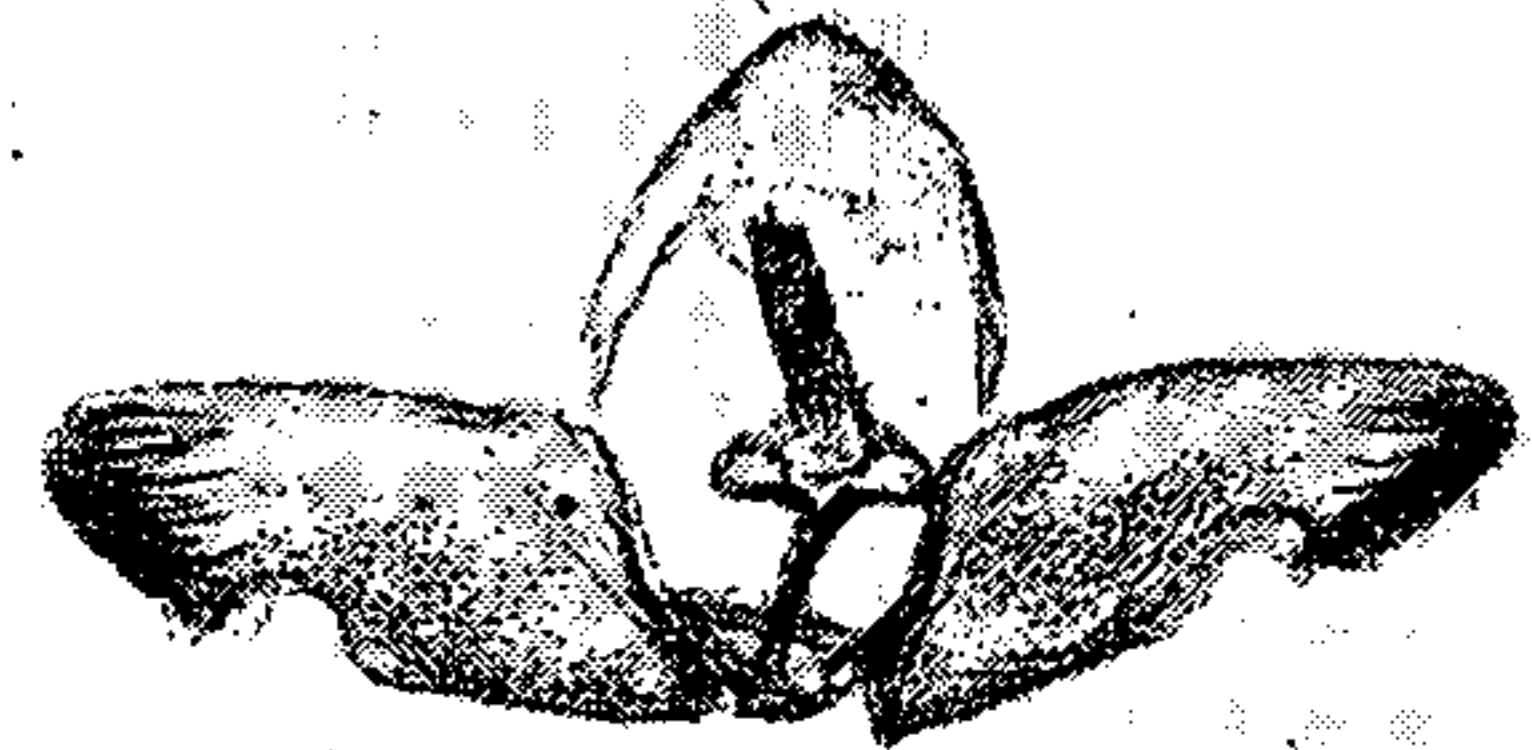

50 *passadenana*



46 *neomexicana*

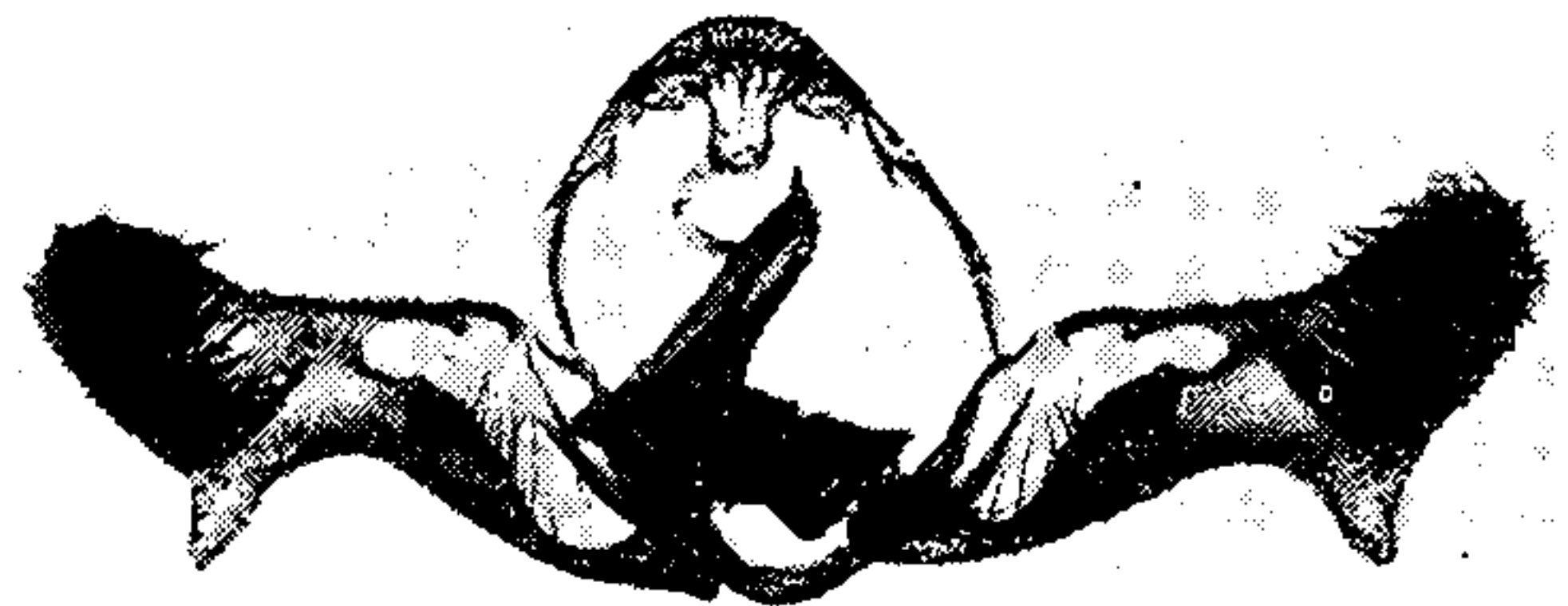

51 *busckana*



47 *montana*



52 *adana*



48 *bushnelli*

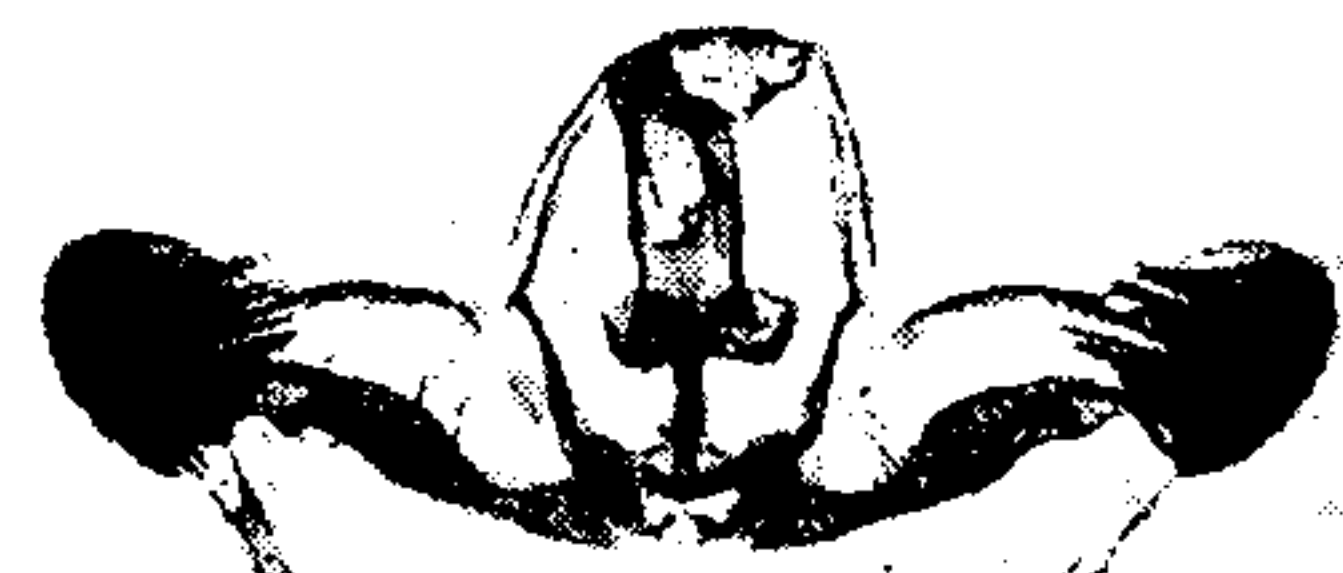

53 *frustrana*

MALE GENITALIA OF RHYACIONIA.

FOR EXPLANATION OF PLATE SEE PAGE 275

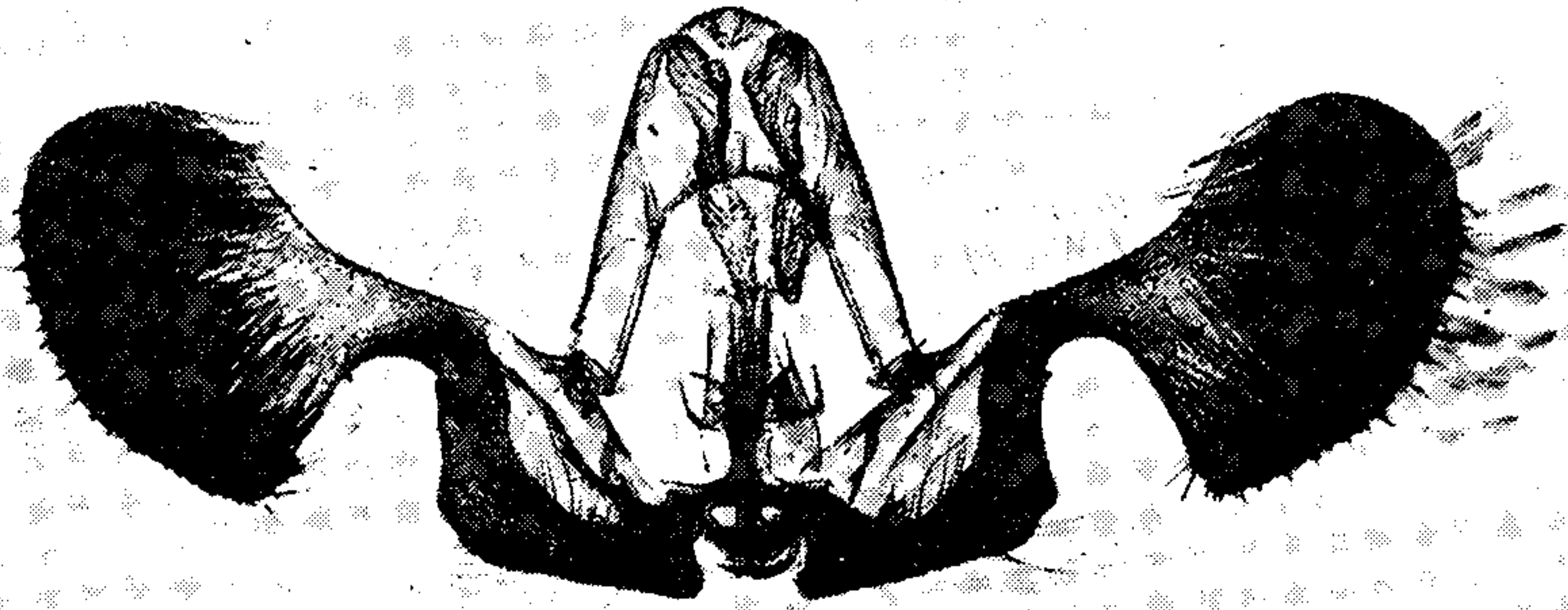

54 *comstockiana*

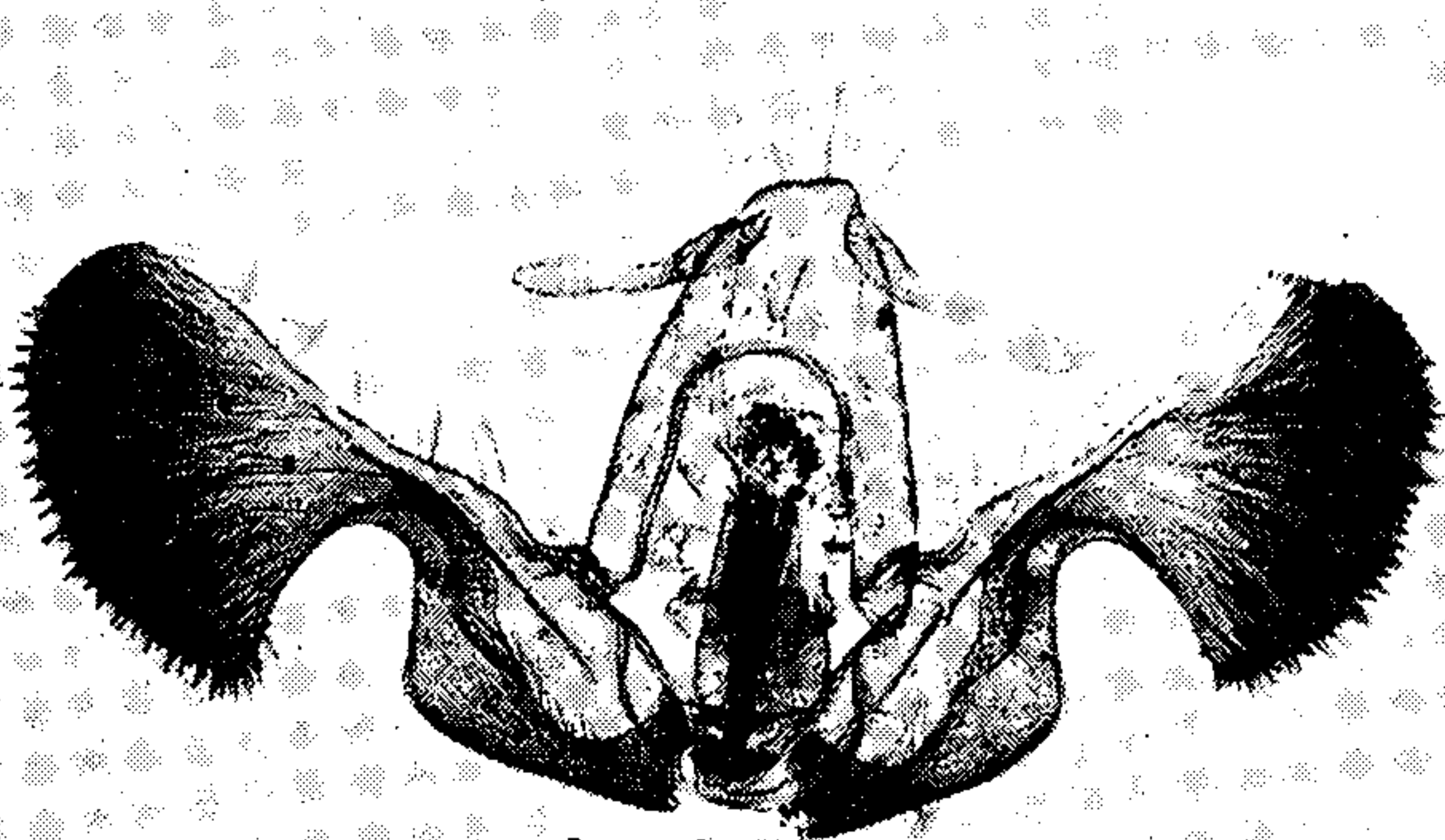

55 *virginiana*

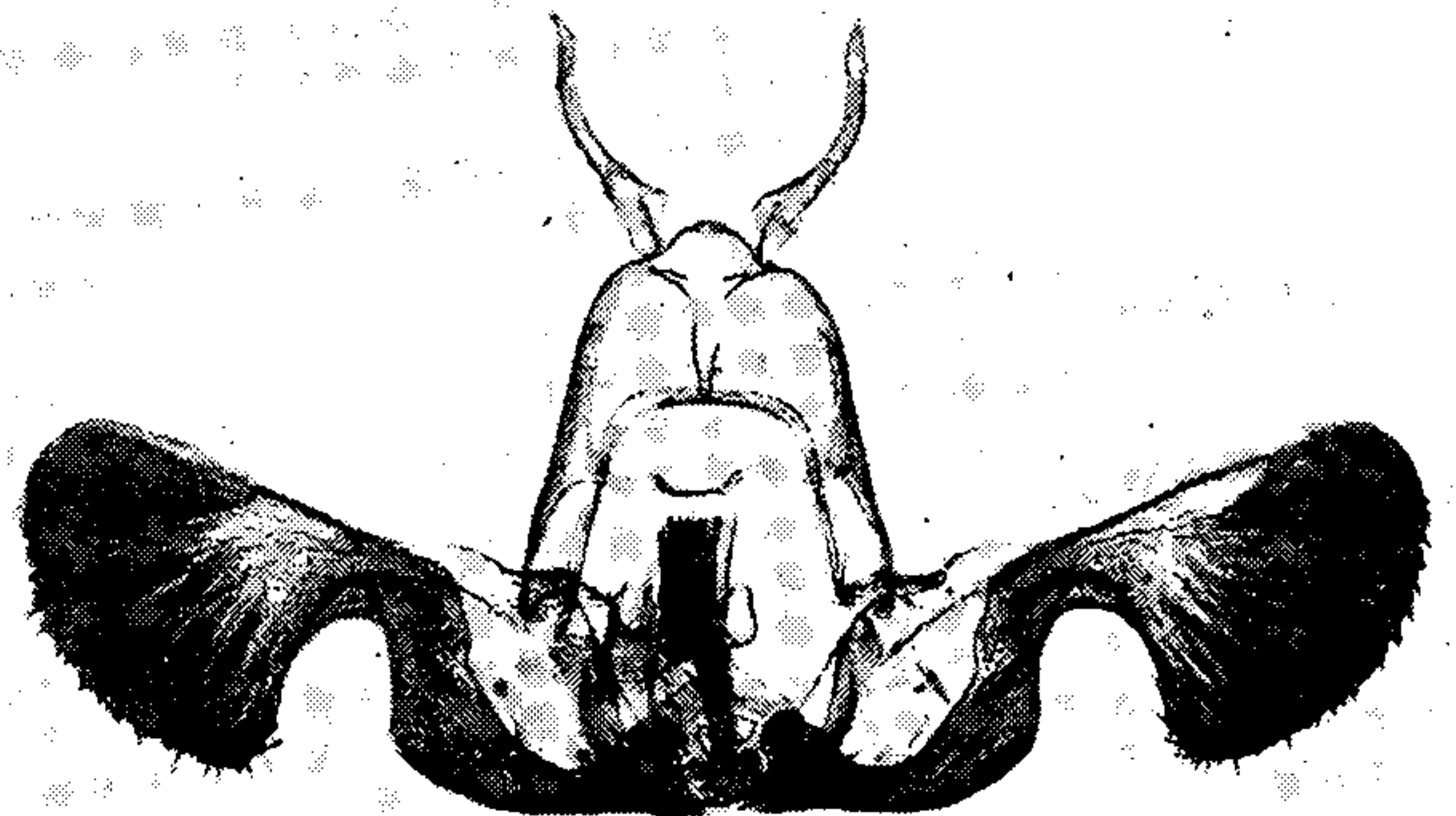

56 *albicapitana*



57 *arizonensis*



58 *metallica*



59 *luculentana*

MALE GENITALIA OF PETROVA.

FOR EXPLANATION OF PLATE SEE PAGE 276



THIS PAGE IS LOCKED TO FREE MEMBERS
Purchase full membership to immediately unlock this page



Never be without a book!

Forgotten Books Full Membership gives universal access to 797,885 books from our apps and website, across all your devices: tablet, phone, e-reader, laptop and desktop computer

A library in your pocket for \$8.99/month

Continue

*Fair usage policy applies



64 *haimbachiana*



69 *colfaxiana*

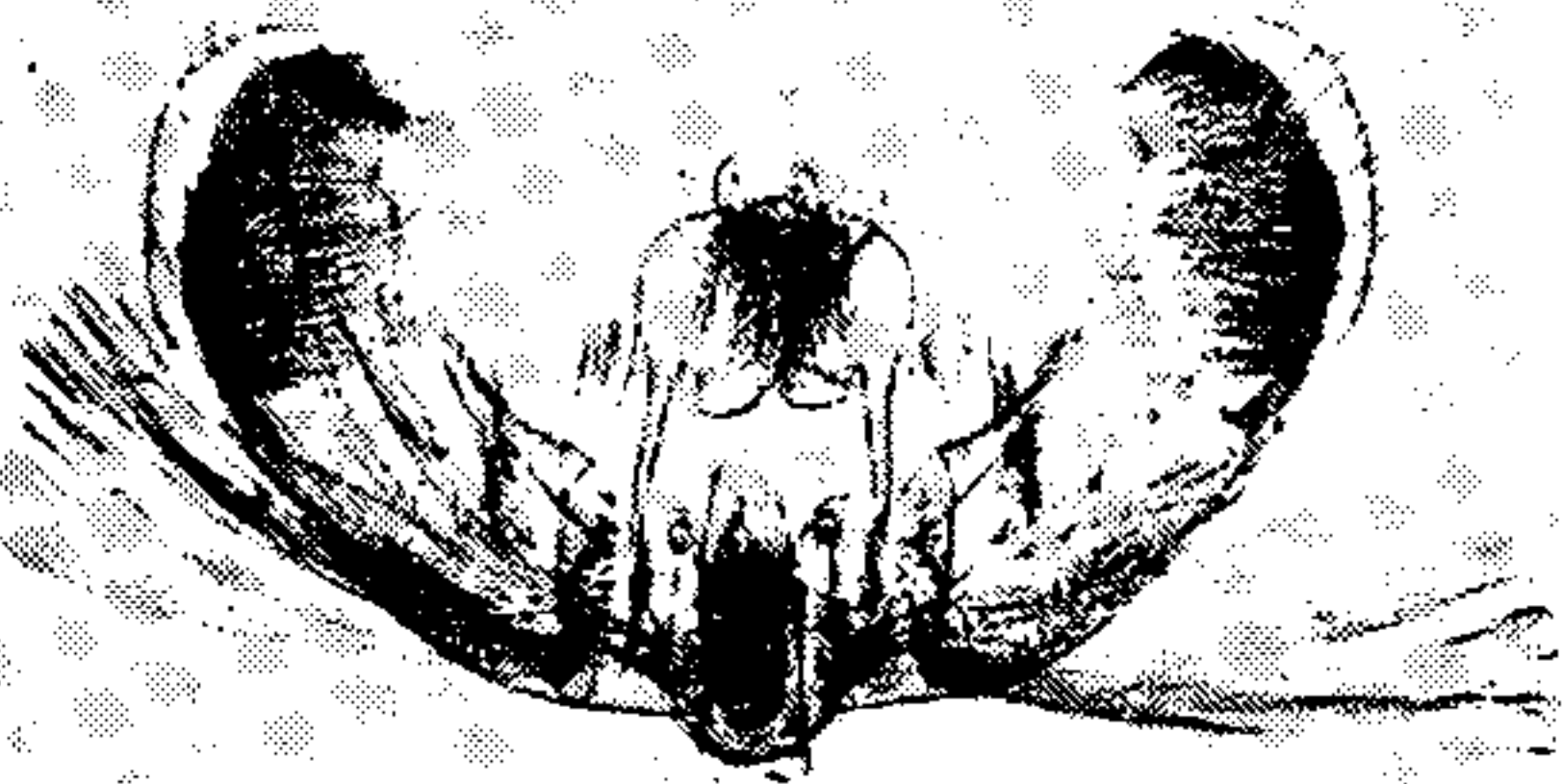

65 *saliciana*



70 *siskiyouana*



66 *incarnana*



71 *coloradensis*

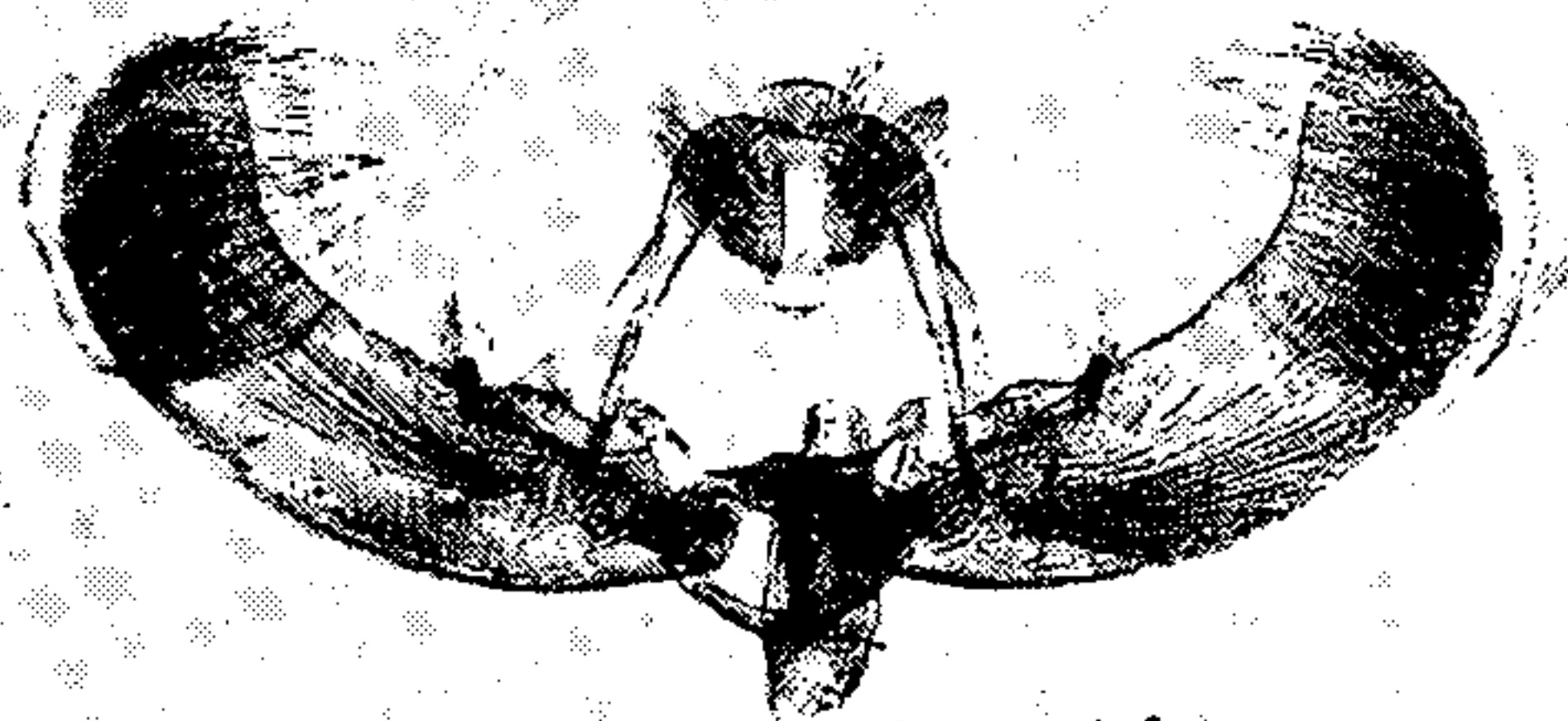

67 *substitutionis*



72 *coloradensis*



73 *taxifoliella*



68 *fasciolana*



74 *ulteriorana*

MALE GENITALIA OF GYPSONOMA AND BARBARA.

FOR EXPLANATION OF PLATE SEE PAGE 276



75 *radiatana*

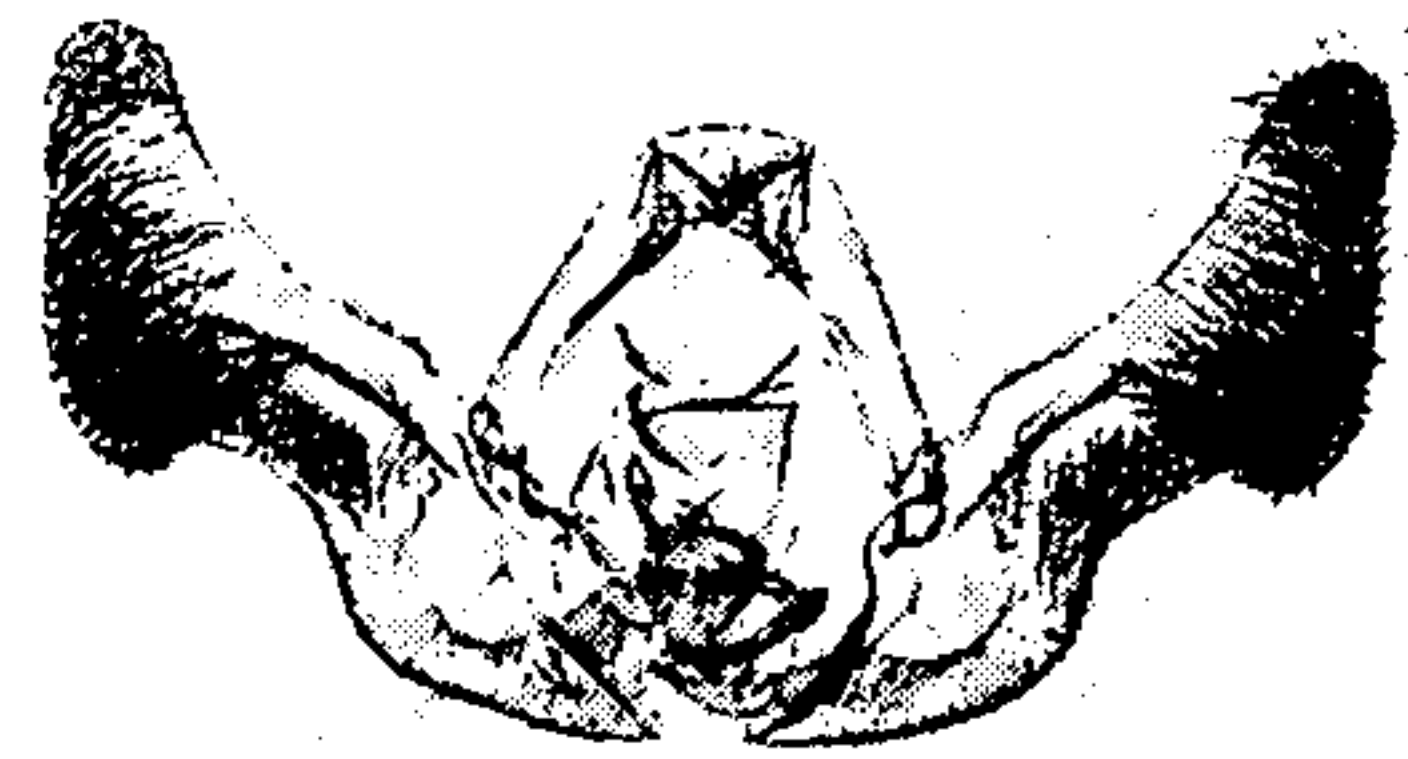

80 *striatana*



76 *awemeana*

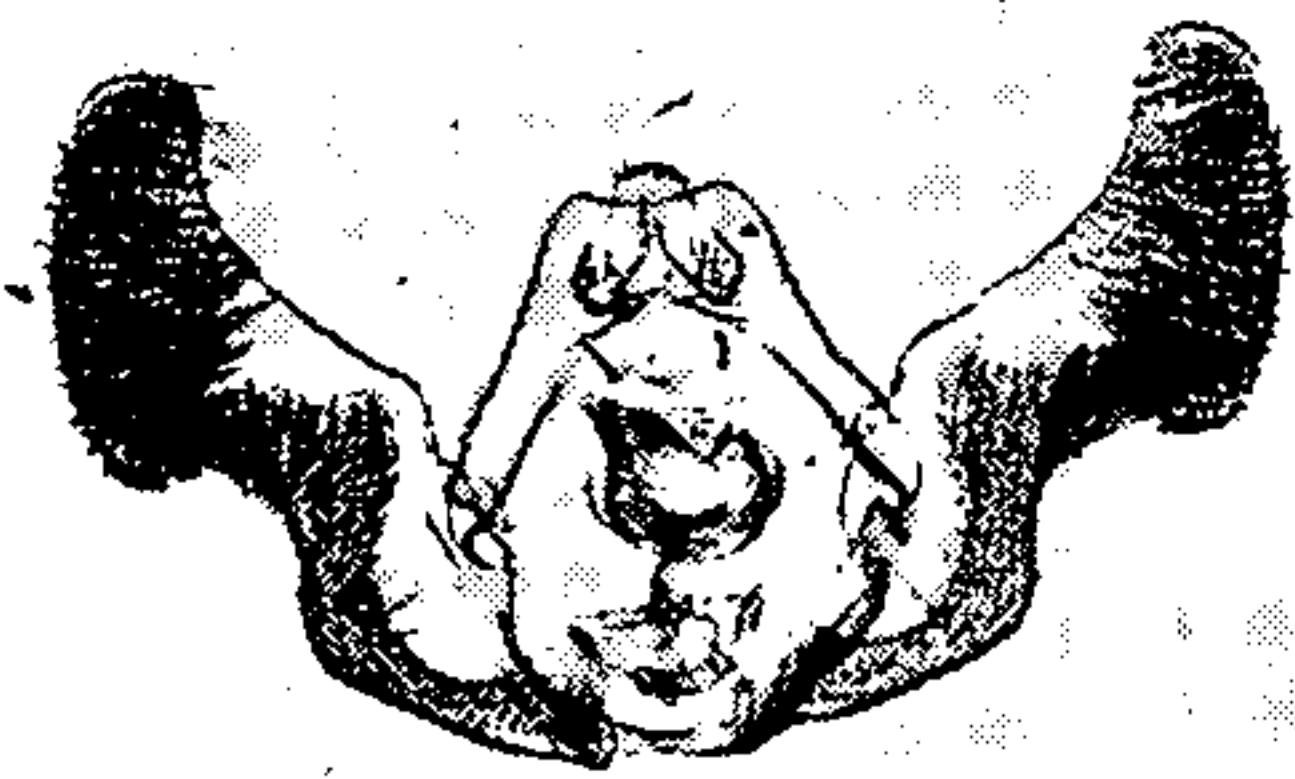

81 *kiscana*

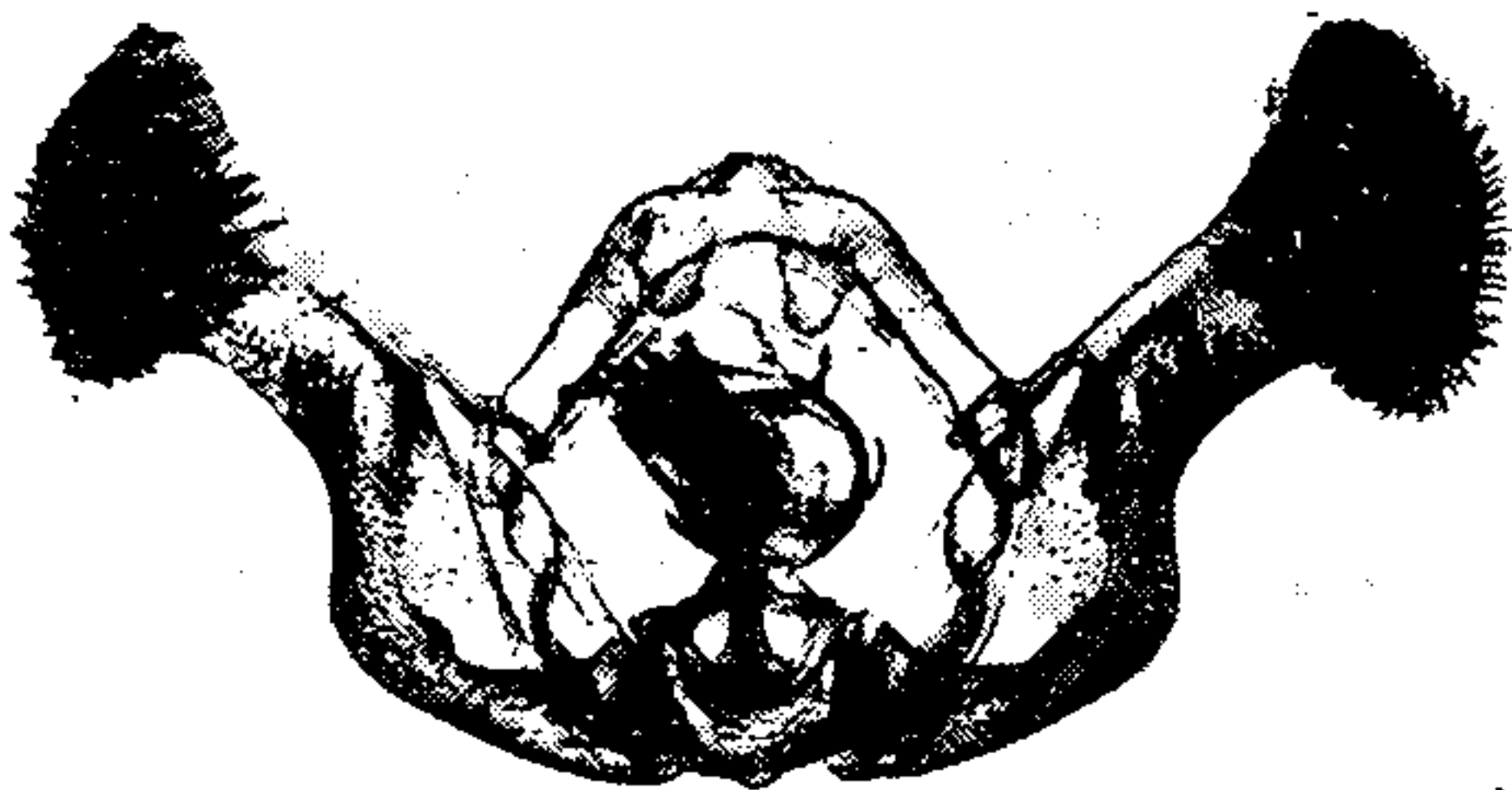

77 *roseotermianana*

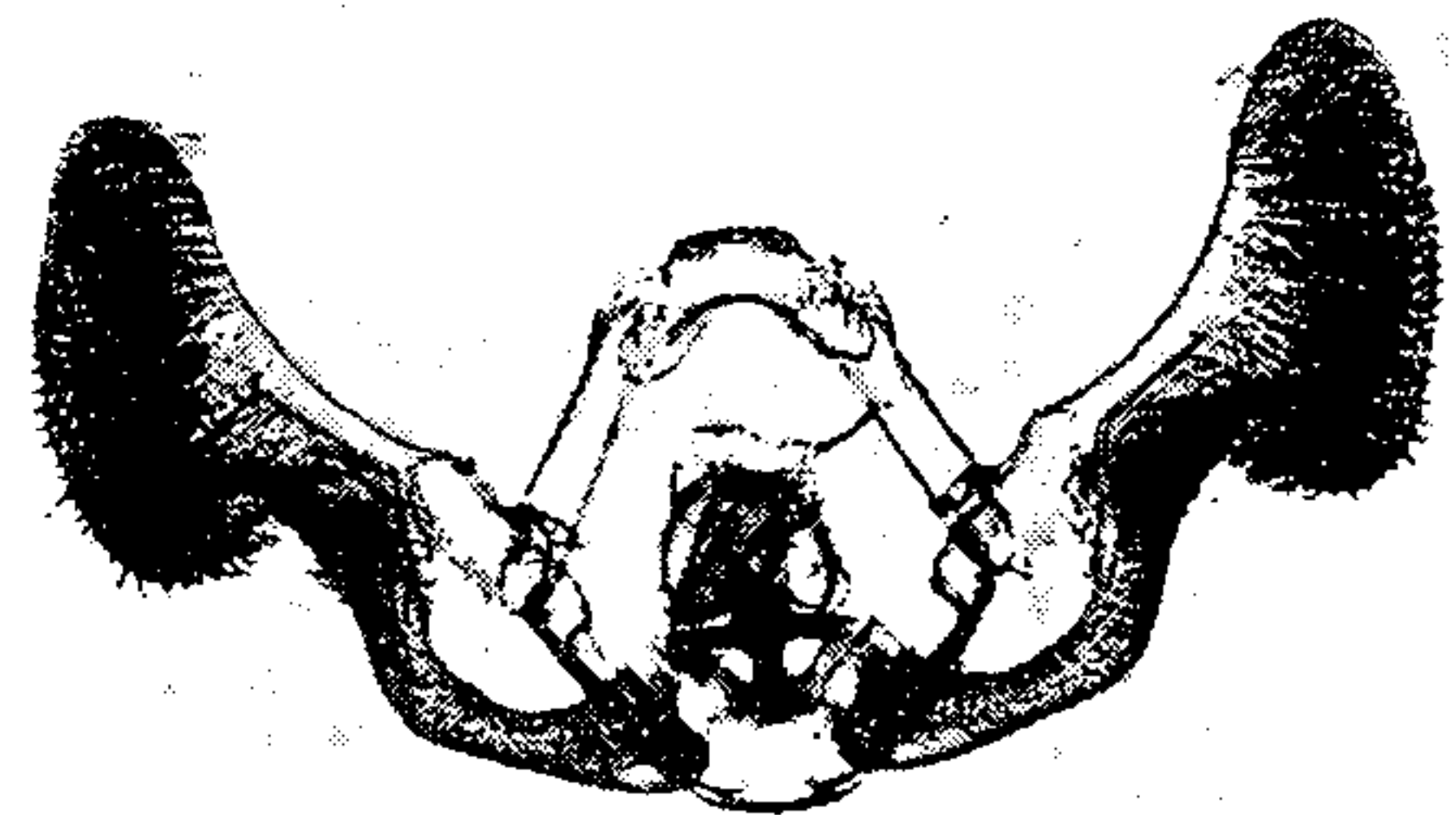

82 *pallidicostana*



78 *claviana*

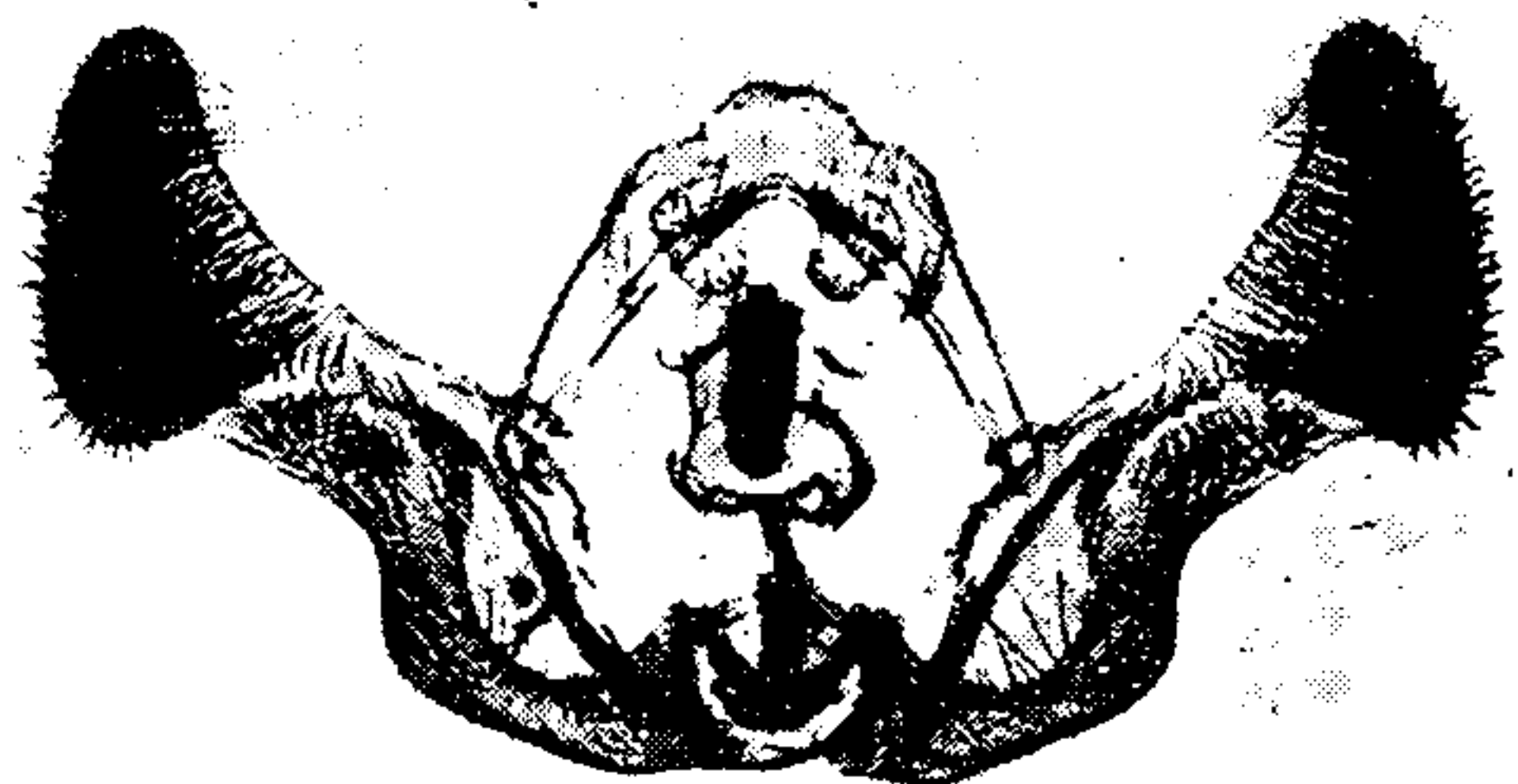

83 *essexana*



79 *occidentalis*

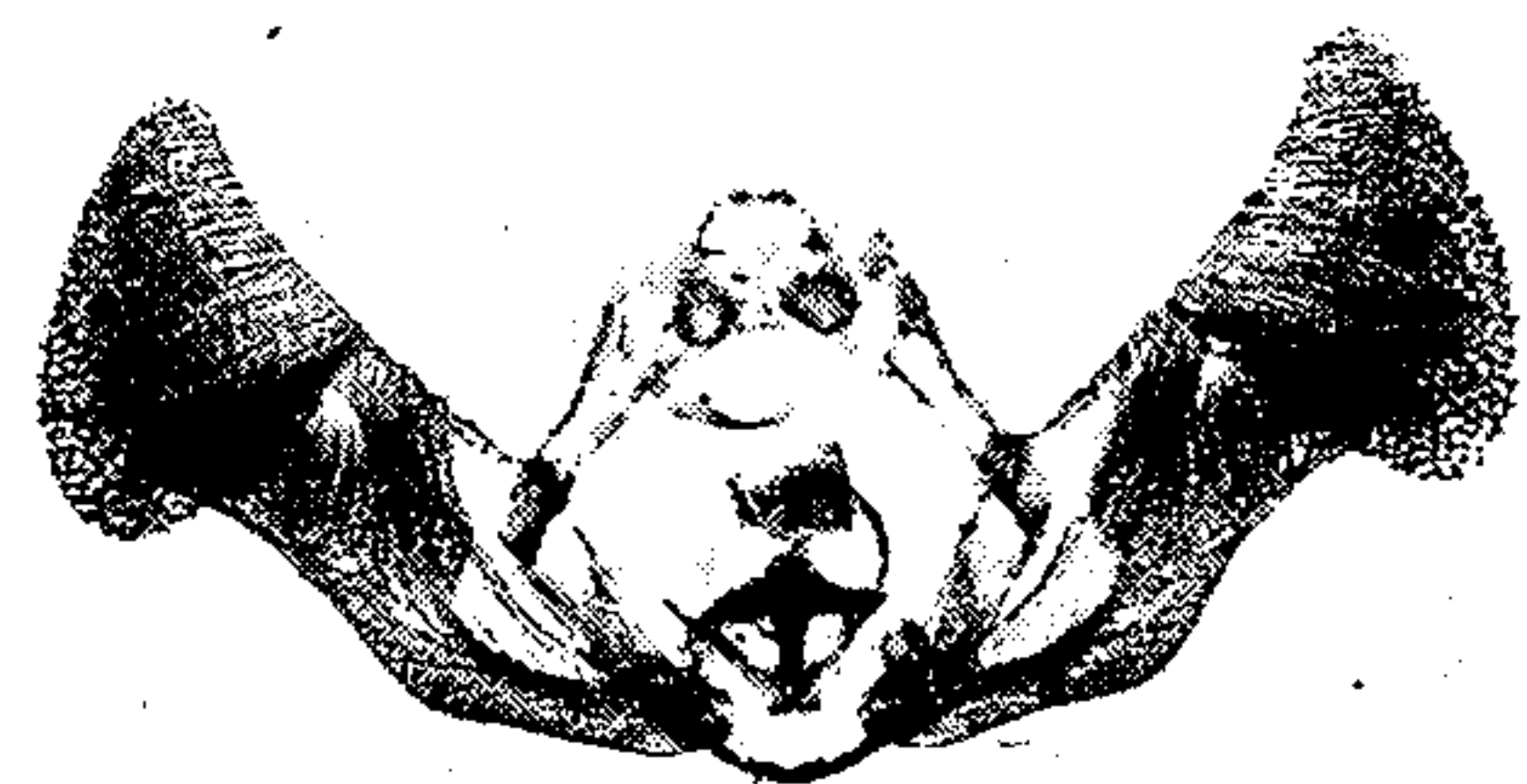

84 *umbraticana*

MALE GENITALIA OF THIODIA.

FOR EXPLANATION OF PLATE SEE PAGE 276



85 *offectalis*

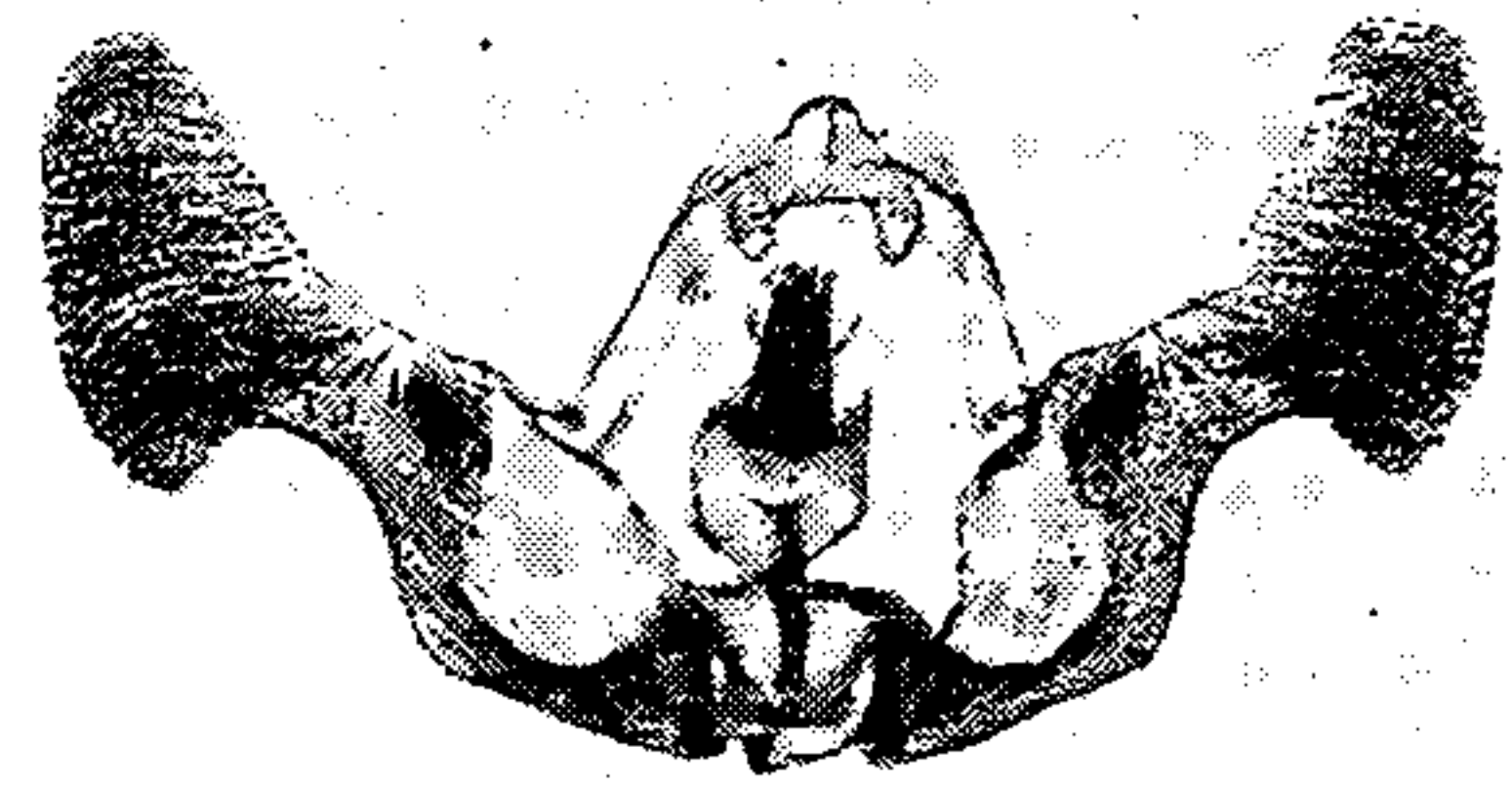

90 *annetteana*

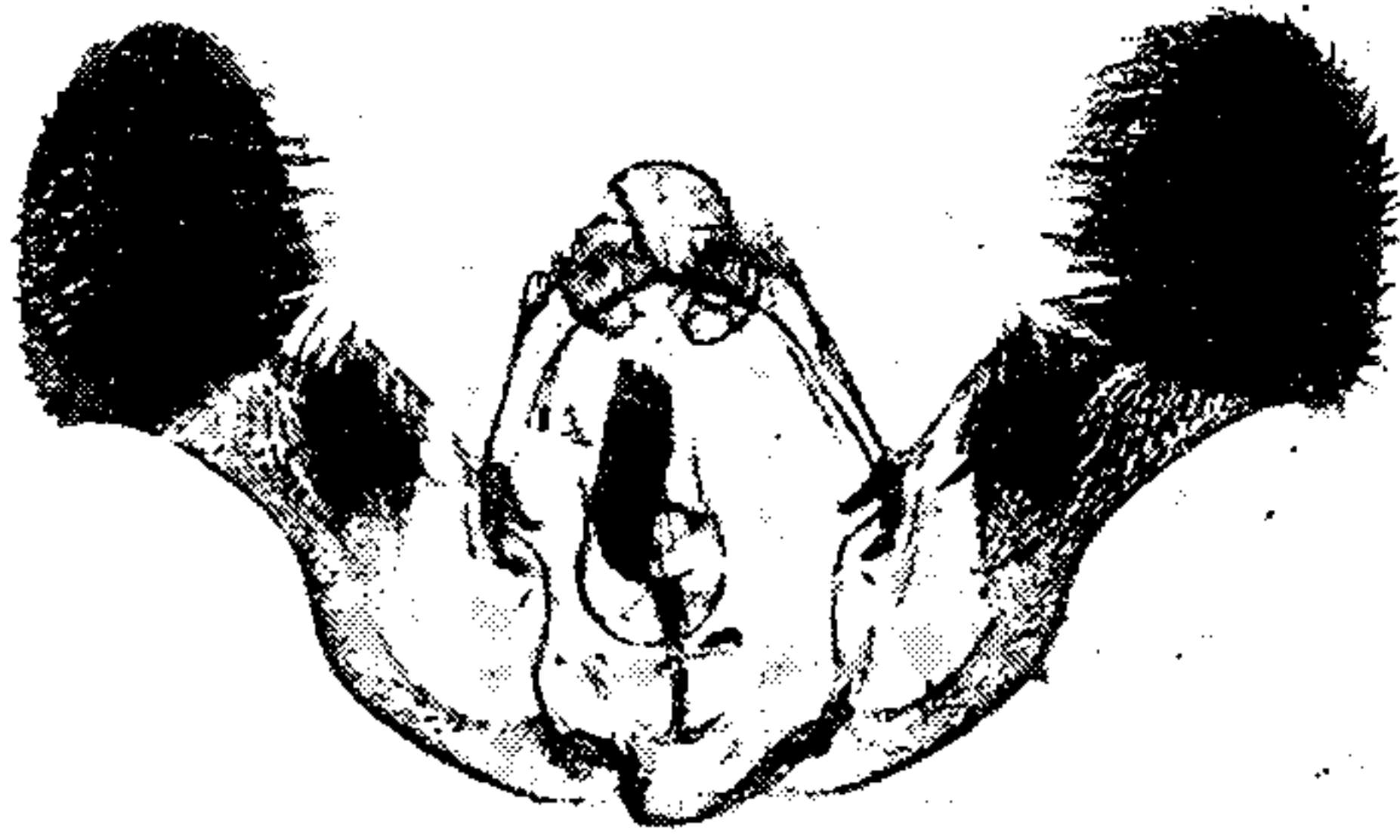

86 *amphorana*

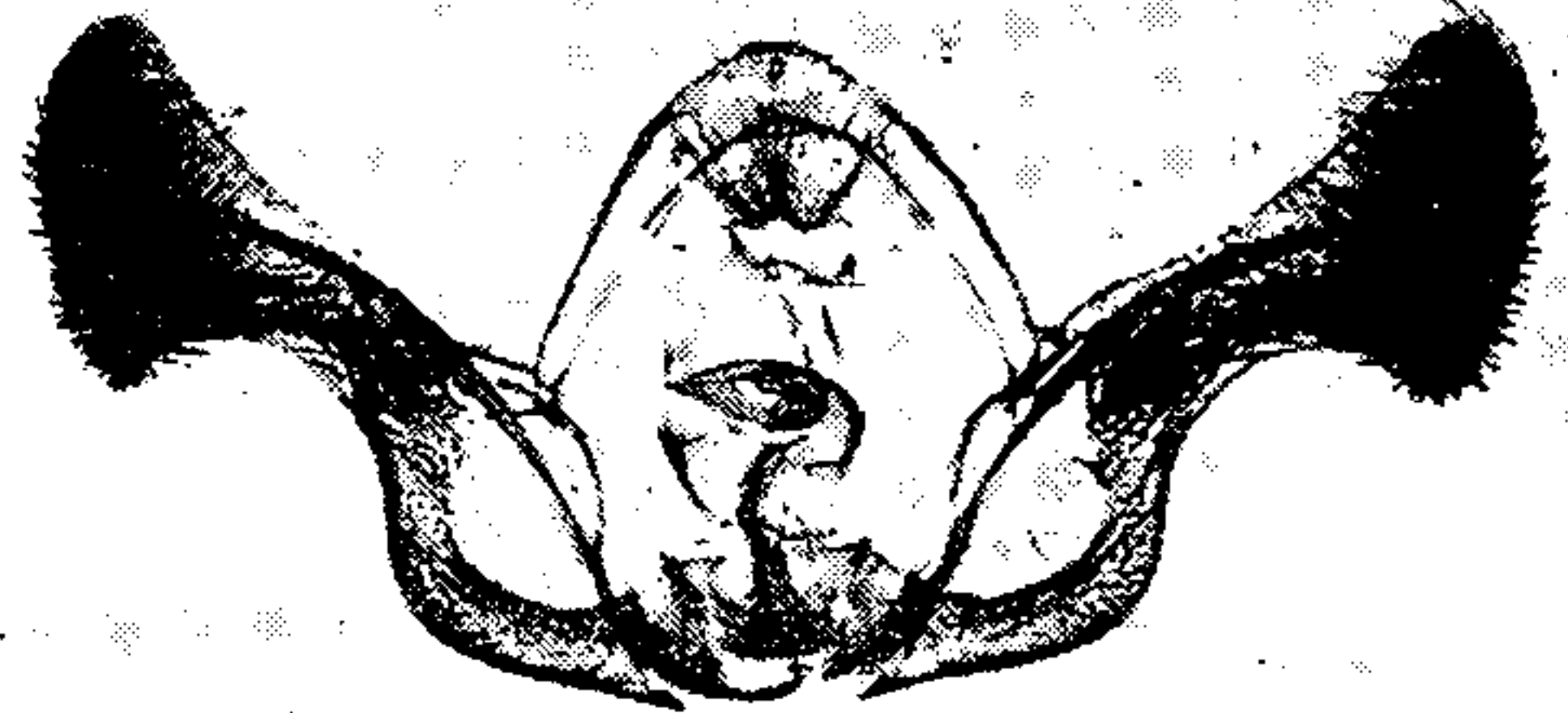

91 *olivaceana*

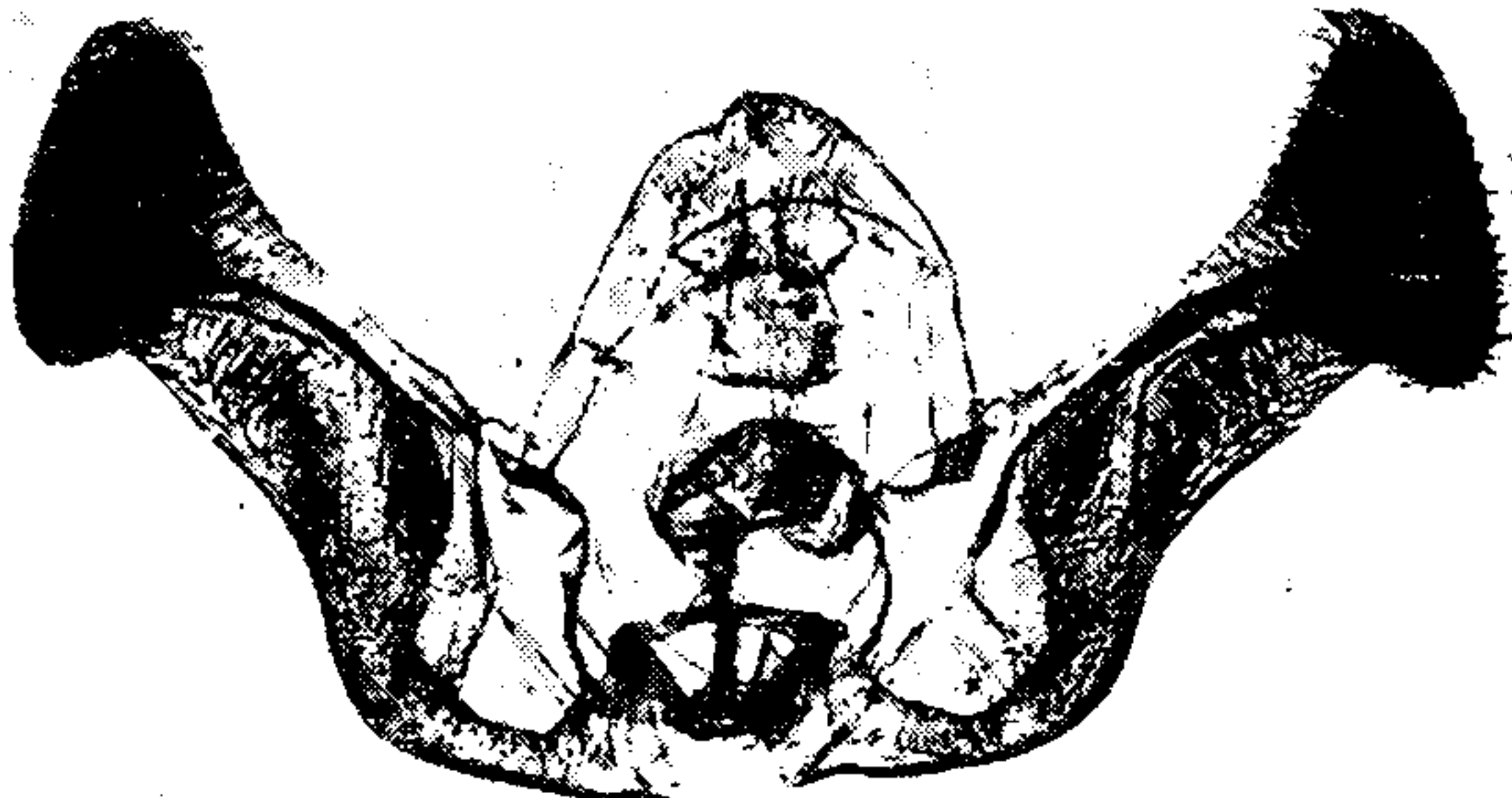

87 *umbrastriana*



92 *griseocapitana*

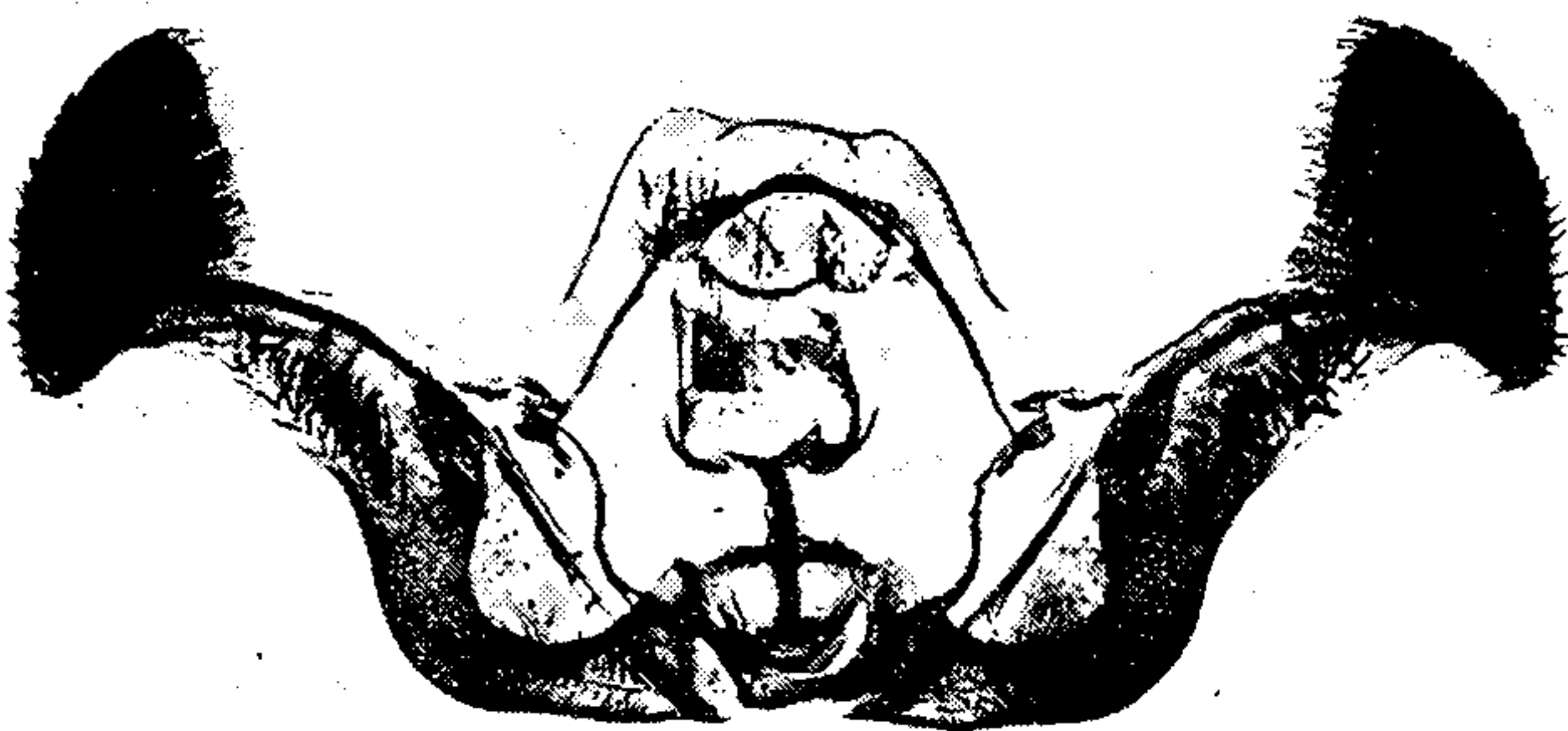

88 *formosana*



93 *influaana*

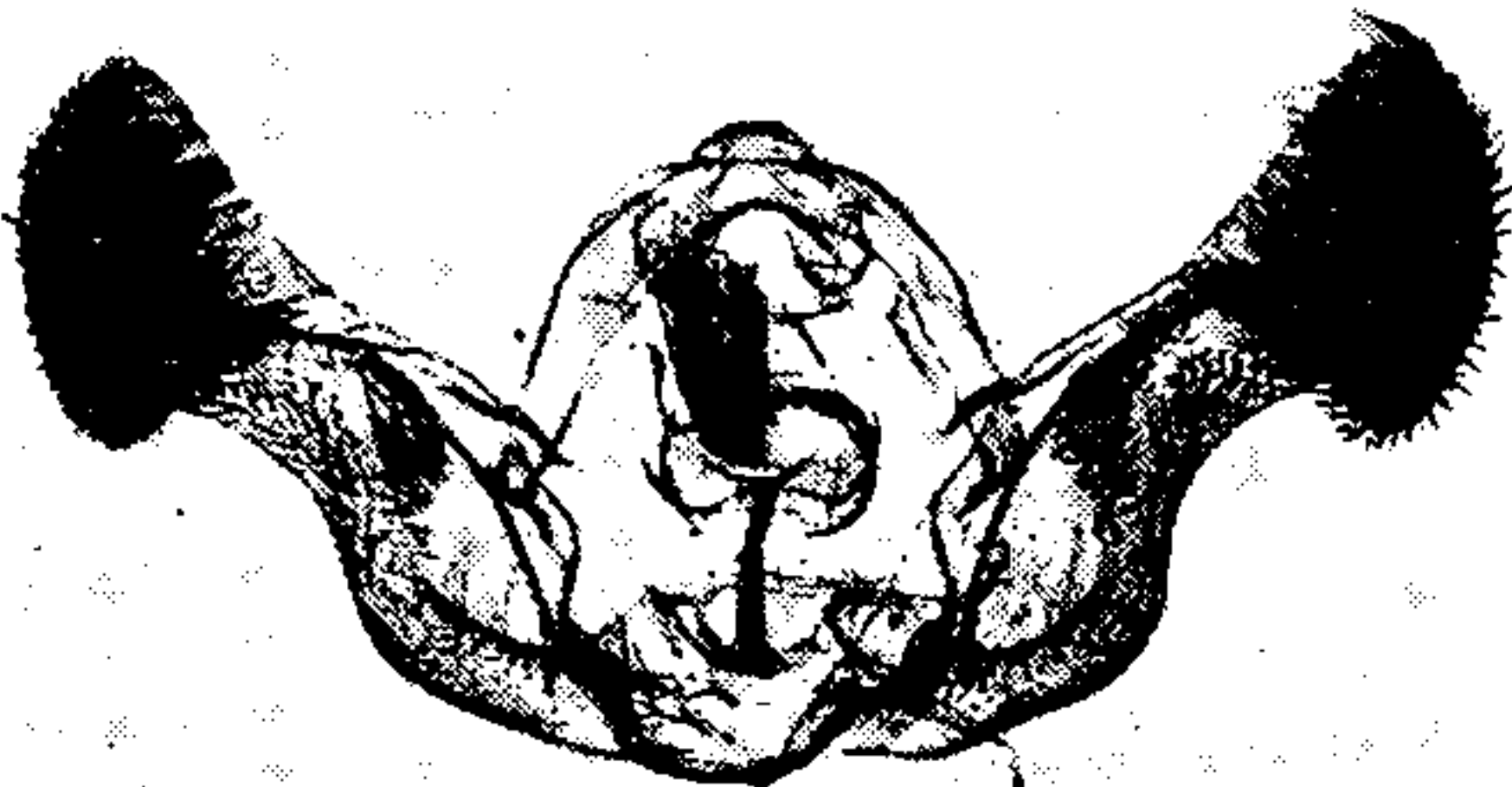

89 *ferruginana*



94 *granulata*

MALE GENITALIA OF THIODIA.

FOR EXPLANATION OF PLATE SEE PAGE 277.



THIS PAGE IS LOCKED TO FREE MEMBERS

Purchase full membership to immediately unlock this page



HISTORY

Tens of thousands of important historical sources, many previously unobtainable, are now available for the first time with a Forgotten Books Full Membership.

Unlimited Access
\$8.99/month

Continue

*Fair usage policy applies

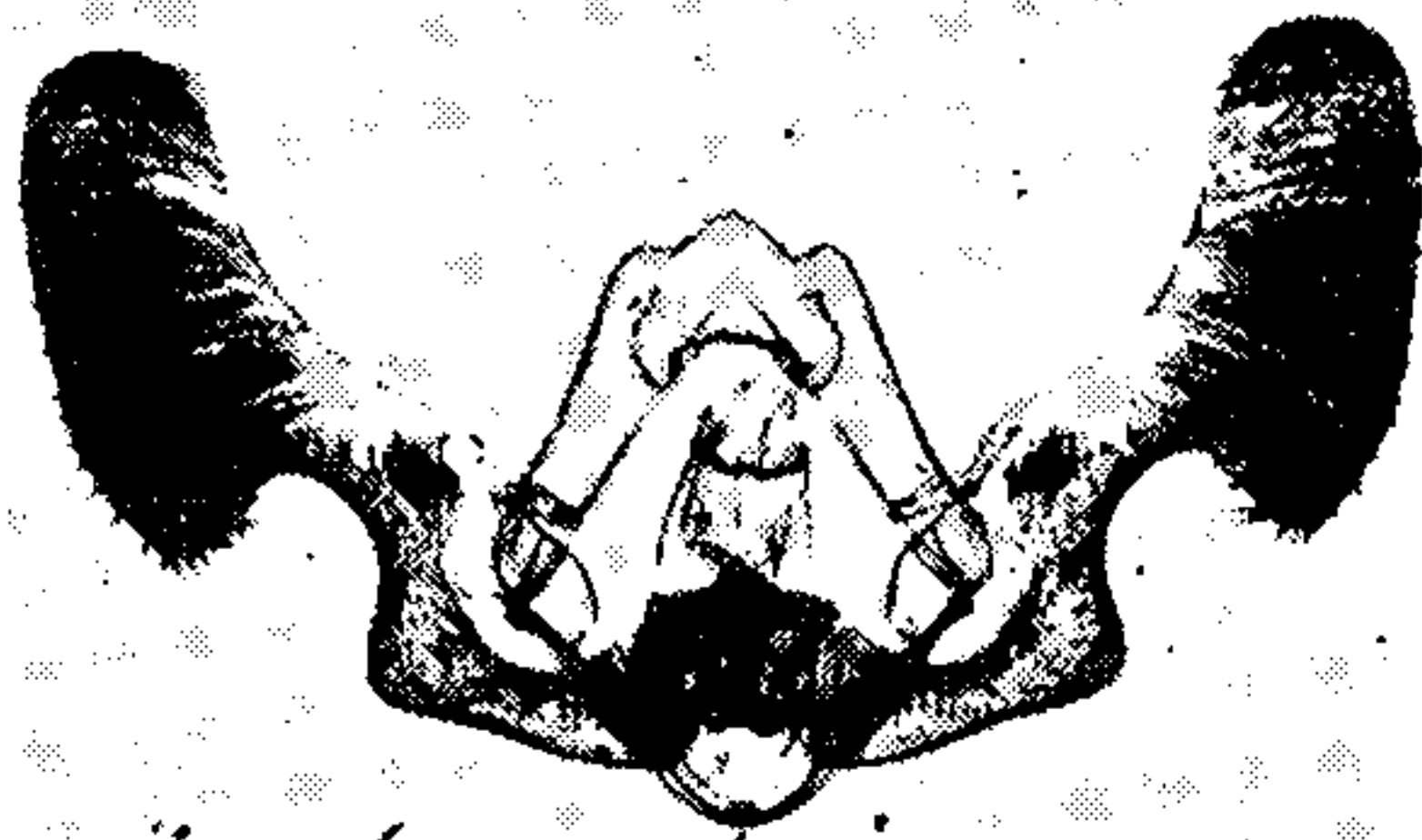

107 *indagatricana*

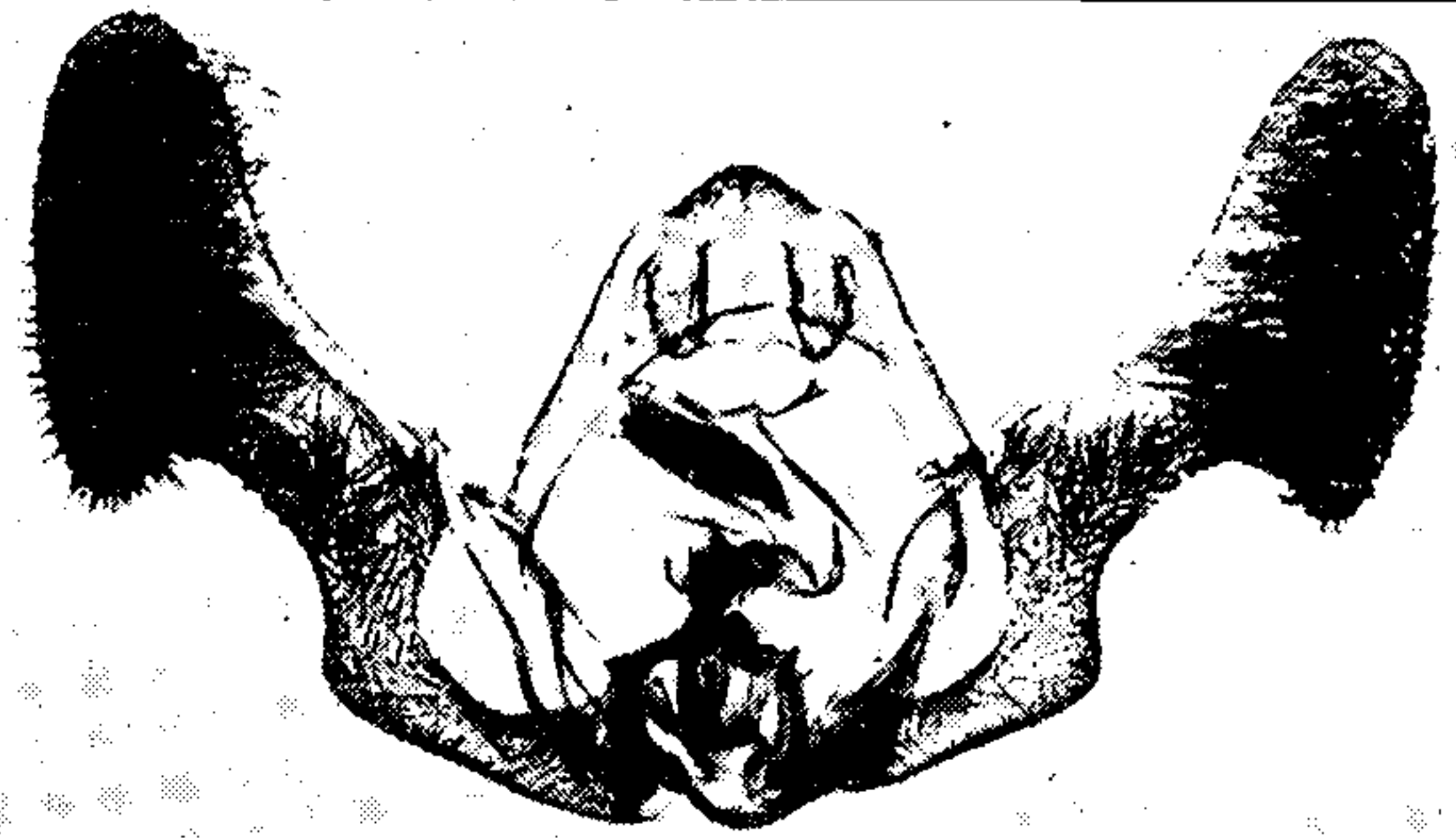

113 *montanana*



108 *imbridana*



114 *benjamini*



109 *dorsiatomana*



115 *corculana*

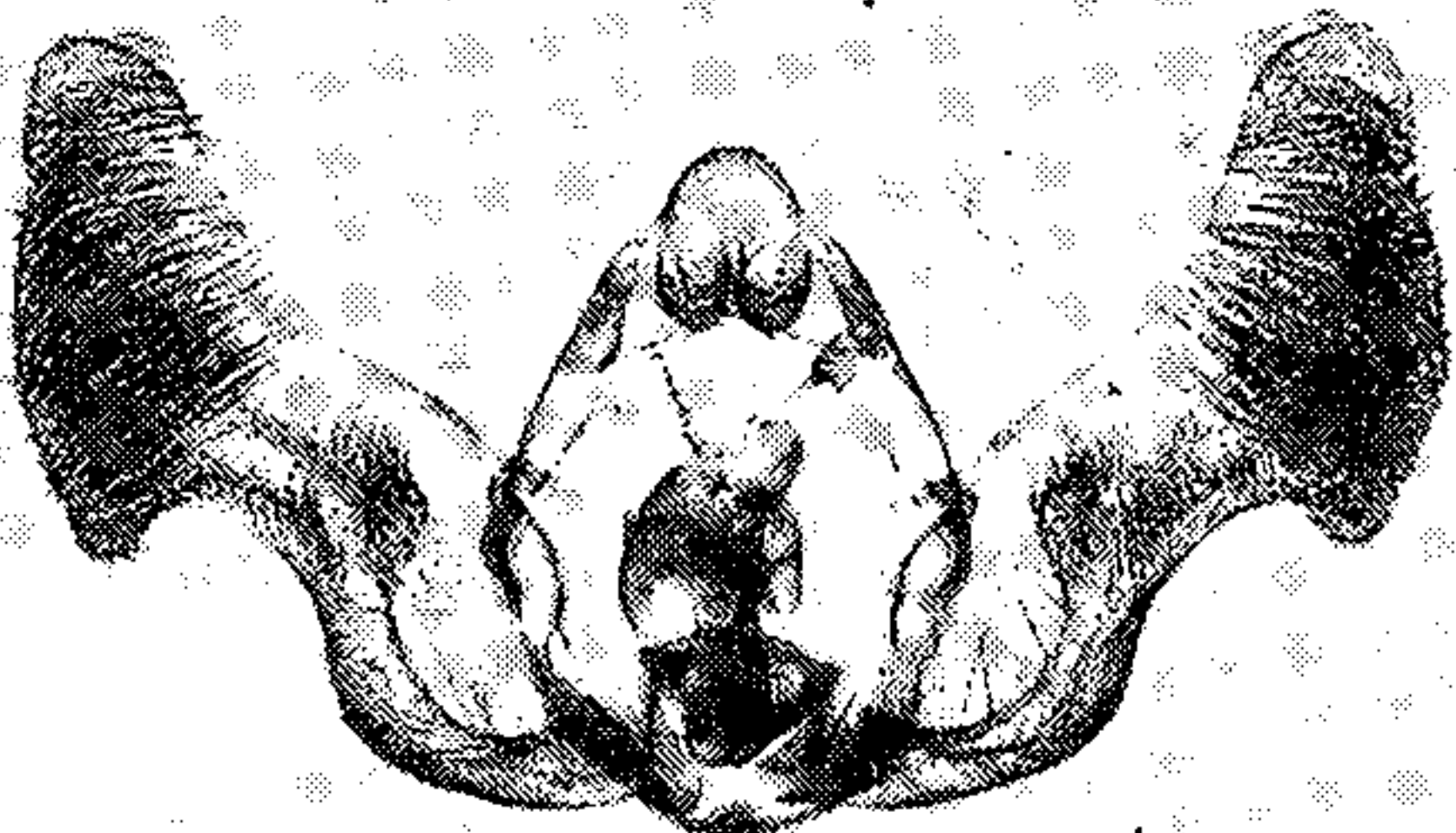

110 *argenticostana*

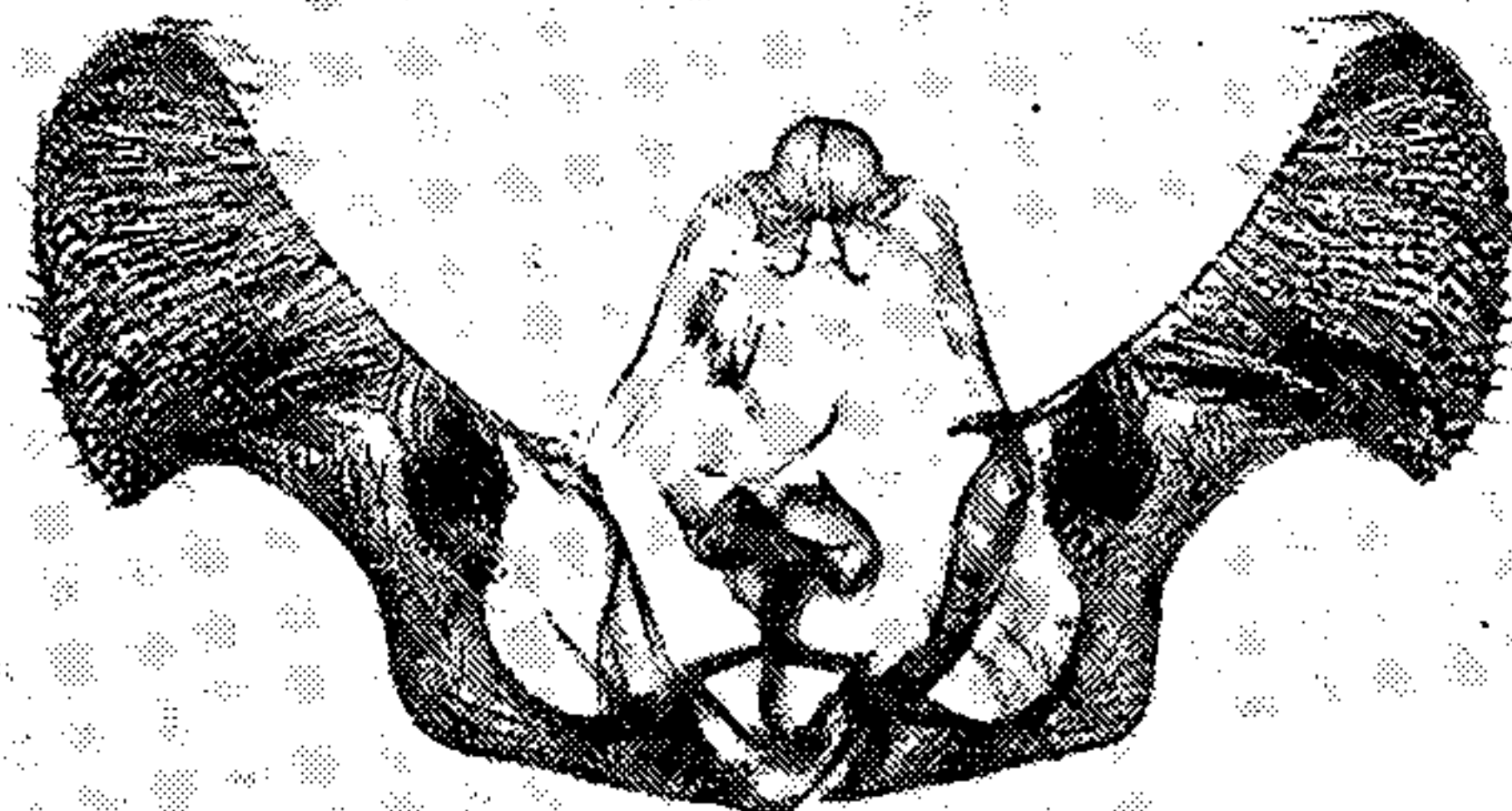

116 *migratana*



111 *transversa*

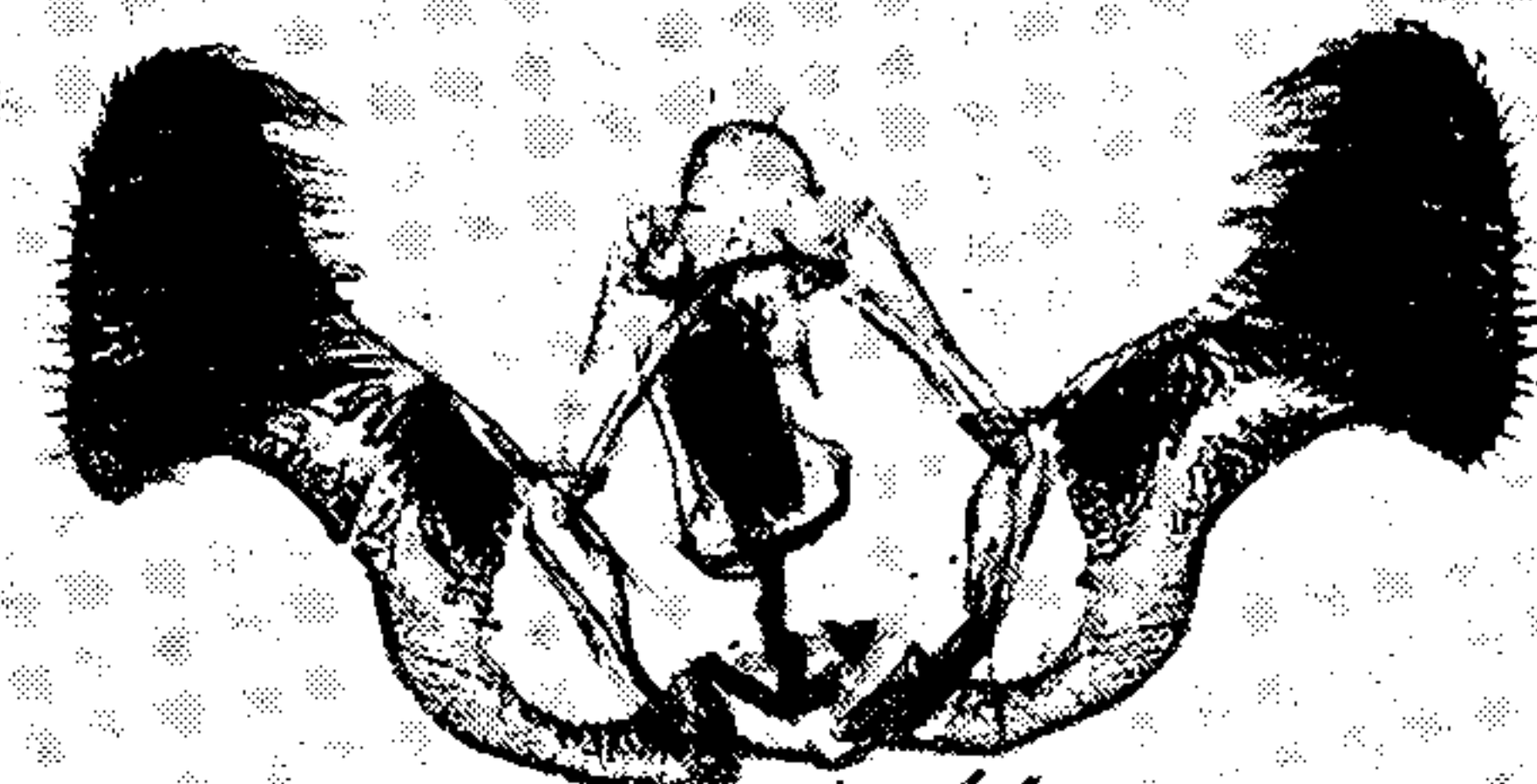

117 *grindeliana*



112 *tarandana*

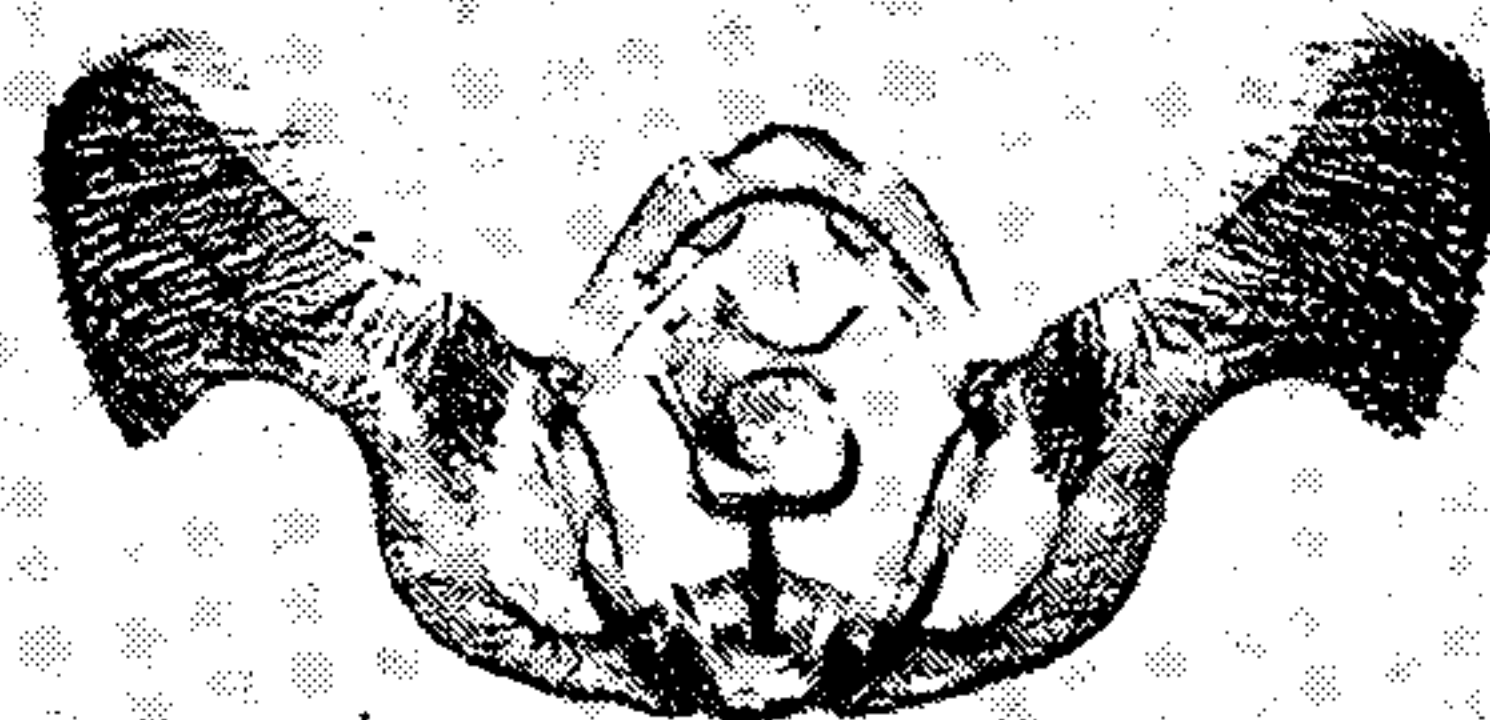

118 *stramineana*

MALE GENITALIA OF THIODIA.

FOR EXPLANATION OF PLATE SEE PAGE 277.



119 *refusana*

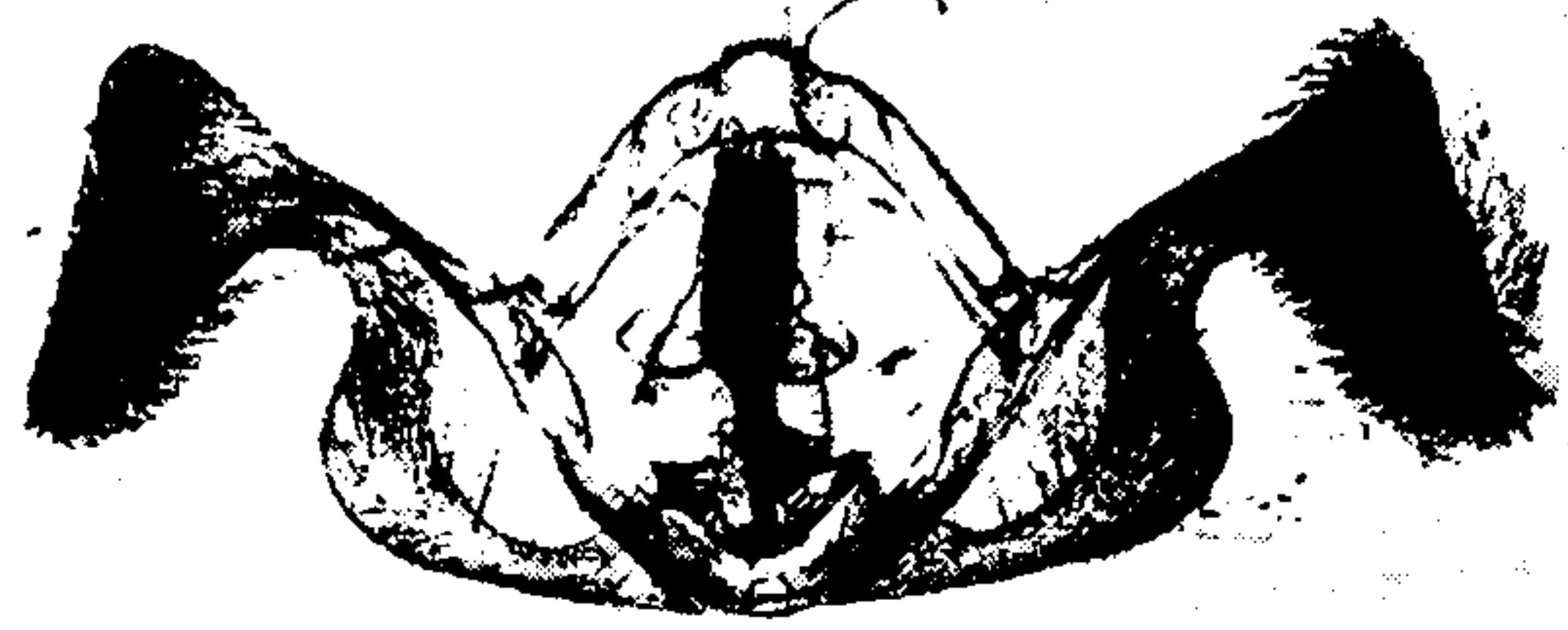

125 *infimbriana*

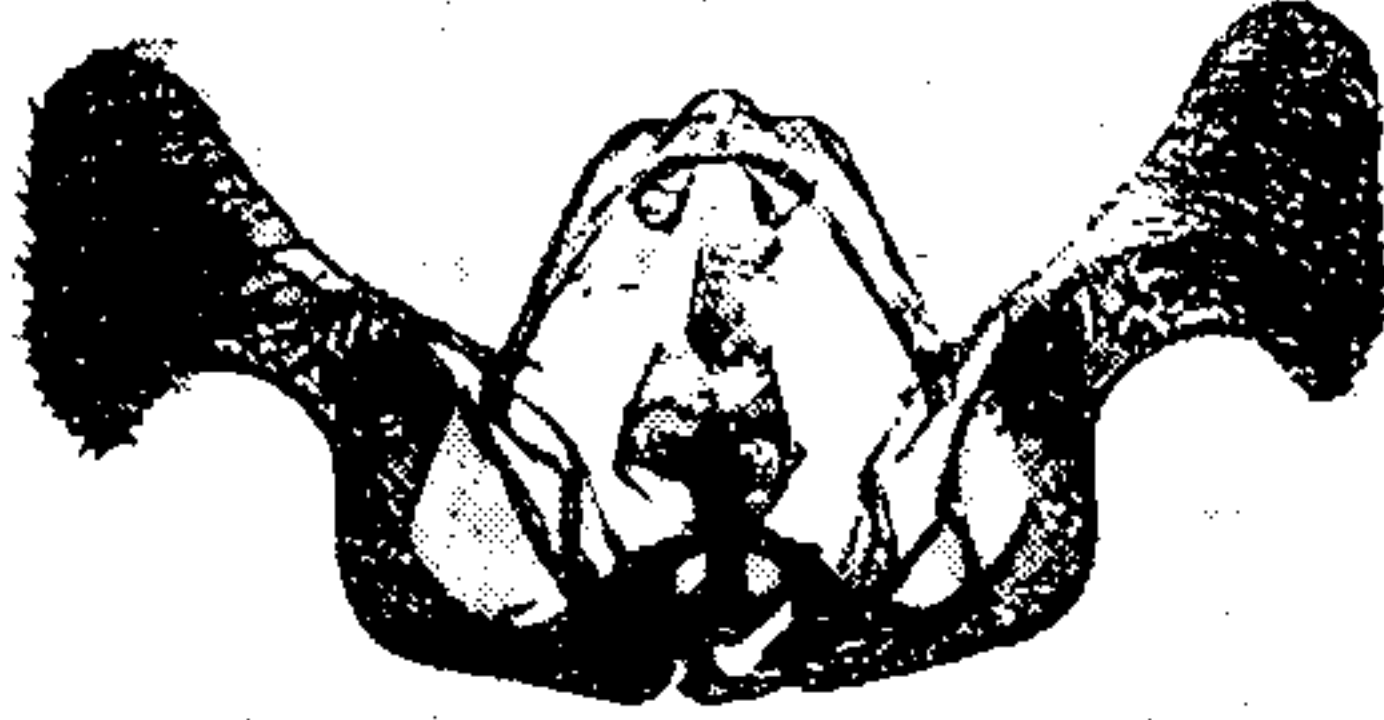

120 *decempunctana*



126 *octopunctana*

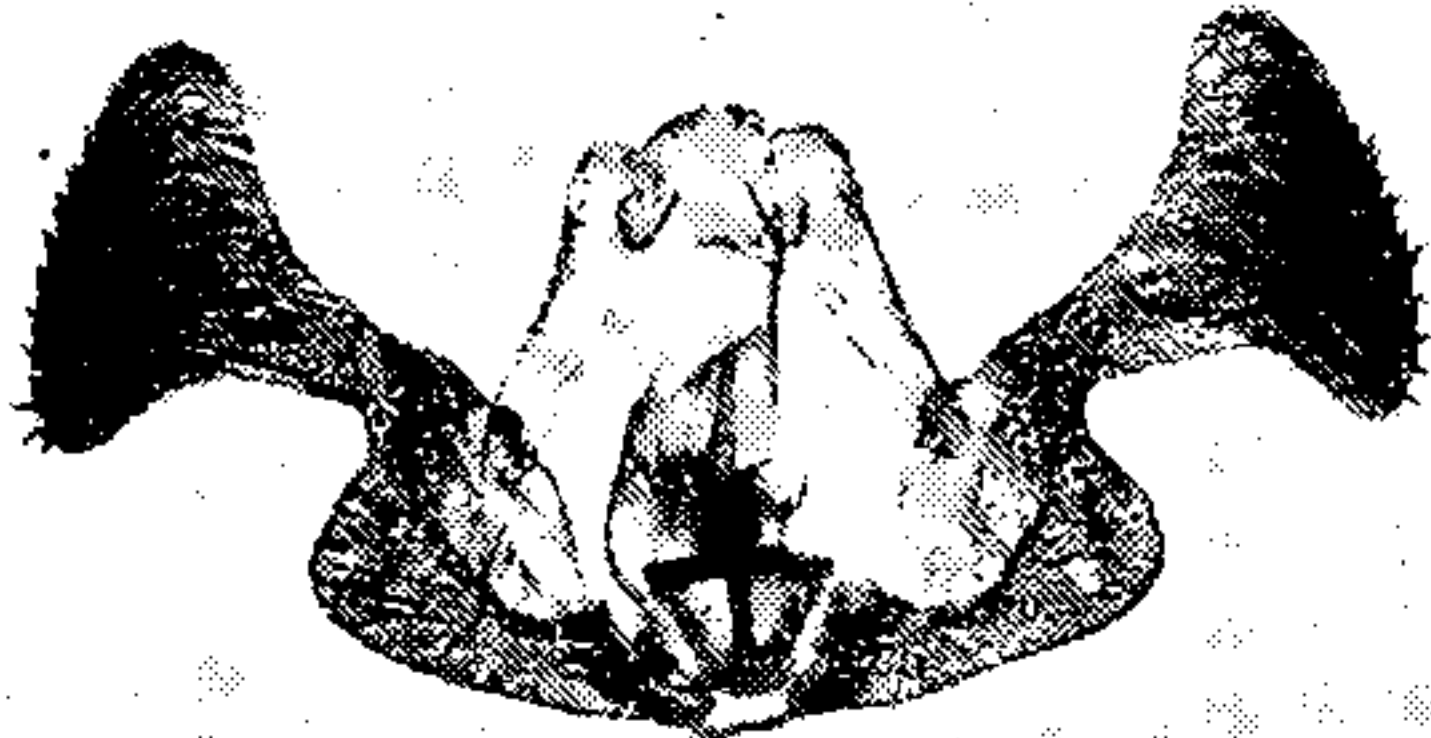

121 *columbiana*

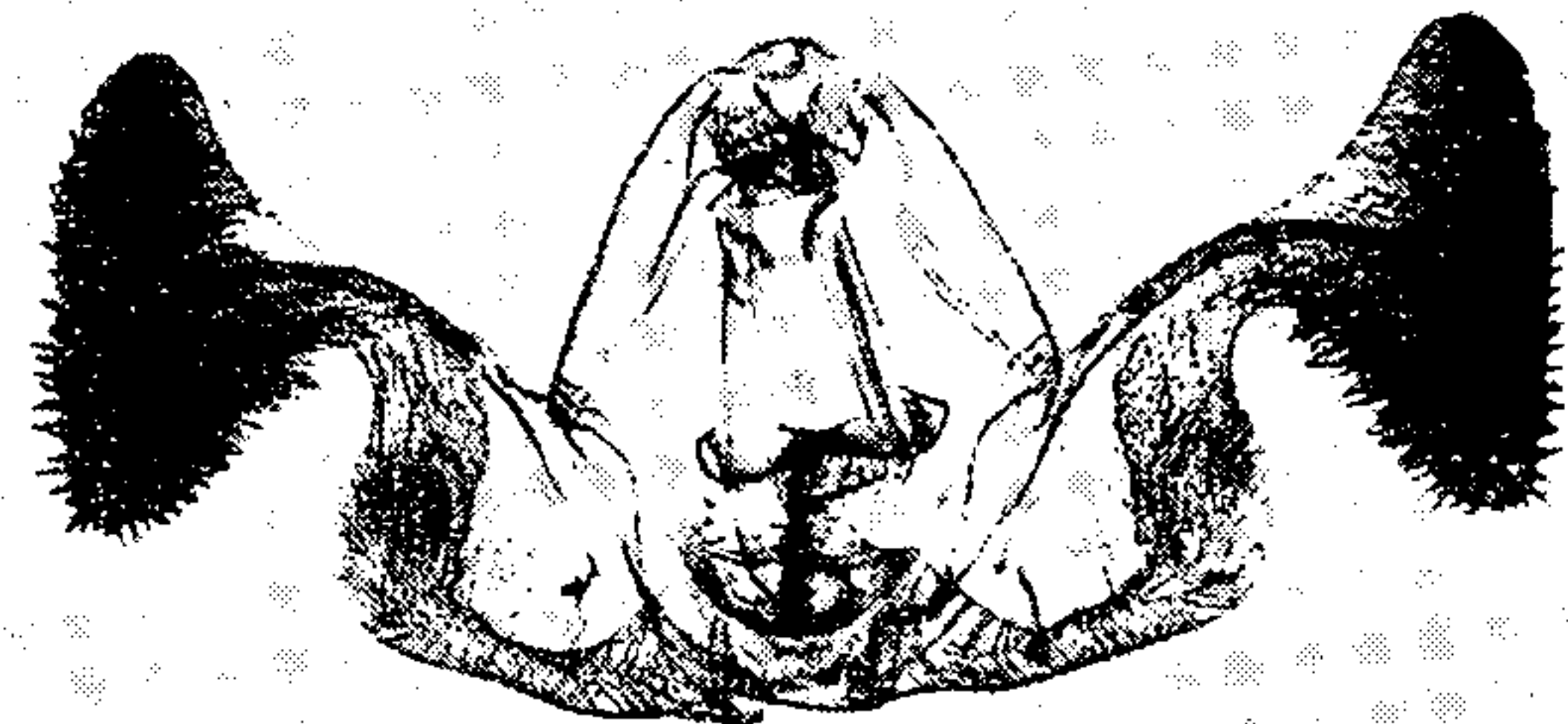

127 *artemisiana*



122 *sublapidana*

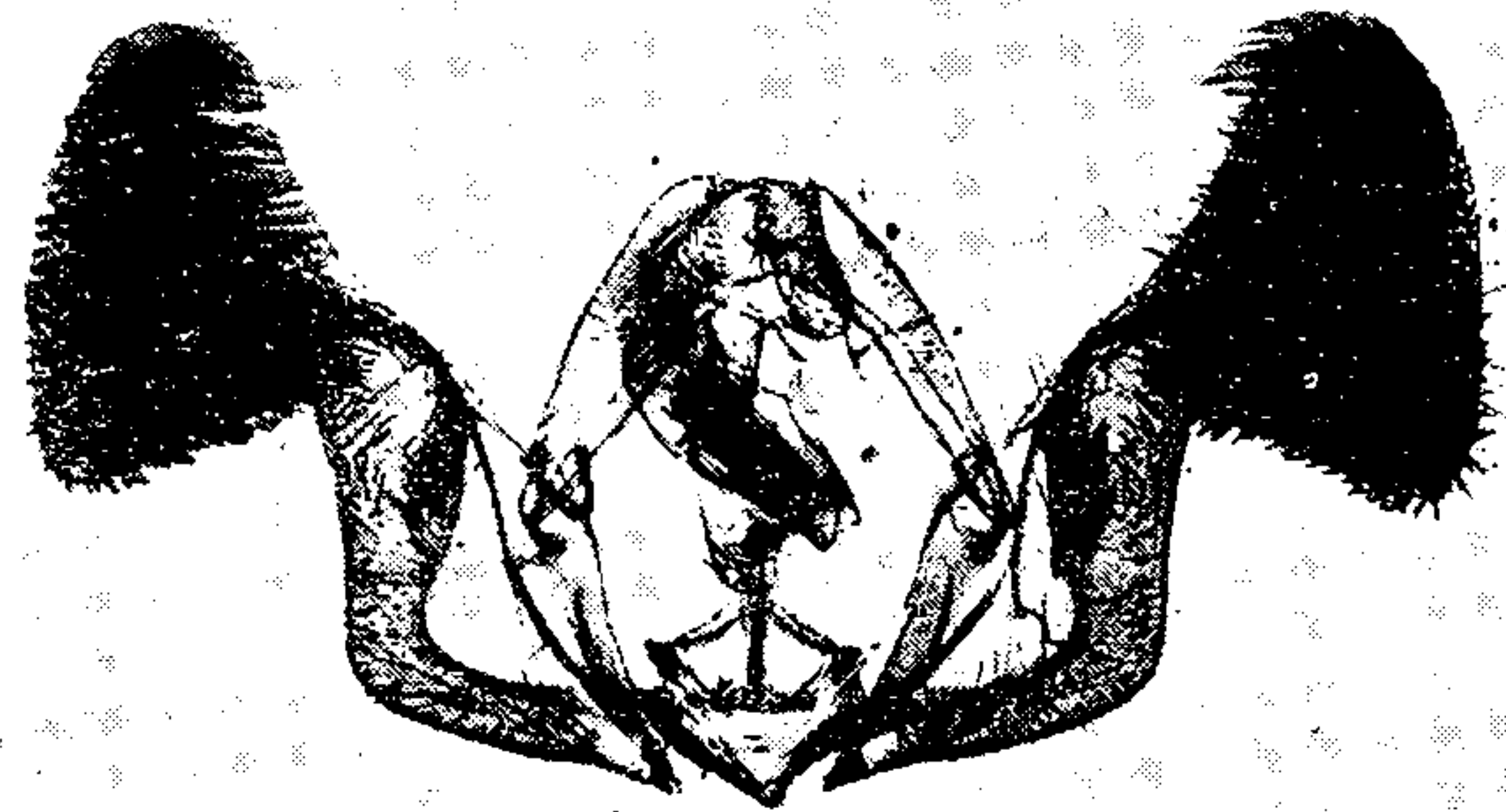

128 *elongana*



123 *salmicolorana*



129 *mormonensis*



124 *scalana*



130 *apacheana*

MALE GENITALIA OF THIODIA.

FOR EXPLANATION OF PLATE SEE PAGES 277 AND 278.



131 *minimana*



132 *cinereolineana*



133 *subminimana*



134 *delphinus*



135 *delphinoidea*

MALE GENITALIA OF THIODIA.

FOR EXPLANATION OF PLATE SEE PAGE 278.



THIS PAGE IS LOCKED TO FREE MEMBERS

Purchase full membership to immediately unlock this page



Never be without a book!

Forgotten Books Full Membership gives universal access to 797,885 books from our apps and website, across all your devices: tablet, phone, e-reader, laptop and desktop computer

A library in your pocket for \$8.99/month

Continue

*Fair usage policy applies

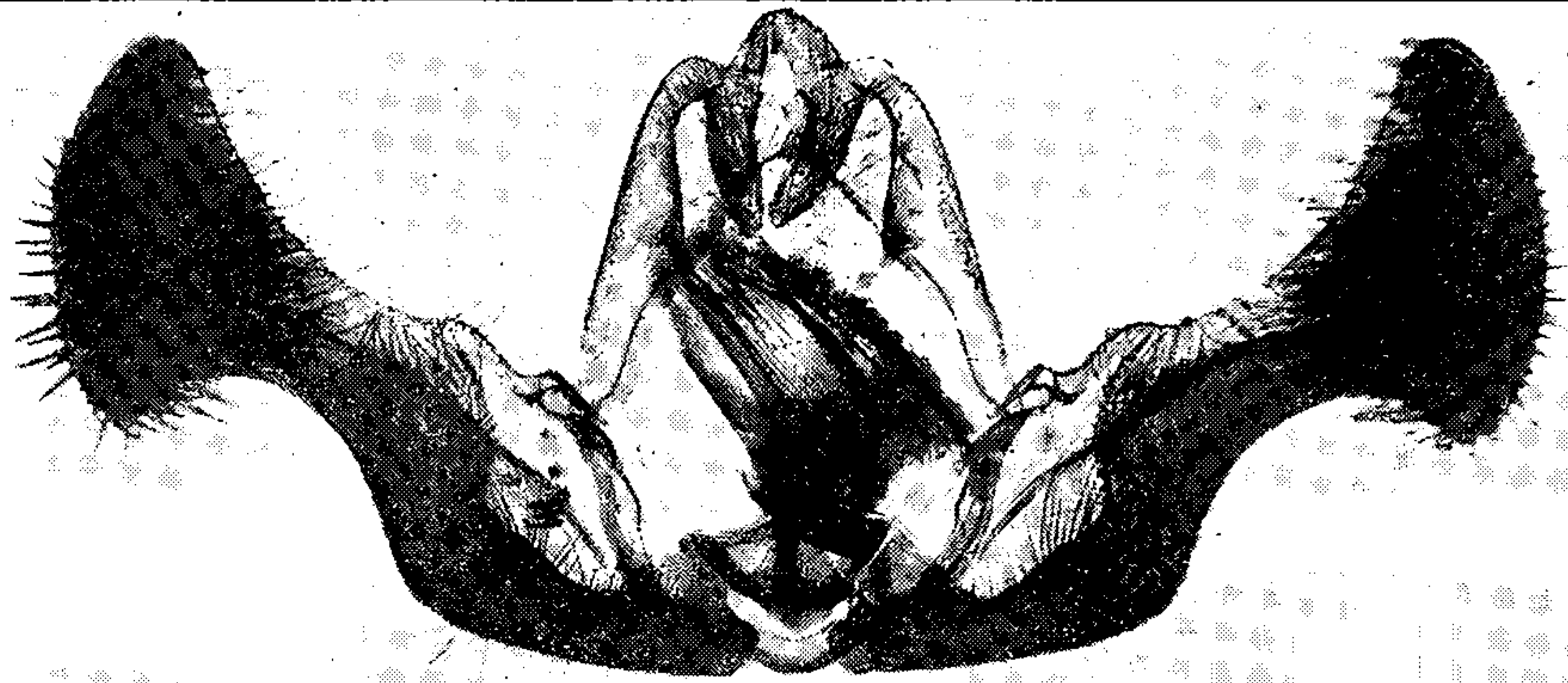

143 *giganteana*



144 *sandana*

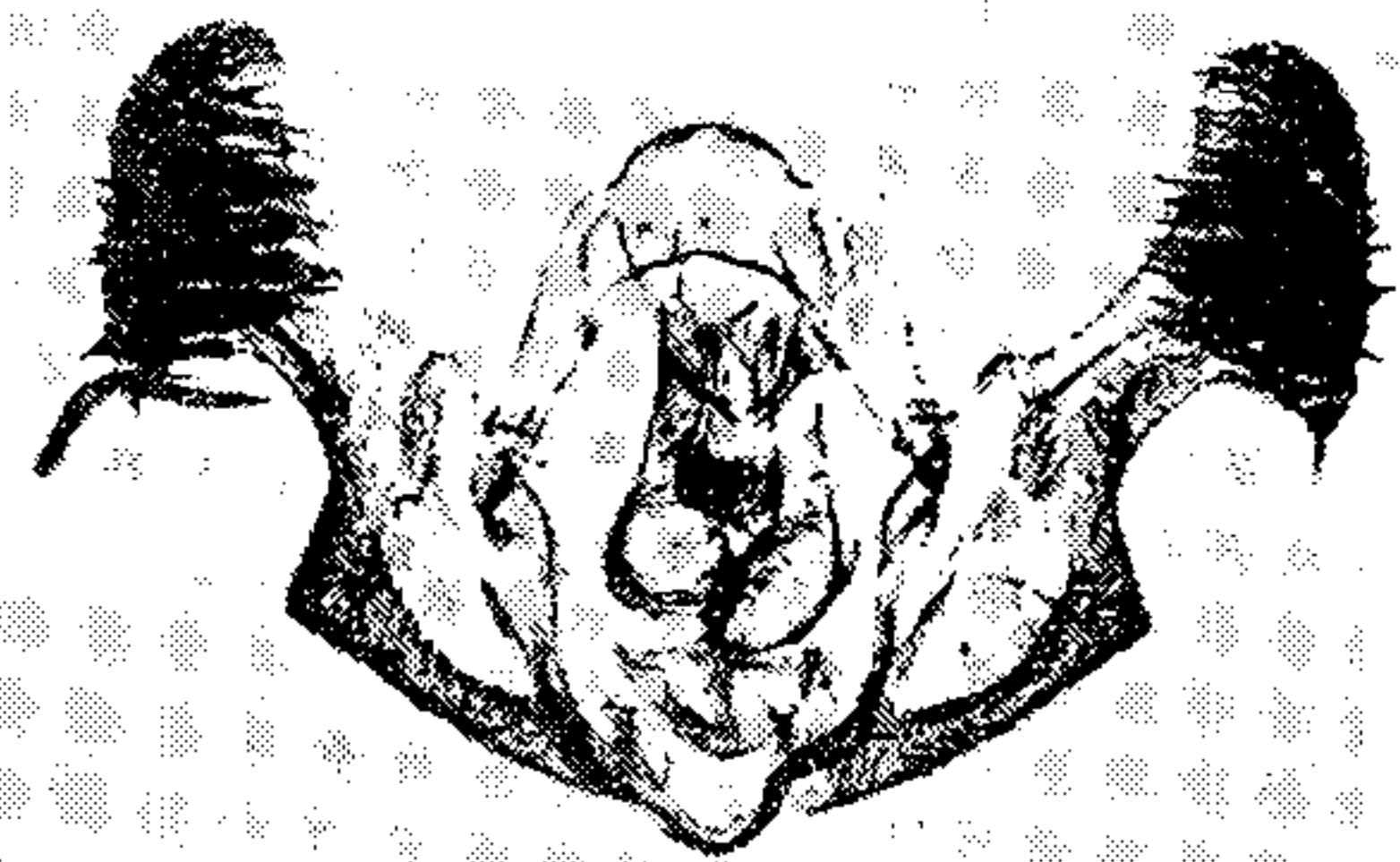

148 *circulana*

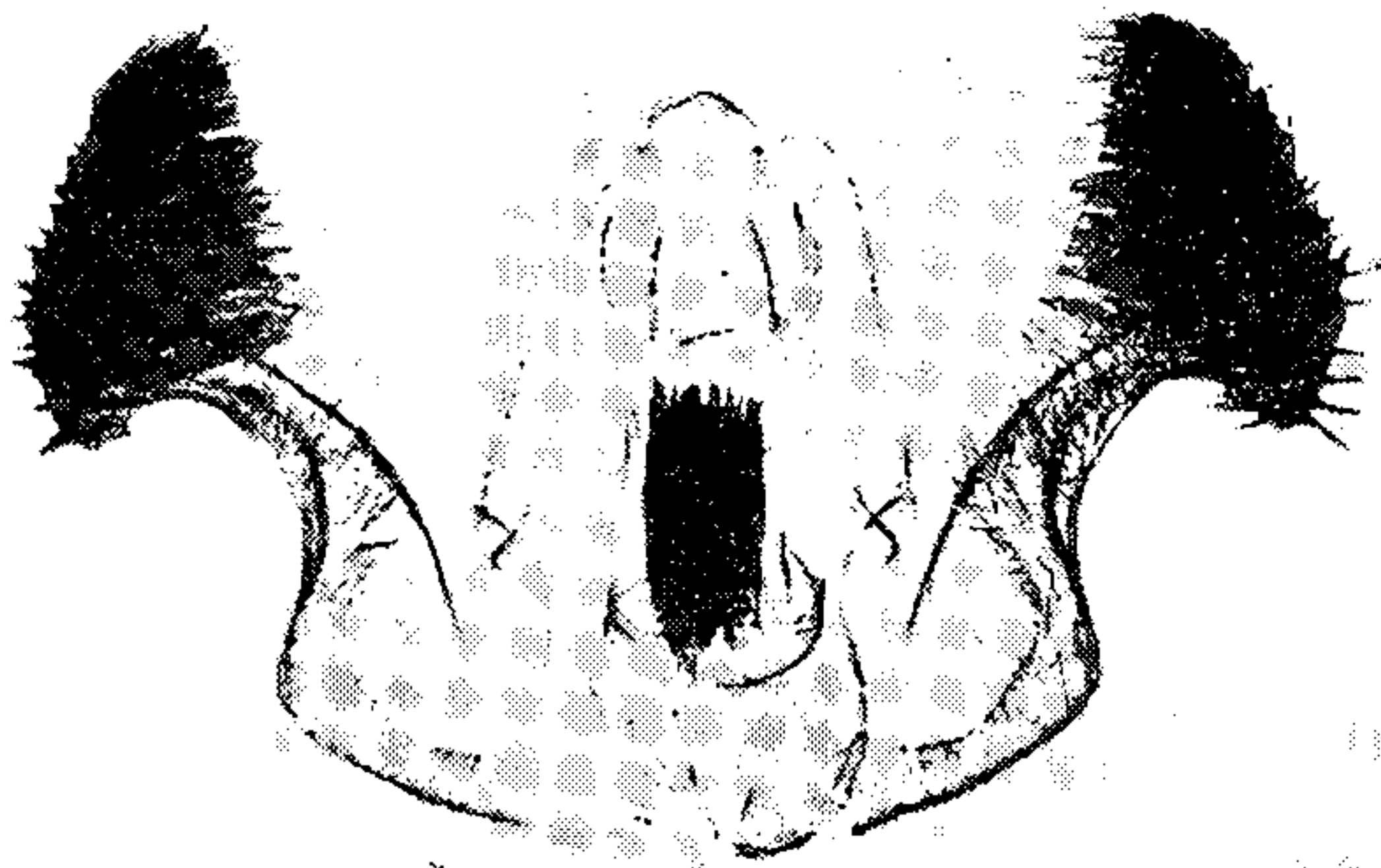

145 *bilineana*

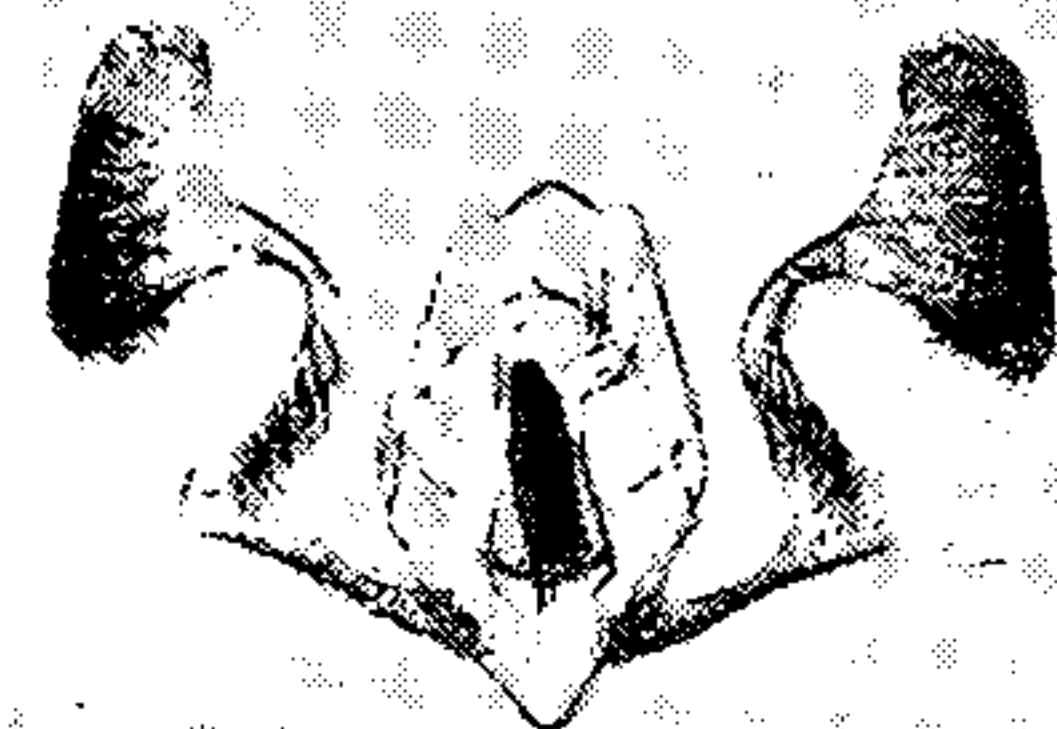

149 *gomonana*

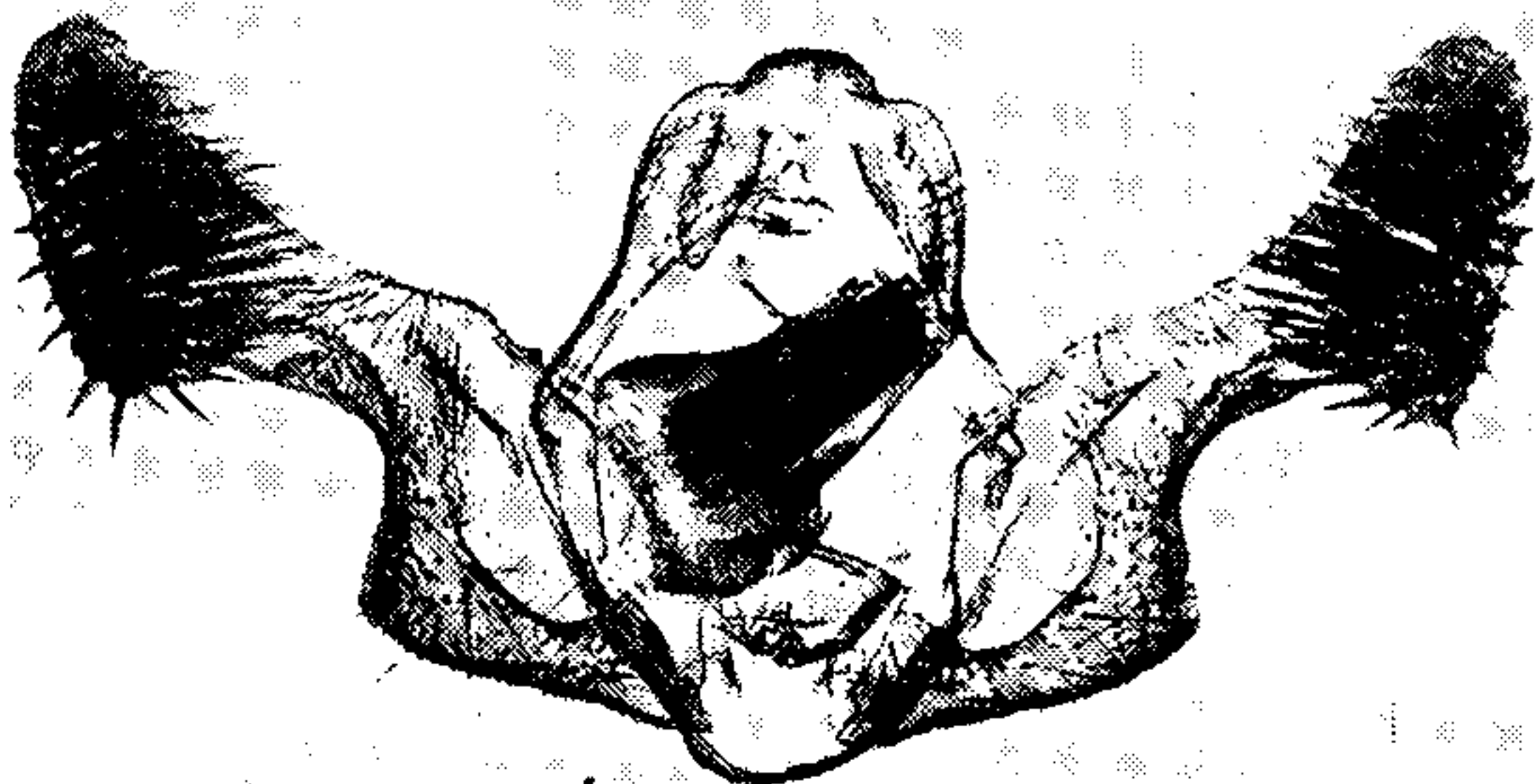

146 *glomerana*

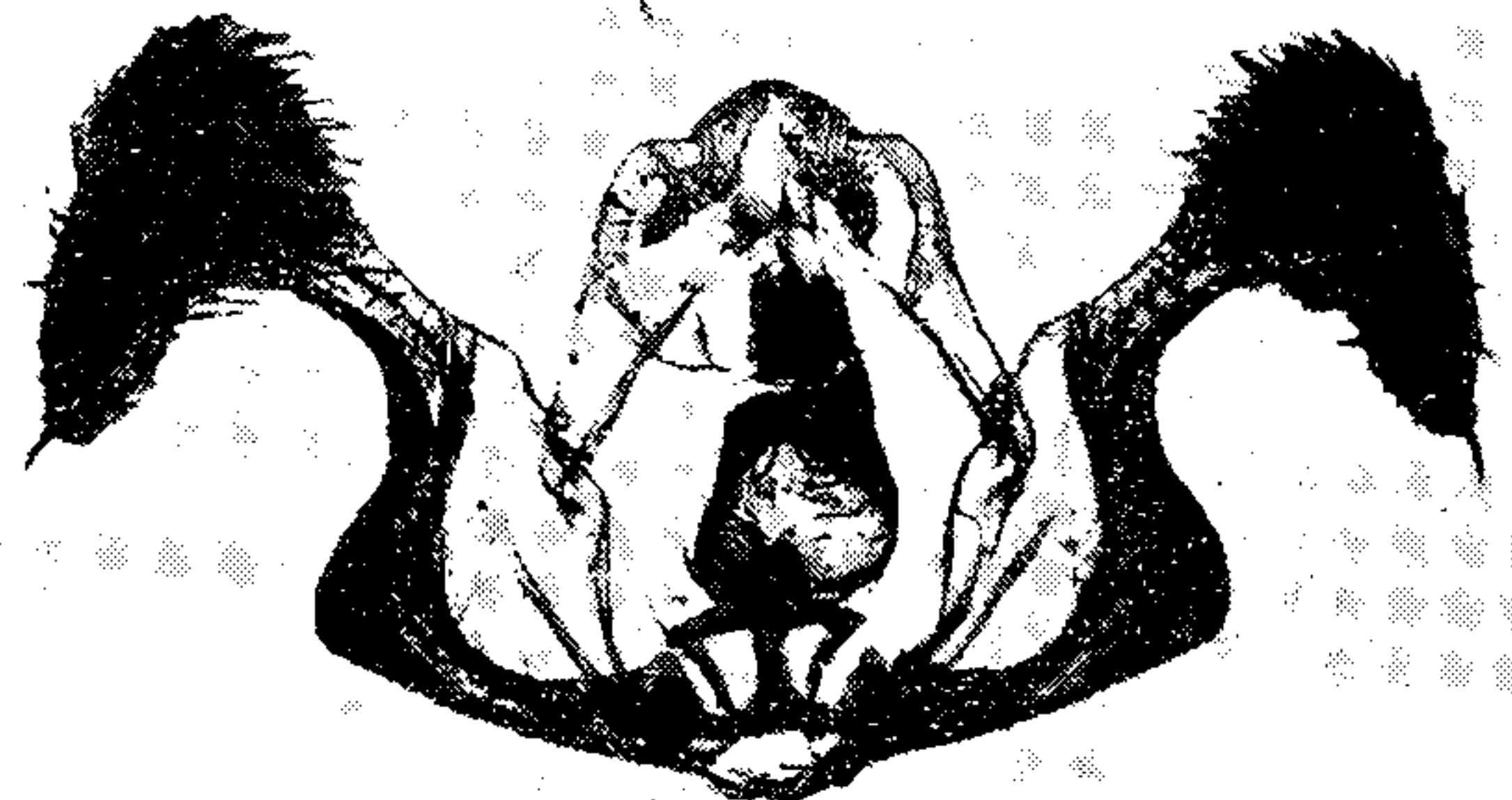

150 *gemellana*



147 *floridana*



151 *sombreana*

MALE GENITALIA OF EUCOSMA.

FOR EXPLANATION OF PLATE SEE PAGE 278

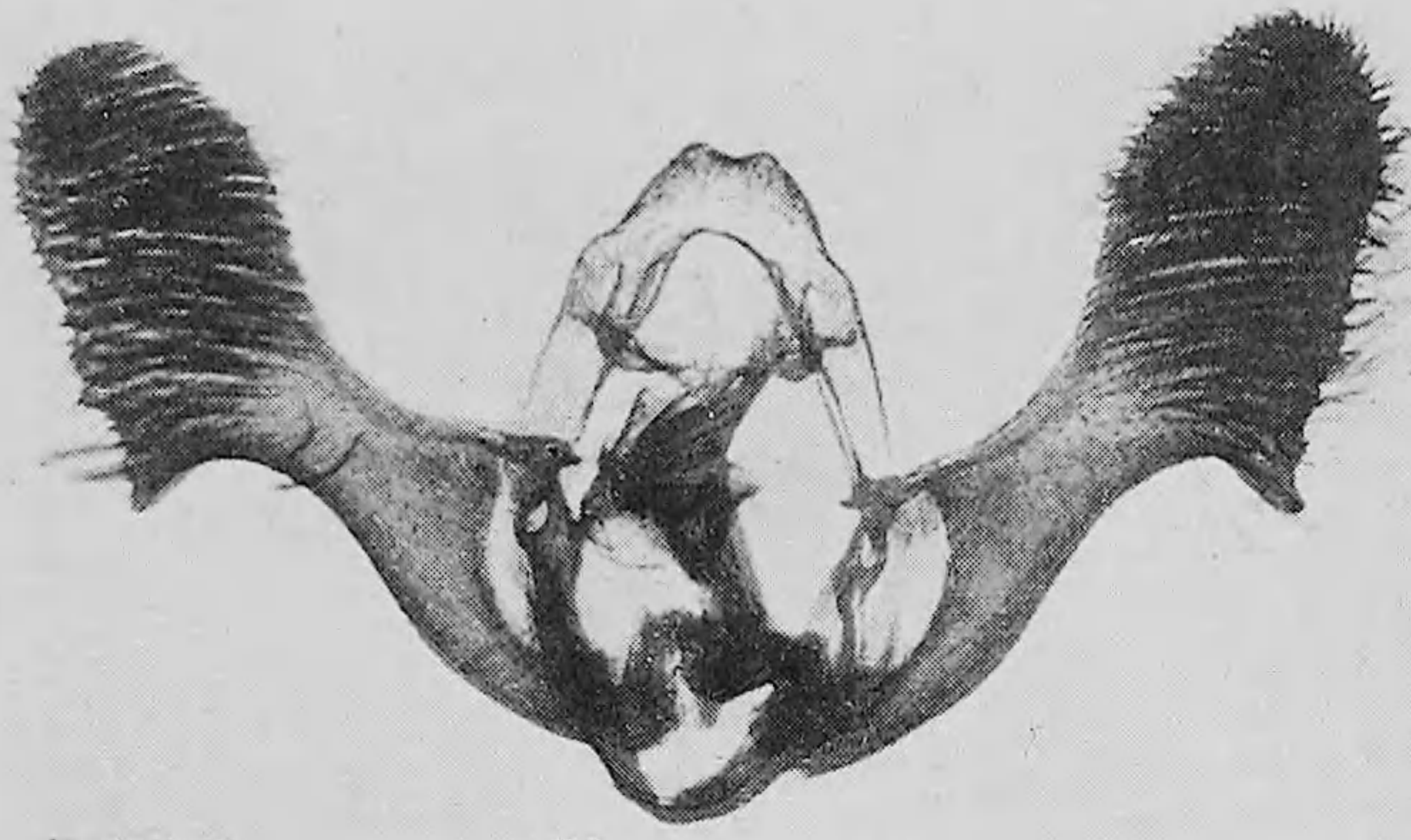

152 *fiskeana*



157 *conspiciendana*

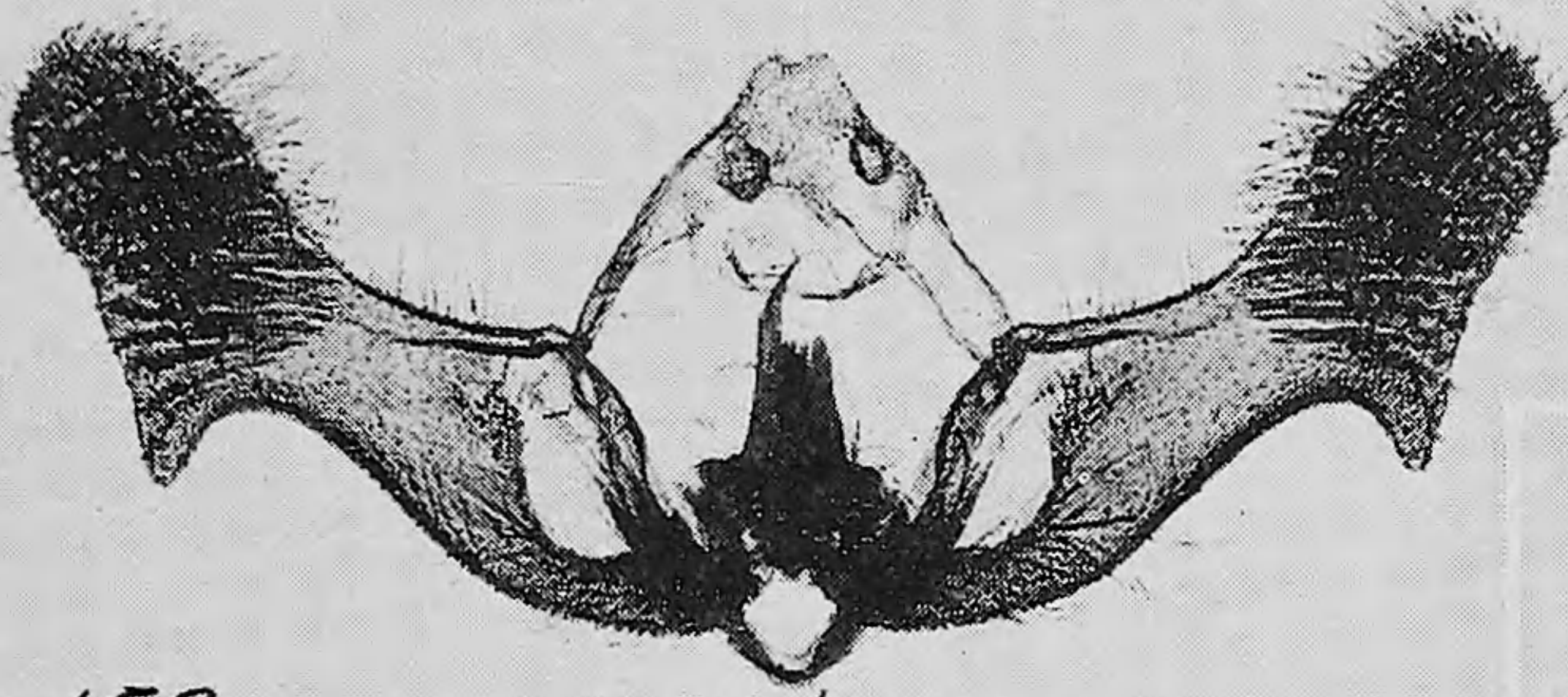

153 *pandana*



158 *excusabilis*

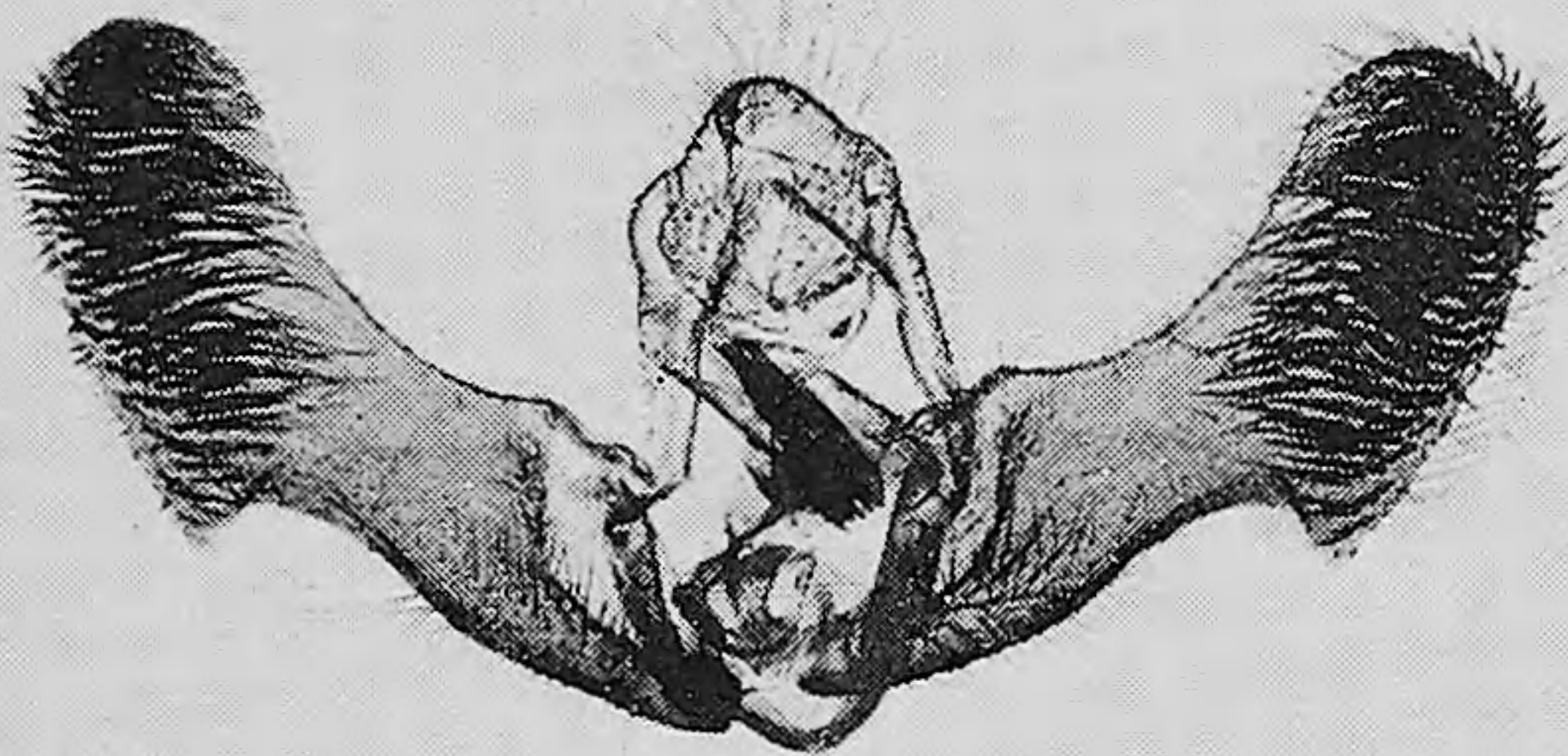

154 *grotiana*

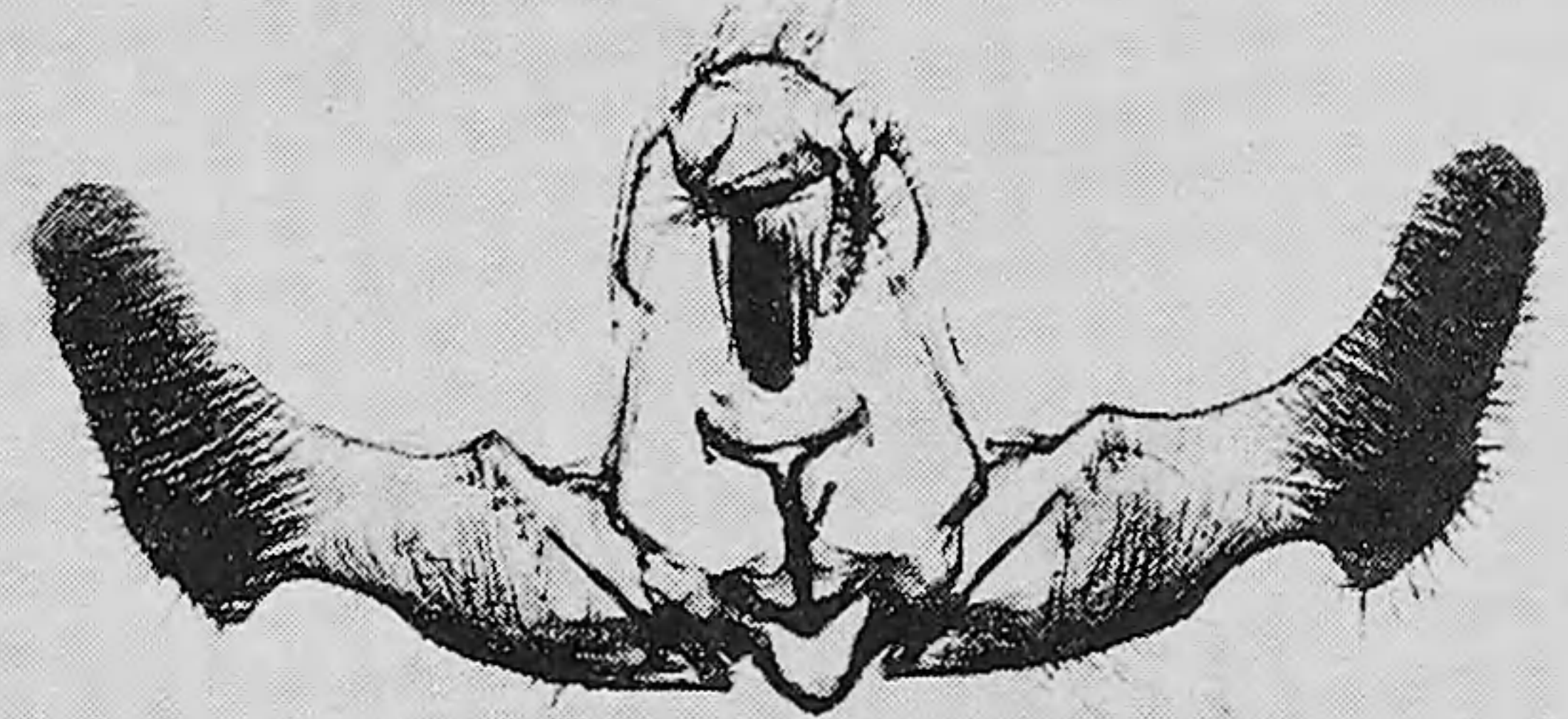

159 *eumaea*

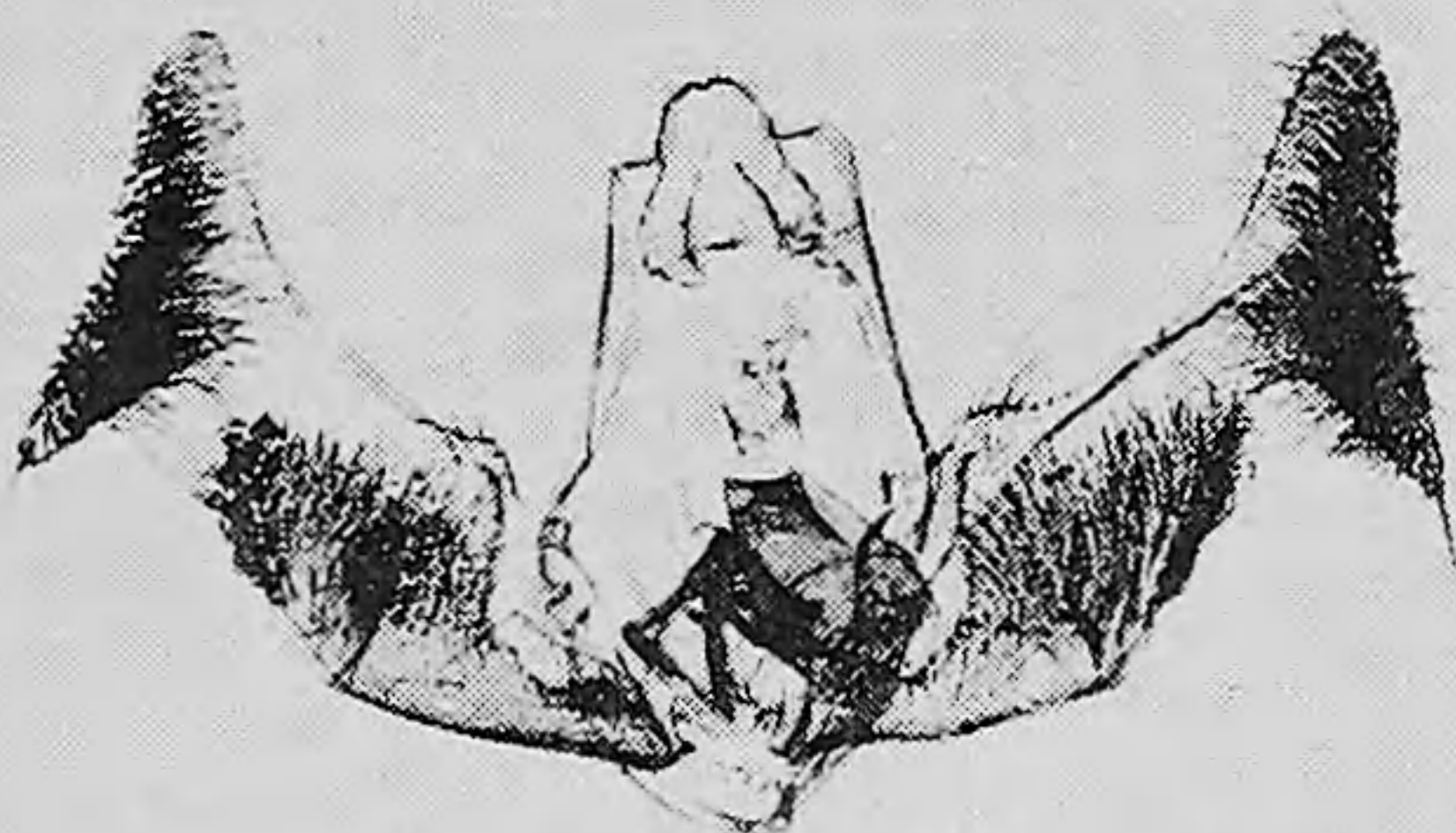

155 *juncticiliana*

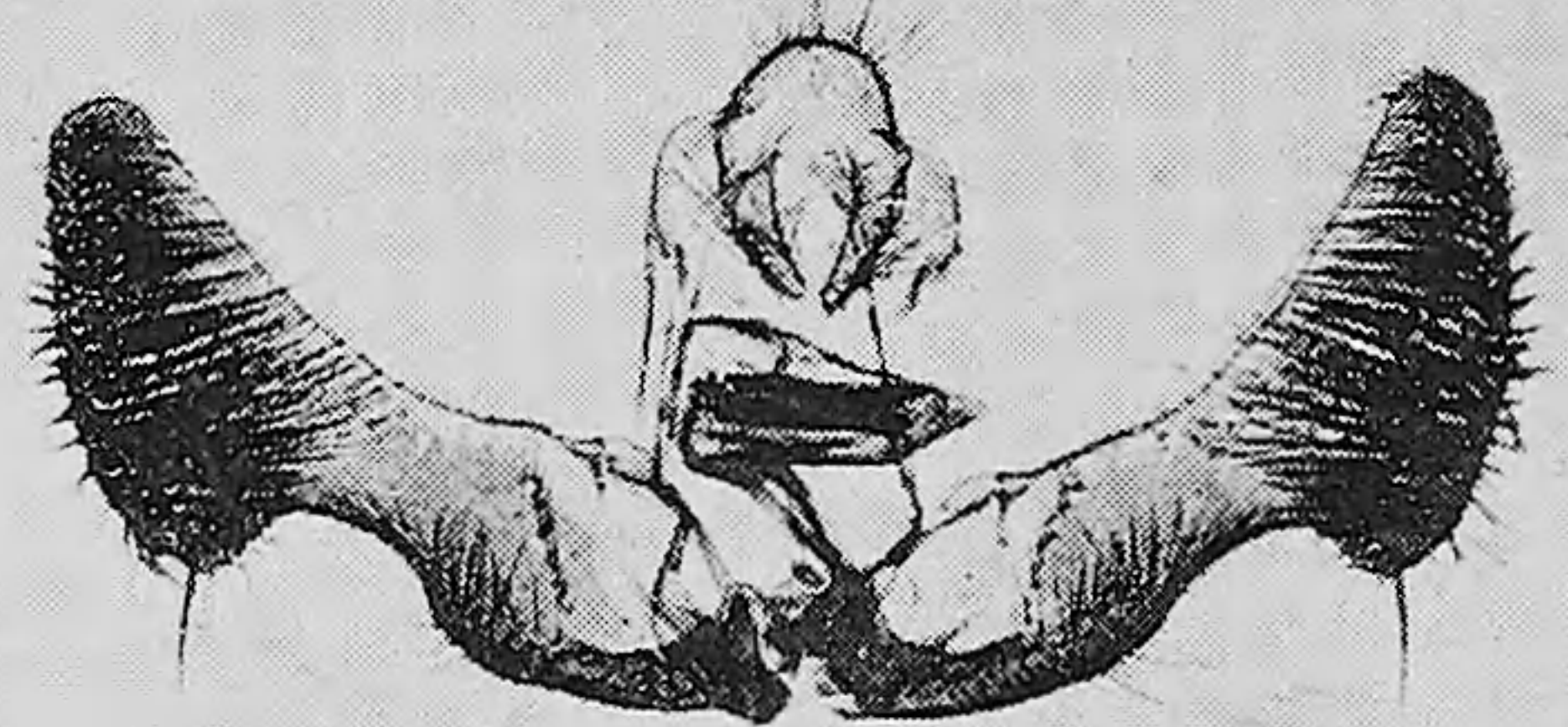

160 *excluseriana*



156 *cataclystiana*

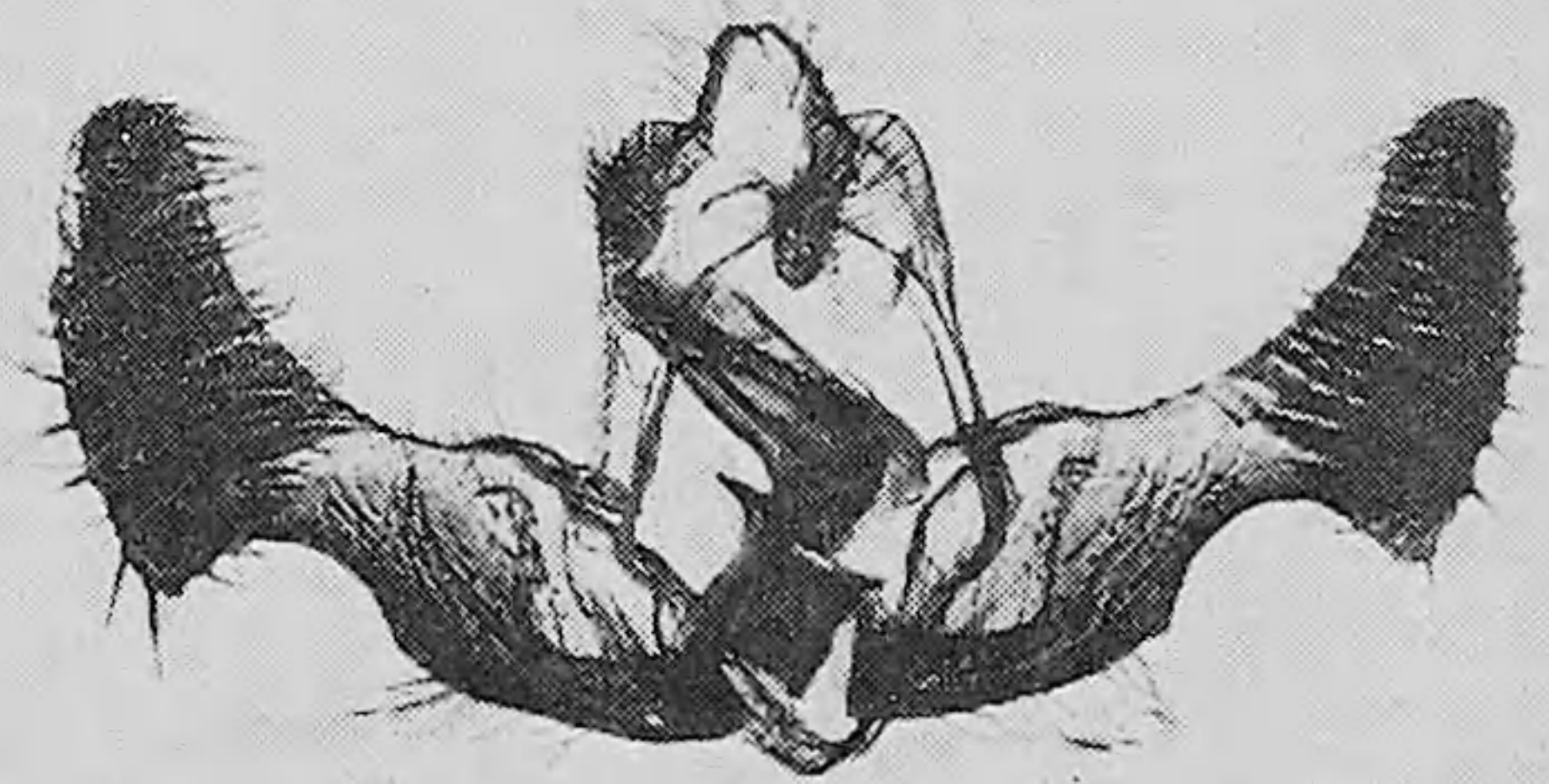

161 *fraudabilis*

MALE GENITALIA OF EUCOSMA.

FOR EXPLANATION OF PLATE SEE PAGE 278

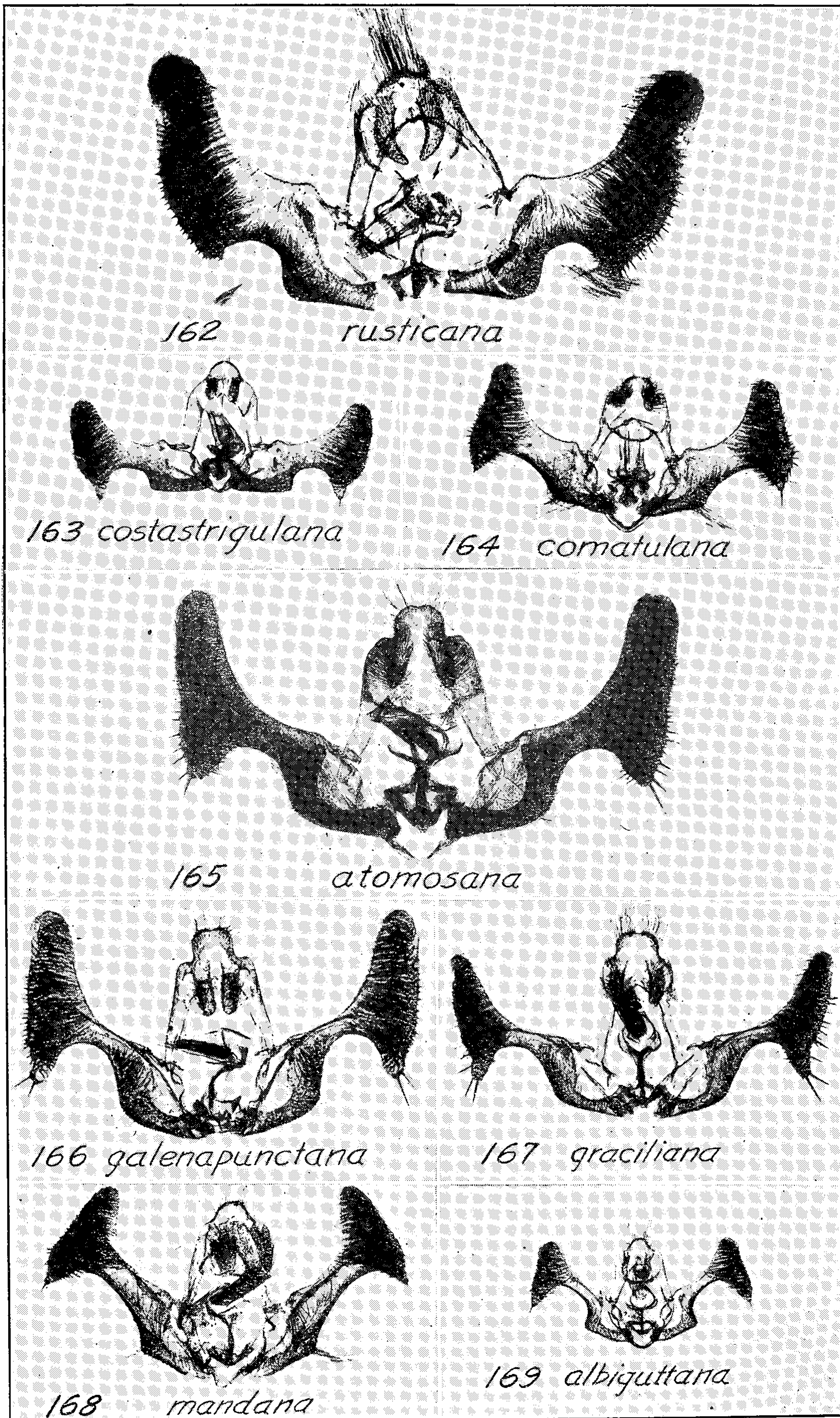

MALE GENITALIA OF EUCOSMA.

FOR EXPLANATION OF PLATE SEE PAGE 279



THIS PAGE IS LOCKED TO FREE MEMBERS

Purchase full membership to immediately unlock this page



HISTORY

Tens of thousands of important historical sources, many previously unobtainable, are now available for the first time with a Forgotten Books Full Membership.

Unlimited Access
\$8.99/month

Continue

*Fair usage policy applies

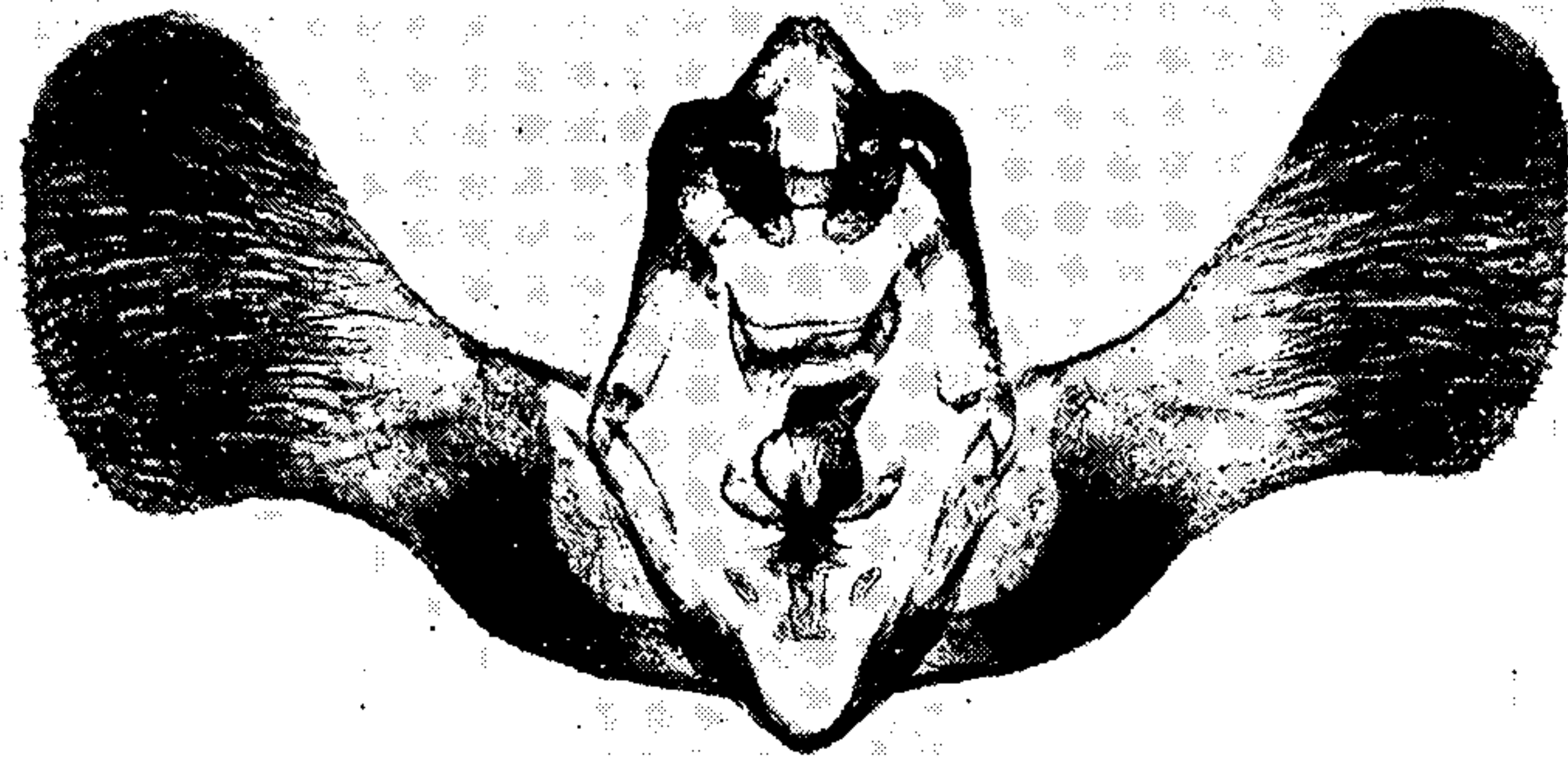

177 *dodana*

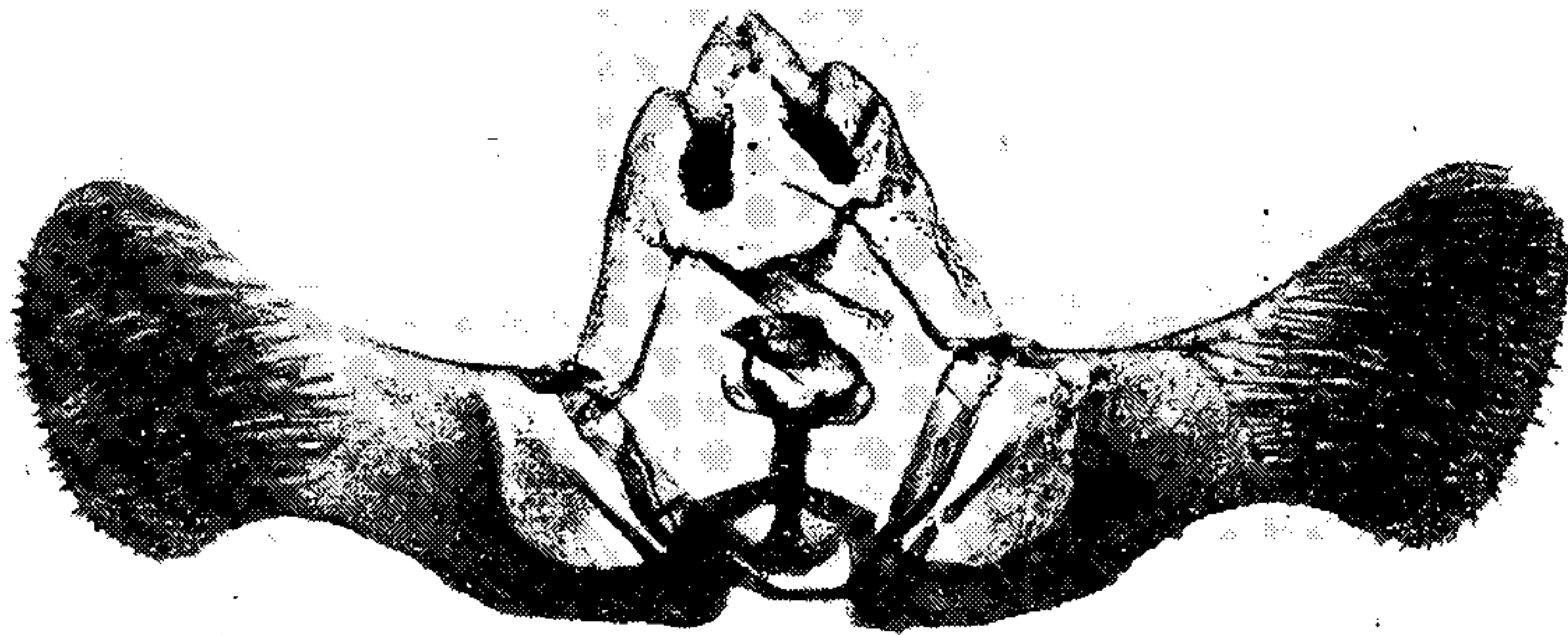

178 *fofana*

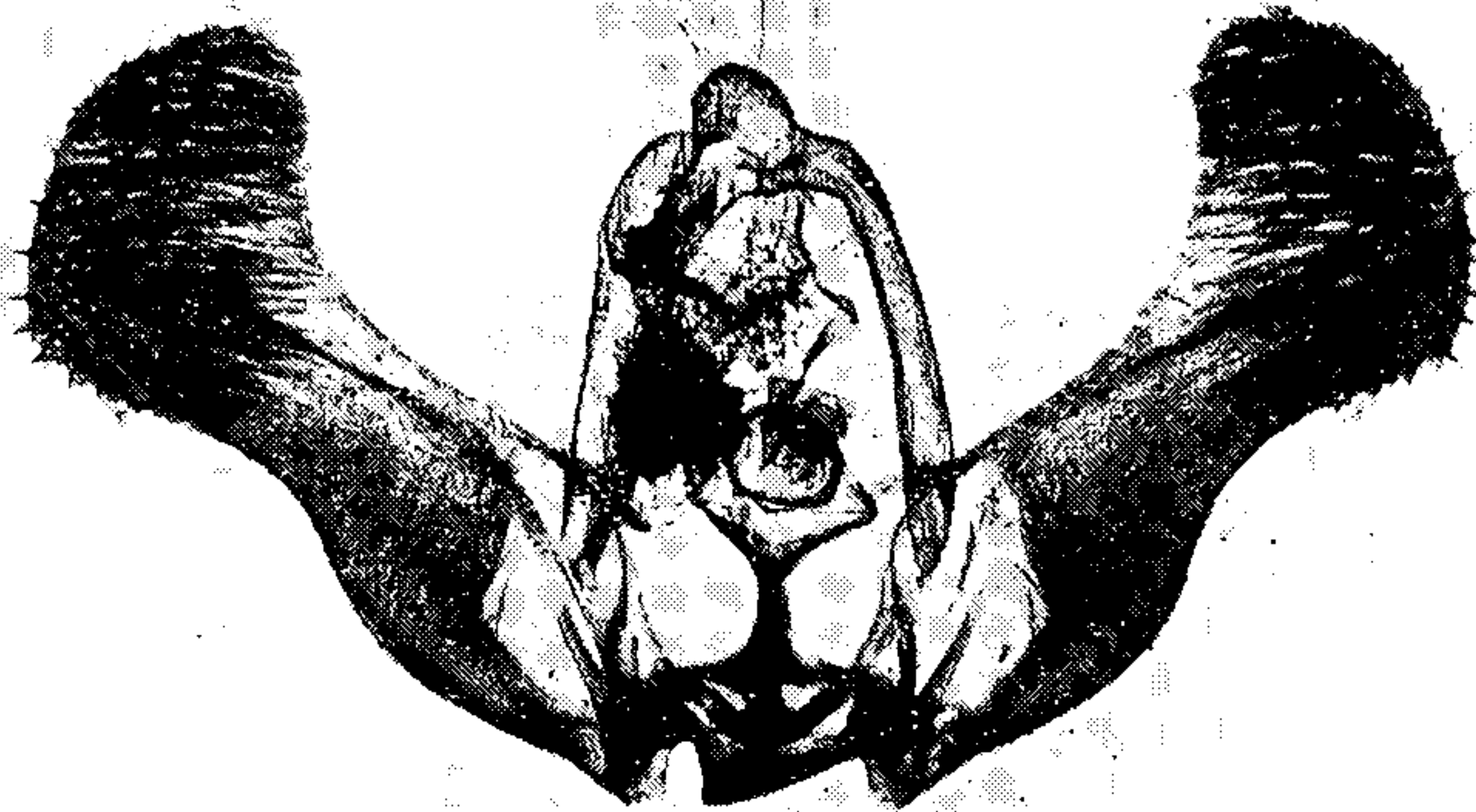

179 *immaculana*

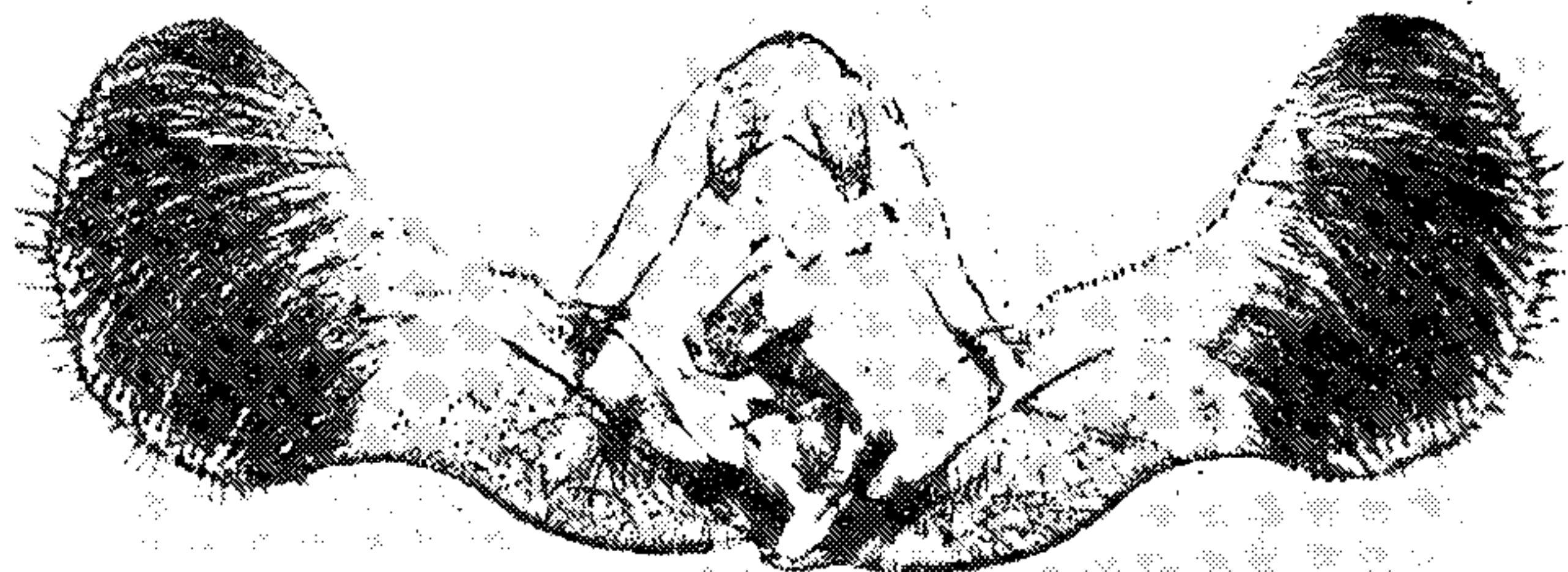

180 *dorsisignatana*

MALE GENITALIA OF EUCOSMA.

FOR EXPLANATION OF PLATE SEE PAGE 279

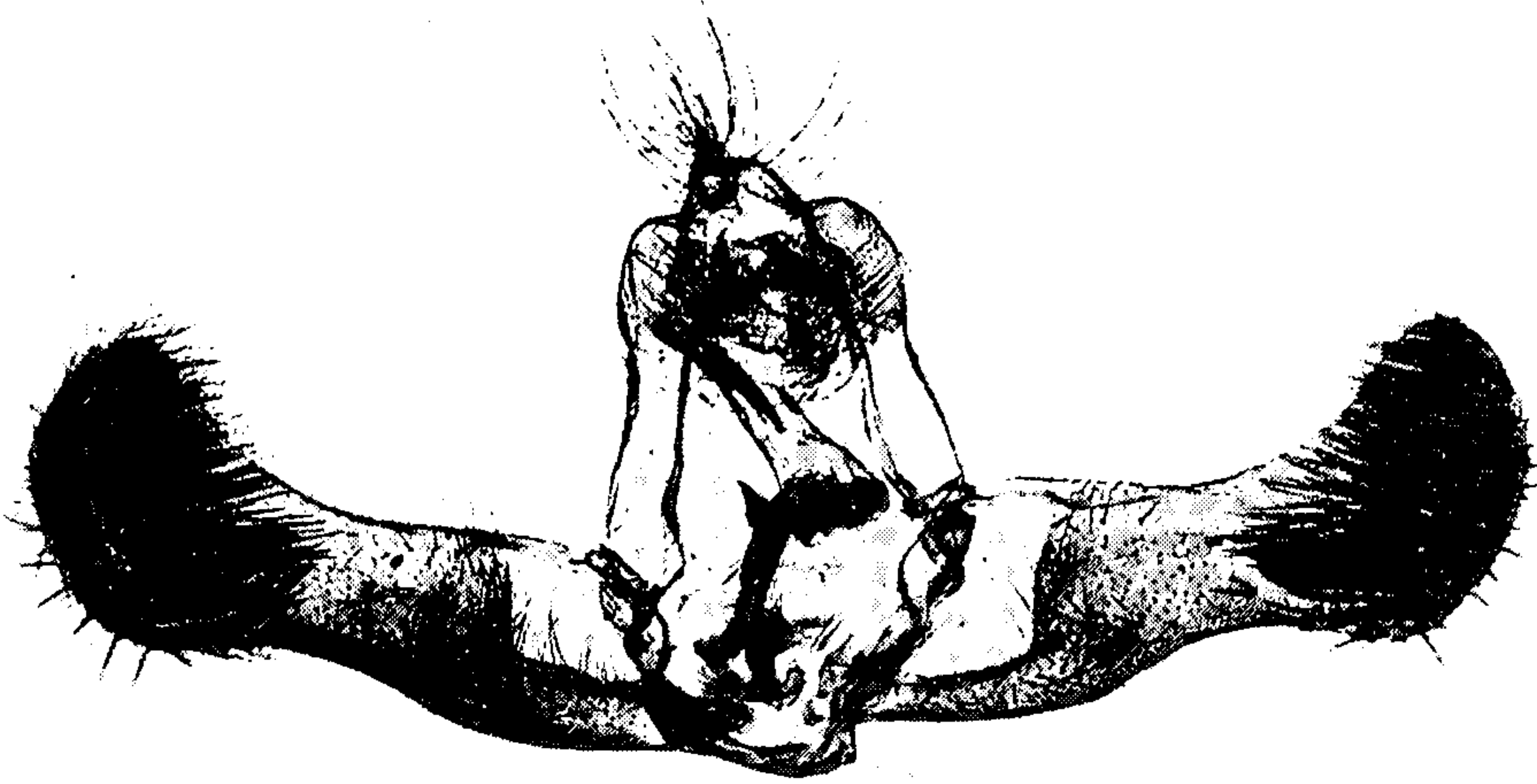

181

sandiego

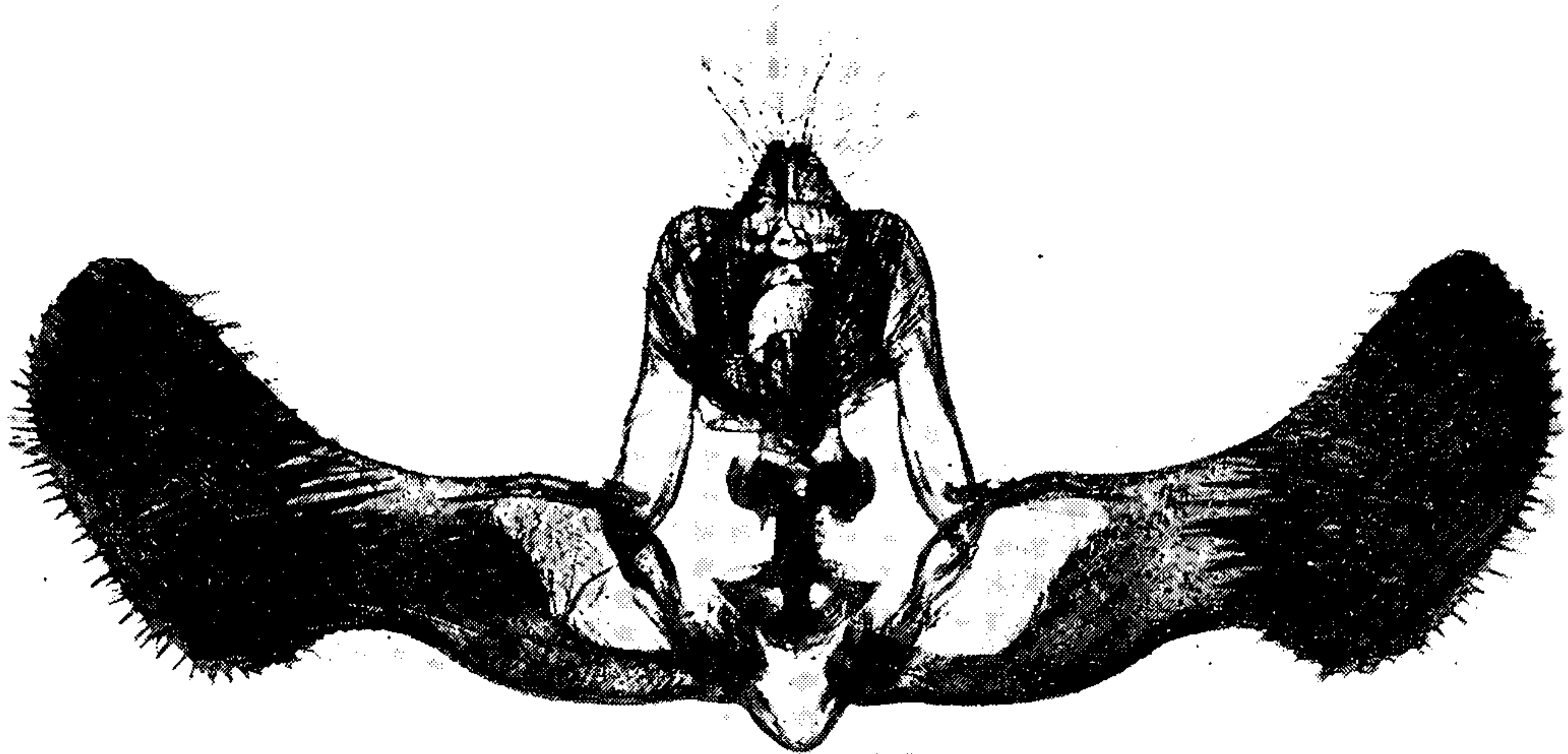

182

canariana

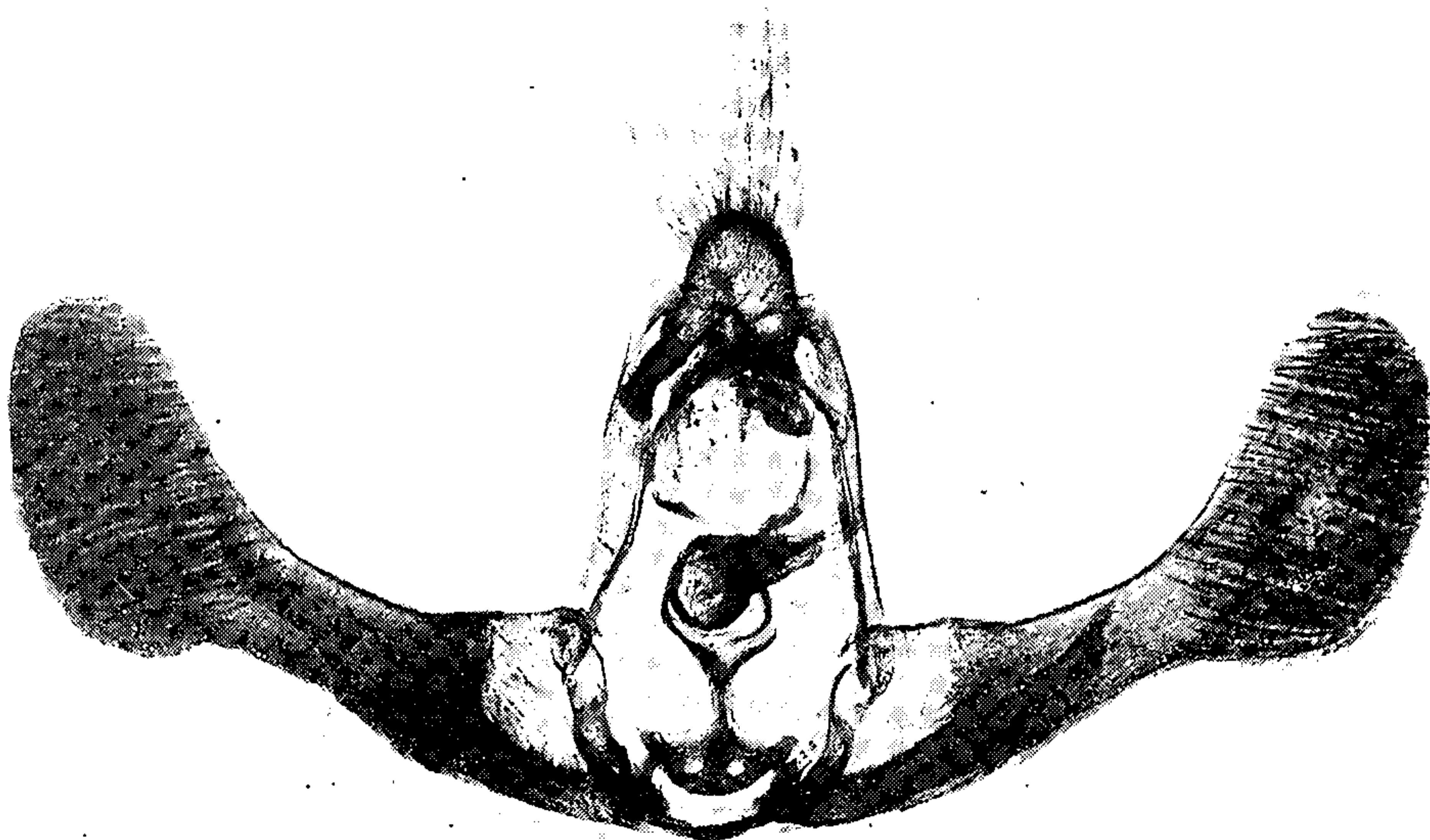

183

denverana

MALE GENITALIA OF EUCOSMA.

FOR EXPLANATION OF PLATE SEE PAGE 279

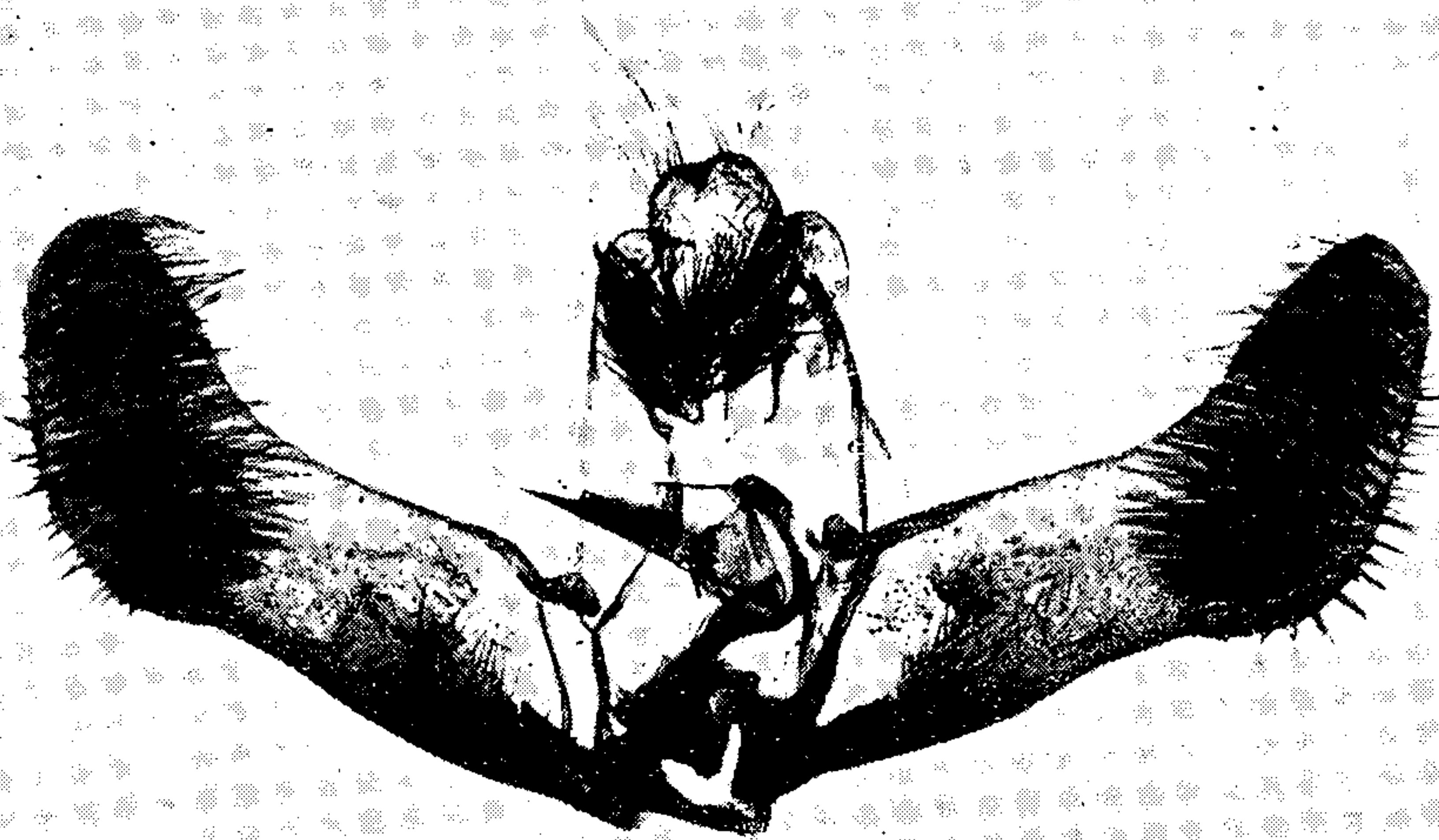

184 *spaldingana*

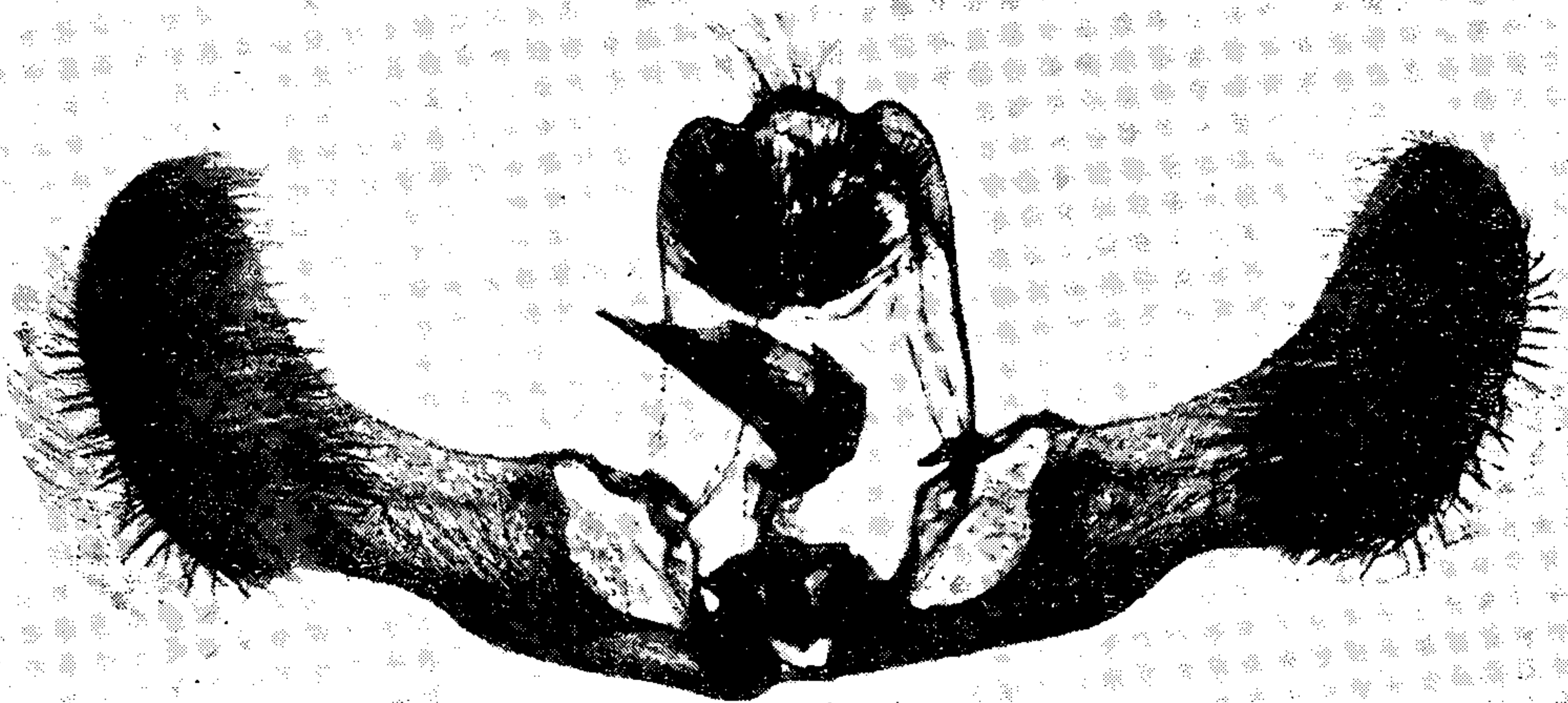

185 *caniceps*

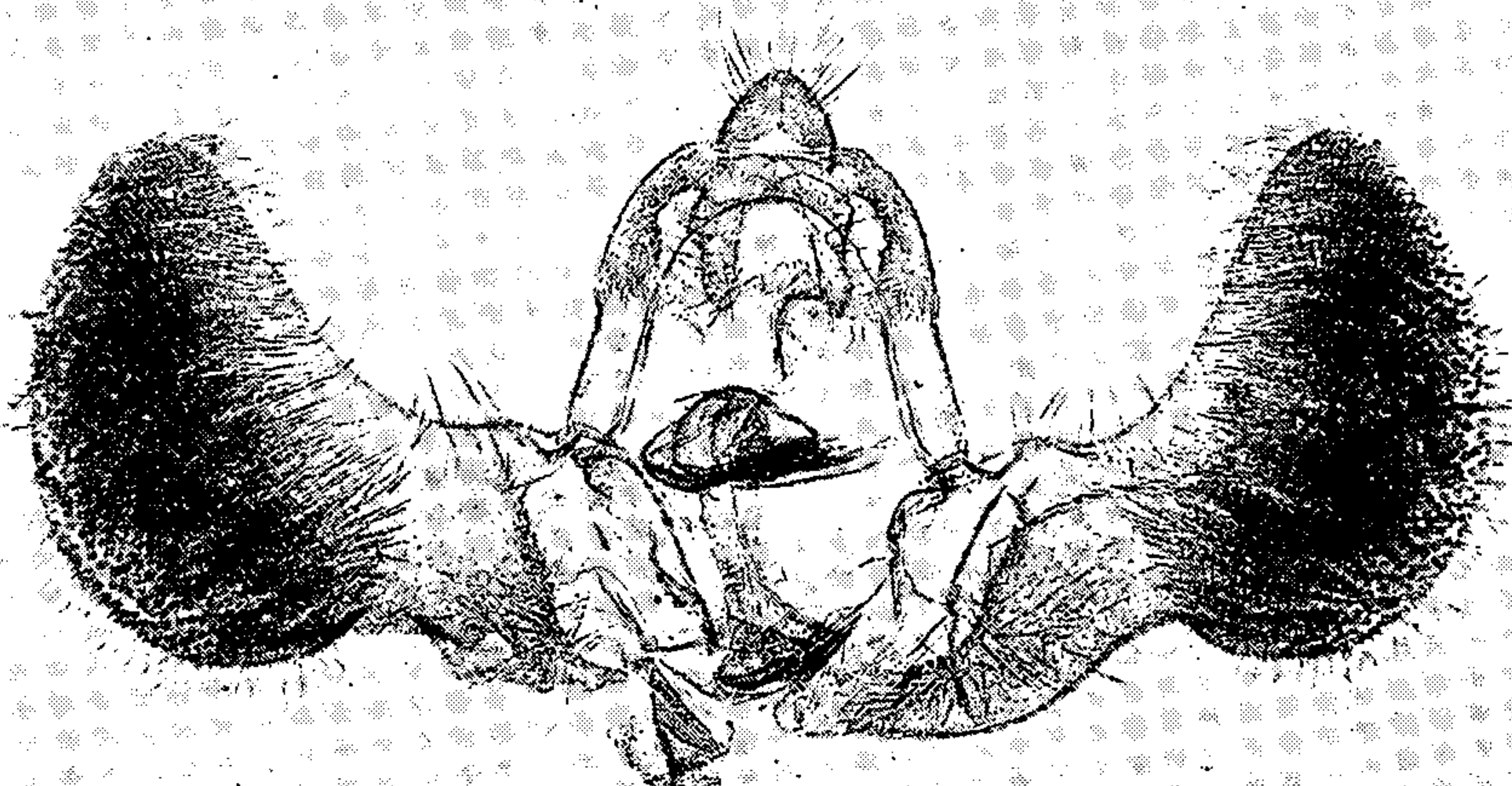

186 *subflavana*

MALE GENITALIA OF EUCOSMA.

FOR EXPLANATION OF PLATE SEE PAGE 279.



THIS PAGE IS LOCKED TO FREE MEMBERS

Purchase full membership to immediately unlock this page



Never be without a book!

Forgotten Books Full Membership gives universal access to 797,885 books from our apps and website, across all your devices: tablet, phone, e-reader, laptop and desktop computer

A library in your pocket for \$8.99/month

Continue

*Fair usage policy applies



191 *grandiflavana*

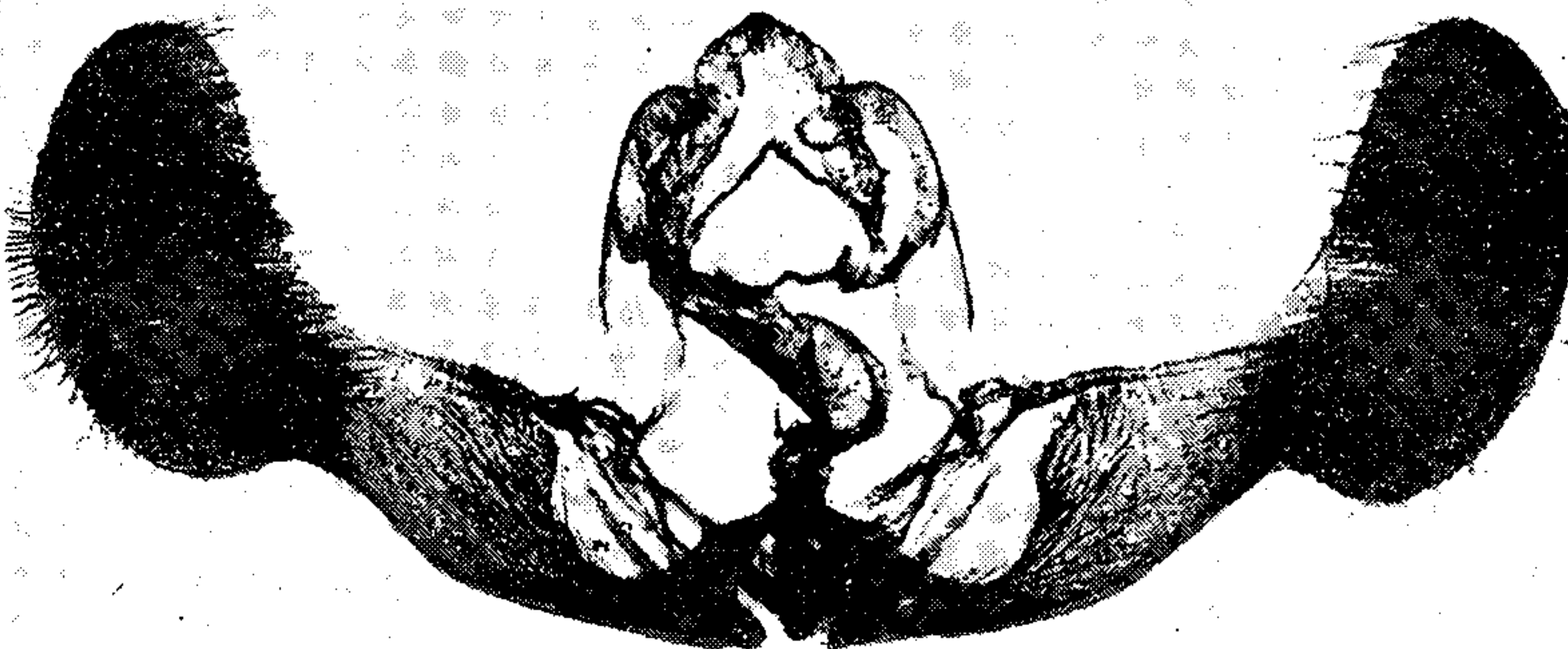

192 *invicta*

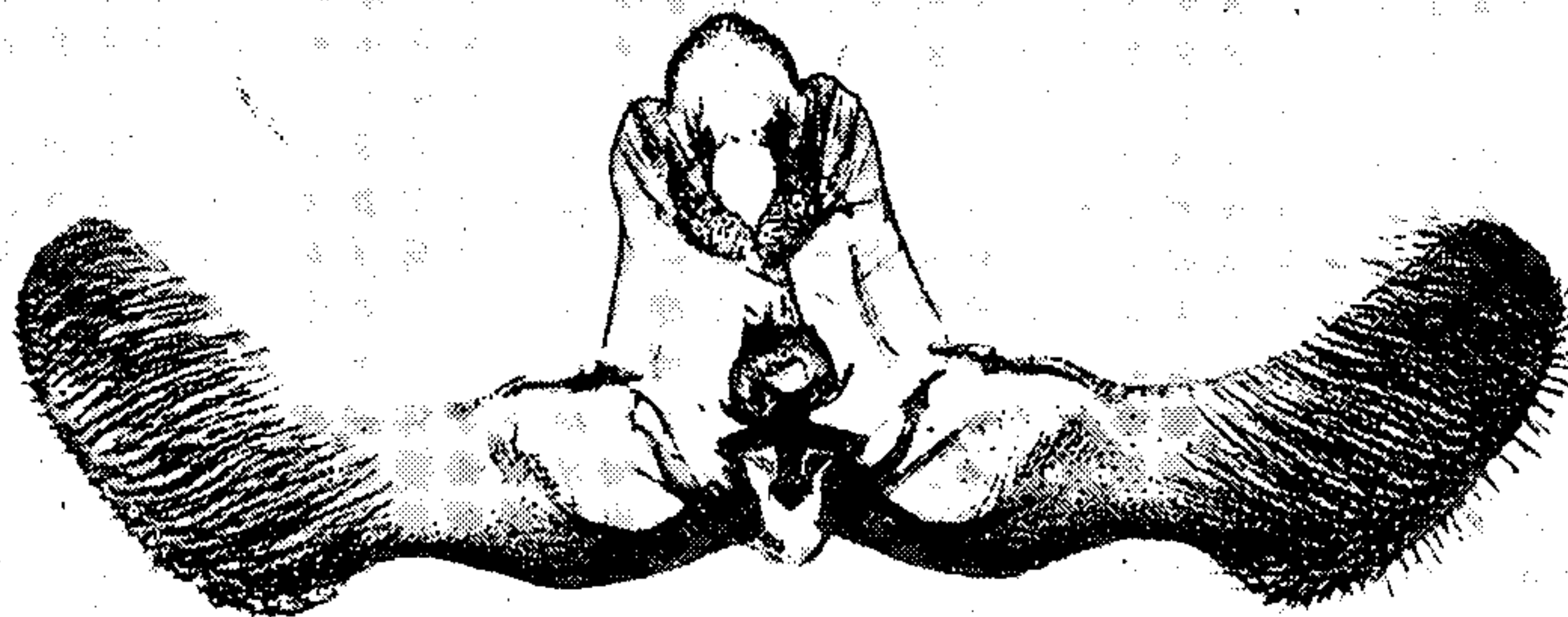

193 *emaciatana*

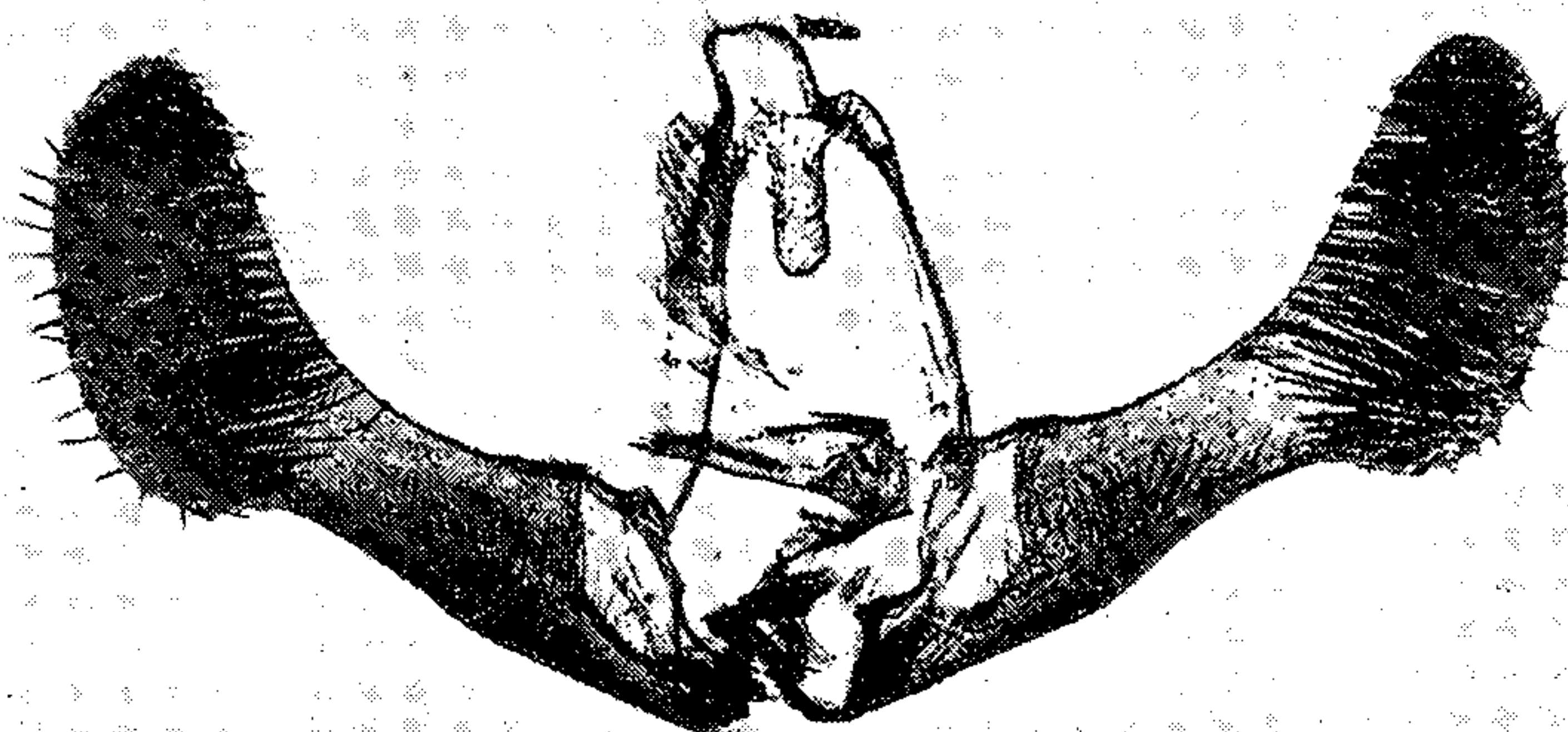

194 *gilletteana*

MALE GENITALIA OF EUCOSMA.

FOR EXPLANATION OF PLATE SEE PAGE 280



195 *snyderana*

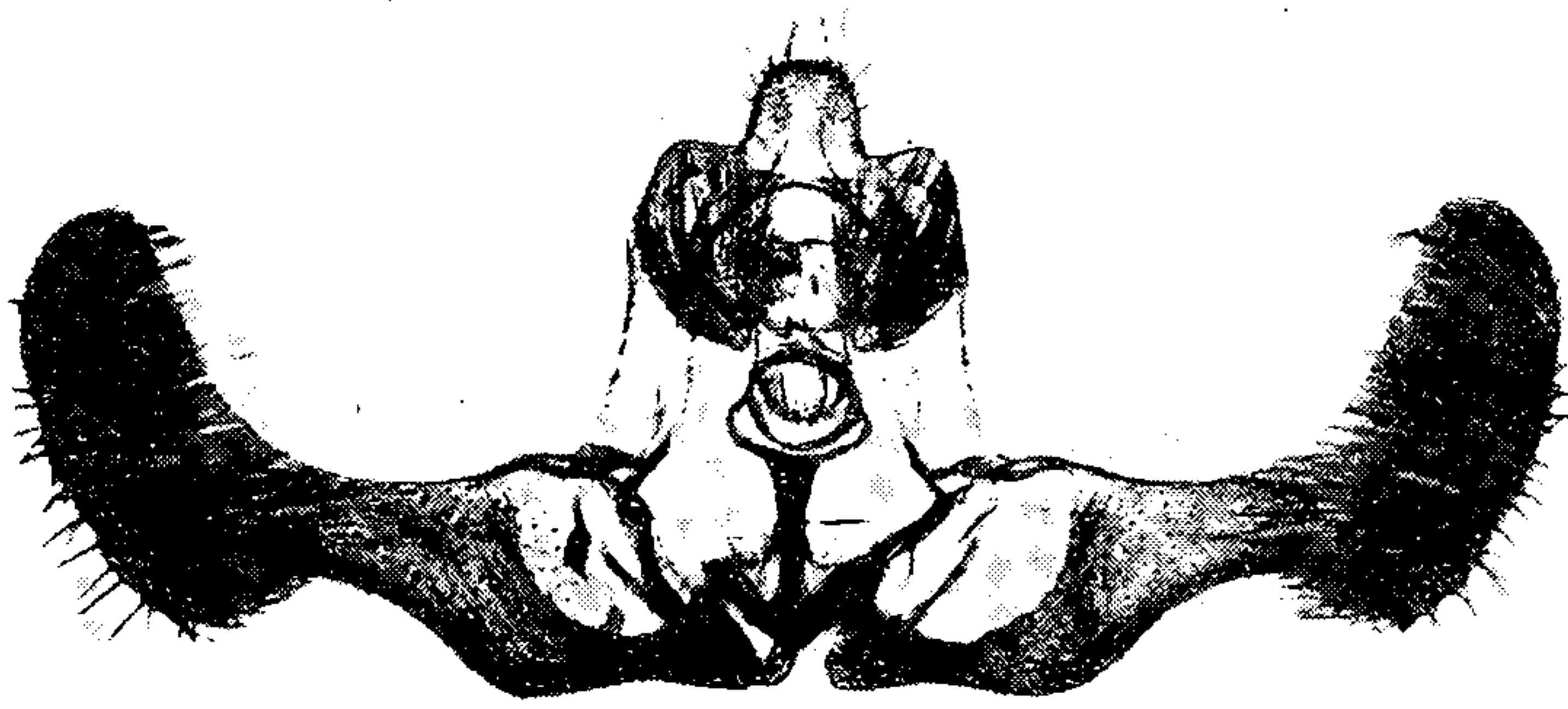

196 *optimana*

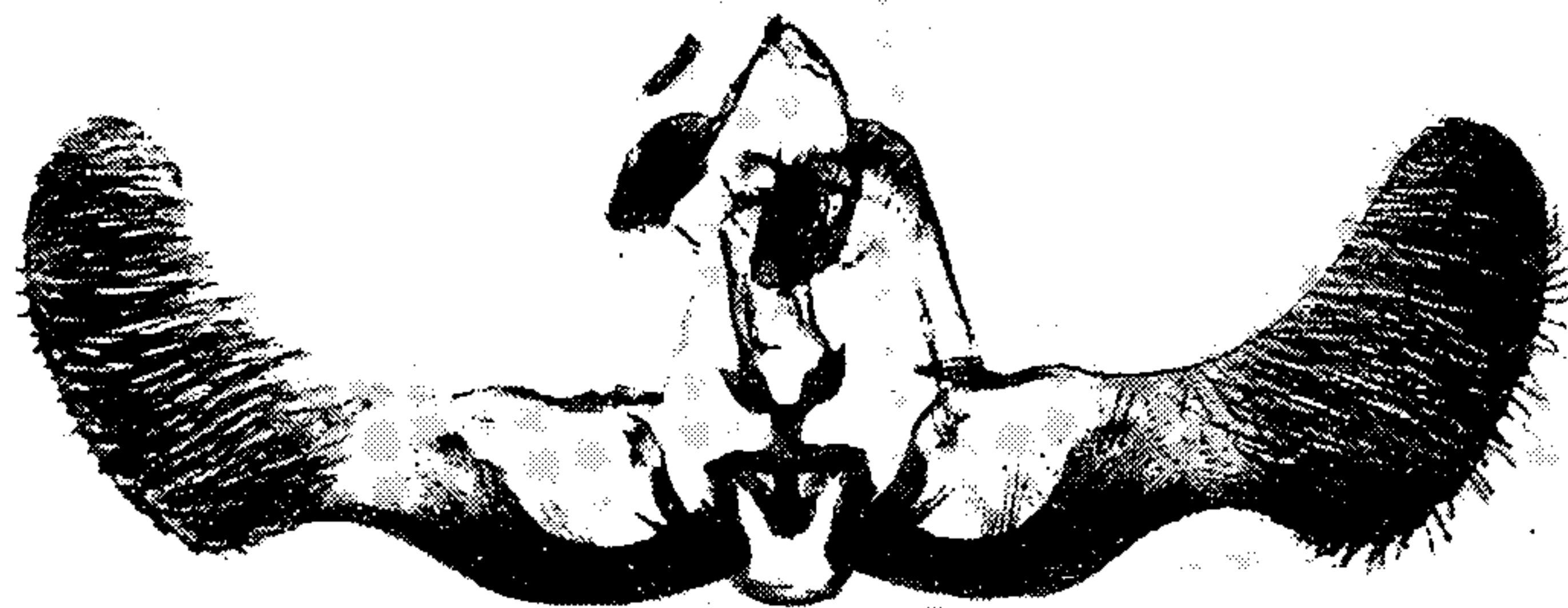

197 *larana*



198 *totana*

MALE GENITALIA OF EUCOSMA.

FOR EXPLANATION OF PLATE SEE PAGE 280.

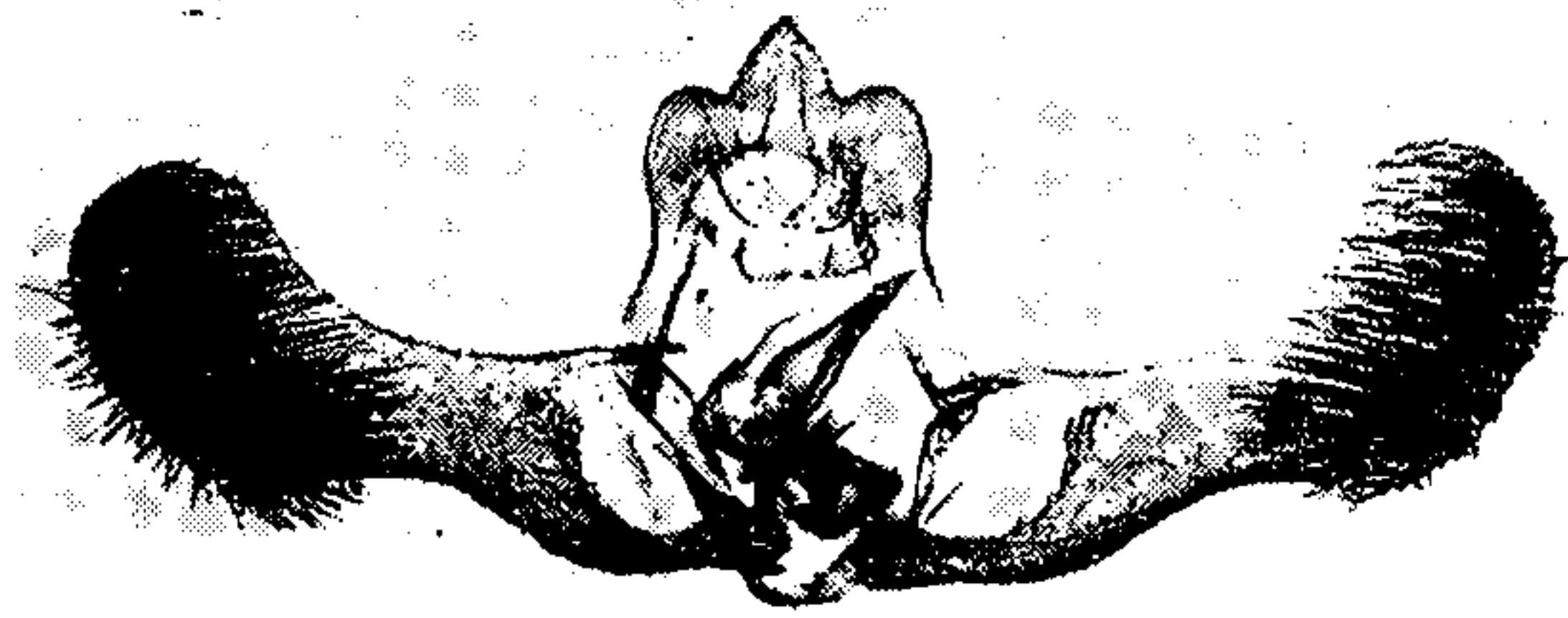

199 *matutina*

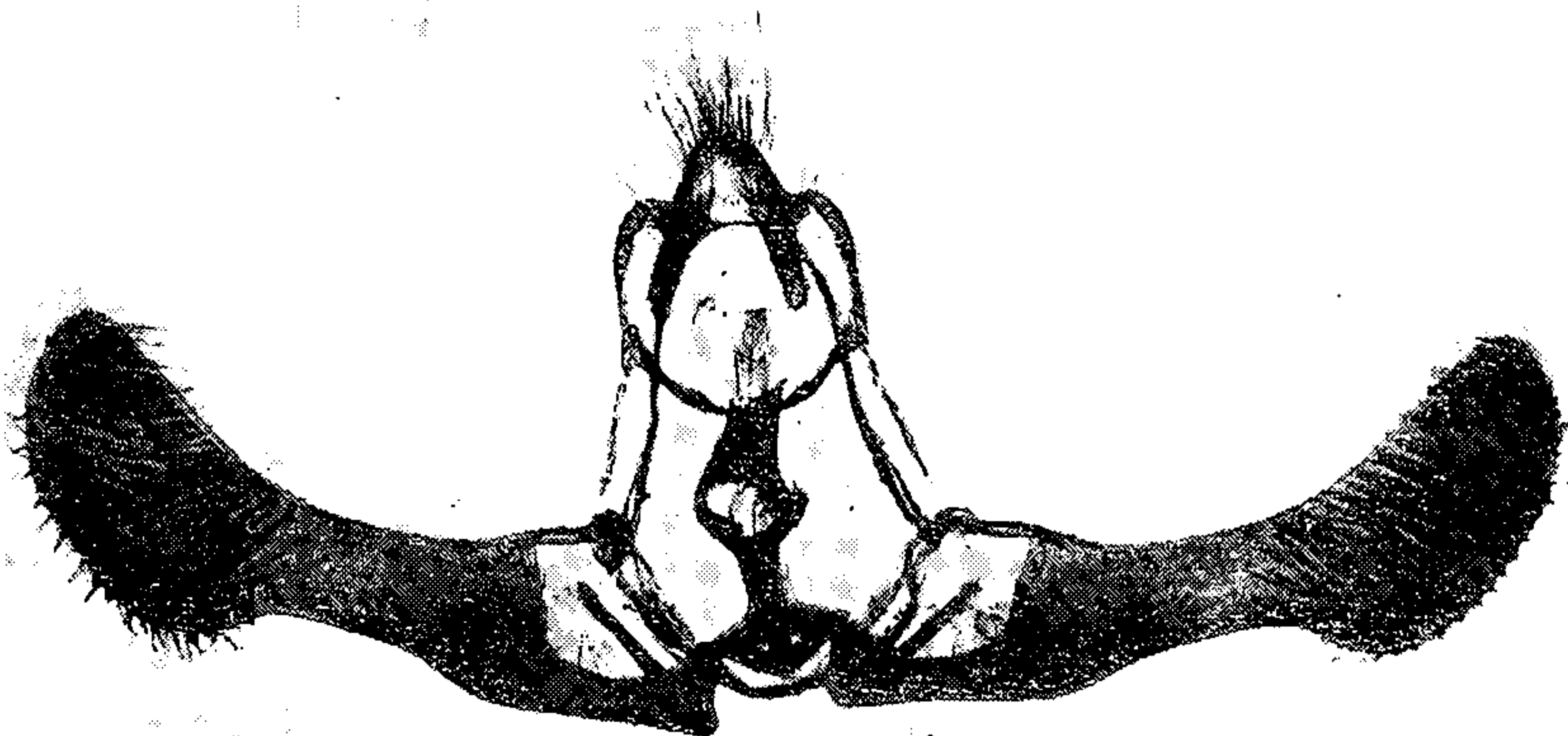

200 *agassizii*

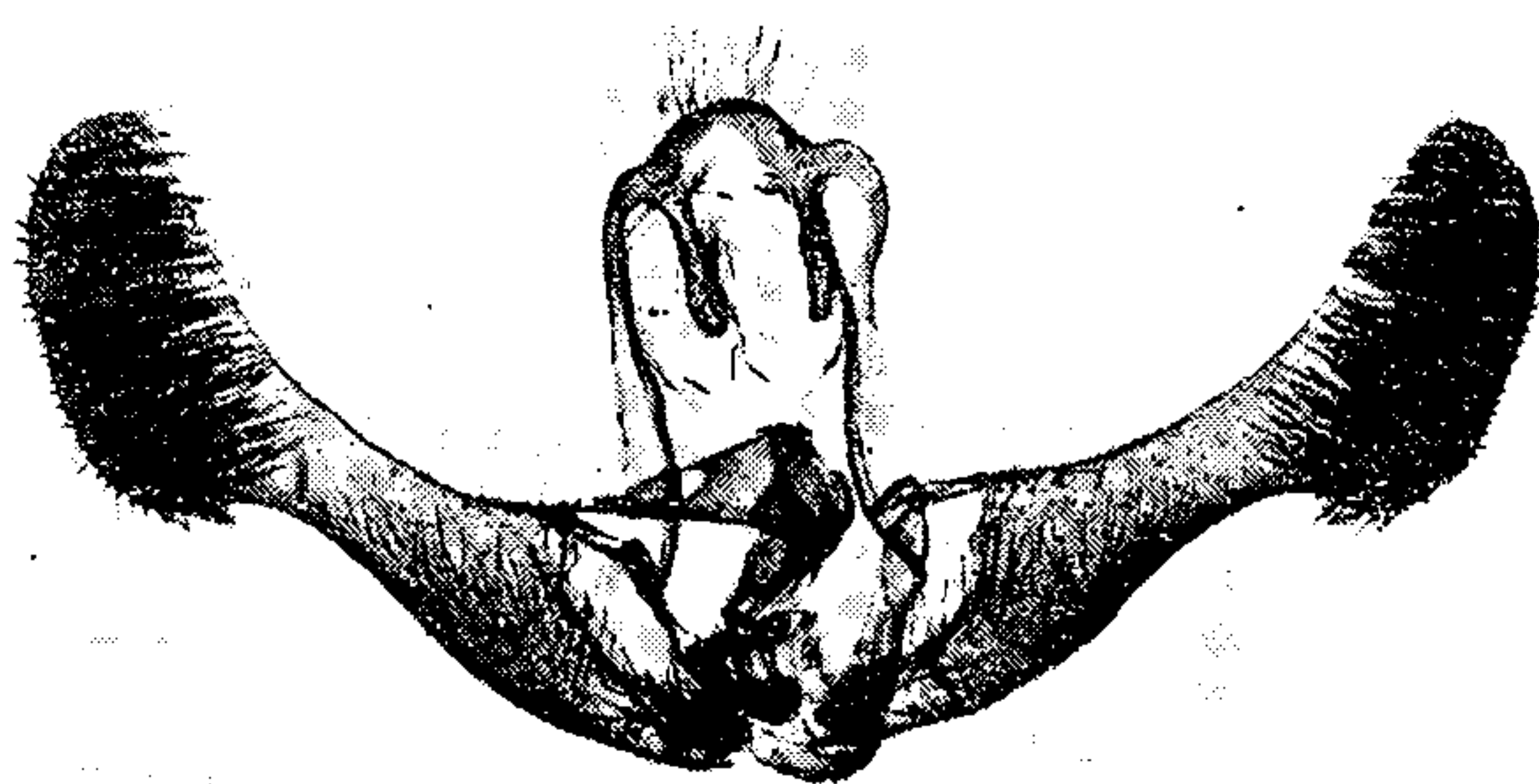

201 *bolanderana*

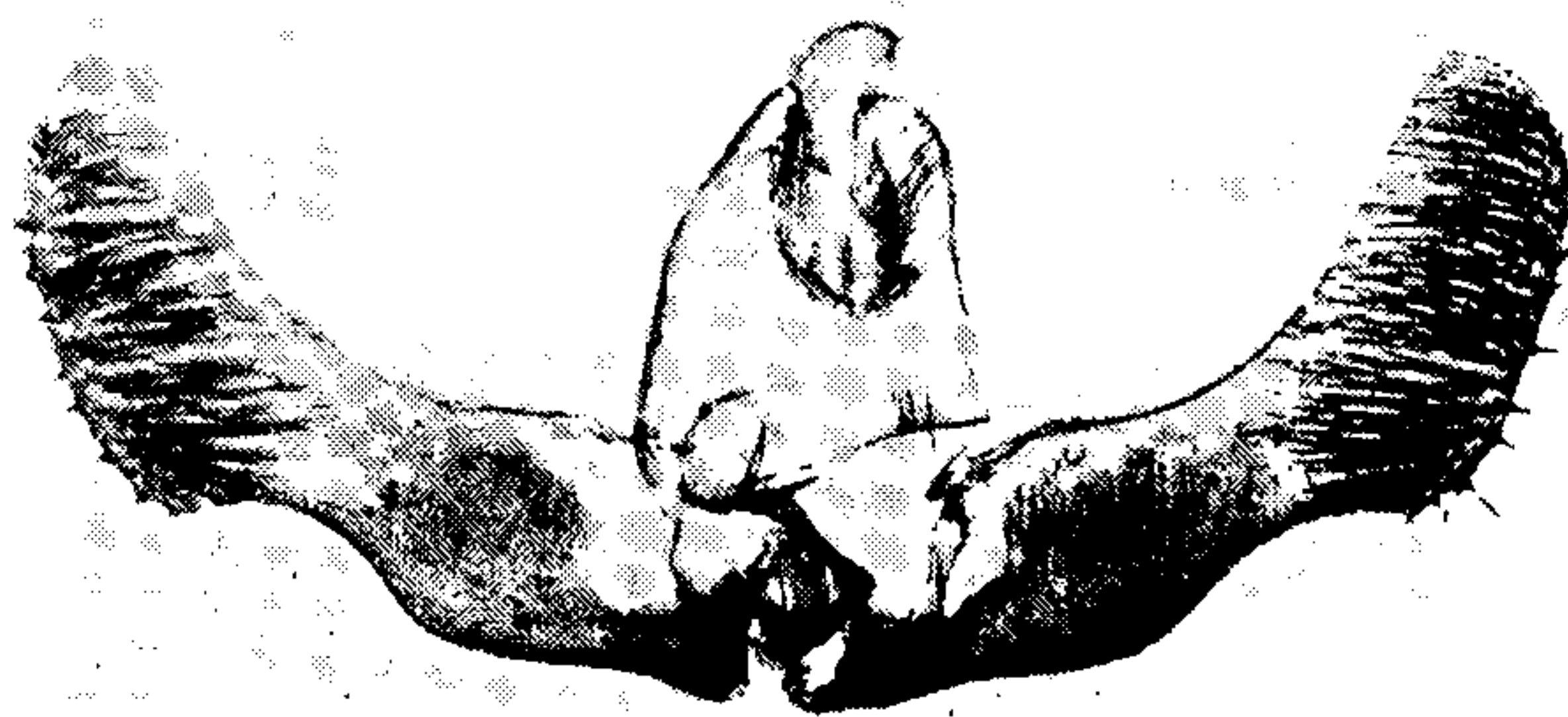

202 *ragonoti*

MALE GENITALIA OF EUCOSMA.

FOR EXPLANATION OF PLATE SEE PAGE 280



THIS PAGE IS LOCKED TO FREE MEMBERS

Purchase full membership to immediately unlock this page



HISTORY

Tens of thousands of important historical sources, many previously unobtainable, are now available for the first time with a Forgotten Books Full Membership.

Unlimited Access
\$8.99/month

Continue

*Fair usage policy applies

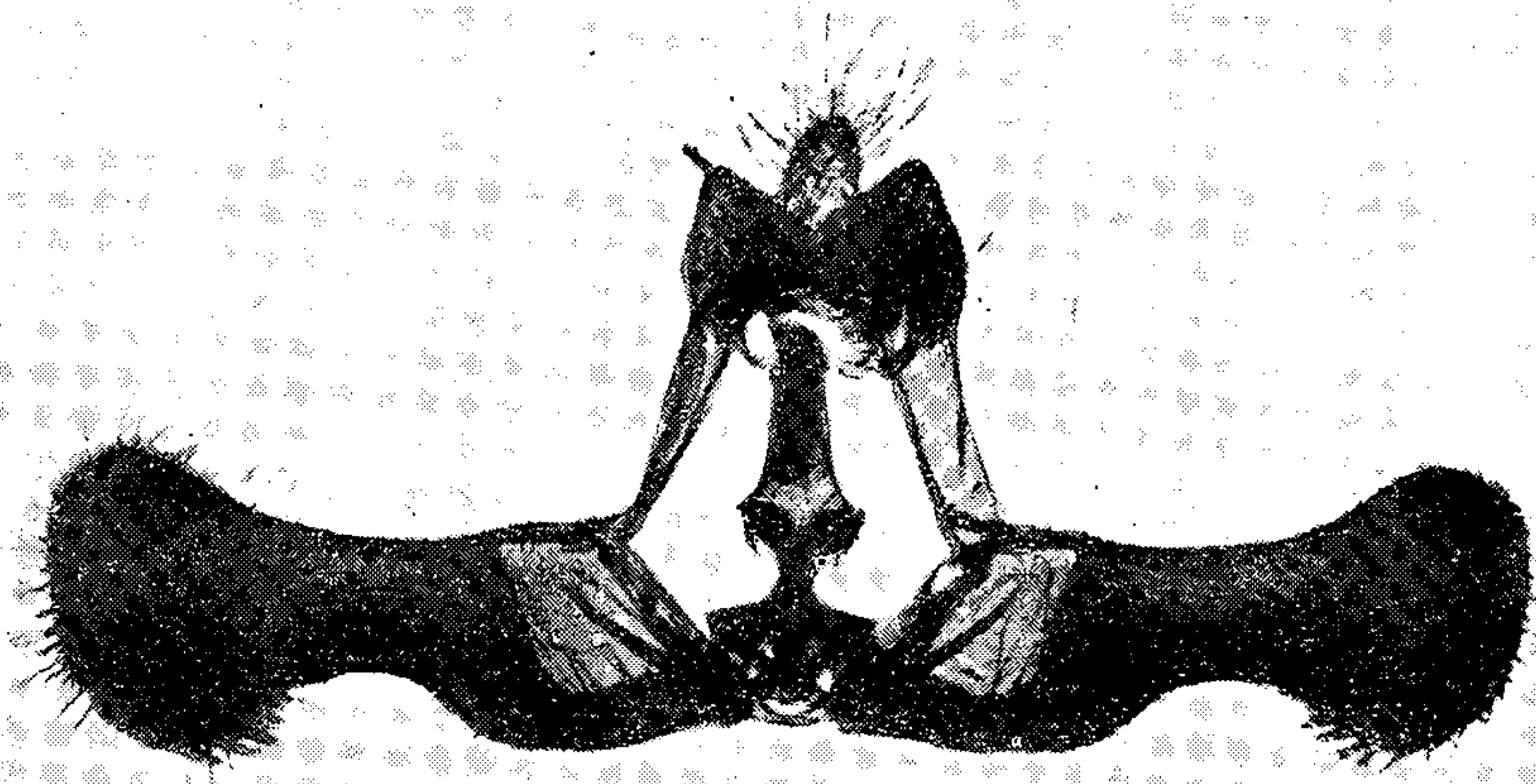

208 *magnidicana*

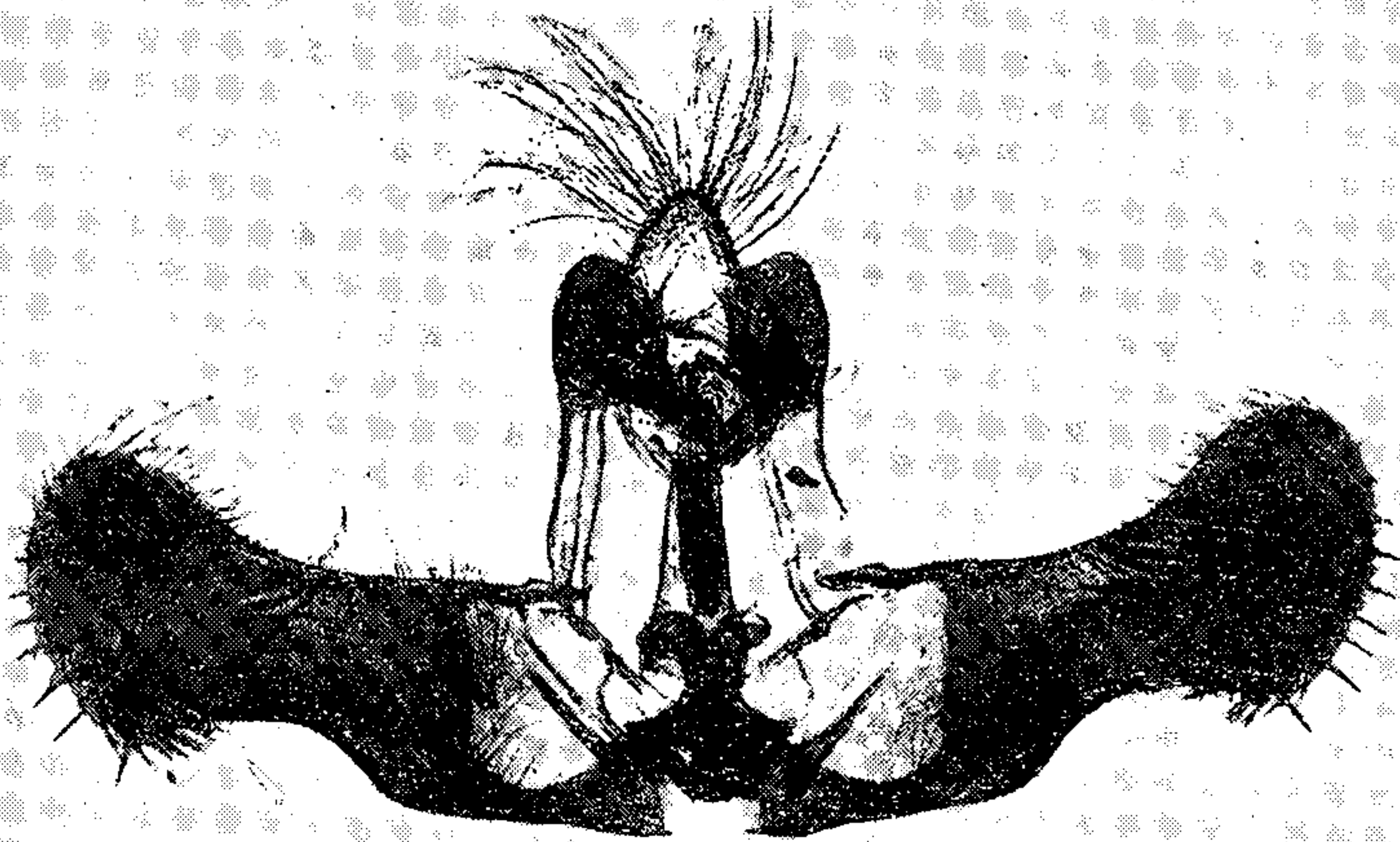

209 *fernaldana*

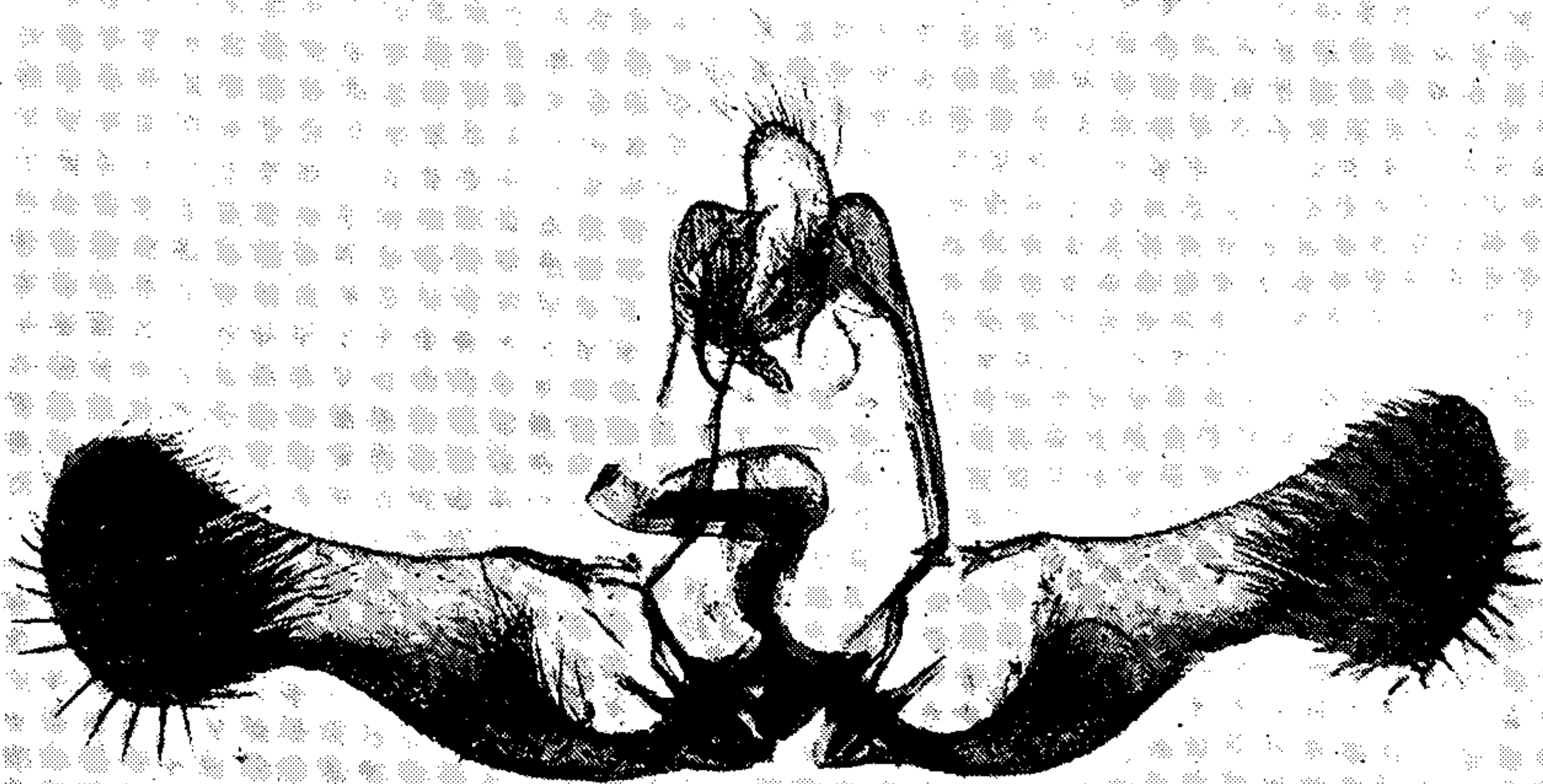

210 *ridingsana*

MALE GENITALIA OF EUCOSMA.

FOR EXPLANATION OF PLATE SEE PAGE 280.

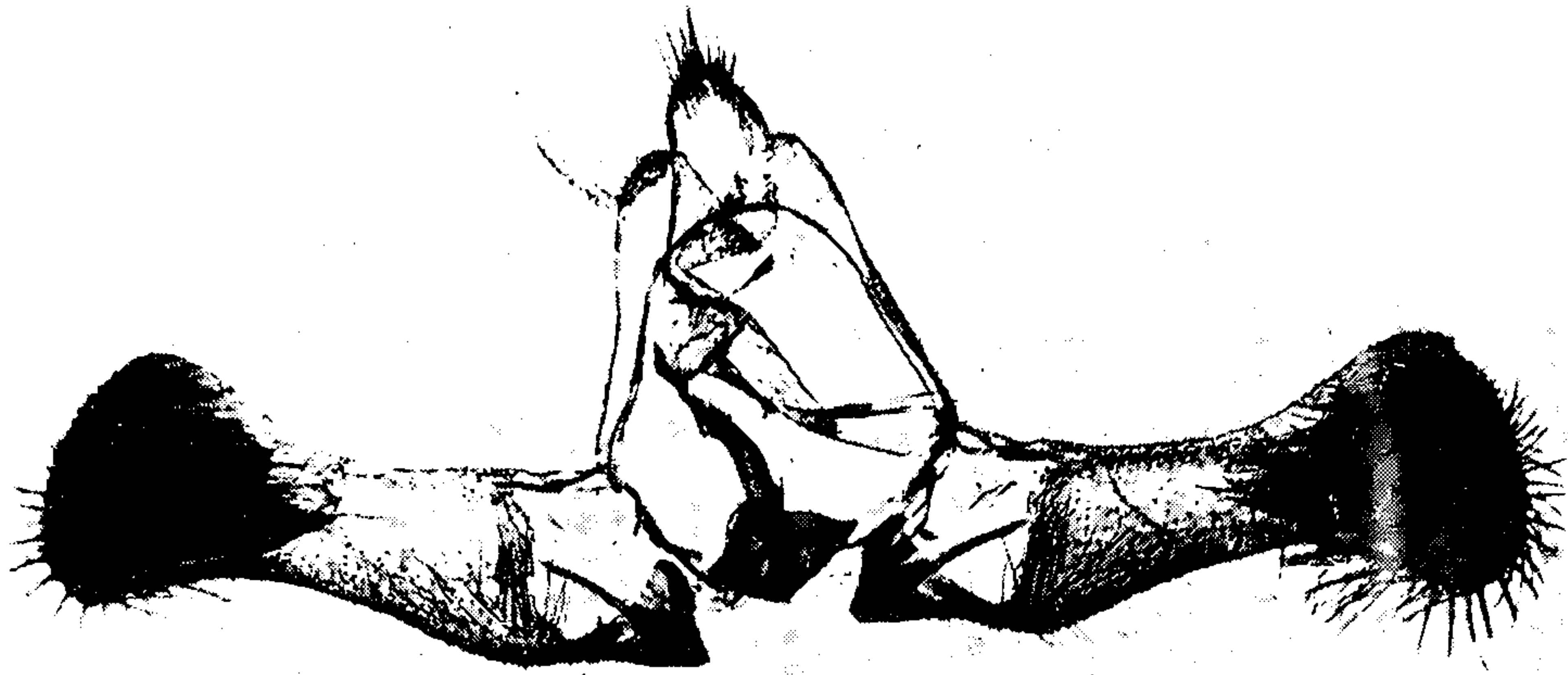

211

nandana

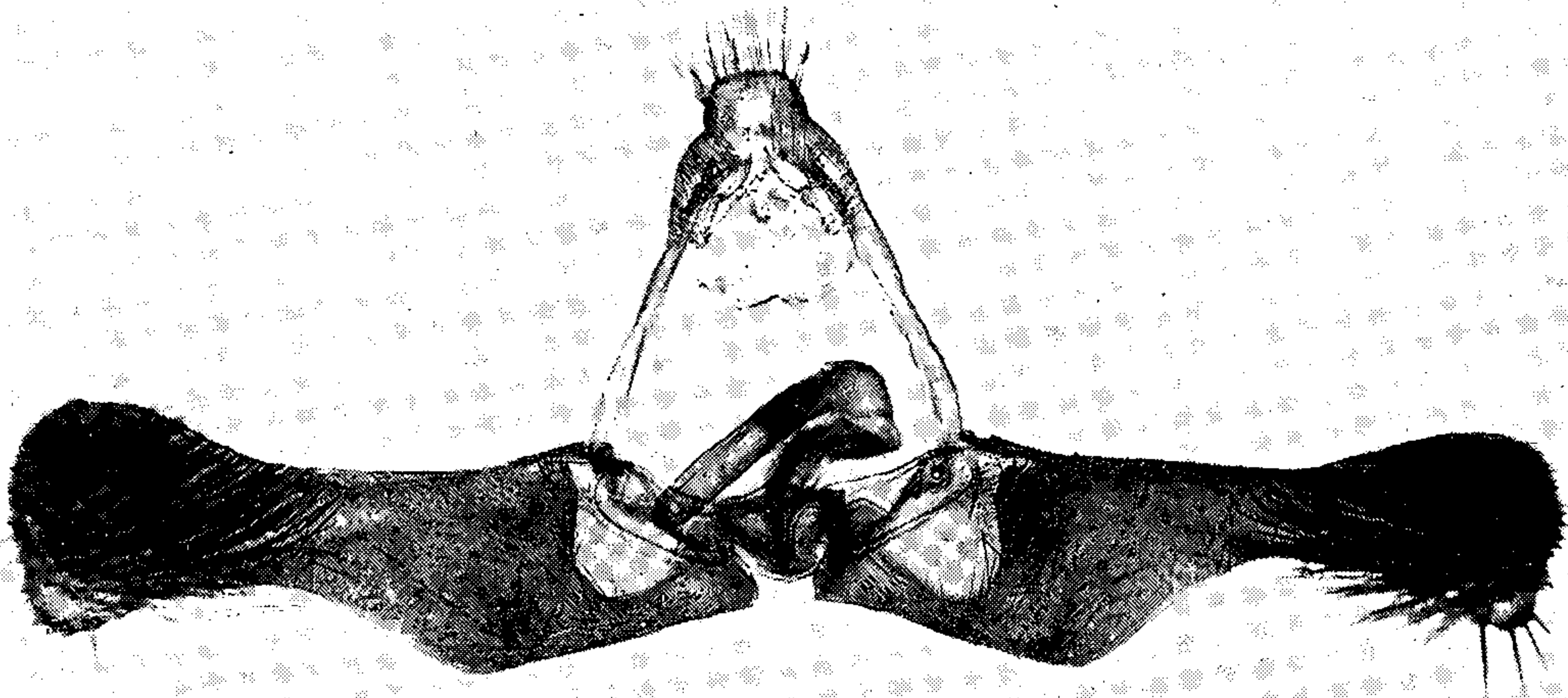

212

mobilensis

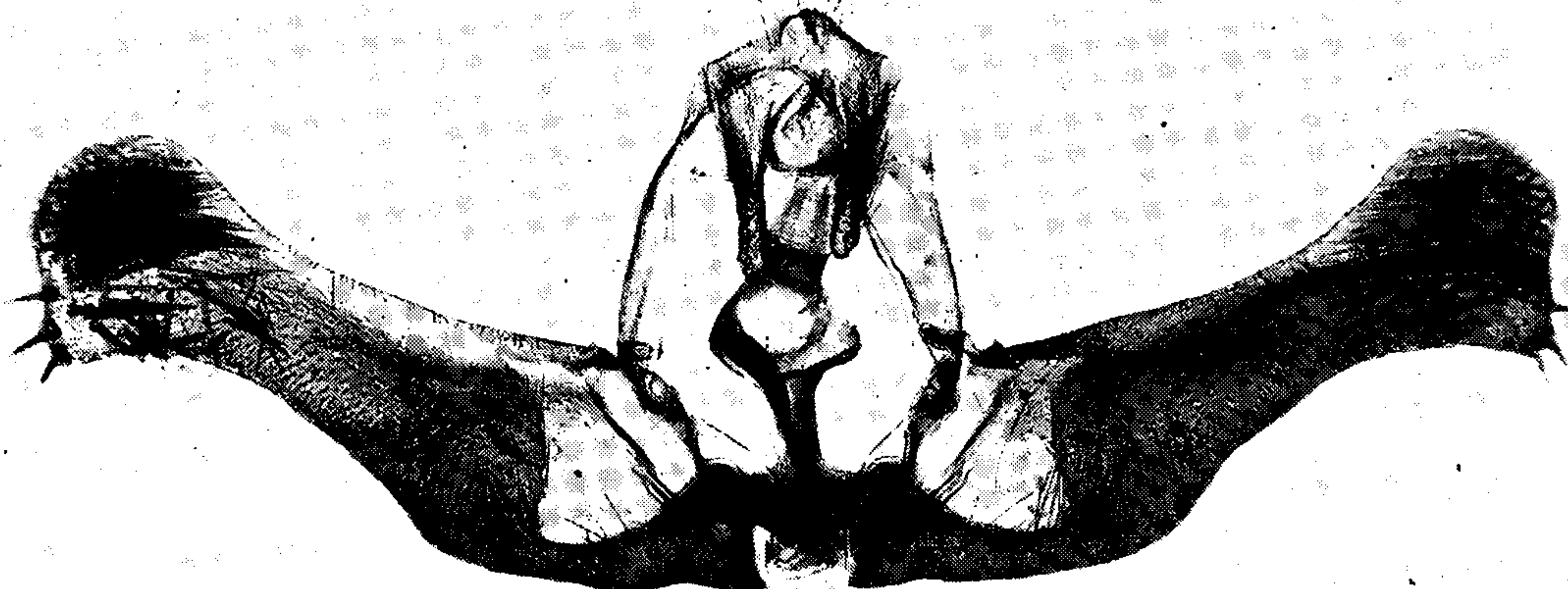

213

crambitana

MALE GENITALIA OF EUCOSMA.

FOR EXPLANATION OF PLATE SEE PAGE 280.

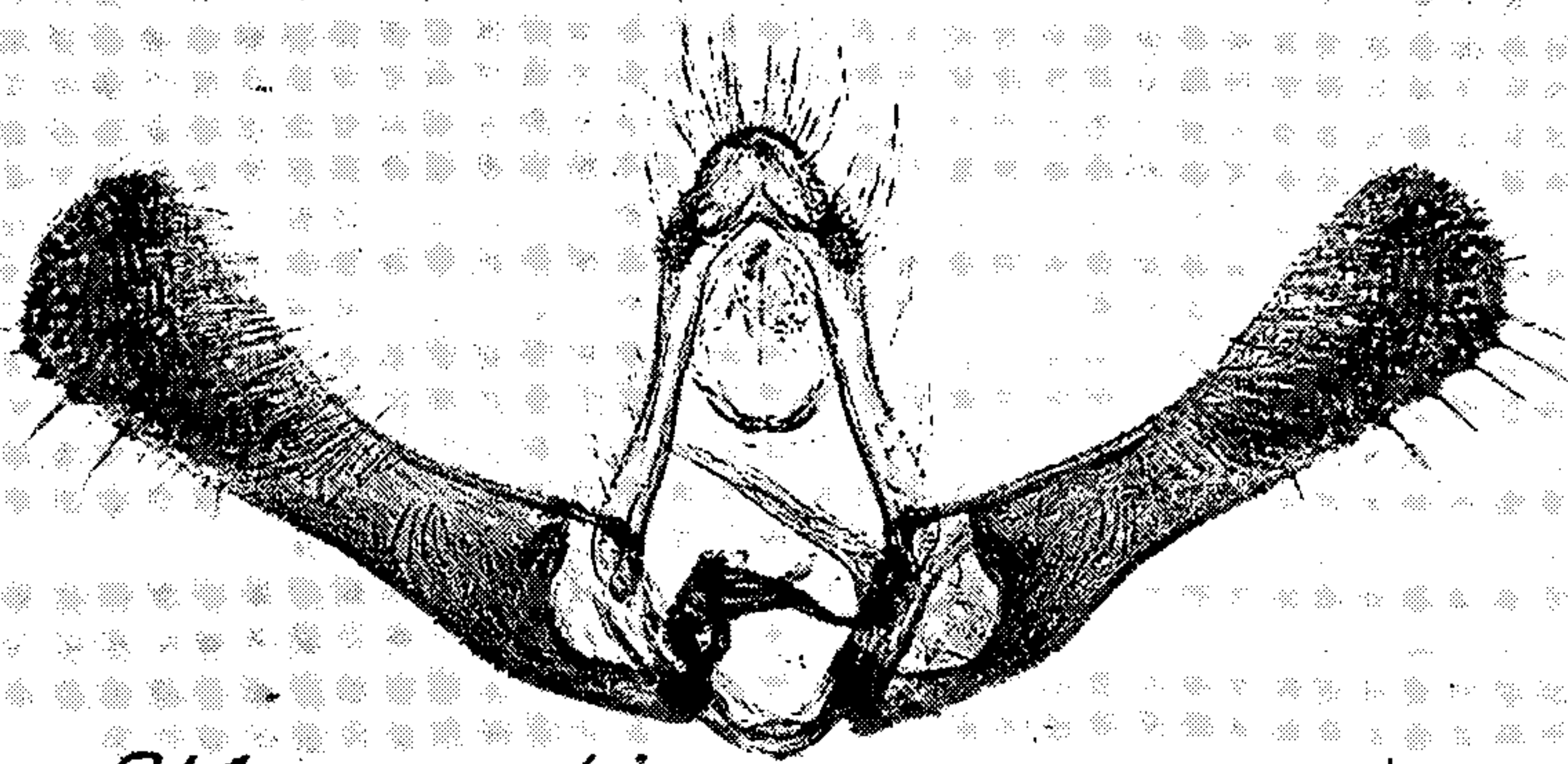

214 *robinsoniana*

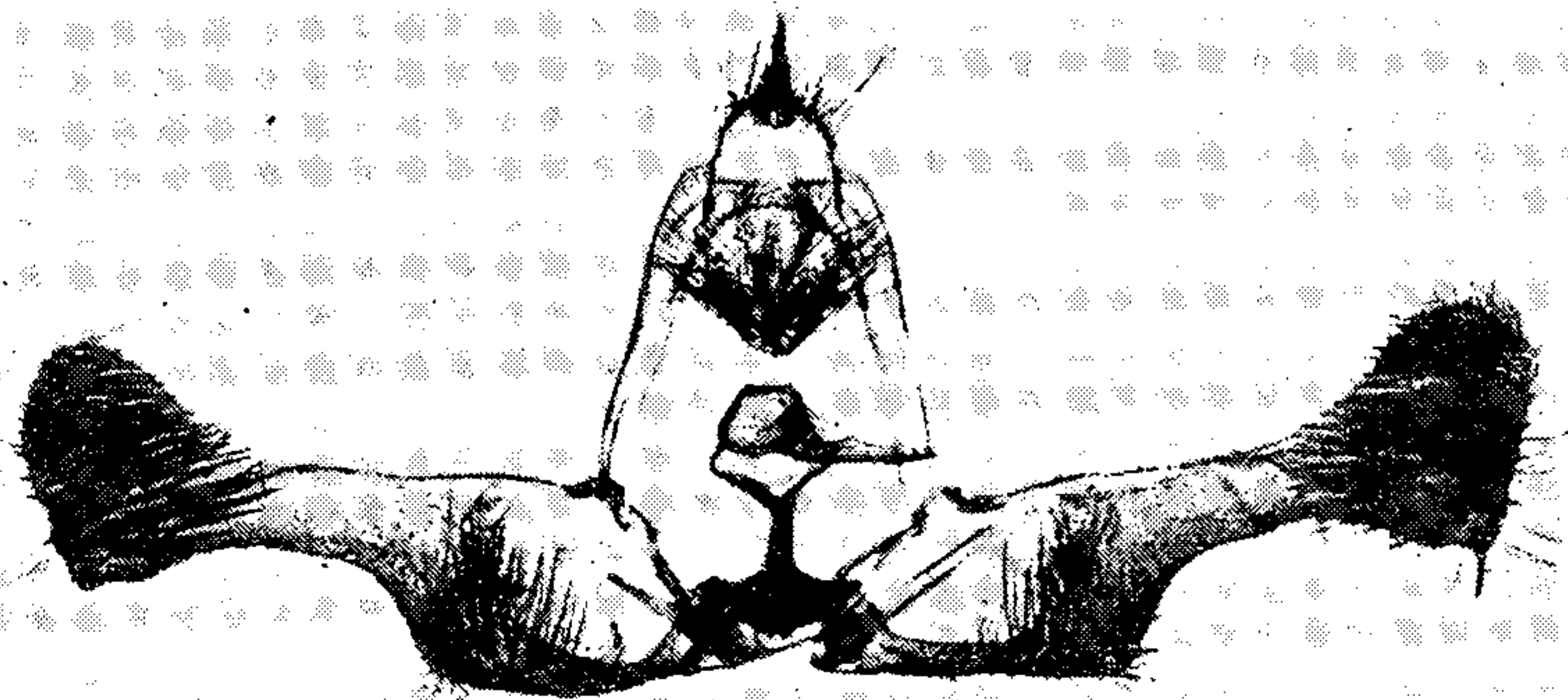

215 *adamantana*

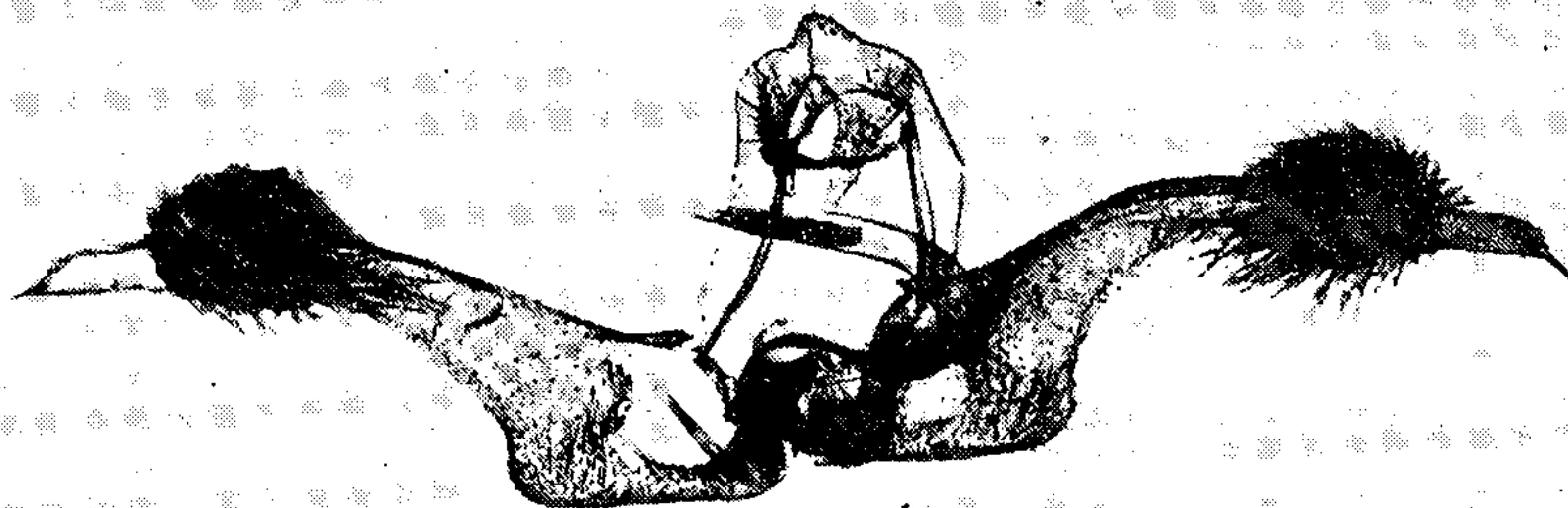

216 *argenteana*

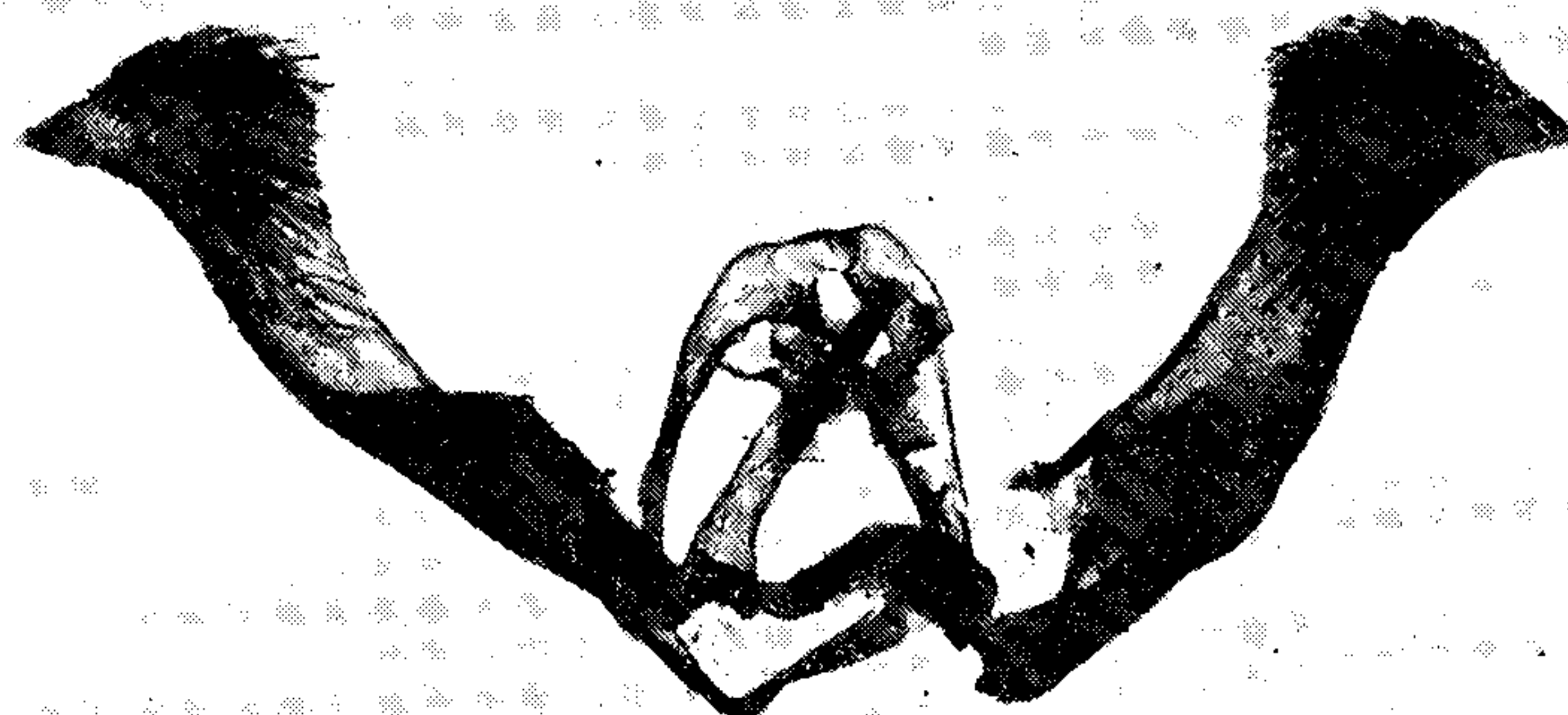

217 *idahoana*

MALE GENITALIA OF EUCOSMA.

FOR EXPLANATION OF PLATE SEE PAGE 280



THIS PAGE IS LOCKED TO FREE MEMBERS
Purchase full membership to immediately unlock this page



Never be without a book!

Forgotten Books Full Membership gives universal access to 797,885 books from our apps and website, across all your devices: tablet, phone, e-reader, laptop and desktop computer

A library in your pocket for \$8.99/month

Continue

*Fair usage policy applies

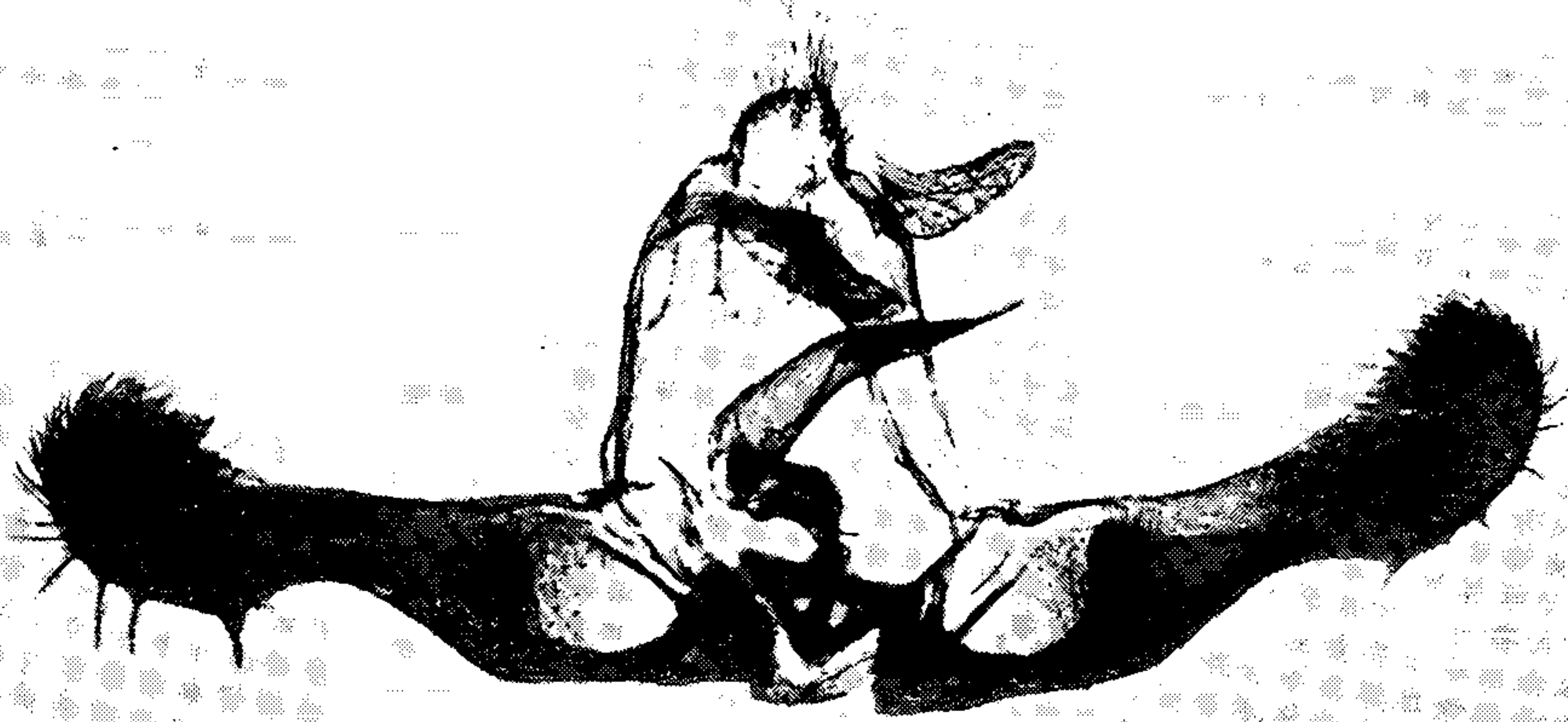

221 *shastana*

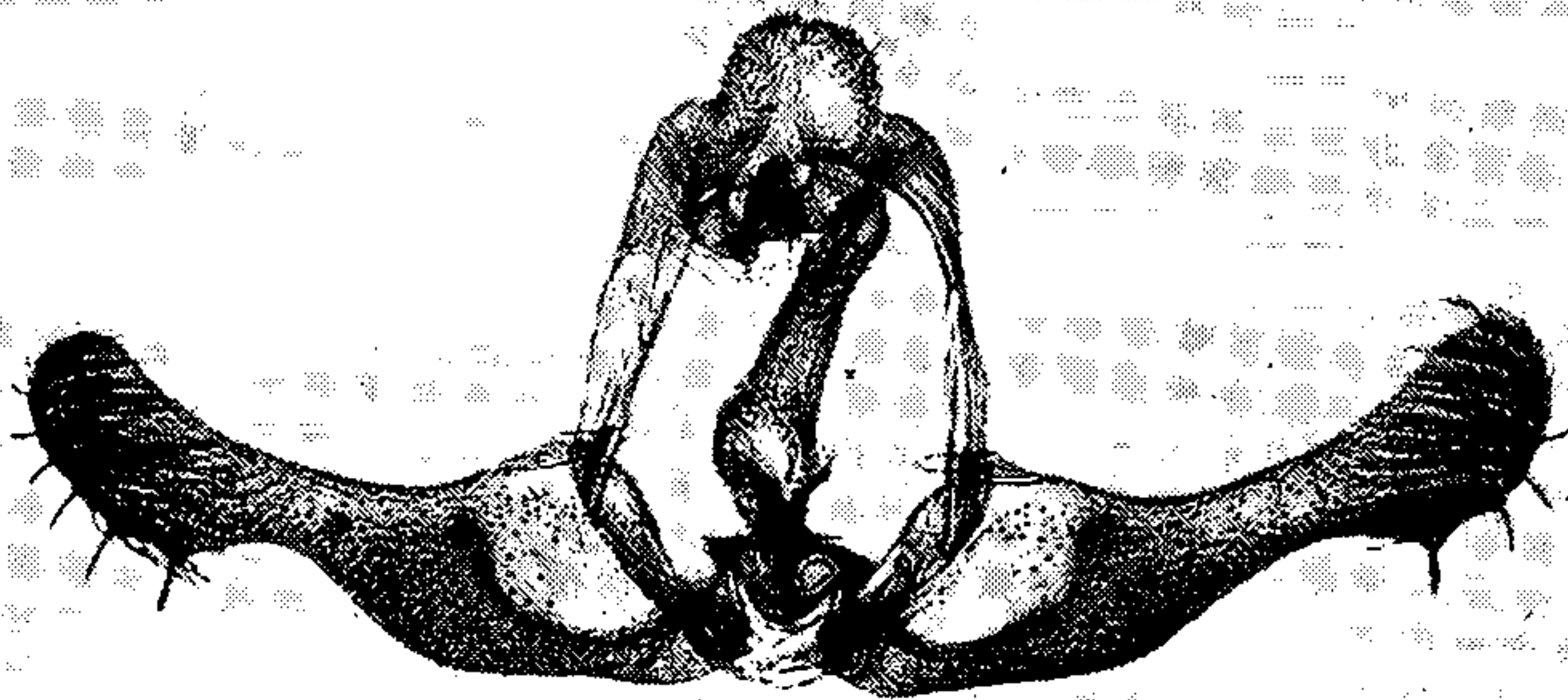

222 *palousana*

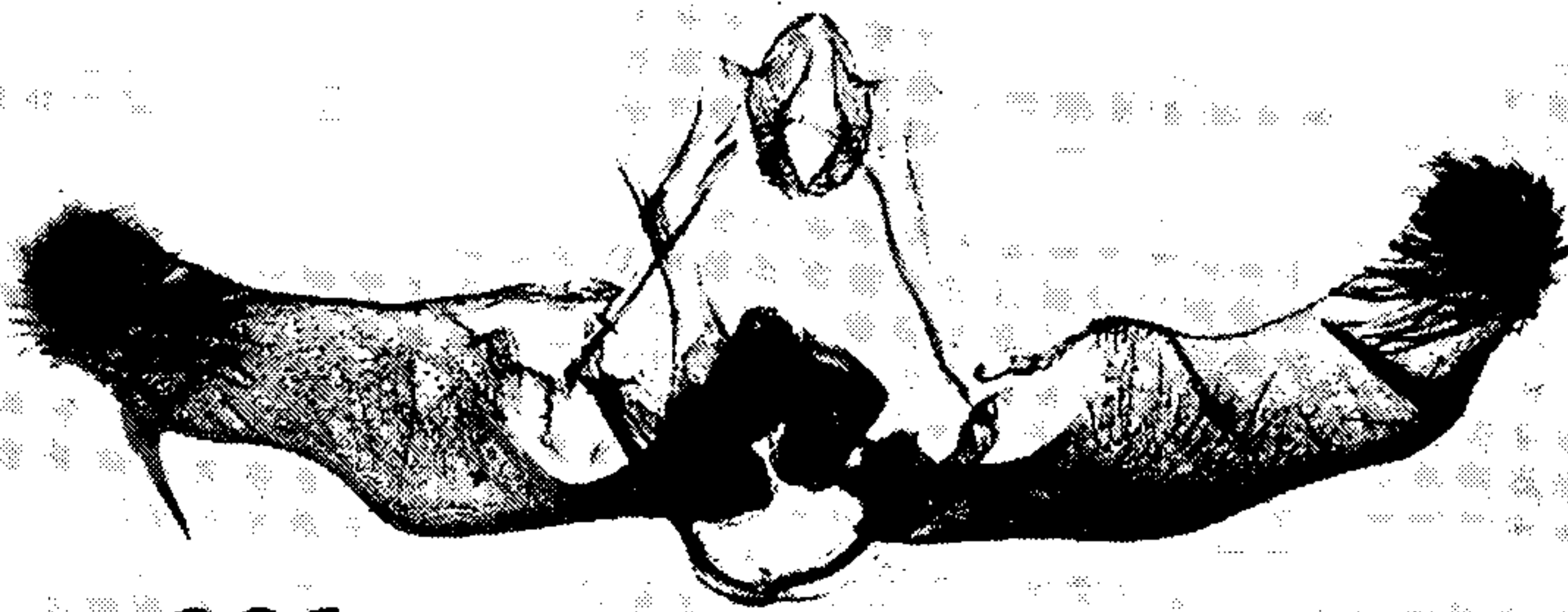

223 *reversana*

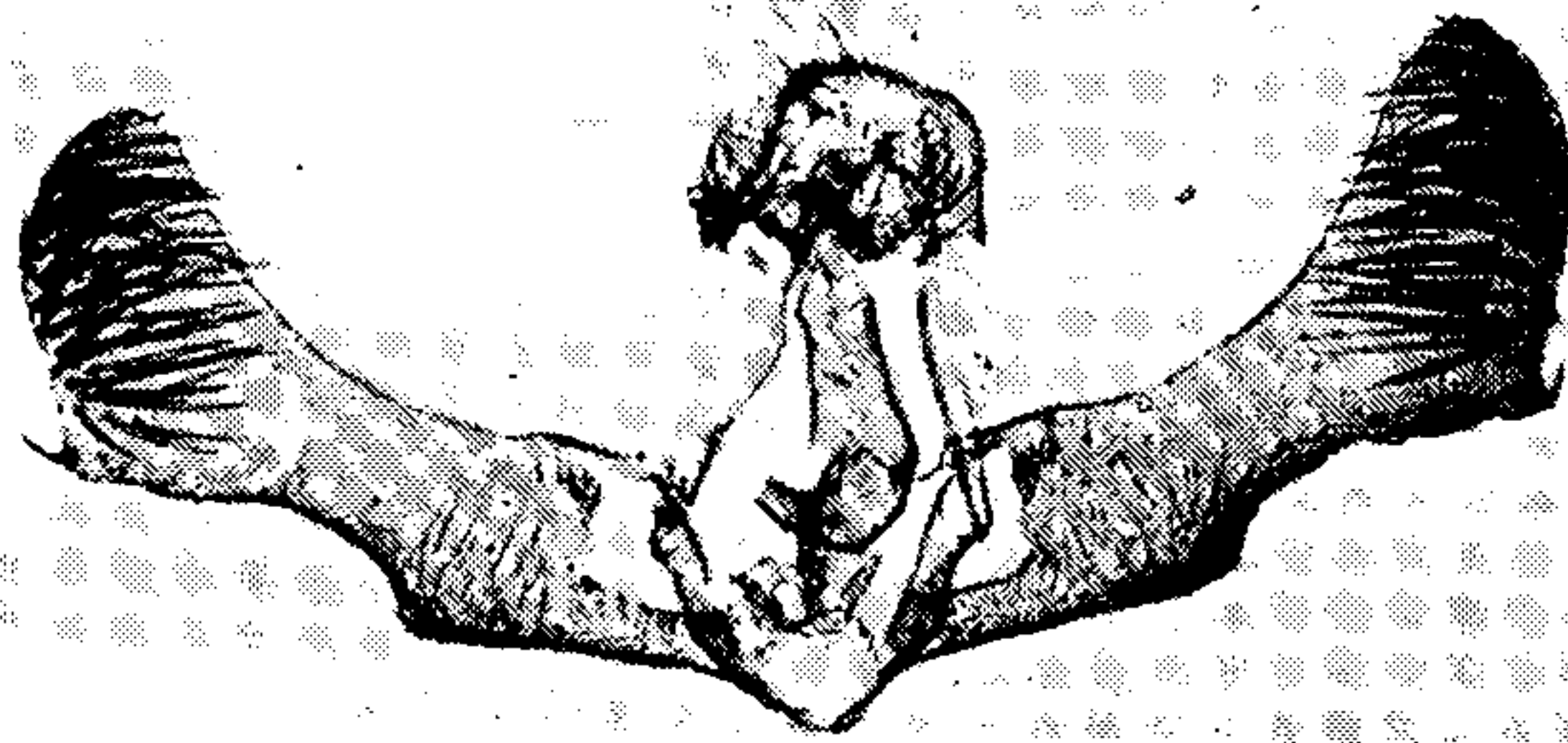

224 *popana*

MALE GENITALIA OF EUCOSMA.

FOR EXPLANATION OF PLATE SEE PAGE 281



225 *palpana*

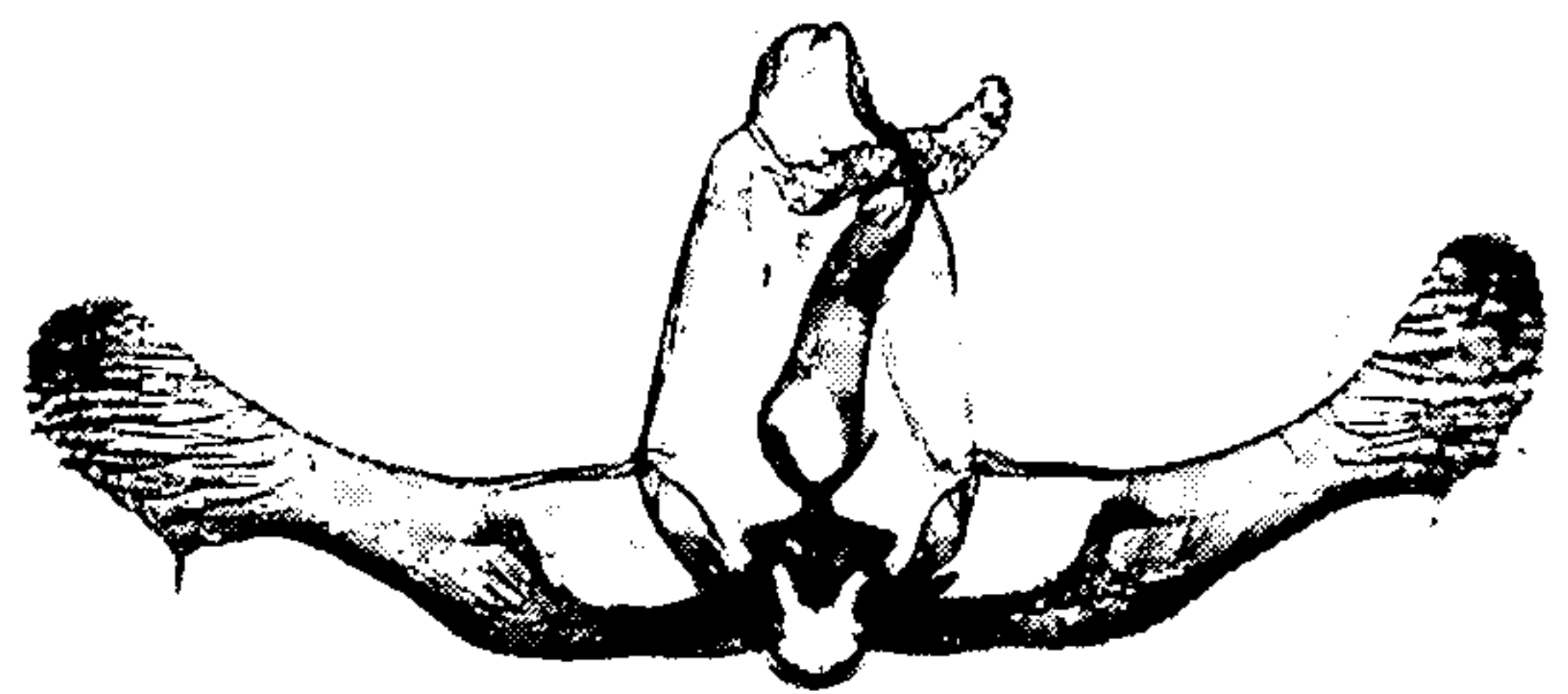

230 *tahoensis*



226 *occipitana*

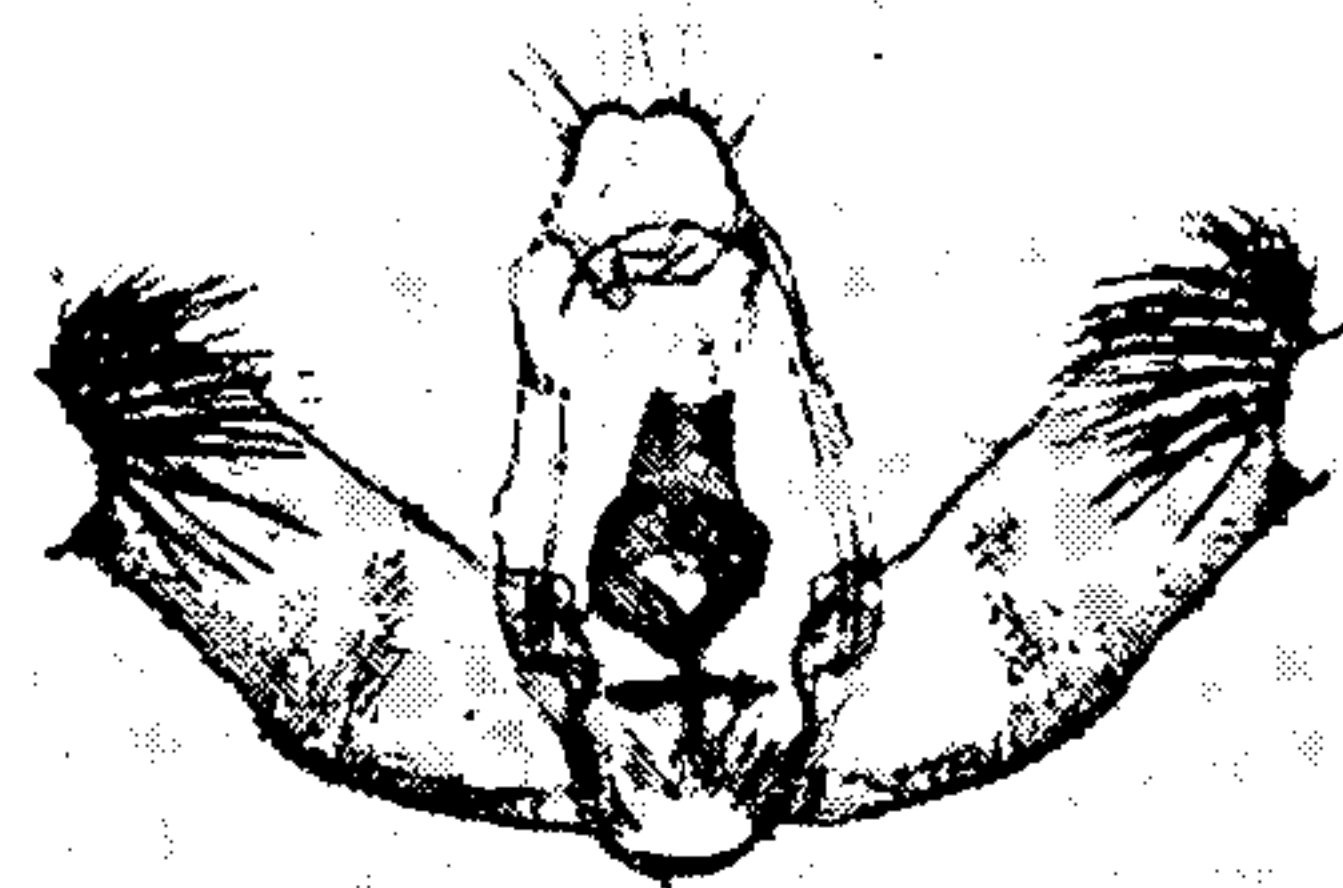

231 *quinquemaculana*

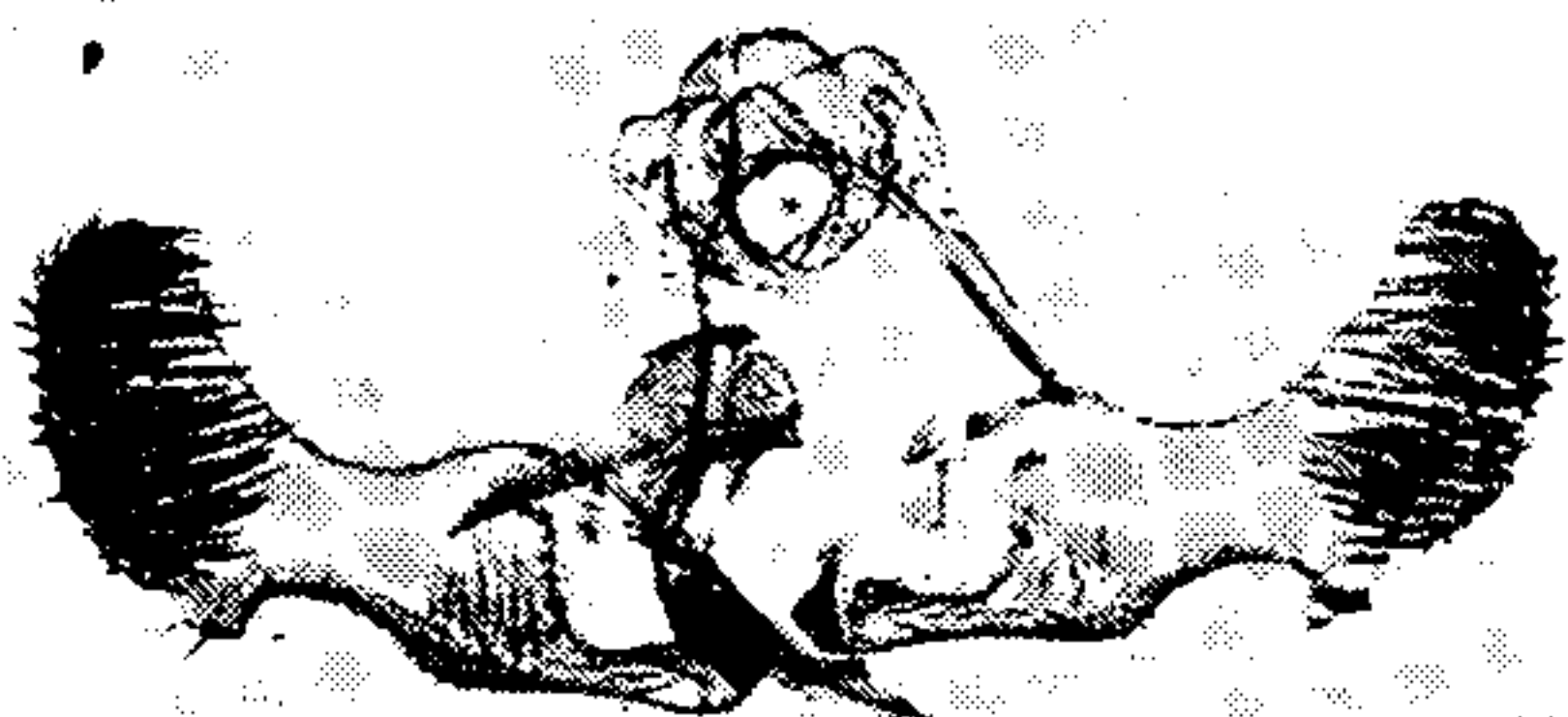

227 *pallidipalpana*

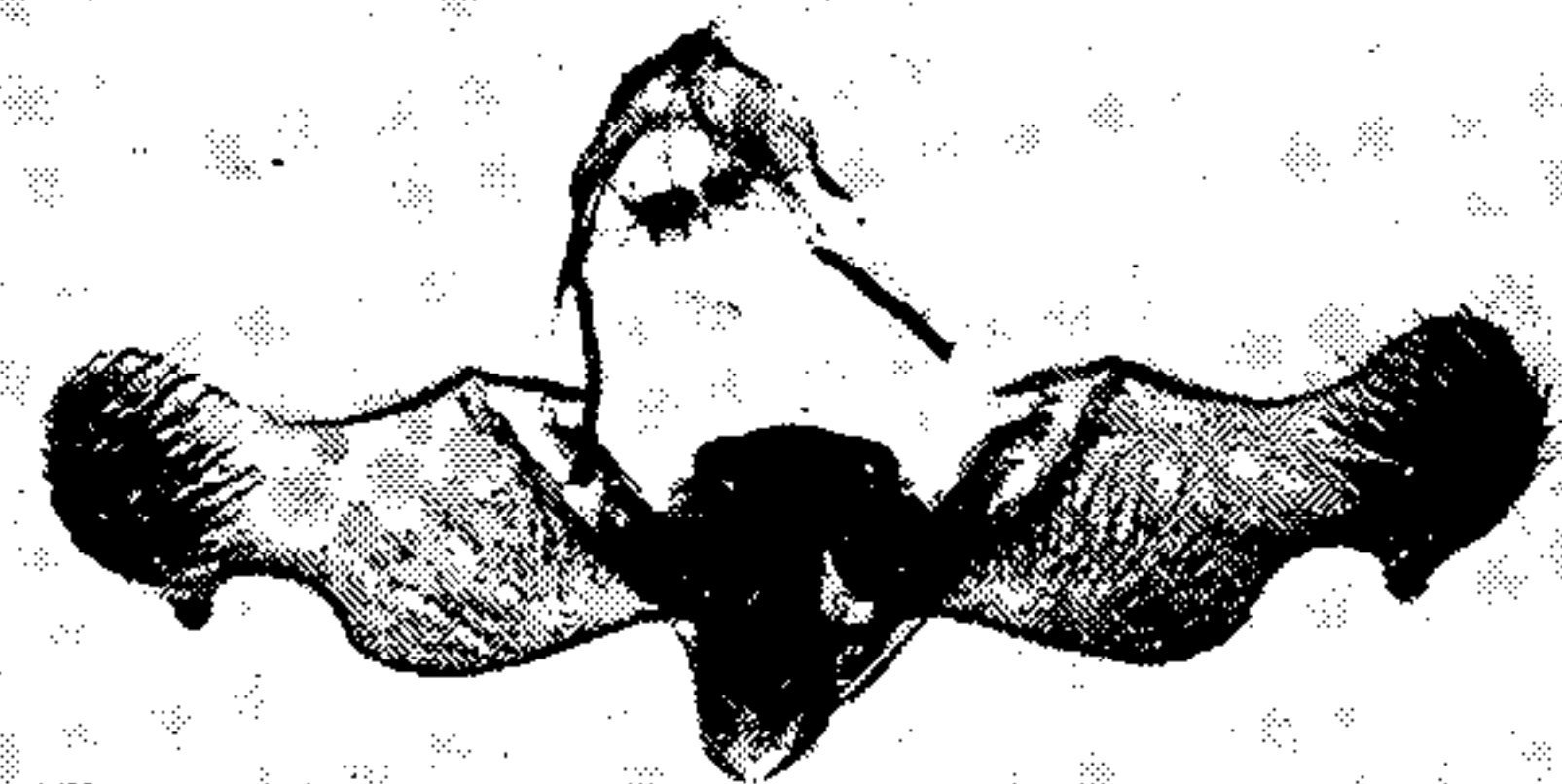

232 *fratrueelis*

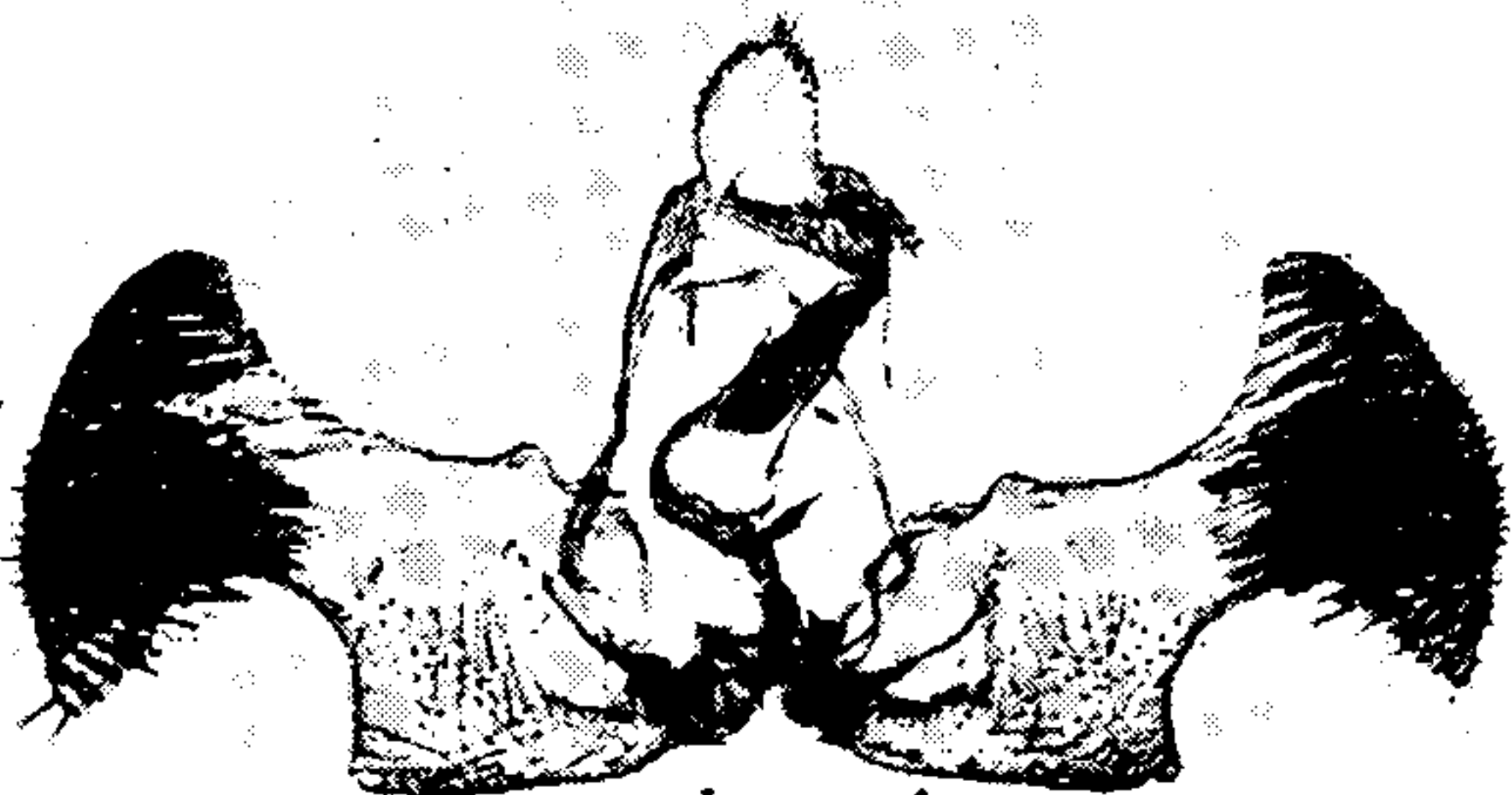

228 *agricolana*



233 *agricolana*



229 *morrisomi*



234 *argentialbana*

MALE GENITALIA OF EUCOSMA.

FOR EXPLANATION OF PLATE SEE PAGE 281

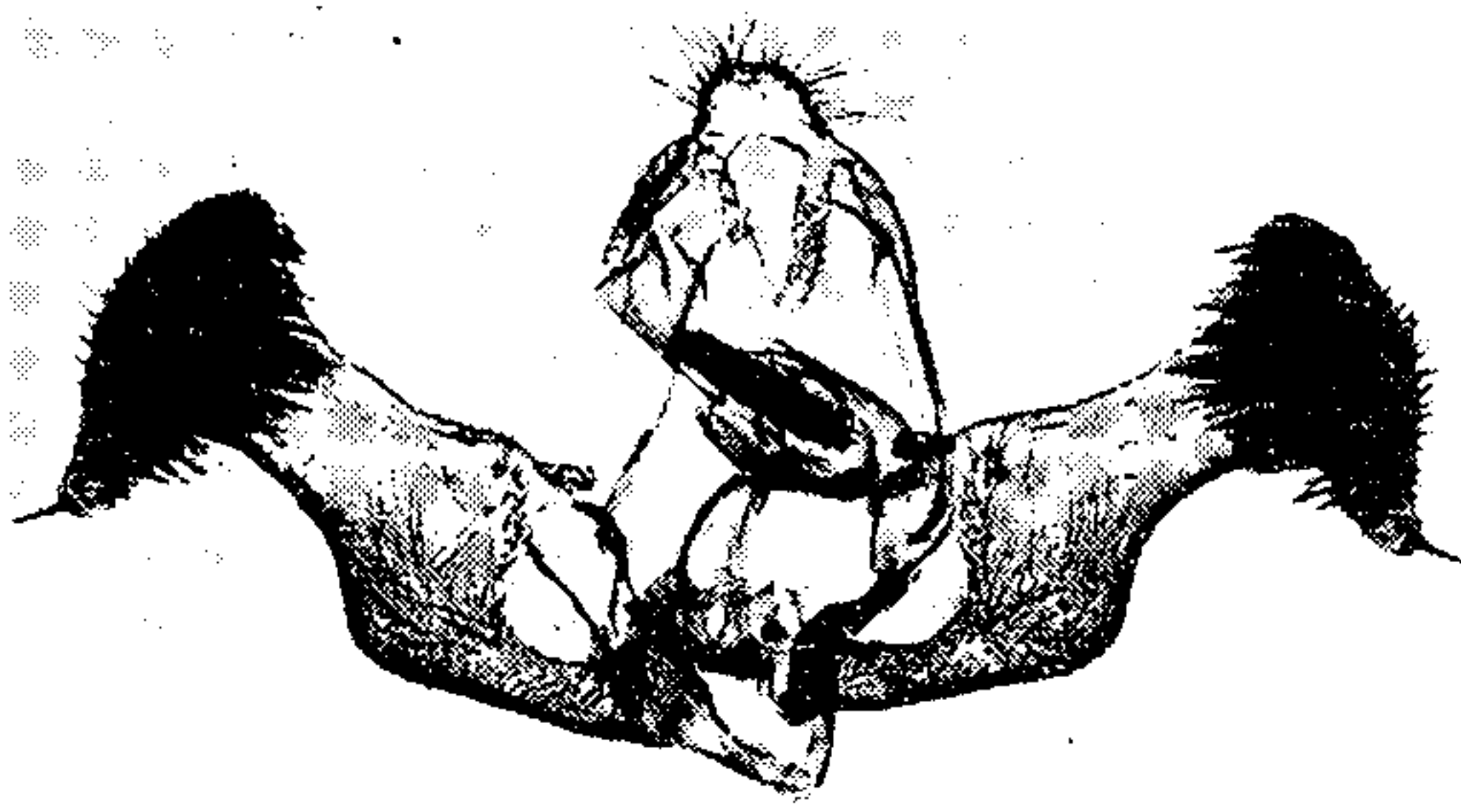

235 *heathiana*



240 *pergandeana*

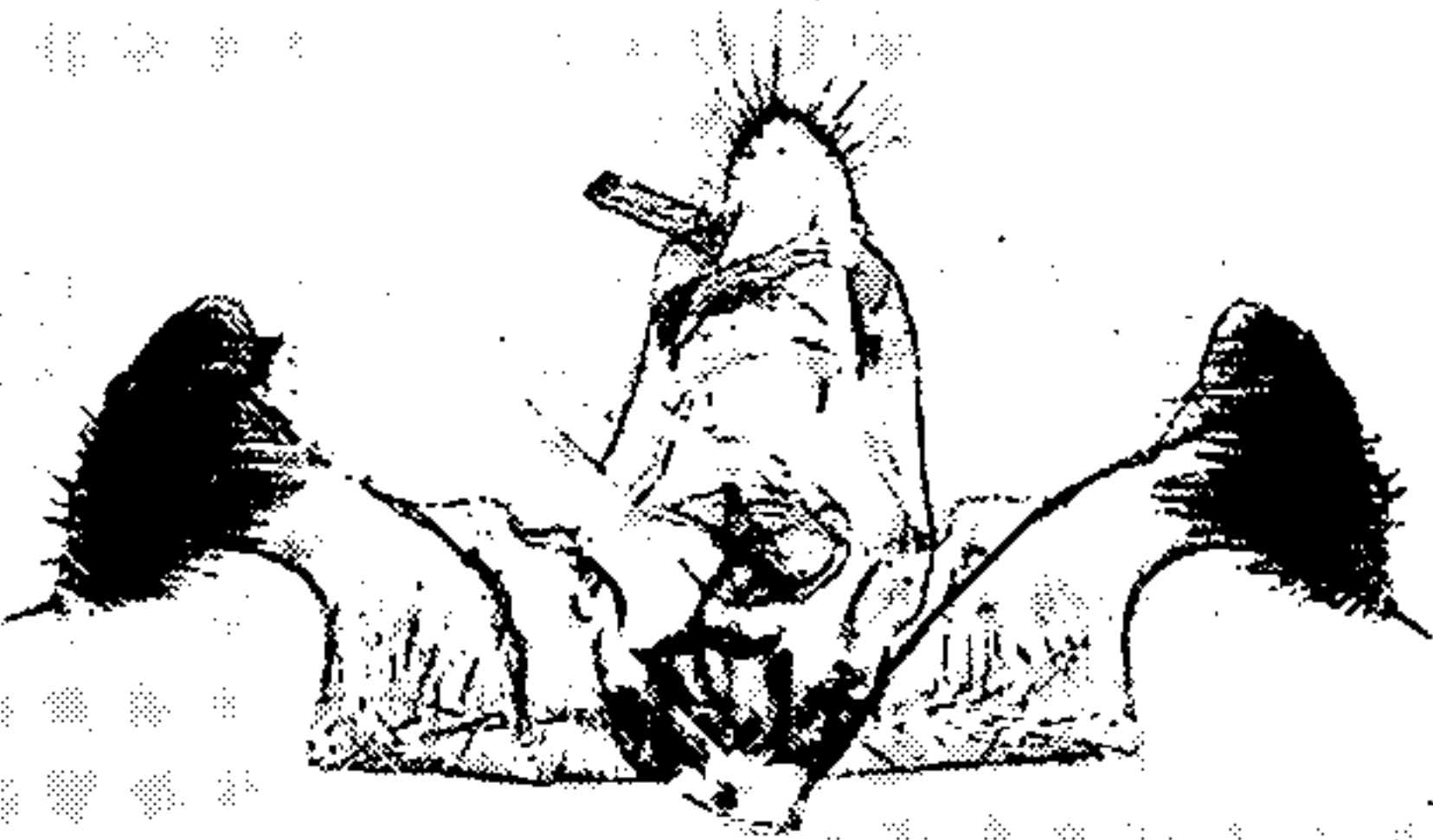

236 *flavana*



241 *hohana*

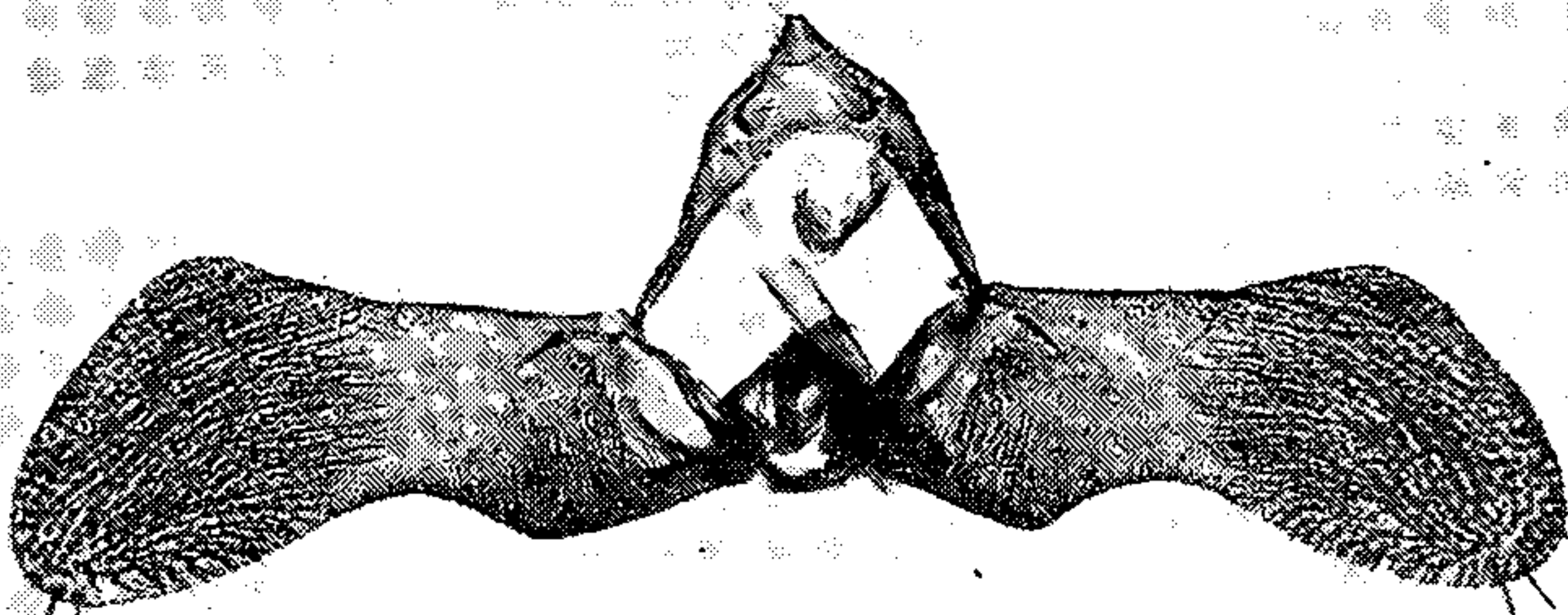

237 *excerptiorana*



242 *consobrinana*

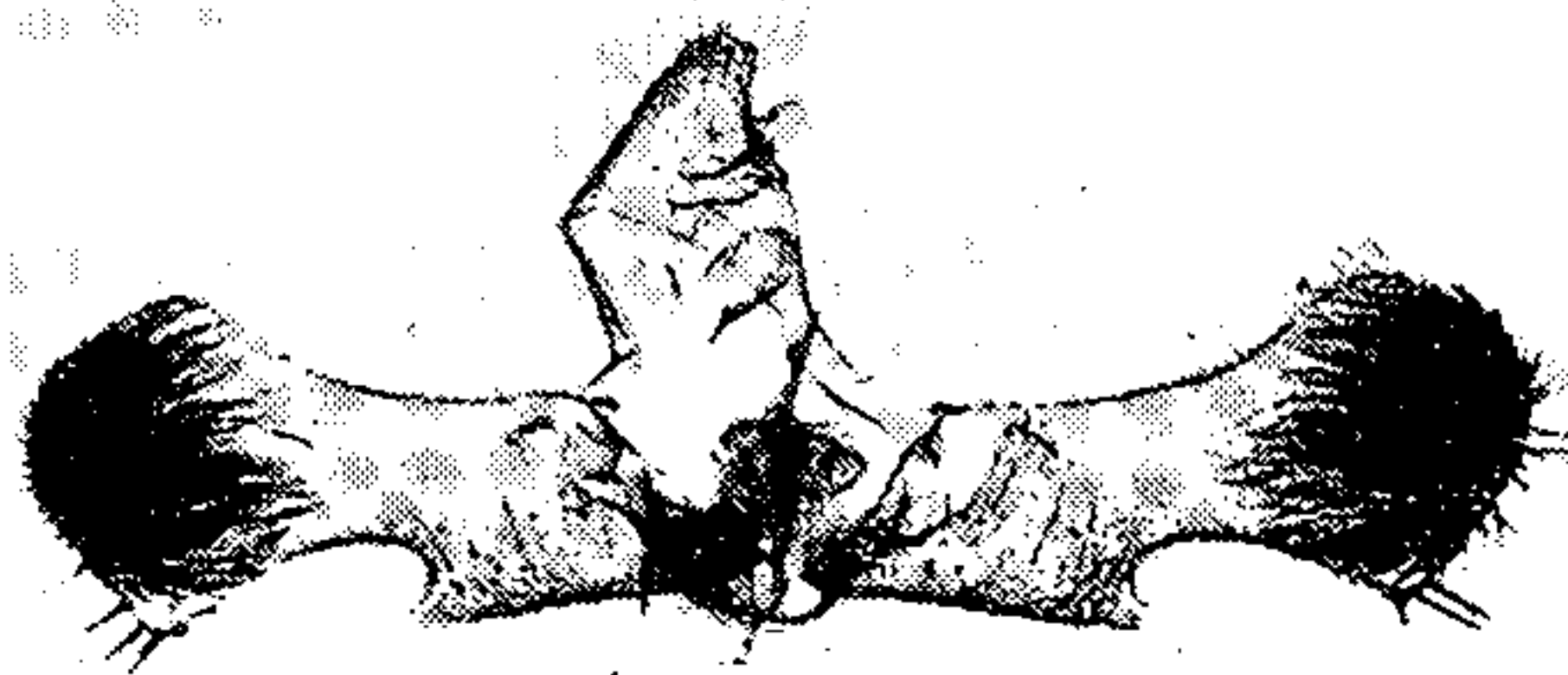

238 *pulveratana*

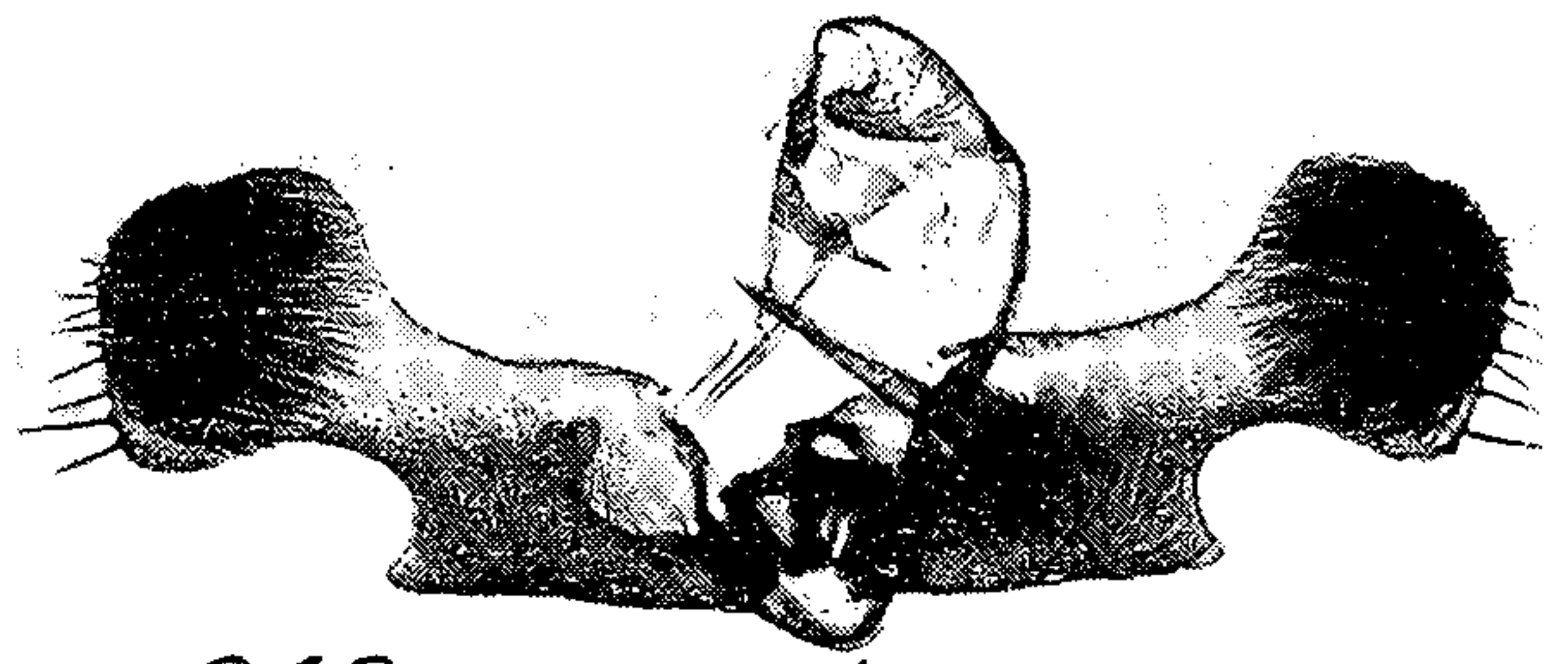

243 *suadana*

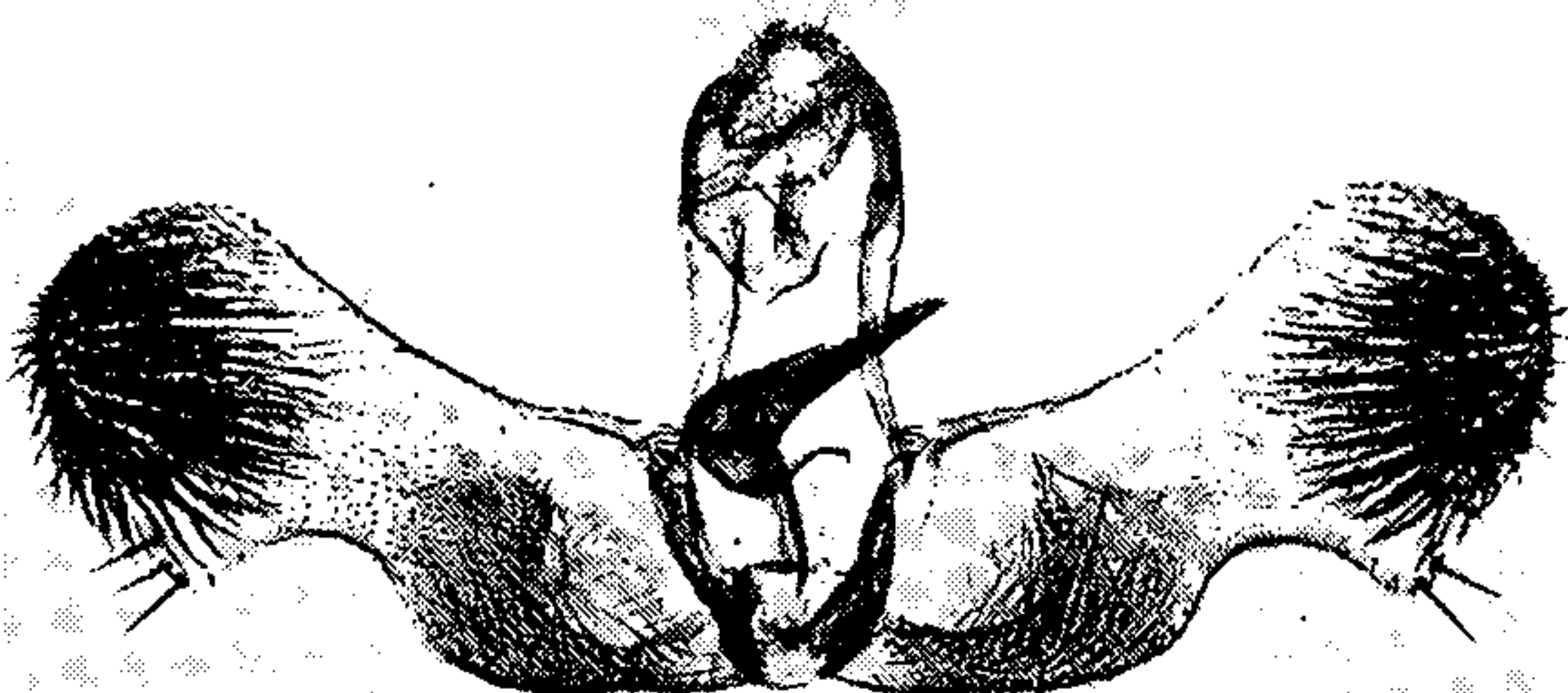

239 *bactrana*



244 *womonana*

MALE GENITALIA OF EUCOSMA.

FOR EXPLANATION OF PLATE SEE PAGE 281.



THIS PAGE IS LOCKED TO FREE MEMBERS

Purchase full membership to immediately unlock this page



HISTORY

Tens of thousands of important historical sources, many previously unobtainable, are now available for the first time with a Forgotten Books Full Membership.

Unlimited Access
\$8.99/month

Continue

*Fair usage policy applies



254 *boxcana*

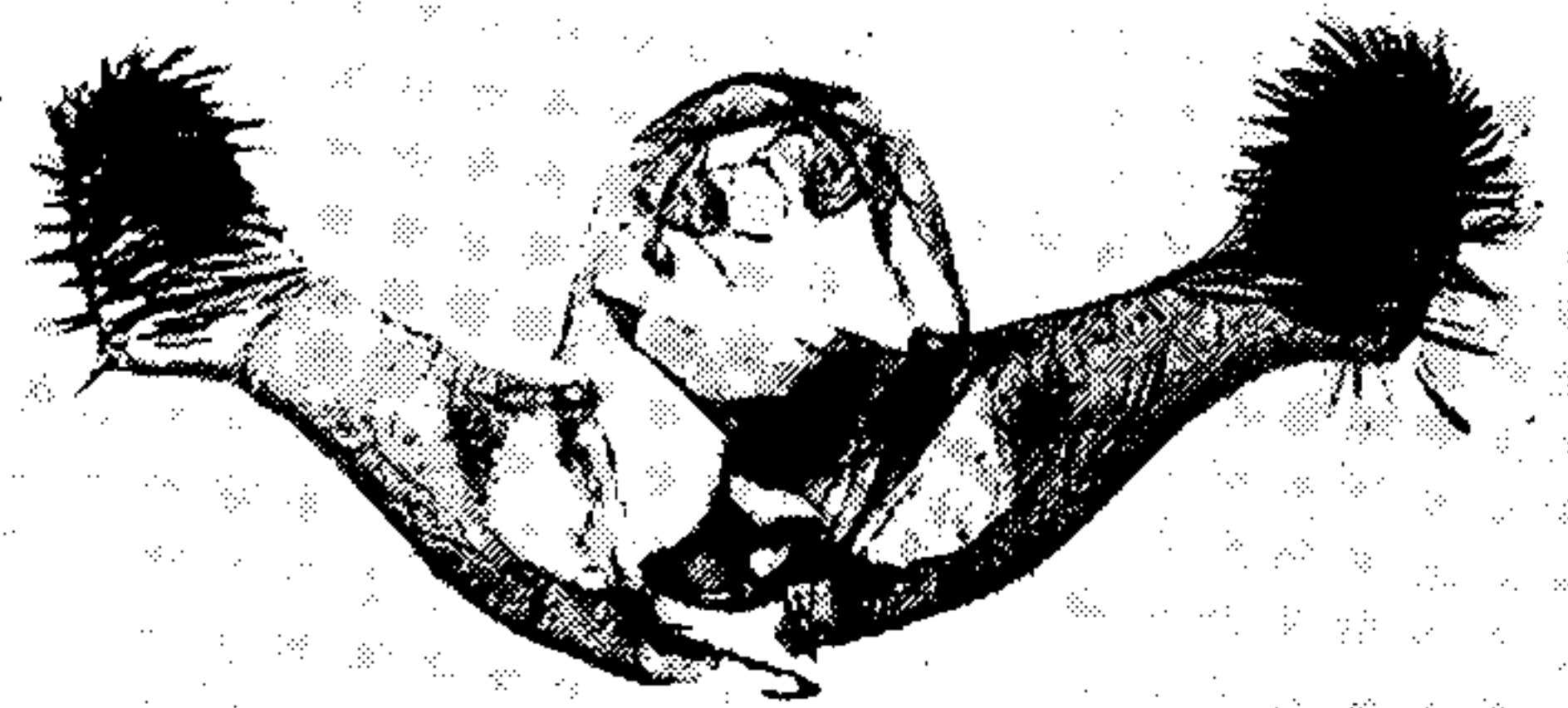

259 *abruptana*



255 *abbreviatana*

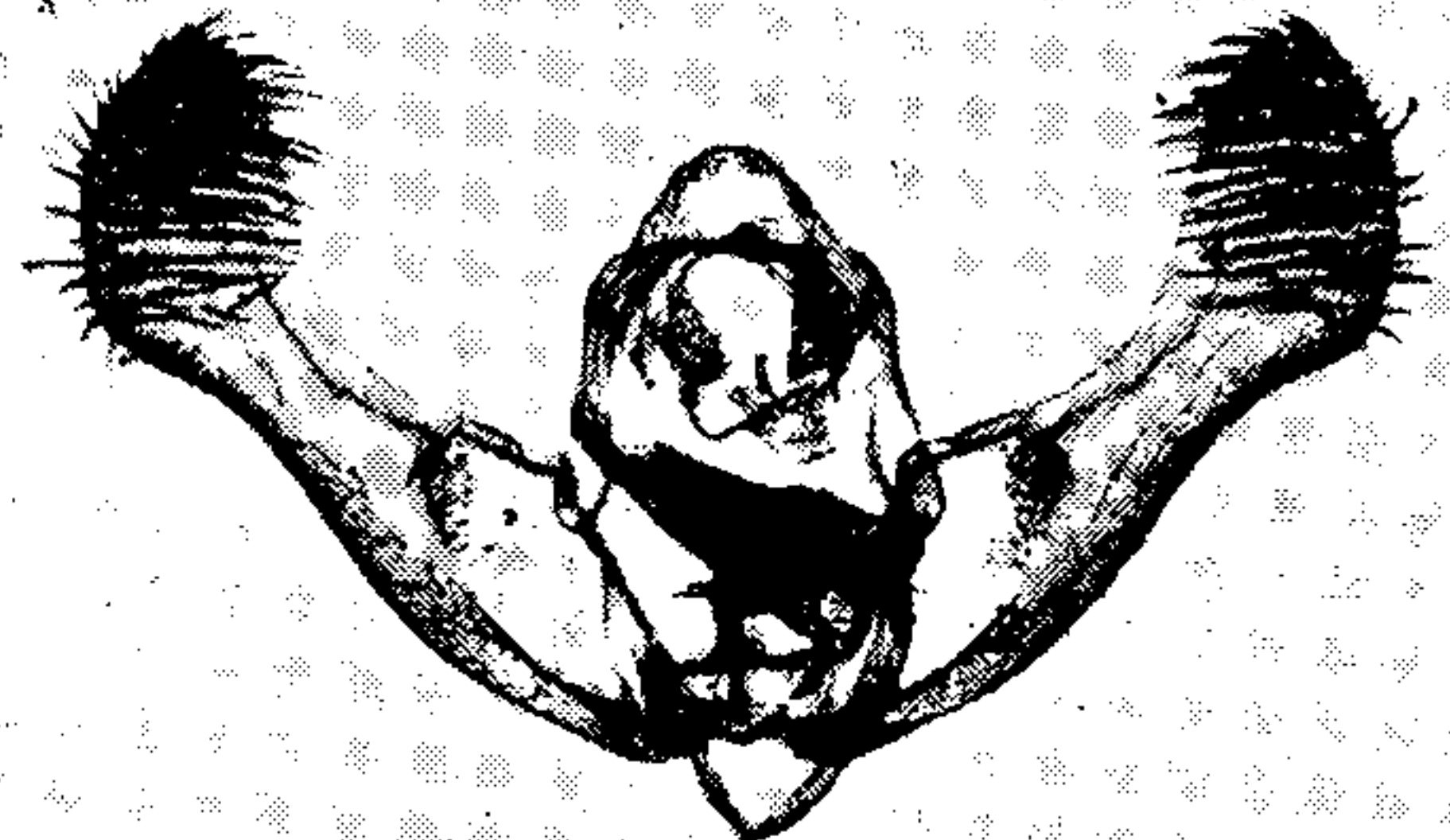

260 *numerosana*



256 *serangias*



261 *grossbecki*

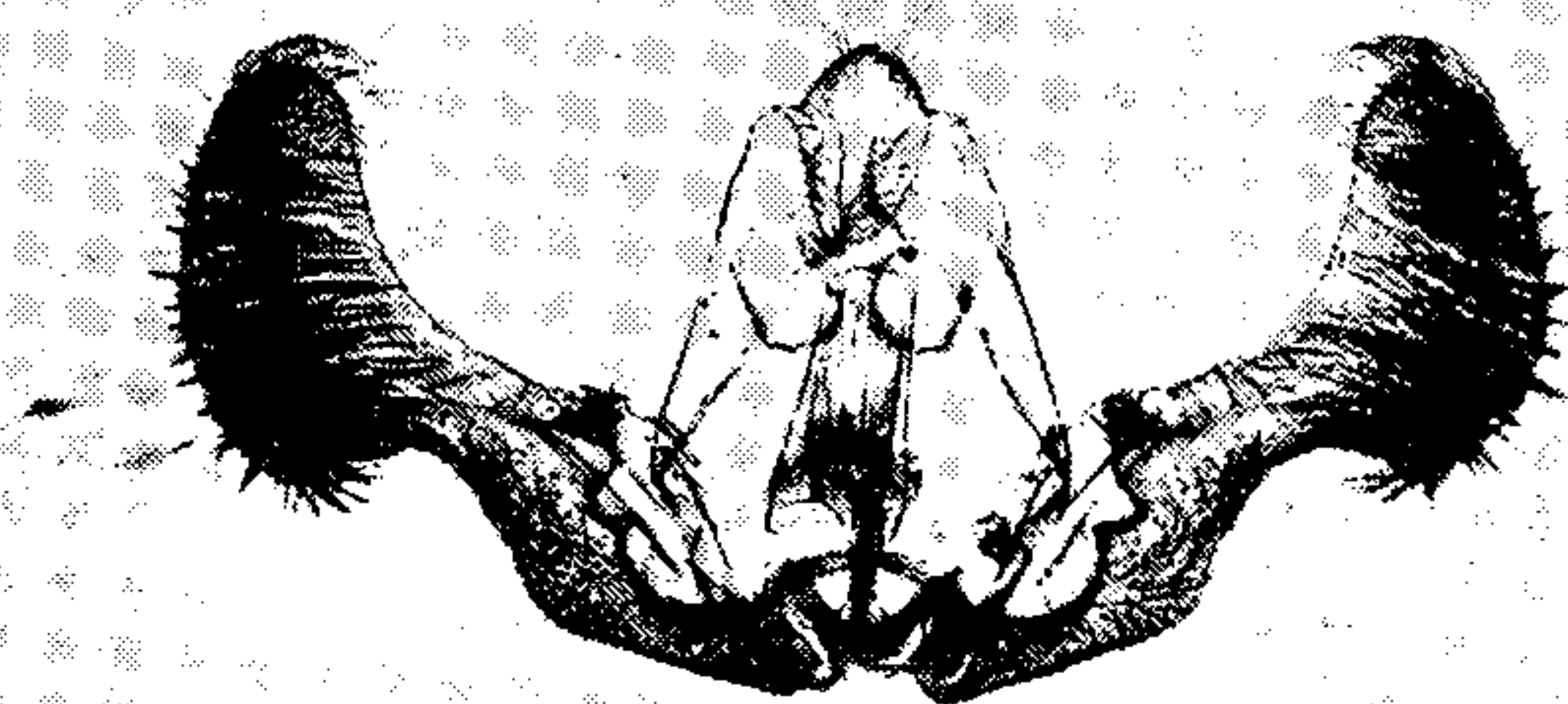

257 *strenuana*



262 *praesumptiosa*



258 *strenuana*



263 *insidiosana*

MALE GENITALIA OF EPIBLEMA.

FOR EXPLANATION OF PLATE SEE PAGE 282.

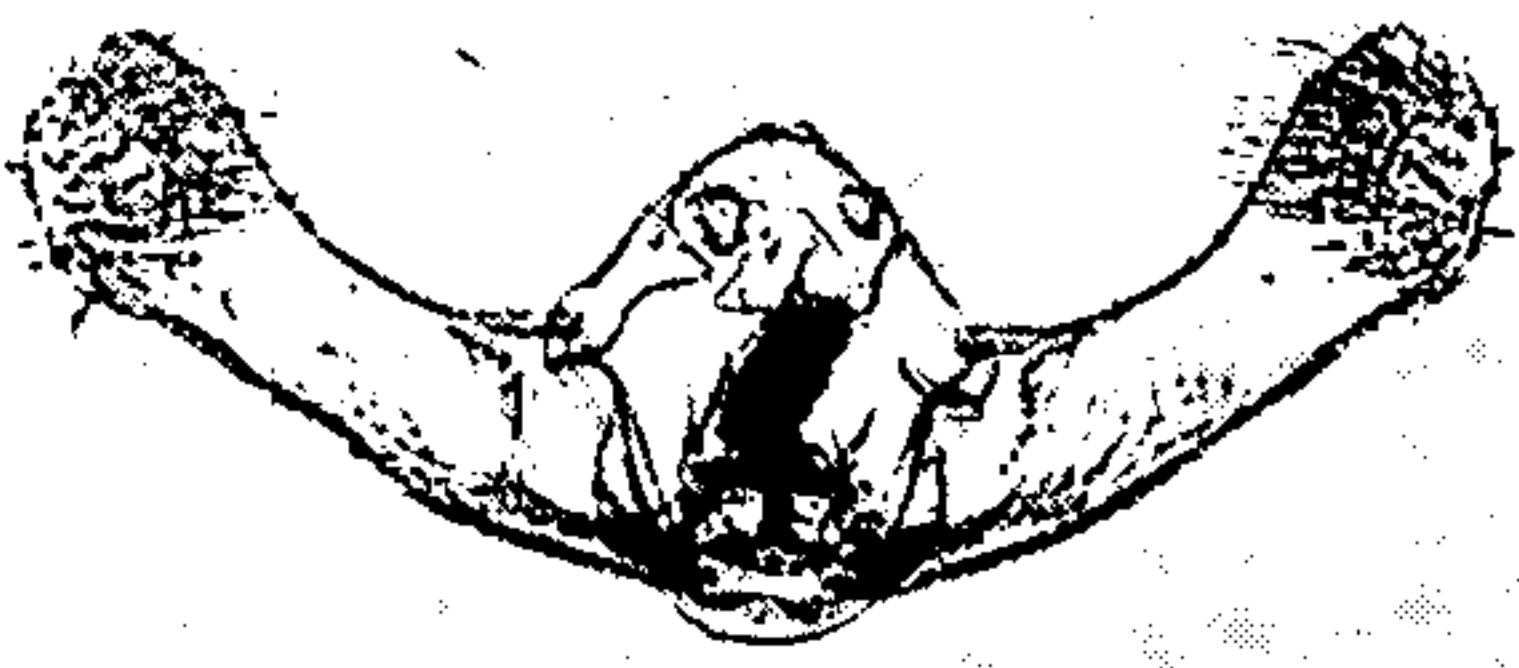

264 *exacerbatricana*



269 *sosana*

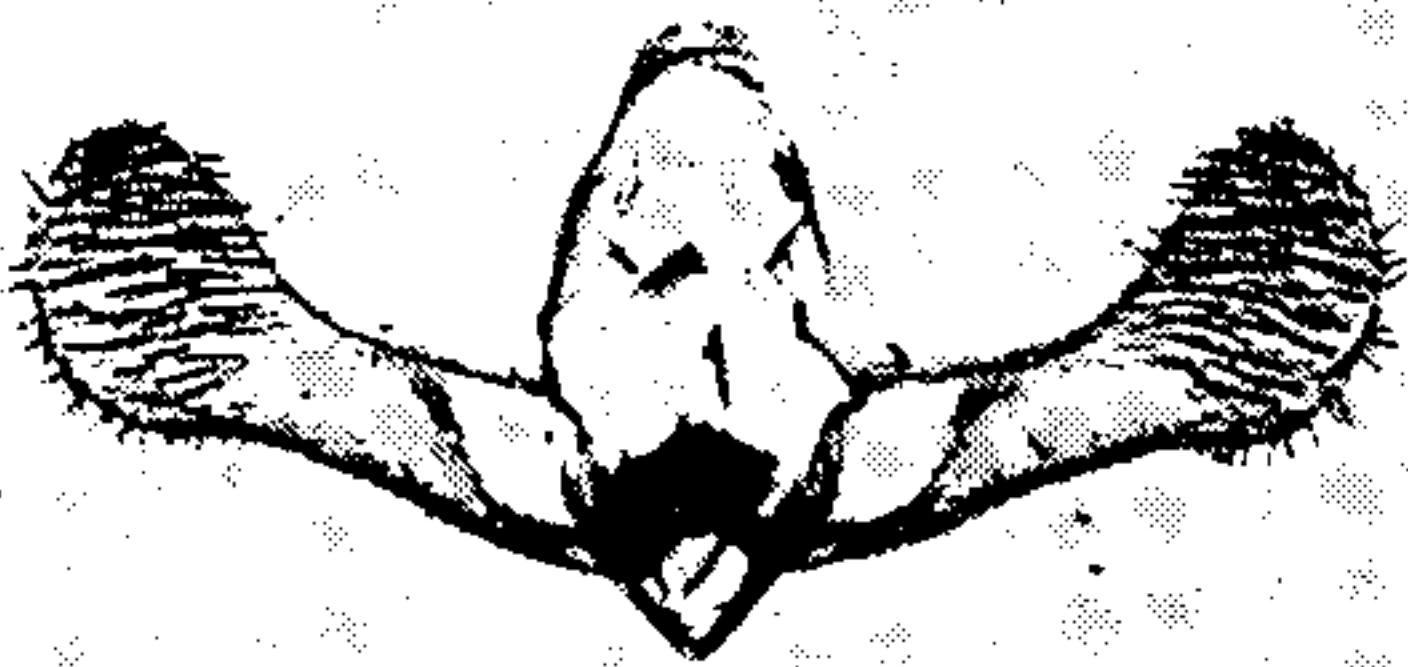

265 *separationis*

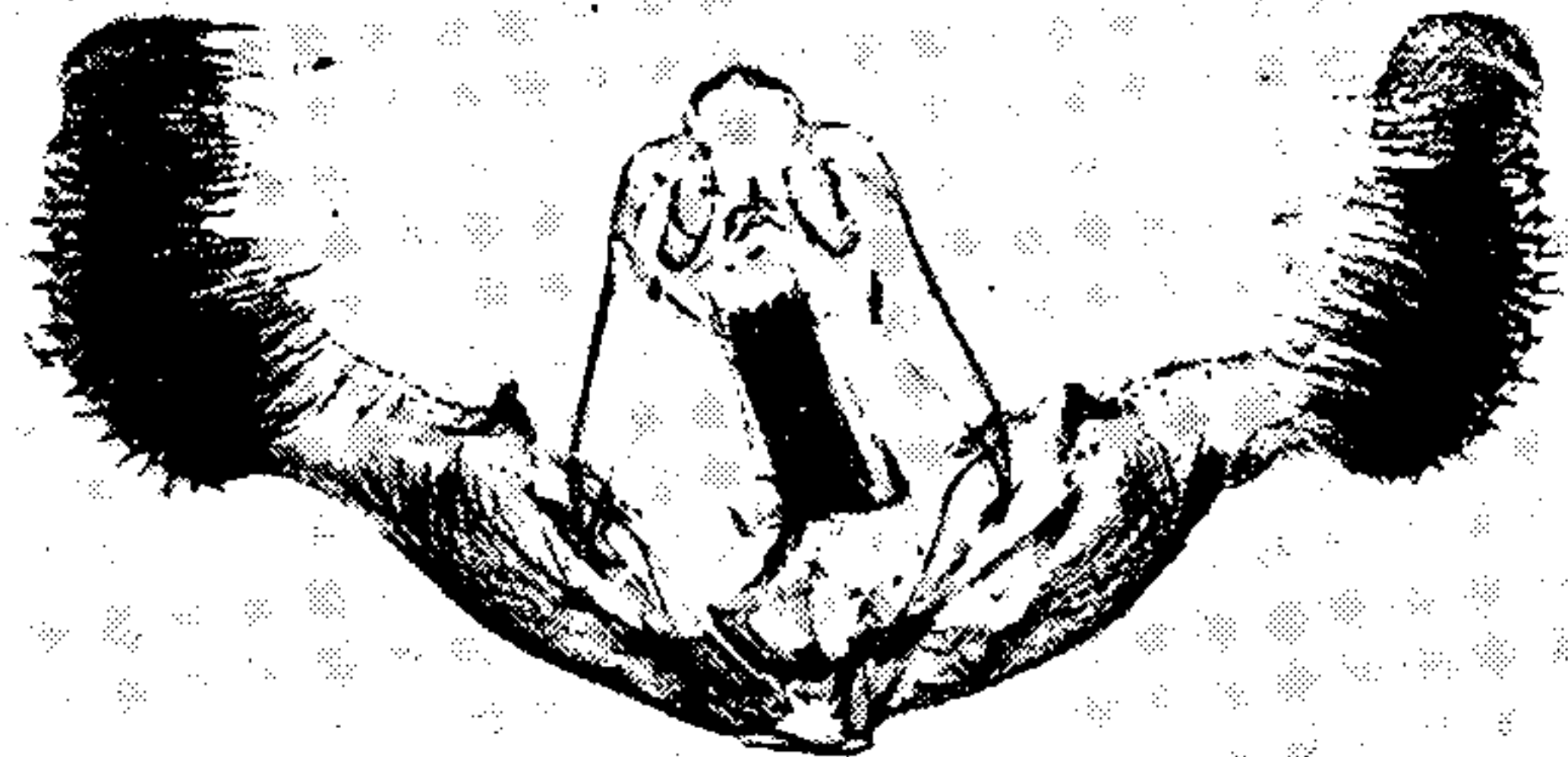

270 *tripartitana*



266 *deflexana*

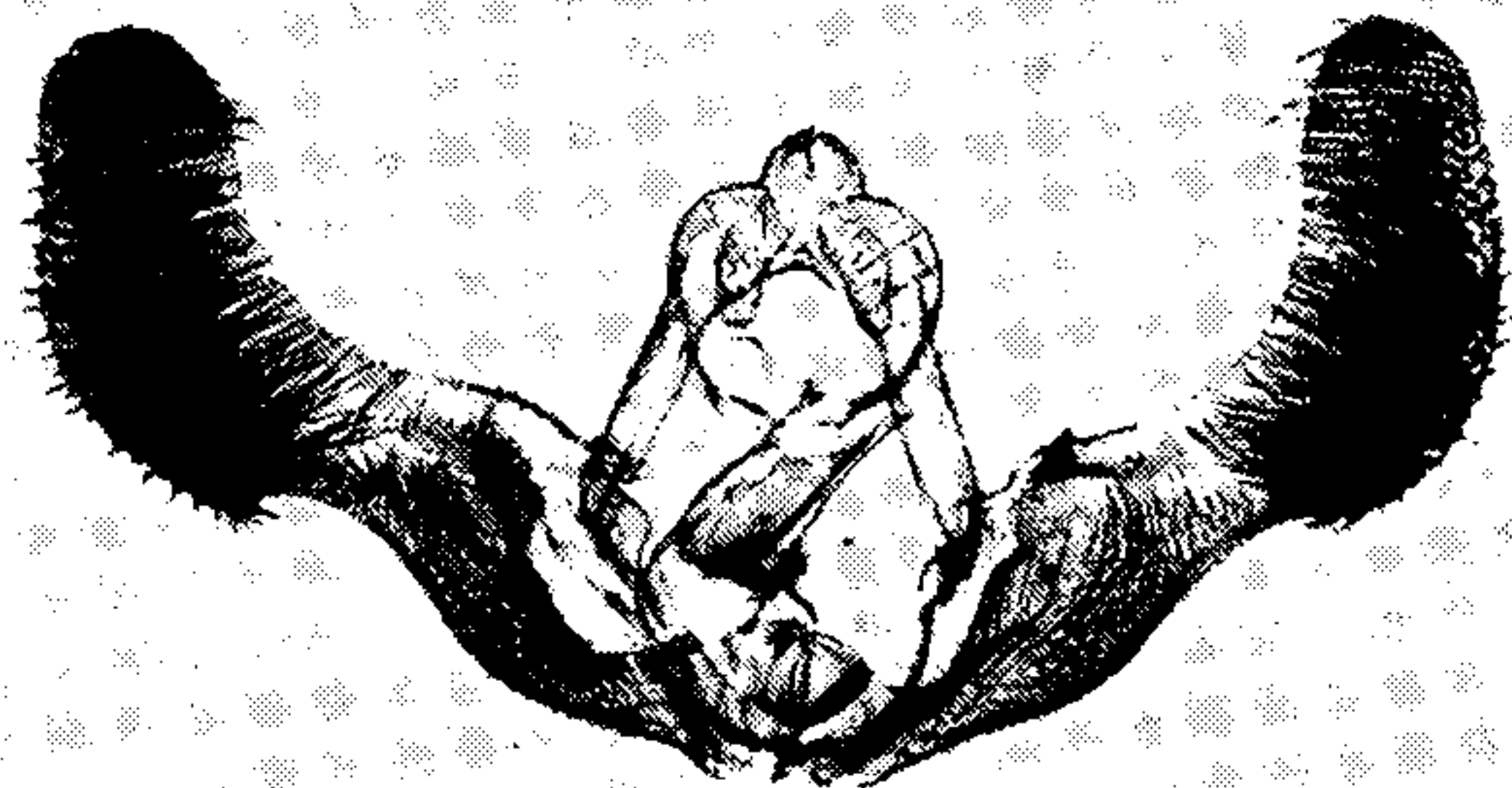

271 *scudderiana*

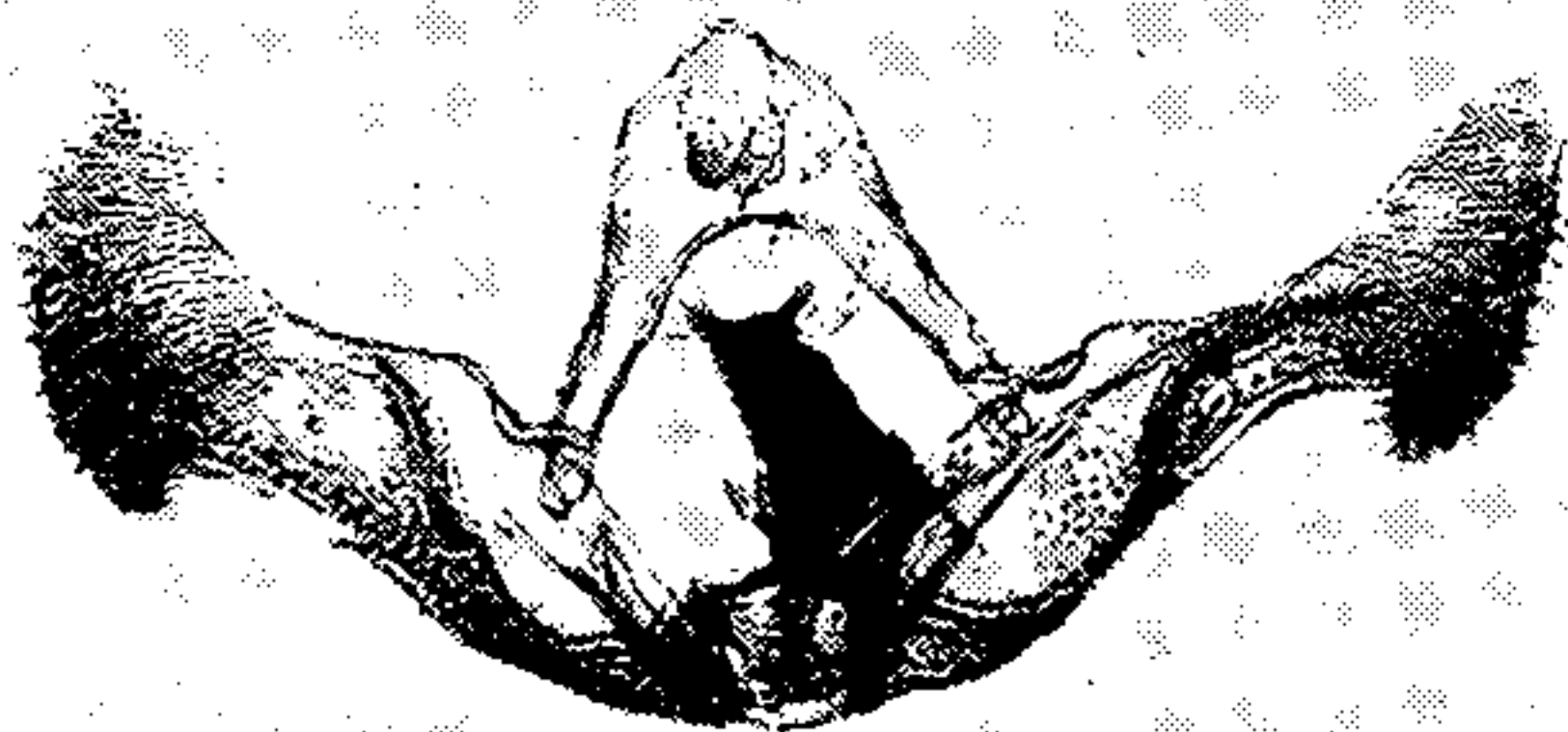

267 *purpurissatana*



272 *kennebecana*

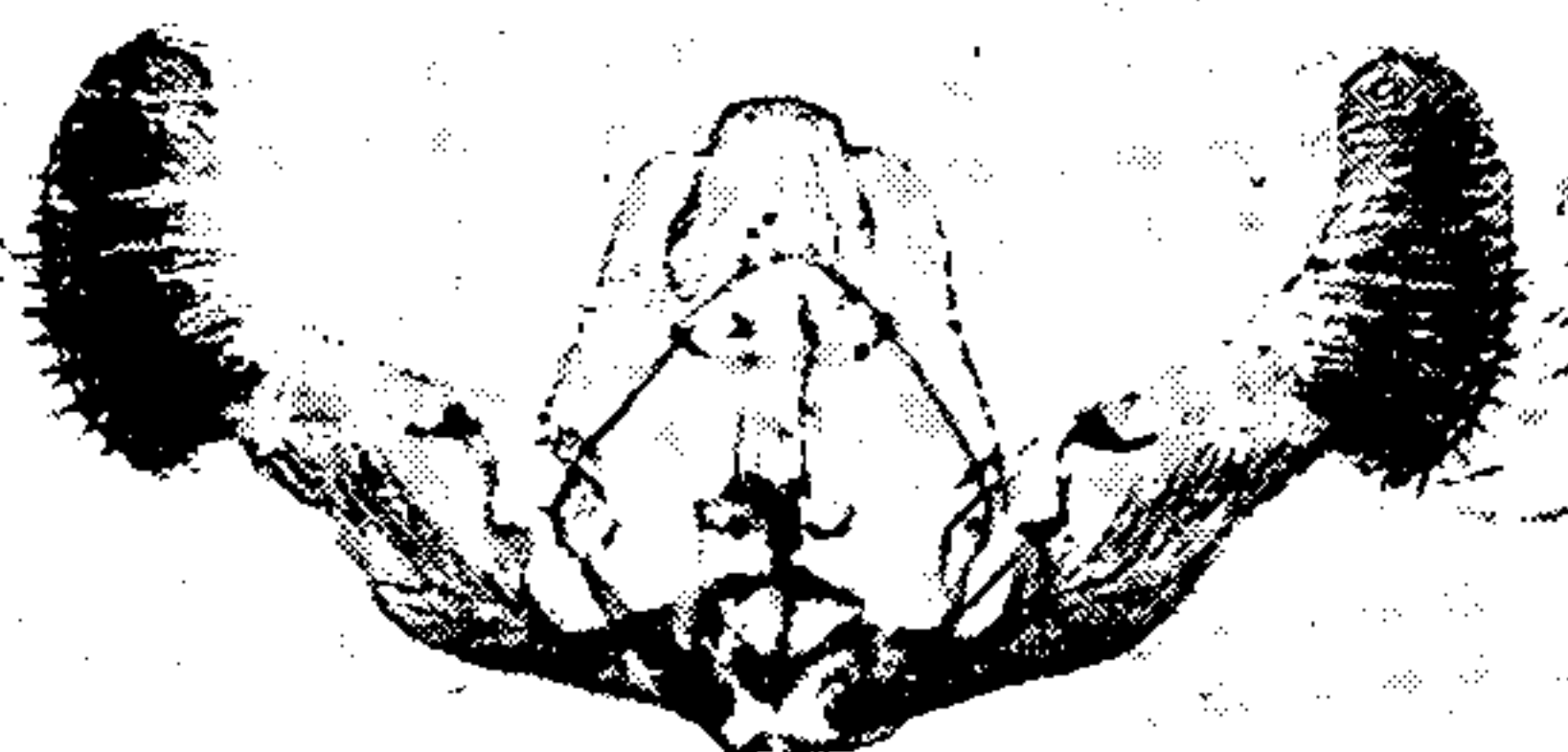

268 *ochraceana*

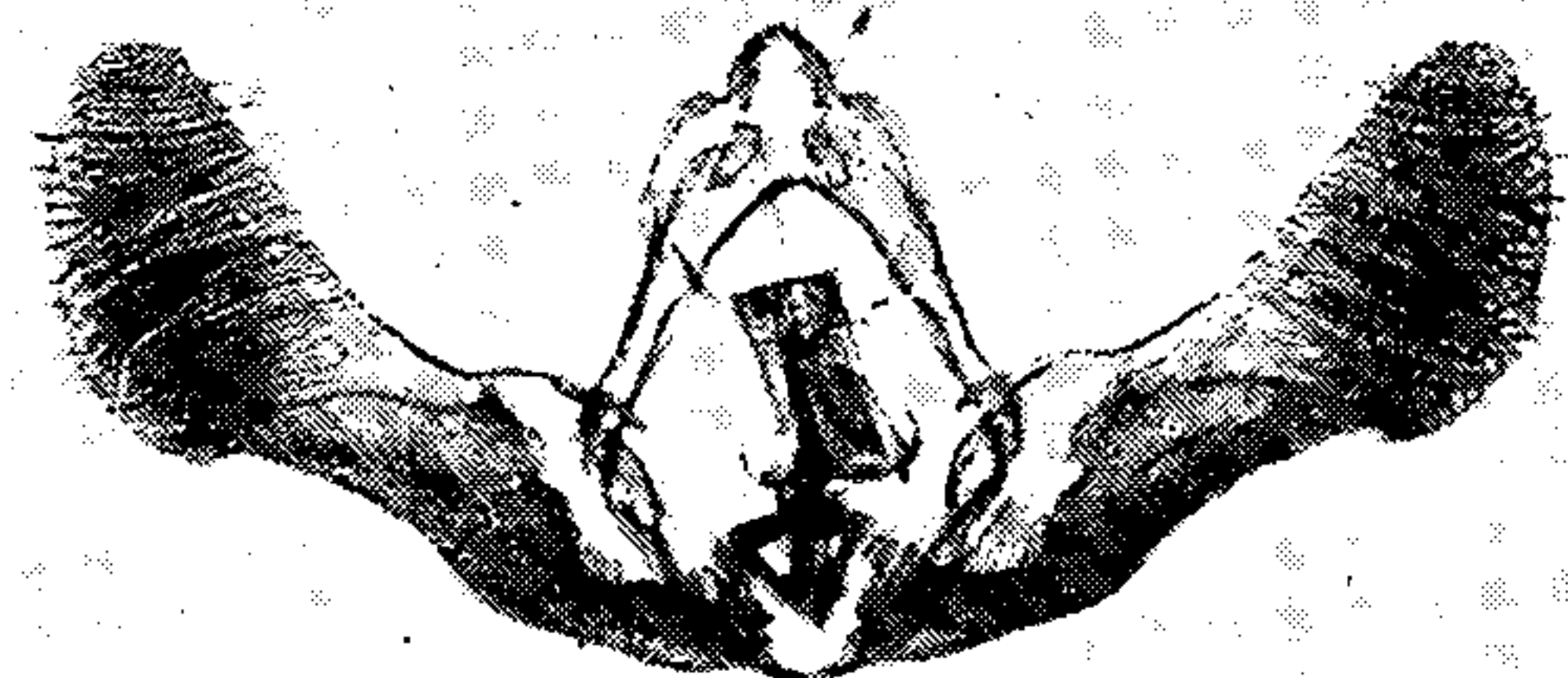

273 *discretivana*

MALE GENITALIA OF EPIBLEMA.

FOR EXPLANATION OF PLATE SEE PAGE 282.

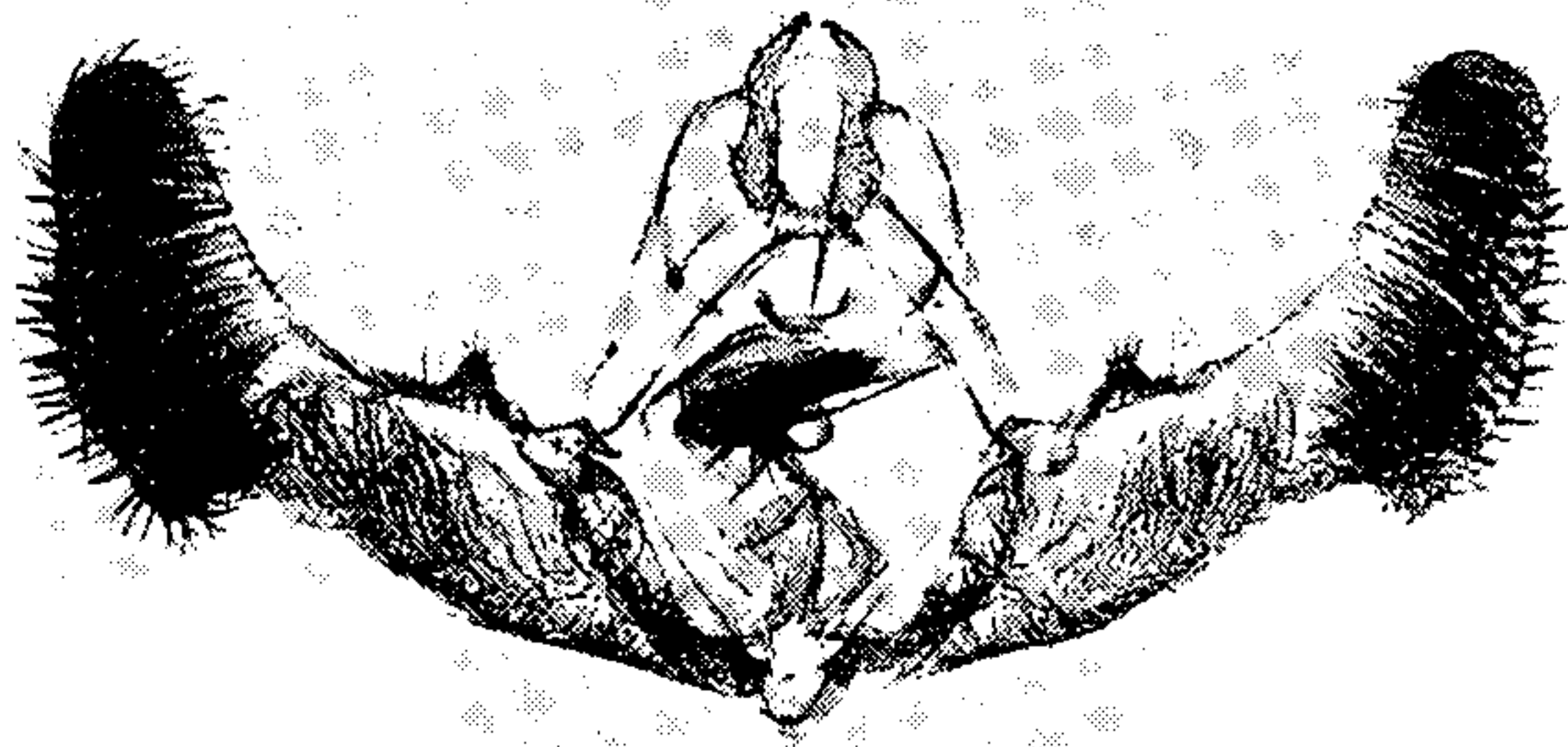

274 *obfusca*



278 *walsinghami*

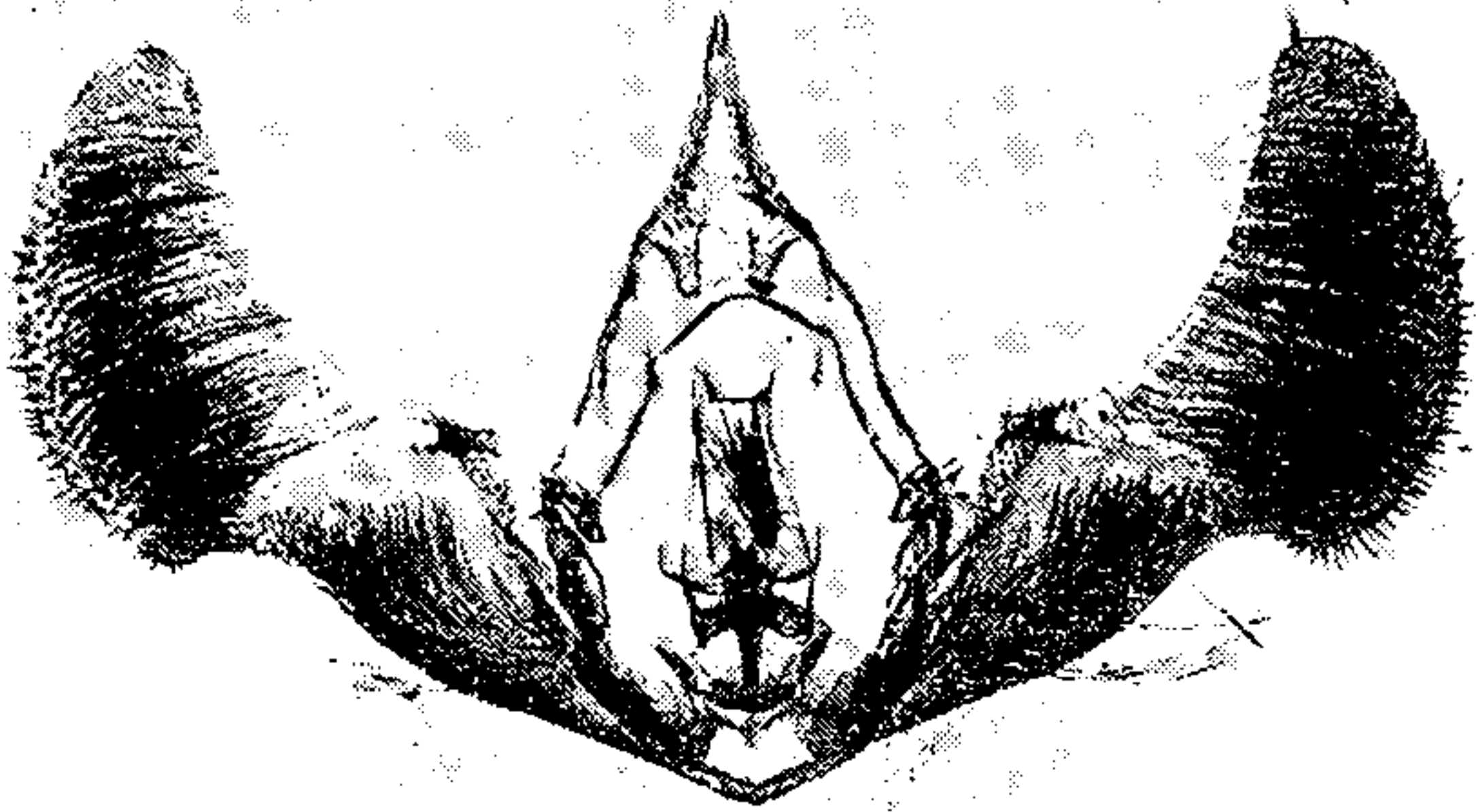

275 *desertana*

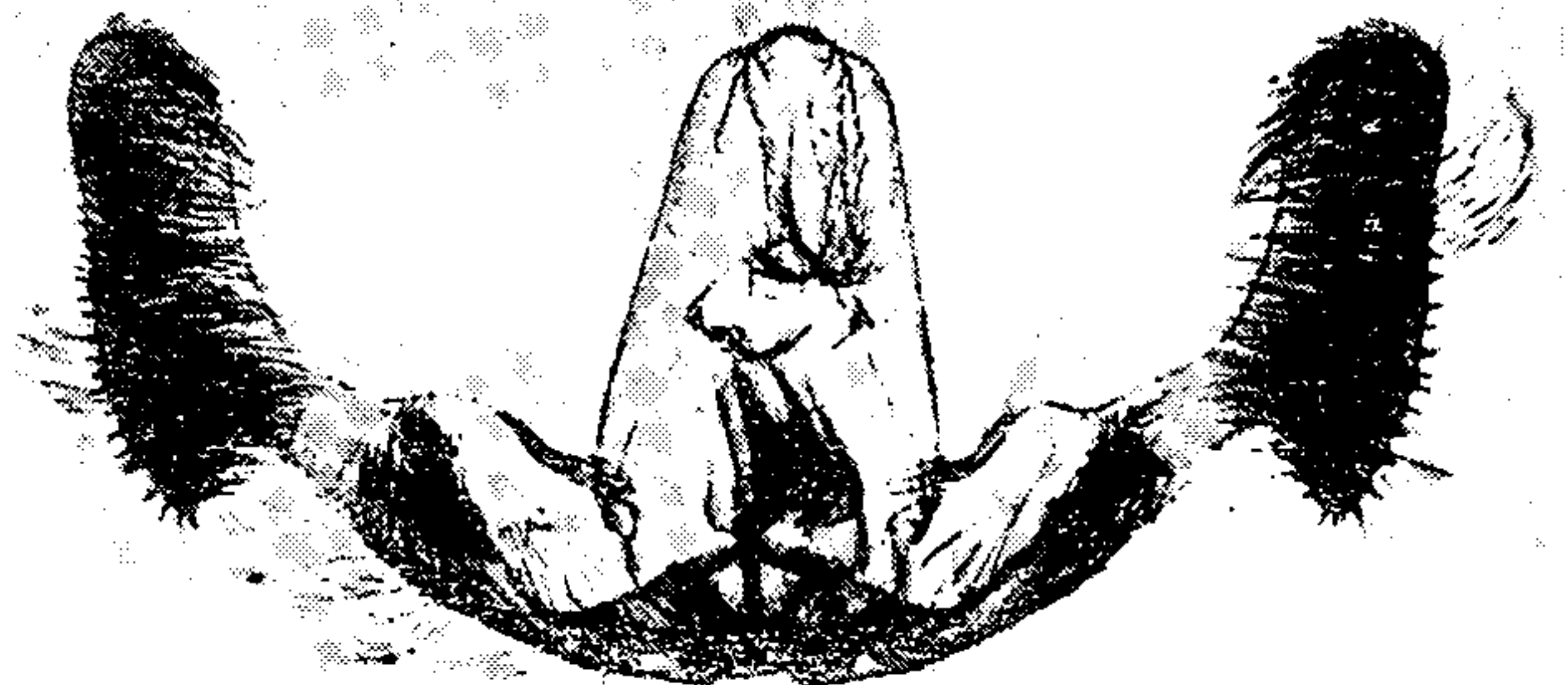

279 *suffusana*

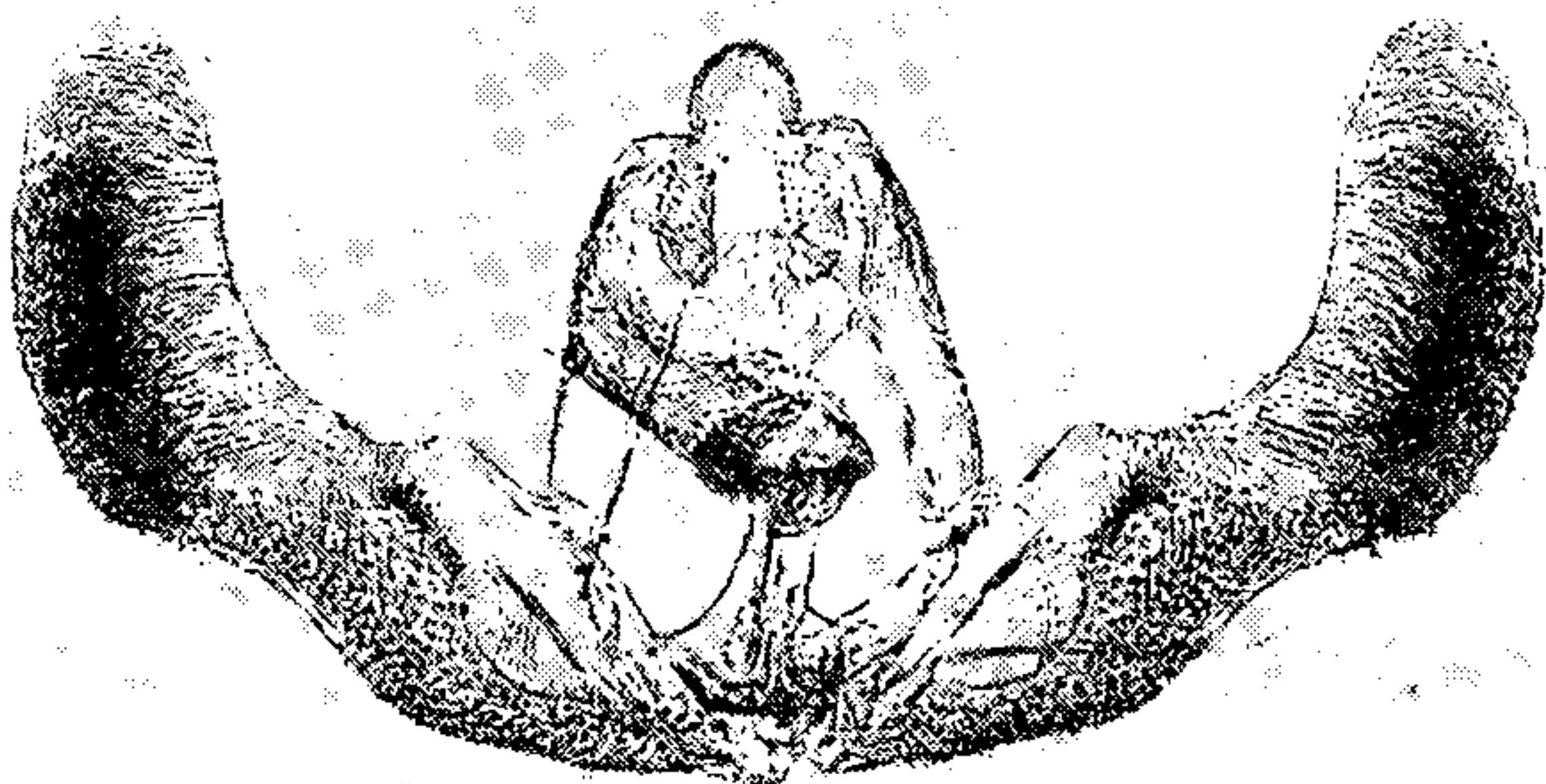

276 *infelix*

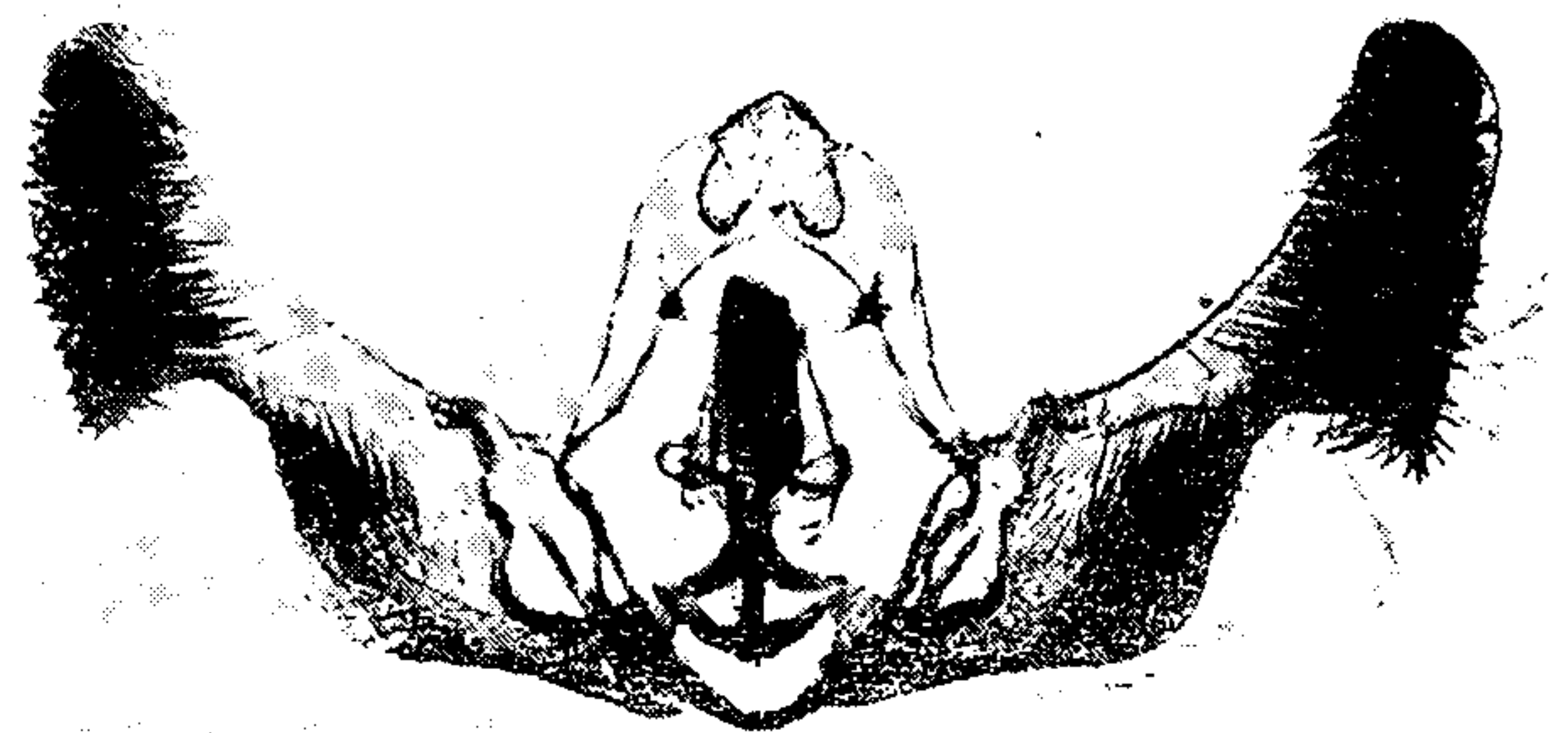

280 *dorsisuffusana*

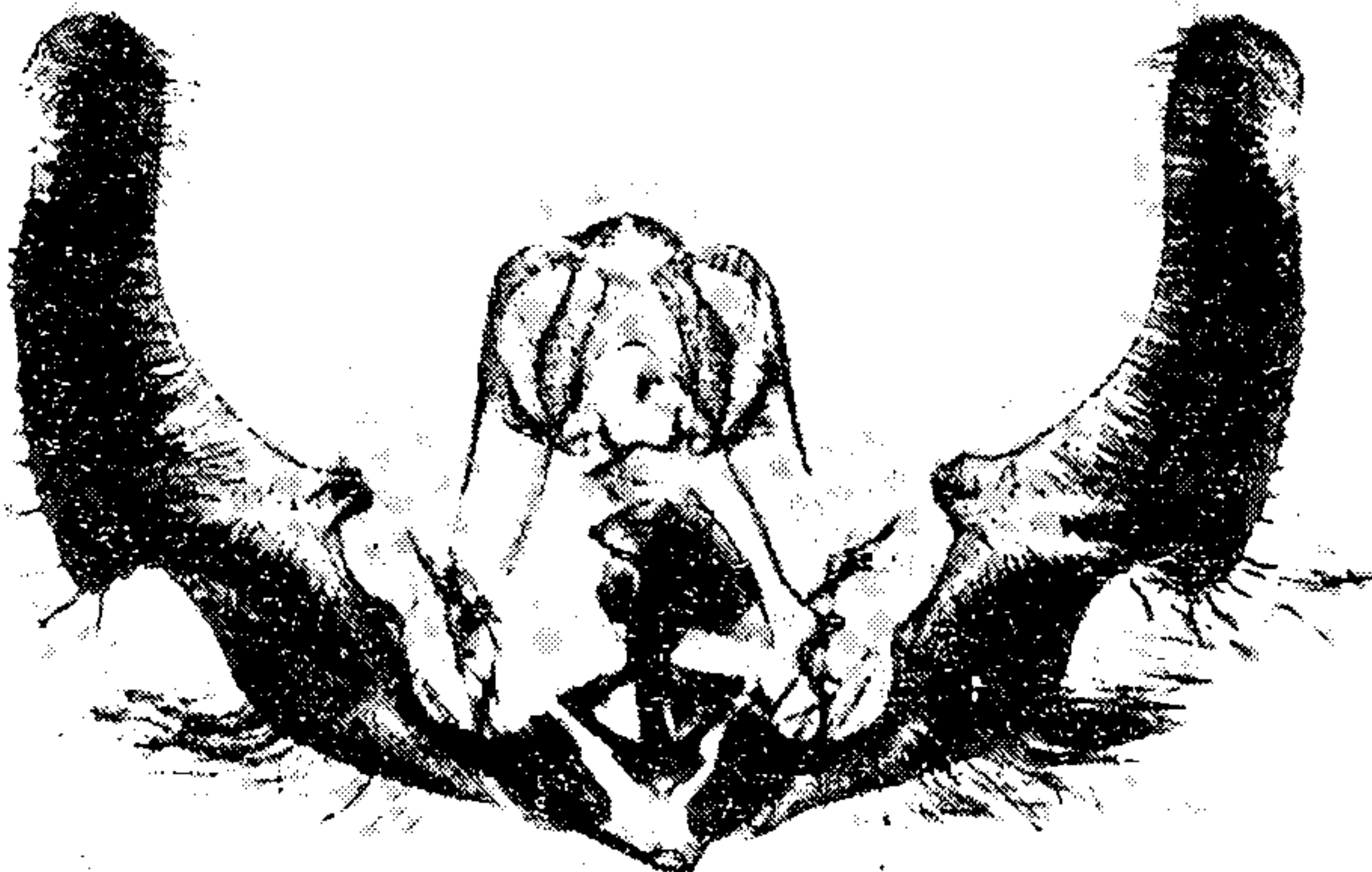

277 *carolinana*

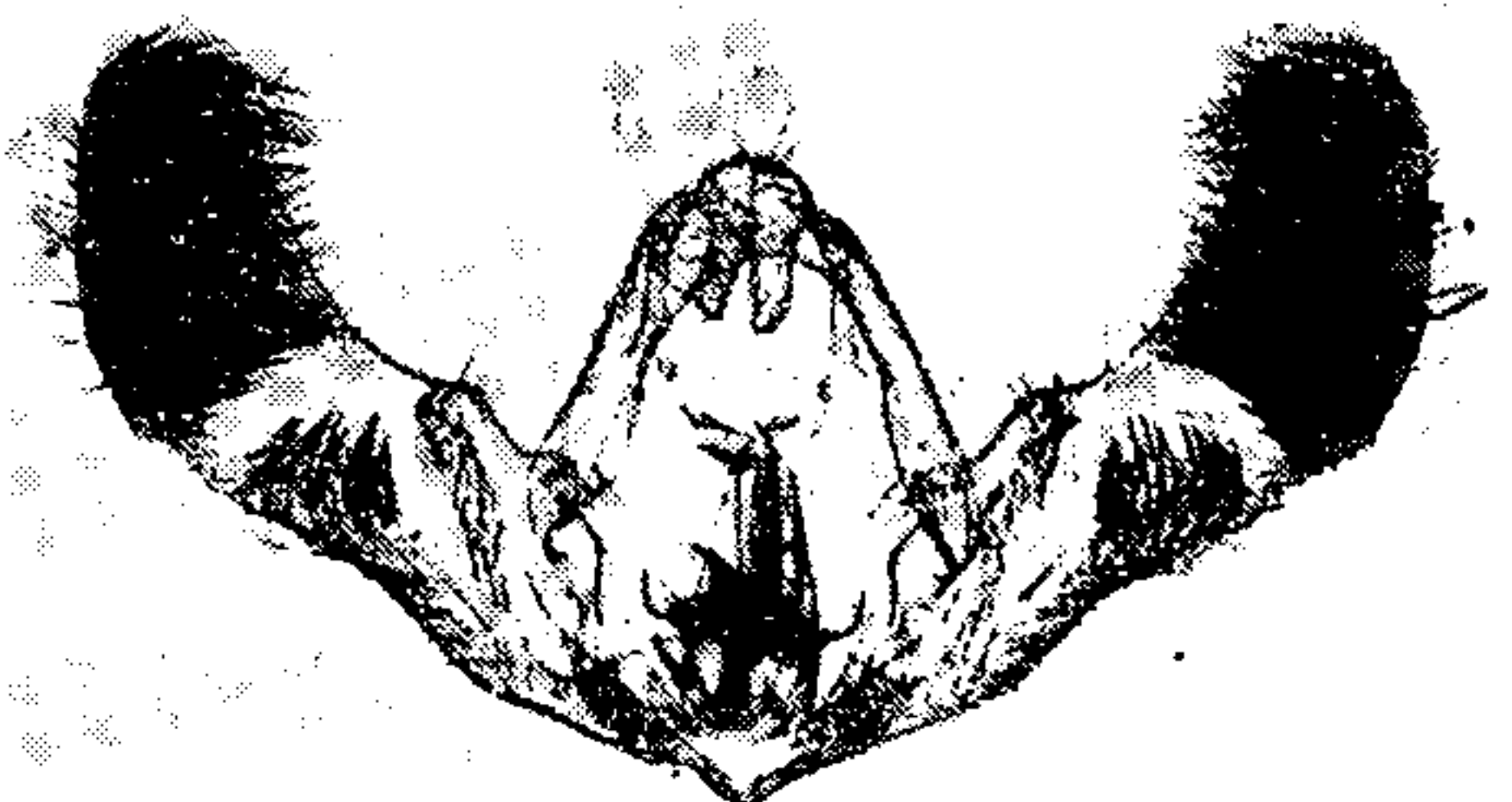

281 *illotana*

MALE GENITALIA OF EPIBLEMA.

FOR EXPLANATION OF PLATE SEE PAGE 282



THIS PAGE IS LOCKED TO FREE MEMBERS

Purchase full membership to immediately unlock this page



Never be without a book!

Forgotten Books Full Membership gives universal access to 797,885 books from our apps and website, across all your devices: tablet, phone, e-reader, laptop and desktop computer

A library in your pocket for \$8.99/month

Continue

*Fair usage policy applies



290 *vovana*

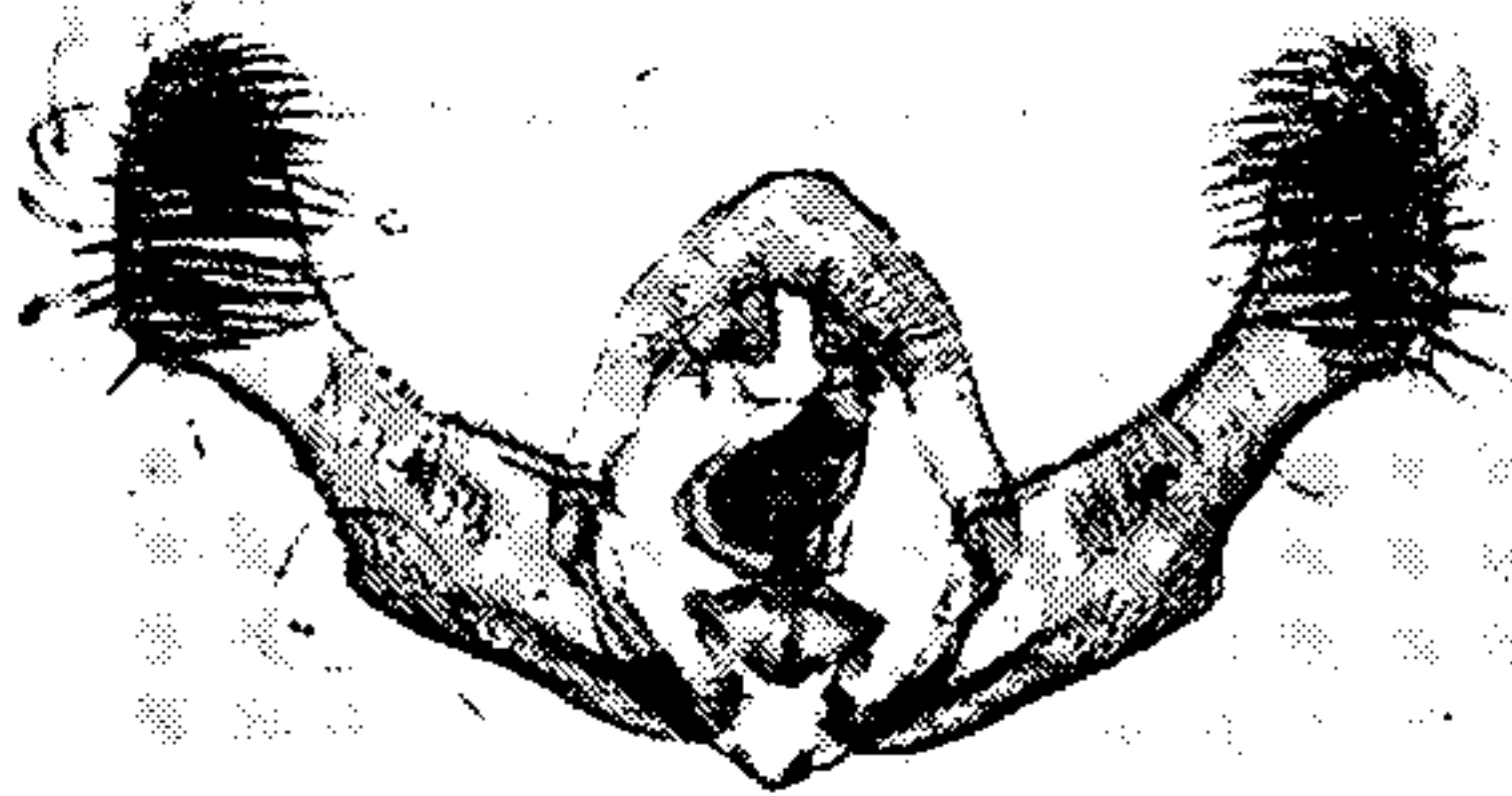

291 *constrictana*



295 *filiata*

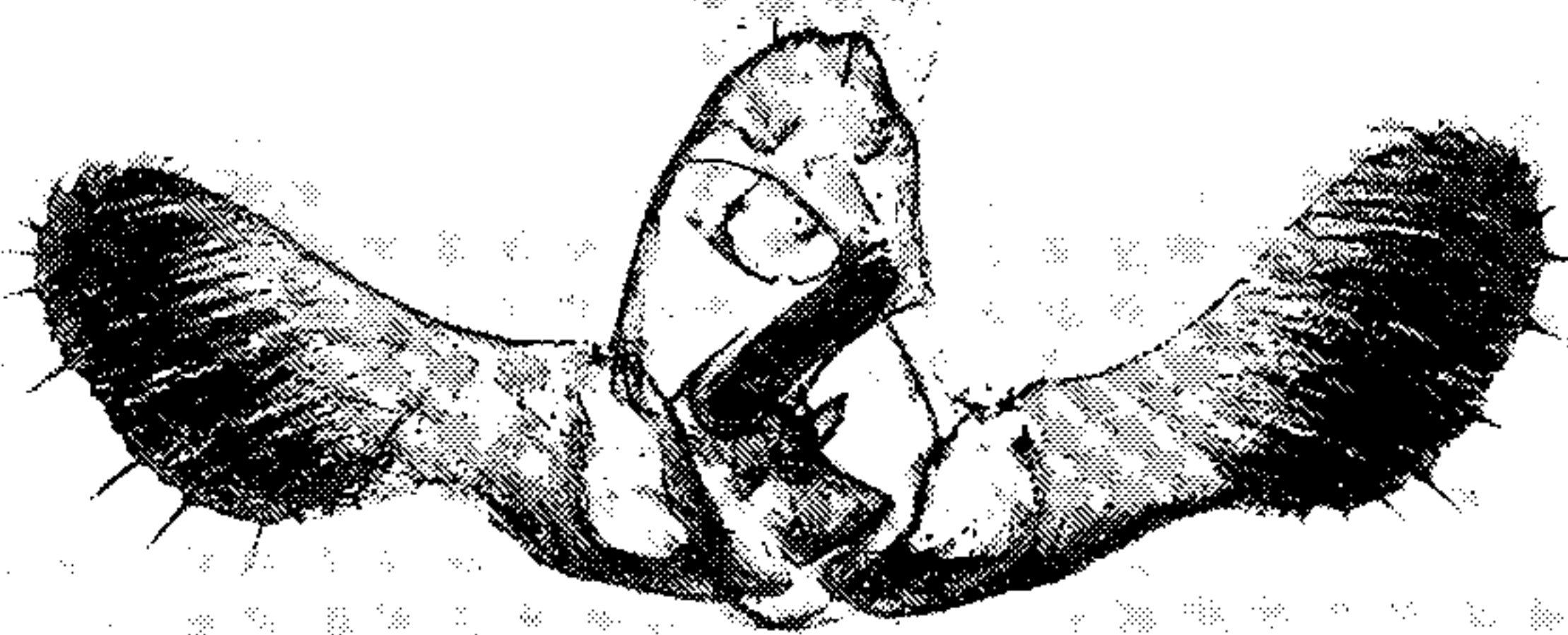

292 *helianthana*

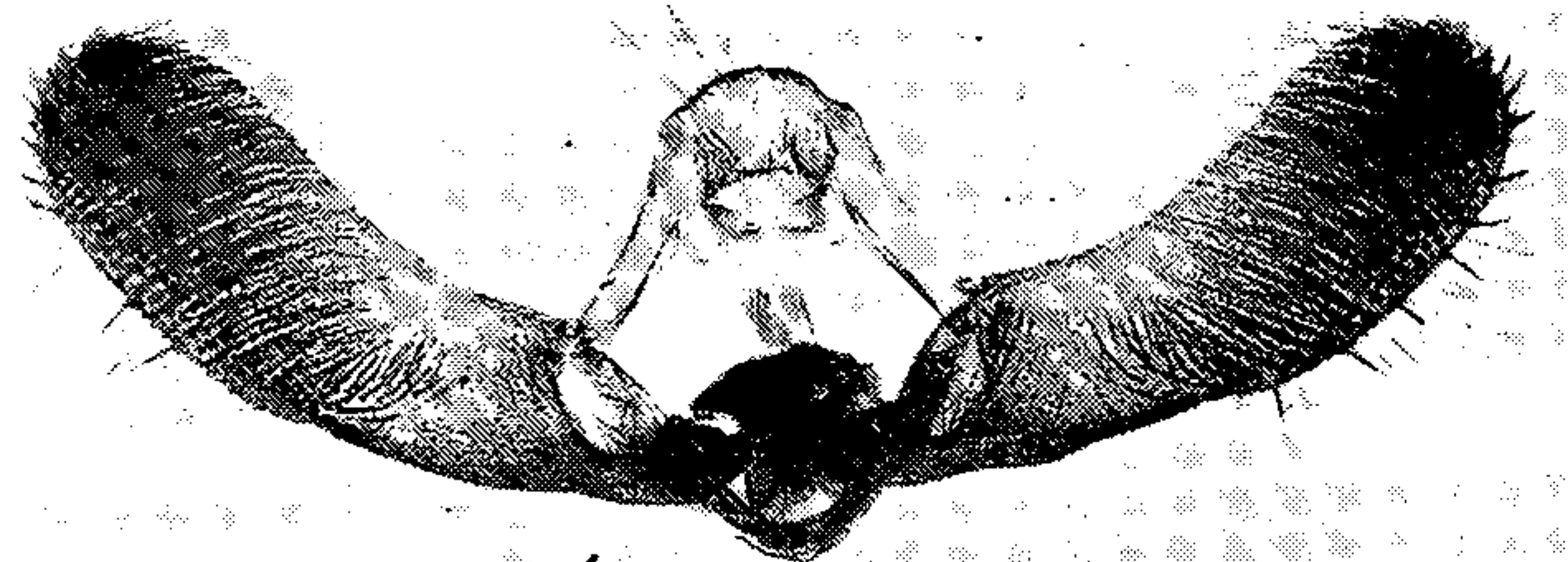

296 *logopana*

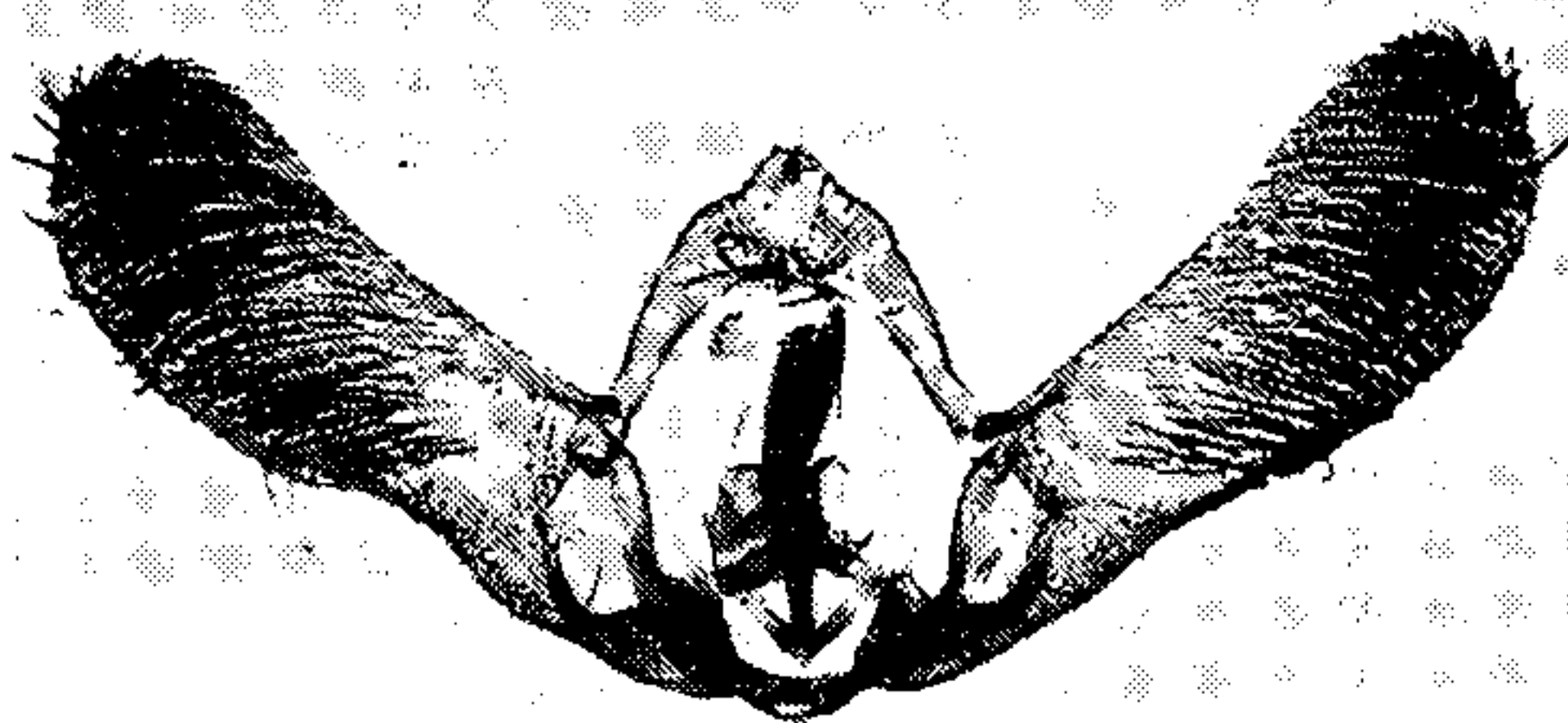

293 *daracana*

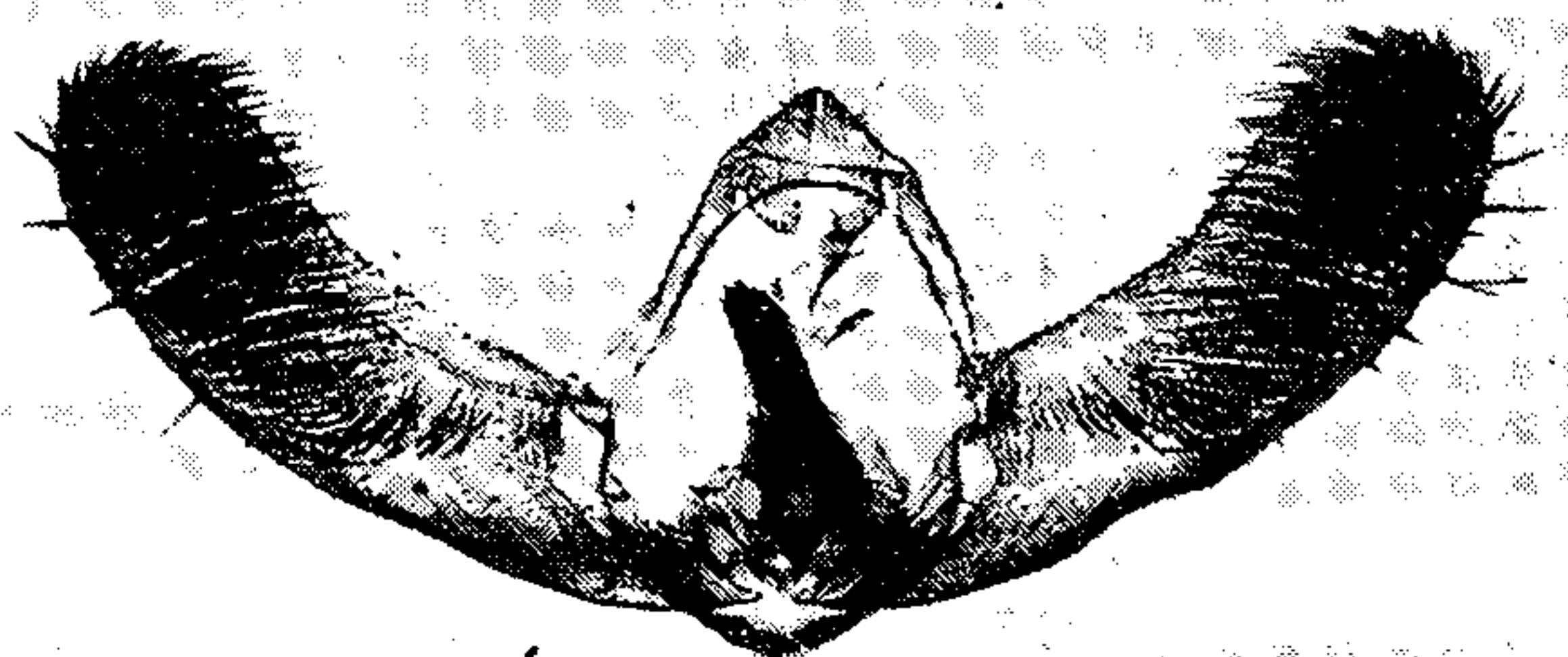

297 *baracana*

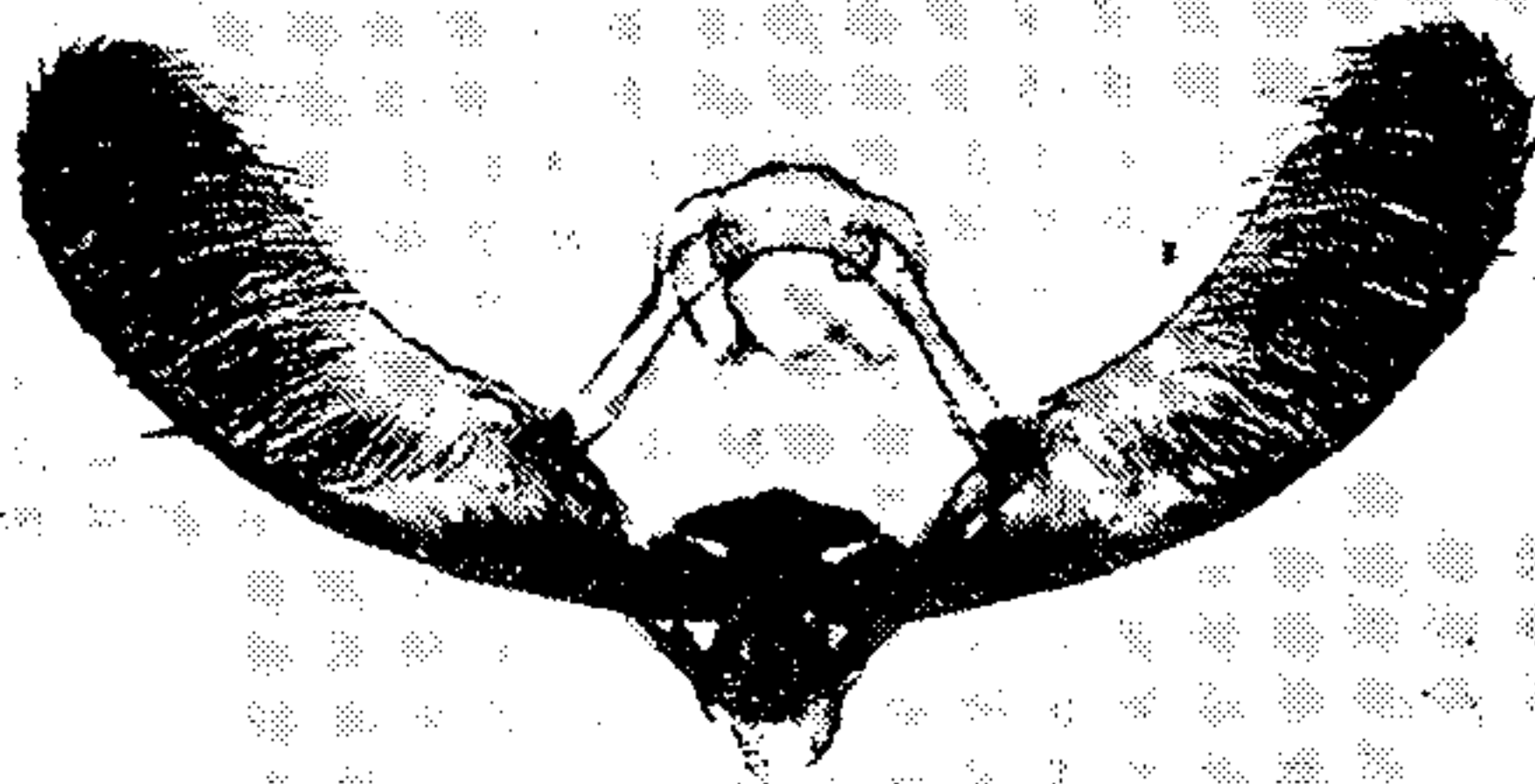

294 *cinerodorsana*



298 *skinnerana*

MALE GENITALIA OF SONIA AND SULEIMA.

FOR EXPLANATION OF PLATE SEE PAGE 283.

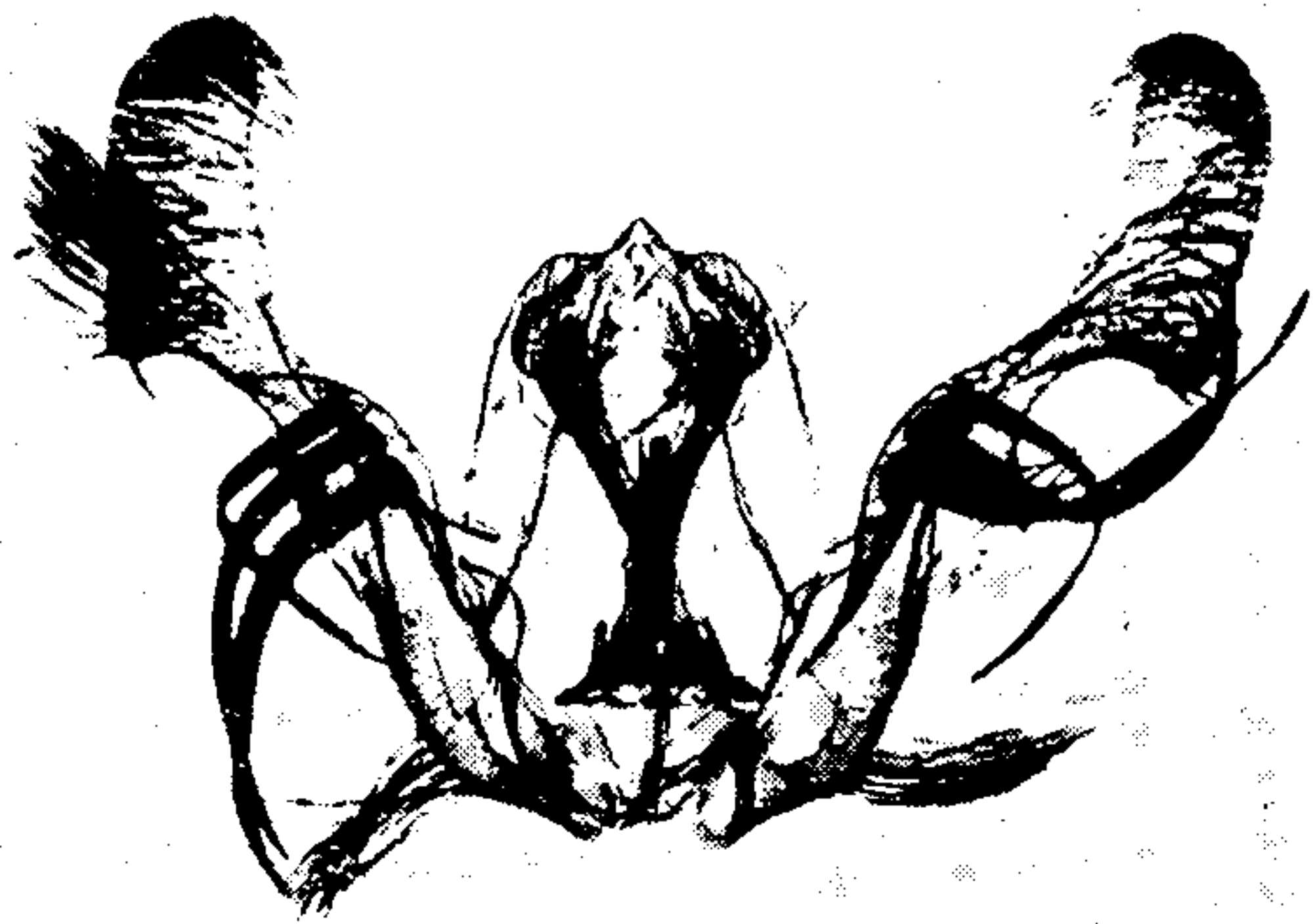

299 *aesculana*



303 *moffatiana*

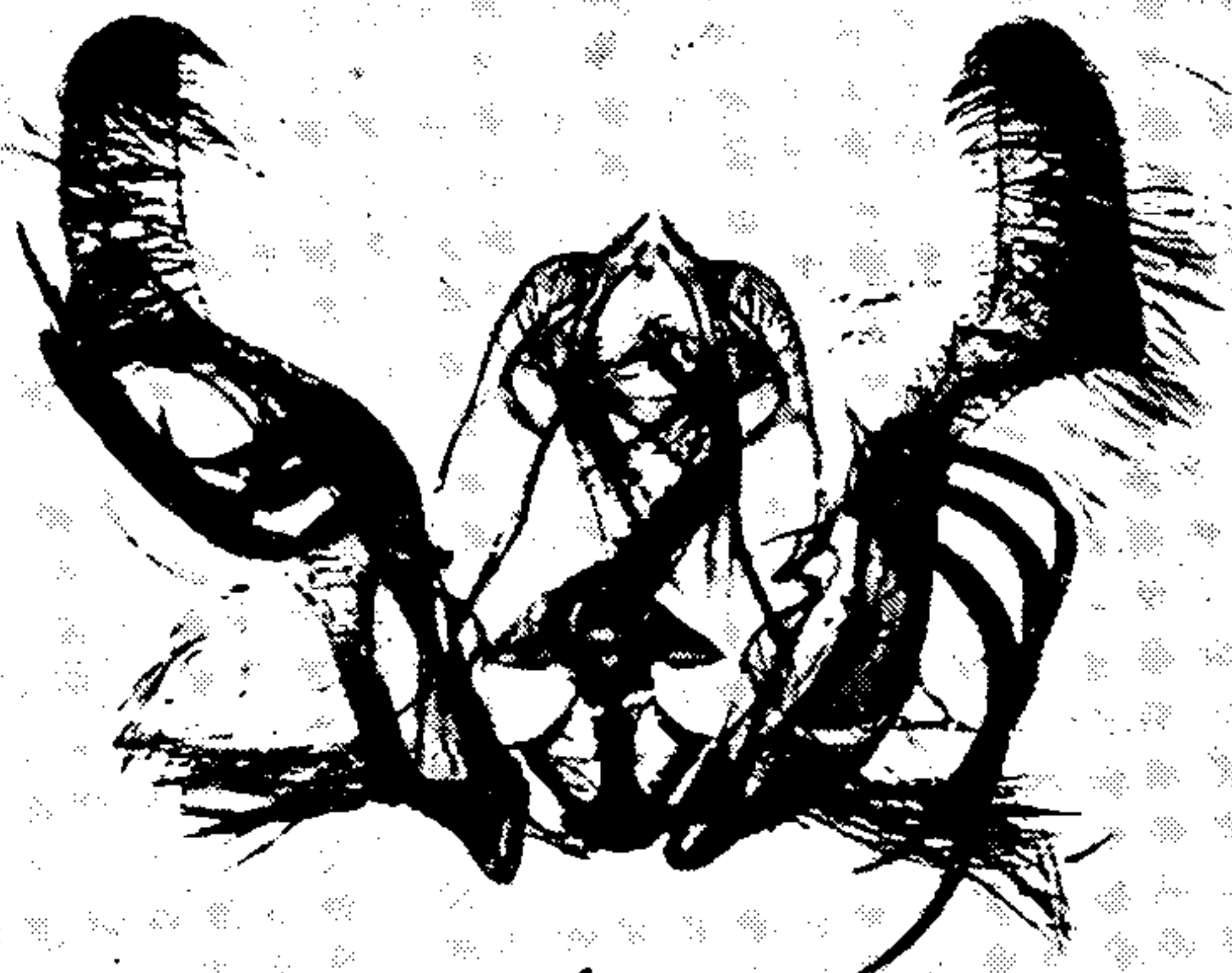

300 *arizonae*

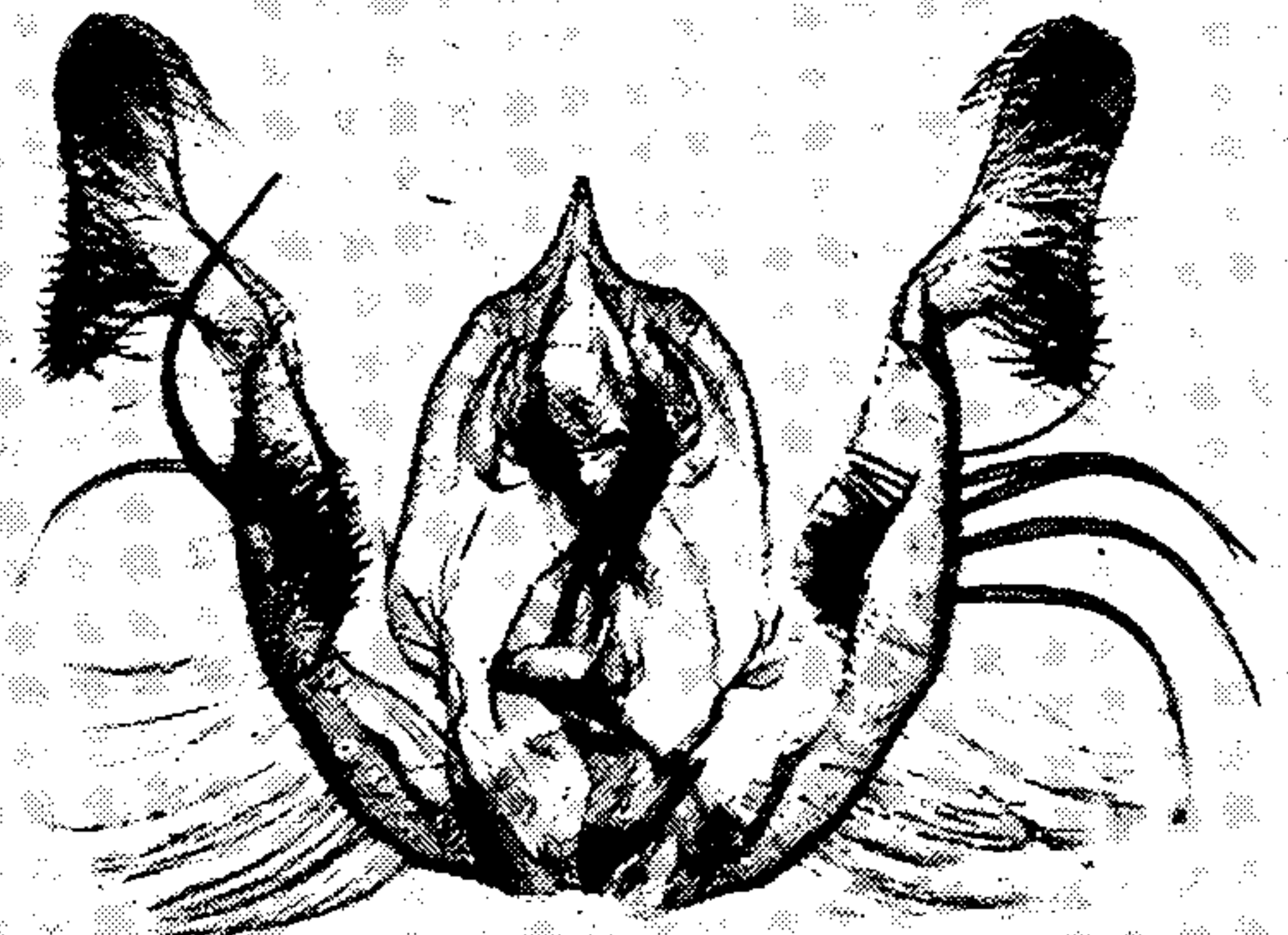

304 *naracana*

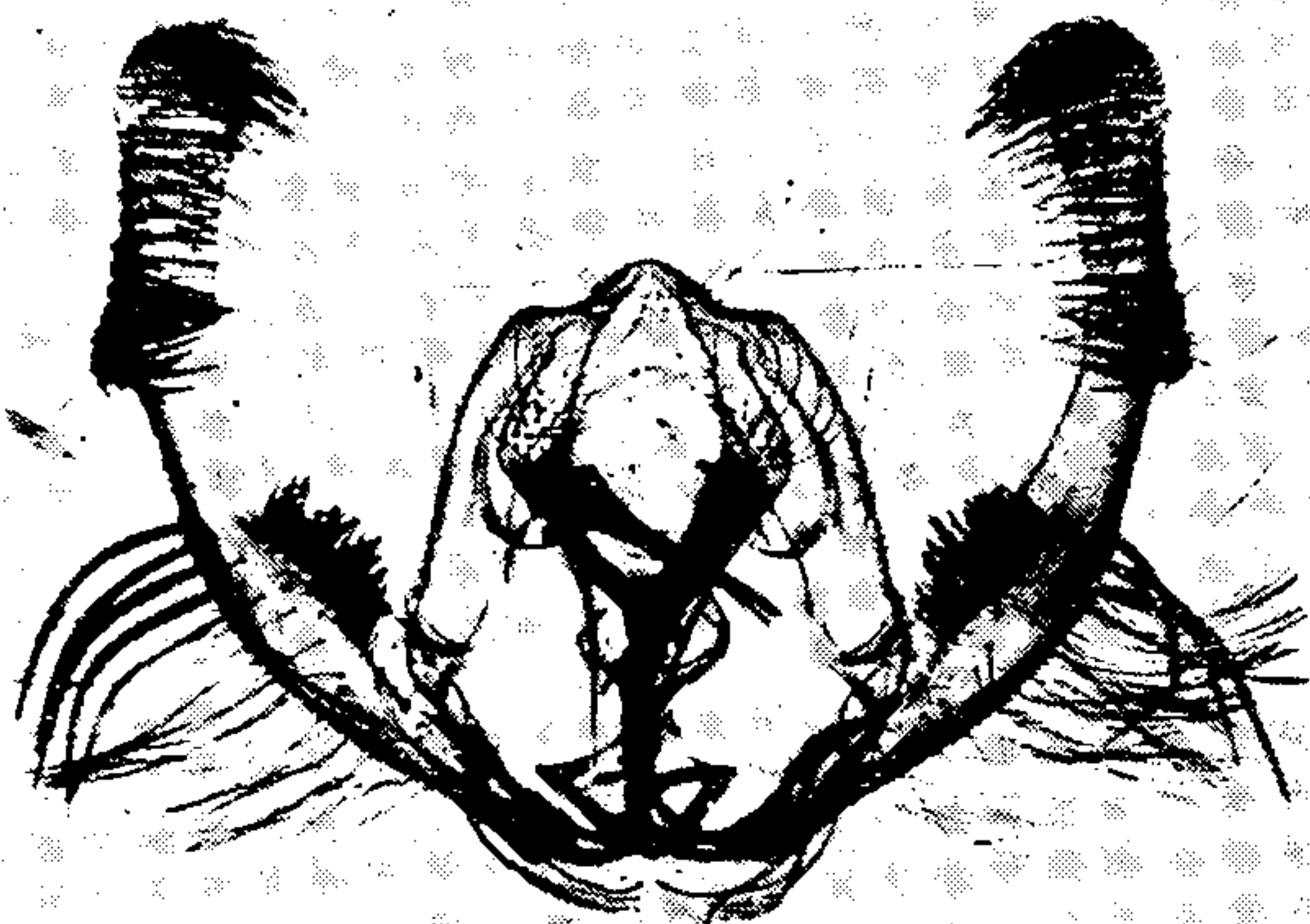

301 *crescentana*



305 *obnigrana*

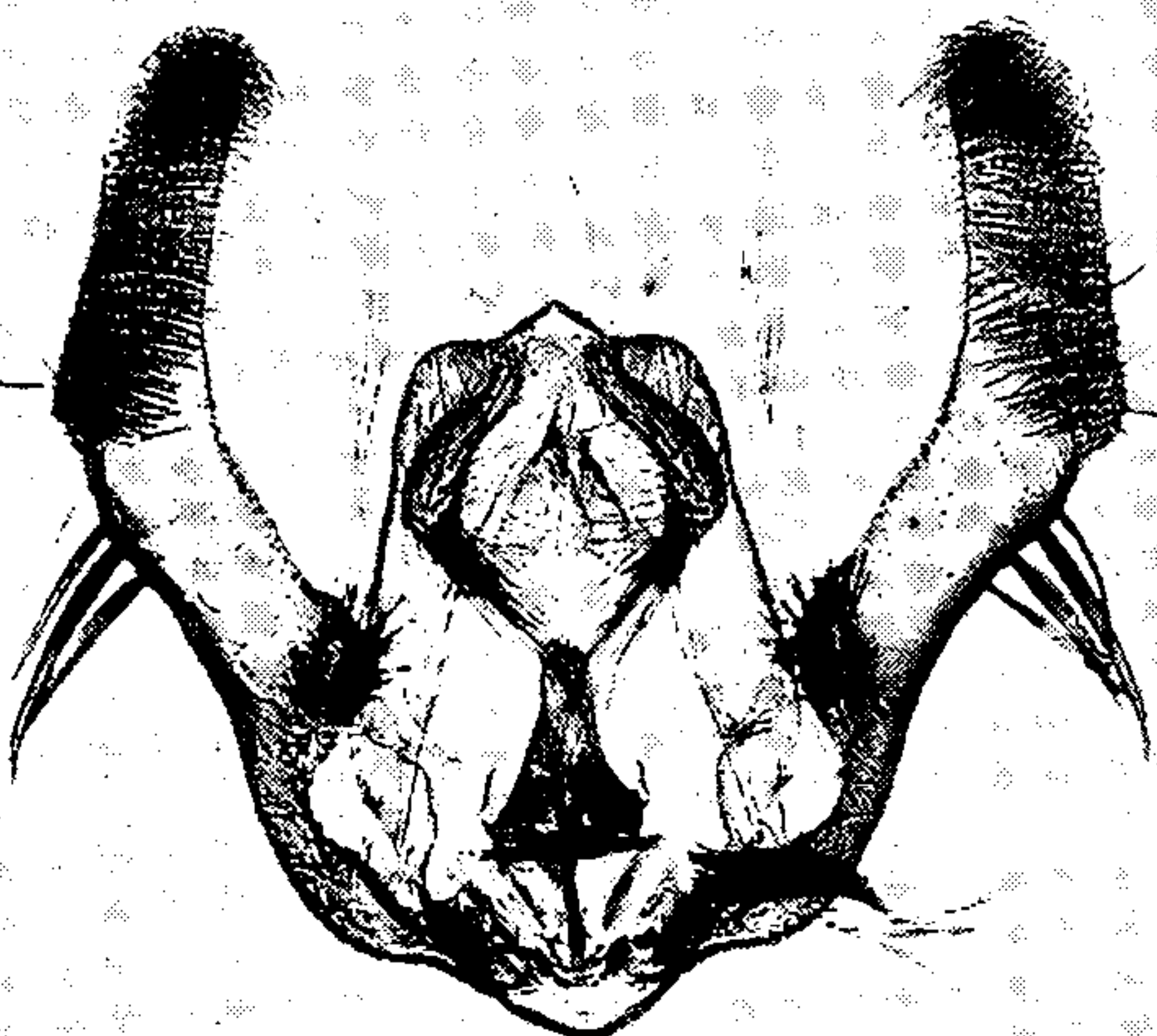

302 *willingana*

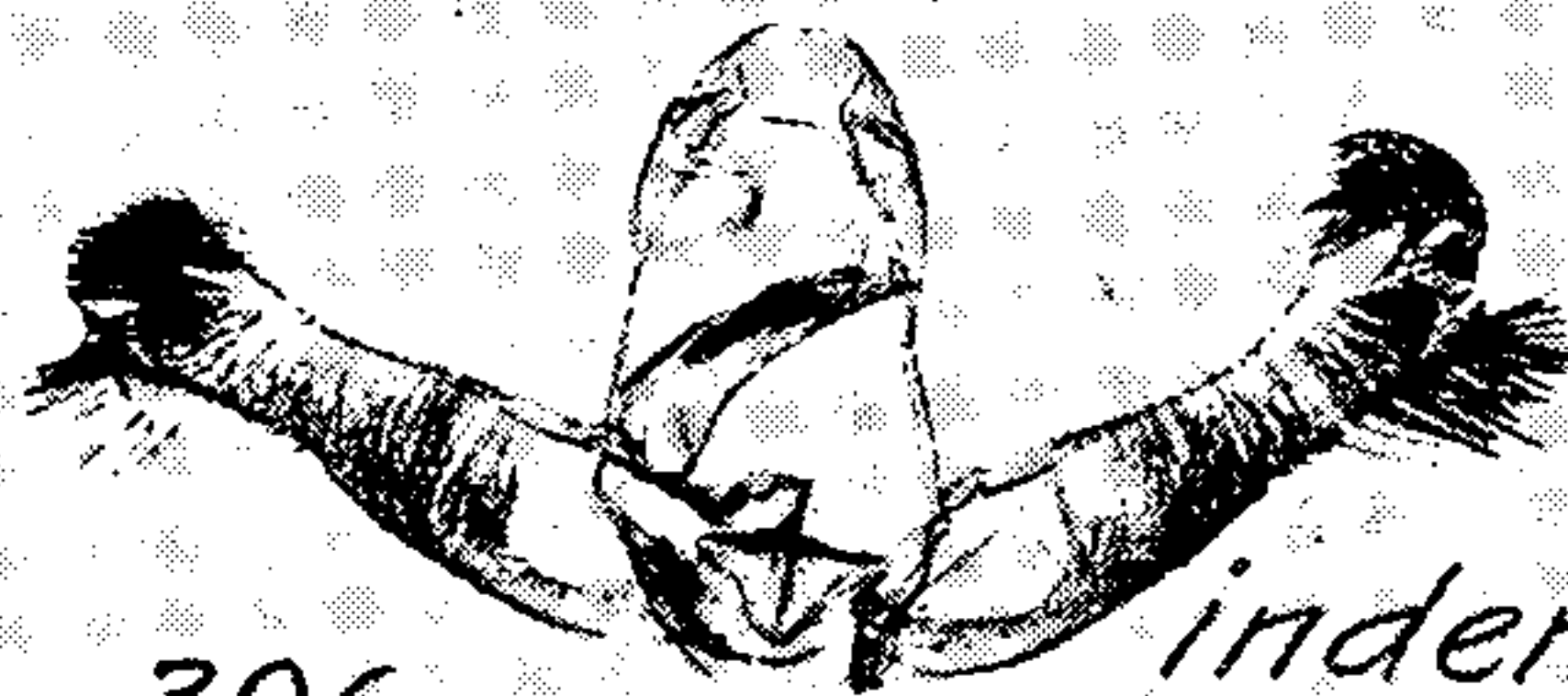

306

indentanus

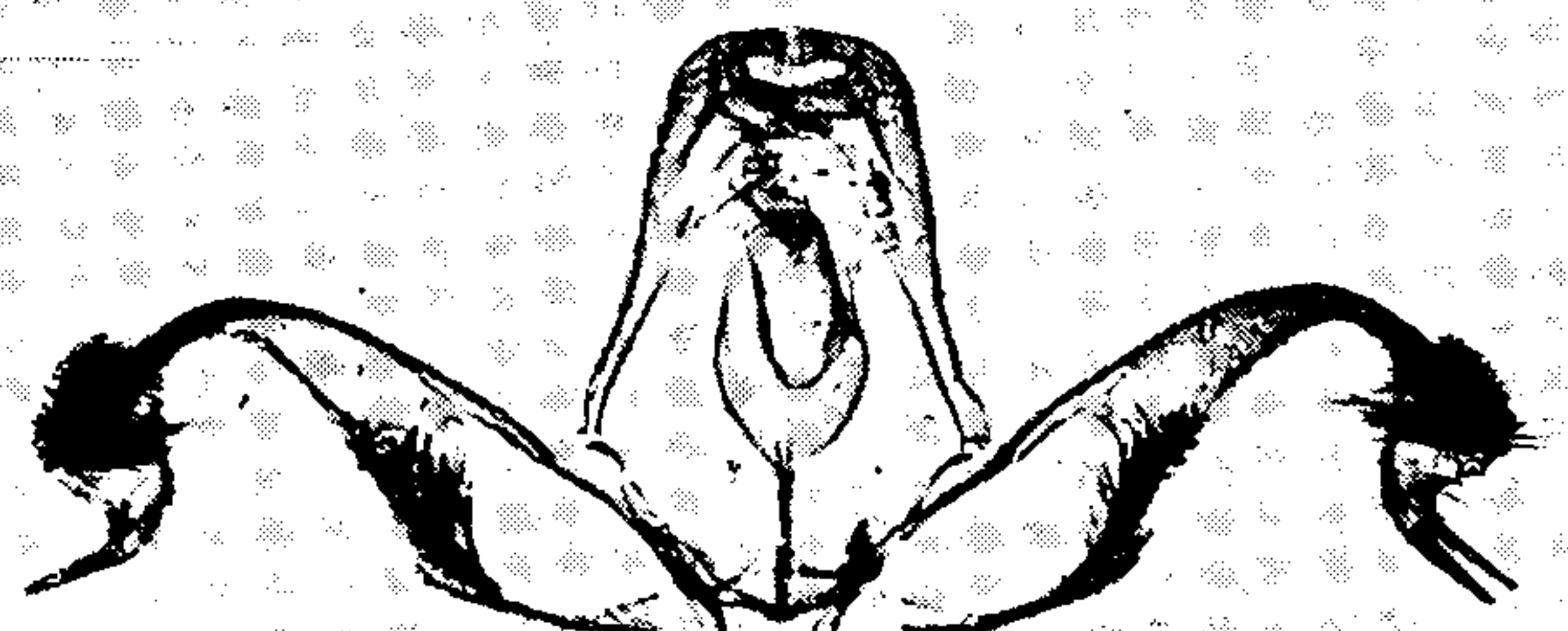

307

ocellana

MALE GENITALIA OF PROTEOTERAS, STREPSICRATES, AND SPILONOTA.

FOR EXPLANATION OF PLATE SEE PAGE 283.



308 *improbana*

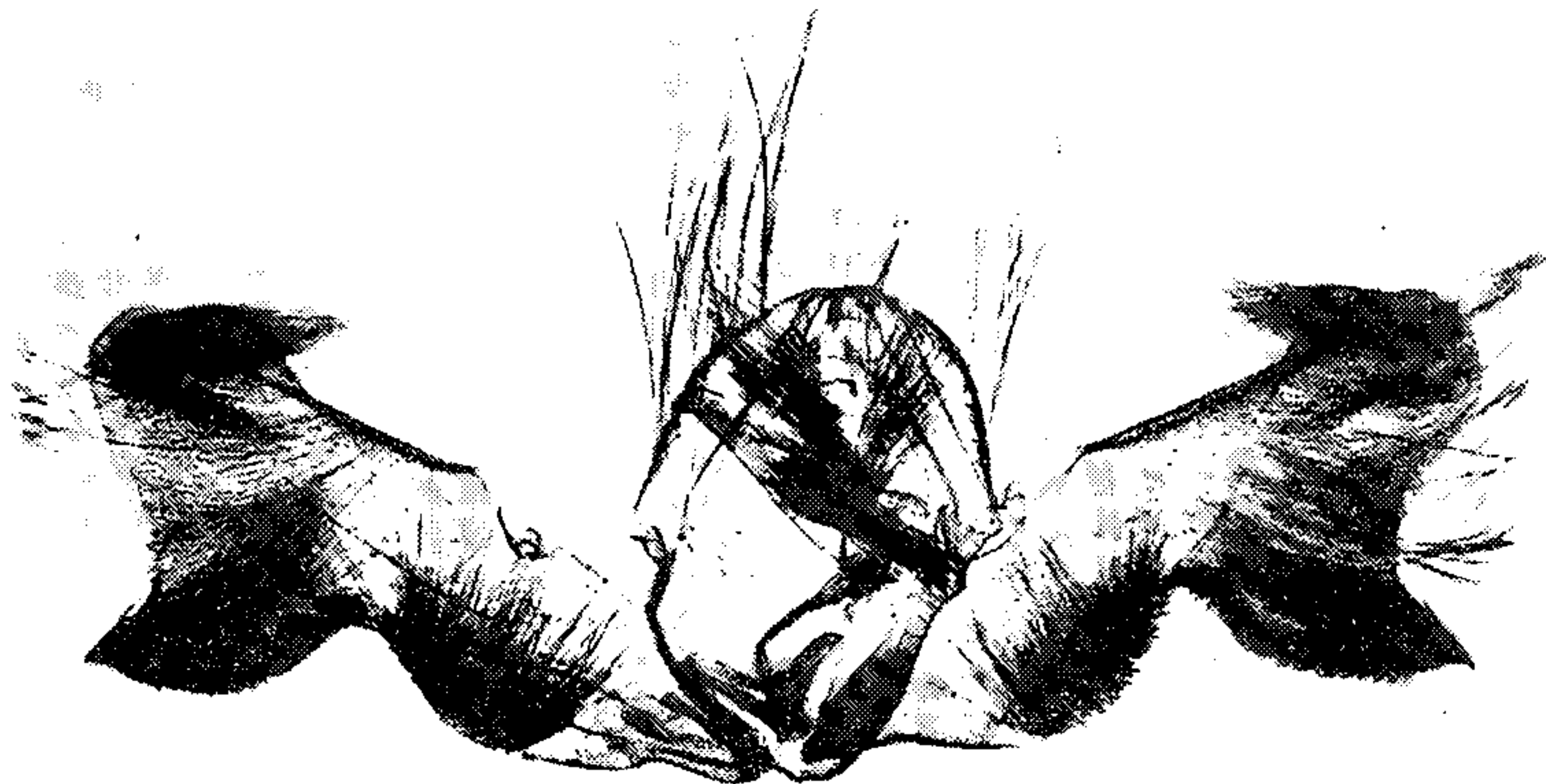

309 *oregonana*



310 *spoliata*



311 *faracana*

MALE GENITALIA OF EXENTERA.

FOR EXPLANATION OF PLATE SEE PAGE 283



THIS PAGE IS LOCKED TO FREE MEMBERS

Purchase full membership to immediately unlock this page



HISTORY

Tens of thousands of important historical sources, many previously unobtainable, are now available for the first time with a Forgotten Books Full Membership.

Unlimited Access
\$8.99/month

Continue

*Fair usage policy applies

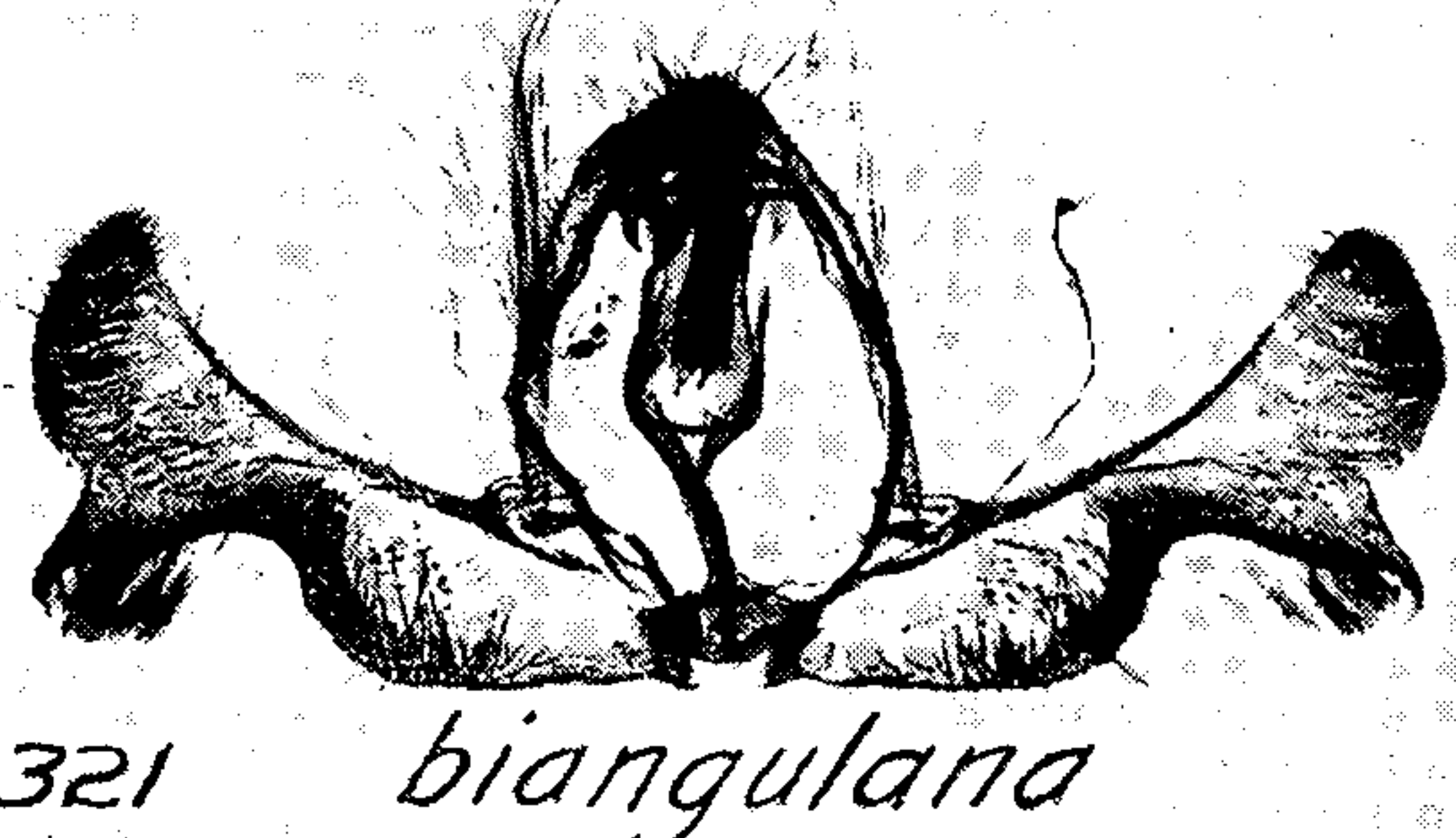
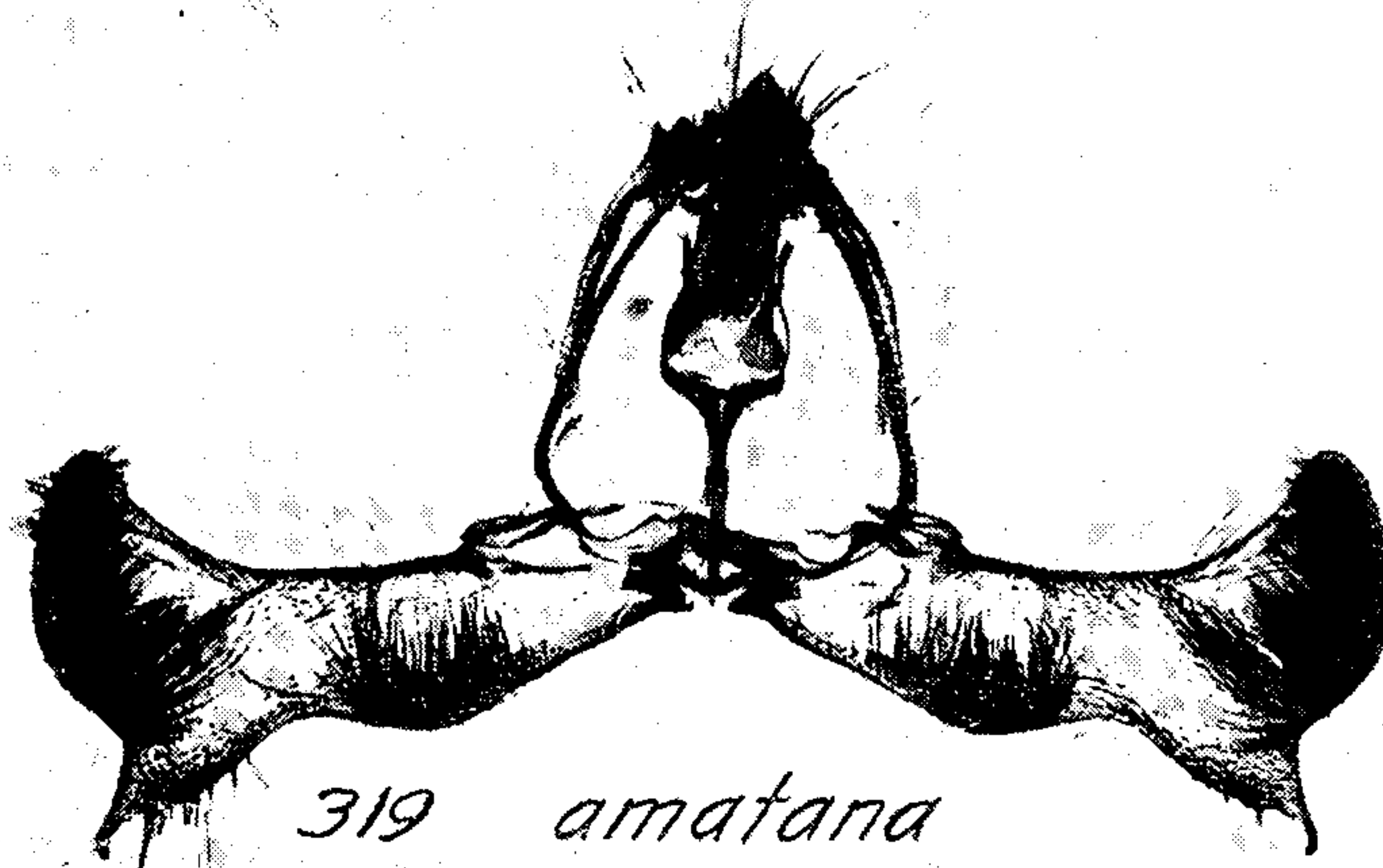
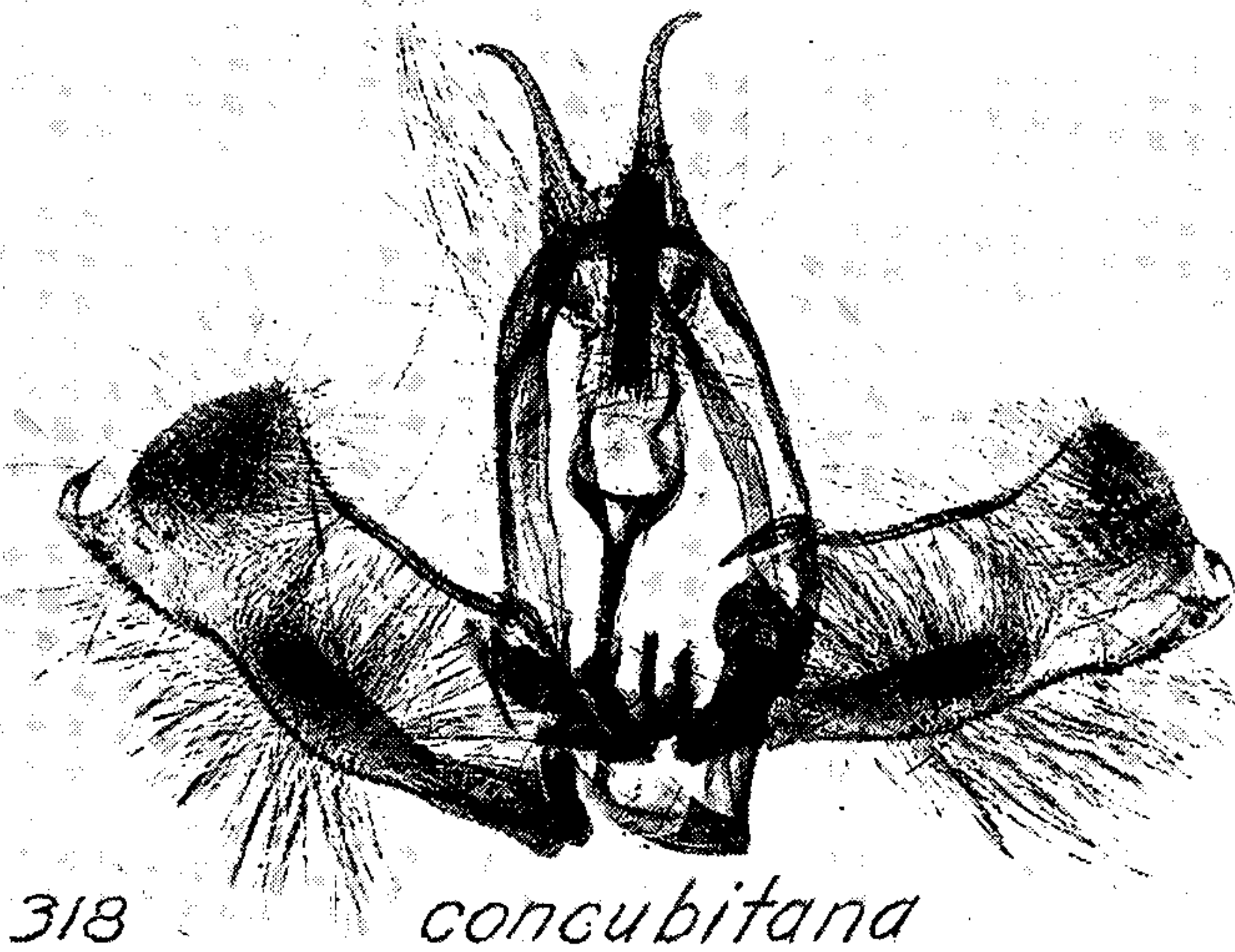

MALE GENITALIA OF GRETCHENA.

FOR EXPLANATION OF PLATE SEE PAGE 283.



322 *bolliana*

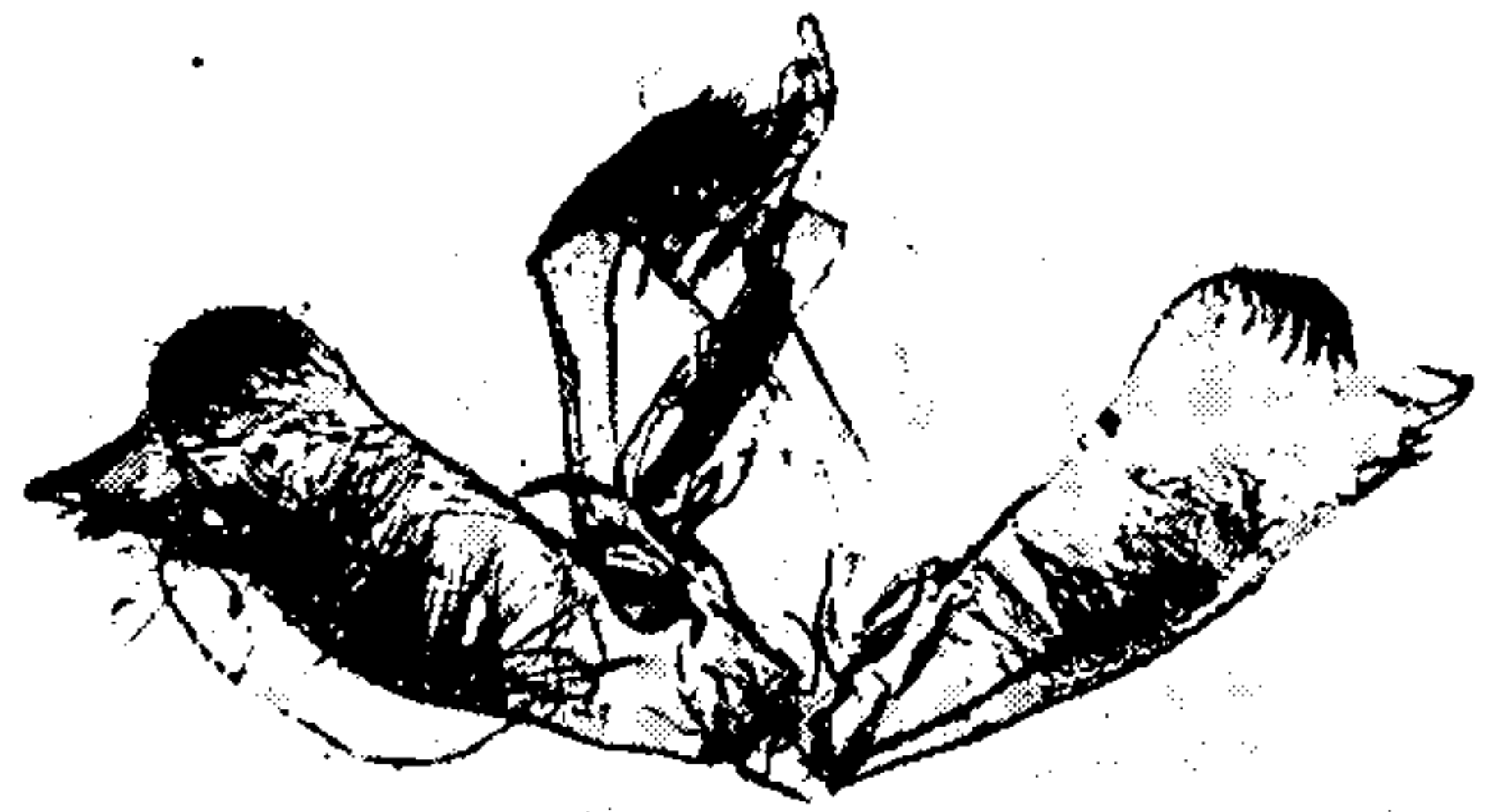

326 *watchungana*

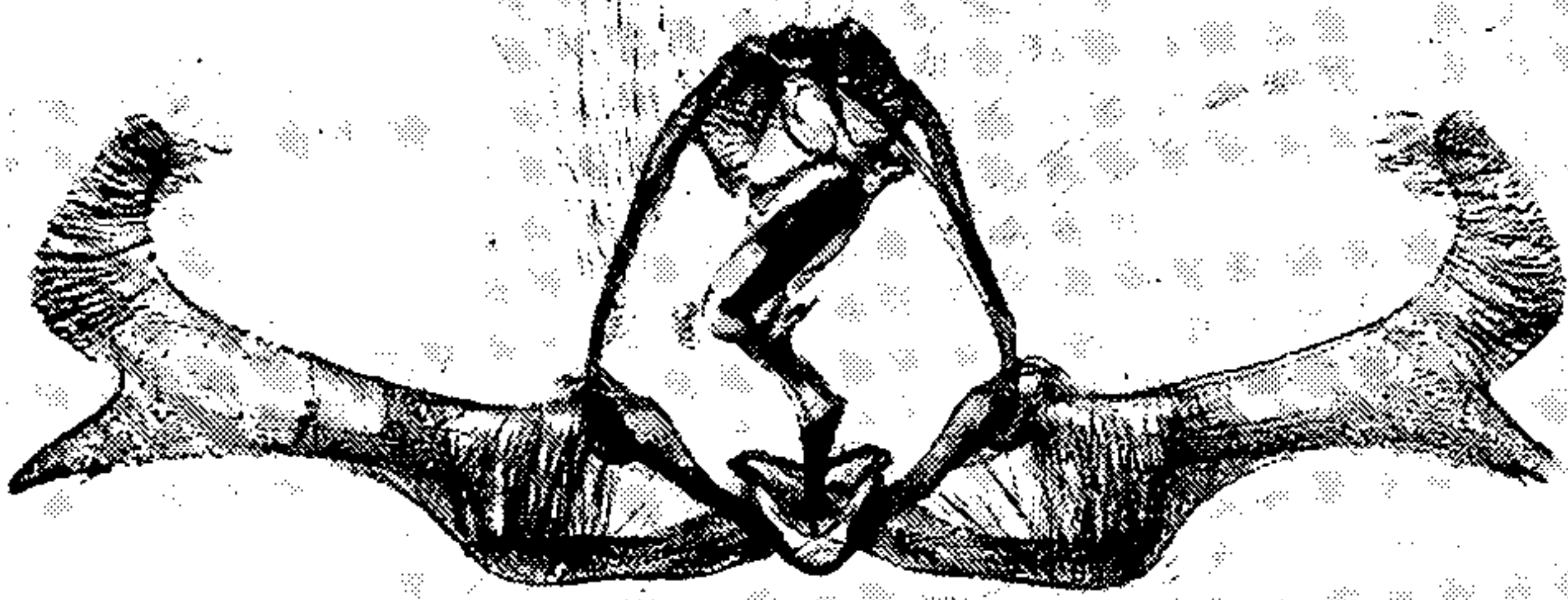

323 *concitaticana*

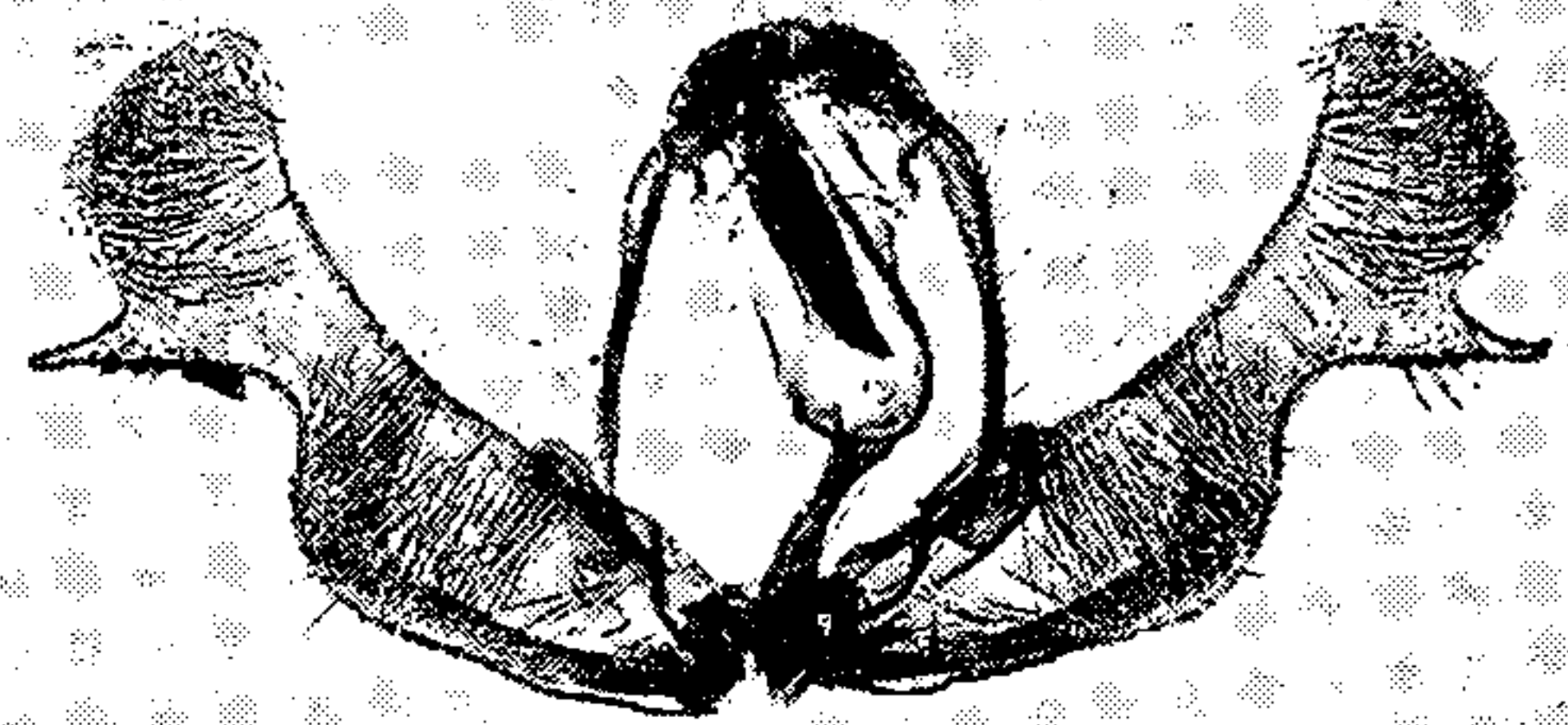

327 *dulciana*

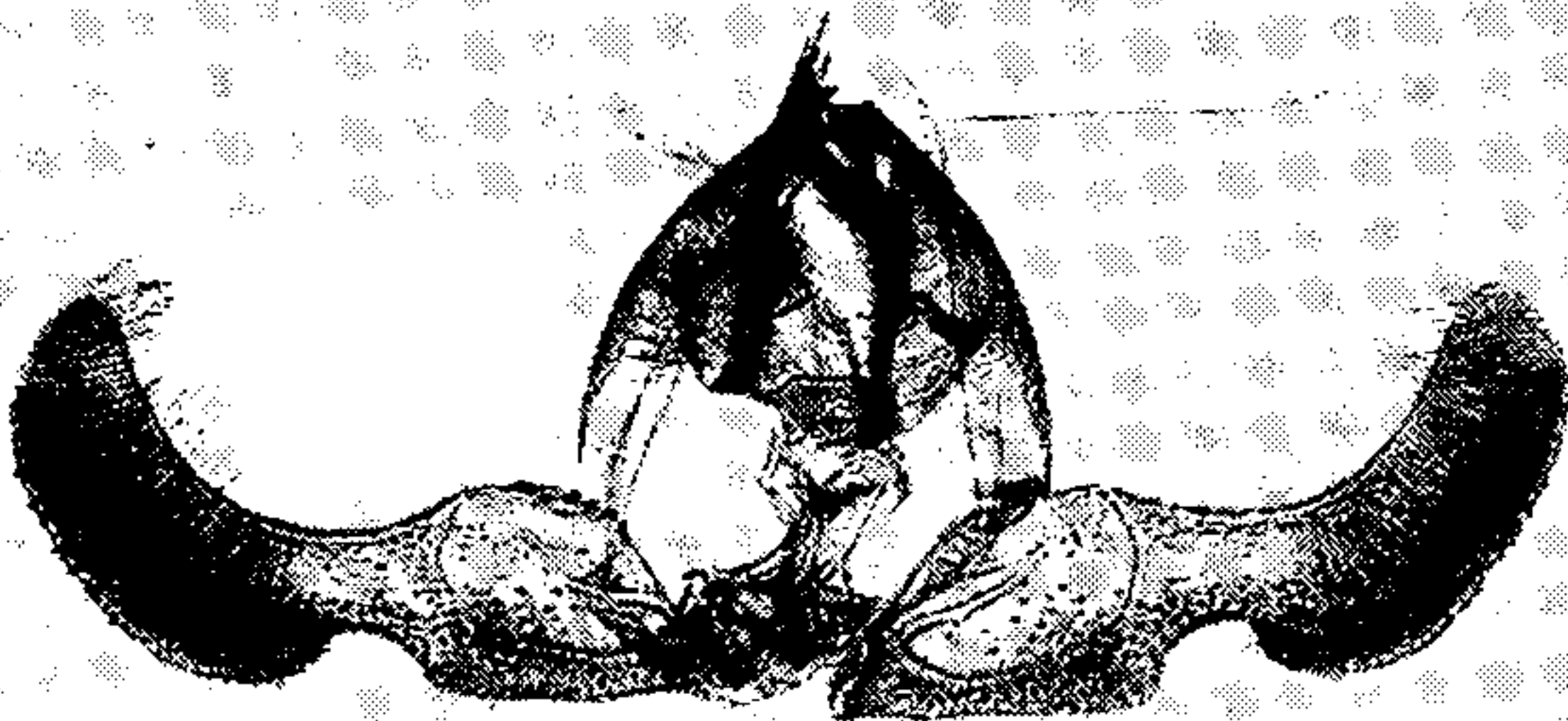

324 *gerulae*

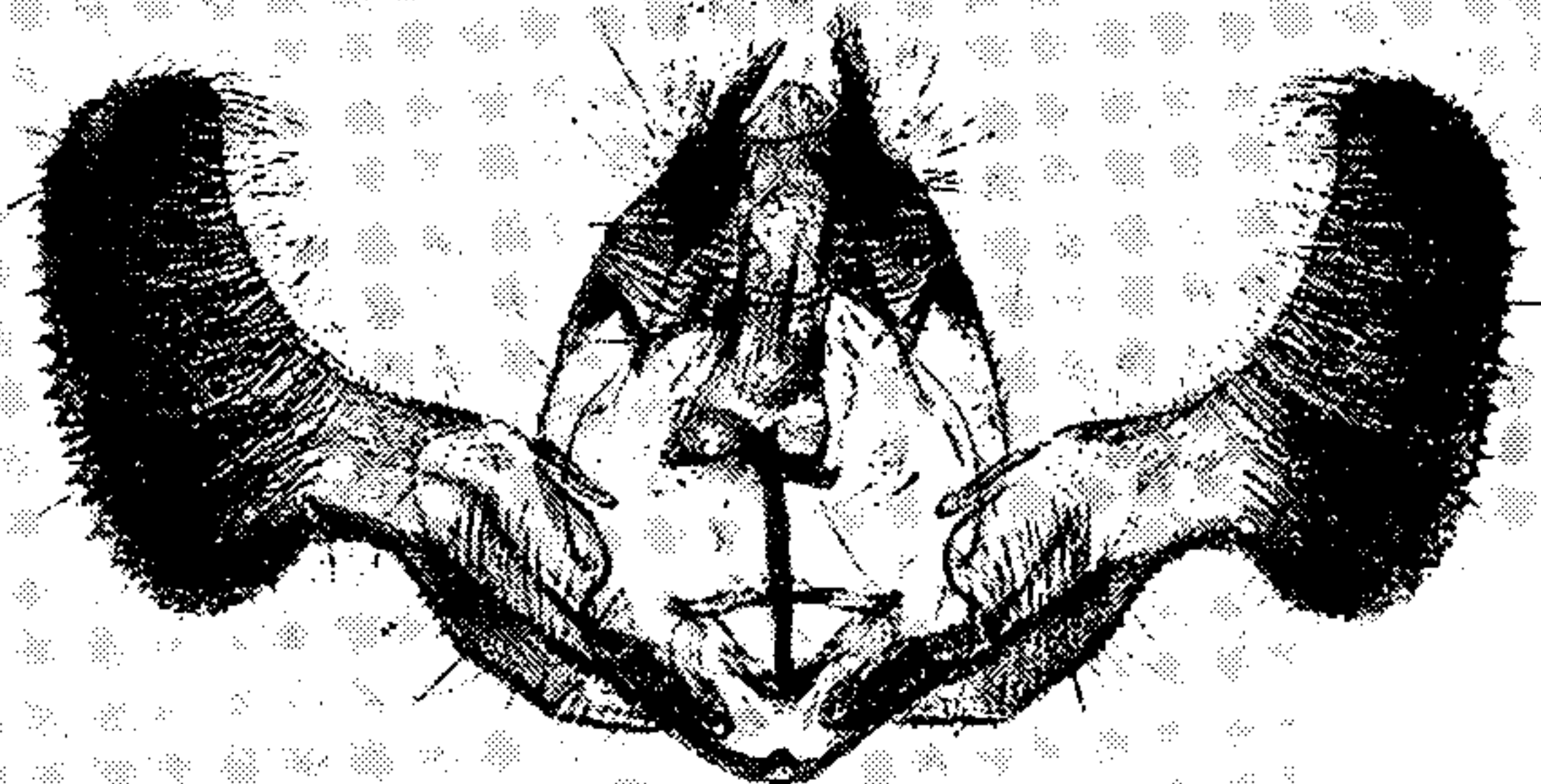

328 *pennsylvaniana*



325 *plebeiana*

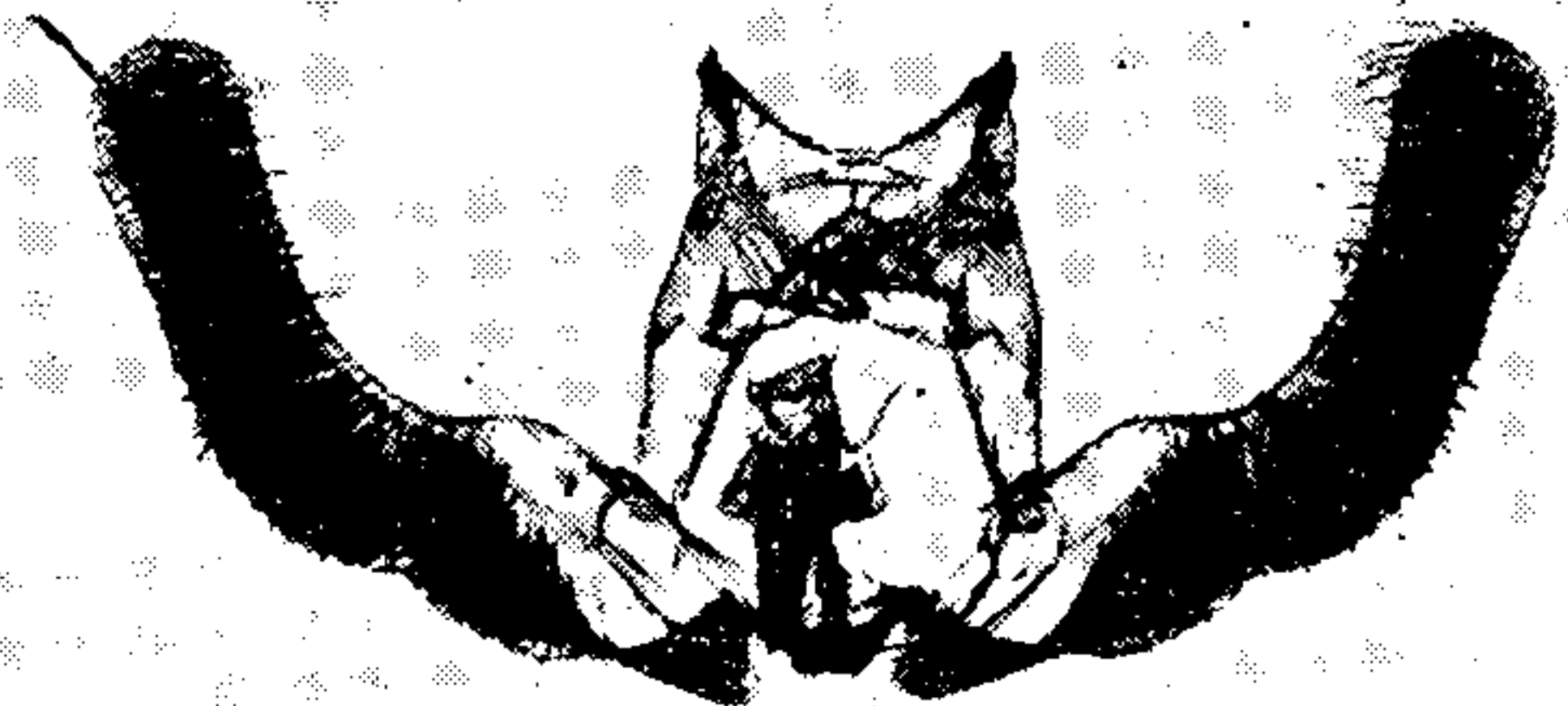

329 *radicana*

MALE GENITALIA OF GRETCHENA, GWENDOLINA, GRISELDA, AND CROCIDOSEMA.

FOR EXPLANATION OF PLATE SEE PAGE 284.



330 *emarginana*

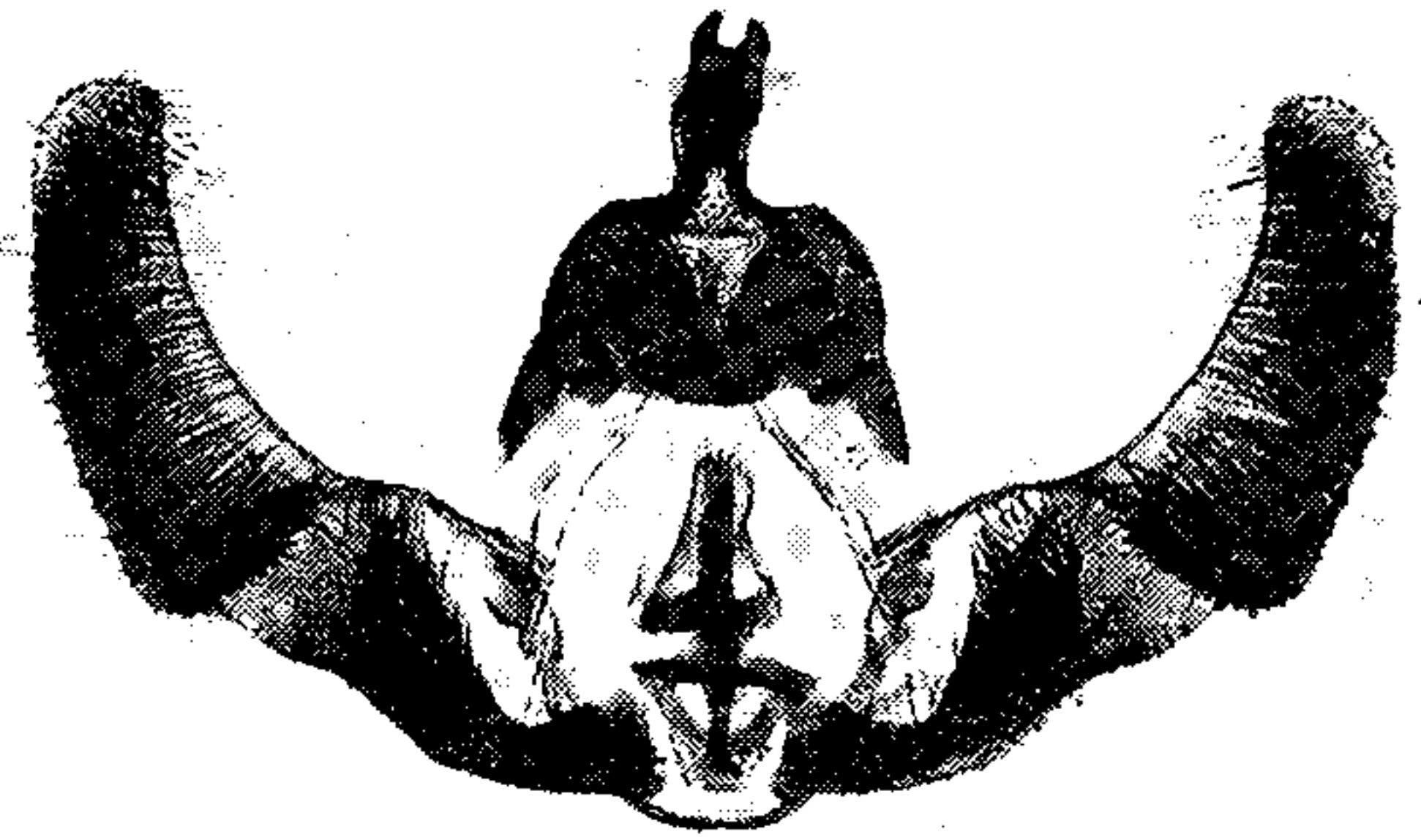

335 *vagana*

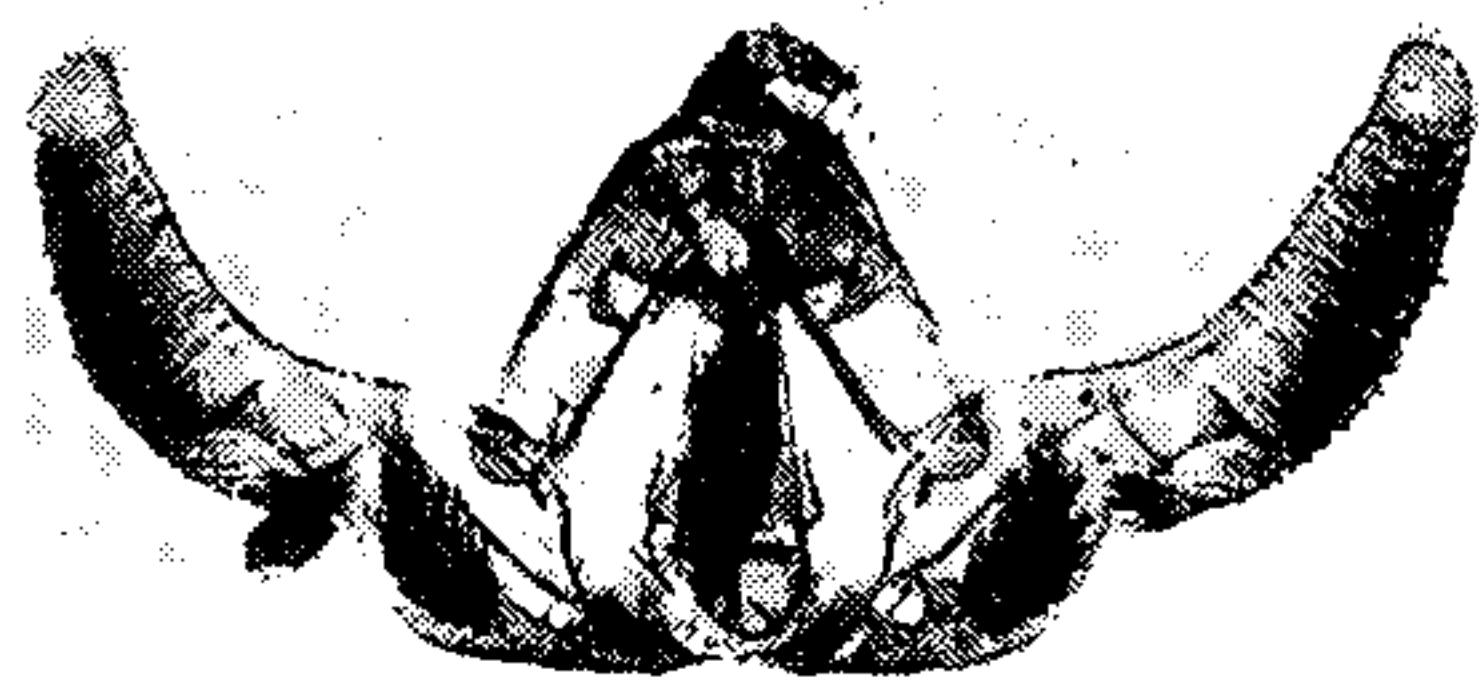

331 *crenana*



336 *alaskae*

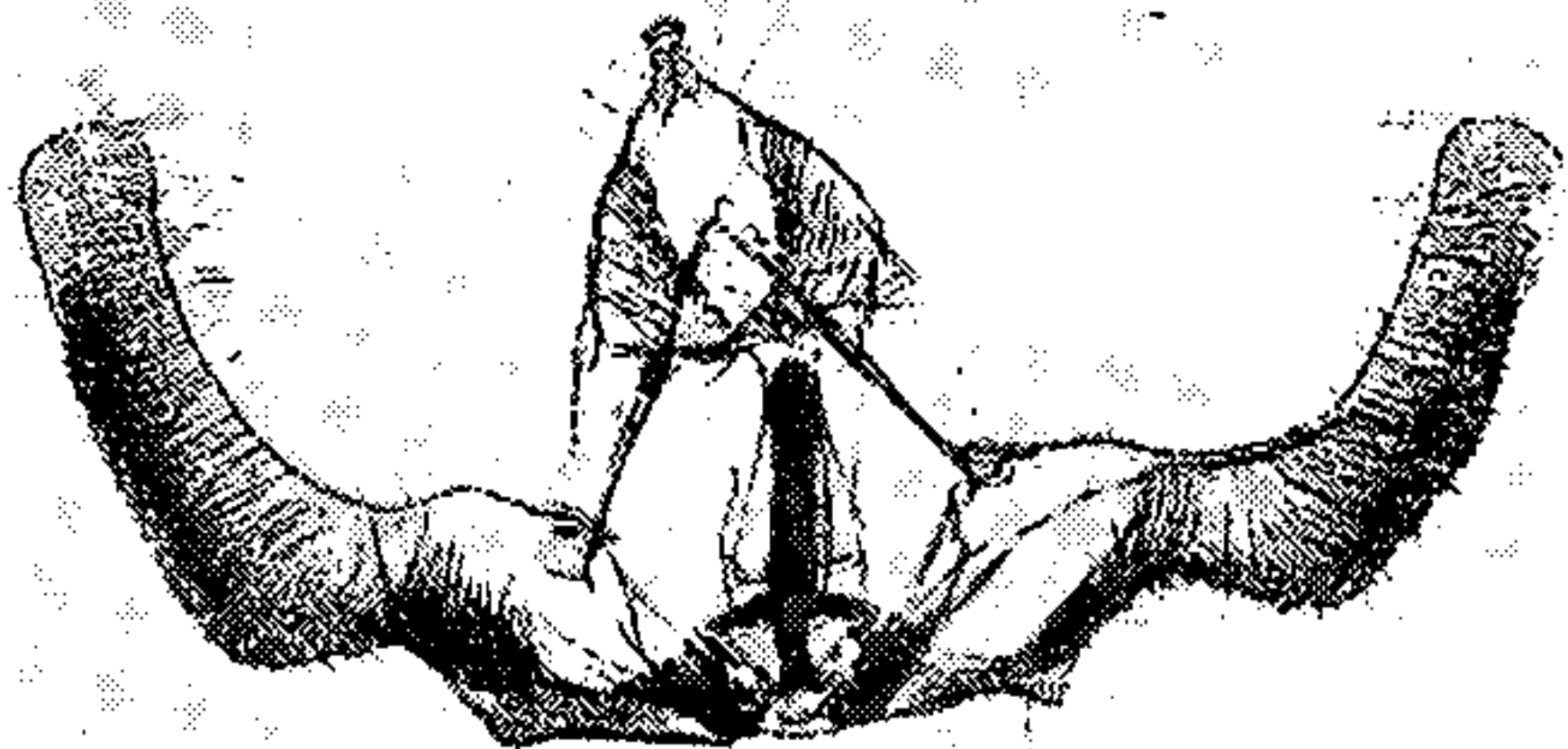

332 *ethnica*

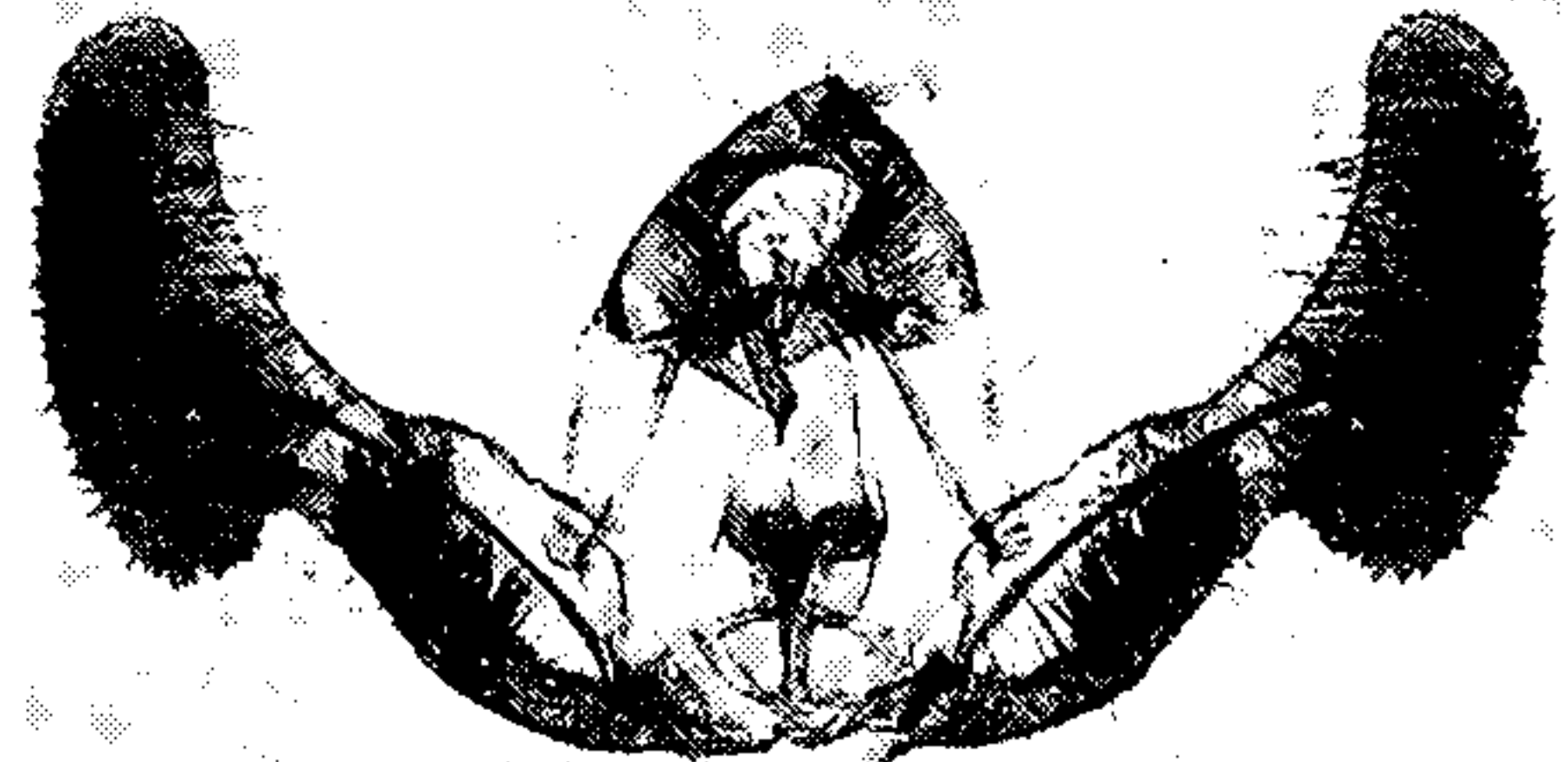

337 *plumbolineana*

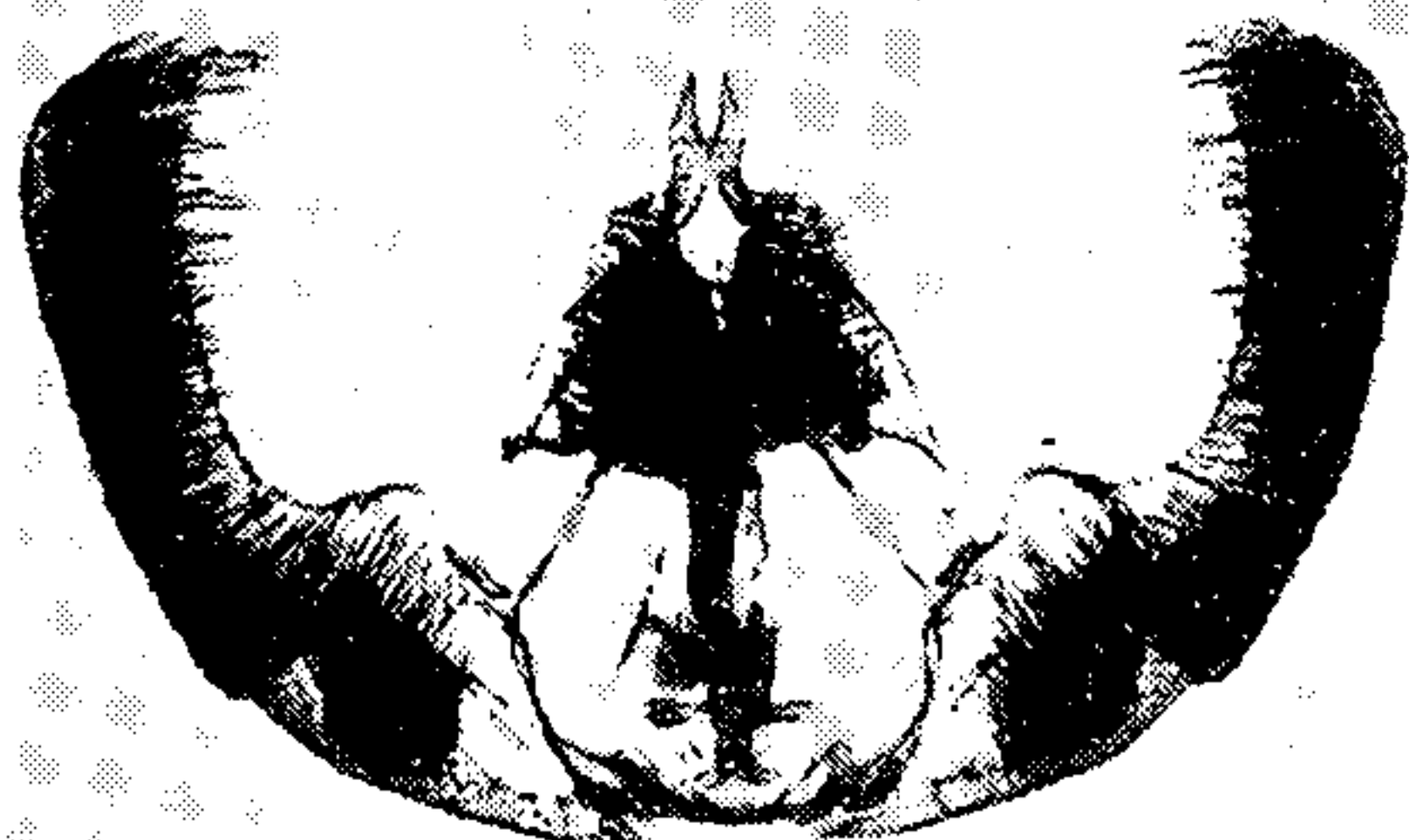

333 *lomonana*

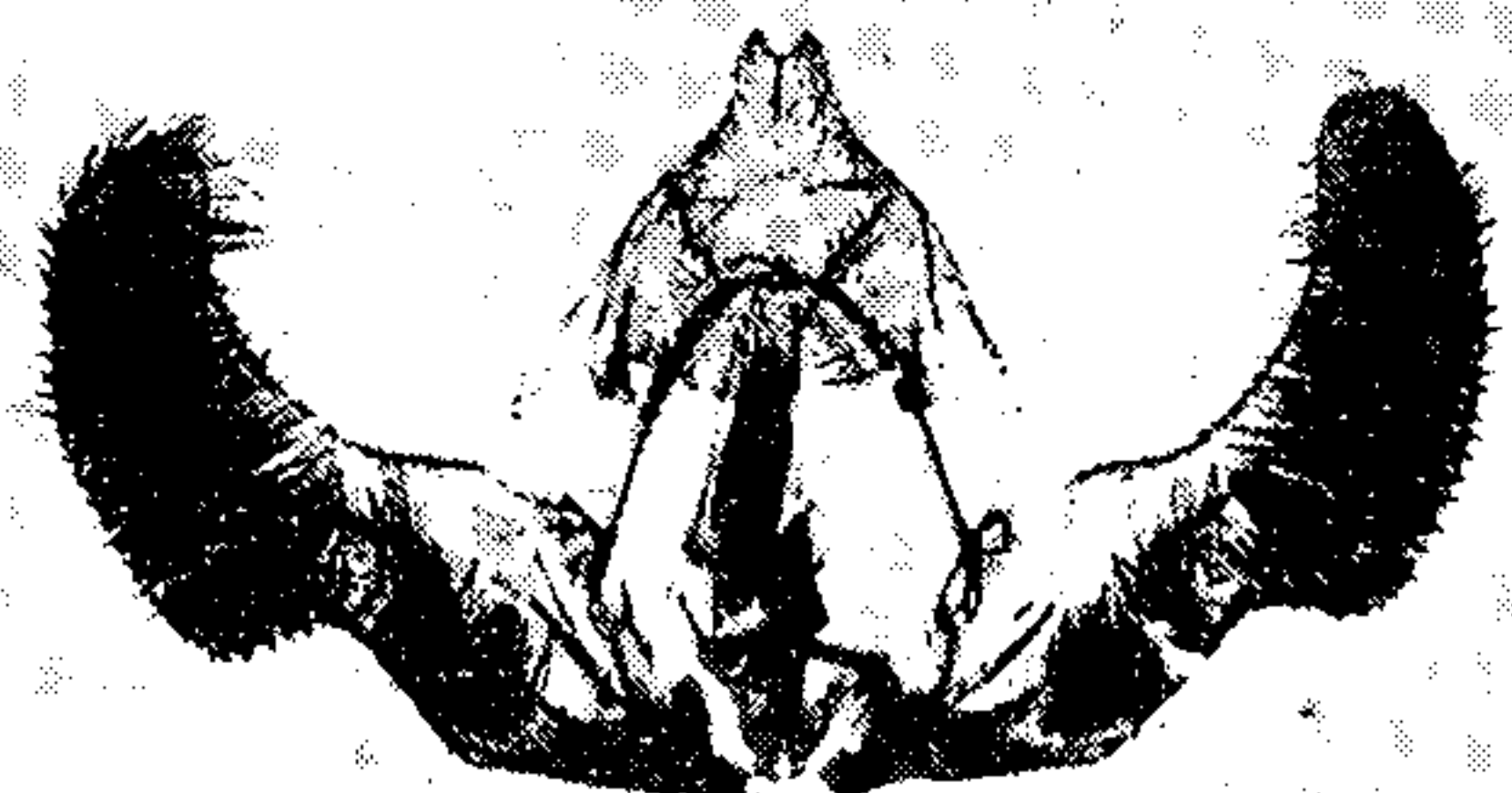

338 *castaneana*



334 *lindana*

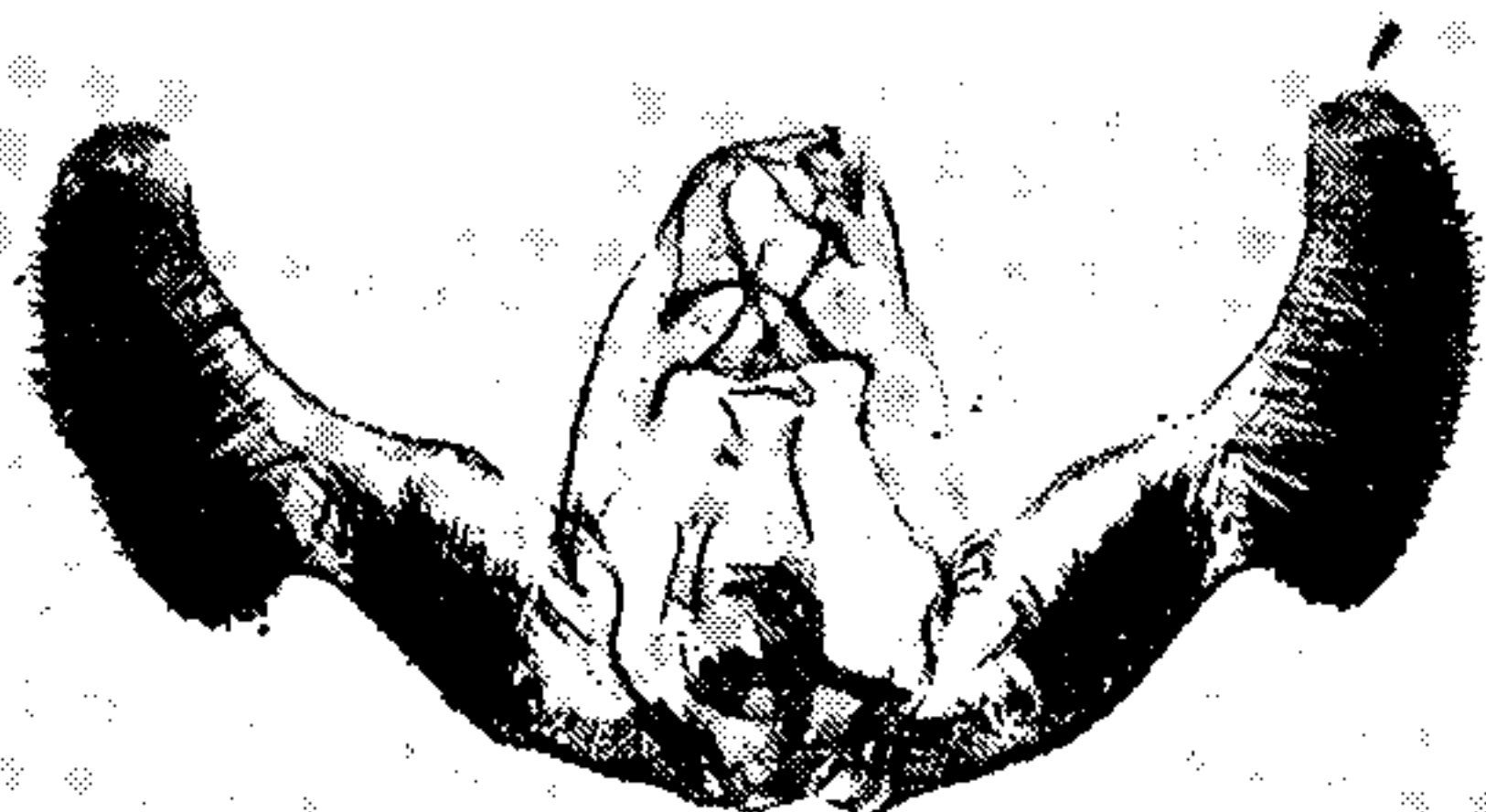

339 *madderana*

MALE GENITALIA OF EPINOTIA.

FOR EXPLANATION OF PLATE SEE PAGE 284.



THIS PAGE IS LOCKED TO FREE MEMBERS
Purchase full membership to immediately unlock this page



Never be without a book!

Forgotten Books Full Membership gives universal access to 797,885 books from our apps and website, across all your devices: tablet, phone, e-reader, laptop and desktop computer

A library in your pocket for \$8.99/month

Continue

*Fair usage policy applies

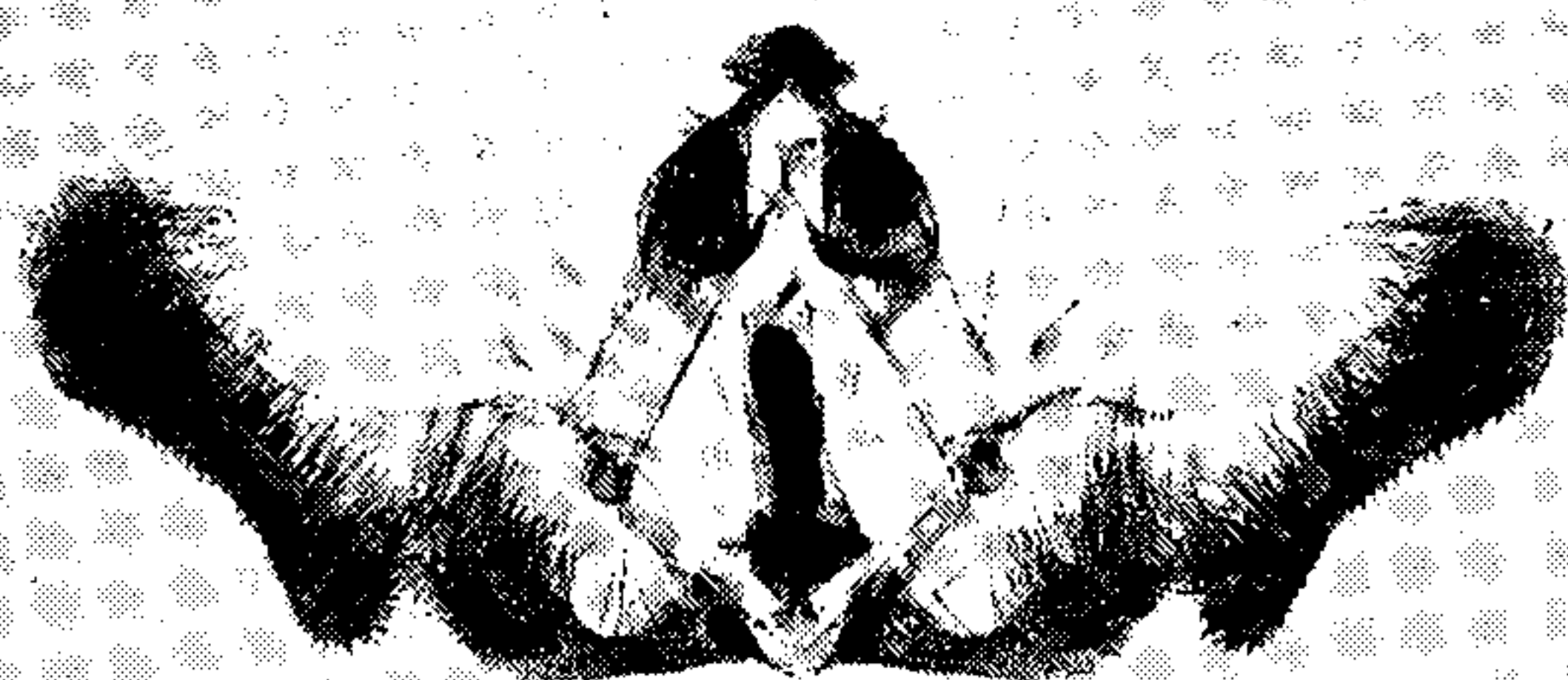

350 *arctostaphylana*



355 *subplicana*

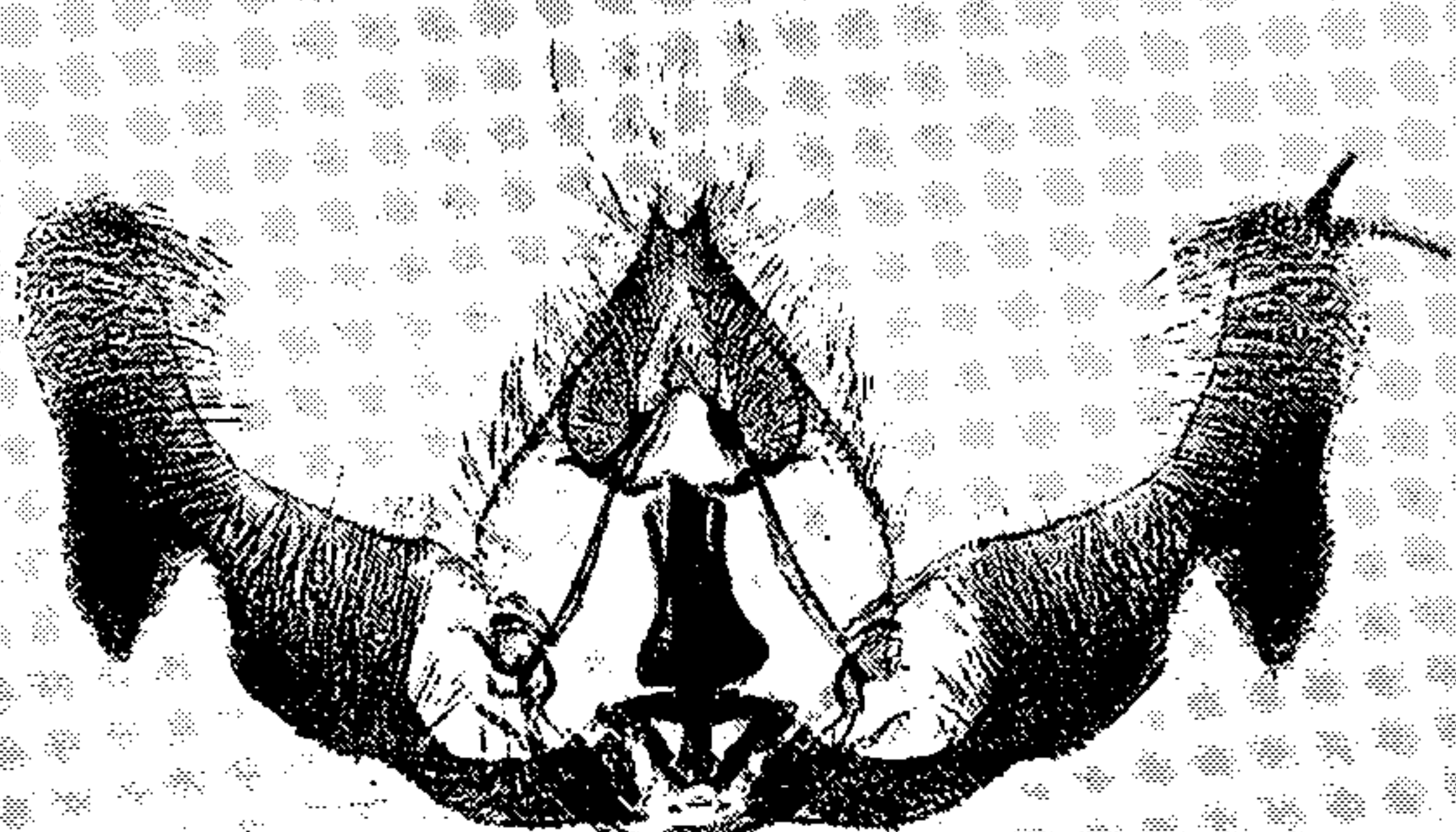

351 *nigralbana*



356 *nisella*

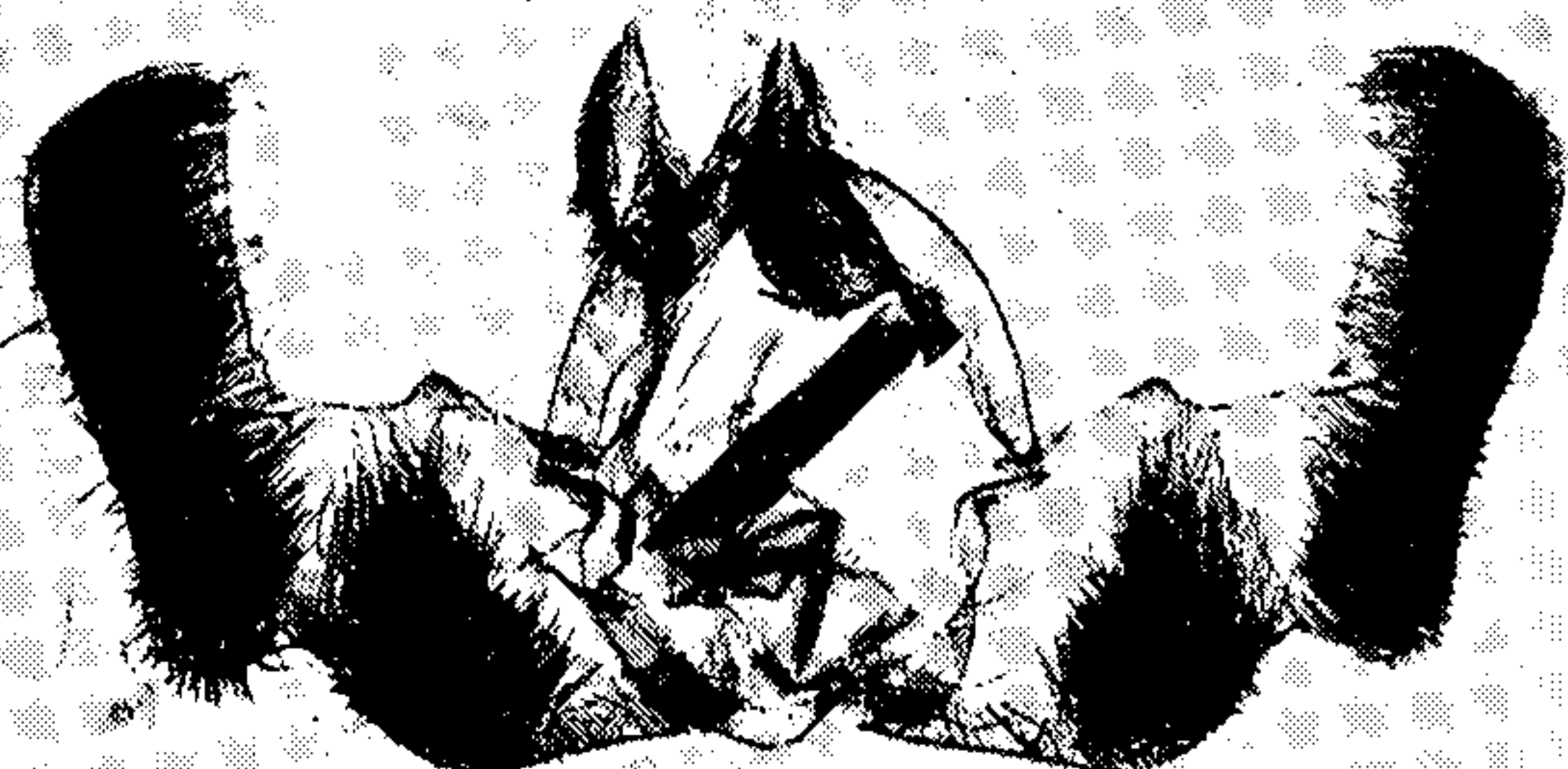

352 *infusca*



357 *transmissiana*



353 *septemberana*

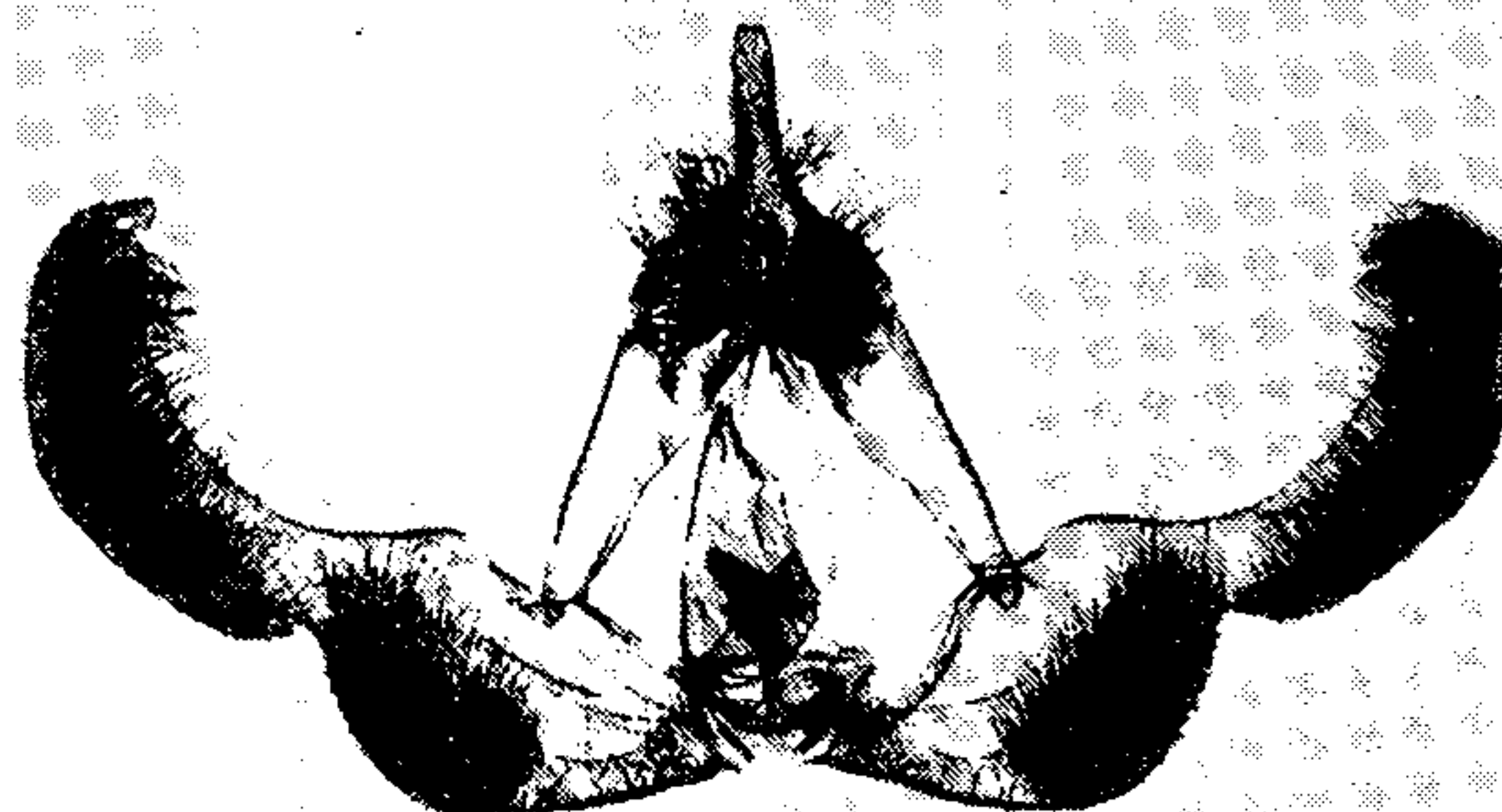

358 *similana*

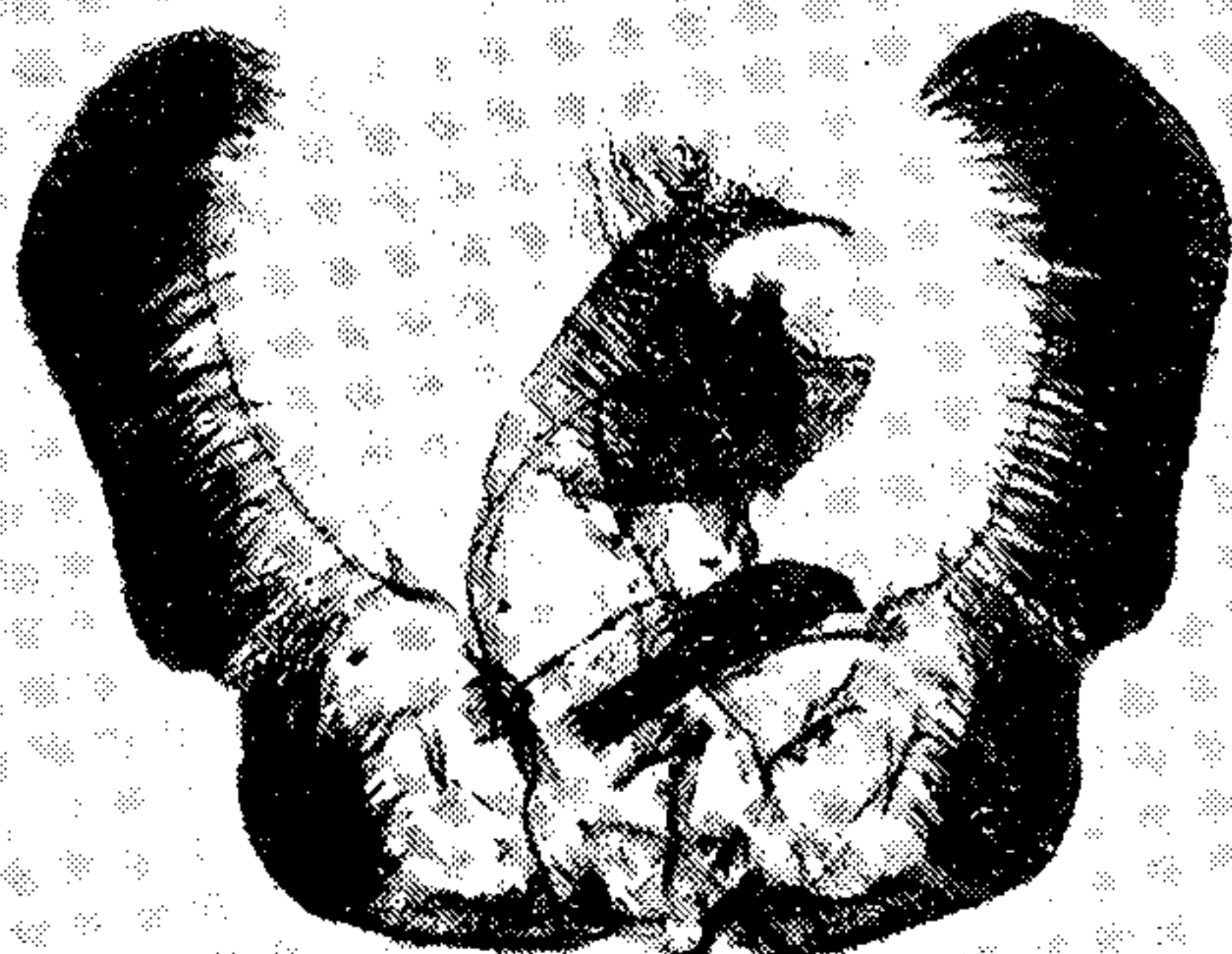

354 *solandriana*



359 *momonana*

MALE GENITALIA OF EPINOTIA.

FOR EXPLANATION OF PLATE SEE PAGE 284.



360 *walkerana*



365 *signiferana*



361 *albangulana*



366 *rectiplicana*

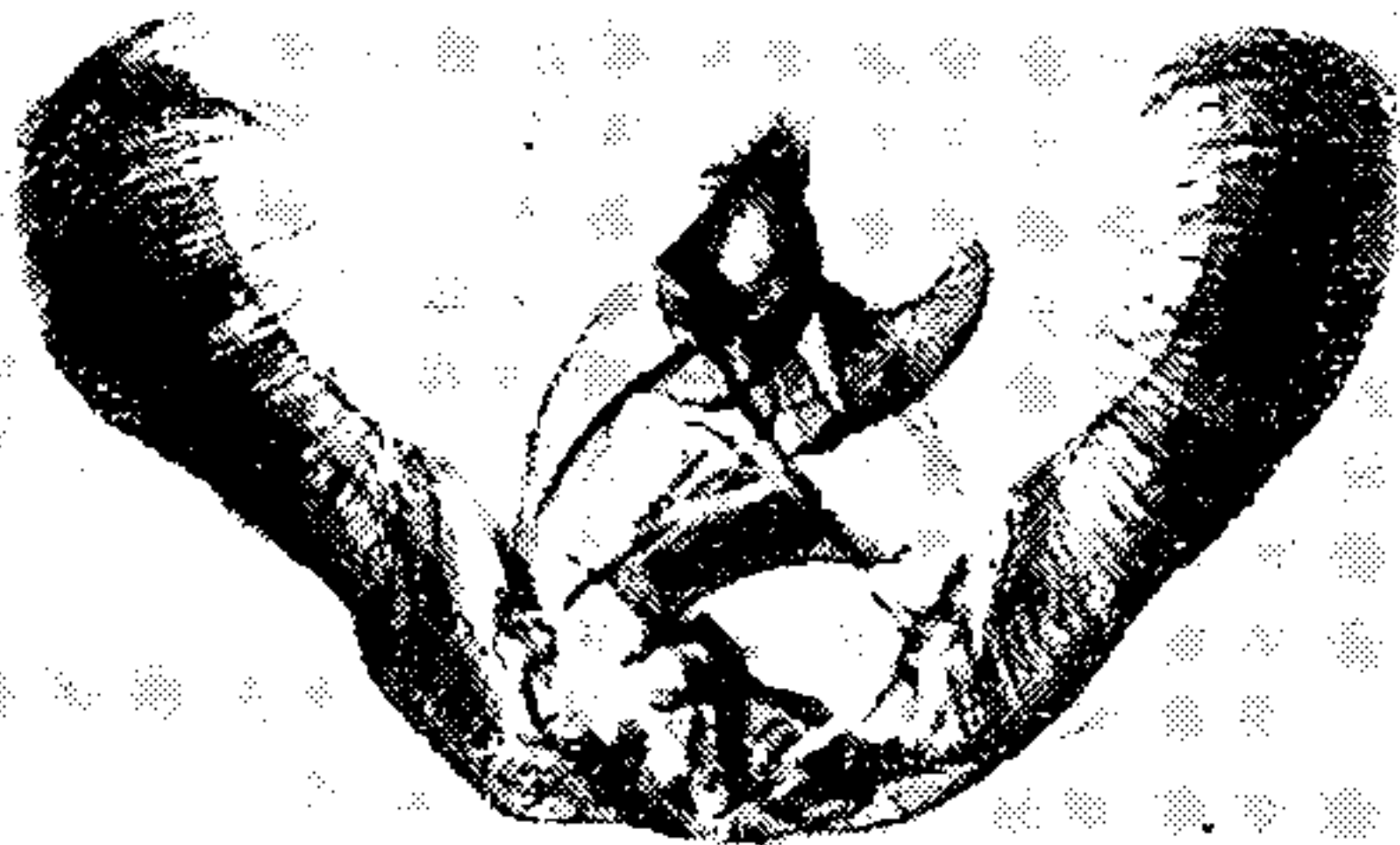

362 *hamptonana*



367 *trossulana*



363 *solicitana*

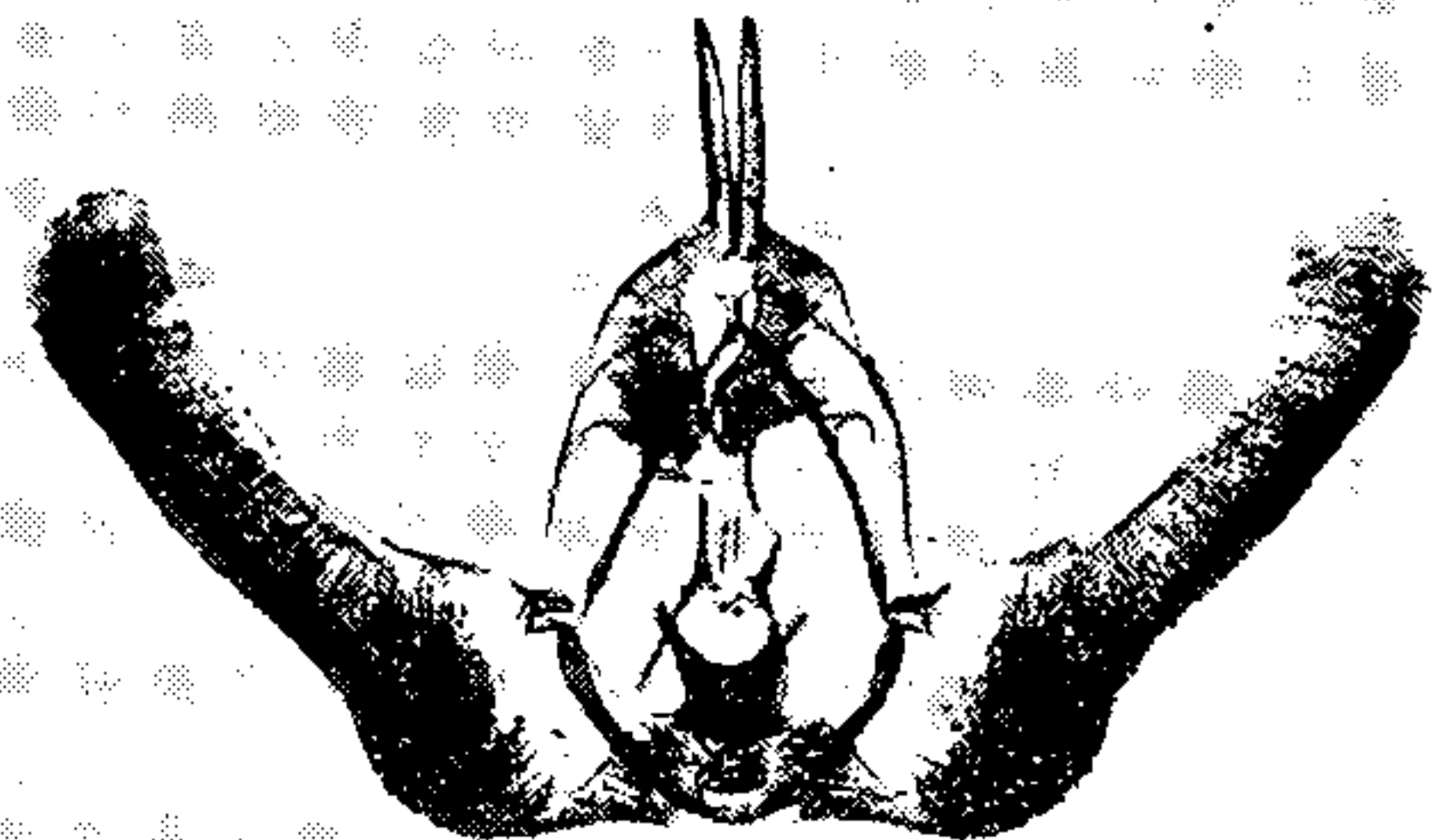

368 *bicordana*



364 *solicitana*



369 *yandana*

MALE GENITALIA OF EPINOTIA.

FOR EXPLANATION OF PLATE SEE PAGE 285.



370 *zandana*



375 *perplexana*

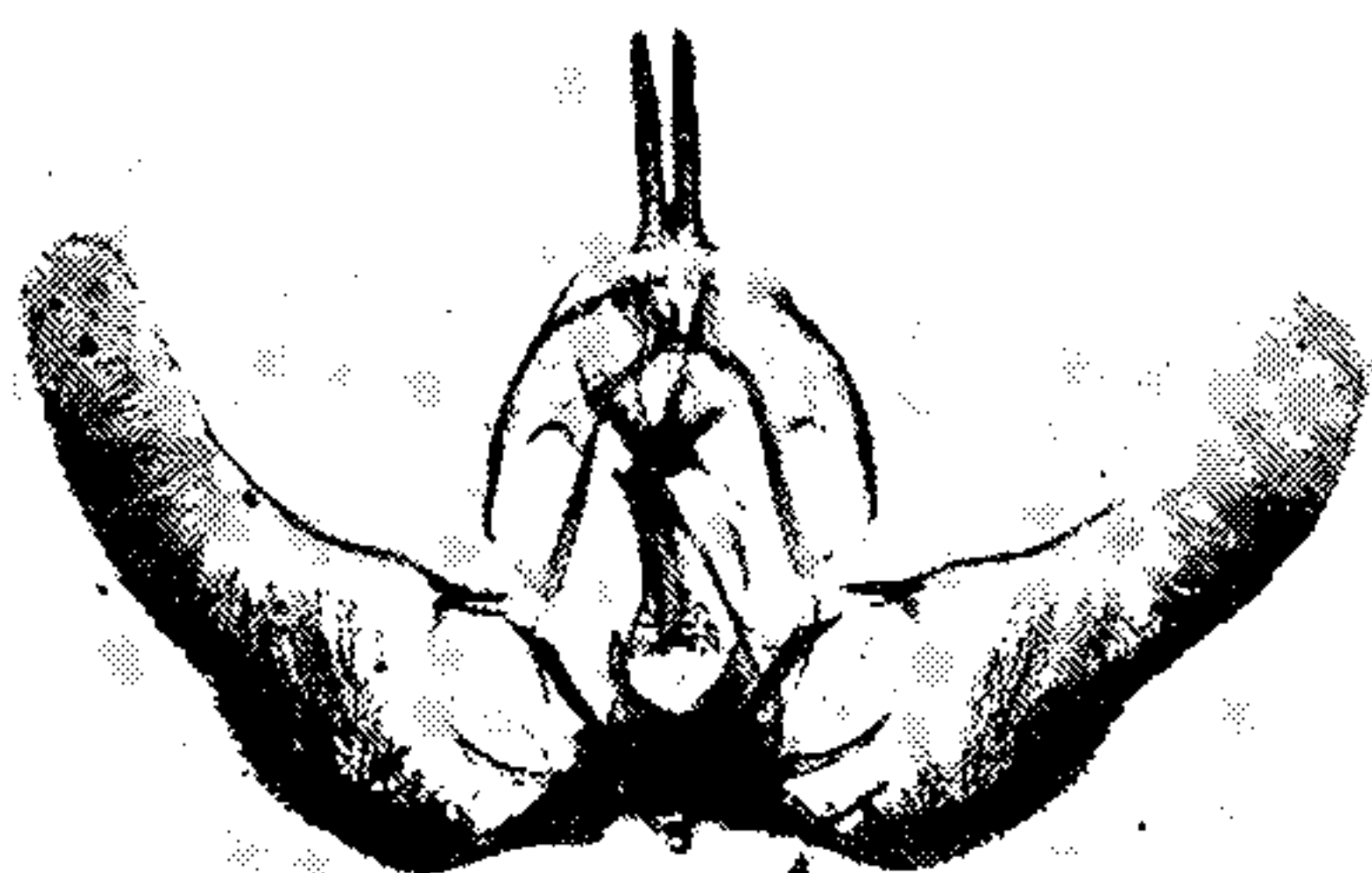

371 *vertumnana*



376 *unica*

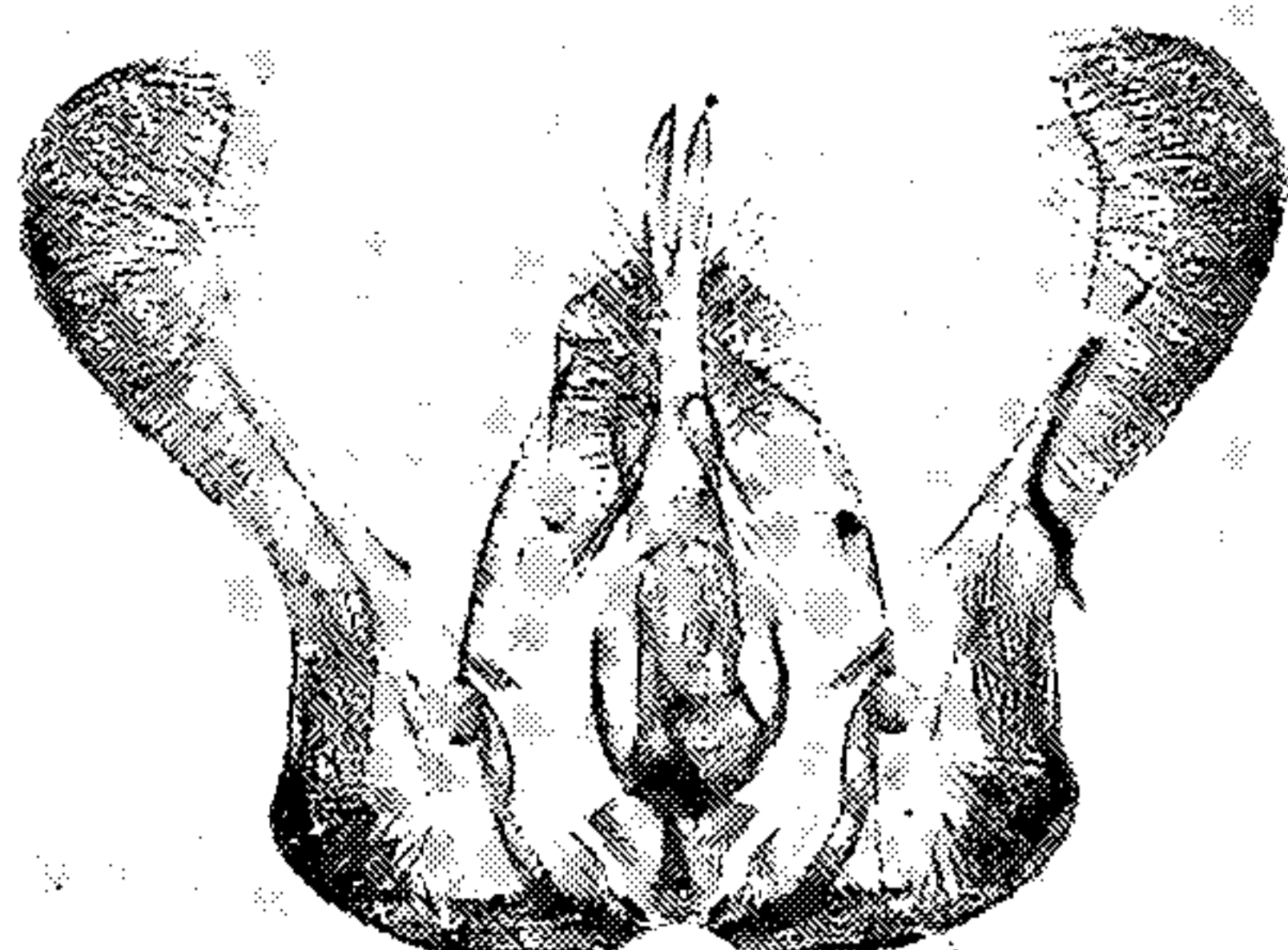

372 *aceriella*

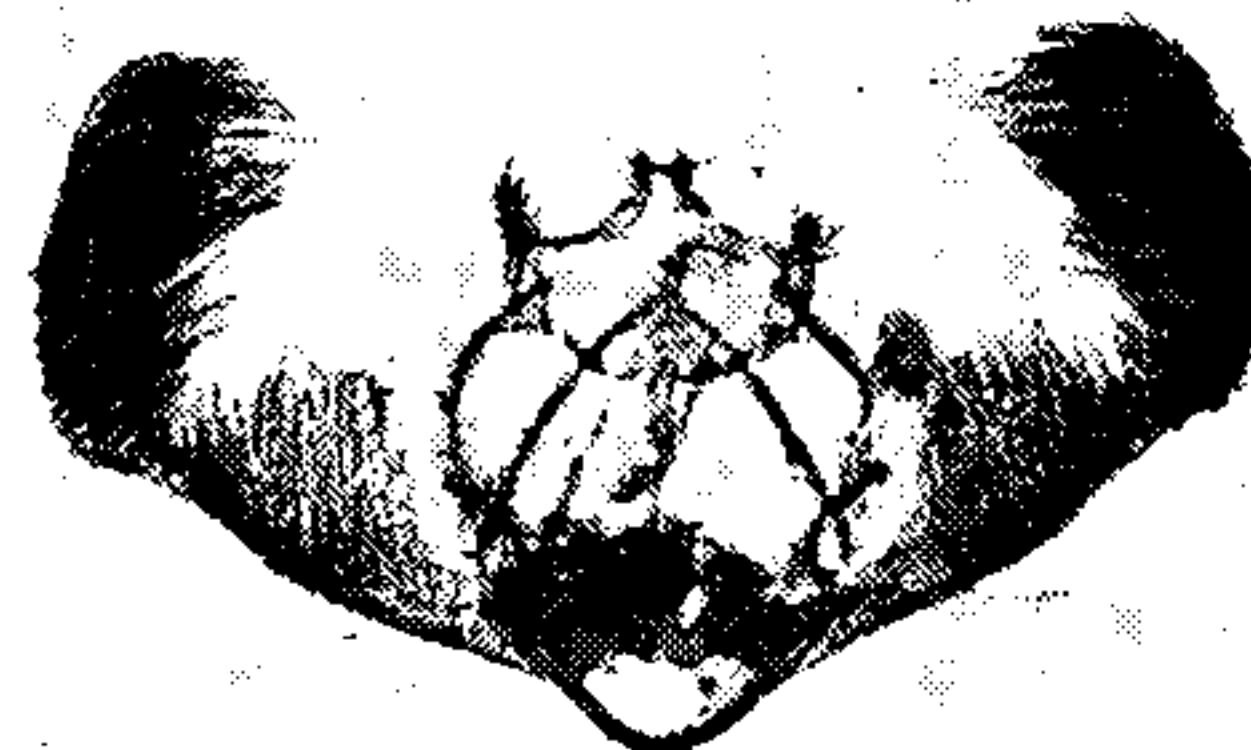

377 *nanana*

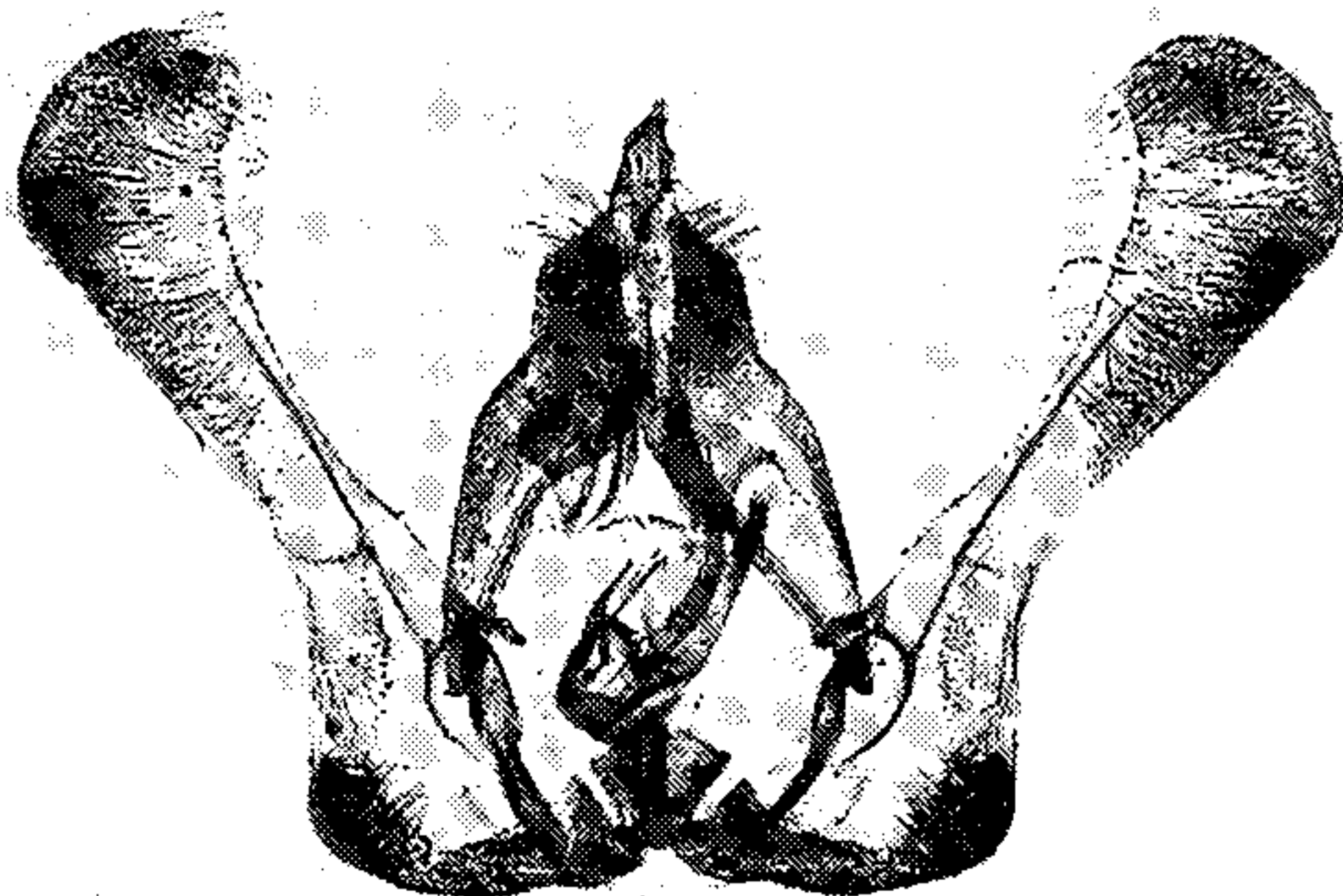

373 *timidella*



378 *normanana*



374 *bigemina*



379 *heucherana*

MALE GENITALIA OF EPINOTIA.

FOR EXPLANATION OF PLATE SEE PAGE 285



THIS PAGE IS LOCKED TO FREE MEMBERS

Purchase full membership to immediately unlock this page



HISTORY

Tens of thousands of important historical sources, many previously unobtainable, are now available for the first time with a Forgotten Books Full Membership.

Unlimited Access
\$8.99/month

Continue

*Fair usage policy applies



388 *nubeculana*



394 *maritima*

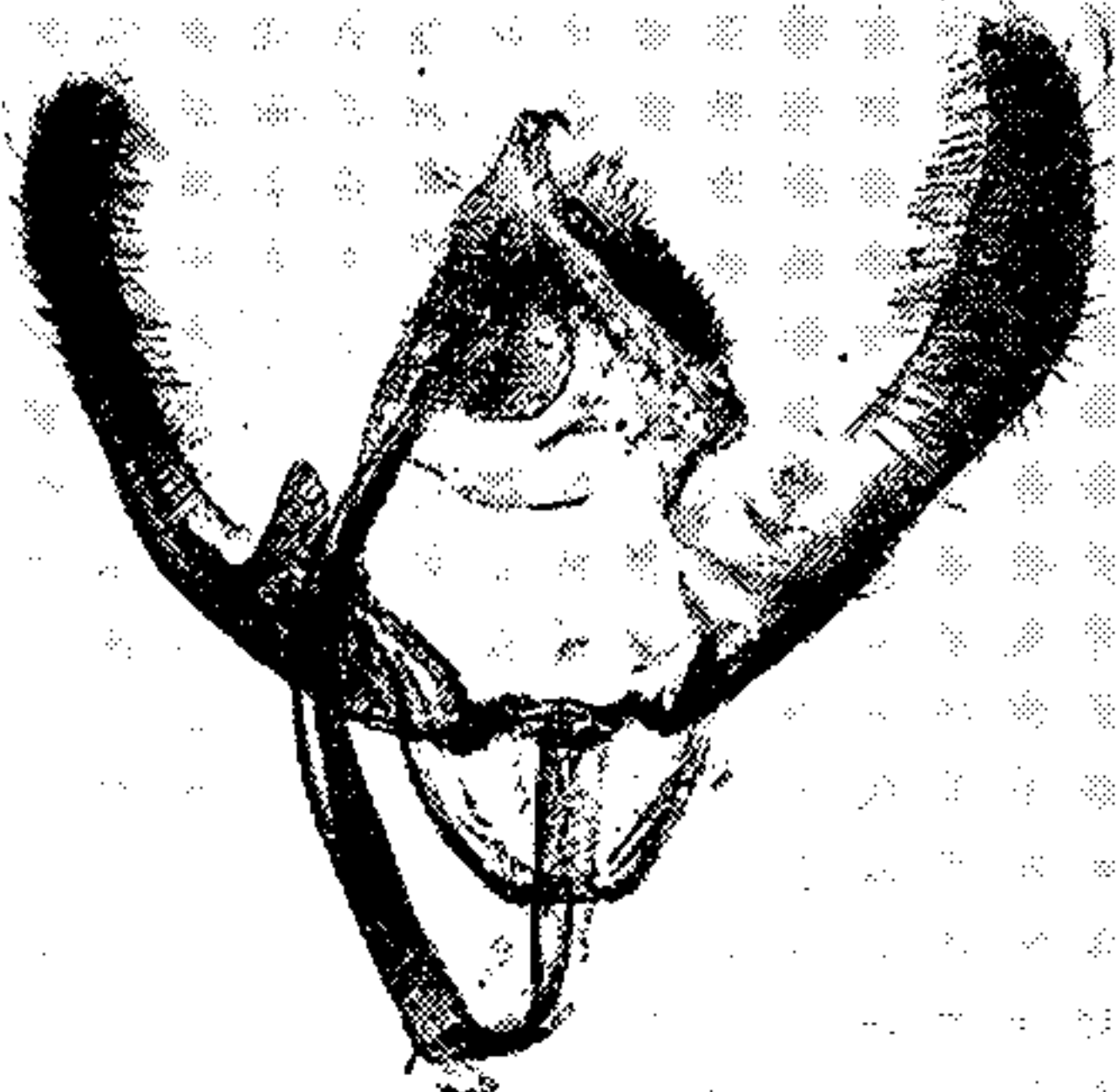

389 *pulchellana*



395 *spiraeifoliana*



396 *burgessiana*



390 *subaequana*

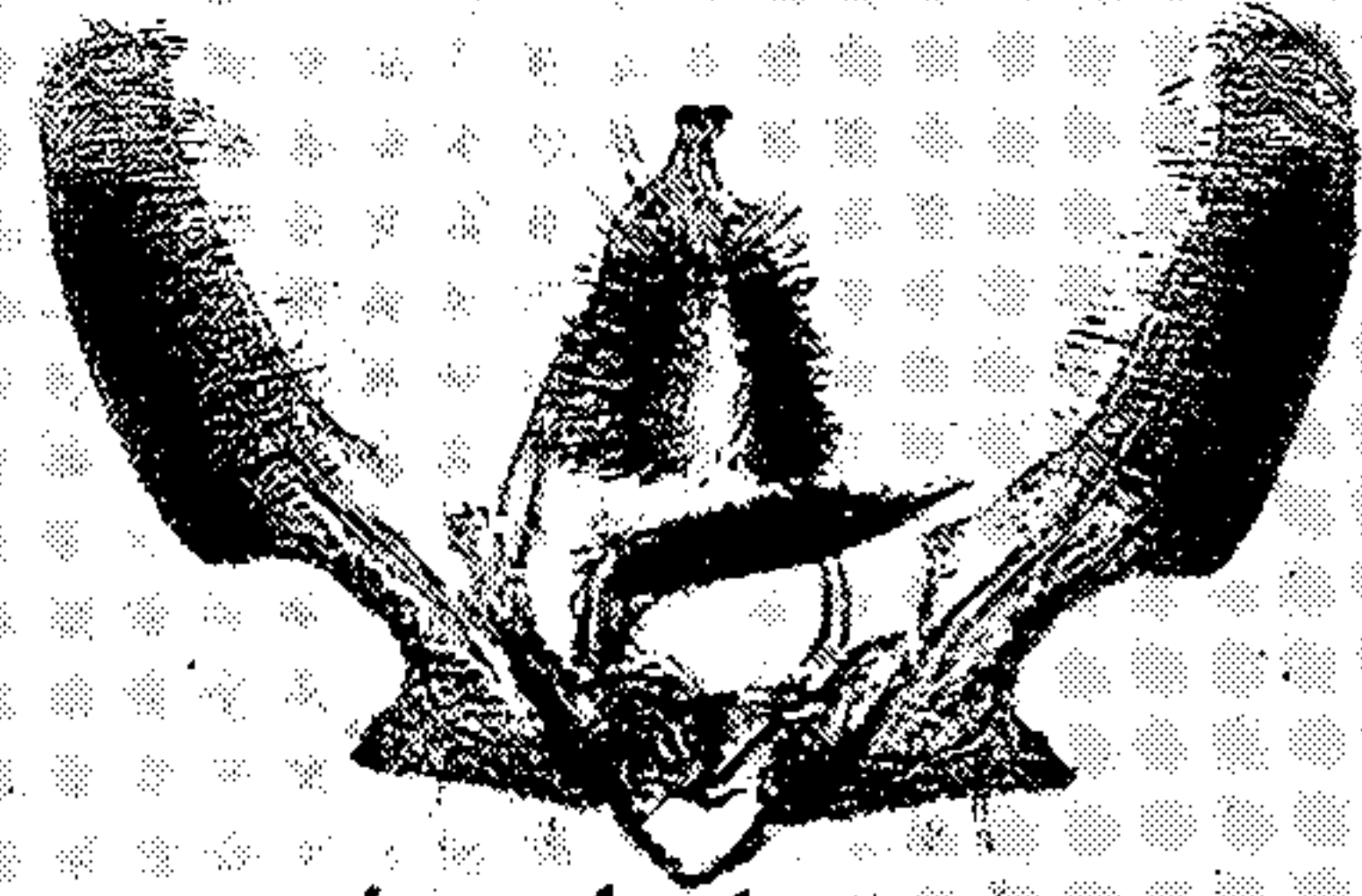

397 *laciniata*



391 *angulifasciana*



392 *discigerana*

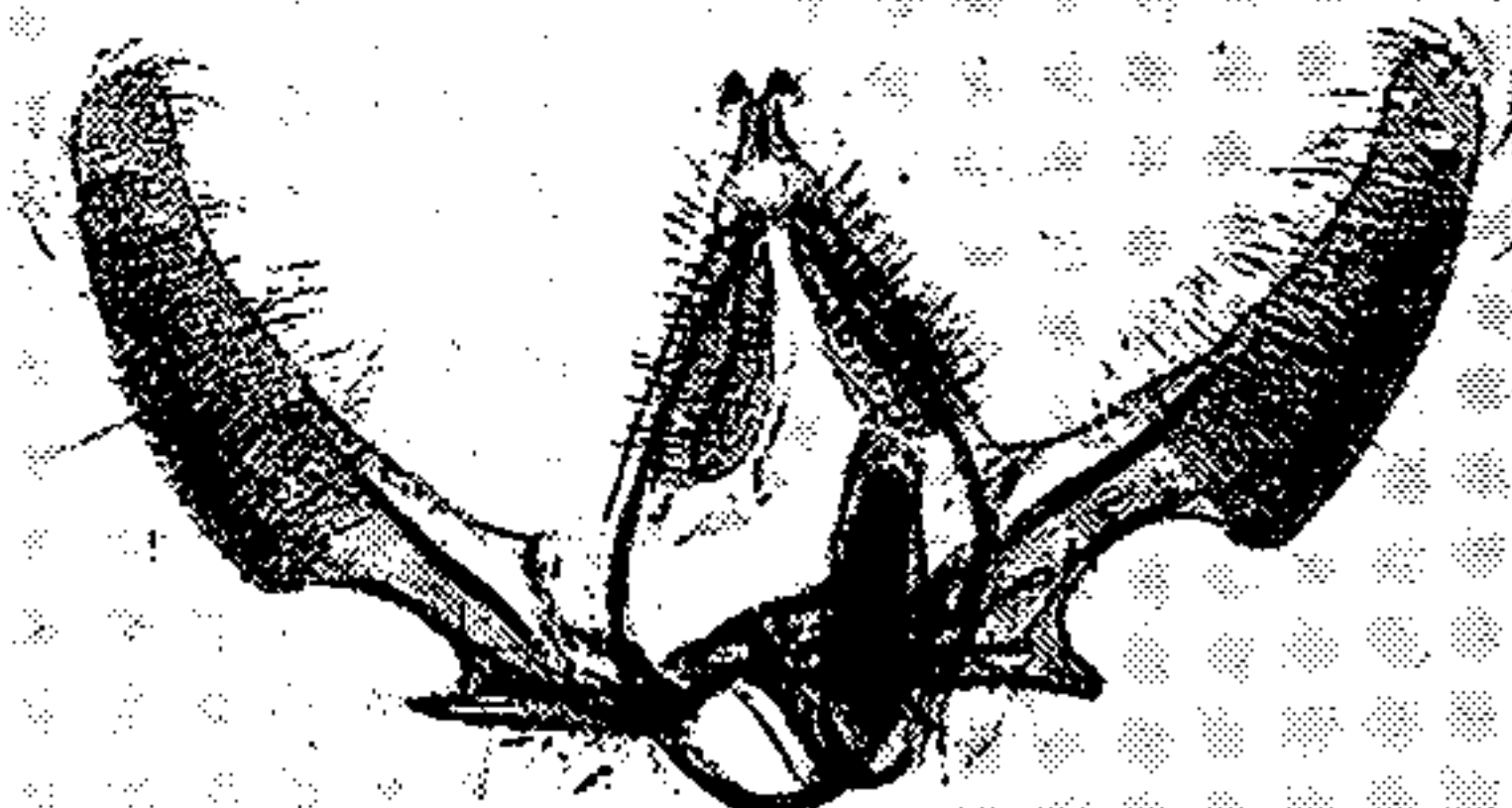

398 *platanana*



393 *semiovana*



399 *fuscociliana*

MALE GENITALIA OF ANCHYLOPERA.

FOR EXPLANATION OF PLATE SEE PAGES 285 AND 286



400 *divisana*

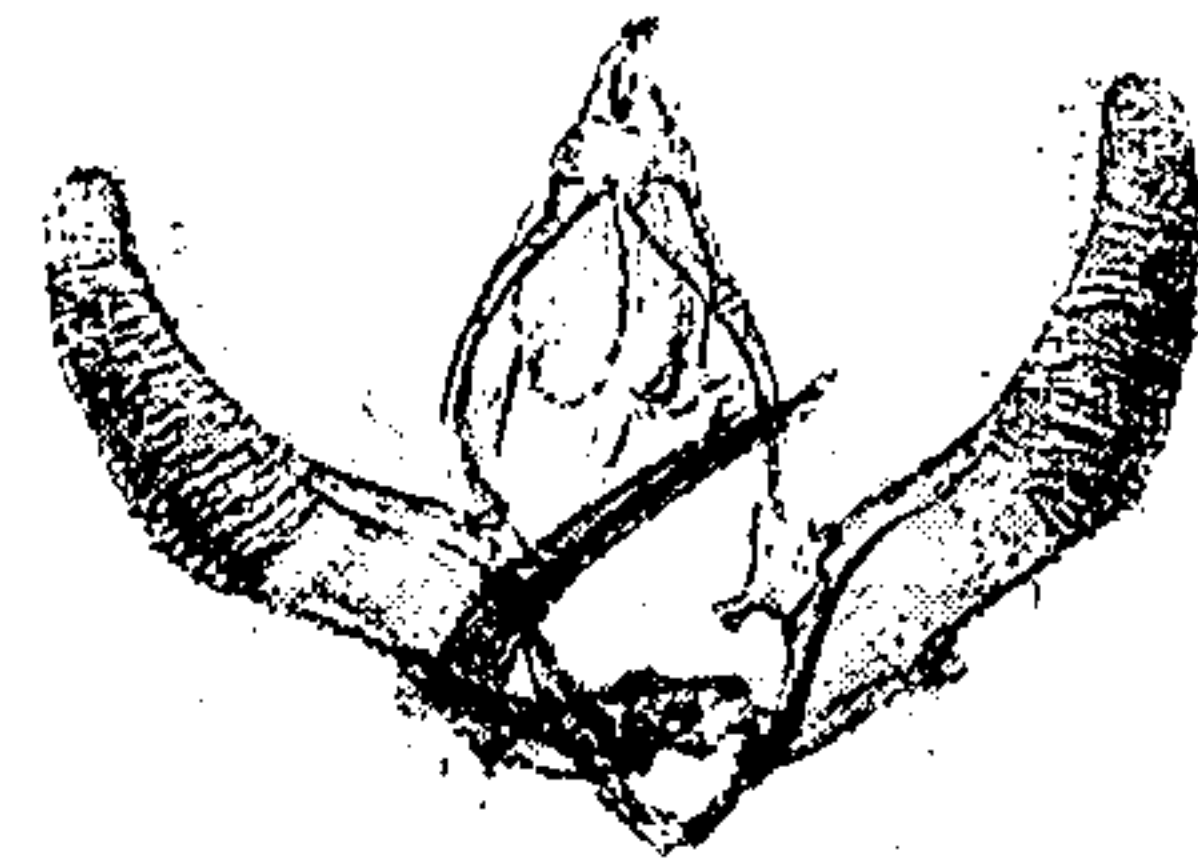

407 *carbonana*

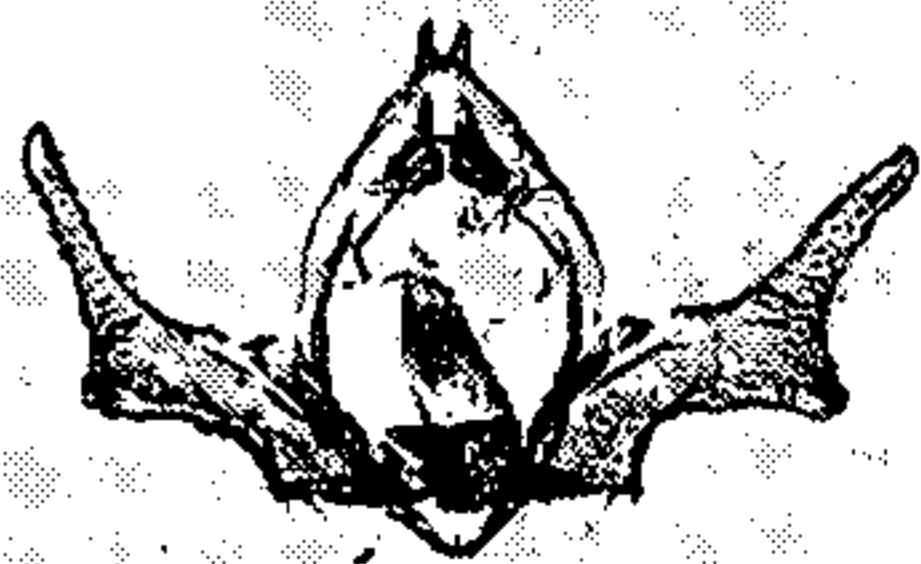

401 *muricana*

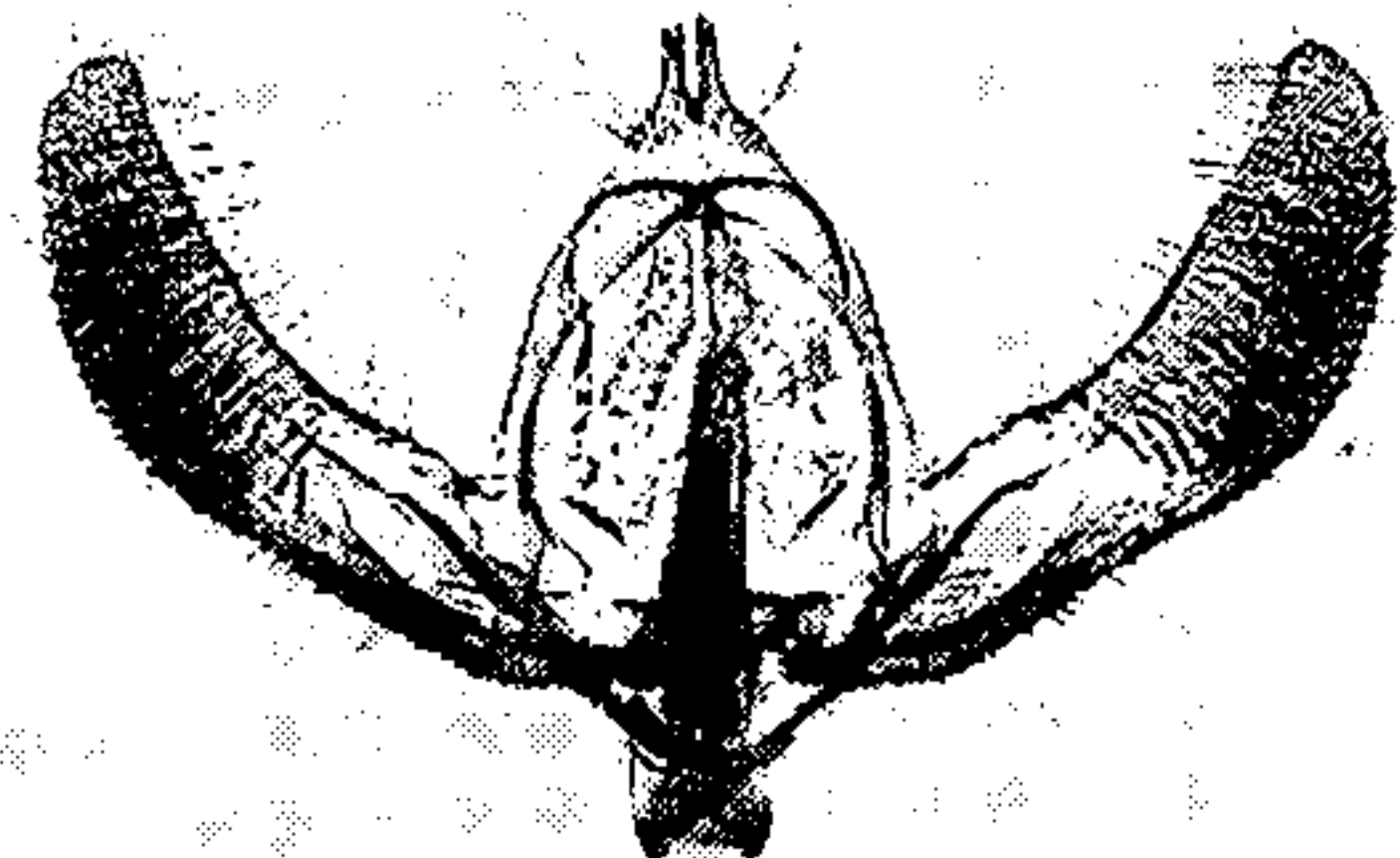

408 *albacostana*



402 *apicana*

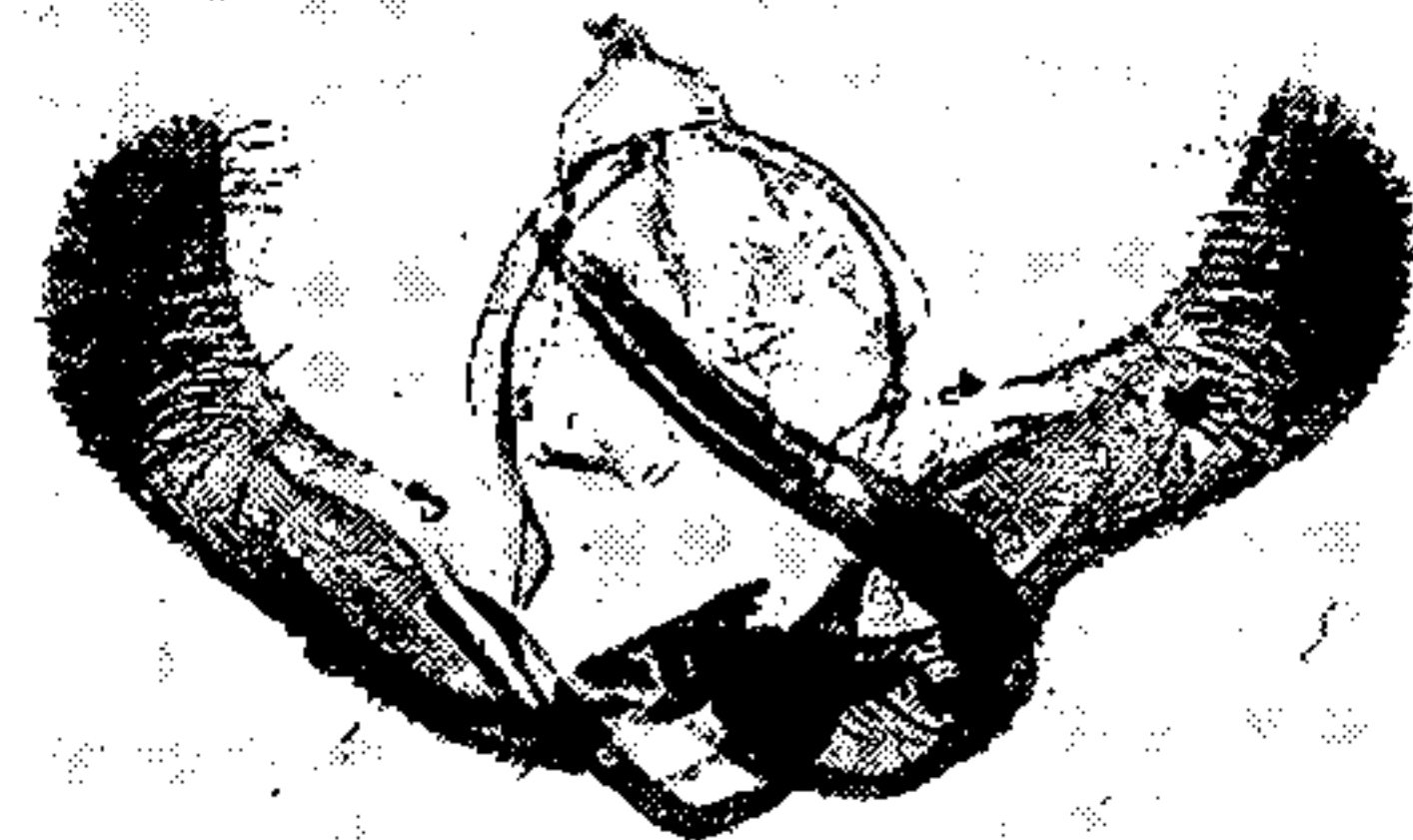

409 *unguicella*



403 *cornifoliata*

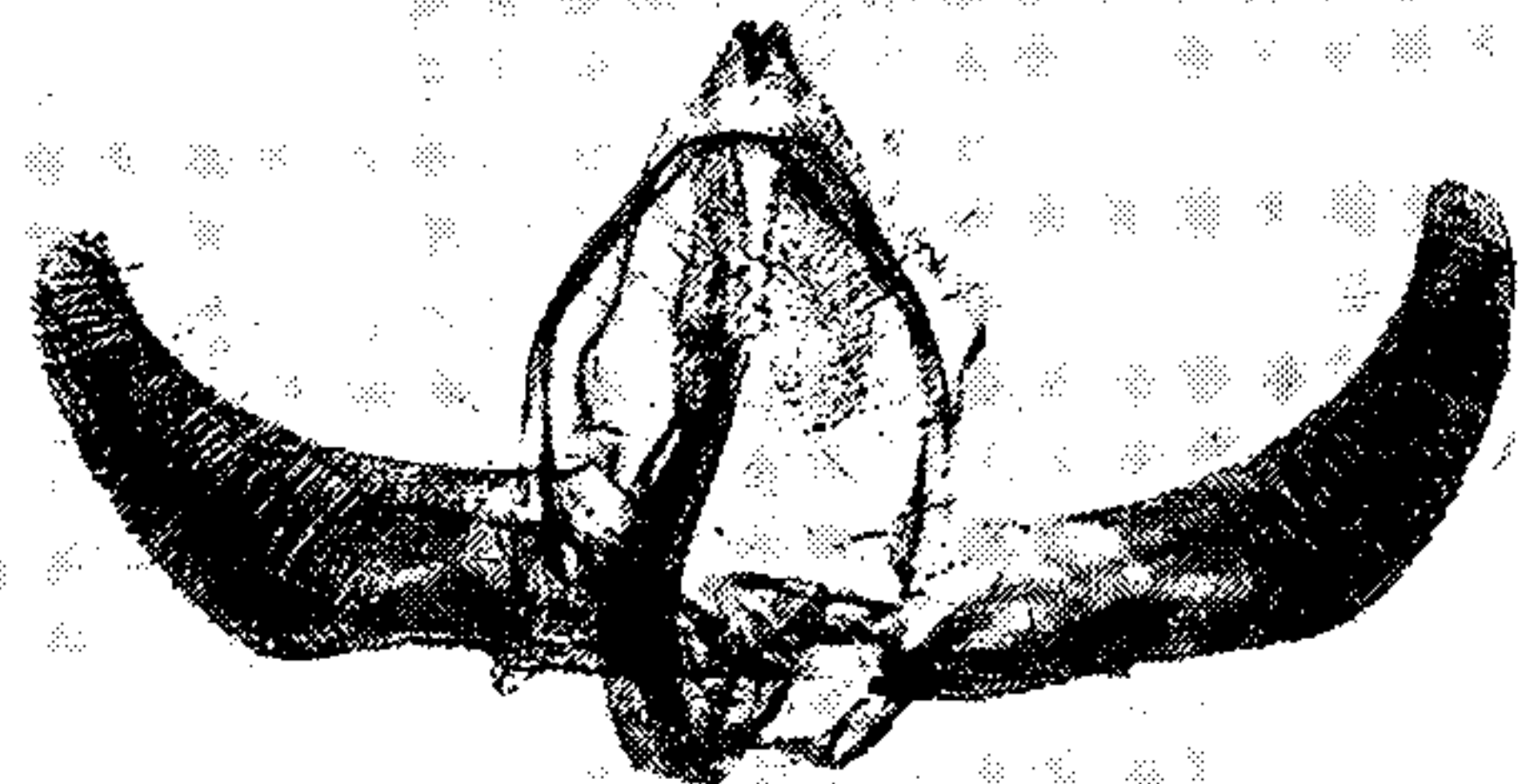

410 *pacificana*



404 *diminutana*

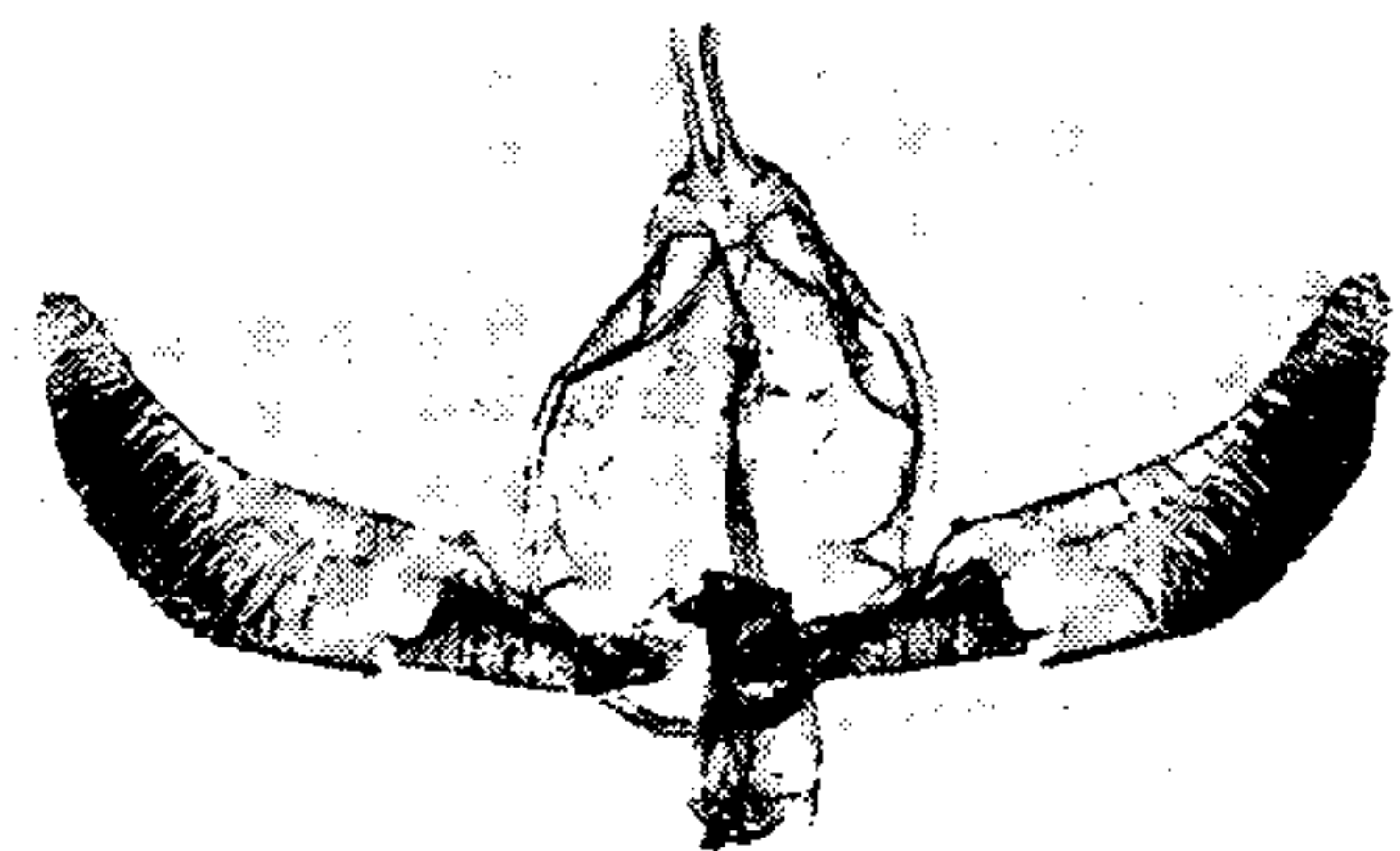

411 *goodelliana*



405 *tineana*

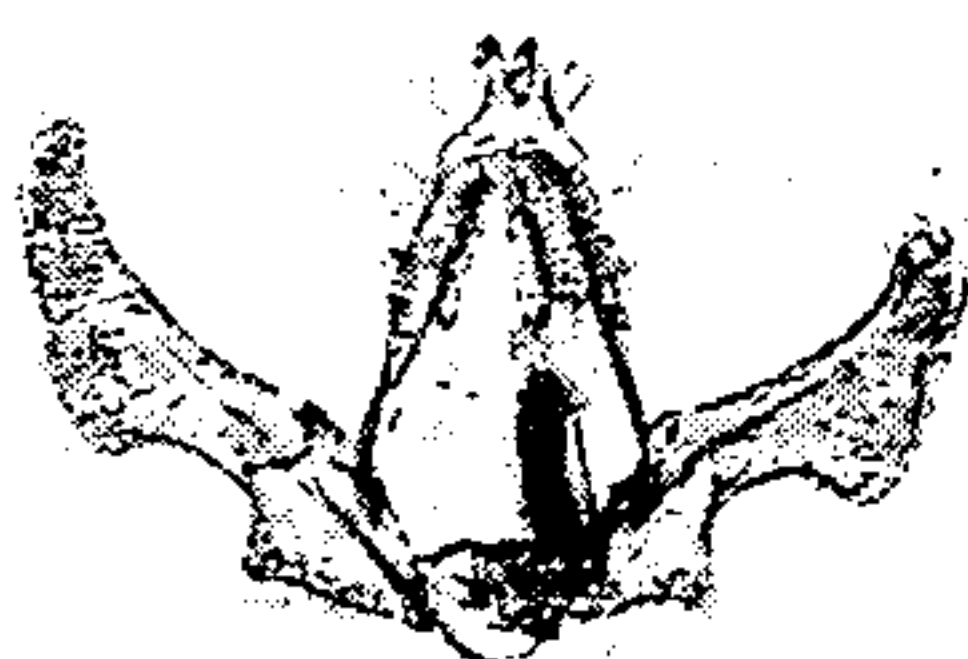

406 *fragariae*



412 *mediofasciana*

MALE GENITALIA OF ANCYLIS.

FOR EXPLANATION OF PLATE SEE PAGE 286.

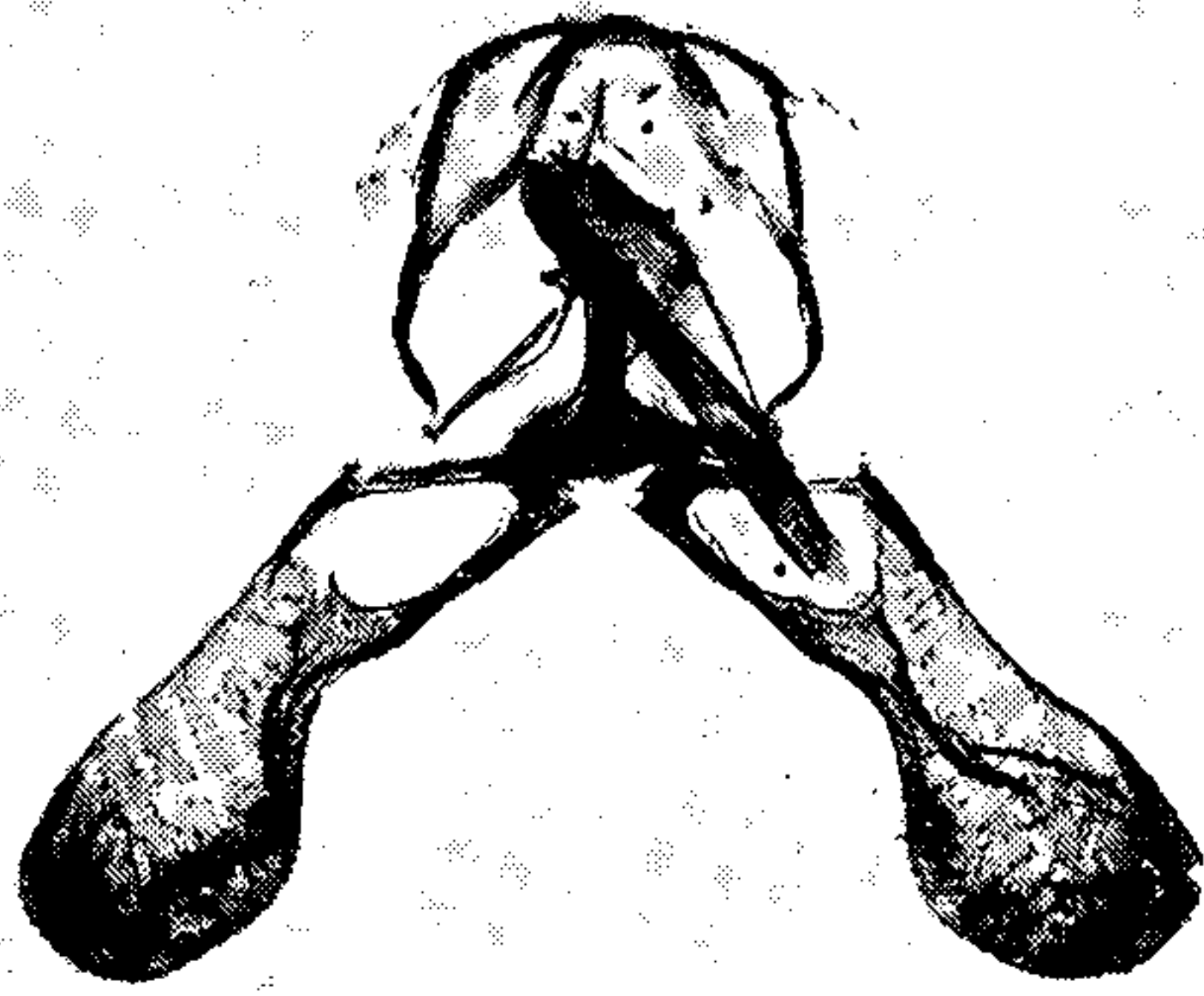

413 *inimicella*



417 *leonana*



414 *dietziana*



418 *roessleri*



415 *finitimana*



419 *ochreicostana*

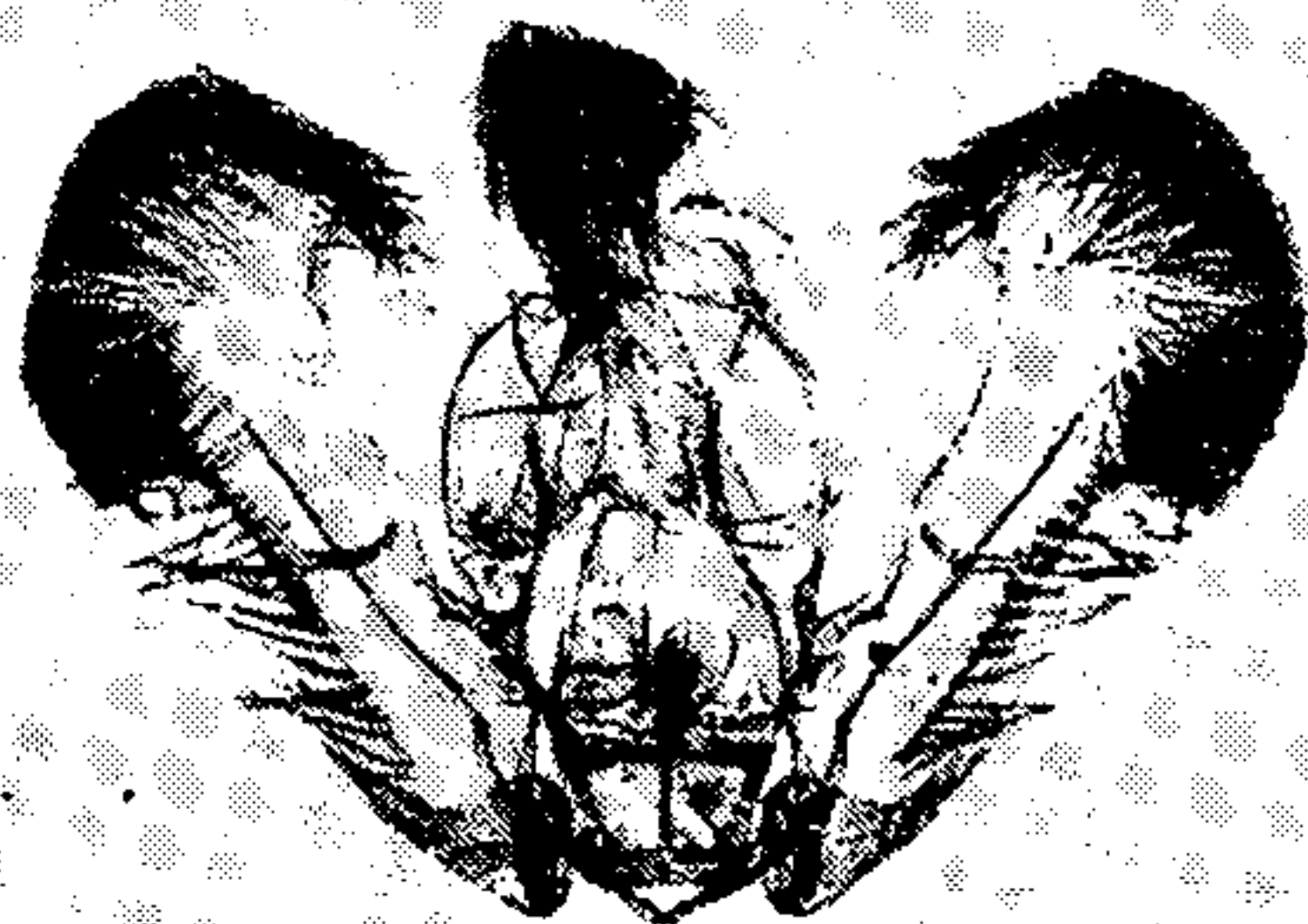

416 *naevana*

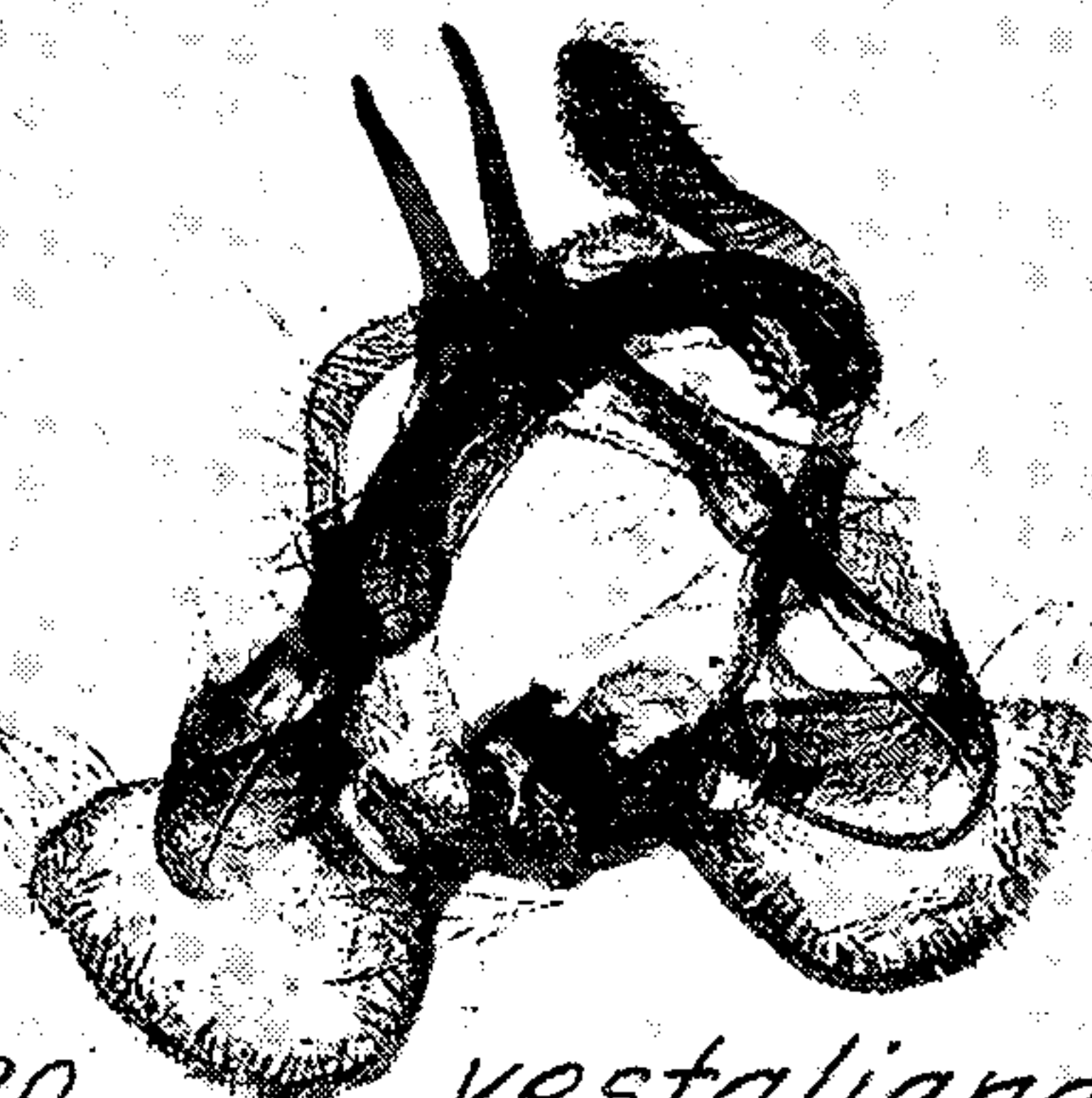

420 *vestaliana*

MALE GENITALIA OF PSEUDOGALLERIA, NORMA, KUNDRYA, RHOPOBOTA, AND HYSTRICOPHORA.



THIS PAGE IS LOCKED TO FREE MEMBERS
Purchase full membership to immediately unlock this page



Never be without a book!

Forgotten Books Full Membership gives universal access to 797,885 books from our apps and website, across all your devices: tablet, phone, e-reader, laptop and desktop computer

A library in your pocket for \$8.99/month

Continue

*Fair usage policy applies

- | | Page. | | Page. |
|--|--------------------|---|---------------|
| <i>apicana</i> (Walker)..... | 244, 247 | <i>Calosetia</i> Stainton..... | 32 |
| <i>Apotomis</i> Hübner..... | 136 | <i>cana</i> (Haworth)..... | 71 |
| <i>apriliana</i> Grote..... | 172, 174, 175, 221 | <i>canana</i> (Walsingham)..... | 79, 131 |
| <i>arctostaphylana</i> (Kearfott)..... | 198, 221 | <i>canariana</i> Kearfott..... | 74, 81 |
| <i>argenteana</i> (Walsingham)..... | 73, 86 | <i>caniceps</i> (Walsingham)..... | 73, 83 |
| <i>argentialbana</i> (Walsingham)..... | 74, 88 | <i>caracana</i> (Kearfott)..... | 158 |
| <i>argenticostana</i> (Walsingham)..... | 34, 57 | <i>caramitis</i> Meyrick..... | 102 |
| <i>argentifurcatana</i> (Grote)..... | 81 | <i>carbonana</i> Heinrich..... | 243, 248 |
| <i>argillacea</i> Meyrick..... | 99 | <i>carcharias</i> Meyrick..... | 109 |
| <i>argyraula</i> Meyrick..... | 81 | <i>carolina</i> (Kearfott)..... | 149 |
| <i>arizonae</i> Kearfott..... | 165, 166, 168 | <i>carolinana</i> (Walsingham)..... | 138, 149 |
| <i>arizonensis</i> (Heinrich) (variety of <i>albica-</i>
<i>tana</i> (Busck)..... | 22, 24 | <i>carphologa</i> (Meyrick)..... | 225 |
| <i>artemisiana</i> (Walsingham)..... | 33, 63 | Carpocapsa Treitschke..... | 3 |
| <i>asphodelana</i> (Kearfott)..... | 254, 257 | <i>castaneana</i> (Walsingham)..... | 196, 203 |
| <i>aspidana</i> (Walsingham)..... | 77, 129 | <i>cataclystiana</i> (Walker)..... | 75, 89, 135 |
| <i>aspidiscana</i> Authors (not Hübner)..... | 41 | <i>Catastega</i> Clemens..... | 195 |
| <i>aspidiscana</i> Hübner..... | 32 | <i>Catoptria</i> Guenée..... | 71 |
| <i>aspista</i> (Meyrick)..... | 139 | <i>cellisana</i> (Riley)..... | 234 |
| <i>atacta</i> (Meyrick)..... | 204 | <i>cercocarpana</i> (Dyar)..... | 198, 219 |
| <i>atomosana</i> (Walsingham)..... | 75, 94 | <i>chersaea</i> Meyrick..... | 119 |
| <i>augustana</i> Fernald..... | 228 | <i>chloroleuca</i> Meyrick..... | 83 |
| <i>aurantiana</i> Walsingham (variety of <i>leonana</i>
Walsingham)..... | 255 | <i>chortaea</i> Meyrick..... | 259 |
| <i>awemeana</i> Kearfott..... | 35, 36, 38 | <i>cinereolineana</i> Heinrich..... | 37, 52 |
| Bactra Stephens..... | 10 | <i>cinerodorsana</i> Heinrich..... | 156, 159 |
| <i>bactrana</i> Heinrich..... | 76, 117 | <i>circulana</i> Hubner..... | 71, 75, 95 |
| <i>baracana</i> (Kearfott)..... | 156, 158 | <i>circulana</i> (Fernald) (not Hübner)..... | 87 |
| Barbara Heinrich..... | 11, 14, 27 | <i>citrana</i> (Hübner)..... | 32 |
| <i>colfaxiana</i> (Kearfott)..... | 28 | <i>clavana</i> (Fernald) (Thiodia)..... | 34, 55 |
| <i>colfaxiana coloradensis</i>
(Heinrich)..... | 28, 29 | <i>clavana</i> (Zeller) (Eucosma)..... | 120 |
| <i>colfaxiana siskiyouana</i>
(Kearfott)..... | 28 | <i>claypoleana</i> (Riley)..... | 169, 170 |
| <i>colfaxiana taxifoliella</i>
(Busck)..... | 28, 29 | <i>cocana</i> Kearfott..... | 76, 104 |
| <i>ulteriorana</i> (Heinrich)..... | 27, 29 | <i>cockleana</i> (Kearfott)..... | 228 |
| <i>barnesiana</i> Dyar..... | 87 | <i>Cocochroea</i> Lederer..... | 136 |
| <i>basipunctana</i> (Walsingham)..... | 196, 209 | <i>colfaxiana</i> (Kearfott)..... | 28 |
| <i>benjamini</i> Heinrich..... | 35, 66 | <i>coloradensis</i> (Heinrich) (variety of <i>colfaxiana</i>
(Kearfott)..... | 28, 29 |
| <i>biangulana</i> (Walsingham)..... | 180, 185 | <i>columbia</i> (Kearfott)..... | 219 |
| <i>biarcuana</i> (Stephens)..... | 249, 253 | <i>columbiana</i> (Walsingham)..... | 37, 44 |
| <i>bicordana</i> Heinrich..... | 174, 199, 220 | <i>comatulana</i> (Zeller)..... | 75, 92 |
| <i>bigemina</i> Heinrich..... | 199, 220 | <i>cometana</i> (Walsingham) (variety of <i>comptana</i>
(Fröhlich)..... | 244, 245 |
| <i>bilineana</i> Kearfott..... | 76, 115 | <i>communana</i> (Curtis)..... | 169 |
| <i>bilunana</i> (Haworth)..... | 195 | <i>comptana</i> (Fröhlich)..... | 244 |
| <i>bimaculana</i> (Donovan)..... | 200 | <i>comstockiana</i> (Fernald)..... | 21, 22 |
| <i>biplagata</i> (Walsingham)..... | 76, 118 | <i>concitatricana</i> Heinrich..... | 10, 188, 189 |
| <i>bipunctella</i> (Walker)..... | 71, 73, 115 | <i>concupitana</i> Heinrich..... | 180, 181 |
| <i>bipustulana</i> (Walker)..... | 178 | <i>conflexana</i> (Walker)..... | 244 |
| <i>biquadrana</i> (Walsingham)..... | 79, 129 | <i>confluana</i> Kearfott..... | 120, 121 |
| <i>blakeana</i> (Grote)..... | 163 | <i>consobrinana</i> Heinrich..... | 79, 128 |
| <i>bobana</i> Kearfott..... | 76, 103 | <i>consociana</i> Heinrich..... | 73, 101 |
| <i>bolanderana</i> (Walsingham)..... | 74, 85 | <i>conspiciendana</i> Heinrich..... | 75, 135 |
| <i>bolliana</i> (Slingerland)..... | 180, 183 | <i>constrictana</i> (Zeller)..... | 160 |
| <i>boxcana</i> (Kearfott)..... | 137, 139 | <i>corculana</i> (Zeller)..... | 35, 41 |
| <i>brightonana</i> (Kearfott)..... | 137, 154 | <i>cornifoliata</i> (Riley) (variety of <i>muricana</i>
(Walsingham)..... | 244, 248 |
| <i>bucephaloides</i> (Walsingham)..... | 36, 71 | <i>cornutana</i> (Dyar)..... | 260 |
| <i>buolana</i> (Schiffmüller)..... | 13, 15 | <i>corosana</i> (Walsingham)..... | 78, 127 |
| <i>burgessiana</i> (Zeller)..... | 234, 239 | <i>corticana</i> (Hübner)..... | 169 |
| <i>burkeana</i> (Kearfott)..... | 22, 26 | <i>costastrigulana</i> Kearfott..... | 75, 92 |
| <i>busckana</i> Heinrich..... | 15, 17, 18 | <i>costomaculana</i> (Clemens)..... | 173, 178 |
| <i>bushnelli</i> (Busck) (variety of <i>frustrana</i> (Com-
stock)..... | 15, 20 | <i>crambitana</i> (Walsingham)..... | 74, 81 |
| <i>californiae</i> Heinrich (variety of <i>stygiata</i>
(Dyar)..... | 254, 256 | <i>crenana</i> (Hübner)..... | 198, 219 |
| <i>Callimosema</i> Clemens..... | 72 | <i>crescentana</i> Kearfott..... | 165, 166, 167 |
| | | <i>crëssoniana</i> (Clemens)..... | 174 |
| | | <i>criddleana</i> (Kearfott) (variety of <i>nisella</i>
(Clerck)..... | 198, 211 |



THIS PAGE IS LOCKED TO FREE MEMBERS

Purchase full membership to immediately unlock this page



HISTORY

Tens of thousands of important historical sources, many previously unobtainable, are now available for the first time with a Forgotten Books Full Membership.

Unlimited Access
\$8.99/month

Continue

*Fair usage policy applies

	Page.
<i>Epinotia</i> Hübner.....	12, 194
<i>aceriella</i> (Clemens).....	200, 224
<i>albangulana</i> (Walsingham).....	198, 212
<i>albicapitana</i> (Kearfott)....	187, 198, 206
<i>albidorsana</i> (Kearfott).....	219
<i>arctostaphylana</i> (Kearfott).....	198, 221
<i>atacta</i> (Meyrick).....	204
<i>augustana</i> Fernald.....	228
<i>basipunctana</i> (Walsingham).....	196, 209
<i>bicordana</i> Heinrich....	174, 199, 220
<i>bigemina</i> Heinrich.....	199, 220
<i>bilunana</i> (Haworth).....	195
<i>bimaculana</i> (Donovon)....	200
<i>carphologa</i> (Meyrick).....	225
<i>castaneana</i> (Walsingham). 196,	203
<i>celtisana</i> (Riley).....	204
<i>cercocarpana</i> (Dyar)....	198, 219
<i>cockleana</i> (Kearfott).....	228
<i>columbia</i> (Kearfott).....	219
<i>crenana</i> (Hübner).....	198, 219
<i>cruciana</i> (Linnaeus)....	195, 199, 228
<i>cruciana alaskae</i> Heinrich	199, 229
<i>cruciana plumbolineana</i> (Kearfott).....	199, 229
<i>digitana</i> Heinrich.....	198, 215
<i>domonana</i> (Kearfott).....	226
<i>efficax</i> (Meyrick).....	226
<i>emarginana</i> (Walsingham).....	195, 198, 218
<i>ethnica</i> Heinrich.....	197, 201
<i>fumoviridana</i> Heinrich..	196, 208
<i>hamptonana</i> (Kearfott). 197, 210	
<i>heucherana</i> Heinrich....	198, 217
<i>hopkinsana</i> (Kearfott)..	197, 206
<i>hopkinsana cupressi</i> Heinrich.....	197, 207
<i>improvisana</i> Heinrich... 196, 269	
<i>infusana</i> (Walsingham)	200, 222
<i>johnsonana</i> (Kearfott)... 196, 203	
<i>laracana</i> (Kearfott)....	198, 204
<i>lindana</i> (Fernald).....	199, 231
<i>lomonana</i> (Kearfott)....	199, 227
<i>madderana</i> (Kearfott)... 196, 204	
<i>marmoreana</i> Heinrich... 200, 222	
<i>medioplagata</i> (Walsingham).....	199, 227
<i>mediostriana</i> (Kearfott)....	219
<i>medioviridana</i> (Kearfott). 196,	202
<i>mercuriana</i> (Hübner).....	195
<i>meritana</i> Heinrich.....	199, 226
<i>miscana</i> (Kearfott).. 197, 213, 214	
<i>momonana</i> (Kearfott).....	196, 197, 212
<i>monticolana</i> (Duponchel). 195	
<i>nanana</i> (Treitschke)....	199, 226
<i>navahs</i> (Meyrick).....	204

	Page.
<i>Epinotia</i> Hübner <i>nigralbana</i> (Walsingham). 198,	216
<i>nisella</i> (Clerck).....	195, 198, 211
<i>nisella criddleana</i> (Kearfott).....	198, 211
<i>nonana</i> (Kearfott).....	199, 225
<i>normanana</i> Kearfott....	199, 225
<i>nothodes</i> (Meyrick).....	206
<i>ophthalmicana</i> (Hübner)... 194	
<i>packardiana</i> (Clemens)....	210
<i>peristicta</i> (Meyrick).....	205
<i>perplexana</i> (Fernald)... 196, 202	
<i>piceafoiana</i> Kearfott.....	226
<i>pulsatillana</i> (Dyar)....	197, 201
<i>pulsatillana siskiyouensis</i> Heinrich.....	197, 202
<i>purpuriciliana</i> (Walsingham).....	199, 228
<i>rectiplicana</i> (Walsingham) 198,	209
<i>ruidosana</i> Heinrich.....	198, 216
<i>sanifica</i> (Meyrick).....	212
<i>semalea</i> (Meyrick).....	213
<i>septemberana</i> Kearfott . 199, 230	
<i>signatana</i> (Clemens).....	224
<i>signiferana</i> Heinrich....	199, 232
<i>silvertoniensis</i> Heinrich. 197, 214	
<i>similana</i> (Hübner).....	14, 194, 197, 200
<i>solandriana</i> (Linnaeus)... 194,	197, 200
<i>solicitana</i> (Walker)....	197, 210
<i>subnisana</i> (Zeller).....	224
<i>subplicana</i> (Walsingham). 196,	208
<i>tedella</i> (Clerck).....	14, 194
<i>tephrinana</i> (Zeller).....	210
<i>terracoctana</i> (Walsingham).....	197, 213
<i>tetraquetrana</i> (Haworth). 195	
<i>timidella</i> (Clemens).....	195
<i>transmissana</i> (Walker).. 198, 215	
<i>trossulana</i> (Walsingham) 199, 231	
<i>unica</i> Heinrich.....	200, 221
<i>vagana</i> Heinrich.....	199, 230
<i>variana</i> (Clemens).....	224
<i>veneratrix</i> (Meyerick).....	227
<i>vertumnana</i> (Zeller)....	198, 204
<i>walkerana</i> (Kearfott)....	196, 210, 212
<i>xandana</i> (Kearfott).....	204
<i>yandana</i> (Kearfott)....	198, 206
<i>zandana</i> (Kearfott)....	198, 205
<i>Episagma</i> Hübner.....	194
<i>Eriopsela</i> Guenée.....	32
<i>essexana</i> Kearfott.....	35, 36, 38
<i>ethnica</i> Heinrich.....	197, 201
<i>Eucosma</i> Hübner.....	12, 71
<i>adamantana</i> (Guenée)....	73, 84
<i>agassizii</i> (Robinson).....	74, 85
<i>agricolana</i> (Walsingham). 74, 91	
<i>albiguttana</i> (Zeller).....	75, 93
<i>amanda</i> Meyrick.....	124
<i>annulata</i> Meyrick.....	106
<i>antichroma</i> Meyrick.....	103

	Page.		Page.
<i>Eucozma</i> Hübner <i>argenteana</i> (Walsingham)	73, 86	<i>Eucozma</i> Hübner <i>bandana</i> Kearfott.....	73, 81
<i>argentialbana</i> (Walsingham).....	74, 88	<i>fernaldana</i> (Grote).....	74, 82
<i>argentifurcatana</i> (Grote)..	81	<i>fiskeana</i> Kearfott.....	78, 127
<i>argillacea</i> Meyrick.....	99	<i>floridana</i> Kearfott....	75, 89, 135
<i>argyraulæ</i> Meyrick.....	81	<i>fofana</i> Kearfott.....	78, 106
<i>aspidana</i> (Walsingham).	77, 129	<i>fratruelis</i> Heinrich.....	75, 98
<i>atomosana</i> (Walsingham)	75, 94	<i>fraudabilis</i> Heinrich.....	75, 98
<i>baetrana</i> Heinrich.....	76, 117	<i>fulminana</i> (Walsingham)	76, 124
<i>barnesiana</i> Dyar.....	87	<i>fuscosparsa</i> (Walsingham)	73, 116
<i>bilineana</i> Kearfott.....	76, 115	<i>galenapunctana</i> Kearfott.	75, 94
<i>biplagata</i> (Walsingham).	76, 118	<i>gandana</i> Kearfott.....	73, 83
<i>bipunctella</i> (Walker).	71, 73, 115	<i>giganteana</i> (Riley).....	78, 114
<i>biquadrana</i> (Walsingham)	79, 129	<i>gilletteana</i> Dyar.....	74, 85
<i>bobana</i> Kearfott.....	76, 103	<i>glomerana</i> (Walsingham).	75, 95
<i>bolanderana</i> (Walsingham).....	74, 85	<i>gomonana</i> Kearfott.....	76, 119
<i>cana</i> (Haworth).....	71	<i>graciliana</i> Kearfott.....	75, 93
<i>canana</i> (Walsingham)....	79, 131	<i>graduatana</i> (Walsingham)	77, 122
<i>canariana</i> Kearfott.....	74, 81	<i>grandiflavana</i> (Walsingham).....	72, 114
<i>caniceps</i> (Walsingham)....	73, 83	<i>griphodes</i> Meyrick.....	95
<i>caramitis</i> Meyrick.....	102	<i>grotiana</i> Kearfott.....	78, 106
<i>carcharias</i> Meyrick.....	109	<i>handana</i> Kearfott.....	73, 102
<i>cataclystiana</i> (Walker)	75, 89, 135	<i>heathiana</i> Kearfott.....	76, 88
<i>chersæa</i> Meyrick.....	119	<i>hipeana</i> (Grote).....	82
<i>chloroleuca</i> Meyrick.....	83	<i>hohana</i> Kearfott.....	78, 129
<i>circulana</i> Hübner.....	71, 75, 95	<i>hyponomeutana</i> (Walsingham).....	72, 114
<i>circulana</i> (Fernald).....	97	<i>idahoana</i> Kearfott.....	73, 86
<i>circulana gemellana</i> Heinrich.....	75, 96	<i>immaculana</i> Kearfott....	73, 102
<i>clavana</i> (Zeller).....	120	<i>invicta</i> (Walsingham)....	78, 107
<i>cocana</i> Kearfott.....	76, 104	<i>irroratana</i> (Walsingham)	73, 101
<i>comatulana</i> (Zeller).....	75, 92	<i>isospora</i> Meyrick.....	120
<i>consobrinana</i> Heinrich...	79, 128	<i>juncticiliana</i> (Walsingham).....	77, 122
<i>consociana</i> Heinrich.....	73, 101	<i>kandana</i> Kearfott.....	99, 101
<i>conspiciendana</i> Heinrich.	75, 135	<i>landana</i> Kearfott....	73, 120, 125
<i>corosane</i> (Walsingham)..	78, 127	<i>larana</i> (Walsingham)....	72, 110
<i>costastrigulana</i> Kearfott..	75, 92	<i>leucomalla</i> Meyrick.....	105
<i>crambitana</i> (Walsingham)	74, 81	<i>lolana</i> Kearfott.....	78, 105
<i>daemonicana</i> Heinrich...	79, 111	<i>lugubrana</i> (Treitschke)...	71
<i>denverana</i> Kearfott.....	73, 116	<i>luridana</i> (Walsingham)..	73, 100
<i>dilatana</i> (Walsingham)..	77, 119	<i>maculatana</i> (Walsingham)	76, 102
<i>discipula</i> Meyrick.....	119	<i>magnificana</i> Heinrich....	74, 83
<i>distigmata</i> (Walker).....	120	<i>mancipiana</i> (Mann).....	71
<i>dodana</i> Kearfott.....	78, 106	<i>mandana</i> Kearfott	77, 124
<i>dodecana</i> (Zeller).....	97	<i>matutina</i> (Grote).....	78, 109
<i>dorsisignatana</i> (Clemens).	77, 120	<i>mediostriata</i> (Walsingham).....	76, 116
<i>dorsisignatana</i> Fernald (not Clemens).....	122	<i>metariana</i> Heinrich.....	79, 133
<i>dorsisignatana confluenta</i> Kearfott.....	120, 121	<i>metaschista</i> Meyrick.....	105
<i>dorsisignatana diffusana</i> Kearfott.....	77, 120, 121	<i>mobilensis</i> Heinrich....	73, 125
<i>dorsisignatana engelana</i> Kearfott.....	77, 120, 122	<i>momana</i> Kearfott.....	78, 105
<i>dorsisignatana similana</i> (Clemens).....	77, 120, 121	<i>monitorana</i> Heinrich....	76, 105
<i>emaciatana</i> (Walsingham)	79, 108	<i>monogrammana</i> (Zeller)..	75, 94
<i>eumæa</i> Meyrick.....	77, 124	<i>morrisoni</i> (Walsingham)..	74, 90
<i>excerptionana</i> Heinrich...	50, 73, 117	<i>nandana</i> Kearfott...	77, 119, 125
<i>exclusoriana</i> Heinrich...	79, 110	<i>occipitana</i> (Zeller).....	79, 111
<i>excusabilis</i> Heinrich.....	77, 123	<i>ochreana</i> (Clemens).....	135
<i>explosa</i> Meyrick.....	134	<i>optimana</i> Dyar.....	74, 85
<i>expolitana</i> Heinrich.....	79, 132	<i>palabundana</i> Heinrich...	71, 267
		<i>pallidipalpata</i> Kearfott...	75, 99
		<i>palousana</i> Kearfott..	79, 130, 131
		<i>palpana</i> (Walsingham)..	79, 113

- | | Page. | | Page. |
|-------------------------------------|--------------------|--|--------------------|
| Eucosma Hübner | | excusabilis Heinrich | 77, 123 |
| <i>pandana</i> Kearfott | 78, 127 | Exentera Grote | 12, 172 |
| <i>paraglypta</i> Meyrick | 97 | <i>apriliana</i> Grote | 172, 174, 175, 221 |
| <i>passerana</i> (Walsingham) | 79, 133 | <i>bipustulana</i> (Walker) | 178 |
| <i>perdricana</i> (Walsingham) | 75, 99 | <i>costomaculana</i> (Clemens) | 173, 178 |
| <i>pergandeana</i> Fernald | 74, 90 | <i>cressoniana</i> (Clemens) | 174 |
| <i>pergandeana flavana</i> Fer- | | <i>diffinana</i> (Walker) | 174 |
| nald | 74, 91 | <i>faracana</i> (Kearfott) | 173, 177 |
| <i>phaeodes</i> Meyrick | 126 | <i>habrosana</i> Heinrich | 173, 178 |
| <i>pholas</i> Meyrick | 134 | <i>haracana</i> (Kearfott) | 173, 176 |
| <i>popana</i> Kearfott | 79, 109 | <i>haracana</i> (Busck) | 175 |
| <i>primulana</i> (Walsingham) | 76, 118 | <i>improbana</i> (Walker) | 172, 173, 174 |
| <i>pulveratana</i> (Walsing- | | <i>improbana oregonana</i> (Wal- | |
| ham) | 79, 128 | singham) | 173, 175 |
| <i>quinquemaculana</i> (Robin- | | <i>maracana</i> (Kearfott) | 173, 177 |
| son) | 73, 79 | <i>praescrpta</i> (Meyrick) | 177 |
| <i>quinquemaculana</i> Fernald | 80 | <i>resoluta</i> (Meyrick) | 176 |
| <i>quintana</i> (Zeller) | 80 | <i>spoliana</i> (Clemens) | 173, 175 |
| <i>ragonoti</i> (Walsingham) | 74, 87 | <i>ultrix</i> (Meyrick) | 177 |
| <i>rescissoriana</i> Heinrich | 76, 104 | <i>virginiana</i> (Clemens) | 173, 179 |
| <i>reversana</i> Kearfott | 79, 112 | explosa Meyrick | 134 |
| <i>rhodophaea</i> Meyrick | 104 | expolitana Heinrich | 79, 132 |
| <i>ridingsana</i> (Robinson) | 74, 81 | exvagana (Walker) | 140 |
| <i>robinsonana</i> (Grote) | 73, 80 | famosa (Meyrick) | 158 |
| <i>rorana</i> Kearfott | 78, 132 | fandana Kearfott | 73, 81 |
| <i>rusticana</i> Kearfott | 76, 125 | faracana (Kearfott) | 173, 177 |
| <i>sandana</i> Kearfott | 75, 95 | fasciolana (Clemens) | 162, 163 |
| <i>sandiego</i> Kearfott | 74, 84 | fastidiosa Meyrick | 41 |
| <i>sardiopa</i> Meyrick | 127 | favillana (Dyar) | 260 |
| <i>sceletopa</i> Meyrick | 132 | fernaldana (Grote) | 74, 82 |
| <i>scintillana</i> (Clemens) | 72, 75, 96, 97 | ferruginana (Fernald) | 35, 40 |
| <i>scintillana randana</i> Kear- | | fertoriana Heinrich | 33, 264 |
| fott | 75, 97 | festivana Heinrich | 33, 265 |
| <i>semnitis</i> Meyrick | 134 | filiana (Busck) | 130, 160, 161 |
| <i>serapicana</i> Heinrich | 71, 266 | finitimana Heinrich | 192 |
| <i>serpentana</i> (Walsingham) | 74, 87 | fiskeana Kearfott | 78, 127 |
| <i>shastana</i> (Walsingham) | 79, 113, 130, 162 | flavana Fernald (variety of <i>pergandeana</i> Fernald) | 74, 91 |
| <i>smithiana</i> (Walsingham) | 88 | flavocellana (Clemens) | 140 |
| <i>snyderana</i> Kearfott | 78, 107 | fletcherana (Kearfott) (Laspeyresia) | 268 |
| <i>sombreana</i> Kearfott | 77, 125, 126 | floridana Kearfott (Eucosma) | 75, 89, 135 |
| <i>sonomana</i> Kearfott | 76, 103 | floridana (Zeller) (variety of <i>comptana</i> (Fröhlich)) | 244, 246 |
| <i>spaldingana</i> Kearfott | 73, 84 | foenella (Linnaeus) | 136 |
| <i>spilophora</i> Meyrick | 106 | fofana Kearfott | 78, 106 |
| <i>spodias</i> Meyrick | 108 | formosana (Clemens) | 32, 35, 39 |
| <i>suadana</i> Heinrich | 78, 130 | fortunana (Kearfott) | 170, 172 |
| <i>subflavana</i> (Walsingham) | 73, 101 | fragariae (Walsh and Riley) (variety of <i>comptana</i> Fröhlich) | 244, 246 |
| <i>subinvicta</i> Kearfott | 78, 107 | fraternana (Busck) | 161 |
| <i>syrtoles</i> Meyrick | 129 | fratruelis Heinrich | 75, 98 |
| <i>tahoensis</i> Heinrich | 79, 112 | fraudabilis Heinrich | 75, 98 |
| <i>tocullionana</i> Heinrich | 76, 105 | frustrana (Comstock) | 15, 19, 20 |
| <i>totana</i> Kearfott | 79, 108 | fulminana (Walsingham) | 76, 124 |
| <i>tryonana</i> Kearfott | 80 | fumoviridana Heinrich | 196, 208 |
| <i>vandana</i> Kearfott | 77, 134 | fuscana Kearfott | 260 |
| <i>wandana</i> Kearfott | 124 | fuscociliana Clemens | 234, 241 |
| <i>womonana</i> Kearfott | 77, 134 | fuscosparsa (Walsingham) | 73, 116 |
| <i>worthingtoniana</i> (Fernald) | 115 | galenapunctana Kearfott | 75, 94 |
| <i>zomonana</i> Kearfott | 78, 134 | gandana Kearfott | 73, 83 |
| EUCOSMINAE | 10 | gemellana Heinrich (variety of <i>circulana</i> Hübner) | 75, 96 |
| eumaea Meyrick | 77, 124 | gemistrigulana (Kearfott) | 22, 26 |
| Euryptychia Clemens | 137 | gerulae Heinrich | 186, 187 |
| Evetria Authors (not Hübner) | 11, 13, 14, 21, 27 | giganteana (Riley) | 78, 114 |
| Evetria Hübner | 14, 194 | gilletteana Dyar | 74, 85 |
| exacerbaticana Heinrich | 138, 146 | | |
| excerptionana Heinrich | 50, 73, 117 | | |
| excluseriana Heinrich | 79, 110 | | |



THIS PAGE IS LOCKED TO FREE MEMBERS
Purchase full membership to immediately unlock this page



Never be without a book!

Forgotten Books Full Membership gives universal access to 797,885 books from our apps and website, across all your devices: tablet, phone, e-reader, laptop and desktop computer

A library in your pocket for \$8.99/month

Continue

*Fair usage policy applies

	Page.		Page.
<i>laciniana</i> (Zeller).....	234, 240	<i>monticolana</i> (Duponchel).....	195
<i>laetana</i> (Fabricius).....	243	<i>mormonensis</i> Heinrich.....	35, 44
<i>lagopana</i> (Walsingham).....	156, 158	<i>morrisoni</i> (Walsingham).....	74, 90
<i>lamiana</i> Clemens.....	236	<i>muricana</i> (Walsingham).....	244, 247
<i>landana</i> Kearfott.....	73, 120, 125	<i>murtfeldtiana</i> (Riley).....	239
<i>lantana</i> (Busck).....	190	<i>naevana</i> (Hübner).....	193
<i>lapidana</i> (Walsingham).....	34, 50	<i>nanana</i> (Treitschke).....	199, 226
<i>laracana</i> (Kearfott).....	198, 204	<i>nandana</i> Kearfott.....	77, 119, 125
<i>larana</i> (Walsingham).....	72, 110	<i>naracana</i> Kearfott.....	166, 168
<i>laricana</i> (Heinemann).....	30, 31	<i>navalis</i> (Meyrick).....	204
Laspeyresia Hübner.....	3	<i>nebulosana</i> (Packard).....	261
LASPEYRESINAE	10	<i>neomexicana</i> (Dyar).....	15, 16, 18
<i>leonana</i> Walsingham.....	253, 255	<i>nepotinana</i> Heinrich.....	33, 263
<i>leucomalla</i> Meyrick.....	105	<i>nigralbana</i> (Walsingham).....	198, 216
<i>leucophaleratana</i> (Packard).....	252	<i>nigromaculana</i> (Haworth).....	32
<i>limigena</i> (Meyrick).....	48	<i>nisella</i> (Clerck).....	195, 198, 211
<i>lindana</i> (Fernald).....	199, 231	<i>nonana</i> (Kearfott).....	199, 225
<i>lineana</i> (Fernald).....	260	Norma Heinrich.....	12, 191
<i>liturana</i> (Walsingham).....	261	<i>dietziana</i> (Kearfott).....	191
<i>lolana</i> Kearfott.....	78, 105	<i>normanana</i> Kearfott.....	199, 225
<i>lomonana</i> (Kearfott).....	199, 227	<i>nothodes</i> (Meyrick).....	206
<i>loricana</i> (Grote).....	243, 253	<i>Notocelia</i> Hübner.....	136
<i>luctiferana</i> (Walker).....	193	<i>nubeculana</i> Clemens.....	233, 234
<i>luculentana</i> (Heinrich).....	22, 25	<i>numerosana</i> (Zeller).....	139, 140, 141
<i>lundana</i> (Fabricius).....	233, 243	<i>obfusca</i> (Dyar).....	138, 148
<i>lugubrana</i> (Treitschke).....	71	<i>obfuscata</i> (Riley).....	148
<i>luridana</i> (Walsingham).....	73, 100	<i>obliterana</i> (Walsingham).....	70
<i>maculatana</i> (Walsingham).....	72, 102	<i>obnigrana</i> Heinrich.....	165, 166, 169
<i>madderana</i> (Kearfott).....	196, 204	<i>occidentalis</i> Heinrich (variety of <i>striatana</i> (Clemens)).....	34, 58
<i>magnidicana</i> Heinrich.....	74, 83	<i>occipitana</i> (Zeller).....	79, 111
<i>mancipiana</i> (Mann).....	71	<i>ocellana</i> (Denis and Schiffermüller) (<i>Spilo-</i> <i>nota</i>).....	30
<i>mandana</i> Kearfott.....	77, 124	<i>ocellana</i> (Clemens) (<i>Ancylis</i>).....	252
<i>maracana</i> (Kearfott).....	173, 177	<i>ochraceana</i> Fernald.....	138, 144
<i>marcidana</i> (Zeller).....	241	<i>ochreana</i> (Clemens).....	135
<i>marcidellum</i> Walsingham.....	190	<i>ochreicostana</i> (Walsingham).....	254, 258
<i>maritima</i> (Dyar).....	234, 236, 238	<i>ochrocephala</i> (Walsingham).....	35, 42, 157
<i>marmontana</i> (Kearfott).....	34, 47	<i>ochroterminana</i> Kearfott.....	35, 40
<i>marmoreana</i> Heinrich.....	200, 222	<i>octopunctana</i> (Walsingham).....	33, 64, 266
<i>matutina</i> (Grote).....	78, 109	<i>oculana</i> (Harris).....	30
<i>mediofasciana</i> (Clemens).....	243, 251	<i>offectalis</i> (Cockerell) (<i>Rhyacionia</i>).....	16
<i>medioplagata</i> (Walsingham).....	199, 227	<i>offectalis</i> (Hulst) (<i>Thiodia</i>).....	36, 70, 71
<i>mediostriata</i> (Kearfott).....	219	OLETHREUTIDAE	9
<i>mediostriata</i> (Walsingham).....	76, 116	OLETHREUTINAE	10
<i>medioviridana</i> (Kearfott).....	196, 202	<i>olivaceana</i> (Riley).....	36, 67
<i>mercuriana</i> (Hübner).....	195	<i>ophthalmicana</i> (Hübner).....	194
<i>meritana</i> Heinrich.....	199, 226	<i>optimana</i> Dyar.....	74, 85
<i>metallica</i> (Busck).....	22, 24	<i>orégonana</i> (Walsingham) (variety of <i>impro-</i> <i>bana</i> (Walker)).....	173, 175
<i>metamelana</i> (Walker).....	236	<i>oregonensis</i> Heinrich.....	34, 47
<i>metariana</i> Heinrich.....	79, 133	<i>ostentatrix</i> Heinrich.....	254, 270
<i>metaschista</i> Meyrick.....	105	<i>otiosana</i> (Clemens).....	136, 137, 154
<i>migratana</i> Heinrich.....	37, 53	<i>oxyleuca</i> (Meyrick).....	158
<i>minimana</i> (Walsingham).....	37, 55, 61	<i>pacificana</i> (Walsingham).....	244, 251
<i>minutana</i> (Kearfott).....	140	<i>packardiana</i> (Clemens).....	210
<i>miscana</i> (Kearfott).....	197, 213, 214	<i>Paedisca</i> Treitschke.....	195
<i>misturana</i> Heinrich.....	34, 54, 55	<i>palabundana</i> Heinrich.....	71, 267
<i>mobilensis</i> Heinrich.....	73, 125	<i>pallidarcis</i> Heinrich.....	34, 60
<i>modicellana</i> Heinrich.....	33, 265	<i>pallidicostana</i> (Walsingham).....	37, 63
<i>moftatiana</i> Fernald.....	166, 168	<i>pallidipalpana</i> Kearfott.....	75, 99
<i>momana</i> Kearfott.....	78, 105	<i>palousana</i> (Kearfott) (<i>Eucosma</i>).....	79, 130, 131
<i>momonana</i> (Kearfott).....	196, 197, 212	<i>palousana</i> (Kearfott) (<i>Sonia</i>).....	161
<i>monitorana</i> Heinrich.....	76, 105	<i>palpana</i> (Walsingham).....	79, 113
<i>monogrammana</i> (Zeller).....	75, 94	<i>Pamplusia</i> Guenée.....	195
<i>monophylliana</i> (Kearfott).....	22, 26	<i>pandana</i> Kearfott.....	78, 127
<i>Monosphragis</i> Clemens.....	136		
<i>montana</i> (Busck).....	15, 17, 18		
<i>montanana</i> (Walsingham).....	36, 65		

- | | Page. | | Page. |
|--|---------------|---|------------------|
| <i>Panoplia</i> Hübner..... | 195 | Proteoteras Riley <i>naracana</i> Kearfott..... | 166, 168 |
| <i>paradisiae</i> Heinrich..... | 255 | <i>obnigrana</i> Heinrich..... | 165, 166, 169 |
| <i>paraglypta</i> Meyrick..... | 97 | <i>praesinospila</i> Meyrick..... | 168 |
| <i>Pardia</i> Guenée..... | 136 | <i>willingana</i> (Kearfoot)..... | 165,
166, 167 |
| <i>parvana</i> (Walsingham)..... | 34, 50, 55 | <i>pruni</i> Heinrich (variety of <i>burgessiana</i>
(Zeller))..... | 234, 239 |
| <i>pasadenana</i> (Kearfott)..... | 15, 16, 18 | Pseudogalleria Ragonot..... | 8, 12 |
| <i>passerana</i> (Walsingham)..... | 79, 133 | <i>inimicella</i> (Zeller).. | 12, 13 |
| <i>pelina</i> (Meyrick)..... | 145 | <i>pseudotsugana</i> (Kearfott)..... | 171 |
| <i>Pelochrista</i> Lederer..... | 71 | <i>pulchellana</i> Clemens..... | 234, 242 |
| <i>pennsylvaniana</i> (Kearfott)..... | 186, 187 | <i>pulsatillana</i> (Dyar)..... | 197, 201 |
| <i>perangustana</i> (Walsingham)..... | 36, 67 | <i>pulveratana</i> (Walsingham)..... | 79, 128 |
| <i>perdricana</i> (Walsingham)..... | 75, 99 | <i>purpuriciliana</i> (Walsingham)..... | 199, 228 |
| <i>perfuscana</i> Heinrich..... | 35, 40 | <i>purpurissatana</i> Heinrich..... | 138, 149 |
| <i>pergandeana</i> Fernald..... | 74, 90 | <i>Pygolopha</i> Lederer..... | 71 |
| <i>periculosana</i> Heinrich..... | 137, 268 | <i>pyricolana</i> (Murtfeldt)..... | 260 |
| <i>peristicta</i> (Meyrick)..... | 205 | <i>pyrifoliana</i> (Clemens)..... | 30 |
| <i>perplexana</i> (Fernald)..... | 196, 202 | <i>quadrana</i> (Guenée)..... | 32 |
| <i>perstructana</i> (Walker)..... | 260 | <i>quinquemaculana</i> (Robinson) (Eucosma)... | 73, 79 |
| Petrova Heinrich..... | 11, 14, 21 | <i>quinquemaculana</i> Fernald (Eucosma)..... | 80 |
| <i>albicapitana</i> (Busck)..... | 22, 23 | <i>quintana</i> (Zeller)..... | 80 |
| <i>albicapitana arizonensis</i>
(Heinrich)..... | 22, 24 | <i>radiatana</i> (Walsingham)..... | 35, 36, 37 |
| <i>burkeana</i> (Kearfott)..... | 22, 26 | <i>radicana</i> (Walsingham)..... | 186 |
| <i>comstockiana</i> (Fernald)... | 21, 22 | <i>ragonoti</i> (Walsingham)..... | 74, 87 |
| <i>edemoidana</i> (Dyar)..... | 22, 25 | <i>randana</i> Kearfott (variety of <i>scintillana</i> (Clem-
ens))..... | 75, 97 |
| <i>gemistrigulana</i> (Kearfott)... | 22, 26 | <i>raracana</i> Kearfott..... | 35, 41 |
| <i>luculentana</i> (Heinrich).... | 22, 25 | <i>ratzeburgiana</i> (Ratzburg)..... | 170, 171, 213 |
| <i>metallica</i> (Busck)..... | 22, 24 | <i>rectiplicana</i> (Walsingham)..... | 198, 209 |
| <i>monophylliana</i> (Kearfott)... | 22, 26 | <i>refusana</i> (Walker)..... | 34, 43 |
| <i>picicolana</i> (Dyar)..... | 22, 27 | <i>rescissoriana</i> Heinrich..... | 76, 104 |
| <i>pinivorana</i> (Zeller)..... | 23 | <i>resinella</i> (Linnaeus)..... | 26 |
| <i>resinella</i> (Linnaeus)..... | 26 | <i>resoluta</i> (Meyrick)..... | 176 |
| <i>sabiniana</i> (Kearfott)..... | 22, 25 | <i>resumptana</i> (Walker)..... | 261 |
| <i>turionana</i> (Hübner)..... | 17 | <i>Retinia</i> Guenée..... | 13 |
| <i>virginiana</i> (Busck)..... | 22, 23 | <i>reversana</i> Kearfott..... | 79, 112 |
| <i>wenzeli</i> (Kearfott)..... | 23 | <i>rhodophaea</i> Meyrick..... | 104 |
| <i>zozana</i> (Kearfott)..... | 22, 26 | Rhopobota Lederer..... | 11, 193 |
| <i>phaeodes</i> Meyrick..... | 126 | <i>luctiferana</i> (Walker).... | 193 |
| <i>Phlaeodes</i> Guenée..... | 195 | <i>naevana</i> (Hübner)..... | 193 |
| <i>pholas</i> Meyrick..... | 134 | <i>naevana ilicifoliana</i>
(Kearfott)..... | 194 |
| <i>Phoxopteris</i> Treitschke..... | 233 | <i>vacciniana</i> (Packard)... | 193 |
| <i>Phoxopteryx</i> Authors..... | 233 | Rhyacionia Hübner..... | 11, 13, 14 |
| <i>Phthinolophus</i> Dyar..... | 31 | <i>adana</i> Heinrich..... | 15, 17, 18 |
| <i>piceafoliana</i> Kearfott..... | 226 | <i>buoliana</i> (Schiffermül-
ler)..... | 13, 15 |
| <i>picicolana</i> (Dyar)..... | 22, 27 | <i>busckana</i> Heinrich.. | 15, 17, 18 |
| <i>pinicolana</i> (Zeller)..... | 171 | <i>duplana</i> (Hübner)..... | 16 |
| <i>pinivorana</i> (Zeller)..... | 23 | <i>frustrana</i> (Comstock).. | 15,
19, 20 |
| <i>plagosana</i> (Clemens)..... | 250 | <i>frustrana bushnelli</i>
(Busck)..... | 15, 20 |
| <i>platanana</i> Clemens..... | 234, 241 | <i>montana</i> (Busck).... | 15, 17, 18 |
| <i>plebeiana</i> Zeller..... | 189, 190 | <i>neomexicana</i> (Dyar) 15, 16, 18 | |
| <i>plumbolineana</i> (Kearfott) (variety of <i>cruci-
ana</i> (Linnaeus))..... | 199, 229 | <i>offectalis</i> (Cockerell).... | 16 |
| Polychrosis Ragonot..... | 10 | <i>pasadenana</i> (Kearfott)... | 15,
16, 18 |
| <i>pomonella</i> (Linnaeus)..... | 3 | <i>rigidana</i> (Fernald)..... | 15, 19 |
| <i>popana</i> Kearfott..... | 79, 109 | <i>subcervinana</i> (Wals-
ingham)..... | 14, 21 |
| <i>praescripta</i> (Meyrick)..... | 177 | <i>ridingsana</i> (Robinson)..... | 74, 81 |
| <i>praesinospila</i> Meyrick..... | 168 | <i>rigidana</i> (Fernald)..... | 15, 19 |
| <i>praesumptiosa</i> Heinrich..... | 139, 141, 143 | <i>robinsonana</i> (Grote)..... | 73, 80 |
| <i>primulana</i> (Walsingham)..... | 76, 118 | <i>roessleri</i> (Zeller)..... | 254, 257 |
| <i>profana</i> (Meyrick)..... | 156 | | |
| <i>Proteopteryx</i> Walsingham..... | 195 | | |
| Proteoteras Riley..... | 8, 11, 165 | | |
| <i>aesculana</i> Riley..... | 165, 166 | | |
| <i>arizonae</i> Kearfott.. | 165, 166, 168 | | |
| <i>crescentana</i> Kearfott | 165, 166, 167 | | |
| <i>moftatiana</i> Fernald.... | 166, 168 | | |

	Page.
<i>rorana</i> Kearfott.....	78, 132
<i>roseotermiana</i> Kearfott.....	35, 36, 38
<i>ruidosana</i> Heinrich.....	198, 216
<i>rusticana</i> Kearfoot.....	76, 125
<i>sabiniana</i> (Kearfott).....	22, 25
<i>sagittana</i> (Walker).....	39
<i>saliciana</i> (Clemens).....	164
<i>salicicolana</i> (Clemens).....	162, 164
<i>saligneana</i> (Clemens).....	137, 147
<i>salmicolorana</i> Heinrich.....	34, 62
<i>sandana</i> Kearfott.....	75, 95
<i>sandiego</i> Kearfott.....	74, 84
<i>sanifica</i> (Meyrick).....	212
<i>sardiopa</i> Meyrick.....	127
<i>scalana</i> (Walsingham).....	33, 65, 187, 266
<i>sceletopa</i> Meyrick.....	132
<i>scintillana</i> (Clemens).....	72, 75, 96, 97
<i>scudderiana</i> (Clemens).....	137, 138, 147
<i>semalea</i> (Meyrick).....	213
<i>Semasia</i> (Authors) (not Stephens).....	32
<i>semiovana</i> (Zeller).....	234, 237
<i>semnitis</i> Meyrick.....	134
<i>separationis</i> Heinrich (variety of <i>praesumptiosa</i> Heinrich).....	139, 143
<i>septemberana</i> Kearfott.....	199, 230
<i>serangias</i> (Meyrick).....	137, 139
<i>seraphicana</i> Heinrich (variety of <i>asphodelana</i> (Kearfott)).....	254, 258
<i>serapicana</i> Heinrich.....	71, 266
<i>serpentana</i> (Walsingham).....	74, 87
<i>shastana</i> (Walsingham).....	79, 113, 130, 162
<i>shawiana</i> (Kearfott).....	272
<i>siculana</i> (Hübner).....	233
<i>signatana</i> (Clemens).....	224
<i>signiferana</i> Heinrich.....	199, 232
<i>silvertoniensis</i> Heinrich.....	197, 214
<i>similana</i> (Clemens) (variety of <i>dorsisignatana</i> (Clemens)).....	77, 120, 121
<i>similana</i> (Hübner) (<i>Epinotia</i>).....	14, 194, 197, 200
<i>siskiyouana</i> (Kearfott) (variety of <i>colfaxiana</i> (Kearfott)).....	28
<i>siskiyouensis</i> Heinrich (variety of <i>pulsatillana</i> (Dyar)).....	197, 202
<i>skinnerana</i> Heinrich.....	42, 156, 157
<i>smithiana</i> (Walsingham) (<i>Eucosma</i>).....	88
<i>smithiana</i> Walsingham (<i>Strepsicrates</i>).....	32
<i>snyderana</i> Kearfott.....	78, 107
<i>solandriana</i> (Linnaeus).....	194, 197, 200
<i>solicitana</i> (Walker).....	197, 210
<i>sombreana</i> Kearfott.....	77, 125, 126
Sonia Heinrich.....	11, 160
<i>constrictana</i> (Zeller).....	160
<i>filiana</i> (Busck).....	130, 160, 161
<i>fraternana</i> (Busck).....	161
<i>palousana</i> (Kearfott).....	161
<i>typicodes</i> (Meyrick).....	161
<i>vovana</i> (Kearfott).....	160, 161
<i>sonomana</i> Kearfott.....	76, 103
<i>sororiana</i> Heinrich.....	33, 263
<i>sosana</i> (Kearfott).....	138, 145
<i>spaldingana</i> Kearfott.....	73, 84
SPARGANOTHIDAE	4
Sparganothis Hübner.....	4
<i>speculigera</i> Meyrick.....	62
<i>spiculana</i> (Zeller).....	34, 57

	Page.
Spilonota Stephens.....	11, 30
<i>larictana</i> (Heinemann).....	30, 31
<i>ocellana</i> (Denis and Schiffermüller).....	30
<i>oculana</i> (Harris).....	30
<i>pyrifoliana</i> (Clemens).....	30
<i>spilophora</i> Meyrick.....	106
<i>spiraeifoliana</i> (Clemens).....	234, 236
<i>spodias</i> Meyrick.....	108
<i>spollana</i> (Clemens).....	173, 175
<i>Steganoptycha</i> Stephens.....	195
<i>stercoreana</i> (Zeller).....	39
<i>stramineana</i> (Walsingham).....	36, 69
<i>strenuana</i> (Walker).....	138, 140
Strepsicrates Meyrick.....	11, 31
<i>ejectana</i> (Walker).....	31, 32
<i>indentana</i> (Dyar).....	31, 32
<i>smithiana</i> (Walsingham).....	32
<i>striatana</i> (Clemens).....	34, 58
<i>stygianna</i> (Dyar).....	254, 256
<i>suadana</i> Heinrich.....	78, 130
<i>subaequana</i> (Zeller).....	233, 235, 236
<i>subcervinana</i> (Walsingham).....	14, 21
<i>subflavana</i> (Walsingham).....	73, 101
<i>subinycta</i> Kearfott.....	78, 107
<i>sublapidana</i> (Walsingham).....	34, 50, 117
<i>subminimana</i> Heinrich.....	37, 61
<i>subnisana</i> (Zeller).....	224
<i>subplicana</i> (Walsingham).....	196, 208
<i>substitutionis</i> Heinrich.....	162, 163
<i>subversana</i> (Zeller).....	140
<i>succedana</i> (Denis and Schiffermüller).....	260
<i>suffusana</i> (Zeller).....	138, 152
Suleima Heinrich.....	11, 155
<i>baracana</i> (Kearfott).....	156, 158
<i>caracana</i> (Kearfott).....	158
<i>cinerodorsana</i> Heinrich.....	156, 159
<i>daracana</i> (Kearfott).....	156
<i>famosa</i> (Meyrick).....	158
<i>helianthana</i> (Riley).....	155, 156
<i>lagopana</i> (Walsingham).....	156, 158
<i>oxyleuca</i> (Meyrick).....	158
<i>profana</i> (Meyrick).....	156
<i>skinnerana</i> Heinrich.....	42
	156, 157
<i>syrtoles</i> Meyrick.....	129
<i>tahoensis</i> Heinrich.....	79, 112
<i>taleana</i> (Grote).....	260
<i>tandana</i> (Kearfott).....	137, 154
<i>taradana</i> (Möschler).....	37, 52
<i>taxifoliella</i> (Busck) (variety of <i>colfaxiana</i> (Kearfott)).....	28, 29
<i>tedella</i> (Clerck).....	14, 194
<i>tenuiana</i> (Walsingham).....	37, 54, 55
<i>tephrinana</i> (Zeller).....	210
<i>terracoctana</i> (Walsingham).....	197, 213
<i>tetraquetra</i> (Haworth).....	195
Thiodia Hübner.....	5, 12, 32
<i>albicepsana</i> (Walker).....	58
<i>alterana</i> Heinrich.....	34, 46
<i>amphorana</i> (Walsingham).....	35, 42
<i>annetteana</i> Kearfott.....	34, 43
<i>apacheana</i> (Walsingham).....	37, 48
<i>argenticostana</i> (Walsingham).....	34, 57



THIS PAGE IS LOCKED TO FREE MEMBERS

Purchase full membership to immediately unlock this page



HISTORY

Tens of thousands of important historical sources, many previously unobtainable, are now available for the first time with a Forgotten Books Full Membership.

Unlimited Access
\$8.99/month

Continue

*Fair usage policy applies

	Page.		Page.
walsinghamsi (Kearfott).....	137, 150, 151, 152	Zeiraphera Treitschke <i>communana</i> (Curtis) .	169
wandana Kearfott.....	124	<i>corticana</i> (Hübner)..	169
watchungana (Kearfott).....	180, 182	<i>diniana</i> Guenée....	170, 171
wenzeli (Kearfott).....	23	<i>fortunana</i> (Kearfott)..	170, 172
willingana (Kearfott).....	165, 166, 167	<i>instrutana</i> (Claypole).	170
womonana Kearfott.....	77, 134	<i>pinicolana</i> (Zeller)...	171
worthingtoniana (Fernald).....	115	<i>pseudotsugana</i> (Kear-	
xandana (Kearfott).....	204	fott).....	171
yandana (Kearfott).....	198, 206	<i>ratzeburgiana</i> (Ratze-	
zandana (Kearfott).....	198, 205	burg).....	170, 171, 213
Zeiraphera Treitschke	11, 12, 169	zomonana Kearfott.....	78, 134
<i>claypoleana</i> (Riley)	169, 170	zozana (Kearfott).....	22, 26

ADDITIONAL COPIES
OF THIS PUBLICATION MAY BE PROCURED FROM
THE SUPERINTENDENT OF DOCUMENTS
GOVERNMENT PRINTING OFFICE
WASHINGTON, D. C.
AT
50 CENTS PER COPY

PURCHASER AGREES NOT TO RESELL OR DISTRIBUTE THIS
COPY FOR PROFIT.—PUB. RES. 57, APPROVED MAY 11, 1923

