

# Forgotten Books

— [www.forgottenbooks.com](http://www.forgottenbooks.com) —

Copyright © 2016 FB &c Ltd.

All rights reserved. No part of this publication may be reproduced, distributed, or transmitted in any form or by any means, including photocopying, recording, or other electronic or mechanical methods, without the prior written permission of the publisher, except in the case of brief quotations embodied in critical reviews and certain other noncommercial uses permitted by copyright law.

# TIMBER

BY

J. R. BATERDEN

ASSOC. M. INST. C. E.



LONDON

ARCHIBALD CONSTABLE & CO. LTD.

10 ORANGE STREET LEICESTER SQUARE W.C.

1908

BRADBURY, AGNEW, & CO. LD., PRINTERS,  
LONDON AND TONBRIDGE.

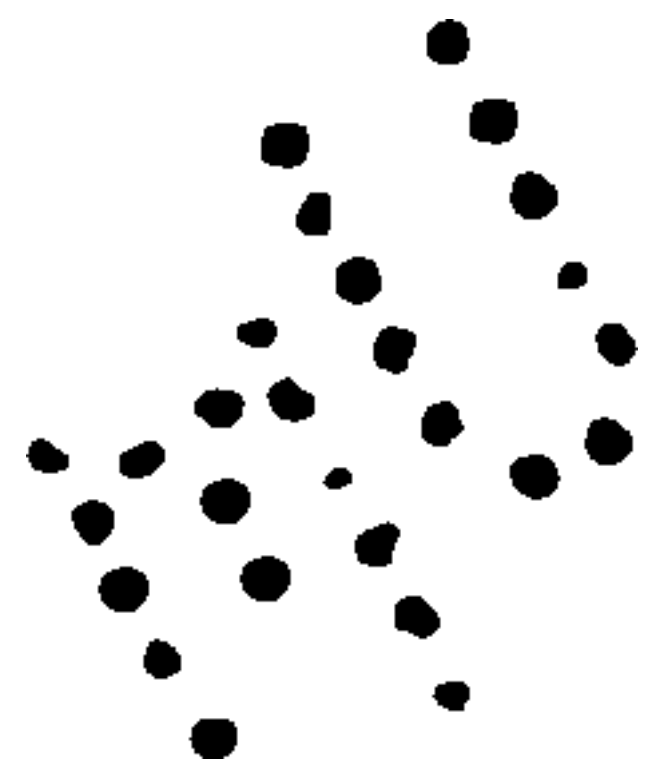

Forestry  
Sachin  
1-13-1928  
16246

## PREFACE

---

WHEN the publishers asked me to undertake this work it was stipulated that it was to be essentially a "practical work," and that botany was only incidentally to be touched upon. Only those timbers have been dealt with which are most generally used, either in their native districts or in the general timber trade, together with some others which are likely before long to come into the market. Those most largely used have been dealt with at greatest length.

It is impossible for any one individual to have a close acquaintance with even all the well-known timbers of commerce; even in "the trade" those well acquainted with a class of timber in which they deal often know comparatively little about others. The timber trade, like most others, is now highly specialised. I have, in order to supplement my own experience, had recourse for information to those well acquainted with particular timbers of which I have not equal experience, and I have to thank many professional friends in all parts of the world, and many strangers, for valuable assistance. Much useful information concerning United States timber has been drawn from the bulletins and circulars of the United States Department of Agriculture, Division of Forestry, whose officials have been most helpful in placing information at my disposal; the same applies to the Agents General and officials of our own Colonial Governments.

The botanical names for some timbers are variously given by different authorities—I have taken them from what I considered the most accurate sources, and have always given the spelling as it is given in official or Government records when these are obtainable. There are few subjects about which there is more difference of opinion than about timber, for one seldom finds that two people describe even the colour of two pieces of timber in the same terms. I have given no information of which I am not either certain from my own knowledge, or which I have not gained from authentic sources. Whilst this work cannot within its scope be exhaustive, I trust that I have treated all the important matters connected with the subject adequately, and that it may serve a useful purpose. The writing of it has been a great pleasure to me.

J. R. BATERDEN.

NEWCASTLE-ON-TYNE.

*August, 1908.*

# CONTENTS

CHAP.	PAGE
I. TIMBER . . . . .	1
II. THE WORLD'S FOREST SUPPLY. QUANTITIES OF TIMBER USED. TIMBER IMPORTS INTO GREAT BRITAIN . . .	17
III. EUROPEAN TIMBER . . . . .	29
IV. TIMBER OF THE UNITED STATES AND CANADA . . . . .	65
V. TIMBERS OF SOUTH AMERICA, CENTRAL AMERICA, AND WEST INDIA ISLANDS . . . . .	121
VI. TIMBERS OF INDIA, BURMA, AND ANDAMAN ISLANDS . . . . .	160
VII. TIMBER OF THE STRAITS SETTLEMENTS, MALAY PENINSULA, JAPAN, AND SOUTH AND WEST AFRICA . . . . .	191
VIII. AUSTRALIAN TIMBERS . . . . .	209
IX. TIMBERS OF NEW ZEALAND AND TASMANIA . . . . .	238
X. CAUSES OF DECAY AND DESTRUCTION OF TIMBER . . . . .	255
XI. SEASONING AND IMPREGNATION OF TIMBER . . . . .	269
XII. DEFECTS IN TIMBER AND GENERAL NOTES . . . . .	288
XIII. STRENGTH AND TESTING OF TIMBER . . . . .	301
XIV. "FIGURE" IN TIMBER . . . . .	320
APPENDIX . . . . .	329
BIBLIOGRAPHY . . . . .	333



# LIST OF ILLUSTRATIONS

FIG.		PAGE
1.	PINE TIMBER . . . . .	8
2.	CROSS SECTION OF 14-INCH PITCH PINE LOG . . . . .	9
3.	BLOCK OF OAK . . . . .	11
4.	CROSS SECTION OF HICKORY . . . . .	12
5.	LONGITUDINAL CELLS AND CELLS OF MEDULLARY RAYS . . . . .	13
6.	" PINING " OF BOARDS . . . . .	14
7.	NORTHERN OR SCOTCH PINE . . . . .	31
8.	LARCH . . . . .	36
9.	COMMON OAK IN WINTER . . . . .	38
10.	CROSS SECTION OF OAK . . . . .	42
11.	CROSS SECTION OF ASH . . . . .	53
12.	COMMON BIRCH . . . . .	54
13.	BEECH . . . . .	57
14.	ENGLISH ELM . . . . .	60
15.	LOBLOLLY PINE FOREST AND LOBLOLLY SLEEPERS . . . . .	72
16.	SUGAR PINE, INCENSE CEDAR, AND WESTERN YELLOW PINE . . . . .	75
17.	TYPICAL FOREST MIXTURE IN WASHINGTON . . . . .	78
18.	RED CEDAR . . . . .	88
19.	CROSS SECTION OF CHESTNUT . . . . .	96
20.	REDWOOD FOREST . . . . .	107
21.	FIRE-SCARRED " BIG TREE " AND SUGAR PINE . . . . .	109
22.	MAPLE PLANK . . . . .	112
23.	" SNIPING " OF GREENHEART . . . . .	122
24.	HEART FLAW IN GREENHEART . . . . .	123
25.	FELLING A MAHOGANY TREE . . . . .	154
26.	FORMER METHOD OF SQUARING MAHOGANY . . . . .	155
27.	DRESSING AFRICAN MAHOGANY . . . . .	157
28.	DEODAR . . . . .	165



## LIST OF ILLUSTRATIONS

FIG.		PAGE
29.	TEAK AND DWANI . . . . .	180
30.	JARRAH FOREST . . . . .	212
31.	OPENING OUT OF A SECTION FROM A EUCALYPTUS LOG . . . . .	215
32.	EUCALYPTUS LOG SECTION ( <i>see</i> FIG. 31) . . . . .	215
33.	WANDOO TREE . . . . .	217
34.	BLUE GUM FOREST . . . . .	245
35.	CRUSHING TESTS OF TASMANIAN BLUE GUM . . . . .	248
36.	WORM-EATEN TIMBER . . . . .	263
37.	TELEGRAPH POLES STACKED FOR SEASONING . . . . .	270
38.	SHOWING METHOD OF STACKING SLEEPERS FOR SEASONING . . . . .	271
39.	COMMON METHOD OF STACKING PLANKS FOR SEASONING . . . . .	273
40.	CREOSOTING TANK EMPTY . . . . .	280
41.	CREOSOTING TANK FILLED WITH POLES . . . . .	281
42.	HEARTSHAKE . . . . .	288
43.	STARSHAKE . . . . .	288
44.	SEASONING CHECKS OR OPENING OUT . . . . .	289
45.	CUPSHAKE . . . . .	290
46.	RINGSHAKE . . . . .	290
47.	CUPSHAKE OFTEN FOUND IN PITCH PINE . . . . .	290
48.	SHOWING THE EFFECT OF CUP OR RING SHAKE WHEN THE TIMBER IS CUT UP . . . . .	290
49.	SHOWING RISK OF KNOTS ON UNDERSIDE OF LOADED BEAMS . . . . .	292
50.	SAP ON CORNERS OF TIMBER . . . . .	294
51.	SHOWING THE CAUSE OF WANY AND SAPPY TIMBER . . . . .	295
52.	RIGHT METHOD OF LAYING FLOORING . . . . .	296
53.	WRONG METHOD OF LAYING FLOORING . . . . .	296
54.	EFFECTS PRODUCED BY GRAIN OF OAK IN PANELLING . . . . .	322

# TIMBER

---

## CHAPTER I

### TIMBER

Timber being displaced by Steel—New uses for Timber—Street Paving, Pulp Manufacture, Telegraph and Telephone Poles—Advantages and Disadvantages of Timber compared with Iron and Steel—The artistic side of Timber Structures—Wide-reaching Subject and Difficulties of Explanation—Plants from which Timber is produced—Description of the Structure of Wood—Annual Rings, etc.—Causes of Shrinkage and Expansion of Timber.

A NEW work on timber may by some be considered of questionable value, for do we not live in the “steel age”? It is true that steel plays a much more important part in constructional work than was formerly the case, and its use will doubtless be increased; the use of ferro-concrete will tend to displace a great quantity of timber in building and other work, chiefly owing to the smaller risk of fire. In the huge “sky-scraper” of forty-seven stories now being erected in New York by the Singer Sewing Machine Company not a cubic foot of timber enters into the permanent construction.\* Ferro-concrete is also much used for foundation work where formerly timber was employed, yet as in

\* Since the above was written a fire has occurred on one of the upper stories of this building.

the case of electric lighting, which it was prophesied would run gas lighting out of the market, the use of the latter increases yearly, so in the case of timber, greatly increased quantities are imported into Great Britain every year, the increase for 1907 over that for 1906 being about 4 per cent., although the year just closed has been one of the worst known in the building trade.

Although timber has to a certain extent been superseded by other material for building and shipbuilding work, yet it is now used for many purposes for which it was not used in the past. To mention only a few, it is within quite recent years that timber has been adopted for street paving, and now in Great Britain this class of paving can be reckoned by square miles. The same applies to nearly all the countries of the world, and its use in this form is continually increasing. Immense quantities of the smaller softwood trees, spruce and others, are converted into pulp for the manufacture of paper; this too is quite a recent business, yet in 1906 nearly 9,000,000 tons were used for pulp in the United States alone. The immense consumption of wood for this purpose is brought vividly before us when we are told that the average circulation of a popular daily halfpenny paper requires 200 trees for pulp. Millions of acres of forest are converted into railway sleepers every year, whilst telegraph and telephone poles are erected by millions, and for the casing of electric wires in dwelling-houses many miles of small scantling white wood are employed; even in ferro-concrete a large quantity of timber is used for temporary purposes.

Timber was probably one of the earliest, if not the earliest, materials used by man for constructional purposes. With it he built himself a shelter from the elements, it provided him with fuel and oftentimes food, and the tree cut down and let fall across a stream formed the first bridge;

from it, too, he made his "dug-out" to travel along and across the rivers of the district in which he dwelt ; so on down through the ages, for shipbuilding and constructive purposes, timber has continued to our own time to be one of the most largely used of nature's products.

Timber as a constructional material has many advantages over iron or steel ; it will stand excessive strains and shocks without giving way suddenly—that is, it will give indications for some time before arriving at its ultimate breaking point ; it is often cheaper, in many situations much cheaper, and will last longer in exposed situations without requiring any protection such as painting, which is absolutely necessary with iron or steel. In case of damage or fracture it is in many instances easier to repair. Timber piers and quays possess remarkable resilience under the excessive bumping and knocks which they have to sustain. It is true they are more liable to take fire, but this applies more particularly to the decking, and even in iron piers the decking is generally of timber. In the case of fire in a building such as is now largely erected in towns, where the beams carrying weight are almost invariably of steel, these become so buckled and twisted by the action of fire and water as to become useless, so that although it is true that the less timber or combustible material used in a building the less risk there is of fire, yet when a fire does occur the results are practically the same, both materials are rendered useless ; but the warping and twisting of steel girders and columns often push over the outer walls, which does not happen in the case of timber. Then, although small scantlings of timber will be destroyed by fire, it must be a very intense heat which will destroy a large timber beam. The outside becomes charred, and the inner portion thus protected ; and timber beams often stand in buildings after a severe fire, when steel joists would become

red hot, buckle and twist, and fall. It is a very difficult matter to thoroughly burn a 12-inch beam of timber.

As to the æsthetic side of timber work, it will be readily admitted that nothing from an artistic point of view can excel the old timber-framed houses in our old towns, and they are not only artistic but substantial, as their long life shows ; and when we look at some of these which were built several centuries ago, the thought comes to our mind, what will be the condition of the steel structures now being erected several centuries hence ?

A well-known writer on architectural matters, Mr. T. G. Jackson, in a recent work, "Reason in Architecture," says : "All experience hitherto tends to show, that an architect who wishes his building to go down to posterity, will do wisely to let iron play as small a part in his construction as possible."

One of the reasons why so much less timber is now used in the large buildings erected for commercial purposes is that greater strength can be obtained in steel with much less depth of girder, and thus a gain in height is obtained which is of great advantage.

There are few more extensive and wide-reaching subjects on which to treat than timber, which in this book refers to dead timber, the timber of commerce, as distinct from the living tree ; such a great number of different kinds of wood are now being brought from various parts of the world, new kinds are continually being added, and what renders the subject more difficult to explain is that timber of practically the same character which comes from different countries goes under different names. If one were always to adhere to the botanical name there would be less confusion, although botanists differ as to names, and except in the case of the older and better known timbers one rarely takes up two books dealing with timber and finds the

botanical names the same; moreover, trees of the same species may produce a much poorer quality of timber when obtained from different countries or even from different localities in the same country, so that botanical knowledge will not allow us to dispense with other tests. The wood of the northern pine (*P. sylvestris*) varies considerably in quality if obtained in parts of Norway from that obtained in Sweden or Russia, and there is even a difference between the pine of South Sweden and that obtained from North Sweden.

In practical work one has to keep to the vernacular, but that changes not only with countries, but with localities in the same country, and makes the difficulties of distinguishing the different timbers particularly troublesome, especially in places such as India and the East, where there are so many languages and dialects, and the same timber is known by different names in each. In London the Baltic redwood planking is known as "yellow deal," but the man in the north of England who talks about yellow deal is thought to be referring to Canadian yellow pine, and which in its native district and America generally is called "white pine." Baltic redwood is referred to sometimes as pine, sometimes as fir; again Oregon pine and Douglas fir, which are the same timber, are much confused, and if the timber man finds that you do not like Oregon he will sometimes offer you Douglas fir, telling you it is a different wood and much superior. This is not done to deceive you, but from a belief that they are different timbers, and of this the author has had experience. The timber merchant has much to answer for in the way of calling, or miscalling, various timbers. A quantity of different woods are known under the common name of "whitewood," which comes from America, the Baltic, Galatz and other places, and is often the produce of quite different trees; sometimes the same timber is

called cypress, and at other times poplar. Tasmanian blue gum, according to a letter in the *Timber Trades Journal* some time ago, is now being imported under the name of Tasmanian oak, whilst the sap boards of the American red gum (satin walnut) and Tupeloe are sold as "hazel pine." Quite as much confusion prevails in the American timber trade as in that of Great Britain. If then there is such confusion in the trade, one cannot be surprised at the novice in timber selection being confused. After all it matters little what is the name given to certain classes of timber (although when it has to be described in a specification it would not be amiss if the botanical name were given, so that the required material might be defined), the main thing is to see that we get suitable timber for the work required, and there are certain practical methods of distinguishing most of the timbers in general use.

Timber is produced only by the Spermatophyta, or seed-bearing plants, which are subdivided into the Gymnosperms and Angiosperms; the Conifer or cone-bearing tree, to which belong the pines, larches, and firs, is one of the three natural orders of Gymnosperms. These are generally classed as "softwoods," although yew, which is classed with them, is certainly not soft; they are more extensively scattered and more generally used than any other class of timber, and are simple and regular in structure. The so-called "hardwoods" are "Dicotyledons" or broad-leaved trees; a subdivision of the Angiosperms, they are generally of slower growth, and produce harder timber than the conifers, but not necessarily so; basswood, poplar, sycamore, and some of the gums, though classed with hardwoods, are not nearly so hard as some of the pines. The palms and bamboos are Monocotyledons, the other of the two divisions of the Angiosperms. The chief characteristics of the conifers and the dicotyledons

## TIMBER

are the annual rings in the cross section of the wood, the produce of successive seasons ; these trees are often spoken of as exogenous or outward growing, their diameter increasing yearly, in contrast to the palms, called inogenous, and which, as a rule, grow only in length, their diameter being the same at five years old as at fifty.

Wood is composed of duramen or heartwood, and alburnam or sapwood, and when dry consists approximately of 49 per cent. by weight of carbon, 6 per cent. of hydrogen, 44 per cent. of oxygen, and 1 per cent. of ash, which is fairly uniform for all series. The sapwood is the external and youngest portion of the tree, and often a very considerable proportion. It lies next the bark, and after a course of years, sometimes many, as in the case of oaks, sometimes few, as in the case of the firs, it becomes hardened and ultimately forms the duramen. Sapwood is generally of a white or light colour, almost invariably lighter in colour than the heartwood, and is very conspicuous in the darker coloured woods, as for instance the yellow sapwood of mahogany and similar coloured wood, and the reddish brown heartwood or the yellow sap of *lignum vitæ* and the dark green heartwood. Sapwood forms a much larger proportion of some trees than others, but being on the outer circumference it always forms a large proportion of the timber, and even in sound, hard pine will be from 40 per cent. to 60 per cent. of the tree, and in some cases much more. It is really imperfect wood, whilst the duramen or heartwood is the perfect wood ; the heartwood of the mature tree was the sapwood of its earlier years. Young trees when cut down are almost all sapwood, and practically useless as timber ; it is, however, through the sapwood that the life-giving juices which sustain the tree arise from the soil, and if the sapwood be cut through, as is done when "girdling" teak, the tree



quickly dies, as it can derive no further nourishment from the soil. Although absolutely necessary to the growing tree, sapwood is objectionable to the timber user, as it is the first part to decay. What is called the pith was once the seedling tree, and in many of the pines and firs, especially after they have been seasoning for a good while, this is distinctly noticeable in the centre of the tree, and detaches itself from the surrounding wood.

On looking at the cross section of most timbers of

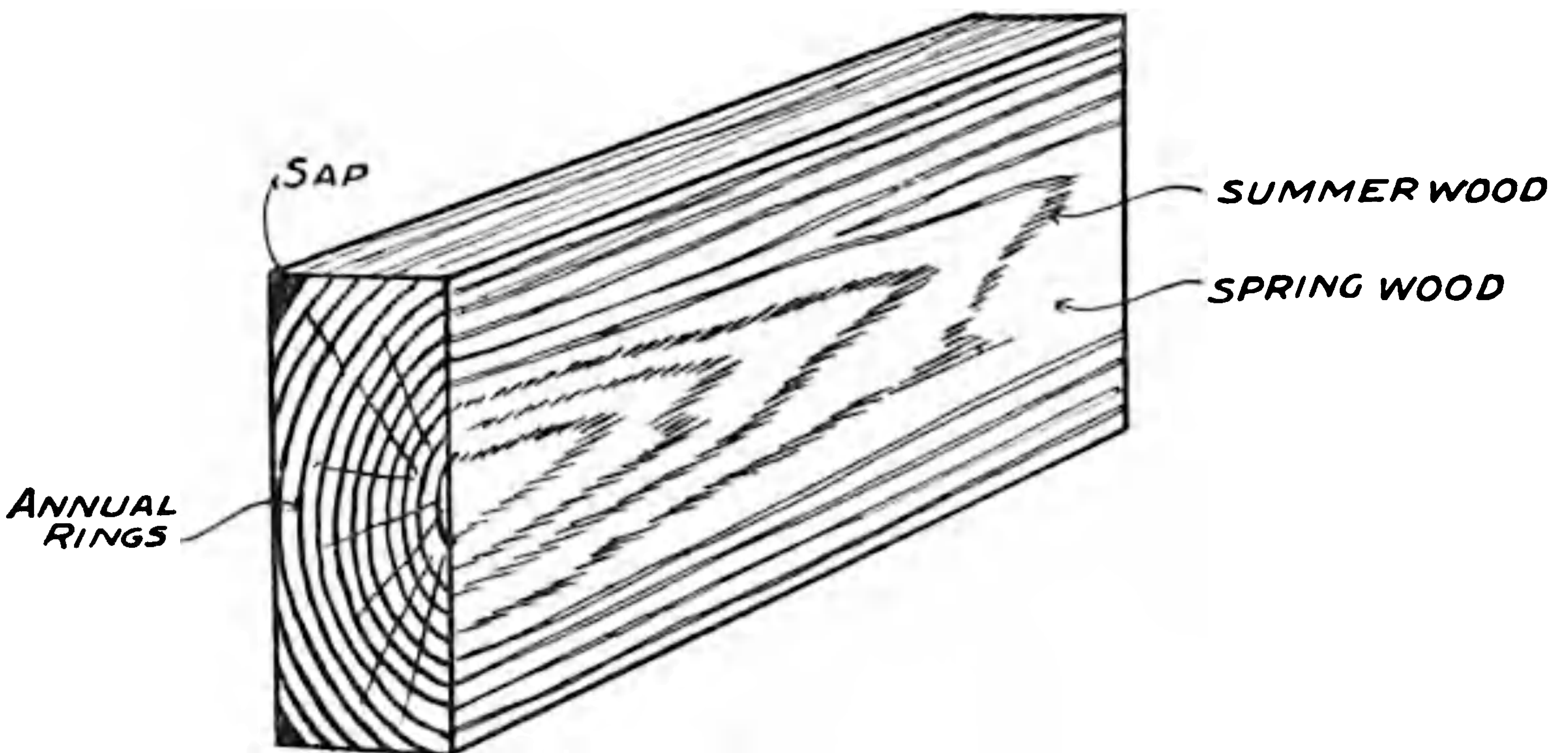

FIG. 1.—Pine Timber.

commerce we see what are called the annual rings, representing generally a year's growth; these are especially clear and distinct in the pines and firs, and are approximately circular; they form the pleasing patterns noticeable on boards, Figs. 1 and 2. It will be seen that they consist of alternate light and dark bands gradually shading into one another, or dark lines with a light coloured space between; the distance apart of the rings tells us whether the trees are of quick or slow growth, those with rings far apart generally indicate quick growing timber, those with rings close together a timber of slow growth, but even in trees



**THIS PAGE IS LOCKED TO FREE MEMBERS**

Purchase full membership to immediately unlock this page

# DELVE INTO FANTASY, MAGIC, MYTHOLOGY & FOLKLORE

Forgotten Books'  
Full Membership gives  
access to 797,885 ancient  
and modern, fiction and  
non-fiction books.

**Continue**

\*Fair usage policy applies

In his own specimen, a section of a 14-inch log (see Fig. 2), the rings are as follows :—

	4	rings	for	first	inch.
	6	„	„	second	inch.
	7	„	„	third	„
	8	„	„	fourth	„
	9	„	„	fifth	„
	15	„	„	sixth	„
	25	„	„	seventh	„
	30	„	„	eighth	„

Baltic redwood (*P. sylvestris*) :—

First inch out from heart	13, 11,	4, 3, 6	rings.
Second „ „ „	16, 18,	7, 5, 8	„
Third „ „ „	11, 14,	8, 5, 7	„
Fourth „ „ „	13, 15,	13, 5, 6	„

In another case only 25 rings for 4 inches, which would be called a soft log, but occasionally one finds 25 rings to an inch in this timber.

Douglas fir or Oregon :—

First 2 inches out from centre,	10, 9, 9	rings.
Four inches from centre,	29, 17, 15, 27, 25	rings.
Next 3 inches in one case showed	42	rings.

The dark bands are the summer wood, the lighter and inner portion the spring wood; the latter is generally much wider and the former much harder; in some of the rings the darker portion is wider than in others, showing variations of growth owing to various causes, and in one ring it may be wider in one part of the circumference than it is on the opposite side, due possibly to the effect of sunlight acting more on one side of the tree than on the other, so that, counting the rings for some inches out

from the centre of the tree, one sometimes finds several more rings on the same space on one side than on the other. The rings are sometimes found contorted, due to the action of winds, and in some trees are wavy in outline, as in some of the oaks. In oaks and other hardwoods the dark shaded portion which forms the patterns on boards is the spring wood and the lighter portion the summer wood, just the contrary to what it is in pine.

Many of the tropical trees show clearly distinct rings, and in others, such as greenheart, the rings are clearly defined in one part and in other parts appear to blend into each other, forming dark undefined bands. In these tropical woods there is no time of the "fall of the leaf," as in conifers and other timber of the northern hemisphere, so the annual rings are not generally so clearly defined.

Wood is called "coarse grained" or of "bigger bait" if the annual rings are wide apart, and "fine grained" if they are close.

**Shrinkage of Timber.**—Looking at the cross section of a piece of ordinary hardwood with a magnifying glass it appears exactly like a web of cloth or spider's web, with the annual rings in one direction and the medullary rays crossing them at right angles and connecting them together. The medullary rays, which are always present, even when the annual rings are absent, though sometimes so fine as to be invisible, except with the microscope,

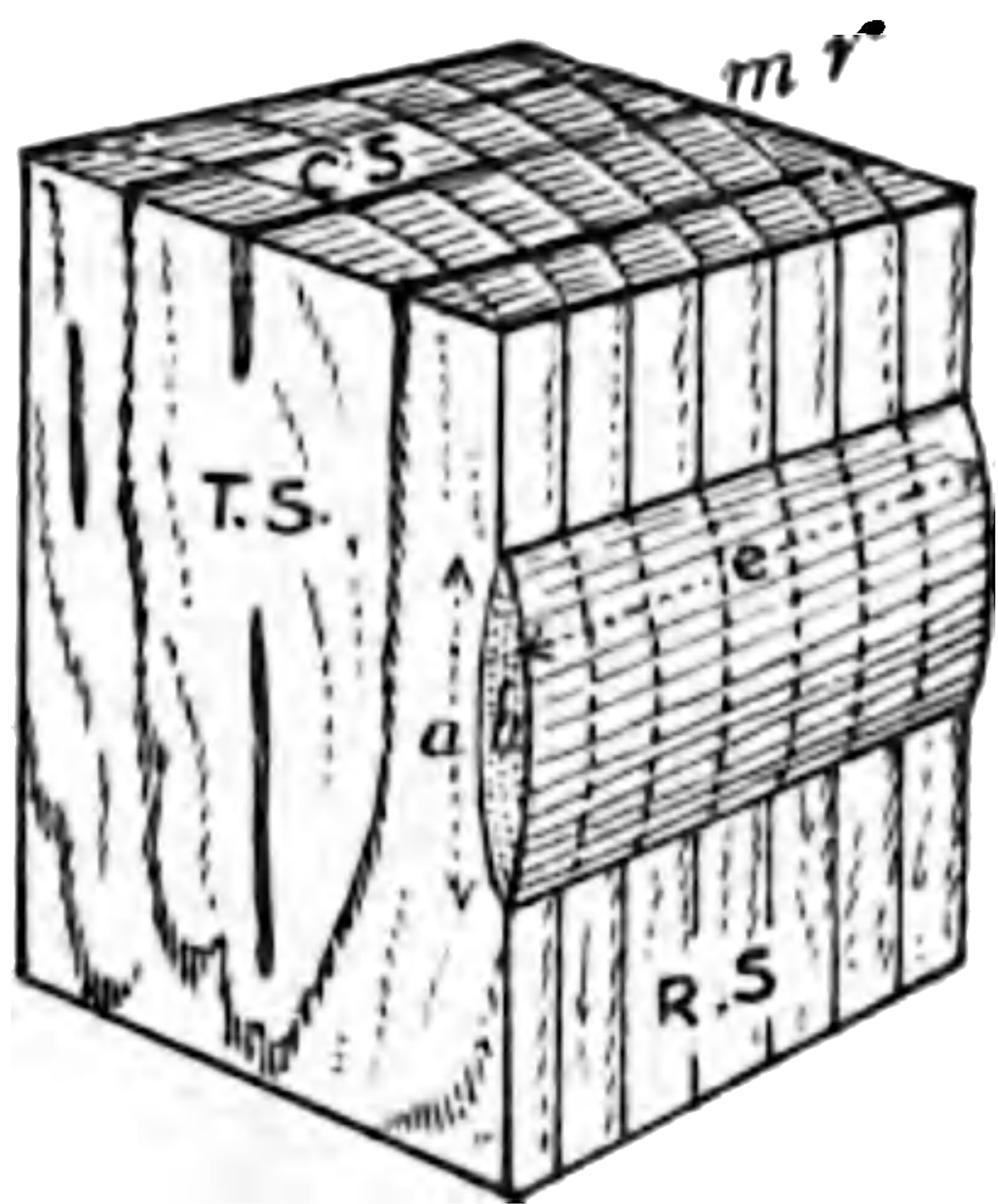

FIG. 3.—Block of Oak. C. S., cross section; R. S., radial section; T. S., tangential section; *m. r.*, medullary rays; *a*, height; *b*, width; *e*, length of med. ray. (After Roth.)

generally appear in cross section as hard, thin bands, and in some cases they are an inch deep on the vertical section, Figs. 3 and 5. The spaces between are filled to a greater or less extent by what look like small pinholes running longitudinally through the wood in circular lines, and form the annual rings ; these pores are very conspicuous in most woods except conifers. The web-like arrangement is very noticeable in hickory, where the concentric and radiating lines are clearly marked (Fig. 4).

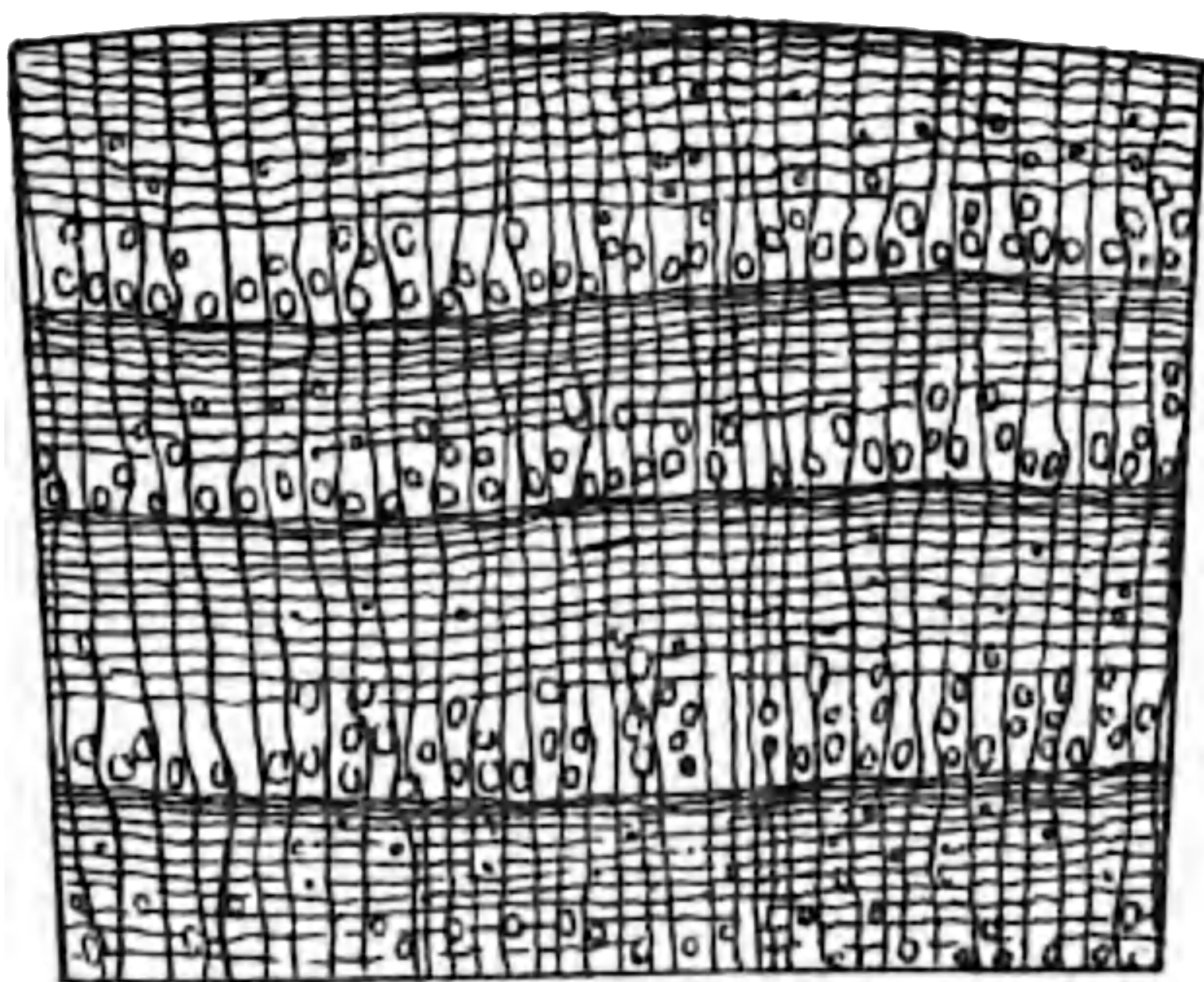

FIG. 4.—Cross Section of Hickory.

These tubes or cells or pores, as they are generally called, appear circular in section to the naked eye, but they are various sided figures, from a parallelogram to nearly a circle, and when cut through longitudinally, as in planing wood, show as channels or indentations on the surface and form the “grain” of wood. The so-called pores are cells or tubes, enclosed by walls of cellulose, which, with other material, forms the fibres of the wood. The tubes are not continuous, each one is distinct from the other, and they are closed at the ends. Their length is from  $\frac{1}{20}$  to  $\frac{1}{5}$  of an inch, and is from fifty to one hundred times greater than their breadth. After a certain amount of moisture has been extracted from the timber these cell walls begin to shrink ; but, as has been said, their length being very much greater than their width, although shrinking may take place in both directions, it is not appreciable in the long diameter of the cells, and as

These tubes or cells or pores, as they are generally called, appear circular in section to the naked eye, but they are various sided figures, from a parallelogram to nearly a circle, and when cut through longitudinally, as in planing wood, show as channels or indentations on the surface and form the “grain” of wood. The so-called

the long diameter is in the direction of the longitudinal axis of the tree, it will be understood why the shrinkage of boards and timber generally is inappreciable in a long length. Some of these cells have thick walls, others have thin walls, and as both kinds are generally mixed the shrinkage is greater in one case than in the other, causing different strains to occur. Again, the cells forming the

medullary rays, which constitute a considerable proportion of all wood, have their length at right angles to the others (see Fig. 5) and like the others shrink most in the direction of their breadth, so that two severe strains at right angles to each other are set up, and, with those previously referred to, cause the splitting and cracking which occur when timber is being seasoned. If done too

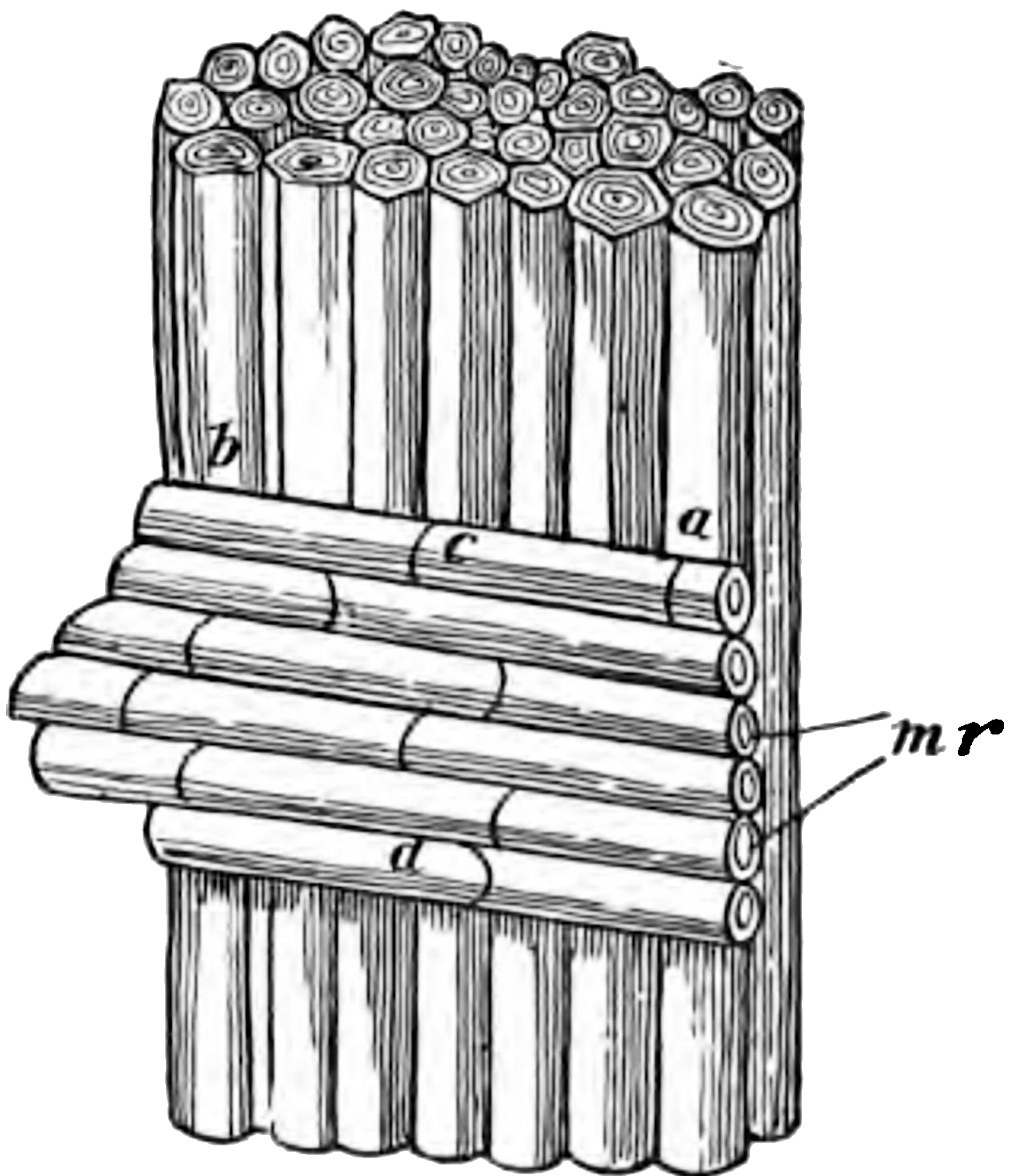

FIG. 5.—*a, b*, longitudinal cells or wood fibres; *c, d*, cells of medullary ray.

rapidly the cells have not time to “give” or adapt themselves to the altered circumstances; they became distorted or ruptured, and the wood is damaged.

Shrinkage of wood then is caused by the walls of the cells or pores becoming thinner, and as the thicker walled cells are found in the harder woods, these as a rule shrink and split the most. Wood shrinks or twists to an extent dependent upon the quality and size of the timber; this is more evident if it be dried too rapidly, is more noticeable in

the harder wood than in that of a softer nature, in thin boards than in thick boards, in wide boards than in narrow boards or logs, but occurs in all timber, although no outward manifestation may exist. Pine, spruce, and coniferous timber, owing to its very regular structure, suffers less in seasoning than oak and other hard woods, because, although the same laws take effect, the softness of the material probably allows the cell walls to be crushed by the contracting forces, and so the primary law is modified. Timber loses water more rapidly at the ends than on the longitudinal faces, and shrinks more quickly there and tends to split; a wet board having one side exposed to the sun, the water is extracted from that side, and the board buckles.



FIG. 6.

On examining flooring or panelling one often notices that there is an opening at the joints, although when originally laid or fixed

the joints were perfectly flush (Fig. 6), and were it not for the tongues and grooves the planks would often lift up; the timber has “pined” or shrunk on drying, for however well seasoned timber may be when placed in the dry atmosphere of a dwelling-house—and much of it is not well seasoned—it will probably in time lose some more of its moisture and tend to shrink. Owing to its structure, as has been said, timber is not appreciably affected in length, that is, along the grain, by seasoning. Rondelet found many years ago that fir might shrink from  $\frac{1}{75}$  to  $\frac{1}{360}$  of its length, and oak from  $\frac{1}{80}$  to  $\frac{1}{412}$ . Mr. Hurst makes an allowance of  $\frac{1}{4}$  inch for northern pine and  $\frac{1}{8}$  inch for white deals nine inches in width, being  $\frac{1}{36}$  and  $\frac{1}{72}$  respectively, and recent American experience has shown that whilst the longitudinal shrinkage is usually

less than 0·1 inch per 100, the shrinkage in width may amount to 3 per cent. for soft pine, spruce, cedar, and light conifers, 4 per cent. for hard pine, larch, locust, and old oaks, 5 per cent. for elm, ash, walnut, maple, beech, and sycamore, 6 per cent. for birch, chestnut, and basswood, whilst hickory and young oaks may sometimes shrink up to 10 per cent., or one inch in a 10-inch board.

The narrower the plank the less noticeable the amount of shrinkage; hence in good work panelling is often done in narrow strips three or four inches wide, which so minimises the action as to be unnoticeable.

**Expansion of Timber.**—It must not be forgotten that timber, in common with every other material, expands as well as contracts. If we extract the moisture from a piece of wood and so cause it to shrink, it may be swelled to its original volume by soaking it in water, but owing to the protection given to most timber in dwelling-houses it is not much affected by wet or weather, the shrinkage is more apparent, more lasting, and of more consequence to the architect, builder, or owner than the slight expansion which takes place, as although the amount of moisture contained in wood varies with the time of day, the consequence of damp or moisture on good timber used in houses only makes itself apparent by the occasional jamming of a door or window in wet or damp weather. Considerable expansion, however, takes place in the wood paving of streets, and when this form of paving was in its infancy much trouble occurred owing to all allowances not having been made for this contingency, the trouble being doubtless increased owing to the blocks not being properly seasoned; kerbing was lifted or pushed out of line and gully grids were broken by this action. As a rule in street paving a space of one or two inches wide is now left next to the kerb, which is filled with clay, sawdust and tar, or



some soft material, so that the blocks may expand longitudinally without injuring the contour or affecting the kerbs. But even with this arrangement it is not at all unusual for an inch or more to have to be cut off paving blocks parallel to the channels some years after the paving has been laid, owing to the expansion of the wood exceeding the amount allowed. Considerable variation occurs in the expansion of wood blocks, but it occurs in the Australian hardwoods as well as in the pine timber, and is often greater in the former than in the latter. Expansion takes place in the direction of the length of the blocks as they are laid across the street, and causes no trouble in the other direction, the reason being that the lengthway of a block is across the grain of the timber, and they expand or contract as a plank does. On one occasion, in a roadway forty feet wide, expansion occurred until it amounted to four inches a side, or eight inches in all. This continual expansion and contraction is doubtless the cause of a good deal of wood paving in streets and buildings working loose.



**THIS PAGE IS LOCKED TO FREE MEMBERS**

Purchase full membership to immediately unlock this page

# Know Your Bible

Forgotten Books'  
Full Membership  
provides unlimited  
access to more than  
28,000 volumes of  
Christian literature for  
\$8.99/month

**HOLY  
BIBLE**

**Continue**

\*Fair use policy applies

we get about 25 per cent., Germany 26 per cent., Russia 33 per cent., and Sweden 44 per cent. of the total area of the country under timber.

Turning to the Western hemisphere, we find the United States (exclusive of Alaska) with a forest area of at least 500,000,000 acres, and Canada with about 800,000,000, although only about 300,000,000 can be looked upon as merchantable timber. Canada's chief timber supplies lie in Ontario with 7,750,000, Quebec 70,000,000, and British Columbia 182,000,000 acres.

In British India some 135,000,000 acres are covered by forest, of which more than one half are more or less under Government control.

Australian forests cover about 173,500,000 acres, those of Tasmania 11,000,000, and New Zealand 20,500,000, being about 10 per cent. of the combined area of these countries—two-thirds of Tasmania are forest covered, and about one-third of New Zealand.

Japan has a forest area of about 28,500,000 acres.

Of the timber resources of Africa but little is known, though they must be considerable: large supplies of mahogany come from the west coast. In Matabeleland there is said to be 1,250,000 acres of forest, and a smaller area in Mashonaland, whilst there are enormous supplies in the region of the Congo; but in Cape Colony, so destructive have been the native races for generations that the colony is almost wholly dependent for its timber supply on foreign sources, what timber there exists is difficult of access; the Crown reserve only amounts to half a million acres. The French colony of Algeria, in the north, possesses over 8,000,000 acres, of which over half belongs to the State.

As regards South America, though there are no statistics available, it may be stated that large portions of Colombia,

Venezuela, British, French, and Dutch Guiana, on the north, are covered with excellent timber; so are millions of acres in Brazil, especially in Bahia, Minas Geraes, and the basin of the Amazon. The great forest of Matto Grosso, probably the largest in the world, may cover over 500,000,000 acres, whilst the northern portions of Argentina and a large part of Paraguay are covered with extensive tracts of timber.

As regards China, although little or no timber is found along the Gulf of Pechili, stone mile-posts having had to be put down on the railways because the natives stole the wooden ones for fuel, other portions of the country are well wooded, especially the central provinces, where magnificent pine timber is to be found.

We may at a reasonable estimate, and from fairly reliable sources, place the forest land of the world at the present time at over 2,200,000,000 acres, an area nearly as large as Europe, about one-sixteenth of the land area of the globe, and sufficient to provide more than an acre and a half of woodland for every inhabitant. These look enormous resources, and at first glance would appear to be equal to any reasonable call upon them, but when we consider the constant and increasing consumption, when we realise that vast areas of forest in the United States, Canada, Norway, Sweden, and even New Zealand and Tasmania, which thirty years ago produced great quantities of timber, are now worked out, our opinion becomes modified. Large areas of country where forest once stood are required for tillage as the population increases, and this particularly affects countries such as the United States and Canada, where there is a large immigrant population, and millions of acres of woodland which have been cut down will never be replaced. Yellow pine (*P. strobus*), which thirty years ago was the chief timber

imported from Canada and the States, has disappeared from large districts, and although it still holds second place in the cut of United States timber, it is chiefly used for home consumption, the quantity brought into Great Britain being only one-fifth of what it was; consequently this timber, formerly plentiful and cheap here, is now scarce and dear. Kauri, of New Zealand, which thirty years ago was the chief export from the island, will, according to the opinion of an expert, be extinct in a few years.

Millions of acres are destroyed by fire yearly, and enormous waste and destruction of timber have gone on for many years in Canada and the United States, probably more than has been converted to useful purposes.

The United States furnish as good an object lesson as one could have of the enormous quantity of timber used, and of how rapidly a country with enormous resources may be depleted, and it is unique in this respect, that its Forestry Department furnishes particulars which are not to be had elsewhere.

Rapid as has been the increase of population in the United States, the timber consumption has been still more rapid. The increase of population from 1880 to 1900 was 52 per cent., the increase of lumber cut was 94 per cent. The following are a few details of the annual consumption of wood taken from the United States statistics for 1905, which are only approximate, and the actual figures may be from 10 per cent. to even 25 per cent. more:—

12,800,000,000	cubic feet used for fuel
2,911,000,000	„ „ „ lumber.
200,000,000	„ „ „ mine timbers.
408,000,000	„ „ „ pulp.
280,000,000	„ „ „ sleepers.
128,000,000	„ „ „ tan bark.

89,000,000 cubic feet used for distillation.  
30,000,000 „ „ „ cooperage.  
25,000,000 „ „ „ veneers.

Besides which there were used over

15,000,000,000 shingles for roofs.

3,111,157,000 laths.

3,500,000 telegraph and telephone poles.

Something like 3,000 square miles of forest are required annually to provide the American railways with sleepers.

These particulars bring out the startling fact that the amount used for fuel in the United States—and it has been put down as a very conservative estimate—is 64 per cent. of the total timber cut, which is estimated at about 20,000,000,000 cubic feet; this will be gradually much reduced as the coal mines of the country become developed. The amount of lumber used per head of population in the United States is 34 cubic feet, the average for the whole of Europe is only 5 cubic feet.

At a meeting of the Hardwood Timber Association (who cut about one-third of the total timber supply of the United States) at Memphis, Tenn., in 1906, a conservative estimate placed before the meeting stated that there was not enough timber standing to continue commercially for more than twenty years.

A recent leaflet of the United States Department of Agriculture calls attention to the waning hardwood supply, and although the existing supplies of softwoods are being rapidly decreased, both the States and Canada possess resources of that class of timber on the Pacific slope which is only beginning to come into the market; but these regions possess no hardwoods, so there is the unpleasant outlook to be faced that when the existing supplies of hardwoods are used up there are no others to take their place.

The hardwood cut in 1906 was 15 per cent. less than in 1899, although this was a time when American industries were rapidly advancing, when the output of nearly all structural material used considerably increased, and even softwoods increased by 15·6 per cent., so the diminution was evidently due to lessened supplies, and high prices consequent thereon. During this same period the prices of the various classes of hardwoods advanced from 25 to 65 per cent.; white oak "quartered" increased 50 per cent. in price from 1887 to 1900, and 60 per cent. up to the present time. Oak, which in 1899 produced one half the hardwood supply, fell off 36·5 per cent., yellow poplar, which came second, fell off 37·9 per cent., elm 50·8 per cent., cottonwood and ash 36·4 and 20·3 per cent. between that date and 1906. Indiana, Ohio, and Illinois, which in 1899 produced 25 per cent. of the hardwood supply, in 1906 produced only 14 per cent., the reason being that the forest land had been turned to agricultural use. Probably 2,000,000,000 cubic feet is not an excessive estimate of the hardwood timber used per annum in the States, whilst the largest estimate sets the supply at about 33,000,000,000 cubic feet, which means at the same rate of consumption only about sixteen years' supply. To show that the pinch is felt, much greater latitude is now allowed in specifications for lengths and scantlings, showing that "we are down to rock bottom and require every sound piece of timber that can be put upon the market." The situation is summed up as follows:—"We have apparently about a fifteen years' supply of hardwood timber now ready to cut. Of the four great hardwood regions, the Ohio valley States have been almost completely turned into agricultural States, and the Lake State and the Lower Mississippi valley are rapidly following their example."

The consensus of opinion as to the average length of

time the supply of timber for pulpwood would last in the United States was twenty-one years; opinions in different districts varied from thirteen to twenty years. Even now large quantities of timber for their pulp manufactories are brought from Canada.

Of the quantity of timber cut in any country only a proportion comes into use for merchantable timber, and this is especially noticeable in Canada and the States. The waste in conversion is enormous; much of this is unavoidable, but a great deal is doubtless due to the profusion of material, which could be, and with waning supplies doubtless will be, much decreased. It has been stated that to produce a railway sleeper worth 35 cents out of some of the Californian trees, timber equal to five times this amount in value is wasted; 70 to 74 per cent. of loblolly pine is wasted in producing sleepers in Texas, one reason of this waste being that a large proportion of the American railway sleepers are hewn and not sawn; in the conversion of red cedar (*J. virginiana*) for pencils nearly 70 per cent. is waste.

With the facts as stated it is some comfort to know that the Government officials of the United States consider that the timber cut has now nearly if not quite reached its maximum. The damage done by fire in the States has been estimated at £5,000,000 per annum, and probably 10,000,000 acres of forest are destroyed.

The same drain is being made on the forests of Canada, Sweden, Norway, and Russia, although to some extent at present Russia's enormous resources compared with its output and its population place her in a more favourable position than the others. The world's timber supplies are being used up in a reckless manner.

**Afforestation.**—It is true that almost without exception the Governments of all countries possessing forests have



taken up the question of afforestation or the planting of trees which in time will take the place of those cut down; some countries, indeed, have adopted this practice for many years. France and Germany have for generations, and amid far-reaching political changes, steadily pursued an enlightened national policy in the care of their forests. France was the pioneer and has pursued the practice since 1669. There is the well-known instance along the west coast between the Gironde and the Adour, known as the Landes, where M. Bremontier, a civil engineer, planted the Maritime pine about the year 1789. As the result of this planting not only were large areas of land which were being covered by the drifting sands of the Atlantic seaboard preserved and made valuable as pasturage for cattle, but there are now about 220,000 acres covered with valuable pine woods which yield a handsome return on the original expenditure.

Switzerland has pursued this policy for 100 years, and to show the value of this management it may be stated that the city of Zurich owns 2,400 acres of the Sihlwald, which in the year 1889 yielded a return of £1 13s. per acre, or £4,000 for the whole property. Its working is so regulated that areas of equal productive capacity are covered by stocks of every age, from the seedling to the mature tree of ninety years.

In 1895, 5,500,000 trees were planted in the south of Sweden, and 2,000 lbs. of fir seed sown.

Although in 1875 a commission found that Norway had consumed 401,000,000 cubic feet of timber, whilst the reproduction was only 293,000,000, leaving a shortage of 108,000,000 cubic feet, yet it was not until 1893 that the matter of protecting her forests was taken up, and the present annual output exceeds the natural increase, so that the supply is not only decreasing, but the average size of



**THIS PAGE IS LOCKED TO FREE MEMBERS**

Purchase full membership to immediately unlock this page

# DELVE INTO FANTASY, MAGIC, MYTHOLOGY & FOLKLORE

Forgotten Books'  
Full Membership gives  
access to 797,885 ancient  
and modern, fiction and  
non-fiction books.

**Continue**

\*Fair usage policy applies

afforestation and are large users and exporters of timber will be denuded of their natural-grown timber before the planted supplies become available and will find themselves in a similar position to Great Britain. Again, as countries increase in population, not only will the forest area be reduced, but, as we have already explained, the tendency will be in the direction of larger requirements of timber for home supply, and in time they will have none to export.

It has been said that he who makes two blades of grass to grow where one had grown before is a benefactor to his race. The same may be said of those who by replanting timber trees, or resorting to measures for preserving timber, cause less of it to be used and so ensure its forests a longer life. Evelyn, in his "Silva," written more than 200 years ago, says, "We had better be without gold than without timber."

Besides the intrinsic value of forests to a country in providing its inhabitants with timber, their physical advantages should also be considered. Humboldt, in his "Travels," pointed out many years ago that "In felling the trees which cover the tops and sides of mountains men in every climate prepare two calamities for future generations, a want of wood and a scarcity of water"; for there is no doubt that, in addition to the heavy transpiration of moisture through the leaves of trees, there is a steady though moderate evaporation from the surface of the forest-clad soil also, thus restoring to the air for future precipitation a proportion of what has been absorbed in the form of rain. In many parts of the United States the farmer of to-day looks upon the hollows on the surface of his land, which when the country was better wooded were the courses of streams and which would be invaluable to an agriculturist. Forests also serve the useful purpose

of regulating the flow of streams and rivers; to the stripping of the Apennines of their trees is said to be due in great measure the rapid flooding of the Tiber, Po, and other Italian rivers, owing to the rapidity with which the rain or snow falling upon their steep, rocky slopes is delivered into the plains below.

**Imports of Timber into Great Britain.**—Great Britain is the largest importer of timber in the world; whilst she has a plentiful supply of stone and slate, and manufactures her bricks, cement, iron, and steel, for practically the whole of the enormous quantity of timber used she is dependent on foreign supplies, and to her more than to any other country is it a matter of importance that the sources from which she draws her supplies of this valuable product should not be dried up or so diminished as to curtail her allowance.

According to the Board of Trade returns the value of timber imported into Great Britain in 1907 was £27,094,865, and the total quantity imported close on 10,000,000 loads, or about 500,000,000 cubic feet. In addition to the above must be added £1,920,026 for manufactured wood in the shape of furniture, fittings, doors, windows, etc., woodware and turnery imported during 1907, making up the total import value of wood and wooden goods to over £29,000,000. As regards the value of timber imported from different countries into Great Britain, at the present time they stand in the following order:—Russia (1), Canada (2), Sweden (3), United States (4), Norway (5), “Other Countries” (6), British India (7), Germany (8); and as regards quantity of timber they stand as follows:—Russia (1), Sweden (2), Canada (3), United States (4), Norway (5), British India (6), “Other Countries” (7), Germany (8). The larger proportion of the deliveries for 1907, over two-thirds of the whole, was divided amongst

the following ports in the order of precedence as to quantity :—London, Cardiff, Hull, Liverpool, Hartlepool, Manchester, Newport, the Tyne, Grimsby, Grangemouth, Glasgow, Bo'ness; the balance being distributed amongst more than one hundred other ports.

Russia and Sweden supply us with about two-fifths of the quantity imported, and about half their total export, and we pay these two countries for timber something over £10,000,000 a year, or nearly double the amount which we pay for timber to British Colonies. Over 80 per cent. of the total imports into Great Britain are conifers.

## CHAPTER III

### EUROPEAN TIMBER

Chief Timbers imported into Great Britain—Forests of Russia, Norway, Sweden, and Germany—White Sea Trade—Baltic Redwood—Baltic Whitewood—Fir, Larch—English Oak—Dantzic and Adriatic Oak—Common Yew—Hornbeam—Sycamore—Plane—Spanish Chestnut—Horse Chestnut—Alder—Willows—Lime—Apple—Pear—Cherry—Plum—Common Cypress—Laburnum—Box—Ash—Birch—Acacia—Beech—Poplar—English Elm—Laurel—Holly—Bruyère—Hazel—Hawthorn—Walnut.

MUCH the larger proportion of the timber imported into Great Britain comes from Russia, Norway, Sweden, and Germany, from the Baltic and Finnish Gulf ports and the White Sea, and forms the bulk of the timber used in the building trade.

Although there are something like 42,000,000 acres of forest in Sweden, chiefly pine and spruce, suitable timber of sizes for conversion into deals and planks has shown signs that the supply is suffering depletion, and Norway, with its 16,000,000 acres of forest, of which 73 per cent. consists of pine and spruce, or fir, only supplies a comparatively small quantity of deals, the bulk coming in as planed wood. Russia, Norway, Sweden, and Germany supply Great Britain with about 65 per cent. of her total imports of timber, and although Norway and Sweden for long held the lead, Russia now stands first both as to quantity and value. Enormous strides have been made within the last few years in developing the large forest resources of the provinces

of Archangel and Vologda, comprising something like 190,000,000 acres, of which nearly half are in the province of Archangel, the produce being shipped on the White Sea, and owing to its excellent quality this timber holds a high place in the market and commands a high price. About 65 per cent. of the timber shipped on the White Sea, and recently at Petchora, is pine, 32 per cent. spruce, and 3 per cent. larch; the latter timber is as yet little known, but when timber merchants become better acquainted with the excellent qualities of Siberian larch, it will doubtless, like the local pine and spruce, find a ready sale. Pine and spruce are found in about equal quantities in these provinces, and in the eastern portion and the Petchora valley there are great quantities of larch.

**Red Fir** (*P. cembra*), birch, poplar, and alder are also found in considerable quantities, but not much of these latter timbers has so far come into the foreign market. Practically the whole of the White Sea trade is in sawn goods. Out of a total of 158,000 St. Petersburg standards shipped in 1906, 108,000 came to Great Britain. Archangel is the chief port of shipment, doing three-fourths of the trade. There are now twenty-five sawmills in Archangel, employing over five thousand hands, whilst others are to be found in Onega, Kem, Soroka, Keret and various other places along the shores of the White Sea, and even at Petchora and elsewhere well within the Arctic Circle. When we consider the difficulties of transport, for roads are few and bad and railways practically non-existent, and the long distances, in some cases over 500 miles, which the timber has to be brought down the rivers to the sawmills on the coast, and the very short season, only four or five months in the year, during which the trade can be carried on, one cannot but admire the energy and resource of the Swedes



FIG. 7.—Northern or Scotch Pine (*Pinus Sylvestris*).

and Norwegians who largely command the business and have brought the White Sea timber trade up to its already very considerable proportions.

Great Britain imports a much smaller proportion of the



trade of Norway and Sweden than she did eight or ten years ago.

The chief timbers used in the building trade of Europe are known as Baltic redwood and Baltic whitewood, although, as will be seen from the above remarks, the name has a much wider signification now than when the timber was shipped from only three or four ports in the Baltic.

**Baltic Redwood** is the timber of the northern pine (*Pinus sylvestris*), Fig. 7, or what is incorrectly called Scotch fir. The tree in the more northern regions attains a height of 80 ft. at 150 or 200 years old, and gets rid of its branches to a height of over 30 ft. above ground level. It is imported from the old ports of Memel, Dantzic, and Riga, in hewn logs, and from these and numerous other ports on the coasts of the Baltic Sea and Finnish Gulf, as well as from the White Sea, in planks, deals, and battens. The logs are not sawn, but are dressed with the axe almost perfectly square; there is a slight camber on the sides to allow the water to drain off. The timber in the log generally goes by the old name of Memel or Baltic, and a very excellent quality is now coming from Windau, and can be had in lengths of 35 to 40 ft. and about 12 inches square. The cut timber is known as "yellow deal" in the London market. The name redwood is doubtless derived from the reddish tinge in the whitish yellow coloured wood, and which is more noticeable when the timber is wet. Some of the more northern and hill-grown wood is redder in colour and more resinous, and this colour is liked best for outdoor work. The timber is even and straight in grain; tough, moderately hard, easily worked and durable. Brindley, the old English engineer, said that "Red Riga deal or pine wood would endure as long as oak in all situations," but this is doubtful; in protected situations it



**THIS PAGE IS LOCKED TO FREE MEMBERS**

Purchase full membership to immediately unlock this page

# Know Your Bible

Forgotten Books'  
Full Membership  
provides unlimited  
access to more than  
28,000 volumes of  
Christian literature for  
\$8.99/month

**HOLY  
BIBLE**

**Continue**

\*Fair use policy applies

and sleepers with Norway, Sweden, and Russia, but only the shorter poles come from Norway. This timber has been largely used in the past for street paving, and is still being used, but is gradually giving way to the more expensive but much longer lasting Jarrah and other hard woods. The pinewood grown in Britain is more cross grained, and not so satisfactory as that produced in the colder climate of Northern Europe.

Amongst other well-known European pines, the timber of which is used locally, are the Black or Austrian pine (*P. austriaca*), Corsican pine (*P. laricio*), which produces some of the best of pine timber and is suited for indoor and outdoor work, Stone or Umbrella pine (*P. pinea*), whitish, moderately resinous, and very light timber, used in Italy and the south of France for general carpentry, and the Aleppo pine (*P. halpensis*), which is of large dimensions. The average weight of Baltic redwood per cubic foot, taken over a large number of fairly seasoned whole and cut logs, is 37·5lbs., max. 43·5, min. 33·9 lbs.

**Spruce or White Fir** (*Picea excelsa*) produces the timber known as "Baltic whitewood" or white deal. It comes from the same districts as the redwood, grows to a height of 90 to 100 ft. or more, with slender trunk, but carries its branches nearer the ground than the redwood; hence the great number of knots to be found in it. The wood is nearly white in colour, a yellowish white with sometimes a reddish or brownish tint, straight in the grain, light, tough and elastic but soft, yet more difficult to work than redwood, owing to the hardness and great number of the small knots it contains, and inferior to it in every way. It is a timber which shrinks a good deal, but has only a moderate thickness of sap, which is sometimes difficult to distinguish owing to its being nearly the same colour as

the heartwood. In the poor qualities it is the timber largely used by the "jerry builder," and in a good deal which owners would not call by that name; inferior in strength and durability to redwood, unfitted for good exterior work, suitable for a cheap description of interior work such as shelves, common tables, flooring and panelling, it is used for all the classes of interior work for which the better class redwood is used, and is probably quite as much used as redwood in ordinary house building; some of the best of it is very good, but it is liable to shrink if less than an inch thick. A large quantity is used for scaffold poles and pit props in mines, of 6 to 8 ft. in length and 6 to 8 inches in diameter. It is much valued as one of the resonance woods for the bellies of fiddles and violins, as the sycamore and maple are for the backs. Not only is there a large trade in planed white as well as yellow boards, which are also imported tongued and grooved, but a great quantity of manufactured joinery, doors and door frames, window frames, etc., comes from Norway and Sweden. The best of the Norwegian timber is used up for flooring and planed goods and manufactured joinery. Spruce forms much the larger proportion of the timber used in the toy trade of Austria and the Tyrol. Good deals, either yellow or white, should be bright in colour and close in grain; a dull colour and open porous grain of a woolly character betoken poor wood. Spruce is hardly distinguishable from fir except by the presence of resin ducts, which are wanting in the latter.

The usual trade terms for Baltic timber are as follows:—

Logs or baulks, various lengths and sizes, up to 40 ft. long.

Battens and deals, various lengths, 4 to 9 inches wide and 2 to 4 inches thick; average lengths about 18 ft.



*Photo by*

*[Henry Irving, Horley.*

**FIG. 8.—Larch (*Larix Europea*).**

Planks are pieces of various lengths and thicknesses, 11 inches wide and over, and 12 ft. and upwards in length.

Boards or flooring are pieces 1 inch thick and under.

Although these names, deals, planks, and battens, are still used, they have not the same significance as when Baltic timber was confined to the sizes 7, 9, and 11 inches, and a reference to Appendix, p. 330, will show the almost unlimited variety of scantlings from which the timber buyer can now make his selection in this wood.

Great quantities of spruce, especially from the smaller-sized trees, are manufactured into pulp for paper.

Fir is a name indiscriminately applied to the pines, spruces, and firs; they come from the same districts in the Baltic. The Northern and Scotch pine are often called fir; the timber is used for the same purposes and the quality is similar to spruce, from which it is not easily distinguishable, except by the absence of resin ducts.

**Silver Fir** (*Abies pectinata*), imported as "Swiss pine," is employed chiefly for the sounding boards of pianos and the bellies of violins. The colour is a pinkish white, light, soft, porous, silky in texture, elastic, easily worked, but not durable if exposed to wet and dry; it is sometimes used as piles on the Continent, and is fairly satisfactory for protecting river banks from scour; it is one of the most sonorous of woods. It is also much used for toy-making, carving, and for packing cases, is largely imported from the Tyrol, and is used in its native district for fencing, internal work, general carpentry, pulp, and charcoal. The well-known Strasburg turpentine is obtained from this tree.

**Larch** (*Larix Europea*), Fig. 8, a tree which attains a height of 60 to 100 ft., grows rapidly, and is useful from an

early age. It is found in the British Isles and in various parts of Europe, especially in the north. Some of the finest varieties of larch timber come from Russia; it is imported in small quantities from the White Sea ports in hewn logs 9 to 13 inches square and up to 27 ft. long, also in planks  $\frac{5}{8}$  to 3 inches thick, 4 to 11 inches wide, and 28 ft.



Photo by]

[Henry Irving, Horley.

FIG. 9.—Common Oak in winter (*Quercus Pedunculata*).

long, and commands a good price. This timber is one of the toughest and most lasting of all the coniferæ, but a good deal of timber which is not larch is sold under that name. It shrinks a good deal, but is strong, durable, straight and even in grain, and free from large knots; is liable to warp, but stands well when thoroughly dry. Harder to work than Baltic fir, the surface is smoother

when finished. The wood is like the best of hard pine, both in appearance, quality, and uses. The heartwood is reddish brown with yellow sap, it is very resinous, and in Siberia, after fires, the scorched trunks of the trees yield a gum similar to gum arabic, known as Orenburg gum. Some kinds of larch give a yellowish white cross-grained and knotty wood, but it is generally of reddish brown colour and has a straight grain, and is more free from knots than spruce. Used for fencing posts and palings, field gates, scaffold poles, and occasionally in Great Britain for telegraph poles and railway sleepers; also for floors, stairs, and positions where there is much wear, and in ship and boat building, being light, tough, and lasting. A fence of larch from twenty-five year old trees is said to last from seventeen to twenty years. Great quantities were used for piling and building work in Venice and other Italian cities in past centuries, and many noted Italian pictures by the old masters have been painted on panels of larch. It will not absorb creosote so readily as pine.

Weight up to 40 lbs. per cubic foot, the white variety being much the lighter. Larch is the source of the Venice turpentine of commerce.

**English Oak**, of which there are two or three varieties distinguished by botanists, the stalk-fruited or common oak (*Quercus pedunculata*), Fig. 9, and the cluster-fruited, sessile, or bay oak (*Q. sessiliflora*). The durmast oak, which is found in the New Forest, would appear to be only a variety of the *Q. sessiliflora*.

The two first named are the prevailing oaks of Northern Europe, although the common oak is the more plentiful in Great Britain, France, and Germany, and its finest development is found in Hungary. It grows as far south as Central Spain.



Much literature has been written as to the superior qualifications of the timber of the common or old English oak over that of the sessile oak, and as to the durmast not being so good as either, but the fact that the timber of those of the first two species at any rate was used indiscriminately for the best work shows that there is practically no difference between them; what difference there may be is due more to the various localities and soils in which the timber grows than to any inherent difference in the timber; in fact much of the oak taken from old buildings, and much prized, appears to have been the wood of *Q. sessiliflora*; even the wood of the durmast oak, though of more open texture when young, shows very little difference from the other varieties when the timber has reached maturity. Few could tell the difference between the timber of the first two named, though the wood of the common oak, which is usually spoken of as the best, is of rather lighter colour than that of the sessile or bay oak; the medullary rays in the latter are very straight, distinct, and far apart, in the common oak they are rather closer, not so straight, and finer. The timber of these oaks is straight grained, fairly free from knots, has good silver grain, is easily worked, and is well suited for ornamental work, as well as for joists, rafters, or wherever stiffness and accuracy of form are required; it splits well and makes good laths, is strong, hard, and tough, warps a good deal in seasoning, and takes a long time to season, hence it sometimes continues to alter its shape after being put into buildings; it is very elastic and easily bent to curves when steamed, and stands changes of temperature better than most timber. Oak contains gallic acid, which corrodes iron fastenings, hence all bolts used in it should be galvanised; young oak is more cross grained and harder to work than old oak. As to its durability, one has only to look at



**THIS PAGE IS LOCKED TO FREE MEMBERS**

Purchase full membership to immediately unlock this page

# DELVE INTO FANTASY, MAGIC, MYTHOLOGY & FOLKLORE

Forgotten Books'  
Full Membership gives  
access to 797,885 ancient  
and modern, fiction and  
non-fiction books.

**Continue**

\*Fair usage policy applies

in colour; the annual rings are slightly wavy as in English oak. It is very easily bent, and fairly durable; it is superior to American oak, largely used in wagon work, and to be had in logs 12 to 18 ft. long, 10 to 16 inches a side, roughly squared with wany edges, some almost octagonal; also in planks 15 inches wide and 2 to 8 inches thick. A large number of Russian cleft spokes are imported, 28 to 30 inches long and  $3\frac{1}{2}$  by 4 inch sides. Oak also comes from Norway and Italy. Austrian or Adriatic oak in round logs with the

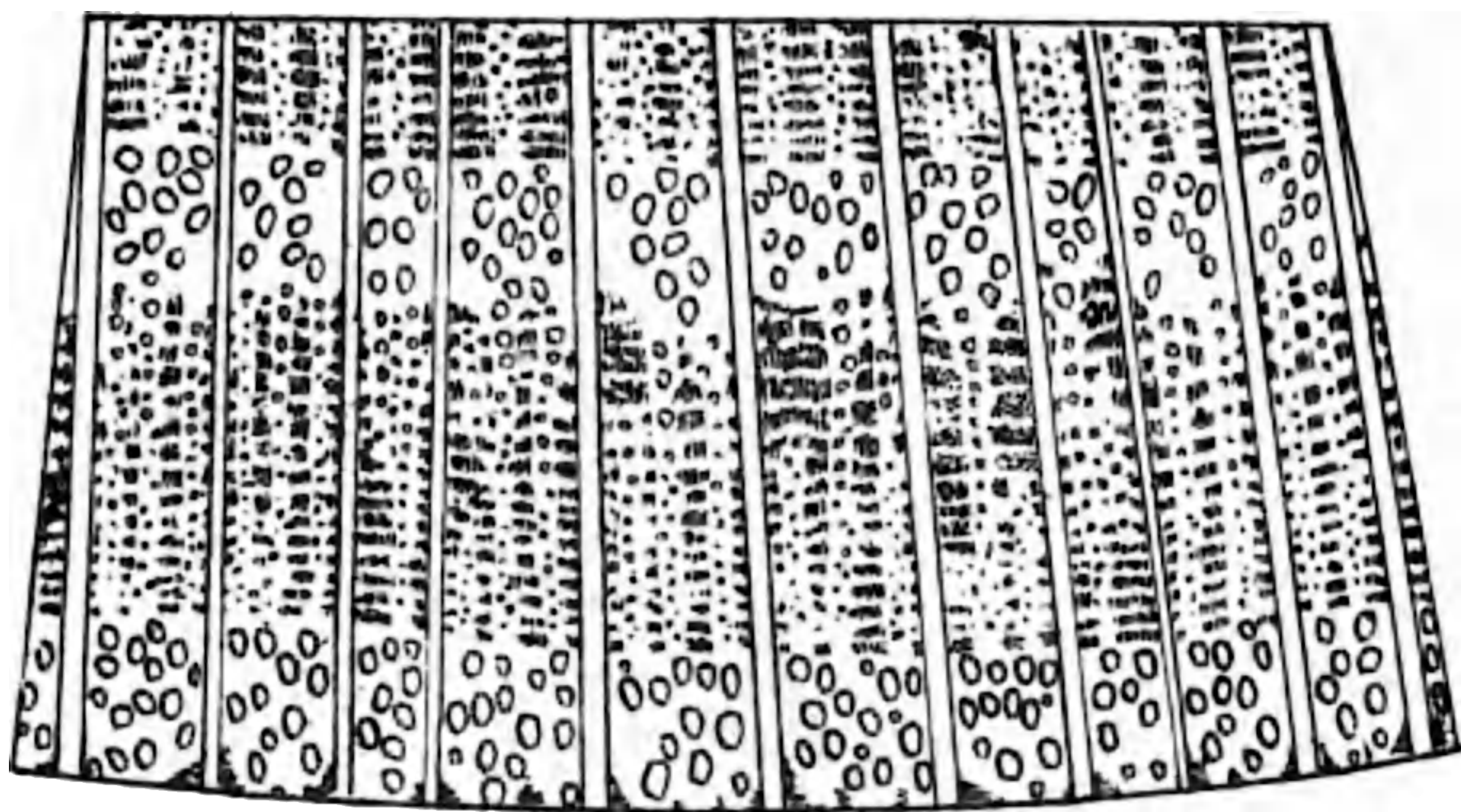

FIG. 10.—Cross section of Oak, magnified about five times. (After Roth.)

bark on is largely imported to the London market from Fiume and other Adriatic ports, and has a ready sale for wainscot and other purposes; it was largely used for parquetry flooring on the recently constructed *SS. Mauretania*, as well as for the saloon fittings, where a great quantity was used as panelling, and beautiful effects obtained. This Adriatic oak is of good size, mild growth, and even in colour. A good deal of oak from the Russian and Roumanian forests is shipped at Odessa in short lengths and from 16 to 24 inches a side, but is not suitable for first-class work. Most of these oaks produce tough,

hard timber, and when worked up few could tell the difference between them. Oak is often "quartered," that is, cut radially to the circumference, so as to show the silver grain to perfection; it is generally of various shades of brown, with a hard, firm, glossy surface, and with exposure changes to an ashen grey and becomes striated; the annual rings are very narrow and regular, wide rings and large pores are signs of weakness; the medullary rays are very conspicuous (Figs. 3 and 10), and produce the beautiful "figure" or silver-grain so characteristic of oak, especially if it be cut on the quarter. Oak is now chiefly used for superior joinery and furniture, occasionally for windows and doors, sills, treads of steps, and largely for wedges, treenails, chocks and framing for railway and other wagons, and in coachbuilding and keys for railway chairs. Good oak gate-posts will outlast iron and take no upkeep; it is the best wood for carving, English oak being especially appreciated for this purpose.

The weight of the different varieties does not vary much—45 to 49 lbs. per cubic foot.

There are numerous oaks grown in Europe, most of which produce excellent timber. The holme or evergreen oak (*Q. ilex*), a native of the Mediterranean districts of France, Spain, and Italy, produces wood more like the English oak than any other kind, and the Turkey oak (*Q. cerris*) produces some of the heaviest of European oak, but the timber is not so much used as that of the common oak, though suitable for the same class of work, and the rays being numerous it has a varied and handsome grain.

Fumed oak is a good deal used in the furniture trade. It is a method adopted to give the wood that olive-brown tint peculiar to old oak. The wood is enclosed in an air-tight chamber, and under the wood are placed tins of liquid

ammonia, the effect of the fumes of which is to darken the timber, and this can be done to any required tint; half a pint of ammonia is sufficient for the timber contained in a chamber 9 ft. by 6 ft. by 3½ ft. A good useful colour can be obtained in one night. The process does not raise the grain, the wood keeping as smooth as at first; any depth of colour can be given with certainty, and the darker shades will penetrate the thickness of a veneer; American red oak does not take the colouring well, English and Riga oak do. The different pieces of wood must be kept separate to allow the fumes to act all round and about them.

**Common Yew** (*Taxus baccata*) is common in Spain and Italy, often seen in English churchyards, and is indigenous to Nottinghamshire. It attains a great age, some specimens having a girth of over 50 ft., but it seldom attains a greater height than 30 or 40 ft. The trunk of the yew is in striking contrast to most British trees, for instead of one trunk there are what appear to be several, like a sheaf of columns growing from the same root. The wood is of pale yellowish red colour—some of the older timber is darker—fine close grain, tough and elastic, susceptible of fine polish, handsomely striped and often dotted like Amboyna wood; annual rings are very narrow and wavy. From the yew were made the weapons of the celebrated English bowmen of olden times, and it is still employed in the manufacture of bows for archery, also of small articles of furniture, and occasionally in chair-making. It is a hard and exceedingly durable wood, and reckoned almost equal to box for fine work. It is often stained black and called German ebony. The Irish yew (*T. fastigiata*) is preferred for bows.

Weight 48 to 50 lbs. per cubic foot.

**Hornbeam** (*Carpinus betulus*) is a British tree which grows to a height of 30 to 50 ft. and produces a hard, tough, strong, white coloured, close cross-grained, inelastic, heavy wood, containing little or no sap; it stands exposure well unless cut from old trees. Under vertical pressure the fibres often double up instead of snapping. Makes good mallets and lasts, and is also used for agricultural implements and turning; takes a fine polish, tools employed upon it soon lose their edge; is difficult to split and make smooth under the plane; it also shrinks a good deal. In Gerald's "Herball," 1633, he says that this wood "waxeth so hard that the toughness and hardness of it may be rather compared to horn than unto wood and therefore it is called hornbeam or hardbeam." It was formerly in Britain and is still in some parts of Europe preferred for making yokes for cattle; hence, according to some authorities, the name. A considerable quantity of the hornbeam used in Britain is imported from France in planks 6 to 19 ft. long, 6 to 12 inches wide, and 3 to 6 inches thick. It grows fairly plentifully in America, but the wood is not exported. The amount of water absorbed into cubes of hornbeam, which attained its maximum at end of the sixth day, ranged from 45 to 79 per cent. of its dry weight, and the weight needed to crush 2-inch cubes of dry wood was from 19,621 to 25,794 lbs. Annual rings fairly close, medullary rays distinct and numerous.

Weight about 47 lbs. per cubic foot.

**Sycamore or Great Maple** (*Acer pseudo-platanus*), often called the plane tree in Scotland, is neither a plane nor a true sycamore; it is common in Britain and Germany, although practically the whole of the sycamore of commerce comes from America. The tree attains a height of 60 ft., and produces an almost white wood, slightly yellow in older

trees, darker near the heart, of uniform texture, compact and firm, though it cannot be considered hard, durable when kept dry, and not liable to warp. It is used for furniture, turning, wooden screws, reels and bobbins, pianos, harps, backs of fiddles and violins, also for coach panels, rollers for wringing and mangling machines, and for the superior sorts of Tunbridge ware and dairy utensils. The annual rings are distinctly marked, and medullary rays fine. The wood is very similar to that of the Norway maple, though rather closer and heavier, and takes a fine polish; much of it is beautifully figured.

Weight about 40 lbs. per cubic foot.

The Egyptian sycamore is a large tree of the fig tribe. Most of the Egyptian coffins discovered are made of sycamore.

The **Plane**, which is such a conspicuous and handsome tree in many London squares and parks and along the Thames Embankment, is a variety of the Eastern plane (*Platanus orientalis*). It is often confounded with the sycamore, but the plane has very broad medullary rays, thus giving a nice figure to much of the wood (which is yellowish red in colour, somewhat like beech, but softer), whereas the rays of the sycamore are very fine. The timber when polished is not unlike the best walnut. The Eastern plane closely resembles the Western plane, called sycamore in the United States, but the timber, though good, is but little used in Great Britain. The boundary of the rings, which are not clearly defined in the Eastern plane, is a means of distinguishing it from the Western plane, in which they are very distinct. In both species the medullary rays are well defined. Used in the pianoforte trade and by cabinet-makers.

Weight of Eastern plane about 33 lbs., Western plane about 40 lbs., per cubic foot.

**Spanish or Sweet Chestnut** (*Castanea sativa*) is found in the south of Europe, Africa, North America, and most parts of England, especially the southern counties. It is a stately and handsome tree, closely allied to the beech, and grows to a great age. It has no large or distinct medullary rays, and this is the characteristic distinction between it and the oak; its annular rings are very distinct and fairly wide. The wood is not unlike the oak in appearance, the colour being of rather a redder tinge, but it has practically no sapwood and is generally of a closer grain than oak, although softer and lighter; it is more liable to split in nailing than oak, but the nails do not blacken the timber. It is a wood of slow growth, easier to work than oak, does not shrink or swell so much, and is remarkably durable; the younger wood is much harder and more flexible than the old. Chestnut was formerly much used in England for large span roofs and for similar purposes to oak, but now chiefly in small sizes by coachbuilders and wheelwrights. Young chestnut trees are much appreciated for hop poles and also for gateposts and fencing. Chestnut is said by some to surpass oak in durability. The wood is heavier and closer grained when grown in warm climates. A good deal has been used in the London district split up for park fencing. In France the smaller pieces are used for hoops and vine props.

Weight about 38 lbs. per cubic foot.

**Horse Chestnut** (*Aesculus hippocastanum*) is quite a distinct tree from the above, and remarkable for its magnificent foliage, rapid growth, and stately size. Most Londoners know the fine avenue of these trees along the main road at Bushey Park, and they present a beautiful sight when in full blossom: the wood is yellowish white, of fine, close, even grain not unlike maple, and in character not unlike poplar; it is not durable. It is used for turning, and is



one of the many whitewoods used by the Tunbridge ware manufacturer. Softer than holly, but preferable to it in some ways for the turner, as it can be had in much larger sizes ; it is also made into charcoal for gunpowder.

Weight 35 to 37 lbs. per cubic foot.

**Alder** (*Alnus glutinosa*) grows both in Europe and Asia, where it is found along the swamps and low banks of rivers as in Great Britain. It is only a small tree, 30 to 60 ft. high ; the wood is white when first cut, but changes to a reddish colour, and then fades to a reddish yellow of different shades ; the roots and knots are beautifully veined, its annual rings are rather broad and wavy, and it is very durable in damp situations or when kept perfectly dry. It is a soft, light timber, uniform in texture, with fine, smooth grain, is easily worked, and shrinks a good deal. It is used for clogs and last-making, patterns, sides of carts, packing cases, and also for wooden bowls, turnery, and occasionally for furniture. German cigar boxes are usually made of alder wood. The roots and hearts are used by cabinet-makers, and much small stuff is grown for making baskets, staves for herring barrels, etc. It was formerly a good deal used for water-pipes, pumps, and sluices. The supply comes chiefly from the Baltic. Vitruvius, the early Roman architect, says that the whole of the buildings of Ravenna on the Adriatic were built upon piles of alder. It is not of much value to the carpenter.

**Grey or White Alder** (*A. incana*) is a native of many parts of continental Europe, produces a white, fine-grained, compact wood, but soon rots in damp situations.

Weight of alder 26 to 41 lbs. per cubic foot.

**Willows**, of which there are about 160 species known, yield a soft, light brownish yellow coloured wood, easily



**THIS PAGE IS LOCKED TO FREE MEMBERS**

Purchase full membership to immediately unlock this page

# Know Your Bible

Forgotten Books'  
Full Membership  
provides unlimited  
access to more than  
28,000 volumes of  
Christian literature for  
\$8.99/month

**HOLY  
BIBLE**

**Continue**

\*Fair use policy applies

**Pear** (*Pyrus communis*), a tree of 20 to 50 ft. in height and of quick growth; the wood is much used for drawing curves and set squares, and also much appreciated for carving, as it is cut with equal facility in all directions of the grain. Much old carving was done in pearwood, and some fine specimens are to be seen in the British Museum. The wood is somewhat like the lime, but harder and tougher, fine grained and strong, though it does not stand well unless thoroughly seasoned. A few state-rooms in the Cunarder *Mauretania* have been carried out in pearwood; the colour is a yellowish brown, and annual rings are distinct.

Weight 40 to 44 lbs. per cubic foot.

**Cherry**, of which there are three varieties, *Pyrus avium*, *P. padus*, and *P. cerasus*. The first is the most widely distributed, and sometimes attains a height of 30 to 40 ft. It produces a handsome pale reddish brown wood, used for cabinet work, walking-sticks, pipes, etc. It is only to be got in small sizes, as is the case with apple, pear, and plum, is easily worked, and is one of the best brown woods of the Tunbridge ware workers; sometimes may be mistaken for birch, but the rays are much more conspicuous in the cherry. The wild cherry is used for furniture in France and other parts of the Continent where the tree abounds.

Weight 42 to 46 lbs. per cubic foot.

**Plum**, which is somewhat similar to pear, is also used for turnery.

Weight about 40 lbs. per cubic foot.

**Common Cypress** (*Cupressus sempervirens*) furnishes a timber sometimes called cedar; it is found in Cyprus, Asia Minor, Persia, and grows in mild localities in Great

leaf  
white  
times

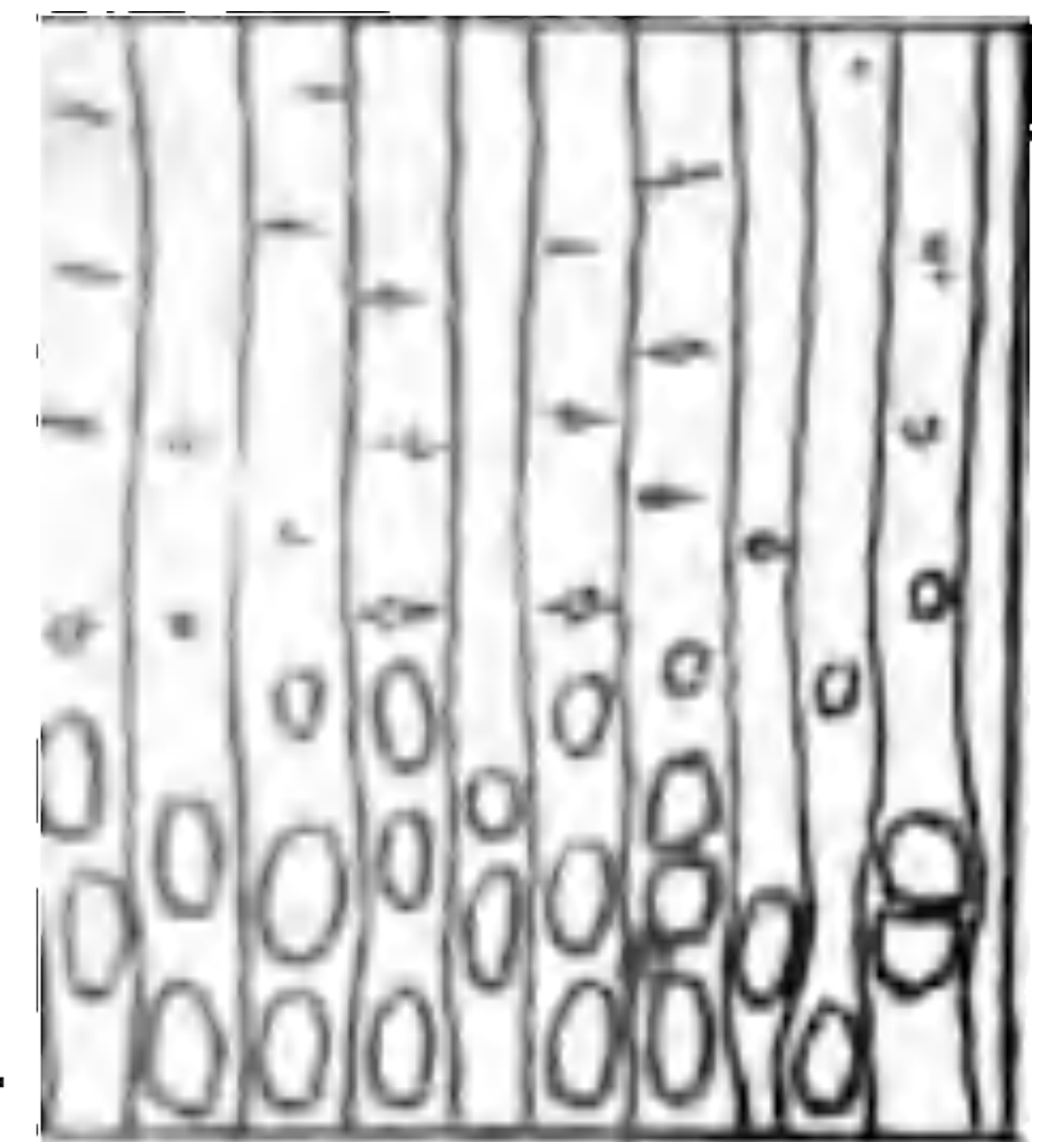

Ash, showing  
rays.

...atest in trees of  
each exhibits the  
the highest degree.  
...own ash is used in  
... in quality and fibre  
... from America that we  
... used in Britain. Ash  
... and crate-making, and  
...awl beams on fishing boats.  
...ie foot.

*(Pyrus aucuparia)*, now common  
found up to 2,660 ft. above sea

attains a greater height than 12 to 14 ft., but in warmer climates is found of twice this size. The wood is heavier than any European wood, and some of it will sink in water; the colour is a beautiful yellow or orange; it is hard, close and silky in grain, easily worked, and takes a fine polish. It is much used by the turner and wood carver—referred to by Virgil as “proper for the turner’s trade”—and in the manufacture of rules and drawing scales, also for planes, handles of turnscrews and other tools, and is preferred to any other wood for flutes and other wind instruments. It was the chief wood used for wood engraving when that process was much more common than it is to-day, admitting as it does of a finish as fine almost as that of metal. It is about the most solid at the pith of any wood to be met with—the pith of all true boxwoods is lozenge shaped in section; the wood is cold and smooth to the touch, the bark and sap together are only about the thickness of stout cardboard. The box of commerce now comes chiefly from the Caucasus and parts of Turkey in Asia, but the supply is scarce and dear, and a good deal of persimmon and other timber is used in place of box. The true box can only be had in short lengths up to 6 ft., and from 2½ to 12 inches in diameter; it is usually sold by weight.

Weight up to 72 lbs. per cubic foot.

**Ash** is a wood of which there are about fifty species, natives of Europe and North America as well as Asia and Japan.

The **Common Ash** (*Fraxinus excelsior*) is a beautiful and umbrageous tree, but extremely injurious to grass and crops immediately under and around it. The wood is greyish or brownish white with longitudinal yellow streaks,

tough, hard and elastic, easily worked, even and close in grain, and is probably superior to any other British timber for toughness and elasticity; too flexible for use in building work. It excels the oak in strength and toughness. It is much used by wheelwrights, coachbuilders, cabinet-makers, and turners, and for hammer shafts, oars, horizontal bars for gymnasiums, golf clubs, and anything requiring toughness combined with flexibility; is easily bent after steaming to any shape, valuable for barrel hoops and motor wheels, not liable to split, and so is a good deal used for butchers' chopping blocks and boards. Often found irregular in the disposition of its fibres, sometimes finely figured, it is then much prized for cabinet work and furniture. Annual rings are distinct, medullary rays and pores are very fine (Fig. 11).

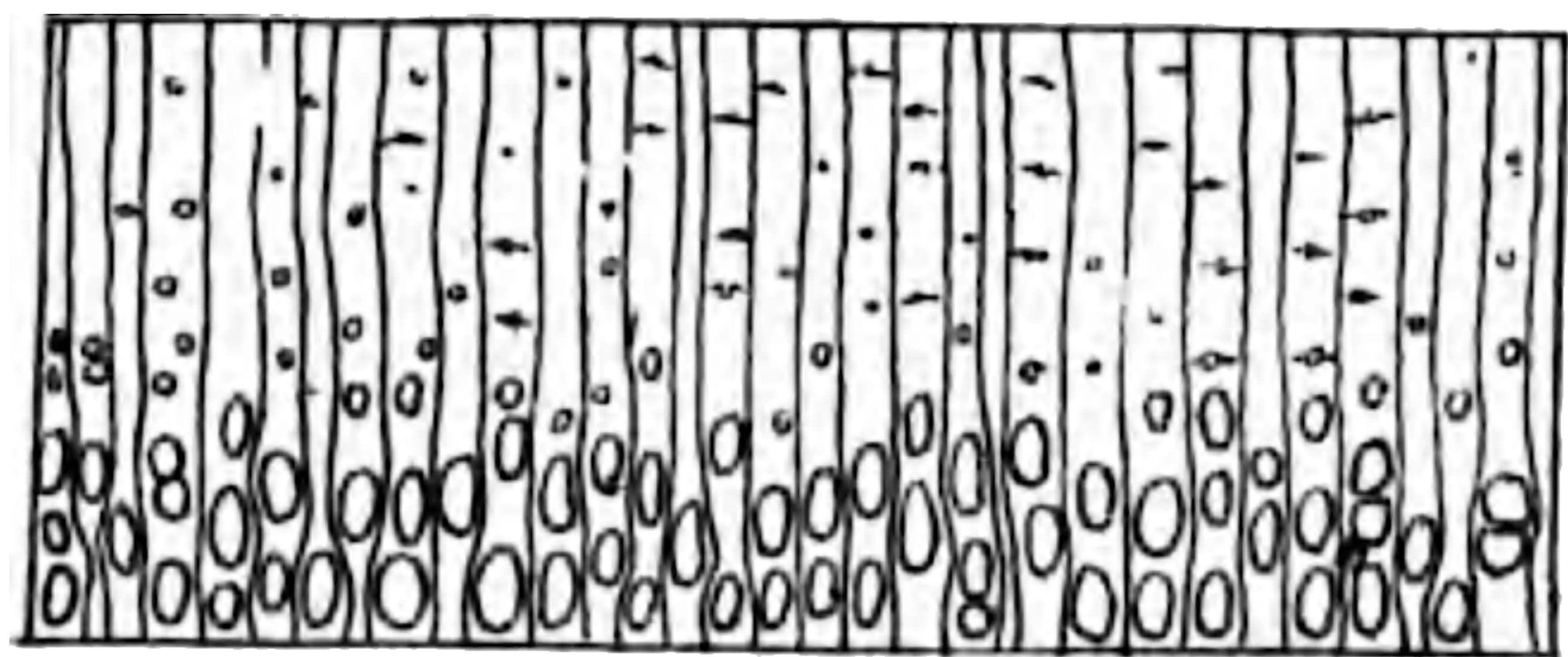

FIG. 11.—Cross section of Ash, showing pores and medullary rays.

The wood of the young trees is almost

as valuable as the old; indeed the value is greatest in trees of which the growth has been rapid, for it then exhibits the characteristic toughness of the timber in the highest degree.

A considerable quantity of native-grown ash is used in England, and Irish ash is unequalled in quality and fibre by any in the world. It is, however, from America that we get the larger proportion of the ash used in Britain. Ash poles are used for sheep hurdles and crate-making, and were at one time much used for trawl beams on fishing boats.

Weight about 49 lbs. per cubic foot.

**Rowan or Mountain Ash** (*Pyrus aucuparia*), now common in suburban gardens, is found up to 2,600 ft. above sea



*Photo by]*

*[Henry Irving, Horley.*

**FIG. 12.**—Common Birch (*Betula alba*).

level. It attains a height of 30 or 40 ft., and produces a tough and elastic wood, but can only be got in small sizes. It is much used for crates and walking-sticks. The tree is intimately bound up with Norse folklore.

Hungarian ash is often richly figured, but varies a good deal in grain, and when used as veneer the glue is apt to discolour it.

**Common Birch** (*Betula alba*), Fig. 12, is a beautiful and rapid growing tree which attains a height of 50 to 60 ft., but only about  $1\frac{1}{2}$  ft. in diameter. It is very straight, gets less in size towards the Arctic regions, where it becomes a mere shrub. It is the last tree to disappear as we go northward. The wood is whitish or light brown in colour, firm and tough, easily worked, cannot be considered durable, but is moderately hard and even in grain, rather coarse, but works up to a satiny lustre; is excellent wood for turners, wheelwrights, and coopers, and is used for suites of bedroom furniture, largely in chair-making, and a good deal is made into charcoal. English-grown wood is often used for handrails, stairheads, etc.; the twigs are made into besoms, and on account of their fragrant smoke are used for smoking herrings, bacon, etc. The wood is also used for box-making in the tinplate trade, and any shortage made good by English elm. Occasionally used as veneer in cabin fittings, it has a nice effect when stained; it is also used for chair seats, and in Russia tea chests for India are made up of two thicknesses glued back to back, with their grain crossways; and a good deal is used for "venesta" panelling. Birch comes from Sweden, where it is made into furniture, and Prussia to Britain, but the greater quantity is brought from the United States and Canada. The wood is, as a rule, softer and rather darker than beech; medullary rays are scarcely noticeable. It is



rather a "caney" wood, and there is no difficulty in blowing bubbles through it.

Weight about 45 to 49 lbs. per cubic foot.

**Common Acacia** (*Robinia pseudo-acacia*) <sup>Native N.A.</sup> grows in Britain and the Continent of Europe, though the acacia of commerce generally comes from America, and is known as the American locust. The wood of acacia is greenish yellow with reddish brown veins; the structure is compact yet porous, the annual rings very distinct. It is very tough, durable wood, hard and heavy, but only to be had in small sizes. Acacia gave favourable results in German mines, but its weight and relative costliness militate against its general employment. It flourishes well in poor soil, and in fifteen to twenty years attains sufficient proportions for pit props.

Weight 42 to 48 lbs. per cubic foot.

**Common Beech** (*Fagus sylvatica*), Fig. 13, forms whole forests in many parts of Europe, is very common in the counties of Surrey, Hants, Bucks, and Sussex, and is one of the stateliest of our English forest trees, attaining a height of 100 ft. The timber is of reddish white or pale brown colour, close, hard, and even in grain, and works up well, twists and cracks easily, and does not readily take a good polish. Being rather brittle it is not well adapted for the purposes of the house joiner, or where strength and durability are required. It is very durable in wet situations, and has been a good deal used for sluices, weirs, etc., but it is not suitable for exposure to variations of atmosphere. Extensively used by cabinet-makers and for chairs and bedroom suites, also by turners for wooden bowls, ladles, butchers' trays, wooden shovels, planes and other joiners' tools, sink drainers, underwater parts of ships, and a good deal of



**THIS PAGE IS LOCKED TO FREE MEMBERS**

Purchase full membership to immediately unlock this page

# DELVE INTO FANTASY, MAGIC, MYTHOLOGY & FOLKLORE

Forgotten Books'  
Full Membership gives  
access to 797,885 ancient  
and modern, fiction and  
non-fiction books.

**Continue**

\*Fair usage policy applies

as it is said to resist the damp, although, as in apparent contradiction to this, beech will take in more creosote than most woods, as much as 22 lbs. per cubic foot having been injected into beech paving blocks, for which this timber has been a good deal used, and has generally given satisfaction. Beech props in German mines gave superior results to either oak, pine, or fir. It is much used for sleepers on the continental railways, and makes good charcoal.

Irish beech, though not so economical in conversion as English beech, stands unrivalled where hardness is a requisite, and is much appreciated by piano manufacturers and for the making of bobbins.

The beech forests of Roumania are virgin soil ; they cover about 3,000,000 acres, but are situate in wild, inaccessible mountain ranges. At present the larger portion of our supplies comes from Canada.

European beech, sycamore, and birch are trees without distinct heartwood.

Weight about 44 lbs. per cubic foot.

**Poplar**, a genus of handsome trees with tall straight stems, is found chiefly in the temperate and cold regions of the Northern hemisphere. There are many varieties ; the wood is soft, light, easily worked, yellowish or brownish white in colour, and of uniform texture ; is not easily splintered, and when dry and well seasoned is fairly durable. Annual rings are very distinct but very fine.

**White Poplar** (*Populus alba*), found in Britain and the southern parts of Europe, attains a height of 80 ft. The wood, of a yellowish brown colour, is used by cabinet-makers, turners, and toy-makers, but is liable to swell and shrink. In restoring the foundation of the Campanile at

Venice, which fell in 1902, some of the piles were found to be white poplar, and in such good condition that they were allowed to remain.

**Grey Poplar** (*P. canescens*) is very similar to the white variety, but the wood is harder and better and makes good flooring, and by some is preferred to pine near fireplaces, as it is said to be less liable to take fire. It is used sometimes for rough doors, barrows, carts, and packing cases, and is much esteemed by turners. It is not liable to split when nails are driven through thin boards.

**Black Poplar** (*P. nigra*) is used for much the same purposes as the white and grey varieties. It grows in England and is fairly common in Ireland, but there it is mostly used locally for rough cart sheathing, as it is not liable to splinter; sometimes used for flooring and roofing. It shrinks a good deal and is not durable. It is largely used for sabots in Holland, where it grows plentifully.

**Lombardy Poplar** (*P. fastigiata*), another well-known variety, is now largely planted in gardens and public places in English towns because of its speedy growth, but the wood is of little value.

In the case of poplar, as of so many of our native timbers, the wood used under this name mostly comes from America, and much which goes by the name of poplar is not poplar at all. The wood of the beautiful **Aspen** (*P. tremula*), which is soft, light, white and smooth, is used for turning, and made into pails and trays, whilst in France it is used for sabots. It was once highly esteemed as a wood for the making of arrows, and in Henry V.'s time an Act was passed, which was not repealed until the time of James I., forbidding the use of the timber for any other purpose



to b)]

FIG. 14.—English Elm (*Ulmus campestris*).

[E. J. Wallis, Kew.]

under a fine of 100s. A good deal of aspen comes from Russia and is used for "venesta" panelling, and a large quantity is made into matches in Sweden.

Weight of poplar about 26 to 33 lbs. per cubic foot.

**English Elm** (*Ulmus campestris*), Fig. 14, a tree of 70 or 80 ft. in height and sometimes 5 ft. in diameter, produces a wood of a reddish brown tint, the sap being brownish white, highly valued for its strength—especially across the grain—toughness, closeness of texture, and great resistance to crushing; stands driving bolts and nails very well, excellent in water or damp situations, and was formerly much used for water-pipes in English towns, many of which, taken up in recent years, bored to 3 or 4 inches diameter, after being in the ground for a great number of years, were in good condition. It was at one time a good deal used for piling in difficult ground—the piles of old London Bridge were of elm, and found in good condition after being in the ground for 800 years—also for keels and other timbers of ships, naves and spokes of wheels, and butchers' blocks; it is not now so much used, owing to the American elm being more readily obtained of the required sizes, but the quality of the latter is inferior. English elm is, however, still supplied to South Wales from Gloucestershire and Somerset for box-making in the tinplate trade whenever there is a scarcity of birch, and used in large widths for wagon and cart planking. The wood is much twisted in grain, which makes it difficult to work, and it is very difficult to split, though if left lying in the open is very liable to split. Medullary rays scarcely noticeable, the pores run in peculiar zig-zag and wavy lines. Used a good deal for coffins; so is the Dutch elm, which is the same tree. The French elm is also chiefly the wood of the *U. campestris*, and grows to a considerable size, but is not generally so hard as English

elm ; sometimes used instead of ash as trawl beams for fishing boats. The wood of the **Wych Elm**, or Scotch elm (*U. montana*), is somewhat lighter in colour than the common elm, and rather harder, clean and straight in grain, tough and flexible ; it is used for naves of wheels, and in boat-building. The tree attains a height of 80 to 100 ft., with a large trunk. Elm was at one time, before iron became so common, often used for divisions in stables, horses having a dislike to biting it.

Weight of common elm about 36 lbs. per cubic foot ; sometimes the weight of wych elm runs up to 43 lbs. per cubic foot.

**Common Laurel** (*Prunus lauro cerasus*) is but rarely found of sufficient size to be used as timber, but, according to a recent note in the *Timber Trades Journal*, some forty tons were sold on an Irish estate some time ago, and several of the largest sticks were quite 12 inches in diameter at the butt end, and a quantity grown on reclaimed peat bog was sold for use in Belfast by Lord Charlmont. The timber, which is very heavy and durable, brought as much as 70s. per ton. The tree originally came from Trebizond, and has been planted in Britain since the sixteenth century.

**Holly** (*Ilex aquifolium*), the common holly, is seldom seen except in hedges, yet many specimens attain a height of 40 feet with a diameter of 8 or 10 inches. It produces a wood of exceedingly fine grain, closer in texture than any English wood, and very hard, of white colour, sometimes almost as white as ivory ; requires great care in the treatment to preserve the whiteness of the wood, it does not readily absorb foreign matter ; much used by turners and for parts of musical instruments, handles of tools and metal teapots, draught-boards, etc., and is often dyed black and

called ebony. Employed by the Tunbridge ware manufacturer for some of his best work, especially that which is to be painted in water colour.

Weight 47 lbs. per cubic foot.

**Bruyère**, commonly called briar (*Erica arboria*), a species of heath which grows in the south of Europe, the roots of which produce a fine, hard wood used in large quantities for tobacco pipes. The Australian myall and the Austrian cherry are used for the same purpose.

**Hazel** (*Corylus avellana*) is a native of Britain and parts of Europe, and grows plentifully in the Home Counties; is a reddish white, soft, highly elastic wood, but not durable; the smaller branches and stems are used for crates, hoops for barrels, stakes, etc., and the larger wood is made into charcoal for forges and for artists' crayons. The roots are sometimes used by cabinet-makers for veneers. It is a hazel which the "water diviner" often uses in his art.

**Hawthorn** (*Cratægus oxyacantha*), a well-known tree, will grow in some situations to a height of 40 ft. and considerable girth; the wood is hard and tough, but it is not much used except occasionally by turners. It is yellowish white in colour, of fine grain, and takes a good polish. It is one of the substitutes for boxwood.

**Walnut.**—The **Common Walnut** (*Juglans regia*), is a native of Persia and the Himalayas, but for a long time has been cultivated in Europe. It is a lofty tree, some 60 to 90 ft. high with large bole; the wood is much valued and chiefly used by cabinet-makers and for furniture; the wood of young trees is nearly white and but little esteemed, that of old trees is brown, veined and shaded with darker



brown and black. The wood of the roots is often beautifully veined. Walnut wood is heavy, fine grained, longitudinal fibre short and brittle, does not split in seasoning, takes a beautiful polish. The tree grows well in Britain, but the wood is pale, rather coarse, and not much used.

Large quantities of excellent walnut come from the Black Sea, called Circassian walnut, in short logs up to 18 inches a side and in planks 6 to 11 ft. long,  $2\frac{1}{2}$  to 8 inches thick, and up to 19 inches wide; similar timber comes from Italy, and is much used in the piano trade, but probably the larger portion of the walnut of commerce comes from the United States. A few short logs up to 36 inches at the butt come occasionally with mahogany from the west coast of Africa, and this trade seems rather to increase. All walnut trees have a peculiar dividing of the pith into a number of small chambers, which forms a serious defect in the centre of every log. Many years ago walnut to a considerable extent took the place of oak in the furniture trade, but it is now more generally used as veneer. Large quantities of French and other walnut were used in the cabin fittings of the *SS. Mauretania*; the grand stairs were constructed entirely of this wood, as much as 10,000 ft. of veneer being used. Walnut is much appreciated for the best gun stocks, for Swiss carving and turnery, in the pianoforte trade, and in France, where the tree is found in large numbers, the wood is largely used for sabots.

Weight about 46 lbs. per cubic foot.



**THIS PAGE IS LOCKED TO FREE MEMBERS**

Purchase full membership to immediately unlock this page

# Know Your Bible

Forgotten Books'  
Full Membership  
provides unlimited  
access to more than  
28,000 volumes of  
Christian literature for  
\$8.99/month

**HOLY  
BIBLE**

**Continue**

\*Fair use policy applies

quantities still uncut in Ontario and Quebec and in the northern United States, but no appreciable amount grows south of a line between Chicago and New York, about 42° north latitude; 77 per cent. of the United States white pine comes from the Lake States, Minnesota, Wisconsin, and Michigan, of which the first two supply 68 per cent. White pine and red or Norway pine are, in the States and Canada, sold together under the name of "Northern pine." White pine stands second in the United States cut of timber, and in 1905 amounted to 405,000,000 cubic feet, of which nearly one-fourth may have been red pine. It is the most valuable of Canadian trees. The timber is becoming scarce and high-priced in Britain, as there is, compared with former days, a comparatively small amount now sent over.

This is one of the many cases of the confusion caused by timber going under different names in different places; the American or rather United States term "yellow pine" applies to all the pine in the eastern States, except white pine and red or Norway pine, and these include longleaf, shortleaf, and other southern pines; thus it will be seen that the timber which in the English market is called yellow pine is the very timber which the Americans exempt from that title.

The wood is of white or pale straw colour, recognised by dark hair lines running in the direction of the grain; it turns a darker colour with age, is generally free from knots, is of uniform colour, clean, straight in grain and easily worked, is fairly strong but inferior in that respect to Baltic redwood, and, even when it was plentiful and cheap, not used for outdoor or substantial work in Great Britain, although it is much used for these purposes in the drier climate of the States and Canada, where, until of late years, it was the chief building timber. It is excellent for

all classes of good joinery, and is easily worked into mouldings and panelling; it is the chief wood used by pattern-makers, as it shrinks but little. It is largely used for decks of passenger steamers owing to the clear white colour. It is lighter than most of the pine timber and readily distinguished in the log by the height it stands out of the water, and for this reason was often used for temporary rafts.

It is imported in square and roughly-squared logs, and known as Quebec square pine or Quebec wany pine (the latter have a wane on the edges, the former are square), up to 40 ft. long and 16 inches square; shorter logs may be had over 24 inches square, also in deals and battens classed in three or four qualities in widths of from 7 up to 25 or even 30 inches, but the larger widths are always in shorter lengths; this applies to timber generally. The first quality may be obtained practically free from knots and all defects. Annual rings clearly marked, medullary rays numerous but not very distinct. Weight 28 to 32 lbs. per cubic foot. A large trade is now done in prepared pine doors, which are exported to Great Britain in large quantities; these as a rule are of good quality and superior to the doors and other manufactured joinery sent from Norway and Sweden, but this cannot be said of some of the American manufactured work, for, according to the American *West Coast Lumberman*, a short time ago, as many as "sixty-two knots have been counted on one side of a door made for a subject of King Edward VII."

There is another white pine, called western white pine (*P. monticola*), which very closely resembles the above both in appearance and quality of timber, cut in Vancouver and the Selkirk range in Canada and in parts of Montana and Eastern Washington, but a good deal of it is put on the United States market with the western yellow pine

(*P. ponderosa*) which grows in the same districts ; it is used for the same purposes as *P. strobus*.

**American Red Pine** (*P. rubra* or *P. resinosa*), commonly called Canadian red pine, is a tree of 50 to 80 ft. in height and 2 ft. in diameter which goes by different names in different localities ; in some places it is called Norway pine, in others yellow pine, and, as has been said, it is classed with white pine in the States timber trade ; it grows to a great extent in Canada and in Minnesota, Wisconsin, and Michigan, in fact over the same area as the white pine. The timber is reddish white, with fine, clean grain, a good deal of sap, somewhat soft though harder than *P. strobus*, but fairly tough and elastic, not liable to warp or split, and durable when seasoned. Chiefly imported into Britain as deals and planks and used for internal house fittings. It is not so much appreciated as Baltic timber, although the price is somewhat lower.

**Longleaf Pine** (*Pinus palustris*) is the pitch pine of the English market and comes from the southern States of North America ; it is shipped from Mobile, Pensacola, Gulf Port, and other places on the Gulf of Mexico. It is sometimes called Georgia yellow pine ; in the States *P. rigida* is often called pitch pine, but where pitch pine is referred to in this book it is to be understood to mean longleaf pine.

This tree furnishes the hardest and most durable as well as one of the strongest pine timbers in the market, imported chiefly in square and hewn logs ; the former are preferable, having less sap, although the hewn can be had in longer lengths and larger scantling. It first came into the English market about forty years ago, since which time it has been the timber most largely used for heavy constructional works,

ousting to a great extent the Memel timber formerly used for that purpose, as it was stronger and could be obtained in longer lengths. The colour is a reddish yellow ; when dried it becomes lighter in colour, but the reddish tint shows conspicuously when the timber is wet ; the annual rings are strongly marked (Fig. 2), and it is full of resinous matter, making the timber very durable, but difficult for joiners to work. It is hard, dense, and strong, the best of it fairly free from knots—sometimes one may see a 40-ft. length without one—straight in the grain, fairly free from sap, and excellent for interior work which is only intended to be varnished, such as roofs or gallery timbers, seats in churches and public buildings, door frames, panelling, etc., owing to its clearly marked and handsome grain ; it is also now much used for the framing of spring mattresses ; one of the best timbers for heavy engineering structures where great strength, long span, and durability are required, it has also been much used for wharves and jetties, and also for ships' masts. It has been stated as one of the defects of this timber that it is subject to cup- and heart- shake (see Chap. XII.); although one certainly finds a large proportion of logs with cupshake at the butt end, the defect often goes but a short distance in, and by cutting a foot or two off the end the rest of the log is found quite sound ; moreover this defect, unless very pronounced, does not detract from the usefulness of the timber when used in the log or in large scantling, and it is only when cut up into small sizes that it causes a loss in conversion ; sometimes when sawn through the centre and left to lie it will open out at the heart. So great has been the run on this timber that it has degenerated in quality and size ; twenty years ago it was quite easy to get logs 45 to 50 and even without much difficulty 60 ft. and over, and 14 inches square, almost free from sap. These sizes are now rare, and the average at present is more like 35 ft. by

11 to 12 inches square, but it can still be had up to 50 ft. at a high price. The large quantity of pitch pine of small scantling and with a large proportion of sap now exported shows that the larger trees have been cut or are more difficult to get; to obtain good pitch pine now requires much more careful selection than formerly, and more allowances must be made, but it can be got in shorter lengths and smaller scantling and in small quantities even up to 50 ft. by 14 inches by 14 inches.

It has been stated that pitch pine "bled" for turpentine becomes reduced in strength and durability, but the late Professor Johnson, in his "Materials of Construction," says "It is as strong bled as unbled." Some logs are to be found beautifully figured, although much of the figure in pitch pine only goes a short depth into the wood, and these are generally secured for cabinet-makers' work. This timber has not been found satisfactory for constructional work in parts of Cape Colony, as in some situations there it rapidly decays when exposed to alternate damp and heat on river beds and near the sea. Such is not the author's experience with this timber in Great Britain and other places, and he has used thousands of logs, in exposed situations and subjected to variations of temperature, which have been in position for over twenty years and are still quite sound. Pitch pine is now imported to a small extent in planks, but much of it comes as stowage with the log timber and is poor stuff. It is better to have planking cut from the imported log, and for good flooring it should be cut on the "quarter." The timber is used a good deal in the States for paving, and it is at present being tried as block paving for workshops in England, made up of four pieces, 2 inches by 8 inches, and 8 inches deep, joined by dowels underneath to form a block about 8 inches by 8 inches. This enables very small pieces of wood to be utilised.

After open-air seasoning for about three months, and taking the average over 300 fair-sized logs, the weight of pitch pine worked out at 45·8 lbs. per cubic foot; the minimum was 35·5 and the maximum 54·6. The percentages of weights were as follows:

5	per cent.	under 40 lbs.	per cubic foot.
27	„	between 40 and 45 lbs.	per cubic foot.
54	„	45 „ 50 „	„ „
14	„	50 „ 55 „	„ „

The average weight is rather less than it was twenty years ago.

**Shortleaf Pine** (*P. echinata*), also called slash pine, Carolina pine, yellow pine, etc., resembles loblolly; it is the common tree of Missouri and Arkansas, and is found in all the southern States; it attains a height of 40 to 80 ft., and as a timber it ranks next to longleaf pine, although as regards strength it is slightly weaker than either of the other southern pines.

Weight about 30 lbs. per cubic foot.

In appearance the longleaf and shortleaf pine trees, particularly the latter, very much resemble the Scotch or Northern pine.

**Loblolly Pine** (*P. taeda*) is a large tree which forms extensive forests in the southern States from Virginia and South Carolina right round to Texas. The timber is wider ringed, coarser, lighter, softer, and contains much more sap than the longleaf pine; as a rule the larger portion of the tree is sap, but the two timbers are sometimes mistaken for one another. One occasionally comes across a log of loblolly even amongst a lot of good pitch pine, but it can generally be detected by its much wider rings, greater





*By permission of U. S. Dept. of Agriculture.*

**FIG. 15.**— Loblolly Pine Forest and Loblolly Sleepers.

quantity of sap, and, as a rule, it comes in shorter lengths and greater scantling, often 16 or 17 inches a side. It is a quick-growing tree, and in forty years has attained a height of 80 ft. and 16 inches diameter. It is the first pine to



**THIS PAGE IS LOCKED TO FREE MEMBERS**

Purchase full membership to immediately unlock this page

# DELVE INTO FANTASY, MAGIC, MYTHOLOGY & FOLKLORE

Forgotten Books'  
Full Membership gives  
access to 797,885 ancient  
and modern, fiction and  
non-fiction books.

**Continue**

\*Fair usage policy applies

in this respect somewhat resembling *P. strobus*. It is suitable for doors and sashes and takes paint well.

A large number of tests shows that loblolly is only 6 per cent. weaker than longleaf pine in compression parallel to grain, and 7 per cent. stronger in bending tests, whilst it is of equal strength in compression across the grain and shearing with grain. Its weak point is the great quantity of sap it contains, which makes it of much less value as a constructional timber unless artificially treated, but if creosoted it should be nearly equal to longleaf (pitch) pine.

Weight about 33 lbs. per cubic foot.

**Cuban Pine** (*P. heterophylla*) resembles the longleaf, but often has wider sap and coarser grain, does not enter the markets to any extent as yet, and is stronger than longleaf in compression parallel to grain and as a beam, and equal to it in shearing strength. It is found along the coast from Carolina to Louisiana.

*P. rigida*, which goes by the name of pitch pine in its native district, is a small or medium-sized tree which does not come much into the foreign markets; grows along the coast from New York to Georgia.

All these southern pines go by the name of "yellow pine" in the American markets. Longleaf is considered best; then follow, in order of importance, shortleaf, loblolly, Cuban, and pitch pine (*P. taeda*); they form more than one-fourth of the whole timber cut in the United States, and amounted in 1905 to 730,000,000 cubic feet. Nearly half came from the States bordering the Great Mississippi, which forms an excellent outlet for the timber. There is little doubt that several of these southern pines are imported into Great Britain under the name of pitch pine, it may be as yet only in small quantity, but this would

account for much of the poor and sappy material recently put on the market. If the timber were creosoted one need have no fear of using any of these.



*[By permission of U. S. Dept. of Agriculture.]*

FIG. 16.—Sugar Pine and Incense Cedar in foreground,  
Western Yellow Pine in background.

**Sugar Pine** (*P. lambertiana*), Fig. 16, forms extensive forests in the Rocky Mountains and furnishes most of the timber of the west United States. It is confined to Oregon

and California, and grows at from 1,500 to 8,000 ft. above sea level. Botanically it closely resembles the *P. strobus*, but is a larger tree and of rapid growth; has an average height of 150 to 175 ft. and a diameter of 4 to 5 ft., with a maximum height of 235 ft. and 12 ft. diameter. The wood is soft, straight grained, easily worked, very resinous, and has a satiny lustre which makes it appreciated for interior work; its colour is very like Baltic redwood. It is extensively used for doors, blinds, sashes, and interior finish, also for druggists' drawers, owing to its freedom from odour, for oars, mouldings, shipbuilding, coopers' work, shingles, and the poorer grades for fruit boxes. It is largely replacing white pine, owing to its cheapness. The timber is fairly free from attacks of fungus, and very durable, as proof of which many mills are now working up large logs which have lain on the ground for thirty or forty years, and though the sapwood has rotted away the heartwood is usually as sound as on the day the tree was felled.

Very little of the timber goes abroad, owing to the difficulties of transport, but in 1905 over 400,000 cubic feet were exported *viâ* Galveston, the larger portion of which went to Australia, and the balance to Great Britain.

Weight about 30 lbs. per cubic foot.

**Western Yellow Pine** (*P. ponderosa*), or bull pine, is the most widely distributed tree in the West, its range comprising almost the whole of the Pacific and Rocky Mountain regions. It is sold under the names of western pine, western white pine, and California white pine, closely resembles the Jeffrey pine (*P. jeffreyi*), and attains a height of nearly 200 ft. with a maximum diameter of 6 to 7 ft.; it is more subject to insect attack than probably any other western conifer, grows much more rapidly than the sugar

pine up to 100 years of age, and the timber is rather heavier and stronger, the heartwood is reddish brown, sapwood yellowish white, and there is often a good deal of it. It is extensively used for beams, flooring, ceilings, and building work generally, also for railway sleepers, and the smaller trees for pit props. Sugar and yellow pine form nearly half of the timber output of California at the present time, redwood nearly the other half. Western yellow pine is very resinous, but less so and lighter than the southern yellow pines. The resinous smell of the wood is very remarkable (Fig. 16).

Weight about 32 lbs. per cubic foot.

**Douglas Fir or Oregon Pine** (*Pseudo-tsuga Douglasii*), Fig. 17, also known as Douglas spruce, yellow or white fir, and red fir, is really neither a pine nor a fir; it is generally known to the trade as Oregon, and it is sometimes said that Douglas fir is the better timber. They are really the same, although, as is often the case, the timber from one locality is better than that from another.<sup>1</sup> It is the chief tree of Washington and Oregon, and the most abundant and most valuable in British Columbia, where it attains its greatest size; in Vancouver Island, or along the shores and along the river valleys near the coast on the mainland, trees of 300 ft. in height are not rare. This timber is shipped from San Francisco and other Pacific ports; it ranks third in order of timber-producing trees of the United States,<sup>2</sup> has nearly trebled its output from 1899 to 1905, and the output will doubtless soon exceed that of the pine of the southern States.

<sup>1</sup> There are two kinds of Douglas fir recognised, one called "red fir," although it is not really a fir, and which is the timber usually imported into Great Britain, and the other called "white fir," and is strictly a fir, but is not such a good timber for general purposes.

<sup>2</sup> In 1906 statistics it ranks second, and white pine third.



*[By permission of U. S. Dept. of Agriculture, Forestry Div.]*

**FIG. 17.—Typical Forest Mixture in Washington.**  
Species from left to right: Douglas Fir, Spruce,  
Hemlock, Cedar, Douglas Fir.

Now that pitch pine is more difficult to get in long lengths and large scantling, Oregon is being largely imported into Great Britain. It has been known as a good, sound timber for many years, but the cost of bringing it across prevented its competing with pitch pine in the English market when that timber was cheap; but now that the price of pitch pine, indeed timber in general, has advanced so much during the last few years, Oregon has a better chance in the market, and is likely to be used in the future for all purposes for which pitch pine has been used in the past. There is little doubt that in the near future it will be the chief timber used for heavy construction in Great Britain, where long lengths and large scantlings are required. There are enormous supplies of this timber, and it can be obtained in almost any required length, such as 100 to 120 ft., and up to 20 inches square, and in shorter lengths of larger sizes. The logs are sawn with perfectly square edges to 10, 12, 14, 16, and 20-inch sides; there is no difficulty in getting them 60 ft. long and 14 to 18 inches square, and the price is about the same as that of pitch pine. Good Oregon is not such a sound, strong timber as good pitch pine; it is more variable in character, and it is doubtful if it will weather as well—we have not had sufficient experience to say. But, as we have said, pitch pine is difficult to get in large sizes, and the Oregon is quite equal to much of the pitch pine now imported. It is of reddish yellow colour, redder than pitch pine, but very like it in general structure, such as annual rings, straightness of grain, etc., so that when logs of the two timbers are lying together it is often difficult to tell one from the other by looking at the surface; but Oregon has little of that resinous quality so characteristic of pitch pine, and the wood when sawn has a much woollier appearance, somewhat resembling Canadian red pine, and in



colour it is not unlike some of the cedars. It is, as a rule, of larger "bait" than pitch pine. A carpenter would call it a rougher wood, and though apparently more open in grain it will nevertheless take in much less creosote than either pitch pine or Baltic timber, and that is rather against its use for sea work. On one occasion some Oregon logs were tanked with Baltic redwood logs; the latter took in nearly 11 lbs. of creosote per cubic foot, whilst the maximum for the Oregon was only  $2\frac{3}{4}$  lbs., and the same thing applies to thin planks. On several occasions the author has made careful comparisons in creosoting this timber, and he has got 7 to 9 lbs. of creosote per cubic foot into pitch pine which has been air drying for about three months, whilst Oregon logs dried under the same conditions and for the same period, and subjected to the same pressure in the cylinders along with the pitch pine, rarely took in more than 3 lbs., and many of them not 3 lbs., per cubic foot, and retanking and repressing made no appreciable difference in the quantity injected. It is a lighter wood than pitch pine, weighing only about  $37\frac{1}{2}$  lbs. per cubic foot after seasoning. This was the average taken over fifty large logs—the maximum weight of any piece was 42 lbs., the minimum 33 lbs. per cubic foot. The average weights were as follows:—

19	per cent.	weighed	33 to 35	lbs.	per cubic foot.
23	"	"	35 to 37	"	"
39	"	"	37 to 40	"	"
19	"	"	40 to 42	"	"

showing that it does not vary so much as pitch pine. It is more easily worked, having none of that stickiness which makes pitch pine so unpleasant for the carpenter or joiner, is well adapted for piling and heavy structural work, and is now largely used for harbour and dock work. It is



**THIS PAGE IS LOCKED TO FREE MEMBERS**

Purchase full membership to immediately unlock this page

# Know Your Bible

Forgotten Books'  
Full Membership  
provides unlimited  
access to more than  
28,000 volumes of  
Christian literature for  
\$8.99/month

**HOLY  
BIBLE**

**Continue**

\*Fair use policy applies

The name fir is, in America as well as in Great Britain, applied to trees and timber which are not fir. In America it is commonly applied to spruce, and in the English markets to Baltic pine. The wood very much resembles spruce, but can be distinguished from it as well as from pine and larch by the absence of resin ducts. Its qualities, uses, and habits are similar to spruce.

Amongst American firs may be mentioned:—

**White Fir** (*Abies grandis* and *Abies concolor*), an important tree. The former occurs from Vancouver to California, and the latter from Oregon to Arizona and eastward to Colorado and New Mexico. The wood is soft and light, coarse grained, not unlike the “Swiss pine” of Europe, but darker and firmer, and is not suitable for any purpose requiring strength. It is used in Canada for boxes and barrels, and to a small extent for pulp. *Abies amabilis* is also a good-sized tree which is found in Washington and Oregon.

**Red Fir** or **Noble Fir** (*A. nobilis*), not to be confounded with Douglas fir, is a very large tree, forming with white fir extensive forests on the Cascade mountains of Oregon, 3,000 to 4,000 ft. above sea level.

**Balsam Fir** (*Abies balsamea*) is sold with pine and spruce, grows from Minnesota to Maine and northward, and is a common tree in Ontario and Quebec; wood light and soft, not durable in the ground. It is used for pulp, but is not one of the best woods for that purpose. The “Canada balsam” of druggists is obtained from blisters on the bark of this tree.

**Larch.** The American and Canadian larches produce excellent timber and are known as tamarack or hackmatack.

The western larch or tamarack (*Larix occidentalis*) is little inferior to oak in strength and durability, grows to a height of 100 to 150 ft., and yields a timber of light brown colour with lighter sapwood, has a fine, slightly satiny grain, and is fairly free from knots; the annual rings are distinct. It is very largely used for railway sleepers in Canada, also for planking sidewalks and footpaths in towns, and it is employed to a small extent in shipbuilding.

The Common or American Larch or Black Larch (*L. americana*) is common in the northern parts of Manitoba; it is a smaller tree than the western larch, about 80 ft. in height and 2 to 3 ft. diameter, and produces hard coarse-grained but strong and durable timber. It is valued for sleepers, telegraph poles and posts. It often inhabits swamps and low-lying ground, where the trees are smaller and the timber produced is of poorer quality.

The American larches, like those of Europe, have straight and tapering stems; their timber resembles that of the best hard pine, both in appearance and quality and in its uses, and it is very durable. They grow plentifully in Canada and the northern parts of the States. Their timber is somewhat similar to, probably rather better than, the European larches, but it is not yet a commercial commodity in Great Britain, nor is it largely used in the United States. The tree is peculiarly liable to disease.

Weight 34 to 42 lbs. per cubic foot.

**Eastern Hemlock** (*Tsuga canadensis*), often called spruce or hemlock spruce, and by the French in Canada "Peruche," is a medium-sized tree found in the same districts as black spruce. It produces a coarse-grained wood, brittle, subject to shakes, easily split, a softish timber but rather firmer than white pine; it is used as a substitute for that timber. It grows plentifully in New York State and Pennsylvania,

and also in Quebec and Ontario, where it forms extensive forests, attains a height of 70 to 100 ft., and 2 ft. in diameter. It is used for rough framing, and in large quantities for railway sleepers, and it holds nails well. Great quantities are used in Canada for piling in wharves and quays. The colour is a light brown tinged with yellow, the sapwood nearly white. It is imported as deals and battens.

Weight about 36 lbs. per cubic foot.

**Western Hemlock** (*Tsuga heterophylla*, or *T. mertensiana* in Canada) is by many considered superior to eastern hemlock, although the difficulty of transport and the high reputation of the latter have hitherto caused it to be little used, but in 1905 a considerable quantity was cut in Washington. To get the timber into the market it is usually manufactured into flooring and scantling and sold as spruce or fir, and an attempt has been made to introduce it as Alaska pine. It is a good deal used for pulp. There is no record of its durability. It has given satisfaction in floors. Not adapted for use partly in and partly out of ground; in fresh water, hemlock piles will last about ten years, but as it is softer than fir it is less able to stand driving successfully. It is straight in grain, will take a good polish, is much used for wainscot panels and newels, and has a beautiful grain when cut in certain ways. Very subject to black streaks or checks  $\frac{3}{4}$  to 3 inches long, about  $\frac{5}{8}$  inch wide, and thin, which run parallel with the grain, and are apt to open out when dried; it is also liable to black knots, and very liable to attack by boring insects. It is not suitable for heavy construction, especially where exposed to weather, but is used for ordinary building work. Though usually of whitish colour the heartwood is sometimes a reddish brown, which may extend to the sap, and

is a serious defect in timber which is to be used as pulp. The western hemlock is a noble tree with very cylindrical, straight, tapering trunk, and has been found with a diameter of 8 ft. and a height of 250 ft. (Fig. 17).

Hemlock of either species is not much appreciated in Canada, as there is abundance of other timber of a similar kind and of better quality. Hemlock, the western variety especially, may be recognised by the silvery character of its surface.

Weight about the same as spruce of the same localities, about 27 lbs. per cubic foot.

**Yew** (*Taxus brevifolia*) is a small to medium-sized tree, forms no forests, but is scattered amongst the conifers. The wood is heavy, hard, stiff and strong, of fine texture with pale yellow sap and orange-red heart, seasons well, and is quite durable.

Extensively used for archery bows, turners' ware, etc.

**Hickory.**—The hickories of commerce are exclusively North American, and some of them are large and beautiful trees of 60 to 70 ft. or more in height. They are closely allied to the walnuts, and the timber is very like walnut in grain and colour, though of a somewhat darker brown. It is one of the finest of American hardwoods in point of strength; in toughness it is superior to ash, rather coarse in texture, smooth, straight in grain, heavy and strong as well as elastic and tenacious, but decays rapidly when exposed to damp and moisture, and is said to be very liable to attack from worms. Great quantities are used for hoops of casks; it makes excellent handspikes, handles of axes or picks, golf clubs, fishing rods, and is largely employed in the making of carriage shafts and in coach-building generally. Hickory is imported into Great

Britain in round logs up to 18 inches diameter; the second growth wood is the best. There are many varieties of hickory—mockernut hickory, also known as whiteheart, big bud, etc. (*Hicoria alba*), big shellbark hickory (*H. sulcata*), small-fruited hickory (*H. microcarpa*), pignut hickory (*H. glabra*), shagbark or shellbark hickory (*H. ovata*), and others, all medium-sized trees which produce the hickory of commerce and also yield the nuts so much esteemed, which in flavour resemble walnuts. The **Bitternut** is not quite so valuable as hickory, but is used for the same purposes. Like many other American hardwoods, hickory is getting scarce. The cross section of hickory is peculiar, the annual rings appear like fine lines instead of like the usual pores, and the medullary rays, which are also very fine but distinct, in crossing these form a peculiar web-like pattern which is one of the characteristic differences between hickory and ash (Figs. 4 and 11), the latter having a very clearly defined zone of spring wood pores; hickory is also of more reddish hue than ash, and is lacking in figure. Hickory is rarely subjected to artificial treatment, but there is this curious fact in connection with the wood, that, contrary to most others, creosote is only with difficulty injected into the sap, although there is no difficulty in getting it into the heartwood.

Weight of hickory 45 to 55 lbs. per cubic foot. Pignut is the heaviest, and from some tests made would appear to be the strongest.

About 5,000,000 cubic feet were cut in the States in 1905, 67 per cent. of which came from Indiana, Arkansas, Kentucky, Tennessee, and Ohio; it is found in parts of Ontario in Canada, but not in any great quantity.

**Cedar.**—The cedar properly so called is the well-known tree of Biblical times, the Cedar of Lebanon (*Cedrus libani*),

but of the ancient forests where this tree grew only a few hundred trees are left, and these are found at an elevation of about 8,000 ft. above sea level. The cedar was well known to the Sumerian founders of Eridu, the oldest city of Babylonia, six to eight thousand years ago. It is a tree of only moderate height, 50 to 80 ft., with massive trunk and large branches; some fine specimens of cedar of Lebanon are to be found in Britain, among other places at Sion House, Goodwood, Hopetown, Dalkeith, and a few scattered about Enfield. The heart of the timber is reddish brown, the sap reddish white, the wood is straight grained but porous, somewhat like larch in appearance, and though the timber had a high reputation in ancient times, that grown in Europe is soft and brittle, liable to warp, but in some outside situations durable. The name cedar is given to many trees which are not true cedars; the Siberian stone pine is called cedar, and the red cedar of California is a species of fir, the Virginian or red cedar of the United States is a species of juniper, and some of the American so-called cedars are cypresses. There are some very fine trees amongst the North American cedars which produce valuable timber suitable for inside or ornamental work and other purposes.

**Red Cedar** is one of the most widely distributed and one of the most valuable of American forest trees. It is rare in Canada, but grows along the St. Lawrence and on the north of Lakes Ontario and Erie, and from there to the Gulf of Mexico and as far west as Texas and Nebraska, and is most extensively found in Alabama, Florida, and Tennessee; few trees exhibit a greater indifference to soil and climate, and it must be very hardy, adapting itself as it does to such a wide range.

There are two varieties, the northern red cedar (*Juniperus*



*virginiana*), Fig. 18, and the southern (*J. barbadensis*), which grows in the sub-tropical coastal region from Georgia to Florida and westward along the shores of the Gulf of



[By permission of U. S. Dept. of Agriculture.]

FIG. 18.—Red Cedar (*Juniperus virginiana*).

Mexico to Texas. The latter is also found in Jamaica and other West Indian islands. The structure and physical properties of the two species are practically the same. The red cedar grows to a height of 50 to 60 ft., and, the



**THIS PAGE IS LOCKED TO FREE MEMBERS**

Purchase full membership to immediately unlock this page

# DELVE INTO FANTASY, MAGIC, MYTHOLOGY & FOLKLORE

Forgotten Books'  
Full Membership gives  
access to 797,885 ancient  
and modern, fiction and  
non-fiction books.

**Continue**

\*Fair usage policy applies

It is usually got in lengths of about 25 ft. and 15 to 20 inches square ; the annual rings are fairly close, eight to fifteen to the inch, and in old trees from twenty to thirty, and the medullary rays are small and faint. It comes to the English market under the name of pencil cedar.

Weight about 31 lbs. per cubic foot.

**White Cedar**, of which there are several varieties, is a similar timber to the red cedar, but is whitish or light greyish brown in colour, and has not the strong fragrance of the latter.

The following are white cedars in the American timber trade :—

**Port Orford Cedar** (*Cupressus lawsoniana*), a very large tree of Oregon, yielding a fine, close-grained, yellowish white durable timber, elastic, easily worked, free of knots, and fragrant, and much used for panelling and furniture.

The **Alaska** or **Yellow Cedar** (*Cupressus nootkatensis*) of the same high regions on the west coast is equal to or better than the above for inside work.

**White Cedar** (*Cupressus thyoides*), also from the western States.

The **Arbor vitæ** or **White Cedar** (*Thuja occidentalis*), a tree of 20 to 40 ft. in height, which grows in the northern States, is much appreciated for sleepers ; used also for shingles (all cedars are appreciated for shingles and are more used for this purpose than any other timber in the United States, and white cedar shingles, if of good quality, have a life of forty to fifty years in the northern States),<sup>1</sup>

<sup>1</sup> Roof shingles in America are from 16 to 24 inches long, 6 to 10 inches broad, and taper in thickness from  $\frac{1}{2}$  to  $1\frac{1}{2}$  inches. In the Alpine districts of Europe they are larger.

posts, coopers' work, boats, and building. This tree appreciates swampy situations. The wood is light, soft, reddish in colour, and bears exposure remarkably well. It is abundant in the Canadian provinces of Quebec and Ontario, where it grows to a considerable height but small diameter, and is the timber chiefly used for telegraph posts.

**Incense Cedar** (*Libocedrus decurrens*) is another large tree which grows in Oregon and California, producing a fine-grained wood (Fig. 16).

**Idaho Cedar** has been largely used in the past for telegraph posts, but many districts from which the supplies have hitherto come will be worked out in ten or fifteen years' time.

**Canoe Cedar** or **Red Cedar** of the West, also called giant arbor vitæ (*T. gigantea* or *T. plicata*), used by the Indians for canoes, is another white cedar of the States timber trade and ranks next to Douglas fir as a timber tree in British Columbia, and in Vancouver Island it attains a great size. It is found in the Selkirk Hills; though rarely more than 150 ft. in height, it is of the considerable diameter of 8 to 10 ft. In Canada it is chiefly used for shingles. The wood takes a fine polish suitable for interior finishing, as there is much variety of shading in the colour. It is also a good deal used for fencing and telegraph posts.

This tree is in the Vancouver district often confused with the yellow cypress or yellow cedar (*Thuja excelsa*), a tree of about the same height, but of less diameter, and which produces timber of a similar character.

The cedar woods above described are soft and stiff, but not strong, of fine texture, season rapidly, shrink and warp but little, are very durable, and owing to this quality are, as has been stated, preferred for shingles and much used

for sleepers. The State of Washington supplies 69 per cent. of the total cut in the United States with the exception of the red or pencil cedar. They are but little known in the English timber trade.

These cedars must not be confounded with the furniture cedar of the English market which is the produce of the *Cedrela odorata* and is of the same species as mahogany.

**Red Gum** (*Liquidambar styraciflua*), sometimes called sweet gum, is the timber known in the English market as satin walnut—one of the many misnomers of the trade.

It is the most common of the three species of gum which grow in the southern States (from Carolina to Kansas and south to the Gulf of Mexico) and is the commonest tree in parts of the south. In the best situations it attains a height of 150 ft., with 5 ft. diameter, but this is exceptional; the stem is straight and cylindrical, and the timber is exported from the southern ports in logs up to 18 ft. long and 24 inches a side. Much of it grows along swampy land subject to flooding, and great difficulty arises in cutting and getting it to market, the green timber being so heavy that much of it will not float. About 60 per cent. of the timber, and in some cases as much as 85 per cent. of trees 15 inches in diameter, is sap, whilst in the larger trees the percentage is less. The sap is a creamy white colour, the heartwood rich reddish brown; the timber is straight in grain and has but few knots, the heartwood is very durable, the sap quickly decays; it is not strong enough for structural work. The external appearance of the wood is of fine grain and smooth, close texture, but when broken the lines of fracture do not run with the apparent direction of the growth; possibly it is this unevenness of grain which renders the wood so difficult to dry without twisting. It is a fairly tough wood, about as strong and stiff as chestnut,



**THIS PAGE IS LOCKED TO FREE MEMBERS**

Purchase full membership to immediately unlock this page

# Know Your Bible

Forgotten Books'  
Full Membership  
provides unlimited  
access to more than  
28,000 volumes of  
Christian literature for  
\$8.99/month

**HOLY  
BIBLE**

**Continue**

\*Fair use policy applies

There is no doubt that close grain, durability, and power of abrasion, the qualities necessary for good paving blocks, are to be found in the red gum if only the timber can be so seasoned as to prevent warping and twisting. In some tests made by Mr. W. Kendrick Hatt, Ph.D., of the United States Forest Service, joists of 16 ft. span, 4 inches by 8 inches to 6 inches by 8 inches, gave an average fibre stress at elastic limit of 2,608 lbs., a modulus of rupture of 4,570 lbs., and a modulus of elasticity of 1,075,000 lbs. per square inch; the average crushing strength parallel to grain was 2,620 lbs. and at right angles to grain 639 lbs. per square inch.

**Tupeloe Gum** or **Tupeloe** (*Nyssa aquatica*), another of the three important gums of the southern United States, is found over the same district as the red gum, but the chief district from which the supplies come is near Mobile and Southern and Central Louisiana, where the country is very swampy and where the tree during the rainy season stands in from 6 to 20 ft. of water.

The heartwood varies in colour from a dull grey to a dull brown, the sap, which is considerable, is white or light yellow, like that of poplar, and after seasoning it is difficult to distinguish the better grades of the sapwood from poplar. It is sold in the American market as bay poplar, as it was substituted for a grade of yellow poplar found near Baltimore which is now getting scarce. In the furniture trade it is sometimes called Circassian walnut, and some manufacturers call the wood nyssa, a subterfuge again, owing to the feeling against these gums. Tupeloe is about the same weight and strength as red gum, but much tougher, and there is the same difficulty in seasoning, so it is cut into boards of one inch thick or less. It is used for furniture drawers and backs, for panel work and

inside finish, but chiefly for boxes, as it is light, strong, and cheap. It is of fine even grain, moderately hard and stiff, not elastic, very tough and hard to split, easily worked, but is not durable in contact with ground; it is also used in the States for flooring, laths, wooden pumps, and turnery, largely for mouldings, and in Great Britain chiefly for casings over electric wire fittings; great quantities are used for this purpose. Great Britain is the best market for tupeloe.

Weight when well seasoned about 32 lbs. per cubic foot. Some of it lost 32 per cent. of its weight by kiln drying for fifteen days and shrunk  $4\frac{1}{2}$  per cent.

**Black Gum** (*Nyssa sylvatica*) is the other of the southern States gums, and, though it has a greater range than tupeloe or red gum, nowhere forms an important part of the forest. Owing to its less abundant supply and the poorer quality of its timber it is not cut as mill timber, but is used for wagon repairs, cattle yokes, and other purposes requiring a strong non-splitting wood, also largely for pulley blocks and belt wheels.

**Chestnut** (*Castanea vulgaris*) was formerly common over the New England States, Pennsylvania supplying 18 per cent. of the total cut, Tennessee coming next, but the timber is getting so scarce that supplies have been drawn from the Canadian boundary and as far west as Minnesota on the north to the centre of Texas on the south; it is one of the chief timbers used in the States for telegraph poles, and something like 53,000,000 cubic feet are required annually for this purpose, also for sleepers and fencing. Chestnut is a long-lived tree attaining an age of 400 to 600 years, but trees over 100 years are usually hollow; it grows quickly, and sprouts from a chestnut stump often attain a height



of 8 ft. in the first year. It has a fairly cylindrical stem and grows to a height of 100 ft.

The wood is light yellow or yellowish brown in colour, the heartwood being readily distinguishable from the lighter coloured sap which very early turns into heartwood, and it hardly ever amounts to 20 per cent. of the volume of the tree; works easily, but splits and shrinks a good deal in drying; the annual rings are very distinct, medullary rays very minute and not visible to the naked

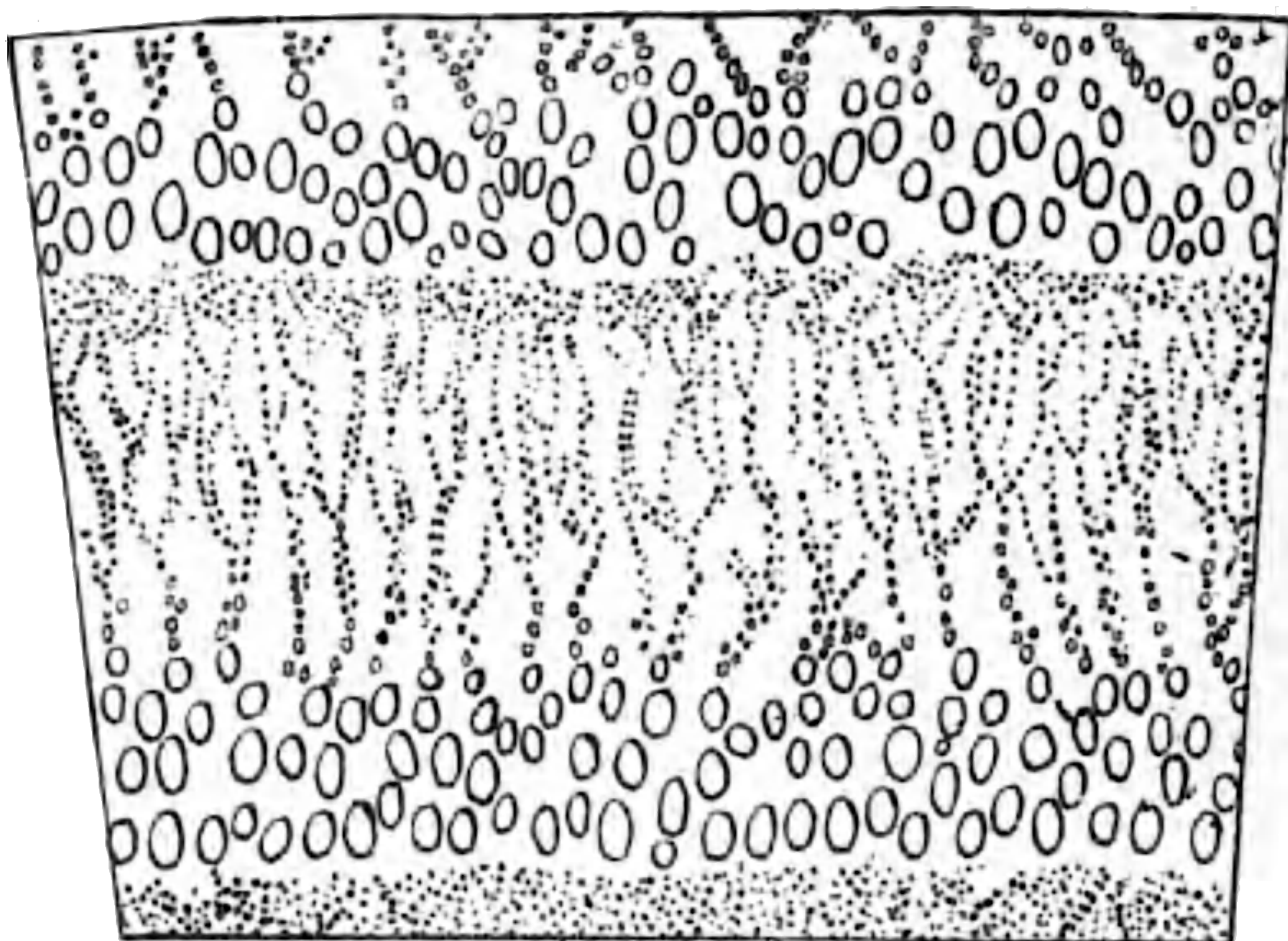

[After Roth.]

FIG. 19.—Cross section of Chestnut.

eye (Fig. 19). Coppice chestnut, that is, chestnut grown on old stumps, furnishes better timber for working than chestnut from the nut; it is heavier, less spongy and straighter in grain, easier to split, and stands exposure longer, but the ends are inclined to split after sawing. Chestnut wood is flexible and elastic, not strong, but very durable when in contact with the soil, which is due to the amount of tannic acid it contains. Owing to the very thin sapwood, chestnut is of use when ten or twelve years old, an age when most hardwoods are useless. Many railways



**THIS PAGE IS LOCKED TO FREE MEMBERS**

Purchase full membership to immediately unlock this page

# DELVE INTO FANTASY, MAGIC, MYTHOLOGY & FOLKLORE

Forgotten Books'  
Full Membership gives  
access to 797,885 ancient  
and modern, fiction and  
non-fiction books.

**Continue**

\*Fair usage policy applies

**Black Spruce** (*Picea nigra*) is a medium-sized but important tree in the eastern States chiefly used for the manufacture of pulp, and great quantities of this as well as of white spruce are used for that purpose. Others of the species are Red spruce (*P. rubens*), closely allied to the above, Engelmann spruce (*P. engelmanni*), and Sitka spruce or Tideland spruce (*P. sitchensis*), which grow plentifully in British Columbia, and the latter particularly is largely used on the west coast for doors, window frames, and shelving and interior finishing, and is a valuable pulp wood. Spruce is one of the resonance woods and is a good deal used as sounding boards for pianos, violins, etc.

**Myrtle or Laurel** (*Umbellularia californica*), a Californian tree, produces timber of light brown colour of great size and beauty, and is very valuable for cabinet and inside work, as it takes a fine polish.

**Cherry** is found extensively in the western States and Canada. The wood is fine grained and of moderate hardness, the colour a beautiful reddish or yellowish brown, not difficult to work, has a satin-like surface when smoothed, and takes a fine polish which somewhat resembles mahogany; the pores are small and indistinct, the medullary rays very distinct but fine. The Black Cherry (*Prunus serotina*), a tree of 50 to 80 ft. high, is especially esteemed and can be obtained in wide boards; cherry mellows and grows richer in colour with age, the varieties with wavy textures are particularly beautiful; the timber is mostly used for cabinet work and furniture, turnery, walking-sticks, etc. The wild cherry of Canada also goes by the name of buckthorn. Stained birch is often used as a substitute for cherry.

**Oaks.**—There are something like fifty species of oak in the United States and Canada: it is the White Oak (*Quercus*

*alba*) which is generally known as American oak, but timber from many of the other species is doubtless exported under the same name. The white oak, which is found from Canada to California and Florida, is a tree of 60 to 80 ft. high and 4 ft. diameter; a good deal comes from Quebec, which grows in the Lake States, and this northern oak is of a better quality than that which comes from further south. The wood is much the same colour as European oak, being pale reddish brown, with coarse grain; it is sound, hard, and tough, very elastic, does not shrink much, and can be bent to any form when steamed; annual rings are distinct, medullary rays very broad and conspicuous, and the pores are very fine and numerous, especially in the summer wood. It is the strongest of American oaks, not so strong, compact, or durable as English or Dantzic oak, but it has the advantage of greater length and square. It is used in shipbuilding, and in parts of buildings where formerly English oak was used, also in wagon building, and largely in the furniture and cabinet trades. In the past it has been much used for sleepers on the United States railways. Several oaks go by the name of white oak with different botanical names in different districts. Western white oak (*Q. garryana*) grows in Vancouver district, and the wood is very like that of English oak.

**Red Oak** (*Q. rubra*) is found over the same regions as the white oak, and is more plentiful; it produces a brownish coloured wood, spongy in grain, moderately durable, but unfit for work requiring strength. It is used for furniture and cask staves, is inferior in quality to the white oak, but almost as hard and heavy.

**Live Oak** (*Q. virens*) grows from Maryland to the Gulf of Mexico and attains a height of 60 ft. and 4 ft. diameter; the

wood is hard, strong, and durable, but of rather quick growth and makes good mallets. The live oak of Florida is now reserved by the United States Government for navy purposes.

**Iron or Post Oak** (*Q. obtusiloba*), of the eastern and southern United States, gives timber of great strength but small in size, the tree being seldom more than 14 inches in diameter. The colour is of a brownish yellow hue, close in grain, and often superior to the white oak in strength and durability. It is much used for posts and fencing.

**Swamp Post Oak** grows in the swampy districts of Carolina and Georgia, and is a larger tree than most of the other oaks, and produces excellent timber, but it grows in districts difficult of access, and is not much used.

**Burr Oak** (*Q. macrocarpa*), one of the most valuable and most widely distributed of American oaks, 60 to 80 ft. in height, and, unlike most of the others, adapts itself to very varying climatic conditions; the wood is very like that of the white oak, and is classed with it; one of the most durable of oaks when in contact with soil.

**Rock Oak** or **Rock Chestnut Oak** (*Q. Prinus*) and **White Chestnut Oak** are other species producing good timber, but scarcely up to that of white oak.

American oak comes into Great Britain in logs 25 to 40 ft. long and 12 to 24 inches square or over, also in planks  $1\frac{1}{2}$  to 4 inches thick, and in boards, moulding strips  $8\frac{1}{2}$  by  $\frac{3}{4}$ , and in other forms, and a good deal is imported "quartered." In the American timber trade oaks are divided into two main classes, White and Black, although Red oak, being the most plentiful, is often referred to.

Weight of American oak generally from 44 to 49 lbs. per cubic foot.



**THIS PAGE IS LOCKED TO FREE MEMBERS**

Purchase full membership to immediately unlock this page

# Know Your Bible

Forgotten Books'  
Full Membership  
provides unlimited  
access to more than  
28,000 volumes of  
Christian literature for  
\$8.99/month

**HOLY  
BIBLE**

**Continue**

\*Fair use policy applies

fine grain, whitish or greyish in colour, often with satin-like lustre, some of it cross grained, shrinks in drying but is not very liable to split, is easily worked, but not durable. Cottonwood is looked upon as a soft timber of fair quality, and in common with the poplar has a large output.

The **Aspen** (*P. tremuloides*) is one of the most widely distributed Canadian trees. The wood is light and easily worked. It is used for wooden ware, light barrels for sugar and flour, and for furniture in Canada, but chiefly for pulp.

**Balsam Poplar** (*P. balsamifera*) has much the same range as aspen, and grows to a great height and considerable diameter in Canada.

**Tulip Tree** (*Liriodendron tulipifera*), better known as *Canary wood*, or canary whitewood, is also called a poplar—yellow poplar—and is shipped in large quantities to Great Britain, chiefly in planks of various thicknesses, which can be got up to 27 inches wide. It somewhat resembles satinwood on the first glance, but the dark streaks on the yellow ground show the difference. It is soft and of fine texture, stiff but not strong nor suitable for outdoor work, shrinks considerably but seasons without much injury, is easily worked, stands very well, bends readily when steamed, and takes stain and paint well. It is used for furniture, table tops, car and ship building, panelling, and also for fretwork and by the carver and toy-maker. It is a large tree of 100 ft. and upwards in height and considerable diameter, and is quite common in Ohio basin and southward to Florida.

Weight 30 to 38 lbs. per cubic foot.

**Canadian and American Ash** are of many varieties, and are imported into Great Britain, chiefly for making carriage

shafts, in short round pieces of small diameter, but it also comes in square logs up to 18 inches a side and cut timber 7 to 20 inches wide, 2 to 3½ thick. A good deal is used for furniture and tram and carriage framing; also for barrels, baskets, oars, tool handles, etc. Amongst the varieties are :—

**American or White Ash** (*Fraxinus americana*), found in Canada, becomes scarce south of New Jersey. It is of a very light brown colour, tough, elastic, straight in grain, and the best material for oars. Slower in growth than English ash, the annual rings are much closer, yet very distinct. Second growth wood is preferred.

**Red Ash** (*F. pubescens*), a timber very similar to, but smaller than, white ash.

**Black Ash** (*F. sambucifolia*) is more widely distributed in Canada than the white ash; the wood is not so hard, but is well suited for cooperage work and basket-making. It is darker in colour than white ash, and is used for the same purposes.

**Blue Ash** of Ohio (*F. quadrangulata*), **Green Ash** (*F. viridis*), **Carolina Ash** (*F. caroliniana*), are chiefly found in the southern United States.

Canadian ash in the log is now nearly a thing of the past, the round wood from the States having nearly displaced it, although quite recently a good number of square logs of Quebec ash were landed in England. American and Canadian ash is generally of light brownish tint, similar in character and used for similar purposes to the common ash of Europe, but it is lighter in weight. Some of it is quartered. In ash the medullary rays are scarcely distinguishable, the pores are very fine and scattered in broken lines, and annual rings are distinct. American ash forms



much the larger proportion of the ash used in the trade in Great Britain.

Weight about 38 lbs. per cubic foot.

**Birch** grows plentifully in the Alleghanies and the Lake regions, west of Virginia, and also in Canada. It is imported largely from Quebec and other Canadian ports in logs of short lengths up to 17 ft. and in planks up to 26 inches wide; it makes excellent furniture, shrinks a good deal in drying, and is not durable when exposed.

**Red or Cherry Birch** (*Betula lenta*), a wood of beautiful reddish or yellowish brown and much of it nicely figured, is straight in grain, hard and durable, takes a fine polish, and is largely used for furniture and cabinet work, for which purpose it is sometimes stained to imitate mahogany, and this is not easily detected if well done.

**Yellow Birch** (*B. lutea*), of Nova Scotia and south to Tennessee, is a large tree the timber of which is firm and fine grained, of light brownish yellow colour, hard, tough, and strong. It is used for cabinet work, wheel hubs, and in shipbuilding.

**White Birch** (*B. papyrifera*), a small tree, the timber of which is very like the English common birch, is the principal timber used for spools, bobbins, bowls, shoe lasts, and pegs. It is also much used in the furniture trade.

A great quantity of birch is used in America for chair-making, and some for floors, interior finishings and turnery, as well as for furniture. The medullary rays in birch are very fine and close and not easily seen, the pores are noticeable as grey specks.

Over 1,500,000 cubic feet of American birch was imported into the Mersey in 1906, about two-thirds of which was in planks.

Weight about 44 lbs. per cubic foot.



**THIS PAGE IS LOCKED TO FREE MEMBERS**

Purchase full membership to immediately unlock this page

# DELVE INTO FANTASY, MAGIC, MYTHOLOGY & FOLKLORE

Forgotten Books'  
Full Membership gives  
access to 797,885 ancient  
and modern, fiction and  
non-fiction books.

**Continue**

\*Fair usage policy applies

(*U. crassifolia*), Winged Elm (*U. alata*), and Red Elm or slippery elm (*U. fulva*), with wood of a reddish tinge, found chiefly along river beds.

The three latter are small trees.

The wood of the American elms, like that of the English elm, is liable to twist and split, especially if used in thin scantlings, and should be kept in water or under cover until required for use; there is a good deal of wane on the edges and sometimes a twist in the imported logs, and to get a 12 × 12 timber it may be necessary to saw down a log of about 13½ or 14 inches square; the thin slabs cut off coming in handy for repairs to boats, or similar work. The best logs are of uniform colour. Rock elm is used for fenders on quays and for the fenders, handrails, and keels of ships, and elm generally for cooperage, saddlery and harness work, agricultural implements, and largely for furniture, as the handsome figure produced when elm is cut tangentially is much admired. Elm is also a good deal used by wheelwrights—the hubs of the wheels in the deacon's "one horse shay" were made of "settlers' ellum," last of its timber, "they couldn't sell 'em"; it is sometimes used for piling, where driving is difficult, but is too costly to be much used for that purpose. The medullary rays and pores of summer wood are fine; the pores are in wavy lines.

Weight about the same as English elm, up to 50 lbs. per cubic foot.

**Orham Wood**, which is used in the English shopfitting trade and a good deal for church seats, is a species of elm with coarse and open grain, of light brown colour, which comes from Canada. *Orme* is the French for elm, hence doubtless the corruption of the word into orham. It works up to a nice smooth surface.

**Sequoia** or **Californian Red Wood** (*Sequoia sempervirens* and *S. washingtoniana*) is only found on a narrow strip of coast line, ten to thirty miles wide, extending from the southern boundary of Oregon to Monterey Bay. *S. semper-*



[By permission of U. S. Dept. of Agriculture.]

FIG. 20.—Redwood Forest (*Sequoia sempervirens*)

The man standing at foot of tree enables one to judge the size of some of this timber.

In this place 85 per cent. of the forest is Redwood, and the average diameter of the Redwood trees at breast high is 7 ft.

*virens* grows to a greater height than any other American tree and is only exceeded in girth by the “big tree” of the allied species. It sometimes reaches 350 ft. with an unbranched trunk for 100 ft. from the ground (Fig. 20).

The timber in quality and uses is somewhat like white

cedar; it varies a good deal, is sometimes brittle and cross grained, sometimes soft and fine grained, but always very durable; rather liable to split, not generally used for carpentry work in Great Britain, though sometimes for drawer linings and a good deal for shop signs, etc.; will not take polish. It comes from San Francisco and neighbourhood, where it is one of the chief building timbers, in conjunction with yellow and sugar pine, and is also used largely there for panelling as a substitute for plastered walls, and largely for shingles; it comes to the English market generally in planks of two inches thick and upwards, but, although practically free from sap and not liable to twist or warp, it is not much appreciated there. The colour is a bright, clear red, sometimes reddish yellow, turning darker on exposure, and with thin, nearly white sapwood. The wood is very light, when well dried, weighing only about 18 lbs. per cubic foot. This tree is rapidly being converted into lumber; about 35,000,000 cubic feet were cut in 1905.

The so-called "big trees" of California, formerly called Wellingtonias, now called *Sequoia washingtoniana*, are found in small groves scattered along the west slope of the Sierra Nevada mountains, amongst the yellow and sugar pine and Douglas fir and the allied species, *S. sempervirens*, "from the middle fork of the American river to the head of Deer Creek, a distance of 260 miles." The utmost search only reveals ten groups, and the total number of these remarkable trees does not exceed 500. They are, however, unique, the grandest, oldest, and most massive stemmed—not quite the tallest—in the world. These two *Sequoia* species are the only remains of the genus of big trees which flourished in the temperate zone of three continents before the glacial epoch, when the great ice wave came down from the north, and one after another the luxuriant



**THIS PAGE IS LOCKED TO FREE MEMBERS**

Purchase full membership to immediately unlock this page

# Know Your Bible

Forgotten Books'  
Full Membership  
provides unlimited  
access to more than  
28,000 volumes of  
Christian literature for  
\$8.99/month

**HOLY  
BIBLE**

**Continue**

\*Fair use policy applies

much below 5,000 ft. nor much more than 10,000 ft. above sea level (Fig. 21).

These trees are thus interesting from a scientific point of view, being the last living representatives of a former geological age.

Redwood is one of the few trees which are but little affected by fungus, thus lasting well for outdoor work or sleepers. Some of the oldest specimens of "big trees" felled were still sound at the heart when cut up.

The average height of the *Sequoia washingtoniana* is about 275 ft., and the trunk diameter near the ground 20 ft., although individual trees from 300 to 320 ft. are not rare. After centuries the tapering stem drops the slender, gracefully curving branches, and the trunk, which is much enlarged and buttressed at the base, becomes naked for 100 to 150 ft.; in very old trees the bark is as much as 2 ft. thick.

Mr. John Muir measured one in King's River Forest 25 ft. in diameter at the ground and 10 ft. in diameter 200 ft. above, and one can ride erect on horseback through the "Father of the forest," whose trunk lies on the ground and whose heart has been eaten out by fire, for a distance of 82 ft.; it is 10 ft. in diameter at 150 ft. from the base, and can still be measured for a length of 365 ft. There is a cross section of one of these trees in the American Museum of Natural History, New York, 16 ft. 2 inches diameter inside the bark, which in places is nearly a foot thick, and if the annual rings are an indication of age it was over 1,500 years old. There is a cross section of another in the Natural History Museum, South Kensington, 16½ ft. diameter cut at 18 ft. above the ground from a tree 276 ft. high. For interesting details of these trees see J. D. Whitney's "Yosemite Guide Book," J. M. Hutchins's "In the Heart of the Sierras," John Muir's

“Mountains of California,” and other books dealing with that region.

The United States Government have some of these big trees in their reserves, but the greater portion are on private lands and will doubtless soon disappear. Dealing with the trunks is difficult owing to their great size; much of the tree is broken up in falling, and the remainder often with gunpowder, causing probably 50 per cent. waste on the timber; it is used locally for grape vines, fencing, shingles, etc. Both the *Sequoia* species are allied to the cypress (*Taxodium distichum*).

**Maple**, of which there are many varieties, grows freely in parts of the northern hemisphere, and is particularly luxuriant in Canada and the northern portions of the United States. One of the most delightful sights in these regions in the autumn is the rich crimson hues of the maple trees. The “maple leaf” is a national Canadian emblem.

The **Striped Maple** (*A. pennsylvanicum*) produces a very white wood much used for inlaying and cabinet work. It is only a small tree.

The **Black Maple** (*A. nigrum*), **Silver Leaved Maple**, **Red Maple** (*A. rubrum*), and the **Broad Leaved Maple** or **Oregon Maple** (*A. macrophyllon*) form extensive forests and produce a light, soft, but not valuable wood.

The **Sugar or Rock Maple** (*A. saccharum*) is specially esteemed; it grows abundantly in Canada, and the United States bordering the Great Lakes, to a height of 60 to 80 ft. and 2 ft. in diameter; the wood is close grained, heavy, fairly hard and strong, the colour light yellowish red or brownish white; it can be worked to a satin-like



surface and takes a fine polish, it is not durable if exposed, and requires a good deal of seasoning. Medullary rays small but distinct. The curly or wavy varieties furnish wood of much beauty, the peculiar contortions of the grain called "bird's eye" being much sought after and used as veneer. Maple is extensively used in all good classes of furniture, cabinet-making, panelling, interior fittings, and turning; it is not liable to warp. Much of it is now used for the floors of mills and workrooms in Great Britain, where it stands the constant friction much better than pine timber, either as planks or blocks; also for picture frames, Tunbridge ware, and the backs, necks, and sides of violins. It is largely employed in America for fence posts, shingles, pails, and railway sleepers. Maple



FIG. 22.

is imported in planks worked on the underside (see Fig. 22), in widths of 4 inches and upwards, and it is holed for secret nailing; it also comes in logs, blocks for flooring, "quartered"

rails, and in large quantities as rollers for wringing and mangling machines, for which there is a great demand. A good deal of sugar is extracted from the sugar maple, and one tree will yield from 5 to 10 lbs. of sugar per season. The peculiarity known as "bird's eye," and which causes a difficulty in working the wood smooth, owing to the little pieces like knots lifting up, is supposed to be due to the action of boring insects. Its resistance to compression across the grain is higher than that of most American timbers.

Weight about 49 lbs. per cubic foot.

**Walnut** (*Juglans nigra*) or **Black Walnut**, a large, beautiful, and quick-growing tree, about 60 ft. and upwards in height, is found in most parts of the United States as far south as



**THIS PAGE IS LOCKED TO FREE MEMBERS**

Purchase full membership to immediately unlock this page

# DELVE INTO FANTASY, MAGIC, MYTHOLOGY & FOLKLORE

Forgotten Books'  
Full Membership gives  
access to 797,885 ancient  
and modern, fiction and  
non-fiction books.

**Continue**

\*Fair usage policy applies

round the log, making very wide, thin boards; it is largely cut as veneer and used as "three ply" for boxes and chair seats, it is also used for sounding boards in pianos and organs. If well seasoned and painted it stands fairly well for outside work.

**Cypress**, of which there are several varieties, the bald cypress, white, black, and red cypress, yields timber similar in character, appearance, and uses to white cedar. The cypress is a large deciduous tree, inhabiting swampy lands, and along rivers and coasts of the southern parts of the United States grows to a height of 150 ft. and 12 ft. in diameter, and produces a wood of beautiful figure and colouring, yellowish or yellowish brown. It is very durable in most situations, as it is very little subject to fungi, light, soft, close grained, and easily worked. It is used for doors, roof shingles, cabinet work, boat-building, etc., and takes a fine polish.

The **Red or Louisiana Cypress** (*Taxodium distichum*), the timber of which at the present time is being placed upon the English market, is generally known as the bald or swamp cypress and is allied to the *Sequoia* species (redwood). It is much used for tanks, vats, and tubs; in New Orleans 90,000 fresh water cisterns are said to be made of this wood, and for this purpose it gives great satisfaction, and has a long life. It can be got in fair lengths and widths; the annual rings are very close. The timber is of fine uniform texture, soft, light, straight in grain and easily worked, but requires careful seasoning; it is very durable in exposed situations, used a good deal in America for conservatories and greenhouses, and by the Navy Department for boats.

A good deal of cypress has been used for railway construction in the southern States. The red and black

varieties are excellent and durable timber ; some consider the black cypress the better wood.

A good many fine specimens of this swamp cypress, which grows best where the roots are always in contact with water, are to be found in Great Britain growing to a height of 100 ft. The timber is said to last well in fencing, but we have not had much experience of it.

**Persimmon**, the Virginian date plum (*Diospyros virginiana*), a tree of 30 to 50 ft. high and 18 to 20 inches in diameter, is noted chiefly for its fruit, but it produces a very hard and elastic timber of considerable value, some of which comes in small pieces into the English market. The colour of the wood is brown, sometimes almost black, with rather broad, cream coloured sap, very close grained, tough and strong, but liable to split. It is used in turnery and now largely as a substitute for box—especially the black or Mexican variety—and a good deal in shuttles for weaving purposes, shoe lasts, etc. It does best in the lower Ohio valley, but is found from New York to Texas. The tree is also found in various parts of the world, including Japan. The annual rings are distinct, and medullary rays very fine. It somewhat resembles hickory, but is of finer texture.

**Locust or False Acacia** grows extensively in the southern States and also in Canada, and produces a timber of greenish yellow colour with reddish or brown markings. It is very durable, heavy, fairly hard and tough, rivalling some of the best oak in this latter quality, makes good treenails and durable fencing posts and door sills, and is a good deal used for fretwork. The timber has great torsional strength, excelling most of the soft woods in this respect. There are several varieties.

The **Black Locust** (*Robinia pseudacacia*), also called yellow locust, is tough, coarse in texture, durable in contact with soil, and shrinks a good deal in seasoning; the yellowish sapwood is very narrow, the heartwood is brownish with shades of red and green. Used in America for wagon hubs, treenails, railway ties, posts, etc., and abroad for furniture, it is one of the best woods for insulator pins on telegraph posts, but it is getting scarce.

The **Honey Locust** (*Gleditsia triacanthos*) is a somewhat similar wood, but so far is not much used, except for fencing and fuel.

Some is known in the trade as brown locust and sold in logs by weight.

Great numbers of locust trees were planted in England many years ago, chiefly owing to the praise given them by William Cobbett.

Locust also grows in Australia, but must not be confounded with the locust of the tropics (*Hymenæa courbaril*). The tree is very subject to damage by a boring insect.

Weight of wood 42 to 48 lbs. per cubic feet.

**Osage Orange** or **Bois d'Arc** (*Maclura aurantiaca*), a tree found in Texas and Louisiana, produces a very hard, heavy wood of brown colour which turns grey on exposure, strong, tough and flexible, of coarse texture which shrinks a good deal in drying, and is very durable. It is much used in the United States for wagon framing and motor wheels, and for the latter has been used in Europe; it is easily split, so is unfit for hubs, but it is very suitable for spokes; it is considered to be one of the timbers likely to supply the place of black locust for insulator pins on telegraph poles.

**Dogwood** (*Cornus florida*), or American box, grows both in the States and Canada, and attains a height of about



**THIS PAGE IS LOCKED TO FREE MEMBERS**

Purchase full membership to immediately unlock this page

# Know Your Bible

Forgotten Books'  
Full Membership  
provides unlimited  
access to more than  
28,000 volumes of  
Christian literature for  
\$8.99/month

**HOLY  
BIBLE**

**Continue**

\*Fair use policy applies

## TESTS OF AMERICAN TIMBER

Carried out by the United States Department of Agriculture.

## RESULTS OF TESTS IN COMPRESSION ENDWISE.

(Pounds per square inch.)

Species.	Number of Tests.	Highest Single Test.	Lowest Single Test.	Average Highest. 10 per cent. of Tests.	Average Lowest. 10 per cent. of Tests.	Average of all Tests.	Proportion of Tests within 10 per cent. of Average.	Proportion of Tests within 25 per cent. of Average.
Reduced to 15 per cent. moisture.								
Longleaf Pine . . .	1,230	11,900	3,400	8,600	5,700	6,900	53	90
Cuban Pine . . .	410	10,600	2,800	9,500	6,500	7,900	61	93
Shortleaf Pine . . .	330	8,500	4,500	7,600	4,800	5,900	47	90
Loblolly Pine . . .	660	11,200	3,900	8,700	5,400	6,500	49	84
Reduced to 12 per cent. moisture.								
White Pine . . .	130	8,500	3,200	6,800	4,000	5,400	49	93
Red Pine . . .	100	8,200	4,300	8,100	4,900	6,700	54	96
Spruce Pine . . .	170	10,000	4,400	8,800	5,600	7,300	66	95
Bald Cypress . . .	655	9,900	2,900	8,500	4,200	6,000	31	74
White Cedar . . .	87	6,200	3,200	6,000	4,400	5,200	79	99
Douglas Spruce (Oregon) <sup>1</sup>	41	8,900	4,100	8,100	4,200	5,700	28	65
White Oak . . .	218	12,500	5,100	11,300	6,300	8,500	40	81
Overcup Oak . . .	216	9,100	3,700	8,600	6,000	7,300	70	95
Post Oak . . .	49	8,200	5,900	8,100	6,000	7,100	58	100
Cow Oak . . .	256	11,500	4,600	9,800	5,600	7,400	51	89
Red Oak . . .	57	9,700	5,400	9,200	5,500	7,200	36	94
Texan Oak . . .	117	11,300	5,800	9,800	6,900	8,100	62	98
Yellow Oak . . .	40	8,600	5,500	8,300	5,800	7,300	58	100
Water Oak . . .	31	9,200	6,200	9,000	6,300	7,800	75	100
Willow Oak . . .	153	11,000	4,200	8,700	5,500	7,200	51	88
Spanish Oak . . .	251	10,600	3,700	9,500	5,100	7,700	61	94
Shagbark Hickory . . .	137	13,700	5,800	10,900	7,500	9,500	79	97
Mockernut Hickory . . .	75	12,200	6,200	11,600	8,000	10,100	65	99
Water Hickory . . .	14	10,000	6,700	9,600	7,000	8,400	71	100
Bitternut Hickory . . .	25	11,500	7,300	11,200	7,800	9,600	60	100
Nutmeg Hickory . . .	72	12,300	6,400	11,000	7,100	8,800	79	97
Pecan Hickory . . .	37	10,500	5,800	10,400	7,300	9,100	51	95
Pignut Hickory . . .	30	13,000	8,700	12,700	8,900	10,900	72	100
White Elm . . .	18	8,800	4,900	8,800	5,000	6,500	28	88
Cedar Elm . . .	44	10,600	6,200	10,100	6,500	8,000	66	95
White Ash . . .	87	9,600	5,000	8,700	5,700	7,200	48	96
Green Ash . . .	10	9,800	6,600	9,800	6,600	8,000	29	100
Sweet Gum (Satin Walnut) . . .	118	8,900	4,600	8,500	5,600	7,100	60	97

<sup>1</sup> Actual tests on "dry" material not reduced for moisture.

RESULTS OF TESTS IN BENDING AT RUPTURE.

(Pounds per square inch.)

Species.	Number of Tests.	Highest Single Test.	Lowest Single Test.	Average Highest. 10 per cent. of Tests.	Average Lowest. 10 per cent. of Tests.	Average of all Tests.	Proportion of Tests within 10 per cent. of Average.	Proportion of Tests within 25 per cent. of Average.
Reduced to 15 per cent. moisture.								
Longleaf Pine . . . .	1,160	17,800	3,300	14,200	8,800	10,900	41	84
Cuban Pine . . . .	390	17,000	2,900	14,600	8,800	11,900	46	83
Shortleaf Pine . . . .	330	15,300	5,000	12,400	7,000	9,200	40	79
Loblolly Pine . . . .	650	14,800	3,900	13,100	8,100	10,100	44	84
Reduced to 12 per cent. moisture.								
White Pine . . . .	120	11,100	4,600	10,100	5,000	7,900	43	81
Red Pine . . . .	95	12,900	3,100	12,300	4,900	9,100	28	60
Spruce Pine . . . .	170	16,300	3,100	13,600	5,800	10,000	43	81
Bald Cypress . . . .	655	14,800	2,300	11,700	5,000	7,900	25	69
White Cedar . . . .	87	9,100	3,500	8,400	4,000	6,300	32	78
Douglas Spruce (Oregon) <sup>1</sup>	41	13,000	3,800	12,000	4,100	7,900	22	58
White Oak . . . .	218	20,300	5,700	18,500	7,600	13,100	39	75
Overcup Oak . . . .	216	19,600	4,900	14,900	6,300	11,300	47	81
Post Oak . . . .	49	16,400	5,100	15,300	7,400	12,300	47	92
Cow Oak . . . .	256	23,000	3,300	12,500	6,500	11,500	32	68
Red Oak . . . .	57	16,500	5,700	15,400	9,100	11,400	46	84
Texan Oak . . . .	117	19,500	8,200	16,900	10,000	13,100	64	86
Yellow Oak . . . .	40	15,000	5,100	14,600	5,700	10,800	28	65
Water Oak . . . .	31	16,000	5,800	15,700	7,200	12,400	40	76
Willow Oak . . . .	153	16,000	3,200	13,800	5,400	10,400	33	70
Spanish Oak . . . .	257	17,300	5,000	15,600	6,900	12,000	40	72
Shagbark Hickory . . . .	187	23,300	5,700	20,300	9,400	16,000	46	84
Mockernut Hickory . . . .	75	20,700	5,300	19,700	7,900	15,200	45	78
Water Hickory . . . .	14	18,000	5,300	17,300	5,400	12,500	21	64
Bitternut Hickory . . . .	25	19,500	7,000	19,300	8,700	15,000	28	60
Nutmeg Hickory . . . .	72	16,600	6,700	15,600	8,100	12,500	40	88
Pecan Hickory . . . .	37	18,300	5,600	18,100	10,300	15,300	38	95
Pignut Hickory . . . .	30	25,000	11,100	24,300	11,500	18,700	43	77
White Elm . . . .	18	14,000	7,300	13,600	7,300	10,300	44	72
Cedar Elm . . . .	44	19,200	6,600	17,300	8,500	13,500	50	86
White Ash . . . .	87	15,000	5,000	14,200	6,300	10,800	37	77
Green Ash . . . .	10	16,000	5,100	16,000	5,100	11,600	20	60
Sweet Gum (Satin Walnut) . . . .	118	14,400	5,100	12,700	6,000	9,500	39	79

<sup>1</sup> Actual tests on "dry" material not reduced for moisture.



RESULTS OF TESTS IN COMPRESSION ACROSS GRAIN, AND SHEARING WITH GRAIN.

(Pounds per square inch.)

Species.	Number of Tests.	Compression across grain.	Shearing with grain not reduced for moisture.
Reduced to 15 per cent. moisture.			
Longleaf Pine . . . . .	1,210	1,000	700
Cuban Pine . . . . .	400	1,000	700
Shortleaf Pine . . . . .	330	900	700
Loblolly Pine . . . . .	690	1,000	700
Reduced to 12 per cent. moisture.			
White Pine . . . . .	130	700	400
Red Pine . . . . .	100	1,000	500
Spruce Pine . . . . .	175	1,200	800
Bald Cypress . . . . .	650	800	500
White Cedar . . . . .	87	700	400
Douglas Spruce (Oregon) <sup>1</sup> . . . . .	41	800	500
White Oak . . . . .	218	2,200	1,000
Overcup Oak . . . . .	216	1,900	1,000
Post Oak . . . . .	49	3,000	1,100
Cow Oak . . . . .	256	1,900	900
Red Oak . . . . .	57	2,300	1,100

<sup>1</sup> Actual tests on "dry" material not reduced for moisture.

Species.	Number of Tests.	Compression across grain with indentation of 3 per cent.	Shearing with grain not reduced for moisture.
Reduced to 12 per cent. moisture.			
Southern Red Oak . . . . .	117	2,000	900
Black Oak . . . . .	40	1,800	1,100
Water Oak . . . . .	30	2,000	1,100
Willow Oak . . . . .	153	1,600	900
Spanish Oak . . . . .	255	1,800	900
Shagbark Hickory . . . . .	135	2,700	1,100
White Hickory . . . . .	75	3,100	1,100
Water Hickory . . . . .	14	2,400	1,000
Bitternut Hickory . . . . .	25	2,200	1,000
Nutmeg Hickory . . . . .	72	2,700	1,100
Pecan Hickory . . . . .	37	2,800	1,200
Pignut Hickory . . . . .	30	3,200	1,200
White Elm . . . . .	18	1,200	800
Cedar Elm . . . . .	44	2,100	1,300
White Ash . . . . .	87	1,900	1,100
Green Ash . . . . .	10	1,700	1,000
Sweet Gum (Satin Walnut) . . . . .	118	1,400	800

This series of tests was on 4-inch by 4-inch sticks. The results are higher than those obtained by Lanza on some of the same timbers, but on larger pieces; the number of his tests on each series were fewer.



**THIS PAGE IS LOCKED TO FREE MEMBERS**

Purchase full membership to immediately unlock this page

# DELVE INTO FANTASY, MAGIC, MYTHOLOGY & FOLKLORE

Forgotten Books'  
Full Membership gives  
access to 797,885 ancient  
and modern, fiction and  
non-fiction books.

**Continue**

\*Fair usage policy applies

twisted. The butt end is tapered off, what is called "sledged" or "sniped," for about 3 ft., a hole is bored a few inches deep, and an iron bolt fixed in it (see Fig. 23), by which means the logs are hauled by natives to the rivers, then slung on each side of flat boats, as greenheart will not float, and taken down to the shipping ports at Berbice, Georgetown, and other places, possibly 150 miles distant from where the trees were felled. There are sawmills at these ports, and an effort is being made to develop a trade in sawn greenheart logs, as well as in planks of  $1\frac{1}{2}$  inch thickness and upwards; the former look very nice about 12 inches square and quite straight, the ends banded with iron hoops and painted to prevent their splitting; they



FIG. 23.

cannot, however, be obtained in longer lengths than from 30 to 35 ft.

One of the weak points of greenheart is its tendency to split for two or three feet at the ends, hence the timber should, if possible, be kept in water or mud until required for use; it is thus kept at the British Guiana ports until withdrawn for shipment. Great care has to be exercised in putting the timber through the sawmill or in cross cutting it, as it is liable to "fly"; the safest plan is to slab the sides before proceeding to convert it—then there is not nearly so much risk of the timber splitting—and large timbers should be kept under cover when being worked and dressed. It is of great compressive and tensile strength, being one of the strongest timbers known, and is placed next to teak

in Lloyd's List for shipbuilding timbers. When freshly cut and for some time after, the wood has a peculiar sour smell, somewhat like the smell of a brewery, or as some would say like cheese. The colour is a yellowish green, the older timber being of a darker colour; the sapwood is lighter and is excessive compared to many other kinds of timber, is often difficult to determine, but is not considered so deleterious as sapwood generally is. In the sawn logs the sapwood is of course much minimised, and although the price is 50 per cent. more, it is probably quite as economical if only short lengths are required, because one gets the exact scantling wanted, whereas in the hewn logs larger sizes have to be bought to enable them to be cut down. The annual rings, which near the heart are often regular, afterwards spread out on one or both sides and running into one another give a darker shade to the wood and become indistinct. The pores are very distinct. This wood burns readily, and is called by the natives "torchwood."



FIG. 24.

Sometimes there are flaws in the timber which are only noticeable when cut up, and it is also subject to a characteristic flaw across the heart (see Fig. 24), but which does not open wider and does not affect large scantlings; it is remarkably free from knots, and clean and straight in the grain. Greenheart sometimes gives way suddenly when the ultimate breaking stress is attained with but little indication beforehand. Care should be exercised in working it owing to the poisonous character of the wood; splinters are very dangerous if they get into the hand, and there has been more than one death recorded due to this. The wood is much prized by fishermen for rods. Sir Edward Grey, in his book on fly fishing, says, "Nothing throws a better line

or is more pleasant to use than greenheart, but it has one disadvantage, that of being more brittle than split cane.”

The greenheart which comes from British Guiana is more appreciated than that which grows in Dutch Guiana, even on the Continent, where a large quantity of the latter is imported.

The weight is generally given as from 60 to 70 lbs. per cubic foot. Two good samples, the cross sections of large logs, weighed by the author, gave about 71 lbs.

Greenheart withstands the attack of the teredo better than most wood; many engineers consider that it is only the sapwood which is attacked and that the worm only goes a couple of inches into the log. Even in Bombay waters, where the teredo is particularly voracious, greenheart dock gates stood without serious damage for nearly ten years and then only required slight repair; pine timber would be destroyed there in a few months, and teak in a few years. The attack of the sea worm on greenheart, that of the *limnoria* especially, is very slow in Great Britain; unprotected greenheart piles stand perfectly sound after being in a situation for over twenty years, where unprotected pine timber would have been destroyed in half the time. The most decisive evidence that greenheart piles are not proof against the teredo has come to the writer's notice lately. A large pier in the Mediterranean, with the construction of which he was associated, was built of this timber twenty years ago, and is now so seriously damaged by the worm that it is being replaced with ferro-concrete. This is in a locality where the teredo is particularly destructive. The greenheart decking which was on this pier is in such good condition after twenty years' exposure that it is intended to replace it on top of the new concrete piles. Greenheart is a timber



**THIS PAGE IS LOCKED TO FREE MEMBERS**

Purchase full membership to immediately unlock this page

# Know Your Bible

Forgotten Books'  
Full Membership  
provides unlimited  
access to more than  
28,000 volumes of  
Christian literature for  
\$8.99/month

**HOLY  
BIBLE**

**Continue**

\*Fair use policy applies

when exposed to the sun. The ants only attack the bark, and this should be stripped off the logs before they are stored. There are three varieties of this timber, red, white, and black, but the red is considered the best. Logs up to 50 ft. in length and 2 to 3 ft. square can be obtained. From this tree is extracted by the bleeding process the well-known Balata, much used in the manufacture of machinery belting, and an extensive trade is done with it in the colony. The bleeding process affects the colour and texture of the wood for a while. It is a similar wood in texture, weight, and colour to the Melkhout of South Africa. There is another timber called balata found in French Guiana, of a yellowish colour, hard, heavy, and strong, very suitable for furniture.

Weight about 65 lbs. per cubic foot.

**Towaronero or Bastard Bullet Tree** (*Humirium floribundum*) produces timber with dense close grain and a resemblance to that of the bullet tree, and by some is considered superior to greenheart where small timber is required. Logs 90 ft. long and 20 inches square can be got free of sap.

**Wallaba** (*Eperna falcata*) is a dark red wood saturated with a sticky resin, much used for house frames, roof shingles, posts, and palings; stands exposure well in all conditions, but is subject to attack by white ants. It has been used largely of late years for telegraph and electrical poles in Barbados and Trinidad. May be had in logs 40 ft. long and 12 to 18 inches square.

Weight about 65 lbs. per cubic foot.

**Purple-heart** (*Copaifera bracteata*) is one of the tall forest trees of British Guiana. The wood is of a purple colour on all cut and exposed faces; hard, durable, close grained, and very tough, it makes handsome furniture and

is excellent for house framing, and also used for making ramrods for guns. It planes fast and well and takes a good polish. The sapwood is a dirty white. It is too hard for ordinary wood-turning tools. It is not so plentiful as mora or bullet tree. The Indians use the bark for making wood-skin canoes of considerable size, accommodating fifteen or sixteen people, and "dug-outs" from the tree itself. It would probably make satisfactory street paving. Some purple-heart veneer is used in the cabinet trade. The purple-heart of Trinidad (*Peltogyne paniculata*) is a small tree producing timber of the same colour as, or rather a browner tint than, that of Guiana, and is probably one of the woods known as "Zapateri." Pao Roxo or Guarubu, of Brazil (*P. macrocarpus*) (which see), is a similar timber.

Weight about 61 lbs. per cubic foot.

**Houbooballi** (*Mimosa guianensis*), a beautiful wood of light brown colour variegated with vertical veins of black and brown, grows plentifully in the Essequibo forests of Guiana. It makes handsome furniture and panelling, and in bottoms of boats will outlast most others. The sapwood is about an inch thick, white and clearly defined. Saws easily and well, turns well, and takes an excellent polish, and is altogether an excellent material to deal with. It can be obtained in logs up to 50 ft. long and 20 inches square. It is probable that the "Zebra wood" used for furniture is the produce of this amongst other trees.

Weight about 56 lbs. per cubic foot.

**Crabwood** (*Carapa guianensis*) is another of the excellent timbers from this part of the world. The wood is reddish brown, much resembling mahogany, takes a fine polish, turns well, and makes durable furniture; an excellent wood



for flooring boards or partitions, it is also used for masts and spars. It is usually supplied in the colony in logs of from 30 to 50 ft. long and 12 to 18 inches square. The tree grows to a height of 120 ft. and 2 to 3 ft. diameter.

Weight about 39 lbs. per cubic foot.

**Suradanni** (*Meliaceæ cedrela*), a dark red coloured wood with black streaks which takes a fine polish, used for making dug-out canoes, planking of boats, wheelwright work, and furniture. A hard substance in the wood, something like the mineral found in teak, rapidly dulls cutting tools.

Weight about 53 lbs. per cubic foot.

**Cirouaballi** (*Nectandra sp.*), of which there are two varieties, brown and yellow—silverballi and siruaballi—is another of the many hardwoods of British Guiana, and can be got in very long lengths up to 80 ft. and 16 to 30 inches square. It is used for the planking of boats and vessels, masts and booms, is insect resisting, works and turns well, and takes good polish.

Weight about 49 lbs. per cubic foot.

**Simarupa** (*Picræna officinalis*), which grows in Northern Brazil as well as in Guiana and the West India Islands, is called Maruba and Acajou blanc in Guadaloupe. It is a most useful wood for partitions and other inside work, resists the attacks of wood ants and other insects, but will not stand exposure to weather; the colour is a light yellow; it saws and planes well, takes good polish, and is cheap and plentiful in Guiana and may be had in logs up to 2 ft. square. It is a similar timber to, and scarcely distinguishable from, the very bitter quassia or Bitterwood (*P. excelsa*) from which the so-called bitter cups are made.

Weight about 30 lbs. per cubic foot.



**THIS PAGE IS LOCKED TO FREE MEMBERS**

Purchase full membership to immediately unlock this page

# DELVE INTO FANTASY, MAGIC, MYTHOLOGY & FOLKLORE

Forgotten Books'  
Full Membership gives  
access to 797,885 ancient  
and modern, fiction and  
non-fiction books.

**Continue**

\*Fair usage policy applies

is considered the best wood in the colony. It is very dense though coarse of grain, and feels cold to the touch like greenheart and boxwood. The heartwood is dark green shading to brown and is sharply defined from the reddish brown sapwood, which is generally about an inch wide.

Weight about 57 lbs. per cubic foot.

**Ducalliballi**, a hard timber of a beautiful reddish brown colour and capable of taking a fine polish, has been used as a furniture and ornamental wood in the colony for many years. The medullary rays are very close, and the pores, as in most of the hard timbers of this part of the world, large and conspicuous. The author a short time ago came across a hewn log about 30 ft. long and 12 inches square in the London Docks which had come over with greenheart, but he cannot find that it is used in Great Britain, and indeed it is but little known. The botanical species is not defined.

**Letterwood** or **Snakewood** (*Brosimum aubletii*) is found in some of the West India Islands, but chiefly in Guiana, where the vernacular name is si-to-oh-balli or bourra-courra. It is exported in short lengths 4 or 5 inches in diameter. The heartwood, which is the only part used, is of a nut brown colour spotted with black, very hard and heavy, one of the most beautiful of woods. Chiefly used for small ornamental turnery, cabinet inlaying, walking-sticks, Indian bows, etc., it often sells at about eightpence per pound. The amount of sapwood is considerable, it is fairly hard, of the same colour as box, and might be used for the same purposes. This tree is closely allied to the breadfruit tree and is becoming scarce.

Weight about 77 to 83 lbs. per cubic foot.

**Lignum Vitæ** (*Guaiacum officinale*) or guaiacum wood. The chief supply comes from the West India Islands,

some from Guiana and other parts of tropical America, and at one time it was very plentiful in the Mauritius. The colour of the heartwood is dark green or greenish black; the sap, which varies a good deal in thickness, is of a dingy yellow hue and very distinct. It is one of the hardest, heaviest, and toughest timbers known; strong, close and wiry in grain, the annual rings are scarcely distinguishable, and the fibres of each layer cross one another diagonally, making it a very difficult matter to split the wood, although it is easily planed. Mr. John Calvert saw an old post of *lignum vitæ* in West Indian waters in the shape of a cross, said to have been placed there by the Spaniards hundreds of years ago; it was not decayed in the water and very little affected between wind and water (*Min. of Proc. Inst. Civil Eng.*, vol. 24). The wood contains about 25 per cent. of gum resin called *guaiacum*, which is used as powder, pill, and tincture. The bark is also used as a medicine. The amount of sapwood on the timber is considerable, but is equally as good, tough, and durable as the heartwood. There is nothing to equal *lignum vitæ* for block sheaves, cog wheels, shafts, and footsteps for vertical shafting in pumps. Sheaves after 50 to 60 years' wear have been found to be perfectly good. It is also much used for mallets, plumbers' mandrils, etc., and in the Bahamas for hinges and fastenings of doors by the sea shore, where ironwork quickly corrodes. The wood is imported in the round state in lengths of 3 or 4 ft., which are usually under 12 inches diameter, although in the Isthmus of Darien it is said to grow 5 to 6 ft. in diameter; it is sold by the ton, and at a recent sale prices varied from £4 15s. to £7 15s.

Its weight is with 12 per cent. of water about 73 lbs. per cubic foot. An inferior substitute for *lignum vitæ*, and with which it has nothing in common and which is much

lighter, comes from Guayaquil. There is also a timber found in Cuba—guayacancillo—which resembles *lignum vitæ* and is used for similar purposes. Sizes about 10 ft. long and upwards and 6 to 10 inches square. Some “*katchina vitæ*” was recently brought from Jamaica with the true *lignum vitæ*.

**Hackia** (*Siderodendron triflorum*), with which the true *lignum vitæ* is often confounded, grows abundantly in British Guiana; it is an equally hard, close-grained, heavy wood, and both are used for the same purposes and both are about equally durable. It can be got 65 ft. long and 16 to 18 inches square without sap.

Weight 50 to 60 lbs. per cubic foot.

**Souari-pikea** or **Butternut Tree** of the genus *Caryocar* is plentiful on the Essequibo river; it yields a tough cross-grained timber, hard to saw, and will not smooth in places as the grain “picks up”; very difficult to split. On it grow the souari or butternuts.

There are many other excellent hardwoods in the colony of British Guiana, but the difficulties of climate and transport, lack of railways, etc., prevent their being brought into the European market, and greenheart is the only timber which is exported in any quantity.

### BRAZIL.

Paroba—Aroeira—Brauna Parda—Brauna do Sertão—Folha de Bolo—Balsamo—Candeia—Cedro—Canella—Goncalo Alves—Cabui—Ipo—Icaranda—Angico—Jacaranda or Rosewood—Vinhatico—Pegui—Guarubu—Sicupira Assu.

**Paroba Vermelha** (*Sapota sp.*) is the finest timber in the province of Minas Geraes for general purposes. It is red



**THIS PAGE IS LOCKED TO FREE MEMBERS**

Purchase full membership to immediately unlock this page

# Know Your Bible

Forgotten Books'  
Full Membership  
provides unlimited  
access to more than  
28,000 volumes of  
Christian literature for  
\$8.99/month

**HOLY  
BIBLE**

**Continue**

\*Fair use policy applies

**Brauna do Sertão\*** (*Buttinum ferrugineum*), a red coloured timber, is used for general construction in Bahia, and is one of the two most valuable woods for sleepers—aroeira being the other—both having a life of over sixteen years on the San Francisco Railway, Bahia.

**Folha de Bolo (Vermelha)** is a wood of red colour, the grain is long and fibrous, and fairly good to work. It is useful for general purposes, and may be depended upon either on surface or underground and either for wet or dry situations.

Weights about 55 lbs. per cubic foot.

**Folha de Bolo (Branca)** is closer in grain than the above, and is an excellent timber of nearly white or light brown colour. It can be got in large logs up to 130 cubic feet.

Weight 56 lbs. per cubic foot.

**Balsamo** (*Myroxylon*), a scented and useful wood of reddish brown colour, only to be got up to 50 ft. cube, is rather uncommon. As sleepers it has a life of over ten years.

Weight about 59 lbs. per cubic foot.

**Candeia** is a very tough and durable timber; the maximum length in which it can be obtained is 20 ft. with a diameter of about 7 inches at the butt; the colour is nearly white. It is much used in mines.

Weight 63 lbs. per cubic foot.

**Cedro** (*Cedrela brasiliensis*), of brown or reddish colour, is one of the many cedars found in Brazil and other places, a valuable scented wood, used in its native district for doors, ceilings, windows, furniture, patterns, clothes chests,

\* Sertão is an Indian term meaning "far west." "The traveller is always approaching the Sertão and yet hears that it is still some days off."—Burton's "Highlands of Brazil."

and other purposes. It is about the same strength as pitch pine, and logs can be obtained in long lengths. Until 1890 it was the only timber used for patterns in parts of Brazil.

Weight 39 lbs. per cubic foot.

**Canella de Velho** is a tough wood of brownish colour, sometimes nearly white, and is chiefly used for pick and hammer handles, for which purpose it is split, not sawn. It is only about six inches in diameter, and the section shows three wings which split off easily. **Canella Preta** (*Cumamodendron oxillare*), a grey coloured wood, is one of the first-class sleeper woods on the Bahia railways, and **Canella Parda** (*Mespilodaphe opifera*) is another wood used for sleepers.

Weight about 50 lbs. per cubic foot.

**Goncalo Alves** (*Astronium fraxinifolium*) is a strong, durable, hard timber, used for uprights and cross pieces in constructional work. It is of a white colour with red streaks, sometimes nearly black, striped with brown. It can be got in large logs. Used for sleepers in Bahia, where the life is over eight years; it is also used for furniture. Goncalo do para is one of the Portuguese names for "Zebra wood."

Weight 69 lbs. per cubic foot.

**Cabui** is a nice grained, hard wood, similar in appearance to goncalo alves.

Weight about 59 lbs. per cubic foot.

**Ipe** is a hard, strong timber of green colour with dark markings, and has been found very useful as blocking pulleys for wire rope transmission plant. It is got only in small, rather crooked logs, and is only used for small work.

Weight 63 lbs. per cubic foot.



**Icaranda** is of more uniform quality than ipe, of a tawny colour with black specks and dashes, an excellent wood where strong wearing surface is required, one of the best in the country for the teeth of mortise wheels.

Weight 62 lbs. per cubic foot.

**Angico** (*Acacia colubrina*) is a fine, dense, smooth wood, found in parts of Brazil, and used for turnery, cabinet-making and ornamental work, also for sleepers. The logs are roughly squared up to 10 inches a side. It is often confused with sabicu and various kinds of rosewood. The colour is a reddish or dark brown streaked with black, and the timber contains medical properties. The bark is good for tanning.

**Jacaranda** is the Brazilian name for various species of *Dalbergia* and allied trees. It is the continental name for rosewood, and from these jacaranda trees and similar species comes the Brazilian rosewood of English commerce. Amongst them are **Jacaranda Cabiuna** (*Dalbergia nigra*), used for furniture and turned articles as well as for timbering in Brazilian mines and sleepers. It is hard and durable, stands wet as well as any wood, of a colour reddish brown and black in streaks and patches.

Weight about 63 lbs. per cubic foot.

**Jacaranda Preto** (*Machærium incorruptibili*) of Bahia is a first-class black furniture wood, and is also used for general construction and sleepers.

**Jacaranda Rozo** (*M. legale*), a brown wood which makes excellent sleepers.

In the Argentine the jacaranda is a small tree which produces logs 15 ft. long by 9 inches square. "Palisander wood," used chiefly for pianos, is probably the produce of these trees.



**THIS PAGE IS LOCKED TO FREE MEMBERS**

Purchase full membership to immediately unlock this page

# DELVE INTO FANTASY, MAGIC, MYTHOLOGY & FOLKLORE

Forgotten Books'  
Full Membership gives  
access to 797,885 ancient  
and modern, fiction and  
non-fiction books.

**Continue**

\*Fair usage policy applies

and is used for general building work. It is a similar timber to the purple-heart of Guiana.

**Sicupira Assu** (*Bowadichia vergelirides*) and **Sicupira Merim** (*B. minor*) are grey coloured woods of straight grain used for beams and planking in shipbuilding, cart axles, and are of the first quality amongst Bahia sleeper woods, having a life of over ten years.

Weight 55 lbs. per cubic foot.

Brazil possesses a very large variety of valuable timbers, excellent in quality and durable. M. de Teive e Argollo, M.I.C.E., has been good enough to send the author particulars of over fifty species of wood from Bahia alone, only some of which space has allowed him to include. The following are a few more:—

**Aderno** (*Astronium sp.*), a red coloured wood.

**Pao d'Arco** (*Tecoma speciosa*), or arch wood, very crooked and of dark yellow colour. Brazilian Indians make bows of it.

**Batinga** (*Astronium speciosa*), of a red colour.

**Cabraiba** and **Oity** (*Moquilia tormentosa*), of a red colour.

**Cana fistula** (*Cassia fistula*), of a brown colour.

**Jatoba** (*Hynocura courbaril*), light yellow in colour.

The above are used for general building and construction work, and most of them make excellent sleepers.

**Pao Paraiba** (*Simaruba versicolor*), white in colour and very light. Used for doors, ceilings, windows, and cigar boxes.

**Tapioca**, light yellow in colour and light. Used for doors, ceilings, windows, cigar boxes, and for furniture.

**Pao d'Oleo** (*Copaifera guianensis*), used for furniture and sleepers, as well as in general construction and in the extraction of copaiba oil. Also for yards and masts of ships. Red in colour.

Weight 56 lbs. per cubic foot.

In Parana to the south there are extensive forests of **Araucaria** (*A. brasiliensis*), called Brazilian pine, somewhat akin to the **Chili Pine** (*A. imbricata*) or Monkey Puzzle of English lawns. It produces a valuable timber, fruit, and turpentine, but is not yet a commercial commodity.

The difficulty in describing the timbers of Brazil is that the same wood is known by different names in different districts; as an engineer from the East says of their timber, "the spelling is a matter of taste," and another English engineer in Uruguay speaks of the Brazilian hardwoods "whose names can neither be spelt nor pronounced"; the same timber, too, goes under different names in the Argentine, Paraguay, and Bolivia from that by which it is known in Brazil. The botanical names are also very uncertain.

#### ARGENTINE TIMBERS.

Quebracho—Lapacho—Guayacan—Curupay—Urunday—Palo Blanco—Pacara—Quina Quina—Horco Cevil—Horco Molle—Cohucho—Tatane—Tarco—Roble del Pais—Tipa Colorado—Algarrobo—Mistol—Cedro—Nogal—Lanza—Nandubay—Palo Cruz—Strength of Argentine Timber—Paraguayan and Bolivian Timber.

One of the characteristic features of the trees of Argentina is their small stature and large diameter; not many of them grow to a greater height than 30 ft., and the majority do not reach this, so one of the drawbacks to the many excellent timbers which this part of the

world produces is that they are only obtainable in short lengths.

**Quebracho**, of which there are two varieties, and of which **Quebracho Colorado** is the most generally useful, best known, and most largely used of the timbers of the republic. It is a dark reddish coloured wood of fine, close grain, dense and heavy, and has a bright surface, is much appreciated and much used for heavy constructional, piling, and submarine work, and is almost invariably used for bridge-building and sleepers in Argentina. In Uruguay it superseded steel sleepers, to which it is superior, but owing to the recent great increase in price other sources of supply are being looked for. It is worked as easily as the best European woods and better than most of them. The timber lasts equally as well in wet as in dry ground and stands changes of temperature well, but until properly seasoned all sawn surfaces should be protected from the sun to prevent the wood from splitting. It becomes darker with age. The shortness of grain in quebracho is its greatest drawback, as in rough handling it is liable to break. Its great durability is due to the quantity of tannin it contains, amounting to as much as 19 per cent. to 22 per cent. in the heartwood. The quality of the timber varies somewhat in different districts: the best comes from the eastern zone of the Chaco within the province of Santa Fé, and is conveyed by rail to the shipping ports. Large quantities are sent in log to Europe and the United States for the manufacture of tannin; the larger proportion of the trade is now done with the latter. In 1906, 256,822 tons of this timber were exported from the Argentine for tannin extract in rough logs called *rollizos*. The logs are got in lengths up to about 25 ft. and 18 inches or 2 ft. a side, and sometimes of larger scantling: they were formerly cut roughly square



**THIS PAGE IS LOCKED TO FREE MEMBERS**

Purchase full membership to immediately unlock this page

# Know Your Bible

Forgotten Books'  
Full Membership  
provides unlimited  
access to more than  
28,000 volumes of  
Christian literature for  
\$8.99/month

**HOLY  
BIBLE**

**Continue**

\*Fair use policy applies

grain and very heavy, used for door frames, wheel hubs, spokes, shafts, pulley blocks, etc., and resists moisture well. It is only to be had in lengths up to 20 ft., for the tree only grows to a height of 15 to 20 ft., with a diameter of 12 to 18 inches. A small sample has been tried for paving in Liverpool.

Weight about 72 lbs. per cubic foot.

Guayacan and lapacho are the only native timbers which rival the quebracho, but they are not so plentiful.

**Curupay** and **Urunday** produce a very similar class of timber, which has been a good deal used for piles and jetty work in the Argentine and in such situations has lasted over 30 years. In some situations Curupay has lasted twice as long as Urunday or even Quebracho; neither is, however, so stiff as Quebracho. Curupay is a hard red wood of great strength, stands damp well, and a good deal of it is used for masts and some for sleepers. Curupay-ria is the heavier kind, but rather inclined to split when exposed to the sun. The tests show Curupay to be rather a stronger timber than Quebracho Colorado; it is particularly strong in tensile strain. These two timbers come chiefly from Paraguay, to the north of Argentina, which furnishes it with a considerable quantity of timber.

Weight about 60 lbs. per cubic foot.

Quebracho, Lapacho, and Curupay are the timbers most used in Argentina.

**Palo Blanco** (*Calycophyllum multiflorum*) is a tree of 20 to 30 ft. in height and about 2 ft. diameter. The wood is almost white—the name means “white wood”—with a close grain and is rather expensive. Used for beams, scantlings, planks, etc.

Weight about 62 lbs. per cubic foot. **Palo Amarilla** and **Palo Santo** are other kinds used for sleepers.

**Pacara** (*Enterolobium timbonva*) is found in Tucuman and the north. Maximum size of logs 15 ft. by 2 ft. square. The wood is light in colour with loose grain, is not strong, and is used for furniture, door frames, etc.

Weight only about 35 lbs. per cubic foot.

**Quina Quina** is a cabinet-makers' wood of fine, smooth, close grain, somewhat like light coloured mahogany. Lengths available, 15 ft. by 11 inches square. It is not well known.

Weight 54 to 64 lbs. per cubic foot.

**Horco cevil** or **Horco molle** (*Piptadinia communis*) is found in the same districts as quina quina and somewhat resembles it. Close, dense, and smooth in grain, it is of about the same hardness as box. Maximum dimensions of logs, 15 ft. by 2 ft. square. It is used for beams, scantlings, flooring of railway wagons, also for cabinet-making and ornamental work, but is not suitable for damp situations.

Weight 56 to 69 lbs. per cubic foot.

**Cohucho** (*Zanthoxylum cocoa*) is another furniture and carriage-building wood of light brown colour with close grain, but is liable to split in the sun.

Weight from 32 to 40 lbs. per cubic foot.

**Tatane** or **Talane** (*Acacia sp.*) is a handsome dark brown, well figured wood, only found in the extreme north and but little known. It is used to a small extent for cabinet work and the panelling of railway carriages.

**Guayibi**, probably the same as the guarubu of Brazil, is a hardwood used for furniture, carts, shafting, boat-building, and pick handles.

Weight about 49 lbs. per cubic foot.

**Tarco** or **Talco** (*Thoninia weinmannifolia*) produces wood of a very fine ivory white colour and well figured; it is



sometimes called "white ebony," is extremely beautiful, and in great demand for the panelling of railway carriages and for cabinet work generally. It grows in the north of the republic, and the maximum sizes obtainable are about 14 ft. long by about 10 to 11 inches square.

**Roble del Pais** (*Fagus batuloides*) is only found in any quantity in the north, where it grows to a height of 26 ft. with a diameter of  $2\frac{1}{2}$  ft. It is a handsome wood and in grain and general appearance resembles American oak; hence, doubtless, the name *roble*, which is Spanish for oak. It is easy to work, has nicely marked grain, and is extensively used for railway carriage panelling, etc.

Weight about 35 lbs. per cubic foot.

**Tipa Colorado** or **Palo Mortero** (*Machærium pseudo tipa*), one of the northern timbers, is the best of two kinds; the other is the white tipa. Only to be had in lengths of about 10 ft. by 10 inches square, it is used for beams, and spokes of wheels. It is easy to work, has a fine, even grain, and is of a light red-brown colour.

Weight about 47 lbs. per cubic foot.

**Algarrobo** (*Prosopis nigra* and *P. alba*), the Spanish name for locust, is found all over the Argentine, but attains its greatest perfection in Cordoba. It is identical with the carob tree of the Eastern Mediterranean region, and the seeds were taken by the Spanish conquerors to South America. There are two kinds of algarrobo, namely, colorado and blanca; the former is the heavier. The timber is very tough and stringy, with fine, compact grain, and in appearance resembles American walnut; it is a hard and handsome wood. The tree seldom reaches a greater height than 8 to 10 ft. with a diameter of 6 to 10 inches. It is used a good deal in the Argentine



**THIS PAGE IS LOCKED TO FREE MEMBERS**

Purchase full membership to immediately unlock this page

# DELVE INTO FANTASY, MAGIC, MYTHOLOGY & FOLKLORE

Forgotten Books'  
Full Membership gives  
access to 797,885 ancient  
and modern, fiction and  
non-fiction books.

**Continue**

\*Fair usage policy applies

**Nandubay** was the wood used for all hardwood posts before quebracho colorado was used for this purpose and is said to be quite as lasting.

Weight up to 64 lbs. per cubic foot.

**Palo Cruz** (*Talebnia nodosa*) produces a good class of wood and is found over a large stretch of the northern part of the country. It is light yellow in colour, and is used for wagon frames, axe handles, etc. The sizes available are about 10 to 11 ft. by 10 inches square.

For particulars of many of these Argentine timbers the author is largely indebted to an interesting article by Mr. Geoffrey Ransome in *The Timber Trades Journal* for March, 1907, but as showing how prolific parts of the country are in varieties of timber, Mr. Charles A. Trery, M.I.C.E., has been good enough to send him particulars of more than 160 different kinds of wood, with their weights and the stresses of many of them, which space does not permit his including.

There is such variation in the tests quoted of different specimens of Argentine timber and such a want of definiteness in many of the particulars given by various authorities that the author has reluctantly decided not to include particulars of their strengths.

Paraguay and Bolivia produce some excellent hardwoods of the same varieties as are found in Brazil and Argentina. Those of Paraguay, besides curupay and urunday, previously referred to and which also grow in Bolivia, are **Peteribi**, of which there are two kinds, a light and a dark wood. It is something like teak and is much used for panelling of railway carriages, and the darker kind for masts. It takes a good polish, makes handsome furniture, and is highly scented. It is very light, excellent for indoor work, and not attacked by boring insects.

**Palo Santo**, found in Paraguayan Chaco and used for turnery and furniture, is one of the tallest and commonest of Paraguayan trees.

**Inviraro** is not unlike oak in appearance, but does not split. It is used by natives for hubs and felloes.

**Cedar** is the chief wood of Paraguay and is much superior to the Argentine cedar, being richer in colour and more durable.

Amongst Bolivian woods are lapach, of different coloured varieties, muruday, of white, yellow, and black varieties, very suitable for sleepers, and corupan, a very durable wood used for hydraulic work, but these are evidently the same timbers with slightly different names which have been described under "Argentina."

#### WEST INDIA ISLANDS AND CENTRAL AMERICAN TIMBER.

Poui — Cyp — Yokewood — Avocado — Manchineel — Tapaná — Olivier —  
 Angelin — Fustic — Waterwood — Fiddlewood — Dogwood — Galaba  
 — Sabicu — Lancewood — Degame — Jucaro Prieto — Quiebra-hacha  
 — Babia — Jiqui Comun — Mahogany — Cedar.

**Poui** or **Ebony** (*Tecoma serratifolia*) is abundant in Trinidad. It is one of the hardest and most durable timbers of the colony, where it is largely used for posts. There are two varieties, the green and the grey. The wood is of close, even grain and will take a fine polish, and may be had in lengths of 30 ft. and upwards and 2 to 3 ft. in diameter.

**Cyp** or **Princewood** (*Cordia gerascanthus*), grown in Jamaica, is a light, useful timber of a uniform brown colour with darker zones; used for shingles on roofs and largely for turning. One of the best timbers of Jamaica.

This as well as the wood of *Hamelia ventricosa* is probably what is called by cabinet-makers "Princewood."

Weight about 43 lbs. per cubic foot.

**Chinette** is a hard, heavy timber which somewhat resembles boxwood.

**Yokewood** (*Catalpa longissima*), a light brownish grey wood somewhat resembling walnut and very durable; excellent for boards and scantlings.

Weight 70 lbs. per cubic foot. Crushing strength 2·09 tons per square inch.

**Avocado** (*Persea gratissima*) is a common tree in the West Indies and known for its fruit, the avocado pear. The timber is hard, uniform in texture, of wavy grain, and reddish in colour. It is called palta in Peru and is found from Mexico to Peru and also in Brazil.

**Manchineel** (*Hippomane manchinella*) is a tawny yellow coloured wood somewhat resembling maple and has an odour of lavender. Being very close grained, hard and durable, it is highly prized for furniture and ornaments in the West Indies and is also suitable for outdoor work. In felling the trees great care has to be taken to avoid contact with the very poisonous juice, which is a powerful irritant, raising blisters on the skin and injuring the sight should it enter the eye.

Weight about 50 lbs. per cubic foot.

**Tapana** (*Hieronyma alchorneoides*) is a wood of handsome dark reddish brown colour, straight in grain, and hard. The tree only grows about 20 ft. high.

**Olivier** (*Bucida bucceras*) is a rapidly-growing tree which attains a height of 30 to 50 ft. with a diameter up to 4 ft.,



**THIS PAGE IS LOCKED TO FREE MEMBERS**

Purchase full membership to immediately unlock this page

# Know Your Bible

Forgotten Books'  
Full Membership  
provides unlimited  
access to more than  
28,000 volumes of  
Christian literature for  
\$8.99/month

**HOLY  
BIBLE**

**Continue**

\*Fair use policy applies

the West Indies, and several thousand tons are exported annually from Jamaica.

Weight up to 46 lbs. per cubic foot.

**Waterwood** (*Chimarrhis cymosa*) is a valuable joiners' wood, the produce of a tree 50 to 60 ft. high, found in St. Vincent. In Dominica the same timber goes by the name of Bois Rivière.

**Fiddlewood** of Barbados (*Citharexylum melanocardium*) is much used for carpentry and wheelwrights' work, also for posts, etc. It is light brown in colour.

**Dogwood** of Grenada and Jamaica (*Piscidia erythrina*) is used chiefly in building. The tree is only 15 to 30 ft. high.

Weight about 56 lbs. per cubic foot.

**Galaba**, the Galba of Trinidad (*Calophyllum calaba*), also known as Santa Maria, is an excellent and durable timber of pale reddish colour, which has few knots, is fairly hard, and does not shrink or split much in seasoning. It is easily worked, and may be considered a fair substitute for the plainest Honduras or Mexican cedar. It stands exposure to weather very well, and has been used in English ships for beams and planking. This timber is also found in Honduras and Central America.

Weight 54 lbs. per cubic foot.

**Sabicu** (*Acacia formosa*) is found in Cuba and other West Indian islands. It somewhat resembles mahogany, is of a dark chestnut colour, and is easily mistaken for it, but is darker and often well figured. Close in grain, it stands the weather very well. It may be got in lengths of 30 to 40 ft. and up to 36 inches square. Used for shipbuilding in Cuba, but is not suitable for engineering work, as the fibres of the timber are often broken during the early stages of the

tree's existence, and the defect is not noticeable until the wood is cut up; for this reason it is seldom used for beams carrying loads. Some sabicu planks were laid on the roadway of St. George's landing stage at Liverpool a short time ago, but were not found suitable for vehicular traffic and had to be taken up after six months. It was used as steps in the Exhibition building of 1851, and the same steps were in use in the Crystal Palace at Sydenham nine years after. Sabicu is classed with karri, jarrah, blue gum, and other timbers in Lloyd's List. It is used by cabinet-makers and turners in Great Britain, and one sometimes sees an advertisement asking for small pieces of this wood.

The wood is heavy, about 59 lbs. per cubic foot, hard, and strong.

**Lancewood** (*Guatteria virgata*) is imported chiefly from Jamaica in the shape of spars 4 or 5 inches in diameter, and in large quantities. It is used for the shafts of dogcarts, carriages, etc., also for fishing rods. The tree is only about 9 inches diameter with the bark on. The grain is close and straight, and the wood wiry, flexible, and tough; the colour is greenish to yellowish, showing no difference between the heart and sapwood; it is often confused with degame wood.

Weight 52 to 63 lbs. per cubic foot.

**Degame** (*Calycophyllum candidissimum*) grows plentifully in Cuba to a height of 40 or 50 ft., and logs may be got about 12 inches square. The wood is of pale yellow colour, very fibrous and close grained, somewhat resembling boxwood: it is strong and elastic, easily worked, almost free from knots, takes a good polish, and is very durable. Used extensively in house framing and joinery: joiners in its



native districts prefer it to almost any other wood ; it is a good turners' wood, and is also used for carriage-building and the yards of ships. Some of it comes to Great Britain along with lancewood spars from Jamaica.

Weight about 56 lbs. per cubic foot.

**Jucaro Prieto** (*Bucidæ*) is another Cuban wood which can be got in logs about 36 ft. and 16 inches square. The wood is dark brown, somewhat resembling black walnut in colour, is free from knots, of fine grain and very hard, strong, tough, and elastic. It weathers well, is easily worked, and takes a good polish. Used a good deal in Cuba for shipbuilding and heavy work, piling, and dock construction ; also extensively by millwrights.

Weight 62 lbs. per cubic foot.

**Quiebra-hacha** (*Copaijera humenæfolia*) is a Cuban tree which produces logs up to 50 ft. long and up to 24 inches square. The colour is similar to that of the darker kinds of mahogany ; very hard but not difficult to work ; excellent for use underground and in water ; it is used for all kinds of posts, sleepers, poles, deck beams, and framing for heavy machinery.

Weight about 78 lbs. per cubic foot.

**Babia** (*Cordia gerascanthoides*) grows in Cuba and Jamaica to a height of about 60 ft. with a diameter of 18 inches. The timber, which is of dark greenish brown colour, with lighter sapwood, strong and durable, is used for framing, carriage-building, and general house fitting.

Weight about 48 lbs. per cubic foot.

**Jiqui Comun** (*Bumelia nigra*), a tree of 50 to 70 ft. in height, and which produces timber up to 18 inches a side, is one of the hardest woods known, of fine and very



**THIS PAGE IS LOCKED TO FREE MEMBERS**

Purchase full membership to immediately unlock this page

# DELVE INTO FANTASY, MAGIC, MYTHOLOGY & FOLKLORE

Forgotten Books'  
Full Membership gives  
access to 797,885 ancient  
and modern, fiction and  
non-fiction books.

**Continue**

\*Fair usage policy applies

much larger size than those which come from the West Indies or Honduras. They are roughly square and vary



*[From photo lent by McNeil, Scott & Co., Liverpool.]*

FIG. 25.—Felling a Mahogany Tree, West Coast of Africa.

in length from 12 to 18 ft. and even up to 25 ft., and 28 to 36 inches and occasionally up to 50 inches a side; longer lengths up to 30 ft. are generally of lesser scantling

(Fig. 27). Some of these big logs weigh 8 or 9 tons, and many of the "figured" logs bring fancy prices. Last year one log,  $29\frac{1}{2}$  ft. long and 31 inches deep at the butt end, was sold at 6s. 10d. per square foot of 1 inch thick, realising £493. Another log was sold at 7s. 9d. per square foot, and a few years ago three large logs from the same tree, 24 to 27 ft. long, the largest being 46 by 51 inches, fell under the hammer at £1,600.

Mahogany, like cedar and other timber of that class, is sold by the square foot of 1 inch in thickness, a considerable allowance being made by the timber measurer from the total cubic contents for waste in conversion, and the sale measure is often 25 per cent. less than the actual contents of the log. West Indian mahogany, in order to get as much as possible out of the log, was often cut (see Fig. 26) with the sides fairly squared, but differing in dimensions. This is now not so often done, as the logs are much smaller than formerly.

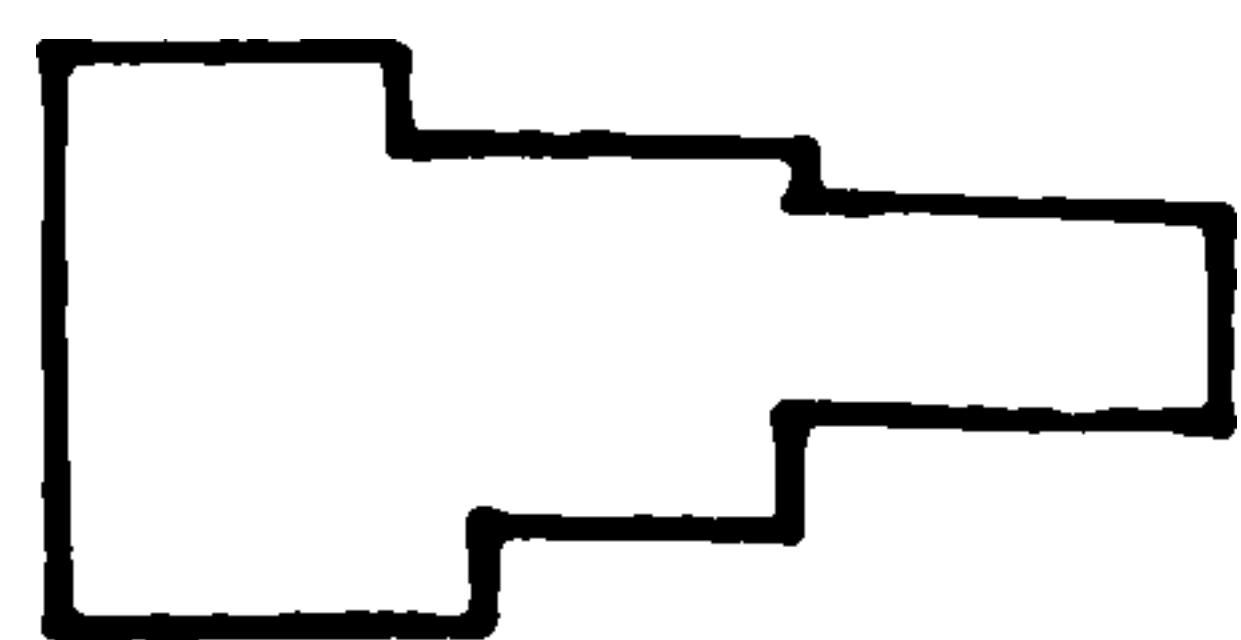

FIG. 26.

The City St. Domingo wood is generally identified by the stop adzing and small sizes, while the wood from Puerto Plata, on the north side of the island, is usually of larger size. Both are subject to serious heartshakes, but the colour is darker than the Cuba wood. The Cuba wood is known by the white chalk-like substance or white specks which fill the pores; it is of firm, silky texture, not too hard, and is very cold to the touch, and both it and the St. Domingo wood are decidedly superior to African, and also to the Honduras wood for finished work; but little is now obtainable, and only in small sizes, seldom over 12 to 14 inches a side, whilst the great widths of the African wood make it appreciated by the cabinet-maker or other user owing to the fewer joints required, and although coarser in grain, the French polisher, by the help of "filling," works up the

wood so that it is almost impossible to tell one variety from the other. Honduras wood is of larger scantling than the Cuba or St. Domingo variety, but is very rarely seen over 30 inches a side, 16 to 24 inches being about the average, and 12 to 25 ft. long. It can be recognised by the black specks or lines in the grain, in contrast to the white specks of the Cuba wood. The logs are often of tapering widths, slightly wany corners, and of a somewhat pale colour when freshly cut; the wood is of silky texture, but, although not much troubled by heartshake, is distinctly inferior to the old Spanish, being lighter and more spongy in grain, though straighter and without much flower. The Belize and Trujillo shipments are most appreciated.

Mahogany is also now brought from Nicaragua, mostly in round logs of mild texture and straight grain, from Costa Rica and Grenada, and is known by these names in the market, and a very good and much appreciated, finely-textured, and good-coloured wood comes from Tobasco, in the south of Mexico, which is generally jogged in the manufacture; occasionally a small quantity comes from Panama, which is rather subject to worms, and often damaged in transit, and from Guatemala, in which the heartshakes are generally serious. It is not possible by description to enable a person to distinguish one variety from another, as this is very difficult, even for experts with a long and close knowledge of the trade, and in small pieces it is scarcely possible even for an expert to do so. Honduras and West Indian wood have a much softer feel when rubbed with the thumb than the African wood.

All mahogany is of varying shades, from reddish brown to dark red, and though some of the African wood is very dark, some of it—the Gaboon wood for instance—is not unlike the colour of teak. It is chiefly used for high-class joinery, furniture, and veneers; not difficult to work, it is



**THIS PAGE IS LOCKED TO FREE MEMBERS**

Purchase full membership to immediately unlock this page

# Know Your Bible

Forgotten Books'  
Full Membership  
provides unlimited  
access to more than  
28,000 volumes of  
Christian literature for  
\$8.99/month

**HOLY  
BIBLE**

**Continue**

\*Fair use policy applies

The wood was first imported into Great Britain from the West Indies in 1724, when it was brought as ballast by a Captain Gibbons, whose brother, a London doctor, wished to use the timber in his house, then in course of construction, but it was so hard, compared to the timber to which they had been used, that the workmen objected. As showing the difference in size of Honduras mahogany now and fifty years ago, a log of this wood was landed in Great Britain in 1844, 13½ ft. long, 48½ inches deep at one end, 86 inches deep at the other, and 37 inches thick, producing 2,289 superficial feet of timber.

The total quantity of mahogany imported into Europe in 1907 was 159,830 tons, and of this quantity 121,743 tons were from the west coast of Africa, more than half of which went to Liverpool, the chief mahogany port. A very large portion is transhipped to the United States. Over 32,000 logs of African mahogany came into the Liverpool market in 1906, and the trade is continually increasing, being in that year fifteen times more than all other kinds of mahogany brought into the port (Figs. 25 and 27).

About 25,000 tons of mahogany were exported from Central America to Europe in 1907, and only about 13,000 tons from the West Indies, whence it comes chiefly to the London market. As regards price there is not much difference between the different varieties; so much depends upon "figure" in this wood that the price varies very much, but the West Indian wood is generally dearer.

Weight of West Indian wood about 50 lbs., and Honduras about 35 lbs. per cubic foot.

**Cedar.**—The cedar of commerce, the furniture cedar, is the wood of the *Cedrela odorata*, of the same family as mahogany, and comes from all the countries which produce mahogany except West Africa, and lately a few logs have

been brought from there. It is imported into Great Britain in large quantities as square logs from the West Indies and Central America, largely from Honduras and Tobasco, some in small sizes from Venezuela ; round logs have also recently been brought from Columbia, near the Isthmus of Panama. The logs are 24 to 26 inches square and up to 28 ft. long. The timber is largely used for furniture and decorative work instead of mahogany, and like mahogany is sold per superficial foot 1 inch thick and often costs quite as much. It is softer and easier to work than mahogany, and lighter. In its native district as well as in Europe it is used for internal house joinery and also for ship and boat building, and particularly in the construction of our light racing boats. Its peculiar odour protects it from attack by insects. The sapwood is narrow and reddish white, the heartwood reddish or cinnamon brown, the annual rings are wide and distinct, and the medullary rays also distinct and numerous.

Weight about 37 lbs. per cubic foot.

In 1907 over 700,000 ft., board measure, of cedar were imported into Liverpool. Cedar is also found in New South Wales, though none is sent to the English market, and there is some very excellent cedar in Paraguay which is largely used in Argentina.



## CHAPTER VI

### TIMBERS OF INDIA, BURMA, AND ANDAMAN ISLANDS

Bamboo—Babool—Tamarind—Jackwood—Hamileel—Cocoanut Tree—Calamander—Sal—Toon—Deodar—Indian Ebony—Palmyra Palm—Padouk—Mango—Red Sanders—Mysore Sandalwood—Vengai—Satinwood—Sundri—Butter Tree—Chittagong Wood—Kumbuk—Red Eyne—Jaman—Sissoo—Blackwood—Mutti—Neem—Anjan—Eng—Gurjun—Boxwood—Kosum—Khair—Palu—Pyinkado—Teak—Kokko—Chuglan—Kaita-da—Lakuch—Thitman—Mohwa—Thingan—Pyinma—Gangau—Thitya—Ingyin—Cangu—Che—Bhotan or Blue Pine—Chir Pine—Khasia Pine—Spruce—Silver Fir—Larch.

**Bamboo** is the most generally useful of all the vegetable productions of India. It is used for boat-building, oars, clubs, walking-sticks, and for scaffolding, bridge-building, and water-pipes; it forms the framework which supports the thatched roofs of houses, and from it are made the war lance of the cavalry and the pole of the dooli. The bamboo, which is really a gigantic grass, is of two distinct kinds, the small, hard, close-grained, solid variety, the male bamboo, which is rare, and the large hollow one which is generally used for uprights and scaffolding. *Bambusa arundinacea* is a very fine species; Kyanhaung (*B. auriculata*) and Tin (*cephalostachyum pergracile*) are two species of bamboo which grow with the teak, also Wagok (*Oxytenanthera albociliata*); they have cavities in their diameter nearly one-third of that of the culms. Some of the bamboos attain a height of 60 to 80 ft. and are about 8 inches in diameter. The wood is very tough and strong



**THIS PAGE IS LOCKED TO FREE MEMBERS**

Purchase full membership to immediately unlock this page

# DELVE INTO FANTASY, MAGIC, MYTHOLOGY & FOLKLORE

Forgotten Books'  
Full Membership gives  
access to 797,885 ancient  
and modern, fiction and  
non-fiction books.

**Continue**

\*Fair usage policy applies

but is good for interior work. Its produce is too valuable as a fruit for the tree to be much used as timber, but much of the wood, especially of its roots, is a cabinet wood of great beauty, extremely hard and difficult to work. The tree grows to a height of 60 ft. and more; the wood is a yellowish white colour with irregular dark blotches occasionally in the heartwood. The medullary rays are very fine and numerous.

Weight 54 lbs. per cubic foot.

**Jackwood** (*Artocarpus integrifolia*), or Jack tree, attains a height of 80 to 100 ft., grows throughout India, and is also found in the Antilles and Brazil, where it goes by the name of Jaqueira. It is a large evergreen producing a coarse, yellowish brown wood, light at first and darkening in colour with age, sometimes known as Jacqueria wood. It is very durable, fairly hard, and used for a variety of purposes, chiefly for the manufacture of cheap furniture, and in Great Britain for cabinet work, backs of brushes, marquetry, etc. Resistance to shear along fibres 672 lbs. per square inch. Crushing strength 3·4 tons, transverse strength 3·04 tons, and coefficient of elasticity 445 tons per square inch (Prof. Unwin, *Impl. Inst. Journal*, Vol. V.).

Weight about 43 lbs. per cubic foot.

**Hamileel** or **Hamillila** (*Berrya ammonilla*) is one of the most durable and useful timbers of Ceylon, but is chiefly used for making casks. The medullary rays are broad, the colour varies from light to dark red, and the heartwood is well defined, hard and close grained, but apt to split; it is very durable. The tree is also found in Burma and Southern India and goes by the general name of Trincomali wood. Resistance to shear along fibres 830 lbs. per square inch, crushing strength 3·1 tons, coefficient of transverse

strength 6·8 tons, coefficient of elasticity 780·7 tons per square inch (Prof. Unwin, *Impl. Inst. Journal*, May, 1899).

Weight 50 to 65 lbs. per cubic foot.

**Cocoanut Tree** (*Cocos nucifera*) is a large palm which produces a very heavy and durable wood of a dark brown colour traversed by longitudinal black seams, and with a fine, dense, even grain. In India and the tropics it is used for house posts, and, although it has very little transverse strength, for rafters and ridge poles about 3 by 1½ inches and up to 20 ft. long, it makes handsome and durable furniture. In Europe it goes under the name of "Porcupine wood." It is one of the fancy woods of commerce, and is used for walking-sticks and also as a veneer for small fancy articles. It is not hollow like so many palms, and attains a height of 30 to 40 ft. and a diameter of 1 to 2 ft.

Weight 40 to 70 lbs. per cubic foot.

**Calamander** (*Diospyros quæsita*) is the most esteemed of Ceylon woods, but is rare and realises a fancy price. It is in appearance somewhat similar to the finest walnut, a rich hazel brown colour mottled and striped with irregular black marks, but it is superior to walnut in the extreme closeness of its grain and richness of its colour. Like ebony and satinwood, calamander is chiefly used for furniture, cabinet work, turnery, and veneers. The medullary rays are fine and equidistant.

Weight 57 lbs. per cubic foot.

The **Sal** (*Shorea robusta*) is the most uniformly gregarious of the trees of India, and in the forests where it grows is always the prevailing tree; it grows in the forests along the Terai at the foot of the Himalayas, near Gaya, and in

the north-east of India. In some places, *i.e.*, in the gorges at the foot of the Nepal Tera hills, the sal attains a height of 100 to 150 ft. with a clear stem of 60 to 80 ft. to the first branch and a diameter of 6 to 8 ft.; such dimensions are, however, exceptional, and as a rule the height is 60 to 80 ft. with 30 to 40 ft. clear stem, and 2 to 2½ ft. diameter. The logs are almost straight without any knots, flaws, or cracks, but the wood dries so slowly that it continues to shrink sometimes for years after other classes of wood have become quite dry. Small scantlings and planks are very liable to warp and split in drying, but the wood is remarkably fibrous and cross grained. Superior to almost all Indian woods for strength, it is well adapted for engineering purposes such as bridges, etc., and for house and ship building and for gun carriages. It is also very much used for railway sleepers, and their life is from eighteen to twenty years. The timber varies in colour from light to dark mahogany colour, possesses great stiffness and durability, and is the best building timber in Northern India. The annual rings are only noticeable on freshly-cut wood. It is classed with greenheart, mora, and a few other timbers in Lloyd's List.

Weight about 55 lbs. per cubic foot.

**Toon** (*Cedrela toona*) is a true cedar and akin to the red cedar of New South Wales and Queensland. When freshly felled it resembles ash, and becomes darker with age until it resembles mahogany in colour. Does not split or warp, it is durable, scented, easily worked, and is the best of the Chittagong woods of commerce. Toon makes excellent tables, chairs, and bookcases, frames and furniture of all sorts, and is also used for doors and windows, but not for beams and joists of roofs, as it is not strong enough, and is, moreover, costly. It is a close-grained timber,



**THIS PAGE IS LOCKED TO FREE MEMBERS**

Purchase full membership to immediately unlock this page

# Know Your Bible

Forgotten Books'  
Full Membership  
provides unlimited  
access to more than  
28,000 volumes of  
Christian literature for  
\$8.99/month

**HOLY  
BIBLE**

**Continue**

\*Fair use policy applies

beautifully veined, and takes a high polish. It is a good deal used for making tea chests, and in Assam good boats are made of it. It is not attacked by ants, but is troubled by a borer. Formerly known as Moulmein cedar.

Weight about 31 to 35 lbs. per cubic foot.

*C. serrata*, a large evergreen, produces the same kind of wood of rather lighter weight.

*C. microcarpa*, another of the species, is a larger tree than *C. toona*; the timber has the annual rings distinctly marked; all are used for the same purposes.

**Deodar** (*Cedrus deodara*), or Himalayan cedar (Fig. 28), is one of the most beautiful trees in India and grows in great quantities in the Himalayan forests at heights of 4,000 to 10,000 ft. above sea level, and the timber is brought down the Ravi, Jhelum, and Chenab rivers in logs 20 to 60 ft. long and 2 to 12 ft. girth. The tree sometimes attains a height of 150 ft. and a diameter of 8 ft. It is a variety of the cedar of Lebanon. The wood is light yellowish brown in colour, of great strength, stiffness, hardness, and durability, and is thus well adapted for engineering purposes and for general constructional work; it is the chief timber of Northern India. The annual rings are uniform, and the medullary rays fine; it has a distinct fragrance, takes a long while to season—it is never well enough seasoned for joinery work under eight or ten years, but for engineering purposes where large beams are used is sufficiently seasoned in three years—takes a high polish but does not take paint or varnish well, and is rather brittle to work; laths from it burn like candles. It is extensively used for sleepers, especially in Northern India, where its life is about fourteen years. It is rather liable to attack from white ants. A coarse turpentine much used in the East for medicinal purposes,

as well as for tar and pitch, is obtained from the trunk. Chir pine is often palmed off as deodar on the unwary, but the latter possesses no resin ducts. Its durability is shown by its having existed for hundreds of years in some of the mosques and in old bridges.

Weight 37 to 45 lbs. per cubic foot.

**Indian Ebony** (*Diospyros ebenaster*), a tree of medium height and seldom more than 8 to 12 inches in diameter, is found in great profusion in Bengal, Coromandel, and Ceylon. It is the chief ebony-yielding tree, and the only one giving a black wood without other markings, although occasionally it is striated with lighter markings. The rings are scarcely recognisable, and it takes a high polish. The sapwood, which is of a dingy grey colour, is a good deal used for door frames. The heartwood is made into furniture, and also for the axles of carts, for which it is admirably fitted by its extreme hardness, toughness, and strength. Besides being used for ornamental furniture it is also used for ceilings, wood carving, etc., and in Europe for turnery, cabinet work, keys of pianos, and rulers. It comes into the market generally as logs, and is sold by the ton.

Weight often exceeding 70 lbs. per cubic foot.

**Palmyra Palm** (*Borassus flabelliformis*) grows in India, Burma, and Ceylon, and is the only timber growing in the Jaffna district, of about 400 square miles in area, in the north of Ceylon. The tree grows to a height of about 60 ft., perfectly straight and of uniform diameter—almost perfectly circular—from 10 to 14 inches a few feet above the ground; the wood is very dark. Although consisting largely of pith, it is sufficiently strong to stand driving as piles in bridge-work, and was used for this purpose many years ago by Mr. H. Byrne, M.I.C.E., instead



of bringing other timber to the site at considerably greater expense.<sup>1</sup> Logs can be obtained 30 ft. long. The timber has a fair life, the first bridges built with it stood for sixteen years without repair, and in favourable situations Mr. Byrne considered their life to be twenty-five years. Some trees contain much less pith than others, and some have absolutely none for 20 ft. of their length. In a good specimen the woody portion is about one-third the diameter at half the height; it is very hard and almost black.

This Palmyra palm and the *T. parviflora* of Jamaica, the trunks of which are said to be suitable for piles and marine work and to stand well in water, are, so far as the author knows, the only palms which have been used for constructive work, but it is probable that many others might be used for similar purposes if required.

Weight 63 to 72 lbs. per cubic foot.

Palms in hundreds of varieties are to be found in tropical and sub-tropical regions; but except that they are often used for light construction work and for basket work, etc., few of them produce timber of commerce, although most of them yield products useful to man.

The **Kiziuba Palm** (*Ceroxylon exorrhiza*), a native of Central and South America, yields wood in small quantities which is used for flooring, umbrella sticks by the natives, and musical instruments, whilst the *Raphia tadijera*, one of the most beautiful and singular of palms, which is found on the banks of the Amazon, is made into wooden blinds and baskets by the Indians; and the *Attalea funera* furnishes the whalebone-like fibre much used for making brooms and brushes. The so-called malacca canes are furnished by the stems of the *Calamis seipionum*, which grows in Sumatra, from whence the canes are exported to Malacca.

<sup>1</sup> Min. of Proc. Inst. C.E., Vol. XXII.



**THIS PAGE IS LOCKED TO FREE MEMBERS**

Purchase full membership to immediately unlock this page

# DELVE INTO FANTASY, MAGIC, MYTHOLOGY & FOLKLORE

Forgotten Books'  
Full Membership gives  
access to 797,885 ancient  
and modern, fiction and  
non-fiction books.

**Continue**

\*Fair usage policy applies

at Simla. One drawback to padouk is that it does not take glue well.

Whilst this is being written the Government of India are advertising as desirous of leasing for fifteen years the padouk timber available in the Andaman Islands. Padouk trees have been found with a clear stem of over 60 ft. in height and 5 ft. in diameter; the wood of the root is closer grained, of deeper colour, and more beautifully marked than that of the stem. The trees are girdled in the same way as teak, and left from three to five years to season. The medullary rays are fine and very numerous, the pores scant and of moderate size. This timber is known as **Mai Pradoo** in Siam.

Weight about 48 lbs. per cubic foot.

**Mango** (*Mangifera indica*) grows all over India; it is also found in Brazil and the Mauritius. Generally of coarse and open grain, an inferior wood, it is nevertheless useful for common doors and door-posts, window frames, and for planking when well seasoned. The wood is of straw colour, light, strong but brittle, and durable when kept dry, but it rapidly decays under exposure. The true heartwood is small, very dark and distinct. The timber is much attacked by worms and ants. The fruit is the most valuable part of the tree. In India timber may be had up to 3 ft. 6 inches in diameter.

Weight about 40 lbs. per cubic foot.

**Red Sanders** (*Pterocarpus santalinus*), also known as red sandalwood, is of dark reddish brown colour, extremely hard, and but little inferior to teak. It is used a good deal for building and it is a good timber for exposed venetian blinds and weather boards, and much in request for carved

door-posts. A dye was formerly extracted from it. Red sanders is a very pretty tree with dense foliage.

Weight 70 lbs. and over per cubic foot.

**Mysore Sandalwood** (*Santalum album*) is a small evergreen. The wood is exported both in small round billets about 3 ft. long and 5 or 6 inches in diameter and in roots and chips. The best quality sells at about sevenpence per pound. The sapwood, of which there is little, is light in colour; the heartwood is of a brownish tint and is hard, and has a very fine, even grain. Sandalwood is of the natural order of santalacæ, natives of the East Indies and tropical islands of the Indian Archipelago, of which the common kind is this white sandalwood, very suitable for and a good deal used in workboxes, desks, and small ornaments; it is much appreciated for preserving natural history specimens, as its fragrance is fatal to insects. Other species are found in the Sandwich and Fiji Islands and New Caledonia and are now brought into commerce, and much of it is the produce of *S. cygnorum* of Western Australia (which see). There is a large export to China, where it is used for carvings, joss sticks, etc. The deeper the colour of the wood and the nearer the root the better the perfume obtained from the oil, which is extracted from the heartwood and root and which forms the basis of many perfumes. The annual rings are distinct, the medullary rays fine. There is a Burmese sandalwood called kalamet which is not yet an article of commerce.

Weight 56 to 63 lbs. per cubic foot.

**Vengai** (*Pterocarpus marsupium*), a large deciduous tree, is after teak and blackwood one of the most important trees of Southern India. The wood is durable, seasons well, and takes a fine polish, and the heartwood is full of

gum resin. It is used for doors and window frames, posts, beams, furniture, agricultural implements, carts, and in boat-building, and also for sleepers. It is largely used in Mysore. The heartwood is a yellowish brown with darker streaks, the sapwood is small, and the medullary rays are very fine and numerous.

Weight averages about 55 lbs. per cubic foot.

**Satinwood** is the most valuable of light-coloured furniture wood. There are two kinds known in commerce, both being somewhat similar in appearance. The satinwood of India and Ceylon is the produce of a moderate-sized deciduous tree (*Chloroxylon swietenia*). It is allied to the mahogany tree and might be called yellow mahogany. In India it is used for building and agricultural implements as well as for furniture, and sleepers of this timber have a life of twenty years in Ceylon. It is sometimes startling to hear of timber of this character, so valuable in other parts of the world, being used in their native districts as we use fir and pine in England and America. A bridge at Peradeniya, near Kandy, with a single arch of 205 ft. span, was built entirely of this timber, and it was used for piling at Colombo many years ago. The West Indian satinwood is considered the best and is most largely used; it comes from St. Domingo, Porto Rico, and the neighbouring districts in lengths up to 19 ft. and 12 to 20 inches a side, also in planks. Both East and West Indian varieties are much the same in appearance, somewhat like box in their yellow or cream colour with inner wood darker than outer, and no distinct heartwood, and of a fine satiny lustre. The annual rings are distinct. If anything the West Indian wood has the smoother and finer grain, but both kinds are hard and close grained, take a fine polish, and can be cut into small mouldings better than most wood. Their



**THIS PAGE IS LOCKED TO FREE MEMBERS**

Purchase full membership to immediately unlock this page

# Know Your Bible

Forgotten Books'  
Full Membership  
provides unlimited  
access to more than  
28,000 volumes of  
Christian literature for  
\$8.99/month

**HOLY  
BIBLE**

**Continue**

\*Fair use policy applies

**Chittagong Wood**, a name somewhat vaguely given by cabinet-makers to various kinds of timber which come from the district of that name, on the east of the Bay of Bengal, is usually the wood of the *Chickrassia tabularis*, a tree of the cedar family which is a native of this district. The timber is hard and varies in colour from yellowish brown to reddish brown with a beautiful satiny lustre and is much valued in India and Europe for cabinet work. It is tough, may be obtained up to 15 inches diameter, seasons and works up well, and the sapwood is of lighter colour. It is a fair-sized tree, attaining a height of about 70 ft. Besides being common in the Chittagong hills it is found in Assam and Eastern Bengal, and after jarul is probably the chief tree in the forests of Burma and the Andamans. A fine furniture wood, it is also used for pianos and carving. In some parts of India it is called cedar or "bastard" cedar. Annual rings distinct.

*Cedrela toona* is another of the woods which come under the name of Chittagong wood.

Weight of *C. tabularis* about 49 lbs. per cubic foot.

**Kumbuk** (*Terminalia glabra*) is a Ceylon timber with reddish white sapwood about an inch thick, and browner heartwood sometimes of the colour of walnut and sometimes almost black. It is apt to split in seasoning and not easy to work, but is hard and close of grain. The boring worms get right into the heartwood. It has been used for sleepers in Ceylon. Medullary rays are fine and numerous.

Weight 48 to 54 lbs. per cubic foot.

**Red Eyne** (*Soyimida febrifuga*) is a Guzerat forest tree, but is not plentiful. The timber is red in colour, hard and heavy, and considered by natives one of the most durable of woods, therefore much used in the construction of

temples. The timber is somewhat cross grained like sal, but is not much attacked by ants.

**Jaman** (*Eugenia jambolana*), which is generally found along river banks, produces a hard, close-grained, dark red wood, rather liable to warp, but which is not much attacked by worms, and is used in native buildings and for agricultural implements, in Ajmere for lining wells, and is fairly durable as sleepers. Jaman is only a small tree.

Weight of wood about 48 lbs. per cubic foot.

**Sissoo** (*Dalbergia sissoo*) is one of the three Indian species of rosewood, *D. latifolia* and *D. cultrata* being the others. One of the most valuable of Indian timbers where strength and elasticity are required, it is the best of Indian timbers for joiners' work. In strength it is only inferior to sal and in some ways surpasses it in value, for instance it is lighter. The heartwood is greyish brown, veined; it is very hard, remarkably strong, elastic and durable, and is used for all kinds of building work in North India, and also for the wheels of gun carriages. It seasons well and does not warp or split.

*D. sissoo* is a beautiful tree which grows rapidly and in any soil.

Weight 50 lbs. per cubic foot.

**Blackwood** or **Shisham**, the rosewood of Southern India (*Dalbergia latifolia*), with no distinct annual rings and fine medullary rays, is an extremely beautiful furniture wood resembling the Brazilian rosewoods, and it is also used for agricultural implements and carving; it is hard to work owing to cross grain and incrustations of lime in the grain. Planking rather tends to split longitudinally until well seasoned and takes a good while to season; the sap is



rather wide, clearly defined, and of straw colour. The heart-wood is nut brown or dark purple with white or dark longitudinal veins or streaks and small whitish specks. May be had in logs up to 20 inches square and is used for sleepers in Mysore. Found over a considerable range, it is abundant in Southern India and shipped from Cochin, Calicut, and other places on the west coast to Great Britain. It also grows in Burma. When fresh sawn the wood has an agreeable smell. The sawdust of rosewood is manufactured into the substance called *bois-durci* of which beautiful ebony-like medallions and other ornaments are made.

Weight 50 lbs. per cubic foot.

**Mutti** (*Terminalia coriaccæ*) is a common tree in Central and Southern India, producing a heavy, hard, tough, fibrous, close-grained, dark brown and beautifully variegated wood, difficult to work, but durable and unaffected by white ants. It is used for beams and telegraph posts, sleepers, and the solid wheels of buffalo carts.

Weight about 60 lbs. per cubic foot.

**Neem** or **Margosa** (*Melia indica*), a large tree common throughout India and Burma, produces a hard, close-grained, fibrous and durable wood, very like mahogany in colour, scented and beautifully mottled, which makes excellent furniture, especially that obtained from old trees. It is very durable, equal indeed to camphor wood, and so bitter that insects will not attack it. Practically imperishable trunks and chests are made of it. As neem is only a small tree, about 20 ft. high, long beams are not available. The bark and leaves are used medicinally. Resistance to shearing along the fibres 1,326 lbs. per square inch, resistance to crushing 2·9 tons, coefficient of transverse



**THIS PAGE IS LOCKED TO FREE MEMBERS**

Purchase full membership to immediately unlock this page

# DELVE INTO FANTASY, MAGIC, MYTHOLOGY & FOLKLORE

Forgotten Books'  
Full Membership gives  
access to 797,885 ancient  
and modern, fiction and  
non-fiction books.

**Continue**

\*Fair usage policy applies

colour similar to the European variety. It is used for house-building and for canoes. Box grows to a considerable size in the Himalayas.

Weight 55 to 65 lbs. per cubic foot.

**Kosum** or **Gausan**, which also goes under other names (*Schleichera trijuga*), a large deciduous tree found in various parts of India, as well as in Burma and Ceylon, yields timber with a heartwood of reddish brown which is very hard, strong, and durable. It is used for oil and sugar mills and is considered the best timber in India for rice pounders, and also used for agricultural implements and carts. It seasons well and takes a good polish. This is the best tree for lac. Rays very fine and numerous.

Weight 50 to 70 lbs. per cubic foot.

The **Khair** or **Kath Tree** or **Cutch** (*Acacia catechu*) is found in most parts of India and Burma and furnishes, besides gum, a useful hard timber of dark or sometimes light reddish brown colour, close and regular in grain, which is used for general building purposes, agricultural implements, etc.

**Palu** (*Mimusops hexandra*), one of the most important forest trees of India and Ceylon, is a very hard, dense wood to be had in logs up to 2 ft. 9 inches diameter. The sap, about an inch thick, is of straw colour, the heartwood dark walnut, and the annual rings are very distinct.

**Pyinkado** (*Xylia dolabriformis*), called ironwood and Acle in the Philippines, is found in the Bombay district, where it goes by the name of Jambu and Errol, and it is one of the chief timbers of Burma (Pyinkado is the Burmese name). The wood is very hard, dense and close grained, often beautifully marked and with a wavy grain; the colour

is reddish brown like mahogany or jarrah. It is used for house-building, bridges, and railway sleepers, but is difficult to get, so much so that sufficient cannot be obtained for the requirements of the Burmese railways. It is hard to work and unless well seasoned is liable to split when exposed to the sun. The pores are filled with a thick glutinous substance which oozes out of the wood after being worked. In Siam it is called Mai deng.

Weight 58 to 66 lbs. per cubic foot.

**Teak** (*Tectona grandis*) (Fig. 29) grows in various parts of India, in Chittagong, Darjeeling, Terai, and Assam, whilst in Java there are extensive plantations; it is also found in the French colonies of Cochin China and in the Dutch East Indies, but the chief supplies come from Burma and Siam. Latterly large quantities have been sent to the European market from Java.

The best quality is got from the south-western slopes of the range of mountains on the Burma-Siamese frontier.

The trunk is straight, and an ordinary full-grown tree in good soil may measure 90 ft. to the first branch and 18 ft. in girth 6 ft. above the ground, but these dimensions as a rule vary from 30 to 60 ft. to the first branch and 6 to 12 ft. in girth. One of the tallest measured was 106 ft. to the first branch. Owing to the difficulties of transport timber of the above sizes is not often brought into the market, and it is exceptional to see logs in Rangoon over 50 ft., and these are not of large girth; for special purposes round logs 40 to 50 ft. long may be brought down, but the usual lengths are 25 to 27 ft. A few come occasionally over 50 ft. to the English market. The bark is thin, of yellowish grey colour, and the leaves are large and round in shape, resembling a cabbage leaf, and about 10 inches in diameter. Teak occurs in small patches in large forests of other trees—



(1900).

The tree is tall and slender, with a dense canopy of leaves. It is surrounded by other trees and a path. The tree is the central focus of the image. The text below the image describes the tree and its surroundings.



**THIS PAGE IS LOCKED TO FREE MEMBERS**

Purchase full membership to immediately unlock this page

# Know Your Bible

Forgotten Books'  
Full Membership  
provides unlimited  
access to more than  
28,000 volumes of  
Christian literature for  
\$8.99/month

**HOLY  
BIBLE**

**Continue**

\*Fair use policy applies

period of years. There is probably no timber so unsatisfactory in conversion as teak; the heartwood is generally rambling, *i.e.*, not straight, very much shaken, and often hollow and rotten for a considerable distance, and a large insect called the "bee hole-borer" plays havoc with the outer layers. This insect is really the larva of a moth (*Duomitus sp.*) allied to the goat moth of Europe which is so destructive to the willow. Damage is also caused to the trees by parrots, woodpeckers, and wild animals which make wounds forming centres of decay. In consequence of these frequent defects it is not possible to run teak through the mill in the same way as fir or pine, each log having to be carefully examined by the sawyer in order that it may be broken up with the least amount of waste.

The ordinary market sizes are approximately as follows :

Squares, 12 to 30 ft. long, 9 inches to 24 inches square.

Slabs, 6 to 24 ft. long, 9 inches to 24 inches wide, 2 inches to 8 inches thick.

Scantlings anything under the above.

Teak, when fresh sawn, is light brown in colour and smells rather like tan. After exposure to weather it turns grey, but when kept under cover it turns a reddish brown which gets richer with age; the wood is of an oily texture, and the annual rings are distinctly marked. It is moderately hard, strong, clean and straight in grain, though rather coarse and open, is fairly easily worked, but contains a metallic substance like phosphate of lime, which blunts the planes. It does not split, crack, shrink, or alter its shape after being cut like so many other timbers, which is doubtless due to the careful seasoning which the timber receives before it is put on to the market. Teak does not corrode iron with which it comes in contact, being in this respect superior to oak, and is much used as backing for armour plate in ironclads, the oil contained in the timber probably

acting as a preventive against rust. Teak is the chief timber used in most parts of India for engineering structures, temples, and heavy work, and is one of the few timbers which resist the white ant. It lasts fairly well in sea water, and the teredo will not choose it in preference to other timber in the same neighbourhood. Its durability in tropical climates is extraordinary; instances are known of teak beams having lasted a thousand years, and it is one of the few really durable Indian timbers. It is a good deal used for sleepers, and half-round timbers of jungle teak have been in the track after at least twenty-five years' service in Bombay and Gujarat. The Burmese use it a good deal for carving, but owing to the grain it cannot be very finely worked. Some of the internal woodwork of Truro Cathedral is of teak; it is largely used for ships' decking, handrails, exposed doors and fittings all over the world, for boat and house building and for furniture in India, and for doors, windows, and first-class joinery work in Great Britain. It is too costly for use out of India except for special work, being the dearest timber with the exception of mahogany imported in any large quantities into Great Britain. It is stronger and stiffer than English oak, although the structure of the wood is somewhat similar. The price of Rangoon logs in the English market varies from £6 10s. to £9, fitches or slabs from £9 10s. to £12, and planks from £14 5s. to £19 15s. per load of 50 cubic ft., and for good ships' decks it will sometimes run up to nearly £30 a load.

From what has been said as to the risk in cutting up teak logs it will be evident that for planking or thin stuff it is advisable to buy teak cut as required and not in the log.

A large quantity of Java teak is now imported, but it is not nearly of such good quality as Rangoon teak. It is not such a mellow wood, being softer, more coarse and open in grain, and in the log as imported is much more burrowed



by insects than the Rangoon timber and is not so well converted ; it is, however, much cheaper, not running to much more than half the cost of Rangoon, and obtains a ready market. Some of the better quality of Java teak is very suitable for certain classes of work where mild-natured teak is not essential, but a large quantity of poor stuff is exported. Logs and planks are also brought from Bangkok and the price is much the same as Moulmein or Rangoon. Great quantities of teak railway keys are now imported.

The total quantity of teak exported from Burma in 1904-5 was 135,385 tons, as against 156,039 tons in the previous year, and of this 87,068 tons were shipped to British India and 34,407 tons, or 25 per cent. of the total, were exported to the United Kingdom. The supply of Rangoon teak is not equal to the demand ; all that can be got is quickly bought up. Teak is classed highest of all timbers at Lloyd's.<sup>1</sup>

Weight, well seasoned, from 37 to 52 lbs. per cubic foot.

In connection with teak may be mentioned the curious circumstance that much emphasis is laid by different forest officials on the damage to the timber caused by careful protection of the forests from fire, which is in contrast to what is the case in America and shows that like causes do not produce like effects. From much evidence bearing on this point, the following remarks made by Mr. Troup in the *Indian Forester* will suffice: " It is impossible by mere figures, however accurate . . . to give any idea of the terrible destruction which is being wrought in our once valuable moist mixed forests by prolonged fire protection. . . . We are most certainly exterminating our teak by fire

<sup>1</sup> Although such a large quantity of teak is used for constructive purposes in India, the author cannot find any carefully recorded series of experiments on large pieces of timber. The modulus of rupture is generally assumed as between 12,000 and 13,000 lbs. per square inch.



**THIS PAGE IS LOCKED TO FREE MEMBERS**

Purchase full membership to immediately unlock this page

# DELVE INTO FANTASY, MAGIC, MYTHOLOGY & FOLKLORE

Forgotten Books'  
Full Membership gives  
access to 797,885 ancient  
and modern, fiction and  
non-fiction books.

**Continue**

\*Fair usage policy applies

Andamans. The wood varies a good deal in strength and weight, but is very useful, and of late a good deal has been sent to the London market. The "burrs" are specially valuable and bring fancy prices. It is the "East Indian walnut" of the European market. Logs cut in the Andamans give about 50 ft. length by about 3 ft. a side; the wood seasons, works, and polishes well, and is fairly durable. Used for sugar-cane crushers, furniture, well curbs, and wheel work, and in South India for boats; in the Andamans it is employed for building generally, and especially for house posts.

Weight 40 to 60 lbs. per cubic foot.

**Chuglan** (*Myristica irya*), called Maloh in Burma, Chuglan being the Andaman and Iriya the Cingalese name. It is a moderate-sized evergreen, producing a dark olive green, hard, handsome wood, which seasons well and takes a good polish. In the Andamans it is chiefly used for furniture.

Weight about 52 lbs. per cubic foot.

**Kaita-da** (*Artocarpus chaplasha*), an Andaman wood which is also found in Assam and Bengal, called Sam in the former and Chaplash in the latter district. The colour varies from yellow to brown; it is moderately hard, even grained, durable, and seasons well. Good for furniture; it looks when polished like coarse satinwood; it is also used for doors, door frames, and general building. This wood neither cracks nor warps in seasoning, and is not much attacked by white ant.

Weight about 30 to 35 lbs. per cubic foot.

**Lakuch** (*A. lakoocha*) is a white, soft, and perishable timber of yellow colour, turning to dark brown on exposure. Much used for building in the Andamans, it is in some places highly prized, but is more important as a fruit than timber

tree. Can be had in large logs. Both Lakuch and Kaita-da, according to Colonel Drury, would appear to be a species of the jack tree.

Weight about 40 lbs. per cubic foot.

**Thitman**, or “**Prince of Woods**” (*Podocarpus neriifolia*), produces a wood of light yellow or yellowish grey, close even grained, and fairly hard. Much esteemed in Burma and of considerable importance in the Andaman Islands, it is excellent to work, and is used for general carpentry, also for oars, spars, and tea boxes. Logs may be got up to 35 ft. and 15 inches square. The medullary rays are very fine and numerous.

Weight 39 to 42 lbs. per cubic foot.

**Mohwa** (*Mimusops littoralis*), Andaman bullet wood, is used for general building work and house posts in the Islands; in Burma it is called Katpali; it is red in colour, smooth and close grained, but apt to split. In the Andamans it is also used for bridges. The tree is seasoned like teak by “girdling,” is not attacked by white ants, but is difficult to cut or saw and drive nails into.

Weight 64 to 72 lbs. per cubic foot.

**Thingan** (*Hopea odorata*), which is a lofty tree, attaining a height of 200 ft. and sometimes 80 ft. to the first branch, grows in the tropical moist forests of Burma and in the Andaman Islands, where it is called Rímdá. It is the chief timber of Southern Tenasserim, and is a good deal used for gun carriages and general carriage work.

It furnishes a beautiful, valuable, and durable wood of yellowish brown colour, hard, close and even grained, and boats made of it are said to last twenty years. Half a dozen logs of thingan were in a London sale catalogue

for July last. Logs 40 ft. long by 2 ft. a side can be obtained. Known as Mai takien in Siam.

Weight about 50 lbs. per cubic foot.

**Pyinma** (*Lythracæ flos reginæ*) is the chief timber tree of Assam, Eastern Bengal, and Chittagong, and one of the most important of the trees of Burma. The above is the Burmese name; it is called Jarul in Bengal. It gives a good useful timber, but much of it grows twisted and knotty, and there is a good deal of waste in conversion. It is used for shipbuilding, boats, carts, gun carriages and gun stocks, also for building work and roof shingles; the wood varies in colour, some being redder than other. It is equal to teak for resisting the teredo. The medullary rays are very fine; annular rings marked by belt of large pores. Called Mai tabak in Siam.

Weight 40 to 45 lbs. per cubic foot.

**Gangau** (*Mesua ferrea*) is a small tree about 20 ft. high which grows amongst the teak in Burma; this is the Burmese and Andaman name, but it is known under various other names in different districts, as, for instance, Nahor in Assam, and Assam ironwood. It grows plentifully in the Andamans, where it is used for general building work, bridges, gunstocks, tool handles, etc.; it is very hard, heavy and strong, and difficult to work, and these are probably the reasons why it is not more used. The wood is dark red, and the pores are filled with yellow resin. Sleepers of this wood are said to be as good as those of pyinkado.

Weight up to 74 and 76 lbs. per cubic foot.

**Thitya** (*Shorea obtusa*) is found in the forests of Burma up to a height of 2,000 ft., a large tree, sometimes 50 ft. to the first branch; the wood is the colour of sal, but more



**THIS PAGE IS LOCKED TO FREE MEMBERS**

Purchase full membership to immediately unlock this page

# Know Your Bible

Forgotten Books'  
Full Membership  
provides unlimited  
access to more than  
28,000 volumes of  
Christian literature for  
\$8.99/month

**HOLY  
BIBLE**

**Continue**

\*Fair use policy applies

and durable, and contains much resin; it is the most valuable timber of the districts in the Himalayas, where it is found from 6,000 to 10,000 ft. above sea level. It is largely used for building and engineering work in Cashmere and the Punjab. For planking, doors, windows, and furniture it is better than the deodar, as it is not so brittle and does not contain the oil which in the deodar so readily absorbs dirt; it is also used for tea boxes.

Weight 28 to 30 lbs. per cubic foot.

**Long-leaved Pine** or **Chir Pine** (*P. longifolia*) is not such good timber as the blue pine, being softer, but is used a good deal in building, for shingles, tea boxes, etc. It grows in greater profusion than the blue pine.

Weight 28 lbs. per cubic foot.

**Khasia Pine** (*P. khasya*) has much the appearance of *P. sylvestris*, and is the chief soft wood for building in the Khasia hills, where over a large area it is known as Tinya, and attains a height of 100 ft. with 3 ft. diameter. It is also found in Burma. It is moderately hard, pale brown in colour, and very resinous.

The white, soft, and easily worked wood of the Spruce Fir of the Himalayas, a tree similar to European spruce, is largely used in Simla and neighbourhood for rough joinery, planking, etc.; and the Silver Fir, which sometimes has a trunk rising 40 ft. before sending out a branch, produces a similar timber, but one which is not suitable for exposed work, nor is it in much demand if the deodar is to be found in its neighbourhood.

**Larch**, somewhat like the European larch, and Cypress, which yields a brown hard wood, are used for building and other purposes.

## CHAPTER VII

### TIMBER OF THE STRAITS SETTLEMENTS, MALAY PENINSULA, JAPAN, AND SOUTH AND WEST AFRICA

**STRAITS SETTLEMENTS :** Tembusu Tembaca—Daru—Balau—Keledang—Kulum—Naito Balam—Penak Chengai—Kranji Sepan—Tong Mang—Tampenis—Champak—Meranti—Bintangor—Rengas Manau—Djati—Billian—Kajoe Bessi—Kariskes—Possi Possi, Tring—Merabau—Molave—Lauan.

**JAPANESE TIMBER :** Shira Gashi—Aka Gashi—Shiron Gashi—Onara—Keyaki—Hinoki—Sugi—Honoki—Aka Matsu—Kuro Matsu—Ash—Katsura.

**SOUTH AFRICA :** Sneezewood—Milkwood—Ironwood—Yellowwood—Stinkwood—Els—Ash—Assegai Wood—Cedarboom—Kajatenhout—Ikusi—Mlange Cedar—Iroko—Opepe—Oganwo—Ekki—Greenheart.

### TIMBER OF THE STRAITS SETTLEMENTS AND MALAY ARCHIPELAGO.

NOTWITHSTANDING that there are quantities of hard, useful timbers in these districts, they are not easily obtainable.

**Tembusu Tembaca** (*Fagraea speciosa*) is found in the Malay States, Sumatra, and other places, where it grows to a height of 80 ft. and 5 ft. diameter with straight, unbranched trunk for a considerable height. The timber is yellowish white, hard, compact, resinous, and very durable and has little or no sap. The annual rings very distinct and close. This timber is used for beams in bridges, house-building, planking, etc.



**Daru** is a fairly large tree, a native of Sumatra. There is no sapwood noticeable; the wood is hard and heavy, somewhat resembling Balau, of yellowish colour, with fine, distinct rays. It is now scarce except in small sizes about 6 inches square. It is used for general building purposes.

Weight about 66 lbs. per cubic foot.

**Balau** or **Ballow** (*Parinarium oblongifolium*) is now rare. The wood is yellow when freshly cut, but becomes orange and eventually dark brown, is not unlike billian, though a little lighter in colour, and has some of its excellent qualities. It is a good, useful timber, is employed for piling, beams, and sleepers in Singapore and other places, and is one of the best timbers for resisting the teredo. Often called Johore teak.

**Keledang** (*Artocarpus lanceofolia*) is a good-sized tree with straight trunk and fairly common. The sapwood is light, the heartwood yellow, becoming dark red with exposure; a good, useful timber, of even grain, hard and heavy, with conspicuous rays; it is a favourite wood for Chinese coffins, durable underground, bends easily, and is not unlike mahogany in appearance.

**Kulum** (*Scordocarpus borneenses*), a common tree of the Malay Peninsula, yielding a first-class timber of deep brown colour, resinous, heavy, and fairly hard; the annual rings are narrow and wavy. It is used for bridge and house building and other general purposes.

Weight about 62 lbs. per cubic foot.

**Naito Balam** (*Payena lucida*), another common tree of this district, which sometimes attains a height of 100 ft., produces a fairly hard red timber, with moderate-sized pores



**THIS PAGE IS LOCKED TO FREE MEMBERS**

Purchase full membership to immediately unlock this page

# DELVE INTO FANTASY, MAGIC, MYTHOLOGY & FOLKLORE

Forgotten Books'  
Full Membership gives  
access to 797,885 ancient  
and modern, fiction and  
non-fiction books.

**Continue**

\*Fair usage policy applies

which stood a tensile strain of 6,790 lbs. per square inch. He also made six tests for transverse stress which gave 8,884 lbs. per square inch, whilst the crushing stress on cubes 2 inches by 2 inches gave an average of 5.33 tons per square inch.

Camphor is found in small crystalline masses in natural cavities in the wood. This is very much prized by the Chinese, but is not the camphor of commerce.

Weight about 47 lbs. per cubic foot.

**Tampenis** (*Sloetia sideroxylon*), a well-known tree from 60 to 80 ft. high, which produces one of the best timbers of these parts, with yellowish white sapwood, and heartwood dark reddish brown, is hard, resinous, and durable, and is said to be proof against fungus and termites. It has irregular, dark, somewhat broad, but distinct rings, and the trunk is unbranched for the greater part of its height.

Weight 67 lbs. per cubic foot.

**Champak** (*Magnolia champaca*), the Malay name for a tall evergreen producing a hard, durable, and ornamental wood of yellowish brown colour and even grain, is largely used in India for planking, panel, carriage work, and furniture. The tree is much cultivated round about Jain and Hindoo temples, and the wood made into beads and necklaces, which are sold to pilgrims. It is called Titu Sepa in Assam. Resistance along fibres as tested by Prof. Unwin 753 lbs., crushing stress 1.57 tons, and transverse stress 3.48 tons per square inch.

Weight about 41 lbs. per cubic foot.

**Meranti** (*Hopea meranti*) grows to a height of 100 ft. with a straight trunk 3 ft. in diameter. It is also fairly abundant in Malacca and Perak. The stem and branches when cut yield a quantity of damar, a kind of gum, of considerable commercial value at Singapore. The timber is a soft red

wood, much used for planking, furniture, and box-making, and is occasionally imported into England in the shape of planks 2 to 4 inches thick. The annual rings are distinct.

Weight 55 lbs. per cubic foot.

**Bintangor** (*Calophyllum inophyllum*), a beautiful evergreen of small size, which usually grows near the sea, and does not thrive inland, yielding a close-grained smooth wood of red colour, variable in character, but a good deal used for sleepers, is much in demand for the sternposts of ships, as well as for piles and scaffolding, and is an excellent cabinet-makers' wood. There are some thirty species; this is considered the best. In Bengal it goes by the name of Pinnay, and in Ceylon Penaga. In the Andamans it may be had in logs up to 25 ft. and 18 inches square. Probably one of the trees from which the poon spars were obtained.

Weight 42 to 59 lbs. per cubic foot.

**Rengas Manau** (*Melanorrhœa maingayo*), often called Straits mahogany, is a fairly hard, dark red wood, coarse in quality; the caustic resin it contains often causes Rengas poisoning amongst those working at the timber. Rengas is the Malay name applied to various trees of this species. There is little or none of this timber exported from the Malay States, but there is a good local demand in Singapore and other places. It is also found in Borneo, where it is called Borneo rosewood. It has very distinct dark rings.

**Djati** is the Malay name for teak. Sourabaya is the port of shipment, and it is sometimes called by this name. It is a kind of teak which grows in Java, and is the only wood used there for sleepers, for which purpose it is very durable and gives great satisfaction, as white ants never attack it when used for this purpose owing to the shaking of the trains, but it is liable to attack when the sleepers are

stacked. It is imported into Great Britain in the shape of planks, and is probably, as a rule, the same timber which goes by the name of Java teak, and of which there are extensive plantations in the island.

Weight with 12 per cent. of moisture 41 lbs. per cubic foot and 37 lbs. when perfectly dry.

**Billian** or **Ironwood** (*Eusideroxylon zuageri*), a very hard, heavy brown coloured timber suitable for shipbuilding and piling, comes from North Borneo. It is not to be obtained in large quantities or in long lengths; the largest sizes run from 25 to 45 ft. long and about 10 inches by 10 inches square, and it is obtainable also in the round. It is one of the few timbers which are practically impervious to the teredo. A log of this timber was bolted to the jetty at Port Darwin or Palmerston, on the northern coast of the colony of South Australia, by Mr. J. W. James, M.I.C.E., on 2nd November, 1886, and it remained intact until examined in December, 1889, when no trace of the teredo could be found in it, and this of several timbers tried was the only one which withstood the teredo, and that in a locality where it is so particularly voracious that the piling of the jetty, which was of Karri timber, had to be encased with Muntz metal. Billian was afterwards used to replace Karri for chafing pieces between high and low water on this same jetty. Billian was not proof against attack by white ants, but was not materially damaged in twelve months, and hereabouts the white ant is as destructive as in any part of the world. There are two varieties of this timber, Billian Chingy and Billian Wangy. The latter, which is much the best, is of a brown colour, and has a structure not unlike greenheart. A small quantity of Billian comes into the English market.

Weight about 70 lbs. per cubic foot.



**THIS PAGE IS LOCKED TO FREE MEMBERS**

Purchase full membership to immediately unlock this page

# Know Your Bible

Forgotten Books'  
Full Membership  
provides unlimited  
access to more than  
28,000 volumes of  
Christian literature for  
\$8.99/month

**HOLY  
BIBLE**

**Continue**

\*Fair use policy applies

quality, close grained, and of straw colour, somewhat resembling satinwood.

Weight about 50 lbs. per cubic foot.

**Lauan** (*Dipterocarpus thurifera*) is another Philippine wood which was at one time much appreciated for shipbuilding for the reason that it had the merit of not splintering when struck with shot.

### JAPANESE TIMBER.

Notwithstanding the extensive forest area of Japan, amounting to about 28,000,000 acres, containing much very valuable timber, it is extremely doubtful if any great quantity will ever come into the foreign markets. A people with so keen a business instinct is unlikely to follow the shortsighted policy of other nations and denude the country of such a valuable asset. The Government has for some time past taken up and studied the question of forestry in the State forests, which represent about half the forest resources of the kingdom, and not only does Japan husband her own natural resources, but she is actively engaged in planting foreign species of timber as well. Large quantities of American timber have been imported in the past, but this the Japanese expect soon to be able to do without. Japanese hardwood was largely used for Chinese railways, especially along the Gulf of Pechili, where timber is very scarce, and £200,000 worth of hardwood sleepers were exported from the island of Hokkaido in 1904, but, with the exception of oak and ash, the author is unaware of any Japanese timber being imported into Great Britain.

**Japanese Oak**, of which there are many varieties, much resembles in texture and quality the American oak, and is attracting the attention of wagon builders and others, owing

to the high price and scarcity of the latter. Unlike the American wood, the Japanese oak sent over is most accurately sawn.

**Shira Gashi** (*Quercus glauca*) is a hard, close-grained, brown wood, traversed by numerous fine medullary rays, elastic and durable. It is much used for shafting, tools, vehicles, wheelwork, etc., and in all situations where it is exposed to frictional wear, as in native mill machinery, etc. It does not attain sufficient size to be generally useful in engineering works, the girth being seldom more than 3 ft.

**Aka Gashi** (*Q. acuta*) is another Japanese oak, the timber of which is hard and of great strength, dark brown in colour; used for shipbuilding and for machinery and carriage-building. Shiron gashi is used for similar purposes. Recently a shipment of several hundred logs of Japanese oak was landed at the London docks; the timber was square, sound, and in fair lengths and excellent sizes; it was a mild-looking wood and of good texture. The shipment also comprised a quantity of planks and boards of the same. In the northern island the oaks grow to a considerable size, but owing to the difficulties of the ground large sizes cannot be got out.

**Onara** (*Q. crispula*) has recently been in the European market under the name "Nara" in lengths up to 16 ft. by 8 inches by 3 inches.

**Keyaki** (*Zelkova keaki*) is the most important of Japanese hardwoods and is allied to the elm. The wood is light brown in colour with the annual rings distinctly marked, and in strength and appearance it resembles teak. A strong, durable, close-grained timber, often knotty, easily worked; it is procurable of sufficient size for all kinds of



construction work. It is also durable in situations alternately wet and dry, used for piles in bridge work and in the best class of structures, and may be seen sound and in good condition at a very great age in some of the temples, a sufficient proof of its durability when properly seasoned. The main beams of the wooden lighthouses erected along the Japanese coasts by English engineers many years back were of keaki up to 28 ft. long and 12 inches square; the keels, sternposts, and stems of lightships were made of the same timber, and the outside was keaki planking 2 inches thick. It is a handsome wood, takes a high polish, and is much prized by cabinet-makers and carvers. Chiefly felled when about 4 ft. in girth, in the temple groves and alongside the main high roads specimens are nevertheless to be seen upwards of 12 feet in girth. It can be had in lengths up to 30 ft., but above 20 ft. the price is higher. One of the difficulties experienced by foreigners in using Japanese timber in the past has been the slight attention paid to seasoning, much of the wood offered for sale being full of sap.

Average weight by three observers  $56\frac{1}{2}$ , 53, and  $43\frac{1}{4}$  lbs. per cubic foot; the variation is doubtless due to some of the pieces being more seasoned than others.

**Hinoki** (*Cupressus obtusa*) is a tall straight-growing tree, the wood of which is compact, durable, easily worked, and has a silky lustre when planed, of a straw colour and free from knots and winds; it is valued as mast timber, and is very similar to yellow pine. Light, tough, and elastic, when fairly seasoned it does not warp, and is very durable in damp situations. It is the favourite softwood for doors, windows, uprights in house construction, and is also used for railway sleepers and boat-building, and extensively for pattern making and cabinet work. Temples and chapels



**THIS PAGE IS LOCKED TO FREE MEMBERS**

Purchase full membership to immediately unlock this page

# DELVE INTO FANTASY, MAGIC, MYTHOLOGY & FOLKLORE

Forgotten Books'  
Full Membership gives  
access to 797,885 ancient  
and modern, fiction and  
non-fiction books.

**Continue**

\*Fair usage policy applies

generally. It can be got in lengths up to 30 ft. It has also been used in tunnel works in Japan.

**Kuro Matsu**, also called Omatsu (*Pinus thunbergii*), is another of the Japanese pines, a great variety of which grow in the country. It is of a hardy nature and a common tree of the hill forests. Although coarser and less resinous than aka matsu it is frequently used with the latter for works in dry situations. The above pine timbers are inferior in strength to their European prototypes, as, owing to the climatic conditions of the country, they are of more rapid and exuberant growth.

**Ash**, of which there are something like twelve varieties, has recently been sent in large quantities to the English markets. It has come in the form of planks ranging from 1½ to 8 inches thick and 6 to 19 inches wide and up to about 30 ft. long, most accurately sawn and practically free from heart knots and shakes, straight grained and of good texture. It is not so dense as English ash, but compares very favourably in quality, texture, and price with Quebec wood, has a nice figure, and is well fitted for light carriage work.

A large quantity called "tamo" was recently shipped to the Continent, particulars of which were given in the *Timber Trades Journal* of October 12th, 1907. Yachidamo is the correct name, and the botanical name is given as *Fraxinus mandschuria*, showing that the wood is considered to be a species of ash, although, seeing that it does not quite resemble any species of commercial wood hitherto known in Europe, and has many features in common with elm and oak, there have been differences of opinion as to its classification. It is very beautifully figured, soft and easy to work, but nevertheless strong and heavy, and will

doubtless be appreciated by cabinet-makers. Its chief fault lies in want of seasoning—the Japanese have never had any idea of seasoning wood—and some pieces split badly. It is fairly free from knots, but some of the knots are dead.

There are two kinds of tamo—tamo-moku, a beautiful curly-grained wood, and tamo-chichinii, which has a wavy grain. Both are used for carriage panels in Japan. “Sen” is a species of white ash, softer than American ash, which shows a beautiful figure; it is only got in lengths of 10 to 12 ft., though up to 17 inches diameter. Quantities of both “sen” and “tamo” are being used on the Chinese and Manchurian railways and largely in Japan for railway sleepers, for which the latter, at any rate, is said to be well suited. “Sen” is largely used for furniture in Japan and is well adapted for that purpose; it takes good polish, does not warp, is hard, and lasts well.

**Katsura** (*Cercidophyllum Japonicum*), of which there are several kinds, attains a height of 80 ft.

Red katsura is said to be well adapted for making cigar boxes. This timber is obtained in good widths and is used for furniture. It has quite a silky appearance when planed, and is considered by the Japanese one of their best woods for fine, neat work.

There are several varieties of maple, one a beautiful “bird’s-eye,” known as itaya-moku, and another with flowery grain called “hana-itaya.”

The above are the best known commercially, although only a few of the excellent timbers which grow in Japan.

Doubtless one reason why such little attention is paid to seasoning or preservative processes is that fire and tempest, and not decay, generally determine the existence of the light Japanese structures. Paint is seldom used, but wood

is sometimes stained with shibio, the juice of the persimmon darkened by lampblack and ashes, and this is some protection from the weather, and does not prevent seasoning as paint would do if used over unseasoned wood.

### SOUTH AFRICAN TIMBER.

Although the forests of South Africa produce large quantities of various kinds of trees, only a few have so far been found available and suitable for constructional work. Amongst these are the following:—

**Sneezewood** (*Pteroxylon utile*) is the best-known native timber in Cape Colony for durability, whether used for piles in water, superstructures of bridges, or other engineering works; it is heavy, hard, tough, strong, close grained, and more difficult to work than teak. It is found in Kaffraria and Pondoland. It is seldom possible to cut a log with sharp edges up to 12 inches square, neither is it obtainable in long lengths, as the tree only grows to a height of 30 to 50 ft. Of a yellowish colour, somewhat resembling satinwood in the grain, and is sometimes nicely figured. The Dutch name for this wood is Neishout. Besides being the chief timber for heavy work, it is employed in cabinet-making and carpentry. It derives its name from the irritating nature of the dust produced by sawing or working the wood, which causes sneezing. The price is high in Cape Colony.

Weight about 68 lbs. per cubic foot.

**Milkwood** (*Mimusops obovata*) is a fairly tough, close-grained wood.

**Red Pear** (*Scolopia ecklonii*) is also a useful hard, close-grained timber.



**THIS PAGE IS LOCKED TO FREE MEMBERS**

Purchase full membership to immediately unlock this page

# Know Your Bible

Forgotten Books'  
Full Membership  
provides unlimited  
access to more than  
28,000 volumes of  
Christian literature for  
\$8.99/month

**HOLY  
BIBLE**

**Continue**

\*Fair use policy applies

near Worcester has been constructed with this timber, chiefly as an experiment. Suitable for "launders" or shoots, it must, however, be cut at the right time, when the fruit is ripe.

Weight from 29 to 37 lbs. per cubic foot.

**Olivewood** (*Olea verrucosa*) is largely used up country for posts, wagon-building, and other purposes.

Weight 68 lbs. per cubic foot.

**Stinkwood** (*Ocotea bullata*), sometimes called Cape mahogany or Cape walnut, is another important South African tree, growing from Cape Colony to Zululand. It is an evergreen, 60 to 90 ft. high and 3 to 5 ft. diameter, and a fairly quick-growing tree. The wood is of a dark brown colour resembling dark walnut, heavy, hard and strong, fairly elastic, tough and durable in contact with ground. It makes handsome furniture, but is chiefly used for planks, beams, doors and windows, railway sleepers, and for all kinds of wagon-building except the spokes.

Weight 53 lbs. per cubic foot.

**Red Els** or **Elder** (*Cunonia capensis*) somewhat resembles red birch, and is used for posts, palings, wagons, and ordinary carpentry, and is excellent for turning. **White Els** (*Platylophus trifoliatus*) is used for palings, posts, and general farm work.

Weight of Red Els about 46 lbs. and White Els 38 lbs. per cubic foot.

**Cape Ash** or **Essenhout** (*Eckebergia capensis*), a tough and useful timber, not unlike elm and close grained, is used for common floors, sides of wagons, and occasionally for furniture. It grows in Cape Colony and Natal and can be got in logs up to 18 inches square.

Weight 48 lbs. per cubic foot.

**Assegai Wood** (*Curtisea faginea*), or Cape lancewood, is a tough wood of light red colour, used for shafts, wheel spokes, assegai shafts, turnery, etc.

Weight 56 to 60 lbs. per cubic foot.

**Cedarboom** (*Widdringtonia juniperoides*), a kind of cypress, has a grain not unlike Havannah West Indian cedar, but of lighter colour. Used for floors, roofs, and other building purposes; it does not, however, stand exposure.

Weight 48 lbs. per cubic foot.

**Kajatenhout** (*Pterocarpus angolensis*) is much appreciated in the Transvaal and Cape Colony for furniture. The colour is a yellowish brown and it often has a pretty pattern.

**Ikusi** or native teak is a most serviceable and durable wood for mining purposes and impervious to the white ant.

Weight about 57 lbs. per cubic foot.

The ikusi forests of Matabeleland cover some 2,000 square miles and are densest between the Umgaza and Ingusa rivers. N'Ishibi resembles ikusi, but is not so heavy.

The **Mlange Cedar** (*Widdringtonia whytei*) is one of the most valuable trees in Nyassaland and attains a height of 150 ft. It yields a valuable timber, easier wrought than deal and much more beautiful. It is fragrant, close grained, and stands damp well. Posts fixed in the ground for thirty years, exposed to damp and drought, were taken up practically intact. The supply of trees is being rapidly exhausted. This is one of the few conifers indigenous to South Africa.

**Mahogany**, which is practically the only timber as yet exported from Africa, has been referred to in another place, but there is little doubt that in years to come, when the



country is opened out, great supplies of other timber will be brought from West Africa. The great Congo Forest, the "dark forest" so ably described by Stanley, covers a compact square area of over 320,000 miles and contains immense supplies of all kinds of valuable timber.

Amongst the timbers of Nigeria and the Gold Coast are the following, none of which are as yet exported to any extent :—

**Iroko**, a dark brown timber of uniform colour; the grain is straight, but coarse and open. It will not take a fine finish, as there is a tendency for it to "pick up" under the plane. A good-sized log of this timber, containing 78 cubic ft., was recently sold at 10*d.* per cubic foot in Liverpool. This is probably *Chlorophora excelsa*.

Weight about 39 lbs. per cubic foot.

**Opepe** is an excellent wood to work and easy to polish.

Weight about 47 lbs. per cubic foot.

**Oganwo** is a kind of cedar, very like Axim mahogany.

**Ekki** (*Lophira procera*) is the African oak, some of which has come in small parcels to the English market. It is very hard, dense, and deep red in colour. The pores are filled with a white deposit. It is a first-class fancy wood.

There is a timber called greenheart which comes from Sapoli, in colour something like mahogany.



**THIS PAGE IS LOCKED TO FREE MEMBERS**

Purchase full membership to immediately unlock this page

# DELVE INTO FANTASY, MAGIC, MYTHOLOGY & FOLKLORE

Forgotten Books'  
Full Membership gives  
access to 797,885 ancient  
and modern, fiction and  
non-fiction books.

**Continue**

\*Fair usage policy applies

rugged bark and aromatic odour give them a peculiar and unmistakable character.

The *Eucalypti* of Australia and Tasmania are known in Europe for their high reputation as hygienic agents in districts infected with malaria, and have been tried on the Italian Campagna with satisfactory results.

The growth of the trees is rapid, *E. globulus*, the Tasmanian blue gum, having attained a height of 26 ft., with a mean circumference of 26 inches in a little over four years in Italy. Other trees of eight years' growth attained to 50 ft. high and 3 ft. in circumference. Mr. H. N. Draper, M.R.I.A., has grown them in the neighbourhood of Dublin to a height of 26 ft. with a circumference of 22 inches in five years. They appear to survive a temperature which does not fall below 23° Fahr., but on one occasion in Italy, when the thermometer fell to 20° Fahr., half the plantation was destroyed.

Now that the forest areas of America and the regions round the Baltic are being denuded of their best timber—and, so far as regards America, we can see within a comparatively short period a dearth in timber supplies from that region—it is pleasant to know that we have the immense virgin forests of our Australian colonies to fall back upon for part of our future supplies, districts in which the felling industry can be carried on all the year round, where there are no icebound ports, so that the timber can always be shipped, and where there is no difficulty in obtaining labour as is the case in fever-stricken climates, such contingencies as seriously trouble timber importers in many of the regions from which our present supplies come.

Little is yet known in the timber market of the timbers of Australia, only a few of them having as yet been

exported to Great Britain, and those only within recent years. They are to be found in great profusion, and, so far as regards hardwoods, furnish a supply and quality unequalled in the world. The extent of merchantable timber in Western Australia is approximately 20,000,000 acres; New South Wales, with only one-third the area, has 15,000,000 acres, which, however, are not so concentrated as in Western Australia; Queensland, 40,000,000 acres; Victoria, 11,000,000 acres; South Australia, 3,800,000 acres.<sup>1</sup> The true forest area of Australia lies in a belt along the coast-line, where the average annual rainfall varies from 35 to 40 inches. As the area of rainfall decreases further inland the trees become of a poorer quality and a softer nature.

It should be carefully noted that with the eucalyptus, as with other evergreen trees, *the heart is the weakest portion*, which is contrary to the general rule, and especially in the case of conifers, and an experienced timberman considers that all eucalyptus timber used for piles should have the heart "boxed." All scantlings should be clear of the pith or centre of heart by at least 3 or 4 inches, and in some cases more, and as the wood invariably shakes in the direction of the medullary rays and across the annual rings, all scantlings should be sawn on that quarter. Thus it will be seen that in the conversion of this class of timber there is a considerable waste. (See Figs. 31 and 32.)

Mr. Charles Dearden, Government timber inspector for Tasmania, writes thus on June 20th, 1905: "I am at a loss to understand engineers and others in their inquiries from our merchants for quotations specifying that heart will be accepted, thus showing the necessity of making our timbers better known to foreign inquirers who are more in touch

<sup>1</sup> As previously stated, the total area covered by forest in Australia is about 173,500,000 acres.



*[By permission of the Government of Western Australia.]*

**FIG. 30.—Jarrah Forest.**



**THIS PAGE IS LOCKED TO FREE MEMBERS**

Purchase full membership to immediately unlock this page

# Know Your Bible

Forgotten Books'  
Full Membership  
provides unlimited  
access to more than  
28,000 volumes of  
Christian literature for  
\$8.99/month

**HOLY  
BIBLE**

**Continue**

\*Fair use policy applies

As showing the density of the timber, a paving block which had been lying in a room nine or ten years and weighed 3 lbs. 14 ozs. only absorbed 2 ozs. of water after an immersion of twenty hours, and this was not increased after the timber had been kept in water for a total period of forty hours. According to *Indian Engineering*, jarrah has recently been used in place of teak on some Government buildings, as it was cheaper and found quite as satisfactory.

Weight about 68 lbs. per cubic foot when cut, and 48 lbs. when dry; 55 lbs. when fairly seasoned. The paving block above referred to weighed 50 lbs. per cubic foot.

**Karri** (*E. diversicolor*) is a taller tree than jarrah, being sometimes branchless for 100 to 120 ft.; in Warren River district it has been met with 300 ft. high and 180 ft. to the first branch. The forests cover 1,000,000 acres from Cape Hamlin to Torbay. The timber is of reddish brown colour, hard and dense, fairly elastic, and closely resembles jarrah, but is not so easily wrought. It is not well suited for damp situations, and when used for telegraph poles it decays at the ground-line. It is used for much the same purposes as jarrah, and can be had in logs up to 100 ft. in length and planks of great width. Specimen planks nearly 5 ft. wide have been obtained. Karri makes excellent wearing paving blocks, but is not so much used for this purpose as jarrah; it shrinks much more. It is much appreciated for wagon frames. For very long piles it will stand hard driving better than jarrah, being larger in fibre and more elastic.

Weight when cut 72 lbs., when fairly seasoned 63 lbs., and when dry 50 lbs. per cubic foot.

Although jarrah and karri are easily distinguished when growing by the difference in the barks, the former having

a rough broken deep-coloured bark, whilst that of the latter is smooth, clean, and of light colour, yet when seen in the log they are so similar in appearance that it is difficult to distinguish them, although karri has a rather more wavy



FIG. 31.—Showing the opening out of a section from a Eucalyptus log after lying in a dry place for four months.



FIG. 32.—The same section of Eucalyptus log as shown in Fig. 31 after being in water for three weeks. The cracks have mostly closed up, but the right-hand top corner broke off when being lifted out of the water.

grain than jarrah. A fairly reliable and easy test is by the ash. A splinter of jarrah when burnt gives a firm black ash, whilst one from karri gives a woolly white ash. The Woods and Forests Department of the colony will, however, if required by the purchaser, have the timber branded with a distinctive mark at a small extra cost. The sapwood in jarrah and karri is a light red colour, but is not generally more than an inch in thickness.

Notwithstanding what has been claimed as to jarrah and



karri being capable of withstanding the teredo, neither timber will do so in situations where the worm is very active, and in some marine works in the Australian colonies and elsewhere has had only a very short life. Jarrah is superior for resisting the sea worm to karri, and at Hartlepool and other places in Great Britain jarrah has withstood the attacks of the limnoria for ten to twelve years in a situation where pine timber would have been destroyed, but at Singapore jarrah piles were nearly eaten through in eighteen months. Both timbers are liable to shrinkage, the trouble with all hardwoods, and those of Australia particularly, and they require long seasoning. Many of the jarrah and karri logs set to the English market split very badly at the ends unless kept in water, and this applies more or less to all Eucalyptus timber. (See Figs. 31 and 32.)

**Tuart** (*E. gomphocephala*), a cream-coloured wood of great strength, density, and hardness, often interlocked in grain, has its annual rings close and distinct. The supplies are small and it is not much known out of the colony. It is used in the framework for railway wagons and buffers, where it has proved satisfactory; also for shafts, felloes, and wheelwrights' work generally, and where great strength and hardness is necessary. Not much definite information as to its durability is obtainable. Grows to a height of 150 ft. and 3 ft. diameter.

Weight about 70 lbs. per cubic foot when fairly seasoned and 60 lbs. when dry.

**Wandoo** (*E. redunca*) (Fig. 33), better known locally as white gum, grows to an average height of 60 ft. to 80 ft. The timber is brownish red in colour, very hard, dense, strong and durable. The annual rings close and distinct,



**THIS PAGE IS LOCKED TO FREE MEMBERS**

Purchase full membership to immediately unlock this page

# DELVE INTO FANTASY, MAGIC, MYTHOLOGY & FOLKLORE

Forgotten Books'  
Full Membership gives  
access to 797,885 ancient  
and modern, fiction and  
non-fiction books.

**Continue**

\*Fair usage policy applies

were hard and sound, and specimens of some of these when tested only gave 6 per cent. less average strength in cross-bending than thoroughly seasoned and unused timber.

Weight when just cut about 79 lbs., when fairly seasoned 70 lbs., and when dry 60 lbs. per cubic foot.

**Yate** (*E. cornuta*), though but little known, is probably one of the heaviest and strongest timbers in the world, one piece bearing the enormous tensile stress of  $17\frac{1}{2}$  tons per square inch, or nearly as much as wrought iron.

Weight 79 lbs. when first cut, 71 lbs. with 12 per cent. of moisture, and 64 lbs. per cubic foot when dry, or only slightly less than *lignum vitæ*.

**Red Gum** (*E. calophylla*), **Salmon Gum** (*E. salmonophloia*), **Morrel** (*E. longicornis*), and **York Gum** (*E. loxophleba*) are others of the hard, dense, reddish coloured timbers of this part of the world, which exist in great quantities, but none of which are, so far, exported to any extent. These gums are much intersected with gum veins, which often impair their stability for important and permanent works. The gum is a valuable product which is used medicinally and for tanning.

**Sandalwood** (*Santalum cygnorum*), in large quantities, is now exported to China and Singapore in competition with the other sandalwoods of commerce. Although only a small tree, 12 ft. to 18 ft. high and 8 to 10 inches in diameter, it is one of the most valuable products of the colony. Its colour is a yellowish brown streaked with dark lines. The sapwood is of a lighter colour and sharply defined.

Weight about 36 lbs. per cubic foot when perfectly dry.

RESULTS OF TESTS OF WESTERN AUSTRALIAN TIMBER, EXTRACTED FROM MR. G. A. JULIUS' TABLES.

Name of Wood.	Weight in pounds per cubic foot with 12 per cent. moisture.	Transverse Strength.		Compressive Strength as Columns.		Compressive Strength at right angles to grain. Lbs. per sq. in.	Shearing Strength along grain. Lbs. per sq. in.	Tensile Strength.		Remarks.				
		Ultimate extreme fibre stress. Lbs. per sq. in.	Modulus of Elasticity. Lbs. per sq. in.	Ultimate Strength per sq. in. Ratio of L to D.	Modulus of Elasticity for ratios of 12/1 Timber. Lbs. per sq. in.			Ultimate Strength. Lbs. per sq. in.	Modulus of Elasticity. Lbs. per sq. in.					
Jarrah . . . . .	55	15,000	2,080,000	12/1	7,710	9,050	7,710	5,140	1,493,000	2,520	1,050	15,500	2,150,000	The whole of the results are quoted at 12 per cent. moisture, in accordance with International Test Standards. The specimens tested transversely for the five last-named timbers averaged 10 sq. inches sectional area, the others averaged about 20 sq. inches in sectional area.
Karri . . . . .	58	17,300	2,680,000	10,200	9,350	10,200	9,350	6,250	2,027,000	2,780	1,050	18,750	2,850,000	
Tuart . . . . .	69	17,900	2,560,000	10,650	8,920	10,650	8,920	5,980	1,895,000	4,000	1,315	16,500	2,625,000	
Wandoo . . . . .	71	16,100	2,190,000	10,850	9,120	10,850	9,120	5,750	1,751,000	4,450	1,310	16,100	2,725,000	
Blackbutt . . . . .	54	14,200	2,000,000	8,450	7,560	8,450	7,560	5,000	1,319,000	2,670	1,130	15,700	2,475,000	
Red Gum . . . . .	56	16,600	2,590,000	9,280	8,050	9,280	8,050	5,600	1,976,000	2,220	1,150	20,200	2,400,000	
Yate . . . . .	71	21,500	2,800,000	11,600	10,180	11,600	10,180	7,100	1,900,000	4,300	1,675	24,200	2,780,000	
York Gum . . . . .	67	14,500	1,800,000	9,900	8,450	9,900	8,450	5,400	1,185,000	4,300	1,280	13,000	2,400,000	
Salmon Gum . . . . .	66	20,100	2,500,000	10,700	9,000	10,700	9,000	5,150	1,500,000	4,060	1,900	19,200	2,800,000	
Morrell . . . . .	64	16,900	2,400,000	11,100	9,450	11,100	9,450	5,500	2,010,000	4,250	1,200	18,000	2,850,000	
Shea Oak . . . . .	52	12,000	1,356,000	—	—	—	—	—	—	—	1,480	9,000	1,071,000	
Banksia . . . . .	35	10,300	1,148,000	—	—	—	—	—	—	—	1,100	8,000	703,000	

**Blackbutt** (*E. patens*) attains a height of 120 ft. and is found scattered over the jarrah and karri areas. It produces timber light in colour, hard and dense, and so tough that it will not yield to ordinary splitting processes. The annual rings are fairly clear and rather wide apart. It is suitable for sleepers, street paving blocks, piles, and main timbers of bridges and wharves. Largely used for wagon building, it is rather expensive to work, and has proved very durable in damp situations. Fence posts have been in the ground fifty years, and railway wagons built of blackbutt were in excellent condition after ten years' rough wear.

#### TIMBERS OF NEW SOUTH WALES.

The forest area of New South Wales resembles that of Western Australia in that it lies largely along the coastline, and the hardwoods are chiefly eucalypti.

**Ironbark**, of which there are four varieties, is the best of the hardwoods of the colony.

**White or Grey Ironbark** (*E. paniculata*) ranks most high. The timber is pale in colour when cut down, darkens on drying, is the hardest of the ironbarks, is rather difficult to work, and cuts almost like horn. Telegraph poles of this timber have remained fairly sound after being erected forty years; their average life is between thirty and forty years.<sup>1</sup> It has stood in some cases for fifty years in bridge timbers in the colony, and in many cases thirty-five years (Mins. of Proc. Inst. C.E., vol. 128). Ironbark may be had in lengths of 60 or 70 ft. It has a certain gumminess in working.

Weight, when green, 76 lbs. per cubic foot, and when seasoned about 71 lbs.

<sup>1</sup> None of the Australian telegraph poles or other timbers are artificially treated.



**THIS PAGE IS LOCKED TO FREE MEMBERS**

Purchase full membership to immediately unlock this page

# Know Your Bible

Forgotten Books'  
Full Membership  
provides unlimited  
access to more than  
28,000 volumes of  
Christian literature for  
\$8.99/month

**HOLY  
BIBLE**

**Continue**

\*Fair use policy applies

right angles to the grain, as distinguished from most wood borers, which follow the grain. The life, used as telegraph poles, is about the same as ironbark. This timber also grows in Queensland. Excellent for turning and carving.

Weight, seasoned, about 63 lbs. per cubic foot.

**White Mahogany** (*E. acmenoides*) somewhat resembles tallow wood in colour, but is of much more open grain and shrinks considerably in seasoning. It is very durable, tough, strong, and excellent for posts, piles, and general building purposes, and good for paving.

**Red or Forest Mahogany** (*E. resinifera*) is also suitable for all building work except beams.

**Blackbutt** (*E. pilularis*), also called mountain ash, is a similar tree to one of the same name in Queensland. Sometimes quite interlocked in grain, but not difficult to split; it is rather subject to gum veins and twists and shrinks in seasoning. It ranks next to tallow wood amongst the hardwoods, and is a first-class timber of khaki colour and enjoys great popularity with architects. Used as decking only on bridges, it is considered one of the best timbers in the colony for street paving, and has been much used for this purpose. Mr. R. W. Richards, city surveyor of Sydney, and formerly of Melbourne, said, in 1897, with reference to street paving, that "jarrah and karri are good timbers, but cannot compare with the blackbutt of New South Wales."<sup>1</sup> Some was laid down in the city of Lincoln in 1897, and a small quantity in Westminster. It is largely used for sleepers.

Weight 61 lbs. per cubic foot.

**Spotted Gum** (*E. maculata*), a lofty tree which gives a pale yellowish brown timber, often with a pretty wavy

<sup>1</sup> Proc. of the Assoc. of Municipal and Co. Engineers, Vol. XXIII.

grain, polishes well, is very tough and durable, and bends easily, and for this reason is largely used for coachbuilding and wheelwrights' work. It is liable to twist and shrink in seasoning. Spotted gum is similar to and often sold as blue gum. It was at one time used for street paving in Sydney, but was discarded as unsatisfactory, owing to its liability to rot.

Weight, seasoned, about 60 lbs. per cubic foot.

**Grey Box** (*E. hemiphloia*), a tough, hard, cross-grained wood of great strength, yellowish white or pale brown colour, is used for the naves and cogs of wheels, large screws, mauls, shaft handles, poles of drays, etc., and also for railway sleepers, and bears a good record for durability. It is sometimes called Canary or common Box.

**Brush Box** (*Tristania conferta*) is another strong, tough, durable timber obnoxious to the white ant. Pale in colour, sometimes brown, it turns grey on exposure. A good deal used for mallets, chisel handles, planes, etc., it is, however, difficult to season, and great care has to be exercised or the planks will warp and crack. Often called Red Box or Bastard Box. The darker coloured varieties from the Northern rivers are the best.

**True Red Box** (*E. polyanthema*) is a timber of the jarrah class, rich red in colour, close in grain, which works easily, is very durable, and becomes, with age, as hard as ironbark. It is used for paving, fencing, and general building work. This timber lasted for fifty years in perfect preservation in St. John's Church, Paramatta. It resembles the woollybutt, which in strength and durability ranks next in order to blackbutt and blue gum, but has the defect of twisting and shrinking whilst seasoning.

Weight, seasoned, about 72 lbs. per cubic foot.



**Grey Gum** (*E. propinqua*) is very like red ironbark, but can be detected by its brittleness—a chip of grey gum bent between the fingers will snap instantly; it is, however, very durable and much appreciated for piles and girders of bridges, etc. It also makes good railway sleepers.

Weight, seasoned, about 65 lbs. per cubic foot.

**Murray Red Gum** (*E. rostrata*) is the common river gum of New South Wales, Victoria, and Queensland. The timber is in colour of various shades of red, and is said to resist white ants, but of its general qualities there is difference of opinion. It is difficult to work, but is used for general engineering and building work and for street paving. Its average hardness, according to tests made by M. Rudeloff, lies between ash and hornbeam. It is close and interlocked in grain and liable to gum veins, but is considered *the* durable wood of Victoria. The New South Wales variety shells badly and shrinks unevenly.

Weight about 56 to 60 lbs. per cubic foot, seasoned.

**Forest Red Gum** (*E. tereticornis*) is of a deep red colour, hard and inlocked in grain, and suitable for the same purposes as Murray red gum.

**Sydney Blue Gum** (*E. saligna*) produces a timber of pale red colour, straight in grain, easy to work, and which as a hardwood is much appreciated by carpenters and joiners; it rarely splits or warps after drying, but is short in grain, and under some conditions decays quickly; for instance, blue gum telegraph poles have a life of only eight or nine years, and in swampy districts will only last three or four years. It is most widely used in the colony for the felloes of wheels, and it is also useful for furniture making.

Weight about 66 lbs. per cubic foot.



**THIS PAGE IS LOCKED TO FREE MEMBERS**

Purchase full membership to immediately unlock this page

# DELVE INTO FANTASY, MAGIC, MYTHOLOGY & FOLKLORE

Forgotten Books'  
Full Membership gives  
access to 797,885 ancient  
and modern, fiction and  
non-fiction books.

**Continue**

\*Fair usage policy applies

brown to dull red. The sapwood is of a light colour. It polishes well. Warps and shrinks badly.

Weight, seasoned, about 57 lbs. per cubic foot.

**Cedar or Red Cedar** (*Cedraia australis*) somewhat resembles Honduras mahogany, but is lighter. It is easily worked and durable and used for the better kinds of furniture, house joinery and cabinet-making, and extensively for panels in railway carriages. It is one of the best of the native softwoods for panelling and interior work. Some of the wood is handsomely marked.

Weight about 28 lbs. to 35 lbs. per cubic foot.

**Rosewood** (*Dysoxylon fraserianum*) is a similar timber to red cedar, of reddish colour, and obtains its name from the odour of the wood when freshly cut. It is used for similar purposes to cedar, but is heavier.

Weight about 50 lbs. per cubic foot.

**Red Bean** (*Dysoxylon muelleri*) is a similar wood to, and often sold as, cedar. Of a uniform deep red colour, it is a good furniture wood, and can be used for the same purposes as any of the softer mahoganies. When freshly cut the timber smells like a Swede turnip, hence it is sometimes called Turnip wood.

**Onion Wood** (*Owenai cepiodora*) derives its name from the smell of the wood, which, however, does not last long. It is often sold as bastard cedar.

**White Beech** (*Gmelina leichhardtii*), a tree of 100 to 150 ft. high and 3 to 5 ft. diameter, furnishes timber which can be put to use soon after being cut, although it is better for seasoning, and is in common use for ordinary carpentry purposes, roof-stocks for carriages and wagons; it is also used for vats and casks, and for some classes of coopers'

work is said to be better than oak; it is not, however, abundant. It is a whitish wood with a tinge of brown, rather close grained and durable, works up well, but is very brittle and cannot safely be employed where much strength is required. An excellent wood for carving.

Weight, thoroughly dry, 36 lbs. per cubic foot.

**Colonial or Moreton Bay Pine** (*Araucaria cunninghamii*) is the principal softwood of the colony and is also to be found in the adjoining colonies. The tree grows to a height of 150 ft. and over and has a diameter of 2 to 4 ft.

It is not a high-class timber, much inferior to the pine timbers of Europe and America, but it is used extensively for packing cases, ceiling linings, etc., and is of a pale colour.

Weight 30 to 33 lbs. per cubic foot.

**Brown Pine** (*Podocarpus elata*) is somewhat similar to Moreton Bay pine, but harder and more durable, fairly free from knots, soft, close grained, and easily worked.

Weight about 45 lbs. per cubic foot.

**Cypress Pine.**—Under this name is included the Red or Black Pine (*Callitris calcarata*) and the Murray or White Pine (*C. verrucosa*). It is a well-known, much used, and well-distributed colonial wood. It has considerable powers of resistance to the white ants and teredo, and is one of the best of Australian timbers in this respect, although its resisting powers in one district may fail in another. The author has been told by more than one Australian engineer that this is the only timber which will resist the teredo, but it is little used in situations infested by this pest. (See statement by Mr. Walsh, p. 225.) Owing to its freedom from attack by the white ant, which will, however, strip the sapwood from it, this timber is the only kind suitable for

buildings where these pests are prevalent, but it is very brittle and will not stand heavy shocks or severe transverse strains. The prevailing colour is brown of various shades. A nail can hardly be driven into the wood without previous boring for fear of splitting it. It is frequently found growing spirally, and for this reason is not generally well adapted for planking. Black cypress pine is sometimes used for panelling in railway carriages.

Weight 50 lbs. per cubic foot.

There are a variety of oaks, or so-called oaks, *Casuarina* and other species. The She Oak, Silky Oak, Red Silky Oak, are varieties of these. The two former are used for coopers' work, wine casks, and butter kegs; the latter, a red variety, for furniture, veneers, gunstocks, picture frames, and turnery. There are two species of Honeysuckle, both of a reddish colour, which are used for knees in boat-building, bullock yokes, wood screws, and turnery.

**Black Bean** (*Castanospermum australe*), also known as Moreton Bay Chestnut, is the usual substitute for walnut in this colony and also in Queensland. It is darker than walnut, of finer grain, and takes a good polish, but will not readily take glue; tough and durable, of a greasy nature; it shrinks very much in drying.

Weight 40 lbs. per cubic foot.

**Tulipwood** (*Harpullia pendula*) is a small tree only about 50 ft. in height, which yields a tough close-grained timber beautifully marked with different shades from yellow to black, which is fairly durable and much esteemed for cabinet work. It somewhat resembles olive wood in appearance. It is said to be the best wood in Australia for lithographers' scrapers.

Weight, after long seasoning, 62 lbs. per cubic foot.



**THIS PAGE IS LOCKED TO FREE MEMBERS**

Purchase full membership to immediately unlock this page

# Know Your Bible

Forgotten Books'  
Full Membership  
provides unlimited  
access to more than  
28,000 volumes of  
Christian literature for  
\$8.99/month

**HOLY  
BIBLE**

**Continue**

\*Fair use policy applies



RESULTS OF TESTS ON NEW SOUTH WALES TIMBER MADE BY PROFESSOR W. H. WARREN, M.I.C.E.—Continued.

Name of Wood.	Weight per cubic foot. In lbs.	Transverse Strength.		Compressive Strength as Columns.			Shearing Strength along Grain. Breaking Stress. Lbs. per sq. in.	Tensile Strength.		Remarks.
		Modulus of Rupture. In lbs. per sq. in.	Modulus of Elasticity. In lbs. per sq. in.	Ratio of length to smallest dimensions. Lbs. per sq. in.	Modulus of Elasticity. Lbs. per sq. in.	Breaking Stress. Lbs. per sq. in.		Modulus of Elasticity. Lbs. per sq. in.		
White Beach . . .	52	15,607	2,421,119	8/1	16/1	24/1	2,066	9,934	2,794,750	
White Mahogany . . .	75	14,500	2,258,372	9,061	7,902	7,699	2,109	19,753	3,741,376	
White Stringy Bark . . .	71	13,931	2,353,044	6,575	5,565	5,685	1,942	19,399	2,761,812	
Tallow Wood . . .	63	17,240	2,516,000	8,470	—	6,470	1,670	15,970	—	Average results from specimens which had been seasoning for over 12 months.
Blackbutt . . .	57	15,880	2,316,000	8,700	—	6,810	1,850	23,400	—	
Spotted Gum . . .	60	16,150	2,496,000	8,100	—	6,360	2,000	16,990	—	
Flooded Gum . . .	63	16,140	2,269,000	9,260	—	7,330	2,040	18,200	—	
Grey Gum . . .	65	15,340	2,347,000	8,810	—	6,370	1,771	19,260	—	
Grey or White Box . . .	68	15,950	2,202,000	8,120	—	5,758	2,020	16,340	—	
Turpentine . . .	57	15,710	1,982,000	8,950	—	5,450	1,730	19,350	—	
Ironbark <sup>1</sup> . . .	71	18,940	2,662,000	10,150	—	7,670	2,200	19,530	—	

<sup>1</sup> In Mr. Whitten's experiment on a 12 inch square beam of Ironbark on supports 26 ft. apart, Modulus of Rupture obtained was 13,953 lbs. per square inch.

On a similar piece of Ironbark 12½ inch square, on supports 28½ ft. apart, tested by Railway Bridges Enquiry Commissioners, Modulus of Rupture obtained was 12,222 lbs. per square inch.

Specimens cut from Railway Commissioners' beam, 3½ x 1½ and 3½ x 2, tested on supports 4 ft. apart, Modulus of Rupture obtained was 15,000 lbs. per square inch.

Mint test on Red and White Ironbark gave a Modulus of Rupture of { 18,306 lbs. per square inch.  
17,136 " " "



sounding boards for musical instruments. The height of the tree is 50 to 70 ft. ; diameter 12 to 24 inches.

Weight 42 lbs. per cubic foot.

**Miall, Brigalow**, and other Acacias are hard, heavy dark-coloured woods used chiefly for turnery, but also for presentation mallets, draughtsmen, and chessmen. Some has been recently selected by the Ordnance Department of Great Britain for the manufacture of spokes for gun-carriage wheels.

#### TIMBERS OF VICTORIA.

Many of the timber trees of Victoria are indigenous to the adjoining colony of New South Wales and have been already described, and also to Tasmania, although they are sometimes marked by different botanical names.

Such are the **Red Gums** found in the neighbourhood of the Murray River, which divides Victoria from New South Wales.

The **Red Ironbark** (*E. leucoxyton*), which is called blue gum in South Australia, as it is somewhat like a gum in appearance, is a much more substantial timber than the red ironbark of New South Wales, and is really a hard, dense, durable timber, much used for bridge beams and piles, and ranks with grey box as a material for sleepers.

**Blue Gum**, which has the same botanical name as the blue gum of Tasmania, but is not nearly such a large or valuable tree, although the timber is strong and durable, is used for railway sleepers and upper timbers in jetties.

The **Spotted Gum** (*E. goniocalyx*) is very similar in appearance to blue gum, for which it is often sold, and is used for the same purposes.



**THIS PAGE IS LOCKED TO FREE MEMBERS**

Purchase full membership to immediately unlock this page

# DELVE INTO FANTASY, MAGIC, MYTHOLOGY & FOLKLORE

Forgotten Books'  
Full Membership gives  
access to 797,885 ancient  
and modern, fiction and  
non-fiction books.

**Continue**

\*Fair usage policy applies

(*E. patens*). The timber is something like English oak in appearance when properly seasoned, and is used for ordinary building material and a good deal for palings, shingles, rails and mining timber.

**Silver-top** or **Bastard Ironbark** (*E. sieberiana*), also known as Gippsland mountain ash and sometimes as white ironwood, is also called mountain ash in New South Wales and ironbark in Tasmania. There is another variety known as woollybutt. Neither is durable in contact with the ground, but both furnish building material of fair quality.

**The Cypress Pine** (*Callitris verrucosa*) is the same as that of New South Wales, as it comes from the Murray River district, which forms the boundary between the two colonies.

**Blackwood** (*Acacia melanoxylon*) produces the valuable fine-grained timber which has been described in the section dealing with Tasmania.

**Evergreen Beech** (*Fagus cunninghamii*) is also found in Tasmania (which see).

Other smaller timber trees or brush timber, such as sassafras (used for saddle trees and boot lasts), box olive and other timbers, which furnish woods of beautiful grain for veneers, carving, etc., are also indigenous to Tasmania.

It may be said generally that the forest region of Southern Victoria corresponds to a considerable extent with that of Tasmania, whilst in the northern part of the colony the trees are of a kind common to New South Wales.

#### TIMBERS OF QUEENSLAND.

The most valuable woods are to be found in the coastal districts. The ironbark and other eucalypti, as well as Moreton Bay pine (*A. cunninghamii*), are most plentiful

**Honeysuckle** is sometimes used for cabinet work, as it is in Tasmania.

The trees in this colony are much smaller than those of the same kind in the other colonies, the eucalypti not exceeding 100 to 120 ft. in height.

The Sandalwood tree grows in abundance on Yorke's Peninsula, is short in stature, produces solid and strong wood, does duty as firewood, and is a deadly enemy to mosquitoes; any one, indeed, who has had the misfortune to camp by a Sandalwood fire in the bush will admit that the mosquitoes show good judgment in keeping away from such objectionable fumes. South Australia is spending a good deal of money on planting the various eucalypti of the neighbouring colonies, as well as foreign trees, but will not be an exporter for many years, if ever.

Amongst foreign trees successfully tried is the American ash (*Fraxinus Americana*), the timber from which has been used in coachbuilding work and compares well in quality with timber of the same kind imported from America.

SECRET

CONFIDENTIAL - SECURITY INFORMATION  
EXCLUDED FROM AUTOMATIC  
DOWNGRADING AND  
DECLASSIFICATION

CONFIDENTIAL - SECURITY INFORMATION  
EXCLUDED FROM AUTOMATIC  
DOWNGRADING AND  
DECLASSIFICATION

CONFIDENTIAL - SECURITY INFORMATION  
EXCLUDED FROM AUTOMATIC  
DOWNGRADING AND  
DECLASSIFICATION



**THIS PAGE IS LOCKED TO FREE MEMBERS**

Purchase full membership to immediately unlock this page

# Know Your Bible

Forgotten Books'  
Full Membership  
provides unlimited  
access to more than  
28,000 volumes of  
Christian literature for  
\$8.99/month

**HOLY  
BIBLE**

**Continue**

\*Fair use policy applies

## CHAPTER IX

### TIMBERS OF NEW ZEALAND AND TASMANIA

NEW ZEALAND: Kauri Pine—Totara—Black Maire—Rimu—Matai—Kahikatea or White Pine—Silver Pine—Puriri—Beeches—Miro—Rata—Honeysuckle.

TASMANIA: Blue Gum—Stringy Bark—Ash or Swamp Gum—Gum Top Stringy Bark—Ironbark—Peppermint—Blackwood—Huon Pine—Celery Top Pine—King William Pine—Beech or Myrtle—Tea Tree—Honeysuckle—Leatherwood, Lancewood, etc.—Oaks—Government Specification for Eucalyptus Timber.

### NEW ZEALAND TIMBERS.

**Kauri Pine** (*Agathis australis*) is the best known of the New Zealand timbers and is indeed the chief timber of the colony. It is yellowish white in colour, straight in grain, with a silky lustre on the surface, and is easily worked. It is light, fairly strong and elastic; amongst the pines it is only exceeded in strength by pitch pine and Baltic redwood. It is generally remarkably free from knots and defects, and may be obtained perfectly clear of them. It can be had in planks nearly 3 ft. wide in the colony—a piece has been got 20 ft. long by 5 ft. wide absolutely clear of knots and shakes, and only recently pieces were to be had in the London market 18 ft. long and 50 inches wide and practically perfect. The timber requires to be seasoned before being put into use, as it shrinks considerably. In one case where it was used on the deck of a vessel it had in twelve months shrunk considerably both longitudinally and cross ways. Good for all classes of joinery

and inside work, it is especially adapted and much used for church work. As sleepers it is stated to have a life of fifteen years on the track. There is a good deal of resin in the wood; it is very inflammable and very durable. Kauri pine brings a good price in the London market, and owing to the great use made of this timber locally, the amount exported, and still more the amount destroyed by fire, the kauri forest will probably be extinct in from ten to fifteen years.

Weight 30 to 39 lbs. per cubic foot.

**Totara** (*Podocarpus totara*), one of the most durable of New Zealand timbers, is a tree of rapid growth. The timber is useful in marine work, resisting the teredo much better than jarrah in Auckland Harbour. Used largely for bridge work; straight, smooth, close and silky in grain, it resembles pencil cedar. The colour varies from brown to rich red. There is a good deal of sapwood of a straw colour in most trees. It is considered equally durable as kauri pine in house construction, but more difficult to work; it is usually employed in the colony for patterns. It is also said to make good paving blocks, as it is not slippery and wears down evenly, and is admirable for heavy construction work and for railway sleepers, furniture, etc. The heart of totara is exclusively used for telegraph poles in New Zealand, which have an average life of about twenty years. The Maoris used it for dug-out canoes. Some of the timber has beautiful markings, and a large trade is done in veneers. Its price in the colony is a little more than that of kauri. A good deal of this timber, in planks, is now being imported into Great Britain.

Weight about 35 lbs. per cubic foot.

**Black Maire** (*Olea cunninghamii*) is a hard, dense, tough, close-grained, and very heavy timber of a deep brown colour



with the heartwood streaked with black. It is very useful for scarfing timbers, thrust blocks, etc., but is not easily obtained in long lengths ; it makes good durable sleepers, piles, and fence posts, and is said to make capital wood for large engraving blocks if properly seasoned, as it does not wear and bears high pressures. The timber takes a long time to season.

Weight 72 lbs. per cubic foot.

**Rimu or Red Pine** (*Dacrydium cupressinum*) can be had in logs up to 45 ft. long and 30 inches square. It is a useful and ornamental wood of handsome deep red coloured heart with light streaks or markings. Solid and clear of grain, its chief drawback is its liability to decay under the influence of wet. Much used in house framing and carpentry, largely for furniture, and especially for the panelling of railway carriages, interior of public buildings, etc., as some of the timber is handsomely marked, and it takes a fine polish and costs less to polish than mahogany or walnut. It is a favourite timber for all kinds of wagon building in the island except the framework, for which Australian tallow wood is preferred. It is very slow in growth. A small amount of this timber now comes into the English market in the form of wide planks, and from some tests made it would appear to have little tendency to shrink and warp in seasoning.

Weight 34 to 40 lbs. per cubic foot.

**Matai or Black Pine** (*Podocarpus spicata*) produces a brownish coloured hardwood of smooth close grain and silky texture, and is almost universally used for flooring in New Zealand, in which position it possesses excellent wearing qualities. The annual rings are clear, distinct, and close. It is also largely used for general outdoor work, general building material, and occasionally for bridge-building and



**THIS PAGE IS LOCKED TO FREE MEMBERS**

Purchase full membership to immediately unlock this page

# DELVE INTO FANTASY, MAGIC, MYTHOLOGY & FOLKLORE

Forgotten Books'  
Full Membership gives  
access to 797,885 ancient  
and modern, fiction and  
non-fiction books.

**Continue**

\*Fair usage policy applies

**Silver Pine** or **Western Pine** (*Dacrydium westlandicum*) and **Yellow Silver Pine** (*D. intermedium*) both furnish a dense white or yellowish white timber of great durability which is useful for inside or outside work. Some of the wood is beautifully marked. The first-mentioned is largely used for bridges, jetty piles, and railway sleepers. These are trees of 40 to 50 ft. in height.

Weight 41 lbs. per cubic foot.

**Puriri** (*Vitex littoralis*) is known as the New Zealand teak and is closely related to the teak of India. It is the most durable timber in the colony and in great request for bridge piles, fencing posts, etc., whilst for railway sleepers it ranks the first of all New Zealand woods, and is said to have lasted twenty-five years on the track. It is only found in the Auckland and Taranaki districts of the North Island. The colour is dark brown; it is excessively hard, dense, and heavy, indeed suitable for any work requiring great strength. In order to split it, it is necessary sometimes to use blasting powder or dynamite.

Weight 62 to 76 lbs. per cubic foot.

There are several beeches, the *Tooth Leaved* and *Entire Leaved* varieties being the most important; the latter has more sap and decays more rapidly than the tooth leaved variety, though both are used for timber in wharves and jetties, sleepers, fencing posts, etc. The wood is of red or reddish brown colour with sharply defined light coloured sapwood; it is usually called by colonists the red birch or beech; is even in grain, compact, and of considerable strength and toughness. The *Tooth Leaved* variety (*Fagus fusca*) was the only timber used for a stiffened suspension bridge—200 ft. span and 20 ft. deep in centre—spanning

Chasm Creek Gorge.<sup>1</sup> The Maoris distinguish it from the other beeches by calling it Tawhai-raw-nui.

**Miro** (*Podocarpus ferruginea*), known as Bastard Black Pine in Otago, is a reddish brown coloured wood and not unlike Matai, but may be detected by the cross section of the dark coloured heartwood. Often star shaken and irregular, it is less durable than Matai. Miro is very suitable for interior work; it is also of considerable strength and may be used for beams carrying heavy weights; it has also been used for piles and timber work of wharves. It is straight and even in grain and can be got in lengths 20 to 30 ft. long.

Weight about 46 lbs. per cubic foot.

**Rata**, of which there are two species (*Metrosideros lucida* and *M. robusta*), is not only useful for shipbuilding, railway sleepers, wharves, wheelwrights' work, etc., but may be referred to as a natural curiosity, insomuch as its seeds are propagated on other forest trees, sometimes at a height of 80 ft. above the ground. It rapidly increases in growth until its limited supply of nourishment is exhausted, when, in search of further nourishment, the roots grow steadily down the sides of the sustaining tree until the ground is reached, after which they gradually assume the appearance of stems, some of them 3 ft. in diameter, put forth shoots at right angles, and grow round the trunk of the supporting tree, gradually crushing it under their enormous pressure. The only tree which it fails to destroy by this process is the Puriri, which opposes greater strength and comes out victorious in the contest.

The wood of the rata is of a reddish brown or reddish yellow colour, and is hard, dense, and heavy, of great

<sup>1</sup> Min. of Proc. Inst. C.E., Vol. 143, p. 254.

strength and durability, and it grows to be a large tree of 100 ft. in height and considerable diameter.

It is to be had in logs up to 50 ft. in length and 2 to 4 ft. square. The wood is destitute of figure and is too tough and hard for cabinet-makers' use. It is commonly called ironwood.

Weight about 65 lbs. per cubic foot.

**The Honeysuckle** (*Knightsia excelsa*) or "Rewarewa," as it is called by the Maoris, grows to a height of 100 ft. with a diameter of 3 ft. and produces a beautifully and peculiarly marked light brown or reddish brown wood, particularly suitable for furniture and decorative purposes such as the saloon fittings on steamers, etc. It is often used for mantel-pieces owing to its incombustible nature. To produce these beautiful markings, the timber, as is generally the case, has to be cut on the quarter, the medullary rays being both deep and wide. It is durable when used for interior work, but will not stand exposure to variations of weather, being indeed purely a furniture or cabinet-makers' wood. All oily substances should be avoided when polishing New Zealand honeysuckle, as it absorbs grease and oil to the detriment of the finely marked grain, and moreover varnishing is said to be a disadvantage. It is now found chiefly in the North Island and mixed with other forest trees.

There are no eucalypti in New Zealand.

#### TASMANIAN TIMBER.

As in Australia, the eucalyptus is the most important of the trees of Tasmania.

The **Blue Gum** (*E. globulus*) for heavy and important structures stands first, and has been known and used in



**THIS PAGE IS LOCKED TO FREE MEMBERS**

Purchase full membership to immediately unlock this page

# Know Your Bible

Forgotten Books'  
Full Membership  
provides unlimited  
access to more than  
28,000 volumes of  
Christian literature for  
\$8.99/month

**HOLY  
BIBLE**

**Continue**

\*Fair use policy applies

and 200 to 350 ft. in extreme height with 100 ft. to the lowest branch. The stem is very straight. The wood is of a varying colour from cream to pink, very heavy, close and straight in grain, and of great strength. It has been much used for piles and in wharf construction generally. Large quantities of logs were imported up to 100 ft. long and 18 to 20 inches square for temporary staging at the Admiralty Harbour Works, Dover, a few years ago, where, owing to the great depth of water into which the piles had to be driven, namely, about 60 ft. at high water, the high specific gravity of the blue gum was of great advantage compared with Oregon timber of the same sizes, which had to be weighted to enable it to sink. It also withstands the attack of the teredo much better than Oregon. It was also used at the Keyham Dockyard extension works, and a large quantity is now being used by the North Eastern Railway Company at Hull. The logs are not sawn, but are cut almost die square with broad axes in the following manner:—Cross cuts about 2 ft. apart are first made in the felled tree, and the timber between is cut off; on the logs as finished one may often see traces of these cross cuts where they have gone slightly below the intended depth. So straight and accurately is the timber converted by this method that in a log 60 or 65 ft. long there is often not half an inch difference between one end and the other. The method is clearly shown in our illustration (Fig. 34), for which the author is indebted to the courtesy of the Agent-General for Tasmania; it also shows a large log already squared, and gives a good idea of the tall straight trunks of a blue gum forest. It is an excellent timber for any work requiring great length and strength, and can be delivered in Great Britain of a length of from 60 ft. and upwards at about the same price as Oregon of similar sizes. One of the objections to the timber is that it splits a good deal, being as bad in

this respect as American elm, although probably, if better seasoned before exportation, this trouble would be overcome. An excellent section of the wood cut from a log lying about on works for a long time was sent to the author and split in several lines from outside to heart in a short time. Mr. Geo. Dudley, of Hobart, who has used it very much for coachbuilding and wheelwrights' work, says that it requires special care in seasoning, and in the case of felloes this takes about two years. It should be ringed at the ends when stored, or it splits there, sometimes very badly. In this timber, as with all the eucalypti, it is necessary when converting that the heart should be cut out to the extent of 3 or 4 inches. This tree is evidently a similar species to one of the same name in several of the Australian colonies, but it grows to a much larger size in Tasmania, and the official publication says it "must not be confounded with some of those similarly named growing in the mainland States."

It is a remarkably sound, clean timber; one can see logs over 60 ft. long without a knot. It is largely used in the colony for sleepers, railway wagon work, and wheelwrights' work, and has been used to a small extent in Great Britain for street paving, but has not been found so satisfactory for this purpose as jarrah. In transverse and tensile strength blue gum compares very favourably with jarrah and karri, but can be obtained in longer lengths than either of these timbers, and in this respect will command a good market. The appearance of the fibres after fracture in cross bending tests are very similar to karri and jarrah under the same conditions. A 9 inches  $\times$  9 inches sawn blue gum log 10 ft. between the supports was tested by Messrs. David Kirkaldy & Son and stood an ultimate bending stress of 17.6 tons with the load in the centre—it failed by the top side compressing, cracked at 3 inches deflection, but bent to 5 inches;



the weight of this sample was 70 lbs. per cubic foot; a sample paving block weighed  $64\frac{1}{2}$  lbs. per cubic foot. Under a compressive test a piece 10 ft. long and 8.98 inches  $\times$  8.90 inches = 79.92 square inches crushed under a total load of 380,100 lbs. = 4,756 lbs. per square inch; the weight of

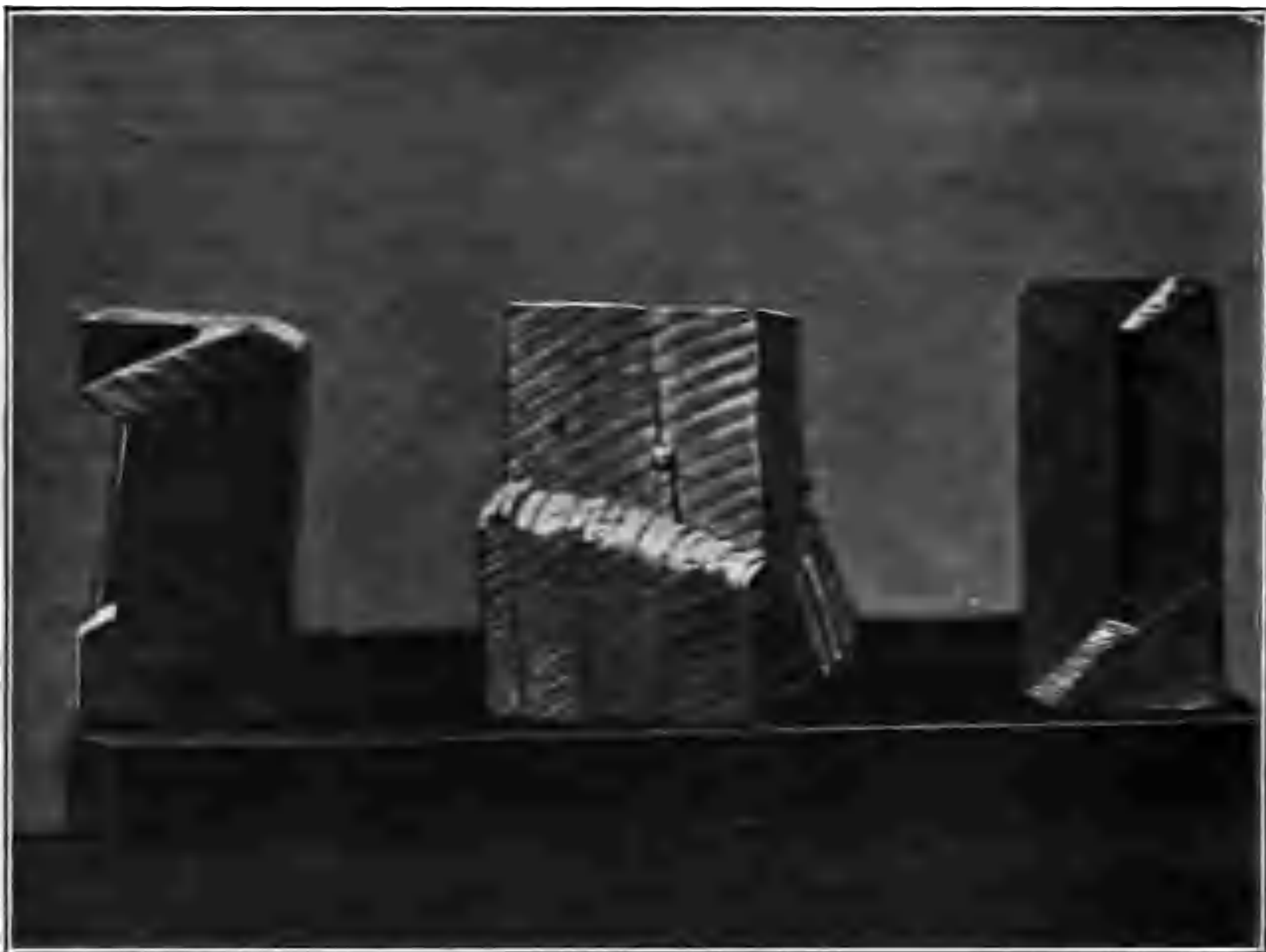

*Photo by]*

*[A. L. Oubridge.*

FIG. 35.—Crushing Tests of Tasmanian Blue Gum.

this sample was  $71\frac{1}{2}$  lbs. per cubic foot. Fig. 35 shows the peculiar twisting of the fibres of blue gum under compressive stress. These samples stood about  $2\frac{1}{2}$  tons per square inch. One sample is particularly noticeable where the timber has opened so clean and sharp as to look like a mortice. A piece of blue gum scantling 146 ft. long and



**THIS PAGE IS LOCKED TO FREE MEMBERS**

Purchase full membership to immediately unlock this page

# DELVE INTO FANTASY, MAGIC, MYTHOLOGY & FOLKLORE

Forgotten Books'  
Full Membership gives  
access to 797,885 ancient  
and modern, fiction and  
non-fiction books.

**Continue**

\*Fair usage policy applies

only, although used for packing cases in connection with the fruit trade. The wood is of light brown colour.

Weight about 53 lbs. per cubic foot.

**Gum Top Stringy Bark** (*E. hæmastoma*) is closer in grain than the swamp gum; it grows to a considerable height, but small diameter, the average with a height of 150 ft. being not more than 3 to 4 ft. The texture of the wood is about a medium between stringy bark and swamp gum; it is largely used and found very satisfactory when seasoned for house-building, flooring, and for coachbuilding and wheelwrights' work.

Weight about 48 to 51 lbs. per cubic foot.

**Ironbark** (*E. sieberiana*) is only found in the north east of the island and in small quantities. It is used for local requirements only and for similar purposes to blue gum and stringy bark.

Weight 48 to 51 lbs. per cubic foot.

There are at least half a dozen other varieties of eucalypti in Tasmania, but those described are the only ones likely to come into the foreign market.

**Peppermint** (*E. amygdalina*) produces a good, durable timber, much used for fencing posts, and makes excellent shingles for roofs. It is only found in small quantities.

Weight 39 lbs. per cubic foot.

**Blackwood** (*Acacia melanoxylon*), a tree of 60 to 80 ft. high with a diameter of 3 to 6 ft., is the most valuable of the fine-grained woods of Tasmania. It is the "Black Sally" of Western New South Wales and the hickory of the southern part of that colony. It is a close, straight grained timber of dark brown or walnut colour, varying in shade and somewhat resembling cedar; the sapwood is

brownish white. It is extensively used for the better class of furniture, panelling for railway carriages, and for pianos, billiard tables, and pulpits; also for anything in connection with wheelwrights' work which requires bending. It is used in the colony for purposes for which teak and mahogany were formerly used, but requires to be thoroughly seasoned. Mr. Geo. Dudley says: "It does not require such special care in seasoning as some other woods, that is it will stand more exposure and will not shrink so much." Some of the wood is beautifully figured. There is a small amount of blackwood imported into Great Britain, and in June, 1907, there were nineteen logs in one sale list.

Weight about 37 lbs. per cubic foot.

**Huon Pine** or **Macquerie Pine** (*Dacrydium franklinii*) is a whitewood which contains but little sap, works easily, and is very durable. It is much used for furniture, boat-building, and joinery, and is said to be superior to any of the imported timber. It stands the weather very well and is a good deal used in railway carriages and similar stock which is exposed to severe weather conditions. It is only now obtainable in small quantities and for local requirements.

**Celery Top Pine** (*Phyllocladus rhomboidalis*) derives its name from the likeness of the leaves to those of the celery; it is a strong and lasting timber, shrinks but little, and on this account is much used for flooring boards and other internal housework, railway carriage building, etc. It is not obtainable in large quantities.

The weight is about 40 lbs. per cubic foot.

**King William Pine** (*Athrotaxis selaginoides*) produces a much lighter timber than the celery top pine. The colour

is a pale pink, and the grain very straight, but open. It is only found in limited quantity, and is largely used locally by cabinet-makers and joiners, and it is very suitable for boat-building.

Weight only about 22 lbs. per cubic foot.

**Beech** or **Myrtle** (*Fagus cunninghamii*), of which there are two kinds, the best of which resembles in character the hardest and heaviest English beech and is of a pink colour when freshly cut, gradually fading to a lighter shade; the other is white and soft. The annual rings are distinctly marked, and the timber requires special care in seasoning. It is not much appreciated in the colony, but makes a fairly good and durable flooring; it is also used instead of mahogany for T squares, set squares, etc., and the better variety makes excellent planes. It is used in Great Britain for fret saw work and carving, and should make a good cabinet wood; it has been used for piano framing. It can be obtained in good lengths and up to 40 inches wide and 3 to 6 inches thick without a knot. Many of the planks are sawn on the quarter and show the silver grain well.

Weight about 47 lbs. per cubic foot.

Amongst the smaller timber trees of Tasmania may be mentioned the **Tea Tree** of several varieties, used for tool handles, fishing rods, etc.

Weight about 50 lbs. per cubic foot.

The **Honeysuckle** (*Banksia marginata*), resembling that of New Zealand, but of small size, is much prized by cabinet-makers. **Leatherwood** and **Lancewood**, both excellent for axe or pick handles, shafts, etc.

**Box** (*Bursaria spinosa*), a close-grained creamy-coloured wood used for turnery and carving, and **Pinkwood** or



**THIS PAGE IS LOCKED TO FREE MEMBERS**

Purchase full membership to immediately unlock this page

# Know Your Bible

Forgotten Books'  
Full Membership  
provides unlimited  
access to more than  
28,000 volumes of  
Christian literature for  
\$8.99/month

**HOLY  
BIBLE**

**Continue**

\*Fair use policy applies

entails upon timber merchants, something should be done. The timber arrives in much the same condition as when Laslett reported unfavourably upon it owing to these defects thirty years ago.

Eucalypti timber, planks at any rate, can be seasoned so as to ensure very little damage to the wood, as a piece of Karri plank has lain upon the author's mantelpiece, in various temperatures, for over six years and is as perfect as when received.

## CHAPTER X

### CAUSES OF DECAY AND DESTRUCTION OF TIMBER

Decay Caused by Bacteria and Fungi—All Timber Liable to Attack—Propagation of Disease—Conditions for Decay—Timber in Certain Situations Practically Indestructible—Harder and Denser Woods Less Liable to Decay—Animals which Destroy Timber in Sea Water — The *Teredo Navalis* — *Limnoria Terebrans* — *Chelura Terebrans*—The *Sphæroma*—The *Pholas*—All Timbers with Few Exceptions Liable to Attack—The White Ant.

THE changes which take place in the structure of wood and cause decay are due to the activity of the lower forms of plant life, bacteria and fungi, chiefly the latter.

Fungi induce changes in the organic matter of the wood, by withdrawing certain substances from it on which they feed, and the term "decay of timber" is now understood to mean a breaking down of the complex chemical compounds which it contains into much simpler ones, due to the activity of these lower organisms which excrete ferments; these dissolve out certain parts of the walls of the cells of the wood and, by so doing, destroy their physical and chemical properties.

The cells which make up the heartwood of a tree contain no living substance. The sap is the life of the tree, and is confined to the outer layers. It is composed of water holding in solution various organic substances—sugars, starches, oils, etc.—and their presence is the cause



of the sapwood of trees being more readily destroyed by fungi than the heartwood, as it is on these substances that the fungi feed.

The fungus threads penetrate the wood cells in all directions and gradually destroy them. The fruiting bodies of fungi are the familiar toadstools so commonly seen on live and dead timber. Fungi are propagated chiefly by the spores or fine filaments found on the lower surface of the fruiting body, which, when ripe, are discharged in clouds, float about in the air, settle on live or dead timber and penetrate into cracks of the bark or wood, where they germinate and gradually spread.

When the fruiting body or toadstool appears on a tree it is a sign that the timber is already badly diseased. The growth of this fungus stops when the tree is cut down, but then it is attacked by a number of other fungi, and the work of destruction is very similar but goes on much more rapidly on dead timber than on the living tree.

In America experience has shown the curious fact that on crests of hills or where winds have a long and free sweep the percentage of diseased timber is uniformly higher than in more sheltered areas, and that is due to the larger number of broken branches forming cavities in which the spores germinate.

All trees and all timber are liable to attack by fungi, although some are more liable than others; for instance, the wood of the cypress (*Taxodium distichum*) and red cedar (*Juniperas virginiana*) of America are remarkably free from fungi and consequent decay, and so far as is known the Locust (*Robinia pseudacia*) is attacked by but one fungus which destroys wood.

So liable is timber to the attack of the numerous fungi that Dr. Von Schrenk, of the United States Department of Agriculture, says: "I will be willing to hazard the



**THIS PAGE IS LOCKED TO FREE MEMBERS**

Purchase full membership to immediately unlock this page

# DELVE INTO FANTASY, MAGIC, MYTHOLOGY & FOLKLORE

Forgotten Books'  
Full Membership gives  
access to 797,885 ancient  
and modern, fiction and  
non-fiction books.

**Continue**

\*Fair usage policy applies

hours, or a temperature of 40° C. (104° Fahr.) will destroy its vitality in one hour. Other fungi are, however, capable of resisting higher temperatures.

Dry air is incapable of causing decomposition. If we can exclude humidity from the wood it will prevent the primary cause of decay. Any kind of wood kept absolutely air-tight will not decay, as, for instance, wood completely submerged in water.

It was owing to absence of air and moisture that the mammoth was preserved for untold ages in the ice of the Russian rivers, and the wonderful preservation of the wooden Egyptian coffins and statues for 5,000 or 6,000 years is largely owing to the dryness of the Egyptian atmosphere.

Timber buried in the ground has in most cases a very long life. In clay it is practically indestructible.

The piled foundations of the ancient lake dwellings in our own and other countries are in fair condition after being in place for thousands of years; the piled foundations of the great and important buildings of Venice, Amsterdam, and other cities have carried their loads for centuries.

A cutting from a Memel pile recently taken out of the soft ground at Hull, now in the possession of the author, is as sound as when it was put down more than a hundred years ago. Another, from a small oak pile taken out of a river bed, which had probably been there a thousand years, is also quite sound. The oak foundation piles from the bridge constructed across the river Tyne by the Romans were, when taken out of the river bed forty years ago, found to be so little the worse after being buried eighteen centuries that pieces of furniture were made from them, and a piece of cypress wood in good condition was a few years back found in the New Orleans Drainage Canal,

having been buried 17 ft. below the present Gulf of Mexico probably for thousands of years.

Wood that is free from atmospheric changes will not decay, nor will wood which is perfectly dry, although this latter condition is not possible of attainment under ordinary conditions, as wood has a great affinity for water and absorbs the moisture from the surrounding atmosphere; but most kinds of timber, if in good condition when used, and afterwards well protected and placed where there is free circulation of air, will last for centuries, as witness the great age to which furniture will keep in good condition even in a moist climate. There are two sycamore coffins from Egypt, now in the British Museum, 4,400 years old and in such good condition that even the colours of their ornamentation are still quite bright. Pliny well knew that timber kept constantly under fresh water was less liable to decay than when exposed to variations of atmosphere, and long before his time Solomon, or his Temple architect, was aware of the necessity of having a free circulation of air round timbers built into walls so as to prevent damp, and for this reason "he made narrowed rests round about that the beams should not be fastened in the walls of the house," and all that the present-day German scientist can advise to prevent decay is the same old doctrine of the free action of air and the avoidance if possible of contact with wood and brickwork, or else the use of antiseptics.

The reason why timber posts decay at ground level is because the higher temperature at that place allows of the production of fungi. Conditions of moisture and warmth affect timber so much that in the same fence a durable wood may decay before one of lesser durability.

Timber should never be painted or tarred before being properly seasoned, as by so doing we bring about the best conditions for cultivating the fungi whose spores were

already there by providing them with a warm and moist chamber, and the interior of the wood will almost certainly be destroyed.

The human being who has contracted an infectious disease is kept apart from his fellows so as to prevent the spread of the disorder, yet decaying timber is too often left lying in the neighbourhood of sound timber, the danger of infection not being realized: the two cases are analogous, and decayed timber, being a very fruitful source of infection owing to the risk of the distribution of the fungus spores it contains, should be removed from the neighbourhood of sound timber or should be destroyed.

As a rule the harder or denser woods are less liable to decay than those of a softer nature, but such is not always the case, as karri timber, which is, if anything, harder and denser than jarrah, is the more liable of the two to decay in damp situations, but both these are less liable than most of the fir and pine timbers. Sapwood is more liable to decay than heartwood, and in structural timbers is the first to decay.

It has been pointed out that timber buried in the ground has generally a very long life, but there are exceptions to all rules, and a curious instance showing the difficulties incurred with timber in the ground has recently come before the author. The instance consisted of pitch pine piles with capping pieces of the same as a foundation to carry cranes and columns for a large foundry in alluvial deposit of considerable depth. The timber would have been creosoted were it not that there was risk of fire. As the ground was too low for shop floor level, the pile heads and caps stood up in some cases for 3 or 4 ft. above the original surface, and the ground was filled up with mixed material, chiefly clay and sand, but there were no ashes. Although the work has only been down about seven years,



**THIS PAGE IS LOCKED TO FREE MEMBERS**

Purchase full membership to immediately unlock this page

# Know Your Bible

Forgotten Books'  
Full Membership  
provides unlimited  
access to more than  
28,000 volumes of  
Christian literature for  
\$8.99/month

**HOLY  
BIBLE**

**Continue**

\*Fair use policy applies

edges of sapwood, decay first, and whilst the top edges are often badly decayed, the lower edges remain quite sound, as the water cannot lie there.

The reason why the floors and joists in basements, or over cellars, are more liable to decay than the rest of the timber in a building is because they are more subject to damp and moisture and often have not proper air currents round them.

The joinings of timbers, whether notched or unnotched, or where one timber rests upon another so that wet or damp is liable to lodge, should have a good coat of Stockholm tar and pitch put on hot; this is an excellent preservative.

Some recent German theory goes to show that the calcium bicarbonate arising from the hydrate of lime in mortar is probably the chief cause in the development of spores, as almost without exception the wood nearest to the walls of buildings is first attacked by rot. When fungus has gained access, all visibly affected parts should be cut away, as well as the adjoining and apparently sound timber for several feet round, and the brickwork should be well cleaned and brushed over with creosote or coated with good plaster.

The most destructive agent with which the engineer has to contend in the case of timber structures erected in sea water is known by the general name of the **sea worm**. One or other of the several pests known by this name are found in sea water all over the world and cause enormous destruction.

The **Teredo Navalis**, often called the "ship worm" from its destructive action on timber ships, as a protection against which they had to be copper sheathed, resembles a long worm, although it is really a mollusc. The animal is

produced by eggs, and is so prolific that the eggs from a single specimen may number a million in one season; they are free swimming in three hours, have a well-developed shell before the end of the day, are very hardy, and nearly all seem to develop to maturity. Its method of operation is to bore by means of small and beautifully formed



*Photo by]*

FIG. 36.—Worm-eaten Timber.

*[A. L. Oubridge.*

Pieces on left and right show the action of the *Teredo*—the latter is from a plank which was in Genoa Harbour for three months. The centre piece shows the work of the *Limnoria*.

shells, and it deposits a thin calcareous coating upon the newly cut surface of the wooden tunnel which it makes, forming an enamelled lining through which the animal can glide backwards and forwards as it expands or contracts. It commences operations from the outside by boring across the grain of the wood, and once a short distance within, it generally turns and works parallel to



the grain, but it will sometimes work right across the grain; the tunnels are distinct from each other.

The teredo gradually increases in length and thickness, and although on the outside of the timber, if closely examined, only small holes about the size of a pin head are to be seen, yet it may be completely riddled (see Fig. 36). An average-sized teredo is  $\frac{1}{4}$  to  $\frac{3}{8}$  inch diameter and 15 inches long, but specimens up to 4 ft. in length and upwards have been obtained with a diameter of over half an inch, and quite recently, in the Transactions of the Royal Society of New South Wales, Mr. H. D. Walsh, M.I.C.E., stated that he had taken a teredo from timber in one of the northern ports of New South Wales 6 ft. long and nearly  $\frac{3}{4}$  inch in diameter.<sup>1</sup> The teredo usually passes round knots and rarely crosses a seam or joint in the wood, and must always command the entrance to its tunnel and have free and permanent access to pure sea water, otherwise it can only exist for a short time, although Mr. J. W. James, M.I.C.E., mentions that he found several still living, but very weak, in timber which, after being taken out of the water, had lain exposed to the tropical sun for two months. The teredo works from a little above low water, or say half-tide level, down to the ground, and timber 25 ft. below lowest water level has been found attacked. It does not devour the wood, but passes it through its body and is very rapid in its work. A young teredo has been found in wood submerged eight days. It thrives best under the influence of heat, and in a tropical climate is most destructive; 6-inch timber has been destroyed in six weeks in the Gulf of Mexico, and piles 12 inches by 15 inches have had to be replaced after six months' service in the same district.

<sup>1</sup> *The Engineer*, 11th October, 1907.



**THIS PAGE IS LOCKED TO FREE MEMBERS**

Purchase full membership to immediately unlock this page

# DELVE INTO FANTASY, MAGIC, MYTHOLOGY & FOLKLORE

Forgotten Books'  
Full Membership gives  
access to 797,885 ancient  
and modern, fiction and  
non-fiction books.

**Continue**

\*Fair usage policy applies

most destructive at about low water level. In Hartlepool, where the North Eastern Railway Company have timber ponds for the storage of the large timber trade of that port, fresh water has to be pumped in to keep it below that degree of saltness which enables the animal to live. The limnoria will attack knots, but prefers softer wood, and it is curious to see in worm-eaten wood how this hard portion stands out in relief when the rest of the timber is eaten.

**The Chelura Terebrans** resembles the ordinary shrimp, is very different in appearance to the limnoria, though about the same size or somewhat larger. It swims on its back, and is a jumper; its burrow, also, affords both residence and food. It attacks the wood entirely from without, reducing it to minute fragments by means of a kind of file; attacking it in any part, but preferring the softer parts. Specimens one-third of an inch long have been measured.

None of these pests will, so far as the author's experience goes, exist in sewage-laden water; some will not exist in muddy waters, and they are most destructive in clear, warm, pure sea water.

The **Sphæroma** is another of these timber destroying animals found in Australian and United States waters. It is rather larger than the limnoria, and simply erodes the surface of the wood and by this means often discloses the ravages of the teredo. Unlike the others, however, it is active in comparatively fresh water.

The **Pholas**, which is very similar in appearance to the common mussel, and is a prized shell fish for food on the shores of the Mediterranean, generally prefers boring in stone, but there is no doubt that in some situations in the tropics it also attacks wood. It bores at right angles to

the surface and makes a hole from  $\frac{1}{2}$  to  $\frac{3}{4}$  inch diameter and about 2 inches deep.

An excellent short and interesting paper dealing with these timber borers, by Mr. Charles H. Snow, M.A.Soc.C.E., is published in the Proceedings of the American Society of Civil Engineers, Vol. XL., 1898.

So far as the author knows, there is no wood which is not liable to attack by the sea worm with the possible exception of billian from North Borneo, and that has not been much used, but appears immune, and some of the palms or similar timbers which the teredo will not generally attack, as the animal prefers a compact wood for its abode. In the paper previously referred to Mr. Walsh mentions turpentine as the only Australian timber which the teredo dislikes, and he found this timber quite sound after an immersion of thirty to forty years, although occasionally the sapwood showed signs of attack by limnoria and sphæroma.

Engineers for a long while pinned their faith on greenheart, as it was considered that the sea worm would only attack the sapwood of that timber, and greenheart certainly resists the attack of the worm for a longer period than any other timber in general use, but, as has been pointed out elsewhere, it is now known that even greenheart only lasts for a limited time in places where the teredo or limnoria is active.

These borers will not attack certain timbers if others more to their liking exist in the neighbourhood, hence the reason of the statements so frequently made to the effect that many timbers are proof against the marine worm. Piles standing by themselves appear to be more open to attack than when placed close to others.

**White Ants.** Boring insects of other kinds attack timber all over the world. The most destructive is the termite

which goes by the name of the white ant and does a great deal of damage in the tropics, both to live and dead timber, though particularly the latter, in dwellings and furniture. It is this insect which does the damage in what we usually call "worm-eaten furniture," which in the temperate zone does not usually occur until the wood becomes very old and dry; but only recently the author saw these pests in great numbers destroying the framework of a piano, and that not a very old one, in an English dwelling-house.

They are almost impossible to exterminate, and varying solutions have been tried on timber to stay their ravages with but moderate success.

The white ants of Northern Australia are larger and more destructive than probably in any other part of the world; even lead and zinc are not proof against them. They attack growing timber as well as structural timber, working through the heart of the trees from roots to top; the only kind which resists them is the cypress pine, which, on this account, is generally used for building work in these latitudes. The two eucalypti, bloodwood and paper bark, withstand the white ant to some extent; while seasoned jarrah and sugar gum sleepers have been about a quarter eaten away in a few months. The timbers which resist the white ants fairly well in one locality are quickly destroyed by those of another. Corbolineum and anti-termite have been tried in Australia and do check their ravages for a time, but they soon lose their efficacy in tropical climates.



**THIS PAGE IS LOCKED TO FREE MEMBERS**

Purchase full membership to immediately unlock this page

# Know Your Bible

Forgotten Books'  
Full Membership  
provides unlimited  
access to more than  
28,000 volumes of  
Christian literature for  
\$8.99/month

**HOLY  
BIBLE**

**Continue**

\*Fair use policy applies

smaller scantlings and for such purposes as floors, doors, panelling, etc., where the tendency is for it to become drier, shrinking and consequent buckling or splitting may

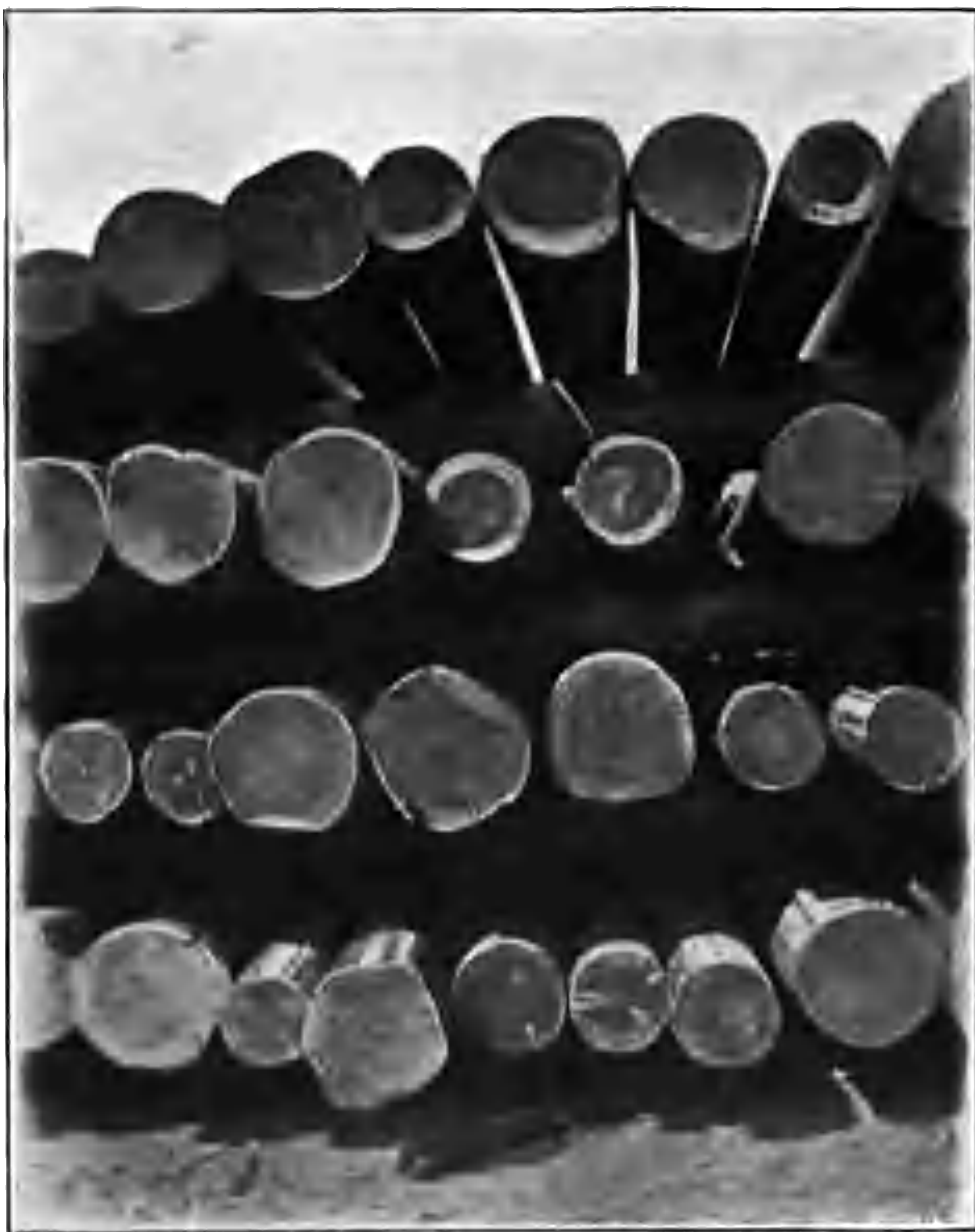

FIG. 37.—Telegraph Poles Stacked for Seasoning.

take place, unless it has been deprived of a good deal of its moisture. There is also the risk of decay when placed in recesses of walls if it contains any considerable amount of moisture.

No definite time can be stated for the seasoning of timber ; it depends upon climate, quality and size of scantling, and also the purpose for which it is required. The thicker the timber, naturally the longer it will take to season, and some timbers require much longer time than others, but it should always be a matter of some months and some-



FIG. 38.—Showing Method of Stacking Sleepers for Seasoning.

times years, and when we consider the value in most situations of thoroughly seasoned wood, time should not be grudged in the operation. Laslett, who had a large experience, gives from four months to twenty-six months for oak in sizes of 4 inches to 24 inches square, for fir of the same sizes three to thirteen months, and for planks half to two-thirds of the above time, according to thickness ; it is not



at all uncommon to stack Baltic or pitch pine logs for three or four months prior to treating them with creosote.

The seasoning of timber causes a good deal of reduction in its weight.

If a log of timber be dried for a time and then cut across in different places, it will be found that the amount of moisture in the wood increases from the ends, showing that for some distance the moisture evaporates that way, being the easiest way out, but the drying, especially in large logs, takes place almost wholly through the faces, and, as a rule, is a very slow operation (see page 304). If the log be largely heartwood, or if the proportion of sap be fairly uniform, it will dry more rapidly.

Timber can be reduced in weight by boiling, and it is a curious fact that placed in live steam it will lose weight rapidly, whilst saturated steam has quite the contrary effect upon it.

Timber after being cut should be stacked in layers, each piece and layer being kept separate so as to allow a free circulation of air, and the stack should rest on bearers or supports which will keep it at least 12 inches above the ground. This should be done in covered sheds if possible, in fact for all planks and battens under 3 inches thick covered sheds are necessary, but, as a rule, large-sized timber is seasoned in the open (see Figs. 37 and 38).

On the Continent, when timber is not placed under sheds, as for instance with railway sleepers, it is often given a slant longitudinally so as to allow the wet to escape more easily.

Fig. 39 shows a common method of seasoning planks in timber sheds, but in some of the White Sea sawmills it is stacked with many of the planks on edge, which gives the timber an excellent chance of drying, but this requires a great deal more space. Some have tried and recommended the placing of timber on end, but this has no



**THIS PAGE IS LOCKED TO FREE MEMBERS**

Purchase full membership to immediately unlock this page

# DELVE INTO FANTASY, MAGIC, MYTHOLOGY & FOLKLORE

Forgotten Books'  
Full Membership gives  
access to 797,885 ancient  
and modern, fiction and  
non-fiction books.

**Continue**

\*Fair usage policy applies

Even the amount of moisture in so called "dry wood" is not always the same. The late Professor J. B. Johnson, in his "Materials of Construction," says "the weight of a pailful of shavings varies with the time of day, being on a summer day greatest in the morning and least in the afternoon. Wood kept on a shelf in an ordinary dwelling-house retains 8 to 10 per cent. of its weight of water, and this percentage is always greater than the percentage of the surrounding air."

The timbers of the temperate zone contain least sap if cut at the fall of the year and thus season more readily, but the time of felling does not affect their strength or durability.

**Artificial Seasoning.**—Kiln drying, where the timber is stacked in a tank and exposed to temperatures of hot air from 150° to 180° Fahr., is a quick, useful, and satisfactory method of seasoning timber when it is required urgently. Some soft woods are put into the tank fresh from the saw; hard woods are allowed to season in the air for some months previously so as to allow shrinkage to take place more gradually, as they are more liable to split by sudden drying. As a rule lower temperatures of 100° to 120° Fahr. are employed when the timber is kiln dried in a green state, and sometimes dry steam is applied to it during the process to enable the seasoning to take place more gradually and with less risk. In the above temperatures pines, spruce, cedar, and soft woods are generally allowed about four days for 1-inch boards, and hard woods, after being air dried for three to six months to allow the first shrinkage to take place, are placed in the kiln for from six to ten days for the same thickness of boards.

Careful stacking of the timber, so as to allow spaces around each piece, is as necessary in kiln drying as in

open air seasoning. One of the advantages of kiln drying is that all parts outside as well as inside are equally dried, and it allows of the timber being quickly brought into use, but there is a risk of unequal shrinking or splitting unless care is taken during the process; kiln drying is seldom used for large-sized timber. The time occupied in kiln drying, as in the open air, depends upon the thickness of timber under treatment, and it will take much longer, longer even than in proportion to size, to dry baulk timber than it will to dry planks; as much as twenty times as long is required to dry a 10-inch log as in the case of a plank one inch thick.

**Charring** the ends of wood and sometimes all over has been tried at various times with a view to preservation, but after the experience of many experiments it is questionable if it is worth the cost. It is not uncommon to char the ends of fence posts before they are put into the ground, and this is required in the specifications of at least one county authority in Great Britain for oak and other posts for handrails on bridge approaches.

**Impregnation of Timber.**—The prevention of the propagation of fungi can generally be attained by a proper system of seasoning when required for building work, but where timber has to be placed in situations more conducive to the production of fungus life, say in the ground as railway sleepers or where it is liable to attack by the sea worm, it is necessary to have recourse to antiseptics of one kind or another.

Methods and processes for the preservation of timber are as old as history. Rot and decay of timber were the bane of the architect and engineer 2,000 years ago as they are to-day. The famous wooden statue of Diana of the Ephesians was kept saturated with oil of Nard by means of

a number of small orifices in the woodwork in order to prevent decay, and even so late as the nineteenth century—so history repeats itself—a famous north-country engineer recommended the coating of piles from the ground level to about low water with whale oil as a preventative against the sea worm. The Ephesians were probably successful, the engineer was not.

The first English patent for the artificial preservation of timber appears to have been taken out in 1738, since which time, as has been truly said, “almost every chemical principle or compound of any plausibility has been suggested for the purpose.” Britton, in his treatise on “Dry Rot in Timber,” enumerates twenty-nine different substances which had been used for preserving wood; at the present time they probably number 200. Over 120 patents exist in America alone. Those dealt with here may be called “the survival of the fittest.”

**Burnettizing** was invented by Sir William Burnett in 1838, and has kept its ground ever since.

It consists of an injection of chloride of zinc in the proportion of one part of the zinc solution, having a specific gravity of 1·6, to 40 parts of water, and it is forced into the wood under pressure of 150 lbs. to the square inch. It was claimed for it that it hardens the fibre and prevents decay.

The process was for some time favoured by the English Government, but is not now, so far as the author knows, employed in this country. It is still, however, either in the original form or with various modifications, extensively used in the case of sleepers on the German, Austrian, Dutch, and French railways, and is the chief method used for the preservation of sleepers on the United States railways, where it is called the zinc chloride process, owing to its cheapness, although creosote is now largely used.



**THIS PAGE IS LOCKED TO FREE MEMBERS**

Purchase full membership to immediately unlock this page

# Know Your Bible

Forgotten Books'  
Full Membership  
provides unlimited  
access to more than  
28,000 volumes of  
Christian literature for  
\$8.99/month

**HOLY  
BIBLE**

**Continue**

\*Fair use policy applies

diversity of opinion as to its advantages, and it is much more suitable in some situations than in others.<sup>1</sup>

**Boucherie's Process**, which appears to be the same as **Marjery's**, consists of the injection of sulphate of copper in the proportion of 1 lb. of copper to 8 or 12 gallons of water, and was at one time used with fair success in England for telegraph poles and is now used in France and Germany; in the latter country posts have a life of over thirteen years. According to a recent statement in *L'Electrician*, Paris, vol. 32 (1906), it is necessary that the wood should be treated not later than eight or ten days after the tree is cut down, and another disadvantage is that the life of the posts is affected by the nature of the soil in which they are placed.

**Kyanizing** is the impregnation of timber with bichloride of mercury in the proportion of 1 lb. of the bichloride to 5 gallons (about 50 lbs.) of water; it is sometimes simply allowed to soak into the wood steeped in the vat, but as a rule it is pressed in the same way as in the case of burnettizing and creosoting, and in the same tanks which are used for creosoting.

Kyanizing is much used by the North Eastern Railway Company in Newcastle-on-Tyne and district for the treatment of wood for coaling staiths, planking of bridges, etc., and for the latter it has proved very satisfactory. The author has a specimen of kyanized plank cut from a bridge deck after being in an exposed situation for forty-one years, which is perfectly hard and sound. The process is said to be a preservative against fire, but that is very doubtful, and in water, particularly sea water, it appears

<sup>1</sup> Latest practice aims at getting not less than half a pound of pure zinc chloride into each cubic foot of timber.

to have invariably failed, as indeed have all the salts of metals. The North Eastern Railway Company always paint the kyanized timberwork to prevent the salts being washed out. This process is a good deal used on the Continent for small timbers such as posts, stakes for grape vines, etc., but as the corrosive is very poisonous care has to be taken in the handling. Timber preserved by this process has a life of seventeen years in Germany.

**Powellized Wood** was the treatment of wood by a strong solution of sugar, invented in Great Britain a few years ago.

**Salt** is an excellent preservative for timber, and in the days of the old wooden ships a layer of salt between the inner and outer planking secured a year's longer classing at Lloyd's; it is recommended by the American Lloyd's and still required by the Lake underwriters for new first-class vessels.

**Creosoting**, which is the system of timber preservation best known and mostly used in Great Britain, was the invention of Mr. John Bethell in 1838, the same year which saw the invention of burnettizing, and these two may be said to be the only systems which are still largely used.

*Creosoting is by far the best preservative for timber.* It is good in all situations and in all conditions, and even those who largely use the zinc chloride and other processes are unanimous in giving the first place to creosoting, and are only deterred from using it because of its much greater cost, or because it is unsuitable for the situation where the timber is to be used, such as interior work.

By this process distilled coal tar is injected under pressure into timber (properly seasoned to allow the



creosote to penetrate) which is placed in iron or steel cylinders 6 to 9 ft. in diameter and of various lengths up to 150 ft. and over, having tightly fitting cast-iron doors at each end. The timber, if in logs, is placed on bogies and run into the cylinders, which are fitted with rails to suit their gauge, or in the case of telegraph poles or smaller timber



FIG. 40.—Creosoting Tank empty.

it is lifted or pushed in. The doors are then secured with screwed bolts, the tanks filled with creosote, and the pressure applied for a shorter or longer length of time dependent upon the size, quality, and condition of timber (see Figs. 40 and 41).

The specification which the author has used for many years for Baltic and pitch pine timber and has found very satisfactory is as follows:—



**THIS PAGE IS LOCKED TO FREE MEMBERS**

Purchase full membership to immediately unlock this page

# DELVE INTO FANTASY, MAGIC, MYTHOLOGY & FOLKLORE

Forgotten Books'  
Full Membership gives  
access to 797,885 ancient  
and modern, fiction and  
non-fiction books.

**Continue**

\*Fair usage policy applies

“The temperature of the creosote when injected into the timber is to be not less than 120° Fahr. and the pressure is to be not less than 150 lbs. per square inch.”

In the case of planking or sleepers, a parcel of say a dozen or more, dependent upon the total quantity to be placed in the tank, is weighed before and after creosoting, and the amount of creosote injected into this parcel is taken as the standard for the amount of creosote which has been injected into the tankful of timber.<sup>1</sup>

It is generally stated that not more than 10 lbs. of creosote per cubic foot will be paid for in pitch pine, and 12 lbs. per cubic foot for Baltic planking and railway sleepers, as this is considered sufficient protection for timber in Great Britain, even against the sea worm, but in the neighbourhood of the Gulf of Mexico and other parts of the American coast infested by the teredo as much as 22 to 25 lbs. per cubic foot is recommended, but this is difficult to obtain. Even in America, where the zinc chloride process is almost in general use, creosoting is invariably applied to timber structures in worm infested parts of the coast, as it is the only process of any use in such a situation. Pitch pine timber often requires to be under a pressure of 150 or 160 lbs. per square inch for ten hours to allow of 7 lbs. of oil per cubic foot being injected; Baltic timber as a rule does not require such long pressing.

It must be a very soft class of wood with a great deal of sapwood and well dried which will admit of 22 lbs. of oil being injected into it, but this is the quantity which the Louisville and Nashville Railway Company try to get into timber as a protection against the teredo.

<sup>1</sup> See previous remarks about creosoting Oregon Pine. It is now being generally admitted that each species of timber requires different treatment, as what may be very suitable for one species is not suitable for others.

For this purpose they use loblolly pine, which has a great deal of sapwood into which the creosote will penetrate much more readily than into the harder, long-leaved pine which we call pitch pine.<sup>1</sup>

Fairly seasoned, sound pitch pine in logs or cut timber occasionally take in 15 lbs. per cubic foot, but this is rare, and the average injected is much less, as the specification shows. Timber merchants in Great Britain think that even 7 lbs. per cubic foot is a strict specification for pitch pine, but if the timber is fairly dried and the oil heated and pressed as specified above there is no difficulty. Only recently several hundred logs of pitch pine were creosoted under the above specification, and there were only three or four which did not take in 7 lbs. per cubic foot at the first tanking; 33 per cent. took in over 10 lbs. and several 13 and 14 lbs. per cubic foot. They had been drying for about three months.

The life of well-seasoned and properly creosoted timber, even in situations inimical to its life, is almost indefinite, and, as a proof of the advantages of the system, creosoted timber piles standing in a row with uncreosoted piles were perfectly intact after ten years, whilst the uncreosoted ones were badly eaten by the sea worm. Creosoted pitch pine piles have withstood the attacks of the luminoria on the north-eastern coast of Great Britain for over twenty years when untreated timber would have been rendered useless in half the time, and the Louisville and Nashville Railway Company have creosoted piles in their structures near New Orleans which have withstood the teredo for twenty-five years in a situation where this pest cuts down untreated piles in one or two years.

Creosoted railway sleepers have never been removed

<sup>1</sup> In recent tests 28 lbs. of creosote per cubic foot was got into loblolly sleepers.

owing to decay, but solely because of the abrasion by rails or chairs caused by traffic.

That there are failures in creosoting is certain. The author has seen a creosoted plank taken out of the ground in as bad a condition as an adjoining uncreosoted one after only a few years' exposure, but this is rare, and on the other hand he has cuttings from the Memel timber of the old East Pier at Blyth, Northumberland, which has stood the wash of the sea and the attacks of the sea worm and weather for forty-seven years; the creosote smells as strong as on the day it was injected and still stains the paper on which the wood is placed.

Doubtless one of the reasons of failure in creosoting is because the timber treated has not been sufficiently dried. Particular care should be taken that logs and planking, more particularly the latter, should be properly separated by laths when in the creosoting tanks, so that the creosote has a proper chance of being injected equally over the surface.

Creosote no doubt, like the salts of metals, tends by exposure to weather and salt water to leach out of the timber—this may be noticed in telegraph poles during hot weather—but, as may be judged from the examples given above, it is a very slow process. Cut timber in the same situation as piling, and used for bracing, begins to be affected by the sea worm at or near low water much sooner than vertical piling, and, chiefly at the ends where the timber has been cut to fit and the creosote partly cut away, it has been attacked after about eighteen years in this country and in some instances sooner. The German Government give statistics extending over fifty years, from which they estimate the average life of creosoted telegraph poles to be twenty and a half years, but many telegraph poles in Great Britain have been in use for forty years. Of sixty poles



**THIS PAGE IS LOCKED TO FREE MEMBERS**

Purchase full membership to immediately unlock this page

# Know Your Bible

Forgotten Books'  
Full Membership  
provides unlimited  
access to more than  
28,000 volumes of  
Christian literature for  
\$8.99/month

**HOLY  
BIBLE**

**Continue**

\*Fair use policy applies

ground as railway sleepers and in sea water it proved a failure after a very short life. It is now but little used.

The approximate costs of treating timber are as follows :

	Per cubic foot.
Burnettizing (Zinc Chloride process),	
Germany . . . . .	2 <i>d.</i> to 2½ <i>d.</i>
Burnettizing (Zinc Chloride process),	
United States . . . . .	2¼ <i>d.</i> ,, 2¾ <i>d.</i>
Zinc Creosote process, Germany . . . . .	2½ <i>d.</i> ,, 3 <i>d.</i>
„ „ „ United States . . . . .	4 <i>d.</i>
Zinc Tannin process, United States . . . . .	3 <i>d.</i> ,, 3½ <i>d.</i>
Creosoting, United States . . . . .	7½ <i>d.</i>
„ North of England . . . . .	4 <i>d.</i> ,, 5 <i>d.</i>
„ Germany . . . . .	4½ <i>d.</i> ,, 7½ <i>d.</i>
Kyanizing, North of England . . . . .	9 <i>d.</i> ,, 10 <i>d.</i>

It will be noticed that the cost of creosoting in America is more than double the cost of treatment by the zinc chloride process, which is the one in general use there ; and this is the reason why the latter has been until recently almost exclusively employed.

When we consider the enormous and increasing quantities of timber which are being used yearly, and that we can look to the not far distant future when the world's chief forests of supply will be depleted, and when we know that any of the artificial methods of treatment in use will increase the life of timber for years, that some will double and treble it, that it is not only a yearly saving, but necessitates much fewer renewals of structures and less inconvenience to trade and traffic, it will be seen that the artificial treatment of timber is an important question for the engineer and architect. It is of course a matter of £ s. d. whether he will by some satisfactory system utilise the cheaper timbers at hand by paying even 25 per cent.

extra for artificially treating them, or use more costly but harder and more durable timber which will not need artificial treatment, or again, in cases where a long life is not required, use the softer timber in its natural state.<sup>1</sup>

**Fireproof Timber.** Many experiments have been made in the direction of rendering the timber fireproof, but not much practical result has been attained, and so called fireproof timber has been but little used. Practical experience has narrowed the efficacious compounds to be used in the fireproof treatment of timber to ammonium chloride, ammonium phosphate, ammonium sulphate, calcium chloride, alum, borax, boracic acid, and a few others.

The solutions, which are said to penetrate right into the interior of the wood, do not affect the workmen's tools, and the treated timber will take paint, stains, varnish, etc., just as well as untreated wood.

According to Professor Vivian B. Lewis, they crystallise in the cells of the wood, and under the influence of heat "the ammonium phosphate decomposes to ammonia gas and phosphoric acid, the former driving all air out of the cells and replacing it by a non-inflammable gas, whilst the phosphoric and boracic acids fuse and coat the cell walls with a glaze which, while allowing the gases from the decomposing cellulose to escape, prevents the access of oxygen from the air to carry on further combustion."

<sup>1</sup> In 1901 there were only fifteen timber treating plants in the United States; in the following six years this number was increased to fifty.



## CHAPTER XII

### DEFECTS IN TIMBER AND GENERAL NOTES

Heartshakes—Ringshakes—Knots—Grain—Sap—Wany Timber—Toughness—Flexibility—Microscopical Sections of Wood—Resonance—Meaning of Durability—Judging Timber.

ALTHOUGH their defects and weak points have been generally dealt with in detail under the different timbers described, it may be well to describe here certain typical defects in detail.

**Heartshakes** are splits noticed in the ends of logs ;

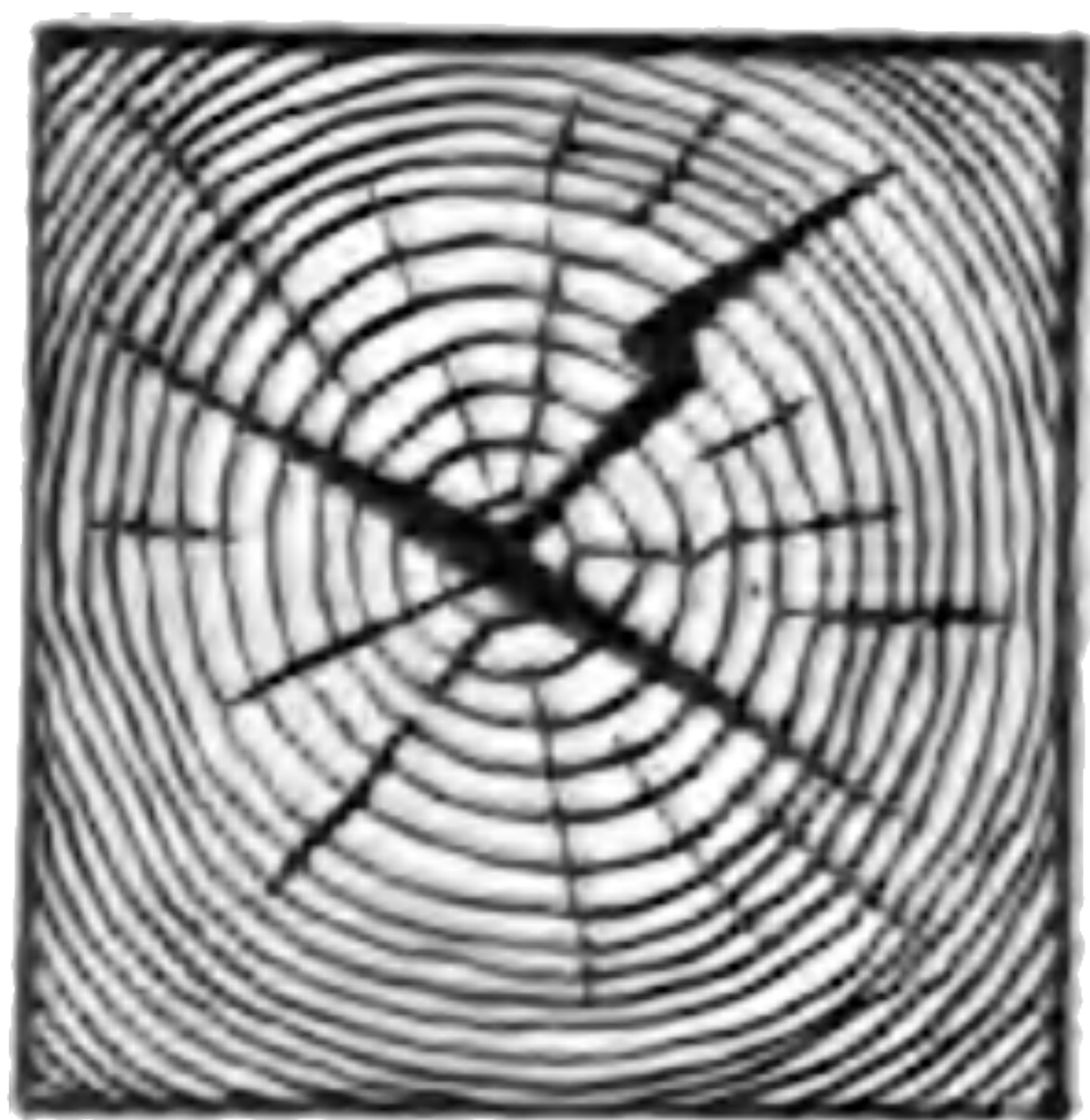

FIG. 42.—Heartshake.



FIG. 43.—Starshake.

they rarely run the full length of the logs of commerce, but sometimes, as in mahogany, teak, greenheart, and other tropical woods, they are found towards the centre of the log and cannot be detected until it is opened out (Fig. 42).

Sometimes these splits at the ends, which generally run along the medullary rays, extend the full cross section of the timber, sometimes only a short distance out from the



**THIS PAGE IS LOCKED TO FREE MEMBERS**

Purchase full membership to immediately unlock this page

# DELVE INTO FANTASY, MAGIC, MYTHOLOGY & FOLKLORE

Forgotten Books'  
Full Membership gives  
access to 797,885 ancient  
and modern, fiction and  
non-fiction books.

**Continue**

\*Fair usage policy applies

**Ringshakes** or **Cupshakes** are openings in the annual rings in the butt ends of logs which separate the rings from one another, leaving an opening between the layers

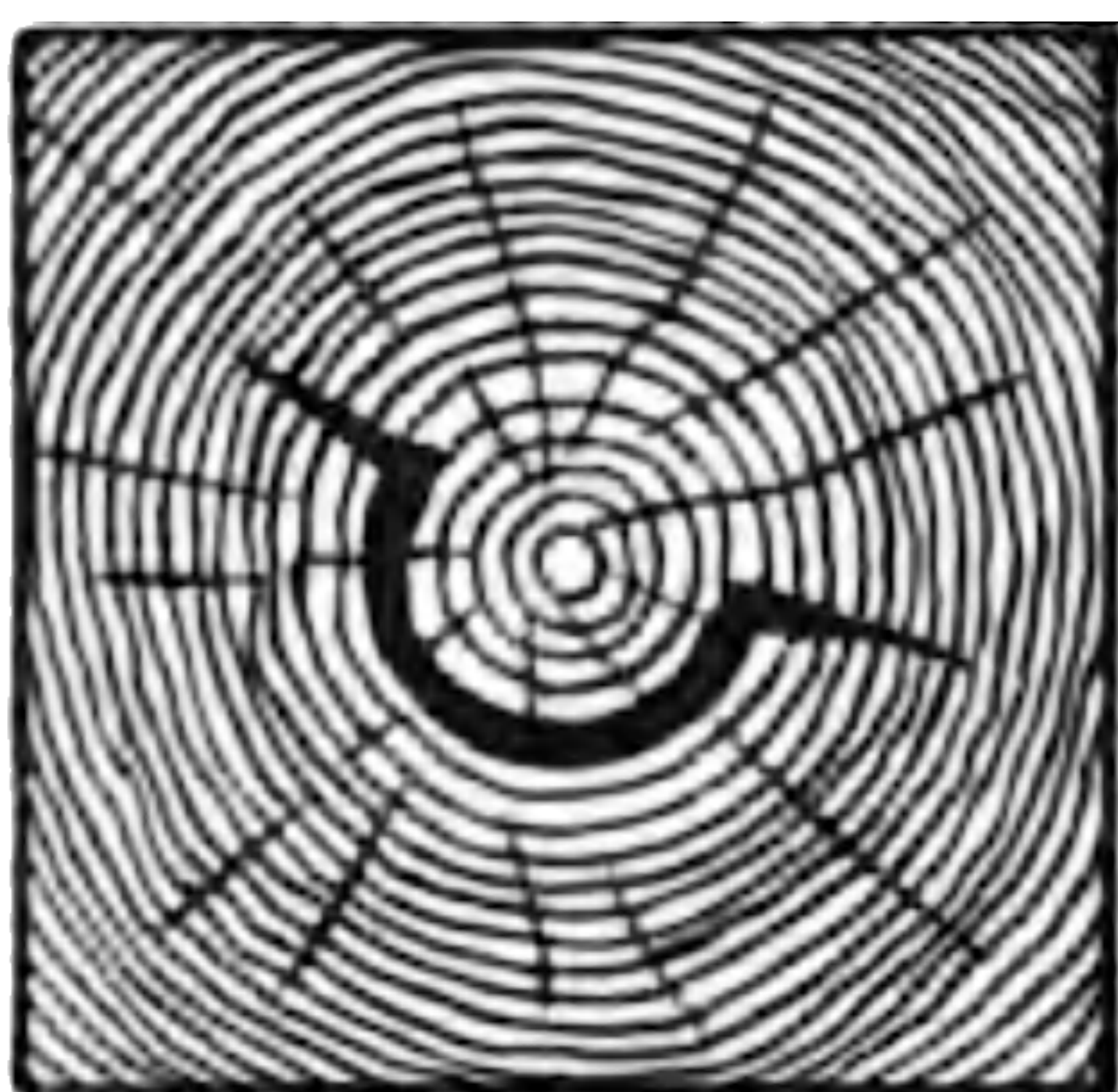

FIG. 45.—Cupshake.

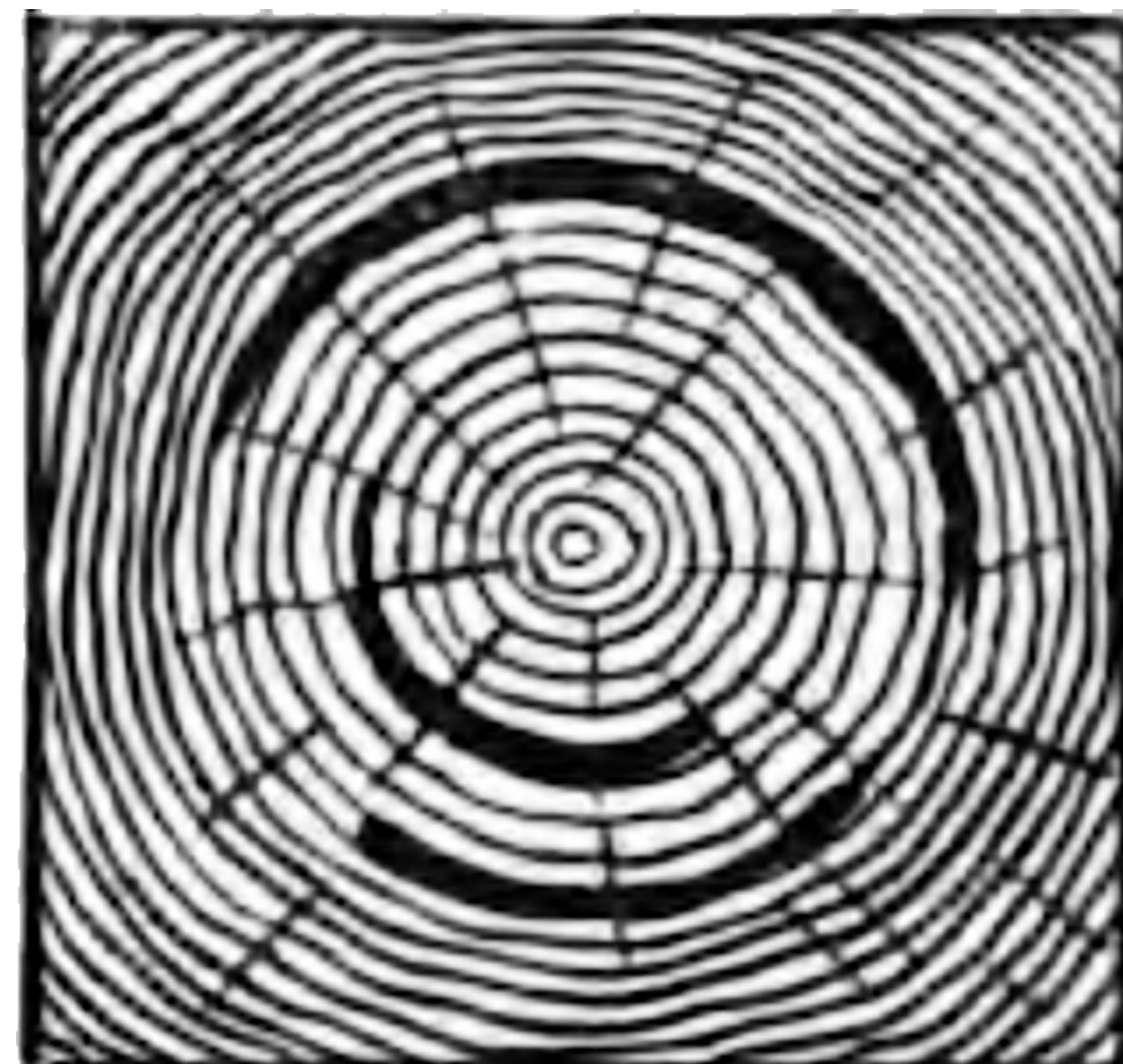

FIG. 46.—Ringshake.

of wood into which one can sometimes insert a thin rule for 18 inches or 2 ft.; sometimes they go right round the log, in other cases only partially round (see Figs. 45 and 46).



FIG. 47.—Cupshake often found in pitch pine.

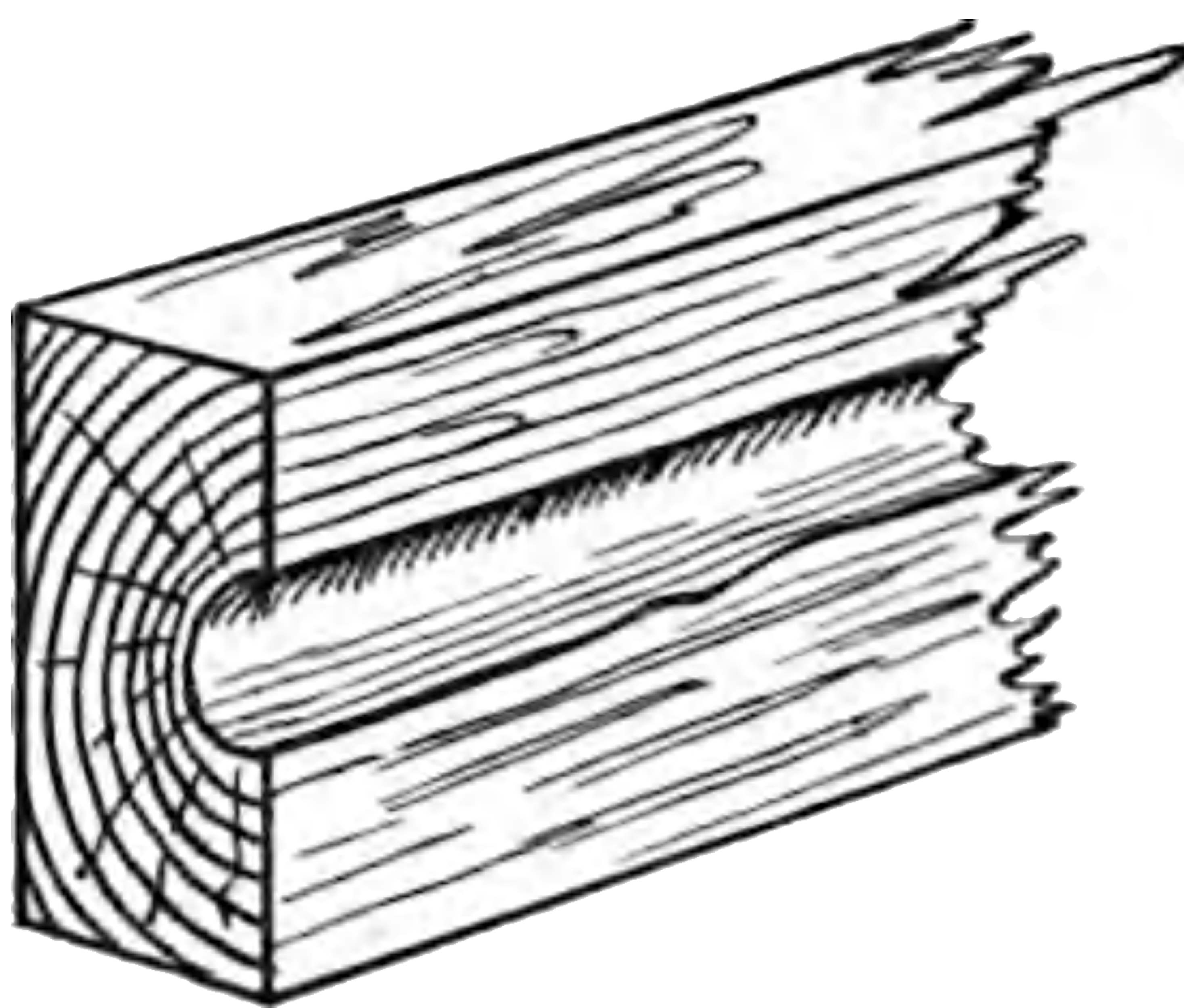

FIG. 48.—Showing the effect of cup or ring shake when the timber is cut up.

A rather characteristic feature of many pitch pine logs is the peculiar cupshake, often formed like a note of interrogation (Fig. 47).<sup>1</sup> The effects of cup and ring shake when timber is cut up is shown by Fig. 48.

<sup>1</sup> In the illustration this happens to be shown in the opposite direction.

Most of these defects only go a short distance into the ends of logs, at any rate it is often found that by cutting 18 inches or 2 ft. off the end the defect is minimised if not done away with, and although logs thus affected should be subjected to careful inspection, these defects are not serious where the timber has to be used in large beams, but they often cause a loss in converting it into small scantling.

When selecting timber one should do so with a view to its intended use; timber required for a beam or joist carrying a steady load and suitable for that purpose might not be suitable for carrying, moving, or jarring loads; timber suitable for either of these purposes might not be at all desirable for use in pile-driving, which, owing to the heavy hammering it has to sustain, should be sound throughout, whereas any that is not sound throughout can be cut up into satisfactory material for joiners' work, as, in the smaller sizes, the faults are eliminated with a certain amount of waste. It is in logs that the defects above referred to are specially noticeable, and it is comforting to know that when used in large sizes the defects are often not of much consequence.

**Variation of Colour** in the same piece of timber, unless natural, should be looked upon with suspicion, as it often shows incipient decay. There is a good deal of difference in the colour of the same species of wood which comes from different districts, some of the northern pine being almost yellow, whilst other is of a reddish hue; sometimes the colour is mixed, the red shading off into the yellow; there should be no sharp division of colour. A reddish tinge on the heartwood of light coloured Baltic timber sometimes denotes decay, but this is a matter in which experience must be the guide.

**Knots** are another objectionable feature in timber, but one which cannot be avoided. Many are found in excellent

logs, and it is useless specifying, as is sometimes done, that the ordinary building timber is "to be free from knots"; loose knots are certainly to be avoided, but one seldom finds these in sound pine timber.

Very large knots, especially if at the edges of timber which has to stand heavy strains, such as beams or columns, are a cause of considerable risk; it may safely be said that in the majority of cases where timber is tested as beams or columns it fails at knots.

Fig. 49 will show the reason for objection to a knot on the underside of a beam carrying a load, where it is much more serious than if on the top side. In bending,

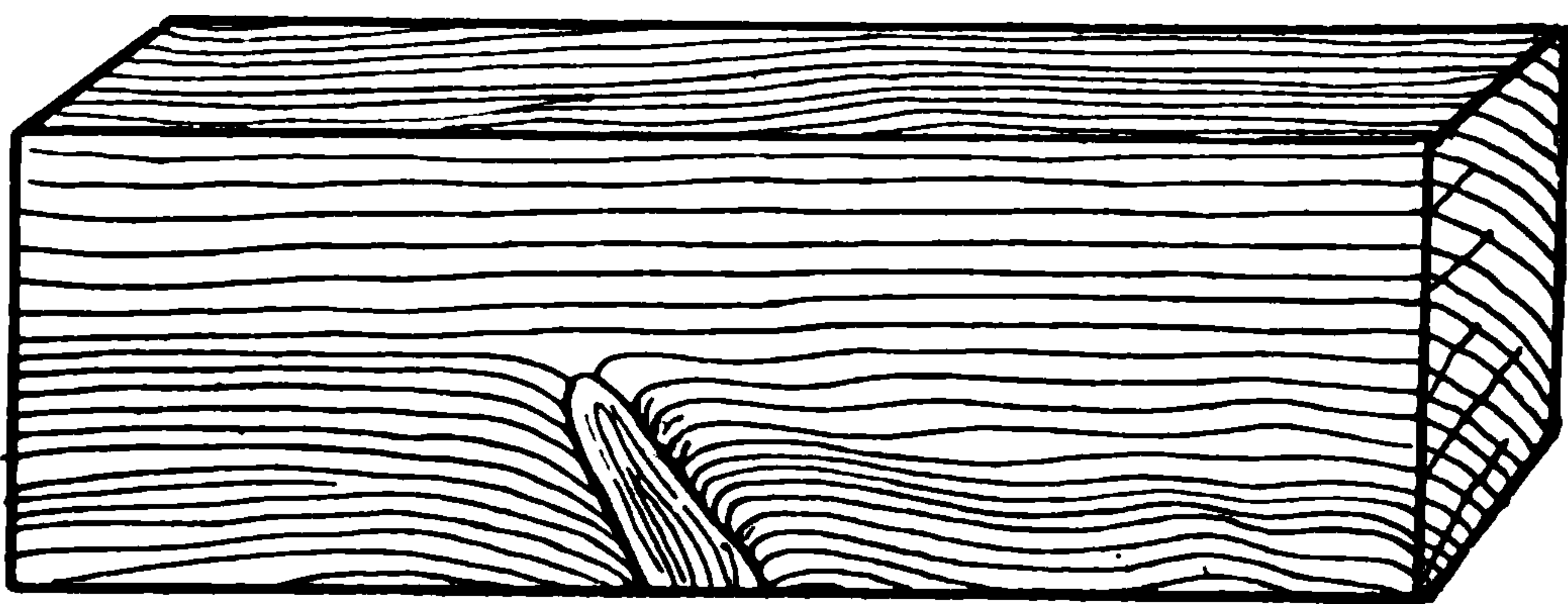

FIG. 49.--Showing risk of knots on underside of loaded beams.

the fibres on the underside of the beam are subjected to tension, the fibres of the wood around the knot like those in a piece of cross-grained timber offer but little resistance to tension, and the presence of a knot in this position has the same effect as putting a saw-cut on the underside of the beam.

A knot is the place where a twig or branch has projected from the parent stem; some timbers are to be got in considerable length with few knots, such as Oregon, Californian redwood, Tasmanian blue gum, kauri, and others, the reason being that these trees do not bear branches within a considerable distance of the ground, whereas European trees, pines and firs used in building, especially the firs



**THIS PAGE IS LOCKED TO FREE MEMBERS**

Purchase full membership to immediately unlock this page

# Know Your Bible

Forgotten Books'  
Full Membership  
provides unlimited  
access to more than  
28,000 volumes of  
Christian literature for  
\$8.99/month

**HOLY  
BIBLE**

**Continue**

\*Fair use policy applies

as little as possible allowed, but it is not much use, and scarcely fair, to put into a specification for large-sized timber that it is to be "free from sap," unless the engineer or architect is prepared to pay a much larger price than for ordinary timber, because, to attain this object, larger-sized timber must be bought in the first instance so as to allow of the timber standing the required size after the sap has been cut off. This adds considerably to the cost, for not only has the larger-sized timber to be paid for, but the cost of sawing has to be added.

As a rule for heavy work three 4-inch or four 3-inch timbers are cut out of a 12-inch log, and there will be a certain amount of sap on the outer sides and corners of two pieces and possibly on the edges of the others.

It would be much more satisfactory to define the amount of sap allowable, as, for instance, "Sap is not to exceed 2 inches or  $2\frac{1}{2}$  inches at the corners of timbers" in an 11 or 12-inch plank, thus:

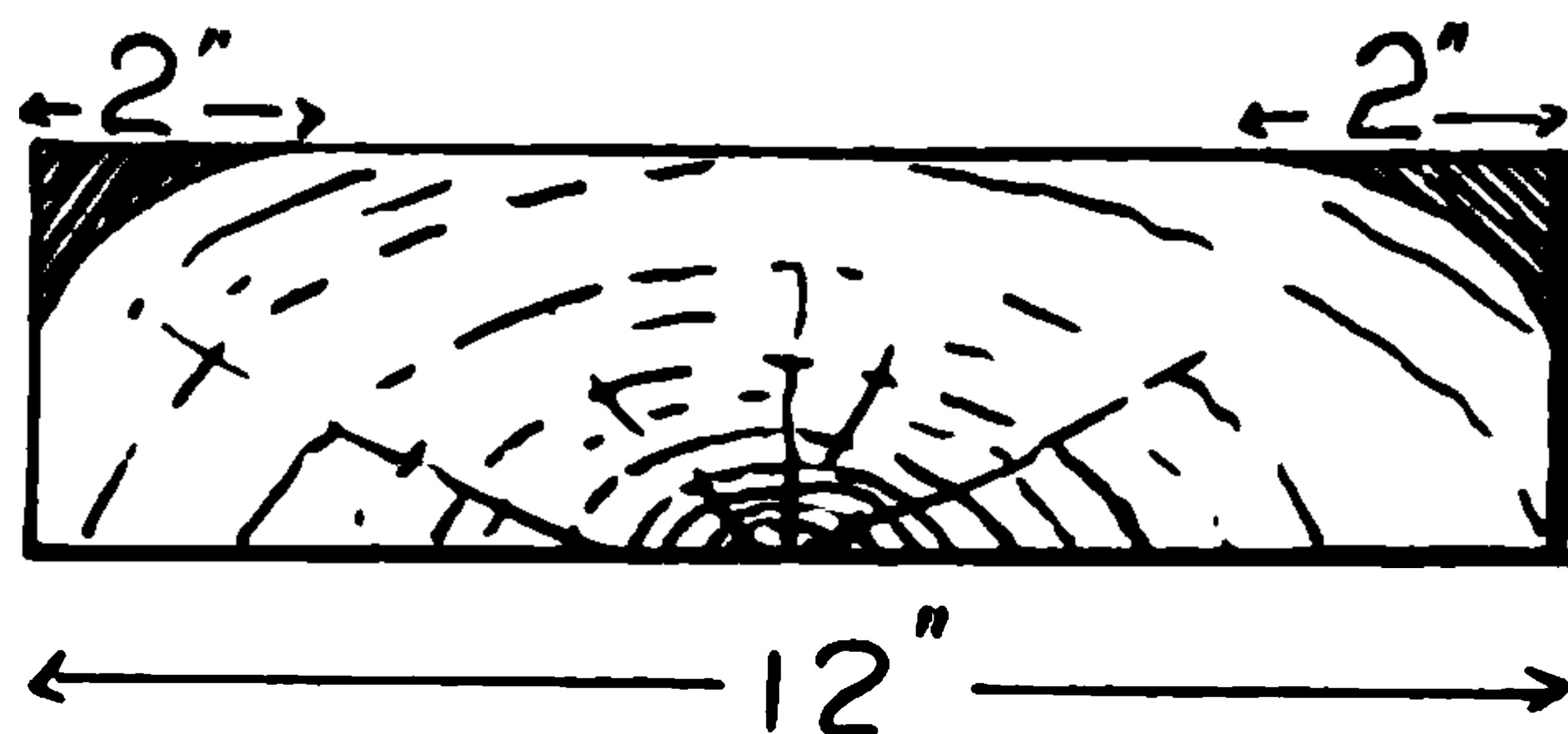

FIG. 50.

On no account should sap be allowed all over one side. Smaller scantlings can by selection be got quite clear of sap, and this is very desirable. The clause "the timber shall be properly seasoned" would prevent the admission of objectionable sap, for some kinds are worse than others. The author does not agree with a distinguished engineering expert who, in giving evidence some time ago, stated that timber seasons in its transit from the Baltic, because, unless the timber be partly seasoned before being put on board, as

it very often is not, its condition may become worse on the voyage, it sweats and "blueing" occurs, and few would take "blue" deals except for the commonest purposes.

It is not easy to detect sap in certain conditions of some of the whitewoods, as the colour of all the timber is much the same, although the sap has generally a dirtier tinge; looking at a pile of round Swedish or Russian redwood logs we see the ring of lighter coloured sap about an inch thick distinctly marked from the reddish tinged heartwood (Fig. 37); but when the timber is squared and a good deal of the sap is cut off in the process the difficulty is increased, particularly so in the case of whitewood, as the sap is then only found at the edges and partly on the sides. Sap is almost invariably found on the edges even if absent from the sides.

Sapwood is not so objectionable where the timber has to be creosoted, as any one looking at a pile of telegraph poles (Fig. 37) will notice the complete ring of sapwood encircling the log, yet the long life of telegraph poles proves this not to be deleterious.<sup>1</sup>

The presence of sap in commercial timber is due to the same cause as wany edges, viz., the desire of the timber converter to get as much timber as possible out of the tree.

"Wany timber" is the expression used for logs the edges of which are not sharp. Some timber is imported "wany," but much of the "square" timber has waness on some parts

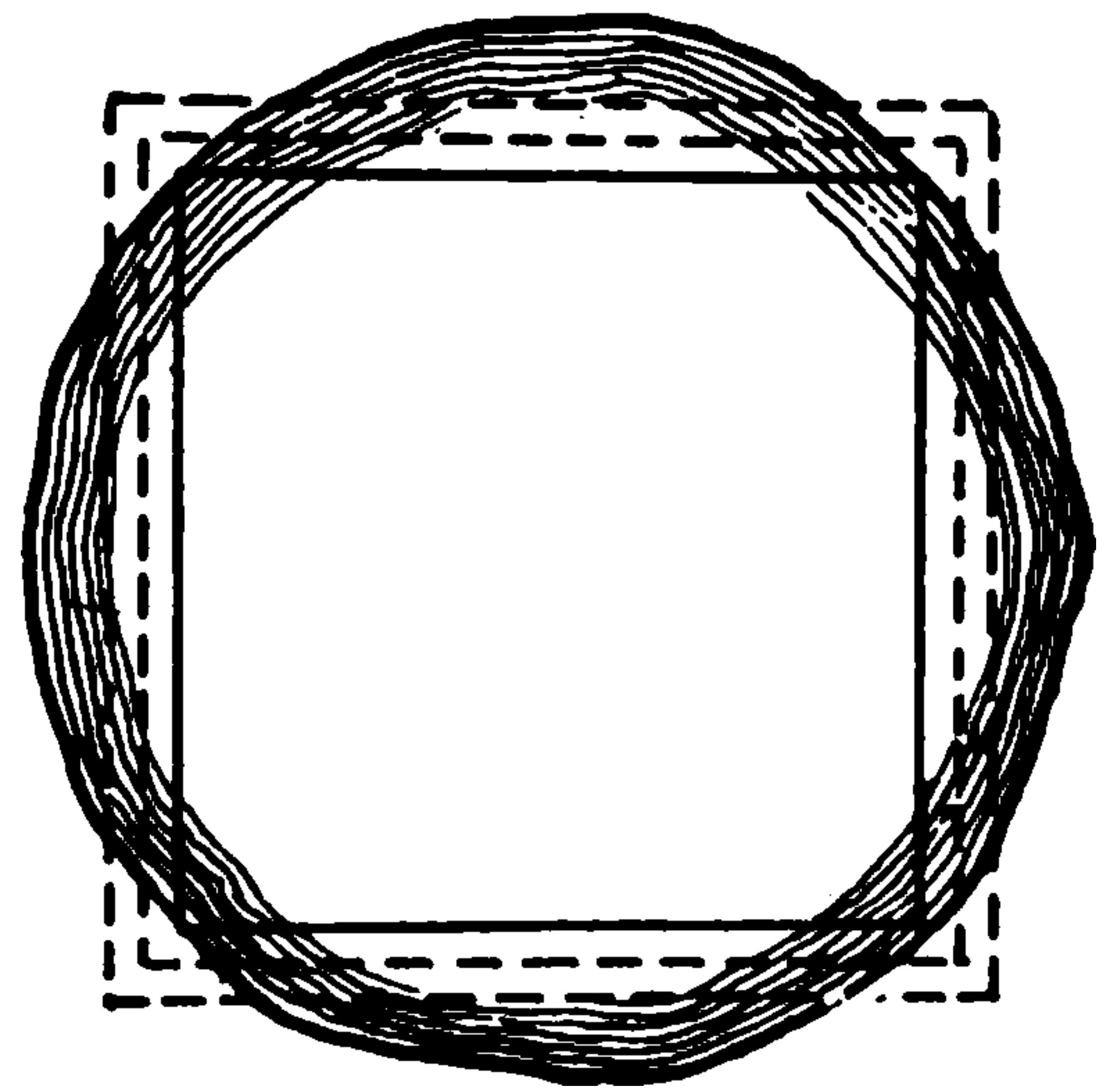

FIG. 51.

<sup>1</sup> As a rule creosote does not enter much into the heartwood, and the presence of a ring of sapwood in timber to be creosoted ensures its perfect preservation. In the case of street paving, however, it is possible that the sappy portion might not wear so well as the rest.



of its edges, and there is a good deal of wane on the edges of some hewn logs. Fig. 51 shows the section of a 17-inch diameter tree; the darker shading is the sapwood. As will be seen by the full lines, there would not be much difficulty in getting a 12-inch perfectly square log, and also one practically free from sap, except just at the corners, out of such a tree, but if the timber be cut along the inner dotted line, which shows a 13-inch log, there will be some wane on the corners and much more sap there, whilst if cut along the outer dotted line, which shows a 14-inch log, there will not only be a good deal of wane on the edges, but

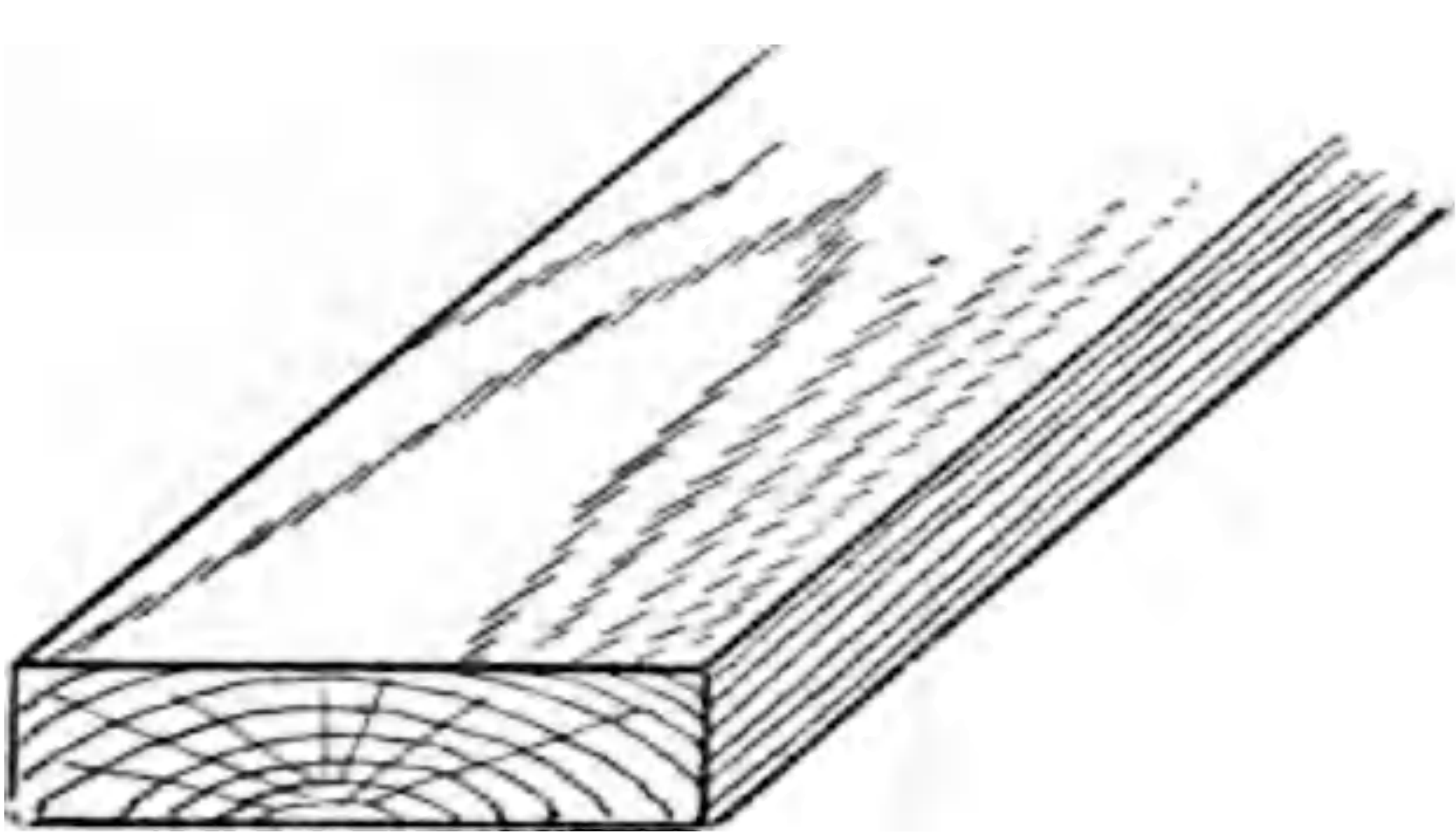

FIG. 52.

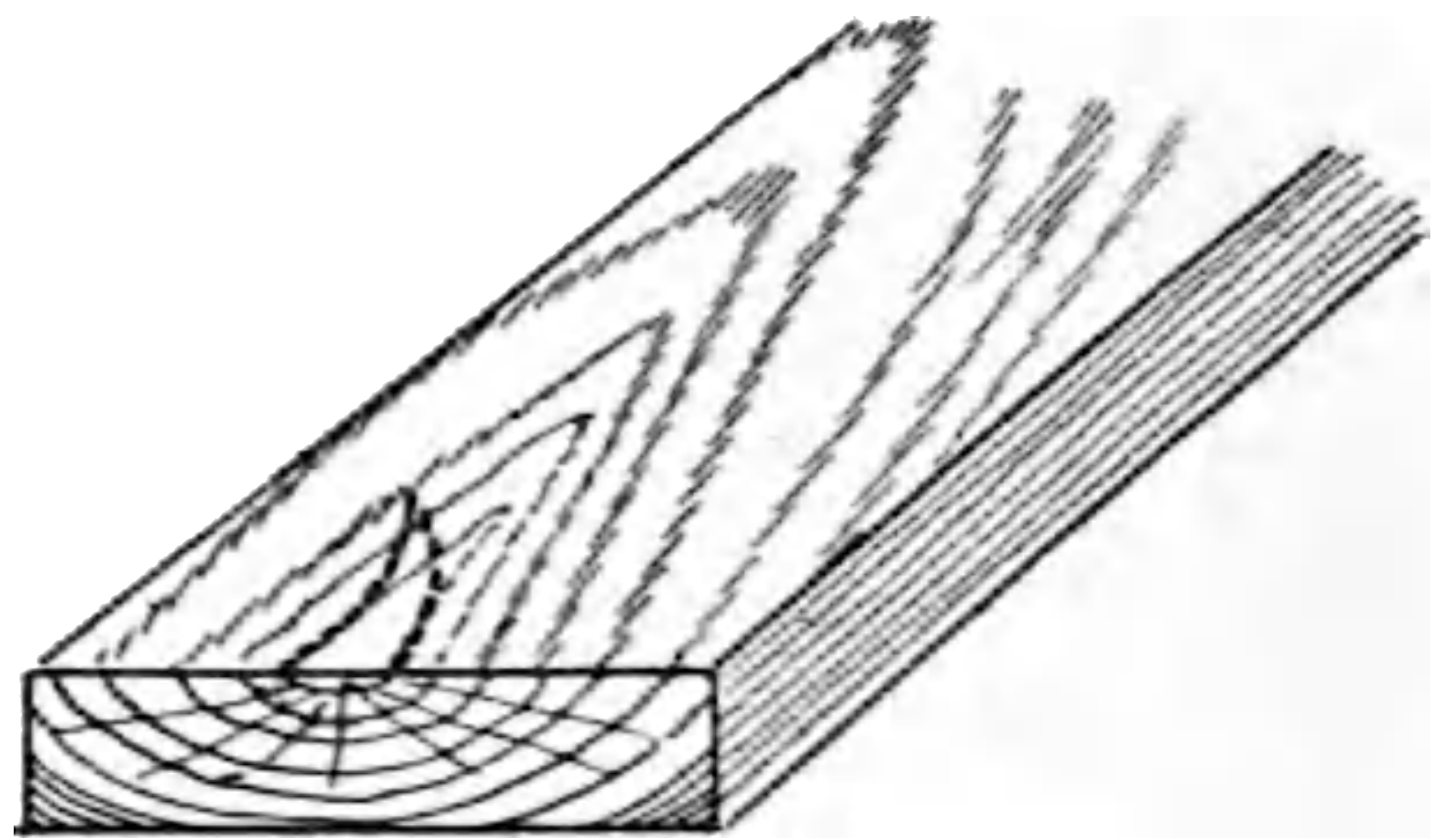

FIG. 53.

the amount of sap will be considerably increased, and may extend along the sides if the sap widens out in places.

The converter naturally tries to get as large-sized merchantable logs as possible out of the trees, hence the wany edges on logs.

A practical view should be taken of timber selection; if only a few logs or pieces of timber are required, there will be no difficulty in getting them free from the defects described; but when a large quantity is required it is impossible to avoid them, although timber containing them must be carefully examined; the best must be made of such timber as can be obtained in the market.

The pines and firs have generally few defects, except sap



**THIS PAGE IS LOCKED TO FREE MEMBERS**

Purchase full membership to immediately unlock this page

# DELVE INTO FANTASY, MAGIC, MYTHOLOGY & FOLKLORE

Forgotten Books'  
Full Membership gives  
access to 797,885 ancient  
and modern, fiction and  
non-fiction books.

**Continue**

\*Fair usage policy applies

amongst others, we are indebted for hundreds of illustrated sections showing the structure of wood. It may be mentioned that so far back as 1770, in a book on "Construction of Timber," by John Hill, M.D., there are some excellent microscopical sections given of a good many European timbers.

This is an excellent and easy method of distinguishing different timbers; by this means we can tell hickory from ash, and oak from either; beech from birch and sycamore, though at a casual glance they appear very similar.

A good log of timber has a clear ringing sound when struck on the end with a hammer, and this is particularly noticeable in the pines and firs; a dull sound denotes decay or defect somewhere, although it may be only local and not of serious import. The least knock or even scratching with a pin at one end of a good log can be distinctly heard at the other end, even over a length of 60 ft., if the timber is sound and healthy.

Resonance is a quality in timber to which particular attention has to be paid by those requiring wood for musical instruments, spruce and silver fir being the favourites for this purpose, and it has to be wood free of defects and of uniform structure and growth.

Where timber is referred to as subject to the depredations of the white ant and other boring insects, this only applies to its native districts or the tropics. In climates such as that of Great Britain timber is rarely attacked by boring insects to any extent until it attains a great age, and timber obtained from the regions infested by these pests is no more liable to attack in Europe than native timber or timber brought from the Baltic or North America; but, on the other hand, European or North American timber imported into the tropics is quite as liable to attack as, probably more so than, native timber.

It should be understood that when a timber is referred to as durable, or fairly durable, this is only a comparative term, and only applies to its use under conditions for which it is adapted and generally used, because although some classes of timber such as greenheart, jarrah, pitch pine, oak, and many hardwoods may be used in most situations and either for interior work or where exposed to the weather, and will have a fairly long life in either, yet with many other timbers it would be quite the contrary. For instance, sycamore, poplar, and other softwoods which last for very long periods if protected from the weather would not be at all durable if placed in situations where they would be alternately wet and dry, and no one would think of using them in Great Britain for, say, a timber quay, irrespective altogether of their want of strength.

The durability or otherwise of timber in various situations is very variable; the poorest timber may, in a dry protected situation, last for centuries; the best of timber in other situations will decay in a few years. Some of the softer woods last longer as railway sleepers—and this is about the most severe test to which timber can be subjected, especially if placed in a cinder ballasted track—than some of the hardwoods, which in ordinary situations could not compare with them in point of longevity. Oak, as we have seen, will last in fairly good condition in some places for 2,000 years, but the best American oak, when used for railway sleepers, only lasts eight or ten years, and in some situations will decay in three years. In America, which is about the only country in the world where large quantities of untreated softwoods are used for railway sleepers, it has been found that the comparatively soft red cedar, the arbor vitæ, and redwood resist decay best, as they are less affected by disease than most timbers; treated hemlock will not last so long in some situations as untreated cedar; some roads get a life

of fifteen years from cypress, whilst others in the same locality only get five years from oak. Again, timber lasts much longer in some climates than in others; the same timbers will have a much longer life in a dry bracing climate than in a moist atmosphere, such as that of Great Britain or parts of the tropics. Yellow pine is much used for outdoor work in its native districts and is found fairly suitable, whereas it would not be so suitable for such a purpose in Great Britain as the Baltic timber.

Those timbers which contain a large proportion of resin are well adapted to resist decay in bad situations, whilst other timbers, such as many of the tropical woods, are protected by various chemical ingredients which ensure them a long life.

To judge timber properly it should be seen in the log or in large pieces as well as cut up. It is almost impossible to judge its quality, or in some cases even to tell one class of timber from another, if only seen in small pieces, especially if the colour be nearly alike. The question as to whether the roof of Westminster Hall is of oak or chestnut, which so often comes up for discussion, is a case in point. There might be some difficulty in deciding the question merely by colour and from a distance, but if one saw a cross section or end view of one of the beams it could be quickly decided, as the one timber is of quite a different structure to the other.

The carpenter and joiner of past days was a much better judge of timber than he of the present day; he had a better chance than his descendant of our time. The former probably cut up the timber himself or saw it cut up from home-grown timber, and knew its peculiarities well; the latter has timber delivered into his hands in sawn and even planed boards ready for use, from all parts of the world, and from trees of which he knows little or nothing, and new timber is continually coming into the market.



**THIS PAGE IS LOCKED TO FREE MEMBERS**

Purchase full membership to immediately unlock this page

# Know Your Bible

Forgotten Books'  
Full Membership  
provides unlimited  
access to more than  
28,000 volumes of  
Christian literature for  
\$8.99/month

**HOLY  
BIBLE**

**Continue**

\*Fair use policy applies

do with the testing of this material know that the smaller the specimen the higher the result. Small sample pieces of timber are obtained in more perfect condition, have fewer flaws and knots, often no knots at all, while these imperfections cannot be avoided in the case of timber of the sizes used in constructional work ; hence in most cases it has been assumed, during recent years, that the results obtained from small test specimens should, when put into practice, be reduced by 50 per cent. or even more.

It is a curious thing that in the case of timber, although one of the oldest constructive materials, and the one of which more is used than any other, we have been content to depend upon what are more or less doubtful tests, whilst in the case of steel, a material only a few years in use, we can rely upon accurate tests. It is not satisfactory, considering the number of powerful testing appliances now in use, that the tests made on timber of large scantling are so very meagre. Although the movement in the direction of remedying this state of things is slow, it is gradually coming to be considered necessary that tests made on timber, to be of any value, should be upon pieces such as are used in actual work, and not upon small or specially prepared specimens. The late Professor J. B. Johnson initiated a valuable series of tests on timber for the United States Government. Professor Lanza also carried out a great number of useful tests on large-sized timber, chiefly white and yellow pine (pitch pine) and spruce, at the Watertown Arsenal, and the Massachusetts Institute of Technology, United States, which have thrown a good deal of practical light on the subject, and the United States Government are continuing these tests. Quite recently the Government of Western Australia has, under the direction of Mr. G. A. Julius, B.Sc., M.E., tested thousands of different-sized pieces of the hardwoods of this and other

Australian colonies, the results of which have been published under the title of "The Physical Characteristics of the Hardwoods of Western Australia." A somewhat similar work, though not on such a large scale, had been undertaken for the Government of New South Wales by Professor W. H. Warren, M.I.C.E., some years earlier. The tests made by Mr. Julius were for cross-breaking, tension, end and cross compression, shearing along grain, hardness, etc., and upon the influence of moisture; they are the most careful and elaborate made upon timber up to date, and it is to be hoped that the example thus set will be followed up by our own and other Governments, and by universities and establishments which possess facilities for work of this character, at once useful to the students engaged upon the work and of great value to the timber user. If there were a large number of careful tests, of the character indicated above, carried out by different authorities and on various kinds of timber, they might be the means of considerably reducing the timber scantlings now used in construction. For instance, if in a case where we now use 12-inch by 12-inch or 12-inch by 6-inch timbers it were found, by the results of a number of satisfactory tests, that timber 12 inches by 10 inches or 12 inches by 5 inches might be used with safety, it would mean a saving of 16 per cent. of timber. This from a monetary point of view alone is considerable, but it would also in many cases make it easier to obtain timber of the required scantling, which in the larger sizes would be a great gain, as the time is approaching, and in the case of some timbers has already arrived, when the obtaining of large sizes and long lengths presents considerable difficulty.

It must not be thought from the above remarks that the author has any wish to depreciate the results of timber tests made by experimenters in the past. To Tredgold,



Barlow, Laslett, and many others in this country, we owe a great deal, since it was from the tests on small pieces of timber made in a primitive manner, but with the best means at their disposal and before the days of large testing machines, that men had to deduce the scantlings required for constructional work ; now, however, when better means are available, endeavours should be made to produce results which can be depended upon with something akin to the reliance placed upon tests of steel, although there are difficulties in connection with the testing of timber which do not occur in the testing of steel.<sup>1</sup>

The amount of moisture in timber considerably affects the result of tests, probably to a greater extent than anything else. The drier the timber, the higher the results obtained ; in other words, *seasoned timber is stronger than green timber*, and that to a very considerable extent, as will be shown ; but in general it will be safer in making calculations for strength of constructional timber to make use of the tests for moderately seasoned wood, as it is not often that highly seasoned timber is used ; it too often has to season in the work.

It is, therefore, useless making comparisons between tests of timber unless we compare their conditions of moisture. It takes a very long time by air seasoning to thoroughly dry timber of large sizes. Two pieces of pitch pine 16 ft. by 12 inches by 12 inches and 16 ft. by 16 inches by 8 inches, after air seasoning for two years, showed that whilst in the outer portion of the wood there was only 17 per cent. of moisture, the inner portion still contained 25 per cent. ;<sup>2</sup>

<sup>1</sup> A number of tests on large-sized columns and beams of oak were made by M. P. S. Girard in France so far back as 1798, but these tests appear to have been lost sight of, and others of less value used. (See Barlow's *Strength of Materials*, 1837.)

<sup>2</sup> Bulletin No. 70, United States Dept. of Agriculture, p. 123.



**THIS PAGE IS LOCKED TO FREE MEMBERS**

Purchase full membership to immediately unlock this page

# DELVE INTO FANTASY, MAGIC, MYTHOLOGY & FOLKLORE

Forgotten Books'  
Full Membership gives  
access to 797,885 ancient  
and modern, fiction and  
non-fiction books.

**Continue**

\*Fair usage policy applies

made on the hornbeam by M. Julius Marchet in 1895 the weight necessary to crush cubes of the wood containing only  $7\frac{1}{2}$  to  $9\frac{1}{2}$  per cent. of moisture was from 2.1 to 2.3 times as much as was required to crush cubes of the same saturated with water.<sup>1</sup>

A most interesting series of tests has been recently carried out by Mr. H. D. Tiemann, M.E., M.F., of the Forestry Service, United States Department of Agriculture, given in detail in Bulletin No. 70, showing the effect of seasoning on the strength of wood, and gives more convincing proof than anything hitherto of the remarkable and constant increase in the strength of wood caused by drying. The following tables show the degree to which the strength is increased over green timber:—

	In compression parallel to grain.		In bending.	
	12 per cent. moisture.	$3\frac{1}{2}$ per cent. moisture.	12 per cent. moisture.	$3\frac{1}{2}$ per cent. moisture.
Longleaf Pine (pitch pine).	1.7 times	2.9 times	1.5 times	2.5 times
Spruce <sup>2</sup> . . . .	2.4 „	3.7 „	1.9 „	2.8 „
Chestnut . . . .	1.8 „	2.8 „	1.6 „	2.1 „
Red Fir . . . .	1.7 „	2.6 „	—	—
Loblolly Pine Heartwood.	2.0 „	3.0 „	—	—

and for a still drier condition with only 1 per cent. of moisture the increase continued. A completely dry spruce block held up a load four times as great as that which a green block sustained.

Stiffness, within the elastic limit, was found to follow a

<sup>1</sup> Min. of Proc. Inst. C.E., Vol. CXXIII., p. 472.

<sup>2</sup> The Spruce referred to in all these tests is the Red Spruce (*Picea rubens*).

similar law, but not to increase quite so rapidly, the ratios being as follows :—

	In compression parallel to grain.		In bending.	
	12 per cent. moisture.	3½ per cent. moisture.	12 per cent. moisture.	3½ per cent. moisture.
Longleaf Pine (pitch pine).	1·2 times	1·6 times	1·1 times	1·6 times
Spruce . . . . .	1·6 ,,	2·3 ,,	1·2 ,,	1·4 ,,
Chestnut . . . . .	1·2 ,,	1·4 ,,	1·2 ,,	1·4 ,,
Red Fir . . . . .	1·3 ,,	1·5 ,,	—	—
Loblolly Pine Heart-wood.	1·4 ,,	1·9 ,,	—	—

The elastic limit increases with the strength, the ratios being :—

	In compression parallel to grain.		In bending.	
	12 per cent. moisture.	3½ per cent. moisture.	12 per cent. moisture.	3½ per cent. moisture.
Longleaf Pine (pitch pine).	1·7 times	2·6 times	1·6 times	2·9 times
Spruce . . . . .	2·7 ,,	3·8 ,,	1·9 ,,	2·9
Chestnut . . . . .	1·5 ,,	2·4 ,,	1·6 ,,	2·3
Red Fir . . . . .	1·8 ,,	2·8 ,,	—	—
Loblolly Pine Heart-wood.	1·6 ,,	2·3 ,,	—	—

The timber with 12 per cent. of moisture was air dried, that with 3½ per cent. was kiln dried.

The following tables, extracted from those of Mr. Tiemann, show how remarkably regular is the increase in the strength of timber as the moisture is extracted from it.

**BENDING STRENGTH.**

Moisture per cent. of dry weight.	Modulus of Rupture. Lbs. per sq. in.			Modulus of Elasticity. 1,000 lbs. per sq. in.			Stress at Elastic Limit. Lbs. per sq. in.		
	Longleaf pine.	Spruce.	Chestnut.	Longleaf pine.	Spruce.	Chestnut.	Longleaf pine.	Spruce.	Chestnut.
1	—	15,400	13,500	—	1,870	1,630	—	10,200	9,350
3	22,600	14,700	12,800	2,890	1,810	1,545	14,500	9,500	8,450
5	20,000	13,800	12,100	2,635	1,755	1,465	12,700	8,700	7,700
10	14,700	11,000	10,200	2,125	1,620	1,310	8,800	6,550	6,200
12	13,300	10,000	9,500	1,990	1,575	1,260	7,750	5,900	5,800
15	11,800	8,800	8,500	1,860	1,515	1,200	6,700	5,200	5,200
20	10,100	7,250	7,200	1,725	1,425	1,110	5,700	4,300	4,450
24	9,150	6,350	6,300	—	1,360	1,053	5,150	3,800	3,950
30	—	5,250	—	—	1,290	—	—	3,200	—

“ Failure usually occurs, except in the extremely dry specimens, by compression parallel to grain of the fibres on top of the beam, showing at first as a fine wavy line across the upper surface at the middle, and gradually extending downwards towards the axis.”



**THIS PAGE IS LOCKED TO FREE MEMBERS**

Purchase full membership to immediately unlock this page

# Know Your Bible

Forgotten Books'  
Full Membership  
provides unlimited  
access to more than  
28,000 volumes of  
Christian literature for  
\$8.99/month

**HOLY  
BIBLE**

**Continue**

\*Fair use policy applies

**SHEARING STRENGTH PARALLEL TO GRAIN AND COMPRESSION STRENGTH  
AT RIGHT ANGLES TO GRAIN.**

Moisture per cent. of dry weight.	Shearing. Lbs. per sq. in.			Compression. Lbs. per sq. in.	
	Longleaf pine.	Spruce.	Chestnut.	Spruce. <sup>1</sup>	
				Deformation of 3 per cent.	Deformation of 15 per cent.
2	2,160	1,360	1,105	1,340	1,640
6	2,050	1,245	1,050	1,115	1,430
10	1,760	1,115	985	950	1,250
12	1,600	1,060	950	880	1,170
14	1,460	1,010	915	820	1,095
24	1,020	815	750	605	810

The above results must not be taken as the strengths of ordinary building timber, as these tests were made upon small and carefully prepared pieces of wood, so as to get as accurate and comparative results as possible, but it is safe to assume that the drying of large pieces would give the same proportional increase of strength.

Shearing parallel to grain is a variable quantity and cannot be depended upon to increase with dryness.

Soaking timber in cold water does not diminish its strength, whilst heating the water does so considerably, and boiling the water causes a still greater diminution.

Timber kiln dried and then resoaked is weaker than timber of equal degree of moisture which has not been dried, and does not fail like the original green beam, but snaps at the bottom like that kiln dried, showing no compression at the top; kiln drying seems to increase permanently the brittleness of wood. A beam of green

<sup>1</sup> These tests were made with the load concentrated over a portion of the area only, as in the case of a pillar resting on a horizontal sill.

timber, although it will not bear nearly so much load as a dry beam, will nevertheless not fail so suddenly.

Since it has been shown that wet timber is not nearly so strong as the same timber when dry, the question arises as to how treating timber with creosote or other anti-septics affects its strength. From a few tests made by Mr. Tiemann on loblolly pine the comparisons are as follows:—

	Length of soaking.	Total load.	Moisture.
	Days.		
Air dry timber .	0	1	9·1 per cent.
Soaked in water .	6	·42	71·5 „
Soaked in creosote .	6	·80	70 „

showing that creosoting only diminishes the strength of timber to about half the extent to which soaking it in water does. Similar tests were made on timber soaked in turpentine and kerosene, and the results showed the same tendency; in each case the strength of the wood was much less decreased than by soaking in water. In the case of kerosene-soaked wood there was no significant weakening effect over that of dry wood. These tests were compression tests made on very small pieces of timber, and not upon a large number even of these, and must be received with caution.<sup>1</sup>

Long time tests were made at the Chalmers Institute, Göteborg, Sweden, by M. Theodore Wijkander, on pine,

<sup>1</sup> Although more recent experiments rather tend to confirm the decrease in strength of timber immediately after being creosoted, compared with seasoned wood, any decrease is only temporary; the presence of creosote does not weaken wood in itself, but only retards the seasoning, and after a time it will become as strong as the original seasoned wood.



spruce, oak, and birch timber, 4 inches square. Between 1893 and 1895 the moduli of breaking and elasticity had increased while deflection had diminished—the wood had become stiffer—it had during this period been stored in dry lofts of the building. In 1901 further tests made on similar timber which during those eight years had been seasoning, and which was further dried for ten or twelve days at 100° Fahr., showed that the modulus of breaking under compression, bending, and shearing stresses had all increased, as well as that of elasticity, and that that of deflection, which had diminished from 1893 to 1895, was on the increase, but not in any particular relation to the lapse of time.<sup>1</sup>

Doubtless one reason why dry timber shows higher tests than wet timber is that the timber shrinks in drying and its volume is diminished, in the case of pines and spruces by about 10 per cent. and some timbers considerably more, but the numbers of fibres in the wood resisting strain remain the same; its cross section, too, is smaller, although the result is generally calculated upon the original section; this, however, would only account for a very small portion of the increase. The remarks as to the gradually increasing strength of wood as it dries point to the conclusion that beams and joists in buildings are capable of bearing safely a heavier load some years after erection than when originally put up.

Timber columns are fairly uniform in tests up to, say, 15 diameters long, and up to this point give way by direct crushing; in longer columns the larger proportion fail by lateral flexure or “buckling” sideways, and generally, as was the case in Lanza’s tests, fail at knots. In the West Australian tests, with columns of a ratio of 18 to 1, 60 per cent. failed by side flexure.

<sup>1</sup> Min. of Proc. Inst. C.E., Vol. CLVII., p. 452.



**THIS PAGE IS LOCKED TO FREE MEMBERS**

Purchase full membership to immediately unlock this page

# DELVE INTO FANTASY, MAGIC, MYTHOLOGY & FOLKLORE

Forgotten Books'  
Full Membership gives  
access to 797,885 ancient  
and modern, fiction and  
non-fiction books.

**Continue**

\*Fair usage policy applies

for testing, probably not so much. One hundred tests on "yellow pine" (pitch pine) beams 3 inches by 10 inches to about  $4\frac{1}{2}$  inches by  $12\frac{1}{8}$  inches, and one piece 6 inches by  $16\frac{1}{2}$  inches, made by Lanza, gave an average modulus of rupture of 7,442 lbs.; yet he says "I should not feel justified in using a greater number than 5,000 lbs. per square inch," although only nine of the samples tested fell below that limit.<sup>1</sup> Laslett, on the basis of small pieces of the same timber, gave the minimum modulus of rupture as 10,044 lbs. per square inch, Hatfield as 9,000 lbs. per square inch, and Rodman 8,796 lbs. per square inch, proving what we have said about the mistake of trusting the results of tests made on small and perfect samples of timber.

Again, for spruce beams tested by Lanza the average modulus of rupture in 161 tests on pieces from 2 inches by 7 inches to 7 inches by 12 inches was 4,521 lbs. per square inch, yet he says that although only seven of the tests fell below 3,000 lbs., that is all that could with safety be used, though if timber were specially selected he might allow 4,000 lbs. For similar timber Rankine gives 9,900, Hatfield 7,506, Laslett 7,506, and Trautwine recommends 5,400 lbs. per square inch.

Mr. H. D. Smith, M.I.C.E., tested to destruction a number of Quebec yellow pine beams, 9 inches by 9 inches, 18 inches by 9 inches, and 12 inches by 12 inches, with a span of 14 ft., and the mean transverse strength was found to be 3,807 lbs. per square inch. On beams of the same timber, tested under similar conditions and at the same place in 1875 by Mr. C. Graham Smith, the mean transverse strength was 4,491 lbs. per square inch for a scantling of 14 inches by 15 inches, with a clear span of 10 ft. 6 inches.<sup>2</sup> For this same class of

<sup>1</sup> "Applied Mechanics," G. Lanza, 1899.

<sup>2</sup> Min. of Proc. Inst. C.E., Vol. CXXVIII., and *Engineering*, May 7th, 1875.

timber, Lanza's tests on thirty-seven beams gave an average modulus of rupture of 4,451 lbs. per square inch; the minimum was 2,456, and he recommends 3,000 lbs. per square inch as the figure to be used.

The results of tests made on superimposed beams by Major Moritz Bock on the Continent and by Mr. H. D. Smith in Liverpool are somewhat different to those which would be anticipated and generally assumed by designers. In both experiments it was found that the bolting together of the beams gave no appreciable increase of strength over beams simply laid one upon another; in one of those tested by Mr. Smith "the bolts bent at each joint of the baulks and pressed sideways into the timber in some cases to the extent of  $\frac{5}{8}$  inch," showing that the beams slid upon one another. The strongest of Major Bock's combined beams had only 50 per cent. the strength of a solid beam of the same size. In the case of superimposed beams secured with oak keys and wedges at the joinings, as well as being bolted with inclined bolts, the strength was found to be 60 per cent. of that of the solid beam.<sup>1</sup>

In cases, therefore, where it is found necessary, because of heavy loads, to secure a greater depth of girder by having two or three beams superimposed, although it is advisable to have them secured with a few bolts, to ensure their not being shifted or knocked out of position sideways, the additional strength of the cumulative beams should only be assumed as about 50 per cent. extra per beam. Beams composed of three baulks are proportionally stronger than those composed of four, and those composed of two baulks are proportionally stronger than those composed of three; but under the same unit stresses three beams are much stiffer than two, and, though in a less degree, two are

<sup>1</sup> Min. of Proc. Inst. C.E., Vols. CVI. and CXXVIII.

stiffer than one, doubtless owing to the friction between the surfaces.

Bolts increase the friction and produce a marked effect on the stiffness of beams, although, with bolted beams as with unbolted, the upper beam slides over the one below it.

In the case of fitch beams, that is, whole or cut timbers laid side by side and bolted together, tests show that the main difference between these and simple beams of the same scantling is that they break more suddenly.

Loads placed upon timber columns, as upon columns of other material, should be in the centre, as all tests show that columns eccentrically loaded give considerable reductions in strength, and Lanza found this particularly noticeable in the case of oak columns.<sup>1</sup>

The question of compression at right angles to the grain and the shearing strength of timber has not as yet been so carefully studied as that for transverse strength and compression parallel to grain.

Pine and spruce will only bear about one-seventh, hickory, oak, ash, and some of the Australian hardwoods about one-half to one-fourth, of the load at right angles to the grain which they will bear parallel to the grain so that, in the case of timber columns carrying heavy loads and having these loads transmitted to timber base plates or caps, proper precautions must be taken that the load on the side timber is not excessive.

Judging by a large number of tests on different timbers it may be stated generally (although a few samples on p. 310 show the contrary) that the strength in cross compression is higher than in shearing, and in some of the harder timbers considerably higher (see tests, pp. 120 and 219).

<sup>1</sup> "Applied Mechanics," G. Lanza, and "The Practical Column under Centre and Eccentric Loads," by J. M. Moncrieff, M. Am. Soc. C.E., American Society of Civil Engineers, Vol. XLV., 1901.



**THIS PAGE IS LOCKED TO FREE MEMBERS**

Purchase full membership to immediately unlock this page

# Know Your Bible

Forgotten Books'  
Full Membership  
provides unlimited  
access to more than  
28,000 volumes of  
Christian literature for  
\$8.99/month

**HOLY  
BIBLE**

**Continue**

\*Fair use policy applies

one with twenty weighed less than one with ten, and another with five weighed 2 lbs. per cubic foot more than one with twelve rings. In the case of pine or fir timber, where the rings are abnormally close, the weight when well dried may be somewhat more than in the case of timber with open rings, but in oak and elm the fairly wide rings form the heaviest wood.

A piece of water-logged American white pine (the yellow pine of the English market) might easily, although when seasoned its weight would only be about half, weigh more than that of a fairly seasoned piece of jarrah or karri. All timber will sink if left long enough in water, as is proved by the fact that dry sawdust from the softest wood will quickly sink if placed in water, but it might take years to so saturate a log of timber as to cause it to sink; thus we find water-logged ships floating about the ocean to the danger of navigation sometimes for years.

If by a large number of tests on fairly large-sized pieces of timber we deduce a fairly accurate modulus of rupture, it would be safe to assume a factor of safety of 4 in the case of ordinary construction work—that is, assume the working strength as one quarter the breaking strength; but in the case of machinery, or in structures carrying moving or jarring loads, a factor of safety of 5 or 6 should be allowed.

Factors of safety, as at present arrived at, are more or less in the nature of guesswork, and are, as has been said, “an expression of ignorance or lack of confidence in the reliability of values of strength,” but with a larger number of reliable tests they may be reduced to a more definite figure and to a minimum.

Some twelve years ago a committee of the American International Association of Railway Superintendents of Bridges and Buildings recommended the following factors

of safety :—For timber in shearing, and compression across grain, 4 ; for columns under 15 diameters high and for end bearing, 5 ; for extreme fibre stress in transverse rupture, 6 ; and in tension with and across the grain, 10.

As there is such great variety in the results arrived at as to the strengths of timber tested by different people, only those tests which have been made upon a large number of samples of the same wood reduced to a standard degree of moisture have been given in this work, and the author has only gone so far into the question of testing timber as to show the inquirer what errors to avoid and lead him by references to more detailed information.

Sufficiently accurate statistics are not yet available for dealing in great detail with tests on timber.



## CHAPTER XIV

### “ FIGURE ” IN TIMBER

“ Figure ” in Timber—Timber Suitable for Carving—Timber Used for Veneer—Markings on Timber.

MANY theories have been propounded as to the cause of “ figure ” in timber ; while it is true that all timber possesses “ figure ” in some degree, which is more noticeable if it be cut in certain ways, yet there are some in which it is more conspicuous than in others, and which for cabinet or furniture work are much appreciated, as it adds to the value of the work produced.

The characteristic figure of oak is due to the broad and deep medullary rays so conspicuous in this timber, and the same applies to New Zealand honeysuckle. Figure due to the same cause is found in the beach and plane, but is not so pronounced. The beautiful figure in “ bird’s eye maple ” is supposed to be due to the boring action of insects in the early wood of the tree, causing pits or grooves, which in time become filled up by being overlain by fresh layers of wood ; these peculiar and unique markings are only found in the older and inner portion of the tree.

Pitch pine has sometimes a very beautiful figure, but it generally does not go deep into the timber ; walnut has quite a variety of figures, and so has English elm. It is in mahogany, however, that we find the greatest variety of figure, and as this timber is only used for furniture and fancy work, a good figuring greatly enhances the value, finely figured logs fetching fancy prices.



**THIS PAGE IS LOCKED TO FREE MEMBERS**

Purchase full membership to immediately unlock this page

# DELVE INTO FANTASY, MAGIC, MYTHOLOGY & FOLKLORE

Forgotten Books'  
Full Membership gives  
access to 797,885 ancient  
and modern, fiction and  
non-fiction books.

**Continue**

\*Fair usage policy applies

the way the light is thrown upon it, showing light if seen from one direction, and dark if viewed from another, as can be easily observed by holding a piece of figured mahogany under artificial light and looking at it from both ends. The characteristic markings on mahogany are "mottle," which is also often found in sycamore, and is conspicuous on the backs of fiddles and violins, and is not in itself valuable; it runs the transverse way of the fibres and

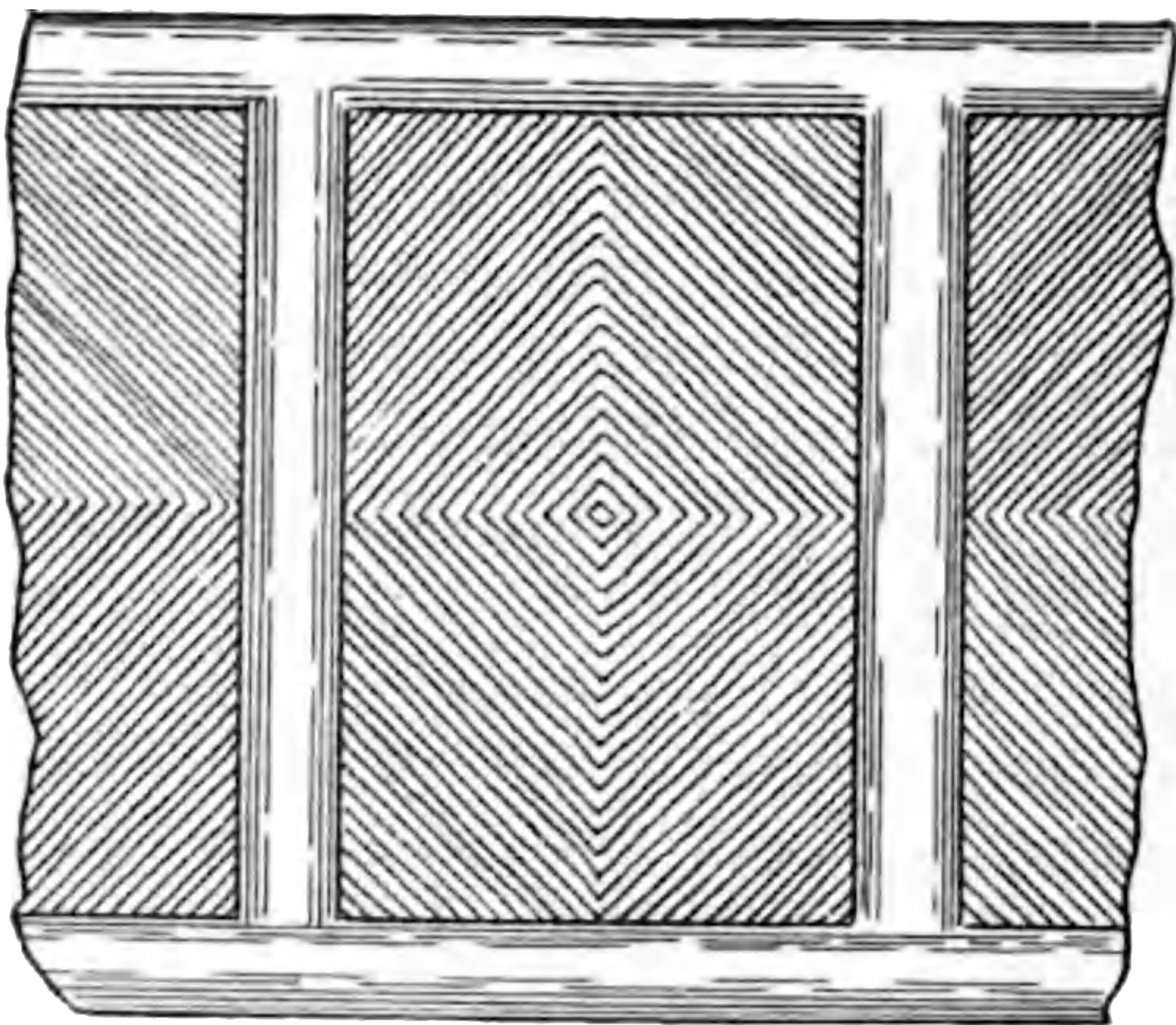

FIG. 54.—Effects produced by grain of oak in panelling.

is probably the effect of wind upon the tree. "Roe," which is said to be caused by the contortion of the woody fibres, and takes a wavy line parallel to them, is also found in the hollow sides of bent stems and in the root structure, and when combined with "mottle" is very valuable. "Dapple" is an exaggerated form of mottle. "Thunder shake" or "tornado shake" is a rupture of the fibres across the grain, which in mahogany does not always break them; the tree swaying in the wind only strains its fibres, and thus produces mottle in the wood.

The well-known "Thuya burrs" are attributed by some to wounds due to the lighting of fires against the trunks of the trees; by others to the growth of adventitious buds from a tree stump.

"Stripe," so conspicuous in the beautiful Andaman "marblewood," which is grey with a dark purple or black stripe, is also spoken of as "figure."

One constantly comes across peculiarities found in timber when opened out. The *Timber Trades Journal* has given illustrations of several; one of these showed two initials evidently cut on the outside of a tree, probably by young lovers in years gone by, which were quite distinct when the tree was cut up, although they were two feet from the outer face. Only a short while ago the writer saw, in one of the trees of the Hull boulevards, imbedded and nearly covered over with new wood, the iron holdfast of a gate, which will probably be a puzzle for future timber converters and a trial for their saws.

On the recently constructed Cunard s.s. *Mauretania* some charming effects were obtained in panelling by careful arrangement of the figure in the wood, and this was particularly characteristic in the Austrian oak panelling, of which a great quantity was used. The wood was fixed in the panels in squares or parallelograms in "Venesta," and so cut and fixed that the grain of the wood formed a diamond pattern in the centre (see Fig. 54), sometimes with straight, sometimes wavy grain, which has a most charming effect, and looks to the casual observer as if it were in one piece, the joints being so well made as to be unnoticeable unless closely examined.

#### TIMBER SUITABLE FOR CARVING.

Amongst the softwoods are yellow pine, basswood, Kauri pine and lime, and for carving one need not look for

better material than a good piece of yellow pine free from knots and shakes. Sycamore, beech, and holly, which are of light or nearly white colour, are also useful softwoods.

Of hardwoods, Italian walnut is admirably suited for fine work, but only the hardest and that of closest grain should be chosen. It is a fine-grained wood of even texture, cuts with something of the fineness of English oak, and is capable of receiving even more finish. English walnut has too much figure to be suitable for this purpose. American walnut is best fitted for sharply cut and shallow carving, as its figure is caney.

Honduras mahogany is very similar to American walnut in grain ; Cuba mahogany is closer.

Of hardwoods there are not many to equal English oak for sharpness, clearness of detail, and lasting qualities, as so much of the carving in English cathedrals and church stalls testifies.

There are some marvellous specimens of minute mediæval carving in box to be seen in the British Museum, and also some good carving in pear tree wood of the same period. Much of Grinling Gibbons' work was done in pear tree, but this wood is not easily procurable.

#### TIMBER USED FOR VENEER.

The manufacture of wood into veneer is one which has made rapid strides of late years. In the United States something like 25,000,000 cubic feet are annually used for this purpose.

Veneers are sawn, sliced, and rotary cut. Their average thickness varies from 5 to 15 to the inch. Beech can be cut as thin as 30 to the inch. In Germany they are cut 25 to the inch, and both French and German merchants cut their veneers thinner than in England.



**THIS PAGE IS LOCKED TO FREE MEMBERS**

Purchase full membership to immediately unlock this page

# Know Your Bible

Forgotten Books'  
Full Membership  
provides unlimited  
access to more than  
28,000 volumes of  
Christian literature for  
\$8.99/month

**HOLY  
BIBLE**

**Continue**

\*Fair use policy applies

the brands of the class of timber in which they deal. Certain letterings are a fair guide to the buyer that he will get good material if they emanate from a good firm, but only in the same way as he may assume he will get good furniture or good clothes from reputable firms. Marks and brands on timber are of little guide to the architect, inspector, or builder, whose only safe plan is to select the material from stock, by doing which he may get as good timber out of seconds as by buying firsts in the parcel, and at less cost.

As a general rule Russian timber is hammer-marked with the importer's initials, and some Archangel and other planks have red marks at the ends denoting the different qualities; Swedish and Norwegian deals are marked with large red, blue, green, or black stencilled letters on their ends, often with a crown or cross between; inferior qualities are sometimes not marked at all. Swedish and Finnish Gulf deals are now generally imported in first, second, third, fourth, and fifth, as well as in an unsorted class, and planed goods in three classes, first, second, third, and also in an unsorted class. The first and second are joiners' wood; the third quality is generally well adapted for engineering work. White Sea deals are imported in four qualities, St. Petersburg and Rigas generally in three qualities, first, second, and third.

American goods are often branded, and sometimes have red marks on the sides or ends to denote quality.

The method of marking pitch pine, Baltic, and other log timber by the Customs measurers on the north-east and other ports is as follows:—The length of the log is near the centre, the Customs number and cubic contents are close together, and nearer the end they are screeved thus:—

X/III	263	X/III
-------	-----	-------

which means length 23 ft. and contents 27 cubic feet,  $\wedge = 10$ ,  $\times = 20$ ,  $\times\times = 30$  (the crossed lines indicating 10 ft.); single strokes represent single feet, and where the cross meets the foot of a stroke, thus  $\wedge/ = 15$ , or  $\times/ = 25$ . In larger logs the strokes have often two crosses, thus  $\times\times = 60$ , or thus  $\times\times\times = 80$ , and a notch above represents half a foot, thus  $\wedge/ \not\! / = 38\frac{1}{2}$  ft.

Australian timber is marked with circles, and Tasmanian timber with diamond shapes on the ends, having within them the initials of the colony from whence they come, as well as the initial of the timber. The following are a few specimens:—

Western Australia.

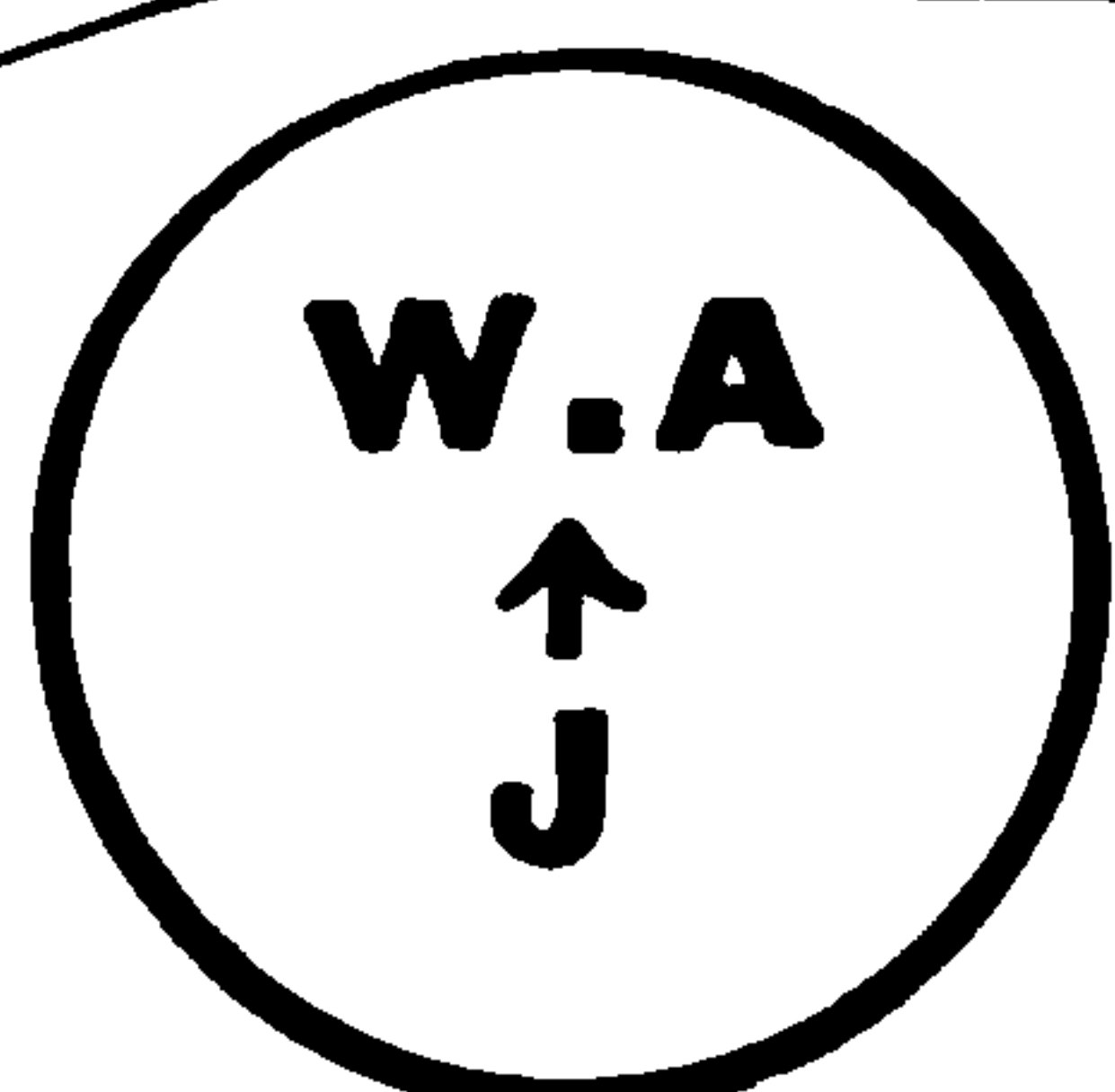

Jarrah.

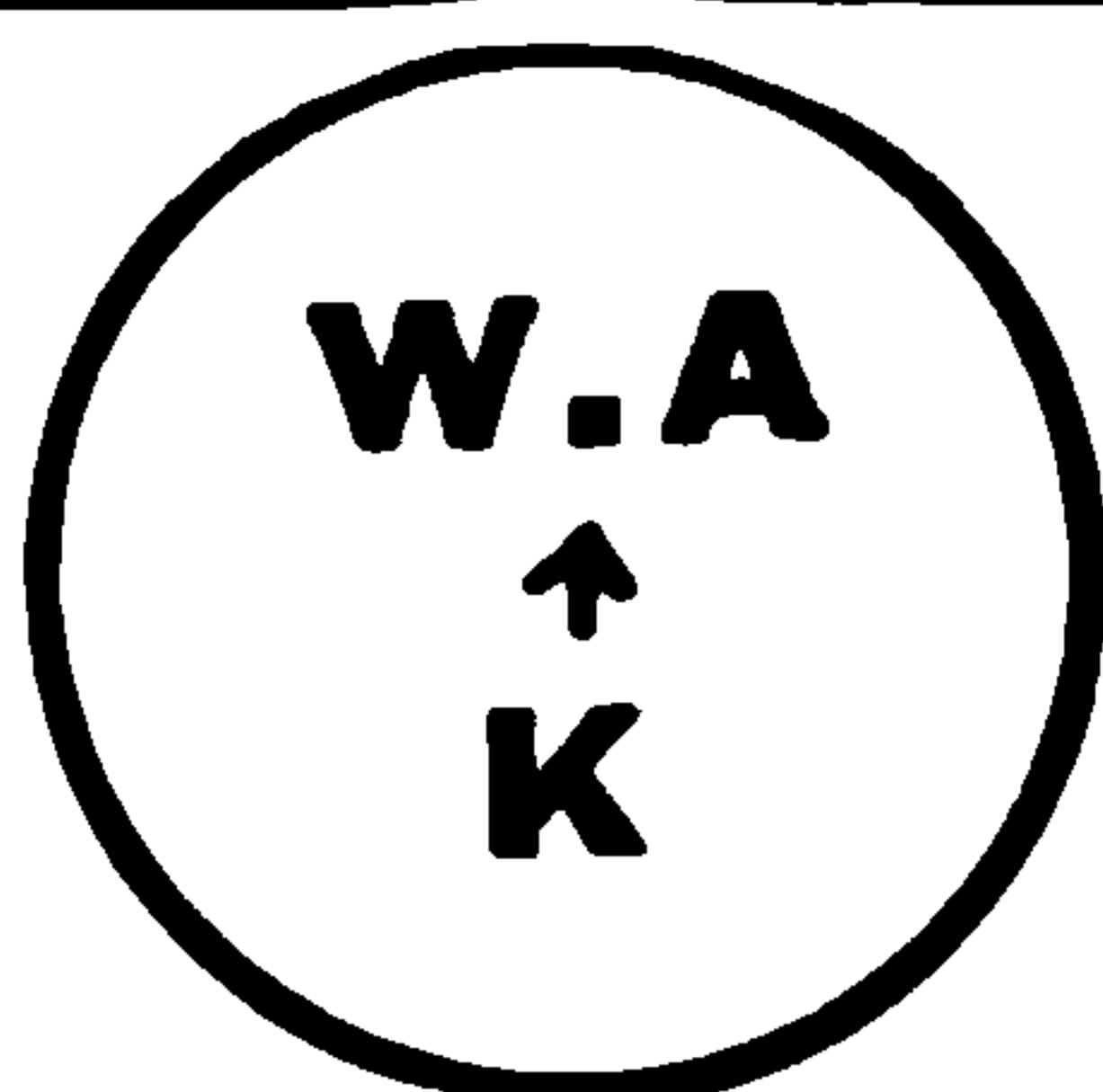

Karri.

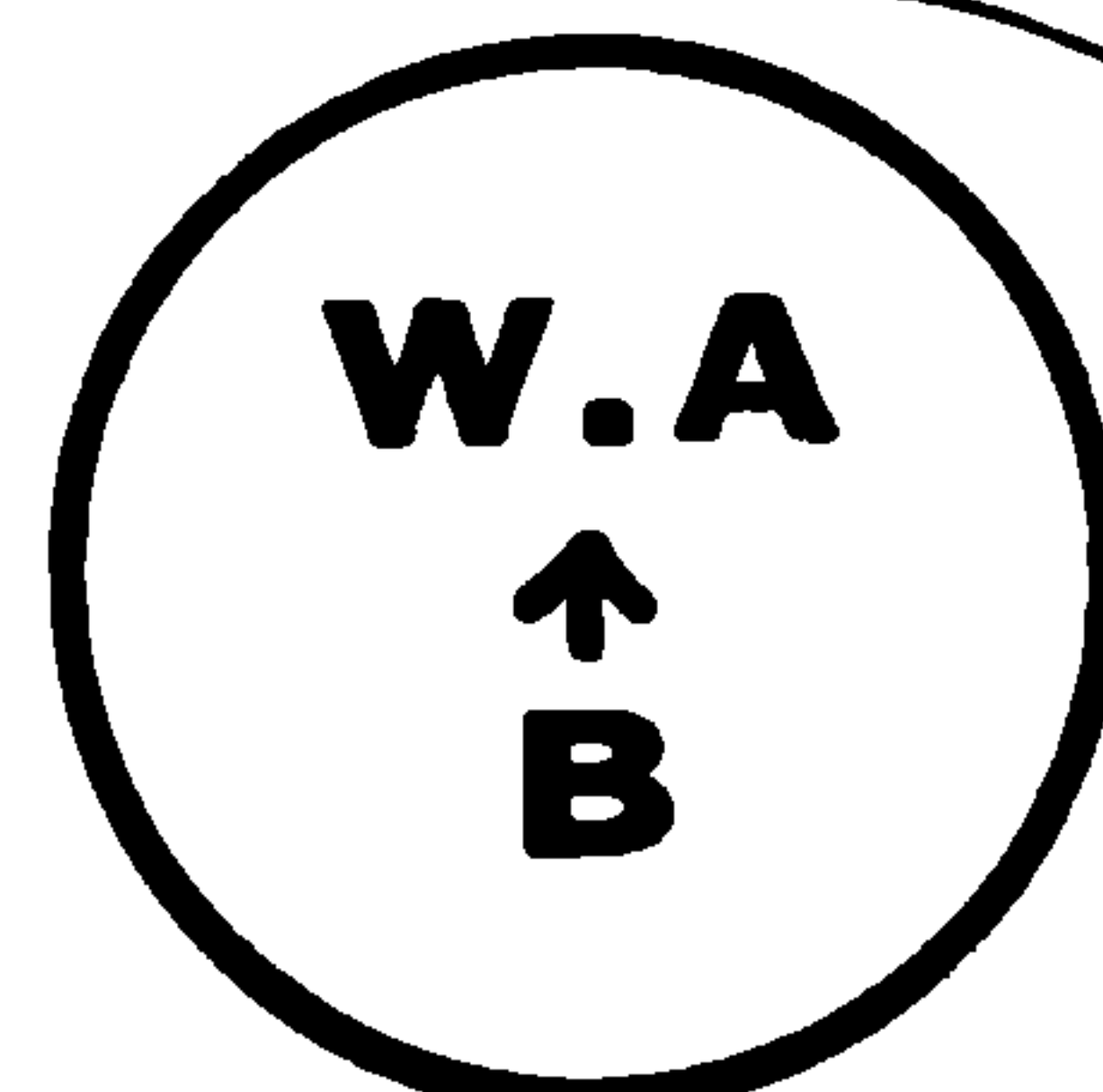

Blackbutt.

New South Wales.

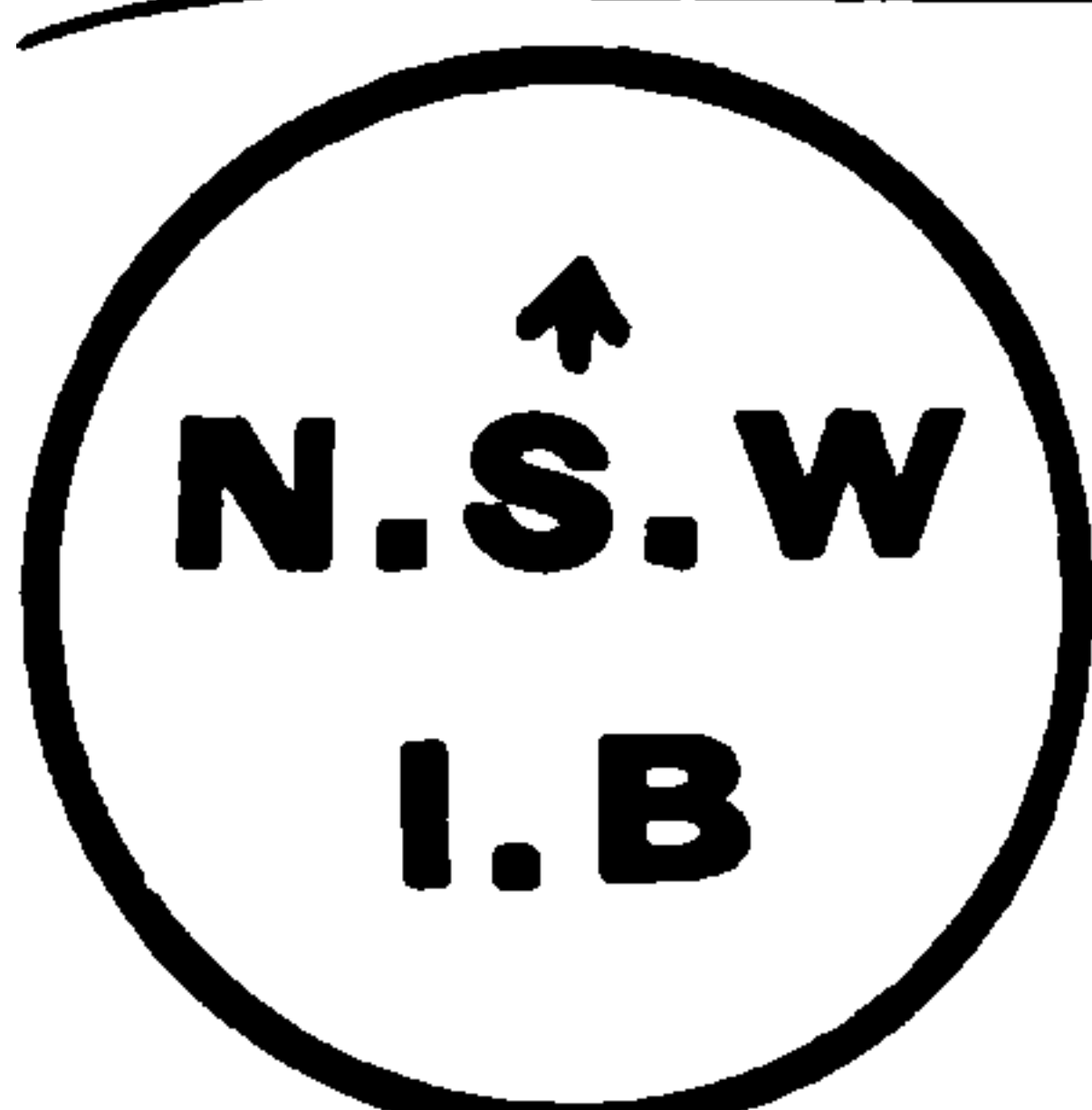

Ironbark.

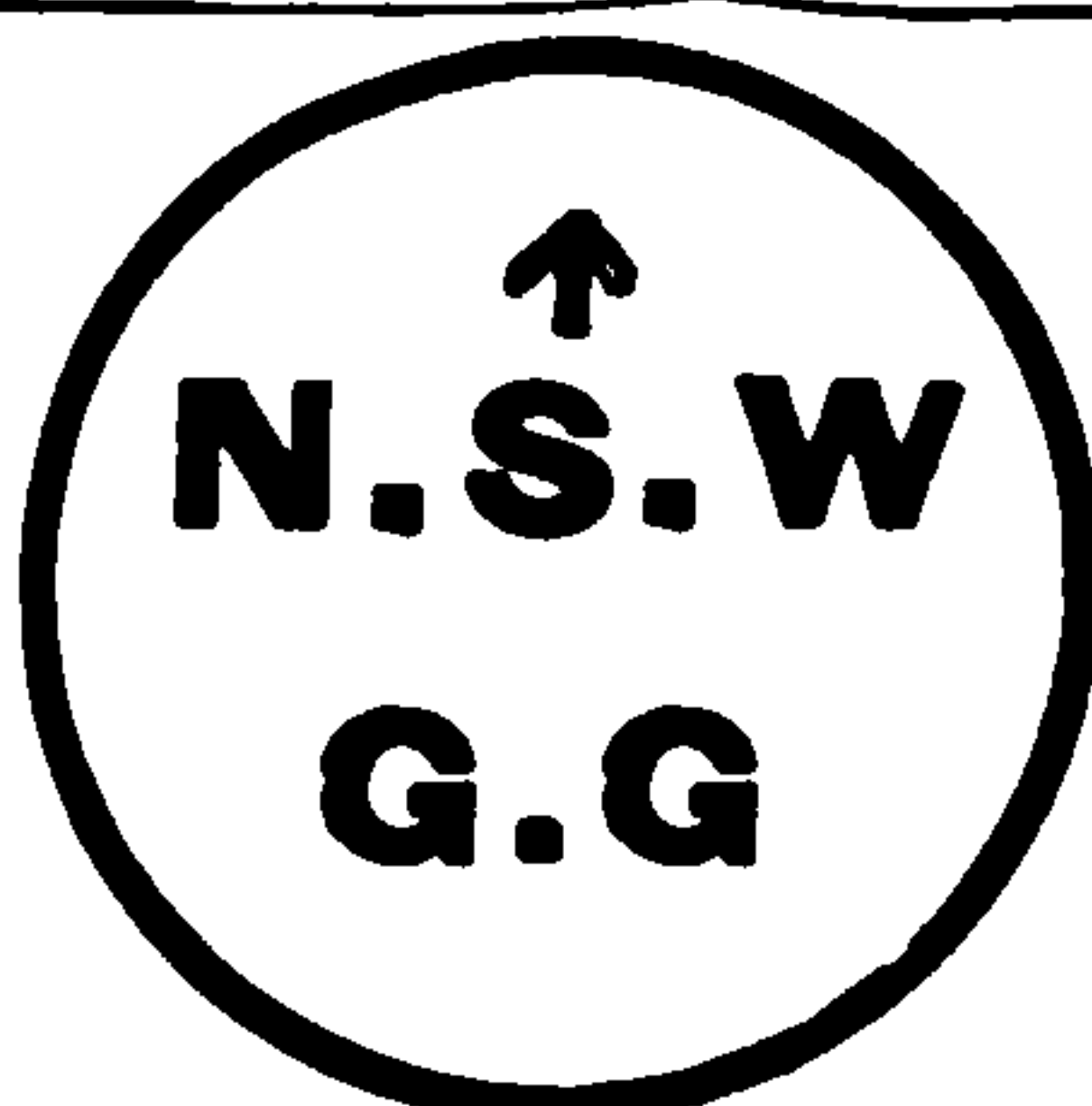

Grey gum.

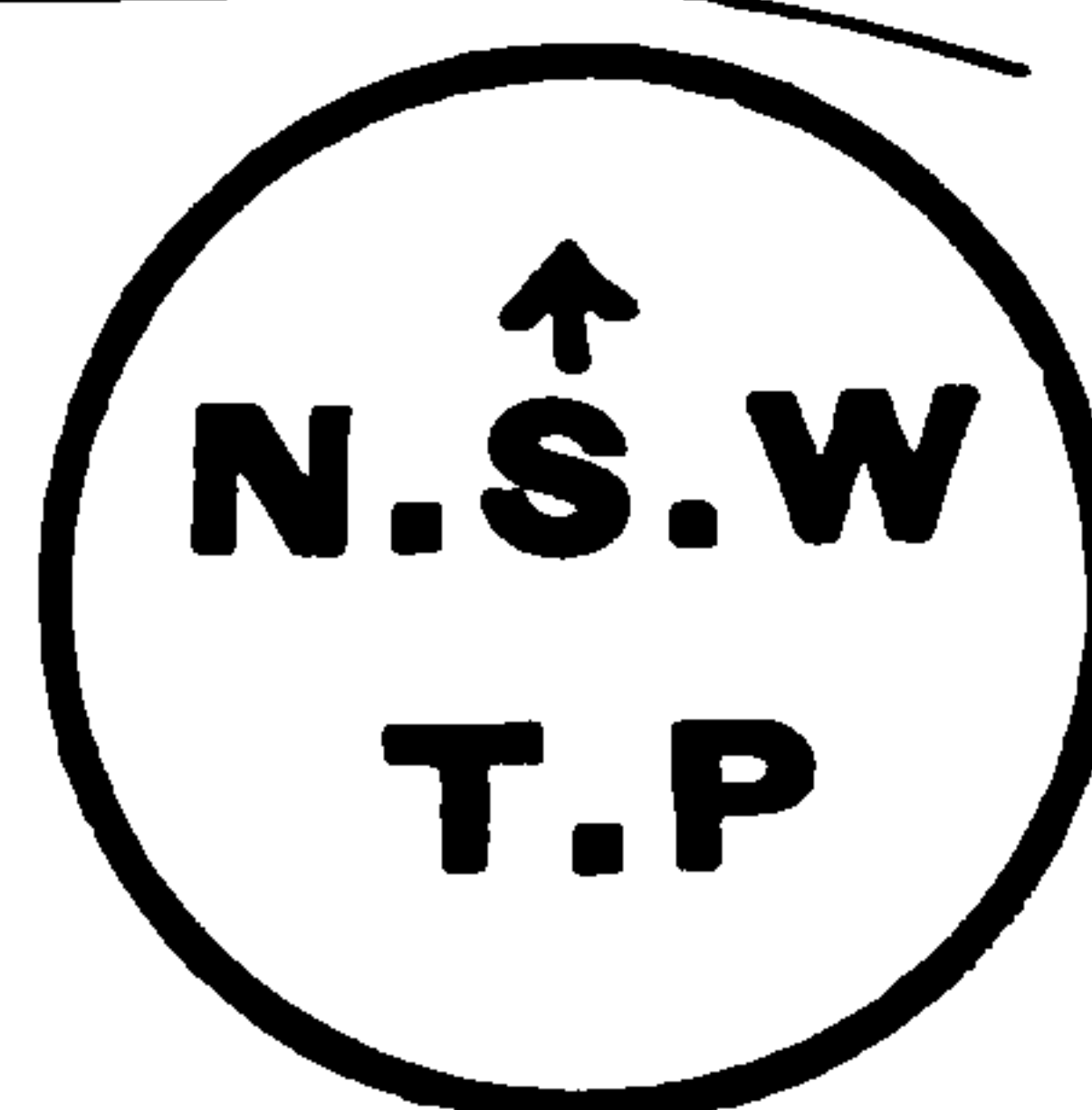

Turpentine.

Tasmania.

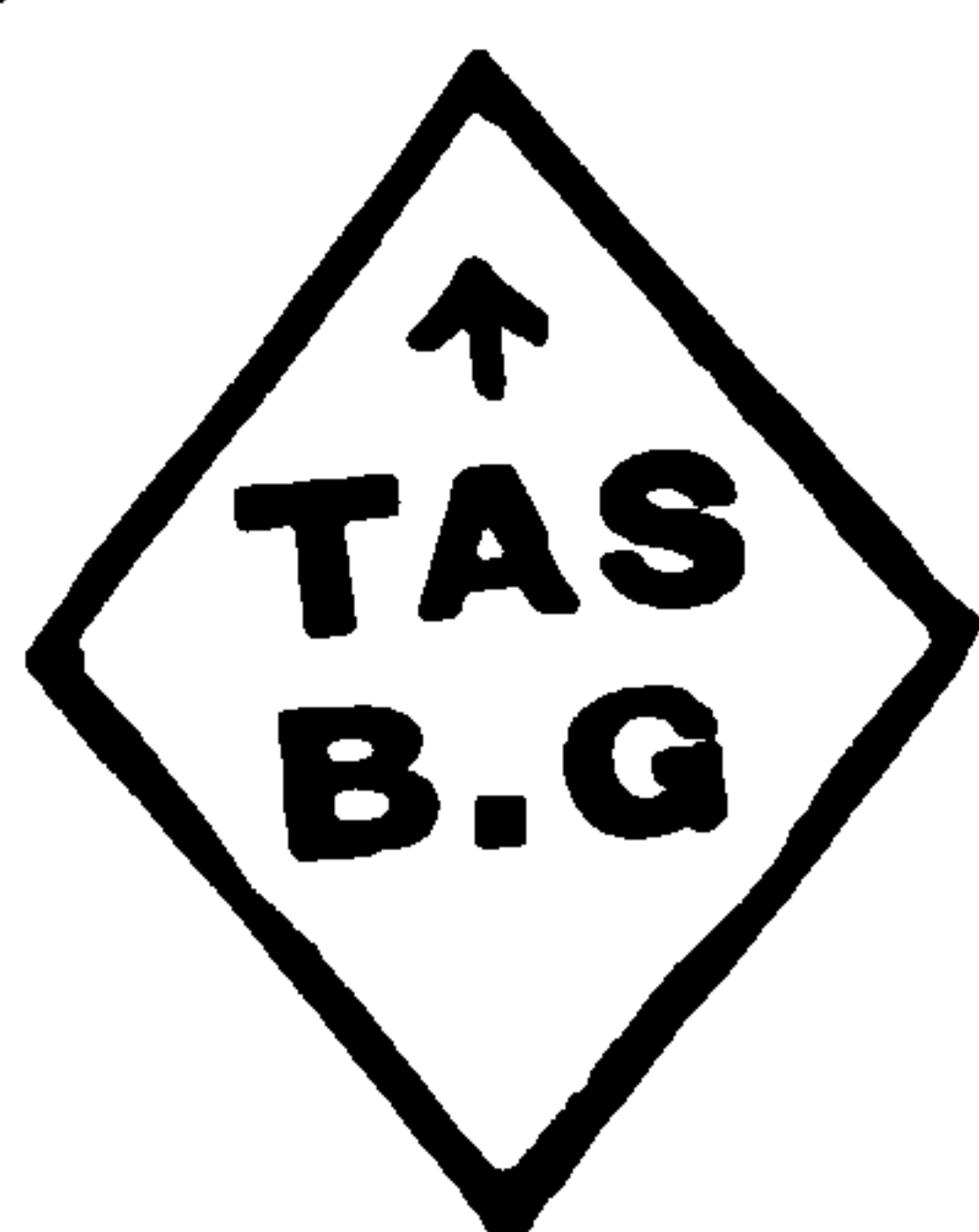

Blue gum.

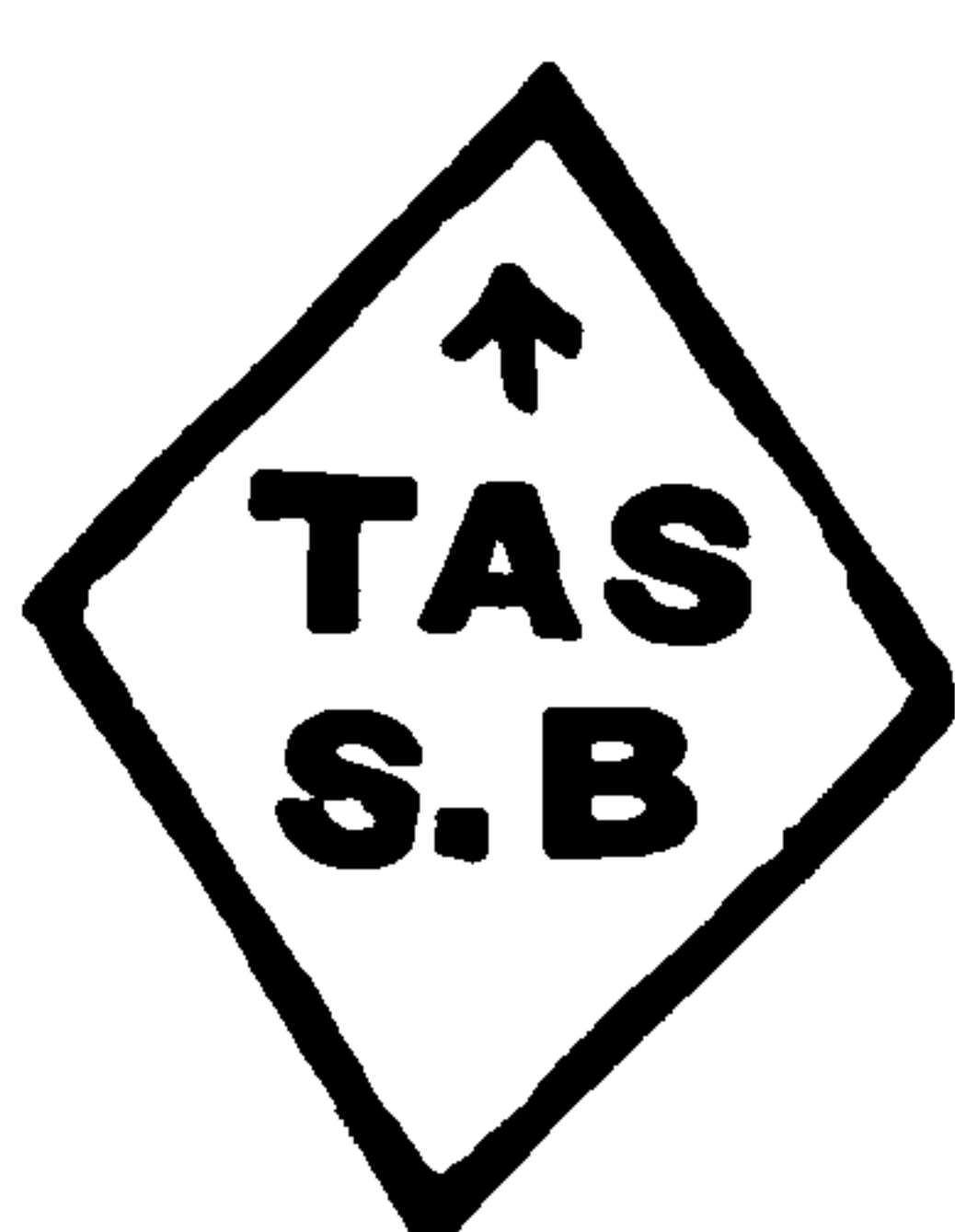

Stringy bark.

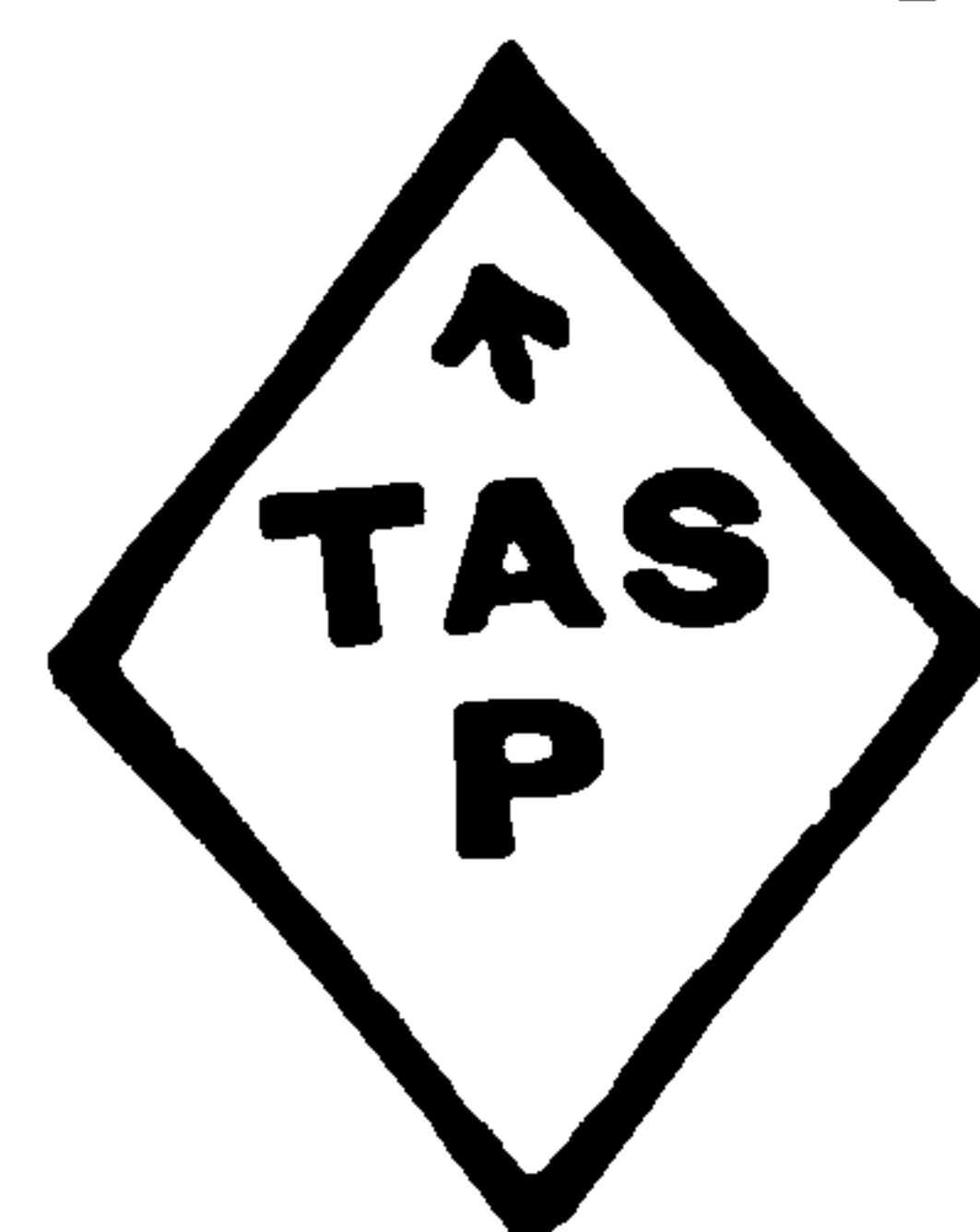

Peppermint.



in addition to which there are numerals 1, 2, 3, 4, etc., either before or after the "broad arrow," when the timber has been inspected and passed by a Government officer, which are for the purpose of identifying him.

Besides the above there are often owners' and other marks on log timber. There are no quality marks on pitch pine, although there are strict regulations concerning it, and although there were formerly marks on Baltic logs, these have been discontinued. Log timber is invariably sold by Customs measurement, and this varies somewhat at different ports. Mahogany, cedar, and other furniture wood is measured up in log and sold by the superficial foot of one inch thick, an allowance being made from the total cubic contents for waste.

A load of timber is 50 cubic feet. A St. Petersburg standard contains 165 cubic feet, and this is the measure by which deals and small cut timber is bought and sold. A cord of wood measures 8 feet by 4 feet by 4 feet, and contains 128 cubic feet, and a fathom is 216 cubic feet. Flooring is generally sold by the "customary square," of 100 feet, and 600 square feet of 1-inch boards equals one load of 50 cubic feet.

The term "lumber" largely used in America applies to cut, split, or sawn timber, such as beams, joists, boards, planks, staves, and the like.



**THIS PAGE IS LOCKED TO FREE MEMBERS**

Purchase full membership to immediately unlock this page

# DELVE INTO FANTASY, MAGIC, MYTHOLOGY & FOLKLORE

Forgotten Books'  
Full Membership gives  
access to 797,885 ancient  
and modern, fiction and  
non-fiction books.

**Continue**

\*Fair usage policy applies

133 standards of spruce deals,  
 575 bundles of flooring,  
 731 „ „ strips,  
 1,463 birch strips,  
 1,771 bundles of maple blocks,  
 1,395 pieces of walnut,  
 2,255 maple boards.

A vessel from Norfolk, United States, brought—

2,827 oak planks,  
 324 ash planks,  
 2,216 dogwood logs,  
 149 persimmon logs.

A vessel from Kingston, Jamaica, brought—

396 pieces of greenheart and ebony,  
 824 „ „ black ebony,  
 836 „ „ lignum vitæ,  
 140 lancewood spars,  
 985 pieces of ebony,  
 19 cedar logs,  
 45 mahogany logs.

It is no uncommon thing for a ship to bring, in addition to a miscellaneous cargo such as above, 1,500 or 2,000 doors or window frames.

There is not the same variety of species of timber in the goods brought by ships from the Baltic, but there is an almost unlimited variety of scantlings. The following list is from a recent sale of Baltic and Archangel timber:—

in.	in.	in.	in.	in.	in.	in.	in.	in.	in.					
4	×	6	3	×	4	2½	×	6	2	×	3½	1½	×	2½
4	×	7	3	×	4½	2½	×	6½	2	×	4	1½	×	4
4	×	8	3	×	5	2½	×	7	2	×	4½	1½	×	4½
4	×	9	3	×	6	2½	×	8	2	×	5	1½	×	5
4	×	11	3	×	7	2½	×	9	2	×	5¼	1½	×	5½
			3	×	8	2½	×	10	2	×	5½	1½	×	6
			3	×	8½	2½	×	11	2	×	6	1½	×	7
			3	×	9				2	×	7	1½	×	8
			3	×	11				2	×	9	1½	×	10
												1½	×	11
												1½	×	12

in.	in.	in.	in.	in.	in.	in.	in.	in.	in.
$1\frac{1}{4}$	$\times 4$	$1\frac{7}{8}$	$\times 5$	$1\frac{3}{4}$	$\times 4\frac{1}{2}$	1	$\times 4$	$\frac{5}{8}$	$\times 2\frac{1}{2}$
$1\frac{1}{4}$	$\times 4\frac{1}{2}$			$1\frac{3}{4}$	$\times 6$	1	$\times 4\frac{1}{2}$	$\frac{5}{8}$	$\times 4$
$1\frac{1}{4}$	$\times 6$			$1\frac{3}{4}$	$\times 9$	1	$\times 5$		
$1\frac{1}{4}$	$\times 7$			$1\frac{3}{4}$	$\times 11$	1	$\times 5\frac{1}{2}$		
$1\frac{1}{4}$	$\times 9$					1	$\times 6$		
						1	$\times 7$	$\frac{1}{2}$	$\times 6$
						1	$\times 9$		

The Archangel and St. Petersburg goods are the wider sizes and run mostly from 7 to 11 and 12 inches.

As showing how in the most out of the way and unlikely localities the timber merchant searches for his supplies, the author had gone carefully through a report on the timber of the Hawaiian Islands prepared by the United States Forestry Department in 1904, and neither in that nor in any other work dealing with the place could he find any likelihood of timber in any quantity from this locality being put on the market; yet, shortly afterwards, he saw in a trade journal that a company had contracted to supply a large number of "Ohia" sleepers per annum to an American railway company. Ohia-lehua (*Metrosideros polymorpha*), which grows to a height of 100 ft. and 4 ft. diameter, produces a wood of reddish colour, and, although it had been used for sleepers in the island, splits and warps so badly that it was not generally considered fit for much else than fuel. Koa (*Acacia koa*), related botanically to the blackwood of Australia and Tasmania (*A. melanoxylon*), is the one fairly abundant Hawaiian tree which is valuable for its timber. It is a highly-prized cabinet wood, a good deal used on the island, and exported to a small extent. The colour varies through rich shades of red and brown; the grain is fine and indistinct. Curly koa is especially prized but very rare.





**THIS PAGE IS LOCKED TO FREE MEMBERS**

Purchase full membership to immediately unlock this page

# Know Your Bible

Forgotten Books' Full Membership provides unlimited access to more than 28,000 volumes of Christian literature for \$8.99/month

**HOLY  
BIBLE**

**Continue**

\*Fair use policy applies

PINCHOT, GIFFORD, "Short Account of the Big Trees of California,"  
United States Dept. of Agric., Div. of Forestry, Bulletin No. 28.

ROTH, FILIBERT, "Timber," United States Dept. of Agric., Div. of  
Forestry, Bulletin No. 10.

SCHLICH, W., Ph.D., "Manual of Forestry," Vol. 5.

*Ibid.*, "Forestry of United Kingdom."

SCHRENK, HERMANN VON, "Factors which cause the Decay of Wood,"  
*Journal of Western Soc. of Engrs.*, May, 1901.

*Ibid.*, "Fungous Diseases of Forest Trees," United States Year Book  
of Dept. of Agriculture for 1900.

SELBY, P. J., "British Forest Trees," 1842.

STONE, HERBERT, F.L.S., "The Timbers of Commerce," London,  
1904.

"Tasmanian Forestry," issued by Dept. of Lands and Surveys  
Hobart, 1905.

*The Timber Trades Journal*, London.

THURSTON, R. H., "Materials of Engineering," Part 1, 5th ed., 1899.

TIEMANN, H. D., M.E., M.F., "Effect of Moisture upon the Strength  
and Stiffness of Wood," United States Dept. of Agric., Div. of  
Forestry, Bulletin No. 70.

TREDGOLD, THOS., "Elementary Principles of Carpentry."

TURNER, JOHN HENRY TUDSBERY, "Notes on Useful Japanese  
Timber," Min. Proc. Inst.C.E., Vol. 89.

UNWIN, PROF. W. C., M.I.C.E., "The Testing of the Materials of  
Construction."

WARD, PROF. H. MARSHALL, D.Sc., "Timber and Some of its  
Diseases."

# INDEX

- A.
- ABIES balsamea, 82  
,, concolor, 82  
,, grandis, 82  
,, nobilis, 82  
,, pectinata, 37  
Acacia arabica, 161  
,, catechu, 178  
,, colubrina, 136  
,, common, 56  
,, false. *See* Locust.  
,, formosa, 150  
,, honialophyllon, 236  
,, koa, 331  
,, melanoxyton, 234, 250  
Acajou, blanc, 128  
Acer macrophyllon, 111  
,, nigrum, 111  
,, pennsylvanicum, 111  
,, pseudo platanus, 45  
,, rubrum, 111  
,, saccharum, 111  
Acle, 178  
Aderno, 138  
Æsculus flava, 97  
,, glabra, 97  
,, hippocastanum, 47  
Afforestation, 23  
African forests, 18, 204  
,, timber, 204  
Afzelia bakeri, 197  
Agathis australis, 238  
Aka gashi, 199  
,, matsu, 201  
Alaska cedar, 90  
Albizia lebbek, 185  
Alder, 48  
Algarrobo, 144  
Alnus glutinosa, 48  
,, incana, 48  
Alphitonia excelsa, 229  
Amboyna wood, 44  
American timber, 65  
,, ,, tests of, 118  
Andaman bullet wood. *See*  
Mohwa.  
,, marble wood, 185  
,, redwood. *See* Padouk.  
Andira inermis, 149  
,, stipulacea, 149  
Angelin, 149  
,, anorgoso, 149  
,, coco, 149  
Angico, 136  
Angiosperms, 6  
Anjan, 177  
Annual rings, 8  
Ants, white, 267  
Apple, 49  
Araucaria brasiliensis, 139  
,, cunninghamii, 227  
Arborvitæ, 90  
Archangel timber, 30  
Argentine timber, 139  
,, ,, strength of, 146  
Aroeira and Aroeira do Sertão, 133  
Artocarpus chaplasha, 186  
,, integrifolia, 162



- Artocarpus lakoocha, 186  
     ,, lancecofolia, 192  
 Ash, 52, 102, 202  
 Ash or swamp gum, 249  
     ,, American, or white, 103  
     ,, black, 103  
     ,, blue, 103  
     ,, Cape, 206  
     ,, Carolina, 103  
     ,, common, 52  
     ,, English, 52  
     ,, Japanese, 202  
     ,, percentage of, in wood, 7  
     ,, red, 103  
     ,, ,, New South Wales, 229  
 Asiatic forests, 18  
 Aspen, 59, 102  
 Assegai wood, 207  
 Astronium fraxinifolium, 135  
     ,, speciosa, 138  
     ,, urunduera, 133  
 Athrotaxis selaginoides, 251  
 Australian forests, 18  
     ,, timber, 209  
     ,, Western, timber,  
         tests of, 219  
 Austrian forests, 17  
 Avocado, 148
- B.
- BABBAR. *See* Babool,  
 Babia, 152  
 Babool, 161  
 Bairnsdale grey box, 233  
 Balanocarpus maximus, 193  
 Balata. *See* Bullet tree.  
 Balau or ballow, 192  
 Balsam fir, 82  
 Balsamo, 134  
 Baltic redwood, 32  
     ,, whitewood, 34
- Bamboo, 160  
 Bambusa arundinacea, 160  
     ,, auriculata, 160  
 Banksia marginata, 252  
 Bassia latifolia, 173  
 Basswood, 113  
 Batinga, 138  
 Beech, 56, 105  
     ,, common, 56  
     ,, entire leaved, 242  
     ,, evergreen, 234  
     ,, or myrtle, 252  
     ,, red, 105  
     ,, tooth leaved, 242  
     ,, white, 105, 226  
 Berrya ammonilla, 162  
 Betula alba, 55  
     ,, lenta, 104  
     ,, lutea, 104  
     ,, papyrifera, 104  
 Bhotan pine, 190  
 Big trees, the, of California, 108  
 Billian, 196  
 Bintangor, 195  
 Birch, common, 55  
     ,, red, 104  
     ,, white, 104  
     ,, yellow, 104  
 Bird's eye maple, 112  
 Bitternut. *See* Hickory.  
 Black ash, 103  
     ,, bean, 228  
     ,, cherry, 98  
     ,, gum, 95  
     ,, Italian poplar, 101  
     ,, locust, 116  
     ,, maire, 239  
     ,, pine. *See* Matai.  
     ,, spruce, 98  
 Blackbutt, 220, 222, 233  
 Blackwood (shisham), 175  
     ,, New Zealand, 250



**THIS PAGE IS LOCKED TO FREE MEMBERS**

Purchase full membership to immediately unlock this page

# DELVE INTO FANTASY, MAGIC, MYTHOLOGY & FOLKLORE

Forgotten Books'  
Full Membership gives  
access to 797,885 ancient  
and modern, fiction and  
non-fiction books.

**Continue**

\*Fair usage policy applies

- Castanea dentata*, 97  
 „ *sativa*, 47  
 „ *vulgaris*, 95  
*Castanospermum australe*, 228  
*Cassia fistula*, 138  
*Catalpa hardy*, 117  
 „ *longissima*, 148  
 „ *speciosa*, 117  
 Cedar, 86, 129, 134, 145, 147, 158,  
 164, 166, 207  
 „ Alaska, 90  
 „ boom, 207  
 „ canoe, 91  
 „ Idaho, 91  
 „ incense, 91  
 „ New South Wales, 226  
 „ of Lebanon, 86  
 „ Port Orford, 90  
 „ red, 87  
 „ white, 90  
 Cedro, 134, 145  
*Cedrela australis*, 226  
 „ *brasiliensis*, 134, 145  
 „ *microcarpa*, 166  
 „ *odorata*, 153  
 „ *serrata*, 166  
 „ *toona*, 164  
*Cedrus deodora*, 166  
 „ *libani*, 86  
 Celery top pine, 251  
*Ceratopetalum apetalum*, 229  
*Cercidophyllum japonicum*, 203  
 Champak, 194  
 Chaplash. *See* Kaita-da.  
 Charring, 275  
 Che, 189  
*Chelura terebrans*, 266  
 Cherry, 50  
 „ black, 98  
 Chestnut, American, 95  
 „ horse, 47, 97  
 „ Spanish or sweet, 47  
*Chickrassia tabularis*, 174  
*Chimarrhis cymosa*, 150  
 Chinette, 148  
 Chir pine, 190  
 Chittagong wood, 174  
*Chlorophora excelsa*, 208  
 „ *tinctoria*, 149  
*Chloroxylon swietenia*, 172  
 Chuglan, 186  
 Cirouaballi, 128  
*Citharexylum melanocardium*, 150  
 Climate, forests and, 26  
 Coachwood, 229  
 Cocoanut tree, 163  
*Cocus nucifera*, 163  
 Cohucho, 143  
 Colonial or Moreton Bay pine, 227  
 Colour in wood, 291  
 Coniferous wood, 6  
 Contraction of timber, 11  
 Conversion of timber, 291  
*Copaifera bracteata*, 126  
 „ *guianensis*, 139  
 „ *humenœfolia*, 152  
 Cord of wood, 328  
*Cordia gerascanthoides*, 152  
 „ *gerascanthus*, 147  
 Cork elm. *See* Rock elm.  
*Cornus florida*, 116  
*Corylus avellana*, 63  
 Cotton tree. *See* Bombax.  
 Cottonwood, 101  
 Crabwood, 127  
*Cratægus oxyacantha*, 63  
 Creosoting, 279  
 „ specification for, 281  
*Cryptomeria japonica*, 201  
 Cuban pine, 74  
*Cumamodendron oxillare*, 135  
*Cunonia capensis*, 206  
*Cupressus lawsoniana*, 90  
 „ *nootkatensis*, 90

Cupressus obtusa, 200  
 „ sempervirens, 50  
 „ thyoides, 90  
 Cupshake, 290  
 Curtisea faginea, 207  
 Curupay, 142  
 Cutch. *See* Khair or Kath tree.  
 Cyp, 147  
 Cypress, black, 114  
 „ common, 50  
 „ Louisiana or swamp, 114  
 „ pine, 227, 234  
 „ white, 114  
 „ yellow, 91

## D.

DACRYDIUM cupressinum, 240  
 „ franklinii, 251  
 „ intermedium, 242  
 „ westlandicum, 242  
 Dalbergia cultrata, 175  
 „ latifolia, 175  
 „ nigra, 136  
 „ sissoo, 175  
 Dammar, 194  
 Daru, 192  
 Date plum. *See* Persimmon.  
 Deals, 35  
 Decay of timber, causes of, 255  
 Degame, 151  
 Deodar, 166  
 Dialium platysepalium, 193  
 Dicotyledons, timber of, 6  
 Dimorphandra mora, 125  
 Diospyros ebenaster, 167  
 „ kurzii, 185  
 „ quæsitæ, 163  
 „ virginiana, 115  
 Dipterocarpus thurifera, 198  
 „ tuberculatus, 177

Dipterocarpus turbinatus, 177  
 Djati, 195  
 Dogwood, 116, 253  
 „ Grenada and Jamaica,  
 150  
 Douglas fir or spruce, 77  
 Dry rot, 257  
 Dryobalanops aromatica, 193  
 Ducalliballi, 130  
 Duramen or heartwood, 7  
 Dysoxylon fraserianum, 226  
 „ muelleri, 226

## E.

EASTERN hemlock, 83  
 East India walnut, 186  
 Ebony, 167  
 Eckebergia capensis, 206  
 Eclurospenunum batshasaii, 137  
 Ekki, 208  
 Elder. *See* Els.  
 Elm, American, 105  
 „ cedar, 105  
 „ English, 61  
 „ rock, 105  
 „ slippery, 106  
 „ white, 105  
 „ wych, 62  
 Els, red 206  
 „ white, 206  
 Eng, 177  
 Engelmann spruce, 98  
 Enterolobium timbonva, 143  
 Eperna falcata, 126  
 Erica arboria, 63  
 Errol. *See* Pyinkado.  
 Essenhout, 202  
 Eucalyptus, 209  
 „ acmenoides, 222  
 „ amygdalina, 250

- Eucalyptus amygdalina regnans*, 233  
 „ *bosistoana*, 233  
 „ *botryoides*, 235  
 „ *calophylla*, 218  
 „ *cornuta*, 218  
 „ *corymbosa*, 235  
 „ *corynocalyx*, 236  
 „ *crebra*, 221  
 „ *diversicolor*, 214  
 „ *globulus*, 244  
 „ *gouphocephala*, 216  
 „ *goniocalyx*, 232  
 „ *hemiphloia*, 223, 233  
 „ *hæmastoma*, 250  
 „ *leucoxylon*, 232  
 „ *longifolia*, 225  
 „ *longicornis*, 218  
 „ *loxophleba*, 218  
 „ *maculata*, 222  
 „ *marginata*, 213  
 „ *melliodora*, 233  
 „ *microcorys*, 221  
 „ *muelleriana*, 233  
 „ *obliqua*, 233, 249  
 „ *odorata*, 236  
 „ *paniculata*, 220  
 „ *patens*, 220  
 „ *pilularis*, 222  
 „ *polyanthema*, 223  
 „ *propinqua*, 224  
 „ *redunca*, 216  
 „ *regnans*, 249  
 „ *resinifera*, 222  
 „ *rostrata*, 224, 236  
 „ *saligna*, 224  
 „ *salmonophloia*, 218  
 „ *siderophloia*, 221  
 „ *sideroxylon*, 221  
 „ *sieberiana*, 234, 250  
 „ *tereticornis*, 224  
*Eugenia jambolana*, 175
- European forests, 17  
*Eusideroxylon zwageri*, 196  
 Evergreen beech, 234  
 Exogenous trees, 7  
 Expansion of timber, 15  
 Eyn, red, 174
- F.
- FAGUS batuloides*, 144  
 „ *cunninghamii*, 234, 252  
 „ *ferruginea*, 105  
 „ *fusca*, 242  
 „ *sylvatica*, 56  
 Fathom of wood, 328  
 Fiddle wood, 150  
 Figure in timber, 320  
 Fir, 34, 82  
 „ balsam, 82  
 „ Douglas, 77  
 „ red, 30  
 „ „ or noble, 82  
 „ silver, 37, 190  
 „ white, 34, 82  
 Fireproof timber, 287  
*Flindersia Bennettiana*, 229  
 Folha de bolo (branca), 134  
 „ „ (vermelha), 134  
 Forest area of Africa, 18  
 „ „ Australia, 18  
 „ „ Europe, 17  
 „ „ India, 18  
 „ „ Japan, 18  
 „ „ New Zealand and  
 Tasmania, 18  
 „ „ South America, 19  
 „ „ United States and  
 Canada, 18  
 Forest red gum, 224  
 Foxiness in wood, 41  
*Fragræa speciosa*, 191



**THIS PAGE IS LOCKED TO FREE MEMBERS**

Purchase full membership to immediately unlock this page

# Know Your Bible

Forgotten Books'  
Full Membership  
provides unlimited  
access to more than  
28,000 volumes of  
Christian literature for  
\$8.99/month

**HOLY  
BIBLE**

**Continue**

\*Fair use policy applies

Hicoria glabra, 86  
 „ microcarpa, 86  
 „ ovata, 86  
 „ sulcata, 86  
 Hieronyma alchorneoides, 148  
 Hinoki, 200  
 Hippomane manchinella, 148  
 Holly, 62  
 Honey locust, 116  
 Honeysuckle, 228, 237, 244, 252  
 Honoki, 201  
 Hopea meranti, 194  
 „ odorata, 187  
 Horco cevil, 143  
 Hornbeam, 45  
 Horse chestnut, 47, 97  
 Houbooballi, 127  
 Humirium floribundum, 126  
 Huon pine or macquerie pine, 250  
 Hymenæa courbaril, 129  
 Hynocura courbaril, 138

## I.

ICARANDA, 136  
 Icica altissima, 129  
 Ikusi, 207  
 Ilex aquifolium, 62  
 In. *See* Eng.  
 Indian forests, 18  
 „ timbers, 160  
 Ingyin, 189  
 Inogenous trees, 7  
 Inveraro, 147  
 Ipe, 135  
 Iriya. *See* Chuglan.  
 Iroko, 208  
 Ironbark, 220, 250  
 „ broad leaved, 221  
 „ narrow leaved, 221  
 „ red, 221, 232  
 „ silver top, 234

Ironbark, white or grey, 220  
 Ironwood, 178, 188, 196, 205

## J.

JACARANDA (rosewood, Brazil), 136  
 „ cabiuna, 136  
 „ preto, 136  
 „ rozo, 136  
 Jack tree, 162  
 Jackwood, 162  
 Jaman, 175  
 Jambu. *See* Pyinkado.  
 Japanese forests, 18, 198  
 „ timber, 198  
 Jaqueira, 162  
 Jarrah, 213  
 Jarul. *See* Pyinma.  
 Jatoba, 138  
 Java teak, 179, 195  
 Jeffrey pine, 76  
 Jiqui comun, 152  
 Jucaro prieto, 152  
 Juglans australia, 145  
 „ cinera, 113  
 „ nigra, 112  
 „ regia, 63  
 Juniperus barbadensis, 88  
 „ virginiana, 88

## K.

KAHIKATEA, 241  
 Kaita-da, 186  
 Kajatenhout, 207  
 Kajoe bessi, 197  
 Kakaralli, 129  
 Kariskes, 197  
 Karri, 214  
 Kath tree, 178

Katpali. *See* Mohwa.  
 Katsura, 203  
 Kauri pine, 238  
 Keekar. *See* Babool.  
 Keledang, 192  
 Keyaki, 199  
 Khair or kath, 178  
 Khasia pine, 190  
 Kiln drying, 274  
 King William pine, 251  
 Knightia excelsa, 244  
 Koa, 331  
 Kokko, 185  
 Kosum, 178  
 Kranji sepan, 193  
 Kulum, 192  
 Kumbuk, 174  
 Kuro matsu, 202  
 Kyanizing, 278

## L.

LABURNUM, 51  
 „ vulgare, 51  
 Lacewood, 101  
 Lakuch, 186  
 Lancewood, Tasmania, 252  
 „ West Indies, 151  
 Lanza, 145  
 Lanza, Prof., Tests on timber by,  
 302, 314  
 Lapacho, 141  
 Larch, 37, 82, 190  
 Larix americana, 83  
 „ europea, 37  
 „ occidentalis, 83  
 Laslett, Thos., 254, 271  
 Lauan, 198  
 Laurel, 62, 98  
 Leatherwood, 252  
 Lecythis ollaria, 129  
 Letterwood or snakewood, 130

Libocedrus decurrens, 91  
 Lignum vitæ, 130  
 Lime. *See* Linden.  
 Linnoria terebrans, 265  
 Linden or lime, 49, 113  
 Liquidambar styraciflua, 92  
 Liriodendron tulipifera, 102  
 Load of timber, 328  
 Loblolly pine, 71  
 Locust, American, 116  
 „ black, 116  
 „ brown, 116  
 „ or false acacia, 56, 115  
 „ honey, 116  
 „ West Indian, 129  
 Longleaf pine, 68, 190  
 Lophira procera, 208  
 Lythracæ flos reginæ, 188

## M.

MACHÆRIUM incorruptibili, 136  
 „ legale, 136  
 „ pseudo tipa, 144  
 Maclura aurantiaca, 116  
 Macquerie pine. *See* Huon pine.  
 Magnolia champaca, 194  
 „ hypoleuca, 201  
 Mahogany, 153  
 „ red or forest, 222  
 „ swamp, Queensland,  
 236  
 „ white, New South  
 Wales, 222  
 Mahwa. *See* Butter tree.  
 Malay Archipelago, timber of, 191  
 Maloh, 186  
 Manchineel, 148  
 Mangifera indica, 170  
 Mango, 170  
 Maple, bird's eye, 112



- Maple, black, 111  
   ,, broad leaved, 111  
   ,, great. *See* Sycamore.  
   ,, Oregon, 111  
   ,, red, 111  
   ,, silver leaved, 111  
   ,, striped, 111  
   ,, sugar or rock, 111  
 Marble wood, Andaman, 185  
 Margosa. *See* Neem.  
 Marks on timber, 325  
 Matai, 240  
 Medullary rays, 11  
 Melaleuca leucadendron, 236  
 Melanorrhœa maingayo, 195  
 Melanoxylon brauna, 133  
 Meliaceæ cedrela, 128  
 Melia indica, 176  
 Melkhout, 205  
 Merabau, 197  
 Meranti, 194  
 Merulius lacrymans, 257  
 Mespilodaphe opifera, 135  
 Messmate, 233  
 Mesua ferrea, 188  
 Metrosideros lucida, 243  
   ,, polymorpha, 331  
   ,, robusta, 243  
 Miall, 232  
 Milkwood, 204  
 Mimosa guianensis, 127  
 Mimusops balata, 125  
   ,, hexandra, 178  
   ,, littoralis, 187  
   ,, obvata, 204  
 Miro, 243  
 Mistol, 145  
 Mlange cedar, 207  
 Mohwa, 187  
 Molave, 197  
 Moquilia tormentosa, 138  
 Mora, 125  
 Mora excelsa, 125  
 Moreton Bay pine, 227  
 Morrel, 218  
 Mountain ash, 53  
 Murray red gum, 224  
 Muskwood, 229  
 Mutti, 176  
 Myristica irya, 186  
 Myrsine grisebachii, 145  
 Myrtle, 98, 252  
 Mysore sandalwood, 171
- N.
- NAHOR. *See* Gangau.  
 Naito balam, 192  
 Nandubay, 146  
 Nectandra rodiei, 121  
 Neem, 176  
 New South Wales, timbers of, 220  
 New South Wales timbers,  
   tests of, 230  
 New Zealand, timbers of, 238  
 Nieshout, 204  
 Nogal, 145  
 Norwegian forests, 17  
 Nyssa aquatica, 94  
   ,, sylvatica, 95
- O.
- OAK, American, 98  
   ,, burr, 100  
   ,, Canadian, 98  
   ,, English or common, 39  
   ,, European, 39  
   ,, fumed, 43  
   ,, iron, 100  
   ,, live, 99



**THIS PAGE IS LOCKED TO FREE MEMBERS**

Purchase full membership to immediately unlock this page

# DELVE INTO FANTASY, MAGIC, MYTHOLOGY & FOLKLORE

Forgotten Books'  
Full Membership gives  
access to 797,885 ancient  
and modern, fiction and  
non-fiction books.

**Continue**

\*Fair usage policy applies

- Pine, Japanese, 201  
 „ Kauri, 238  
 „ Khasia, 190  
 „ King William, 251  
 „ loblolly, 71  
 „ longleaf, 68, 190  
 „ Moreton Bay, 227  
 „ northern, 32  
 „ Oregon, 77  
 „ pitch. *See* Longleaf pine,  
 „ red American, 68  
 „ „ New Zealand, 240  
 „ Scotch, 32  
 „ shortleaf, 71  
 „ silver, New Zealand, 242  
 „ stone, 34  
 „ sugar, 75  
 „ Swiss, 37  
 „ Western yellow, 76  
 „ white, American, 65  
 „ „ New Zealand, 241  
 „ yellow (*P. strobus*). *See*  
 White.  
 Pinkwood or rosewood, New  
 Zealand, 252  
 Pinnay. *See* Bintangor.  
*Pinus austriaca*, 34  
 „ *cembra*, 30  
 „ *densiflora*, 201  
 „ *echinata*, 71  
 „ *excelsa*, 189  
 „ *halpensis*, 34  
 „ *heterophylla*, 74  
 „ *Jeffreyi*, 76  
 „ *khasya*, 190  
 „ *lambertiana*, 75  
 „ *laricio*, 34  
 „ *longifolia*, 190  
 „ *palustris*, 68  
 „ *pineae*, 34  
 „ *ponderosa*, 76  
 „ *resinosa*, 68  
*Pinus rigida*, 74  
 „ *rubra*, 68  
 „ *strobus*, 65  
 „ *sylvestris*, 32  
 „ *tæda*, 71  
 „ *thunbergii*, 202  
*Piptadenia communis*, 143  
*Piscidia erythrina*, 150  
 Pitch pine, 68  
 „ „ tests of, 118, 308  
 Pith, 8  
 Plane, 46, 101  
 „ eastern, 46  
 „ western, 101  
*Platanus occidentalis*, 101  
 „ *orientalis*, 46  
 „ *racemosa*, 101  
*Platylophus trifolius*, 206  
 Plum, 50  
*Podocarpus dacrydioides*, 241  
 „ *elata*, 227  
 „ *elongata*, 205  
 „ *ferruginea*, 243  
 „ *neriifolia*, 187  
 „ *spicata*, 240  
 „ *thunbergii*, 205  
 „ *totara*, 239  
 Poplar, American yellow, 102  
 „ balsam, 102  
 „ black, 59  
 „ grey, 59  
 „ Lombardy, 59  
 „ white, 58  
*Populus alba*, 59  
 „ *balsamifera*, 102  
 „ *canescens*, 59  
 „ *fastigiata*, 59  
 „ *monilifera*, 101  
 „ *nigra*, 59  
 „ *tremula*, 59  
 „ *tremuloides*, 102  
 Pores of wood, 12

Port Orford cedar, 90  
 Possi possi, 197  
 Poui, 147  
 Powellised wood, 279  
 Preserving timber, 275  
 Princewood. *See* Cyp.  
 Proposis alba, 144  
 „ nigra, 144  
 Prunus lauro cerasus, 62  
 „ serotina, 98  
 Pseudotsuga Douglasii, 77  
 Pterocarpus angolensis, 207  
 „ dalbergioides, 169  
 „ indicus, 169  
 „ marsupium, 171  
 „ santalinus, 170  
 Pteroxylon utile, 204  
 Puriri, 242  
 Purple-heart, 126  
 Pyinkado, 178  
 Pyinma, 188  
 Pyrus aucuparia, 53  
 „ avium, 50  
 „ cerasus, 50  
 „ communis, 50  
 „ malus, 49  
 „ padus, 50

## Q.

QUARTER sawing, 43  
 Quebec pine. *See* White pine.  
 Quebracho blanco, 141  
 „ Colorado, 140  
 Queensland, timbers of, 234  
 Quercus acuta, 199  
 „ alba, 99  
 „ cerris, 43  
 „ crispula, 199  
 „ garryana, 99

Quercus glauca, 199  
 „ ilex, 43  
 „ macrocarpa, 100  
 „ obtusiloba, 100  
 „ pedunculata, 39  
 „ prinus, 100  
 „ rubra, 99  
 „ sessiliflora, 39  
 „ virens, 99

Quiebra hacha, 152

Quina quina, 143

## R.

RATA, 243  
 Rays, medullary, 11  
 Red ash, 103, 229  
 „ bean, 226  
 „ beech, 105  
 „ birch, 104  
 „ box, 223  
 „ cedar, 87  
 „ cypress, 114  
 „ els or elder, 206  
 „ eyne, 174  
 „ fir, 30, 82  
 „ gum (satin walnut), 92  
 „ „ (Australian), 218  
 „ maple, 111  
 „ pear, 204  
 „ pine, 68, 201, 240  
 „ sanders, 170  
 „ spruce, 98  
 Redwood, Baltic, 32  
 „ Californian, 107  
 Rengas manau, 195  
 Resin ducts, 37, 82  
 Resonance of wood, 298  
 Rewarewa. *See* Honeysuckle,  
 New Zealand.

- Rimda. *See* Thingan.  
 Rimu, 240  
 Rings, annual, 8  
 Ringshake, 290  
 Robinia pseudacacia, 56, 116  
 Roble del pais, 144  
 Rock elm, 105  
   ,, maple. *See* Sugar maple.  
 Rosewood, Brazilian, 137  
   ,, Indian, 175  
 Rowan or mountain ash, 53  
 Russian forests, 17, 29
- S.
- SABICU, 150  
 St. Petersburg standard, 328  
 Sal, 163  
 Salix alba, 49  
 Salting timber, 279  
 Sandalwood, Australian, 218, 237  
   ,, Indian, 171  
 Sanders, red, 170  
 Santalum album, 171  
   ,, cygnorum, 218  
 Santa Maria. *See* Galaba.  
 Sapota gonocarpa, 133  
 Sapwood, 7, 293  
 Satin walnut. *See* Red gum.  
 Satinwood, 172  
 Schleichera trijuga, 178  
 Scolopia eclonii, 204  
 Scordocarpus borneenses, 192  
 Scotch pine, 32  
 Seasoning, 269  
 Semecarpus pandurata, 189  
 Sen, 203  
 Sequoia or Californian redwood,  
   107  
   ,, sempervirens, 107  
   ,, Washingtoniana, 108
- Shakes in timber, 288  
 Shira gashi, 199  
 Shiron gashi, 199  
 Shisham. *See* Blackwood.  
 Shorea obtusa, 188  
   ,, robusta, 163  
   ,, tumbuggaia, 189  
 Shortleaf pine, 71  
 Shrinkage of timber, 11  
 Sicupira assu, 138  
   ,, merim, 138  
 Siderodendron triflorum, 132  
 Sideroxylon inerme, 205  
 Silver balli. *See* Ciruaballi.  
   ,, fir, 37, 190  
   ,, grain, 43  
 Simaruba versicolor, 138  
 Simarupa, 128  
 Siris tree. *See* Kokko.  
 Siruaballi, 128  
 Sissoo, 175  
 Sitka spruce, 98  
 Si-to-oh-balli. *See* Letterwood,  
   130  
 Sleepers, 273, 283  
 Sloetia sideroxylon, 194  
 Snakewood. *See* Letterwood.  
 Sneezewood, 204  
 Softwoods, 6  
 Sonneratia acida, 197  
 Souari-pikea, 132  
 South American forests, 18  
 Soymida febrifuga, 174  
 Spanish chestnut, 47  
 Sphæroma, 266  
 Spring wood, 10  
 Spruce, black, 98  
   ,, Douglas, 77  
   ,, Engelmann, 98  
   ,, hemlock, 83  
   ,, red, 98  
   ,, sitka, 98



**THIS PAGE IS LOCKED TO FREE MEMBERS**

Purchase full membership to immediately unlock this page

# Know Your Bible

Forgotten Books'  
Full Membership  
provides unlimited  
access to more than  
28,000 volumes of  
Christian literature for  
\$8.99/month

**HOLY  
BIBLE**

**Continue**

\*Fair use policy applies