

formalighting

**working
catalogue**





































2021 | 22

Products Index

Aqualuce Round	98	MonoLED	77
Aqualuce Square	98	Multi Gimbalò	86
Arena Surface	160	MultiGiro	80
Astra	330	MultiGiro Deep	82
Bullet Floodlight	288	MultiQuadro	80
Bullet Recessed	286	MultiQuadro Deep	82
Canali	198	Nippo Round	58
Canali Edge	192	Nippo Square	58
Circo Recessed	100	Occhio Pin	55
Circo Surface	166	Occhio Slot	57
Cobra Pro IP66 Fixed	272	Ola Compasso Track	118
Cobra Pro IP66 Adjustable	274	Ola Zoom Track	120
Colosseo Round	26	Optiwall	268
Colosseo Square	28	Orbit Round	314
Conforto	34	Orbit Square	314
Conos Track	126	Ovo	60
Conos Due Surface	156	Palla Pendant	188
Cornetto	336	Palla Surface	162
Corolla	338	Pixo Pendant	174
Cubetto	164	Pixo Semi Recessed	14
Cubox	326	Pixo Surface	136
Dado Surface	158	Polaris Pendant	182
Dado Track	124	Polaris Recessed	16
Disco	316	Polaris Surface	146
DomoLED Round Recessed	104	Polaris Track	122
DomoLED Round Surface	168	Polaris Wallwasher	22
DomoLED Square Recessed	106	Polo	294
DomoLED Square Surface	168	Punto Round	36
Espresso Concave	49	Punto Square	36
Espresso Wallwasher	50	QuadroLED	78
FioreLED	342	Quadro Recessed	102
Fontanaluce	344	Quadro Surface	166
Frontaluce 90	278	Rocket	308
Gala	316	Rocket Pro	306
Galaxis IP65	284	Roller In & Out	94
Galaxis Pro	92	Rolo Surface	158
Gallio	302	Rolo Track	124
Gallio Due	312	Scudo	304
Gallio Pendant	320	Scudo Recessed	270
Gallio Surface	311	Scudo Wall	318
Gimbalo	84	Spotify Round	45
GirasoleLED Round	325	Spotify Square	47
GirasoleLED Square	325	StellaLED	265
Girofix	80	Terraluce	256
GiroLED	78	Terraluce Deep	255
GiroLED Deep	78	Terraluce Linear	260
Gola Stand Alone Pendant	222	Terraluce Wallwasher	255
Gola Stand Alone Recessed	210	Trafo	340
Gola Stand Alone Surface	214	Twist	143
Gola Stand Alone Wall	218	Twist Deep	144
Gola System Pendant	240	Venus Concave Round	65
Gola System Recessed	228	Venus Concave Square	70
Gola System Surface	232	Venus Round	67
Gola System Wall	236	Venus Square	72
InoxLED	266	Venus Wallwasher Round	69
Iride	32	Venus Wallwasher Square	74
Latoluce	334	Visor	328
Logica Recessed	282	Volume Ceiling	298
Logica Surface	290	Volume Projector	296
Lucciole Pendant	178	Volume Wall	300
Lucciole Ceiling	138	Zero Compasso Track	112
Lucciole Wall	140	Zero Due Surface	152
Lumi Fixed	40	Zero Due Track	114
Lumi Adjustable	42	Zero In & Out Recessed	30
Mago Recessed	96	Zero Pendant	180
Mago Surface	150	Zero Projector Track	116
Micron	52	Zero Projector Surface	154
Miniluce Pendant	186	Zero Semi-Recessed	12
Miniluce Surface	148		

Indoor Lighting

Recessed

Zero Semi Recessed  12	Pixo Semi Recessed  14	Polaris  16	Polaris Diffuser  16	Polaris Wallwasher  22	Colosseo Round  26
Colosseo Square  28 New	Zero In & Out  30	Iride  32	Conforto  34	Punto Fixed Round  37	Punto Fixed Square  37
Punto Adjustable Round  38	Punto Adjustable Square  38	Lumi Fixed  40 New	Lumi Adjustable  42 New	Spotify Fixed  44 New	Spotify Adjustable Round  46 New
Spotify Adjustable Square  47 New	Espresso Concave  49 New	Espresso Wallwasher  50 New	Micron  52	Occhio Pin Fixed  55	Occhio Pin Adjustable  56
Occhio Slot Adjustable  57	Nippo Round  59	Nippo Square  59	Ovo  60	Venus Concave Round  65	Venus Concave Square  70
Venus Round  67	Venus Square  72	Venus Wallwasher Round  69	Venus Wallwasher Square  74	MonoLED  77	GiroLED  78

Indoor Lighting

Recessed





















QuadroLED  78	Girofix  81	Multi Giro  81	Multi Quadro  81	Multi Giro Deep  83	Multi Quadro Deep  83
Gimbalo  84	Multi Gimbalo  86	Galaxis Pro  92	Roller In & Out  94	Mago Round  96	Mago Square  96
Aqualuce Round  98	Aqualuce Square  98	Circo  100	Quadro  102	DomoLED Round  104	DomoLED Square  106

Track







Zero Compasso  112	Zero Due  114	Zero Projector  116	Ola Compasso  118	Ola Zoom  120	Polaris  122
Rolo  124	Dado  124	Conos  126	Eurotype Track System with Dali  130	Eurotype Track System  132	

Indoor Lighting





Surface

Pixo  136	Lucciole Ceiling  138 New	Lucciole Wall  140 New	Twist Round  143	Twist Square  143	Twist Deep Round  144
Twist Deep Square  144	Polaris  146	Miniluce LED  148	Mago  150	Zero Due  152	Zero Projector  154
Conos Due  156	Rolo  158	Dado  158	Arena  160	Palla  162	Cubetto  164
Circo  167	Quadro  167	DomoLED Round  168	DomoLED Square  168		

Pendant

Pixo  174	Lucciole  178 New	Zero  180	Polaris  182	Miniluce  186	Palla  188
---	--	---	--	---	--

Systems

Canali Edge  192 New	Canali  198	Gola Recessed  210	Gola Surface  214	Gola Wall  218	Gola Pendant  222
--	--	---	--	---	--

Outdoor Lighting

Terraluce Deep  254 New	Terraluce  256	Terraluce Linear  260	StellaLED  264	InoxLED  266	Optiwall  268
Scudo Recessed  270	Cobra Pro IP66 Fixed  272 New	Cobra Pro IP66 Adjustable  274 New	Fronteluce  278	Logica 42 Recessed  282 New	Galaxis IP65  284 New
Bullet Recessed  286	Bullet Floodlight  288	Logica Surface  290 New	Polo  294	Volume Projector  297	Volume Ceiling  299
Volume Wall  300	Galileo Ceiling / Ground / Pole  302	Scudo Wall / Ground  304	Rocket Pro  306 New	Rocket  308	Galileo Surface  311
Galileo Due  312	Orbit Round  314	Orbit Square  314	Disco  317	Gala  317	Scudo Wall  319
Galileo Pendant  320	GirasoLED Round  324	GirasoLED Square  324	Cubox  326	Visor  328	Astra  330
Latoluce  334	Cornetto  336	Corolla  338	Trafo  340	FioreLED  342	Fontanaluce  344

Indoor Lighting

Zero

Semi Recessed 40 | 66



Body

Semi-recessed luminaire with round mounting trim in cast aluminium with springs for trim installation on a ceiling thickness of max. 12mm.

Light head and arm in cast aluminium.

The light head is tiltable up to 90° and rotatable horizontally 355°.

Accessories

Coloured filters, honeycomb louvre. Check page 108 for details.

Finish

Powder coat in black or white colour.

LED sources

Light source options: High Power LED, COB LED. CRI: 90 | CCT: 3000K, 4000K. Other CRI and CCT options and Tuneable White version (66) available on request.

Optic

Lens. Narrow, medium and wide beam angle available.

Driver

Supplied with No-dimable remote driver. Dimming Options: 0-10V Dim, DALI.

Applications

Its unique pull-down mechanism, enables it to function as either a downlight or a exposed lamp able to emulate a surface or track fixture. Application areas: retail, hotels, museums, window displays.

Related Products

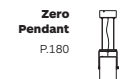
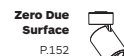
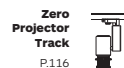
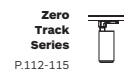
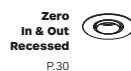

Zero Semi Recessed

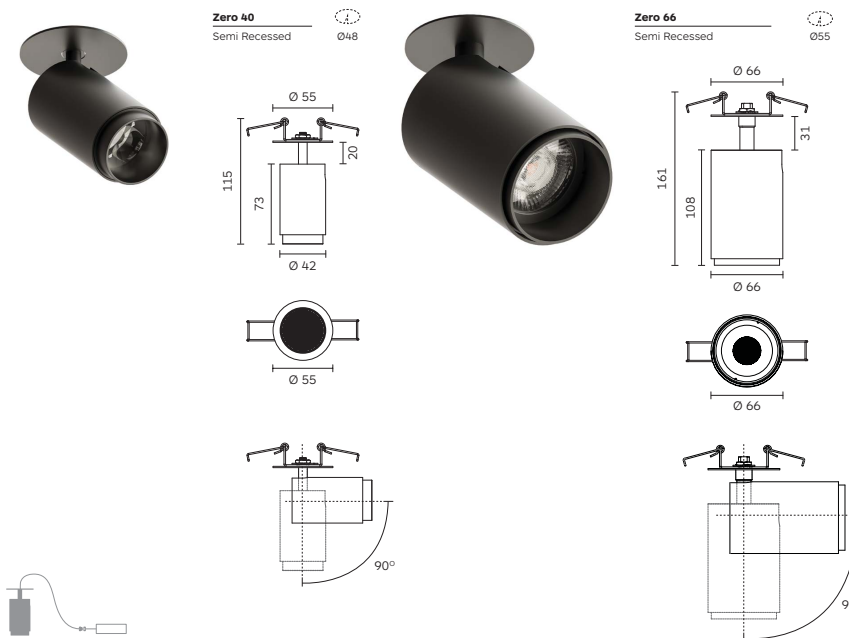

Code ordering example: **R 0 9 2 B C 3 1 - 9 0 3 0 1 6 D 0 1 0**

	Product Code	Light Source Code*	>CRI	CCT**	LED Power	Nominal Lumen	Beam Angle (BA°)	Driver Options	Finish
Zero Semi Recessed 40	RO92 BC31	COB LED	90	30 3000K	6W	705 lm	16 / 26 / 36	D0 No Dim	10 ■ Black
				40 4000K		770 lm		DA Dali Dim	11 ■ White
		BR21 High Power LED			4W	439 lm	07	DC CASAMBI	
Zero Semi Recessed 66	RP62 BC31	COB LED		30 3000K	11W	1160 lm	11 / 16 / 32	D1 0-10V Dim	
				40 4000K		1258 lm			
		BR21 High Power LED			6W	574 lm	05		
						636 lm			
	IU21	TW COB LED		TW 2700K-6500K	13W	1290 lm	16 / 25 / 48		
	GU53	Retrofit MR16-GU5.3	00	00	/	/	00	00 No Driver	

Notes:

* For complete code ordering information, please see page 353.

** For other CCT options, please contact us.

For related accessories, please see page 108-109.

For the most updated product information, please go to our website.

Pixo

Semi Recessed 25



Body

Semi-recessed luminaire with round mounting trim in cast aluminium with springs for trim installation on a ceiling thickness of max. 20mm.

Light body in extruded aluminium, luminaire is available in three different lengths, to fit any ceiling height .

Exchangable front ring in wide range of colours.

Accessories

No accessories available.

Finish

Powder coat in black or white.
Exchangable front ring in different colours.

LED sources

Light source options: High Power LED.
CRI: 90 | CCT: 3000K, 4000K.
Other CRI and CCT options available on request.

Optic

Lens.
Narrow, medium and wide beam angle available.

Driver

Supplied with No-dimable remote driver.
Diming Options: 0-10V Dim, DALI.

Applications

A modern designed pendant ambient light. Its accessories make it the perfect match for sophisticated environments.
Application areas: residential, hotels, restaurants, retail, corridors.

Related Products

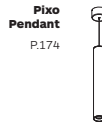

Pixo Semi Recessed 25

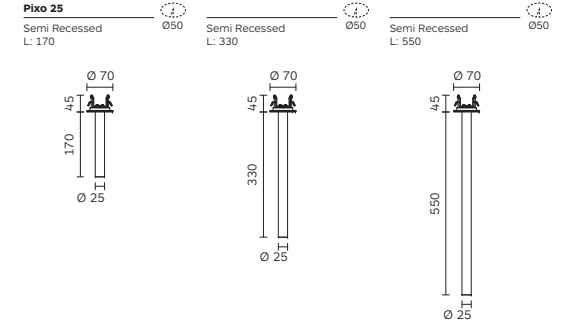

Code ordering example: **R P 3 3 B N 1 1 - 9 0 1 4 W W D 0 1 0**

	Product Code	Product Length	Light Source Code*	>CRI	CCT**	LED Power	Nominal Lumen	Beam Angle (BA°)	Driver Options	Finish
Pixo 25	RP33	170	BN11 High Power LED	90	30 3000K	2W	230 lm	14 / 20 / 26 / 32	D0 No Dim	10 ■ Black
Semi Recessed	RP34	330			40 4000K		260 lm		DA Dali Dim	11 □ White
	RP35	550							D1 0-10V Dim	

Notes:

* For complete code ordering information, please see page 353.
** For other CCT options, please contact us.
For the most updated product information, please go to our website.

Polaris

Designed by **Franco Mirezzi** (Registered)



Body

Square shape mounting trim in cast aluminum with springs for trim installation on ceiling thickness 2-25mm or brackets for trimless installation on ceiling thickness 2-25mm.

Luminaire body in cast aluminum with integrated diamond faceted screen made from thermoplastic.

Polaris 20 available also with satin opal diffuser. Available in different configurations. Adjustable version (Polaris 30): lighthead collectively tiltable in two directions from 0° to 35°.

Accessories

No accessories available.

Finish

Powder coat in black or white. White version available also with integrated black thermoplastic screen.

LED sources

Light source options: High Power LED. CRI: 90 | CCT: 3000K, 4000K. Other CRI, CCT and Tuneable White options available on request.

Optic

Lens plus thermoplastic screen. UGR < 16. Polaris 20 available also with satin opal diffuser. Medium and wide beam angles available.

Driver

Supplied with No-dimable remote driver. Dimming Options: 0-10V Dim, DALI, Phase, CASAMBI.

Applications

An innovative solution for high brilliance and performance. The light source is barely visible, as the miniature light heads create a high contrast and circular light emission. Application areas: residential, hotels, restaurants, retail, corridors.

Related Products



Polaris 20 & Polaris 20 Diffuser

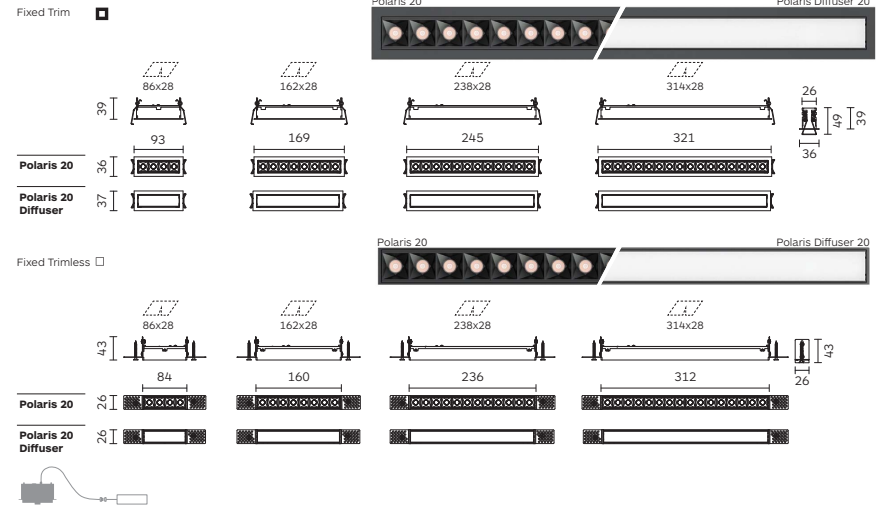

Code ordering example: **R 0 9 5 B 0 1 1 - 9 0 3 0 2 1 D 0 1 0**

	Product Code	Light Source Code*	>CRI	CCT**	LED Power	Nominal Lumen	Beam Angle (BA°)	Driver Options	Finish
Polaris 20 Fixed	RO95 <input checked="" type="checkbox"/> x4	B011 High Power LED	90	30 3000K	4x1W	520 lm	21 / 33 / 45 / 60	D0 No Dim	10 <input checked="" type="checkbox"/> Black
Polaris 20 Fixed	RO96 <input type="checkbox"/> x4	LED	40 4000K	TW 2700K-5700K		600 lm		DA Dali Dim	11 <input type="checkbox"/> White
Polaris 20 Fixed	RO97 <input checked="" type="checkbox"/> x8				8x1W	1040 lm		DP Phase Dim	17 <input checked="" type="checkbox"/> B/W
Polaris 20 Fixed	RO98 <input type="checkbox"/> x8					1200 lm		DC CASAMBI	
Polaris 20 Fixed	RO99 <input checked="" type="checkbox"/> x12				12x1W	1560 lm		D1 0-10V Dim	
Polaris 20 Fixed	RP01 <input type="checkbox"/> x12					1800 lm			
Polaris 20 Fixed	RP02 <input checked="" type="checkbox"/> x16				16x1W	2080 lm			
Polaris 20 Fixed	RP03 <input type="checkbox"/> x16					2400 lm			
Polaris 20 Diffuser Fixed	RP48 <input checked="" type="checkbox"/> x4	B011 High Power LED			4x1W	520 lm	OD Opal Diffuser		10 <input checked="" type="checkbox"/> Black
Polaris 20 Diffuser Fixed	RP49 <input type="checkbox"/> x4	LED				600 lm			11 <input type="checkbox"/> White
Polaris 20 Diffuser Fixed	RP50 <input checked="" type="checkbox"/> x8				8x1W	1040 lm			
Polaris 20 Diffuser Fixed	RP51 <input type="checkbox"/> x8					1200 lm			
Polaris 20 Diffuser Fixed	RP52 <input checked="" type="checkbox"/> x12				12x1W	1560 lm			
Polaris 20 Diffuser Fixed	RP53 <input type="checkbox"/> x12					1800 lm			
Polaris 20 Diffuser Fixed	RP54 <input checked="" type="checkbox"/> x16				16x1W	2080 lm			
Polaris 20 Diffuser Fixed	RP55 <input type="checkbox"/> x16					2400 lm			

Notes:

- * For complete code ordering information, please see page 353.
- ** For other CCT options, please contact us.
- 17**: white light body with black integrated louvre. For black body with white integrated louvre consult us. For the most updated product information, please go to our website.

Polaris 30 Fixed



Polaris 30

Fixed Trim

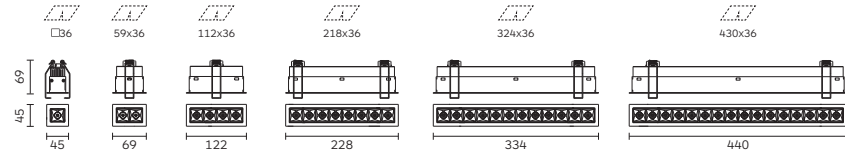

Polaris 30

Fixed Trimless

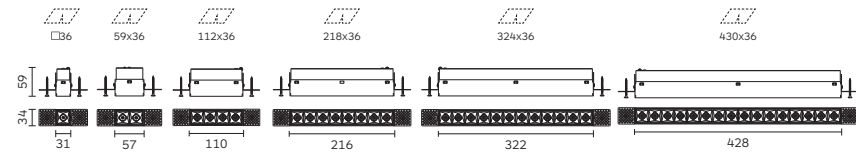

Code ordering example: **R J 3 4 B O 1 1 - 9 0 3 0 3 4 D 0 1 0**

	Product Code	Light Source Code*	>CRI	CCT**	LED Power	Nominal Lumen	Beam Angle (BA°)	Driver Options	Finish
Polaris 30 Fixed 1 LED	RJ34 <input type="checkbox"/> x1	BO11 High Power LED	90	30 3000K	2W	190 lm	34 / 50	D0 No Dim	10 <input type="checkbox"/> Black
	RJ35 <input type="checkbox"/>			40 4000K		240 lm		DA Dali Dim	11 <input type="checkbox"/> White
Polaris 30 Fixed 2 LEDs	RL83 <input type="checkbox"/> x2				2x2W	380 lm		DP Phase Dim	17 <input type="checkbox"/> B/W
	RL79 <input type="checkbox"/>					480 lm		DC CASAMBI	
Polaris 30 Fixed 4 LEDs	RJ36 <input type="checkbox"/> x4				4x2W	760 lm		D1 0-10V Dim	
	RJ37 <input type="checkbox"/>					960 lm			
Polaris 30 Fixed 8 LEDs	RJ38 <input type="checkbox"/> x8				8x2W	1520 lm			
	RJ39 <input type="checkbox"/>					1920 lm			
Polaris 30 Fixed 12 LEDs	RJ40 <input type="checkbox"/> x12				12x2W	2280 lm			
	RJ41 <input type="checkbox"/>					2880 lm			
Polaris 30 Fixed 16 LEDs	RJ42 <input type="checkbox"/> x16				16x2W	3040 lm			
	RJ43 <input type="checkbox"/>					3840 lm			

Notes:

- * For complete code ordering information, please see page 353.
 - ** For other CCT options, please contact us.
 - 17**: white light body with black integrated louvre. For black body with white integrated louvre consult us.
- For the most updated product information, please go to our website.

Polaris 30 Adjustable



Polaris 30

Adjustable Trim

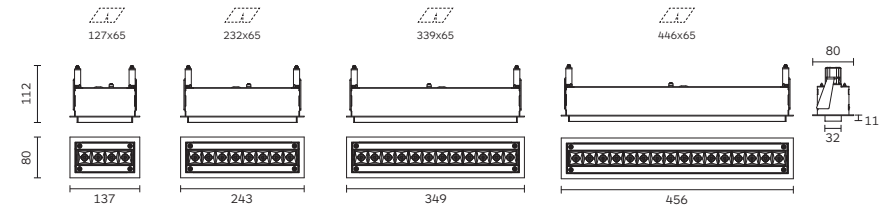

Polaris 30

Adjustable Trimless

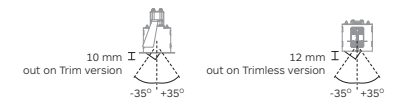
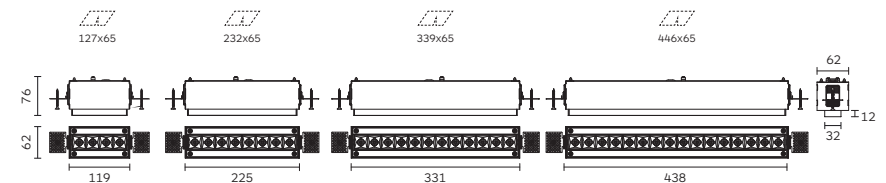

Code ordering example: **R L 7 1 B O 1 1 - 9 0 3 0 3 4 D 0 1 0**

	Product Code	Light Source Code*	>CRI	CCT**	LED Power	Nominal Lumen	Beam Angle (BA°)	Driver Options	Finish
Polaris 30 Adjustable 4 LEDs	RL71 <input type="checkbox"/> x4	BO11 High Power LED	90	30 3000K	4x2W	760 lm	34 / 50	D0 No Dim	10 <input type="checkbox"/> Black
	RL72 <input type="checkbox"/>			40 4000K		960 lm		DA Dali Dim	11 <input type="checkbox"/> White
Polaris 30 Adjustable 8 LEDs	RL73 <input type="checkbox"/> x8				8x2W	1520 lm		DP Phase Dim	17 <input type="checkbox"/> B/W
	RL74 <input type="checkbox"/>					1920 lm		DC CASAMBI	
Polaris 30 Adjustable 12 LEDs	RL75 <input type="checkbox"/> x12				12x2W	2280 lm		D1 0-10V Dim	
	RL76 <input type="checkbox"/>					2880 lm			
Polaris 30 Adjustable 16 LEDs	RL77 <input type="checkbox"/> x16				16x2W	3040 lm			
	RL78 <input type="checkbox"/>					3840 lm			

Notes:

- * For complete code ordering information, please see page 353.
 - ** For other CCT options, please contact us.
 - 17**: white light body with black integrated louvre. For black body with white integrated louvre consult us.
- For the most updated product information, please go to our website.

Polaris 65 Fixed



Polaris 65
Fixed Trim 1 LED 72

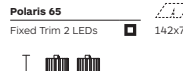
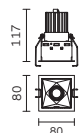

Polaris 65
Fixed Trim 2 LEDs 142x72

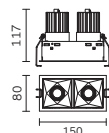

Polaris 65
Fixed Trim 3 LEDs 212x72

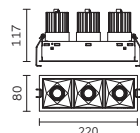

Polaris 65
Fixed Trimless 1 LED 72

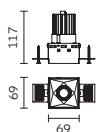

Polaris 65
Fixed Trimless 2 LEDs 142x72

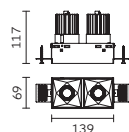

Polaris 65
Fixed Trimless 3 LEDs 212x72

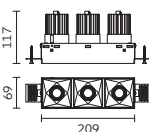

Code ordering example: **R J 4 4 B C 2 2 - 9 0 3 0 3 0 D 0 1 0**

	Product Code	Light Source Code*	>CRI	CCT**	LED Power	Nominal Lumen	Beam Angle (BA°)	Driver Options	Finish
Polaris 65 Fixed 1 LED	RJ44 <input checked="" type="checkbox"/> x1	BC22 COB LED	90	30 3000K	12W	1500 lm	30 / 53	D0 No Dim	10 <input checked="" type="checkbox"/> Black
	RJ45 <input type="checkbox"/>			40 4000K		1520 lm		DA Dali Dim	11 <input type="checkbox"/> White
Polaris 65 Fixed 2 LEDs	RJ46 <input checked="" type="checkbox"/> x2				2x12W	3000 lm		DP Phase Dim	17 <input checked="" type="checkbox"/> B/W
	RJ47 <input type="checkbox"/>					3040 lm		DC CASAMBI	
Polaris 65 Fixed 3 LEDs	RJ48 <input checked="" type="checkbox"/> x3				3x12W	4500 lm		D1 0-10V Dim	
	RJ49 <input type="checkbox"/>					4560 lm			

Notes:

- * For complete code ordering information, please see page 353.
 - ** For other CCT options, please contact us.
 - 17:** white light body with black integrated louvre. For black body with white integrated louvre consult us.
- For the most updated product information, please go to our website.



Polaris 30 Fixed



Polaris 30 Adjustable

Polaris Wallwasher

Designed by **Franco Mirezni** (Registered)



Body

Square shape mounting trim in cast aluminum with springs for trim installation on ceiling thickness 2-25mm or brackets for trimless installation on ceiling thickness 2-25mm.

Luminaire body in cast aluminum with integrated louvre in extruded aluminium, which directs the light to the upper edge of the wall.

Accessories

No accessories available.

Finish

Powder coat in black or white.

LED sources

Light source options: High Power LED.
CRI: 90 | CCT: 3000K, 4000K.
Other CRI, CCT and Tuneable White options available on request.

Optic

Lens.
Wallwasher beam angle available.

Driver

Supplied with No-dimable remote driver.
Dimming Options: 0-10V Dim, DALI, Phase, CASAMBI.

Applications

High performance linear wall washer with miniature dimension. Its special lens optics allows an extensive uniform wall-washing effect in open-plan spaces for general lighting applications.
Application areas: galleries, museums, commercial, hotels.

Related Products



Polaris 20 Wallwasher



Polaris 20

Wallwasher
Trim

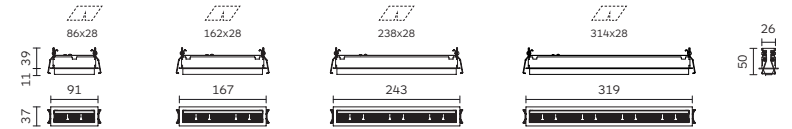

Polaris 20

Wallwasher
Trimless

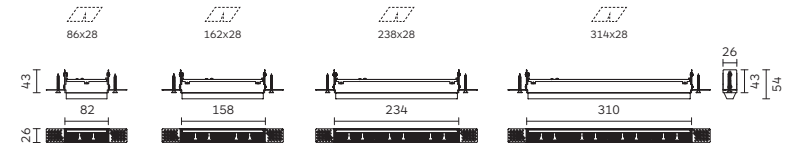

Code ordering example: **RP40BN11-9030WWDO10**

	Product Code	Light Source Code*	>CRI	CCT**	LED Power	Nominal Lumen	Beam Angle (BA°)	Driver Options	Finish
Polaris 20 Wallwasher	RP40 □ x3	BN11 High Power LED	90	30 3000K	3x1.4W	384 lm	WW	DO No Dim	10 ■ Black
3 LEDs	RP41 □			40 4000K		420 lm		DA Dali Dim	11 □ White
Polaris 20 Wallwasher	RP42 ■ x6				6x1.4W	768 lm		DP Phase Dim	
6 LEDs	RP43 □					840 lm		DC CASAMBI	
Polaris 20 Wallwasher	RP44 ■ x9				9x1.4W	1152 lm		D1 0-10V Dim	
9 LEDs	RP45 □					1260 lm			
Polaris 20 Wallwasher	RP46 ■ x12				12x1.4W	1536 lm			
12 LEDs	RP47 □					1680 lm			

Notes:

* For complete code ordering information, please see page 353.

** For other CCT options, please contact us.

WW = Wallwasher

For the most updated product information, please go to our website.

Polaris Wallwasher

Designed by **Franco Mirenzi** (Registered)



Body

Square shape mounting trim in cast aluminum with springs for trim installation on ceiling thickness 2-25mm or brackets for trimless installation on ceiling thickness 2-25mm.

Luminaire body in cast aluminum with integrated satin opal diffuser, which directs the light to the upper edge of the wall.

Accessories

No accessories available.

Finish

Powder coat in black or white.

LED sources

Light source options: High Power LED.
CRI: 90 | CCT: 3000K, 4000K.
Other CRI, CCT and Tuneable White options available on request.

Optic

Satin Opal Diffuser.
Wallwasher beam angle available.

Driver

Supplied with No-dimable remote driver.
Dimming Options: 0-10V Dim, DALI, Phase, CASAMBI.

Applications

High performance, linear wall washer with its layers special PMMA lenses, offers the possibility of extensive uniform wall-washing in open-plan spaces for general lighting applications.
Application areas: galleries, museums, commercial, hotels.

Related Products



Polaris 30 Wallwasher



Polaris 30
Wallwasher 1 Trim 140x36 Wallwasher 2 Trim 273x36 Wallwasher 3 Trim 406x36

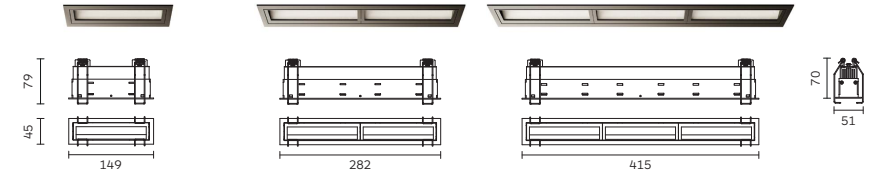

Polaris 30
Wallwasher 1 Trimless 140x36 Wallwasher 2 Trimless 273x36 Wallwasher 3 Trimless 406x36

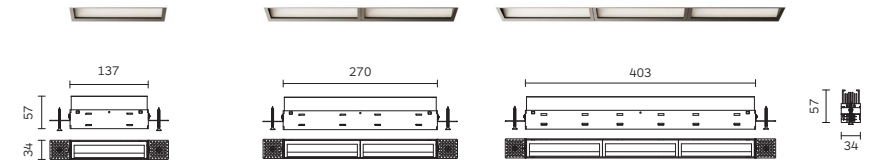

Code ordering example: **RP56BE11-9030WWD010**

	Product Code	Light Source Code*	>CRI	CCT**	LED Power	Nominal Lumen	Beam Angle (BA°)	Driver Options	Finish
Polaris 30 Wallwasher 1	RP56	BE11 High Power LED	90	30	3000K	6W	780 lm	WW	D0 No Dim 10 Black
	RP57			40	4000K		820 lm	DA Dali Dim	11 White
Polaris 30 Wallwasher 2	RP58					12W	1560 lm	DP Phase Dim	
	RP59						1630 lm	DC CASAMBI	
Polaris 30 Wallwasher 3	RP60					18W	2340 lm	D1 0-10V Dim	
	RP61						2450 lm		

Notes:

* For complete code ordering information, please see page 353.

** For other CCT options, please contact us.

WW = Wallwasher

For the most updated product information, please go to our website.

Colosseo

Recessed 75 | 90 | 120



Body

Round mounting trim in cast aluminum with spring for trim installation or brackets for trimless installation on a ceiling thickness 6-15 mm.

Luminaire body inclusive of snoot in cast aluminum.

Easy relamping via removable front ring by snap-in catch action.

Available in 3 sizes. Tiltable in two directions up to 30°.

Accessories

Coloured filters, honeycomb louvre. Check page 108 for details.

Finish

Powder coat in black or white colour.

LED sources

Light source options: High Power LED (75), COB LED (75, 90, 120) Retrofit (90).
CRI: 90 | CCT: 3000K, 4000K.
Other CRI and CCT options and Tuneable White version (66) available on request.

Optic

Lens.
Super narrow (75), narrow, medium and wide beam angle available.

Driver

Supplied with No-dimable remote driver.
Dimming Options: 0-10V Dim, DALI, Phase, CASAMBI.

Applications

A fully adjustable light head designed to accommodate any recessed lighting application and allow lamp aiming while power is on.
Application areas: retail, shopping centers, corridors, window display.

Related Products



Colosseo Round



Colosseo 75
Adjustable Trim ○ Ø75

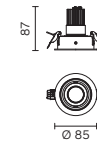

Colosseo 75
Adjustable Trimless ○ Ø75

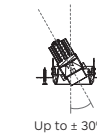
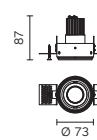

Colosseo 90
Adjustable Trim ○ Ø92



Colosseo 90
Adjustable Trimless ○ Ø90

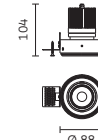

Colosseo 120
Adjustable Trim ○ Ø128

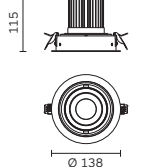

Colosseo 120
Adjustable Trimless ○ Ø122

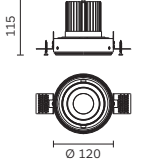

Code ordering example: **R P 1 9 B R 2 1 - 9 0 3 0 0 7 D 0 1 0**

	Product Code	Light Source Code*	>CRI	CCT**	LED Power	Nominal Lumen	Beam Angle (BA°)	Driver Options	Finish
Colosseo 75 Round Adjustable	RP19 ○ BR21	High Power LED	90	30 3000K	4W	400 lm	07 / 24 / 36	D0 No Dim	10 ■ Black
	RP20 ○			40 4000K		430 lm		DA Dali Dim	11 □ White
		MC31 COB LED			6W	660 lm	16 / 26 / 36	DP Phase Dim	
Colosseo 90 Round Adjustable	RO32 ○ MC31	COB LED			11W	1088 lm	11 / 24 / 32	D1 0-10V Dim	
	RO44 ○					1183 lm			
		GU53 Retrofit MR16-GU5.3	00	00	/	/	00	00 No Driver	
Colosseo 120 Round Adjustable	RO33 ○ MC32	COB LED	90	30 3000K	21W	2373 lm	12 / 18 / 32	D0 No Dim	
	RO23 ○			40 4000K		2637 lm		DA Dali Dim	
		GU10 GU10-GZ10						DP Phase Dim	
							DC CASAMBI		
							D1 0-10V Dim		

Notes:

* For complete code ordering information, please see page 353.

** For other CCT options, please contact us.

For related accessories, please see page 108-109.

For the most updated product information, please go to our website.

Colosseo

Recessed 90



Body

Square mounting trim in cast aluminum with spring for trim installation or brackets for trimless installation on a ceiling thickness 6-15 mm.

Luminaire body inclusive of snoot in cast aluminum.

Easy relamping via removable front ring by snap-in catch action.

Available in 3 sizes. Tilttable in two directions up to 30°.

Accessories

Coloured filters, honeycomb louvre. Check page 108 for details.

Finish

Powder coat in black or white colour.

LED sources

Light source options: COB LED, Retrofit.
CRI: 90 | CCT: 3000K, 4000K.
Other CRI and CCT options and Tuneable White version (66) available on request.

Optic

Lens.
Narrow, medium and wide beam angle available.

Driver

Supplied with No-dimable remote driver.
Dimming Options: 0-10V Dim, DALI, Phase, CASAMBI.

Applications

A fully adjustable light head designed to accommodate any recessed lighting application and allow lamp aiming while power is on.
Application areas: retail, shopping centers, corridors, window display.

Related Products



Colosseo Square



Colosseo 90
Adjustable Trim 1 light head □88

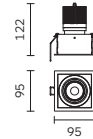

Colosseo 90
Adjustable Trim 2 light heads 168x88

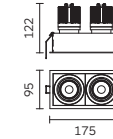

Colosseo 90
Adjustable Trim 3 light heads 247x88

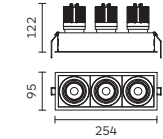

Colosseo 90
Adjustable Trimless 1 light head □85

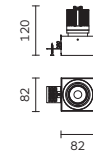

Colosseo 90
Adjustable Trimless 2 light heads 165x85

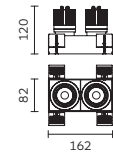

Colosseo 90
Adjustable Trimless 3 light heads 243x85

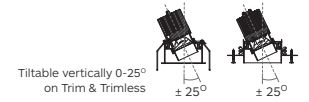
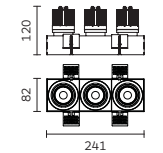

Code ordering example: **R P 6 5 M C 3 1 - 9 0 3 0 1 1 D 0 1 0**

	Product Code	Light Source Code*	>CRI	CCT**	LED Power	Nominal Lumen	Beam Angle (BA°)	Driver Options	Finish
Colosseo 90 Square Adjustable 1 light head	RP65 <input checked="" type="checkbox"/> x1 R075 <input type="checkbox"/>	MC31 COB LED	90	30 3000K 40 4000K	11W	1088 lm 1183 lm	11 / 24 / 32	D0 No Dim DA DALI Dim DP Phase Dim	10 <input checked="" type="checkbox"/> Black 11 <input type="checkbox"/> White
Colosseo 90 Square Adjustable 2 light heads	RP66 <input checked="" type="checkbox"/> x2 RP68 <input type="checkbox"/>				2x11W	2176 lm 2366 lm		DC CASAMBI D1 0-10V Dim	
Colosseo 90 Square Adjustable 3 light heads	RP67 <input checked="" type="checkbox"/> x3 RP69 <input type="checkbox"/>				3x11W	3264 lm 3549 lm			
	GU53	Retrofit MR16-GU5.3	00	00	/	/	00	00 No Driver	
	GU10	GU10-GZ10							

Notes:

* For complete code ordering information, please see page 353.

** For other CCT options, please contact us.

For related accessories, please see page 108-109.

For the most updated product information, please go to our website.

Zero In & Out

Recessed Round 40 | 66



Body

Recessed luminaire with round mounting trim in cast aluminium with springs for trim installation on a ceiling thickness of 1-25mm.

Luminaire body and retractable light head in cast aluminium. Available in 2 different sizes.

The fully retractable light head is tiltable up to 90° and rotatable horizontally 355°.

Accessories

Coloured filters, linear spread, honeycomb louvre, anti-glare tube and anti-glare hood. Check page 108 for details.

Finish

Powder coat in black or white colour.

LED sources

Light source options: High Power LED, COB LED, COB Tuneable White.
CRI: 90 | CCT: 3000K, 4000K, TW.
Other CRI and CCT options available on request.

Optic

Lens. Narrow, medium and wide beam angle available.

Driver

Supplied with no-dimable remote driver. Dimming Options: 0-10V, DALI, CASAMBI.

Applications

Its unique pull-down mechanism, enables it to function as either a downlight or a exposed lamp able to emulate a surface or track fixture. Application areas: retail, hotels, museums, window displays.

Related Products

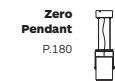
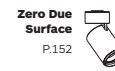
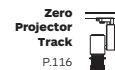
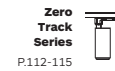
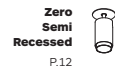

Zero In & Out



Zero In & Out 40
Adjustable Trim Ø78

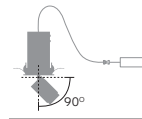
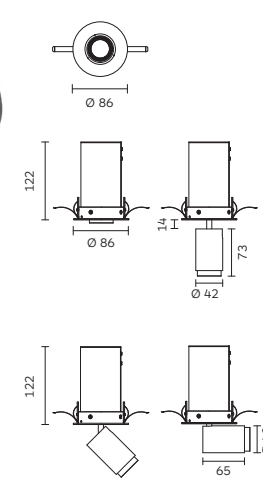

Code ordering example: **R 0 4 2 B C 3 1 - 9 0 3 0 1 6 D 0 1 0**

Zero In & Out 66
Adjustable Trim Ø118

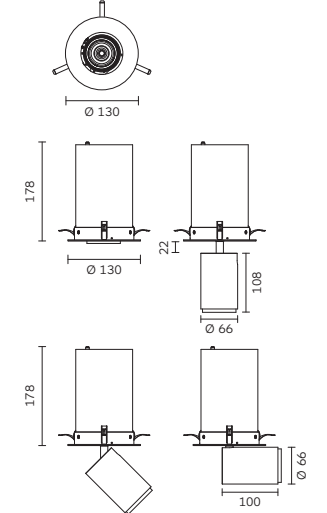

Product Code	Light Source Code*	>CRI	CCT**	LED Power	Nominal Lumen	Beam Angle (BA°)	Driver Options	Finish
Zero In & Out 40 Adjustable	RO42 BC31 COB LED	90	30 3000K	6W	705 lm	16 / 26 / 36	D0 No Dim	10 █ Black
	BR21 High Power LED		40 4000K		770 lm		DA Dali Dim	11 █ White
	BU11 TW COB LED		TW 2700K-6500K	7W	439 lm	07	DC CASAMBI	
Zero In & Out 66 Adjustable	RO43 BC31 COB LED	30	30 3000K	11W	1160 lm	11 / 16 / 32		
	BR21 High Power LED		40 4000K		1258 lm		D1 0-10V Dim	
	IU21 TW COB LED		TW 2700K-6500K	13W	636 lm	05		
					1290 lm	16 / 25 / 48		

Notes:

* For complete code ordering information, please see page 353.

** For other CCT options, please contact us.

For related accessories, please see page 108-109.

For the most updated product information, please go to our website.

Iride

Designed by Walter Amort (Registered)

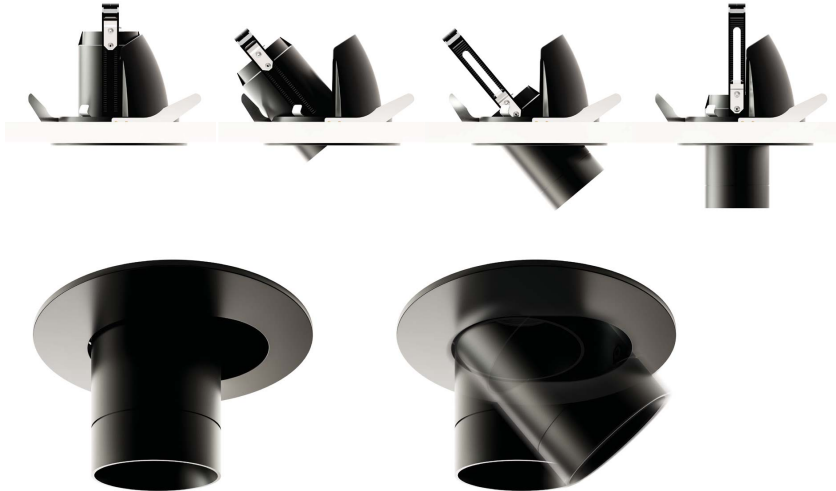

Body

Round mounting trim in cast aluminum with springs for trim installation on a ceiling thickness of 1-25mm.

Luminaire body in cast aluminium and thermoplastic materials.

Easy relamping via removable front ring with twist-lock action for retrofit version. The fully retractable lighthouse is tiltable with up to 35° and rotatable horizontally 350°.

Accessories

Coloured filters, linear spread, honeycomb louvre. Check page 109 for details.

Finish

Powder coat in black or white colour.

LED sources

Light source options: COB LED, Retrofit.
CRI: 90 | CCT: 3000K, 4000K.
Other CRI, CCT and Tuneable White options available on request.

Optic

Lens.
Narrow, medium and wide beam angle available.

Driver

Supplied with No-dimable remote driver.
Dimming Options: 0-10V Dim, DALI, Phase, CASAMBI.

Applications

His unique pull-down mechanism enables it to function as either a downlight, a recessed accent light with great cut-off, or a exposed lamp head able to emulate a surface or track fixture.
Application areas: retail, museums, showrooms, window displays.

Related Products



Iride



Iride 62
Adjustable Trim Ø116

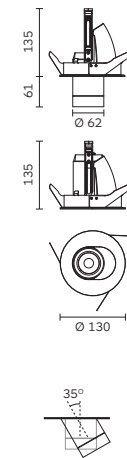

Code ordering example: **R 0 5 8 M C 2 2 - 9 0 3 0 1 8 D 0 1 0**

	Product Code	Light Source Code*	>CRI	CCT**	LED Power	Nominal Lumen	Beam Angle (BA°)	Driver Options	Finish
Iride 62	R058	MC22	90	30 3000K	10W	1220 lm	18 / 24 / 36	D0 No Dim	10 Black
Adjustable				40 4000K		1260 lm		DA Dali Dim	11 White
								DP Phase Dim	
								DC CASAMBI	
								D1 0-10V Dim	
								00 No Driver	
	GU53 Retrofit	MR16-GU5.3	00	00	/	/	00		
	GU10	GU10-GZ10							

Notes:

* For complete code ordering information, please see page 353.

** For other CCT options, please contact us.

For related accessories, please see page 108-109.

For the most updated product information, please go to our website.

Conforto

Recessed 77

Fixed



Wallwasher



Body

Round mounting trim in cast aluminium with clamps for trim installation on a ceiling thickness of max. 30mm.

Luminaire body and front ring in cast aluminium with integrated superpure aluminium reflector.

LED sources

Light source options: COB LED.
CRI: 90 | CCT: 3000K, 4000K.
Other CRI and CCT options available on request.

Optic

Reflector.
Narrow, medium and wallwasher beam angle available.

Accessories

No accessories available.

Finish

Powder coat in white colour.

Driver

Supplied with No-dimable remote driver.
Dimming Options: 0-10V Dim, DALI, Phase, CASAMBI.

Applications

A visual simplicity seamless shape designed for excellent visual comfort keeping homogeneous appearance.
Wallwasher ideal for highlighting the upper part of wall.
Application areas: Retail, hotel, hospital, restaurant, gyms.

Related Products



Conforto



Conforto 77
Fixed Trim Ø68



Conforto 77
Wallwasher Trim Ø68



Code ordering example: **RL85MC22-903018D011**

	Product Code	Light Source Code*	>CRI	CCT**	LED Power	Nominal Lumen	Beam Angle (BA°)	Driver Options	Finish
Conforto 77 Fixed	RL85	BC22 COB LED	90	30 3000K	12W	1498 lm	18 / 40	D0 No Dim	11 White
Conforto 77 Wallwasher	RL86		40	4000K		1522 lm	WW	DP Phase Dim DC CASAMBI D1 0-10V Dim	

Notes:

* For complete code ordering information, please see page 353.
** For other CCT options, please contact us.

WW = Wallwasher
For the most updated product information, please go to our website.

Punto

Recessed Round & Square 76 | 100

Fixed



Adjustable



Body

Round and square shape mounting trim in cast aluminium with springs for trim installation on a ceiling thickness of max. 25mm or brackets for trimless installation on a ceiling thickness 12.5-15mm.

Luminaire body in cast aluminium. Easy relamping tool-free via removable lamp front ring by twist and lock action.

Adjustable version tiltable vertically 0-25° tilt and rotatable horizontally 350°.

Accessories

Coloured filters, linear spread, honeycomb louvre, snoot, anti-glare cone, anti-glare hood. Check page 39 for details.

Finish

Powder coat in black or white colour.

LED sources

Light source options: COB LED. Retrofit.
CRI: 90 | CCT: 3000K, 4000K.
Other CRI and CCT options available on request.

Optic

Lens.
Narrow, medium, wide and wallwasher beam angle available.

Driver

Supplied with No-dimable remote driver.
Dimming Options: 0-10V Dim, DALI, Phase, CASAMBI.

Applications

A visual simplicity seamless shape designed for excellent visual comfort versions include full directional light adjustability for maximum versatility keeping homogeneous appearance.
Application areas: retail, hotels, restaurants, hospitals, gyms.

Related Products



Punto Fixed



Punto 76
Fixed Round Trim Ø71

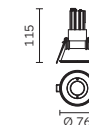

Punto 76
Fixed Square Trim □71



Punto 76
Fixed Round Trimless Ø76

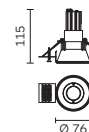

Punto 76
Fixed Square Trimless □76

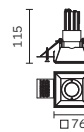

Code ordering example: **R N 2 3 M C 3 1 - 9 0 3 0 1 6 D 0 1 0**

	Product Code	Light Source Code*	>CRI	CCT	LED Power	Nominal Lumen	Beam Angle (00°)	Driver Options	Finish
Punto 76 Fixed Round	RN23 <input checked="" type="checkbox"/>	MC31 COB LED	90	30 3000K	6W	710 lm	16 / 26 / 36	D0 No Dim	10 <input checked="" type="checkbox"/> Black
	RN24 <input type="checkbox"/>			40 4000K		770 lm		DA Dali Dim	11 <input type="checkbox"/> White
								DP Phase Dim	
Punto 76 Fixed Square	RN25 <input checked="" type="checkbox"/>							DC CASAMBI	
	RN26 <input type="checkbox"/>							D1 0-10V Dim	
								00 No Driver	

Notes:

* For complete code ordering information, please see page 353.

** For other CCT options, please contact us.

For the most updated product information, please go to our website.

Punto Adjustable

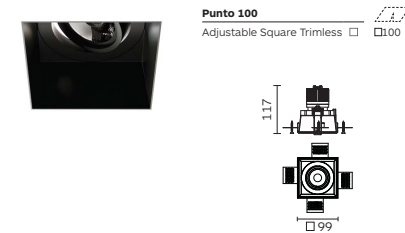

Code ordering example: **R P 2 6 M C 2 2 - 9 0 3 0 1 8 D 0 1 0**

	Product Code	Light Source Code*	>CRI	CCT**	LED Power	Nominal Lumen	Beam Angle (BA°)	Driver Options	Finish
Punto 100 Adjustable Round	RP26 <input checked="" type="radio"/> MC22 <input type="radio"/>	COB LED	90	30 3000K	10W	1276 lm	18 / 24 / 36 / 58	D0 No Dim	10 <input checked="" type="checkbox"/> Black
	RF56 <input type="radio"/>			40 4000K		1296 lm		DA Dali Dim	11 <input type="checkbox"/> White
Punto 100 Adjustable Square	RP27 <input checked="" type="checkbox"/>							DP Phase Dim	
	RF58 <input type="checkbox"/>							DC CASAMBI	
								D1 0-10V Dim	
	GU53 Retrofit	MR16-GU5.3	00	00	/	/	00	00 No Driver	
	GU10	GU10-GZ10							

Notes:
 * For complete code ordering information, please see page 353.
 ** For other CCT options, please contact us.
 For related accessories, please see page 39.
 For the most updated product information, please go to our website.

Optical Accessories

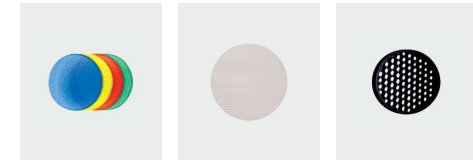

Product / Optical Accessories	Coloured Filters Colours 25, 42, 55, 85	Linear Spread Colour 41	Honeycomb Louvre Colour 10
Punto 100 Adjustable Round & Square	2614*	2615	2504

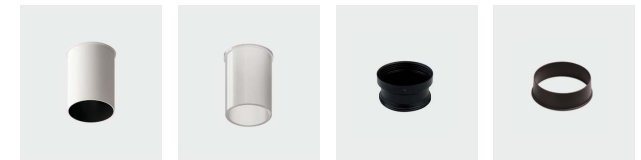

Product / Optical Accessories	Snoot Colour 17	Shoot Colour 40*	Anti-Glare Cone Colours 10, 17	Anti-Glare Hood Colours 10, 17
Punto 100 Adjustable Round & Square	2F01	2F01	2661	2675

* With holder
 * In plastic. Sanded transparent.

Lumi

Recessed 50 | 65



Body

Round shape mounting trim in cast aluminum with twist and lock action for trim installation and additional bracket for trimless installation on a ceiling thickness max. 20mm. Lamp body and lock cone in cast aluminium.

Fixing ring can be installed independently. IP40 luminaire.

LED sources

Light source options: COB LED.
CRI: 90 | CCT: 3000K, 4000K.
Other CRI and CCT options available on request.

Optic

Lens.
Narrow, medium and wide beam angle available.

Accessories

Honeycomb louvre.
Check page 108 for detail

Finish

Powder coat in black or white colour.

Driver

Supplied with No-dimable remote driver.
Dimming Options: 0-10V Dim, DALI, Phase, CASAMBI.

Applications

A concealed light source for minimum glare design of small aperture recessed luminaires that easily blend into the architecture to meet the need of designers.
Application areas: retail, showrooms, residential, restaurants, hotels.

Related Products



Lumi Fixed



Lumi 50
Fixed Trim

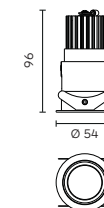

Lumi 50
Fixed Trimless

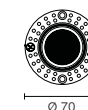
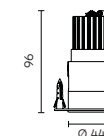

Lumi 65
Fixed Trim

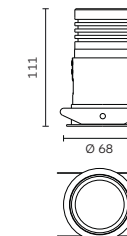

Lumi 65
Fixed Trimless

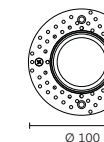
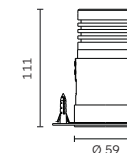

Code ordering example: **RP29BC31-903016D010**

	Product Code	Light Source Code*	>CRI	CCT**	LED Power	Nominal Lumen	Beam Angle (BA°)	Driver Options	Finish
Lumi 50 Fixed	RP29 ● BC31	COB LED	90	30 3000K	6W	710 lm	16 / 26 / 36	D0 No Dim	10 ■ Black
	RP30 ○		40	4000K		770 lm		DA Dali Dim	11 □ White
Lumi 65 Fixed	RP22 ●				11W	1160 lm	18 / 24	DP Phase Dim	
	RP23 ○					1260 lm		DC CASAMBI	
								D1 0-10V Dim	

Notes:

* For complete code ordering information, please see page 353.

** For other CCT options, please contact us.

For related accessories, please see page 108-109.

For the most updated product information, please go to our website.

Lumi

Recessed 65



Body

The new Lumi adjustable is a round-shaped deep recessed downlight with minimal glare and light dispersion having a cast aluminum body.

It features an almost invisible led source, rotates 360° horizontally, and tilts ±25° vertically while remaining inside the ceiling level.

This modular lighting system combines a special optic lens producing a uniform lighting effect that provides high visual comfort. Lumi Adjustable is available with trim and trimless versions for installation

Accessories

Honeycomb louvre.
Check page 108 for detail

Finish

Powder coat in black or white colour.

LED sources

Light source options: COB LED.
CRI: 90 | CCT: 3000K, 4000K.
Other CRI and CCT options available on request.

Optic

Lens.
Narrow, medium, and wide beam angle available.

Driver

Supplied with a Non-dimmable remote driver.
Dimming Options: 0-10V Dim, DALI, Phase, CASAMBI.

Applications

A concealed light source for minimum glare design of small aperture recessed luminaires that easily blend into the architecture to meet the need of designers.
Application areas: Corridors, retail, showrooms, residential, restaurants, hotels.

Related Products



Lumi Adjustable



Lumi 65
Adjustable Trim Ø75

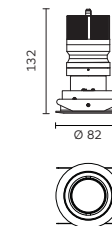

Lumi 65
Adjustable Trimless Ø75

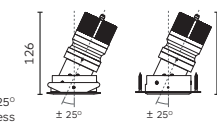
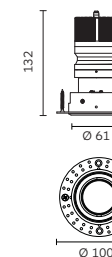

Code ordering example: **R P 9 7 B C 3 1 - 9 0 3 0 1 6 D 0 1 0**

	Product Code	Light Source Code*	>CRI	CCT**	LED Power	Nominal Lumen	Beam Angle (BA°)	Driver Options	Finish
Lumi 65 Adjustable	RP97	BC31	COB LED	90	30 3000K	1160 lm	18 / 24	D0 No Dim	10 Black
	RP98			40 4000K		1260 lm		DA Dali Dim	11 White
								DP Phase Dim	
								DC CASAMBI	
								D1 0-10V Dim	

Notes:

* For complete code ordering information, please see page 353.

** For other CCT options, please contact us.

For related accessories, please see page 108-109.

For the most updated product information, please go to our website.

Spotify

Recessed Downlight

Fixed / Adjustable



Accessories for Spotify Fixed & Adjustable

Body

Spotify product family is a small recessed downlight available in square and round shapes, providing high visual comfort thanks to a deep recessed LED Engine.

Following formalighting's Eco Design philosophy, Spotify is available in Trim and Trimless, fixed and adjustable versions with modular and tool-free LED-engine and optical accessories site changeable options.

The Body is made of high-grade Aluminium.

For adjustable version: Tiltable vertically 0-32° tilt and rotatable horizontally 355°. Adjustable 32° always inside ceiling level.

Accessories

Tool free changeable. Honeycomb louvre, Linear Spread, Concave Trim, Anti-Glare Cone, Snoot. Check page 108 for details.

Finish

Powder coat in black and white colour.

LED sources

Light source options: High Power LED. CRI: 90 | CCT: 3000K, 4000K. SunLike LED. CRI: 98 | CCT: 3000K, 4000K. Other CRI and CCT options available on request.

Optic

High grade PMMA Lenses. Narrow, medium and wide beam angle available. Wallwasher beam angle available.

Driver

Remote driver 220-240VAC included. Dimming options: 0-10V, DALI,Phase, Casambi.

Applications

Application areas: High end residential and retail projects, hotels, museums and galleries.

Related Products

Lumi Recessed
P.40-43

Micron IP54 Recessed
P.52

Occhio Pin / Slot Recessed
P.54

Nippo Recessed
P.58

Spotify Fixed Round



Spotify 76
Fixed Round Trim Ø70

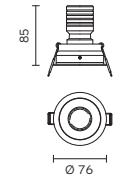

Spotify 76
Fixed Round Trimless Ø70

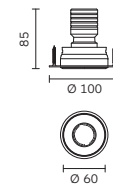

Code ordering example: **R P 7 9 M R 2 1 - 9 0 3 0 1 0 D 0 1 0**

	Product Code	Light Source Code*	>CRI	CCT**	LED Power	Nominal Lumen	Beam Angle (BA°)	Driver Options	Finish
Spotify Fixed Round	RP79	MR21 High Power LED	90	30 3000K	8.3W	672 lm	10 / 24 / 30	D0 No Dim	10 Black
				40 4000K		790 lm		DA Dali Dim	11 White
	RP80	MK11 SunLike LED	97		9.5W	888 lm	18 / 24 / 34	DP Phase Dim	
						924 lm		DC CASAMBI	
								D1 0-10V Dim	

Notes:

* For complete code ordering information, please see page 353.

** For other CCT options, please contact us.

For related accessories, please see page 108-109.

For the most updated product information, please go to our website.

Spotify Adjustable Round



Spotify 76
Adjustable Round Trim  

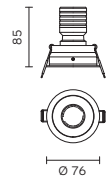

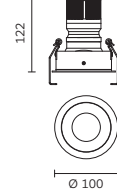

Spotify 100
Adjustable Round Trim  

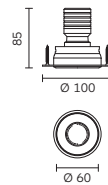

Spotify 76
Adjustable Round Trimless  



Spotify 100
Adjustable Round Trimless  

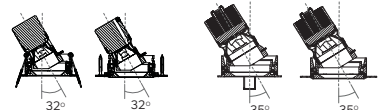
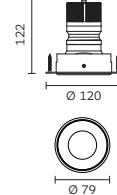

Tilttable up to 32° for Spotify 76
Tilttable up to 35° for Spotify 100
in left / right directions.



Code ordering example: **R P 7 7 M R 2 1 - 9 0 3 0 1 0 D 0 1 0**

	Product Code	Light Source Code*	>CRI	CCT**	LED Power	Nominal Lumen	Beam Angle (BA°)	Driver Options	Finish
Spotify 76 Adjustable Round	RP77 <input checked="" type="checkbox"/>	MR21 High Power LED	90	30 3000K	8.3W	672 lm	10 / 24 / 30	D0 No Dim	10 <input checked="" type="checkbox"/> Black
	RP78 <input type="checkbox"/>	MK11 SunLike LED	97	40 4000K	9.5W	790 lm	18 / 24 / 34	DA Dali Dim	11 <input type="checkbox"/> White
						924 lm		DP Phase Dim DC CASAMBI	
Spotify 100 Adjustable Round	RP91 <input checked="" type="checkbox"/>	MC31 COB LED	90	30 3000K	11W	1160 lm	11 / 26	D1 0-10V Dim	
	RP92 <input type="checkbox"/>		40	4000K		1260 lm			

Notes:
* For complete code ordering information, please see page 353.
** For other CCT options, please contact us.
For related accessories, please see page 106-109.
For the most updated product information, please go to our website.

Spotify Adjustable Square



Spotify 100
Adjustable Square Trim  

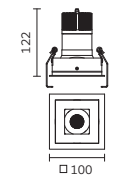

Spotify 100
Adjustable Square Trimless  

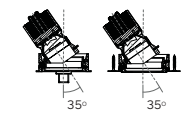
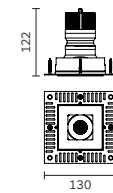

For Trim & Trimless version
Tilttable up to 35°
in left / right directions.

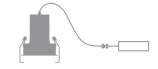

Code ordering example: **R P 9 3 M C 3 1 - 9 0 3 0 1 0 D 0 1 0**

	Product Code	Light Source Code*	>CRI	CCT**	LED Power	Nominal Lumen	Beam Angle (BA°)	Driver Options	Finish
Spotify 100 Adjustable Square	RP93 <input checked="" type="checkbox"/>	MC31 COB LED	90	30 3000K	11W	1160 lm	11 / 26	D0 No Dim	10 <input checked="" type="checkbox"/> Black
	RP94 <input type="checkbox"/>			40 4000K		1260 lm		DA Dali Dim DP Phase Dim DC CASAMBI D1 0-10V Dim	11 <input type="checkbox"/> White

Notes:
* For complete code ordering information, please see page 353.
** For other CCT options, please contact us.
For related accessories, please see page 106-109.
For the most updated product information, please go to our website.

Espresso

Recessed Spotlight

Concave / Wallwasher

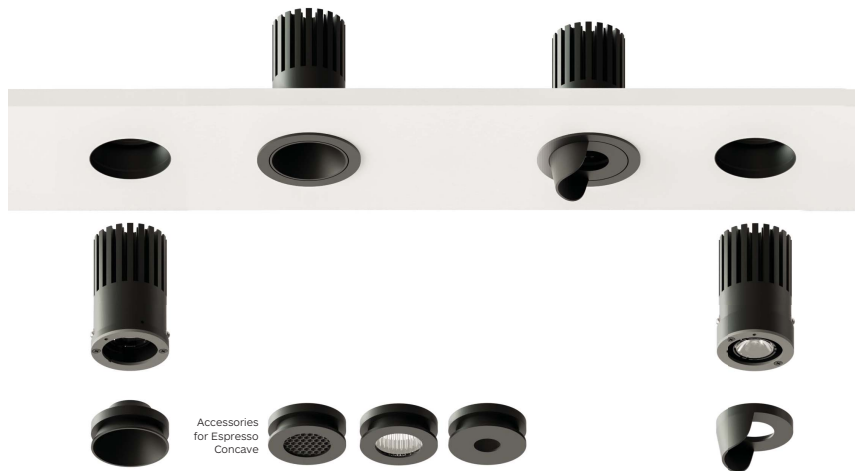

Accessories for Espresso Concave

Body

Espresso product family is a miniature round recessed LED luminaire providing high performance accent or wall wash lighting from deep regressed light source.

Following formalighting's Eco Design philosophy, Espresso is available in Trim and Trim less version with modular and tool free LED-engine and optical accessories site changeable options.

The Body is made of high grade Aluminium.

Accessories

Tool free changeable. Honeycomb, Linear Spread, Pin Hole. Check page 51 for details.

Finish

Powder coat in black or white colour.

LED sources

Light source options: High Power LED. CRI: 90 | CCT: 3000K, 4000K. Other CRI and CCT options available on request.

Optic

High Grade PMMA Lenses. Narrow, medium and wide beam angle available. Wallwasher beam angle available.

Driver

Remote driver 220-240VAC included. Dimming options: 0-10V, DALI,Phase, Casambi

Applications

Application areas: High end residential and retail projects, hotels, museums and galleries

Related Products



Espresso Concave



Espresso Concave Round Trim $\varnothing 45$

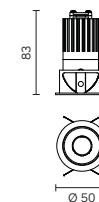

Espresso Concave Round Trimless $\varnothing 45$

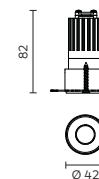

Code ordering example: **RP81MR21-903015D010**

	Product Code	Light Source Code*	>CRI	CCT**	LED Power	Nominal Lumen	Beam Angle (BA°)	Driver Options	Finish
Espresso Concave Round	RP81 \bullet	MR21 High Power LED	90	30 3000K	3.9 W	439 lm	15 / 20 / 32	D0 No Dim	10 \blacksquare Black
	RP82 \circ			40 4000K		483 lm		DA Dali Dim DP Phase Dim DC CASAMBI D1 0-10V Dim	11 \square White

Notes:

* For complete code ordering information, please see page 353.

** For other CCT options, please contact us.

For related accessories, please see page 51.

For the most updated product information, please go to our website.

Espresso Wallwasher



Espresso Wallwasher
Round Trim Ø45

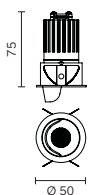

Espresso Wallwasher
Round Trimless Ø45

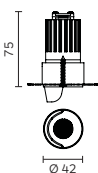

Code ordering example: **RP83 MR21-90 30 WW D0 10**

	Product Code	Light Source Code*	>CRI	CCT**	LED Power	Nominal Lumen	Beam Angle (BA°)	Driver Options	Finish
Espresso Wallwasher Round	RP83	MR21 High Power LED	90	30 3000K	3.9 W	439 lm	WW	D0 No Dim	10 Black
	RP84			40 4000K		483 lm		DA Dali Dim DP Phase Dim DC CASAMBI D1 0-10V Dim	11 White

Notes:
 * For complete code ordering information, please see page 353.
 ** For other CCT options, please contact us.
 For related accessories, please see page 51.
WW = Wallwasher
 For the most updated product information, please go to our website.

Optical Accessories

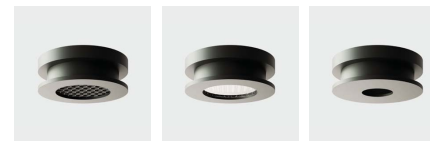

Product / Optical Accessories	Honeycomb Louvre Colour 10	Linear Spread Colour 41	Pin Hole Colours 10, 11
Espresso Concave	2E52*	2E51*	2E50*
Espresso Wallwasher	/	/	/

* For Downlight only, To be ordered separately.
 ** For Wallwasher version, inclusive of glare shield accessory.

Micron

Recessed

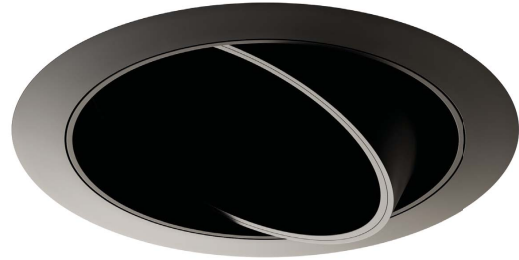

Body

Round shape mounting trim in cast aluminum with springs for trim installation on a ceiling thickness max. 20mm.

Lamp body in cast aluminium and fixing ring in steel. Fixing ring can be installed independently.

Easy relamping via removable light head by snap-in catch action. Available in IP20/IP54 versions. Tilttable vertically 0-35° tilt and rotatable horizontally 350°.

Accessories

No accessories available.

Finish

Powder coat in black or white colour.

LED sources

Light source options: COB LED, Retrofit.
CRI: 90 | CCT: 3000K, 4000K.
Other CRI and CCT options available on request.

Optic

Lens.
Narrow, medium and wide beam angle available.

Driver

Supplied with No-dimable remote driver.
Dimming Options: 0-10V Dim, DALI, Phase, CASAMBI.

Applications

A concealed light source for minimum glare design of small aperture recessed luminaires that easily blend into the architecture to meet the need of designers.
Application areas: retail, showrooms, residential, restaurants, hotels.

Related Products

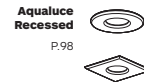

Micron

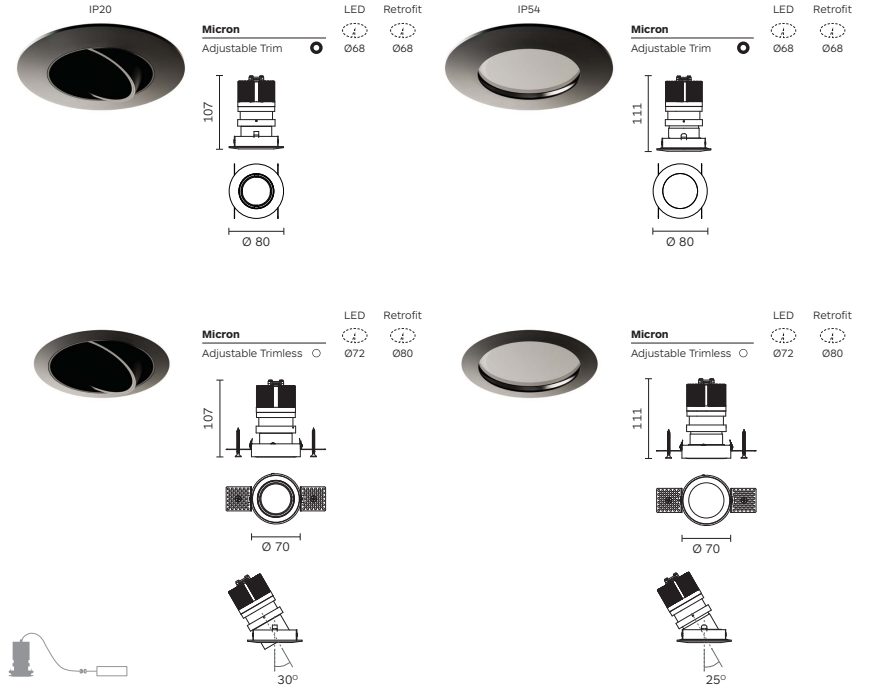

Code ordering example: **R L 5 9 M C 2 2 - 9 0 3 0 1 8 D 0 1 0**

	Product Code	Ingress Protection	Light Source Code*	>CRI	CCT**	LED Power	Nominal Lumen	Beam Angle (BA°)	Driver Options	Finish	
Micron Adjustable	RL59 <input checked="" type="radio"/>	IP20	MC22 COB LED	<input checked="" type="checkbox"/>	90	30 3000K	10W	1220 lm	18 / 24 / 36	D0 No Dim	10 <input checked="" type="checkbox"/> Black
	RO56 <input type="radio"/>				40 4000K		1260 lm		DA Dali Dim	11 <input type="checkbox"/> White	
	RL60 <input checked="" type="radio"/>	IP54							DP Phase Dim		
	RO57 <input type="radio"/>								DC CASAMBI		
									D1 0-10V Dim		
	GU53 Retrofit	MR16-GU5.3	<input checked="" type="checkbox"/>	00	00	/	/	00	00 No Driver		
	GU10	GU10-GZ10	<input checked="" type="checkbox"/>								

Notes:

- * For complete code ordering information, please see page 353.
 - ** For other CCT options, please contact us.
- For the most updated product information, please go to our website.

Occhio

Recessed 65 | 87

Pin Fixed



Pin Adjustable



Slot Adjustable



Body

Round shape mounting trim in cast aluminium with brackets for trim installation on a ceiling thickness max. 20mm.

Light body in cast aluminium. Available in two different designs, Pin and Slot. IP44 version for water protection ideal for bathroom.

Designed with deep regressed lamp position for glare-free comfort. Adjustable version tiltable vertically 0-35°.

LED sources

Light source options: COB LED, Retrofit.
CRI: 90 | CCT: 3000K, 4000K.
Other CRI and CCT options available on request.

Optic

Reflector.
Narrow, medium and wide beam angle available.

Accessories

Occhio 65: Honeycomb louvre.
Occhio 87: Coloured filters, linear spread, honeycomb louvre, protective recessed ring, protective ring.
Check page 109 for details.

Finish

Powder coat in black, white or grey colour.

Driver

Supplied with No-dimable remote driver.
Dimming Options: 0-10V Dim, DALI, Phase, CASAMBI.

Applications

Outstanding lighting fixture. Occhio Pin provides a consistent ceiling appearance whilst the Occhio Slot provides the maximum adjustment in this type of small fixture.
Application areas: bathrooms, residential, museums, retail, hotels.

Occhio Pin Fixed



IP20



IP44



Occhio Pin 65
Pin Fixed Trim Ø57



Occhio Pin 87
Pin Fixed Trim Ø75

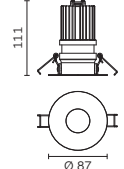

Occhio Pin 87
Pin Fixed Trim Ø75

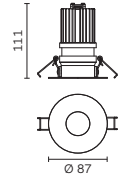

Related Products

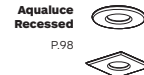

Code ordering example: **R N 5 7 G U 0 4 - 0 0 0 0 0 0 1 0**

	Product Code	Ingress Protection	Light Source Code*	>CRI	CCT**	LED Power	Nominal Lumen	Beam Angle (BA°)	Driver Options	Finish
Occhio 65 Pin Fixed	RN57	IP20	GU04 Retrofit MR11-GU4	00	00	/	/	00	00 No Driver	10 Black
			MC31 COB LED	90	30 3000K	6W	616 lm	16 / 30	D0 No Dim	11 White
					40 4000K		643 lm	18 / 24 / 36	DA Dali Dim	75 Grey
Occhio 87 Pin Fixed	RK96	IP20	MC22 COB LED			10W	1220 lm	18 / 24 / 36	DP Phase Dim	
			RL38	IP44				1260 lm		DC CASAMBI
									D1 0-10V Dim	
			GU53 Retrofit MR16-GU5.3	00	00	/	/	00	00 No Driver	
			GU10 GU10-GZ10							

Notes:

* For complete code ordering information, please see page 353.

** For other CCT options, please contact us.

For related accessories, please see page 108-109.

For the most updated product information, please go to our website.

Occhio Pin Adjustable

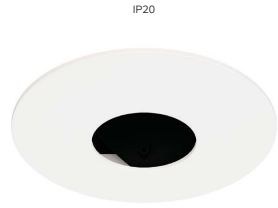

IP20

Occhio Pin 65
Pin Adjustable Trim Ø57

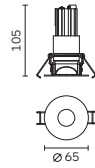

Occhio Pin 87
Pin Adjustable Trim Ø75

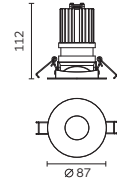

IP44

Occhio Pin 87
Pin Adjustable Trim Ø75

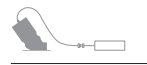
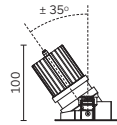
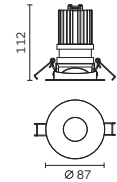

Code ordering example: **R N 5 8 G U 0 4 - 0 0 0 0 0 0 0 1 0**

	Product Code	Ingress Protection	Light Source Code*	>CRI	CCT**	LED Power	Nominal Lumen	Beam Angle (BA°)	Driver Options	Finish
Occhio 65 Pin Adjustable	RN58	IP20	GU04 Retrofit MR11-GU4	00	00	/	/	00	00 No Driver	10 Black
			MC31 COB LED	90	30 3000K	6W	616 lm	16 / 30	D0 No Dim	11 White
					40 4000K	643 lm		DA Dali Dim	75 Grey	
Occhio 87 Pin Adjustable	RL01	IP20	MC22 COB LED			10W	1220 lm	18 / 24 / 36	DP Phase Dim	
			RL42	IP44				1260 lm		DC CASAMBI
								D1 0-10V Dim		
			GU53 Retrofit MR16-GU5.3	00	00	/	/	00	00 No Driver	
			GU10 GU10-GZ10							

Notes:
 * For complete code ordering information, please see page 353.
 ** For other CCT options, please contact us.
 For related accessories, please see page 106-109.
 For the most updated product information, please go to our website.

Occhio Slot Adjustable

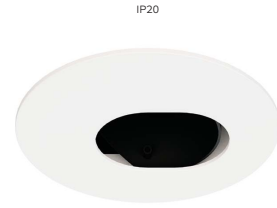

IP20

Occhio Pin 65
Slot Adjustable Trim Ø57

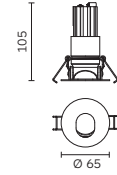

Occhio Pin 87
Slot Adjustable Trim Ø75

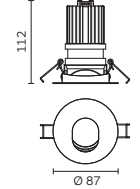

IP44

Occhio Pin 87
Slot Adjustable Trim Ø75

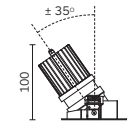
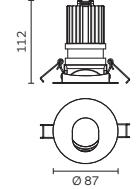

Code ordering example: **R N 5 6 G U 0 4 - 0 0 0 0 0 0 0 1 0**

	Product Code	Ingress Protection	Light Source Code*	>CRI	CCT**	LED Power	Nominal Lumen	Beam Angle (BA°)	Driver Options	Finish
Occhio 65 Slot Adjustable	RN56	IP20	GU04 Retrofit MR11-GU4	00	00	/	/	00	00 No Driver	10 Black
			MC31 COB LED	90	30 3000K	6W	616 lm	16 / 30	D0 No Dim	11 White
					40 4000K	643 lm		DA Dali Dim	75 Grey	
Occhio 87 Slot Adjustable	RL05	IP20	MC22 COB LED			10W	1220 lm	18 / 24 / 36	DP Phase Dim	
			RL46	IP44				1260 lm		DC CASAMBI
								D1 0-10V Dim		
			GU53 Retrofit MR16-GU5.3	00	00	/	/	00	00 No Driver	
			GU10 GU10-GZ10							

Notes:
 * For complete code ordering information, please see page 353.
 ** For other CCT options, please contact us.
 For related accessories, please see page 106-109.
 For the most updated product information, please go to our website.

Nippo

Recessed Adjustable Round & Square



Body

Round or square shape mounting trim in cast aluminium with springs for trim installation on a ceiling thickness max. 25mm.

Luminaire body in cast aluminium inclusive of dark light cone reflector in super pure aluminium.

Designed for optimum heat dissipation. Easy relamping via removable front reflector and by twist-lock action.

Tilttable vertically 0-25° and rotatable horizontally 350°.

Accessories

Coloured filters, linear spread, honeycomb louvre. Check page 109 for details.

Finish

Powder coat in white or grey colour.

LED sources

Light source options: COB LED, Retrofit.
CRI: 90 | CCT: 3000K, 4000K.
Other CRI and CCT options available on request.

Optic

Reflector + Diffuser.
Narrow, medium and wide beam angle available.

Driver

Supplied with No-dimable remote driver.
Diming Options: 0-10V Dim, DALI, Phase, CASAMBI.

Applications

Adjustable fixture include a specular darklight cone reflector offering excellent glare-free visual comfort to minimize impact while piercing through ambient light levels.
Application areas: hotels, residential, retail, galleries.

Related Products

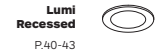

Nippo Adjustable Round & Square

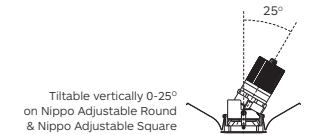
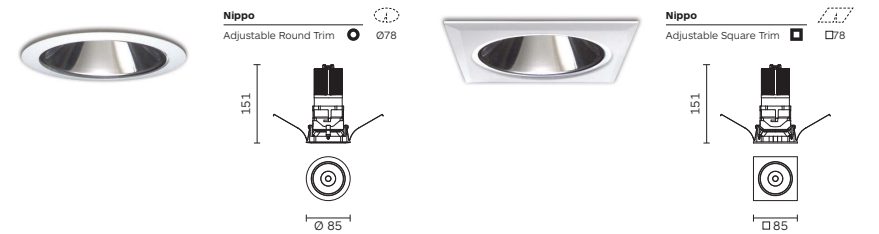

Code ordering example: **R J 1 1 M C 2 2 - 9 0 3 0 1 6 D 0 1 1**

	Product Code	Ingress Protection	Light Source Code*	>CRI	CCT**	LED Power	Nominal Lumen	Beam Angle (BA°)	Driver Options	Finish
Nippo Adjustable Round	RJ11 ○ IP20	MC22	COB LED	90	30 3000K	12W	1490 lm	16 / 26	D0 No Dim	11 □ White
	RL54 ○ IP44				40 4000K		1520 lm		DA Dali Dim	75 ■ Grey
Nippo Adjustable Square	RL48 □ IP20								DP Phase Dim	
	RL55 □ IP44								DC CASAMBI	
									D1 0-10V Dim	
		IP20	GU53 Retrofit MR16-GU5.3	00	00	/	/	00	00 No Driver	
			GU10 GU10-GZ10							

Notes:

* For complete code ordering information, please see page 353.

** For other CCT options, please contact us.

For related accessories, please see page 108-109.

For the most updated product information, please go to our website.

Ovo

Recessed 65 | 90 | 160

Fixed / Adjustable



Body

Round shape mounting trim in cast aluminum with brackets (160) or clamps (90, 65) for trim installation on ceiling thickness max. 12mm or brackets for trimless installation on ceiling thickness max. 30mm.

Luminaire body in cast aluminium. Regressed lamp holder position for minimum glare.

Adjustable version tiltable vertically 0-30° tilt and rotatable horizontally 350°.

LED sources

Light source options: COB LED, Retrofit.
CRI: 90 | CCT: 3000K, 4000K.
Other CRI and CCT options available on request.

Related Products



Optic

Lens or reflector.
Narrow, medium and wide beam angle available.

Accessories

No accessories available.

Finish

Powder coat in black, white or grey colour.

Driver

Supplied with No-dimable remote driver.
Dimming Options: 0-10V Dim, DALI, Phase, CASAMBI.

Applications

Organic form, provide excellent glare control to minimize impact while piercing through ambient light levels to meet the highest functional requirements of architectural lighting design.
Application areas: hotels, residential, retail, galleries.

Ovo Fixed



Ovo 65
Fixed Trim ○ Ø59



Ovo 90
Fixed Trim ○ Ø79



Ovo 160
Fixed Trim ○ Ø150

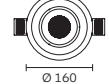
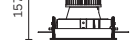

Ovo 65
Fixed Trimless ○ Ø59



Ovo 90
Fixed Trimless ○ Ø86



Ovo 160
Fixed Trimless ○ Ø150

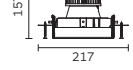

Code ordering example: **R J 7 6 M C 3 1 - 9 0 3 0 1 6 D 0 1 0**

	Product Code	Light Source Code*	>CRI	CCT**	LED Power	Nominal Lumen	Beam Angle (BA°)	Driver Options	Finish
Ovo 65 Fixed	RJ76 ○	MC31 COB LED	90	30 3000K	6W	616 lm	16 / 24 / 32	D0 No Dim	10 ■ Black
	RJ77 ○			40 4000K		643 lm		DA Dali Dim	11 □ White
Ovo 90 Fixed	RJ68 ○	MC22 COB LED			10W	1238 lm	18 / 24 / 34	DP Phase Dim	75 ■ Grey
	RJ72 ○					1260 lm		DC CASAMBI	
		GU53 Retrofit	00	00	/	/	00	D1 0-10V Dim	
		MR16-GU5.3						00 No Driver	
		GU10							
		GU10-GZ10							
Ovo 160 Fixed	RJ63 ○	MC33 COB LED	90	30 3000K	33W	3220 lm	12 / 22 / 32	D0 No Dim	
	RJ64 ○			40 4000K		3300 lm		DA Dali Dim	
								DP Phase Dim	
								DC CASAMBI	
								D1 0-10V Dim	

Notes:

* For complete code ordering information, please see page 353.

** For other CCT options, please contact us.

For the most updated product information, please go to our website.

Ovo Adjustable



Ovo 65
Adjustable Trim Ø59

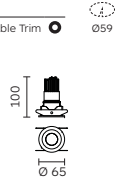

Ovo 90
Adjustable Trim Ø79

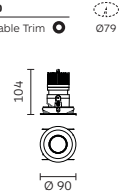

Ovo 160
Adjustable Trim Ø150

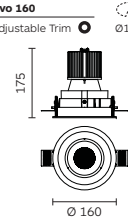

Ovo 65
Adjustable Trimless Ø59

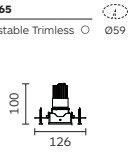

Ovo 90
Adjustable Trimless Ø86

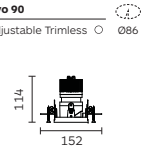

Ovo 160
Adjustable Trimless Ø150

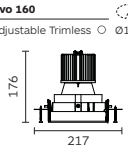

Ø 57



Ø 84



Ø 147



± 25°



± 30°

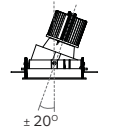

± 20°

Code ordering example: **R J 2 9 M C 3 1 - 9 0 3 0 1 6 D 0 1 0**

	Product Code	Light Source Code*	>CRI	CCT**	LED Power	Nominal Lumen	Beam Angle (BA°)	Driver Options	Finish
Ovo 65 Adjustable	RJ29 <input checked="" type="radio"/>	MC31 COB LED	90	30 3000K	6W	616 lm	16 / 24 / 32	D0 No Dim	10 <input checked="" type="checkbox"/> Black
	RJ30 <input type="radio"/>			40 4000K		643 lm		DA Dali Dim	11 <input type="checkbox"/> White
Ovo 90 Adjustable	RH31 <input checked="" type="radio"/>	MC22 COB LED			10W	1238 lm	18 / 24 / 34	DP Phase Dim	75 <input checked="" type="checkbox"/> Grey
	RJ31 <input type="radio"/>					1260 lm		DC CASAMBI	D1 0-10V Dim
		GU53 Retrofit MR16-GU5.3	00	00	/	/	00	00 No Driver	
		GU10 GU10-GZ10							
Ovo 160 Adjustable	RJ32 <input checked="" type="radio"/>	MC33 COB LED	90	30 3000K	33W	3220 lm	12 / 22 / 32	D0 No Dim	
	RJ33 <input type="radio"/>			40 4000K		3300 lm		DA Dali Dim	
								DP Phase Dim	
								DC CASAMBI	
								D1 0-10V Dim	

Notes:

* For complete code ordering information, please see page 353.

** For other CCT options, please contact us.

For the most updated product information, please go to our website.



Venus

Recessed Round & Square 70 | 125

Concave Fixed & Adjustable



Fixed & Adjustable



Wallwasher



Body

Round or square shape mounting trim in cast aluminum with brackets for trim installation on ceiling thickness max. 32mm or trimless installation on ceiling thickness max. 25mm.

Concave shape luminaire body in cast aluminum with catch retainer for easy trim insertion/removal and integrated steel sheet, inclusive of tool-less locking point and safety cable.

Adjustable version tiltable vertically 0-30° (70) or 0-45° (125) and rotatable horizontally 350° for both models.

Accessories

Venus 125 & Venus 125 Concave: Coloured filters, linear spread, honeycomb louvre. Check page 108 for details.

Finish

Powder coat in black or white colour.

LED sources

Light source options: COB LED, Retrofit.
CRI: 90 | CCT: 3000K, 4000K.
Other CRI and CCT options available on request.

Related Products

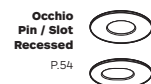

Optic

Reflector + diffuser.
Narrow, medium and wide beam angle available.

Driver

Supplied with No-dimable remote driver.
Dimming Options: 0-10V Dim, DALI, Phase, CASAMBI.

Applications

Represent the pinnacle of innovation and design of small aperture recessed luminaires that easily blend into the architecture to meet the need of designers.
Application areas: retail, showrooms, residential, restaurants, hotels.

Venus Concave Fixed Round



Venus 125 Concave

Fixed Round Trim



Venus 125 Concave

Fixed Round Trimless

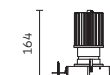

Code ordering example: **R 0 1 9 M C 2 2 - 9 0 3 0 2 2 D 0 1 0**

	Product Code	Ingress Protection	Light Source Code*	>CRI	CCT**	LED Power	Nominal Lumen	Beam Angle (BA°)	Driver Options	Finish
Venus 125	RO19 ○	IP20	MC22 COB LED	90	30 3000K	22W	2418 lm	22 / 36	D0 No Dim	10 ■ Black
Concave	RO20 ○				40 4000K		2456 lm		DA Dali Dim	11 □ White
Fixed	RO21 ○	IP44							DP Phase Dim	
Round	RO22 ○								DC CASAMBI	
									D1 0-10V Dim	
	GU53	Retrofit	MR16-GU5.3	00	00	/	/	00	00	No Driver
	GU10		GU10-GZ10							

Notes:

* For complete code ordering information, please see page 353.

** For other CCT options, please contact us.

For related accessories, please see page 108-109.

For the most updated product information, please go to our website.

Venus Concave Adjustable Round

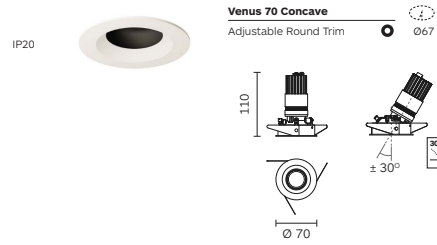

Venus 70 Concave
Adjustable Round Trim ○ Ø67

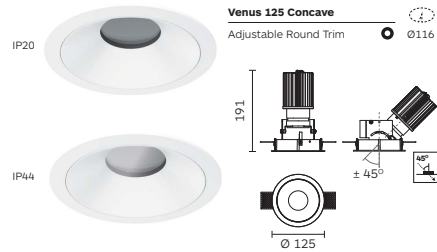

Venus 125 Concave
Adjustable Round Trim ○ Ø116

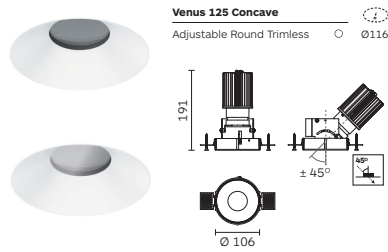

Venus 125 Concave
Adjustable Round Trimless ○ Ø116

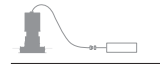

Code ordering example: **R 0 4 0 M C 3 1 - 9 0 3 0 1 8 D 0 1 0**

	Product Code	Ingress Protection	Light Source Code*	>CRI	CCT**	LED Power	Nominal Lumen	Beam Angle (BA°)	Driver Options	Finish
Venus 70 Concave Adjustable Round	RO40 ○	IP20	MC31 COB LED	90	30 3000K	6W	616 lm	18 / 24 / 32	D0 No Dim	10 ■ Black
					40 4000K			DA Dali Dim	11 □ White	
Venus 125 Concave Adjustable Round	RN59 ○	IP20	MC22 COB LED	90	30 3000K	22W	2418 lm	20 / 30	DP Phase Dim	10 ■ Black
							2456 lm		DC CASAMBI	
									D1 0-10V Dim	
	RN61 ○	IP44								
	RN62 ○									
	GU53	Retrofit MR16-GU5.3		00	00	/	/	00	00 No Driver	
	GU10	GU10-GZ10								

Notes:
 * For complete code ordering information, please see page 353.
 ** For other CCT options, please contact us.
 For related accessories, please see page 106-109.
 For the most updated product information, please go to our website.

Venus Fixed Round



Venus 125
Fixed Round Trim ○ Ø116

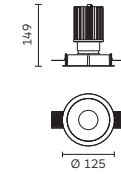

Venus 125
Fixed Round Trimless ○ Ø116

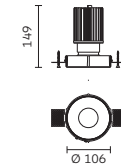

Code ordering example: **R G 3 8 M C 2 2 - 9 0 3 0 2 2 D 0 1 0**

	Product Code	Ingress Protection	Light Source Code*	>CRI	CCT**	LED Power	Nominal Lumen	Beam Angle (BA°)	Driver Options	Finish
Venus 125 Fixed Round	RG38 ○	IP20	MC22 COB LED	90	30 3000K	22W	2418 lm	22 / 36	D0 No Dim	10 ■ Black
					40 4000K		2456 lm		DA Dali Dim	11 □ White
									DP Phase Dim	
									DC CASAMBI	
	RO24 ○	IP44						DP Phase Dim		
	RO28 ○							DC CASAMBI		
								D1 0-10V Dim		
	GU53	Retrofit MR16-GU5.3		00	00	/	/	00	00 No Driver	
	GU10	GU10-GZ10								

Notes:
 * For complete code ordering information, please see page 353.
 ** For other CCT options, please contact us.
 For related accessories, please see page 106-109.
 For the most updated product information, please go to our website.

Venus Adjustable Round

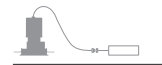
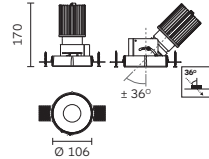
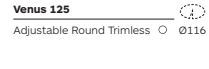
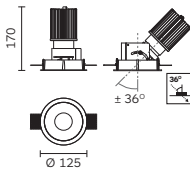
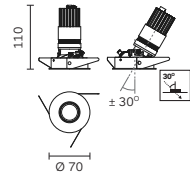
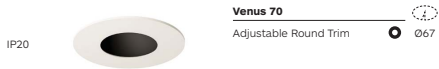

Code ordering example: **R 0 3 8 M C 3 1 - 9 0 3 0 1 8 D 0 1 0**

	Product Code	Ingress Protection	Light Source Code*	>CRI	CCT**	LED Power	Nominal Lumen	Beam Angle (BA°)	Driver Options	Finish
Venus 70 Adjustable Round	RO38 ○	IP20	MC31 COB LED	90	30 3000K	6W	616 lm	18 / 24 / 32	D0 No Dim	10 ■ Black
					40 4000K			DA Dali Dim	11 □ White	
Venus 125 Adjustable Round	RG30 ○		MC22 COB LED			22W	2418 lm	20 / 30	DP Phase Dim	
	RG31 ○						2456 lm		DC CASAMBI	
	RO25 ○ IP44								D1 0-10V Dim	
	RO29 ○									
	GU53	Retrofit	MR16-GU5.3	00	00	/	/	00	00 No Driver	
	GU10		GU10-GZ10							

Notes:

- * For complete code ordering information, please see page 353.
 - ** For other CCT options, please contact us.
- For related accessories, please see page 106-109.
For the most updated product information, please go to our website.

Venus Wallwasher Round

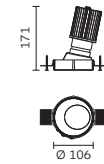
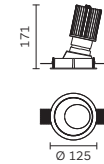

Code ordering example: **R G 4 6 M C 2 2 - 9 0 3 0 W W D 0 1 0**

	Product Code	Ingress Protection	Light Source Code*	>CRI	CCT**	LED Power	Nominal Lumen	Beam Angle (BA°)	Driver Options	Finish
Venus 125 Wallwasher Round	RG46 ○ IP40		MC22 COB LED	90	30 3000K	22W	2418 lm	WW	D0 No Dim	10 ■ Black
					40 4000K		2456 lm	DA Dali Dim	11 □ White	
									DP Phase Dim	
									DC CASAMBI	
									D1 0-10V Dim	
	GU53	Retrofit	MR16-GU5.3	00	00	/	/	00	00 No Driver	
	GU10		GU10-GZ10							

Notes:

- * For complete code ordering information, please see page 353.
 - ** For other CCT options, please contact us.
- WW** = Wallwasher
For the most updated product information, please go to our website.

Venus Concave Fixed Square



Venus 125 Concave
Fixed Square Trim 114

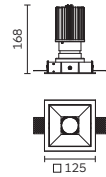

Venus 125 Concave
Fixed Square Trimless 114

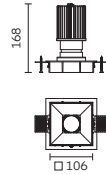

Code ordering example: **R H 5 2 M C 2 2 - 9 0 3 0 2 2 D 0 1 0**

	Product Code	Ingress Protection	Light Source Code*	>CRI	CCT**	LED Power	Nominal Lumen	Beam Angle (BA°)	Driver Options	Finish
Venus 125 Concave Fixed Square	RH52 <input type="checkbox"/>	IP20	MC22 COB LED	90	30 3000K	22W	2418 lm	22 / 36	D0 No Dim	10 <input type="checkbox"/> Black
	RH54 <input type="checkbox"/>				40 4000K		2456 lm		DA Dali Dim	11 <input type="checkbox"/> White
	RJ03 <input type="checkbox"/>	IP44							DP Phase Dim	
	RJ05 <input type="checkbox"/>								DC CASAMBI	
									D1 0-10V Dim	
			GU53 Retrofit MR16-GU5.3	00	00	/	/	00	00 No Driver	
			GU10 GU10-GZ10							

Notes:
 * For complete code ordering information, please see page 353.
 ** For other CCT options, please contact us.
 For related accessories, please see page 106-109.
 For the most updated product information, please go to our website.

Venus Concave Adjustable Square



Venus 70 Concave
Adjustable Round Trim Ø67

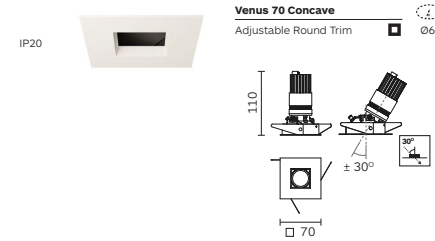

Venus 125 Concave
Adjustable Square Trim 114

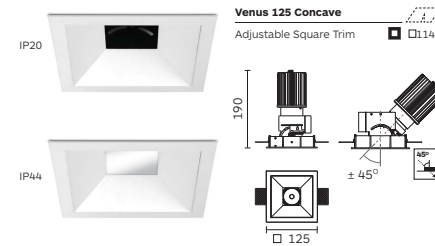

Venus 125 Concave
Adjustable Square Trimless 114

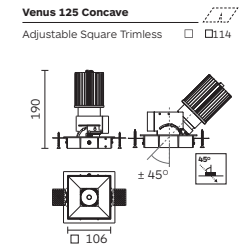

Code ordering example: **R O 4 1 M C 3 1 - 9 0 3 0 1 8 D 0 1 0**

	Product Code	Ingress Protection	Light Source Code*	>CRI	CCT**	LED Power	Nominal Lumen	Beam Angle (BA°)	Driver Options	Finish
Venus 70 Concave Adjustable Square	RO41 <input type="checkbox"/>	IP20	MC31 COB LED	90	30 3000K	6W	616 lm	18 / 24 / 32	D0 No Dim	10 <input type="checkbox"/> Black
					40 4000K		643 lm		DA Dali Dim	11 <input type="checkbox"/> White
Venus 125 Concave Adjustable Square	RH51 <input type="checkbox"/>	IP20	MC22 COB LED			22W	2418 lm	20 / 30	DP Phase Dim	
	RH53 <input type="checkbox"/>						2456 lm		DC CASAMBI	
	RJ02 <input type="checkbox"/>	IP44							D1 0-10V Dim	
	RJ04 <input type="checkbox"/>									
			GU53 Retrofit MR16-GU5.3	00	00	/	/	00	00 No Driver	
			GU10 GU10-GZ10							

Notes:
 * For complete code ordering information, please see page 353.
 ** For other CCT options, please contact us.
 For related accessories, please see page 106-109.
 For the most updated product information, please go to our website.

Venus Fixed Square



Venus 125
Fixed Square Trim 114

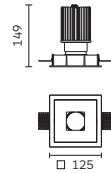

Venus 125
Fixed Square Trimless 114

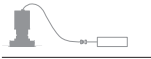
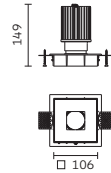

Code ordering example: **R G 7 8 M C 2 2 - 9 0 3 0 2 2 D 0 1 0**

	Product Code	Ingress Protection	Light Source Code*	>CRI	CCT**	LED Power	Nominal Lumen	Beam Angle (BA°)	Driver Options	Finish
Venus 125 Fixed Square	RG78 <input type="checkbox"/>	IP20	MC22 COB LED	90	30 3000K	22W	2418 lm	22 / 36	D0 No Dim	10 <input type="checkbox"/> Black
	RG79 <input type="checkbox"/>				40 4000K		2456 lm		DA Dali Dim	11 <input type="checkbox"/> White
	RO26 <input type="checkbox"/>	IP44							DP Phase Dim	
	RO30 <input type="checkbox"/>								DC CASAMBI	
									D1 0-10V Dim	
			GU53 Retrofit MR16-GU5.3	00	00	/	/	00	00 No Driver	
			GU10 GU10-GZ10							

Notes:
 * For complete code ordering information, please see page 353.
 ** For other CCT options, please contact us.
 For related accessories, please see page 106-109.
 For the most updated product information, please go to our website.

Venus Adjustable Square



Venus 70 Concave
Adjustable Square Trim 067

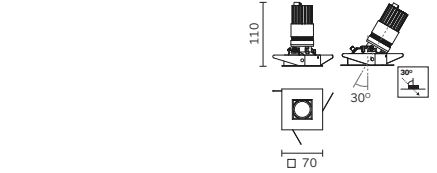

Venus 125 Concave
Adjustable Square Trim 114

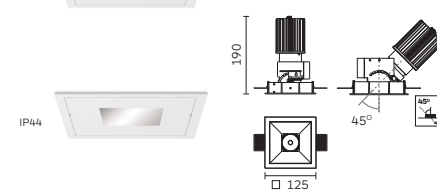

Venus 125 Concave
Adjustable Square Trimless 114

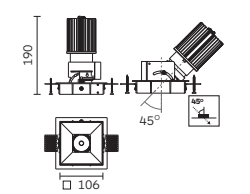

Code ordering example: **R O 3 9 M C 3 1 - 9 0 3 0 1 8 D 0 1 0**

	Product Code	Ingress Protection	Light Source Code*	>CRI	CCT**	LED Power	Nominal Lumen	Beam Angle (BA°)	Driver Options	Finish
Venus 70 Adjustable Square	RO39 <input type="checkbox"/>	IP20	MC31 COB LED	90	30 3000K	6W	616 lm	18 / 24 / 32	D0 No Dim	10 <input type="checkbox"/> Black
					40 4000K		643 lm		DA Dali Dim	11 <input type="checkbox"/> White
Venus 125 Adjustable Square	RG70 <input type="checkbox"/>	IP20	MC22 COB LED			22W	2418 lm	20 / 32	DP Phase Dim	
	RG71 <input type="checkbox"/>						2456 lm		DC CASAMBI	
	RO27 <input type="checkbox"/>	IP44							D1 0-10V Dim	
	RO31 <input type="checkbox"/>									
			GU53 Retrofit MR16-GU5.3	00	00	/	/	00	00 No Driver	
			GU10 GU10-GZ10							

Notes:
 * For complete code ordering information, please see page 353.
 ** For other CCT options, please contact us.
 For related accessories, please see page 106-109.
 For the most updated product information, please go to our website.

Venus Wallwasher Square

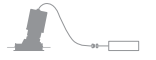

Venus 125
Wallwasher Square Trim 114

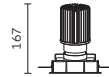

Venus 125
Wallwasher Square Trimless 114

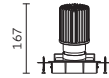

Code ordering example: **R G 5 2 M C 2 2 - 9 0 3 0 W W D 0 1 0**

	Product Code	Ingress Protection	Light Source Code*	>CRI	CCT**	LED Power	Nominal Lumen	Beam Angle (BA°)	Driver Options	Finish
Venus 125 Wallwasher Square	RG52 <input checked="" type="checkbox"/>	IP40	MC22 COB LED	90	30 3000K	22W	2418 lm	WW	D0 No Dim	10 <input checked="" type="checkbox"/> Black
	RG53 <input type="checkbox"/>				40 4000K		2456 lm		DA Dali Dim	11 <input type="checkbox"/> White
									DP Phase Dim	
									DC CASAMBI	
									D1 0-10V Dim	
	GU53	Retrofit	MR16-GU5.3	00	00	/	/	00	00 No Driver	
	GU10		GU10-GZ10							

Notes:

* For complete code ordering information, please see page 353.
** For other CCT options, please contact us.

WW = Wallwasher

For the most updated product information, please go to our website.



Product Name: Venus Round

Location of Project: MGM, Macao

MonoLED/GiroLED/QuadroLED

Recessed

Fixed



Adjustable



Body

Round or square recessed spotlight. Luminaire body in cast aluminium with optimal passive thermal management. Quick and easy installation via concealed springs for snap-in catch action for minimum ceiling thickness.

Supplied pre-wired with 240mm cable and male/female plugs ready to plug-in (multi or single unit) to power LED converter unit.

Adjustable versions tiltable vertically 0-25° and rotatable horizontally 350°.

Accessories

Extension cable.
Check page 79 for details.

Finish

Powder coat in black, white, nickel or grey colour.

LED sources

High power LED.
CRI: 90 | CCT: 3000K, 4000K.
Other CRI and CCT options available on request.

Optic

Lens.
Narrow and wide beam angle available.

Driver

Remote driver not included to be order separately.

Applications

Miniature recessed luminaires with a disappearing look and ideal for display and under cabinet illumination.
Application areas: cabinet displays, showcases, under-cabinet, undershelf, retail, residential, restaurants, galleries, museums, showroom.

Related Products



MonoLED



MonoLED
Fixed Round Trim Ø22

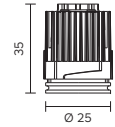

Code ordering example: 2 9 7 4 BN11 - 90 30 14 D0 10

	Product Code	Light Source Code*	>CRI	CCT**	LED Power	Nominal Lumen	Beam Angle (BA°)	Driver Options	Finish
MonoLED Round	2974	BN11 High Power LED	90	30 3000K	2W	150 lm	14 / 40	00 No Driver	10 Black
				40 4000K		162 lm			
				BL UE BLUE		/			
				RE DO RED					
				GR EN GREEN					
				YE LL YELL					
				RG BO RGB	3x1W				
				RG BW RGBW					

Notes:

* For complete code ordering information, please see page 353.

** For other CCT options, please contact us.

For related accessories, please see page 79.

For the most updated product information, please go to our website.

GiroLED / GiroLED Deep / QuadroLED

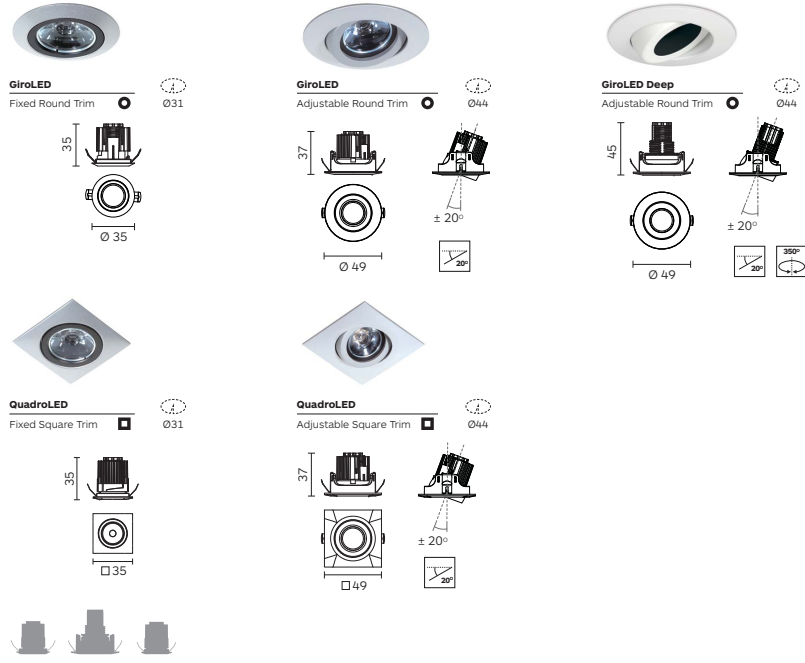

Code ordering example: **R D 3 7 B N 3 7 - 9 0 3 0 1 4 0 0 1 0**

	Product Code	Light Source Code*	>CRI	CCT**	LED Power	Nominal Lumen	Beam Angle (BA°)	Driver Options	Finish
GiroLED Fixed	RD37 ○	BN11 High Power LED	90	30 3000K	2W	150 lm	14 / 40	00 No Driver	10 ■ Black
GiroLED Adjustable	RD39 ○			40 4000K		162 lm			11 □ White
GiroLED Deep	RH34 ○		BL	UE BLUE		/			34 ■ Nickel
QuadroLED Fixed	RD38 □		RE	DO RED					75 ■ Grey
QuadroLED Adjustable	RD40 □		GR	EN GREN					
			YE	LL YELL					
			RG	BO RGB	3x1W				
			RG	BW RGBW					

Notes:
 * For complete code ordering information, please see page 353.
 ** For other CCT options, please contact us.
 For related accessories, please see page 79.
 For the most updated product information, please go to our website.

Optical Accessories

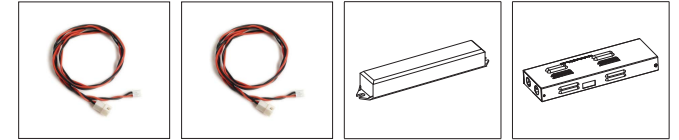

Product / Optical Accessories	Extension Cable For single colour L: 1000mm	Extension Cable For RGB L: 1000mm	Electronic LED Driver Input: 220-240V 50/60Hz For 1-6 pcs LED 2W 500mA	DMX LED Driver DMX driver and power supply unit. Input: 100-240V 50/60Hz For 2-12 pcs MonoLED RGB
MonoLED				2986
GiroLED	2477	2983	2790	/
GiroLED Deep				/
QuadroLED				/

LED Driver Measurements

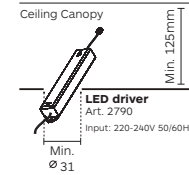

Single Colour Wiring Diagram

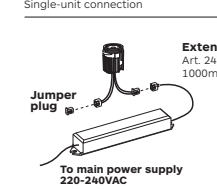

Single Colour Wiring Diagram

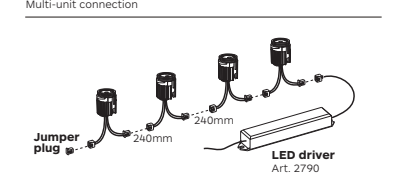

LED Driver Measurements

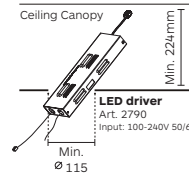

RGB Wiring Diagram

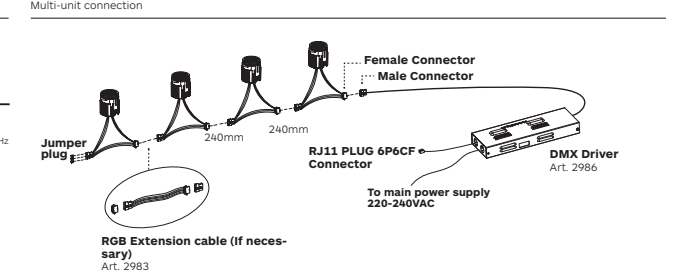

Girofix / MultiGiro / MultiQuadro

Recessed



Body

Round or Square mounting trim in cast aluminium with spring for installation mounting on a ceiling thickness of 1-25mm.

Luminaire body in cast aluminum. Easy relamping tool-free via removable lamp front ring. Every model is available in two different sizes.

MultiGiro and MultiQuadro tiltable vertically 0-25° and rotatable horizontally 350°.

Accessories

MultiGiro 89, MultiQuadro 89: Coloured filters, linear spread, honeycomb louvre, anti-glare hood. Check page 108 for details.

Finish

Powder coat in black, white or grey colour.

LED sources

COB LED, Retrofit.
CRI: 90 | CCT: 3000K, 4000K.
Other CRI and CCT options available on request.

Optic

Lens.
Narrow, medium and wide beam angle available.

Driver

Supplied with No-dimable remote driver.
Dimming Options: 0-10V Dim, DALI, Phase, CASAMBI.

Applications

A fully adjustable light head designed to accommodate any recessed lighting application and allow lamp aiming while power is on.
Application areas: retail, shopping centers, corridors, window display.

Related Products



Girofix / MultiGiro / MultiQuadro

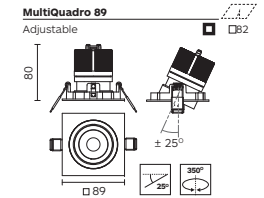
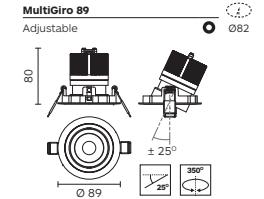
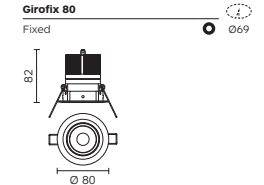
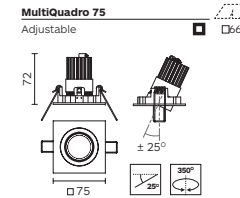
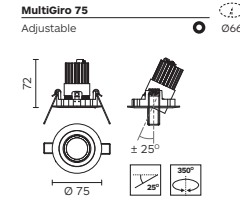
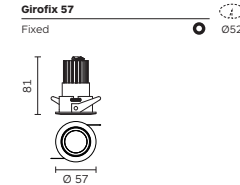
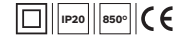

Code ordering example: **R P 2 8 M C 3 1 - 9 0 3 0 1 6 D 0 1 0**

	Product Code	Light Source Code*	>CRI	CCT**	LED Power	Nominal Lumen	Beam Angle (BA°)	Driver Options	Finish
Girofix 57 Fixed	RP28	MC31 COB LED	90	30 3000K	6W	710 lm	16 / 26 / 36	D0 No Dim	10 Black
MultiGiro 75 Adjustable	RN45			40 4000K		770 lm		DA Dali Dim	11 White
MultiQuadro 75 Adjustable	RN46							DP Phase Dim	75 Grey
								DC CASAMBI	
		GU04 Retrofit MR11-GU4	00	00	/	/	00	D1 0-10V Dim	
								00 No Driver	
Girofix 80 Fixed	RO90	MC22 COB LED	90	30 3000K	10W	1276 lm	18 / 24 / 36	D0 No Dim	
MultiGiro 89 Adjustable	RN41			40 4000K		1296 lm		DA Dali Dim	
MultiQuadro 89 Adjustable	RN42							DP Phase Dim	
								DC CASAMBI	
		GU53 Retrofit MR16-GU5.3	00	00	/	/	00	D1 0-10V Dim	
		GU10 GU10-GZ10						00 No Driver	

Notes:

* For complete code ordering information, please see page 353.

** For other CCT options, please contact us.

For related accessories, please see page 106-109.

For the most updated product information, please go to our website.

MultiGiro Deep & MultiQuadro Deep

Recessed

Multi Giro Deep



Multi Quadro Deep



Body

Round or Square mounting trim in cast aluminum with springs for trim installation mounting on a ceiling thickness of 1-25mm or brackets for trimless installation mounting on a ceiling thickness 12.5-15mm.

Luminaire body in cast aluminum. Easy relamping tool-free via removable lamp front ring.

Available with configuration up to 2 lightheads. Tiltable vertically 0-25° and rotatable horizontally 350°.

Accessories

Coloured filters, linear spread, honeycomb louvre, anti-glare hood. Check page 108 for details.

Finish

Powder coat in black, white or grey colour.

LED sources

COB LED, Retrofit. CRI: 90 | CCT: 3000K, 4000K. Other CRI and CCT options available on request.

Optic

Lens. Narrow, medium and wide beam angle available.

Driver

Supplied with No-dimable remote driver. Dimming Options: 0-10V Dim, DALI, Phase, CASAMBI.

Applications

A fully adjustable light head designed to accommodate any recessed lighting application and allow lamp aiming while power is on. Application areas: retail, shopping centers, corridors, window display.

Related Products

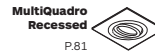

MultiGiro Deep & MultiQuadro Deep



MultiGiro Deep
Adjustable Trim 1 light head \emptyset 90



MultiQuadro Deep
Adjustable Trim 1 light head 82

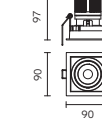

MultiQuadro Deep
Adjustable Trim 2 light heads 82x155

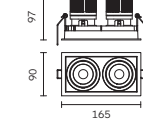

MultiGiro Deep
Adjustable Trimless 1 light head \emptyset 90

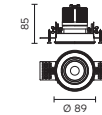

MultiQuadro Deep
Adjustable Trimless 1 light head 187x113

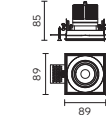

MultiQuadro Deep
Adjustable Trimless 2 light heads 264x113

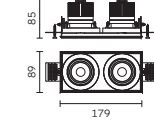

Code ordering example: **RP21** x1 **GU53** - 00 00 00 00 10

	Product Code	Light Source Code*	>CRI	CCT**	LED Power	Nominal Lumen	Beam Angle (BA°)	Driver Options	Finish
MultiGiro Deep Adjustable Round 1 light head	RP21 <input checked="" type="checkbox"/> x1	GU53 Retrofit MR16-GU5.3	00	00	/	/	00	00 No Driver	10 <input checked="" type="checkbox"/> Black
	RG97 <input type="checkbox"/>	GU10 GU10-GZ10						DA No Dim	11 <input type="checkbox"/> White
		MC22 COB LED	90	30 3000K	10W	1220 lm	18 / 24 / 36	DP Phase Dim	75 <input type="checkbox"/> Grey
MultiQuadro Deep Adjustable Square 1 light head	RP24 <input type="checkbox"/> x1	MC22 COB LED			10W	1220 lm		DC CASAMBI	
	RG17 <input type="checkbox"/>					1260 lm		D1 0-10V Dim	
		GU53 Retrofit MR16-GU5.3	00	00	/	/	00	00 No Driver	
MultiQuadro Deep Adjustable Square 2 light heads	RP25 <input checked="" type="checkbox"/> x2	MC22 COB LED	90	30 3000K	2x10W	2440 lm	18 / 24 / 36	DA No Dim	
	RG19 <input type="checkbox"/>					2520 lm		DP Phase Dim	
		GU53 Retrofit MR16-GU5.3	00	00	/	/	00	D1 0-10V Dim	
	GU10 GU10-GZ10						00 No Driver		

Notes:

* For complete code ordering information, please see page 353.

** For other CCT options, please contact us.

For related accessories, please see page 108-109.

For the most updated product information, please go to our website.

Gimbalo

Recessed 60 | 100 | 130



Body

Round shape mounting trim in cast aluminium with springs for trim installation on ceiling thickness 1-25mm or bracket for trimless installation on a ceiling thickness 12.5 or -15 mm.

Fully adjustable gimbals and luminaire body in cast aluminium.

Available in 3 sizes.

Tilttable on a dual axis gimbals up to 40° in all directions.

Accessories

Coloured filters, linear spread, honeycomb louvre, anti-glare hood.
Check page 109 for details.

Finish

Powder coat in black, white or grey colour.

LED sources

COB LED, Retrofit.
CRI: 90 | CCT: 3000K, 4000K.
Other CRI and CCT options available on request.

Optic

Lens.
Narrow, medium and wide beam angle available.

Driver

Supplied with No-dimable remote driver.
Dimming Options: 0-10V Dim, DALI, Phase, CASAMBI.

Applications

Features a fully adjustable double gimbal concept design elegant luminaire to accommodate any recessed lighting application.
Application areas: retail, shopping centers, corridors, window display.

Related Products



Gimbalo

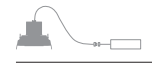
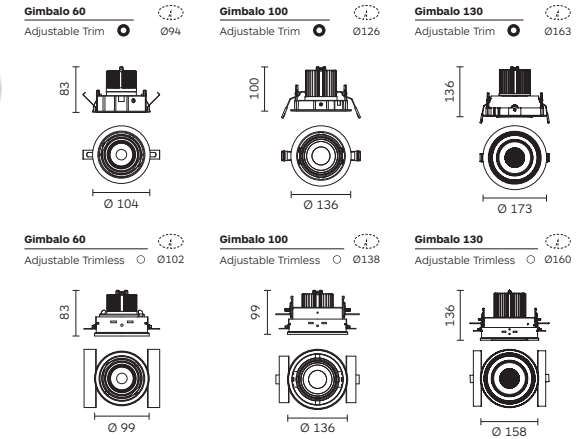

Code ordering example: **R L 5 2 M C 2 2 - 9 0 3 0 1 8 D 0 1 0**

	Product Code	Light Source Code*	>CRI	CCT**	LED Power	Nominal Lumen	Beam Angle (BA°)	Driver Options	Finish
Gimbalo 60	RL52 ●	MC22 COB LED	90	30 3000K	10W	1220 lm	18 / 24 / 36	D0 No Dim	10 ■ Black
	Adjustable RL53 ○			40 4000K		1260 lm		DA Dali Dim DP Phase Dim DC CASAMBI D1 0-10V Dim	11 □ White 75 ■ Grey
		GU53 Retrofit MR16-GU5.3	00	00	/	/	00	00 No Driver	
		GU10 GU10-GZ10							
Gimbalo 100	RG04 ●	MC33 COB LED	90	30 3000K	21W	2200 lm	15 / 24 / 38	D0 No Dim	
	Adjustable RG05 ○			40 4000K		2300 lm		DA Dali Dim	
Gimbalo 130	RH01 ●	MC33			33W	3220 lm	12 / 22 / 32	DP Phase Dim	
	Adjustable RH02 ○					3300 lm		DC CASAMBI D1 0-10V Dim	
	AR11 Retrofit	AR111-G53	00	00	/	/	00	00 No Driver	

Notes:

* For complete code ordering information, please see page 353.

** For other CCT options, please contact us.

For related accessories, please see page 108-109.

For the most updated product information, please go to our website.

Multi Gimbalo

Recessed 35 | 60 | 100 | 130



Body

Square shape mounting trim in cast aluminium with twist and lock mechanism for trim installation on ceiling thickness 1-25mm or bracket for trimless installation on a ceiling thickness 12.5 or 15 mm.

Fully adjustable gimbals and luminaire body in cast aluminium.

Available in 3 sizes and in configuration up to 3 light heads. Tilttable on a dual axis gimbals up to 40° in all directions.

Accessories

Coloured filters, linear spread, honeycomb louvre, anti-glare hood, anti-glare tube. Check page 91 for details.

Finish

Powder coat in black, white or grey colour.

LED sources

COB LED, High Power LED, Retrofit. CRI: 90 | CCT: 3000K, 4000K. Other CRI and CCT options available on request.

Optic

Lens. Narrow, medium and wide beam angle available.

Driver

Supplied with No-dimable remote driver. Dimming Options: 0-10V Dim, DALI, Phase, CASAMBI.

Applications

Luminaire features a fully adjustable double gimbal concept combined with an elegant design. Ideal to accommodate any recessed lighting application. Application areas: retail, shopping centers, corridors, window display.

Related Products



Multi Gimbalo 35

Single, Double & Triple

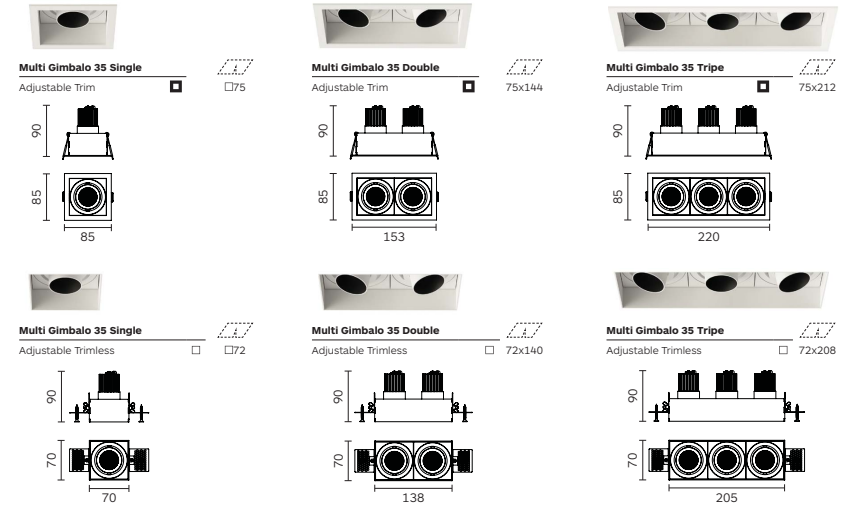

Code ordering example: **R P 7 1 M C 3 1 - 9 0 3 0 1 6 D 0 1 0**

Product Code	Light Source Code*	>CRI	CCT**	LED Power	Nominal Lumen	Beam Angle (BA°)	Driver Options	Finish
Multi Gimbalo 35 Singel Adjustable	RP71 <input checked="" type="checkbox"/> x1 MC31 COB LED	90	30 3000K	5.9W	705 lm	16 / 26 / 36	D0 No Dim	10 <input checked="" type="checkbox"/> Black
	RP72 <input type="checkbox"/>		40 4000K		770 lm		DA Dali Dim	11 <input type="checkbox"/> White
	MR21 High Power LED			3.9W	438 lm	07	DP Phase Dim	75 <input checked="" type="checkbox"/> Grey
Multi Gimbalo 35 Double Adjustable	RP73 <input checked="" type="checkbox"/> x2 MC31 COB LED			2x5.9W	1410 lm	16 / 26 / 36	D1 0-10V Dim	
	RP74 <input type="checkbox"/>				1540 lm			
	MR21 High Power LED			2x3.9W	876 lm	07		
					966 lm			
Multi Gimbalo 35 Triple Adjustable	RP75 <input checked="" type="checkbox"/> x3 MC31 COB LED			3x5.9W	2115 lm	16 / 26 / 36		
	RP76 <input type="checkbox"/>				2310 lm			
	MR21 High Power LED			3x3.9W	1314 lm	07		
					1449 lm			

Notes:
 * For complete code ordering information, please see page 353.
 ** For other CCT options, please contact us.
 For related accessories, please see page 91.
 For the most updated product information, please go to our website.

Multi Gimbalo 60

Single, Double & Triple



Multi Gimbalo 60 Single
Adjustable Trim 102

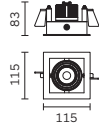

Multi Gimbalo 60 Double
Adjustable Trim 174x102

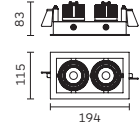

Multi Gimbalo 60 Triple
Adjustable Trim 254x102

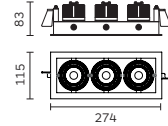

Multi Gimbalo 60 Single
Adjustable Trimless 113

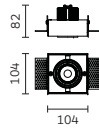

Multi Gimbalo 60 Double
Adjustable Trimless 187x113

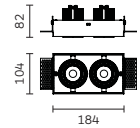

Multi Gimbalo 60 Triple
Adjustable Trimless 264x113

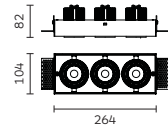

For Trim & Trimless version
Tiltable up to 25°



Code ordering example: **R K 8 6 M C 2 2 - 9 0 3 0 1 8 D 0 1 0**

Product Code	Light Source Code*	>CRI	CCT**	LED Power	Nominal Lumen	Beam Angle (BA°)	Driver Options	Finish
Multi Gimbalo 60 Single Adjustable	MC22 COB LED	90	30 3000K	10W	1220 lm	18 / 24 / 36	DO No Dim	10 ■ Black
			40 4000K		1260 lm		DA Dali Dim	11 □ White
Multi Gimbalo 60 Double Adjustable				2x10W	2440 lm		DP Phase Dim	75 ■ Grey
					2520 lm		DC CASAMBI	
Multi Gimbalo 60 Triple Adjustable				3x10W	3660 lm		D1 0-10V Dim	
					3780 lm			
	GU53 Retrofit	MR16 -GU5.3	00	00	/	/	00	No Driver
	GU10	GU10-GZ10						

Notes:

- * For complete code ordering information, please see page 353.
- ** For other CCT options, please contact us.
- For related accessories, please see page 91.
- For the most updated product information, please go to our website.

Multi Gimbalo 100

Single, Double & Triple



Multi Gimbalo 100 Single
Adjustable Trim 130

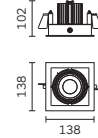

Multi Gimbalo 100 Double
Adjustable Trim 254x130

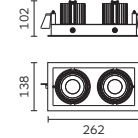

Multi Gimbalo 100 Triple
Adjustable Trim 374x130

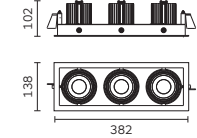

Multi Gimbalo 100 Single
Adjustable Trimless 140

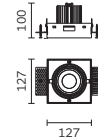

Multi Gimbalo 100 Double
Adjustable Trimless 265x140

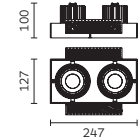

Multi Gimbalo 100 Triple
Adjustable Trimless 384x140

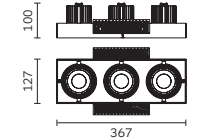

For Trim & Trimless version
Tiltable up to 30°

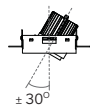

Code ordering example: **R J 2 1 M C 3 3 - 9 0 3 0 1 5 D 0 1 0**

Product Code	Light Source Code*	>CRI	CCT**	LED Power	Nominal Lumen	Beam Angle (BA°)	Driver Options	Finish
Multi Gimbalo 100 Single Adjustable	MC33 COB LED	90	30 3000K	21W	2200 lm	15 / 24 / 38	DO No Dim	10 ■ Black
			40 4000K		2300 lm		DA Dali Dim	11 □ White
Multi Gimbalo 100 Double Adjustable				2x21W	4400 lm		DP Phase Dim	75 ■ Grey
					4600 lm		DC CASAMBI	
Multi Gimbalo 100 Triple Adjustable				3x21W	6600 lm		D1 0-10V Dim	
					6900 lm			

Notes:

- * For complete code ordering information, please see page 353.
- ** For other CCT options, please contact us.
- For related accessories, please see page 91.
- For the most updated product information, please go to our website.

Multi Gimbalo 130



Single, Double & Triple

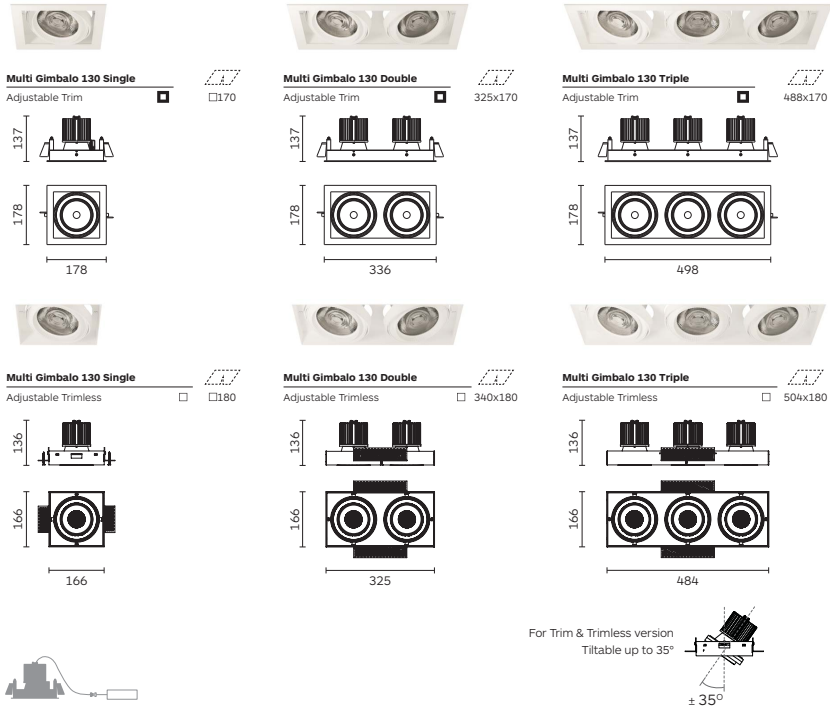

Code ordering example: **R L 2 7 M C 3 3 - 9 0 3 0 1 2 D 0 1 0**

Product Code	Light Source Code*	>CRI	CCT**	LED Power	Nominal Lumen	Beam Angle (BA°)	Driver Options	Finish
Multi Gimbalo 130 Single Adjustable	RL27 □ x1 MC33 COB LED	90	30 3000K	33W	3220 lm	12 / 22 / 32	D0 No Dim	10 ■ Black
	RL30 □		40 4000K		3300 lm		DA Dali Dim	11 □ White
Multi Gimbalo 130 Double Adjustable	RL28 □ x2			2x33W	6440 lm		DP Phase Dim	75 ■ Grey
	RL31 □				6600 lm		DC CASAMBI	
Multi Gimbalo 130 Triple Adjustable	RL29 □ x3			3x33W	9660 lm		D1 0-10V Dim	
	RL32 □				9900 lm			
	AR11 Retrofit AR111-G53	00	00	/	/	00	00 No Driver	

Notes:
 * For complete code ordering information, please see page 353.
 ** For other CCT options, please contact us.
 For related accessories, please see page 91.
 For the most updated product information, please go to our website.

Optical Accessories

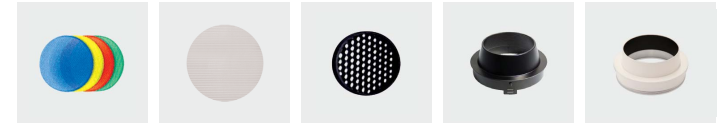

Product / Optical Accessories	Coloured Filters Colours 25, 42, 55, 85	Linear Spread Colour 41	Honeycomb Louvre Colour 10	Anti-Glare Hood Colours 10, 17	Anti-Glare Tube Colours 10, 17
Multi Gimbalo 35	2E37*	/	2B76	/	/
Multi Gimbalo 60	2662*	2663	2634	2321	2418
Multi Gimbalo 100	2B87*	2B88	2633	2B69	2B82
Multi Gimbalo 130	2599*	2598	2334	2327	2C44

* With holder

Galaxis Pro

Recessed 140 | 160 | 200 | 230



Body

Round mounting trim in cast aluminium with springs for trim installation on a ceiling thickness of max. 25mm.

Luminaire body and heat dissipator for passive cooling in extruded aluminium.

Secondary reflector in highly reflective pure aluminium. Available in four different sizes.

Accessories

No accessories available.

Finish

Powder coat in black or white colour.

LED sources

COB LED.
CRI: 90 | CCT: 3000K, 4000K.
Other CRI and CCT options available on request.

Optic

Lens in PMMA + secondary reflector in aluminium. Wide beam angle available

Driver

Supplied with No-dimable remote driver.
Diming Options: 0-10V Dim, DALI, Phase, CASAMBI.

Applications

Provide a visual comfortable energy-efficient with a wide uniform general lighting solution, also ideal for use in under canopy or bathroom locations.
Application areas: offices, corridors, hospitals, hotels.

Related Products

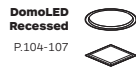

Galaxis Pro



Galaxis Pro 140
Fixed Trim Ø125

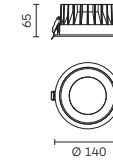

Galaxis Pro 200
Fixed Trim Ø180

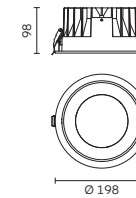

Galaxis Pro 160
Fixed Trim Ø145

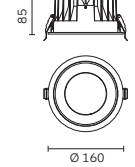

Galaxis Pro 230
Fixed Trim Ø215

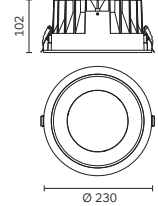

Code ordering example: **R K 1 7 B C 2 1 - 9 0 3 0 6 5 D 0 1 0**

	Product Code	Light Source Code*	>CRI	CCT**	LED Power	Nominal Lumen	Beam Angle (BA°)	Driver Options	Finish
Galaxis Pro 140 Fixed	RK17	BC21 COB LED	90	30 3000K	20W	2660 lm	65	D0 No Dim	10 Black
				40 4000K		2680 lm		DA Dali Dim	11 White
Galaxis Pro 160 Fixed	RK15				30W	3200 lm	75	DP Phase Dim	
							3280 lm		DC CASAMBI
Galaxis Pro 200 Fixed	RK13				39W	4300 lm	72	D1 0-10V Dim	
							4380 lm		
Galaxis Pro 230 Fixed	RK12				50W	5400 lm	75		
							5680 lm		

Notes:

* For complete code ordering information, please see page 353.

** For other CCT options, please contact us.

For the most updated product information, please go to our website.

Roller In & Out

Recessed 102 | 136 | 195



Body

Round mounting trim in cast aluminum with springs for trim installation on a ceiling thickness max. 25mm. Luminaire body in cast aluminium and thermoplastic materials.

Easy relamping via removable front ring by snap-in catch action (195 and 136) or via twist and lock action (102).

Tiltable with In & Out mechanism: **Roller 102**: In 25° - Out 30°; **Roller 136**: In 30° - Out 50°; **Roller 195**: In 40° - Out 60°.

Accessories

Roller In & Out 136 and 195: Honeycomb louvre. Roller In & Out 195: Coloured filters, linear spread. Check page 108 for details.

Finish

Powder coat in black or white colour.

LED sources

COB LED (136, 195), Retrofit (102, 195). CRI: 90 | CCT: 3000K, 4000K.

Other CRI and CCT options available on request.

Optic

Reflector + diffuser. Narrow, medium and wide beam angle available.

Driver

Supplied with No-dimable remote driver. Dimming Options: 0-10V Dim, DALI, Phase, CASAMBI.

Applications

An ideal lighting system when there is a special demand for maximum flexibility of lighting coverage. Application areas: retail, gyms, galleries, showrooms, residential, restaurants, hotels, window displays.

Related Products

Roller In & Out



Roller In & Out 102
Adjustable Trim Ø94



Roller In & Out 136
Adjustable Trim Ø126



Roller In & Out 195
Adjustable Trim Ø187

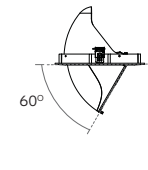
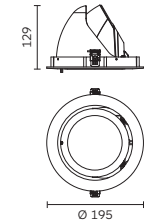
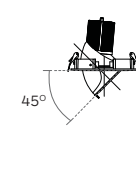
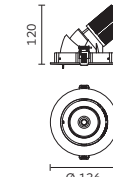
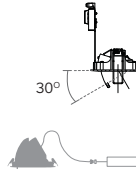

Code ordering example: **5 7 7 2 G U 5 3 - 0 0 0 0 0 0 1 0**

	Product Code	Light Source Code*	>CRI	CCT**	LED Power	Nominal Lumen	Beam Angle (BA°)	Driver Options	Finish
Roller In & Out 102 Adjustable	5772	GU53 Retrofit MR16-GU5.3 GU10 GU10-GZ10	00	00	/	/	00	00 No Driver	10 Black 11 White
Roller In & Out 136 Adjustable	RE29	BC22 COB LED	90	30 3000K 40 4000K	25W	2602 lm 2643 lm	12 / 22 / 38	D0 No Dim DA Dali Dim	
Roller In & Out 195 Adjustable	RD29	BC21			38W	4114 lm 4177 lm	12 / 26 / 38	DP Phase Dim DC CASAMBI D1 0-10V Dim	

Notes:

* For complete code ordering information, please see page 353.

** For other CCT options, please contact us.

For related accessories, please see page 108-109.

For the most updated product information, please go to our website.

Mago

Recessed Round & Square 115 | 145



Body

Round shape mounting trim in cast aluminium with brackets for trim installation on ceiling thickness max. 25 mm or trimless installation on ceiling thickness max. 30 mm.

Luminaire body in cast aluminium inclusive of a convex lens. Transparent safety cover included.

LED sources

COB LED.
CRI: 90 | CCT: 3000K, 4000K.
Other CRI and CCT options available on request.

Related Products



Accessories

No accessories available.

Finish

Powder coat in black or white colour.

Optic

Convex Lens.
Narrow, medium beam angle available.

Driver

Supplied with No-dimable remote driver.
Dimming Options: 0-10V Dim, DALI, Phase, CASAMBI.

Applications

The revolutionary convex lens provides an evenly and effective light, minimizing the glare. Its affordable price combined with its wide light distribution, make it the ideal solution for a vast range of uses.
Application areas: office, hotels, restaurants, lobbies, corridors, conference rooms.

Mago

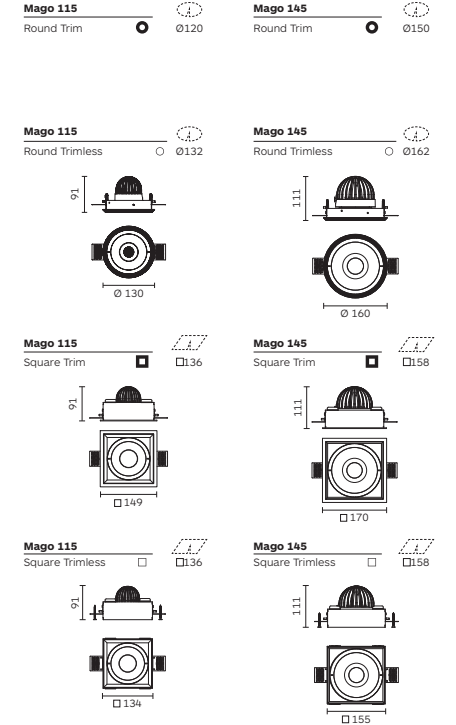

Code ordering example: **R H 8 6 B C 2 2 - 9 0 3 0 4 0 D 0 1 0**

	Product Code	Light Source Code*	>CRI	CCT**	LED Power	Nominal Lumen	Beam Angle (BA°)	Driver Options	Finish
Mago 115 Round	RN86 <input checked="" type="checkbox"/> BC22	COB LED	90	30 3000K	12W	1500 lm	40	D0 No Dim	10 <input checked="" type="checkbox"/> Black
	RN87 <input type="checkbox"/>			40 4000K		1600 lm		DA Dali Dim	11 <input type="checkbox"/> White
Mago 115 Square	RN96 <input checked="" type="checkbox"/>							DP Phase Dim	
	RN97 <input type="checkbox"/>							DC CASAMBI	
Mago 145 Round	RN90 <input checked="" type="checkbox"/> BC33	COB LED			21W	2200 lm	45	D1 0-10V Dim	
	RN91 <input type="checkbox"/>					2350 lm			
Mago 145 Square	RO01 <input checked="" type="checkbox"/>								
	RO02 <input type="checkbox"/>								

Notes:

* For complete code ordering information, please see page 353.
** For other CCT options, please contact us.
For the most updated product information, please go to our website.

Aqualuce

Recessed



Body

Round shape mounting trim in cast aluminium with springs for trim installation on a ceiling thickness max. 20mm. Trim equipped with silicone water seal.

Independent light body in steel. IP54 (protection against dust and water) fixture.

Easy relamping via removable front ring by snap-in catch action.

Accessories

No accessories available.

Finish

Powder coat in black or white colour.

LED sources

COB LED, Retrofit.
CRI: 90 | CCT: 3000K, 4000K.
Other CRI and CCT options available on request.

Optic

Diffuser. Wide beam angle available.

Driver

Supplied with No-dimable remote driver.
Diming Options: 0-10V Dim, DALI, Phase, CASAMBI.

Applications

An ideal lighting system for areas with water splashes or where condensation occurs.
Application areas: bathrooms, gyms, saunas, spas, residential, retail, under canopy areas.

Aqualuce

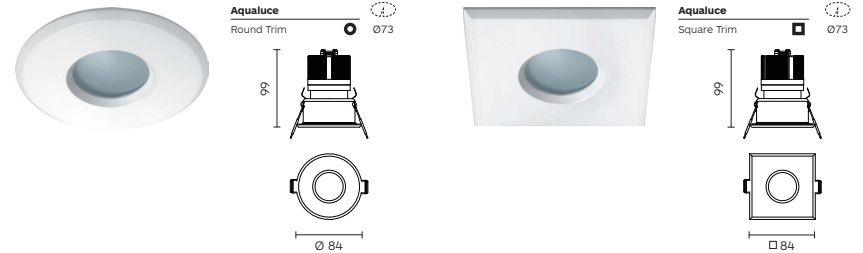

Bathroom Light Installation Guide *

Plan view

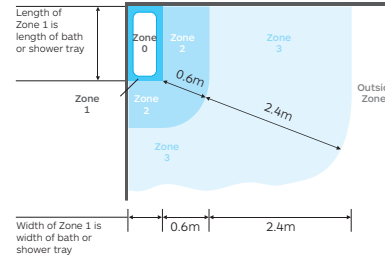

Elevation view

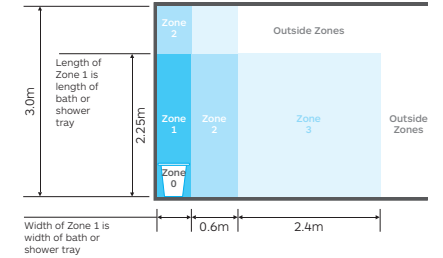

Code ordering example: **RE47MC22-903000D010**

Product Code	Light Source Code*	>CRI	CCT**	LED Power	Nominal Lumen	Beam Angle (BA°)	Driver Options	Finish
Aqualuce Round	RE47 MC22 COB LED	90	30 3000K	10W	1350 lm	00	D0 No Dim	10 Black
			40 4000K		1510 lm		DA Dali Dim	11 White
Aqualuce Square	RE48						DP Phase Dim	
							DC CASAMBI	
							D1 0-10V Dim	
							00 No Driver	
GU53 Retrofit	MR16-GU5.3	00	00	/	/	00		
GU10	GZ10-GU10							

Notes:

- * For complete code ordering information, please see page 353.
 - ** For other CCT options, please contact us.
 - * Bathroom lights must be installed in accordance with IEE regulations. Forma's IP44 shower range can be installed in zones 1, 2, 3.
- For the most updated product information, please go to our website.

Circo

Recessed Round 300 | 400 | 630



Body

Round mounting trim in polycarbonate with brackets for trim/trimless installation on a ceiling thickness of max. 30mm.

Luminaire body in injection molded polycarbonate with easy removable satin-opal diffuser inclusive of durable silicon gasket. IP66 (dust tight and jetproof).

Easy maintenance. No tools required due to the removable diffuser. Available in three different sizes.

Accessories

No accessories available.

Finish

Powder coat in white colour.

LED sources

SMD LED.
CRI: 90 | CCT: 3000K, 4000K.
Other CRI and CCT options available on request.

Optic

Satin opal diffuser. Extra wide beam angle available.

Driver

Supplied with No-dimable remote driver.
Dimming Options: 0-10V Dim, DALI, Phase, CASAMBI.

Applications

Recessed architectural decorative luminaire designed to provide specification of exceptional glare free and high IP grade quality lighting at prices to fit budgets.
Application areas: retail, hospitality, offices, schools and community buildings.

Related Products



Circo

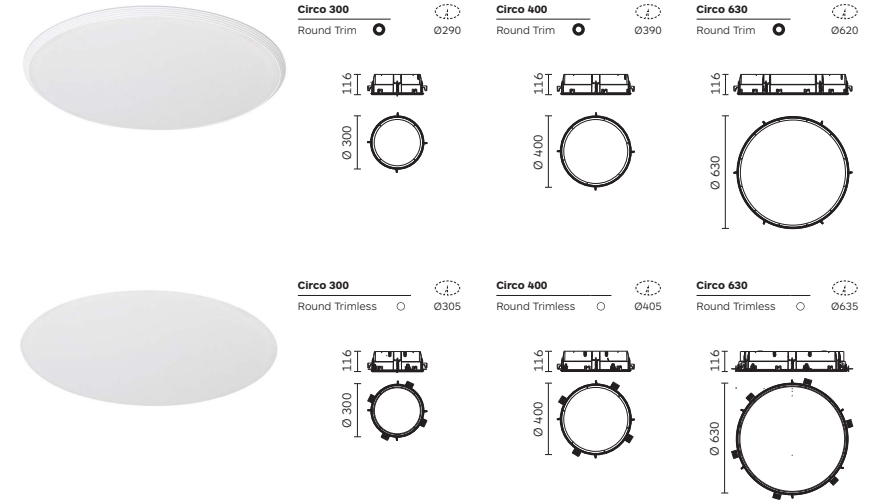

Code ordering example: **RD36BM11-903000D011**

	Product Code	Light Source Code*	>CRI	CCT**	LED Power	Nominal Lumen	Beam Angle (BA°)	Driver Options	Finish	
Circo 300 Round	RD36 <input checked="" type="radio"/>	BM11	SMD LED	90	30 3000K	30W	2650 lm	EW(00)	D0 No Dim	11 <input type="checkbox"/> White
	RD59 <input type="radio"/>			40 4000K		2850 lm		DA Dali Dim		
Circo 400 Round	RD34 <input checked="" type="radio"/>				45W	3800 lm		DP Phase Dim		
	RD57 <input type="radio"/>					4000 lm		DC CASAMBI		
Circo 630 Round	RD32 <input checked="" type="radio"/>				80W	6800 lm		D1 0-10V Dim		
	RD55 <input type="radio"/>					7100 lm				

Notes:

* For complete code ordering information, please see page 353.
** For other CCT options, please contact us.

EW = Extra Wide. Ordering code: **00**
For the most updated product information, please go to our website.

Quadro

Recessed Square 300 | 400 | 630



Quadro



Quadro 300
Square Trim  



Quadro 400
Square Trim  

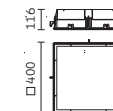

Quadro 630
Square Trim  

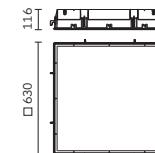

Quadro 300
Square Trimless  

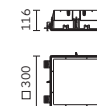

Quadro 400
Square Trimless  

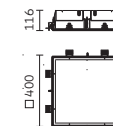

Quadro 630
Square Trimless  

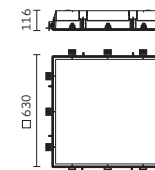

Body

Square mounting trim in polycarbonate with brackets for trim/trimless installation on a ceiling thickness of max. 30mm.

Luminaire body in injection molded polycarbonate with easy removable satin-opal diffuser inclusive of durable silicon gasket. IP66 (dust tight and jetproof).

Easy maintenance. No tools required due to the removable diffuser. Available in three different sizes.

LED sources

SMD LED.
CRI: 90 | CCT: 3000K, 4000K.
Other CRI and CCT options available on request.

Related Products



Optic

Satin opal diffuser. Extra wide beam angle available.

Accessories

No accessories available.

Driver

Supplied with No-dimable remote driver.
Dimming Options: 0-10V Dim, DALI, Phase, CASAMBI.

Finish

Powder coat in white colour.

Applications

Recessed architectural decorative luminaire designed to provide specification of exceptional glare free and high IP grade quality lighting at prices to fit budgets.
Application areas: retail, hospitality, offices, schools and community buildings.



Code ordering example: **R D 3 5 B M 1 1 - 2 0 3 0 0 0 D 0 1 1**

	Product Code	Light Source Code*	>CRI	CCT**	LED Power	Nominal Lumen	Beam Angle (BA°)	Driver Options	Finish
Quadro 300 Square	RD35 <input checked="" type="checkbox"/> BM11	SMD LED	90	30 3000K	30W	2650 lm	EW(00)	DO No Dim	11 <input type="checkbox"/> White
	RD60 <input type="checkbox"/>			40 4000K		2850 lm		DA Dali Dim	
Quadro 400 Square	RD33 <input checked="" type="checkbox"/>				45W	3800 lm		DP Phase Dim	
	RD58 <input type="checkbox"/>					4000 lm		DC CASAMBI	
Quadro 630 Square	RD31 <input checked="" type="checkbox"/>				80W	6800 lm		D1 0-10V Dim	
	RD56 <input type="checkbox"/>					7100 lm			

Notes:

* For complete code ordering information, please see page 353.

** For other CCT options, please contact us.

EW = Extra Wide. Ordering code: **00**

For the most updated product information, please go to our website.

DomoLED

Recessed Round 95 | 180 | 235



Body

Round mounting trim in cast aluminium with springs for trim installation on a ceiling thickness of max. 25mm or brackets for trimless installation on a ceiling thickness of 12-15mm.

Luminaire body of formed white coated steel. Diffuser made of satin opal acrylic.

Front trim/diffuser is fitted by snap-in catch action. IP44 (protection against dust and spraying water). Available in three sizes.

Accessories

No accessories available.

Finish

Powder coat in black, white or grey colour.

LED sources

SMD LED.
CRI: 90 | CCT: 3000K, 4000K.
Other CRI and CCT options available on request.

Optic

Satin opal diffuser.
Extra wide beam angle available.

Driver

Supplied with No-dimable remote driver.
Diming Options: 0-10V Dim, DALI, Phase, CASAMBI.

Applications

Provide a visual comfortable energy-efficient with a wide uniform general lighting solution, also ideal for use in under canopy or bathroom locations.
Application areas: offices, receptions, hospitals, bathrooms, canopy, residential, hotels.

Related Products

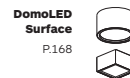
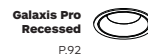

DomoLED Round

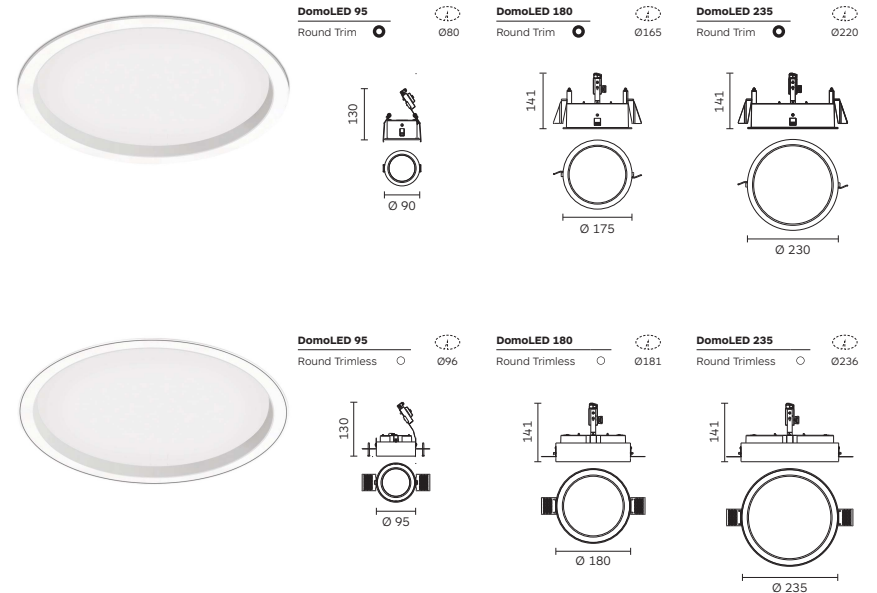

Code ordering example: **RE 2 3 B M 1 1 - 9 0 3 0 0 0 D 0 1 0**

	Product Code	Light Source Code*	>CRI	CCT**	LED Power	Nominal Lumen	Beam Angle (BA°)	Driver Options	Finish
DomoLED 95	RE23	BM11 SMD LED	90	30 3000K	8W	930 lm	EW(00)	D0 No Dim	10 Black
Round	RE24			40 4000K		950 lm		DA Dali Dim	11 White
DomoLED 180	RE21	BM11			22W	2520 lm		DP Phase Dim	75 Grey
Round	RE22					2650 lm		DC CASAMBI	
DomoLED 235	RE19	BM11			35W	3600 lm		D1 0-10V Dim	
Round	RE20					3760 lm			

Notes:

* For complete code ordering information, please see page 353.

** For other CCT options, please contact us.

EW = Extra Wide. Ordering code: **00**

For the most updated product information, please go to our website.

DomoLED

Recessed Square 95 | 180 | 235

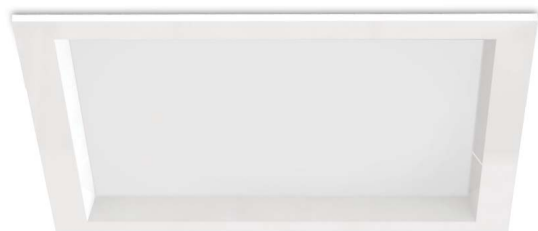

Body

Square mounting trim in cast aluminium with springs for trim installation on a ceiling thickness of max. 25mm or brackets for trimless installation on a ceiling thickness of 12-15mm.

Luminaire body of formed white coated steel. Diffuser made of satin opal acrylic.

Front trim/diffuser is fitted by snap-in catch action. IP44 (protection against dust and spraying water). Available in three sizes.

Accessories

No accessories available.

Finish

Powder coat in black, white or grey colour.

LED sources

SMD LED.
CRI: 90 | CCT: 3000K, 4000K.
Other CRI and CCT options available on request.

Optic

Satin opal diffuser.
Extra wide beam angle available.

Driver

Supplied with No-dimable remote driver.
Dimming Options: 0-10V Dim, DALI, Phase, CASAMBI.

Applications

Provide a visual comfortable energy-efficient with a wide uniform general lighting solution, also ideal for use in under canopy or bathroom locations.
Application areas: offices, receptions, hospitals, bathrooms, canopy, residential, hotels.

Related Products

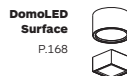
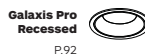

DomoLED Square

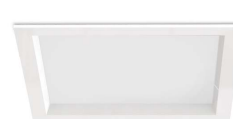

DomoLED 95
Square Trim 80



DomoLED 180
Square Trim 165

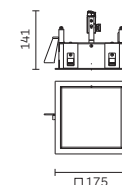

DomoLED 235
Square Trim 220

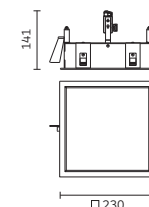

DomoLED 95
Square Trimless 98

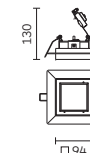

DomoLED 180
Square Trimless 181

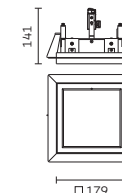

DomoLED 235
Square Trimless 236

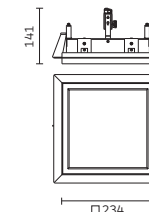

Code ordering example: **R D 2 6 B M 1 1 - 9 0 3 0 0 0 D 0 1 0**

	Product Code	Light Source Code*	>CRI	CCT**	LED Power	Nominal Lumen	Beam Angle (BA°)	Driver Options	Finish
DomoLED 95 Square	RD26 <input checked="" type="checkbox"/> BM11	SMD LED	90	30 3000K	8W	930 lm	EW(00)	D0 No Dim	10 <input checked="" type="checkbox"/> Black
	RE28 <input type="checkbox"/>			40 4000K		950 lm		DA Dali Dim	11 <input type="checkbox"/> White
DomoLED 180 Square	RD18 <input checked="" type="checkbox"/> BM11				22W	2520 lm		DP Phase Dim	75 <input checked="" type="checkbox"/> Grey
	RE27 <input type="checkbox"/>					2650 lm		DC CASAMBI	
DomoLED 235 Square	RE25 <input checked="" type="checkbox"/> BM11				35W	3600 lm		D1 0-10V Dim	
	RE26 <input type="checkbox"/>					3760 lm			

Notes:

* For complete code ordering information, please see page 353.

** For other CCT options, please contact us.

EW = Extra Wide. Ordering code: **00**

For the most updated product information, please go to our website.

Optical Accessories

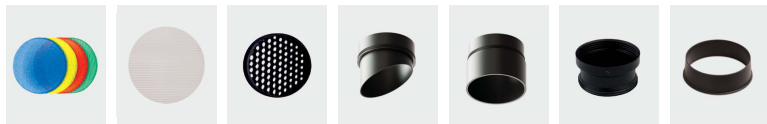

Product / Optical Accessories	Coloured Filters Colours 25, 42, 55, 85	Linear Spread Colour 41	Honeycomb Louvre Colour 10	Wallwasher Visor Colours 10, 17	Anti-Glare Tube Colours 10, 17	Anti-Glare Cone Colours 10, 17	Anti-Glare Hood Colours 10, 17
Zero 40 Semi Recessed	2E36	/	2E35	/	/	/	/
Zero 66 Semi Recessed	2D63	/	2C65	/	/	/	/
Colosseo 75	2E37	/	2B76	/	/	/	/
Colosseo 90	2E38	/	2B95	/	/	/	/
Colosseo 120	2E39	/	2368	/	/	/	/
Zero In & Out 40	2E36*	2E44*	2E35	/	2E43	/	/
Zero In & Out 66	2D63*	2D62*	2C65	2D94	2D67	/	/
Lumi 50	/	/	2B76	/	/	/	/
Lumi 65	/	/	2B95	/	/	/	/
Venus 125 Concave	2614	2615	2504	/	/	/	/
Venus 125							
MultiGiro 89	2C46*	2C45	2065	/	/	2661	/
MultiQuadro 89							
MultiGiro Deep	2614	2615	2504	/	/	2661	2675
MultiQuadro Deep							
Roller In & Out 136	/	/	2368	/	/	/	/
Roller In & Out 195	2B89*	2B90	2367	/	/	/	/



Product / Optical Accessories	Honeycomb Louvre Colours 10, 11	Honeycomb Louvre Colours 10, 11	Linear Spread Colours 41	Linear Spread Colours 41	Concave Trim Colours 10, 11	Concave Trim Colours 10, 11	Anti-Glare Cone Colours 10, 11	Snoot Colours 10, 11
Spoty-fi 76 Fixed Round	2E54 *	/	2E59 *	/	2E55 *	/	2E57 *	2E56 *
Spoty-fi 76 Adjustable Round								
Spoty-fi 100 Adjustable Round	2E92 *	/	2E93 *	/	2E94 *	/	2E95 *	2E96 *
Spoty-fi 100 Adjustable Square	/	2E97 *	/	2E98 *	/	2E99 *	/	/

* With holder
* For Downlight only. To be ordered separately.

Optical Accessories

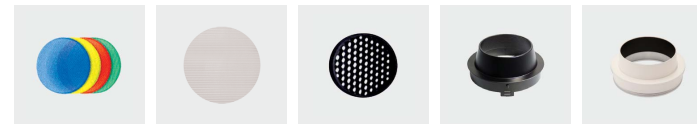

Product / Optical Accessories	Coloured Filters Colours 25, 42, 55, 85	Linear Spread Colour 41	Honeycomb Louvre Colour 10	Anti-Glare Hood Colours 10, 17	Anti-Glare Tube Colours 10, 17
Iride 62	2614*	2615*	2504	/	/
Nippo Round & Square	2662*	2663	2634	/	/
Gimbalo 60	2662*	2663	2634	2321	2418
Gimbalo 100	2B87*	2B88	2633	2B69	2B82
Gimbalo 130	2599*	2598	2334	2327	2C44

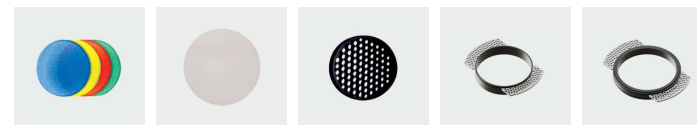

Product / Optical Accessories	Coloured Filters Colours 25, 42, 55, 85	Linear Spread Colour 41	Honeycomb Louvre Colour 10	Protective Ring Recessed Colours 10, 17	Protective Ring Colours 10, 17
Occhio 65 Round	/	/	2B76	/	/
Occhio 87 Round	2614*	2615	2504	2D07	2D06

* With holder
* For Downlight only. To be ordered separately.

Track Lighting

Zero Compasso

Track 40 | 66 | 100 | 130



Body

Track mounted spotlight, inclusive of integrated driver, with lighthouse in cast aluminium.

Available with 3 circuit universal track adapter or Dali track adapter.

Designed for passive cooling.

Available in four different sizes. Versatile aiming angle tiltable vertically 0°-90° and rotatable horizontally 350°.

Accessories

Coloured filters, linear spread, honeycomb louvre, anti-glare tube, wallwasher visor. Check page 128 for details.

Finish

Powder coat in black or white colour.

LED sources

Light Source Options: High Power LED, COB LED.
CRI: 90 | CCT: 3000K, 4000K.
Other CRI and CCT versions available on request.

Optic

Lens.
Super narrow (7°), narrow, medium and wide beam angle available.

Driver

inclusive of integrated no-dimable driver.
Dimming Options: DALI, CASAMBI, 0-10V (100,130), Phase (100, 130).*

Applications

A modern design consisting for the purpose to meet the highest requirements of the latest advanced lighting technology.
Application areas: retail, museums, hospitality, residential, offices, lobbies.

Related Products

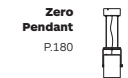
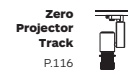
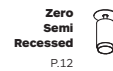

Zero Compasso



Zero Compasso 40
Track

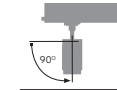
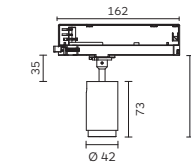

Zero Compasso 66
Track

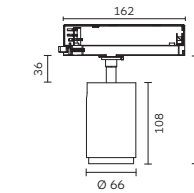

Zero Compasso 100
Track

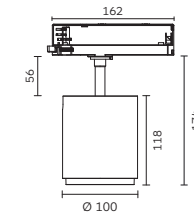

Zero Compasso 130
Track

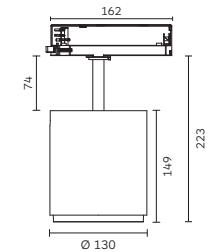

Code ordering example: **6 5 7 1 B R 2 1 - 9 0 3 0 0 7 D 0 1 0**

	Product Code	Light Source Code*	>CRI	CCT**	LED Power	Nominal Lumen	Beam Angle (BA°)	Driver Options	Finish
Zero Compasso 40 Track	6571	BR21 High Power LED	90	30 3000K	4W	439 lm	07	D0 No Dim	10 ■ Black
					40 4000K	483 lm		DA Dali Dim	11 □ White
		BC31 COB LED	6W	705 lm	16 / 26 / 36	DC CASAMBI			
Zero Compasso 66 Track	6573	BR21 High Power LED			6W	574 lm	05		
					636 lm				
		BC31 COB LED	11W	1160 lm	11 / 16 / 32				
Zero Compasso 100 Track	6575	BR21 High Power LED			18W	1947 lm	07	D0 No Dim	
					2153 lm		DA Dali Dim		
		BC33 COB LED	21W	2569 lm	15 / 24 / 38	DP Phase Dim			
Zero Compasso 130 Track	6577	BR21 High Power LED			27W	2920 lm	07	D1 0-10V Dim	
					3230 lm				
		BC33 COB LED	33W	3598 lm	12 / 22 / 32				
					3800 lm				

Notes:

* For complete code ordering information, please see page 353.

** For other CCT options, please contact us.

For related accessories, please see page 128-129.

For the most updated product information, please go to our website.

Zero Due

Track 40 | 66 | 100 | 130



Body

Track mounted spotlight with lighthouse and driver canopy in cast aluminium.

Available with 3 circuit universal track adapter or Dali track adapter.

Designed for passive cooling.

Available in three different sizes. Versatile aiming angle tiltable vertically 0°-90° and rotatable horizontally 350°.

Accessories

Coloured filters, linear spread, honeycomb louvre, visor, anti-glare tube, wallwasher visor. Check page 128 for details.

Finish

Powder coat in black or white colour.

LED sources

Light Source Options: High Power LED, COB LED. CRI: 90 | CCT: 3000K, 4000K. Other CRI and CCT versions available on request.

Optic

Reflector. Super narrow (7°), narrow, medium and wide beam angle available.

Driver

Inclusive of integrated no-dimable driver. Dimming Options: DALI, CASAMBI, 0-10V (100,130), Phase (100, 130).

Applications

A modern design consisting for the purpose to meet the highest requirements of the latest advanced lighting technology. Application areas: retail, museums, hospitality, residential, offices, lobbies.

Related Products

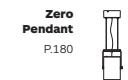
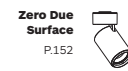
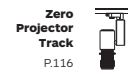
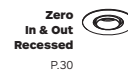
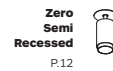

Zero Due

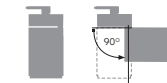
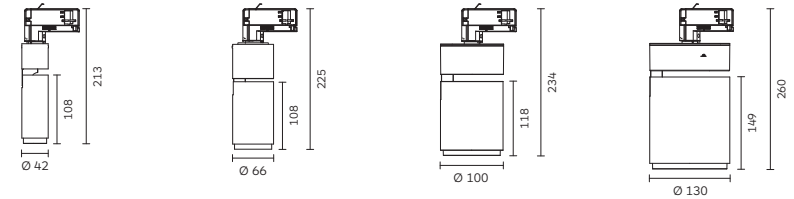

Code ordering example: **6 5 7 2 B R 2 1 - 9 0 3 0 0 7 D 0 1 0**

	Product Code	Light Source Code*	>CRI	CCT**	LED Power	Nominal Lumen	Beam Angle (BA°)	Driver Options	Finish
Zero Due 40 Track	6572	BR21 High Power LED	90	30 3000K	4W	439 lm	07	D0 No Dim	10 ■ Black
					40 4000K	483 lm		DA Dali Dim	11 □ White
		BC31 COB LED	5W	460 lm	16 / 26 / 36	DC CASAMBI			
Zero Due 66 Track	6574	BR21 High Power LED			6W	574 lm	05	D0 No Dim	
					11W	636 lm		DA Dali Dim	
		BC22 COB LED	11W	1160 lm	11 / 16 / 32	DC CASAMBI			
Zero Due 100 Track	6576	BR21 High Power LED			18W	1947 lm	07	D0 No Dim	
					21W	2153 lm		DA Dali Dim	
		BC33 COB LED	21W	2569 lm	15 / 24 / 38	DP Phase Dim			
Zero Due 130 Track	6578	BR21 High Power LED			27W	2920 lm	07	DC CASAMBI	
					33W	3230 lm		D1 0-10V Dim	
		BC33 COB LED	33W	3598 lm	12 / 22 / 32				

Notes:

* For complete code ordering information, please see page 353.

** For other CCT options, please contact us.

For related accessories, please see page 128-129.

For the most updated product information, please go to our website.

Zero Projector



Body

Advanced & Multi functional LED track spot, Zero Projector offers a high-precision illumination with sharp outlines and a high degree of lighting uniformity. The versatile aiming angle is tiltable vertically 0°-90° and rotatable horizontally 350°.

Framing Projector spot features four adjustable shutters allowing the beam to be framed to the desired size shape (circle, square/rectangle, or irregular 4 sided shapes). It offers options of bidirectional zooming lens for resolving complex focal points, project sharpness adjustment, and lens rotation. Furthermore, it allows gobo insertion for logo projection easily and has an on-board knob to adjust the dimming and a switch to change the CCT.

Accessories

Framing and shape lenses are included in the specific projector. Contact us for custom made logo projection lens.

Finish

Powder coat in black or white colour.

LED sources

COB LED with 3 CCT Options.
CRI: 97 | CCT: 3000K, 4000K, 6000K | 2700K, 4000K, 6000K
Other CRI and CCT options, Tuneable White, DimToWarm RGB/W versions available on request.

Optic

Zoomable Lens System with 4 adjustable shutters to control the shape and size of the projection area.
Available beam angle range : 20°- 36°/15° - 25°







Driver

Integrated on-board dimming.
Other Dimming Options: 0-10V Dim, DALI, Phase, CASAMBI.

Applications

Particularly designed for accent lighting of objects in window display exhibition areas and for the projection of advertising images.
Application areas: museums, hospitality, retail, interior design.

Related Products

- Zero Semi Recessed**  P.12
- Zero In & Out Recessed**  P.30
- Zero Track Series**  P.112-115
- Zero Due Surface**  P.152
- Zero Projector Surface**  P.154
- Zero Pendant**  P.180

Zero Framing Projector



6593

Track

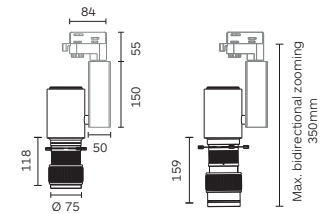

6594

Track

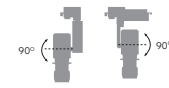
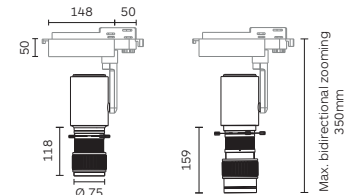

Code ordering example: **6 5 9 3 B C 3 2 - 9 7 3 0 1 5 D 1 1 0**

	Product Code	Light Source Code*	>CRI	CCT**	LED Power	Nominal Lumen	Beam Angle (BA°)	Driver Options	Finish
Zero Framing Projector 100	6593	BC32	COB LED	97	30	3000K	28.6W	2585 lm	BS (15°-25°)
Track				40	4000K	2849 lm		BW (20°-36°)	11  White
	6594							D0 No Dim	
								DA Dali Dim	

Notes:

- * For complete code ordering information, please see page 353.
- ** For other CCT options, please contact us.
- BS:** Beam shaping, Beam Angle: 15° - 25°, **BW:** Beam Wide, Beam Angle: 20° - 36°.
- For the most updated product information, please go to our website.

Ola Compasso

Track 55 | 100 | 130



Body

Track mounted spotlight with lighthouse and arm in cast aluminium.
Available with three circuit universal track adapter or Dali track adapter.

Lighthouse designed for passive cooling.

Available in three different sizes. Versatile aiming angle tiltable vertically 0°-90° in two directions and rotatable horizontally 350°.

Accessories

No accessories available.

Finish

Powder coat in black or white colour.

LED sources

Light source options: COB LED, High Power LED.
CRI: 90 | CCT: 3000K, 4000K.
Other CRI and CCT options available on request.

Optic

Lens.
Super narrow (7°), narrow, medium and wide beam angle available.

Driver

Track adaptor inclusive of integrated no-dimable driver.
Dimming Options : DALI, Casambi.

Applications

A chic and alluring light fixture, designed by formalighting's passionate engineers. His circular shaped classic design easily integrated into various architectural environments.
Application areas: retail, museums, residential, restaurants.

Related Products



Ola Compasso



Ola Compasso 55

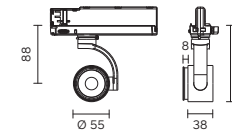

Ola Compasso 100

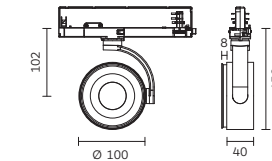

Ola Compasso 130

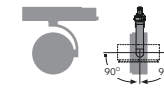
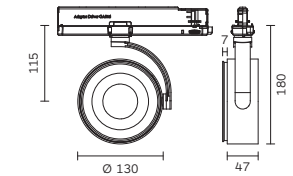

Code ordering example: **6 5 3 6 B R 2 1 - 9 0 3 0 0 7 D 0 1 0**

	Product Code	Light Source Code*	>CRI	CCT**	LED Power	Nominal Lumen	Beam Angle (BA°)	Driver Options	Finish
Ola Compasso 55 Track	6536	BR21 High Power LED	90	30 3000K	4W	400 lm	07	D0 No Dim	10 ■ Black
					40 4000K	430 lm	DA Dali Dim	11 □ White	
		BC22 COB LED	12W	1415 lm	18 / 24 / 36	DC CASAMBI			
Ola Compasso 100 Track	6533	BR21 4xHigh Power LED			16W	1640 lm	07		
					1930 lm				
		BC33 COB LED	17W	1934 lm	15 / 24 / 38				
Ola Compasso 130 Track	6534	BR21 6xHigh Power LED			20W	2320 lm	07		
					2560 lm				
		BR11 High Power LED	24W	2550 lm	17 / 25 / 46				
			2730 lm						
BC33 COB LED	25W	2930 lm	12 / 22 / 32						
					3090 lm				

Notes:

* For complete code ordering information, please see page 353.

** For other CCT options, please contact us.

For the most updated product information, please go to our website.

Ola Zoom

Track 100



Body

Track mounted spotlight with lighthouse and arm in cast aluminium.

Available with three circuit universal track adapter or DALI track adapter.

Lighthouse designed for passive cooling.

Beam Angle manually adjustable through ring rotation, from 10° to 35°. Tilttable vertically 0°-90° in two directions and rotatable horizontally 350°.

Accessories

No accessories available.

Finish

Powder coat in black or white colour.

LED sources

Light source options: COB LED.
CRI: 90 | CCT: 3000K, 4000K.
Other CRI and CCT options available on request.

Optic

Lens.
Adjustable beam angle (10-35°)

Driver

Track adapter inclusive of integrated no-dimable driver.
Dimming Options : 0-10V, DALI, Casambi.

Applications

A chic and alluring light fixture, designed by formalighting's passionate engineers. His circular shaped classic design easily integrated into various architectural environments. Application areas: retail, museums, residential, restaurants.

Related Products



Ola Zoom



Ola Zoom 100
Track

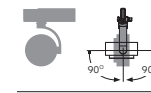
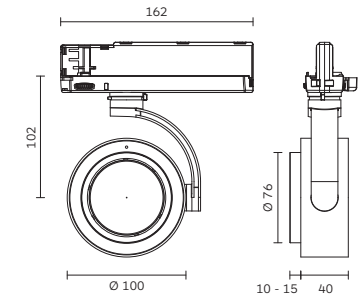

Code ordering example: **6 5 4 5 B C 3 1 - 9 0 3 0 B S D 0 1 0**

	Product Code	Light Source Code*	>CRI	CCT**	LED Power	Nominal Lumen	Beam Angle (BA°)	Driver Options	Finish
Ola Zoom 100	6545	BC31 COB LED	90	30 3000K	11W	1160 lm	BS (10-35°)	D0 No Dim	10 ■ Black
Track				40 4000K		1260 lm		DA Dali Dim DC CASAMBI D1 0-10V Dim	11 □ White

Notes:

* For complete code ordering information, please see page 353.

** For other CCT options, please contact us.

BS: Beam shaping, Beam Angle:10-35°.

For the most updated product information, please go to our website.

Polaris

Designed by **Franco Mireni** (Registered)



Body

Track mounted spotlight with light body in cast aluminium inclusive of Integrated diamond faceted no-dazzle screen in thermoplastic.

Available with 3 circuit universal track adapter or Dali track adapter.

Luminaire body in cast aluminium with integrated diamond faceted screen made from thermoplastic.

Versatile aiming angle tiltable vertically 0°-90° in two directions and rotatable horizontally 350°.

Accessories

No accessories available.

Finish

Powder coat in black or white. White version available also with integrated black thermoplastic screen.

LED sources

Light source options: High Power LED. CRI: 90 | CCT: 3000K, 4000K. Other CRI, CCT and Tuneable White options available on request.

Optic

Lens plus thermoplastic screen. UGR < 16.

Driver

Inclusive of integrated no-dimable driver. Dimming Options: DALI, CASAMBI.

Applications

An innovative solution for high brilliance and performance. The light source is barely visible, as the miniature light heads create a high contrast and circular light emission. Application areas: residential, hotels, restaurants, retail, corridors.

Related Products

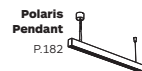

Polaris 30



Polaris 30

Track with 4 LEDs

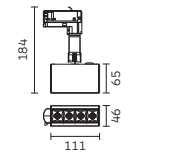

Polaris 30

Track with 8 LEDs

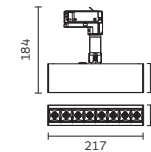

Polaris 30

Track with 12 LEDs

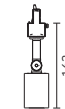
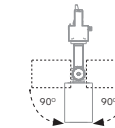
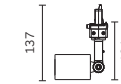
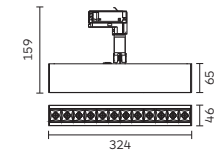

Code ordering example: **6 4 8 0 B O 1 1 - 9 0 3 0 3 4 D O 1 0**

	Product Code	Light Source Code*	>CRI	CCT**	LED Power	Nominal Lumen	Beam Angle (BA°)	Driver Options	Finish
Polaris 30 4 LEDs	6480	BO11 High Power LED	90	30 3000K	4x2W	760 lm	34 / 50	DO No Dim	10 ■ Black
				40 4000K		960 lm		DA Dali Dim	11 □ White
Polaris 30 8 LEDs	6481				8x2W	1520 lm		DC CASAMBI	17 ▣ B/W
						1920 lm			
Polaris 30 12 LEDs	6482				12x2W	2280 lm			
						2880 lm			

Notes:

* For complete code ordering information, please see page 353.

** For other CCT options, please contact us.

17: white light body with black integrated louvre. For black body with white integrated louvre consult us.

For the most updated product information, please go to our website.

Rolo & Dado

Rolo designed by Simon Fisher



Body

Track mounted round spotlight with light-head and driver box in cast aluminium.

Available with 3 circuit universal track adapter or Dali track adapter.

Easy relamping by the removable lamp front ring via simple snap-in catch action.

Versatile aiming angle tiltable vertically 0°-90° and rotatable horizontally 350°.

Accessories

Honeycomb louvre.
Check page 129 for details.

Finish

Powder coat in black, white or grey colour.

LED sources

Light source options: COB LED, High Power LED, Retrofit.
CRI: 90 | CCT: 3000K, 4000K.
Other CRI and CCT options available on request.

Optic

Lens.
Super narrow (7°), narrow, medium and wide beam angle available.

Driver

Driver box inclusive of no-dimable driver.
Dimming Options: 0-10V Dim, DALI, Phase, CASAMBI.

Applications

A versatile and very directional tiny spotlight. The very compact sizes make it ideal for applications where the distance between ceiling and spot is an issue.
Application areas: retail, museums, residential, hospitality, window displays.

Related Products



Rolo & Dado



Rolo

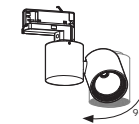
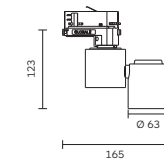

Dado

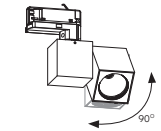
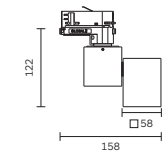

Code ordering example: **6 2 8 8 B R 2 1 - 9 0 3 0 0 7 D 0 1 1**

	Product Code	Light Source Code*	>CRI	CCT**	LED Power	Nominal Lumen	Beam Angle (BA°)	Driver Options	Finish
Rolo Track	6288	BR21 High Power LED	90	30 3000K	4W	400lm	07	D0 No Dim	10 ■ Black
Dado Track	6287	BC31 COB LED		40 4000K	11W	1080lm 1180lm	11 / 16 / 32	DA Dali Dim DP Phase Dim DC CASAMBI D1 0-10V Dim	11 □ White 75 ■ Grey
	GU53 Retrofit	GU5.3-MR16	00	00	/	/	00	DP Phase Dim	
	GU10	GZ10-GU10							

Notes:

* For complete code ordering information, please see page 353.

** For other CCT options, please contact us.

For related accessories, please see page 128-129.

For the most updated product information, please go to our website.

Conos

Designed by Franco Mirezzi

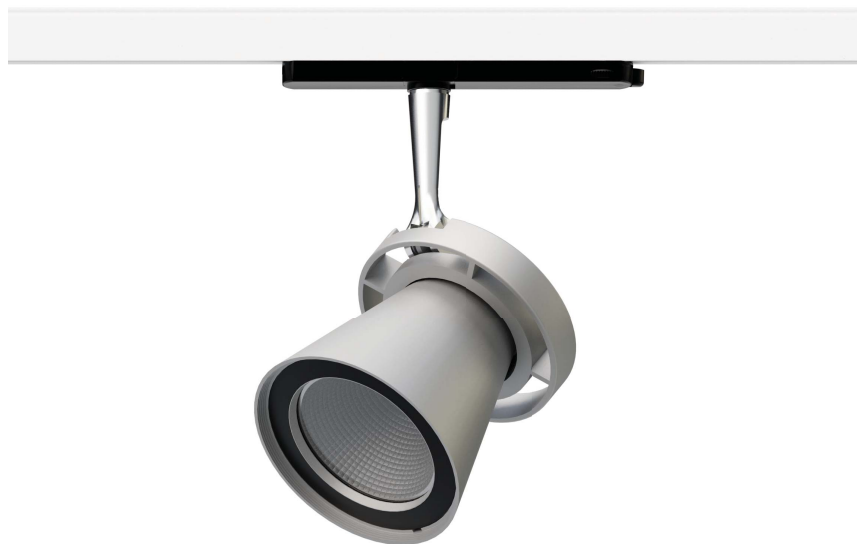

Body

Track mounted spotlight with light head and arm in cast aluminium. Equipped with super pure aluminium reflector.

Available with 3 circuit universal track adapter or Dali track adapter.

Easy relamping via removable front housing by snap-in catch action.

Available in 3 different sizes.

Versatile aiming angle tiltable vertically 0°-90° and rotatable horizontally 350°. Possibility to lock the fixture at the desired tilt angle.

Accessories

Honeycomb louvre.
Check page 128 for details.

Finish

Powder coat in black, white or grey colour.

LED sources

Light source options: COB LED, Retrofit.
CRI: 90 | CCT: 3000K, 4000K.
Other CRI and CCT options available on request.

Optic

Lens.
COB: Narrow, medium and wide beam angle.

Driver

Track adaptor inclusive of integrated no-dimable driver.
Dimming Options : DALI, Casambi.

Applications

A concept in spotlight design with continuous line applications for the benefit of increasing the possibility of display lighting. Conos 100/68 are ideal for small spaces. Application areas: retail, museums, residential, hospitality, window displays.

Related Products

Conos Due Surface
P.156



Conos



Conos 68

Track

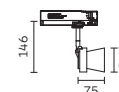
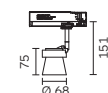

Conos 100

Track

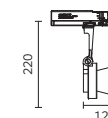
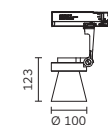

Conos 154

Track

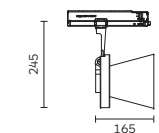
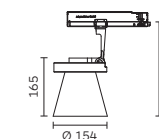

Code ordering example: **6 4 9 4 | C 2 2 - 9 0 3 0 1 6 D 0 1 0**

	Product Code	Light Source Code*	>CRI	CCT	LED Power	Nominal Lumen	Beam Angle (BA°)	Driver Options	Finish
Conos 68 Track	6494	IC22 COB LED	90	30 3000K	7W	830 lm	16 / 28 / 40	D0 No Dim	10 ■ Black
				40 4000K		860 lm		DA Dali Dim	11 □ White
						3600 lm		DC CASAMBI	75 ■ Grey
	GU53 Retrofit MR16-GU5.3	00	00	/	/	00	DP Phase Dim		
	GU10	GU10-GZ10							
Conos 100 Track	6492	IC22 COB LED	90	30 3000K	22W	2170 lm	12 / 21 / 39	D0 No Dim	
				40 4000K		2200 lm		DA Dali Dim	
Conos 154 Track	6323	IC21 COB LED	90	30 3000K	30W	3570 lm	14 / 24 / 38	DC CASAMBI	
						3600 lm		DP Phase Dim	
	AR11 Retrofit AR111-G53	00	00	/	/	00			

Notes:

* For complete code ordering information, please see page 353.

** For other CCT options, please contact us.

For related accessories, please see page 128-129.

For the most updated product information, please go to our website.

Optical Accessories

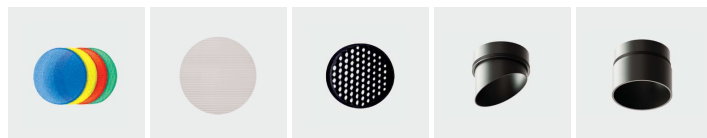

Product / Optical Accessories	Coloured Filters Colours 25, 42, 55, 85	Linear Spread Colour 41	Honeycomb Louvre Colour 10	Wallwasher Visor Colours 10, 17	Anti-glare Tube Colours 10, 17
Zero Compasso 40 Track	2E36	2E44	2E35	/	2E43
Zero Due 40 Track					
Zero Compasso 66 Track					
Zero Due 66 Track					
Zero Compasso 100 Track BC33	2E10*	2E12*	2C66	2E14	2E16
Zero Due 100 Track BC33					
Zero Compasso 100 Track BR21	/	/	2C70	/	/
Zero Due 100 Track BR21					
Zero Compasso 130 Track BC33	2E11*	2E13*	2C67	2E15	2E17
Zero Due 130 Track BC33					
Zero Compasso 130 Track BR21	/	/	2E45	/	/
Zero Due 130 Track BR21					
Conos 68 Track			2B95		
Conos 100 Track	/	/	2368	/	/
Conos 154 Track			2367		

* With holder

Optical Accessories



Product / Optical Accessories	Honeycomb Louvre Colour 10	Visor Colours 10, 17	Snoot Colours 10, 17	Anti-glare Tube Colours 10, 17
Rolo Track GUS.3	2672	/	/	/
Dado Track GUS.3	2634			

* With holder

Eurotype Track System with Dali Bus

Surface Mounted Track & Flanged Recessed Track

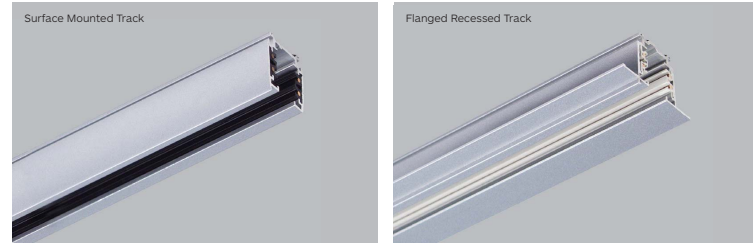

Product Code	Length (L)	Finish
2D65	1m	10 Black
2D65	2m	11 White
2D65	3m	75 Grey

Product Code	Length (L)	Finish
2D66	1m	10 Black
2D66	2m	11 White
2D66	3m	75 Grey

Notes: Connection to the 220-250V single-phase mains: 16A overall load, corresponding to 3500/4000 VA over the three circuits.

Features

Three circuit main-voltage track system with Data Bus.

Track in extruded aluminium fitted with four 16A rolled copper conductors and 2 conductors for Data signal housed in extruded insulated black thermoplastic.

Equipped with three separately controllable current circuit.

Completed of a vast range of accessories to fit to the needs of any specific project.



..... The drawing is Reflected Ceiling View.
 Directive Lug on the back of connectors.

Reference Diagram for Choice of Connctors (Surface Mounted Track)

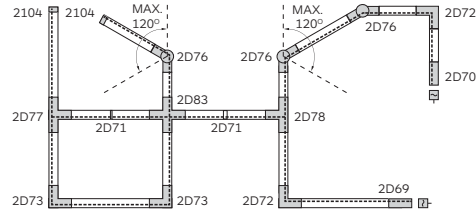

Reference Diagram for Choice of Connctors (Flanged Recessed Track)

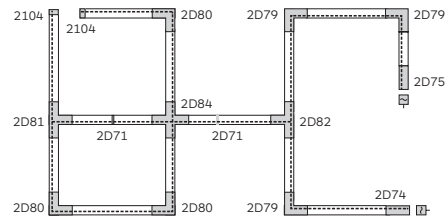

Installation Components

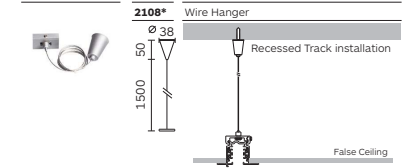
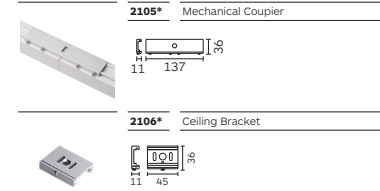

Accessories

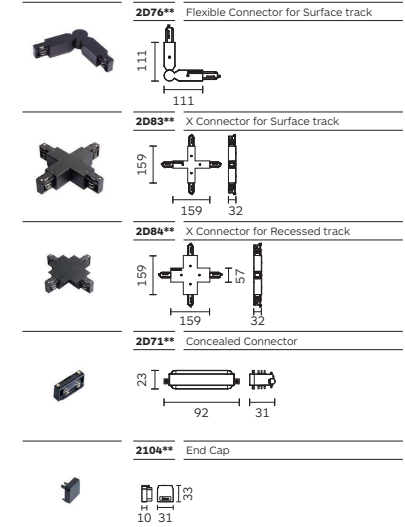
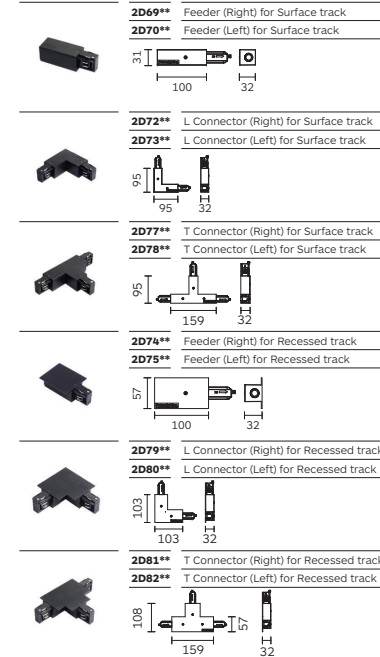

Notes:
 * Available in colours 10, 11, 75.
 ** Available in colours 10 & 11.

Eurotype Track System

Surface Mounted Track & Flanged Recessed Track

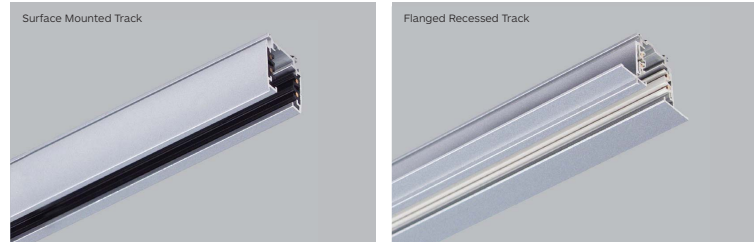

Product Code	Length (L)	Finish
2089	1m	10 Black
2090	2m	11 White
2091	3m	75 Grey

Notes: Connection to the 220-250V single-phase mains: 16A overall load, corresponding to 3500/4000 VA over the three circuits.

Features

Three circuit main-voltage track system.

Track in extruded aluminium fitted with four 16A rolled copper conductors housed in extruded insulated black thermoplastic.

Equipped with three separately controllable current circuit.

Completed of a vast range of accessories to fit to the needs of any specific project.



Directive Lug

--- The drawing is Reflected Ceiling View.

..... Directive Lug on the back of connectors.

Reference Diagram for Choice of Conneters (Surface Mounted Track)

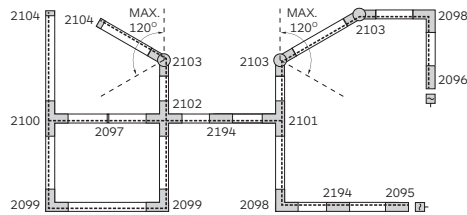

Reference Diagram for Choice of Conneters (Flanged Recessed Track)

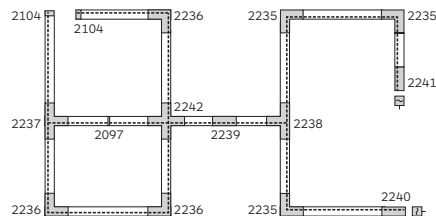

Installation Components

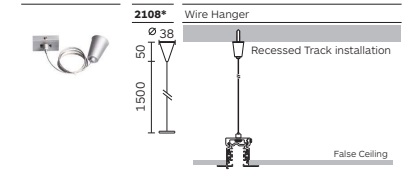
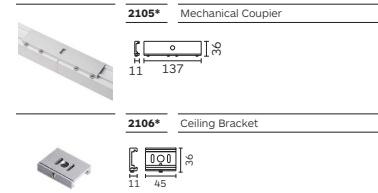

Couplings

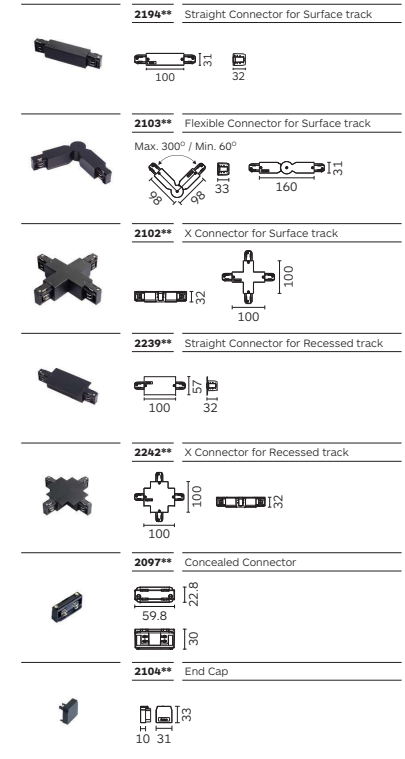
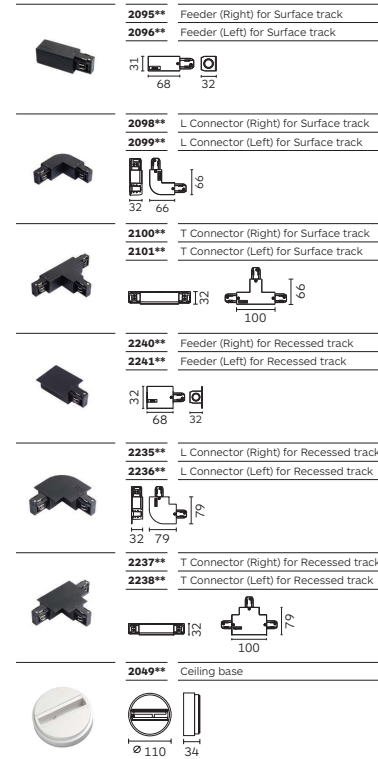

Notes:
 * Available in colours 10, 11, 75.
 ** Available in colours 10 & 11.

Surface Lighting

Pixo

Surface 36 | 77



Body

Ceiling mounted luminaire with light body in extruded aluminium.

Light body available in two diameters (36mm and 77mm) and three different length.

Exchangable front ring in wide range of colours.

LED sources

COB LED.
CRI: 90 | CCT: 3000K, 4000K.
Other CRI and CCT versions available on request.

Optic

Lens.
Narrow, medium and wide beam angle available.

Accessories

Decorative front ring available in different colours, Acrylic decorative diffuser, Honeycomb louvre.
Check page 170 for details.

Finish

Powder coat in black or white.
Exchangable front ring available in different colours.

Driver

Supplied with integrated no-dimable driver.
Dimming Options (Pixo 77): 0-10V Dim, DALI, Phase, CASAMBI.

Applications

A modern designed surface ambient light. Its accessories make it the perfect match for sophisticated environments.
Application areas: residential, hotels, restaurants, retail, corridors.

Related Products

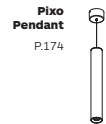
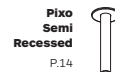

Pixo

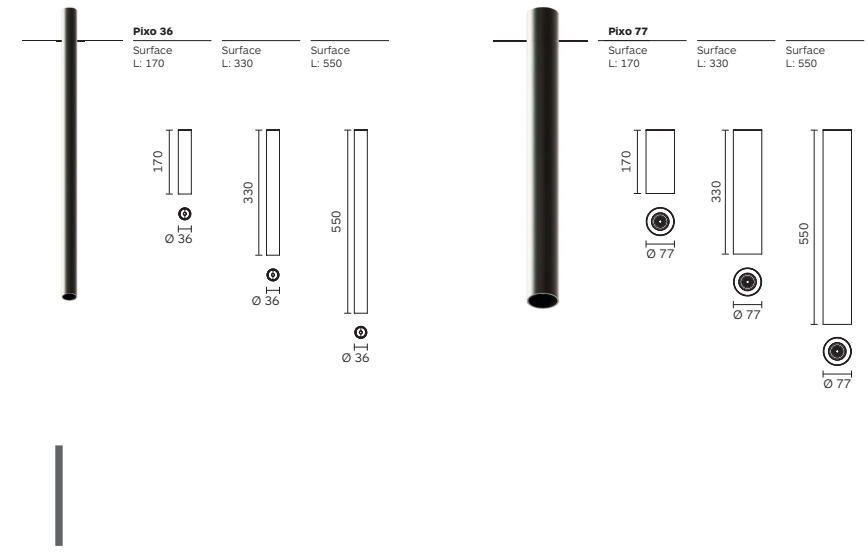

Code ordering example: **1 3 8 7 B C 3 1 - 9 0 3 0 2 0 D 0 1 0**

	Product Code	Product Length	Light Source Code*	>CRI	CCT**	LED Power	Nominal Lumen	Beam Angle (BA°)	Driver Options	Finish
Pixo 36 Surface	1387	170	BC31 COB LED	90	30 3000K	5W	500 lm	20 / 26 / 36	D0 No Dim	10 ■ Black
	1389	330			40 4000K		550 lm			11 □ White
	1391	550								
Pixo 77 Surface	1388	170	BC22 COB LED			12W	1570 lm	12 / 20 / 32	D0 No Dim	
							1600 lm		DP Phase Dim	
									DC CASAMBI	
								D1 0-10V Dim		
	1390	330							D0 No Dim	
	1392	550							DP Phase Dim	
									DC CASAMBI	
									D1 0-10V Dim	
									DA Dali Dim	

Notes:

* For complete code ordering information, please see page 353.

** For other CCT options, please contact us.

For related accessories, please see page 170-171.

For the most updated product information, please go to our website.

Lucciole

Ceiling



Body

A delicate & striking ceiling mounted-lighting with subtle light effect. The traditional yet modern Italian-style sophisticated glass lamps are wall-mounted by a round chrome-plated fixture body of 95mm diameter. The chrome-plated fixture body and the use of non-toxic acrylic glass in a lamp adds to its decorative appeal while also ensuring its durability.

Inspired by Firefly's ability of natural glow, it features a lamp's body of various shapes, sizes, and designs. A very eco-friendly and 100% recyclable lamp with diffuse light distribution.

Accessories

No accessories available

Finish

Decorative Chrome, White, Black, Bronze, Copper, Brass

LED sources

SMD LED 6.5W, CRI >90, CCT : 3000K, 4000K, 636lm
COB LED 6.5W, CRI >90, CCT : 1800K, 3000K, 636lm

Optic

Acrylic glass, non-toxic, non-harmful
more light and transparent than glass.

Driver

It is supplied with an integrated non-dimmable driver 0-10V.
Casambi, DALI On Request

Applications

The Lucciole's goal is to be a lighting system that provides elegant lighting effects, suitable for environments where the decorative aspect has a scenic function.
Application areas: residential, hotels, restaurants, retail, corridors.

Related Products

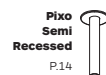

Lucciole Ceiling



Lucciole
Ceiling

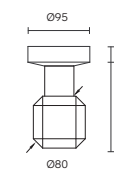
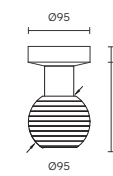
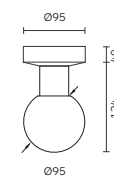

Code ordering example: **D 1 1 4 B M 1 1 - 9 0 3 0 0 0 D 0 1 0**

	Product Code	Light Source Code*	>CRI	CCT**	LED Power	Nominal Lumen	Beam Angle (BA°)	Driver Options	Finish
Lucciole Ceiling	D114	BM11 SMD LED	90	30 3000K	6.5W	636 lm	00	D0 No Dim	10 ■ Black
			40 4000K					DA Dali Dim	11 □ White
Lucciole Ceiling	D115							DC CASAMBI	27 ■ Chrome
								D1 0-10V Dim	30 ■ Brozen
Lucciole Ceiling	D120	BB32 COB LED		TW from 1800K to 3000K	6.5W	636 lm		DA Dali Dim	35 ■ Copper
								DC CASAMBI	40 ■ Brass
								D1 0-10V Dim	

Notes:

* For complete code ordering information, please see page 353.

** For other CCT options, please contact us.

For the most updated product information, please go to our website.

Lucciole

Wall Mounted



Body

Wall-mount uplight that indirectly bounces light back into your environment, the Lucciole wall lighting series is a blend of beauty and elegance. An L-shaped fixture body of 95x160mm connects the lamp to the wall. The chrome-plated fixture body and the use of non-toxic acrylic glass in a lamp adds to its decorative appeal while also ensuring its durability.

Inspired by Firefly's ability of natural glow, it features a lamp's body of various shapes, sizes and designs. A very eco-friendly and 100% recyclable lighting with diffuse light distribution.

Accessories

No accessories available

Finish

Decorative Chrome, White, Black, Bronze, Copper, Brass

LED sources

SMD LED 6.5W, CRI >90, CCT : 3000K, 4000K, 636lm
COB LED 6.5W, CRI >90, CCT : 1800K, 3000K, 636lm

Optic

Acrylic glass, non-toxic, non-harmful more light and transparent than glass

Driver

It is supplied with an integrated non-dimmable driver 0-10V.
Casambi, DALI On Request

Applications

The Lucciole's goal is to be a lighting system that provides elegant lighting effects, suitable for environments where the decorative aspect has a scenic function.
Application areas: residential, hotels, restaurants, retail, corridors.

Related Products

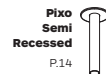

Lucciole Wall Mounted

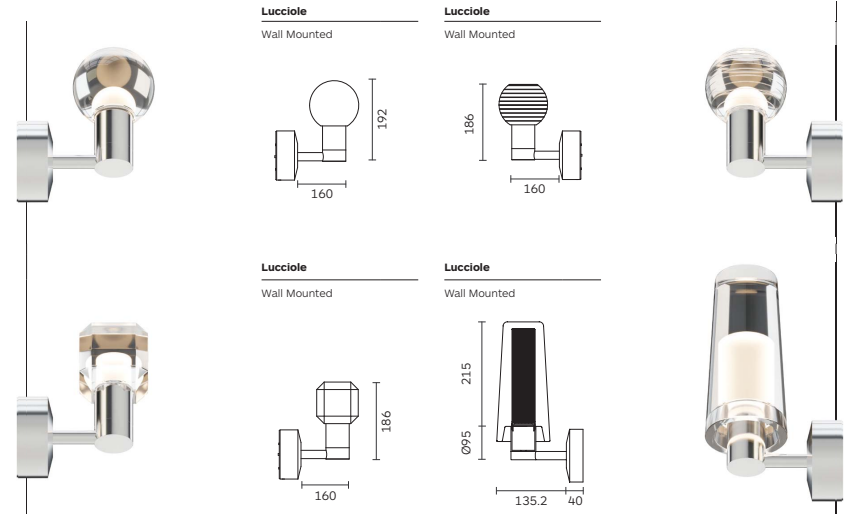

Code ordering example: **D 1 1 9 B M 1 1 - 9 0 3 0 0 0 D 0 1 0**

	Product Code	Light Source Code*	>CRI	CCT**	LED Power	Nominal Lumen	Beam Angle (BA°)	Driver Options	Finish
Lucciole Wall Mounted	D119	BM11	SMD LED	90	30	3000K	6.5W	636 lm	00
				40	4000K				
Lucciole Wall Mounted	D122								
Lucciole Wall Mounted	D123	BB32	COB LED	TW	from 1800K	6.5W	636 lm		
					to 3000K				
Lucciole Wall Mounted	D127								

Notes:

* For complete code ordering information, please see page 353.

** For other CCT options, please contact us.

For the most updated product information, please go to our website.

Twist & Twist Deep

Surface



Body

Ceiling mounted downlight with light body in cast aluminium.

Quick and easy installation and relamping via snap-in catch action.

Twist: tiltable vertically 0-20° and rotatable horizontally 350°.

Twist Deep fixed: internal aluminium light body shape with black baffle. Decorative colour ring in cast aluminium. Decorative transparent extension in thermoplastic.

Twist Deep adjustable: tiltable vertically 0-30° and rotatable horizontally 350°.

Accessories

Twist Deep Fixed COB: Decorative front ring available in different colours, acrylic decorative diffuser, colored filters, linear spread, honeycomb louvre. Twist Round-Square, Anti-glare hood, seni recessed kit. Check page 170 for details.

Finish

Powder coat in black, white or grey colour. Exchangable front ring available in different colours.

LED sources

Light Source Options: Retrofit (GU10/GU5.3), COB LED (only 1367).

CRI: 90 | CCT: 3000K, 4000K.

Other CRI and CCT versions available on request.

Optic

Twist Deep COB (1367): Lens, Narrow, Medium and Wide beam anhle available

Driver

Supplied with integrated no-dimable driver. Diming Options: 0-10V Dim, DALI, Phase, CASAMBI.

Applications

Series of ceiling mounted luminaires with simple design used to provide ambient or accent lighting. Ideal to be installed in concrete ceilings or restricted voids. Able to direct the light where required. Application areas: residential, retail, galleries, restaurants, hotels, lobbies, corridors.

Related Products

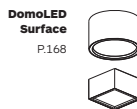

Twist

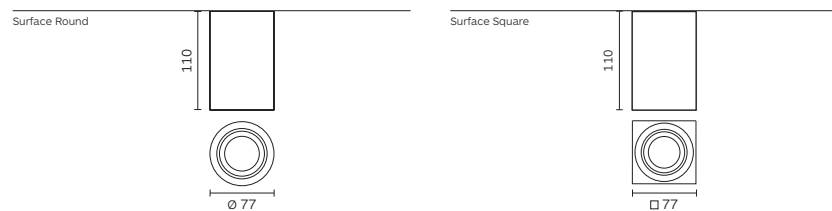

Code ordering example: **1 0 2 1 G U 1 0 - 0 0 0 0 0 0 1 0**

	Product Code	Light Source Code*	>CRI	CCT**	LED Power	Nominal Lumen	Beam Angle (BA°)	Driver Options	Finish
Twist Surface Round	1021	GU10 Retrofit GU10-GZ10	00	00	/	/	00	00 No Driver	10 ■ Black 11 □ White
Twist Surface Square	1020								75 ■ Grey

Notes:
 * For complete code ordering information, please see page 353.
 ** For other CCT options, please contact us.
 For related accessories, please see page 170-171.
 For the most updated product information, please go to our website.

Twist Deep Fixed

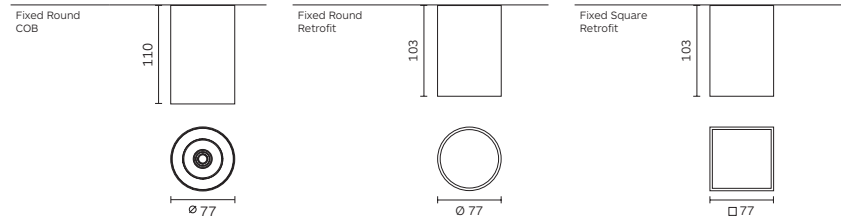

COB Version with colour ring



Code ordering example: **1 3 6 7 B C 2 2 - 9 0 3 0 1 6 D 0 1 0**

	Product Code	Light Source Code*	>CRI	CCT	LED Power	Nominal Lumen	Beam Angle (BA°)	Driver Options	Finish
Twist Deep Fixed Round COB	1367	BC22 COB LED	90	30 3000K	12W	1550 lm	16 / 25 / 36 / 58	D0 No Dim	10 ■ Black
				40 4000K		1570 lm		DP Phase Dim	11 □ White
Twist Deep Fixed Round Retrofit	1024	GU10 Retrofit GU10-GZ10	00	00	/	/	00	00 No Driver	75 ■ Grey
Twist Deep Fixed Square Retrofit	1025								

Notes:
 * For complete code ordering information, please see page 353.
 ** For other CCT options, please contact us.
 For related accessories, please see page 170-171.
 For the most updated product information, please go to our website.

Twist Deep Adjustable

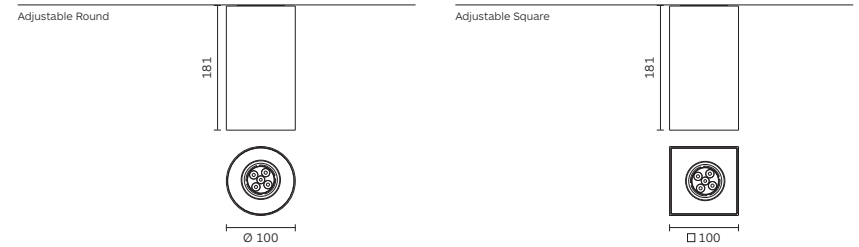

Code ordering example: **1 1 7 7 G U 5 3 - 0 0 0 0 0 0 D P 1 0**

	Product Code	Light Source Code*	>CRI	CCT**	LED Power	Nominal Lumen	Beam Angle (BA°)	Driver Options	Finish
Twist Deep Adjustable Round	1177	GU53 Retrofit MR16-GU5.3	00	00	/	/	00	DP Phase Dim	10 ■ Black
									11 □ White
Twist Deep Adjustable Square	1195								75 ■ Grey

Notes:
 * For complete code ordering information, please see page 353.
 ** For other CCT options, please contact us.
 For related accessories, please see page 170-171.
 For the most updated product information, please go to our website.

Polaris

Surface 30 with 8 / 12 / 16 light heads



Body

Surface mounted luminaire with light body in extruded aluminium inclusive of integrated diamond faceted nodazzle louvre in thermoplastic.

Surface Mounted arms in cast aluminium. Light body measuring 45mm in width and 65mm in height.

Available in configuration with 8, 12 and 16 light heads.

Light heads collectively tiltable in two directions from 0° to 90° through the surface mounted arms.

Accessories

No accessories available.

Finish

Powder coat in black or white. White version available also with integrated black thermoplastic screen.

LED sources

High Power LED.
CRI: 90 | CCT: 3000K, 4000K.
Other CRI, CCT and Tuneable White options available on request.

Optic

Lens plus thermoplastic screen.
UGR < 16.
Four different (medium and wide) beam angles available.

Driver

Supplied with integrated no-dimable driver.
Dimming Options: 0-10V Dim, DALI, Phase, CASAMBI.

Applications

An innovative solution for high brilliance and performance. The light source is barely visible, as the miniature light heads create a high contrast and circular light emission. Application areas: residential, hotels, restaurants, retail, corridors.

Related Products

Polaris Recessed Series
P.16-21



Polaris Wallwasher Series
P.22-25



Polaris Track
P.122



Polaris Pendant
P.182



Polaris



Polaris 30



Polaris 30

Surface with 8 LEDs

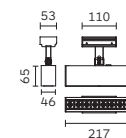

Polaris 30

Surface with 12 LEDs

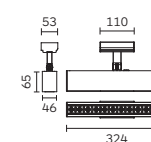

Polaris 30

Surface with 16 LEDs

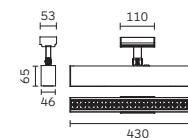

Code ordering example: **1 3 5 0 B O 1 1 - 9 0 3 0 3 4 D 0 1 0**

	Product Code	Light Source Code*	>CRI	CCT**	LED Power	Nominal Lumen	Beam Angle (BA°)	Driver Options	Finish
Polaris 30 Surface with 8 LEDs	1350	BO11 High Power LED	90	30 3000K	8x2W	1520 lm	34 / 50	D0 No Dim	10 ■ Black
				40 4000K		1920 lm			11 □ White
Polaris 30 Surface with 12 LEDs	1351				12x2W	2280 lm		D0 No Dim	17 ▨ B/W
						2880 lm		DA Dali Dim	
Polaris 30 Surface with 16 LEDs	1346				16x2W	3040 lm		DC CASAMBI	
						3840 lm		D1 0-10V Dim	

Notes:

* For complete code ordering information, please see page 353.

** For other CCT options, please contact us.

17: white light body with black integrated louvre. For black body with white integrated louvre consult us. For the most updated product information, please go to our website.

Miniluce

Surface 900 | 1200 | 1500



Body

Surface mounted linear luminaire with luminaire body in extruded aluminium.

End caps in cast aluminium, diffuser made of satin opal acrylic.

Mountable horizontally or vertically according with the needs of the projects. Available in 3 different lengths.

Accessories

No accessories available.

Finish

Powder coat in white or grey colour.

LED sources

SMD LED.
CRI: 90 | CCT: 3000K, 4000K.
Other CRI and CCT versions available on request.

Optic

Satin acrylic opal diffuser.
Extra wide beam angle.

Driver

Supplied with integrated no-dimable driver.
Dimming Options: 0-10V Dim, DALI, Phase, CASAMBI.

Applications

A simple and stylish design. The 3 directional emitting satin acrylic cover enables the architect and lighting designers the ability to integrate it into most applications including wet rooms.
Application areas: office, schools, gyms, community buildings, supermarkets, retail.

Related Products



Miniluce

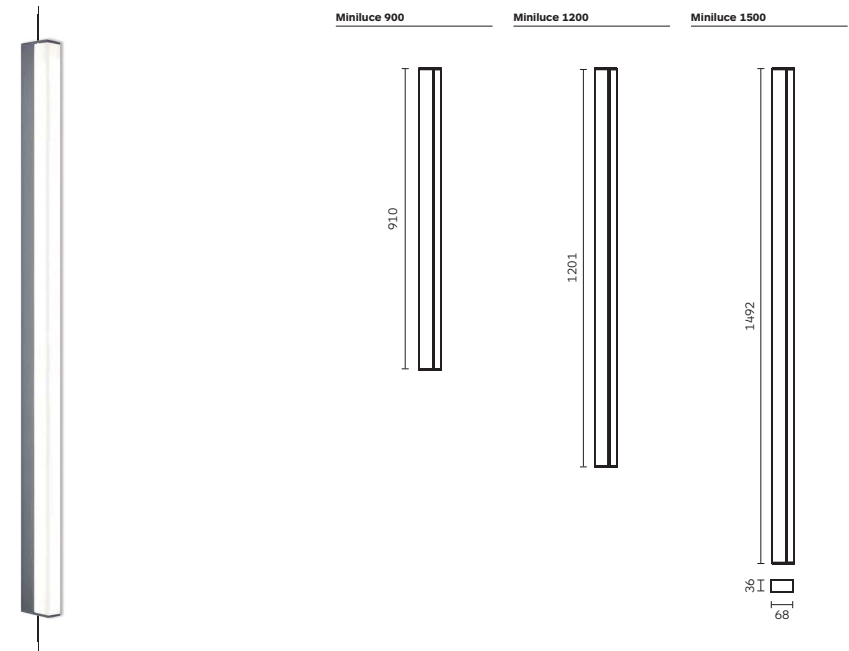

Code ordering example: **1 2 1 0 B M 1 1 - 9 0 3 0 0 0 D 0 7 5**

	Product Code	Light Source Code*	>CRI	CCT**	LED Power	Nominal Lumen	Beam Angle (BA°)	Driver Options	Finish
Miniluce 900 Surface	1210	BM11 SMD LED	90	30 3000K	26W	2912 lm	EW (00)	DO No Dim	75 Grey
				40 4000K		3065 lm	DA Dali Dim		
Miniluce 1200 Surface	1211				35W	3920 lm		DC CASAMBI	
						4130 lm	D1 0-10V Dim		
Miniluce 1500 Surface	1212				44W	4928 lm			
						5192 lm			

Notes:

* For complete code ordering information, please see page 353.

** For other CCT options, please contact us.

EW = Extra Wide. Ordering code: **00**

For the most updated product information, please go to our website.

Mago

Surface 115 | 145



Body

Ceiling mounted luminaire with light body in cast aluminium inclusive of an special convex lens in silicone.

Available in two dimensions (115, 145).

LED sources

COB LED.
CRI: 90 | CCT: 3000K, 4000K.
Other CRI and CCT versions available on request.

Related Products

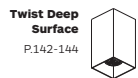

Optic

Convex Lens with wide beam angle.

Accessories

No accessories available.

Driver

Supplied with integrated no-dimable driver.
Diming Options: 0-10V Dim, DALI, Phase, CASAMBI.

Finish

Powder coat in black or white colour.

Applications

The revolutionary convex lens provides an evenly and effective light minimizing the glare. Its affordable price combine with its wide light distribution, make it the ideal solution for a vast range of architectural applications. Application areas: office, hotels, restaurants, lobbies, corridors, conference rooms.

Mago

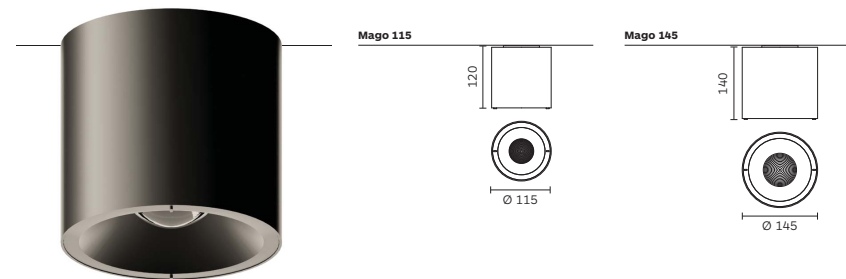

Code ordering example: **1 3 8 2 B C 2 2 - 9 0 3 0 4 0 D 0 1 0**

	Product Code	Light Source Code*	>CRI	CCT**	LED Power	Nominal Lumen	Beam Angle (BA°)	Driver Options	Finish
Mago 115 Surface	1382	BC22 COB LED	90	30 3000K	12W	1500 lm	40	DO No Dim	10 ■ Black
				40 4000K		1600 lm		DA Dali Dim	11 □ White
Mago 145 Surface	1383	BC33			21W	2200 lm	45	DP Phase Dim	
						2350 lm		DC CASAMBI	
								D1 0-10V Dim	

Notes:

- * For complete code ordering information, please see page 353.
 - ** For other CCT options, please contact us.
- For the most updated product information, please go to our website.

Zero Due

Surface Wall & Ceiling 40 | 66 | 100 | 130



Body

Ceiling and wall mounted spotlight with light body and driver canopy in cast aluminium.

Light body is designed for passive cooling. Available in 3 different sizes.

Tilttable vertically 0-90° and rotatable horizontally 360°.

LED sources

Light Source Options: High Power LED, COB LED.
CRI: 90 | CCT: 3000K, 4000K.
Other CRI and CCT versions available on request.

Optic

Lens.
COB: Narrow, medium and wide beam angle.
High Power LED: 7° beam angle.

Accessories

Coloured filters, linear spread, honeycomb louvre, visor, anti-glare tube.
Check page 171 for details.

Finish

Powder coat in black or white colour.

Driver

Supplied with no-dimable driver.
Dimming Options: 0-10V Dim, DALI, Phase, CASAMBI.

Applications

A modern design consisting for the purpose to meet the highest requirements of the latest advanced lighting technology.
Application areas: retail, museums, hospitality, residential, offices, lobbies.

Related Products

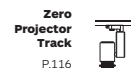
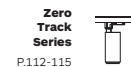
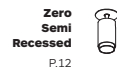

Zero Due

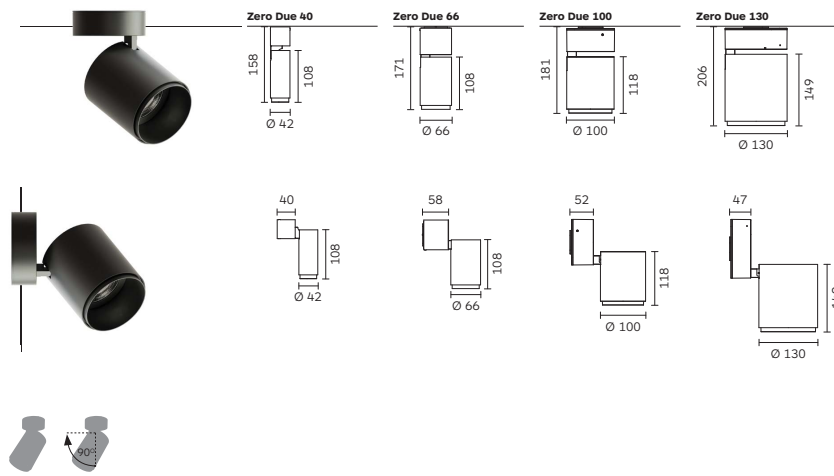

Code ordering example: **1 4 2 1 B R 2 1 - 9 0 3 0 0 7 D 0 1 0**

	Product Code	Light Source Code*	>CRI	CCT**	LED Power	Nominal Lumen	Beam Angle (BA°)	Driver Options	Finish
Zero Due 40 Ceiling & Wall	1421	BR21 High Power LED	90	30 3000K	4W	439 lm	07	D0 No Dim	10 ■ Black
					40 4000K	483 lm		11 □ White	
					BC31 COB LED	5W	460lm	16 / 26 / 36	
Zero Due 66 Ceiling & Wall	1431	BR21 High Power LED			6W	574 lm	05	D0 No Dim	
						636 lm		DP Phase Dim	
					BC31 COB LED	11W	1160 lm	11 / 16 / 32	
Zero Due 100 Ceiling & Wall	1432	BR21 High Power LED			18W	1947 lm	07	D0 No Dim	
						2153 lm		DA Dali Dim	
					BC33 COB LED	21W	2569 lm	15 / 24 / 38	DP Phase Dim
Zero Due 130 Ceiling & Wall	1433	BR21 High Power LED				2703 lm		DC CASAMBI	
						2703 lm		D1 0-10V Dim	
					BC33 COB LED	33W	3598 lm	12 / 22 / 32	
					3800 lm				

Notes:

* For complete code ordering information, please see page 353.

** For other CCT options, please contact us.

For related accessories, please see page 170-171.

For the most updated product information, please go to our website.

Zero Projector

Surface



Body

Advanced & Multi functional LED surface mounted spot, Zero Projector offers a high-precision illumination with sharp outlines and a high degree of lighting uniformity. The versatile aiming angle is tiltable vertically 0°-90° and rotatable horizontally 350°.

Framing Projector spot features four adjustable shutters allowing the beam to be framed to the desired size shape (circle, square/rectangle, or irregular 4 sided shapes). It offers options of bidirectional zooming lens for resolving complex focal points, project sharpness adjustment, and lens rotation. Furthermore, it allows gobo insertion for logo projection easily and has an on-board knob to adjust the dimming and a switch to change the CCT.

Accessories

Framing and shape lens are included in the specific projector. Contact us for custom made logo projection lens.

Finish

Powder coat in black or white colour.

LED sources

COB LED with 3 CCT Options
 CRI: 97 | CCT: 3000K, 4000K, 6000K | 2700K, 4000K, 6000K
 Other CRI and CCT options, Tuneable White, DimToWarm
 RGB/W versions available on request.

Optic

Zoomable Lens System with 4 adjustable shutters to control the shape and size of the projection area.
 Available beam angle range : 20°- 36°/15° - 25°

Driver

Integrated on-board dimming
 Other Dimming Options: 0-10V Dim, DALI, Phase, CASAMBI

Applications

Particularly designed for accent lighting of objects in window display exhibition areas and for the projection of advertising images.
 Application areas: museums, hospitality, retail, interior design.

Related Products

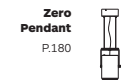
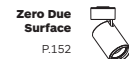
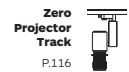
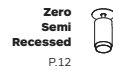

Zero Framing Projector

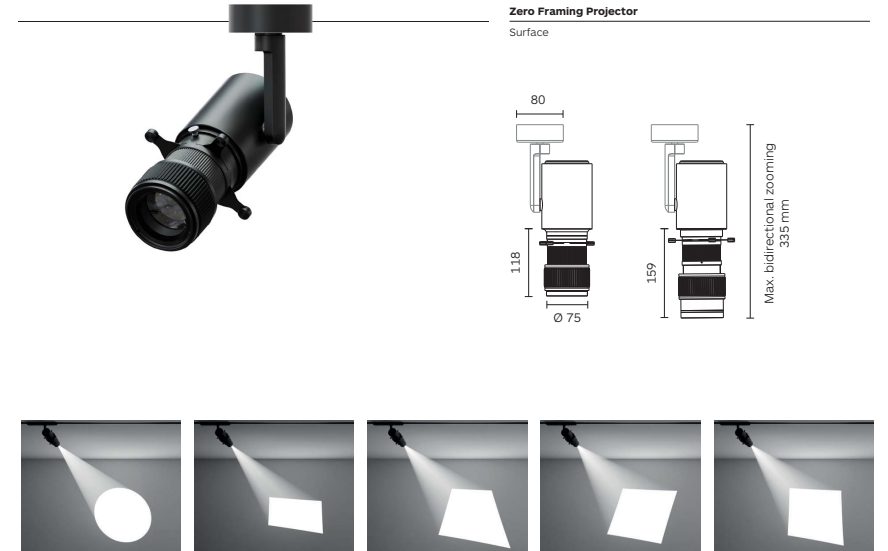

Zero Framing Projector
Surface

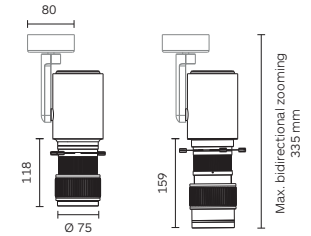

Code ordering example: **1 4 4 9 B C 3 2 - 9 7 3 0 B S D 0 1 0**

	Product Code	Light Source Code*	>CRI	CCT**	LED Power	Nominal Lumen	Beam Angle (BA°)	Driver Options	Finish
Zero Framing Projector 100 Surface	1449	BC32 COB LED	97	30 3000K	24.8W	2372 lm	BS (15°-25°)	D0 No Dim	10 ■ Black
				40 4000K		2615 lm	BW (20°-36°)	DA Dali Dim	11 □ White

Notes:

* For complete code ordering information, please see page 353.
 ** For other CCT options, please contact us.
BS: Beam shaping, Beam Angle: 15° - 25°, **BW:** Beam Wide, Beam Angle: 20° - 36°.
 For the most updated product information, please go to our website.

Conos Due

Surface Wall or Ceiling 68 | 100 | 154



Body

Wall/ceiling mounted luminaire with light body in cast aluminium and driver canopy in thermoplastic.

Reflector in super pure aluminium.

For retrofit version, easy relamping via removable front housing by snap-in catch action

Available in three sizes.

Tilttable vertically 0-100° and routable horizontally 350°.

Accessories

Honeycomb louvre.
Check page 171 for details.

Finish

Powder coat in black, white or grey colour.

LED sources

Lighting source Options: COB LED, Retrofit (GU10/GU5.3/GU53).
CRI: 90 | CCT: 3000K, 4000K.
Other CRI and CCT versions available on request.

Optic

Reflector.
Narrow, medium and wide beam angle available.

Driver

Supplied with no-dimable driver in the driver canopy.
Dimming Options: 0-10V Dim, DALI, Phase, CASAMBI.

Applications

A crisp, compact design coupled with powerful capabilities. Provide a clean, unobtrusive look at the ceiling as it integrates well with virtually any interior while offering excellent aiming flexibility.
Application areas: retail, residential, restaurants, hotels.

Related Products



Conos Due

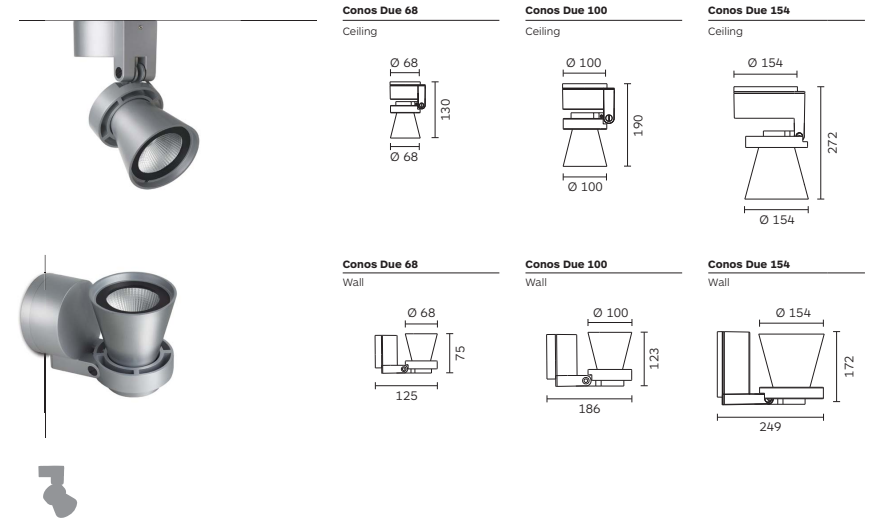

Code ordering example: **1 3 6 3 G U 5 3 - 0 0 0 0 D P 1 0**

	Product Code	Light Source Code*	>CRI	CCT**	LED Power	Nominal Lumen	Beam Angle (BA°)	Driver Options	Finish
Conos Due 68 Ceiling	1363	GU53 Retrofit GU5.3 -MR16	00	00	/	/	00	DP Phase Dim	10 ■ Black
Conos Due 68 Wall	1364	GU10 GU10-GZ10							11 □ White
		IC22 COB LED	90	30 3000K	7W	830 lm	16 / 28 / 40	D0 No Dim	75 ■ Grey
				40 4000K		860 lm		DP Phase Dim	
Conos Due 100 Ceiling	1361	IC22 COB LED			22W	2170 lm	12 / 21 / 39	DA Dall Dim	
Conos Due 100 Wall	1362					2200 lm		DC CASAMBI	
								D1 0-10V Dim	
Conos Due 154 Ceiling	1198	IC21 COB LED	90	30 3000K	30W	3570 lm	14 / 24 / 38	D0 No Dim	
Conos Due 154 Wall	1206			40 4000K		3600 lm		DP Phase Dim	
								DA Dall Dim	
								DC CASAMBI	
								D1 0-10V Dim	
	AR11	Retrofit AR111-G53	00	00	/	/	00	DP Phase Dim	

Notes:

* For complete code ordering information, please see page 353.

** For other CCT options, please contact us.

For related accessories, please see page 170-171.

For the most updated product information, please go to our website.

Rolo & Dado

Surface



Body

Wall/ceiling mounted spotlight with light body and driver box in cast aluminium.

For retrofit version, easy relamping by the removable lamp front ring via simple snap-in catch action.

Tilttable vertically 0-90° and routable horizontally 350°.

LED sources

Lighting source Options: COB LED, Retrofit (GU10/GU5.3).
CRI: 90 | CCT: 3000K, 4000K.
Other CRI and CCT versions available on request.

Optic

Lens.
Narrow, medium and wide beam angle available.

Accessories

Linear spread, honeycomb louvre.
Check page 171 for details.

Finish

Powder coat in white or grey colour.

Driver

Supplied with no-dimable driver in the driver box.
Dimming Options: 0-10V Dim, DALI, Phase, CASAMBI.

Applications

A versatile and very directional spotlight. The very compact sizes make it ideal for applications where the distance between ceiling and spot is an issue.
Application areas: retail, museums, residential, hospitality, window displays.

Related Products



Rolo & Dado

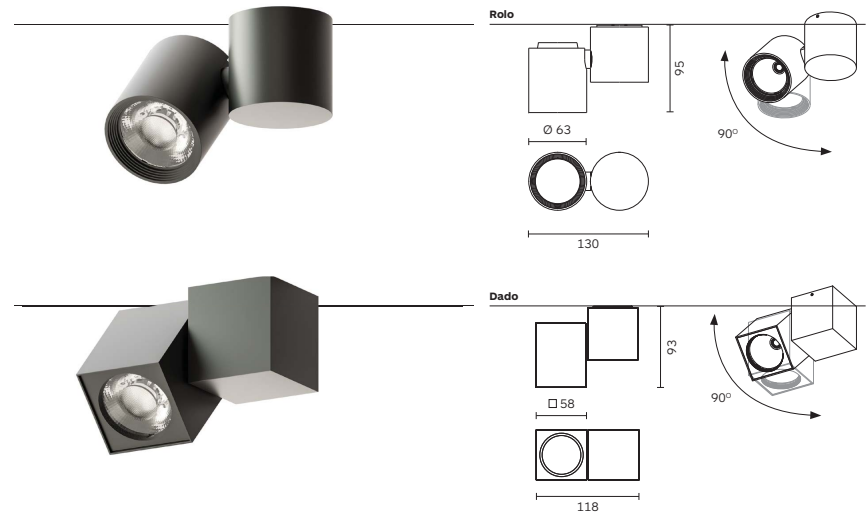

Code ordering example: **1 1 5 9 B R 2 1 - 9 0 3 0 0 7 D 0 1 0**

	Product Code	Light Source Code*	>CRI	CCT**	LED Power	Nominal Lumen	Beam Angle (BA°)	Driver Options	Finish
Rolo Surface	1159	BR21 High Power LED	90	30 3000K	4W	400lm	07	D0 No Dim	10 ■ Black
Dado Surface	1158		40	4000K		430lm			11 □ White
		BC31 COB LED			11W	1080lm	11 / 16 / 32		75 ■ Grey
						1180lm			
	GU53	Retrofit GU5.3 -MR16	00	00	/	/	00	DP Phase Dim	
	GU10	GU10-GZ10							

Notes:

* For complete code ordering information, please see page 353.

** For other CCT options, please contact us.

For related accessories, please see page 170-171.

For the most updated product information, please go to our website.

Arena

Surface 70 | 130



Body

Wall/ceiling mounted luminaire with light body in cast aluminium designed with integrated heat-sink for a passive heat dissipation.

Driver canopy in thermoplastic.

Available in two sizes. Equipped with pull-out mechanism, tiltable vertically 0-90° and rotatable horizontally 350°.

Fixture can be easily locked at the chosen angle.

Accessories

No accessories available.

Finish

Powder coat in white or grey colour.

LED sources

COB LED.
CRI: 90, 95 | CCT: 3000K, 4000K.
Other CRI and CCT options available on request.

Related Products

Optic

Lens.
Narrow, medium and wide beam angle available.

Driver

Driver canopy supply with No-dimable driver.
Dimming Options: 0-10V Dim, DALI, Phase, CASAMBI.

Applications

Its crisp high tech design integrates well with virtually any interior while offering excellent aiming flexibility. When mounted on the wall it makes an ideal indirect light fixture. Application areas: museums, retail, hospitality, office lobbies.

Arena

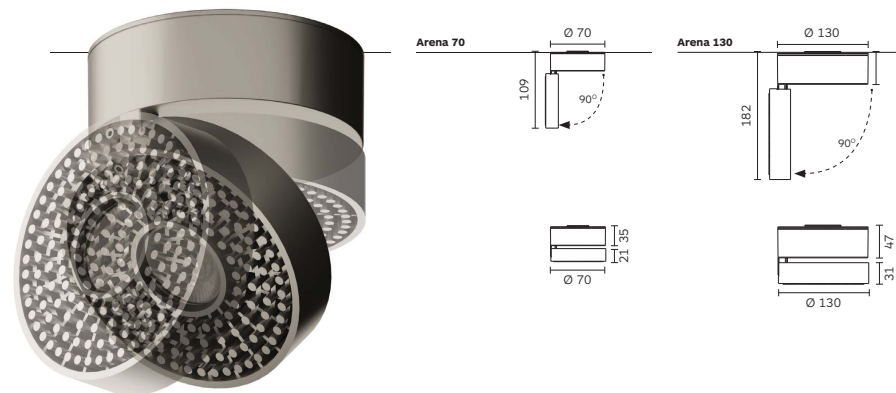

Code ordering example: **1 1 5 2 B C 3 1 - 9 0 3 0 1 9 0 0 1 1**

	Product Code	Light Source Code*	>CRI	CCT**	LED Power	Nominal Lumen	Beam Angle (BA°)	Driver Options	Finish	
Arena 70	1152	BC31	COB LED	90	30 3000K	6W	616 lm	19 / 24 / 34	D0 No Dim	11 <input type="checkbox"/> White
Surface				40 4000K		643 lm		DP Phase Dim	75 <input type="checkbox"/> Grey	
Arena 130	1151	BC22			12W	1552 lm	19 / 24 / 34	D0 No Dim		
Surface						1577 lm		DA Dali Dim		
								DC Phase Dim		
								DP CASAMBI		
								D1 0-10V Dim		

Notes:

* For complete code ordering information, please see page 353.

** For other CCT options, please contact us.

For the most updated product information, please go to our website.

Palla

Surface 70 | 100 | 130



Body

Ceiling and wall mounted spotlight with light body and driver canopy in cast aluminium.

Light body is designed for passive cooling.

Available in 3 different sizes.

Light head tiltable vertically 0-90° and rotatable horizontally 350°.

Accessories

Honeycomb louvre, Visor, Snoot, Anti-glare tube. Check page 171 for details.

Finish

Powder coat in black or white colour.

LED sources

COB LED.
CRI: 90 | CCT: 3000K, 4000K.
Other CRI and CCT versions available on request.

Optic

Lens.
Narrow, medium and wide beam angle available.

Driver

Supplied with no-dimable driver in the driver canopy.
Dimming Options: 0-10V Dim, DALI, Phase, CASAMBI.

Applications

A crisp high tech designed ideal for both direct and indirect lighting applications and it integrates well with virtually any interior while offering excellent and different beam lighting distribution.
Application areas: retail, hotels, restaurants, offices, lobbies.

Related Products

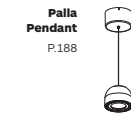

Palla

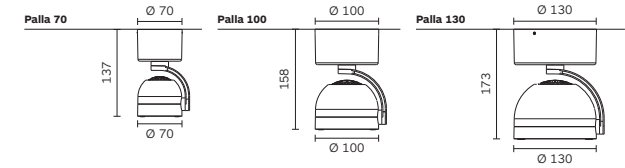

Code ordering example: **1 3 7 9 B C 2 2 - 9 0 3 0 1 6 D 0 1 0**

	Product Code	Light Source Code*	>CRI	CCT**	LED Power	Nominal Lumen	Beam Angle (BA°)	Driver Options	Finish
Palla 70 Surface	1379	BC22	90	30 3000K	12W	1500 lm	16 / 25 / 36	D0 No Dim	10 ■ Black
						1550 lm		DP Phase Dim	11 □ White
Palla 100 Surface	1380	BC33			21W	2200 lm	15 / 24 / 38	D0 No Dim	
						2300 lm		DP Phase Dim	
Palla 130 Surface	1381	BC33			33W	3220 lm	12 / 22 / 32	DC CASAMBI	
						3300 lm		D1 0-10V Dim	

Notes:

* For complete code ordering information, please see page 353.

** For other CCT options, please contact us.

For related accessories, please see page 170-171.

For the most updated product information, please go to our website.

Cubetto

Surface



Body

Wall square mounted luminaire with body in cast aluminium inclusive of slots with opal light diffuser.

Available in five different light distribution versions.

LED sources

Single LED.
CRI: 90 | CCT: 3000K, 4000K.
Other CRI and CCT options available on request.

Related Products



Optic

Equipped with acrylic satin opal diffuser. The slots of the different version offers a wide range of light distribution and beam angles.

Accessories

No accessories available.

Driver

Inclusive of integrated no-dimable driver.

Finish

Powder coat in white or grey colour.

Applications

A simple modernistic fixture ideal for today's architectural developments. With its Up/Down version it gives that special narrow beam light effect for a personalized application.
Application areas: facades, lobbies, walkways, corridors, restaurants, hotels.

Cubetto



Cubetto S1

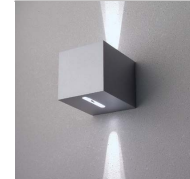

Cubetto S2

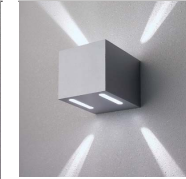

Cubetto SG

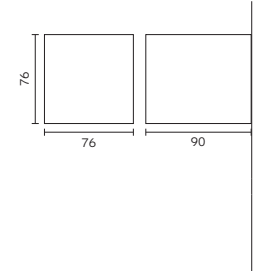

Cubetto G1



Cubetto G2



Code ordering example: **1 1 6 4 B N 1 1 - 9 0 3 0 0 0 D 0 1 1**

	Product Code	Light Source Code*	>CRI	CCT**	LED Power	Nominal Lumen	Beam Angle (BA°)	Driver Options	Finish
Cubetto S1	1164	BN11 Single LED	90	30 3000K	1W	109 lm	00	D0 No Dim	11 □ White
Cubetto S2	1165			40 4000K		116 lm			75 ■ Grey
Cubetto SG	1166								
Cubetto G1	1167								
Cubetto G2	1168								

Notes:

* For complete code ordering information, please see page 353.
** For other CCT options, please contact us.
For the most updated product information, please go to our website.

Circo & Quadro

Surface 300 | 400 | 600



Body

Ceiling/wall round or square mounted luminaire with light trim in cast aluminium, light body and diffuser in injection moulded polycarbonate.

Diffuser finished in opal satin is inclusive of durable silicon gasket.

Easy to remove trough snap-and catch action.

Available in 2 shapes (round and square) and 3 sizes.

Accessories

No accessories available.

Finish

Powder coat in white colour.

LED sources

SMD LED.
CRI: 90 | CCT: 3000K, 4000K.
Other CRI and CCT options available on request.*

Optic

Polycarbonate satin opal diffuser.
Extra wide beam angle.

Driver

Inclusive of integrated no-dimable driver.
Dimming Options: 0-10V Dim, DALI, Phase, CASAMBI.

Applications

Architectural decorative luminaires designed to provide specification-grade quality at prices to fit the budgets for commercial and institutional interiors.
Application areas: retail, hospitality, offices, schools and community buildings.

Related Products

Circo Recessed
P.100



Quadro Recessed
P.102



Circo & Quadro

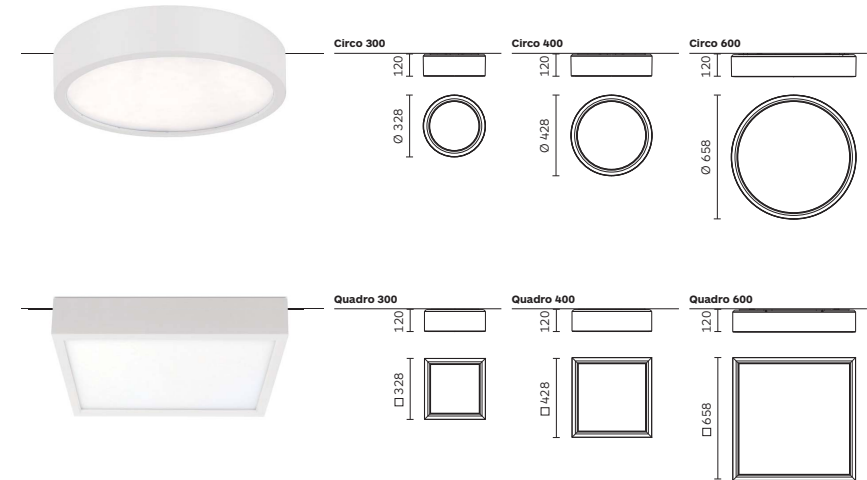

Code ordering example: **1 2 8 9 B M 1 1 - 9 0 3 0 0 0 1 1**

	Product Code	Light Source Code*	>CRI	CCT**	LED Power	Nominal Lumen	Beam Angle (BA°)	Driver Options	Finish
Circo 300 Surface	1289	BM11 SMD LED	90	30 3000K	30W	2650 lm	EW (00)	D0 No Dim	11 □ White
				40 4000K		2850 lm		DA Dali Dim	
Circo 400 Surface	1286				45W	3978 lm		DP Phase Dim	
							4275 lm		DC CASAMBI
Circo 600 Surface	1283				80W	7072 lm		D1 0-10V Dim	
Quadro 300 Surface	1280				30W	2650 lm			
							2850 lm		
Quadro 400 Surface	1276				45W	3978 lm			
							4275 lm		
Quadro 600 Surface	1273				80W	7072 lm			
						7600 lm			

Notes:

* For complete code ordering information, please see page 353.

** For other CCT options, please contact us.

EW = Extra Wide. Ordering code: **00**

For the most updated product information, please go to our website.

DomoLED

Surface Round & Square 95 | 180 | 235



Body

Round or square ceiling mounted luminaire with light trim in cast aluminium inclusive of diffuser made of satin opal acrylic. Light body in white coated steel.

Easy installation via twist and lock action.

Front trim/diffuser removable by snap-in catch action. Available in 3 different sizes.

LED sources

SMD LED.
CRI: 90 | CCT: 3000K, 4000K.
Other CRI and CCT options available on request.

Related Products

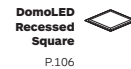

Accessories

No accessories available.

Optic

Acrylic satin opal diffuser.
Extra wide beam angle.

Driver

Inclusive of integrated no-dimable driver.
Dimming Options: 0-10V Dim, DALI, Phase, CASAMBI.

Finish

Powder coat in black, white or grey colour.

Applications

A simple and stylish design. The 3 directional emitting satin acrylic cover enables the architect and lighting designers the ability to integrate it into most applications including wet rooms.
Application areas: office, schools, gyms, community buildings, supermarkets, retail.

DomoLED

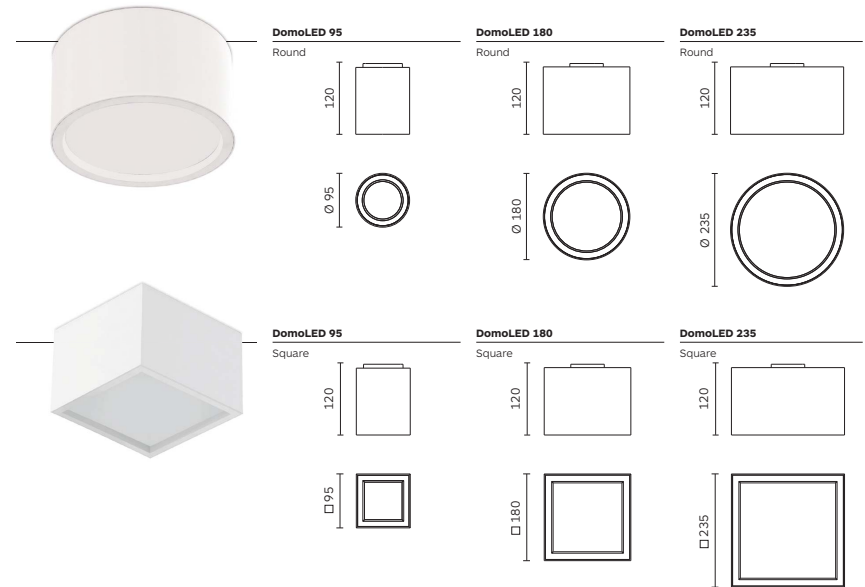

Code ordering example: **1 2 3 3 B M 1 1 - 9 0 3 0 0 0 0 1 0**

		Product Code	Light Source Code*	>CRI	CCT**	LED Power	Nominal Lumen	Beam Angle (BA°)	Driver Options	Finish
DomoLED 95 Surface	Round	1233	BM11 SMD LED	90	30 3000K	8W	928 lm	EW (00)	D0 No Dim	10 ■ Black
	Square	1236			40 4000K		976 lm		DP Phase Dim	11 □ White
DomoLED 180 Surface	Round	1232				22W	2552 lm		D0 No Dim	
	Square	1235					2684 lm		DA Dali Dim	
DomoLED 235 Surface	Round	1231				35W	3944 lm		DP Phase Dim	
	Square	1234					4148 lm		DC CASAMBI	
									D1 0-10V Dim	75 ■ Grey

Notes:





* For complete code ordering information, please see page 353.





** For other CCT options, please contact us.

EW = Extra Wide. Ordering code: **00**

For the most updated product information, please go to our website.

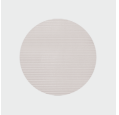
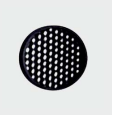
Optical Accessories





Product / Optical Accessories					
	Acrylic diffuser	Honeycomb Louvre Colour 10	Colour Ring Colour 33	Colour Ring Colour 35	Colour Ring Colour 55
Pixo 36 Surface	2E05	/	2E07	2E07	2E07
Pixo 77 Surface	2E06	2E09	2E08	2E08	2E08



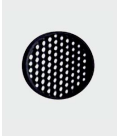

Product / Optical Accessories						
	Coloured Filters Colours 25, 42, 55, 85	Linear Spread Colour 41	Honeycomb Louvre Colour 10	Colour Ring Colour 33	Colour Ring Colour 35	Colour Ring Colour 55
Twist Deep Fixed COB Fixed Round	2E33	2E34	2E09	2E32	2E32	2E32

Product / Optical Accessories		
	Anti-Glare Hood Colours 10, 17, 75	* Semi Recessed Kit Colour 10
Twist Round / Square	2675	2233 / 2232

* Semi Recessed Kit for Usage of GU5.3 MR16 LED. Transformer not included. To be ordered separately.

Optical Accessories

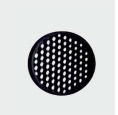
Product / Optical Accessories				
	Honeycomb Louvre Colour 10	Visor Colours 10, 17	Snoot Colours 10, 17	Anti-glare Tube Colours 10, 17
Palla 70 Surface	2B95	2B98	2B96	2B97
Palla 100 Surface	2B99	2D60	2C01	2D59
Palla 130 Surface	2C04	2D61	2C05	2C06

Product / Optical Accessories					
	Coloured Filters Colours 25, 42, 55, 85	Linear Spread Colour 41	Honeycomb Louvre Colour 10	Wallwasher Visor Colours 10, 17	Anti-glare Tube Colours 10, 17
Zero Due 40 Ceiling / Wall	2E36	2E44	2E35	/	2E43
Zero Due 66 Ceiling / Wall	2D63*	2D62*	2C65	2D94	2D67
Zero Due 100 Ceiling / Wall BC33	2E10*	2E12*	2C66	2E14	2E16
Zero Due 100 Ceiling / Wall BR21	/	/	2C70	/	/
Zero Due 130 Ceiling / Wall BC33	2E11*	2E13*	2C67	2E15	2E17
Zero Due 130 Ceiling / Wall BR21	/	/	2E45	/	/
Conos Due 68 Surface			2B95		
Conos Due 100 Surface	/	/	2368	/	/
Conos Due 154 Surface			2367		
Rolo Surface GU5.3	/	/	2672	/	/
Dado Surface GU5.3	/	/	2634	/	/

* With holder

Pendant Lighting

Pixo

Pendant 25 | 36 | 77



Body

Pendant mounted luminaire with light body in extruded aluminium.

Light body available in three diameter (25, 36 and 77mm) and four different length, to fit any ceiling height.

Exchangable front ring in wide range of colours. Supplied with ceiling canopy and pre-installed 1.5m electrical cable.

LED sources

Light source options: High Power LED (Pixo 25), COB LED (Pixo 36 and 77).

CRI: 90 | CCT: 3000K, 4000K, TuneableWhite.
Other CRI and CCT options available on request.

Optic

Lens.
Narrow, medium and wide beam angle available.

Accessories

Honeycomb (77). Decorative ring available in different colours.

Transparent acrylic decorative diffuser.
Check page 176 for details.

Finish

Powder coat in black or white.
Exchangable front ring in different colours.

Driver

Supplied with integrated no-dimable driver.
Dimming Options (only for Pixo 77): 0-10V Dim, Phase, CASAMBI.

Applications

A modern designed pendant ambient light. Its accessories make it the perfect match for sophisticated environments.
Application areas: residential, hotels, restaurants, retail, corridors.

Related Products

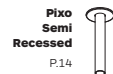

Pixo 25 & 36

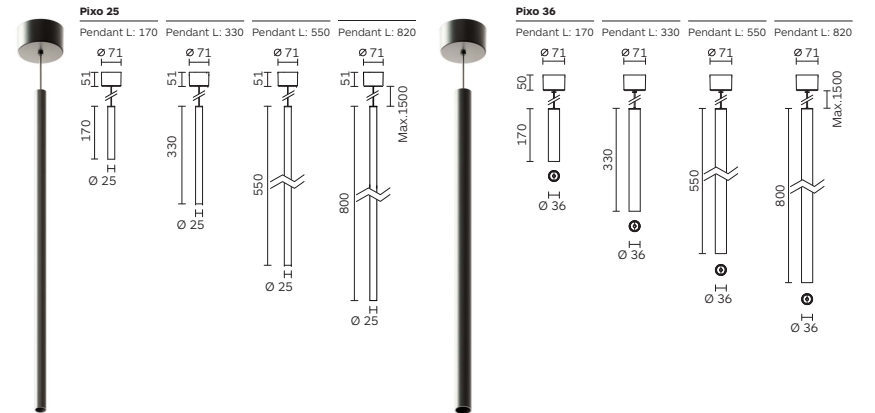

Code ordering example: **7 2 8 2 B N 1 1 - 9 0 3 0 1 4 D 0 1 0**

	Product Code	Product Length	Light Source Code*	>CRI	CCT**	LED Power	Nominal Lumen	Beam Angle (BA°)	Driver Options	Finish
Pixo 25 Pendant	7282	170	BN11 High Power LED	90	30 3000K	2W	230 lm	14 / 20 / 26 / 32	D0 No Dim	10 ■ Black
	7283	330			40 4000K		260 lm			11 □ White
	7284	550								
	7285	800								
Pixo 36 Pendant	7235	170	BC31 COB LED			5W	500 lm	20 / 26 / 36	D0 No Dim	
	7236	330					550 lm			
	7238	550								
	7240	800								

Notes:

* For complete code ordering information, please see page 353.

** For other CCT options, please contact us.

For related accessories, please see page 176.

For the most updated product information, please go to our website.

Pixo 77

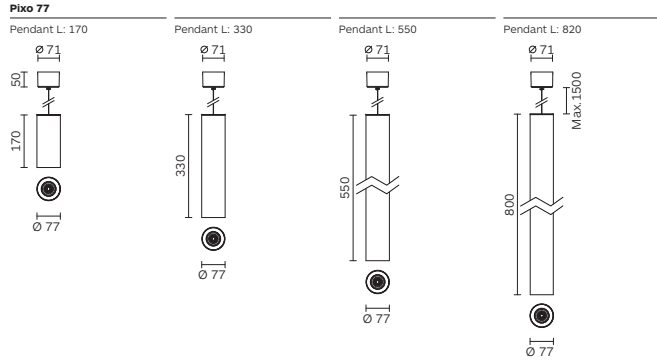

Code ordering example: **7 2 3 4 B C 2 2 - 9 0 3 0 1 2 D 0 1 0**

	Product Code	Product Length	Light Source Code*	>CRI	CCT**	LED Power	Nominal Lumen	Beam Angle (BA°)	Driver Options	Finish
Pixo 77	7234	170	BC22 COB LED	90	30 3000K	12W	1570 lm	12 / 20 / 32	D0 No Dim	10 ■ Black
Pendant	7237	330			40 4000K		1600 lm		DP Phase Dim	11 □ White
	7239	550							DC CASAMBI	
	7241	800							D1 0-10V Dim	

Optical Accessories



Product / Optical Accessories	Honeycomb Louvre Colour 10	Acrylic diffuser	Colour Ring Colour 33	Colour Ring Colour 35	Colour Ring Colour 55
Pixo 36	/	2E05	2E07	2E07	2E07
Pixo 77	2E09	2E06	2E08	2E08	2E08

Notes:
 * For complete code ordering information, please see page 353.
 ** For other CCT options, please contact us.
 For the most updated product information, please go to our website.



Lucciole

Pendant



Body

The Lucciole pendant suspension series brings a new perspective to the pendant lighting by incorporating non-toxic acrylic glass lamps, which are ceiling-mounted with a round chrome-plated fixture body of 95mm diameter, which not only enhances the visual appeal but also ensures the durability —supplied with a suspension cable of 2200mm (field adjustable included).

Inspired by Firefly's ability of natural glow, it features suspension lamps of various shapes, sizes, and designs. A very eco-friendly and 100% recyclable lamp with diffuse light distribution.

Accessories

Supplied with 2200mm suspension cables (field adjustable) included

Finish

Decorative Chrome, White, Black, Bronze, Copper, Brass

LED sources

SMD LED 6.5W, CRI >90, CCT : 3000K, 4000K, 636lm
COB LED 6.5W, CRI >90, CCT : 1800K, 3000K, 636lm

Optic

Acrylic glass, non-toxic, non-harmful
more light and transparent than glass

Driver

It is supplied with an integrated non-dimmable driver 0-10V.
Casambi, DALI On Request

Applications

The Lucciole's goal is to be a lighting system that provides elegant lighting effects, suitable for environments where the decorative aspect has a scenic function.
Application areas: residential, hotels, restaurants, retail, corridors.

Related Products

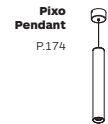
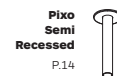

Lucciole Pendant

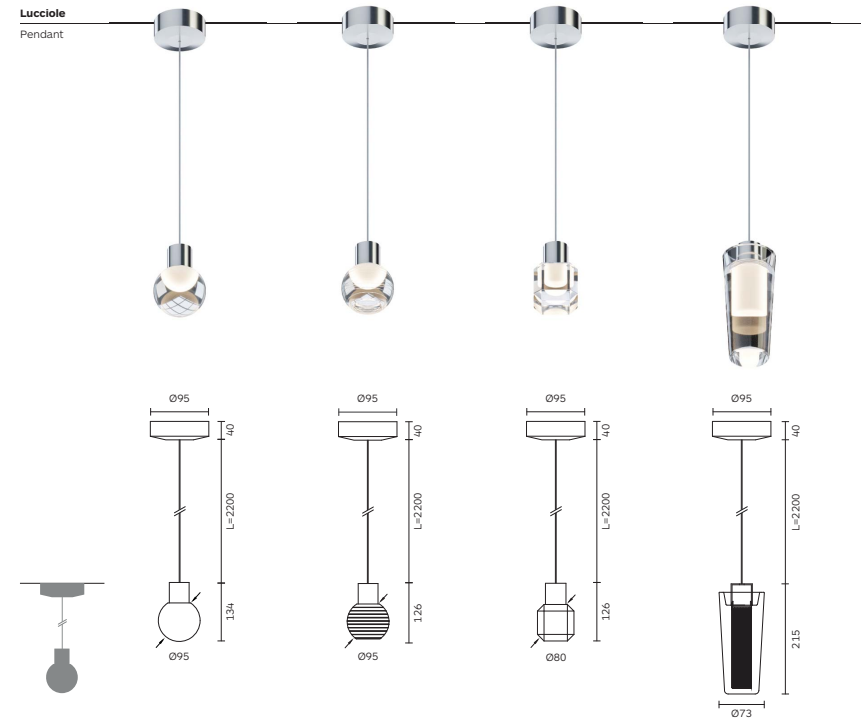

Code ordering example: **D719BM11-903000D010**

	Product Code	Light Source Code*	>CRI	CCT**	LED Power	Nominal Lumen	Beam Angle (BA°)	Driver Options	Finish
Lucciole Pendant	D719	BM11	SMD LED	90	30	3000K	6.5W	636 lm	00
				40		4000K			
Lucciole Pendant	D720							D0	No Dim
								DA	Dali Dim
								DC	CASAMBI
								D1	0-10V Dim
								30	Brzen
Lucciole Pendant	D725	BB32	COB LED	TW	from 1800K	6.5W	636 lm	DA	Dali Dim
					to 3000K			DC	CASAMBI
								40	Brass
Lucciole Pendant	D729							D1	0-10V Dim

Notes:

* For complete code ordering information, please see page 353.

** For other CCT options, please contact us.

For the most updated product information, please go to our website.

Zero

Pendant 66 | 100 | 130



Body

Pendant mounted spotlight with light body and mounting clamps in cast aluminium.

Supplied with ceiling canopy and pre-installed 1.5m electrical cable with 2 x 1.5m pendant steel wires.

Top cover options of different coloured finishes.

Available in 3 different sizes.

Versatile aiming angle tiltable vertically 0°-90° in two directions and rotatable horizontally 360°.

Accessories

Coloured filters, linear spread, honeycomb louvre, visor, anti-glare tube. Check page 181 for details.

Finish

Powder coat in black or white colour.

LED sources

Light Source Options: High Power LED, COB LED. CRI: 90 | CCT: 3000K, 4000K. Other CRI and CCT versions available on request.

Optic

Lens. COB: Narrow, medium and wide beam angle. High Power LED: 7° beam angle.

Driver

Supplied with no-dimable driver. Dimming Options: 0-10V Dim, DALI, Phase, CASAMBI.

Applications

A pendant luminaire featuring a clean aesthetic, ideal also for high ceiling spaces and for local 'task' lighting when placed over counters and tables. Application areas: restaurants, hotels, lobbies, residential, retail.

Related Products

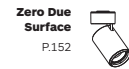
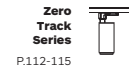
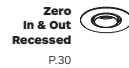
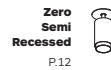

Zero

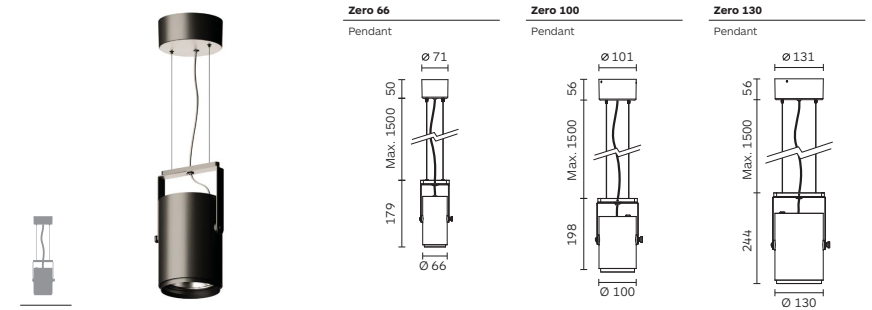

Code ordering example: **7 1 8 9 B R 2 1 - 9 0 3 0 0 5 D 0 1 0**

	Product Code	Light Source Code*	>CRI	CCT**	LED Power	Nominal Lumen	Beam Angle (BA°)	Driver Options	Finish
Zero 66 Pendant	7189	BR21 High Power LED	90	30 3000K	6W	574 lm	05	D0 No Dim	10 ■ Black
		BC31 COB LED		40 4000K	11W	1160 lm 1258 lm	11 / 16 / 32	DP Phase Dim	11 □ White
Zero 100 Pendant	7188	BR21 High Power LED			18W	1947 lm 2153 lm	07	D0 No Dim DA Dali Dim	
		BC33 COB LED			21W	2569 lm 2703 lm	15 / 24 / 38	DP Phase Dim DC CASAMBI	
Zero 130 Pendant	7168	BR21 High Power LED			27W	2920 lm 3230 lm	07	D1 0-10V Dim	
		BC33 COB LED			33W	3598 lm 3800 lm	12 / 22 / 32		

Optical Accessories

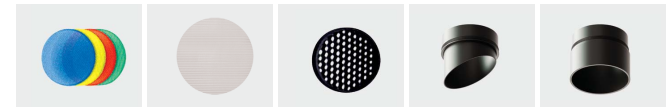

Product / Optical Accessories	Coloured Filters Colours 25, 42, 55, 85	Linear Spread Colour 41	Honeycomb Louvre Colour 10	Visor Colours 10, 17	Anti-glare Tube Colours 10, 17
Zero 66 Pendant	2D63*	2D62*	2C65	/	2D67
Zero 100 Pendant For BC33	2E10*	2E12*	2C66	2E14	2E16
Zero 100 Pendant For BR21	/	/	2C70	/	/
Zero 130 Pendant For BC33	2E11*	2E13*	2C67	2E15	2E17
Zero 130 Pendant For BR21	/	/	2E45	/	/

* With holder

Notes:

* For complete code ordering information, please see page 353.
** For other CCT options, please contact us.
For the most updated product information, please go to our website.

Polaris

Pendant 20 & 30



Body

Pendant mounted luminaire with light body in extruded aluminium. Available in two different sizes. Both are available in a version inclusive of integrated diamond faceted no-dazzle screen in thermoplastic.

Polaris 20 comes also equipped with a satin opal diffuser. Supplied with ceiling canopy and pre-installed 1.5m electrical cable and with 2 x 1.5m pendant steel wires.

Accessories

No accessories available.

Finish

Powder coat in black or white. White version available with integrated black thermoplastic screen. Polaris 20: available with opal diffuser.

LED sources

High Power LED. CRI: 90 | CCT: 3000K, 4000K. Other CRI, CCT and Tuneable White options available on request.

Optic

Polaris 20 & 30: Lens plus thermoplastic screen. UGR < 16. Four different (medium and wide) beam angles available. Polaris 20: acrylic opal satin diffuser.

Driver

Supplied with integrated no-dimable driver. Dimming Options: 0-10V Dim, DALI, Phase, CASAMBI.

Applications

An innovative solution for high brilliance and performance. The light source is barely visible, as the miniature light heads create a high contrast and circular light emission. Application areas: residential, hotels, restaurants, retail, corridors.

Related Products



Polaris



Polaris 20

Polaris 20

Pendant with diffuse L:690

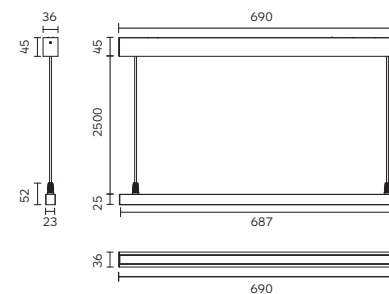

Polaris 20

Pendant with diffuse L:915

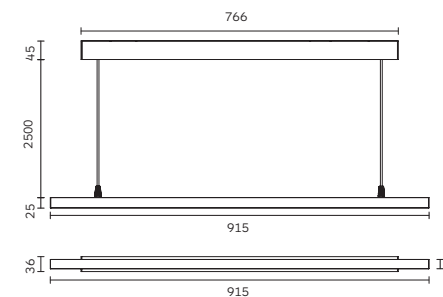

Code ordering example: **7 2 8 0 B O 1 1 - 9 0 3 0 O D 0 1 0**

	Product Code	Light Source Code*	>CRI	CCT**	LED Power	Nominal Lumen	Beam Angle (BA°)	Driver Options	Finish
Polaris 20	7280	BO11 High Power LED	90	30 3000K	36x1W	4680 lm	OD Opal Diffuser	D0 No Dim	10 ■ Black
Pendant with diffuse L: 690				40 4000K		5400 lm		DA Dali Dim	11 □ White
Polaris 20	7281				48x1W	6240 lm		DC CASAMBI	
Pendant with diffuse L: 915						7200 lm		D1 0-10V Dim	

Notes:

* For complete code ordering information, please see page 353.

** For other CCT options, please contact us.

For the most updated product information, please go to our website.

Polaris

Polaris 20



Polaris 20

Pendant with 36 LEDs

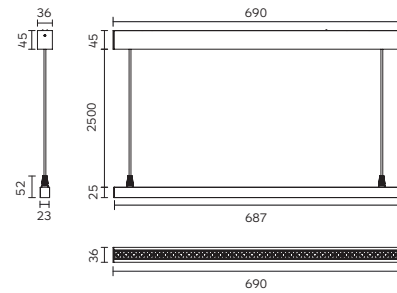

Polaris 20

Pendant with 48 LEDs

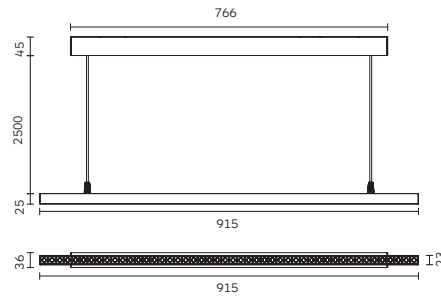

Code ordering example: **7 2 7 5 B 0 1 1 - 9 0 3 0 2 1 D 0 1 0**

	Product Code	Light Source Code*	>CRI	CCT**	LED Power	Nominal Lumen	Beam Angle (BA°)	Driver Options	Finish
Polaris 20 Pendant with 36 LEDs	7275	B011 High Power LED	90	30 3000K	36x1	4680 lm	21 / 33 / 45 / 60	D0 No Dim	10 ■ Black
			40	4000K		5400 lm		DA Dali Dim	11 □ White
Polaris 20 Pendant with 48 LEDs	7276				48x1	6240 lm		DC CASAMBI	17 ▣ B/W
						7200 lm		D1 0-10V Dim	

Notes:

- * For complete code ordering information, please see page 353.
 - ** For other CCT options, please contact us.
 - 17**: white light body with black integrated louvre. For black body with white integrated louvre consult us.
- For the most updated product information, please go to our website.

Polaris

Polaris 30



Polaris 30

Pendant 36 LEDs

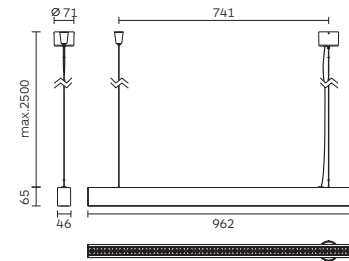

Polaris 30

Pendant 48 LEDs

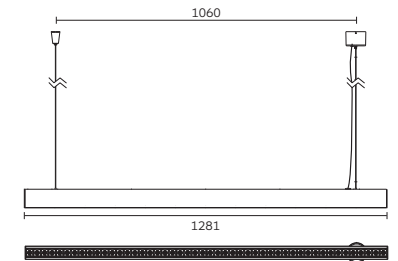

Code ordering example: **7 2 0 5 B 0 1 1 - 9 0 3 0 3 4 D 0 1 0**

	Product Code	Light Source Code*	>CRI	CCT**	LED Power	Nominal Lumen	Beam Angle (BA°)	Driver Options	Finish
Polaris 30 Pendant 36 LEDs	7205	B011 High Power LED	90	30 3000K	36x2W	6840 lm	34 / 50	D0 No Dim	10 ■ Black
			40	4000K		8640 lm		DA Dali Dim	11 □ White
Polaris 30 Pendant 48 LEDs	7211				48x2W	9120 lm		DC CASAMBI	17 ▣ B/W
						11520 lm		D1 0-10V Dim	

Notes:

- * For complete code ordering information, please see page 353.
 - ** For other CCT options, please contact us.
 - 17**: white light body with black integrated louvre. For black body with white integrated louvre consult us.
- For the most updated product information, please go to our website.

Miniluce

Pendant 900 | 1200 | 1500



Body

Pendant mounted linear luminaire with luminaire body in extruded aluminium.

End caps in cast aluminium, diffuser made of satin opal acrylic.

Supplied with ceiling canopy, pre-installed 1.5m electrical cable and with two 1.5m pendant steel wires. Available in 3 different length.

Accessories

No accessories available.

Finish

Powder coat in black, white or grey colour.

LED sources

SMD LED
CRI: 90 | CCT: 3000K, 4000K.
Other CRI and CCT options available on request.

Optic

Satin acrylic opal diffuser. Extra wide beam angle.

Driver

Supplied with integrated no-dimable driver.
Dimming Options: 0-10V Dim, DALI, Phase, CASAMBI.

Applications

A simple and stylish design. The 3 directional emitting satin acrylic cover enables the architect and lighting designers the ability to integrate it into most applications including wet rooms.
Application areas: office, schools, gyms, community buildings, supermarkets, retail.

Miniluce

Miniluce

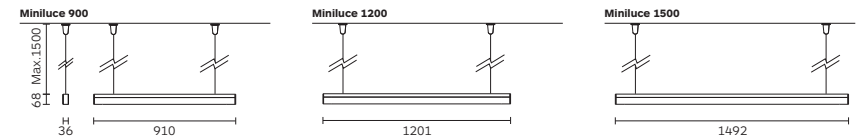

Code ordering example: **7 1 1 5 B M 1 1 - 9 0 3 0 0 0 D 0 7 5**

	Product Code	Light Source Code*	>CRI	CCT**	LED Power	Nominal Lumen	Beam Angle (BA°)	Driver Options	Finish		
Miniluce 900 Pendant	7115	BM11	SDM LED	90	30	3000K	26W	2912 lm	EW (00)	D0 No Dim	75 Grey
				40	4000K	3065 lm	DA Dali Dim				
Miniluce 1200 Pendant	7116	BM11			35W	3920 lm		DC CASAMBI			
					4130 lm	D1 0-10V Dim					
Miniluce 1500 Pendant	7117	BM11			44W	4928 lm					
					5192 lm						

Notes:

* For complete code ordering information, please see page 353.

** For other CCT options, please contact us.

EW = Extra Wide. Ordering code: **00**.

For the most updated product information, please go to our website.

Palla

Pendant 70 | 100 | 130



Body

Pendant mounted spotlight with light body and driver canopy in cast aluminium.

Supplied with ceiling canopy and pre-installed 1.5m electrical cable.

Top cover options of different coloured finishes. Available in 3 different sizes.

Accessories

Honeycomb louvre, Snoot.
Check page 189 for details.

Finish

Powder coat in black or white colour.

LED sources

COB LED.
CRI: 90 | CCT: 3000K, 4000K.
Other CRI and CCT versions available on request.

Related Products



Optic

Lens.
Narrow, medium and wide beam angle available.

Driver

Supplied with no-dimable driver in the driver canopy.
Dimming Options: 0-10V Dim, DALI, Phase, CASAMBI.

Applications

A crisp high tech designed ideal for both direct and indirect lighting applications and it integrates well with virtually any interior while offering excellent and different beam lighting distribution.

Application areas: retail, hotels, restaurants, offices, lobbies.

Palla

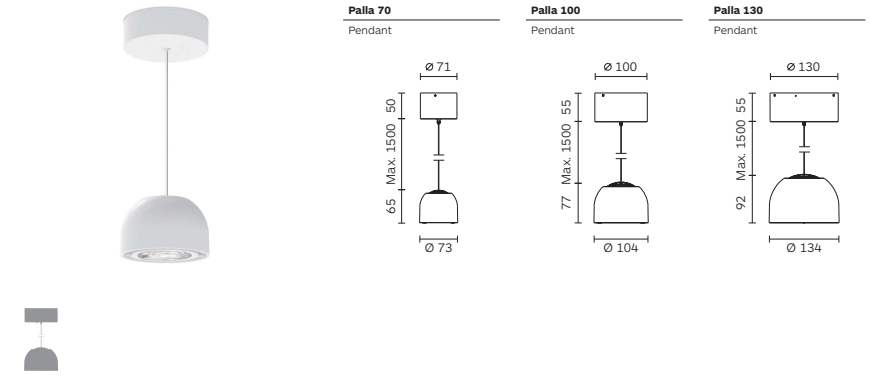

Code ordering example: **7 2 3 1 B C 2 2 - 9 0 3 0 1 6 D 0 1 0**

	Product Code	Light Source Code*	>CRI	CCT**	LED Power	Nominal Lumen	Beam Angle (BA°)	Driver Options	Finish	
Palla 70 Pendant	7231	BC22	COB LED	90	30 3000K	12W	1500 lm	16 / 25 / 36	D0 No Dim	10 ■ Black
				40 4000K	1550 lm	DA Dali Dim	11 □ White			
Palla 100 Pendant	7232	BC33			21W	2200 lm	15 / 24 / 38	DP Phase Dim		
					2300 lm	DC CASAMBI				
Palla 130 Pendant	7233	BC33			33W	3220 lm	12 / 22 / 32	D1 0-10V Dim		
						3300 lm				

Optical Accessories

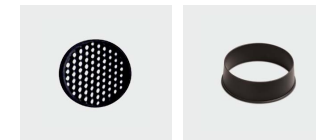

Product / Optical Accessories	Honeycomb Louvre Colour 10	Snoot Colours 10, 17
Palla 70 Surface	2B95	2B96
Palla 100 Surface	2B99	2C01
Palla 130 Surface	2C04	2C05

Notes:

* For complete code ordering information, please see page 353.

** For other CCT options, please contact us.

For the most updated product information, please go to our website.



«Light and the rational forms are locked in combat; light sets them into motion, bends what is straight, makes parallels oval, inscribes circles in the intervals, makes the intervals active».

Paul Klee

Indoor Lighting Systems

Canali Edge

EdgeForms System



Body

The new Canali edge is a revolutionary edge-less lighting system featuring easy and clean installation, eliminating wired connections and gearboxes in the cove. Canali Edge profile features easy-to-clip on adjustable spotlights, together with a dedicated channel for linear cove lights fixed by magnets, all in extruded aluminum. The Integrated 3 phase track system with DALI bus enables full DALI control on both linear and track spots. Small and powerful in-track integrated drivers make it very easy to move and reposition the spotlights and the linear lights.

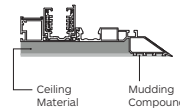

LED sources

Spotlights: Zero 42, Zero 66 & Zero 80 LED spotlights from zero track range, which can be easily-clip-on and move along the channel.

Cove Light: Microline, a high-performance LED linear light available in various length configurations and CCTs.

Accessories

Track Accessories: Feeder for left and right, Concealed Connector, End Cap. For more detailed information about the accessories, please go to page 131.

Accommodation modules for: fire sprinklers, surveillance camera, HVAC diffuser, speakers, WiFi access point available upon request.

Applications

New Canali edge is best suited for discreet lighting applications to enhance the architectural detail. It can be applied in multiple areas such as retail, museums, galleries, exhibits, jewelry, shops, residential, lift lobbies due to its versatile design property.

Canali Edge

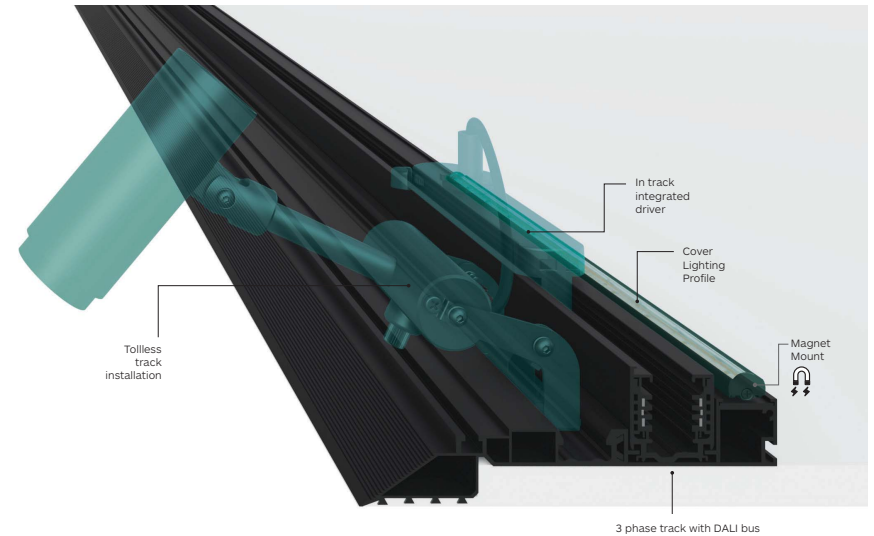

Canali Edge Traverse Profile

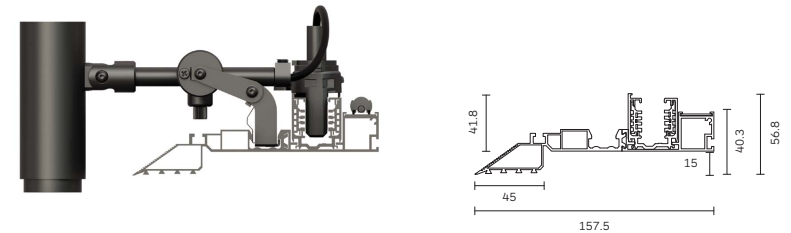

Code ordering example: **8 4 0 9 1 0 0 0 - 0 0 0 0 0 0 1 0**

Product Code	Length Code	Length in mm	Length in m	>CRI	CCT	Driver Options	Finish
8409	1000	1000 mm	1 m	00	00	00 No Driver	10 ■ Black
	2000	2000 mm	2 m				
	3000	3000 mm	3 m				

Canali Edge - Spot Lights



Canali Edge Zero 40

Spot Lights

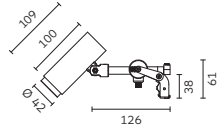

Canali Edge Zero 66

Spot Lights

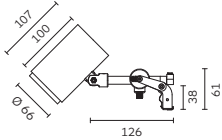

Canali Edge Zero 80

Spot Lights

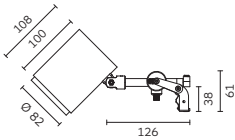

Code ordering example: **8 4 1 0 B N 2 1 - 9 0 3 0 1 6 D 0 1 0**

	Product code	Light source code	>CRI	CCT**	LED power	Nominal lumen	Beam angle (BA°)	Driver Options	Finish
Canali Edge Zero 40	8410	BN21 High Power LED	90	30 3000K	8W	961 lm	16 / 26 / 36	DO No Dim	10 ■ Black
				40 4000K					
Canali Edge Zero 66	8411				12W	1436 lm	11 / 16 / 32	DC CASAMBI	
Canali Edge Zero 80	8412				18W	2009 lm	12 / 18 / 32	DN On-board Dimmer	
									2180 lm

Notes:
 * For complete code ordering information, please see page 353.
 ** For other CCT options, please contact us.
 For related accessories, please see page 197.
 Transformer and driver are not included. To be ordered separately.
 For the most updated product information, please go to our website.

Canali Edge - Linear Cover Lights



Canali Edge Microline 014

Linear Cover Lights

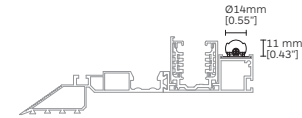

Min. L= 35mm (1.37")

Mounting options

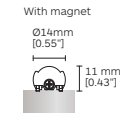
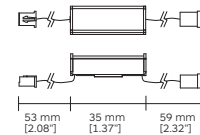

Max. L= 2105mm (82.87")

Increment: 30mm (1.18")

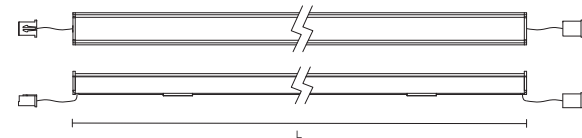

Code ordering example: **G 4 4 5 0 9 9 5 - 9 7 2 7 O D 0 0 1 0**

	Product code	Length code***	Light Source	>CRI	CCT**	LED power	Nominal lumen	Diffuser	Driver Options	Finish	
Canali Edge Microline 014 16W/m	G445	0995	LED	97	27 2700K	16W/m	1287lm/m	OD	00 No Driver	10 ■ Black	
					30 3000K			TD			28 ■ Brass Polished
					35 3500K			RD			35 ■ Gold
					40 4000K				70 ■ Aluminium		

Recommended Driver: Driver to be ordered separately. Work with 24VDC Constant Voltage LED Driver positioned remotely. Suggested Driver: 2V24D0, 2V24D1, 2V24DA. Please see page 197 for further information.

Notes:
 * For complete code ordering information, please see page 353.
 ** For other CCT options, Tuneable White [] / RGB / RGBW version, please contact us.
 *** For complete list of length codes, please see pages 196.
 For the most updated product information, please go to our website.

OD = Opal diffuser. Ordering code: **OD**
 TD = Transparent lenticular diffuser. Ordering code; **TD**
 RD = Opal rigid diffuser. Ordering code; **RD**.

Complete Length Codes List

Microline Ø14 | 16W/m | G445

Available length codes

LED Power	Length code	Length in mm	Length in inches	Nominal Lumen	LED Power	Length code	Length in mm	Length in inches	Nominal Lumen	LED Power	Length code	Length in mm	Length in inches	Nominal Lumen
0.48W	0035	35	1.37	45 lm	12.00W	0755	755	29.72	972 lm	23.52W	1475	1475	58.07	1898 lm
0.96W	0065	65	2.56	84 lm	12.48W	0785	785	30.91	1010 lm	24.00W	1505	1505	59.25	1937 lm
1.44W	0095	95	3.74	122 lm	12.96W	0815	815	32.09	1049 lm	24.48W	1535	1535	60.43	1976 lm
1.92W	0125	125	4.92	161 lm	13.44W	0845	845	33.27	1088 lm	24.96W	1565	1565	61.61	2014 lm
2.40W	0155	155	6.10	199 lm	13.92W	0875	875	34.45	1126 lm	25.44W	1595	1595	62.80	2053 lm
2.88W	0185	185	7.28	238 lm	14.40W	0905	905	35.63	1165 lm	25.92W	1625	1625	63.98	2091 lm
3.36W	0215	215	8.46	277 lm	14.88W	0935	935	36.81	1203 lm	26.40W	1655	1655	65.16	2130 lm
3.84W	0245	245	9.65	315 lm	15.36W	0965	965	37.99	1242 lm	26.88W	1685	1685	66.34	2169 lm
4.32W	0275	275	10.83	354 lm	15.84W	0995	995	39.17	1281 lm	27.36W	1715	1715	67.52	2207 lm
4.80W	0305	305	12.01	393 lm	16.32W	1025	1025	40.35	1319 lm	27.84W	1745	1745	68.70	2246 lm
5.28W	0335	335	13.19	431 lm	16.80W	1055	1055	41.54	1358 lm	28.32W	1775	1775	69.88	2284 lm
5.76W	0365	365	14.37	470 lm	17.28W	1085	1085	42.72	1396 lm	28.80W	1805	1805	71.06	2323 lm
6.24W	0395	395	15.55	508 lm	17.76W	1115	1115	43.90	1435 lm	29.28W	1835	1835	72.24	2362 lm
6.72W	0425	425	16.73	547 lm	18.24W	1145	1145	45.08	1474 lm	29.76W	1865	1865	73.43	2400 lm
7.20W	0455	455	17.91	586 lm	18.72W	1175	1175	46.26	1512 lm	30.24W	1895	1895	74.61	2439 lm
7.68W	0485	485	19.09	624 lm	19.20W	1205	1205	47.44	1551 lm	30.72W	1925	1925	75.79	2477 lm
8.16W	0515	515	20.28	663 lm	19.68W	1235	1235	48.62	1589 lm	31.20W	1955	1955	76.97	2516 lm
8.64W	0545	545	21.46	701 lm	20.16W	1265	1265	49.80	1628 lm	31.68W	1985	1985	78.15	2555 lm
9.12W	0575	575	22.64	740 lm	20.64W	1295	1295	50.98	1667 lm	32.16W	2015	2015	79.33	2593 lm
9.60W	0605	605	23.82	779 lm	21.12W	1325	1325	52.17	1705 lm	32.64W	2045	2045	80.51	2632 lm
10.08W	0635	635	25.00	817 lm	21.60W	1355	1355	53.35	1744 lm	33.12W	2075	2075	81.69	2671 lm
10.56W	0665	665	26.18	856 lm	22.08W	1385	1385	54.53	1782 lm	33.60W	2105	2105	82.87	2709 lm
11.04W	0695	695	27.36	894 lm	22.56W	1415	1415	55.71	1821 lm					
11.52W	0725	725	28.54	933 lm	23.04W	1445	1445	56.89	1860 lm					

Driver Options

Constant Voltage for Linear Cover Lights

Microline Ø14

8141 Constant Voltage LED Adaptor Driver. 1 Driver for Maximum 2m long fixtures.

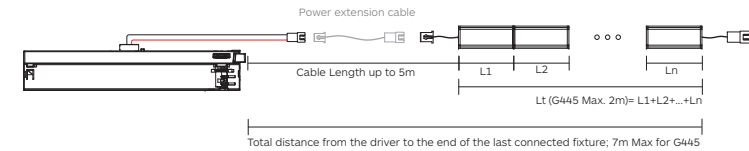

G445

Power extension cable. Art. **2D58**. 1m (if necessary).

Optical Accessories

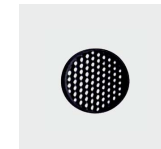

Product / Optical Accessories

Honeycomb Louvre
Colour 10

Canali Edge Zero 40

2E35

Canali Edge Zero 66

2C65

Canali Edge Zero 80

2F10

Canali

EdgeForms System

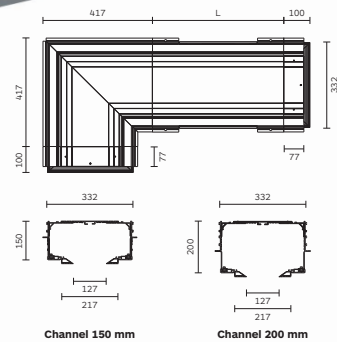
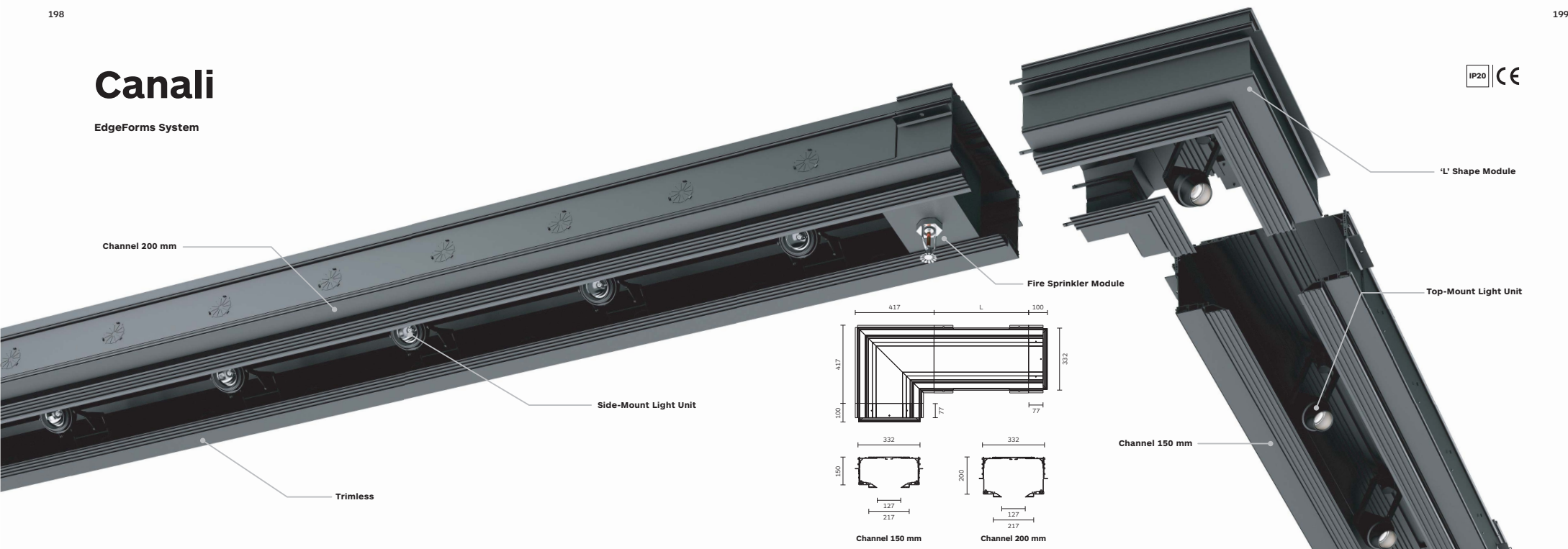

Body

All channel parts in extruded aluminium. Luminaire spot body in cast aluminium, luminaire connection arm in extruded aluminium.

Clean, unobtrusive trimless installation with above-ceiling suspension. Easy modular structure with 150mm, 200mm and 90° "L" unit.

The system is completed by traverse set, end set and end cover plate. 3 circuit track mounted inside the channel. Spotlight units are mounted on the top or side of channel interior.

Possibility to upgrade the system after the installation adding fixtures or circuits.

Accessories

Accommodation modules for: fire sprinklers, surveillance camera, HVAC diffuser, speakers, WiFi access point available upon request.

Finish

Powder coat in black colour.

LED sources

For light source data refer to the single spotlight technical information.

Optic

Lens or reflector, according with the single spotlight technical information.

Driver

Driver not included or integrated, according with the chosen spotlight. Different diming options available on request.

Applications

A comprehensive range of trimless multi - directional display lighting system available in wide variety of sizes and configurations, using a wide option of lamp types. Application areas: retail, museums, galleries, exhibits, jewelry shops, residential, lift lobbies.

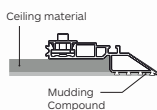

Code	High (H)	Length (L)	Code	High (H)
Channel			'L' Shape Joint	
8130	150	500	8110	150
8131	1000		8115	200
8132	2000			
8133	200			
8134				
8135				
Traverse set included. In extruded aluminium.			Traverse set included. In extruded aluminium.	
Traverse Set			End cover plate	
8101	500		8136	150
8102	1000		8137	200
8103	2000			
8104	3000			
In extruded aluminium. Pair.			In extruded aluminium. Pair Includes Art. 8105.	
Ends set			End cover	
8105				

Camera module, HVAC Diffuser module and PA Speaker module, available upon request.

Canali Side Mounted



Canali Micro Gimbalò

Side mounted

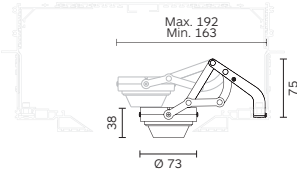

Canali Gimbalò

Side mounted

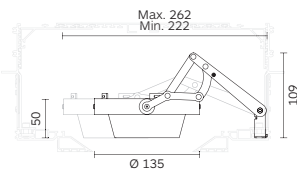

Canali Zero 66

Side mounted

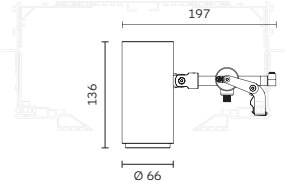

Code ordering example: **8 3 0 1 G U 5 3 - 0 0 0 0 0 D 0 1 0**

	Product code	Light source code	>CRI	CCT**	LED power	Nominal lumen	Beam angle (BA°)	Driver Options	Finish
Canali Micro Gimbalò	8301	GU53 Retrofit	MR16-GU5.3	00	00	\	00	D0 No Dim	10 ■ Black
Canali Gimbalò	8303	AR11	AR111-G53	00	00	\	00		
Canali Zero 66	8370	BC22 COB LED		90	30 3000K 40 4000K	22W 2422 lm 2577 lm	16 / 30 / 60	D0 No Dim DA Dali Dim DP Phase Dim DC CASAMBI D1 1-10V Dim	

Notes:

* For complete code ordering information, please see page 353.
 ** For other CCT options, please contact us.
 Transformer and driver are not included. To be ordered separately.
 For the most updated product information, please go to our website.

Canali Top Mounted



Canali Mini Swinger

Top mounted

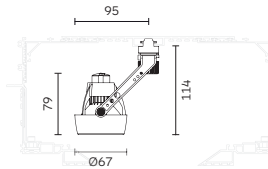

Canali Micro Conos

Top mounted

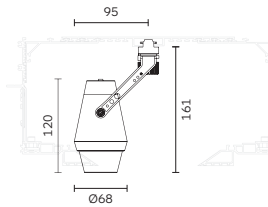

Code ordering example: **8 3 0 7 G U 5 3 - 0 0 0 0 0 D 0 1 0**

	Product code	Light source code*	>CRI	CCT**	LED power	Nominal lumen	Beam angle (BA°)	Driver Options	Finish
Canali Mini Swinger	8307	GU53 Retrofit	MR16-GU5.3	00	00	\	00	D0 No Dim	10 ■ Black
Canali Micro Conos	8309	AR11	AR111-G53	00	00	\	00		

Notes:

* For complete code ordering information, please see page 353.
 ** For other CCT options, please contact us.
 Transformer not included. To be ordered separately.
 For channel height 150 mm only.
 For the most updated product information, please go to our website.

Indoor Lighting

Gola Stand Alone



Recessed - Trim

Gola 40 Stand Alone Recessed	Gola 60 Stand Alone Recessed	Gola 95 Stand Alone Recessed
		
211	212	213



Recessed - Trimless

Gola 40 Stand Alone Recessed	Gola 60 Stand Alone Recessed	Gola 95 Stand Alone Recessed
		
211	212	213

Surface

Gola 40 Stand Alone Surface	Gola 60 Stand Alone Surface	Gola 95 Stand Alone Surface
		
215	216	217



Wall

Gola 40 Stand Alone Wall	Gola 60 Stand Alone Wall	Gola 95 Stand Alone Wall
		
219	220	221



Pendant

Gola 40 Stand Alone Pendant	Gola 60 Stand Alone Pendant	Gola 95 Stand Alone Pendant
		
223	224	225

Wall Up & Down

Gola 40 Stand Alone Wall Up & Down	Gola 95 Stand Alone Wall Up & Down
	
219	221

Pendant Up & Down

Gola 40 Stand Alone Pendant Up & Down	Gola 95 Stand Alone Pendant Up & Down
	
223	235

Indoor Lighting

Gola System



Recessed - Trim

Gola 40 System Recessed	Gola 60 System Recessed	Gola 95 System Recessed
		
229	230	231



Recessed - Trimless

Gola 40 System Recessed	Gola 60 System Recessed	Gola 95 System Recessed
		
229	230	231



Surface

Gola 40 System Surface	Gola 60 System Surface	Gola 95 System Surface
		
233	234	235

Wall

Gola 40 System Wall	Gola 60 System Wall	Gola 95 System Wall
		
237	238	239



Wall Up & Down

Gola 40 System Wall Up & Down	Gola 95 System Wall Up & Down
	
237	239

Pendant

Gola 40 System Pendant	Gola 60 System Pendant	Gola 95 System Pendant
		
241	242	243

Pendant Up & Down

Gola 40 System Pendant Up & Down	Gola 95 System Pendant Up & Down
	
241	243

Gola System

40 | 60 | 95

Recessed

Surface

Pendant

Wall

Gola Series

GOLA is the modular lighting system that makes it possible to design bright geometries and create countless different scenes.

It is a professional tool suitable for technical lighting that is both decorative at the same time.

The host of compositional configurations and types of installations make it a highly effective tool in the hands of lighting designers.

Available in a stand-alone version for individual installation or modular for system installation GOLA comes in four widths GOLA 40/60/95 mm with various lengths and can be ceiling mounted, suspension, ceiling or wall mounted trim or trimless recessed fixtures.

With direct or up & down emission only for Gola 40 and Gola 95 version.

Available in a wide range of outputs and power supplies.

Gola Codes

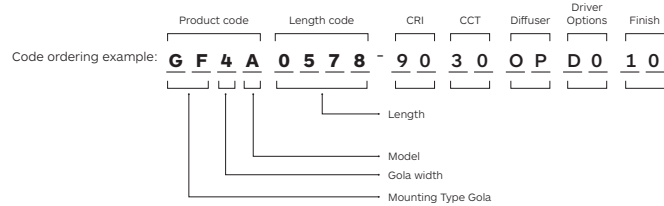

Stand Alone Code

Mounting type code	Gola width code	Module code	Gola length code length		LED CRI	CCT-LED	Diffuser code	Driver Options	Body colour
GF Recessed Trim	4 40 mm	A Stand alone	0568 mm	0578 mm	90 >90	30 3000K	OP Opal	D0 No Dim	10 Black
GM Recessed Trimless	6 60 mm		0848 mm	0858 mm	40 4000K	UG UGR<19**	DA Dali Dim	11 White	
GN Surface	9 95 mm		1128 mm	1138 mm			D1 0-10V Dim	75 Grey	
GW Wall			1408 mm	1418 mm					
GK Wall Up & Down*			1688 mm	1698 mm					
GP Pendant			1968 mm	1978 mm					
GH Pendant Up & Down*			2248 mm	2258 mm					
			2528 mm	2538 mm					
			2808 mm	2818 mm					

System Code

Mounting type code	Gola width code	Module code	Gola length code length		LED CRI	CCT-LED	Diffuser code	Driver Options	Body colour
GF Recessed Trim	4 40 mm	S System	0564 mm	0598 mm	90 >90	30 3000K	OP Opal	D0 No Dim	10 Black
GM Recessed Trimless	6 60 mm		0844 mm	0608 mm	40 4000K	UG UGR<19**	DA Dali Dim	11 White	
GN Surface	9 95 mm		1124 mm	0657 mm			D1 0-10V Dim	75 Grey	
GW Wall			1404 mm	0662 mm					
GK Wall Up & Down*			1684 mm	1146 mm					
GP Pendant			1964 mm	1146 mm					
GH Pendant Up & Down*			2244 mm	1219 mm					
			2524 mm						
			2804 mm						

Only for System version

Mounting type code	Gola width code	Module code	Gola length code length		LED CRI	CCT-LED	Diffuser code	Driver Options	Body colour
GF Recessed Trim	4 40 mm	L "L" Light Module	0593 mm	0598 mm	90 >90	30 3000K	OP Opal	D0 No Dim	10 Black
GM Recessed Trimless	6 60 mm	T "T" Light Module	0603 mm	0608 mm	40 4000K	UG UGR<19**	DA Dali Dim	11 White	
GN Surface	9 95 mm		0657 mm	0662 mm			D1 0-10V Dim	75 Grey	
GW Wall			1146 mm	1146 mm					
GK Wall Up & Down*			1146 mm	1146 mm					
GP Pendant			1219 mm	1219 mm					
GH Pendant Up & Down*									

Notes:

- * Available only for GOLA 40 and GOLA 95.
- ** Available only for GOLA 40 and GOLA 60.

Gola Mounting Type Options

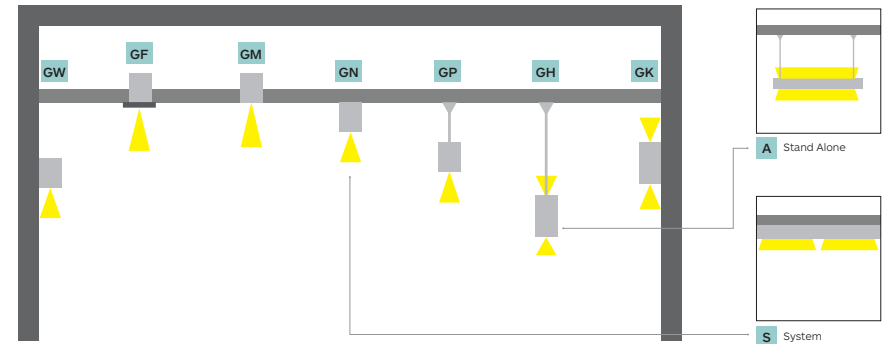

The T Joint & L Joint on the System

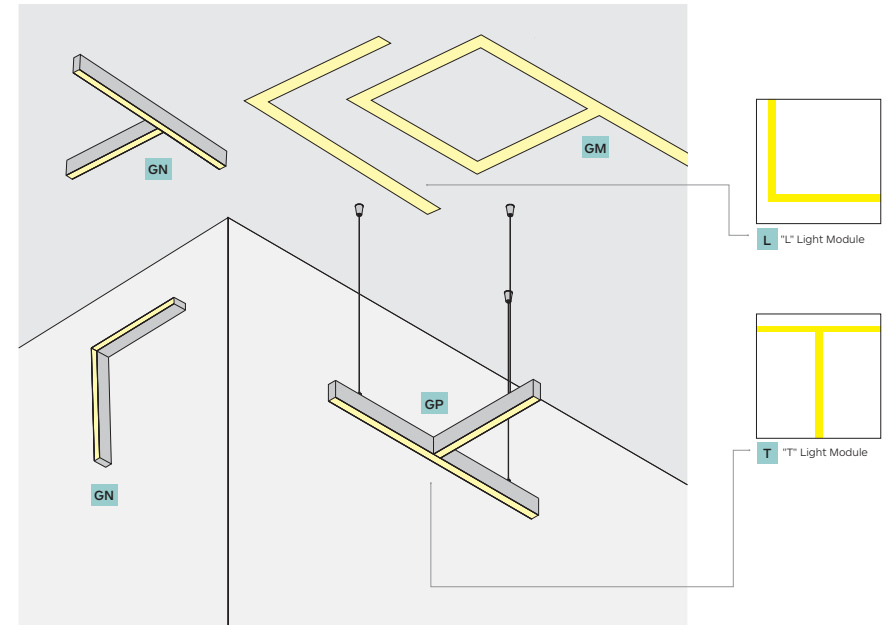

Gola Stand Alone

40 | 60 | 95 Recessed

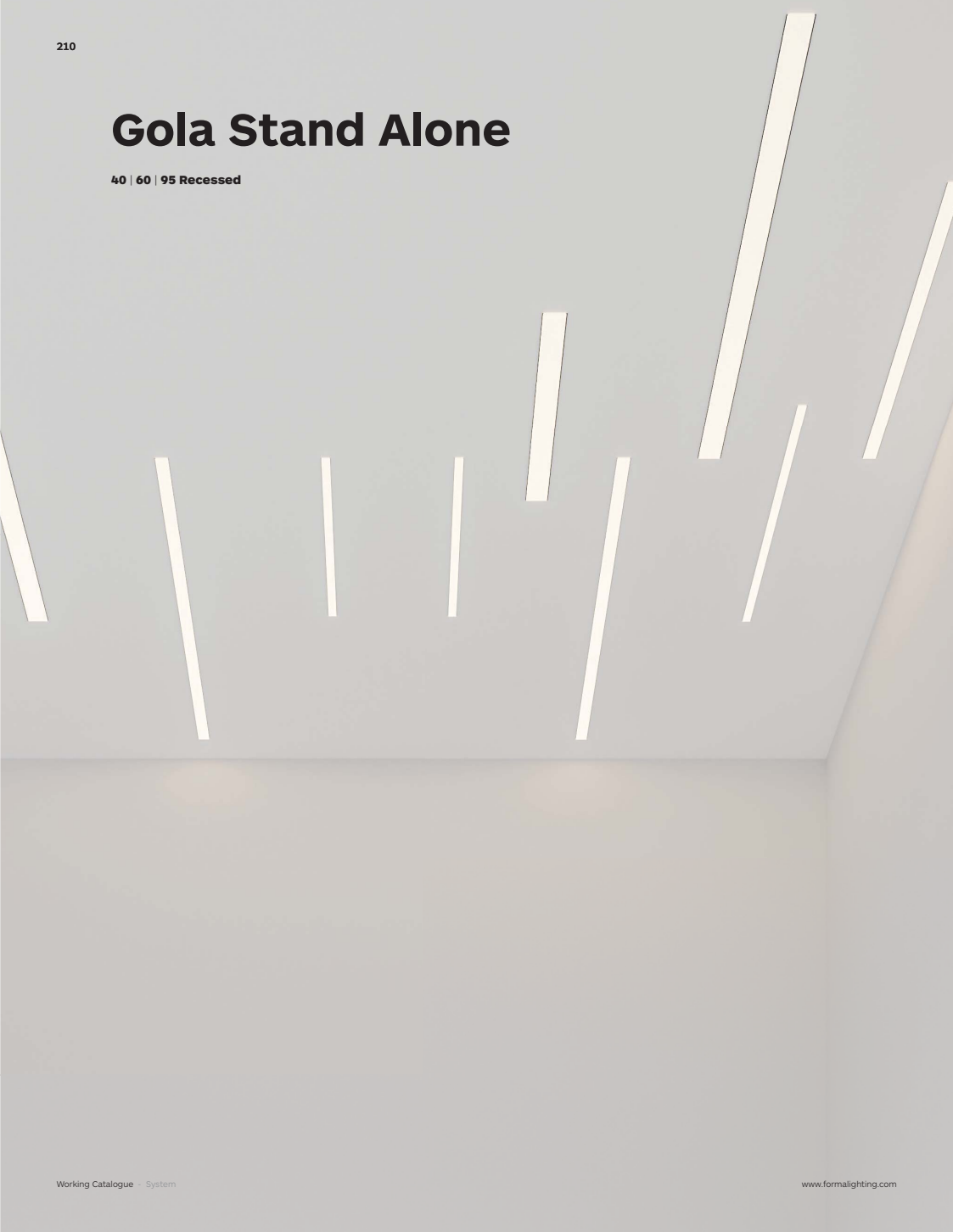

Gola 40 Recessed Stand Alone Mounting Option



Linear Light Module



Gola 40 Stand Alone

Trim

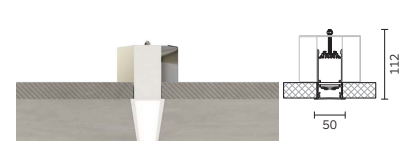
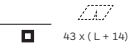

Gola 40 Stand Alone

Trimless

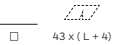

Code ordering example: **G F 4 A 0 5 7 8 - 9 0 3 0 O P D 0 1 0**

	Product Code	Length code*	Length in mm	Length in inches	LED Power	>CRI	CCT	Diffuser	Driver Options	Finish
Gola 40 Stand Alone Recessed Trim	GF4A	0578	578	22.76	13.2 W	90	30 3000K	OP Opal	D0 No Dim	10 Black
		0858	858	33.78	19.8 W		40 4000K	UG UGR<19	DP Phase Dim	11 White
		1138	1138	44.80	26.4 W				D1 0-10V Dim	75 Grey
		1418	1418	55.83	33.0 W					
		1698	1698	66.85	39.6 W					
		1978	1978	77.87	46.2 W					
		2258	2258	88.90	52.8 W					
		2538	2538	99.92	59.4 W					
Gola 40 Stand Alone Recessed Trimless	GM4A	0568	568	22.36	13.2 W	90	30 3000K	OP Opal	D0 No Dim	10 Black
		0848	848	33.39	19.8 W		30 3000K	UG UGR<19	DP Phase Dim	11 White
		1128	1128	44.41	26.4 W				D1 0-10V Dim	75 Grey
		1408	1408	55.43	33.0 W					
		1688	1688	66.46	39.6 W					
		1968	1968	77.48	46.2 W					
		2248	2248	88.50	52.8 W					
		2528	2528	99.53	59.4 W					
	2808	2808	110.55	66.0 W						

Notes:

* For complete code ordering information, please see page 208.
 For related accessories, please see page 246-249.
 For the most updated product information, please go to our website.

Gola 60 Recessed Stand Alone

Mounting Option



Linear Light Module

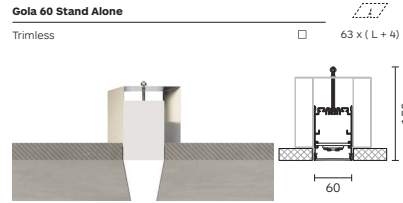
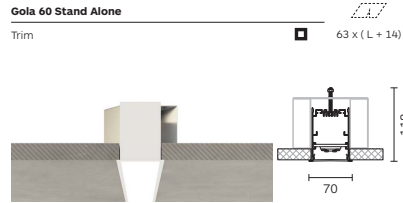

Code ordering example: **G F 6 A 0 5 7 8 - 9 0 3 0 O P D 0 1 0**

	Product Code	Length code*	Length in mm	Length in inches	LED Power	>CRI	CCT	Diffuser	Driver Options	Finish
Gola 60 Stand Alone Recessed Trim	GF6A	0578	578	22.76	13.2 W	90	30 3000K	OP Opal	D0 No Dim	10 Black
		0858	858	33.78	19.8 W	40	4000K	UG UGR<19	DP Phase Dim	11 White
		1138	1138	44.80	26.4 W				D1 0-10V Dim	75 Grey
		1418	1418	55.83	33.0 W					
		1698	1698	66.85	39.6 W					
		1978	1978	77.87	46.2 W					
		2258	2258	88.90	52.8 W					
		2538	2538	99.92	59.4 W					
	2818	2818	110.94	66.0 W						
Gola 60 Stand Alone Recessed Trimless	GM6A	0568	568	22.36	13.2 W	90	30 3000K	OP Opal	D0 No Dim	10 Black
		0848	848	33.39	19.8 W	30	3000K	UG UGR<19	DP Phase Dim	11 White
		1128	1128	44.41	26.4 W				D1 0-10V Dim	75 Grey
		1408	1408	55.43	33.0 W					
		1688	1688	66.46	39.6 W					
		1968	1968	77.48	46.2 W					
		2248	2248	88.50	52.8 W					
		2528	2528	99.53	59.4 W					
	2808	2808	110.55	66.0 W						

Notes:

* For complete code ordering information, please see page 208.
 For related accessories, please see page 246-249.
 For the most updated product information, please go to our website.

Gola 95 Recessed Stand Alone

Mounting Option



Linear Light Module

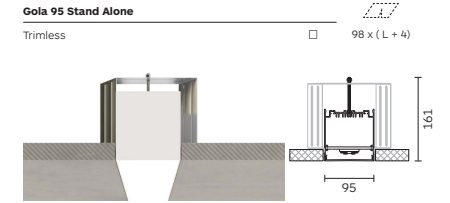
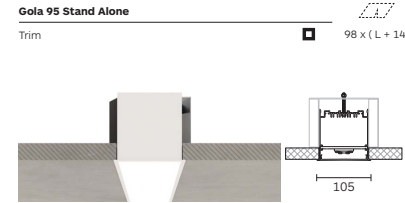

Code ordering example: **G F 9 A 0 5 7 8 - 9 0 3 0 O P D 0 1 0**

	Product Code	Length code*	Length in mm	Length in inches	LED Power	>CRI	CCT	Diffuser	Driver Options	Finish
Gola 95 Stand Alone Recessed Trim	GF9A	0578	578	22.76	26.4 W	90	30 3000K	OP Opal	D0 No Dim	10 Black
		0858	858	33.78	39.6 W	40	4000K		DP Phase Dim	11 White
		1138	1138	44.80	52.8 W				D1 0-10V Dim	75 Grey
		1418	1418	55.83	66.0 W					
		1698	1698	66.85	79.2 W					
		1978	1978	77.87	92.4 W					
		2258	2258	88.90	105.6 W					
		2538	2538	99.92	118.8 W					
	2818	2818	110.94	132.0 W						
Gola 95 Stand Alone Recessed Trimless	GM9A	0568	568	22.36	26.4 W	90	30 3000K	OP Opal	D0 No Dim	10 Black
		0848	848	33.39	39.6 W	30	3000K		DP Phase Dim	11 White
		1128	1128	44.41	52.8 W				D1 0-10V Dim	75 Grey
		1408	1408	55.43	66.0 W					
		1688	1688	66.46	79.2 W					
		1968	1968	77.48	92.4 W					
		2248	2248	88.50	105.6 W					
		2528	2528	99.53	118.8 W					
	2808	2808	110.55	132.0 W						

Notes:

* For complete code ordering information, please see page 208.
 For related accessories, please see page 246-249.
 For the most updated product information, please go to our website.

Gola Stand Alone

40 | 60 | 95 Surface

Gola 40 Surface Stand Alone Mounting Option



Linear Light Module

Gola 40 Stand Alone
Surface



Code ordering example: **G N 4 A 0 5 6 8 - 9 0 3 0 O P D 0 1 0**

	Product Code	Length code*	Length in mm	Length in inches	LED Power	>CRI	CCT	Diffuser	Driver Options	Finish
Gola 40 Stand Alone Surface	GN4A	0568	568	22.36	13.2 W	90	30 3000K	OP Opal	D0 No Dim	10 Black
		0848	848	33.39	19.8 W		40 4000K	UG UGR<19	DP Phase Dim	11 White
		1128	1128	44.41	26.4 W				D1 0-10V Dim	75 Grey
		1408	1408	55.43	33.0 W					
		1688	1688	66.46	39.6 W					
		1968	1968	77.48	46.2 W					
		2248	2248	88.50	52.8 W					
		2528	2528	99.53	59.4 W					
	2808	2808	110.55	66.0 W						

Notes:

* For complete code ordering information, please see page 208.

For related accessories, please see page 246-249.

For the most updated product information, please go to our website.

Gola 60 Surface Stand Alone

Mounting Option



Linear Light Module



Gola 60 Stand Alone
Surface

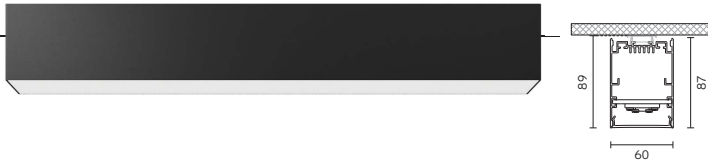

Code ordering example: **GN6A0568-9030OPD010**

	Product Code	Length code*	Length in mm	Length in inches	LED Power	>CRI	CCT	Diffuser	Driver Options	Finish
Gola 60 Stand Alone Surface	GN6A	0568	568	22.36	13.2 W	90	30 3000K	OP Opal	D0 No Dim	10 ■ Black
		0848	848	33.39	19.8 W	40	4000K	UG UGR<19	DP Phase Dim	11 □ White
		1128	1128	44.41	26.4 W				D1 0-10V Dim	75 ■ Grey
		1408	1408	55.43	33.0 W					
		1688	1688	66.46	39.6 W					
		1968	1968	77.48	46.2 W					
		2248	2248	88.50	52.8 W					
		2528	2528	99.53	59.4 W					
		2808	2808	110.55	66.0 W					

Notes:

* For complete code ordering information, please see page 208.
For related accessories, please see page 246-249.
For the most updated product information, please go to our website.

Gola 95 Surface Stand Alone

Mounting Option



Linear Light Module



Gola 95 Stand Alone
Surface

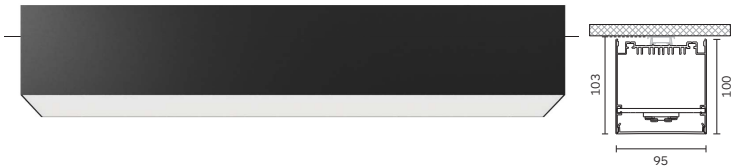

Code ordering example: **GN9A0568-9030OPD010**

	Product Code	Length code*	Length in mm	Length in inches	LED Power	>CRI	CCT	Diffuser	Driver Options	Finish
Gola 95 Stand Alone Surface	GN9A	0568	568	22.36	26.4 W	90	30 3000K	OP Opal	D0 No Dim	10 ■ Black
		0848	848	33.39	39.6 W	40	4000K		DP Phase Dim	11 □ White
		1128	1128	44.41	52.8 W				D1 0-10V Dim	75 ■ Grey
		1408	1408	55.43	66.0 W					
		1688	1688	66.46	79.2 W					
		1968	1968	77.48	92.4 W					
		2248	2248	88.50	105.6 W					
		2528	2528	99.53	118.8 W					
		2808	2808	110.55	132.0 W					

Notes:

* For complete code ordering information, please see page 208.
For related accessories, please see page 246-249.
For the most updated product information, please go to our website.

Gola Stand Alone

40 | 60 | 95 Wall & Wall Up & Down



Gola 40 Wall Stand Alone Mounting Option



Linear Light Module

Gola 40 Stand Alone

Wall

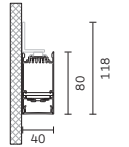

Gola 40 Stand Alone

Wall Up & Down

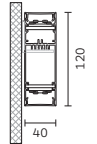

Code ordering example: **G W 4 A 0 5 6 8 - 9 0 3 0 O P D 0 1 0**

	Product Code	Length code*	Length in mm	Length in inches	LED Power	>CRI	CCT	Diffuser	Driver Options	Finish	
Gola 40 Stand Alone Wall	GW4A	0568	568	22.36	13.2 W	90	30 3000K	OP Opal	D0 No Dim	10 ■ Black	
		0848	848	33.39	19.8 W		40 4000K	UG UGR<19		DP Phase Dim	11 □ White
		1128	1128	44.41	26.4 W		D1 0-10V Dim	75 ■ Grey			
		1408	1408	55.43	33.0 W						
		1688	1688	66.46	39.6 W						
		1968	1968	77.48	46.2 W						
		2248	2248	88.50	52.8 W						
		2528	2528	99.53	59.4 W						
Gola 40 Stand Alone Wall Up & down	GK4A	2808	2808	110.55	66.0 W	90	30 3000K	OP Opal	D0 No Dim	10 ■ Black	
		0848	848	33.39	39.6 W		30 3000K	UG UGR<19		DP Phase Dim	11 □ White
		1128	1128	44.41	52.8 W		D1 0-10V Dim	75 ■ Grey			
		1408	1408	55.43	66.0 W						
		1688	1688	66.46	79.2 W						
		1968	1968	77.48	92.4 W						
		2248	2248	88.50	105.6 W						
		2528	2528	99.53	118.8 W						
2808	2808	110.55	132.0 W								

Notes:

* For complete code ordering information, please see page 208.

For related accessories, please see page 246-249.

For the most updated product information, please go to our website.

Gola 60 Wall Stand Alone

Mounting Option



Linear Light Module



Gola 60 Stand Alone
Wall

Code ordering example: **G W 6 A 0 5 6 8 - 9 0 3 0 O P D 0 1 0**

	Product Code	Length code*	Length in mm	Length in inches	LED Power	>CRI	CCT	Diffuser	Driver Options	Finish				
Gola 60 Stand Alone Wall	GW6A	0568	568	22.36	13.2 W	90	30 3000K	OP Opal	D0 No Dim	10 ■ Black				
		0848	848	33.39	19.8 W						40 4000K	UG UGR<19	D1 0-10V Dim	11 □ White
		1128	1128	44.41	26.4 W									
		1408	1408	55.43	33.0 W									
		1688	1688	66.46	39.6 W									
		1968	1968	77.48	46.2 W									
		2248	2248	88.50	52.8 W									
		2528	2528	99.53	59.4 W									
		2808	2808	110.55	66.0 W									

Notes:
 * For complete code ordering information, please see page 208.
 For related accessories, please see page 246-249.
 For the most updated product information, please go to our website.

Gola 95 Wall Stand Alone

Mounting Option



Linear Light Module



Gola 95 Stand Alone
Wall

Gola 95 Stand Alone
Wall Up & Down

Code ordering example: **G W 9 A 0 5 6 8 - 9 0 3 0 O P D 0 1 0**

	Product Code	Length code*	Length in mm	Length in inches	LED Power	>CRI	CCT	Diffuser	Driver Options	Finish			
Gola 95 Stand Alone Wall	GW9A	0568	568	22.36	26.4 W	90	30 3000K	OP Opal	D0 No Dim	10 ■ Black			
		0848	848	33.39	39.6 W						40 4000K	DP Phase Dim	11 □ White
		1128	1128	44.41	52.8 W								
		1408	1408	55.43	66.0 W								
		1688	1688	66.46	79.2 W								
		1968	1968	77.48	92.4 W								
		2248	2248	88.50	105.6 W								
		2528	2528	99.53	118.8 W								
		2808	2808	110.55	132.0 W								
		Gola 95 Stand Alone Wall Up & down	GK9A	0568	568								
0848	848			33.39	79.2 W	30 3000K	DP Phase Dim	11 □ White					
1128	1128			44.41	105.6 W								
1408	1408			55.43	132.0 W								
1688	1688			66.46	158.4 W								
1968	1968			77.48	184.8 W								
2248	2248			88.50	211.2 W								
2528	2528			99.53	237.6 W								
2808	2808			110.55	264.0 W								

Notes:
 * For complete code ordering information, please see page 208.
 For related accessories, please see page 246-249.
 For the most updated product information, please go to our website.

Gola Stand Alone

40 | 60 | 95 Pendant & Pendant Up & Down



Gola 40 Pendant Stand Alone Mounting Option



Linear Light Module

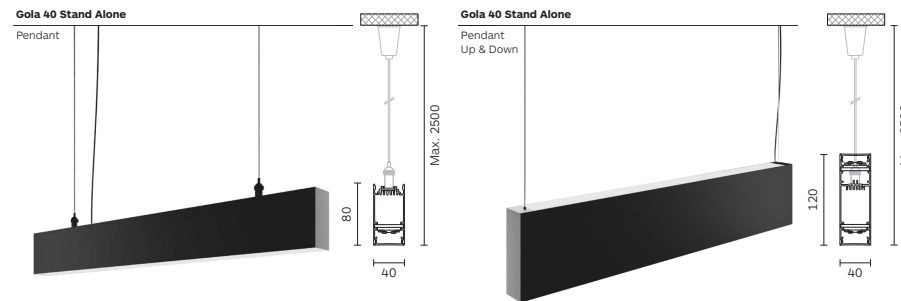

Code ordering example: **GP4A0568-9030OPD010**

	Product Code	Length code*	Length in mm	Length in inches	LED Power	>CRI	CCT	Diffuser	Driver Options	Finish	
Gola 40 Stand Alone Pendant	GP4A	0568	568	22.36	13.2 W	90	30 3000K	OP Opal	D0 No Dim	10 Black	
		0848	848	33.39	19.8 W		40 4000K	UG UGR<19		DP Phase Dim	11 White
		1128	1128	44.41	26.4 W		D1 0-10V Dim	75 Grey			
		1408	1408	55.43	33.0 W						
		1688	1688	66.46	39.6 W						
		1968	1968	77.48	46.2 W						
		2248	2248	88.50	52.8 W						
		2528	2528	99.53	59.4 W						
Gola 40 Stand Alone Pendant Up & down	GH4A	0568	568	22.36	19.8 W	90	30 3000K	OP Opal	D0 No Dim	10 Black	
		0848	848	33.39	33.0 W		30 3000K	UG UGR<19		DP Phase Dim	11 White
		1128	1128	44.41	46.2 W		D1 0-10V Dim	75 Grey			
		1408	1408	55.43	59.4 W						
		1688	1688	66.46	72.6 W						
		1968	1968	77.48	85.8 W						
		2248	2248	88.50	99.0 W						
		2528	2528	99.53	112.2 W						
	2808	2808	110.55	118.8 W							

Notes:

* For complete code ordering information, please see page 208.
 For related accessories, please see page 246-249.
 For the most updated product information, please go to our website.

Gola 60 Pendant Stand Alone

Mounting Option



Linear Light Module

Gola 60 Stand Alone

Pendant

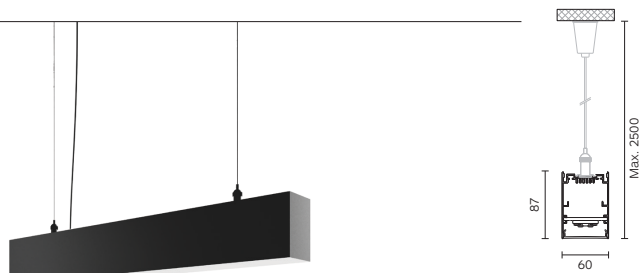

Code ordering example: **GP6A0568-9030OPD010**

	Product Code	Length code*	Length in mm	Length in inches	LED Power	>CRI	CCT	Diffuser	Driver Options	Finish
Gola 60 Stand Alone Pendant	GP6A	0568	568	22.36	13.2 W	90	30 3000K	OP Opal	D0 No Dim	10 Black
		0848	848	33.39	19.8 W		40 4000K			UG UGR<19
		1128	1128	44.41	26.4 W	D1 0-10V Dim	75 Grey			
		1408	1408	55.43	33.0 W					
		1688	1688	66.46	39.6 W					
		1968	1968	77.48	46.2 W					
		2248	2248	88.50	52.8 W					
		2528	2528	99.53	59.4 W					
		2808	2808	110.55	66.0 W					

Notes:

* For complete code ordering information, please see page 208.
 For related accessories, please see page 246-249.
 For the most updated product information, please go to our website.

Gola 95 Pendant Stand Alone

Mounting Option



Linear Light Module

Gola 95 Stand Alone

Pendant

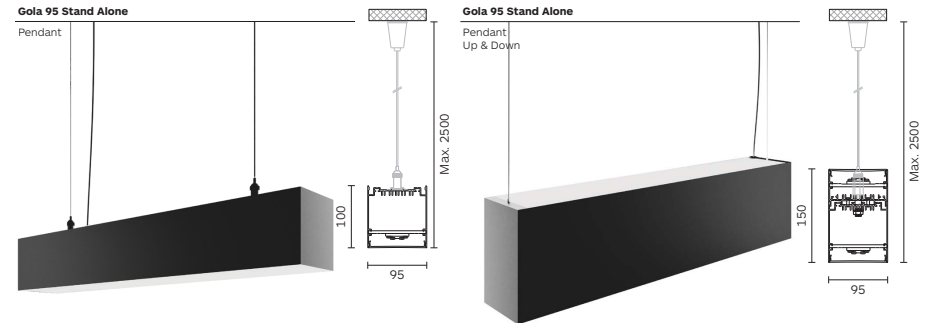

Code ordering example: **GP9A0568-9030OPD010**

	Product Code	Length code*	Length in mm	Length in inches	LED Power	>CRI	CCT	Diffuser	Driver Options	Finish
Gola 95 Stand Alone Pendant	GP9A	0568	568	22.36	26.4 W	90	30 3000K	OP Opal	D0 No Dim	10 Black
		0848	848	33.39	39.6 W		40 4000K			DP Phase Dim
		1128	1128	44.41	52.8 W	D1 0-10V Dim	75 Grey			
		1408	1408	55.43	66.0 W					
		1688	1688	66.46	79.2 W					
		1968	1968	77.48	92.4 W					
		2248	2248	88.50	105.6 W					
		2528	2528	99.53	118.8 W					
		2808	2808	110.55	132.0 W					

	Product Code	Length code*	Length in mm	Length in inches	LED Power	>CRI	CCT	Diffuser	Driver Options	Finish
Gola 95 Stand Alone Pendant Up & down	GH9A	0568	568	22.36	52.8 W	90	30 3000K	OP Opal	D0 No Dim	10 Black
		0848	848	33.39	66.0 W		30 3000K			DP Phase Dim
		1128	1128	44.41	92.4 W	D1 0-10V Dim	75 Grey			
		1408	1408	55.43	118.8 W					
		1688	1688	66.46	145.2 W					
		1968	1968	77.48	171.6 W					
		2248	2248	88.50	184.8 W					
		2528	2528	99.53	224.4 W					
		2808	2808	110.55	237.6 W					

Notes:

* For complete code ordering information, please see page 208.
 For related accessories, please see page 246-249.
 For the most updated product information, please go to our website.



Gola System

Mounting Option

Linear Light Module



"L" Light Module



"T" Light Module



Linear Shape



"L" Shape

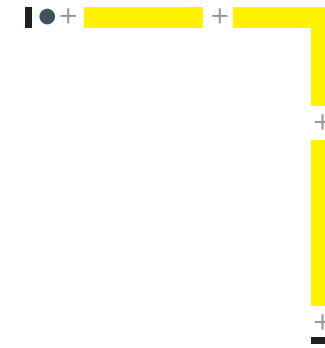

"T" Shape

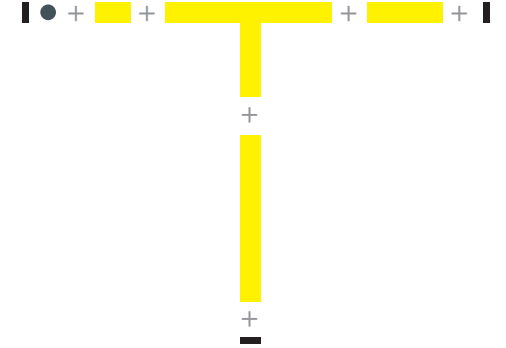

Rectangular Shape

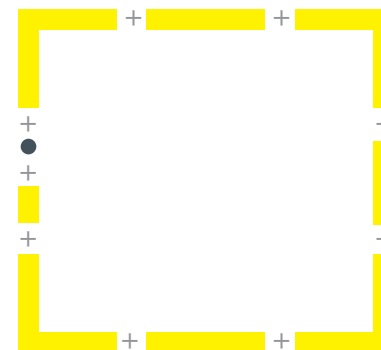

Notes

Mounting Option	End Cap	Electrified feeder
Linear Shape	End Cap Trim: 2X G040ECF/G060ECF/G095ECF End Cap Trimless: 2X G040ECM/G060ECM/G095ECM End Cap Up & Down: 2X G040ECU/G095ECU	1X GELM3 / 1X GELM5
"L" Shape	End Cap Trim: 2X G040ECF/G060ECF/G095ECF End Cap Trimless: 2X G040ECM/G060ECM/G095ECM End Cap Up & Down: 2X G040ECU/G095ECU	1X GELM3 / 1X GELM5
"T" Shape	End Cap Trim: 3X G040ECF/G060ECF/G095ECF End Cap Trimless: 3X G040ECM/G060ECM/G095ECM End Cap Up & Down: 3X G040ECU/G095ECU	1X GELM3 / 1X GELM5
Rectangular Shape	/	1X GELM3 / 1X GELM5

Gola System

40 | 60 | 95 Recessed System

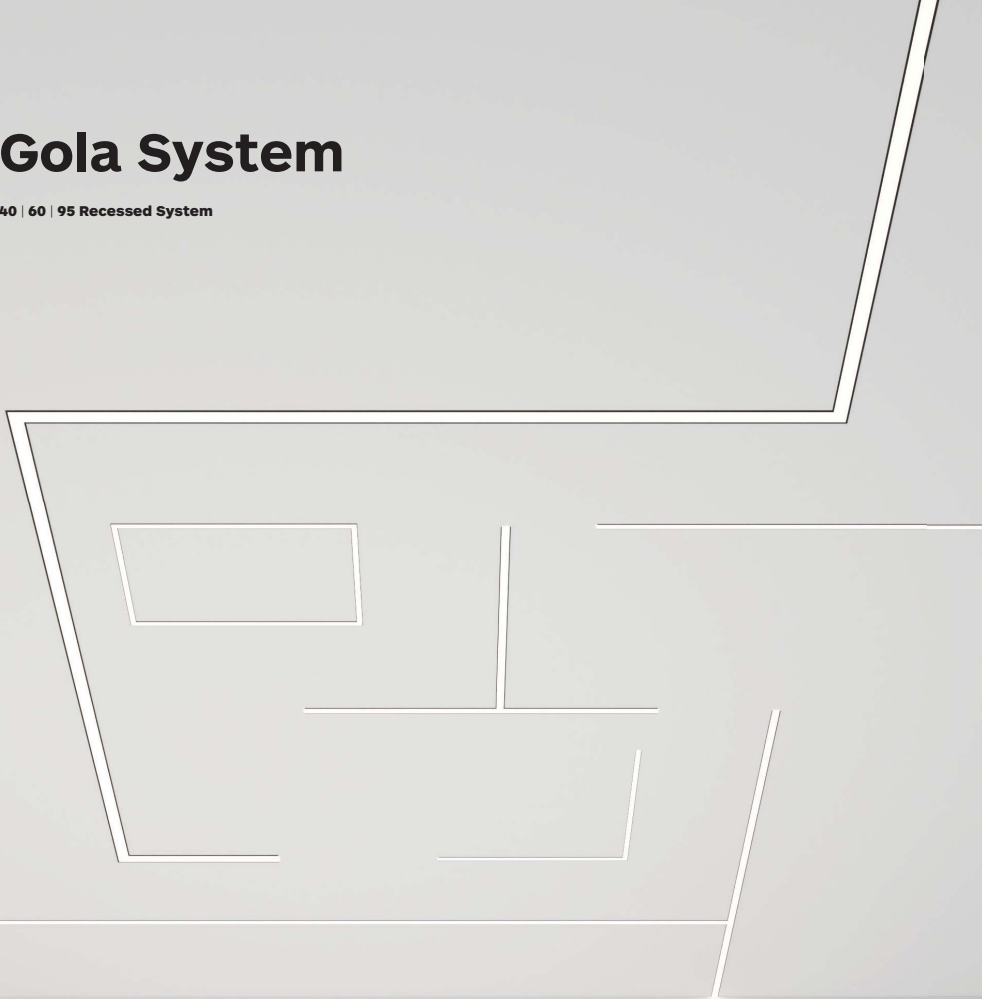

Gola 40 Recessed System Mounting Option



Linear Light Module



"L" Light Module



"T" Light Module



Gola 40 System

Trim

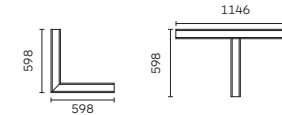
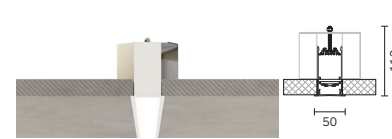
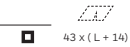

Gola 40 System

Trimless

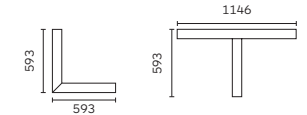
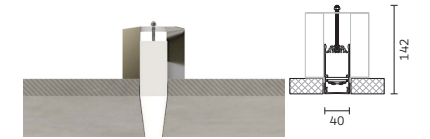
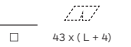

Code ordering example: **GF4S0564-9030OPD010**

	Product Code	Length code*	Length in mm	Length in inches	LED Power	>CRI	CCT	Diffuser	Driver Options	Finish
Gola 40 System Recessed Trim	GF4S	0564	564	22.20	13.2 W	90	30 3000K	OP Opal	D0 No Dim	10 ■ Black
		0844	844	33.23	19.8 W		40 4000K	UG UGR<19	11 □ White	
		1124	1124	44.25	26.4 W		D1 0-10V Dim	75 ■ Grey		
Gola 40 System Recessed Trimless	GM4S	1404	1404	55.28	33.0 W	90	30 3000K	OP Opal	D0 No Dim	10 ■ Black
		1684	1684	66.30	39.6 W		40 4000K	UG UGR<19	11 □ White	
		1964	1964	77.32	46.2 W		D1 0-10V Dim	75 ■ Grey		
		2244	2244	88.35	52.8 W					
		2524	2524	99.37	59.4 W					
		2804	2804	110.39	66.0 W					
Gola 40 System Recessed Trim "L" Light Module	GF4L	0598	598	23.54	26.4W	90	30 3000K	OP Opal	D0 No Dim	10 ■ Black
						30 3000K	UG UGR<19	DP Phase Dim	11 □ White	
								D1 0-10V Dim	75 ■ Grey	
Gola 40 System Recessed Trim "T" Light Module	GF4T	1146	1146	45.12	39.6W					
Gola 40 System Recessed Trimless "L" Light Module	GM4L	0593	593	23.35	26.4W					
Gola 40 System Recessed Trimless "T" Light Module	GM4T	1146	1146	45.12	39.6W					

Notes:

* For complete code ordering information, please see page 208.

For related accessories, please see page 246-249.

For the most updated product information, please go to our website.

Gola 60 Recessed System



Mounting Option

Linear Light Module

"L" Light Module

"T" Light Module



Gola 60 System

Trim 63 x (L + 14)

Gola 60 System

Trimless 63 x (L + 4)

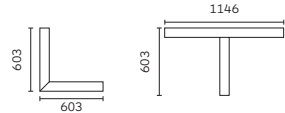
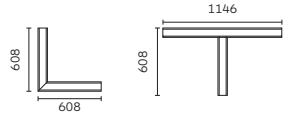
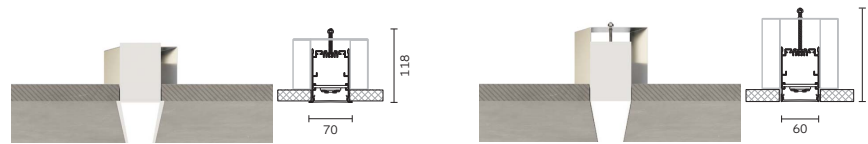

Code ordering example: **G F 6 S 0 5 6 4 - 9 0 3 0 O P D 0 1 0**

	Product Code	Length code*	Length in mm	Length in inches	LED Power	>CRI	CCT	Diffuser	Driver Options	Finish
Gola 60 System Recessed Trim	GF6S	0564	564	22.20	13.2 W	90	30 3000K	OP Opal	DO No Dim	10 ■ Black
	0844	844	33.23	19.8 W	40 4000K		UG UGR<19	DP Phase Dim	11 □ White	
	1124	1124	44.25	26.4 W	D1 0-10V Dim		75 ■ Grey			
Gola 60 System Recessed Trimless	GM6S	1404	1404	55.28	33.0 W					
	1684	1684	66.30	39.6 W						
	1964	1964	77.32	46.2 W						
	2244	2244	88.35	52.8 W						
	2524	2524	99.37	59.4 W						
	2804	2804	110.39	66.0 W						
Gola 60 System Recessed Trim "L" Light Module	GF6L	0608	608	23.94	26.4W	90	30 3000K	OP Opal	DO No Dim	10 ■ Black
	30 3000K	UG UGR<19	DP Phase Dim	11 □ White						
Gola 60 System Recessed Trim "T" Light Module	GF6T	1146	1146	45.12	39.6W			D1 0-10V Dim	75 ■ Grey	
Gola 60 System Recessed Trimless "L" Light Module	GM6L	0603	603	23.74	26.4W					
Gola 60 System Recessed Trimless "T" Light Module	GM6T	1146	1146	45.12	39.6W					

Notes:

* For complete code ordering information, please see page 208.
 For related accessories, please see page 246-249.
 For the most updated product information, please go to our website.

Gola 95 Recessed System



Mounting Option

Linear Light Module

"L" Light Module

"T" Light Module



Gola 95 System

Trim 98 x (L + 14)

Gola 95 System

Trimless 98 x (L + 4)

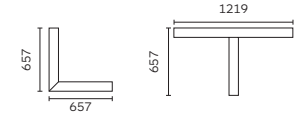
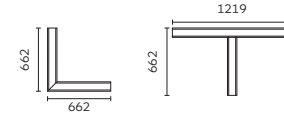
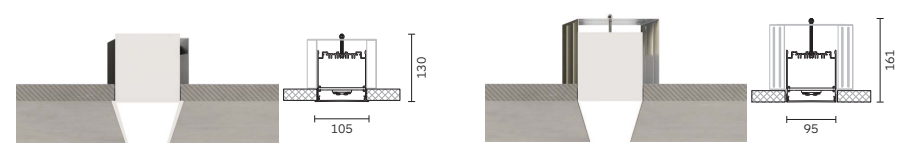

Code ordering example: **G F 9 S 0 5 6 4 - 9 0 3 0 O P D 0 1 0**

	Product Code	Length code*	Length in mm	Length in inches	LED Power	>CRI	CCT	Diffuser	Driver Options	Finish
Gola 95 System Recessed Trim	GF9S	0564	564	22.20	26.4 W	90	30 3000K	OP Opal	DO No Dim	10 ■ Black
	0844	844	33.23	39.6 W	40 4000K		UG UGR<19	DP Phase Dim	11 □ White	
	1124	1124	44.25	52.8 W	D1 0-10V Dim		75 ■ Grey			
Gola 95 System Recessed Trimless	GM9S	1404	1404	55.28	66.0 W					
	1684	1684	66.30	79.2 W						
	1964	1964	77.32	92.4 W						
	2244	2244	88.35	105.6 W						
	2524	2524	99.37	118.8 W						
	2804	2804	110.39	132.0 W						
Gola 95 System Recessed Trim "L" Light Module	GF9L	0662	662	26.06	52.8W	90	30 3000K	OP Opal	DO No Dim	10 ■ Black
	30 3000K	UG UGR<19	DP Phase Dim	11 □ White						
Gola 95 System Recessed Trim "T" Light Module	GF9T	1219	1219	47.99	79.2W			D1 0-10V Dim	75 ■ Grey	
Gola 95 System Recessed Trimless "L" Light Module	GM9L	0657	657	25.87	52.8W					
Gola 95 System Recessed Trimless "T" Light Module	GM9T	1219	1219	47.99	79.2W					

Notes:

* For complete code ordering information, please see page 208.
 For related accessories, please see page 246-249.
 For the most updated product information, please go to our website.

Gola System

40 | 60 | 95 Surface System

Gola 40 Surface System

Mounting Option



Linear Light Module



"L" Light Module



"T" Light Module



Gola 40 System

Surface

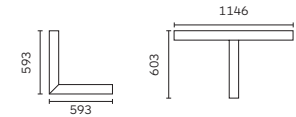

Code ordering example: **G N 4 S 0 5 6 4 - 9 0 3 0 O P D 0 1 0**

	Product Code	Length code*	Length in mm	Length in inches	LED Power	>CRI	CCT	Diffuser	Driver Options	Finish
Gola 40 System Surface	GN4S	0564	564	22.20	13.2 W	90	30 3000K	OP Opal	D0 No Dim	10 Black
		0844	844	33.23	19.8 W		40 4000K	UG UGR<19	DP Phase Dim	11 White
		1124	1124	44.25	26.4 W				D1 0-10V Dim	75 Grey
		1404	1404	55.28	33.0 W					
		1684	1684	66.30	39.6 W					
		1964	1964	77.32	46.2 W					
		2244	2244	88.35	52.8 W					
Gola 40 System Surface "L" Light Module	GN4L	0593	593	23.54	26.4W	90	30 3000K	OP Opal	D0 No Dim	10 Black
							30 3000K	UG UGR<19	DP Phase Dim	11 White
									D1 0-10V Dim	75 Grey
Gola 40 System Surface "T" Light Module	GN4T	1146	1146	45.12	39.6W					

Notes:

* For complete code ordering information, please see page 208.

For related accessories, please see page 246-249.

For the most updated product information, please go to our website.

Gola 60 Surface System

Mounting Option



Linear Light Module



"L" Light Module



"T" Light Module



Gola 60 System Surface

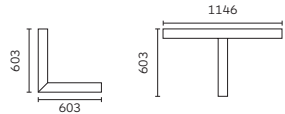
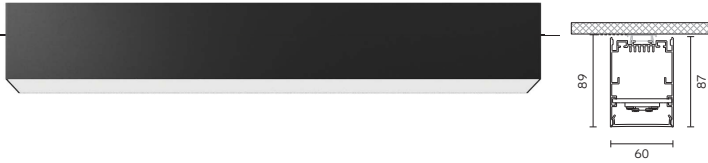

Code ordering example: **G N 6 S 0 5 6 4 - 9 0 3 0 O P D 0 1 0**

	Product Code	Length code*	Length in mm	Length in inches	LED Power	>CRI	CCT	Diffuser	Driver Options	Finish
Gola 60 System Surface	GN6S	0564	564	22.20	13.2 W	90	30 3000K	OP Opal	D0 No Dim	10 ■ Black
		0844	844	33.23	19.8 W		40 4000K	UG UGR<19	DP Phase Dim	11 □ White
		1124	1124	44.25	26.4 W				D1 0-10V Dim	75 ■ Grey
		1404	1404	55.28	33.0 W					
		1684	1684	66.30	39.6 W					
		1964	1964	77.32	46.2 W					
		2244	2244	88.35	52.8 W					
		2524	2524	99.37	59.4 W					
2804	2804	110.39	66.0 W							
Gola 60 System Surface "L" Light Module	GN6L	0603	603	23.74	26.4W	90	30 3000K	OP Opal	D0 No Dim	10 ■ Black
						30 3000K	UG UGR<19	DP Phase Dim	11 □ White	75 ■ Grey
								D1 0-10V Dim		
Gola 60 System Surface "T" Light Module	GN6T	1146	1146	45.12	39.6W					

Notes:
 * For complete code ordering information, please see page 208.
 For related accessories, please see page 246-249.
 For the most updated product information, please go to our website.

Gola 95 Surface System

Mounting Option



Linear Light Module



"L" Light Module



"T" Light Module



Gola 95 System Surface

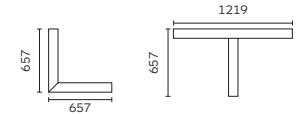
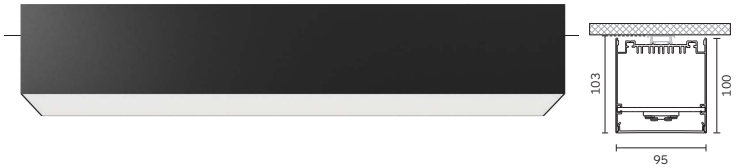

Code ordering example: **G N 9 S 0 5 6 4 - 9 0 3 0 O P D 0 1 0**

	Product Code	Length code*	Length in mm	Length in inches	LED Power	>CRI	CCT	Diffuser	Driver Options	Finish
Gola 95 System Surface	GN9S	0564	564	22.20	26.4 W	90	30 3000K	OP Opal	D0 No Dim	10 ■ Black
		0844	844	33.23	39.6 W		40 4000K		DP Phase Dim	11 □ White
		1124	1124	44.25	52.8 W				D1 0-10V Dim	75 ■ Grey
		1404	1404	55.28	66.0 W					
		1684	1684	66.30	79.2 W					
		1964	1964	77.32	92.4 W					
		2244	2244	88.35	105.6 W					
		2524	2524	99.37	118.8 W					
2804	2804	110.39	132.0 W							
Gola 95 System Surface "L" Light Module	GN9L	0657	657	25.87	52.8 W	90	30 3000K	OP Opal	D0 No Dim	10 ■ Black
						30 3000K		DP Phase Dim	11 □ White	75 ■ Grey
								D1 0-10V Dim		
Gola 95 System Surface "T" Light Module	GN9T	1219	1219	47.99	79.2 W					

Notes:
 * For complete code ordering information, please see page 208.
 For related accessories, please see page 246-249.
 For the most updated product information, please go to our website.

Gola System

40 | 60 | 95 Wall System



Gola 40 Wall System

Mounting Option



Linear Light Module



"L" Light Module



Gola 40 System

Wall



Gola 40 System

Wall Up & Down

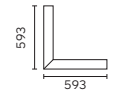
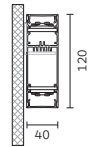
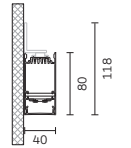

Code ordering example: **G W 4 S 0 5 6 4 - 9 0 3 0 O P D 0 1 0**

	Product Code	Length code*	Length in mm	Length in inches	LED Power	>CRI	CCT	Diffuser	Driver Options	Finish
Gola 40 System Wall	GW4S	0564	564	22.20	13.2 W	90	30 3000K	OP Opal	D0 No Dim	10 ■ Black
		0844	844	33.23	19.8 W		40 4000K	UG UGR<19	DP Phase Dim	11 □ White
		1124	1124	44.25	26.4 W				D1 0-10V Dim	75 ■ Grey
		1404	1404	55.28	33.0 W					
		1684	1684	66.30	39.6 W					
		1964	1964	77.32	46.2 W					
		2244	2244	88.35	52.8 W					
Gola 40 System Wall Up & down	GK4S	0564	564	22.20	26.4 W	90	30 3000K	OP Opal	D0 No Dim	10 ■ Black
		0844	844	33.23	39.6 W		30 3000K	UG UGR<19	DP Phase Dim	11 □ White
		1124	1124	44.25	52.8 W				D1 0-10V Dim	75 ■ Grey
		1404	1404	55.28	66.0 W					
		1684	1684	66.30	79.2 W					
		1964	1964	77.32	92.4 W					
		2244	2244	88.35	92.4 W					
Gola 40 System Wall "L" Light Module	GW4L	0593	593	23.54	26.4 W	90	30 3000K	OP Opal	D0 No Dim	10 ■ Black
		0593	593	23.54	52.8 W		30 3000K	UG UGR<19	DP Phase Dim	11 □ White
Gola 40 System Wall Up & down "L" Light Module	GK4L	0593	593	23.54	52.8 W			D1 0-10V Dim	75 ■ Grey	

Notes:

* For complete code ordering information, please see page 208.

For related accessories, please see page 246-249.

For the most updated product information, please go to our website.

Gola 60 Wall System

Mounting Option



Linear Light Module



"L" Light Module



Gola 60 System
Wall

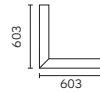
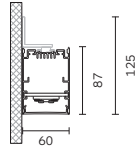

Code ordering example: **G W 6 S 0 5 6 4 - 9 0 3 0 O P D 0 1 0**

	Product Code	Length code*	Length in mm	Length in inches	LED Power	>CRI	CCT	Diffuser	Driver Options	Finish	
Gola 60 System Wall	GW6S	0564	564	22.20	13.2 W	90	30 3000K	OP Opal	D0 No Dim	10 ■ Black	
		0844	844	33.23	19.8 W		40 4000K	UG UGR<19	DP Phase Dim	11 □ White	
		1124	1124	44.25	26.4 W	D1 0-10V Dim	75 ■ Grey	1404	1404	55.28	33.0 W
		1684	1684	66.30	39.6 W						
		1964	1964	77.32	46.2 W						
		2244	2244	88.35	52.8 W						
		2524	2524	99.37	59.4 W						
		2804	2804	110.39	66.0 W						
Gola 60 System Wall "L" Light Module	GW6L	0603	603	23.74	26.4 W	90	30 3000K	OP Opal	D0 No Dim	10 ■ Black	
		0603	603	23.74	26.4 W		30 3000K	UG UGR<19	DP Phase Dim	11 □ White	
		0603	603	23.74	26.4 W	30 3000K	UG UGR<19	D1 0-10V Dim	75 ■ Grey		

Notes:
 * For complete code ordering information, please see page 208.
 For related accessories, please see page 246-249.
 For the most updated product information, please go to our website.

Gola 95 Wall System

Mounting Option



Linear Light Module



"L" Light Module



Gola 95 System
Wall

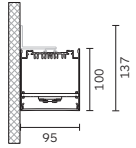

Gola 95 System
Wall Up & Down

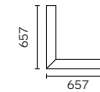
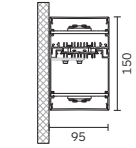

Code ordering example: **G W 9 S 0 5 6 4 - 9 0 3 0 O P D 0 1 0**

	Product Code	Length code*	Length in mm	Length in inches	LED Power	>CRI	CCT	Diffuser	Driver Options	Finish	
Gola 95 System Wall	GW9S	0564	564	22.20	26.4 W	90	30 3000K	OP Opal	D0 No Dim	10 ■ Black	
		0844	844	33.23	39.6 W		40 4000K	UG UGR<19	DP Phase Dim	11 □ White	
		1124	1124	44.25	52.8 W	D1 0-10V Dim	75 ■ Grey	1404	1404	55.28	66.0 W
		1684	1684	66.30	79.2 W						
		1964	1964	77.32	92.4 W						
		2244	2244	88.35	105.6 W						
		2524	2524	99.37	118.8 W						
		2804	2804	110.39	132.0 W						
Gola 95 System Wall Up & down	GK9S	0564	564	22.20	52.8 W	90	30 3000K	OP Opal	D0 No Dim	10 ■ Black	
		0844	844	33.23	79.2 W		30 3000K	UG UGR<19	DP Phase Dim	11 □ White	
		1124	1124	44.25	105.6 W	D1 0-10V Dim	75 ■ Grey	1404	1404	55.28	132.0 W
		1684	1684	66.30	158.4 W						
		1964	1964	77.32	184.8 W						
		2244	2244	88.35	211.2 W						
		2524	2524	99.37	237.6 W						
		2804	2804	110.39	264.0 W						
Gola 95 System Wall "L" Light Module	GW9L	0657	657	25.87	52.8 W	90	30 3000K	OP Opal	D0 No Dim	10 ■ Black	
		0657	657	25.87	52.8 W		30 3000K	UG UGR<19	DP Phase Dim	11 □ White	
Gola 95 System Wall Up & down "L" Light Module	GK9L	0657	657	25.87	105.6 W	90	30 3000K	OP Opal	D0 No Dim	10 ■ Black	
		0657	657	25.87	105.6 W		30 3000K	UG UGR<19	DP Phase Dim	11 □ White	
Gola 95 System Wall Up & down "L" Light Module	GK9L	0657	657	25.87	105.6 W	90	30 3000K	OP Opal	D0 No Dim	10 ■ Black	
		0657	657	25.87	105.6 W		30 3000K	UG UGR<19	DP Phase Dim	11 □ White	
Gola 95 System Wall Up & down "L" Light Module	GK9L	0657	657	25.87	105.6 W	90	30 3000K	OP Opal	D0 No Dim	10 ■ Black	
		0657	657	25.87	105.6 W		30 3000K	UG UGR<19	DP Phase Dim	11 □ White	
Gola 95 System Wall Up & down "L" Light Module	GK9L	0657	657	25.87	105.6 W	90	30 3000K	OP Opal	D0 No Dim	10 ■ Black	
		0657	657	25.87	105.6 W		30 3000K	UG UGR<19	DP Phase Dim	11 □ White	

Notes:
 * For complete code ordering information, please see page 208.
 For related accessories, please see page 246-249.
 For the most updated product information, please go to our website.

Gola System

40 | 60 | 95 Pendant System



Gola 40 Pendant System

Mounting Option



Linear Light Module



"L" Light Module



"T" Light Module



Gola 40 System

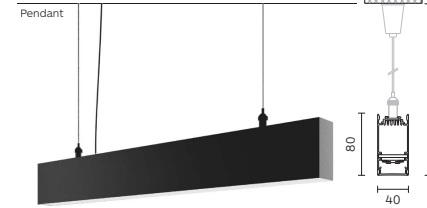

Gola 40 System

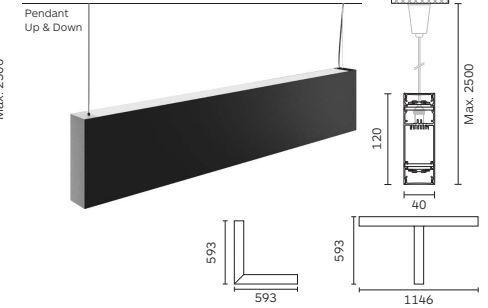

Code ordering example: **GP4S0564-9030OPD010**

	Product Code	Length code*	Length in mm	Length in inches	LED Power	>CRI	CCT	Diffuser	Driver Options	Finish
Gola 40 System Pendant	GP4S	0564	564	22.20	13.2 W	90	30 3000K	OP Opal	D0 No Dim	10 ■ Black
		0844	844	33.23	19.8 W					
		1124	1124	44.25	26.4 W					
		1404	1404	55.28	33.0 W					
		1684	1684	66.30	39.6 W					
		1964	1964	77.32	46.2 W					
		2244	2244	88.35	52.8 W					
		2524	2524	99.37	59.4 W					
Gola 40 System Pendant Up & down	GH4S	0564	564	22.20	19.8 W	90	30 3000K	OP Opal	D0 No Dim	10 ■ Black
		0844	844	33.23	33.0 W					
		1124	1124	44.25	46.2 W					
		1404	1404	55.28	59.4 W					
		1684	1684	66.30	72.6 W					
		1964	1964	77.32	85.8 W					
		2244	2244	88.35	99.0 W					
		2524	2524	99.37	112.2 W					
2804	2804	110.39	125.4 W							
Gola 40 System Pendant "L" Light Module	GP4L	0593	593	23.35	26.4W	90	30 3000K	OP Opal	D0 No Dim	10 ■ Black
		30 3000K	UG UGR<19	DP Phase Dim	11 □ White					
Gola 40 System Pendant "T" Light Module	GP4T	1146	1146	45.12	39.6W					
		D1 0-10V Dim	75 ■ Grey							
Gola 40 System Pendant Up & Down "L" Light Module	GH4L	0593	593	23.35	39.6W					
		D1 0-10V Dim	75 ■ Grey							
Gola 40 System Pendant Up & Down "T" Light Module	GH4T	1146	1146	45.12	59.4W					
		D1 0-10V Dim	75 ■ Grey							

Notes:

* For complete code ordering information, please see page 208.
 For related accessories, please see page 246-249.
 For the most updated product information, please go to our website.

Gola 60 Pendant System

Mounting Option

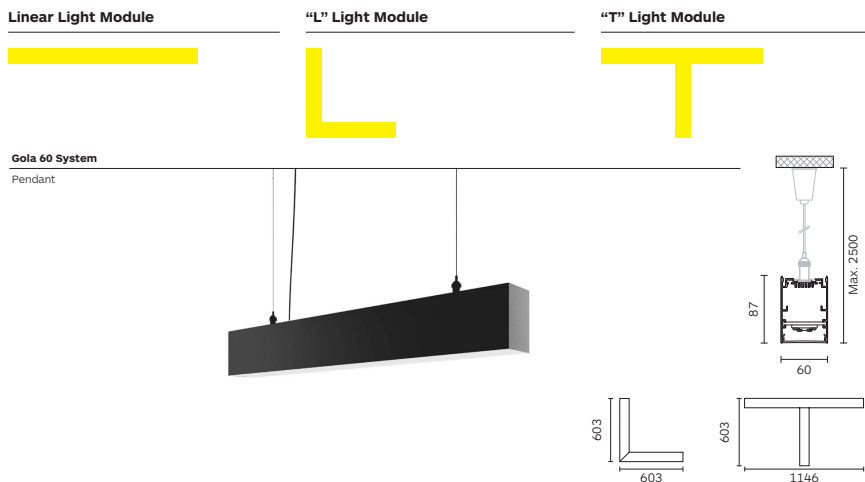

Code ordering example: **GP6S0564-9030OPD010**

	Product Code	Length code*	Length in mm	Length in inches	LED Power	>CRI	CCT	Diffuser	Driver Options	Finish				
Gola 60 System Pendant	GP6S	0564	564	22.20	13.2 W	90	30 3000K	OP Opal	D0 No Dim	10 ■ Black				
		0844	844	33.23	19.8 W						40 4000K	UG UGR<19	DP Phase Dim	11 □ White
		1124	1124	44.25	26.4 W									
		1404	1404	55.28	33.0 W									
		1684	1684	66.30	39.6 W									
		1964	1964	77.32	46.2 W									
		2244	2244	88.35	52.8 W									
		2524	2524	99.37	59.4W									
2804	2804	110.39	66.0 W											
Gola 60 System Pendant "L" Light Module	GP6L	0603	603	23.74	26.4W	90	30 3000K	OP Opal	D0 No Dim	10 ■ Black				
		0603	603	23.74	26.4W						30 3000K	UG UGR<19	DP Phase Dim	11 □ White
Gola 60 System Pendant "T" Light Module	GP6T	1146	1146	45.12	39.6W			D1 0-10V Dim	75 ■ Grey					

Notes:
 * For complete code ordering information, please see page 208.
 For related accessories, please see page 246-249.
 For the most updated product information, please go to our website.

Gola 95 Pendant System

Mounting Option

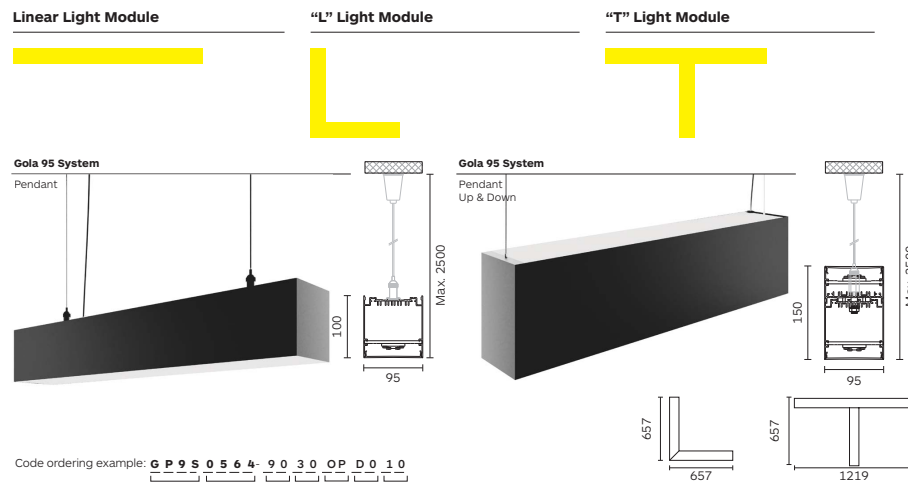





























Code ordering example: **GP9S0564-9030OPD010**

	Product Code	Length code*	Length in mm	Length in inches	LED Power	>CRI	CCT	Diffuser	Driver Options	Finish			
Gola 95 System Pendant	GP9S	0564	564	22.20	26.4 W	90	30 3000K	OP Opal	D0 No Dim	10 ■ Black			
		0844	844	33.23	39.6 W						40 4000K	DP Phase Dim	11 □ White
		1124	1124	44.25	52.8 W								
		1404	1404	55.28	66.0 W								
		1684	1684	66.30	79.2 W								
		1964	1964	77.32	92.4 W								
		2244	2244	88.35	105.6 W								
		2524	2524	99.37	118.8 W								
2804	2804	110.39	237.6 W										
Gola 95 System Pendant Up & down	GH9S	0564	564	22.20	52.8 W	90	30 3000K	OP Opal	D0 No Dim	10 ■ Black			
		0844	844	33.23	66.0 W						30 3000K	DP Phase Dim	11 □ White
		1124	1124	44.25	92.4 W								
		1404	1404	55.28	118.8 W								
		1684	1684	66.30	145.2 W								
		1964	1964	77.32	171.6 W								
		2244	2244	88.35	184.8 W								
		2524	2524	99.37	224.4 W								
2804	2804	110.39	237.6 W										
Gola 95 System Pendant "L" Light Module	GP9L	0657	657	25.87	58.2 W	90	30 3000K	OP Opal	D0 No Dim	10 ■ Black			
		0657	657	25.87	58.2 W						30 3000K	DP Phase Dim	11 □ White
Gola 95 System Pendant "T" Light Module	GP9T	1219	1219	47.99	79.2 W			D1 0-10V Dim	75 ■ Grey				
Gola 95 System Pendant Up & Down "L" Light Module	GH9L	0657	657	25.87	105.6 W								
		0657	657	25.87	105.6 W								
Gola 95 System Pendant Up & Down "T" Light Module	GH9T	1219	1219	47.99	158.4 W								











Notes:
 * For complete code ordering information, please see page 208.
 For related accessories, please see page 246-249.
 For the most updated product information, please go to our website.

Gola Accessories

Accessories

Accessories / Product	Gola 40 System	Gola 60 System	Gola 95 System	Finish
End Cap Trim In cast aluminium	G040ECF 	G060ECF 	G095ECF 	10 ■ Black 11 □ White 75 ■ Grey
End Cap Trimless In cast aluminium	G040ECM 	G060ECM 	G095ECM 	
End Cap Up & Down In cast aluminium	G040ECU 	\	G095ECU 	
Mechanical 'L' Joint For Trim version In extruded aluminium	G040FLHJ 	G060FLHJ 	\	
Mechanical 'L' Joint For Trimless version In extruded aluminium	G040MLHJ 	G060MLHJ 	\	
Mechanical 'L' Joint For Surface version In extruded aluminium	G040MLHJ 	G060MLHJ 	\	
Mechanical 'T' 3 Joint For Trim version In extruded aluminium	G040FT3J 	G060FT3J 	\	
Mechanical 'T' 3 Joint For Trimless version In extruded aluminium	G040MT3J 	G060MT3J 	\	
Mechanical 'T' 3 Joint For Surface version In extruded aluminium	G040MT3J 	G060MT3J 	\	
Cover In extruded aluminium	G040C 	G060C 	G095C 	
Suspension Kit Max. 2500 mm	GSUS 	GSUS 	GSUS 	
Electrical Supply Kit Max. 2500 mm	GELS 	GELS 	GELS 	

Accessories

Accessories / Product	Gola 40 System	Gola 60 System	Gola 95 System	Finish
Bracket Trim	G040BF 	G060BF 	G095BF 	10 ■ Black 11 □ White 75 ■ Grey
Bracket Trimless	G040BM 	G060BM 	G095BM 	
Bracket Wall	G040BWM 	G060BWM 	G095BWM 	
Bracket Wall Up & Down	G040BWU 	/	G095BWU 	
Electrified feeder *	GELF3 Feeder 3 poles - female 1 pc for max 350W	GELF5 Feeder 5 poles - female 1 pc for max 350W	GELF5 Feeder 5 poles - female 1 pc for max 350W	
	GELM3 Feeder 3 poles - male 1 pc for max 350W	GELM5 Feeder 5 poles - male 1 pc for max 350W	GELM5 Feeder 5 poles - male 1 pc for max 350W	

Note:

* Electrified feeder it is not possible to choose a different color from the standard

Accessories System

Bracket Trim & Trimless

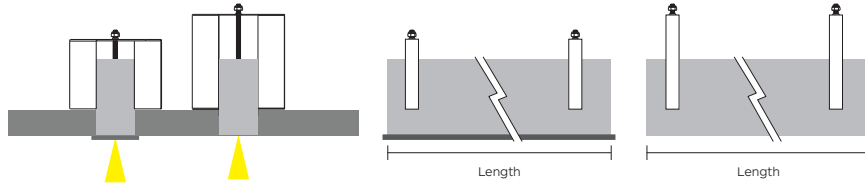

Bracket Trim	Bracket Trimless	Length code	Length in mm	Length in inches	No. of Bracket
		0564	564	22.36	2
		0844	844	33.39	2
		1124	1124	44.41	2
G040BF	G040BM	1404	1404	55.43	2
G060BF	G060BM	1684	1684	66.46	2
G095BF	G095BM	1964	1964	77.48	3
		2244	2244	88.50	3
		2524	2524	99.53	3
		2804	2804	110.55	4

Bracket Wall & Bracket Wall Up & Down

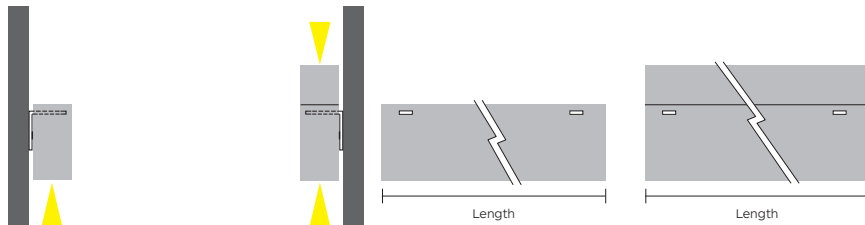

Bracket Wall	Bracket Wall Direct / Indirect	Length code	Length in mm	Length in inches	No. of Bracket
		0564	564	22.36	2
		0844	844	33.39	2
		1124	1124	44.41	2
		1404	1404	55.43	2
G040BMW	G040BWMU	1684	1684	66.46	2
G060BMW	G095BWMU	1964	1964	77.48	3
G095BMW		2244	2244	88.50	3
		2524	2524	99.53	3
		2804	2804	110.55	4

Accessories System

Suspension Kit

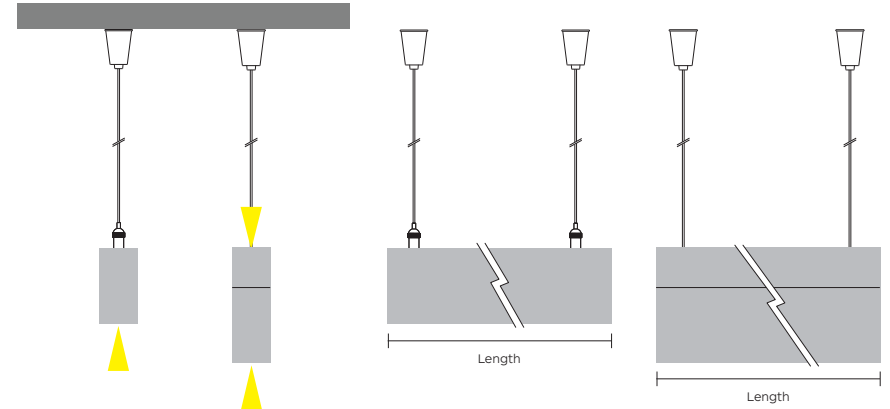

Suspension Kit	Length code	Length in mm	Length in inches	No. of Suspension Kit
	0564	564	22.36	2
	0844	844	33.39	2
	1124	1124	44.41	2
	1404	1404	55.43	2
GSUS	1684	1684	66.46	2
	1964	1964	77.48	3
	2244	2244	88.50	3
	2524	2524	99.53	3
	2804	2804	110.55	4

Outdoor Lighting

Outdoor Lighting

<p>Terraluce Deep</p>  <p>254 New</p>	<p>Terraluce</p>  <p>256</p>	<p>Terraluce Linear</p>  <p>260</p>	<p>StellaLED</p>  <p>264</p>	<p>InoxLED</p>  <p>266</p>	<p>Optiwall</p>  <p>268</p>
<p>Scudo Recessed</p>  <p>270</p>	<p>Cobra Pro IP66 Fixed</p>  <p>272 New</p>	<p>Cobra Pro IP66 Adjustable</p>  <p>274 New</p>	<p>Fronteluce</p>  <p>278</p>	<p>Logica 42 Recessed</p>  <p>282 New</p>	<p>Galaxis IP65</p>  <p>284 New</p>
<p>Bullet Recessed</p>  <p>286</p>	<p>Bullet Floodlight</p>  <p>288</p>	<p>Logica Surface</p>  <p>290 New</p>	<p>Polo</p>  <p>294</p>	<p>Volume Projector</p>  <p>297</p>	<p>Volume Ceiling</p>  <p>299</p>
<p>Volume Wall</p>  <p>300</p>	<p>Galileo Ceiling / Ground / Pole</p>  <p>302</p>	<p>Scudo Wall / Ground</p>  <p>304</p>	<p>Rocket Pro</p>  <p>306 New</p>	<p>Rocket</p>  <p>308</p>	<p>Galileo Surface</p>  <p>311</p>
<p>Galileo Due</p>  <p>312</p>	<p>Orbit Round</p>  <p>314</p>	<p>Orbit Square</p>  <p>314</p>	<p>Disco</p>  <p>317</p>	<p>Gala</p>  <p>317</p>	<p>Scudo Wall</p>  <p>319</p>
<p>Galileo Pendant</p>  <p>320</p>	<p>GirasoLED Round</p>  <p>324</p>	<p>GirasoLED Square</p>  <p>324</p>	<p>Cubox</p>  <p>326</p>	<p>Visor</p>  <p>328</p>	<p>Astra</p>  <p>330</p>
<p>Latoluce</p>  <p>334</p>	<p>Cornetto</p>  <p>336</p>	<p>Corolla</p>  <p>338</p>	<p>Trafo</p>  <p>340</p>	<p>FioreLED</p>  <p>342</p>	<p>Fontanaluce</p>  <p>344</p>

Terraluce

Deep & Wallwasher



Body

Round ground recessed uplight with external trim in stainless steel (AISI 316) and light body in cast aluminium. Light ring inclusive of toughened safety glass and weatherproof durable silicone gasket.

On the Terraluce Deep honeycomb installed to achieve a softer and precise light effect.

Inclusive of thermoplastic recessed box.

LED sources

High Power LED.
CRI: 90 | CCT: 3000K, 4000K.
Other CRI and CCT options available on request.

Optic

Lens. Narrow, medium and wide beam angle available. Terraluce 77 available in wallwasher version.

Related Products

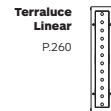

Terraluce Deep & Wallwasher

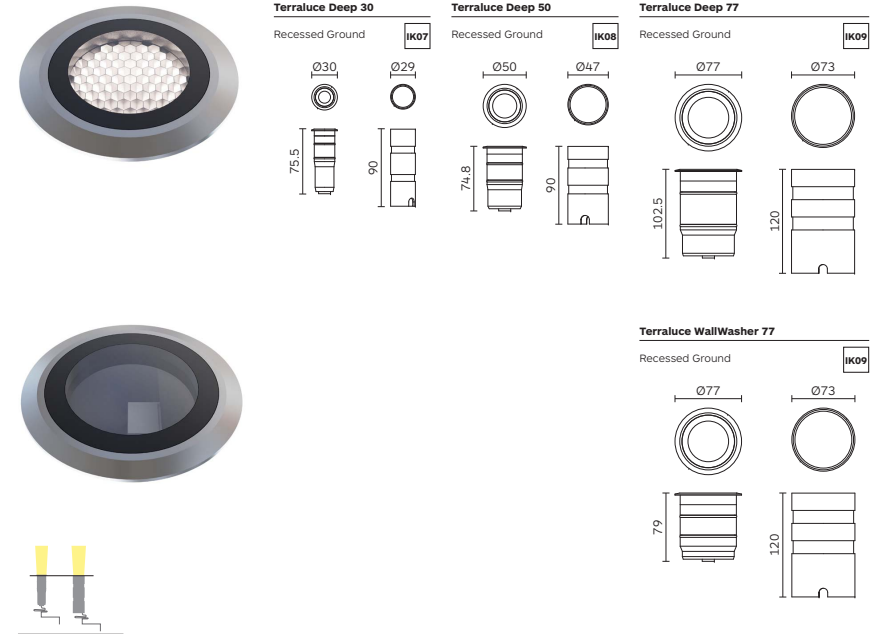

Code ordering example: **3 6 3 3 B R 3 1 - 8 0 3 0 1 7 D 0 8 4**

	Product Code	Light Source Code*	>CRI	CCT**	LED Power	Nominal Lumen	Beam Angle (BA°)	Driver Options	Finish
Terraluce Deep 30	3633	BR31 High Power LED	80	30 3000K	2W	218 lm	17 / 23 / 28	D0 No Dim	84 Stainless Steel
				40 4000K		303 lm			
Terraluce Deep 50	3634				4W	502 lm	12 / 21 / 27		
						541 lm			
Terraluce Deep 77	3635	BR32 High Power LED			6.3W	657 lm	15 / 25 / 34		
						709 lm			
Terraluce Wallwasher 77	3636	BR31 High Power LED			5.6W	675 lm			
						728 lm			

Notes:

- * For complete code ordering information, please see page 353.
- ** For other CCT options, please contact us.
- For related accessories, please see page 259.

Accessories

Power supply unit.

Driver

Work with 24V DC power supply unit positionated remotely. Power supply unit not included to be ordered separately.

Finish

External finish in stainless steel (AISI 316).

Applications

Uplighting system with the options of fixed, adjustable, symmetric and asymmetric optic system reflectors to wash or highlight the architectural structure or surfaces. Application areas: facades, parks, golf courses, driveways, sculptures.

Terraluce

Round ground recessed uplight



Body

Round ground recessed uplight with trim in stainless steel (AISI 316) and light body in cast aluminium.

Light trim inclusive of toughened safety glass, weatherproof durable silicone gasket and external screws made of stainless steel.

Thermoplastic recessed box included additional recessed box for concrete installation available upon request. Weight resistance 1300/3000 kg.

Adjustable version tiltable vertically 0-15° in two directions.

Accessories

Extension signal cable, IP 68 fast connector, electronic power supply, IP68 3-way junction box, power supply unit. Check page 259 for details.

Finish

External finish in stainless steel (AISI 316).

LED sources

High Power LED (38, 130). COB (220). Retrofit. CRI: 90 | CCT: 3000K, 4000K, RGB/W, TuneableWhite. Other CRI and CCT options available on request.

Optic

Reflector. Beam angle according to chosen lamp. Special beam effect can be obtained by the installation of the appropriate accessory.

Driver

Terraluce 38: Work with 24V DC power supply unit positionated remotely (not included). Terraluce 130/ 220. Supplied with remote or integrated no-dimmable driver. Dimming Options: DMX, CASAMBI, 0-10V Dim, DALI, Phase.

Applications

Uplighting system with the options of fixed, adjustable, symmetric and asymmetric optic system reflectors to wash or highlight the architectural structure or surfaces. Application areas: facades, parks, golf courses, driveways, sculptures.

Related Products

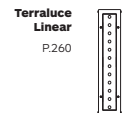

Terraluce 38 & Terraluce 130



Terraluce 38
Ground Recessed

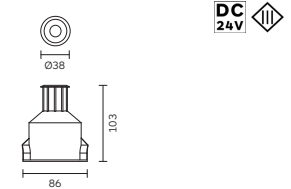

Terraluce 130 Adjustable ± 15°
Ground Recessed

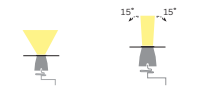
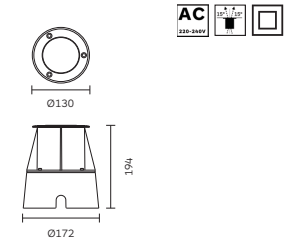

Terraluce 38 Terraluce 130 Adjustable

Code ordering example: **3 5 1 2 B R 1 1 - 8 0 3 0 2 0 0 8 4**

	Product Code	Light Source Code*	>CRI	CCT**	LED Power	Nominal Lumen	Beam Angle (BA°)	Driver Options	Finish
Terraluce 38	3512¹	BR11 High Power LED	80	30 3000K	1W	147 lm	14/36	00 No Driver	84 Stainless Steel
				40 4000K		158 lm			
Terraluce 130 Adjustable ± 15°	3157²	BN11 High Power LED	80	30 3000K	3W	480 lm	24	D0 No Dim	
				40 4000K		504 lm			
				RG	B0	3 x 1W	00	DX DMX	
					BW			DC CASAMBI	
		GU53 Retrofit GU5.3-MR16	00	00			00	00 No Driver	

Notes:

* For complete code ordering information, please see page 353.

** For other CCT options, please contact us.

For related accessories, please see page 259.

¹ Terraluce 38: 24V DC operation

² Driver in IP67 double cable entry box (Dim. 116 x 80 x 69 mm). Supplied with hard wired with 300 mm rubber cable 2 x 1.5 mm².

1 500Kg Max. 50°C; **2** 1300Kg Max. 40°C

Wiring Diagram

For Art. 3512

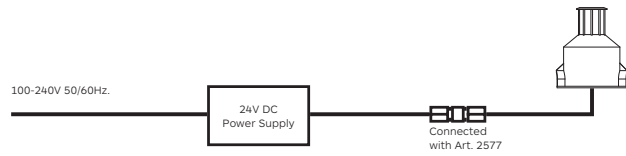

For Art. 3157

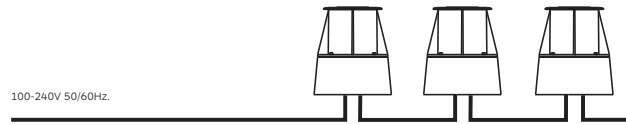

For Art. 3512

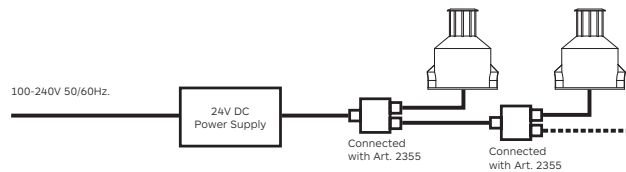

Accessories



Product / Accessories	Electronic Power Supply IP20	Electronic Power Supply IP65	3-Way Junction Box IP68	Fast Connector M20 IP68
	Housing made of high thermoplastic material. Input: 220-240V 50/60Hz. Output: 24V DC Max. 10W.	Input: 100-240V 50/60Hz. Output: 24V DC Max. 75W.	2 set of gasket rings included suitable for wide range of cable diameters:	(\varnothing 6 + 12 mm) Connection must be done inside a recess box.

Terraluce Deep 30

Terraluce Deep 50

Terraluce Deep 70

Terraluce Wallwasher 77

Terraluce 38

Terraluce 130

	2137	2D93	2355	2577
	/	/		

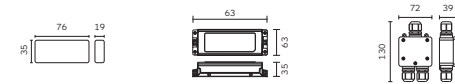

Notes:

Connection to the Electrical Power Supply can be done inside an accessible Junction Box (by others) or inside the Thermoplastic Box and by means of IP67 Fast Connector Art. 2577. This ensures the safety and prevents ingress of moisture into the fitting.

Terraluce Linear

Recessed walk-drive over Uplighters

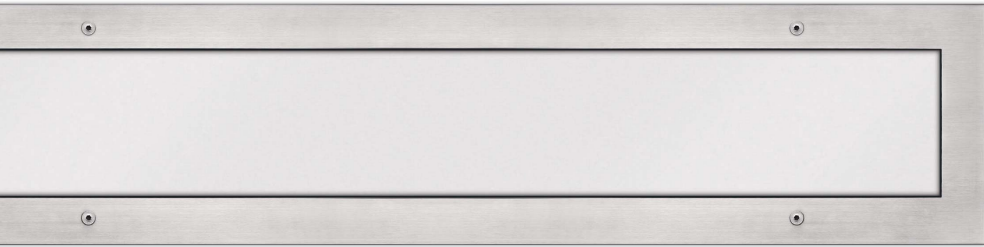

Body

Linear recessed walk-drive over uplighters with trim in stainless steel (AISI 316) and light housing in extruded aluminium.

Light trim inclusive of toughened safety glass, weatherproof durable silicone and external screws of stainless steel.

Thermoplastic recessed box included additional recessed box for installation in concrete available upon request.

Equipped with hard wire rubber cable.
Weight resistance 1000 kg.

Accessories

IP68 fast connector, aluminium white louvre, IP68 3-way junction box.
Check page 263 for details.

Finish

External finish in stainless steel (AISI 316).

LED sources

Terraluce Linear Lens: High Power LED.
Terraluce Linear Opal Diffuser: SMD.
CRI: 80 | CCT: 3000K, 4000K, TuneableWhite, RGB/W.
Other CRI and CCT options available on request.

Optic

Lens or frosted glass diffuser.
Beam angle according to chosen lamp.

Driver

Supplied with integrated no-dimmable or DMX driver.
Dimming Options: 0-10V Dim, DALI, Phase, CASAMBI.

Applications

A minimal visual impact and maximum flexibility and can be used to create continuous light line as a marker light and to light wash low walls. It is a Cool Touch as the temperature on the glass is low. Application areas: signboards, playgrounds, town squares, sculptures, architectural enhancement, pathways.

Related Products



Terraluce Linear

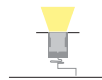

Terraluce Linear Lens

Recessed Ground

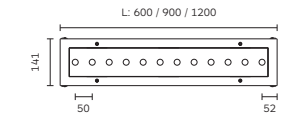

Terraluce Linear Opal diffuser

Recessed Ground

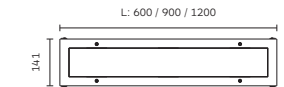

Code ordering example: **3 3 1 0 B N 1 1 - 8 0 3 0 2 5 D 0 8 4**

	Product Code	Light Source Code*	Length (L)	>CRI	CCT**	LED Power	Nominal Lumen	Beam Angle (BA°)	Driver Options	Finish		
Terraluce Linear Lens	3310	BN11	High Power LED	600	80	30	3000K	12x2W	1500 lm	25	D0 No Dim	84 Stainless Steel
						40	4000K		1800 lm	DX	DMX	
	3311			900			18x2W	2250 lm		DA	Dali Dim	
								2700 lm		DP	Phase	
Terraluce Linear Opal diffuser	3312			1200		24x2W	3000 lm			D1	0-10V Dim	
							3600 lm		DC	CASAMBI		
	3500	BT11	SMD LED	600			40W	2400 lm	EW (00)			
								2600 lm				
3501			900			60W	3600 lm					
							3900 lm					
3502			1200			80W	4800 lm					
							5200 lm					

Notes:

* For complete code ordering information, please see page 353.

** For other CCT options, please contact us.

For more light sources configuration options, please see page 262.

For related accessories, please see page 263.

EW = Extra Wide. Ordering code: **00**.

1000Kg Max. 40°C

Terraluce Linear Family configuration options

Code ordering example: 3500BT11 - 8030000084

Terraluce Linear LED

Lens | Opal | Ground Recessed



Product Code	Light Source Code	Length (L)	>CRI	CCT	LED Power	Nominal Lumen	Beam Angle (BA°)	Driver Options	Finish
3500	BT11 SMD LED	600	80	30 3000K	40W	2400 lm	EW (00)	D0 No Dim	84  Stainless Steel
				40 4000K		2600 lm		DX DMX	
3310	BN11 High Power LED				12x2W	1500 lm	25	DA Dali Dim	
							1800 lm		
								DP Phase	
								DC CASAMBI	
			RG	B0	12x2W	/	00	DX DMX	
				BW				DC CASAMBI	
3501	BT11 SMD LED	900	80	30 3000K	60W	3600 lm	EW (00)	D0 No Dim	
				40 4000K		3900 lm		DX DMX	
3311	BN11 High Power LED				18x2W	2250 lm	25	DA Dali Dim	
							2700 lm		
								DP Phase	
								DC CASAMBI	
			RG	B0	18x2W	/	00	DX DMX	
				BW				DC CASAMBI	
3502	BT11 SMD LED	1200	80	30 3000K	80W	4800 lm	EW (00)	D0 No Dim	
				40 4000K		5200 lm		DX DMX	
3312	BN11 High Power LED				24x2W	3000 lm	25	DA Dali Dim	
							3600 lm		
								DP Phase	
								DC CASAMBI	
			RG	B0	24x3W	/	00	DX DMX	
				BW				DC CASAMBI	

Notes:

For other CCT options, please contact us.
 EW = Extra Wide. Ordering code: **00**
 DMX signal converter with facility to connect In/Out cables for multiple connections. (Occupies 3 control channels).

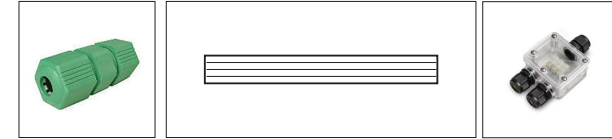
Accessories



Product / Accessories	Fast Connector M20	Louvre	3-Way Junction Box
	IP68	Available in colour 10.	IP68
	 6 + 12 mm) Connection must be done inside an accessible box.	In aluminium.	2 set of gasket rings included suitable for wide range of cable diameters:  Ø5 - Ø8 mm)  Ø9 - Ø14 mm)
		For L: 654 mm For L: 954 mm For L: 1254 mm	
Terraluce Linear	2577	2514 2515 2516	2355

StellaLED | InoxLED

Recessed step/driveway uplight

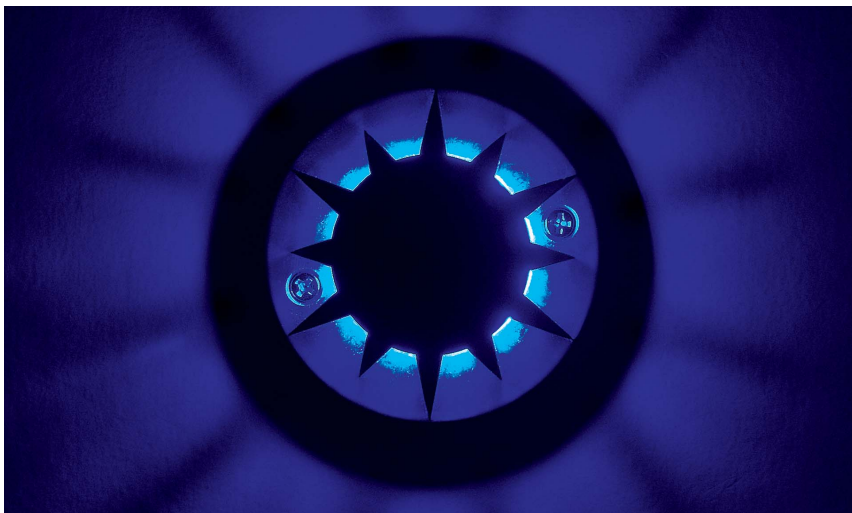

Body

Recessed step/driveway uplight. StellaLED trim and light body in cast aluminium.

InoxLED trim in stainless steel (AISI 316) and light body in cast aluminium. Inclusive of toughened safety convex clear polycarbonate and weatherproof durable silicone gasket and external counter sink captive screws made of stainless steel.

Thermoplastic box and recessed box for installation in concrete to be ordered separately.

LED sources

High Power LED.
CRI: 80 | CCT: 3000K, 4000K.
Other CRI and CCT options available on request.

Optic

Frosted acrylic diffuser.

Related Products

Optiwall
P.268



Accessories

Power supply unit, IP67 box, thermoplastic box, IP68 fast connector, IP68 3-way junction box. Check page 267 for details.

Finish

Stella LED: Powder coat in grey colour. Inox LED: stainless steel (AISI 316).

Driver

Work with 24V DC power supply unit positioned remotely. Power supply unit not included to be ordered separately.

Applications

A fully comprehensive range of path luminaires that can be installed on wooden/gypsum board walls, in concrete or as a recessed ground/wall luminaire. Miniature design ideal to fit in any architectural environment. Application areas: staircases, lighting steps, walkways, traffic flow, gardens, parks, garage parking.

StellaLED

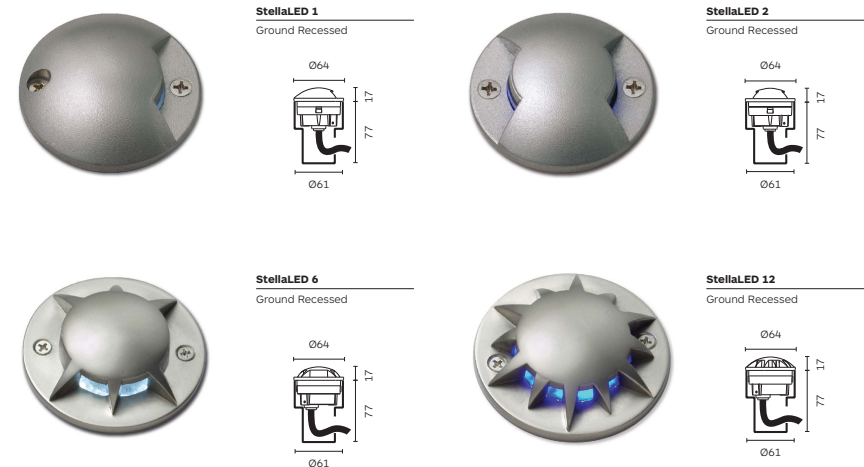

Code ordering example: **3 4 5 7 B N 1 1 - 8 0 3 0 0 0 0 2 9**

	Product Code	Light Source Code*	>CRI	CCT**	LED Power	Nominal Lumen	Beam Angle (BA°)	Driver Options	Finish
StellaLED 1	3457	BN11	High Power LED	80	30	3000K	1W	130 lm	EW (00)
				40	4000K	137 lm		00 No Driver	29 Grey (Outdoor)
StellaLED 2	3458								
StellaLED 6	3459								
StellaLED 12	3460								

Notes:

- * For complete code ordering information, please see page 353.
 - ** For other CCT options, please contact us.
- For related accessories, please see page 267.
EW = Extra Wide. Ordering code: **00**.

↓
1000Kg Max. 40°C

InoxLED



InoxLED 1
Ground Recessed

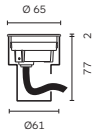

InoxLED 3
Ground Recessed

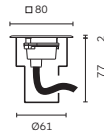

InoxLED 4
Ground Recessed

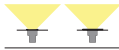
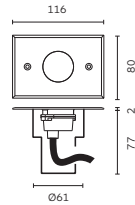

Code ordering example: **3 4 6 5 B N 1 1 - 8 0 3 0 0 0 0 2 9**

	Product Code	Light Source Code*	>CRI	CCT**	LED Power	Nominal Lumen	Beam Angle (BA°)	Driver Options	Finish
InoxLED 1	3465	BN11 High Power LED	80	30 3000K	1W	130 lm	EW (00)	00 No Driver	29 Grey (Outdoor)
				40 4000K		137 lm			
InoxLED 3	3466								
InoxLED 4	3467								

Notes:
 * For complete code ordering information, please see page 353.
 ** For other CCT options, please contact us.
 For related accessories, please see page 267.
 EW = Extra Wide. Ordering code: **00**.
 Complete with thermoplastic box for in-ground recess. **1000Kg Max. 40°C**

Accessories



Product / Accessories	Electronic Power Supply IP20	Electronic Power Supply IP67	Electronic Power Supply IP65	3-Way Junction Box IP68	Fast Connector M20 IP68
	Housing made of high thermoplastic material. Input: 220-240V 50/60Hz. Output: 24V DC Max. 10W.	Input: 220-240V 50/60Hz. Output: 24V DC Max.12W. With 3 meters cable length for DC output. With 2 entries with PG9 cable glands.	Input: 100-240V 50/60Hz. Output: 24V DC Max. 75W.	2 set of gasket rings included suitable for wide range of cable diameters: (Ø5 - Ø8 mm) (Ø8 - Ø14 mm)	(Ø + 12 mm) Connection must be done inside a recess box.

StellaLED 1 / 2 / 6 / 12	2137	2688	2D93	2355	2577
InoxLED 1 / 3 / 4					



Product / Accessories **Thermoplastic Box**
 Thermoplastic box for installation as recessed into wall or ground (included).

StellaLED 1 / 2 / 6 / 12
InoxLED 1 / 3 / 4
2619



Wiring diagram

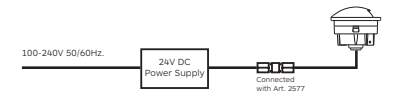

Wiring diagram

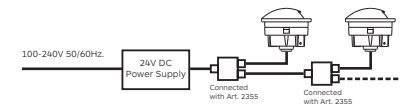

Notes:
 Connection to the Electrical Power Supply can be done inside an accessible Junction Box (by others) or inside the Thermoplastic Box and by means of IP67 Fast Connector Art. 2577. This ensures the safety and prevents ingress of moisture into the fitting.

Optiwall

Wall recessed steplight



Body

Wall recessed steplight with front frame in cast aluminium inclusive of toughened thermal-shock safety glass diffuser, weatherproof durable silicone gasket and external screws made of stainless steel.

Front frame with slot design for wall washing effect. Easy installations via the included hard wire 600mm long cable (type H05-RN-F 3x0,75mm²).

Inclusive of thermoplastic recessed box. Additional recessed box for pre-installation in concrete during wall construction is available on request.

Available in two style (with or without external counter sink) and three shapes - round, square and rectangular.

Accessories

IP68 extension signal cable, IP68 junction box. Check page 348 for details.

Finish

3094, 3095, 3096: Superior polyester powder coat in black, grey or sanded white colour.
3097, 3098, 3099: External finish in Stainless Steel.

LED sources

SMD LED.
 CRI: 80 | CCT: 3000K, 4000K.
 Other CRI and CCT options available on request.

Optic

Frosted glass diffuser

Driver

Supplied with integrated no-dimmable driver.

Applications

Optiwall: equipped with a special shaped glass to direct an asymmetric light distribution on the ground. Optiwall Stainless Steel: equipped with opal diffuser to give an uniform light distribution. Application areas: staircases, lighting steps, corridors, walkways, guidance in the dark.

Related Products

StellaLED
 P.264



Optiwall

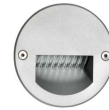

Optiwall 1

Wall recessed

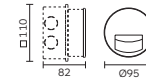

Optiwall 2

Wall recessed

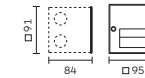

Optiwall 3

Wall recessed

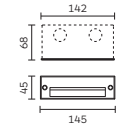

Optiwall Stainless Steel 4

Wall recessed

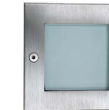
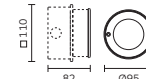

Optiwall Stainless Steel 5

Wall recessed

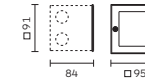

Optiwall Stainless Steel 6

Wall recessed

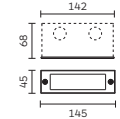

Code ordering example: **3 0 9 4 B T 1 1 - 8 0 3 0 0 0 D 0 1 0**

	Product Code	Light Source Code*	>CRI	CCT**	LED Power	Nominal Lumen	Beam Angle (BA°)	Driver Options	Finish
Optiwall 1	3094	BT11 SMD LED	80	30 3000K	1.5W	192 lm	EW (00)	D0 No Dim	10 ■ Black 29 ■ Grey (Outdoor) 54 □ Sanded White (Outdoor)
Optiwall 2	3095			40 4000K		211 lm			
Optiwall 3	3096	BM11 SMD LED			1.9W	256 lm 282 lm			
Optiwall 4	3097	BE11 SMD LED			1.5W	192 lm 211 lm			84 ■ Stainless Steel
Optiwall 5	3098								
Optiwall 6	3099	BE11 SMD LED			1.9W	256 lm 282 lm			

Notes:

* For complete code ordering information, please see page 353.
 ** For other CCT options, please contact us.
 For related accessories, please see page 348.
 EW = Extra Wide. Ordering code: **00**.

Scudo

Designed by Franco Mireni



Body

Recessed luminaire with light housing and front trim in cast aluminium. Recessed box in thermoplastic. Wall version equipped with glare free grid in cast in extruded aluminium.

Products inclusive of toughened thermal-shock frosted glass, weatherproof durable silicone gasket and external screws made of stainless steel. Ceiling installation via clamping wings for ceiling thickness 10mm to max.40mm.

Front cover designed to avoid accumulation of dust and water. Electrical installation includes option for single or double cable entries.

Accessories

No accessories available.

Finish

Superior polyester powder coat in black or grey colour.

LED sources

SMD LED.
CRI: 80 | CCT: 3000K, 4000K.
Other CRI and CCT options available on request.

Optic

Diffuser of frosted glass or polycarbonate.
Optional front grid.
Extra wide beam angle.

Driver

Supplied with integrated no-dimmable driver.
Dimming Options: 0-10V Dim, DALI, Phase.

Applications

Floodlight providing a soft and uniform, glare free, light distribution on the illuminated surfaces. Application areas: canopies, gyms, swimming pools, garages.

Related Products



Scudo Recessed



Scudo Asymmetric Glass Diffuser
Ceiling Recessed

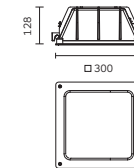

Scudo Ramp Glass Diffuser + Grid
Wall Recessed

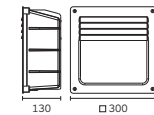

Code ordering example: **3 4 9 5 B M 1 1 - 8 0 3 0 0 0 D 0 1 0**

	Product Code	Light Source Code*	>CRI	CCT**	LED Power	Nominal Lumen	Beam Angle (BA°)	Driver Options	Finish
Scudo Ceiling Asymmetric	3495	BM11 SMD LED	80	30 3000K	30W	4284 lm	EW (00)	D0 No Dim	10 ■ Black
				40 4000K		4482 lm		DA Dali Dim	29 ■ Grey (Outdoor)
Scudo Ramp Wall	3494							D1 0-10V Dim	
								DP Phase	

Notes:

- * For complete code ordering information, please see page 353.
- ** For other CCT options, please contact us.
- EW = Extra Wide. Ordering code: **00**.

Cobra Pro IP66

Fixed

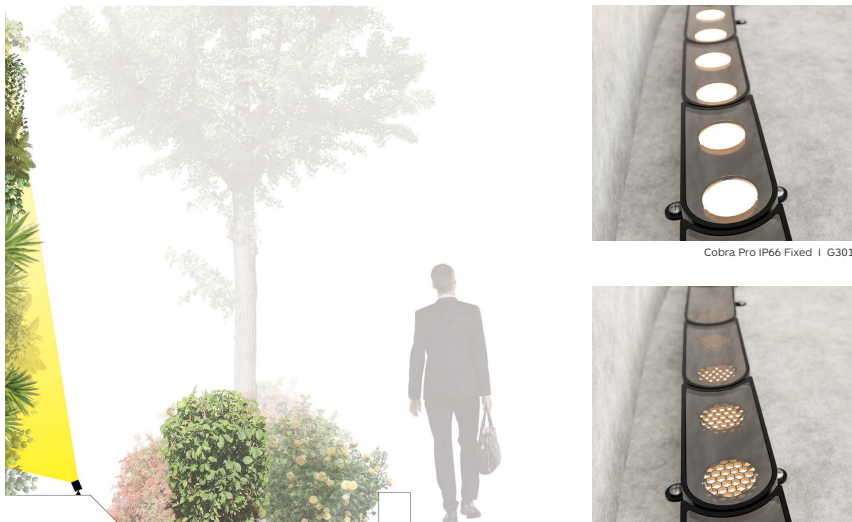

Cobra Pro IP66 Fixed | G301

Cobra Pro IP66 Fixed with Honeycomb | G306

Body

Surface mounted modular system in extruded aluminium. Available in different length configurations based on a 83mm link (2 LED per link) with a 76mm increment. Section 34x36.6mm.

Its flexible structure maintain a constant 38mm pitch between the LED.

Mounting options:
Fixed brackets.

* Plastic free packaging.

Accessories

Mounting accessories included.
Aluminium louvre Art. 2C97
Extension cable Art. 2D47 to be ordered separately.
Check page 277 for details.

Finish

Powder coat in black colour.

LED sources

Power LED.
CRI: 90 | R9: > 50 | CCT: 2700K, 3000K, 3500K, 4000K.
3-Step MacAdam.
Other CRI and CCT options available on request.

Optic

Lens.
Beam angle: 17° / 29° / elliptical (15° x 50°).

Driver

Driver not included to be ordered separately.
Work with 1050 mA Constant Current Driver positioned remotely. Dimming Options: No Dimming, 0-10V Dim, DALI. See page 243 for further information.

Applications

Ideal for external indirect cove illumination, it creates a wall grazing effect for columns and curved architectural surfaces. Its flexible structure maintain a constant pitch between LED, insuring a continuous illumination without any shadows or dark areas. Application areas: Cove light, wallwash, residential, hospitality, restaurants, museums.

Related Products

Cobra Pro IP66 Adjustable
P. 274



Cobra Pro IP66 Fixed



Cobra Pro IP66

Fixed



Min. L= 83mm (2 x LED) 1 Link

Without honeycombo | G301

With honeycombo | G306

Mounting options

With fixed brackets

With Louvre Art. 2C97

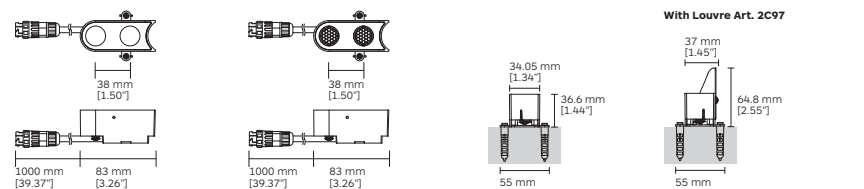

Max. L= 1223mm (32 x LED) 16 Links

16 Links

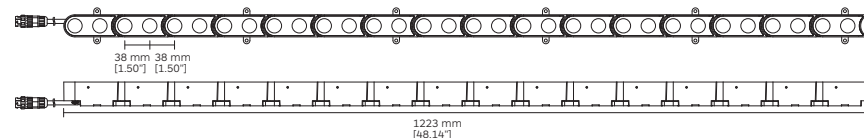

Available length codes

No. of LEDs	Voltage	LED Power	Length code	Length in mm	Length in inches	Nominal Lumen	No. of Links	Voltage	LED Power	Length code	Length in mm	Length in inches	Nominal Lumen
2	3.3V	3.1W	0083	83	3.26	366 lm	18	29.7V	28.3W	0691	691	27.20	3294 lm
4	6.6V	6.3W	0159	159	6.25	732 lm	20	33V	31.5W	0767	767	30.19	3660 lm
6	9.9V	9.4W	0235	235	9.25	1098 lm	22	36.3V	34.6W	0843	843	33.18	4026 lm
8	13.2V	12.6W	0311	311	12.24	1464 lm	24	39.6V	37.8W	0919	919	36.18	4392 lm
10	16.5V	15.7W	0387	387	15.23	1830 lm	26	42.9V	40.9W	0995	995	39.17	4758 lm
12	19.8V	18.9W	0463	463	18.22	2196 lm	28	46.2V	44.1W	1071	1071	42.16	5124 lm
14	23.1V	22W	0539	539	21.22	2562 lm	30	49.5V	47.2W	1147	1147	45.15	5490 lm
16	26.4V	25.2W	0615	615	24.21	2928 lm	32	52.8V	50.4W	1223	1223	48.14	5856 lm

Code ordering example: **G 3 0 1 0 0 8 3 - 9 0 2 7 1 7 D 0 1 0**

	Product code*	Length code	Light Source	>CRI	CCT**	LED Power	Nominal Lumen	Beam angle (BA°)	Driver Options	Finish
Cobra Pro IP66 Fixed	G301	0083	2 x LED	90	27 2700K	1.5W/LED	183lm/LED	17 / 29 / EL	D0 No Dimming	10 Black
		1223	32 x LED		30 3000K				D1 0-10V Dim	
	G306				35 3500K				DA Dali Dim	
Min & Max. Length					40 4000K					

Remote Driver included

Notes:

* For complete code ordering information, please see page 353.
** For other CCT options, please contact us.
For related accessories, please see page 277.
EL = Elliptical Beam (15° x 50°).

Cobra Pro IP66

Adjustable



Cobra Pro IP66 Adjustable | G302



Cobra Pro IP66 Adjustable with Honeycomb | G307

Body

Surface mounted modular system in extruded aluminium. Available in different length configurations based on a 83mm link (2 LED per link) with a 76mm increment. Section 31.9x32.6mm.

Its flexible structure maintain a constant 38mm pitch between the LED.

Mounting options:
Adjustable brackets (45° in two directions).

* Plastic free packaging.

LED sources

Power LED.
CRI: 90 | R9: >50 | CCT: 2700K, 3000K, 3500K, 4000K.
3-Step MacAdam.
Other CRI and CCT options available on request.

Optic

Lens.
Beam angle: 17° / 29° / elliptical (15° x 50°).

Related Products

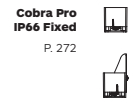

Accessories

Mounting accessories included.
Aluminium louvre Art. 2C97.
Extension cable Art. 2D47 to be ordered separately.
Check page 277 for details.

Finish

Powder coat in black colour.

Driver

Driver not included to be ordered separately.
Work with 1050 mA Constant Current Driver positioned remotely. Dimming Options: No Dimming, 0-10V Dim, DALI. See page 243 for further information.

Applications

Ideal for external indirect cove illumination, it creates a wall grazing effect for columns and curved architectural surfaces. Its flexible structure maintain a constant pitch between LED, insuring a continuous illumination without any shadows or dark areas. Application areas: Cove light, wallwash, residential, hospitality, restaurants, museums.

Cobra Pro IP66 Adjustable



Cobra Pro IP66
Adjustable



Min. L= 83mm (2 x LED) 1 Link

Without honeycomb | G302 With honeycomb | G307

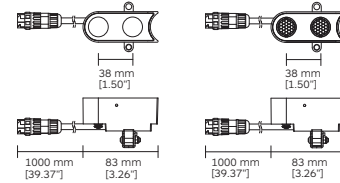

Mounting options

With adjustable brackets

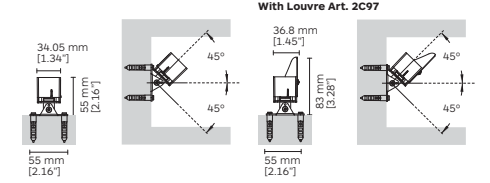

Max. L= 1223mm (32 x LED) 16 Links

16 Links

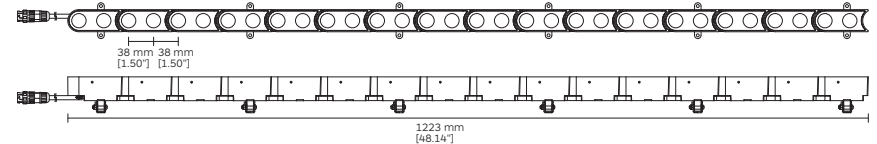

Available length codes

No. of LEDs	Voltage	LED Power	Length code	Length in mm	Length in inches	Nominal Lumen	No. of Links	Voltage	LED Power	Length code	Length in mm	Length in inches	Nominal Lumen
2	3.3V	3.1W	0083	83	3.26	366 lm	18	29.7V	28.3W	0691	691	27.20	3294 lm
4	6.6V	6.3W	0159	159	6.25	732 lm	20	33V	31.5W	0767	767	30.19	3660 lm
6	9.9V	9.4W	0235	235	9.25	1098 lm	22	36.3V	34.6W	0843	843	33.18	4026 lm
8	13.2V	12.6W	0311	311	12.24	1464 lm	24	39.6V	37.8W	0919	919	36.18	4392 lm
10	16.5V	15.7W	0387	387	15.23	1830 lm	26	42.9V	40.9W	0995	995	39.17	4758 lm
12	19.8V	18.9W	0463	463	18.22	2196 lm	28	46.2V	44.1W	1071	1071	42.16	5124 lm
14	23.1V	22W	0539	539	21.22	2562 lm	30	49.5V	47.2W	1147	1147	45.15	5490 lm
16	26.4V	25.2W	0615	615	24.21	2928 lm	32	52.8V	50.4W	1223	1223	48.14	5856 lm

Code ordering example: **G 3 0 2 0 0 8 3 - 9 0 2 7 1 7 D 0 1 0**

	Product code*	Length code	Light Source	>CRI	CCT**	LED Power	Nominal Lumen	Beam angle (BA°)	Driver Options	Finish
Cobra Pro IP66 Adjustable	G302	0083	2 x LED	90	27 2700K	1.5W/LED	183lm/LED	17 / 29 / EL	D0 No Dimming	10 Black
		1223	32 x LED		30 3000K				D1 0-10V Dim	
	G307				35 3500K				DA Dali Dim	
Min & Max. Length					40 4000K					

Remote Driver included

Notes:

- * For complete code ordering information, please see page 353.
 - ** For other CCT options, please contact us.
- For related accessories, please see page 277.
EL = Elliptical Beam (15° x 50°).

Cobra Pro IP66

Fixed | G301



Fixed with honeycomb | G306



Cobra Pro IP66

Adjustable | G302



Adjustable with honeycomb | G307



Driver Options

Constant Current

Cobra Pro IP66

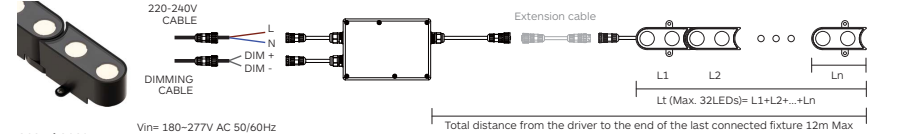

G301 / G302

Vin= 180-277V AC 50/60Hz
Iout= 1050mA V=2-57V P= 60W Max.
Dimensions: 123.5x81.5x23mm

Cobra Pro IP66 with honeycomb

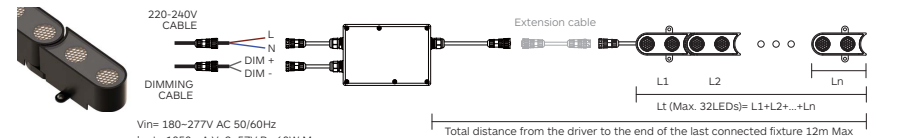

G306 / G307

Vin= 180-277V AC 50/60Hz
Iout= 1050mA V=2-57V P= 60W Max.
Dimensions: 123.5x81.5x23mm

Accessories

Product / Accessories	Louvre Colour 10	Extension cable 1000mm long
Cobra Pro IP66 Fixed	2C97	2D47
Cobra Pro IP66 Adjustable		

* Please refer to the user manuals for further details.

Fronteluce 90

Multi system linear projector



Body

Linear projector with light housing in aluminium extrusion. End caps and mounting brackets in cast aluminium.

Product inclusive of toughened safety glass, weatherproof durable silicone gasket, breather device and external screws made of stainless steel. Front cover in hinged aluminium frame designed to avoid accumulation of dust and water.

Electrical installation includes double cable entry. Available in two sizes.

Light adjustable vertically up to 195° and horizontally 0-35°.

Accessories

Mounting brackets, suspension set, pole mounted bracket sets, wall sets, billboard sets, IP68 fast connector, IP65 extension cable. Check page 280-281 for details.

Finish

Superior polyester powder coat in grey colour.

LED sources

High Power LED, SMD LED. CRI: 80 | CCT: 3000K, 4000K. Other CRI and CCT options available on request.

Optic

Frosted glass diffuser or lens, according with the chosen model.

Driver

Supplied with integrated no-dimmable driver. Dimming Options: 0-10V Dim, DALI, Phase.

Applications

Extremely compact linear luminaire offering minimal visual impact and huge flexibility. A vast range of accessories makes possible to mount it in many different way (ground, ceiling, wall, pole). Application areas: facades, under canopy areas, billboards, sculptures, art installations.

Fronteluce 90



Fronteluce 90

Surface

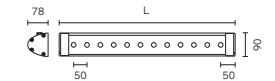

Fronteluce 90 Opal diffuser

Surface

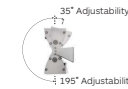
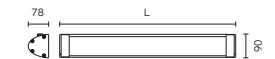

Code ordering example: **3 1 9 8 B N 1 1 - 8 0 3 0 2 5 D 0 2 9**

	Product Code	Light Source Code*	Length (L)	>CRI	CCT**	LED Power	Nominal Lumen	Beam Angle (BA°)	Driver Options	Finish
Fronteluce 90	3198	BN11 High Power LED	674	80	30 3000K	12 x 2W	1500 lm	25	D0 No Dim	29 Grey (Outdoor)
			974		40 4000K	1800 lm		DX DMX		
						18 x 2W	2250 lm		DA Dali Dim	
	3586		1274			24 x 2W	3000 lm		D1 0-10V Dim	
							3600 lm		DP Phase	
Fronteluce 90 Opal diffuser	3486	BT11 SMD LED	674	80	30 3000K	40W	2400 lm	EW (00)	D0 No Dim	
			974		40 4000K	2600 lm		DX DMX		
						60W	3600 lm		DA Dali Dim	
	3487		1274			80W	4800 lm		D1 0-10V Dim	
							5200 lm		DP Phase	

Notes:

* For complete code ordering information, please see page 353.

** For other CCT options, please contact us.

For related accessories, please see page 280-281.

EW = Extra Wide. Ordering code: **00**.

Accessories



Product / Accessories	Mounting brackets	Mounting brackets	Mounting brackets	Suspension set
	Available in colour 29	Available in colour 29	Available in colour 29	Available in colour 29
	2 pcs. adjustable.	2 pcs. adjustable.	2 pcs. adjustable and extendable.	2 pcs. 1500mm wire hangers and one power supply cable.
Fronteluce 90	2379	2380	2381	2382

Fronteluce 90 Opal diffuser

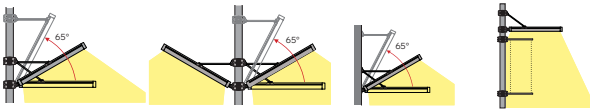
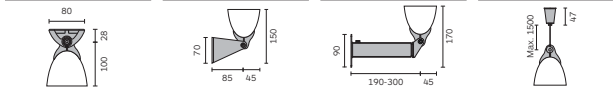

Product / Accessories	Pole mounted bracket set	Pole mounted bracket set	Wall mounted set	Billboard set
	Available in colour 29	Available in colour 29	Available in colour 29	Available in colour 29
	Ø 102 mm Ø 120 mm	Ø 102 mm Ø 120 mm		For one banner
	For one fixture	For two fixtures		
Fronteluce 90	2394 2395	2565 2566	2567	2568 2569

Fronteluce 90 Opal diffuser

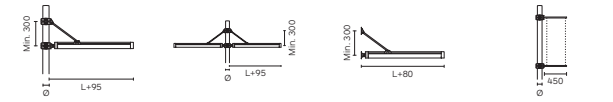

Accessories

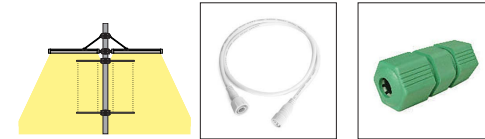

Product / Accessories	Billboard set	Extension signal cable	Fast connector M20
	Available in colour 29	L: 1000 L: 2000	IP68
	Ø 102 mm Ø 120 mm suitable for two banners.	For RGB with M/F connectors.	(Ø 6 + 12 mm)
Fronteluce 90	2570 2571	2478 2479	2577

Fronteluce 90 Opal diffuser

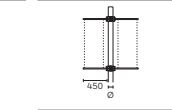

With Adjustable Mounting brackets



With Adjustable & Extendable Mounting brackets



With Wall mounted set



With Pole mounted bracket set for one fixture



With Suspension set



With Pole mounted bracket set for two fixtures

Logica

Ceiling recessed downlight



Body

Logica is a round recessed outdoor ceiling lighting featuring minimal glare and light dispersion, housing in aluminum extrusion.

It integrates toughened safety glass and a weatherproof long-lasting silicone gasket that guarantees durability and excellent dust and water protection (IP66).

Easy installation via clamping wings for ceiling thickness 1 to max 30mm, with aluminium or stainless trim.

LED sources

SMD LED
CRI:90 | CCT: 3000K, 4000K.
Other CRI and CCT options available on request.

Optic

Lens.
Narrow, medium, and wide beam angles available.

Accessories

Honeycomb Louvre, T Joint Connectors, Extension Cable.
Check page 283 for details.

Finish

Superior Polyester powder coat in grey and black colour, white or Stainless Steel.

Driver

Remote power supply not included, to be ordered separately.
Product operate on 24V DC Driver (IP67 Driver)

Applications

Application areas: Canopies, entrances, warehouses, garages, facades, gardens, residential.

Related Products

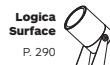

Logica
Surface
P. 290

Logica



Logica 42
Recessed  Ø45

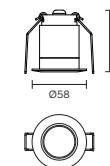

Code ordering example: **R Q 0 6 B R 2 2 - 9 0 3 0 0 7 D 0 1 0**

	Product Code	Light Source Code*	>CRI	CCT**	LED Power	Nominal Lumen	Beam Angle (BA°)	Driver Options	Finish
Logica 42 Recessed	RQ06	BR21	High Power LED	90	30 3000K 40 4000K	4W 480 lm	07	D0 No Dim	10 ■ Black 29 ■ Grey 84 ■ Stainless Steel

Accessories

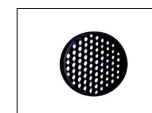

Honeycomb Louvre

Available in colour 10



T Joint Connectors

Available in colour 10

IP67



Extension signal cable

IP67
L: 1000 mm / 2000 mm

Logica 42 Recessed	2390	2E60	2E61
--------------------	------	------	------

Notes:

* For complete code ordering information, please see page 353.

** For other CCT options, please contact us.

Galaxis IP65

Ceiling recessed downlight



Body

The Galaxy IP65 is a modern, distinctive outdoor recessed downlight that features easy installation with spring and UGR<19. It comes in four sizes with pure aluminum reflectors in 3 finish options- Mirror, Sanded, and Black Coated.

This modular lighting incorporates an SMD LED light source that creates a uniform lighting effect providing high visual comfort.

The Galaxy IP65 is available for trim installation version and has excellent heat management, thanks to the die-cast aluminum heat sink.

Accessories

Reflector, Honeycomb Louvre
Check page 349 for details.

Finish

Superior polyester powder coat in black & white colour.

LED sources

SMD LED.
CRI 90 | CCT: 3000K, 4000K
Other CRI and CCT options available on request.

Optic

Sand, Mirror & Black Reflector, Wide Beam Angle

Driver

Remote driver 220-240VAC included.
Dimmable option or request 0-10V, Casambi

Applications

Galaxies IP65 is a fixed recessed luminaire for exterior and interior lighting, perfect use for walkways, airports, railway stations, cantilever roofs, stadiums, car parks, petrol stations, swimming pools, gyms, corridors, and spas.

Related Products

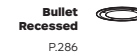
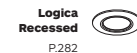

Galaxis IP65

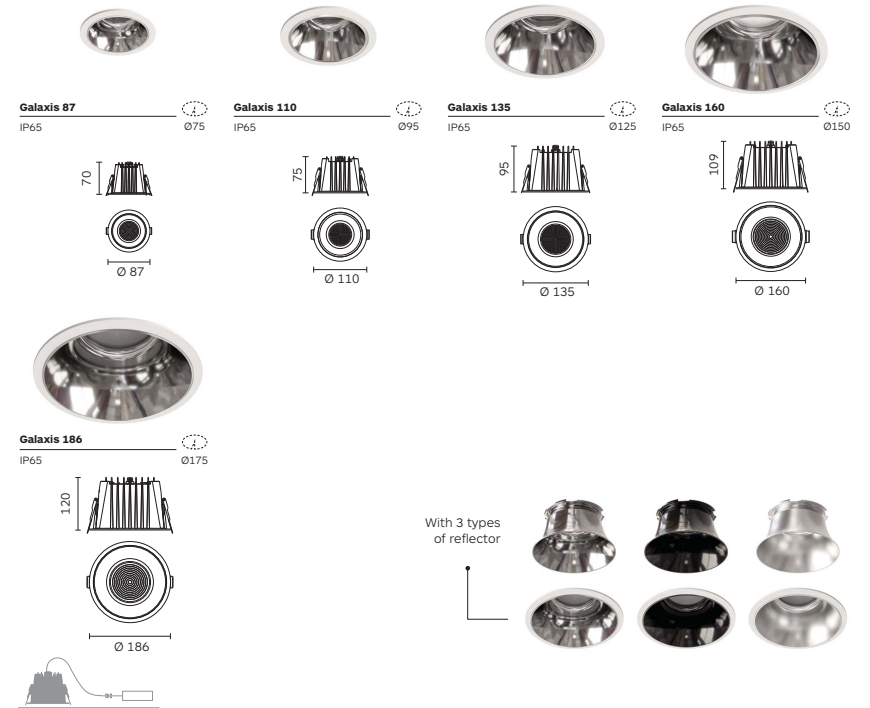

Code ordering example: **3 6 4 7 B A 1 1 - 9 0 3 0 6 0 D 0 1 0**

	Product Code	Light Source Code*	>CRI	CCT**	LED Power	Nominal Lumen	Beam Angle (BA°)	Driver Options	Finish
Galaxis 87 IP65	3647	BA11 SMD LED	90	30 3000K	4.8W	704 lm	60	D0 No Dim	10 ■ Black
				40 4000K		736 lm		DA Dali Dim	54 □ Sanded White (Outdoor)
Galaxis 110 IP65	3648				8.4W	1200 lm		DP Phase Dim	
						1272 lm		DC CASAMBI	
Galaxis 135 IP65	3649				11.5W	1692 lm		D1 0-10V Dim	
						1800 lm			
Galaxis 160 IP65	3650				22W	3120 lm			
						3300 lm			
Galaxis 186 IP65	3651				30W	4248 lm			
						4536 lm			

Notes:

* For complete code ordering information, please see page 353.
** For other CCT options, please contact us.
For related accessories, please see page 349.

Bullet

Ceiling recessed uplight



Body

Recessed mounted luminaire with light housing in aluminium extrusion. Inclusive of toughened safety glass, weatherproof durable silicone gasket and external screws made of stainless steel. Ring and back plug cover in cast aluminium.

Front cover designed to avoid accumulation of dust and water.

Recessed ceiling installation via clamping wings for ceiling thickness 1 to max.30mm.

Accessories

No accessories available.

Finish

Superior polyester powder coat in black or grey colour.

LED sources

COB.
CRI: 80 | CCT: 3000K, 4000K.
Other CRI and CCT options available on request.

Optic

Lens. Narrow, medium and wide beam angle available.

Driver

Supplied with remote no-dimmable driver. Dimming Options recessed: 0-10V Dim, DALI, Phase, CASAMBI. Dimming Options Surface: 0-10V, Phase.

Applications

Versatile luminaire, Bullet recessed provides a pleasant illumination with a high level of lumen. The ideal solution in moist environment such as swimming pool or garage. Application areas: canopies, entrances, warehouses, garages.

Related Products



Bullet

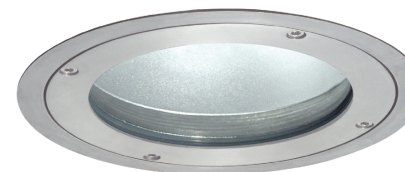

Bullet 127
Recessed  Ø118

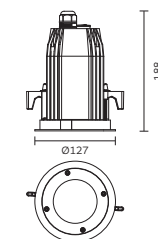

Bullet 166
Recessed  Ø158

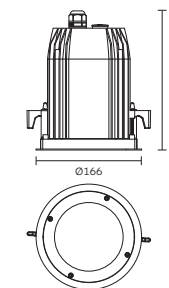

Code ordering example: **3 4 9 9 B B 1 2 - 8 0 3 0 1 4 D 0 1 0**

	Product Code	Light Source Code*	>CRI	CCT**	LED Power	Nominal Lumen	Beam Angle (BA°)	Driver Options	Finish
Bullet 127	3499	BB12	80	30	3000K	14W	2152 lm	14 / 22 / 32	D0 No Dim
				40	4000K		2220 lm		DX DMX
Bullet 166	3497	BB13			20W	3067 lm	16 / 28 / 40	DA	Dali Dim
								D1	0-10V Dim
								DP	Phase
								DC	CASAMBI

Notes:

- * For complete code ordering information, please see page 353.
- ** For other CCT options, please contact us.

Bullet

Ceiling recessed uplight



Body

Surface mounted luminaire with light body, luminaire base and brackets in aluminium extrusion. Inclusive of toughened safety glass, weatherproof durable silicone gasket and external screws made of stainless steel.

Front cover designed to avoid accumulation of dust and water.

Surface version tiltable vertically 0-140° and rotatable horizontally 350°, inclusive of mechanical locking system to ensure aiming stability.

Accessories

Coloured filter, linear spread, Visor, spikes.
Check page 289 for details.

Finish

Superior polyester powder coat in black or grey colour.

LED sources

COB.
CRI: 80 | CCT: 3000K, 4000K.
Other CRI and CCT options available on request.

Optic

Lens. Narrow, medium and wide beam angle available.

Driver

Supplied with remote (recessed) or integrated (surface) no-dimmable driver. Dimming Options recessed: 0-10V Dim, DALI, Phase, CASAMBI. Dimming Options Surface: 0-10V, Phase.

Applications

Versatile luminaire offering an accent illumination to enhance elements of the outdoor landscape. The visor shield protects the environment from unpleasant bright light. Application areas: facades, gardens, signboards, sculptures, residential.

Related Products

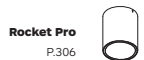
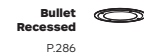

Bullet



Extendable pole available for all the range.



Bullet 89
Floodlight

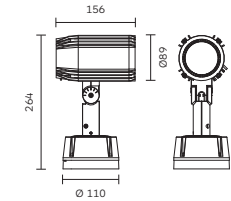

Bullet 130
Floodlight

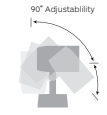
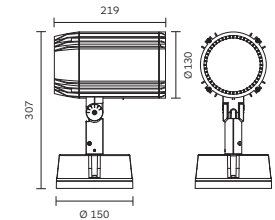

Code ordering example: **3 4 9 8 B B 1 2 - 8 0 3 0 1 4 D 0 1 0**

	Product Code	Light Source Code*	>CRI	CCT**	LED Power	Nominal Lumen	Beam Angle (BA°)	Driver Options	Finish
Bullet 89	3498	BB12	80	30 3000K	14W	2152 lm	14 / 22 / 32	D0 No Dim	10 Black
				40 4000K		2220 lm		D1 0-10V Dim	29 Grey (Outdoor)
Bullet 130	3496	BB13			20W	3067 lm	16 / 28 / 40	DP Phase	
						3170 lm			

Accessories



Product / Accessories	Coloured Filters	Linear Spread	Visor	Spikes
	Colours 25, 42, 55, 85	Colour 41	Colours 10	Colour 10
Bullet 89	2607	2608	2328	2330 / 2322
Bullet 130	2610*	2609	2329	2330

In plastic.
- H. 235 for code 2330.
- H. 230 for code 2322.
The 50 mm upper part must stay above ground level according to standards.

Notes:

- * For complete code ordering information, please see page 353.
- ** For other CCT options, please contact us.
- * Available only for white colour version.

Logica

26 | 42 | 50 | 120



Logica



Logica 26 Surface Mounted **IK06** **Logica 42** Surface Mounted **IK06** **Logica 50** Surface Mounted **IK06** **Logica 72** Surface Mounted **IK07**

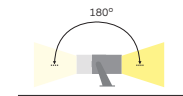
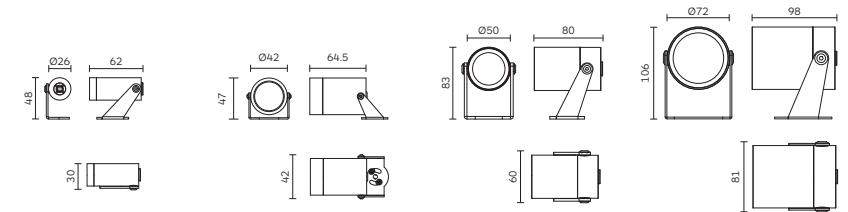

Code ordering example: **3 6 1 4 B R 2 1 - 8 0 3 0 1 7 D 0 1 0**

	Product Code	Light Source Code*	>CRI	CCT**	LED Power	Nominal Lumen	Beam Angle (BA°)	Driver Options	Finish
Logica 26	3614	BR21 High Power LED	80	30 3000K 40 4000K	2W	180 lm 303 lm	15 / 19 / 29	DO No Dim	84 Stainless Steel
Logica 42	3613	BR21 High Power LED	90	30 3000K 40 4000K	4W	410 lm 480 lm	07		
Logica 50	3615	BR32 COB	80	30 3000K 40 4000K	4.5W	511 lm 511 lm	15 / 26 / 50		
Logica 72	3616	BR42 COB			9W	1150 lm 1150 lm	15 / 28 / 55		

Recommended Driver: Driver to be ordered separately. Work with 24VDC LED Driver positioned remotely. Suggested Driver: 2V24D0.

Notes:

* For complete code ordering information, please see page 353.
 ** For other CCT options, please contact us.
 For related accessories, please see page 292.

Body

Accent floodlight with body in stainless steel (AISI 316), inclusive of toughened safety glass and weatherproof durable silicone gasket. Front cover is designed to avoid accumulation of dust and water.

Fixture is available in 4 different sizes. Tilttable vertically 0-90° and rotatable horizontally 0-350°.

LED sources

High Power LED.
 CRI: 80 | CCT: 3000K, 4000K.
 Other CRI and CCT options available on request.

Related Products



Optic

Reflector.
 Narrow, medium and wide beam angle available.

Accessories

Anchor bolt kit, spikes, Honeycomb Louvre, DALI Dimmable Driver, T Joint Connectors.
 Check page 292 for details.

Driver

Work with 24V DC power supply unit positioned remotely. Power supply unit not included to be ordered separately.

Finish

External finish in stainless steel (AISI 316).

Applications

Floodlight with a subtle and comfortable light emission. Ideal solution for a proper illumination of outdoor green areas and sculptures. The earth spike allows a portable and temporary use. Application areas: trees, landscapes, gardens, golf courses, pathways, billboards, sculptures.

Accessories



Product / Accessories	Spike	Spike	Anchor Bolt Kit
	Available in colour 10 In plastic.	Available in colour 10 In plastic.	In steel To ditch in concrete.
Logica 26 Surface Mounted	/	2E21	/
Logica 50 Surface Mounted	/	2E21	/
Logica 120 Surface Mounted	2E20	/	2E22



Product / Accessories	Honeycomb Louvre	Spike	Power Supply	T Joint Connectors	Extension signal cable
	Available in colour 10	Available in colour 10 In plastic.	IP67 AC/DC 24V Power supply 220-240VAC	Available in colour 10 IP67	IP67 L : 1000 mm / 2000 mm
Logica 42 Surface Mounted	2390	2373	2F03	2E60	2E61

Wiring Diagram

For Art. 3613

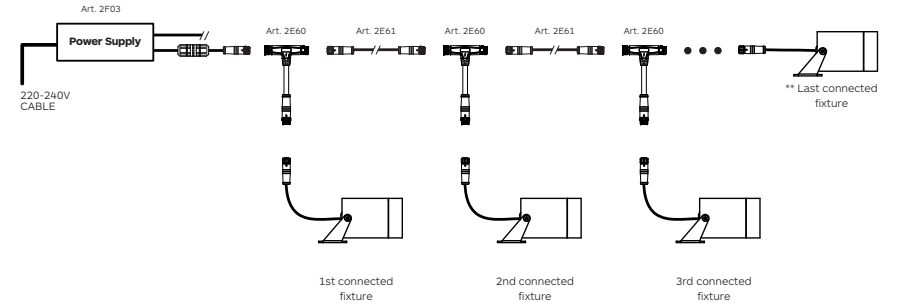

** The Maximum 20 connected fixtures on the 1 driver.

Polo

Accent spotlight

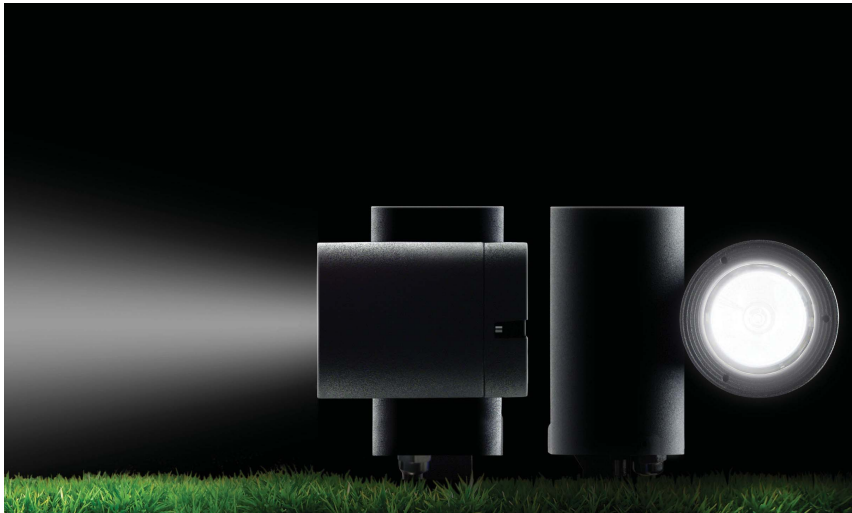

Body

Accent spotlight with body and driver housing in cast aluminium, inclusive of toughened safety glass, weatherproof durable silicone gasket and external screws in stainless steel.

Front cover is designed to avoid accumulation of dust and water.

Fixture is available in 2 different sizes.
PG7 cable entry.

Tilttable vertically 0-180° and routable horizontally 0-350°.

Accessories

Protective grill, visor, spikes.
Check page 348 for details.

Finish

Superior polyester powder coat in black or grey colour.

LED sources

COB (68), High Power LED (35).
CRI: 80 | CCT: 3000K, 4000K.
Other CRI and CCT options available on request.

Optic

Reflector (68), Lens (35).
Narrow, medium and wide beam angle available.

Driver

Supplied with integrated no-dimmable driver.
Dimming Options: Phase.

Applications

The visor glare shield cap or the protective grill help to protect the environment from unpleasant bright light. The earth spike is for portable or temporary use. Application areas: trees, landscapes, gardens, golf courses, pathways, billboards, sculptures.

Related Products



Polo



Polo 35

Surface mounted

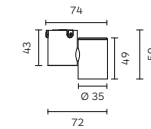

Polo 68

Surface mounted

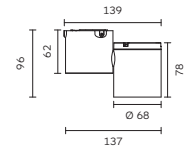

Code ordering example: **3 1 3 9 BN11-80 30 15 D0 10**

	Product Code	Light Source Code*	>CRI	CCT**	LED Power	Nominal Lumen	Beam Angle (BA°)	Driver Options	Finish	
Polo 35	3139	BN11	High Power LED	80	30 3000K	3W	65 lm	15	D0 No Dim	10 ■ Black
					40 4000K		80 lm	DP Phase	29 ■ Grey (Outdoor)	
Polo 68	3510	BC22	COB LED		9W	1275 lm	20 / 30 / 40			
						1308 lm				
	GU53 Retrofit	GU5.3-MR16	00	00	/	/	00	00 No Driver		

Notes:

* For complete code ordering information, please see page 353.
** For other CCT options, please contact us.
For related accessories, please see page 348.

Volume

58 | 70 | 110

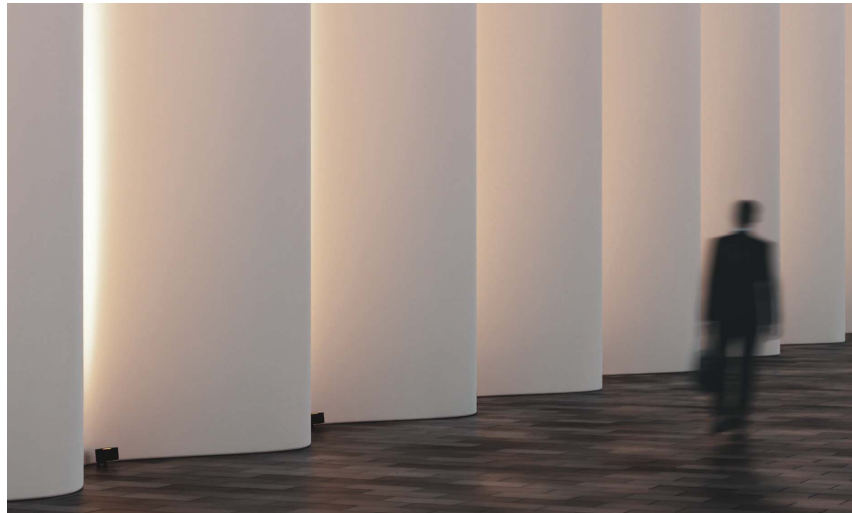

Body

Surface mounting projectorlight with luminaire housing in cast aluminium. Inclusive of toughened safety glass and weatherproof durable silicone gasket.

Base and brackets in cast aluminium with external screws made of stainless steel.

Front cover is designed to avoid accumulation of dust and water. Volume Projector is tiltable vertically 0-180° and routable horizontally 0-350°.

Accessories

Anti-glare snoot, spike, anchor bolt kit. Check page 349 for details.

Finish

Superior polyester powder coat in black colour.

LED sources

High Power LED.
CRI: 80 | CCT: 3000K, 4000K.
Other CRI and CCT options available on request.

Optic

Lens.
Super narrow, narrow, medium and wide beam angle available.

Driver

Supplied with integrated no-dimmable driver.
Dimming Options: Phase.

Applications

Volume Projector is a great solution to illuminate statues and green sculpture enhancing their volumes and details. The super narrow beam versions are perfect accent lights. Application areas: sculptures, gardens, facades, signboards.

Related Products

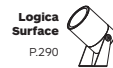

Volume Projector



Volume Projector 58 IK06 Surface Mounted
Volume Projector 70 IK06 Surface Mounted
Volume Projector 110 IK07 Surface Mounted

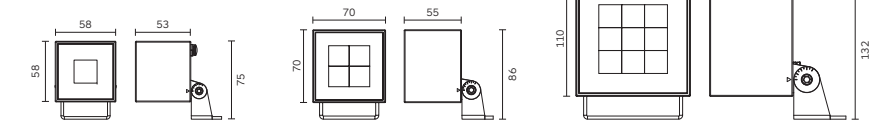

Volume Projector Super Narrow 58 IK06 Surface Mounted
Volume Projector Super Narrow 110 IK07 Surface Mounted



Code ordering example: **3 6 2 0 B R 3 1 - 8 0 3 0 1 7 D 0 1 0**

	Product Code	Light Source Code*	>CRI	CCT**	LED Power	Nominal Lumen	Beam Angle (BA°)	Driver Options	Finish
Volume Projector 58	3620	BR21	High Power LED	80	30 3000K	4.2W	502 lm	17 / 21 / 27	DP No Dim
					40 4000K		541 lm		DP Phase
Volume Projector 70	3622	BR11	High Power LED		8.4W	944 lm	17 / 21 / 25		
							944 lm		
Volume Projector 110	3623				18.9W	1863 lm	16 / 20 / 26		
							2420 lm		
Volume Projector Super Narrow 58	3621	BR12	High Power LED		2.1W	173 lm	03		
							173 lm		
Volume Projector Super Narrow 110	3624				10.5W	865 lm			
							865 lm		

Notes:
 * For complete code ordering information, please see page 353.
 ** For other CCT options, please contact us.
 For related accessories, please see page 349.

Volume

58 | 70 | 110



Volume Ceiling

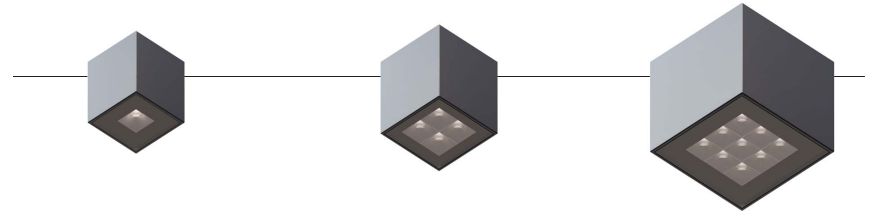

Volume Ceiling 58
Ceiling Mounted

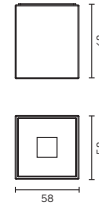

Volume Ceiling 70
Ceiling Mounted



Volume Ceiling 110
Ceiling Mounted

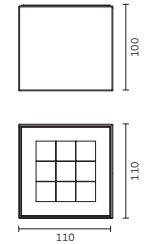

Code ordering example: 3 6 2 5 BR21 - 80 30 17 D0 10

	Product Code	Light Source Code*	>CRI	CCT**	LED Power	Nominal Lumen	Beam Angle (BA°)	Driver Options	Finish
Volume Ceiling 58	3625	BR21 High Power LED	80	30 3000K	4.2W	502 lm	17 / 21 / 27	D0 No Dim	29 Grey (Outdoor)
				40 4000K		541 lm		DP Phase	
Volume Ceiling 70	3626	BR11 High Power LED			8.4W	944 lm	17 / 21 / 25		
						944 lm			
Volume Ceiling 110	3627				18.9W	1863 lm	16 / 20 / 26		
						2420 lm			

Notes:

- * For complete code ordering information, please see page 353.
- ** For other CCT options, please contact us.
- For related accessories, please see page 349.

Body

Ceiling or wall mounted luminaire with light housing in cast aluminium. Inclusive of toughened safety glass and weatherproof durable silicone gasket.

Wall mounted version inclusive of screen in extruded aluminium to better direct the light against the wall.

Front cover is designed to avoid accumulation of dust and water.

LED sources

High Power LED.
CRI: 80 | CCT: 3000K, 4000K.
Other CRI and CCT options available on request.

Optic

Lens.
Super narrow, narrow, medium and wide beam angle available.

Accessories

Anti-glare snoot.
Check page 349 for details.

Driver

Supplied with integrated no-dimmable driver.
Dimming Options: Phase.

Finish

Superior polyester powder coat in grey colour.

Applications

Its sober appearance makes this fixture ideal for today's architecture. Provides high level of illuminance and the possibility to direct the light where needed. Application areas: garages, entrances, walkways, balconies.

Related Products



Volume Wall



Volume 70

Wall Mounted

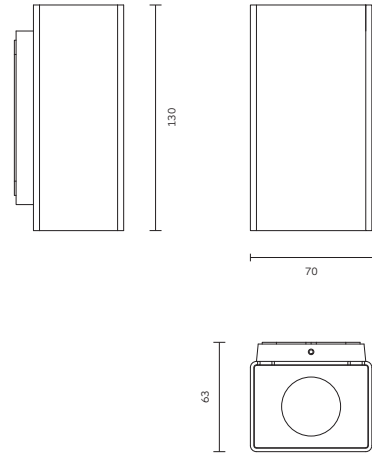

Code ordering example: **3 6 2 8 B R 2 1 - 8 0 3 0 0 3 D 0 1 0**

	Product Code	Light Source Code*	>CRI	CCT**	LED Power	Nominal Lumen	Beam Angle (BA°)	Driver Options	Finish		
Volume Wall	3628	BR21	High Power LED	80	30	3000K	8.4W	1004 lm	03 / 70	D0 No Dim	54 Sanded White
Up & Down 70				40	4000K	1082 lm		DP Phase			

Notes:

- * For complete code ordering information, please see page 353.
- ** For other CCT options, please contact us.



Galileo

Multi System floodlight projectors

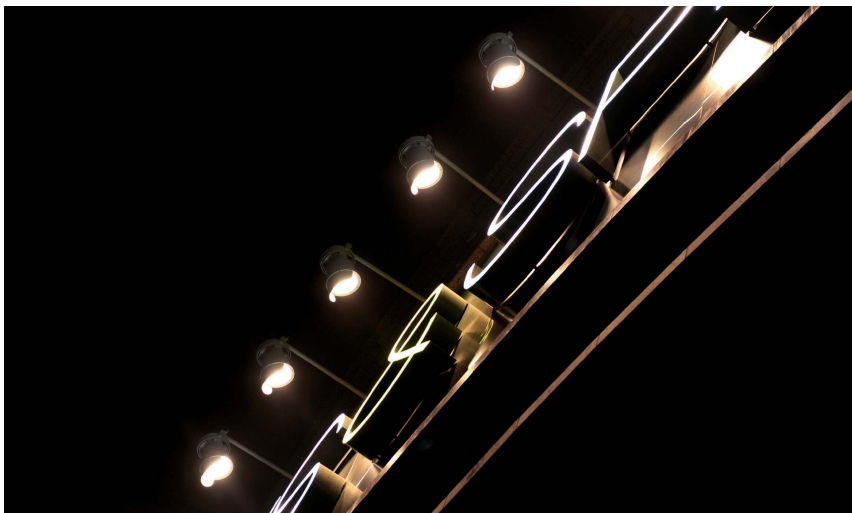

Body

Surface ceiling and pole mounted floodlight in cast aluminium, with toughened safety glass, weatherproof durable silicone gasket and external screws made of stainless steel.

Front cover is designed to avoid accumulation of dust and water. Ready for electrical installation with single or double cable entries.

Galileo pole: tiltable vertically from min. 90° to max. 180°. Galileo Due: tiltable vertically 0-100° and rotatable horizontally 350°.

Accessories

IP68 fast connector, spike, visor, pole mounted brackets. Check page 303 for details.

Finish

Superior polyester powder coat in black or grey colour.

LED sources

High Power LED.
CRI: 80 | CCT: 3000K, 4000K.
Other CRI and CCT options available on request.

Optic

Lens.
Narrow, medium and wide beam angle available.

Driver

Supplied with integrated no-dimmable driver.
Dimming Options: 0-10V Dim, DALI, Phase, CASAMBI.

Applications

Projector-floodlight for outdoor architectural lighting; but it is also suitable for indoor area. Light emission can be directed and precisely adjusted and locked to the required angle. Application areas: subways, buildings, landmarks, billboards, sculptures, trees.

Related Products

Galileo Pendant
P.320



Galileo Ceiling | Ground | Pole

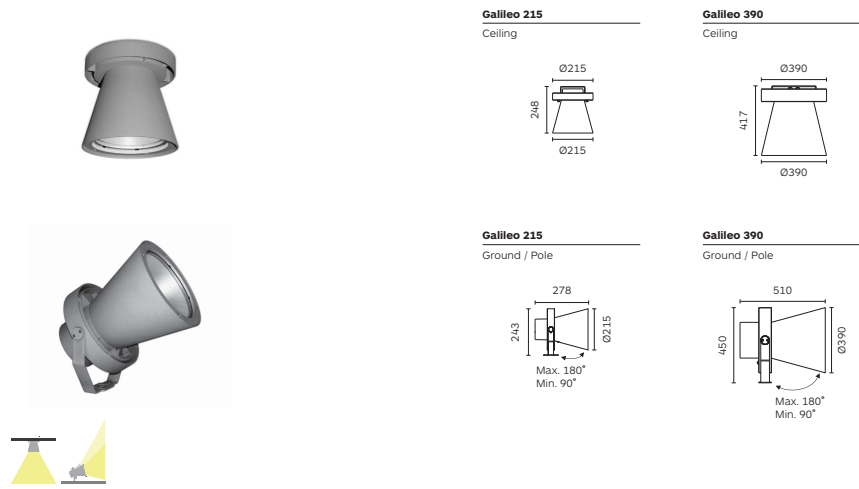

Code ordering example: **3 2 9 2 B N 1 1 - 8 0 3 0 1 5 D 0 1 0**

	Product Code	Light Source Code*	>CRI	CCT**	LED Power	Nominal Lumen	Beam Angle (BA°)	Driver Options	Finish
Galileo 215 Ceiling	3292	BN11	High Power LED	80	30 3000K 40 4000K	23W 2622 lm 3151 lm	15 / 23 / 45	D0 No Dim DX DMX	10 Black 29 Grey (Outdoor)
Galileo 215 Ground / Pole	3277	BC21	COB LED		30W	3200 lm 3300 lm	14 / 24 / 38	DA DALI Dim D1 0-10V Dim	
Galileo 390 Ceiling	3276	BN11	High Power LED	80	30 3000K 40 4000K	42W 5208 lm 6300 lm	15 / 23 / 45	DP Phase DC CASAMBI	
Galileo 390 Ground / Pole	3269								

Accessories

Product / Accessories	Visor	Fast Connector M20	Pole mounted bracket set	
Available in colours 10 and 29	Available in colours 10 and 29	IP68 (Ø 6 + 12 mm)	Ø 102 mm	Ø 120 mm
Galileo 215 Surface Ceiling / Ground / Pole	2593	2577	2509	2510
Galileo 390 Surface Ceiling / Ground / Pole	2592			

Notes:
* For complete code ordering information, please see page 353.
** For other CCT options, please contact us.

Scudo

Designed by Franco Mireni

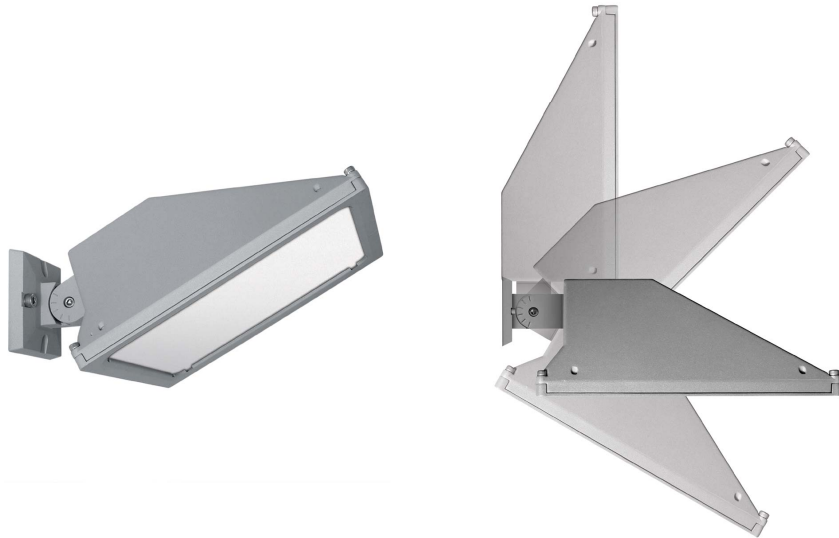

Body

Surface luminaire with light housing in cast aluminium inclusive of toughened thermal-shock frosted glass, weatherproof durable silicone gasket and external screws made of stainless steel. Glare free grid in cast aluminium.

Available with wall, ground and pole mounting options.

Front cover designed to avoid accumulation of dust and water. Electrical installation includes option for single or double cable entries.

Accessories

IP68 fast connector, Pole mounted basket set. Check page 348 for details.

Finish

Superior polyester powder coat in black or grey colour.

LED sources

SMD LED.
CRI: 80 | CCT: 3000K, 4000K.
Other CRI and CCT options available on request.

Related Products



Optic

Diffuser.
Optional front grid.
Extra wide beam angle.

Driver

Supplied with integrated no-dimmable driver.
Dimming Options: 0-10V Dim, DALI, Phase.

Applications

Floodlight providing a soft and uniform, glare free, light distribution on the illuminated surface. Scudo can be mounted on the ground, wall, wall extension, ceiling and pole. Application areas: canopies, gyms, swimming pools, garages, facades, billboards, sculptures.

Scudo Wall | Ground



Scudo Wall / Ground with Glass diffuser

Adjustable Surface Mounted

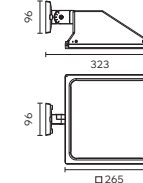

Scudo Wall / Ground with Glass diffuser + Grid

Adjustable Surface Mounted

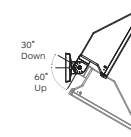
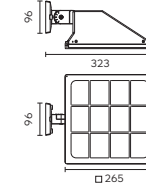

Code ordering example: **3 4 8 9 B M 1 1 - 8 0 3 0 0 0 D 0 1 0**

	Product Code	Light Source Code*	>CRI	CCT**	LED Power	Nominal Lumen	Beam Angle (BA°)	Driver Options	Finish
Scudo Wall / Ground Adjustable	3489	BM11 SMD LED	80	30 3000K	30W	4284 lm	EW (00)	D0 No Dim	10 ■ Black
			40	4000K		4482 lm		DA Dali Dim	29 ■ Grey (Outdoor)
Scudo Wall / Ground with Grid Adjustable	3490							D1 0-10V Dim	
								DP Phase	

Notes:

* For complete code ordering information, please see page 353.
** For other CCT options, please contact us.
For related accessories, please see page 348.
EW = Extra Wide. Ordering code: **00**.

Rocket Pro

130 | 150



Body

Round ceiling mounted luminaire, light body and ring in cast aluminium.

Central housing in aluminium extrusion, with toughened safety glass, weatherproof durable silicone gasket and external screws made of stainless steel.

Front cover is designed to avoid accumulation of dust and water.

Available in two version (regular and wallwasher) and two different sizes.

Accessories

No accessories available.

Finish

Superior polyester powder coat in grey and sanded white colour.

LED sources

COB. High Power LED (Wallwasher).
CRI: 80 | CCT: 3000K, 4000K.
Other CRI and CCT options available on request.

Optic

Lens.
Narrow, medium, wide and wallwasher beam angle available.

Driver

Supplied with integrated no-dimmable driver.

Applications

The evolution of the classic form lighting Rocket, a ideal solution for outdoor architectural environment. Rocket Pro provides a uniform illumination with a high level of lumen. Application areas: facades, entrances, walkways, corridors balconies.

Related Products



Rocket Pro

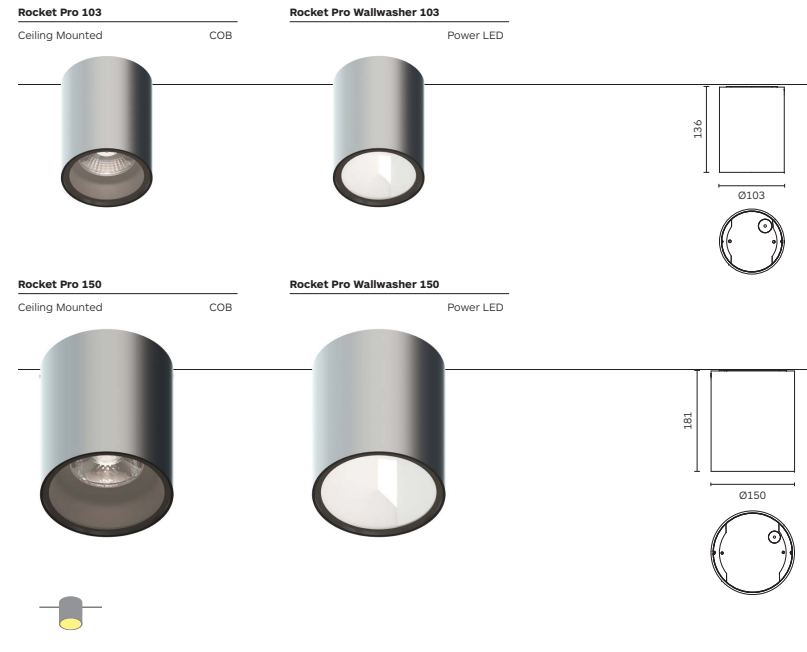

Code ordering example: **3 6 2 9 B R 4 1 - 8 0 3 0 1 5 D 0 2 9**

	Product Code	Light Source Code*	>CRI	CCT**	LED Power	Nominal Lumen	Beam Angle (BA°)	Driver Options	Finish
Rocket Pro 103	3629	BR41 COB	80	30 3000K	13W	1425 lm	15 / 33 / 49	D0 No Dim	29 Grey (Outdoor)
				40 4000K		1526 lm		DP Phase	54 Sanded White
Rocket Pro Wallwasher 103	3631	BR11 High Power LED			8W	859 lm	WW		
						859 lm			
Rocket Pro 150	3630	BR52 COB			26W	3096 lm	15 / 33 / 50		
						3310 lm			
Rocket Pro Wallwasher 150	3632	BR11 High Power LED			18W	1425 lm	WW		
						1425 lm			

Notes:

* For complete code ordering information, please see page 353.

** For other CCT options, please contact us.

Rocket

Wall / Ceiling luminaires



Body

Round wall/ceiling mounted luminaire with trim, light body and ring in cast aluminium.
Central housing in aluminium extrusion, with toughened safety glass, weatherproof durable silicone gasket and external screws made of stainless steel.

Front cover is designed to avoid accumulation of dust and water.

Electrical installation includes double cable entry.

Available in two sizes.

Accessories

No accessories available.

Finish

Superior polyester powder coat in black and grey colour.

LED sources

COB LED.
CRI: 80 | CCT: 3000K, 4000K.
Other CRI and CCT options available on request.

Optic

Reflector.
Narrow, medium and wide beam angle available.

Driver

Supplied with integrated non-dimmable driver.
Dimming Options: 0-10V Dim, DALI, Phase, CASAMBI.

Applications

A simple modernistic appearance makes this fixture ideal for today's architectural developments. Provides a personalized application and a high level of illuminance. The Up/Down light version provides a special narrow beam light effect. Application areas: facades, entrances, walkways, corridors balconies.

Related Products

Rocket Pro
P.306 

Visor
P.328 

Astra
P.330 

Rocket



Rocket 111
Ceiling Surface mounted



Rocket 150
Ceiling Surface mounted

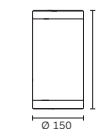

Rocket 111
Wall Surface mounted

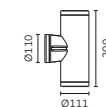

Rocket 150
Wall Surface mounted

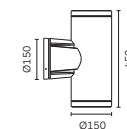

Code ordering example: **3 5 0 6 B B 1 2 - 8 0 3 0 1 4 D 0 1 0**

	Product Code	Light Source Code*	>CRI	CCT**	LED Power	Nominal Lumen	Beam Angle (BA°)	Driver Options	Finish
Rocket 111 Ceiling	3506	BB12 COB LED	80	30 3000K	14W	2152 lm	14 / 22 / 32	D0 No Dim	10 ■ Black
				40 4000K		2220 lm		DA Dali Dim	29 ■ Grey (Outdoor)
Rocket 111 Wall	3504				2 x 14W	4304 lm		D1 0-10V Dim	
						4440 lm		DP Phase	
Rocket 150 Ceiling	3505	BB13 COB LED			20W	3067 lm	16 / 28 / 40	DC CASAMBI	
						3170 lm			
Rocket 150 Wall	3503				2 x 20W	6134 lm			
						6340 lm			

Notes:

* For complete code ordering information, please see page 353.

** For other CCT options, please contact us.

Galileo

Multi System floodlight projectors



Body

Surface floodlight in cast aluminium, with toughened safety glass, weatherproof durable silicone gasket and external screws made of stainless steel. Front cover is designed to avoid accumulation of dust and water.

Fixture available in 2 design (Galileo and Galileo Due) and two different mounting options (wall and ceiling).

Ready for electrical installation with single or double cable entries. Galileo Due: tiltable vertically 0-100° and rotatable horizontally 350°.

Accessories

IP68 fast connector, spike, visor.
Check page 313 for details.

Finish

Superior polyester powder coat in black or grey colour.

LED sources

High Power LED.
CRI: 80 | CCT: 3000K, 4000K.
Other CRI and CCT options available on request.

Optic

Lens.
Narrow, medium and wide beam angle available.

Driver

Supplied with integrated no-dimmable driver.
Dimming Options: 0-10V Dim, DALI, Phase, CASAMBI.

Applications

Projector-floodlight for outdoor architectural lighting; but it is also suitable for indoor area. Light emission can be directed and precisely adjusted and locked to the required angle. Application areas: subways, buildings, landmarks, billboards, sculptures, trees.

Related Products

**Galileo
Pendant**
P.320



Galileo Surface



Galileo 215 Up or Down
Surface mounted

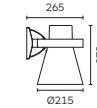

Galileo 390 Up or Down
Surface mounted

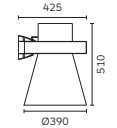

Galileo 215 Up & Down
Surface mounted

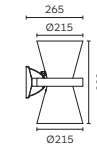

Galileo 390 Up & Down
Surface mounted

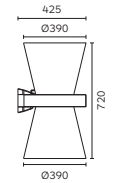

Code ordering example: **3 3 2 8 B N 1 1 - 8 0 3 0 1 5 D 0 1 0**

	Product Code	Light Source Code*	>CRI	CCT**	LED Power	Nominal Lumen	Beam Angle (BA°)	Driver Options	Finish
Galileo 215 Up or Down	3328	BN11 High Power LED	80	30 3000K	23W	2622 lm	15 / 23 / 45	D0 No Dim	10 Black
				40 4000K		3151 lm		DX DMX	29 Grey (Outdoor)
Galileo 215 Up & Down	3333	BC21 COB LED			46W	5244 lm		DA Dall Dim	
						6302 lm		D1 0-10V Dim	
					30W	3200 lm	14 / 24 / 38	DP Phase	
Galileo 390 Up or Down	3325	BN11 High Power LED	80	30 3000K	42W	5208 lm	15 / 23 / 45	DC CASAMBI	
				40 4000K		6300 lm			
					84W	10416 lm			
Galileo 390 Up & Down	3331					12600 lm			

Notes:

* For complete code ordering information, please see page 353.
** For other CCT options, please contact us.
For related accessories, please see page 313.

Galileo Due



Galileo Due 215 Ceiling
Surface mounted

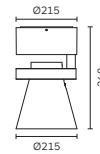

Galileo Due 215 Ground
Surface mounted

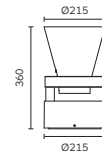

Galileo Due 215 Wall
Surface mounted

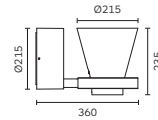

Code ordering example: **3 2 8 9 B N 1 1 - 8 0 3 0 1 5 D 0 1 0**

	Product Code	Light Source Code*	>CRI	CCT**	LED Power	Nominal Lumen	Beam Angle (BA°)	Driver Options	Finish
Galileo Due 215 Ground / Ceiling	3289	BN11 High Power LED	80	30 3000K	23W	2622 lm	15 / 23 / 45	D0 No Dim	10 ■ Black
				40 4000K		3151 lm		DX DMX	29 ■ Grey (Outdoor)
Galileo Due 215 Wall	3285	BC21 COB LED			30W	3200 lm 3300 lm	14 / 24 / 38	DA Dali Dim D1 0-10V Dim DP Phase DC CASAMBI	

Notes:

* For complete code ordering information, please see page 353.
** For other CCT options, please contact us.
For related accessories, please see page 313.

Accessories



Visor

Available in colours 10 and 29



Spike

Available in colour 10



Fast Connector M20

IP68

Product / Accessories

Product / Accessories	Visor	Spike		Fast Connector M20
		H: 230	H: 235	
Galileo 215 Surface Up or Down / Up & Down	2593	/	/	
Galileo 390 Surface Up or Down / Up & Down	2592	/	/	2577
Galileo Due 215 Wall / Ground / Ceiling	2593	2322	2330	

In plastic.
The 50 mm upper part stay above ground level according to standards.

(Ø 5 + 12 mm)

Orbit

Wall / Ceiling luminaires



Body

Round or square wall/ceiling luminaire with body in cast aluminium, inclusive of vandal resistance polycarbonate opal diffusers and weatherproof durable silicone gasket.

Countersunk external screws made of stainless steel.

Simple to install with 2 cable entries to facilitate through wiring and easy click system removable diffuser.

LED sources

SMD LED.
CRI: 80 | CCT: 3000K, 4000K.
Other CRI and CCT options available on request.

Optic

Acrylic satin opal diffuser.
Extra wide beam angle.

Accessories

No accessories available.

Finish

Superior polyester powder coat in black, sanded white or grey colour.

Driver

Supplied with integrated no-dimmable driver.
Dimming Options: 0-10V Dim, DALI, Phase.

Applications

Energy saving luminaire, its diffused light emission is designed to also create a halo light effect. Application areas: entrances, walkways, corridors, balconies, security lighting purposes.

Related Products



Orbit



Orbit Round

Wall / Ceiling surface

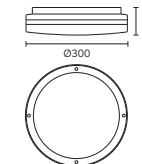

Orbit Square

Wall / Ceiling surface

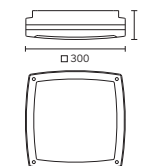

Code ordering example: **1 2 5 8 B M 1 1 - 8 0 3 0 0 0 D 0 1 0**

	Product Code	Light Source Code*	>CRI	CCT**	LED Power	Nominal Lumen	Beam Angle (BA°)	Driver Options	Finish
Orbit Round	1258	BM11 SMD LED	80	30 3000K	30W	2560 lm	EW (00)	D0 No Dim	10 ■ Black
				40 4000K		2720 lm		DA Dali Dim	29 ■ Grey (Outdoor)
Orbit Square	1259							D1 0-10V Dim	54 □ Sanded White
								DP Phase	

Notes:

- * For complete code ordering information, please see page 353.
- ** For other CCT options, please contact us.

EW = Extra Wide. Ordering code: **00**.

Disco & Gala

Wall / Ceiling luminaires



Body

Round or square surface luminaires with body and satin opal diffuser in injection molded polycarbonate inclusive of durable silicone gasket.

External frame in cast aluminium with countersunk screws. Simple to install with 2 cable entries to facilitate through wiring and easy click system removable diffuser.

Available in 3 sizes.

Accessories

No accessories available.

Finish

Superior polyester powder coat in black or grey colour.

LED sources

SMD LED.
CRI: 80 | CCT: 3000K, 4000K.
Other CRI and CCT options available on request.

Optic

Acrylic satin opal diffuser.
Extra wide beam angle.

Driver

Supplied with integrated no-dimmable driver.
Dimming Options: 0-10V Dim, DALI, Phase.

Applications

Up to 685mm luminaire to provide large areas of uniform and high light output. Easy installation and maintenance due to the click system design diffuser. Application areas: lobbies, walkways, corridors, balconies.

Related Products



Disco & Gala

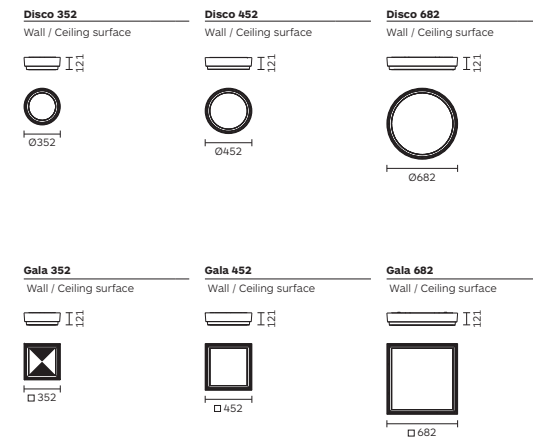

Code ordering example: **3 4 8 4 B M 1 1 - 8 0 3 0 0 0 D 0 1 0**

	Product Code	Light Source Code*	>CRI	CCT**	LED Power	Nominal Lumen	Beam Angle (BA°)	Driver Options	Finish
Disco 352	3484	BM11 SMD LED	80	30 3000K	30W	2650 lm	EW (00)	D0 No Dim	10 Black
				40 4000K		2850 lm		DA Dali Dim	29 Grey (Outdoor)
Gala 352	3485							D1 0-10V Dim	
								DP Phase	
Disco 452	3482				45W	3800 lm			
						4000 lm			
Gala 452	3483								
Disco 682	3480				80W	6800 lm			
						7100 lm			
Gala 682	3481								

Notes:

* For complete code ordering information, please see page 353.
** For other CCT options, please contact us.
EW = Extra Wide. Ordering code: **00**.

Scudo

Designed by Franco Mirezzi



Body

Surface mounted luminaire with light housing in cast aluminium inclusive of toughened thermal-shock frosted glass or polycarbonate diffuser, weatherproof durable silicone gasket and external screws made of stainless steel.

Glare free optional grid in cast aluminium. Front cover designed to avoid accumulation of dust and water.

Electrical installation includes option for single or double cable entries.

Accessories

IP68 fast connector.
Check page 348 for details.

Finish

Superior polyester powder coat in black or grey colour.

LED sources

SMD LED.
CRI: 80 | CCT: 3000K, 4000K.
Other CRI and CCT options available on request.

Optic

Diffuser of frosted glass or polycarbonate.
Optional front grid.
Extra wide beam angle.

Driver

Supplied with integrated no-dimmable driver.
Dimming Options: 0-10V Dim, DALI, Phase.

Applications

Floodlight providing a soft and uniform, glare free, light distribution on the illuminated surface. Surface version can be mounted on the ground, wall, wall extension, ceiling and pole. Application areas: canopies, gyms, swimming pools, garages, facades, billboards, sculptures.

Related Products



Scudo Wall



Scudo Wall Polycarbonate diffuser
Fixed Surface Mounted **IP65**

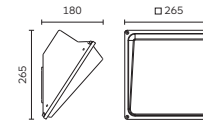

Scudo Wall Glass diffuser
Fixed Surface Mounted **IP66**

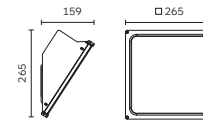

Scudo Wall Glass diffuser + Grid
Fixed Surface Mounted **IP66**

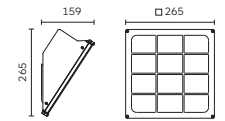

Code ordering example: **3 4 9 1 B M 1 1 - 8 0 3 0 0 0 D 0 1 0**

	Product Code	Light Source Code*	>CRI	CCT**	LED Power	Nominal Lumen	Beam Angle (BA*)	Driver Options	Finish
Scudo Wall Polycarbonate diffuser Fixed	3491	BM11 SMD LED	80	30 3000K	30W	4284 lm	EW (00)	D0 No Dim	10 ■ Black
Scudo Wall Fixed	3492			40 4000K		4482 lm		DA Dali Dim	29 ■ Grey (Outdoor)
Scudo Wall with Grid Fixed	3493							D1 0-10V Dim	
								DP Phase	

Notes:

- * For complete code ordering information, please see page 353.
- ** For other CCT options, please contact us.
- For related accessories, please see page 348.
- EW = Extra Wide. Ordering code: **00**.
- IP65 for item code 3491. IP66 for items code 3492 and 3493.

Galileo

Multi System floodlight projectors / Pendant



Body

Floodlight pendant mounted luminaire with light body in cast aluminium. Available in two different sizes and two different models (wires or rods).

Inclusive of toughened safety glass, weatherproof durable silicone gasket and external screws made of stainless steel.

Front cover is designed to avoid accumulation of dust and water.

Electrical installation option for single or double cable entries. Supplied with two hard wires with 2000mm cable (type H07RN-F 3x1mm).

Accessories

IP68 fast connector.
Check page 323 for details.

Finish

Superior polyester powder coat in black or grey colour.

LED sources

High Power LED.
CRI: 80 | CCT: 3000K, 4000K.
Other CRI and CCT options available on request.

Optic

Lens.
Narrow, medium and wide beam angle available.

Driver

Supplied with integrated no-dimmable driver.
Dimming Options: 0-10V Dim, DALI, Phase, CASAMBI.

Applications

Projector-floodlight for outdoor architectural lighting; but it is also suitable for indoor area. Application areas: subways, buildings, landmarks, billboards, sculptures, trees.

Related Products



Galileo



Galileo 215 Up or Down
Pendant

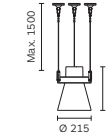

Galileo 215 Up & Down
Pendant

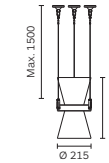

Galileo 390 Up or Down
Pendant

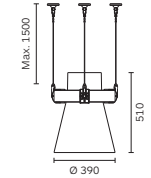

Galileo 390 Up & Down
Pendant

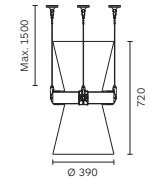

Code ordering example: **3 3 3 9 B N 1 1 - 8 0 3 0 1 5 D 0 1 0**

	Product Code	Light Source Code*	>CRI	CCT**	LED Power	Nominal Lumen	Beam Angle (BA°)	Driver Options	Finish
Galileo 215 Pendant Up or Down	3339	BN11 High Power LED	80	30 3000K	23W	2622 lm	15 / 23 / 45	D0 No Dim	10 ■ Black
				40 4000K	3151 lm	DX DMX	29 ■ Grey (Outdoor)		
Galileo 215 Pendant Up & Down	3343	BC21 COB LED	80	30 3000K	46W	5244 lm		DA Dali Dim	
				40 4000K	6302 lm	D1 0-10V Dim			
				30W	3200 lm	14 / 24 / 38	DP Phase		
Galileo 390 Pendant Up or Down	3338	BN11 High Power LED	80	30 3000K	42W	5208 lm	15 / 23 / 45	DC CASAMBI	
				40 4000K	6300 lm				
Galileo 390 Pendant Up & Down	3341				84W	10416 lm			
						12600 lm			

Notes:

* For complete code ordering information, please see page 353.
** For other CCT options, please contact us.
For related accessories, please see page 323.

Galileo



Galileo 215 Up or Down

Pendant with rods

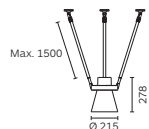

Galileo 390 Up or Down

Pendant with rods

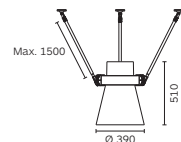

Galileo 215 Up & Down

Pendant with rods

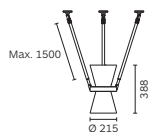

Galileo 390 Up & Down

Pendant with rods

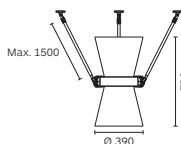

Code ordering example: 3 3 & 7 B N 1 1 - 8 0 3 0 1 5 D 0 1 0

	Product Code	Light Source Code*	>CRI	CCT**	LED Power	Nominal Lumen	Beam Angle (BA*)	Driver Options	Finish
Galileo 215 with rods Up or Down	3347	BN11	High Power LED	80	30 3000K	23W 2622 lm	15 / 23 / 45	D0 No Dim	10 ■ Black
					40 4000K	3151 lm		DX DMX	29 ■ Grey (Outdoor)
Galileo 215 with rods Up & Down	3351	BN11	High Power LED	80	30 3000K	42W 5208 lm	15 / 23 / 45	DA Dali Dim	
					40 4000K	6302 lm		D1 0-10V Dim	
					30W	3200 lm		DP Phase	
Galileo 390 with rods Up or Down	3346	BN11	High Power LED	80	30 3000K	42W 5208 lm	15 / 23 / 45	DC CASAMBI	
					40 4000K	6300 lm			
Galileo 390 with rods Up & Down	3349				84W	10416 lm			12600 lm

Notes:
 * For complete code ordering information, please see page 353.
 ** For other CCT options, please contact us.
 For related accessories, please see page 323.

Accessories



Fast Connector M20

IP68

⌀ 6 + 12 mm

Product / Accessories

Galileo 215 Pendant Up or Down / Up & Down

Galileo 390 Pendant Up or Down / Up & Down

Galileo 215 Pendant With rods Up or Down / Up & Down

Galileo 390 Pendant With rods Up or Down / Up & Down

2577

GirasoLED

Surface mounted grazing light

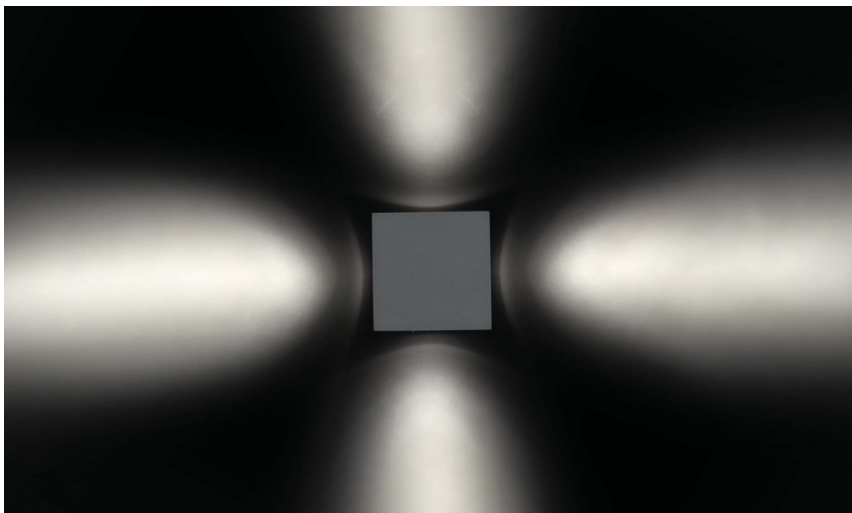

Body

Surface mounted light with body in cast aluminium, toughened thermal shock clear glass diffusers, weatherproof durable silicone gasket and external screws made of stainless steel.

Simple to install via cable entry with grommet. Can be connected directly to the main power.

Available in 2 versions - Round and Square.

LED sources

High Power LED.
CRI: 80 | CCT: 3000K, 4000K.
Other CRI and CCT options available on request.

Optic

Lens.
Narrow beam angle available.

Accessories

No accessories available.

Finish

Superior polyester powder coat in black or grey colour.

Driver

Supplied with integrated no-dimmable driver.

Applications

Its simple modernistic appearance making it ideal for today's architectural developments. It gives a high performance personalized lighting effect with minimal costs. Application areas: safety and security, facades, entrances, walkways, corridors.

Related Products



GirasoLED



GirasoLED Round

Surface mounted

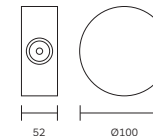

GirasoLED Square

Surface mounted

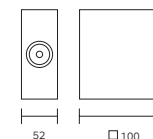

Code ordering example: **3 4 1 9 B N 1 1 - 8 0 3 0 1 0 D 0 1 0**

	Product Code	Light Source Code*	>CRI	CCT**	LED Power	Nominal Lumen	Beam Angle (BA°)	Driver Options	Finish
GirasoLED Round	3419	BN11	High Power LED	80	30 3000K	4x1W	240 lm	10 No Dim	10 Black
				40 4000K		272 lm			29 Grey (Outdoor)
GirasoLED Square	3418								

Notes:

* For complete code ordering information, please see page 353.

** For other CCT options, please contact us.

Cubox

Wall mounted grazing light



Body

Wall mounted light with body in cast aluminium, toughened thermal shock clear glass diffusers, weatherproof durable silicone gasket and external screws made of stainless steel.

Simple to install via cable entry, Ingress Protection 54.

LED sources

High Power LED.
CRI: 80 | CCT: 3000K, 4000K.
Other CRI and CCT options available on request.

Related Products



Accessories

Slot grid.
Check page 348 for details.

Finish

Superior polyester powder coat in black or grey colour.

Optic

Single or Up & Down emission.
Narrow and wide beam angle available.

Driver

Supplied with integrated no-dimmable driver.

Applications

Fixture in shape of a cube with Dual lights emission; it is available also with option of narrow beam upward.
Application areas: entrances, corridors, walkways, gateposts, columns.

Cubox



S2 (2 slots) ; Product code: 3474

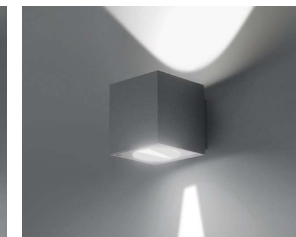

SG ; Product code: 3414

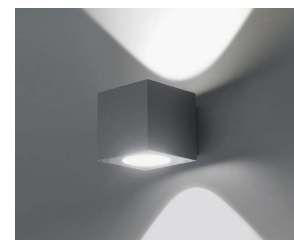

G2 ; Product code: 3415

Cubox

Wall mounted

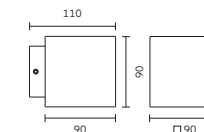

Code ordering example: **3 4 7 4 B R 1 1 - 8 0 3 0 1 5 D 0 1 0**

	Product Code	Light Source Code*	>CRI	CCT**	LED Power	Nominal Lumen	Beam Angle (BA°)	Driver Options	Finish
Cubox S2 (2 slots)	3474	BR11	High Power LED	80	30 3000K	2x3W	140 lm	D0 No Dim	10 ■ Black
				40 4000K		160 lm			29 ■ Grey (Outdoor)
Cubox SG	3414						SG (15 & 99)		
Cubox G2	3415						99		

Notes:

- * For complete code ordering information, please see page 353.
 - ** For other CCT options, please contact us.
- For related accessories, please see page 348.

Visor

Wall mounted grazing light



Body

Wall mounted grazing light with light body and adjustable visor in cast aluminium. Diffuser in tempered safety glass. Inclusive of molded silicone gasket and stainless steel screws.

Designed for longitudinal uplighting and or downlighting. Ingress protection 54.

Adjustable Visor able to rotate 270° around the fixture.

LED sources

SMD LED.
CRI: 80 | CCT: 3000K, 4000K.
Other CRI and CCT options available on request.

Optic

Visor in cast aluminium plus diffuser.
Extra Wide beam angle.

Related Products



Accessories

No accessories available.

Finish

Superior polyester powder coat in grey colour.

Driver

Supplied with integrated no-dimable driver.

Applications

An extremely compact outdoor wall luminaire with adjustable visor with joint to direct the light where is required, specially designed for longitudinal uplighting and or downlighting. Application areas: doorways entrances, corridors, walkways, gatepost, columns.

Visor



Visor

Wall mounted

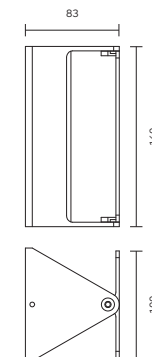

Code ordering example: **3 5 4 7 B M 1 1 - 8 0 3 0 0 0 2 9**

	Product Code	Light Source Code*	>CRI	CCT**	LED Power	Nominal Lumen	Beam Angle (BA°)	Driver Options	Finish
Visor	3547	BM11 SMD LED	80	30 3000K	8x1W	640 lm	EW (00)	D0 No Dim	29 Grey (Outdoor)
				40 4000K		680 lm			

Notes:

* For complete code ordering information, please see page 353.

** For other CCT options, please contact us.

EW = Extra Wide. Ordering code: **00**.

Astra

Surface mounted light effect luminaire



Body

Surface mounted luminaire with body in cast aluminium, inclusive of toughened thermal shock glass diffuser or focused glass lens, weatherproof durable silicone gasket and external screws made of stainless steel.

Front cover is designed to avoid accumulation of dust and water.

Simple to install with 2 cable entries to facilitate through wiring.

Accessories

Pole mounted bracket set.
Check page 333 for details.

Finish

Superior polyester powder coat in black or grey colour.

LED sources

COB LED. CRI: 90 | CCT: 3000K, 4000K.
Other CRI and CCT options available on request.

Related Products

Rocket
P.308



Optic

Reflector in metalized PC and glass convex diffuser.
Narrow, wide and wallwasher beam angle available.
Up & down version available also with a combination of narrow and wide beam angle.

Driver

Supplied with integrated no-dimmable driver.
Dimming Options: 0-10V Dim, DALI, Phase.

Applications

Its simple modern design makes it ideal for today architectural developments. Up/Down version offers special narrow beam light effect, while the floodlight asymmetric version providing high illuminance.
Application areas: facades, entrances, walkways.

Astra Up & Down



WI - Wide ; Product code: 3533

NA - Narrow ; Product code: 3558

Astra Up & Down

Surface mounted

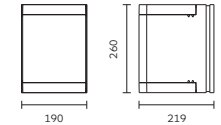

WN - Wide & Narrow ; Product code: 3557

WW - Asymmetric ; Product code: 3560



Code ordering example: **3 5 3 3 B B 1 2 - 9 0 3 0 W I D 0 1 0**

	Product Code	Light Source Code*	>CRI	CCT**	LED Power	Nominal Lumen	Beam Angle (BA°)	Driver Options	Finish
Astra Up & Down Wide	3533	BB12 COB LED	90	30 3000K	2x16W	4530 lm	WI	D0 No Dim	10 ■ Black
			40	4000K		5068 lm		DX DMX	29 ■ Grey (Outdoor)
Astra Up & Down Wide / Narrow	3557						WN	DA Dali Dim	
								D1 0-10V Dim	
Astra Up & Down Narrow	3558						NA	DP Phase	
Astra Up & Down Asymmetric	3560						WW		

Notes:

- * For complete code ordering information, please see page 353.
 - ** For other CCT options, please contact us.
- For related accessories, please see page 333.

Astra Up or Down



Wide ; Product code: 3556



Narrow ; Product code: 3559



Asymmetric ; Product code: 3561

Astra Up or Down

Surface mounted

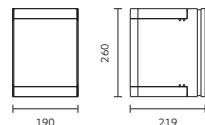

Code ordering example: **3 5 5 6 B B 1 2 - 9 0 3 0 6 0 D 0 1 0**

	Product Code	Light Source Code*	>CRI	CCT**	LED Power Up or Down	Nominal Lumen Up or Down	Beam Angle (BA°)	Driver Options	Finish
Astra Up or Down Wide	3556	BB12 COB LED	90	30 3000K	22W	2941 lm	60	D0 No Dim	10 ■ Black
				40 4000K		3042 lm		DX DMX	29 ■ Grey (Outdoor)
Astra Up or Down Narrow	3559						08	DA Dali Dim	
								D1 0-10V Dim	
Astra Up or Down Asymmetric	3561						WW	DP Phase	

Notes:
 * For complete code ordering information, please see page 353.
 ** For other CCT options, please contact us.
 For related accessories, please see page 333.

Accessories



Product / Accessories	Pole mounted bracket set		Pole mounted bracket set	
	Ø 102 mm	Ø 120 mm	Ø 102 mm	Ø 120 mm
Astra Up & Down	2508	2507	2563	2564
Astra Up or Down	With connector for one fixture. Available in colours 10 and 29.		With connector for two fixtures. Available in colours 10 and 29.	

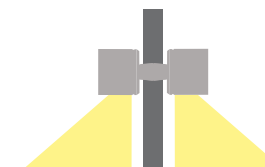

Latoluce

400 | 600

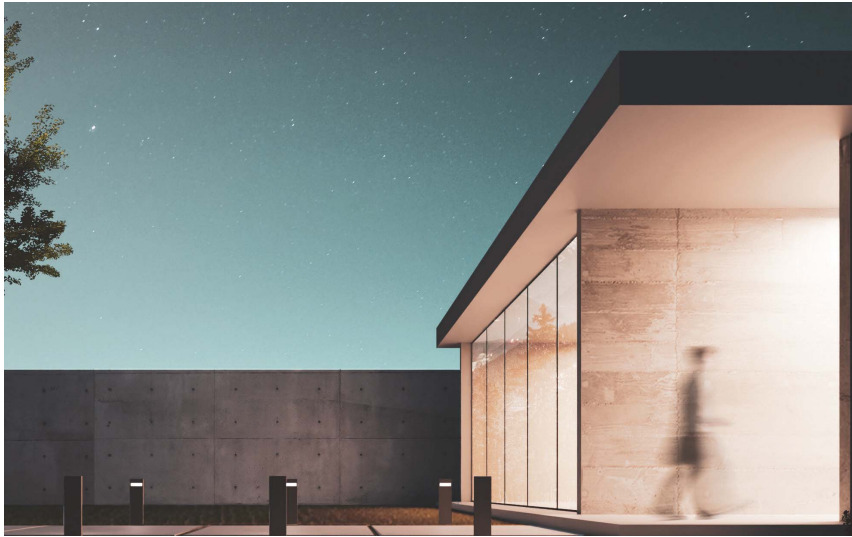

Body

Bullard Luminaire with body in extruded aluminum and asymmetrical shielded light distribution. Luminaire with high level of visual comfort and uniform illumination of the surface.

The safety glass is fitted within the luminaire for easy cleaning.

LED sources

SMD LED. CRI: 80 | CCT: 3000K, 4000K.
Other CRI and CCT options available on request.

Related Products

Trafo
P.340



Optic

Opal satin acrylic diffuser with asymmetric beam angle.

Accessories

No accessories available.

Driver

Supplied with integrated no-dimmable driver.

Finish

Superior polyester powder coat in grey colour

Applications

Compact outdoor luminaire. Its appearance blends into any exterior design to provide lighting designers and architects many application possibilities.
Application areas: landscapes, parks, walkways, pathways, walls, entrances, golf courses, gardens, bridges.

Latoluce



Latoluce 400

Surface Mounted

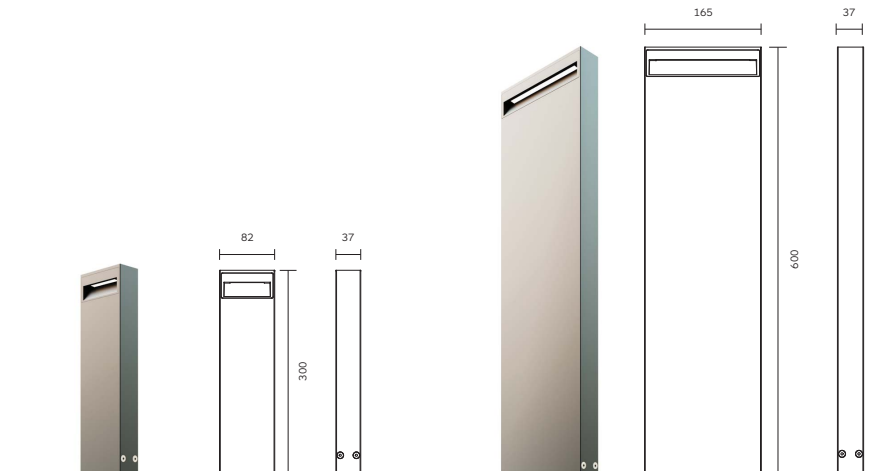

Latoluce 600

Surface Mounted



Code ordering example: **3 6 1 8 B B 3 1 - 8 0 3 0 A S D 0 2 9**

	Product Code	Light Source Code*	>CRI	CCT**	LED Power	Nominal Lumen	Beam Angle (BA°)	Driver Options	Finish
Latoluce 400	3618	BB31 SMD LED	80	30 3000K	3W	480 lm	AS	DO No Dim	29 Grey (Outdoor)
				40 4000K		480 lm			
Latoluce 600	3619				6W	900 lm			
						900 lm			

Notes:

* For complete code ordering information, please see page 353.

** For other CCT options, please contact us.

AS = Asymmetric Beam (15° x 50°)

Cornetto

Designed by Franco Mireni



Body

Surface mounted/bollard light system with diffuser base's, housed ribbed LED dissipator and top canopy in cast aluminium.

Vandal proof prismatic diffuser in polycarbonate thermoplastic, light pole in extruded aluminium, inclusive of weatherproof silicone gasket and concealed stainless steel screws.

Designed for an indirect light technique have the reflector and canopy with inner white finish.

Accessories

Anchor bolt kit.
Check page 348 for details.

Finish

Superior polyester powder coat in black or grey colour.

LED sources

COB LED. CRI: 90 | CCT: 3000K, 4000K.
Other CRI and CCT options available on request.

Optic

Prismatic acrylic diffuser.

Related Products

Trafo
P.340



Corolla
P.338



Cornetto



Cornetto

Wall

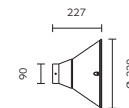

Cornetto

Bollard

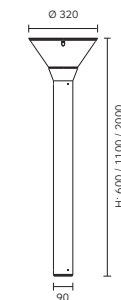

Code ordering example: **3 4 4 1 M B 1 3 - 8 0 3 0 0 0 D 0 1 0**

	Product Code	Light Source Code*	Height (H)	>CRI	CCT**	LED Power	Nominal Lumen	Beam Angle (BA°)	Driver Options	Finish	
Cornetto Wall	3441	MB13	COB LED	/	80 30	3000K	19W	2919 lm	EW (00)	D0 No Dim	10 ■ Black
					40	4000K	3008 lm		DP Phase	29 ■ Grey (Outdoor)	
Cornetto Bollard	3444								D1 0-10V Dim		
	3447										
	3450										

Notes:

* For complete code ordering information, please see page 353.
** For other CCT options, please contact us.
For related accessories, please see page 348.
EW = Extra Wide. Ordering code: **00**.

Corolla

Designed by Franco Mirezzi



Body

Wall/pole/bollard mounted light system with light body and trim in cast aluminium.

Light body inclusive of tempered glass diffuser, weatherproof silicone gasket and stainless steel screws.

Electrical installation option for single or double cable entry.

Anchor bolt kit for concrete foundation installation is available as accessory.

Accessories

Anchor bolt kit.
Check page 348 for details.

Finish

Superior polyester powder coat in black or grey colour.

LED sources

COB LED. CRI: 90 | CCT: 3000K, 4000K.
Other CRI and CCT options available on request.

Optic

Lens.
Narrow, medium and wide beam angle available.

Driver

Supplied with integrated no-dimmable driver.
Dimming Options: 0-10V Dim, DALI, Phase.

Applications

Outdoor lighting system to illuminate upwards or downwards on the ground providing optimal visual comfort. Offer in different mounting alternative (post/wall). Application areas: landscapes, parks, walkways, pathways, walls, entrances, golf courses, gardens, bridges.

Related Products

Trafo
P.340



Corolla

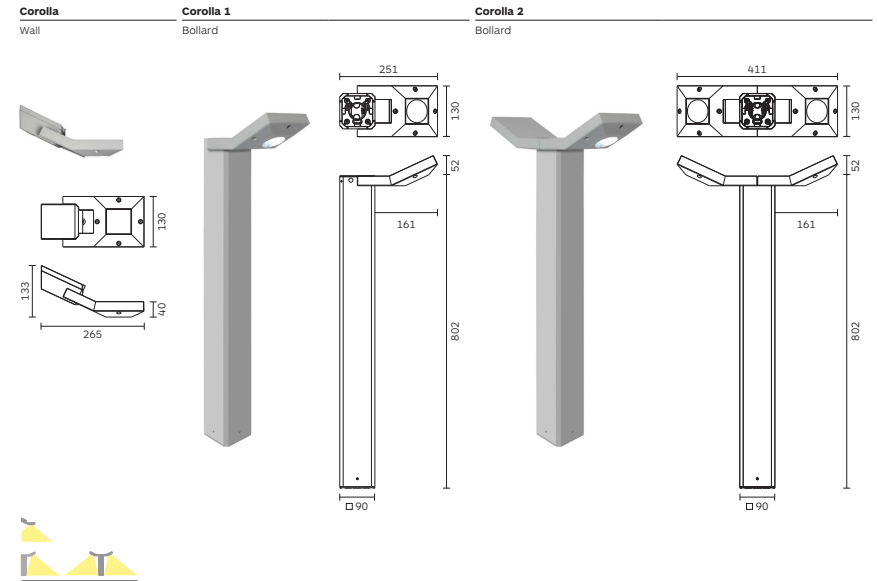

Code ordering example: **3 5 0 7 B C 2 2 - 8 0 3 0 2 0 D 0 1 0**

	Product Code	Light Source Code*	>CRI	CCT**	LED Power	Nominal Lumen	Beam Angle (BA°)	Driver Options	Finish	
Corolla Wall	3507	BC22	COB LED	80	30 3000K	9W	1275 lm	20 / 30 / 40	D0 No Dim	10 ■ Black
				40 4000K			1308 lm		DA Dali Dim	29 ■ Grey (Outdoor)
Corolla Bollard 1	3508								D1 0-10V Dim	
									DP Phase	
Corolla Bollard 2	3509					2x9W	2550 lm			2616 lm

Notes:

- * For complete code ordering information, please see page 353.
 - ** For other CCT options, please contact us.
- For related accessories, please see page 348.

Trafofo

Designed by Franco Mirenzi



Body

Wall and bollard mounted light system with body visor housing and ribbed LED dissipator in cast aluminium, inclusive weatherproof silicone gasket and concealed stainless steel screws.

Light pole in extruded aluminium. The safety glass is fitted within the luminaire for easy cleaning.

Easy installation via the included hard wire rubber cable and IP67 fast connector.

Accessories

Anchor bolt kit.
Check page 348 for details.

Finish

Superior polyester powder coat in white or grey colour.

LED sources

High Power LED. CRI: 80 | CCT: 3000K, 4000K.
Other CRI and CCT options available on request.

Optic

Frosted glass diffuser.

Driver

Supplied with integrated no-dimmable driver.
Dimming Options: 0-10V Dim, Phase.

Applications

Extremely compact designed outdoor luminaire. Its appearance blends into any exterior design to provide lighting designers and architects many application possibilities. Application areas: landscapes, parks, walkways, pathways, walls, entrances, golf courses, gardens, bridges.

Related Products

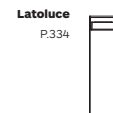
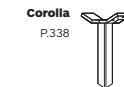

Trafofo



Trafofo Wall Single

Single Up or Down

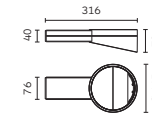

Trafofo Wall Double

Double Up & Down

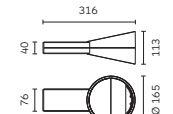

Trafofo Bollard

Single

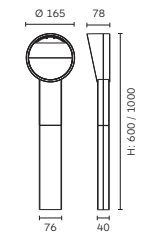

Trafofo Bollard

Double

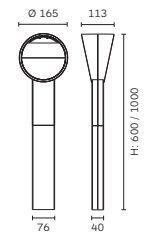

Code ordering example: **3 4 5 1 B N 1 1 - 8 0 3 0 0 0 0 1 1**

	Product Code	Light Source Code*	Height (H)	>CRI	CCT**	LED Power	Nominal Lumen	Beam Angle (BA°)	Driver Options	Finish
						Up or Down	Up or Down			
Trafofo Wall Single Up or Down	3451	BN11 High Power LED /	80	30	3000K	6W	705 lm	EW (00)	DO No Dim	11 White
					4000K		750 lm		DP Phase	29 Grey
Trafofo Bollard Single	3453		600						D1 0-10V Dim	
	3454		1000							
Trafofo Wall Double Up & Down	3452		/			2x6W	1410 lm			
							1500 lm			
Trafofo Bollard Double	3455		600							
	3456		1000							

Notes:

* For complete code ordering information, please see page 353.

** For other CCT options, please contact us.

For related accessories, please see page 348.

EW = Extra Wide. Ordering code: **00**.

For the items code 3452, 3455 and 3456 LED power is double (6.3W x 2).

FioreLED

Designed by Franco Mireni



Body

Miniature ground/wall spot light system with base, back plug cover and light head in cast aluminium, inclusive of toughened safety glass, optical lenses, weatherproof durable silicone gasket, stainless steel screws and flexible arm made of brass with external black heat-shrink sheath.

Fixture is available in 2 different bases, Round or Rectangular.

Electrical installation includes double cable entry for through wiring.

Accessories

Spikes for ground installation.
Check page 348 for details.

Finish

Superior polyester powder body coat in black colour with base in grey colour.

LED sources

High Power LED. CRI: 80 | CCT: 3000K, 4000K.
Other CRI and CCT options available on request.

Optic

Lens.
Medium, wide and superwide beam angle available.

Driver

Supplied with integrated no-dimmable driver.
Dimming Options: 0-10V Dim, DALI, Phase.

Applications

The glare shield cap integrated in the design maintains the environment from unpleasant glare light. Earth spike for portable or temporary use. Application areas: greenhouses, flowers, trees, plants, bushes, sculptures.

Related Products

Polo

P,294



FioreLED



FioreLED

Round base

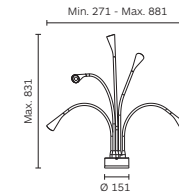

FioreLED

Rectangular base

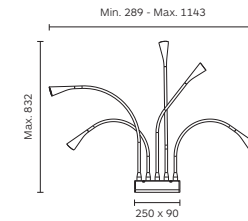

Code ordering example: **3 4 3 7 B N 1 1 - 8 0 3 0 1 6 D 0 9 2**

	Product Code	Light Source Code*	>CRI	CCT**	LED Power	Nominal Lumen	Beam Angle (BA°)	Driver Options	Finish		
FioreLED Round base	3437	BN11	High Power LED	80	30	3000K	5x2W	1175 lm	16 / 26 / 40	D0 No Dim	92 Black/Grey
				40	4000K	1250 lm		DA Dali Dim			
FioreLED Rectangular base	3438							D1 0-10V Dim			
								DP Phase			

Notes:

- * For complete code ordering information, please see page 353.
 - ** For other CCT options, please contact us.
- For related accessories, please see page 348.

Fontanaluce

Recessed / Surface mounted underwater luminaire

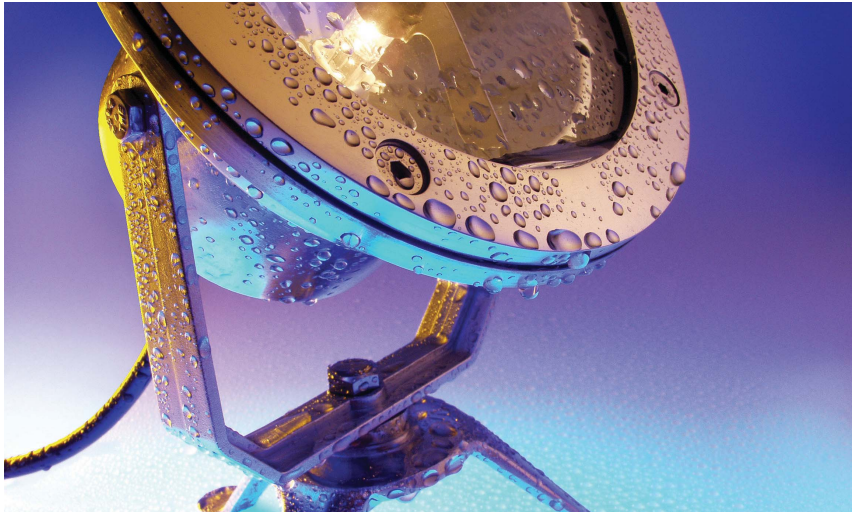

Body

Recessed/ground mounted underwater luminaire with housing and tripod base (ground version) in cast stainless steel (AISI 316) with toughened thermal-shock glass, durable silicone gasket and external screws of stainless steel.

IP68 fixture (pressure water tight up to 600mm).

Easy electrical installation via the included hard wire rubber cable.

Ground version equipped with mechanical locking system to ensure aiming stability.

Accessories

IP65 extension signal cable, IP65 junction box. Check page 346 for details.

Finish

External finish in stainless steel (AISI 316).

LED sources

High Power LED. CRI: 80 | CCT: 3000K, 4000K. Other CRI and CCT options available on request.

Optic

Lens. Medium and wide beam angle available.

Driver

Supplied, According with the chosen model, with no-dimmable or DMX remote driver inclusive of IP67 driver box. Dimming Options: 0-10V Dim, DALI, Phase, CASAMBI.

Applications

Designed for use into fresh water (no salt or spring water installation) integrating RGB color-changing or dimming control technology. Can be flush recessed in the wall or as free standing portable light and may be used for indoor or outdoor applications. Application areas: pools, fountains, ponds, gardens.

Related Products

Fronteluce

P.278



Fontanaluce



Fontanaluce

Recessed

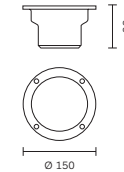

Fontanaluce

Surface

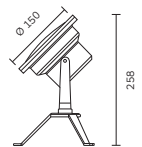

Code ordering example: **3 0 7 5 B N 1 1 - 8 0 3 0 1 1 D 0 8 4**

	Product Code	Light Source Code*	>CRI	CCT**	LED Power	Nominal Lumen	Beam Angle (BA*)	Driver Options	Finish	
Fontanaluce Recessed	3075	BN11	High Power LED	80	30 3000K	12W	1510 lm	11 / 24 / 40	D0 No Dim	84 Stainless Steel
					40 4000K		1650 lm	DX DMX		
Fontanaluce Surface	3073							DA Dali Dim		
								D1 0-10V Dim		
								DP Phase		
								DC CASAMBI		
			RG	B0 RGB		/	00	DX DMX		
				BW RGBW				DC CASAMBI		

Notes:

* For complete code ordering information, please see page 353.

** For other CCT options, please contact us.

For related accessories, please see page 346.

Accessories

Product / Accessories	Extension Signal cable	Extension Signal cable	Junction Box
	IP65 / L: 1000 mm	IP65 / L: 2000 mm	IP65
	For RGB with M/F connectors. Must be operated outside the water.	For RGB with M/F connectors. Must be operated outside the water.	Empty box with multi-cable entries. Electronic power supply for LED not included. To be ordered separately and to be placed inside junction box. Dimension: 130 x 94 x 56mm
Fontaluca Recessed	2478	2479	2576
Fontaluca Ground			

Single colour wiring diagram

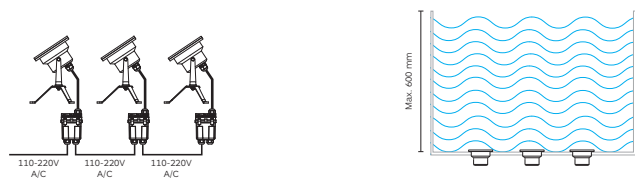

RGB wiring diagram

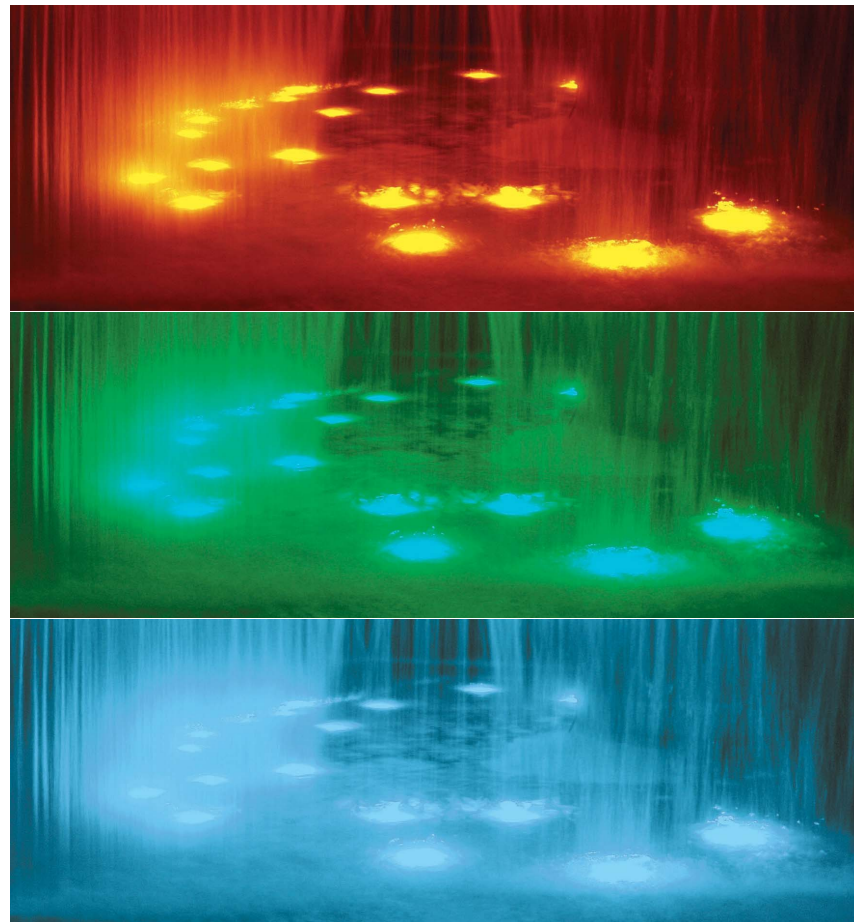
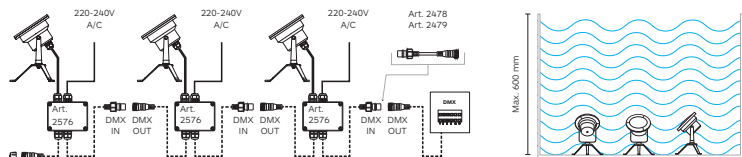

Product name: Fontaluca Recessed

Accessories



Product / Accessories	Anchor Bolt Kit In steel	Anchor Bolt Kit In steel	Fast connector M20 IP68	3-Way Junction Box IP68	Slot 1 Available in colour 79
	To ditch in concrete.	To ditch in concrete.	Ø 6 - 12 mm) Connection must be done inside an accessible box.	2 set of gasket rings included suitable for wide range of cable diameters: Ø5 - Ø8 mm) Ø8 - Ø14 mm)	
Trafo	2231	/	/	/	/
Cornetto	/	2601	/	/	/
Optiwall	/	/	2577	2355	/
Cubox	/	/	/	/	2064
Corolla	/	2601	/	/	/
Scudo Wall Ground	/	/	2577	/	/
Scudo Wall	/	/	/	/	/



Product / Accessories	Protective Grill	Visor	Spike	Spike	Pole mounted bracket set
	Available in colours 10 and 29 In die cast aluminium.	Available in colours 10 and 29 In die cast aluminium.	Available in colour 10 The 50 mm upper part must stay above ground level according to standards.	Available in colour 10 In plastic. The 50 mm upper part must stay above ground level according to standards.	Available in colours 10, 29
Polo 68	2375	2378	/	2372	/
Polo 35	/	/	/	2373	/
FioreLED Rectangular base	/	/	2330	/	/
FioreLED Round base	/	/	/	2652	/
Scudo Wall Ground	/	/	/	/	2509 2510

Accessories



Product / Accessories	Reflector colour 27	Reflector colour 73	Reflector colour 10	Honeycomb Louvre colour 10
Galaxis 87 IP65		2E70		2E71
Galaxis 110 IP65		2E72		2E73
Galaxis 135 IP65		2E74		2E76
Galaxis 160 IP65		2E77		2E78
Galaxis 186 IP65		2E79		2E80



Product / Accessories	Spike Available in colour 10	Spike Available in colour 10	Anchor Bolt Kit In steel To ditch in concrete.
Volume 58 3620 3621	/	2E21	/
Volume 70 3622	/	2E21	/
Volume 110 3623 3624	2E20	/	2E22



Product / Accessories	Anti Glare Snoot Available in colour 10	Anti Glare Snoot Available in colour 10	Anti Glare Snoot Available in colour 10
Volume 58 3625 3620 3621	2E23	/	/
Volume 70 3626 3622	/	2E24	/
Volume 110 3627 3623 3624	/	/	2E25

Symbols & Icons

Code system

Global presence

Symbols & Icons

Trim Round	
Trim Square	
Trimless Round	
Trimless Square	
Round ceiling cut	
Square ceiling cut	
<p>The CE mark signifies that a product conforms with the relevant ECC directives requirements. The CE marking is compulsory to indicate LVD and EMC conformity.</p> <p>The CE mark is also a self certification that the manufacturer claims that the product is safe. The value of such claim is directly related to the case of Formalighting: All products are designed, developed, manufactured under the scope of ISO 9001 quality systems.</p> <p>All formalighting products are tested in Europe and certified by an independent laboratory that is registered and audited by an approved European testing authority.</p>	
<p>Others third party product approvals</p> <p>Our products include electrical and electronic components that carry other world wide Test House approvals such as those shown:</p>	
<p>CLASS I Luminaires of insulation Class I - with earth connector.</p>	
<p>CLASS II Luminaires of insulation Class II - With safety isolation, this means the tension conduction element are protected by additional isolation. The isolation of an earth wire it is not necessary and the connection to it is not allowed.</p>	
<p>CLASS III Luminaires of insulation Class III - designed for operation of protected low voltage supply (>42V).</p>	
<p>Passes the 850C glow wire test in accordance with ICE 695-2-1.</p>	
<p>Passes the 960C glow wire test in accordance with ICE 695-2-1.</p>	
Dim2Warm	
Tunable White	
Zoom	
Recyclable	
220-240V Alternating Current	
24V Direct Current	

IP__ Degree of Ingress Protection

1st Number	Protection Against Dust and Solid Objects	2nd Number	Protection Against Moisture and Liquids
0	No-Protection	0	No-Protection
1	Protection against solid objects >50 mm	1	Protection against dripping water
2	Protection against solid objects >12 mm	2	Protection against dripping water tilted > 15 deg
3	Protection against solid objects >2.5 mm	3	Protection against spraying water > 30 deg
4	Protection against solid objects >1 mm	4	Protection against spraying water
5	Dust - protected	5	Protection against water jet
6	Dust - tight	6	Protection against waves
		7	Protection against the effects of immersion
		8	Protection against submersion

Level of Shock Resistance

IK00	Not protected	
IK01	Protected against 0.15 J shocks	
IK02	Protected against 0.2 J shocks	
IK03	Protected against 0.35 J shocks	
IK04	Protected against 0.5 J shocks	
IK05	Protected against 0.7 J shocks	
IK06	Protected against 1 J shocks	
IK07	Protected against 2 J shocks	
IK08	Protected against 5 J shocks	
IK09	Protected against 10 J shocks	
IK10	Protected against 20 J shocks	

Code system

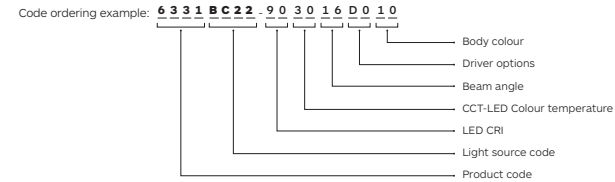

LED CRI	Driver Options	Body Colour
80 CRI > 80	00 No Driver	10 Black
90 CRI > 90	D0 No dimming	11 White
95 CRI > 95	DL Laser Dim	17 Black / White (B&W)
	DA Dali Dim	26 White / Gold (W&G)
	DP Phase	27 Chrome Polished
	DX DMX	28 Brass Polished
	DC CASAMBI	29 Grey (for Outdoor use)
	D1 0-10V Dim	33 Silver
	DN On-board Dimmer	34 Nickel
		35 Gold
		54 Sanded White (for outdoor use)
		55 Red
		74 Nickel Polished
		75 Grey (RAL 9006)
		79 Natural Aluminium
		84 Stainless Steel
		92 Black / Grey (B&G)

CCT-LED Colour temperature	
27	Warm White 2700K
30	Warm White 3000K
40	Neutral White 4000K
50	Cool White 5000K
57	Cool White 5700K
TW	Tunable White 1800K - 6000K

How to order

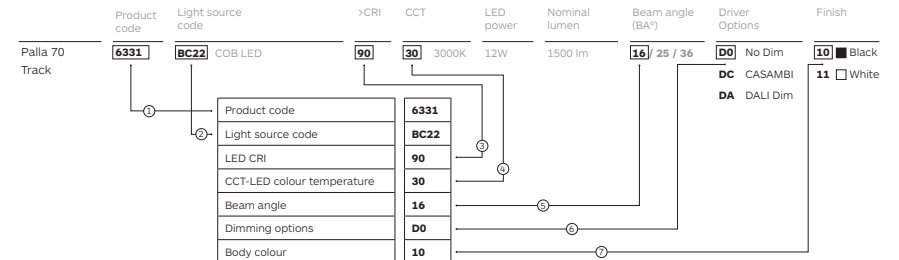

All dimensions in the catalogue in mm.

Global presence

Celebrating 50 years of vision, dedication and innovation, Formalighting's versatile and high-quality product offerings extends internationally via our headquarters in Hong Kong, London, Milan, Shanghai and the USA. Our well chosen and selected partners as well as our affiliated international offices broaden our global presence further in markets such as Australia, Japan, South East Asia, India and the Middle East.

Through our commitment to growth and investment within formalighting's professional team, infrastructure and product ranges, we are able to provide increasing service to our global retail and hospitality clients as well as lighting designers and specifiers strengthening our position as a leading international supplier of innovative architectural lighting solutions and systems.

With 50 years' experience in designing and manufacturing architectural lighting, formalighting's comprehensive portfolio offers a competitive range of European designed and expertly engineered products that carry CB, CE, CCC and UL certifications.

Furthermore formalighting's latest award-winning motorized range of track, pendant, and recessed fixtures, featuring remote-controlled adjustable pan and tilt, dim, dim to warm, tuneable white and beam shaping lens, are available worldwide incorporating the latest, most advanced lighting technologies.

Headquarters

Europe / Milan

Tel (+39) 02 9354 0300
Fax (+39) 02 9343 5117
E-mail formaitalia@formalighting.it

Asia / Hong Kong

Tel (+ 852) 2516 6500
Fax (+ 852) 2516 6525
E-mail forma@forma.com.hk

USA / New York

Tel (+ 1) 470 419 4003
E-mail info.us@formalighting.com

Formalighting is constantly developing and improving its products therefore all information, drawings illustrations, specifications, photometric values in this catalogue are indicative and shall not form part of any commitment to our company that reserve the right to change specifications without prior notification or public announcement. Technical information on the installation-instruction has precedence over the information in the catalogue. Our general terms and conditions shall apply notwithstanding any stipulation on the contrary to all the orders and agreement with formalighting. You can obtain a copy of these conditions on demand.

Publication date: August 2021
©Copyright formalighting

With thank to all contributors for the realization of this catalogue

Designed by formalighting Graphic Design Department

No part of this catalogue may be copied without written authorization of formalighting

formalighting

HONG KONG

-

LONDON

-

MILAN

-

SHANGHAI

-

NEW YORK