

Creating unprecedented products with unprecedented performance.

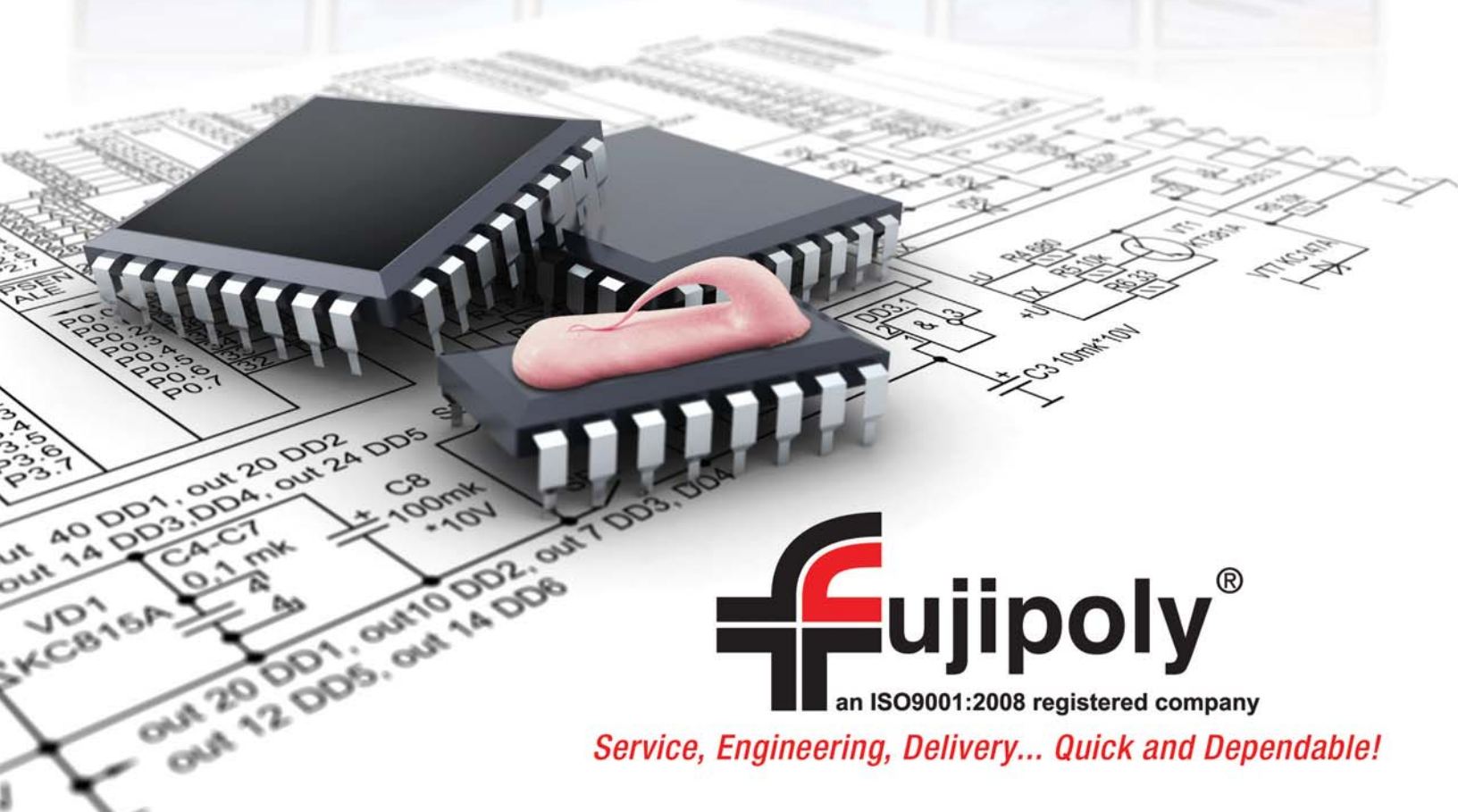

**Fujipoly**<sup>®</sup>  
an ISO9001:2008 registered company

*Service, Engineering, Delivery... Quick and Dependable!*

SARCON<sup>®</sup> THERMAL INTERFACE MATERIALS    ZEBRA<sup>®</sup> ELASTOMERIC CONNECTORS  
CUSTOM SILICONE EXTRUSIONS

**FUJIPOLY.COM**

# FUJIPOLY TABLE of CONTENTS



1	<b>Fujipoly® Introduction</b>
2-13	<b>Zebra® Elastomeric Connectors</b> Complete selection of low resistance, high conductivity, high density silicone connectors
14-15	<b>LCD Bezels and Connectors</b> Wide assortment of standard sizes for common LCD displays
16-35	<b>SARCON® Thermal Management Materials</b> Thermally conductive silicone components in sheets, rolls, die-cuts, pads, sleeves and cases
16	<b>Technical Overview, Products</b>
17	<b>Sarcon® Thin Film Profiles</b>
18-25	<b>Thermal Gap Filler Pads</b>
26	<b>Sarcon® GR-Pm, XR-Pe Silicone Putty</b>
27	<b>Sarcon® XR-Um, XR-Um-AL, XR-v, XR-v-AL, Silicone Putty</b>
28	<b>Sarcon® GR-Sd, GR-SL, Low Compression Force Gap Filler</b>
29	<b>Sarcon® Thermally Conductive Greases</b>
30-31	<b>Sarcon® SPG-15A, SPG-30A "Form in Place" Gap Filler</b>
32	<b>Sarcon® Non-Silicone Gap Filler</b>
33	<b>Sarcon® Thin Film Profiles in Rolls and Sheets</b>
34	<b>Sarcon® "Sleeve" Shape Thermal Extrusions</b>
34	<b>Sarcon® "Case" Shape Thermal Extrusions</b>
35	<b>Sarcon® Die-cut Gaskets</b>
36	<b>Fusible Tapes</b> Insulative and conductive self-fusing tapes
37	<b>Custom Silicone Rubber Extrusions</b> Complex co-extruded shapes, gaskets and seals
38-45	<b>Design Guidelines-all products</b> Handy engineering and installation information
46-48	<b>Engineering Notes</b>
49	<b>Ordering Information</b> Fujipoly® Locations and Distributors

## **Fuji Polymer Industries Co., Ltd.**

### **Sales Department**

175 Kajiyashiki, Toyota,  
Aichi 4700533 JAPAN  
tel: 81-565-65-1729 fax: 81-565-65-1857  
e-mail: [fujipoly@mx.fujipoly.co.jp](mailto:fujipoly@mx.fujipoly.co.jp)  
ISO9001 (Aichi Plant)

## **Fujipoly America Corp.**

900 Milk Street  
P.O. Box 119  
Carteret, NJ 07008-0119  
tel: 732.969.0100 fax: 732.969.3311  
e-mail: [info@fujipoly.com](mailto:info@fujipoly.com)  
web site: [www.fujipoly.com](http://www.fujipoly.com)  
ISO9001-2008

## **Fujipoly (Thailand) Co., Ltd.**

55/8 Moo 13 Navanakorn Industrial Estate Phase 4  
Phaholyothin Road, Klong Nueng, Klong Luang  
Pathumthanee 12120 Thailand  
tel: 66-2-529-2732 fax: 66-2-529-2223  
e-mail: [marketing@fujipoly.co.th](mailto:marketing@fujipoly.co.th)  
ISO9001 ISO14001

## **Fujipoly Europe Ltd.**

Avant Business Centre, Unit 8  
Third Avenue  
Bletchley, Milton Keynes MK1 1DR U.K.  
tel: 44-1-908-277800 fax: 44-1-908-277900  
e-mail: [sales@fujipolyeurope.co.uk](mailto:sales@fujipolyeurope.co.uk)

## **Fujipoly Singapore Pte, Ltd.**

1001 Jalan Bukit Merah #02-17/20  
Singapore 159455  
tel: 65-6272 3766 fax: 65-6272 3577  
e-mail: [info@fujipoly.com.sg](mailto:info@fujipoly.com.sg)  
ISO9001

## **Fujipoly Hong Kong Ltd.**

Unit F & J, Block 1,4 Fl.  
Kwai Tak Industrial Centre  
15-33 Kwai Tak Street, Kwai Chung, N.T., Hong Kong  
tel: 852-24283770 fax: 852-24899637  
e-mail: [info@fujipoly.com.hk](mailto:info@fujipoly.com.hk)

## **Fujipoly China Ltd. (China Factory)**

Gaobao Road, The First Industrial Park  
Tutang Estate, Changping Town, Dongguan City,  
Guangdong, 523581, China  
tel: 86-769-83989660 fax: 86-769-83989662  
e-mail: [info@fujipoly.com.hk](mailto:info@fujipoly.com.hk)  
ISO9001/ISO14001

## **Fuji Polymer Industries Co., Ltd.**

### **Taipei Liaison Office**

Room B, 7F., No. 59, Tiansiang Rd.  
Jhongsan District  
Taipei City 10452, Taiwan  
tel: 886-2-2586-5771 fax: 886-2-2586-5745  
e-mail: [fujipolytw@fujipoly.com.tw](mailto:fujipolytw@fujipoly.com.tw)

## **Fuji Malaysia Sdn.Bhd. (Malaysia Factory)**

Plot 26, Phase 4, Free Industrial Zone  
Hilir Sungai Keluang 3, Bayan Lepas Penang, 11900 Malaysia  
e-mail: [info@fujipoly.com.my](mailto:info@fujipoly.com.my)

# FUJIPOLY SILICONE ELECTRONIC PACKAGING COMPONENTS

## *A NETWORK of DEPENDABLE PRODUCTS to INCREASE YOUR PRODUCTS' DEPENDABILITY*

*A worldwide network to serve your electronic packaging needs. Fujipoly's multi-plant system was established for, and continues to grow toward, excellence in meeting customers' needs matched with excellence in product performance.*

*We manage a globally responsive, diverse group of facilities. Technologies have been both developed and acquired. Locations have been established based on a borderless business strategy to meet the growing trend of internationalization.*

*Manufacturing and distribution centers located in Europe, North America and Asia keep us close to our customers' needs while giving them convenient access to our increasing technologies.*

*Less than 5% of silicone potential has been researched to date. And, probably even more applications than we can now imagine are possible.*

*The inherent advantages of silicone already seem limitless. There are very few commercial or industrial products which do not contain some form of it as a molded, extruded or die-cut shape.*

*The composition of formulations is almost infinite - each offering strong advantages in one characteristic or another, many with great superiority over other materials.*

*Fujipoly's proprietary research and specific treatments are focused on obtaining the highest overall performances for the field of electronic packaging. Some of these areas are:*

- Heat Resistance
- Flame Retardance
- Low Compression Set
- Oil & Solvent Resistance
- Weather Resistance
- Thermal Conductivity
- Electrical Conductivity
- Electrical Insulation
- Cold Resistance
- Self adhesion
- Variety of Shapes and Sizes Possible
- Aging Resistance
- Ease of Custom Manufacturing



# ZEBRA® Elastomeric Connectors

ZEBRA® Elastomeric Electronic Connectors are a comprehensive group of high performance interconnect devices with applications throughout the entire field of electronics.

With the expansion of micro-electronics and miniaturization of all products, the same high reliability must be maintained.

ZEBRA® Elastomeric Connectors are an obvious choice. And one which offers a variety of alternatives based on the primary design objectives. Some of the more important considerations are:

- High Density; increased number of I/O's
- Low resistance, high current capacity
- Low insertion force, low compression force
- Redundant contact engagement
- High electrical and mechanical reliability
- Chemical stability, degradation resistance
- Cost-effectiveness, ease of assembly

ZEBRA® Elastomeric Connectors have alternating conductive and non-conductive layers. See diagram below. The conductive layers are oriented vertically in the thickness direction, making contact from top to bottom.

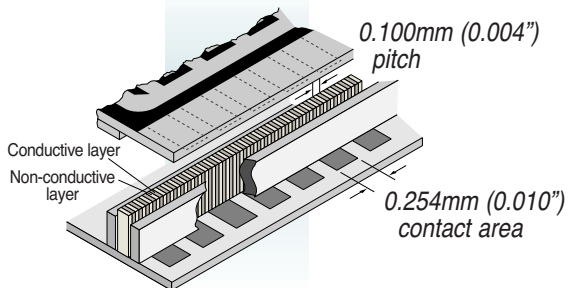

Typical ZEBRA® Connector interface between two contact areas; such as, PCB to LCD, or PCB to PCB.

All styles offer redundant contact depending on the pitch of the conductive layers, some as small as 0.05 mm centerline (see drawing above).

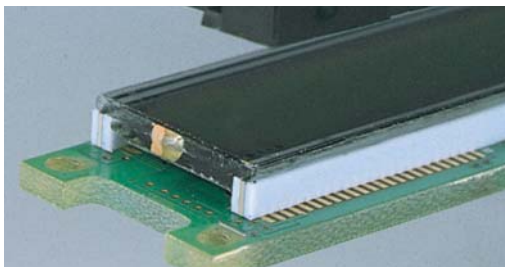

ZEBRA® Silver Connector in medical instrument display.

## APPLICATIONS:

- LCD and EL displays
- Board-to-board
- Chip-to-board
- Memory cards
- Flex circuit-to-board
- Burn-in sockets
- Miniature and low profile interconnect - general electronics

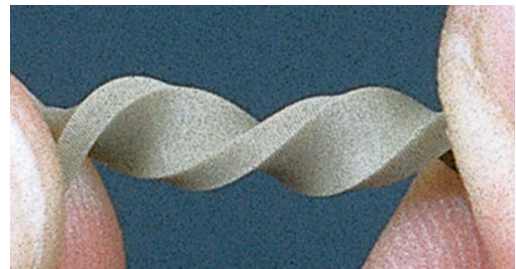

High strength bonding unitizes layers into one rugged body.

Each of the styles is also available with outer support sections along the entire length on one or both sides (except Series 8000). The support is available in sponge or solid silicone rubber, and creates a larger width area. This eliminates the need for a holder while still allowing a very low compression force during deflection. For optional ordering information, see instructions on page 6 under "Self-Supported Connectors".

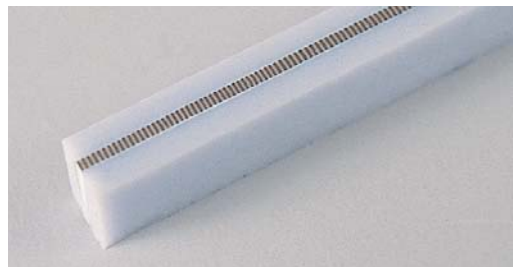

Typical ZEBRA® Connector with optional silicone rubber self-support sections on each side.

# ZEBRA® CONNECTOR TECHNICAL DATA

The six ZEBRA® Elastomeric Connector designs below are detailed in their dimensional and performance characteristics. Follow the general guidelines to determine the design characteristics most suitable for your application. See following pages for detailed characteristics.

The photo enlargements at right demonstrate the multiple contact points per circuit conductor pad for typical ZEBRA® connector designs.

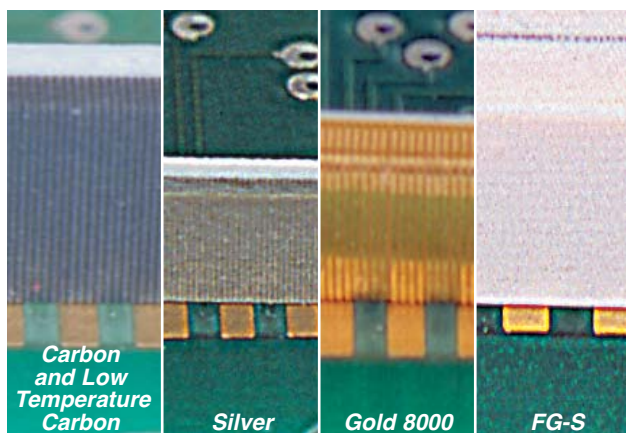

Name	Application Guidelines	Typical Products
<b>Carbon</b>	Economical general use with contact pitches at 140, 240 or 500 per inch	LCD's for aerospace, aircraft, military, meters, instruments, cameras
<b>Low Temperature Carbon</b>	Low temperature, outdoor applications, specifications as low as -60°C with contact pitches at 240 per inch	
<b>Silver</b>	300mA current carrying capacity, rugged long-life aging with contact pitches at 240 per inch	Electroluminescent displays, component-to-board, burn-in sockets, PCB to PCB, chip on glass, LCD's, chip on foil, COF's
<b>Gold 8000</b>	Zero insertion force, tight pitch, low compression force, very low resistance, very high current carrying capacity; contact pitches at 100, 133, 166 per inch	
<b>FG-S</b>	Zero insertion force, very low compression force, low resistance, high current carrying capacity, 240 gold-plated contacts per inch in a single row	

## TYPICAL PERFORMANCE CHARACTERISTICS:

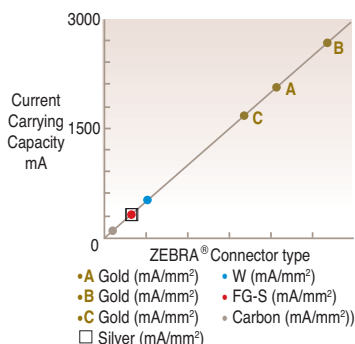
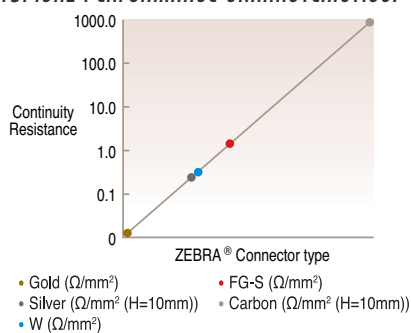

## SIDE SUPPORT or INSULATION BARRIER:

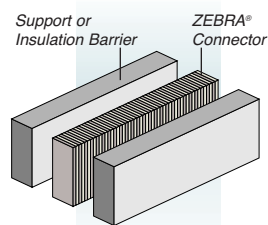

Drawing at left shows side support or insulation on one or both sides, or one of each.

Various materials are available from the minimum insulating barrier of 0.05mm to support layers of up to 1.5mm. Support layers can be soft silicone rubber, or medium and soft silicone sponge. Recommended height is twice the width for minimum force deflection.

See page 6 for details. Consult customer service for ordering specifications.

## Part Number Nomenclature:

To specify a connector to your exact requirements, substitute the metric measurements for width, length and height according to instructions below; example part# Ag(2.0 IB1 x 20 x 2.0)-U; **Note: For Carbon Zebra, make sure to advise pitch desired.**

**ZEBRA® Ag (2.0 - IB1 x 20 x 2.0)**

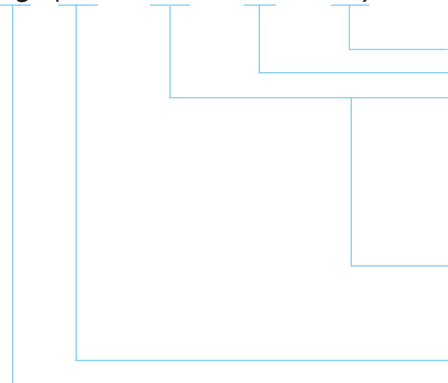

- Height
- Length
- Insulation Barrier or Solid Support (if required)
  - LT, CA, Ag only
  - IB1 0.05mm Insulation barrier 1 side only
  - IB2 0.05mm Insulation barrier 2 sides
  - SS1 Solid Support 1 side only (specify ZEBRA® thickness; i.e., SS1-1.5)
  - SS2 Solid Support 2 sides (specify ZEBRA® thickness; i.e., SS2-1.5)
  - SPG Sponge Support 2 sides (see standards page 6)
- Au only: Wire Pitch (Insulation Barrier component not needed for Au)
  - Au-A 0.25mm (0.010") wire pitch
  - Au-B 0.19mm (0.0075") wire pitch
  - Au-C 0.15mm (0.006") wire pitch

Width  
 ZEBRA® series: • FG-S for single contact row  
 • LT for Low Temperature Carbon • CA for Carbon • Ag for Silver • Au for Gold

# ZEBRA® Elastomeric Connectors

## ZEBRA® CARBON and LOW TEMPERATURE CARBON CONNECTORS

FUJIPOLY ZEBRA® connectors (see figure 1) have alternating layers of conductive carbon-filled and non-conductive silicone rubber. They make reliable connections by being deflected between contacting surfaces. ZEBRA® connectors are used for connecting any LCD from small displays for watches to large area displays for instruments. Table A shows the different types of ZEBRA® connectors available. Table C shows performance characteristics.

Figure 1 shows the three dimensions of the ZEBRA® connector. When ordering, the three dimensions should be specified within the limits shown in table B.

For best overall performance, ZEBRA® connectors must be ordered and used with a ratio of H/W equal to or greater than 1.5.

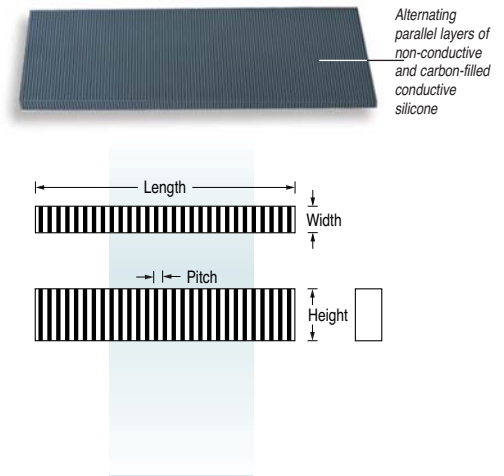

Figure 1

Series	LCD Contact Spacing Center-to-Center Minimum	Pitch: Sum of the Thickness of an Adjacent Conductive and Non-conductive Layer		Conductive Layers per inch Minimum	Individual Conductive and Insulating Layer Thickness		Available Lengths Maximum
		Nominal	Maximum		Minimum	Maximum	
1002 (CZ410/CZ710)	0.015 in. 0.38 mm	0.004 in. 0.10 mm	0.006 in. 0.15 mm	240	0.001 in. 0.025 mm	0.004 in. 0.10 mm	9.0 in. 230 mm
2004 (CZ418)	0.020 in. 0.50 mm	0.007 in. 0.18mm	0.010 in. 0.25 mm	140	0.002 in. 0.050 mm	0.006 in. 0.15 mm	9.0 in. 230 mm
2005 (CZ405/CZ705)	0.010 in. 0.25 mm	0.002 in. 0.050 mm	0.004 in. 0.10 mm	500	0.0004 in. 0.010 mm	0.0024 in. 0.060 mm	9.0 in. 230 mm
LT 200 (CZ610)	0.015 in. 0.38 mm	0.004 in. 0.10 mm	0.006 in. 0.15 mm	240	0.001 in. 0.025 mm	0.004 in. 0.10 mm	5.0 in. 127 mm

TABLE A

### Measurement

### Tolerance (inches/mm)

Length=L	0.157 in. to 2.40 in. — ± 0.008 in. /..... 2.410 in. to 6.00 in. — ± 0.015 in. /..... 6.010 in. to 7.87 in. — ± 0.020 in. /..... 7.880 in. to 9.00 in. — ± 0.039 in. /.....	4.00 mm to 61.00 mm — ± 0.20 mm 61.2 mm to 152.4 mm — ± 0.38 mm 152.6 mm to 200.0 mm — ± 0.50 mm 200.1 mm to 230.0 mm — ± 1.00 mm
Height=H	0.020 in. to 0.750 in. ± 0.005 in. /..... above 0.750 in./19.0 mm consult factory	0.50 mm to 19mm ± 0.127 mm
Width=W	0.015 in. to 0.039 in. — ± 0.002 in. /..... 0.040 in. to 0.079 in. — ± 0.003 in. /..... 0.080 in. to 0.118 in. — ± 0.005 in. /..... above 0.118 in./3.00 mm consult factory.	0.38 mm to 1.0 mm — ± 0.050 mm 1.01 mm to 2.0 mm — ± 0.076 mm 2.01 mm to 3.0 mm — ± 0.127 mm

TABLE B

ZEBRA® Connectors	Temperature Range		Current Carrying Capacity 0.040" x 0.040" pad	Resistance Between Layers
	Minimum	Maximum		
Carbon	-40°F -40°C	212°F 100°C	0.005 amps	10 <sup>12</sup> ohms
Low Temperature LT 200	-85°F -65°C	260°F 125°C	0.005 amps	10 <sup>12</sup> ohms

TABLE C

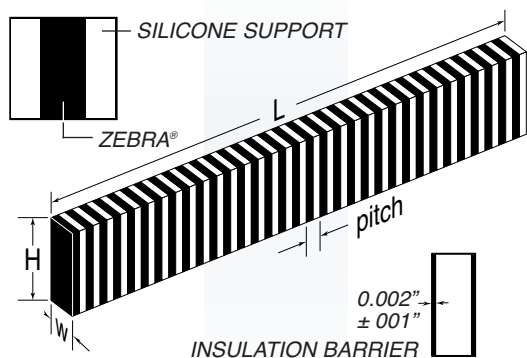

Figure 2 Recommended Height (H) should be 1.5 x Width (W) dimension for minimum force deflection. Maximum Skewness 2% of Height.

### ZEBRA® CONNECTOR DIMENSIONS

Figure 2 shows the three dimensions of the ZEBRA® connector. When ordering, the three dimensions should be specified within the limits shown in Table B. For best overall performance, ZEBRA® connectors must be ordered and used with a ratio of H/W equal to or greater than 1.5. Details show silicone support (left) and insulation barrier (right). Each is available on one or both sides. Configurations may also include support on one side and insulation on the other.

### ZEBRA® CONNECTOR INSULATING BARRIER

Description	Insulating Barrier
Color (one only)	White
Hardness, Durometer A	30
Dielectric Strength volts/mil.	500
Resistance, ohms	10 <sup>12</sup>
Insulating Barrier Width (B) in.*	0.002 ± 0.001
(B) mm	0.050 ± 0.025

TABLE D \*The tolerance of W<sub>i</sub> is equal to the sum of the tolerances of W.

### NOMINAL RESISTANCE CALCULATION

To calculate the resistance of the ZEBRA® connector use the following formulas:

Where: C<sub>w</sub> = Contact pad width in inches  
 H = ZEBRA® connector height in inches  
 W = ZEBRA® connector width in inches

Metric:

$$R = \frac{60 \times H}{E_w \times W}$$

Inches:

$$R = \frac{2.37 \times H}{E_w \times W}$$

Where:

R = Resistance (Ω)  
 E<sub>w</sub> = Electrode Pad width (mm or inches)  
 W = Connector width (mm or inches)  
 H = Connector height (mm or inches)

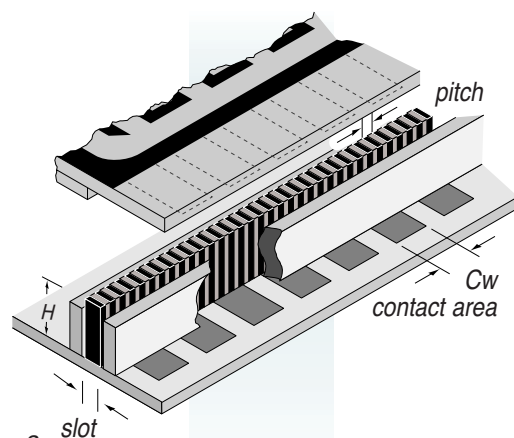

Figure 3

### NOMINAL FORCE DEFLECTION - PLAIN ZEBRA® OR INSULATION BARRIER TYPE

ZEBRA® connectors should be deflected 5% to 25% of H. To calculate F-Force for deflection, use the following formula:

Where:

F = Force (N)

$$D = \frac{H - H_1}{H} \times 100 (\%)$$

H = Height of connector (mm or inches)

H<sub>1</sub> = Deflected height of connector (mm or inches)

W = Width of connector (mm or inches)

W<sub>1</sub> = Width of ZEBRA portion (mm or inches)

L = Length of connector (mm or inches)

Metric:

$$F(N) = 9 \times D \times W \times L \times 9.8 \times 10^3$$

Inches:

$$F(N) = 5806 \times D \times W \times L \times 9.8 \times 10^3$$

### NOMINAL FORCE DEFLECTION - SILICONE SUPPORT TYPE

Metric:

$$F(N) = [(9 \times D \times W_1 \times L) + \{2.2 \times D \times (W - W_1) \times L\}] \times 9.8 \times 10^3$$

Inches:

$$F(N) = [(5806 \times D \times W_1 \times L) + \{1419 \times D \times (W - W_1) \times L\}] \times 9.8 \times 10^3$$

# ZEBRA® Elastomeric Connectors

## ZEBRA® SOLID SELF-SUPPORTED CONNECTORS

The Solid Self-Supporting ZEBRA® connector utilizes a standard ZEBRA® connector element supported by a soft, non-conductive silicone rubber on one or two sides. The silicone rubber creates a larger width that eliminates the need for a holder, and yet the force required for deflection is very low. The standard Solid Self-Supporting ZEBRA® connector has a 0.020"/0.50mm wide ZEBRA® connector element and is available in 8 different widths to accommodate LCD's with a glass lip overhang of 0.050"/1.27 mm minimum.

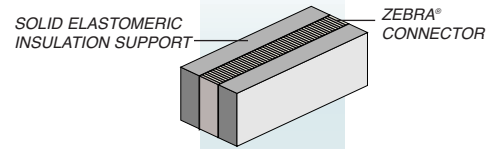

ZEBRA® Element	LCD Contact Spacing in/mm	Standard Connector Widths	
2004 (CZ418)	0.020/0.50	0.050 in./ 1.27 mm	0.090 in./ 2.3 mm
1002 (CZ410/CZ710)	0.010/0.25	0.060 in./ 1.50 mm	0.100 in./ 2.5 mm
2005 (CZ405/CZ705)	0.006/0.15	0.070 in./ 1.8 mm	0.120 in./ 3.00 mm
		0.080 in./ 2.0 mm	0.140 in./ 3.50 mm

### Measurement

### Tolerance (inches/mm)

<b>Length=L</b>	0.157 in. to 2.40 in. — ± 0.008 in. .... / ..... 2.410 in. to 6.00 in. — ± 0.015 in. .... / ..... 6.010 in. to 7.87 in. — ± 0.020 in. .... / ..... 7.880 in. to 9.00 in. — ± 0.039 in. .... / .....	4.00 mm to 61.00 mm — ± 0.20 mm 61.2 mm to 152.4 mm — ± 0.38 mm 152.6 mm to 200.0 mm — ± 0.50 mm 200.1 mm to 230.0 mm — ± 1.00 mm
<b>Height=H</b>	0.039 in. to 0.750 in. ± 0.005 in. .... / ..... above 0.750 in./19.0 mm consult factory	1.0 mm to 19mm ± 0.127 mm
<b>Width=W</b>	0.050 in. to 0.079 in. — ±0.006 in. .... / ..... 0.080 in. to 0.100 in. — ±0.007 in. .... / ..... 0.101 in. to 0.140 in. — ±0.008 in. .... / ..... above 0.140 in./3.50 mm and for custom widths consult factory.	1.27 mm to 2.00 mm — ± 0.15 mm 2.03 mm to 2.54 mm — ± 0.18 mm 2.55 mm to 3.50 mm — ± 0.20 mm

ZEBRA® Connectors	Temperature Range		Current Carrying Capacity	Resistance
	Minimum	Maximum	0.040" x 0.040" pad	Between Layers
All series	-40°F -40°C	212°F 100°C	0.005 amps	10 <sup>12</sup> ohms

## ZEBRA® SPONGE SELF-SUPPORTED CONNECTORS

The Self Supporting Sponge ZEBRA® connector utilizes standard ZEBRA® connector elements supported by a silicone sponge rubber on one or two sides. The silicone sponge creates a larger width that can eliminate the need for a holder, and yet the force required for deflection is very low. The standard Self Supporting Sponge ZEBRA® connector is available in a host of widths to accommodate LCD's with a glass lip overhang of 0.060"/1.5 mm minimum. The Self Supporting Sponge ZEBRA® connector is used to connect LCD's to printed circuit boards and eliminates bowing of the printed circuit board due to the low force required to make contact.

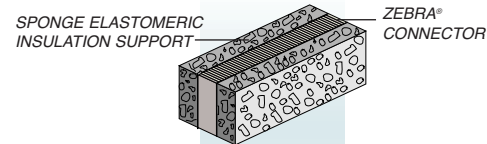

ZEBRA® Element	LCD Contact Spacing in/mm	Standard Connector Widths		
2004 (CZ418)	0.020/0.50	.060 in./ 1.5 mm	.087 in./ 2.0 mm	.118 in./ 3.0 mm
1002 (CZ410)	0.010/0.25	.063 in./ 1.6 mm	.091 in./ 2.3 mm	.126 in./ 3.2 mm
2005 (CZ405)	0.006/0.15	.067 in./ 1.7 mm	.100 in./ 2.5 mm	.138 in./ 3.5 mm
		.070 in./ 1.8 mm	.102 in./ 2.6 mm	.150 in./ 3.8 mm
		.075 in./ 1.9 mm	.106 in./ 2.7 mm	.157 in./ 4.0 mm
		.079 in./ 2.0 mm	.110 in./ 2.8 mm	

### Measurement

### Tolerance (inches/mm)

<b>Length=L</b>	0.157 in. to 2.40 in. — ± 0.008 in. .... / ..... 2.410 in. to 6.00 in. — ± 0.015 in. .... / ..... 6.010 in. to 7.87 in. — ± 0.020 in. .... / .....	4.00 mm to 61.00 mm — ± 0.20 mm 61.2 mm to 152.4 mm — ± 0.38 mm 152.6 mm to 200.0 mm — ± 0.50 mm
<b>Height=H</b>	0.039 in. to 0.750 in. ± 0.005 in. .... / ..... above 0.750 in./19.0 mm consult factory	1.0 mm to 19mm ± 0.127 mm
<b>Width=W</b>	0.060 in. to 0.157 in. — ±0.004 in. .... / ..... above 0.157 in./4.00 mm consult factory.	1.52 mm to 4.0 mm — ± 0.1 mm

ZEBRA® Connectors	Temperature Range		Current Carrying Capacity	Resistance
	Minimum	Maximum	0.040" x 0.040" pad	Between Layers
All series	-55°F -50°C	260°F 125°C	0.005 amps	10 <sup>12</sup> ohms



## ZEBRA® GOLD 8000 CONNECTORS

The FUJIPOLY ZEBRA® Series 8000 elastomeric connector elements are D-shaped, low durometer silicone elastomer cores around which flat metallic gold-plated conductors are vulcanized in a row parallel to each other. The tips of the metallic conductors are turned upward so that point contact can be effected; in addition, contact is made to the flat area when the connector element is positioned between two printed circuit boards. The point contact will penetrate surface oxides or contaminants which might be present on the surface of the contact pads, thus assuring reliable electrical connection on two planes. Also available are standard board to board assemblies which include connector and holder.

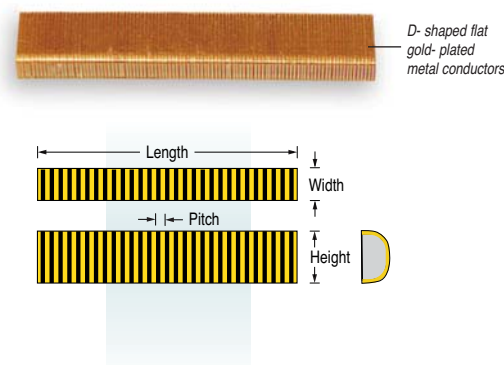

### DIMENSIONAL SPECIFICATIONS

Connector Dimensions*	Minimum		Maximum	
Length=L	0.200" ± 0.005"	5.08mm ± 0.127mm	6.000" ± 0.030"	152.4mm ± 0.762mm
Height=H	0.100" ± 0.005"	2.54mm ± 0.127mm	0.500" ± 0.015"	12.70mm ± 0.381mm
Width=W	0.060" ± 0.005"	1.52mm ± 0.127mm	0.125" ± 0.010"	3.18mm ± 0.254mm

**Note:** For good design practice and low deflection force requirements, the height "H" should be twice the width "W". For other sizes consult factory.

### MATERIALS

Connector Component	Materials Used
Conductive Elements	Gold-plated copper wire. gold 0.00025mm (0.00001"), nickel 0.0013mm (0.00005").
Wire Size and Spacing (Series 8000 A,B and C)	A. 0.05mm x 0.127mm (0.002" x 0.005") flat wire on 0.25mm (0.010") center-to-center spacing. (Min. 100 wires/ inch.) B. 0.05mm x 0.10mm (0.002" x 0.004") flat wire on 0.19mm (0.0075") center-to-center spacing. (Min. 133 wires/inch.) C. 0.025mm x 0.076mm (0.001" x 0.003") flat wire on 0.15mm (0.006") center-to-center spacing. (Min. 166 wires/inch.)
Connector body	Non-conductive tan color silicone rubber. UL-94-HB rating, 500 volts/mil dielectric strength.
Film	0.025mm (0.001") thick polyamide dielectric strength of film ASTM-D-149, 2000 volts/mil.

### PERFORMANCE CHARACTERISTICS

Parameter	Conditions and Performance
Contact Resistance	Less than 25 milliohms on 0.025" wide contact pads; 0.100 amperes DC, Kelvin- type four probe test method
Insulation Resistance	Minimum 10 <sup>12</sup> ohms between adjacent conductive elements.
Current Carrying Capacity	Series 8000 A and B, 500 mA per wire max.; Series 8000 C, 250 mA per wire max.
Capacitance	Maximum 0.100 picofarads per adjacent pad at 1 MHz and 0.100" high ("H").
Inductance	Maximum 7 nanohenries per adjacent pad at 1 MHz and 0.100" high ("H").
Repeated Actuations	500 actuations without appreciable change in contact resistance (deflection of 15%).
Deflection	8% to 20%. Recommended deflection 10 to 15% of original height.
Deflection Force/Inch	4lbs. per linear inch for 15% deflection for a 0.062" ("W") x 0.285 ("H") connector.
Operating Temperature Range	-20° C min., 125° C max.
Salt Spray Test	MIL-STD-202E, method 101D, condition B. 5% salt solution 95° F, 48 hours. There was no evidence of blistering or peeling of the contact material.
Temperature Cycling	MIL-STD-202E, method 102A, condition D, -55° C, 25° C, 125° C. There was no change in the physical properties of the specimens.
Humidity (Steady State)	MIL-STD-202E, method 103B, condition C modified. 95% RH room temperature. There was no appreciable change in contact resistance after 500 hours exposure.
Corrosive Environment	1,000 hours exposure at 1 ppm H <sub>2</sub> S and 1 ppm O <sub>2</sub> , 60° C AND 75% RH. Slight change in contact resistance; no evidence of contact peeling or blistering.

# ZEBRA® Elastomeric Connectors

## ZEBRA® FG-S CONNECTORS

The FG-S Connectors have anisotropic conduction properties. Thin metal wires are embedded with a vertical orientation within the silicone rubber on 0.10 mm centers. Low resistance and high current carrying capacity make this series very versatile for most typical interconnect applications.

The basic FG-S design is one row of gold-plated tips of Phosphor Bronze wires embedded in silicone rubber which will connect two parallel sets of contact, both having one row of contact pads.

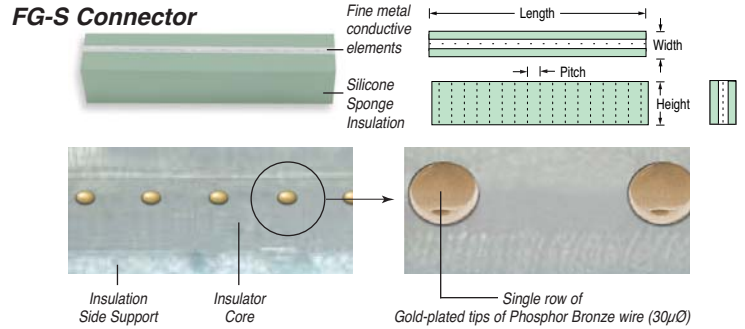

Property	Unit	Measure FG-S			Method
<b>Insulation Material</b>	–	silicone rubber		silicone sponge	–
<b>Color</b>	–	clear or white		blue	Visual
<b>Specific Gravity</b>	g/cm <sup>3</sup>	1.02		0.74	ASTM D792
<b>Hardness</b>	Durometer A	47		–	ASTM D2240
<b>Tensile Strength</b>	MPa	3		–	ASTM D412
<b>Elongation</b>	%	240		–	ASTM D412
<b>Volume Resistivity</b>	MΩ-m	7.0 x 10 <sup>6</sup>		–	ASTM D257
<b>Conductive Material</b>	Type	tips of Phosphor Bronze wire; Gold-Plated			–
<b>Wire Diameter</b>	µm	30			–
<b>Gold-Plated Thickness</b>	µm	0.15			–
<b>Dimensions, Tolerances</b>					
<b>Width (W)</b>	mm .../... in	1.40 to 3.00 ± 0.20 .../... 0.055" to 0.120" ± 0.008"			–
<b>Length (L)</b>	mm .../... in	10.00 to 25.00 ± 0.25 .../... 0.393" to 0.984" ± 0.010" 25.01 to 50.00 ± 0.30 .../... 0.985" to 1.96" ± 0.012" 50.01 to 80.00 ± 0.40 .../... 1.97" to 3.14" ± 0.016" 80.01 to 120.00 ± 0.50 .../... 3.15" to 4.72" ± 0.020"			–
<b>Height (H)</b> (note: H ≥ W)	mm .../... in	1.40 to 4.00 ± 0.10 .../... 0.055" to 0.157" ± 0.004" 4.01 to 10.00 ± 0.15 .../... 0.158" to 0.393" ± 0.006"			–
<b>Core: Width (W)</b>	mm .../... in	0.40 ± 0.08 .../... 0.016" ± 0.003"			–
<b>Pitch (P)</b>	mm .../... in	0.10 ± 0.05 .../... 0.004" ± 0.002"			–
<b>Skewness</b>	degrees	2° maximum			–
<b>Recommended Dimensions:</b> <b>Connector Height versus</b> <b>Electrode Width and Gap</b>	mm .../... in	<b>Connector Height</b>	<b>Electrode Width</b>	<b>Electrode Gap</b>	–
		min. 1.4 .../... 0.055"	0.21 .../... 0.008" or more	0.21 .../... 0.008" or more	
		2.0 .../... 0.079"	0.22 .../... 0.009" or more	0.22 .../... 0.009" or more	
		3.0 .../... 0.118"	0.24 .../... 0.009" or more	0.24 .../... 0.009" or more	
		4.0 .../... 0.157"	0.25 .../... 0.010" or more	0.25 .../... 0.010" or more	
		5.0 .../... 0.197"	0.27 .../... 0.011" or more	0.27 .../... 0.011" or more	
		6.0 .../... 0.236"	0.29 .../... 0.011" or more	0.29 .../... 0.011" or more	
		7.0 .../... 0.276"	0.31 .../... 0.012" or more	0.31 .../... 0.012" or more	
		8.0 .../... 0.315"	0.32 .../... 0.013" or more	0.32 .../... 0.013" or more	
		9.0 .../... 0.354"	0.34 .../... 0.014" or more	0.34 .../... 0.014" or more	
		max. 10.0 .../... 0.393"	0.36 .../... 0.014" or more	0.36 .../... 0.014" or more	

## CROSS-SECTIONAL VIEW

Figure 2 shows the dimensions of the ZEBRA® FG-S Connectors. When ordering, the dimensions should be specified within the limits shown in Table B.

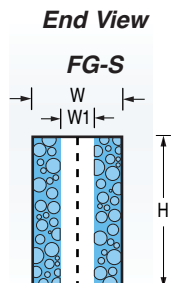

Figure 2

Note: Vertical contact wires may appear at each end of the length dimension, but do not affect performance.  
Maximum skewness < 2°

## TYPICAL INSTALLATION

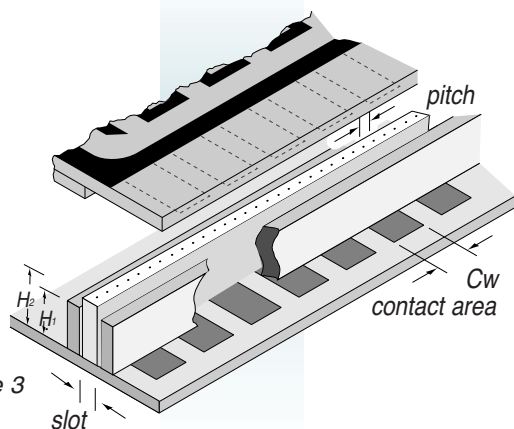

Figure 3

## COMPARISON DATA

Measurement	FG-S	Test Condition
Continuity Resistance	0.50Ω/pad (0.25mm Width Pad)	see below
Current Carrying Capacity	30 mA/wire	
Insulation Resistance	> 20 MΩ (Gap=0.25mm)	
Temperature Range	-40° C to +85° C -40° F to +185° F	
Compression Range	5% to 20% H < 3mm, 0.15 ~ 0.60mm H ≥ 3mm consult factory for application specifics	

## TYPICAL PERFORMANCE CHARACTERISTICS

FG-S CONNECTOR: COMPRESSION % vs. LOAD AND RESISTANCE  
Specimen: Connector FG-S (2mmW x 10mmL x 3mmH)

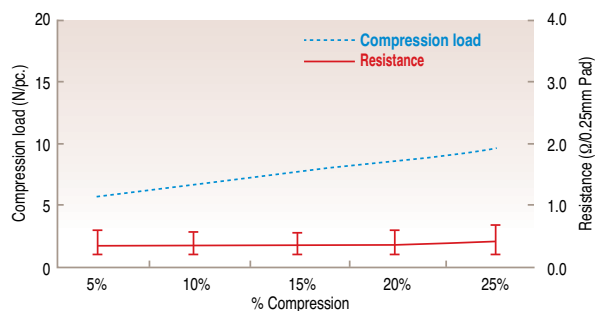

### Compression % vs. Force (N/pc.)

%	5%	10%	15%	20%	25%
Aver. N/pc.	5.7	6.6	7.5	8.4	9.6

### Resistance vs. Compression % (Ω/0.25mm Pad)

%	5%	10%	15%	20%	25%
Aver. Ω	0.36	0.35	0.35	0.36	0.38
Max. Ω	0.61	0.59	0.59	0.62	0.70
Min. Ω	0.23	0.22	0.22	0.22	0.22

## TEST METHOD FOR COMPRESSION % vs. LOAD AND RESISTANCE

Test Method for FG-S Connectors in the charts on this page used the following physical and electrical parameters:

- Electrodes: (Upper) Gold-plated PCB (common type electrode)  
(Lower) 0.5mm P, 0.25mm Pad's W, Gold-plated PCB
- Space of electrodes @ 0.25, 50VDC
- Measurement: Digital ohm meter & Compression load meter
- Using Amps: 100mA D.C.
- Condition: Measured at room temperature 30 minutes later



# Elastomeric Connectors

## ZEBRA® HIGH PERFORMANCE SILVER CONNECTORS

FUJIPOLY low resistance ZEBRA® elastomeric connectors are constructed of alternating parallel layers of electrically conductive and non-conductive silicone elastomer. The electrically conductive layer is filled with silver-metal particles.

The composite alternating layers provide reliable electrical connection when placed between two aligned conducting surfaces.

The low resistance ZEBRA® provides a redundant connection with a minimum of two conductive layers recommended per PC contact pad. The connector is available with insulating barrier or silicone supports (See page 6). The connectors are used for connecting electroluminescent (EL) and plasma type displays to PC boards or for connecting hybrid circuits to PC boards, among other applications.

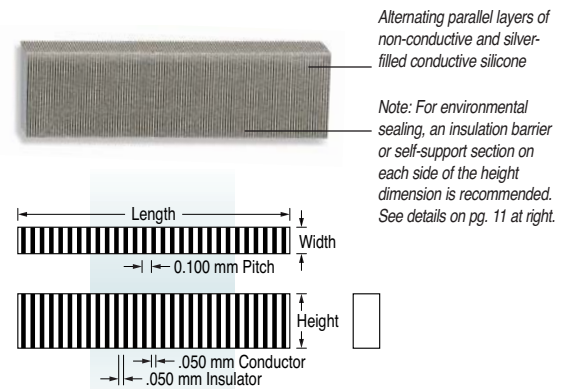

Low resistance ZEBRA® connectors are positioned between two aligned surfaces and are mechanically clamped together with a lid or another PC board. The connectors may be free standing or positioned in a retainer depending on packaging profiles and design.

Series	Contact Spacing Center-to-Center Minimum	Pitch: Sum of the Thickness of an Adjacent Conductive and Non-conductive Layer		Conductive Layers per inch Minimum	Individual Conductive and Insulating Layer Thickness		Available Lengths
		Nominal	Maximum		Minimum	Maximum	
5002 (SZ100)	0.015 in. 0.38 mm	0.004 in. 0.100 mm	0.006 in. 0.152 mm	240	0.001 in. 0.025 mm	0.003 in. 0.075 mm	5.00 in. 127 mm

TABLE A (For requirements over 4" consult factory)

Measurement	Tolerance (inches/mm)
Length=L	0.250 ± 0.005 in. to 5.000 ± 0.025 in. / 6.35 ± 0.12mm to 127.00 ± 0.64mm
Height=H	0.040 ± 0.003 in. to 0.500 ± 0.007 in. / 1.00 ± 0.08mm to 12.70 ± 0.18mm
Width=W	0.020 ± 0.003 in. to 0.100 ± 0.005 in. / 0.50 ± 0.08mm to 2.54 ± 0.13mm

TABLE B

ZEBRA® Connectors	Temperature Range		Current Carrying Capacity 0.040" x 0.040" pad	Resistance Between Layers
	Minimum	Maximum		
Silver ZEBRA®	-40°F -40°C	185°F 85°C	0.3 amps	10 <sup>12</sup> ohms

TABLE C

### SELF-SUPPORT AND INSULATION BARRIER

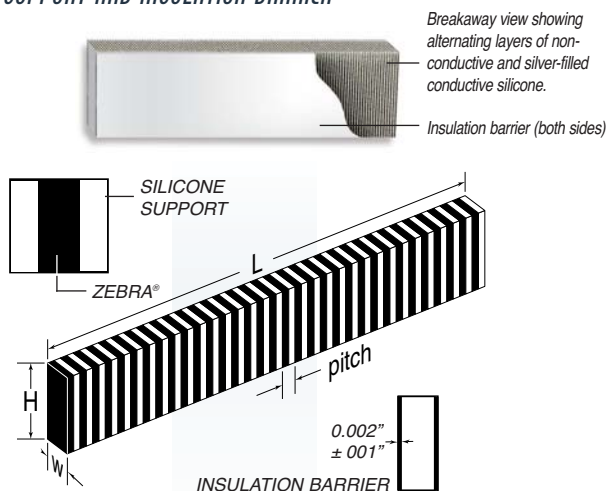

Details show silicone support (left) and insulation barrier (right). Each is available on one or both sides. Configurations may also include support on one side and insulation on the other.

**Note:** Recommended Height (H) should be twice Width (W) dimension for minimum force deflection. Maximum Skewness 2% of Height.

### DESIGN RECOMMENDATIONS

Recommended deflection range is 5-25% of free height. Minimum deflection will vary with packaging applications and should consider overall height, PC board warpage, finish, etc. (Contact FUJIPOLY Product Application Engineering for assistance.) Design recommendations for solid ZEBRA® over 0.400" deflect 0.050" maximum. Silicone supported over 0.400" deflect 0.060" typical.

### TEST CONDITIONS:

The use of an insulating barrier or silicone self-support material on one or both sides of the connector is recommended. The silicone support is utilized to reduce clamp force and provide an element of environmental protection for a cost-effective connection.

Item	Standard	Test Method
High Temperature	MIL-202D-108A	85° C 1500 hr
Low Temperature	—	-40° C 500 hr
Moisture	MIL-202D-103B	40° C 95% RH x 500 hr (250mA/pad)
Thermal cycle	MIL-202E-107G	65°C/25°C/150°C/25°C, 5 cycles

### NOMINAL RESISTANCE CALCULATION

For the purpose of calculating the resistance of silver ZEBRA® connectors and testing them for compliance please use the following formula:

Where:  $R$  = Resistance in Ohms  
 $W_1$  = Width of ZEBRA® portion (inches or mm)  
 $E_W$  = Electrode pad width (inches or mm)  
 $H$  = ZEBRA® height (inches or mm)

Metric (mm)      English (inches)

$$R = \frac{H \times 0.01}{E_W \times W_1} + 0.10 \qquad R = \frac{H \times 0.0004}{E_W \times W_1} + 0.10$$

Example: if ZEBRA® is 0.100"/2.54 mm H and 0.030"/0.762mm  $W_1$ , then the maximum resistance on a 0.050"/1.27 mm wide pad will be:

Metric

$$R = \frac{2.54 \times 0.01}{0.762 \times 1.27} + 0.10 = 0.127 \text{ ohms}$$

English:

$$R = \frac{0.100 \times 0.0004}{0.030 \times 0.050} + 0.10 = 0.127 \text{ ohms}$$

### NOMINAL FORCE DEFLECTION - PLAIN ZEBRA® OR INSULATION BARRIER TYPE

ZEBRA® connectors should be deflected 5% to 25% of H. To calculate F-Force for deflection, use the following formula:

Where:

$F$  = Force (N)  
 $D = \frac{H - H_1}{H} \times 100$  (%)

$H$  = Height of connector (mm or inches)  
 $H_1$  = Deflected height of connector (mm or inches)  
 $W$  = Width of connector (mm or inches)  
 $W_1$  = Width of ZEBRA portion (mm or inches)  
 $L$  = Length of connector (mm or inches)

Metric:

$$F(N) = 10.0 \times D \times W \times L \times 9.8 \times 10^{-3}$$

Inches:

$$F(N) = 6452 \times D \times W \times L \times 9.8 \times 10^{-3}$$

### NOMINAL FORCE DEFLECTION - SILICONE SUPPORT TYPE

Metric:

$$F(N) = [(10.0 \times D \times W_1 \times L) + \{2.2 \times D \times (W - W_1) \times L\}] \times 9.8 \times 10^{-3}$$

Inches:

$$F(N) = [(6452 \times D \times W_1 \times L) + \{1149 \times D \times (W - W_1) \times L\}] \times 9.8 \times 10^{-3}$$

# ZEBBRA® Dummy Elastomeric Connectors

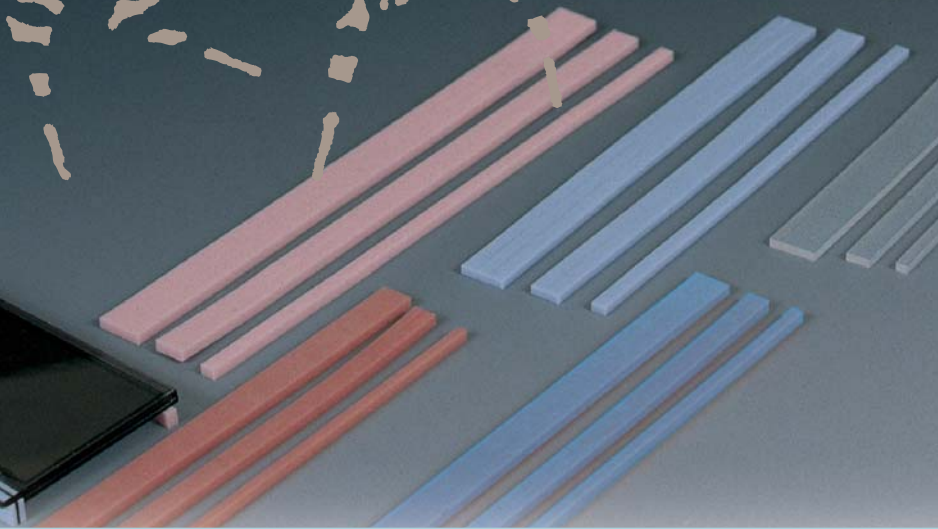

Non-conductive silicone strips made in the same exacting tolerances as the conductive ZEBBRA® connectors.

Used in locations adjacent to the active connector to balance the overall leveling and positioning of the display; also to control shock and vibration, and for use as an environmental seal between bezels and LC displays.

Can be installed in the same plane as the connector, and also between the bezel and the display in a variety of easy installation methods.

Consistent dimensional tolerance control assures accurate electronic packaging.

## APPLICATIONS:

- LCD and EL display balancing
- Bezel gasket, environmental seal
- Shock, vibration damping

Two types are available which match the mechanical functions of the active ZEBBRA® connectors: extruded and closed cell sponge. A range of compression characteristics are available based on the material durometer selections shown below.

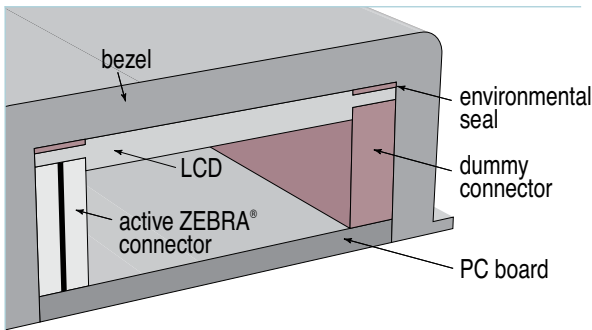

Typical Dummy ZEBBRA® installation as an environmental seal and as dummy connector.

Type	Application Guidelines	Dimensions (mm)
Extruded	19 Durometer - translucent	<b>maximum:</b> Length 457.0 Width 152.0 Thickness 0.38min., then in increments of 0.127 up to 1.78
	25 Durometer - pink, blue	
Sponge	20 Durometer - pink	<b>maximum:</b> Thickness 0.38min., then in increments of 0.127 up to 1.78

Custom configurations are also available. For further information, contact Customer Service.

## Part Number Nomenclature:

To specify a Dummy connector to your exact requirements, substitute the metric measurements for width, length and height according to the instructions below.

**ZEBBRA® DC 1.5 x 20 x 1.78 - EXT - 19**

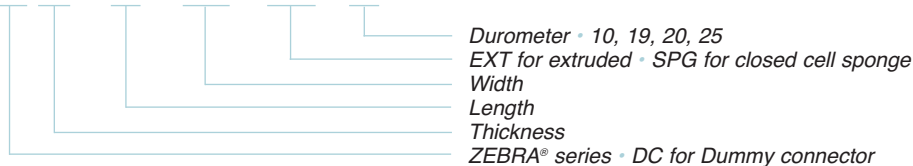

# ZEBRA® Series Elastomeric Matrix Connectors

Excellent for **Land Grid Arrays** and similar type interconnects. Extremely accurate silicone rubber electronic connectors with anisotropic conductive properties. A range of 300 to 2,000 fine metal wires per 1 cm<sup>2</sup> are embedded in the thickness direction of the transparent silicone rubber sheet. The fine metal conductors are gold-plated to ensure low resistance and the ability to withstand a relatively high current flow.

High density and greatly increased number of I/O's are possible; especially beyond 200 connections. Eliminates the costs of soldering and related rework. Facilitates denser and less expensive packaging.

After inserting the correctly sized connector pad between the opposing groups of electrodes, all that is necessary is to apply the appropriate pressure to allow the electrodes to be properly connected.

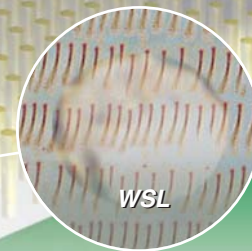
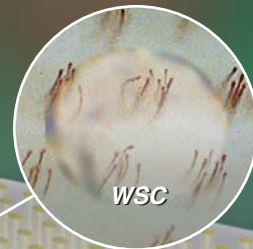
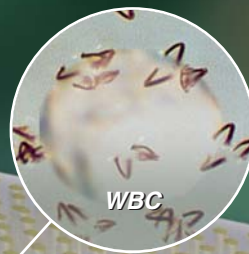

## APPLICATIONS:

- Ball Grid Arrays
- Tape Carrier Packs
- Quad Flat Packs
- Integrated Circuits
- Leadless Chip Carriers
- Printed Circuit Board

## FUNCTION:

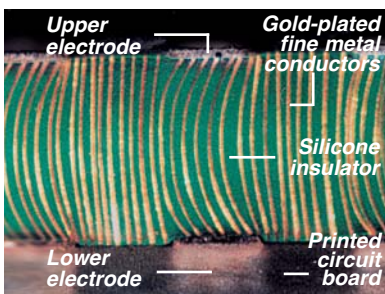

35X magnification side view exhibits compression of fine metal conductors

## TYPICAL CHARACTERISTICS:

Measure	Unit	Thickness		Remarks
		0.5	1.0	
Continuity Resistance	$\Omega \cdot \text{mm}^2$	0.25	0.45	$\pm 30\%$
Current Density	$\text{mA}/\text{mm}^2$	500		N/A
Resistance Between Adjacent Conductors	$\Omega$	10 <sup>10</sup> or more		C pattern $\rho = 0.35$
Light Transmission	%	90		1.0 mm thick L pattern $\rho = 1.0$
Operating Temperature	$^{\circ}\text{C}$	-20 to +100		N/A

W Series	Pitch (P)	Pattern Side View	Pattern Plan View	Thicknesses	Applied Electrode Gaps	Suitable Electrodes		Maximum Dimensions		Applications
						Width	Length	Length	Width	
WSL	1.0			0.50mm	over 0.4	over 0.3	over 1.5	76.0mm	5.0mm	Combination type
				1.00mm	over 0.5	over 0.5	over 1.5			
WSC	0.35			0.50mm	* (over 0.6) over 0.6	(over 0.7) over 0.9	(over 0.9) over 0.9	50.0mm	50.0mm	Matrix type electrode
				1.00mm	(over 0.7) over 0.7	(over 0.7) over 0.9	(over 0.9) over 0.9			
WBC	0.35			0.50mm	(over 0.6) over 0.6	(over 0.7) over 0.9	(over 0.9) over 0.9	50.0mm	50.0mm	Matrix type electrode
				1.00mm	(over 0.7) over 0.7	(over 0.7) over 0.9	(over 0.9) over 0.9			

**Notes:** (1) The **WSL** and **WSC** types have straight metal conductors protruding slightly from both top and bottom of the silicone rubber sheet to ensure perfect connections with slight pressure. Designed for mounting applications.

(2) The **WBC** type has curved fine metal conductors embedded in a silicone rubber sheet which are flush with the top and bottom planes. The curved configuration facilitates repeated compressions. Ideal for inspection applications.

\* (The upper: 12.5mm x 12.5mm product  
The lower: 25mm x 25mm, 37.5mm x 37.5mm or 50mm x 50mm product)

## Part Number Nomenclature:

**WSL-102-2.0 x 20.0 x 0.5**

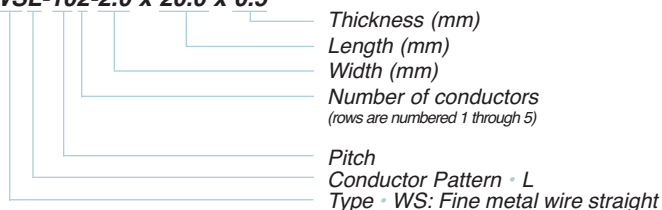

**WSC-035-5.0 x 20.0 x 0.5**

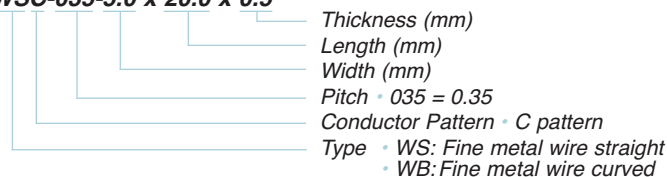

# ZEBRA® Bezel and Connector Assemblies

Fujipoly® LCD connector assemblies with clear bezels provide an attractive and reliable way of mounting LCD's onto a PC board. Electrical connection between LCD and PC board contact surfaces is made by two Series 2004 ZEBRA® connectors, which consist of alternating parallel layers of conductive and non-conductive silicone rubber repeating on a 0.18mm (.007") pitch.

Because the LCD is mounted on rubber components, the assembly provides shock and vibration protection for the display. The clear bezel introduces an extra measure of protection for the LCD.

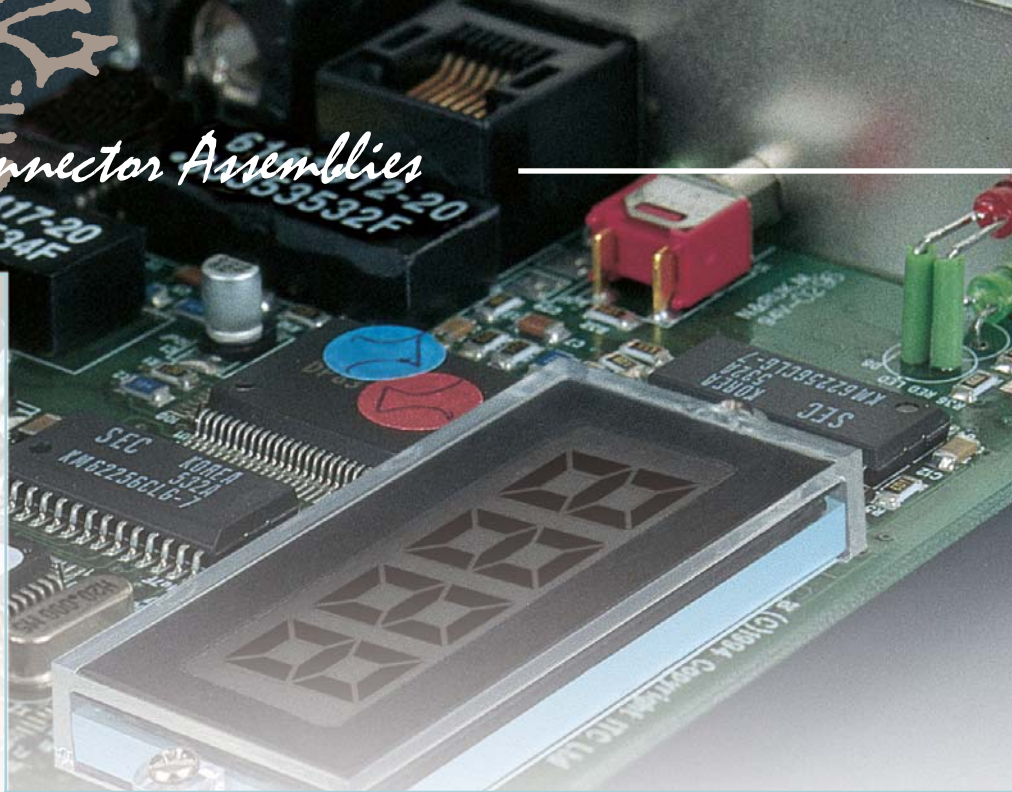

## APPLICATIONS:

- Flat Mount Dual Inline LCD's
- Clocks, Meters, Calculators, Appliances, Automotive Dashboards, Gas Pumps, Industrial Displays, Instrumentation, Computing Devices.

Flat Mount LCD connectors are designed to mount Dual Inline LCD's flat onto printed circuit boards without pins or soldering. The connectors consist of two ZEBRA® connectors inserted into a specially designed plastic holder. See pages 2 through 11 for specific connector selection information. The retainer positions the LCD and aligns it with the printed circuit board contacts via two locating studs. A gas tight environmental seal is created when the ZEBRA® connectors are deflected between the LCD and the printed circuit board when the bezel is tightened into position.

## COMPATIBILITY:

The operating temperature range for the connector assembly exceeds that for the LCD. The ZEBRA® connectors provide a gas-tight seal of the contact surfaces to assure reliable operation in hostile environments. The bezel protects the LCD polarizer from scratches and may be used directly in the window provided in the instrument enclosure.

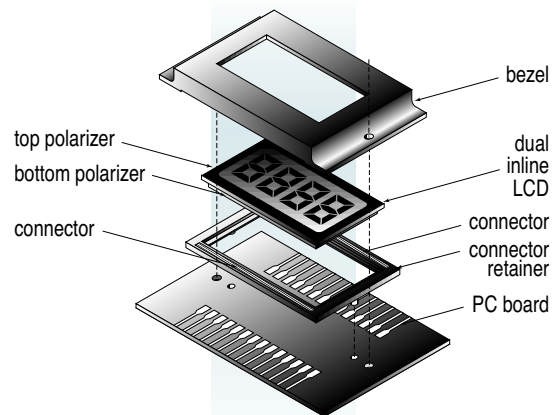

Dual Inline assembly with two ZEBRA® connectors.

The connector assembly consists of a retainer, two ZEBRA® connectors, viewing area mask and, if required, a bezel. Assembly is simple: place the retainer on the PC board using the locating studs for alignment, insert the ZEBRA® connectors, LCD, and mask and secure the bezel with two screws. The LCD connectors are available in one basic configuration for Dual Inline Displays where the viewing area is in the center.

A complete range of sizes accommodate LCD's up to 1.50" x 2.75" (38.10 x 69.85 mm). For dimension details, find assembly part number below and match with bezel and retainer component information on opposite page.

<b>operating temperature</b>	-40°C to 95°C (-40°F to +203°F)
<b>storage temperature</b>	-56°C to 95°C (-65°F to +203°F)
<b>nominal resistance</b>	1000 ohms
<b>humidity range</b>	0 to 100% R.H.

Assembly Number	For LCD Size	Bezel Mask Color	Bezel Color	Bezel & Retainer Information
09-10050	13.72 x 23.88	0.54 x 0.94	none	clear
09-19137	30.50 x 50.80	1.20 x 2.00	black	clear
09-10103	30.50 x 50.80	1.20 x 2.00	black	clear
09-19102	30.50 x 50.80	1.20 x 2.00	none	black
09-19143	30.50 x 69.85	1.20 x 2.75	black	clear
09-10067	38.10 x 69.85	1.50 x 2.75	black	clear

Refer to opposite page for details



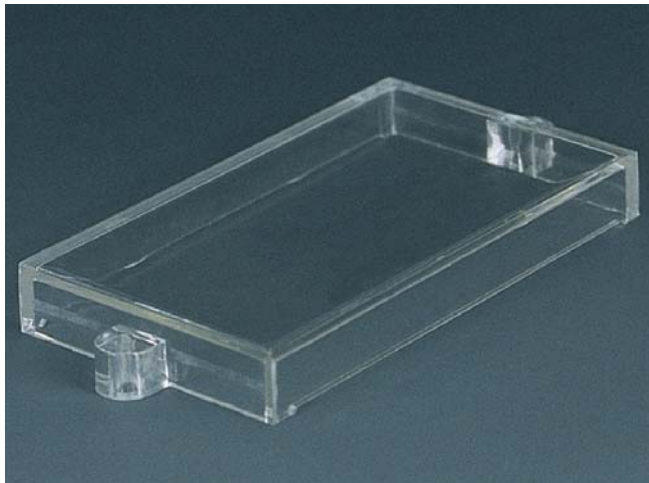

Bezel for 09-19137 shown.

## LCD BEZELS AND MASKS

Easy to assemble bezel with viewing area mask slips over the LCD and over the connector retainers shown below. The scratch resistant, tough acrylic face may be used directly in the window provided for end use without a separate face cover.

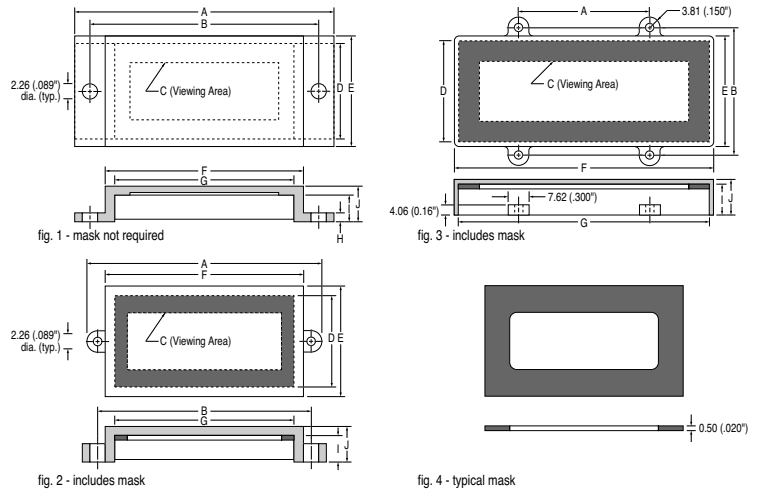

Bezel & Mask Details for Connector Assembly No.	Ref. Figure	Bezel Color	Viewing Area																			
			A	B	C	D	E	F	G	H	I	J										
09-10050	fig. 1	clear	37.85	1.490	33.53	1.320	22.61x8.64	.890x.340	13.92	.550	16.51	.650	29.21	1.150	26.67	1.050	1.27	.050	3.82	.150	5.08	.200
09-19137	fig. 2	clear	68.07	2.680	61.89	2.437	45.72x19.05	1.800x.750	30.94	1.218	33.47	1.318	57.60	2.268	54.73	2.155	n/a	5.84	.230	7.11	.280	
09-10103	fig. 2	clear	68.07	2.680	61.89	2.437	45.72x19.05	1.800x.750	30.94	1.218	33.47	1.318	57.60	2.268	54.73	2.155	n/a	5.84	.230	7.11	.280	
09-19102	fig. 1	black	73.96	2.912	67.56	2.660	48.46x20.32	1.908x.800	30.61	1.205	33.20	1.307	61.26	2.412	54.51	2.146	1.40	.055	5.08	.200	6.48	.255
09-19143	fig. 3	clear	44.35	1.746	38.32	1.509	64.77x17.78	2.550x.700	30.86	1.215	33.60	1.323	76.53	3.013	73.91	2.910	n/a	8.35	.329	9.63	.379	
09-10067	fig. 3	clear	44.45	1.750	45.47	1.790	60.96x21.59	2.400x.850	38.65	1.522	41.40	1.630	76.71	3.020	73.91	2.910	n/a	8.51	.335	9.78	.385	

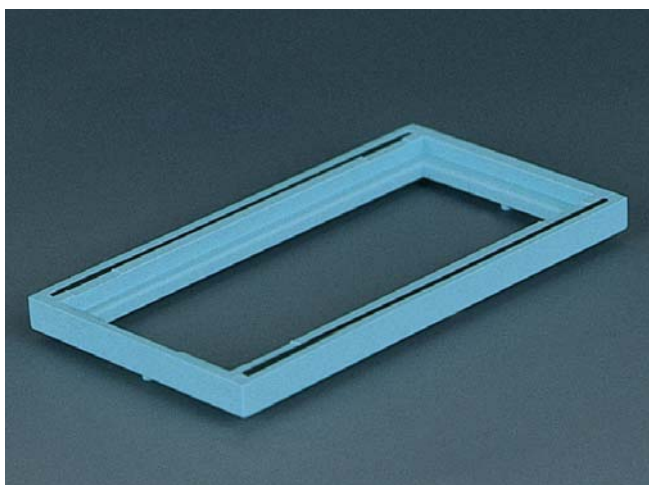

Bezel for 09-19137 shown.

## ZEBRA® CONNECTOR RETAINERS

Standard connector retainers include two ZEBRA® series 2004 silicone rubber connectors with alternating conductive and non-conductive parallel layers, each on a 0.18 mm (.007") pitch for dual in-line LCD applications. Provides a tight environmental seal with shock and vibration protection for the display. Two locating studs on bottom facilitate assembly.

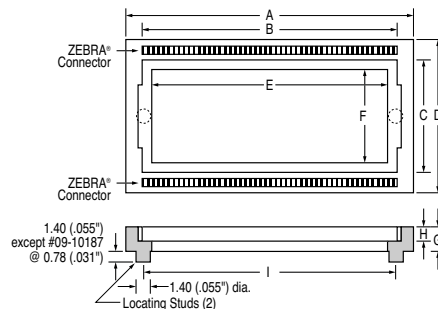

Connector Retainer Details for Connector Assembly No.	A	B	C	D	E	F	G	H	I	Fits Bezel Style Above									
09-10050	26.57	1.046	24.02	.946	10.29	.405	13.72	.540	24.02	.946	10.29	.405	2.54	.100	1.65	.065	23.80	.937	fig. 1
09-19137	54.36	2.140	51.30	2.020	24.13	.950	30.50	1.200	47.24	1.860	20.57	.810	3.43	.135	1.78	.070	50.80	2.000	fig. 2
09-10103	54.36	2.140	51.30	2.020	24.13	.950	30.50	1.200	47.24	1.860	20.57	.810	3.43	.135	1.78	.070	50.80	2.000	fig. 2
09-19102	54.40	2.142	51.30	2.020	23.52	.926	30.50	1.200	47.24	1.860	20.57	.810	3.43	.135	1.91	.075	50.80	2.000	fig. 1
09-19143	75.53	2.895	70.71	2.784	24.13	.950	30.50	1.200	65.91	2.595	20.07	.790	6.35	.250	1.91	.075	69.85	2.750	fig. 3
09-10067	75.53	2.895	70.71	2.784	31.87	1.255	38.10	1.500	65.91	2.595	27.69	1.090	6.35	.250	1.91	.075	69.85	2.750	fig. 3

# SARCON® Thermal Management Components

More power and light weight. In the past, these two characteristics in electronics were mutually exclusive. Now, micro-electronics are just that, and in addition, need thermal management components to further complement these objectives.

SARCON® is an advanced silicone rubber with high thermal conductivity and superior flame-retardancy. By combining the inherent silicone rubber properties of heat resistance, electrical insulation and long-term aging into one compound, this universally applicable material can be made in an unlimited number of thermal management configurations.



UL FILE NUMBER: E58126

## APPLICATIONS:

- Thermal conductive insulators for semiconductors
- Compression jointing materials for thermistors and temperature sensors
- Thermal conductive material for all types of heaters

**FORMULATIONS/CONFIGURATIONS:** A variety of specific compounds are available for a wide range of performance requirements in Sheets, Rolls, Die-cuts, Sleeves, Gel, Extrusions, Moldings

## THERMAL CONDUCTIVITY CONVERSION TABLE

Thermal Conductivity	BTU-in/hrft²F	Cal/cm - sec - °C	Watt/m·K
BTU-in / hrft²F	1	3.4x10 <sup>-4</sup>	0.14
Cal / cm - sec - °C	2.9x10 <sup>3</sup>	1	4.2x10 <sup>2</sup>
Watt / m·K	6.9	2.4x10 <sup>-3</sup>	1

SARCON®	Type	Application Guidelines	Typical Thermal Conductivity		
			Cal/cm - sec - °C	Watt/m·K	Pg.#
SARCON® GHR	Thin Film	High thermal conductivity with 0.05mm glass cloth reinforcement	3.4 x 10 <sup>-3</sup>	1.40	17
SARCON® GR-Td		High thermal conductivity mesh reinforced gap filler pad, 0.25mm thin, available in rolls	3.6 x 10 <sup>-3</sup>	1.50	24-25
SARCON® GR-Tac		High thermal conductivity mesh reinforced gap filler pad, 0.25mm thin, with high tack	3.8 x 10 <sup>-3</sup>	1.60	24-25
SARCON® GSR		Highest thermal conductivity with 0.05mm glass cloth reinforcement	7.0 x 10 <sup>-3</sup>	2.90	17
SARCON® GTR		General purpose with 0.05 mm glass cloth reinforcement	2.2 x 10 <sup>-3</sup>	0.90	17
SARCON® HR		High thermal conductivity	4.1 x 10 <sup>-3</sup>	1.70	17
SARCON® QR		Low hardness with high thermal conductivity	2.6 x 10 <sup>-3</sup>	1.10	17
SARCON® TR		General purpose for moldings and extrusions	2.9 x 10 <sup>-3</sup>	1.20	17
SARCON® UR		Very high thermal conductivity	6.2 x 10 <sup>-3</sup>	2.60	17
SARCON® GR-d		Standard Gap Filler	General purpose gap filler pad, UL94 V-0/V-1 class	3.6 x 10 <sup>-3</sup>	1.50
SARCON® GR-L	General purpose gap filler pad, UL94 V-0 class		6.8 x 10 <sup>-3</sup>	2.80	20
SARCON® GR-ae	General purpose gap filler pad, UL94 V-0/V-1 class		3.1 x 10 <sup>-3</sup>	1.30	20
SARCON® GR-Sd	Low Compression Force Gap Filler	Low modulus gap filler material	3.4 x 10 <sup>-3</sup>	1.50	28
SARCON® GR-SL		Lowest modulus gap filler material	6.5 x 10 <sup>-3</sup>	2.70	28
SARCON® GR-m	High Performance Gap Filler	High thermal conductivity gap filler pad	14.4 x 10 <sup>-3</sup>	6.00	22
SARCON® XR-e		Very thermal heat conductivity gap filler pad	26.3 x 10 <sup>-3</sup>	11.00	22
SARCON® XR-j		Highest performance heat conductivity gap filler pad	33.4 x 10 <sup>-3</sup>	14.00	22
SARCON® XR-m		New low thermal resistance gap filler pad	40.8 x 10 <sup>-3</sup>	17.00	22
SARCON® SPG-15A	"Form in Place"	High viscosity type silicone compound gap filler	3.6 x 10 <sup>-3</sup>	1.50	30
SARCON® SPG-30A		High viscosity type silicone compound gap filler	7.7 x 10 <sup>-3</sup>	3.20	31
SARCON® GR-Pm	Putty	High thermal conductivity gap filler pad	14.4 x 10 <sup>-3</sup>	6.00	26
SARCON® XR-Pe		High performance thermal conductivity gap filler pad	26.3 x 10 <sup>-3</sup>	11.00	26
SARCON® XR-Um		Highest thermal conductive putty type silicone sheet	40.8 x 10 <sup>-3</sup>	17.00	27
SARCON® XR-Um-AL		Highest thermal conductive putty type silicone sheet with Aluminum film	40.8 x 10 <sup>-3</sup>	17.00	27
SARCON® XR-v		Highest thermal conductive thin film putty thermal interface	14.4 x 10 <sup>-3</sup>	6	27
SARCON® XR-v-AL		Highest thermal conductive thin film putty thermal interface with aluminum barrier	14.4 x 10 <sup>-3</sup>	6	27
SARCON® NR-c		Non-Silicone	Highly conformable non-flammable non-silicone gap filler	3.6 x 10 <sup>-3</sup>	1.50
Mica		Shown for comparison purposes only	1.4 x 10 <sup>-3</sup>	0.59	
Polyester		Shown for comparison purposes only	0.34 x 10 <sup>-3</sup>	0.14	

## SARCON® TECHNICAL INFORMATION



## TYPICAL MATERIAL PROPERTIES

Test Properties		SARCON® TR			SARCON® HR			SARCON® UR			SARCON® QR		
Physical properties	Color	Greenish Gray			Brown			Gray			Black		
	Hardness (ASTM D2240, type A)	75			85			79			55		
	Tensile strength (MPa)	5.4			4.9			2.5			2.3		
	Elongation (%)	100			60			110			250		
	Tear Strength (kN/m) (Angle Non-slit)	9			7			8			13		
Heat aging (Aging test by heating in air, to 200° C)		3 days	10 days	20 days	3 days	10 days	20 days	3 days	10 days	20 days	3 days	10 days	20 days
	Change in hardness (Point)	±0	+5	+9	+1	+1	+3	+8	+11	+15	±0	+1	+5
	Change in tensile strength (%)	±0	±0	+6	-12	-12	-12	+19	+42	+62	±0	+14	+24
	Change in elongation (%)	-16	-26	-34	-18	-24	-35	-46	-49	-49	-7	-15	-27
	Volume resistivity (MΩ-m)	1 x 10 <sup>7</sup>			1 x 10 <sup>7</sup>			1 x 10 <sup>7</sup>			1 x 10 <sup>6</sup>		
Electrical properties	Breakdown voltage (kV/mm)	20			19			17			22		
	Dielectric constant	50Hz	10 <sup>3</sup> Hz	10 <sup>6</sup> Hz	50Hz	10 <sup>3</sup> Hz	10 <sup>6</sup> Hz	50Hz	10 <sup>3</sup> Hz	10 <sup>6</sup> Hz	50Hz	10 <sup>3</sup> Hz	10 <sup>6</sup> Hz
		4.9	4.9	4.9	5.7	5.4	4.9	5.3	5.3	5.3	4.7	4.6	4.6
	Dielectric dissipation factor	0.002	0.001	0.002	0.004	0.002	0.002	0.003	0.001	0.001	0.003	0.002	0.0008
	Thermal properties	Thermal conductivity (W/m-K)	1.2			1.7			2.6			1.1	
	Flame retardant (UL94)	V-0			V-0			V-0			V-0		

## TYPICAL PRODUCT PROPERTIES

Properties	Unit	SARCON® TR			SARCON® HR			SARCON® UR			SARCON® QR		
		30T	45T	85T	30H	45H	85H	30U	45U	85U	30Q	45Q	85Q
Color	visual	Greenish Gray			Brown			Gray			Black		
Thickness	mm	0.30 <sup>+0.1/-0</sup>	0.45 <sup>+0.05</sup>	0.85 <sup>+0.05</sup>	0.30 <sup>+0.1/-0</sup>	0.45 <sup>+0.05</sup>	0.85 <sup>+0.05</sup>	0.30 <sup>+0.1/-0</sup>	0.45 <sup>+0.05</sup>	0.85 <sup>+0.05</sup>	0.30 <sup>+0.1/-0</sup>	0.45 <sup>+0.05</sup>	0.85 <sup>+0.05</sup>
Material	Binder	Silicone			Silicone			Silicone			Silicone		
	Filler	Alumina			Alumina+ALN			Alumina+ALN			Alumina		
	Reinforcement	n/a			n/a			n/a			n/a		
Thermal Resistance	°C·in <sup>2</sup> /W	0.62	0.73	1.35	0.42	0.52	0.76	0.26	0.35	0.56	0.57	0.77	1.25
Thermal Resistance w/PSA*	°C·in <sup>2</sup> /W	n/a			n/a			n/a			n/a		
Specific Gravity	g/cm <sup>3</sup>	2.3			2.4			2.6			2.2		
Hardness (ASTM D2240)	type A	75			85			79			55		
Tensile Strength	kN/m	1.7	2.3	4.3	1.7	2.3	4.2	0.9	1.2	2.2	0.8	1.0	2.0
Elongation	%	100			60			110			250		
Tear Strength	N	3	4	8	2	3	6	3	4	7	5	6	11
Volume Resistivity	MΩ-m	1x10 <sup>7</sup>	1x10 <sup>7</sup>	1x10 <sup>7</sup>	1x10 <sup>7</sup>	1x10 <sup>7</sup>	1x10 <sup>7</sup>	1x10 <sup>7</sup>	1x10 <sup>7</sup>	1x10 <sup>7</sup>	1x10 <sup>6</sup>	1x10 <sup>6</sup>	1x10 <sup>6</sup>
Withstand Voltage	kV/minute	7	8	10	6	7	10	6	8	10	7	8	11
Dielectric Constant	1KHz	4.4	4.5	4.9	4.9	4.5	5.7	4.3	4.6	5.3	4.1	4.2	4.9
Maximum Use Temperature	°C	-60°C to +180°C			-60°C to +180°C			-60°C to +180°C			-60°C to +180°C		
Adhesive coating	-	n/a			n/a			n/a			n/a		

\* FTM P-3010 (ASTM D5470 Equivalent)

Properties	Unit	SARCON® GTR			SARCON® GHR			SARCON® GSR			
		15GTR	20GTR	30GTR	15GHR	20GHR	30GHR	20GSR	30GSR	45GSR	85GSR
Color	visual	Greenish Gray			Brown			White			
Thickness	mm	0.15 <sup>+0.02/-0.04</sup>	0.20 <sup>+0.02/-0.04</sup>	0.30 <sup>+0.10/-0</sup>	0.15 <sup>+0.02/-0.04</sup>	0.20 <sup>+0.02/-0.04</sup>	0.30 <sup>+0.10/-0</sup>	0.20 <sup>+0.05</sup>	0.30 <sup>+0.10/-0</sup>	0.45 <sup>+0.05</sup>	0.85 <sup>+0.05</sup>
Material	Binder	Silicone			Silicone			Silicone			
	Filler	Alumina			Alumina+ALN			Boron Nitride			
	Reinforcement	Fiberglass			Fiberglass			Fiberglass			
Thermal Resistance	°C·in <sup>2</sup> /W	0.51	0.56	0.66	0.55	0.57	0.61	0.30	0.34	0.39	0.51
Thermal Resistance w/PSA*	°C·in <sup>2</sup> /W	0.78	0.83	0.93	0.63	0.66	0.72	0.64	0.66	0.71	0.83
Specific Gravity	-	2.2			2.4			1.7			
Hardness (ASTM D2240)	type A	87	87	92	92	92	95	90	90	90	88
Tensile Strength	kN/m	11			8			14	15	18	15
Elongation	%	2 or less			2 or less			3 or less			
Volume Resistivity	MΩ-m	1x10 <sup>7</sup>	1x10 <sup>7</sup>	1x10 <sup>7</sup>	1x10 <sup>7</sup>	1x10 <sup>7</sup>	1x10 <sup>7</sup>	1x10 <sup>7</sup>	1x10 <sup>7</sup>	1x10 <sup>7</sup>	1.0x10 <sup>7</sup>
Withstand Voltage	kV/minute	4	6	7	2	4	8	3	5	7	10
Dielectric Constant	1KHz	2.5	3.2	3.5	3.0	3.3	3.9	2.6	3.0	3.2	3.7
Maximum Use Temperature	°C	-60°C to +180°C			-60°C to +180°C			-60°C to +180°C			
Adhesive coating	-	Available			Available			Available			

\* FTM P-3010 (ASTM D5470 Equivalent)

All dimensions in millimeters

# SARCON<sup>®</sup> Thermal Gap Filler Pads

SARCON<sup>®</sup> Thermal Gap Filler Pads are highly conformable and high heat conducting gel materials in a versatile sheet form. They easily fit and adhere to most all shapes and sizes of components, including protrusions and recessed areas.

In areas where space between surfaces is uneven or varies and where surface textures are a concern regarding efficient thermal transfer, the supple consistency of the pads is excellent for filling air gaps and uneven surfaces.

Four series, each with a different construction, accommodate most every demanding application.

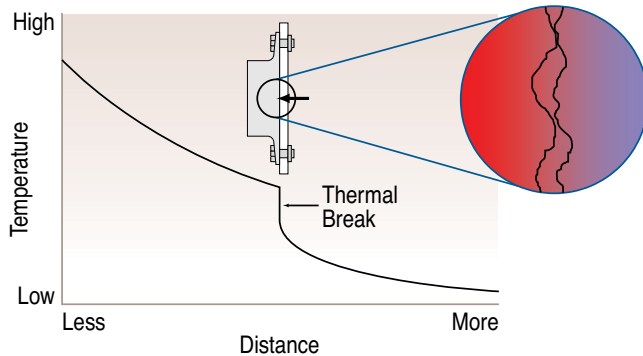

Thermal impedance of semiconductor mounted to substrate is appreciably increased at junction of porous surfaces.

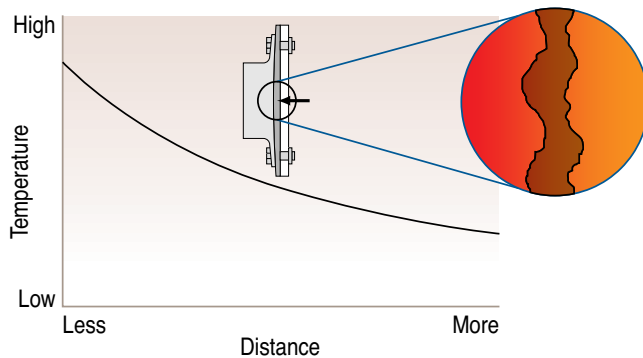

Thermal impedance of semiconductor mounted to substrate with gap filler pad is eliminated yielding higher temperature gradient.

## Construction

### GR and XR Series



### GR-H and XR-H Series



### GR-F Series only

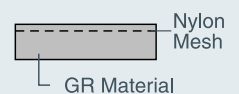

### GR-HF Series only

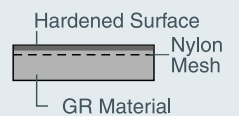

As shown above, even the most highly polished mating surfaces do not make reliable contact surfaces. Complete physical contact is necessary to minimize the resistance to heat flow for the best thermally conductive path. All such surface voids, when properly filled with a conformable, thermally conductive GR series gap filler pad, will in most cases exhibit the continuous characteristics of a solid metal of the same dimensions.

The basic GR Gap Filler Pad series can be further enhanced for special handling and die-cutting requirements as described following in the chart at the lower left.

Gap filler materials are supplied in a fully cured state and remain pliable, easily conforming to minute surface irregularities.

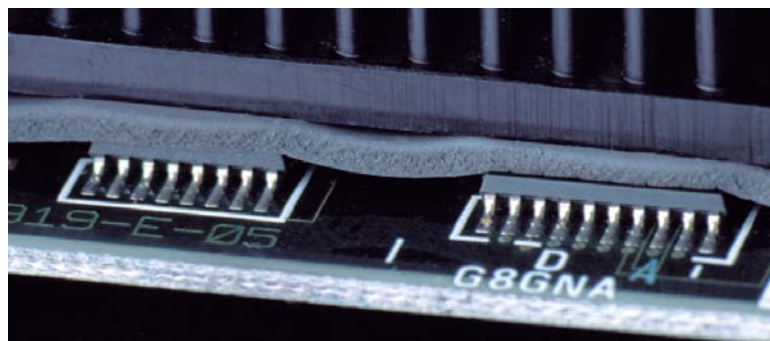

UL FILE NUMBER: E58126

**PART NUMBER NOMENCLATURE:**

Standard: To specify a part number to your exact specifications, substitute the metric measurements for thickness, width and length according to the instructions below; example part# 50 GR-Hd-100.0-100.0

**50 GR-Hd - 100.0 x 100.0**

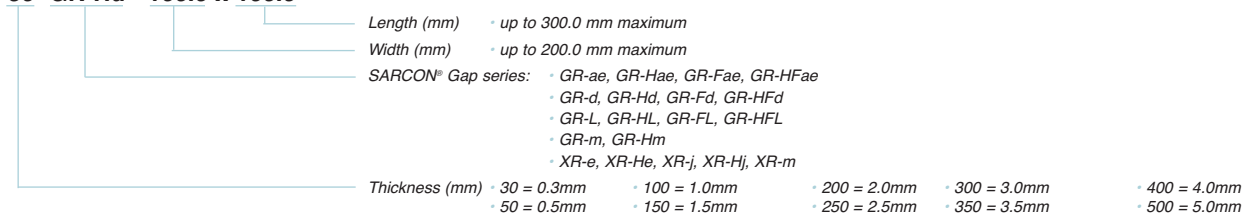

Construction Description	“GR-ae”	“GR-d”	“GR-L”	“GR-m”	XR-e	“XR-j”	“XR-m”
General purpose silicone compound	<b>GR-ae</b> (G-ae) UL94 V-0	<b>GR-d</b> (G-d) UL94 V-0	<b>GR-L</b> (G-L) UL94 V-0	<b>GR-m</b> (G-m) UL94 V-0	<b>XR-e</b> (X-e) UL94 V-0	<b>XR-j</b> (X-j) UL94 V-0	<b>XR-m</b> (X-m) UL94 V-0
	<b>Applications:</b> • Between chassis wall and other surface • Between semi conductor and heat sink • Large area heat transfer to heat sink • Between CPU and heat sink						
Same general purpose silicone compound as above plus additional hardening of the top surface to facilitate handling and installation during complex assemblies.	<b>GR-Hae</b> (G-Hae)	<b>GR-Hd</b> (G-Hd)	<b>GR-HL</b> (G-HL)	<b>GR-Hm</b> (G-Hm)	<b>XR-He</b> (G-He)	<b>XR-Hj</b> (G-Hj)	N/A
	<b>Applications:</b> Same as above, except hardened top surface allows handling without distortion in cases where this feature is required.						
Same general purpose silicone compound as above plus mesh reinforcement stiffener to prevent stretching; i.e., elongation of die-cut holes.	<b>GR-Fae</b> (G-Fae)	<b>GR-Fd</b> (G-Fd)	<b>GR-FL</b> (G-FL)	N/A	N/A	N/A	N/A
	<b>Applications:</b> Same as GR basic formula, plus specific construction for intricate die-cut shapes to prevent distortion of the die-cut shape during die-cutting and installation.						
Same general purpose silicone compound as above plus additional hardening of the top surface to facilitate handling and installation during complex assemblies, and mesh reinforcement stiffener to prevent stretching; i.e., elongation of die-cut holes.	<b>GR-HFae</b> (G-HFae)	<b>GR-HFd</b> (G-HFd)	<b>GR-HFL</b> (G-HFL)	N/A	N/A	N/A	N/A
	<b>Applications:</b> Same as GR basic formula, plus specific construction with hardened top surface and mesh reinforcement for die-cutting and handling without distortion.						

# SARCON® Thermal Gap Filler Pads

Typical Properties	Unit	SARCON® GR										SARCON® GR-H									
Cross Section	Composition	 GR Material										 Hardened Surface GR Material									
Extractable Volatiles	Content % Cyclodimethyl Siloxane	Fujipoly D4-D10 <0.0010 wt%										Fujipoly D4-D10 <0.0010 wt%									
Continuous Use	°C	Fujipoly -60 to +200										Fujipoly -60 to +200									
Flame Retardance	UL-94V standard	UL UL94 V-0										UL UL94 V-0									
Dimensions Available	Thickness (mm)	Fujipoly 0.5 <sup>0.1</sup> 1.0 <sup>0.2</sup> 1.5 <sup>0.2</sup> 2.0 <sup>0.3</sup> 2.5 <sup>0.3</sup> 3.0 <sup>0.3</sup> 3.5 <sup>0.3</sup> 4.0 <sup>0.4</sup> 5.0 <sup>0.5</sup>										Fujipoly 0.5 <sup>0.1</sup> 1.0 <sup>0.2</sup> 1.5 <sup>0.2</sup> 2.0 <sup>0.2</sup> 2.5 <sup>0.3</sup> 3.0 <sup>0.3</sup> 3.5 <sup>0.3</sup> 4.0 <sup>0.4</sup> 5.0 <sup>0.5</sup>									
	Width (mm)	Fujipoly 200 standard, larger width by request										Fujipoly 200 standard, larger width by request									
	Length (mm)	Fujipoly 300 standard, larger length by request										Fujipoly 300 standard, larger length by request									
Packaging	Standard	Fujipoly										Fujipoly									
Each Sheet is placed between top and bottom film liners for die cutting handling ease.																					

GR-d Series	Identifier	Test Method	50G-d	100G-d	150G-d	200G-d	250G-d	300G-d	350G-d	400G-d	500G-d	50G-Hd	100G-Hd	150G-Hd	200G-Hd	250G-Hd	300G-Hd	350G-Hd	400G-Hd	500G-Hd		
Thickness	mm	Fujipoly	0.5 <sup>0.1</sup>	1.0 <sup>0.2</sup>	1.5 <sup>0.2</sup>	2.0 <sup>0.3</sup>	2.5 <sup>0.3</sup>	3.0 <sup>0.3</sup>	3.5 <sup>0.3</sup>	4.0 <sup>0.3</sup>	5.0 <sup>0.3</sup>	0.5 <sup>0.1</sup>	1.0 <sup>0.2</sup>	1.5 <sup>0.2</sup>	2.0 <sup>0.3</sup>	2.5 <sup>0.3</sup>	3.0 <sup>0.3</sup>	3.5 <sup>0.3</sup>	4.0 <sup>0.3</sup>	5.0 <sup>0.3</sup>		
Thermal Resistance	°C·in <sup>2</sup> /W (°C·cm <sup>2</sup> /W)	Fujipoly FTM P-3050 (ASTM D5470 Equivalent)	14.5 psi	0.69	1.03	1.39	1.52	2.10	2.35	2.56	3.25	3.52	0.62	1.15	1.64	1.92	2.60	2.59	3.19	3.26	3.64	
			(100kPa)	(4.45)	(6.64)	(8.96)	(9.78)	(13.58)	(15.15)	(16.51)	(20.95)	(22.70)	(3.98)	(7.41)	(10.60)	(12.40)	(16.77)	(16.72)	(20.61)	(21.04)	(23.51)	
			43.5 psi	0.53	0.81	1.16	1.13	1.71	1.77	2.00	2.42	2.58	0.52	1.01	1.39	1.57	2.00	2.26	2.35	2.56	2.95	
			(300kPa)	(3.44)	(5.25)	(7.46)	(7.31)	(11.02)	(11.40)	(12.93)	(15.61)	(16.67)	(3.36)	(6.50)	(8.95)	(10.14)	(12.88)	(14.56)	(15.13)	(16.53)	(19.02)	
			72.5 psi	0.46	0.73	1.02	0.97	1.47	1.48	1.66	2.03	2.17	0.48	0.95	1.22	1.36	1.68	1.89	1.94	2.17	2.50	
			(500kPa)	(2.96)	(4.71)	(6.59)	(6.24)	(9.49)	(9.58)	(10.70)	(13.11)	(14.03)	(3.12)	(6.11)	(7.88)	(8.79)	(10.87)	(12.18)	(12.52)	(14.01)	(16.14)	
Color	Visual	Fujipoly	Gray										Gray									
Thermal Conductivity	Watt/m·K	FTM P-1620 (ASTM D2326 Equivalent)	1.5										1.5									
Volume Resistivity	MΩ·m	ASTM D257	1x10 <sup>6</sup>										1x10 <sup>6</sup>									
Withstand Voltage	kV/min	ASTM D149	14										13									
Specific Gravity	-	ASTM D792	2.6										2.6									
Hardness	Shore OO	ASTM D2240	49										49									
Elongation	%	ASTM D412	100										80									
Compression	psi @ 10% (N @ 10%) (area=25x25mm)	Fujipoly	30	28	26	23	18	14	13	11	10	48	45	35	28	25	18	16	13	11		
			(127)	(123)	(113)	(100)	(76)	(60)	(55)	(48)	(41)	(205)	(194)	(149)	(121)	(107)	(78)	(68)	(56)	(49)		
			(394)	(384)	(324)	(303)	(267)	(242)	(230)	(199)	(155)	(898)	(586)	(327)	(275)	(247)	(242)	(226)	(204)	(197)		
			50% sustain after 1 minute																			

GR-L Series	Identifier	Test Method	50G-L	100G-L	150G-L	200G-L	250G-L	300G-L	350G-L	400G-L	500G-L	50G-HL	100G-HL	150G-HL	200G-HL	250G-HL	300G-HL	350G-HL	400G-HL	500G-HL		
Thickness	mm	Fujipoly	0.5 <sup>0.1</sup>	1.0 <sup>0.2</sup>	1.5 <sup>0.2</sup>	2.0 <sup>0.3</sup>	2.5 <sup>0.3</sup>	3.0 <sup>0.3</sup>	3.5 <sup>0.3</sup>	4.0 <sup>0.3</sup>	5.0 <sup>0.3</sup>	0.5 <sup>0.1</sup>	1.0 <sup>0.2</sup>	1.5 <sup>0.2</sup>	2.0 <sup>0.3</sup>	2.5 <sup>0.3</sup>	3.0 <sup>0.3</sup>	3.5 <sup>0.3</sup>	4.0 <sup>0.3</sup>	5.0 <sup>0.3</sup>		
Thermal Resistance	°C·in <sup>2</sup> /W (°C·cm <sup>2</sup> /W)	Fujipoly FTM P-3050 (ASTM D5470 Equivalent)	14.5 psi	0.27	0.44	0.68	0.86	1.12	1.26	1.41	1.56	1.80	0.32	0.55	0.76	1.02	1.21	1.35	1.48	1.79	1.99	
			(100kPa)	(1.77)	(2.87)	(4.40)	(5.57)	(7.24)	(8.10)	(9.12)	(10.06)	(11.61)	(2.05)	(3.56)	(4.89)	(6.56)	(7.83)	(8.74)	(9.56)	(11.57)	(12.85)	
			43.5 psi	0.23	0.39	0.62	0.77	0.98	1.06	1.20	1.32	1.49	0.28	0.47	0.68	0.91	1.06	1.17	1.28	1.54	1.66	
			(300kPa)	(1.50)	(2.50)	(3.98)	(4.94)	(6.31)	(6.83)	(7.74)	(8.51)	(9.62)	(1.79)	(3.06)	(4.40)	(5.86)	(6.84)	(7.54)	(8.24)	(9.92)	(10.72)	
			72.5 psi	0.22	0.35	0.57	0.71	0.89	0.94	1.08	1.17	1.31	0.26	0.44	0.62	0.82	0.96	1.05	1.15	1.38	1.49	
			(500kPa)	(1.39)	(2.29)	(3.67)	(4.45)	(5.75)	(6.06)	(6.99)	(7.58)	(8.47)	(1.70)	(2.83)	(3.99)	(5.30)	(6.18)	(6.75)	(7.44)	(8.90)	(9.59)	
Color	Visual	Fujipoly	Gray										gray									
Thermal Conductivity	watt/m·k	FTM P-1620 (ASTM D2326 Equivalent)	2.8										2.8									
Volume Resistivity	MΩ·m	ASTM D257	3x10 <sup>6</sup>										2x10 <sup>6</sup>									
Withstand Voltage	kV/min	ASTM D149	7										10									
Specific Gravity	-	ASTM D792	2.7										2.7									
Hardness	Shore OO	ASTM D2240	53										53									
Elongation	%	ASTM D412	64										32									
Compression	psi @ 10% (N @ 10%) (area = 25x25mm)	Fujipoly	27	25	19	15	15	10	9	9	40	37	30	21	20	15	15	11	9			
			(118)	(108)	(83)	(63)	(64)	(45)	(40)	(38)	(174)	(157)	(128)	(90)	(84)	(66)	(66)	(49)	(37)			
			119	101	96	90	81	81	63	60	220	211	184	125	113	103	103	79	67			
			(510)	(434)	(413)	(389)	(350)	(347)	(270)	(258)	(946)	(906)	(790)	(539)	(488)	(444)	(341)	(288)				
			50% sustain after 1 minute																			

GR-ae Series	Identifier	Test Method	50G-ae	100G-ae	150G-ae	200G-ae	250G-ae	300G-ae	350G-ae	400G-ae	500G-ae	50G-Hae	100G-Hae	150G-Hae	200G-Hae	250G-Hae	300G-Hae	350G-Hae	400G-Hae	500G-Hae		
Thickness	mm	Fujipoly	0.5 <sup>0.1</sup>	1.0 <sup>0.2</sup>	1.5 <sup>0.2</sup>	2.0 <sup>0.3</sup>	2.5 <sup>0.3</sup>	3.0 <sup>0.3</sup>	3.5 <sup>0.3</sup>	4.0 <sup>0.3</sup>	5.0 <sup>0.3</sup>	0.5 <sup>0.1</sup>	1.0 <sup>0.2</sup>	1.5 <sup>0.2</sup>	2.0 <sup>0.3</sup>	2.5 <sup>0.3</sup>	3.0 <sup>0.3</sup>	3.5 <sup>0.3</sup>	4.0 <sup>0.3</sup>	5.0 <sup>0.3</sup>		
Thermal Resistance	°C·in <sup>2</sup> /W (°C·cm <sup>2</sup> /W)	Fujipoly FTM P-3050 (ASTM D5470 Equivalent)	14.5 psi	0.63	0.94	1.20	1.51	1.92	1.93	2.13	2.16	2.76	0.67	1.02	1.35	1.81	1.92	2.21	2.21	3.14		
			(100kPa)	(4.08)	(6.09)	(7.74)	(9.74)	(12.42)	(12.47)	(13.74)	(13.92)	(17.83)	(4.31)	(6.59)	(8.72)	(11.68)	(12.42)	(14.28)	(14.28)	(20.27)		
			43.5 psi	0.50	0.69	0.92	1.07	1.37	1.27	1.48	1.53	1.94	0.54	0.84	1.09	1.42	1.41	1.60	1.60	2.20		
			(300kPa)	(3.21)	(4.44)	(5.92)	(6.88)	(8.86)	(8.20)	(9.55)	(9.85)	(12.52)	(3.47)	(5.39)	(7.02)	(9.14)	(9.11)	(10.34)	(10.34)	(14.20)		
			72.5 psi	0.43	0.58	0.76	0.86	1.09	1.03	1.21	1.25	1.60	0.46	0.72	0.92	1.12	1.12	1.26	1.26	1.76		
			(500kPa)	(2.78)	(3.76)	(4.93)	(5.52)	(7.04)	(6.67)	(7.78)	(8.09)	(10.33)	(2.96)	(4.66)	(5.92)	(7.24)	(7.23)	(8.11)	(8.11)	(11.38)		
Color	Visual	Fujipoly	Apricot										Apricot									
Thermal Conductivity	watt/m·k	FTM P-1620 (ASTM D2326 Equivalent)	1.3										1.3									
Volume Resistivity	MΩ·m	ASTM D257	1x10 <sup>6</sup>										1x10 <sup>6</sup>									
Withstand Voltage	kV/min	ASTM D149	12										13									
Specific Gravity	-	ASTM D792	2.0										2.0									
Hardness	Shore OO	ASTM D2240	24										24									
Elongation	%	ASTM D412	300										300									
Compression	psi @ 10% (N @ 10%) (area = 25x25mm)	Fujipoly	27	30	17	17	8	4	3	37	40	15	9	6	5							
			(118)	(131)	(72)	(72)	(36)	(17)	(12)	(158)	(174)	(65)	(39)	(24)	(21)							
			89	63	52	27	14	12	141	114	58	46	30	25								
			(383)	(271)	(224)	(224)	(115)	(60)	(53)	(606)	(492)	(250)	(197)	(130)	(106)							
			50% sustain after 1 minute																			

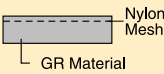
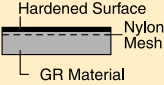
Typical Properties		Unit	SARCON® GR-F								SARCON® GR-HF									
<b>Cross Section</b>	<b>Composition</b>																			
<b>Extractable Volatiles</b>	<b>Content %</b> Cyclodimethyl Siloxane	Fujipoly	D4-D10 <0.0010 wt%								D4-D10 <0.0010 wt%									
<b>Continuous Use</b>	<b>°C</b>	Fujipoly	-60 to +200								-60 to +200									
<b>Flame Retardance</b>	<b>UL-94V standard</b>	UL	V0 - V1 (please check individual product specifications)								V0 - V1 (please check individual product specifications)									
<b>Dimensions Available</b>	<b>Thickness (mm)</b>	Fujipoly	0.5 <sup>±0.1</sup>	1.0 <sup>±0.2</sup>	1.5 <sup>±0.2</sup>	2.0 <sup>±0.3</sup>	2.5 <sup>±0.3</sup>	3.0 <sup>±0.3</sup>	3.5 <sup>±0.3</sup>	4.0 <sup>±0.4</sup>	5.0 <sup>±0.5</sup>	0.5 <sup>±0.1</sup>	1.0 <sup>±0.2</sup>	1.5 <sup>±0.2</sup>	2.0 <sup>±0.3</sup>	2.5 <sup>±0.3</sup>	3.0 <sup>±0.3</sup>	3.5 <sup>±0.3</sup>	4.0 <sup>±0.4</sup>	5.0 <sup>±0.5</sup>
	<b>Width (mm)</b>	Fujipoly	200 standard, larger width by request																	
	<b>Length (mm)</b>	Fujipoly	300 standard, larger length by request																	
<b>Packaging</b>	<b>Standard</b>	Fujipoly	Each Sheet is placed between top and bottom film liners for die cutting handling ease.																	

GR-d Series	Identifier	Test Method	50G-Fd	100G-Fd	150G-Fd	200GF-d	250G-Fd	300G-d	(350G-Fd)	(400G-Fd)	(500G-Fd)	50G-HFd	100G-HFd	150G-HFd	200G-HFd	250G-HFd	300G-HFd	(350G-HFd)	(400G-HFd)	(500G-HFd)	
<b>Thickness</b>	mm	Fujipoly	0.5 <sup>±0.1</sup>	1.0 <sup>±0.2</sup>	1.5 <sup>±0.2</sup>	2.0 <sup>±0.3</sup>	2.5 <sup>±0.3</sup>	3.0 <sup>±0.3</sup>	3.5 <sup>±0.3</sup>	4.0 <sup>±0.3</sup>	5.0 <sup>±0.3</sup>	0.5 <sup>±0.1</sup>	1.0 <sup>±0.2</sup>	1.5 <sup>±0.2</sup>	2.0 <sup>±0.3</sup>	2.5 <sup>±0.3</sup>	3.0 <sup>±0.3</sup>	3.5 <sup>±0.3</sup>	4.0 <sup>±0.3</sup>	5.0 <sup>±0.3</sup>	
<b>Thermal Resistance</b>	°C-in <sup>2</sup> /W (°C-cm <sup>2</sup> /W)	14.5 psi	0.63	1.15	1.68	2.00	2.48	2.97	3.12	3.53	4.20	0.63	1.17	1.59	2.07	2.61	2.89	3.35	3.56	4.22	
		(100kPa)	(4.06)	(7.41)	(10.81)	(12.93)	(16.02)	(19.18)	(20.10)	(22.75)	(27.12)	(4.04)	(7.56)	(10.27)	(13.33)	(16.81)	(18.66)	(21.63)	(22.96)	(27.23)	
		43.5 psi	0.60	1.03	1.44	1.69	2.05	2.42	2.47	2.86	3.17	0.59	1.07	1.40	1.79	2.15	2.39	2.71	2.85	3.33	
		(300kPa)	(3.89)	(6.67)	(9.31)	(10.92)	(13.20)	(15.64)	(15.92)	(18.43)	(20.45)	(3.82)	(6.93)	(9.03)	(11.55)	(13.85)	(15.39)	(17.48)	(18.39)	(21.50)	
		(ASTM D5470 Equivalent)	72.5 psi	0.57	0.94	1.30	1.52	1.81	2.13	2.18	2.47	2.63	0.56	1.00	1.28	1.62	1.95	2.13	2.41	2.52	2.99
			(500kPa)	(3.67)	(6.09)	(8.41)	(9.80)	(11.67)	(13.77)	(14.05)	(15.93)	(16.95)	(3.63)	(6.44)	(8.25)	(10.46)	(12.55)	(13.74)	(15.53)	(16.28)	(19.27)
<b>Color</b>	Visual	Fujipoly	Gray								Gray										
<b>Thermal Conductivity</b>	watt/m·k	FTM P-1620 (ASTM D2326 Equivalent)	1.5								1.5										
<b>Volume Resistivity</b>	MΩ·m	ASTM D257	1x10 <sup>6</sup>								1x10 <sup>6</sup>										
<b>Withstand Voltage</b>	kV/min	ASTM D149	9								9										
<b>Specific Gravity</b>	-	ASTM D792	2.6								2.6										
<b>Hardness</b>	Shore OO	ASTM D2240	49								49										
<b>Elongation</b>	%	ASTM D412	60								60										
<b>Compression</b>	psi @10%	Fujipoly	39	35	35	26	19	17	15	12	11	51	47	46	36	34	28	223	21	16	
	(N @10%)	(area=25x25mm)	(167)	(152)	(151)	(110)	(80)	(72)	(64)	(53)	(47)	(221)	(203)	(197)	(154)	(145)	(119)	(960)	(88)	(70)	
	50% sustain after 1 minute		(220)	(163)	(114)	71	59	46	43	41	41	(273)	(235)	(181)	116	95	89	73	73	57	
			(945)	(702)	(489)	(306)	(253)	(196)	(185)	(178)	(175)	(1174)	(1008)	(776)	(498)	(409)	(381)	(316)	(315)	(247)	

GR-L Series	Identifier	Test Method	50G-FL	100G-FL	150G-FL		50G-HFL	100G-HFL	150G-HFL
<b>Thickness</b>	mm	Fujipoly	0.5 <sup>±0.1</sup>	1.0 <sup>±0.2</sup>	1.5 <sup>±0.2</sup>		0.5 <sup>±0.1</sup>	1.0 <sup>±0.2</sup>	1.5 <sup>±0.2</sup>
<b>Thermal Resistance</b>	°C-in <sup>2</sup> /W (°C-cm <sup>2</sup> /W)	14.5 psi	0.41	0.66	0.87		0.45	0.67	0.93
		(100kPa)	(2.64)	(4.24)	(5.60)		(2.88)	(4.33)	(6.03)
		43.5 psi	0.35	0.58	0.75		0.36	0.59	0.82
		(300kPa)	(2.26)	(3.71)	(4.85)		(2.33)	(3.78)	(5.29)
		(ASTM D5470 Equivalent)	72.5 psi	0.33	0.52	0.69	0.34	0.54	0.76
			(500kPa)	(2.11)	(3.37)	(4.44)	(2.17)	(3.47)	(4.92)
<b>Color</b>	Visual	Fujipoly	Gray				Gray		
<b>Thermal Conductivity</b>	watt/m·k	FTM P-1620 (ASTM D2326 Equivalent)	2.8				2.8		
<b>Volume Resistivity</b>	MΩ·m	ASTM D257	4x10 <sup>6</sup>				3x10 <sup>6</sup>		
<b>Withstand Voltage</b>	kV/min	ASTM D149	8				10		
<b>Specific Gravity</b>	-	ASTM D792	2.7				2.7		
<b>Hardness</b>	Shore OO	ASTM D2240	53				53		
<b>Elongation</b>	%	ASTM D412	40				30		
<b>Compression</b>	psi @ 10%	Fujipoly	45	40	35		53	43	33
	(N @10%)	(area = 25x25mm)	(194)	(173)	(152)		(226)	(184)	(140)
	50% sustain after 1 minute		263	247	224		290	250	216
			(1131)	(1064)	(965)		(1247)	(1075)	(929)

GR-ae Series	Identifier	Test Method	50G-Fae	100G-Fae	150G-Fae	200G-Fae	250G-Fae	300G-Fae	350G-Fae	400G-Fae	500G-Fae	50G-HFae	100G-HFae	150G-HFae	200G-HFae	250G-HFae	300G-HFae	350G-HFae	400G-HFae	500G-HFae
<b>Thickness</b>	mm	Fujipoly	0.5 <sup>±0.1</sup>	1.0 <sup>±0.2</sup>	1.5 <sup>±0.2</sup>	2.0 <sup>±0.3</sup>	2.5 <sup>±0.3</sup>	3.0 <sup>±0.3</sup>	3.5 <sup>±0.3</sup>	4.0 <sup>±0.3</sup>	5.0 <sup>±0.3</sup>	0.5 <sup>±0.1</sup>	1.0 <sup>±0.2</sup>	1.5 <sup>±0.2</sup>	2.0 <sup>±0.3</sup>	2.5 <sup>±0.3</sup>	3.0 <sup>±0.3</sup>	3.5 <sup>±0.3</sup>	4.0 <sup>±0.3</sup>	5.0 <sup>±0.3</sup>
<b>Thermal Resistance</b>	°C-in <sup>2</sup> /W (°C-cm <sup>2</sup> /W)	14.5 psi	(4.27)	(7.67)		(12.88)						(4.48)	(7.97)		(13.07)					
		(100kPa)	0.64	1.06		1.64						0.67	1.10		1.72					
		43.5 psi	(4.13)	(6.81)		(10.58)						(4.35)	(7.10)		(11.10)					
		(300kPa)	0.60	0.96		1.41						0.64	0.99		1.5					
		(ASTM D5470 Equivalent)	72.5 psi																	
			(500kPa)																	
<b>Color</b>	Visual	Fujipoly	Apricot								Apricot									
<b>Thermal Conductivity</b>	watt/m·k	FTM P-1620 (ASTM D2326 Equivalent)	1.3								1.3									
<b>Volume Resistivity</b>	MΩ·m	ASTM D257	12								11									
<b>Withstand Voltage</b>	kV/min	ASTM D149																		
<b>Specific Gravity</b>	-	ASTM D792																		
<b>Hardness</b>	Shore OO	ASTM D2240																		
<b>Elongation</b>	%	ASTM D412																		
<b>Compression</b>	psi @ 10%	Fujipoly	30	21		16						31	40		19					
	(N @10%)	(area = 25x25mm)	(127)	(91)		(68)						(133)	(171)		(80)					
	50% sustain after 1 minute		179	112		58						227	159		83					
			(771)	(482)		(248)					(978)	(682)		(359)						

# SARCON<sup>®</sup> Thermal Gap Filler Pads

GR-m Series	Identifier	Test Method	50G-m	100G-m	150G-m	200G-m	250G-m	300G-m	50G-Hm	100G-Hm	150G-Hm	200G-Hm	250G-Hm	300G-Hm		
Thickness	mm	Fujipoly	0.5 <sup>±0.1</sup>	1.0 <sup>±0.2</sup>	1.5 <sup>±0.2</sup>	2.0 <sup>±0.3</sup>	2.5 <sup>±0.3</sup>	3.0 <sup>±0.3</sup>	0.5 <sup>±0.1</sup>	1.0 <sup>±0.2</sup>	1.5 <sup>±0.2</sup>	2.0 <sup>±0.3</sup>	2.5 <sup>±0.3</sup>	3.0 <sup>±0.3</sup>		
	°C-in <sup>2</sup> /W		14.5 psi (100kPa)	0.20 (1.30)	0.33 (2.11)	0.53 (3.45)	0.61 (3.91)	0.72 (4.67)	0.81 (5.24)	0.21 (1.37)	0.31 (1.99)	0.48 (3.08)	0.62 (4.00)	0.77 (4.96)	0.87 (5.61)	
	Thermal Resistance (°C-cm <sup>2</sup> /W)		FTM P-3050 (ASTM D5470 Equivalent)	43.5 psi (300kPa)	0.16 (1.02)	0.27 (1.76)	0.44 (2.87)	0.53 (3.44)	0.63 (4.05)	0.67 (4.32)	0.18 (1.16)	0.27 (1.71)	0.42 (2.71)	0.55 (3.57)	0.68 (4.38)	0.77 (4.94)
				72.5 psi (500kPa)	0.14 (0.91)	0.25 (1.63)	0.40 (2.61)	0.49 (3.14)	0.55 (3.55)	0.56 (3.63)	0.16 (1.06)	0.24 (1.56)	0.39 (2.51)	0.51 (3.26)	0.62 (4.00)	0.69 (4.48)
Color	Visual	Fujipoly	Dark Reddish Gray						Dark Reddish Gray							
Thermal Conductivity	watt/m·k	FTM P-1620 (ASTM D2326 Equivalent)	6						6							
Volume Resistivity	MΩ·m	ASTM D257	1x10 <sup>6</sup>						1x10 <sup>6</sup>							
Withstand Voltage	kV/min	ASTM D149	13						13							
Specific Gravity	-	ASTM D792	3.2						3.2							
Hardness	Shore OO	ASTM D2240	52						52							
Elongation	%	ASTM D412	80						80							
Compression	psi @ 10% (N @10%)	Fujipoly (area = 25x25mm)	19 (83)	24 (105)	19 (82)	18 (79)	16 (69)	13 (56)	32 (136)	36 (153)	33 (143)	21 (91)	22 (93)	19 (81)		
	50% sustain after 1 minute		122 (526)	115 (496)	106 (456)	90 (387)	83 (358)	69 (296)	175 (751)	170 (733)	157 (674)	124 (531)	115 (493)	97 (417)		

XR-e Series	Identifier	Test Method	100X-e	150X-e	200X-e	30X-He	50X-He	100X-He	150X-He	200X-He		
Thickness	mm	Fujipoly	1.0 <sup>±0.2</sup>	1.5 <sup>±0.2</sup>	2.0 <sup>±0.3</sup>	0.3 <sup>±0.1</sup>	0.5 <sup>±0.1</sup>	1.0 <sup>±0.2</sup>	1.5 <sup>±0.2</sup>	2.0 <sup>±0.3</sup>		
	°C-in <sup>2</sup> /W		14.5 psi (100kPa)	0.24 (1.56)	0.35 (2.26)	0.48 (3.09)	0.13 (0.81)	0.17 (1.12)	0.26 (1.66)	0.36 (2.33)	0.47 (3.06)	
	Thermal Resistance (°C-cm <sup>2</sup> /W)		FTM P-3050 (ASTM D5470 Equivalent)	43.5 psi (300kPa)	0.22 (1.43)	0.32 (2.04)	0.42 (2.71)	0.11 (0.71)	0.14 (0.92)	0.23 (1.47)	0.33 (2.11)	0.44 (2.82)
				72.5 psi (500kPa)	0.21 (1.33)	0.29 (1.87)	0.36 (2.35)	0.10 (0.66)	0.13 (0.85)	0.21 (1.38)	0.30 (1.94)	0.41 (2.65)
Color	Visual	Fujipoly	Gray			Gray						
Thermal Conductivity	watt/m·k	FTM P-1620 (ASTM D2326 Equivalent)	11			11						
Volume Resistivity	MΩ·m	ASTM D257	7x10 <sup>6</sup>			7x10 <sup>6</sup>						
Withstand Voltage	kV/min	ASTM D149	11			11						
Specific Gravity	-	ASTM D792	3.3			3.3						
Hardness	Shore OO	ASTM D2240	64			64						
Elongation	%	ASTM D412	40			40						
Compression	psi @ 10% (N @10%)	Fujipoly (area = 25x25mm)	20 (84)	23 (98)	22 (93)	5 (24)	13 (58)	23 (100)	23 (99)	26 (113)		
	50% sustain after 1 minute		186 (799)	181 (777)	179 (771)	120 (515)	201 (865)	197 (847)	192 (826)	183 (787)		

max size of 30X-He and 50X-He are 50x50mm.

XR-j Series	Identifier	Test Method	100X-j	150X-j	200X-j	30X-Hj	50X-Hj	100X-Hj	150X-Hj	200X-Hj		
Thickness	mm	Fujipoly	1.0 <sup>±0.2</sup>	1.5 <sup>±0.2</sup>	2.0 <sup>±0.3</sup>	0.3 <sup>±0.1</sup>	0.5 <sup>±0.1</sup>	1.0 <sup>±0.2</sup>	1.5 <sup>±0.2</sup>	2.0 <sup>±0.3</sup>		
	°C-in <sup>2</sup> /W		14.5 psi (100kPa)	0.17 (1.09)	0.25 (1.61)	0.31 (2.00)	0.10 (0.64)	0.12 (0.76)	0.19 (1.20)	0.29 (1.87)	0.35 (2.29)	
	Thermal Resistance (°C-cm <sup>2</sup> /W)		FTM P-3050 (ASTM D5470 Equivalent)	43.5 psi (300kPa)	0.16 (1.01)	0.23 (1.46)	0.26 (1.67)	0.09 (0.59)	0.10 (0.65)	0.16 (1.04)	0.25 (1.62)	0.31 (2.02)
				72.5 psi (500kPa)	0.15 (0.95)	0.21 (1.35)	0.12 (0.76)	0.09 (0.55)	0.09 (0.61)	0.15 (0.95)	0.23 (1.49)	0.29 (1.87)
Color	Visual	Fujipoly	Light Gray			Light Gray						
Thermal Conductivity	watt/m·k	FTM P-1620 (ASTM D2326 Equivalent)	14			14						
Volume Resistivity	MΩ·m	ASTM D257	7x10 <sup>6</sup>			7x10 <sup>6</sup>						
Withstand Voltage	kV/min	ASTM D149	11			11						
Specific Gravity	-	ASTM D792	3.2			3.2						
Hardness	Shore OO	ASTM D2240	64			64						
Elongation	%	ASTM D412	40			40						
Compression	psi @ 10% (N @10%)	Fujipoly (area = 25x25mm)	24 (103)	28 (123)	31 (132)	10 (45)	29 (124)	24 (103)	29 (123)	30 (129)		
	50% sustain after 1 minute		181 (778)	178 (767)	166 (713)	137 (591)	204 (876)	187 (805)	181 (776)	172 (741)		

max size of 30X-Hj and 50X-Hj are 50x50mm.

XR-m Series	Identifier	Test Method	30X-m	50X-m	100X-m	150X-m	200X-m		
Thickness	mm	Fujipoly	0.3 <sup>±0.06</sup>	0.5 <sup>±0.1</sup>	1.0 <sup>±0.2</sup>	1.5 <sup>±0.2</sup>	2.0 <sup>±0.3</sup>		
	°C-in <sup>2</sup> /W		14.5 psi (100kPa)	0.07 (0.44)	0.08 (0.49)	0.14 (0.92)	0.20 (1.30)	0.27 (1.73)	
	Thermal Resistance (°C-cm <sup>2</sup> /W)		FTM P-3050 (ASTM D5470 Equivalent)	43.5 psi (300kPa)	0.06 (0.38)	0.06 (0.40)	0.13 (0.81)	0.18 (1.14)	0.23 (1.50)
				72.5 psi (500kPa)	0.04 (0.23)	0.06 (0.37)	0.12 (0.75)	0.16 (1.03)	0.21 (1.35)
Color	Visual	Fujipoly	Light Gray						
Thermal Conductivity	watt/m·k	FTM P-1620 (ASTM D2326 Equivalent)	17						
Volume Resistivity	MΩ·m	ASTM D257	1x10 <sup>6</sup>						
Withstand Voltage	kV/min	ASTM D149	15						
Specific Gravity	-	ASTM D792	3.2						
Hardness	Shore OO	ASTM D2240	80						
Elongation	%	ASTM D412	35						
Compression	psi @ 10% (N @10%)	Fujipoly (area = 10x10mm)	109 (75)	104 (72)	33 (23)	29 (20)	28 (19)		
	50% sustain after 1 minute		626 (432)	164 (113)	52 (36)	42 (29)	32 (22)		

max size of 30X-m and 50X-m are 150x200mm.



GR-m Series	Identifier	Test Method	GR-F	GR-HF
Thickness	mm	Fujipoly		
Thermal Resistance	°C·in <sup>2</sup> /W (°C·cm <sup>2</sup> /W)		14.5 psi (100kPa)	
		FTM P-3050 (ASTM D5470 Equivalent)	43.5 psi (300kPa)	
			72.5 psi (500kPa)	
Color	Visual	Fujipoly		
Thermal Conductivity	watt/m·k	FTM P-1620 (ASTM D2326 Equivalent)	Not Available At This Time	Not Available At This Time
Volume Resistivity	MΩ·m	ASTM D257		
Withstand Voltage	kV/min	ASTM D149		
Specific Gravity	-	ASTM D792		
Hardness	Shore OO	ASTM D2240		
Elongation	%	ASTM D412		
Compression	psi @ 10% (N @10%) (area = 25x25mm)	Fujipoly		
		50% sustain after 1 minute		

XR-e Series	Identifier	Test Method	XR-F	XR-HF
Thickness	mm	Fujipoly		
Thermal Resistance	°C·in <sup>2</sup> /W (°C·cm <sup>2</sup> /W)		14.5 psi (100kPa)	
		FTM P-3050 (ASTM D5470 Equivalent)	43.5 psi (300kPa)	
			72.5 psi (500kPa)	
Color	Visual	Fujipoly		
Thermal Conductivity	watt/m·k	FTM P-1620 (ASTM D2326 Equivalent)	Not Available At This Time	Not Available At This Time
Volume Resistivity	MΩ·m	ASTM D257		
Withstand Voltage	kV/min	ASTM D149		
Specific Gravity	-	ASTM D792		
Hardness	Shore OO	ASTM D2240		
Elongation	%	ASTM D412		
Compression	psi @ 10% (N @10%) (area = 25x25mm)	Fujipoly		
		50% sustain after 1 minute		

XR-j Series	Identifier	Test Method	XR-F	XR-HF
Thickness	mm	Fujipoly		
Thermal Resistance	°C·in <sup>2</sup> /W (°C·cm <sup>2</sup> /W)		14.5 psi (100kPa)	
		FTM P-3050 (ASTM D5470 Equivalent)	43.5 psi (300kPa)	
			72.5 psi (500kPa)	
Color	Visual	Fujipoly		
Thermal Conductivity	watt/m·k	FTM P-1620 (ASTM D2326 Equivalent)	Not Available At This Time	Not Available At This Time
Volume Resistivity	MΩ·m	ASTM D257		
Withstand Voltage	kV/min	ASTM D149		
Specific Gravity	-	ASTM D792		
Hardness	Shore OO	ASTM D2240		
Elongation	%	ASTM D412		
Compression	psi @ 10% (N @10%) (area = 25x25mm)	Fujipoly		
		50% sustain after 1 minute		

XR-m Series	Identifier	Test Method	XR-F	XR-HF
Thickness	mm	Fujipoly		
Thermal Resistance	°C·in <sup>2</sup> /W (°C·cm <sup>2</sup> /W)		14.5 psi (100kPa)	
		FTM P-3050 (ASTM D5470 Equivalent)	43.5 psi (300kPa)	
			72.5 psi (500kPa)	
Color	Visual	Fujipoly		
Thermal Conductivity	watt/m·k	FTM P-1620 (ASTM D2326 Equivalent)	Not Available At This Time	Not Available At This Time
Volume Resistivity	MΩ·m	ASTM D257		
Withstand Voltage	kV/min	ASTM D149		
Specific Gravity	-	ASTM D792		
Hardness	Shore OO	ASTM D2240		
Elongation	%	ASTM D412		
Compression	psi @ 10% (N @10%) (area = 10x10mm)	Fujipoly		
		50% sustain after 1 minute		

# SARCON® Thermal Management Components

SARCON® GR-Td and GR-Tac are a very soft, highly conformable, thermal interface medium. The composite construction offers the combined benefits of both a soft Gap Filler Pad and a thin polyester reinforced thermal conductor.

This unique blend of technologies provides the following advantages:

- **Soft, low stress on component**
- **Naturally tacky, ease of assembly, adhesive not required**
- **Thin, low thermal resistance**
- **Polyester reinforced. Tight tolerances more easily maintained.**
- **Available in rolls or sheets, suitable for high or low volume applications**

**UL FILE NUMBER:** E58126

## AVAILABLE CONFIGURATIONS:

Sheets, Die-cuts, Rolls

## APPLICATIONS:

- Semiconductors to heat sink
- Chassis walls to other surfaces
- Component to heat spreader
- CD-Rom, DVD-Rom cooling

## Part Number Nomenclature:

**25GR-Td - 300 x 200**

- |        |          |               |
|--------|----------|---------------|
| Length | • Rolls  | • 10 (meters) |
|        | • Sheets | • 200 (mm)    |
| Width  | • Rolls  | • 100 mm      |
|        |          | • 200 mm      |
|        |          | • 400 mm      |
|        | • Sheets | • 300 mm      |

Material type • GR-Td  
• GR-Tac

## FEATURES:

- Highly conformable
- Excellent between surfaces where space and surface textures vary

## CONSTRUCTION:

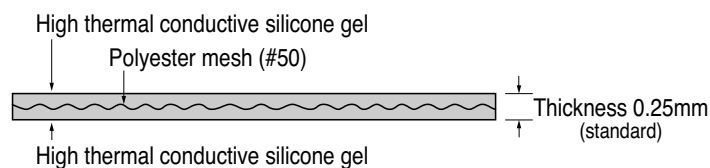

# SARCON® GR-Td and GR-Tac

## TECHNICAL INFORMATION



### TYPICAL PROPERTIES SARCON® 25GR-Td, 25GR-Tac

Test Properties	Test Method	Unit	Measure Sarcon 25GR-Td Moderate Tack				Measure Sarcon 25GR-Tac High Tack				
Thermal properties	Thermal conductivity	FTM P-1612	W/m · K	1.5 (ASTM-D2326 equivalent)				1.5 (ASTM-D2326 equivalent)			
	Thermal resistance	FTM P-3050	psi °C·in <sup>2</sup> /W (°C·cm <sup>2</sup> /W)	14.5 psi	43.5 psi	72.5 psi		14.5 psi	43.5 psi	72.5 psi	
Electrical properties	Operating temperature	Fujipoly	°C	-40°C to +150°C				-40°C to +150°C			
	Volume resistivity	ASTM D257	MΩ·m	3 x 10 <sup>6</sup>				2 x 10 <sup>6</sup>			
	Breakdown voltage	ASTM D149	kV	5				4			
	Withstand voltage	ASTM D149	kV/min	3				3.5			
	Color	Fujipoly	Visual	Gray				Dark Reddish Gray			
	Thickness	Fujipoly	mm	0.25				0.25			
	Sheet sizes	Fujipoly	mm	200mm wide x 300mm length				200mm wide x 300mm length			
	Roll sizes	Fujipoly	mm	100mm, 200mm, 400mm wide x 10m length							
Physical properties	Hardness	ASTM D2240	Asker - C Shore 00	-				35			
	Tensile strength	ASTM D412	MPa	11				9			
	Elongation	ASTM D412	%	15				25			
	Tear strength	ASTM D624	kN/m	21				14			
	Specific gravity	ASTM D792	-	2.5				2.6			
	Extractable volatiles	Fujipoly	wt %					0.0029 (D4 ~ D20) Siloxane			
	Flammability	UL94	-	VTM-O equivalent				VTM-O equivalent			
	Compression	Fujipoly	N (area=25x25mm)	54 @ 10%, 171 @ 20%, 329 @ 30%, 500 @ 40%, 681 @ 50%				41 @ 10%, 123 @ 20, 247 @ 30%, 379 @ 40%, 548 @ 50%			
Heat aging +70°C				<b>Initial</b>	<b>100hrs</b>	<b>500hrs</b>	<b>1000hrs</b>	<b>Initial</b>	<b>100hrs</b>	<b>500hrs</b>	<b>1000hrs</b>
	Specific gravity	ASTM D792	-	2.5	2.5	2.5	2.5	2.6	2.6	2.7	2.7
	Tensile strength	ASTM D412	MPa	11	7	7	6	9	9	9	9
	Elongation	ASTM D412	%	15	15	15	15	25	25	20	15
+150°C	Tear strength	ASTM D624	kN/m	20	14	11	11	14	15	15	14
	Volume resistivity	ASTM D257	MΩ·m	3 x 10 <sup>6</sup>	8 x 10 <sup>6</sup>	2 x 10 <sup>6</sup>	8 x 10 <sup>6</sup>	2 x 10 <sup>6</sup>	1 x 10 <sup>6</sup>	9 x 10 <sup>4</sup>	9 x 10 <sup>4</sup>
	Thermal conductivity	FTM P-1620	Watt/m·K	1.5	1.5	1.5	1.5	1.6	1.6	1.6	1.6
	Specific gravity	ASTM D792	-	2.5	2.5	2.5	2.6	2.7	2.7	2.7	
	Tensile strength	ASTM D412	MPa	11	6	5	5	9	9	9	9
	Elongation	ASTM D412	%	15	15	15	15	25	20	20	15
	Tear strength	ASTM D624	kN/m	20	14	11	11	14	15	18	19
	Volume resistivity	ASTM D257	MΩ·m	3 x 10 <sup>6</sup>	8 x 10 <sup>6</sup>	8 x 10 <sup>6</sup>	2 x 10 <sup>6</sup>	2 x 10 <sup>6</sup>	8 x 10 <sup>4</sup>	2 x 10 <sup>4</sup>	3 x 10 <sup>4</sup>
Humidity test +60°C 90% RH	Thermal conductivity	FTM P-1612	Watt/m·K	1.5	1.5	1.5	1.5	1.6	1.6	1.6	1.6
	Specific gravity	ASTM D792	-	2.5	2.5	2.5	2.5	2.6	2.6	2.6	2.7
	Tensile strength	ASTM D412	MPa	11	7	7	7	9	9	9	9
	Elongation	ASTM D412	%	15	15	15	15	25	20	20	15
	Tear strength	ASTM D624	kN/m	20	14	14	14	14	14	16	15
	Volume resistivity	ASTM D257	MΩ·m	3 x 10 <sup>6</sup>	2 x 10 <sup>6</sup>	4 x 10 <sup>6</sup>	2 x 10 <sup>6</sup>	2 x 10 <sup>6</sup>	9 x 10 <sup>4</sup>	6 x 10 <sup>4</sup>	5 x 10 <sup>4</sup>
Thermal conductivity	FTM P-1620	Watt/m·K	1.5	1.5	1.5	1.5	1.6	1.6	1.6	1.6	

# SARCON® Thermal Management Components



SARCON® Silicone Putty is a highly conformable, thermally conductive, non-flammable interface materials. It's thermal performance is equal to our most highly rated GR-m and XR-e Silicone Gap Filler Pads.

Three formulations are available, GR-Pm and XR-Pe. The specifications for each can be found in the chart below.

The surface consistency is excellent for filling small air gaps and uneven mating surfaces, making reliable contact with various shapes and sizes of components.

- Very low compression force at high compression rate
- Suitable for gaps as small as 0.3mm or less
- UL94 V-0 certified
- Available in three formulations

## AVAILABLE CONFIGURATIONS:

Sheets, Die-cuts

## APPLICATIONS:

- Between chassis wall and heat sink
- Between CPU and heat sink
- Between semiconductor and heat sink
- Component to heat spreader

## CONSTRUCTION:

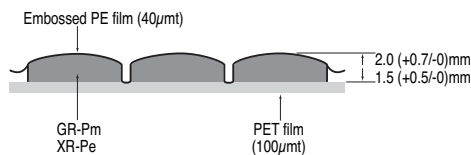

## APPLICATION GUIDE:

To determine the size and volume of SARCON® to be used, follow this helpful example:

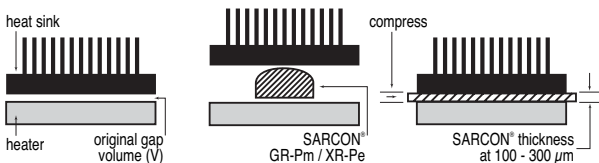

$$V = 45\text{mm}^3 \text{ (0.2mm H x 15mm W x 15mm L)}$$

$$\sqrt{45 (V) \div 2 \text{ (thickness)}} \text{ note: allows 50\% compression}$$

$$= 4.74\text{mm}; \text{ use } 5\text{mm} \times 5\text{mm} \text{ @ } 2.0\text{mm thickness}$$

## Part Number Nomenclature:

**200 GR-Pm - 200 x 300**

Length (mm) • 300 max.  
Width (mm) • 200 max.

SARCON® material type:  
• GR-Pm • XR-Pe

Thickness (mm) • 2.0 • 1.5

All dimensions in millimeters

UL FILE NUMBER: E58126

## TYPICAL CHARACTERISTICS:

Test Property	Unit	GR-Pm	XR-Pe	Method
Thermal Conductivity	Watt/m·K	6	11	ASTM D5470
Thermal Resistance Compression	°C·in²/W (original thickness 2.0mm)	30%	0.32	ASTM D5470
		50%	0.25	
		70%	0.18	
		90%	0.08	
Flame Retardancy	UL94	V-0	V-0	UL94
Operating Temperature	Max Range	-60 to +200	-60 to +200	Fujipoly
	Recommended Range	-40 to +150	-40 to +150	
Color	Visual	Dark Reddish Gray	Light Gray	-
Plasticity	mm	0.23	0.25	ASTM D962
Specific Gravity	-	3.1	3.3	ASTM D792
Volume Resistivity	MΩ·m	1 x 10 <sup>6</sup>	7 x 10 <sup>5</sup>	ASTM D257
Breakdown Voltage	kV/mm	13	11	ASTM D149
Dielectric Constant:	50Hz	6.4	NA	ASTM D149
	1kHz	6.4	7.5	
	1MHz	6.4	7.5	
Dissipation Factor:	50Hz	0.035	NA	ASTM D149
	1kHz	0.005	0.018	
	1MHz	0.001	0.008	
Compression:	10%	3.9	7.8	Fujipoly
	50% Sustain	13.7	19.6	

**DESCRIPTION:**

- Sarcon® XR-Um, XR-v: Silicone (Gel) compound
- Sarcon® XR-Um-AL, XR-v-AL: Silicone (Gel) compound with Aluminum film (10µmT)

**APPLICATIONS:**

- Thermal transfer from CPU and other heat generating devices to heat sink

	Unit	XR-Um	XR-Um-AL	XR-v	XR-v-AL	Method
Thermal Conductivity	W/m-K	17	17	6	6	ASTM D5470
Flame Retardancy	UL94	V-0	V-0 equivalent	V-0	V-0 equivalent	UL94

**TYPICAL CHARACTERISTICS:**

Test Property	Unit		14.5 psi (100kPa)	43.5 psi (300kPa)	72.5 psi (500kPa)
Thermal Resistance	°C·in²/W (°C·cm²/W)	20X-Um	0.02	0.02	0.02
			(0.16)	(0.12)	(0.11)
		30X-Um	0.03	0.03	0.02
			(0.20)	(0.17)	(0.15)
		40X-Um	0.05	0.04	0.04
			(0.30)	(0.27)	(0.25)
		50X-Um	0.06	0.05	0.04
			(0.36)	(0.31)	(0.28)
		20X-Um-AL	0.04	0.04	0.03
			(0.29)	(0.25)	(0.22)
Test Method		30X-Um-AL	0.05	0.04	0.04
			(0.35)	(0.28)	(0.26)
FTM P-3050		40X-Um-AL	0.07	0.05	0.04
			(0.42)	(0.33)	(0.29)
(ASTM D5470 Equivalent)		50X-Um-AL	0.08	0.06	0.05
			(0.50)	(0.38)	(0.31)
		11X-v	0.02	0.01	0.01
			(0.13)	(0.09)	(0.08)
		11X-v-AL	0.06	0.04	0.03
			(0.38)	(0.24)	(0.17)

**SARCON® XR-Um:**

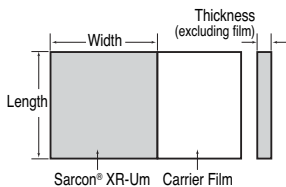

Item	Size	Tolerance	
Width (mm)	10.0 - 50.0	± 1.0	XR-v, XR-Um
Length (mm)	10.0 - 50.0	± 1.0	XR-v, XR-Um
Thickness (mm)	0.11	± 0.03	XR-v
	0.20	± 0.04	XR-Um
	0.30	± 0.06	XR-Um
	0.40	± 0.08	XR-Um
	0.50	± 0.10	XR-Um

**SARCON® XR-Um-AL:**

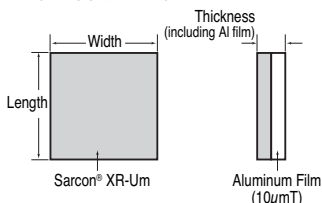

Item	Size	Tolerance	
Width (mm)	10.0 - 50.0	± 1.0	XR-v-AL, XR-Um-AL
Length (mm)	10.0 - 50.0	± 1.0	XR-v-AL, XR-Um-AL
Thickness (mm)	0.11	± 0.03	XR-v-AL
	0.20	± 0.04	XR-Um-AL
	0.30	± 0.06	XR-Um-AL
	0.40	± 0.08	XR-Um-AL
	0.50	± 0.10	XR-Um-AL

All dimensions in millimeters

Sarcon® XR-Um, XR-v is the highest thermal conductive putty type silicone sheet. The material's putty nature greatly contributes to reduction of contact resistance and consequently to its low thermal resistance. It is a customer friendly material due to its easy application by printing.

Sarcon® XR-Um-AL, XR-v-AL has one surface with aluminum film, which enables users to remove the carrier film after installation (before operation) with no-pull-out effect.

- Putty nature enables low contact thermal resistance
- Low Molecular Siloxane content is very low
- Has a flame retardancy of UL specification 94 V-0

UL FILE NUMBER: E58126

**DURABILITY:**

Test Conditions	20X-Um 15x15	11X-v 15x15	
+120°C Aging	Initial	0.03	0.23
	250 hrs	0.03	0.23
	500 hrs	0.03	0.25
	1,000 hrs	0.03	0.25
+150°C Aging	Initial	0.03	0.23
	250 hrs	0.04	0.22
	500 hrs	0.04	0.23
	1,000 hrs	0.04	0.23
+85°C 85%RH Aging	Initial	0.03	0.24
	250 hrs	0.03	0.21
	500 hrs	0.03	0.20
	1,000 hrs	0.03	0.20
-40°C to +125°C Heat Shock	Initial	0.03	0.26
	250 hrs	0.03	0.22
	500 hrs	0.03	0.23
	1,000 hrs	0.03	0.24

**EXTRACTABLE VOLATILE:**

Low Molecular Weight Siloxane Content

D <sub>n</sub>	XR-Um	XR-v	Test Method
Total less D <sub>20</sub>	Less than 0.0010 wt%	Less than 0.10 wt%	Gas Chromatographic Analysis by Abstracting Acetone (XR-Um) Carbon Tetrachloride (XR-v)

**Part Number Nomenclature:**

30 - XR-Um - 10 - 10

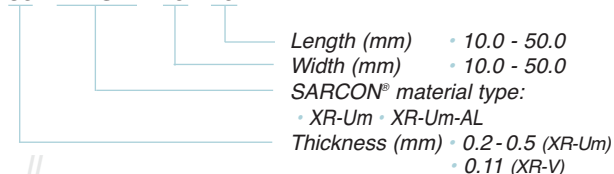

# SARCON<sup>®</sup> Thermal Management Components

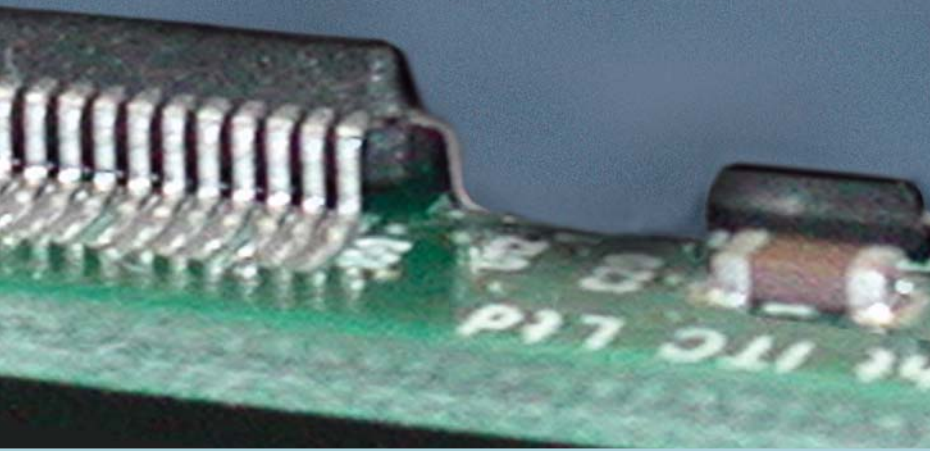

SARCON<sup>®</sup> GR-Sd and GR-SL are two of the lowest modulus type of Thermal Gap Filler Pad material available. Ideally suited for applications requiring low compression force on the component. It offers the high performance of the original GR-d and GR-L materials in a versatile sheet form that very easily conforms in and around protrusions and depressions on components to make complete, reliable physical contact.

**Absolute lowest modulus with high adhesion**

- Easily fills air gaps, uneven surfaces
- Lower thermal resistance due to complete surface contact
- Low molecular silicone content in compliance with Bellcore specification TR-NWT00930

## AVAILABLE CONFIGURATIONS:

Sheets

## APPLICATIONS:

- Semiconductors to heat sink
- Chassis walls to other surfaces
- Components to heat spreader
- CD-ROM, DVD-ROM cooling

## CONSTRUCTION:

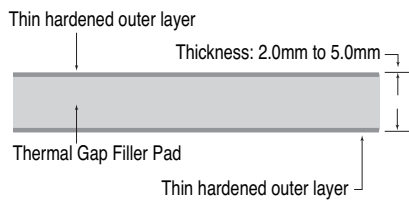

## APPLICATION GUIDE:

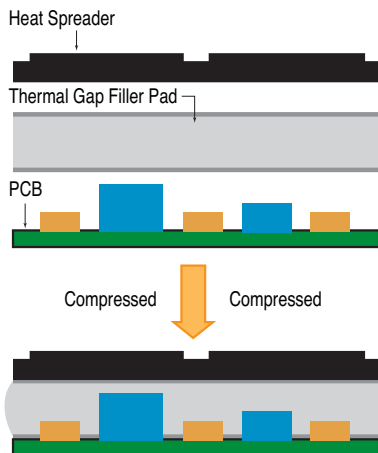

UL FILE NUMBER: E58126

TYPICAL CHARACTERISTICS: Note: Maximum compression is 50%

Test Property	Unit	Measure				Method	
		GR-Sd		GR-SL			
Thickness	mm	2.5	5.0	2.5	5.0	-	
Thermal Conductivity	Watt/m·K	1.5		2.7*		ASTM D5470 *ASTM D2326	
Thermal Resistance	14.5 psi	1.70	2.65	0.94	1.69	Fujipoly	
	°C·in <sup>2</sup> /W (100kPa)	(10.97)	(17.10)	(6.05)	(10.91)		
	43.5 psi	1.27	1.97	0.76	1.17		
	°C·in <sup>2</sup> /W (300kPa)	(8.21)	(12.73)	(4.90)	(7.56)		
°C·cm <sup>2</sup> /W	72.5 psi	1.26	1.63	0.51	0.89	Fujipoly	
	(500kPa)	(8.14)	(10.49)	(3.30)	(5.75)		
Flame Retardancy	UL94	V-1		V-0		UL94	
Operating Temperature	Maximum Range	-60 to +200		-60 to +200		Fujipoly	
	Recommended Range	-40 to +150		-40 to +150			
Color	Visual	Gray		Gray		-	
Tensile Strength	MPa	0.1		0.06		ASTM D412	
Breakdown Voltage	kV/mm	14		15		ASTM D149	
Compression (area = 25 x 25 mm)	N	10%	60	22	28	18	Fujipoly
	50% sustain	178	89	196	72		

## Part Number Nomenclature:

250 GR-Sd - 200 x 300

- Length (mm) • 300 max.
- Width (mm) • 200 max.
- SARCON<sup>®</sup> material type • GR-Sd • GR-SL
- Thickness (mm) • 2.5
- 5.0

# SARCON<sup>®</sup> Thermally Conductive Greases

Sarcon<sup>®</sup> SG-07SL and SG-26SL are highly thermally conductive, non-reactive silicone-based greases that offer low thermal resistance and maintain a non-flowable composition. Unique binding agents and product formulation ensure the lowest amount of bleed and evaporation. Suited for thin bond line applications.

Sarcon<sup>®</sup> SG-07NS and SG-26NS are non-silicone, polysynthetic-based thermal greases that have high thermal conductivity properties. Infused with heat-conductive metal oxides, this non-migrating material operates consistently in high temperatures. Sarcon<sup>®</sup> non-silicone greases offer all the benefits of a silicone-based compound without the problem of contamination.



## TYPICAL PROPERTIES:

	Unit	SG 07SL	SG 26SL	SG 07NS	SG 26NS
Type	–	Silicone	Silicone	Non-Silicone	Non-Silicone
Specific Gravity, @ 25°C	–	2.2	2.2	2.4	2.2
Viscosity*	Cps	10,000	95,000	15,000	85,000
Flow Rate**	grams/minute	95	6	75	8
Color	–	White	Gray	White	Gray
Evaporation, @ 200°C, 24hrs.	%/Wt	0.52	0.44	0.68	0.5
Thermal Conductivity	W/m.°K	0.75	2.6	0.75	2.6
Volume Resistivity	Ohm-cm	$2.1 \times 10^{14}$	$2.8 \times 10^{14}$	$1.4 \times 10^{14}$	$2.1 \times 10^{14}$
Dielectric Strength	V/mil	386	412	314	392
Operating Temperature Range	°C	-55 to 205	-55 to 205	-55 to 200	-55 to 200

\* Viscosity: Brookfield Viscometer, Spindle No.CP-51, 5 RPM. \*\* Flow test: 30cc Syringe, 0.09" orifice at 25PSI.

## FEATURES:

- Silicone and non-silicone formulations
- Thermal conductivity up to 2.6 W/m°K
- Low bleed and evaporation
- No migration for non-silicone formulations over wide temperature range
- Non-toxic
- Thin bond lines 1 mil
- Easy to apply and re-work

## APPLICATIONS:

- Standard dc/dc power converter and dc/ac inverter
- High performance CPUs
- Between any heat generating semiconductor and heat sink
- Custom power modules
- Telecommunications and automotive electronics

## PACKAGING OPTIONS:

- Pre-filled syringes: 3cc (6g), 10cc (28g), 30cc (72g)
- Jar containers: 1 lb. (454g)
- Custom packaging: Available on request

# SARCON® "Form in Place" Gap Filler

SARCON® SPG-15A is a highly conformable/thermally conductive, high viscosity type silicone compound. It provides a thermal solution for the recent trends of integrating higher frequency electronics into smaller devices. SARCON® SPG-15A easily forms and adheres to most surfaces, shapes, and sizes of components.

SARCON® SPG-15A makes complete and reliable physical contact with the component and opposing surfaces. It provides handling properties that are superior to thermal grease & potting materials.

- Thermal transfer from heat-generating device to heat spreader or heat sink.

## FEATURES:

- Fill large gaps while providing superior thermal transfer.
- Conformable with very low compression forces.
- Excellent vibration absorption capabilities.
- Maintains all initial properties across a wide temperature range.
- Used to "Form-In-Place" and remain form stable.
- Requires no heat curing.
- Will not cause corrosion on any metal surface.

UL FILE NUMBER: E58126

## RELIABILITY:

Thermal resistance under heat, cold, humid and thermal shock conditions.

## SPECIFICATIONS:

Property	Unit	SPG-15A	Method
Specific Gravity	—	2.8	ASTM D792
Viscosity	Pa·s	2,000	Fujipoly
Flow Rate	cc/min	8	Fujipoly
Thermal Conductivity	Watt/m·K	1.5	Fujipoly
Volume Resistivity	MΩ·m	1 x 10 <sup>6</sup>	ASTM D257
Breakdown Voltage	kV/mm	10	ASTM D149
Withstand Voltage	kV/min	8	ASTM D149
TGA Weight Loss	wt%	0.10	After +150°C, 24hrs aging
Operating Temp. Range	°C	-40 to +150	Recommended
Thermal Resistance	°C·in <sup>2</sup> /W	0.6 at 1.0mm gap	ASTM D5470
Compression Load/Modulus	N	Peak	19.6
		Sustain	1.0

### +150°C Aging

Gaps	Initial	100hrs	250hrs	500hrs	1,000hrs
1.0mm	0.6	0.6	0.6	0.6	0.6
2.0mm	1.1	1.1	1.2	1.2	1.2
3.0mm	1.6	1.9	1.9	1.9	1.9

### -40°C Aging

Gaps	Initial	100hrs	250hrs	500hrs	1,000hrs
1.0mm	0.6	0.6	0.6	0.6	0.6
2.0mm	1.1	1.1	1.1	1.1	1.1
3.0mm	1.6	1.6	1.6	1.6	1.6

### +60°C 95%RH Aging

Gaps	Initial	100hrs	250hrs	500hrs	1,000hrs
1.0mm	0.6	0.6	0.6	0.6	0.6
2.0mm	1.1	1.1	1.2	1.2	1.2
3.0mm	1.6	1.9	1.9	1.9	1.9

### -40°C to +125°C Heat Shock

Gaps	Initial	100hrs	250hrs	500hrs	1,000hrs
1.0mm	0.6	0.6	0.6	0.6	0.6
2.0mm	1.1	1.2	1.3	1.3	1.3
3.0mm	1.6	2.0	2.0	2.0	2.0

Unit of Thermal Resistance: °C·in<sup>2</sup>/W based on ASTM D5470 Test Method.

Contact Surface: 3.14cm<sup>2</sup> (0.49in<sup>2</sup>)

Filled SPG1-A material's weight: 1.0mm - 0.9g; 2.0mm - 1.8g; 3.0mm - 2.6g

Viscosity under heat, cold, humid and thermal shock conditions.

Test Conditions	Unit	Initial	1,000 hrs later
+150°C Aging	Pa·s*	2,000	3,100
-40°C Aging		2,000	2,000
+60°C 95%RH Aging		2,000	2,000
-40°C to +125°C Heat Shock		2,000	2,200

\*Accurate Rotary Viscometer (RV1)

## PRODUCT CONSTRUCTION:

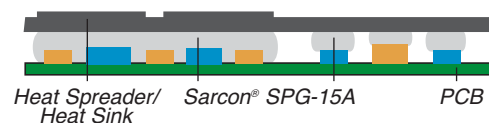

## Part Number Nomenclature:

### SPG-15A

- Packaging    Tube    • 30 ml  
                   Cartridge • 325 ml
- Material Type



# SARCON® "Form in Place" Gap Filler



SARCON® SPG-30A is a highly conformable/thermally conductive, high viscosity type silicone compound. It provides a thermal solution for the recent trends of integrating higher frequency electronics into smaller devices. SARCON® SPG-30A easily forms and adheres to most surfaces, shapes, and sizes of components.

SARCON® SPG-30A makes complete and reliable physical contact with the component and opposing surfaces. It provides handling properties that are superior to thermal grease & potting materials.

- Thermal transfer from heat-generating device to heat spreader or heat sink.

## FEATURES:

- Fill large gaps while providing superior thermal transfer.
- Conformable with very low compression forces.
- Excellent vibration absorption capabilities.
- Maintains all initial properties across a wide temperature range.
- Used to "Form-In-Place" and remain form stable.
- Requires no heat curing.
- Will not cause corrosion on any metal surface.

## SPECIFICATIONS:

Property	Unit	SPG-30A	Method
Specific Gravity	-	3.2	ASTM D792
Viscosity	Pa·s	2,700	Fujipoly
Flow Rate	cc/min	-	Fujipoly
Thermal Conductivity	Watt/m·K	3.2	Fujipoly
Volume Resistivity	MΩ·m	1 x 10 <sup>6</sup>	ASTM D257
Breakdown Voltage	kV/mm	15	ASTM D149
Withstand Voltage	kV/min	-	ASTM D149
TGA Weight Loss	wt%	-	After +150°C, 24hrs aging
Operating Temp. Range	°C	-40 to +150	Recommended
Thermal Resistance	°C·in <sup>2</sup> /W	0.3 at 1.0mm gap	ASTM D5470
Compression Load/Modulus	N	Peak	-
		Sustain	-
			Fujipoly

## PRODUCT CONSTRUCTION:

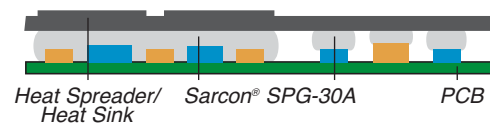

## Part Number Nomenclature:

### SPG-30A

- Packaging Tube • 30 ml
- Cartridge • 325 ml
- Material Type

UL FILE NUMBER: E58126

## RELIABILITY:

Thermal resistance under heat, cold, humid and thermal shock conditions.

### +150°C Aging

Gaps	Initial	100hrs	250hrs	500hrs	1,000hrs
1.0mm	0.3	0.3	0.3	0.3	0.3
2.0mm	0.5	0.6	0.6	0.6	0.6
3.0mm	0.8	0.8	0.9	0.9	0.9

### -40°C Aging

Gaps	Initial	100hrs	250hrs	500hrs	1,000hrs
1.0mm	0.3	0.3	0.3	0.3	0.3
2.0mm	0.5	0.5	0.5	0.5	0.5
3.0mm	0.8	0.9	0.9	0.9	0.9

### +60°C 95%RH Aging

Gaps	Initial	100hrs	250hrs	500hrs	1,000hrs
1.0mm	0.3	0.3	0.3	0.3	0.2
2.0mm	0.5	0.5	0.5	0.5	0.5
3.0mm	0.8	0.8	0.8	0.8	0.8

### -40°C to +125°C Heat Shock

Gaps	Initial	100hrs	250hrs	500hrs	1,000hrs
1.0mm	0.3	0.3	0.3	0.3	0.3
2.0mm	0.5	0.5	0.5	0.5	0.5
3.0mm	0.8	0.9	0.9	0.9	0.9

Unit of Thermal Resistance: °C·in<sup>2</sup>/W based on ASTM D5470 Test Method.

Contact Surface: 3.14cm<sup>2</sup> (0.49in<sup>2</sup>)

Filled SPG1-A material's weight: 1.0mm - 0.9g; 2.0mm - 1.8g; 3.0mm - 2.6g

Viscosity under heat, cold, humid and thermal shock conditions.

Test Conditions	Unit	Initial	1,000 hrs later
+150°C Aging	Pa·s*	2,000	3,100
-40°C Aging		2,000	2,000
+60°C 95%RH Aging		2,000	2,000
-40°C to +125°C Heat Shock		2,000	2,200

\*Accurate Rotary Viscometer (RV1)

# SARCON<sup>®</sup> Thermal Management Components

## SARCON<sup>®</sup> NON-SILICONE GAP FILLER

SARCON<sup>®</sup> NR-c is a highly conformable, thermally conductive, non-flammable acrylate resin (non-silicone) sheet with thermally conductive fillers.

Available in sheets and die-cut forms for formal interface uses wherever gap filler pads are traditionally used.

- No silicone extractions
- Lower thermal resistance
- UL 94V-0
- Very thin 0.5mm thickness
- Available in sheets for scoring or die-cutting

UL FILE NUMBER: E58126

AVAILABLE CONFIGURATIONS:

Sheets, Die-cuts

TYPICAL CHARACTERISTICS:

Test Property	Unit	Measure	Method
Thermal Conductivity	Watt/m·K	1.5	-
Flame Retardancy	UL94	V-0	-
Operating Temperature		-40° to +105°	-
Color	-	Light Gray	-
Specific Gravity	-	2.1	A
Hardness	Asker-C (Shore-00)	27 (53)	B
Tensile Strength	MPa	0.2	A
Elongation	%	150	A
Tear Strength	kN/m	1.5	A
Volume Resistivity	MΩ-m	2x10 <sup>9</sup>	C
Breakdown Voltage	kV/mm	11	C

Specimen A = 2.0mm thickness

Specimen B = 20mm width x 60mm length x 10mm thickness

Specimen C = 120mm width x 120mm length x 1.0mm thickness

Part Number Nomenclature:

50 N-c 120 x 120

Length (mm) • 300 max.  
Width (mm) • 200 max.

SARCON<sup>®</sup> N-c series N-c, N-Hc, N-Tc, N-HTc  
Thickness (mm) • 50 = 0.5mm\* • 100 = 1.00mm  
• 200 = 2.00mm

\*50N-Tc, 50N-HTc only

Thermal Resistance	Unit: (°C·in <sup>2</sup> /W)		
	14.5 psi (100kPa)	43.5 psi (300kPa)	72.5 psi (500kPa)
100N-c	1.02 (6.60)	0.78 (5.05)	0.61 (3.96)
150N-c	1.24 (8.01)	0.95 (6.12)	0.80 (5.13)
200N-c	1.75 (11.26)	1.32 (8.53)	1.08 (6.97)
300N-c	2.52 (16.24)	1.93 (12.45)	1.58 (10.19)
100N-Hc	1.03 (6.62)	0.86 (5.54)	0.77 (4.97)
150N-Hc	1.58 (10.21)	1.37 (8.85)	1.24 (7.99)
200N-Hc	2.10 (13.56)	1.71 (11.02)	1.48 (9.56)
300N-Hc	2.88 (18.60)	2.24 (14.43)	1.87 (12.08)
50N-Tc	0.62 (4.02)	0.59 (3.81)	0.57 (3.67)
100N-Tc	1.17 (7.55)	1.09 (7.06)	1.06 (6.81)
200N-Tc	1.69 (10.89)	1.57 (10.10)	1.45 (9.34)
300N-Tc	2.08 (13.44)	1.90 (12.25)	1.74 (11.23)
50N-HTc	0.68 (4.41)	0.66 (4.26)	0.64 (4.15)
100N-HTc	1.16 (7.50)	1.09 (7.05)	1.04 (6.70)
150N-HTc	1.66 (10.71)	1.55 (10.01)	1.45 (9.38)
200N-HTc	2.16 (13.97)	1.92 (12.39)	1.77 (11.43)
300N-HTc	3.08 (19.84)	2.55 (16.45)	2.23 (14.42)



## SARCON® THIN FILM PROFILES IN ROLLS AND SHEETS

Flat stock in rolls or single sheets for your custom finishing. Can be die-cut or trimmed to any proprietary shape on your finishing equipment. Available in six thicknesses and all SARCON® formulations.

### PART NUMBER NOMENCLATURE:

**30 GTR - AD - 100 x 100**

- Length - Rolls - 100 meters for up to 0.30mm  
- 50 meters for all others
- Sheets - As specified in chart
- Width - See chart below
- Roll - R
- Sheet - S (GSR)
- Adhesive Option (not available for TR, HR, UR, QR)
- Material Type - T for SARCON® TR - GHR for SARCON® GHR  
- H for SARCON® HR - GSR for SARCON® GSR  
- GTR for SARCON® GTR - Q for SARCON® QR  
- U for SARCON® UR
- Thickness (mm) - 15 (0.15 ±0.05) - 30 (0.30 <sup>+0/-0.05</sup>)  
- 20 (0.20 ±0.05) - 45 (0.45 ±0.05)  
- 85 (0.85 ±0.05)

### SHEETS: AVAILABLE DIMENSIONS

SARCON® Material	Thickness	Width	Length
TR	30 (0.30 +0.10/-0.00), 45 (0.45 +/-0.05), 85 (0.85 +/-0.05)	N/A	N/A
HR	30 (0.30 +0.10/-0.00), 45 (0.45 +/-0.05), 85 (0.85 +/-0.05)	N/A	N/A
GTR	15 (0.15 +0.02/-0.04), 20 (0.20 +0.02/-0.04), 30 (0.30 +0.10/-0.00)	N/A	N/A
GHR	15 (0.15 +0.02/-0.04), 20 (0.20 +0.02/-0.04), 30 (0.30 +0.10/-0.00)	N/A	N/A
GSR	20 (0.20 +/-0.05), 30 (0.30 +0.10/-0.00), 45 (0.45 +/-0.05), 85(0.85 +/-0.05)	300.0	300.0
UR	30 (0.30 +0.10/-0.00), 45 (0.45 +/-0.05), 85 (0.85 +/-0.05)	N/A	N/A
QR	30 (0.30 +0.10/-0.00), 45 (0.45 +/-0.05), 85 (0.85 +/-0.05)	N/A	N/A
GTR-AD (w/adhesive)	N/A	N/A	N/A
GHR-AD (w/adhesive)	N/A	N/A	N/A
GSR-AD (w/adhesive)	0.20, 0.30, 0.45, 0.85	300.0	300.0

### ROLLS: AVAILABLE DIMENSIONS

SARCON® Material	Thickness	Width	Length
TR	0.30, 0.45, 0.85	36.0, 85.0	100.0 meters for all thicknesses up to 0.30
HR	0.30, 0.45, 0.85	36.0, 85.0	
GTR	0.15, 0.20, 0.30	10.0min. - 475.0max.	
GHR	0.15, 0.20, 0.30	10.0min. - 475.0max.	
GSR	N/A	N/A	
UR	0.30, 0.45, 0.85	36.0, 85.0	
QR	0.30, 0.45, 0.85	36.0, 85.0	
GTR-AD (w/adhesive)	0.15, 0.20, 0.30	10.0min. - 450.0max.	50.0 meters for thicknesses over 0.30
GHR-AD (w/adhesive)	0.15, 0.20, 0.30	18/24/36/50/70/100	
GSR-AD (w/adhesive)	N/A	N/A	

# SARCON® Thermal Management Components

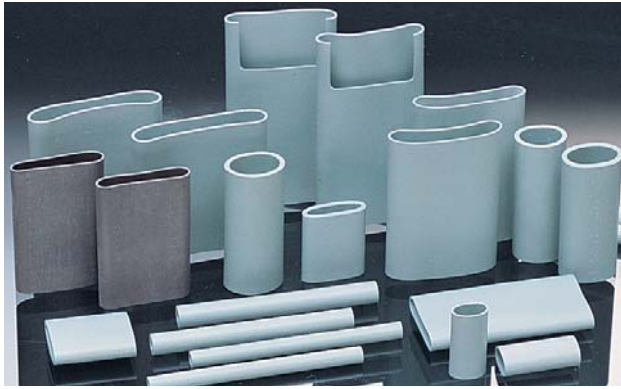

## SARCON® “SLEEVE” SHAPE THERMAL EXTRUSIONS

Tube shapes available in three thicknesses. TR, HR or UR formulations. The flexible structures conform to most applications. All standard items in stock; custom lengths and diameters available.

**APPLICATIONS:** Semiconductor packages, thermistors

**PART NUMBER NOMENCLATURE:**

**30-T-11-25L**

Length (mm)	· 25 · 30 · 35
Inner diameter (mm)	· 11 · 13.5 · 17
Material Type	· T for SARCON® TR · H for SARCON® HR · U for SARCON® UR
Thickness (mm)	· 30 (0.30 ± 0.1) · 45 (0.45 ± 0.05) · 85 (0.85 ± 0.05)

Usable Transistors	Applicable SARCON® Tubes	Inner Diameter
TO-220 type	30T-11-25L, 30T-11-30L, 45T-11-25L, 45T-11-30L, 85T-11-25L, 85T-11-30L	11 ± 1
TO-3PF type	30T-13.5-25L, 30T-13.5-30L, 45T-13.5-25L, 45T-13.5-30L, 85T-13.5-25L, 85T-13.5-30L	13.5 ± 1
TO-3PL type	45T-17-35L, 85T-17-35L	17 ± 1

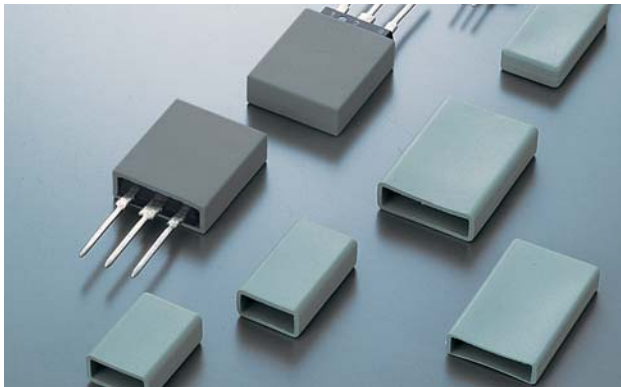

## SARCON® “CASE” SHAPE THERMAL EXTRUSIONS

Box-shaped caps for transistors. High thermal dissipation rate. Open on one end; installs by just slipping over the desired components. Available in TR and HR materials. All standard items in stock; custom sizes available.

**APPLICATIONS:** Semiconductor packages, thermistors

**PART NUMBER NOMENCLATURE:**

**30T-TO-220-02 225**

Length	
Case Number	
Applicable Transistor	
Material Type	· T for SARCON® TR · H for SARCON® HR
Thickness (mm)	· 30T (0.30 ± 0.1) · 45 (0.45 ± 0.05) · 50 (0.50 ± 0.05) · 90 (0.90 ± 0.10)

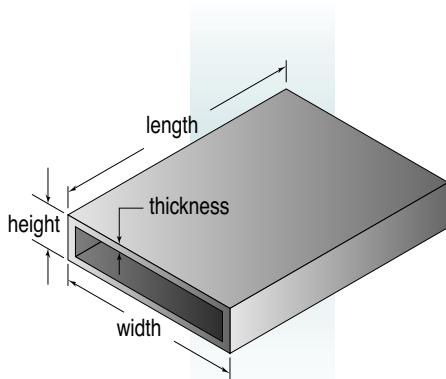

Part Number	Type	Inside Dimensions			Case Thickness
		Length	Width	Height	
30T-TO-220-02225	TR	22.5	11.0	4.5	0.30
45T-TO-220-01220	TR	22.0	11.0	5.0	0.45
90T-TO-220-01220	TR	22.0	11.0	5.0	0.90
30T-TO-3P-03281	TR	28.1	16.0	4.5	0.30
50T-TO-3P-02275	TR	27.5	16.5	5.0	0.50
90T-TO-3P-01280	TR	28.0	18.0	5.0	0.90
45H-TO-220-01220	HR	22.0	11.0	5.0	0.45
90H-TO-220-01220	HR	22.0	11.0	5.0	0.90
50H-TO-3P-02275	HR	27.5	16.5	5.0	0.50
90H-TO-3P-01280	HR	28.0	18.0	5.0	0.90

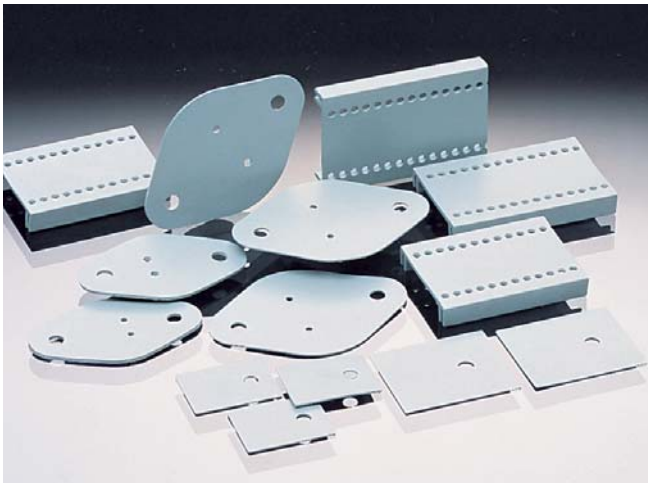

## SARCON® DIE-CUT GASKETS

Standard die-cut parts. Effective also as a mounting cushion to prevent deformation. Customs available in unlimited sizes and shapes.

**APPLICATIONS:** Semiconductor packages and heat sinks

### PART NUMBER NOMENCLATURE:

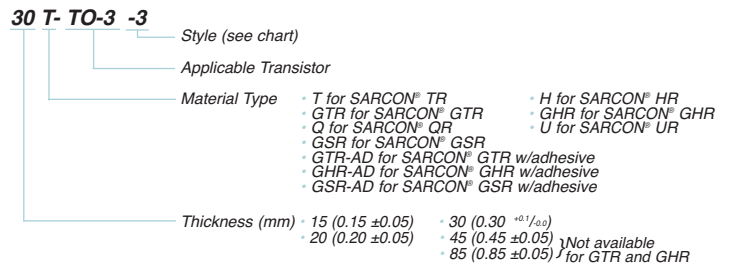

Configuration	Style	A	B	C	D	E	F	G	Lead Holes	Screw Torque
<b>TO-3</b> <b>2/3 Leads</b> 	-189	1.653 42.00	1.142 29.00	0.122 3.10	0.059 1.50	0.079 2.00				
<b>Plastic Power Devices</b> 	-191 (TO-220)	0.708 18.00	0.512 13.00	0.177 4.50	0.118 3.00					
	-192 (TO-3PF)	0.945 24.00	0.787 20.00	0.295 7.50	0.122 3.10					

# SELF-FUSING Silicone Rubber Tapes



## INSULATION

Self-fusing silicone rubber general purpose class H electrical tape is ideal for insulating or conductive applications where a quick, reliable weather-resistant electrical or hydraulic leak seal is required. The highly elastic material wraps around problem areas, immediately conforming to the applied surface with a tight fitting adhesion. Originally developed for military applications, and now available for general commercial use.

SPECIFICATION: MIL-AA-59163

APPLICATION:

### Conductive Type

- EMI/RFI shielding • Electrostatic discharge

### Insulation Type

- Electrical, electronic and general use
- Over-moldings, pottings
- Die-cut gasket
- Replacement of custom insulator pads

By spiral wrapping each successive layer slightly over the previous one, the tape fuses to itself over the component. Bonding only to itself, the permanent fusion begins within three minutes after contact.

Once the amalgamation is cured, the protected area withstands exposure to moisture, electrical and mechanical shock, temperature extremes, UV and ozone without degradation. Accordingly, its use in a wide range of situations, not normally handled by a tape product, is extremely feasible and offers a considerable cost reduction versus otherwise common or alternate methods.

The insulation type can be substituted anywhere other forms of insulating materials are used; such as, in place of custom die-cut pads, potting compounds and even over-moldings.

Resiliency and long-term aging properties are excellent; applicable in a very wide temperature range from -45°C to +250°C (-49°F to +480°F).

Two profiles are available, rectangular and delta shaped. The rectangular is a typical tape shape is used universally for most applications; the delta shape facilitates spiral wrapping around cables and harnesses by way of its natural tendency to conform in a helix.

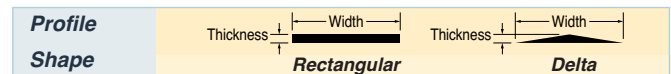

## PART NUMBER NOMENCLATURE:

### FLAT - 5TV - 8 - 1.0 - 50

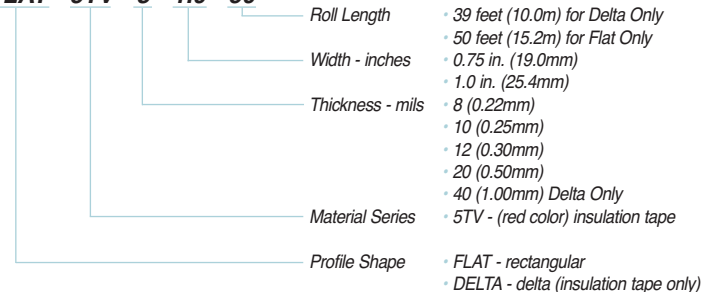

Insulation Tape Part Number	Color	Hardness (Shore A)	Tensile Strength (kg)	Elongation (%)	Tear Strength (%)	Adhesive Force (gr)	Withstand Voltage (AC kV)	Volume Resistivity (Ω-cm)		Typical Thermal Weight Loss (%)	Typical Content Siloxane (wt.%)
								Normal	Moist		
FLAT-5TV-8-.75	red	50±5	> 1.1	> 400	> 100	> 300	> 4.0	1.0x10 <sup>15</sup>	1.0x10 <sup>10</sup>	6.20% 225°C(440°F) x24 Hrs.	D4~D10=0.27 D11~D20=0.40 total=0.67
FLAT-5TV-8-1.0	red	50±5	> 1.5	> 400	> 100	> 400	> 4.0	1.0x10 <sup>15</sup>	1.0x10 <sup>10</sup>		
FLAT-5TV-10-.75	red	50±5	> 1.8	> 400	> 100	> 300	> 4.2	1.0x10 <sup>15</sup>	1.0x10 <sup>10</sup>		
FLAT-5TV-10-1.0	red	50±5	> 2.5	> 400	> 100	> 400	> 4.2	1.0x10 <sup>15</sup>	1.0x10 <sup>10</sup>		
FLAT-5TV-12-.75	red	50±5	> 2.7	> 400	> 100	> 300	> 4.5	1.0x10 <sup>15</sup>	1.0x10 <sup>10</sup>		
FLAT-5TV-12-1.0	red	50±5	> 3.5	> 400	> 100	> 400	> 4.5	1.0x10 <sup>15</sup>	1.0x10 <sup>10</sup>		
FLAT-5TV-20-.75	red	50±5	> 4.5	> 400	> 100	> 300	> 5.0	1.0x10 <sup>15</sup>	1.0x10 <sup>10</sup>		
FLAT-5TV-20-1.0	red	50±5	> 6.0	> 400	> 100	> 400	> 5.0	1.0x10 <sup>15</sup>	1.0x10 <sup>10</sup>		
DELTA-5TV-40-1.0	red	50±5	> 5.6	> 400	> 100	> 400	> 6.0	1.0x10 <sup>15</sup>	1.0x10 <sup>10</sup>		

# CUSTOM Silicone Rubber Extrusions



## COEXTRUSIONS

### APPLICATIONS:

RFI/EMI gaskets and shielding  
Electrostatic discharge (ESD)  
Electrical and Electronic parts used in:  
cameras      computers  
switches      instrumentation  
displays      controls

Complex shapes of silicone rubber consisting of different properties such as conductive and non-conductive segments, or color coding. Specifically custom designed to eliminate multiple extruded components by combining different elements into one unitized design.

Quick turnaround and cost-effective tooling preparation for your proprietary needs. For engineering assistance and more detailed information, please contact customer service.



## GASKETS AND SEALS

### APPLICATIONS:

Enclosure seals  
O-rings, bonded O-rings  
Tubing  
Complex shapes used in:  
automotive      architectural      electrical  
aerospace      marine      hydraulics  
appliances      medical      manufacturing

High performance, high quality silicone rubber. Available in standard and custom material formulations, extruded to your exact requirements.

Quick turnaround and cost-effective tooling preparations for your proprietary needs. For engineering information, please contact customer service.

## INDEX

Fujipoly electronic packaging components provide the finest performance available. To assure expected long-term results, refer to the following simple guidelines for each product area.

	<i>Page</i>
<b>Glossary of Connector Terminology</b> .....	38
<b>ZEBRA® Elastomeric Connectors</b> .....	39-42
<b>ZEBRA® “W” Matrix Connectors</b> .....	43
<b>SARCON® Thermal Management Components</b> .....	44-45

## GLOSSARY OF CONNECTOR TERMINOLOGY

<b>ASPECT RATIO (AR)</b>	Ratio of ZEBRA® connector height to width. (Aspect ratio of 1.5 and higher is recommended to minimize the amount of force required to deflect the ZEBRA® connector.)
<b>BEZEL</b>	Positioning device designed to surround the LCD edges while applying force to the ZEBRA® connector. Usually the decorative portion of the connector package. Plastic or metal cover placed over the LCD.
<b>BRIDGE</b>	Rib section on a ZEBRA® connector holder serving to reinforce the holder as well as minimize the length of individual ZEBRA® connection spans.
<b>COMPRESSION SET</b>	Amount by which a compressed ZEBRA® connector will not recover to its original height when compression is removed within the prescribed deflection limits. (typical maximum of 25%)
<b>CONNECTOR PITCH</b>	Center-to-center measurement of conductive layers.
<b>CONTACT DENSITY</b>	Number of conductive layers per inch.
<b>DEFLECTION</b>	Difference in original height versus compressed height of connector
<b>GAP</b>	Space on a PC board or LCD which does not contain contact pads.
<b>HOLDER / RETAINER</b>	Positioning device used to contain the ZEBRA® connector to assure proper alignment between two mating surfaces.
<b>LCD PITCH AND/OR PC BOARD PITCH</b>	Centerline-to-centerline distance between contact pads.
<b>LIP WIDTH</b>	Distance from outside edge of front glass to edge of back glass.
<b>PAD WIDTH</b>	Distance measured edge-to-edge of contact pad (CW).
<b>PAD LENGTH</b>	Distance measured end-to-end of contact pad (CL).
<b>PAD MATERIALS</b>	LCD contact pads are normally indium tin oxide. PC board contact pads may be gold, carbon-coated or solder-coated. Plating methods can result in significant variations in contact pad thickness, but should be kept as flat as possible.
<b>REGISTRATION</b>	Vertical alignment of contact pads between two mating surfaces.
<b>SEPARATION</b>	Distance between two mating surfaces.
<b>STRESS RELAXATION</b>	The function which relates to the loss of back stress of the compressed connector over time. Expressed as a percent of original stress.
<b>TOLERANCE STACK-UP</b>	Minimum and maximum dimensions of separation between LCD contacts and PC board contacts as determined by consideration of tolerance variations in flatness and parallelism of components.



# ZEBRA® Design Guidelines - Connectors

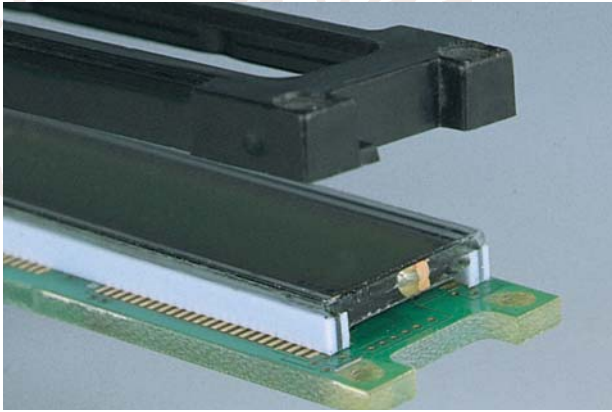

Micro-electronics interconnect packaging applications by their very nature leave a minimum of space in which to assemble mating components. High reliability and very small interconnections, with an ever-increasing number of I/O's, are a must if design objectives are to be met. ZEBRA® connectors can be found in most product types of this nature, and continue to gain wider acceptance as product packages decrease in size. Since each style consists of integral conductors, insulators and self-support structures, there is generally no added componentry required for installation – thus a very important by-product of hardware and installation cost-effectiveness can be realized.

**AS EASY AS 1...2...3:** Using ZEBRA® elastomeric electronic connectors requires only a brief orientation in order to assure that the components provide the finest performance possible. The basic design steps consist of:

1. Layout of your package
2. Select the proper connector and size
3. Design the bezel or retainer

## DESIGN FEATURES AND CHARACTERISTICS

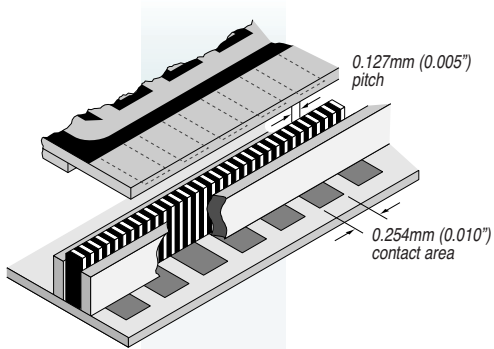

ZEBRA® connectors are composed of alternating layers of conductive and non-conductive silicone rubber. Contact density of the ZEBRA® connector is greater than the contact pad density of either the LCD or PC board, making it an ideal design choice. When placed between the LCD and PC board at least one conductive layer will connect matched contact pads and at least one insulating layer will isolate adjacent circuits.

- SOLDERLESS CONNECTIONS** Pressure type contact eliminates lead straightening, hole drilling and soldering.
- NON-ABRASIVE CONTACTS** (Zero insertion force) Contact to the LCD is made by deflecting the ZEBRA® connector between the LCD and PC board. ZEBRA® connectors are non-abrasive and will not damage indium oxide contact pads on the LCD. Repeated assembly and disassembly of package components will not affect performance.
- ENVIRONMENTAL RELIABILITY** The LCD, when mounted with a ZEBRA® rubber connector, creates a gas tight seal at the contact interface. Assures contact in chemically corrosive atmospheres while at the same time protecting the glass display from shock and vibrations.
- SMALL GLASS OVERHANG** With a ZEBRA® connector, LCD terminal overhangs can be as narrow as 0.030"/8mm permitting more efficient use of glass size related to character height. (Metal pins normally require a 0.150"/3.9mm glass overhang, reducing character height by as much as 0.240"/6.1mm for a dual in-line LCD.)
- HIGH DENSITY CONTACT** ZEBRA® connectors are available in a variety of contact densities. The most dense allows contact pad spacing as close as 0.010"/0.25mm center-to-center. This spacing can be compared to 0.050"/1.3mm minimum for pins, allowing for increased capacity of LCD formats.
- TEMPERATURE RANGE** -55° TO +260° F/-50° C TO +125° C (-60° TO +125° C available on request)
- CURRENT CARRYING CAPACITY** 40 amps per square inch of contact pad. (0.050A for .035 x .035 pad)
- CONNECTION RESISTANCE** Typically 500 to 2,500 ohms.
- INSULATION RESISTANCE** Typically 10<sup>12</sup> ohms.
- DEFLECTION FORCE REQUIRED** 1.5 pounds per linear inch for a 0.020" wide ZEBRA®.
- LIFE** 100,000 hours minimum.
- CONDUCTIVE LAYERS** up to 500 per inch.

## PHYSICAL AND ELECTRICAL MEASUREMENTS - NOMINAL

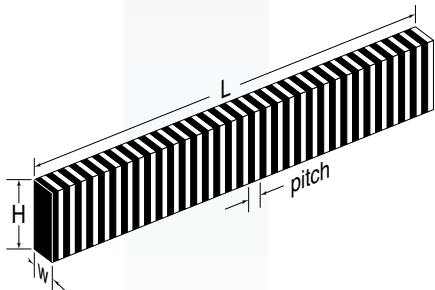

**DIMENSIONS** - The above figure shows the dimensions of the ZEBRA® connector. For best overall performance ZEBRA® connectors should be designed with an aspect ratio of H/W equal to or greater than 1.5.

**MECHANICAL - FORCE DEFLECTION** - Recommended deflection is 5% to 25% of the height (H) dimension. To calculate F (force in pounds) for deflection the following formula may be used:

**For Carbon ZEBRA's**  
Metric:  $F = 9 \times D \times W \times L \times 9.8 \times 10^3$

**Inches:**  
 $F = 5806 \times D \times W \times L \times 9.8 \times 10^3$

**For Silver ZEBRA's**  
Metric:  $F = 10.0 \times D \times W \times L \times 9.8 \times 10^3$

**Inches:**  
 $F = 6452 \times D \times W \times L \times 9.8 \times 10^3$

**Where:**  
F = Force (N)  
 $D = \frac{H - H_1}{H}$   
H = Height of connector (mm or inches)

$H_1$  = Deflected height of connector (mm or inches)  
W = Width of connector (mm or inches)  
L = Length of connector (mm or inches)

**RESISTANCE** - To calculate the resistance of ZEBRA® connectors, choose one of the following formulas:

**For Carbon ZEBRA's** Inches:  
 $R = \frac{2.37 \times H}{E_w \times W} = \text{ohms}$

**Where:**  $E_w$  = Electrode pad width (in)  
W = Connector width (in)  
H = Connector height (in)  
 $R = \frac{60 \times H}{C_w \times W} = \text{ohms}$

**Metric:**  $E_w$  = Electrode pad width (cm)  
W = Connector width (cm)  
H = Connector height (cm)

**For Silver ZEBRA's** Inches:  
 $R = \frac{H \times 0.0004}{W \times E_w} + 0.10 = \text{ohms}$

**Where:** W = Width of ZEBRA® (in)  
 $E_w$  = Electrode pad width (in)  
H = Height of ZEBRA® (in)  
 $R = \frac{H \times 0.01}{W \times E_w} + 0.10 = \text{ohms}$

**Metric:** W = Width of ZEBRA® (mm)  
 $E_w$  = Electrode pad width (mm)  
H = Height of ZEBRA® (mm)

## ENVIRONMENTAL SEALING

The ZEBRA® connector will provide a gas tight seal. Adverse effects of temperature, shock and vibration, atmospheric corrosion as well as harsh chemical environments will not affect LCD or PC board contacts, when sealed through use of a ZEBRA® connector.

# ZEBRA® Design Guidelines - Connectors

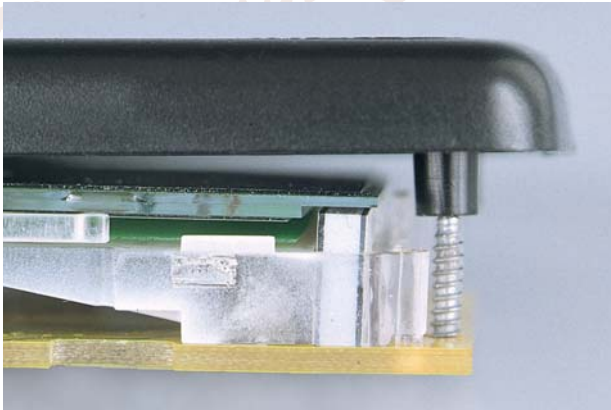

## 1. LAYOUT OF YOUR PACKAGE:

Shown at left is a typical LCD-to-printed circuit board interconnect using ZEBRA® elastomeric connectors in a cellular telephone handset. The components are stacked and consist of only three items to be addressed:

**Liquid Crystal Display (LCD)**  
**ZEBRA® connector**  
**Printed Circuit Board (PCB)**

It is essential that contact mating characteristics be kept as similar to the other components as possible. Any factors restricting positive contact interface should be compensated for in the design. Some of these are as follows:

### 1.1 PRINTED CIRCUIT BOARD DESIGN CONSIDERATIONS

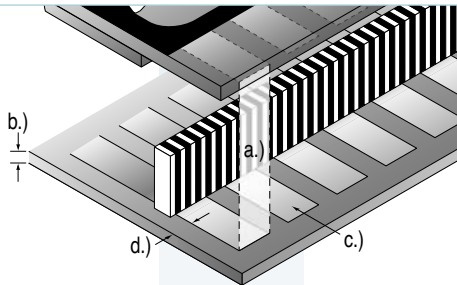

- Registration of contact pads** between the LCD and PC board is critical in effecting contact. Contact pads of both should ideally be of the same size and equally matched in tolerances for width and pitch.
- Consider carefully PC board thickness** and the related flatness tolerances. Proper design should involve the control of "waviness" tolerances and board stiffness. Both elements are essential in the appropriate design and selection of the ZEBRA® connector. Connector deflection and width are important considerations in determining the size of the ZEBRA® connector to be used in order to maintain proper deflection without "bowing" the PC board.
- Contact pad material** on the PC board, as well as the LCD, should be smooth and regular with thickness tolerances established.
- Consider the area on the PC board** to be dedicated to the LCD and the presence of neighboring components. Location of the LCD above or on the PC board should permit free clearance on all four sides of the PC board profile of at least 0.250"/6.2mm for packaging and/or fastening.

### 1.2 LCD DESIGN CONSIDERATIONS

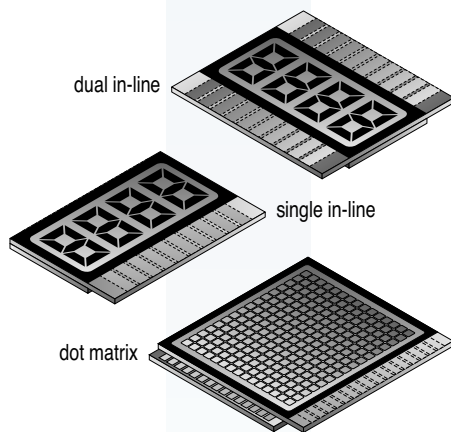

- Select LCD configuration**, e.g., Single In-Line (SIL); Dual In-Line (DIL); or contacts on both planes. Example: Dot Matrix.
- Select an LCD** which in its design has contact pads on the reverse side of the viewing area (facing PC board). For those instances where contact pads cannot be stationed facing the PC board, a custom elastomer may be required.
- Pitch** of LCD contact pads.
- Length, width, and thickness** of combined front glass and back glass of LCD.
- Determine lip width** (distance from outside edge of front glass to edge of back glass). This dimension should be at least 0.060"/1.5mm and preferably 0.100"/2.5mm. Ideally, contact pads should extend to the outer edge of the lip on the glass.

### 1.3 CALCULATING THE SEPARATION FACTORS

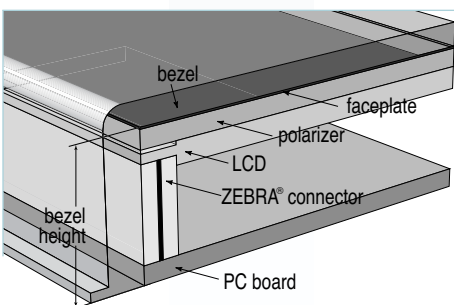

**Consideration must be given to tolerance control** on the elements that comprise the connector package. There are separate flatness and parallelism tolerances for the LCD glass, polarizers, reflectors and PC board. Materials used for the contact pads of the LCD and contact pads of the PC board also have thickness variations which must be considered. Flatness of the PC board and parallelism between the components are also factors. These tolerance values are vital criteria in determining separation variations between the LCD and PC board. The sum of the tolerances of these elements plus nominal separation determine the height (H) of the connector which will meet your design application.

# ZEBRA® Design Guidelines - Connectors

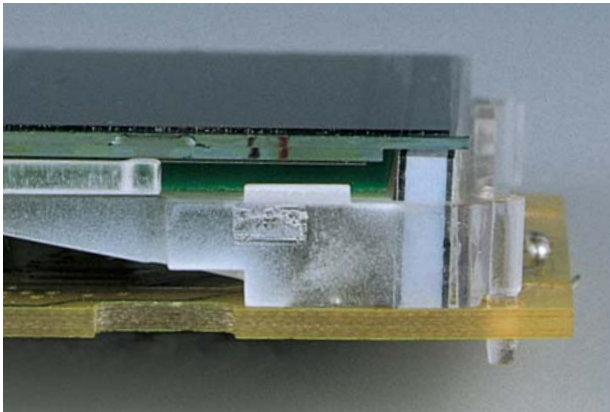

## 2. SELECT THE CONNECTOR AND SIZE

ZEBRA® elastomeric connectors offer a wide variety of application possibilities, in many cases where no other type of interconnect device is possible. They require a minimum of installation hardware considerations, allowing for very small packaging structures to support low profile display and microelectronic interfacing.

When properly dimensioned, long-life performance can be assured and gas-tight connections without additional precautions can be realized.

### 2.1 CONNECTOR PITCH AND LENGTH

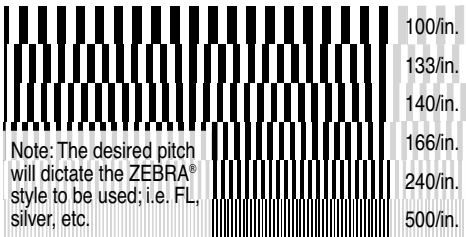

- Select a ZEBRA® connector that will assure that at least one conductive layer connects between contact pads, for example, of an LCD and PC board to be interconnected, and at least one insulating layer is between adjacent contact pads.**
- ZEBRA® connectors can accommodate applications with contact spacing of .010"/.254 mm center-to-center or greater.**
- The overall length should extend a minimum of 0.020" beyond the edge of the contact at each end of the connector.**

### 2.2 CONNECTOR HEIGHT

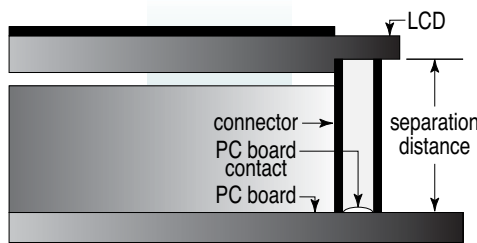

- ZEBRA® connector height is determined by the separation distance between LCD and PC board contact pads, including tolerance variations. ZEBRA® connectors can be supplied with a height of up to 1"/25mm.**
- ZEBRA® connector height is the most critical dimension in determining the functional performance of the connected components. Calculate the tolerance stack-up of the PC board, LCD, polarizer, and ZEBRA®. Multiply the maximum separation distance by 1.10 (adding 10% to separation distance) to establish uncompressed ZEBRA® connector height.**
- The following example shows calculations used in determining uncompressed ZEBRA® connector height.**

**Example:** Separation distance in this application equals 0.200"/5.08mm with tolerance of +/- 0.005"/0.13mm representing the tolerance stack-up from one end of the LCD and PC board separation to the other end. The minimum separation in our application equals 0.195"/4.9mm; the maximum separation equals 0.205"/5.2mm. Multiply the maximum separation of 0.205"/5.2mm by 1.10 to develop the uncompressed ZEBRA® connector height. The resulting 0.225"/5.7mm uncompressed height of ZEBRA® connector is the correct ZEBRA® connector height to assure adequate contact and achieve the minimal 0.195"/4.9mm separation for assembled height of the LCD, PC board package, and to insure contacts in areas where the minimum separation of 0.195"/4.9mm prevails. To achieve the 0.200"/5.08mm assembled height, it is necessary to deflect the 0.225"/5.7mm free height ZEBRA® connector by 10%. The design result falls within the 5%-25% deflection range recommended for effective ZEBRA® connector contact.

### 2.3 CONNECTOR WIDTH

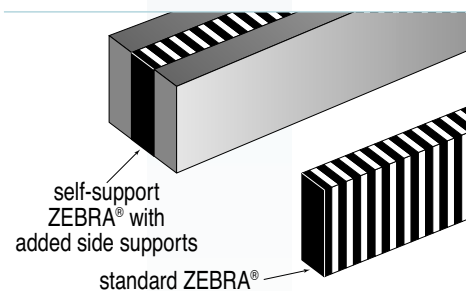

- Force deflection considerations of the ZEBRA® connector (Refer to Force Deflection formula) result in a recommendation of 0.025"/0.6mm as the width for connectors of lengths between 0.25"/6mm and 2.5"/63.5mm. Continuous connector spans of 2.6"/66mm to 8"/203mm require a minimum 0.035"/0.9mm wide connector to allow easy assembly of the ZEBRA® connector into the slot of a holder. Ideally, the ZEBRA® connector length should be limited to 2.5"/63.5mm due to possible insertion difficulties of the connector in the slot of the holder.**
- ZEBRA® connectors with a width of 0.025"/0.6mm to 0.035"/0.9mm require the use of a holder. (See design of ZEBRA® connector holder.) Fujipoly offers standard self-supporting ZEBRA® connectors eliminating the need for fabricating a holder for heights up to 0.200"/5.08mm.**

# ZEBRA® Design Guidelines - Connectors

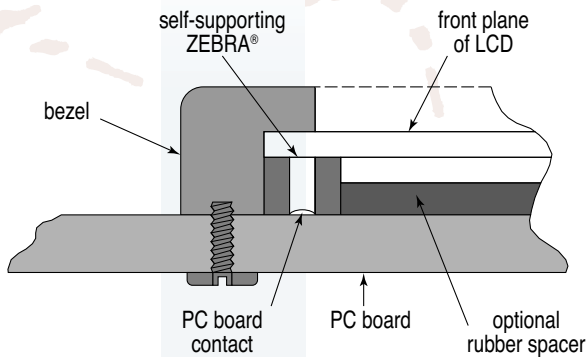

## 3. DESIGNING THE CONNECTOR HOLDER

Once the ZEBRA® style and design have been decided upon, two last considerations should be resolved; namely:

- Support of the ZEBRA® connector in its operating position
- Application of pressure onto connector height dimension to cause deflection and proper contact to the conductive contact pads.

The most common alternatives are among the following:

- A Self-Supporting ZEBRA® connector**
- A Custom Holder - for your specific configuration**
- Clamping or fastening devices**

### 3.1 STANDARD SUPPORTED SIZES

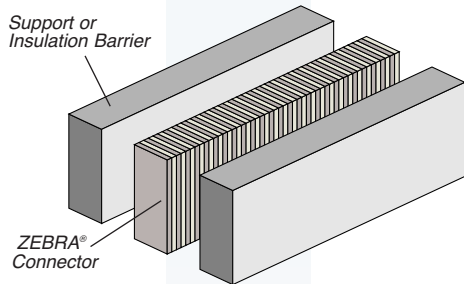

The supported connector typically contains a thin elastomeric 0.020"/.51mm wide strip attached to either one or both sides. It is a sponge or solid silicone rubber support medium which allows a lower compression force over a wide range while also providing a greater width-to-height ratio. Thus, the free-standing stance is more stable, especially as compression is introduced.

#### Carbon and Silver Filled Standard Dimensions (in./mm)

	min.	max.
<b>width</b>	0.050/1.27	0.157/3.44
<b>height</b>	0.050/1.27	1.000/25.4
<b>length</b>	0.250/6.35	9.000/229.0 carbon; 5.000/127.0 silver

### 3.2 DIMENSIONING A STANDARD OR CUSTOM CONNECTOR HOLDER

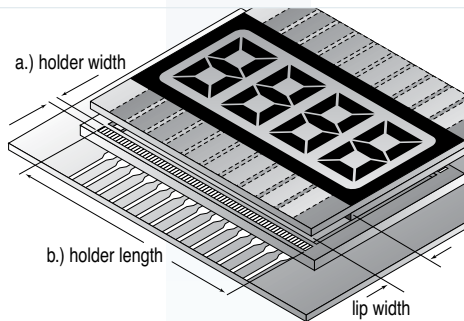

- a.) **Holder/Retainer width:** Determine LCD lip width as well as clearance on the PC board allowed to accommodate the LCD.
- b.) **Holder length:** Holder should extend a minimum of 0.1"/2.5mm beyond the edges of the front of the glass of the LCD and/or the PC board pad lengths in order to provide support, and proper positioning and placement of aligning pins of the holder. Where wall thickness of the holder must be thin and length of contact area is in excess of 2.5"/63.5mm, it may be necessary to provide a bridge or separator in the holder slot at 2.5"/63.5mm intervals, or the wall thickness of the frame on either side of the slot must be adequate to inhibit inward "bowing". Design considerations should preclude such bridges or separators from interfering with the contacts designed to be between LCD and PC board.

The difference between slot width and ZEBRA® width should be approximately 0.005"/0.13mm to allow for easy insertion and removal.

- c.) **The following design considerations should be evaluated:**

**Plastic Holders:** Reinforced plastic is preferable because it affords superior physical and electrical design properties. Temperature range of LCD should be consistent with temperature specifications of plastic selected. Chamfer the slot in the holder as shown in the illustration. Add 0.005"/0.13mm to the width of the slot for insertion of the ZEBRA® connector. Allow a minimum of 0.050"/1.3mm wall thickness or greater as height approaches 0.150"/3.8mm/ Locating pins should be molded to bottom of ZEBRA® connector holder to provide registration between LCD and the PC board contacts. See Figure #1.

**Metal Holders:** In designing metal holders, specify an insulating barrier or supports on the sides of the ZEBRA® connector to assure electrical insulation to eliminate shorting, etc.

**Locating pins:** Should be provided on the ZEBRA® connector holder to provide registration between LCD and PC board contacts. Check with the LCD manufacturer regarding the glass seal in designing either plastic or metal holders. Provide room in the ZEBRA® connector holder for the seal. Provision should be made to accommodate loose polarizers and reflectors if such elements are included in the design.

### 3.3 DESIGNING THE BEZEL

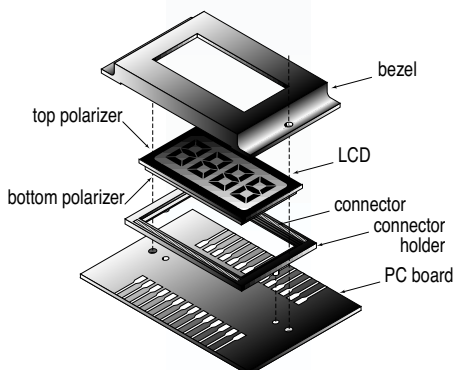

In determining design requirements for the bezel, specific design elements should be considered:

- a.) **Using separation distance factors,** determine required height of the bezel. Length and width of the LCD plus holder tolerances will establish length and width dimensions.
- b.) **Must the LCD be protected?** If so, the bezel should incorporate a cover element.
- c.) **Is sealing required** to prevent dust and/or moisture intrusion? Under what environmental conditions will the LCD be expected to function?
- d.) **What is the LCD viewing area?** Be sure that bezel edges do not interfere.
- e.) **Is masking required** for any portion of the LCD viewing area?
- f.) **Can the housing or case of the end product be used to provide the necessary pressure** and protection required for the LCD/PC board connection? If so, a bezel may not be necessary.
- g.) **Will there be a need for clamps or fasteners?** Consult Fujipoly as a design reference source for bezel configurations.

# ZEBRA® Design Guidelines - "W" Matrix Connectors

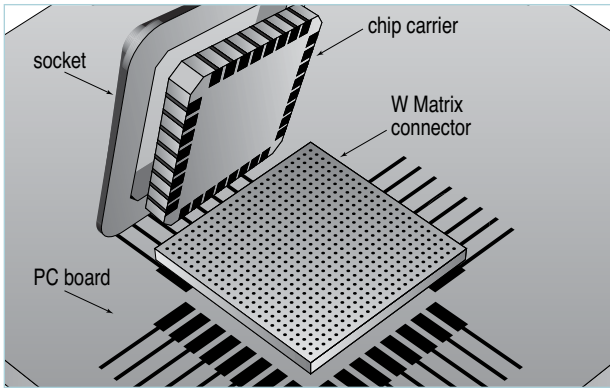

The ZEBRA® W series elastomeric connectors are highly accurate silicone rubber pads with fine metal wires embedded in the thickness direction. The wires are gold-plated, providing low resistance and relatively high current flow with anisotropic conduction properties.

Standard pitch patterns offer dense I/O's at closely positioned centerlines. To specify the appropriate design layout for your application, the following simple steps are recommended:

1. Determine the pitch
2. Decide if interconnect is static or repeated compressions
3. Specify overall dimensions

## 1. DETERMINING IF THE APPLICATION IS STATIC OR REQUIRES REPEATED COMPRESSIONS

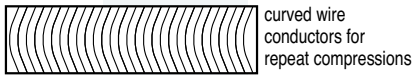

- a.) **Static interconnect** between mating conductors use the WSL (1.0mm pitch) or WSC (0.35mm pitch) versions. The fine wire conductors protrude slightly from both top and bottom of the silicone rubber to ensure contact with conductors under just very slight pressure (about 10% compression).
- b.) **Repeated compression interconnects** such as testing pads use the WBC (0.35mm pitch) version containing curved conductors with spring properties which allow the connector to recover to original height without compression set after repeated deformations.

## 2. DETERMINE PITCH REGISTRATION

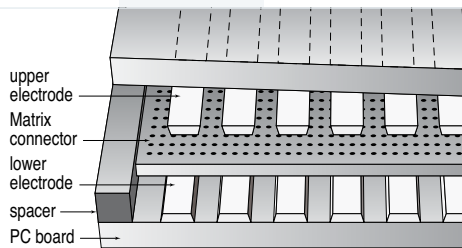

- a.) **Pitches available:** 1.0mm and 0.35mm for "W" series; and, 1.0mm, 0.8mm and 0.5mm for "P" series
- b.) **Select the pitch** which assures that at least one conductor connects between the contact pads to be mated, and that at least one insulating area is between adjacent contact pads.
- c.) **If redundant contact is desired**, select the pitch that assures at least two conductors connect between the contact pads to be mated and at least one insulating layer is between adjacent contact pads.

## 3. DETERMINE EXTERIOR DIMENSIONS

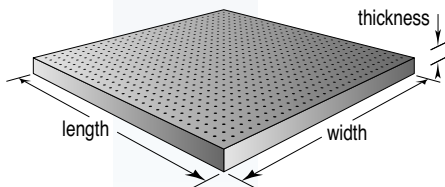

- a.) **Length** - allow an additional 0.5mm (.020") beyond the edge of the conductor at each end of the row in the length direction. Maximum length is 40.0 mm
- b.) **Width** - allow an additional 0.5mm (.020") beyond the edge of the conductors at each end of the row in the width direction. Maximum width is 20.0 mm
- c.) **Thickness** - two thicknesses are available for each style of "W" connector: 0.5 and 1.0mm. Allow 10% compression of original height to achieve reliable contact. Consider using a compression stop spacer (see drawing) to control compressed height. More than 20% compression is not recommended.

## REFERENCE - TYPICAL ENVIRONMENTAL TESTING CHARACTERISTICS

Test	Method	Description	Connector Results		
			Live Current	Embedded in Circuit No Current	Not Embedded No Current
Accelerated Moisture Resistance	MIL-202D-106c	Test cycle: -20°C/23°C/65°C, 95% RH, 1 Test cycle/day x 10 days	-	No change	No change
Moisture	MIL-202D-103B	40°C @ 95% R.H. Continuous 1500 hours	No change	No change	No change
Thermal Shock	MIL-202E-107D	Test cycle: -65°C/25°C/150°C/25°C, 5 cycles	-	No change	No change
SO <sub>2</sub> Gas Corrosion	MIL-IEC-68-2-42	SO <sub>2</sub> gas, 25PPM, 25°C 75% RH, 21 days	-	No change	0.20'0.35 Ω-mm <sup>2</sup>
Thermal Resistance	MIL-202D-108A	120°C, 500 hours	-	No change	No change

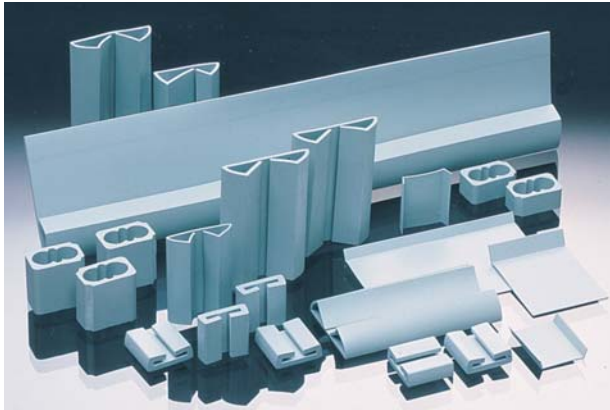

SARCON®'s versatility in thermal management applications is doubly enhanced by way of the variety of end-use configurations possible, and the many standard material formulations available in each.

The silicone rubber based materials offer other useful elements such as electrical insulation, protective coverings and gasketing as integral features in most designs.

Along with a few simple recommendations to help in obtaining the optimum performance for your application, a few suggestions are included which may help you to take advantage of some of these other features.

## 1. THERMAL TRANSFER

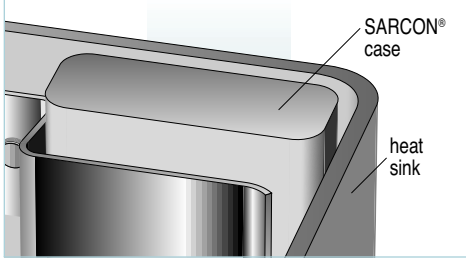

- Consider the most efficient SARCON® materials regarding thermal conductivity.** See charts on pages 16 and 17.
- Take advantage of the heat transfer characteristics** of any nearby sheet metal components by using the SARCON® component as a thermally conductive bridge from the heat generating component to the sheet metal. See drawing at left.

## 2. DUAL FUNCTIONALITY

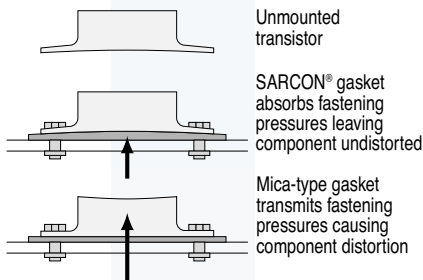

- Use the SARCON® component also as a functional gasket,** seal cushion, insulator or protective cover. See sketch at left for seal cushion application
- Vibration dampening and environmental sealing** against outside contaminants can be included in the design elements.
- Choose from many related product configurations** shown on pages 18 to 33.
- Custom shapes** can be arranged if your design requires a specific treatment.

## 3. ATTACHMENT

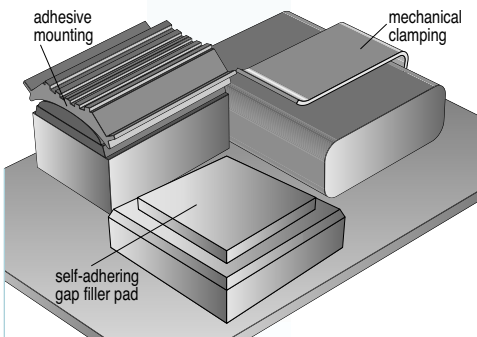

- No special preparations** are necessary to attach the SARCON® component
- Some of the most common alternatives include:**  
 pressure sensitive adhesive  
 silicone adhesive  
 mechanical clamping  
 hardware attachment - screws, rivets  
 self-adhering silicone gel
- Consider using the self-adhering SARCON® Gap Filler Pads** shown on pages 18 to 28 of the catalog product section.
- Note also that SARCON® is very elastic,** providing a very tight fit over uneven surfaces. This eliminates the need for gap-filling agents in order to achieve high rates of thermal dissipation without variation. The sleeves and cases shown on page 31 of the catalog can be designed as an interference fit which can slip snugly over appropriately configured components.

# SARCON® Design Guidelines - Thermal Management

## 4. CLAMPING TORQUE

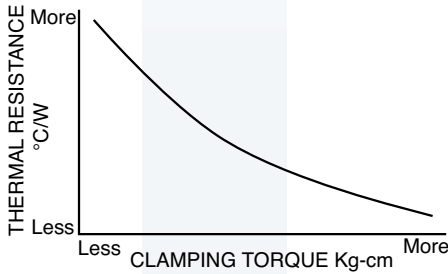

a.) Clamping torque of the installed **SARCON®** material will decrease the thermal resistance as the torque is increased.

See the chart below for specific measurements of each type of **SARCON®** material.

b.) Test method: Fujipoly Test Method FTM P-3010 (ASTM D5470 Equivalent)

### CLAMPING TORQUE VS. THERMAL RESISTANCE - TYPICAL

SARCON® Type		Thermal Resistance at Various Forces		
		3kg·cm	5 kg·cm	7 kg·cm
TR	30T	0.65	0.62	0.59
	45T	0.76	0.73	0.71
	85T	1.37	1.35	1.32
HR	30H	0.44	0.42	0.39
	45H	0.54	0.52	0.51
	85H	0.73	0.76	0.74
UR	30U	0.30	0.26	0.25
	45U	0.38	0.35	0.33
	85U	0.62	0.56	0.52
QR	30Q	0.61	0.57	0.52
	45Q	0.83	0.77	0.71
	85Q	1.42	1.25	1.18

SARCON® Type		Thermal Resistance at Various Forces		
		3kg·cm	5 kg·cm	7 kg·cm
GTR	15GTR	0.58	0.51	0.50
	20GTR	0.60	0.56	0.54
	30GTR	0.68	0.66	0.64
GHR	15GHR	0.58	0.55	0.53
	20GHR	0.61	0.57	0.54
	30GHR	0.67	0.61	0.59
GSR	20GSR	0.31	0.30	0.30
	30GSR	0.37	0.34	0.33
	45GSR	0.40	0.39	0.37
	85GSR	0.52	0.51	0.50

## 5. SARCON® SILICONE PUTTY

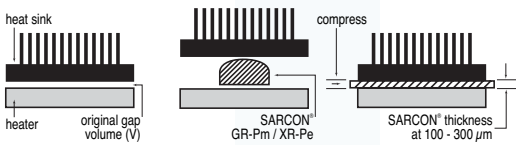

a.) **SARCON® Silicone Putty shown on page 27** is a highly conformable, non-flammable thermal interface material with a very low compression rate.

b.) **Suitable for gaps as small as 0.3 mm or less.** See application guide at left.

c.) **Calculate size and volume to be used as follows:**

**Example:**

$$\sqrt{V \div \text{thickness}}$$

Compressed thickness: 0.2mm  
Component size: 15mm x 15mm

$$V = 0.2 \times 15 \times 15$$

$$V = 45\text{mm}^3$$

$$\sqrt{45\text{mm}^3 \div 2.0\text{mm original thickness}}$$

4.74mm (Use 5.0mm x 5.0mm) @ 2.0mm thickness

---

---

---

---

---

---

---

---

---

---

---

---

---

---

---

---

---

---

---

---

---

---

---

---

---

---

---

---

---

---







## FUJIPOLY® LOCATIONS

### Fuji Polymer Industries Co., Ltd.

**Sales Department**  
175 Kajiyashiki,  
Toyota, Aichi 4700533 JAPAN  
tel: 81-565-65-1729 fax: 81-565-65-1857  
e-mail: fujipoly@mx.fujipoly.co.jp  
ISO9001(Aichi Plant)

### Fujipoly America Corp.

900 Milk Street  
P.O. Box 119 • Carteret, NJ 07008-0119  
tel: 732.969.0100 fax: 732.969.3311  
e-mail: info@fujipoly.com  
web site: www.fujipoly.com  
ISO9001-2008   

### Fujipoly (Thailand) Co., Ltd.

55/8 Moo 13 Navanakorn Industrial Estate Phase 4  
Phaholyothin Road, Klong Nueng, Klong Luang  
Pathumthanee 12120 Thailand  
tel: 66-2-529-2732 fax: 66-2-529-2223  
e-mail: marketing@fujipoly.co.th  
ISO9001 ISO14001

### Fujipoly Europe Ltd.

Avant Business Centre, Unit 8  
Third Avenue  
Bletchley, Milton Keynes MK1 1DR U.K.  
tel: 44-1-908-277800 fax: 44-1-908-277900  
e-mail: sales@fujipolyeurope.co.uk

### Fujipoly Singapore Pte, Ltd.

1001 Jalan Bukit Merah #02-17/20  
Singapore 159455  
tel: 65-6272 3766 fax: 65-6272 3577  
e-mail: info@fujipoly.com.sg  
ISO9001

### Fujipoly Hong Kong Ltd.

Unit F & J, Block 1,4/FI.  
Kwai Tak Industrial Centre  
15-33 Kwai Tak Street, Kwai Chung, N.T., Hong Kong  
tel: 852-24283770 fax: 852-24899637  
e-mail: info@fujipoly.com.my

### Fujipoly Malaysia Sdn.Bhd. (Malaysia Factory)

Plot 26, Phase 4, Free Industrial Zone, Hilir  
Sungai Keluang3,  
Bayan Lepas Penang, 11900 Malaysia  
e-mail: info@fujipoly.com.my

### Fujipoly China Ltd. (China Factory)

Gaobao Road, The First Industrial Park  
Tutang Estate, Changping Town, Dongguan City,  
GuangDong, 523581, China  
tel: 86-769-83989660 fax: 86-769-83989662  
e-mail: info@fujipoly.com.hk  
ISO9001 ISO14001

### Fuji Polymer Industries Co., Ltd.

**Taipei Liaison Office**  
Room B, 7F, No. 59, Tiansiang Rd.  
Jhongsan District  
Taipei City 10452, Taiwan  
tel: 886-2-2586-5771 fax: 886-2-2586-5745  
e-mail: fujipolytw@fujipoly.com.tw

## FUJIPOLY® DISTRIBUTORS

### France **Compelma S.A.S.**

Z.A. des GODETS  
33, rus des petits ruisseaux  
91370 VERRIÈRES LE BUISSON  
France  
tel: +33 (0)1 69 75 21 21 fax: +33 (0)1 60 11 40 19  
e-mail: info@compelma.com  
web: www.compelma.com

### Belgium & Netherlands **MAVOM N.V.**

Molenberglei 14  
2627 Schelle  
Belgium  
tel: +32 (0)3 880 07 60 | tel: +31 (0)172 436361  
fax: +32 (0)3 880 07 80 | fax: +31 (0)172 420310  
e-mail: info@mavom.be | e-mail: info@mavom.nl  
web site: www.mavom.be | web: www.mavom.nl

### Italy **Murata Elettronica S.p.A**

Via S. Carlo, 1  
20040 Caponago-MI  
Italy  
tel: +39 (0)2 95968 1 fax: +39 (0)2 95968 353  
e-mail: info@murat.it  
web: www.murata.eu

### Germany **Nucletron Technologies GmbH**

Gaertnerstr. 60  
80992 Muenchen  
Germany  
tel: +49 89 14 90 02-0 fax: +49 89 14 90 02-11  
e-mail: info@nucletron.de  
web site: www.nucletron.de

### UK **Osco Limited**

Avant Business Centre • Unit 6 Third Avenue  
Bletchley • Milton Keynes • MK1 1DR  
U.K.  
tel: +44 (0)1908 376 688 fax: +44 (0)1908 379 916  
e-mail: sales@osco.uk.com  
web site: www.osco.uk.com

### Sweden **Promoco Scandinavia AB**

tel: +46 (0)8 792 06 90 fax: +46 (0)8 792 20 90  
e-mail: info@promoco.se  
web: www.promoco.se

### Denmark **Newtronic ApS**

tel: +45 7669 7090 fax: +45 7627 7090  
e-mail: nr@newtronic.dk  
web: www.newtronic.dk

### Turkey **Mechsoft**

tel: +312 482 59 49 fax: +312 482 54 39  
e-mail: gokhan.erdogdu@mechsoft.com.tr  
web: www.mechsoft.com.tr

### Spain **Nufesa Electronics**

tel: +34 93 340 50 25 fax: +34 93 352 88 46  
e-mail: commercial@nufesa.com  
web: www.nufesa.com

### Israel **Elimec**

P.O. Box 5006 • 1 Lishanski Street  
Rishon LeZion, 75150  
Israel  
tel: +972 3 951 41 22 fax: +972 3 951 41 66  
e-mail: mail@elimec.co.il  
web: www.elimec.com



**ZEBRA® and SARCON®, are registered trademarks of Fujipoly®**

STATEMENT OF LIEU OF WARRANTY: All technical information and data in this document is based on tests and is believed to be accurate and reliable. Nevertheless, since the products described herein are not provided to conform with mutually accepted specifications and the use thereof is unknown, the manufacturer and seller of the product do not guarantee results, freedom from patent infringement, or suitability of the product for any application thereof. The manufacturer and seller of the product described in this document will provide all possible technical assistance and will replace any products proven defective. No statement or recommendation made by the manufacturer or seller not contained herein shall have any force of effect unless in conformity with an agreement signed by an officer of the seller or manufacturer. Product testing by the purchaser is recommended in order to confirm expected results. Copyright© 2010 Fujipoly®



an ISO9001:2008 registered company

***A Global Network To Serve All Your  
Thermal Interface Material and Elastomeric Connector Needs.***

Japan USA Thailand Europe Singapore Hong Kong China Taiwan Malaysia