

FUJITSU

Refrigerant
R410A
INVERTER

AIRSTAGE™

FUJITSU GENERAL AMERICA, INC.
353 Route 46 West, Fairfield, NJ 07004
airstagevrf.com



ISO 9001
Certified number: 01 100 89394
Fujitsu General (Thailand) Co., Ltd.



ISO 9001
Certified number: 01 100 79289
Fujitsu General (Shanghai) Co., Ltd.



ISO 9001
Certified number: 00620011061R2M
Fujitsu General Central Air-conditioner (Wuxi) Co., Ltd.

- Specifications and design are subject to change without notice for future improvement. For further details, please check with an authorized distributor.
- "AIRSTAGE™" is a worldwide trademark of FUJITSU GENERAL LIMITED and is a registered trademark in Japan and other countries or areas.
- Other company and product names mentioned herein may be registered trademarks, trademarks or trade names of their respective owners.
- Actual products' colors may be different from the colors shown in this printed material.
- Internet sales are strictly prohibited and unauthorized. Any HVAC systems purchased on the Internet, from an online retailer or any similar e-tailing website, OR where the original factory serial numbers of the display have been removed, defaced, or replaced in any way WILL NOT BE COVERED BY WARRANTY.

Distributed by :

VRF
Variable
Refrigerant
Flow System

Heat Pump & Heat Recovery

Creation of Comfort



Fujitsu General creates high-quality and environmentally-friendly products that provide a comfortable environment by using the air conditioning technology, innovation and creativity which we developed over 35 years ago.

High Quality Development and Production Environment

The Headquarters-JAPAN R&D Center is equipped with a wide range of testing equipment envisioning a variety of operating conditions. This includes a testing tower with a 198 ft. (60m) height difference for buildings. We provide high quality & reliable products that meet the customers' needs from all over the world through this advanced R&D center and 6 factories based in China and Thailand.



JAPAN R&D center and 198 ft. (60m) height testing tower
Central R&D center for global air conditioner development. Advanced products are developed and next generation technologies are researched.



FUJITSU GENERAL CENTRAL AIR-CONDITIONER(WUXI)CO.,LTD (China)
VRF Main factory. ISO9001 and ISO14001 certified. This factory has high quality and high reliability systems for manufacturing VRF systems.

FUJITSU GENERAL's VRF AIRSTAGE Series has been developed based on our long-term air conditioning technology know-how and was first provided 13 years ago. We have offered a series of products for large homes to large-scale buildings to meet the various market needs.



AIRSTAGE™ History

2001

2003

2006

2007

2009

2010

2012

2013

Green Initiatives
Fujitsu introduces inverter technology and the use of environmentally friendly R410A refrigerant.



RoHS Compliant
Restriction of Hazardous Substances is an EU directive intended to protect the environment by forcing manufacturers to use environmentally friendly materials in all consumer electronics.



Green Advancement
Use of 100% inverter driven DC compressors.



Heat Recovery type

10 models



Heat Pump type

9 models



AIRSTAGE VR-II 60Hz

6 to 24 tons / Heat Recovery
100% Inverter driven

AIRSTAGE V-II 60Hz

6 to 24 tons / Heat Pump
100% Inverter driven

TABLE OF CONTENTS

FEATURES

Design Versatility	6
Easy Installation	7
High Reliability	8
Comfort & Convenience	9
Inverter Technology	10
Easy Service & Maintenance	11

MODEL LINEUP

Indoor and Outdoor Model Table	12
--------------------------------------	----

OUTDOOR UNITS

V-II Heat Pump Model	14
VR-II Heat Recovery Model	18

INDOOR UNITS

Compact Cassette	22
Cassette	24
Slim Compact Duct	26
Medium Static Pressure Duct	28
High Static Pressure Duct	30
Floor/Ceiling	32
Ceiling	34
Compact Wall Mount	36
Wall Mount	38
Outdoor Air Unit	40

CONTROLLERS

Comparison Table of Controllers	42
Summary of Software, Controllers, Converters & Adapters, Service & Monitoring Tools	43
Individual Touch Panel Controller	46
Central Remote Controller	48
Touch Panel Controller	50
System Controller & System Controller Lite..	52
Control System Diagram	56

SOFTWARE

Airstage Portal	57
Service Tool	58
Design Simulator	60
Building Information Management	62

OPTIONAL PARTS

Auto Louver Grille Kit	63
Connection Units	64
RB Units	65
Duct Models	66
Cassette, Ceiling	67

APPLICATIONS

Medical and Healthcare Facilities	68
Educational and Religious Facilities	69
Multi-Tenant Dwellings	70
Office Buildings and Retail Spaces	71



Bring More Green to the Bottom Line

Airstage VRF provides an efficient heating and cooling solution for your entire building, using advanced controls and simple building management integration.

SCHE UP TO **30.1** Simultaneous Cooling and Heating Efficiency

IEER UP TO **24.3** Integrated Energy Efficiency Ratio

Heat Recovery Simultaneous cooling and heating operation using one refrigerant system.

Energy Savings Management Available advanced scheduling, energy apportionment billing, and remote monitoring provides convenient management of energy savings.

Modular Scalable solution for small and large buildings providing flexible capacities from 6 to 3,200 tons using 1 controller.

Inverter Technology Like cruise control for your car, compressors only run as fast as needed to handle individual loads.



Fujitsu Airstage... Better Comfort, Better Life. www.airstagevrf.com



Variable Refrigerant Flow System For Small and Large Buildings

- Extensive lineup from 6 to 24 Tons
- Connectable capacity ratio up to 150%
- 33 different indoor units available in 9 styles
- Up to 45 indoor units per one VRF system
- Three outdoor units may be combined with twining kits to create up to 24 tons
- 5-Year Parts, 7-Year Compressor Warranty. See Warranty Statement for details.
- Extensive training for Engineers, Architects, Contractors and Distributors



6 Ton, 8 Ton 10 Ton (VR-II Only)

High Efficiency & Reliability



Design Versatility

Overall piping length
3,280 ft.

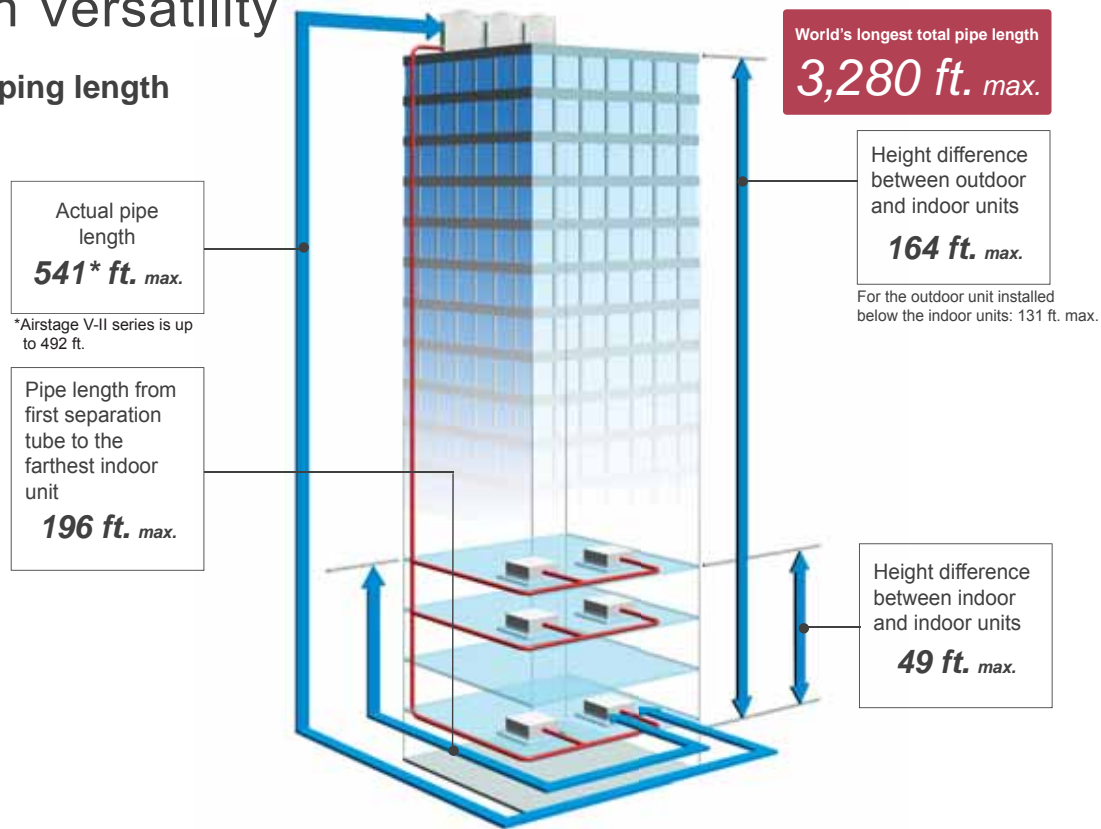

High static pressure

The outdoor unit can have a condenser hood easily connected with a static pressure of .32 in.WG / 80Pa standard. This allows outdoor units to be installed within mechanical rooms in high rise buildings.

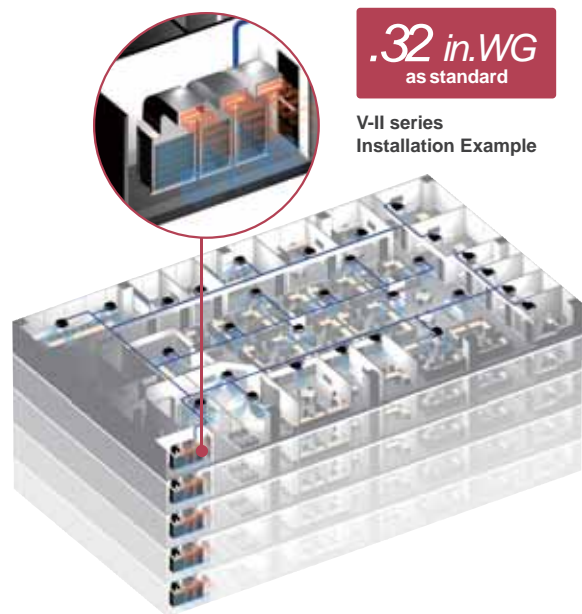

Large diameter fan and DC motor has been used allowing an external static pressure of .32 in.WG / 80Pa.

Wide operating range

Installation in wide temperature conditions is possible due to an increase in operational range.

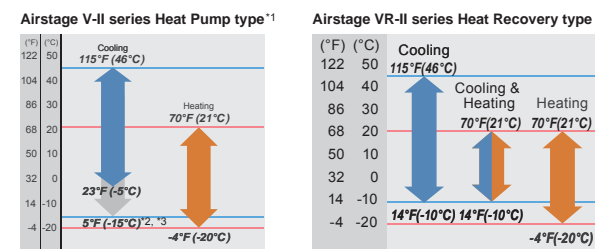

*1 VRF Heat Pump System does NOT provide simultaneous Heating and Cooling. System operates in either Heating mode OR Cooling mode.

*2 Operation range based on a single condensing unit; when multiple condensing units are used on a single refrigerant circuit (12 ton thru 24 ton) the cooling lower operating range is limited to 23°F (-5°C).

*3 When cooling operation will be required at outdoor air temperature below 23°F (-5°C), the outdoor unit must be installed higher than or equal to the elevation of the indoor units.

Easy Installation

Easily transported

Easily craned into position using lifting belt hooks

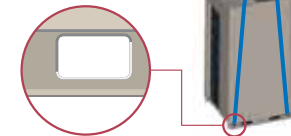

Design of outdoor unit allows for lifting straps to be used

Slots in base of the unit allow for easy transportation by forklift.

Can be transported in a small elevator

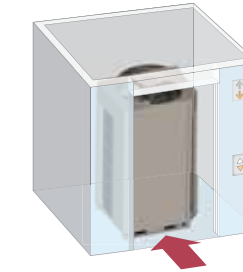

Simple signal line connection

Communication wiring can be connected continuously to any component, making installation easier.

Up to maximum length **11,811 ft / 3,600 m**

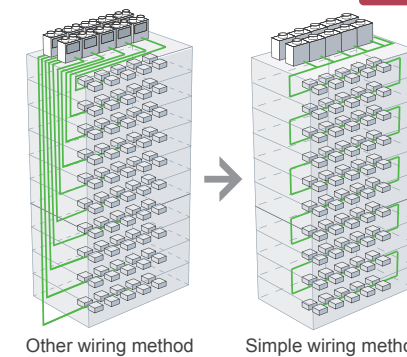

Easy access

By adopting an L-Shape front panel that can be removed, the work space for installation and service has been greatly expanded by this design. For multiple installations, work is performed easily and efficiently even in a narrow space.

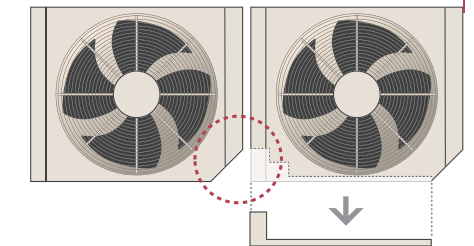

High capacity connection

Various combinations from 6 Tons to 24 Tons with 33 indoor unit models, 9 types, can be selected. A minimum of 50% to a maximum of 150% or 130% indoor unit connectable capacity.

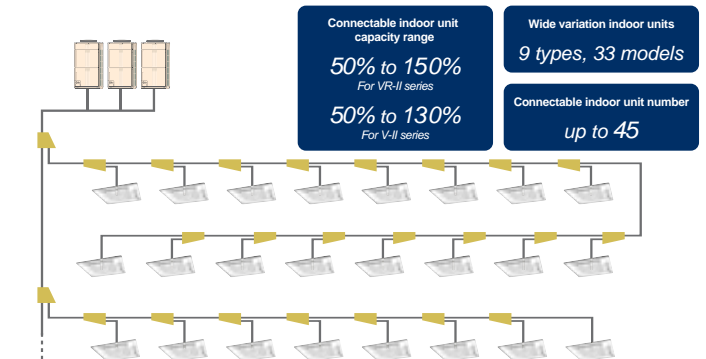

Note: When total indoor unit capacity is greater than 100%, individual indoor units will operate at a slightly lower capacity when maximum capacity is required.

Automatic address setting

The address of each indoor unit can be automatically set by the touch of a button on the outdoor unit.

Note: In a multiple refrigerant system installation there could be a case where Automatic addressing sequence cannot be initiated.

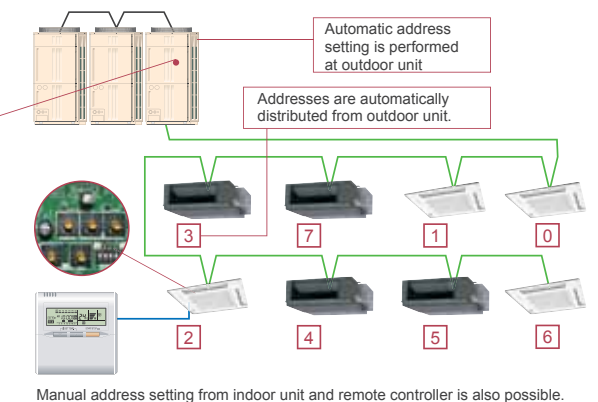
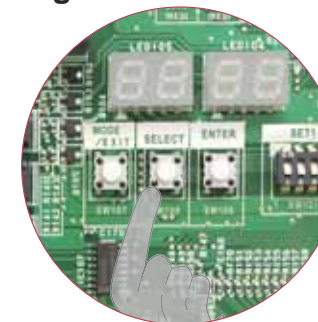

High Reliability

Life-extending operation

Outdoor unit operation rotation

The compressor starting order is rotated so that the running time is shared.

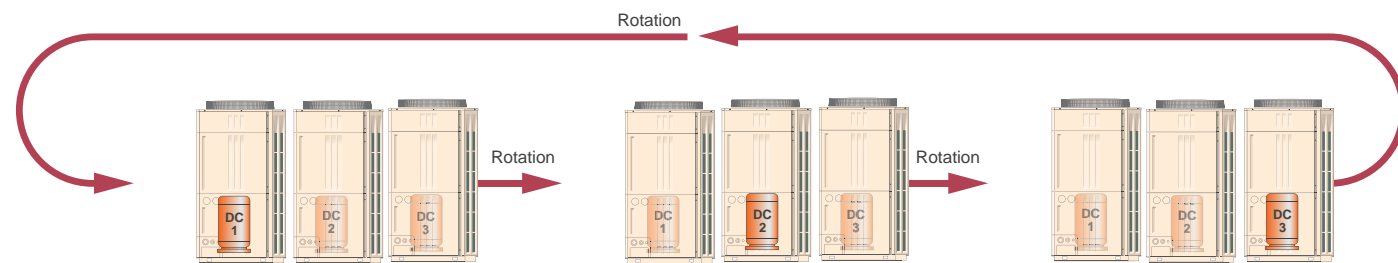

Note: The inverter compressors start in priority. Rotate operation is alternated by the start / stop timing of the compressors.

Oil return design

Individual oil separator and intelligent oil feedback operation logic are adopted. Oil return pipe of oil separator is connected directly to the compressor suction line through capillary and through solenoid valve.

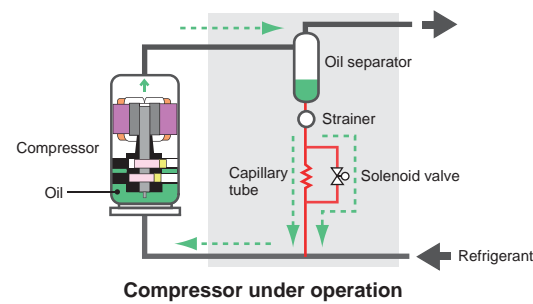

Refrigerant circulation control

Innovative compressor control logic balances refrigerant mass flow rate of each outdoor unit by controlling inverter speed.

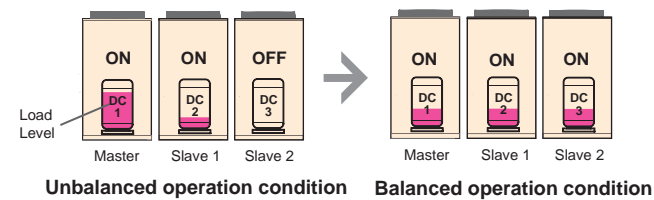

Adoption of blue fin heat exchanger

Blue fin treatment to the outdoor unit's heat exchanger improves corrosion resistance.

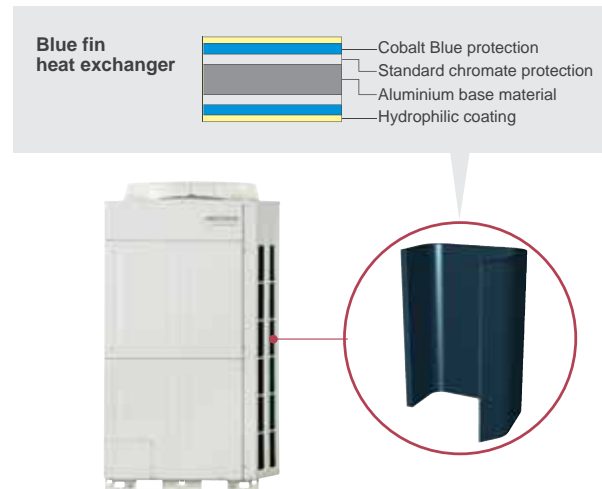

Liquid back flow protection

By adopting a large sized accumulator, the refrigerant which is not completely vaporized is left inside the accumulator and only a stable supply of gas is fed from the accumulator.

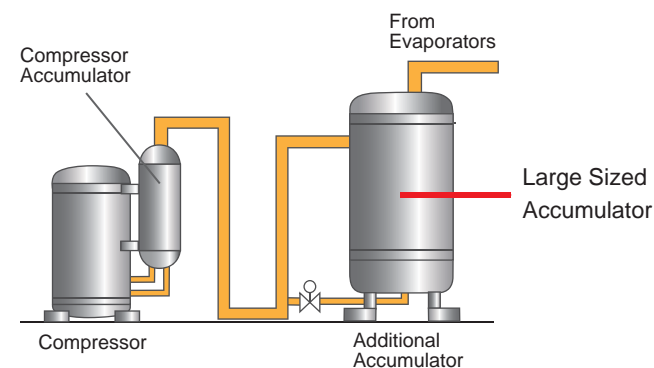

Comfort and Convenience

Centralized Control

It is possible to manage the operation and comfort of an entire building by using a Fujitsu VRF Control System. Controllers can be selected to meet the number of indoor units and control requirements of the occupants.

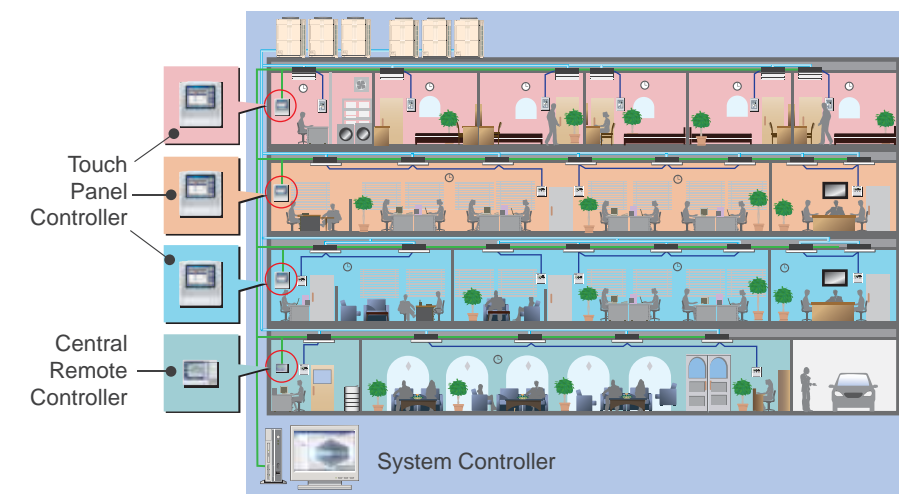

Quiet operation

Low noise mode: Two low noise modes can be selected automatically using *quiet priority setting* or *capacity priority setting*, depending on the usage environment and outside temperature load.

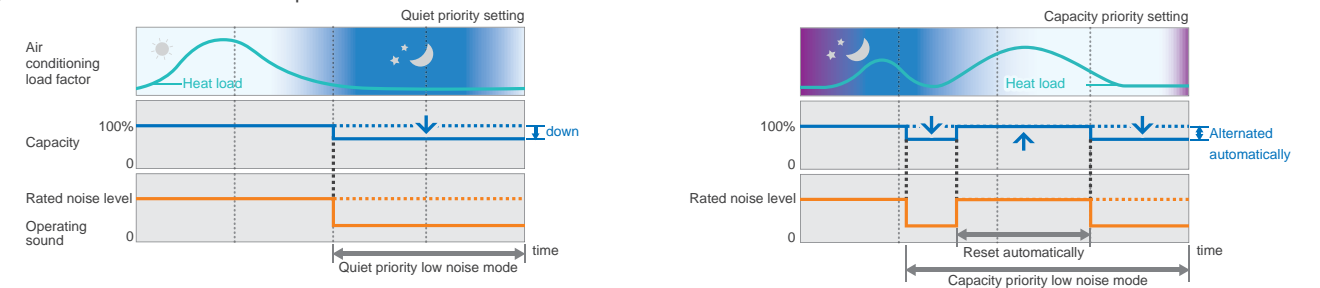

Low noise design: Compressor noise has been significantly reduced by shielding the compressor compartment.

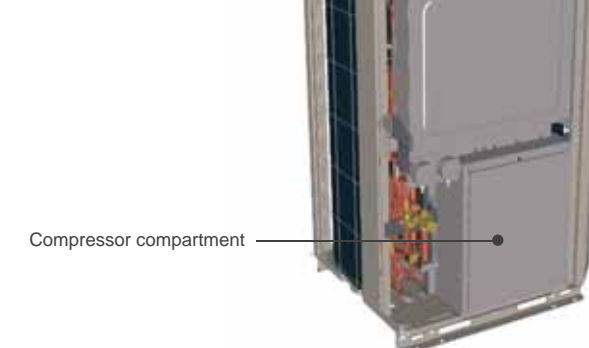

Remote monitoring

The Web Monitoring system allows you to view system operation at all times over the internet ensuring trouble free operation.

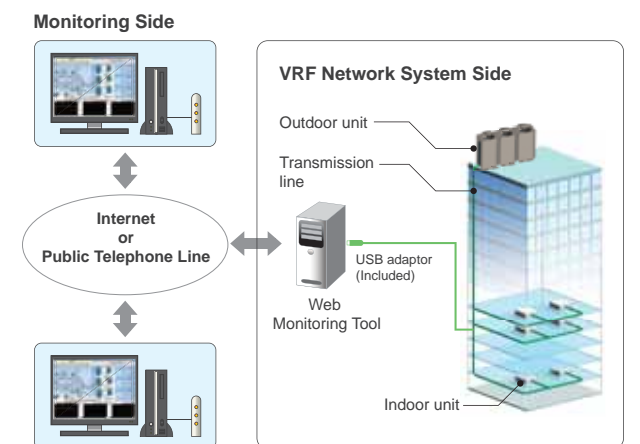

The operating VRF network system in the building can be monitored in real time over the Internet.

Inverter Technology

All inverter compressor

Constant Comfort and Energy Savings through Inverter Technology

Airstage Outdoor Units include DC Inverter Control of compressors. Inverter control is like having cruise control for your heating and cooling system. DC twin rotary compressors only run as fast as they need to handle the cooling or heating demand. This provides for smoother and more stable operation.

Inverter Benefits

- Soft start resulting in low inrush current
- High efficiency operation
- Lower RPM = quieter operation
- Built in protections improve compressor life

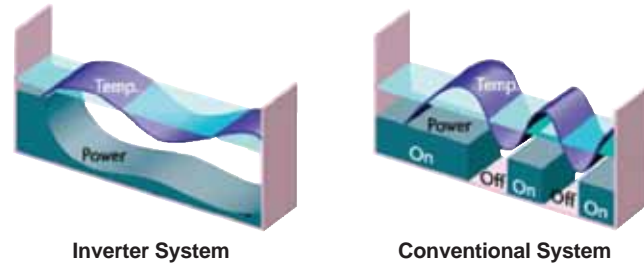

High efficiency compressor speed control

Comfortable space with small room temperature changes and little energy loss is created by 0.1Hz steps compressor speed control.

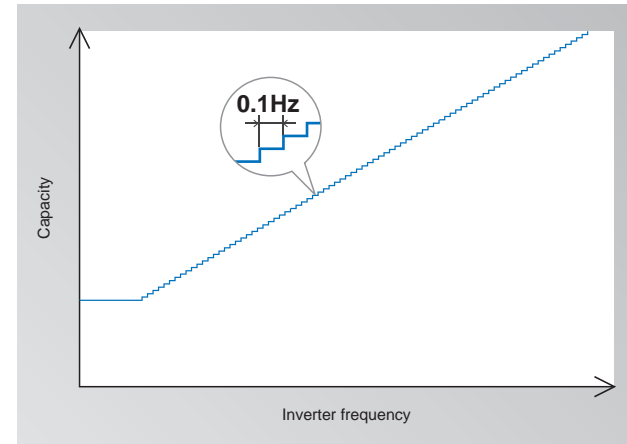

Large capacity DC inverter compressor

Large capacity high efficiency DC twin rotary compressor with excellent intermediate capability.



Single Twin Rotary Compressor

Some manufactures use scroll compressors, and multiple compressors consisting of one variable and one fixed. Using this older technology makes the condenser more expensive and it weighs more.

Fujitsu uses twin rotary technology which is more efficient and has up to 7% improved COP over the older technology.

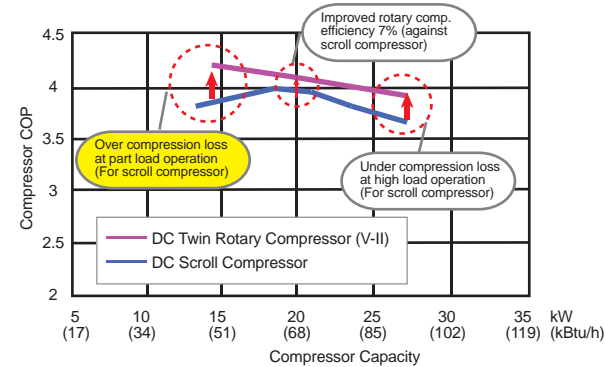

Easy Service & Maintenance

Designed for easy service and maintenance

Inspection and replacement of main parts is easy due to innovative construction and an LED operational display.

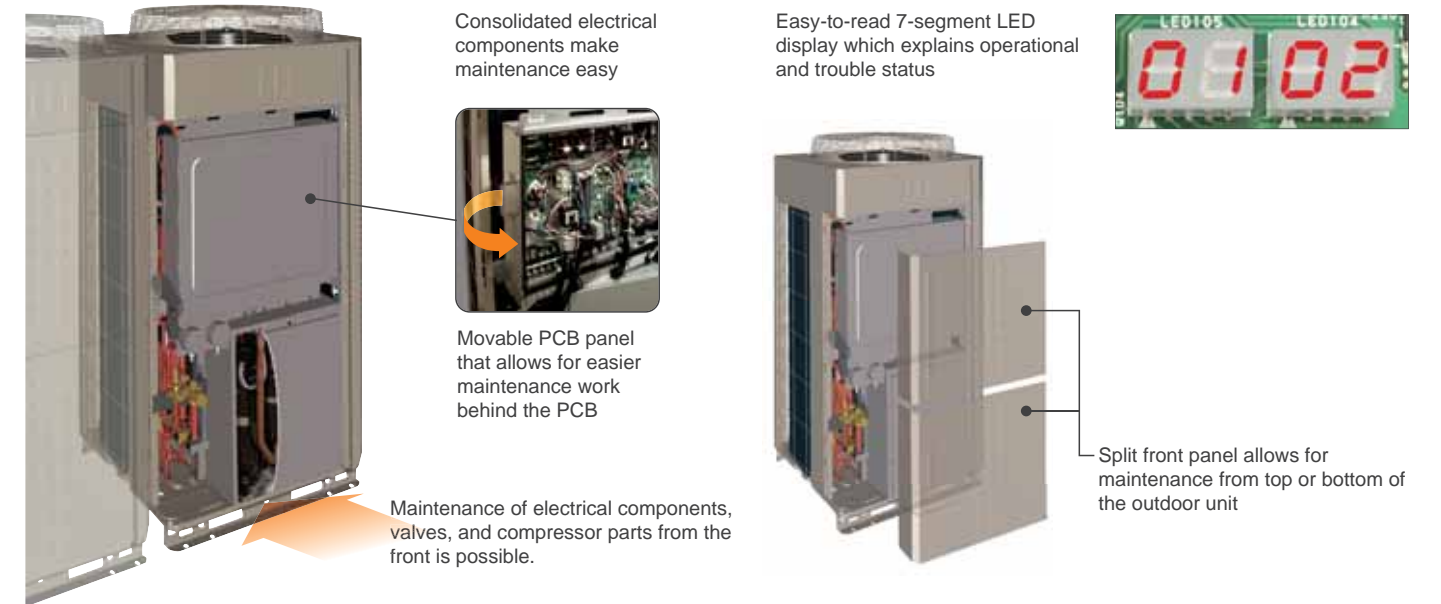

Error status can be checked easily via the indoor unit wired controller

An error code is displayed on a liquid crystal screen.

Wired Remote Controller

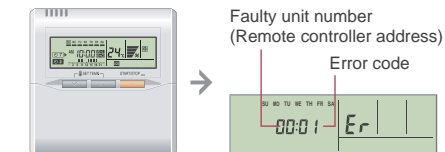

Simple Remote Controller

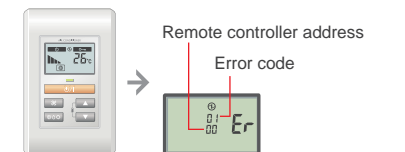

Trouble diagnosis by Service Tool

Suitable maintenance is possible by analysis of the operation data. Connection anywhere in the VRF network is easy.

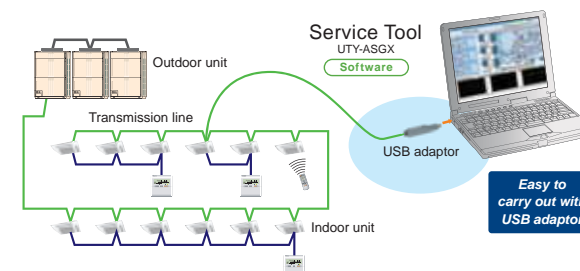

Flexible piping connection

Piping and wiring are available to the front, left and right, and bottom.

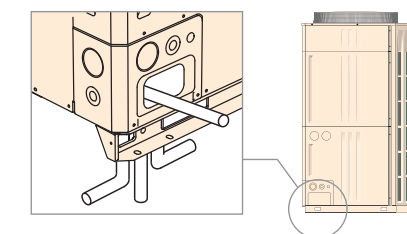























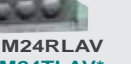
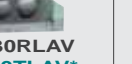





Outdoor units lineup

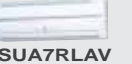
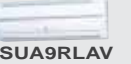
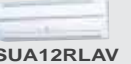

V-I Heat Pump	72,000 BTU (6 Tons) 21.1kW (8HP)  AOUA72RLBV UNIT : AOUA72RLBV	96,000 BTU (8 Tons) 28.1kW (10HP)  AOUA96RLBV UNIT : AOUA96RLBV	144,000 BTU (12 Tons) 42.2kW (16HP)  AOUA144RLBVG UNIT : AOUA72RLBV UNIT : AOUA72RLBV	168,000 BTU (14 Tons) 49.2kW (18HP)  AOUA168RLBVG UNIT : AOUA72RLBV UNIT : AOUA96RLBV	V-I Heat Pump	192,000 BTU (16 Tons) 56.2kW (20HP)  AOUA192RLBVG UNIT : AOUA96RLBV UNIT : AOUA96RLBV	216,000 BTU (18 Tons) 63.3kW (24HP)  AOUA216RLBVG UNIT : AOUA72RLBV UNIT : AOUA72RLBV UNIT : AOUA72RLBV	240,000 BTU (20 Tons) 70.3kW (26HP)  AOUA240RLBVG UNIT : AOUA72RLBV UNIT : AOUA72RLBV UNIT : AOUA96RLBV	264,000 BTU (22 Tons) 77.3kW (28HP)  AOUA264RLBVG UNIT : AOUA72RLBV UNIT : AOUA96RLBV UNIT : AOUA96RLBV	288,000 BTU (24 Tons) 84.3kW (30HP)  AOUA288RLBVG UNIT : AOUA96RLBV UNIT : AOUA96RLBV UNIT : AOUA96RLBV	
	VR-II Heat Recovery	72,000 BTU (6 Tons) 21.1kW (8HP)  AOUA72TLBV UNIT : AOUA72TLBV	96,000 BTU (8 Tons) 28.1kW (10HP)  AOUA96TLBV UNIT : AOUA96TLBV	120,000 BTU (10 Tons) 35.2 kW (12HP)  AOUA120TLBV UNIT : AOUA120TLBV		144,000 BTU (12 Tons) 42.2kW (16HP)  AOUA144TLBVG UNIT : AOUA72TLBV UNIT : AOUA72TLBV	168,000 BTU (14 Tons) 49.2kW (18HP)  AOUA168TLBVG UNIT : AOUA72TLBV UNIT : AOUA96TLBV	VR-II Heat Recovery	192,000 BTU (16 Tons) 56.2kW (20HP)  AOUA192TLBVG UNIT : AOUA72TLBV UNIT : AOUA120TLBV	216,000 BTU (18 Tons) 63.3kW (24HP)  AOUA216TLBVG UNIT : AOUA96TLBV UNIT : AOUA120TLBV	240,000 BTU (20 Tons) 70.3kW (26HP)  AOUA240TLBVG UNIT : AOUA120TLBV UNIT : AOUA120TLBV

Indoor units lineup

V-I Heat Pump Models
VR-II Heat Recovery Models

Capacity range (Btuh)	7,000	9,000	12,000	14,000	18,000	24,000	30,000	36,000	48,000	60,000
Compact Cassette¹	 AUUA7RLAV AUUA7TLAV*	 AUUA9RLAV AUUA9TLAV*	 AUUA12RLAV AUUA12TLAV*	 AUUA14RLAV AUUA14TLAV*	 AUUA18RLAV AUUA18TLAV*	 AUUA24RLAV AUUA24TLAV*				
Cassette²					 AUUB18RLAV AUUB18TLAV*	 AUUB24RLAV AUUB24TLAV*	 AUUB30RLAV AUUB30TLAV*	 AUUB36RLAV AUUB36TLAV*		
Slim Compact Duct	 ARUL7RLAV ARUL7TLAV*	 ARUL9RLAV ARUL9TLAV*	 ARUL12RLAV ARUL12TLAV*	 ARUL14RLAV ARUL14TLAV*	 ARUL18RLAV ARUL18TLAV*					
Medium Static Pressure Duct						 ARUM24RLAV ARUM24TLAV*	 ARUM30RLAV ARUM30TLAV*	 ARUM36RLAV ARUM36TLAV*		
High Static Pressure Duct								 ARUH36RLAV ARUH36TLAV*	 ARUH48RLAV ARUH48TLAV*	 ARUH60RLAV ARUH60TLAV*
Floor / Ceiling			 ABUA12RLAV ABUA12TLAV*	 ABUA14RLAV ABUA14TLAV*	 ABUA18RLAV ABUA18TLAV*	 ABUA24RLAV ABUA24TLAV*				
Ceiling						 ABUA30RLAV ABUA30TLAV*	 ABUA36RLAV ABUA36TLAV*			
Compact Wall Mounted	 ASUA7RLAV ASUA7TLAV*	 ASUA9RLAV ASUA9TLAV*	 ASUA12RLAV ASUA12TLAV*	 ASUA14RLAV ASUA14TLAV*						
Wall Mounted					 ASUB18RLAV ASUB18TLAV*	 ASUB24RLAV ASUB24TLAV*				

Outdoor Air Unit

Airflow Rate (CFM (m³/h))	636 (1,080)	989 (1,680)	1,236 (2,100)
Outdoor Air Unit NEW	 AAUA48TLAV*	 AAUA72TLAV*	 AAUA96TLAV*

1 Compact Cassette Grille UTG-CCGV sold separately. Must order one with each Compact Cassette.
2 Cassette Grille UTG-LCGV sold separately. Must order one with each Cassette.
* Can be used with Heat Pump or Heat Recovery Outdoor Units.

HEAT PUMP TYPE

AIRSTAGE™ V-II series

Smart and cutting edge design
 Extensive lineup from 6 to 24 Tons in 2 Ton increments
 Connectable indoor unit capacity ratio up to 130%

System Outline



Excellent energy savings

Heat pump type inverter control is used to achieve economic cooling and heating operation for individual rooms to entire buildings.



Annual cooling operation

Use annual cooling operation for rooms and other spaces that require constant temperature control throughout the year.



Easy installation and maintenance

Flexible communication method and piping connections make installation and maintenance easy even for large systems.

System configuration example

- This system is used for medium-sized and large buildings. Connecting each outdoor unit makes it possible to create a high-capacity system.
- Connection of multiple indoor units using separation tubes and headers.

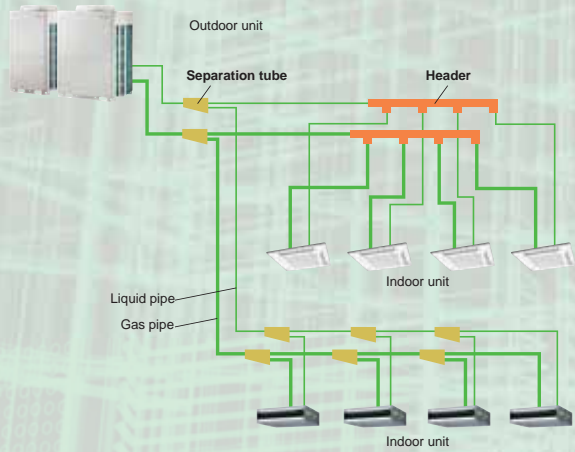

Large Office



Energy saving technology that boosted operation efficiency



Powerful large propeller fan

By using CFD*1 technology, A newly designed fan achieves high performance and low noise operation.

*1. CFD = Computational Fluid Dynamics



DC fan motor

Power consumption has been reduced by 25% compared to previous models by using a compact and high performance DC fan motor.



Subcool heat exchanger

High Heat Exchange efficiency is achieved by using an internal projection shape double pipe construction.



Sine-wave DC inverter control

High efficiency operation is realized by using a sine wave DC inverter control.



DC twin rotary compressor

Significantly greater efficiency is achieved by use of a large capacity DC twin rotary compressor with substantially increased refrigerant intake and compression efficiency.



4-face heat exchanger

Heat exchange efficiency is significantly improved by the introduction of a new 4-face heat exchanger that increases effective surface area.

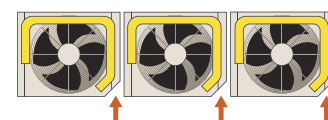

Front intake port (corner cut includes air intake)

In multiple outdoor unit installations, the unique front intake design improves airflow into the Heat Exchanger.

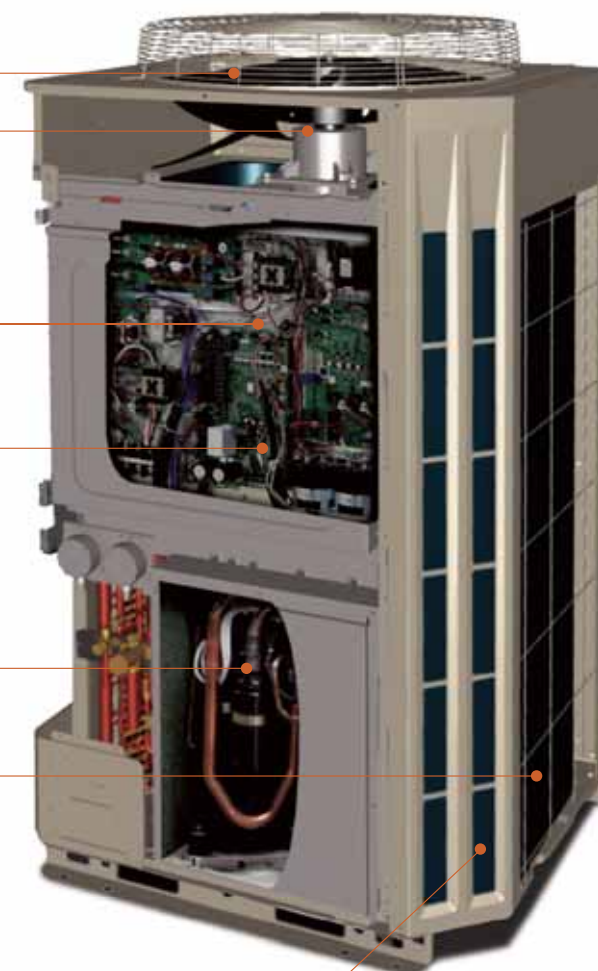

Room temperature set point limitation

The minimum and maximum temperature range can be set providing energy savings while considering the comfort of the occupants.

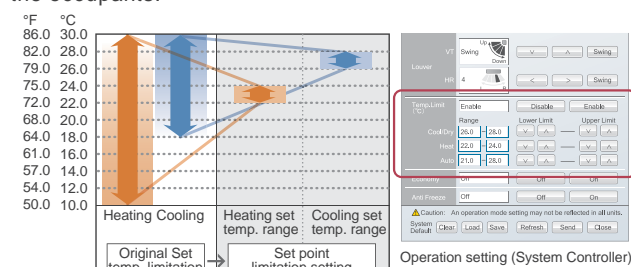





Peak cut operation

To reduce peak demand charges, this function sets a maximum value (maximum average power) for the entire air conditioning system during specified peak periods. Consumption is monitored using a field-installed power meter. During a Peak Cut condition, the heating or cooling delivered to each indoor unit will be adjusted by: shifting indoor set temperature, applying a forced off function to specified units, or by stopping the entire system.



Specifications

Capacity range		Tons	6	8	12	14
						
Model name			AOUA72RLBV	AOUA96RLBV	AOUA144RLBVG	AOUA168RLBVG
Unit 1			AOUA72RLBV	AOUA96RLBV	AOUA72RLBV	AOUA72RLBV
Unit 2					AOUA72RLBV	AOUA96RLBV
Unit 3						AOUA96RLBV
Indoor Unit Connectable Capacity			50% to 130%			
Connectable Indoor Units			2 to 14	2 to 16	2 to 24	2 to 29
Power source			3-phase, 208-230V, 60Hz			
MAX.CRT.BKR		(A)	50	50	50 x 2	50 x 2
Capacity (Nominal)	Cooling	Btu/h	72,000	96,000	144,000	168,000
		kW	21.1	28.1	42.2	49.2
Input Power ^{*1} (Nominal)	Heating	Btu/h	81,000	108,000	162,000	188,000
		kW	23.7	31.7	47.5	55.1
Airflow Rate	Cooling	CFM (m³/h)	6,533 (11,100)		6,533 x 2 (11,100 x 2)	
	Heating	in.WG (Pa)	0.32 (80)		0.32 (80)	
Sound Pressure Level	Cooling	dB(A)	60		63	
	Heating		61		64	
Compressor	Type x Quantity		Rotary (inv) x 1		(Rotary (inv) x 1) x 2	
	Motor Output	kW	3.9		3.9 x 2	
	Crankcase Heater	W	25		25 x 2	
Refrigerant	Type		R410A		R410A	
	Pre-charge	lbs (kg)	24.7 (11.2)		24.7 x 2 (11.2 x 2)	
Dimensions	Height	in. (mm)	66-9/16 (1,690)		66-9/16 (1,690)	
	Width		36-5/8 (930)		36-5/8 x 2 (930 x 2)	
	Depth		30-1/8 (765)		30-1/8 x (765)	
Weight	Net	lbs (kg)	490 (222)		490 x 2 (222 x 2)	
Connection Pipe Diameter	Liquid	in. (mm)	1/2 (12.70)		1/2 (12.70)	
	Suction Gas		7/8 (22.22)		1-1/8 (28.58)	
Operation Range	Cooling	°F (°C)	5 to 115 (-15 to 46)		23 to 115 (-5 to 46)	
	Heating		-4 to 70 (-20 to 21)		-4 to 70 (-20 to 21)	
Cooling (Non-Ducted / Ducted)	EER		12.5 / 12.3	11.7 / 11.6	12.4 / 11.0	11.6 / 11.2
	IEER		21.7 / 18.2	20.8 / 17.8	19.5 / 14.6	19.5 / 17.1
Heating (Non-Ducted / Ducted)	COP		3.76 / 3.64	3.55 / 3.47	3.68 / 3.46	3.60 / 3.54

Note : Specifications are based on the following conditions.
 Cooling : Indoor temperature of 80°F (26.7°C) DB / 67°F (19.4°C) WB, and outdoor temperature of 95°F (35.0°C) DB / 75°F (23.9°C) WB.
 Heating : Indoor temperature of 70°F (21.1°C) DB / 60°F (15.6°C) WB, and outdoor temperature of 47°F (8.3°C) DB / 43°F (16.1°C) WB.
 Pipe length : 25ft. (7.5 m); Height difference between outdoor unit and indoor unit : 0ft. (0 m).
^{*1} Electrical data is only for outdoor unit.

Non-stop oil recovery operation

A comfortable room condition is maintained during oil recovery mode because the product continues to operate without stopping the cooling or heating operation.

*: Not available on AIRSTAGE VR-II series.



Off timer

Each remote controller is equipped with an OFF timer function that automatically stops operation when a fixed time has elapsed from the start of operation. This prevents wasting energy. (Note: Except simple remote controller)

Economy operation

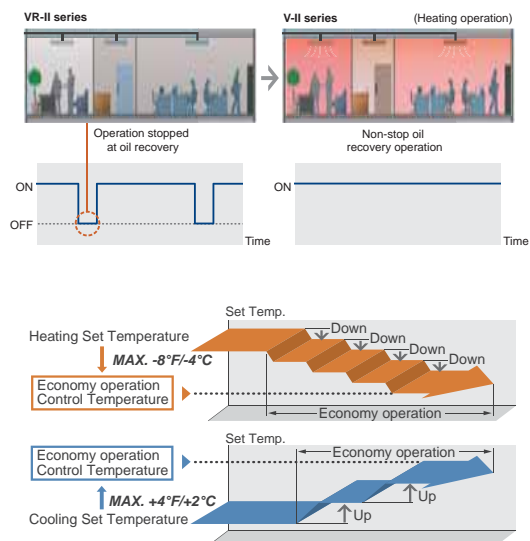
Economy operation can be set by remote controller. The temperature setting is offset automatically over a certain period of time.



Capacity range		Tons	16	18	20	22	24
							
Model name			AOUA192RLBVG	AOUA216RLBVG	AOUA240RLBVG	AOUA264RLBVG	AOUA288RLBVG
Unit 1			AOUA96RLBV	AOUA72RLBV	AOUA72RLBV	AOUA72RLBV	AOUA96RLBV
Unit 2			AOUA96RLBV	AOUA72RLBV	AOUA72RLBV	AOUA96RLBV	AOUA96RLBV
Unit 3				AOUA72RLBV	AOUA96RLBV	AOUA96RLBV	AOUA96RLBV
Indoor Unit Connectable Capacity			50% to 130%				
Connectable Indoor Units			2 to 31	2 to 32	2 to 35	2 to 45	2 to 45
Power source			3-phase, 208-230V, 60Hz				
MAX.CRT.BKR		(A)	50 x 2	50 x 3	50 x 3	50 x 3	50 x 3
Capacity (Nominal)	Cooling	Btu/h	184,000	216,000	240,000	264,000	288,000
		kW	53.9	63.3	70.3	77.4	84.4
Input Power ^{*1} (Nominal)	Heating	Btu/h	206,000	242,000	270,000	296,000	324,000
		kW	60.4	70.9	79.1	86.8	95.0
Airflow Rate	Cooling	CFM (m³/h)	6,533 x 2 (11,100 x 2)		6,533 x 3 (11,100 x 3)		
	Heating	in.WG (Pa)	0.32 (80)		0.32 (80)		
Sound Pressure Level	Cooling	dB(A)	63		64		
	Heating		64		65		
Compressor	Type x Quantity		(Rotary (inv) x 1) x 2		(Rotary (inv) x 1) x 3		
	Motor Output	kW	3.9 x 2		3.9 x 3		
	Crankcase Heater	W	25 x 2		25 x 3		
Refrigerant	Type		R410A		R410A		
	Pre-charge	lbs (kg)	24.7 x 2 (11.2 x 2)		24.7 x 3 (11.2 x 3)		
Dimensions	Height	in. (mm)	66-9/16 (1,690)		66-9/16 (1,690)		
	Width		36-5/8 x 2 (930 x 2)		36-5/8 x 3 (930 x 3)		
	Depth		30-1/8 (765)		30-1/8 (765)		
Weight	Net	lbs (kg)	490 x 2 (222 x 2)		490 x 3 (222 x 3)		
Connection Pipe Diameter	Liquid	in. (mm)	5/8 (15.88)		5/8 (15.88)		3/4 (19.05)
	Suction Gas		1-1/8 (28.58)		1-3/8 (34.92)		1-3/8 (34.92)
Operation Range	Cooling	°F (°C)	23 to 115 (-5 to 46)		23 to 115 (-5 to 46)		
	Heating		-4 to 70 (-20 to 21)		-4 to 70 (-20 to 21)		
Cooling (Non-Ducted / Ducted)	EER		11.4 / 11.1	12.0 / 12.0	11.3 / 11.9	10.3 / 10.9	9.6 / 10.0
	IEER		19.6 / 17.3	20.2 / 17.2	19.6 / 17.2	19.0 / 16.4	18.0 / 15.3
Heating (Non-Ducted / Ducted)	COP		3.55 / 3.44	3.72 / 3.60	3.53 / 3.58	3.21 / 3.21	3.21 / 3.21

Dimensions

6, 8Tons (8, 10HP) : AOUA72RLBV / AOUA96RLBV

(Unit : in.(mm))

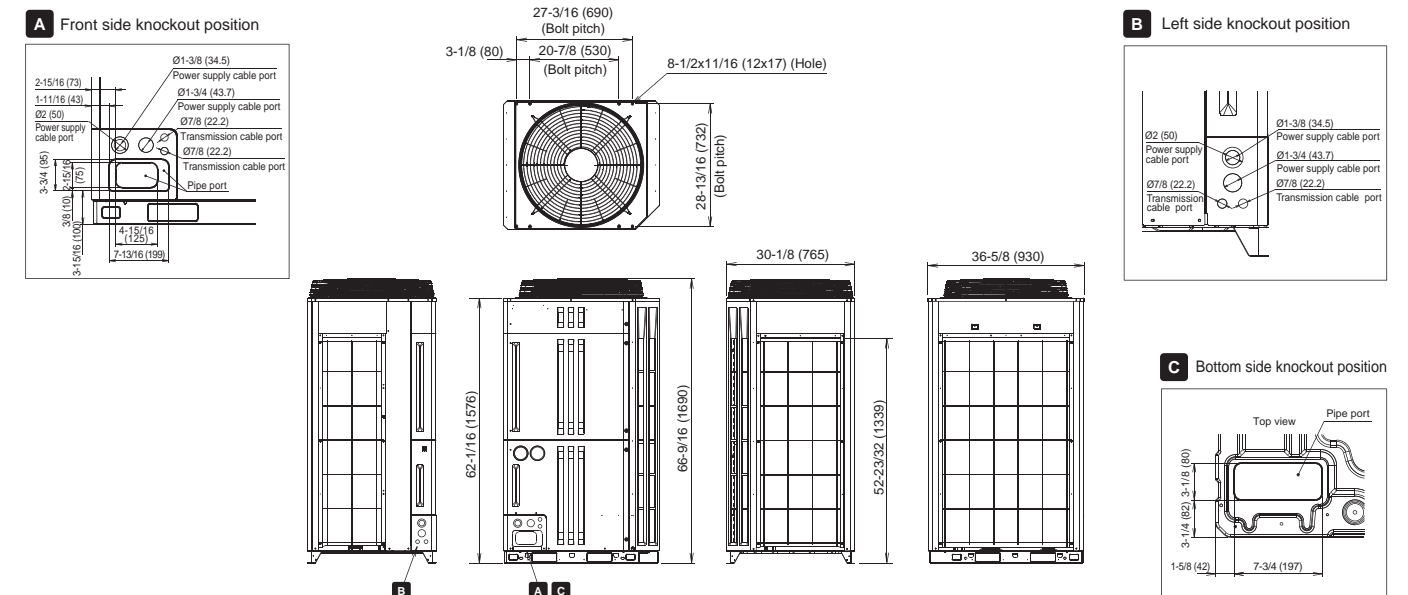

HEAT RECOVERY TYPE

AIRSTAGE VR-II series

Smart and cutting edge design
 Extensive lineup from 6 to 24 Tons in 2 Ton increments
 Connectable indoor unit capacity ratio up to 150%

System Outline



Simultaneous cooling and heating operation using 1 refrigerant system

Cooling and heating can be freely selected for each indoor unit to provide simultaneous cooling and heating in the rooms with large temperature differences, etc.



Annual cooling operation

Use annual cooling operation for the rooms and other spaces that require constant temperature control throughout the year.

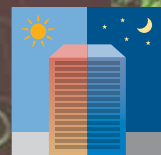

Handles changes in temperature differences

The operation mode can be freely changed when there are large temperature differences during the day, such as between seasons.

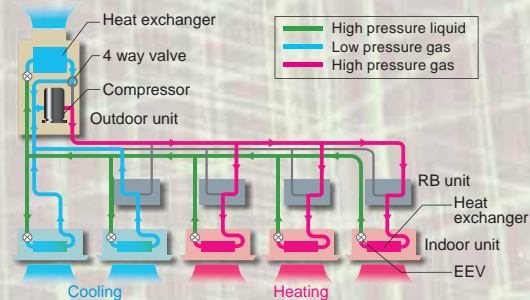

Our Heat recovery systems achieve high operating energy efficiency by drawing heat from the room to be cooled and transferring it as energy for rooms that are to be heated.

Energy saving of the operating systems has been improved as heating and cooling modes can be operated at the same time on the same air conditioning piping system.

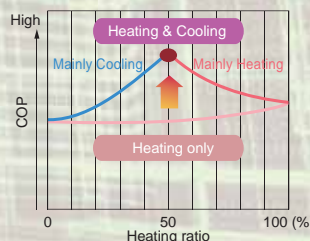

Flexible piping connection

Refrigerant piping layout flexibility is made possible with the use of separation tubes and various RB Unit configurations.

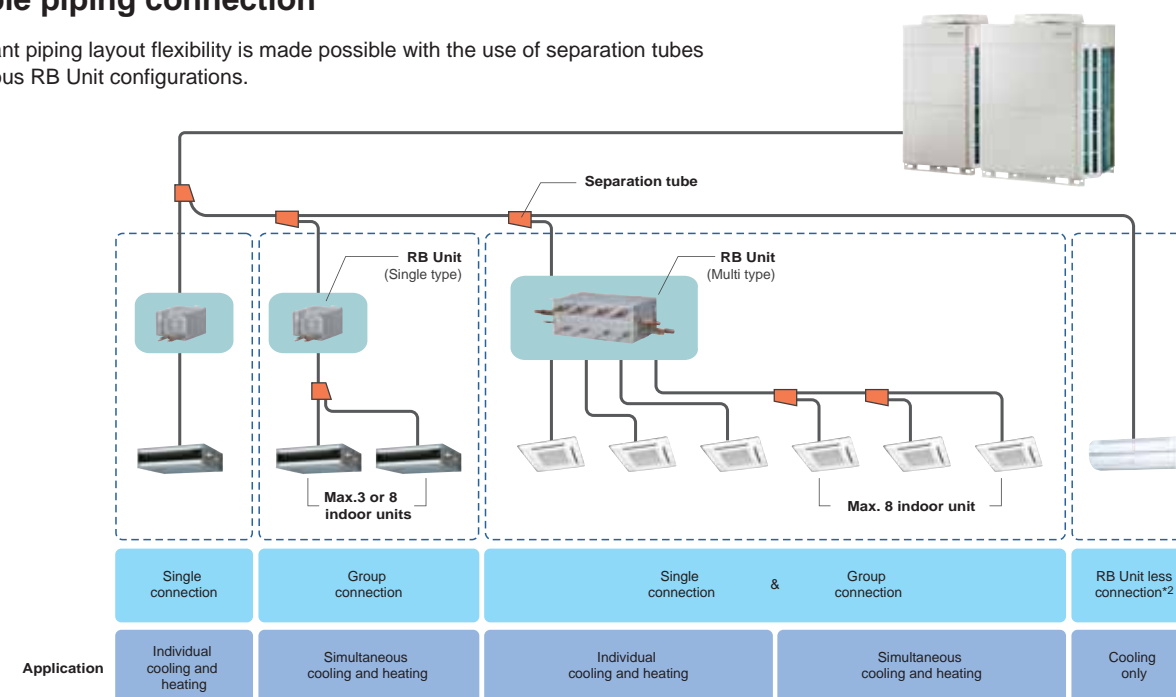

- The RB unit can be freely positioned between the first branch and the indoor unit.
- The maximum height difference between RB units is 49ft.(15m).
- *2. RB Unit is not necessary for cooling only use.

Flexible installation of Refrigerant Branch (RB) unit

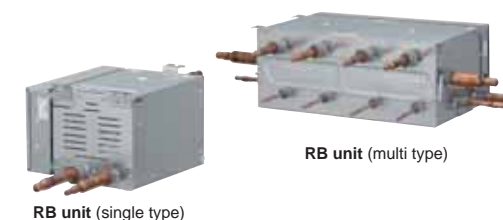
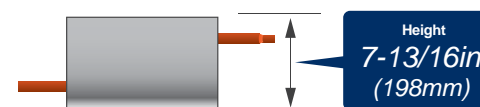

- Small & slim design saves space
- A drain pipe is not required
- The control box position can be changed to meet the installation conditions



Installation possible from either side for freedom of the control box



Installation possible on the upper-side for use in narrow space

Easy to maintain in a narrow space.

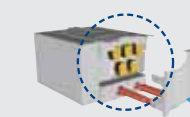

• Maintenance can be performed from the side.

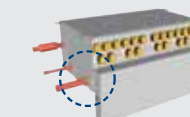

• Electronics enclosure can be temporarily slid down for service access.

Simple installation series connection design

• 2-way connection

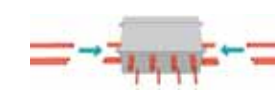



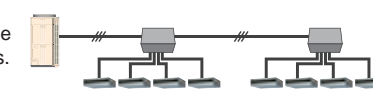

• Up to 2 units can be connected in series.

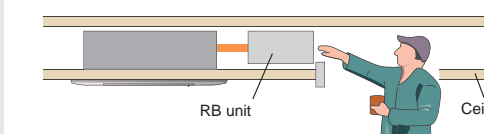

• Parts can be replaced easily even in a narrow ceiling space.



Specifications





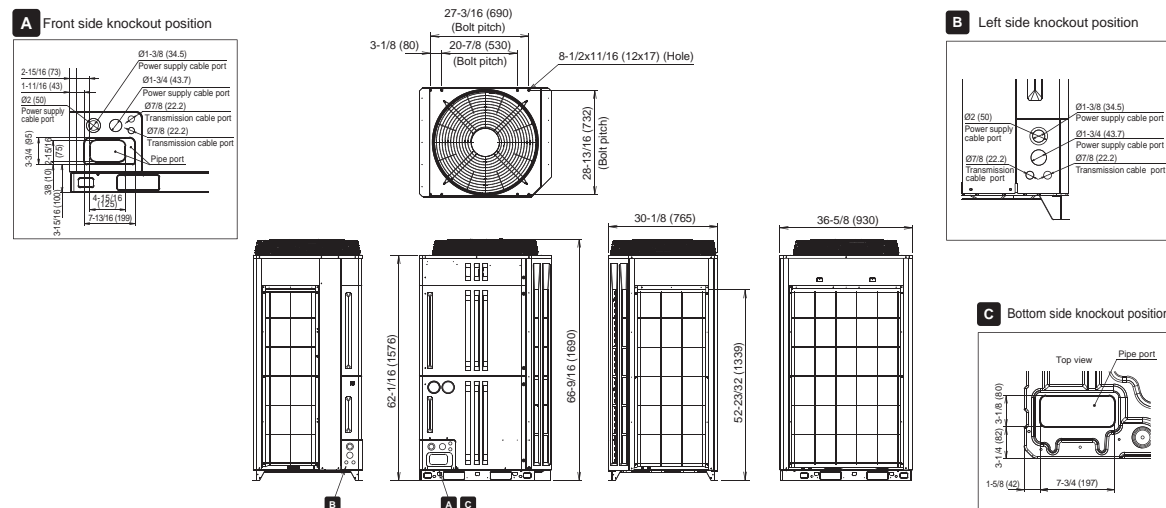

Capacity range		Tons	6	8	10	12
						
Model name			AOUA72TLBV	AOUA96TLBV	AOUA120TLBV	AOUA144TLBVG
Unit 1			AOUA72TLBV	AOUA96TLBV	AOUA120TLBV	AOUA72TLBV
Unit 2						AOUA72TLBV
Unit 3						AOUA72TLBV
Indoor Unit Connectable Capacity			50% to 150%			
Connectable Indoor Units			2 to 14	2 to 16	2 to 18	2 to 22
Power source			3-phase, 208-230V, 60Hz			
MAX.CRT.BKR		(A)	50	50	60	50 x 2
Capacity (Nominal)	Cooling	Btu/h	72,000	96,000	120,000	144,000
		kW	21.1	28.1	35.2	42.2
	Heating	Btu/h	81,000	108,000	135,000	162,000
		kW	23.7	31.7	39.6	47.5
Input Power*1 (Nominal)	Cooling	kW	5.31	7.56	9.75	11.69
	Heating	kW	5.35	7.82	10.11	12.73
Airflow Rate	High	CFM (m³/h)	6,533 (11,100)		7,652 (13,000)	6,533 x 2 (11,100 x 2)
External Static Pressure		in.WG (Pa)	0.32 (80)			
Sound Pressure Level	Cooling	dB(A)	57	59	61	60
	Heating		58	59	62	61
Compressor	Type x Quantity		(Rotary (inv) x 1)		(Rotary (inv) x 1) x 2	
	Motor Output	kW	7.5		11.0	7.5 x 2
	Crankcase Heater	W	35 x 2		(35 x 2) x 2	
Refrigerant	Type		R410A			
	Pre-charge	lbs (kg)	26.01 (11.80)		26.01 x 2 (11.80 x 2)	
Dimensions	Height	in. (mm)	66-9/16 (1,690)		66-9/16 (1,690)	66-9/16 (1,690)
	Width		36-5/8 (930)		48-13/16 (1,240)	36-5/8 x 2 (930 x 2)
	Depth		30-1/8 (765)		30-1/8 (765)	
Weight	Net	lbs (kg)	597 (271)	597 (271)	639 (290)	597 x 2 (271 x 2)
	Liquid	in. (mm)	1/2 (12.70)		1/2 (12.70)	1/2 (12.70)
Discharge Gas	5/8 (15.88)		3/4 (19.05)	3/4 (19.05)	5/8 (15.88)	
Suction Gas	7/8 (22.22)		1-1/8 (28.58)	7/8 (22.22)		
Operation Range	Cooling	°F (°C)	14 to 115 (-10 to 46)			
	Heating		-4 to 70 (-20 to 21)			
Cooling (Non-Ducted / Ducted)	EER		12.50 / 12.30	11.70 / 11.30	11.30 / 11.30	11.40 / 11.40
	IEER		24.10 / 20.00	23.60 / 20.20	23.80 / 20.10	22.20 / 20.40
Heating (Non-Ducted / Ducted)	COP		4.06 / 3.64	3.72 / 3.60	3.61 / 3.49	3.44 / 3.44
	SCHE (Non-Ducted / Ducted)		24.0 / 30.1	25.5 / 26.5	25.8 / 25.4	22.2 / 22.2

Note : Specifications are based on the following conditions.
 Cooling : Indoor temperature of 80°F (26.7°C) DB / 67°F (19.4°C) WB, and outdoor temperature of 95°F (35.0°C) DB / 75°F (23.9°C) WB.
 Heating : Indoor temperature of 70°F (21.1°C) DB / 60°F (15.6°C) WB, and outdoor temperature of 47°F (8.3°C) DB / 43°F (6.1°C) WB.
 Pipe length : 25ft. (7.5 m); Height difference between outdoor unit and indoor unit : 0ft. (0 m).

Dimensions 6, 8Tons (8, 10HP) : AOUA72TLBV / AOUA96TLBV

(Unit : in.(mm))



		14	16	18	20	22	24	
								
Model name		AOUA168TLBVG	AOUA192TLBVG	AOUA216TLBVG	AOUA240TLBVG	AOUA264TLBVG	AOUA288TLBVG	
Unit 1		AOUA96TLBV	AOUA120TLBV	AOUA120TLBV	AOUA120TLBV	AOUA96TLBV	AOUA96TLBV	
Unit 2		AOUA72TLBV	AOUA72TLBV	AOUA96TLBV	AOUA120TLBV	AOUA96TLBV	AOUA96TLBV	
Unit 3						AOUA72TLBV	AOUA96TLBV	
Indoor Unit Connectable Capacity		50% to 150%						
Connectable Indoor Units		2 to 26	2 to 30	2 to 34	2 to 37	2 to 41	2 to 45	
Power source		3-phase, 208-230V, 60Hz						
MAX.CRT.BKR		(A)	50 x 2	60 x 50	60 x 50	60 x 2	50 x 3	
Capacity (Nominal)	Cooling	Btu/h	168,000	192,000	216,000	240,000	264,000	288,000
		kW	49.2	53.9	63.3	70.3	77.4	84.4
	Heating	Btu/h	189,000	216,000	243,000	270,000	297,000	324,000
		kW	55.1	60.4	71.2	79.1	86.8	95.0
Input Power*1 (Nominal)	Cooling	kW	14.03	15.78	18.27	20.19	22.35	25.00
	Heating	kW	13.93	14.79	18.91	21.70	23.20	26.07
Airflow Rate	High	CFM (m³/h)	6,533 x 2 (11,100 x 2)	7,652 + 6,533		7,652 x 2 (13,000 x 2)	6,533 x 3 (11,100 x 3)	6,533 x 2 (11,100 x 2)
External Static Pressure		in.WG (Pa)	0.32 (80)					
Sound Pressure Level	Cooling	dB(A)	61	62	63	64	63	
	Heating		62	63	64	65	63	
Compressor	Type x Quantity		(Rotary (inv) x 1) x 2		(Rotary (inv) x 1) x 2		(Rotary (inv) x 1) x 3	
	Motor Output	kW	7.5 x 2	11.0 + 7.5		11.0 x 2	7.5 x 3	
	Crankcase Heater	W	(35 x 2) x 2		(35 x 2) x 2		(35 x 2) x 3	
Refrigerant	Type		R410A					
	Pre-charge	lbs (kg)	26.01 x 2 (11.80 x 2)	26.01 x 2 (11.80 x 2)		26.01 x 2 (11.80 x 2)	26.01 x 3 (11.80 x 3)	
Dimensions	Height	in. (mm)	66-9/16 (1,690)		66-9/16 (1,690)	66-9/16 (1,690)	66-9/16 x 3 (1,690)	
	Width		36-5/8 x 2 (930 x 2)		48-13/16 + 36-5/8 (1,240 + 930)		48-13/16 x 2 (1,240 x 2)	
	Depth		30-1/8 (765)		30-1/8 (765)		30-1/8 x 3 (765)	
Weight	Net	lbs (kg)	597 x 2 (271 x 2)	639 + 597 (290 + 271)	639 + 597 (290 + 271)	639 x 2 (290 x 2)	597 x 3 (271 x 3)	597 x 3 (271 x 3)
	Liquid	in. (mm)	1/2 (12.70)		1/2 (12.70)		1/2 (12.70)	
Discharge Gas	7/8 (22.22)		5/8 (15.88)	5/8 (15.88)		1-1/8 (28.58)		
Suction Gas	7/8 (22.22)		1-1/8 (28.58)		7/8 (22.22)			
Operation Range	Cooling	°F (°C)	14 to 115 (-10 to 46)					
	Heating		-4 to 70 (-20 to 21)					
Cooling (Non-Ducted / Ducted)	EER		11.00 / 11.00	11.20 / 11.10	10.90 / 10.90	10.90 / 10.90	10.90 / 10.90	10.60 / 10.60
	IEER		22.20 / 20.00	24.30 / 20.50	20.00 / 19.20	20.80 / 20.20	20.80 / 20.10	20.80 / 20.10
Heating (Non-Ducted / Ducted)	COP		3.48 / 3.48	3.75 / 3.57	3.47 / 3.47	3.36 / 3.36	3.45 / 3.40	3.36 / 3.31
	SCHE (Non-Ducted / Ducted)		22.0 / 22.0	25.0 / 27.1	25.2 / 25.2	23.7 / 23.7	22.0 / 22.0	22.0 / 22.0

10Tons (12HP) : AOUA120TLBV

(Unit : in.(mm))

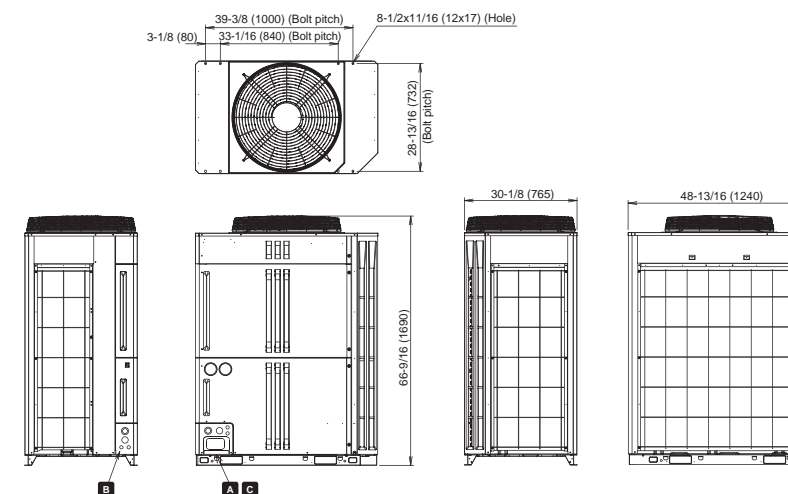

Compact Cassette

V-II Models	VR-II Models
AUUA7RLAV	AUUA7TLAV
AUUA9RLAV	AUUA9TLAV
AUUA12RLAV	AUUA12TLAV
AUUA14RLAV	AUUA14TLAV
AUUA18RLAV	AUUA18TLAV
AUUA24RLAV	AUUA24TLAV



Compact size panel design that fits a standard ceiling panel 23-5/8 x 23-5/8in (600x600mm)

2-stage turbo fan

High efficiency design by 2 stage structure

Evenly spread air distribution across the heat exchanger is possible due to the 2 stage turbo fan which produces two separate airflow streams.

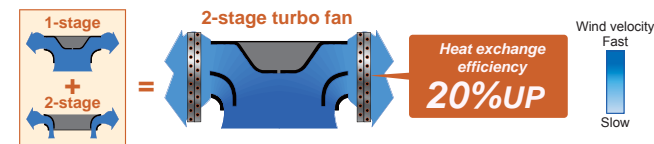

Quiet quality

Optimization of wing form (laminar wing type) and wing number (7 blades each)

Designed using Computational Fluid Dynamics (CFD) simulations.

Adoption of laminar wing

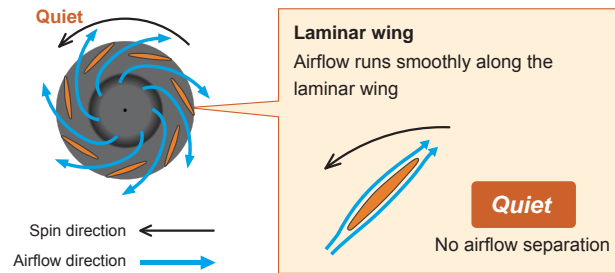

Improvement of airflow distribution

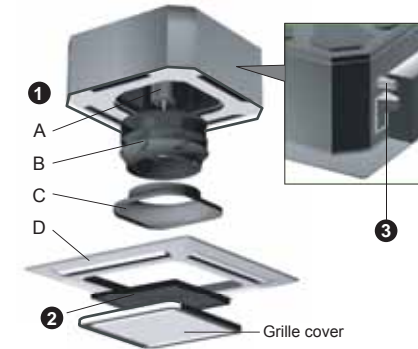

1 Easy maintenance of fan and motor

Access and maintenance of the fan and motor can be accomplished by removing the panel. The fan and motor can be easily removed.

A : Fan motor B : 2-stage turbo fan
C : Bell-mouth D : Panel

2 Air filter : standard equipment

3 Adaptation of transparent drainage parts

During installation, maintenance and operation, the drain pump and kit can be checked easily.

Condensate Drain Pump (Standard)

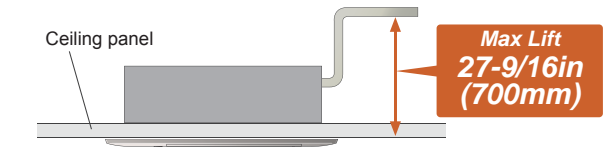

High ceiling mode

The compact cassette can be installed up to a height of 9' 10-1/8" (3.0m) (AUUA12/14/18/24).

Model code	The maximum height from floor to ceiling ft.(m)	
	Standard mode	High ceiling mode
7	8' 10-5/16" (2.7)	—
9	8' 10-5/16" (2.7)	—
12	8' 10-5/16" (2.7)	9' 10-1/8" (3.0)
14	8' 10-5/16" (2.7)	9' 10-1/8" (3.0)
18	8' 10-5/16" (2.7)	9' 10-1/8" (3.0)
24	8' 10-5/16" (2.7)	9' 10-1/8" (3.0)

Compact design

World's first 24,000Btu model in the compact cassette category (Easy installation by taking off ceiling panel of 23-5/8 x 23-5/8in (600 x 600mm))

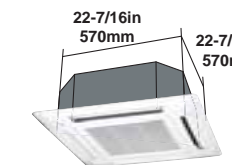

Optional parts

Air Outlet Shutter Plate : UTR-YDZB
Insulation Kit for High Humidity : UTZ-KXGC
Fresh Air Intake Kit : UTZ-VXAA
IR Receiver is standard for communicating with Optional Wireless Controller.

Specifications

Model name	V-II		AUUA7RLAV	AUUA9RLAV	AUUA12RLAV	AUUA14RLAV	AUUA18RLAV	AUUA24RLAV
	VR-II		AUUA7TLAV	AUUA9TLAV	AUUA12TLAV	AUUA14TLAV	AUUA18TLAV	AUUA24TLAV
Power source	Single phase, 208-230V, 60Hz							
Capacity	Cooling	Btu/h	7,500	9,500	12,000	14,000	18,000	24,000
		kW	2.2	2.8	3.5	4.1	5.3	7.0
	Heating	Btu/h	9,500	10,900	13,500	15,600	20,000	27,000
		kW	2.8	3.2	4.0	4.6	5.9	7.9
Input power		W	25	25	29	35	36	84
Airflow rate	High	CFM	318 (540)	324 (550)	353 (600)	400 (680)	418 (710)	606 (1,030)
	Med	(m ³ / h)	265 (450)	265 (450)	312 (530)	347 (590)	341 (580)	489 (830)
	Low		206 (350)	206 (350)	230 (390)	230 (390)	235 (400)	265 (450)
Sound pressure level	High	dB(A)	34	35	37	38	41	50
	Med		30	30	34	34	35	44
	Low		25	25	27	27	27	30
Dimensions (H x W x D)	in.(mm)		9-21/32 x 22-7/16 x 22-7/16 (245 x 570 x 570)					
Weight	lbs.(kg)		33 (15)			38 (17)		
Connection pipe diameter	Liquid (Flare)	in.(mm)	ø 1/4 (6.35)				ø 3/8 (9.52)	
	Gas (Flare)		ø 1/2 (12.70)				ø 5/8 (15.88)	
	Drain		ø 3/4 (25) (I.D.) ; ø 1-1/16 (32) (O.D.)					
Grille (sold separately)	Model name		UTG-CCGV					
	Dimensions (H x W x D)		1-31/32 x 27-9/16 x 27-9/16 (50 x 700 x 700)					
	Weight		6 (2.6)					

Note : Specifications are based on the following conditions.
Cooling : Indoor temperature of 80°F(26.7°C)DB/67°F(19.4°C)WB, and outdoor temperature of 95.0°F(35°C)DB/75°F(23.9°C)WB.
Heating : Indoor temperature of 70°F(21.1°C)DB/60°F(15.6°C)WB, and outdoor temperature of 47°F(8.3°C)DB/43°F(6.1°C)WB.
Pipe length : 25ft.(7.5 m), Height difference : 0ft.(0 m) (Outdoor unit - Indoor unit).
Built-in protective functions may limit capacity or shut off unit if unit is operated outside of unit design operating temperature ranges.

Dimensions Unit: In (mm)

Models: AUUA7 / AUUA9 / AUUA12 / AUUA14 / AUUA18 / AUUA24

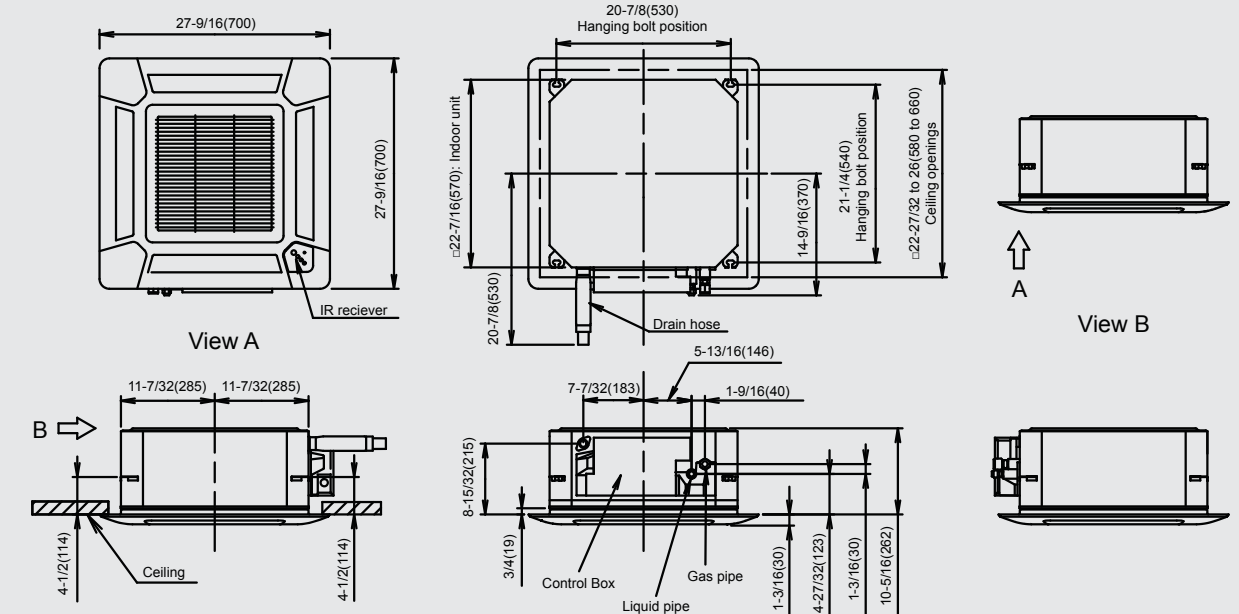

Cassette

- | | |
|-------------------|-------------------|
| V-II Models | VR-II Models |
| AUUB18RLAV | AUUB18TLAV |
| AUUB24RLAV | AUUB24TLAV |
| AUUB30RLAV | AUUB30TLAV |
| AUUB36RLAV | AUUB36TLAV |

Powerful, wide airflow and quiet operation



High efficiency turbo fan with 3-dimensional blade

High efficiency airflow distribution has been achieved by the introduction of a 3 dimensional blade which increases the air passing over the heat exchanger.

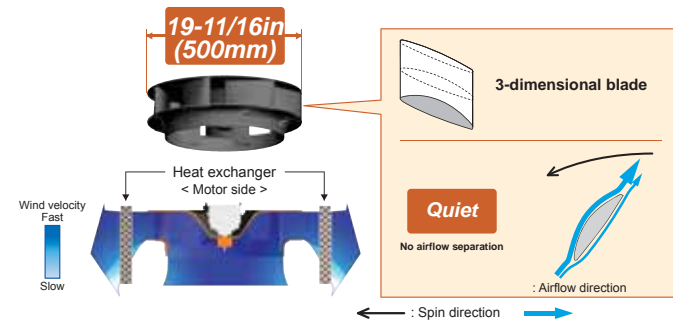

Quiet quality

Optimization of wing form (laminar wing type) and wing number (7 blades each)

Designed using Computational Fluid Dynamics (CFD) simulations

Adoption of laminar wing

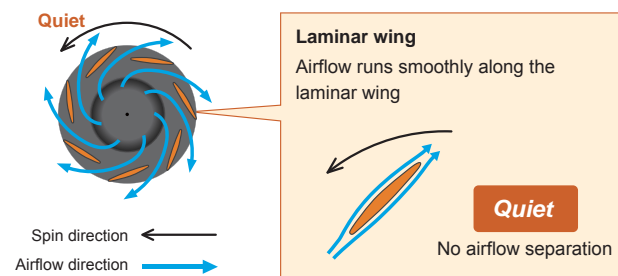

Improvement of the airflow distribution

The louver design distributes air leaving a space between the chassis and the ceiling allowing far and wide air flow distribution.

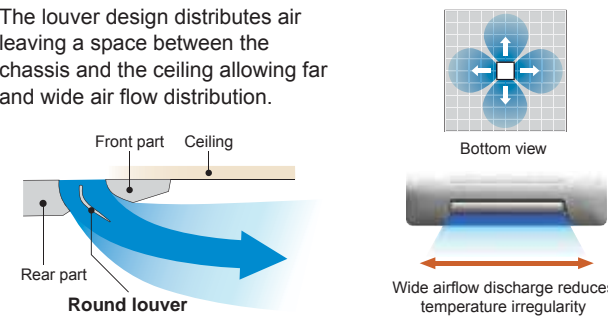

Condensate Drain Pump (Standard)

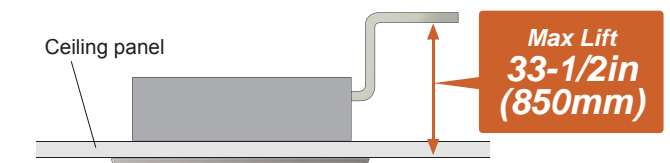

High ceiling mode

This cassette can be installed up to a height of 13'9". (4.2m) (AUUB36).

Model code	The maximum height from floor to ceiling ft. (m)	
	Standard mode	High ceiling mode
18	9' 10-1/8" (3.0)	11' 6" (3.5)
24	9' 10-1/8" (3.0)	11' 6" (3.5)
30	10' 6" (3.2)	11' 9-3/4" (3.6)
36	10' 6" (3.2)	13' 9-3/8" (4.2)

Hanger position can be adjusted after installation

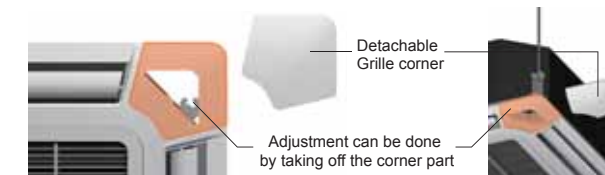

Optional parts

- | | | | |
|----------------------------|------------|------------------------------------|---------------------|
| IR Receiver Kit : | UTY-LRHYB1 | Insulation Kit for High Humidity : | UTZ-KXGA / UTZ-KXGB |
| Air Outlet Shutter Plate : | UTR-YDZC | Wide Panel : | UTG-AGYA-W |
| Panel Spacer : | UTG-BGYA-W | Fresh Air Intake Kit : | UTZ-VXGA |

Specifications

Model name	V-II		AUUB18RLAV	AUUB24RLAV	AUUB30RLAV	AUUB36RLAV		
	VR-II		AUUB18TLAV	AUUB24TLAV	AUUB30TLAV	AUUB36TLAV		
Power source	Single phase, 208-230V, 60Hz							
Capacity	Cooling	Btu/h	18,000	24,000	30,000	36,000		
		kW	5.3	7.0	8.8	10.6		
	Heating	Btu/h	20,000	27,000	34,000	40,000		
		kW	5.9	7.9	10.0	11.7		
Input power		W	39	46	59	80		
Airflow rate	High	CFM (m³/h)	677 (1,150)	753 (1,280)	942 (1,600)	1,059 (1,800)		
			Med	553 (940)	612 (1,040)	765 (1,300)	765 (1,300)	
			Low	512 (870)	512 (870)	647 (1,100)	647 (1,100)	
Sound pressure level	High	dB(A)	36	38	40	44		
			Med	30	33	38	38	
			Low	29	29	33	33	
Dimensions (H x W x D)	in.(mm)		9-11/16 x 33-1/16 x 33-1/16 (246 x 840 x 840)		11-11/32 x 33-1/16 x 33-1/16 (288 x 840 x 840)			
Weight	lbs.(kg)		51 (23)		60 (27)			
Connection pipe diameter	Liquid (Flare)	ø 3/8 (9.52)						
		Gas (Flare)	in.(mm)		ø 5/8 (15.88)		ø 3/4 (19.05)	
	Drain	ø 3/4 [I.D.] ; ø 1-1/16 [O.D.]						
Grille (sold separately)	Model name		UTG-LCGV					
	Dimensions (H x W x D)		in.(mm)				1-31/32 x 37-13/32 x 37-13/32 (50 x 950 x 950)	
	Weight		lbs.(kg)				13 (5.5)	

Note : Specifications are based on the following conditions.
 Cooling : Indoor temperature of 80°F(26.7°C)DB/67°F(19.4°C)WB, and outdoor temperature of 95.0°F(35°C)DB/75°F(23.9°C)WB.
 Heating : Indoor temperature of 70°F(21.1°C)DB/60°F(15.6°C)WB, and outdoor temperature of 47°F(8.3°C)DB/43°F(6.1°C)WB.
 Pipe length : 25ft.(7.5 m), Height difference : 0ft.(0 m) (Outdoor unit - Indoor unit).
 Built-in protective functions may limit capacity or shut off unit if unit is operated outside of unit design operating temperature ranges.

Dimensions Unit: In (mm)

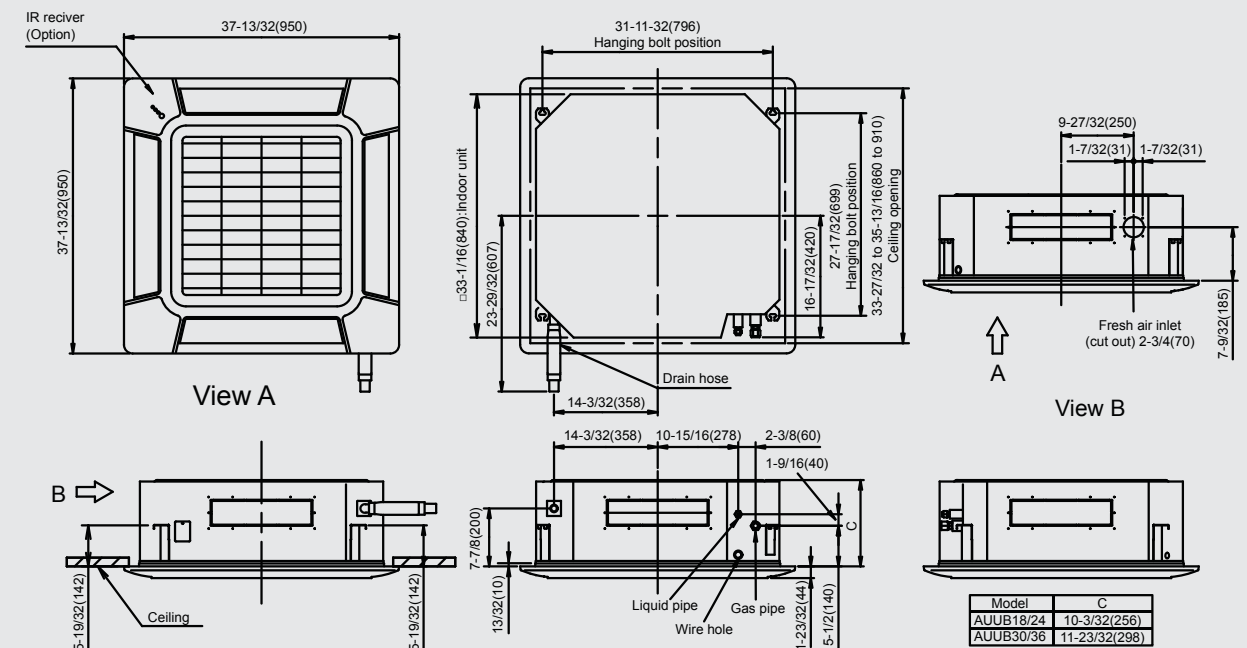

Slim Compact Duct

V-II Models
(Drain pump internal model)

ARUL7RLAV
ARUL9RLAV
ARUL12RLAV
ARUL14RLAV
ARUL18RLAV

VR-II Models
(Drain pump internal model)

ARUL7TLAV
ARUL9TLAV
ARUL12TLAV
ARUL14TLAV
ARUL18TLAV



ARUL7RLAV
ARUL9RLAV
ARUL7TLAV
ARUL9TLAV



ARUL12RLAV
ARUL14RLAV
ARUL18RLAV
ARUL14TLAV

Slim design and wide range of static pressure for flexible installation.

Slim design

This model has a slim design so it can be installed in narrow ceilings.

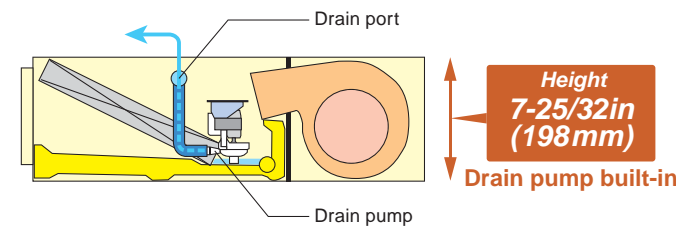

Note: Condensate drain pump cannot be used when unit is in vertical position.

Flexible installation

Slim Compact Duct units can be mounted horizontally or vertically and can deliver up to 0.36" external static pressure providing the power and flexibility to meet the needs of most applications.

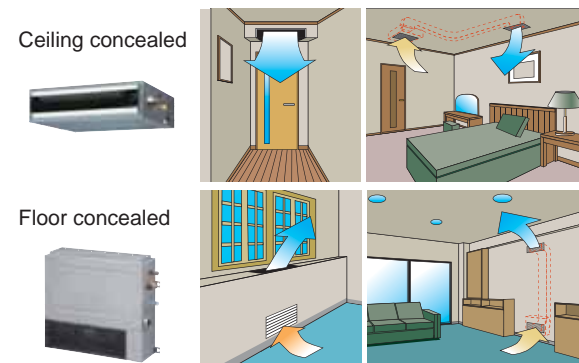

Condensate Drain Pump (Standard)

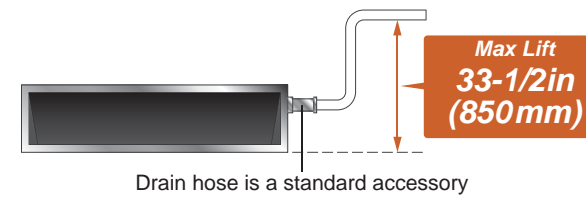

Note: Condensate drain pump cannot be used when unit is in vertical position.

Selectable External Static Pressure

The external static pressure can be selected for any value from 0 to 0.36 in.WG. (0 to 90 Pa). Static pressure setting can be changed using the remote controller.



Static pressure range
0.36 in. WG
(0 to 90 Pa)

Air-intake

Air intake direction can be selected to match the installation site.

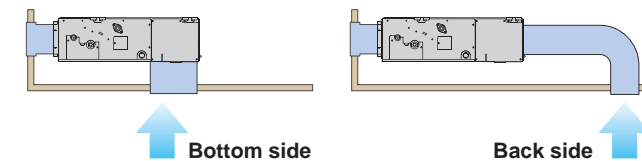

In locations where fan noise may be a concern, do not use bottom inlet without providing an elbow to prevent line of sight to the fan.

Auto Louver Grille Kit (Option)

Simple flat Auto Louver will provide comfortable airflow and blend with any interior.

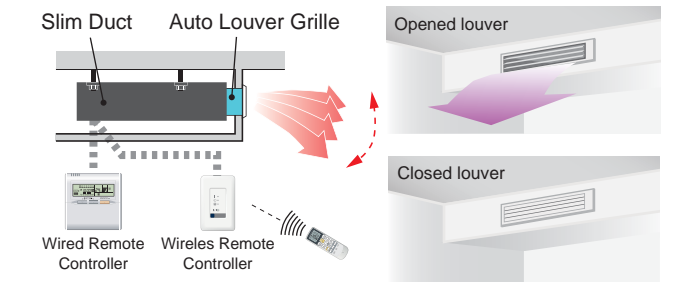

- Operation with indoor unit
- Up and down auto swing
- Auto-closing louver

See Page 59 for more details.

Filter (Included)

ARUL7 / 9 / 12 / 14 / 18

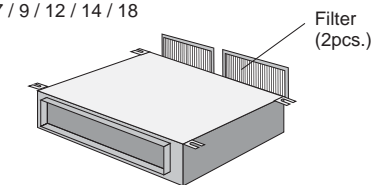

Optional parts

Remote Sensor Unit : UTY-XSZX

IR Receiver Unit : UTB-YWC

Auto Louver Grille Kit : UTD-GXSA-W (for ARUL7/9/12/14RLAV)

UTD-GXSB-W (for ARUL18RLAV)

Specifications

Model name	V-II		ARUL7RLAV	ARUL9RLAV	ARUL12RLAV	ARUL14RLAV	ARUL18RLAV	
	VR-II		ARUL7TLAV	ARUL9TLAV	ARUL12TLAV	ARUL14TLAV	ARUL18TLAV	
Power source	Single phase, 208-230V, 60Hz							
Capacity	Cooling	Btu/h	7,500	9,500	12,000	14,000	18,000	
		kW	2.2	2.8	3.5	4.1	5.3	
	Heating	Btu/h	9,500	10,900	13,500	15,600	20,000	
		kW	2.8	3.2	4.0	4.6	5.9	
Input power	W		44	50	54	92	83	
Airflow rate	High	CFM	324 (550)	353 (600)	353 (600)	471 (800)	553 (940)	
		m ³ /h	288 (490)	324 (550)	300 (510)	418 (710)	494 (840)	
		Low	258 (440)	283 (480)	265 (450)	359 (610)	441 (750)	
Static pressure range	in.WG (Pa)		0 to 0.36 (0 to 90)	0 to 0.36 (0 to 90)	0 to 0.36 (0 to 90)	0 to 0.36 (0 to 90)	0 to 0.36 (0 to 90)	
Standard static pressure			0.10 (25)	0.10 (25)	0.10 (25)	0.10 (25)	0.10 (25)	
Sound pressure level	High	dB(A)	28	29	30	34	34	
			Med	25	26	27	32	32
			Low	22	24	24	28	28
Dimensions (H x W x D)	in.(mm)		7-25/32 x 27-9/16 x 24-13/32 (198 x 700 x 620)				7-25/32 x 35-7/16 x 24-13/32 (198 x 900 x 620)	
Weight	lbs.(kg)		40 (18)		42 (19)		51 (23)	
Connection pipe diameter	Liquid (Flare)	in.(mm)	ø 1/4 (6.35)				ø 3/8 (9.52)	
			ø 1/2 (12.70)				ø 5/8 (15.88)	
	Gas (Flare)	ø 3/4 [I.D.] ; ø 1-1/16 [O.D.]						

Note : Specifications are based on the following conditions.

Cooling : Indoor temperature of 80°F(26.7°C)DB/67°F(19.4°C)WB, and outdoor temperature of 95.0°F(35°C)DB/75°F(23.9°C)WB.

Heating : Indoor temperature of 70°F(21.1°C)DB/60°F(15.6°C)WB, and outdoor temperature of 47°F(8.3°C)DB/43°F(6.1°C)WB.

Pipe length : 25ft.(7.5 m), Height difference : 0ft.(0 m) (Outdoor unit - Indoor unit).

Built-in protective functions may limit capacity or shut off unit if unit is operated outside of unit design operating temperature ranges.

Dimensions Unit: In (mm)

Models: ARUL7 / ARUL9 / ARUL12 / ARUL14 / ARUL18

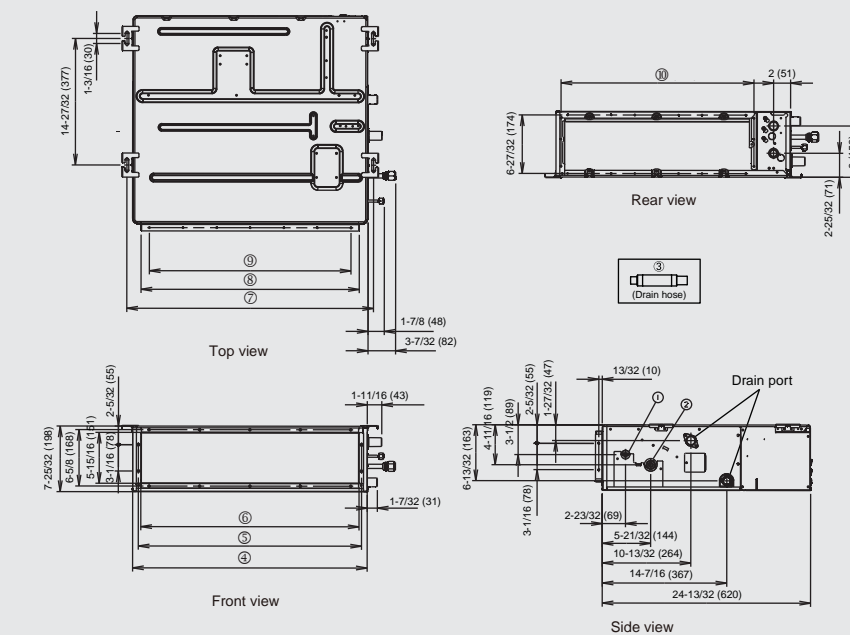

		ARUL7, ARUL9, ARUL12, ARUL14	ARUL18
① Refrigerant pipe flare connection	Liquid	ø 1/4 (6.35)	ø 3/8 (9.52)
	Gas	ø 1/2 (12.70)	ø 5/8 (15.88)
② Drain hose connection	Drain Hose	I.D. 31/32 (25), O.D. 1-1/4 (32)	
③		27-9/16 (700)	35-7/16 (900)
④		26-5/32 (664)	34-1/32 (864)
⑤		25-19/32 (650)	33-15/32 (850)
⑥		28-29/32 (734)	36-25/32 (934)
⑦		25-19/32 (650)	33-15/32 (850)
⑧		3-15/16 (100) x 6	3-15/16 (100) x 8
⑨		23-5/8 (600)	8 = 31-1/2 (800)
⑩		22-19/32 (574)	30-15/32 (774)

Medium Static Pressure Duct

V-II Models
ARUM24RLAV
ARUM30RLAV
ARUM36RLAV

VR-II Models
ARUM24TLAV
ARUM30TLAV
ARUM36TLAV



Slim design allows for easy installation in tight locations as little as 10-5/8in (270mm) in height.

Slim & Compact design

In the case of bottom return air connection, not only does the indoor unit design allow for installation in a narrow ceiling space of up to 10-5/8in (270mm), further space savings have been achieved by mounting the electrical control box internally inside the chassis.

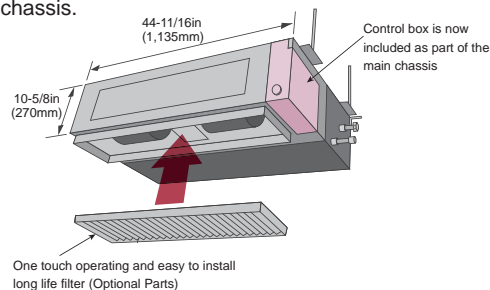

Easy maintenance

Structural improvement is attained by making the bottom panel two pieces, front and rear. The internal fan casing is also manufactured in two pieces, namely upper and lower. The maintenance of the motor and fan can be easily carried out by removing the rear panel and the lower part of the casing while leaving the main chassis installed.

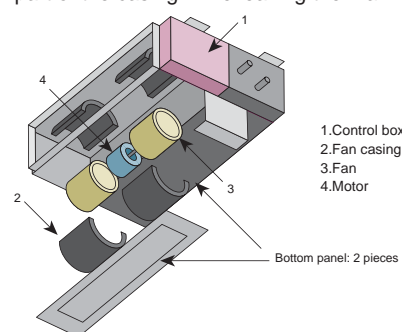

Two-direction drain piping

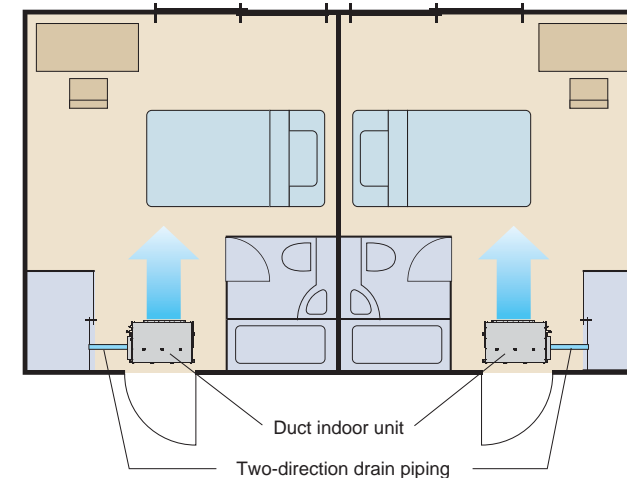

Installation styles

Embedded in Ceiling

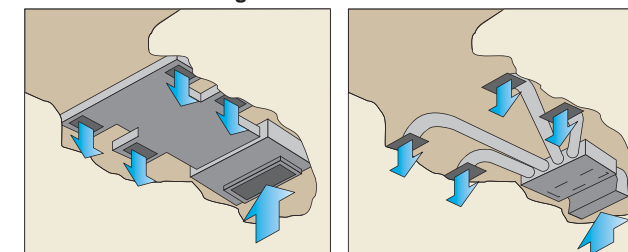

Hanging from Ceiling

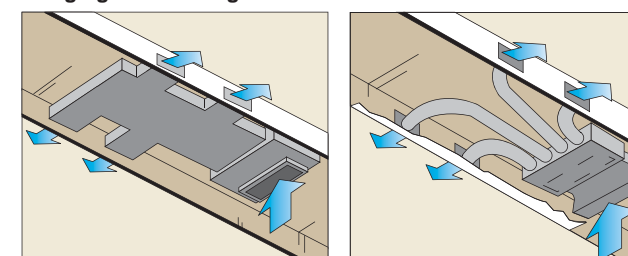

VR-II Models (TLAV) Use High Efficiency DC Fan Motors

Improved motor efficiency from previous model.

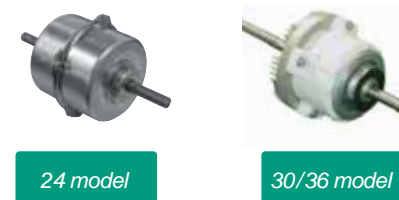

Optional parts

Remote Sensor Unit : UTY-XSZX (Temperature Sensor)
 Long Life Filter* : UTD-LF25NA
 Flange (Round) : UTD-RF204 (Set of 4)
 IR Receiver Unit : UTB-YWC
 Flange (Rectangular) : UTD-SF045T
 Drain Pump Unit : UTZ-PX1NBA

*Note, Duct models do not include a standard filter.

Specifications

Model name	V-II		VR-II		V-II		VR-II	
	ARUM24RLAV	ARUM24TLAV	ARUM30RLAV	ARUM30TLAV	ARUM36RLAV	ARUM36TLAV	ARUM36RLAV	ARUM36TLAV
Power source	1 Phase ~ 208/230V 60Hz							
Capacity	Cooling	Btu/h	24,000	24,000	30,000	30,000	36,000	36,000
		kW	7.0	7.0	8.8	8.8	10.6	10.6
	Heating	Btu/h	27,000	27,000	34,000	34,000	40,000	40,000
		kW	7.9	7.9	10.0	10.0	11.7	11.7
Input power	W	200	125	200	190	320	222	
Airflow rate	High	CFM (m³/h)	706 (1,200)	859 (1,460)	706 (1,200)	1,042 (1,770)	1,012 (1,720)	1,112 (1,890)
	Med	647 (1,100)	724 (1,230)	647 (1,100)	812 (1,380)	983 (1,670)	895 (1,520)	
	Low	589 (1,000)	589 (1,000)	589 (1,000)	589 (1,000)	942 (1,600)	677 (1,150)	
Static pressure range	in.WG (Pa)	0.12 to 0.60 (30 to 150)	0 to 0.60 (0 to 150)	0.12 to 0.60 (30 to 150)	0 to 0.60 (0 to 150)	0.12 to 0.60 (30 to 150)	0 to 0.60 (0 to 150)	
Standard static pressure		0.40 (100)	0.16 (40)	0.40 (100)	0.16 (40)	0.40 (100)	0.16 (40)	
Sound pressure level	High	dB(A)	40	36	40	40	43	41
	Med	38	31	38	33	41	35	
	Low	36	28	36	28	39	29	
Dimensions (H x W x D)	in.(mm)	10-5/16 x 44-11/16 x 27-9/16 (270 x 1,135 x 700)						
Weight	lbs.(kg)	95 (43)	86 (39)	95 (43)	86 (39)	93 (42)	86 (39)	
Connection pipe diameter	Liquid (Flare)		ø 3/8 (9.52)					
	Gas (Flare)	in.(mm)	ø 5/8 (15.88)				ø 3/4 (19.05)	
	Drain		ø 3/4 [I.D.] ; ø 1-1/16 [O.D.]					

Note : Specifications are based on the following conditions.
 Cooling : Indoor temperature of 80°F(26.7°C)DB/67°F(19.4°C)WB, and outdoor temperature of 95.0°F(35°C)DB/75°F(23.9°C)WB.
 Heating : Indoor temperature of 70°F(21.1°C)DB/60°F(15.6°C)WB, and outdoor temperature of 47°F(8.3°C)DB/43°F(6.1°C)WB.
 Pipe length : 25ft.(7.5 m), Height difference : 0ft.(0 m) (Outdoor unit - Indoor unit).
 Built-in protective functions may limit capacity or shut off unit if unit is operated outside of unit design operating temperature ranges.

Dimensions Unit: In (mm)

Models: ARUM24 / ARUM30 / ARUM36

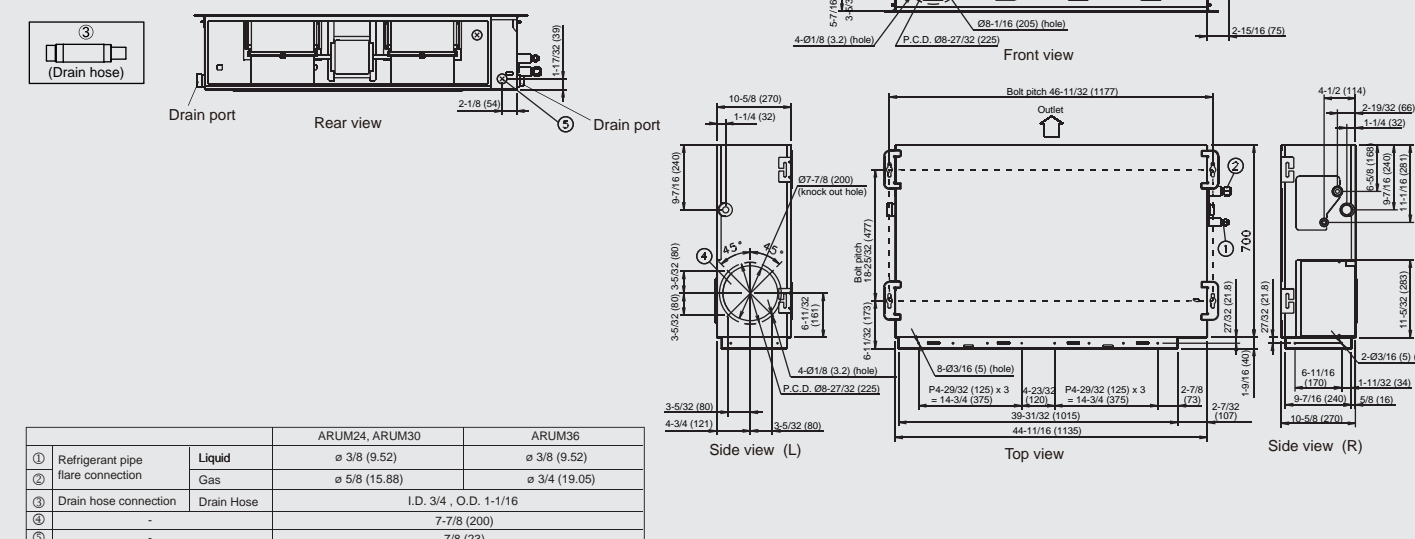

High Static Pressure Duct

V-II Models

ARUH36RLAV
ARUH48RLAV
ARUH60RLAV

VR-II Models

ARUH36TLAV
ARUH48TLAV
ARUH60TLAV

High Static Pressure Ducted Units combine efficient casing design with non metallic fan wheels and casings to reduce noise levels; units are capable of delivering hot or cold air at static pressures up to 1 in.WG. These units are perfect for conditioning hard-to-reach areas and are able to meet the needs of many different types of applications.



Easy installation (Compact size & Lightweight)

A compact and lightweight chassis has been developed to simplify installation and provide better flexibility for tight installation spaces.

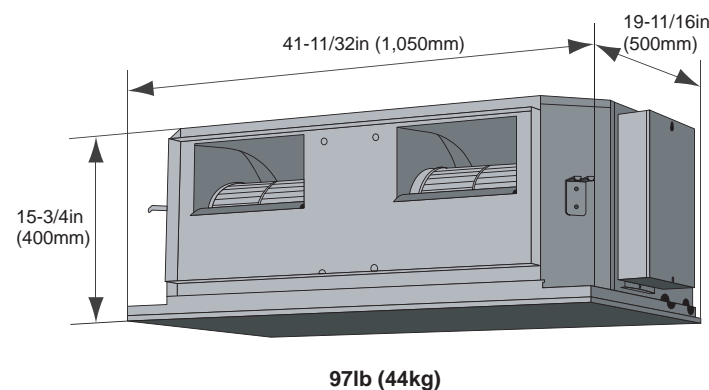

High static pressure design

Up To
**1 in.WG
(250Pa)**
(ARUH48/60)

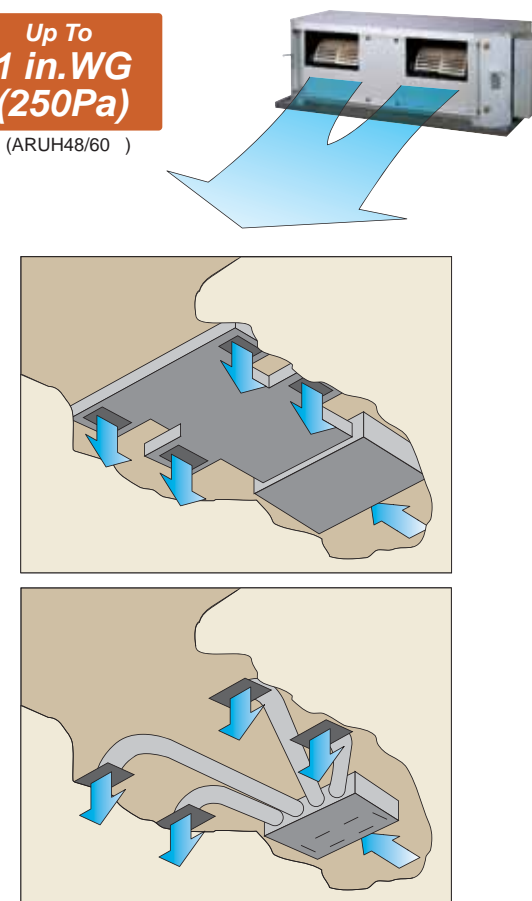

Low noise

Indoor unit

Efficient chassis design has enabled less turbulent air flow. Non-metallic fan wheel and casing reduces fan noise.

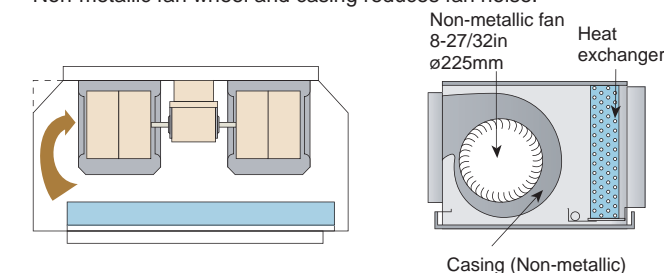

Med. noise level
43dB(A)
(ARUH48)

Optional parts

Long-Life Filter* : UTD-LF60KA

IR Receiver Unit : UTB-YWC

Remote Sensor Unit: UTY-XSZX

*Note, High Static Pressure Duct models do not include a standard filter.

Specifications

Model name	V-II		ARUH36RLAV	ARUH48RLAV	ARUH60RLAV
	VR-II		ARUH36TLAV	ARUH48TLAV	ARUH60TLAV
Power source	Single phase, 208-230V, 60Hz				
Capacity	Cooling	Btu/h	36,000	48,000	60,000
		kW	10.6	14.1	17.6
	Heating	Btu/h	40,000	54,000	67,000
		kW	11.7	15.8	19.6
Input power	W	530	750	810	
Airflow rate	High	CFM m ³ /h	1,324 (2,250)	1,766 (3,000)	1,972 (3,350)
	Med		1,030 (1,750)	1,589 (2,700)	1,678 (2,850)
	Low		824 (1,400)	1,354 (2,300)	1,501 (2,550)
Static pressure range	in.WG	0.40 to 0.80 (100 to 200)		0.40 to 1.00 (100 to 250)	
Standard static pressure	(Pa)	0.40 (100)			
Sound pressure level	High	dB(A)	43	47	48
	Med		37	43	44
	Low		32	40	41
Dimensions (H x W x D)	in.(mm)	15-3/4 x 41-11/32 x 19-11/16 (400 x 1,050 x 500)			
Weight	lbs.(kg)	97 (44)	99 (45)		
Connection pipe diameter	Liquid (Flare)	in.(mm)	ø 3/8 (9.52)		
	Gas (Flare)		ø 3/4 (19.05)		
	Drain		ø 3/4 [I.D.] ; ø 1-1/16 [O.D.]		

Note : Specifications are based on the following conditions.

Cooling : Indoor temperature of 80°F(26.7°C)DB/67°F(19.4°C)WB, and outdoor temperature of 95.0°F(35°C)DB/75°F(23.9°C)WB.

Heating : Indoor temperature of 70°F(21.1°C)DB/60°F(15.6°C)WB, and outdoor temperature of 47°F(8.3°C)DB/43°F(6.1°C)WB.

Pipe length : 25ft.(7.5 m), Height difference : 0ft.(0 m) (Outdoor unit - Indoor unit).

Built-in protective functions may limit capacity or shut off unit if unit is operated outside of unit design operating temperature ranges.

Dimensions Unit: In (mm)

Models: ARUH34 / ARUH48 / ARUH54

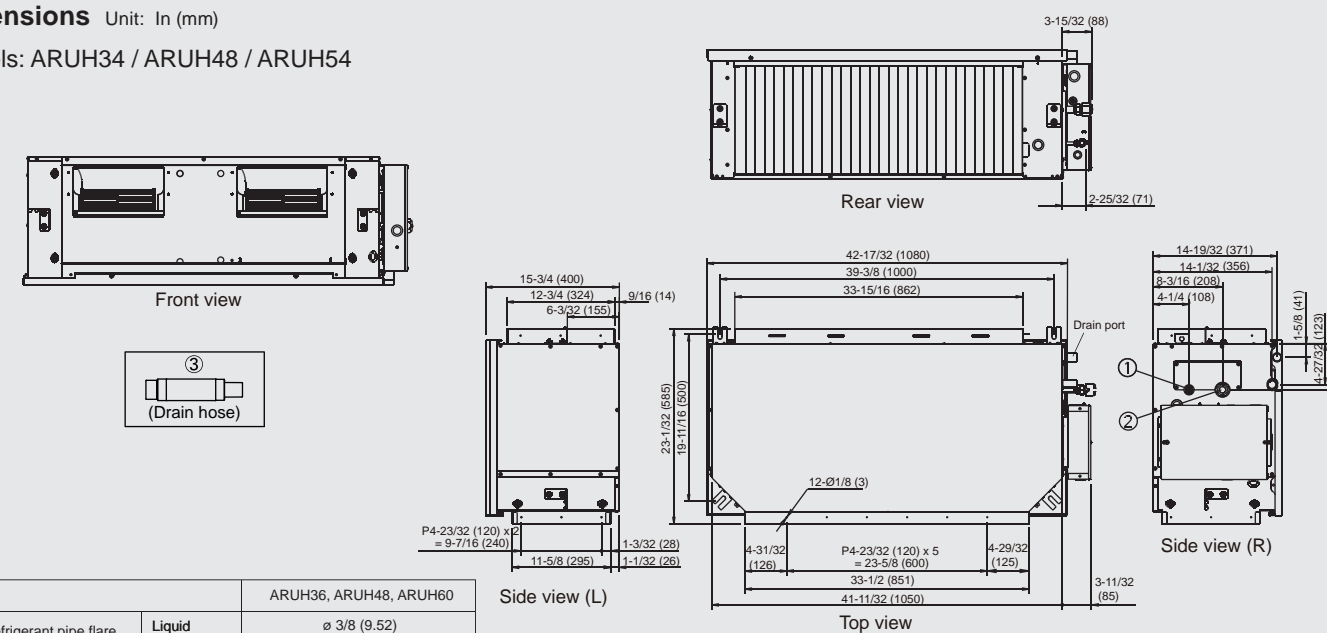

		ARUH36, ARUH48, ARUH60
①	Refrigerant pipe flare connection	Liquid ø 3/8 (9.52) Gas ø 3/4 (19.05)
③	Drain hose connection	Drain Hose I.D. 3/32 (25), O.D. 1-1/4 (32)

Floor / Ceiling

V-II Models	VR-II Models
ABUA12RLAV	ABUA12TLAV
ABUA14RLAV	ABUA14TLAV
ABUA18RLAV	ABUA18TLAV
ABUA24RLAV	ABUA24TLAV



The slim and lightweight design allows the unit to be suspended from the ceiling or installed on the floor. This type suits many room designs.

Flexible installation

Example of floor installation

Floor console



Example of ceiling installation

Under ceiling



Double auto swing

A combination of up/down and right/left directional swing allows three-dimensional air direction control.

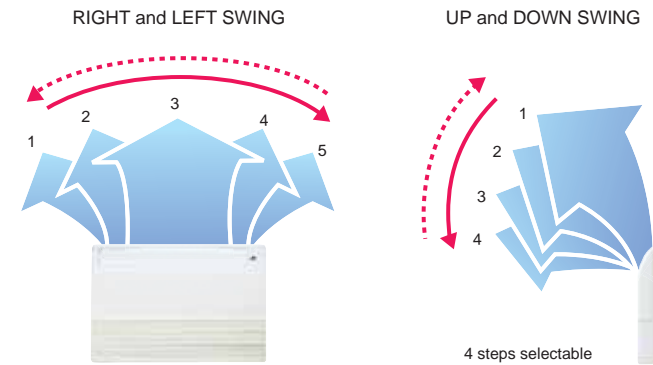

High power DC fan motor

- High power
- Wide rotation range
- High efficiency

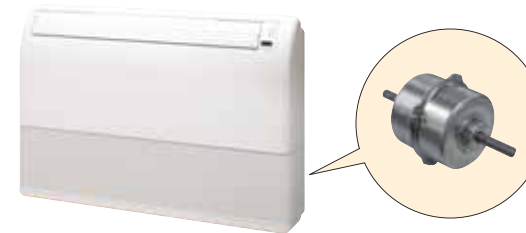

Super vane

Double Louver Super vane with newly developed special configuration boosts airflow, quickly sending cool air to every corner of the room.

Auto-closing louver

When operation is stopped, the louvers will automatically close.

Compact design

Symmetrical, slim and compact design.

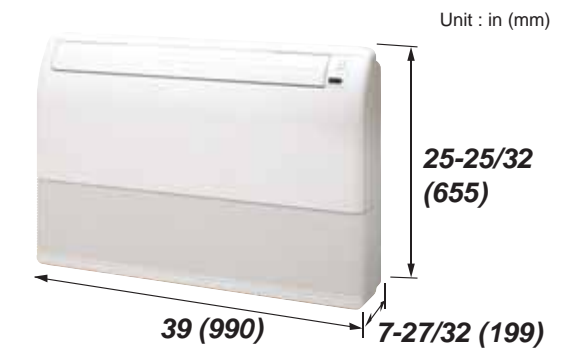

Note: IR Receiver is standard for communicating with Optional Wireless Controller.

Specifications

Model name	V-II		ABUA12RLAV	ABUA14RLAV	ABUA18RLAV	ABUA24RLAV
	VR-II		ABUA12TLAV	ABUA14TLAV	ABUA18TLAV	ABUA24TLAV
Power source	Single phase, 208-230V, 60Hz					
Capacity	Cooling	Btu/h	12,000	14,000	18,000	24,000
		kW	3.5	4.1	5.3	7.0
	Heating	Btu/h	13,500	15,600	20,000	27,000
		kW	4.0	4.6	5.9	7.9
Input power	W	30	42	74	99	
Airflow rate	High	CFM	388 (660)	459 (780)	589 (1,000)	589 (1,000)
	Med	(m ³ / h)	336 (570)	377 (640)	424 (720)	483 (820)
	Low		288 (490)	324 (550)	341 (580)	400 (680)
Sound pressure level	High	dB(A)	36	40	46	47
	Med		32	36	39	42
	Low		28	34	35	37
Dimensions (H x W x D)	in.(mm)	7-27/32 x 38-31/32 x 25-25/32 (199 x 990 x 655)				
Weight	lbs.(kg)	56 (25)		60 (27)		
Connection pipe diameter	Liquid (Flare)	ø 1/4 (6.35)		ø 3/8 (9.52)		
	Gas (Flare)	ø 1/2 (12.70)		ø 5/8 (15.88)		
	Drain	ø 3/4 [I.D.]; ø 1-1/16 [O.D.]				

Note : Specifications are based on the following conditions.

Cooling : Indoor temperature of 80°F(26.7°C)DB/67°F(19.4°C)WB, and outdoor temperature of 95.0°F(35°C)DB/75°F(23.9°C)WB.

Heating : Indoor temperature of 70°F(21.1°C)DB/60°F(15.6°C)WB, and outdoor temperature of 47°F(8.3°C)DB/43°F(6.1°C)WB.

Pipe length : 25ft.(7.5 m), Height difference : 0ft.(0 m) (Outdoor unit - Indoor unit).

Built-in protective functions may limit capacity or shut off unit if unit is operated outside of unit design operating temperature ranges.

Dimensions Unit: In (mm)

Models: ABUA12 / ABUA14 / ABUA18 / ABUA24

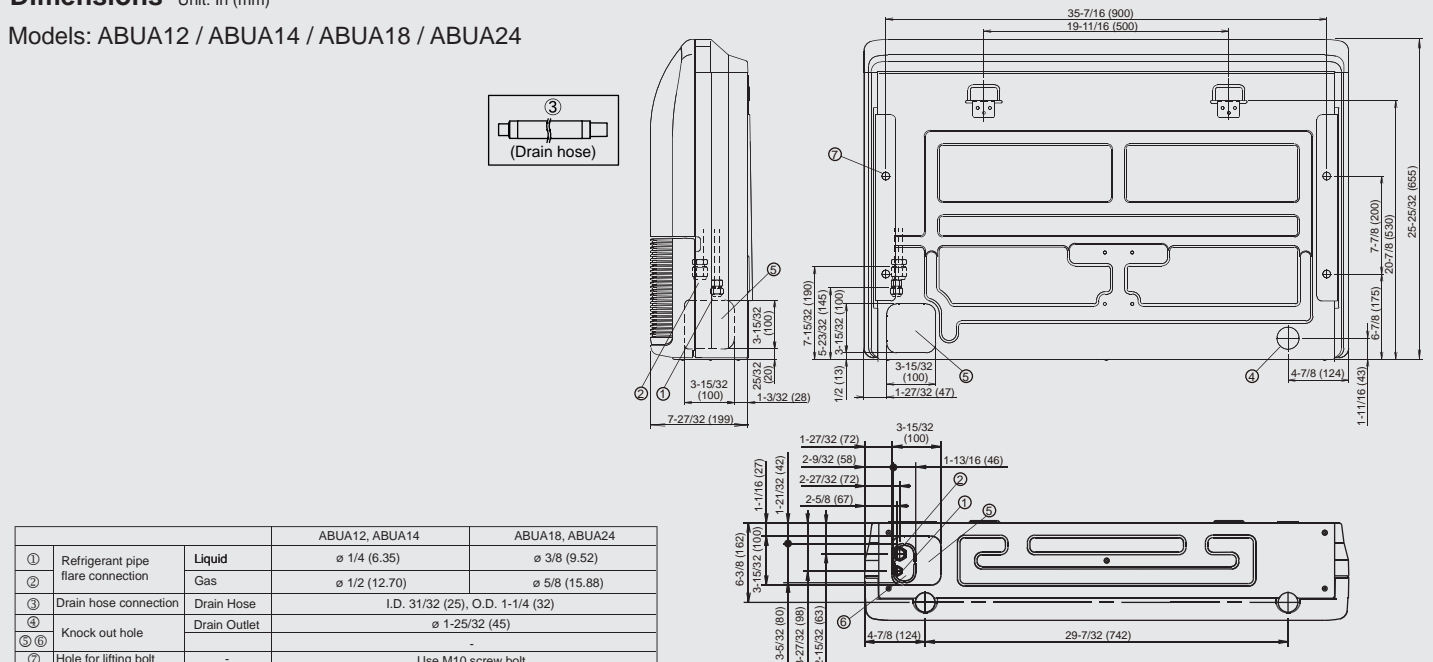

		ABUA12, ABUA14	ABUA18, ABUA24
① Refrigerant pipe flare connection	Liquid	ø 1/4 (6.35)	ø 3/8 (9.52)
②	Gas	ø 1/2 (12.70)	ø 5/8 (15.88)
③ Drain hose connection	Drain Hose	I.D. 31/32 (25), O.D. 1-1/4 (32)	
④	Knock out hole	ø 1-25/32 (45)	
⑤⑥	Drain Outlet		
⑦	Hole for lifting bolt	Use M10 screw bolt	

Ceiling

V-II Models
ABUA30RLAV **ABUA30TLAV**
ABUA36RLAV **ABUA36TLAV**



Powerful ceiling-hung indoor units are easy to install and can provide plenty of warm or cold air to a large space. Ceiling-hung units are the perfect solution for large spaces such as classrooms, restaurants, and kitchens.

Installation

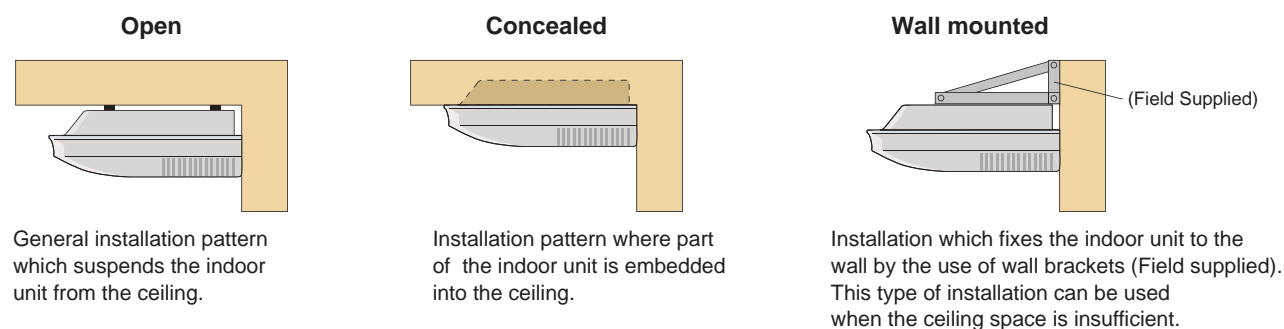

Double auto swing and wide airflow

Auto airflow direction and auto swing

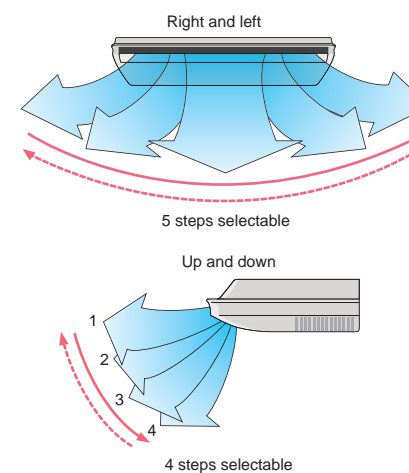

Quiet, powerful airflow

Powerful airflow ensures comfort to every corner of a large room.

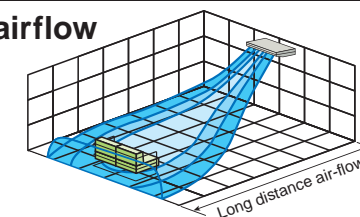

Slim & compact design

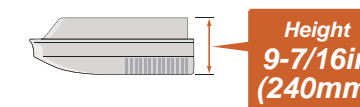

Condensate drain pump (Optional)

Optional drain lift-up mechanism allows flexible installation.

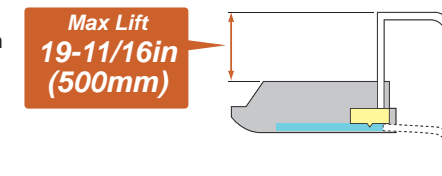

Fresh air intake

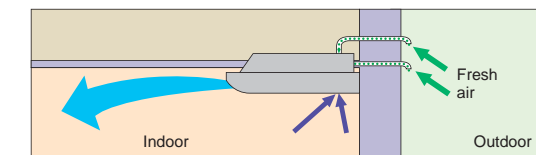

High power DC fan motor

- High power
- Wide rotation range
- High efficiency

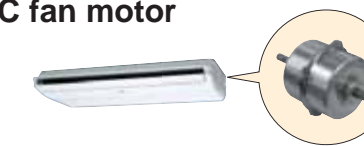

Air filter

High Efficiency long-life filter doubles the life of the filter compared to standard filters.

Optional parts

Drain Pump Unit : UTR-DPB24T
 Flange: UTD-RF204

Note: IR Receiver is standard for communicating with Optional Wireless Controller.

Specifications

Model name	V-II		ABUA30RLAV	ABUA36RLAV
	VR-II		ABUA30TLAV	ABUA36TLAV
Power source	Single phase, 208-230V, 60Hz			
Capacity	Cooling	Btu/h	30,000	36,000
		kW	8.8	10.6
	Heating	Btu/h	34,000	40,000
		kW	10.0	11.7
Input power	W		66	85
Airflow rate	High	CFM	859 (1,630)	995 (1,690)
	Med	(m ³ /h)	806 (1,370)	824 (1,400)
	Low		671 (1,140)	689 (1,170)
Sound pressure level	High	dB(A)	42	45
	Med		38	38
	Low		33	34
Dimensions (H x W x D)	in.(mm)		9-7/16 x 5ft. 5-11/32 x 27 -9/16 (240 x 1,660 x 700)	
Weight	lbs.(kg)		104 (47)	106 (48)
Connection pipe diameter	Liquid (Flare)	in.(mm)	ø 3/8 (9.52)	ø 3/8 (9.52)
	Gas (Flare)		ø 5/8 (15.88)	ø 3/4 (19.05)
	Drain		ø 3/4 [I.D.] ; ø 1-1/16 [O.D.]	

Note : Specifications are based on the following conditions.
 Cooling : Indoor temperature of 80°F(26.7°C)DB/67°F(19.4°C)WB, and outdoor temperature of 95.0°F(35°C)DB/75°F(23.9°C)WB.
 Heating : Indoor temperature of 70°F(21.1°C)DB/60°F(15.6°C)WB, and outdoor temperature of 47°F(8.3°C)DB/43°F(6.1°C)WB.
 Pipe length : 25ft.(7.5 m), Height difference : 0ft.(0 m) (Outdoor unit - Indoor unit).
 Built-in protective functions may limit capacity or shut off unit if unit is operated outside of unit design operating temperature ranges.

Dimensions

Unit: In (mm)
 Models: ABUA30 / ABUA36

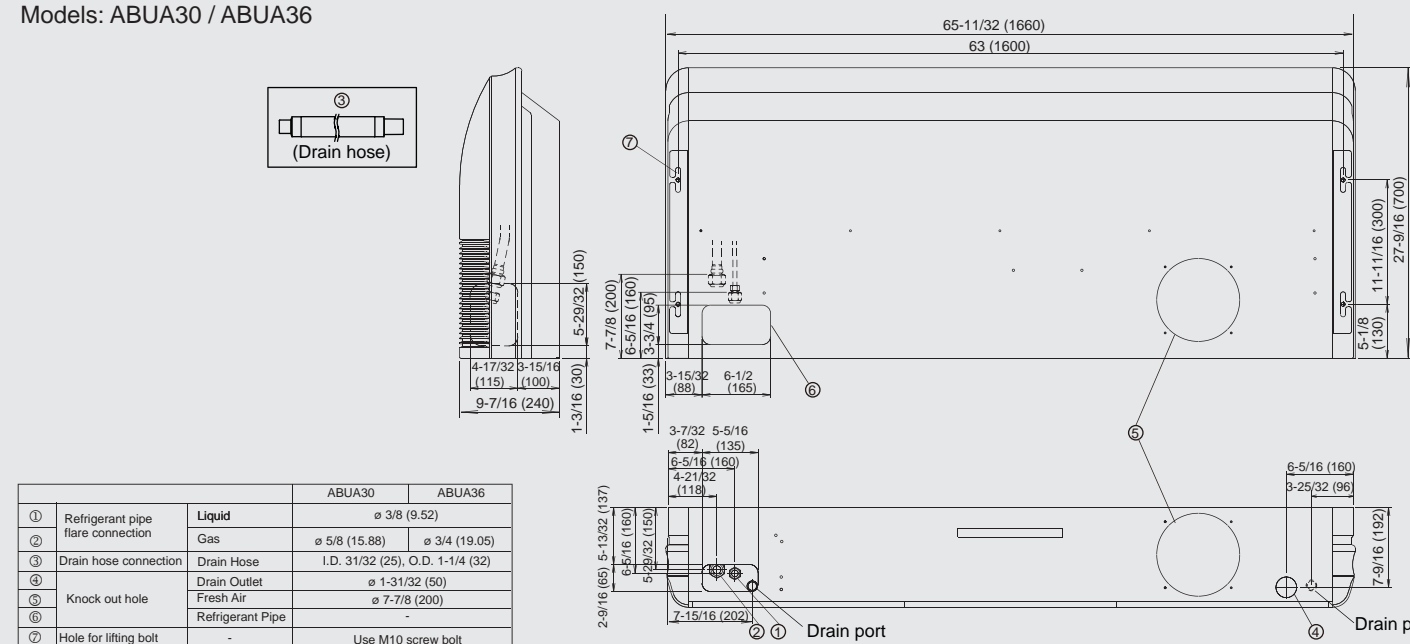

		ABUA30	ABUA36
①	Refrigerant pipe flare connection	Liquid ø 3/8 (9.52)	Gas ø 5/8 (15.88) ø 3/4 (19.05)
②	Drain hose connection	Drain Hose I.D. 31/32 (25), O.D. 1-1/4 (32)	
③	Drain Outlet	ø 1-31/32 (50)	
④	Knock out hole	Fresh Air ø 7-7/8 (200)	Refrigerant Pipe -
⑤	Hole for lifting bolt	Use M10 screw bolt	

Compact Wall Mounted

V-II Models	VR-II Models
ASUA7RLAV	ASUA7TLAV
ASUA9RLAV	ASUA9TLAV
ASUA12RLAV	ASUA12TLAV
ASUA14RLAV	ASUA14TLAV



Compact and stylish design

Filter features

High performance filters provide high quality air conditioning

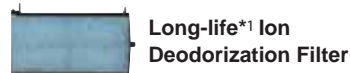

Long-life*1 Ion Deodorization Filter

The filter deodorizes by powerfully decomposing absorbed odors using the oxidizing and reducing effects of ions generated by the ultra-fine-particle ceramic.



Apple-catechin Filter*2

Fine dust, invisible mold spores, and harmful microorganisms are absorbed onto the filter by static electricity, and further growth is inhibited and deactivated by the polyphenol extracted from apples.

*1 The filter can be used for approx. 3 years if it is washed under water to restore its surface action when it is dirty.
*2 Both filters can be mounted on the same unit.

Deodorizing effect (Odor reduction rate)

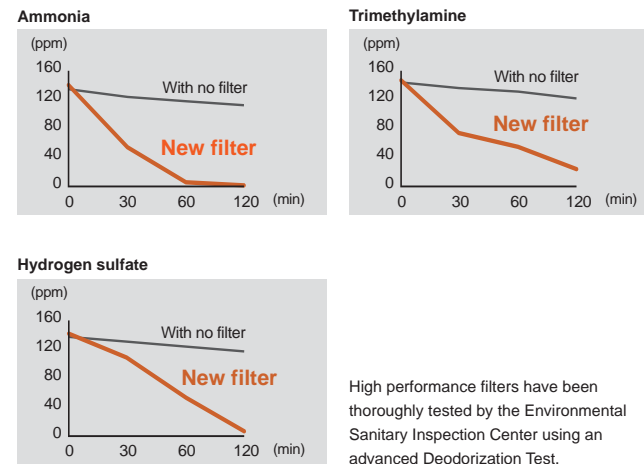

Compact size

Powerful output in a compact design

Width
31-1/8 in. (790mm)

Powerful, compact unit features a large, high pressure fan (3-1/2in./90mm diameter) in a center mounted configuration with a Lambda type heat exchanger.

Symmetrical design

Symmetrical, clean design that suits all interiors.

High power DC fan motor

- High power
- Wide rotation range
- High efficiency
- Compact size

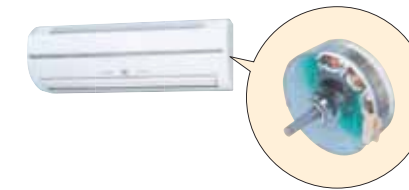

Auto swing louver

The Auto Swing Louver function ensures that the air direction corresponds to the mode selected.

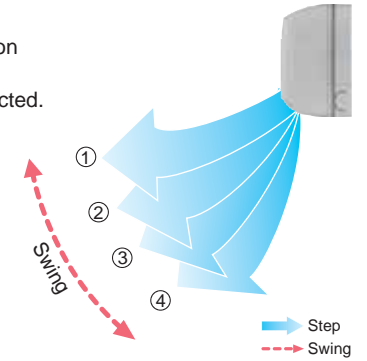

Easy maintenance

The front panel can be removed for easy access during maintenance.



Note: IR Receiver is standard for communicating with Optional Wireless Controller.

Specifications

Model name	V-II		ASUA7RLAV	ASUA9RLAV	ASUA12RLAV	ASUA14RLAV	
	VR-II		ASUA7TLAV	ASUA9TLAV	ASUA12TLAV	ASUA14TLAV	
Power source	Single phase, 208-230V, 60Hz						
Capacity	Cooling	Btu/h	7,500	9,500	12,000	14,000	
		kW	2.2	2.8	3.5	4.1	
	Heating	Btu/h	9,500	10,900	13,500	15,600	
		kW	2.8	3.2	4.0	4.6	
Input power		W	16	16	19	30	
Airflow rate	High	CFM (m ³ /h)	288 (490)	294 (500)	330 (560)	394 (670)	
			Med	265 (450)	265 (450)	283 (480)	288 (490)
			Low	218 (370)	218 (370)	247 (420)	247 (420)
Sound pressure level	High	dB(A)	35	36	39	44	
			Med	33	33	35	37
			Low	27	27	31	32
Dimensions (H x W x D)	in.(mm)		10-13/16 x 31-3/32 x 8-15/32 (275 x 790 x 215)				
Weight	lbs.(kg)		20 (9)				
Connection pipe diameter	Liquid (Flare)	ø 1/4 (6.35)					
	Gas (Flare)	ø 1/2 (12.70)					
	Drain	ø 17/32 (13.8) [I.D.] ; ø 5/8 (15.8) - ø 21/32 (16.7) [O.D.]					

Note : Specifications are based on the following conditions.
Cooling : Indoor temperature of 80°F(26.7°C)DB/67°F(19.4°C)WB, and outdoor temperature of 95.0°F(35°C)DB/75°F(23.9°C)WB.
Heating : Indoor temperature of 70°F(21.1°C)DB/60°F(15.6°C)WB, and outdoor temperature of 47°F(8.3°C)DB/43°F(6.1°C)WB.
Pipe length : 25ft.(7.5 m), Height difference : 0ft.(0 m) (Outdoor unit - Indoor unit).
Built-in protective functions may limit capacity or shut off unit if unit is operated outside of unit design operating temperature ranges.

Dimensions

Unit: In (mm)
Models: ASUA7 / ASUA9 / ASUA12 / ASUA14

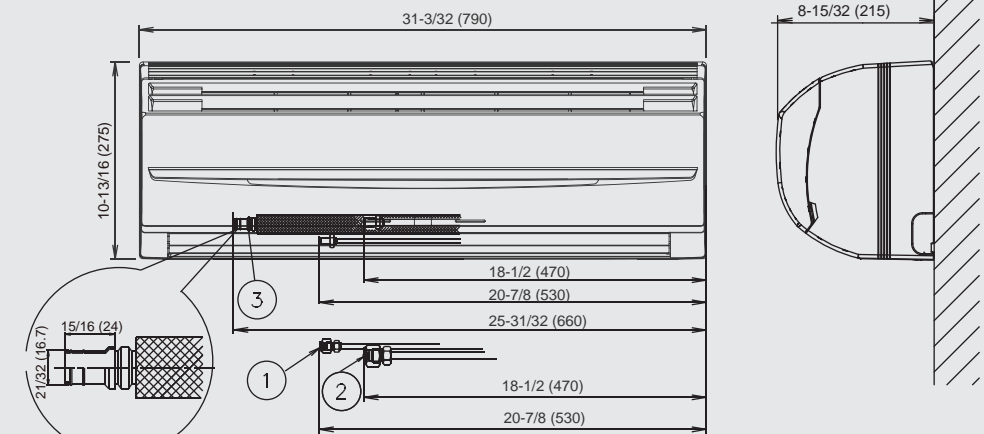

			ASUA7, ASUA9, ASUA12, ASUA14
①	Refrigerant pipe flare connection	Liquid	ø 1/4 (6.35)
②		Gas	ø 1/2 (12.70)
③	Drain hose connection	Drain Hose	I.D. 17/32 (13.8), O.D. 5/8 to 21/32 (15.8-16.7) Drain hose: L=23-5/8 (600)

Wall Mounted

V-II Models
ASUB18RLAV
ASUB24RLAV

VR-II Models
ASUB18TLAV
ASUB24TLAV



Compact & Slim design

Stylish, slim and elegant, these popular wall mounted units are perfect for smaller rooms where a clean, aesthetic design is preferred. Variable speed DC fan motors deliver heating or cooling quietly and comfortably.



“Vertical airflow” provides powerful floor level heating

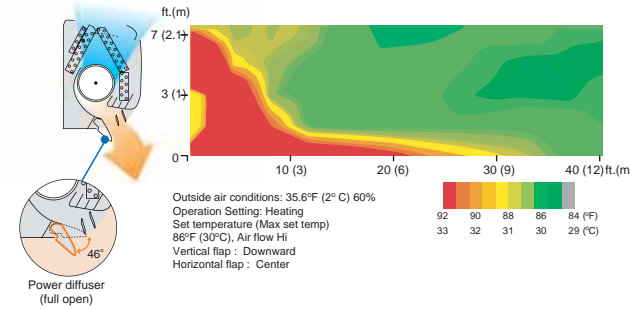

“Horizontal airflow” does not blow cool air directly at the occupants in the room

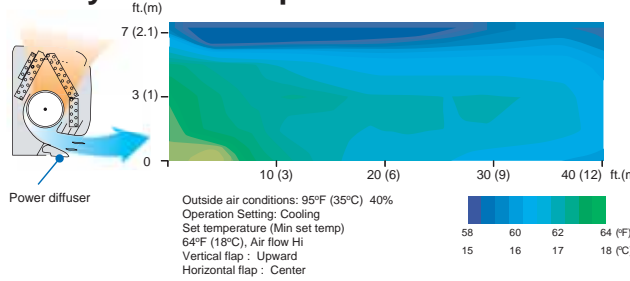

Air conditioner filter features

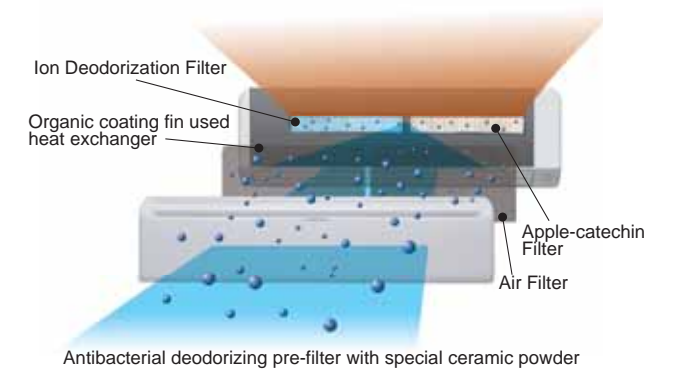

Long-life*1 Ion Deodorization Filter

The filter deodorizes by powerfully decomposing absorbed odors using the oxidizing and reducing effects of ions generated by the ultra-fine-particle ceramic.

Apple-catechin Filter*2

Fine dust, invisible mold spores, and harmful microorganisms are absorbed onto the filter by static electricity, and further growth is inhibited and deactivated by the polyphenol extracted from apples.

*1 The filter can be used for approx. 3 years if it is washed under water to restore its surface action when it is dirty.

*2 Both filters can be mounted on the same unit.

Easy maintenance

Simplification of drain pan cleaning improves maintenance-ability.

Note: IR Receiver is standard for communicating with Optional Wireless Controller.

Specifications

Model name	V-II		ASUB18RLAV	ASUB24RLAV
	VR-II		ASUB18TLAV	ASUB24TLAV
Power source	Single phase, 208-230V , 60Hz			
Capacity	Cooling	Btu/h	18,000	24,000
		kW	5.3	7.0
	Heating	Btu/h	20,000	24,000
		kW	5.9	7.9
Input power	W		35	64
Airflow rate	High	CFM (m ³ / h)	494 (840)	647 (1,100)
	Med		453 (770)	536 (910)
	Low		406 (690)	430 (730)
Sound pressure level	High	dB(A)	41	48
	Med		39	43
	Low		35	35
Dimensions (H x W x D)	in.(mm)		12-19/32 x 39-9/32 x 8-31/32 (320 x 998 x 228)	
Weight	lbs.(kg)		31 (14)	
Connection pipe diameter	Liquid (Flare)	ø 3/8 (9.52)		
	Gas (Flare)	in.(mm)		ø 5/8 (15.88)
	Drain	ø 15/32 (12) [I.D.] ; ø 5/8 (16) [O.D.]		

Note : Specifications are based on the following conditions.

Cooling : Indoor temperature of 80°F(26.7°C)DB/67°F(19.4°C)WB,and outdoor temperature of 95.0°F(35°C)DB/75°F(23.9°C)WB.

Heating : Indoor temperature of 70°F(21.1°C)DB/60°F(15.6°C)WB,and outdoor temperature of 47°F(8.3°C)DB/43°F(6.1°C)WB.

Pipe length : 25ft.(7.5 m), Height difference : 0ft.(0 m) (Outdoor unit - Indoor unit).

Built-in protective functions may limit capacity or shut off unit if unit is operated outside of unit design operating temperature ranges.

Dimensions Unit: In (mm)

Models: ASUB18 / ASUB24

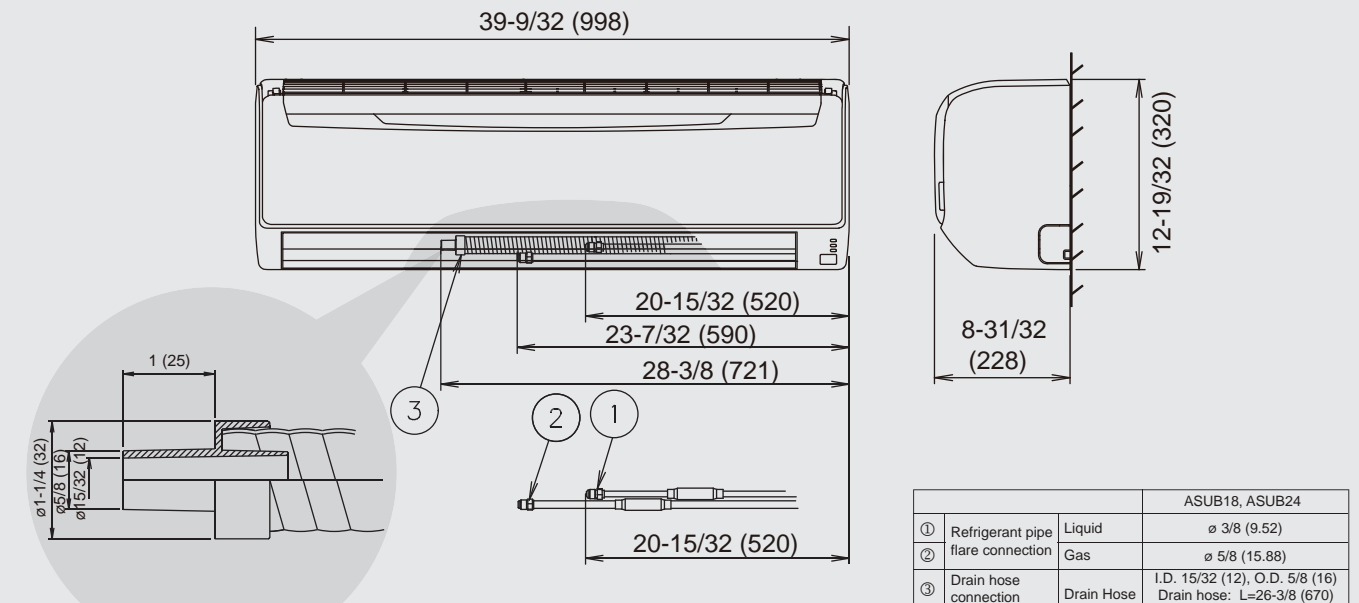

Outdoor Air Unit

Models

AAUA48TLAV NEW

AAUA72TLAV NEW

AAUA96TLAV NEW



The 100% Outdoor Air Unit efficiently processes the outdoor air in cooling or heating to supply outdoor air for ventilation.

One VRF system can provide air conditioning and ventilation air at the same time.

Outdoor Air Unit can be connected in the same VRF*1 system as other VRF indoor units and provides conditioned outdoor air for ventilation, using our highly advanced technology.

*1 V-II, VR-II

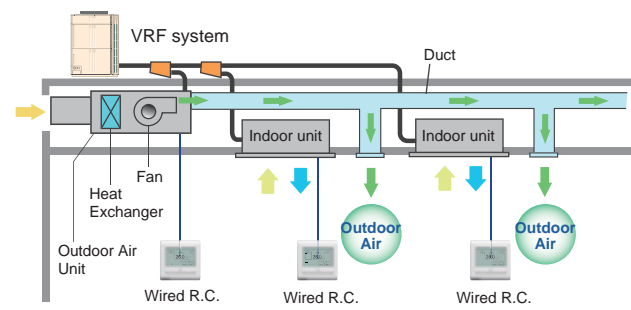
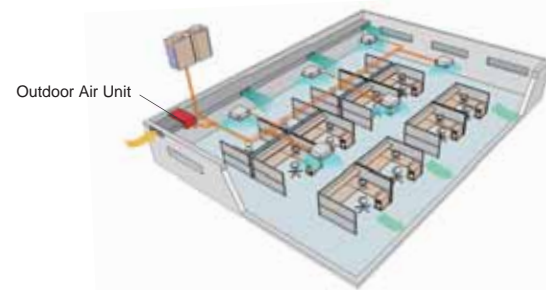

* Connected capacity must be between 50% to 100% of the outdoor unit capacity. When a system contains different types of indoor units, Outdoor Air Unit cannot be more than 30% of outdoor unit capacity.

High energy savings and flexible duct design using a DC motor

- Using a permanent magnet motor greatly reduces electricity consumption compared to an AC motor.
- Compared with an AC motor, changing the speed allows it to respond flexibly to the external static pressure from 0.20 to 0.96 in. WG. (50Pa to 240Pa). Even if dampers are not used, static pressure can be adjusted and duct design is easy.
- Static pressure can be set easily using the wired remote controller.

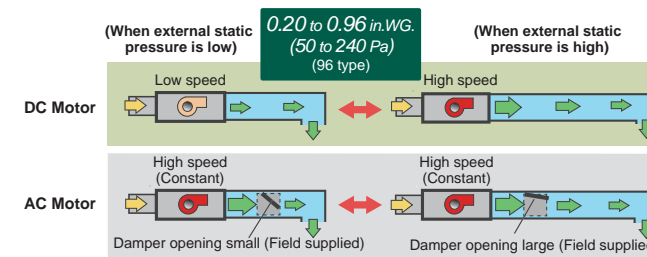
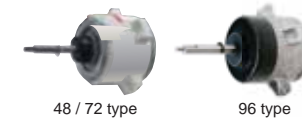

Various Controllers

There are a variety of optional controllers, such as individual controller, central controller and building management controller.

Individual Controllers

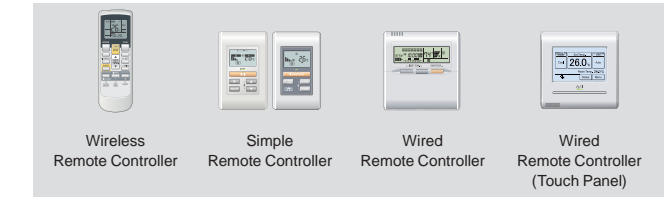

Central Controllers



The temperature setting is discharge air temperature setting. The air volume is set to a constant speed.

Top class compact design

- Top class lightweight compact design at just 53-13/16 in. (425mm) in height, 121 lbs. (55kg) in weight for AAUA72TLAV type. This unit can be installed easily even in narrow spaces.

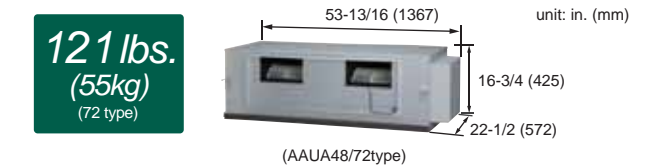

Specifications

Model No.		AAUA48TLAV	AAUA72TLAV	AAUA96TLAV
Power source		208-230/1/60		
Capacity	Cooling	48,000	72,000	96,000
	Heating	30,000	47,000	59,000
Input Power	Cooling / Heating	179	292	370
Airflow Rate	CFM	636	989	1,236
	(m ³ /h)	(1,080)	(1,680)	(2,100)
Static Pressure	Standard (range)	0.74	0.80	0.80
	(in. WG / Pa)	(0.20~0.74)	(0.20~0.80)	(0.20~0.96)
Sound Pressure Level		42	44	47
Dimensions (H x W x D)		16-3/4x53-13/16x22-1/2	16-3/4x53-13/16x22-1/2	17-11/16x62-5/16x27-9/16
	(mm)	(425x1,367x572)	(425x1,367x572)	(450x1,583x700)
Weight		106 (48)	121 (55)	157 (71)
Connection Pipe Diameter (Small / Large)		Ø3/8 / Ø3/4 (Ø9.52 / Ø19.05)	Ø1/2 / Ø7/8 (Ø12.70 / Ø22.22)	Ø1/2 / Ø7/8 (Ø12.70 / Ø22.22)
Operation Range	Cooling	41 to 109 (5 to 43)	41 to 109 (5 to 43)	41 to 109 (5 to 43)
	Heating	19 to 70 (-7 to 21)	19 to 70 (-7 to 21)	19 to 70 (-7 to 21)
Refrigerant		R410A	R410A	R410A







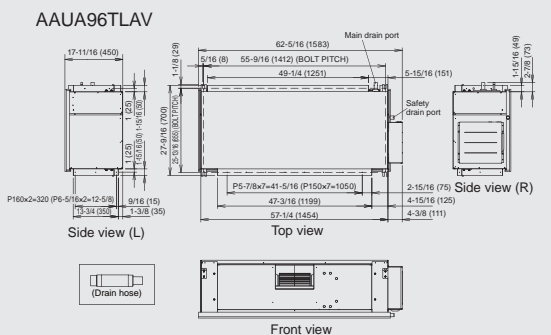
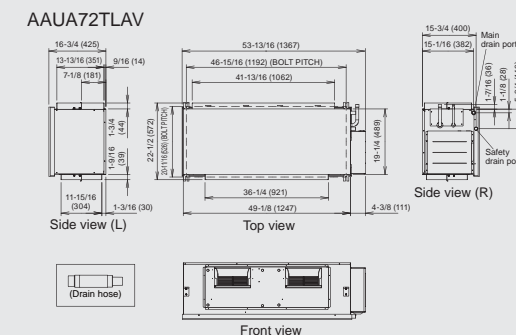
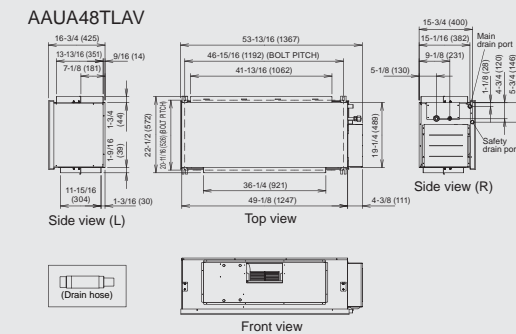

Note : Specifications are based on the following conditions.
Cooling : Outdoor temperature of 91°FDB (33°CDB) / 82°FWB (28°CWB).
Heating : Outdoor temperature of 32°FDB (0°CDB) / 27°FWB (-2.9°CWB).
Pipe length : 25ft. (7.5 m)

Dimensions (Unit: In (mm))

Models: AAUA48TLAV / AAUA72TLAV / AAUA96TLAV



Comparison Table of Controllers

Item											
Model name	UTY-RNRU	UTY-RNKU	UTY-RSKU	UTY-RHKU	UTY-LNHU	UTY-DCGY	UTY-DTGY	UTY-ALGX	UTY-APGX		
Max. controllable remote controller groups	1	1	1	1	1	100	400	400	1600		
Max. controllable indoor units	16	16	16	16	16	100	400	400	1600		
Max. controllable groups	-	-	-	-	-	16	400	400	1600		
Air conditioning control function	On / Off	● ^{*3}	●	●	●	●	●	●	●		
	Operation mode setting	●	●	●	-	●	●	●	●		
	Fan speed setting	●	●	●	●	●	●	●	●		
	Room temp. setting	●	●	●	●	●	●	●	●		
	Room temp. set point limitation	●	-	-	-	●	●	●	●		
	Test operation	●	●	●	-	●	●	-	-		
	Up/down air direction flap setting	●	●	-	-	●	●	●	●		
	Right/left air direction flap setting	●	●	-	-	●	●	●	●		
	Group setting	-	-	-	-	-	●	●	●		
	RC prohibition	-	-	-	-	-	●	●	●		
	Anti freeze setting	●	-	-	-	-	●	●	●		
	Away setting	●	-	-	-	-	-	-	-		
	Economy mode setting	●	●	-	-	●	●	●	●		
Display	Failure	●	●	●	●	-	●	●	●		
	Defrosting	●	●	●	●	-	●	●	●		
	Current time	●	●	-	-	●	●	●	●		
	Day of week	●	●	-	-	-	●	●	●		
	R.C. prohibition	●	●	●	●	-	●	●	●		
	Cooling/heating priority	●	●	●	●	-	●	●	●		
	Address display	●	●	●	●	-	●	●	●		
	Room temp	●	-	-	-	-	-	-	-		
	Multi language	●	-	-	-	-	●	●	●		
	Summer time	●	-	-	-	-	●	●	●		
	Name registration	●	-	-	-	-	●	●	●		
	Backlight	●	-	●	●	-	●	●	-		
	2D floor layout / 3D building display	-	-	-	-	-	-	-	-	●	
Timer	Schedule timer	Period	Week	Week	-	-	-	Week	Year	Year	Year
		On/Off, Temp, mode, times per day	8 ^{*3*4}	4	-	-	-	20	20	144	144
	On/off timer	-	●	-	-	●	-	-	-	-	
	Sleep timer	-	-	-	-	●	-	-	-	-	
	Program timer	-	-	-	-	●	-	-	-	-	
	Auto off timer	●	-	-	-	-	-	-	-	-	
	Day off	●	●	-	-	-	●	●	●	●	
Min. unit of timer setting (Minutes)	10 · 30	30	-	-	5	10	10	10	10		
Control	Status monitoring system	-	-	-	-	-	●	●	●	●	
	Electricity charge apportionment	-	-	-	-	-	-	-	○	●	
	Error history	●	●	●	●	-	●	●	●	●	
	Emergency stop	-	-	-	-	-	● ^{*2}	● ^{*2}	-	-	
	Remote management	-	-	-	-	-	-	-	○	●	
	Energy saving management	-	-	-	-	-	-	-	○	○	
	E-mail notification for malfunction	-	-	-	-	-	-	-	●	●	
Key lock	● Child lock	-	-	-	-	● Password setting	● Password setting	● Password setting	● Password setting		

*1 "Operation mode" setting is not available for this model. *2 This function is available only through external input. control. *3 On / Off (Occupied / Unoccupied) *4 Mode deleted

● : Supported ○ : Optional function
- : Not supported yet

Controller

Individual Touch Panel Controller (Wired Remote)

UTY-RNRU

Easy operation by high-definition large STN-LCD touch panel screen

- Easy finger touch operation with LCD panel
- Built-in weekly/daily timer (ON/OFF, Temp., Occupied Status)
- Backlight enables easy operation in a darkened room
- Room temperature display
- Control up to 16 indoor units
- Auto changeover with dead band
- Setback Function (Away)
- Non polar two wire
- Corresponds to 7 different languages (English, Chinese, French, German, Spanish, Russian, Polish)

Max. controllable
16
indoor units



Wired Remote Controller

UTY-RNKU

The room temperature can be controlled by detecting the temperature from the built-in sensor

- Simple operation with Built-in Weekly / Daily Timer.
- Control up to 16 indoor units.
- Up to 2 wired remote controllers can be connected to a single indoor unit.

Max. controllable
16
indoor units

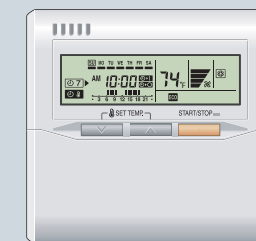

Simple Remote Controller

UTY-RSKU

UTY-RHKU (Without ability to change operation mode)

Compact remote controller provides access to basic functions

- Up to 16 indoor units can be controlled with one remote controller.
- Suitable for hotels or offices as it is easily operated with no complex functions.

Max. controllable
16
indoor units



UTY-RSKU



UTY-RHKU
Without ability to
change operation mode

Wireless Remote Controller

UTY-LNHU

Simple and sophisticated operations with a choice of 4 daily timers

- A single controller controls up to 16 indoor units.

Built-in timers

Select from 4 different timer programs: On / Off / Program / Sleep

Program timer: The program timer operates the ON and OFF timer once within a 24 hour period.

Max. controllable
16
indoor units

Selectable
4
daily timers



UTY-LNHU

Central Remote Controller

UTY-DCGY

Central control of small- and medium-sized buildings and tenants.

- Individual control and monitor of 100 indoor units
- 5 inch TFT color screen
- User friendly view and easy operation
- External input / output contact
- Detachable power supply unit
- Corresponds to 7 different languages: English, Chinese, French, German, Spanish, Russian, Polish.

Max. controllable
100
indoor units

Max. controllable
16
groups



Easy Installation

- The control panel and power supply unit can be installed separately.
- For flexibility in installation, the Control panel can be built into the wall or affixed on the wall.

Controller

Touch Panel Controller UTY-DTGY

- Large-sized 7.5-inch TFT color
- LCD Easy touch panel operation
- Stylish shape and design to suit all applications
- No additional component is required for installation
- Up to 400 indoor units can be controlled
- Selectable 2 display types (Icon / List) in monitoring mode
- Corresponds to 7 different languages: English, Chinese, French, German, Spanish, Russian, Polish.

Max. controllable
400*
indoor units



System Controller

Software

UTY-APGX

The System Controller's advanced integrated monitoring & control of VRF network system provides monitoring & control of small to large scale buildings.

- Up to a maximum of 4 VRF network systems, 1600* indoor units, and 400* outdoor units can be controlled.
- Functions include air conditioning control function, central remote control, schedule management, and energy saving function.
- Corresponds to 7 different languages: English, Chinese, French, German, Spanish, Russian, Polish.
- **Option:** UTY-PEGX Energy Manager

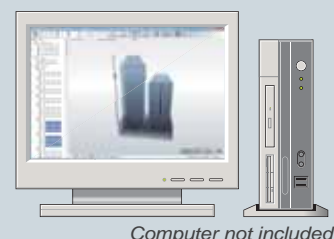

Computer not included.

Max. controllable
4
VRF network systems

Max. controllable
400*
Outdoor units

Max. controllable
1,600*
indoor units



USB Adapter included.

System Controller Lite

Software NEW

UTY-ALGX

System Controller Lite has standard functions sufficient for air conditioner management in small and medium scale buildings.

- A maximum of 1 VRF network system, 400* indoor units, and 100 outdoor units can be controlled.
- In addition to precision temperature control, a variety of management functions are also available, providing customers with a wide variety of choices.
- **Options:** UTY-PLGXR1 Remote Centralized Control
UTY-PLGXA1 Electricity Charge Apportionment
UTY-PLGXE1 Energy Saving Management

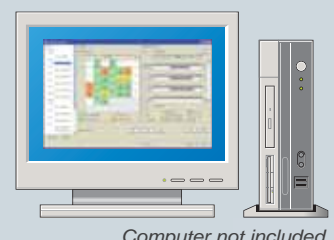

Computer not included.

Max. controllable
1
VRF network systems

Max. controllable
100
Outdoor units

Max. controllable
400*
indoor units



USB Adapter included.

IR Receiver Unit

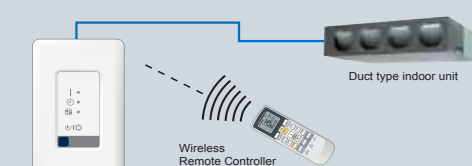

IR Receiver Unit

UTB-YWC

Necessary to control all duct type models by Wireless Remote Controller

IR Receiver Kit

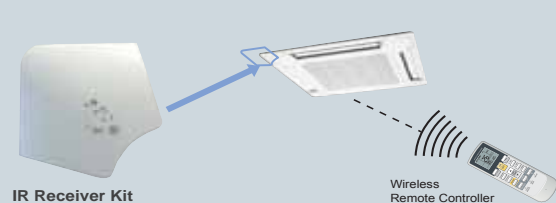

IR Receiver Kit

UTY-LRHYB1

Cassette type indoor unit can be controlled with Wireless Remote Controller

Converter & Adapter

Network Converter UTY-VGGXZ1

- This network converter is used for connecting select single split systems or group remote controllers with the VRF network system.
- Please select the function by switching the dip switch settings during installation.

Max. controllable
16
Network Converter units



(UTY-VGGXZ1)

Network Converter for LONWORKS® UTY-VLGX

Max. controllable
4
Units to BMS

Max. controllable
128
indoor units

- For connection between VRF network system and a LONWORKS® open network for management of small to medium-sized BMS.
- The UTY-VLGX permits central monitoring and control of a VRF network system from a BMS through a LONWORKS® interface.
- Up to 128 Indoor units can be connected to one Network Converter for LONWORKS®



(UTY-VLGX)

BACnet® Gateway

Software

Max. controllable
4
VRF network systems

Max. controllable
400
outdoor units

Max. controllable
1,600
indoor units

UTY-ABGX

- The VRF network system can be incorporated into a Building Management System.
- Enables central control of up to 1,600 indoor units through BACnet®, a global standard for open networks.
- Conforms to ANSI / ASHRAE Standards® 135-2004 BACnet® Application Specific Controller (B-ASC) BACnet® / IP over Ethernet.
- Connects up to 4 VRF network systems (1,600 indoor units / 400 outdoor units) per gateway.
- Certified by BTL

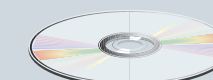

CD-ROM (Software)



Software Protection Key



USB Adapter included.

External Switch Controller

UTY-TEKX

Air conditioner switching can be controlled by connecting other sensor switches

- In combination with a field supplied Card-Key Switch or other sensor, the External Switch Controller allows control of the ON / OFF, Room temperature, Fan speed and Master control functions. This makes this product suitable for installations such as hotel rooms.
- Card-key or other sensor switches are available as field supplied parts.

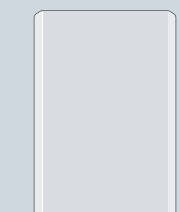

Signal Amplifier

UTY-VSGXZ1, UTY-VSGX

- Transmission Line length can be extended up to 3,600m with multiple Signal Amplifiers.
- Up to 8 signal amplifiers can be installed in a VRF network system.
- A signal amplifier is required,
 - (1) When the total wiring length of the transmission line exceeds 500m.
 - (2) When the total number of units on the transmission line exceeds 64.

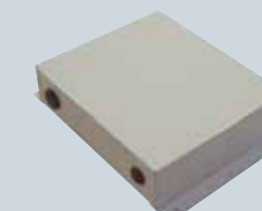

Service & Monitoring

Service Tool

Software

Max. Monitor and control
400
indoor units

Max. Monitor and control
100
outdoor units

UTY-ASGX

Extensive monitoring and analysis functions for installation and maintenance

- Operation status can be checked and analyzed to detect even the smallest abnormalities.
- Storage of data on system operation status on a PC.
- Up to 400 indoor units (a single VRF network system) can be controlled and monitored for large scale buildings.
- This software can be connected to any point in the transmission line with USB adaptor (field supplied).

Computer not included.



USB Adapter included.

Web Monitoring Tool

Software

Max. controllable
4
VRF network systems

Monitor up to
1,600
indoor units

UTY-AMGX

Product features

- Troubleshooting is performed by monitoring each system remotely during periodical system checks.
- Error notification can be automatically transmitted to several locations using the internet*1.
- Requires either a dedicated internet connection or public telephone line.
- Determination of an error occurrence can be made through error warnings and equipment status information obtained from a remote location.
- The monitoring data in a remote site can be optionally downloaded. And, this data can be displayed in offline mode of the service tool.
- Monitoring site computer is not required to install special software, requires only Internet Explorer.

*1: Use of internet mail system required.



USB Adapter included.

* For a Heat Recovery network systems with more than 320 indoor units, consult the D&T manual for proper wiring and the use of signal amplifiers.

Individual Touch Panel Controller NEW

(Wired Remote Controller) UTY-RNRU

Easy operation by high-definition large STN-LCD touch panel screen

- Easy finger touch operation with LCD panel
- Built-in weekly/Daily timer(ON/OFF(Occupied/Unoccupied),Temp.)
- Backlight enables easy operation in a darkened room
- Room temperature display
- Control up to 16 indoor units
- Corresponds to 7 different languages (English, Chinese, French, German, Spanish, Russian, Polish)

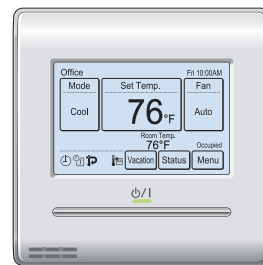

Max. controllable
16
indoor units

High performance and compact size

- In addition to the individual control, various energy saving controls can be realized using one remote controller only.



Accurate and comfortable control

- Indoor temperature can be detected accurately by the inclusion of a thermo sensor in the body of the wired controller.

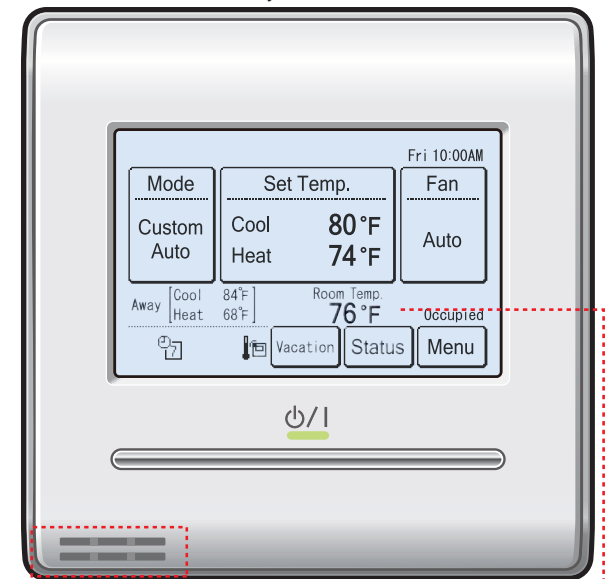

Room temperature sensor

Room temperature display

Backlight

- Backlight enables easy operation in a darkened room.
- For the lighting time of Backlight, 30 or 60 seconds can be set.
- Backlight activates while the buttons are operated and goes off 30 or 60 seconds after the operation stops.

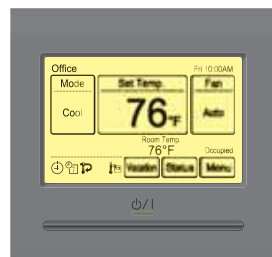

Various energy saving control

Custom Auto

- Maintains 2 separate set points for heating and cooling.
- Automatically changes mode between heating and cooling.

Cooling set temp. 81°F. Heating set temp. 79°F

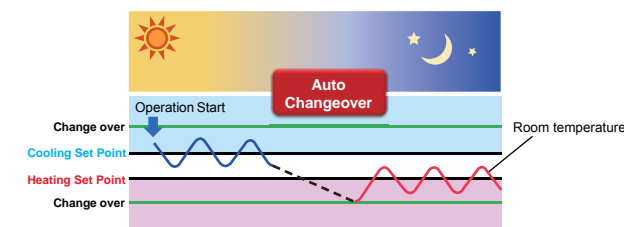

Auto OFF Timer

- The indoor unit automatically turns off after a set time has passed.
- The time interval for which auto off works can be set.

2 schedules Weekly Timer

- 2 schedules such as for the summer and winter can be set.
- 8 setting changeable per day of week (Setting items: ON/OFF(Occupied/Unoccupied), Temperature, Time)

Optimum start function

- The operation setting of this function can create a comfortable state when the setting time arrives by operating before the setting time.

Cooling operation

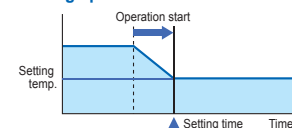

Heating operation



Set Temperature Auto Return

- The setting temperature automatically returns to the previous setting temperature.
- The time range in which the set temperature can be changed is 10 to 120 minutes.

Set Temperature Upper and Lower Limit Setting

- The set temperature range can be set for each operation mode. (Cooling / Heating / Auto)

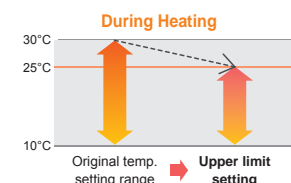
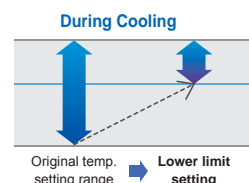

Various convenient functions

Away mode

- Cooling / Heating is automatically started when the room temperature reaches the setback temperature, even if the indoor unit is off.

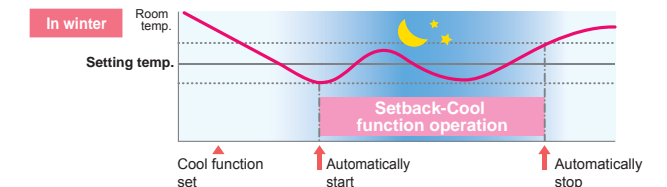
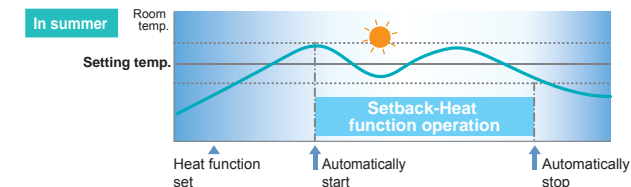

Displays setting status and Limitations

- The remote controller settings can be easily checked

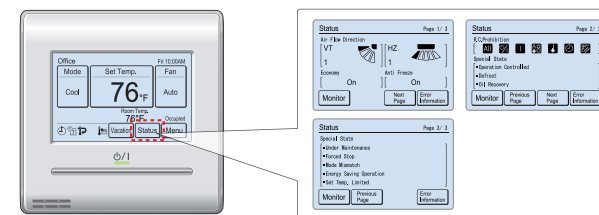

Summer Time display

- This function can be set easily from Menu screen

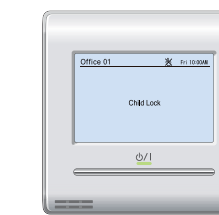
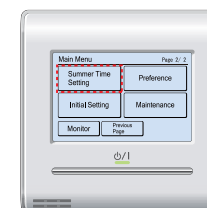

Child lock

- Lock / unlock method: Push the ON/OFF button and the screen (4 seconds)

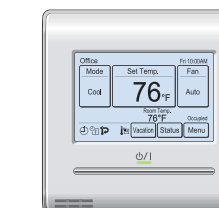

Name Registration

- Indoor unit names can be registered in the remote controller screen. This makes it easy to identify the indoor unit you want to control in the room.

Simplified installation

Uses non-polar 2-wire type

- The faulty wiring can be prevented by using non-polar 2-wire.

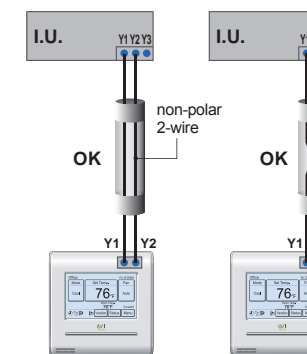

Auto Address Setting

- Reduce errors and install time compared with the current specification Rotary SW
- When will be set remote controller groups, can also be set automatically new Wired remote controller address
- After auto address setting of new wired remote controller groups, what number can also confirm addresses

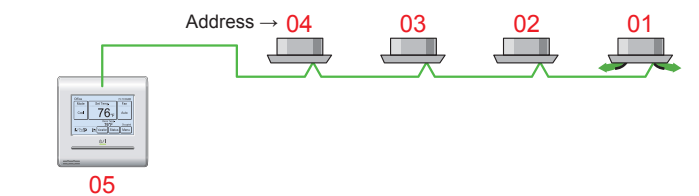

Easy Maintenance

Error History Display

- The errors that occur in the indoor unit or remote controller are saved as a history.
- A maximum of 32 error incidents can be saved.

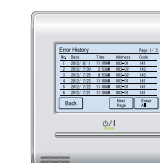

Specifications

Model name	UTY-RNRU
Power Supply	DC 12V
Dimensions (H x W x D) (in.(mm))	4-3/4 x 4-3/4 x 13/16 (120 x 120 x 20.4)
Weight (oz.(g))	8 (220)

DC12V is supplied by the indoor unit.



Central Remote Controller

UTY-DCGY

Central control of small and medium-sized buildings. The operation status of all indoor units can be viewed at a glance on a large LCD monitor.

- Individual control and monitoring up to 100 indoor units
- 5 inch TFT color screen
- User friendly view and easy operation
- External input / output contact
- Detachable power supply unit
- Programmable in 7 different languages: English, Chinese, French, German, Spanish, Russian, Polish



Max. controllable
100
Indoor units

Max. controllable
16
groups

User friendly operation

Operation status monitor displays for all indoor units
Intuitive display and operation buttons

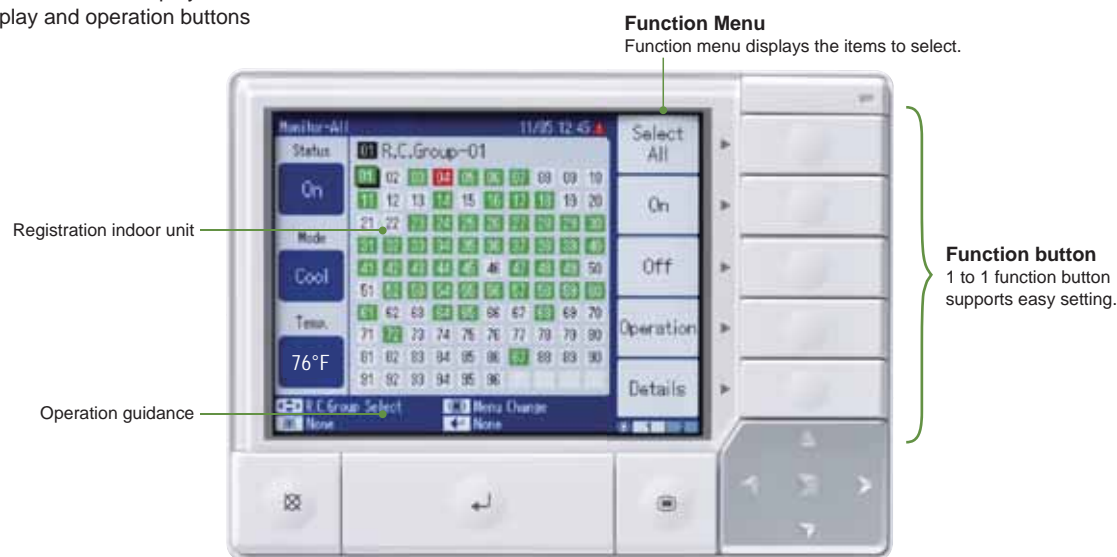

System overview

- It allows multiple indoor units grouping (Max.16 groups controlled)
- Interlock with external device

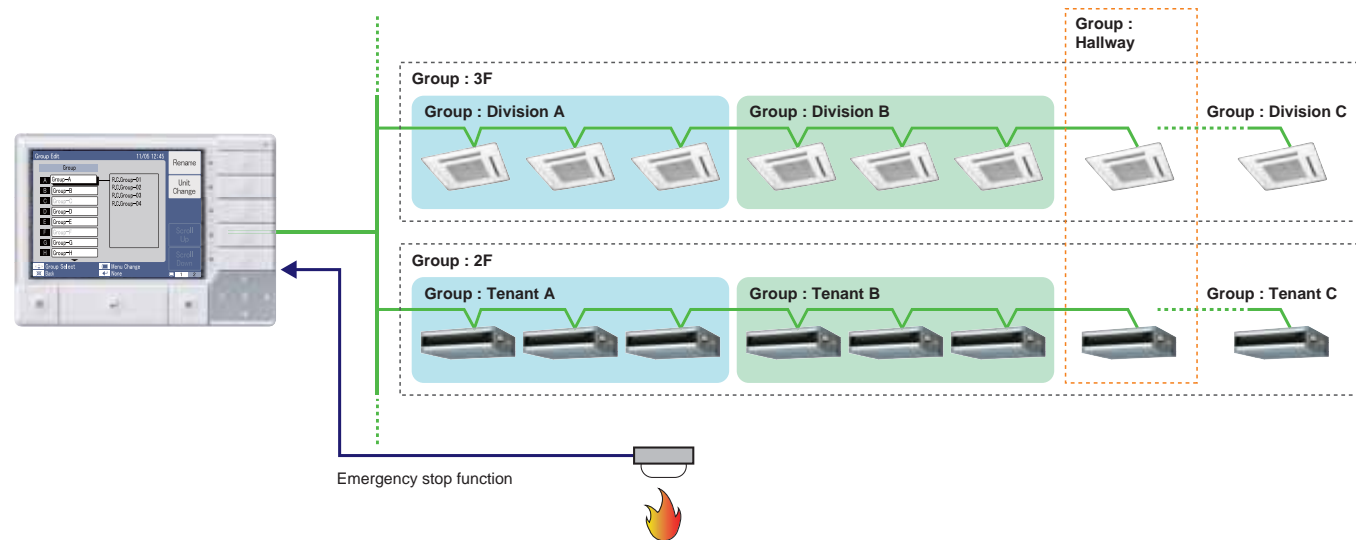

Functions

Diverse control of indoor units

- Individual control (On / Off, Mode, set Temp, Fan speed, Economy operation, Antifreeze operation)

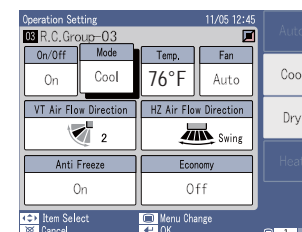

- Remote controller prohibition (All, On / Off, Mode, Temp, Timer, Filter) : R.C prohibition setting prohibits individual remote control operation from this controller

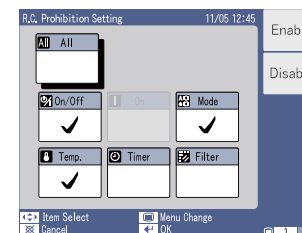

- Room temperature set point upper and lower limitation

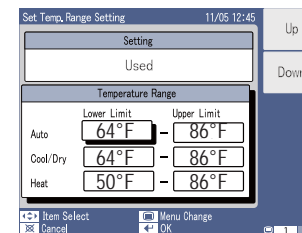

- Weekly timer : Weekly timer can set the timer by various combinations.

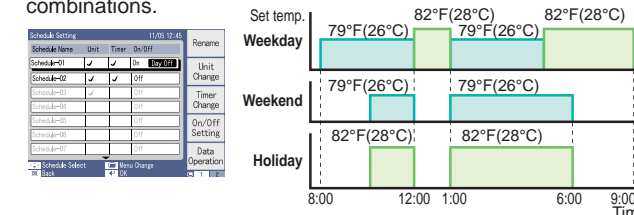

- Automatic clock adjustment : The time setting for all controllers on the system can be set simultaneously.

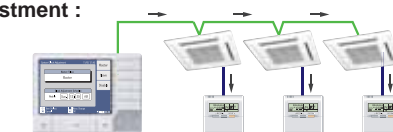

Error history

- Saves up to 200 error messages.
- Allows for accurate analysis and troubleshooting.

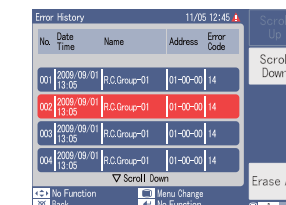

Easy Installation

- The control panel and power supply unit can be installed separately.
- For flexibility in installation, the Control panel can be built into the wall or installed on the wall.

Setting pattern 1

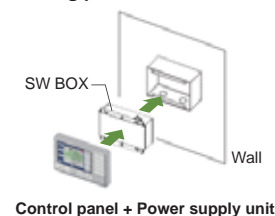

Setting pattern 2

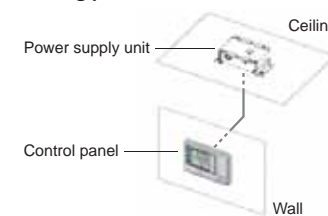

- Automatic or manual indoor unit registration

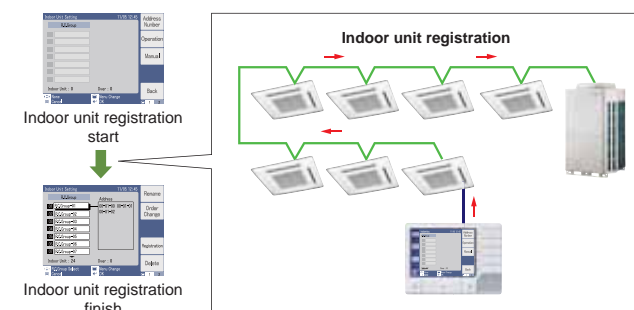

Specifications

Model name	UTY-DCGY	
Power Supply	Control Panel DC 5 V	Power Supply Unit 100-240V, 50-60Hz, Single phase
Dimensions (H x W x D) in. (mm)	4-23/32 x 6-3/8 x 1 (120 x 162 x 26)	3-29/32 x 5-5/16 x 1-17/32 (99 x 135 x 39.2)
Weight oz. (g)	10.9 (308)	12.5 (355)

<PACKING LIST>

Packing List	Control Panel / Power Supply Unit / Connecting cable, etc.
--------------	--

Touch Panel Controller

UTY-DTGY

High visibility and easy operation via high resolution 7.5 inch TFT-LCD touch panel screen

- Large-sized 7.5-inch TFT color display
- Easy touch-panel operation
- Stylish shape and design suits many applications
- No additional components are required for installation
- Up to 400 indoor units can be controlled
- Choose from 2 display types (icon / list) when in monitoring mode
- Programmable in 7 different languages: English, Chinese, French, German, Spanish, Russian, Polish



Max. controllable
400*
Indoor units

* For Heat Recovery network systems with more than 320 indoor units, consult the D&T manual for proper wiring and the use of signal amplifiers.

Functions

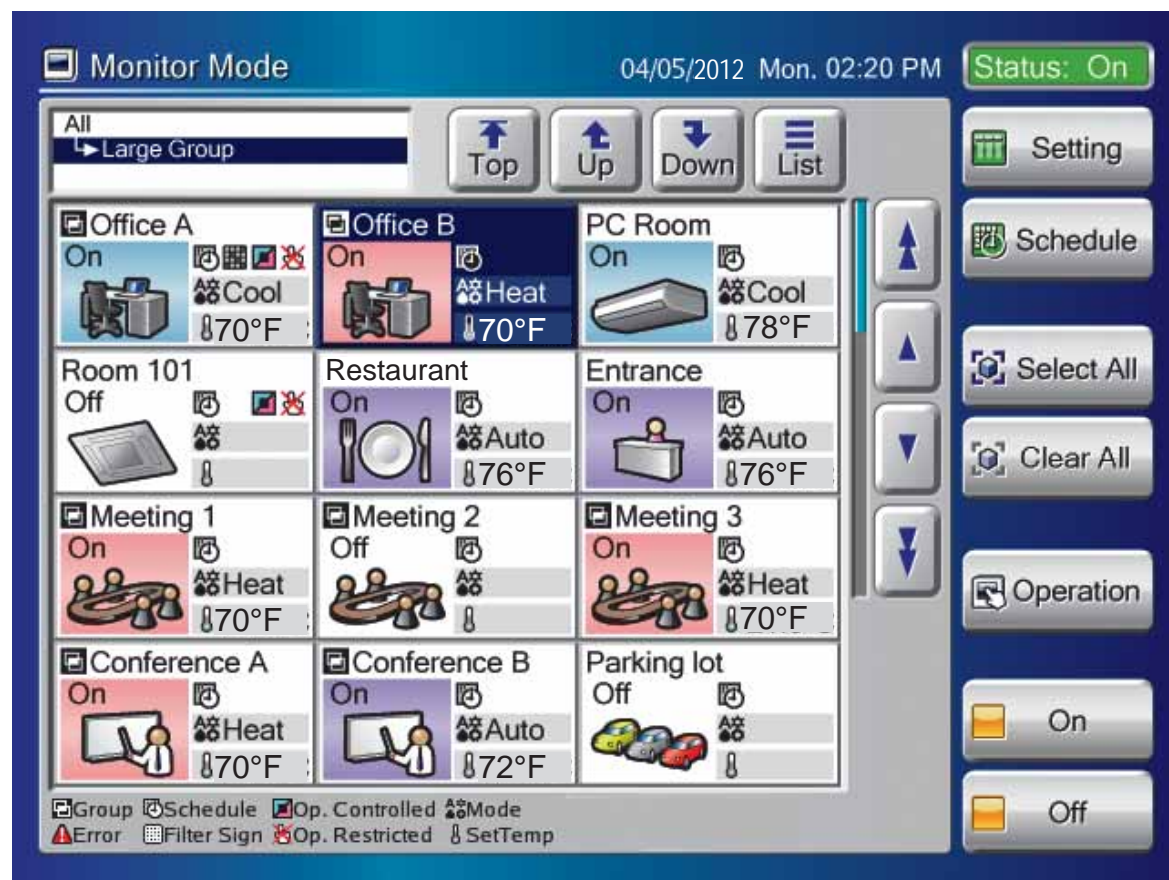

Actual screen size

Easy operation

- Easy-to-understand icon-driven Graphical User Interface (GUI)



- Operation can be selected using your finger or the dedicated touch pen by pressing the appropriate on-screen icon
- Up-to-date status display
- Background color identifies current control operation; Blue for monitoring, green for operational control

Easy maintenance

- Flat touch screen is easily cleaned
- Non-glare coating on touch panel controller minimizes fingerprint marking
- Easy-to-remove front cover



Up to 400 indoor units can be controlled

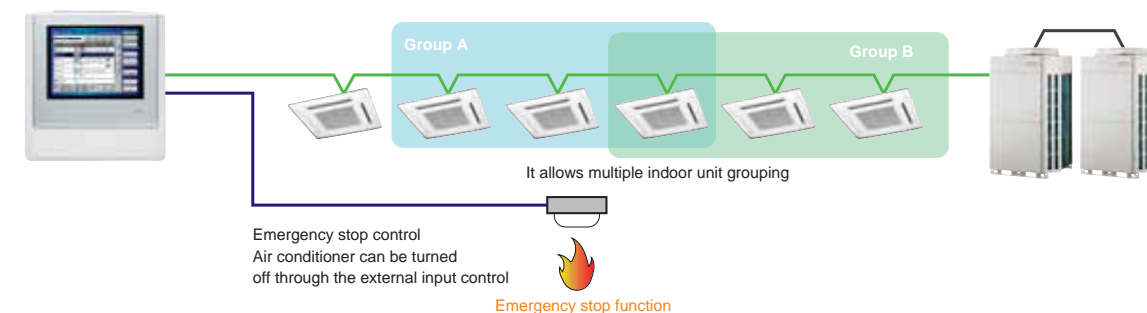

Function

- Up to 400 indoor units can be controlled
- Multiple indoor units can be grouped and controlled
- Schedule timer function is standard (20 patterns per day)
- Emergency stop function (through the external input control)
- Temperature upper and lower limit setting



Individual control



Flexible grouping



Schedule control



Indoor units operation monitoring

Automatic clock adjustment

The time setting of each controller can be set in batch automatically.

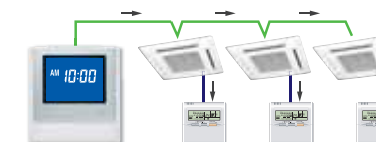

Versatility

- **Emergency stop function:** Air conditioner can be turned off through the external input control
- The stored data can be transferred via USB port
- CSV format data edited by PC can be imported to Touch Panel Controller.

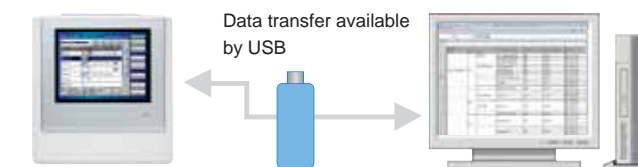

Easy installation

- Touch Panel Controller does not require mounting an additional power supply.
- No additional components are required for installation.



Specifications

Model name	UTY-DTGY
Power Supply	100-240V 50/60Hz
Dimensions (H x W x D) in. (mm)	10-1/4 (260) x 9-11/16 (246) x 2-1/8 (54)
Weight lbs. oz. (g)	4lbs. 11.8oz. (2150)
Interface	USB 2.0



System Controller

Software

UTY-APGX

System Controller provides advanced monitoring & control of VRF network systems.

- Advanced functions and control from a single dedicated PC.
- Up to 4 VRF network systems (1600 indoor units, and 400 outdoor units) can be controlled from a single System Controller.
- Precision building air conditioning control.
- Additional Energy Saving options



Max. controllable
4
VRF network systems

Max. controllable
400*
Outdoor units

Max. controllable
1,600*
Indoor units

* For a Heat Recovery network systems with more than 320 indoor units, consult the D&T manual for proper wiring and the use of signal amplifiers.

System Controller Lite

Software

UTY-ALGX NEW

System Controller Lite has standard functions sufficient for air conditioner management in small and medium scale buildings.

- Up to a maximum of 1 VRF network system, 400 indoor units, and 100 outdoor units can be controlled.
- In addition to air conditioning precision control function, a variety of management software is available as an option to give customers a wide range of choice.



Max. controllable
1
VRF network systems

Max. controllable
100
Outdoor units

Max. controllable
400
Indoor units

User friendly view and operation

- **Click & Operate** : The property is shown visually from the perspective most suitable for operation and operated accordingly (Click & Operate). You can select from among the 4 displays of site, building, floor, or list.

- **Freely define groups for batched control** : Indoor units can be freely grouped for simple batched control from a tree menu. Grouping by hierarchal structure, such as by section, division or department is possible.

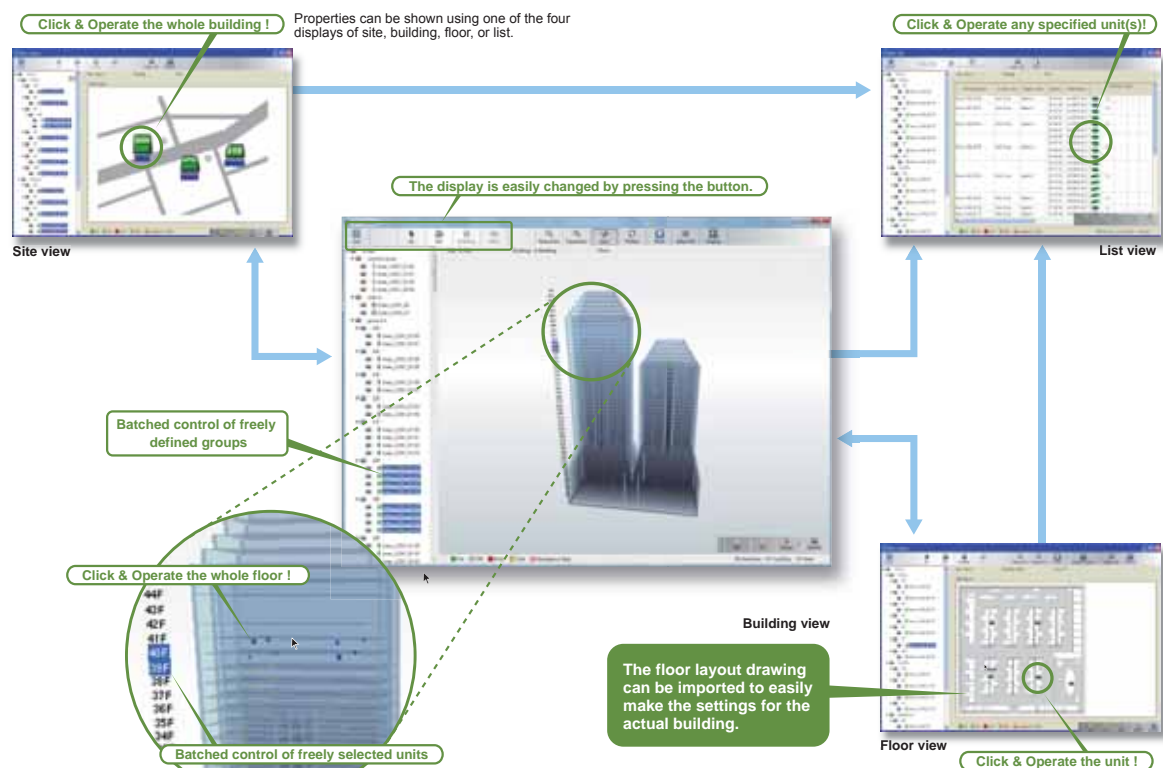

Note:
2D floor layout / 3D building display are not available for System Controller Lite.

Diverse operation management & Data management

Schedule management

- Annual schedules can be set for each remote controller group / user defined group.
- Start / stop, operating mode, remote controller prohibition, and temperature settings can be set up to 143 times per day at 10 minute intervals for up to 101 configurations for each remote controller group.
- Settings can be made for periods straddling midnight.
- Allows programming of special settings for holidays, including public holidays, for a complete year.
- Low noise operation of outdoor unit can be scheduled.



Diverse control of indoor unit

- Indoor unit operation state, operation mode, etc. are displayed
- Indoor unit start / stop and operation mode switching
- Room temperature set point limitation



Remote controller prohibition

This prohibits changes to the operation mode, temperature, start/stop, etc.



Error display & E-mail notification

Error is notified with popup message, audible sound and E-mail real time when error occurs. Error for the past 1 year are logged and can be reviewed later.



Operating & control record

Displays the history of operation status and control.



Data base import/export

Imports/exports registration data, layout data, and image data. Only the administrator can make this setting.



Automatic clock adjustment

The time setting of each controller can be set in batch automatically.

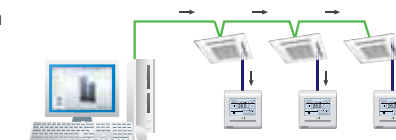

Electricity charge apportionment

Electricity charge apportionment calculation framework

Suppose you want to find the power consumed by the air conditioners of each tenant from the electricity charge for each month. With electricity charge apportionment function, used energy apportionment ratio will be provided, calculating in detail the energy consumed by the units used by each tenant. This information is then used to calculate the charges for the electricity consumed for air conditioning by each tenant from the total electricity charges in the bill from the electric power company. (See figure at right) The detailed calculation takes into consideration such things as unused rooms and nighttime electricity charges and shows them in a charges calculation sheet.

System Configuration Example

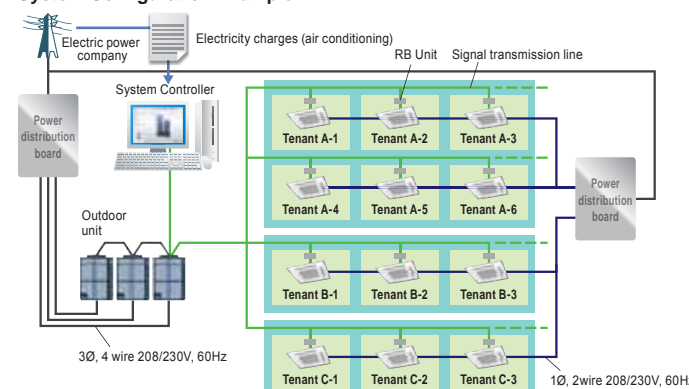

Standard for System Controller
Option for System Controller Lite UTY-PLGXA1

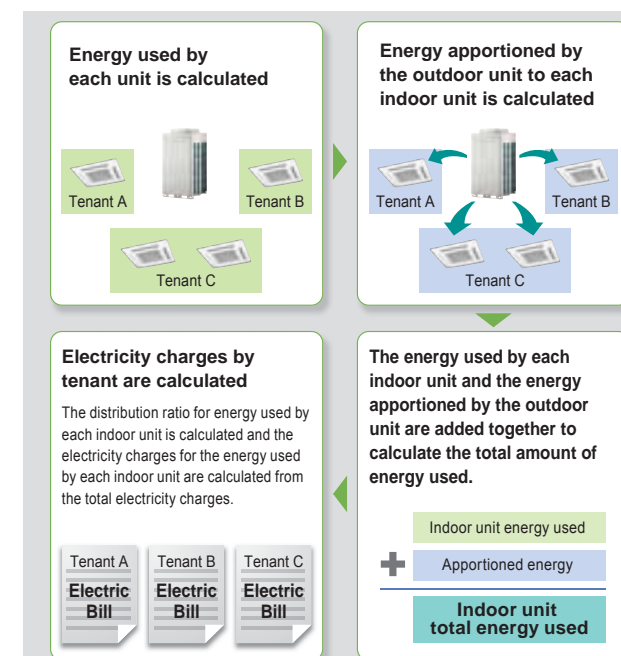

System Controller and System Controller Lite (continued)

Remote management

System Controller may be used on site or remotely over various networks for remote central control. System Controller requires 2 softwares working together. VRF Controller runs on site and communicate with VRF system. VRF Explorer runs remotely and provides user interface and communicate with the VRF Controller. VRF Controller and VRF Explorer program may run in a single PC or in different PCs separated by network. By using VRF Explorer software, one PC can perform central control of 10 VRF system sites with max. 20 buildings per site.

Standard for System Controller
Option for System Controller Lite UTY-PLGXR1

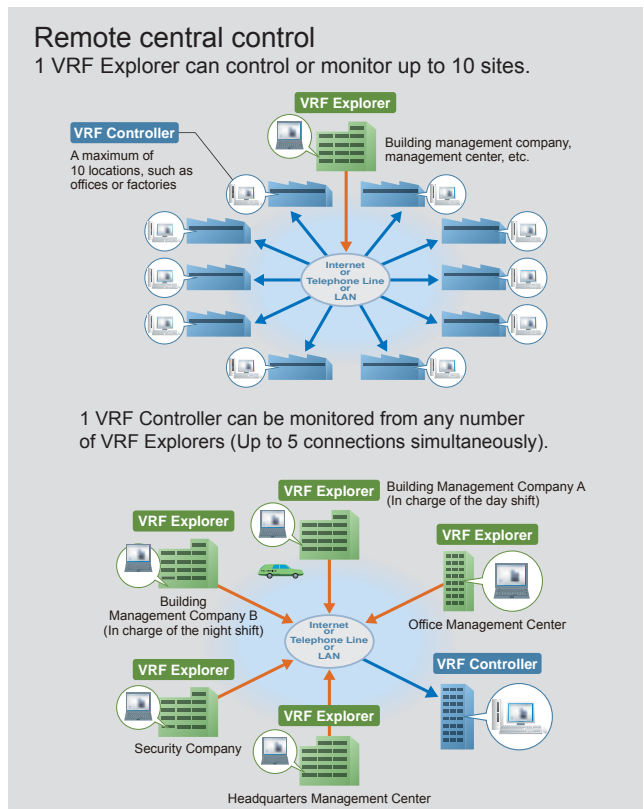
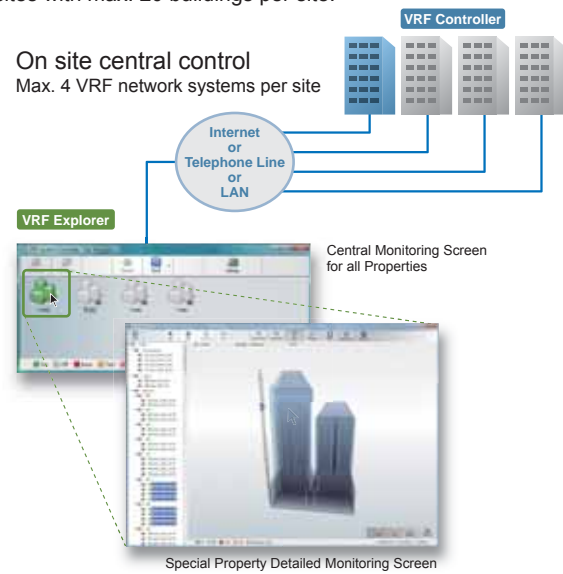

Energy saving management

Several energy saving operations can be set and managed. Energy saving options can be used while keeping occupants comfortable.

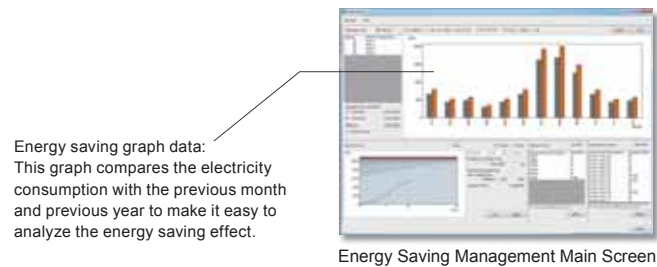

Option for System Controller UTY-PEGX
Option for System Controller Lite UTY-PLGXE1

Peak cut operation

A power meter can be connected to detect the total power consumption of the system while using energy saving features to carefully control the power consumed. Shifting set temperature, indoor unit rotation and other features maintains comfort while conducting control options. Target power consumption for individual groups can be maintained.

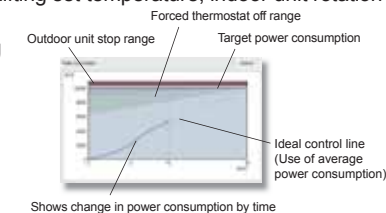

Indoor unit rotation operation

Operation of indoor units can be rotated to reduce power consumption while maintaining comfort. Rotation quantity and rate can be set.

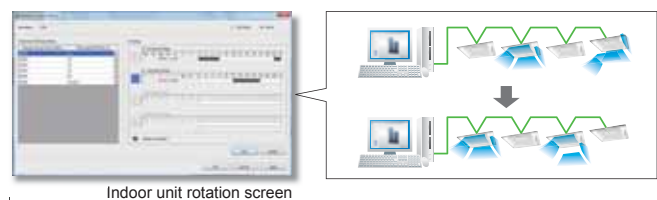

Outdoor unit capacity save

Outdoor unit capacity save sets a limit for maximum power consumption for the system by limiting capacity. Can be set from 50% to 100%.

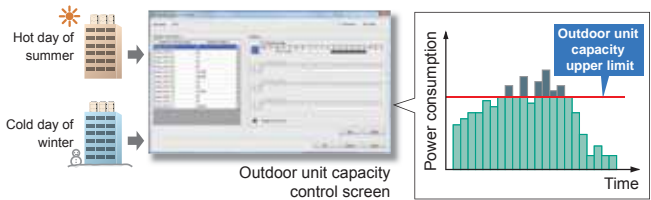

FUNCTIONS SUMMARY

Function	Type	System controller		System controller lite			
		UTY-APGX	Option UTY-PEGX	UTY-ALGX	Option UTY-PLGXR1	Option UTY-PLGXA1	Option UTY-PLGXE1
System specification	Max. VRF networks supported	4	-	1	-	-	-
	Max. indoor unit / remote controller groups per VRF network	400	-	400	-	-	-
	Max. outdoor units per System controller	100	-	100	-	-	-
	Max. indoor units / remote controller groups per System controller	1600	-	400	-	-	-
	Max. outdoor units per System controller	400	-	100	-	-	-
Site supervision	Multi site display	10	-	10	-	-	-
	Number of building / 1 site	20	-	-	-	-	-
	Number of floor per 1 site	200	-	-	-	-	-
	Number of floor per 1 building	50	-	-	-	-	-
	3D graphical layout view	○	-	-	-	-	-
	2D graphical layout view	○	-	-	-	-	-
	List display	○	-	○	-	-	-
Error management	Error notification	○	-	○	-	-	-
	Audible alarm	○	-	○	-	-	-
	Error e-mail notification	○	-	○	-	-	-
History	Error history	○	-	○	-	-	-
	Operation history	○	-	○	-	-	-
	Control history	○	-	○	-	-	-
Operation control	Individual control	On/Off	○	-	○	-	-
		Operation mode	○	-	○	-	-
		Room temperature	○	-	○	-	-
		Fan speed	○	-	○	-	-
		Air flow direction	○	-	○	-	-
		Economy mode	○	-	○	-	-
		Room temperature set point limitation	○	-	○	-	-
	Individual management	Test operation	○	-	○	-	-
		Antifreeze	○	-	○	-	-
		Remote control prohibition setting	○	-	○	-	-
	Other	Temperature upper and lower limit setting	○	-	○	-	-
		Filter sign reset	○	-	○	-	-
		Memory operation	○	-	○	-	-
Schedule	Annual Schedule	○	-	○	-	-	
	Special day setting	○	-	○	-	-	
	On / off per day	72	-	72	-	-	
	On / off per week	504	-	504	-	-	
	Day off	○	-	○	-	-	
	Min. unit of timer setting (Minutes)	10	-	10	-	-	
	Low noise mode Weekly schedule	○	-	○	-	-	
Remote management	Remote monitoring	○	-	-	○	-	
	Remote operation control	○	-	-	○	-	
	Remote function setting	○	-	-	○	-	
Electricity charge apportionment	Apportionment charge/bill calculation	○	-	-	○	-	
	Tenant (block) setting	○	-	-	○	-	
	Common facilities apportionment setting	○	-	-	○	-	
	Rated power consumption allotment setting	○	-	-	○	-	
	Individual calculation at cooling and heating	-	○*	-	○	-	
Energy saving management	Electricity meter supported	-	○	-	-	○	
	Indoor unit rotation	-	○	-	-	○	
	Peak cut control	-	○	-	-	○	
	Outdoor unit capacity save	-	○	-	-	○	
	Record of energy saving operation	-	○	-	-	○	
	Energy saving information	-	○	-	-	○	
	Power consumption monitor	-	○	-	-	○	
Others	Electricity meter supported	-	○	-	-	○	
	Database import/export	○	-	○	-	-	
	Automatic clock adjustment	○	-	○	-	-	
Multi language	7 languages	-	7 languages	-	-		

○ : Available. - : Not available.
*:Power calculation application software is necessary, please contact your local Fujitsu representative.

PERSONAL COMPUTER SPECIFICATIONS

Operating system	<ul style="list-style-type: none"> Microsoft® Windows® XP SP3 (32-bit) Professional (*1) Microsoft® Windows® Vista® SP2 (32-bit) Home Premium, Business (*2) Microsoft® Windows® 7 SP1 (32/64-bit) Home Premium, Professional (*2) Microsoft® Windows® 8 (32/64-bit) Windows 8, Windows 8 Pro (*2) [Supported languages] (*1) English only (*2) English, Chinese, French, German, Russian, Spanish, and Polish
CPU	Intel® Core™ i3 2GHz or higher
Memory	2GB or more (Windows® XP, Vista®, 7 32-bit), 4GB or more (Windows® 7 64-bit, Windows® 8)
HDD	40GB or more of free space
Display	1024 x 768 or higher resolution
Interface	USB port is required for each of the followings for Server PC ; • Wibu Key (Software protection key) • Echelon® U10 USB Network Interface (Required for each VRF Network) Ethernet port is required for remote connection using internet.
Accelerator	Requires the internal graphics accelerator be compatible with Microsoft® DirectX® 9.0 (for only System Controller)
Software required	Adobe® Reader® 9.0 or later

Personal computer must be field supplied. U10 USB Network Interface must be field supplied. Contact Echelon® Corporation or its local sales representative for detail.
Product Name : U10 USB Network Interface - TP/FT-10 Channel Model Number : 75010R

Control System Diagram

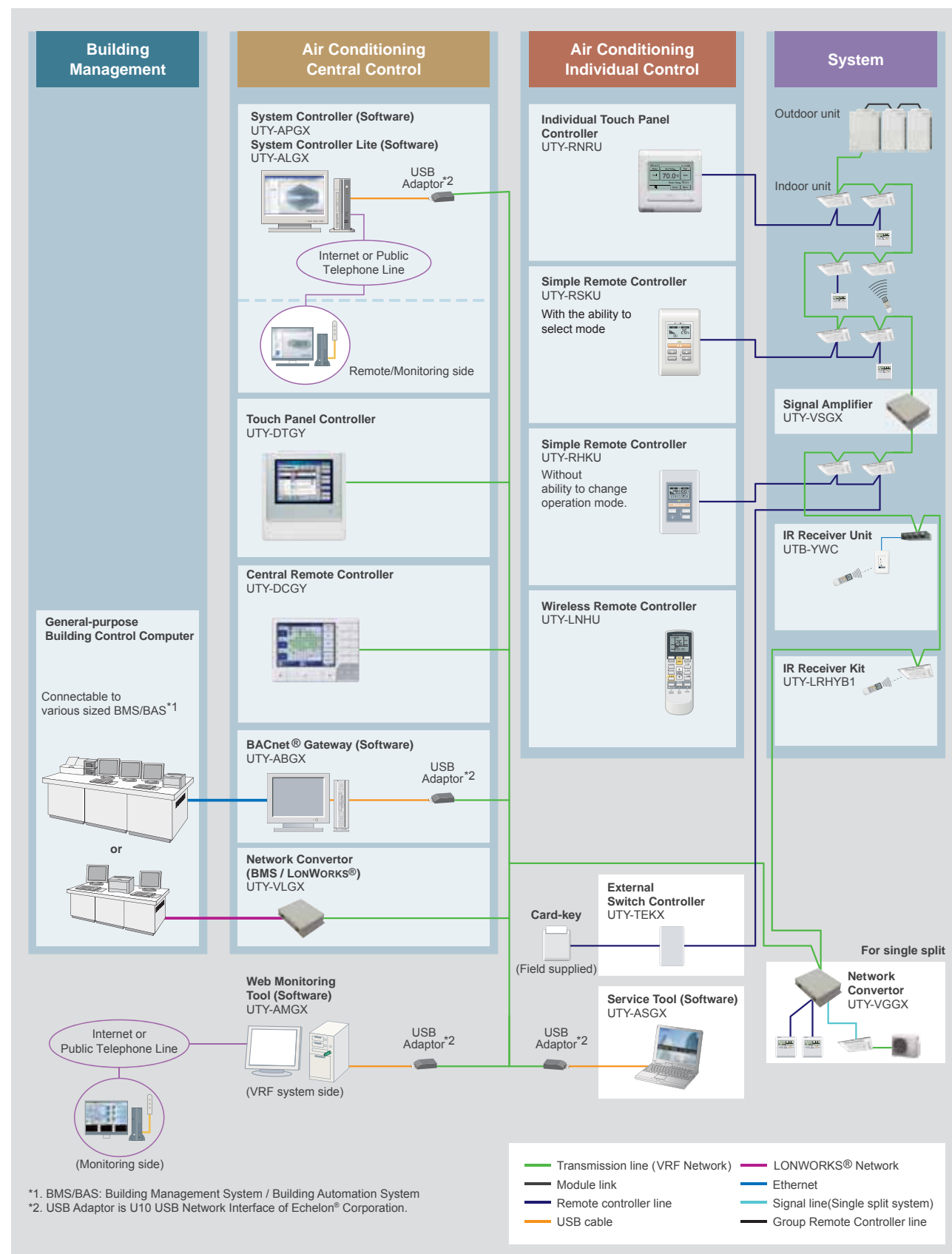

Airstage Portal portal.fujitsugeneral.com

The Airstage Portal provides a single source for all information for Fujitsu Airstage VRF systems. From the Airstage Portal, all registered users have access to: Manuals, Literature, Design Simulator Software, Commissioning Forms, Troubleshooting Guides, Design & Technical Manuals and Online Training.

Additional features, such as the Airstage Project Manager, are available to Fujitsu Reps, Fujitsu Distributors and Fujitsu Sales Engineers. The Airstage Project Manager supports projects from the design stage through completion and ensures clear and effective communication between all Fujitsu team members.

The Airstage Project Manager applies technology to simplify project management and ensure a successful VRF installation.

A central place for project members to coordinate.

Who Has Access to the Portal?

- Engineers
- Contractors
- Fujitsu Distributors
- Independent Airstage Sales Reps
- Fujitsu Regional Sales Managers (RSMs)
- Fujitsu Sales Engineers (SEs)



What's on the Portal? Tools for Engineers and Contractors

Information & Downloads

- Access to Literature Online
- Access to all Manuals
- Download Design Simulator

Technical Information

- Troubleshooting Guides
- Instructional Videos
- Frequently Asked Questions

Training

- Designing Airstage Systems
- Reinforce information covered in on-site training classes
- Learn about new and advanced Airstage features

Warranty & Commissioning

- Submit Commissioning Report
- Print Extended Warranty Certificate
- Parts Identification Diagrams

Tools for Fujitsu Sales Team

Maintain Projects

- Upload Design Simulator files
- Track project status

Submittals & Closeout Documentation

- Automatically generate submittals & closeout documents
- Commissioning Report and closeout documents are archived for future reference

Warranty

- Process warranty claims



Service Tool Software

UTY-ASGX

Extensive monitoring and analysis functions for installation and maintenance.

- Operation status can be checked and analyzed to detect even the small abnormalities.
- Data collected and stored on site can be checked later, off-line, off-site for more detail analysis.
- One VRF network system with maximum number of up to 400 units can be monitored and controlled.
- Operation status and various sensor information can be monitored and checked real time in the form of list, refrigerant circuit diagram, graphs as well.
- Simple operation control functions are useful during maintenance.
- The recent error history can be retrieved from units on demand to perform analysis on the cause of the error, after connecting Service Tool to the VRF network system.
- Commissioning tool supports test runs, data storage for each unit and saving of data as CSV files, which may be formatted to create commissioning report.
- Connectable to any point of transmission line with USB adapter*1 (included)
- Connection between VRF network system to field-supplied personal computer is possible via small U10 USB interface.

Control and Monitor Up To
100
Outdoor units

Control and Monitor Up To
400
Indoor units



Wiring connection

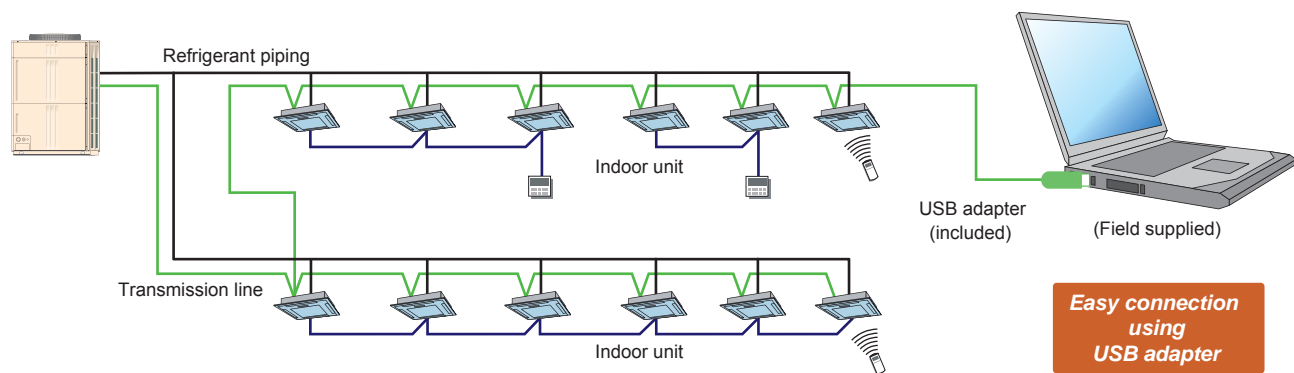

*USB Adapter is U10 USB Network interface of Echelon® Corporation.

Functions

1) System List

Displays the overall operation status of all or specified units in the system in a list form.

2) Equipment Detail (Diagram)

Displays the detail information for sensor values, electrical components etc. for the specified units in schematic. The information here can be used along with the detail information in list form, to check the operation status of units and make detail analysis on the cause, in case an error occurs.

3) Equipment Detail (List)

Displays the detail information for sensor values, electrical components etc. of units in a specified refrigerant system in list form. The information here can be used along with the detail information in diagram form, to check the operation status of units and make detail analysis on the cause, in case an error occurs.

4) Operation History

The indoor units or outdoor unit operation history can be recorded. The displayed operation history can be printed out and saved to a CSV file.

Ref	Unit	S.C.D.	Phase	Model	Type	Capacity (kW)	Operation	Mode	Set Temp (°C)	Room Temp (°C)	H.S.T. (°C)	H.S.T. (°C)	H.S.T. (°C)	H.S.T. (°C)	H.S.T. (°C)	H.S.T. (°C)	H.S.T. (°C)	H.S.T. (°C)	H.S.T. (°C)	
00	00		Out	Heat Pump	--	--	OH	Heat	26	15.2	18	18	18	18	18	18	18	18	18	18
01	01	11A 1a1	In	Wall Mounted	3000	31A	OH	Cool	26	15.2	18	18	18	18	18	18	18	18	18	18
02	02	11A 1a2	In	Wall Mounted	3000	31A	OH	Cool	26	15.2	18	18	18	18	18	18	18	18	18	18
03	03	11A 1a3	In	Wall Mounted	3000	31A	OH	Cool	26	15.2	18	18	18	18	18	18	18	18	18	18

5) Error History

Displays the error information for each unit. The error information can sequentially be displayed up to 50 items as they occur starting with the latest error.

6) Remote File Download

Operation and error history can be downloaded. User can choose which data download by specifying the system, unit and time frame.

7) Commissioning Tool

During a test run, the outdoor unit/indoor unit sensor data can be saved for completing the commissioning report. After the end of test running, this data can be exported in CSV file format.

8) Network Topology Analyzer

A list of units connected to the VRF system network is displayed in network segments in tree form.

9) Remote Setting

Setting of the indoor unit can be performed remotely.

10) System Time Setting

Time of day setting, for all controllers in a system, can be performed simultaneously.

11) Software Version

The software version of units are acquired and displayed.

12) Central Release

Limitations on individual indoor units can be released from the central controller (remote controller limit, temperature limit).

13) Model Name Writer

A custom model name can be given for an indoor unit.

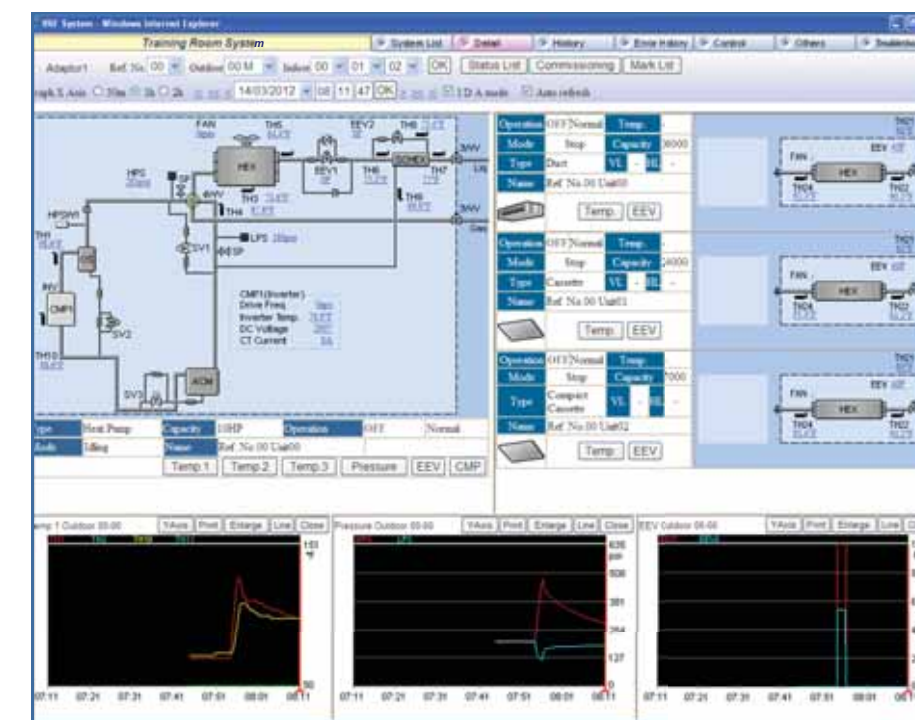

14) Error Memory Reader

When an error occurs in an indoor unit, the system records the operation data before the error and saves to a CSV file.

Note: To perform "Error Memory Reading", the Service Tool must be connected directly to the corresponding outdoor unit. Refer to the Operation Manual of the Service Tool for detail.

15) Time Guard Information

Data for determining maintenance schedule (integrated time for compressor, fan, etc.) for the indoor and outdoor units can be output to a CSV file.

PERSONAL COMPUTER SPECIFICATIONS

Operating System	AT compatible machine that runs Microsoft® Windows® Microsoft® Windows® XP Professional (English version / Service pack 3 or later) Microsoft® Windows® Vista® Home Premium, Business Edition (English version/Service pack 2 or later) Microsoft® Windows® 7 Professional (English version/Service pack 1 or later)
CPU	Intel® Pentium® / Celeron®, AMD Athlon™ / Duron™ 1 GHz or higher
HDD	10 GB or more of free space
Memory	1 GB (Vista, 7), 512 MB (XP) or more
Interface	USB port for U10 USB Network Interface and Software protection key.
Required Software	Internet Explorer 6.0 or 7.0 or 8.0 / Adobe® Reader® 9.0 or later
Required Hardware	CD-ROM drive
<PACKING LIST>	
Packing List	CD-ROM / Wibu Key, U10 USB Adapter

Personal computer must be field supplied.

Design Simulator

Easy Equipment Selection, Complete Selection Output, Reliable Project Management

Design Simulator makes it easy to select equipment for complex building air conditioning systems. The software output contains all important design data including: Equipment Schedule, Piping Layout, etc. (all of the documentation needed to estimate a project.) Design Simulator simplifies the design process. To design a system, just select the indoor unit types, designate the groups, and the software will automatically select the outdoor unit and create the piping and wiring diagram. Design Simulator also checks all of the equipment information to ensure proper installation.

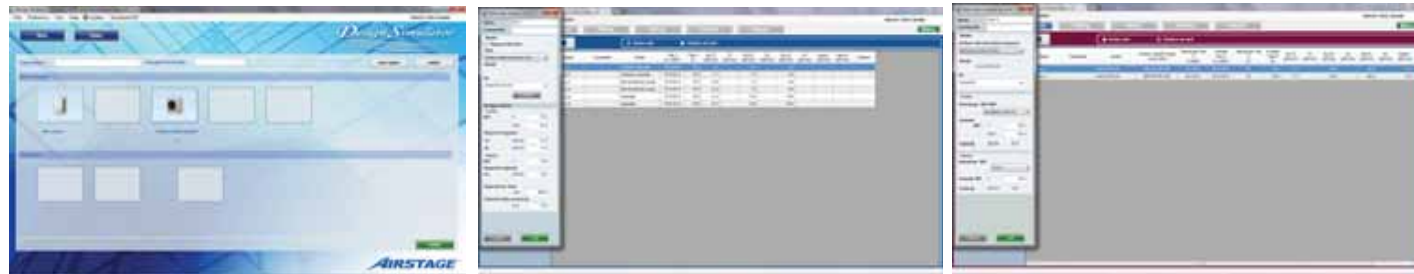

Step 1 Select the model

Choose the model for each system.

Step 2 Select the Indoor Unit

Choose the unit types and the conditions and the software will select the correct indoor unit. Indoor unit can also be selected manually.

Step 2b Select the Outdoor Air Unit

If desired, choose the "Outside air unit" option. Outside air units are selected based on required airflow.



Step 3 Select the Outdoor Unit

Using the Drag & Drop function, connect the indoor unit to the appropriate outdoor unit.

Step 4 Piping Length / Piping Diagram

Piping diagram is created automatically. As piping lengths are entered, system automatically calculates refrigerant charge.

Step 5 Wiring / Controller Diagram

Automatically creates the wiring diagram. Simple grouping functions create a custom wiring diagram for the project.

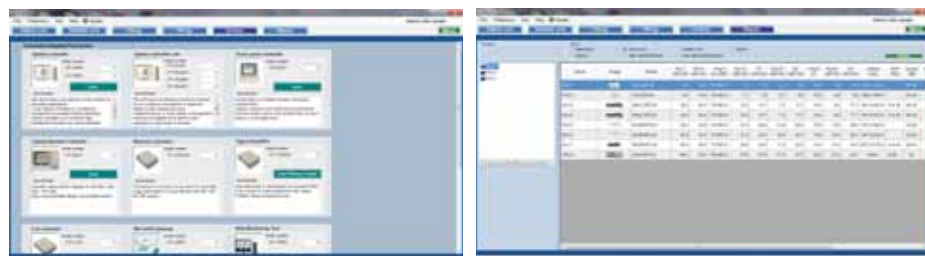

Step 6 Select Converters and Central Control

Choose additional devices to meet the needs of the project.

Step 7 Report Output

Design Simulator creates a project output with all of the project schedules and schematic drawings.

Setting

Software can be customized for any geographic location.

- Units (US conventional / Metric)
- Language Setting
- Custom Database Function
- Output Settings

Software Requirements

Software	Design Simulator
Operating System	Microsoft Windows XP / Vista / 7 / 8
System Requirements	CPU: Intel® Core™ i3 Processor 2GHz or higher
	Hardware Memory: 2GB or more (Windows® XP, Windows Vista®, Windows® 7 32-bit) 4GB or more (Windows® 7 64-bit), HDD: 10GB or more of free space
	Display 1024 x 768 dots or more
	Software Internet Explorer 7.0 or later
	Software Acrobat Reader 9.0 or later
	Microsoft Word 2003 / 2007 / 2010

Specifications

Item	Function
Subject model	VRF V-II, VR-II, includes Outdoor Air Units
Preferences	Multiple language setting (Choose from 25 different languages)
	Multiple unit setting
	Project detail information setting
	Brand/User name setting
	User option setting
Model selection	Auto mode selection (Indoor unit/Outdoor unit/Piping/Wiring)
	Manual mode selection
	Optional parts selection
	Controller/Adapter/Convertor selection
Drawing	Auto drawing (Piping diagram/Wiring diagram)
	Auto product information display
Output data	Material list display
	Product detail display (Photo, Specifications, Options)
	Diagrams display (Piping/Wiring)
	Additional refrigerant volume (Input piping length)
Report format	CAD data (2D-DXF, 3D-RFA)
	Word (rtf)
	CSV
Update	DXF, RFA
	Auto update via internet
	Download the latest data from the Airstage Portal (portal.fujitsugeneral.com)

Note: 1. Specifications are subject to change without notice 2. New models will be added as they are introduced.

Output

Equipment selections and schedules can be output in standard industry file formats.



- Word format
- Excel format
- Auto CAD format
- 2D Data
- 3D Data (RevitMep data)
- Wiring and piping schematic drawings

Auto Update

Software updates automatically with the latest product data.

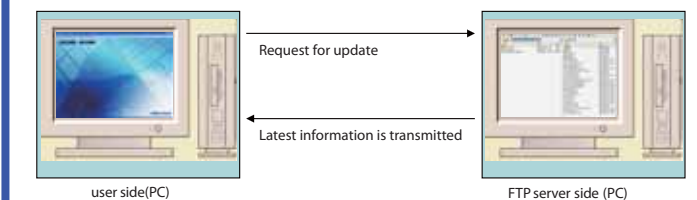

- Maintains software integrity
- Maintains software history
- Updates product information

Building Information Modeling (BIM)

FUJITSU provides the Building Information Modeling (BIM) object models and contents for our VRF system and some products to the architect, designer and contractor using Autodesk® Revit® technology from our Website and Autodesk® Seek Website, etc.

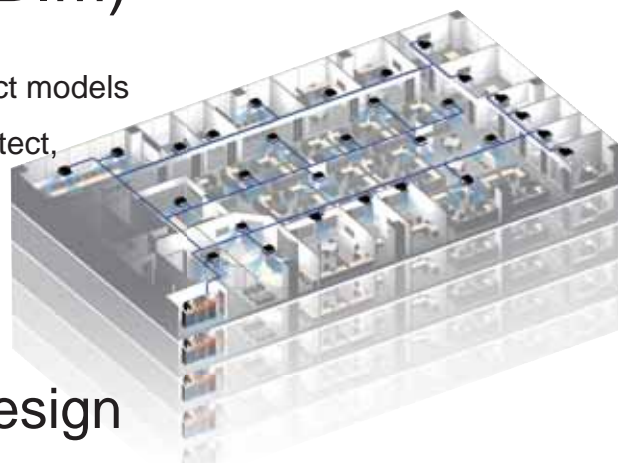

BIM Object Models Ensure Proper Design

Many products available

We provide BIM data for indoor units, outdoor units, and accessories. We will continue to create and provide products to support the global market.

Object models: VRF "AIRSTAGE™ V-II" /8 Rooms Multi "HF1"
Files : Indoor units 75 files / Outdoor units 22 files / Options 15 files

3D and 2D product data

We provide 3D data that is similar to the product appearance. 2D CAD design operations are supported and 2D display is also provided. The data can also be output in other formats, such as DXF and DWG, which are used by other design CAD.

Installation limitation

The equipment installation limitation range is shown. The distance range from the wall, etc., is automatically displayed to make it easy to provide highly reliable layout designs.

Installation information

Other information, such as symbols showing the airflow direction that are required for installation drawings, is built in and can be automatically reflected in 2D drawings. Installation drawings can be created easily.

Product specifications & Link information

Contains the basic information required for air conditioner design, including unit size, capacity, input power, noise, and airflow rate.

Data volume

Fujitsu Revit® files are small, requiring very little system resources.

Required software

- Autodesk® Revit® series software
- Autodesk® Revit® Architecture
- Autodesk® Revit® MEP
- Autodesk® Revit® Structure

- Data format
- RFA

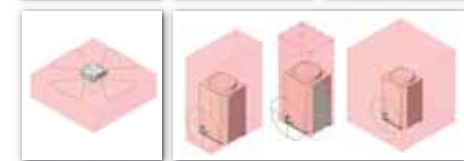
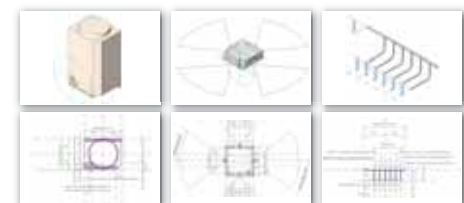

Product parameter	
Power source	
Input power	
Capacity	
Airflow rate	
Sound pressure level	
Dimensions	
Weight	
Connection pipe diameter	
Refrigerant	
Material/Color	

Auto Louver Grille Kit

UTD-GXSA-W, UTD-GXSB-W

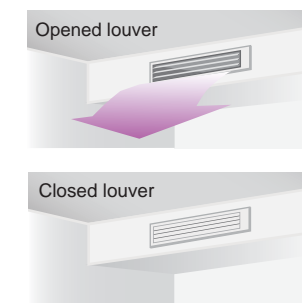

- Operation with indoor unit**
Auto Louver can be controlled by remote controller of indoor unit.
- Up and Down auto swing**
 - Fixed airflow or auto swing
 - 4 angle settings
- Auto-closing louver**
When operation of indoor unit is stopped, the louver will automatically close.



Dimensions

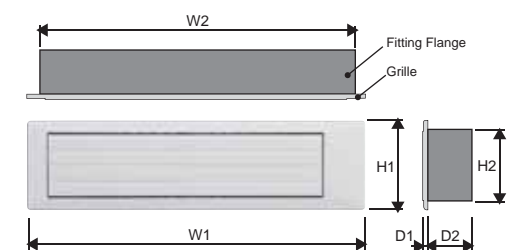

Model Name	W1	W2	H1	H2	D1	D2
UTD-GXSA-W	26-7/8	25-13/32	7-3/32	5-13/16	11/32	3-5/16
UTD-GXSB-W	34-3/4	33-1/4				

Unit: in.

Flexible Control

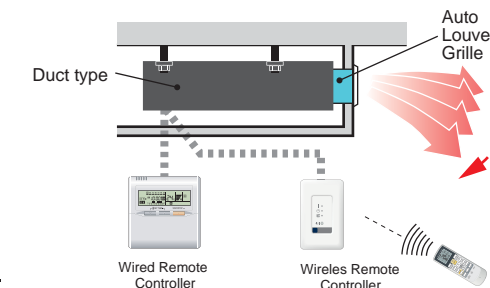

Specifications

Model name	UTD-GXSA-W	UTD-GXSB-W
Applicable Indoor Unit	ARUL7/9/12/14RLAV ARUL7/9/12/14TLAV	ARUL18RLAV ARUL18TLAV
Power Supply	Connecting with Control box of indoor unit	
Fixing of Auto Louver Grille	Screw fixing to Flange or Rectangular Duct	
Extension Square Duct Limit	39-3/8" (Max. duct length between indoor unit and grille)	
Net Dimension (H x W x D)	7-3/32x26-7/8x(3-5/16+11/32) [180x683x(84+9)]	7-3/32x34-3/4x(3-5/16+11/32) [180x883x(84+9)]
Weight	Net	4.4 (2.0)
	Gross	6.7 (3.0)
Color	White	
Louver Motor	Stepping Motor	
Accessories	Fitting Flange, etc.	
Operation range	Cooling	64 to 90 (18 to 32) % RH
	Heating	80% or less 50 to 86 (10 to 30)

Optional Parts

Connection Units

Separation Tube		
$X < 96.5$ kBTU/h	96.5 kBTU/h $< X < 193$ kBTU/h	193 kBTU/h $< X$
Gas Pipe UTP-AX090A	Gas Pipe UTP-AX180A	Gas Pipe UTP-AX567A
Liquid Pipe UTP-AX090A	Liquid Pipe UTP-AX180A	Liquid Pipe UTP-AX567A
Suction Gas Pipe UTP-BX090A	Suction Gas Pipe UTP-BX180A	Suction Gas Pipe UTP-BX567A
Discharge Gas Pipe UTP-BX090A	Discharge Gas Pipe UTP-BX180A	Discharge Gas Pipe UTP-BX567A
Liquid Pipe UTP-BX090A	Liquid Pipe UTP-BX180A	Liquid Pipe UTP-BX567A

Header		Outdoor Unit Branch Kit
6 Branch	8 Branch	
Gas Pipe UTR-H0906L* UTR-H1806L**	Gas Pipe UTR-H0908L* UTR-H1808L**	Gas Pipe UTP-CX567A
Liquid Pipe UTR-H0906L* UTR-H1806L**	Liquid Pipe UTR-H0908L* UTR-H1808L**	Liquid Pipe UTP-CX567A
Suction Gas Pipe UTP-J0906A* UTP-J1806A**	Suction Gas Pipe UTP-J0908A* UTP-J1808A**	Suction Gas Pipe UTP-DX567A
Discharge Gas Pipe UTP-J0906A* UTP-J1806A**	Discharge Gas Pipe UTP-J0908A* UTP-J1808A**	Discharge Gas Pipe UTP-DX567A
Liquid Pipe UTP-J0906A* UTP-J1806A**	Liquid Pipe UTP-J0908A* UTP-J1808A**	Liquid Pipe UTP-DX567A

* $X < 96.5$ kBTU/h
 ** 96.5 kBTU/h $< X < 193$ kBTU/h

Specifications

Separation Tube			
Model name (2 Pipe)	UTP-AX090A	UTP-AX180A	UTP-AX567A
Total cooling capacity of indoor unit (X)(kBTU/h)	$X < 96.5$	$96.5 \leq X < 193$	$193 \leq X$
Model name (3 Pipe)	UTP-BX090A	UTP-BX180A	UTP-BX567A
Total cooling capacity of indoor unit (X)(kBTU/h)	$X < 96.5$	$96.5 \leq X < 193$	$193 \leq X$
Header			
Model name (2 Pipe)	3-6 Branches	UTR-H0906L	UTR-H1806L
	3-8 Branches	UTR-H0908L	UTR-H1808L
Total cooling capacity of indoor unit (X)(kBTU/h)		$X < 96.5$	$96.5 \leq X < 193$
Model name (3 Pipe)	3-6 Branches	UTP-J0906A	UTP-J1806A
	3-8 Branches	UTP-J0908A	UTP-J1808A
Total cooling capacity of indoor unit (X)(kBTU/h)		$X < 96.5$	$96.5 \leq X < 193$
Outdoor unit Branch kit			
Model name		UTP-CX567A (for V-II)	UTP-DX567A (for VR-II)
Quantity Required	2 outdoor units	1	
	3 outdoor units	2	

RB Unit	
Single type UTP-RU01AH / UTP-RU01BH / UTP-RU01CH	Multi type UTP-RU04BH

RB Unit		Single type			Multi type
Type		UTP-RU01AH	UTP-RU01BH	UTP-RU01CH	UTP-RU04BH
Model name					
Power source		Single phase 230V, 60Hz			
Input power	W	28	28	41	110
Number of branches		1	1	1	4
Maximum capacity of connectable indoor units(Q)	kBTU/h	$Q \leq 27$	$Q \leq 60$	$Q \leq 96$	$Q \leq 191$ *1
Maximum capacity of connectable indoor units per branch(Q)	kBTU/h	$Q \leq 27$	$Q \leq 60$	$Q \leq 96$	$Q \leq 60$
Maximum number of connectable indoor units per branch		3	8	8	8
Dimensions (HxWxD)	in.(mm)	7-13/16 x 11-3/4 x 10-9/16 (198 x 298 x 268)			10-1/4 x 25-7/8 x 16-7/8 (260 x 658 x 428)

*1: In case of two RB units connected in series (total 8-branches), maximum capacity of connectable indoor units is up to 191kBTU/h

Optional Parts

For Duct Models

Flange
Round **Rectangular**

UTD-RF204 (Set of 4 pcs) UTD-SF045T

IR Receiver Unit

UTB-YWC

Auto Louver Grille Kit
 For Slim duct type

UTD-GXSA-W (For 7/9/12/14 type)
 UTD-GXSB-W (For 18 type)

Remote Sensor Unit
 Accurate temperature is possible sensing room temperature using a remote sensor unit.

UTY-XSZX

Long-Life Filter

UTD-LF25NA UTD-LF60KA

Drain Pump Unit

UTZ-PX1NBA

Type	Compatibility	Model Name
Flange (Round)	Duct Type (ARUM24-36)	UTD-RF204
Flange (Rectangular)	Duct Type (ARUM24-36)	UTD-SF045T
IR Receiver Unit	All Duct Type	UTB-YWC
Long-Life Filter	High Static Duct Type (ARUH36-60)	UTD-LF60KA
	Duct Type (ARUM24-36)	UTD-LF25NA
Auto Louver Grille Kit	Slim Compact Duct (ARUL7-14)	UTD-GXSA-W
	Slim Compact Duct (ARUL18)	UTD-GXSB-W
Remote Sensor Unit	All Duct Type	UTY-XSZX
Drain Pump Unit	Duct Type (ARUM24-36)	UTZ-PX1NBA

For Cassette Models

Wide Panel

Indoor unit 37.5" (950 mm)
 Panel 23.5" (600 mm)
 23.5" (600 mm)
 UTG-AGYA-W

Air Outlet Shutter Plate
 Closes the air outlet when 3 directional airflow is required.

UTR-YDZC UTR-YDZB

Fresh Air Intake Kit
 For Compact Cassette type For Cassette type

UTZ-VXAA UTZ-VXGA

Panel Spacer

9.5" (242 mm)
 Panel spacer
 UTG-BGYA-W

Insulation Kit For High Humidity

Insulation Kit
 UTZ-KXGA / UTZ-KXGB / UTZ-KXGC

IR Receiver Kit
 Wireless Remote Controller sold separately.

UTY-LRHYB1

Type	Compatibility	Model Name
Wide Panel	Cassette Type (AUUB18-36)	UTG-AGYA-W
Air Outlet Shutter Plate	Cassette Type (AUUB18-36)	UTR-YDZC
	Compact Cassette Type (AUUA7-24)	UTR-YDZB
Fresh Air Intake Kit	Cassette Type (AUUB18-36)	UTZ-VXGA
	Compact Cassette Type (AUUA7-24)	UTZ-VXAA
Panel Spacer	Cassette Type (AUUB18-36)	UTG-BGYA
	Cassette Type (AUUB30-36)	UTZ-KXGA
Insulation Kit for High Humidity	Cassette Type (AUUB18-24)	UTZ-KXGB
	Compact Cassette Type (AUUA7-24)	UTZ-KXGC
	Cassette Type (AUUB18-36)	UTY-LRHYB1

For Ceiling Models

Drain Pump Unit

UTR-DPB24T

Type	Compatibility	Model Name
Drain Pump Unit	Ceiling Type (ABUA30-36)	UTR-DPB24T

Applications

There are many applications for Airstage VRF systems including such markets as education, healthcare, hospitality, utilities, office buildings, apartment buildings, condominiums, and restaurants.

Medical and Healthcare Facilities



VRF gives each patient individual control of their room temperature. Central control ensures that air conditioning is only delivered to rooms that are occupied.

■ **INDIVIDUAL CONTROL**

VRF gives each patient or each room individual control of their room temperature.

■ **CLEAN AIR**

VRF systems can use ductless indoor units reducing the time and expense of maintaining a HVAC system and eliminating the risk of duct-borne molds and bacteria.

■ **CENTRAL CONTROL**

Powerful central control ensures that heating or cooling is only delivered to rooms that are occupied. This provides enormous savings for facilities with revolving occupancy.

■ **RELIABLE PERFORMANCE**

Since each refrigerant circuit has the ability to operate independently, a properly designed VRF system can add a layer of security to a HVAC system. If an individual unit needs to be shut down for repairs, the rest of the system can operate normally.

■ **HEALTHIER FACILITY**

VRF systems can be integrated with fresh air systems to ensure that air quality meets the needs of the occupants. VRF provides the most comfortable environment for all occupants.

■ **INDIVIDUAL COMFORT**

With VRF, each patient can have their own controller to set the room temperature for their maximum comfort.



Educational and Religious Facilities

In a school, an investment in VRF is an investment in your community. VRF is more efficient than conventional systems, providing financial savings to the school for many years. Also, a quiet VRF HVAC system (as quiet as 19 dB) creates a much better learning environment for students.

■ **HEALTHIER FACILITY**

VRF systems can be integrated with fresh air systems to ensure that air quality meets the needs of the teachers and students.

■ **CENTRAL CONTROL**

Powerful central control can monitor and control individual schools, or an entire college campus, from a single location.

■ **ZONING**

Save energy by only heating or cooling the classrooms that are occupied. Set temperature can be pre-programmed to meet the energy budget for the school district.

■ **COMFORT**

VRF helps achieve a healthier, quieter, more comfortable and productive learning environment.

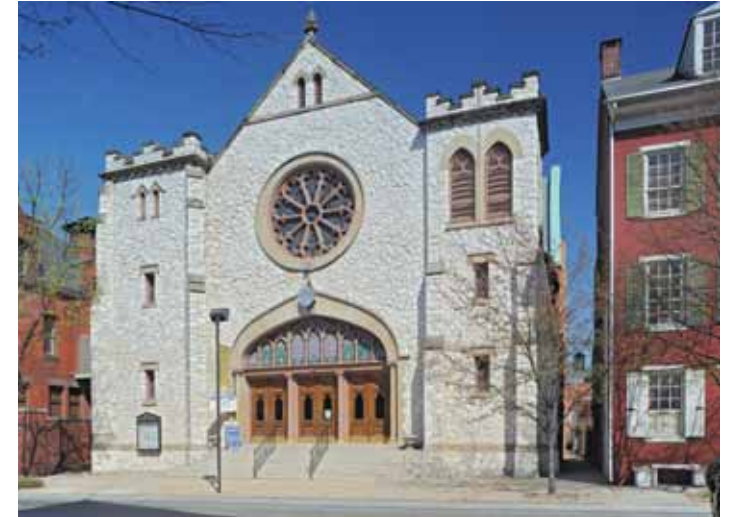



Multi-Tenant Dwellings

VRF improves the quality of multi-tenant buildings while reducing tenant complaints. High quality VRF systems let owners save on energy costs and reduced maintenance costs. With VRF, each tenant has individual control over the temperature setting for the comfort of their home.

■ QUALITY

By delivering quiet, efficient heating and cooling, VRF improves the quality of multi-tenant buildings and reduces tenant complaints.

■ ENERGY SAVINGS

Efficient VRF systems reduce the total energy costs for buildings over most other options. High quality systems reduce maintenance and service costs.

■ INDIVIDUAL BILLING

Using the Energy Charge Apportionment feature, landlords can easily bill each tenant for the percentage of total energy the individual tenant consumes.

■ INDIVIDUAL COMFORT

With VRF, each tenant can have their own controller to set their room temperature for their maximum comfort.

■ CONVENIENT CENTRAL CONTROL

Landlord can monitor and control all indoor units from a central location. Landlord can even troubleshoot or solve tenant complaints remotely.

■ QUIET

Indoor units as quiet as 19dB ensures a quiet, comfortable living environment for all tenants.



Office Buildings and Retail Spaces

VRF provides a comfortable work environment for all employees. Zoning ensures that energy is only used to cool/heat occupied offices. Quiet indoor units and precise temperature control creates the most comfortable and productive work environment.

■ QUIET

Indoor units (as quiet as 19dB) and outdoor units (less than 64dB) creates a pleasant work environment and reduces noise complaints.

■ ZONING

Save energy by only heating or cooling occupied offices. No more hot/cold calls since each zone or tenant has individual control of the set temperature.

■ CONTROL

Powerful controls options can manage and monitor entire building from a single location.



■ EASE OF INSTALLATION

Can be installed in occupied office spaces with minimal disruption to occupants. Can even be installed without disrupting the existing HVAC system.

■ FLEXIBLE

As tenants and office configurations change, VRF system configurations can also be modified (within original design constraints) to meet the needs of new tenants.

■ COMFORT

VRF provides a comfortable work environment for all employees. Quiet indoor units and precise temperature control creates the most comfortable and productive work environment.