

FUJITSU Storage
ETERNUS DX S4/S3 series Hybrid Storage Systems,
ETERNUS AF series, ETERNUS DX200F All-Flash Arrays

ETERNUS CLI User's Guide



CLI operations for configuration, management, and maintenance

This page is intentionally left blank.

Preface

This manual describes how to use the Command Line Interface (CLI) to configure and manage the FUJITSU Storage ETERNUS DX60 S4/DX100 S4/DX200 S4, ETERNUS DX500 S4/DX600 S4, ETERNUS DX60 S3/DX100 S3/DX200 S3, ETERNUS DX500 S3/DX600 S3, ETERNUS DX8100 S3/DX8700 S3/DX8900 S3, ETERNUS AF250 S2/AF650 S2, ETERNUS AF250/AF650, or ETERNUS DX200F (hereinafter referred to as ETERNUS DX/AF).

This manual is written for standard-level users who are familiar with the basic functions of the ETERNUS DX/AF.

This manual is written for controller firmware versions V10L80 (V10L81 for Unified storage) and later. Some of the functions and operations herein may not be supported for firmware versions earlier than V10L80.

Twenty-Fourth Edition
April 2018

Content and Structure

This manual contains the following nine chapters and appendices:

- Chapter 1 Overview

This chapter introduces the ETERNUS DX/AF Command Line Interface (CLI).

- Chapter 2 Status Display

This chapter explains the commands used for displaying the status details for the ETERNUS DX/AF as a whole, as well as for various ETERNUS DX/AF components.

- Chapter 3 Configuration Settings and Display

This chapter explains the commands used for RAID group management, volume management, Thin Provisioning Pool management, Deduplication/Compression management, Flexible Tier management, and host interface management, these being the basic settings for the ETERNUS DX/AF.

- Chapter 4 Copy Function Settings and Display

This chapter explains the commands used for Advanced Copy management.

- Chapter 5 System Settings and Display

This chapter explains the commands used for user account management, network management (Redundant IP/SNMP etc.), date and time/NTP, system configuration (Box ID, storage system name), power synchronization, and SSH/SSL security configuration.

- Chapter 6 Information Settings and Display

This chapter explains the commands used to provide performance data and a variety of other information.

● Chapter 7 NAS Function Setting and Display

This chapter explains the commands related to NAS function management.

● Chapter 8 Storage Cluster Management

This chapter explains the commands related to the management of the Storage Cluster functions.

● Chapter 9 CLI Original Function

This chapter explains the commands used by some original functions of the CLI environment.

The appendices describe "Error Messages/Error Codes", "List of Supported Commands", "Firmware Version Support for Commands", "Basic Setting Examples", "Status List", and "Default Value List".

Latest Information

The information in this manual is subject to change without notice for functionality expansion and improvement of the ETERNUS DX/AF. The latest version of this manual and the latest information for the ETERNUS DX/AF are released in the following web-site. Access the following address if needed.

<http://www.fujitsu.com/global/support/products/computing/storage/disk/manuals/>

Related Manuals

The following manuals contain further relevant information on the ETERNUS DX/AF:

- FUJITSU Storage ETERNUS DX60 S4 Hybrid Storage Systems Overview
- FUJITSU Storage ETERNUS DX60 S3 Hybrid Storage Systems Overview
- FUJITSU Storage ETERNUS DX60 S4, ETERNUS DX60 S3 Hybrid Storage Systems Site Planning Guide
- FUJITSU Storage ETERNUS DX60 S4, ETERNUS DX60 S3 Hybrid Storage Systems Design Guide (Basic)
- FUJITSU Storage ETERNUS DX60 S4, ETERNUS DX60 S3 Hybrid Storage Systems Configuration Guide (Basic)
- FUJITSU Storage ETERNUS DX60 S4, ETERNUS DX60 S3 Hybrid Storage Systems Operation Guide (Basic)

- FUJITSU Storage ETERNUS DX100 S4/DX200 S4 Hybrid Storage Systems Overview
- FUJITSU Storage ETERNUS DX100 S3/DX200 S3 Hybrid Storage Systems Overview
- FUJITSU Storage ETERNUS DX100 S4/DX200 S4, ETERNUS DX100 S3/DX200 S3 Hybrid Storage Systems Site Planning Guide
- FUJITSU Storage ETERNUS DX100 S4/DX200 S4, ETERNUS DX100 S3/DX200 S3 Hybrid Storage Systems Design Guide (Basic)
- FUJITSU Storage ETERNUS DX100 S4/DX200 S4, ETERNUS DX100 S3/DX200 S3 Hybrid Storage Systems Configuration Guide (Basic)
- FUJITSU Storage ETERNUS DX100 S4/DX200 S4, ETERNUS DX100 S3/DX200 S3 Hybrid Storage Systems Operation Guide (Basic)

- FUJITSU Storage ETERNUS DX500 S4/DX600 S4 Hybrid Storage Systems Overview
- FUJITSU Storage ETERNUS DX500 S3/DX600 S3 Hybrid Storage Systems Overview
- FUJITSU Storage ETERNUS DX500 S4/DX600 S4, ETERNUS DX500 S3/DX600 S3 Hybrid Storage Systems Site Planning Guide

- FUJITSU Storage ETERNUS DX500 S4/DX600 S4, ETERNUS DX500 S3/DX600 S3 Hybrid Storage Systems Design Guide (Basic)
- FUJITSU Storage ETERNUS DX500 S4/DX600 S4, ETERNUS DX500 S3/DX600 S3 Hybrid Storage Systems Configuration Guide (Basic)
- FUJITSU Storage ETERNUS DX500 S4/DX600 S4, ETERNUS DX500 S3/DX600 S3 Hybrid Storage Systems Operation Guide (Basic)

- FUJITSU Storage ETERNUS DX8100 S3/DX8700 S3/DX8900 S3 Hybrid Storage Systems Overview
- FUJITSU Storage ETERNUS DX8100 S3/DX8700 S3/DX8900 S3 Hybrid Storage Systems Site Planning Guide
- FUJITSU Storage ETERNUS DX8100 S3/DX8700 S3/DX8900 S3 Hybrid Storage Systems Operation Guide (Basic)

- FUJITSU Storage ETERNUS AF250 S2 All-Flash Arrays Overview
- FUJITSU Storage ETERNUS AF250 All-Flash Arrays Overview
- FUJITSU Storage ETERNUS AF250 S2, ETERNUS AF250 All-Flash Arrays Site Planning Guide
- FUJITSU Storage ETERNUS AF250 S2, ETERNUS AF250 All-Flash Arrays Design Guide (Basic)
- FUJITSU Storage ETERNUS AF250 S2, ETERNUS AF250 All-Flash Arrays Configuration Guide (Basic)
- FUJITSU Storage ETERNUS AF250 S2, ETERNUS AF250 All-Flash Arrays Operation Guide (Basic)

- FUJITSU Storage ETERNUS AF650 S2 All-Flash Arrays Overview
- FUJITSU Storage ETERNUS AF650 All-Flash Arrays Overview
- FUJITSU Storage ETERNUS AF650 S2, ETERNUS AF650 All-Flash Arrays Site Planning Guide
- FUJITSU Storage ETERNUS AF650 S2, ETERNUS AF650 All-Flash Arrays Design Guide (Basic)
- FUJITSU Storage ETERNUS AF650 S2, ETERNUS AF650 All-Flash Arrays Configuration Guide (Basic)
- FUJITSU Storage ETERNUS AF650 S2, ETERNUS AF650 All-Flash Arrays Operation Guide (Basic)

- FUJITSU Storage ETERNUS DX200F All-Flash Arrays Overview
- FUJITSU Storage ETERNUS DX200F All-Flash Arrays Site Planning Guide
- FUJITSU Storage ETERNUS DX200F All-Flash Arrays Design Guide (Basic)
- FUJITSU Storage ETERNUS DX200F All-Flash Arrays Configuration Guide (Basic)
- FUJITSU Storage ETERNUS DX200F All-Flash Arrays Operation Guide (Basic)

- FUJITSU Storage ETERNUS DX S4/S3 series Hybrid Storage Systems Configuration Guide (NAS)
- FUJITSU Storage ETERNUS DX, ETERNUS AF Configuration Guide -Server Connection- (*1)
- FUJITSU Storage ETERNUS DX S4/S3 series Hybrid Storage Systems, ETERNUS AF series, ETERNUS DX200F All-Flash Arrays Configuration Guide (Web GUI)
- FUJITSU Storage ETERNUS DX S4/S3 series Hybrid Storage Systems, ETERNUS AF series, ETERNUS DX200F All-Flash Arrays ETERNUS Web GUI User's Guide
- FUJITSU Storage ETERNUS DX S4/S3 series Hybrid Storage Systems, ETERNUS AF series, ETERNUS DX200F All-Flash Arrays Message List
- FUJITSU Storage ETERNUS SF Storage Cruiser Operation Guide

*1: Download the necessary manuals to match the environment (such as the server OS and the Fibre Channel card type) from the specified Web site.

Trademarks

- Microsoft, Windows, and Windows Server are either registered trademarks or trademarks of Microsoft Corporation in the United States and/or other countries.
- Oracle and Java are registered trademarks of Oracle and/or its affiliates.
- IBM, AIX, and Tivoli are trademarks of International Business Machines Corporation, registered in many jurisdictions worldwide.
- Linux® is the registered trademark of Linus Torvalds in the U.S. and other countries.
- HP-UX is a trademark of Hewlett-Packard Company in the United States and other countries.
- VMware, VMware logos, Virtual SMP, and VMotion are either registered trademarks or trademarks of VMware, Inc. in the U.S. and/or other countries.
- Veritas and the Veritas Logo are trademarks or registered trademarks of Veritas Technologies LLC or its affiliates in the U.S. and other countries.
- VxWorks is the registered trademark of Wind River Systems, Inc.
- The company names, product names and service names mentioned in this document are registered trademarks or trademarks of their respective companies.

Additional Information

■ Naming conventions

- Oracle Solaris might be described as Solaris, Solaris Operating System, or Solaris OS.
- The following abbreviations are used for Microsoft® Windows Server®.

Official name	Abbreviation
Microsoft® Windows Server® 2008 R2 Datacenter	Windows Server 2008 R2
Microsoft® Windows Server® 2008 R2 Enterprise	
Microsoft® Windows Server® 2008 R2 Standard	
Microsoft® Windows Server® 2008 R2 for Itanium-Based Systems	
Microsoft® Windows Server® 2008 R2 HPC Edition	
Microsoft® Windows Server® 2008 Datacenter	Windows Server 2008
Microsoft® Windows Server® 2008 Enterprise	
Microsoft® Windows Server® 2008 Standard	
Microsoft® Windows Server® 2008 for Itanium-Based Systems	
Microsoft® Windows Server® 2008 HPC Edition	

■ Typographic conventions

Typeface	Meaning	Example
[]	Brackets indicate that the enclosed parameter is optional.	[<i>parameter</i>]
[]	A separator within brackets indicates that only one of the separated parameters can be specified.	[<i>parameter</i> <i>parameter</i>]
{ }	A separator within braces indicates that only one of the separated parameters must be specified.	{ <i>parameter</i> <i>parameter</i> }
	<div style="border: 1px solid black; padding: 5px; margin: 10px 0;">  Caution Note that some cases, two or more parameters can be specified by separating them with a comma. </div>	

- Italics are used to show variables such as values and characters that appear in command parameters and outputs.

■ ETERNUS DX/AF naming conventions

The following naming conventions are used in this manual for the ETERNUS DX/AF models.

Storage system models	Naming conventions
ETERNUS DX60 S4/DX100 S4/DX200 S4, ETERNUS DX500 S4/DX600 S4, ETERNUS DX60 S3/DX100 S3/DX200 S3, ETERNUS DX500 S3/DX600 S3, ETERNUS DX8100 S3/DX8700 S3/DX8900 S3 Hybrid Storage Systems ETERNUS DX200F All-Flash Arrays	ETERNUS DX
ETERNUS DX60 S4/DX100 S4/DX200 S4, ETERNUS DX500 S4/DX600 S4, ETERNUS DX60 S3/DX100 S3/DX200 S3, ETERNUS DX500 S3/DX600 S3, ETERNUS DX8100 S3/DX8700 S3/DX8900 S3 Hybrid Storage Systems ETERNUS AF250 S2/AF650 S2, ETERNUS AF250/AF650, ETERNUS DX200F All-Flash Arrays	ETERNUS DX/AF
ETERNUS DX60 S4/DX100 S4/DX200 S4 Hybrid Storage Systems	DX60 S4/DX100 S4/DX200 S4
ETERNUS DX500 S4/DX600 S4 Hybrid Storage Systems	DX500 S4/DX600 S4
ETERNUS DX60 S3/DX100 S3/DX200 S3 Hybrid Storage Systems	DX60 S3/DX100 S3/DX200 S3
ETERNUS DX500 S3/DX600 S3 Hybrid Storage Systems	DX500 S3/DX600 S3
ETERNUS DX8100 S3/DX8700 S3/DX8900 S3 Hybrid Storage Systems	DX8100 S3/DX8700 S3/DX8900 S3
ETERNUS DX60 S4/DX100 S4/DX200 S4, ETERNUS DX500 S4/DX600 S4 Hybrid Storage Systems	ETERNUS DX S4 series
ETERNUS DX60 S3/DX100 S3/DX200 S3, ETERNUS DX500 S3/DX600 S3, ETERNUS DX8100 S3/DX8700 S3/DX8900 S3 Hybrid Storage Systems	ETERNUS DX S3 series
ETERNUS DX60 S2/DX80 S2/DX90 S2, ETERNUS DX410 S2/DX440 S2, ETERNUS DX8100 S2/DX8700 S2 Hybrid Storage Systems	ETERNUS DX S2 series
ETERNUS AF250 S2/AF650 S2, ETERNUS AF250/AF650 All-Flash Arrays	ETERNUS AF ETERNUS AF series

Storage system models	Naming conventions
ETERNUS AF250 S2/AF650 S2 All-Flash Arrays	ETERNUS AF S2 series
	AF250 S2/AF650 S2
ETERNUS AF250/AF650 All-Flash Arrays	AF250/AF650
ETERNUS AF250 S2 All-Flash Arrays	AF250 S2
ETERNUS AF650 S2 All-Flash Arrays	AF650 S2
ETERNUS AF250 All-Flash Arrays	AF250
ETERNUS AF650 All-Flash Arrays	AF650
ETERNUS DX200F All-Flash Arrays	DX200F

■ Symbol conventions

The following symbols are used throughout this manual:



This symbol indicates restrictions and cautions for setting up and operating the ETERNUS DX/AF.

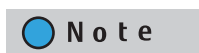

This symbol indicates supplementary information about functions and methods that may be useful when setting up and operating the ETERNUS DX/AF.

Table of Contents

Chapter 1	Overview	28
1.1	Accessing CLI	29
1.1.1	User Policy	30
1.2	The Command Syntax	32
1.2.1	Command Format	32
1.2.2	Keywords and Parameters	33
1.2.3	Controller Enclosure Syntax	34
1.2.4	Drive Enclosure Syntax	34
1.2.5	Drive Syntax	35
1.2.6	Alias Name Syntax	35
1.2.7	Thin Provisioning Pool Syntax	36
1.2.8	Flexible Tier Pool Syntax	37
1.2.9	Flexible Tier Sub Pool Syntax	38
1.2.10	RAID Group Syntax	39
1.2.11	Volume Syntax	40
1.2.12	Host Syntax	41
1.2.13	Host Group Syntax	42
1.2.14	Host Response Syntax	43
1.2.15	Host Interface Port Syntax	44
1.2.16	Port Group Syntax	45
1.2.17	LUN Group Syntax	46
1.2.18	Eco-mode Schedule Syntax	47
1.2.19	Server Syntax	47
1.2.20	Domain Syntax	47
1.2.21	Shared Folder Syntax	48
1.2.22	Shared Folder Owner Name or Group Name Syntax	48
1.2.23	NFS Connection Host, CIFS Connection Host, or NFS/CIFS Connection Host Syntax	49
1.2.24	CIFS User Name or CIFS Group Name Syntax	49
1.3	Size of Drives and Logical Units	50
1.4	Command Auto-complete and History Recall	50
1.5	Command Editing Hotkeys	51
1.6	Viewing Command Help	52
1.7	Error Message Format	53
1.8	Multiple Sessions	53
1.9	Slave Controller Logins	54

1.10	CLI User Authority	54
1.11	Note for Specifying FTP Server	54
1.12	Command Descriptions	54
Chapter 2	Status Display	55
2.1	Storage System Status	56
	show status	58
	show enclosure-status	59
	show fru-ce	70
	show fru-fe	96
	show fru-de	104
	show disks	107
	show hardware-information	111
Chapter 3	Configuration Settings and Display	113
3.1	RAID Group Management	114
3.1.1	RAID Group	114
	show raid-groups	115
	show raid-group-progress	118
	create raid-group	120
	set raid-group	122
	delete raid-group	124
	expand raid-group	125
3.1.2	Hot Spares	127
	set global-spare	128
	release global-spare	129
	set dedicated-spare	130
	release dedicated-spare	131
3.1.3	Eco-mode Management	132
	show eco-mode	133
	set eco-mode	134
	show eco-schedule	135
	create eco-schedule	137
	set eco-schedule	140
	delete eco-schedule	143
	show eco-raid-group	144
	set eco-raid-group	145
	release eco-raid-group	147
3.2	Volume Management	148
3.2.1	Volume	148
	show volumes	149
	show volume-progress	159

	show volume-mapping	161
	create volume	164
	set volume	172
	delete volume	174
	delete all-volumes	176
	format volume	178
	expand volume	180
	set volume-parameters	183
	show migration	185
	start migration	186
	stop migration	191
	show balancing-thin-pro-volumes	192
	start balancing-thin-pro-volume	194
	stop balancing-thin-pro-volume	195
	start zero-reclamation	196
	stop zero-reclamation	197
	show volume-qos	198
	set volume-qos	200
3.2.2	Flexible Tier Volumes	202
	create flexible-tier-volume	203
	set flexible-tier-volume	206
	format flexible-tier-volume	208
	expand flexible-tier-volume	209
	delete flexible-tier-volume	210
	delete all-flexible-tier-volumes	211
	start flexible-tier-migration	212
3.2.3	ODX Buffer Volume	214
	show odx-mode	215
	set odx-mode	216
	create odx-buffer-volume	217
	set odx-buffer-volume	220
	delete odx-buffer-volume	222
3.2.4	Extreme Cache	223
	show extreme-cache	225
	set extreme-cache	228
	set volume-exc	231
	show extreme-cache-pool	233
	create extreme-cache-pool	235
	delete extreme-cache-pool	237
3.2.5	WVOL	238
	show wvol-mode	239
	set wvol-mode	240
	show wvol-task	241
3.3	Thin Provisioning Pool Management	245
3.3.1	Thin Provisioning Pool	245
	show thin-provisioning	250

	set thin-provisioning	251
	show thin-pro-pools	254
	show thin-pro-pool-progress	257
	create thin-pro-pool	259
	set thin-pro-pool	264
	delete thin-pro-pool	266
	expand thin-pro-pool	267
	format thin-pro-pool	269
3.3.2	Thin Provisioning Pool Eco-mode Management	270
	show eco-thin-pro-pool	272
	set eco-thin-pro-pool	273
	release eco-thin-pro-pool	275
3.4	Deduplication/Compression	276
3.5	Flexible Tier Management	281
3.5.1	Flexible Tier Pool	281
	show flexible-tier-mode	282
	show flexible-tier-pools	283
	show flexible-tier-pool-progress	286
	delete flexible-tier-pool	289
	show flexible-tier-sub-pools	290
	set flexible-tier-sub-pool	293
	stop shrinking-flexible-tier-pool	294
3.5.2	FTRPE Migration	295
	show ftrpe-migration	296
3.5.3	FTRP Balancing	297
	show balancing-flexible-tier-pools	298
	start balancing-flexible-tier-pool	300
	stop balancing-flexible-tier-pool	301
3.6	Host Interface Management	302
3.6.1	Host Interface Port Parameters	305
	show fc-parameters	306
	set fc-parameters	311
	show sas-parameters	315
	set sas-parameters	316
	show iscsi-parameters	318
	set iscsi-parameters	323
	show fcoe-parameters	333
	set fcoe-parameters	336
3.6.2	Host Identifiers (Host Alias)	339
	show host-wwn-names	340
	create host-wwn-name	341
	set host-wwn-name	343
	delete host-wwn-name	345
	discover host-wwn-names	346
	show host-sas-addresses	348

	create host-sas-address	349
	set host-sas-address	351
	delete host-sas-address	353
	discover host-sas-addresses	354
	show host-iscsi-names	355
	create host-iscsi-name	357
	set host-iscsi-name	360
	delete host-iscsi-name	363
	discover host-iscsi-names	364
3.6.3	Mapping (When LUN Groups are Used)	366
	show host-affinity	367
	set host-affinity	373
	copy host-affinity	377
	release host-affinity	379
3.6.4	Mapping (When Host Affinity Mode is Not Used)	382
	show mapping	383
	set mapping	387
	copy mapping	389
	release mapping	391
3.6.5	Host Groups	393
	show host-groups	394
	create host-group	397
	set host-group	399
	delete host-group	401
3.6.6	Port Groups	402
	show port-groups	403
	create port-group	405
	set port-group	406
	delete port-group	408
3.6.7	LUN Groups	409
	show lun-groups	410
	create lun-group	412
	set lun-group	414
	copy lun-group	416
	delete lun-group	417
	show host-path-state	418
	set host-path-state	420
	show host-lu-qos-performance	421
	start host-lu-qos-performance	429
	stop host-lu-qos-performance	430
3.6.8	Host Response	431
	show host-response	432
	set host-response	435
	delete host-response	440
3.6.9	Host Sense Conversion	441
	show host-sense	442

	set host-sense	443
	delete host-sense	445
3.6.10	Reset Group for Host Interface Port	446
	show ca-reset-group	447
	set ca-reset-group	449
3.6.11	Ping Command for iSCSI Hosts	450
	test iscsi-ping	451
3.6.12	Host LU QoS	453
	show qos-mode	454
	set qos-mode	455
	show lu-qos-groups	456
	set lu-qos-group	458
	delete lu-qos-group	460
	show host-lu-qos	461
	set host-lu-qos	467
	show qos-schedule	471
	set qos-schedule	472
	delete all-qos-setting	475
3.6.13	Login Host Display	476
	show ca-port-login-host	477

Chapter 4 Copy Function Settings and Display 481

4.1	Advanced Copy Management	482
4.1.1	SnapOPC+ Outline	483
4.1.2	Preparations for the Advanced Copy Function	483
4.1.3	Copy Session Management	488
	show advanced-copy-license	490
	set advanced-copy-license	491
	delete advanced-copy-license	492
	show advanced-copy-policy	493
	set advanced-copy-policy	494
	show advanced-copy-parameters	495
	set advanced-copy-parameters	496
	show snap-data-volume	498
	initialize snap-data-volume	499
	show snap-data-pool	500
	delete snap-data-pool-volume	501
	show advanced-copy-sessions	502
	start advanced-copy	507
	stop advanced-copy	508
4.1.4	Remote Equivalent Copy Management	509
	show host-port-mode	523
	set host-port-mode	524
	show rec-path	526
	import rec-path	529

	show backup-rec-path-information	531
	export backup-rec-path	532
	convert rec-path	534
	measure rec-round-trip-time	536
	set rec-round-trip-time	538
	set rec-multiplicity	539
	show rec-buffer	541
	set rec-buffer	542
	delete rec-buffer	546
	show rec-disk-buffer	547
	create rec-disk-buffer	549
	set rec-disk-buffer	551
	delete rec-disk-buffer	553
	format rec-disk-buffer	554
	release rec-disk-buffer	555
	set rec-path-qos	557
Chapter 5	System Settings and Display	559
5.1	User Management	560
5.1.1	Role	561
	show role	562
	create role	563
	set role	565
	delete role	567
5.1.2	User Policy	568
	show user-policy	570
	set user-policy	571
	show users	574
	create user	576
	set user	578
	delete user	580
	show login-users	581
	set password	582
	initialize all-users	584
5.1.3	Account Authentication	585
	import ssh-public-key	586
	delete ssh-public-key	588
	show maintenance-key	589
5.1.4	RADIUS Server Settings	591
	show radius	592
	set radius	594
5.2	Network Management	597
5.2.1	Network Settings	597
	show network	598

	set network	602
	show firewall	608
	set firewall	610
	show network-stat	614
	test network	618
5.2.2	SNMP	620
	show snmp	621
	set snmp	622
	show snmp-manager	624
	create snmp-manager	625
	set snmp-manager	626
	delete snmp-manager	627
	show snmp-view	628
	create snmp-view	630
	set snmp-view	632
	delete snmp-view	634
	show snmp-user	635
	create snmp-user	637
	set snmp-user	639
	delete snmp-user	641
	show community-profile	642
	create community-profile	644
	set community-profile	646
	delete community-profile	648
	show snmp-trap	649
	set snmp-trap	650
	delete snmp-trap	652
	test snmp-trap	653
	export enhanced-mib	654
5.2.3	E-mail Notification	656
	show email-notification	657
	set email-notification	659
	test email	664
5.2.4	Event Notification	665
	show event-notification	666
	set event-notification	669
	show lcd-suppress	683
	set lcd-suppress	684
5.2.5	SMI-S	686
	show smi-s	687
	set smi-s	688
5.2.6	SSH/SSL Security Configuration	689
	create ssh-server-key	691
	create ssl-certificate	692
	export ssl-certificate-request	694
	import ssl-certificate	698

	show ssl-version	700
	set ssl-version	701
5.2.7	AIS Connect Settings	703
	show ais-connect	704
	set ais-connect	706
	set ais-connect-remote-session	711
	test ais-connect	712
	send ais-connect-log	713
	test ais-connect-event-notification	714
	import ais-ssl-certificate	715
	show ais-communication-log	716
	set remote-support-mode	717
5.3	System Settings	718
5.3.1	Date, Time and NTP	718
	show date	719
	set date	720
	show ntp	723
	set ntp	724
5.3.2	ETERNUS DX/AF Name	726
	show storage-system-name	727
	set storage-system-name	728
5.3.3	Encryption Mode	729
	show encryption	730
	set encryption	731
5.3.4	Box ID	732
	show boxid	733
	set boxid	734
5.3.5	Power Synchronization	735
	show power-synchronization	736
	set power-synchronization	738
5.3.6	Self-Encrypting Drive (SED) Authentication Settings	741
	show sed-authentication	742
	set sed-authentication	743
5.3.7	Syslog Server Settings	744
	show syslog-notification	745
	set syslog-notification	746
5.3.8	Audit Log Settings	748
	show audit	749
	set audit	750
5.3.9	Key Management Server Linkage Function	752
	show sed-key-machine-name	754
	set sed-key-machine-name	755
	show sed-key-servers	756
	set sed-key-server	757
	import ssl-kmip-certificate	758
	show sed-key-groups	759

	create sed-key-group	761
	set sed-key-group	763
	delete sed-key-group	765
	change sed-key	766
	recover sed-key-group	767
5.3.10	Power-Off/Reboot System	768
	shutdown	769
5.3.11	Deduplication/Compression Mode Setting	770
	show dedup-mode	771
	set dedup-mode	772
5.3.12	Unified License Configuration	773
5.3.13	Non-disruptive Storage Migration Function	774
	show non-disruptive-storage-migration	779
	set non-disruptive-storage-migration	780
	discover external-storage	781
	show external-drive	783
	create external-drive	787
	delete external-drive	789
	show external-raid-group	790
	create external-raid-group	792
	delete external-raid-group	794
	recover external-raid-group	795
Chapter 6	Information Settings and Display	796
6.1	Performance	797
6.1.1	Performance Information	797
	show performance	798
	start performance	806
	stop performance	807
6.1.2	Performance Tuning Parameters	808
	show raid-tuning	809
	set raid-tuning	810
	show cache-parameters	812
	set cache-parameters	813
6.2	Event Log Information	816
	show events	817
	delete events	819
6.3	Environment Information	820
	show power-consumption	821
6.4	Maintenance Operation and Maintenance Information	823
6.4.1	Hardware Maintenance	823
	hot expansion	825

6.4.2	Remote Directory	826
	show remote-dir	827
6.4.3	Controller Firmware	829
	show firmware-version	830
6.4.4	Log	831
	export log	832
6.4.5	Panic Dump	836
	show panic-dump	837
	export panic-dump	838
6.4.6	Configuration Information	840
	show config-information	841
	export config-information	842
6.4.7	Error Information	844
	show disk-error	845
	clear disk-error	846
	show port-error	847
6.4.8	Bad Data Information in Volumes	853
	show bad-data-info	854
6.5	Utility	855
6.5.1	Diagnostic Utilities	855
	show diagnosis	856
6.5.2	LED	861
	show led	862
	set led	864
6.5.3	Other Notification	866
	show event-parameters	867
	set event-parameters	868
6.5.4	Subsystem Parameters	869
	show subsystem-parameters	870
	set subsystem-parameters	872
6.5.5	Reservations	877
	show reservation	878
	release reservation	880
6.5.6	Cache Utilities	881
	show pinned-data	882
6.5.7	Disk Patrol	883
	show disk-patrol	884
	set disk-patrol	885

Chapter 7 NAS Function Setting and Display 886

7.1	Shared Folders	890
	show nas-share	892
	create nas-share	896
	set nas-share	908

	delete nas-share	921
	clear nas-data	923
	show nas-share-progress	924
	show nas-home-directory	927
	delete nas-home-directory	931
7.2	Network Interface	933
	show nas-interface	934
	create nas-interface	936
	set nas-interface	939
	delete nas-interface	942
7.3	Network Interface Bonding Settings	943
	show nas-bonding	944
	set nas-bonding	945
	delete nas-bonding	947
7.4	Network Interface Multipath Configuration	949
	show nas-multipath	950
	set nas-multipath	951
	delete nas-multipath	952
7.5	Network Settings	953
	show nas-port	954
	set nas-port	956
	show nas-dns	959
	set nas-dns	960
	show nas-route	962
	set nas-route	964
	delete nas-route	966
	show nas-route6	968
	set nas-route6	970
	delete nas-route6	972
7.6	NAS Server Configuration	973
	show nas-server	975
	set nas-server	976
	show nas-cache-distribution	979
	initialize nas-cache-distribution	980
7.7	Authentication Settings	981
	show nas-ad	983
	set nas-ad	984
	show nas-ldap	986
	set nas-ldap	987
	show nas-local-user	989
	create nas-local-user	992
	set nas-local-user	995
	delete nas-local-user	998

	show nas-local-group	999
	create nas-local-group	1001
	delete nas-local-group	1003
7.8	FTP/FXP Function	1004
	show nas-ftp	1005
	set nas-ftp	1006
	delete nas-ftp	1007
7.9	Network Connection Testing	1008
	test nas-ping	1009
	test nas-ping6	1010
	test nas-traceroute	1011
	test nas-traceroute6	1012
7.10	File System Maintenance	1013
	show nas-df	1014
	show nas-fsstat	1016
	show nas-fsmntstat	1017
	reconfigure nas-fs	1018
7.11	Snapshot	1019
	show nas-snapshot	1020
	set nas-snapshot	1023
	delete nas-snapshot	1026
	start nas-snapshot	1027
	stop nas-snapshot	1028
7.12	Quota	1029
	show nas-quota	1030
	create nas-quota	1033
	set nas-quota	1037
	delete nas-quota	1039
7.13	NAS Packet Capture	1040
	show nas-pcap	1041
	start nas-pcap	1042
	stop nas-pcap	1043
	clear nas-pcap	1044
7.14	NAS Audit Log	1045
	show nas-audit	1046
	set nas-audit	1047
	show nas-audit-log-information	1048
	clear nas-audit-log	1050
7.15	NAS Engine User Setting	1051
	show nas-engine-user	1052
	create nas-engine-user	1053
	delete nas-engine-user	1055

7.16	NAS Function Restoration	1056
	forced nas-fsmount	1058
	forced nas-fsunmount	1060
	forced nas-fsoffline	1061
	forced nas-fsonline	1062
	show nas-fsck	1063
	start nas-fsck	1064
	forced nas-fslock	1066
	recover nas-engine	1067
	forced online	1068
	show nas-log-info	1069
	set nas-log-info	1070
	show nas-lock	1072
	delete nas-lock	1074
	show nas-file-inflate	1076
	start nas-file-inflate	1079
	stop nas-file-inflate	1082
Chapter 8 Storage Cluster Management		1083
8.1	Storage Cluster	1084
	show storage-cluster-license	1086
	set storage-cluster-license	1087
	delete storage-cluster-license	1089
	show tfo-groups	1090
	create tfo-group	1092
	set tfo-group	1095
	delete tfo-group	1098
	show tfo-pair	1100
	set tfo-pair	1106
	release tfo-pair	1107
	recover tfo-pair	1109
	forced tfo-group-activate	1111
Chapter 9 CLI Original Function		1112
9.1	CLI Environment	1113
	set clienv-force-unlock	1114
	set clienv-idle-timeout	1115
	logoff/logout/exit	1116
	help	1117

Appendix A	Error Messages/Error Codes	1119
<hr/>		
A.1	Error Messages	1119
A.2	Error Codes.....	1185
A.2.1	Copy Session Error Codes	1185
Appendix B	List of Supported Commands	1186
<hr/>		
B.1	List of Supported Commands (of the Target Model).....	1186
B.2	List of Supported Commands (Policies).....	1204
B.3	List of Supported Commands (Default Roles).....	1219
Appendix C	Firmware Version Support for Commands	1231
<hr/>		
Appendix D	Basic Setting Examples	1244
<hr/>		
D.1	Settings When Using Volumes	1244
D.1.1	RAID Configuration Setting Procedure	1245
D.1.2	Host Access Setting Procedure.....	1246
D.2	Settings for Various Host Accesses	1247
D.2.1	Specifying a Host and Performing Mapping (Host Affinity Mode).....	1248
D.2.2	Specifying a Port Group and Performing LUN Mapping.....	1249
D.2.3	Specifying a Port and Setting LUN Mapping	1249
D.3	Setting Cancellation.....	1250
D.3.1	Canceling Mapping.....	1251
D.3.2	Deleting LUN Groups	1251
D.3.3	Deleting Port Groups	1252
D.3.4	Deleting Host Groups.....	1252
D.3.5	Deleting Registered Hosts	1252
D.3.6	Deleting Volumes	1253
D.3.7	Deleting RAID Groups	1253
Appendix E	Status List	1254
<hr/>		
E.1	General Status	1254
E.2	Component Status	1254
E.3	Drive Status	1255
E.4	Volume Status.....	1255

E.5	Pool Status (TPP/FTRP/FTSP Status)	1256
E.6	RAID Group Status.....	1257
E.7	Key Status.....	1257
E.8	Key Server Status	1258
Appendix F Default Value List		1259

List of Figures

Figure 3.1	Relationship between TPPs and TPVs	247
Figure 3.2	Overview of the Thin Provisioning Pool Eco-mode setting	271
Figure 4.1	SnapOPC+ outline	483
Figure 4.2	Overview of the path information file	511
Figure 4.3	Example of an REC path information file	517
Figure 4.4	Overview of REC multiplicity	519
Figure 4.5	Structure of an REC disk buffer	521
Figure 4.6	Setup procedure for an REC disk buffer	522
Figure 5.1	RADIUS server overview	591
Figure 5.2	How to register the SSL certificate	690
Figure 5.3	Syslog server overview	744
Figure 5.4	Audit log function overview	748
Figure 5.5	Non-disruptive Storage Migration function overview	774
Figure 5.6	Structure of the Non-disruptive Storage Migration function	777
Figure D.1	Host connection example	1246

List of Tables

Table 1.1	List of the US-ASCII character codes (hexadecimal)	33
Table 1.2	Drive and logical unit sizes	50
Table 1.3	List of command editing hotkeys	51
Table 5.1	Default roles and policies	561
Table A.1	List of error messages.....	1119
Table A.2	List of copy session error codes.....	1185
Table B.1	List of supported commands for status display (of the target model)	1186
Table B.2	List of supported commands for RAID group management (of the target model)	1186
Table B.3	List of supported commands for volume management (of the target model)	1187
Table B.4	List of supported commands for Thin Provisioning Pool management (of the target model).....	1189
Table B.5	List of supported commands for Flexible Tier management (of the target model).....	1189
Table B.6	List of supported commands for host interface management (of the target model)	1190
Table B.7	List of supported commands for Advanced Copy management (of the target model)	1192
Table B.8	List of supported commands for user management (of the target model)	1193
Table B.9	List of supported commands for network management (of the target model)	1194
Table B.10	List of supported commands for system management (of the target model).....	1196
Table B.11	List of supported commands for performance management (of the target model).....	1198
Table B.12	List of supported commands for event log information management (of the target model)	1198
Table B.13	List of supported commands for environmental information management (of the target model)	1198
Table B.14	List of supported commands for maintenance operation and maintenance information management (of the target model)	1198
Table B.15	List of supported commands for utility management (of the target model)	1199
Table B.16	List of supported commands for NAS function management (of the target model)	1200
Table B.17	List of supported commands for Storage Cluster management (of the target model)	1203
Table B.18	List of supported commands for CLI original function management (of the target model)	1203
Table B.19	List of supported commands (policies)	1204
Table B.20	List of supported commands (default roles)	1219
Table E.1	List of general statuses.....	1254
Table E.2	List of component statuses.....	1254
Table E.3	List of drive statuses.....	1255
Table E.4	List of volume statuses.....	1255
Table E.5	List of pool statuses.....	1256
Table E.6	List of RAID group statuses	1257
Table E.7	List of key statuses	1257
Table E.8	List of key server statuses.....	1258
Table F.1	List of the default values for RAID group management commands	1259
Table F.2	List of the default values for volume management commands.....	1259
Table F.3	List of the default values for Thin Provisioning management commands	1260
Table F.4	List of the default values for Flexible Tier management commands.....	1260
Table F.5	List of the default values for host interface management commands.....	1260
Table F.6	List of the default values for Advanced Copy management commands.....	1263
Table F.7	List of the default values for user management commands.....	1264
Table F.8	List of the default values for network management commands.....	1264
Table F.9	List of the default values for system management commands.....	1267
Table F.10	List of the default values for performance management commands.....	1268
Table F.11	List of the default values for maintenance operation/information management commands.....	1268
Table F.12	List of the default values for utility management commands	1269
Table F.13	List of the default values for NAS function management commands	1270

Table F.14	List of the default values for Storage Cluster management commands.....	1271
Table F.15	List of the default values for management commands for CLI original functions	1271

Chapter 1

Overview

The ETERNUS DX/AF command line interface (hereinafter referred to as "CLI") is installed in controllers of the ETERNUS DX/AF. The CLI is used for performing settings and maintenance via commands and command scripts.

This chapter describes the outlines for the CLI.

Note

- Self-Encrypting Drives (SED) cannot be installed in the DX60 S4/DX60 S3. Therefore, functions that are related to SEDs are unavailable.
 - There are no drive enclosures in the DX200F. Therefore, functions that are related to drive enclosures are unavailable. In addition, the controller enclosure only has SSDs installed.
 - The functions that are supported in each model vary. For details of the latest support status, refer to "Design Guide (Basic)" of each model.
-

1.1 Accessing CLI

The CLI software embedded in each ETERNUS DX/AF controller module enables storage systems to be configured, monitored, and managed. This may be done via LAN connection to the controller module's Ethernet port, using telnet, an SSH application, or a terminal emulator on a remote administrator client. For telnet connection, a user name and password are required. For SSH, in addition to a user name and password, SSH public key authentication is also supported. For details, refer to the description of the "import ssh-public-key" command.

Default IP address, user name, and password are as follows:

IP address:	192.168.1.1
user name:	root
password:	root

The default IP address is assigned to the following ports.

- With the DX60 S4/DX100 S4/DX200 S4, the DX60 S3/DX100 S3/DX200 S3, the AF250 S2/AF250, and the DX200F RMT port
- With the DX500 S4/DX600 S4, the DX500 S3/DX600 S3, the DX8100 S3/DX8700 S3/DX8900 S3, and the AF650 S2/AF650 FST port

The network for the MNT port must be configured from the "set network" command.

CLI will display the following pre-login message on the terminal:

```
ETERNUS login is required. [2010-01-01 05:38:00]
```

The date and time are the local values. However, this message may not be displayed when logged in with SSH. This is due to the fact it depends on terminal software.

■ Non-interactive CLI command execution

Use of SSH public key authentication enables non-interactive (scriptable) CLI command execution. Perform the following procedure to execute the CLI command interactively:

Procedure

- 1 Create a key pair for SSH authentication in a client.
- 2 Convert the created public key file into IETF format.
- 3 Register the public key in the ETERNUS DX/AF.
- 4 Check that CLI is available in the ETERNUS DX/AF by using the public key authentication.
- 5 Execute a CLI command using a here document in the SSH client.

End of procedure

If the password has expired, only the following commands can be used.

- logoff/logout/exit
- set clienv-force-unlock
- show maintenance-key
- apply firmware -application-type hot-continue (*1)
- show diagnosis -type raid-groups
- show diagnosis -type disks
- stop diagnosis -type raid-groups (*1)
- stop diagnosis -type disks (*1)
- clear diagnosis -type raid-groups (*1)
- clear diagnosis -type disks (*1)
- set password (*2)

*1: The Maintenance Operation policy is required.

*2: The "-name" parameter of the "set password" command cannot be specified. If the "-name" parameter is specified, the error message "E8007" is displayed.

If the message for a password change is displayed, change the password using the "set password" command. The usage restriction on the commands is removed when the account is logged back in after the password change.

■ Account lockout

If the number of logon failures for a lockout is set in the account lockout policy, when the wrong password is entered in succession, that account cannot log in for a fixed period of time.

1.2 The Command Syntax

This section explains command syntax.

1.2.1 Command Format

The command format is as follows:

Command name Parameter Parameter . . . Parameter

command-name: Verb section + Object section (Ex: create volume)

parameter: Hyphen(-) + Parameter name section + Operand section (Ex: -n 80)

- Basically, a command name consists of a verb section and an object section (Example: "create volume"). However, there are also some commands that consist of one word (Example: "logoff" and "shutdown").
- A parameter consists of a parameter name section and an operand section. A parameter name is appended with a hyphen (-) before it (Example: "-name").
- An operand is always required after a parameter name (Example: "-name abcdef").
- The maximum length of the CLI command including the command names and the parameters is 5,120 characters.

1.2.2 Keywords and Parameters

Command and parameter names are not case-sensitive and can be entered in either or both uppercase and lowercase. Operands, however, are case-sensitive. Any of the printable US-ASCII codes 0x20 – 0x7E (hexadecimal notation) are allowed as input characters. Note that the following additional restrictions apply:

- Question marks (?) cannot be used.
- When spaces () are used as characters, they must be enclosed by double quotation marks (") (Example: "ABC DEF","ABC DEF,GHIJKL").
- When double quotation marks (") and single quotation marks (') are used as characters, they must be escaped with a backslash (\). Example: \"

A list of the US-ASCII character codes (hexadecimal) is shown below.

Table 1.1 List of the US-ASCII character codes (hexadecimal)

Symbol	US-ASCII code	Symbol	US-ASCII code	Symbol	US-ASCII code	Symbol	US-ASCII code
(space)	0x20	8	0x38	P	0x50	h	0x68
!	0x21	9	0x39	Q	0x51	i	0x69
"	0x22	:	0x3A	R	0x52	j	0x6A
#	0x23	;	0x3B	S	0x53	k	0x6B
\$	0x24	<	0x3C	T	0x54	l	0x6C
%	0x25	=	0x3D	U	0x55	m	0x6D
&	0x26	>	0x3E	V	0x56	n	0x6E
'	0x27	?	0x3F	W	0x57	o	0x6F
(0x28	@	0x40	X	0x58	p	0x70
)	0x29	A	0x41	Y	0x59	q	0x71
*	0x2A	B	0x42	Z	0x5A	r	0x72
+	0x2B	C	0x43	[0x5B	s	0x73
,	0x2C	D	0x44	\	0x5C	t	0x74
-	0x2D	E	0x45]	0x5D	u	0x75
.	0x2E	F	0x46	^	0x5E	v	0x76
/	0x2F	G	0x47	_	0x5F	w	0x77
0	0x30	H	0x48	'	0x60	x	0x78
1	0x31	I	0x49	a	0x61	y	0x79
2	0x32	J	0x4A	b	0x62	z	0x7A
3	0x33	K	0x4B	c	0x63	{	0x7B
4	0x34	L	0x4C	d	0x64		0x7C
5	0x35	M	0x4D	e	0x65	}	0x7D
6	0x36	N	0x4E	f	0x66	~	0x7E
7	0x37	O	0x4F	g	0x67		

1.2.3 Controller Enclosure Syntax

For the DX8700 S3/DX8900 S3, the controller enclosure syntax is used when specifying the controller enclosure number. The format is indicated by an "x" (hexadecimal number). The range is 0 to b.

1.2.4 Drive Enclosure Syntax

The format that can be used for drive enclosure numbers is either "xx" or "x" ("xx" and "x" indicate hexadecimal numbers). "xx" indicates a two-digit number for the drive enclosure number and "x" indicates a one-digit number for the drive enclosure number. When a two-digit enclosure number is specified, the format "xx" must be used. When a one-digit enclosure number is specified, either format can be specified. For example, "1" can be specified for a one-digit number. However, if the format "xx" is used, 0 must be specified before the enclosure number. For example, when an enclosure number is 1, "01" must be specified.

The specifiable ranges are as follows.

DX60 S4/DX60 S3: 1 to 3

DX100 S4/DX100 S3: 1 to a

DX200 S4/DX200 S3: 1 to a

DX500 S4/DX500 S3: 0 to a and 10 to 1a

DX600 S4/DX600 S3: 0 to a, 10 to 1a, 20 to 2a, and 30 to 3a

DX8100 S3: 00, 10, 20, and 30

DX8700 S3: 0 to 3f

DX8900 S3: 0 to bf

AF250 S2/AF250: 1

AF650 S2/AF650: 00, 10, 20, 30, 01, 11, 21, 31

 **Note**

There are no drive enclosures in the DX200F.

1.2.5 Drive Syntax

The format that can be used for drive numbers is either "xxyy" or "xyy".

"xx" or "x" indicates the enclosure number. For the DX60 S4/DX100 S4/DX200 S4, the DX60 S3/DX100 S3/DX200 S3, the AF250 S2/AF250, and the DX200F, 00 or 0 indicates the controller enclosure. For details, refer to ["1.2.4 Drive Enclosure Syntax" \(page 34\)](#).

The "yy" is the drive number (a two-digit decimal). The specifiable ranges for "yy" are as follows.

3.5" drive: 00 to 11

2.5" drive: 00 to 23

3.5" drive in a high-density drive enclosure: 00 to 59 (*1)

*1: 3.5" drives (only for high-density drive enclosures)

Drive numbers can be combined as follows:

- A single drive number: 1003
- A list of drive numbers: 1003,004
- A hyphenated range of drive numbers from *a* to *z*: 0210-0211
- A list of drive numbers, drive ranges, or both, separated by commas (,). Spaces are not permitted before or after commas (,): 0003,0006,010-011

1.2.6 Alias Name Syntax

The format of an alias is a character string that has a maximum of 16 US-ASCII characters. Usable characters are those given in ["1.2.2 Keywords and Parameters" \(page 33\)](#) of the document overview. Commas (,) cannot be used.

1.2.7 Thin Provisioning Pool Syntax

There are two methods for specifying Thin Provisioning Pool identifiers; Thin Provisioning Pool numbers or Thin Provisioning Pool names.

- Thin Provisioning Pool number

A Thin Provisioning Pool number is automatically created by the system when a Thin Provisioning Pool is created. This is a decimal number. Thin Provisioning Pool numbers can be displayed by using the "show thin-pro-pools" command.

Thin Provisioning Pool numbers can be combined as follows:

- A single Thin Provisioning Pool number: 1
 - A list of Thin Provisioning Pool numbers: 1,8,12
 - A hyphenated range of Thin Provisioning Pool numbers from *a* to *z*: 2-5
 - A list of Thin Provisioning Pool numbers, Thin Provisioning Pool ranges, or both, separated by commas (,). Spaces are not permitted before or after commas (,): 1,3,10-12
- Thin Provisioning Pool name
- A Thin Provisioning Pool name must be specified when creating a Thin Provisioning Pool. For details about the syntax, refer to "[1.2.6 Alias Name Syntax](#)" (page 35). Some commands accept a comma-separated list of Thin Provisioning Pool names. A Thin Provisioning Pool name and a Thin Provisioning Pool number cannot both be specified in the same command. Do not include spaces before or after commas (,).

 **Caution**

- Two or more parameters might not be able to be specified for several commands. For details, refer to the command descriptions.
 - Since Thin Provisioning Pools and Flexible Tier Sub Pools (FTSP) use the same resource, the same number and name cannot be used for both a Thin Provisioning Pool and an FTSP. If the Thin Provisioning Pool number or the Thin Provisioning Pool name that is specified for a command is already used for an FTSP, the command is not executed.
-

1.2.8 Flexible Tier Pool Syntax

There are two methods for identifying an entered Flexible Tier Pool (FTRP); FTRP numbers or FTRP names.

- FTRP number
An FTRP number is automatically created by the system when an FTRP is created. This is a decimal number. FTRP numbers can be displayed by using the "show flexible-tier-pools" command.

FTRP numbers can be combined as follows:

- A single FTRP number: 1
 - A list of FTRP numbers: 1,8,12
 - A hyphenated range of FTRP numbers from *a* to *z*: 2-5
 - A list of FTRP numbers, ranges, or both, separated by commas (,): 1,3,10-12
- FTRP name
An FTRP name must be specified when creating a FTRP. For details about the syntax, refer to ["1.2.6 Alias Name Syntax" \(page 35\)](#). Some commands accept a comma-separated list of FTRP names. An FTRP name and an FTRP number cannot both be specified in the same command. Do not include spaces before or after commas (,).

 **Caution**

Two or more parameters might not be able to be specified for several commands. For details, refer to the command descriptions.

1.2.9 Flexible Tier Sub Pool Syntax

There are two methods for identifying an entered Flexible Tier Sub Pool (FTSP); FTSP numbers or FTSP names.

- FTSP number
An FTSP number is automatically created by the system when an FTSP is created. This is a decimal number. FTSP numbers can be displayed by using the "show flexible-tier-sub-pools" command.

FTSP numbers can be combined as follows:

- A single FTSP number: 1
 - A list of FTSP numbers: 1,8,12
 - A hyphenated range of FTSP numbers from *a* to *z*: 2-5
 - A list of FTSP numbers, ranges, or both, separated by commas (,): 1,3,10-12
- FTSP name
An FTSP name must be specified when creating an FTSP. For details about the syntax, refer to ["1.2.6 Alias Name Syntax" \(page 35\)](#). Some commands accept a comma-separated list of FTSP names. An FTSP name and an FTSP number cannot both be specified in the same command. Do not include spaces before or after commas (,).

 **Caution**

- Two or more parameters might not be able to be specified for several commands. For details, refer to the command descriptions.
 - Since Thin Provisioning Pools and FTSPs use the same resource, the same number and name cannot be used for both a Thin Provisioning Pool and an FTSP. If the FTSP number or FTSP name that is specified for a command is already used for a Thin Provisioning Pool, the command is not executed.
-

1.2.10 RAID Group Syntax

There are two methods for specifying RAID group identifiers; RAID group numbers or RAID group names.

- RAID group number
A RAID group number is automatically created by the system when a RAID group is created. This is a decimal number. RAID group numbers can be displayed by using the "show raid-groups" command or the "show external-raid-groups" command.

RAID group numbers can be combined as follows:

- A single RAID group number: 1
 - A list of RAID group numbers: 1,8,12
 - A hyphenated range of RAID group numbers from *a* to *z*: 2-5
 - A list of RAID group numbers, RAID group ranges, or both, separated by commas (,). Spaces are not permitted before or after commas (,): 1,3,10-12
- RAID group name
A RAID group name must be specified when creating a RAID group. For details about the syntax, refer to ["1.2.6 Alias Name Syntax" \(page 35\)](#). Some commands accept a comma-separated list of RAID group names. A RAID group name and a RAID group number cannot both be specified in the same command. Do not include spaces before or after commas (,).

 **Caution**

Two or more parameters might not be able to be specified for several commands. For details, refer to the command descriptions.

1.2.11 Volume Syntax

There are two methods to specify a volume identifier; a volume number or a volume name.

- Volume number

A volume number is automatically created by the system when a volume is created. This is a decimal number. Volume numbers can be displayed by using the "show volumes" command.

Volume numbers may be combined as follows:

- A volume number: 1
- A list of volume numbers: 5,10
- A hyphenated range of volume numbers from *a* to *z*: 2-5
- A list of volume numbers, volume ranges, or both, separated by commas (,). Spaces are not permitted before or after commas (,): 1,3,10-12

- Volume name

When creating new volumes or when changing volume names, the following character strings cannot be used as a prefix:

- \$SYSVOL
- \$VOL_META
- \$DEDUP

To specify a volume name, use the volume name that is set when the volume is created. Note that this does not apply when a volume is created or renamed.

For details about the syntax, refer to ["1.2.6 Alias Name Syntax" \(page 35\)](#). Some commands accept a comma-separated list of volume names. A volume name and a volume number cannot both be specified in the same command unless a volume is created or renamed. Do not include spaces before or after commas (,).

 **Caution**

Two or more parameters might not be able to be specified for several commands. For details, refer to the command descriptions.

1.2.12 Host Syntax

There are two methods to specify a host identifier; a host number or a host name.

- Host number

A host number is automatically created by the system when a host identifier or a host alias is registered. This is a decimal number.

The following types of host identifier are available:

- Host WWN name (FC)
- SAS address (SAS)
- iSCSI host name (iSCSI)

The identifier can be displayed by using the following commands:

- "show host-wwn-names"
- "show host-sas-addresses"
- "show host-iscsi-names"

Host numbers may be combined as follows:

- A single host number: 1
- A list of host numbers: 2,3
- A hyphenated range of host numbers from *a* to *z*: 2-5
- A list of host numbers, host ranges, or both, separated by commas (,). Spaces are not permitted before or after commas (,): 1,3,10-12

- Host name

A host alias must be specified when registering a host identifier. For details about the syntax, refer to ["1.2.6 Alias Name Syntax" \(page 35\)](#). Some commands accept a comma-separated list of host names. A host name and a host number cannot both be specified in the same command. Do not include spaces before or after commas (,).

 **Caution**

Two or more parameters might not be able to be specified for several commands. For details, refer to the command descriptions.

1.2.13 Host Group Syntax

There are two methods to specify an host group identifier; an host group number or an host group name.

- Host group number
An host group number is automatically created by the system when an host group is created. This is a decimal number. Host group numbers can be displayed by using the "show host-groups" command.
Host group numbers may be combined as follows:
 - A single host group number: 1
 - A list of host group numbers: 2,8
 - A hyphenated range of host group numbers from *a* to *z*: 2-5
 - A list of host group numbers, host group ranges, or both, separated by commas (,). Spaces are not permitted before or after commas (,): 1,3,10-12
- Host group name
An host group name must be specified when creating an host group. For details about the syntax, refer to ["1.2.6 Alias Name Syntax" \(page 35\)](#). Some commands accept a comma-separated list of host group names. An host group name and an host group number cannot both be specified in the same command. Do not include spaces before or after commas (,).

 **Caution**

Two or more parameters might not be able to be specified for several commands. For details, refer to the command descriptions.

1.2.14 Host Response Syntax

There are two methods to specify a host response identifier; a host response number or a host response name.

- Host response number

The host response number can be assigned by the user. This is a decimal number. A host response number of "#0" is the system default and it cannot be assigned by the user. However, the parameters for host response #0 can be changed. Host response settings can be displayed by using the "show host-response" command.

Host response numbers may be combined as follows:

- A single host response number: 1
 - A list of host response numbers: 2,5
 - A hyphenated range of host response numbers from *a* to *z*: 2-5
 - A list of host response numbers, host response ranges, or both, separated by commas (,). Spaces are not permitted before or after commas (,): 1,3,10-12
- Host response name
- A host response name must be specified when registering a host response. For details about the syntax, refer to ["1.2.6 Alias Name Syntax" \(page 35\)](#). Some commands accept a comma-separated list of host response names. A host response name and a host response number cannot both be specified in the same command. Do not include spaces before or after commas (,).

 **Caution**

Two or more parameters might not be able to be specified for several commands. For details, refer to the command descriptions.

1.2.15 Host Interface Port Syntax

The format of the host interface port is indicated as "xyz" or "wxyz".

- For the DX60 S4/DX100 S4/DX200 S4, the DX500 S4/DX600 S4, the DX60 S3/DX100 S3/DX200 S3, the DX500 S3/DX600 S3, the DX8100 S3, the AF250 S2/AF650 S2, the AF250/AF650, and the DX200F
A fixed 3-digit "xyz" numbering format is used for the host interface port.
The controller module (CM) number is indicated with an "x", the channel adapter (CA) number is indicated with a "y", and the host interface port number is indicated with a "z".

For example, "110" indicates CM#1-CA#1-Port#0.

Multiple parameters can be specified by separating them with a comma (.). To indicate both CM#0-CA#0-Port#0 and CM#1-CA#1-Port#0, specify "-port 000,110".

- For the DX8700 S3/DX8900 S3
A fixed 4-digit "wxyz" numbering format is used for the host interface port.
The controller enclosure (CE) number is indicated with a "w", the controller module (CM) number is indicated with an "x", the channel adapter (CA) number is indicated with a "y", and the host interface port number is indicated with a "z".
For the DX8700 S3, the values 0 to 3 can be specified for "w", 0 to 1 for "x", 0 to 3 for "y" and 0 to 3 for "z".
For the DX8900 S3, the values 0 to b (hex) can be specified for "w", 0 to 1 for "x", 0 to 3 for "y" and 0 to 3 for "z".

For example, "0110" indicates CE#0-CM#1-CA#1-Port#0.

Multiple parameters can be specified by separating them with a comma (.). To indicate both CE#0-CM#0-CA#0-Port#0 and CE#1-CM#0-CA#1-Port#0, specify "-port 0000,1010".

1.2.16 Port Group Syntax

There are two methods to specify an port group identifier; an port group number or an port group name.

- Port group number
An port group number is automatically created by the system when an port group is created. This is a decimal number. Port group numbers can be displayed by using the "show port-groups" command.

Port group numbers may be combined as follows:

- A single port group number: 1
 - A list of port group numbers: 2,8
 - A hyphenated range of port group numbers from *a* to *z*: 2-5
 - A list of port group numbers, port group ranges, or both, separated by commas (,). Spaces are not permitted before or after commas (,): 1,3,10-12
- Port group name
An port group name must be specified when creating an port group. For details about the syntax, refer to ["1.2.6 Alias Name Syntax" \(page 35\)](#). Some commands accept a comma-separated list of port group names. An port group name and an port group number cannot both be specified in the same command. Do not include spaces before or after commas (,).

 **Caution**

Two or more parameters might not be able to be specified for several commands. For details, refer to the command descriptions.

1.2.17 LUN Group Syntax

There are two methods to specify a LUN group identifier; a LUN group number or a LUN group name.

Note

In GUI, "LUN group number" and "LUN group name" is respectively displayed instead of "affinity group number" and "affinity group name".

- LUN group number
A LUN group number is automatically created by the system when a LUN group is created. This is a decimal number. LUN group numbers can be displayed by using the "show lun-groups" command.

LUN group numbers can be combined as follows:

- A single LUN group number: 1
 - A list of LUN group numbers: 2,8
 - A hyphenated range of LUN group numbers from *a* to *z*: 2-5
 - A list of LUN group numbers, LUN group ranges, or both, separated by commas (,). Spaces are not permitted before or after commas (,): 1,3,10-12
- LUN group name
A LUN group name must be specified when creating a LUN group. For details about the syntax, refer to ["1.2.6 Alias Name Syntax" \(page 35\)](#). Some commands accept a comma-separated list of LUN group names. A LUN group name and a LUN group number cannot both be specified in the same command. Do not include spaces before or after commas (,).
-

Caution

Two or more parameters might not be able to be specified for several commands. For details, refer to the command descriptions.

1.2.18 Eco-mode Schedule Syntax

There are two methods to specify an Eco-mode schedule identifier; an Eco-mode schedule number or an Eco-mode schedule name.

- Eco-mode schedule number
An Eco-mode schedule number is automatically created by the system when an Eco-mode schedule is created. This is a decimal number. Eco-mode schedule numbers can be displayed by using the "show eco-schedule" command.

Eco-mode schedule numbers may be combined as follows:

- A single Eco-mode schedule number: 1
 - A list of Eco-mode schedule numbers: 2,5
 - A hyphenated range of Eco-mode schedule numbers from *a* to *z*: 2-5
 - A list of Eco-mode schedule numbers, Eco-mode schedule ranges, or both, separated by commas (,). Spaces are not permitted before or after commas (,): 1,3,10-12
- Eco-mode schedule name
An Eco-mode schedule name must be specified when creating an Eco-mode schedule. For details about the syntax, refer to ["1.2.6 Alias Name Syntax" \(page 35\)](#). Some commands accept a comma-separated list of Eco-mode schedule names. An Eco-mode schedule name and an Eco-mode schedule number cannot both be specified in the same command. Do not include spaces before or after commas (,).

 **Caution**

Two or more parameters might not be able to be specified for several commands. For details, refer to the command descriptions.

1.2.19 Server Syntax

There are two methods to specify a server identifier; a server IP address or a host name.

The specifiable range is 1 to 255 characters.
Alphanumeric characters and symbols can be used.

- Alphanumeric characters
US-ASCII code 0x30 to 0x39, 0x41 to 0x5A, and 0x61 to 0x7A
- Symbols "-", ".", and ":"
US-ASCII code 0x2D, 0x2E, and 0x3A

1.2.20 Domain Syntax

Specify domain names and domain administrator user IDs with a range of 1 to 255 characters.
Alphanumeric characters and symbols (US-ASCII code 0x20 to 0x7E) can be used.
However, "?" (US-ASCII code 0x3F) and "\" (US-ASCII code 0x5C) cannot be used.

1.2.21 Shared Folder Syntax

Shared folder names can be specified with a maximum of 76 characters.

Alphanumeric characters and symbols (US-ASCII code 0x20 to 0x7E) can be used. However, the following symbols and strings cannot be used:

- Symbols

Symbol	US-ASCII code	Symbol	US-ASCII code	Symbol	US-ASCII code	Symbol	US-ASCII code
"	0x22	,	0x2C	<	0x3C	[0x5B
%	0x25	/	0x2F	=	0x3D	\	0x5C
*	0x2A	:	0x3A	>	0x3E]	0x5D
+	0x2B	;	0x3B	?	0x3F		0x7C

- Space

The "space" character corresponding to US-ASCII code 0x20.

- Character strings with ". ", ". . ", ".snap", "global", "homes", "printers", or "ipc\$" (characters are case insensitive)
- Character strings suffixed with "\$bak"
- Character strings prefixed with "@gmt" (characters are case insensitive)

1.2.22 Shared Folder Owner Name or Group Name Syntax

Shared folder owner names or group names can be specified with a maximum of 255 characters.

Alphanumeric characters and symbols (US-ASCII code 0x20 to 0x7E) can be used. However, the following symbols cannot be used.

Symbol	US-ASCII code	Symbol	US-ASCII code	Symbol	US-ASCII code	Symbol	US-ASCII code
"	0x22	/	0x2F	=	0x3D	[0x5B
*	0x2A	:	0x3A	>	0x3E]	0x5D
+	0x2B	;	0x3B	?	0x3F		0x7C
,	0x2C	<	0x3C	@	0x40		

 **Caution**

- Because the following character strings are special reserved words, even if they are registered in the authentication server, they cannot be specified as the owner name of the shared folder.
"shareuser\$", "bin", "daemon", "adm", "lp", "sync", "shutdown", "halt", "mail", "uucp", "operator", "games", "gopher", "ftp", "nobody", "vcsa", "rpc", "nscd", "ntp", "saslauth", "mailnull", "smmisp", "rpcuser", "nfsnobody", "sshd", "nslcd", "tcpdump", and "oprofile"
- Because the following character strings are special reserved words, even if they are registered in the authentication server, they cannot be specified as the group name of the shared folder.
"shareuser\$", "bin", "daemon", "sys", "adm", "tty", "disk", "lp", "mem", "kmem", "wheel", "mail", "uucp", "man", "games", "gopher", "video", "dip", "ftp", "lock", "audio", "nobody", "users", "utmp", "utempter", "floppy", "vcsa", "rpc", "nscd", "cdrom", "tape", "dialout", "ntp", "saslauth", "mailnull", "smmisp", "rpcuser", "nfsnobody", "sshd", "ldap", "tcpdump", and "oprofile"

1.2.23 NFS Connection Host, CIFS Connection Host, or NFS/CIFS Connection Host Syntax

Alphanumeric characters (US-ASCII code 0x30 to 0x39, 0x41 to 0x5A, and 0x61 to 0x7A) and the following symbols can be used for NFS connection host names, CIFS connection host names, or NFS/CIFS connection host names.

Symbol	US-ASCII code
*	0x2A
,	0x2C
-	0x2D
.	0x2E
/	0x2F
:	0x3A
_	0x5F

However, based on RFC952, only alphanumeric characters (US-ASCII code 0x30 to 0x39, 0x41 to 0x5A, and 0x61 to 0x7A) and "-" (US-ASCII code 0x2D) can be specified for the host names of single host and FQDN.

Multiple hosts can be specified by separating them with a comma (.). There is no limit on the number of characters (limited by the maximum length, 5,120 characters, of a CLI command). However, the specifiable number of characters for a single host is up to 255 characters.

A wildcard (*) cannot be specified for IPv4.

1.2.24 CIFS User Name or CIFS Group Name Syntax

Alphanumeric characters and symbols (US-ASCII code 0x20 to 0x7E) can be used for CIFS user names or CIFS group names. However, the following symbols cannot be used:

Symbol	US-ASCII code	Symbol	US-ASCII code
"	0x22	=	0x3D
*	0x2A	>	0x3E
+	0x2B	?	0x3F
/	0x2F	@	0x40
:	0x3A	[0x5B
;	0x3B]	0x5D
<	0x3C		0x7C

Multiple user names can be specified by separating them with a comma (.). Duplicate users cannot be specified. Up to 2,048 characters can be entered for the character string. The characters are case insensitive.

1.3 Size of Drives and Logical Units

The size of drives and logical units (such as RAID groups and volumes) are presented in base 2 (binary) formats.

Table 1.2 Drive and logical unit sizes

Unit	Size in binary
Kilobyte (KB)	1024 bytes
Megabyte (MB)	1024KB (1,048,576 bytes)
Gigabyte (GB)	1024MB (1,073,741,824 bytes)
Terabyte (TB)	1024GB (109,951,162,776 bytes)
Petabyte (PB)	1024TB (1,125,899,906,842,624 bytes)

In some size presentations, the units are converted as follows in consideration of readability:

0.00KB to 1023.99KB
1.00MB to 1023.99MB
1.00GB to 1023.99GB
1.00TB to 1023.99TB
1.00PB to

1.4 Command Auto-complete and History Recall

CLI supports an auto-complete command function and also a command history recall function. When using the auto-complete command function, if too few letters are entered to uniquely identify a keyword, the CLI lists keywords that match the entered string and redisplay the string so it can be completed. The auto-complete function applies to a command name, a parameter name and an operand name. It does NOT apply when two or more operands are used that are separated with a comma (,). Except for operand names, even if not all the letters of the keyword are not entered, once enough letters are entered to identify a unique keyword, it is handled as a complete character string.

The history contains all the commands entered in the active CLI session. A command from the history can be recalled, edited, and run.

For details about usable keys, refer to ["1.5 Command Editing Hotkeys" \(page 51\)](#).

1.5 Command Editing Hotkeys

The following table lists the CLI command editing functions:

Table 1.3 List of command editing hotkeys

To	Press
Complete a partially entered keyword	Tab
Get previous command from history	Up Arrow, Ctrl-P, or Ctrl-p
Get next command from history	Down Arrow, Ctrl-N, or Ctrl-n
Move cursor left	Left Arrow, Ctrl-B, or Ctrl-b
Move cursor right	Right Arrow, Ctrl-F, or Ctrl-f
Move back one word	Esc-B or Esc-b
Move forward one word	Esc-F or Esc-f
Move cursor to start of line	Ctrl-A or Ctrl-a
Move cursor to end of line	Ctrl-E or Ctrl-e
Transpose current and previous character	Ctrl-T or Ctrl-t
Delete current character	Ctrl-D or Ctrl-d
Delete previous character	Ctrl-H or Ctrl-h
Delete word up to cursor	Ctrl-W or Ctrl-w
Delete rest of word	Esc-D or Esc-d
Delete text up to cursor	Ctrl-U or Ctrl-u
Delete the rest of a line	Ctrl-K or Ctrl-k
Convert the rest of a word to uppercase	Esc-C or Esc-c
Convert the rest of a word to lowercase	Esc-L or Esc-l
Enter command and redisplay prompt	Ctrl-Z or Ctrl-z
Refresh input line	Ctrl-L or Ctrl-l

1.6 Viewing Command Help

By inputting a question mark (?) after the CLI command name or the parameter name, a brief description can be displayed. By using the "help" command, the command syntax can also be displayed. For further information, refer to the ["help" command](#).

If a question mark [?] is entered by itself, the entire verb list is displayed.

```
CLI> ?
copy                - copy
create              - create
delete              - delete
discover            - discover
exit                - Exit the CLI sessions.
... (snip)
```

If [s?] is entered, all the verbs beginning with "s" are displayed.

```
CLI> s?
set                 show                 start                 stop
```

If [show ?] is entered (note the space between the "show" and "?"), only the "show" command is possible, so all the "show" command objects are displayed.

```
CLI> show ?
advanced-copy-licens - Display the Extended Advanced Copy license status.
advanced-copy-parame - Display the Advanced Copy parameters.
advanced-copy-policy - Display the currently registered Advance Copy policy.
advanced-copy-sessio - Display the list of Advance Copy sessions.
lun-groups           - Display a list of lun groups or display the details of a specified lun group.
... (snip)
```

If [show m?] is entered, all the "show" command objects beginning with "m" are displayed.

```
CLI> show m?
mapping             migration
```

If [create raid-group ?] is entered (note the space between the "create raid-group" and "?"), the parameters that can be specified for the "create raid-group" command are displayed.

Bracketed parameters are optional. All other parameters are required.

```
CLI> create raid-group ?
-name                - Name of a RAID group
-disks               - Disks to use in the RAID group
-level               - RAID level
[-assigned-cm]      - Assigned controller for the RAID group
```

Long parameters and command names are truncated at 20 characters, as in the following example.

Note that one or more spaces are required before a question mark.

```
CLI> show host-response ?
[-host-response-num - Host response numbers to display details
[-host-response-nam - Host response names to display details
```

1.7 Error Message Format

This section explains the CLI error messages format. For commands other than "show" commands that display information, if the CLI command ends normally, there is no output on the terminal. The CLI prompt is returned to the next line. If an error occurs, an error message is displayed. For further details of the error messages, refer to ["Appendix A Error Messages/Error Codes" \(page 1119\)](#).

```
Error: E0019 Inconsistent parameter.  
  A      B  
        [001C-0002] -disks 003  
        C          D
```

- A: Error message number (E + 4-digit fixed number)
- B: Error message (human-readable message)
- C: Internal error code (4-digit fixed number + hyphen + 4-digit fixed number)
- D: Details (the specified parameters, etc.)

Note that there are messages without an error message number. The location of the error is indicated by a circumflex (^). This will display where there is a syntax error. Check the input parameters and the error message as indicated by the circumflex (^).

The following are examples.

```
CLI> create raid-group -a  
                        ^  
Error: Missing parameter data
```

```
CLI> show disks -de 1 -de 2  
                    ^
```

1.8 Multiple Sessions

A maximum of 16 CLI sessions can run on a single system simultaneously (including accesses with the Software role). A session for an exclusive resource may conflict with a GUI session or another CLI session. When a resource is locked by exclusive access control, the command terminates with an error message. If this occurs, wait until the GUI session or another CLI session that uses the locked resource completes, and then execute the command again. Resources can be forcibly released by using the "set clienv-force-unlock" command. This is useful when a terminal is suddenly disconnected or unexpected errors occur.

1.9 Slave Controller Logins

For the ETERNUS DX/AF, there is always one controller that is the master and the rest are slaves. Normal logins are to the master controller, and are able to access all the normal functions. However, if the master controller becomes inaccessible, a redundant IP address function is available that allows a (reduced functionality) login to the slave controller. Slave controller login is only possible if a redundant IP address has been preset, and only some of the "show" commands to check the status of components are available. It also allows the "change master" command to be used to forcibly swap the master-slave relationship of the two controllers. The "change master" command can only be used by a user account that has the Maintenance Operation policy and that is logged in to the slave controller. Commands that are not supported by the current login type will fail with an error message if attempted.

1.10 CLI User Authority

User authority is determined by the role and policy. For details on roles and policies, refer to ["5.1 User Management" \(page 560\)](#).

1.11 Note for Specifying FTP Server

An Ethernet port must be specified for CLI commands that are used to access FTP servers. If an FTP server is specified in a domain name format, the DNS server assigned to the specified Ethernet port resolves the domain name.

1.12 Command Descriptions

This section explains the commands in a functional order. Each command topic includes one or more of the following sections.

- Description
A description of the command
- Syntax
The command syntax
- Parameters
A description of parameter(s)
- Output (only for reference commands)
A description of information displayed by the command
- Example(s)
One or more examples of the command

Chapter 2

Status Display



This chapter explains the commands related to storage system status.

2.1 Storage System Status

This section explains the commands that display the status of the system.

- Summary status

Display Items	The command syntax
Summary status of the system	<code>show status</code>

- Enclosure status

Display Items	The command syntax
Summary status of each enclosure	<code>show enclosure-status</code>
Controller enclosure status	<code>show enclosure-status -type ce</code>
Drive enclosure status	<code>show enclosure-status -type de</code> <code>-de <i>enclosure_number</i></code>
The status of the controller enclosure and all drive enclosures	<code>show enclosure-status -type all</code>

- Component status of the controller enclosure

Display Items	The command syntax
Controller module status	<code>show fru-ce -type {cm0 cm1}</code>
PSU status in the controller enclosures	<code>show fru-ce -type {psu0 psu1}</code>
The status of a specific controller enclosure	<code>show fru-ce -type</code> {ce0 ce1 ce2 ce3 ce4 ce5 ce6 ce7 ce8 ce9 cea ceb}
The status of a specific CM in the controller enclosure	<code>show fru-ce -type</code> {ce0cm0 ce0cm1 ce1cm0 ce1cm1 ce2cm0 ce2cm1 ce3cm0 ce3cm1 ce4cm0 ce4cm1 ce5cm0 ce5cm1 ce6cm0 ce6cm1 ce7cm0 ce7cm1 ce8cm0 ce8cm1 ce9cm0 ce9cm1 ceacm0 ceacm1 cebcm0 cebcm1}
The status of a specific PSU in the controller enclosure	<code>show fru-ce -type</code> {ce0psu0 ce0psu1 ce1psu0 ce1psu1 ce2psu0 ce2psu1 ce3psu0 ce3psu1 ce4psu0 ce4psu1 ce5psu0 ce5psu1 ce6psu0 ce6psu1 ce7psu0 ce7psu1 ce8psu0 ce8psu1 ce9psu0 ce9psu1 ceapsu0 ceapsu1 cebpsu0 cebpsu1}
The status of all components in the controller enclosure	<code>show fru-ce</code>

- Component status of the frontend enclosure

Display Items	The command syntax
The status of the SVC in the frontend enclosure	<code>show fru-fe -type {svc0 svc1}</code>
The status of the FRT in the frontend enclosure	<code>show fru-fe -type {frt0 frt1 frt2 frt3}</code>
The status of the PSU in the frontend enclosure	<code>show fru-fe -type {psu0 psu1 psu2 psu3}</code>
The status of all components in the frontend enclosure	<code>show fru-fe</code>

- component status of the drive enclosure

Display Items	The command syntax
Expander status in a specific drive enclosure	<code>show fru-de -de enclosure_number -type {exp0 exp1}</code>
The status of all expanders in all drive enclosures	<code>show fru-de -type {exp0 exp1}</code>
Fan Expander Module status in a specific drive enclosure	<code>show fru-de -de enclosure_number -type {fem0 fem1}</code>
The status of all Fan Expander Modules in all drive enclosures	<code>show fru-de -type {fem0 fem1}</code>
PSU status in a specific drive enclosure	<code>show fru-de -de enclosure_number -type {psu0 psu1 psu2 psu3}</code>
The status of all PSUs in all drive enclosures	<code>show fru-de -type {psu0 psu1 psu2 psu3}</code>
The status of all components in a specific drive enclosure	<code>show fru-de -de enclosure_number</code>
The status of all components in all drive enclosures	<code>show fru-de</code>

- Drive status

Display Items	The command syntax
The status of all undefined drives	<code>show disks -type undefined</code>
The status of all drives in the controller enclosure	<code>show disks -type ce</code>
The status of all drives in a specific drive enclosure	<code>show disks -type de -de enclosure_number</code>
Details of specific drives	<code>show disks -disks disks</code>
Details of all drives	<code>show disks -disks all</code>
Product IDs of all drives	<code>show disks -disks productid</code>

- Hardware information

Display Items	The command syntax
Hardware information	<code>show hardware-information</code>

show status

This command displays a summary of the system status. It will display if any components in the system are in an error or warning condition. It does not indicate if host servers are able to access the system.

■ Syntax

```
show status
```

■ Parameters

No parameters.

■ Output

Item name	Description
Summary status	Summary of the system status.
Empty	The ETERNUS DX/AF is not defined or installed.
Normal	The ETERNUS DX/AF is in normal state.
Pinned Data	PIN data exists in the ETERNUS DX/AF.
Unused	An undefined component is installed in the ETERNUS DX/AF.
Warning	A component that is the target for preventive maintenance exists in the ETERNUS DX/AF.
Maintenance	Maintenance is currently being performed on the ETERNUS DX/AF.
Error	A component with an error exists in the ETERNUS DX/AF.
Loop Down	The ETERNUS DX/AF is in the BackEnd Down state.
Not Ready	"Not Ready" is a status where an abnormality is detected at a power-off, and I/O access from the host cannot be received.
Subsystem Down	The ETERNUS DX/AF is not available.
Change Assigned CM	Hot expansion and recovery of the controller is required.

■ Example(s)

The following example displays a summary of the system status:

```
CLI> show status
Summary Status [Normal]

CLI> show status
Summary Status [Error]

CLI> show status
Summary Status [Warning]
```

show enclosure-status

This command displays a summary of the controller enclosure, frontend enclosure or the drive enclosure status. Details will be displayed if the type of enclosure is specified.

Syntax

```
show enclosure-status [-type {all | ce | fe | de [-ce enclosure_number] [-de enclosure_number]]
```

Parameter

- type** Optional. This parameter specifies the enclosure type. If the type is omitted, only summary information will be displayed.
- all** Detailed status of both the controller enclosure and all the drive enclosures are displayed.
 - ce** Detailed status of the controller enclosure is displayed.
 - fe** Detailed status of the frontend enclosure is displayed (for the DX8700 S3/DX8900 S3 only).
 - de** Detailed status of the specified drive enclosure is displayed.
- ce** Optional. This parameter can specify the controller enclosure number only when "ce" is specified for "-type" (for the DX8700 S3/DX8900 S3 only). For details, refer to ["1.2.3 Controller Enclosure Syntax" \(page 34\)](#). If this parameter is omitted, all the controller enclosures are selected.
- Example: -type ce -ce 1
(When specifying controller enclosure #1)
- de** Optional. This parameter can specify the drive enclosure number only when "de" is specified for "-type". For details, refer to ["1.2.4 Drive Enclosure Syntax" \(page 34\)](#). If this parameter is omitted, all the drive enclosures are selected.
- Example: -type de -de 1
(When specifying drive enclosure #1)

Output

The following information is the output information when all the parameters are omitted.

Item name	Description
Storage System Name	ETERNUS DX/AF name
Model Upgrade Status	Model upgrade status. This indicates whether or not the model can or has been upgraded. If the model can and has been upgraded, [Upgraded] is displayed. If the model can but has not been upgraded yet, [Not Upgraded] is displayed. If the model cannot be upgraded, [Not Possible] is displayed.
Model Name	Model name of the system
Serial Number	Serial number of the system
Device Identification Number	Device identification number used by the ETERNUS Multipath Driver or other external software to identify the storage system.
Status	Status of the system

Item name	Description
Cache Mode	The cache control mode (Write Back Mode or Write Through [factors]) For Write Through Mode, the main cause is displayed in "(factors)". The factors for all the CMs are collected and if there are multiple factors, they are shown separated with a slash (/).
Write Through (Pinned Data)	A large amount of pinned data was generated.
Write Through(Battery)	The battery charge rate is low.
Write Through (Maintenance)	The following maintenance operation is currently running: <ul style="list-style-type: none"> • Hot controller firmware update • Changing the controlling CM of the RAID group • Hot expanding the CM
Write Through(1CM)	The ETERNUS DX/AF is operating with only one CM.
Remote Support	The remote support state (Operating, Maintenance, Stopping, or Not yet Set) Stopping indicates a temporarily stopped status.
Operation Mode	The operation mode (Normal [normal operation mode] or Maintenance Mode [Maintenance mode])
CLI Connecting Controller Module	Controller module that has an active CLI connection.
Firmware Version	Current firmware version Example: Firmware Version [V10L10-0000 for Unified Storage] (When using a unified storage system.) Firmware Version [V10L10-0000] (When a unified storage system is not used.)
Controller Enclosure	Controller enclosure status
Frontend Enclosure	Frontend enclosure status (Only for the DX8700 S3/DX8900 S3)
Drive Enclosure #n	Indicates the number of the drive enclosure and its status The character string, "#n", in the field indicates the drive enclosure number. Example: Drive Enclosure #01 (2.5" 24DE) [status] (For the status of drive enclosure #01 [2.5" type 24-drive DE])

The following information is output for the controller enclosure components.

Item name	Description
Intake Temp	Intake temperature status, status code, and intake temperature values. Each controller has two redundant intake temperature sensors, and both temperature values is displayed in Celsius. If a sensor fails, "Failed" is displayed.
Exhaust Temp	Exhaust temperature status, status code, and exhaust temperature values. Each controller has two redundant exhaust temperature sensors, and both temperature values is displayed in Celsius. If a sensor fails, "Failed" is displayed.
CM#n	Controller Module status and the status code. The "#n" in the field indicates the controller module number. Example: CM#1 [Status / Status Code] (For controller module#1)
CM#n PFM#m	Controller Module's PCIe Flash Module status and the status code (only for the DX500 S4/DX600 S4, the DX500 S3/DX600 S3, and the DX8700 S3/DX8900 S3). The "#n" in the field indicates the controller module number and the "#m" in the field indicates the PCIe Flash Module number.

Item name	Description
PSU#n	Power Supply Unit status and the status code. The "#n" in the field indicates the Power Supply Unit number. Example: PSU#1 [Status / Status Code] (For Power Supply Unit#1)
CE-DISK#xyy	Drive status (only for the DX60 S4/DX100 S4/DX200 S4, the DX60 S3/DX100 S3/DX200 S3, the AF250 S2/AF250, and the DX200F) Example: CE-Drive#1 [status] (Drive #001 status) (For details, refer to "1.2.5 Drive Syntax" (page 35).)

The following information is displayed if the frontend enclosure is specified (only for the DX8700 S3/DX8900 S3).

Item name	Description
Intake Temp	Intake temperature status, status code, and intake temperature values. Each controller has two redundant intake temperature sensors, and both temperature values is displayed in Celsius. If a sensor fails, "Failed" is displayed.
Exhaust Temp	Exhaust temperature status and the status code. The exhaust temperature value of the frontend enclosure is not displayed.
FRT#n	Front End Router (FRT) status and the status code. The "#n" in the field indicates the FRT number.
SVC#n	Service Controller (SVC) status and the status code. The "#n" in the field indicates the SVC number.
FANU#n	Fan Unit (FANU) status and the status code. The "#n" in the field indicates the FANU number.
OPNL	Operation panel (OPNL) status and the status code.
PSU#n	Frontend enclosure Power Supply Unit (PSU) status and the status code. The "#n" in the field indicates the PSU number.

The following information is displayed if the drive enclosure is specified.

Item name	Description
Intake Temp	Intake temperature status, status code, and intake temperature values. Each controller has two redundant intake temperature sensors, and both temperature values is displayed in Celsius. If a sensor fails, "Failed" is displayed.
Exhaust Temp	Exhaust temperature status and the status code. Note that exhaust temperature values are not displayed.
IOM#n	Status and the status code of the I/O module. The I/O module number is indicated by the character string "#n" within the field.
FEM#n	Status and the status code of the Fan Expander Module. (This information only appears for high-density drive enclosures.) The fan expander module number is indicated by the character string "#n" within the field. FEM#1 is displayed regardless of the number of CMs.
FEM#n EXP#m	Status and the status code of the Expander in the Fan Expander Module. (This information only appears for high-density drive enclosures.) The fan expander module number is indicated by the character string "#n" and the expander number is indicated by the character string "#m" within the field. FEM#1 EXP#0 and FEM#1 EXP#1 are displayed regardless of the number of CMs.

Item name	Description
PSU#n	Status and the status code of the drive enclosure Power Supply Unit (PSU). The Power Supply Unit number is indicated by the character string "#n" within the field. PSU#2 and PSU#3 are only displayed for high-density drive enclosures.
DE-DISK#xyy	Drive status Example: DE#1-Drive#1 [status] (Drive #101 status) (For details, refer to "1.2.5 Drive Syntax" (page 35) .)

■ Example(s)

The following information is displayed when no parameters are specified (for the DX100 S3/DX200 S3):

```
CLI> show enclosure-status
Enclosure View
Storage System Name           [ETERNUS DX100]
Model Upgrade Status          [Not Possible]
Model Name                     [ET06F21A]
Serial Number                  [000000]
Device Identification Number   [010000]
Status                         [Normal]
Cache Mode                     [Write Back Mode]
Remote Support                 [Not yet Set]
Operation Mode                 [Maintenance Mode]
CLI Connecting Controller Module [CM#0]
Firmware Version              [V10L11-0000]

Controller Enclosure (3.5")    [Normal]
Drive Enclosure #01 (2.5" 24DE) [Error]
Drive Enclosure #02 (3.5" 12DE) [Error]
Drive Enclosure #03 (3.5" 60DE) [Error]
```

The following information is displayed when no parameters are specified (for the DX8700 S3/DX8900 S3):

```
CLI> show enclosure-status
Enclosure View
Storage System Name           [ETERNUS DX8900]
Model Upgrade Status          [Not Possible]
Model Name                     [ET873SA]
Serial Number                  [000000]
Device Identification Number   [010000]
Status                         [Normal]
Cache Mode                     [Write Back Mode]
Remote Support                 [Not yet Set]
Operation Mode                 [Maintenance Mode]
CLI Connecting Controller Module [CE#0 CM#0]
Firmware Version              [V10L40-0000]

Controller Enclosure #0        [Normal]
Frontend Enclosure             [Normal]
Drive Enclosure #00 (2.5" 24DE) [Error]
Drive Enclosure #01 (3.5" 12DE) [Error]
Drive Enclosure #02 (3.5" 60DE) [Error]
```

The following example shows the information that is displayed when the controller enclosure is specified (for the DX60 S3 /DX100 S3/DX200 S3):

```
CLI> show enclosure-status -type ce
Controller Enclosure Information
Location      Status      Error Code  Sensor 1 / Sensor 2
Intake Temp   Normal      0x0000     25 (C) / 25 (C)
Exhaust Temp  Normal      0x0000     25 (C) / 25 (C)

Controller Enclosure Status
Controller Module Status/Status Code
CM#0          [Normal / 0xE001]
CM#1          [Normal / 0xE001]
Power Supply Unit Status/Status Code
PSU#0        [Normal / 0xE001]
PSU#1        [Normal / 0xE001]
Disk Status
CE-Disk#0    [Rebuild/Copyback ] CE-Disk#1 [Rebuild/Copyback ]
CE-Disk#2    [Available ] CE-Disk#3 [Broken ]
CE-Disk#4    [Available ] CE-Disk#5 [Available(Predictive Failure)]
CE-Disk#6    [Available(Predictive Failure)] CE-Disk#7 [Present ]
CE-Disk#8    [Present ] CE-Disk#9 [Present ]
CE-Disk#10   [Present ] CE-Disk#11 [Spare ]
```

The following example shows the information that is displayed when the controller enclosure is specified (for the DX500 S4/DX600 S4 and the DX500 S3/DX600 S3):

```
CLI> show enclosure-status -type ce
Controller Enclosure Information
Location      Status      Error Code  Sensor 1 / Sensor 2
Intake Temp   Normal      0x0000     25 (C) / 25 (C)
Exhaust Temp  Normal      0x0000     25 (C) / 25 (C)

Controller Enclosure Status
Controller Module Status/Status Code
CM#0          [Normal / 0xE001]
CM#1          [Normal / 0xE001]
PCIe Flash Module Status/Status Code
CM#0 PFM#0    [Normal / 0xE001]
CM#0 PFM#1    [Normal / 0xE001]
CM#1 PFM#0    [Normal / 0xE001]
CM#1 PFM#1    [Normal / 0xE001]
Power Supply Unit Status/Status Code
PSU#0        [Normal / 0xE001]
PSU#1        [Normal / 0xE001]
```

The following example shows the information that is displayed when the controller enclosure is specified (for the DX8100 S3):

```
CLI> show enclosure-status -type ce
Controller Enclosure Information
Location      Status      Error Code  Sensor 1 / Sensor 2
Intake Temp   Normal      0x0000     25 (C) / 25 (C)
Exhaust Temp  Normal      0x0000     25 (C) / 25 (C)

Controller Enclosure Status
Controller Module Status/Status Code
CM#0          [Normal / 0xE001]
CM#1          [Normal / 0xE001]
Power Supply Unit Status/Status Code
PSU#0        [Normal / 0xE001]
PSU#1        [Normal / 0xE001]
```

The following example shows the information that is displayed when controller enclosure #0 is specified (for the DX8700 S3/DX8900 S3):

```
CLI> show enclosure-status -type ce -ce 0
Controller Enclosure #0 Information
Location      Status      Error Code  Sensor 1 / Sensor 2
Intake Temp   Normal      0x0000      20 (C) / 20 (C)
Exhaust Temp  Normal      0x0000      25 (C) / 25 (C)

Controller Enclosure #0 Status
Controller Module Status/Status Code
CM#0          [Normal    / 0xE001]
CM#1          [Normal    / 0xE001]
PCIe Flash Module Status/Status Code
CM#0 PFM#0    [Undefined / 0x6000]
CM#0 PFM#1    [Undefined / 0x6000]
CM#1 PFM#0    [Undefined / 0x6000]
CM#1 PFM#1    [Undefined / 0x6000]
Power Supply Unit Status/Status Code
PSU#0         [Normal    / 0xE001]
PSU#1         [Normal    / 0xE001]
```

The following example shows the information that is displayed when the frontend enclosure is specified (for the DX8700 S3/DX8900 S3):

```
CLI> show enclosure-status -type fe
Frontend Enclosure Information
Location      Status      Error Code  Sensor 1 / Sensor 2
Intake Temp   Normal      0x0000      20 (C) / 20 (C)
Exhaust Temp  Normal      0x0000      - / -

Frontend Enclosure Status
Front End Router Status/Status Code
FRT#0         [Normal    / 0xE001]
FRT#1         [Normal    / 0xE001]
FRT#2         [Normal    / 0xE001]
FRT#3         [Normal    / 0xE001]
Service Controller Status/Status Code
SVC#0         [Normal    / 0xE001]
SVC#1         [Normal    / 0xE001]
FAN Unit Status/Status Code
FANU#0        [Normal    / 0xE001]
FANU#1        [Normal    / 0xE001]
FANU#2        [Normal    / 0xE001]
FANU#3        [Normal    / 0xE001]
Operation Panel Status/Status Code
OPNL          [Normal    / 0xE001]
Power Supply Unit Status/Status Code
PSU#0         [Normal    / 0xE001]
PSU#1         [Normal    / 0xE001]
PSU#2         [Normal    / 0xE001]
PSU#3         [Normal    / 0xE001]
```

The following example shows the information that is displayed when drive enclosure #1 is specified:

```
CLI> show enclosure-status -type de -de 1
Drive Enclosure #01 Information
Location      Status      Error Code  Sensor 1 / Sensor 2
Intake Temp   Normal      0x0000      25 (C) / 25 (C)
Exhaust Temp  Normal      0x0000      - / -

Drive Enclosure #01 Status
I/O Module Status/Status Code
IOM#0         [Normal    / 0xE001]
IOM#1         [Normal    / 0xE001]
Power Supply Unit Status/Status Code
PSU#0         [Normal    / 0xE001]
PSU#1         [Normal    / 0xE001]
Disk Status
DE#01-Disk#0 [Available ] DE#01-Disk#1 [Available ]
DE#01-Disk#2 [Available ] DE#01-Disk#3 [Rebuild/Copyback ]
DE#01-Disk#4 [Rebuild/Copyback ] DE#01-Disk#5 [Available ]
DE#01-Disk#6 [Available ] DE#01-Disk#7 [Available(Predictive Failure)]
DE#01-Disk#8 [Available ] DE#01-Disk#9 [Available ]
DE#01-Disk#10 [Available(Predictive Failure)] DE#01-Disk#11 [Broken ]
```

The following example shows the information that is displayed when drive enclosure #1 is specified (for a high-density drive enclosure) :

```

CLI> show enclosure-status -type de -de 1
Drive Enclosure #01 Information
Location      Status      Error Code  Sensor 1 / Sensor 2
Intake Temp   Normal      0x0000      25 (C) / 25 (C)
Exhaust Temp  Normal      0x0000      - / -

Drive Enclosure #01 Status
I/O Module Status/Status Code
IOM#0         [Normal / 0xE001]
IOM#1         [Normal / 0xE001]
Fan Expander Module Status/Status Code
FEM#0         [Normal / 0xE001]
FEM#0 EXP#0   [Normal / 0xE001]
FEM#0 EXP#1   [Normal / 0xE001]
FEM#1         [Normal / 0xE001]
FEM#1 EXP#0   [Normal / 0xE001]
FEM#1 EXP#1   [Normal / 0xE001]
Power Supply Unit Status/Status Code
PSU#0         [Normal / 0xE001]
PSU#1         [Normal / 0xE001]
PSU#2         [Normal / 0xE001]
PSU#3         [Normal / 0xE001]
Disk Status
DE#01-Disk#0 [Available ] DE#01-Disk#1 [Available ]
DE#01-Disk#2 [Available ] DE#01-Disk#3 [Rebuild/Copyback ]
DE#01-Disk#4 [Rebuild/Copyback ] DE#01-Disk#5 [Available ]
DE#01-Disk#6 [Available ] DE#01-Disk#7 [Available (Predictive Failure)]
DE#01-Disk#8 [Available ] DE#01-Disk#9 [Available ]
DE#01-Disk#10 [Available (Predictive Failure)] DE#01-Disk#11 [Broken ]
DE#01-Disk#12 [Available ] DE#01-Disk#13 [Available ]
DE#01-Disk#14 [Available ] DE#01-Disk#15 [Available ]
DE#01-Disk#16 [Available ] DE#01-Disk#17 [Available ]
DE#01-Disk#18 [Available ] DE#01-Disk#19 [Available ]
DE#01-Disk#20 [Available ] DE#01-Disk#21 [Available ]
DE#01-Disk#22 [Available ] DE#01-Disk#23 [Available ]
DE#01-Disk#24 [Available ] DE#01-Disk#25 [Available ]
DE#01-Disk#26 [Available ] DE#01-Disk#27 [Available ]
DE#01-Disk#28 [Available ] DE#01-Disk#29 [Available ]
DE#01-Disk#30 [Available ] DE#01-Disk#31 [Available ]
DE#01-Disk#32 [Available ] DE#01-Disk#33 [Available ]
DE#01-Disk#34 [Available ] DE#01-Disk#35 [Available ]
DE#01-Disk#36 [Available ] DE#01-Disk#37 [Available ]
DE#01-Disk#38 [Available ] DE#01-Disk#39 [Available ]
DE#01-Disk#40 [Available ] DE#01-Disk#41 [Available ]
DE#01-Disk#42 [Available ] DE#01-Disk#43 [Available ]
DE#01-Disk#44 [Available ] DE#01-Disk#45 [Available ]
DE#01-Disk#46 [Available ] DE#01-Disk#47 [Available ]
DE#01-Disk#48 [Available ] DE#01-Disk#49 [Available ]
DE#01-Disk#50 [Available ] DE#01-Disk#51 [Available ]
DE#01-Disk#52 [Available ] DE#01-Disk#53 [Available ]
DE#01-Disk#54 [Available ] DE#01-Disk#55 [Available ]
DE#01-Disk#56 [Available ] DE#01-Disk#57 [Available ]
DE#01-Disk#58 [Available ] DE#01-Disk#59 [Available ]

```

The following example shows the information that is displayed when all of the enclosures are specified (for the DX60 S3/ DX100 S3/DX200 S3, the DX500 S4/DX600 S4, and the DX500 S3/DX600 S3):

```

CLI> show enclosure-status -type all
Controller Enclosure Information
Location      Status      Error Code  Sensor 1 / Sensor 2
Intake Temp   Normal      0x0000      25 (C) / 25 (C)
Exhaust Temp  Normal      0x0000      25 (C) / 25 (C)

Controller Enclosure Status
Controller Module Status/Status Code
CM#0 [Normal / 0xE001]
CM#1 [Normal / 0xE001]
Power Supply Unit Status/Status Code
PSU#0 [Normal / 0xE001]
PSU#1 [Normal / 0xE001]
Disk Status
CE-Disk#0 [Rebuild/Copyback ] CE-Disk#1 [Rebuild/Copyback ]
CE-Disk#2 [Available ] CE-Disk#3 [Broken ]
CE-Disk#4 [Available ] CE-Disk#5 [Available(Predictive Failure)]
CE-Disk#6 [Available(Predictive Failure)] CE-Disk#7 [Present ]
CE-Disk#8 [Present ] CE-Disk#9 [Present ]
CE-Disk#10 [Present ] CE-Disk#11 [Spare ]

Drive Enclosure #01 Information
Location      Status      Error Code  Sensor 1 / Sensor 2
Intake Temp   Normal      0x0000      25 (C) / 25 (C)
Exhaust Temp  Normal      0x0000      - / -

Drive Enclosure #01 Status
I/O Module Status/Status Code
IOM#0 [Normal / 0xE001]
IOM#1 [Normal / 0xE001]
Power Supply Unit Status/Status Code
PSU#0 [Normal / 0xE001]
PSU#1 [Normal / 0xE001]
Disk Status
DE#01-Disk#0 [Available ] DE#01-Disk#1 [Available ]
DE#01-Disk#2 [Available ] DE#01-Disk#3 [Rebuild/Copyback ]
DE#01-Disk#4 [Rebuild/Copyback ] DE#01-Disk#5 [Available ]
DE#01-Disk#6 [Available ] DE#01-Disk#7 [Available(Predictive Failure)]
DE#01-Disk#8 [Available ] DE#01-Disk#9 [Available ]
DE#01-Disk#10 [Available(Predictive Failure)] DE#01-Disk#11 [Broken ]

```

The following example shows the information that is displayed when all of the enclosures are specified (for the DX8100 S3):

```

CLI> show enclosure-status -type all
Controller Enclosure Information
Location      Status      Error Code  Sensor 1 / Sensor 2
Intake Temp   Normal      0x0000      25 (C) / 25 (C)
Exhaust Temp  Normal      0x0000      -

Controller Enclosure Status
Controller Module Status/Status Code
CM#0 [Normal / 0xE001]
CM#1 [Normal / 0xE001]
Power Supply Unit Status/Status Code
PSU#0 [Normal / 0xE001]
PSU#1 [Normal / 0xE001]

Drive Enclosure #01 Information
Location      Status      Error Code  Sensor 1 / Sensor 2
Intake Temp   Normal      0x0000      25 (C) / 25 (C)
Exhaust Temp  Normal      0x0000      -

Drive Enclosure #01 Status
I/O Module Status/Status Code
IOM#0 [Normal / 0xE001]
IOM#1 [Normal / 0xE001]
Power Supply Unit Status/Status Code
PSU#0 [Normal / 0xE001]
PSU#1 [Normal / 0xE001]
Disk Status
DE#01-Disk#0 [Available ] DE#01-Disk#1 [Available ]
DE#01-Disk#2 [Available ] DE#01-Disk#3 [Rebuild/Copyback ]
DE#01-Disk#4 [Rebuild/Copyback ] DE#01-Disk#5 [Available ]
DE#01-Disk#6 [Available ] DE#01-Disk#7 [Available(Predictive Failure)]
DE#01-Disk#8 [Available ] DE#01-Disk#9 [Available ]
DE#01-Disk#10 [Available(Predictive Failure)] DE#01-Disk#11 [Broken ]

```

The following example shows the information that is displayed when all of the enclosures are specified (for the DX8700 S3/DX8900 S3):

```

CLI> show enclosure-status -type all
Controller Enclosure #0 Information
Location      Status      Error Code  Sensor 1 / Sensor 2
Intake Temp   Normal      0x0000     20 (C)   / 20 (C)
Exhaust Temp  Normal      0x0000     25 (C)   / 25 (C)

Controller Enclosure #0 Status
Controller Module Status/Status Code
CM#0          [Normal     / 0xE001]
CM#1          [Normal     / 0xE001]
PCIe Flash Module Status/Status Code
CM#0 PFM#0    [Undefined  / 0x6000]
CM#0 PFM#1    [Undefined  / 0x6000]
CM#1 PFM#0    [Undefined  / 0x6000]
CM#1 PFM#1    [Undefined  / 0x6000]
Power Supply Unit Status/Status Code
PSU#0         [Normal     / 0xE001]
PSU#1         [Normal     / 0xE001]

Controller Enclosure #1 Information
Location      Status      Error Code  Sensor 1 / Sensor 2
Intake Temp   Normal      0x0000     20 (C)   / 20 (C)
Exhaust Temp  Normal      0x0000     25 (C)   / 25 (C)

Controller Enclosure #1 Status
Controller Module Status/Status Code
CM#0          [Normal     / 0xE001]
CM#1          [Normal     / 0xE001]
PCIe Flash Module Status/Status Code
CM#0 PFM#0    [Undefined  / 0x6000]
CM#0 PFM#1    [Undefined  / 0x6000]
CM#1 PFM#0    [Undefined  / 0x6000]
CM#1 PFM#1    [Undefined  / 0x6000]
Power Supply Unit Status/Status Code
PSU#0         [Normal     / 0xE001]
PSU#1         [Normal     / 0xE001]

Frontend Enclosure Information
Location      Status      Error Code  Sensor 1 / Sensor 2
Intake Temp   Normal      0x0000     20 (C)   / 20 (C)
Exhaust Temp  Normal      0x0000     -         / -

Frontend Enclosure Status
Front End Router Status/Status Code
FRT#0         [Normal     / 0xE001]
FRT#1         [Normal     / 0xE001]
FRT#2         [Normal     / 0xE001]
FRT#3         [Normal     / 0xE001]
Service Controller Status/Status Code
SVC#0         [Normal     / 0xE001]
SVC#1         [Normal     / 0xE001]
FAN Unit Status/Status Code
FANU#0        [Normal     / 0xE001]
FANU#1        [Normal     / 0xE001]
FANU#2        [Normal     / 0xE001]
FANU#3        [Normal     / 0xE001]
Operation Panel Status/Status Code
OPNL          [Normal     / 0xE001]
Power Supply Unit Status/Status Code
PSU#0         [Normal     / 0xE001]
PSU#1         [Normal     / 0xE001]
PSU#2         [Normal     / 0xE001]
PSU#3         [Normal     / 0xE001]

Drive Enclosure #00 Information
Location      Status      Error Code  Sensor 1 / Sensor 2
Intake Temp   Normal      0x0000     29 (C)   / 29 (C)
Exhaust Temp  Normal      0x0000     -         / -

```

```
Drive Enclosure #00 Status
I/O Module Status/Status Code
IOM#0      [Normal      / 0xE001]
IOM#1      [Normal      / 0xE001]
Power Supply Unit Status/Status Code
PSU#0      [Normal      / 0xE001]
PSU#1      [Normal      / 0xE001]
Disk Status
DE#00-Disk#0 [Available          ] DE#00-Disk#1 [Available          ]
DE#00-Disk#2 [Available          ] DE#00-Disk#3 [Available          ]
DE#00-Disk#4 [Present            ] DE#00-Disk#5 [Present            ]
DE#00-Disk#6 [Present            ] DE#00-Disk#7 [Present            ]
DE#00-Disk#8 [Present            ] DE#00-Disk#9 [Present            ]
DE#00-Disk#10 [Present            ] DE#00-Disk#11 [Present            ]
```

show fru-ce

This command displays the status of components (or Field Replaceable Units: FRU) of the controller enclosure.

Syntax

```
show fru-ce [-type {cm0 | cm1 | psu0 | psu1 | ce0 | ce1 | ce2 | ce3 | ce4 | ce5 | ce6 | ce7 | ce8 | ce9 |
cea | ceb | ce0cm0 | ce0cm1 | ce1cm0 | ce1cm1 | ce2cm0 | ce2cm1 | ce3cm0 | ce3cm1 | ce4cm0 |
ce4cm1 | ce5cm0 | ce5cm1 | ce6cm0 | ce6cm1 | ce7cm0 | ce7cm1 | ce8cm0 | ce8cm1 | ce9cm0 |
ce9cm1 | ceacm0 | ceacm1 | cebcm0 | cebcm1 | ce0psu0 | ce0psu1 | ce1psu0 | ce1psu1 | ce2psu0 |
ce2psu1 | ce3psu0 | ce3psu1 | ce4psu0 | ce4psu1 | ce5psu0 | ce5psu1 | ce6psu0 | ce6psu1 | ce7psu0 | ce7psu1 | ce8psu0
| ce8psu1 | ce9psu0 | ce9psu1 | ceapsu0 | ceapsu1 | cebpsu0 | cebpsu1}]
```

Parameter

- type Optional. This parameter specifies the target component (FRU) name. The details and status of each component embedded in the controller enclosure will be displayed. Only one parameter can be specified. If this parameter is omitted, all of the FRUs are displayed.

- cm*X* Details and status of Controller Module Unit #*X* and the sub-components
 (DX60 S4/DX100 S4/DX200 S4, DX500 S4/DX600 S4, DX60 S3/DX100 S3/DX200 S3, DX500 S3/
 DX600 S3, DX8100 S3, AF250 S2/AF650 S2, AF250/AF650, and DX200F only)

- psu*X* Details and status of Power Supply Unit #*X*
 (DX60 S4/DX100 S4/DX200 S4, DX500 S4/DX600 S4, DX60 S3/DX100 S3/DX200 S3, DX500 S3/
 DX600 S3, DX8100 S3, AF250 S2/AF650 S2, AF250/AF650, and DX200F only)

- ce*W* Details and status of Controller Enclosure #*W* and the sub-components
 (DX8700 S3/DX8900 S3 only)
 For details on the specification methods, refer to ["1.2.3 Controller Enclosure Syntax" \(page 34\)](#).

- ce*W*cm*X* Details and status of Controller Enclosure #*W*, Controller Module Unit #*X* and the sub-compo-
 nents
 (DX8700 S3/DX8900 S3 only)

- ce*W*psu*X* Details and status of Controller Enclosure #*W* and Power Supply Unit #*X*
 (DX8700 S3/DX8900 S3 only)

Output

The following table shows the output information when the controller enclosure, the controller module and the sub-components are specified.

Item name	Description
CM#W Information	W: The controller enclosure number (DX8700 S3/DX8900 S3 only)
Cache Mode	Cache control mode ("Write Back Mode" or "Write Through [factors]") For Write Through Mode, the main cause is displayed in "(factors)". Displays a summary of factors for all the CMs within the controller enclosure of the displayed target. If there are multiple factors, they are shown separated by a slash (/).
Write Through (Pinned Data)	A large amount of pinned data was generated.
Write Through (Battery)	The battery charge rate is low.

Item name	Description
Write Through(Maintenance)	The following maintenance operation is currently running: <ul style="list-style-type: none"> • Hot controller firmware update • Changing the controlling CM of the RAID group • Hot expanding the CM
Write Through(1CM)	The ETERNUS DX/AF is operating with only one CM.
(CE#W) CM#X Information	W: The controller enclosure number, X: The controller module number (For the DX8700 S3/DX8900 S3, CE#W is also displayed)
CPU Status/Status Code	Controller Module (CM#X) status and the status code
Memory Size	Memory size of a controller module
Parts Number	Parts number
Serial Number	Serial number
Hardware Revision	Hardware version
CPU Clock	CPU clock frequency
CM Active EC	EC number of the active firmware (The current operating firmware)
CM Next EC	EC number of the stand-by firmware (The generation number of the firmware after the next reboot)
BIOS Active EC	EC number of the active firmware (The current operating firmware)
BIOS Next EC	EC number of the stand-by firmware (The generation number of the firmware after the next reboot)
CM EXP Active EC	EC number of the active firmware (The current operating firmware)
CM EXP Next EC	EC number of the stand-by firmware (The generation number of the firmware after the next reboot)
NAS Engine Information	This information only appears for the Unified Storage.
Status/Status Code	NAS function status and the status code
(CE#W) CM#X Internal Parts Status and Status Code	W: The controller enclosure number, X: The controller module number (For the DX8700 S3/DX8900 S3, CE#W is also displayed)
Memory#	Memory status and the status code
Memory# Parts Number	Memory parts number
Memory# Serial Number	Memory serial number
Memory# Hard Revision	Memory hardware revision
BUD#	BUD (Bootup and Utility Device) status and the status code
BUD# Parts Number	BUD parts number
BUD# Serial Number	BUD serial number
BUD# Hard Revision	BUD hardware revision
CM FAN	CM FAN status and the status code (DX500 S4/DX600 S4, DX500 S3/DX600 S3, DX8100 S3/DX8700 S3/DX8900 S3, and AF650 S2/AF650 only)
CA# Parts Number	CA parts number
CA# Serial Number	CA serial number
CA# Hard Revision	CA hardware revision
CA Slot#	CA Slot status and the status code
DMA Port#	DMA Port status and the status code (DX60 S4/DX100 S4/DX200 S4, DX500 S4/DX600 S4, DX60 S3/DX100 S3/DX200 S3, DX500 S3/DX600 S3, DX8100 S3, AF250 S2/AF650 S2, AF250/AF650, and DX200F only)
Frontend cable(FRT#)	Frontend cable status and the status code (DX8700 S3/DX8900 S3 only)
BIOS#	BIOS status and the status code

Item name	Description
CM EXP	CM EXP status and the status code
CM EXP# InPort#	CM EXP InPort status and the status code
SAS Cable# (OUT)	SAS Cable (OUT) status and the status code
Management Cable(SVC#)	Management cable status and the status code (DX8700 S3/DX8900 S3 only)
CM RTC	CM RTC status and the status code
CM NVRAM	CM NVRAM status and the status code
CM FPGA	CM FPGA status and the status code
CM LAN Port#	CM LAN Port status and the status code (DX60 S4/DX100 S4/DX200 S4, DX500 S4/DX600 S4, DX60 S3/DX100 S3/DX200 S3, DX500 S3/DX600 S3, DX8100 S3, AF250 S2/AF650 S2, AF250/AF650, and DX200F only)
DI# Port#	DI port status and the status code
SATA SSD Controller	Boot and Utility Device (BUD) controller status and the status code (Only for the DX100 S4/DX200 S4, the DX100 S3/DX200 S3, and the DX200F)
SATA SSD Controller Active EC	Edition Control (EC) number that is currently operating in the relevant BUD controller (Only for the DX100 S4/DX200 S4, the DX100 S3/DX200 S3, the AF250 S2/AF250, and the DX200F)
SATA SSD Controller Next EC	EC number that will start up next in the relevant BUD controller (Only for the DX100 S4/DX200 S4, the DX100 S3/DX200 S3, the AF250 S2/AF250, and the DX200F)
SATA SSD Controller Firmware Version	BUD controller firmware version (Only for the DX100 S4/DX200 S4, the DX100 S3/DX200 S3, the AF250 S2/AF250, and the DX200F)
SCU	System Capacitor Unit (SCU) status and the status code (Only for the DX60 S3/DX100 S3/DX200 S3, the AF250, and the DX200F) SCUs are electric double layer capacitors embedded in a controller module. SCUs provide the power to move the cache data to memory if there is a power outage.
SCU Voltage	Charging voltage of SCU (Only for the DX60 S3/DX100 S3/DX200 S3, the AF250, and the DX200F)
BBU	BBU (Battery backup Unit) status and the status code (Only for the DX60 S4/DX100 S4/DX200 S4 and the AF250 S2) BBUs are battery backup units embedded in a controller module. BBUs provide the power to move the cache data to memory if there is a power outage.
BBU Charge Rate	BBU charge rate (%) (Only for the DX60 S4/DX100 S4/DX200 S4 and the AF250 S2)
(CE#W) CM#X CA#Y Port#Z Information	W: The controller enclosure number, X: The controller module number, Y: The Channel Adapter number, Z: The port number For FC, iSCSI, FCoE, and SAS (For the DX8700 S3/DX8900 S3, CE#W is also displayed)
Port Type	Indicates whether the host interface port type is FC, iSCSI, FCoE, or SAS.
Port Mode	Indicates whether the host interface port mode is CA, RA, CA/RA auto, or Initiator.
Status/Status Code	Host interface Port (Port#m) status and the status code
Multiple VLAN	This information only appears when the port type is iSCSI. This information indicates whether multiple VLAN is enabled. When multiple VLAN is enabled, "Enable" is displayed. When multiple VLAN is disabled, "Disable" is displayed. When the port mode is RA, "-" is displayed.
Number of IP Addresses	This information only appears when the port type is iSCSI. This information indicates the number of IP addresses with enabled ports. When "Enable" is displayed for the Multiple VLAN item, the number of IP addresses with enabled ports (from 1 to 16) is displayed. When "Disable" or "-" is displayed for the Multiple VLAN item, "1" is displayed.

Item name	Description
CA Active EC	EC number of the active firmware (the current operating firmware)
CA Next EC	EC number of the stand-by firmware (the generation number of the firmware after the next reboot)
Connection	Connection condition
Loop ID	Loop ID
Transfer Rate	Transfer rate (A value specified by the operator)
Link Status	Link status (Link Up, Link Down, or if requesting auto negotiation, then the actual transfer rate is displayed.)
Port WWN	Port World-Wide-Name
Node WWN	Node World-Wide-Name
iSCSI Name	iSCSI Name
iSCSI Alias Name	iSCSI Alias Name
Host Affinity	Indicates whether Host Affinity Mode is enabled.
Host Response	Host response information assigned to this port
iSNS Server Port No	iSNS Server Port Number
TCP Port No	TCP Port Number
TCP Window Size	TCP Window Size
FC Frame Size	FC Frame Size
VLAN ID	VLAN ID
Header Digest	Indicates whether or not Header Digest is added.
Date Digest	Indicates whether or not Date Digest is added.
Bandwidth Limit	Bandwidth limit (upper limit performance value)
Target Portal Group Number	Target Portal Group Number
CmdSN Count	CmdSN Count
Err Recovery Lvl	Error Recovery Level
Task Retain Time	The time required for processes stopped due to disconnection to restart from where they were stopped after reconnection
Reconnection Wait Time	The time required to reconnect the TCP connection
Fabric Name	Fabric Name
SFP Type	SFP Type This information only appears when the port type is FC, iSCSI 10G, SAS 12G, or FCoE.
SFP Information	(For FC, 10Gbit/s iSCSI [SFP+ with/without modules], 12Gbit/s SAS, and FCoE)
Temperature	Temperature (Present, Warning[Low/High], and Alarm[Low/High])
Voltage	Voltage (Present, Warning[Low/High], and Alarm[Low/High])
Current	Current (Present, Warning[Low/High], and Alarm[Low/High])
TX Power	Transmitter power (Present, Warning[Low/High], and Alarm[Low/High])
RX Power	Receiver power (Present, Warning[Low/High], and Alarm[Low/High])
(CE#W) CM#X CA#Y Port#Z Information	(W: The controller enclosure number, X: The controller module number, Y: The Channel Adapter number, Z: The port number) (For NAS) (For the DX8700 S3/DX8900 S3, CE#W is also displayed)
Port Type	Host interface port type (NAS)
Status/Status Code	Host interface port status and the status code
CA Active EC	EC number of the active firmware (the current operating firmware)

Item name	Description
CA Next EC	EC number of the stand-by firmware (the generation number of the firmware after the next reboot)
MAC Address	MAC address of the port
SFP Type	SFP type of the port (for 10G NAS). (This information does not appear when 1G NAS is used)
SFP Information	(For 10G NAS) (The following information does not appear when 1G NAS is used)
Temperature	Temperature (Present, Warning[Low/High], and Alarm[Low/High])
Voltage	Voltage (Present, Warning[Low/High], and Alarm[Low/High])
Current	Current (Present, Warning[Low/High], and Alarm[Low/High])
TX Power	Transmitter power (Present, Warning[Low/High], and Alarm[Low/High])
RX Power	Receiver power (Present, Warning[Low/High], and Alarm[Low/High])
(CE#W) CM#X CA#Y Port#Z Information	(W: The controller enclosure number, X: The controller module number, Y: The channel adapter number, Z: The port number) (For FCLINK or OCLINK) (For the DX8700 S3/DX8900 S3, CE#W is also displayed)
Port Type	Host interface port type (FCLINK or OCLINK)
Status/Status Code	Host interface port (Port#m) status and status code
(CE#W) CM#X PFM#Y Information	(W: The controller enclosure number, X: The controller module number, Y: The PCIe Flash Module number) (DX500 S4/DX600 S4, DX500 S3/DX600 S3, and DX8700 S3/DX8900 S3 only. For the DX8700 S3/DX8900 S3, CE#W is also displayed)
Type	PCIe Flash Module type
Status/Status Code	PCIe Flash Module status and the status code
Health	Remaining usable capacity (operating life) of the PCIe Flash Module (unit: %). When the remaining capacity is 5% or less, "Warning" appears in the Status/Status Code field. When the remaining capacity is 0%, "Error" appears in the Status/Status Code field.
Capacity	PCIe Flash Module physical capacity
Parts Number	PCIe Flash Module parts number
Serial Number	PCIe Flash Module serial number
Hard Revision	PCIe Flash Module hardware revision
(CE#W) BCU/BTU Information	(W: The controller enclosure number) (DX500 S4/DX600 S4, DX500 S3/DX600 S3, DX8100 S3/DX8700 S3/DX8900 S3, and AF650 S2/AF650 only. For the DX8700 S3/DX8900 S3, CE#W is also displayed.)
BCU Status/Status Code	BCU status and the status code
BTU Status/Status Code	BTU status and the status code
BCU# ChargeRate	Charging rate of BCU
BCU# Expires	Expiry date of the BCU
BCU# Parts Number	BCU parts number
BCU# Serial Number	BCU serial number
BCU# Hard Revision	BCU hardware revision
SCCI#X Information or PPC#X Information	(X: SCCI number or PPC number)
Status/Status Code	Status and the status code of SCCI or PPC
PSU	(Power Supply Unit)
Status/Status Code	PSU status and the status code

■ Example(s)

The following example displays each status and detail of controller module #0 for FC (For the DX60 S4/DX100 S4/DX200 S4):

```

CLI> show fru-ce -type cm0
CM#0 Information
CPU Status/Status Code    [Normal      / 0xE001]
Memory Size               [1.5GB]
Parts Number              []
Serial Number             []
Hard Revision             []
CPU Clock                 [2.00GHz]
CM Active EC              [EC#1]
CM Next EC                [EC#1]
BIOS Active EC           [EC#0]
BIOS Next EC             [EC#0]
CM EXP Active EC         [EC#1]
CM EXP Next EC          [EC#1]
NAS Engine Information
Status/Status Code       [Normal      / 0xE001]
CM#0 Internal Parts Status/Status Code
Memory#0                 [Normal      / 0xE001]
Memory#0 Parts Number    [18JSF25672PZ-1G1F0]
Memory#0 Serial Number   [0951D864C0D0]
Memory#0 Hard Revision   [4631]
Memory#1                 [Undefined   / 0x0000]
Memory#1 Parts Number    []
Memory#1 Serial Number   []
Memory#1 Hard Revision   []
Memory#2                 [Undefined   / 0x0000]
Memory#2 Parts Number    []
Memory#2 Serial Number   []
Memory#2 Hard Revision   []
Memory#3                 [Undefined   / 0x0000]
Memory#3 Parts Number    []
Memory#3 Serial Number   []
Memory#3 Hard Revision   []
Memory#4                 [Undefined   / 0x0000]
Memory#4 Parts Number    []
Memory#4 Serial Number   []
Memory#4 Hard Revision   []
Memory#5                 [Undefined   / 0x0000]
Memory#5 Parts Number    []
Memory#5 Serial Number   []
Memory#5 Hard Revision   []
Memory#6                 [Undefined   / 0x0000]
Memory#6 Parts Number    []
Memory#6 Serial Number   []
Memory#6 Hard Revision   []
Memory#7                 [Undefined   / 0x0000]
Memory#7 Parts Number    []
Memory#7 Serial Number   []
Memory#7 Hard Revision   []
BUD                      [Normal      / 0xE001]
BUD Parts Number         [QEMU HARDDISK QM00]
BUD Serial Number        [QM00002      0 10]
BUD Hard Revision        [0 10 6 ]
CA#0 Parts Number        []
CA#0 Serial Number       []
CA#0 Hard Revision       []
CA Slot#0-0              [Normal      / 0xE001]
CA Slot#0-1              [Undefined   / 0x0000]
CA#1 Parts Number        []
CA#1 Serial Number       []
CA#1 Hard Revision       []
CA Slot#1-0              [Undefined   / 0x4000]
CA Slot#1-1              [Undefined   / 0x0000]
CA#2 Parts Number        []
CA#2 Serial Number       []
CA#2 Hard Revision       []
CA Slot#2-0              [Undefined   / 0x0000]
CA Slot#2-1              [Undefined   / 0x0000]
CA#3 Parts Number        []
CA#3 Serial Number       []
CA#3 Hard Revision       []

```

```

CA Slot#3-0                [Undefined / 0x0000]
CA Slot#3-1                [Undefined / 0x0000]
DMA Port#0                 [Normal / 0xE001]
DMA Port#1                 [Normal / 0xE001]
BIOS#0                     [Normal / 0xE001]
BIOS#1                     [Normal / 0xE001]
CM EXP                     [Normal / 0xE001]
CM EXP InPort#0           [Normal / 0xE001]
CM EXP InPort#1           [Normal / 0xE001]
CM EXP InPort#2           [Undefined / 0xE001]
CM EXP InPort#3           [Undefined / 0xE001]
SAS Cable#0(OUT)          [Normal / 0xE001]
SAS Cable#1(OUT)          [Undefined / 0x0000]
SAS Cable#2(OUT)          [Undefined / 0x0000]
SAS Cable#3(OUT)          [Undefined / 0x0000]
CM RTC                     [Normal / 0xE001]
CM NVRAM                   [Normal / 0xE001]
CM FPGA                    [Normal / 0xE001]
CM LAN Port#0              [Normal / 0xE001]
CM LAN Port#1              [Normal / 0xE001]
CM LAN Port#2              [Normal / 0xE001]
DI#0 Port#0                [Normal / 0xE001]
DI#0 Port#1                [Normal / 0xE001]
DI#1 Port#0                [Undefined / 0x0000]
DI#1 Port#1                [Undefined / 0x0000]
SATA SSD Controller Information
Status/Status Code        [Undefined / 0x0000]
Active EC                  [EC#1]
Next EC                    [EC#2]
Firmware Version          [V10L10-0000]
BBU                        [Normal / 0xE001]
BBU Charge Rate           [100%]
CM#0 CA#0 Port#0 Information
Port Type                  [FC]
Port Mode                  [CA]
Status/Status Code        [Normal / 0xE001]
CA Active EC               [EC#0]
CA Next EC                 [EC#0]
Connection                 [Loop]
Loop ID                    [0x00]
Transfer Rate              [Auto Negotiation]
Link Status                [Unknown]
Port WWN                   [500000E0D1000000]
Node WWN                   [500000E0D1000000]
Host Affinity              [Disable]
Host Response              [0]
SFP Type                   [ShortWave]
SFP Information
  Present      Warning (Low/High)      Alarm (Low/High)
Temperature    [40.11C]                [-15.00C/100.00C]    [-30.00C/128.00C]
Voltage        [4.24V]                  [3.00V/5.00V]        [2.00V/7.00V]
Current        [10.25mA]                 [5.00mA/12.00mA]     [2.00mA/15.00mA]
TX Power       [1.35mW]                  [0.50mW/1.50mW]     [0.00mW/1.80mW]
RX Power       [1.35mW]                  [0.50mW/1.50mW]     [0.00mW/1.80mW]
CM#0 CA#0 Port#1 Information
Port Type                  [FC]
Port Mode                  [CA]
Status/Status Code        [Normal / 0xE001]
CA Active EC               [EC#0]
CA Next EC                 [EC#0]
Connection                 [Loop]
Loop ID                    [0x00]
Transfer Rate              [Auto Negotiation]
Link Status                [Unknown]
Port WWN                   [500000E0D1000000]
Node WWN                   [500000E0D1000000]
Host Affinity              [Disable]
Host Response              [0]
SFP Type                   [ShortWave]
SFP Information
  Present      Warning (Low/High)      Alarm (Low/High)
Temperature    [40.11C]                [-15.00C/100.00C]    [-30.00C/128.00C]
Voltage        [4.24V]                  [3.00V/5.00V]        [2.00V/7.00V]
Current        [10.25mA]                 [5.00mA/12.00mA]     [2.00mA/15.00mA]
TX Power       [1.35mW]                  [0.50mW/1.50mW]     [0.00mW/1.80mW]
RX Power       [1.35mW]                  [0.50mW/1.50mW]     [0.00mW/1.80mW]

```

The following example displays each status and detail of controller module #0 for FC (For the DX60 S4/DX100 S4/DX200 S4, the DX60 S3/DX100 S3/DX200 S3, the AF250 S2/AF250, and the DX200F):

```

CLI> show fru-ce -type cm0
CM#0 Information
CPU Status/Status Code      [Normal          / 0xE001]
Memory Size                  [1.5GB]
Parts Number                 []
Serial Number                []
Hard Revision                []
CPU Clock                    [2.00GHz]
CM Active EC                 [EC#1]
CM Next EC                   [EC#1]
BIOS Active EC               [EC#0]
BIOS Next EC                 [EC#0]
CM EXP Active EC             [EC#1]
CM EXP Next EC               [EC#1]
NAS Engine Information
Status/Status Code          [Normal          / 0xE001]
CM#0 Internal Parts Status/Status Code
Memory#0                     [Normal          / 0xE001]
Memory#0 Parts Number        [18JSF25672PZ-1G1F0]
Memory#0 Serial Number       [0951D864C0D0]
Memory#0 Hard Revision       [4631]
Memory#1                     [Undefined       / 0x0000]
Memory#1 Parts Number        []
Memory#1 Serial Number       []
Memory#1 Hard Revision       []
Memory#2                     [Undefined       / 0x0000]
Memory#2 Parts Number        []
Memory#2 Serial Number       []
Memory#2 Hard Revision       []
Memory#3                     [Undefined       / 0x0000]
Memory#3 Parts Number        []
Memory#3 Serial Number       []
Memory#3 Hard Revision       []
Memory#4                     [Undefined       / 0x0000]
Memory#4 Parts Number        []
Memory#4 Serial Number       []
Memory#4 Hard Revision       []
Memory#5                     [Undefined       / 0x0000]
Memory#5 Parts Number        []
Memory#5 Serial Number       []
Memory#5 Hard Revision       []
Memory#6                     [Undefined       / 0x0000]
Memory#6 Parts Number        []
Memory#6 Serial Number       []
Memory#6 Hard Revision       []
Memory#7                     [Undefined       / 0x0000]
Memory#7 Parts Number        []
Memory#7 Serial Number       []
Memory#7 Hard Revision       []
BUD                           [Normal          / 0xE001]
BUD Parts Number             [QEMU HARDDISK  QM00]
BUD Serial Number            [QM00002         0 10]
BUD Hard Revision            [0 10 6 ]
CA#0 Parts Number            []
CA#0 Serial Number           []
CA#0 Hard Revision           []
CA Slot#0-0                  [Normal          / 0xE001]
CA Slot#0-1                  [Undefined       / 0x0000]
CA#1 Parts Number            []
CA#1 Serial Number           []
CA#1 Hard Revision           []
CA Slot#1-0                  [Undefined       / 0x4000]
CA Slot#1-1                  [Undefined       / 0x0000]
CA#2 Parts Number            []
CA#2 Serial Number           []
CA#2 Hard Revision           []
CA Slot#2-0                  [Undefined       / 0x0000]
CA Slot#2-1                  [Undefined       / 0x0000]

```

```

CA#3 Parts Number      []
CA#3 Serial Number    []
CA#3 Hard Revision    []
CA Slot#3-0          [Undefined / 0x0000]
CA Slot#3-1          [Undefined / 0x0000]
DMA Port#0           [Normal / 0xE001]
DMA Port#1           [Normal / 0xE001]
BIOS#0               [Normal / 0xE001]
BIOS#1               [Normal / 0xE001]
CM EXP               [Normal / 0xE001]
CM EXP InPort#0      [Normal / 0xE001]
CM EXP InPort#1      [Normal / 0xE001]
CM EXP InPort#2      [Undefined / 0xE001]
CM EXP InPort#3      [Undefined / 0xE001]
SAS Cable#0(OUT)     [Normal / 0xE001]
SAS Cable#1(OUT)     [Undefined / 0x0000]
SAS Cable#2(OUT)     [Undefined / 0x0000]
SAS Cable#3(OUT)     [Undefined / 0x0000]
CM RTC               [Normal / 0xE001]
CM NVRAM              [Normal / 0xE001]
CM FPGA               [Normal / 0xE001]
CM LAN Port#0         [Normal / 0xE001]
CM LAN Port#1         [Normal / 0xE001]
CM LAN Port#2         [Normal / 0xE001]
DI#0 Port#0          [Normal / 0xE001]
DI#0 Port#1          [Normal / 0xE001]
DI#1 Port#0          [Undefined / 0x0000]
DI#1 Port#1          [Undefined / 0x0000]
SATA SSD Controller Information
  Status/Status Code [Undefined / 0x0000]
  Active EC           [EC#1]
  Next EC             [EC#2]
  Firmware Version    [V10L10-0000]
SCU                   [Normal / 0xE001]
SCU Voltage           [10.80V]
CM#0 CA#0 Port#0 Information
Port Type             [FC]
Port Mode             [CA]
Status/Status Code   [Normal / 0xE001]
CA Active EC          [EC#0]
CA Next EC           [EC#0]
Connection            [Loop]
Loop ID               [0x00]
Transfer Rate         [Auto Negotiation]
Link Status           [Unknown]
Port WWN              [500000E0D1000000]
Node WWN              [500000E0D1000000]
Host Affinity         [Disable]
Host Response         [0]
SFP Type              [ShortWave]
SFP Information
  Present             Warning (Low/High)      Alarm (Low/High)
  Temperature         [40.11C]             [-15.00C/100.00C]   [-30.00C/128.00C]
  Voltage              [4.24V]              [3.00V/5.00V]       [2.00V/7.00V]
  Current              [10.25mA]             [5.00mA/12.00mA]    [2.00mA/15.00mA]
  TX Power             [1.35mW]              [0.50mW/1.50mW]    [0.00mW/1.80mW]
  RX Power             [1.35mW]              [0.50mW/1.50mW]    [0.00mW/1.80mW]
CM#0 CA#0 Port#1 Information
Port Type             [FC]
Port Mode             [CA]
Status/Status Code   [Normal / 0xE001]
CA Active EC          [EC#0]
CA Next EC           [EC#0]
Connection            [Loop]
Loop ID               [0x00]
Transfer Rate         [Auto Negotiation]
Link Status           [Unknown]
Port WWN              [500000E0D1000000]
Node WWN              [500000E0D1000000]
Host Affinity         [Disable]
Host Response         [0]
SFP Type              [ShortWave]
SFP Information
  Present             Warning (Low/High)      Alarm (Low/High)
  Temperature         [40.11C]             [-15.00C/100.00C]   [-30.00C/128.00C]
  Voltage              [4.24V]              [3.00V/5.00V]       [2.00V/7.00V]
  Current              [10.25mA]             [5.00mA/12.00mA]    [2.00mA/15.00mA]
  TX Power             [1.35mW]              [0.50mW/1.50mW]    [0.00mW/1.80mW]
  RX Power             [1.35mW]              [0.50mW/1.50mW]    [0.00mW/1.80mW]

```

The following example displays each status and detail of controller module #0 for FC (the DX500 S4/DX600 S4, the DX500 S3/DX600 S3, and the AF650 S2/AF650):

```

CLI> show fru-ce -type cm0
CM#0 Information
CPU Status/Status Code      [Normal      / 0xE001]
Memory Size                  [1.5GB]
Parts Number                 []
Serial Number                []
Hard Revision                []
CPU Clock                    [2.00GHz]
CM Active EC                 [EC#1]
CM Next EC                   [EC#1]
BIOS Active EC               [EC#0]
BIOS Next EC                 [EC#0]
CM EXP Active EC             [EC#1]
CM EXP Next EC               [EC#1]
NAS Engine Information
  Status/Status Code        [Normal      / 0xE001]
CM#0 Internal Parts Status/Status Code
Memory#0                     [Normal      / 0xE001]
Memory#0 Parts Number        [18JSF25672PZ-1G1F0]
Memory#0 Serial Number       [0951D864C0D0]
Memory#0 Hard Revision       [4631]
Memory#1                     [Undefined   / 0x0000]
Memory#1 Parts Number        []
Memory#1 Serial Number       []
Memory#1 Hard Revision       []
Memory#2                     [Undefined   / 0x0000]
Memory#2 Parts Number        []
Memory#2 Serial Number       []
Memory#2 Hard Revision       []
Memory#3                     [Undefined   / 0x0000]
Memory#3 Parts Number        []
Memory#3 Serial Number       []
Memory#3 Hard Revision       []
Memory#4                     [Undefined   / 0x0000]
Memory#4 Parts Number        []
Memory#4 Serial Number       []
Memory#4 Hard Revision       []
Memory#5                     [Undefined   / 0x0000]
Memory#5 Parts Number        []
Memory#5 Serial Number       []
Memory#5 Hard Revision       []
Memory#6                     [Undefined   / 0x0000]
Memory#6 Parts Number        []
Memory#6 Serial Number       []
Memory#6 Hard Revision       []
Memory#7                     [Undefined   / 0x0000]
Memory#7 Parts Number        []
Memory#7 Serial Number       []
Memory#7 Hard Revision       []
BUD                           [Normal      / 0xE001]
BUD Parts Number              [QEMU HARDDISK  QM00]
BUD Serial Number             [QM00002        0 10]
BUD Hard Revision             [0 10 6 ]
CM FAN                        [Normal      / 0xE001]
CA#0 Parts Number             []
CA#0 Serial Number            []
CA#0 Hard Revision            []
CA Slot#0-0                   [Normal      / 0xE001]
CA Slot#0-1                   [Undefined   / 0x0000]
CA#1 Parts Number             []
CA#1 Serial Number            []
CA#1 Hard Revision            []
CA Slot#1-0                   [Undefined   / 0x4000]
CA Slot#1-1                   [Undefined   / 0x0000]
CA#2 Parts Number             []
CA#2 Serial Number            []
CA#2 Hard Revision            []
CA Slot#2-0                   [Undefined   / 0x0000]
CA Slot#2-1                   [Undefined   / 0x0000]
CA#3 Parts Number             []
CA#3 Serial Number            []
CA#3 Hard Revision            []
CA Slot#3-0                   [Undefined   / 0x0000]
CA Slot#3-1                   [Undefined   / 0x0000]

```

```

DMA Port#0                [Normal      / 0xE001]
DMA Port#1                [Normal      / 0xE001]
BIOS#0                   [Normal      / 0xE001]
BIOS#1                   [Normal      / 0xE001]
CM EXP                   [Normal      / 0xE001]
CM EXP InPort#0          [Normal      / 0xE001]
CM EXP InPort#1          [Normal      / 0xE001]
CM EXP InPort#2          [Undefined   / 0xE001]
CM EXP InPort#3          [Undefined   / 0xE001]
SAS Cable#0(OUT)         [Normal      / 0xE001]
SAS Cable#1(OUT)         [Undefined   / 0x0000]
SAS Cable#2(OUT)         [Undefined   / 0x0000]
SAS Cable#3(OUT)         [Undefined   / 0x0000]
CM RTC                   [Normal      / 0xE001]
CM NVRAM                 [Normal      / 0xE001]
CM FPGA                  [Normal      / 0xE001]
CM LAN Port#0            [Normal      / 0xE001]
CM LAN Port#1            [Normal      / 0xE001]
CM LAN Port#2            [Normal      / 0xE001]
DI#0 Port#0              [Normal      / 0xE001]
DI#0 Port#1              [Normal      / 0xE001]
DI#1 Port#0              [Undefined   / 0x0000]
DI#1 Port#1              [Undefined   / 0x0000]
SATA SSD Controller Information
  Status/Status Code     [Undefined   / 0x0000]
  Active EC               [EC#1]
  Next EC                 [EC#2]
  Firmware Version       [V10L10-0000]
CM#0 CA#0 Port#0 Information
Port Type                 [FC]
Port Mode                 [CA]
Status/Status Code       [Normal      / 0xE001]
CA Active EC              [EC#0]
CA Next EC                [EC#0]
Connection                [Loop]
Loop ID                   [0x00]
Transfer Rate             [Auto Negotiation]
Link Status               [Unknown]
Port WWN                  [500000E0D1000000]
Node WWN                  [500000E0D1000000]
Host Affinity             [Disable]
Host Response             [0]
SFP Type                  [ShortWave]
SFP Information
  Present                 Warning (Low/High)      Alarm (Low/High)
  Temperature             [40.11C]                [-15.00C/100.00C]      [-30.00C/128.00C]
  Voltage                  [4.24V]                  [3.00V/5.00V]          [2.00V/7.00V]
  Current                  [10.25mA]                [5.00mA/12.00mA]      [2.00mA/15.00mA]
  TX Power                 [1.35mW]                 [0.50mW/1.50mW]       [0.00mW/1.80mW]
  RX Power                 [1.35mW]                 [0.50mW/1.50mW]       [0.00mW/1.80mW]
CM#0 CA#0 Port#1 Information
Port Type                 [FC]
Port Mode                 [CA]
Status/Status Code       [Normal      / 0xE001]
CA Active EC              [EC#0]
CA Next EC                [EC#0]
Connection                [Loop]
Loop ID                   [0x00]
Transfer Rate             [Auto Negotiation]
Link Status               [Unknown]
Port WWN                  [500000E0D1000000]
Node WWN                  [500000E0D1000000]
Host Affinity             [Disable]
Host Response             [0]
SFP Type                  [ShortWave]
SFP Information
  Present                 Warning (Low/High)      Alarm (Low/High)
  Temperature             [40.11C]                [-15.00C/100.00C]      [-30.00C/128.00C]
  Voltage                  [4.24V]                  [3.00V/5.00V]          [2.00V/7.00V]
  Current                  [10.25mA]                [5.00mA/12.00mA]      [2.00mA/15.00mA]
  TX Power                 [1.35mW]                 [0.50mW/1.50mW]       [0.00mW/1.80mW]
  RX Power                 [1.35mW]                 [0.50mW/1.50mW]       [0.00mW/1.80mW]

```



```

CM#0 PFM#0 Information
Type [HHHL]
Status/Status Code [Normal / 0xE001]
Health [0%]
Capacity [700GB]
Parts Number []
Serial Number []
Hard Revision []
CM#0 PFM#1 Information
Type [HHHL]
Status/Status Code [Normal / 0xE001]
Health [50%]
Capacity [700GB]
Parts Number []
Serial Number []
Hard Revision []
BCU/BTU Information
BCU#0 Status/Status Code [Normal / 0xE001]
BTU#0 Status/Status Code [Normal / 0xE001]
BCU#0 ChargeRate [0%]
BCU#0 Expires [0-00]
BCU#0 Parts Number []
BCU#0 Serial Number []
BCU#0 Hard Revision []
BCU#1 Status/Status Code [Normal / 0xE001]
BTU#1 Status/Status Code [Normal / 0xE001]
BCU#1 ChargeRate [0%]
BCU#1 Expires [0-00]
BCU#1 Parts Number []
BCU#1 Serial Number []
BCU#1 Hard Revision []
BCU#2 Status/Status Code [Normal / 0xE001]
BTU#2 Status/Status Code [Normal / 0xE001]
BCU#2 ChargeRate [0%]
BCU#2 Expires [0-00]
BCU#2 Parts Number []
BCU#2 Serial Number []
BCU#2 Hard Revision []

```

The following example displays each status and detail of controller module #0 (For the DX8100 S3):

```

CLI> show fru-ce -type cm0
CM#0 Information
CPU#0 Status/Status Code [Normal / 0xE001]
CPU#1 Status/Status Code [Undefined / 0x0000]
Memory Size [1.5GB]
Parts Number []
Serial Number []
Hard Revision []
CPU#0 Clock [2.00GHz]
CPU#1 Clock [0.00GHz]
CM Active EC [EC#1]
CM Next EC [EC#1]
BIOS Active EC [EC#0]
BIOS Next EC [EC#0]
CM EXP Active EC [EC#1]
CM EXP Next EC [EC#1]
CM#0 Internal Parts Status/Status Code
Memory#0 [Normal / 0xE001]
Memory#0 Parts Number [18JSF25672PZ-1G1F0]
Memory#0 Serial Number [0951D864C0D0]
Memory#0 Hard Revision [4631]
Memory#1 [Undefined / 0x0000]
Memory#1 Parts Number []
Memory#1 Serial Number []
Memory#1 Hard Revision []
Memory#2 [Undefined / 0x0000]
Memory#2 Parts Number []
Memory#2 Serial Number []
Memory#2 Hard Revision []
Memory#3 [Undefined / 0x0000]
Memory#3 Parts Number []
Memory#3 Serial Number []
Memory#3 Hard Revision []
Memory#4 [Undefined / 0x0000]
Memory#4 Parts Number []
Memory#4 Serial Number []
Memory#4 Hard Revision []
Memory#5 [Undefined / 0x0000]
Memory#5 Parts Number []
Memory#5 Serial Number []
Memory#5 Hard Revision []
Memory#6 [Undefined / 0x0000]
Memory#6 Parts Number []
Memory#6 Serial Number []
Memory#6 Hard Revision []
Memory#7 [Undefined / 0x0000]
Memory#7 Parts Number []
Memory#7 Serial Number []
Memory#7 Hard Revision []
BUD#0 [Normal / 0xE001]
BUD#0 Parts Number [QEMU HARDDISK QM00]
BUD#0 Serial Number [QM00002 0 10]
BUD#0 Hard Revision [0 10 6 ]
BUD#1 [Normal / 0xE001]
BUD#1 Parts Number [QEMU HARDDISK QM00]
BUD#1 Serial Number [QM00002 0 10]
BUD#1 Hard Revision [0 10 6 ]
CM FAN [Normal / 0xE001]
CA#0 Parts Number []
CA#0 Serial Number []
CA#0 Hard Revision []
CA Slot#0-0 [Normal / 0xE001]
CA Slot#0-1 [Undefined / 0x0000]
CA#1 Parts Number []
CA#1 Serial Number []
CA#1 Hard Revision []
CA Slot#1-0 [Undefined / 0x4000]
CA Slot#1-1 [Undefined / 0x0000]
DMA Port#0 [Normal / 0xE001]
DMA Port#1 [Normal / 0xE001]
BIOS#0 [Normal / 0xE001]
BIOS#1 [Normal / 0xE001]
CM EXP#0 [Normal / 0xE001]
CM EXP#0 InPort#0 [Normal / 0xE001]

```

```

CM EXP#0 InPort#1      [Normal      / 0xE001]
SAS Cable#0(OUT)      [Normal      / 0xE001]
SAS Cable#1(OUT)      [Undefined   / 0x0000]
CM EXP#1               [Undefined   / 0x0000]
CM EXP#1 InPort#0     [Undefined   / 0x0000]
CM EXP#1 InPort#1     [Undefined   / 0x0000]
SAS Cable#2(OUT)      [Undefined   / 0x0000]
SAS Cable#3(OUT)      [Undefined   / 0x0000]
CM RTC                 [Normal      / 0xE001]
CM NVRAM               [Normal      / 0xE001]
CM FPGA                [Normal      / 0xE001]
CM LAN Port#0         [Normal      / 0xE001]
CM LAN Port#1         [Normal      / 0xE001]
CM LAN Port#2         [Normal      / 0xE001]
DI#0 Port#0           [Normal      / 0xE001]
DI#0 Port#1           [Normal      / 0xE001]
DI#1 Port#0           [Undefined   / 0x0000]
DI#1 Port#1           [Undefined   / 0x0000]
NAND Controller       [Undefined   / 0x0000]

CM#0 CA#0 Port#0 Information
Port Type             [FC]
Port Mode             [CA]
Status/Status Code   [Normal      / 0xE001]
CA Active EC         [EC#0]
CA Next EC           [EC#0]
Connection            [Loop]
Loop ID              [0x00]
Transfer Rate         [Auto Negotiation]
Link Status           [Unknown]
Port WWN              [500000E0D1000000]
Node WWN              [500000E0D1000000]
Host Affinity         [Disable]
Host Response         [0]
SFP Type              [ShortWave]
SFP Information

  Present              Warning (Low/High)      Alarm (Low/High)
  Temperature          [40.11C]              [-15.00C/100.00C]      [-30.00C/128.00C]
  Voltage              [4.24V]                [3.00V/5.00V]         [2.00V/7.00V]
  Current              [10.25mA]              [5.00mA/12.00mA]     [2.00mA/15.00mA]
  TX Power             [1.35mW]               [0.50mW/1.50mW]      [0.00mW/1.80mW]
  RX Power             [1.35mW]               [0.50mW/1.50mW]      [0.00mW/1.80mW]

CM#0 CA#0 Port#1 Information
Port Type             [FC]
Port Mode             [CA]
Status/Status Code   [Normal      / 0xE001]
CA Active EC         [EC#0]
CA Next EC           [EC#0]
Connection            [Loop]
Loop ID              [0x00]
Transfer Rate         [Auto Negotiation]
Link Status           [Unknown]
Port WWN              [500000E0D1000000]
Node WWN              [500000E0D1000000]
Host Affinity         [Disable]
Host Response         [0]
SFP Type              [ShortWave]
SFP Information

  Present              Warning (Low/High)      Alarm (Low/High)
  Temperature          [40.11C]              [-15.00C/100.00C]      [-30.00C/128.00C]
  Voltage              [4.24V]                [3.00V/5.00V]         [2.00V/7.00V]
  Current              [10.25mA]              [5.00mA/12.00mA]     [2.00mA/15.00mA]
  TX Power             [1.35mW]               [0.50mW/1.50mW]      [0.00mW/1.80mW]
  RX Power             [1.35mW]               [0.50mW/1.50mW]      [0.00mW/1.80mW]

BCU/BTU Information
BCU#0 Status/Status Code [Normal      / 0xE001]
BTU#0 Status/Status Code [Normal      / 0xE001]
BCU#0 ChargeRate       [0%]
BCU#0 Expires          [0-00]
BCU#0 Parts Number     []
BCU#0 Serial Number    []
BCU#0 Hard Revision    []
BCU#1 Status/Status Code [Normal      / 0xE001]
BTU#1 Status/Status Code [Normal      / 0xE001]
BCU#1 ChargeRate       [0%]
BCU#1 Expires          [0-00]
BCU#1 Parts Number     []
BCU#1 Serial Number    []
BCU#1 Hard Revision    []

```

```
BCU#2 Status/Status Code [Normal      / 0xE001]
BTU#2 Status/Status Code [Normal      / 0xE001]
BCU#2 ChargeRate         [0%]
BCU#2 Expires            [0-00]
BCU#2 Parts Number       []
BCU#2 Serial Number      []
BCU#2 Hard Revision      []
SCCI#0 Information
Status/Status Code      [Normal      / 0xE001]
SCCI#1 Information
Status/Status Code      [Normal      / 0xE001]
CE PSU#0 Information
Status/Status Code      [Normal      / 0xE001]
CE PSU#1 Information
Status/Status Code      [Normal      / 0xE001]
```

The following example displays each status and detail of controller enclosure #0 (For the DX8700 S3/DX8900 S3):

```

CLI> show fru-ce -type ce0
CE#0 Information
Cache Mode [Write Back Mode]
CE#0 CM#0 Information
CPU Status/Status Code [Normal / 0xE001]
Memory Size [8.0GB]
Parts Number []
Serial Number []
Hard Revision []
CPU Clock [0.04GHz]
CM Active EC [EC#1]
CM Next EC [EC#1]
BIOS Active EC [EC#0]
BIOS Next EC [EC#0]
CM EXP Active EC [EC#1]
CM EXP Next EC [EC#1]
CE#0 CM#0 Internal Parts Status/Status Code
Memory#0 [Normal / 0xE001]
Memory#0 Parts Number []
Memory#0 Serial Number []
Memory#0 Hard Revision []
Memory#1 [Undefined / 0x0000]
Memory#1 Parts Number []
Memory#1 Serial Number []
Memory#1 Hard Revision []
Memory#2 [Undefined / 0x0000]
Memory#2 Parts Number []
Memory#2 Serial Number []
Memory#2 Hard Revision []
Memory#3 [Undefined / 0x0000]
Memory#3 Parts Number []
Memory#3 Serial Number []
Memory#3 Hard Revision []
Memory#4 [Undefined / 0x0000]
Memory#4 Parts Number []
Memory#4 Serial Number []
Memory#4 Hard Revision []
Memory#5 [Undefined / 0x0000]
Memory#5 Parts Number []
Memory#5 Serial Number []
Memory#5 Hard Revision []
Memory#6 [Undefined / 0x0000]
Memory#6 Parts Number []
Memory#6 Serial Number []
Memory#6 Hard Revision []
Memory#7 [Undefined / 0x0000]
Memory#7 Parts Number []
Memory#7 Serial Number []
Memory#7 Hard Revision []
BUD#0 [Normal / 0xE001]
BUD#0 Parts Number []
BUD#0 Serial Number []
BUD#0 Hard Revision []
BUD#1 [Normal / 0xE001]
BUD#1 Parts Number []
BUD#1 Serial Number []
BUD#1 Hard Revision []
CM FAN [Normal / 0xE001]
CA#0 Parts Number []
CA#0 Serial Number []
CA#0 Hard Revision []
CA Slot#0-0 [Normal / 0xE001]
CA Slot#0-1 [Undefined / 0x0000]
CA#1 Parts Number []
CA#1 Serial Number []
CA#1 Hard Revision []
CA Slot#1-0 [Undefined / 0x0000]
CA Slot#1-1 [Undefined / 0x0000]
CA#2 Parts Number []
CA#2 Serial Number []
CA#2 Hard Revision []
CA Slot#2-0 [Undefined / 0x0000]
CA Slot#2-1 [Undefined / 0x0000]

```

```

CA#3 Parts Number      []
CA#3 Serial Number    []
CA#3 Hard Revision     []
CA Slot#3-0           [Undefined / 0x0000]
CA Slot#3-1           [Undefined / 0x0000]
Frontend Cable (FRT#0) [Normal / 0xE001]
Frontend Cable (FRT#1) [Normal / 0xE001]
Frontend Cable (FRT#2) [Normal / 0xE001]
Frontend Cable (FRT#3) [Normal / 0xE001]
BIOS#0                [Normal / 0xE001]
BIOS#1                [Normal / 0xE001]
CM EXP                [Normal / 0xE001]
CM EXP InPort#0       [Normal / 0xE001]
CM EXP InPort#1       [Normal / 0xE001]
CM EXP InPort#2       [Normal / 0xE001]
CM EXP InPort#3       [Normal / 0xE001]
SAS Cable#0 (OUT)     [Normal / 0xE001]
SAS Cable#1 (OUT)     [Undefined / 0x6000]
SAS Cable#2 (OUT)     [Undefined / 0x6000]
SAS Cable#3 (OUT)     [Undefined / 0x6000]
Management Cable (SVC#0) [Normal / 0xE001]
Management Cable (SVC#1) [Normal / 0xE001]
CM RTC                [Normal / 0xE001]
CM NVRAM              [Normal / 0xE001]
CM FPGA               [Normal / 0xE001]
CM LAN Port#0         [Normal / 0xE001]
CM LAN Port#1         [Normal / 0xE001]
CM LAN Port#2         [Normal / 0xE001]
DI#0 Port#0          [Normal / 0xE001]
DI#0 Port#1          [Normal / 0xE001]
DI#1 Port#0          [Normal / 0xE001]
DI#1 Port#1          [Normal / 0xE001]
CE#0 CM#0 CA#0 Port#0 Information
Port Type             [FC]
Port Mode             [CA]
Status/Status Code   [Normal / 0xE001]
CA Active EC         [EC#0]
CA Next EC           [EC#0]
Connection            [Loop]
Loop ID              [0x00]
Transfer Rate         [Auto Negotiation]
Link Status           [8Gbit/s Link Up]
Port WWN              [500000E0DA800020]
Node WWN              [500000E0DA800000]
Host Affinity         [Disable]
Host Response         [0]
SFP Type              [SFP+ (MMF) ]
SFP Information
  Present            Warning (Low/High)      Alarm (Low/High)
  Temperature        [0.00C]                [0.00C/0.00C]    [0.00C/0.00C]
  Voltage            [0.00V]                [0.00V/0.00V]    [0.00V/0.00V]
  Current            [0.00mA]               [0.00mA/0.00mA]  [0.00mA/0.00mA]
  TX Power           [0.00mW]                [0.00mW/0.00mW] [0.00mW/0.00mW]
  RX Power           [0.00mW]                [0.00mW/0.00mW] [0.00mW/0.00mW]
CE#0 CM#0 CA#0 Port#1 Information
Port Type             [FC]
Port Mode             [CA]
Status/Status Code   [Normal / 0xE001]
CA Active EC         [EC#0]
CA Next EC           [EC#0]
Connection            [Loop]
Loop ID              [0x00]
Transfer Rate         [Auto Negotiation]
Link Status           [8Gbit/s Link Up]
Port WWN              [500000E0DA800021]
Node WWN              [500000E0DA800000]
Host Affinity         [Disable]
Host Response         [0]
SFP Type              [SFP+ (MMF) ]
SFP Information
  Present            Warning (Low/High)      Alarm (Low/High)
  Temperature        [0.00C]                [0.00C/0.00C]    [0.00C/0.00C]
  Voltage            [0.00V]                [0.00V/0.00V]    [0.00V/0.00V]
  Current            [0.00mA]               [0.00mA/0.00mA]  [0.00mA/0.00mA]
  TX Power           [0.00mW]                [0.00mW/0.00mW] [0.00mW/0.00mW]
  RX Power           [0.00mW]                [0.00mW/0.00mW] [0.00mW/0.00mW]
CE#0 CM#1 Information
CPU Status/Status Code [Normal / 0xE001]
Memory Size           [8.0GB]

```

```

Parts Number          []
Serial Number         []
Hard Revision         []
CPU Clock             [0.04GHz]
CM Active EC          [EC#1]
CM Next EC            [EC#1]
BIOS Active EC        [EC#0]
BIOS Next EC          [EC#0]
CM EXP Active EC      [EC#1]
CM EXP Next EC        [EC#1]
CE#0 CM#1 Internal Parts Status/Status Code
Memory#0              [Normal      / 0xE001]
Memory#0 Parts Number []
Memory#0 Serial Number []
Memory#0 Hard Revision []
Memory#1              [Undefined  / 0x0000]
Memory#1 Parts Number []
Memory#1 Serial Number []
Memory#1 Hard Revision []
Memory#2              [Undefined  / 0x0000]
Memory#2 Parts Number []
Memory#2 Serial Number []
Memory#2 Hard Revision []
Memory#3              [Undefined  / 0x0000]
Memory#3 Parts Number []
Memory#3 Serial Number []
Memory#3 Hard Revision []
Memory#4              [Undefined  / 0x0000]
Memory#4 Parts Number []
Memory#4 Serial Number []
Memory#4 Hard Revision []
Memory#5              [Undefined  / 0x0000]
Memory#5 Parts Number []
Memory#5 Serial Number []
Memory#5 Hard Revision []
Memory#6              [Undefined  / 0x0000]
Memory#6 Parts Number []
Memory#6 Serial Number []
Memory#6 Hard Revision []
Memory#7              [Undefined  / 0x0000]
Memory#7 Parts Number []
Memory#7 Serial Number []
Memory#7 Hard Revision []
BUD#0                 [Normal      / 0xE001]
BUD#0 Parts Number   []
BUD#0 Serial Number  []
BUD#0 Hard Revision  []
BUD#1                 [Normal      / 0xE001]
BUD#1 Parts Number   []
BUD#1 Serial Number  []
BUD#1 Hard Revision  []
CM FAN                [Normal      / 0xE001/ 0xE001]
CA#0 Parts Number    []
CA#0 Serial Number   []
CA#0 Hard Revision   []
CA Slot#0-0          [Normal      / 0xE001]
CA Slot#0-1          [Undefined  / 0x0000]
CA#1 Parts Number    []
CA#1 Serial Number   []
CA#1 Hard Revision   []
CA Slot#1-0          [Undefined  / 0x0000]
CA Slot#1-1          [Undefined  / 0x0000]
CA#2 Parts Number    []
CA#2 Serial Number   []
CA#2 Hard Revision   []
CA Slot#2-0          [Undefined  / 0x0000]
CA Slot#2-1          [Undefined  / 0x0000]
CA#3 Parts Number    []
CA#3 Serial Number   []
CA#3 Hard Revision   []
CA Slot#3-0          [Undefined  / 0x0000]
CA Slot#3-1          [Undefined  / 0x0000]
Frontend Cable (FRT#0) [Normal      / 0xE001]
Frontend Cable (FRT#1) [Normal      / 0xE001]
Frontend Cable (FRT#2) [Normal      / 0xE001]
Frontend Cable (FRT#3) [Normal      / 0xE001]
BIOS#0               [Normal      / 0xE001]
BIOS#1               [Normal      / 0xE001]

```

```

CM EXP                               [Normal      / 0xE001]
CM EXP InPort#0                      [Normal      / 0xE001]
CM EXP InPort#1                      [Normal      / 0xE001]
CM EXP InPort#2                      [Normal      / 0xE001]
CM EXP InPort#3                      [Normal      / 0xE001]
SAS Cable#0 (OUT)                   [Normal      / 0xE001]
SAS Cable#1 (OUT)                   [Undefined   / 0x6000]
SAS Cable#2 (OUT)                   [Undefined   / 0x6000]
SAS Cable#3 (OUT)                   [Undefined   / 0x6000]
Management Cable (SVC#0)            [Normal      / 0xE001]
Management Cable (SVC#1)            [Normal      / 0xE001]
CM RTC                               [Normal      / 0xE001]
CM NVRAM                             [Normal      / 0xE001]
CM FPGA                              [Normal      / 0xE001]
CM LAN Port#0                       [Normal      / 0xE001]
CM LAN Port#1                       [Normal      / 0xE001]
CM LAN Port#2                       [Normal      / 0xE001]
DI#0 Port#0                         [Normal      / 0xE001]
DI#0 Port#1                         [Normal      / 0xE001]
DI#1 Port#0                         [Normal      / 0xE001]
DI#1 Port#1                         [Normal      / 0xE001]
CE#0 CM#1 CA#0 Port#0 Information
Port Type                            [FC]
Port Mode                            [CA]
Status/Status Code                   [Normal      / 0xE001]
CA Active EC                         [EC#0]
CA Next EC                           [EC#0]
Connection                           [Loop]
Loop ID                              [0x00]
Transfer Rate                        [Auto Negotiation]
Link Status                          [8Gbit/s Link Up]
Port WWN                             [500000E0DA800030]
Node WWN                             [500000E0DA800000]
Host Affinity                        [Disable]
Host Response                        [0]
SFP Type                             [SFP+ (MMF) ]
SFP Information
  Present      Warning (Low/High)      Alarm (Low/High)
Temperature   [0.00C]                 [0.00C/0.00C]   [0.00C/0.00C]
Voltage       [0.00V]                 [0.00V/0.00V]   [0.00V/0.00V]
Current       [0.00mA]                [0.00mA/0.00mA] [0.00mA/0.00mA]
TX Power      [0.00mW]                [0.00mW/0.00mW] [0.00mW/0.00mW]
RX Power      [0.00mW]                [0.00mW/0.00mW] [0.00mW/0.00mW]
CE#0 CM#1 CA#0 Port#1 Information
Port Type                            [FC]
Port Mode                            [CA]
Status/Status Code                   [Normal      / 0xE001]
CA Active EC                         [EC#0]
CA Next EC                           [EC#0]
Connection                           [Loop]
Loop ID                              [0x00]
Transfer Rate                        [Auto Negotiation]
Link Status                          [8Gbit/s Link Up]
Port WWN                             [500000E0DA800031]
Node WWN                             [500000E0DA800000]
Host Affinity                        [Disable]
Host Response                        [0]
SFP Type                             [SFP+ (MMF) ]
SFP Information
  Present      Warning (Low/High)      Alarm (Low/High)
Temperature   [0.00C]                 [0.00C/0.00C]   [0.00C/0.00C]
Voltage       [0.00V]                 [0.00V/0.00V]   [0.00V/0.00V]
Current       [0.00mA]                [0.00mA/0.00mA] [0.00mA/0.00mA]
TX Power      [0.00mW]                [0.00mW/0.00mW] [0.00mW/0.00mW]
RX Power      [0.00mW]                [0.00mW/0.00mW] [0.00mW/0.00mW]
CE#0 CM#0 PFM#0 Information
Type                                  [-]
Status/Status Code                   [Undefined   / 0x6000]
Health                                [80%]
Capacity                              [700GB]
Parts Number                         [CA07555-D052]
Serial Number                        [PP132400W2]
Hard Revision                        [A1 ]
CE#0 CM#0 PFM#1 Information
Type                                  [-]
Status/Status Code                   [Undefined   / 0x6000]
Health                                [80%]
Capacity                              [1400GB]
Parts Number                         [CA07555-D053]

```



```

Serial Number          [PP132411W4]
Hard Revision          [A0  ]
CE#0 CM#1 PFM#0 Information
Type                  [-]
Status/Status Code   [Undefined / 0x6000]
Health                [80%]
Capacity              [700GB]
Parts Number          [CA07555-D052]
Serial Number         [PP132440W2]
Hard Revision         [A1  ]
CE#0 CM#1 PFM#1 Information
Type                  [-]
Status/Status Code   [Undefined / 0x6000]
Health                [80%]
Capacity              [1400GB]
Parts Number          [CA07555-D053]
Serial Number         [PP132451W4]
Hard Revision         [A0  ]
BCU/BTU Information
BCU#0 Status/Status Code [Normal / 0xE001]
BTU#0 Status/Status Code [Normal / 0xE001]
BCU#0 ChargeRate       [100%]
BCU#0 Expires          [2099-12]
BCU#0 Parts Number     []
BCU#0 Serial Number    []
BCU#0 Hard Revision    []
BCU#1 Status/Status Code [Normal / 0xE001]
BTU#1 Status/Status Code [Normal / 0xE001]
BCU#1 ChargeRate       [100%]
BCU#1 Expires          [2099-12]
BCU#1 Parts Number     []
BCU#1 Serial Number    []
BCU#1 Hard Revision    []
BCU#2 Status/Status Code [Normal / 0xE001]
BTU#2 Status/Status Code [Normal / 0xE001]
BCU#2 ChargeRate       [100%]
BCU#2 Expires          [2099-12]
BCU#2 Parts Number     []
BCU#2 Serial Number    []
BCU#2 Hard Revision    []
CE#0 PSU#0 Information
Status/Status Code [Normal / 0xE001]
CE#0 PSU#1 Information
Status/Status Code [Normal / 0xE001]

```

The following example displays each status and detail of controller enclosure #0 and control module #0 (For the DX8700 S3/DX8900 S3):

```

CLI> show fru-ce -type ce0cm0
CE#0 CM#0 Information
CPU Status/Status Code      [Normal      / 0xE001]
Memory Size                  [8.0GB]
Parts Number                 []
Serial Number                []
Hard Revision                []
CPU Clock                    [0.04GHz]
CM Active EC                 [EC#1]
CM Next EC                   [EC#1]
BIOS Active EC               [EC#0]
BIOS Next EC                 [EC#0]
CM EXP Active EC             [EC#1]
CM EXP Next EC               [EC#1]
CE#0 CM#0 Internal Parts Status/Status Code
Memory#0                     [Normal      / 0xE001]
Memory#0 Parts Number        []
Memory#0 Serial Number       []
Memory#0 Hard Revision        []
Memory#1                     [Undefined   / 0x0000]
Memory#1 Parts Number        []
Memory#1 Serial Number       []
Memory#1 Hard Revision        []
Memory#2                     [Undefined   / 0x0000]
Memory#2 Parts Number        []
Memory#2 Serial Number       []
Memory#2 Hard Revision        []
Memory#3                     [Undefined   / 0x0000]
Memory#3 Parts Number        []
Memory#3 Serial Number       []
Memory#3 Hard Revision        []
Memory#4                     [Undefined   / 0x0000]
Memory#4 Parts Number        []
Memory#4 Serial Number       []
Memory#4 Hard Revision        []
Memory#5                     [Undefined   / 0x0000]
Memory#5 Parts Number        []
Memory#5 Serial Number       []
Memory#5 Hard Revision        []
Memory#6                     [Undefined   / 0x0000]
Memory#6 Parts Number        []
Memory#6 Serial Number       []
Memory#6 Hard Revision        []
Memory#7                     [Undefined   / 0x0000]
Memory#7 Parts Number        []
Memory#7 Serial Number       []
Memory#7 Hard Revision        []
BUD#0                        [Normal      / 0xE001]
BUD#0 Parts Number           []
BUD#0 Serial Number          []
BUD#0 Hard Revision          []
BUD#1                        [Normal      / 0xE001]
BUD#1 Parts Number           []
BUD#1 Serial Number          []
BUD#1 Hard Revision          []
CM FAN                       [Normal      / 0xE001]
CA#0 Parts Number            []
CA#0 Serial Number           []
CA#0 Hard Revision           []
CA Slot#0-0                  [Normal      / 0xE001]
CA Slot#0-1                  [Undefined   / 0x0000]
CA#1 Parts Number            []
CA#1 Serial Number           []
CA#1 Hard Revision           []
CA Slot#1-0                  [Undefined   / 0x0000]
CA Slot#1-1                  [Undefined   / 0x0000]
CA#2 Parts Number            []
CA#2 Serial Number           []
CA#2 Hard Revision           []
CA Slot#2-0                  [Undefined   / 0x0000]
CA Slot#2-1                  [Undefined   / 0x0000]
CA#3 Parts Number            []
CA#3 Serial Number           []
CA#3 Hard Revision           []

```

```

CA Slot#3-0                [Undefined / 0x0000]
CA Slot#3-1                [Undefined / 0x0000]
Frontend Cable(FRT#0)     [Normal / 0xE001]
Frontend Cable(FRT#1)     [Normal / 0xE001]
Frontend Cable(FRT#2)     [Normal / 0xE001]
Frontend Cable(FRT#3)     [Normal / 0xE001]
BIOS#0                    [Normal / 0xE001]
BIOS#1                    [Normal / 0xE001]
CM EXP                    [Normal / 0xE001]
CM EXP InPort#0           [Normal / 0xE001]
CM EXP InPort#1           [Normal / 0xE001]
CM EXP InPort#2           [Normal / 0xE001]
CM EXP InPort#3           [Normal / 0xE001]
SAS Cable#0(OUT)          [Normal / 0xE001]
SAS Cable#1(OUT)          [Undefined / 0x6000]
SAS Cable#2(OUT)          [Undefined / 0x6000]
SAS Cable#3(OUT)          [Undefined / 0x6000]
Management Cable(SVC#0)  [Normal / 0xE001]
Management Cable(SVC#1)  [Normal / 0xE001]
CM RTC                    [Normal / 0xE001]
CM NVRAM                  [Normal / 0xE001]
CM FPGA                   [Normal / 0xE001]
CM LAN Port#0             [Normal / 0xE001]
CM LAN Port#1             [Normal / 0xE001]
CM LAN Port#2             [Normal / 0xE001]
DI#0 Port#0              [Normal / 0xE001]
DI#0 Port#1              [Normal / 0xE001]
DI#1 Port#0              [Normal / 0xE001]
DI#1 Port#1              [Normal / 0xE001]
CE#0 CM#0 CA#0 Port#0 Information
Port Type                 [FC]
Port Mode                 [CA]
Status/Status Code       [Normal / 0xE001]
CA Active EC              [EC#0]
CA Next EC                [EC#0]
Connection                [Loop]
Loop ID                   [0x00]
Transfer Rate             [Auto Negotiation]
Link Status               [8Gbit/s Link Up]
Port WWN                  [500000E0DA800020]
Node WWN                  [500000E0DA800000]
Host Affinity             [Disable]
Host Response             [0]
SFP Type                  [SFP+ (MMF)]
SFP Information
  Present      Warning (Low/High)      Alarm (Low/High)
Temperature   [0.00C]                  [0.00C/0.00C]    [0.00C/0.00C]
Voltage       [0.00V]                  [0.00V/0.00V]    [0.00V/0.00V]
Current       [0.00mA]                 [0.00mA/0.00mA]  [0.00mA/0.00mA]
TX Power      [0.00mW]                 [0.00mW/0.00mW]  [0.00mW/0.00mW]
RX Power      [0.00mW]                 [0.00mW/0.00mW]  [0.00mW/0.00mW]
CE#0 CM#0 CA#0 Port#1 Information
Port Type                 [FC]
Port Mode                 [CA]
Status/Status Code       [Normal / 0xE001]
CA Active EC              [EC#0]
CA Next EC                [EC#0]
Connection                [Loop]
Loop ID                   [0x00]
Transfer Rate             [Auto Negotiation]
Link Status               [8Gbit/s Link Up]
Port WWN                  [500000E0DA800021]
Node WWN                  [500000E0DA800000]
Host Affinity             [Disable]
Host Response             [0]
SFP Type                  [SFP+ (MMF)]
SFP Information
  Present      Warning (Low/High)      Alarm (Low/High)
Temperature   [0.00C]                  [0.00C/0.00C]    [0.00C/0.00C]
Voltage       [0.00V]                  [0.00V/0.00V]    [0.00V/0.00V]
Current       [0.00mA]                 [0.00mA/0.00mA]  [0.00mA/0.00mA]
TX Power      [0.00mW]                 [0.00mW/0.00mW]  [0.00mW/0.00mW]
RX Power      [0.00mW]                 [0.00mW/0.00mW]  [0.00mW/0.00mW]
CE#0 CM#0 PFM#0 Information
Type                     [-]
Status/Status Code       [Undefined / 0x6000]
Health                   [80%]
Capacity                 [700GB]
Parts Number              [CA07555-D052]
Serial Number             [PP132400W2]

```

```

Hard Revision           [A1   ]
CE#0 CM#0 PFM#1 Information
Type                   [-]
Status/Status Code    [Undefined / 0xE000]
Health                 [80%]
Capacity               [1400GB]
Parts Number           [CA07555-D053]
Serial Number          [PP132411W4]
Hard Revision          [A0   ]
BCU/BTU Information
BCU#0 Status/Status Code [Normal / 0xE001]
BTU#0 Status/Status Code [Normal / 0xE001]
BCU#0 ChargeRate       [100%]
BCU#0 Expires          [2099-12]
BCU#0 Parts Number     []
BCU#0 Serial Number    []
BCU#0 Hard Revision    []
BCU#1 Status/Status Code [Normal / 0xE001]
BTU#1 Status/Status Code [Normal / 0xE001]
BCU#1 ChargeRate       [100%]
BCU#1 Expires          [2099-12]
BCU#1 Parts Number     []
BCU#1 Serial Number    []
BCU#1 Hard Revision    []
BCU#2 Status/Status Code [Normal / 0xE001]
BTU#2 Status/Status Code [Normal / 0xE001]
BCU#2 ChargeRate       [100%]
BCU#2 Expires          [2099-12]
BCU#2 Parts Number     []
BCU#2 Serial Number    []
BCU#2 Hard Revision    []

```

If the host interface is SAS, iSCSI, or FCoE; or FC, the output related to "CM#x CA#x Port#x Information" is different. For SAS 12G, the following information is displayed:

```

CM#0 CA#0 Port#0 Information
Port Type              [SAS]
Port Mode              [CA]
Status/Status Code    [Normal / 0xE001]
CA Active EC           [EC#0]
CA Next EC            [EC#0]
Transfer Rate          [Auto Negotiation]
Link Status            PHY#0[Link Down ] PHY#1[Link Down ]
                      PHY#2[Link Down ] PHY#3[Link Down ]
Port WWN               [500000E0D1000011]
Node WWN               [500000E0D1000000]
Host Affinity          [Disable]
Host Response          [3]
SFP Type               [12G SFP]
CM#0 CA#0 Port#1 Information
Port Type              [SAS]
Port Mode              [CA]
Status/Status Code    [Normal / 0xE001]
CA Active EC           [EC#0]
CA Next EC            [EC#0]
Transfer Rate          [Auto Negotiation]
Link Status            PHY#0[Link Down ] PHY#1[Link Down ]
                      PHY#2[Link Down ] PHY#3[Link Down ]
Port WWN               [500000E0D1000011]
Node WWN               [500000E0D1000000]
Host Affinity          [Disable]
Host Response          [3]
SFP Type               [12G SFP]

```

For iSCSI, the following information is displayed:

```

CM#0 CA#0 Port#0 Information
Port Type           [iSCSI]
Port Mode           [CA]
Status/Status Code [Normal       / 0xE001]
Multi IP Address    [Enable]
Number of IP Address [16]
CA Active EC        [EC#0]
CA Next EC          [EC#0]
Transfer Rate       [1Gbps/Auto]
Link Status         [Link Down]
iSCSI Name          [iqn.2000-09.com.fujitsu:storage-system.eternus-dx1:00000000]
iSCSI Alias Name    []
Host Affinity       [Disable]
Host Response       [0]
iSNS Server Port No [0x0000]
TCP Port No         [0x0000]
TCP Window Size     [0x00]
VLAN ID             [-]
Header Digest       [OFF]
Data Digest         [OFF]
Bandwidth Limit     [-]
Target Portal Group No [0x0000]
CmdSN Count         [Unlimited]
Err Recovery Lvl    [0x00]
Task Retain Time    [-]
Reconnection Wait Time [-]
SFP Type           [SFP+]
SFP Information

      Present          Warning (Low/High)      Alarm (Low/High)
Temperature      [40.11C]          [-15.00C/100.00C]      [-30.00C/128.00C]
Voltage          [4.24V]             [3.00V/5.00V]         [2.00V/7.00V]
Current          [10.25mA]           [5.00mA/12.00mA]      [2.00mA/15.00mA]
TX Power         [1.35mW]            [0.50mW/1.50mW]      [0.00mW/1.80mW]
RX Power         [1.35mW]            [0.50mW/1.50mW]      [0.00mW/1.80mW]
CM#0 CA#0 Port#1 Information
Port Type           [iSCSI]
Port Mode           [CA]
Status/Status Code [Normal       / 0xE001]
Multi IP Address    [Disable]
Number of IP Address [1]
CA Active EC        [EC#0]
CA Next EC          [EC#0]
Transfer Rate       [1Gbps/Auto]
Link Status         [Link Down]
iSCSI Name          [iqn.2000-09.com.fujitsu:storage-system.eternus-dx1:00000000]
iSCSI Alias Name    []
Host Affinity       [Disable]
Host Response       [0]
iSNS Server Port No [0x0000]
TCP Port No         [0x0000]
TCP Window Size     [0x00]
VLAN ID             [-]
Header Digest       [OFF]
Data Digest         [OFF]
Bandwidth Limit     [-]
Target Portal Group No [0x0000]
CmdSN Count         [Unlimited]
Err Recovery Lvl    [0x00]
Task Retain Time    [-]
Reconnection Wait Time [-]
SFP Type           [SFP+]
SFP Information

      Present          Warning (Low/High)      Alarm (Low/High)
Temperature      [40.11C]          [-15.00C/100.00C]      [-30.00C/128.00C]
Voltage          [4.24V]             [3.00V/5.00V]         [2.00V/7.00V]
Current          [10.25mA]           [5.00mA/12.00mA]      [2.00mA/15.00mA]
TX Power         [1.35mW]            [0.50mW/1.50mW]      [0.00mW/1.80mW]
RX Power         [1.35mW]            [0.50mW/1.50mW]      [0.00mW/1.80mW]
  
```

For FCoE, the following information is displayed:

```

CM#0 CA#0 Port#0 Information
Port Type                [FCoE]
Status/Status Code      [Normal          / 0xE001]
CA Active EC            [EC#0]
CA Next EC              [EC#0]
Transfer Rate           [10Gbps]
Link Status              [Unknown]
Port WWN                 [500000E0D1000010]
Node WWN                 [500000E0D1000000]
Host Affinity           [-]
Host Response           [-]
FC Frame Size           [Unknown]
VLAN ID                  [0x0000]
Fabric Name              [-]
CM#0 CA#0 Port#1 Information
Port Type                [FCoE]
Status/Status Code      [Normal          / 0xE001]
CA Active EC            [EC#0]
CA Next EC              [EC#0]
Transfer Rate           [10Gbps]
Link Status              [Unknown]
Port WWN                 [500000E0D1000010]
Node WWN                 [500000E0D1000000]
Host Affinity           [-]
Host Response           [-]
FC Frame Size           [Unknown]
VLAN ID                  [0x0000]
Fabric Name              [-]
SFP Type                 [SFP+]
SFP Information
      Present          Warning (Low/High)      Alarm (Low/High)
Temperature            [40.11C]          [-15.00C/100.00C]      [-30.00C/128.00C]
Voltage                [4.24V]             [3.00V/5.00V]         [2.00V/7.00V]
Current                [10.25mA]          [5.00mA/12.00mA]     [2.00mA/15.00mA]
TX Power               [1.35mW]          [0.50mW/1.50mW]      [0.00mW/1.80mW]
RX Power               [1.35mW]          [0.50mW/1.50mW]      [0.00mW/1.80mW]

```

For NAS, the following information is displayed:

```

CM#0 CA#0 Port#0 Information
Port Type                [NAS]
Status/Status Code      [Normal          / 0xE001]
CA Active EC            [EC#1]
CA Next EC              [EC#2]
MAC Address              [00-16-E6-10-84-64]
SFP Type                 [SFP+ Copper]
SFP Information
      Present          Warning (Low/High)      Alarm (Low/High)
Temperature            [-]                  [-/-]                 [-/-]
Voltage                [-]                  [-/-]                 [-/-]
Current                [-]                  [-/-]                 [-/-]
TX Power               [-]                  [-/-]                 [-/-]
RX Power               [-]                  [-/-]                 [-/-]

```

For FCLINK, OCLINK, and RFCF-RA, the following information is displayed:

```

CM#0 CA#0 Port#0 Information
Port Type                [FCLINK]
Status/Status Code      [Normal          / 0xE001]
CM#0 CA#0 Port#1 Information
Port Type                [OCLINK]
Status/Status Code      [Normal          / 0xE001]
CM#1 CA#1 Port#0 Information
Port Type                [FC]
Port Mode                [RFCF-RA]
Status/Status Code      [Normal          / 0xE001]

```

The following example displays the SCU Information:

```
SCU Information
SCU#0 Status/Status Code [Normal      / 0xE001]
SCU#0 Voltage            [9.40V]
SCU#0 Expires            [0-00]
SCU#0 Parts Number       []
SCU#0 Serial Number      []
SCU#0 Hard Revision      []
SCU#1 Status/Status Code [Normal      / 0xE001]
SCU#1 Voltage            [9.40V]
SCU#1 Expires            [0-00]
SCU#1 Parts Number       []
SCU#1 Serial Number      []
SCU#1 Hard Revision      []
```

The following example displays the status of PSU#0:

```
CLI> show fru-ce -type psu0
CE PSU#0 Information
Status/Status Code [Normal      / 0xE001]
```

show fru-fe

This command displays the status of the components (or Field Replaceable Units: FRU) in the frontend enclosures.

Caution

This command is only supported in the DX8700 S3/DX8900 S3.

■ Syntax

```
show fru-fe [-type {svc0 | svc1 | frt0 | frt1 | frt2 | frt3 | psu0 | psu1 | psu2 | psu3}]
```

■ Parameter

- type Optional. This parameter specifies the target component (FRU) name. However, only one parameter can be specified. If this parameter is omitted, all the FRUs are displayed.
- svcX Details and status of Service Controller (SVC) #X
- frtX Details and status of FRT#X of the frontend enclosure
- psuX Details and status of Power Supply Unit #X of the frontend enclosure

■ Output

Item name	Description
FRT#X Information	(X: Front End Router [FRT] number)
Status/Status Code	FRT status and the status code
Parts Number	FRT part number
Serial Number	FRT serial number
Hard Revision	FRT hardware version
FRT#X Internal Parts Information	(X: FRT number)
Frontend Cable (CE#W CM#X) Information	(W: The controller enclosure number, X: The controller module number)
Type	Frontend cable type (Cu: Copper, AOC: Active Optical Cable, and "-": Unknown)
Status/Status Code	Frontend cable status and the status code
Parts Number	Frontend cable part number
Serial Number	Frontend cable serial number
Hard Revision	Frontend cable hardware version
SVC#X Information	(X: Service Controller [SVC] number)
Status/Status Code	SVC status and the status code
Parts Number	SVC part number
Serial Number	SVC serial number
Hard Revision	SVC hardware version
LAN Control	SVC LAN Control (master or slave)
Active EC	Active firmware (or the currently running firmware) EC number
Next EC	Standby firmware EC number (or the next firmware generation number after a reboot)

Item name	Description
Firmware Version	SVC firmware version
SVC#X Internal Parts Information	(X: SVC number)
Management Cable (CE#w CM#x)	Management Cable status and the status code
SCCI#X Information or PPC#X Information	(X: SCCI number or PPC number)
Status/Status Code	SCCI or PPC status and the status code
FANU#X Information	(X: FAN Unit [FANU] number)
Status/Status Code	FANU status and the status code
Parts Number	FANU part number
Serial Number	FANU serial number
Hard Revision	FANU hardware version
OPNL Information	
Status/Status Code	Operation panel (OPNL) status and the status code
Parts Number	OPNL part number
Serial Number	OPNL serial number
Hard Revision	OPNL hardware version
FE PSU#X Information	(X: The frontend enclosure PSU number)
Status/Status Code	Frontend enclosure PSU status and the status code

■ Example(s)

The following example displays the status of the frontend enclosure components (or the maintenance part units):

```
CLI> show fru-fe
FRT#0 Information
Status/Status Code      [Normal      / 0xE001]
Parts Number            []
Serial Number           []
Hard Revision           []
FRT#0 Internal Parts Information
Frontend Cable(CE#0 CM#0) Information
Type                    [Cu]
Status/Status Code      [Normal      / 0xE001]
Parts Number            []
Serial Number           []
Hard Revision           []
Frontend Cable(CE#0 CM#1) Information
Type                    [AOC]
Status/Status Code      [Normal      / 0xE001]
Parts Number            []
Serial Number           []
Hard Revision           []
Frontend Cable(CE#1 CM#0) Information
Type                    [-]
Status/Status Code      [Normal      / 0xE001]
Parts Number            []
Serial Number           []
Hard Revision           []
Frontend Cable(CE#1 CM#1) Information
Type                    [Cu]
Status/Status Code      [Normal      / 0xE001]
Parts Number            []
Serial Number           []
Hard Revision           []
Frontend Cable(CE#2 CM#0) Information
Type                    [Cu]
Status/Status Code      [Normal      / 0xE001]
Parts Number            []
Serial Number           []
Hard Revision           []
Frontend Cable(CE#2 CM#1) Information
Type                    [Cu]
Status/Status Code      [Normal      / 0xE001]
Parts Number            []
Serial Number           []
Hard Revision           []
Frontend Cable(CE#3 CM#0) Information
Type                    [Cu]
Status/Status Code      [Normal      / 0xE001]
Parts Number            []
Serial Number           []
Hard Revision           []
Frontend Cable(CE#3 CM#1) Information
Type                    [Cu]
Status/Status Code      [Normal      / 0xE001]
Parts Number            []
Serial Number           []
Hard Revision           []
FRT#1 Information
Status/Status Code      [Normal / 0xE001]
Parts Number            []
Serial Number           []
Hard Revision           []
FRT#1 Internal Parts Information
Frontend Cable(CE#0 CM#0) Information
Type                    [Cu]
Status/Status Code      [Normal / 0xE001]
Parts Number            []
Serial Number           []
Hard Revision           []
```

```

Frontend Cable(CE#0 CM#1) Information
Type [AOC]
Status/Status Code [Normal / 0xE001]
Parts Number []
Serial Number []
Hard Revision []
Frontend Cable(CE#1 CM#0) Information
Type [-]
Status/Status Code [Normal / 0xE001]
Parts Number []
Serial Number []
Hard Revision []
Frontend Cable(CE#1 CM#1) Information
Type [Cu]
Status/Status Code [Normal / 0xE001]
Parts Number []
Serial Number []
Hard Revision []
Frontend Cable(CE#2 CM#0) Information
Type [Cu]
Status/Status Code [Normal / 0xE001]
Parts Number []
Serial Number []
Hard Revision []
Frontend Cable(CE#2 CM#1) Information
Type [Cu]
Status/Status Code [Normal / 0xE001]
Parts Number []
Serial Number []
Hard Revision []
Frontend Cable(CE#3 CM#0) Information
Type [Cu]
Status/Status Code [Normal / 0xE001]
Parts Number []
Serial Number []
Hard Revision []
Frontend Cable(CE#3 CM#1) Information
Type [Cu]
Status/Status Code [Normal / 0xE001]
Parts Number []
Serial Number []
Hard Revision []

FRT#2 Information
Status/Status Code [Normal / 0xE001]
Parts Number []
Serial Number []
Hard Revision []
FRT#2 Internal Parts Information
Frontend Cable(CE#0 CM#0) Information
Type [Cu]
Status/Status Code [Normal / 0xE001]
Parts Number []
Serial Number []
Hard Revision []
Frontend Cable(CE#0 CM#1) Information
Type [AOC]
Status/Status Code [Normal / 0xE001]
Parts Number []
Serial Number []
Hard Revision []
Frontend Cable(CE#1 CM#0) Information
Type [-]
Status/Status Code [Normal / 0xE001]
Parts Number []
Serial Number []
Hard Revision []
Frontend Cable(CE#1 CM#1) Information
Type [Cu]
Status/Status Code [Normal / 0xE001]
Parts Number []
Serial Number []
Hard Revision []

```

```

Frontend Cable(CE#2 CM#0) Information
Type [Cu]
Status/Status Code [Normal / 0xE001]
Parts Number []
Serial Number []
Hard Revision []
Frontend Cable(CE#2 CM#1) Information
Type [Cu]
Status/Status Code [Normal / 0xE001]
Parts Number []
Serial Number []
Hard Revision []
Frontend Cable(CE#3 CM#0) Information
Type [Cu]
Status/Status Code [Normal / 0xE001]
Parts Number []
Serial Number []
Hard Revision []
Frontend Cable(CE#3 CM#1) Information
Type [Cu]
Status/Status Code [Normal / 0xE001]
Parts Number []
Serial Number []
Hard Revision []

FRT#3 Information
Status/Status Code [Normal / 0xE001]
Parts Number []
Serial Number []
Hard Revision []
FRT#3 Internal Parts Information
Frontend Cable(CE#0 CM#0) Information
Type [Cu]
Status/Status Code [Normal / 0xE001]
Parts Number []
Serial Number []
Hard Revision []
Frontend Cable(CE#0 CM#1) Information
Type [AOC]
Status/Status Code [Normal / 0xE001]
Parts Number []
Serial Number []
Hard Revision []
Frontend Cable(CE#1 CM#0) Information
Type [-]
Status/Status Code [Normal / 0xE001]
Parts Number []
Serial Number []
Hard Revision []
Frontend Cable(CE#1 CM#1) Information
Type [Cu]
Status/Status Code [Normal / 0xE001]
Parts Number []
Serial Number []
Hard Revision []
Frontend Cable(CE#2 CM#0) Information
Type [Cu]
Status/Status Code [Normal / 0xE001]
Parts Number []
Serial Number []
Hard Revision []
Frontend Cable(CE#2 CM#1) Information
Type [Cu]
Status/Status Code [Normal / 0xE001]
Parts Number []
Serial Number []
Hard Revision []
Frontend Cable(CE#3 CM#0) Information
Type [Cu]
Status/Status Code [Normal / 0xE001]
Parts Number []
Serial Number []
Hard Revision []
Frontend Cable(CE#3 CM#1) Information
Type [Cu]
Status/Status Code [Normal / 0xE001]
Parts Number []
Serial Number []
Hard Revision []

```

```

SVC#0 Information
  Status/Status Code           [Normal / 0xE001]
  Parts Number                  []
  Serial Number                 []
  Hard Revision                 []
  LAN Control                   [Master]
  Active EC                     [EC#1]
  Next EC                       [EC#2]
  Firmware Version             [V10L40-0000]
SVC#0 Internal Parts Information
  Management Cable(CE#0 CM#0)   [Normal / 0xE001]
  Management Cable(CE#0 CM#1)   [Normal / 0xE001]
  Management Cable(CE#1 CM#0)   [Normal / 0xE001]
  Management Cable(CE#1 CM#1)   [Normal / 0xE001]
  Management Cable(CE#2 CM#0)   [Normal / 0xE001]
  Management Cable(CE#2 CM#1)   [Normal / 0xE001]
  Management Cable(CE#3 CM#0)   [Normal / 0xE001]
  Management Cable(CE#3 CM#1)   [Normal / 0xE001]
SVC#1 Information
  Status/Status Code           [Normal / 0xE001]
  Parts Number                  []
  Serial Number                 []
  Hard Revision                 []
  LAN Control                   [Master]
  Active EC                     [EC#1]
  Next EC                       [EC#2]
  Firmware Version             [V10L40-0000]
SVC#1 Internal Parts Information
  Management Cable(CE#0 CM#0)   [Normal / 0xE001]
  Management Cable(CE#0 CM#1)   [Normal / 0xE001]
  Management Cable(CE#1 CM#0)   [Normal / 0xE001]
  Management Cable(CE#1 CM#1)   [Normal / 0xE001]
  Management Cable(CE#2 CM#0)   [Normal / 0xE001]
  Management Cable(CE#2 CM#1)   [Normal / 0xE001]
  Management Cable(CE#3 CM#0)   [Normal / 0xE001]
  Management Cable(CE#3 CM#1)   [Normal / 0xE001]
SCCI#0 Information
  Status/Status Code           [Normal / 0xE001]
SCCI#1 Information
  Status/Status Code           [Normal / 0xE001]
FANU#0 Information
  Status/Status Code           [Normal / 0xE001]
  Parts Number                  []
  Serial Number                 []
  Hard Revision                 []
FANU#1 Information
  Status/Status Code           [Normal / 0xE001]
  Parts Number                  []
  Serial Number                 []
  Hard Revision                 []
FANU#2 Information
  Status/Status Code           [Normal / 0xE001]
  Parts Number                  []
  Serial Number                 []
  Hard Revision                 []
FANU#3 Information
  Status/Status Code           [Normal / 0xE001]
  Parts Number                  []
  Serial Number                 []
  Hard Revision                 []
OPNL Information
  Status/Status Code           [Normal / 0xE001]
  Parts Number                  []
  Serial Number                 []
  Hard Revision                 []
FE PSU#0 Information
  Status/Status Code           [Normal / 0xE001]
FE PSU#1 Information
  Status/Status Code           [Normal / 0xE001]
FE PSU#2 Information
  Status/Status Code           [Normal / 0xE001]
FE PSU#3 Information
  Status/Status Code           [Normal / 0xE001]

```

The following example displays the status of SVC#0:

```
CLI> show fru-fe -type svc0
SVC#0 Information
  Status/Status Code      [Normal / 0xE001]
  Parts Number            []
  Serial Number           []
  Hard Revision           []
  LAN Control             [Master]
  Active EC               [EC#1]
  Next EC                 [EC#2]
  Firmware Version        [V10L40-0000]
SVC#0 Internal Parts Information
Management Cable(CE#0 CM#0) [Normal / 0xE001]
Management Cable(CE#0 CM#1) [Normal / 0xE001]
Management Cable(CE#1 CM#0) [Normal / 0xE001]
Management Cable(CE#1 CM#1) [Normal / 0xE001]
Management Cable(CE#2 CM#0) [Normal / 0xE001]
Management Cable(CE#2 CM#1) [Normal / 0xE001]
Management Cable(CE#3 CM#0) [Normal / 0xE001]
Management Cable(CE#3 CM#1) [Normal / 0xE001]
```

The following example displays the status of FRT#0:

```
CLI> show fru-fe -type frt0
FRT#0 Information
  Status/Status Code      [Normal / 0xE001]
  Parts Number            []
  Serial Number           []
  Hard Revision           []
FRT#0 Internal Parts Information
Frontend Cable(CE#0 CM#0) Information
Type [Cu]
Status/Status Code      [Normal / 0xE001]
Parts Number            []
Serial Number           []
Hard Revision           []
Frontend Cable(CE#0 CM#1) Information
Type [AOC]
Status/Status Code      [Normal / 0xE001]
Parts Number            []
Serial Number           []
Hard Revision           []
Frontend Cable(CE#1 CM#0) Information
Type [-]
Status/Status Code      [Normal / 0xE001]
Parts Number            []
Serial Number           []
Hard Revision           []
Frontend Cable(CE#1 CM#1) Information
Type [Cu]
Status/Status Code      [Normal / 0xE001]
Parts Number            []
Serial Number           []
Hard Revision           []
Frontend Cable(CE#2 CM#0) Information
Type [Cu]
Status/Status Code      [Normal / 0xE001]
Parts Number            []
Serial Number           []
Hard Revision           []
Frontend Cable(CE#2 CM#1) Information
Type [Cu]
Status/Status Code      [Normal / 0xE001]
Parts Number            []
Serial Number           []
Hard Revision           []
```

```
Frontend Cable(CE#3 CM#0) Information
Type                               [Cu]
Status/Status Code                 [Normal / 0xE001]
Parts Number                       []
Serial Number                      []
Hard Revision                      []
Frontend Cable(CE#3 CM#1) Information
Type                               [Cu]
Status/Status Code                 [Normal / 0xE001]
Parts Number                       []
Serial Number                      []
Hard Revision                      []
```

The following example displays the status of PSU#0 of the frontend enclosure:

```
CLI> show fru-fe -type psu0
FE PSU#0 Information
Status/Status Code                 [Normal / 0xE001]
```

show fru-de

This command displays the status of the components (or Field Replaceable Units: FRU) in the drive enclosures.

Syntax

```
show fru-de [-de enclosure_number] [-type {iom0 | iom1 | fem0 | fem1 | psu0 | psu1 | psu2 | psu3}]
```

Parameter

-de Optional. This parameter specifies the drive enclosure number. Only one parameter can be specified. For details, refer to ["1.2.4 Drive Enclosure Syntax" \(page 34\)](#). If this parameter is omitted, all of the connected drive enclosures are displayed.

Example: -de 1
 (Only drive enclosure #1)

-type Optional. This parameter specifies the target component (FRU) name. The sub components embedded in a drive enclosure will also be displayed. Only one parameter can be specified. If this parameter is omitted, all the FRUs are displayed.

- iom0** Details and status of the I/O module #0
- iom1** Details and status of the I/O module #1
- fem0** Details and status of the Fan Expander Module #0 (only for high-density drive enclosures)
- fem1** Details and status of the Fan Expander Module #1 (only for high-density drive enclosures)
- psu0** Details and status of the Power Supply Unit #0
- psu1** Details and status of the Power Supply Unit #1
- psu2** Details and status of the Power Supply Unit #2 (only for high-density drive enclosures)
- psu3** Details and status of the Power Supply Unit #3 (only for high-density drive enclosures)

Output

The following table shows the output information for the IOM.

Item name	Description
DE#n IOM#m Information	n: The drive enclosure number, m: The IOM number
Status/Status Code	IOM#n status and the status code
Error Code	Error code for identifying the error events that have occurred in the expander. This information is only displayed when the Status is not "Normal" or "Undefined".
WWN	World Wide Name (for FEM#1, a hyphen [-] is shown.)
Active EC	EC number of the active firmware (current operating firmware)
Next EC	EC number of the stand-by firmware (the generation number of the firmware after the next reboot)
Firmware Version	Version of the active firmware (current operating firmware)
DE#n IOM#m Internal Parts Status/Status Code	n: The drive enclosure number, m: The IOM number
SAS Cable (IOM Port) #0(IN)	SAS Cable #0(IN)(IOM port #0) status and the status code

Item name	Description
Error Code	Error code for identifying the error events that have occurred in port#0. This information is only displayed when the Status is not "Normal" or "Undefined".
SAS Cable (IOM Port) #1 (OUT)	SAS Cable #1 (OUT) (IOM port #1) status and the status code
Error Code	Error code for identifying the error events that have occurred in the above port#1.
IOM FEM Port#0	IOM FEM port#0 status and the status code (only for high-density drive enclosures) The connection destination of this port is the FEM#1 EXP#0 port.
Error Code	Error code for identifying the error events that have occurred in the above port#0 (only for high-density drive enclosures).
IOM FEM Port#1	IOM FEM port#1 status and the status code (only for high-density drive enclosures) The connection destination of this port is the FEM#1 EXP#1 port.
Error Code	Error code for identifying the error events that have occurred in the above port#1 (only for high-density drive enclosures).

The following table shows the output information for the Fan Expander Modules.

Item name	Description
DE#n FEM#m Information	n: The drive enclosure number, m: The FEM number (Information on FEM#1 appears regardless of the number of controller modules)
Status/Status Code	FEM (FEM#n) status and the status code
Error Code	Error code for identifying the error events that occurred in a Fan Expander Module. This information is only displayed when the Status is not "Normal" or "Undefined".
DE#n FEM#m Internal Parts Status/Status Code	n: The drive enclosure number, m: The FEM number (Information on FEM#1 appears regardless of the number of controller modules)
FEM EXP#0 Port	FEM (EXP#0) status and the status code
Error Code	Error code for identifying the error events that occurred in the above port#0. This information is only displayed when the Status is not "Normal" or "Undefined".
FEM EXP#1 Port	FEM (EXP#1) status and the status code
Error Code	Error code for identifying the error events that occurred in the above port#1. This information is only displayed when the Status is not "Normal" or "Undefined".
DE#n FEM#m EXP#l Information	n: The drive enclosure number, m: The FEM number, l: The EXP number (Information on FEM#1 appears regardless of the number of controller modules)
Status/Status Code	EXP (EXP#l) status and the status code
Error Code	Error code for identifying the error events that have occurred in the expander of a Fan Expander Module. This information is only displayed when the Status is not "Normal" or "Undefined".
WWN	World Wide Name
Active EC	EC number of the active firmware (the current operating firmware)
Next EC	EC number of the stand-by firmware (the generation number of the firmware after the next reboot)
Firmware Version	Version of the active firmware (the current operating firmware)
PSU	Power Supply Unit
Status/Status Code	Power supply unit (PSU#n) status and the status code
Error Code	Error code for identifying the error events that have occurred in a power supply unit. This information is only displayed when the Status is not "Normal" or "Undefined".

■ Example(s)

The following example displays the status of Expander #0 in drive enclosure #1:

```
CLI> show fru-de -de 1 -type iom0
DE#1 IOM#0 Information
  Status/Status Code      [Normal      / 0xE001]
  WWN                     [500000E0D060C4FF]
  Active EC                [EC#1]
  Next EC                  [EC#1]
  Firmware Version        [V10L10-0000]
DE#1 IOM#0 Internal Parts Status/Status Code
  SAS Cable(IOM Port)#0(IN) [Normal / 0xE001]
  SAS Cable(IOM Port)#1(OUT) [Normal / - ]
```

The following example displays the status of Expander #0 in drive enclosure #1 (high-density drive enclosure):

```
CLI> show fru-de -de 1 -type iom0
DE#1 IOM#0 Information
  Status/Status Code      [Normal      / 0xE001]
  WWN                     [500000E0D060C4FF]
  Active EC                [EC#1]
  Next EC                  [EC#2]
  Firmware Version        [V10L10-0000]
DE#1 IOM#0 Internal Parts Status/Status Code
  SAS Cable(IOM Port)#0(IN) [Normal / 0xE001]
  SAS Cable(IOM Port)#1(OUT) [Normal / 0xE001]
  IOM FEM Port#0          [Normal / 0xE001]
  IOM FEM Port#1          [Normal / 0xE001]
```

The following example displays the status of the Fan Expander Module in drive enclosure #1:

```
CLI> show fru-de -de 1 -type fem0
DE#1 FEM#0 Information
  Status/Status Code      [Normal      / 0xE001]
DE#1 FEM#0 Internal Parts Status/Status Code
  FEM EXP#0 Port          [Normal / 0xE001]
  FEM EXP#1 Port          [Normal / 0xE001]
DE#1 FEM#0 EXP#0 Information
  Status/Status Code      [Normal      / 0xE001]
  WWN                     [500000E0D060C4FF]
  Active EC                [EC#1]
  Next EC                  [EC#2]
  Firmware Version        [V10L10-0000]
DE#1 FEM#0 EXP#1 Information
  Status/Status Code      [Normal      / 0xE001]
  WWN                     [500000E0D060C4FF]
  Active EC                [EC#1]
  Next EC                  [EC#2]
  Firmware Version        [V10L10-0000]
```

The following example displays the status of PSU#0 in drive enclosure #2:

```
CLI> show fru-de -de 2 -type psu0
DE#2 PSU#0 Information
  Status/Status Code      [Normal      / 0xE001]
```

show disks

This command displays the details and status of the drive. As an option, an enclosure (all drives contained in the specified enclosure), specific drives, or all the undefined drives can be specified.

Syntax

```
show disks [-type {undefined | ce | de [-de enclosure_number]}] [-disks {disks | all | productid}] [-csv]
```

Parameter

- type** Optional. This parameter specifies which drive information will be displayed. This parameter cannot be specified with the "-disks" parameter. If all of the parameters are omitted, all drives registered in the system will be displayed.
- undefined All the undefined drives
- ce All drives in the controller enclosure (only for the DX60 S4/DX100 S4/DX200 S4, the DX60 S3/DX100 S3/DX200 S3, the AF250 S2/AF250, and the DX200F)
- de All drives in the specified drive enclosure
When using this parameter, the "-de" parameter and the drive enclosure number must also be specified.
- de** Optional. This parameter specifies the number of the drive enclosure for which details are to be obtained. Only one parameter can be specified. For details, refer to ["1.2.4 Drive Enclosure Syntax" \(page 34\)](#). This parameter cannot be used for other category types.
- disks** Optional. This parameter specifies which drive number to display the detailed information of the drive for. One or more parameters can be specified. For details, refer to ["1.2.5 Drive Syntax" \(page 35\)](#). Specifying "all" will display the details of all drives. When using the "productid" parameter, the product ID list of all drives is displayed. This function is useful when updating disk firmware.
- all Details of all drives
- productid The Product ID list of all drives
- csv** Optional. This parameter is used to show the details and status of the drives in a CSV format.

Note

- This parameter cannot be specified simultaneously with other parameters.
- Information that was output in the CSV format cannot be specified for setup commands (or command names that start with "create" or "set").

Output

For summary, the following items are displayed.

Item name	Description
Location	Drive slot number
Status	Drive status

Item name	Description
Size	Drive capacity The drive capacity that is displayed for the "SSD-L" type differs from the product's actual capacity. For example, the drive capacity of a 1.92TB SSD-L is displayed as "2TB".
Type	Drive type The following information is displayed. <ul style="list-style-type: none"> • Drive size 2.5" or 3.5" • Drive classification Online, Nearline, SSD For Self-Encrypting Drives, "SED" is displayed. In addition, for drives that support Advanced Format, "AF" is displayed. • SSD type SSD: SSDs with an interface speed of 6Gbit/s SSD-M: SSDs with an interface speed of 12Gbit/s SSD-L: SSDs with an interface speed of 12Gbit/s
Speed	Rotating speed (unit: rpm)
Usage	Drive usage Example: Data, Spare, etc.
Health	Remaining usable capacity (operating life) of the SSD (unit: %)

For details, the following items are displayed.

Item name	Description
Location	Drive slot number
Status	Drive status
Error Code	Error code for identifying the error events that have occurred in a drive. This information is only displayed when the Status is not "Available".
Size	Drive capacity The drive capacity that is displayed for the "SSD-L" type differs from the product's actual capacity. For example, the drive capacity of a 1.92TB SSD-L is displayed as "2TB".
Type	Drive type The following information is displayed. <ul style="list-style-type: none"> • Drive size 2.5" or 3.5" • Drive classification Online, Nearline, SSD For Self-Encrypting Drives, "SED" is displayed. In addition, for drives that support Advanced Format, "AF" is displayed. • SSD type SSD: SSDs with an interface speed of 6Gbit/s SSD-M: SSDs with an interface speed of 12Gbit/s SSD-L: SSDs with an interface speed of 12Gbit/s
Speed	Rotating speed (unit: rpm)
Usage	Drive usage Example: Data, Spare, etc.
Health	Remaining usable capacity (operating life) of the SSD (unit: %)
RAID Group	RAID group to which this drive belongs
Motor Status	Drive motor status by ECO functions
Rebuild/Copy back Progress	Progress status of Rebuild and Copy back
Vendor ID	Vendor ID

Item name	Description
Product ID	Product ID
Serial Number	Serial number
WWN	World Wide Name
Firmware Revision	Drive firmware version
Total completed passes	Total number of disk patrols
Progress with current pass	Progress rate of the current disk patrol
Completed passes since last Power On	Total number of disk patrols that were performed since the ETERNUS DX/AF was last turned on

For the product ID list, the following items are displayed.

Item name	Description
Product ID	Product ID
Revision	Drive firmware version

■ Example(s)

The following example displays a summary of all the drives:

```
CLI> show disks
Location      Status      Size      Type      Speed (rpm)  Usage      Health (%)
-----
CE-Disk#0    Available  4TB 3.5 SSD      System      100
CE-Disk#1    Available  4TB 3.5 SSD-M    System      100
CE-Disk#2    Available  4TB 3.5 SSD-L    System      100
CE-Disk#3    Available  4TB 3.5 Nearline SED AF  7200 System      100
```

The following example displays a summary of all the drives in a CSV format by specifying "-csv":

```
CLI> show disks -csv
[Location],[Status],[Size],[Type],[Speed],[Usage],[Health],[RAID Group],[Motor Status],[Rebuild/Copyback Progress],[Vendor ID],[Product ID],[Serial Number],[WWN],[Firm-
ware Revision],[Total completed passes],[Progress with current pass],[Completed passes since last Power On]
CE-Disk#0,Available,2.0TB,Unknown,-,System,100%,-,Active,-,FUJITSU,PRODUCT-00000001,SERIAL-00000001,0000000000000000,REV-0001,0Cycles,0%,0Cycles
CE-Disk#1,Available,2.0TB,Unknown,-,System,100%,-,Active,-,FUJITSU,PRODUCT-00000001,SERIAL-00000002,0000000000000000,REV-0001,0Cycles,0%,0Cycles
CE-Disk#2,Available,2.0TB,Unknown,-,System,100%,-,Active,-,FUJITSU,PRODUCT-00000001,SERIAL-00000003,0000000000000000,REV-0001,0Cycles,0%,0Cycles
CE-Disk#3,Available,2.0TB,Unknown,-,System,100%,-,Active,-,FUJITSU,PRODUCT-00000001,SERIAL-00000004,0000000000000000,REV-0001,0Cycles,0%,0Cycles
```

The following example displays a summary of all the drives in the controller enclosure:

```
CLI> show disks -type ce
Location      Status      Size      Type      Speed (rpm)  Usage      Health (%)
-----
CE-Disk#0    Available  4TB 3.5 Online    7200 System      100
CE-Disk#1    Available  4TB 3.5 Online    7200 System      100
CE-Disk#2    Available  4TB 3.5 Online    7200 Data        100
CE-Disk#3    Available (Predictive Failure)  4TB 3.5 Online    7200 Data        100
CE-Disk#4    Available  4TB 3.5 Online    7200 Data        100
CE-Disk#5    Available  4TB 3.5 Online    7200 Data        100
CE-Disk#6    Available  4TB 3.5 Online    7200 Data        100
CE-Disk#7    Available  4TB 3.5 Online    7200 Data        100
CE-Disk#8    Available  4TB 3.5 Online    7200 Data        100
CE-Disk#9    Available  4TB 3.5 Online    7200 Present     100
CE-Disk#10   Available  4TB 3.5 Online    7200 Global Hot Spare 100
CE-Disk#11   Available  4TB 3.5 Online    7200 Dedicated Hot Spare 100
CE-Disk#11   Available  4TB 3.5 Nearline SED AF  7200 Dedicated Hot Spare 100
```

The following example displays a summary of all the drives in drive enclosure #1:

```
CLI> show disks -type de -de 1
Location      Status
-----
DE#1-Disk#0  Available (Predictive Failure)
DE#1-Disk#1  Available
DE#1-Disk#2  Available
DE#1-Disk#3  Available
DE#1-Disk#4  -
DE#1-Disk#5  Available
DE#1-Disk#6  -
DE#1-Disk#7  -
DE#1-Disk#8  -
DE#1-Disk#9  Available
DE#1-Disk#10 Available
DE#1-Disk#11 Available
DE#1-Disk#11 Available

Size      Type      Speed(rpm)  Usage      Health(%)
-----
4TB 3.5 Online 7200 Data    100
4TB 3.5 Online 7200 Data    100
4TB 3.5 Online 7200 Data    100
4TB 3.5 Online 7200 Data    100
-
4TB 3.5 Online 7200 Data    100
-
-
4TB 3.5 Online 7200 Data    100
4TB 3.5 Online 7200 Global Hot Spare 100
4TB 3.5 Online 7200 Dedicated Hot Spare 100
4TB 3.5 Nearline SED AF 7200 Dedicated Hot Spare 100
```

The following example displays a summary of all the undefined drives:

```
CLI> show disks -type undefined
Location      Status
-----
DE#4-Disk#0  Available
DE#4-Disk#1  Available
DE#5-Disk#1  Available
DE#6-Disk#11 Available (Predictive Failure)
DE#6-Disk#11 Available (Predictive Failure)

Size      Type      Speed(rpm)  Usage      Health(%)
-----
4TB 3.5 Online 7200 Data    100
4TB 3.5 Online 7200 Data    100
4TB 3.5 Online 7200 Data    100
4TB 3.5 Online 7200 Data    100
4TB 3.5 Nearline SED AF 7200 Data    100
```

The following example displays the details of drive #100 (drive #00 in drive enclosure #1):

```
CLI> show disks -disks 100
Drive Enclosure #1 Disk #0 Information
Location      [DE#1-Disk#0]
Status        [Error] (Error Code : 0x0010)
Size          [4TB]
Type          [3.5 Nearline SED AF]
Speed        [7200rpm]
Usage         [Data]
Health        [100%]
RAID Group    [1000 : RGP001]
Motor Status  [Active]
Rebuild/Copyback Progress [-]
Vendor ID     [FUJITSU]
Product ID    [FT373207C-K]
Serial Number  [1234567890]
WWN          [1111111111111111]
Firmware Revision [12CD]
<Disk Patrol Information>
  Total completed passes [64565Cycle]
  Progress with current pass [79%]
  Completed passes since last Power On [30737Cycle]
```

The following example displays the product ID list:

```
CLI> show disks -disks productid
Product ID      Revision
-----
ST373455SS      12CD
ST99999999      3456
```

show hardware-information

This command displays the hardware information for each enclosure and sub-component.

Syntax

```
show hardware-information
```

Parameter

No parameters.

Output

For each enclosure, the following items are displayed. All possible drive enclosures are displayed, irrespective of whether or not they are currently installed. Drive enclosures that do not exist are indicated by hyphens.

Item name	Description
Serial No.	Serial number embedded in the enclosure
Other Information	Individual identifier embedded in the controlling Fujitsu enclosure.

For each component, the following items are displayed. For single controller models, both controller module #1 and expander module #1 are indicated by hyphens. Information is not displayed for drive enclosures that do not exist.

Item name	Description
Part No.	Part number embedded in the component
Serial No.	Serial number embedded in the component
Version	Hardware revision of the component

Example(s)

The following example displays hardware information (for the DX100 S3/DX200 S3 and the DX8100 S3):

```
CLI> show hardware-information
Enclosure          Serial No.          Other Information
Controller Enclosure STCE000012          CE000012
Drive Enclosure#01  ST35DE000009       ST35DE000009
Drive Enclosure#02  -                   -
Drive Enclosure#03  -                   -
Drive Enclosure#04  -                   -
Drive Enclosure#05  -                   -
Drive Enclosure#06  -                   -
Drive Enclosure#07  -                   -
Drive Enclosure#08  -                   -
Drive Enclosure#09  -                   -
Drive Enclosure#0a  -                   -

Component          Part No.            Serial No.          Version
CM#0               CA07111-C631       PP09280285         AA
CM#1               CA07111-C631 P     P0928028A          AA
PSU#0              CA05954-0860       FA09060095         06A
PSU#1              CA05954-0860       FA09060095         06A
DE#01-IOM#0       CA05967-1610+A0   JWXB13020322       AA
DE#01-IOM#1       CA05967-1610+A0   JWXB13130128       AA
DE#01-PSU#0       CA05967-1651       BBZT1317000233     01A/S1F
DE#01-PSU#1       CA05967-1651       BBZT1317000236     01A/S1F
```

The following example displays hardware information (for the DX8700 S3/DX8900 S3):

```

CLI> show hardware-information
Enclosure                Serial No.                Other Information
Controller Enclosure#0   STCE000012                CE000012
Controller Enclosure#1   -                          -
Controller Enclosure#2   -                          -
Controller Enclosure#3   -                          -
Controller Enclosure#4   -                          -
Controller Enclosure#5   -                          -
Controller Enclosure#6   -                          -
Controller Enclosure#7   -                          -
Controller Enclosure#8   -                          -
Controller Enclosure#9   -                          -
Controller Enclosure#a   -                          -
Controller Enclosure#b   -                          -
Drive Enclosure#00      JWXMP13470044             35DE_12G
Drive Enclosure#01      -                          -
Drive Enclosure#02      -                          -
Drive Enclosure#03      -                          -
Drive Enclosure#04      -                          -
Drive Enclosure#05      -                          -
Drive Enclosure#06      -                          -
Drive Enclosure#07      -                          -
Drive Enclosure#08      -                          -
Drive Enclosure#09      -                          -
Drive Enclosure#0a      -                          -
Drive Enclosure#0b      -                          -
Drive Enclosure#0c      -                          -
Drive Enclosure#0d      -                          -
Drive Enclosure#0e      -                          -
Drive Enclosure#0f      -                          -

Component                Part No.                  Serial No.                Version
CE#0-CM#0                CA07111-C631             PP09280285                AA
CE#0-CM#1                CA07111-C631 P          P0928028A                 AA
CE#0-CM#0-PFM#0          CA07555-D052             PP132400W2                A1
CE#0-CM#0-PFM#1          CA07555-D053             PP132411W4                A0
CE#0-CM#1-PFM#0          CA07555-D052             PP132440W2                A1
CE#0-CM#1-PFM#1          CA07555-D053             PP132451W4                A0
CE#0-PSU#0               CA05954-0860             FA09060095                06A
CE#0-PSU#1               CA05954-0860             FA09060095                06A
SVC#0                    CA07111-C661             PP085102T0                06A
SVC#1                    CA07111-C661             PP085102T0                06A
FRT#0                    CA07111-C661             PP085102T0                06A
FRT#1                    CA07111-C661             PP085102T0                06A
FRT#2                    CA07111-C661             PP085102T0                06A
FRT#3                    CA07111-C661             PP085102T0                06A
FE-PSU#0                 CA05954-0860             FA09060095                06A
FE-PSU#1                 CA05954-0860             FA09060095                06A
FE-PSU#2                 CA05954-0860             FA09060095                06A
FE-PSU#3                 CA05954-0860             FA09060095                06A
DE#00-IOM#0              CA05967-1610+A0         JWXB13020322              AA
DE#00-IOM#1              CA05967-1610+A0         JWXB13130128              AA
DE#00-PSU#0              CA05967-1651            BBZT1317000233            01A/S1F
DE#00-PSU#1              CA05967-1651            BBZT1317000236            01A/S1F

```

Chapter 3

Configuration Settings and Display



This chapter explains the commands used for basic settings of the storage system. These settings include RAID group management, volume management, Thin Provisioning Pool management, Flexible Tier management, and host interface management.

3.1 RAID Group Management

This section explains the commands used for the following settings:

- RAID group settings
- Hot spares settings
- Eco-mode settings

For information about how to operate External RAID Groups, refer to ["5.3.13 Non-disruptive Storage Migration Function" \(page 774\)](#).

3.1.1 RAID Group

This section explains the commands used for RAID group management. All drives contained in a RAID group must be the same drive type.

The functions to control RAID groups are as follows:

- Creating a RAID group
- Changing an existing RAID group
- Deleting RAID groups
- LDE, Logical Device Expansion (expanding a RAID group)

show raid-groups

This command displays a summary list of all the RAID groups or the details of a specified RAID group(s).

Syntax

```
show raid-groups [-rg-number rg_numbers | -rg-name rg_names | -csv]
```

Parameter

-rg-number or -rg-name

Optional. This parameter specifies RAID group identifiers. One or more RAID groups can be specified. For details, refer to ["1.2.10 RAID Group Syntax" \(page 39\)](#). If the RAID group identifier is omitted, a summary list of all the RAID groups is displayed.

rg_numbers RAID group number

rg_names RAID group name

-csv

Optional. This parameter shows a summary list of all the RAID groups in a CSV format.

Note

- This parameter cannot be specified simultaneously with other parameters.
- Information that was output in the CSV format cannot be specified for setup commands (or command names that start with "create" or "set").

Output

Item name	Description
RAID Group	RAID group identifiers
No.	RAID group number
Name	RAID group name
RAID Level	RAID level
Consist of Fast Recovery	Drives configured for the Fast Recovery RAID Group. (This information is displayed for RAID groups with RAID6-FR RAID level. A hyphen [-] is displayed for other RAID levels.) The drive configuration, the number of configurations, and the number of hot spares for RAID6 are displayed. Example: (3D+2P)x2+1HS
Assigned CM	Assigned CM number (CM number to control a RAID group)
Status	RAID group status
Total Capacity (MB)	Total capacity (Unit: MB)
Free Capacity (MB)	Free capacity (Unit: MB)
Stripe Depth (Unit: KB)	Stripe Depth (Unit: KB) (Only when viewing details)
Key Group	Usage status of the key group (Only when viewing details)
Disk List	List of drives that belong to a RAID group (only when viewing details)
Disk	Location of the drives that belong to a RAID group

Item name	Description
Status	Status of the drives that belong to a RAID group
Usage	Usage of the drives that belong to a RAID group
Mirroring	Pair drive information in case of RAID1 or RAID1+0
Fast Recovery Disk	Fast Recovery drive. When the RAID level is RAID6-FR, if the hot spare area is being used, the drive that failed is displayed.

■ Example(s)

The following example displays a summary list of all the drives registered in the system:

```
CLI> show raid-groups
RAID Group      RAID      Assigned  Status      Total      Free
No.  Name        Level    CM          Capacity (MB) Capacity (MB)
-----
 1  RAIDGROUP001  RAID1+0  CM#0      Spare in Use      134656      132535
 2  RAIDGROUP002  RAID5    CM#1      Available          134656      132532
 3  RAIDGROUP003  RAID5    CM#1      SED Locked         134656      132532
```

The following example displays a summary list of all the drives registered in the system (for the DX8700 S3/DX8900 S3):

```
CLI> show raid-groups
RAID Group      RAID      Assigned  Status      Total      Free
No.  Name        Level    CM          Capacity (MB) Capacity (MB)
-----
 1  RAIDGROUP001  RAID1+0  CE#1 CM#0  Spare in Use      134656      132535
 2  RAIDGROUP002  RAID5    CE#3 CM#1  Available          134656      132532
 3  RAIDGROUP003  RAID5    CE#3 CM#1  SED Locked         134656      132532
```

The following example displays a summary of the RAID groups in a CSV format by specifying "-csv":

```
CLI> show raid-groups -csv
[RAID Group No.],[RAID Group Name],[RAID Level],[Assigned CM],[Status],[Total Capacity (MB)],[Free Capacity (MB)]
1,RAIDGROUP001,RAID1+0,CM#0,Spare in Use,134656,132535
2,RAIDGROUP002,RAID5,CM#1,Available,134656,132532
3,RAIDGROUP003,RAID5,CM#1,SED Locked,134656,132532
```

The following example displays details of the RAID5(4+1) RAID group named "R1". In this example, two drives have failed and two hot spares are in use. These hot spares have also failed. When multiple drives fail, the drive in "Failed Usable" status indicates the last drive that has failed:

```

CLI>show raid-groups -rg-name R1
RAID Group      RAID Level  Consist of  Assigned  Status      Total      Free      Stripe      Key      Fast Recovery
No. Name        Level      Fast Recovery CM          CM          Capacity(MB) Capacity(MB) Depth(KB) Group      Disk
-----
0 R1            RAID5      -           CM#0      Broken      1116160    1116136    64 Enable -
<Disk List>
Disk           Status      Usage      Mirroring
-----
CE-Disk#0     Available  Data
CE-Disk#1     Available  Data
CE-Disk#2     Available  Data
CE-Disk#3     Broken     Data
CE-Disk#4     Broken     Data
CE-Disk#5     Broken     Dedicated Hot Spare
CE-Disk#6     Failed Usable Global Hot Spare
  
```

The following example displays the details of RAID group #0. When the RAID level is RAID1 or RAID1+0, the mirroring information is also displayed:

```

CLI> show raid-groups -rg-number 0
RAID Group      RAID Level  Consist of  Assigned  Status      Total      Free      Stripe      Key      Fast Recovery
No. Name        Level      Fast Recovery CM          CM          Capacity(MB) Capacity(MB) Depth(KB) Group      Disk
-----
0 RAIDGROUP1    RAID1+0    -           CM#0      Spare in Use 560128     60104     64 Disable -
<Disk List>
Disk           Status      Usage      Mirroring
-----
CE-Disk#2     Broken     Data      -
CE-Disk#3     Available  Data      CE-Disk#5
CE-Disk#4     Available  Data      CE-Disk#7
CE-Disk#5     Available  Data      CE-Disk#3
CE-Disk#7     Available  Global Hot Spare CE-Disk#4
  
```

The following example displays the details of RAID Group #0 when the RAID level is RAID6-FR:

```

CLI> show raid-groups -rg-number 0
RAID Group      RAID Level  Consist of  Assigned  Status      Total      Free      Stripe      Key      Fast Recovery
No. Name        Level      Fast Recovery CM          CM          Capacity(MB) Capacity(MB) Depth(KB) Group      Disk
-----
0 R1            RAID6-FR   (3D+2P)x2+1HS CM#0      Broken      1116160    1116136    64 Enable DE#01-Disk#5
<Disk List>
Disk           Status      Usage      Mirroring
-----
DE#01-Disk#0  Available  Data
DE#01-Disk#1  Available  Data
DE#01-Disk#2  Available  Data
DE#01-Disk#3  Available  Data
DE#01-Disk#4  Available  Data
DE#01-Disk#5  Broken     Data
DE#01-Disk#6  Available  Data
DE#01-Disk#7  Available  Data
DE#01-Disk#8  Available  Data
DE#01-Disk#9  Available  Data
DE#01-Disk#10 Available  Data
  
```

show raid-group-progress

This command displays the progress of the Rebuild/Copyback process and the expansion process of all RAID groups (Logical Device Expansion). Individual RAID groups can also be specified.

Syntax

```
show raid-group-progress [-rg-number rg_numbers | -rg-name rg_names]
```

Parameter

-rg-number or -rg-name

Optional. This parameter specifies RAID group identifiers. If the RAID group identifier is omitted, a progress list of all the RAID groups is displayed. For details, refer to ["1.2.10 RAID Group Syntax" \(page 39\)](#).

rg_numbers RAID group number

rg_names RAID group name

Output

Item name	Description
RAID Group	RAID group identifiers
No.	RAID group number
Name	RAID group name
Status	RAID group status
Rebuild/Copyback	Information on the recovery progress
Progress	Progress (0 – 100%)
Estimated time left	Estimated remaining recovery time
-	Formatting is not performed or is complete.
calculating	The remaining time is being calculated.
30days or more	The remaining time is 30 days or more.
Xday Yh Zmin	The remaining time is less than 30 days but 1 day or more.
Yh Zmin	The remaining time is less than 1 day but 1 hour or more.
Zmin	The remaining time is less than 1 hour but 1 minute or more.
Less than 1min	The remaining time is less than 1 minute.
Remaining size	Remaining capacity of recovery
-	Formatting is not performed or is complete.
XMB	Remaining capacity (rounded up to the nearest whole number) X: decimal number
Expanding Progress	Progress status of expanding RAID groups (Logical Device Expansion)

■ Example(s)

The following example displays a progress list of all the RAID groups:

```
CLI> show raid-group-progress
RAID Group      Status
No.  Name
-----
  0  RAIDGROUP001  Copyback
  1  RAIDGROUP012  Available
  2  RAIDGROUP013  Available
  3  RAIDGROUP014  SED Locked
Rebuild/Copyback
Progress Estimated time left Remaining size Expanding
Progress
-----
  0  87% 12h 59min 1024MB -
  1  - - - 19%
  2  87% Less than 1min 16MB -
  3  0% 30days or more 134217728MB -
```

The following example displays only the progress status of the RAID group #1:

```
CLI> show raid-group-progress -rg-number 1
RAID Group      Status
No.  Name
-----
  1  RAIDGROUP012  Available
Rebuild/Copyback
Progress Estimated time left Remaining size Expanding
Progress
-----
  1  - - - 19%
```

The following example displays the progress status of the RAID group named "RAIDGROUP001" and "RAIDGROUP012":

```
CLI> show raid-group-progress -rg-name RAIDGROUP001,RAIDGROUP012
RAID Group      Status
No.  Name
-----
  0  RAIDGROUP001  Copyback
  1  RAIDGROUP012  Available
Rebuild/Copyback
Progress Estimated time left Remaining size Expanding
Progress
-----
  0  87% 12h 59min 1024MB -
  1  - - - 19%
```

create raid-group

This command creates a RAID group with the specified RAID group name, RAID level, and drives. When registering a hot spare, refer to the "set global-spare" or the "set dedicated-spare" command.

■ Syntax

```
create raid-group -name alias_name -disks disks -level {0 | 1 | 5 | 6 | 10 | 50 | 6fr}
[-assigned-cm {0 | 1 | 00 | 01 | 10 | 11 | 20 | 21 | 30 | 31 | 40 | 41 | 50 | 51 | 60 | 61 | 70 | 71 | 80 | 81 | 90 | 91 | a0 | a1
| b0 | b1 | auto}]
[-stripe-depth {64kb | 128kb | 256kb | 512kb | 1024kb}]
[-fr-consist {(3D+2P)x2+1HS | (4D+2P)x2+1HS | (6D+2P)x2+1HS | (9D+2P)x2+1HS |
(12D+2P)x2+1HS | (5D+2P)x4+1HS | (13D+2P)x2+1HS | (8D+2P)x3+1HS | (4D+2P)x5+1HS | (3D+2P)x6+1HS}]
```

■ Parameter

- name This parameter specifies the alias name of a RAID group. Only one name can be specified. For details, refer to ["1.2.6 Alias Name Syntax" \(page 35\)](#).
- alias_name* RAID group name
- disks This parameter specifies which drives will form the RAID group. For details, refer to ["1.2.5 Drive Syntax" \(page 35\)](#).
- disks* Drive
- level This parameter specifies the RAID level.
- | | |
|-----|--------------------------|
| 0 | RAID0 |
| 1 | RAID1 |
| 5 | RAID5 |
| 6 | RAID6 |
| 10 | RAID1+0 |
| 50 | RAID5+0 |
| 6fr | RAID6-FR (Fast Recovery) |
- assigned-cm Optional. This parameter specifies the assigned controller (CM number) of the specified RAID group. If "auto" is specified, the fixed controller, which is calculated automatically by the system, is assigned. If this parameter is omitted, the process is performed as if "auto" was set.

0	CM#0 (DX60 S4/DX100 S4/DX200 S4, DX500 S4/DX600 S4, DX60 S3/DX100 S3/DX200 S3, DX500 S3/DX600 S3, DX8100 S3, AF250 S2/AF650 S2, AF250/AF650, and DX200F only)
1	CM#1 (DX60 S4/DX100 S4/DX200 S4, DX500 S4/DX600 S4, DX60 S3/DX100 S3/DX200 S3, DX500 S3/DX600 S3, DX8100 S3, AF250 S2/AF650 S2, AF250/AF650, and DX200F only)
w/x	CE#w-CM#x (DX8700 S3/DX8900 S3 only) "w" is the controller enclosure (CE) number and "x" is the controller module (CM) number. Example: "01" indicates CE#0-CM#1 For the controller enclosure number, the range that the value can be specified with is 0 to b (hex). For the controller module number, 0 or 1 can be specified.
auto	Automatically (default)

-stripe-depth

Optional. This parameter specifies the stripe depth for the RAID group that is to be created. If omitted, then it is handled as if "64kb" is selected. The available values vary depending on the RAID level and the number of drives.

64kb	64KB
128kb	128KB (Only for RAID 5 configurations of 10 or more drives, RAID 0 configurations, and RAID1+0 configurations)
256kb	256KB (Only for RAID 5 configurations of 9 or less drives, RAID 0 configurations, and RAID1+0 configurations)
512kb	512KB (Only for RAID 5 configurations of 5 or less drives, RAID 0 configurations, and RAID1+0 configurations)
1024kb	1,024KB (Only for RAID0 configurations and RAID1+0 configurations)

-fr-consist

Optional. This parameter specifies the drives that consist of the Fast Recovery RAID group. In the case of RAID6-FR configurations, this parameter must be specified.

(3D+2P)x2+1HS	RAID6(3+2) × 2, HS × 1
(4D+2P)x2+1HS	RAID6(4+2) × 2, HS × 1
(6D+2P)x2+1HS	RAID6(6+2) × 2, HS × 1
(9D+2P)x2+1HS	RAID6(9+2) × 2, HS × 1
(12D+2P)x2+1HS	RAID6(12+2) × 2, HS × 1
(5D+2P)x4+1HS	RAID6(5+2) × 4, HS × 1
(13D+2P)x2+1HS	RAID6(13+2) × 2, HS × 1
(8D+2P)x3+1HS	RAID6(8+2) × 3, HS × 1
(4D+2P)x5+1HS	RAID6(4+2) × 5, HS × 1
(3D+2P)x6+1HS	RAID6(3+2) × 6, HS × 1

■ Example(s)

The following example creates a RAID group named "RGP001". RAID1 level is assigned using drives #003 and #004:

```
CLI> create raid-group -name RGP001 -level 1 -disks 003,004
```

set raid-group

This command changes the information of an existing RAID group.

Syntax

```
set raid-group {-rg-number rg_number | -rg-name rg_name} [-name name]  
[-assigned-cm {0 | 1 | 00 | 01 | 10 | 11 | 20 | 21 | 30 | 31 | 40 | 41 | 50 | 51 | 60 | 61 | 70 | 71 | 80 | 81 | 90 | 91 | a0 | a1  
| b0 | b1 | auto}]  
[-key-group {enable | disable}]
```

Parameter

-rg-number or -rg-name

This parameter specifies RAID group identifiers.

Only one RAID group identifier can be specified when changing a RAID group alias name. One or more RAID group identifiers can be specified when changing the assigned CM. For details, refer to ["1.2.10 RAID Group Syntax" \(page 39\)](#).

Caution

The following RAID groups cannot be renamed:

- RAID groups that are registered in an FTRP
- RAID groups that are registered as Extreme Cache Pools

rg_number RAID group number

rg_name RAID group name

-name Optional. This parameter specifies the new RAID group name. If this parameter is omitted, the name is not changed. For details, refer to ["1.2.6 Alias Name Syntax" \(page 35\)](#).

name RAID group name

-assigned-cm

Optional. This parameter specifies the assigned controller module number of the RAID group. If "auto" is specified, the fixed controller, which is calculated automatically by the system, is assigned. If this parameter is omitted, the assigned CM is not changed.

Caution

The assigned CM for the RAID group that is registered as an Extreme Cache Pool cannot be changed.

0 CM#0 (DX60 S4/DX100 S4/DX200 S4, DX500 S4/DX600 S4, DX60 S3/DX100 S3/DX200 S3, DX500 S3/DX600 S3, DX8100 S3, AF250 S2/AF650 S2, AF250/AF650, and DX200F only)

1 CM#1 (DX60 S4/DX100 S4/DX200 S4, DX500 S4/DX600 S4, DX60 S3/DX100 S3/DX200 S3, DX500 S3/DX600 S3, DX8100 S3, AF250 S2/AF650 S2, AF250/AF650, and DX200F only)

`w/x` CE#w-CM#x (DX8700 S3/DX8900 S3 only)
"w" is the controller enclosure (CE) number and "x" is the controller module (CM) number.
Example: "01" indicates CE#0-CM#1
For the controller enclosure number, the range that the value can be specified with is 0 to b (hex).
For the controller module number, 0 or 1 can be specified.

`auto` Automatically (default)

`-key-group` Optional. The Security Setting policy is required. This parameter specifies whether to use the key group. If omitted, the existing setting is not changed.

 **Caution**

This parameter is only supported in models that can be installed with SEDs.

`enable` The key group is used (the SED authentication key that is managed by the key server is used).

`disable` The key group is not used (the common key in the ETERNUS DX/AF is used).

■ Example(s)

The following example changes the RAID group named "RGP001". The new name is "RAID002":

```
CLI> set raid-group -rg-name RGP001 -name RAID002
```

The following example changes the CM number that is associated with the RAID group named "RGP001" (for the DX60 S4/DX100 S4/DX200 S4, the DX500 S4/DX600 S4, the DX60 S3/DX100 S3/DX200 S3, the DX500 S3/DX600 S3, the DX8100 S3, the AF250 S2/AF650 S2, the AF250/AF650, and the DX200F).

The new CM number is "CM#1":

```
CLI> set raid-group -rg-name RGP001 -assigned-cm 1
```

The following example changes the CM number that is associated with RAID groups #2 and #4 (for the DX60 S4/DX100 S4/DX200 S4, the DX500 S4/DX600 S4, the DX60 S3/DX100 S3/DX200 S3, the DX500 S3/DX600 S3, the DX8100 S3, the AF250 S2/AF650 S2, the AF250/AF650, and the DX200F).

The new CM number is "CM#1":

```
CLI> set raid-group -rg-number 2,4 -assigned-cm 1
```

The following example changes the CM number that is associated with RAID groups #2 and #4 (for the DX8700 S3/DX8900 S3).

The new CM number is "CE#3 CM#1":

```
CLI> set raid-group -rg-number 2,4 -assigned-cm 31
```

The following example sets a key group for RAID groups #2 and #4:

```
CLI> set raid-group -rg-number 2,4 -key-group enable
```

delete raid-group

This command deletes an existing RAID group(s). A RAID group cannot be deleted if one or more volumes exist in the RAID group.

Caution

- The following RAID groups cannot be deleted:
 - RAID groups where the volumes are registered
 - RAID groups are being expanded
 - RAID groups that are registered in a TPP or an FTRP
 - RAID groups that are registered as REC Disk Buffers
 - RAID groups that are registered as Extreme Cache Pools

Syntax

```
delete raid-group {-rg-number rg_numbers | -rg-name rg_names}
```

Parameter

-rg-number or -rg-name

This parameter specifies RAID group identifiers. One or more RAID group identifiers can be specified. For details, refer to ["1.2.10 RAID Group Syntax" \(page 39\)](#).

rg_numbers RAID group number

rg_names RAID group name

Example(s)

The following example deletes the RAID group named "R1":

```
CLI> delete raid-group -rg-name R1
```

The following example deletes consecutive RAID groups #1 - #8:

```
CLI> delete raid-group -rg-number 1-8
```

expand raid-group

This command expands a RAID group (Logical Device Expansion). The capacity of an existing RAID group is expanded by adding new drives to the RAID group. A new RAID level can also be specified. Any volumes in the existing RAID group are relocated to the new RAID group.

Caution

- RAID5+0 and RAID6-FR are not supported, not even for pure capacity expansion operations.
- Expanding a RAID level other than RAID0 to RAID0 is not supported.
- When RAID group capacity is expanded without changing the RAID level, specify only the new drives to be added for the "-disks" parameter.
- If the RAID level is changed with RAID group expansion, at least one drive that is already configured in an expansion source RAID group and all the new drives that are to be added must be specified for the "-disks" parameter.

Syntax

```
expand raid-group {-rg-number rg_number | -rg-name rg_name}  
-disks disks [-level {0 | 5 | 6 | 10}] [-name name]
```

Parameter

-rg-number or -rg-name

This parameter specifies a RAID group identifier. However, only one RAID group identifier can be specified at a time. For details, refer to ["1.2.10 RAID Group Syntax" \(page 39\)](#).

rg_number RAID group number

rg_name RAID group name

-disks This parameter specifies the drives to add to a RAID group. One or more parameters can be specified. This parameter specifies the drive numbers for the drives that configure the RAID group before expansion and the numbers for the drives that are to be added. For details, refer to ["1.2.5 Drive Syntax" \(page 35\)](#).

disks Drive

-level Optional. This parameter specifies the new RAID level of the expanded RAID group. RAID5+0 level is not supported.

0 RAID0

5 RAID5

6 RAID6

10 RAID1+0

-name Optional. This parameter specifies the new RAID group name to be used for the expanded RAID group. For details, refer to ["1.2.6 Alias Name Syntax" \(page 35\)](#).

names RAID group name

■ Example(s)

The following example expands the RAID group named "RGP001" using six drives (#101-#103, #201-#203), and changes the RAID level to RAID5:

```
CLI> expand raid-group -rg-name RGP001 -disks 101-103,201-203 -level 5
```

3.1.2 Hot Spares

This section explains the commands that are related to hot spares. Hot spares are reserved drives that are used when a failure or abnormality occurs within a RAID group drive. There are two types of hot spares:

- **Global Hot Spare (Global HS)**
A hot spare that can be used by all RAID groups (except RAID0).
When multiple hot spares are installed, the most appropriate drive is automatically selected and incorporated into a RAID group.
- **Dedicated Hot Spare (Dedicated HS/DHS)**
A hot spare that is only available to the specified RAID group (one RAID group).
The Dedicated Hot Spare cannot be registered in a RAID group that is registered in TPPs, FTRPs, Extreme Cache Pools, or REC disk buffers.
If the Dedicated Hot Spare has not been assigned (or if unavailable), the Global Hot Spare will be used.

If a drive failure occurs, a data copy (rebuild) to the hot spare is automatically started.

If copybackless (*1) is disabled, and the failed drive is replaced with a normal drive, data is copied back to the drive that was replaced. The hot spare that was used in place of the failed drive returns as a spare drive for when failure occurs.

If copybackless is enabled, the hot spare is assigned to the RAID group after the rebuild completes and is changed to a data drive. Originally the failed drive that was assigned to the RAID group is changed to a hot spare after the rebuild completes. If the failed drive is replaced by a normal drive, the drive that was replaced can be used as a hot spare.

*1: Copybackless is a function that makes copyback unnecessary by assigning the original hot spare to RAID groups as is, and the drive after the replacement as a hot spare.

Note

Register dedicated hot spares in a RAID group that is used for saving important data so that the hot spares are prioritized for use.

Caution

Hot spares must be of the same drive type as the drives in the RAID group. Also, the hot spares must have the same or larger capacity as the drives in the RAID group. If a RAID group is configured with drives that have different rotational speeds, the performance of all of the drives in the RAID group is reduced to that of the drive with the lowest rotational speed.

A list of registered hot spares can be displayed by using the "show disks" command.

set global-spare

This command assigns a drive as a Global Hot Spare. A Global Hot Spare is shared by all of the RAID groups except for RAID0. A list of registered hot spares can be displayed by using the "show disks" command.

■ Syntax

```
set global-spare -disks disks
```

■ Parameter

-disks This parameter specifies the drives to be registered as Global Hot Spares. One or more drives can be specified. For details, refer to ["1.2.5 Drive Syntax" \(page 35\)](#).

disks Drive

■ Example(s)

The following example registers drives #101 and #102 as Global Hot Spares:

```
CLI> set global-spare -disks 101,102
```

The following example assigns drives #101 and #102 as Global Hot Spares and drive #103 as a Global Hot Spare. Adding additional Global Hot Spares does not remove any hot spares that are previously set:

```
CLI> set global-spare -disks 101,102  
CLI> set global-spare -disks 103
```

release global-spare

This command releases Global Hot Spare(s). The drive will then have an unassigned (present) status.

■ Syntax

```
release global-spare -disks disks
```

■ Parameter

-disks This parameter specifies the drives to be released from the Global Hot Spare. One or more drives can be specified. For details, refer to "[1.2.5 Drive Syntax](#)" (page 35).

disks Drive

■ Example(s)

The following example releases drive #011 from the Global Hot Spares:

```
CLI> release global-spare -disks 011
```

The following example releases drives #101 to #105 from the Global Hot Spares:

```
CLI> release global-spare -disks 101-105
```

set dedicated-spare

This command assigns a drive as a Dedicated Hot Spare.

A dedicated hot spare can only be assigned to a single RAID group. However, one RAID group can have one or more dedicated hot spares. A list of registered hot spares can be displayed by using the "show disks" command.

■ Syntax

```
set dedicated-spare -disks disks {-rg-number rg_numbers | -rg-name rg_names}
```

■ Parameter

-disks This parameter specifies the drives to be registered as Dedicated Hot Spares. One or more drives can be specified. If two or more parameters are specified, they must be specified in the same order as the associated RAID group identifier parameters. For details, refer to ["1.2.5 Drive Syntax" \(page 35\)](#).

disks Drive

-rg-number or -rg-name

This parameter specifies the RAID group identifiers to which the Dedicated Hot Spares will be assigned. One or more RAID group identifiers can be specified. If two or more RAID group identifiers are specified, they must be specified in the same order as the associated drive parameters. For details, refer to ["1.2.10 RAID Group Syntax" \(page 39\)](#).

rg_numbers RAID group number

rg_names RAID group name

■ Example(s)

The example assigns drive #110 as a dedicated hot spare to the RAID group "R1":

```
CLI> set dedicated-spare -disks 110 -rg-name R1
```

The following example assigns drives #110 and #111 as dedicated hot spares to the RAID group named "RGP001":

```
CLI> set dedicated-spare -disks 110,111 -rg-name RGP001
```

The following example assigns two different drives to two different RAID groups. Drive #110 is assigned as a Dedicated Hot Spare to the RAID group named "RGP1". Drive #111 is assigned as a Dedicated Hot Spare to the RAID group named "RGP2":

```
CLI> set dedicated-spare -disks 110,111 -rg-name RGP1,RGP2
```

The following example first assigns drive #101 as a Dedicated Hot Spare and then adds drive #102 as a Dedicated Hot Spare to the same RAID group. Adding additional Dedicated Hot Spares does not remove any hot spares that are previously set:

```
CLI> set dedicated-spare -disks 101 -rg-name RGP1  
CLI> set dedicated-spare -disks 102 -rg-name RGP1
```

release dedicated-spare

This command releases a dedicated hot spare(s). The drive will then have an unassigned (present) status.

■ Syntax

```
release dedicated-spare -disks disks
```

■ Parameter

-disks This parameter specifies the drives that are registered as Dedicated Hot Spares. One or more drives can be specified. For details, refer to "[1.2.5 Drive Syntax](#)" (page 35).

disks Drive

■ Example(s)

The following example releases Dedicated Hot Spare #110:

```
CLI> release dedicated-spare -disks 110
```

The following example releases Dedicated Hot Spares #110 and #111:

```
CLI> release dedicated-spare -disks 110,111
```

3.1.3 Eco-mode Management

This section explains the commands that are related to the Eco-mode functions. They are only applicable when the Eco-mode is enabled using the "set eco-mode" command.

 **Caution**

The commands described in this section are not supported in the AF250 S2/AF650 S2, the AF250/AF650, and the DX200F.

The functions that are related to Eco-mode management are as follows:

- Setting/Releasing the Eco-mode
- Creating the Eco-mode schedule
- Changing the Eco-mode schedule
- Deleting the Eco-mode schedule
- Setting the RAID group association
- Releasing the RAID group association

The three steps involved in enabling the Eco-mode functions are as follows:

Procedure

- 1 Enable the Eco-mode.
- 2 Create an Eco-mode schedule.
- 3 Assign the Eco-mode schedule to RAID groups.

End of procedure

show eco-mode

This command displays the current Eco-mode status and parameter settings.

■ Syntax

```
show eco-mode
```

■ Parameter

No parameters.

■ Output

Item name	Description
Mode	Indicates whether the Eco-mode function is enabled.
Host I/O Monitoring Time	Monitoring interval time of the host I/O
Disk Motor Control Limit Count	Number of times that a disk motor will power off and on in one day

■ Example(s)

The following example displays the current Eco-mode settings:

```
CLI> show eco-mode
Mode [Enable]
Host I/O Monitoring Time [60 min.]
Disk Motor Control Limit Count [5]
```

set eco-mode

This command enables or disables the Eco-mode. The Eco-mode is a function that turns off the disk motor when the disks are not being accessed. The Eco-mode function cannot be used unless the Eco-mode is enabled.

■ Syntax

```
set eco-mode [-mode {enable | disable}]
```

■ Parameter

-mode Optional. This parameter specifies if the Eco-mode is enabled. If omitted, the existing setting is not changed.

enable	Eco-mode is enabled.
disable	Eco-mode is disabled.

■ Example(s)

The following example enables the Eco-mode:

```
CLI> set eco-mode -mode enable
```

The following example disables the Eco-mode:

```
CLI> set eco-mode -mode disable
```

show eco-schedule

This command displays a summary of the Eco-mode schedules and the Eco-mode schedule events.

Syntax

```
show eco-schedule [-schedule-number schedule_numbers | -schedule-name schedule_names]
```

Parameter

-schedule-number or -schedule-name

Optional. This parameter specifies the Eco-mode schedule identifier to display details. One or more Eco-mode schedule identifiers can be specified. If this parameter is omitted, all the Eco-mode schedules are displayed. For details, refer to ["1.2.18 Eco-mode Schedule Syntax" \(page 47\)](#).

schedule_numbers Eco-mode schedule number

schedule_names Eco-mode schedule name

Output

Item name	Description
ECO Schedule	Eco-mode schedule identifiers
No.	Eco-mode schedule number
Name	Eco-mode schedule name
Event	Eco-mode schedule event identifiers
No.	Eco-mode schedule event number
Type	Eco-mode schedule event type
Details	Explanation for the Eco-mode schedule event type
Time	Starting time and ending time of the Eco-mode schedule

Example(s)

The following example displays a list of all the registered Eco-mode schedules:

```
CLI> show eco-schedule
ECO Schedule
No. Name
-----
0 SC001
1 SC002
2 SC003_TEMP
```

The following example displays the schedule information of the Eco-mode schedule named "SC001":

```
CLI> show eco-schedule -schedule-name SC001
ECO Schedule
No. Name
-----
 0 SC001
Event
No. Type           Details                               Time
-----
 1 Every-day                from [06:00] to [18:00]
 2 Every-week   Monday-Friday                from [06:00] to [18:00]
 3 Specific-day 6days from December 13        from [06:00] to [18:00]
 4 Specific-week December 1st week Monday-Friday from [06:00] to [18:00]
```

The following example displays the schedule information of the Eco-mode schedules named "SC002" and "SC003_TEMP" at the same time:

```
CLI> show eco-schedule -schedule-name SC002,SC003_TEMP
ECO Schedule
No. Name
-----
 2 SC002
Event
No. Type           Details                               Time
-----
 1 Every-day                from [06:00] to [18:00]
 2 Every-week   Monday-Friday                from [06:00] to [18:00]

ECO Schedule
No. Name
-----
 3 SC003_TEMP
Event
No. Type           Details                               Time
-----
 1 Specific-day 6days from December 13        from [06:00] to [18:00]
 2 Specific-week December 1st week Monday-Friday from [06:00] to [18:00]
```

create eco-schedule

An Eco-mode schedule is a schedule that applies Eco-mode functions. The Eco-mode schedule specifies the time that a disk motor is rotated (it does NOT specify when the motor will be turned off). A maximum of 64 Eco-mode schedules can be created. One Eco-mode schedule consists of a maximum of 8 Eco-mode schedule events (at least one Eco-mode schedule event is required in one Eco-mode schedule). This command can create one Eco-mode schedule and only one Eco-mode schedule event. If two or more Eco-mode schedule events are created and defined, use the "set eco-schedule" command. Refer to the following:

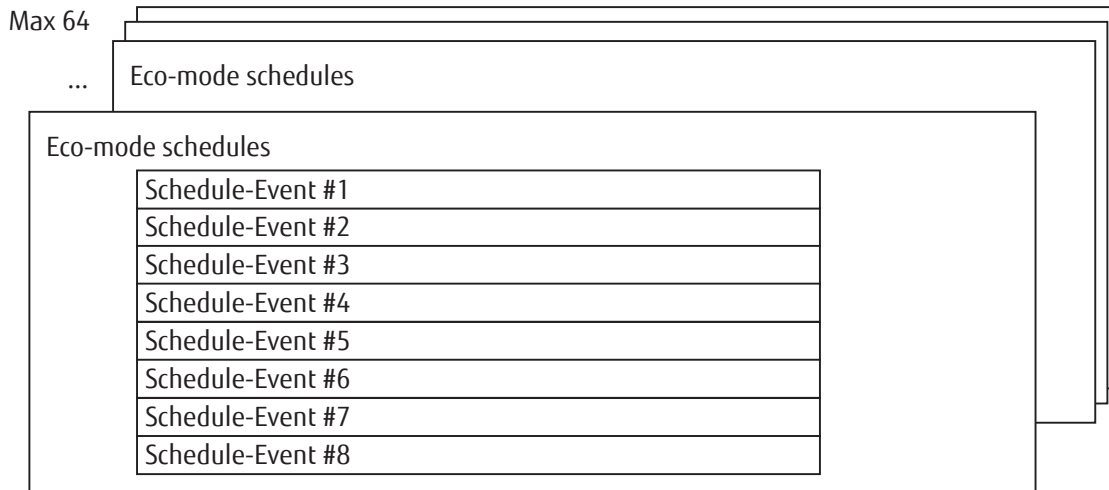

Syntax

```
create eco-schedule -name schedule_name -event-type {every-day |
every-week,{mon | tue | wed | thu | fri | sat | sun},{mon | tue | wed | thu | fri | sat | sun} | specific-day,MMDD,R |
specific-week,MM,{1st | 2nd | 3rd | 4th | last},{mon | tue | wed | thu | fri | sat | sun},{mon | tue | wed | thu | fri | sat |
sun}}
-event-from hhmm -event-to hhmm
```

Parameter

- name This parameter specifies the Eco-mode schedule name. Only one Eco-mode schedule name can be specified. For details, refer to "[1.2.18 Eco-mode Schedule Syntax](#)" (page 47).
schedule_name Eco-mode schedule name
- event-type This parameter specifies the Eco-mode schedule event type.
 - every-day The Eco-mode schedule is applied to every day. A suboperand is not required.
 Example: -event-type every-day
 - every-week The Eco-mode schedule is applied to every week. This format is "every-week,STA,END". The start day of the week (STA) and the end day of the week (END) are separated by a comma (,). The day of the week must be specified in the following format. The end day of the week must be after the start day of the week. The first day starts from Monday.

Example: Correct -> -event-type every-week,mon,fri
(from Monday to Friday is OK)

Example: Incorrect -> -event-type every-week,fri,tue
(from Friday to Tuesday is not OK)

Example: Correct -> -event-type every-week,mon,mon
(only Monday is OK)

mon Monday
tue Tuesday
wed Wednesday
thu Thursday
fri Friday
sat Saturday
sun Sunday

specific-day The Eco-mode schedule is applied to a specific day. This format is "specific-day,MMDD,R". The specific month MM (01 – 12) and the specific day DD (01 – 31) are separated by a comma (,) (when every month is required, specify "em" instead of 01 – 12). When the last day of the month is required, specify "99" instead of 01 – 31. The number of days that the schedule will apply is specified as R, and a value between 1 – 7 can be set.

Example: -event-type specific-day,0501,3
(For three days, from May 1st to May 3rd)

Example: -event-type specific-day,0630,2
(For two days, from June 30th to July 1st)

specific-week

The Eco-mode schedule is applied to a specific week. This format is "specific-week,MM,W,STA,END". The specific month MM (01 – 12) and the specific week W (1st, 2nd, 3rd, 4th, or last) are separated by a comma (,) (when every month is required, specify "em" instead of 01 – 12). The start day of the week (STA) and the end day of the week (END) are separated by a comma (,). The day of the week must be specified in the following format. The end day of the week must be after the start day of the week. The first day starts from Monday.

Example: -event-type specific-week,05,3rd,mon,wed
(From the 3rd Monday to the 3rd Wednesday in May)

Example: -event-type specific-week,05,3rd,wed,mon
(From the 3rd Wednesday to the 3rd Monday in May)
(When May 1st is a Monday)

mon Monday
tue Tuesday
wed Wednesday
thu Thursday
fri Friday
sat Saturday
sun Sunday

- event-from This parameter specifies that the Eco-mode schedule will start at a specific time. The format is "hhmm". "hh" is the starting hour (00 – 23) and "mm" is the starting minute (00 or 30). A disk motor will power ON at the time specified by this parameter.
- event-to This parameter specifies that the Eco-mode schedule will end at a specific time. The format is "hhmm". "hh" is the ending hour (00 – 23) and "mm" is the ending minute (00 or 30).

■ Example(s)

The following example creates an Eco-mode schedule. The Eco-mode schedule name is "SC001". The Eco-mode schedule will apply every day from 06:00 to 18:00:

```
CLI> create eco-schedule -name SC001 -event-type every-day -event-from 0600 -event-to 1800
```

set eco-schedule

This command is used to add Eco-mode schedule events or make changes to the specified Eco-mode schedule.

Syntax

```
set eco-schedule {-schedule-number schedule_number | -schedule-name schedule_name}  
[-name schedule_name] [-event-number {1 | 2 | 3 | 4 | 5 | 6 | 7 | 8}]  
[-event-type {every-day | every-week,{mon | tue | wed | thu | fri | sat | sun},{mon | tue | wed | thu | fri | sat | sun} |  
specific-day,MMDD,R | specific-week,MM,{1st | 2nd | 3rd | 4th | last},{mon | tue | wed | thu | fri | sat | sun},  
{mon | tue | wed | thu | fri | sat | sun}}] [-event-from hhmm] [-event-to hhmm]
```

Parameter

-schedule-number or -schedule-name

This parameter specifies an Eco-mode schedule identifier. Only one Eco-mode schedule identifier can be specified. For details, refer to ["1.2.18 Eco-mode Schedule Syntax" \(page 47\)](#).

schedule_number Schedule number

schedule_name Schedule name

-name Optional. This parameter specifies a new Eco-mode schedule name. If omitted, the existing setting is not changed. For details, refer to ["1.2.6 Alias Name Syntax" \(page 35\)](#).

schedule_name Schedule name

-event-number

Optional. This parameter specifies the Eco-mode schedule event number to change or to add the Eco-mode schedule event to the Eco-mode schedule. The Eco-mode schedule event number is a value from 1 to 8. Only one number can be specified. The Eco-mode schedule event number can be displayed by using the "show eco-schedule" command. If omitted, the Eco-mode schedule event specified by this parameter value is not changed.

1 – 8 Schedule event number

-event-type Optional. This parameter specifies the Eco-mode schedule event type. If omitted, the existing setting is not changed.

every-day The Eco-mode schedule is applied to every day. A suboperand is not required.

Example: -event-type every-day

every-week The Eco-mode schedule is applied to every week. This format is "every-week,STA,END". The start day of the week (STA) and the end day of the week (END) are separated by a comma (,). The day of the week must be specified in the following format. The end day of the week must be after the start day of the week. The first day starts from Monday.

Example: Correct -> -event-type every-week,mon,fri
(from Monday to Friday is OK)

Example: Incorrect -> -event-type every-week,fri,tue
(from Friday to Tuesday is not OK)

Example: Correct -> -event-type every-week,mon,mon
(only Monday is OK)

mon Monday
tue Tuesday
wed Wednesday
thu Thursday
fri Friday
sat Saturday
sun Sunday

specific-day The Eco-mode schedule is applied to a specific day. This format is "specific-day,MMDD,R". The specific month MM (01 – 12) and the specific day DD (01 – 31) are separated by a comma (,) (when every month is required, specify "em" instead of 01 – 12). When the last day of the month is required, specify "99" instead of 01 – 31. The number of days that the schedule will apply is specified as R, and a value between 1 – 7 can be set.

Example: -event-type specific-day,0501,3
(For three days, from May 1st to May 3rd)

Example: -event-type specific-day,0630,2
(For two days, from June 30th to July 1st)

specific-week

The Eco-mode schedule is applied to a specific week. This format is "specific-week,MM,W,STA,END". The specific month MM (01 – 12) and the specific week W (1st, 2nd, 3rd, 4th, or last) are separated by a comma (,) (when every month is required, specify "em" instead of 01 – 12). The start day of the week (STA) and the end day of the week (END) are separated by a comma (,). The day of the week must be specified in the following format. The end day of the week must be after the start day of the week. The first day starts from Monday.

Example: Correct -> -event-type specific-week,05,3rd,mon,wed
(from the 3rd Monday to the 3rd Wednesday in May is OK)

Example: Incorrect -> -event-type specific-week,05,3rd,wed,mon
(from the 3rd Wednesday to the 3rd Monday in May is not OK)
(When May 1st is a Monday)

mon Monday
tue Tuesday
wed Wednesday
thu Thursday
fri Friday
sat Saturday
sun Sunday

-event-from Optional. This parameter specifies that the Eco-mode schedule will start at a specific time. The format is "hhmm". "hh" is the starting hour (00 – 23) and "mm" is the starting minute (00 or 30). If omitted, the existing setting is not changed.

A disk motor will power ON at the time specified by this parameter.

-event-to Optional. This parameter specifies that the Eco-mode schedule will end at a specific time. The format is "hhmm". "hh" is the ending hour (00 – 23) and "mm" is the ending minute (00 or 30). If omitted, the existing setting is not changed.

■ Example(s)

The following example adds Eco-mode schedule event #2 in the Eco-mode schedule named "SC001":

```
CLI> set eco-schedule -schedule-name SC001 -event-number 2 -event-type every-day -event-from 0600 -event-to 1800
```

The following example changes the Eco-mode schedule name. The new Eco-mode schedule name is "SC002_NEW":

```
CLI> set eco-schedule -schedule-name SC001 -name SC002_NEW
```

delete eco-schedule

This command deletes an Eco-mode schedule(s) or a single Eco-mode schedule event. One or more Eco-mode schedules can be deleted at the same time. Only one Eco-mode schedule event can be deleted at the same time.

■ Syntax

```
delete eco-schedule {-schedule-number schedule_numbers | -schedule-name schedule_names}  
[-event-number {1 | 2 | 3 | 4 | 5 | 6 | 7 | 8}]
```

■ Parameter

-schedule-number or -schedule-name

This parameter specifies the Eco-mode schedule identifier. One or more parameters can be specified. However, if one or more parameters are specified, the "-event-number" parameter cannot be specified. For details, refer to ["1.2.18 Eco-mode Schedule Syntax" \(page 47\)](#).

schedule_numbers Schedule number

schedule_names Schedule name

-event-number

Optional. This parameter specifies the Eco-mode schedule event number to be deleted. The Eco-mode schedule event number is a value from 1 to 8 and can be displayed by using the "show eco-schedule" command. Only one event number can be specified. If the event-number is omitted, the Eco-mode schedule is deleted.

1 – 8 Schedule event number

■ Example(s)

The following example will delete the Eco-mode schedule named "SC002":

```
CLI> delete eco-schedule -schedule-name SC002
```

The following example will delete Eco-mode schedule event #2 in the Eco-mode schedule named "SC001":

```
CLI> delete eco-schedule -schedule-name SC001 -event-number 2
```

The following example will delete both the Eco-mode schedules named "SC002" and "SC003" at the same time:

```
CLI> delete eco-schedule -schedule-name SC002,SC003
```

show eco-raid-group

This command displays a list of the RAID groups that have an Eco-mode schedule associated with them.

Syntax

```
show eco-raid-group
```

Parameter

No parameters.

Output

Item name	Description
RAID Group	RAID group identifiers
No.	RAID group number
Name	RAID group name
Level	RAID level
Status	RAID group status
Assigned CM	Controller module to be assigned to the target RAID group
Capacity (MB)	RAID group capacity
ECO Schedule	Eco-mode schedule identifiers
Action	Eco-mode schedule action. It means whether the Eco-mode schedule is associated.
No.	Eco-mode schedule number (In the case of a schedule by a cooperative software, "128" is displayed.)
Name	Eco-mode schedule name (In the case of a schedule by a cooperative software, "External" is displayed.)
Motor Status	Current status of the disk motors
Control Status	Control status by a control command

Example(s)

The following example displays a list of all the RAID groups that are associated with the Eco-mode schedule (for the DX60 S4/DX100 S4/DX200 S4, the DX500 S4/DX600 S4, the DX60 S3/DX100 S3/DX200 S3, and the DX500 S3/DX600 S3):

```
CLI> show eco-raid-group
```

RAID Group No.	Name	Level	Status	Assigned CM	Capacity (MB)	ECO Schedule Action	No.	Name	Motor Status	Control Status
28	RGP028	RAID1	Available	CM#0	53647	Drive power off	1	SC001	Active	[OFF]
29	RGP029	RAID1+0	Available	CM#0	60000	Drive motor off	1	SC001	Active	[OFF]
30	RGP030	RAID5	Available	CM#1	89654	Drive always on	128	External	Active	[OFF]
31	RGP031	RAID0	Present	CM#1	22301	Drive always on	2	SC002	Active	[OFF]

The following example displays a list of all the RAID groups that are associated with the Eco-mode schedule (for the DX8700 S3/DX8900 S3):

```
CLI> show eco-raid-group
```

RAID Group No.	Name	Level	Status	Assigned CM	Capacity (MB)	ECO Schedule Action	No.	Name	Motor Status	Control Status
28	RGP028	RAID1	Available	CE#3 CM#0	53647	Drive power off	1	SC001	Active	[OFF]
29	RGP029	RAID1+0	Available	CE#3 CM#0	60000	Drive motor off	1	SC001	Active	[OFF]
30	RGP030	RAID5	Available	CE#3 CM#1	89654	Drive always on	128	External	Active	[OFF]
31	RGP031	RAID0	Present	CE#3 CM#1	22301	Drive always on	2	SC002	Active	[OFF]

set eco-raid-group

This command is used to associate an Eco-mode schedule with a specified RAID group(s).

Caution

- The RAID group where the SDPV is registered does not become the target of the motor stoppage due to Eco-mode.
- The RAID group where the ODX buffer volume is registered does not become the target of the motor stoppage due to Eco-mode.
- When software that detects abnormalities in hardware regularly accesses the ETERNUS DX/AF, even if Eco-mode is enabled, there are situations where the disk motor does not stop (*1).
*1: This not only affects the motor stoppage, but includes the cutting of the drives power as well.
- Set the same Eco-mode schedule to all the RAID groups that configure WSVs.
- Eco-mode cannot be set for RAID groups that are registered as Extreme Cache Pools.

Syntax

```
set eco-raid-group {-rg-number rg_numbers | -rg-name rg_names}  
[-schedule-number schedule_number | -schedule-name schedule_name]  
-action {enable | power-enable | disable}
```

Parameter

-rg-number or -rg-name

This parameter specifies a RAID group identifier. One or more parameters can be specified. For details, refer to "[1.2.10 RAID Group Syntax](#)" (page 39).

Caution

- RAID groups in which there are no volumes cannot be specified.
- Eco-mode cannot be used for RAID groups that contain SSDs.
- RAID groups that are registered as REC disk buffers cannot be specified.

rg_numbers RAID group number

rg_names RAID group name

-schedule-number or -schedule-name

Optional. This parameter specifies an Eco-mode schedule identifier. Only one Eco-mode schedule number can be specified. If omitted, the existing setting is not changed. For details, refer to "[1.2.18 Eco-mode Schedule Syntax](#)" (page 47).

To set software linkage, specify "128" for "-schedule-number". In this case, "External" is automatically set as the schedule name.

schedule_number Schedule number

schedule_name Schedule name

-action	This parameter specifies whether the associated definition is enabled.
enable	The motor is suspended (the specified Eco-mode schedule is enabled, and the drive motor is suspended except during the specified scheduled time period).
power-enable	The drives power is cut (the specified Eco-mode schedule is enabled, and power for the drive is cut except during the specified scheduled time period).
disable	The drive always operates (the specified Eco-mode schedule is disabled, and the drive operates continuously regardless of the specified schedule).

■ Example(s)

The following example associates the Eco-mode schedule named "SC001" with the RAID group named "RGP001":

```
CLI> set eco-raid-group -rg-name RGP001 -schedule-name SC001 -action enable
```

The following example associates the Eco-mode schedule named "SC001" with the RAID groups #1- #10 at the same time:

```
CLI> set eco-raid-group -rg-number 1-10 -schedule-name SC001 -action enable
```

The following example disables the Eco-mode function of the RAID group named "RGP001":

```
CLI> set eco-raid-group -rg-name RGP001 -action disable
```

The following example associates Eco-mode schedule #1 with the RAID group named "RGP001". The second command associates the Eco-mode schedule #2 with the same RAID group. These executions result in Eco-mode schedule #1 being released:

```
CLI> set eco-raid-group -rg-name RGP001 -schedule-number 1 -action enable  
CLI> set eco-raid-group -rg-name RGP001 -schedule-number 2 -action enable
```

release eco-raid-group

This command releases the Eco-mode schedule that is associated with a specific RAID group(s).

■ Syntax

```
release eco-raid-group {-rg-number rg_numbers | -rg-name rg_names}
```

■ Parameter

-rg-number or -rg-name

This parameter specifies a RAID group identifier. One or more parameters can be specified. For details, refer to ["1.2.10 RAID Group Syntax" \(page 39\)](#).

rg_numbers RAID group number

rg_names RAID group name

■ Example(s)

The following example releases an Eco-mode schedule associated with the RAID group named "RGP001":

```
CLI> release eco-raid-group -rg-name RGP001
```

The following example releases an Eco-mode schedule associated with RAID groups #1 – #10 at the same time:

```
CLI> release eco-raid-group -rg-number 1-10
```

3.2 Volume Management

This section explains the commands related to the management of volumes.

For details on the commands relating to volumes (Flexible Tier Volumes [FTVs]) that are assigned to Flexible Tier Pools (FTRPs), refer to ["3.2.2 Flexible Tier Volumes" \(page 202\)](#).

For information about External Volumes, refer to ["5.3.13 Non-disruptive Storage Migration Function" \(page 774\)](#).

3.2.1 Volume

This section explains the details of the commands that are related to the management of volumes.

- Creating volumes
- Changing existing volume information
- Deleting volumes
- Formatting volumes
- LUN concatenation (expanding volumes)
- RAID Migration (moving volumes)
- Balancing TPVs
- Starting/stopping Zero Reclamation
- QoS performance settings of the volume

show volumes

This command lists details of all the existing volumes or specified volumes.

This command is also used to display the details of Flexible Tier Volumes (FTVs).

Note

Depending on the model, the support state of the encryption-related functions may differ.

Syntax

```
show volumes [{-rg-number rg_number | -rg-name rg_name} |  
{-external-rg-number external_rg_number | -external-rg-name external_rg_name} |  
{-pool-number pool_number | -pool-name pool_name} |  
{-ftvp-number ftvp_number | -ftvp-name ftvp_name} |  
-type {standard | sdv | sdpv | tpv | ftv | wsv} | -mode {detail | expansion | uid | wsv | ftv | tfo | default} | -csv]
```

Parameter

-rg-number or -rg-name

Optional. This parameter specifies RAID group identifiers. The information of the volumes that belong to the specified RAID group will be displayed. If omitted, a summary of all the volumes that exist in the system is displayed. For details, refer to ["1.2.10 RAID Group Syntax" \(page 39\)](#).

Caution

- Only one parameter can be specified.
- Other parameters (except for "-mode default") cannot be specified at the same time.

rg_number RAID group number

rg_name RAID group name

-external-rg-number or external-rg-name

Optional. This parameter specifies External RAID Group identifiers. The information of the volumes that belong to the specified External RAID Group will be displayed. If omitted, a summary of all the volumes that exist in the system is displayed. For details, refer to ["1.2.10 RAID Group Syntax" \(page 39\)](#).

Caution

- Only one parameter can be specified.
- Other parameters (except for "-mode default") cannot be specified at the same time.

external_rg_number

External RAID Group number

external_rg_name

External RAID Group name

-pool-number or -pool-name

Optional. This parameter specifies the Thin Provisioning Pool identifier. The details of the volumes on a Thin Provisioning Pool will be displayed. If omitted, a summary of all the volumes that exist in the system is displayed. If the Thin Provisioning function is disabled, this parameter cannot be specified. For details, refer to ["1.2.7 Thin Provisioning Pool Syntax" \(page 36\)](#).

 **Caution**

- Only one parameter can be specified.
- Other parameters (except for "-mode default") cannot be specified at the same time.

<i>pool_number</i>	Thin Provisioning Pool number
<i>pool_name</i>	Thin Provisioning Pool name

-ftrp-number or -ftrp-name

Optional. This parameter specifies the Flexible Tier Pool (FTRP) identifier. The details of the volumes on an FTRP will be displayed. If omitted, a summary of all the volumes that exist in the system is displayed. For details, refer to ["1.2.8 Flexible Tier Pool Syntax" \(page 37\)](#).

 **Caution**

- Only one parameter can be specified.
- Other parameters (except for "-mode default" and "-mode ftv") cannot be specified at the same time.

<i>ftrp_number</i>	FTRP number
<i>ftrp_name</i>	FTRP name

-type

Optional. This parameter specifies the volume type to display the specific type. If the volume type is omitted, it is handled as selecting all types.

 **Caution**

- Only one parameter can be specified.
- Other parameters (except for "-mode default") cannot be specified at the same time.

standard	A normal/open volume (Standard)
sdv	A Snap Data Volume (SDV) for Advanced Copy functions
sdpv	A Snap Data Pool Volume (SDPV) for Advanced Copy functions
tpv	A Thin Provisioning Volume (TPV) (including various NAS volumes) If the Thin Provisioning function is disabled, "tpv" cannot be specified.
ftv	A Flexible Tier Volume (FTV) (including VMware Virtual Volumes [VVOL])
wsv	A Wide Striping Volume (WSV)

-mode Optional. This parameter toggles the extended output mode. If the mode is omitted, "default" is set.

 **Caution**

- Only one parameter can be specified.
- When the "-mode expansion", "-mode uid" or "-mode wsv" parameter is specified, other parameters cannot be specified at the same time.

detail	Detailed information of the volume can be displayed.
expansion	Detailed information of the configuration of an expanded volume (LUN concatenation volume) can be displayed. Only LUN concatenation volumes are displayed.
uid	NAA identifiers (UIDs) are displayed. All types of volumes are displayed.
wsv	The information for the concatenated RAID groups of the WSV is displayed. Only WSVs are displayed.
ftv	The usage status of the FTSPs for the FTV is displayed. The FTSPs are listed in the following order according to disk speed; SSD SEDs, SSDs, Online SEDs, Online disks, Nearline SEDs, and then Nearline disks. This option can be specified together with the "-ftsp-number" parameter or the "-ftsp-name" parameter. "Used Capacity" indicates the total used capacity for the FTSPs. "Volume Used Capacity" indicates the used capacity for the FTSPs of an FTV. "Usage Rate" indicates (Volume Used Capacity)/(total capacity of all the FTVs) × 100. The result for this formula is rounded down to the nearest whole number. This may result in the sum of the displayed "Usage Rate" values not being 100% even when the actual value is 100%. When no FTSPs are used, the "Usage Rate" is 0%. This information is only displayed for FTVs.
tfo	A summary of the volumes that belong to the TFO Group can be displayed. If the Storage Cluster license is not registered, this parameter cannot be specified.
default	The same result as when this parameter is omitted.

-csv Optional. This parameter shows the volume information in a CSV format.

 **Note**

- This parameter cannot be specified simultaneously with other parameters.
- Information that was output in the CSV format cannot be specified for setup commands (or command names that start with "create" or "set").

Output

Item name	Description
Volume	Volume identifiers
No.	Volume number
Name	Volume name
Status	Volume status
Type	Volume type and volume usage (This information is displayed when the NAS function is enabled.)
Usage Details	Detailed volume usage (This information is displayed when the NAS function is enabled.)

Item name	Description
NAS System Volume Format Status	The progress status of the NAS system volume format (If the volume type is not a relevant volume, a hyphen [-] is displayed.)
Encryption	Encryption status
Expansion	The number that configures volume if expanded
RG or TPP or FTRP	RAID group identifiers, External RAID Group identifiers, Thin Provisioning Pool identifiers, or Flexible Tier Pool identifiers
No.	RAID group number, External RAID Group number, Thin Provisioning Pool number, or Flexible Tier Pool number
Name	RAID group name, External RAID Group name, Thin Provisioning Pool name, or Flexible Tier Pool name
Size(MB)	Volume size. For SDVs, Virtual-size is displayed.
Reserved Deletion	Reserved deletion sign for SDPV only
Copy Protection	Copy protection
Data Integrity	Data protection function
Default	Standard data block guard
T10-DIF	T10-DIF
Allocation	Allocation type for a TPV or an FTV If the volume does not support the Allocation function, a hyphen (-) is displayed. For Deduplication/Compression Volumes, DEDUP_SYS Volumes, or DEDUP_MAP Volumes, [Thin] is displayed.
Thin	Volumes of which the Allocation method is "thin" (normal TPV)
Thick	Volumes of which the Allocation method is "thick" (a volume that ensures the physical capacity is the same as the logical capacity)
NAS FS Block Size	NAS file system block size (unit: KB). If the volume type is not a NAS user volume (nas-tpv), a hyphen (-) is displayed. In addition, this item does not appear if the unified storage system is not used.
NAS FS Version	NAS file system format. If the volume type is not a NAS user volume (nas-tpv) or if the information could not be collected, a hyphen (-) is displayed. In addition, this item does not appear if the unified storage system is not used.
1	The file system format of the volumes that were created with firmware versions earlier than V10L21 (volumes that cannot expand the capacity). Block size of 256KB / Maximum volume size depends on the model
2	The file system format of the volumes that were created with firmware version V10L21 (volumes that can expand the capacity). Block size of 256KB / Maximum volume size of 128TB
3	The file system format of the volumes that were created with firmware version V10L31 (volumes that can expand the capacity). Block size of 8KB / Maximum volume size of 4TB Block size of 32KB / Maximum volume size of 16TB Block size of 256KB / Maximum volume size of 128TB
4	The file system format of the volumes that were created with firmware versions V10L33 or later (volumes that can expand the capacity). Block size of 8KB / Maximum volume size of 32TB Block size of 32KB / Maximum volume size of 128TB Block size of 256KB / Maximum volume size of 128TB

Item name	Description
5	The file system format of the volumes that were created with firmware versions V10L51 or later (volumes that can expand the capacity. Quota settings for each NAS shared folder is supported). Block size of 8KB / Maximum volume size of 32TB Block size of 32KB / Maximum volume size of 128TB Block size of 256KB / Maximum volume size of 128TB
Used Status	Usage status for a TPV or an FTV
Measurements	Measurements for a TPV or an FTV
Attention (%)	Attention level for a TPV or an FTV A hyphen (-) is displayed for Deduplication/Compression volumes, DEDUP_SYS volumes, or DEDUP_MAP volumes.
Balancing Level	Balancing level for TPV only
Priority	FTRP number to which the FTV is preferentially allocated
Used Capacity (MB)	Used capacity for a TPV or an FTV
EXC	Indicates whether the Extreme Cache (EXC) function or the Extreme Cache Pool function is enabled for each volume. For models that do not support the EXC function or the Extreme Cache Pool function, this item is not displayed. A hyphen (-) is displayed for volume types that do not support the EXC function or the Extreme Cache Pool function. The EXC function or the Extreme Cache Pool function cannot be used regardless of the setting of each volume when the EXC function or the Extreme Cache Pool function is disabled for the ETERNUS DX/AF.
Size on RAID Group	Actual capacity that the volume uses in the relevant RAID group. This information is displayed when the "-mode detail" parameter, the "-mode wsv" parameter, or the "-mode expansion" parameter is specified. When the "-mode detail" parameter is specified, this information is not displayed for LUN concatenation volumes and WSVs. To display the actual capacity that the LUN concatenation volumes and the WSVs use in each RAID group, specify the "-mode expansion" parameter or the "-mode wsv" parameter. This information is not displayed for volume types that are not Standard (Open), SDVs, SDPVs, or WSVs.
UID	Universal Identifier of the volume For DEDUP_SYS Volumes or DEDUP_MAP Volumes, a hyphen (-) is displayed.
External LU Info	Whether External LU Information is inherited or not. If the Non-disruptive Storage Migration License is not registered, this item is not displayed.
Inherited	External LU Information is inherited.
-	External LU Information is not inherited or the volume is not an External Volume.
ID	LUN ID of the volume. This information is displayed when the "-mode detail" parameter or the "-mode uid" parameter is specified.
Mode	State of the UID setting
Default	Initial UID of the volume
Custom	The UID changed due to a TFO Pair or some other setting.
External	UID that is inherited from an External LU
ALUA	ALUA setting of the volume. This information is displayed when the "-mode detail" parameter is specified. If the volume type is Standard volume, WSV, TPV, FTV, SDV, or MVV, this item is displayed. For all other volume types, a hyphen (-) is displayed. For DEDUP_SYS Volumes or DEDUP_MAP Volumes, a hyphen (-) is also displayed.

A list of the parameters and the output items for these parameters is shown below.

Parameter	Volume No. Volume Name	Status	Type	Usage Details	NAS System Volume Format Status	Encryption	Expansion (concatenation)	Wide Stripe Size	WSV Concatenation	RG or TPP or FTRP No. RG or TPP or FTRP Name	TFOG No. TFOG Name	Size(MB)	Size on RAID Group (KB)	Reserved Deletion	Copy Protection	Data Integrity	Allocation	NAS FS Block Size	NAS FS Version	Free	UID ID UID Mode	Used Status	Measurements	Attention (%)	Balancing Level	Priority	Used Capacity(MB)	EXC	ALUA
No parameters -csv	D	D	D	-	-	-	-	-	-	D	-	D	-	-	D	-	-	-	-	-	-	-	-	-	-	-	-	-	-
-mode detail	D	D	D	-	-	D	D	-	-	D	D	D	D	-	D	D	D	D	D	-	D	-	-	-	-	-	-	D	D
-rg-number -rg-name	D	D	D	-	-	-	-	-	-	D	D	D	-	-	D	-	-	-	-	-	D	-	-	-	-	-	-	-	-
-external-rg-number -external-rg-name	D	D	D	-	-	-	-	-	-	D	D	D	-	-	D	-	-	-	-	-	-	-	-	-	-	-	-	-	-
-pool-number -pool-name	D	D	-	D	D	-	-	-	-	D	D	D	-	-	D	-	D	-	-	-	-	D	D	D	D	-	D	-	-
-ftvp-number -ftvp-name	D	D	-	D	D	-	-	-	-	D	D	D	-	-	D	-	D	-	-	-	-	D	D	D	-	D	D	-	-
-type standard	D	D	-	-	-	-	-	-	-	D	D	D	-	-	D	-	-	-	-	-	-	-	-	-	-	-	-	-	-
-type sdv	D	D	-	-	-	-	-	-	-	D	-	D	-	-	D	-	-	-	-	-	-	-	-	-	-	-	-	-	-
-type sdpv	D	D	-	-	-	-	-	-	-	D	-	D	-	D	D	-	-	-	-	-	-	-	-	-	-	-	-	-	-
-type tpv	D	D	-	D	D	-	-	-	-	D	D	D	-	-	D	-	D	-	-	-	-	D	D	D	D	-	D	-	-
-type ftv	D	D	-	D	D	-	-	-	-	D	D	D	-	-	D	-	D	-	-	-	-	D	D	D	-	D	D	-	-
-type wsv	D	D	-	-	-	-	-	D	-	D	D	D	-	-	D	-	-	-	-	-	-	-	-	-	-	-	-	-	-
-mode expansion	D	D	D	-	-	-	D	-	-	D	D	D	D	-	-	-	-	-	-	-	-	-	-	-	-	-	-	-	-
-mode uid	D	D	D	-	-	-	-	-	-	D	D	D	-	-	-	-	-	-	-	-	D	-	-	-	-	-	-	-	-
-mode wsv	D	D	-	-	-	-	-	D	D	D	D	D	D	-	-	-	-	-	-	-	-	-	-	-	-	-	-	-	-
-mode ftv	D	D	-	D	D	-	-	-	-	D	D	D	-	-	-	-	-	-	-	-	-	D	D	D	-	D	D	-	-
-mode tfo	D	D	D	-	-	-	-	-	-	D	D	D	-	-	-	-	-	-	-	-	-	-	-	-	-	-	-	-	-
-mode default	D	D	D	-	-	-	-	-	-	D	-	D	-	-	D	-	-	-	-	-	-	-	-	-	-	-	-	-	-

D: Displayed, -: Not displayed

■ Example(s)

The following example displays a list of all the volumes that exist in the system:

```
CLI> show volumes
```

Volume No.	Name	Status	Type	RG or TPP or FTRP No.	RG or TPP or FTRP Name	Size (MB)	Copy Protection
0	OLU#0	Available	Standard (Block)	0	RLU#0	256	Disable
1	OLU#1	Available	Standard (Block)	0	RLU#0	256	Disable
2	OLU#2	Available	Standard (Block)	0	RLU#0	256	Disable
3	OLU#3	Available	Standard (Block)	0	RLU#0	256	Disable
4	OLU#4	Available	Standard (Block)	1	RLU#1	256	Disable
5	OLU#5	Available	Standard (Block)	1	RLU#1	256	Disable
6	TPV#0	Available	TPV (File)	1	TPP#1	256	Disable
7	TPV#1	Available	TPV (Block)	1	TPP#1	256	Disable
8	TPV#2	Available	TPV (System)	1	TPP#1	256	Disable
9	VVOL#0	Available	FTV (Block/VVOL)	2	FTRP#0	256	Disable
10	TPV#10	Available	TPV (System)	1	TPP#1	256	Disable
11	TPV#11	Available	TPV (System)	1	TPP#1	256	Disable
12	EVOL#0	Available	Migration	0	VLU#0	256	Disable

The following example displays the volume information in a CSV format by specifying "-csv":

```
CLI> show volumes -csv
```

[Volume No.], [Volume Name], [Status], [Type], [RG or TPP or FTRP No.], [RG or TPP or FTRP Name], [Size (MB)], [Copy Protection]

```
0,OLU#0,Available,Standard (Block),0,RLU#0,256,Disable
1,OLU#1,Available,Standard (Block),0,RLU#0,256,Disable
2,OLU#2,Available,Standard (Block),0,RLU#0,256,Disable
3,OLU#3,Available,Standard (Block),0,RLU#0,256,Disable
4,OLU#4,Available,Standard (Block),1,RLU#1,256,Disable
5,OLU#5,Available,Standard (Block),1,RLU#1,256,Disable
6,TPV#0,Available,TPV (File),1,TPP#1,256,Disable
7,TPV#1,Available,TPV (Block),1,TPP#1,256,Disable
8,TPV#2,Available,TPV (System),1,TPP#1,256,Disable
```

The following example displays all the volumes in the system with the detailed display mode (when the NAS function is enabled):

```
CLI> show volumes -mode detail
```

Volume No.	Name	Status	Type	Encryption	EMC	Expansion (Concatenation)	RG or TPP or FTRP No.	RG or TPP or FTRP Name	TFOG No.	TFOG Name	Size (MB)	Size on RAID Group (KB)	Copy Protection	Data Integrity	Allocation	NSD	FT	Block	NS	FS	UID	Mode	ALUA
0	OLU#0	Available	Standard (Block)	OFF	Disable	-	0	RLU#0	-	-	256	262144	Disable	Default	-	-	-	-	-	-	6000000001000000010000000000	Custom	Follow Host Response
1	OLU#1	Available	Standard (Block)	OFF	Disable	-	0	RLU#0	-	-	256	262144	Disable	TI-CR	-	-	-	-	-	-	600000000100000001000000010000	Custom	ACTIVE / ACTIVE
2	OLU#2	Available	Standard (Block)	OFF	Disable	-	0	RLU#0	0	TFOG0000	256	262144	Disable	Default	-	-	-	-	-	-	600000000100000001000000030000	Custom	ACTIVE-ACTIVE / PREFERRED_PATH
3	OLU#3	Available	Standard (Block)	OFF	Disable	-	0	RLU#0	0	TFOG0000	256	262144	Disable	Default	-	-	-	-	-	-	600000000100000001000000030000	Default	Follow Host Response
4	OLU#4	Available	Standard (Block)	OFF	Disable	-	1	RLU#1	1	TFOG0001	256	262144	Disable	Default	-	-	-	-	-	-	600000000100000001000000040000	Default	Follow Host Response
5	OLU#5	Available	Standard (Block)	OFF	Disable	-	1	RLU#1	1	TFOG0001	256	262144	Disable	Default	-	-	-	-	-	-	600000000100000001000000050000	Default	Follow Host Response
6	TPV#0	Available	TPV (File)	OFF	Disable	-	2	TPP#01	1	TFOG0001	256	262144	Disable	Default	-	256	3	600000000100000001000000050000	Default	Follow Host Response			

The following example displays all the volumes in the system with the detailed display mode (when the Deduplication/Compression mode setting is enabled and the Non-disruptive Storage Migration License is registered):

```
CLI> show volumes -mode detail
```

Volume No.	Name	Status	Type	Encryption	EMC	Expansion (Concatenation)	RG or TPP or FTRP No.	RG or TPP or FTRP Name	TFOG No.	TFOG Name	Size (MB)	Size on RAID Group (KB)	Copy Protection	Data Integrity	Allocation	External	UID	ID	Info	ID	Mode	ALUA	
0	OLU#0	Available	Standard (Block)	OFF	Disable	-	0	RLU#0	-	-	256	262144	Disable	Default	-	-	-	-	-	-	600000000100000001000000000000	Custom	Follow Host Response
1	OLU#1	Available	Standard (Block)	OFF	Disable	-	0	RLU#0	-	-	256	262144	Disable	Default	-	-	-	-	-	-	600000000100000001000000010000	Custom	ACTIVE / ACTIVE
2	OLU#2	Available	Standard (Block)	OFF	Disable	-	0	RLU#0	0	TFOG0000	256	262144	Disable	Default	-	-	-	-	-	-	600000000100000001000000020000	Custom	ACTIVE-ACTIVE / PREFERRED_PATH
6	SDNDUP_001	Available	Standard (Block)	OFF	Disable	-	1	TRINRD_POOL_001	-	-	256	-	Disable	Default	Thin	-	-	-	-	-	-	-	
7	SDNDUP_002	Available	Standard (Block)	OFF	Disable	-	1	TRINRD_POOL_001	-	-	256	-	Disable	Default	Thin	-	-	-	-	-	-	-	
8	SDNDUP_003	Available	Standard (Block)	OFF	Disable	-	1	TRINRD_POOL_001	-	-	256	-	Disable	Default	Thin	-	-	-	-	-	-	-	
9	SDNDUP_004	Available	Standard (Block)	OFF	Disable	-	1	TRINRD_POOL_001	-	-	256	-	Disable	Default	Thin	-	-	-	-	-	-	-	
10	EVOL#0	Available	Migration	OFF	Disable	-	0	VLU#0	-	-	256	262144	Disable	Default	-	Inherited	600000000100000001000000090000	Default	Follow Host Response				
11	OLU#1	Available	Standard (Block)	OFF	Disable	-	1	RLU#1	-	-	256	262144	Disable	Default	-	-	-	-	-	-	00000000000000000000000000000025	External	Follow Host Response

The following example displays a list of all the volumes that exist in the RAID group named "RGP010". Free space information is also displayed:

```
CLI> show volumes -rg-name RGP010
```

Volume No.	Name	Status	Type	RG or TPP or FTRP No.	RG or TPP or FTRP Name	Size (MB)	Copy Protection
0	OLU#0	Available	Standard (Block)	0	RGP010	0	TFOG0000
1	OLU#1	Available	Standard (Block)	0	RGP010	1	TFOG0001
							Free 30337

The following example only displays a list of SDV type volumes:

```
CLI> show volumes -type sdv
```

Volume No.	Name	Status	RG or TPP or FTRP No.	RG or TPP or FTRP Name	Size (MB)	Copy Protection
10	SDV	Available	0	RLU#0	102400	Disable

The following example only displays a list of SDPV type volumes:

```
CLI> show volumes -type sdpv
```

Volume No.	Name	Status	RG or TPP or FTRP No.	Name	Size(MB)	Copy Protection	Reserved Deletion
10	SDPV	Available	0	RLU#0	102400	Disable	No

The following example only displays a list of TPV type volumes (when the NAS function is enabled):

```
CLI> show volumes -type tpv
```

Volume No.	Name	Status	Usage Details	NAS System Volume Format Status	RG or TPP or FTRP No.	Name	TFOG No.	Name	Size(MB)	Copy Protection	Allocation Used Status	Measurements Attention Balancing Used Level Capacity(MB)				
7	VOL007	Available	Block	-	1	TPP001	0	TFOG000	1024	Disable	Thin	Normal	100	70	High	0
20	TPV020	Available	Block	-	2	TPP002	0	TFOG000	1024	Disable	Thin	Normal	>500	80	Low	0
21	TPV021	Available	NAS CM#0 System	Not Process	20	TPP020	-	-	1024	Disable	Thick	Normal	100	80	Low	0
22	TPV022	Available	NAS CM#1 System	Creating filesystem	20	TPP020	-	-	1024	Disable	Thick	Normal	100	80	Low	0
23	TPV023	Available	NAS FS Management	Mounting	20	TPP020	-	-	1024	Disable	Thin	Normal	100	80	Low	0
24	TPV024	Available	NAS FS Management	Checking filesystem	20	TPP020	-	-	1024	Disable	Thin	Normal	100	80	Low	0
25	TPV025	Available	NAS FS Management	Complete	20	TPP020	-	-	1024	Disable	Thin	Normal	100	80	Low	0
26	TPV026	Available	NAS FS Management	Error	20	TPP020	-	-	1024	Disable	Thin	Normal	100	80	Low	0
27	TPV027	Available	NAS Data	-	20	TPP020	-	-	1024	Disable	Thin	Normal	100	80	Low	0
28	TPV028	Available	NAS Backup	-	20	TPP020	-	-	1024	Disable	Thin	Normal	100	80	Low	0
29	TPV029	Available	NAS Snap Shot	-	0	TPP	-	-	1024	Disable	Thin	Normal	100	80	Low	0
30	TPV030	Available	NAS CM#0 EX System	Not Process	0	TPP	-	-	1024	Disable	Thick	Normal	100	80	Low	0
30	TPV030	Available	NAS CM#1 EX System	Creating filesystem	0	TPP	-	-	1024	Disable	Thick	Normal	100	80	Low	0

The following example only displays a list of TPV type volumes (when the Deduplication/Compression mode setting is enabled):

```
CLI> show volumes -type tpv
```

Volume No.	Name	Status	RG or TPP or FTRP No.	Name	TFOG No.	Name	Size(MB)	Copy Protection	Allocation Used Status	Measurements Attention Balancing Used Level Capacity(MB)				
7	VOL007	Available	01	TPP001	0	TFOG000	1024	Disable	Thin	Normal	100	70	High	0
8	VOL008	Available	02	TPP002	0	TFOG000	1024	Disable	Thick	Normal	>500	80	Low	0
34	SESDUP_SYS20	Available	20	TPP020	-	-	1024	Disable	Thin	Normal	100	80	Low	0
35	SESDUP_20_0	Available	20	TPP020	-	-	1024	Disable	Thin	Normal	100	80	Low	0
36	SESDUP_20_1	Available	20	TPP020	-	-	1024	Disable	Thin	Normal	100	80	Low	0
37	SESDUP#1	Available	20	TPP020	-	-	1024	Disable	Thin	Normal	100	80	Low	0

The following example only displays a list of FTV type volumes:

```
CLI> show volumes -type ftv
```

Volume No.	Name	Status	RG or TPP or FTRP No.	Name	TFOG No.	Name	Size(MB)	Copy Protection	Allocation Used Status	Measurements Attention Priority Used Level Capacity(MB)				
14	FTV0	Available	0	FTRP_NAME#0	0	TFOG000	25600	Disable	Thin	Normal	1	10	-	0
15	FTV1	Available	0	FTRP_NAME#0	0	TFOG000	25600	Disable	Thick	Normal	1	10	-	0

The following example only displays a list of WSV type volumes:

```
CLI> show volumes -type wsv
```

Volume No.	Name	Status	Wide Stripe Size	RG or TPP or FTRP No.	Name	TFOG No.	Name	Size(MB)	Copy Protection
8	WSV	Available	Normal	0	RLU#0	0	TFOG000	1024	Disable

The following example displays a list of all the volumes that exist in the Thin Provisioning Pool named "TPP001" (when the NAS function is enabled):

```
CLI> show volumes -pool-number 0
```

Volume No.	Name	Status	Usage Details	NAS System Volume Format Status	RG or TPP or FTRP No.	Name	TFOG No.	Name	Size(MB)	Copy Protection	Allocation Used Status	Measurements Attention Balancing Used Level Capacity(MB)				
11	TPV0	Available	Block	-	0	TPP	0	TFOG000	51200	Disable	Thin	Normal	0	10	High	0
12	TPV1	Available	Block	-	0	TPP	0	TFOG000	51200	Disable	Thin	Normal	0	10	High	0
13	TPV2	Available	Block	-	0	TPP	1	TFOG001	51200	Disable	Thin	Normal	0	10	High	0
20	TPV020	Available	NAS CM#0 System	Not Process	0	TPP	-	-	1024	Disable	Thick	Normal	100	80	Low	0
21	TPV021	Available	NAS CM#1 System	Creating filesystem	0	TPP	-	-	1024	Disable	Thick	Normal	100	80	Low	0
22	TPV022	Available	NAS FS Management	Mounting	0	TPP	-	-	1024	Disable	Thick	Normal	100	80	Low	0
23	TPV023	Available	NAS FS Management	Checking filesystem	0	TPP	-	-	1024	Disable	Thick	Normal	100	80	Low	0
24	TPV024	Available	NAS FS Management	Complete	0	TPP	-	-	1024	Disable	Thick	Normal	100	80	Low	0
25	TPV025	Available	NAS FS Management	Error	0	TPP	-	-	1024	Disable	Thick	Normal	100	80	Low	0
26	TPV026	Available	NAS Data	-	0	TPP	-	-	1024	Disable	Thin	Normal	100	80	Low	0
27	TPV027	Available	NAS Backup	-	0	TPP	-	-	1024	Disable	Thin	Normal	100	80	Low	0

The following example displays a list of all the volumes that exist in the Thin Provisioning Pool named "TPP001" (when the Deduplication/Compression mode setting is enabled):

```
CLI> show volumes -pool-number 0
```

Volume No.	Name	Status	RG or TPP or FTRP No.	Name	TFOG No.	Name	Size(MB)	Copy Protection	Allocation Used Status	Measurements Attention Balancing Used Level Capacity(MB)				
11	TPV0	Available	0	TPP001	-	-	51200	Disable	Thin	Normal	0	10	High	0
12	TPV1	Available	0	TPP001	-	-	51200	Disable	Thick	Normal	0	10	High	0
34	SESDUP_SYS1	Available	0	TPP001	-	-	1024	Disable	Thin	Normal	100	80	Low	0
35	SESDUP_1_0	Available	0	TPP001	-	-	1024	Disable	Thin	Normal	100	80	Low	0
36	SESDUP_1_1	Available	0	TPP001	-	-	1024	Disable	Thin	Normal	100	80	Low	0
37	SESDUP#1	Available	0	TPP001	-	-	1024	Disable	Thin	Normal	100	80	Low	0

The following example displays the detailed information for expanded volumes:

```
CLI> show volumes -mode expansion
Volume
No. Name Status Type Expansion (Concatenation) RG or TPP or FTRP TFOG No. Name Size (MB) RAID Group (KB)
-----
0 OLU#0 Available Standard(Block) - 0 RLU#0 0 TFOG0000 256 262144
1 OLU#1 Available Standard(Block) - 0 RLU#0 0 TFOG0000 256 262144
2 OLU#2 Available Standard(Block) - 0 RLU#0 1 TFOG0001 256 262144
3 OLU#3 Available Standard(Block) - 0 RLU#0 1 TFOG0001 256 262144
4 OLU#4 Available Standard(Block) - 1 RLU#1 - 256 262144
5 OLU#5 Available Standard(Block) - 1 RLU#1 - 256 262144
6 OLU#6 Available Standard(Block) - 1 RLU#1 - 256 262144
7 OLU#7 Available Standard(Block) - 1 RLU#1 - 256 262144
8 WSV Available WSV(Block) - 0 RLU#0 - 1024 -
9 SDPV Available SDPV(Block) - 0 RLU#0 - 1024 1048576
10 SDV Available SDV(Block) - 0 RLU#0 - 10240 104857600
11 TPV0 Available TPV(Block) - 0 TPP - 51200 -
12 TPV1 Available TPV(Block) - 0 TPP - 51200 -
13 TPV2 Available TPV(File) - 0 TPP - 51200 -
14 FTV0 Available FTV(Block) - 0 FTRP_NAME#0 - 25600 -
15 FTV1 Available FTV(Block) - 0 FTRP_NAME#0 - 25600 -
16 test Available Standard(Block) 2 0 RLU#0 - 2048 -
1/ 2 0 RLU#0 - ( 1024) 1048576
2/ 2 1 RLU#1 - ( 1024) 1048576
```

The following example displays an NAA Identifier (UID) (when the NAS function is enabled):

```
CLI> show volumes -mode uid
Volume
No. Name Status Type RG or TPP or FTRP TFOG No. Name Size (MB) UID ID Mode
-----
0 OLU#0 Available Standard(Block) 0 RLU#0 0 TFOG0000 256 600000E00D1000000010000000000000 Custom
1 OLU#1 Available Standard(Block) 0 RLU#0 0 TFOG0000 256 600000E00D100000001000000010000 Custom
2 OLU#2 Available Standard(Block) 0 RLU#0 1 TFOG0001 256 600000E00D100000001000000020000 Default
3 OLU#3 Available Standard(Block) 0 RLU#0 1 TFOG0001 256 600000E00D100000001000000030000 Default
```

The following example displays information on an FTV (when the NAS function is disabled):

```
CLI> show volumes -mode ftv
Volume
No. Name Status RG or TPP or FTRP TFOG No. Name Size (MB) Copy Protection Allocation Used Status Measurements Attention Priority Used Capacity (MB)
-----
14 FTV0 Available 0 FTRP_NAME#0 0 TFOG0000 10240 Disable Thin Normal 0 70 - 0
<Flexible Tier Sub Pool List>
Flexible Tier Sub Pool Disk RAID Status Total Used Volume Used Usage
No. Name Attribute Level Capacity Capacity Capacity Rate
-----
0 FTVS#0 Nearline SED RAID0 Available 2.00 TB 0.00 MB 0.00 MB 0 %
Volume
No. Name Status RG or TPP or FTRP TFOG No. Name Size (MB) Copy Protection Allocation Used Status Measurements Attention Priority Used Capacity (MB)
-----
15 FTV1 Available 0 FTRP_NAME#0 0 TFOG0000 10240 Disable Thin Normal 0 70 - 0
<Flexible Tier Sub Pool List>
Flexible Tier Sub Pool Disk RAID Status Total Used Volume Used Usage
No. Name Attribute Level Capacity Capacity Capacity Rate
-----
0 FTVS#0 Nearline SED RAID0 Available 2.00 TB 0.00 MB 0.00 MB 0 %
```

The following example displays RAID group concatenation information on a WSV:

```
CLI> show volumes -mode wsv
Volume
No. Name Status Wide Stripe WSV Concatenation Size (MB) Size on RAID Group (KB)
-----
8 WSV Available Normal 2 0 RLU#0 0 TFOG0000 256 131072
1/ 2 0 RLU#0 131072
2/ 2 1 RLU#1
```

The following example displays the existing WVOL and WVOL Metadata exclusive FTV (when the NAS function is disabled):

```
CLI> show volumes
Volume
No. Name Status Type RG or TPP or FTRP No. Name Size (MB) Copy Protection
-----
0 WVOL#0 Available FTV (WVOL) 0 FTRP#0 10240 Disable
1 $WVOL_META Available FTV (System) 0 FTRP#0 4096 Disable
```

The following example displays the existing WVOL and WVOL Metadata exclusive FTV (when the NAS function is enabled):

```
CLI> show volumes
Volume
No. Name Status Type RG or TPP or FTRP No. Name Size (MB) Copy Protection
-----
0 WVOL#0 Available FTV (Block/WVOL) 0 FTRP#0 10240 Disable
1 $WVOL_META Available FTV (System) 0 FTRP#0 4096 Disable
```

The following example displays the existing WVOL and WVOL Metadata exclusive FTV (when the NAS function is enabled and the FTRP is specified):

```
CLI> show volumes -type ftv
Volume
No. Name Status Usage Details NAS System Volume Format Status RG or TPP or FTRP No. Name TFOG No. Name Size (MB) Copy Protection Allocation Used Measurements Attention Priority Used Capacity (MB)
-----
0 WVOL#0 Available Block - 0 FTRP_NAME#0 - - 25600 Disable Thin Normal 1 10 - 0
1 WVOL_META Available WVOL Metadata - 0 FTRP_NAME#0 - - 4096 Disable Thick Normal 1 10 - 0
```

The following example displays a list of all the volumes that exist in External RAID Group #0.

```
CLI> show volumes -external-rg-name ERGP00
Volume
No. Name Status Type RG or TPP or FTRP No. Name TFOG No. Name Size (MB) Copy Protection
-----
0 EVOL#0 Available Migration 0 VLU#0 - - 256 Disable
```

show volume-progress

This command displays the progress of formatting, migration (RAID Migration), encryption, balancing, and Zero Reclamation for volumes.

This command is also used to display the progress of Flexible Tier Volume (FTV) processes.

Note

Depending on the model, the support state of the encryption-related functions may differ.

Syntax

```
show volume-progress [-volume-number volume_numbers | -volume-name volume_names | -csv]
```

Parameter

-volume-number or -volume-name

Optional. This parameter specifies the volume identifiers. One or more parameters can be specified at the same time. If the volume identifier is omitted, the progress status of all the volumes is displayed. For details, refer to ["1.2.11 Volume Syntax" \(page 40\)](#).

volume_numbers Volume number

volume_names Volume name

-csv

Optional. This parameter shows the volume progress information in a CSV format.

Caution

- This parameter cannot be specified simultaneously with other parameters.
- If this parameter is specified, the progress information for encryption and decryption is not displayed.
- Information that was output in the CSV format cannot be specified for setup commands (or command names that start with "create" or "set").

Output

Item name	Description
Volume	Volume identifiers
No.	Volume number
Name	Alias name of volume
Status	Volume status
Formatting	Information on the formatting progress
Progress	Progress A value from 0% to 99% or "-" is displayed. ("-" indicates that formatting is not performed or is complete)
Estimated time left	Estimated remaining formatting time
-	Formatting is not performed or is complete.

Item name	Description
calculating	The remaining time is being calculated.
30days or more	The remaining time is 30 days or more.
Xday Yh Zmin	The remaining time is less than 30 days but 1 day or more.
Yh Zmin	The remaining time is less than 1 day but 1 hour or more.
Zmin	The remaining time is less than an hour but 1 minute or more.
Less than 1min	The remaining time is less than a minute.
Remaining size	Remaining capacity for formatting
-	Formatting is not performed or is complete.
XMB	Remaining capacity (rounded up to the nearest whole number) X: decimal number
Migrating Progress	Progress status of migrating (RAID Migration)
Encrypting Progress	Progress status of encrypting
Balancing Progress	Progress status of balancing
Zero Reclamation Progress	Progress status of Zero Reclamation

■ Example(s)

The following example displays the progress status of volume #1:

```
CLI> show volume-progress -volume-number 1
Volume No. Name Status Formatting Progress Estimated time left Remaining size Migrating Progress Encrypting Progress Balancing Progress Zero Reclamation Progress
1 VOL001 Available 99% Less than 1min Less than 1MB - - - - -
```

The following example displays the progress status of the volumes named "VOL001" and "VOL012":

```
CLI> show volume-progress -volume-name VOL001,VOL012
Volume No. Name Status Formatting Progress Estimated time left Remaining size Migrating Progress Encrypting Progress Balancing Progress Zero Reclamation Progress
1 VOL001 Available 80% 30days or more 134217728MB - - - - -
12 VOL012 Rebuild 80% 01day 23h 59min 128MB - - - - -
```

The following example displays the progress status of all the volumes:

```
CLI> show volume-progress
Volume No. Name Status Formatting Progress Estimated time left Remaining size Migrating Progress Encrypting Progress Balancing Progress Zero Reclamation Progress
1 VOL001 Available 80% 01h 00min 128MB - - - - -
2 VOL002 Available - - - 10% - - - - -
3 TPV003 Rebuild - - - 80% - - - - -
4 VOL004 Rebuild 90% 01min Less than 1MB - - - 60% - -
10 VOL010 Available 80% calculating 1MB 40% - - - - -
```

The following example displays the progress information of the volumes in a CSV format by specifying "-csv":

```
CLI> show volume-progress -csv
[Volume No.],[Volume Name],[Status],[Formatting Progress],[Estimated time left],[Remaining size],[Migrating Progress],[Balancing Progress],[Zero Reclamation Progress]
1,VOL001,Available,80%,01h 00min,128MB,-,-,-
3,TPV003,Rebuild,-,-,-,80%,-
4,VOL004,Rebuild,90%,01min,Less than 1MB,-,-,60%
10,VOL010,Available,80%,calculating,1MB,40%,-,-
```

show volume-mapping

This command displays the LUNs (Logical Unit Numbers) that are mapped to volumes.

Syntax

```
show volume-mapping  
[-volume-number volume_numbers | -volume-name volume_names] [-mode {all | host-lun | default}]
```

Parameter

-volume-number or -volume-name

Optional. This parameter specifies the volume identifiers. One or more parameters can be specified at the same time. If the volume identifier is omitted, a list of all the volumes is displayed. For details, refer to ["1.2.11 Volume Syntax" \(page 40\)](#).

volume_numbers Volume number

volume_names Volume name

-mode Optional. This parameter toggles the extended output mode. If the mode is omitted, "default" is set.

all In addition to the normal display items, the information of the LUNs that can be accessed from the host of each connected CA port is also displayed.

host-lun Only the information of the LUNs that can be accessed from the host of each connected CA port is displayed.

default A list of all of the volumes is displayed.

Output

Item name	Description
Volume	Volume identifiers
No.	Volume number
Name	Volume name
Type	Volume type
UID	Volume UID (Universally Unique Identifier)
LUN	LUN
LUN Group	LUN group identifiers
No.	LUN group number
Name	LUN group name
Port	CA port number
Host	Host identifiers
No.	Host number
Name	Host name

■ Example(s)

The following example displays the LUNs that are mapped to volume #0 (for the DX60 S4/DX100 S4/DX200 S4, the DX500 S4/DX600 S4, the DX60 S3/DX100 S3/DX200 S3, the DX500 S3/DX600 S3, the AF250 S2/AF650 S2, the AF250/AF650, and the DX200F):

```
CLI> show volume-mapping -volume-number 0
Volume                               Type      UID
No.  Name
-----
  0  OLU#0                               Standard  600000E00D2A0000002A000000000000
<Mapping>
LUN  LUN Group      Port
No.  Name
-----
  10  0 AG001         -
  0   - -          CM#0 CA#0 Port#0
  0   - -          CM#1 CA#0 Port#0
  0   - -          CM#1 CA#0 Port#1
```

The following example displays the LUNs that are mapped to volume #0 (for the DX8700 S3/DX8900 S3):

```
CLI> show volume-mapping -volume-number 0
Volume                               Type      UID
No.  Name
-----
  0  OLU#0                               Standard  600000E00D2A0000002A000000000000
<Mapping>
LUN  LUN Group      Port
No.  Name
-----
  10  0 AG001         -
  0   - -          CE#3 CM#0 CA#0 Port#0
  0   - -          CE#3 CM#1 CA#0 Port#0
  0   - -          CE#3 CM#1 CA#0 Port#1
```

The following example displays the information of only the LUNs for volume #0 that can be accessed from the host (for the DX60 S4/DX100 S4/DX200 S4, the DX500 S4/DX600 S4, the DX60 S3/DX100 S3/DX200 S3, the DX500 S3/DX600 S3, the AF250 S2/AF650 S2, the AF250/AF650, and the DX200F):

```
CLI> show volume-mapping -mode host-lun -volume-number 0
Volume                               Type      UID
No.  Name
-----
  0  OLU#0                               Standard  600000E00D2A0000002A000000000000
<Host LUN>
LUN  Port          Host          LUN Group
No.  Name          No.  Name
-----
  0  CM#0 CA#0 Port#0  - -          - -
  0  CM#1 CA#0 Port#0  - -          - -
  0  CM#1 CA#0 Port#1  - -          - -
```

The following example displays the information of only the LUNs for volume #0 that can be accessed from the host (for the DX8700 S3/DX8900 S3):

```
CLI> show volume-mapping -mode host-lun -volume-number 0
Volume                               Type      UID
No.  Name
-----
  0  OLU#0                               Standard  600000E00D2A0000002A000000000000
<Host LUN>
LUN  Port          Host          LUN Group
No.  Name          No.  Name
-----
  0  CE#3 CM#0 CA#0 Port#0  - -          - -
  0  CE#3 CM#1 CA#0 Port#0  - -          - -
  0  CE#3 CM#1 CA#0 Port#1  - -          - -
```

The following example displays the information of all the LUNs for volume #0 (for the DX60 S4/DX100 S4/DX200 S4, the DX500 S4/DX600 S4, the DX60 S3/DX100 S3/DX200 S3, the DX500 S3/DX600 S3, the AF250 S2/AF650 S2, the AF250/AF650, and the DX200F):

```

CLI> show volume-mapping -mode all -volume-number 0
Volume                               Type      UID
No.  Name
-----
  0  OLU#0                               Standard  600000E00D2A0000002A000000000000
<Mapping>
  LUN  LUN Group      Port
  No.  Name
  -----
  10   0 AG001        -
  0    - -          CM#0 CA#0 Port#0
  0    - -          CM#1 CA#0 Port#0
  0    - -          CM#1 CA#0 Port#1
<Host LUN>
  LUN  Port          Host          LUN Group
  No.  Name          No.  Name
  -----
  0  CM#0 CA#0 Port#0  - -          - -
  0  CM#1 CA#0 Port#0  - -          - -
  0  CM#1 CA#0 Port#1  - -          - -
  
```

The following example displays the information of all the LUNs for volume #0 (for the DX8700 S3/DX8900 S3):

```

CLI> show volume-mapping -mode all -volume-number 0
Volume                               Type      UID
No.  Name
-----
  0  OLU#0                               Standard  600000E00D2A0000002A000000000000
<Mapping>
  LUN  LUN Group      Port
  No.  Name
  -----
  10   0 AG001        -
  0    - -          CM#0 CA#0 Port#0
  0    - -          CM#1 CA#0 Port#0
  0    - -          CM#1 CA#0 Port#1
<Host LUN>
  LUN  Port          Host          LUN Group
  No.  Name          No.  Name
  -----
  0  CE#3 CM#0 CA#0 Port#0  - -          - -
  0  CE#3 CM#1 CA#0 Port#0  - -          - -
  0  CE#3 CM#1 CA#0 Port#1  - -          - -
  
```

create volume

This command creates volumes in the specified RAID group. When creating two or more volumes at a time, they can be created in one RAID group based on the "-name" and the "-count" parameters. The created volumes are formatted automatically. For External Volumes, a format is not performed and the stored data is inherited.

The "create flexible-tier-volume" command is used to create Flexible Tier Volumes (FTVs).

Caution

Encryption-related functions cannot be used in the DX60 S4/DX60 S3.

Note

- Depending on the model, the support state of the encryption-related functions may differ.
- When expanding the NAS volume, the maximum volume size differs depending on the block size. The maximum volume size for each block size is as follows.

NAS FS Version	Firmware version	Block size	Block size (Maximum)	Volume size (Maximum)
2	V10L30 or earlier	256KB	32TB	128TB
3	V10L31 or earlier	8KB	1TB	4TB
		32KB	4TB	16TB
		256KB	32TB	128TB
4	V10L33 or later	8KB	1TB	32TB
		32KB	4TB	128TB
		256KB	32TB	128TB
5	V10L51 or later	8KB	1TB	32TB
		32KB	4TB	128TB
		256KB	32TB	128TB

- When encrypting the snapshot acquisition target NAS volume, encryption must be enabled when creating the SDPV.

Syntax

```
create volume -name name { {-rg-number rg_number | -rg-name rg_name } |
{-external-rg-number {external_rg_number | all} | -external-rg-name external_rg_name} |
{-pool-number pool_number | -pool-name pool_name } }
-type {open | standard | sdv | sdpv | tpv | wsv | nas-tpv | nas-tpv-backup | cm0-nas-ex-sysvol | cm1-nas-ex-sysvol | dedup-tpv}
[-size {size{tb | gb | mb} | max} | -virtual-size virtual_size{tb | gb | mb}] [-count count]
[-copy-protection {enable | disable}] [-attention attention] [-encryption {enable | disable}]
[-wide-stripe-size {normal | small}] [-concatenation-order {auto | manual}]
[-volume-number volume_number] [-exc {enable | disable}]
[-data-integrity {default | t10-dif}] [-allocation {thin | thick}]
[-nas-block-size {8kb | 32kb | 256kb}]
```

■ Parameter

-name This parameter specifies a volume name. For details, refer to ["1.2.11 Volume Syntax" \(page 40\)](#).

Caution

In a VMware Virtual Volumes (VVOL) operating environment, when attempting to create a volume with a name "VVOL#X" while a VVOL creation process is running in the background, the VVOL volume names may conflict and cause VVOL related operations to terminate abnormally.

name Volume name

-rg-number or -rg-name

This parameter specifies a RAID group identifier to create new volumes. Note that multiple RAID groups can be specified when "-type wsv" is set. For details, refer to ["1.2.10 RAID Group Syntax" \(page 39\)](#). This parameter cannot be specified when tpv, nas-tpv, nas-tpv-backup, cm0-nas-ex-sysvol, cm1-nas-ex-sysvol, or dedup-tpv is specified for the "-type" parameter.

rg_number RAID group number

rg_name RAID group name

-external-rg-number or -external-rg-name

This parameter specifies an External RAID Group identifier to create new External Volumes. For the specified External RAID Group, an External Volume is created. An External RAID Group specified with "Migration" for "Usage" can be specified.

This parameter cannot be specified when a type other than "open" or "standard" is specified for "-type". Note that multiple External RAID Group numbers can be specified. If "all" is specified, an External Volume is created for all External RAID Groups that have "Migration" specified for "Usage" but have no allocated External Volumes.

For details, refer to ["1.2.10 RAID Group Syntax" \(page 39\)](#).

When multiple External Volumes are created, some of the volumes may be created even if the command fails. In this case, a message stating that some volumes cannot be created is displayed. Then, check the volumes that have been created using the "show volumes" command.

external_rg_number

External RAID Group number

external_rg_name

External RAID Group name

all All External RAID Groups specified with "Migration" for "Usage"

-pool-number or -pool-name

This parameter specifies a Thin Provisioning Pool identifier to create new volumes. For details, refer to ["1.2.7 Thin Provisioning Pool Syntax" \(page 36\)](#). If the Thin Provisioning function is disabled, this parameter cannot be specified. This parameter can be specified when tpv, nas-tpv, nas-tpv-backup, cm0-nas-ex-sysvol, cm1-nas-ex-sysvol, or dedup-tpv is specified for the "-type" parameter.

pool_number Thin Provisioning Pool number

pool_name Thin Provisioning Pool name

-type	This parameter specifies the volume type.
open	A Standard volume. A created "open" type volume is displayed as a "standard" volume.
standard	A normal/open volume (Standard)
sdv	A Snap Data Volume (SDV) for Advanced Copy functions
sdpv	A Snap Data Pool Volume (SDPV) for Advanced Copy functions
tpv	A Thin Provisioning Volume
wsv	A Wide Striping Volume (WSV)
nas-tpv	A NAS user volume
nas-tpv-backup	A NAS backup Volume
cm0-nas-ex-sysvol	NAS expanded system volume for CM0 If a NAS expanded system volume already exists, this parameter cannot be specified.
cm1-nas-ex-sysvol	NAS expanded system volume for CM1 If a NAS expanded system volume already exists, this parameter cannot be specified.
dedup-tpv	A Thin Provisioning Volume for Deduplication/Compression (Deduplication/Compression Volume) (only for Thin Provisioning Pools that have the Deduplication/Compression setting enabled) If the Deduplication/Compression mode of the ETERNUS DX/AF is disabled, this parameter cannot be specified.

 **Caution**

- If a malfunction occurs while creating a NAS volume (a tpv, nas-tpv, nas-tpv-backup, cm0-nas-ex-sysvol, or cm1-nas-ex-sysvol), or if the NAS volume was not created normally, the following procedures must be performed to resolve the issue.
 - After the system status and the NAS engine status becomes normal, delete the volume (a tpv, nas-tpv, nas-tpv-backup, cm0-nas-ex-sysvol, or cm1-nas-ex-sysvol). System volumes do not need to be deleted. After that, create the volume again.
Using the "show volume" command, check the progress status (NAS System Volume Format Status) of the NAS system volume format. A completion status is displayed if the NAS volume is created normally.
Check the status of the NAS engine using the "show fru-ce" command.
- If the level of the RAID group is RAID6-FR, standard volumes can be specified.
- If the capacity of the TPP is depleted while a TPV is being created, an error occurs. Perform a volume creation after expanding the TPP.
- Take the following notes into consideration when specifying Deduplication/Compression Volumes (dedup-tpv).
 - If Deduplication/Compression Volumes larger than the logical capacity of the DEDUP_SYS Volume are deleted or formatted repeatedly, creation of the Deduplication/Compression Volume may fail due to a temporary capacity shortage.
 - The total capacity of the Deduplication/Compression volume within the specified pool cannot be specified if it exceeds 10 times the capacity of the DEDUP_SYS volume.

-size Optional. This parameter specifies the volume size.

Note

- If a Standard volume or a TPV (excluding nas-tpv and nas-tpv-backup) is selected, the volume capacity can be specified (from 24MB to 128TB).
- If a SDV is selected, this parameter cannot be specified.
- If SDPV is selected, a pool volume size that is smaller than (or equal to) 2TB can be specified.
- SDPV must be specified in units of GB.
- If a NAS volume (nas-tpv and nas-tpv-backup) is selected, the range of the volume capacity can be specified from a minimum of 400GB to a maximum of 128TB.
 In the NAS volume, it is necessary to have 300GB for the system management area, and 100GB or more for the user area for storing user data.
- If a TPV is created, the upper limit value of the total logical capacity of all TPVs and FTVs must be checked.
- For NAS expanded system volumes (cm0-nas-ex-sysvol and cm1-nas-ex-sysvol), the range that can be specified for the volume capacity is from a minimum of 1GB to a maximum of 4TB.
- For Deduplication/Compression Volumes, an upper limit check of the total logical capacity of all TPVs and FTVs is not supported.
- If "max" is specified for this parameter, volumes are created using the entire capacity of the maximum free area of the specified RAID group.
 - The target volume types are Standard (Open), SDPV, and WSV.
 - If multiple free areas exist within the specified RAID group, the volume is created using only the largest free area.
 - If two or more volumes are specified for the "-count" parameter, the specified number of volumes are created in units of MB by dividing the maximum capacity of the free area by the specified number.
 - If SDPV is specified with the "-type" parameter, several GB of an unused area may remain. This is because the SDPV capacity must be in multiples of SDPE resolution.
 - For WSVs, among the maximum free areas of the concatenated RAID groups, a volume is created using the maximum free area of each RAID group based on the smallest maximum free capacity. If WSVs are created by specifying multiple RAID groups in which the maximum capacity of each free area differs, unused areas may remain in the RAID groups with large maximum free areas.
- With a firmware version earlier than V10L70, when creating volumes that are used for Advanced Copy, specify the volume capacity without specifying "max". If a volume that was created by specifying "max" is used with Advanced Copy, the capacity of the copy source volume may not match the capacity of the copy destination volume and may result in a copy failure.
- This parameter cannot be specified when the "-external-rg-number" or the "-external-rg-name" parameter is specified as the capacity of the imported External Drive is inherited.

<i>size</i>	Volume capacity Select whether terabytes (TB), gigabytes (GB), or megabytes (MB) are used for the capacity. Example: 1tb, 120gb, 512mb
<i>max</i>	Volumes are created using the entire capacity of the maximum free area of the specified RAID group.

-virtual-size Optional. This parameter can specify the volume size when selecting an SDV type. This parameter cannot be specified when selecting a type other than SDV.

virtual_size Volume size

- count** Optional. This parameter specifies the number of volumes to be created. If omitted, a single volume is created with the name determined by the "-name" parameter. Requesting two or more volumes results in the creation of volumes with names determined by the "-name" parameter with a trailing index number, starting from "0".
Only "1" can be specified when "-concatenation-order manual" is specified.
- Example: For "-count 3 -name abc", the volumes named "abc0", "abc1", and "abc2" are created. If these volumes already exist, the names of the created volumes use incrementing index numbers.
Only "1" can be specified when nas-tpv, nas-tpv-backup, cm0-nas-ex-sysvol, or cm1-nas-ex-sysvol is specified for "-type".
- This parameter cannot be specified when the "-external-rg-number" or the "-external-rg-name" parameter is specified.
- | | |
|--------------|-------------------|
| <i>count</i> | Number of volumes |
|--------------|-------------------|
- copy-protection** Optional. This parameter protects a volume from being specified for the copy destination. It is possible to set it even when there is already a copy session. The copy license is necessary for this setting. If this parameter is omitted, "disable" is set.
This parameter cannot be specified if cm0-nas-ex-sysvol or cm1-nas-ex-sysvol is specified for the "-type" parameter.
- | | |
|---------|--|
| enable | Volume is protected at the copy destination. |
| disable | Volume is not protected at the copy destination. |
- attention** Optional. This parameter specifies the attention level of the Thin Provisioning Volume (TPV). This parameter can be specified when tpv, nas-tpv, nas-tpv-backup, cm0-nas-ex-sysvol, or cm1-nas-ex-sysvol is specified for "-type". The settable range is 1 – 100%. If this parameter is omitted, the default value (80%) is set. If the type of volume to be created is "dedup-tpv", this parameter cannot be specified.
- | | |
|------------------|---|
| <i>attention</i> | Attention level of the Thin Provisioning Volume (TPV) |
|------------------|---|
- encryption** Optional. This parameter specifies whether the encryption by a CM is performed. When "enable" is selected, the specified volume data is encrypted. If this parameter is omitted, "disable" is set. This parameter cannot be specified when tpv, nas-tpv, nas-tpv-backup, cm0-nas-ex-sysvol, cm1-nas-ex-sysvol, or dedup-tpv is specified for the "-type" parameter.
- This parameter cannot be specified when the "-external-rg-number" or the "-external-rg-name" parameter is specified.
- | | |
|---------|-----------------------------------|
| enable | The volume data is encrypted. |
| disable | The volume data is not encrypted. |
- wide-stripe-size** Optional. This parameter specifies the Wide Stripe Size for the WSV that is to be created. This parameter can only be specified when the "-type wsv" parameter is set. If omitted, then it is handled as if "normal" is selected.
- | | |
|--------|---|
| normal | The Wide Stripe Size for the WSV is set to 16MB. |
| small | The Wide Stripe Size for the WSV is set to 2MB. Note that if the Stripe Size of the RAID group exceeds 2MB, the actual Stripe Size of the RAID group is used for the WSV that is to be created. |

-concatenation-order

Optional. This parameter specifies whether to manually set the concatenation order for the RAID groups of a WSV that is to be created. This parameter can only be specified when the "-type wsv" parameter is set. If omitted, then it is handled as if "auto" is selected.

auto The concatenation order for the RAID groups is automatically set.

manual The RAID groups are concatenated in the order specified by the "rg-number" or "-rg-name" parameter.

-volume-number

Optional. This parameter specifies whether the volume number is assigned automatically or manually. Only one volume number can be specified. If omitted, the volume number is automatically assigned. This parameter cannot be specified when a value that is "2" or more is set for the "-count" parameter. If an existing volume number is set, an error occurs.

 **Caution**

In a VVOL operating environment, when specifying the same volume number as the VVOL scheduled for creation while a VVOL creation process is running in the background, the VVOL creation process may terminate abnormally.

volume_number Volume number

-exc

Optional. This parameter specifies whether the Extreme Cache (EXC) function or the Extreme Cache Pool function is enabled for the volume that is to be created. If the RAID group that is configured with SSDs is specified as the volume creation destination or if the pool that is configured with SSDs is specified as the volume creation destination, this parameter cannot be specified. In addition, if the type of volume to be created is "dedup-tpv", this parameter cannot be specified.

 **Caution**

- The EXC function or the Extreme Cache Pool function cannot be used regardless of the setting of each volume when the EXC function or the Extreme Cache Pool function is disabled for the ETERNUS DX/AF.
- The EXC function or the Extreme Cache Pool function is available for Open volumes, Standard volumes, WSVs, and TPVs (including nas-tpv, nas-tpv-backup, cm0-nas-ex-sysvol, and cm1-nas-ex-sysvol). However, dedup-tpv is not supported.
- This parameter is not available for models that do not support the EXC function or the Extreme Cache Pool function.
- This parameter cannot be specified when the "-external-rg-number" or the "-external-rg-name" parameter is specified.

enable The EXC function or the Extreme Cache Pool function is enabled. (Default value for Open volumes, Standard volumes, WSVs, and TPVs [including nas-tpv, nas-tpv-backup, cm0-nas-ex-sysvol, and cm1-nas-ex-sysvol])

disable The EXC function or the Extreme Cache Pool function is disabled.

-data-integrity

Optional. This parameter sets the method for ensuring data integrity. If the type of volume to be created is "dedup-tpv", this parameter cannot be specified.

- default Ensures data integrity in the whole storage system with a normal data block guard.
- t10-dif By using T10-DIF, end-to-end data integrity is ensured. T10-DIF can only be specified if "open" or "standard" is specified in "-type". This parameter cannot be specified when the "-external-rg-number" or the "-external-rg-name" parameter is specified. To use T10-DIF, the host must also support T10-DIF such as by installing T10-DIF supported HBAs.
- allocation Optional. If omitted, "thin" is set. During normal operations, the value of this parameter does not need to be changed from the default value ("thin"). When "thick" is specified, the same logical capacity is allocated to the physical capacity when the volume is created.
The parameter can be specified if the volume types are TPV and NAS user volumes ("nas-tpv"), or NAS backup volumes ("nas-tpv-backup").
Although cm0-nas-ex-sysvol and cm1-nas-ex-sysvol are TPVs, they cannot be specified because this parameter is set to Thick. Although "dedup-tpv" is a TPV, this parameter cannot be specified.
- thin A physical volume is allocated to an area when the area accepts write I/Os (default).
- thick A physical volume with the same size as the logical capacity is allocated when volumes are created.
- nas-block-size Optional. This parameter specifies the block size for the NAS volume. A small block size improves the usage efficiency of the NAS volume capacity in exchange for a reduced maximum capacity for files and the volume. This parameter can only be specified for the NAS TPV ("nas-tpv"). If omitted, "256kb" is set.
- 8kb The NAS volume is created using a block size of 8KB
(with a maximum volume size of 32TB and a maximum file size of 1TB).
- 32kb The NAS volume is created using a block size of 32KB
(with a maximum volume size of 128TB and a maximum file size of 4TB).
- 256kb The NAS volume is created using a block size of 256KB (default)
(with a maximum volume size of 128TB and a maximum file size of 32TB).

■ Example(s)

The following example creates a volume named "VOL001" in the RAID group named "RGP001". The volume type is Standard. The volume size is 2TB:

```
CLI> create volume -name VOL001 -rg-name RGP001 -type standard -size 2tb
```

The following example creates consecutive Standard volumes named "VOL0" – "VOL9" in the RAID group named "RGP001":

```
CLI> create volume -name VOL -count 10 -rg-name RGP001 -type standard -size 20gb
```

The following example creates a volume named "SDV1" in the RAID group named "RGP002". The volume type is SDV, the physical size is 20GB, and the logical size is 100GB:

```
CLI> create volume -name SDV1 -rg-name RGP002 -type sdv -size 20gb -virtual-size 100gb
```

The following example creates a Thin Provisioning Volume named "TPV1" in Thin Provisioning Pool#01. The volume type is tpv, and the attention level threshold is 80%:

```
CLI> create volume -name TPV1 -pool-number 1 -type tpv -size 20gb -attention 80
```

The following example creates a volume named "TPV1" in Thin Provisioning Pool#01. The volume type is dedup-tpv, and the physical capacity is 20GB:

```
CLI> create volume -name TPV1 -pool-number 1 -type dedup-tpv -size 20gb
```

The following example creates a volume named NAS-VOL1 in Thin Provisioning Pool#01, but a Warning message is displayed because Thin Provisioning Pool#01 is in the "overprovisioning" state:

```
CLI> create volume -name NAS-VOL1 -pool-number 1 -type nas-tpv -size 800gb  
Warning: The relevant TPP is in overprovisioning status. Please be sure to add new disks to the TPP before it runs out of space.
```

The following example creates an External Volume in External RAID Group #01 and #02.

```
CLI> create volume -name EVOL -external-rg-number 1,2 -type standard
```

The following example created External Volumes in all External RAID Groups and failed to create some of the volumes.

```
CLI> create volume -name EVOL -external-rg-number all -type standard  
Partially failed. Some volumes were successfully created. Please check the created volumes using "show volumes".  
Error: ED002 Internal command retry timeout.  
[0301-c143]
```

The following example expanded capacity, but a Warning message is displayed because there is TPP/FTRP in overprovisioning that cannot be solved.

```
CLI > create volume -name TPV1 -pool-number 1 -type tpv -size 20gb -attention 80  
Warning: There are one or more TPPs or FTRPs that are in overprovisioning status but cannot be resolved by adding new drives.  
Please review the Thin Provisioning configuration and the current setting of the maximum pool capacity.
```

set volume

This command changes the registered volume information.

The "set flexible-tier-volume" command is used to change a Flexible Tier Volume (FTV).

Caution

Encryption-related functions cannot be used in the DX60 S4/DX60 S3.

Note

Depending on the model, the support state of the encryption-related functions may differ.

Syntax

```
set volume {-volume-number volume_number | -volume-name volume_name} [-name name]  
[-copy-protection {enable | disable}] [-attention attention] [-encryption {enable | disable}]  
[-uid uid | default | original] [-alua {follow-host-response | active | passive}]
```

Parameter

-volume-number or -volume-name

This parameter specifies the volume identifier to be changed. Only one volume can be specified at the same time. This parameter cannot be specified for DEDUP_SYS volumes and DEDUP_MAP volumes. For details, refer to ["1.2.11 Volume Syntax" \(page 40\)](#).

volume_number Volume number

volume_name Volume name

-name Optional. This parameter specifies the new volume name. If omitted, the existing setting is not changed. For details, refer to ["1.2.11 Volume Syntax" \(page 40\)](#).

name Volume name

-copy-protection

Optional. This parameter protects a volume from being specified for the copy destination. It is possible to set it even when there is already a copy session. The copy license is necessary for this setting. If TFOV is set for the specified volume, "enable" cannot be specified. If this parameter is omitted, "disable" is set.

enable Volume is protected at the copy destination.

disable Volume is not protected at the copy destination.

-attention Optional. This parameter specifies the attention level of the Thin Provisioning Volume (TPV). This parameter can be specified when the volume type is TPV. The settable range is 1 – 100%. If the specified volume is a Deduplication/Compression volume (dedup-tpv), this parameter cannot be specified. If this parameter is omitted, attention level is not changed.

attention Attention level of the Thin Provisioning Volume (TPV)

- encryption** Optional. This parameter specifies whether the encryption by a CM is performed. When "enable" is selected, the specified volume data is encrypted. If omitted, then it is handled as if "disable" is selected. This does not mean that the volume data is decrypted when "disable" is selected. If the specified volume is "TPV", this parameter cannot be specified.
- This parameter cannot be specified for External Volumes.
- | | |
|---------|-------------------------------|
| enable | The volume data is encrypted. |
| disable | No operation. |
- uid** Optional. This parameter specifies the UID of the target volume. Thirty-two-digit hexadecimal numbers ("0" to "9", "A" to "F", and "a" to "f") can be specified. If this parameter is omitted, the existing setting remains unchanged.
- If the specified volume has a UID (or LUN ID) that is inherited from an External LU or an External Volume, this parameter cannot be specified.
- | | |
|---------------------|---|
| <i>uid</i> | UID of the target volume |
| default or original | The UID, serial number, and product ID are reverted to the default setting for the target volume. |
- alua** Optional. This parameter specifies the ALUA setting for the target volume. If this parameter is omitted, the existing setting remains unchanged.
- | | |
|----------------------|--|
| follow-host-response | The ALUA setting follows the host response setting (default). |
| active | The ACTIVE / ACTIVE setting takes priority regardless of the host response setting. |
| passive | The ACTIVE-ACTIVE / PREFERRED_PATH setting takes priority regardless of the host response setting. |

■ Example(s)

The following example changes the volume named "VOL003". The new name is "VOLUME003":

```
CLI> set volume -volume-name VOL003 -name VOLUME003
```

The following example changes the volume named "VOL003" to "VOLUME003", enables copy protection, and changes the attention level to 80:

```
CLI> set volume -volume-name VOL003 -name VOLUME003 -copy-protection enable -attention 80
```

delete volume

This command deletes existing volumes. Snap Data Pool Volumes (SDPV) and FTVs cannot be deleted using this command.

- All mappings associated with the host must be released before a specified volume is deleted.
- The target NAS volume must be unmounted before deletion.
- If the NAS audit log function is enabled, NAS expanded system volumes cannot be deleted.
- When deleting a NAS system volume while a NAS volume exists, follow the instructions given by the maintenance engineer.
- If an assigned quota setting exists for the deletion target volume, that quota setting is also deleted.
- All migrating volumes (RAID Migration) must be stopped before a specified volume is deleted.
- Advanced Copy sessions to be deleted must be stopped before a specified volume is deleted.

To delete SDPVs, use the "delete snap-data-pool-volume" command. The "delete flexible-tier-volume" command is used to delete Flexible Tier Volumes (FTVs).

■ Syntax

```
delete volume {-volume-number volume_numbers | -volume-name volume_names} [-force]
```

■ Parameter

-volume-number or -volume-name

This parameter specifies the volume identifiers to be deleted. One or more identifiers can be specified at the same time. DEDUP_SYS volumes and DEDUP_MAP volumes cannot be specified. If the Deduplication/Compression setting of the corresponding TPP is changed to disable, Deduplication/Compression System Volumes in the relevant TPP are automatically deleted. For details, refer to ["1.2.11 Volume Syntax" \(page 40\)](#).

Caution

If the "-force" parameter is omitted and the NAS system volume is deleted, the confirmation message is displayed in the response prompt.

volume_numbers Volume number

volume_names Volume name

-force Optional. This parameter forcibly deletes a specified NAS TPV.

Caution

If the NAS volume is forcibly deleted, a NAS function restoration (or maintenance work) is required after the deletion. The confirmation message is displayed in the response prompt.

■ Example(s)

The following example deletes both the volume named "VOL001" and "VOL002" at the same time:

```
CLI> delete volume -volume-name VOL001,VOL002
```

The following example forcibly deletes NAS TPV #2:

```
CLI> delete volume -volume-number 2 -force
If deleting NAS volume using [-force] option when NAS Engine is not in Normal status,
further maintenance work to recover NAS Engine is required.
Please refer to the maintenance manual for more details.
Enter "y" to continue or "n" to cancel this operation.
> y
```

The following example deletes the NAS system volume (when the "-force" parameter is not specified):

```
CLI> delete volume -volume-name $SYSVOL1,$SYSVOL2,$SYSVOL3
The specified volume(s) includes NAS system volume(s).
Are you sure you want to delete this volume(s)?
Enter "y" to continue or "n" to cancel this operation.
> y
```

delete all-volumes

This command deletes all volumes from the specified RAID group or Thin Provisioning Pool.

If the specified RAID group or Thin Provisioning Pool contains a Snap Data Pool Volume (SDPV), all of the non-SDPV volumes are deleted.

If the specified RAID group contains an expansion source volume of the LUN Concatenation, the expansion destination volume and the corresponding expansion source volume are both deleted.

If the specified RAID group contains an expansion destination volume and a corresponding expansion source volume does not exist, the volumes are not deleted. If this occurs, delete the expansion source volume and try again.

The Thin Provisioning Volume (TPV) cannot be deleted with the "-rg-number" or the "-rg-name" parameter. For the Thin Provisioning Volume, the "-pool-number" or the "-pool-name" parameter is used.

The "delete all-flexible-tier-volumes" command is used to delete all of the Flexible Tier Volumes (FTVs) in a Flexible Tier Pool (FTRP).

■ Syntax

```
delete all-volumes {-rg-number rg_number | -rg-name rg_name} |  
{-pool-number pool_number | -pool-name pool_name}
```

■ Parameter

-rg-number or -rg-name

This parameter specifies the RAID group identifiers to delete all the volumes contained in the RAID groups. Only one RAID group can be specified at the same time. RAID groups that include NAS volumes and NAS system volumes cannot be specified. In addition, RAID groups that include DEDUP_SYS volumes and DEDUP_MAP volumes cannot be specified. If the Deduplication/Compression setting of the corresponding TPP is changed to disable, Deduplication/Compression System Volumes in the relevant TPP are automatically deleted. For details, refer to ["1.2.10 RAID Group Syntax" \(page 39\)](#).

▶ Caution

This parameter cannot be specified with the "-pool-number" or the "-pool-name" parameter.

rg_number RAID group number

rg_name RAID group name

-pool-number or -pool-name

This parameter specifies the Thin Provisioning Pool identifiers to delete all the volumes contained in the Thin Provisioning Pools. Only one Thin Provisioning Pool can be specified at the same time. For details, refer to ["1.2.7 Thin Provisioning Pool Syntax" \(page 36\)](#).

▶ Caution

This parameter cannot be specified with the "-rg-number" or the "-rg-name" parameter.

pool_number Thin Provisioning Pool number

pool_name Thin Provisioning Pool name

■ Example(s)

The following example deletes all the volumes contained in the RAID group named "RGP001":

```
CLI> delete all-volumes -rg-name RGP001
```

The following example deletes all the volumes contained in the Thin Provisioning Pool named "TPP001":

```
CLI> delete all-volumes -pool-name TPP001
```

format volume

This command formats volumes.

To format Flexible Tier Volumes (FTVs), use the "format flexible-tier-volume" command.

Caution

- Do not format NAS user volumes (*nas-tpv*) and NAS backup volumes (*nas-tpv-backup*). If a format was performed, first delete the NAS volume and then recreate it.
- If a copy session exists in the Deduplication/Compression Volume (*dedup-tpv*) or a migration for the relevant data is being performed, the DEDUP_SYS Volume in the same pool cannot be formatted.
- If Deduplication/Compression Volumes larger than the logical capacity of the DEDUP_SYS Volume are deleted or formatted repeatedly, creation of the Deduplication/Compression Volume may fail due to a temporary capacity shortage.
- If the error message for "ED500" is displayed, a format may be running for a Deduplication/Compression Volume that belongs to a Thin Provisioning Pool (TPP) in which the capacity is depleted. Perform a format after expanding the capacity of the TPP. In addition, if the error message for "ED500" is displayed while the capacity is depleted, the data and the physically allocated area that is being used is released.

Note

- When formatting the TPV where the allocation method is "thin", the physical allocation area used by the TPV is released.
- When formatting the TPV where the allocation method is "thick", the physical allocation area used by the TPV is not released. To release the physical allocation area, delete the TPV.

Syntax

```
format volume {-volume-number volume_numbers | -volume-name volume_names} [-force]
```

Parameter

-volume-number or -volume-name

This parameter specifies the volume identifiers to be formatted. One or more volumes can be specified at the same time. For details, refer to ["1.2.11 Volume Syntax" \(page 40\)](#).

Caution

- To specify NAS system volumes, the Maintenance Operation policy is required.
- If a DEDUP_SYS Volume is specified, the DEDUP_MAP Volume is also formatted.
- NAS expanded system volumes cannot be specified.
- This parameter cannot be specified for External Volumes.

volume_numbers Volume number

volume_names Volume name

-force Optional. This parameter forcibly formats NAS system volumes.

■ Example(s)

The following example only formats the volume named "VOL001":

```
CLI> format volume -volume-name VOL001
```

The following example formats \$DEDUP_SYS1:

```
CLI> format volume -volume-name $DEDUP_SYS1
```

The following example formats consecutive volumes #80 - #99 at the same time:

```
CLI> format volume -volume-number 80-99
```

expand volume

This command executes volume expansion (LUN concatenation). It adds free space to expand the capacity of a currently registered volume, allowing free space to be assigned efficiently. In addition, this command can also expand the capacity of Thin Provisioning Volumes (including NAS user volumes [nas-tpv] and Deduplication/Compression Volumes [dedup-tpv]) and DEDUP_SYS Volumes.

The "expand flexible-tier-volume" command is used to expand Flexible Tier Volumes (FTVs).

Note

When expanding NAS volumes, the maximum volume size varies depending on the block size. The following table shows the maximum volume size for each block size.

NAS FS Version	Firmware version	Block size	Block size (Maximum)	Volume size (Maximum)
2	V10L30 or earlier	256KB	32TB	128TB
3	V10L31 or earlier	8KB	1TB	4TB
		32KB	4TB	16TB
		256KB	32TB	128TB
4	V10L33 or later	8KB	1TB	32TB
		32KB	4TB	128TB
		256KB	32TB	128TB
5	V10L51 or later	8KB	1TB	32TB
		32KB	4TB	128TB
		256KB	32TB	128TB

Caution

- Volumes cannot be expanded for the following cases.
 - If the specified volume is an SDV, an SDPV, a WSV, a NAS system volume, a NAS backup volume, a NAS expanded system volume, a DEDUP_MAP volume, and an External Volume.
 - If the specified volume is a Deduplication/Compression volume and the total capacity of the Deduplication/Compression volumes within the Thin Provisioning Pool (TPP) exceeds 10 times the capacity of the DEDUP_SYS volume.
 - If a snapshot setting has been performed in the specified volume.
 - If T10-DIF has been set in the specified volume.
 - If TFO pairs exist in the specified volume.
 - If the specified volume size exceeds the maximum volume size.
 - If Storage Migration is running in the specified volume.
 - If OPC/EC/REC is being performed in the specified volume.
 - If ODX is being performed in the specified volume.
 - If LDE is running in the RAID group that includes the specified volume. LDE is running in the specified RAID group.
- When expanding the Deduplication/Compression Volume, stop or suspend the Advanced Copy session.
- When expanding the DEDUP_SYS Volume, stop or suspend all Advanced Copy sessions of the Deduplication/Compression Volume in the Thin Provisioning Pool (TPP) to which the DEDUP_SYS Volume belongs.

Syntax

```
expand volume {-volume-number volume_number | -volume-name volume_name}  
[-rg-number rg_numbers | -rg-name rg_names] -size size{tb | gb | mb}
```

Parameter

-volume-number or -volume-name

This parameter specifies the volume identifier to be expanded. Only one volume can be specified at the same time. For details, refer to ["1.2.11 Volume Syntax" \(page 40\)](#).

volume_number Volume number

volume_name Volume name

-rg-number or -rg-name

Optional. This parameter specifies the RAID group identifiers to which the volume will belong after expansion. One or more RAID groups can be specified at the same time (up to a maximum of 15). If two or more RAID groups are specified, they must be specified in the same order as the expansion size parameter. For details, refer to ["1.2.10 RAID Group Syntax" \(page 39\)](#).

Caution

- This parameter cannot be specified when the volume types are Thin Provisioning Volumes (including NAS user volumes [nas-tpv]).
- The following RAID groups cannot be specified:
 - RAID groups that operate as Thin Provisioning pools
 - RAID groups that operate as Flexible Tier Sub Pools

rg_numbers RAID group number

rg_names RAID group name

-size

This parameter specifies the capacity that is to be added when expanding a volume. When expanding a TPV, specify the capacity that is required after expansion is performed. Terabytes (TB), gigabytes (GB), or megabytes (MB) can be specified. For volume expansion, concatenated source volumes and volumes that are to be concatenated must be 1GB or more. Multiple parameters can be specified, but these parameters must match the equivalent RAID group identifiers that are specified in the previous parameter.

A volume with a maximum capacity of 128TB can be created (for an ODX buffer volume, the maximum is 1TB).

Example: 1tb, 120gb, 512mb

Caution

- For NAS user volumes, the volume capacity can be specified from within the range of 400GB to 128TB.
- If the specified volume is a TPV, the upper limit value of the total logical capacity of all TPVs and FTVs must be checked.
- For Deduplication/Compression Volumes, an upper limit check of the total logical capacity of all TPVs and FTVs is not supported.

size Capacity of the volume after it is expanded (in TB, GB, or MB)

■ Example(s)

The following example expands the volume named "VOL001" as a new 800GB area in RAID group #5:

```
CLI > expand volume -volume-name VOL001 -rg-number 5 -size 800gb
```

The following example expands the volume named "VOL001" as a new 800GB area in RAID group #5 and a new 400GB area in RAID group #6:

```
CLI > expand volume -volume-name VOL001 -rg-number 5,6 -size 800gb,400gb
```

The following example expands the Thin Provisioning Volume named "TPV001" as a new 800GB area:

```
CLI > expand volume -volume-name TPV001 -size 800gb
```

The following example expands \$DEDUP_SYS1 as a new 8TB area:

```
CLI > expand volume -volume-name $DEDUP_SYS1 -size 8tb
```

The following example expands the Thin Provisioning Volume named "TPV001", but a Warning message is displayed because the relevant Thin Provisioning Pool is in the "overprovisioning" state:

```
CLI > expand volume -volume-name TPV001 -size 900gb  
Warning: The relevant TPP is in overprovisioning status. Please be sure to add new disks to the TPP before it runs out of space.
```

set volume-parameters

This command changes various settings for the volumes. Unlike the "set volume" command or the "set flexible-tier-volume" command, this command can change multiple volume settings at the same time.

Note

- To change volume settings other than this parameter, use the "set volume" command or the "set flexible-tier-volume" command.
- If all of the parameters that are required for changing the settings are omitted, the command terminates with an error.

Syntax

```
set volume-parameters  
{ -volume-number { volume_numbers | all } | -volume-name volume_name }  
[ -allocation { thin | thick } ] [ -delete-external-lu-info { yes | no } ]
```

Parameter

-volume-number or -volume-name

This parameter specifies the identifier of the volume that is being configured. Multiple volumes can be specified simultaneously only if the "-volume-number" parameter is specified. If the "-allocation" parameter is specified, "all" cannot be specified. For details, refer to ["1.2.11 Volume Syntax" \(page 40\)](#).

volume_numbers Volume number
volume_name Volume name
all All volumes of configurable devices

-allocation This parameter specifies whether the same physical capacity as the logical capacity is allocated to the specified volume (when the allocation method for the volume is "thick") or not (when the allocation method for the volume is "thin").
The types of volumes where the settings can be changed are TPV and NAS TPV.

Caution

- If the Allocation method of the volume is "thin", an I/O error may occur due to a capacity depletion. Also, when the value of the parameter is changed from "thick" to "thin", operations may be affected. Be careful when changing this setting.
- After the Allocation method of the volume is changed from "thick" to "thin", by using the "start zero-reclamation" command to perform an optimization of the capacity, the area that was allocated to "thick" is released and becomes usable. When the capacity is not optimized, the usable capacity does not change even after the Allocation method of the volume is changed to "thin".
- If "thin" is changed to "thick", since the physical area is secured, be careful of pool capacity depletion. If the capacity is insufficient, an error (termination) will occur.
- For TPVs in which Deduplication/Compression is enabled, "thick" cannot be specified.

thin A physical volume is allocated to an area when the area accepts write I/Os. (default)
thick A physical volume with the same size as the logical capacity is allocated when volumes are created.

-delete-external-lu-info

Optional. This parameter specifies whether to delete the External LU information. If an External Volume (including a volume that is in the middle of a Non-disruptive Storage Migration) is specified, this parameter cannot be specified. This parameter cannot be specified for a volume without a UID (or LUN ID) that is inherited from an External LU. If omitted, the External LU information is not deleted.

yes	The External LU information of the target volume is deleted.
no	The External LU information of the target volume is not changed.

■ Example(s)

The following example sets the Allocation method to "thin" for the volume named "FTV0001":

```
CLI> set volume-parameters -volume-name FTV0001 -allocation thin
```

The following example sets the Allocation method to "thin" for volumes #80 to #82:

```
CLI> set volume-parameters -volume-number 80-82 -allocation thin
```

The following example deletes the External LU information of volume #80:

```
CLI> set volume-parameters -volume-number 80 -delete-external-lu-info yes
```

The following example deletes the External LU information of all volumes that satisfy the configurable requirements in the ETERNUS DX/AF:

```
CLI> set volume-parameters -volume-number all -delete-external-lu-info yes
```

show migration

This command displays a list of the migrating volumes that are undergoing migration.
This command is also used for RAID Migration in which the destination is a Flexible Tier Pool (FTRP).

Syntax

```
show migration
```

Parameter

No parameters.

Output

Item name	Description
Migration Source Volume	Migration source volume identifiers
No.	Migration source volume number
Name	Migration source volume name
Migration Status	Volume migration status
Progress	Volume migration progress
Error Code	Volume migration error code (For details, refer to " A.2.1 Copy Session Error Codes " (page 1185).)
Work Volume No.	Working volume number (In order to be used as a migration destination)

Example(s)

The following example displays a list of all migrating volumes:

```
CLI> show migration
Migration Source Volume      Migration Progress  Error  Work Volume
No.   Name                  Status             Code   No.
-----
- - - - - Reserve          -                -      -
1 Volume-Number#01         Error             20%  0x16    5
2 Volume-Number#02         Suspend           10%  0x1c    6
3 Volume-Number#03         Active            90%  0x00    4
```

start migration

This command starts the RAID Migration function or the Non-disruptive Storage Migration function. These functions move the currently registered volumes to another RAID group or Thin Provisioning Pool (TPP). The capacity of a volume can also be expanded at the same time. In addition, unsupported volumes of the Deduplication/Compression function can be changed to supported volumes (dedup-tpv). Furthermore, the reverse is also possible.

The "start flexible-tier-migration" command is used to perform RAID Migration in which the destination is a Flexible Tier Pool (FTRP).

Caution

- Encryption-related functions cannot be used in the DX60 S4/DX60 S3.
- If the capacity of the migration destination TPP is depleted, an error occurs. Perform a migration after expanding the capacity of the TPP.

Note

Depending on the model, the support state of the encryption-related functions may differ.

Syntax

```
start migration {-volume-number volume_number | -volume-name volume_name}  
{-rg-number rg_number | -rg-name rg_name | -pool-number pool_number | -pool-name pool_name}  
-size size{tb | gb | mb} [-encryption {enable | disable}] [-zero-reclamation {enable | disable}]  
[-wide-stripe-size {normal | small}] [-concatenation-order {auto | manual}]  
[-data-integrity {default | t10-dif}] [-allocation {thin | thick}]  
[-dedup {enable | disable}]
```

Parameter

-volume-number or -volume-name

This parameter specifies the volume identifier to be moved. Only one volume can be specified at the same time. For details, refer to ["1.2.11 Volume Syntax" \(page 40\)](#). FTVs that are used exclusively for WVOL metadata cannot be specified. In addition, for the TPVs/FTVs that are used as the copy destination volume of SnapOPC/SnapOPC+, only TPP/FTRP can be specified for the migration destination.

volume_number Volume number

volume_name Volume name

-rg-number or -rg-name

-pool-number or -pool-name

This parameter specifies a RAID group or Thin Provisioning Pool as the volume migration destination. Only one Thin Provisioning Pool can be specified at the same time. Use the "-rg-number" or the "-rg-name" parameter to specify the RAID group as the migration destination.

Note that when multiple RAID groups are specified, the migration destination becomes a Wide Stripe Volume. Use the "-pool-number" or the "-pool-name" parameter to specify the Thin Provisioning Pool as the migration destination. For details, refer to ["1.2.10 RAID Group Syntax" \(page 39\)](#) or ["1.2.7 Thin Provisioning Pool Syntax" \(page 36\)](#).

 **Caution**

This command cannot be executed for the following cases:

- The Deduplication/Compression function of the migration destination Deduplication/Compression volume (dedup-tpv) pool is disabled.
- The migration destination is a RAID group that is registered as an Extreme Cache Pool.
- The migration source is an ODX buffer volume and the migration destination is a Deduplication/Compression volume (dedup-tpv).
- The migration source is a NAS user volume or a NAS system volume and the migration destination is a RAID group.

<i>rg_number</i>	RAID group number
<i>rg_name</i>	RAID group name
<i>pool_number</i>	Thin Provisioning Pool number
<i>pool_name</i>	Thin Provisioning Pool name

-size Optional. This parameter specifies the volume size of the migration destination. A different volume size from the source size can only be specified for the destination when performing migration between RAID groups with a volume size that is larger than the source size. If the volume size that is specified for the destination is smaller than the source size, a parameter error occurs. If omitted, the same size as the source volume is set. Select whether terabytes (TB), gigabytes (GB), or megabytes (MB) are used for the capacity. The size cannot be changed when the migration destination is a Thin Provisioning Pool. If the migration source volume is a NAS user volume or a NAS system volume, this parameter cannot be specified.

Example: 1tb, 120gb, 512mb

size Volume capacity (in TB, GB, or MB)

-encryption Optional. The Security Setting policy is required. This parameter specifies whether the encryption by a CM is performed. When "enable" is selected, the specified volume data is encrypted. If omitted, the encryption setting of the migration source volume is inherited.

enable The volume data is encrypted.

disable The volume data is not encrypted.

-zero-reclamation

This parameter specifies whether Zero Reclamation is performed after migration is complete. If omitted, then it is handled as if "disable" is selected. This parameter cannot be set when the migration destination is a RAID group. "enable" cannot be specified while Zero Reclamation is being performed for a migration source volume. Deduplication/Compression volumes cannot be specified.

enable Zero Reclamation is started after migration is complete.

disable Zero Reclamation is not started after migration is complete.

-wide-stripe-size

Optional. This parameter specifies the Wide Stripe Size of a migration destination WSV. This parameter can only be specified when the migration destination is a WSV. If omitted, then it is handled as if "normal" is selected.

normal The Wide Stripe Size for the WSV is set to 16MB.

small The Wide Stripe Size for the WSV is set to 2MB. Note that if the Stripe Size of the RAID group exceeds 2MB, the actual Stripe Size of the RAID group is used for the WSV that is to be created.

-concatenation-order

Optional. This parameter specifies whether to manually set the concatenation order for the RAID groups of a migration destination WSV. This parameter can only be set when the migration destination is a WSV. If omitted, then it is handled as if "auto" is selected.

auto The concatenation order for the RAID groups is automatically set.

manual The RAID groups are concatenated in the order specified by the "rg-number" or "-rg-name" parameter.

-data-integrity

Optional. This parameter sets the data integrity method. If omitted, the setting for the target volume is retained.

 **Caution**

To change the data integrity method during a migration, stop the host access.

default The default data block guard is used to ensure data integrity in the whole storage system. This parameter must be specified when a T10-DIF-specified volume is migrated to volumes for which the T10-DIF cannot be set, such as non-Open and non-Standard volumes.

t10-dif By using T10-DIF, end-to-end data integrity is ensured. However, if the specified volume has a UID (or LUN ID) that is inherited from an External LU or an External Volume, this parameter cannot be specified.
This option can only be specified if "open" or "standard" is specified in "-type". To use T10-DIF, support for T10-DIF is required, such as by HBAs as well as the host.

-allocation

Optional. If omitted, the setting value of the migration source volume is inherited. However, if the migration source volume is a Thick Provisioning Volume and the specification is "-dedup enable", this parameter cannot be specified. As a result, "-allocation thin" is used for the operation.

When "thick" is specified, allocate the same physical capacity as the logical capacity to the migration destination TPV. When "thick" is specified, although errors during operation caused by a pool capacity depletion rarely occurs, the usable capacity of the pool is reduced.

This parameter can only be specified when "-pool-number" or "-pool-name" is specified and when a migration to TPVs is performed.

When a Thick Provisioning Volume is being created in the migration destination, "-zero-reclamation enable" cannot be specified. If the "-dedup" parameter is omitted in the Deduplication/Compression Volume (dedup-tpv) of the migration source, "-allocation thick" cannot be specified.

If the migration source volume is a NAS system volume, this parameter cannot be specified.

thin A physical volume is allocated to an area when the area accepts write I/Os.

thick A physical volume with the same size as the logical capacity is allocated to the migration destination TPV.

-dedup

Optional. This parameter specifies whether to enable the Deduplication/Compression setting of the migration destination volume. If omitted, the migration source volume setting is retained.

Only Thin Provisioning Pools can be specified for the migration destination.

If the Deduplication/Compression function (Deduplication/Compression mode setting) of the ETERNUS DX/AF is disabled, this parameter cannot be specified. If the "-rg-number" parameter or the "-rg-name" parameter is specified, this parameter cannot be specified.

If the migration source volume is a TPV/FTV that is used for the copy destination volume of SnapOPC/SnapOPC+, "-dedup enable" cannot be specified.

- enable The Deduplication/Compression setting of the migration destination volume is enabled.
- disable The Deduplication/Compression setting of the migration destination volume is disabled.

To enable the Deduplication/Compression setting of the migration destination volume, the Deduplication/Compression setting of the migration destination Thin Provisioning Pool must be enabled. The relationship of the Deduplication/Compression setting between the migration source volume and the migration destination volume is shown below.

Migration source	Migration destination			
-volume-number -volume-name	-rg-number -rg-name -pool-number -pool-name	-dedup		
		When omitted	When enabled	When disabled
Deduplication/ Compression Volume (dedup-tpv)	Pool different from the migration source volume	Deduplication/ Compression Volume (dedup-tpv)	Deduplication/ Compression Volume (dedup-tpv)	TPV
	Pool same as the migration source volume	Impossible	Impossible	TPV
	RAID	Standard/WSV	Impossible	Impossible
TPV/FTV	Pool different from the migration source volume	TPV	Deduplication/ Compression Volume (dedup-tpv)	TPV
	Pool same as the migration source volume	Impossible	Deduplication/ Compression Volume (dedup-tpv)	Impossible
	RAID	Standard/WSV	Impossible	Impossible
Standard/WSV	Pool	TPV	Deduplication/ Compression Volume (dedup-tpv)	TPV
	RAID	Standard/WSV	Impossible	Impossible

If Deduplication/Compression Volumes (dedup-tpv) are migrated to a TPP that has the Deduplication/Compression setting disabled, the volumes become normal TPVs.

■ Example(s)

The following example moves the volume named "VOL003" to the RAID group named "RGP004". The new volume size is 512GB:

```
CLI> start migration -volume-name VOL003 -rg-name RGP004 -size 512gb
```

The following example moves the volume named "VOL003" to the Thin Provisioning Pool named "TPP001". The Deduplication/Compression setting of the migration destination volume is enabled:

```
CLI> start migration -volume-name VOL003 -pool-name TPP01 -dedup enable
```

The following example moves the volume named "VOL001" to the Thin Provisioning Pool named "TPP002", but a Warning message is displayed because "TPP002" is in the "overprovisioning" state:

```
CLI> start migration -volume-name VOL001 -pool-name TPP002  
Warning: The relevant TPP is in overprovisioning status. Please be sure to add new disks to the TPP before it runs out of space.
```

stop migration

This command can be used to stop the RAID Migration progress if it has commenced. The migration source/destination volumes cannot be deleted unless the RAID Migration has been stopped or has completed.

This command is also used for RAID Migration in which the destination is a Flexible Tier Pool (FTRP).

■ Syntax

```
stop migration {-volume-number volume_numbers | -volume-name volume_names}
```

■ Parameter

-volume-number or -volume-name

This parameter specifies the migration source volume numbers or names corresponding to an already started migration. Details can be displayed using the "show migration" command. One or more parameters can be specified at the same time. For details, refer to ["1.2.11 Volume Syntax" \(page 40\)](#).

volume_numbers Volume number

volume_names Volume name

■ Example(s)

The following example stops the RAID Migration of volume #1:

```
CLI> stop migration -volume-number 1
```

show balancing-thin-pro-volumes

This command displays information such as the status and progress of TPV balancing. If the Thin Provisioning function is disabled, this command cannot be used.

■ Syntax

```
show balancing-thin-pro-volumes [-volume-number volume_number | -volume-name volume_name]
```

■ Parameter

-volume-number or -volume-name

Optional. This parameter specifies a volume number or a volume name that is to be displayed. Only one volume can be specified. For details, refer to ["1.2.11 Volume Syntax" \(page 40\)](#).

Example: -volume-number 1

An error occurs when a volume other than a TPV is specified.

If omitted, only the balancing progress information of the volume that is being balanced is displayed. If a balancing is executed for a volume that does not exist, nothing is displayed.

When specifying a volume, the balancing progress information and the usage capacity of each raid group for the target volume is displayed regardless of whether a volume is being balanced. If the specified volume is not being balanced, a hyphen (-) is displayed for those other than "Volume" and "Balancing Level" in the balancing progress information.

volume_number Volume number

volume_name Volume name

■ Output

Item name	Description
Volume	Volume identifiers
No.	Volume number
Name	Volume name
Balancing Level	Balancing level
Balancing Process	Balancing process
Status	Balancing process status
Progress(%)	Balancing process progress
Work Volume No.	Working volume number
Error code	Error code
Elapsed Time	Elapsed time
RAID Group	RAID group identifiers (Only when specifying Volume)
No.	RAID group number
Name	RAID group name
Used Capacity(MB)	Used capacity (Unit : MB) (Only when specifying Volume)

■ Example(s)

The following example displays all the volumes where the balancing process is being executed:

```
CLI> show balancing-thin-pro-volumes
Volume
No.   Name                               Balancing Level   Balancing Status   Process Progress(%)   Work Volume No.   Error code   Elapsed Time
-----
  0   TPV00                               High              Active              99                1023   0x00   02h34min50sec
  1   TPV01                               Medium             Active              50                2047   0x00   01h23min45sec
  2   TPV02                               Low                Error               30                4095   0x73   00h30min30sec
```

The following example displays the specified volume (if a balancing process has been executed in the specified volume):

```
CLI> show balancing-thin-pro-volumes -volume-number 1
Volume
No.   Name                               Balancing Level   Balancing Status   Process Progress(%)   Work Volume No.   Error code   Elapsed Time
-----
  1   TPV01                               Medium             Active              50                2047   0x00   01h23min45sec
<RAID Group List>
RAID Group      Used
No.   Name                               Capacity(MB)
-----
  1   RAIDGROUP001                       1344
  2   RAIDGROUP002                       2688
```

The following example displays the specified volume (if a balancing process has not been executed in the specified volume):

```
CLI> show balancing-thin-pro-volumes -volume-number 1
Volume
No.   Name                               Balancing Level   Balancing Status   Process Progress(%)   Work Volume No.   Error code   Elapsed Time
-----
  1   TPV01                               Medium             -                  -                  -        -        -
<RAID Group List>
RAID Group      Used
No.   Name                               Capacity(MB)
-----
  1   RAIDGROUP001                       1344
  2   RAIDGROUP002                       2688
```

start balancing-thin-pro-volume

This command starts evenly relocating the Thin Provisioning Volumes (TPVs) among RAID groups. If the Thin Provisioning function is disabled, this command cannot be used.

■ Syntax

```
start balancing-thin-pro-volume {-volume-number volume_number | -volume-name volume_name}
```

■ Parameter

-volume-number or -volume-name

This parameter specifies the TPV to start balancing. Only one parameter can be specified. For details, refer to ["1.2.11 Volume Syntax" \(page 40\)](#).

Caution

Deduplication/Compression Volumes (dedup-tpv) and Deduplication/Compression System Volumes (DEDUP_SYS Volumes and DEDUP_MAP Volumes) cannot be specified.

volume_number Volume number

volume_name Volume name

■ Example(s)

The following example starts balancing TPV01:

```
CLI> start balancing-thin-pro-volume -volume-name TPV01
```

stop balancing-thin-pro-volume

This command stops evenly relocating the TPVs among RAID groups. Specify the TPV that is being balanced. If the Thin Provisioning function is disabled, this command cannot be used.

■ Syntax

```
stop balancing-thin-pro-volume {-volume-number volume_numbers | -volume-name volume_names}
```

■ Parameter

-volume-number or -volume-name

This parameter specifies the TPV to stop balancing. One or more parameters can be specified at the same time. For details, refer to ["1.2.11 Volume Syntax" \(page 40\)](#).

volume_numbers Volume number

volume_names Volume name

■ Example(s)

The following example stops balancing TPV01 and TPV02:

```
CLI> stop balancing-thin-pro-volume -volume-name TPV01,TPV02
```

start zero-reclamation

This command starts Zero Reclamation. Zero Reclamation affects Thin Provisioning and Flexible Tier Pools (FTRP) by releasing physical allocations in consecutive 21MB 0 data blocks in TPVs and FTVs as unused areas. To stop or display the progress of a Zero Reclamation process that is started by this command, use the "stop zero-reclamation" and "show volume-progress" commands.

■ Syntax

```
start zero-reclamation {-volume-number volume_number | -volume-name volume_name}
```

■ Parameter

-volume-number or -volume-name

This parameter specifies the volume identifier for which Zero Reclamation is to be started. Multiple volumes can be specified in a single command. For details, refer to ["1.2.11 Volume Syntax" \(page 40\)](#).

Caution

Deduplication/Compression Volumes (dedup-tpv) and Deduplication/Compression System Volumes (DEDUP_SYS Volumes and DEDUP_MAP Volumes) cannot be specified.

<i>volume_number</i>	Volume number
<i>volume_name</i>	Volume name

■ Example(s)

The following example starts Zero Reclamation for an FTV that is named "FTV0001":

```
CLI> start zero-reclamation -volume-name FTV0001
```

The following example starts Zero Reclamation for volumes #80 – #99:

```
CLI> start zero-reclamation -volume-number 80-99
```

stop zero-reclamation

This command stops Zero Reclamation. To display the progress of a Zero Reclamation process that is stopped by this command, use the "show volume-progress" command.

■ Syntax

```
stop zero-reclamation {-volume-number volume_number | -volume-name volume_name}
```

■ Parameter

-volume-number or -volume-name

This parameter specifies the volume identifier for which Zero Reclamation is to be stopped. Multiple volumes can be set in a single command. For details, refer to ["1.2.11 Volume Syntax" \(page 40\)](#).

volume_number Volume number

volume_name Volume name

■ Example(s)

The following example stops Zero Reclamation for a TFV that is named "FTV0001":

```
CLI> stop zero-reclamation -volume-name FTV0001
```

The following example stops Zero Reclamation for volumes #80 – #99:

```
CLI> stop zero-reclamation -volume-number 80-99
```

show volume-qos

This command displays the performance setting for the Volume QoS.

Caution

This command is not supported in the DX60 S4/DX60 S3.

■ Syntax

```
show volume-qos [-volume-number volume_number | -volume-name volume_name | -all]
```

■ Parameter

-volume-number, -volume-name, or -all

Optional. This parameter specifies the volume identifier for the target volume to display the QoS performance. Multiple volumes can be specified for "-volume-number" and "-volume-name". For details, refer to ["1.2.11 Volume Syntax" \(page 40\)](#). If the "-all" parameter is specified, the QoS performance setting is displayed for all volumes including volumes with a bandwidth limit of "0" (no upper limit). If this parameter is omitted, the QoS performance setting is displayed for volumes that have a bandwidth limit other than "0" (no upper limit).

volume_number Volume number

volume_name Volume name

-all All Volumes including volumes with a bandwidth limit of "0" (no upper limit).

■ Output

Item name	Description
Volume	Volume identifiers
No.	Volume number
Name	Volume name
Bandwidth Limit	QoS performance bandwidth limit (upper limit performance value) configured in the volume

■ Example(s)

The following example shows information when parameters are omitted:

```
CLI> show volume-qos
Volume
No.    Name                               Bandwidth Limit
-----
1      VOL00001                            1
10     VOL00010                             3
100    VOL00100                             9
1000   VOL01000                             12
10000  VOL10000                             15
```

The following example displays the QoS performance setting for volume #1:

```
CLI> show volume-qos -volume-number 1
Volume
No.   Name                               Bandwidth Limit
-----
  1  VOL00001                             0
```

set volume-qos

This command configures the performance setting for the Volume QoS.

Caution

This command is not supported in the DX60 S4/DX60 S3.

■ Syntax

```
set volume-qos {-volume-number volume_number | -volume-name volume_name}  
-bandwidth-limit bandwidth_limit
```

■ Parameter

-volume-number or -volume-name

This parameter specifies the volume identifier for the target volume to configure the QoS performance. Multiple volumes can only be specified with the "-volume-number" parameter. For details, refer to ["1.2.11 Volume Syntax" \(page 40\)](#).

<i>volume_number</i>	Volume number
<i>volume_name</i>	Volume name

-bandwidth-limit

This parameter specifies the bandwidth limit (upper limit performance value) configured in the volume. The range that can be set is 0 (unlimited) to 15 (maximum limit).

Example: -volume-number 1 -bandwidth-limit 1

Multiple bandwidth limits can be specified simultaneously. When configuring different values, this parameter must be set with the same amount of numbers that are specified for the "-volume-number" parameter or the "-volume-name" parameter.

Example: -volume-number 1,2 -bandwidth-limit 1,2

The same "-bandwidth-limit" parameter can be specified to multiple "-volume" parameters.

Example: -volume-number 1,2,4 -bandwidth-limit 1

bandwidth_limit

0	Unlimited
1	15,000 IOPS (800MB/s)
2	12,600 IOPS (700MB/s)
3	10,020 IOPS (600MB/s)
4	7,500 IOPS (500MB/s)
5	5,040 IOPS (400MB/s)
6	3,000 IOPS (300MB/s)

7	1,020 IOPS (200MB/s)
8	780 IOPS (100MB/s)
9	600 IOPS (70MB/s)
10	420 IOPS (40MB/s)
11	300 IOPS (25MB/s)
12	240 IOPS (20MB/s)
13	180 IOPS (15MB/s)
14	120 IOPS (10MB/s)
15	60 IOPS (5MB/s)

■ Example(s)

The following example configures the QoS performance setting for the volume named "FTV0001":

```
CLI> set volume-qos -volume-name FTV0001 -bandwidth-limit 0
```

The following example configures the QoS performance setting for volume #80 – #82:

```
CLI> set volume-qos -volume-number 80-82 -bandwidth-limit 13,14,15
```

3.2.2 Flexible Tier Volumes

This section explains the details of the commands that are related to the management of volumes that is used by the Flexible Tier function (or the Automated Storage Tiering function).

In the same way as normal volumes, use the "show volumes" command to display a list of the Flexible Tier Volumes and the "show volume-progress" command to display the formatting progress of Flexible Tier Volumes.

In the same way as RAID Migration, use the "stop migration" command to stop Flexible Tier Migration and the "show migrations" command to display a list of the migrating volumes for Flexible Tier Migration.

For details, refer to ["3.5 Flexible Tier Management" \(page 281\)](#).

Caution

The commands that are described in this section are not supported in the DX60 S4/DX60 S3.

Note

Perform Flexible Tier (or Automated Storage Tiering) operations with ETERNUS SF Storage Cruiser. For information about operating Automated Storage Tiering, refer to "FUJITSU Storage ETERNUS SF Storage Cruiser Operation Guide for Optimization Function".

If a Flexible Tier Volume is configured (created/modified/deleted) using CLI, status updates must be operated from ETERNUS SF Storage Cruiser.

Functions to control Flexible Tier Volumes are as follows:

- Creating volumes
- Changing an existing volume information
- Formatting volumes
- Expanding volumes
- Deleting volumes
- Flexible Tier migration (migrating volumes)

The commands that are used for normal volumes and FTVs are shown below.

Function	Command used for normal volumes	Command used for FTVs
Creating volumes	create volume	create flexible-tier-volume
Changing volume settings	set volume	set flexible-tier-volume
Formatting volumes	format volume	format flexible-tier-volume
Expanding volumes	expand volume	expand flexible-tier-volume
Expanding volumes	show volumes	
Displaying the progress of volume processes	show volume-progress	
Deleting volumes	delete volume	delete flexible-tier-volume delete all-flexible-tier-volume
Starting RAID Migration	start migration	start flexible-tier-migration
Stopping RAID Migration	stop migration	
Displaying a list of volumes undergoing RAID Migration	show migrations	

create flexible-tier-volume

This command creates a volume (Flexible Tier Volume [FTV]) in the specified Flexible Tier Pool (FTRP). Multiple FTVs can be created in the same FTRP by using the "-count" parameter. This command has the same function as the "create volume" command, except that an FTV is created in an FTRP.

Syntax

```
create flexible-tier-volume -name alias_name {-ftrp-number ftrp_number | -ftrp-name ftrp_name}  
-size size {tb | gb | mb} [-priority {ftsp_number | auto}] [-count count] [-attention attention]  
[-copy-protection {enable | disable}] [-volume-number volume_number]  
[-allocation {thin | thick}] [-type {default | vvol-metadata}]
```

Parameter

-name This parameter specifies the FTV name. Only one name can be specified. For details, refer to ["1.2.11 Volume Syntax" \(page 40\)](#).

Caution

In a VMware Virtual Volumes (VVOL) operating environment, when attempting to create a volume with a name "VVOL#X" while a VVOL creation process is running in the background, the VVOL volume names may conflict and cause VVOL related operations to terminate abnormally.

alias_name FTV name

-ftrp-number or -ftrp-name

This parameter specifies the FTRP identifier to which the FTV that is to be created is allocated. For details, refer to ["1.2.8 Flexible Tier Pool Syntax" \(page 37\)](#).

ftrp_number FTRP number

ftrp_name FTRP name

-size This parameter specifies the FTV size. Select whether terabytes (TB), gigabytes (GB), or megabytes (MB) are used for the capacity.

Example: 1tb, 120gb, 512mb

size FTV capacity (in TB, GB, or MB)

-priority Optional. This parameter specifies the FTSP number of the Flexible Tier Sub Pool (FTSP) to which the FTV that is to be created is preferentially allocated. If this parameter is omitted or "auto" is specified for this parameter, the allocated FTSP is determined automatically.

ftsp_number FTSP number

auto The allocated FTSP is determined automatically.

-count Optional. This parameter specifies the number of FTVs that are to be created. If omitted, only one FTV is created with the name that is specified by the "-name" parameter. When two or more is specified for the "-count" parameter, a sequential number starting from 0, such as 0,1, and 2, is added after the FTV name that is specified by the "-name" parameter.

Example: When "-name abc -count 3" is specified, FTVs "abc0", "abc1", and "abc2" are created. If these volumes already exist, the names of the created volumes use incrementing index numbers.

count Number of FTVs

-attention Optional. This parameter specifies the threshold (Attention) for the FTV. A value between 1% and 100% can be set. If omitted, the default value (80%) is set.

attention Threshold (Attention) for the FTV

-copy-protection

Optional. This parameter prevents the FTV from being specified as the copy destination. When "enable" is specified, the FTV cannot be specified as the copy destination. If this parameter is omitted or "auto" is specified for this parameter, the FTV can be specified as the copy destination.

enable The FTV is protected.

disable The FTV is not protected.

-volume-number

Optional. This parameter specifies whether the volume number is assigned automatically or manually. Only one volume number can be specified. If omitted, the volume number is automatically assigned. This parameter cannot be specified when a value that is "2" or more is set for the "-count" parameter. If an existing volume number is set, an error occurs.

 **Caution**

In a VVOL operating environment, when specifying the same volume number as the VVOL scheduled for creation while a VVOL creation process is running in the background, the VVOL creation process may terminate abnormally.

volume_number Volume number

-allocation Optional. If omitted, "thin" is set. During normal operations, the value of this parameter does not need to be changed from the default value ("thin"). When "thick" is specified, the same logical capacity is allocated to the physical capacity when the volume is created.

thin A physical volume is allocated to an area when the area accepts write I/Os (default).

thick A physical volume with the same size as the logical capacity is allocated when volumes are created.

-type Optional. This parameter specifies the type of FTV (normal FTV or VVOL Metadata exclusive FTV) to create. Backups of VVOL management Metadata for ETERNUS SF Storage Cruiser are stored in the created VVOL Metadata exclusive FTVs.

Normally, VVOL Metadata exclusive FTVs are created automatically during the creation of a VVOL. However, this parameter can recreate VVOL Metadata exclusive FTVs if they were deleted.

Only one VVOL Metadata exclusive FTV can be created for each ETERNUS DX/AF. The capacity is 1,040MB.

VVOL Metadata exclusive FTVs are fixed to "thick". If "vvol-metadata" is specified, "-name", "-size", and "-allocation" cannot be specified. In addition, if the VVOL function is disabled, this parameter cannot be specified.

If omitted, "default" is set.

default	Normal FTVs are created (default).
wvol-metadata	WVOL Metadata exclusive FTVs are created.

■ Example(s)

The following example creates an FTV that is named "FTV0002". FTRP#0 is set for the FTRP to which the FTV is preferentially allocated, 80% is set for the Attention level threshold, and the copy destination volume protection function is enabled:

```
CLI> create flexible-tier-volume -name FTV0002 -ftrp-number 0 -attention 80 -copy-protection enable
```

set flexible-tier-volume

This command modifies the information for the Flexible Tier Volumes (FTVs) that are already registered in the ETERNUS DX/AF.

■ Syntax

```
set flexible-tier-volume {-volume-number volume_number | -volume-name volume_name}  
[-name name] [-priority {ftsp_number | auto}] [-attention attention] [-copy-protection {enable | disable}]  
[-uid uid | default | original] [-alua {follow-host-response | active | passive}]
```

■ Parameter

-volume-number or -volume-name

This parameter specifies the FTV identifier for which the settings are to be changed. Only one parameter can be specified in a single command. For details, refer to ["1.2.11 Volume Syntax" \(page 40\)](#).

volume_number Volume number

volume_name Volume name

-name Optional. This parameter specifies the new name of the target FTV. For details, refer to ["1.2.11 Volume Syntax" \(page 40\)](#). If omitted, the alias name of the target FTV remains unchanged.

name FTV name

-priority Optional. This parameter specifies the FTSP number of the Flexible Tier Sub Pool (FTSP) to which the target FTV is preferentially allocated. If "auto" is specified for this parameter, the allocated FTSP is determined automatically. If omitted, this parameter is not changed.

ftsp_number FTSP number

auto The allocated FTSP is determined automatically.

-attention Optional. This parameter specifies the threshold (Attention) for the target FTV. A value between 1% and 100% can be set. If omitted, this parameter is not changed.

attention Threshold (Attention) for the target FTV

-copy-protection

Optional. This parameter prevents the FTV from being specified as the copy destination. When "enable" is specified, the target FTV cannot be specified as the copy destination. When "disable" is specified, the target FTV can be specified as the copy destination. If omitted, the setting remains unchanged.

enable The FTV is protected.

disable The FTV is not protected.

-uid Optional. This parameter specifies the UID of the target volume. Thirty-two-digit hexadecimal ("0" to "9", "A" to "F", and "a" to "f") numbers can be specified. If this parameter is omitted, the existing setting remains unchanged.

<i>uid</i>	UID of the target volume
default or original	The UID, serial number, and product ID are reverted to the default setting for the target volume.
-alua	Optional. This parameter specifies the ALUA setting for the target volume. If this parameter is omitted, the existing setting remains unchanged.
follow-host-response	The ALUA setting follows the host response setting (default).
active	The ACTIVE / ACTIVE setting takes priority regardless of the host response setting.
passive	The ACTIVE-ACTIVE / PREFERRED_PATH setting takes priority regardless of the host response setting.

■ Example(s)

The following example renames an FTV named "FTV0003" to "FTV_0003":

```
CLI> set flexible-tier-volume -volume-name FTV0003 -name FTV_0003
```

The following example changes the FTSP to which the target FTV is preferentially allocated to volume#03, sets the Attention level threshold to 60%, and enables the copy destination volume protection function for volume#02 (FTV):

```
CLI> set flexible-tier-volume -volume-number 2 -priority 3 -attention 60 -copy-protection enable
```

format flexible-tier-volume

This command formats the Flexible Tier Volumes (FTVs) that are already registered in the ETERNUS DX/AF.

■ Syntax

```
format flexible-tier-volume {-volume-number volume_numbers | -volume-name volume_names} [-force]
```

■ Parameter

-volume-number or -volume-name

This parameter specifies the FTV identifiers that are to be formatted. Multiple FTVs can be formatted in a single command. This command results in an error response if a non-FTV volume is specified. For details, refer to ["1.2.11 Volume Syntax" \(page 40\)](#).

volume_numbers Volume number

volume_names Volume name

-force Optional. This parameter forcefully formats FTVs that should not be formatted.
If this parameter is specified, VMware Virtual Volumes (VVOL) Metadata exclusive FTVs can be formatted.

■ Example(s)

The following example formats an FTV named "FTV0001":

```
CLI> format flexible-tier-volume -volume-name FTV0001
```

The following example formats consecutive volumes #80 – #99 at the same time:

```
CLI> format flexible-tier-volume -volume-number 80-99
```

expand flexible-tier-volume

This command expands the capacity of the Flexible Tier Volumes (FTVs) that are already registered in the ETERNUS DX/AF.

■ Syntax

```
expand flexible-tier-volume {-volume-number volume_number | -volume-name volume_name} -size size{tb | gb | mb}
```

■ Parameter

-volume-number or -volume-name

This parameter specifies the FTV identifier for which the capacity is to be expanded. For details, refer to ["1.2.11 Volume Syntax" \(page 40\)](#).

volume_number Volume number

volume_name Volume name

-size Optional. This parameter specifies the volume size after capacity expansion. Select whether terabytes (TB), gigabytes (GB), or megabytes (MB) are used for the capacity.

Example: 1tb, 120gb, 512mb

size FTV capacity (in TB, GB, or MB)

■ Example(s)

The following example expands the FTV named "FTV0001" as a new 800GB area:

```
CLI > expand flexible-tier-volume -volume-name FTV0001 -size 800gb
```

delete flexible-tier-volume

This command deletes the Flexible Tier Volumes (FTVs) that are already registered in the ETERNUS DX/AF.

- All mappings associated with the host must be released before specified FTVs are deleted.
- All migrating FTVs (Flexible Tier migration) must be stopped before specified FTVs are deleted.
- Advanced Copy sessions to be deleted must be stopped before specified FTVs are deleted.

■ Syntax

```
delete flexible-tier-volume {-volume-number volume_numbers | -volume-name volume_names} [-force]
```

■ Parameter

-volume-number or -volume-name

This parameter specifies the FTV identifiers that are to be deleted. Multiple FTVs can be deleted in a single command. This command results in an error response if a non-FTV volume is specified. For details, refer to ["1.2.11 Volume Syntax" \(page 40\)](#).

volume_numbers Volume number

volume_names Volume name

-force Optional. This parameter forcefully deletes FTVs that should not be deleted. If this parameter is specified, VMware Virtual Volumes (VVOL) and VVOL Metadata exclusive FTVs can be deleted.

■ Example(s)

The following example deletes an FTV named "FTV0001":

```
CLI> delete flexible-tier-volume -volume-name FTV0001
```

The following example deletes consecutive volumes #80 – #99 at the same time:

```
CLI> delete flexible-tier-volume -volume-number 80-99
```

The following example forcefully deletes a VVOL:

```
CLI> delete flexible-tier-volume -volume-number 1 -force
```

delete all-flexible-tier-volumes

This command collectively deletes the Flexible Tier Volumes (FTVs) for which the specified Flexible Tier Pool (FTRP) is allocated and that are already registered in the ETERNUS DX/AF.

- All mappings associated with the host must be released before specified FTVs are deleted.
- All migrating FTVs (Flexible Tier migration) must be stopped before specified FTVs are deleted.
- Advanced Copy sessions to be deleted must be stopped before specified FTVs are deleted.

■ Syntax

```
delete all-flexible-tier-volumes {-ftrp-number ftrp_numbers | -ftrp-name ftrp_names}
```

■ Parameter

-ftrp-number or -ftrp-name

This parameter specifies the FTRP identifier that is allocated to the FTVs that are to be deleted. Only one parameter can be specified. For details, refer to ["1.2.8 Flexible Tier Pool Syntax" \(page 37\)](#).

ftrp_numbers FTRP number

ftrp_names FTRP name

■ Example(s)

The following example deletes all the FTVs for which an FTRP that is named "FTRP001" is allocated.

```
CLI> delete all-flexible-tier-volumes -ftrp-name FTRP001
```

start flexible-tier-migration

This command starts Flexible Tier Migration. Flexible Tier Migration is RAID Migration in which the migration destination is a Flexible Tier Pool (FTRP). The "start migration" command is used for normal RAID Migration in which the migration destination is not an FTRP.

Caution

- The capacity of volumes cannot be changed during Flexible Tier Migration.
- The migrated volume type is changed to FTV.

In the same way as RAID Migration, use the "stop migration" command to stop Flexible Tier Migration that is started by executing this command and the "show migrations" command to show a list of the migrating volumes for Flexible Tier Migration that is started by executing this command.

Syntax

```
start flexible-tier-migration {-volume-number volume_number | -volume-name volume_name}  
{-ftrp-number ftrp_number | -ftrp-name ftrp_name} [-priority {ftsp_number | auto}]  
[-zero-reclamation {enable | disable}] [-data-integrity {default}]  
[-allocation {thin | thick}]
```

Parameter

-volume-number or -volume-name

This parameter specifies the identifier of the migration source volume. Only one parameter can be specified at a time. For details, refer to ["1.2.11 Volume Syntax" \(page 40\)](#).

volume_number Volume number
volume_name Volume name

-ftrp-number or -ftrp-name

This parameter specifies the FTRP identifier for the volume migration destination. Only one parameter can be specified. For details, refer to ["1.2.8 Flexible Tier Pool Syntax" \(page 37\)](#).

ftrp_number FTRP number
ftrp_name FTRP name

-priority Optional. This parameter specifies the FTSP number of the Flexible Tier Sub Pool (FTSP) to which the migrated FTV is preferentially allocated. If this parameter is omitted or "auto" is specified for this parameter, the allocated FTSP is determined automatically by the ETERNUS DX/AF.

ftsp_number FTSP number
auto The allocated FTSP is determined automatically.

-zero-reclamation

This parameter specifies whether Zero Reclamation is performed after migration is complete. If omitted, then it is handled as if "disable" is selected. "enable" cannot be specified while Zero Reclamation is being performed for a migration source volume.

- enable Zero Reclamation is started after migration is complete.
- disable Zero Reclamation is not started after migration is complete.

-data-integrity

This parameter sets the method for ensuring data integrity.

- default The default data block guard is used to ensure data integrity in the whole storage system. This option must be specified when a T10-DIF-enabled volume is migrated.

-allocation Optional. If omitted, the existing setting is not changed. When "thick" is specified, the same physical capacity as the logical capacity of the migration destination FTV is allocated in advance.

- thin A physical volume is allocated to an area when the area accepts write I/Os.
- thick A physical volume with the same size as the logical capacity is allocated to the migration destination FTV.

■ Example(s)

The following example migrates an FTV named "FTV0003" to an FTRP named "FTRP000". (The volume type of the FTV that is named "FTV0003" remains FTV:)

```
CLI> start flexible-tier-migration -volume-name FTV0003 -ftrp-name FTRP000
```

The following example migrates Volume#5 to FTRP#3 and the migrated volume is preferentially allocated to FTSP#4. (The volume type of Volume#5 is changed to FTV:)

```
CLI> start flexible-tier-migration -volume-number 5 -ftrp-number 3 -priority 4
```

The following example migrates Volume TPV00A to FTRP#4 and the migrated volumes is preferentially allocated automatically to an FTSP. (The volume type of the FTV that is named "TPV00A" remains FTV. The name of the volume remains unchanged.)

```
CLI> start flexible-tier-migration -volume-name TPV000A -ftrp-number 4 -priority auto
```

3.2.3 ODX Buffer Volume

This section describes the commands that are related to the management of volumes for the backup area that is used for Offloaded Data Transfer (ODX).

The functions to control ODX Buffer volumes are as follows:

- Setting the ODX mode
- Creating an ODX Buffer volume
- Setting an ODX Buffer volume
- Deleting an ODX Buffer volume

The commands that are used for ODX Buffer volumes are shown below.

Function	Command
Creating volumes	create odx-buffer-volume
Changing volume settings	set odx-buffer-volume
Formatting volumes	format volume
Expanding volumes	expand volume
Displaying a list of volumes	show volumes
Displaying the progress of volume processes	show volume-progress
Deleting volumes	delete odx-buffer-volume
Starting RAID Migration	start migration
Stopping RAID Migration	stop migration
Displaying a list of volumes undergoing RAID Migration	show migrations

show odx-mode

This command displays the operation mode for the Offloaded Data Transfer function.

■ Syntax

```
show odx-mode
```

■ Parameter

No parameters.

■ Output

Item name	Description
Offloaded Data Transfer Mode	Operation mode for the Offloaded Data Transfer function (Disable: disabled, Enable: enabled)

■ Example(s)

The following example displays the operation mode for the Offloaded Data Transfer function:

```
CLI> show odx-mode  
Offloaded Data Transfer Mode [Enable]
```

set odx-mode

This command specifies the operation mode for the Offloaded Data Transfer function.

■ Syntax

```
set odx-mode -mode {enable | disable}
```

■ Parameter

- mode This parameter specifies whether to enable or disable the Offloaded Data Transfer function.
- enable The Offloaded Data Transfer function is enabled.
 - disable The Offloaded Data Transfer function is disabled.

■ Example(s)

The following example enables the Offloaded Data Transfer function:

```
CLI> set odx-mode -mode enable
```

The following example disables the Offloaded Data Transfer function:

```
CLI> set odx-mode -mode disable
```

create odx-buffer-volume

This command creates the ODX Buffer volume. The ODX mode setting must be enabled. Only one ODX Buffer volume can be registered for an ETERNUS DX/AF (multiple ODX Buffer volumes cannot be created).

Caution

Encryption-related functions cannot be used in the DX60 S4/DX60 S3.

Note

Depending on the model, the support state of the encryption-related functions may differ.

Syntax

```
create odx-buffer-volume -name name {-rg-number rg_number | -rg-name rg_name |  
-pool-number pool_number | -pool-name pool_name | -ftrp-number ftrp_number | -ftrp-name ftrp_name}  
-type {open | standard | tpv | ftv} -size {size{tb | gb | mb} | max} [-priority {ftrp_number | auto}]  
[-attention attention] [-encryption {enable | disable}]  
[-allocation {thin | thick}]
```

Parameter

-name This parameter specifies the name for the ODX Buffer volume. Only one name can be specified. For details, refer to ["1.2.11 Volume Syntax" \(page 40\)](#).

name ODX Buffer volume name

-rg-number or -rg-name

This parameter specifies the identifier of the RAID group in which the ODX Buffer volume is to be created. For details, refer to ["1.2.10 RAID Group Syntax" \(page 39\)](#). This parameter can be set when "open" or "standard" are set for the "-type" parameter.

rg_number RAID group number

rg_name RAID group name

-pool-number or -pool-name

This parameter specifies the identifier of the TPP in which the ODX Buffer volume is to be created. For details, refer to ["1.2.7 Thin Provisioning Pool Syntax" \(page 36\)](#). This parameter can be specified when "tpv" is set for the "-type" parameter.

pool_number Thin Provisioning Pool number

pool_name Thin Provisioning Pool name

-ftrp-number or -ftrp-name

This parameter specifies the identifier of the FTRP in which the ODX Buffer volume is to be created. For details, refer to ["1.2.9 Flexible Tier Sub Pool Syntax" \(page 38\)](#). This parameter can be specified when "ftv" is set for the "-type" parameter.

ftrp_number FTRP number

ftrp_name FTRP name

-type This parameter specifies the volume type of the ODX Buffer volume.

open Standard volume (Standard). "open" type volumes that are created are displayed as standard volumes.

standard Normal open volumes (Standard)

tpv Thin Provisioning Volume (TPV)

ftv Flexible Tier Volume (FTV)

-size This parameter specifies the size of the ODX Buffer volume. Select whether terabytes (TB), gigabytes (GB), or megabytes (MB) are used for the capacity. From 1GB to 1TB can be specified. Example: 1tb (1TB), 120gb (120GB), 1024mb (1024MB)

size ODX Buffer volume capacity (in TB, GB, or MB)

max An ODX Buffer volume is created using the entire capacity of the maximum free area of the specified RAID group. This option can be specified only when the volume type is Standard (Open). If multiple free areas exist in the specified RAID group, the volume is created by using only the largest of the free areas.

-priority Optional. This parameter is only enabled when the volume type of the ODX Buffer volume is FTV. Specify the FTSP number to set the priority for allocating a Flexible Tier Sub Pool (FTSP) to the FTV that is to be created. If this parameter is omitted or "auto" is specified, the FTSP is automatically allocated.

ftsp_number FTSP number

auto The FTSP is automatically allocated.

-attention Optional. This parameter is only enabled when the volume type of the ODX Buffer volume is TPV or FTV. Specify the threshold (attention level) for the TPV or FTV. From 1% to 100% can be specified. If this parameter is omitted, the default value (80%) is set.

attention Threshold (attention level) for the TPV or FTV

-encryption Optional. This parameter is only enabled when the volume type of the ODX Buffer volume is Open (Standard). Specify this parameter to encrypt a volume. If "enable" is specified, the volume data that is specified is encrypted. If this parameter is omitted, "disable" is specified.

enable The volume data is encrypted.

disable No operation.

-allocation Optional. If omitted, "thin" is set. During normal operations, the value of this parameter does not need to be changed from the default value ("thin"). When "thick" is specified, the same logical capacity is allocated to the physical capacity when the volume is created. The specifiable volume types are TPV and NAS user volumes ("nas-tpv"), or NAS backup volumes ("nas-tpv-backup").

thin	A physical volume is allocated to an area when the area accepts write I/Os (default).
thick	A physical volume with the same size as the logical capacity is allocated when volumes are created.

■ Example(s)

The following example creates the ODX Buffer volume that is named "VOL001" in a RAID group that is named "RGP001". The volume type is Standard. The volume size is 1GB:

```
CLI> create odx-buffer-volume -name VOL001 -rg-name RGP001 -type standard -size 1gb
```

The following example creates an encrypted ODX Buffer volume:

```
CLI> create odx-buffer-volume -name VOL001 -rg-name RGP001 -type standard -size 1tb -encryption enable
```

The following example creates the ODX Buffer volume called TPV1 in TPP#01. The volume type of the ODX Buffer volume is TPV and the attention level is 80%:

```
CLI> create odx-buffer-volume -name TPV1 -pool-number 01 -type tpv -size 100gb -attention 80
```

The following example adds the ODX Buffer volume called TPV1 in TPP#01, but a Warning message is displayed because "TPP#01" is in the "overprovisioning" state:

```
CLI> create odx-buffer-volume -name TPV1 -pool-number 1 -type tpv -size 800gb  
Warning: The relevant TPP is in overprovisioning status. Please be sure to add new disks to the TPP before it runs out of space.
```

The following example creates the ODX Buffer volume that is called FTV0002 and allocates the ODX Buffer volume to FTRP#0. The volume type of the ODX Buffer volume is FTV and the attention level being set to 80%:

```
CLI> create odx-buffer-volume -type ftv -name FTV0002 -ftrp-number 0 -size 500gb -attention 80
```

set odx-buffer-volume

This command changes the information of the ODX Buffer volume that is registered in the ETERNUS DX/AF.

Caution

Encryption-related functions cannot be used in the DX60 S4/DX60 S3.

Note

Depending on the model, the support state of the encryption-related functions may differ.

Syntax

```
set odx-buffer-volume {-volume-number volume_number | -volume-name volume_name}  
[-name name] [-priority {ftsp_number | auto}] [-attention attention] [-encryption {enable | disable}]
```

Parameter

-volume-number or -volume-name

This parameter specifies the identifier of the ODX Buffer volume for which the settings are to be changed. Only one volume can be specified at the same time. For details, refer to ["1.2.11 Volume Syntax" \(page 40\)](#).

volume_number ODX Buffer volume number

volume_name ODX Buffer volume name

-name Optional. This parameter specifies the new name for the ODX Buffer volume. For details about the contents that can be entered, refer to ["1.2.11 Volume Syntax" \(page 40\)](#). If omitted, the alias name of the target volume is not changed.

name ODX Buffer volume name

-priority Optional. This parameter is only enabled when the type of the ODX Buffer volume is FTV. Specify the FTSP number to set the priority for allocating a Flexible Tier Sub Pool (FTSP) to the target FTV. If "auto" is input, the FTSP is automatically allocated. If omitted, the FTSP is not changed.

ftsp_number FTSP number

auto The FTSP is automatically allocated.

-attention Optional. This parameter is only enabled when the type of the ODX Buffer volume is TPV or FTV. Specify the threshold (attention level) for the TPV or FTV. From 1% to 100% can be specified. If omitted, the threshold value is not changed.

attention Threshold (attention level) for the TPV or FTV

-encryption Optional. This parameter is only enabled when the type of the ODX Buffer volume is Open (Standard). Specify this parameter to encrypt a volume. If "enable" is specified, the data of the specified ODX Buffer volume is encrypted. If this parameter is omitted, "disable" is specified.

enable The data of the ODX Buffer volume is encrypted.

disable No operation.

■ Example(s)

The following example changes the ODX Buffer volume name from "FTV0003" to "FTV_0003":

```
CLI> set odx-buffer-volume -volume-name FTV0003 -name FTV_0003
```

The following example changes the attention to "60%" and the priority for FTSP allocation for the ODX Buffer volume #02 (FTV) to FTSP #3:

```
CLI> set odx-buffer-volume -volume-number 2 -priority 3 -attention 60
```

delete odx-buffer-volume

This command deletes an ODX Buffer volume that is registered in the ETERNUS DX/AF.

- The RAID Migration function and the balancing TPV function for RAID groups must be stopped.
- Copy sessions for the ODX Buffer volume must be stopped.

■ Syntax

```
delete odx-buffer-volume {-volume-number volume_number | -volume-name volume_name}
```

■ Parameter

-volume-number or -volume-name

This parameter specifies the identifier of the ODX Buffer volume that is to be deleted. Only one volume can be specified. If a volume other than the ODX Buffer volume is specified, an error occurs. For details, refer to ["1.2.11 Volume Syntax" \(page 40\)](#).

volume_number Volume number

volume_name Volume name

■ Example(s)

The following example deletes an ODX Buffer volume that is named "ODTV001".

```
CLI> delete odx-buffer-volume -volume-name ODTV001
```

3.2.4 Extreme Cache

This section explains the commands that are related to the Extreme Cache function and the Extreme Cache Pool function.

This function improves read performance by using flash memory as the secondary cache. For the Extreme Cache function, PFM's are used as the secondary cache. For the Extreme Cache Pool function, SSDs (including SSD SEDs) are used as the secondary cache.

Performance wise, Extreme Cache function that uses PFM's is faster than the Extreme Cache Pool function. For the DX500 S4/ DX600 S4, the DX500 S3/ DX600 S3, and the DX8700 S3/ DX8900 S3, using the Extreme Cache function is recommended.

Caution

- The Extreme Cache function is not available for the following ETERNUS DX/AF storage systems:
 - DX60 S4/ DX60 S3
 - DX100 S4/ DX100 S3
 - DX200 S4/ DX200 S3
 - DX8100 S3
 - AF250 S2/ AF250
 - AF650 S2/ AF650
 - DX200F
 - ETERNUS DX/AF storage systems not equipped with a PFM
- The Extreme Cache Pool function is not available for the following ETERNUS DX/AF storage systems:
 - DX60 S4/ DX60 S3
 - DX8100 S3
 - AF250 S2/ AF250
 - AF650 S2/ AF650
 - DX200F
- Value SSDs cannot be used as the secondary cache for the Extreme Cache Pool function.

To use the Extreme Cache function and the Extreme Cache Pool function, enable the functions, and set the cache capacity and control function.

Described below are the commands used with the Extreme Cache function and the Extreme Cache Pool function:

Function	Command used
Sets the Extreme Cache function for the ETERNUS DX/AF (enable/disable) Sets the PFM memory size to use as cache Sets the cache control function Sets the Extreme Cache Pool function for the ETERNUS DX/AF (enable/disable)	set extreme-cache
Displays the setting information of the Extreme Cache function or the Extreme Cache Pool function	show extreme-cache
Sets the Extreme Cache function or the Extreme Cache Pool function for a volume unit during a volume creation (enable/disable)	create volume [-exc]
Configures the setting function of the Extreme Cache function or the Extreme Cache Pool function for the existing volume (enable/disable)	set volume-exc
Displays the Extreme Cache function or the Extreme Cache Pool function in the volume unit (enable/disable)	show volumes [-mode detail]
Creates Extreme Cache Pools Creates an Extreme Cache Pool dedicated RAID group and an Extreme Cache Pool dedicated volume in the assigned CM	create extreme-cache-pool

Function	Command used
Displays summary information for all of the Extreme Cache Pools that exist in the ETERNUS DX/AF, or detailed information of the Extreme Cache Pool for the specified CM	show extreme-cache-pool
Deletes the Extreme Cache Pool dedicated RAID group and the Extreme Cache Pool dedicated volume from the assigned CM	delete extreme-cache-pool

The Extreme Cache function for Flexible Tier Volumes (FTVs) is controlled by a software application.

show extreme-cache

This command displays whether the Extreme Cache (EXC) function or the Extreme Cache Pool function is enabled. This command also displays the currently-specified capacity, and the maximum capacity of the PCIe Flash Modules (PFMs) that is used as secondary cache for each ETERNUS DX/AF.

Syntax

```
show extreme-cache
```

Parameter

No parameters.

Output

Item name	Description
Mode	Indicates whether the EXC function or the Extreme Cache Pool function is enabled.
Initial Caching Threshold	Initial cache threshold. Initial cache threshold is a number of data access counts taken until the data is stored in the PFM or SSD as cached data for the first time. The initial cache threshold value is enabled when the ETERNUS DX/AF is powered on, or the EXC function/Extreme Cache Pool function becomes enabled, and when all the space in the PFM or SSD is used up for the first time.
Caching Threshold	Cache threshold. The cache threshold is the number of data access counts taken until the data is stored as cached data in the PFM or SSD. The caching threshold value is enabled after the ETERNUS DX/AF is powered on, or the EXC function/Extreme Cache Pool function becomes enabled, and when all the space in the PFM or SSD is used up for the first time.
Monitoring I/O	Indicates whether the cache pages that are used for read I/O and write I/O are counted up as the monitoring target.
Caching Priority	Displays the priority when staging the information on the drive to EXC or Extreme Cache Pool. Setting a larger value reduces the time until staging but there is a possibility that the host I/O will be impacted.
EXC Current Capacity(GB)	Currently specified PFM capacity of each ETERNUS DX/AF that is used as an EXC (unit: GB)
EXC Max Capacity(GB)	Maximum capacity that can be used as an EXC for each ETERNUS DX/AF (unit: GB)
Location	Location of the CM that is showing the EXC capacity information (only for the DX8700 S3/DX8900 S3)
Current Capacity(GB)	Currently specified PFM capacity of each ETERNUS DX/AF that is used as an EXC (unit: GB) (only for the DX8700 S3/DX8900 S3)
Total PFM Capacity(GB)	Total capacity (GB) of the installed PFM (only for the DX8700 S3/DX8900 S3)

■ Example(s)

The following example displays the result of a command execution when the EXC function is enabled (for the DX500 S4/ DX600 S4 and the DX500 S3/DX600 S3):

```
CLI> show extreme-cache
Mode [Extreme Cache]
Initial Caching Threshold [1]
Caching Threshold [5]
Monitoring I/O [Read]
Caching Priority [10]
EXC Current Capacity(GB) [1400]
EXC Max Capacity(GB) [2800]
```

The following example displays the result of a command execution when the Extreme Cache Pool function is enabled:

```
CLI> show extreme-cache
Mode [Extreme Cache Pool]
Initial Caching Threshold [1]
Caching Threshold [5]
Monitoring I/O [Read]
Caching Priority [10]
```

The following example displays the result of a command execution when the EXC function and the Extreme Cache Pool function are disabled (for the DX500 S4/DX600 S4 and the DX500 S3/DX600 S3):

```
CLI> show extreme-cache
Mode [Disable]
Initial Caching Threshold [1]
Caching Threshold [5]
Monitoring I/O [Read]
Caching Priority [10]
EXC Current Capacity(GB) [0]
EXC Max Capacity(GB) [2800]
```

The following example displays the result of a command execution when the EXC function is enabled (for the DX8700 S3/ DX8900 S3):

```
CLI> show extreme-cache
Mode [Extreme Cache]
Initial Caching Threshold [1]
Caching Threshold [5]
Monitoring I/O [Read]
Caching Priority [10]
<EXC Capacity Information>
  Location  Current      Total PFM
           Capacity(GB) Capacity(GB)
-----
CE#0 CM#0      1400        1400
CE#0 CM#1       700        1400
CE#1 CM#0         0           0
CE#1 CM#1       700         700
```

The following example displays the result of a command execution when the EXC function is disabled (for the DX8700 S3/ DX8900 S3):

```
CLI> show extreme-cache
Mode [Disable]
Initial Caching Threshold [1]
Caching Threshold [5]
Monitoring I/O [Read]
Caching Priority [10]
<EXC Capacity Information>
  Location    Current      Total PFM
             Capacity(GB) Capacity(GB)
-----
CE#0 CM#0    -            1400
CE#0 CM#1    -            1400
CE#1 CM#0    -             0
CE#1 CM#1    -             700
```

set extreme-cache

This command enables or disables the Extreme Cache (EXC) function or the Extreme Cache Pool function for the ETERNUS DX/AF.

When the EXC function or the Extreme Cache Pool function is enabled, this command also sets the secondary cache memory capacity for each ETERNUS DX/AF. The EXC function uses PFMs as secondary cache memory. The Extreme Cache Pool function uses SSDs as secondary cache memory.

The EXC function or the Extreme Cache Pool function is disabled by default.

When the EXC function or the Extreme Cache Pool function is enabled, this command can set the threshold and the monitoring target.

Caution

To enable or disable the EXC function or the Extreme Cache Pool function for each volume, use the "set volume-exc" command.

■ Syntax

```
set extreme-cache [-mode {enable | disable | pool}] [-capacity capacity]  
[-initial-caching-threshold initial_caching_threshold]  
[-caching-threshold {disable | caching_threshold}]  
[-monitoring-io {read | read-write}] [-update-exc]  
[-caching-priority caching_priority]
```

■ Parameter

-mode	Optional. This parameter specifies whether the EXC function or the Extreme Cache Pool function is enabled for the ETERNUS DX/AF. If this parameter is omitted, the existing setting remains unchanged.
enable	The EXC function is enabled for the ETERNUS DX/AF.
disable	The EXC function or the Extreme Cache Pool function is disabled for the ETERNUS DX/AF and the capacity that is used for the EXC is set to 0GB. (The setting value before the EXC function is disabled is not retained when the EXC function is enabled again.)
pool	The Extreme Cache Pool function is enabled for the ETERNUS DX/AF.
-capacity	Optional. This parameter specifies the PFM capacity that is used as cache for each ETERNUS DX/AF (and is only supported in the DX500 S4/DX600 S4 and the DX500 S3/DX600 S3). If this parameter is omitted, the existing setting remains unchanged.

Caution

- An error occurs when this parameter is specified together with the "-mode disable" parameter or when the EXC function or the Extreme Cache Pool function is disabled for the ETERNUS DX/AF and this parameter is specified with the "-mode" parameter omitted.
- For the DX8700 S3/DX8900 S3, "-capacity" cannot be specified when the EXC function is enabled because the areas for the EXC function are secured by all the PFMs that have been installed.
- When expanding the PFM, refer to the description of the "-update-exc" parameter.

This parameter allows a multiple of 100GB to be specified for the cache size. If a value that is indivisible by 100GB is specified, an error occurs.

Example: "-capacity 500gb" can be specified. "-capacity 550gb" cannot be specified.

"0gb" can be specified.

Only "gb" can be specified for the capacity.

capacity PFM capacity

-initial-caching-threshold

Optional. This parameter specifies a number of data access counts taken until the data is stored in the PFM or SSD as cached data for the first time. The initial cache threshold is a number of data access counts taken until the data is stored in the PFM or SSD as cached data for the first time. Staging data becomes more frequent during a Random Read when this value is smaller. The settable range is 1 to 16. The default value is "1". If this parameter is omitted, the existing setting remains unchanged.

Caution

- Setting a value smaller than the Caching Threshold is recommended.
- This parameter cannot be specified if the EXC function or the Extreme Cache Pool function is disabled.

initial_caching_threshold

Initial caching threshold (1 - 16)

-caching-threshold

Optional. The parameter value specifies the number of data access counts taken until the data is stored as cached data in the PFM or SSD. The caching threshold value is enabled after the ETERNUS DX/AF is powered on, or the EXC function or the Extreme Cache Pool function becomes enabled, and when all the space in the PFM or SSD is used up for the first time. Staging data in the PFM or SSD becomes more frequent when this value is smaller. The settable range is 1 to 16. The default value is "5". If this parameter is omitted, the existing setting remains unchanged.

Caution

- Setting a value larger than the Initial Caching Threshold is recommended.
- This parameter cannot be specified if the EXC function or the Extreme Cache Pool function is disabled.

disable

Data disposal is prohibited. The cached data in the PFM or Extreme Cache Pool cannot be rewritten.

caching_threshold Caching threshold (1 - 16)

-monitoring-io

Optional. This parameter specifies whether the cache pages in the PFM or Extreme Cache Pool that are used for read I/O and write I/O are counted up as the monitoring target. The default value is "read".

read Only the cache pages that are used for read I/O are monitored.

read-write The cache pages that are used for read I/O and write I/O are monitored.

-update-exc

Optional. This parameter updates the capacity of the area for the EXC function (and is supported only in the DX8700 S3/DX8900 S3).

If new PFMs are added, the capacity of the area for the EXC function and the total capacity of the installed PFMs may not match. In that case, execute this command by specifying "-update-exc" parameter to recalculate the total capacity of the PFM and update the capacity of the area for the EXC function.

-caching-priority

Optional. This parameter specifies the priority when staging to the EXC function or the Extreme Cache Pool function.

When staging the information on the drive to the EXC function or the Extreme Cache Pool function, conflicts may occur with host I/Os.

If the set value is large, the time until staging becomes short but the load on the drive increases. Because of that, there is a possibility of delays to the host I/O in the pool where the selected drive belongs. In addition, if the set value is small, the time until staging becomes long but the load on the drive decreases.

The specifiable range is 1 to 10. The default value is 10. If omitted, this parameter remains unchanged.

caching_priority The priority when staging to the EXC function or the Extreme Cache Pool function (1 to 10)

■ Example(s)

The following example enables the EXC function for the ETERNUS DX/AF and sets the cache capacity to 1000GB:

```
CLI> set extreme-cache -mode enable -capacity 1000gb
```

The following example enables the Extreme Cache Pool function for the ETERNUS DX/AF:

```
CLI> set extreme-cache -mode pool
```

set volume-exc

This command enables or disables the Extreme Cache (EXC) function or the Extreme Cache Pool function for each volume.

Caution

- The EXC function or the Extreme Cache Pool function is not used regardless of the setting of each volume when the EXC function or the Extreme Cache Pool function is disabled for the ETERNUS DX/AF. Whether the EXC function or the Extreme Cache Pool function is enabled for a volume can be checked by using the "-mode detail" parameter of the "show volumes" command.
- The EXC function or the Extreme Cache Pool function is disabled for volumes when the volumes are moved to a RAID group or a TPP that consists of SSDs by RAID Migration. When volumes are moved from a RAID group or a TPP that consists of SSDs to a RAID group or a TPP that consists of disks, the EXC function or the Extreme Cache Pool function is enabled for the volumes. When volumes are moved between RAID groups or TPPs that consist of disks, whether the EXC function or the Extreme Cache Pool function is enabled or disabled remains unchanged for the volumes.
- The EXC function or the Extreme Cache Pool function for FTVs is controlled by a software application (the EXC function or the Extreme Cache Pool function is available for the FTV even if an FTRP contains an FTSP that consists of SSDs).

Syntax

```
set volume-exc {-volume-number volume_numbers | -volume-name volume_name | -all}  
-mode {enable | disable}
```

Parameter

-volume-number, -volume-name, or -all

This parameter specifies the volume that the setting is changed for. When the "-all" parameter is specified, the settings are changed for all of the volumes that the EXC function or the Extreme Cache Pool function is available for.

Caution

The "-all" parameter applies the change in settings to all of the Open volumes, Standard volumes, WSVs, and TPVs (this does not apply when the volume belongs to a RAID group that consists of SSDs or a TPP that consists of SSDs).

This parameter allows multiple volume numbers and a range of volume numbers to be specified. For details, refer to ["1.2.11 Volume Syntax" \(page 40\)](#).

This parameter allows only a single volume name to be specified.

This parameter can be used for Open volumes, Standard volumes, WSVs, and TPVs that do not belong to a RAID group that consists of SSDs or a TPP that consists of SSDs. If a volume that cannot be set is specified for a volume number or a volume name, this command results in an error.

volume_numbers Volume number

volume_name Volume name

-all All volumes

-mode This parameter specifies whether to enable the EXC function or the Extreme Cache Pool function for the volume.

 **Caution**

- The EXC function or the Extreme Cache Pool function cannot be used regardless of the setting of each volume when the EXC function or the Extreme Cache Pool function is disabled for the ETERNUS DX/AF.
- The EXC function or the Extreme Cache Pool function cannot be used if External Volumes are specified.

enable	The EXC function or the Extreme Cache Pool function is enabled.
disable	The EXC function or the Extreme Cache Pool function is disabled.

■ Example(s)

The following example enables the EXC function or the Extreme Cache Pool function for all of the volumes that are registered in the ETERNUS DX/AF and can be applied to the EXC function:

```
CLI> set volume-exc -mode enable -all
```

The following example disables the EXC function or the Extreme Cache Pool function for volumes 0, 2, 5, 9, 10, and 11:

```
CLI> set volume-exc -volume-number 0,2,5,9-11 -mode disable
```

show extreme-cache-pool

This command displays a summary of all Extreme Cache Pools that exist in the ETERNUS DX/AF or details of the Extreme Cache Pools for the specified CM(s).

Syntax

```
show extreme-cache-pool [-cm {cm_numbers | all}]
```

Parameter

-cm Optional. This parameter specifies the controller module (CM) number to display the Extreme Cache Pool information. Multiple CM numbers can be specified by separating them with a comma (.). However, the same CM number cannot be specified twice.
When "all" is specified, detailed information of all the Extreme Cache Pools that exist in the ETERNUS DX/AF is displayed.
If omitted, summary information of all the Extreme Cache Pools that exist in the ETERNUS DX/AF is displayed.

cm_numbers

CM number to display detailed information of Extreme Cache Pool.

0 CM#0 (DX100 S4/DX200 S4, DX500 S4/DX600 S4, DX100 S3/DX200 S3, and DX500 S3/DX600 S3 only)

1 CM#1 (DX100 S4/DX200 S4, DX500 S4/DX600 S4, DX100 S3/DX200 S3, and DX500 S3/DX600 S3 only)

wx CE#w-CM#x (DX8700 S3/DX8900 S3 only)
"w" is the controller enclosure (CE) number and "x" is the controller module (CM) number.

Example: "01" indicates CE#0-CM#1

For the controller enclosure number, the range that the value can be specified with is 0 to b (hex).

For the controller module number, 0 or 1 can be specified.

all Detailed information of all the Extreme Cache Pools that exist in the ETERNUS DX/AF

Output

Item name	Description
Location	Assigned CM for Extreme Cache Pool
Capacity(GB)	Capacity of Extreme Cache Pool
Encryption	Encryption status (Enable/Disable/"Enable[SED]")
Member Disks	SSDs that are used to configure Extreme Cache Pool dedicated RAID groups. If multiple member drives exist, they are displayed separated by commas (,).

■ Example(s)

The following example shows information when parameters are omitted (for the DX100 S4/DX200 S4, the DX500 S4/DX600 S4, the DX100 S3/DX200 S3, and the DX500 S3/DX600 S3).

Summary information for all Extreme Cache Pools is displayed:

```
CLI> show extreme-cache-pool
Location  Capacity(GB)
-----  -
CM#0      1600
CM#1      -
```

The following example shows information that is displayed when CM#0 is specified (for the DX100 S4/DX200 S4, the DX500 S4/DX600 S4, the DX100 S3/DX200 S3, and the DX500 S3/DX600 S3).

Detailed information for Extreme Cache Pool is displayed:

```
CLI> show extreme-cache-pool -cm 0
<Extreme Cache Pool Information>
Location      [CM#0]
Capacity(GB)  [1600]
Encryption    [Enable]
Member Disks  [DE#01-Disk#0, DE#01-Disk#1]
```

The following example shows information when parameters are omitted (for the DX8700 S3/DX8900 S3).

Summary information for all Extreme Cache Pools is displayed:

```
CLI> show extreme-cache-pool
Location  Capacity(GB)
-----  -
CE#0 CM#0      1600
CE#0 CM#1      1600
CE#1 CM#0      -
CE#1 CM#1      1600
```

The following example shows information that is displayed when CE#0 CM#0 is specified (for the DX8700 S3/DX8900 S3).

Detailed information for Extreme Cache Pool is displayed:

```
CLI> show extreme-cache-pool -cm 00
<Extreme Cache Pool Information>
Location      [CE#0 CM#0]
Capacity(GB)  [1600]
Encryption    [Enable]
Member Disks  [DE#01-Disk#0, DE#01-Disk#1]
```

The following example shows information that is displayed when CM#1 is specified (for the DX100 S4/DX200 S4, the DX500 S4/DX600 S4, the DX100 S3/DX200 S3, and the DX500 S3/DX600 S3. Configured with Self-Encrypting SSDs [SSD SED]).

Detailed information for Extreme Cache Pool is displayed:

```
CLI> show extreme-cache-pool -cm 1
<Extreme Cache Pool Information>
Location      [CM#1]
Capacity(GB)  [1600]
Encryption    [Enable(SED)]
Member Disks  [DE#01-Disk#0, DE#01-Disk#1]
```

create extreme-cache-pool

This command creates Extreme Cache Pools. An Extreme Cache Pool dedicated RAID group and an Extreme Cache Pool dedicated volume are created simultaneously.

Caution

- RAID0 is the only supported RAID level for the Extreme Cache Pool dedicated RAID group. The group is configured with SSDs.
- Only one Extreme Cache Pool dedicated RAID group can be created for each assigned CM.
- Only one Extreme Cache Pool dedicated volume is created in each Extreme Cache Pool dedicated RAID group. Because Extreme Cache Pool dedicated volumes are created, the maximum number of volumes that can be registered in each ETERNUS DX/AF is reduced.

Syntax

```
create extreme-cache-pool -disks disks -cm cm_number  
[-encryption {enable | disable}]
```

Parameter

-disks This parameter specifies the SSDs that are used to configure the Extreme Cache Pool dedicated RAID group. Multiple drives can be specified by separating them with a comma (.). The range of drives cannot be specified.

Caution

- SSDs (including SSD SEDs) are the only supported configuration drive for the Extreme Cache Pool dedicated RAID group.
- The supported number of member drives is one for the DX100 S4/DX200 S4 and the DX100 S3/DX200 S3, and up to four for the DX500 S4/DX600 S4, the DX500 S3/DX600 S3, and the DX8700 S3/DX8900 S3.
- The maximum capacity for an Extreme Cache Pool dedicated volume is 400GB for the DX100 S4/DX200 S4 and the DX100 S3/DX200 S3, and 1600GB for the DX500 S4/DX600 S4, the DX500 S3/DX600 S3, and the DX8700 S3/DX8900 S3.
For the DX100 S3/DX200 S3, an SSD with a capacity that exceeds the maximum capacity of a volume for Extreme Cache Pools (400GB) can be used. However, a volume capacity that exceeds the maximum capacity of a volume for Extreme Cache Pools (400GB if an 800GB SSD is used) cannot be used.
- Select the SSDs within the drive enclosures that are directly connected to the controller module (CM number) that is to be specified with the "-cm" parameter.
- A mix of SSDs and SED SSDs cannot be specified.

disks Drives

- cm This parameter specifies the assigned controller module (CM) number for Extreme Cache Pool.
- cm_number* CM number
- 0 CM#0 (DX100 S4/DX200 S4, DX500 S4/DX600 S4, DX100 S3/DX200 S3, and DX500 S3/DX600 S3 only)
 - 1 CM#1 (DX100 S4/DX200 S4, DX500 S4/DX600 S4, DX100 S3/DX200 S3, and DX500 S3/DX600 S3 only)
 - wx* CE#w-CM#x (DX8700 S3/DX8900 S3 only)
"w" is the controller enclosure number, and "x" is the controller module number.
Example: "01" indicates CE#0-CM#1
For the controller enclosure number, the range that the value can be specified with is 0 to b (hex).
For the controller module number, 0 or 1 can be specified.
- encryption Optional. This parameter specifies whether to set the firmware encryption for the Extreme Cache Pool dedicated volume. If omitted, it is handled as if "disable" is selected.

 **Caution**

- If "disable" is specified, the created Extreme Cache Pool cannot be used as a secondary cache for the I/O to the encrypted volume.
- If encrypted volumes are included in the volumes controlled by the assigned CM, select "enable".
- If SED SSD is selected for the "-disks" parameter, this parameter cannot be specified.

-
- enable Firmware encryption is enabled.
disable Firmware encryption is disabled.

■ Example(s)

The following example creates an Extreme Cache Pool on CM#0:

```
CLI> create extreme-cache-pool -disks 003,004 -cm 0 -encryption enable
```

delete extreme-cache-pool

This command deletes an Extreme Cache Pool dedicated RAID group and an Extreme Cache Pool dedicated volume.

Syntax

```
delete extreme-cache-pool -cm {cm_numbers | all}
```

Parameter

-cm This parameter specifies the assigned controller module (CM) number of an Extreme Cache Pool dedicated RAID group and Extreme Cache Pool dedicated volume to be deleted. Multiple CM numbers can be specified by separating them with a comma (.). However, the same CM number cannot be specified twice.

<i>cm_numbers</i>	CM number
0	CM#0 (DX100 S4/DX200 S4, DX500 S4/DX600 S4, DX100 S3/DX200 S3, and DX500 S3/DX600 S3 only)
1	CM#1 (DX100 S4/DX200 S4, DX500 S4/DX600 S4, DX100 S3/DX200 S3, and DX500 S3/DX600 S3 only)
wx	CE#w-CM#x (DX8700 S3/DX8900 S3 only) "w" is the controller enclosure number, and "x" is the controller module number. Example: "01" indicates CE#0-CM#1 For the controller enclosure number, the range that the value can be specified with is 0 to b (hex). For the controller module number, 0 or 1 can be specified.
all	All the Extreme Cache Pool dedicated RAID group and the Extreme Cache Pool dedicated volume that exist in the ETERNUS DX/AF

Example(s)

The following example deletes all the Extreme Cache Pool dedicated RAID groups and Extreme Cache Pool dedicated volumes that exist in the ETERNUS DX/AF:

```
CLI> delete extreme-cache-pool -cm all
```

The following example deletes the Extreme Cache Pool dedicated RAID group and the Extreme Cache Pool dedicated volume on CM#0:

```
CLI> delete extreme-cache-pool -cm 0
```

3.2.5 WWOL

The ETERNUS DX/AF supports Virtual Volumes (WWOL) that are VMware vSphere specific logical volumes. WWOL configuration and management is performed from ETERNUS SF Storage Cruiser. In addition, ETERNUS VASA Provider (software for coordinating vCenter Server with the ETERNUS DX/AF) is required on the storage management server. For details, refer to "Design Guide (Basic)" of each model.

CLI supports the commands for switching the WWOL mode, the operational commands of the WWOL Metadata exclusive FTV, and the WWOL Task operational commands of the CLI asynchronous command.

This section explains the commands that are related to the WWOL of the ETERNUS DX/AF.

▶ Caution

- To use the WWOL related functions, the WWOL mode must be enabled using the "set wvol-mode" command.
- WWOL mode is not supported in the DX60 S4/DX60 S3.
- WWOLs are created in FTRPs. The WWOL volume type is FTV.
- For WWOL, additional information called WWOL management information (Metadata) is required. WWOL Metadata is automatically created in the WWOL Metadata exclusive FTV during a WWOL creation.
- Perform changes to the WWOL settings from ETERNUS SF Storage Cruiser. For operations other than activation of the WWOL function, do not change the settings from CLI.
- Normally, the WWOL function is enabled when configuring the WWOL access path from ETERNUS SF Storage Cruiser. After creating an FTRP, if a chunk size modification of the ETERNUS DX/AF is performed together with a settings modification for the Thin Provisioning maximum pool capacity, even if a WWOL setting is performed from ETERNUS SF Storage Cruiser afterwards, the WWOL function does not become enabled. Before modifying the WWOL setting, enable the WWOL function by executing the "set wvol-mode" from CLI. For details on the chunk size, refer to ["3.3 Thin Provisioning Pool Management" \(page 245\)](#).

```
CLI> set wvol-mode -mode enable
Since the maximum pool capacity was changed, a different chunk size has been applied to the newly created Flexible Tier Pools.
Please do not register Flexible Tier Pools with different chunk size to the same WWOL Datastore.
Enter "y" to continue. Enter "n" to discard this command.
```

- If multiple FTRPs are registered to the storage container (WWOL datastore), do not mix FTRPs that have different chunk sizes within the same storage container.

WWOL control functions are as follows.

Function	Command used
Setting the WWOL mode (enable / disable)	set wvol-mode
Displaying the WWOL mode	show wvol-mode
Displaying WWOL information (The WWOL volume type is FTV.)	show volumes
Forcefully deleting WWOL Metadata exclusive FTVs	delete flexible-tier-volume
Recreating deleted WWOL Metadata exclusive FTVs	create flexible-tier-volume
Forcefully formatting WWOL Metadata exclusive FTVs	format flexible-tier-volume
Referencing the progress information of the WWOL task	show wvol-task

show vvol-mode

This command shows the VVOL mode of the ETERNUS DX/AF.

■ Syntax

```
show vvol-mode
```

■ Parameter

No parameters.

■ Output

Item name	Description
Mode	Displays whether the VVOL function is enabled or disabled (Enable/Disable)

■ Example(s)

The following example shows that the VVOL mode of the ETERNUS DX/AF is enabled:

```
CLI> show vvol-mode  
Mode                [Enable]
```

The following example shows that the VVOL mode of the ETERNUS DX/AF is disabled:

```
CLI> show vvol-mode  
Mode                [Disable]
```

set vvol-mode

This command sets whether the VVOL function of the ETERNUS DX/AF is enabled or disabled. VVOL functions are automatically enabled when VVOL related configurations are set from the software.

Caution

- To enable the VVOL function, the Thin Provisioning function must be enabled.
- If the VVOL function is changed from enabled to disabled, the ETERNUS DX/AF must be rebooted.

Syntax

```
set vvol-mode -mode {enable | disable}
```

Parameter

-mode This parameter specifies whether to enable the VVOL function.

Caution

- When disabling the VVOL function, the following requirements must all be fulfilled.
 - VVOL does not exist
 - VVOL task does not exist
- If a Flexible Tier Pool that is set with a smaller chunk size than the default chunk size set in the ETERNUS DX/AF exists, a confirmation message is displayed when the VVOL function is enabled.

enable	The VVOL function is enabled.
disable	The VVOL function is disabled.

Example(s)

The following example enables the VVOL function:

```
CLI> set vvol-mode -mode enable
```

The following example shows an output when an attempt is made to enabled the VVOL function while a Flexible Tier Pool that is set with a chunk size smaller than the default chunk size that is set in the ETERNUS DX/AF exists:

```
CLI> set vvol-mode -mode enable
Since the maximum pool capacity was changed, a different chunk size has been applied to the newly created Flexible Tier Pools.
Please do not register Flexible Tier Pools with different chunk size to the same VVOL Datastore.
Enter "y" to continue. Enter "n" to discard this command.
```

show wvol-task

This command collects and shows the progress information of the WVOL task. In addition, If the WVOL task state is Success or Error, that WVOL task is deleted.

Note

- Information that corresponds to the following API is output.
 - If the "-task-guid" parameter is omitted
getCurrentTask(), activateProviderEx()
 - If the "-task-guid" parameter is specified
getTaskUpdate()
- If the process of the API is synchronous and the process of CLI is asynchronous, VASA uses this command and continues to poll until the WVOL Task state becomes Success or Error.
- Required information is determined by each API as "Result". The "Result" output of CLI is classified by "Result Type". If WVOL GUID and Snapshot Info are reported, "Result" is displayed regardless of the WVOL Task state. Other than that, "Result" is displayed only if the WVOL Task state is Success.
- Once this command reports the WVOL task state as Success or Error for the WVOL task, the WVOL Task information is deleted. To delete the WVOL Task, this command must be executed with the "-task-guid" parameter specified. However, the WVOL Task is automatically deleted the moment the WVOL Task state changes to Success or Error only if the WVOLS are deleted via the software. Using this command to collect the progress information is not necessary.
- The normal output result of the CLI asynchronous command is the same as the normal output of this command if the "-task-guid" parameter is specified.

Syntax

```
show wvol-task [{-task-guid task_guid}]
```

Parameter

- task-guid Optional. This parameter specifies the WVOL Task GUID for displaying information. Specify the WVOL task GUID with a 32-digit (hex) numerical value that excludes the hyphen (-). Only one WVOL Task GUID can be specified.
If the specified WVOL Task state is Success or Error, that WVOL Task will be deleted. If omitted, WVOL Task information for all the currently executing tasks is displayed.

task_guid WVOL Task GUID

Output

Item name	Description
GUID	WVOL Task GUID
API Name	API name of the WVOL Task creation source
State	WVOL Task state (Error/Queued/Running/Success) When Error or Success is displayed for the WVOL Task, that WVOL Task is deleted. If Error or Success is not reported, the moment the progress information is collected, WVOL Tasks are not deleted. However, the WVOL Task is automatically deleted the moment the WVOL Task state changes to Success or Error only if the WVOLS are deleted via the software.
Error	Error that occurred in the WVOL Task. The reason is displayed in the error code.

Item name	Description
Queued	The VVOL task has been put in queue.
Running	The VVOL task is running. The progress rate is shown in Progress. (0 to 100%)
Success	The VVOL task finished.
Cancelable	Displays whether the VVOL Task can be canceled. If cancelable, the VVOL Task can be canceled with the "delete vol-task" command.
True	Can be canceled.
False	Cannot be canceled.
Cancelled	Displays whether the VVOL Task cancellation was initiated with the "delete vol-task" command.
True	Cancellation was initiated.
False	Cancellation was not initiated.
	<div style="border: 1px solid black; padding: 5px; margin: 10px 0;"> <p> Note</p> <p>When the cancellation process is complete, the State becomes Success. If the VVOL Task is checked with this command, that VVOL task is deleted.</p> </div>
Progress Update	Indicates whether the progress information can be collected.
Available	The progress information can be collected.
Not Available	The progress information cannot be collected.
Start Time	Start time of the VVOL Task
Estimate Time To Complete	Estimated time to complete the VVOL Task
Error Code	Error Code For states other than Error, a hyphen (-) is displayed.
Progress(%)	Progress rate of the VVOL Task (unit: %) For states other than Running, a hyphen (-) is displayed.
Host GUID	Displays the GUID of the host that created the VVOL Task. Displayed only if the VVOL Task was created by a policy other than Software Control. A hyphen (-) is displayed for the Software Control policy.
Volume Number	Volume number of the created volume. When API Name is "updateStorageProfileForVirtualVolume", this volume number is to be specified.
Volume GUID	GUID of the created volume. When API Name is "updateStorageProfileForVirtualVolume", this GUID is to be specified.
Chunk Size(KB)	Chunk size (unit: KB)
Unshared Chunks Count	Number of unshared chunks
Scanned Chunks	Number of scanned chunks
Snapshot Volume Number	Volume number of the volume created as the Snapshot destination
Snapshot Volume GUID	GUID of the volume created as the Snapshot destination
Parent Volume Number	Volume number of the Snapshot source volume
Parent Volume GUID	GUID of the Snapshot source volume

■ Example(s)

The following example shows VVOL Task information of the ETERNUS DX/AF:

```
CLI> show vvol-task
<VVOL Task Information>
GUID [3f2504e04f8911d39a0c0305e82c3301]
API Name [createVirtualVolume]
State [Running]
Cancelable [True]
Cancelled [False]
Progress Update [Available]
Start Time [2012-04-11 11:59:00]
Estimate Time To Complete [2012-04-11 12:00:00]
Error Code [-]
Progress(%) [60]
Host GUID [3f2504e04f8911d39a0c0305e82c213e]
<Result>
  Volume Number [2]
  Volume GUID [3f2504e04f8911d39a0c0305e82c330a]

<VVOL Task Information>
GUID [3f2504e04f8911d39a0c0305e82c3302]
API Name [createVirtualVolume]
State [Success]
Cancelable [False]
Cancelled [False]
Progress Update [Available]
Start Time [2012-04-11 12:01:00]
Estimate Time To Complete [2012-04-11 12:01:30]
Error Code [-]
Progress(%) [-]
Host GUID [3f2504e04f8911d39a0c0305e82c213e]
<Result>
  Volume Number [3]
  Volume GUID [3f2504e04f8911d39a0c0305e82c3309]

<VVOL Task Information>
GUID [3f2504e04f8911d39a0c0305e82c3303]
API Name [createVirtualVolume]
State [Error]
Cancelable [False]
Cancelled [False]
Progress Update [Available]
Start Time [2012-04-11 12:00:00]
Estimate Time To Complete [2012-04-11 12:00:30]
Error Code [XXXX]
Progress(%) [-]
Host GUID [3f2504e04f8911d39a0c0305e82c213e]
<Result>
  Volume Number [4]
  Volume GUID [3f2504e04f8911d39a0c0305e82c330c]

<VVOL Task Information>
GUID [3f2504e04f8911d39a0c0305e82c3304]
API Name [unsharedChunksVirtualVolume]
State [Success]
Cancelable [True]
Cancelled [False]
Progress Update [Available]
Start Time [2012-04-11 12:01:00]
Estimate Time To Complete [2012-04-11 12:01:30]
Error Code [-]
Progress(%) [-]
Host GUID [3f2504e04f8911d39a0c0305e82c213e]
<Result>
  Chunk Size(KB) [102400]
  Unshared Chunks Count [26214400]
  Scanned Chunks [300]
```

```
<VVOL Task Information>
GUID [3f2504e04f8911d39a0c0305e82c1231]
API Name [prepareToSnapshotVirtualVolume]
State [Queued]
Cancelable [True]
Cancelled [False]
Progress Update [Available]
Start Time [2012-04-11 12:01:15]
Estimate Time To Complete [2012-04-11 12:10:00]
Error Code [-]
Progress(%) [-]
Host GUID [3f2504e04f8911d39a0c0305e82c213e]
<Result>
  Snapshot Volume Number [3]
  Snapshot Volume GUID [3f2504e04f8911d39a0c0305e82c3303]
  Parent Volume Number [1]
  Parent Volume GUID [3f2504e04f8911d39a0c0305e82c3301]
```

3.3 Thin Provisioning Pool Management

This section explains the commands used for the following settings:

- Thin Provisioning Pool settings
- Eco-mode settings

Caution

The Thin Provisioning function is not supported by the DX60 S4/DX60 S3 1CM configuration and the DX100 S4/DX200 S4/DX100 S3/DX200 S3 1CM configuration.

3.3.1 Thin Provisioning Pool

This section explains the commands used for Thin Provisioning Pool management.

- Setting/releasing Thin Provisioning Pools
- Creating a Thin Provisioning Pool
- Changing an existing Thin Provisioning Pool
- Deleting Thin Provisioning Pools
- Expanding a Thin Provisioning Pool
- Formatting a Thin Provisioning Pool

Overview of the Thin Provisioning Pool settings

The procedure for the Thin Provisioning Pool (TPP) settings is as follows:

Procedure

1 Configuration settings

Before creating TPPs, the Thin Provisioning function should be enable to the system. Use the "set thin-provisioning" command to enable the function and use the "show thin-provisioning" command to confirm it.

Note

- When the Thin Provisioning function and Flexible Tier function are not being used, the Thin Provisioning function can be disabled. Use the "set thin-provisioning" command to disable the Thin Provisioning function.
- While VMware Virtual Volume (VVOL) is running, if the chunk size is changed at the same time the maximum pool capacity setting is changed, the following warning message related to VVOL is displayed. Check the content of the message and consider whether or not to continue the process.

```
CLI> set thin-provisioning -thin-pro enable -max-pool-capacity 16pb
By this setting change, a new chunk size will be applied to the newly created Flexible Tier Pools.
Please do not register Flexible Tier Pools with different chunk size to the same VVOL Datastore.
Enter "y" to continue. Enter "n" to discard this command.
```

2 TPP management

Use the "create thin-pro-pool" command to create a TPP.

Use the "show thin-pro-pools" command to confirm the creation of a TPP. After a TPP is created, use the "set thin-pro-pool" command to change the settings of a created TPP.

Note

- A TPP can be deleted by using the "delete thin-pro-pool" command.
 - The maximum number of pools is 256. However, a limited is applied by the maximum number of installed drives divided by two.
 - The maximum number of pools is the maximum total number of TPPs and FTSPs that can be created in the ETERNUS DX/AF.
-

3 Expanding TPP

Use the "expand thin-pro-pool" command to expand a TPP area.

4 Thin Provisioning Volume (TPV) management

Prepare a TPP and a TPV. A TPV can be created from a TPP. A TPV can be created in the same way as a normal volume is created by using the "create volume" command.

Note

- The total logical capacity of the TPVs in all the TPPs must not exceed the maximum pool capacity of the ETERNUS DX/AF.
 - A TPV can be deleted by using the "delete volume" command.
 - A TPV can be expanded by using the "expand volume" command.
 - A TPV can be balanced by using the "start balancing-thin-pro-volume" command. If a TPV balancing is performed, a work volume that has the same capacity as the target TPV is temporarily created in the TPP to which the target TPV belongs. If the total logical capacity of the TPVs in all the TPPs, which includes this work volume, exceeds the maximum pool capacity, a TPV balancing cannot be performed. The work volume is deleted after the TPV balancing is complete.
 - A volume can be migrated by using the "start migration" command.
 - Different TPV management operations cannot be performed simultaneously for a single TPV.
-

End of procedure

The following figure shows the relationship between TPPs and TPVs:

Figure 3.1 Relationship between TPPs and TPVs

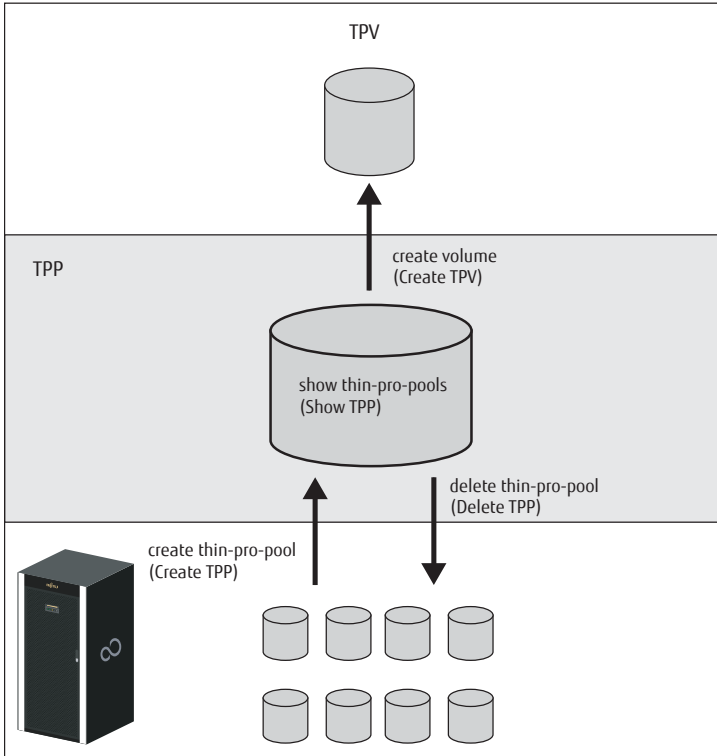

■ Chunk size

A physical capacity unit that is assigned to the logical volume that was created in the TPP and the FTRP the moment a Write I/O is accepted from the host.

The available chunk sizes are 21 MB, 42 MB, 84 MB, and 168 MB. The chunk size of the TPPs and the FTRPs that are created with firmware version V10L70 or earlier is fixed to 21 MB.

The chunk size is set according to the chunk size that is set in the ETERNUS DX/AF when TPPs and FTRPs are created.

If the Thin Provisioning function is enabled with the "set thin-provisioning" command, the chunk size of the ETERNUS DX/AF is automatically determined according to the capacity specified for the "-max-pool-capacity" parameter (or the total capacity of the TPPs or FTSPs that can be created in the ETERNUS DX/AF).

After expanding the total capacity of TPPs and FTSPs that can be created in the ETERNUS DX/AF with the "set thin-provisioning" command, if TPPs and FTRPs are created, the chunk size may be different from the TPPs and FTRPs that were created before the expansion. As a result of that, TPPs and FTRPs with different chunk sizes are mixed within the ETERNUS DX/AF.

The chunk size of a created TPP cannot be changed.

If TPPs and FTRPs that have different chunk sizes are mixed, creating TPPs and FTSPs with the same capacity as the total capacity of TPPs and FTSPs that can be created in the ETERNUS DX/AF is not possible.

The maximum capacity, the maximum number, and the chunk size of the TPP that can be registered in the ETERNUS DX/AF are shown in the following table.

Details	Firmware version	Model																
		DX60 S4	DX100 S4	DX200 S4	DX500 S4	DX600 S4	DX60 S3	DX100 S3	DX200 S3	DX500 S3	DX600 S3	DX8100 S3	DX8700 S3/DX8900 S3	AF250 S2	AF650 S2	AF250	AF650	DX200F
TPP maximum pool capacity (*1) (Unit: TB)	Earlier than V10L70	-	-	-	-	-	64	256	256	384	1,024	128	2,048	-	-	256	1,024	256
	V10L70 and later	512	2,048	2,048	3,072	8,192	512	2,048	2,048	3,072	8,192	1,024	16,384	2,048	8,192	2,048	8,192	2,048
Maximum number of TPPs (*2)	-	12	72	132	256	256	12	72	132	256	256	24	256	24	96	24 (*3)	96 (*3)	12
Chunk size of the TPP	Earlier than V10L70	-	-	-	-	-	21MB (fixed)						-	-	21MB (fixed)			
	V10L70 and later	21MB, 42MB, 84MB, 168MB																

*1: The maximum value of the total capacity of TPPs and FTRPs that can be created in the ETERNUS DX/AF.

*2: The sum of the TPPs and FTSPs that can be created in the ETERNUS DX/AF.

*3: If the firmware version of the ETERNUS DX/AF is earlier than V10L70, the maximum number of TPPs is 12 for the AF250 and 48 for the AF650.

■ Pool capacities that can be created

- If only chunk size pools that correspond to the maximum pool size exist
A pool can be created up to the maximum pool size capacity.
- If pools with different chunk sizes are mixed within the ETERNUS DX/AF
A pool can be created until the total value of the capacity that is converted to the currently set magnification value reaches the maximum pool size capacity.

Example:

If 512TB exists for a TPP that was already created with a chunk size of 21MB using a maximum TPP capacity setting of 8PB (chunk size 168MB)

A TPP capacity that can be newly created = 8PB - (512TB x 168MB / 21MB) = 4PB

- The chunk sizes that correspond to the maximum capacity of the TPP that is registered in the ETERNUS DX/AF are shown in the following table.

Setting value of the maximum pool capacity for each model								Chunk size
DX60 S4/DX60 S3	DX100 S4/DX200 S4 DX100 S3/DX200 S3	DX500 S4/DX500 S3	DX600 S4/DX600 S3	DX8100 S3	DX8700 S3/DX8900 S3	AF250 S2/AF250/DX200F	AF650 S2/AF650	
up to 64 TB	up to 256 TB	up to 384 TB	up to 1,024 TB	up to 128 TB	up to 2,048 TB	up to 256 TB	up to 1,024 TB	21MB
128 TB	512 TB	768 TB	2,048 TB	256 TB	4,096 TB	512 TB	2,048 TB	42MB
256 TB	1,024 TB	1,536 TB	4,096 TB	512 TB	8,192 TB	1,024 TB	4,096 TB	84MB
512 TB	2,048 TB	3,072 TB	8,192 TB	1,024 TB	16,384 TB	2,048 TB	8,192 TB	168MB

■ Maximum FTRP capacity that can be used for VVOL

The maximum FTRP capacities that can be used for VVOL are shown in the following table.

Model	Maximum FTRP capacity that can be used for VVOL
DX100 S4/DX200 S4 DX100 S3/DX200 S3	256 TB
DX500 S4/DX500 S3	384 TB
DX600 S4/DX600 S3	1024 TB
DX8100 S3	128 TB
DX8700 S3/DX8900 S3	2048 TB
AF250 S2/AF250	256 TB
AF650 S2/AF650	1024 TB
DX200F	256 TB

A capacity larger than the maximum pool capacity that is set in the ETERNUS DX/AF cannot be used. For example, if the maximum pool capacity is set to 128TB in the DX600 S4, the maximum FTRP capacity that can be used for VVOL is 128TB.

show thin-provisioning

This command displays information on whether the Thin Provisioning function is enabled and displays the maximum capacity of the pools that can be created in the ETERNUS DX/AF.

Syntax

```
show thin-provisioning
```

Parameter

No parameters.

Output

Item name	Description
Thin provisioning	Displays the setting of the Thin Provisioning function (Enable or Disable).
Maximum pool capacity	Maximum pool capacity (Example: 128 TB, 1024 TB, 1.5 PB) (If the Thin Provisioning function is disabled, a hyphen [-] is displayed.)

Example(s)

The following example displays the case when the Thin Provisioning function is enabled:

```
CLI> show thin-provisioning
Thin provisioning      [Enable]
Maximum pool capacity [128 TB]
```

The following example displays the case when the Thin Provisioning function is disabled:

```
CLI> show thin-provisioning
Thin provisioning      [Disable]
Maximum pool capacity [-]
```

set thin-provisioning

This command enables or disables the Thin Provisioning function and sets the maximum capacity for pools that can be created in the ETERNUS DX/AF. Note that the Thin Provisioning function is not supported by the ETERNUS DX/AF with a single controller.

The capacity of the Thin Provisioning Pool that can actually be created may be smaller than the maximum capacity of the pool that can be created in the ETERNUS DX/AF. For details, refer to ["Pool capacities that can be created" \(page 248\)](#).

Caution

- A maximum pool capacity that exceeds the maximum physical capacity can be set. However, the upper limit of the physical capacity that is actually assigned is the maximum physical capacity of each model.
- The FTRP capacity that can be used for VMware Virtual Volume (VVOL) is different from the maximum pool capacity of Thin Provisioning. For details, refer to ["Maximum FTRP capacity that can be used for VVOL" \(page 249\)](#).

■ Syntax

```
set thin-provisioning [-thin-pro {enable | disable}]  
[-max-pool-capacity {32tb | 64tb | 128tb | 256tb | 384tb | 512tb | 768tb | 1024tb | 1.5pb | 2pb | 3pb | 4pb | 8pb | 16pb}]
```

■ Parameter

-thin-pro Optional. This parameter specifies whether the Thin Provisioning function is enabled. If this parameter is omitted, the existing setting remains unchanged.

Caution

When the Thin Provisioning function or the Flexible Tier function is used, the "disable" option cannot be specified.

enable The Thin Provisioning function is used.

disable The Thin Provisioning function is not used.

-max-pool-capacity

Optional. However, if the "-thin-pro" parameter is changed from disable to enable, this parameter becomes required. This parameter specifies the maximum capacity of the pools (the total capacity of the TPPs and the FTSPs) that can be created in the ETERNUS DX/AF. If this parameter is omitted, the existing setting remains unchanged.

The values that can be specified for each model are shown below.

DX60 S4: 32tb (default), 64tb, 128tb, 256tb, and 512tb
DX100 S4/DX200 S4: 32tb (default), 64tb, 128tb, 256tb, 512tb, 1024tb, and 2pb
DX60 S3: 32tb (default), 64tb, 128tb, 256tb, and 512tb
DX100 S3/DX200 S3: 32tb (default), 64tb, 128tb, 256tb, 512tb, 1024tb, and 2pb
DX500 S4/DX500 S3: 64tb (default), 128tb, 256tb, 384tb, 768tb, 1.5pb, and 3pb
DX600 S4/DX600 S3: 128tb (default), 256tb, 512tb, 768tb, 1024tb, 2pb, 4pb, and 8pb
DX8100 S3: 64tb (default), 128tb, 256tb, 512tb, and 1024tb
DX8700 S3/DX8900 S3: 256tb (default), 512tb, 768tb, 1024tb, 1.5pb, 2pb, 4pb, 8pb, and 16pb
AF250 S2/AF250: 32tb (default), 64tb, 128tb, 256tb, 512tb, 1024tb, and 2pb
AF650 S2/AF650: 128tb (default), 256tb, 512tb, 768tb, 1024tb, 2pb, 4pb, and 8pb
DX200F: 32tb (default), 64tb, 128tb, 256tb, 512tb, 1024tb, and 2pb

 **Caution**

- This parameter can only be specified when the Thin Provisioning function is used.
- The maximum capacity can only be expanded from the current maximum capacity.
- The actual pool capacity (logical) that can be used varies depending on the drive capacity (physical). For example, if a DX200F has twenty-four 800GB SSDs installed, even though "32tb" is specified for the parameter, the usable capacity is limited to 16TB.

32tb	The maximum pool capacity is set to 32TB.
64tb	The maximum pool capacity is set to 64TB.
128tb	The maximum pool capacity is set to 128TB.
256tb	The maximum pool capacity is set to 256TB.
384tb	The maximum pool capacity is set to 384TB.
512tb	The maximum pool capacity is set to 512TB.
768tb	The maximum pool capacity is set to 768TB.
1024tb	The maximum pool capacity is set to 1024TB.
1.5pb	The maximum pool capacity is set to 1.5PB.
2pb	The maximum pool capacity is set to 2PB.
3pb	The maximum pool capacity is set to 3PB.
4pb	The maximum pool capacity is set to 4PB.
8pb	The maximum pool capacity is set to 8PB.
16pb	The maximum pool capacity is set to 16PB.

■ Example(s)

The following example sets the maximum pool capacity to 128TB:

```
CLI> set thin-provisioning -thin-pro enable -max-pool-capacity 128tb
```

The following example expands the maximum pool capacity which changes the current default chunk size of the ETERNUS DX/AF with the VVOL mode enabled and the FTRP already created (and to prevent FTRPs with different chunk sizes from being registered in the same storage container (VVOL Datastore), a warning message is output):

```
CLI> set thin-provisioning -thin-pro enable -max-pool-capacity 16pb  
By this setting change, a new chunk size will be applied to the newly created Flexible Tier Pools.  
Please do not register Flexible Tier Pools with different chunk size to the same VVOL Datastore.  
Enter "y" to continue. Enter "n" to discard this command.
```

show thin-pro-pools

This command displays a summary list of all the Thin Provisioning Pools or the details of the specified Thin Provisioning Pool(s).

Note

Depending on the model, the support state of the encryption-related functions may differ.

Syntax

```
show thin-pro-pools [-pool-number pool_numbers | -pool-name pool_names]
```

Parameter

-pool-number or -pool-name

Optional. This parameter specifies the Thin Provisioning Pool identifiers. One or more Thin Provisioning Pool identifiers can be specified. For details, refer to ["1.2.7 Thin Provisioning Pool Syntax" \(page 36\)](#). If the Thin Provisioning Pool identifier is omitted, a summary list of all the Thin Provisioning Pools is displayed.

pool_numbers Thin Provisioning Pool number
pool_names Thin Provisioning Pool name

Output

Item name	Description
Thin Pro	Thin Provisioning Pool identifiers
No.	Thin Provisioning Pool number
Name	Thin Provisioning Pool name
Disk attribute	Drive attribute that composes the Thin Provisioning Pool (Online / Nearline / SSD / Online SED / Nearline SED / SSD SED)
RAID Level	RAID level
Consist of Fast Recovery	Drives configured for the Fast Recovery RAID group. (This information is displayed for RAID groups with RAID6-FR RAID level. A hyphen [-] is displayed for other RAID levels.) The drive configuration, the number of configurations, and the number of hot spares for RAID6 are displayed. Example: (3D+2P)x2+1HS
Status	Thin Provisioning Pool status
Total Capacity	Total capacity of the Thin Provisioning Pool
Provisioned Capacity	Provisioning capacity of the Thin Provisioning Pool (total logical capacity of the TPV that belongs to the TPP)
Provisioned Rate(%)	Provisioning rate of the Thin Provisioning Pool (ratio [%] of the total logical capacity of the TPVs that exist in the TPP to the total capacity of the TPP) (If the Deduplication/Compression setting of the Thin Provisioning pool is enabled or "Error", a hyphen [-] is displayed.)
Used Capacity	Used capacity of the Thin Provisioning Pool

Item name	Description
Used status	Alarm status (Normal / Warning / Attention)
Warning(%)	Warning level range
Attention(%)	Attention level range
Encryption	Encryption status (Enable / Disable)
Chunk Size	Chunk size of the Thin Provisioning Pool
RAID Group	RAID group identifiers
No.	RAID group number
Name	RAID group name
RAID Level	RAID level
Assigned CM	Assigned CM
Status	RAID group status
Total Capacity	Total capacity of RAID group (Unit: MB)
Free Capacity	Free capacity of RAID group (Unit: MB)
Stripe Depth	Stripe depth (Unit: KB) (Except for 64KB)
Fast Recovery Disk	Fast Recovery drive
Deduplication	Status of the Deduplication setting of the Thin Provisioning pool
Enable	Deduplication setting is enabled
Disable	Deduplication setting is disabled
Error	<p>The Deduplication setting is enabled, but part of the function cannot be used. Displayed if a hardware failure occurs and a process fails while the Deduplication setting is being changed and a DEDUP_SYS Volume format is running, and when the following Deduplication functions become unusable.</p> <ul style="list-style-type: none"> • "create", "delete", "expand", and "format" the Deduplication/Compression Volume • Capacity expansion of the DEDUP_SYS Volume • Diagnosis of the DEDUP_SYS Volume and the DEDUP_MAP Volume <p>Check the status of the ETERNUS DX/AF and after resolving the cause of the failure, try again. If the Deduplication setting of the Thin Provisioning pool has failed, disable the Deduplication setting of the Thin Provisioning pool and try again.</p>
-	The information acquisition of the Deduplication setting for the Thin Provisioning pool has failed.
Compression	Status of the Compression setting of the Thin Provisioning pool
Enable	Compression setting is enabled
Disable	Compression setting is disabled
Error	<p>The Compression setting is enabled, but part of the function cannot be used. Displayed if a hardware failure occurs and a process fails while the Compression setting is being changed and a DEDUP_SYS Volume format is running, and when the following Compression functions become unusable.</p> <ul style="list-style-type: none"> • "create", "delete", "expand", and "format" the Deduplication/Compression Volume • Capacity expansion of the DEDUP_SYS Volume • Diagnosis of the DEDUP_SYS Volume and the DEDUP_MAP Volume <p>Check the status of the ETERNUS DX/AF and after resolving the cause of the failure, try again. If the Compression setting of the Thin Provisioning pool has failed, disable the Compression setting of the Thin Provisioning pool and try again.</p>
-	The information acquisition of the Compression setting for the Thin Provisioning pool has failed.
Dedup Rate(%)	<p>Capacity reduction rate (If both the Deduplication setting and the Compression setting are "Disable" or the information acquisition of the capacity reduction rate for the Deduplication function or the Compression function has failed, a hyphen [-] is displayed.)</p>

■ Example(s)

The following example displays a summary list of all the Thin Provisioning Pools registered in the system (when the Deduplication/Compression mode setting is disabled):

```
CLI> show thin-pro-pools
```

Thin Pro No. Name	Disk Attribute	RAID Level	Status	Total Capacity	Provisioned Capacity	Rate(%)	Used Capacity	Used Status	Warning(%)	Attention(%)	Encryption	Chunk Size(MB)
0 TPP01	Online	RAID1+0	Available	95.25 GB	0.00 MB	0	0.00 MB	Normal	80	60	Enable	21
1 TPP02	Nearline	RAID1+0	Available	95.25 GB	0.00 MB	0	0.00 MB	Normal	80	75	Disable	42
2 TPP03	Online	RAID1+0	Available	5.25 GB	0.00 MB	0	0.00 MB	Normal	99	75	Enable	84
3 TPP04	Nearline SED	RAID1+0	Available	5.25 GB	0.00 MB	0	0.00 MB	Normal	99	75	Enable	168

The following example displays a summary list of all the Thin Provisioning Pools registered in the system (when the Deduplication/Compression mode setting is enabled):

```
CLI> show thin-pro-pools -pool-name TPP001
```

Thin Pro No. Name	Disk Attribute	RAID Level	Status	Total Capacity	Provisioned Capacity	Rate(%)	Used Capacity	Used Status	Warning(%)	Attention(%)	Encryption	Chunk Size(MB)	Deduplication	Compression	Dedup Rate(%)
0 TPP001	Nearline SED	RAID1	Available	1.25 GB	0.00 MB	-	0.00 MB	Normal	90	75	Disable	21	Enable	Disable	50

```
<Raid Group List>
```

RAID Group No. Name	RAID Level	Consist of Fast Recovery	Assigned CM	Status	Total Capacity	Used Capacity	Stripe Depth	Fast Recovery Disk
0 TPP001_0	RAID1	-	CM#0	Available	32.25 GB	0.00 MB	-	-

The following example displays the details of Thin Provisioning Pool #0 (when the Deduplication/Compression mode setting is disabled):

```
CLI> show thin-pro-pools -pool-number 0
```

Thin Pro No. Name	Disk Attribute	RAID Level	Status	Total Capacity	Provisioned Capacity	Rate(%)	Used Capacity	Used Status	Warning(%)	Attention(%)	Encryption	Chunk Size(MB)
0 TPP	Nearline SED	RAID1	Available	1.25 GB	0.00 MB	0	0.00 MB	Normal	90	75	Disable	21

```
<Raid Group List>
```

RAID Group No. Name	RAID Level	Consist of Fast Recovery	Assigned CM	Status	Total Capacity	Used Capacity	Stripe Depth	Fast Recovery Disk
0 TPP_0	RAID1	-	CM#0	Available	32.25 GB	0.00 MB	-	-

The following example displays the details of Thin Provisioning Pool #0 (when the Deduplication/Compression mode setting is disabled in the DX8700 S3/DX8900 S3):

```
CLI> show thin-pro-pools -pool-number 0
```

Thin Pro No. Name	Disk Attribute	RAID Level	Status	Total Capacity	Provisioned Capacity	Rate(%)	Used Capacity	Used Status	Warning(%)	Attention(%)	Encryption	Chunk Size(MB)
0 TPP	Nearline SED	RAID1	Available	1.25 GB	0.00 MB	0	0.00 MB	Normal	90	75	Disable	21

```
<Raid Group List>
```

RAID Group No. Name	RAID Level	Consist of Fast Recovery	Assigned CM	Status	Total Capacity	Used Capacity	Stripe Depth	Fast Recovery Disk
0 TPP_0	RAID1	-	CE#1 CM#0	Available	32.25 GB	0.00 MB	-	-

The following example displays the details of Thin Provisioning Pool #001 (when the Deduplication/Compression mode setting is enabled):

```
CLI> show thin-pro-pools -pool-number 3
```

Thin Pro No. Name	Disk Attribute	RAID Level	Status	Total Capacity	Provisioned Capacity	Rate(%)	Used Capacity	Used Status	Warning(%)	Attention(%)	Encryption	Chunk Size(MB)	Deduplication	Compression	Dedup Rate(%)
0 TPP001	Nearline SED	RAID1	Available	1.25 GB	0.00 MB	-	0.00 MB	Normal	90	75	Disable	21	-	-	50

```
<Raid Group List>
```

RAID Group No. Name	RAID Level	Consist of Fast Recovery	Assigned CM	Status	Total Capacity	Used Capacity	Stripe Depth	Fast Recovery Disk
0 TPP_0	RAID6-FR	(3D+2P)x2+1HS	CM#0	Partially Exposed Rebuild(Fast)	32.25 GB	0.00 MB	64 KB	DE#01-Disk#5

The following example displays the details of Thin Provisioning Pool #001 in which the Deduplication/Compression function cannot be used (when the Deduplication/Compression mode setting is enabled):

```
CLI> show thin-pro-pools -pool-number 3
```

Thin Pro No. Name	Disk Attribute	RAID Level	Status	Total Capacity	Provisioned Capacity	Rate(%)	Used Capacity	Used Status	Warning(%)	Attention(%)	Encryption	Chunk Size(MB)	Deduplication	Compression	Dedup Rate(%)
0 TPP001	Nearline SED	RAID1	Available	1.25 GB	0.00 MB	-	0.00 MB	Normal	90	75	Disable	21	-	-	-

```
<Raid Group List>
```

RAID Group No. Name	RAID Level	Consist of Fast Recovery	Assigned CM	Status	Total Capacity	Used Capacity	Stripe Depth	Fast Recovery Disk
0 TPP_0	RAID6-FR	(3D+2P)x2+1HS	CM#0	Partially Exposed Rebuild(Fast)	32.25 GB	0.00 MB	64 KB	DE#01-Disk#5

show thin-pro-pool-progress

This command displays the formatting progress of the Thin Provisioning Pool.

Syntax

```
show thin-pro-pool-progress [-pool-number pool_numbers | -pool-name pool_names]
```

Parameter

-pool-number or -pool-name

Optional. This parameter specifies the Thin Provisioning Pool identifiers. One or more Thin Provisioning Pool identifiers can be specified. For details, refer to ["1.2.7 Thin Provisioning Pool Syntax" \(page 36\)](#). If the Thin Provisioning Pool identifier is omitted, a progress list of all the Thin Provisioning Pools is displayed.

pool_numbers Thin Provisioning Pool number

pool_names Thin Provisioning Pool name

Output

Item name	Description
Thin Pro	Thin Provisioning Pool identifiers
No	Thin Provisioning Pool number
Name	Thin Provisioning Pool name
Status	Thin Provisioning Pool status
Format	Information on the formatting progress
Progress	Progress status (0 – 100%)
Estimated time left	Estimated remaining formatting time
-	Formatting is not performed or is complete.
calculating	The remaining time is being calculated.
30days or more	The remaining time is 30 days or more.
Xday Yh Zmin	The remaining time is less than 30 days but 1 day or more.
Yh Zmin	The remaining time is less than 1 day but an hour or more.
Zmin	The remaining time is less than 1 hour but 1 minute or more.
Less than 1min	The remaining time is less than a minute.
Remaining size	Remaining capacity for formatting
-	Formatting is not performed or is complete.
XMB	Remaining capacity (rounded up to the nearest whole number) X: decimal number

■ Example(s)

The following example displays a list of the formatting progress for all the Thin Provisioning Pools:

```
CLI> show thin-pro-pool-progress
Thin Pro      Status      Format
No. Name      -----
0 TPP001     Available   30% 30days or more   134217728MB
1 TPP002     Available   50% calculating      128MB
2 TPP003     Available   80% 01h 00min        64MB
```

The following example displays only the progress status of Thin Provisioning Pool#1:

```
CLI> show thin-pro-pool-progress -pool-number 1
Thin Pro      Status      Format
No. Name      -----
0 TPP001     Available   30% 30days or more   134217728MB
```

The following example displays the progress status of the Thin Provisioning Pools named "TPP001" and "TPP002":

```
CLI> show thin-pro-pool-progress -rg-name TPP001,TPP002
Thin Pro      Status      Format
No. Name      -----
0 TPP001     Available   30% 30days or more   134217728MB
1 TPP002     Available   50% calculating      128MB
```

create thin-pro-pool

This command creates a Thin Provisioning Pool with the specified Thin Provisioning Pool name, drive attribute, reliability, encryption, and a RAID group. The Deduplication function and the Compression function can also be enabled/disabled. The Thin Provisioning Pool is formatted automatically after it is created. When registering a hot spare, refer to the "set global-spare" or the "set dedicated-spare" command.

Caution

Encryption-related functions cannot be used in the DX60 S4/DX60 S3.

Note

- Depending on the model, the support state of the encryption-related functions may differ.
- To expand the Thin Provisioning Pool that is created with this command, use the "expand thin-pro-pool" command.

Syntax

```
create thin-pro-pool -name alias_name  
-attribute {online | nearline | ssd | sed | online-sed | nearline-sed | ssd-sed}  
-level {0 | 1 | 5 | 6 | 10 | 6fr} [-warning warning] [-attention attention]  
-rg-mode {auto | manual} [-capacity capacity] [-disks disks]  
[-assigned-cm {0 | 1 | 00 | 01 | 10 | 11 | 20 | 21 | 30 | 31 | 40 | 41 | 50 | 51 | 60 | 61 | 70 | 71 | 80 | 81 | 90 | 91 | a0 | a1  
| b0 | b1 | auto}]  
[-encryption {enable | disable}]  
[-stripe-depth {64kb | 128kb | 256kb | 512kb | 1024kb}]  
[-fr-consist {(4D+2P)x2+1HS | (6D+2P)x2+1HS | (8D+2P)x3+1HS | (4D+2P)x5+1HS}]  
[-fr-mode {less-disks | prior-fr}] [-dedup {enable | deduplication-only | compression-only | ready | disable}]  
[-chunk-size {21mb | 42mb | 84mb | 168mb}]
```

Parameter

-name This parameter specifies the alias name of a Thin Provisioning Pool. Only one name can be specified. For details, refer to ["1.2.6 Alias Name Syntax" \(page 35\)](#).

alias_name Thin Provisioning Pool name

- attribute** This parameter specifies the drive attribute of a Thin Provisioning Pool.
- online** Online disks
 - nearline** Nearline disks
 - ssd** SSDs (This option is supported only in models that can be installed with SSDs)
The SSD type (SSD classification) cannot be specified.
 - sed** SEDs (This option is supported only in models that can be installed with SEDs)
 - online-sed** Online SEDs (This option is supported only in models that can be installed with Online SEDs)
 - nearline-sed** Nearline SEDs (This option is supported only in models that can be installed with Nearline SEDs)
 - ssd-sed** Self-Encrypting SSDs (This option is supported only in models that can be installed with Self-Encrypting SSDs)
The SSD type cannot be specified.
- level** This parameter specifies the RAID level for the Thin Provisioning Pools that are created.
- 0** RAID0
 - 1** RAID1
 - 5** RAID5
 - 6** RAID6
 - 10** RAID1+0
 - 6fr** RAID6-FR (Fast Recovery)
- warning** Optional. This parameter specifies the warning level of the Thin Provisioning Pool. The settable range is 5 – 99%. If this parameter is omitted, the default value (90%) is set. The warning level range should be equal to or higher than the "-attention" setting range.
- warning* Warning level of the Thin Provisioning Pool
- attention** Optional. This parameter specifies the attention level of the Thin Provisioning Pool. The settable range is 5 – 80%. If this parameter is omitted, the default value (75%) is set. The attention level range should be equal to or lower than the "-warning" setting range.
- attention* Attention level of the Thin Provisioning Pool
- rg-mode** This parameter specifies the method of selecting the drive when creating the RAID group.
- auto** The drive is automatically allocated. The drive capacity must be specified with the "-capacity" parameter.
 - manual** The drive is manually allocated. The drive is specified with the "-disks" parameter.
- capacity** Optional. This parameter specifies the drive capacity that is used to create a RAID group. This parameter must be specified if "-rg-mode auto" is selected.
- capacity* Drive capacity
Example: 1tb, 900gb, and 900mb

- disks** Optional. This parameter specifies which drives are used to configure the RAID group. This parameter can only be specified when "-rg-mode manual" is selected. One or more drives can be specified at the same time. For details, refer to ["1.2.5 Drive Syntax" \(page 35\)](#).
- | | |
|--------------|-------|
| <i>disks</i> | Drive |
|--------------|-------|
- assigned-cm** Optional. This parameter specifies the assigned controller for the specified RAID group. This parameter can only be specified when "-rg-mode manual" is selected. If "auto" is specified, the fixed controller, which is calculated automatically by the system, is assigned. If this parameter is omitted, "auto" mode is selected.
- | | |
|------------|--|
| 0 | CM#0 (DX60 S4/DX100 S4/DX200 S4, DX500 S4/DX600 S4, DX60 S3/DX100 S3/DX200 S3, DX500 S3/DX600 S3, DX8100 S3, AF250 S2/AF650 S2, AF250/AF650, and DX200F only) |
| 1 | CM#1 (DX60 S4/DX100 S4/DX200 S4, DX500 S4/DX600 S4, DX60 S3/DX100 S3/DX200 S3, DX500 S3/DX600 S3, DX8100 S3, AF250 S2/AF650 S2, AF250/AF650, and DX200F only) |
| <i>w</i> x | CE#w-CM#x (DX8700 S3/DX8900 S3 only)
"w" is the controller enclosure (CE) number and "x" is the controller module (CM) number.
Example: "01" indicates CE#0-CM#1

For the controller enclosure number, the range that the value can be specified with is 0 to b (hex).
For the controller module number, 0 or 1 can be specified. |
| auto | Automatically (default) |
- encryption** Optional. This parameter specifies whether the encryption by a CM is performed. When "enable" is selected, the specified pool volume data is encrypted. If omitted, then it is handled as if "disable" is selected.
- | | |
|---------|--|
| enable | The pool volume data is encrypted. |
| disable | The pool volume data is not encrypted. |
- stripe-depth** Optional. This parameter specifies the stripe depth for the Thin Provisioning Pool that is to be created. If omitted, then it is handled as if "64kb" is selected. The available values vary depending on the RAID level and the number of drives. When "auto" is specified for the "-rg-mode" parameter, only "64kb" can be specified.
- | | |
|--------|---|
| 64kb | 64KB |
| 128kb | 128KB (Only for RAID 5 configurations of 10 or more drives, RAID0 configurations, and RAID1+0 configurations) |
| 256kb | 256KB (Only for RAID 5 configurations of 9 or less drives, RAID0 configurations, and RAID1+0 configurations) |
| 512kb | 512KB (Only for RAID 5 configurations of 5 or less drives, RAID0 configurations, and RAID 1+0 configurations) |
| 1024kb | 1,024KB (Only for RAID0 configurations and RAID1+0 configurations) |
- fr-consist** This parameter specifies the drive configuration of the Fast Recovery RAID group. This parameter must be specified when "6fr" is specified for the "-level" parameter and "manual" is specified for the "-rg-mode" parameter.

(4D+2P)x2+1HS RAID6(4+2) × 2, HS × 1 (configured with 13 drives)
(6D+2P)x2+1HS RAID6(6+2) × 2, HS × 1 (configured with 17 drives)
(8D+2P)x3+1HS RAID6(8+2) × 3, HS × 1 (configured with 31 drives)
(4D+2P)x5+1HS RAID6(4+2) × 5, HS × 1 (configured with 31 drives)

-fr-mode This parameter is specified for determining the Fast Recovery RAID group configuration by the ETERNUS DX/AF. This parameter must be specified when "6fr" is specified for the "-level" parameter and "auto" is specified for the "-rg-mode" parameter.

less-disks Priority is given to reducing the number of drives.

prior-fr Priority is given to the Fast Recovery rebuild speed.

-dedup Optional. This parameter is specified to enable the Deduplication/Compression setting for the Thin Provisioning pool. If omitted, the Deduplication/Compression setting of the Thin Provisioning pool is disabled.

This parameter can only be specified if the Deduplication/Compression mode setting is enabled.

If the Deduplication/Compression setting of the Thin Provisioning Pool is enabled, Deduplication/Compression System Volumes (DEDUP_SYS Volumes and DEDUP_MAP Volumes) are created in the specified Thin Provisioning Pool. In this state, Deduplication/Compression Volumes (dedup-tpv) can be created in the specified Thin Provisioning Pool.

For details on the Deduplication/Compression setting, refer to ["3.4 Deduplication/Compression" \(page 276\)](#).

 **Caution**

- If the "-rg-mode auto" parameter is specified, only "-enable", "-deduplication-only", "-compression-only", or "-disable" can be specified.
 - If the "-rg-mode auto" parameter is specified and this parameter is specified with "-disable", the number of RAID groups that configure the Thin Provisioning pool is one.
 - If the "-rg-mode auto" parameter is specified and this parameter is specified with "-enable", "-deduplication-only", or "-compression-only", the number of RAID groups that configure the Thin Provisioning pool is two or more. If two or more RAID groups cannot be created, because the recommended configuration is not satisfied, the command terminates with an error.
- If the "-rg-mode manual" parameter is specified, "-ready" or "-disable" can be specified for this parameter. In addition, the number of RAID groups that configure the Thin Provisioning pool is one. Although the Deduplication/Compression setting can be enabled with the following procedure even for a single RAID group, it is not recommended because there is a risk of a performance degradation. If the "-rg-mode manual" parameter is specified, Thin Provisioning pools that have the Deduplication/Compression setting enabled are not created just by executing this command. To enable the setting, the following procedure must be performed.

(1) Execute the "create thin-pro-pool -rg-mode manual -dedup ready" command.

(2) Change the Thin Provisioning pool to have 2 or more RAID groups using the "expand thin-pro-pool" command (or changing the settings to the recommended configuration).

(3) Specify "enable", "deduplication-only", or "compression-only" for the "-dedup" parameter of the "set thin-pro-pool" command and then enable the Deduplication/Compression setting of the Thin Provisioning pool.

enable	A Thin Provisioning pool with a chunk size of 21MB is created with the Deduplication/Compression setting enabled.
deduplication-only	A Thin Provisioning pool with a chunk size of 21MB is created with the Deduplication setting enabled.
compression-only	A Thin Provisioning pool with a chunk size of 21MB is created with the Compression setting enabled.
ready	A Thin Provisioning pool with a chunk size of 21MB is created for use with the Deduplication/Compression function.
disable	A Thin Provisioning pool is created with the Deduplication/Compression setting disabled.

-chunk-size Optional. This parameter specifies the chunk size of the Thin Provisioning pool that is to be created. Normally, this parameter does not need to be specified. If omitted, the setting values are as follows:

- If the "-dedup" parameter is "enable", "deduplication-only", "compression-only", or "ready" "21mb" (21MB) is specified.
- If the "-dedup" parameter is "disable" or omitted The current default chunk size of the ETERNUS DX/AF is specified.

21mb	A Thin Provisioning pool with a chunk size of 21MB is created.
42mb	A Thin Provisioning pool with a chunk size of 42MB is created.
84mb	A Thin Provisioning pool with a chunk size of 84MB is created.
168mb	A Thin Provisioning pool with a chunk size of 168MB is created.

■ Example(s)

The following example creates a Thin Provisioning Pool named "TPP001" that uses four online disks (#003 to #006):

```
CLI> create thin-pro-pool -name TPP001 -attribute online -encryption enable -level 10 -warning 90 -attention 80  
-rg-mode manual -disks 003-006 -assigned-cm 0
```

set thin-pro-pool

This command changes the information of an existing Thin Provisioning Pool (name, warning level, and attention level, and Deduplication/Compression setting).

■ Syntax

```
set thin-pro-pool {-pool-number pool_number | -pool-name pool_name}  
[-name name] [-warning warning] [-attention attention]  
[-dedup {enable | deduplication-only | compression-only | disable}]
```

■ Parameter

-pool-number or -pool-name

This parameter specifies the Thin Provisioning Pool identifier. Only one Thin Provisioning Pool identifier can be specified.

pool_number Thin Provisioning Pool number

pool_name Thin Provisioning Pool name

-name Optional. This parameter specifies the new Thin Provisioning Pool name. If this parameter is omitted, the name is not changed. For details, refer to ["1.2.6 Alias Name Syntax" \(page 35\)](#).

name Thin Provisioning Pool name

-warning Optional. This parameter specifies the warning level of the Thin Provisioning Pool. The settable range is 5 – 99%. If this parameter is omitted, the warning level is not changed. The warning level range should be equal to or higher than the "-attention" setting range.

warning Warning level of the Thin Provisioning Pool

-attention Optional. This parameter specifies the attention level of the Thin Provisioning Pool. The settable range is 5 – 80%. If this parameter is omitted, the attention level is not changed. The attention level range should be equal to or lower than the "-warning" setting range.

attention Attention level of the Thin Provisioning Pool

-dedup Optional. This parameter specifies whether to enable the Deduplication setting, the Compression setting, or both settings of the Thin Provisioning Pool. If this parameter is omitted, the current setting of the Thin Provisioning Pool is not changed.

This parameter can only be specified if the Deduplication/Compression mode setting is enabled. If Deduplication/Compression Volumes (dedup-tpv) exist in the Thin Provisioning Pool, the Deduplication/Compression setting of the Thin Provisioning Pool cannot be disabled.

If the Deduplication/Compression setting is already enabled, the setting can only be changed to disable. If the Deduplication/Compression setting of the Thin Provisioning Pool is enabled, Deduplication/Compression System Volumes (DEDUP_SYS Volumes and DEDUP_MAP Volumes) are created in the specified Thin Provisioning Pool and is in a state where Deduplication/Compression Volumes (dedup-tpv) can be created.

For details on the Deduplication/Compression setting, refer to ["3.4 Deduplication/Compression" \(page 276\)](#).

 **Caution**

- To enable the Deduplication/Compression setting of the Thin Provisioning Pool, 4GB or more free space is required in the Thin Provisioning Pool.
- Depending on the state of the I/O load on the ETERNUS DX/AF, the setting may take some time to be reflected.

enable	The Deduplication/Compression setting of the Thin Provisioning pool is enabled.
deduplication-only	The Deduplication setting of the Thin Provisioning pool is enabled.
compression-only	The Compression setting of the Thin Provisioning pool is enabled.
disable	The Deduplication/Compression setting of the Thin Provisioning pool is disabled.

■ Example(s)

The following example changes the Thin Provisioning Pool name from "TPP0001" to "TPP0010":

```
CLI> set thin-pro-pool -pool-name TPP0001 -name TPP0010
```

The following example changes the attention to 60% and the warning to 80% for Thin Provisioning Pool #02:

```
CLI> set thin-pro-pool -pool-number 02 -attention 60 -warning 80
```

The following example enables the Deduplication/Compression setting of Thin Provisioning Pool #02:

```
CLI> set thin-pro-pool -pool-number 02 -dedup enable
```

delete thin-pro-pool

This command deletes an existing Thin Provisioning Pool(s). A Thin Provisioning Pool cannot be deleted if one or more volumes exist in the pool. All volumes in the specified Thin Provisioning Pool must be deleted before the Thin Provisioning Pool is deleted.

■ Syntax

```
delete thin-pro-pool {-pool-number pool_numbers | -pool-name pool_names}
```

■ Parameter

-pool-number or -pool-name

This parameter specifies the Thin Provisioning Pool identifiers. One or more Thin Provisioning Pool identifiers can be specified. For details, refer to ["1.2.7 Thin Provisioning Pool Syntax" \(page 36\)](#).

<i>pool_numbers</i>	Thin Provisioning Pool number
<i>pool_names</i>	Thin Provisioning Pool name

■ Example(s)

The following example deletes Thin Provisioning Pool #01:

```
CLI> delete thin-pro-pool -pool-number 01
```

The following example deletes the Thin Provisioning Pool named TPP05:

```
CLI> delete thin-pro-pool -pool-name TPP05
```

expand thin-pro-pool

This command expands the capacity of an existing Thin Provisioning Pool with the specified drives and assigned CM. A Thin Provisioning Pool can be expanded by adding a new RAID group.

Syntax

```
expand thin-pro-pool {-pool-number pool_number | -pool-name pool_name} -rg-mode {auto|manual} [-disks disks]  
[-capacity capacity]  
[-assigned-cm {0 | 1 | 00 | 01 | 10 | 11 | 20 | 21 | 30 | 31 | 40 | 41 | 50 | 51 | 60 | 61 | 70 | 71 | 80 | 81 | 90 | 91 | a0 | a1  
| b0 | b1 | auto}]
```

Parameter

-pool-number or -pool-name

This parameter specifies the Thin Provisioning Pool identifiers.

Only one Thin Provisioning Pool identifier can be specified. For details, refer to ["1.2.7 Thin Provisioning Pool Syntax" \(page 36\)](#).

pool_number Thin Provisioning Pool number

pool_name Thin Provisioning Pool name

-rg-mode This parameter specifies the method of selecting the drive when creating the new RAID group.

auto The drive is automatically allocated. The capacity of the drive is specified with the "-capacity" parameter.

manual The drive is manually allocated. The drive is specified with the "-disks" parameter.

-disks Optional. This parameter specifies which drives are used to configure the RAID group. This parameter can only be specified when "-rg-mode manual" is selected. One or more drives can be specified at the same time. For details, refer to ["1.2.5 Drive Syntax" \(page 35\)](#). When "-disks" is specified, "-capacity" cannot be specified.

disks Drive

-capacity Optional. This parameter specifies the total capacity of the drives that are used to create a RAID group. This parameter can only be specified when "-rg-mode auto" is specified. The drive that corresponds to the capacity is automatically set. When "-capacity" is specified, "-disks" cannot be specified.

capacity Total capacity of the drives that are used to create a RAID group
Example: 1tb, 900gb, and 900mb

-assigned-cm

Optional. This parameter specifies the assigned controller (CM number) of the specified RAID group. This parameter can only be specified when "-rg-mode manual" is specified. If "auto" is specified, the fixed controller, which is calculated automatically by the system, is assigned. If omitted, the "auto" mode is set.

0 CM#0 (DX60 S4/DX100 S4/DX200 S4, DX500 S4/DX600 S4, DX60 S3/DX100 S3/DX200 S3, DX500 S3/DX600 S3, DX8100 S3, AF250 S2/AF650 S2, AF250/AF650, and DX200F only)

1 CM#1 (DX60 S4/DX100 S4/DX200 S4, DX500 S4/DX600 S4, DX60 S3/DX100 S3/DX200 S3, DX500 S3/DX600 S3, DX8100 S3, AF250 S2/AF650 S2, AF250/AF650, and DX200F only)

<i>w</i>	CE#w-CM#x (DX8700 S3/DX8900 S3 only) "w" is the controller enclosure (CE) number and "x" is the controller module (CM) number. Example: "01" indicates CE#0-CM#1 For the controller enclosure number, the range that the value can be specified with is 0 to b (hex). For the controller module number, 0 or 1 can be specified.
<i>auto</i>	Automatically (default)

■ Example(s)

The following example expands Thin Provisioning Pool#01 by adding a RAID group (drives 001 to 004/CM#0):

```
CLI> expand thin-pro-pool -pool-number 01 -disks 001-004 -assigned-cm 0
```

The following example expands Thin Provisioning Pool#02 by adding a RAID group (capacity 900GB/CM#1):

```
CLI> expand thin-pro-pool -pool-number 02 -capacity 900gb -assigned-cm 1
```

format thin-pro-pool

This command will format the Thin Provisioning Pool(s).

■ Syntax

```
format thin-pro-pool {-pool-number pool_number | -pool-name pool_name} -mode {all | unformatted}
```

■ Parameter

-pool-number or -pool-name

This parameter specifies the Thin Provisioning Pool identifiers. One or more Thin Provisioning Pool identifiers can be specified. For details, refer to ["1.2.7 Thin Provisioning Pool Syntax" \(page 36\)](#).

pool_number Thin Provisioning Pool number

pool_name Thin Provisioning Pool name

-mode This parameter specifies the range of the format.

all All the areas are formatted (all of the data is deleted).

unformatted Unformatted areas are formatted. When there are no unformatted areas, the command ends normally (no action from the command is performed).

Caution

When the "-mode all" parameter is specified to format all of the areas, all of the existing data is deleted. Normally, the "-mode unformatted" parameter is used to format only unformatted areas.

■ Example(s)

The following example formats all the area of Thin Provisioning Pool#01:

```
CLI> format thin-pro-pool -pool-number 01 -mode all
```

The following example formats the unformatted area of the Thin Provisioning Pool named "TPP05":

```
CLI> format thin-pro-pool -pool-name TPP05 -mode unformatted
```

3.3.2 Thin Provisioning Pool Eco-mode Management

This section explains the commands that are related to the Eco-mode functions of a Thin Provisioning Pool. They are only applicable when the Eco-mode is enabled using the "set eco-mode" command.

 **Caution**

The commands described in this section are not supported in the AF250 S2/AF650 S2, the AF250/AF650, and the DX200F.

The three steps involved in enabling the Eco-mode functions are as follows:

Procedure

- 1 Enable the Eco-mode.
- 2 Create an Eco-mode schedule.
- 3 Assign the Eco-mode schedule to Thin Provisioning Pools.

End of procedure

For the Eco-mode and Eco-mode schedule settings, refer to ["3.1.3 Eco-mode Management" \(page 132\)](#).

■ Summary of Thin Provisioning Pool Eco-mode settings

Setting of the Thin Provisioning Pools (TPP) with Eco-mode is as follows:

Procedure

- 1 Assign the Eco-mode to a TPP.
To assign an Eco-mode schedule to TPP, use the "set eco-thin-pro-pool" command.
To check the Eco-mode schedule, use the "show eco-thin-pro-pool" command. An Eco-mode schedule can be released from an assigned TPP by using the "release eco-thin-pro-pool" command.

End of procedure

The following figure shows Thin Provisioning Eco-mode setting management:

Figure 3.2 Overview of the Thin Provisioning Pool Eco-mode setting

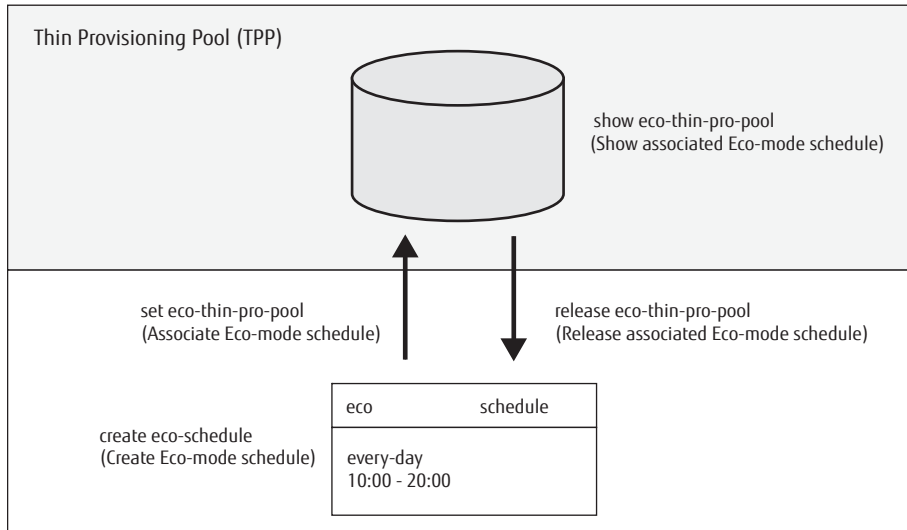

show eco-thin-pro-pool

This command displays the list of Eco-mode schedules that are associated with Thin Provisioning Pools.

Syntax

```
show eco-thin-pro-pool
```

Parameter

No parameters.

Output

Item name	Description
Thin Pro	Thin Provisioning Pool identifiers
No.	Thin Provisioning Pool number
Name	Thin Provisioning Pool name
Disk attribute	Drive attribute that composes the Thin Provisioning Pool (Online / Nearline / Online SED / Nearline SED)
RAID Level	RAID level
Status	Thin Provisioning Pool status
ECO Schedule	Eco-mode schedule
Action	Eco-mode schedule action. This indicates whether the Eco-mode schedule has been associated.
No.	Eco-mode schedule number (In the case of a schedule by a cooperative software, [128] is displayed.)
Name	Eco-mode schedule name (In the case of a schedule by a cooperative software, [External] is displayed.)
Motor Status	Current status of drive motors
Control Status	Control status by a control command

Example(s)

The following example displays a list of all the Thin Provisioning Pools that have an Eco-mode schedule associated with them:

```
CLI> show eco-thin-pro-pool
Thin Pro      Disk      RAID   Status   ECO Schedule   Motor   Control
No. Name      attribute Level            Action        No. Name      Status      Status
-----
0 TPP        Nearline RAID1   Available Drive motor off 0 hoge      Active      [OFF]
```

set eco-thin-pro-pool

This command is used to associate an Eco-mode schedule with a specified Thin Provisioning Pool(s). When registering an Eco-mode schedule, refer to the "create eco-schedule" command. Eco-mode cannot be used for Thin Provisioning Pool(s) that contain SSDs.

■ Syntax

```
set eco-thin-pro-pool {-pool-number pool_numbers | -pool-name pool_names}  
[-schedule-number schedule_number | -schedule-name schedule_name]  
-action {enable | power-enable | disable}
```

■ Parameter

-pool-number or -pool-name

This parameter specifies the Thin Provisioning Pool identifiers. One or more Thin Provisioning Pool identifiers can be specified. A Thin Provisioning Pool without any volumes cannot be specified. For details, refer to ["1.2.7 Thin Provisioning Pool Syntax" \(page 36\)](#).

<i>pool_numbers</i>	Thin Provisioning Pool number
<i>pool_names</i>	Thin Provisioning Pool name

-schedule-number or -schedule-name

Optional. This parameter specifies an Eco-mode schedule identifier. Only one Eco-mode schedule identifier can be specified.
If omitted, the existing setting is not changed. For details, refer to ["1.2.18 Eco-mode Schedule Syntax" \(page 47\)](#).

<i>schedule_number</i>	Eco-mode schedule number
<i>schedule_name</i>	Eco-mode schedule name

-action This parameter specifies whether the Eco-mode function is enabled.

enable	The motor is stopped (When Eco-mode operation is enabled, other than the specified scheduled time period, the drive motor is stopped)
power-enable	The drives power is turned off (When Eco-mode operation is enabled, other than the specified scheduled time period, the drives power is cut)
disable	Allows normal operation (When Eco-mode operation is disabled, normal operations are allowed at all times regardless of the specified schedule)

■ Example(s)

The following example associates the Eco-mode schedule named "SC001" with Thin Provisioning Pool#01:

```
CLI> set eco-thin-pro-pool -pool-number 01 -schedule-name SC001 -action enable
```

The following example associates the Eco-mode schedule named "SC001" with Thin Provisioning Pools #01 - #05 at the same time:

```
CLI> set eco-thin-pro-pool -pool-number 01-05 -schedule-name SC001 -action enable
```

The following example disables the Eco-mode function of the Thin Provisioning Pool named "TPP01":

```
CLI> set eco-thin-pro-pool -pool-name TPP01 -action disable
```

The following example associates Eco-mode schedule #1 with the Thin Provisioning Pool named "TPP001". The second command associates the Eco-mode schedule #2 with the same Thin Provisioning Pool. These executions result in Eco-mode schedule #1 being released:

```
CLI> set eco-thin-pro-pool -pool-name TPP001 -schedule-number 1 -action enable  
CLI> set eco-thin-pro-pool -pool-name TPP001 -schedule-number 2 -action enable
```

release eco-thin-pro-pool

This command releases the Eco-mode schedule that is associated with a specific Thin Provisioning Pool(s).

■ Syntax

```
release eco-thin-pro-pool {-pool-number pool_numbers | -pool-name pool_names}
```

■ Parameter

-pool-number or -pool-name

This parameter specifies the Thin Provisioning Pool identifiers. One or more Thin Provisioning Pool identifiers can be specified. For details, refer to ["1.2.7 Thin Provisioning Pool Syntax" \(page 36\)](#).

<i>pool_numbers</i>	Thin Provisioning Pool number
<i>pool_names</i>	Thin Provisioning Pool name

■ Example(s)

The following example releases an Eco-mode schedule associated with the Thin Provisioning Pool named "TPP001":

```
CLI>release eco-thin-pro-pool -pool-name TPP01
```

The following example releases an Eco-mode schedule associated with Thin Provisioning Pools #01- #05 at the same time:

```
CLI>release eco-thin-pro-pool -pool-number 01-05
```

3.4 Deduplication/Compression

This section describes the setting of the Deduplication/Compression function.

The Deduplication/Compression function is a function that eliminates or compresses, or performs both for duplicate data in the TPP. Each TPP can be set, enabled or disabled, individually with deduplication or compression.

To use the Deduplication/Compression function, enabling the Deduplication/Compression function for the ETERNUS DX/AF and the TPP, and creating a Thin Provisioning Volume for Deduplication/Compression (or Deduplication/Compression Volume) in the TPP is required.

For details, refer to ["Setting the Deduplication/Compression function" \(page 278\)](#).

Caution

- This function is supported in the DX200 S4, the DX500 S4/DX600 S4, the DX200 S3, the DX500 S3/DX600 S3, the AF250 S2/AF650 S2, and the AF250/AF650. However, this function is not supported in the Unified Storage. In a Unified Storage, Deduplication/Compression cannot be performed for both NAS user volumes (nas-tpv) and Thin Provisioning Volumes (TPV) for SAN.
- If the Deduplication/Compression function is used in the DX200 S4, the DX500 S4/DX600 S4, the DX200 S3, and the DX500 S3/DX600 S3, "Memory Extension" is required. Depending on the model, "Memory Extension" is installed before shipment.
- If the Deduplication/Compression mode setting of the ETERNUS DX/AF is changed from "enable" to "disable", the ETERNUS DX/AF must be rebooted. If the setting is changed from "disable" to "enable", rebooting the ETERNUS DX/AF is not required.
- The Maintenance Operation policy is required for changing the Deduplication/Compression mode setting to "disable".
- Deduplication/Compression of the data is performed by the synchronization with the I/O from the server. Depending on the I/O environment, if the Deduplication/Compression function is enabled, the performance may degrade.
- If the I/O load is high, changing the setting of the Deduplication/Compression function one TPP at a time is recommended.
- During a CM failure or a hot firmware replacement, the capacity reduction rate may temporarily degrade.
- If Deduplication/Compression Volumes (dedup-tpv) exist in a TPP, the Deduplication/Compression mode setting cannot be disabled.
- For information on the specification of this function, refer to "Design Guide (Basic)" of each model.

Note

- Specify whether to enable the Deduplication/Compression function for each TPV. However NAS volumes are not supported. Mixing TPVs that have the Deduplication/Compression function enabled (or Deduplication/Compression Volumes) and TPVs that have it disabled in a single TPP is supported.
- Duplication checks are performed for all Deduplication/Compression Volumes in the same TPP. A duplication check cannot be performed for Deduplication/Compression Volumes in different TPPs.
- Use the RAID Migration function when enabling the Deduplication/Compression function for existing volumes. In addition, the RAID Migration function is also used when Deduplication/Compression Volumes are converted to existing volumes.
- If the copy source is a Deduplication/Compression Volume, perform the copy process after extending the data. If the copy destination is a Deduplication/Compression Volume, a deduplication is performed for the data that is transferred from the copy source. Because of that, the copy performance is affected.
- Specifying Deduplication/Compression Volumes in different TPPs for the copy source Deduplication/Compression Volume and the copy destination Deduplication/Compression Volume is recommended when a local copy is performed.
- When a remote copy is performed, non-deduplicated/uncompressed data is transferred to the copy destination.

Volumes that are used with the Deduplication/Compression function are shown below.

- Deduplication/Compression Volume
Virtual volumes that are recognized from the server
- Data storage area (DEDUP_SYS Volume)
Area for storing deduplicated/compressed data. Also used for storing control information for other data such as the update log information (journal).
- Mapping table (DEDUP_MAP Volume)
Table for mapping the logical data that can be checked from the server and deduplicated/compressed data that is stored in the TPP.

The commands that are used with the volumes that are related to the Deduplication/Compression function are described below.

Function	Command to use	Deduplication/ Compression Volume	DEDUP_SYS Volume	DEDUP_MAP Volume
Create	create volume	x	Automatic creation	Automatic creation
Delete	delete volume delete all-volumes	x	Automatic deletion	Automatic deletion
Show	show volumes	x	x	x
Name change	set volume	x	-	-
Format	format volume	x	x	x Formats at the same time as DEDUP_SYS
Eco mode (pool specification)	set eco-thin-pro-pool	-	-	-
TPV capacity expansion	expand volume	x	x	-
Change various volume settings	set volume-parameters	-	-	-
RAID Migration	start migration	x	-	-
Balancing	start balancing-thin-pro-volume	-	-	-
TPV/FTV capacity optimization	start zero-reclamation	-	x	x
Advanced Copy Function (local copy)	start advanced-copy (source volume)	x	-	-
Performance information acquisition	show performance	x	-	-
QoS	set volume-qos	x	-	-
Create ODX buffer volume	create odx-buffer-volume	-	-	-
Extreme Cache	create volume set volume-exc	-	x	x
Extreme Cache Pool	create volume set volume-exc	-	x	x

x: Available, -: Unavailable

■ Setting the Deduplication/Compression function

The following procedure explains how to set the Deduplication/Compression function.

For information on how to operate the Thin Provisioning pool, refer to ["3.3 Thin Provisioning Pool Management" \(page 245\)](#).

Procedure

1 Setting the Deduplication/Compression mode of the ETERNUS DX/AF

To use the Deduplication/Compression function, the Deduplication/Compression mode setting must be enabled in advance.

Use the "set dedup-mode" command to enable the Deduplication/Compression mode setting. Use the "show dedup-mode" command to check the setting.

2 Setting the Thin Provisioning function

The Thin Provisioning function must be enabled before creating TPPs.

Use the "set thin-provisioning" command to enable the Thin Provisioning function. Use the "show thin-provisioning" command to check the setting.

Note

The maximum capacity (-max-pool-capacity) of the pool that can be created in the ETERNUS DX/AF is the maximum value set for each ETERNUS DX/AF. This maximum capacity includes Deduplication/Compression System Volumes (DEDUP_SYS Volumes and DEDUP_MAP Volumes) in [Step 3](#). Deduplication/Compression Volumes (dedup-tpv) are not included.

3 Creating TPPs and setting the Deduplication/Compression function

The following two methods are available for setting Deduplication/Compression in TPPs.

- Perform the Deduplication/Compression setting during a TPP creation. (Recommended)
- Perform the Deduplication/Compression setting after a TPP creation.

● When performing the Deduplication/Compression setting during a TPP creation. (Recommended)

- 1 Create a TPP that has the Deduplication/Compression setting enabled by using the "-rg-mode auto -dedup {enable | deduplication-only | compression-only}" parameter of the "create thin-pro-pool" command. To distribute the assigned CM, create two or more RAID groups for each TPP. An error occurs if two or more RAID groups are not created.
- 2 Check the TPP state by using the "show thin-pro-pools" command.

- When performing the Deduplication/Compression setting after a TPP creation.
 - 1 Create a TPP by using the "-rg-mode manual -dedup ready" parameter of the "create thin-pro-pool" command.
At this point, the number of RAID groups that configure the pool is one.
To distribute the assigned CM, creating two or more RAID groups for each TPP by using the "expand thin-pro-pool" command is recommended.
 - 2 Enable the Deduplication/Compression setting by using the "-dedup {enable | deduplication-only | compression-only}" parameter of the "set thin-pro-pool" command.
 - 3 Check the TPP state by using the "show thin-pro-pools" command.

Note

- In order to distribute the assigned CM, creating two or more RAID groups in each TPP is recommended.
- Deduplication/Compression System Volumes are automatically created in TPPs that are enabled with the Deduplication/Compression setting.
The general term for DEDUP_SYS volumes and DEDUP_MAP volumes is Deduplication/Compression System Volumes.
 - \$DEDUP_SYS
One DEDUP_SYS volume is created.
 - \$DEDUP_MAP
Two DEDUP_MAP volumes are created (or if there is one RAID group within the TPP, one DEDUP_MAP volume is created).
- If the Deduplication/Compression setting is changed to disable using the "-dedup" parameter of the "set thin-pro-pool" command, the Deduplication/Compression System Volumes in the target TPP are deleted.
- For information about the capacities of the DEDUP_SYS volumes and the DEDUP_MAP volumes, and about the maximum number of TPPs that can have the Deduplication/Compression setting, refer to ["Specifications of the Deduplication/Compression function" \(page 280\)](#).

4 Capacity expansion of the DEDUP_SYS Volume

Before creating the Deduplication/Compression Volume (dedup-tpv), expand the capacity of the DEDUP_SYS Volume as required. The capacity of DEDUP_SYS Volumes can be expanded to 128TB. Use the "expand volume" command to expand the DEDUP_SYS Volume area. Use the "show volumes" command to check the expansion.

Note

In order to prevent the capacity of the Deduplication/Compression Volume from exceeding the corresponding maximum capacity (128TB) of the DEDUP_SYS Volume, migrate the Deduplication/Compression Volume in the TPP to a non-Deduplication/Compression Volume or to a separate TPP by using RAID Migration.

5 Deduplication/Compression Volume (dedup-tpv) creation

Create a Deduplication/Compression Volume (dedup-tpv) in the TPP where the Deduplication/Compression setting was enabled in [Step 3](#).

Create the Deduplication/Compression Volume (dedup-tpv) by using the "-type dedup-tpv" parameter of the "create volume" command. Use the "show volumes" command to check the created volume. The details are shown in "Usage Details". In addition, the Deduplication/Compression setting cannot be changed to enable/disable with the "set volume" command.

Block Dedup: Deduplication/Compression Volume
 Dedup System: DEDUP_SYS Volume
 Dedup Map: DEDUP_MAP Volume

End of procedure

■ Changing existing volumes to Deduplication/Compression Volumes

Non-target volumes (TPV) of the Deduplication/Compression function can be changed to target volumes (Deduplication/Compression Volume [dedup-tpv]). In addition, target volumes (dedup-tpv) can also be changed to non-target volumes (TPV).

Change the non-target volume of the Deduplication/Compression function to a target volume (dedup-tpv) by using the "-dedup" parameter of the "start migration" command.

■ Specifications of the Deduplication/Compression function

The specifications of the Deduplication/Compression function are shown below.

Model name		DX200 S4, DX200 S3, AF250 S2, AF250	DX500 S4, DX500 S3	DX600 S4, DX600 S3, AF650 S2, AF650
Number of TPPs available with the Deduplication/Compression setting		4	4	8
Maximum capacity of Thin Provisioning		256TB	384TB	1,024TB
Maximum logical capacity that can be targets of Deduplication/Compression (per pool)		(*1)		
Logical capacity of DEDUP_SYS Volume (per pool)	default	8TB		
	maximum	128TB		
Logical capacity of DEDUP_MAP Volumes	per volume	5,641,339MB (fixed)		
	per pool	5.38TB x number of DEDUP_MAP Volumes (*2)		

*1: If the effects of the Deduplication/Compression function cannot be estimated, making the logical capacity of the DEDUP_SYS Volume insufficient is recommended.

If the effects of the Deduplication/compression function cannot be estimated, depending on the number of RAID groups that are to be created in the TPP, the total logical capacity of the Deduplication/Compression Volume that can be created differs.

- If the TPP is configured with two or more RAID groups, the total logical capacity of the Deduplication/Compression Volume is a maximum of 10 times or less than the logical capacity of the DEDUP_SYS Volume.
- If the TPP has one RAID group, the total logical capacity of the Deduplication/Compression Volume is a maximum of 5 times or less than the logical capacity of the DEDUP_SYS Volume.

*2: For the DEDUP_MAP Volume, "1" if there is one RAID group and "2" if there are two or more RAID groups in the TPP.

3.5 Flexible Tier Management

This section describes the commands that are related to the Flexible Tier function.

Caution

The commands that are described in this section are not supported in the DX60 S4/DX60 S3.

Note

Perform operations for Flexible Tier (or Automated Storage Tiering) with ETERNUS SF Storage Cruiser.
For information on how to operate automated storage tiering, refer to "FUJITSU Storage ETERNUS SF Storage Cruiser Operation Guide for Optimization Function".
If Flexible Tier is set (changed/deleted) with CLI, a status update operation from ETERNUS SF Storage Cruiser is required.

The Flexible Tier control functions are as follows:

- Deleting the FTRP
- Changing the existing FTSP
- Deleting the RAID group registered in the FTRP
- Checking the FTRPE migration (incomplete migration)
- Checking the Flexible Tier Pool balancing
- Starting the Flexible Tier Pool balancing (FTRP specification)
- Stopping the Flexible Tier Pool balancing

3.5.1 Flexible Tier Pool

This section explains the commands that are related to the management of Flexible Tier Pools (FTRP).

- Deleting FTRPs
- Changing an existing Flexible Tier Sub Pool (FTSP)

For details about Flexible Tier Volume (FTV) management, refer to ["3.2.2 Flexible Tier Volumes" \(page 202\)](#).

show flexible-tier-mode

This command displays the setting status of the Flexible Tier function.

■ Syntax

```
show flexible-tier-mode
```

■ Parameter

No parameters.

■ Output

Item name	Description
Flexible Tier Mode	Indicates whether the Flexible Tier function is enabled (Enable/Disable).

■ Example(s)

The following example displays the setting status of the Flexible Tier function:

```
CLI> show flexible-tier-mode  
Flexible Tier Mode [Disable]  
  
CLI> show flexible-tier-mode  
Flexible Tier Mode [Enable]
```

show flexible-tier-pools

This command displays an overview list of Flexible Tier Pools (FTRPs) that are already registered in the ETERNUS DX/AF and detailed information for a specified FTRP. When the FTRP number or the FTRP name is specified, information is displayed for the specified FTRP and the Flexible Tier Sub Pool (FTSP) that are registered in the specified FTRP. When the FTRP number or the FTRP name is omitted, a list of the FTRPs that are already registered in the ETERNUS DX/AF is displayed.

■ Syntax

```
show flexible-tier-pools [-ftrp-number ftrp_number | -ftrp-name ftrp_name]
```

■ Parameter

-ftrp-number or -ftrp-name

Optional. This parameter specifies the FTRP identifier to display detailed information for. Multiple parameters can be selected in a single command.
If omitted, a list of all the FTRPs that are already registered in the ETERNUS DX/AF is displayed.

ftrp_number FTRP number

ftrp_name FTRP name

■ Output

- When the parameter is omitted.

Item name	Description
Flexible Tier Pool	FTRP identifiers
No.	FTRP number
Name	FTRP name
Status	FTRP status
Total Capacity	Total capacity of the FTRP
Provisioned Capacity	Provisioned capacity of the FTRP (total logical capacity of the FTVs that belong to the FTRP)
Provisioned Rate	Provisioned rate of the FTRP (ratio [%] of the total logical capacity of the FTVs that exist in the FTRP to the total capacity of the FTRP)
Used Capacity	Used capacity of the FTRP
Used Status	Alarm status (Normal / Warning / Attention)
Warning(%)	Warning level range
Attention(%)	Attention level range
Encryption	Encryption status (Enable / Disable)
Chunk Size	Chunk size of the FTRP A unit of the physical volume capacity that is assigned to the created logical volume in the FTRP when the Write I/O is accepted from the host. The chunk size is determined according to the maximum pool capacity of the ETERNUS DX/AF when FTRPs are created.
Shrinking	Execution status of the Flexible Tier Pool shrinking
Executing	Flexible Tier Pool shrinking

Item name	Description
Error	Error during the Flexible Tier Pool shrinking If an "Error" occurs, stop the process of the Flexible Tier Pool shrinking using the "stop shrinking-flexible-tier-pool" command.
-	A Flexible Tier Pool shrinking is not currently running.

- When the parameter is specified.

Item name	Description
Flexible Tier Pool	FTRP identifiers
No.	FTRP number
Name	FTRP name
Status	FTRP status
Total Capacity	Total capacity of the FTRP
Provisioned Capacity	Provisioned capacity of the FTRP (total logical capacity of the FTVs that belong to the FTRP)
Provisioned Rate	Provisioned rate of the FTRP (ratio [%] of the total logical capacity of the FTVs that exist in the FTRP to the total capacity of the FTRP)
Used Capacity	Used capacity of the FTRP
Used Status	Alarm status (Normal / Warning / Attention)
Warning(%)	Warning level range
Attention(%)	Attention level range
Encryption	Encryption status (Enable / Disable)
Chunk Size	Chunk size of the FTRP A unit of the physical volume capacity that is assigned to the created logical volume in the FTRP when the Write I/O is accepted from the host. The chunk size is determined according to the maximum pool capacity of the ETERNUS DX/AF when FTRPs are created.
Shrinking	Execution status of the Flexible Tier Pool shrinking
Executing	Flexible Tier Pool shrinking
Error	Error during the Flexible Tier Pool shrinking If an "Error" occurs, stop the process of the Flexible Tier Pool shrinking using the "stop shrinking-flexible-tier-pool" command.
-	A Flexible Tier Pool shrinking is not currently running.
Flexible Tier Sub Pool	FTSP identifiers
No.	FTSP number
Name	FTSP name
Disk Attribute	Drive attribute that composes the FTSP (Online / Nearline / SSD / Online SED / Nearline SED / SSD SED)
RAID Level	RAID level that is used for creating the FTSP
Status	FTSP status
Total Capacity	Total capacity of the FTSP
Used Capacity	Used capacity of the FTSP
Shrinking	Execution status of the Flexible Tier Pool shrinking
Executing	Flexible Tier Pool shrinking
Error	Error during the Flexible Tier Pool shrinking If an "Error" occurs, stop the process of the Flexible Tier Pool shrinking using the "stop shrinking-flexible-tier-pool" command.
-	A Flexible Tier Pool shrinking is not currently running.

■ Example(s)

The following example displays an overview list of the FTRPs that are already registered in the ETERNUS DX/AF:

```
CLI> show flexible-tier-pools
Flexible Tier Pool  Status      Total      Provisioned      Used      Used      Warn-  Atten-  Encryp-  Chunk  Shrinking
No.  Name      Status      Capacity      Capacity      Rate(%)  Capacity      Status      ing(%)  tion(%)  tion    Size(MB)
-----
 0  FTRP001  Available  129.00 GB     0.0GB        0%        0.00 MB Normal    90      75  Disable  21  -
 1  FTRP_NAME#0  Available  0.00 MB      0.00MB       0%        0.00 MB Normal    90      75  Disable  42  -
```

The following example displays the detailed information of an FTRP that is named "FTRP001":

```
CLI> show flexible-tier-pools -ftrp-name FTRP001
Flexible Tier Pool  Status      Total      Provisioned      Used      Used      Warn-  Atten-  Encryp-  Chunk  Shrinking
No.  Name      Status      Capacity      Capacity      Rate(%)  Capacity      Status      ing(%)  tion(%)  tion    Size(MB)
-----
 0  FTRP001  Available  258.00 GB     0.0GB        0%        0.00 MB Normal    90      75  Disable  21  Executing
<Flexible Tier Sub Pool List>
Flexible Tier Sub Pool Disk      RAID      Status      Total      Used      Shrinking
No.  Name      Attribute  Level      Capacity  Capacity
-----
 0  FTSP000  Nearline SED RAID0  Available  129.00 GB  0.00 MB  Executing
 1  FTSP001  Nearline SSD RAID0  Available  129.00 GB  0.00 MB  -
```

The following example displays detailed information for FTRP#00:

```
CLI> show flexible-tier-pools -ftrp-number 0
Flexible Tier Pool  Status      Total      Provisioned      Used      Used      Warn-  Atten-  Encryp-  Chunk  Shrinking
No.  Name      Status      Capacity      Capacity      Rate(%)  Capacity      Status      ing(%)  tion(%)  tion    Size(MB)
-----
 0  FTRP001  Available  129.00 GB     0.0GB        0%        0.00 MB Normal    90      75  Disable  21  -
<Flexible Tier Sub Pool List>
Flexible Tier Sub Pool Disk      RAID      Status      Total      Used      Shrinking
No.  Name      Attribute  Level      Capacity  Capacity
-----
 0  FTSP      Nearline SED RAID0  Available  129.00 GB  0.00 MB  -
```

show flexible-tier-pool-progress

This command displays the progress rate of formatting Flexible Tier Pools (FTRPs) that are already registered in the ETERNUS DX/AF. When the FTRP number or the FTRP name is specified, the progress rates for the specified FTRPs are displayed. Note that the progress rate is not displayed when a specified FTRP is not being formatted. When the FTRP number or the FTRP name is omitted, a list of the progress rates for the FTRPs being formatted that are already registered in the ETERNUS DX/AF is displayed.

Syntax

```
show flexible-tier-pool-progress [-ftrp-number ftrp_number | -ftrp-name ftrp_name]
```

Parameter

-ftrp-number or -ftrp-name

Optional. This parameter specifies the FTRP identifier to display detailed information for. Multiple parameters can be selected in a single command. If omitted, a list of all the FTRPs that are already registered in the ETERNUS DX/AF and that are being formatted is displayed.

ftrp_number FTRP number
ftrp_name FTRP name

Output

Item name	Description
Flexible Tier Pool No	FTRP identifier
No	FTRP number
Name	FTRP name
Status	FTRP status
Flexible Tier Sub Pool	FTSP identifier
No	FTSP number
Name	FTSP name
Status	FTSP status
Formatting	Information on the formatting progress
Progress	Progress status (0 – 100%)
Estimated time left	Estimated remaining formatting time
-	Formatting is not performed or is complete.
calculating	The remaining time is being calculated.
30days or more	The remaining time is 30 days or more.
Xd _{day} Yh Zmin	The remaining time is less than 30 days but 1 day or more.
Yh Zmin	The remaining time is less than 1 day but 1 hour or more.
Zmin	The remaining time is less than 1 hour but 1 minute or more.
Less than 1min	The remaining time is less than 1 minute.

Item name	Description
Remaining size	Remaining capacity of a formatting
-	Formatting is not performed or is complete.
XMB	Remaining capacity (rounded up to the nearest whole number) X: decimal number

■ Example(s)

The following example displays a list of the Flexible Tier Pools that are being formatted:

```

CLI> show flexible-tier-pool-progress
Flexible Tier Pool  Status
No. Name
-----
 0 FTRP000          Available
<Flexible Tier Sub Pool List>
Flexible Tier Sub Pool Status      Format
No. Name                          Progress  Estimated time left  Remaining size
-----
 0 FTSP0000          Available      84%  30min                1MB
 1 FTSP0001          Available      20%  calculating           512MB

Flexible Tier Pool  Status
No. Name
-----
 3 FTRP003          Available
<Flexible Tier Sub Pool List>
Flexible Tier Sub Pool Status      Format
No. Name                          Progress  Estimated time left  Remaining size
-----
16 FTSP0016          Available      99%  Less than 1min       32MB
  
```

The following example displays the progress rate of formatting for an FTRP that is named "FTRP001":

```

CLI> show flexible-tier-pool-progress -ftrp-name FTRP001
Flexible Tier Pool  Status
No. Name
-----
 1 FTRP001          Available
<Flexible Tier Sub Pool List>
Flexible Tier Sub Pool Status      Format
No. Name                          Progress  Estimated time left  Remaining size
-----
 4 FTSP0004          Available      50%  calculating           512MB
  
```

The following example displays the progress rate of formatting for FTRP#00 and FTRP#02:

```

CLI> show flexible-tier-pool-progress -ftrp-number 0,2
Flexible Tier Pool      Status
No. Name
-----
 0 FTRP000             Available
<Flexible Tier Sub Pool List>
Flexible Tier Sub Pool Status      Format
No. Name                          Progress  Estimated time left  Remaining size
-----
 0 FTSP0000             Available      84%  01day 23h 59min    128MB
 1 FTSP0001             Available      20%  23h 00min          1024MB

Flexible Tier Pool      Status
No. Name
-----
 2 FTRP002             Available
<Flexible Tier Sub Pool List>
Flexible Tier Sub Pool Status      Format
No. Name                          Progress  Estimated time left  Remaining size
-----
17 FTSP0017             Available      99%  05min              99MB
18 FTSP0018             Available      10%  01h 01min          256MB
19 FTSP0019             Available      0%   calculating        134217728MB

```

delete flexible-tier-pool

This command deletes the Flexible Tier Pools (FTRPs) that are already registered in the ETERNUS DX/AF. All Flexible Tier Sub Pools (FTSPs) in the target FTRPs are also deleted. If a volume is registered in the specified FTRP, the FTRP cannot be deleted.

Caution

Delete all volumes in the target FTRP before deleting the FTRP.

■ Syntax

```
delete flexible-tier-pool {-ftrp-number ftrp_number | -ftrp-name ftrp_name}
```

■ Parameter

-ftrp-number or -ftrp-name

This parameter specifies the FTRP identifiers that are to be deleted. Multiple FTRPs can be deleted in a single command.

ftrp_number FTRP number

ftrp_name FTRP name

■ Example(s)

The following example deletes FTRP#01:

```
CLI> delete flexible-tier-pool -ftrp-number 01
```

The following example deletes an FTRP that is named "FTRP05":

```
CLI> delete flexible-tier-pool -ftrp-name FTRP05
```

show flexible-tier-sub-pools

This command displays an overview list of the Flexible Tier Sub Pools (FTSPs) that are already registered in the ETERNUS DX/AF and detailed information for a specified FTSP. When the FTSP number or the FTSP name is specified, information on the specified FTSP and the RAID group (RLU) that are registered in the specified FTSP is displayed. When the FTSP number or the FTSP name is omitted, a list of the FTSPs that are already registered in the ETERNUS DX/AF is displayed.

■ Syntax

```
show flexible-tier-sub-pools [-ftsp-number ftsp_number | -ftsp-name ftsp_name]
```

■ Parameter

-ftsp-number or -ftsp-name

Optional. This parameter specifies the FTSP identifier to display detailed information for. Multiple parameters can be selected in a single command.
If omitted, a list of all the FTSPs that are already registered in the ETERNUS DX/AF is displayed.

ftsp_number FTSP number

ftsp_name FTSP name

■ Output

- When the parameter is omitted.

Item name	Description
Flexible Tier Sub Pool	FTSP identifiers
No.	FTSP number
Name	FTSP name
Flexible Tier Pool	Assigned FTRP identifiers
No.	Assigned FTRP number
Name	Assigned FTRP name
Disk attribute	Drive attribute that composes the FTSP (Online / Nearline / SSD / Online SED / Nearline SED / SSD SED)
RAID Level	RAID level
Status	FTSP status
Total Capacity	Total capacity of the FTSP
Used Capacity	Used capacity of the FTSP
Shrinking	Execution status of the Flexible Tier Pool shrinking
Executing	Flexible Tier Pool shrinking
Error	Error during the Flexible Tier Pool shrinking If an "Error" occurs, stop the process of the Flexible Tier Pool shrinking using the "stop shrinking-flexible-tier-pool" command.
-	A Flexible Tier Pool shrinking is not currently running.

- When the parameter is specified.

Item name	Description
Flexible Tier Sub Pool	FTSP identifiers
No.	FTSP number
Name	FTSP name
Flexible Tier Pool	Assigned FTRP identifiers
No.	Assigned FTRP number
Name	Assigned FTRP name
Disk Attribute	Drive attribute that composes the FTSP (Online / Nearline / SSD / Online SED / Nearline SED / SSD SED)
RAID Level	RAID level
Status	FTSP status
Total Capacity	Total capacity of the FTSP
Used Capacity	Used capacity of the FTSP
Shrinking	Execution status of the Flexible Tier Pool shrinking
Executing	Flexible Tier Pool shrinking
Error	Error during the Flexible Tier Pool shrinking If an "Error" occurs, stop the process of the Flexible Tier Pool shrinking using the "stop shrinking-flexible-tier-pool" command.
-	A Flexible Tier Pool shrinking is not currently running.
Raid Group	RAID group identifiers
No.	RAID group number
Name	RAID group name
RAID Level	RAID level
Consist of Fast Recovery	Drive configuration of the Fast Recovery RAID group (This information is displayed when the RAID level is RAID6-FR. For other RAID levels, a hyphen [-] is displayed.) Shows the RAID6 drive configurations, number of units, and number of hot spares. Example: (4D+2P)x2+1HS
Assigned CM	Assigned CM
Status	RAID group status
Total Capacity	Total capacity of the RAID group
Used Capacity	Used capacity of the RAID group
Stripe Depth	Stripe depth
Fast Recovery Disk	Fast Recovery drive
Deleting	Execution status of the RAID group deletion process due to the process of the Flexible Tier Pool shrinking
Executing	Deletion processing of a RAID group and an executing data migration due to the deletion process of the RAID group.
Error	Error during the deletion process of the RAID group If an "Error" occurs, stop the process of the Flexible Tier Pool shrinking using the "stop shrinking-flexible-tier-pool" command.
-	A deletion process of the RAID group is not currently running.

■ Example(s)

The following example displays an overview list of the Flexible Tier Sub Pools that are already registered in the ETERNUS DX/AF:

```
CLI> show flexible-tier-sub-pools
Flexible Tier Sub Pool Flexible Tier Pool   Disk      RAID      Status      Total      Used      Shrinking
No. Name                No. Name                Attribute  Level
-----
  0 FTSP0000             0 FTRP000               Online    RAID1+0   Available   1.25 GB   0.00 MB -
 10 FTSP0010             0 FTRP000               Nearline RAID5   Available   250 GB   25.00 MB -
 53 FTSP0053             0 FTRP000               SSD      RAID6     Available   500 GB   64.00 MB -
 55 FTSP0055             0 FTRP000               Nearline SED RAID6   Available   500 GB   64.00 MB Executing
```

The following example displays detailed information for an FTSP that is named "FTSP0000":

```
CLI> show flexible-tier-sub-pools -ftsp-name FTSP0000
Flexible Tier Sub Pool Flexible Tier Pool   Disk      RAID      Status      Total      Used      Shrinking
No. Name                No. Name                Attribute  Level
-----
  0 FTSP0000             0 FTRP000               Nearline SED RAID1+0   Available   1.25 GB   0.00 MB -
<Raid Group List>
Raid Group              RAID   Consist of  Assigned Status      Total      Used      Stripe  Fast Recovery Deleting
No. Name                Level  Fast Recovery CM
-----
  2 FTSP_NAME#0_0       RAID1  -           CM#0     Available   32.25 GB   0.00 MB   - -     -
```

The following example displays detailed information for an FTSP that is named "FTSP0000" (for the DX8700 S3/DX8900 S3):

```
CLI> show flexible-tier-sub-pools -ftsp-name FTSP0000
Flexible Tier Sub Pool Flexible Tier Pool   Disk      RAID      Status      Total      Used      Shrinking
No. Name                No. Name                Attribute  Level
-----
  0 FTSP0000             0 FTRP000               Nearline SED RAID1+0   Available   1.25 GB   0.00 MB -
<Raid Group List>
Raid Group              RAID   Consist of  Assigned Status      Total      Used      Stripe  Fast Recovery Deleting
No. Name                Level  Fast Recovery CM
-----
  2 FTSP_NAME#0_0       RAID1  -           CE#1 CM#0 Available   32.25 GB   0.00 MB   - -     -
```

The following example displays detailed information for FTSP#10:

```
CLI> show flexible-tier-sub-pools -ftsp-number 10
Flexible Tier Sub Pool Flexible Tier Pool   Disk      RAID      Status      Total      Used      Shrinking
No. Name                No. Name                Attribute  Level
-----
 10 FTSP0010             0 FTRP000               Nearline SED RAID5     Available   250 GB   25.00 MB Executing
<Raid Group List>
Raid Group              RAID   Consist of  Assigned Status      Total      Used      Stripe  Fast Recovery Deleting
No. Name                Level  Fast Recovery CM
-----
  2 FTSP_NAME#0_0       RAID1  -           CM#0     Available   32.25 GB   0.00 MB   - -     Executing
  3 FTSP_NAME#0_1       RAID1  -           CM#0     Available   32.25 GB   0.00 MB   - -     -
```

The following example displays detailed information for a RAID6-FR RAID group:

```
CLI> show flexible-tier-sub-pools -ftsp-number 1
Flexible Tier Sub Pool Flexible Tier Pool   Disk      RAID      Status      Total      Used      Shrinking
No. Name                No. Name                Attribute  Level
-----
  1 FTSP0001             1 FTRP001               Nearline SED RAID6-FR Available   1.25 GB   0.00 MB Error
<Raid Group List>
Raid Group              RAID   Consist of  Assigned Status      Total      Used      Stripe  Fast Recovery Deleting
No. Name                Level  Fast Recovery CM
-----
  2 FTSP_NAME#0_0       RAID6-FR (3D+2P)x2+1HS CM#0     Partially Exposed Rebuild(Fast) 32.25 GB   0.00 MB   64 KB DE#01-Disk#5 Error
```

set flexible-tier-sub-pool

This command changes the information for the Flexible Tier Sub Pools (FTSPs) that are already registered in the ETERNUS DX/AF.

Syntax

```
set flexible-tier-sub-pool {-ftsp-number ftsp_number | -ftsp-name ftsp_name}  
[-assigned-cm {0 | 1 | 00 | 01 | 10 | 11 | 20 | 21 | 30 | 31 | 40 | 41 | 50 | 51 | 60 | 61 | 70 | 71 | 80 | 81 | 90 | 91 | a0 | a1  
| b0 | b1 | auto}]
```

Parameter

-ftsp-number or -ftsp-name

This parameter specifies the FTSP identifier. Only one FTSP identifier can be specified in a single command.

ftsp_number FTSP number

ftsp_name FTSP name

-assigned-cm

Optional. This parameter specifies the assigned CM for the RAID group that is added to the target FTSP. When "auto" is specified, the assigned CM is automatically determined by the ETERNUS DX/AF. If omitted, the assigned CM is not changed.

0 CM#0 (DX100 S4/DX200 S4, DX500 S4/DX600 S4, DX100 S3/DX200 S3, DX500 S3/DX600 S3, DX8100 S3, AF250 S2/AF650 S2, AF250/AF650, and DX200F only)

1 CM#1 (DX100 S4/DX200 S4, DX500 S4/DX600 S4, DX100 S3/DX200 S3, DX500 S3/DX600 S3, DX8100 S3, AF250 S2/AF650 S2, AF250/AF650, and DX200F only)

*w**x* CE#*w*-CM#*x* (DX8700 S3/DX8900 S3 only)

"*w*" is the controller enclosure (CE) number and "*x*" is the controller module (CM) number.

Example: "01" indicates CE#0-CM#1

For the controller enclosure number, the range that the value can be specified with is 0 to b (hex).

For the controller module number, 0 or 1 can be specified.

auto Automatically (default)

Example(s)

The following example automatically sets the assigned CM for FTSP0001:

```
CLI> set flexible-tier-sub-pool -ftsp-name FTSP0001 -assigned-cm auto
```

stop shrinking-flexible-tier-pool

This command stops the Flexible Tier Pool shrinking that is started with the "start shrinking-flexible-tier-pool" command. With this command, the deletion process of the RAID group that is scheduled for deletion with the "start shrinking-flexible-tier-pool" command is stopped.

Caution

The Maintenance Operation policy is required for executing the "start shrinking-flexible-tier-pool" command. The "start shrinking-flexible-tier-pool" command is a function that deletes specific RAID groups selected from the RAID groups that are registered in the FTRP.

Note

- If the FTSP is deleted or there is a change in the priority allocated FTSP of the FTV by executing Flexible Tier Pool shrinking, their respective processes are stopped.
- If executing Flexible Tier Pool shrinking causes an error during the deletion process of the RAID group, this command must be used to stop the Flexible Tier Pool shrinking.

Syntax

```
stop shrinking-flexible-tier-pool {-rg-number rg_number | -rg-name rg_name}
```

Parameter

-rg-number or -rg-name

This parameter specifies the RAID group identifier to stop the deletion process. Only one RAID group identifier can be specified at the same time. For details, refer to "[1.2.10 RAID Group Syntax](#)" (page 39).

rg_number RAID group number

rg_name RAID group name

Example(s)

The following example stops the deletion process of RAID group #0 that makes up the FTRP:

```
CLI> stop shrinking-flexible-tier-pool -rg-number 0
```

The following example stops the deletion process of RAID group RAID0 that makes up the FTRP:

```
CLI> stop shrinking-flexible-tier-pool -rg-name RAID0
```

3.5.2 FTRPE Migration

This section explains the commands that are related to FTRPE (Flexible Tier Pool Element) Migrations.

- Checking the FTRPE Migration (unfinished migration)
-

Caution

Only user accounts with the Software role can execute FTRPE Migration. User accounts without the Software role cannot use the FTRPE Migration function.

Note

FTRPE migration sessions are shared with sessions for data migrations due to the Flexible Tier Pool shrinking.

show ftrpe-migration

This command displays information for the FTRPE Migration sessions that are not complete. Completed FTRPE Migration sessions cannot be displayed.

This command is only used to display information for migration sessions in which the destination is a Flexible Tier Sub Pool (FTSP).

Syntax

```
show ftrpe-migration
```

Parameter

No parameters.

Output

Item name	Description
Source Volume	Migration source volume identifiers
No.	Migration source volume number
Name	Migration source volume name
FTRPE Offset	The migration source FTRPE offset
Destination Flexible Tier Sub Pool	Migration destination FTSP identifiers
No.	Migration destination FTSP number
Name	Migration destination FTSP name
Migration Status	Migration status (Idle, Reserve, Active, Error, Suspend, or -)
Progress	Migration progress
Error Code	Error code of a migration error (when no error occurs, 0x00)

Example(s)

The following example displays FTRPE Migration session information:

```
CLI>show ftrpe-migration
Source Volume           FTRPE   Destination      Migration Progress(%) Error
No.   Name             Offset   Flexible Tier Sub Pool Status          Code
-----
  1   FTV_NAME#0       0x00000000  1 FTSP_NAME#0   Active          0 0x00
12345 FTV_NAME#1       0x000003000  2 FTSP_NAME#1   Error           0 0x01
```

3.5.3 FTRP Balancing

This section explains the commands that are related to the balancing process for Flexible Tier Pools (FTRP). FTRP balancing is a function that performs a balancing process on a per FTV basis and equalizes the physical allocation capacity between RAID groups that configure the FTSP. By using this function, the ETERNUS DX/AF determines the allocation for the biased Flexible Tier Volumes (FTV).

- Checking the Flexible Tier Pool balancing
- Starting Flexible Tier Pool balancing (FTRP specification)
- Stopping Flexible Tier Pool balancing

 **Note**

FTRP balancing is executed by selecting the FTRP to balance. If FTRP balancing is executed, the physical area in the FTSP is sorted. FTRP balancing does not migrate the physical area across FTSPs.

show balancing-flexible-tier-pools

This command displays balancing information for the Flexible Tier Pools (FTRPs) that are registered in the ETERNUS DX/AF. When an FTRP number or an FTRP name is specified, this command displays balancing information for the specified FTRP and the Flexible Tier Sub Pools (FTSPs) that are registered in this FTRP. When the FTRP number or the FTRP name is omitted, this command displays the balancing information of all the FTRPs that are registered in the ETERNUS DX/AF.

■ Syntax

```
show balancing-flexible-tier-pools [-ftrp-number ftrp_number | -ftrp-name ftrp_name]
```

■ Parameter

-ftrp-number or -ftrp-name

Optional. This parameter specifies which FTRP to display the balancing information for. Only one FTRP can be specified at the same time. If omitted, the balancing information of all the FTRPs that are registered in the ETERNUS DX/AF is displayed.

For details, refer to "[1.2.8 Flexible Tier Pool Syntax](#)" (page 37).

ftrp_number FTRP number

ftrp_name FTRP name

■ Output

- When the parameter is omitted.

Item name	Description
Flexible Tier Pool	FTRP identifiers
No.	FTRP number
Name	FTRP name
Balancing Level	Balancing level (High / Medium / Low / -) of each FTRP (A hyphen [-] is displayed when an Not Ready error or a Subsystem Down error occurs in the ETERNUS DX/AF)
Balancing Process	FTRP balancing progress
Status	Balancing status (Active/Error/-) for the FTRP (A hyphen [-] is displayed when balancing is not being performed)
Progress(%)	Balancing progress for the FTRP (A hyphen [-] is displayed when balancing is not being performed)
Error code	Error code of an FTRP balancing process status error. (If there are no error with the balancing process, "0x00" is displayed. A hyphen [-] is displayed if a balancing process is not running.)

- When an FTRP number or an FTRP name is specified.

Item name	Description
Flexible Tier Pool	FTRP identifiers
No.	FTRP number
Name	FTRP name
Balancing Level	Balancing level (High / Medium / Low / -) of each FTRP (A hyphen [-] is displayed when a Not Ready error or a Subsystem Down error occurs in the ETERNUS DX/AF)
Balancing Process	FTRP balancing progress
Status	Balancing status (Active/Error/-) for the FTRP (A hyphen [-] is displayed when balancing is not being performed)
Progress(%)	Balancing progress for the FTRP (A hyphen [-] is displayed when balancing is not being performed)
Error code	Error code of an FTRP balancing process status error. (If there are no error with the balancing process, "0x00" is displayed. A hyphen [-] is displayed if a balancing process is not running)
Flexible Tier Sub Pool	FTRP identifiers (This item only appears when an FTRP is specified)
No.	FTSP number
Name	FTSP name
Balancing Level	Balancing level (High/Medium/Low/-) of each FTSP (This item only appears when an FTRP is specified)

■ Example(s)

The following example displays the balancing information of all the FTRPs that are registered in the ETERNUS DX/AF:

```
CLI> show balancing-flexible-tier-pools
Flexible Tier Pool   Balancing   Balancing Process   Error
No. Name            Level      Status  Progress(%) code
1 FTRP_NAME001     Low       Active   70 0x00
2 FTRP_NAME002     Medium    Active   33 0x00
3 FTRP_NAME003     Low       Active   10 0x00
4 FTRP_NAME004     High      -        -  -
```

The following example displays detailed balancing information for an FTRP that is named FTRP_NAME#1:

```
CLI> show balancing-flexible-tier-pools -ftrp-name FTRP_NAME#1
Flexible Tier Pool   Balancing   Balancing Process   Error
No. Name            Level      Status  Progress(%) code
1 FTRP_NAME#1      Low       Active   50 0x00
<Flexible Tier Sub Pool List>
Flexible Tier Sub Pool Balancing
No. Name            Level
0 FTSP000          Medium
1 FTSP001          Medium
2 FTSP002          Low
```

start balancing-flexible-tier-pool

This command starts evenly relocating the Flexible Tier Pools (FTRPs) among RAID groups. Specify the FTRP that is to be balanced.

■ Syntax

```
start balancing-flexible-tier-pool {-ftrp-number ftrp_number | -ftrp-name ftrp_name}
```

■ Parameter

-ftrp-number or -ftrp-name

This parameter specifies the FTRP to which the FTV to start balancing is allocated. For details, refer to ["1.2.8 Flexible Tier Pool Syntax" \(page 37\)](#).

ftrp_number FTRP number

ftrp_name FTRP name

■ Example(s)

The following example starts balancing FTRP01:

```
CLI> start balancing-flexible-tier-pool -ftrp-name FTRP01
```

stop balancing-flexible-tier-pool

This command stops evenly relocating the Flexible Tier Pools (FTRPs) among RAID groups. Specify the FTRP that is being balanced.

■ Syntax

```
stop balancing-flexible-tier-pool {-ftrp-number ftrp_number | -ftrp-name ftrp_name}
```

■ Parameter

-ftrp-number or -ftrp-name

This parameter specifies the FTRP to which the FTV to stop balancing is allocated. For details, refer to ["1.2.8 Flexible Tier Pool Syntax" \(page 37\)](#).

<i>ftrp_number</i>	FTRP number
<i>ftrp_name</i>	FTRP name

■ Example(s)

The following example stops balancing FTRP01:

```
CLI> stop balancing-flexible-tier-pool -ftrp-name FTRP01
```

3.6 Host Interface Management

This section explains the commands related to the management of the host interface. The functions to manage the host interface (SAN) are as follows:

- Host interface port parameters
- Host identifiers (Host Alias)
- Mapping (when using LUN groups)
- Mapping (When the host affinity mode is disabled)
- Host Groups
- Port Groups
- LUN Groups
- Host response
- Changing the host sense
- Reset group of the host interface port
- Ping command for iSCSI hosts
- Host LU QoS
- Login host display

■ Host interface type

There are six host interface types; Fibre Channel (FC), Serial Attached SCSI (SAS), Internet Small Computer System Interface (iSCSI), Fibre Channel over Ethernet (FCoE), FCLINK, and OCLINK.

The speed for each type of host interface is as follows:

Host interface	Speed
Fibre Channel (FC)	32Gbit/s, 16Gbit/s, 8Gbit/s
Fibre Channel over Ethernet (FCoE)	10Gbit/s
Serial Attached SCSI (SAS)	12Gbit/s, 6Gbit/s
Internet Small Computer System Interface (iSCSI)	10Gbit/s, 1Gbit/s
FCLINK	8Gbit/s
OCLINK	17MB/s

The host interface types that are supported by each ETERNUS DX/AF model are as follows.

Target model	Host interface type
DX60 S4	FC, SAS, iSCSI
DX100 S4/DX200 S4	FC, SAS, iSCSI
DX500 S4/DX600 S4	FC, iSCSI
DX60 S3	FC, SAS, iSCSI
DX100 S3/DX200 S3	FC, FCoE, SAS, iSCSI
DX500 S3/DX600 S3	FC, FCoE, iSCSI
DX8100 S3/DX8700 S3 (*1)	FC, FCoE, iSCSI, FCLINK, OCLINK
DX8900 S3	FC, FCoE, iSCSI
AF250 S2/AF250	FC, iSCSI
AF650 S2/AF650	FC, iSCSI
DX200F	FC, iSCSI

*1: For UNIX/industry standard server connections, selecting from FC, iSCSI, and FCoE is possible. For mainframe connections, selecting from FCLINK and OCLINK is possible.

For details on the NAS function, refer to "[Chapter 7 NAS Function Setting and Display](#)" (page 886). For details on the host interface, refer to the "Overview" manual of the currently used ETERNUS DX/AF.

■ Host affinity

Host affinity is set to associate hosts, host interface ports, and LUNs. Specify which hosts are allowed access.

■ Host Affinity Mode

Host Affinity Mode can be set to each host interface port respectively. When the Host Affinity Mode is enabled, LUN groups can be associated with host HBAs (or host groups). When the Host Affinity Mode is disabled, LUN groups are not required. Volumes can be associated with the host LUNs from all of the host servers.

■ Host group

A host group is a group of HBAs (HBAs to set multipath) on hosts that access the same LUN groups. HBAs on different hosts can be set to one host group. Once the host group is created, the settings of all the hosts (HBAs) that belong to the host group can be changed by simply changing the settings of the host group.

■ CA port group

A CA port group is a group of ports that have the same port settings. Ports that access the same LUN group, such as the ports that use multipath connections to servers and the ports that connect servers that configure a cluster, are set to a single port group. The single port group can be allocated to multiple host groups. Once the CA port group is created, the settings of all the ports that belong to the port group can be changed by simply changing the settings of the port group.

■ LUN group

A LUN group is a group of LUNs that are accessed from the same host group and CA port group.

■ Mapping method

The following is an example when Host Affinity Mode is enabled:

```
CLI> set fc-parameters -port 000 -host-affinity enable
CLI> create raid-group -name r1 -level 1 -disks 006,007
CLI> create volume -name v -count 3 -rg-name r1 -type standard -size 256mb
CLI> create lun-group -name a1 -volume-name v0,v1,v2 -lun 0-2
CLI> create host-wwn-name -name h1 -wwn a00000e0d0100000
CLI> set host-affinity -host-name h1 -lg-name a1 -port 000
```

Procedure

- 1 Enable Host Affinity Mode of host interface port 000. (FC)
- 2 Create a RAID group named "r1".
- 3 Create volumes named "v0", "v1" and "v2" in the RAID group named "r1".
- 4 Create a LUN group named "a1", the mapping relation of volume named v0/v1/v2 and LUN 0/1/2.
- 5 Register a host WWN named "h1" (FC).

- 6 Use mapping (host affinity mode) to set the relationship between host interface port 000, the LUN group named "a1", and the host identifier named "h1".

End of procedure

The following is an example when Host Affinity Mode is disabled:

```
CLI> set fc-parameters -port 000,001 -host-affinity disable
CLI> create raid-group -name r1 -level 1 -disks 006,007
CLI> create volume -name v -count 3 -rg-name r1 -type standard -size 256mb
CLI> set mapping -volume-name v0,v1,v2 -lun 0-2 -port 000,001
```

Procedure

- 1 Disable the Host Affinity Mode (FC).
- 2 Create a RAID group named "r1".
- 3 Create volumes named "v0", "v1" and "v2" in the RAID group named "r1".
- 4 Use mapping to set the relationship between host interface ports 000 and 001, volumes v0, v1, and v2, and LUNs 0, 1, and 2.

End of procedure

For details on setting host affinity with host groups, port groups, and LUN groups, refer to ["D.1.2 Host Access Setting Procedure" \(page 1246\)](#).

3.6.1 Host Interface Port Parameters

This section explains the commands related to setting up parameters for each host interface.

show fc-parameters

This command displays the parameters of each FC host interface port.

Syntax

```
show fc-parameters
```

Parameter

No parameters.

Output

Item name	Description
Port	Each host interface port number
Port Mode	Indicates whether either CA or RA mode is set. The RA mode is used for Remote Equivalent Copy.
Connection	Connection of each FC port (loop connection [FC-AL] or fabric connection)
Loop ID Assign	How to assign the loop ID (Loop ID is shown only when selecting manual.) (Either ascending order or descending order is shown when selecting automatic.)
Transfer Rate	FC transfer rate (Auto Negotiation / 4Gbit/s / 8Gbit/s / 16Gbit/s / 32Gbit/s)
Frame Size	FC frame size (512bytes/1024bytes/2048bytes)
Host Affinity	Host affinity mode of each host interface port
Host Response No.	Host response number (A hyphen [-] is displayed when the host affinity mode is enabled.)
Host Response Name	Host response name (A hyphen [-] is displayed when the host affinity mode is enabled.)
Reset Scope	Range of reset action I_T_L (I: Initiator, T: Target, L: LUN) or T_L (T: Target, L: LUN)
Reserve Cancel at Chip Reset	Indicates whether reservations are canceled or not when a host interface port is reset.
REC Line No.	REC line number (0 – 127) (A hyphen [-] is displayed in the field when the port mode is not the RA mode or the CA/RA auto mode.)
REC Transfer Mode Sync	Synchronous mode for the REC transfer mode (Enable: enabled, Disable: disabled) (A hyphen [-] is displayed in the field when the port mode is not the RA mode or the CA/RA auto mode.)
REC Transfer Mode Stack	Asynchronous stack mode for the REC transfer mode (Enable: enabled, Disable: disabled) (A hyphen [-] is displayed in the field when the port mode is not the RA mode or the CA/RA auto mode.)
REC Transfer Mode Consistency	Asynchronous consistency mode for the REC transfer mode (Enable: enabled, Disable: disabled) (A hyphen [-] is displayed in the field when the port mode is not the RA mode or the CA/RA auto mode.)
REC Transfer Mode Through	Asynchronous through mode for the REC transfer mode (Enable: enabled, Disable: disabled) (A hyphen [-] is displayed in the field when the port mode is not the RA mode or the CA/RA auto mode.)
TFO Transfer Mode	TFO transfer mode (transfer mode of the Storage Cluster) (Enable: enabled, Disable: disabled) (A hyphen [-] is displayed in the field when the port mode is not the RA mode or the CA/RA auto mode.)
WWN Mode	Indicates whether or not the WWPN/WWNN of the relevant port was changed from the default setting.
Default	WWPN/WWNN has not changed (Default setting)
Custom	WWPN/WWNN has been changed
WWPN	The Port WWN that is set for the relevant port

■ Example(s)

The following example shows the parameters displayed for each FC interface port (for the DX60 S4/DX100 S4/DX200 S4, the DX500 S4/DX600 S4, the DX60 S3/DX100 S3/DX200 S3, the DX500 S3/DX600 S3, the AF250 S2/AF650 S2, the AF250/AF650, and the DX200F).

In this example, each CA has 2 ports and each CM has 2 CAs:

```

CLI> show fc-parameters
Port                               CM#0 CA#0 Port#0      CM#0 CA#0 Port#1
Port Mode                           CA                     RA
Connection                           FC-AL                  FC-AL
Loop ID Assign                        Manual (0x01)          Auto (Ascending)
Transfer Rate                          Auto Negotiation       8Gbit/s
Frame Size                             2048bytes              -
Host Affinity                          Enable                  -
Host Response No.                       -                       -
Host Response Name                      -                       -
Reset Scope                             I T L                  -
Reserve Cancel at Chip Reset            Disable                 -
REC Line No.                             -                       127
REC Transfer Mode Sync                   -                       Enable
REC Transfer Mode Stack                  -                       Disable
REC Transfer Mode Consistency            -                       Enable
REC Transfer Mode Through                -                       Disable
TFO Transfer Mode                        Enable                  Disable
WNN Mode                                 Custom                  Default
WWPN                                     6162636430303130     6162636430303131

Port                               CM#0 CA#1 Port#0      CM#0 CA#1 Port#1
Port Mode                           CA                     RA
Connection                           FC-AL                  FC-AL
Loop ID Assign                        Manual (0x01)          Auto (Ascending)
Transfer Rate                          Auto Negotiation       8Gbit/s
Frame Size                             2048bytes              -
Host Affinity                          Enable                  -
Host Response No.                       -                       -
Host Response Name                      -                       -
Reset Scope                             I T L                  -
Reserve Cancel at Chip Reset            Enable                 -
REC Line No.                             -                       -
REC Transfer Mode Sync                   -                       -
REC Transfer Mode Stack                  -                       -
REC Transfer Mode Consistency            -                       -
REC Transfer Mode Through                -                       -
TFO Transfer Mode                        Enable                  Disable
WNN Mode                                 Custom                  Default
WWPN                                     6162636430303130     6162636430303131

Port                               CM#1 CA#0 Port#0      CM#1 CA#0 Port#1
Port Mode                           RA                     CA/RA
Connection                           FC-AL                  FC-AL
Loop ID Assign                        Manual (0x01)          Manual (0x01)
Transfer Rate                          Auto Negotiation       8Gbit/s
Frame Size                             -                       2048bytes
Host Affinity                          -                       Enable
Host Response No.                       -                       -
Host Response Name                      -                       -
Reset Scope                             -                       I T L
Reserve Cancel at Chip Reset            -                       Disable
REC Line No.                             0                       1
REC Transfer Mode Sync                   Enable                  Enable
REC Transfer Mode Stack                  Enable                  Disable
REC Transfer Mode Consistency            Disable                 Enable
REC Transfer Mode Through                Enable                  Disable
TFO Transfer Mode                        Enable                  Disable
WNN Mode                                 Custom                  Default
WWPN                                     6162636430303130     6162636430303131

Port                               CM#1 CA#1 Port#0      CM#1 CA#1 Port#1
Port Mode                           Initiator              CA
Connection                           FC-AL                  FC-AL
Loop ID Assign                        Manual (0x01)          Manual (0x01)
Transfer Rate                          Auto Negotiation       8Gbit/s
Frame Size                             -                       2048bytes
Host Affinity                          -                       Enable
Host Response No.                       -                       -
Host Response Name                      -                       -
Reset Scope                             -                       I T L
Reserve Cancel at Chip Reset            -                       Enable
REC Line No.                             -                       -
REC Transfer Mode Sync                   -                       -
REC Transfer Mode Stack                  -                       -
REC Transfer Mode Consistency            -                       -
REC Transfer Mode Through                -                       -
TFO Transfer Mode                        Enable                  Disable
WNN Mode                                 Custom                  Default
WWPN                                     6162636430303130     6162636430303131
  
```

The following example shows the parameters displayed for each FC interface port (for the DX8700 S3/DX8900 S3). In this example, each CA has 2 ports and each CM has 2 CAs:

```

CLI> show fc-parameters
Port                               CE#3 CM#0 CA#0 Port#0  CE#3 CM#0 CA#0 Port#1
Port Mode                           CA                      RA
Connection                           FC-AL                   FC-AL
Loop ID Assign                        Manual(0x01)            Auto(Ascending)
Transfer Rate                         Auto Negotiation        8Gbit/s
Frame Size                            2048bytes               -
Host Affinity                         Enable                  -
Host Response No.                     -                       -
Host Response Name                    -                       -
Reset Scope                            I T L                   -
Reserve Cancel at Chip Reset          Disable                 -
REC Line No.                           -                       127
REC Transfer Mode Sync                 -                       Enable
REC Transfer Mode Stack                -                       Disable
REC Transfer Mode Consistency          -                       Enable
REC Transfer Mode Through              -                       Disable
TFO Transfer Mode                      Enable                  Disable
WWN Mode                               Custom                  Default
WWPN                                   6162636430303130      6162636430303131

Port                               CE#3 CM#0 CA#1 Port#0  CE#3 CM#0 CA#1 Port#1
Port Mode                           CA                      RA
Connection                           FC-AL                   FC-AL
Loop ID Assign                        Manual(0x01)            Auto(Ascending)
Transfer Rate                         Auto Negotiation        8Gbit/s
Frame Size                            2048bytes               -
Host Affinity                         Enable                  -
Host Response No.                     -                       -
Host Response Name                    -                       -
Reset Scope                            I T L                   -
Reserve Cancel at Chip Reset          Enable                  -
REC Line No.                           -                       -
REC Transfer Mode Sync                 -                       -
REC Transfer Mode Stack                -                       -
REC Transfer Mode Consistency          -                       -
REC Transfer Mode Through              -                       -
TFO Transfer Mode                      Enable                  Disable
WWN Mode                               Custom                  Default
WWPN                                   6162636430303130      6162636430303131

Port                               CE#3 CM#1 CA#0 Port#0  CE#3 CM#1 CA#0 Port#1
Port Mode                           RA                      CA/RA
Connection                           FC-AL                   FC-AL
Loop ID Assign                        Manual(0x01)            Manual(0x01)
Transfer Rate                         Auto Negotiation        8Gbit/s
Frame Size                            -                       2048bytes
Host Affinity                         -                       Enable
Host Response No.                     -                       -
Host Response Name                    -                       -
Reset Scope                            -                       I T L
Reserve Cancel at Chip Reset          -                       Disable
REC Line No.                           0                       1
REC Transfer Mode Sync                 Enable                  Enable
REC Transfer Mode Stack                Enable                  Disable
REC Transfer Mode Consistency          Disable                Enable
REC Transfer Mode Through              Enable                  Disable
TFO Transfer Mode                      Enable                  Disable
WWN Mode                               Custom                  Default
WWPN                                   6162636430303130      6162636430303131

Port                               CE#3 CM#1 CA#1 Port#0  CE#3 CM#1 CA#1 Port#1
Port Mode                           Initiator               CA
Connection                           FC-AL                   FC-AL
Loop ID Assign                        Manual(0x01)            Manual(0x01)
Transfer Rate                         Auto Negotiation        8Gbit/s
Frame Size                            -                       2048bytes
Host Affinity                         -                       Enable
Host Response No.                     -                       -
Host Response Name                    -                       -
Reset Scope                            -                       I T L
Reserve Cancel at Chip Reset          -                       Enable
REC Line No.                           -                       -
REC Transfer Mode Sync                 -                       -
REC Transfer Mode Stack                -                       -
REC Transfer Mode Consistency          -                       -
REC Transfer Mode Through              -                       -
TFO Transfer Mode                      Enable                  Disable
WWN Mode                               Custom                  Default
WWPN                                   6162636430303130      6162636430303131
  
```

The following example shows the parameters displayed for each FC interface port (for the DX500 S4/DX600 S4, the DX500 S3/DX600 S3, and the AF650 S2/AF650).

In this example, each CA has 4 ports and each CM has 2 CAs:

```

CLI> show fc-parameters
Port                               CM#0 CA#0 Port#0    CM#0 CA#0 Port#1    CM#0 CA#0 Port#2    CM#0 CA#0 Port#3
Port Mode                          CA                  CA                  RA                  RA
Connection                          FC-AL              FC-AL              Fabric              Fabric
Loop ID Assign                      Manual(0x01)       Auto(Ascending)     Auto(Descending)   Manual(0x01)
Transfer Rate                        Auto Negotiation   8Gbit/s             8Gbit/s             8Gbit/s
Frame Size                          2048bytes         512bytes            -                   -
Host Affinity                       Enable             Disable              -                   -
Host Response No.                   -                 6                   -                   -
Host Response Name                  -                 HP06                -                   -
Reset Scope                          I T L             I T L               -                   -
Reserve Cancel at Chip Reset        Disable           Disable              -                   -
REC Line No.                        -                 -                   0                   1
REC Transfer Mode Sync              -                 -                   Enable              Enable
REC Transfer Mode Stack             -                 -                   Enable              Disable
REC Transfer Mode Consistency       -                 -                   Disable             Enable
REC Transfer Mode Through           -                 -                   Enable              Disable
TFO Transfer Mode                  -                 -                   -                   -
WWN Mode                            Custom            Default              Custom              Default
WWPN                               6162636430303130 6162636430303131 6162636430303132 6162636430303133

Port                               CM#0 CA#1 Port#0    CM#0 CA#1 Port#1    CM#0 CA#1 Port#2    CM#0 CA#1 Port#3
Port Mode                          CA                  CA                  RA                  RA
Connection                          FC-AL              FC-AL              Fabric              Fabric
Loop ID Assign                      Manual(0x01)       Auto(Ascending)     Auto(Descending)   Manual(0x01)
Transfer Rate                        Auto Negotiation   8Gbit/s             8Gbit/s             8Gbit/s
Frame Size                          2048bytes         512bytes            -                   -
Host Affinity                       Enable             Disable              -                   -
Host Response No.                   -                 6                   -                   -
Host Response Name                  -                 HP06                -                   -
Reset Scope                          I T L             I T L               -                   -
Reserve Cancel at Chip Reset        Enable           Enable              -                   -
REC Line No.                        -                 -                   -                   -
REC Transfer Mode Sync              -                 -                   -                   -
REC Transfer Mode Stack             -                 -                   -                   -
REC Transfer Mode Consistency       -                 -                   -                   -
REC Transfer Mode Through           -                 -                   -                   -
TFO Transfer Mode                  -                 -                   -                   -
WWN Mode                            Custom            Default              Custom              Default
WWPN                               6162636430303130 6162636430303131 6162636430303132 6162636430303133

Port                               CM#1 CA#0 Port#0    CM#1 CA#0 Port#1    CM#1 CA#0 Port#2    CM#1 CA#0 Port#3
Port Mode                          CA                  CA                  CA                  CA
Connection                          FC-AL              FC-AL              Fabric              Fabric
Loop ID Assign                      Manual(0x01)       Auto(Ascending)     Auto(Descending)   Manual(0x01)
Transfer Rate                        Auto Negotiation   8Gbit/s             8Gbit/s             8Gbit/s
Frame Size                          2048bytes         512bytes            512bytes           512bytes
Host Affinity                       Enable             Disable              Disable             Disable
Host Response No.                   -                 6                   5                   5
Host Response Name                  -                 HP06                HP05                HP05
Reset Scope                          I T L             I T L               I T L               I T L
Reserve Cancel at Chip Reset        Enable           Disable             Disable             Enable
REC Line No.                        -                 -                   -                   -
REC Transfer Mode Sync              -                 -                   -                   -
REC Transfer Mode Stack             -                 -                   -                   -
REC Transfer Mode Consistency       -                 -                   -                   -
REC Transfer Mode Through           -                 -                   -                   -
TFO Transfer Mode                  -                 -                   -                   -
WWN Mode                            Custom            Default              Custom              Default
WWPN                               6162636430303130 6162636430303131 6162636430303132 6162636430303133

Port                               CM#1 CA#1 Port#0    CM#1 CA#1 Port#1    CM#1 CA#1 Port#2    CM#1 CA#1 Port#3
Port Mode                          CA                  CA                  Initiator           Initiator
Connection                          FC-AL              FC-AL              Fabric              Fabric
Loop ID Assign                      Manual(0x01)       Auto(Ascending)     Auto(Descending)   Manual(0x01)
Transfer Rate                        Auto Negotiation   8Gbit/s             8Gbit/s             8Gbit/s
Frame Size                          2048bytes         512bytes            -                   -
Host Affinity                       Enable             Disable              -                   -
Host Response No.                   -                 6                   -                   -
Host Response Name                  -                 HP06                -                   -
Reset Scope                          I T L             I T L               -                   -
Reserve Cancel at Chip Reset        Disable           Disable             Disable             -
REC Line No.                        -                 -                   -                   -
REC Transfer Mode Sync              -                 -                   -                   -
REC Transfer Mode Stack             -                 -                   -                   -
REC Transfer Mode Consistency       -                 -                   -                   -
REC Transfer Mode Through           -                 -                   -                   -
TFO Transfer Mode                  -                 -                   -                   -
WWN Mode                            Custom            Default              Custom              Default
WWPN                               6162636430303130 6162636430303131 6162636430303132 6162636430303133
  
```

The following example shows the parameters displayed for each FC interface port (for the DX8700 S3/DX8900 S3). In this example, each CA has 4 ports and each CM has 2 CAs:

```

CLI> show fc-parameters
Port Mode                               CE#3 CM#0 CA#0 Port#0 CE#3 CM#0 CA#0 Port#1 CE#3 CM#0 CA#0 Port#2 CE#3 CM#0 CA#0 Port#3
Connection                               FC-AL                   FC-AL                   Fabric                   Fabric
Loop ID Assign                           Manual (0x01)           Auto (Ascending)       Auto (Descending)       Manual (0x01)
Transfer Rate                             Auto Negotiation       8Gbit/s                8Gbit/s                 8Gbit/s
Frame Size                               2048bytes              512bytes                -                       -
Host Affinity                             Enable                  -                       -                       -
Host Response No.                         -                       6                       -                       -
Host Response Name                       -                       HP06                    -                       -
Reset Scope                               I T L                  I T L                   -                       -
Reserve Cancel at Chip Reset             Disable                 Disable                  -                       -
REC Line No.                             -                       -                       0                       1
REC Transfer Mode Sync                   -                       -                       Enable                   Enable
REC Transfer Mode Stack                   -                       -                       Enable                   Disable
REC Transfer Mode Consistency             -                       -                       Disable                  Enable
REC Transfer Mode Through                 -                       -                       Enable                   Disable
TFO Transfer Mode                         -                       -                       -                       -
WNN Mode                                 Custom                  Default                  Custom                    Default
WPN                                       6162636430303130     6162636430303131     6162636430303132     6162636430303133

Port Mode                               CE#3 CM#0 CA#1 Port#0 CE#3 CM#0 CA#1 Port#1 CE#3 CM#0 CA#1 Port#2 CE#3 CM#0 CA#1 Port#3
Connection                               FC-AL                   FC-AL                   Fabric                   Fabric
Loop ID Assign                           Manual (0x01)           Auto (Ascending)       Auto (Descending)       Manual (0x01)
Transfer Rate                             Auto Negotiation       8Gbit/s                8Gbit/s                 8Gbit/s
Frame Size                               2048bytes              512bytes                -                       -
Host Affinity                             Enable                  -                       -                       -
Host Response No.                         -                       6                       -                       -
Host Response Name                       -                       HP06                    -                       -
Reset Scope                               I T L                  I T L                   -                       -
Reserve Cancel at Chip Reset             Enable                 Enable                   -                       -
REC Line No.                             -                       -                       -                       -
REC Transfer Mode Sync                   -                       -                       -                       -
REC Transfer Mode Stack                   -                       -                       -                       -
REC Transfer Mode Consistency             -                       -                       -                       -
REC Transfer Mode Through                 -                       -                       -                       -
TFO Transfer Mode                         -                       -                       -                       -
WNN Mode                                 Custom                  Default                  Custom                    Default
WPN                                       6162636430303130     6162636430303131     6162636430303132     6162636430303133

Port Mode                               CE#3 CM#1 CA#0 Port#0 CE#3 CM#1 CA#0 Port#1 CE#3 CM#1 CA#0 Port#2 CE#3 CM#1 CA#0 Port#3
Connection                               FC-AL                   FC-AL                   Fabric                   Fabric
Loop ID Assign                           Manual (0x01)           Auto (Ascending)       Auto (Descending)       Manual (0x01)
Transfer Rate                             Auto Negotiation       8Gbit/s                8Gbit/s                 8Gbit/s
Frame Size                               2048bytes              512bytes                512bytes                512bytes
Host Affinity                             Enable                  Disable                  Disable                   Disable
Host Response No.                         -                       6                       5                       5
Host Response Name                       -                       HP06                    HP05                     HP05
Reset Scope                               I T L                  I T L                   I T L                     I T L
Reserve Cancel at Chip Reset             Enable                 Disable                  Disable                    Enable
REC Line No.                             -                       -                       -                       -
REC Transfer Mode Sync                   -                       -                       -                       -
REC Transfer Mode Stack                   -                       -                       -                       -
REC Transfer Mode Consistency             -                       -                       -                       -
REC Transfer Mode Through                 -                       -                       -                       -
TFO Transfer Mode                         -                       -                       -                       -
WNN Mode                                 Custom                  Default                  Custom                    Default
WPN                                       6162636430303130     6162636430303131     6162636430303132     6162636430303133

Port Mode                               CE#3 CM#1 CA#1 Port#0 CE#3 CM#1 CA#1 Port#1 CE#3 CM#1 CA#1 Port#2 CE#3 CM#1 CA#1 Port#3
Connection                               FC-AL                   FC-AL                   Initiator                 Initiator
Loop ID Assign                           Manual (0x01)           Auto (Ascending)       Auto (Descending)       Manual (0x01)
Transfer Rate                             Auto Negotiation       8Gbit/s                8Gbit/s                 8Gbit/s
Frame Size                               2048bytes              512bytes                -                       -
Host Affinity                             Enable                  Disable                  -                       -
Host Response No.                         -                       6                       -                       -
Host Response Name                       -                       HP06                    -                       -
Reset Scope                               I T L                  I T L                   -                       -
Reserve Cancel at Chip Reset             Disable                 Disable                  -                       -
REC Line No.                             -                       -                       -                       -
REC Transfer Mode Sync                   -                       -                       -                       -
REC Transfer Mode Stack                   -                       -                       -                       -
REC Transfer Mode Consistency             -                       -                       -                       -
REC Transfer Mode Through                 -                       -                       -                       -
TFO Transfer Mode                         -                       -                       -                       -
WNN Mode                                 Custom                  Default                  Custom                    Default
WPN                                       6162636430303130     6162636430303131     6162636430303132     6162636430303133
    
```

set fc-parameters

This command sets up the parameters to control each Fibre Channel (FC) host interface port. Host Affinity Mode can be changed by using this command.

For a change of host port mode, refer to the "set host-port-mode" command.

Syntax

```
set fc-parameters -port {port_numbers | all}
[-host-affinity {enable | disable}] [-connect {loop | fabric}]
[-rate {auto | 4g | 8g | 16g | 32g}]
[-loop-id-assign {auto-ascending | auto-descending | manual}]
[-loop-id loop_id] [-frame-size {512 | 1024 | 2048}]
[-host-response-number host_response_number] [-host-response-name host_response_name]
[-reset-scope {initiator-lun | target-lun}] [-reserve-cancel {enable | disable}]
[-rec-line-no rec_line_no]
[-rec-transfer-sync {enable | disable}]
[-rec-transfer-stack {enable | disable}]
[-rec-transfer-consistency {enable | disable}]
[-rec-transfer-through {enable | disable}]
[-tfo-transfer-mode {enable | disable}]
[-revert-wwn]
```

Parameter

-port This parameter specifies the FC interface port number to be set up. Two or more parameters can be specified by separating them with a comma (,).

Example: -port 000,110

For details, refer to "[1.2.15 Host Interface Port Syntax](#)" (page 44).

port_numbers FC interface port

xyz "x" is the controller module (CM) number, "y" is the CA number, and "z" is the FC port number (DX60 S4/DX100 S4/DX200 S4, DX500 S4/DX600 S4, DX60 S3/DX100 S3/DX200 S3, DX500 S3/DX600 S3, DX8100 S3, AF250 S2/AF650 S2, AF250/AF650, and DX200F only).

Example: "123" indicates CM#1-CA#2-Port#3

wxyz "w" is the controller enclosure (CE) number, "x" is the controller module (CM) number, "y" is the CA number, and "z" is the host port number (DX8700 S3/DX8900 S3 only).

Example: "0123" indicates CE#0-CM#1-CA#2- Port#3

all All FC interface ports

-host-affinity

Optional. This parameter specifies the Host Affinity Mode. If omitted, the existing setting is not changed. The host affinity is the security capability of the system against host servers. The access from hosts can be limited by enabling Host Affinity Mode. If the RA mode or Initiator mode is being set for the specified ports, this parameter cannot be specified.

enable Host Affinity Mode is enabled.

disable Host Affinity Mode is disabled.

-connect Optional. This parameter specifies the connection condition of the FC port. If omitted, the existing setting is not changed. The default value is a loop (FC-AL) connection.

Note

Normally, "loop" is specified for direct connections with servers and "fabric" is specified for switch connections. Specify "fabric" for 16Gbit/s or faster direct connections.

loop	Loop connection (default)
fabric	Fabric connection

-rate Optional. This parameter specifies the FC transfer rate. If the speed is 32 Gbit/s, the transfer rate cannot be set to 4 Gbit/s. If omitted, the existing setting is not changed.

auto	Auto negotiation
4g	4Gbit/s
8g	8Gbit/s
16g	16Gbit/s

-loop-id-assign Optional. This parameter specifies how to assign the loop ID. It is only applicable when "-connect loop" is specified. If omitted, the existing setting is not changed.

auto-ascending	It automatically assigns ascending order.
auto-descending	It automatically assigns descending order.
manual	It assigns manually.

-loop-id Optional. This parameter specifies the loop ID (a hexadecimal number). This is only applicable when "-loop-id-assign manual" is specified. The range of values is between 0x00 and 0x7d (a hexadecimal number). If omitted, the existing setting is not changed.

<i>loop_id</i>	Loop ID
----------------	---------

-frame-size Optional. This parameter specifies the FC frame size. If omitted, the existing setting is not changed. If the RA mode or Initiator mode is being set for the specified ports, this parameter cannot be specified.

512	512 bytes
1024	1,024 bytes
2048	2,048 bytes

-host-response-number or **-host-response-name**

Optional. This parameter specifies a host response identifier. Only one host response identifier can be specified at the same time. If omitted, the existing setting is not changed. If the RA mode or Initiator mode is being set for the specified ports, this parameter cannot be specified. For details, refer to ["1.2.14 Host Response Syntax" \(page 43\)](#).

<i>host_response_number</i>	Host response number
<i>host_response_name</i>	Host response name

- reset-scope Optional. This parameter specifies the range of reset action. If omitted, the existing setting is not changed. If the RA, Initiator mode is set, this parameter cannot be specified.
- initiator-lun Reset (Cancel) the command request from the server that sent the command reset request.
- target-lun Reset (Cancel) the command request from all servers that are connected to the port (regardless of whether the LUN is recognized).
- reserve-cancel
- Optional. This parameter specifies whether or not SCSI reservation (persistent reservation) is canceled when host interface ports are reset. If omitted, the existing setting is not changed. If the RA mode is set for the specified port, this parameter cannot be specified.
- enable Reservations are canceled.
- disable Reservations are not canceled.
- rec-line-no Optional. This parameter specifies the REC line number. If omitted, the existing setting is not changed. This parameter can only be specified for the ports that both of the following conditions apply to: the Advanced Copy license has been registered and the port mode is the RA mode or the CA/RA auto mode.
- rec_line_no* REC line number (0 – 127)
- rec-transfer-sync
- Optional. This parameter specifies the synchronous mode for the copy transfer mode. If omitted, the existing setting is not changed. This parameter can only be specified for the ports that both of the following conditions apply to: the Advanced Copy license has been registered and the port mode is the RA mode or the CA/RA auto mode.
- enable An REC in synchronous transfer mode is permitted for the target CA port.
- disable An REC in synchronous transfer mode is suppressed for the target CA port.
- rec-transfer-stack
- Optional. This parameter specifies the asynchronous stack mode for the copy transfer mode. If omitted, the existing setting is not changed. This parameter can only be specified for the ports that both of the following conditions apply to: the Advanced Copy license has been registered and the port mode is the RA mode or the CA/RA auto mode.
- enable An REC in asynchronous stack mode is permitted for the target CA port.
- disable An REC in asynchronous stack mode is suppressed for the target CA port.
- rec-transfer-consistency
- Optional. This parameter specifies the asynchronous consistency mode for the copy transfer mode. If omitted, the existing setting is not changed. This parameter can only be specified for the ports that both of the following conditions apply to: the Advanced Copy license has been registered and the port mode is the RA mode or the CA/RA auto mode.
- enable An REC in asynchronous consistency mode is permitted for the target CA port.
- disable An REC in asynchronous consistency mode is suppressed for the target CA port.
- rec-transfer-through
- Optional. This parameter specifies the asynchronous through mode for the copy transfer mode. If omitted, the existing setting is not changed. This parameter can only be specified for the ports that both of the following conditions apply to: the Advanced Copy license has been registered and the port mode is the RA mode or the CA/RA auto mode.

- enable An REC in asynchronous through mode is permitted for the target CA port.
- disable An REC in asynchronous through mode is suppressed for the target CA port.

-tfo-transfer-mode

Optional. This parameter specifies the TFO transfer mode (transfer mode of the Storage Cluster). If omitted, the existing setting is not changed. This parameter can only be specified for the ports that both of the following conditions apply to: the Storage Cluster license has been registered and the port mode is the RA mode or the CA/RA auto mode.

- enable A Storage Cluster transfer is permitted for the target CA port.
- disable A Storage Cluster transfer is suppressed for the target CA port.

-revert-wwn Optional. This parameter is specified when reverting WWPN/WWNN back to the default configuration state after it has been changed by the Storage Cluster. If omitted, the existing setting is not changed.

■ Example(s)

The following example sets up the parameters to control CM#1 CA#1 Port#0 (FC interface). Host Affinity Mode is disabled:

```
CLI> set fc-parameters -port 110 -host-affinity disable
```

The following example sets up the parameters to control CM#0 CA#0 Port#1 (FC interface). The FC port is a fabric connection:

```
CLI> set fc-parameters -port 001 -connect fabric
```

show sas-parameters

This command displays the parameters of each SAS host interface port.

Syntax

```
show sas-parameters
```

Parameter

No parameters.

Output

Item name	Description
Port	Each host interface port number
Host Affinity	Host affinity mode of each host interface port
Transfer Rate	SAS transfer rate (Auto Negotiation / 1.5Gbit/s / 3Gbit/s / 6Gbit/s / 12Gbit/s)
Host Response No.	Host response number (A hyphen [-] is shown when the host affinity mode is enabled.)
Host Response Name	Host response name (A hyphen [-] is shown when the host affinity mode is enabled.)
Reset Scope	Range of reset action I_T_L (I: Initiator, T: Target, L:LUN) or T_L (T: Target, L: LUN)
Reserve Cancel at Chip Reset	Indicates whether reservations are canceled or not when a host interface port is reset.

Example(s)

The following example displays the parameters of all SAS host interface ports:

```
CLI> show sas-parameters
Port                CM#0 CA#0 Port#0  CM#0 CA#0 Port#1
Host Affinity       Disable           Disable
Transfer Rate       3Gbit/s          3Gbit/s
Host Response No.   5                 6
Host Response Name  HP05             HP06
Reset Scope         T_L              T_L
Reserve Cancel at Chip Reset Enable            Enable

Port                CM#0 CA#1 Port#0  CM#0 CA#1 Port#1
Host Affinity       Disable           Disable
Transfer Rate       6Gbit/s          6Gbit/s
Host Response No.   7                 8
Host Response Name  HP07             HP08
Reset Scope         T_L              T_L
Reserve Cancel at Chip Reset Enable            Enable

Port                CM#1 CA#0 Port#0  CM#1 CA#0 Port#1
Host Affinity       Disable           Disable
Transfer Rate       3Gbit/s          3Gbit/s
Host Response No.   9                 10
Host Response Name  HP09             HP10
Reset Scope         T_L              T_L
Reserve Cancel at Chip Reset Enable            Enable

Port                CM#0 CA#1 Port#0  CM#0 CA#1 Port#1
Host Affinity       Disable           Disable
Transfer Rate       6Gbit/s          6Gbit/s
Host Response No.   11                12
Host Response Name  HP11             HP12
Reset Scope         T_L              T_L
Reserve Cancel at Chip Reset Enable            Enable
```

set sas-parameters

This command sets up the parameters of each SAS interface port. It can also be used to change Host Affinity Mode.

■ Syntax

```
set sas-parameters -port {xyz | all} [-host-affinity {enable | disable}] [-rate {auto | 1.5g | 3g | 6g | 12g}]  
[-host-response-number host_response_number | -host-response-name host_response_name]  
[-reset-scope {initiator-lun | target-lun}] [-reserve-cancel {enable | disable}]
```

■ Parameter

- port** This parameter specifies which SAS interface port is to be set.
Example: -port 000
For details, refer to "[1.2.15 Host Interface Port Syntax](#)" (page 44).
- xyz* "x" is the controller module (CM) number, "y" is the CA number, and "z" is the SAS port number.
Example: 110 (CM#1 ,CA1 , SAS port#0)
- all* All SAS interface ports
- host-affinity** Optional. This parameter specifies Host Affinity Mode. If omitted, the existing setting is not changed. Host affinity is a security mechanism used to restrict access by a given host to only a specific set of LUNs.
- enable* Host Affinity Mode is enabled.
disable Host Affinity Mode is disabled.
- rate** Optional. This parameter specifies the SAS transfer rate. If omitted, the existing setting is not changed.
- auto* Auto negotiation
1.5g 1.5Gbit/s
For 12Gbit/s SAS CA, 1.5Gbit/s cannot be specified.
3g 3Gbit/s
6g 6Gbit/s
12g 12Gbit/s
- host-response-number or -host-response-name** Optional. This parameter specifies the host response identifier. Only one identifier can be specified at any given time. If omitted, the existing setting is not changed. For details, refer to "[1.2.14 Host Response Syntax](#)" (page 43).
- host_response_number* Host response number
host_response_name Host response name
- reset-scope** Optional. This parameter specifies the range of reset action. If omitted, the existing setting is not changed.

initiator-lun Reset (Cancel) the command request from the server that sent the command reset request.
target-lun Reset (Cancel) the command request from all servers that are connected to the port (regardless of whether the LUN is recognized).

-reserve-cancel

Optional. This parameter specifies whether or not reservations are canceled when a host interface port is reset. If omitted, the existing setting is not changed.

enable Reservations are canceled.
disable Reservations are not canceled.

■ **Example(s)**

The following example disables Host Affinity Mode for SAS interface port#0 on CM#1 CA#0 :

```
CLI> set sas-parameters -port 100 -host-affinity disable
```

The following example sets the initiator LUN as the reset scope for SAS interface port #0 on CM#0 CA#1:

```
CLI> set sas-parameter -port 010 -reset-scope initiator-lun
```

show iscsi-parameters

This command displays the parameters of each iSCSI host interface port.

Syntax

```
show iscsi-parameters [-port {port_numbers | all}]
```

Parameter

-port Optional. This parameter specifies which iSCSI interface port on which information is to be displayed. Multiple comma-separated ports may be specified. If this parameter is omitted, the information on all the iSCSI ports (excluding the virtual ports of the iSCSI ports) is displayed. To display the information on the virtual ports, specify this parameter. For details, refer to ["1.2.15 Host Interface Port Syntax" \(page 44\)](#).

port_numbers iSCSI interface port

xyz "x" is the controller module (CM) number, "y" is the CA number, and "z" is the iSCSI port number (DX60 S4/DX100 S4/DX200 S4, DX500 S4/DX600 S4, DX60 S3/DX100 S3/DX200 S3, DX500 S3/DX600 S3, DX8100 S3, AF250 S2/AF650 S2, AF250/AF650, and DX200F only).

Example: "110" indicates CM#1-CA#1-Port#0

wxyz "w" is the controller enclosure (CE) number, "x" is the controller module (CM) number, "y" is the CA number, and "z" is the host port number (DX8700 S3/DX8900 S3 only).

Example: "0120" indicates CE#0-CM#1-CA#2-Port#0

all All iSCSI interface ports

Output

Item name	Description
CM#xCA#yPort#z	Port number (only for the DX60 S4/DX100 S4/DX200 S4, the DX500 S4/DX600 S4, the DX60 S3/DX100 S3/DX200 S3, the DX500 S3/DX600 S3, the DX8100 S3, the AF250 S2/AF650 S2, the AF250/AF650, and the DX200F)
CE#w CM#xCA#yPort#z	Port number (only for the DX8700 S3/DX8900 S3)
Port Mode	Port mode
Type	Module type (1G iSCSI, 10G iSCSI, 10G Base-T iSCSI, or iSCSI-RA)
Host Affinity	Host affinity mode (Enable: enabled, Disable: disabled)
iSCSI Name	iSCSI name
Alias Name	Alias to the iSCSI name
Host Response No.	Host response number
Host Response Name	Host response name
Reset Scope	Range of reset action I_T_L (I: Initiator, T: Target, L: LUN) or T_L (T: Target, L: LUN)
Reserve Cancel at Chip Reset	Indicates whether reservations are canceled when a host interface port is reset (Enable: canceled, Disable: not canceled).
IPv4	Indicates whether an IPv4 address is used (Enable: used, Disable: not used).
IP Address	IP address

Item name	Description
Subnet Mask	Subnet mask
Gateway Address	Gateway address
IPv6	Indicates whether an IPv6 address is used (Enable: used, Disable: not used).
Link Local IP Address	Link local IP address
Connect IP Address	Global address or unique local address
IPv6 Gateway Address	Gateway server address in IPv6 format
MAC Address	MAC address
TCP Port Number	TCP port number
TCP Window Size	TCP window scale expansion
TCP Congestion Control Option	Indicates whether to use the TCP congestion control option. (Enable: used, Disable: not used)
iSNS Server	Indicates whether an iSNS server is used. (Enable: used, Disable: not used)
iSNS Server IP Address	IP address of an iSNS server
iSNS Server Port Number	iSNS server port number
CHAP	Indicates whether CHAP authentication is used. (Enable: used, Disable: not used)
CHAP User Name	User name for CHAP authentication
Header Digest	Indicates whether the PDU header's CRC32C checksum is validated. (Enable: validated, Disable: not validated)
Data Digest	Indicates whether the PDU data's CRC32C checksum is validated. (Enable: validated, Disable: not validated)
Jumbo Frame	Indicates whether jumbo frame can be specified. (Enable: jumbo frame can be specified, Disable: jumbo frame cannot be specified)
Transfer Rate	Transfer speed of the iSCSI port
Link Status	Actual transfer speed and link status (including "Link Up" and "Link Down")
CmdSN Count	Number of commands that are simultaneously acceptable from a host
VLAN ID	Indicates whether VLAN connection is enabled. (Enable: enabled, Disable: disabled) When "Enabled" is displayed, the VLAN ID is also displayed.
MTU	MTU size
Limit Band width	Bandwidth limit (upper limit performance value)
REC Line No.	REC line number (0 – 127) (A hyphen [-] is displayed in the field when the port mode is not the RA mode or the CA/RA auto mode.)
REC Transfer Mode Sync	Synchronous mode for the REC transfer mode (Enable: enabled, Disable: disabled) (A hyphen [-] is displayed in the field when the port mode is not the RA mode or the CA/RA auto mode.)
REC Transfer Mode Stack	Asynchronous stack mode for the REC transfer mode (Enable: enabled, Disable: disabled) (A hyphen [-] is displayed in the field when the port mode is not the RA mode or the CA/RA auto mode.)
REC Transfer Mode Consistency	Asynchronous consistency mode for the REC transfer mode (Enable: enabled, Disable: disabled) (A hyphen [-] is displayed in the field when the port mode is not the RA mode or the CA/RA auto mode.)
REC Transfer Mode Through	Asynchronous through mode for the REC transfer mode (Enable: enabled, Disable: disabled) (A hyphen [-] is displayed in the field when the port mode is not the RA mode or the CA/RA auto mode.)
TFO Transfer Mode	TFO transfer mode (transfer mode of the Storage Cluster) (Enable: enabled, Disable: disabled) (A hyphen [-] is displayed in the field when the port mode is not the RA mode or the CA/RA auto mode.)
Multiple VLAN	Indicates whether the multiple VLAN setting is enabled.
Available IP Address Information	Virtual port number for which virtual port information is enabled

■ Example(s)

The following example displays the result of performing a command when the "-port" parameter is not specified:

```
CLI> show iscsi-parameters
CM#0 CA#0 Port#0
Type                               1G iSCSI
Port Mode                           CA
Host Affinity                       Disable
iSCSI Name                          iqn.2000-09.com.fujitsu:storage-system.eternus_dx1:000000
Alias Name                          ALIAS00
Host Response No.                   1
Host Response Name                  HP0
Reset Scope                         I_T_L
Reserve Cancel at Chip Reset       Disable
IPv4                                 Enable
IP Address                          192.168.2.64
Subnet Mask                          255.255.255.0
Gateway Address                     0.0.0.0
IPv6                                 Enable
Link Local IP Address              FE80::290:CCFF:FEA4:3A49
Connect IP Address                 2001:DB8::8:800:200C:417A
IPv6 Gateway Address              FE80::2AA:FF:FE9A:21B8

MAC Address                        01:02:03:04:05:06
TCP Port Number                    3260
TCP Window Size                    0
iSNS Server                        Disable
iSNS Server IP Address             -
iSNS Server Port Number            3205
CHAP                               Disable
CHAP User Name                     user00
Header Digest                      CRC32
Data Digest                        OFF
Jumbo Frame                        Enable
Transfer Rate                      1Gbps/Full Duplex
Link Status                        1Gbit/s Link Up
CmdSN Count                        80
VLAN ID                            Enable
                                  4090
MTU                                 -
Limit Band width                   -
REC Line No.                       -
REC Transfer Mode Sync             -
REC Transfer Mode Stack            -
REC Transfer Mode Consistency      -
REC Transfer Mode Through          -
TFO Transfer Mode                  -

. . . continue
```

The following example displays the result of performing a command when the "-port" parameter is not specified (for the DX8700 S3/DX8900 S3):

```
CLI> show iscsi-parameters
CE#0 CM#0 CA#0 Port#0
Type                               1G iSCSI
Port Mode                           CA
Host Affinity                        Disable
iSCSI Name                          iqn.2000-09.com.fujitsu:storage-system.eternus_dx1:000000
Alias Name                          ALIAS00
Host Response No.                    1
Host Response Name                   HP0
Reset Scope                          I_T_L
Reserve Cancel at Chip Reset        Disable
IPv4                                  Enable
IP Address                          192.168.2.64
Subnet Mask                          255.255.255.0
Gateway Address                      0.0.0.0
IPv6                                  Enable
Link Local IP Address                FE80::290:CCFF:FEA4:3A49
Connect IP Address                   2001:DB8::8:800:200C:417A
IPv6 Gateway Address                 FE80::2AA:FF:FE9A:21B8

MAC Address                         01:02:03:04:05:06
TCP Port Number                      3260
TCP Window Size                      0
iSNS Server                          Disable
iSNS Server IP Address               -
iSNS Server Port Number              3205
CHAP                                  Disable
CHAP User Name                       user00
Header Digest                        CRC32
Data Digest                          OFF
Jumbo Frame                          Enable
Transfer Rate                        1Gbps/Full Duplex
Link Status                          1Gbit/s Link Up
CmdSN Count                          80
VLAN ID                              Enable
                                      4090

MTU                                  -
Limit Band width                     -
REC Line No.                         -
REC Transfer Mode Sync                -
REC Transfer Mode Stack               -
REC Transfer Mode Consistency         -
REC Transfer Mode Through             -
TFO Transfer Mode                    -

. . . continue
```

The following example displays when the "-port" parameter is specified and the multiple IP address setting is enabled for the port that is specified for the "-port" parameter:

```
CLI> show iscsi-parameters
CM#0 CA#0 Port#0
Type                               1G iSCSI
Port Mode                           CA
Host Affinity                        Disable
iSCSI Name                          iqn.2000-09.com.fujitsu:storage-system.eternus_dx1:000000
Alias Name                          ALIAS00
Host Response No.                   1
Host Response Name                  HP0
Reset Scope                          I_T_L
Reserve Cancel at Chip Reset        Disable
IPv4                                 Enable
IP Address                          192.168.2.64
Subnet Mask                         255.255.255.0
Gateway Address                     0.0.0.0
IPv6                                 Enable
Link Local IP Address               FE80::290:CCFF:FEA4:3A49
Connect IP Address                  2001:DB8::8:800:200C:417A
IPv6 Gateway Address                FE80::2AA:FF:FE9A:21B8

MAC Address                         01:02:03:04:05:06
TCP Port Number                     3260
TCP Window Size                     0
TCP Congestion Control Option       Disable
iSNS Server                         Disable
iSNS Server IP Address              -
iSNS Server Port Number             3205
CHAP                                 Disable
CHAP User Name                      user00
Header Digest                       CRC32
Data Digest                         OFF
Jumbo Frame                         Enable
Transfer Rate                       1Gbps/Full Duplex
Link Status                         1Gbit/s Link Up
CmdSN Count                         80
VLAN ID                             Enable
                                   4090

MTU                                  -
Limit Band width                    -
REC Line No.                        -
REC Transfer Mode Sync               -
REC Transfer Mode Stack              -
REC Transfer Mode Consistency        -
REC Transfer Mode Through            -
TFO Transfer Mode                    -

Multi IP Address                     Enable
Available IP Address Information #1

IPv4[1]                             Enable
IP Address[1]                       192.168.2.65
Subnet Mask[1]                      255.255.255.0
Gateway Address[1]                  0.0.0.0
IPv6[1]                             Disable
Link Local IP Address[1]             -
Connect IP Address[1]               -
IPv6 Gateway Address[1]             -
TCP Port Number[1]                  3260
TCP Window Scale[1]                 0
iSNS Server[1]                      Disable
iSNS Server IP Address[1]           -
iSNS Server Port Number[1]          3205
Jumbo Frame[1]                     Disable
VLAN ID[1]                          Enable
                                   4091

. . . continue
```

set iscsi-parameters

This command sets up the parameters of each iSCSI host interface port. It can also be used to change Host Affinity Mode.

Syntax

```
set iscsi-parameters -port {port_numbers | all} [-multiple-vlan {enable | disable}]
[-additional-ip additional-ip] [-additional-ip-function {enable | disable}]
[-host-affinity {enable | disable}]
[-iscsi-name {iscsi_name | ""}]
[-alias-name alias_name]
[-host-response-number host_response_number] [-host-response-name host_response_name]
[-reset-scope {initiator-lun | target-lun}] [-reserve-cancel {enable | disable}]
[-ipv4-flag {enable | disable}] [-ip ip_address] [-netmask netmask] [-gateway gateway]
[-ipv6-flag {enable | disable}] [-link-local-ip ip_address] [-connect-ip {ip_address | auto}]
[-ipv6-gateway {gateway | auto}]
[-tcp-port tcp_port_number] [-tcp-window-scale tcp_window_scale]
[-isns-server-ip isns_server_ip] [-isns-server {enable | disable}]
[-isns-server-port isns_server_port_number]
[-chap {enable | disable}] [-chap-user {chap_user_name | ""}]
[-header-digest {enable | disable}] [-data-digest {enable | disable}]
[-jumbo-frame {enable | disable}]
[-rate {auto|1gauto | 10gauto | 1gfull | 100mfull}]
[-cmds-n-count {unlimited | 20 | 40 | 80 | 120 | 180}]
[-vlan-id {enable | disable}] [-vlan-id-value {0 - 4095}]
[-mtu mtu_size] [-bandwidth bandwidth_limit]
[-chap-ca {enable | disable}]
[-chap-user-ca {chap_user_name-ca | ""}]
[-chap-ra {enable | disable}]
[-chap-user-ra {chap_user_name-ra | ""}]
[-rec-line-no rec-line-no]
[-rec-transfer-sync {enable | disable}] [-rec-transfer-stack {enable | disable}]
[-rec-transfer-consistency {enable | disable}] [-rec-transfer-through {enable | disable}]
[-tfo-transfer-mode {enable | disable}]
```

Parameter

-port This parameter specifies which iSCSI interface port is to be set. Multiple comma-separated ports may be specified.

Example: -port 000,110

For details, refer to ["1.2.15 Host Interface Port Syntax" \(page 44\)](#).

port_numbers iSCSI interface port

xyz "x" is the controller module (CM) number, "y" is the CA number, and "z" is the iSCSI port number (DX60 S4/DX100 S4/DX200 S4, DX500 S4/DX600 S4, DX60 S3/DX100 S3/DX200 S3, DX500 S3/DX600 S3, DX8100 S3, AF250 S2/AF650 S2, AF250/AF650, and DX200F only).

Example: "110" indicates CM#1-CA#1-Port#0

wxyz "w" is the controller enclosure (CE) number, "x" is the controller module (CM) number, "y" is the CA number, and "z" is the host port number (DX8700 S3/DX8900 S3 only).
Example: "0120" indicates CE#0-CM#1-CA#2-Port#0

all All iSCSI interface ports

-multiple-vlan

Optional. This parameter specifies whether the multiple VLAN setting is enabled.

When this parameter is specified, multiple port numbers or the "-all" option cannot be specified for the "-port" parameter.

When "disabled" is specified, the virtual port information for the ports that are specified with the "-port" parameter is deleted.

When this parameter is specified, the "-additional-ip" parameter and the "-additional-ip-function" parameter cannot be specified.

This parameter can only be specified when the port mode of the ports that are specified with the "-port" parameter is the CA mode or the CA/RA auto mode.

When this parameter is specified, only the "-port" parameter can be specified.

enable The multiple VLAN function is enabled.

disable The multiple VLAN function is disabled.

-additional-ip

Optional. This parameter specifies the virtual port number that is set for the target port.

When this parameter is specified, multiple port numbers or the "-all" option cannot be specified for the "-port" parameter.

This parameter can only be specified when the port mode of the ports that are specified with the "-port" parameter is the CA mode or the CA/RA auto mode and the VLAN function is enabled.

When this parameter is specified, only the parameters that can be specified for the multiple IP address setting can be specified together.

additional-ip Target virtual port number (1 - 15)

-additional-ip-function

Optional. This parameter specifies whether the target virtual port is enabled.

When "disable" is specified, the virtual port information of the port that is specified with the "-additional-ip" parameter is deleted.

When "disable" is specified, only the "-port" parameter and the "-additional-ip" parameter can be specified together.

This parameter can only be specified when the port mode for the ports that are specified with the "-port" parameter is the CA mode or the CA/RA auto mode, the multiple IP address setting is enabled, and the VLAN function is enabled.

enable The target virtual port is enabled.

disable The target virtual port is disabled.

-host-affinity

Optional. This parameter specifies the Host Affinity Mode. If omitted, the existing setting is not changed.

Host affinity is a security mechanism used to restrict access by a given host to only a specific set of LUNs. This parameter cannot be specified when the port is set to the RA mode.

enable Host Affinity Mode is enabled.

disable Host Affinity Mode is disabled.

-iscsi-name Optional. This parameter specifies the iSCSI name for the specified host interface port. If omitted, the existing setting is not changed. This parameter cannot be specified for iSCSI-RA (host interfaces that are only used for connecting older models).

- Up to 223 alphanumeric characters including, hyphen minus (-), full stop (.), and colon (:), can be used to specify this parameter.
- "iqn." or "eui." must be added in front of the character string.
- Characters are not case-sensitive.

iscsi_name iSCSI name

-alias-name Optional. This parameter specifies an alias to the iSCSI name that corresponds to the "-iscsi-name" parameter. A maximum of 31 alphanumeric characters can be used. The available characters are the ones that is shown in ["1.2.2 Keywords and Parameters" \(page 33\)](#), except for a comma (,). To delete an alias name, specify a null character ("").

This name is not used for control purposes. It is only handled as a comment corresponding to the iSCSI name.

alias_name Alias name

"" The alias name is deleted.

-host-response-number or -host-response-name

Optional. This parameter specifies the host response identifier. Only one identifier can be specified at any given time. If omitted, the existing setting is not changed. For details, refer to ["1.2.14 Host Response Syntax" \(page 43\)](#). This parameter cannot be specified when the port is set to the RA mode.

host_response_number Host response number

host_response_name Host response name

-reset-scope

Optional. This parameter specifies the range of reset action. If omitted, the existing setting is not changed. This parameter cannot be specified when the port is set to the RA mode.

initiator-lun Reset (Cancel) the command request from the server that sent the command reset request.

target-lun Reset (Cancel) the command request from all servers that are connected to the port (regardless of whether the LUN is recognized).

-reserve-cancel

Optional. This parameter specifies whether or not reservations are canceled when a host interface port is reset. If omitted, the existing setting is not changed. This parameter cannot be specified when the port is set to the RA mode.

enable Reservations are canceled.

disable Reservations are not canceled.

-ipv4-flag Optional. This parameter specifies whether to use an IPv4 address. "disable" cannot be specified for this parameter if "disable" is specified for the "-ipv6-flag" parameter. This parameter can be specified for the multiple IP address setting.

enable An IPv4 address is used.

disable An IPv4 address is not used.

- ip** Optional. This parameter specifies the IP address that is used to connect to an iSCSI network using IPv4 standard notation (a base 256 "d.d.d.d" string). If omitted, the existing setting is not changed. This parameter can be specified for the multiple IP address setting.
- Example: -ip 192.168.1.1
- ip_address* IP address
- netmask** Optional. This parameter specifies the subnet mask that is used to connect to an iSCSI network using IPv4 standard notation (a base 256 "d.d.d.d" string). If omitted, the existing setting is not changed. This parameter can be specified for the multiple IP address setting.
- Example: -netmask 255.255.255.0
- netmask Subnet mask
- gateway** Optional. This parameter specifies the gateway server address using IPv4 standard notation (a base 256 "d.d.d.d" string). If omitted, the existing setting is not changed. This parameter can be specified as a parameter for the multiple IP address setting.
- Example: -gateway 10.1.0.250
- gateway* Gateway server address
- ipv6-flag** Optional. This parameter specifies whether to use an IPv6 address. "disable" cannot be specified for this parameter if "disable" is specified for the "-ipv4-flag" parameter. This parameter can be specified as a parameter for the multiple IP address setting.
- enable An IPv6 address is used.
- disable An IPv6 address is not used.
- link-local-ip** Optional. This parameter specifies a link local address in IPv6 format. If omitted, the existing setting is not changed. If IPv6 addresses are used and a link local address is not set when this parameter is omitted, an IP address is automatically created and set based on the WWN of the ETERNUS DX/AF. This parameter can be specified as a parameter for the multiple IP address setting.
- When IPv6 is enabled and this parameter is specified as a parameter for the multiple IP address setting without a link local address, a link local address is not automatically created.
- Example: -link-local-ip fe80::250
- ip_address* Link local address
- connect-ip** Optional. This parameter specifies a global address (including 6to4 addresses) or a unique local address in IPv6 format. To delete an IP address that is already set, specify ALLO (an IP address with all zero bits). This parameter can be specified as a parameter for the multiple IP address setting.
- Example: -connect-ip 2000:100::10:1:0:250
- Example: -connect-ip ::
- Example: -connect-ip auto
- ip_address* Global address or unique local address in IPv6 format
- auto The global address or the unique local address is automatically set in IPv6 format.

-ipv6-gateway

Optional. This parameter specifies the gateway server address in IPv6 format. The types of IP addresses that can be specified are global addresses (including 6to4 addresses), link local addresses, and unique local addresses. To delete an IP address that is already set, specify ALL0 (an IP address with all zero bits). This parameter can be specified as a parameter for the multiple IP address setting.

Example: `-ipv6-gateway 10.1.0.250`

Example: `-ipv6-gateway 0::0`

Example: `-ipv6-gateway auto`

ip_address Global address

auto The gateway IP address is automatically set in IPv6 format.

-tcp-port

Optional. This parameter specifies TCP port number for iSCSI Target function. The default TCP port number value is 3260. This parameter can be specified as a parameter for the multiple IP address setting.

tcp_port_number TCP port number (0 – 28671)

-tcp-window-scale

Optional. This parameter specifies the TCP window scale expansion.

This parameter can be specified as a parameter for the multiple IP address setting. This parameter cannot be specified for iSCSI-RA (host interfaces that are only used for connecting older models).

tcp_window_scale

TCP window scale (0 – 14)

Note that expected performance may not be possible under a high I/O load when "0" or "1" is specified. Even if "8" or more is specified for the value, the operation is performed the same as when "7" is specified.

-isns-server-ip

Optional. This parameter specifies the IP address of an iSNS server (*1) using IPv4 standard notation (a base 256 "d.d.d.d" string) or IPv6 format. The types of IP addresses that can be specified are global addresses (including 6to4 addresses), link local addresses, and unique local addresses. IP addresses in IPv4 format can be specified when "enable" is specified for the "-ipv4-flag" parameter. IP addresses in IPv6 format can be specified when "enable" is specified for the "-ipv6-flag" parameter. The iSNS server must belong to the same iSCSI network as the one to which the iSCSI interface port specified by the "-port" parameter belongs. If omitted, the existing setting is not changed. This parameter cannot be specified when the port is set to the RA mode.

This parameter can be specified as a parameter for the multiple IP address setting.

*1: iSNS server: Internet Storage Name Server

Example: `-isns-server-ip 10.1.1.12`

Example: `-isns-server-ip fe80::250`

isns_server_ip IP address of an iSNS server

-isns-server

Optional. This parameter specifies whether or not an iSNS server is used. If omitted, the existing setting is not changed.

This parameter can be specified as a parameter for the multiple IP address setting.

The iSNS server can be enabled for up to four ports, including the physical ports and the virtual ports in a single port.

enable An iSNS server is used.
disable An iSNS server is not used.

-isns-server-port

Optional. This parameter specifies iSNS server port number. The default iSNS server port number value is 3205. This parameter cannot be specified when the port is set to the RA mode. This parameter can be specified as a parameter for the multiple IP address setting.

isns_server_port_number iSNS server port number (0 – 65535)

-chap

Optional. This parameter specifies whether or not CHAP authentication is used. If omitted, the existing setting is not changed.

enable A CHAP authentication is used.
disable A CHAP authentication is not used.

-chap-user

Optional. This parameter specifies the user name for CHAP authentication. It is only applicable if CHAP authentication is used. Up to 255 alphanumeric characters and symbols for CA ports and up to 63 alphanumeric characters and symbols for RA ports can be used. If this parameter is specified, then the command displays a CHAP user password prompt. If omitted, the existing setting is not changed. To delete a registered CHAP user name, specify a null character ("").

chap_user_name User name for CHAP authentication
"" The registered CHAP user name is deleted.

-header-digest

Optional. This parameter specifies whether or not the PDU header's CRC32C checksum is validated. The initial value is set to disabled. Specify "disable" for the "-header-digest" parameter to disable the Digest function. When "enable" is specified for the "-header-digest" parameter, data transfer may fail. If omitted, the existing setting is not changed. This parameter cannot be specified when the port is set to the RA mode.

enable PDU header is validated by CRC32C.
disable PDU header is not validated.

-data-digest

Optional. This parameter specifies whether or not the PDU data's CRC32C checksum is validated. The initial value is set to disabled. Specify "disable" for the "-data-digest" parameter to disable the Digest function. When "enable" is specified for the "-data-digest" parameter, data transfer may fail. If omitted, the existing setting is not changed. This parameter cannot be specified when the port is set to the RA mode.

enable PDU data is validated by CRC32C.
disable PDU data is not validated.

-jumbo-frame

Optional. This parameter specifies whether or not jumbo frame can be specified. If omitted, the existing setting is not changed. The initial value is set to disabled.

This parameter can be specified as a parameter for the multiple IP address setting.
This parameter cannot be specified when the port is in RA mode or CA/RA auto mode.

enable The jumbo frame is accepted.
disable The jumbo frame is not accepted.

 **Caution**

To transfer data via Jumbo Frame, make sure the device that is to be connected to the iSCSI network supports Jumbo Frame.

- rate** Optional. This parameter specifies the connection speed of the iSCSI port. If omitted, the existing setting is not changed. The default value is 10Gbit/s for 10Gbit/s iSCSI, 1Gbit/s for 1Gbit/s iSCSI and iSCSI-RA (for connecting older models), and Auto for 10Gbit/s Base-T iSCSI.
- | | |
|----------|---|
| 1gauto | 1Gbit/s Auto
(1Gbit/s iSCSI CA/RA auto mode and 10Gbit/s Base-T iSCSI CA/RA auto mode only) |
| 10gauto | 10Gbit/s Auto
(1Gbit/s iSCSI CA/RA auto mode and 10Gbit/s Base-T iSCSI CA/RA auto mode only) |
| 1gfull | 1Gbit/s Full Duplex
(iSCSI-RA [for connecting older models] only) |
| 100mfull | 100Mbit/s Full Duplex
(iSCSI-RA [for connecting older models] only) |
| auto | Auto negotiation
(iSCSI-RA [for connecting older models] and 10Gbit/s Base-T iSCSI CA/RA auto mode only) |
- cmds-n-count** Optional. For Advanced authority users, this parameter specifies the number of commands that are simultaneously acceptable from a host. The initial value is set to unlimited. This parameter cannot be specified when the port is set to the RA mode.
- | | |
|-----------|--|
| unlimited | The number of commands is not limited. |
| 20 | Limited to a maximum of 20 commands. |
| 40 | Limited to a maximum of 40 commands. |
| 80 | Limited to a maximum of 80 commands. |
| 120 | Limited to a maximum of 120 commands. |
| 180 | Limited to a maximum of 180 commands. |
- vlan-id** Optional. This parameter specifies VLAN connection enable or disabled. When "enable" sets, must be set the "-vlan-id-value" parameter. To set "enable", the "-vlan-id-value" parameter must be set. This parameter can be specified as a parameter for the multiple IP address setting.
- | | |
|---------|---------------------------|
| enable | VLAN connection enabled. |
| disable | VLAN connection disabled. |
- vlan-id-value** Optional. This parameter specifies the VLAN ID value for connect to VLAN. When "-vlan-id enable" is done, this parameter must be set. "-vlan-id" must be set to "enable" for this parameter. This parameter can be specified as a parameter for the multiple IP address setting.
- | | |
|----------|--------------------------|
| 0 – 4095 | VLAN ID value (0 – 4095) |
|----------|--------------------------|
- mtu** Optional. Specify the MTU size when RA is used. The specified value is only valid when the RA mode or CA/RA auto mode is used. The initial value is 1300. From 576 to 9000 can be specified when IPv6 is disabled and from 1280 to 9000 can be specified when IPv6 is enabled. If omitted, the existing setting is not changed.
- | | |
|-----------------|-----------------------|
| <i>mtu_size</i> | MTU size (576 – 9000) |
|-----------------|-----------------------|

- bandwidth Optional. This parameter specifies the bandwidth limit when iSCSI-RA (only for connecting older models) is used. The specified value is only valid for iSCSI-RA, which is only used for connecting older models. The initial value is 400Mbit/s. The allowed range is from 10 to 400. If omitted, the existing setting is not changed.
- bandwidth_limit* Bandwidth limit (upper limit performance value) (10 – 400)
- chap-ca Optional. This parameter specifies whether or not CHAP authentication is used. If omitted, this setting is not changed. This parameter is used for the CA setting of CA/RA dual-purpose ports.
- enable A CHAP authentication is used.
disable A CHAP authentication is not used.
- chap-user-ca Optional. This parameter specifies the user name for CHAP authentication. It is only applicable if CHAP authentication is used. If omitted, this setting is not changed. Up to 255 alphanumerical characters and symbols can be used. When this parameter is specified, a prompt that requires entering the CHAP user pass-word appears. To delete a registered CHAP user name, specify a null character (""). This parameter is used for the CA setting of CA/RA dual-purpose ports.
- chap_user_name-ca* User name for CHAP authentication
"" The registered CHAP user name is deleted.
- chap-ra Optional. This parameter specifies whether or not CHAP authentication is used. this setting is not changed. This parameter is used for the RA setting of CA/RA dual-purpose ports.
- enable CHAP authentication is used.
disable CHAP authentication is not used.
- chap-user-ra Optional. This parameter specifies the user name for CHAP authentication. It is only applicable if CHAP authentication is used. If omitted, this setting is not changed. Up to 63 alphanumerical characters and symbols can be used. When this parameter is specified, a prompt to require entering CHAP user password. To delete a registered CHAP user name, specify a null character (""). This parameter is used for the RA setting of CA/RA dual-purpose ports.
- chap_user_name-ra* User name for CHAP authentication
"" The registered CHAP user name is deleted.
- rec-line-no Optional. This parameter specifies the REC line number. If omitted, the existing setting is not changed. This parameter can only be specified for the ports that both of the following conditions apply to: the Advanced Copy license has been registered and the port mode is RA mode or CA/RA auto mode.
- rec-line-no* REC line number (0 – 127)
- rec-transfer-sync Optional. This parameter specifies the synchronous mode for the copy transfer mode. If omitted, the existing setting is not changed. This parameter can only be specified for the ports that both of the following conditions apply to: the Advanced Copy license has been registered and the port mode is RA mode or CA/RA auto mode.
- enable An REC in synchronous transfer mode is permitted for the target CA port.
disable An REC in synchronous transfer mode is suppressed for the target CA port.

-rec-transfer-stack

Optional. This parameter specifies the asynchronous stack mode for the copy transfer mode. If omitted, the existing setting is not changed. This parameter can only be specified for the ports that both of the following conditions apply to: the Advanced Copy license has been registered and the port mode is RA mode or CA/RA auto mode.

enable An REC in asynchronous stack mode is permitted for the target CA port.

disable An REC in asynchronous stack mode is suppressed for the target CA port.

-rec-transfer-consistency

Optional. This parameter specifies the asynchronous consistency mode for the copy transfer mode. If omitted, the existing setting is not changed. This parameter can only be specified for the ports that both of the following conditions apply to: the Advanced Copy license has been registered and the port mode is RA mode or CA/RA auto mode.

enable An REC in asynchronous consistency mode is permitted for the target CA port.

disable An REC in asynchronous consistency mode is suppressed for the target CA port.

-rec-transfer-through

Optional. This parameter specifies the asynchronous through mode for the copy transfer mode. If omitted, the existing setting is not changed. This parameter can only be specified for the ports that both of the following conditions apply to: the Advanced Copy license has been registered and the port mode is RA mode or CA/RA auto mode.

enable An REC in asynchronous through mode is permitted for the target CA port.

disable An REC in asynchronous through mode is suppressed for the target CA port.

-tfo-transfer-mode

Optional. This parameter specifies the TFO transfer mode (transfer mode of the Storage Cluster). If omitted, the existing setting is not changed. This parameter can only be specified for the ports that both of the following conditions apply to: the Storage Cluster license has been registered and the port mode is RA or CA/RA auto mode.

enable A Storage Cluster transfer is permitted for the target CA port.

disable A Storage Cluster transfer is suppressed for the target CA port.

■ **Example(s)**

The following example sets up the parameters to control CM#1 CA#0 Port#0 (iSCSI interface). Host Affinity Mode is disabled:

```
CLI> set iscsi-parameters -port 100 -host-affinity disable
```

The following example sets "192.168.1.1" for the IP address, "255.255.255.0" for the subnet mask, and "user01" for the CHAP user name of CM#0 CA#0 Port#1 (iSCSI interface):

```
CLI> set iscsi-parameters -port 001 -ip 192.168.1.1 -netmask 255.255.255.0 -chap-user user01
Password :
Confirm Password :
```

The following example enables the jumbo frame function on all iSCSI interface ports:

```
CLI> set iscsi-parameters -port all -jumbo-frame enable
```

The following example automatically sets the IP address and the gateway IP address to connect to CM#0 CA#0 Port#1 (iSCSI interface):

```
CLI> set iscsi-parameters -port 001 -connect-ip auto -ipv6-gateway auto
Connect Address List :
0. Cancel
1. 2001:1:2:3:4:5:6:7
2. 2002:1:2:3:4:5:6:7
3. 2003:1:2:3:4:5:6:7
4. 2004:1:2:3:4:5:6:7
5. 2005:1:2:3:4:5:6:7
Please specify the number of an address to set up from a Connect Address List.

Input the number (0/1-5)> 2

IPv6 Gateway Address List :
0. Cancel
1. 2001:1000:120::1234:0
2. 2001:1000:120::1234:1111
3. 2001:1000:120::1234:6000
Please specify the number of an address to set up from an IPv6 Gateway Address List.

Input the number (0/1-3)> 2
```

The following example enables the multiple IP address setting:

```
CLI> set iscsi-parameters -port 001 -multi-ip enable
```

The following example enables the information on virtual port #1 of iSCSI port #001, for which the multiple IP address setting is enabled:

```
CLI> set iscsi-parameters -port 001 -additional-ip 1 -additional-ip-function enable -ipv4-flag enable -ip 192.168.1.1 -
netmask 255.255.255.0
```

show fcoe-parameters

This command displays the parameters of each Fiber Channel over Ethernet (FCoE) host interface port.

■ Syntax

```
show fcoe-parameters
```

■ Parameter

No parameters.

■ Output

Item name	Description
Port	Each host interface port number
Port Mode	Each port mode (CA)
Transfer Rate	FC transfer rate (10Gbit/s)
Frame Size	FC frame size (512bytes / 1024bytes / 2048 bytes)
Host Affinity	Host affinity mode of each host interface port
Host Response No.	Host response number (A hyphen [-] is displayed when the host affinity mode is enabled.)
Host Response Name	Host response name (A hyphen [-] is displayed when the host affinity mode is enabled.)
Reset Scope	Range of reset action I_T_L (I: Initiator, T: Target, L: LUN) or T_L (T: Target, L: LUN)
Reserve Cancel at Chip Reset	Indicates whether reservations are canceled when a host interface port is reset (Enable: canceled, Disable: not canceled).
FCF VLAN ID	FCF VLAN ID Enable/Disable and setting value. (The setting value is displayed when FCF VLAN ID is enabled)
FCF Fabric Name	FCF Fabric Name Enable/Disable and setting value (The setting value is displayed when FCF Fabric Name is enabled)
MAC Address	MAC address

■ Example(s)

The following example shows the parameters displayed for each FCoE interface port (for the DX100 S3/DX200 S3 and the DX500 S3/DX600 S3).

In this example, each CA has 2 ports and each CM has 2 CAs:

```

CLI> show fcoe-parameters
Port                               CM#0 CA#0 Port#0      CM#0 CA#0 Port#1
Port Mode                           CA                     RA
Transfer Rate                       10Gbit/s              10Gbit/s
Frame Size                          2048bytes             2048bytes
Host Affinity                       Enable                Enable
Host Response No.                   1                    2
Host Response Name                   HP01                 HP02
Reset Scope                         I_T_L                I_T_L
Reserve Cancel at Chip Reset        Disable              -
FCF VLAN ID                         Disable              Disable
FCF Fabric Name                     Disable              Disable
MAC Address                         01:02:03:04:05:06   01:02:03:04:05:07

Port                               CM#0 CA#1 Port#0      CM#0 CA#1 Port#1
Port Mode                           CA                     CA
Transfer Rate                       10Gbit/s              10Gbit/s
Frame Size                          2048bytes             2048bytes
Host Affinity                       Enable                Enable
Host Response No.                   -                    -
Host Response Name                   -                    -
Reset Scope                         I_T_L                I_T_L
Reserve Cancel at Chip Reset        Disable              Enable
FCF VLAN ID                         Enable                Enable
FCF Fabric Name                     55                   100
MAC Address                         0001000100010001    0002000200020002
MAC Address                         01:02:03:04:05:06   01:02:03:04:05:07

Port                               CM#1 CA#0 Port#0      CM#1 CA#0 Port#1
Port Mode                           CA                     CA
Transfer Rate                       10Gbit/s              10Gbit/s
Frame Size                          1024bytes             1024bytes
Host Affinity                       Disable              Disable
Host Response No.                   3                    4
Host Response Name                   HP03                 HP04
Reset Scope                         I_T_L                I_T_L
Reserve Cancel at Chip Reset        Disable              Enable
FCF VLAN ID                         Disable              Disable
FCF Fabric Name                     Disable              Disable
MAC Address                         01:02:03:04:05:06   01:02:03:04:05:07

Port                               CM#1 CA#1 Port#0      CM#1 CA#1 Port#1
Port Mode                           CA                     CA
Transfer Rate                       10Gbit/s              10Gbit/s
Frame Size                          1024bytes             1024bytes
Host Affinity                       Disable              Enable
Host Response No.                   -                    -
Host Response Name                   -                    -
Reset Scope                         I_T_L                I_T_L
Reserve Cancel at Chip Reset        Disable              Enable
FCF VLAN ID                         Enable                Enable
FCF Fabric Name                     56                   101
MAC Address                         0003000300030003    0004000400040004
MAC Address                         01:02:03:04:05:06   01:02:03:04:05:07
    
```

The following example shows the parameters displayed for each FCoE interface port (for the DX8700 S3/DX8900 S3). In this example, each CA has 2 ports and each CM has 2 CAs:

```

CLI> show fcoe-parameters
Port                               CE#0 CM#0 CA#0 Port#0  CE#0 CM#0 CA#0 Port#1
Port Mode                           CA                      RA
Transfer Rate                       10Gbit/s              10Gbit/s
Frame Size                          2048bytes             2048bytes
Host Affinity                        Enable                 Enable
Host Response No.                   1                     2
Host Response Name                   HP01                  HP02
Reset Scope                          I_T_L                 I_T_L
Reserve Cancel at Chip Reset        Disable                -
FCF VLAN ID                         Disable                Disable
FCF Fabric Name                     Disable                Disable
MAC Address                          01:02:03:04:05:06    01:02:03:04:05:07

Port                               CE#0 CM#0 CA#1 Port#0  CE#0 CM#0 CA#1 Port#1
Port Mode                           CA                      CA
Transfer Rate                       10Gbit/s              10Gbit/s
Frame Size                          2048bytes             2048bytes
Host Affinity                        Enable                 Enable
Host Response No.                   -                     -
Host Response Name
Reset Scope                          I_T_L                 I_T_L
Reserve Cancel at Chip Reset        Disable                Enable
FCF VLAN ID                         Enable                 Enable
FCF Fabric Name                     Enable                 Enable
MAC Address                          0001000100010001     0002000200020002
MAC Address                          01:02:03:04:05:06    01:02:03:04:05:07

Port                               CE#0 CM#1 CA#0 Port#0  CE#0 CM#1 CA#0 Port#1
Port Mode                           CA                      CA
Transfer Rate                       10Gbit/s              10Gbit/s
Frame Size                          1024bytes             1024bytes
Host Affinity                        Disable                Disable
Host Response No.                   3                     4
Host Response Name                   HP03                  HP04
Reset Scope                          I_T_L                 I_T_L
Reserve Cancel at Chip Reset        Disable                Enable
FCF VLAN ID                         Disable                Disable
FCF Fabric Name                     Disable                Disable
MAC Address                          01:02:03:04:05:06    01:02:03:04:05:07

Port                               CE#0 CM#1 CA#1 Port#0  CE#0 CM#1 CA#1 Port#1
Port Mode                           CA                      CA
Transfer Rate                       10Gbit/s              10Gbit/s
Frame Size                          1024bytes             1024bytes
Host Affinity                        Disable                Enable
Host Response No.                   -                     -
Host Response Name
Reset Scope                          I_T_L                 I_T_L
Reserve Cancel at Chip Reset        Disable                Enable
FCF VLAN ID                         Enable                 Enable
FCF Fabric Name                     Enable                 Enable
MAC Address                          0003000300030003     0004000400040004
MAC Address                          01:02:03:04:05:06    01:02:03:04:05:07
  
```

set fcoe-parameters

This command sets up the parameters to control each FCoE host interface port. Host Affinity Mode can be changed by using this command.

Syntax

```
set fcoe-parameters -port {port_numbers | all}
[-host-affinity {enable | disable}] [-rate {10g}]
[-frame-size {512 | 1024 | 2048}]
[-host-response-number host_response_number | -host-response-name host_response_name]
[-reset-scope {initiator-lun | target-lun}] [-reserve-cancel {enable | disable}]
[-fcf-vlan-id {enable | disable}] [-fcf-vlan-id-value {0 - 4095}]
[-fcf-fabric-name {enable | disable}] [-fcf-fabric-name-value WWW]
```

Parameter

-port This parameter specifies the FCoE interface port number to be set up. Two or more ports can be specified by separating them with a comma (,).

Example: -port 000,110

For details, refer to ["1.2.15 Host Interface Port Syntax" \(page 44\)](#).

port_numbers FCoE interface port

xyz "x" is the controller module (CM) number, "y" is the CA number, and "z" is the FCoE port number (DX100 S3/DX200 S3, DX500 S3/DX600 S3, and DX8100 S3 only).

Example: "120" indicates CM#1-CA#2-Port#0

wxyz "w" is the controller enclosure (CE) number, "x" is the controller module (CM) number, "y" is the CA number, and "z" is the host port number (DX8700 S3/DX8900 S3 only).

Example: "0120" indicates CE#0-CM#1-CA#2- Port#0

all All the FCoE interface ports

-host-affinity

Optional. This parameter specifies the Host Affinity Mode. If omitted, the existing setting is not changed. The host affinity is the security capability of the system against host servers. By enabling Host Affinity Mode, it can limit the access from hosts. If the Initiator mode is being set for the specified ports, this parameter cannot be specified.

enable Host Affinity Mode is enabled.

disable Host Affinity Mode is disabled.

-rate Optional. This parameter specifies the FC transfer rate. If omitted, the existing setting is not changed.

10g 10Gbit/s

-frame-size Optional. This parameter specifies the FC frame size. If omitted, the existing setting is not changed.

512 512 bytes

1024 1,024 bytes

2048 2,048 bytes

-host-response-number or -host-response-name

Optional. This parameter specifies a host response identifier. Only one host response identifier can be specified at the same time. If omitted, the existing setting is not changed. For details, refer to ["1.2.14 Host Response Syntax" \(page 43\)](#).

host_response_number Host response number

host_response_name Host response name

-reset-scope Optional. This parameter specifies the range of reset action. If omitted, the existing setting is not changed.

initiator-lun Reset (Cancel) the command request from the server that sent the command reset request.

target-lun Reset (Cancel) the command request from all servers that are connected to the port (regardless of whether the LUN is recognized).

-reserve-cancel

Optional. This parameter specifies whether or not SCSI reservation (persistent reservation) is canceled when host interface ports are reset. If omitted, the existing setting is not changed. If the RA mode is set for the specified port, this parameter cannot be specified.

enable Reservations are canceled.

disable Reservations are not canceled.

-fcf-vlan-id Optional. This parameter specifies the FCF VLAN ID setting disable or enable. To set "enable", the "-fcf-vlan-id_value" parameter must be set.

enable FCF VLAN ID manual setting.

disable FCF VLAN ID auto setting

-fcf-vlan-id-value

Optional. This parameter specifies the FCF VLAN ID for connection to FCF (FCoE switch). This parameter must be set to set "-fcf-vlan-id" to "enable".

0 – 4095 FCF VLAN ID

-fcf-fabric-name

Optional. This parameter specifies the FCF Fabric Name (WWN) setting disable or enable. To set "enable", the "-fcf-fabric-name-value" parameter must be set.

enable Connection check for FCF using FCF Fabric Name (WWN).

disable Connection check nothing.

-fcf-fabric-name-value

Optional. This parameter specifies the FCF Fabric Name for connect check to FCF (FCoE switch). This parameter must be set to set "-fcf-fabric-name" to "enable".

WWN WWN value (8 byte)

■ Example(s)

The following example sets up the parameters to control CM#1 CA#1 Port#0 (FCoE interface). Host Affinity Mode is disabled:

```
CLI> set fcoe-parameters -port 110 -host-affinity disable
```

The following example sets up the parameters to control CM#0 CA#0 Port#1 (FCoE interface). The FC frame size is 2,048 bytes, the FCF VLAN ID is 55, and the FCF Fabric name is 0001000100010001:

```
CLI> set fcoe-parameters -port 001 -frame-size 2048 -fcf-vlan-id enable -fcf-vlan-id-value 55 -fcf-fabric-name enable  
-fcf-fabric-name-value 0001000100010001
```

3.6.2 Host Identifiers (Host Alias)

This section explains commands related to the definition of host identifiers.

show host-wwn-names

This command displays a list of all the existing FC or FCoE host identifiers.

■ Syntax

```
show host-wwn-names
```

■ Parameter

No parameters.

■ Output

Item name	Description
Host	Host identifiers
No.	Host number
Name	Host WWN nickname
WWN	World wide name
Host Response	Assigned host response identifiers
No.	Assigned host response number
Name	Assigned host response name

■ Example(s)

The following example displays a list of all the existing host identifiers:

```
CLI> show host-wwn-names
Host
No.  Name                WWN                Host Response
-----
0    HBA1                40000000abc80e38  0 Default
1    HBA2                40000000abc80e00  0 Default
2    HBA3                40000000abc80e01  0 Default
3    HBA4                40000000abc80e02  0 Default
4    HBA5                40000000abc80e03  0 Default
```

create host-wwn-name

This command registers the host alias that corresponds to the WWN (World Wide Name) that identifies FC or FCoE type HBAs (Host Bus Adapters). Only one WWN can be registered at the same time. The maximum number of available definitions depends on the number of available host interface ports and the model type. This enables the alias to be used instead of the numeric WWN when mapping volumes to host servers.

■ Syntax

```
create host-wwn-name -wwn wwn -name name  
[-host-response-number host_response_number | -host-response-name host_response_name]  
[-host-group-number host_group_number | -host-group-name host_group_name |  
-new-host-group-name new_host_group_name]
```

■ Parameter

-wwn This parameter specifies the WWN that corresponds to an HBA. The WWN is a 16-byte hexadecimal number.

Example: -wwn 40000000abc80e38

wwn World Wide Name

-name This parameter specifies the host WWN alias. For details, refer to ["1.2.6 Alias Name Syntax" \(page 35\)](#).

name WWN alias

-host-response-number or -host-response-name

Optional. This parameter specifies the host response identifier. Two or more parameters cannot be specified at the same time. For details, refer to ["1.2.14 Host Response Syntax" \(page 43\)](#). If omitted, the existing setting is not changed.

host_response_number Host response number

host_response_name Host response name

-host-group-number or -host-group-name

Optional. This parameter specifies the host group number or the host group name. Only one host group can be specified at the same time. For details, refer to ["1.2.13 Host Group Syntax" \(page 42\)](#).

host_group_number Host group number

host_group_name Host group name

-new-host-group-name

Optional. This parameter specifies a new host group name. Only one host group can be specified at the same time. For details, refer to ["1.2.13 Host Group Syntax" \(page 42\)](#).

new_host_group_name New host group name

■ Example(s)

The following example registers host alias "HBA1". The WWN is "e000000000e0e000" and host response #1 is assigned:

```
CLI> create host-wwn-name -wwn e000000000e0e000 -name HBA1 -host-response-number 1
```

The following example registers host alias "HBA1". The WWN is "e000000000e0e000". The registered host alias is added to host group "HG1":

```
CLI> create host-wwn-name -wwn e000000000e0e000 -name HBA1 -host-group-name HG1
```

The following example registers host alias "HBA1". The WWN is "e000000000e0e000" and host response #1 is assigned. The registered host alias is added to host group "HG2", which is created in host response #1:

```
CLI> create host-wwn-name -wwn e000000000e0e000 -name HBA1 -host-response-number 1 -new-host-group-name HG2
```

set host-wwn-name

This command changes an existing FC or FCoE host identifier.

■ Syntax

```
set host-wwn-name {-host-number host_number | -host-name host_name} [-wwn wwn]  
[-name name] [-host-response-number host_response_number |  
-host-response-name host_response_name]
```

■ Parameter

-host-number or -host-name

This parameter specifies the FC or FCoE host identifier to be changed. If only the host response identifier is being set, then two or more FC or FCoE host identifiers can be specified at the same time. If not, then only one can be specified. For details, refer to ["1.2.12 Host Syntax" \(page 41\)](#).

host_number FC host number or FCoE host number

host_name FC host name or FCoE host name

-wwn Optional. This parameter specifies the WWN to be changed. The WWN is a 16-byte hexadecimal number. Only one parameter can be specified at the same time. If omitted, the existing setting is not changed.

Example: -wwn 40000000abc78856

wwn WWN

-name Optional. This parameter specifies the host WWN alias. Only one parameter can be specified at the same time. For details, refer to ["1.2.6 Alias Name Syntax" \(page 35\)](#). If omitted, the existing setting is not changed.

name WWN alias

-host-response-number or -host-response-name

Optional. This parameter specifies the host response identifier to be changed. One or more parameters can be specified at the same time. For details, refer to ["1.2.14 Host Response Syntax" \(page 43\)](#). If omitted, the existing setting is not changed.

host_response_number Host response number

host_response_name Host response name

■ Example(s)

The following example changes the host response definition of the host named "HBA1":

```
CLI> set host-wwn-name -host-name HBA1 -host-response-number 2
```

The following example changes the host response definition of the FC hosts with consecutively numbered identifiers #1 – #10 at the same time:

```
CLI> set host-wwn-name -host-number 1-10 -host-response-number 5
```

The following example changes the host named "HBA1". The new alias is "HBA123":

```
CLI> set host-wwn-name -host-name HBA1 -name HBA123
```

delete host-wwn-name

This command deletes existing FC or FCoE host identifier(s).

■ Syntax

```
delete host-wwn-name {-host-number host_numbers | -host-name host_names}
```

■ Parameter

-host-number or -host-name

This parameter specifies the FC or FCoE host identifiers to be deleted. One or more parameters can be specified at the same time. For details, refer to ["1.2.12 Host Syntax" \(page 41\)](#).

host_numbers FC host number or FCoE host number

host_names FC host name or FCoE host name

■ Example(s)

The following example deletes the FC hosts with consecutively numbered identifiers #1-#3:

```
CLI> delete host-wwn-name -host-number 1-3
```

The following example only deletes the host named "HBA2":

```
CLI> delete host-wwn-name -host-name HBA2
```

discover host-wwn-names

This command displays a list of the host World-Wide-Names (WWNs) discovered from the specified FC and FCoE interface ports.

Syntax

```
discover host-wwn-names [-port {port_numbers | all | all-fc | all-fcoe}]
```

Parameter

-port Optional. This parameter specifies the FC and FCoE interface ports to discover host WWN names. Two or more ports can be specified by separating them with a comma (.). If omitted, all the FC and FCoE interface ports are selected.

Example: -port 000,100

For details, refer to ["1.2.15 Host Interface Port Syntax" \(page 44\)](#).

port_numbers FC and FCoE interface ports

xyz "x" is the controller module (CM) number, "y" is the CA number, and "z" is the host port number (DX60 S4/DX100 S4/DX200 S4, DX500 S4/DX600 S4, DX60 S3/DX100 S3/DX200 S3, DX500 S3/DX600 S3, DX8100 S3, AF250 S2/AF650 S2, AF250/AF650, and DX200F only).

Example: 110 (CM#1-CA#1-Port#0)

wxyz "w" is the controller enclosure (CE) number, "x" is the controller module (CM) number, "y" is the CA number, and "z" is the host port number (DX8700 S3/DX8900 S3 only).

Example: 0123 (CE#0-CM#1-CA#2-Port#3)

all All the FC/FCoE interface ports (default)

all-fc All the FC interface ports

all-fcoe All the FCoE interface ports

Output

Item name	Description
CM#x CA#y Port#z	Port number (only for the DX60 S4/DX100 S4/DX200 S4, the DX500 S4/DX600 S4, the DX60 S3/DX100 S3/DX200 S3, the DX500 S3/DX600 S3, the DX8100 S3, the AF250 S2/AF650 S2, the AF250/AF650, and the DX200F)
CE#w CM#x CA#y Port#z	Port number (only for the DX8700 S3/DX8900 S3)
xxxxxxxxxxxxxxxx	Discovered WWNs

■ Example(s)

The following example displays a list of the host WWNs discovered from all the FC and FCoE interface ports on CM#0 (for FC 4 port models):

```
CLI> discover host-wwn-names -port 000,011
CM#0 CA#0 Port#0 (FC-CA)
aabbccddeeff0011
aabbccddeeff0012
ffeefeefffeeff03

CM#0 CA#1 Port#1 (FCoE)
aabbccddeeff0011
aabbccddeeff0012
ffeefeefffeeff03
```

show host-sas-addresses

This command displays a list of all the SAS host identifiers in the system.

■ Syntax

```
show host-sas-addresses
```

■ Parameter

No parameters.

■ Output

Item name	Description
Host	Host identifiers
No.	Host number
Name	Host nickname
SAS Address	SAS address
Host Response	Assigned host response identifiers
No.	Assigned host response number
Name	Assigned host response name

■ Example(s)

The following example displays a list of all registered SAS host identifiers:

```
CLI> show host-sas-addresses
Host
No.  Name                SAS Address                Host Response
-----
  1  HBA1                500605b000b5f344         1  HP001
```

create host-sas-address

This command registers a host alias for the SAS (Serial Attached SCSI) address that is used to identify a SAS type HBA (Host Bus Adapter). This alias can then be used instead of a numeric SAS address when mapping volumes to hosts.

Only one SAS address can be specified at any given time. The maximum number of available definitions depends on the number of available host interface ports and the model.

■ Syntax

```
create host-sas-address -address address -name name  
[-host-response-number host_response_number | -host-response-name host_response_name]  
[-host-group-number host_group_number | -host-group-name host_group_name |  
-new-host-group-name new_host_group_name]
```

■ Parameter

-address This parameter specifies the SAS address, which is a 16 character hexadecimal number that corresponds to a HBA.

Example: -address 500605b000b5f344

address SAS address

-name This parameter specifies the SAS address alias. For details, refer to ["1.2.6 Alias Name Syntax" \(page 35\)](#).

name SAS address alias

-host-response-number or **-host-response-name**

Optional. This parameter specifies a host response identifier. Only one identifier can be specified at any given time. For details, refer to ["1.2.14 Host Response Syntax" \(page 43\)](#). If omitted, the existing setting is not changed.

host_response_number Host response number

host_response_name Host response name

-host-group-number or **-host-group-name**

Optional. This parameter specifies the host group identifier. The "-host-group-number" or the "-host-group-name" parameter must be specified. Only one host group can be specified at the same time. For details, refer to ["1.2.13 Host Group Syntax" \(page 42\)](#).

host_group_number Host group number

host_group_name Host group name

-new-host-group-name

Optional. This parameter specifies a new host group name. Only one host group can be specified at the same time. For details, refer to ["1.2.13 Host Group Syntax" \(page 42\)](#).

new_host_group_name New host group name

■ Example(s)

The following example registers the alias "HBA1" for the HBA with SAS address "500605b000b5f344":

```
CLI> create host-sas-address -address 500605b000b5f344 -name HBA1
```

The following example registers the alias "HBA1" for the HBA with SAS address "500605b000b5f344". The registered host alias is added to host group "HG1":

```
CLI> create host-sas-address -address 500605b000b5f344 -name HBA1 -host-group-name HG1
```

The following example registers the alias "HBA1" for the HBA with SAS address "500605b000b5f344". The registered host alias is added to host group "HG2", which is created in host response #1:

```
CLI> create host-sas-address -address 500605b000b5f344 -name HBA1 -host-response-number 1 -new-host-group-name HG2
```

set host-sas-address

This command changes the details of an existing SAS host.

■ Syntax

```
set host-sas-address {-host-number host_number | -host-name host_name}  
[-address address] [-name name] [-host-response-number host_response_number |  
-host-response-name host_response_name]
```

■ Parameter

-host-number or -host-name

This parameter specifies the identifier of the SAS host whose details are to be changed. If only the host response identifier is being set, then one or more SAS host identifiers can be specified at the same time. If not, then only one SAS host identifier can be specified. For details, refer to ["1.2.12 Host Syntax" \(page 41\)](#).

host_number SAS host number

host_name SAS host name

-address Optional. This parameter specifies the SAS address, which is a 16 character hexadecimal number that corresponds to a HBA. Only one SAS address can be specified at any given time. If omitted, the existing setting is not changed.

Example: -address 500605b000b5f344

address SAS address

-name Optional. This parameter specifies the new SAS address alias. Only one name can be specified at the same time. For details, refer to ["1.2.6 Alias Name Syntax" \(page 35\)](#). If omitted, the existing setting is not changed.

name SAS address alias

-host-response-number or -host-response-name

Optional. This parameter specifies a host response identifier. One or more parameters can be specified at the same time. For details, refer to ["1.2.14 Host Response Syntax" \(page 43\)](#). If omitted, the existing setting is not changed.

host_response_number Host response number

host_response_name Host response name

■ Example(s)

The following example changes the host named "HBA1", assigning it host response number "2":

```
CLI> set host-sas-address -host-name HBA1 -host-response-number 2
```

The following example changes the host response definition of all the hosts with consecutively numbered identifiers #1 to #10 at the same time:

```
CLI> set host-sas-address -host-number 1-10 -host-response-number 5
```

delete host-sas-address

This command deletes existing SAS host identifier(s).

■ Syntax

```
delete host-sas-address {-host-number host_numbers | -host-name host_names}
```

■ Parameter

-host-number or -host-name

This parameter specifies which SAS host identifiers are to be deleted. One or more identifiers can be specified at the same time. For details, refer to ["1.2.12 Host Syntax" \(page 41\)](#).

<i>host_numbers</i>	SAS host number
<i>host_names</i>	SAS host name

■ Example(s)

The following example deletes the SAS hosts with consecutively numbered identifiers #1 – #3:

```
CLI> delete host-sas-address -host-number 1-3
```

The following example only deletes the host named "HBA2":

```
CLI> delete host-sas-address -host-name HBA2
```

discover host-sas-addresses

This command displays a list of the SAS addresses that have been discovered for the specified SAS interface port(s).

Syntax

```
discover host-sas-addresses [-port {xyz | all}]
```

Parameter

-port Optional. This parameter specifies the SAS interface port(s) whose discovered host SAS addresses are to be listed. If this parameter is omitted, the hosts discovered for all SAS host interface ports are displayed.

Example: -port 000,100

For details, refer to ["1.2.15 Host Interface Port Syntax" \(page 44\)](#).

xyz "x" is the controller module (CM) number, "y" is the CA number, and "z" is the SAS port number.
Example: "123" indicates CM#1-CA#2-SAS Port#3

all All the SAS interface ports (default)

Output

Item name	Description
CM#x CA#y Port#z	Port number
xxxxxxxxxxxxxxxx	Discovered SAS address

Example(s)

The following example displays a list of the SAS Addresses discovered for all the SAS interface ports on both CMs:

```
CLI> discover host-sas-addresses -port all
CM#0 CA#0 Port#0
500605b000b5d8e4
500605b000b5e004

CM#1 CA#0 Port#0
500605b000b5f144
500605b000b5f244
500605b000b5f344
```

show host-iscsi-names

This command displays a list of the iSCSI hosts registered in the system. When iSCSI host identifiers are specified, iSCSI host details of the specified iSCSI host identifiers are displayed:

Syntax

```
show host-iscsi-names [-host-number host_numbers | -host-name host_names]
```

Parameter

-host-number or -host-name

Optional. This parameter specifies which iSCSI host identifier(s) details are to be displayed. One or more identifiers can be specified at the same time. If omitted, a summary list is displayed. For details, refer to ["1.2.12 Host Syntax" \(page 41\)](#).

host_numbers iSCSI host number

host_names iSCSI host name

Output

When the iSCSI host identifier parameter is omitted, then an iSCSI host summary list for all the iSCSI host identifiers is displayed.

Item name	Description
Host	Host identifiers
No.	Host number
Name	Host nickname
Host Response	Assigned host response identifiers
No.	Assigned host response number
Name	Assigned host response name
IP Address	IP address which corresponds to an HBA. If the IP address is not specified, the * mark is displayed. When the IP address format is IPv4, "(IPv4)" is displayed. When the IP address format is IPv6, "(IPv6)" is displayed.
iSCSI Name	iSCSI host name which corresponds to an HBA
CmdSN Count	Number of commands that can be accepted at the same time

When the iSCSI host identifier parameter is specified, the detailed information of the specified iSCSI host identifier is displayed.

Item name	Description
Host No.	Host number
Host Name	Host nickname
iSCSI Name	iSCSI host name which corresponds to an HBA
Alias Name	Alias name which corresponds to the iSCSI name
IP Address	IP address which corresponds to an HBA. If the IP address is not specified, the * mark is displayed. When the IP address format is IPv4, "(IPv4)" is displayed. When the IP address format is IPv6, "(IPv6)" is displayed.
Chap User Name	CHAP user name

Item name	Description
Host Response No.	Assigned host response number
Host Response Name	Assigned host response name
CmdSN Count	Number of commands that can be accepted at the same time

■ Example(s)

The following example displays the iSCSI host summary list:
 "*" mark on IP Address stands for any IP addresses:

```
CLI> show host-iscsi-names
Host No.      Host Response No. Name      IP Address      iSCSI Name      CmdSN Count
-----
1 HBA-ISCASI-001  1 HP01          192.168.1.1     iqn.1991-05.com.microsoft  20
2 HBA-ISCASI-002  1 HP01          2001:DB8::8:800:200C:417A  iqn.1993-05.com.microsoft  120
3 HBA-ISCASI-003  1 HP01          *(IPv6)         iqn.1993-05.com.microsoft  Unlimited
```

The following example displays the iSCSI host details of the host named "HBA1":

```
CLI> show host-iscsi-names -host-name HBA1
Host No.      1
Host Name     HBA1
iSCSI Name    iqn.1991-05.com.microsoft
Alias Name    IQN-DXL
IP Address    10.1.1.1
Chap User Name User01
Host Response No. 1
Host Response Name HP01
CmdSN Count   180
```

create host-iscsi-name

This command registers a host alias for the iSCSI (internet Small Computer System Interface) name and the IP address used to identify an iSCSI-type HBA (Host Bus Adapter).

Only one iSCSI name can be specified at a time. The maximum number of available definitions depends on the number of available host interface ports and the model. This command enables an alias to be used instead of a long iSCSI name when mapping volumes to hosts.

The following three types of parameters are used for registering an iSCSI identifier:

1. `-iscsi-name`. This parameter is used to specify the name that corresponds to a HBA.
2. `-alias-name`. This parameter is used to specify an alias for the `-iscsi-name` parameter. This parameter is only used as a user comment and is not used for control purposes.
3. `-name`. This parameter is used to specify the alias name. A unique name can be used.

Caution

If an iSCSI host without an IP address setting (any IP address) has the same iSCSI name as the iSCSI host with an IP address setting, the relevant host cannot be set in the same host group.

Syntax

```
create host-iscsi-name -iscsi-name iscsi_name [-alias-name alias_name]  
[-ip-version {ipv4 | ipv6}] [-ip ip_address] -name name [-chap-user chap_user]  
[-host-response-number host_response_number | -host-response-name host_response_name]  
[-cmds-n-count {unlimited | 20 | 40 | 80 | 120 | 180}]  
[-host-group-number host_group_number | -host-group-name host_group_name |  
-new-host-group-name new_host_group_name]
```

Parameter

`-iscsi-name` This parameter specifies the iSCSI name that corresponds to a HBA.

- Between 4 and 223 alphanumeric characters, including hyphens (-), dots (.), and colons (:), can be used.
- "iqn." or "eui." must be added in front of the character string.
- Characters are not case-sensitive.

iscsi_name iSCSI name

`-alias-name` Optional. This parameter specifies an alias to the iSCSI name that corresponds to the `-iscsi-name` parameter. A maximum of 31 alphanumeric characters can be used. Usable characters are those given in the ["1.2.2 Keywords and Parameters" \(page 33\)](#) of the document overview. Commas (,) cannot be used.

This name is not used for control purposes. It is only handled as a comment corresponding to the iSCSI name.

alias_name Alias name of the iSCSI name

`-ip-version` Optional. This parameter specifies the IP address format for the host that is to be registered. If omitted, it is handled as if "ipv4" is specified.

ipv4 IPv4 format
ipv6 IPv6 format

-ip Optional. This parameter specifies an IP address for the corresponding HBA. Only IPv4 standard notation (a base 256 "d.d.d.d" string) and IPv6 format are allowed for the character string. The types of IPv6 addresses that can be specified are global addresses (including 6to4 addresses), link local addresses, and unique local addresses.

Example: -ip 192.168.1.10
Example: -ip fe80::223:4567:89ab:cdef

If omitted, any IP addresses are allowed. With the same iSCSI name designation, a specific IP address is distinguished from the omitted one.

ip_address IP address for the corresponding HBA

-name This parameter specifies the iSCSI host alias. For details, refer to ["1.2.6 Alias Name Syntax" \(page 35\)](#).

name Alias name which corresponds to the iSCSI host

-chap-user Optional. When using CHAP authentication, this parameter is used to specify a CHAP user name. Up to 255 alphanumerical characters and symbols can be used. If this parameter is specified, then the command displays a CHAP user password prompt.

chap_user CHAP user name

-host-response-number or -host-response-name

Optional. This parameter specifies a host response identifier. Only one identifier can be specified at any given time. For details, refer to ["1.2.14 Host Response Syntax" \(page 43\)](#). If omitted, the existing setting is not changed.

host_response_number Host response number

host_response_name Host response name

-cmds-n-count

Optional. This parameter specifies the number of commands that can be accepted at the same time.

unlimited Unlimited
20 20 commands
40 40 commands
80 80 commands
120 120 commands
180 180 commands

-host-group-number or -host-group-name

Optional. This parameter specifies the host group identifier. The "-host-group-number" or the "-host-group-name" parameter must be specified. Only one host group can be specified at the same time. For details, refer to ["1.2.13 Host Group Syntax" \(page 42\)](#).

host_group_number Host group number

host_group_name Host group name

-new-host-group-name

Optional. This parameter specifies a new host group name. Only one host group can be specified at the same time. For details, refer to ["1.2.13 Host Group Syntax" \(page 42\)](#).

new_host_group_name New host group name

■ Example(s)

The following example registers the alias "HBA1" for the iSCSI host "iqn.1991-05.com.microsoft", and the iSCSI ip address "10.111.10.1". The host response number #1 is also assigned:

```
CLI> create host-iscsi-name -iscsi-name iqn.1991-05.com.microsoft -ip-version ipv4 -ip 10.111.10.1 -name HBA1 -host-response-number 1
```

The following example registers an iSCSI host to both of the HBAs that are in a single server. The iSCSI name is the property of the server and is the same for both HBAs. Each HBA has a different IP address. The following commands register "HBA11" and "HBA12" as the respective alias for each HBA. When two iSCSI HBAs are used, the iSCSI names will also be different:

```
CLI> create host-iscsi-name -iscsi-name iqn.1991-05.com.microsoft -ip-version ipv4 -ip 10.1.0.1 -name HBA11  
CLI> create host-iscsi-name -iscsi-name iqn.1991-05.com.microsoft -ip-version ipv4 -ip 10.1.1.1 -name HBA12
```

The following example registers the alias "HBA1" for the iSCSI host "iqn.1991-05.com.microsoft", and any IP addresses are allowed by omitting the "-ip" parameter:

```
CLI> create host-iscsi-name -iscsi-name iqn.1991-05.com.microsoft -ip-version ipv4 -name HBA1
```

In addition to the above example, IP addresses with the same iSCSI name can be specified as a different alias:

```
CLI> create host-iscsi-name -iscsi-name iqn.1991-05.com.microsoft -ip-version ipv4 -name HBA1  
CLI> create host-iscsi-name -iscsi-name iqn.1991-05.com.microsoft -ip-version ipv4 -ip 10.1.0.1 -name HBA2
```

The following example registers the alias "HBA1" for the iSCSI host "iqn.1991-05.com.microsoft". The registered host alias is added to host group "HG1":

```
CLI> create host-iscsi-name -iscsi-name iqn.1991-05.com.microsoft -ip-version ipv4 -name HBA1 -host-group-name HG1
```

The following example registers the alias "HBA1" for the iSCSI host "iqn.1991-05.com.microsoft". The registered host alias is added to host group "HG2", which is created in host response #1:

```
CLI> create host-iscsi-name -iscsi-name iqn.1991-05.com.microsoft -ip-version ipv4 -name HBA1 -host-group-name HG1
```

The following example registers alias "HBA1" for iSCSI host "iqn.1991-05.com.microsoft", and iSCSI IP address "fe80::223:4567:89ab:cdef", which is using standard IPv6 notation. Host response number #1 is also assigned:

```
CLI> create host-iscsi-name -iscsi-name iqn.1991-05.com.microsoft -ip-version ipv6 -ip fe80::223:4567:89ab:cdef -name HBA1 -host-response-number 1
```

set host-iscsi-name

This command changes the details of an existing iSCSI host.

Caution

If the iSCSI name is the same for the iSCSI host with an IP address setting as the iSCSI host without an IP address setting (any IP address), the setting for the relevant iSCSI name cannot be changed.

Syntax

```
set host-iscsi-name {-host-number host_number | -host-name host_name} [-iscsi-name iscsi_name]  
[-alias-name alias_name] [-ip-version {ipv4 | ipv6}] [-ip ip_address] [-name name]  
[-chap-user {chap_user | ""}]  
[-host-response-number host_response_number | -host-response-name host_response_name]  
[-cmds-n-count {unlimited | 20 | 40 | 80 | 120 | 180}]
```

Parameter

-host-number or -host-name

This parameter specifies the identifier of the host whose details are to be changed. If only the host response identifier is being set, then one or more identifiers can be specified at the same time. If not, then only one host identifier can be specified. For details, refer to ["1.2.12 Host Syntax" \(page 41\)](#).

host_number iSCSI host number
host_name iSCSI host name

-iscsi-name Optional. This parameter specifies the iSCSI name that corresponds to an HBA. Between 4 and 223 alphanumeric characters, including hyphens (-), dots (.), and colons (:), can be used. If omitted, the existing setting is not changed. Only one name can be specified at the same time.

iscsi_name iSCSI name

-alias-name Optional. This parameter specifies an alias to the iSCSI name that corresponds to the "-iscsi-name" parameter. A maximum of 31 alphanumeric characters can be used. Usable characters are those given in the ["1.2.2 Keywords and Parameters" \(page 33\)](#) of the document overview. Commas (,) cannot be used. If omitted, the existing setting is not changed. Only one name can be specified at the same time.

This name is not used for control purposes. It is only handled as a comment corresponding to the iSCSI name.

alias_name Alias name which corresponds to the iSCSI host

-ip-version Optional. This parameter specifies the format of the IP address after the setting change. If this parameter is omitted, the existing setting is not changed. If this parameter is omitted and the "-ip" parameter is specified, a parameter value that corresponds to the format of the IP address that is specified for the "-ip" parameter is specified.

ipv4 IPv4 format
ipv6 IPv6 format

-ip Optional. This parameter specifies the IP address for the HBA using IPv4 standard notation (a base 256 "d.d.d.d" string) or IPv6 format. This parameter can also change the IP address format to a different format, such as from IPv4 to IPv6. The types of IPv6 addresses that can be specified are global addresses (including 6to4 addresses), link local addresses, and unique local addresses. Only one IP address can be specified at any given time. If omitted, the existing setting is not changed.

Example: `-ip 192.168.1.10`

Example: `-ip fe80::223:4567:89ab:cdef`

When changing the access from a specific IP address to any IP address, delete relevant host name using the "delete host-iscsi-name" command, and then create the same host name again using the "create host-iscsi-name" command (without specifying the "-ip" parameter).

ip_address IP address for the HBA

-name Optional. This parameter specifies the new iSCSI-host alias. For details, refer to ["1.2.6 Alias Name Syntax" \(page 35\)](#). If omitted, the existing setting is not changed. Only one name can be specified at the same time.

name New iSCSI host alias name

-chap-user Optional. When using CHAP authentication, this parameter is used to specify a CHAP user name. Up to 255 alphanumeric characters and some symbols can be used. If this parameter is specified, then the command displays a CHAP user password prompt. To delete an existing CHAP user name, specify a NULL character (""). If omitted, the existing setting is not changed. Only one user can be specified at any given time.

chap_user CHAP user name

"" The existing CHAP user name is deleted.

-host-response-number or -host-response-name

Optional. This parameter specifies the host response identifier. One or more identifiers can be specified at the same time. For details, refer to ["1.2.14 Host Response Syntax" \(page 43\)](#). If omitted, the existing setting is not changed.

host_response_number Host response number

host_response_name Host response name

-cmds-n-count

Optional. This parameter specifies the number of commands that can be accepted at the same time.

unlimited Unlimited

20 20 commands

40 40 commands

80 80 commands

120 120 commands

180 180 commands

■ Example(s)

The following example changes the host named "HBA21", assigning it the new IP address "10.1.1.2" (the IP address format can also be changed to a different format, such as from IPv4 to IPv6):

```
CLI> set host-iscsi-name -host-name HBA21 -ip 10.1.1.2
```

The following example changes the host named "HBA21", assigning it host response number "2":

```
CLI> set host-iscsi-name -host-name HBA21 -host-response-number 2
```

The following example changes the host response definition of all the hosts with consecutively numbered identifiers #1-#10 at the same time:

```
CLI> set host-iscsi-name -host-number 1-10 -host-response-number 5
```

The following example changes the host named "HBA21". The new alias name is "HBA22" and the number of commands that can be accepted at the same time is 80.

```
CLI> set host-iscsi-name -host-name HBA21 -name HBA22 -cmds-n-count 80
```

The following example changes the format of the 0 (almighty) IP address for a host to IPv6 (IP address for HBA21 = 0.0.0.0):

```
CLI> set host-iscsi-name -host-name HBA21 -ip-version ipv6
```

delete host-iscsi-name

This command deletes existing iSCSI host identifier(s).

■ Syntax

```
delete host-iscsi-name {-host-number host_numbers | -host-name host_names}
```

■ Parameter

-host-number or -host-name

This parameter specifies the iSCSI host identifiers to be deleted. One or more identifiers can be specified at the same time. For details, refer to ["1.2.12 Host Syntax" \(page 41\)](#).

host_numbers iSCSI host number

host_names iSCSI host name

■ Example(s)

The following example deletes the iSCSI hosts with consecutively numbered identifiers #1 - #3:

```
CLI> delete host-iscsi-name -host-number 1-3
```

The following example only deletes the host named "HBA2":

```
CLI> delete host-iscsi-name -host-name HBA2
```

discover host-iscsi-names

This command displays a list of the iSCSI host names that have been discovered for the specified iSCSI port(s). The iSCSI parameters must be set up first using the "set iscsi-parameters" command.

Caution

- An iSNS server definition must be set to use this command.
- Host Affinity Mode must be enabled to use this command.
- Even if an iSNS server is defined, expected IP addresses may not be displayed.
 - If multiple hosts run one of the following host OSs, have an identical iSCSI name, and have different IP addresses, the IP address of only one of the hosts can be displayed.
 - Windows Server 2008 R2
 - Windows Server 2008
 - Solaris 10
- Host information cannot be displayed if the host is running Solaris 11.

Syntax

```
discover host-iscsi-names [-port {port_numbers | all}] [-additional-ip additional-ip]
```

Parameter

-port Optional. This parameter specifies the iSCSI interface port(s) whose discovered host iSCSI names are to be listed. One or more host interface ports can be specified at the same time. If this parameter is omitted, the hosts that are discovered for all the iSCSI interface ports are displayed.

Example: -port 000,100

For details, refer to ["1.2.15 Host Interface Port Syntax" \(page 44\)](#).

port_numbers iSCSI interface port

xyz "x" is the controller module (CM) number, "y" is the CA number, and "z" is the iSCSI port number (DX60 S4/DX100 S4/DX200 S4, DX500 S4/DX600 S4, DX60 S3/DX100 S3/DX200 S3, DX500 S3/DX600 S3, DX8100 S3, AF250 S2/AF650 S2, AF250/AF650, and DX200F only).

Example: "120" indicates CM#1-CA#2-Port#0

wxyz "w" is the controller enclosure (CE) number, "x" is the controller module (CM) number, "y" is the CA number, and "z" is the iSCSI port number (DX8700 S3/DX8900 S3 only).

Example: "0120" indicates CE#0-CM#1-CA#2-Port#0

all All the iSCSI interface ports (default)

-additional-ip

Optional. This parameter specifies the virtual port information number that is set for the target port. Multiple numbers can be specified by inserting commas between them. This parameter requires the "-port" parameter to be specified. However, this parameter cannot be specified when multiple ports or the "all" option cannot be specified for the "-port" parameter. If this parameter is omitted, "0" (this indicates the actual port) is set for the value of this parameter.

additional-ip Virtual port information number (1 – 15)
 all All virtual port information numbers

■ Output

Item name	Description
CM#x CA#y Port#z	The target host interface port (only for the DX60 S4/DX100 S4/DX200 S4, the DX500 S4/DX600 S4, the DX60 S3/DX100 S3/DX200 S3, the DX500 S3/DX600 S3, the DX8100 S3, the AF250 S2/AF650 S2, the AF250/AF650, and the DX200F)
CE#w CM#x CA#y Port#z	The target host interface port (only for the DX8700 S3/DX8900 S3)
Alias	The alias of the iSCSI host discovered
iSCSI Name	The discovered iSCSI name
IP Address	The IP address of the discovered iSCSI host
Additional IP	The virtual port information number (1 – 15)

■ Example(s)

The following example displays a list of the iSCSI hosts that are discovered for the iSCSI interface ports #0 and #1 on CM#0 CA#0:

```
CLI> discover host-iscsi-names -port 000,011
CM#0 CA#0 Port#0
Alias                    iSCSI Name                    IP Address
-----
IQN-DXL1                iqn.1991-05.com.microsoft     2001::123:1234:2309:0001

CM#0 CA#0 Port#1
Alias                    iSCSI Name                    IP Address
-----
IQN-DXL1                iqn.1991-05.com.microsoft     10.17.31.234
IQN-DXL2                iqn.1993-05.com.microsoft     2001::123:1234:2309:0102
```

The following example displays when a virtual port information number is specified:

```
CLI> discover host-iscsi-names -port 000 -additional-ip 1
CM#0 CA#0 Port#0
Alias                    iSCSI Name                    IP Address
-----
IQN-DXL1                iqn.1991-05.com.microsoft     2001::123:1234:2309:0001

<Additional IP List>
Additional IP 1
Alias                    iSCSI Name                    IP Address
-----
IQN-DXL1                iqn.1991-05.com.microsoft     10.17.31.234
IQN-DXL2                iqn.1993-05.com.microsoft     2001::123:1234:2309:0102
```

3.6.3 Mapping (When LUN Groups are Used)

This section explains the commands related to the mapping function that are available when Host Affinity Mode is enabled or LUN groups, port groups, or host groups are used. A LUN group must be defined and created before commands are used.

show host-affinity

This command displays a list of the mapping definitions that associate LUN groups with host identifiers. The target mapping can be displayed by specifying LUN groups, port groups, host groups, host identifiers or host interface ports. However, if the ports with Host Affinity Mode "disabled" belong to a port group with LUN mapping set, the ports are displayed.

Caution

The LUN Overlap volume information indicates whether the same volume is defined for multiple LUN groups or whether a volume is mapped to a LUN.

Syntax

```
show host-affinity [-port {port_numbers | all}]  
[-ag-number ag_numbers | -ag-name ag_names | -lg-number lg_numbers | -lg-name lg_names]  
[-host-number host_numbers | -host-name host_names]  
[-port-group-number port_group_number | -port-group-name port_group_name]  
[-host-group-number host_group_number | -host-group-name host_group_name]
```

Parameter

-port Optional. This parameter specifies the host interface ports to be narrowed down. Two or more parameters can be specified by separating them with a comma (.). If omitted, all the host interface ports are selected.

Example: -port 000,100

For details, refer to ["1.2.15 Host Interface Port Syntax" \(page 44\)](#).

port_numbers Host interface port

xyz "x" is the controller module (CM) number, "y" is the CA number, and "z" is the host port number (DX60 S4/DX100 S4/DX200 S4, DX500 S4/DX600 S4, DX60 S3/DX100 S3/DX200 S3, DX500 S3/DX600 S3, DX8100 S3, AF250 S2/AF650 S2, AF250/AF650, and DX200F only).

Example: "123" indicates CM#1-CA#2-Port#3

wxyz "w" is the controller enclosure (CE) number, "x" is the controller module (CM) number, "y" is the CA number, and "z" is the host port number (DX8700 S3/DX8900 S3 only).

Example: "0123" indicates CE#0-CM#1-CA#2- Port#3

all All the host interface ports (default)

-ag-number or -ag-name

Optional. This parameter specifies the affinity group identifiers to be narrowed down. One or more parameters can be specified at the same time. For details, refer to ["1.2.17 LUN Group Syntax" \(page 46\)](#). If omitted, this parameter is ignored.

Caution

Specifying this parameter is not recommended. Specify the "-lg-number" parameter or the "-lg-name" parameter instead.

ag_numbers Affinity group number

ag_names Affinity group name

-lg-number or -lg-name

Optional. This parameter specifies the LUN group identifiers to be narrowed down. One or more parameters can be specified at the same time. For details, refer to ["1.2.17 LUN Group Syntax" \(page 46\)](#). If omitted, this parameter is ignored.

lg_numbers LUN group number

lg_names LUN group name

-host-number or -host-name

Optional. This parameter specifies the host identifiers to be narrowed down. One or more parameters can be specified at the same time. For details, refer to ["1.2.12 Host Syntax" \(page 41\)](#). If omitted, this parameter is ignored.

host_numbers Host number

host_names Host group name

-port-group-number or -port-group-name

Optional. This parameter specifies the port group identifiers to be narrowed down. One or more parameters can be specified at the same time. For details, refer to ["1.2.16 Port Group Syntax" \(page 45\)](#). If omitted, this parameter is ignored.

port_group_number Port group number

port_group_name Port group name

-host-group-number or -host-group-name

Optional. This parameter specifies the host group identifiers to be narrowed down. One or more parameters can be specified at the same time. For details, refer to ["1.2.13 Host Group Syntax" \(page 42\)](#). If omitted, this parameter is ignored.

host_group_number Host group number

host_group_name Host group name

■ Output

Item name	Description
CM#x CA#y Port#z	Port number (only for the DX60 S4/DX100 S4/DX200 S4, the DX500 S4/DX600 S4, the DX60 S3/DX100 S3/DX200 S3, the DX500 S3/DX600 S3, the DX8100 S3, the AF250 S2/AF650 S2, the AF250/AF650, and the DX200F)
CE#w CM#x CA#y Port#z	Port number (only for the DX8700 S3/DX8900 S3)
Host	Host identifiers
No.	Host number
Name	Host name

Item name	Description
LUN Group	LUN group identifiers
No.	LUN group number
Name	LUN group name
LUN Overlap Volumes	Indicates whether the same volume identifier is defined between LUN groups or that a LUN mapping is set for the volume. If the same definitions exist, "Yes" is displayed for the target LUN groups. Otherwise, "No" is displayed.
LUN Mask Group No.	LUN mask group number If there is no association, a hyphen (-) is displayed.

- When a host affinity is set for the port group (Host Affinity Mode is enabled).

Item name	Description
Port Group	Port group identifiers
No.	Port group number
Name	Port group name
Host Group	Host group identifiers
No.	Host group number
Name	Host group name
LUN Group	LUN group identifiers
No.	LUN group number
Name	LUN group name
LUN Overlap Volumes	Indicates whether the same volume identifier is defined between LUN groups or that a LUN mapping is set for the volume. If the same definitions exist, "Yes" is displayed for the target LUN groups. Otherwise, "No" is displayed.
LUN Mask Group No.	LUN mask group number If there is no association, a hyphen (-) is displayed.
Connection List	List of connections
Port	Port number
Host	Host identifiers
No.	Host number
Name	Host name

- When a host affinity is set for the port group (Host Affinity Mode is disabled).

Item name	Description
Port Group	Port group identifiers
No.	Port group number
Name	Port group name
Host Group	Host group identifiers
No.	Host group number
Name	Host group name
LUN Group	LUN group identifiers
No.	LUN group number
Name	LUN group name
LUN Overlap Volumes	Indicates whether the same volume identifier is defined between LUN groups or that a LUN mapping is set for the volume. If the same definitions exist, "Yes" is displayed for the target LUN groups. Otherwise, "No" is displayed.

Item name	Description
Port List	List of ports
CM#x CA#y Port#z	Port number

■ Example(s)

The following example displays all of the existing mappings:

```

CLI> show host-affinity
Port Group          Host Group          LUN Group          LUN Overlap
No. Name            No. Name            No. Name            Volumes
-----
  1  pg1             0  hg               0  lg1              No
<Connection List>
Port                Host
No. Name
-----
CM#0 CA#0 Port#0   -
CM#0 CA#0 Port#1   0  A
CM#0 CA#0 Port#1   1  B

Port Group          Host Group          LUN Group          LUN Overlap
No. Name            No. Name            No. Name            Volumes
-----
  2  pg01           1  FCoE             1  lg2              No
<Connection List>
Port                Host
No. Name
-----
CM#0 CA#0 Port#0   -
CM#0 CA#0 Port#1   7  FCoE#2

Port Group          Host Response       LUN Group          LUN Mask
No. Name            No. Name            No. Name            Group No.
-----
  4  pg04           0  Default          10  lg2              0
<Port List>
CM#1 CA#1 Port#0
CM#1 CA#1 Port#1

CM#0 CA#0 Port#0 (Host Affinity Mode Enable)
Host                LUN Group          LUN Overlap LUN Mask
No. Name            No. Name            Volumes     Group No.
-----
  8  FCoE#3         0  lg1              No          0

CM#0 CA#0 Port#1 (Host Affinity Mode Enable)
CM#1 CA#1 Port#0 (Host Affinity Mode Disable)
CM#1 CA#1 Port#1 (Host Affinity Mode Disable)
  
```

The following example displays all of the existing mappings (for the DX8700 S3/DX8900 S3):

```

CLI> show host-affinity
Port Group          Host Group          LUN Group          LUN Overlap
No. Name            No. Name            No. Name            Volumes
-----
  1 pg1              0 hg                0 lg1               No
<Connection List>
  Port              Host
                   No. Name
-----
  CE#0 CM#0 CA#0 Port#0 -
  CE#0 CM#0 CA#0 Port#1 0 A
  CE#0 CM#0 CA#0 Port#1 1 B

Port Group          Host Group          LUN Group          LUN Overlap
No. Name            No. Name            No. Name            Volumes
-----
  2 pg01            1 FCoE              1 lg2               No
<Connection List>
  Port              Host
                   No. Name
-----
  CE#0 CM#0 CA#0 Port#0 -
  CE#0 CM#0 CA#0 Port#1 7 FCoE#2

Port Group          Host Response       LUN Group          LUN Mask
No. Name            No. Name            No. Name            Group No.
-----
  4 pg04            0 Default           10 lg2              0
<Port List>
  CE#0 CM#1 CA#1 Port#0
  CE#0 CM#1 CA#1 Port#1

CE#0 CM#0 CA#0 Port#0 (Host Affinity Mode Enable)
Host
No. Name              LUN Group          LUN Overlap LUN Mask
                   No. Name            Volumes      Group No.
-----
  8 FCoE#3            0 lg1              No            0

CE#0 CM#0 CA#0 Port#1 (Host Affinity Mode Enable)
CE#0 CM#1 CA#1 Port#0 (Host Affinity Mode Disable)
CE#0 CM#1 CA#1 Port#1 (Host Affinity Mode Disable)
  
```

The following example displays all of the mappings that is set to host interface port CA#0 Port#1 on CM#0:

```

CLI> show host-affinity -port 001
CM#0 CA#0 Port#1 (Host Affinity Mode Enable)
Host
No. Name              LUN Group          LUN Overlap LUN Mask
                   No. Name            Volumes      Group No.
-----
  1 HBA1              4 LUN004           No            0
  
```

The following example only displays the mapping that is set to LUN group #4:

```

CLI> show host-affinity -lg-number 4
CM#0 CA#0 Port#0 (Host Affinity Mode Enable)
Host
No. Name              LUN Group          LUN Overlap LUN Mask
                   No. Name            Volumes      Group No.
-----
  1 HBA1              4 LUN004           No            0

Host
No. Name              LUN Group          LUN Overlap LUN Mask
                   No. Name            Volumes      Group No.
-----
  1 HBA1              4 LUN004           No            0
  
```

The following example only displays the mapping that is set to the host named "HBA5":

```
CLI> show host-affinity -host-name HBA5
CM#1 CA#1 Port#1 (Host Affinity Mode Enable)
Host
No.  Name                LUN Group          LUN Overlap LUN Mask
-----
5   HBA5                6 LUN006          No           0
```

The following is an example of LUN Overlap volumes. This means the same volume identifier in the "LUN001" LUN group is defined in the "LUN002" LUN group. In this case, "Yes" is displayed for both the "LUN001" and "LUN002" LUN groups. In other LUN groups, "No" is displayed:

```
CLI> show host-affinity -port 000
CM#0 CA#0 Port#0 (Host Affinity Mode Enable)
Host
No.  Name                LUN Group          LUN Overlap LUN Mask
-----
1   HBA1                1 LUN001          Yes           0
2   HBA2                2 LUN002          Yes           -
3   HBA3                3 LUN003          No           0
```

set host-affinity

This command associates LUN groups with host identifiers through an individual host interface port. This is used to provide security from unauthorized access. The maximum number of host affinity definitions depends on the number of available host interface ports and the system model.

Caution

If the iSCSI host without an IP address setting (any IP address) is mixed with the iSCSI host with an IP address setting when multiple specifications of the iSCSI host with the same iSCSI name is used for the iSCSI interface port, the relevant iSCSI host cannot be associated with the iSCSI interface port.

■ Syntax

```
set host-affinity {-port port_numbers {-ag-number ag_numbers | -ag-name ag_names |  
-lg-number lg_numbers | -lg-name lg_names} |  
{-host-number host_numbers | -host-name host_names} |  
{-port-group-number port_group_number | -port-group-name port_group_name}  
{-ag-number ag_number | -ag-name ag_name | -lg-number lg_number | -lg-name lg_name}  
{-host-group-number host_group_numbers | -host-group-name host_group_names |  
-host-response-number host_response_number |  
-host-response-name host_response_name}  
}
```

■ Parameter

-port This parameter specifies the host interface port to associate LUN groups with host servers. Two or more parameters can be specified by separating them with a comma (,).

Example: -port 000,100

For details, refer to ["1.2.15 Host Interface Port Syntax" \(page 44\)](#).

port_numbers Host interface port

xyz "x" is the controller module (CM) number, "y" is the CA number, and "z" is the host port number (DX60 S4/DX100 S4/DX200 S4, DX500 S4/DX600 S4, DX60 S3/DX100 S3/DX200 S3, DX500 S3/DX600 S3, DX8100 S3, AF250 S2/AF650 S2, AF250/AF650, and DX200F only).

Example: "123" indicates CM#1-CA#2-Port#3

wxyz "w" is the controller enclosure (CE) number, "x" is the controller module (CM) number, "y" is the CA number, and "z" is the host port number (DX8700 S3/DX8900 S3 only).

Example: "0123" indicates CE#0-CM#1-CA#2-Port#3

-ag-number or -ag-name

This parameter specifies the affinity group identifiers that will be associated. One or more parameters can be specified at the same time. For details, refer to ["1.2.17 LUN Group Syntax" \(page 46\)](#). If two or more affinity groups are specified, the associated host identifier parameters must be specified in the same order.

 **Caution**

Specifying this parameter is not recommended. Specify the "-lg-number" parameter or the "-lg-name" parameter instead.

ag_numbers Affinity group number

ag_names Affinity group name

-lg-number or -lg-name

This parameter specifies the LUN group identifiers that will be associated. One or more parameters can be specified at the same time. For details, refer to ["1.2.17 LUN Group Syntax" \(page 46\)](#). If two or more LUN groups are specified, the associated host identifier parameters must be specified in the same order.

lg_numbers LUN group number

lg_names LUN group name

-host-number or -host-name

This parameter specifies the host identifiers to be associated. One or more parameters can be specified at the same time. For details, refer to ["1.2.12 Host Syntax" \(page 41\)](#). If two or more host identifiers are specified, the LUN group identifier parameters must be specified in the same order.

host_numbers Host number

host_names Host name

-port-group-number or -port-group-name

This parameter specifies the port group number or the port group name. Only one port group can be specified at the same time. For details, refer to ["1.2.16 Port Group Syntax" \(page 45\)](#).

port_group_number Port group number

port_group_name Port group name

-ag-number or -ag-name

(When this parameter is used with the "-port-group-number" or the "-port-group-name" parameter) Optional. This parameter specifies the affinity group identifiers that will be associated. Only one parameter can be specified at the same time. For details, refer to ["1.2.17 LUN Group Syntax" \(page 46\)](#).

 **Caution**

Specifying this parameter is not recommended. Specify the "-lg-number" parameter or the "-lg-name" parameter instead.

ag_number Affinity group number

ag_name Affinity group name

-lg-number or -lg-name

(When this parameter is used with the "-port-group-number" or the "-port-group-name" parameter)
 Optional. This parameter specifies the LUN group identifiers that will be associated. Only one parameter can be specified at the same time. For details, refer to ["1.2.17 LUN Group Syntax" \(page 46\)](#).

lg_number LUN group number

lg_name LUN group name

-host-group-number, -host-group-name, -host-response-number, or -host-response-name

This parameter specifies the host group identifier or the host response identifier. Only one host group or host response can be specified at the same time. For details, refer to ["1.2.14 Host Response Syntax" \(page 43\)](#) and ["1.2.13 Host Group Syntax" \(page 42\)](#).

host_group_numbers Host group number

host_group_names Host group name

host_response_number Host response number

host_response_name Host response name

The available combinations for optional parameters are shown below.

Parameter	-port	-lg-number (-ag-number)	-lg-name (-ag-name)	-host-number	-host-name	-port-group-number	-port-group-name	-host-group-number	-host-group-name	-host-response-number	-host-response-name
-port	–	* (*1)		*		No	No	No	No	No	No
-lg-number (-ag-number)	R	–	No	*		No	No	No	No	No	No
-lg-name (-ag-name)	R	No	–	*		No	No	No	No	No	No
-host-number	R	* (*1)		–	No	No	No	No	No	No	No
-host-name	R	* (*1)		No	–	No	No	No	No	No	No
-port-group-number	No	*		No	No	–	No	*		*	
-port-group-name	No	*		No	No	No	–	*		*	
-host-group-number	No	*		No	No	*		–	No	No	No
-host-group-name	No	*		No	No	*		No	–	No	No
-host-response-number	No	* (*2)		No	No	*		No	No	–	No
-host-response-name	No	* (*2)		No	No	*		No	No	No	–

No: Not available, R: Required, Yes: Available (the options can be omitted), *: Either one of these options must be specified

*1: Both of the parameter combinations can be omitted when a path is set in a host affinity that is already set with a port group. Therefore, an error occurs when a LUN group is not specified and the port group and the host group are not associated with the host affinity setting.

*2: The "-lg-number" parameter or the "-lg-name" parameter cannot be specified when LUN mapping is already set with a port group and the host response for LUN mapping will be changed. Therefore, a host response must be specified when a LUN group is not specified ("Default" must be specified to set the default host response).

■ Example(s)

The following example sets the relationship between host interface CA#0 Port#0 on CM#0, LUN group #1, and host #1:

```
CLI> set host-affinity -port 000 -lg-number 1 -host-number 1
```

The following example sets the relationship between host interface CA#0 Port#0 on CE#0 CM#0, LUN group #1, and host #1 (DX8700 S3/DX8900 S3):

```
CLI> set host-affinity -port 0000 -lg-number 1 -host-number 1
```

The following example sets the relationship between host interface CA#0 Port#0 on CM#1, LUN groups #1 – #3, and hosts #1 – #3:

```
CLI> set host-affinity -port 100 -lg-number 1-3 -host-number 1-3
```

The following example sets the relationship between the same LUN group #1 and both host #1 and #2:

```
CLI> set host-affinity -port 000 -lg-number 1 -host-number 1,2
```

The following example sets the relationship between the host interface CA#0 Port#0 on CM#1 and CA#0 Port#1 on CM#1, the LUN group named "LUN001", and the host named "HBA001":

```
CLI> set host-affinity -port 100,101 -lg-name LUN001 -host-name HBA001
```

(identical with the following)

```
CLI> set host-affinity -port 100 -lg-name LUN001 -host-name HBA001  
CLI> set host-affinity -port 101 -lg-name LUN001 -host-name HBA001
```

The following example sets the relationship between the port group named "PG001", the LUN group named "LUN001", and the host group named "HG001":

```
CLI> set host-affinity -port-group-name PG001 -lg-name LUN001 -host-group-name HG001
```

The following example sets the relationship between port group #1, all of the hosts, and LUN group #1. Host response #1 is assigned to port group #1:

```
CLI> set host-affinity -port-group-number 1 -lg-number 1 -host-response-number 1
```

The following example sets the relationship between port group #1, all of the hosts, and affinity group #1. Host response #1 is assigned to port group #1:

```
CLI> set host-affinity -port-group-number 1 -ag-number 1 -host-response-number 1
```

copy host-affinity

This command copies the mapping definition from one specified host interface port to another host interface port. This command cannot be used when Host Affinity Mode is disabled for the host interface port.

■ Syntax

```
copy host-affinity -source-port source_port_number  
-destination-port {destination_port_numbers | all}
```

■ Parameter

-source-port This parameter specifies the host interface port of the copy source. Only one parameter can be specified at the same time.

Example-source-port 000

For details, refer to ["1.2.15 Host Interface Port Syntax" \(page 44\)](#).

source_port_number Host interface port of the copy source

xyz "x" is the controller module (CM) number, "y" is the CA number, and "z" is the host port number (DX60 S4/DX100 S4/DX200 S4, DX500 S4/DX600 S4, DX60 S3/DX100 S3/DX200 S3, DX500 S3/DX600 S3, DX8100 S3, AF250 S2/AF650 S2, AF250/AF650, and DX200F only)

Example: "123" indicates CM#1-CA#2-Port#3

wxyz "w" is the control enclosure (CE) number, "x" is the controller module (CM) number, "y" is the CA number, and "z" is the host port number (DX8700 S3/DX8900 S3 only)

Example: "0123" indicates CE#0-CM#1-CA#2-Port#3

-destination-port

This parameter specifies the host interface ports of the copy destination. Two or more parameters can be specified by separating them with a comma (,).

Example: -destination-port 000,100

For details, refer to ["1.2.15 Host Interface Port Syntax" \(page 44\)](#).

If "all" is selected, all of the host interface ports will be changed.

destination_port_number Host interface port of the copy destination

xyz "x" is the controller module (CM) number, "y" is the CA number, and "z" is the host port number (DX60 S4/DX100 S4/DX200 S4, DX500 S4/DX600 S4, DX60 S3/DX100 S3/DX200 S3, DX500 S3/DX600 S3, DX8100 S3, AF250 S2/AF650 S2, AF250/AF650, and DX200F only)

Example: "123" indicates CM#1-CA#2-Port#3

wxyz "w" is the control enclosure (CE) number, "x" is the controller module (CM) number, "y" is the CA number, and "z" is the host port number (DX8700 S3/DX8900 S3 only)

Example: "0123" indicates CE#0-CM#1-CA#2-Port#3

all All the ports with the same type as the port that is specified using the "-source-port" parameter.

■ Example(s)

The following example copies the host affinity definition from host interface CA#0 Port#0 on CM#0 to host interface CA#0 Port#0 on CM#1:

```
CLI> copy host-affinity -source-port 000 -destination-port 100
```

The following example copies the host affinity definition from host interface CA#0 Port#0 on CE#0 CM#0 to host interface CA#0 Port#0 on CE#0 CM#1 (for the DX8700 S3/DX8900 S3):

```
CLI> copy host-affinity -source-port 0000 -destination-port 0100
```

The following example copies the host affinity definition from host interface CA#0 Port#0 on CM#0 to all the host interface ports:

```
CLI> copy host-affinity -source-port 000 -destination-port all
```

release host-affinity

This command releases the associated LUN groups from the host identifiers. This command cannot be used when Host Affinity Mode is disabled for the host interface port.

Syntax

```
release host-affinity
{-port {port_numbers [-host-number host_numbers | -host-name host_names] | all}
{-port-group-number port_group_number | -port-group-name port_group_name }
{-host-group-number host_group_number | -host-group-name host_group_name }
```

Parameter

-port This parameter specifies the host interface ports to be released. Two or more parameters can be specified by separating them with a comma (,).

Example: -port 000,100

For details, refer to ["1.2.15 Host Interface Port Syntax" \(page 44\)](#).

If this parameter is specified together with the host identifier, only the mapping definition for the specified host identifiers is released.

port_numbers Host interface port

xyz "x" is the controller module (CM) number, "y" is the CA number, and "z" is the host port number (DX60 S4/DX100 S4/DX200 S4, DX500 S4/DX600 S4, DX60 S3/DX100 S3/DX200 S3, DX500 S3/DX600 S3, DX8100 S3, AF250 S2/AF650 S2, AF250/AF650, and DX200F only).

Example: "123" indicates CM#1-CA#2- Port#3

wxyz "w" is the controller enclosure (CE) number, "x" is the controller module (CM) number, "y" is the CA number, and "z" is the host port number (DX8700 S3/DX8900 S3 only).

Example: "0123" indicates CE#0-CM#1-CA#2- Port#3

all All the host interface ports
The settings for all of the ports are released. When this parameter is specified, the "-host-number" or "-host-name" parameter cannot be specified.

-host-number or -host-name

Optional. This parameter specifies the host identifiers that are released from the host identifiers of the specified host interface port. One or more parameters can be specified at the same time. If omitted, all definitions of the specified host interface ports are released.

host_numbers Host number

host_names Host name

-port-group-number or -port-group-name

This parameter specifies the port group number or the port group name. Only one port group can be specified at the same time. For details, refer to ["1.2.16 Port Group Syntax" \(page 45\)](#).

port_group_number Port group number
port_group_name Port group name

-host-group-number or -host-group-name

This parameter specifies the host group number or the host group name. Only one host group can be specified at the same time. For details, refer to ["1.2.13 Host Group Syntax" \(page 42\)](#).

host_group_number Host group number
host_group_name Host group name

The available combinations for optional parameters are shown below.

Parameter	-port port_numbers	-port all	-host-number	-host-name	-port-group-number	-port-group-name	-host-group-number	-host-group-name
-port port_numbers	–	–	**		No	No	No	No
-port all	–	–	No	No	No	No	No	No
-host-number	R	No	–	No	No	No	No	No
-host-name	R	No	No	–	No	No	No	No
-port-group-number	No	No	No	No	–	No	**	
-port-group-name	No	No	No	No	No	–	**	
-host-group-number	No	No	No	No	*		–	No
-host-group-name	No	No	No	No	*		No	–

No: Not available, R: Required, Yes: Available (the options can be omitted), *: Either one of these options must be specified, **: Either one of these options is available

■ Example(s)

The following example releases all of the host affinity settings that have been made on host interface CA#0 Port#0 on CM#1:

```
CLI> release host-affinity -port 100
```

The following example only releases the host affinity settings of the host named "H1" on CA#0 Port#1 on CM#0:

```
CLI> release host-affinity -port 001 -host-name H1
```

The following example releases the host affinity settings of the host named "H1" on host interfaces CA#1 Port#0 and CA#1 Port#1 on CM#0:

```
CLI> release host-affinity -port 010,011 -host-name H1
```

The following example respectively releases the host affinity settings of the host named "H1" and "H2" on CA#0 Port#0 and CA#0 Port#1 on CM#1:

```
CLI> release host-affinity -port 100,101 -host-name H1,H2
```

The following example respectively releases the host affinity settings of host #1 and #2 on the host interface CA#0 Port#0 on CM#0:

```
CLI> release host-affinity -port 000 -host-number 1,2
```

3.6.4 Mapping (When Host Affinity Mode is Not Used)

This section explains the commands for mapping when Host Affinity Mode is disabled. When Host Affinity Mode is not enabled, mapping is the definition of the associated volumes with the host LUNs that applies for all the connected host servers.

show mapping

This command displays a list of the mapping definitions that associate the volumes with LUNs. Individual volumes or host interface ports can be specified. This command cannot be used when Host Affinity Mode for the host interface port is enabled.

Syntax

```
show mapping [-port {port_numbers | all}]  
[-volume-number volume_numbers | -volume-name volume_names]
```

Parameter

-port Optional. This parameter specifies the host interface ports. Two or more parameters can be specified by separating them with a comma (.). If omitted, all the host interface ports are displayed.

Example: -port 000,100

For details, refer to ["1.2.15 Host Interface Port Syntax" \(page 44\)](#).

port_numbers Host interface port

xyz "x" is the controller module (CM) number, "y" is the CA number, and "z" is the host port number (DX60 S4/DX100 S4/DX200 S4, DX500 S4/DX600 S4, DX60 S3/DX100 S3/DX200 S3, DX500 S3/DX600 S3, DX8100 S3, AF250 S2/AF650 S2, AF250/AF650, and DX200F only).

Example: "123" indicates CM#1-CA#2-Port#3

wxyz "w" is the controller enclosure (CE) number, "x" is the controller module (CM) number, "y" is the CA number, and "z" is the host port number (DX8700 S3/DX8900 S3 only).

Example: "0123" indicates CE#0-CM#1-CA#2- Port#3

all All the host interface ports (default)

-volume-number or -volume-name

Optional. This parameter specifies the volume identifiers. One or more parameters can be specified. For details, refer to ["1.2.11 Volume Syntax" \(page 40\)](#). If omitted, all the volume identifiers are displayed.

volume_numbers Volume number

volume_names Volume name

Output

Item name	Description
CM#x CA#y Port#z (Host Affinity Mode Disable)	Host interface port. This is followed by a string that indicates whether the host affinity mode is enabled. (only for the DX60 S4/DX100 S4/DX200 S4, the DX500 S4/DX600 S4, the DX60 S3/DX100 S3/DX200 S3, the DX500 S3/DX600 S3, the DX8100 S3, the AF250 S2/AF650 S2, the AF250/AF650, and the DX200F)
CE#w CM#x CA#y Port#z (Host Affinity Mode Disable)	Host interface port. This is followed by a string that indicates whether the host affinity mode is enabled. (only for the DX8700 S3/DX8900 S3)
LUN	Logical unit number (LUN)
Volume	Volume identifiers

Item name	Description
No.	Volume number
Name	Volume name
Status	Volume status
Size(MB)	Volume size

■ Example(s)

The following example displays all of the existing mappings:

```

CLI> show mapping
CM#0 CA#0 Port#0 (Host Affinity Mode Disable)
LUN  Volume                               Status                               Size (MB)
     No.   Name
-----
  0    0  OLU#0                               Available                             256
  1    1  OLU#1                               Available                             256
  2    2  OLU#2                               Available                             256
  3    3  OLU#3                               Available                             256
  4    4  OLU#4                               Available                             256
  5    5  OLU#5                               Available                             256
  6    6  OLU#6                               Available                             256
  7    7  OLU#7                               Available                             256

CM#0 CA#0 Port#1 (Host Affinity Mode Enable)

CM#1 CA#0 Port#0 (Host Affinity Mode Disable)
LUN  Volume                               Status                               Size (MB)
     No.   Name
-----
  0    0  OLU#0                               Available                             256
  1    1  OLU#1                               Available                             256
  2    2  OLU#2                               Available                             256
  3    3  OLU#3                               Available                             256
  4    4  OLU#4                               Available                             256
  5    5  OLU#5                               Available                             256
  6    6  OLU#6                               Available                             256
  7    7  OLU#7                               Available                             256

CM#1 CA#0 Port#1 (Host Affinity Mode Disable)
LUN  Volume                               Status                               Size (MB)
     No.   Name
-----
  0    0  OLU#0                               Available                             256
  1    1  OLU#1                               Available                             256
  2    2  OLU#2                               Available                             256
  3    3  OLU#3                               Available                             256
  4    4  OLU#4                               Available                             256
  5    5  OLU#5                               Available                             256
  6    6  OLU#6                               Available                             256
  7    7  OLU#7                               Available                             256
  
```

The following example displays all of the existing mappings (for the DX8700 S3/DX8900 S3):

```

CLI> show mapping
CE#0 CM#0 CA#0 Port#0 (Host Affinity Mode Disable)
LUN Volume Status Size (MB)
  No. Name
-----
  0 0 OLU#0 Available 256
  1 1 OLU#1 Available 256
  2 2 OLU#2 Available 256
  3 3 OLU#3 Available 256
  4 4 OLU#4 Available 256
  5 5 OLU#5 Available 256
  6 6 OLU#6 Available 256
  7 7 OLU#7 Available 256

CE#0 CM#0 CA#0 Port#1 (Host Affinity Mode Enable)

CE#0 CM#1 CA#0 Port#0 (Host Affinity Mode Disable)
LUN Volume Status Size (MB)
  No. Name
-----
  0 0 OLU#0 Available 256
  1 1 OLU#1 Available 256
  2 2 OLU#2 Available 256
  3 3 OLU#3 Available 256
  4 4 OLU#4 Available 256
  5 5 OLU#5 Available 256
  6 6 OLU#6 Available 256
  7 7 OLU#7 Available 256

CE#0 CM#1 CA#0 Port#1 (Host Affinity Mode Disable)
LUN Volume Status Size (MB)
  No. Name
-----
  0 0 OLU#0 Available 256
  1 1 OLU#1 Available 256
  2 2 OLU#2 Available 256
  3 3 OLU#3 Available 256
  4 4 OLU#4 Available 256
  5 5 OLU#5 Available 256
  6 6 OLU#6 Available 256
  7 7 OLU#7 Available 256
  
```

The following example only displays the mappings associated with the volume named "VOL001":

```

CLI> show mapping -volume-number 0
CM#0 CA#0 Port#0 (Host Affinity Mode Disable)
LUN Volume Status Size (MB)
  No. Name
-----
  0 0 OLU#0 Available 256

CM#0 CA#0 Port#1 (Host Affinity Mode Enable)

CM#1 CA#0 Port#0 (Host Affinity Mode Disable)
LUN Volume Status Size (MB)
  No. Name
-----
  0 0 OLU#0 Available 256

CM#1 CA#0 Port#1 (Host Affinity Mode Disable)
LUN Volume Status Size (MB)
  No. Name
-----
  0 0 OLU#0 Available 256
  
```

The following example displays the mappings associated with host interface port #0 on CM#0 CA#0:

```
CLI> show mapping -port 000
CM#0 CA#0 Port#0 (Host Affinity Mode Disable)
LUN  Volume                               Status                               Size (MB)
     No.   Name
-----
  0    0   OLU#0                               Available                             256
  1    1   OLU#1                               Available                             256
  2    2   OLU#2                               Available                             256
  3    3   OLU#3                               Available                             256
  4    4   OLU#4                               Available                             256
  5    5   OLU#5                               Available                             256
  6    6   OLU#6                               Available                             256
  7    7   OLU#7                               Available                             256
```

set mapping

This command is a mapping method that is available when Host Affinity Mode is disabled and associates the specified volumes with the host LUNs (logical unit number) through the specified host interface port. Usually a LUN can be assigned a value from 0 to 255. However, for an HP-UX host environment, a value from 0 to 511 can be assigned. This command cannot be used when the Host Affinity Mode of the host interface port is enabled.

■ Syntax

```
set mapping -port {port_numbers}  
{-volume-number volume_numbers | -volume-name volume_names} -lun luns
```

■ Parameter

-port This parameter specifies the host interface ports to be associated volumes with LUNs. Two or more parameters can be specified by separating them with a comma (,).

Example: -port 000,100

For details, refer to ["1.2.15 Host Interface Port Syntax" \(page 44\)](#).

port_numbers Host interface port

xyz "x" is the controller module (CM) number, "y" is the CA number, and "z" is the host port number (DX60 S4/DX100 S4/DX200 S4, DX500 S4/DX600 S4, DX60 S3/DX100 S3/DX200 S3, DX500 S3/DX600 S3, DX8100 S3, AF250 S2/AF650 S2, AF250/AF650, and DX200F only).

Example: "123" indicates CM#1-CA#2-Port#3

wxyz "w" is the controller enclosure (CE) number, "x" is the controller module (CM) number, "y" is the CA number, and "z" is the host port number (DX8700 S3/DX8900 S3 only).

Example: "0123" indicates CE#0-CM#1-CA#2- Port#3

-volume-number or -volume-name

This parameter specifies volumes identifiers to be associated. One or more parameters can be specified at the same time. For details, refer to ["1.2.11 Volume Syntax" \(page 40\)](#). If two or more LUNs are specified, these parameters must be specified in the same order.

Example:

-volume-number 10-12 -lun 1-3

-> The volume #10 and LUN 1 are pairs.

-> The volume #11 and LUN 2 are pairs.

-> The volume #12 and LUN 3 are pairs.

-volume-name v1,v2 -lun 1-2

-> The volume named "v1" and LUN 1 are pairs.

-> The volume named "v2" and LUN 2 are pairs.

volume_numbers Volume number

volume_names Volume name

-lun This parameter specifies the LUNs to be associated. If two or more volumes are specified, these parameters must be specified in the same order.

Two or more parameters can be specified by separating them with a comma (,), a hyphen (-), or both.

Example: `-lun 1,2 -lun 0-10 -lun 1,2-9`

luns LUN

■ Example(s)

The following example sets the relationship between host interface port #0 on CM#0 CA#1, the volume named "VOL001", and LUN #1:

```
CLI> set mapping -port 010 -volume-name VOL001 -lun 1
```

The following example sets the relationship between host interface port #0 and #1 on CM#0 CA#0, the volume named "VOL002", and LUN #2:

```
CLI> set mapping -port 000,001 -volume-name VOL002 -lun 2
```

(identical with the following)

```
CLI> set mapping -port 000 -volume-name VOL002 -lun 2  
CLI> set mapping -port 001 -volume-name VOL002 -lun 2
```

The following example sets the relationship between host interface port #0 on CM#0 CA#0, volumes #0 – #9, and LUNs #0 – #9:

```
CLI> set mapping -port 000 -volume-number 0-9 -lun 0-9
```

The following example displays the results when the specified volumes #101 and #102 belong to different ports or groups:

```
CLI> set mapping -port 000 -volume-number 101-105 -lun 0-9  
Warning: The following volumes have been linked with other group(s) and/or port(s).  
Volume Number        [101,102]
```

copy mapping

This command copies the mapping definition from one specified host interface port to others. This command cannot be used when Host Affinity Mode for the host interface port is enabled.

■ Syntax

```
copy mapping -source-port source_port_number  
-destination-port {destination_port_numbers | all}
```

■ Parameter

-source-port This parameter specifies the host interface port of the copy source. Only one parameter can be specified at the same time.

Example: `-source-port 000`

For details, refer to ["1.2.15 Host Interface Port Syntax" \(page 44\)](#).

source_port_number Host interface port of the copy source

xyz "x" is the controller module (CM) number, "y" is the CA number, and "z" is the host port number (DX60 S4/DX100 S4/DX200 S4, DX500 S4/DX600 S4, DX60 S3/DX100 S3/DX200 S3, DX500 S3/DX600 S3, DX8100 S3, AF250 S2/AF650 S2, AF250/AF650, and DX200F only)

Example: "123" indicates CM#1-CA#2-Port#3

wxyz "w" is the control enclosure (CE) number, "x" is the controller module (CM) number, "y" is the CA number, and "z" is the host port number (DX8700 S3/DX8900 S3 only)

Example: "0123" indicates CE#0-CM#1-CA#2-Port#3

-destination-port

This parameter specifies the host interface ports to be released. Two or more parameters can be specified by separating them with a comma (,).

Example: `-destination-port 000,100`

For details, refer to ["1.2.15 Host Interface Port Syntax" \(page 44\)](#).

If "all" is selected, all of the host interface ports will be changed.

destination_port_number Host interface port of the copy destination

xyz "x" is the controller module (CM) number, "y" is the CA number, and "z" is the host port number (DX60 S4/DX100 S4/DX200 S4, DX500 S4/DX600 S4, DX60 S3/DX100 S3/DX200 S3, DX500 S3/DX600 S3, DX8100 S3, AF250 S2/AF650 S2, AF250/AF650, and DX200F only)

Example: "110" indicates CM#1-CA#1-Port#0

wxyz "w" is the control enclosure (CE) number, "x" is the controller module (CM) number, "y" is the CA number, and "z" is the host port number (DX8700 S3/DX8900 S3 only)

Example: "0123" indicates CE#0-CM#1-CA#2-Port#3

all All the ports with the same type as the port that is specified using the "-source-port" parameter.

■ Example(s)

The following example copies the mapping definition from host interface port #0 on CM#0 CA#0 to host interface port #0 on CM#1 CA#0:

```
CLI> copy mapping -source-port 000 -destination-port 100
```

The following example copies the mapping definition from host interface port #0 on CE#0 CM#0 CA#0 to host interface port #0 on CE#0 CM#1 CA#0 (for the DX8700 S3/DX8900 S3):

```
CLI> copy mapping -source-port 0000 -destination-port 0100
```

The following example copies the mapping definition from host interface port #0 on CM#0 CA#0 to host interface ports #0 and #1 on CM#1 CA#1:

```
CLI> copy mapping -source-port 000 -destination-port 110,111
```

release mapping

This command releases the mapping definition of volumes with LUNs. This command cannot be used when Host Affinity Mode for the host interface port is enabled.

Syntax

```
release mapping -port {port_numbers | all} [-lun luns]
```

Parameter

-port This parameter specifies the host interface ports to be released. Two or more parameters can be specified by separating them with a comma (,).

Example: -port 000,100

For details, refer to ["1.2.15 Host Interface Port Syntax" \(page 44\)](#).

If the following LUN parameter is omitted, all mappings associated with the specified host interface port are released. If this parameter is specified together with a LUN parameter, then only the mapping definition of the host interface port and the specified LUN is released.

port_numbers Host interface port

xyz "x" is the controller module (CM) number, "y" is the CA number, and "z" is the host port number (DX60 S4/DX100 S4/DX200 S4, DX500 S4/DX600 S4, DX60 S3/DX100 S3/DX200 S3, DX500 S3/DX600 S3, DX8100 S3, AF250 S2/AF650 S2, AF250/AF650, and DX200F only).

Example: "123" indicates CM#1-CA#2-Port#3

wxyz "w" is the controller enclosure (CE) number, "x" is the controller module (CM) number, "y" is the CA number, and "z" is the host port number (DX8700 S3/DX8900 S3 only).

Example: "0123" indicates CE#0-CM#1-CA#2- Port#3

all All the host interface ports

-lun Optional. This parameter specifies which specific LUN mappings will be released from the mapping associations. Two or more parameters can be specified by separating them with a comma (,), a hyphen (-), or both. If omitted, all the definitions of the specified host interface port are deleted.

Example: -lun 1,2 -lun 1-3 -lun 1-3.5

luns LUN

Example(s)

The following example releases all of the mapping that is set to host interface port #0 on CM#0 CA#0:

```
CLI> release mapping -port 000
```

The following example only releases the mapping definition of LUN #2 that is set to host interface port #1 on CM#1 CA#1:

```
CLI> release mapping -port 111 -lun 2
```

The following example releases all of the mappings that are set to host interface ports #0 and #1 on CM#1 CA#0:

```
CLI> release mapping -port 100,101
```

The following example releases all the registered mappings:

```
CLI> release mapping -port all
```

3.6.5 Host Groups

This section explains the commands related to host groups. The host group is used to control multiple hosts as a group.

show host-groups

This command displays existing host groups.

Syntax

```
show host-groups  
[-host-group-number host_group_numbers | -host-group-name host_group_names | -all]  
[-host-number host_numbers | -host-name host_names]
```

Parameter

-host-group-number, -host-group-name, or -all

Optional. This parameter specifies the host group identifiers that will be displayed in detail. When -all is specified, the details of all the existing host groups are displayed. One or more parameters can be specified. For details, refer to ["1.2.13 Host Group Syntax" \(page 42\)](#). If omitted, a summary of all the existing host groups will be displayed.

<i>host_group_numbers</i>	Host group number
<i>host_group_names</i>	Host group name
-all	All the existing host groups

-host-number or -host-name

Optional. This parameter specifies the host that is included in the host group that is to be displayed in detail. One or more parameters can be specified. For details, refer to ["1.2.12 Host Syntax" \(page 41\)](#).

<i>host_numbers</i>	Host number
<i>host_names</i>	Host name

Output

When the parameter is omitted, a summary of all the existing host groups is displayed.

Item name	Description
Host Group	Host group identifiers
No.	Host group number
Name	Host group name
Host Response	Host response identifiers
No.	Host response number
Name	Host response name
Host Type	Host type

When the parameter is specified, the details of the specified host group are displayed.

Item name	Description
Host Group	Host group identifiers
No.	Host group number
Name	Host group name

Item name	Description
Host Response	Host response identifiers
No.	Host response number
Name	Host response name
Host Type	Host type
Host	Host identifiers
No.	Host number
Name	Host name
WWN	Host WWN

■ Example(s)

The following example displays a summary of all the existing host groups:

```
CLI> show host-groups
Host Group      Host Response      Host Type
No.  Name          No.  Name
-----
  0  hg           250  Solaris MPxIO    FC/FCoE
  1  FCoE         250  Solaris MPxIO    FC/FCoE
  2  iscsi        254  AIX Single Path  iSCSI
```

The following example displays details of host group #0:

```
CLI> show host-groups -host-group-number 0
Host Group      Host Response      Host Type
No.  Name          No.  Name
-----
  0  hg           250  Solaris MPxIO    FC/FCoE
<Host List>
Host
No.  Name
-----
  0  A           aaaaaaaaaaaaaaaaaa
  1  B           bbbbbbbbbbbbbbbbbb
```

The following example displays the details of all the host groups:

```
CLI> show host-groups -all
Host Group      Host Response      Host Type
No.  Name          No.  Name
-----
  0  hg           250  Solaris MPxIO    FC/FCoE
<Host List>
Host
No.  Name
-----
  0  A           aaaaaaaaaaaaaaaaaa
  1  B           bbbbbbbbbbbbbbbbbb

Host Group      Host Response      Host Type
No.  Name          No.  Name
-----
  1  FCoE         250  Solaris MPxIO    FC/FCoE
<Host List>
Host
No.  Name
-----
  7  FCoE#2      aaaabbbbcccc0002
```

The following example displays details of host #0:

```
CLI> show host-groups -host-number 0
Host Group          Host Response      Host Type
No.  Name           No.  Name
-----
   0  hg             250  Solaris MPxIO    FC/FCoE
<Host List>
Host
No.  Name
-----
   0  A             aaaaaaaaaaaaaaaaaa
```

create host-group

This command creates host groups.

Note

- This command overwrites host responses that are set when the host is registered (when a host response is not specified, "Default" is set for the host response).
- For the DX60 S4/DX100 S4/DX200 S4, the DX500 S4/DX600 S4, the DX60 S3/DX100 S3/DX200 S3, the DX500 S3/DX600 S3, the DX8100 S3, the AF250 S2/AF650 S2, the AF250/AF650, and the DX200F, up to eight hosts can be set for a single host group.
For the DX8700 S3/DX8900 S3, up to 64 hosts can be set for a single host group.
- Hosts that belong to a host group must have the same host response settings as the host group. When the same hosts are registered in a new host group A and an existing host group B, the host response settings for host group B are changed to the host group A settings. In addition, if the same hosts are registered in host group B and another existing host group C, the host response settings for host group C are also changed to host group B (and so forth).
- If an iSCSI host without an IP address setting (any IP address) has the same iSCSI name as the iSCSI host with an IP address setting, the relevant host cannot be set in the same host group.

Syntax

```
create host-group  
-name host_group_name -host-type {fc | iscsi | sas}  
[-host-response-number host_response_numbers | -host-response-name host_response_name]  
{-host-number host_numbers | -host-name host_names}
```

Parameter

-name This parameter specifies a name of the host group. Only one name can be specified at the same time. For details, refer to ["1.2.6 Alias Name Syntax" \(page 35\)](#).

host_group_name Host group name

-host-type This parameter specifies the host type. Only one host type can be specified at the same time.

fc FC/FCoE

iscsi iSCSI

sas SAS

-host-response-number or **-host-response-name**

Optional. This parameter specifies the host response identifier that is to be used to set the host sense. Only one host response can be specified at the same time. For details, refer to ["1.2.14 Host Response Syntax" \(page 43\)](#).

host_response_numbers Host response number

host_response_name Host response name

-host-number or -host-name

This parameter specifies the host identifiers to be associated. One or more parameters can be specified at the same time. For details, refer to ["1.2.12 Host Syntax" \(page 41\)](#).

host_numbers Host number

host_names Host name

■ Example(s)

The following example creates a host group. FC is specified for the "host-type" parameter, 10 is specified for the "host-response-number" parameter, and 1 and numbers 3 to 5 are specified for the "host-number" parameter:

```
CLI> create host-group -name HG001 -host-type fc -host-response-number 10 -host-number 1,3-5
```

set host-group

This command changes the host group name, adds hosts to a host group, and deletes hosts from a host group.

Note

- A host can be added to or deleted from a host group for which mapping is set.
- A host cannot be deleted from a host group when no hosts belong to the host group after the host is deleted.
- For the DX60 S4/DX100 S4/DX200 S4, the DX500 S4/DX600 S4, the DX60 S3/DX100 S3/DX200 S3, the DX500 S3/DX600 S3, the DX8100 S3, the AF250 S2/AF650 S2, the AF250/AF650, and the DX200F, up to eight hosts can be set for a single host group.
For the DX8700 S3/DX8900 S3, up to 64 hosts can be set for a single host group.
- Hosts that belong to a host group must have the same host response settings as the host group. When the same hosts are registered in a new host group A and an existing host group B, the host response settings for host group B are changed to the host group A settings. In addition, if the same hosts are registered in host group B and another existing host group C, the host response settings for host group C are also changed to host group B (and so forth).
- When a host that is added to the new host group A belongs to host group B, the host response settings for host group B are changed to the host group A settings. In addition, if the same hosts are registered in host group B and another existing host group C, the host response settings for host group C are also changed to host group B (and so forth).
- An iSCSI host without an IP address setting (any IP address) cannot be set with the same iSCSI name as the iSCSI host with an IP address setting in the same host group.
- If a host is added to the host group in which host affinity is set, host affinity is automatically set for the added host. However, when an iSCSI host is added, if the iSCSI host without an IP address setting (any IP address) and the iSCSI host with an IP address setting that have the same iSCSI name are added in the host port, host affinity cannot be set.

Syntax

```
set host-group {-host-group-number host_group_number | -host-group-name host_group_name}  
[-host-response-number host_response_number | -host-response-name host_response_name]  
[-name host_group_name] [-add-host-number host_numbers | -add-host-name host_names |  
-release-host-number host_numbers | -release-host-name host_names]
```

Parameter

-host-group-number or -host-group-name

This parameter specifies the host group identifier to be changed. Only one host group can be specified at the same time. For details, refer to ["1.2.13 Host Group Syntax" \(page 42\)](#).

<i>host_group_number</i>	Host group number
<i>host_group_name</i>	Host group name

-host-response-number or -host-response-name

Optional. This parameter specifies the host response identifier that is to be used to set the host sense. Only one host response can be specified at the same time. For details, refer to ["1.2.14 Host Response Syntax" \(page 43\)](#). If omitted, the existing setting is not changed.

<i>host_response_number</i>	Host response number
<i>host_response_name</i>	Host response name

-name Optional. This parameter specifies the new host group name. Only one name can be specified at the same time. For details, refer to ["1.2.6 Alias Name Syntax" \(page 35\)](#). If omitted, the existing setting is not changed.

host_group_name Host group name

-add-host-number, -add-host-name, -release-host-number, or -release-host-name

Optional. This parameter specifies the host that is to be added or deleted. Two or more parameters can be specified by separating them with a comma (,).

Example: `-add-host-number 1,2`

For details, refer to ["1.2.12 Host Syntax" \(page 41\)](#).

host_numbers Numbers of the hosts that are to be added or deleted

host_names Names of the hosts that are to be added or deleted

■ Example(s)

The following example changes the host group named "HG001". The new name is "NEW_HG002". The host response number is changed to 2:

```
CLI> set host-group -host-group-name HG001 -host-response-number 2 -name NEW_HG002
```

The first command will create the host group named "HG0001". Host numbers 1 and 2 belong to this host group. The second command will add other definitions to the host group. Host number 3 and host numbers 5 to 7 are specified for the host group:

```
CLI> create host-group -host-group-name HG0001 -host-number 1,2  
CLI> set host-group -host-group-name HG0001 -add-host-number 3,5-7
```

delete host-group

This command deletes the specified host group(s).

Note

- When "disable" is selected for the "-keep-host-mode" parameter, the host that belongs to the host group is also deleted.
- Host groups for which mapping is set cannot be deleted.

Syntax

```
delete host-group {-host-group-number host_group_numbers | -host-group-name host_group_names}  
[-keep-host-mode {enable | disable}]
```

Parameter

-host-group-number or -host-group-name

This parameter specifies the host group identifiers to be deleted. One or more parameters can be specified at the same time. For details, refer to ["1.2.13 Host Group Syntax" \(page 42\)](#).

<i>host_group_numbers</i>	Host group number
<i>host_group_names</i>	Host group name

-keep-host-mode

This parameter specifies whether the hosts are deleted. If omitted, this parameter is handled as though "enable" is selected.

enable	Hosts are not deleted.
disable	Hosts are also deleted

Example(s)

The following example only deletes host group #1:

```
CLI> delete host-group -host-group-number 1
```

The following example deletes host group # 1 and host groups #3 to #5:

```
CLI> delete host-group -host-group-number 1,3-5
```

3.6.6 Port Groups

This section explains the commands related to port groups. The port group is used to control multiple ports as a group.

show port-groups

This command displays a list of existing port groups.

Syntax

```
show port-groups  
[-port-group-number port_group_numbers | -port-group-name port_group_names | -all]
```

Parameter

-port-group-number, -port-group-name, or -all

Optional. This parameter specifies the port group identifiers that will be displayed in detail. When the "-all" parameter is specified, the details of all the existing port groups are displayed. One or more parameters can be specified. For details, refer to ["1.2.16 Port Group Syntax" \(page 45\)](#). If omitted, a summary of all the existing port groups will be displayed.

<i>port_group_numbers</i>	Port group number
<i>port_group_names</i>	Port group name
-all	All the existing port groups

Output

When the parameter is omitted, a summary of all the existing port groups is displayed.

Item name	Description
Port Group	Port group identifiers
No.	Port group number
Name	Port group name
CA Type	CA type

When the parameter is specified, the details of the specified port group are displayed.

Item name	Description
Port Group	Port group identifiers
No.	Port group number
Name	Port group name
CA Type	CA type
CM#xCA#yPort#z	Port number (only for the DX60 S4/DX100 S4/DX200 S4, the DX500 S4/DX600 S4, the DX60 S3/DX100 S3/DX200 S3, the DX500 S3/DX600 S3, the DX8100 S3, the AF250 S2/AF650 S2, the AF250/AF650, and the DX200F)
CE#w CM#x CA#yPort#z	Port number (only for the DX8700 S3/DX8900 S3 only)

■ Example(s)

The following example displays a summary of all the existing port groups:

```
CLI> show port-groups
Port Group          CA Type
No. Name
-----
 0 pg               FC
 1 pgl              FC
```

The following example displays details of port group #0:

```
CLI> show port-groups -port-group-number 0
Port Group          CA Type
No. Name
-----
 0 pg               FC
<Port List>
  CM#0 CA#0 Port#1
```

The following example displays the details of all the port groups:

```
CLI> show port-groups -all
Port Group          CA Type
No. Name
-----
 0 pg               FC
<Port List>
  CM#0 CA#0 Port#1

Port Group          CA Type
No. Name
-----
 1 pgl              FC
<Port List>
  CM#0 CA#0 Port#0
  CM#0 CA#0 Port#1
```

The following example displays the details of all the port groups (for the DX8700 S3/DX8900 S3):

```
CLI> show port-groups -all
Port Group          CA Type
No. Name
-----
 0 pg               FC
<Port List>
  CE#0 CM#0 CA#0 Port#1

Port Group          CA Type
No. Name
-----
 1 pgl              FC
<Port List>
  CE#0 CM#0 CA#0 Port#0
  CE#0 CM#0 CA#0 Port#1
```

create port-group

This command creates port groups.

Note

- A port group can be created even when the same ports that belong to an existing port group are to be specified for the port group.
- A port group can be created even when mapping is already set for all the specified ports that are in different groups.
- A port group can be created even when the specified port does not belong to a port group and the host affinity (LUN mapping) is already set for the port.
- Ports with host affinity "disabled" cannot belong to a port group.
- Up to eight ports can be set for a single port group.

Syntax

```
create port-group -name name {-port port_numbers}
```

Parameter

-name This parameter specifies a name of the port group. Only one name can be specified at the same time. For details, refer to ["1.2.6 Alias Name Syntax" \(page 35\)](#).

name Port group name

-port This parameter specifies the host interface port. Two or more parameters can be specified by separating them with a comma (.).

Example: -port 000, 011

For details, refer to ["1.2.15 Host Interface Port Syntax" \(page 44\)](#).

port_numbers Host interface port

xyz "x" is the controller module (CM) number, "y" is the CA number, and "z" is the host port number (for the DX60 S4/DX100 S4/DX200 S4, the DX500 S4/DX600 S4, the DX60 S3/DX100 S3/DX200 S3, the DX 500 S3/DX600 S3, the DX8100 S3, the AF250 S2/AF650 S2, the AF250/AF650, and the DX200F only).

Example: "123" indicates CM#1-CA#2-Port#3

wxyz "w" is the controller enclosure (CE) number, "x" is the controller module (CM) number, "y" is the CA number, and "z" is the host port number (for the DX8700 S3/DX8900 S3 only).

Example: "0123" indicates CE#0-CM#1-CA#2-Port#3

Example(s)

The following example creates CM#0 CA#0 Port#1 (FC interface) and CM#0 CA#1 Port#1 (FC interface) as a port group named "PG0001":

```
CLI> create port-group -name PG0001 -port 001,011
```

set port-group

This command changes the port group name, adds ports to port groups, and deletes ports from port groups.

Caution

If a host interface port is added to the port group in which host affinity is set, host affinity is automatically set for the added host interface port. However, when an iSCSI interface port is added, if the iSCSI host without an IP address setting (any IP address) is set with the same iSCSI name as the iSCSI host with an IP address setting in the target iSCSI interface port, host affinity is not set.

Note

- A port can be added to a port group even when this makes the ports that belong to this port group identical to the ports of another existing port group.
- A port can be added even when mapping is already set for the port in a different group.
- A port can be added to or deleted from a port group for which mapping is set.
- When a port is deleted from a port group, the mapping information for the port is deleted (the information when the port belongs to the port group is not retained).
- A port cannot be deleted from a port group when no ports belong to the port group after the port is deleted.
- After a port is deleted from a port group, the port group might not have any logical paths. In this case, the mapping setting between port groups must be also deleted.
- Up to eight ports can be set for a single port group.

Syntax

```
set port-group {-port-group-number port_group_number | -port-group-name port_group_name}  
[-name port_group_name] [-add-port ports | -release-port ports]
```

Parameter

-port-group-number or -port-group-name

This parameter specifies the port group identifier to be changed. Only one port group can be specified at the same time. For details, refer to "[1.2.16 Port Group Syntax](#)" (page 45).

port_group_number Port group number

port_group_name Port group name

-name Optional. This parameter specifies the new port group name. Only one name can be specified at the same time. For details, refer to "[1.2.6 Alias Name Syntax](#)" (page 35). If omitted, the existing setting is not changed.

name New port group name

-add-port or -release-port

Optional. This parameter specifies the host interface port that is to be added or deleted. Two or more parameters can be specified by separating them with a comma (,).

Example: -add-port 000, 011

For details, refer to ["1.2.15 Host Interface Port Syntax" \(page 44\)](#).

ports Host interface ports

xyz "x" is the controller module (CM) number, "y" is the CA number, and "z" is the host port number (DX60 S4/DX100 S4/DX200 S4, DX500 S4/DX600 S4, DX60 S3/DX100 S3/DX200 S3, DX500 S3/DX600 S3, DX8100 S3, AF250 S2/AF650 S2, AF250/AF650, and DX200F only).

Example: "123" indicates CM#1-CA#2-Port#3

wxyz "w" is the controller enclosure (CE) number, "x" is the controller module (CM) number, "y" is the CA number, and "z" is the host port number (DX8700 S3/DX8900 S3 only).

Example: "0120" indicates CE#0-CM#1-CA#2- Port#0

■ Example(s)

The following example changes the port group named "PG001". The new name is "NEW_PG002":

```
CLI> set port-group -port-group-name PG001 -name NEW_PG002
```

The first command creates the port group named "PG0001".

This port group contains CM#0 CA#0 Port#1 (FC interface) and CM#0 CA#1 Port#1 (FC interface).

The second command adds other definitions to the port group named "PG0001". CM#1 CA#0 Port#1 (FC interface) and CM#1 CA#1 Port#1 (FC interface) are added to the port group:

```
CLI> create port-group -port-group-name PG0001 -port 001,011  
CLI> set port-group -port-group-name PG0001 -add-port 101,111
```

The first command creates the port group named "PG0001" (for the DX8700 S3/DX8900 S3).

This port group contains CE#0 CM#0 CA#0 Port#1 (FC interface) and CE#0 CM#0 CA#1 Port#1 (FC interface).

The second command adds other definitions to the port group named "PG0001". CE#0 CM#1 CA#0 Port#1 (FC interface) and CE#0 CM#1 CA#1 Port#1 (FC interface) are added to the port group:

```
CLI> create port-group -port-group-name PG0001 -port 0001,0011  
CLI> set port-group -port-group-name PG0001 -add-port 0101,0111
```

delete port-group

This command deletes the specified port group(s).

Note

Port groups for which mapping is set cannot be deleted.

Syntax

```
delete port-group {-port-group-number port_group_numbers | -port-group-name port_group_names}
```

Parameter

-port-group-number or -port-group-name

This parameter specifies the port group identifiers to be deleted. One or more parameters can be specified at the same time. For details, refer to "[1.2.16 Port Group Syntax](#)" (page 45).

<i>port_group_numbers</i>	Port group number
<i>port_group_names</i>	Port group name

Example(s)

The following example only deletes port group #1:

```
CLI> delete port-group -port-group-number 1
```

The following example deletes port group # 1 and port groups #3 to #5:

```
CLI> delete port-group -port-group-number 1,3-5
```

3.6.7 LUN Groups

This section explains the commands used for LUN group control. A LUN group is a definition of the association between LUNs as seen from the host and volumes. LUN groups are only valid when the Host Affinity Mode is enabled.

 **Note**

The definition of LUN groups is the same as affinity groups, except that the name is different.

show lun-groups

This command displays a list of existing LUN groups. If no parameters are specified, a summary list of all the existing LUN groups is displayed. If LUN groups are specified, the details of the associated volumes and LUNs are displayed.

Caution

The LUN Overlap volume information indicates whether the same volume is defined for multiple LUN groups or whether a volume is mapped to a LUN.

■ Syntax

```
show lun-groups [-lg-number lg_numbers | -lg-name lg_names]
```

■ Parameter

-lg-number or -lg-name

Optional. This parameter specifies the LUN group identifiers that will be displayed in detail. One or more parameters can be specified. If omitted, a summary of all the existing LUN groups will be displayed.

lg_numbers LUN group number

lg_names LUN group name

■ Output

When the parameter is omitted, a summary of all the existing LUN groups is displayed.

Item name	Description
LUN Group	LUN group identifiers
No.	LUN group number
Name	LUN group name
LUN Overlap Volumes	Indicates whether the same volume identifier is defined between LUN groups or that a LUN mapping is set for the volume. If the same definitions exist, "Yes" is displayed for the target LUN groups. Otherwise, "No" is displayed.

When the parameter is specified, the details of the specified LUN group are displayed.

Item name	Description
LUN Group No.	LUN group number
LUN Group Name	LUN group name
LUN	Logical unit number (LUN)
Volume	Volume identifiers
No.	Volume number
Name	Volume name
Status	Volume status
Size(MB)	Volume size

Item name	Description
LUN Overlap Volumes	Indicates whether the same volume identifier is defined between LUN groups or that a LUN mapping is set for the volume. If the same definitions exist, "Yes" is displayed for the target LUN groups. Otherwise, "No" is displayed.
UID	Identifier (device name) to identify a volume

■ Example(s)

The following example displays a summary of all the existing LUN groups. In addition, the LUN Overlap volume information flag is displayed:

```
CLI> show lun-groups
LUN Group      LUN Overlap
No.  Name      Volumes
-----
 4 LUN004      Yes
 5 LUN005      No
 6 LUN006      Yes
```

The following example displays details of LUN group #6:

```
CLI> show lun-groups -lg-number 6
LUN Group No.6
LUN Group Name AG006
LUN Volume      Status      Size(MB) LUN Overlap UID
No.  Name
-----
 1    1 VOLUME_001  Available  32 No      600000E00D1000000010000000000000
 2    2 VOLUME_002  Available  32 No      600000E00D1000000010000000010000
 3    3 VOLUME_003  Available  32 No      600000E00D1000000010000000020000
4095  5 VOLUME_005  Available  32 No      600000E00D1000000010000000030000
```

create lun-group

This command creates a LUN group.

The maximum number of LUN groups that can be created is 1,024 for the DX60 S4/DX100 S4/DX200 S4, the DX500 S4/DX600 S4, the DX60 S3/DX100 S3/DX200 S3, the DX500 S3/DX600 S3, the DX8100 S3, the AF250 S2/AF650 S2, the AF250/AF650, and the DX200F, and 6,144 for the DX8700 S3/DX8900 S3. However, if the Expand Host Mode is enabled with the "set subsystem-parameters" command, 2,048 LUN groups can be created for the DX500 S4/DX600 S4 and the DX500 S3/DX600 S3.

■ Syntax

```
create lun-group -name name  
{-volume-number volume_numbers | -volume-name volume_names} -lun luns
```

■ Parameter

-name This parameter specifies a name of the LUN group. Only one LUN group name can be specified at the same time. For details, refer to ["1.2.6 Alias Name Syntax" \(page 35\)](#).

name LUN group name

-volume-number or -volume-name

This parameter specifies the volume identifiers to associate volumes with host LUNs. One or more parameters can be specified at the same time. For details, refer to ["1.2.11 Volume Syntax" \(page 40\)](#). If two or more LUNs are specified, these parameters must be specified in the same order.

Example:

-volume-number 10-12 -lun 1-3

-> The volume #10 and LUN 1 are pairs.

-> The volume #11 and LUN 2 are pairs.

-> The volume #12 and LUN 3 are pairs.

-volume-name v1,v2 -lun 1-2

-> The volume named "v1" and LUN 1 are pairs.

-> The volume named "v2" and LUN 2 are pairs.

volume_numbers Volume number

volume_names Volume name

-lun This parameter specifies the host LUNs to associate volumes with. Two or more parameters can be specified by separating them with a comma (,), a hyphen (-), or both. If two or more volumes are specified, these parameters must be specified in the same order.

Example: **-lun 0,1 -lun 0-10 -lun 0,1-10**

luns Host LUN

■ Example(s)

The following example creates the LUN group named "LUN001". It will associate volume #8 with LUN #10:

```
CLI> create lun-group -name LUN001 -volume-number 8 -lun 10
```

The following example creates the LUN group named "LUN001". It will associate consecutive volumes #0-#10 with LUNs #0 - #10:

```
CLI> create lun-group -name LUN001 -volume-number 0-10 -lun 0-10
```

set lun-group

This command changes an existing LUN group and can also be used to add a definition to the LUN group.

■ Syntax

```
set lun-group {-lg-number source_lg_number | -lg-name source_lg_name} [-name name]  
[{-volume-number volume_numbers | -volume-name volume_names} {-lun luns}]
```

■ Parameter

-lg-number or -lg-name

This parameter specifies the LUN group identifier to be changed. Only one LUN group can be specified at the same time. For details, refer to ["1.2.17 LUN Group Syntax" \(page 46\)](#).

source_lg_number LUN group number

source_lg_name LUN group name

-name Optional. This parameter specifies the new LUN group name. Only one name can be specified at the same time. If omitted, the existing setting is not changed.

name New LUN group name

-volume-number or -volume-name

Optional. This parameter specifies the volume identifiers to add a definition to the specified LUN group, and is paired with the "-lun" parameter. One or more parameters can be specified at the same time. If omitted, the existing setting is not changed. For details, refer to ["1.2.11 Volume Syntax" \(page 40\)](#). If two or more LUNs are specified, these parameters must also be specified in the same order as the associated volumes. Any already assigned definitions cannot be specified.

Example:

```
-volume-number 10-12 -lun 1-3
```

-> The volume #10 and LUN 1 are pairs.

-> The volume #11 and LUN 2 are pairs.

-> The volume #12 and LUN 3 are pairs.

```
-volume-name v1,v2 -lun 1-2
```

-> The volume named "v1" and LUN 1 are pairs.

-> The volume named "v2" and LUN 2 are pairs.

volume_numbers Volume number

volume_names Volume name

-lun Optional. This parameter specifies LUNs to add a definition to the specified LUN group, and is paired with volume identifiers. If omitted, the existing setting is not changed. If two or more volume identifiers are specified, these parameters must be specified in the same order as the associated LUNs. Any already assigned definitions cannot be specified. LUNs that are defined in the specified LUN group cannot be specified. Two or more parameters can be specified by separating them with a comma (,), a hyphen (-), or both.

Example: -lun 0,1 -lun 0-10 -lun 1,6-8

/luns Host LUN

■ Example(s)

The following example changes the LUN group named "LUN001". The new name is "NEW_LUN002":

```
CLI> set lun-group -lg-name LUN001 -name NEW_LUN002
```

In the following example, the first command creates the LUN group named "LUN001". This LUN group will contain a definition of the association of consecutive volumes #0 – #10 and consecutive LUNs #0 – #10. The second command adds other definitions to the LUN group. Consecutive volumes #101 – #105 will be associated with LUNs #11 – #15. Existing definitions are retained after the second command is executed. Only the definitions specified in the second command are added:

```
CLI> create lun-group -name LUN001 -volume-number 0-10 -lun 0-10  
CLI> set lun-group -lg-name LUN001 -volume-number 101-105 -lun 11-15
```

The following example displays the results when the specified volumes #101 and #102 belong to different ports or groups:

```
CLI> set lun-group -lg-name LUN001 -volume-number 101-105 -lun 11-15  
Warning: The following volumes have been linked with other group(s) and/or port(s).  
Volume Number      [101,102]
```

copy lun-group

This command copies a LUN group.

■ Syntax

```
copy lun-group -name name  
{-source-lg-number source_lg_number | -source-lg-name source_lg_name}
```

■ Parameter

-name This parameter specifies the LUN group name of the target LUN group. Only one name can be specified at the same time.

name New LUN group name

-source-lg-number or **-source-lg-name**

This parameter specifies the LUN group identifier which is the source of the copy. Only one LUN group can be specified at the same time. For details, refer to ["1.2.17 LUN Group Syntax" \(page 46\)](#).

source_lg_number LUN group number

source_lg_name LUN group name

■ Example(s)

The following example copies the definitions contained in the LUN group named "LUN001", and creates a new LUN group named "LUN002" with those same definitions:

```
CLI> copy lun-group -name LUN002 -source-lg-name LUN001
```

delete lun-group

This command deletes the specified LUN groups, or releases a definition from the specified LUN group.

Syntax

```
delete lun-group {-lg-number lg_numbers | -lg-name lg_names} [-lun luns]
```

Parameter

-lg-number or -lg-name

This parameter specifies the LUN group identifies to be deleted. One or more parameters can be specified at the same time. For details, refer to ["1.2.17 LUN Group Syntax" \(page 46\)](#). By specifying the "-lun" parameter, one or more definitions included in the LUN group can be deleted. In this case, the LUN group is not deleted.

lg_numbers LUN group number

lg_names LUN group name

-lun Optional. This parameter specifies the LUNs that will be removed from the LUN group definitions. Two or more parameters can be specified by separating them with a comma (,), a hyphen (-), or both. If omitted, the specified LUN groups are deleted.

Example: -lun 1,2 -lun 1-3 -lun 1-3,5

luns Host LUN

Example(s)

The following example only deletes LUN group #1:

```
CLI> delete lun-group -lg-number 1
```

The following example deletes LUN groups #1 and #2:

```
CLI> delete lun-group -lg-number 1,2
```

The following example only releases the definition of LUN #1 associated with the LUN group named "LUN001":

```
CLI> delete lun-group -lg-name LUN001 -lun 1
```

The following example only releases the definitions of LUN #1 and #2 associated with the LUN group named "LUN001":

```
CLI> delete lun-group -lg-name LUN001 -lun 1,2
```

The following example respectively releases the definitions of LUN #1 and #2 that are associated with the LUN groups named "LUN001" and "LUN002":

```
CLI> delete lun-group -lg-name LUN001,LUN002 -lun 1,2
```

show host-path-state

This command displays the path status (access availability status from the target host) that is defined in the mapping of the associated host interface ports that are set.

Syntax

```
show host-path-state [-port {port_numbers | all}]
```

Parameter

-port Optional. This parameter specifies the host interface port that is to be displayed. Multiple parameters can be set by separating each one by a comma (.). If omitted, the process is performed as if all of the host interface ports are selected.

Example: -port 000,100

For details, refer to ["1.2.15 Host Interface Port Syntax" \(page 44\)](#).

port_numbers Host interface port

xyz "x" is the controller module (CM) number, "y" is the CA number, and "z" is the host port number (DX60 S4/DX100 S4/DX200 S4, DX500 S4/DX600 S4, DX60 S3/DX100 S3/DX200 S3, DX500 S3/DX600 S3, DX8100 S3, AF250 S2/AF650 S2, AF250/AF650, and DX200F only).

Example: "123" indicates CM#1-CA#2- Port#3

wxyz "w" is the controller enclosure (CE) number, "x" is the controller module (CM) number, "y" is the CA number, and "z" is the host port number (DX8700 S3/DX8900 S3 only).

Example: "0123" indicates CE#0-CM#1-CA#2- Port#3

all All of the host interface ports (default)

Output

Item name	Description
Port	Port number
Host	Host identifiers
No.	Host number
Name	Host name
Path State	Access availability status from the target host

■ Example(s)

The following example displays the status of all the paths for all the associated host interface ports (for the DX60 S4/DX100 S4/DX200 S4, the DX500 S4/DX600 S4, the DX60 S3/DX100 S3/DX200 S3, the DX500 S3/DX600 S3, the DX8100 S3, the AF250 S2/AF650 S2, the AF250/AF650, and the DX200F):

```
CLI> show host-path-state
Port                Host                Path State
                   No.   Name
-----
CM#0 CA#0 Port#0    0 FC#0             Online
CM#0 CA#0 Port#0    1 FC#1             Online
CM#1 CA#0 Port#1    0 FC#0             Online
CM#1 CA#0 Port#1    1 FC#1             Offline
```

The following example displays the status of all the paths for all the associated host interface ports (for the DX8700 S3/DX8900 S3):

```
CLI> show host-path-state
Port                Host                Path State
                   No.   Name
-----
CE#0 CM#0 CA#0 Port#0 0 FC#0             Online
CE#0 CM#0 CA#0 Port#0 1 FC#1             Online
CE#0 CM#1 CA#0 Port#1 0 FC#0             Online
CE#0 CM#1 CA#0 Port#1 1 FC#1             Offline
```

The following example displays the status of all the paths associated with host interface port CM#0 CA#0 Port#0 (for the DX60 S4/DX100 S4/DX200 S4, the DX500 S4/DX600 S4, the DX60 S3/DX100 S3/DX200 S3, the DX500 S3/DX600 S3, the DX8100 S3, and the DX200F):

```
CLI> show host-path-state -port 000
Port                Host                Path State
                   No.   Name
-----
CM#0 CA#0 Port#0    0 FC#0             Online
CM#0 CA#0 Port#0    1 FC#1             Online
```

The following example displays the status of all the paths associated with host interface port CE#0 CM#0 CA#0 Port#0 (for the DX8700 S3/DX8900 S3):

```
CLI> show host-path-state -port 0000
Port                Host                Path State
                   No.   Name
-----
CE#0 CM#0 CA#0 Port#0 0 FC#0             Online
CE#0 CM#0 CA#0 Port#0 1 FC#1             Online
```

set host-path-state

This command changes the access availability status from hosts that are associated to the specified host interface port that is defined in the mapping and changes the path access status.

Syntax

```
set host-path-state -port port_numbers {-host-number host_numbers | -host-name host_names}  
-state {offline | online}
```

Parameter

-port This parameter specifies the host interface port. Multiple parameters can be set by separating each one by a comma (,).

Example: -port 000,100

For details, refer to ["1.2.15 Host Interface Port Syntax" \(page 44\)](#).

port_numbers Host interface port

xyz "x" is the controller module (CM) number, "y" is the CA number, and "z" is the host port number (DX60 S4/DX100 S4/DX200 S4, DX500 S4/DX600 S4, DX60 S3/DX100 S3/DX200 S3, DX500 S3/DX600 S3, DX8100 S3, AF250 S2/AF650 S2, AF250/AF650, and DX200F only).

Example: "123" indicates CM#1-CA#2-Port#3

wxyz "w" is the controller enclosure (CE) number, "x" is the controller module (CM) number, "y" is the CA number, and "z" is the host port number (DX8700 S3/DX8900 S3 only).

Example: "0123" indicates CE#0-CM#1-CA#2- Port#3

-host-number or -host-name

This parameter specifies the identifier of the related host. Multiple parameters can be set at the same time. For details on the contents that can be entered, refer to ["1.2.12 Host Syntax" \(page 41\)](#). When multiple parameters are set, the parameters must be set to correspond to the order of the parameters that are specified for the "-port" parameter.

host_numbers Host number

host_names Host name

-state This parameter specifies whether to allow access from the target host.

offline Access is not allowed.

online Access is allowed.

Example(s)

The following example does not allow access for the host#0 of the host interface port CM#1 CA#0 Port#0:

```
CLI> set host-path-state -port 100 -host-number 0 -state offline
```

show host-lu-qos-performance

This command displays the Host-LU QoS performance measurement information for each port, host, and LUN. To display this information, GUI or CLI must be used to obtain this information.

Caution

This command is not supported in the DX60 S4/DX60 S3.

Syntax

```
show host-lu-qos-performance [-port port_numbers  
[-host-number host_number | -host-name host_name]]
```

Parameter

-port Optional. This parameter specifies the port and the LUN or host that are associated with the port for which the Host-LU QoS performance measurement information is to be displayed. Multiple ports cannot be specified.

Example: -port 000,100

For details, refer to ["1.2.15 Host Interface Port Syntax" \(page 44\)](#).

port_numbers Port interface port

xyz "x" is the controller module (CM) number, "y" is the CA number, and "z" is the host port number (DX100 S4/DX200 S4, DX500 S4/DX600 S4, DX100 S3/DX200 S3, DX500 S3/DX600 S3, DX8100 S3, AF250 S2/AF650 S2, AF250/AF650, and DX200F only).
Example: "123" indicates CM#1-CA#2-Port#3

wxyz "w" is the controller enclosure (CE) number, "x" is the controller module (CM) number, "y" is the CA number, and "z" is the host port number (DX8700 S3/DX8900 S3 only).
Example: "0123" indicates CE#0-CM#1-CA#2- Port#3

-host-number or -host-name

Optional. This parameter specifies the host or the LUNs that are associated with the host for which the Host-LU QoS performance measurement information is to be displayed. The "-port" parameter must be set to use this parameter. Multiple hosts cannot be specified. For details, refer to ["1.2.12 Host Syntax" \(page 41\)](#).

host_number Host number

host_name Host name

Output

- When all of the parameters are omitted.

Item name	Description
Port	Port number
IOPS	Number of I/Os per second for a port
Ave	Average number of I/Os per second for a port
Min	Minimum number of I/Os per second for a port

Item name	Description
Max	Maximum number of I/Os per second for a port
Throughput(MB/s)	Transfer amount per second for a port (in MB/s)
Ave	Average transfer amount per second for a port
Min	Minimum transfer amount per second for a port
Max	Maximum transfer amount per second for a port
Delay Time(ms)	Delay time (in milliseconds)
Total	Accumulated delay time for the start of a command due to the QoS control of a port. "Overflow" is displayed when a long time passes from the start of performance measurement to the end of performance measurement and the accumulated delay time exceeds the limit.
Ave	Average delay time for a single command due to the QoS control of a port

- When the port number is specified (the host affinity mode is enabled).

Item name	Description
CM#xCA#yPort#z	Host interface port number (only for the DX100 S4/DX200 S4, the DX500 S4/DX600 S4, the DX100 S3/DX200 S3, the DX500 S3/DX600 S3, the DX8100 S3, the AF250 S2/AF650 S2, the AF250/AF650, and the DX200F)
CE#w CM#xCA#yPort#z	Host interface port number (only for the DX8700 S3/DX8900 S3)
Port Type	Port type
Host Affinity	Host affinity (Enable: enabled, Disable: disabled)
Performance Monitoring	Measurement status (ON: performance is being measured, OFF: performance measuring is stopped)
Monitoring Start Time	Performance measurement start time
Monitoring Stop Time	Performance measurement stop time
IOPS	Number of I/Os per second for a port
Ave	Average number of I/Os per second for a port
Min	Minimum number of I/Os per second for a port
Max	Maximum number of I/Os per second for a port
Throughput(MB/s)	Transfer amount per second for a port (in MB/s)
Ave	Average transfer amount per second for a port
Min	Minimum transfer amount per second for a port
Max	Maximum transfer amount per second for a port
Delay Time(ms)	Delay time (in milliseconds)
Total	Accumulated delay time for the start of a command due to the QoS control of a port. "Overflow" is displayed when a long time passes from the start of performance measurement to the end of performance measurement and the accumulated delay time exceeds the limit.
Ave	Average delay time for a single command due to the QoS control of a port
Host	Host interface
No.	Host number
Name	Host name
IOPS	Number of I/Os per second for a host
Ave	Average number of I/Os per second for a host
Min	Minimum number of I/Os per second for a host
Max	Maximum number of I/Os per second for a host

Item name	Description
Throughput(MB/s)	Transfer amount per second for a host (in MB/s)
Ave	Average transfer amount per second for a host
Min	Minimum transfer amount per second for a host
Max	Maximum transfer amount per second for a host
Delay Time(ms)	Delay time (in milliseconds)
Total	Accumulated delay time for the start of a command due to the QoS control of a host. "Overflow" is displayed when a long time passes from the start of performance measurement to the end of performance measurement and the accumulated delay time exceeds the limit.
Ave	Average delay time for a single command due to the QoS control of a host

- When the port number is specified (the host affinity mode is disabled).

Item name	Description
CM#xCA#yPort#z	Host interface port number (only for the DX100 S4/DX200 S4, the DX500 S4/DX600 S4, the DX100 S3/DX200 S3, the DX500 S3/DX600 S3, the DX8100 S3, the AF250 S2/AF650 S2, the AF250/AF650, and the DX200F)
CE#w CM#xCA#yPort#z	Host interface port number (only for the DX8700 S3/DX8900 S3)
Port Type	Port type
Host Affinity	Host affinity (Enable: enabled, Disable: disabled)
Performance Monitoring	Measurement status (ON: performance is being measured, OFF: performance measuring is stopped)
Monitoring Start Time	Performance measurement start time
Monitoring Stop Time	Performance measurement stop time
IOPS	Number of I/Os per second for a port
Ave	Average number of I/Os per second for a port
Min	Minimum number of I/Os per second for a port
Max	Maximum number of I/Os per second for a port
Throughput(MB/s)	Transfer amount per second for a port (in MB/s)
Ave	Average transfer amount per second for a port
Min	Minimum transfer amount per second for a port
Max	Maximum transfer amount per second for a port
Delay Time(ms)	Delay time (in milliseconds)
Total	Accumulated delay time for the start of a command due to the QoS control of a port. "Overflow" is displayed when a long time passes from the start of performance measurement to the end of performance measurement and the accumulated delay time exceeds the limit.
Ave	Average delay time for a single command due to the QoS control of a port
LUN	LUN number
IOPS	Number of I/Os per second for a LUN
Ave	Average number of I/Os per second for a LUN
Min	Minimum number of I/Os per second for a LUN
Max	Maximum number of I/Os per second for a LUN
Throughput(MB/s)	Transfer amount per second for a LUN (in MB/s)
Ave	Average transfer amount per second for a LUN
Min	Minimum transfer amount per second for a LUN
Max	Maximum transfer amount per second for a LUN

Item name	Description
Delay Time(ms)	Delay time (in milliseconds)
Total	Accumulated delay time for the start of a command due to the QoS control of a LUN. "Overflow" is displayed when a long time passes from the start of performance measurement to the end of performance measurement and the accumulated delay time exceeds the limit.
Ave	Average delay time for a single command due to the QoS control of a LUN

- When the port number and the host are specified (the host affinity mode is enabled).

Item name	Description
CM#xCA#yPort#z	Host interface port number (only for the DX100 S4/DX200 S4, the DX500 S4/DX600 S4, the DX100 S3/DX200 S3, the DX500 S3/DX600 S3, the DX8100 S3, the AF250 S2/AF650 S2, the AF250/AF650, and the DX200F)
CE#w CM#xCA#yPort#z	Host interface port number (only for the DX8700 S3/DX8900 S3)
Port Type	Port type
Host Affinity	Host affinity (Enable: enabled, Disable: disabled)
Performance Monitoring	Measurement status (ON: performance is being measured, OFF: performance measuring is stopped)
Monitoring Start Time	Performance measurement start time
Monitoring Stop Time	Performance measurement stop time
Host No.	Host number
Host Name	Host name
WWN	Host WWN (when the port type is FC or FCoE)
SAS Address	Host SAS address (when the port type is SAS)
iSCSI Name	Host iSCSI name (when the port type is iSCSI)
IP Address	Host IP address (when the port type is iSCSI)
IOPS	Number of I/Os per second for a host
Ave	Average number of I/Os per second for a host
Min	Minimum number of I/Os per second for a host
Max	Maximum number of I/Os per second for a host
Throughput(MB/s)	Transfer amount per second for a host (in MB/s)
Ave	Average transfer amount per second for a host
Min	Minimum transfer amount per second for a host
Max	Maximum transfer amount per second for a host
Delay Time(ms)	Delay time (in milliseconds)
Total	Accumulated delay time for the start of a command due to the QoS control of a host. "Overflow" is displayed when a long time passes from the start of performance measurement to the end of performance measurement and the accumulated delay time exceeds the limit.
Ave	Average delay time for a single command due to the QoS control of a host
LUN	LUN number
IOPS	Number of I/Os per second for a LUN
Ave	Average number of I/Os per second for a LUN
Min	Minimum number of I/Os per second for a LUN
Max	Maximum number of I/Os per second for a LUN

Item name	Description
Throughput(MB/s)	Transfer amount per second for a LUN (in MB/s)
Ave	Average transfer amount per second for a LUN
Min	Minimum transfer amount per second for a LUN
Max	Maximum transfer amount per second for a LUN
Delay Time(ms)	Delay time (in milliseconds)
Total	Accumulated delay time for the start of a command due to the QoS control of a LUN. "Overflow" is displayed when a long time passes from the start of performance measurement to the end of performance measurement and the accumulated delay time exceeds the limit.
Ave	Average delay time for a single command due to the QoS control of a LUN

Note

When the port type that is described above is iSCSI and a host without an IP address is specified, performance measurement information is obtained from multiple IP address. When an IP address is not specified, "IP Address: host IP address" shows the actual IP address of the host that is logged in to the ETERNUS DX/AF.

Example(s)

The following example displays the performance measurement information when the parameters are omitted (for the DX100 S4/DX200 S4, the DX500 S4/DX600 S4, the DX100 S3/DX200 S3, the DX500 S3/DX600 S3, the DX8100 S3, the AF250 S2/AF650 S2, the AF250/AF650, and the DX200F).

For CM#1 CA#0 Port#0, Delay Total Time exceeds the limit and "Overflow" is displayed:

```
CLI> show host-lu-qos-performance
Port          IOPS          Throughput (MB/s)          Delay Time (ms)
Ave      Min      Max      Ave      Min      Max      Total      Ave
-----
CM#0 CA#0 Port#0      100      10      100      2      1      3      20      10
CM#0 CA#0 Port#1      10      1      30      10      2      100      120      10
CM#1 CA#0 Port#0      10      1      30      10      2      100      Overflow      10
```

The following example displays the performance measurement information when no parameters are set (for the DX8700 S3/DX8900 S3).

For CE#0 CM#1 CA#0 Port#0, Delay Total Time exceeds the limit and "Overflow" is displayed:

```
CLI> show host-lu-qos-performance
Port          IOPS          Throughput (MB/s)          Delay Time (ms)
Ave      Min      Max      Ave      Min      Max      Total      Ave
-----
CE#0 CM#0 CA#0 Port#0      100      10      100      2      1      3      20      10
CE#0 CM#0 CA#0 Port#1      10      1      30      10      2      100      120      10
CE#0 CM#1 CA#0 Port#0      10      1      30      10      2      100      Overflow      10
```

The following example displays the performance measurement information when a host interface port with the host affinity mode enabled is set:

```
CLI> show host-lu-qos-performance -port 000
CM#0 CA#0 Port#0 Port Performance Information
Port Type          FC
Host Affinity      Enable
Performance Monitoring ON
Monitoring Start Time 2012-04-11 12:00:00
Monitoring Stop Time 2012-04-11 12:05:00
```

Port	Total	IOPS			Throughput (MB/s)			Delay Time (ms)	
		Ave	Min	Max	Ave	Min	Max	Total	Ave
000	100	1	100	2	1	100	1000	1	

LUN	IOPS			Throughput (MB/s)			Delay Time (ms)	
	Ave	Min	Max	Ave	Min	Max	Total	Ave
0	100	10	120	2	1	5	Overflow	15
1	1555	35	5820	3	1	8	120	10

The following example displays the performance measurement information when a host interface port with the host affinity mode disabled is set:

```
CLI> show host-lu-qos-performance -port 001
CM#0 CA#0 Port#1 Port Performance Information
Port Type          FC
Host Affinity      Disable
Performance Monitoring OFF
Monitoring Start Time 2012-04-11 12:00:00
Monitoring Stop Time 2012-04-11 12:05:00
```

Port	Total	IOPS			Throughput (MB/s)			Delay Time (ms)	
		Ave	Min	Max	Ave	Min	Max	Total	Ave
001	100	1	100	2	1	100	1000	1	

LUN	IOPS			Throughput (MB/s)			Delay Time (ms)	
	Ave	Min	Max	Ave	Min	Max	Total	Ave
0	100	10	120	2	1	5	1000	15

The following example displays the performance measurement information when a host interface port with the host affinity mode enabled and a host (the port type is FC) are set:

```
CLI> show host-lu-qos-performance -port 000 -host-number 0
CM#0 CA#0 Port#0 Port Performance Information
Port Type          FC
Host Affinity      Enable
Performance Monitoring ON
Monitoring Start Time 2012-04-11 12:00:00
Monitoring Stop Time 2012-04-11 12:05:00
```

Host Performance Information

```
Host No.          0
Host Name        HOST#0
WWN              aabbccddeeff0011
```

Host	Total	IOPS			Throughput (MB/s)			Delay Time (ms)	
		Ave	Min	Max	Ave	Min	Max	Total	Ave
000	100000	80000	120000	24	9	34	Overflow	56	

LUN	IOPS			Throughput (MB/s)			Delay Time (ms)	
	Ave	Min	Max	Ave	Min	Max	Total	Ave
0	100	10	120	2	1	5	Overflow	15
1	1555	35	5820	3	1	8	120	10

The following example displays the performance measurement information when a host interface port with the host affinity mode enabled and a host (the port type is iSCSI and the host IP address is set) are set:

```

CLI> show host-lu-qos-performance -port 000 -host-number 0
CM#0 CA#0 Port#0 Port Performance Information
Port Type          ISCSI
Host Affinity      Enable
Performance Monitoring ON
Monitoring Start Time 2012-04-11 12:00:00
Monitoring Stop Time 2012-04-11 12:05:00

Host Performance Information
Host No.           0
Host Name          HOST#0
iSCSI Name         iqn.1991-05.com.microsoft
IP Address         192.168.43.1

      IOPS                Throughput (MB/s)                Delay Time (ms)
      Ave      Min      Max      Ave      Min      Max      Total      Ave
-----
Host Total      2000      25      5000      24      9      34      555      12

LUN            IOPS                Throughput (MB/s)                Delay Time (ms)
LUN            Ave      Min      Max      Ave      Min      Max      Total      Ave
-----
0              100      10      120      2      1      5      420      15
1              1555     35      5820     3      1      8      120      10
    
```

The following example displays the performance measurement information when a host interface port with the host affinity mode enabled and a host (the port type is iSCSI and the host IP address is not set) are set:

```

CLI> show host-lu-qos-performance -port 000 -host-number 0
CM#0 CA#0 Port#0 Port Performance Information
Port Type          ISCSI
Host Affinity      Enable
Performance Monitoring ON
Monitoring Start Time 2012-04-11 12:00:00
Monitoring Stop Time 2012-04-11 12:05:00

Host Performance Information
Host No.           0
Host Name          HOST#0
iSCSI Name         iqn.1991-05.com.microsoft
IP Address         192.168.43.151

      IOPS                Throughput (MB/s)                Delay Time (ms)
      Ave      Min      Max      Ave      Min      Max      Total      Ave
-----
Host Total      2000      25      5000      24      9      34      555      12

LUN            IOPS                Throughput (MB/s)                Delay Time (ms)
LUN            Ave      Min      Max      Ave      Min      Max      Total      Ave
-----
0              100      10      120      2      1      5      420      15
1              1555     35      5820     3      1      8      120      10

Host Performance Information
Host No.           0
Host Name          HOST#0
iSCSI Name         iqn.1991-05.com.microsoft
IP Address         192.168.43.152

      IOPS                Throughput (MB/s)                Delay Time (ms)
      Ave      Min      Max      Ave      Min      Max      Total      Ave
-----
Host Total      2000      25      5000      24      9      34      555      12

LUN            IOPS                Throughput (MB/s)                Delay Time (ms)
LUN            Ave      Min      Max      Ave      Min      Max      Total      Ave
-----
0              100      10      120      2      1      5      420      15
1              1555     35      5820     3      1      8      120      10
    
```

The following example displays the performance measurement information when performance measurements are not performed and a host interface port is set:

```
CLI> show host-lu-qos-performance -port 000
CM#0 CA#0 Port#0 Port Performance Information
Port Type          ISCSI
Host Affinity      Enable
Performance Monitoring OFF
```

The following example displays the performance measurement information when performance measurements are not performed and a host interface port is set (for the DX8700 S3/DX8900 S3):

```
CLI> show host-lu-qos-performance -port 0000
CE#0 CM#0 CA#0 Port#0 Port Performance Information
Port Type          ISCSI
Host Affinity      Enable
Performance Monitoring OFF
```

start host-lu-qos-performance

This command starts the collection of Host-LU QoS performance information.

Caution

This command is not supported in the DX60 S4/DX60 S3.

Syntax

```
start host-lu-qos-performance [-port {port_numbers | all}]
```

Parameter

-port Optional. This parameter specifies the ports from which the Host-LU QoS performance information is collected. Two or more parameters can be specified by separating them with a comma (,).

Example: -port 000, 100

For more details, refer to ["1.2.15 Host Interface Port Syntax" \(page 44\)](#).

<i>port_numbers</i>	Port
<i>xyz</i>	"x" is the controller module (CM) number, "y" is the CA number, and "z" is the host port number (DX100 S4/DX200 S4, DX500 S4/DX600 S4, DX100 S3/DX200 S3, DX500 S3/DX600 S3, DX8100 S3, AF250 S2/AF650 S2, AF250/AF650, and DX200F only). Example: "123" indicates CM#1-CA#2-Port#3
<i>wxyz</i>	"w" is the controller enclosure (CE) number, "x" is the controller module (CM) number, "y" is the CA number, and "z" is the host port number (DX8700 S3/DX8900 S3 only). Example: "0123" indicates CE#0-CM#1-CA#2- Port#3
all	All the ports

Example(s)

The following example starts the collection of Host-LU QoS performance information:

```
CLI> start host-lu-qos-performance
```

The following is an example of when ports are specified (for the DX100 S4/DX200 S4, the DX500 S4/DX600 S4, the DX100 S3/DX200 S3, the DX500 S3/DX600 S3, the DX8100 S3, the AF250 S2/AF650 S2, the AF250/AF650, and the DX200F):

```
CLI> start host-lu-qos-performance -port 000,101
```

stop host-lu-qos-performance

This command stops the collection of Host-LU QoS performance information.

Caution

This command is not supported in the DX60 S4/DX60 S3.

■ Syntax

```
stop host-lu-qos-performance [-port {port_numbers | all}]
```

■ Parameter

-port Optional. This parameter specifies the ports from which the Host-LU QoS performance information is collected. Two or more parameters can be specified by separating them with a comma (,).

Example: -port 000, 100

For more details, refer to ["1.2.15 Host Interface Port Syntax" \(page 44\)](#).

<i>port_numbers</i>	Port
<i>xyz</i>	"x" is the controller module (CM) number, "y" is the CA number, and "z" is the host port number (DX100 S4/DX200 S4, DX500 S4/DX600 S4, DX100 S3/DX200 S3, DX500 S3/DX600 S3, DX8100 S3, AF250 S2/AF650 S2, AF250/AF650, and DX200F only). Example: "123" indicates CM#1-CA#2-Port#3
<i>wxyz</i>	"w" is the controller enclosure (CE) number, "x" is the controller module (CM) number, "y" is the CA number, and "z" is the host port number (DX8700 S3/DX8900 S3 only). Example: "0123" indicates CE#0-CM#1-CA#2- Port#3
all	All the ports

■ Example(s)

The following example stops the collection of Host-LU QoS performance information:

```
CLI> stop host-lu-qos-performance
```

The following example stops the collection of Host-LU QoS performance information for the specified ports:

```
CLI> stop host-lu-qos-performance -port 000,101
```

3.6.8 Host Response

This section explains commands related to set up the host response.

show host-response

This command displays the host response settings. If the host response name or number is omitted, a summary of all host responses is displayed. If the host response name or number is included as a parameter, then the details of the specified host response parameters are displayed.

Syntax

```
show host-response  
[-host-response-number host_response_numbers | -host-response-name host_response_names]
```

Parameter

-host-response-number or -host-response-name

Optional. This parameter specifies the host response identifier and detailed information of the host response is displayed. One or more parameters can be specified. If omitted, a summary list is displayed. For details, refer to ["1.2.14 Host Response Syntax" \(page 43\)](#).

host_response_numbers Host response number

host_response_names Host response name

Output

When a parameter is specified, details of the specified host response is displayed.

Item name	Description
Host Response No.	Host response number
Host Response Name	Host response name
LUN	LUN setting information category
LUN Addressing	LUN addressing format
LUN Expand Mode	Indicates whether the range of the LUN mapping reference is expanded to 4096. (This information is not used when the Flat Space Addressing mode is used for LUN addressing)
ALUA	ALUA setting information category
Asymmetric / Symmetric Logical Unit Access	Access type for volumes
TPGS Mode	Indicates whether Target Port Group Support (TPGS) is enabled.
TPG Referrals	Indicates whether the TPG Referrals function is enabled.
Inquiry Command	Inquiry Command setting information category
Peripheral Device Type (Peripheral Device Addressing)	Peripheral Device Type for unconnected LUNs in the Peripheral Device Addressing mode
Peripheral Device Type (Flat Space Addressing)	Peripheral Device Type for LUN0 in the Flat Space Addressing mode
SCSI Version	SCSI version
NACA	Indicates whether the NACA bit is set.
Device ID Type	Designator Type, which includes information for identification of the logical unit in the Device ID page

Item name	Description
Product ID	Indicates whether the "Default" product ID (product ID for the ETERNUS DX S4 series, the ETERNUS DX S3 series, the AF250 S2/AF650 S2, the AF250/AF650, or the DX200F) is responded or the "eternus-dx-s2" product ID (product ID for the ETERNUS DX S2 series) is responded.
Test Unit Ready Command	Test Unit Read Command setting information category
Response Status for Reservation	Response status for reservation
Sense	Sense setting information category
Change Volume Mapping	Indicates whether a change in volume mapping is notified.
Change Volume Capacity	Indicates whether a change in the volume capacity is notified.
Vendor Unique Sense	Indicates whether a vendor unique sense code is notified.
Mode Sense Command	MODE SENSE command information category
Response Status for Reservation (Write Exclusive)	Displays the response to the MODE SENSE command issued during Reservation. This is enabled only if the Reservation Type is Write Exclusive.
Other	Other setting information category
Command Monitoring Time	Monitoring time for command executions
Load Balance Response Status	Response status for load balancing
iSCSI Discovery Reply Mode	iSCSI Discovery response mode
iSCSI Reservation Range	iSCSI reservation unit

When no parameters are specified, a summary list is displayed.

Item name	Description
Host Response No.	Host response number
Host Response Name	Host response name

■ Example(s)

The following example displays the details of host response #0:

```
CLI> show host-response -host-response-number 0
Host Response No.0
Host Response Name                               Default
LUN
  LUN Addressing                                Peripheral Device Addressing (Default)
  LUN Expand Mode                               Disable (Default)
ALUA
  Asymmetric / Symmetric Logical Unit Access    ACTIVE-ACTIVE / PREFERRED_PATH (Default)
  TPGS Mode                                     Enable (Default)
  TPG Referrals                                 Disable (Default)
Inquiry Command
  Peripheral Device Type                         No Device Type(3Fh) (Default)
  (Peripheral Device Addressing)
  Peripheral Device Type                         No Device Type(3Fh) (Default)
  (Flat Space Addressing)
  SCSI Version                                  Version 6 (Default)
  NACA                                          OFF (Default)
  Device ID Type                                Type3 (Default)
  Product ID                                    Default
Test Unit Ready Command
  Response Status for Reservation                Normal (Default)
Sense
  Change Volume Mapping                         Report (Default)
  Change Volume Capacity                        Report (Default)
  Vendor Unique Sense                           Not Report (Default)
Mode Sense Command
  Response Status for Reservation (Write Exclusive) Conflict (Default)
Other
  Command Monitoring Time                       25 (Default)
  Load Balance Response Status                  Unit Attention (Default)
  iSCSI Discovery Reply Mode                    Reply all port (Default)
  iSCSI Reservation Range                       System (Default)
```

The following example lists a summary of all the existing host responses:

```
CLI> show host-response
Host Response
No. Name
-----
  0 Default
250 Solaris MPxIO
251 HP-UX
252 AIX
253 AIX VxVM
254 VS850/SVC
255 BS2000
```

set host-response

This command defines or changes host responses. The maximum number of available host response definitions depends on the number of available host interface ports and the system model. Host response #0 is reserved by the system as a default. The name of default #0 cannot be changed. However, the values can be modified.

When initially defining a host response, the host response number must be used and a host response name must be set.

■ Syntax

```
set host-response
{-host-response-number host_response_number |
-host-response-name host_response_name}
[-name name]
[-lun-address {prhl-dev | flat-space}]
[-lun-expand-mode {enable | disable}]
[-symmetric {active | passive}]
[-tpgs {enable | disable}]
[-tpg-referrals {enable | disable}]
[-prhl-dev-type {no-dev-type | no-support | no-connect}]
[-flat-prhl-dev-type {no-dev-type | ctrl-dev}]
[-scsi-version {6 | 5 | 4 | 3}] [-naca {on | off}]
[-dev-id-type {type1 | type1-3 | type3}]
[-product-id {default | eternus-dx-s2}]
[-rsv-rsp-status {enable | disable}]
[-lun-mapping {enable | disable}]
[-lun-capacity {enable | disable}]
[-vendor-unique-sense {enable | disable}]
[-monitor-time monitor_time]
[-load-balance-rsp-status {busy | queue-full | unit-attention}]
[-iscsi-disc-rsp {all | port}]
[-iscsi-rsv-range {port | system}]
[-rsv-mode-sense {good | conflict}]
```

■ Parameter

-host-response-number or -host-response-name

This parameter specifies the host response identifier. The system default is host response #0. When a new host response is created, an unassigned host response number must be specified. Check which host response numbers have been assigned using the "show host-response" command. Only one parameter can be specified at the same time. For details, refer to ["1.2.14 Host Response Syntax" \(page 43\)](#).

Caution

Host responses with the following combination of numbers and names cannot be changed.

- No.0 Default
- No.201 – 248 Preset reserved
- No.250 Solaris MPxIO
- No.251 HP-UX
- No.252 AIX

- No.253 AIX VxVM
- No.254 VS850/SVC
- No.255 BS2000

host_response_number Host response number

host_response_name Host response name

-name Optional. This parameter specifies the host response name for this host response identifier. If this parameter is omitted, the existing setting remains unchanged. This parameter cannot be specified for host response #0. For details, refer to ["1.2.6 Alias Name Syntax" \(page 35\)](#).

 **Caution**

This parameter is required when initially defining a host response.

name Host response name

-lun-address

Optional. This parameter specifies the format for LUN addressing. If this parameter is omitted, the existing setting remains unchanged.

prhl-dev The Peripheral Device Addressing mode is set. (Default)
The range for LUN mapping that this mode can reference is specified by the "-lun-expand-mode" parameter.

flat-space The Flat Space Addressing mode is set.
With this mode, up to 4096 LUNs can be referenced for LUN mapping.

-lun-expand-mode

Optional. This parameter specifies whether the range of LUN mapping reference is expanded to 4096 when "prhl-dev" is specified for the "-lun-address" parameter. When "flat-space" is specified for the "-lun-address" parameter, this parameter cannot be specified. If this parameter is omitted, the existing setting remains unchanged.

enable The range of the LUN mapping reference is set to 4096.

disable The range of the LUN mapping reference is set to 256. (default)

-symmetric Optional. This parameter specifies the method that is used to access a Logical Unit. If omitted, the existing setting is not changed.

active ACTIVE/ACTIVE (Default for the DX8700 S3/DX8900 S3)

passive ACTIVE-ACTIVE/PREFERRED-PATH (Default for the DX60 S4/DX100 S4/DX200 S4, the DX500 S4/DX600 S4, the DX60 S3/DX100 S3/DX200 S3, the DX500 S3/DX600 S3, the DX8100 S3, the AF250 S2/AF650 S2, the AF250/AF650, and the DX200F)

-tpgs Optional. This parameter specifies whether to enable Target Port Group Support (TPGS).

enable TPGS is enabled (default).

disable TPGS is disabled.

-tpg-referrals

Optional. This parameter specifies whether to enable the TPG Referrals. When "enable" is set for this parameter, TPG Referrals are only performed when TPGS is enabled and Asymmetric/Symmetric Logical Unit Access is set to ACTIVE/ACTIVE-PRFERRED_PATH.

 **Caution**

Set "enable" for this parameter only for connection environments in which the ETERNUS Multipath Driver that is being used supports TPG Referrals.

- enable TPG Referrals is enabled.
- disable TPG Referrals is disabled (default).

-prhl-dev-type

Optional. This parameter specifies the Byte-0 value for the Inquiry command response. If this parameter is omitted, the existing setting remains unchanged.

- no-dev-type The Byte-0 value is converted to "0x3F (No Device Type)" for the response. (default)
- no-support The Byte-0 value is converted to "0x7f (Not Supported)" for the response.
- no-connect The Byte-0 value is converted to "0x20 (Not Connected)" for the response.

-flat-prhl-dev-type

Optional. This parameter specifies the peripheral device type for LUN0 when the Flat Space Addressing mode is used.

- no-dev-type No Device Type (3Fh) (default)
- ctrl-dev Controller Device (0Ch)

-scsi-version

Optional. This parameter specifies the data version of the Inquiry Standard. If this parameter is omitted, the existing setting remains unchanged.

- 6 The data version is 6th (default).
- 5 The data version is 5th.
- 4 The data version is 4th.
- 3 The data version is 3rd.

-naca

Optional. This parameter specifies whether the NACA bit is set. If this parameter is omitted, the existing setting remains unchanged.

- on The NACA bit is set.
- off The NACA bit is not set.

-dev-id-type

Optional. This parameter specifies the Vital Product Data (VPD) information type to respond to the host. The VPD information contains the device information (including the Vendor ID, the product ID for each model, and the volume number) of the volume. Type 1 and Type 3 indicate the data format. If this parameter is omitted, the existing setting remains unchanged.

- type1 type1
- type1-3 type1 + type3
- type3 type3 (default)

- product-id** Optional. This parameter specifies which product ID is responded. If this parameter is omitted, the existing setting remains unchanged.
- | | |
|---------------|---|
| default | The default product ID (ETERNUS DX S4 series, ETERNUS DX S3 series, ETERNUS AF series, or DX200F) is responded. |
| eternus-dx-s2 | The product ID for the ETERNUS DX S2 series is responded. |
- rsv-rsp-status** Optional. This parameter specifies the Reservation Conflict response corresponding to the Test Unit Ready. If this parameter is omitted, the existing setting remains unchanged.
- | | |
|---------|--------------------------------------|
| enable | This function is enabled. |
| disable | This function is disabled. (default) |
- lun-mapping** Optional. This parameter specifies if the notification is sent when the LUN mapping is changed. If this parameter is omitted, the existing setting remains unchanged.
- | | |
|---------|--------------------|
| enable | Notified (default) |
| disable | Not notified |
- lun-capacity** Optional. This parameter specifies if a notification is sent when the LUN capacity is changed. If this parameter is omitted, the existing setting remains unchanged.
- | | |
|---------|--------------------|
| enable | Notified (default) |
| disable | Not notified |
- vendor-unique-sense** Optional. This parameter specifies whether an asynchronous sense, which is a vendor unique sense code that does not link with host I/Os, is notified. If this parameter is omitted, the existing setting remains unchanged.
- | | |
|---------|------------------------|
| enable | Notified |
| disable | Not notified (default) |
- monitor-time** Optional. This parameter specifies the timeout value of a host command. The range of the values is 10 – 255 and the unit for timeout is in seconds. If this parameter is omitted, the existing setting remains unchanged. The default value is 25 seconds.
- | | |
|---------------------|--|
| <i>monitor_time</i> | Timeout value of a host command (10 – 255 seconds) |
|---------------------|--|
- load-balance-rsp-status** Optional. This parameter specifies the response status responded to host servers. If this parameter is omitted, the existing setting remains unchanged.
- | | |
|----------------|---|
| busy | Busy status is responded to host servers. |
| queue-full | Queue-Full status is responded to host servers. |
| unit-attention | Unit-Attention status is responded to host servers. (default) |

-iscsi-disc-rsp

Optional. This parameter specifies the reply mode for the iSCSI Discovery request.

- | | |
|------|---|
| all | Replies to the server with the information for all the iSCSI ports (iSCSI names and IP addresses). |
| port | Replies to the server with only the information for the specified iSCSI ports (iSCSI names and IP addresses). |

-iscsi-rsv-range

Optional. This parameter specifies the reservation management range for iSCSI connections.

- | | |
|--------|-------------------------------|
| port | Each CA port |
| system | Each storage system (Default) |

-rsv-mode-sense

Optional. This parameter specifies the response when the MODE SENSE command is issued during a reservation. This parameter is enabled only if the Reservation Type is Write Exclusive.

- | | |
|----------|--|
| good | Responds with "GOOD".
SPC-4 compliance. When using Veritas InfoScale (formerly Symantec Storage Foundation), specifying "good" is required. |
| conflict | Responds with "CONFLICT". (Default) |

■ **Example(s)**

The following example sets up the host response for host response #1. The new host response name is "win-x". The response status is Busy status. The host command timeout is 30 seconds:

```
CLI> set host-response -host-response-number 1 -name win-x -load-balance-rsp-status busy -monitor-time 30
```

delete host-response

This command deletes specified host response.

Syntax

```
delete host-response {  
-host-response-number host_response_numbers |  
-host-response-name host_response_names}
```

Parameter

-host-response-number or -host-response-name

This parameter specifies the host response identifiers to be deleted. Host response #0 is the system default and it cannot be deleted. One or more parameters can be specified at the same time. For details, refer to ["1.2.14 Host Response Syntax" \(page 43\)](#).

Caution

Host responses with the following combination of numbers and names cannot be deleted.

- No.0 Default
- No.201 – 248 Preset reserved
- No.250 Solaris MPxIO
- No.251 HP-UX
- No.252 AIX
- No.253 AIX VxVM
- No.254 VS850/SVC
- No.255 BS2000

<i>host_response_numbers</i>	Host response number
<i>host_response_names</i>	Host response name

Example(s)

The following example deletes the host responses with consecutively numbered identifiers #1 - #3:

```
CLI> delete host-response -host-response-number 1-3
```

The following example only deletes the host response named "HOSTRESP1":

```
CLI> delete host-response -host-response-name HOSTRESP1
```

3.6.9 Host Sense Conversion

This section explains the commands related to host sense conversion.

show host-sense

This command displays a list of the host responses and the associated sense code conversion information. Only preset information can be shown.

Syntax

```
show host-sense  
{-host-response-number host_response_numbers | -host-response-name host_response_names}
```

Parameter

-host-response-number or -host-response-name

This parameter specifies the host response identifiers whose entries are to be displayed. One or more host response identifiers can be specified at the same time. For details, refer to ["1.2.14 Host Response Syntax" \(page 43\)](#).

host_response_numbers Host response number

host_response_names Host response name

Output

Item name	Description
Host Response	Host response identifiers
No.	Host response number
Name	Host response name
Sense No.	Host sense number
Original Sense Code	Original sense code. A sense key, an additional sense code, and a sub sense code (additional sense code qualifier) appear in this order from left to right, delimited one by one by a slash.
Converted Sense Code	Converted sense code. A sense key, an additional sense code, and a sub sense code (additional sense code qualifier) appear in this order from left to right, delimited one by one by a slash.

Example(s)

The following example displays the host responses and associated sense conversions:

```
CLI> show host-sense -host-response-number 1,2  
Host Response      Sense Original  Converted  
No. Name           No.  Sense Code  Sense Code  
1  fj0001           1    04/**/**    06/**/**  
2  fj0002           1    03/**/**    04/**/**
```

set host-sense

This parameter specifies the preset host sense corresponding to the specific host operating system.

Syntax

```
set host-sense
{-host-response-number host_response_numbers | -host-response-name host_response_names}
-pretset {no-conversion | custom}
[-original-sk original_sk] [-original-asc original_asc] [-original-ascq original_ascq]
[-converted-sk converted_sk] [-converted-asc converted_asc]
[-converted-ascq converted_ascq]
```

Parameter

-host-response-number or -host-response-name

This parameter specifies the host response identifier that is to be used to set the host sense. One or more parameters can be specified. For details, refer to ["1.2.14 Host Response Syntax" \(page 43\)](#).

host_response_numbers
Host response number

host_response_names
Host response name

-pretset This parameter specifies the preset host sense corresponding to the specific host operating system.

no-conversion

It will revert to the default host sense value (Default).

custom Custom setting. The following sense parameters can be specified only when this setting is selected.

-original-sk Optional. This parameter specifies the sense key that corresponds to the sense of the conversion source. This parameter can only be specified when "-pretset custom" is specified. This parameter must be specified by using either a hexadecimal number or the wildcard (*).

original_sk Sense key that corresponds to the sense of the conversion source

-original-asc

Optional. This parameter specifies the sense code, which is an additional sense code, that corresponds to the sense of the conversion source. This parameter can only be specified when "-pretset custom" is specified. This parameter must be specified by using either a hexadecimal number or the wildcard (*).

original_asc Sense code that corresponds to the sense of the conversion source

-original-ascq

Optional. This parameter specifies the sub sense code, which is an additional sense code qualifier that corresponds to the sense of the conversion source. This parameter can only be specified when "-pretset custom" is selected. This parameter must be specified by using either a hexadecimal number or the wildcard (*).

original_ascq
Additional sense code qualifier that corresponds to the sense of the conversion source

-converted-sk

Optional. This parameter specifies the sense key that corresponds to the sense of the conversion destination. This parameter can only be specified when "-preset custom" is selected. This parameter must be specified by using either a hexadecimal number or the wildcard (*).

converted_sk Sense key that corresponds to the sense of the conversion destination

-converted-asc

Optional. This parameter specifies the sense code, which is an additional sense code that corresponds to the sense of the conversion destination. This parameter can only be specified when "-preset custom" is selected. This parameter must be specified by using either a hexadecimal number or the wildcard (*).

converted_asc Additional sense code that corresponds to the sense of the conversion destination

-converted-ascq

Optional. This parameter specifies the sub sense code, which is an additional sense code qualifier that corresponds to the sense of the conversion destination. This parameter can only be specified when "-preset custom" is selected. This parameter must be specified by using either a hexadecimal number or the wildcard (*).

converted_ascq Additional sense code qualifier that corresponds to the sense of the conversion destination

■ Example(s)

The following example sets the preset host sense for "custom" to host response #1:

```
CLI> set host-sense -host-response-number 1 -preset custom -original-sk 3 -original-asc * -original-ascq * -converted-sk 4  
-converted-asc * -converted-ascq *
```

The following example reverts the host sense that is set to host response #1 to the default value:

```
CLI> set host-sense -host-response-number 1 -preset no-conversion
```

delete host-sense

This command deletes (clears) the specified host sense.

■ Syntax

```
delete host-sense  
{-host-response-number host_response_numbers | -host-response-name host_response_names}  
-sense-number sense_numbers
```

■ Parameter

-host-response-number or -host-response-name

This parameter specifies host response identifiers to which the host sense to be deleted belongs. The range is 1 to 200. One or more parameters can be specified at the same time. For details, refer to ["1.2.14 Host Response Syntax" \(page 43\)](#).

host_response_numbers Host response number

host_response_names Host response name

-sense-number

This parameter specifies the host sense number that is to be deleted. The host sense number is automatically registered in the system when the host sense conversion information is created. Between 1 to 8 can be specified. The host sense number can be checked by using the "show host-sense" command. One or more parameters can be specified at the same time.

sense_numbers Host sense number (1 – 8)

■ Example(s)

The following example respectively deletes the host sense #1 corresponding to the host response #1 to #3:

```
CLI> delete host-sense -host-response-number 1-3 -sense-number 1
```

3.6.10 Reset Group for Host Interface Port

This section explains the commands related to defining the reset groups for each host interface port.

show ca-reset-group

This command displays a list of the host interface ports that are in each of the reset groups. The number of reset groups is dependent on the number of host interface ports available.

Syntax

```
show ca-reset-group
```

Parameter

No parameters.

Output

Item name	Description
Port	Host interface port in the reset group For the DX60 S4/DX100 S4/DX200 S4, the DX500 S4/DX600 S4, the DX60 S3/DX100 S3/DX200 S3, the DX500 S3/DX600 S3, the DX8100 S3, the AF250 S2/AF650 S2, the AF250/AF650, and the DX200F, the port is displayed in an "xyz" format (where "x" is the CM number, "y" is the CA number, and "z" is the port number). For the DX8700 S3/DX8900 S3, the port is displayed in an "wxyz" format (where "w" is the CE number, "x" is the CM number, "y" is the CA number, and "z" is the port number).
Reset Group	Reset group

Example(s)

The following example shows each reset group configured with four host interface ports:

```
CLI> show ca-reset-group
      Port
Reset Group 000 001 002 003
Reset Group 010 011 012 013
Reset Group 100 101 102 103
Reset Group 110 111 112 113
```

The following example shows a reset group that is configured with 16 host interface ports:

```
CLI> show ca-reset-group
      Port
Reset Group 000 001 002 003 010 011 012 013 100 101
            102 103 110 111 112 113
```

The following example shows each reset group configured with four host interface ports (for the DX8700 S3/DX8900 S3):

```
CLI> show ca-reset-group
      Port
Reset Group 0000 0001 0002 0003
Reset Group 0010 0011 0012 0013
Reset Group 0100 0101 0102 0103
Reset Group 0110 0111 0112 0113
```

The following example shows a reset group that is configured with 16 host interface ports (for the DX8700 S3/DX8900 S3):

```
CLI> show ca-reset-group
      Port
Reset Group 0000 0001 0002 0003 0010 0011 0012 0013 0100 0101
            0102 0103 0110 0111 0112 0113
```

set ca-reset-group

This command sets a reset group of host interface ports (Channel Adapter on controller module). The same number of reset groups as the host interface ports that are installed in the storage system can be set as the maximum. One reset group can be set at a time. In the initial state, all host interface ports are set in one reset group.

■ Syntax

```
set ca-reset-group [-group port_numbers]
```

■ Parameter

-group This parameter sets up a combination of host interface ports that will be reset as a group. Two or more host interface ports can be specified by separating them with a comma (,).

Example: -group 000,100

For details, refer to "[1.2.15 Host Interface Port Syntax](#)" (page 44).

Caution

If a host interface port in the specified group is already set for another group, this port is released from the group and reconfigured in the specified group.

port_numbers	Host interface port
<i>xyz</i>	"x" is the controller module (CM) number, "y" is the CA number, and "z" is the host port number (DX60 S4/DX100 S4/DX200 S4, DX500 S4/DX600 S4, DX60 S3/DX100 S3/DX200 S3, DX500 S3/DX600 S3, DX8100 S3, AF250 S2/AF650 S2, AF250/AF650, and DX200F only). Example: "123" indicates CM#1-CA#2-Port#3
<i>wxyz</i>	"w" is the controller enclosure (CE) number, "x" is the controller module (CM) number, "y" is the CA number, and "z" is the host port number (DX8700 S3/DX8900 S3 only). Example: "0123" indicates CE#0-CM#1-CA#2-Port#3

■ Example(s)

The following example sets up the reset groups.

The reset groups are configured with CM#0 CA#0 Port#0 and CM#0 CA#0 Port#1:

```
CLI> set ca-reset-group -group 000,001
```

3.6.11 Ping Command for iSCSI Hosts

This section explains the ping related commands used in an iSCSI environment.

test iscsi-ping

This command issues a ping command from the specified host interface port to the specified iSCSI host.

Note

- When a response is successfully returned for the ping command, "Success" is displayed.
- When a response is not returned for the ping command, "Failure" is displayed and this CLI command abnormally terminates with an error message.
However, when a response is not returned because of a connection failure between the host and the specified port, only "Failure" is displayed.

Syntax

```
test iscsi-ping -port port_number -ip iscsi_host [-count count] [-additional-ip additional-ip]
```

Parameter

-port This parameter specifies the source host interface port used to issue the ping command. Only one host interface port can be specified at any given time.

Example: -port 000

For details, refer to ["1.2.15 Host Interface Port Syntax" \(page 44\)](#).

port_number Host interface port

xyz "x" is the controller module (CM) number, "y" is the CA number, and "z" is the host port number (DX60 S4/DX100 S4/DX200 S4, DX500 S4/DX600 S4, DX60 S3/DX100 S3/DX200 S3, DX500 S3/DX600 S3, DX8100 S3, AF250 S2/AF650 S2, AF250/AF650, and DX200F only).

Example: "123" indicates CM#1-CA#2-Port#3

wxyz "w" is the controller enclosure (CE) number, "x" is the controller module (CM) number, "y" is the CA number, and "z" is the iSCSI port number (DX8700 S3/DX8900 S3 only).

Example: "0123" indicates CE#0-CM#1-CA#2- Port#3

-ip This parameter specifies the IP address of the target iSCSI host using IPv4 standard notation (a base 256 "d.d.d.d" string) or IPv6 format. The types of IPv6 addresses that can be specified are global addresses (including 6to4 addresses), link local addresses, and unique local addresses. Only one iSCSI host can be specified at any given time.

iscsi_host IP address of the target iSCSI host

-count Optional. This parameter specifies the number of times that the ping command is to be issued. Any value between 1 and 10 can be specified. If omitted, this parameter value defaults to 1.

count Number of times that the ping command is to be issued (1 – 10)

-additional-ip

Optional. This parameter specifies the virtual port information number of the port for which the virtual port information is enabled. If this parameter is omitted, "0" (this indicates the actual port information) is set for the value of this parameter.

Only one virtual port information number can be specified.

additional-ip Virtual port information number (1 – 15)

■ Example(s)

The following example causes two pings to be issued from port#0 on CM#1 CA#0 to the iSCSI host 192.168.2.10. In this case, a "Success" string is displayed. This result indicates that a normal response was received to both pings:

```
CLI> test iscsi-ping -port 100 -ip 192.168.2.10 -count 2  
Success
```

The following example causes two pings to be issued from port#0 on CE#0 CM#1 CA#0 to the iSCSI host 192.168.2.10 (for the DX8700 S3/DX8900 S3). In this case, a "Success" string is displayed. This result indicates that a normal response was received to both pings:

```
CLI> test iscsi-ping -port 0100 -ip 192.168.2.10 -count 2  
Success
```

The following example uses the same command as the previous example, but in this case, a "Failure" string is displayed. This result indicates that a normal response was not received for at least one of the pings:

```
CLI> test iscsi-ping -port 100 -ip 192.168.2.10 -count 2  
Failure
```

The following example sends three pings from port#0 on CM#1 CA#0 to iSCSI host 2001:0db8:0020:0003:1000:0100:0020:0003. In this case, a "Success" string is displayed. This result indicates that a normal response was received for all of the pings:

```
CLI> test iscsi-ping -port 100 -ip 2001:0db8:0020:0003:1000:0100:0020:0003 -count 3  
Success
```

The following example displays the command execution result when the multiple IP address setting is enabled and virtual port information number #1 of the port for which the virtual port information is enabled is specified:

```
CLI> test iscsi-ping -port 100 -ip 192.168.2.10 -additional-ip 1  
Success
```

3.6.12 Host LU QoS

This section explains the commands related to Host LU QoS.

 **Caution**

The commands that are described in this section are not supported in the DX60 S4/DX60 S3.

show qos-mode

This command displays the setting status of the QoS function and QoS performance flexibility function.

■ Syntax

```
show qos-mode
```

■ Parameter

No parameters.

■ Output

Item name	Description
QoS Mode	Setting status of the QoS function (Enable or Disable)
Flexible Mode	ModeSetting status of the QoS performance flexibility function (Enable or Disable)

■ Example(s)

The following example displays the setting status of the QoS function and QoS performance flexibility function:

```
CLI> show qos-mode
QoS Mode      [Disable]
Flexible Mode [Disable]

CLI> show qos-mode
QoS Mode      [Enable]
Flexible Mode [Disable]

CLI> show qos-mode
QoS Mode      [Enable]
Flexible Mode [Enable]
```

set qos-mode

This command sets up the QoS function and the QoS performance flexibility function.

■ Syntax

```
set qos-mode [-mode {enable | disable}] [-flexible-mode {enable | disable}]
```

■ Parameter

-mode Optional. This parameter specifies whether to enable or disable the QoS function. When "disable" is specified, the QoS performance flexibility function is also disabled.

enable This parameter enables the QoS function.

disable This parameter disables the QoS function.

-flexible-mode

Optional. This parameter specifies whether to enable or disable the QoS performance flexibility function. This parameter can only be specified when "enable" is specified for the "-mode" parameter or the QoS function is already enabled.

enable This parameter enables the QoS performance flexibility function.

disable This parameter disables the QoS performance flexibility function.

■ Example(s)

The following example enables the QoS function:

```
CLI> set qos-mode -mode enable
```

The following example disables the QoS function:

```
CLI> set qos-mode -mode disable
```

The following example enables the QoS function and the QoS performance flexibility function:

```
CLI> set qos-mode -mode enable -flexible-mode enable
```

The following example disables the QoS performance flexibility function:

```
CLI> set qos-mode -flexible-mode disable
```

show lu-qos-groups

This command displays detailed settings of the LU QoS Group.

Syntax

```
show lu-qos-groups [-lu-qos-group lu_qos_group_number] [-lun lun | all]
```

Parameter

-lu-qos-group

Optional. This parameter specifies the LU QoS Group to display detailed information.

lu_qos_group_number LU QoS group number

-lun

Optional. This parameter specifies which Host LUNs to display detailed information for. When "all" is specified, the information for the LUNs with "0" (Unlimited) as the bandwidth limit is also displayed. If omitted, the information for the LUNs is not displayed.

lun Host LUN

all All Host LUNs

Output

- When a list of the LU QoS Groups is displayed.

Item name	Description
LU QoS Group No.	Registered LU QoS Group numbers

- When the LU QoS Groups to display detailed information for are specified.

Item name	Description
LU QoS Group No.	Registered LU QoS Group numbers
LUN	Host LUN
Bandwidth Limit	Bandwidth limit (upper limit performance value) that is set to the LU QoS Group

Example(s)

The following example displays a list of the LU QoS Groups:

```
CLI> show lu-qos-groups
LU QoS Group
No.
-----
    1
    2
```

The following example displays the detailed information of the LU QoS Group #1 and #2:

```
CLI> show lu-qos-groups -lu-qos-group 1,2
LU QoS Group No.1
LUN Bandwidth Limit
-----
  2                      15
LU QoS Group No.2
LUN Bandwidth Limit
----
  4                      12
```

set lu-qos-group

This command performs detailed settings of the LU QoS Group.

■ Syntax

```
set lu-qos-group -lu-qos-group lu_qos_group_number -lun luns -bandwidth-limit bandwidth-limit
```

■ Parameter

-lu-qos-group

This parameter specifies the LU QoS Group number to set for LU QoS.

Any value between 0 to 1055 can be specified for the DX100 S4/DX200 S4, the DX500 S4/DX600 S4, the DX100 S3/DX200 S3, the DX500 S3/DX600 S3, the DX8100 S3, the AF250 S2/AF650 S2, the AF250/AF650, and the DX200F. For the DX8700 S3/DX8900 S3, the values are between 0 to 2431.

lu_qos_group_number LU QoS Group number

-lun

This parameter specifies the Host-LUN that is to be set. Any value between 0 and 1023 can be specified. Two or more Host-LUNs can be specified.

Example: -lun 1,2 -lun 0-10 -lun 1,2-9

lun Host-LUN (0 – 1023)

-bandwidth-limit

This parameter specifies the bandwidth limit (upper limit performance value) for the Host-LUN. Any value between 0 (unlimited) and 15 (Max) can be specified. Two or more values can be specified. When two or more values are specified, the same number of values as the Host-LUNs that are specified by the "-lun" parameter must be specified.

Example: -bandwidth-limit 1,2
-bandwidth-limit 0-10
-bandwidth-limit 1,2-9

The same "-bandwidth-limit" parameter value can be specified for multiple "-lun" parameter values.

Example: -lun 1,2,4 -bandwidth-limit 1

bandwidth-limit Bandwidth limit (upper limit performance value) for the Host-LUN (0 - 15)

0	Unlimited
1	15,000 IOPS (800MB/s)
2	12,600 IOPS (700MB/s)
3	10,020 IOPS (600MB/s)
4	7,500 IOPS (500MB/s)
5	5,040 IOPS (400MB/s)
6	3,000 IOPS (300MB/s)
7	1,020 IOPS (200MB/s)
8	780 IOPS (100MB/s)
9	600 IOPS (70MB/s)

10	420 IOPS (40MB/s)
11	300 IOPS (25MB/s)
12	240 IOPS (20MB/s)
13	180 IOPS (15MB/s)
14	120 IOPS(10MB/s)
15	60 IOPS (5MB/s)

■ Example(s)

The following example sets the LU QoS Group:

```
CLI> set lu-qos-group -lu-qos-group 1 -lun 2 -bandwidth-limit 15  
CLI> set lu-qos-group -lu-qos-group 1 -lun 1,2 -bandwidth-limit 1  
CLI> set lu-qos-group -lu-qos-group 1 -lun 1,2 -bandwidth-limit 1,2
```

delete lu-qos-group

This command deletes LU QoS Groups.

■ Syntax

```
delete lu-qos-group -lu-qos-group lu_qos_group_number
```

■ Parameter

-lu-qos-group

This parameter specifies the LU QoS Group number that is to be deleted. Two or more LU QoS Groups can be specified.

lu_qos_group_number LU QoS Group number

■ Example(s)

The following example deletes LU QoS Group#1:

```
CLI> delete lu-qos-group 1
```

show host-lu-qos

This command displays the detailed setting information for the Host-LU QoS function.

Syntax

```
show host-lu-qos [-mode {port-qos | host-qos | lu-qos}] [-port {port_numbers | all}]  
[-host-type {fc | iscsi | sas} -host-number host_number | -host-name host_name]  
[-lu-qos-group lu_qos_group_number]
```

Parameter

- mode** Optional. This parameter specifies which QoS settings are displayed.
- | | |
|----------|----------|
| port-qos | Port QoS |
| host-qos | Host QoS |
| lu-qos | LU QoS |
- port** Optional. This parameter limits the QoS settings that are to be displayed to those that are related to the specified port.
- Example: -port 000
- For details, refer to ["1.2.15 Host Interface Port Syntax" \(page 44\)](#).
- | | |
|---------------------|--|
| <i>port_numbers</i> | Host interface port |
| <i>xyz</i> | "x" is the controller module (CM) number, "y" is the CA number, and "z" is the host port number (DX100 S4/DX200 S4, DX500 S4/DX600 S4, DX100 S3/DX200 S3, DX500 S3/DX600 S3, DX8100 S3, AF250 S2/AF650 S2, AF250/AF650, and DX200F only).
Example: "123" indicates CM#1-CA#2-Port#3 |
| <i>wxyz</i> | "w" is the controller enclosure (CE) number, "x" is the controller module (CM) number, "y" is the CA number, and "z" is the host port number (DX8700 S3/DX8900 S3 only).
Example: "0123" indicates CE#0-CM#1-CA#2- Port#3 |
| all | All the host interface ports |
- host-type** Optional. This parameter specifies the type of host to set Host QoS for. The host can be specified by using the "-host-number" or "-host-name" parameter. Only one host type can be specified at the same time.
- | | |
|-------|---------|
| fc | FC/FCoE |
| iscsi | iSCSI |
| sas | SAS |
- host-number or -host-name**
- Optional. This parameter limits the QoS settings that are to be displayed to those that are related to the specified host. The "-host-type" parameter must also be specified to use this parameter. For details, refer to ["1.2.12 Host Syntax" \(page 41\)](#).
- | | |
|--------------------|-------------|
| <i>host_number</i> | Host number |
| <i>host_name</i> | Host name |

-lu-qos-group

Optional. This parameter limits the QoS settings that are to be displayed to those that are related to the specified LU QoS Group.

lu_qos_group_number LU QoS Group number

■ Output

- When the Host-LU QoS settings are displayed.

Item name	Description
Port (Bandwidth Limit)	Host interface port (and its bandwidth limit [upper limit performance value])
Host	Host identifiers
No.	Host number
Name	Host name
(Bandwidth Limit)	Bandwidth limit (upper limit performance value) for the host
LU QoS Group	LU QoS Group number that is set for the LU QoS

- When the Host-LU QoS settings are displayed with the target port, the target host, and the target LU QoS group specified.

Item name	Description
Port (Bandwidth Limit)	Host interface port (and its bandwidth limit [upper limit performance value])
Host	Host identifiers
No.	Host number
Name	Host name
(Bandwidth Limit)	Bandwidth limit (upper limit performance value) for the host
LU QoS Group	LU QoS Group number that is set for the LU QoS
Event	Event
No.	Event number of the QoS schedule
Port	Host interface port details
Schedule No.	QoS schedule number for the host interface port
Bandwidth Limit	Bandwidth limit (upper limit performance value) of the QoS schedule for the host interface port
Host	Host details
Schedule No.	QoS schedule number for the host
Bandwidth Limit	Bandwidth limit (upper limit performance value) of the QoS schedule for the host
Schedule No.	QoS schedule number for the LU QoS
LU QoS Group	Bandwidth limit (upper limit performance value) of the QoS schedule for the LU QoS

- When the Port QoS settings are displayed.

Item name	Description
Port	Host interface port
Bandwidth Limit	Bandwidth limit (upper limit performance value) for the host interface port

- When the Port QoS settings are displayed with the target port specified.

Item name	Description
Port	Host interface port
Bandwidth Limit	Bandwidth limit (upper limit performance value) for the host interface port

Item name	Description
Event	Event
No.	Event number of the QoS schedule
Schedule No.	QoS schedule number for the host interface port
Bandwidth Limit	Bandwidth limit (upper limit performance value) of the QoS schedule for the host interface port

- When the Host QoS settings are displayed.

Item name	Description
Host	Host identifiers
No.	Host number
Name	Host name
Bandwidth Limit	Bandwidth limit (upper limit performance value) for the host
Host Type	Host type
WWN/iSCSI Name/SAS Address	WWN (for FC/FCoE), iSCSI name (for iSCSI), or SAS address (for SAS) of the host

- When the Host QoS settings are displayed with the target host specified.

Item name	Description
Host	Host identifiers
No.	Host number
Name	Host name
Bandwidth Limit	Bandwidth limit (upper limit performance value) for the host
Host Type	Host type
WWN/iSCSI Name/SAS Address	WWN (for FC/FCoE), iSCSI name (for iSCSI), or SAS address (for SAS) of the host
No.	Event number of the QoS schedule
Schedule No.	QoS schedule number for the host
Bandwidth Limit	Bandwidth limit (upper limit performance value) of the QoS schedule for the host

- When the LU Host-LU QoS settings are displayed.

Item name	Description
Port (Bandwidth Limit)	Host interface port (and its bandwidth limit [upper limit performance value])
Host	Host identifiers
No.	Host number
Name	Host name
(Bandwidth Limit)	Bandwidth limit (upper limit performance value) for the host
LUN (Bandwidth Limit)	LUN number (bandwidth limit [or upper limit performance value] that is set in the LUN)

■ Example(s)

The following example displays the Host-LU QoS settings (for the DX100 S4/DX200 S4, the DX500 S4/DX600 S4, the DX100 S3/DX200 S3, the DX500 S3/DX600 S3, the DX8100 S3, the AF250 S2/AF650 S2, the AF250/AF650, and the DX200F):

```
CLI> show host-lu-qos
Port (Bandwidth Limit)      Host      (Bandwidth Limit) LU QoS
                             No.      Name              Group
-----
CM#0 CA#0 Port#0 ( 0)      0 Host#FC_0        ( 0) -
CM#0 CA#0 Port#0 ( 0)      2 Host#FC_1        ( 1) 2
CM#0 CA#1 Port#0 ( 2)      0 Host#iSCSI_0     ( 5) 2
CM#1 CA#0 Port#0 ( 3)      0 Host#FC_0        ( 0) 3
CM#1 CA#0 Port#0 ( 3)      2 Host#FC_1        ( 1) 3
CM#1 CA#1 Port#0 (15)      0 Host#iSCSI_0     ( 5) 2
```

The following example displays the Host-LU QoS settings (for the DX8700 S3/DX8900 S3):

```
CLI> show host-lu-qos
Port (Bandwidth Limit)      Host      (Bandwidth Limit) LU QoS
                             No.      Name              Group
-----
CE#0 CM#0 CA#0 Port#0 ( 0)  0 Host#FC_0        ( 0) -
CE#0 CM#0 CA#0 Port#0 ( 0)  2 Host#FC_1        ( 1) 2
CE#0 CM#0 CA#1 Port#0 ( 2)  0 Host#iSCSI_0     ( 5) 2
CE#0 CM#1 CA#0 Port#0 ( 3)  0 Host#FC_0        ( 0) 3
CE#0 CM#1 CA#0 Port#0 ( 3)  2 Host#FC_1        ( 1) 3
CE#0 CM#1 CA#1 Port#0 (15)  0 Host#iSCSI_0     ( 5) 2
```

The following example displays the details of the Host-LU QoS settings (for the DX100 S4/DX200 S4, the DX500 S4/DX600 S4, the DX100 S3/DX200 S3, the DX500 S3/DX600 S3, the DX8100 S3, the AF250 S2/AF650 S2, the AF250/AF650, and the DX200F):

```
CLI> show host-lu-qos -port 000
Port (Bandwidth Limit)      Host      (Bandwidth Limit) LU QoS
                             No.      Name              Group
-----
CM#0 CA#0 Port#0 ( 0)      0 Host#FC_0        ( 0) -
<Event>
No. Port                    Host                    Schedule No. LU QoS
  Schedule No. Bandwidth Limit Schedule No. Bandwidth Limit      Group
-----
  1          10              5          -          -          5          3
  2          20              8          -          -          -          -
  5          30              10         -          -          -          -

Port (Bandwidth Limit)      Host      (Bandwidth Limit) LU QoS
                             No.      Name              Group
-----
CM#0 CA#0 Port#0 ( 0)      2 Host#FC_1        ( 1) 2
<Event>
No. Port                    Host                    Schedule No. LU QoS
  Schedule No. Bandwidth Limit Schedule No. Bandwidth Limit      Group
-----
  1          10              5          1          3          15          3
  2          20              8          3          5          25          4
  5          30              10         5          7          35          5
```

The following example displays the details of the Host-LU QoS settings (for the DX8700 S3/DX8900 S3):

```

CLI> show host-lu-qos -port 0000
Port (Bandwidth Limit)      Host      (Bandwidth Limit) LU QoS
                             No. Name
-----
CE#0 CM#0 CA#0 Port#0 ( 0)    0 Host#FC_0      ( 0) -
<Event>
No. Port                      Host      Schedule No. LU QoS
  Schedule No. Bandwidth Limit Schedule No. Bandwidth Limit Schedule No. LU QoS
-----
  1          10                5          -          -          5          3
  2          20                8          -          -          -          -
  5          30                10         -          -          -          -
Port (Bandwidth Limit)      Host      (Bandwidth Limit) LU QoS
                             No. Name
-----
CE#0 CM#0 CA#0 Port#0 ( 0)    2 Host#FC_1      ( 1) 2
<Event>
No. Port                      Host      Schedule No. LU QoS
  Schedule No. Bandwidth Limit Schedule No. Bandwidth Limit Schedule No. LU QoS
-----
  1          10                5          1          3          15         3
  2          20                8          3          5          25         4
  5          30                10         5          7          35         5
  
```

The following example displays the Port QoS settings (for the DX100 S4/DX200 S4, the DX500 S4/DX600 S4, the DX100 S3/DX200 S3, the DX500 S3/DX600 S3, the DX8100 S3, the AF250 S2/AF650 S2, the AF250/AF650, and the DX200F):

```

CLI> show host-lu-qos-parameters -mode port-qos
Port      Bandwidth Limit
-----
CM#0 CA#0 Port#0      0
CM#0 CA#1 Port#0      2
CM#1 CA#0 Port#0      3
CM#1 CA#1 Port#0     15
  
```

The following example displays the Port QoS settings (for the DX8700 S3/DX8900 S3):

```

CLI> show host-lu-qos-parameters -mode port-qos
Port      Bandwidth Limit
-----
CE#0 CM#0 CA#0 Port#0      0
CE#0 CM#0 CA#1 Port#0      2
CE#0 CM#1 CA#0 Port#0      3
CE#0 CM#1 CA#1 Port#0     15
  
```

The following example displays the details of the Port QoS settings (for the DX100 S4/DX200 S4, the DX500 S4/DX600 S4, the DX100 S3/DX200 S3, the DX500 S3/DX600 S3, the DX8100 S3, the AF250 S2/AF650 S2, the AF250/AF650, and the DX200F):

```

CLI> show host-lu-qos -mode port-qos -port 000
Port      Bandwidth Limit
-----
CM#0 CA#0 Port#0      0
<Event>
No. Schedule No. Bandwidth Limit
-----
  1          10                5
  2          20                8
  5          30                10
  
```

The following example displays the details of the Port QoS settings (for the DX8700 S3/DX8900 S3):

```
CLI> show host-lu-qos -mode port-qos -port 0000
Port                               Bandwidth Limit
-----
CE#0 CM#0 CA#0 Port#0              0
<Event>
No. Schedule No. Bandwidth Limit
-----
1           10           5
2           20           8
5           30          10
```

The following example displays the Host QoS settings:

```
CLI> show host-lu-qos-parameters -mode host-qos
Host                               Bandwidth Limit Host Type WWN/iSCSI Name/SAS Address
No. Name
-----
0 Host#FC_0                        0 FC/FCoE AABBCDDDEEFF0001
1 Host#FC_1                        1 FC/FCoE AABBCDDDEEFF0011
2 Host#SAS_0                       4 SAS FFAABBCDDDEE0011
0 Host#iSCSI_0                    5 iSCSI ign.1991-05.com.microsoft
```

The following example displays the details of the Host QoS settings:

```
CLI> show host-lu-qos -mode host-qos -host type iscsi -host-number 0
Host                               Bandwidth Limit Host Type WWN/iSCSI Name/SAS Address
No. Name
-----
0 Host#iSCSI_0                    5 iSCSI ign.1991-05.com.microsoft
<Event>
No. Schedule No. Bandwidth Limit
-----
1           2           3
3           4          14
```

The following example displays the LU Host-LU QoS settings (for the DX100 S4/DX200 S4, the DX500 S4/DX600 S4, the DX100 S3/DX200 S3, the DX500 S3/DX600 S3, the DX8100 S3, the AF250 S2/AF650 S2, the AF250/AF650, and the DX200F):

```
CLI> show host-lu-qos-parameters -mode lu-qos
Port (Bandwidth Limit)            Host (Bandwidth Limit) LUN (Bandwidth Limit)
No. Name
-----
CM#0 CA#0 Port#0 (15)            0 HBA1 ( 0) 0 ( 0)
CM#0 CA#0 Port#0 ( 0)            0 Host#FC_0 ( 0) 0 ( 0)
CM#0 CA#0 Port#0 ( 0)            0 Host#FC_0 ( 0) 1 ( 0)
CM#0 CA#0 Port#0 ( 0)            0 Host#FC_0 ( 0) 2 ( 0)
CM#0 CA#0 Port#0 ( 0)            2 Host#FC_1 ( 1) 0 ( 5)
CM#0 CA#0 Port#0 ( 0)            2 Host#FC_1 ( 1) 1 ( 5)
CM#0 CA#0 Port#0 ( 0)            2 Host#FC_1 ( 1) 2 ( 6)
```

The following example displays the LU Host-LU QoS settings (for the DX8700 S3/DX8900 S3):

```
CLI> show host-lu-qos-parameters -mode lu-qos
Port (Bandwidth Limit)            Host (Bandwidth Limit) LUN (Bandwidth Limit)
No. Name
-----
CE#0 CM#0 CA#0 Port#0 (15)            0 HBA1 ( 0) 0 ( 0)
CE#0 CM#0 CA#0 Port#0 ( 0)            0 Host#FC_0 ( 0) 0 ( 0)
CE#0 CM#0 CA#0 Port#0 ( 0)            0 Host#FC_0 ( 0) 1 ( 0)
CE#0 CM#0 CA#0 Port#0 ( 0)            0 Host#FC_0 ( 0) 2 ( 0)
CE#0 CM#0 CA#0 Port#0 ( 0)            2 Host#FC_1 ( 1) 0 ( 5)
CE#0 CM#0 CA#0 Port#0 ( 0)            2 Host#FC_1 ( 1) 1 ( 5)
CE#0 CM#0 CA#0 Port#0 ( 0)            2 Host#FC_1 ( 1) 2 ( 6)
```

set host-lu-qos

This command performs detailed settings for the Host-LU QoS function. This command can change the QoS settings for Port QoS, Host QoS, and LU QoS.

Syntax

```
set host-lu-qos -mode {port-qos | host-qos | lu-qos}
{-port {port_numbers | all} [-bandwidth-limit bandwidth-limits] [-event-number event-numbers]
[-schedule-number {schedule_numbers | ""}]}
{-host-type {fc | iscsi | sas} {-host-number host_numbers | -host-name host_names}
[-bandwidth-limit bandwidth-limits] [-event-number event_numbers]
[-schedule-number {schedule_numbers | ""}]}
{-port port_numbers [-host-number host_numbers | -host-name host_names]
[-lu-qos-group {lu_qos_group_numbers | ""}] [-event-number event_numbers]
[-schedule-number {schedule_numbers | ""}]}
```

Parameter

- mode This parameter specifies which QoS settings are changed.
- | | |
|----------|----------|
| port-qos | Port QoS |
| host-qos | Host QoS |
| lu-qos | LU QoS |
- port This parameter specifies the host interface port when Port QoS or LU QoS is set.
- Example: -port 00
For details, refer to ["1.2.15 Host Interface Port Syntax" \(page 44\)](#).

Note

- When "lu-qos" is specified for the "-mode" parameter, "all" cannot be specified.
- When "lu-qos" is specified for the "-mode" parameter, the type (FC, iSCSI, SAS) of all the ports that are specified by the "-host-number" or "-host-name" parameter must be the same.

port_numbers	Host interface port
xyz	"x" is the controller module (CM) number, "y" is the CA number, and "z" is the host port number (DX100 S4/DX200 S4, DX500 S4/DX600 S4, DX100 S3/DX200 S3, DX500 S3/DX600 S3, DX8100 S3, AF250 S2/AF650 S2, AF250/AF650, and DX200F only). Example: "123" indicates CM#1-CA#2-Port#3
wxyz	"w" is the controller enclosure (CE) number, "x" is the controller module (CM) number, "y" is the CA number, and "z" is the host port number (DX8700 S3/DX8900 S3 only). Example: "0123" indicates CE#0-CM#1-CA#2- Port#3
all	All host interface ports

-bandwidth-limit

Optional. This parameter specifies the bandwidth limit (upper limit performance value) for Port QoS or Host QoS. Any value between 0 (unlimited) and 15 (Max) can be specified. When multiple values are specified, the number of values that are specified for this parameter must be the same as the "-port" parameter and the "-host-number" parameter.

bandwidth-limits Bandwidth limit (upper limit performance value) for Port QoS or Host QoS (0 – 15)

	Port QoS	Host QoS
0	Unlimited	Unlimited
1	27,000 IOPS (1,000 MB/s)	15,000 IOPS (800 MB/s)
2	21,000 IOPS (850 MB/s)	12,600 IOPS (700 MB/s)
3	15,000 IOPS (700 MB/s)	10,020 IOPS (600 MB/s)
4	10,020 IOPS (600 MB/s)	7,500 IOPS (500 MB/s)
5	8,040 IOPS (500 MB/s)	5,040 IOPS (400 MB/s)
6	6,000 IOPS (400 MB/s)	3,000 IOPS (300 MB/s)
7	5,040 IOPS (300 MB/s)	1,020 IOPS (200 MB/s)
8	4,020 IOPS (250 MB/s)	780 IOPS (100 MB/s)
9	3,000 IOPS (200 MB/s)	600 IOPS (70 MB/s)
10	2,040 IOPS (160 MB/s)	420 IOPS (40 MB/s)
11	1,020 IOPS (125 MB/s)	300 IOPS (25 MB/s)
12	720 IOPS (90 MB/s)	240 IOPS (20 MB/s)
13	480 IOPS (60 MB/s)	180 IOPS (15 MB/s)
14	240 IOPS (30 MB/s)	120 IOPS (10 MB/s)
15	120 IOPS (15 MB/s)	60 IOPS (5 MB/s)

-host-type This parameter specifies the type of host to set Host QoS for. The host can be specified by using the "-host-number" or "-host-name" parameter.

fc	FC/FCoE
iscsi	iSCSI
sas	SAS

-host-number or -host-name

This parameter specifies the host for setting Host QoS or LU QoS. The number of hosts that can be set is 1,024 (host numbers are not restricted). For details, refer to ["1.2.12 Host Syntax" \(page 41\)](#).

<i>host_numbers</i>	Host number
<i>host_names</i>	Host name

-lu-qos-group

Optional. This parameter specifies the LU QoS Group number to set for LU QoS. When multiple values are specified, the number of values that are specified for this parameter must be the same as the "-port" parameter or the "-host-number" parameter. Specify a null character ("") to restore the initial setting.

<i>lu_qos_group_numbers</i>	LU QoS Group number
""	The initial setting is restored.

-event-number

Optional. This parameter specifies the event number for the QoS schedule. A schedule number is assigned to each event number. Any value between 1 to 7 can be specified. Multiple event numbers can be specified. When multiple values are specified, the number of values that are specified for this parameter must be the same as the "-port" parameter and the "-host-number" parameter. If omitted, the default QoS schedule (event number 0) is set.

event_numbers Event number

-schedule-number

Optional. This parameter specifies the QoS schedule number. Multiple QoS schedule numbers can be specified. When multiple values are specified, the number of values that are specified for this parameter must be the same as the "-port" parameter or the "-host-number" parameter. Specify a null character ("") to release the assigned QoS schedule.

schedule_numbers QoS schedule number
"" The assigned QoS schedule is released.

■ **Example(s)**

The following example sets the Port QoS and the default QoS schedule for the Port QoS:

```
CLI> set host-lu-qos -mode port-qos -port 000 -bandwidth-limit 15
```

The following example sets the Host QoS and the default QoS schedule for the Host QoS:

```
CLI> set host-lu-qos -mode host-qos -host-type iscsi -host-number 12 -bandwidth-limit 0
```

The following example sets the LU QoS and the default QoS schedule for the LU QoS (for a port with the Host Affinity mode enabled):

```
CLI> set host-lu-qos -mode lu-qos -port 000 -host-number 12 -lu-qos-group 1
```

The following example sets the LU QoS and the default QoS schedule for the LU QoS (for a port with the Host Affinity mode disabled):

```
CLI> set host-lu-qos -mode lu-qos -port 000 -lu-qos-group 1
```

The following example restores the initial setting of the LU QoS and sets the default QoS schedule for the LU QoS (for a port with the Host Affinity mode enabled):

```
CLI> set host-lu-qos -mode lu-qos -port 000 -host-number 12 -lu-qos-group ""
```

The following example restores the initial setting of the LU QoS and sets the default QoS schedule for the LU QoS for all of the host affinities of the specified port:

```
CLI> set host-lu-qos -mode lu-qos -port 000 -lu-qos-group ""
```

The following example sets the QoS schedule for the Port QoS:

```
CLI> set host-lu-qos -mode port-qos -port 000 -bandwidth-limit 15 -event-number 2 -schedule-number 0
```

The following example sets the QoS schedule for the Host QoS:

```
CLI> set host-lu-qos -mode host-qos -host-type iscsi -host-number 12 -bandwidth-limit 0 -event-number 7 -schedule-number 1
```

The following example sets the QoS schedule for the LU QoS (for a port with the Host Affinity mode enabled):

```
CLI> set host-lu-qos -mode lu-qos -port 000 -host-number 12 -lu-qos-group 1 -event-number 2 -schedule-number 4
```

The following example sets the QoS schedule for the LU QoS (for a port with the Host Affinity mode disabled):

```
CLI> set host-lu-qos -mode lu-qos -port 000 -lu-qos-group 1 -event-number 1 -schedule-number 5
```

The following example restores the initial settings of the QoS schedule for the Port QoS:

```
CLI> set host-lu-qos -mode port-qos -port 000 -event-number 2 -schedule-number ""
```

show qos-schedule

This command shows the details of the QoS schedule.

Syntax

```
show qos-schedule [-schedule-number schedule-number]
```

Parameter

-schedule-number

Optional. This parameter specifies the QoS schedule number to display details. One or more QoS schedule numbers can be specified. If this parameter is omitted, all the QoS schedules are displayed.

schedule-number QoS schedule number

Output

Item name	Description
No.	QoS schedule number
Type	QoS schedule event type
Details	Explanation for the QoS schedule event type
Time	Starting QoS schedule time and ending QoS schedule time
from	Starting time
to	Ending time

Example(s)

The following example displays the QoS schedules:

```
CLI> show qos-schedule
No.  Type      Details                                     Time
-----
  0  Every-day  from [18:10] to [12:20]
  1  Every-week  Monday-Tuesday from [00:00] to [18:30]
  2  Specific-day 1day(s) from Every-month 15 from [00:40] to [18:30]
 512 Specific-day 1day(s) from December 31 from [00:00] to [23:50]
2047 Specific-week Every-month last week Monday-Sunday from [00:00] to [06:00]
```

set qos-schedule

This command sets the details of the QoS schedule.

■ Syntax

```
set qos-schedule -schedule-number schedule_number
[-event-type
{every-day |
every-week,{mon | tue | wed | thu | fri | sat | sun},{mon | tue | wed | thu | fri | sat | sun} |
specific-day,MMDD,R |
specific-week,MM,{1st | 2nd | 3rd | 4th | last},{mon | tue | wed | thu | fri | sat | sun},
{mon | tue | wed | thu | fri | sat | sun} | none}]
[-event-from hhmm]
[-event-to hhmm]
```

■ Parameter

-schedule-number

This parameter specifies the QoS schedule number. Multiple QoS schedule numbers can only be specified when "none" is specified for the "-event-type" parameter. For the DX100 S4/DX200 S4, the DX500 S4/DX600 S4, the DX100 S3/DX200 S3, the DX500 S3/DX600 S3, the DX8100 S3, the AF250 S2/AF650 S2, the AF250/AF650, and the DX200F, the specifiable range is 0 to 1023. For the DX8700 S3/DX8900 S3, the specifiable range is 0 to 2047.

Example: -schedule-number 1,2
-schedule-number 0-10
-schedule-number 1,2-9

schedule_number QoS schedule number

-event-type Optional. This parameter specifies the QoS schedule event type.

every-day The QoS schedule is applied to every day. "every-day" is the only format. A suboperand is not required.

Example: -event-type every-day

every-week The QoS schedule is applied to every week. This format is "every-week,STA,END". The start day of the week (STA) and the end day of the week (END) are separated by a comma (.). The day of the week must be specified in the following format. The end day of the week must be after the start day of the week. The first day starts from Monday.

Example: Correct -> -event-type every-week,mon,fri
(from Monday to Friday is OK)

Example: Incorrect -> -event-type every-week,fri,tue
(from Friday to Tuesday is not OK)

Example: Correct -> -event-type every-week,mon,mon
(only Monday is OK)

mon	Monday
tue	Tuesday
wed	Wednesday
thu	Thursday
fri	Friday
sat	Saturday
sun	Sunday

specific-day The QoS schedule is applied to a specific day. This format is "specific-day,MMDD,R". The specific month MM (01 – 12) and the specific day DD (01 – 31) are separated by a comma (,) (when every month is required, specify "em" instead of 01 – 12). When the last day of the month is required, specify "99" instead of 01 – 31. The number of days that the schedule will apply is specified as R, and a value between 1 – 7 can be set.

Example: -event-type specific-day,0501,3
(For three days, from May 1st to May 3rd)

Example: -event-type specific-day,0630,2
(For two days, from June 30th to July 1st)

specific-week

The QoS schedule is applied to a specific week. This format is "specific-week,MM,W,STA,END". The specific month MM (01 – 12) and the specific week W (1st, 2nd, 3rd, 4th, or last) are separated by a comma (,) (when every month is required, specify "em" instead of 01 – 12). The start day of the week (STA) and the end day of the week (END) are separated by a comma (,). The day of the week must be specified in the following format. The end day of the week must be after the start day of the week. The first day starts from Monday.

Example: Correct -> -event-type specific-week,05,3rd,mon,wed
(from the 3rd Monday to the 3rd Wednesday in May is OK)

Example: Incorrect -> -event-type specific-week,05,3rd,wed,mon
(from the 3rd Wednesday to the 3rd Monday in May is not OK)
(When May 1st is a Monday)

mon	Monday
tue	Tuesday
wed	Wednesday
thu	Thursday
fri	Friday
sat	Saturday
sun	Sunday

none Specify this value to delete the specified QoS schedule.

Example: -event-type none

-event-from Optional. This parameter specifies that the QoS schedule will start at a specific time. The format is "hhmm". "hh" is the starting hour (00 – 23) and "mm" is the starting minute (00, 10, 20, 30, 40, or 50).

hhmm Starting time of the QoS schedule

-event-to Optional. This parameter specifies that the QoS schedule will end at a specific time. The format is "hhmm". "hh" is the ending hour (00 – 23) and "mm" is the ending minute (00, 10, 20, 30, 40, or 50).

hhmm Completion time of the QoS schedule

■ Example(s)

The following example creates an QoS schedule. The QoS schedule number is 0. The QoS schedule will apply every day from 06:00 to 18:00:

```
CLI> set qos-schedule -schedule-number 0 -event-type every-day -event-from 0600 -event-to 1800
```

The following example deletes the QoS schedule:

```
CLI> set qos-schedule -schedule-number 0 -event-type none
```

delete all-qos-setting

This command deletes all QoS related setting information including Host-LU QoS related settings, volume QoS settings and other scheduled settings. QoS operation related settings (QoS operation mode, QoS performance flexibility mode, and Host-LU QoS performance information acquisition state) are not deleted.

■ Syntax

```
delete all-qos-setting
```

■ Parameter

No parameters.

■ Example(s)

The following example deletes all QoS related setting information:

```
CLI> delete all-qos-setting
```

3.6.13 Login Host Display

This section explains the commands related to displaying the hosts currently logged in to the CA port.

show ca-port-login-host

This command displays the hosts currently logged in to the CA port.

Note

- If this command is executed without specifying any parameters, the information for all the hosts currently logged in to the CA ports is displayed (except for the corresponding storage systems of the remote copy).
- CA for NAS (NAS port), FCLINK, and OCLINK are not displayed.
- To check whether there are logins from the corresponding storage systems of the remote copy, specify "remote-copy" for the "-display-mode" parameter.

Caution

If the remote copy license of the Advanced Copy license is not registered, this command cannot be executed.

Syntax

```
show ca-port-login-host  
[ { -port port_number | -wwn wwn | -ip-address ip_address | -iscsi-name iscsi_name | -sas-address sas_address } ]  
[ -display-mode { default | remote-copy } ]
```

Parameter

- port Optional. This parameter specifies the CA port number. All the hosts currently logged in to the specified CA port are displayed. Only one parameter can be specified at a time. For details on the specification method, refer to ["1.2.15 Host Interface Port Syntax" \(page 44\)](#).
- xyz* "x" is the controller module (CM) number, "y" is the CA number, and "z" is the host port number (DX60 S4/DX100 S4/DX200 S4, DX500 S4/DX600 S4, DX60 S3/DX100 S3/DX200 S3, DX500 S3/DX600 S3, DX8100 S3, AF250 S2/AF650 S2, AF250/AF650, and DX200F only).
Example: "121" indicates CM#1-CA#2-Port#1
- wxyz* "w" is the controller enclosure (CE) number, "x" is the controller module (CM) number, "y" is the CA number, and "z" is the host port number (DX8700 S3/DX8900 S3 only).
Example: "0123" indicates CE#0-CM#1-CA#2- Port#3
- wwn Optional. This parameter specifies the WWN. The port location of the currently logged in host that is specified with the WNN is displayed. Only one parameter can be specified at a time.
- Example: -wwn 40000000abc78856
- wwn* World Wide Name (16-byte hexadecimal number)

-ip-address Optional. This parameter specifies the IP address. The port location of the currently logged in host that is specified with the IP address is displayed. Only one parameter can be specified at a time.

Example: -ip-address 192.168.1.20
 Example: -ip-address fe80::1b:332f:d0

ip_address IP address (IPv4 or IPv6)

-iscsi-name Optional. This parameter specifies the iSCSI name. The port location of the currently logged in host that is specified with the iSCSI name is displayed. Only one parameter can be specified at a time. The characters are case insensitive.

iscsi_name iSCSI name

-sas-address

Optional. This parameter specifies the SAS address. The port location of the currently logged in host that is specified with the SAS address is displayed. Only one parameter can be specified at a time.

sas_address SAS address

-display-mode

Optional. This parameter specifies the display mode. If omitted, the information of the hosts currently logged in to the CA port is displayed. If hosts are specified and this parameter is omitted, a list of ports for currently logged in hosts that match the specification is displayed.

default The information of the hosts currently logged in to the CA port is displayed.

remote-copy The CA port information for the corresponding storage systems of the remote copy is displayed.

■ Output

Item name	Description
FC Port List	List of hosts currently logged in to the FC port. The FC host is displayed if included in the display target.
Location	FC port location. If the port is specified, this item is not displayed. CM#x CA#y Port#z or CE#w CM#x CA#y Port#z (DX8700 S3/DX8900 S3 only)
WWN	World Wide Name
iSCSI Port List	List of hosts currently logged in to the iSCSI port. The iSCSI host is displayed if included in the display target.
Location	iSCSI port location. If the port is specified, this item is not displayed. CM#x CA#y Port#z or CE#w CM#x CA#y Port#z (DX8700 S3/DX8900 S3 only)
IP Address	IP address
iSCSI Name	iSCSI name
SAS Port List	List of hosts currently logged in to the SAS port. The SAS host is displayed if included in the display target.

Item name	Description
Location	SAS port location. If the port is specified, this item is not displayed. CM#x CA#y Port#z or CE#w CM#x CA#y Port#z (DX8700 S3/DX8900 S3 only)
SAS Address	SAS address
FCoE Port List	List of hosts currently logged in to the FCoE port. The FCoE host is displayed if included in the display target.
Location	FCoE port location. If the port is specified, this item is not displayed. CM#x CA#y Port#z or CE#w CM#x CA#y Port#z (DX8700 S3/DX8900 S3 only)
WWN	World Wide Name
Port Location List	List of ports where the specified host is currently logged in. If the host is specified (or the "-wnn" parameter, the "-ip-address" parameter, the "-iscsi-name" parameter, or the "-sas-address" parameter is specified), this item is displayed.
Location	Port location. CM#x CA#y Port#z or CE#w CM#x CA#y Port#z (DX8700 S3/DX8900 S3 only)

■ Example(s)

The following example displays the results when the parameters are omitted. All the ports and hosts are displayed. (For the DX60 S4/DX100 S4/DX200 S4, the DX500 S4/DX600 S4, the DX60 S3/DX100 S3/DX200 S3, the DX500 S3/DX600 S3, the DX8100 S3, the AF250 S2/AF650 S2, the AF250/AF650, and the DX200F):

```

CLI> show ca-port-login-host
<FC Port List>
Location          WWN
-----
CM#0 CA#0 Port#0  40000000abc80e38
                   40000000abc80e39
CM#0 CA#0 Port#1  40000000abc80e38
                   40000000abc80e39

<iSCSI Port List>
Location          IP Address          iSCSI Name
-----
CM#0 CA#1 Port#0  192.168.1.1        iqn.1991-05.com.microsoft
CM#0 CA#1 Port#1  192.168.1.2        iqn.1991-06.com.microsoft
                   192.168.1.3        iqn.1991-07.com.microsoft

<SAS Port List>
Location          SAS Address
-----
CM#1 CA#0 Port#0  500605b000b5f344
CM#1 CA#0 Port#1  500605b000b5f345

<FCoE Port List>
Location          WWN
-----
CM#1 CA#1 Port#0  40000000abc80e38
CM#1 CA#1 Port#1  40000000abc80e39
    
```

The following example displays the port location of the currently logged in host in which the WWN is 40000000abc80e39 (for the DX8700 S3/DX8900 S3):

```
CLI> show ca-port-login-host -wwn 40000000abc80e39
Location
-----
CE#0 CM#0 CA#1 Port#0
CE#0 CM#0 CA#1 Port#1
CE#0 CM#0 CA#1 Port#2
```

The following example displays the corresponding storage systems of the remote copy currently logged in to CE#0 CM#0 CA#0 Port#0 (FC port / FCoE port) (for the DX8700 S3/DX8900 S3):

```
CLI> show ca-port-login-host -port 0000 -display-mode remote-copy
WWN
-----
40000000abc80e38
40000000abc80e39
40000000abc80e40
```

The following example displays the hosts currently logged in to CE#0 CM#0 CA#1 Port#0 (iSCSI port) (for the DX8700 S3/DX8900 S3):

```
CLI> show ca-port-login-host -port 0010
IP Address                               iSCSI Name
-----
192.168.1.1                               iqn.1991-05.com.microsoft
192.168.1.2                               iqn.1991-06.com.microsoft
192.168.1.3                               iqn.1991-07.com.microsoft
```

The following example displays the hosts currently logged in to CM#0 CA#3 Port#0 (SAS port) (For the DX60 S4/DX100 S4/DX200 S4, the DX500 S4/DX600 S4, the DX60 S3/DX100 S3/DX200 S3, the DX500 S3/DX600 S3, the DX8100 S3, the AF250 S2/AF650 S2, the AF250/AF650, and the DX200F):

```
CLI> show ca-port-login-host -port 030 -display-mode default
SAS Address
-----
500605b000b5f344
500605b000b5f345
```

Chapter 4

Copy Function Settings and Display



This chapter explains the commands related to the Advanced Copy management function.

4.1 Advanced Copy Management

Advanced Copy is a function that copies an arbitrary volume of data at a certain point. The management unit of Advanced Copy is referred to as "copy session" or "session". Only SnapOPC+ type sessions can be started using CLI. However, all types of copy sessions can be displayed and stopped.

The CLI commands for Advanced Copy are listed in the following table:

Note

External Volumes cannot be specified as the copy source or copy destination.

Function	Command
Advanced Copy license	set advanced-copy-license delete advanced-copy-license show advanced-copy-license
Advanced Copy policy	set advanced-copy-policy show advanced-copy-policy
Advanced Copy parameter	set advanced-copy-parameters show advanced-copy-parameters
Snap Data Volume (SDV)	initialize snap-data-volume show snap-data-volume
Snap Data Pool (Pool/SDPV)	show snap-data-pool delete snap-data-pool-volume
Advanced Copy session	start advanced-copy (only SnapOPC+) stop advanced-copy (all types) show advanced-copy-sessions (all types)

For details on REC (Remote Equivalent Copy), refer to ["4.1.4 Remote Equivalent Copy Management" \(page 509\)](#). Advanced Copy functions for the ETERNUS DX/AF have the following features:

- Quick copy processes can be performed in units of a volume using ETERNUSmgr or CLI commands.
- Snapshots of volumes can be created using the Windows Volume Shadow Copy Service function.
- Backups and replications can be created using ETERNUS SF AdvancedCopy Manager.

This section explains how to perform Advanced copy in units of a volume using CLI of the ETERNUS DX/AF. For details about setting parameters for each command, refer to this manual.

Note that snapshots of the specified volume are created by the ETERNUS Advanced Copy function for the ETERNUS DX/AF. The purposes of the Advanced Copy function (such as creating backups and replications) and the procedure for using the Advanced Copy function via OS or software depends on the OS or software that is used. For details about purposes and procedures, refer to the manual of the OS or software that will be used.

Manage the Advanced Copy function by performing copy operations, and by checking and deleting copy sessions after preparing the Advanced Copy function.

4.1.1 SnapOPC+ Outline

SnapOPC+ is a function that, to the server, appears to copy a volume (the copy source) in an ETERNUS DX/AF to a different volume (the copy destination) in the same ETERNUS DX/AF at a specific point in time. Only a logical copy is performed initially, following which the SnapOPC+ records changes as the data is updated. Access to changed areas is then referenced via the SnapOPC+ record, while access to the unchanged areas is transparently passed back to the original data (in the copy source area). The expected amount of updates must be considered when deciding the size of the copy destination area. By its nature, SnapOPC+ is best used for the temporary backup of file server files and other low modification rate data, as provision against operating failures and software errors.

Figure 4.1 SnapOPC+ outline

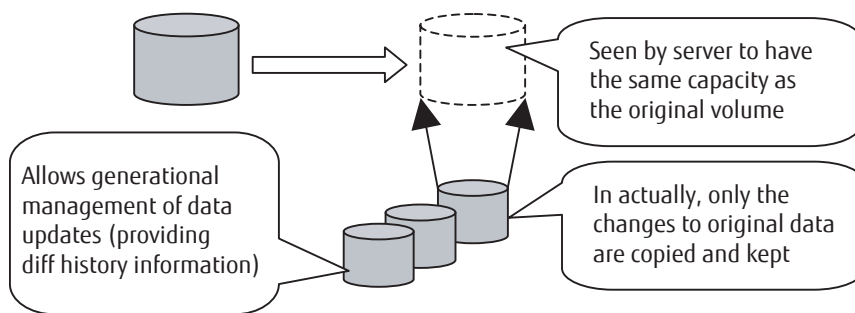

4.1.2 Preparations for the Advanced Copy Function

4.1.2.1 Basic Settings

■ License registration

Register the license for using the Advanced Copy function.
If the license is not registered, the Advanced Copy function cannot be used.

[Example]
Registering the license key "1234567890123456"

```
CLI> set advanced-copy-license -key 1234567890123456
```

■ License registration status check

Check the status of the Advanced Copy license registration.

[Example]

```
CLI> show advanced-copy-license
```

■ Copy parameter settings (required)

Set the internal table size to match the capacity of the volume to be copied, and the copy speed in the device. Copy table size (table size) and resolution vary according to the copy capacity and number of sessions that are operated at the same time.

● Resolution

This value determines the amount of data each bit in the copy bitmap represents.

The allowed resolution settings of "1 (standard)", "2", "4", "8", "16", "32", and "64" respectively give 8KB, 16KB, 32KB, 64KB, 128KB, 256KB, and 512KB regions of data per bitmap bit. The same value is used for all the copy sessions in the ETERNUS DX/AF.

Set the resolution as small as possible. When a large value is specified, the performance may be reduced. When unsure about whether the copy target area might be increased in future use, specify the maximum resolution.

To change the resolution of a copy session that is currently being performed, cancel the copy session and start again.

● Internal table size

A dedicated memory area is required for Advanced Copy management and is allocated as a table size. The table size and resolution settings are determined by the copy capacity and the number of sessions (volumes) that will be run simultaneously.

$$\text{(Table size [S]) [MB]} = (S1) + (S2)$$

S1: Refers to the table size (MB) for OPC / QuickOPC / SnapOPC / SnapOPC+ without EC/REC and OPC Restoration.

S2: Refers to the table size (MB) for OPC / QuickOPC / SnapOPC / SnapOPC+ with OPC Restoration.

Caution

- Round the derived value up to the next multiple of 8 to obtain the correct setting for the copy table size.
- A copy table of the appropriate size (as derived above) is created in each CM.
- If the total table size value (S) exceeds the maximum size allowed, adjust the resolution (M) upward until the maximum table size is no longer exceeded. The resolution (M) should be as small as possible.
- Maximum allowed table sizes are as follows:

Device name	Maximum copy table size (per CM)
DX60 S4/DX60 S3	128MB
DX100 S4/DX100 S3	512MB
DX200 S4/DX200 S3	512MB
DX500 S4/DX500 S3	1,024MB
DX600 S4/DX600 S3	4,096MB
DX8100 S3	1,024MB
DX8700 S3/DX8900 S3	12,288MB
AF250 S2/AF250	512MB
AF650 S2/AF650	4,096MB
DX200F	512MB

- Allowance should be made for possible increases in the copy capacity.
- If the resolution is changed while a copy session exists, the changed resolution is only applied to copy sessions that are set after the resolution is changed. A copy session that is set before the resolution changes uses the resolution that is set before it is changed.
- The same bitmap ratio (M) value must be used by both the copy source device and copy destination device. If the bitmap ratio settings for the copy source and copy destination devices are different, REC cannot be performed. Note that the table sizes (S) do not need to be identical. If different recommended resolutions are calculated for the copy source and copy destination devices, use whichever resolution is greater for both devices. If the resolution (M) is changed, recalculate the table size (S) setting for the device with the new resolution.

- The table size for OPC / QuickOPC / SnapOPC / SnapOPC+ without EC / REC and OPC Restoration (S1)

M: Resolution (The same value is used in the ETERNUS DX/AF. Set "x1" if possible.)

C1: The total copy capacity (GB) for OPC / QuickOPC / SnapOPC / SnapOPC+ without EC / REC and OPC Restoration (*1)

N1: The number of sessions for OPC / QuickOPC / SnapOPC / SnapOPC+ without EC / REC and OPC Restoration

$$S1 \text{ [MB]} = ([2 \times C1 / M] + N1) \times 8 \text{ [KB]} / 1024 \text{ (Round up decimal point)}$$

- The table size for OPC / QuickOPC / SnapOPC / SnapOPC+ with OPC Restoration (S2)

M: Resolution (The same value is used in the ETERNUS DX/AF. Set "x1" if possible.)

C2: The total copy capacity (GB) for OPC / QuickOPC / SnapOPC / SnapOPC+ with OPC Restoration in the volume (*1)

N2: The number of sessions for OPC / QuickOPC / SnapOPC / SnapOPC+ with OPC Restoration

$$S2 \text{ [MB]} = ([2 \times C2 / M] + N2) \times 2 \times 8 \text{ [KB]} / 1024 \text{ (Round up decimal point)}$$

*1: For EC, OPC, QuickOPC, SnapOPC, SnapOPC+, and REC copy sources, the copy capacity is the total capacity of all volumes (slices or partitions) in the ETERNUS DX/AF that are defined as copy sources. For REC copy destinations, the copy capacity is the total capacity of all the volumes (slices or partitions) in the ETERNUS DX/AF that are defined as copy destinations. If the ETERNUS DX/AF is used for both the "EC, OPC, QuickOPC, SnapOPC, SnapOPC+, or REC copy source" and the "REC

copy source", the copy capacity is the total capacity of both.

The copy capacity for multi-copy sessions and for generation management by SnapOPC+ sessions is the total capacity of copy source volumes (slices or partitions), multiplied by the number of copy destinations (or generations) for each copy source.

Example:

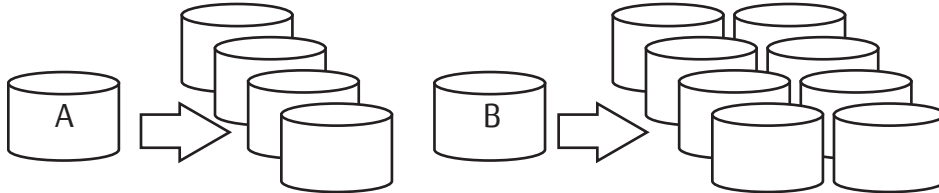

Copy area in the copy source logical volume A: 200M,
number of copy destinations (generations): 4
Copy area in the copy source logical volume B: 500MB,
number of copy destinations (generations): 8
Add $200 \times 4 + 500 \times 8 = 4800\text{MB}$ to the copy capacity (C1).

The number of copy sessions (N1) is $4 + 8 = 12$.

When executing OPC Restoration from a copy destination with multi-copy and SnapOPC+ multigeneration enabled, select one copy destination and apply the above formula. Other copy destinations are calculated as being normal multi-copy and SnapOPC+ multi-generation.

● Copy speed

Specify one of the following copy speed modes to match the operation to give priority during the copy operation:

- auto (default): Automatically changes the copy speed in response to the operation load status.
- very-low: Operates with a slower copy speed than the "low" mode.
- low: Reduces the effect on host access.
- middle: Operates with a slightly slower copy speed than the "high" mode.
- high: Operates by making maximum use of internal resources.

[Example]

Setting the Bitmap ratio to 2, table size to 32MB, and copy speed to Low.

```
CLI> set advanced-copy-parameters -resolution 2 -table-size 32 -ec-opc-priority low
```

4.1.2.2 Copy Destination Volume Creation

With the following procedures, create a Snap Data Volume (SDV), which is a generation management volume for the copy destination volume, and create a Snap Data Pool Volume (SDPV) for storing the copied data that configures a pool area, which is a Snap Data Pool (SDP).

If the copy destination volume is TPV or FTV, the following procedure is not necessary.

■ RAID group creation

Create a RAID group used for SDV in the normal procedure.
(Refer to this manual for how to create a RAID group.)

When considering the effect on performance, creating SDVs in a RAID group that is not used for the operation is recommended, although the SDVs can be created in an existing RAID group.

■ SDV (Snap Data Volume) creation

Create SDVs, the copy destination for SnapOPC+, in the RAID group created in step (1).

[Example]

Creating one SDV with 10 GB virtual capacity in RAID group#2.

```
CLI> create volume -name SDV001 -rg-number 2 -type sdv -virtual-size 10gb -count 1
```

After creating the SDV, check the volume number.

```
CLI> show snap-data-volume
```

Volume Format is performed automatically after the SDV is created. Set the mapping to the LUN.

■ SDP (Snap Data Pool) creation

Create SDPVs in the created RAID group.

[Example]

Creating one SDPV having 1 [TB] capacity in the RAID group#4

```
CLI> create volume -name SDPV01 -rg-number 4 -type sdpv -size 1tb -count 1
```

Volume Format is performed automatically after the SDPV is created.

4.1.2.3 Operation settings

■ Operation policy settings

Set the actions related to the threshold or the information notification of the volume overflow that occurs during copy operations.

For the notification setting of the copy destination TPV or FTV overflow, the warning level or the attention level of each pool applies.

For details, refer to ["3.3 Thin Provisioning Pool Management" \(page 245\)](#) or ["3.5 Flexible Tier Management" \(page 281\)](#).

[Example]

Setting for notification of "information", "warning", and "error" if up to 60% and 80%, and more than 95% of the SDPV capacity is used respectively.

```
CLI> set advanced-copy-policy -level information -threshold 60
CLI> set advanced-copy-policy -level warning -threshold 80
CLI> set advanced-copy-policy -level error -threshold 95
```

[Example]

Set whether to send a notification for each threshold with an e-mail message or not.

```
CLI> set event-notification -level i-sdp-policy-information -method email -suppression disable
```

[Example]

Change the attention level of Thin Provisioning Pool #02 to 60% and the warning level to 80%.

```
CLI> set thin-pro-pool -pool-number 02 -attention 60 -warning 80
```

4.1.3 Copy Session Management

4.1.3.1 Copy management

After preparation for Advanced Copy is complete, create a copy session to start copying volumes. During operation, also check the status of the copy sessions and delete unnecessary copy sessions.

■ SnapOPC+ copy execution

Create a copy session by using the "start advanced-copy" command to start the SnapOPC+ copy.

[Example]

Starting the SnapOPC+ copy from the copy source volume#0 to the copy destination volume (SDV) #100.

```
CLI> start advanced-copy -source-volume-number 0 -destination-volume-number 100
```

[Example]
Performing copies of seven generations with day-by-day rotation.

```
(Monday)
CLI> start advanced-copy -source-volume-number 0 -destination-volume-number 100
(Tuesday)
CLI> start advanced-copy -source-volume-number 0 -destination-volume-number 101
(Wednesday)
CLI> start advanced-copy -source-volume-number 0 -destination-volume-number 102
(Thursday)
CLI> start advanced-copy -source-volume-number 0 -destination-volume-number 103
(Friday)
CLI> start advanced-copy -source-volume-number 0 -destination-volume-number 104
(Saturday)
CLI> start advanced-copy -source-volume-number 0 -destination-volume-number 105
(Sunday)
CLI> start advanced-copy -source-volume-number 0 -destination-volume-number 106
(Monday)
CLI> start advanced-copy -source-volume-number 0 -destination-volume-number 100
(Tuesday)
CLI> start advanced-copy -source-volume-number 0 -destination-volume-number 101
:
(Daily copy operations are repeated hereinafter)
:
```

When setting the SnapOPC+ session of volume#0100 for Monday,

- The SnapOPC+ session for the last Monday is deleted.
- The SDP used for the SnapOPC+ session for the last Monday is released and a new SnapOPC+ session is set as a new backup point.

If the update size exceeds the SDV capacity, additional capacity is allocated from the SDPV area in units of SDPE.

■ Copy session check

Check the status of the copy sessions by using the "show advanced-copy-sessions" command.
The "show advanced-copy-sessions" command displays the status of all the copy sessions.

[Example]

```
CLI> show advanced-copy-sessions
```

■ Copy session deletion

Delete unnecessary copy sessions by using the "stop advanced-copy" command.
The areas used by the deleted copy sessions become unused.
Data in the copy destination volume loses its meaning (becomes undefined).

[Example]

Deleting the copy session with copy session ID 1.

```
CLI> stop advanced-copy -session-id 1 -delete-mode normal
```

show advanced-copy-license

This command displays the registration status of the Advanced Copy license.

Syntax

```
show advanced-copy-license
```

Parameter

No parameters.

Output

Item name	Description
Copy Type	Copy type (local, remote, or a hyphen [-]). For the "free" license, a hyphen (-) is displayed.
Status	Copy license status
Local	Local copy license (Hyphen [-], "Free", "Trial", "Trial Expiration" or "Registered") "Free" is only displayed for the DX60 S4/DX100 S4/DX200 S4, the DX60 S3/DX100 S3/DX200 S3, the AF250 S2/AF250, and the DX200F. "Trial Expiration" is only displayed for the DX500 S4/DX600 S4, the DX500 S3/DX600 S3, the DX8100 S3/DX8700 S3/DX8900 S3, and the AF650 S2/AF650.
Remote	Remote copy license (Hyphen [-], "Trial", or "Registered")
Trial registration Date	Registration date of the trial version license. "-" is displayed for the license that is not the trial version.
Local	Registration date of the trial version license for local copy
Remote	Registration date of the trial version license for remote copy
Trial expiration Date	Trial license expiration date. "-" is displayed for the license that is not the trial version.
Local	Trial license expiration date for local copy
Remote	Trial license expiration date for remote copy

Example(s)

The following example displays the registration status of the Advanced Copy license (when the license has been registered):

```
CLI> show advanced-copy-license
Copy   Status      Trial registration   Trial expiration
Type   Status      Date                Date
-----
Local  [Trial]      2010/11/27 (1)     2011/01/05
Remote [Registered] -
```

The following example displays the registration status of the Advanced Copy license (when using a free license):

```
CLI> show advanced-copy-license
Copy   Status      Trial registration   Trial expiration
Type   Status      Date                Date
-----
-      [Free]      -
```

set advanced-copy-license

This command registers an Advanced Copy license. There are three types of Advanced Copy licenses: a "legitimate version", a "trial version", and a "free" version. The "free" license is available only for the DX60 S4/DX100 S4/DX200 S4, the DX60 S3/DX100 S3/DX200 S3, the AF250 S2/AF250, and the DX200F. If the "legitimate version" license is registered in an ETERNUS DX/AF, when trying to register a "legitimate version" license with a lower software level than the already registered license, an error occurs. The trial period of an already registered trial version license can be changed only once by registering another trial version license. If a second attempt is made, an error occurs. In addition, when a trial version license key is registered again, the trial period may be shortened due to the valid period of the license key.

■ Syntax

```
set advanced-copy-license {-key key | -type free}
```

■ Parameter

- | | |
|------------|---|
| -key | This parameter specifies the Advanced Copy license key. The license key is 16 letters (fixed). For the "free" version license, specify the "-type" parameter. |
| <i>key</i> | Advanced Copy license key |
| -type | This parameter specifies the "free" version Advanced Copy license. The "free" version license does not require the license key. |
| free | Free version license (only for the DX60 S4/DX100 S4/DX200 S4, the DX60 S3/DX100 S3/DX200 S3, the AF250 S2/AF250, and the DX200F) |

■ Example(s)

The following example registers an Advanced Copy license:

```
CLI> set advanced-copy-license -key 1234567890123456
```

The following example registers a "free" Advanced Copy license:

```
CLI> set advanced-copy-license -type free
```

delete advanced-copy-license

This command deletes the registered Advanced Copy license.

■ Syntax

```
delete advanced-copy-license -execution {yes | no}
```

■ Parameter

- execution This parameter confirms that the operation should proceed. The Advanced Copy license is deleted only when the user explicitly specifies "-execution yes".
- | | |
|-----|--|
| yes | The registered Advanced Copy license is deleted. |
| no | No operation. |

■ Example(s)

The following example deletes the registered Advanced Copy license:

```
CLI> delete advanced-copy-license -execution yes
```

show advanced-copy-policy

This command displays the Advanced Copy policies for all the Snap Data Pools that are assigned to the system.

■ Syntax

```
show advanced-copy-policy
```

■ Parameter

No parameters.

■ Output

Item name	Description
SDP-ID	Snap Data Pool number
Information	Threshold value that is registered as the Advanced Copy policy Information level
Warning	Threshold value that is registered as the Advanced Copy policy Warning level
Error	Threshold value that is registered as the Advanced Copy policy Error level

■ Example(s)

The following example displays the Advanced Copy policy:

```
CLI> show advanced-copy-policy
SDP-ID  Information  Warning  Error
0       50%          90%     99%
```

set advanced-copy-policy

This command sets the Advanced Copy pool policy (the threshold value of the Snap Pool area usage for each policy level).

■ Syntax

```
set advanced-copy-policy -level {information | warning | error} -threshold threshold
```

■ Parameter

- level** This parameter specifies the policy level of the Advanced Copy. Only one policy level can be specified at the same time.
- information** Information level.
- Settable range is 1 – 97%.
 - Default value is 50%.
- warning** Warning level.
- Settable range is 2 – 98%.
 - Default value is 70%.
- error** Error level.
- Settable range is 3 – 99%.
 - Default value is 99%.
- threshold** This parameter specifies a threshold corresponding to the specified policy level.
It must be based on the following rule:
- 0% < Information level < Warning level < Error level < 100%
- threshold* Threshold corresponding to the specified policy level

■ Example(s)

The following example sets the Warning level to 80%:

```
CLI> set advanced-copy-policy -level warning -threshold 80
```

show advanced-copy-parameters

This command displays the current settings of the Advanced Copy parameters.

■ Syntax

```
show advanced-copy-parameters
```

■ Parameter

No parameters.

■ Output

Item name	Description
Resolution	Resolution
Advanced Copy Table Size	Advanced Copy table size
EC/OPC Priority	EC/OPC priority and EC/OPC rate mode that is currently set in the system (Example: Auto, Very Low Priority, Low Priority, Middle Priority, High Priority)
Current EC/OPC Priority	EC/OPC priority that is currently used
SDPE	Resolution of a snap data pool volume
Warning	Threshold value of the Advanced Copy table usage
Used Advanced Copy Table Size	Advanced Copy table size that is currently used
Usable Advanced Copy Size	Usable Advanced Copy table size
Copy Schedule Mode	Copy Schedule Mode (Example: Session balancing, Destination RAID Group balancing)

■ Example(s)

The following example displays the Advanced Copy parameters:

```
CLI> show advanced-copy-parameters
Resolution                [x2]
Advanced Copy Table Size  [128MB]
EC/OPC Priority            [Auto]
Current EC/OPC Priority   [Low Priority]
SDPE                      [1GB]
Warning                   [80%]
Used Advanced Copy Table Size [30MB]
Usable Advanced Copy Size [20GB]
Copy Schedule Mode        [Session balancing]
```

set advanced-copy-parameters

This command sets up parameters to use the Advanced Copy functions.

Syntax

```
set advanced-copy-parameters [-resolution {1 | 2 | 4 | 8 | 16 | 32 | 64}] [-table-size table_size]
[-sdpe {1g | 2g | 4g}] [-ec-opc-priority {auto | very-low | low | middle | high}] [-warning warning_level]
[-copy-schedule-mode {session-balancing | dst-rg-balancing}]
```

Parameter

-resolution Optional. This parameter specifies the Advanced Copy resolution. The default value for the DX60 S4/DX100 S4/DX200 S4, the DX60 S3/DX100 S3/DX200 S3, the AF250 S2/AF250, and the DX200F is "16", and "1" for the DX500 S4/DX600 S4, the DX500 S3/DX600 S3, the DX8100 S3/DX8700 S3/DX8900 S3, and the AF650 S2/AF650. If omitted, the existing setting is not changed.

1	×1
2	×2
4	×4
8	×8
16	×16
32	×32
64	×64

-table-size Optional. This parameter specifies the Advanced Copy table size. The size can be specified in multiples of 8MB. Note that the maximum value depends on the memory size that is to be installed in the controllers. The initial value is set to 128MB for the DX60 S4/DX100 S4/DX200 S4, the DX60 S3/DX100 S3/DX200 S3, the AF250 S2/AF250, and the DX200F, and 0MB for the DX500 S4/DX600 S4, the DX500 S3/DX600 S3, the DX8100 S3/DX8700 S3/DX8900 S3, and the AF650 S2/AF650. If omitted, the existing setting is not changed.

The specifiable Advanced Copy table size for each model are shown below:

DX60 S4/DX60 S3: 0 to 128MB
 DX100 S4/DX100 S3: 0 to 512MB
 DX200 S4/DX200 S3: 0 to 512MB
 DX500 S4/DX500 S3: 0 to 1,024MB
 DX600 S4/DX600 S3: 0 to 4,096MB
 DX8100 S3: 0 to 1,024MB
 DX8700 S3/DX8900 S3: 0 to 12,288MB
 AF250 S2/AF250: 0 to 512MB
 AF650 S2/AF650: 0 to 4,096MB
 DX200F: 0 to 512MB

table_size Advanced Copy table size

- sdpe** Optional. This parameter specifies the resolution for the SDPV. The initial value is set to 1GB. If omitted, the existing setting is not changed.
- | | |
|----|---------------|
| 1g | 1GB (default) |
| 2g | 2GB |
| 4g | 4GB |
- ec-opc-priority** Optional. This parameter specifies the EC/OPC rate mode (EC/OPC priority). The initial value is "auto". If omitted, the existing setting is not changed.
- | | |
|----------|-------------------------|
| auto | Automatically (default) |
| very-low | Very low priority |
| low | Low priority |
| middle | Middle priority |
| high | High priority |
- warning** Optional. This parameter specifies the threshold value for Advanced Copy table usage. This value is indicated by percent (%). The initial value is set to 80%. If omitted, the existing setting is not changed. In addition, the system has a function that notifies users when this value reaches the specified upper limit value. This upper limit value is set by using this parameter. For details, refer to the "show event-notification" command.
- | | |
|----------------------|---|
| <i>warning_level</i> | Threshold value for Advanced Copy table usage |
|----------------------|---|
- copy-schedule-mode** Optional. This parameter specifies the Copy Schedule Mode. If omitted, the existing setting is not changed.
- | | |
|-------------------|--|
| session-balancing | Session balancing is performed. |
| dst-rg-balancing | Destination RAID Group balancing is performed. |

■ Example(s)

The following example sets up Advanced Copy parameters. The resolution is set to twice the default, the table size is set to 128MB, and the EC/OPC priority is set to automatic mode.

```
CLI> set advanced-copy-parameters -resolution 2 -table-size 128 -ec-opc-priority auto
```

show snap-data-volume

This command displays all the registered Snap Data Volumes (SDV). The SDVs that are displayed can also be narrowed down by using the option parameter. The display includes the logical size, the physical size, the used size, and various other items.

Syntax

```
show snap-data-volume [-volume-number volume_numbers | -volume-name volume_names]
```

Parameter

-volume-number or -volume-name

Optional. This parameter specifies the Snap Data Volume (SDV) identifiers that are to be displayed. One or more SDVs can be specified at the same time. If this parameter is omitted, all the SDVs are displayed. For details, refer to ["1.2.11 Volume Syntax" \(page 40\)](#).

volume_numbers SDV number

volume_names SDV name

Output

Item name	Description
Volume	SDV identifiers
No.	SDV number
Name	SDV name
Status	SDV status
Size(MB)	SDV size (unit: MB)
Logical Size(MB)	Logical size of SDV (unit: MB)
Physical Size(MB)	Physical size of SDV (unit: MB)
Host Used Size(MB)	Size that is used by hosts (unit: MB)
Copy Used Size(MB)	Size that is used for copy sessions (unit: MB)
Host SDP Using Size(MB)	Size of the area in the Snap Data Pool (SDP) that is used by hosts (unit: MB)
Copy SDP Using Size(MB)	Size of the area in the Snap Data Pool (SDP) that is used for copy sessions (unit: MB)

Example(s)

The following example displays all the registered SDVs:

```
CLI> show snap-data-volume
Volume
No.   Name           Status           Size(MB)  Logical  Physical  Host Used  Copy Used  Host SDP  Copy SDP
-----
100  SDV001         Available        102400    5120    4144     3120     1024     3120     1024
105  SDV002         Available        102400    5120    4144     3120     1024     3120     1024
108  SDV003         Available        102400    5120    4144     3120     1024     3120     1024
```

initialize snap-data-volume

This command initializes Snap Data Volumes (SDV). Volume types other than snap data volumes cannot be specified.

■ Syntax

```
initialize snap-data-volume {-volume-number volume_numbers | -volume-name volume_names}
```

■ Parameter

-volume-number or -volume-name

This parameter specifies the Snap Data Volume (SDV) identifiers to be initialized. One or more SDVs can be specified at the same time. For details, refer to ["1.2.11 Volume Syntax" \(page 40\)](#).

volume_numbers SDV number

volume_names SDV name

■ Example(s)

The following example initializes the consecutive SDVs from #1 through #5:

```
CLI> initialize snap-data-volume -volume-number 1-5
```

show snap-data-pool

This command displays the snap data pool (SDP). The display includes the total size and the assigned size of the SDP area.

Syntax

```
show snap-data-pool
```

Parameter

No parameters.

Output

Item name	Description
Total Size(GB)	Total size (unit: GB)
Unencrypted	Total size of the unencrypted data
Encrypted	Total size of the encrypted data
Host Size(GB)	Size of the data that is directly updated from a host (unit: GB)
Unencrypted	Size of the unencrypted data that is directly updated from a host
Encrypted	Size of the encrypted data that is directly updated from a host
Copy Size(GB)	Size of copied data (unit: GB)
Unencrypted	Size of unencrypted data that is copied using the SDP due to a shortage of SDV capacity
Encrypted	Size of encrypted data that is copied using the SDP due to a shortage of SDV capacity
No.	Snap Data Pool Volume number
Name	Snap Data Pool Volume name
Status	Snap Data Pool Volume status
Reserved Deletion	Indicates whether the deletion of snap data pool volume is reserved.
Size(MB)	Snap Data Pool Volume size

Example(s)

The following example displays the SDPs:

```
CLI> show snap-data-pool
Snap Data Pool Information
      Total Size(GB) Host Size(GB) Copy Size(GB)
-----
Unencrypted          4           0           0
Encrypted            0           0           0

Snap Data Pool Volume List
No.  Name                               Status                               Reserved Deletion Size(MB)
-----
  2  SDPV#01                             Not Ready                             No                2048
  3  SDPV#11                             Partially Exposed Rebuild             No                2048
```

delete snap-data-pool-volume

This command deletes Snap Data Pool Volumes (SDPV). Other volume types cannot be deleted by this command.

■ Syntax

```
delete snap-data-pool-volume {-volume-number volume_numbers | -volume-name volume_names}  
-mode {force | reservation}
```

■ Parameter

-volume-number or -volume-name

This parameter specifies the SDPV identifiers to be deleted. One or more volumes can be specified at the same time. For details, refer to ["1.2.11 Volume Syntax" \(page 40\)](#).

volume_numbers SDPV number

volume_names SDPV name

-mode This parameter specifies the deletion mode.

force The SDPV is immediately deleted even when an SDP element (SDPE) has been assigned to it.
Up to 128 volumes can be specified at the same time.

reservation The SDPV is deleted when the SDPE is no longer used.

■ Example(s)

The following example forcibly deletes the SDPV named "SDPV1":

```
CLI> delete snap-data-pool-volume -volume-name SDPV1 -mode force
```

The following example deletes SDPV #1 through #10 when the SDPE is no longer used:

```
CLI> delete snap-data-pool-volume -volume-number 1-10 -mode reservation
```

show advanced-copy-sessions

This command displays a list of the Advance Copy sessions that are being started. The number of sessions for each Advanced Copy type can be displayed when all parameters are omitted. A list of the sessions that are to be displayed can be narrowed down to the Advanced Copy type, the requestor, and the volume type. Details for a session can also be displayed by specifying the session-ID, which is the number used to identify a session. Note that only one session can be displayed at a time.

Note

- SnapOPC+ sessions that were started with Web GUI or CLI are only displayed for the DX60 S4/DX100 S4/DX200 S4, the DX60 S3/DX100 S3/DX200 S3, the AF250 S2/AF250, and the DX200F. All sessions are displayed for the DX500 S4/DX600 S4, the DX500 S3/DX600 S3, the DX8100 S3/DX8700 S3/DX8900 S3, and the AF650 S2/AF650. In addition, by specifying parameters in combination, output results can be refined.
- The status of some reserved copy sessions may be displayed as "Reserved" immediately after the session starts. The type of sessions in Reserved status can only be distinguished as being either OPC, EC, XCOPY, or ODX. In this case, sessions that are distinguished as OPC or EC may be determined as being another type of session once the type of copy session can be confirmed.
- WVOL copy sessions are not displayed. To display the WVOL copy session list, use the "show wvol-copy-session" command.

Syntax

```
show advanced-copy-sessions
[-session-id id] -type {all | ec | opc | qopc | sopc | sopc+ | mon | rec | xcopy | odx}
[-requestor {all | gui | cli | guicli | smis | scsi | lan}] [-volume-type {all | open | standard}]
```

Parameter

-session-id Optional. This parameter specifies the session ID that is to be used to display details. The session ID is the number to identify a session. Only one session ID can be displayed at a time. If this parameter is omitted, the details cannot be displayed.

Note

This parameter cannot be specified with other parameters.

id Session ID

-type Optional. This parameter specifies the Advanced Copy type that is used to display a list of the sessions. If this parameter is omitted, the Advanced Copy type cannot be narrowed down.

Note

- This parameter can be specified with the "-requestor" and "-volume-type" parameters.
- The "-session-id" parameter cannot be specified with this parameter.

all	All sessions for all the types are displayed.
ec	All EC sessions are displayed.
opc	All OPC sessions are displayed.
qopc	All QuickOPC sessions are displayed.
sopc	All SnapOPC sessions are displayed.
sopc+	All SnapOPC+ sessions are displayed.
mon	All Monitor sessions are displayed.
rec	All REC sessions are displayed.
xcopy	All XCopy sessions are displayed.
odx	All ODX copy sessions are displayed.

-requestor Optional. This parameter specifies the requestor that is to be used to narrow down the sessions. If omitted, this parameter is handled as though "-requestor all" is specified.

Note

- This parameter must be specified with the "-type" parameter.
- This parameter can be specified with the "-volume-type" parameter.
- The "-session-id" parameter cannot be specified with this parameter.

all	Sessions to be displayed are not restricted by the requestors. If omitted, this operand is assigned.
gui	Only sessions being started from GUI are displayed.
cli	Only sessions being started from CLI are displayed.
guicli	Only sessions being started from both GUI and CLI are displayed.
smis	Only sessions being started from SMI-S are displayed.
scsi	Only sessions being started from SCSI are displayed.
lan	Only sessions being started from Software via LAN except from SMI-S are displayed.

-volume-type

Optional. This parameter specifies the type of volume that is to be used to narrow down the sessions. If omitted, this parameter is handled as though "-volume-type all" is specified.

Note

- This parameter must be specified with the "-type" parameter.
- The "-requestor" parameter can be specified with this parameter.
- The "-session-id" parameter cannot be specified with this parameter.

all	Sessions to be displayed are not restricted by the volume type. If omitted, this operand is assigned.
standard	Only sessions associated with the Standard volume type are displayed.
open	Same as "standard".

■ Output

- When all parameters are omitted.

Item name	Description
Number of EC Sessions	Number of the Advanced Copy type EC sessions
Number of OPC Sessions	Number of the Advanced Copy type OPC sessions
Number of QuickOPC Sessions	Number of the Advanced Copy type QuickOPC sessions
Number of SnapOPC Sessions	Number of the Advanced Copy type SnapOPC sessions
Number of SnapOPC+ Sessions	Number of the Advanced Copy type SnapOPC+ sessions
Number of Monitor Sessions	Number of the Advanced Copy type Monitor sessions
Number of REC Sessions	Number of the Advanced Copy type Remote Equivalent Copy (REC) sessions
Number of XCopy Sessions	Number of the Advanced Copy type XCOPY sessions
Number of ODX Sessions	Number of the Advanced Copy type ODX sessions

- When a list is displayed.

Item name	Description
SID	Session ID of this system is displayed in decimal number
Generation	The generation is displayed only when the SnapOPC+ type is selected.
Type	Advanced Copy type (EC, OPC, QuickOPC, SnapOPC, SnapOPC+, Monitor, REC, ODX, or XCOPY) is displayed.
Volume Type	Volume type that is to be copied in the session
Source Volume	Copy source volume identifiers
No.	Copy source volume number
Name	Copy source volume name
Destination Volume	Copy destination volume identifiers (This information is displayed when types other than Monitor are selected.)
No.	Copy destination volume number
Name	Copy destination volume name
Status	Session status (Idle, Reserve, Active, Error Suspend, Suspend, or Halt)
Phase	The session phase (No Pair, Copying, Equivalent, Tracking, Tracking&Copying, or Ready) is displayed when EC, QuickOPC, Monitor, or REC is selected.
Error Code	Error code (for details, refer to "A.2.1 Copy Session Error Codes" (page 1185).) in a 2-digit hexadecimal number
Requestor	The requestor that started the session (GUI, CLI, SMI-S, SCSI or LAN) is displayed.

- When details are displayed

Item name	Description
SID, Generation, Type, Volume Type, Source Volume, Destination Volume, Status, Phase, Error Code, and Requestor	Refer to the above information when a list is displayed.
Source Block Address (LBA)	The copy source Start Logical Block Address (LBA) in the specified range is displayed in 16-digit hexadecimal.

Item name	Description
Destination Block Address (LBA)	The copy destination Start LBA in the specified range is displayed in 16-digit hexadecimal.
Total Data Size(MB)	Total data size
Copied Data Size(MB)	Copied data size
Modified Data Size(MB)	Tracking data size
SDP Used Capacity(MB)	Used Snap Data Pool block is displayed when the type SnapOPC or SnapOPC+ is selected. (If the copy destination volume of SnapOPC/SnapOPC+ is TPV or FTV, a hyphen (-) is displayed.)
SDP-ID (assigned to SDV)	Snap Data Pool ID that is assigned to SDV is displayed when the type SnapOPC or SnapOPC+ is selected. (If the copy destination volume of SnapOPC/SnapOPC+ is TPV or FTV, a hyphen (-) is displayed.)
Direction	In the relevant copy session, the direction of the copy is displayed when the type REC is selected (Primary: copy source, Secondary: copy destination).
Sync	Operation mode of the session is displayed. Details are as follows: Sync: Synchronous Operation Mode Async: Asynchronous Operation Mode
Transfer Mode	Transfer mode of the session is displayed. Details are as follows: Through Mode: Asynchronous Through Mode Stack Mode: Asynchronous Stack Mode Consistency Mode: Asynchronous Consistency Mode (a mode that guarantees data transfer ordering to the connection destination storage system for all the specified REC sessions)
Recovery Mode	The recovery mode of the session is displayed only when the type REC is selected. Automatic: A mode to restart copying automatically when the REC copy path has recovered from abnormal status. Manual: A mode not to restart copying automatically when the REC copy path has recovered from abnormal status.
Split Mode	The split mode of the relevant session is displayed only when the type REC is selected. Automatic: A mode in which Write I/O accesses to copy source are accepted when the copy path of REC is in abnormal status. Manual: A mode in which Write I/O accesses to copy source are accepted when the copy path of REC is in abnormal status. Specified sense information is sent to the host.
Remote Session-ID	The session ID of another which is remotely connected with this system
Remote Box-ID	The identifier of another which is remotely connected with this system
Time Stamp	Time stamp is displayed in local time. The previous time stamp backed-up is displayed when the Status is Active or Suspend. The time that the accident occurred is displayed when the Status is Error Suspend or Halt.
Elapsed Time	The elapsed time from starting the session is displayed (unit: day, hour, min, sec).
Resolution	The resolution of the session is displayed (x2, x4, x8, x16).
License	The license information of the session is displayed (Regular, Trial, Unknown).
Copy Range	The copy range is displayed. (Totally, Extent)
Secondary Access Permission	Indicates whether the Secondary area can be accessed when the Status is Active. (Read Only at Equivalency, No Read/Write)
Concurrent Suspend Status	Transition status of Concurrent Suspend. (Normal, Exec, Error, Unknown)
Change Error	Execution result of the Change command. (Normal, Mode Change Error, Reverse Error)
Remain Time	Estimated time until the transition to Suspend status is complete.

■ Example(s)

The following example displays the number of sessions for each Advanced Copy type. In this example, a list of sessions is not displayed:

```
CLI> show advanced-copy-sessions
Number of EC Sessions      : 2
Number of OPC Sessions    : 1
Number of QuickOPC Sessions : 1
Number of SnapOPC Sessions : 1
Number of SnapOPC+ Sessions : 1
Number of Monitor Sessions : 1
Number of REC Sessions    : 1
Number of XCopy Sessions  : 1
Number of ODX Sessions    : 1
```

The following example displays all the sessions for all Advanced Copy types:

```
CLI> show advanced-copy-sessions -type all
SID  Gene-ration  Type      Volume Type      Source Volume No. Name      Destination Volume No. Name      Status  Phase      Error Code  Requestor
-----
0    1/12 SnapOPC+ Standard 8000 VOLUME0000123456 4000 VOLUME1111123456 -        -        0x00      CLI
1    - QuickOPC Standard 8002 VOLUME0000123457 4002 VOLUME1111123457 -        -        0x00      SMI-S
2    - Monitor Standard 8003 VOLUME1111 -        -        0x00      GUI
3    - EC Standard 8004 VOLUME001 4004 VOLUME002 -        -        0x00      GUI
4    - EC Standard 8005 VOLUME005 4005 VOLUME505 -        -        0x00      GUI
5    - OPC Standard 8006 VOLUME006 4006 VOLUME606 -        -        0x00      GUI
6    - REC Standard 8007 VOLUME007 4007 VOLUME707 -        -        0x00      GUI
7    - XCopy Standard 8008 VOLUME008 4008 VOLUME808 -        -        0x00      GUI
15   - ODX Standard 8009 VOLUME006 4009 VOLUME909 -        -        0x00      GUI
8002 - SnapOPC Standard 8001 VOLUME0000111111 3000 VOLUME3000 -        -        0x00      SCSI
```

The following example only displays the EC type sessions:

```
CLI> show advanced-copy-sessions -type ec
SID  Gene-ration  Type      Volume Type      Source Volume No. Name      Destination Volume No. Name      Status  Phase      Error Code  Requestor
-----
3    - EC Standard 8004 VOLUME001 4004 VOLUME002 -        -        0x00      GUI
4    - EC Standard 8005 VOLUME005 4005 VOLUME505 -        -        0x00      GUI
```

The following example only displays the sessions that are being started by GUI amongst all the sessions. When narrowing down the sessions by requestor, the "-type" parameter must be specified with the "-requestor" parameter.

```
CLI> show advanced-copy-sessions -type all -requestor gui
SID  Gene-ration  Type      Volume Type      Source Volume No. Name      Destination Volume No. Name      Status  Phase      Error Code  Requestor
-----
2    - Monitor Standard 8003 VOLUME1111 -        -        0x00      GUI
3    - EC Standard 8004 VOLUME001 4004 VOLUME002 -        -        0x00      GUI
4    - EC Standard 8005 VOLUME005 4005 VOLUME505 -        -        0x00      GUI
15   - OPC Standard 8006 VOLUME006 4006 VOLUME606 -        -        0x00      GUI
```

The following example displays the details of session #3: Multiple sessions cannot be specified at the same time.

```
CLI> show advanced-copy-sessions -session-id 3
# SID  Gene-ration  Type      Volume Type      Source Volume No. Name      Destination Volume No. Name      Status  Phase      Error Code  Requestor
# 3    - EC Standard 8004 VOLUME001 4004 VOLUME002 -        -        0x00      GUI
Source Block Address (LBA) : 0x1234567890123456
Destination Block Address (LBA) : 0x1234567890123456
Total Data Size (MB)      : 1024
Copied Data Size (MB)     : 512
Modified Data Size (MB)  : -
SDP Used Capacity (MB)   : -
SDP-ID (assigned to SDV) : -
Direction                : -
Sync                     : -
Transfer Mode            : -
Recovery Mode           : -
Split Mode              : -
Remote Session-ID       : -
Remote Box-ID           : -
Time Stamp              : 2010-11-17 18:30:00
Elapsed Time            : 1 day 1 hour 32 min 35 sec
Resolution              : x2
License                 : Regular
Copy Range              : Extent
Secondary Access Permission : No Read/Write
Concurrent Suspend Status : Normal
Change Error           : Normal
Remain Time            : 1 day 1 hour 32 min 35 sec
```

start advanced-copy

This command starts an Advanced Copy SnapOPC+ session. All other Copy types cannot be started using this command.

Caution

- For controller firmware versions earlier than V10L60, SDV can be specified as the copy destination volume.
- For controller firmware versions V10L60 and later, SDV, TPV, or FTV can be specified as the copy destination volume.
- External Volumes cannot be specified.

■ Syntax

```
start advanced-copy  
{-source-volume-number volume_number | -source-volume-name volume_name}  
{-destination-volume-number volume_number | -destination-volume-name volume_name}
```

■ Parameter

-source-volume-number or -source-volume-name

This parameter specifies the volume identifier of the copy source. Only one volume can be specified at the same time. For details, refer to ["1.2.11 Volume Syntax" \(page 40\)](#).

volume_number Copy source volume number
volume_name Copy source volume name

-destination-volume-number or -destination-volume-name

This parameter specifies the volume identifier of copy destination. For controller firmware versions earlier than V10L60, the type must be SDV. For controller firmware versions V10L60 and later, the type must be SDV, TPV, or FTV. Only one volume identifier can be specified at the same time. For details, refer to ["1.2.11 Volume Syntax" \(page 40\)](#).

volume_number Copy destination volume number
volume_name Copy destination volume name

■ Example(s)

The following example starts an Advanced Copy session from the volume named "OPEN1" to the volume named "SDV1":

```
CLI> start advanced-copy -source-volume-name OPEN1 -destination-volume-name SDV1
```

stop advanced-copy

This command stops an Advanced Copy session or sessions.

Note

- All Advanced Copy sessions can be stopped.
- WWOL copy sessions cannot be stopped. To stop WWOL copy sessions, use the "stop wvol-copy-session" command.

Syntax

```
stop advanced-copy -session-id session_ids [-delete-mode {forced | normal}]
```

Parameter

-session-id This parameter specifies the session IDs that are to be stopped. One or more numbers can be specified at the same time.

Example:

- session-id 0 (Only 0)
- session-id 0,1 (0 and 1)
- session-id 2-5 (2 to 5)
- session-id 0,2-5 (0, and 2 to 5)

session_ids Session ID

-delete-mode

Optional. The Copy Session Management policy is required.

This parameter specifies the deletion mode. This parameter can be specified for any type of Advanced Copy session. When the Copy type is SnapOPC, the specified session and all prior sessions are deleted. If omitted, this parameter is handled as though "normal" is specified. When multiple sessions are specified, this parameter is applied to all the selected sessions.

forced Sessions are forcibly deleted.

normal Sessions are not forcibly deleted (default).

Example(s)

The following example forcibly stops Advanced Copy session ID #1:

```
CLI> stop advanced-copy -session-id 1 -delete-mode forced
```

4.1.4 Remote Equivalent Copy Management

Remote Equivalent Copy (REC) is a function that is used to perform Equivalent Copy (EC) between remote storage systems. CLI for settings related to REC allows the composing of REC path information, setting information, tuning performance and other similar actions, but cannot support starting sessions and session management. For controlling sessions, use ETERNUS SF AdvancedCopy Manager (ACM). For further information, refer to the related documentation. For details about the license that is required for REC session connections, refer to the "set advanced-copy-license" and the "show advanced-copy-license" commands.

Caution

The REC functions are not supported in the DX60 S4/DX60 S3. The DX60 S4/DX60 S3 only support port mode switching.

The CLI commands for Remote Equivalent Copy are listed in the following table:

Function	Command
Port mode	set host-port-mode show host-port-mode
REC path	import rec-path show rec-path export backup-rec-path show backup-rec-path-information convert rec-path
Round trip time	measure rec-round-trip-time set rec-round-trip-time
REC multiplicity	set rec-multiplicity
REC buffer	set rec-buffer delete rec-buffer show rec-buffer
REC disk buffer	create rec-disk-buffer set rec-disk-buffer delete rec-disk-buffer show rec-disk-buffer format rec-disk-buffer release rec-disk-buffer
REC QoS	set rec-path-qos

This section explains the CLI commands related to the environment settings used to control the REC. The minimum requirements for both the copy source storage system and the copy destination storage system is a path information file that defines the data transmission line and related performance boosting settings.

4.1.4.1 Summaries of REC Environment Settings through CLI

Even though REC sessions may be started by using ETERNUS SF AdvancedCopy Manager (ACM) upon applying the REC environment settings using CLI, it is recommended that round trip times be measured to optimize the performance between storage systems. The steps involved in setting the REC environment using CLI are as follows:

Procedure

- 1** Switch the host interface ports to RA mode or CA/RA auto mode (on both the copy source and the copy destination storage systems).
Use the "set host-port-mode" command to set the host interface port that is to be used to establish an REC path to RA mode or CA/RA auto mode. The currently set mode can also be displayed by using the "show host-port-mode" command. Parameter settings for each host interface port can be set by using the "set fc-parameters" and "set iscsi parameters" commands.
- 2** Create TEXT type REC path information (TEXT type is recommended for CLI).
Describe the REC path information using a text editor, commercial software, etc. For details, refer to the descriptions that follow.
- 3** Apply the REC path information.
Use the "import rec-path" command to apply the REC path information to the target storage systems (both the copy source and the copy destination). If a syntax error is detected, the command will terminate with an error message and an error line. Make sure that the information in the REC path information file matches the actual setup.
- 4** Measure and apply round trip times.
Firstly, measure the round trip time using the "measure rec-round-trip-time" command in automatic mode and apply it in the system. Individual round trip times can be manually measured and applied afterwards if necessary. Multiplicity can also be set to fine tune the REC performance. For detail, refer to the set rec-multiplicity command.
- 5** Define REC buffers (Only for REC Asynchronous Consistency Mode).
If the mode is used, define an REC buffer using the "set rec-buffer" command. The configuration and status of the REC buffer can be checked by using the "show rec-buffer" command.

End of procedure

The following functions (services) are also supported:

- Exporting the REC path information system backup file to an FTP server.
- Converting the REC path information file type bi-directionally, from TEXT type to BINARY type, or from BINARY type to TEXT type.

4.1.4.1.1 Path Information File

In order to control the REC, a path information file must be created. This file contains Box IDs, information identifying ETERNUS DX/AF storage systems and remote adapters, host interface port information for the host interface adapters installed in the ETERNUS DX/AF. This file is set to RA (Remote Adapter) mode. In the ETERNUS DX/AF, two different path information file formats are supported; TEXT type and BINARY type.

- TEXT type
Path information is directly described using a text editor or similar tool (details follow). This is the recommended approach for CLI-use.
- BINARY type
Path information is created and revised using the GUI edit function. This is the recommended approach for GUI-use.

The contents of a typical REC path information file are as follows:

Figure 4.2 Overview of the path information file

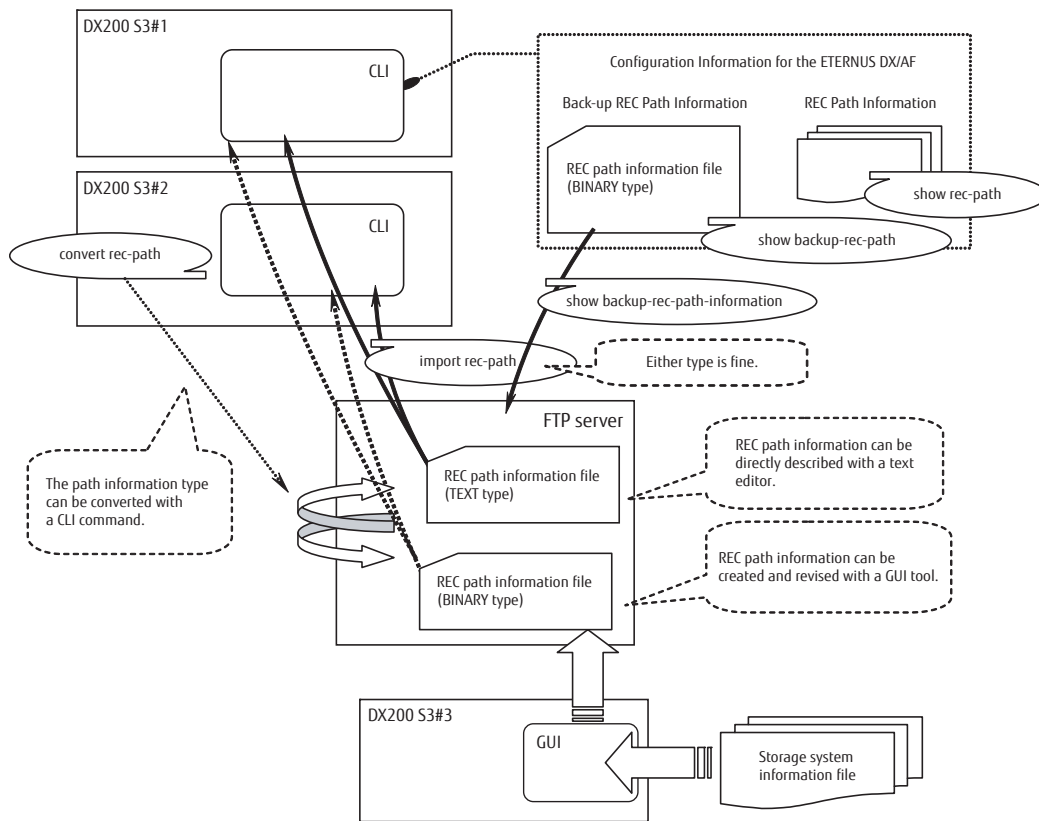

4.1.4.1.2 Path Information File Syntax (TEXT type)

For CLI-use, a path information file should be created using text editor, or something similar. The TEXT type path information file description rules are as follows:

■ Basic rules

- Only ASCII characters may be used.
- All label names must be in lowercase. The following is a correct example.

```
storage 10
```

The following example has an uppercase label (a syntax error):

```
STORAGE 10
```

- Lines 'starting' (first non-space character) with a hash mark (#) are handled as comment lines. The following example shows a correct comment line:

```
# definition of storage system
```

The following line is NOT handled as a comment line because the "box-id" string appears before the hash mark:

```
box-id ###DXL###
```

- The number of space is not restricted. Note that at least one or more space keys are required between a label name and operand, to set value. The following example is also identified as a correct line.

```
storage      10
```

The following example has no spaces between the "storage" label name and the operand value "10" (a syntax error):

```
storage10
```

- The ASCII characters CR+LF (hexadecimal code 0x0d0a) are expected for newlines, with CR or LF alone also being interpreted as a newline. When exporting the system backup path information, newlines are output as ASCII code CR+LF.
- The maximum number of characters for each line is 255 (including the newline characters).

■ Authentication strings

eternus-rec-path-text-xxxx

The authentication string must be described from the first column of the top line. Any space characters must not be inserted.

The xxxx defines the version of the path information file. The version that can be applied differs depending on connection source device, connection destination device, and the firmware version.

The following table indicates the specification methods for the versions of the path information file.

Connection source device series/model	Firmware version	Version of the path information file	Connection destination device series/model	
			DX100 S4/DX200 S4, DX500 S4/DX600 S4, DX100 S3/DX200 S3, DX500 S3/DX600 S3, DX8100 S3, AF250 S2/AF650 S2, AF250/AF650, DX200F	DX8700 S3/DX8900 S3
DX100 S3/DX200 S3, DX500 S3/DX600 S3, DX8100 S3, DX200F	Earlier than V10L40	0101	x	-
	V10L40 and later	0101	x	-
		0202	x	x
DX8700 S3/DX8900 S3	V10L40 and later	0101	x	x*
		0202	x	x
AF250/AF650	V10L60 and later	0202	x	x
DX100 S4/DX200 S4	V10L70 and later	0202	x	x
DX500 S4/DX600 S4, AF250 S2/AF650 S2	V10L80 and later	0202	x	x

x: REC connections available, x*: REC connections possible, -: REC connections not possible

- Version 0101 of the path information file
The specifiable ports are 0 to 7 for the controller module, 0 to 3 for the CA, and 0 to 3 for the host interface port.
To connect to the DX8700 S3/DX8900 S3, use version 0202.
For x*, if CM#2 to CM#7 is specified, a configuration to CE#1 to CE#3 is performed.
 - CE number
The value (quotient) obtained by dividing the CM number by 2.
 - CM number
The remaining value (remainder) obtained by dividing the CM number by 2.
Example: If CM#2 was specified, the result is CE#1CM#0 (2 / 2 = 1 with a remainder of 0)
Example: If CM#7 was specified, the result is CE#3CM#1 (7 / 2 = 3 with a remainder of 1)
- Version 0202 of the path information file
The specifiable ports are 0 to b for the controller enclosure, 0 to 2 for the controller module, 0 to 3 for the CA, and 0 to 3 for the host interface port.
The following example shows version 0101 of the path information file.

```
eternus-rec-path-text-0101
```

■ Storage system definitions

storage Defines an identification number (0-127) for each of the local and remote storage systems. Usable numbers can be freely selected within this range. The following example uses "0" as the storage system id number:

```
storage 0
```

box-id Defines a Box ID for the target storage system. Note the following:

- The Box ID value must be double-quoted ("").
- Lowercase characters are automatically converted to uppercase.
- Hash marks (#) are automatically appended to Box IDs shorter than 40 characters in length.
- The Box ID can be confirmed using the "show boxid" command.

```
box-id "00DXL#####ET06F21AUABCPJ000000#####"
```

device-type Defines a device type for the target storage system. The storage system is specified by two numbers that indicate the unit type and the unit sub type. The meaning of these numbers are shown in the table below.

Storage series / models	Unit type	Sub unit type
DX100 S4/DX200 S4	5	7
DX500 S4/DX600 S4	5	8
DX100 S3/DX200 S3	5	7
DX500 S3/DX600 S3	5	8
DX8100 S3	5	8
DX8700 S3/DX8900 S3	5	9
AF250 S2/AF250	5	7
AF650 S2/AF650	5	8
DX200F	5	7

Examples are shown below.

```
device-type 4, 5
```

cmX-caY-portZ

Define the World Wide Name (WWN) or iSCSI parameters of a host interface port to be set to RA mode or CA/RA auto mode in the target storage system. The X in a label name is the controller module number, the Y is the CA number, and the Z is the host interface port number.

Examples are shown below. In this example, the host interface port of CM#0 is defined when version 0101 of the path information file is used.

- RA mode or CA/RA auto mode can be switched by using the "set host-port-mode" command.
- Host interface port WWNs or iSCSI name can be confirmed using the "show fru-ce" command.
- The limitation for the number of characters for each iSCSI parameter is as follows:
 - iSCSI name: At least 4 and a maximum of 223.
 - RA port CHAP authentication username: At least 1 and a maximum of 63.
 - RA port CHAP authentication password: At least 12 and a maximum of 32.
 - When CHAP authentication is disabled, CHAP authentication username and password should be omitted.
 - Alias: At least 0 and a maximum of 31, which must be enclosed with double quotations ("").

Examples are shown below.

```
cm0-ca0-port0 40000000abc80e38
cm0-ca0-port1 40000000abc80e3a
cm0-ca3-port2 40000000abc80e3c
cm0-ca3-port3 40000000abc80e3e
```

Example host interface port iSCSI parameter definitions:

```
cm0-ca0-port0 iqn.2010-12.com.fujitsu:storage-system.eternus-dx400:00040080,10.11.12.13,eternus,eternus,"eternus000"
cm0-ca1-port1 iqn.2010-12.com.fujitsu:storage-system.eternus-dx400:00040080,10.11.12.22,,,""
cm1-ca0-port0 iqn.2010-12.com.fujitsu:storage-system.eternus-dx400:00040080,fe80::250,,,""
cm1-ca1-port1 iqn.2010-12.com.fujitsu:storage-system.eternus-dx400:00040080,2000:100::10:1:0:250,,,""
```

ceW-cmX-caY-portZ

Define the World Wide Name (WWN) or iSCSI parameters of a host interface port to be set to RA mode or CA/RA auto mode in the target storage system. The W in a label name is the controller enclosure number (and "0" is specified for the DX100 S4/DX200 S4, the DX500 S4/DX600 S4, the DX100 S3/DX200 S3, the DX500 S3/DX600 S3, the AF250 S2/AF650 S2, the AF250/AF650, and the DX200F), the X is the controller module number, the Y is the CA number, and the Z is the host interface port number.

Examples are shown below. In this example, the host interface port of CE#0 CM#0 is defined when version 0202 of the path information file is used.

- RA mode or CA/RA auto mode can be switched by using the "set host-port-mode" command.
- Host interface port WWNs or iSCSI name can be confirmed using the "show fru-ce" command.
- The limitation for the number of characters for each iSCSI parameter is as follows:
 - iSCSI name: At least 4 and a maximum of 223.
 - RA port CHAP authentication username: At least 1 and a maximum of 63.
 - RA port CHAP authentication password: At least 12 and a maximum of 32.
 - When CHAP authentication is disabled, CHAP authentication username and password should be omitted.
 - Alias: At least 0 and a maximum of 31, which must be enclosed with double quotations ("").

Examples are shown below.

```
ce0-cm0-ca0-port0 40000000abc80e38
ce0-cm0-ca0-port1 40000000abc80e3a
ce0-cm0-ca3-port2 40000000abc80e3c
ce0-cm0-ca3-port3 40000000abc80e3e
```

Example host interface port iSCSI parameter definitions:

```
ce0-cm0-ca0-port0 iqn.2010-12.com.fujitsu:storage-system.eternus-dx400:00040080,10.11.12.13,eternus,eternus,"eternus000"
ce0-cm0-ca1-port1 iqn.2010-12.com.fujitsu:storage-system.eternus-dx400:00040080,10.11.12.22,,,""
ce0-cm1-ca0-port0 iqn.2010-12.com.fujitsu:storage-system.eternus-dx400:00040080,fe80::250,,,""
ce0-cm1-ca1-port1 iqn.2010-12.com.fujitsu:storage-system.eternus-dx400:00040080,2000:100::10:1:0:250,,,""
```

■ Inter storage system REC path information definitions

In order to use REC, a file that specifies the inter-storage-system copy paths must be created. This contains REC path information indicating the whole paths (copy source, copy destination, and the path between them) that are to be used for REC.

The following examples describe the various inter-storage-system REC path information parameters.

storage-link X,Y

Defines the numbers of the two storage systems (the copy source and the copy destination) that are to be linked. The numbers are those used in the storage system definitions. The following example shows numbers from the storage system definitions being used.

```
storage-link 5,6
```

path-type {direct | switched}

Defines the type of path connection of the connected device. If the device is connected directly, the descriptor is "direct". If the device is connected remotely, the descriptor is "switched". The following example is specified when using a direct connection type:

```
path-type direct
```

The following example is specified when using a remote connection type:

```
path-type switched
```

line-speed {1-65535}

Defines an effective line speed for the path between the linked storage systems. This is the WAN bandwidth that is actually available and used for the REC. The possible range is from 1 to 65535 and the units are megabits per second (= Mbit/s). This definition is only specified for switched type paths. The following example specifies 100 Mbit/s as the effective line speed:

```
line-speed 100
```

port-link cmX-ca Y-portZ,cm W-ca V-portU

Respectively defines the target host interface ports in the local and remote storage systems in the same order as used in the "storage-link" field. The following example is when version 0101 of the path information file is used. For "storage-link 5,6" used in the above storage system definition example, cm0-ca0-port1 belongs to storage system #5 and cm1-ca2-port3 belongs to storage system #6. In the "cmX-portY-portZ,cmW-portV-portU" format, X and W indicate the controller module number, Y and V indicate the host adapter on the specified controller module ("0" is specified for the DX100 S4/DX200 S4, the DX100 S3/DX200 S3, the AF250 S2/AF250, and the DX200F), and Z and U indicate the host interface port number of the specified host adapter.

```
port-link cm0-ca0-port1,cm1-ca2-port3
```

Note that space characters may not be inserted before and after the commas (,). The following example has a space character after the comma (,) (a syntax error):

```
port-link cm0-ca0-port1, cm1-ca2-port3
```

port-link ceW-cmX-caY-portZ,ceV-cmU-caT-portS

Respectively defines the target host interface ports in the local and remote storage systems in the same order as used in the "storage-link" field. The following example is when version 0202 of the path information file is used. For "storage-link 5,6" used in the above storage system definition example, ce0-cm0-ca0-port1 belongs to storage system #5 and ce0-cm1-ca2-port3 belongs to storage system #6. In the "ceW-cmX-caY-portZ,ceV-cmU-caT-portS" format, W and V indicate the controller enclosure number (and "0" is specified for the DX100 S4/DX200 S4, the DX500 S4/DX600 S4, the DX100 S3/DX200 S3, the DX500 S3/DX600 S3, the AF250 S2/AF650 S2, the AF250/AF650, and the DX200F), X and U indicate the controller module number, Y and T indicate the host adapter on the specified controller module ("0" is specified for the DX100 S4/DX200 S4, the DX100 S3/DX200 S3, the AF250 S2/AF250, and the DX200F), and Z and S indicate the host interface port number of the specified host adapter.

```
port-link ce0-cm0-ca0-port1,ce0-cm1-ca2-port3
```

Note that space characters may not be inserted before and after the commas (,). The following example has a space character after the comma (,) (a syntax error):

```
port-link ce0-cm0-ca0-port1, ce0-cm1-ca2-port3
```

The example REC path information file that follows is based on the path topology shown below:

Figure 4.3 Example of an REC path information file

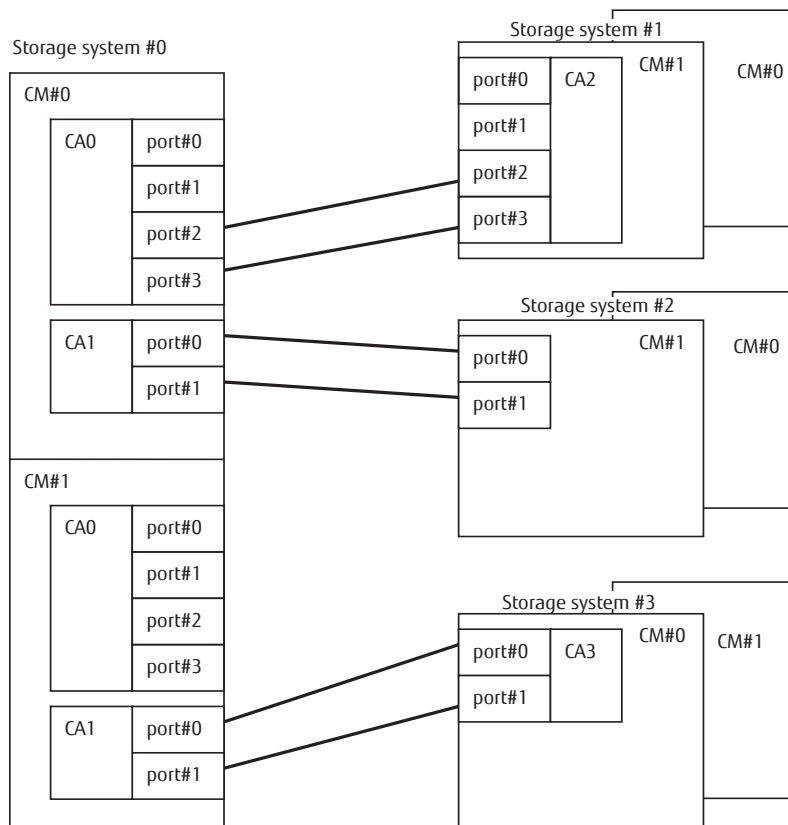

```
eternus-rec-path-text-0101
# REC Path information file for ETERNUS
# Definition of storage system
# Storage system #0
storage 0
box-id      "00ETERNUSDXMS2ET00000A####EI000000#####"
device-type 4,5
cm0-ca0-port2 40000000abc80e42
cm0-ca0-port3 40000000abc80e43
cm0-ca1-port0 40000000abc80e50
cm0-ca1-port1 40000000abc80e51
cm1-cal-port0 irq.2010-12.com.fujitsu:storage-system.eternus-dx400:00040080,10.11.12.13,eternus,eternus,"n0p110"
cm1-cal-port1 irq.2010-12.com.fujitsu:storage-system.eternus-dx400:00040080,10.11.12.14,,,""

# Storage system #1
storage 1
box-id      "00ETERNUSDXMS2ET00000A####EI000001#####"
device-type 4,5
cm1-ca2-port2 40000000abc80e42
cm1-ca2-port3 40000000abc80e43

# Storage system #2
storage 2
box-id      "00DXL#####ET06F21AUABCPJ000002#####"
device-type 4,4
cm1-ca0-port0 40000000abc80e42
cm1-ca0-port1 40000000abc80e43

# Storage system #3
storage 3
box-id      "00ETERNUSDXMS2ET00000A####EI000003#####"
device-type 4,5
cm0-ca3-port0 irq.2010-12.com.fujitsu:storage-system.eternus-dx400:00040080,10.11.12.93,eternus,eternus,"n3p030"
cm0-ca3-port1 irq.2010-12.com.fujitsu:storage-system.eternus-dx400:00040080,10.11.12.94,,,""

# Definition of REC path information
# Linked between 0 and 1
storage-link 0,1
path-type      direct
port-link cm0-ca0-port2,cm1-ca2-port2
port-link cm0-ca0-port3,cm1-ca2-port3

# Linked between 2 and 0
storage-link 2,0
path-type      switched
line-speed     1000
port-link cm1-ca0-port0,cm0-cal-port0
port-link cm1-ca0-port1,cm0-cal-port1

# Linked between 0 and 3
storage-link 0,3
path-type      switched
line-speed     1000
port-link cm1-cal-port0,cm0-ca3-port0
port-link cm1-cal-port1,cm0-ca3-port1
```

4.1.4.1.3 REC Multiplicity

An REC multiplicity value must be set for the REC path between storage systems, and is determined based on the following two values:

- Effective line speed (as described in the REC path information file)
- Round trip time (as actually measured using a CLI command)

The schematic diagram for determining the REC multiplicity is as follows:

Figure 4.4 Overview of REC multiplicity

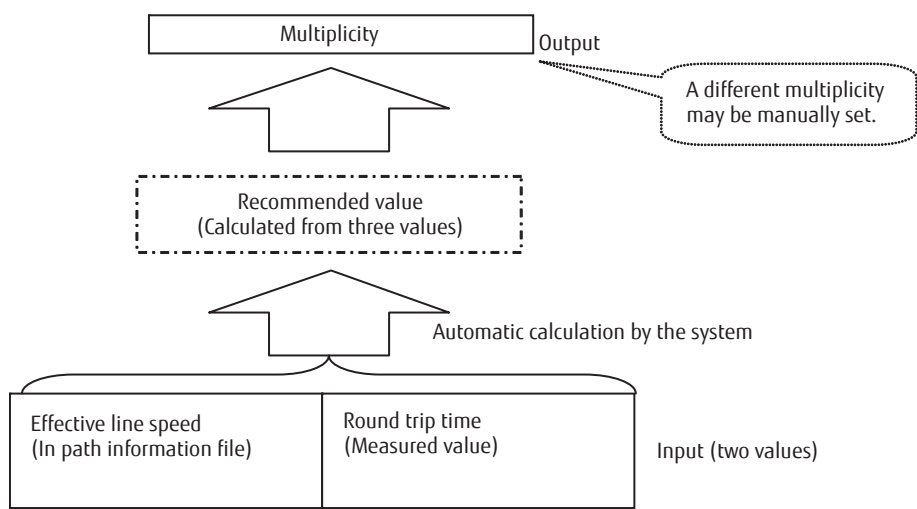

4.1.4.1.4 Assigning REC Buffers

An area that is used to divide REC buffers is called a partition. This area can also be called a group. An REC buffer must be assigned when the REC Asynchronous Consistency Mode is used. Up to 8,192MB (*1) can be assigned in the memory space area of REC buffers, and this can be separated into several partitions for each CM. The maximum number of partitions in the system is 8 (*1). The maximum size of a partition is 2,048MB and the minimum is 128MB. Each partition is handled by specifying its partition number from 0 to 7 (*1).

*1: These are the specification values for the DX600 S4. Values differ among models and types. For details, refer to the "set rec-buffer" command.

The following example shows how partitions can be assigned for the DX600 S4:

Case 1: No partitions assigned:

8,192MB

Case 2: The maximum size memory is assigned to a single partition:

2,048MB	
---------	--

Case 3: 2,048MB of memory is assigned to four separate partitions:

2,048MB	2,048MB	2,048MB	2,048MB
---------	---------	---------	---------

Case 4: 1,024MB of memory is assigned to eight separate partitions:

1,024MB	1,024MB	1,024MB	1,024MB	1,024MB	1,024MB	1,024MB	1,024MB
---------	---------	---------	---------	---------	---------	---------	---------

Case 5: 2,048MB of memory is assigned to one partition, and 1,024MB of memory is assigned to six separate partitions:

2,048MB	1,024MB	1,024MB	1,024MB	1,024MB	1,024MB	1,024MB
---------	---------	---------	---------	---------	---------	---------

4.1.4.1.5 Assigning REC Disk Buffers

If an REC disk buffer is assigned for the REC Asynchronous Consistency mode, even if an REC buffer overflow occurs, the REC disk buffer is used. An REC disk buffer is made from four or eight drives and is displayed as a RAID group of RAID1+0. However, it is only used as an REC disk buffer. Up to 4 REC disk buffers can be assigned to one REC buffer.

If multiple REC disk buffers are assigned to a single REC buffer, the REC disk buffers must satisfy the following conditions.

- The drive types must be the same
- The number of drives must be the same
- The encryption state must be the same
- The Stripe Depth must be the same (recommended)
- The capacity must be the same (recommended)

If the REC that is using the REC buffer is operating, "Suspend" the corresponding REC session in advance.

The following figure shows how the REC disk buffer is used:

Figure 4.5 Structure of an REC disk buffer

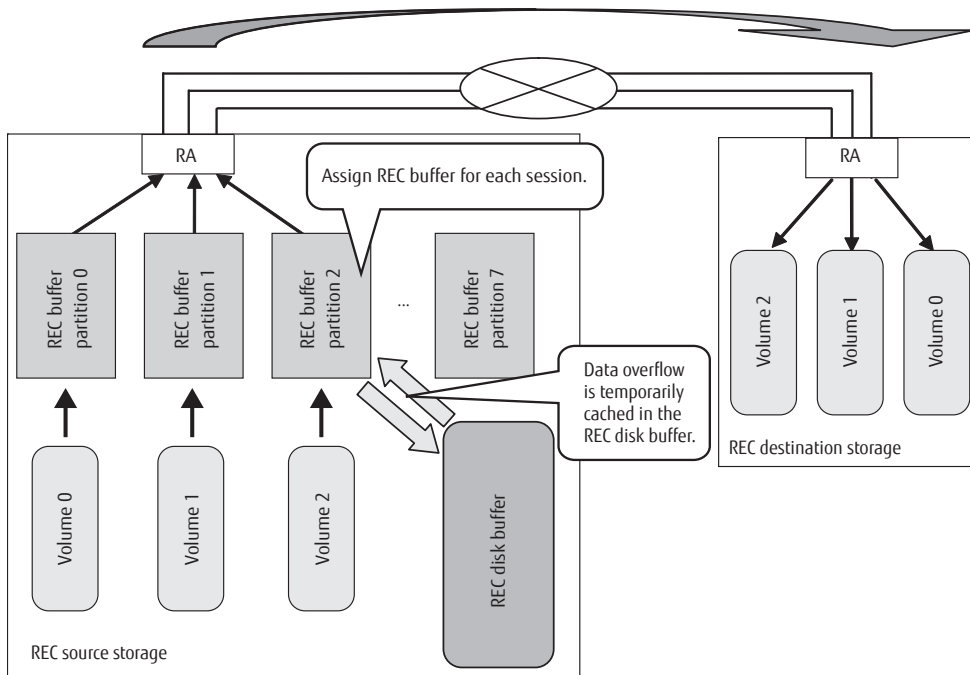

■ Summary of REC disk buffer settings through CLI

The steps involved in settings an REC disk buffer using CLI are as follows:

Procedure

- 1** Create an REC disk buffer.
To create an REC disk buffer, choose four or eight drives that do not belong to a RAID group by using the "create rec-disk-buffer" command.
Then create a volume from this RAID group. This is a RAID group that can be displayed by using the "show rec-disk-buffer" command.
- 2** Format REC disk buffer volumes.
Format REC disk buffers by using the "format rec-disk-buffer" command.
- 3** Associate REC buffer with REC disk buffer.
To associate an REC buffer with an REC disk buffer, use the "set rec-disk-buffer" command.

Note

- To release the REC disk buffer from the REC buffer, use the "release rec-disk-buffer" command. This can be confirmed by using the "show rec-disk-buffer" command.
- To delete an REC disk buffer, use the "delete rec-disk-buffer" command.

End of procedure

The following figure shows the process involved in setting the REC disk buffer through CLI:

Figure 4.6 Setup procedure for an REC disk buffer

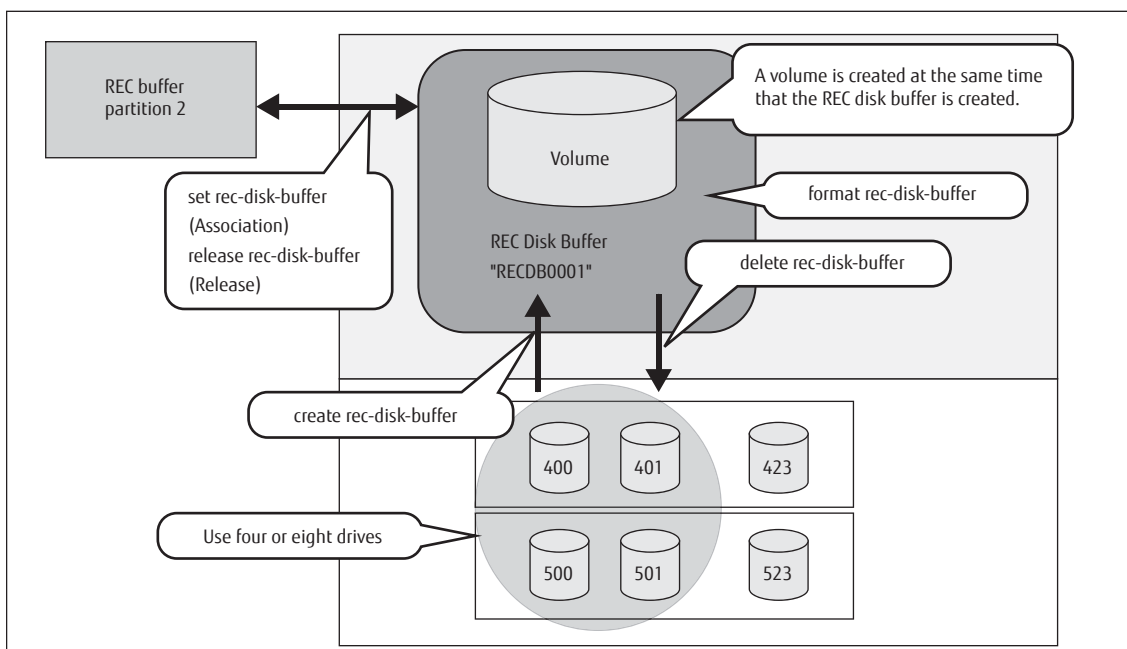

show host-port-mode

This command displays operation mode that is set to each host interface port.

Syntax

```
show host-port-mode
```

Parameter

No parameters.

Output

Item name	Description
CM#xCA#yPort#z	Host interface port number (Only for the DX60 S4/DX100 S4/DX200 S4, the DX500 S4/DX600 S4, the DX60 S3/DX100 S3/DX200 S3, the DX500 S3/DX600 S3, the DX8100 S3, the AF250 S2/AF650 S2, the AF250/AF650, and the DX200F)
CE#w CM#xCA#yPort#z	Host interface port number (Only for the DX8700 S3/DX8900 S3)
Port Mode	Operation mode for a host interface port

Example(s)

The following example displays operation mode that is set to all the host interface ports on a system:

```
CLI> show host-port-mode
Port Mode
CM#0 CA#0 Port#0 RA
CM#0 CA#0 Port#1 CA
CM#0 CA#1 Port#0 CA
CM#0 CA#1 Port#1 CA
CM#1 CA#0 Port#0 CA
CM#1 CA#0 Port#1 CA
CM#1 CA#1 Port#0 NAS-CA
CM#1 CA#1 Port#1 NAS-CA
```

set host-port-mode

This command sets which mode to use for host interface ports.

Caution

- Host interface ports used to REC functions must be switched to RA mode or CA/RA auto mode.
- When switching to RA mode or CA/RA auto mode, all host mapping information associated with the port is lost.
- When reverting to CA mode, all REC path information defined for the port is lost.
- When the port mode is switched from the RA mode or the CA/RA auto mode to another mode, the REC Transfer Mode setting (Consistency/Stack/Through/Sync) of the port is changed to the default value ("enable" for all of the setting).
- When the port mode is switched from the RA mode to the CA/RA auto mode or vice versa, the REC transfer mode setting (Consistency/Stack/Through/Sync) of the port is retained.
- When the port mode is switched from the RA mode or the CA/RA auto mode to another mode, the line number (REC Line No.) setting of the port is changed to the default value (0).
- When the port mode is switched from the RA mode to the CA/RA auto mode or vice versa, the line number (REC Line No.) setting for the port is retained.

Syntax

```
set host-port-mode -port {port_numbers | all} -mode {ra | ca | initiator | cara}
```

Parameter

-port This parameter specifies the number of the host interface port that is to be switched. Two or more parameters can be specified by separating them with a comma (,).

Example: -port 000,100

For details, refer to "[1.2.15 Host Interface Port Syntax](#)" (page 44).

port_numbers Host interface port

xyz "x" is the controller module (CM) number, "y" is the CA number, and "z" is the host port number (DX60 S4/DX100 S4/DX200 S4, DX500 S4/DX600 S4, DX60 S3/DX100 S3/DX200 S3, DX500 S3/DX600 S3, DX8100 S3, AF250 S2/AF650 S2, AF250/AF650, and DX200F only).
Example: 123 (CM#1-CA#2-Port#3)

wxyz "w" is the controller enclosure (CE) number, "x" is the controller module (CM) number, "y" is the CA number, and "z" is the host port number (DX8700 S3/DX8900 S3 only).
Example: 0123 (CE#0-CM#1-CA#2-Port#3)

all All the host interface ports

-mode	Optional. This parameter specifies operation mode for the host interface port. RA mode must be set when the REC functions are used. The RA mode can only be set for FC ports and iSCSI ports. The Initiator mode can only be set for FC ports.
ra	RA mode (for REC)
ca	CA mode
initiator	Initiator mode (for Storage Migration)
cara	CA/RA auto mode

■ Example(s)

The following example switches CM#1 CA#0 Port#0 to the RA mode (for the DX100 S4/DX200 S4, the DX500 S4/DX600 S4, the DX100 S3/DX200 S3, the DX500 S3/DX600 S3, the DX8100 S3, the AF250 S2/AF650 S2, the AF250/AF650, and the DX200F):

```
CLI> set host-port-mode -port 100 -mode ra
```

The following example switches CE#0 CM#1 CA#0 Port#0 to the RA mode (for the DX8700 S3/DX8900 S3):

```
CLI> set host-port-mode -port 0100 -mode ra
```

The following example reverts CM#1 CA#0 Port#3 to the CA mode:

```
CLI> set host-port-mode -port 103 -mode ca
```

The following example switches all the host interface ports to the RA mode:

```
CLI> set host-port-mode -port all -mode ra
```

show rec-path

This command is used to display the detailed REC path information of a system, and also displays the status of any remotely connected devices. If this parameter is omitted, the information regarding all remote storage systems is listed. If this parameter is specified, the path information for a single device can be displayed.

Syntax

```
show rec-path [-remote-boxid remote_storage_box_id]
```

Parameter

-remote-boxid

Optional. This parameter specifies the Box ID of the storage system whose REC path information details are to be displayed. Only one Box ID can be specified at a time. If this parameter is omitted, a list of the storage system and its remote storage systems is displayed

- Box IDs use a maximum of 40 alphanumeric characters, spaces, and pound key characters (#).
- All alphabetic characters are handled as uppercase.
- The pound key characters (#) are automatically appended when the input characters are less than 40.

remote_storage_box_id Box ID

Output

- When the parameter is omitted.

Item name	Description
E	Error sign. If "*" mark is output, it means that path information status between storage systems is not normal. You can check details by trying this command with this remote Box ID.
Remote Box ID	Box ID of a remote storage system registered in the system
Path Type	Connection form of a remote storage system registered in the system
Line Speed (Mbit/s)	Effective line speed of a remote storage system registered in the system
Round Trip Time (ms)	Round trip time of a remote storage system registered in the system. If a round trip time is not measured, "Unknown" is displayed.
Multiplicity	Multiplicity
Current	Actual multiplicity of a remote storage system registered in the system. If "Auto" is displayed, it indicates that a recommended multiplicity is used.
Recommended	Multiplicity recommended by the system. If the round trip time is "Unknown", "*" is displayed.
Priority Level	Copy level of a remote storage system registered in the system. "auto" indicates that the EC/OPC rate is used.
Copy Schedule Mode	Copy Schedule Mode

- When the parameter is specified.

Item name	Description
Local Box ID (Current Storage System)	Box ID of a local storage system
Remote Box ID	Box ID of the specified remote storage system
Path type	Connection form of a remote storage system registered in the system

Item name	Description
Effective Line Speed	Effective line speed of a remote storage system registered in the system. A unit is Mbit/s.
Round Trip Time	Round trip time of a remote storage system registered in the system. A unit is millisecond.
Current Multiplicity	Multiplicity recommended by the system
Recommended Multiplicity	Multiplicity of the remote storage system registered in the system. If the round trip time is "Unknown", "****" is displayed.
Priority Level	Copy level of a remote storage system registered in the system
Copy schedule Mode	Copy Schedule Mode
Path Information	Path details
Local Port	Host interface port number of the local storage system
Status	Path status ("Error", "Warn", or "Normal") between the local storage system and the remote storage system. When the path status is not normal, this information is followed by symbols that indicate the place that is suspected to have an error or the reason for the warning. The details of the symbols are displayed under "Error detail description(s)".
Bandwidth Limit	Bandwidth limit value (unit: Mbit/s) If there is no limit, "Unlimited" is displayed.
Remote Port WWN / iSCSI Name (IP Address)	World Wide Name (WWN) of FC-RA of the remote storage system or iSCSI name and IP address of iSCSI-RA (for connecting older models) of the remote storage system.
Error detail description(s)	Symbols that indicate the place that is suspected to have an error and detailed descriptions of the symbols. These descriptions appear only when the path status is not normal.

■ Example(s)

The following example displays a list of remote storage systems connected to this system. In this case, an error in the path information status is indicated with a "*" mark.

```
CLI> show rec-path
Remote Storage System
E Remote Box ID
-----
Path Type Line Speed Round Trip Multiplicity Priority Copy Schedule
(Mbit/s) Time (ms) Current/Recommended Level Mode
-----
00DXL#####ET06F21AUABCPJ000002##### Direct - - - - 3 Session
* 00DXL#####ET06F21AUABCPJ000004##### Switched 10 20 4 3 - Destination
00DXL#####ET06F21AUABCPJ000006##### Switched 10 Unknown 4 3 - Session
```

The following example displays the path information details for the specified storage system. Note that if spaces or hash mark (#) characters are used, the Box ID must be specified with double quotations ("):

```
CLI> show rec-path -remote-boxid "00DXL#####ET06F21AUABCPJ000000#####"
Storage Information
Local Box ID (Current Storage System) 00DXL#####ET06F21AUABCPJ000001#####
Remote Box ID 00DXL#####ET06F21AUABCPJ000000#####
Line Information
Path Type Switched
Effective Line Speed 10 (Mbit/s)
Round Trip Time 12 (ms)
Current Multiplicity Auto
Recommended Multiplicity 3
Priority Level -
Copy Schedule Mode Session balancing
Path Information (to Remote Storage System)
Local Port Status Bandwidth Limit Remote Port WWN / iSCSI Name (IP Address)
(Mbit/s)
-----
CM#0 CA#0 Port#0 Normal Unlimited 500000E0D0C40005
CA#0 Port#1 Error [I T ] Unlimited 500000E0D0C40006
Error [T ] Unlimited 500000E0D0C40087
Normal 1 500000E0D0C40086
CA#0 Port#2 Error [R ] 120 500000E0D0C40007
CM#1 CA#1 Port#2 Error [C ] 1000 500000E0D0C40006
CM#1 CA#2 Port#0 Error [B ] 65535 500000E0D0C40085
Error detail description(s)
R: The copy path between the local device and remote device is in unstable status.
For example, link-down repeatedly occurs in a certain period of time or communication fails.
B: The resolution settings are different between the local device and remote device.
T: The error occurs in the FC-RA port or iSCSI-RA port on the remote device.
C: The error occurs in the cable.
I: The error occurs in the FC-RA port or iSCSI-RA port on the local device.
```

The following example displays the path information details for the specified storage system. In this case, iSCSI-RA (for connecting older models) is used:

```
CLI> show rec-path -remote-boxid "00DXL#####ET06F21AUABCPJ000000#####"
Storage Information
Local Box ID (Current Storage System) 00DXL#####ET06F21AUABCPJ000001#####
Remote Box ID                          00DXL#####ET06F21AUABCPJ000000#####
Line Information
Path Type                               Switched
Effective Line Speed                    10 (Mbit/s)
Round Trip Time                         12 (ms)
Current Multiplicity                    Auto
Recommended Multiplicity                 3
Priority Level                           -
Copy Schedule Mode                      Destination RAID Group balancing
Path Information (to Remote Storage System)
Local Port      Status      Bandwidth Limit Remote Port WWN / iSCSI Name (IP Address)
(Mbit/s)
-----
CM#0 CA#2 Port#1 Error [B      ]      Unlimited irq.2010-10.com (FE80::290:CCFF:FEA4:3A49)
CM#1 CA#1 Port#0 Error [T      ]      Unlimited irq.2010-11.com (2001:DB8::8:800:200C:417A)
      CA#2 Port#0 Normal           1 irq.2010-12.com (192.168.2.64)
      CA#2 Port#0 Error [I C T S ]      120 irq.2011-01.com (192.168.2.65)
      CA#2 Port#1 Normal           65535 irq.2010-12.com.fujitsu:storage-system.eternus-dx400:00040093405060808091 (192.168.2.66)

Error detail description(s)
B: The resolution settings are different between the local device and remote device.
T: The error occurs in the FC-RA port or iSCSI-RA port on the remote device.
C: The error occurs in the cable.
S: The error occurs in the switch or switch settings.
I: The error occurs in the FC-RA port or iSCSI-RA port on the local device.
```

import rec-path

This command is used to import an REC path information file from a specified FTP server and apply it to a system. Either type, TEXT or BINARY is available.

Note

- For details, refer to ["4.1.4 Remote Equivalent Copy Management" \(page 509\)](#).
- If a TEXT type path information file has syntax errors, the number of the problem line is included with the error message.
- This command may also be used to apply a GUI-created BINARY type path information file.

Syntax

```
import rec-path -port {maintenance | remote | fst} -server server_name  
-user login_user_account -filename filename [-indicator {enable | disable}]
```

Parameter

- port This parameter specifies which Ethernet port is used to connect to the FTP server. For details, refer to ["1.11 Note for Specifying FTP Server" \(page 54\)](#).
- | | |
|-------------|---|
| maintenance | Maintenance port (MNT port) |
| remote | Remote port (RMT port) |
| fst | FST port (DX500 S4/DX600 S4, DX500 S3/DX600 S3, DX8100 S3/DX8700 S3/DX8900 S3, and AF650 S2/AF650 only) |
- server This parameter specifies the name of the FTP server that contains the REC path information file. The server name format is IPv4 standard notation (a base 256 "d.d.d.d" string) or a fully qualified domain name.
- Example: -server 192.168.1.20
Example: -server foo.bar
- server_name* FTP server name
- user This parameter specifies the user name that is to be used to access the FTP server. When this parameter is specified, the command displays an FTP server password prompt.
- login_user_account* User name
- filename This parameter specifies the REC path information filename.
- filename* Filename
- indicator Optional. This parameter specifies whether the progress indicator is displayed. If omitted, the progress indicator is displayed.
- | | |
|---------|--------------------------------------|
| enable | Progress indicator is displayed. |
| disable | Progress indicator is not displayed. |

■ Example(s)

The following example imports an REC path information file from the FTP server named "ftp.a.com" using the maintenance port (MNT port). For the FTP server, the user name is "cli-user" and the filename is "/tmp/rec-path1.txt".

The entered password in "Password :" is not displayed:

```
CLI> import rec-path -port maintenance -server ftp.a.com -filename /tmp/rec-path1.txt -user cli-user
Password :
importing /tmp/rec-path1.txt from ftp.a.com
complete.
```

The following example is the same as above, except that the progress indicator is not displayed.

The entered password in "Password :" is not displayed:

```
CLI> import rec-path -port maintenance -server ftp.a.com -filename /tmp/rec-path1.txt -user cli-user -indicator disable
Password :
```

show backup-rec-path-information

This command displays a summary of the REC path information file backed up in a system. The information includes date and file size of the backup file.

■ Syntax

```
show backup-rec-path-information
```

■ Parameter

No parameters.

■ Output

Item name	Description
Date	Date of the backed up REC path information file
File Size	File size of the backed up REC path information file

■ Example(s)

The following example displays the date and file size of the backup REC path information file.

```
CLI> show backup-rec-path-information
Date      2009-06-02 15:24:17
File Size 51224 Bytes
```

export backup-rec-path

Each storage system contains a backup path information file. This is a backup copy of the original path information file. When the original path information file is imported, information that is described in the original path information file is reflected to the configuration information database and a backup copy is stored in the ETERNUS DX/AF. If the original file was TEXT type, it is automatically converted to BINARY type. This command exports the backup path information file to an external FTP server.

Note

- If the same file on an FTP server already exists, it would be overwritten.
- If the backup file is exported as TEXT type, comment lines are eliminated from the file. Therefore, even if the originally imported path information file was also TEXT type, the TEXT type exported backup file may not be identical.

Syntax

```
export backup-rec-path -port {maintenance | remote | fst} -server server_name  
-user login_user_account -filename filename -type {text | binary} [-indicator {enable | disable}]
```

Parameter

- port This parameter specifies which Ethernet port is used to connect to the FTP server. For details, refer to ["1.11 Note for Specifying FTP Server" \(page 54\)](#).
- | | |
|-------------|---|
| maintenance | Maintenance port (MNT port) |
| remote | Remote port (RMT port) |
| fst | FST port (DX500 S4/DX600 S4, DX500 S3/DX600 S3, DX8100 S3/DX8700 S3/DX8900 S3, and AF650 S2/AF650 only) |
- server This parameter specifies the name of the FTP server name that is to receive the backup REC path information file. The server name format is IPv4 standard notation (a base 256 "d.d.d.d" string) or a fully qualified domain name.
- Example: -server 192.168.1.20
Example: -server foo.bar
- server_name* FTP server name
- user This parameter specifies the user name that is to be used to access the FTP server. When this parameter is specified, the command displays an FTP server password prompt.
- login_user_account* User name
- filename This parameter specifies the REC path information filename.
- filename* Filename
- type This parameter specifies the type of path information file that is to be exported.
- | | |
|--------|-------------|
| text | TEXT type |
| binary | BINARY type |

-indicator Optional. This parameter specifies whether the progress indicator is displayed. If omitted, the progress indicator is displayed.

enable Progress indicator is displayed.

disable Progress indicator is not displayed.

■ Example(s)

The following example exports an REC path information file to the FTP server named "ftp.a.com" using the maintenance port (MNT port). For the FTP server, the user name is "cli-user" and the filename is "/tmp/rec-path1.txt". The file type is TEXT.

The entered password in "Password :" is not displayed:

```
CLI> export backup-rec-path -port maintenance -server ftp.a.com -filename /tmp/rec-path1.txt -user cli-user -type text
Password :
exporting /tmp/rec-path1.txt from ftp.a.com
complete.
```

The following example is the same as above, except that the progress indicator is not displayed.

The entered password in "Password :" is not displayed:

```
CLI> export backup-rec-path -port maintenance -server ftp.a.com -filename /tmp/rec-path1.txt -user cli-user -type text -
indicator disable
Password :
```

convert rec-path

This command is used to convert the type of the REC path information file to the file type that is saved on and to an FTP server by passing it through the ETERNUS DX/AF. This conversion only affects the REC path information file on the FTP server, and has no effect on the current system setup.

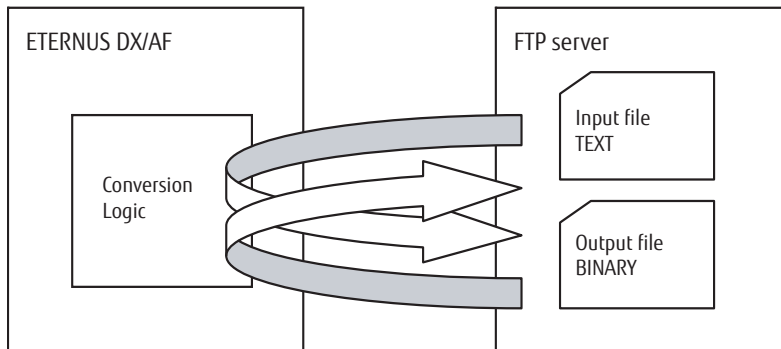

Caution

- If the same file on an FTP server already exists, it would be overwritten.
- If a TEXT type path information file has syntax errors, the number of the problem line is included with the error message.

Syntax

```
convert rec-path -port {maintenance | remote | fst} -server server_name  
-user login_user_account -source-file source_file -output-file output_file  
-mode {t2b | b2t} [-indicator {enable | disable}]
```

Parameter

- port** This parameter specifies which Ethernet port is used to connect to the FTP server. For details, refer to ["1.11 Note for Specifying FTP Server" \(page 54\)](#).
- | | |
|--------------------|---|
| maintenance | Maintenance port (MNT port) |
| remote | Remote port (RMT port) |
| fst | FST port (DX500 S4/DX600 S4, DX500 S3/DX600 S3, DX8100 S3/DX8700 S3/DX8900 S3, and AF650 S2/AF650 only) |
- server** Both a conversion source file and a conversion destination file must be in an FTP server. This parameter specifies the FTP server name. The server name format is IPv4 standard notation (a base 256 "d.d.d.d" string) or a fully qualified domain name.
- Example: `-server 192.168.1.20`
Example: `-server foo.bar`
- | | |
|--------------------|-----------------|
| <i>server_name</i> | FTP server name |
|--------------------|-----------------|

- user This parameter specifies the user name that is to be used to access the FTP server. When this parameter is specified, the command displays an FTP server password prompt.
login_user_account User name that is to be used to access the FTP server
- source-file This parameter specifies the REC path information filename as the conversion source.
source_file Filename
- output-file This parameter specifies the REC path information filename as the conversion destination.
output_file Filename
- mode This parameter specifies conversion mode.
 - t2b TEXT type is converted to BINARY.
 - b2t BINARY type is converted to TEXT.
- indicator Optional. This parameter specifies whether the progress indicator is displayed. If omitted, the progress indicator is displayed.
 - enable Progress indicator is displayed.
 - disable Progress indicator is not displayed.

■ Example(s)

The following example imports an REC path information file to the FTP server named "ftp.a.com" using the maintenance port (MNT port) and exports the file to the server after the file is converted. For the FTP server, the user name is "cli-user" and the conversion source filename is "/tmp/rec-path.txt" and the conversion destination filename is "/tmp/bin/rec_path.bin". The conversion mode is a direction from TEXT type to BINARY. The entered password in "password :" is not displayed:

```
CLI> convert rec-path -port maintenance -server ftp.a.com -user cli-user -source-file /tmp/rec_path.txt
-output-file /tmp/bin/rec_path.bin -mode t2b
password :
importing /tmp/rec_path.txt from ftp.a.com
exporting /tmp/rec_path.bin to ftp.a.com
complete.
```

The following example is the same as above, except that the progress indicator is not displayed. The entered password in "Password :" is not displayed:

```
CLI> convert rec-path -port maintenance -server ftp.a.com -user cli-user -source-file /tmp/rec_path.txt
-output-file /tmp/bin/rec_path.bin -mode t2b -indicator disable
Password :
```

measure rec-round-trip-time

After setting up the REC path information, the round trip times to all remote storage systems where a time has not yet been set must be measured. This command measures the round trip time for each REC path, displays it, and can also save it in the system if so desired.

Caution

- If the round trip time is measured with "-mode auto" specified, the path multiplicity is automatically set to the recommended multiplicity.
- If the round trip time is measured with "-mode manual" specified, the path multiplicity is automatically changed to the recommended multiplicity only if the results are saved to the system.

Syntax

```
measure rec-round-trip-time -mode {auto | manual}  
[-remote-boxid remote_storage_system_box_id] [-save {yes | no}]
```

Parameter

- mode** This parameter specifies the round trip time measurement and the setting mode.
- auto** Automatic mode. Round trip times are measured for all remote storage systems for which the round trip time has not yet set, and these times are set to the system as base information to optimize REC performance. This mode is recommended for initial setup.
- manual** Manual mode. Round trip times are measured for the specified single remote storage system. The displayed times can then be saved to the system if desired.
- remote-boxid** Optional. This parameter specifies the Box ID of a single remote storage system. Only one Box ID can be specified at a time.
- When "-mode auto" is specified, this parameter cannot be specified and when "-mode manual" is specified, this parameter must be specified.
 - Box IDs use a maximum of 40 alphanumeric characters, spaces, and pound key characters (#).
 - All alphabetic characters are handled as uppercase.
 - The pound key characters (#) are automatically appended when the input characters are less than 40.
- remote_storage_system_box_id* Remote storage system Box ID
- save** Optional. This parameter specifies the save mode. If omitted, the displayed round trip time can be saved to the system if requested by the operator. If "-mode auto" is specified, this parameter cannot be specified.
- yes** Path multiplicity is automatically set to the recommended multiplicity.
- no** Path multiplicity is not set.

■ Output

- When the "manual" mode is selected.

Item name	Description
Remote Box ID	Box ID of a remote storage system
Round Trip Time(ms)	Measured round trip time

■ Example(s)

The following example measures the round trip times to all remote storage systems for which a round trip time has not yet been set, and automatically reflects this to the system. remote storage systems for which a round trip time has already been set are not remeasured or otherwise affected.

```
CLI> measure rec-round-trip-time -mode auto
```

The following example displays the measured round trip time, and confirms with the operator whether or not the result is to be saved to the system. In this example, the measured round trip time is reflected to the system.

```
CLI> measure rec-round-trip-time -mode manual -remote-boxid "00DXL#####ET06F21AUABCPJ000002#####"
Remote Box ID          Round Trip Time(ms)
-----
00DXL#####ET06F21AUABCPJ000002#####          20
Enter 'y' to save this round trip time or 'n' to cancel.
> y
Complete.
```

The following example is the same as the above except entering a cancel. In this case, the round trip time is not reflected to the system.

```
CLI> measure rec-round-trip-time -mode manual -remote-boxid "00DXL#####ET06F21AUABCPJ000002#####"
Remote Box ID          Round Trip Time(ms)
-----
00DXL#####ET06F21AUABCPJ000002#####          20
Enter 'y' to save this round trip time or 'n' to cancel.
> n
Canceled.
```

set rec-round-trip-time

The REC round trip time is set based on the result of the "measure rec-round-trip-time" command. However, the REC round trip time for individual paths can be tuned in order to maximize REC performance. This command is used to manually set the REC round trip time.

Caution

If the round trip time is specified, the path multiplicity is automatically changed to the recommended multiplicity.

■ Syntax

```
set rec-round-trip-time -remote-boxid remote_storage_system_box_id -time round_trip_time
```

■ Parameter

-remote-boxid

This parameter specifies the Box ID of a single remote storage system. This is the storage system for which the REC round trip time is to be manually set. Only one Box ID can be specified at a time.

Note

- Box IDs use a maximum of 40 alphanumeric characters, spaces, and pound key characters (#).
- All alphabetic characters are handled as uppercase.
- Hash marks (#) are automatically appended to Box IDs shorter than 40 characters in length.

remote_storage_system_box_id Remote storage system Box ID

-time This parameter specifies the REC round trip time. The possible values are from 1 to 65535 milliseconds. The following ranges are recommended:

Asynchronous Through Mode: 100ms or less
Synchronous Transfer Mode: 50ms or less

round_trip_time REC round trip time (1 – 65535)

■ Example(s)

The following example sets the multiplicity to 5.

```
CLI> set rec-round-trip-time -remote-boxid "00DXL#####ED06F21AUABCPJ000001#####" -time 5
```

set rec-multiplicity

REC multiplicity does not need to be set because the recommended multiplicity (which is automatically calculated by the system) is normally used in most cases. However, REC multiplicity for individual paths can be tuned in order to maximize REC performance. For remote connections, use this command to manually set the REC multiplicity. For direct connections, use this command to manually set the priority level.

Syntax

```
set rec-multiplicity -remote-boxid remote_storage_system_box_id  
{-multiplicity {auto | multiplicity} | -priority-level {auto | priority_level}}  
[-copy-schedule-mode {session-balancing | dst-rg-balancing}]
```

Parameter

-remote-boxid

This parameter specifies the Box ID of a single remote storage system. This is the storage system for which the REC multiplicity is to be set. Only one Box ID can be specified at a time.

- Box IDs use a maximum of 40 alphanumeric characters, spaces, and pound key characters (#).
- All alphabetic characters are handled as uppercase.
- The pound key characters (#) are automatically appended when the input characters are less than 40.

remote_storage_system_box_id Remote storage system Box ID

-multiplicity

This parameter specifies the REC multiplicity value for remote connections. From 1 to 1024 or "auto" can be set for the value. The "-multiplicity" option and the "-priority-level" option cannot be specified at the same time.

auto The recommended REC multiplicity is used.

multiplicity REC multiplicity value (1 – 1024)

-priority-level

This parameter specifies the priority level value for direct connections. From 1 to 8 can be set for the value. If "auto" is specified, the EC/OPC priority is used. The "-multiplicity" option and the "-priority-level" option cannot be specified at the same time.

auto The EC/OPC priority is used.

priority_level Priority level value (1 – 6)

-copy-schedule-mode

This parameter specifies the Copy Schedule Mode. If omitted, the existing setting is not changed.

session-balancing Session balancing is performed.

dst-rg-balancing Destination RAID Group balancing is performed.

Example(s)

The following example sets the REC multiplicity to 5:

```
CLI> set rec-multiplicity -remote-boxid "00DXL#####ED06F21AUABCPJ000001#####" -multiplicity 5
```

The following example sets the Copy Level to 3.

```
CLI> set rec-multiplicity -remote-boxid "00DXL#####ED06F21AUABCPJ000001#####" -priority-level 3
```

The following example sets the Copy Schedule Mode to Session balancing.

```
CLI> set rec-multiplicity -remote-boxid "00DXL#####ED06F21AUABCPJ000001#####" -copy-schedule-mode session-balancing
```

show rec-buffer

This command is used to display the information defined for REC buffers.

Syntax

```
show rec-buffer
```

Parameter

No parameters.

Output

Item name	Description
Part.	Assigned partition number
Usage	REC buffer usage
Remote Box ID	Box ID of a storage system that uses an REC buffer
Status	REC buffer status
Mirror Status	Mirroring status of an REC buffer
Size (MB)	REC buffer size
Forwarding Interval (s)	Forwarding interval (unit: second)
Monitoring Time (m)	Monitoring time (unit: minute)
Halt Wait Timer (s)	HALT wait timer (unit: second)
IO Resp Mode	I/O response priority mode
Immed-Halt Mode	Immediate Halt mode
High-BW Mode	High Bandwidth mode

Example(s)

The following example displays the REC buffer information and the REC buffer status.

```
CLI> show rec-buffer
Part. Usage Remote Box ID Status Mirror Status Size Forwarding Monitoring Halt Wait IO Resp Immed-Halt High-BW
-----
1 Receive 00DXL#####ET06F21AUABCPJ000002##### Active Normal 128 4 3 10 Enable Enable Enable
2 Send 00DXL#####ET06F21AUABCPJ000002##### Inactive Recovering 128 1 1 5 Enable Enable Enable
3 (Unused) - - - - - - - - - - - -
4 (Unused) - - - - - - - - - - - -
```

set rec-buffer

This command sets up REC buffers for use by the REC Asynchronous Consistency Mode. Only one REC buffer for the DX100 S4 and the DX100 S3, up to 4 REC buffers for the DX200 S4, the DX200 S3, the AF250 S2/AF250, and the DX200F, and up to 8 REC buffers for the DX500 S4/DX600 S4, the DX500 S3/DX600 S3, the DX8100 S3/DX8700 S3/DX8900 S3, and the AF650 S2/AF650 can be set. When an REC buffer is newly defined, all the parameters must be specified. When an existing REC buffer is changed, only the needed parameters may be specified.

The size of each REC buffer can be selected as follows:

- DX100 S4 and DX100 S3: 128MB
- DX200 S4, DX200 S3, AF250 S2/AF250, and DX200F: 128MB, 256MB, and 512MB
- DX500 S4/DX600 S4, DX500 S3/DX600 S3, DX8100 S3/DX8700 S3/DX8900 S3, and AF650 S2/AF650: 128MB, 256MB, 512MB, 1,024MB, and 2,048MB

The maximum value of the total REC buffer size in the ETERNUS DX/AF is shown below.

- DX100 S4 and DX100 S3: 128MB
- DX200 S4, DX200 S3, AF250 S2/AF250, and DX200F: 512MB
- DX500 S4/DX600 S4, DX500 S3/DX600 S3, DX8100 S3/DX8700 S3/DX8900 S3, and AF650 S2/AF650: 8,192MB

However, depending on the memory capacity that is installed in the ETERNUS DX/AF, there are cases when the REC buffer cannot be set up to the upper limit of the model. In addition, REC buffer uses the shared areas of the cache memory. There are cases when the REC buffer cannot be set up to the upper limit of the model according to the maximum pool capacity of the TPP/FTSP, the TFOV maximum capacity, the copy table size, and the REC buffer capacity.

Caution

- Receive and Send REC buffers must both be independently defined if the REC buffer is to be used bi-directionally.
- The REC buffer uses twice as much memory capacity as the selected REC buffer capacity because the REC buffer is made redundant between the CMs.

■ Syntax

```
set rec-buffer -partition {0 | 1 | 2 | 3 | 4 | 5 | 6 | 7}
[-remote-boxid remote_storage_system_box_id]
[-buffer-size {128mb | 256mb | 512mb | 1024mb | 2048mb}]
[-buffer-type {receive | send}]
[-forwarding-interval {1 | 2 | 4 | 8 | 15 | 30 | 45 | 60 | 75 | 90 | 105 | 120}]
[-halt-wait-timer {0 | 5 | 10 | 15}]
[-monitoring-time {0 | 1 | 2 | 3 | 4 | 5 | 6 | 7 | 8 | 9 | 10 | 11 | 12 | 13 | 14 | 15}]
[-io-response-mode {enable | disable}]
[-immed-halt-mode {enable | disable}]
[-high-bandwidth-mode {enable | disable}]
```

■ Parameter

-partition This parameter specifies the REC buffer partition number. This can also be called the group number. This number starts from 0. Only one number can be specified at a time. The selectable range is as follows:

DX100 S4: 0
DX200 S4: 0 to 3
DX500 S4/DX600 S4: 0 to 7
DX100 S3: 0
DX200 S3: 0 to 3
DX500 S3/DX600 S3: 0 to 7
DX8100 S3/DX8700 S3/DX8900 S3: 0 to 7
AF250 S2/AF250: 0 to 3
AF650 S2/AF650: 0 to 7
DX200F: 0 to 3

Note

When the specified number is already used, existing set values are overwritten.

-remote-boxid

Optional. This parameter specifies the Box ID of a single remote storage system that is to be defined. Only one Box ID can be specified at a time. Only one Send/Receive REC buffer transfer can be set using the Box ID of a single remote storage system. This parameter must be specified for the initial setup. If omitted, this parameter value is not changed.

- Box IDs use a maximum of 40 alphanumeric characters, spaces, and pound key characters (#).
- All alphabetic characters are handled as uppercase.
- The pound key characters (#) are automatically appended when the input characters are less than 40.

remote_storage_system_box_id Remote storage system Box ID

-buffer-size Optional. This parameter specifies the REC buffer size. This parameter must be specified for the initial setup. If omitted, this parameter value is not changed. The size of each REC buffer can be selected as follows:

DX100 S4: 128MB
DX200 S4: 128MB, 256MB, and 512MB
DX500 S4/DX600 S4: 128MB, 256MB, 512MB, 1,024MB, and 2,048MB
DX100 S3: 128MB
DX200 S3: 128MB, 256MB, and 512MB
DX500 S3/DX600 S3: 128MB, 256MB, 512MB, 1,024MB, and 2,048MB
DX8100 S3/DX8700 S3/DX8900 S3: 128MB, 256MB, 512MB, 1,024MB, and 2,048MB
AF250 S2/AF250: 128MB, 256MB, 512MB
AF650 S2/AF650: 128MB, 256MB, 512MB, 1,024MB, and 2,048MB
DX200F: 128MB, 256MB, 512MB

-buffer-type

Optional. This parameter specifies the REC buffer type. This parameter must be specified for the initial setup. If omitted, this parameter value cannot be changed.

receive Use as a Receive buffer.
send Use as a Send buffer.

-forwarding-interval

Optional. This parameter specifies the interval at which data should be transferred. A long interval will reduce the Host I/O overhead, but increase the amount of data susceptible to loss in the event of disaster. This parameter must be specified for the initial setup. If omitted, this parameter value is not changed.

1	1 second (Recommended value)
2	2 seconds
4	4 seconds
8	8 seconds
15	15 seconds
30	30 seconds
45	45 seconds
60	60 seconds
75	75 seconds
90	90 seconds
105	105 seconds
120	120 seconds

-halt-wait-timer

Optional. This parameter specifies the maximum no-response time for which host I/O responses may be delayed in order to prioritize data transfers from the REC buffer when it is in a high-load state. When this time is exceeded, response to host I/O is restarted, but the copy session is halted. This parameter must be specified for the initial setup. If omitted, this parameter value cannot be changed.

0	Disabled
5	5 seconds
10	10 seconds
15	15 seconds (Recommended value)

-monitoring-time

Optional. This parameter specifies the monitoring time for high-load state REC buffers. The possible range is from 0 to 15 minutes. Zero means the monitoring function is disabled. When the REC buffer has large amounts of data to be stored and is in a high-load state, the time required for I/O responses to the server is gradually incremented by the "-halt-wait-timer" parameter value. Once the delay state has continued for longer than this parameter value, all REC Asynchronous Consistency Mode sessions that are currently transferring data are halted to allow priority processing of the server responses. If omitted, this parameter value is not changed.

0	Disabled
1 – 15	1 to 15 minutes (5 minutes is recommended).

-io-response-mode

Optional. This parameter specifies whether to enable the I/O priority mode. Specifying "enable" for this parameter may improve the Write I/O response during initial copying of an REC Consistency mode copy session. If heavy-load Write I/O continues, an extended period of time may be required to achieve an equivalent state. To prevent this from occurring, make sure that the Write I/O during an initial copy is well below the REC line throughput.

- enable The I/O response priority mode is enabled.
- disable The I/O response priority mode is disabled.

-immed-halt-mode

Optional. This parameter specifies whether to enable the immediate halt mode. Specifying "enable" for this parameter may improve the Write I/O response while an REC Consistency mode copy session maintains an equivalent state. If the Write I/O response is affected even slightly, the REC buffer is changed to HALT status and the copy order may not be guaranteed for an extended period of time. This parameter is effective only when the HALT wait timer is set to 0 seconds.

- enable The Immediate Halt mode is enabled.
- disable The Immediate Halt mode is disabled.

-high-bandwidth-mode

Optional. This parameter specifies whether to enable the high bandwidth mode. By transferring data all at once, the number of communications is reduced and the throughput is improved especially with high-bandwidth/high-delay networks.

- enable The High Bandwidth mode is enabled.
- disable The High Bandwidth mode is disabled.

■ Example(s)

The following example sets up partition #1:

```
CLI> set rec-buffer -partition 1 -buffer-type receive -remote-boxid  
"00DXL#####ET06F21AUABCPJ000002#####" -buffer-size 128mb -forwarding-interval 1 -halt-wait-timer 15 -monitoring-  
time 5
```

The following example changes the defined size of partition #2 to 256MB:

```
CLI> set rec-buffer -partition 2 -buffer-size 256mb
```

delete rec-buffer

This command is used to delete an existing REC buffer definition.

■ Syntax

```
delete rec-buffer -partition {0 | 1 | 2 | 3 | 4 | 5 | 6 | 7}
```

■ Parameter

-partition This parameter specifies the REC buffer group number that is to be deleted. This number starts from 0. Two or more numbers cannot be specified at the same time. The selectable range is as follows:

DX100 S4: 0
DX200 S4: 0 to 3
DX500 S4/DX600 S4: 0 to 7
DX100 S3: 0
DX200 S3: 0 to 3
DX500 S3/DX600 S3: 0 to 7
DX8100 S3/DX8700 S3/DX8900 S3: 0 to 7
AF250 S2/AF250: 0 to 3
AF650 S2/AF650: 0 to 7
DX200F: 0 to 3

■ Example(s)

The following example deletes partition #1:

```
CLI> delete rec-buffer -partition 1
```

show rec-disk-buffer

This command displays a list of all of the REC disk buffers or displays only the REC disk buffers that are specified by the REC buffer partition number(s).

Detailed information of the RAID group that is displayed when this command is used can be checked by using the "show raid-groups" command.

Note

Depending on the model, the support state of the encryption-related functions may differ.

Syntax

```
show rec-disk-buffer [-partition partition_numbers]
```

Parameter

-partition Optional. This parameter specifies the REC buffer partition number for REC disk buffers. One or more numbers can be specified. If this parameter is specified, the CM-CPU information is also displayed.

This number starts from 0. The selectable range is as follows:

DX100 S4: 0
DX200 S4: 0 to 3
DX500 S4/DX600 S4: 0 to 7
DX100 S3: 0
DX200 S3: 0 to 3
DX500 S3/DX600 S3: 0 to 7
DX8100 S3/DX8700 S3/DX8900 S3: 0 to 7
AF250 S2/AF250: 0 to 3
AF650 S2/AF650: 0 to 7
DX200F: 0 to 3

Example:

-partition 1 (Only #1 is specified)
-partition 5,7 (Both #5 and 7 are specified)
-partition 2-5 (#2 through #5 are specified)
-partition 1,3,4-7 (#1, #3, and #4 through #7 are specified)

Output

Item name	Description
Partition number	An REC Buffer Group partition number. If the REC disk buffer is not associated to REC buffer, it displays "-".
Status	When REC Disk buffer is associated to REC buffer, it displays the status of REC Disk buffer as "Active", "Rebuilding", "Error", "Formatting", "Not supported", "Not mirrored". Otherwise, it displays the status the same as RAID groups.
Progress (%)	REC Disk buffer progress, formatting or rebuilding. If there is nothing to format and/or rebuild, it displays "-".
Encryption	REC Disk buffer encryption method. It will be displayed as "SED", "Encrypting", "Decrypting", "OFF", or "CM". When the encryption function is disabled for the ETERNUS DX/AF, it is not displayed.

Item name	Description
Session count	Number of sessions which used this REC disk buffer.
Elapsed time(s)	Elapsed time of between last copy worked time to current time.
Total disk buffer size (MB)	Total REC disk buffer capacity.
Total storage data size (MB)	Total REC disk buffer size which used to send data stored.
Free disk buffer size (MB)	Total REC disk buffer remain size
No of RGs	Number of RLUs that associated RLU (REC disk buffer)
RG#1	Associated RAID group #1
RG#2	Associated RAID group #2
RG#3	Associated RAID group #3
RG#4	Associated RAID group #4
RG#5	Associated RAID group #5
RG#6	Associated RAID group #6
CM	CM number indication. If "-partition" is specified, the CE number and the CM number are shown.
MID	CM module ID. This information appears when the "-partition" parameter is specified.
Disk buffer(MB)	Disk buffer size of its CM. This information appears when the "-partition" parameter is specified.
Storage data(MB)	Storage data size of its CM. This information appears when the "-partition" parameter is specified.
Free disk buffer(MB)	Free disk buffer size of its CM. This information appears when the "-partition" parameter is specified.

■ Example(s)

The following example displays a summary of all the REC disk buffers:

```
CLI> show rec-disk-buffer
Partition Status      Progress Encryption Session Elapsed   Total disk buffer Total storage   Free disk buffer No of  RG#1  RG#2  RG#3  RG#4  RG#5  RG#6
number              (%)              count    time(s)  size (MB)  size (MB)  size (MB)  RGS
-----
  1 Active            -                -        2        1        2097152    1572864    524288        6   12   13   14   15   16   17
  - Encryption      80 Encryption    -        -        2097152    -          -             1   20
  - Formatting      - Encryption    -        -        2097152    -          -             1   21
```

The following example displays the details of the REC disk buffers associated with partition #1 (for the DX200 S4, the DX500 S4/DX600 S4, the DX200 S3, the DX500 S3/DX600 S3, the DX8100 S3, the AF250 S2/AF650 S2, the AF250/AF650, and the DX200F):

```
CLI> show rec-disk-buffer -partition 1
Partition Status      Progress Encryption Session Elapsed   Total disk buffer Total storage   Free disk buffer No of  RG#1  RG#2  RG#3  RG#4  RG#5  RG#6
number              (%)              count    time(s)  size (MB)  size (MB)  size (MB)  RGS
-----
  1 Active            -                -        2        1        2097152    1572864    524288        6   12   13   14   15   16   17
<CM Info>
CM      MID Disk buffer size(MB) Storage data size(MB) Free disk buffer(MB)
-----
CM#0   10      2097152          1572864          524288
CM#0   18         0                0                0
CM#1   11         0                0                0
CM#1   19         0                0                0
```

The following example displays the details of the REC disk buffers associated with partition #1 (for the DX8700 S3/DX8900 S3):

```
CLI> show rec-disk-buffer -partition 1
Partition Status      Progress Encryption Session Elapsed   Total disk buffer Total storage   Free disk buffer No of  RG#1  RG#2  RG#3  RG#4  RG#5  RG#6
number              (%)              count    time(s)  size (MB)  size (MB)  size (MB)  RGS
-----
  1 Active            -                -        2        1        2097152    1572864    524288        6   12   13   14   15   16   17
<CM Info>
CM      MID Disk buffer size(MB) Storage data size(MB) Free disk buffer(MB)
-----
CE#0  CM#0  10      2097152          1572864          524288
CE#0  CM#0  18         0                0                0
CE#1  CM#1  11         0                0                0
CE#1  CM#1  19         0                0                0
```

create rec-disk-buffer

This command creates an REC disk buffer for the REC Asynchronous Consistency Mode that is used when an REC buffer overflow occurs.

Syntax

```
create rec-disk-buffer -name rg_name -disks disks [-encryption {enable | disable}]  
[-assigned-cm {0 | 1 | 00 | 01 | 10 | 11 | 20 | 21 | 30 | 31 | 40 | 41 | 50 | 51 | 60 | 61 | 70 | 71 | 80 | 81 | 90 | 91 | a0 | a1  
| b0 | b1 | auto}]  
[-stripe-depth {64kb | 128kb | 256kb | 512kb | 1024kb}]
```

Parameter

-name This parameter specifies the alias name of a RAID group for the REC disk buffer. Only one name can be specified. For details, refer to ["1.2.6 Alias Name Syntax" \(page 35\)](#).

rg_name Alias name of a RAID group

-disks This parameter specifies which drives will form the RAID group. For details, refer to ["1.2.5 Drive Syntax" \(page 35\)](#). Specify four or eight drives that are not used with other RAID groups.

Caution

- Specify the same drive type for all the drives (required).
- Specify drives with the same capacity (recommended).
- Specify drives with the same rotational speed (recommended).

disks Drive

-encryption Optional. This parameter specifies whether the encryption by a CM is performed. The following parameters can be specified.

enable The REC disk buffer data is encrypted.

disable The REC disk buffer data is not encrypted. (Default)

-assigned-cm

Optional. This parameter specifies the assigned controller module (CM) number of the REC disk buffer. If "auto" is specified, the controller is automatically assigned by the system. If omitted, "auto" mode is selected. The following parameters can be specified.

0 CM#0 (DX100 S4/DX200 S4, DX500 S4/DX600 S4, DX100 S3/DX200 S3, DX500 S3/DX600 S3, DX8100 S3, AF250 S2/AF650 S2, AF250/AF650, and DX200F only)

1 CM#1 (DX100 S4/DX200 S4, DX500 S4/DX600 S4, DX100 S3/DX200 S3, DX500 S3/DX600 S3, DX8100 S3, AF250 S2/AF650 S2, AF250/AF650, and DX200F only)

*w**x* CE#*w*-CM#*x* (DX8700 S3/DX8900 S3 only)
"w" is the controller enclosure (CE) number and "x" is the controller module (CM) number.
Example: "01" indicates CE#0-CM#1.
For the controller enclosure number, the range that the value can be specified with is 0 to b (hex).
For the controller module number, 0 or 1 can be specified.

auto Automatically (default)

-stripe-depth

Optional. This parameter specifies the stripe depth for the REC Disk Buffer that is to be created. If omitted, it is handled as if "64kb" is specified.

64kb	64KB
128kb	128KB
256kb	256KB
512kb	512KB
1024kb	1,024KB

■ **Example(s)**

The following example creates an REC disk buffer using drives #001, #002, #011 and #012:

```
CLI> create rec-disk-buffer -name REC01 -encryption enable -assigned-cm 0 -disks 001-002, 011-012
```

set rec-disk-buffer

This command assigns REC disk buffers with the REC buffer.

Syntax

```
set rec-disk-buffer -partition {0 | 1 | 2 | 3 | 4 | 5 | 6 | 7} {-rg-number rg_number | -rg-name rg_name}
```

Parameter

-partition This parameter specifies the partition number for which an REC buffer is to be defined. The partition numbers that can be specified for each storage system model are as follows:

DX100 S4: 0
DX200 S4: 0 to 3
DX500 S4/DX600 S4: 0 to 7
DX100 S3: 0
DX200 S3: 0 to 3
DX500 S3/DX600 S3: 0 to 7
DX8100 S3/DX8700 S3/DX8900 S3: 0 to 7
AF250 S2/AF250: 0 to 3
AF650 S2/AF650: 0 to 7
DX200F: 0 to 3

-rg-number or -rg-name

This parameter specifies the RAID group identifier of the REC disk buffer for assignment of the REC buffer. A maximum of two parameters can be specified. For details, refer to ["1.2.10 RAID Group Syntax" \(page 39\)](#).

The number of REC disk buffers that can be assigned to REC buffers are as follows. Specify the RAID groups so that the number of assigned REC disk buffers matches the numbers listed below after assigning the REC disk buffers.

DX100 S4/DX200 S4 (1CM model): 1
DX100 S4/DX200 S4 (2CM model): 1 or 2
DX500 S4/DX600 S4: 1 or 2
DX100 S3/DX200 S3 (1CM model): 1
DX100 S3/DX200 S3 (2CM model): 1 or 2
DX500 S3/DX600 S3: 1 or 2
DX8100 S3: 1 or 2
DX8700 S3: 1, 2, or 4
DX8900 S3: 1, 2, 4, or 6
AF250 S2/AF250: 1 or 2
AF650 S2/AF650: 1 or 2
DX200F: 1 or 2

rg_number RAID group number

rg_name RAID group name

■ Example(s)

The following example assigns an REC disk buffer which has RG number 0 to REC buffer partition 1:

```
CLI> set rec-disk-buffer -partition 1 -rg-number 0
```

The following example assigns two REC disk buffers which are named REC001 and REC002 to REC buffer partition 2:

```
CLI> set rec-buffer -partition 2 -rg-name REC001, REC002
```

delete rec-disk-buffer

This command is used to delete the RAID group(s) of the REC disk buffer.

■ Syntax

```
delete rec-disk-buffer {-rg-number rg_numbers | -rg-name rg_names}
```

■ Parameter

-rg-number or -rg-name

This parameter specifies the RAID group identifier of the REC disk buffer for assignment of the REC buffer. One or more RAID groups can be specified. For details, refer to ["1.2.10 RAID Group Syntax" \(page 39\)](#).

rg_number RAID group number

rg_name RAID group name

■ Example(s)

The following example deletes the REC disk buffer that was created as RAID group number 0:

```
CLI> delete rec-disk-buffer -rg-number 0
```

format rec-disk-buffer

This command formats the RAID group(s) of the REC disk buffer(s).

■ Syntax

```
format rec-disk-buffer {-rg-number rg_numbers | -rg-name rg_names}
```

■ Parameter

-rg-number or -rg-name

This parameter specifies the RAID group identifier of the REC disk buffer for assignment of the REC buffer. One or more RAID groups can be specified. For details, refer to ["1.2.10 RAID Group Syntax" \(page 39\)](#).

rg_number RAID group number

rg_name RAID group name

■ Example(s)

The following example formats the REC disk buffers that are assigned to RAID group number 0:

```
CLI> format rec-disk-buffer -rg-number 0
```

release rec-disk-buffer

This command releases the assignment of the REC disk buffer(s) with REC buffer(s).

Syntax

```
release rec-disk-buffer -partition {0 | 1 | 2 | 3 | 4 | 5 | 6 | 7}  
{-mode all | -rg-number rg_numbers | -rg-name rg_names}
```

Parameter

-partition This parameter specifies the partition number for which REC disk buffer(s) are to be released. The range is 0 to 7. One or more parameters can be specified at the same time.

The number of partitions available depends on the system model as follows:

DX100 S4: 0
DX200 S4: 0 to 3
DX500 S4/DX600 S4: 0 to 7
DX100 S3: 0
DX200 S3: 0 to 3
DX500 S3/DX600 S3: 0 to 7
DX8100 S3/DX8700 S3/DX8900 S3: 0 to 7
AF250 S2/AF250: 0 to 3
AF650 S2/AF650: 0 to 7
DX200F: 0 to 3

-rg-number, -rg-name, or -mode all

This parameter specifies the RAID group identifier of the REC disk buffer that is assigned to the REC buffer. One or more RAID groups can be specified. For details, refer to ["1.2.10 RAID Group Syntax" \(page 39\)](#).

The number of REC disk buffers that can be assigned to REC buffers are as follows. Specify the RAID groups so that the number of assigned REC disk buffers matches "0" or the numbers listed below after releasing the assigned REC disk buffers.

DX100 S4/DX200 S4 (1CM model): 1
DX100 S4/DX200 S4 (2CM model): 1 or 2
DX500 S4/DX600 S4: 1 or 2
DX100 S3/DX200 S3 (1CM model): 1
DX100 S3/DX200 S3 (2CM model): 1 or 2
DX500 S3/DX600 S3: 1 or 2
DX8100 S3: 1 or 2
DX8700 S3: 1, 2, or 4
DX8900 S3: 1, 2, 4, or 6
AF250 S2/AF250: 1 or 2
AF650 S2/AF650: 1 or 2
DX200F: 1 or 2

rg_number RAID group number

rg_name RAID group name

-mode all All of the REC disk buffers that are associated with the REC buffer are deleted.

■ Example(s)

The following example releases the REC disk buffer from REC buffer partition #1:

```
CLI> release rec-disk-buffer -partition 1 -rg-number 1
```

set rec-path-qos

This command specifies the performance bandwidth limit (upper limit performance value) for the remote copy path.

Syntax

```
set rec-path-qos -port port_number{-wwn wwn | -iscsi-name iscsi_name
{-ip ip | -link-local-ip link_local_ip | -connect-ip connect_ip}
-bandwidth-limit bandwidth_limit
```

Parameter

-port This parameter specifies the host interface port number of the local storage system. Only one host interface port number can be specified at the same time.

port_number Host interface port

xyz "x" is the controller module (CM) number, "y" is the CA number, and "z" is the host port number (DX100 S4/DX200 S4, DX500 S4/DX600 S4, DX100 S3/DX200 S3, DX500 S3/DX600 S3, DX8100 S3, AF250 S2/AF650 S2, AF250/AF650, and DX200F only).
Example: "123" indicates CM#1-CA#2-Port#3

wxyz

"w" is the controller enclosure (CE) number, "x" is the controller module (CM) number, "y" is the CA number, and "z" is the host port number (DX8700 S3/DX8900 S3 only).
Example: "0123" indicates CE#0-CM#1-CA#2- Port#3

-wwn or -iscsi-name

This parameter specifies the WWN (an 8-byte hexadecimal number) of the FC-RA for the remote storage system or the iSCSI name of the iSCSI-RA for the remote storage system. Only one WWN or iSCSI name can be specified at the same time.

wwn World Wide Name

iscsi_name iSCSI Name

-ip, -link-local-ip, or -connect-ip

This parameter specifies an IP address (IPv4 format), an IPv6 link-local address, or an IPv6 global address of the iSCSI-RA for the remote storage system. Only one address can be specified at the same time.

ip IP address (IPv4 format)

link_local_ip Link-local address (IPv6 format)

connect_ip Global address (IPv6 format)

-bandwidth-limit

This parameter specifies the performance bandwidth limit (upper limit performance value) for the remote copy path. The range of possible values is from 0 (unlimited) to 65535 (Max) and the unit is Mbit/s. Only one performance limit value can be specified at the same time.

bandwidth_limit Performance bandwidth limit (upper limit performance value) (0 to 65535)

■ Example(s)

The following example specifies the WWN QoS performance limit value of "500000E0D0C40005" on CM#0 CA#0 Port#0 to 1:

```
CLI> set rec-path-qos -port 000 -wwn 500000E0D0C40005 -bandwidth-limit 1
```

The following example specifies the iSCSI name QoS performance limit value of "irq.2010-12.com" (192.168.2.64) on CM#1 CA#2 Port#0 to 65535:

```
CLI> set rec-path-qos -port 120 -iscsi-name irq.2010-12.com -ip 192.168.2.64 -bandwidth-limit 65535
```

The following example specifies the iSCSI name QoS performance limit value of "irq.2010-11.com" (2001:DB8::8:800:200C:417A) to 120:

```
CLI> set rec-path-qos -port 110 -iscsi-name irq.2010-11.com -link-local-ip 2001:DB8::8:800:200C:417A -bandwidth-limit 120
```

The following example specifies the iSCSI name QoS performance limit value of "rq.2010-10.com" (FE80::290:CCFF:FEA4:3A49) to 0:

```
CLI> set rec-path-qos -port 021 -iscsi-name irq.2010-10.com -connect-ip FE80::290:CCFF:FEA4:3A49 -bandwidth-limit 0
```

Chapter 5

System Settings and Display



This chapter explains the commands related to the system settings.

5.1 User Management



This section explains the commands that manage a user account and a password.

5.1.1 Role

Roles define the user roles and the policies based on the definitions that are assigned to each role. Policies are given to users as roles. There are default roles that are preset in the ETERNUS DX/AF and user-defined roles (custom roles). The following table shows the roles and their policies.

■ Default roles

The default roles and corresponding policies are shown in the following table.

Table 5.1 Default roles and policies

Policy	Default role						
	Monitor	Admin	Storage Admin	Account Admin	Security Admin	Maintainer	Software (*1)
Status Display	Yes	Yes	Yes		Yes	Yes	
RAID Group Management		Yes	Yes			Yes	
Volume - Create / Modify		Yes	Yes			Yes	
Volume - Delete / Format		Yes	Yes			Yes	
Host Interface Management		Yes	Yes			Yes	
Advanced Copy Management		Yes	Yes			Yes	
Copy Session Management		Yes	Yes			Yes	
Storage Management		Yes				Yes	
User Management		Yes		Yes			
Authentication / Role		Yes		Yes			
Security Setting		Yes			Yes		
Maintenance Information		Yes			Yes	Yes	
Maintenance Operation						Yes	
Software Control							Yes
Firmware Management		Yes				Yes	
NAS Management		Yes	Yes			Yes	

*1: A role that is dedicated for external software. This role enables external software to access CLI.

■ Custom roles

Create custom roles when an operation cannot be performed with only the default roles.

Multiple policies can be assigned to a single custom role.

For details on creating and setting custom roles, refer to the "create role" and "set role" commands.

show role

This command displays all the registered user-defined role information.

■ Syntax

```
show role
```

■ Parameter

No parameters.

■ Output

Item name	Description
Role Name	User-defined role name
Policies	Assigned policies

■ Example(s)

The following example displays all the registered user-defined roles:

```
CLI > show role
Role Name      Policies
-----
Monitor        [1
Admin           [1,2,3,4,5,6,7,8, 10,11,12,13, 15, 18,19]
StorageAdmin   [1,2,3,4,5,6,7,8, 19]
AccountAdmin    [ 11,12
SecurityAdmin   [1, 13, 15
Maintainer      [1,2,3,4,5,6,7,8, 10, 15,16, 18,19]
Software        [ 17
```

create role

This command creates a new user-defined role to which any policy is assigned. Multiple policies can be assigned to one role. Role names that are already registered cannot be used to create new roles.

■ Syntax

```
create role -name name -policy policy
```

■ Parameter

-name This parameter specifies a unique name for the new role. Usable characters are alphanumeric (case-sensitive), exclamation mark (!), hyphen (-), underscore (_), and dot (.) characters. A minimum of 1 letter and a maximum of 16 letters are required.

name Name for the new role

-policy This parameter specifies the policies that are assigned to the role. Use the numbers that are listed below to specify policies. Multiple policies can be specified by separating them with a comma (,) or a hyphen (-). Note that spaces are not permitted before or after commas (,).

<i>policy</i>	Policy that is assigned to the role
1	Status Display
2	RAID Group Management
3	Volume - Create/Modify
4	Volume - Delete/Format
5	Host Interface Management
6	Advanced Copy Management
7	Copy Session Management
8	Storage Migration Management
9	Resource Domain Management (not supported)
10	Storage Management
11	User Management
12	Authentication/Role
13	Security Setting
14	Audit Setting (not supported)
15	Maintenance Information
16	Maintenance Operation
17	Software Control (not supported)
18	Firmware Management
19	NAS Management

■ Example(s)

The following example creates a Total Administrator as Role 1 to which the "Status Display", "User Management", and "Authentication Management" policies are assigned:

```
CLI> create role -name Role1 -policy 1,11,12
```

set role

This command changes the registered user-defined role information. Note that this command cannot change the role name or the role types. This command can also change the role that is currently assigned to the user. Any changes are enabled after the next login.

■ Syntax

```
set role -role-name role_name [-policy policy]
```

■ Parameter

-role-name This parameter specifies a role name. Two or more parameters cannot be specified at the same time.

role_name Role name

-policy Optional. This parameter specifies policies to set for the role. Use the numbers that are listed below to specify policies. Multiple policies can be specified by separating them with a comma (,) or a hyphen (-). Note that spaces are not permitted before or after commas (,).
If omitted, this parameter is not changed.

<i>policy</i>	Policy that is assigned to the role
1	Status Display
2	RAID Group Management
3	Volume - Create/Modify
4	Volume - Delete/Format
5	Host Interface Management
6	Advanced Copy Management
7	Copy Session Management
8	Storage Migration Management
9	Resource Domain Management (not supported)
10	Storage Management
11	User Management
12	Authentication/Role
13	Security Setting
14	Audit Setting (not supported)
15	Maintenance Information
16	Maintenance Operation
17	Software Control (not supported)
18	Firmware Management
19	NAS Management

■ Example(s)

The following example specifies "Resource Domain Management" policies for Role1.

```
CLI> set role -role-name Role1 -policy 10
```

delete role

This command deletes a specified user-defined role. Note that any roles that are already assigned to users cannot be deleted.

■ Syntax

```
delete role -name name
```

■ Parameter

-name This parameter specifies the role name that is to be deleted. Only one parameter can be specified at the same time.

name Role name

■ Example(s)

The following example deletes the role named "Role2":

```
CLI> delete role -name Role2
```

5.1.2 User Policy

For user policies (password policy and account lockout policy), one exists in the ETERNUS DX/AF and the setting can be changed. The user policy setting can be enabled or disabled per user account.

When the password of a newly created user account is set or when the password of an existing user account is changed, a password that is based on the policy can be applied. The policy that is used at this time is the password policy. The account lockout policy is a policy that is applied when a user logs in and determines whether to lock the user out if multiple failed login attempts are detected.

In addition, user policies are cannot be applied to the following user accounts:

- Software role user account
- User accounts used for external authentication (RADIUS authentication)

■ Password policy

● Password policy setting

The password policy setting is performed by an account manager (user account with the User Management role) using the following procedure.

Procedure

1 Changing the password policy

Change the password policy as required by using the "set user-policy" command.

● Note

- Only one password policy can be set per ETERNUS DX/AF.
 - If the user account is initialized by using the "initialize all-users" command, the password policy is also initialized.
-

2 Enabling or disabling the password policy setting

The password policy setting for each user account can be set to enable or disable by using the "create user" command or the "set user" command.

● Applying the password policy

The password policy is applied for any one of the following methods of the account user.

- A password is changed based on the password policy by using the "set password" command.
- If a user account that has a password that expires in 14 days (or less than 15 days) is used to log in, a warning message is displayed. The password is changed by using the "set password" command.
- If a user account that has an expired password is used to log in, no operations can be performed until the password is changed. The password is changed by using the "set password" command.

● Note

- After the password policy is set by an account manager, the password policy is applied when the password of the account user is changed at the next login.
- For users, the existing password can be used to log in until it is changed with the "set password" command.

■ Account lockout policy

● Setting the account lockout policy

The account lockout policy setting is performed by an account manager (user account with the User Management role) using the following procedure.

Procedure

1 Changing the account lockout policy

Change the account lockout policy during a local authentication as required by using the "set user-policy" command.

2 Enabling or disabling the account lockout policy setting

The account lockout policy setting for each user account can be set to enable or disable by using the "create user" command or the "set user" command.

● Applying the account lockout policy

If the local authentication fails more than the set lockout threshold value (the "-lockout-threshold" parameter of the "set user-policy" command), the relevant user account is locked out for the set lockout duration.

To have the lockout released, a request for a lockout release must be sent to the account manager.

● Note

- After the lockout period, the lockout state is automatically released.
- If the account manager changes the user account settings, the lockout state is released.
- The lockout state is initialized by rebooting the ETERNUS DX/AF.

show user-policy

This command displays the password policy and account lockout policy of the user account.

Syntax

```
show user-policy
```

Parameter

No parameters.

Output

Item name	Description
Password Policy	Displays the password policy.
Minimum Password Length	Minimum number of characters for the password
Password Complexity	Shows whether or not the password must satisfy the complexity requirement.
Enable	The password must satisfy the complexity requirement.
Disable	The password does not need to satisfy the complexity requirement.
Password History	Number of generations for the password history management If the password history management is not performed, "0" is displayed.
Minimum Password Age	Period in which the password cannot be changed Minimum number of days until the user account password can be changed When the user account password can be changed, "0" is displayed.
Maximum Password Age	Password expiration Maximum number of days in which the user account password will expire If the user account password has an indefinite period of validity, "0" is displayed.
Account Lockout Policy	Displays the account lockout policy.
Account Lockout Threshold	Number of failed login attempts before the user account is locked out Threshold for the number of failed confirmations until the account is locked out If a lockout is not performed for failed confirmations, "0" is displayed.
Account Lockout Duration	Lockout period before the locked out account is automatically released If the lockout is not automatically released, "0" is displayed.

Example(s)

The following example displays the password policy and account lockout policy for user accounts:

```
CLI> show user-policy
<Password Policy>
Minimum Password Length      [4]
Password Complexity          [Disable]
Password History             [10]
Minimum Password Age(day)    [1]
Maximum Password Age(day)    [999]
<Account Lockout Policy>
Account Lockout Threshold    [3]
Account Lockout Duration(min) [99999]
```

set user-policy

This command sets the password policy and the account lockout policy used during local authentications for the user account.

The password policy and the account lockout policy set with this command can be specified if new user accounts are created with the "create user" command or if the existing user account information is changed with the "set user" command.

Caution

If user accounts are initialized with the "initialize all-users" command, the password policy setting and the account lockout policy setting are also initialized.

■ Syntax

```
set user-policy [-password-length length]  
[-password-complexity {enable | disable}]  
[-password-history number_of_passwords] [-password-min-age days]  
[-password-max-age days] [-lockout-threshold threshold]  
[-lockout-duration minutes]
```

■ Parameter

-password-length

Optional. This parameter specifies the number of bytes for the minimum password length with a range of 4 to 64. The default value is 4. If omitted, this parameter remains unchanged.

length Minimum password length (4 to 64)

-password-complexity

Optional. This parameter specifies whether the password must satisfy the complexity requirement. The default value is "disable". If omitted, this parameter remains unchanged.

Note

If "enable" is specified, characters from three or more of the following four categories must be used.

- Uppercase letters (A to Z)
- Lowercase letters (a to z)
- Decimal number (0 to 9)
- Symbols (such as "!", "\$", "#", and "%")

enable The password must satisfy the complexity requirement.

disable The password does not need to satisfy the complexity requirement (default).

-password-history

Optional. This parameter specifies the number of generations for the password history management within a range of 0 to 16. By specifying the number of generations to remember, the current password or a recently used password cannot be set as the new password when the password is changed. The default value is "0". If the set value is "0", the password history management is not performed. If omitted, this parameter remains unchanged.

number_of_passwords Number of generations for the password history management (0 to 16)

-password-min-age

Optional. This parameter specifies the minimum number of days until the password can be changed within a range of 0 to 999. If the set value is "0", the password can be changed at any time. If omitted, this parameter remains unchanged.

days Password change restriction period (0 to 999)

-password-max-age

Optional. This parameter specifies the maximum number of days the password is valid within a range of 0 to 999. The default value is "0". If the set value is "0", the password validity period is indefinite. If omitted, this parameter remains unchanged.

Note

When logged in with a user account that has a password with a validity period of under 14 days, the valid number of days for that password is displayed and a message prompting the user to change the password is displayed.

days Password validity period (0 to 999)

-lockout-threshold

Optional. This parameter specifies the number of failed login attempts before the user account is locked out within a range of 0 to 999. The default value is "0". If the set value is "0", an account lockout due to authentication failures will not occur. If omitted, this parameter remains unchanged.

threshold Number of failed login attempts before the user account is locked out (0 to 999)

-lockout-duration

Optional. This parameter specifies the lockout duration (in minutes) until the locked out account is automatically unlocked within a range of 0 to 99999. The default value is 30. If omitted, this parameter remains unchanged.

Caution

- If "0" is specified, the lockout is not automatically released. Only the account manager (user account with the User Management role) can release the lock.
- If the "-lockout-threshold" parameter is "0", a lockout duration cannot be specified. If the "-lockout-threshold" parameter is 1 to 999, a lockout duration can be specified.

minutes Lockout duration (0 to 99999)

■ Example(s)

This example changes the following settings of the password policy and the account lockout policy.

- Minimum password length: 8 characters
- Password must satisfy the complexity requirement
- Number of generations for the password history management: 10 generations
- Password change restriction period: 1 day
- Password validity period: 365 days
- Number of failed login attempts before being locked out: 10
- Lockout duration: 120 minutes

```
CLI> set user-policy -password-length 8 -password-complexity enable -password-history 10 -password-min-age 1  
-password-max-age 365 -lockout-threshold 10 -lockout-duration 120
```

show users

This command displays all of the registered user accounts.

■ Syntax

```
show users
```

■ Parameter

No parameters.

■ Output

Item name	Description
User Name	User account name
User Role	Role name
Availability	Indicates whether the user account is enabled.
Enable	Enables the user account
Disable	Disables the user account
SSH Public Key	Indicates whether an SSH public key is registered.
Registered	The SSH public key is registered.
Not Registered	The SSH public key is not registered.
Enforce Password Policy	Indicates whether the password policy is applied to the user account.
Yes	The password policy is applied to the user account.
No	The password policy is not applied to the user account.
Enforce Lockout Policy	Indicates whether the account lockout policy is applied to the user account.
Yes	The account lockout policy is applied to the user account.
No	The account lockout policy is not applied to the user account.
Last Password Setting Date	The last time the password was changed If the password policy is not registered, a hyphen (-) is displayed.
Days to Password Changeable	Number of days until the password can be changed. If the "Minimum Password Age" of the password policy is "Unrestricted", a hyphen (-) is displayed. When the number of days until the password can be changed becomes "0 days", "less than 24 hours" is displayed. When the password can be changed, "changeable" is displayed.
Days to Expiration	Number of days the password is valid If the "Maximum Password Age" of the password policy is "Unrestricted", a hyphen (-) is displayed. When the number of days for the password validity becomes "0 days", "less than 24 hours" is displayed. When the password validity period expires, "expired" is displayed.

■ Example(s)

The following example displays all of the existing user accounts:

```
CLI> show users
User Name      User Role      Availability  SSH Public Key  Enforce Password Policy  Enforce Lockout Policy  Last Password Setting Date  Days to Password Changeable  Days to Expiration
-----
f.ce           Maintainer     [Enable ]     [Not Registered] [Yes]                    [Yes]                    2015-12-31 00:00:03         changeable                    80
root           Admin          [Enable ]     [Not Registered] [Yes]                    [Yes]                    2016-10-10 10:00:03         10                            180
manager        Admin          [Enable ]     [Registered ]   [No ]                   [Yes]                    -                            -
user1          Monitor        [Enable ]     [Registered ]   [Yes]                   [No ]                    2016-10-19 12:10:03         less than 24 hours           189
user2          Monitor        [Disable]     [Registered ]   [No ]                   [No ]                    -                            -
user3          Monitor        [Enable ]     [Registered ]   [Yes]                   [No ]                    2016-10-19 12:10:03         changeable                    less than 24 hours
user4          Monitor        [Enable ]     [Registered ]   [Yes]                   [No ]                    2016-10-18 12:10:03         changeable                    expired
```

create user

This command creates a new user account.

Note

- User account names that are already registered cannot be used.
- User policies (password policy and account lockout policy) cannot be applied to user accounts with the Software role.

Syntax

```
create user -name name -role role [-function {enable | disable}]  
[-enforce-password-policy {yes | no}] [-enforce-lockout-policy {yes | no}]
```

Parameter

-name This parameter specifies a unique name for the new user account. Usable characters are alphanumeric (case-sensitive), exclamation mark (!), hyphen (-), underscore (_), and dot (.) characters. A minimum of 1 letter and a maximum of 32 letters are required.

Caution

User names that are already registered cannot be specified.

name Name for the new user account

-role This parameter specifies the role. For details, refer to ["5.1.1 Role" \(page 561\)](#).

role Total Administrator role or user-defined role

Total Administrator role	
Maintainer	Maintenance operator
SecurityAdmin	Security administrator
AccountAdmin	Account administrator
StorageAdmin	ETERNUS DX/AF administrator
Administrator	Total administrator
Monitor	Monitor
Software	Software

User-defined role
Role that is created using the "create role" command.

-function Optional. This parameter specifies whether the created user account will be enabled. If "disable" is specified, the relevant user account cannot log in to CLI. If omitted, "enable" is set.

enable The user account created is enabled immediately (default).
disable The user account is created but not enabled.

-enforce-password-policy

Optional. This parameter specifies whether the password policy is applied to the user account. The password policy setting is reflected immediately. The password policy is used when the password is set. The password policy cannot be applied to user accounts with the Software role. If omitted, "no" is set.

- yes The password policy is applied to the user account.
- no The password policy is not applied to the user account (default).

-enforce-lockout-policy

Optional. This parameter specifies whether the account lockout policy is applied to the user account. The account lockout policy cannot be applied to user accounts with the Software role. If omitted, "no" is set.

- yes The account lockout policy is applied to the user account.
- no The account lockout policy is not applied to the user account (default).

■ Example(s)

The following example creates a new user account named "user1" with the Account Admin role and is applied with the password policy and the account lockout policy.

The entered password for "Password:" and "Confirm Password:" is not displayed:

```
CLI> create user -name user1 -role AccountAdmin -function enable -enforce-password-policy yes -enforce-lockout-policy yes
Password:
Confirm Password:
```

set user

This command changes the information of an existing user account.

Note

- User account names cannot be changed.
- The user account information of the currently logged in user can be used, and any changes are enabled after the next login.
- The account information for the factory shipped default users (f.ce and root) can also be changed with this command.
- User policies (password policy and account lockout policy) cannot be applied to user accounts with the Software role.

Syntax

```
set user -name name [-role role] [-function {enable | disable}]  
[-enforce-password-policy {yes | no}] [-enforce-lockout-policy {yes | no}]
```

Parameter

- name** This parameter specifies the user account name. Only one user account name can be specified at the same time.
- name* User account name
- role** Optional. This parameter specifies the role. If omitted, the existing setting is not changed.
- role* Total Administrator role or user-defined role
- | | |
|--------------------------|-----------------------------|
| Total Administrator role | |
| Maintainer | Maintenance operator |
| SecurityAdmin | Security administrator |
| AccountAdmin | Account administrator |
| StorageAdmin | ETERNUS DX/AF administrator |
| Administrator | Total administrator |
| Monitor | Monitor |
| Software | Software |
- Custom role
Role that is created using the "create role" command.
- function** Optional. This parameter specifies whether the modified user account is enabled. If omitted, this parameter remains unchanged. If "disable" is specified, the relevant account cannot log in to CLI.
- enable The modified user account is enabled immediately (default).
- disable The user account is modified but not enabled.

-enforce-password-policy

Optional. This parameter specifies whether the password policy is applied to the modified user account. The password policy setting is reflected immediately. The password policy is used when the password is set. If omitted, this parameter remains unchanged. The password policy cannot be applied to user accounts with the Software role.

- yes The password policy is applied to the modified user account.
- no The password policy is not applied to the modified user account (default).

-enforce-lockout-policy

Optional. This parameter specifies whether the account lockout policy is applied to the modified user account. If omitted, this parameter remains unchanged. The account lockout policy cannot be applied to user accounts with the Software role.

- yes The account lockout policy is applied to the modified user account.
- no The account lockout policy is not applied to the modified user account (default).

■ Example(s)

This example changes the information of the user account named "user1" to the following settings.

- Admin role
- Apply the password policy
- Apply the account lockout policy

```
CLI> set user -name user1 -role Admin -function enable -enforce-password-policy yes -enforce-lockout-policy yes
```

delete user

This command deletes the specified user account. The currently logged in user account can be deleted, and deletion is enabled after the next login. Even if a disabled user account is specified, the user account can be deleted. In addition, if a SSH public key is registered, the key is also automatically deleted when this command is executed.

■ Syntax

```
delete user -name name
```

■ Parameter

-name This parameter specifies the user account name to be deleted. Only one user name can be specified at the same time.

name User account name

■ Example(s)

The following example deletes the user account named "user1":

```
CLI> delete user -name user1
```

show login-users

This command displays the login users.

Users who are logged in to GUI or to the master CM to which the command is executed from CLI or software are displayed. Users who are logged in to the slave CM from CLI or software are not displayed.

■ Syntax

```
show login-users
```

■ Parameter

No parameters.

■ Output

Item name	Description
Interface	User interface type
Session ID	User session ID
User Name	User account name
User Role	Role name
Login Date	Login date and time
Lock	Resource lock
IP Address	IP address of logged in users

■ Example(s)

The following example displays the information of the users who are logged in:

```
CLI> show login-users
Interface Session ID User Name          User Role   Login Date   Lock   IP Address
-----
GUI        65535 f.ce             Maintainer  2012-07-02 10:12:05 No    2001:db8::1234:0:0:9abc
GUI        5 root                Admin       2012-07-02 10:13:05 No    2002:COA8:2101::1
CLI        * 6 anonymous          Monitor     2012-07-02 10:14:05 No    192.168.0.2
CLI        10 root              Admin       2012-07-02 11:12:05 No    fe80::20a:e4ff:fe9b:f50f
SOFT      112 esf_user         Software    2012-07-02 12:12:07 Yes   192.168.0.1
```

set password

This command changes the password of the specified user account or the password of the currently logged in user account. The password can be entered from the terminal after the command input. If the password policy is applied, the password that is based on the policy is set. Use the "show users" command or the "show user-policy" command to check the application of the password policy.

Syntax

```
set password [-name name]
```

Parameter

-name Optional. This parameter specifies the user name to change the password. Only one user name can be specified at the same time. If omitted, the password of the current user is changed.

Note

Only users with the User Management policy can specify this parameter.

name User name

Output

Item name	Description
Password Information	Displayed if the password is changed for a user account that has been applied with the password policy. Not displayed if the password is changed for a user account that has not been applied with the password policy.
Last Password Setting Date	The last time the password was changed If the password policy is not registered, a hyphen (-) is displayed.
Days to Password Changeable(day)	Number of days until the password can be changed. If the "Minimum Password Age" of the password policy is "Unrestricted", a hyphen (-) is displayed. When the number of days until the password can be changed becomes "0 days", "less than 24 hours" is displayed. When the password can be changed, "changeable" is displayed.
Days to Expiration(day)	Number of days the password is valid If the "Maximum Password Age" of the password policy is "Unrestricted", a hyphen (-) is displayed. When the number of days for the password validity becomes "0 days", "less than 24 hours" is displayed. When the password validity period expires, "expired" is displayed.

■ Example(s)

The following example changes the password of the current user while logged in with a user account that has the User Management policy (when the password policy is not applied):

```
CLI> set password
Password :
New Password :
Confirm Password :
```

The following example changes the password of a different user (user2) from a user account that has the User Management policy (when the password policy is not applied):

```
CLI> set password -name user2
New Password :
Confirm Password :
```

The following example changes the password of the current user while logged in with a user account that does not have the User Management policy (when the password policy is not applied):

```
CLI> set password
Password :
New Password :
Confirm Password :
```

The following example changes the password of a user account that has been applied with the password policy:

```
CLI> set password
<Password Information>
Last Password Setting Date      [2016-01-31 00:00:03]
Days to Password Changeable(day) [2]
Days to Expiration(day)        [310]
<Change Password>
Password :
New Password :
Confirm Password :
```

initialize all-users

This command clears all of the existing user accounts. Note that only the initial default user is enabled.

■ Syntax

```
initialize all-users -execution {yes | no}
```

■ Parameter

-execution	This parameter specifies the execution mode. User accounts are initialized only when selecting "yes".
yes	All the user accounts are initialized.
no	No operation.

■ Example(s)

The following example initializes all of the registered user accounts:

```
CLI> initialize all-users -execution yes
```

5.1.3 Account Authentication

Importing of Secure SHell (SSH) public keys, and the maintenance key for performing maintenance work are described here.

The following describes the commands used with account authentications.

Function	Command
Importing SSH public keys	import ssh-public-key
Deleting SSH public key	delete ssh-public-key
Generation, display, and destruction of the maintenance key	show maintenance-key

import ssh-public-key

For SSH (Secure SHell) connections, passwords or certificate keys can be used for authentication. This command is used to import a SSH public key into an ETERNUS DX/AF from an FTP server when using the certificate key method of authentication.

- One certificate key corresponds to a single user account.
- Even if a specific user account is disabled, a key may still be imported.
- If a public key is already registered and this command is executed, the imported information setting of the SSH public key is overwritten.

The key types that are supported are as follows:

- IETF style DSA for SSH v2 (Strength 1,024bit, 2,048bit, or 4,096bit)
- IETF style RSA for SSH v2 (Strength 1,024bit, 2,048bit, or 4,096bit)

■ Syntax

```
import ssh-public-key -account-name account_name  
-port {maintenance | remote | fst} -server server_name  
-user login_user_account -filename filename [-indicator {enable | disable}]
```

■ Parameter

-account-name

This parameter specifies a user account name used for a certificate key for authentication. Only one user name can be specified at the same time.

account_name User account name

-port

This parameter specifies which Ethernet port is used to connect to the FTP server. For details, refer to ["1.11 Note for Specifying FTP Server" \(page 54\)](#).

maintenance Maintenance port (MNT port)

remote Remote port (RMT port)

fst FST port (DX500 S4/DX600 S4, DX500 S3/DX600 S3, DX8100 S3/DX8700 S3/DX8900 S3, and AF650 S2/AF650 only)

-server

This parameter specifies an FTP server name where the public key is stored. The server name format is IPv4 standard notation (a base 256 "d.d.d.d" string) or a fully qualified domain name.

Example: -server 192.168.1.20

Example: -server foo.bar

server_name FTP server name

-user

This parameter specifies the user account name that is to be used to access the FTP server. When this parameter is specified, the command displays an FTP server password prompt.

login_user_account User account name that is to be used to access the FTP server

-filename

This parameter specifies the name of the file that contains a public key.

filename Filename

-indicator Optional. This parameter specifies whether the progress indicator is displayed. If omitted, the progress indicator is displayed.

enable Progress indicator is displayed.

disable Progress indicator is not displayed.

■ Example(s)

For a user account named "manager", the following example imports a public key for SSH authentication from an FTP server named "ftp.a.com" using the maintenance port (MNT port). The user name used to log into the FTP server is "cli-user" and the file that contains the SSH public key is "/tmp/ssh_key1".

The entered password in "Password :" is not displayed:

```
CLI> import ssh-public-key -account-name manager -port maintenance -server ftp.a.com -filename /tmp/ssh_key1 -user cli-user
Password :
importing /tmp/ssh_key1 from ftp.a.com
complete.
```

The following example is the same as above, except that the progress indicator is not displayed.

The entered password in "Password :" is not displayed:

```
CLI> import ssh-public-key -user-account manager -port maintenance -server ftp.a.com -filename /tmp/ssh_key1 -user cli-user
-indicator disable
Password :
```

delete ssh-public-key

This command deletes an existing public key for SSH authentication. Even if a specified user account is disabled at that time, the SSH public key can be deleted.

■ Syntax

```
delete ssh-public-key -account-name account_name
```

■ Parameter

-account-name

This parameter specifies an existing user account name with the SSH certificate key registered for authentication-use. Only one user account name can be specified at once.

account_name User account name

■ Example(s)

The following example deletes the SSH public key for the "manager" user account.

```
CLI> delete ssh-public-key -account-name manager
```

show maintenance-key

This command generates, displays, and discards the required maintenance key for performing maintenance work by the maintenance engineer.

Caution

The maintenance key that is displayed with this command is used as a temporary login for specialized maintenance use. Be careful with the handling of the information that is displayed.

■ Syntax

```
show maintenance-key [{"-generate [-time lifetime_hours] | -delete}]
```

■ Parameter

- generate** Optional. This parameter generates and displays a new maintenance key. The generated maintenance key is only valid for temporarily logging in to the controller module (CM) where this command was executed. When temporarily logging in to different CMs, execute this command in the relevant CMs. The generated maintenance key is automatically discarded after the valid period elapses or when the CM is rebooted.

Caution

If a valid maintenance key already exists, this command discards it and generates a new maintenance key. In order to ensure security, the maintenance key is a character string that is impossible to guess. When requesting maintenance work, make sure to give the correct information (such as uppercase letters, lowercase letters, and symbols) to the maintenance engineer.

- time** Optional. This option specifies the valid period of the maintenance key that is to be generated. This option can only be specified with the "-generate" parameter. If omitted, "12" (hours) is set.

lifetime_hours 1 to 48 (hours)

- delete** Optional. This parameter deletes a valid maintenance key if one already exists. If the maintenance work is complete, in order to ensure security, delete the maintenance key with this parameter without waiting for the maintenance key to expire.

Caution

Regardless of the existence of a valid maintenance key, this command completes successfully.

■ Output

Item name	Description
Controller Module	Controller module (CM or CE-CM) where the command was executed The maintenance key is only valid for the displayed CM.
Maintenance key	Maintenance key In order to ensure security, the maintenance key is a character string that is impossible to guess. When requesting maintenance work, make sure to give the correct information (such as uppercase letters, lowercase letters, and symbols) to the maintenance engineer. If a valid maintenance key does not exist, a hyphen (-) is displayed.
Time left	The time left before the maintenance key is invalidated If the time left is an hour or more, the time is displayed with a format of [xx h yy min]. If the time left is less than an hour, the time is displayed with a format of [yy min zz sec]. If a valid maintenance key does not exist, a hyphen (-) is displayed.

■ Example(s)

The following example generates a new maintenance key with a valid period of 36 hours:

```
CLI> show maintenance-key -generate -time 36
Controller Module   [CE#0 CM#0]
Maintenance key     [Rd$5@dted9E9]
Time left           [36 h 00 min]
```

The following example shows an output when a valid maintenance key exists:

```
CLI> show maintenance-key
Controller Module   [CE#0 CM#0]
Maintenance key     [Rd$5@dted9E9]
Time left           [11 h 59 min]
```

The following example deletes the maintenance key:

```
CLI> show maintenance-key -delete
Controller Module   [CE#0 CM#0]
Maintenance key     [-]
Time left           [-]
```

The following example shows an output when no valid maintenance keys exist:

```
CLI> show maintenance-key
Controller Module   [CE#0 CM#0]
Maintenance key     [-]
Time left           [-]
```

5.1.4 RADIUS Server Settings

RADIUS (Remote Authentication Dial In User) is the networking protocol for the centralized management of the authentication, authorization and accounts of network users.

This section explains the commands to set authentication, authorize and account by the server.

- Displaying the RADIUS authentication server(s) settings.
- Setting the RADIUS authentication server(s).

Figure 5.1 RADIUS server overview

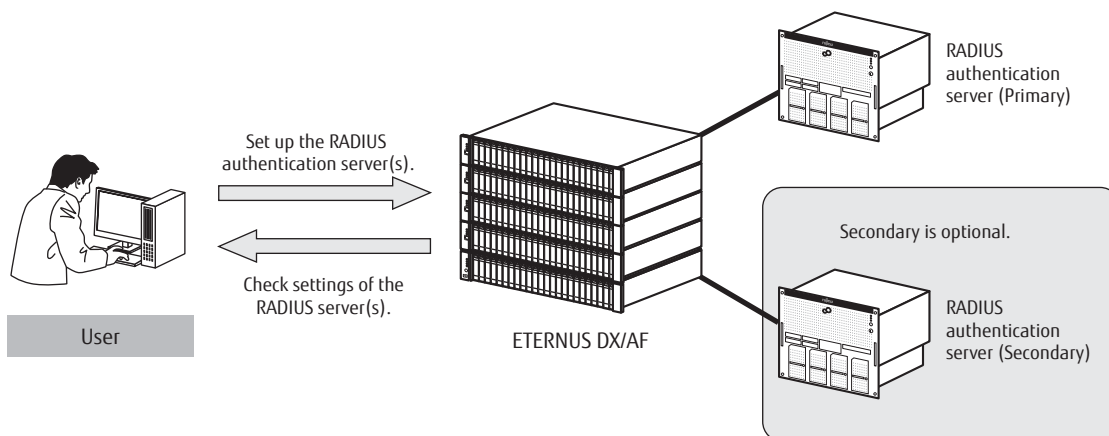

show radius

This command displays the settings of the RADIUS server.

Syntax

```
show radius
```

Parameter

No parameters.

Output

Item name	Description
RADIUS authentication	Display the system's mode.
After error	Indicates which method is used after an error is detected.
Primary server	FQDN or IP address (IPv4 or IPv6) of the primary authentication server
Primary port	Port that is used for primary settings
Primary port number	Port number of the primary authentication server for the authentication protocol
Primary authentication mode	Authentication method type of the primary authentication server
Primary shared secret	Shared secret of the primary authentication server
Primary retry timeout	Retry timeout value of the primary authentication server
Secondary server	FQDN or IP address (IPv4 or IPv6) of the secondary authentication server
Secondary port	Port that is used for secondary settings
Secondary port number	Port number of the secondary authentication server for the authentication protocol
Secondary authentication mode	Authentication method type of the secondary authentication server
Secondary shared secret	Shared secret of the secondary authentication server.
Secondary retry timeout	Retry timeout value of the secondary authentication server.

Example(s)

The following example displays the settings of the RADIUS authentication servers:

```
CLI> show radius
RADIUS authentication      [Enable]
After error                [No]
Primary server             [10.21.134.198]
Primary port               [MNT]
Primary port number       [1812]
Primary authentication mode [CHAP]
Primary shared secret     [xxxxxxxxxxxxxxxxxxxxxxxxxxxxxxxxxxxx]
Primary retry timeout     [20]
Secondary server          [10.17.80.6]
Secondary lan port        [RMT]
Secondary port number     [1912]
Secondary authentication mode [PAP]
Secondary shared secret   [yyyyyyyyyyyyyyyyyyyyyyyyyyyyyyyy]
Secondary retry timeout   [20]
```

The following example shows when the secondary server is not valid.

```
CLI> show radius
RADIUS authentication      [Enable]
After error               [No]
Primary server            [10.21.134.198]
Primary port              [MNT]
Primary port number       [1812]
Primary authentication mode [CHAP]
Primary shared secret     [xxxxxxxxxxxxxxxxxxxxxxxxxxxxxxxxxxxx]
Primary retry timeout     [20]
Secondary server         [-]
Secondary lan port        [RMT]
Secondary port number     [1912]
Secondary authentication mode [PAP]
Secondary shared secret   [yyyyyyyyyyyyyyyyyyyyyyyyyyyyyyyyyy]
Secondary retry timeout   [20]
```

The following example shows when RADIUS authentication is disabled.

```
CLI> show radius
RADIUS authentication      [Disable]
After error               [No]
Primary server            [10.21.134.198]
Primary port              [MNT]
Primary port number       [1812]
Primary authentication mode [CHAP]
Primary shared secret     [xxxxxxxxxxxxxxxxxxxxxxxxxxxxxxxxxxxx]
Primary retry timeout     [20]
Secondary server         [-]
Secondary port            [RMT]
Secondary port number     [1912]
Secondary authentication mode [PAP]
Secondary shared secret   [yyyyyyyyyyyyyyyyyyyyyyyyyyyyyyyyyy]
Secondary retry timeout   [20]
```

set radius

This command sets up the RADIUS authentication server. A secondary server cannot be set up without setting up a primary server. Set the secondary IP address to "0.0.0.0." to disable the secondary-server setting.

Syntax

```
set radius -mode {enable | disable} [-after-error {internal | internal-net | no}]  
[-primary-server {primary_server | ""}] [-primary-port {maintenance | remote}]  
[-primary-port-number port_number] [-primary-authentication-mode {chap | pap}]  
[-primary-shared-secret shared_secret_code] [-primary-retry-timeout{10 | 20 | 30 | 40 | 50 | 60}]  
[-secondary-server secondary_server] [-secondary-port {maintenance | remote}]  
[-secondary-port-number port_number] [-secondary-authentication-mode {chap | pap}]  
[-secondary-shared-secret shared_secret_code] [-secondary-retry-timeout{10 | 20 | 30 | 40 | 50 | 60}]
```

Parameter

- mode** This parameter specifies enable or disable for RADIUS authentication, authorization and accounts functions. To enable RADIUS authentication, the primary server must be set in advance or at the same time that this parameter is set. RADIUS authentication can be disabled regardless of the primary server setting status.
- enable RADIUS function is enabled.
 - disable RADIUS function is disabled.
- after-error** Optional. This parameter specifies what happens when an error occurs. If this parameter is omitted, this setting is not changed.
- internal Authenticate and authorize for any error that occurs.
 - internal-net Authenticate and authorize for an error that occurs due to a network problem.
 - no No authenticate and/or no authorize.
- primary-server** Optional. This parameter specifies the primary server. Only one server can be specified. If the primary server is not set, specify the primary server for this parameter to enable RADIUS authentication. The server name format should be IPv4 standard notation (a base 256 "d.d.d.d" string), IPv6 address format, or a fully qualified domain name (FQDN). The types of IPv6 addresses that can be specified are global addresses (including 6to4 addresses), link local addresses, and unique local addresses. Up to 63 alphanumeric characters can be specified. To delete the primary server, specify a null character ("").
- Example: -primary-server 192.168.1.20
Example: -primary-server fd80::abd0:223:ad
Example: -primary-server foo.bar
Example: -primary-server "" (when deleting)
- primary_server* Primary server name
 - "" The primary server is deleted.
- primary-port** Optional. This parameter specifies the port number of the primary server for the authentication protocol.

maintenance Maintenance port (MNT port)
remote Remote port (RMT port)

-primary-port-number

Optional. This parameter specifies the UDP port number of the primary server for the authentication protocol. Specify the port number within 1 to 5 digits. The port number cannot be set above 65535. If omitted, the existing setting is not changed. The default value is 1812.

port_number UDP port number of the primary server

-primary-authentication-mode

Optional. This parameter specifies the authentication method type of the primary server. If omitted, the existing setting is not changed. The following methods can be specified:

chap Use CHAP. (Default)
pap Use PAP.
PAP: Password Authentication Protocol

-primary-shared-secret

Optional. This parameter specifies the shared secret of the primary server (up to 64 alphanumeric characters). If omitted, the existing setting is not changed.

shared_secret_code Shared secret of the primary server

-primary-retry-timeout

Optional. This parameter specifies the retry timeout value of the primary server. If omitted, 30 seconds (default value) is used. The timeout value should be selected from following values:

10 10 seconds
20 20 seconds
30 30 seconds (Default value)
40 40 seconds
50 50 seconds
60 60 seconds

-secondary-server

Optional. This parameter specifies the secondary server. Only one server can be specified. The server name format should be IPv4 standard notation (a base 256 "d.d.d.d" string), IPv6 address format, or a fully qualified domain name (FQDN). The types of IPv6 addresses that can be specified are global addresses (including 6to4 addresses), link local addresses, and unique local addresses. Up to 64 alphanumeric characters can be specified.

Example: -secondary-server 192.168.1.20

Example: -secondary-server fd80::abd0:223:ad

Example: -secondary-server foo.bar

secondary_server Secondary server

-secondary-port

Optional. This parameter specifies the LAN port for secondary settings. If omitted, the existing setting is not changed.

maintenance	Maintenance port (MNT port)
remote	Remote port (RMT port)

-secondary-port-number

Optional. This parameter specifies the UDP port number of the secondary server for the authentication protocol. Specify the port number within 1 to 5 digits. The port number cannot be set above 65535. If omitted, the existing setting is not changed. The default value is 1812.

<i>port_number</i>	UDP port number of the secondary server
--------------------	---

-secondary-authentication-mode

Optional. This parameter specifies the authentication method of the secondary server. CHAP or PAP can be selected for the authentication method. If omitted, the existing setting is not changed. The following methods can be specified.

chap	Use CHAP. (Default)
pap	Use PAP.

PAP: Password Authentication Protocol

-secondary-shared-secret

Optional. This parameter specifies the shared secret of the secondary server. Up to 64 alphanumeric characters can be specified for the shared value. If omitted, the existing setting is not changed.

<i>shared_secret_code</i>	Shared secret of the secondary server
---------------------------	---------------------------------------

-secondary-retry-timeout

Optional. This parameter specifies the retry timeout value of the secondary server. If omitted, 30 seconds (default value) is used. The timeout value should be selected from following values:

10	10 seconds
20	20 seconds
30	30 seconds (Default value)
40	40 seconds
50	50 seconds
60	60 seconds

■ Example(s)

The following example sets the RADIUS authentication server:

```
CLI> set radius -mode -after-error no -primary-server 10.21.134.198 -primary-port maintenance -primary-port-number 1812  
-primary-authentication-mode chap -primary-shared-secret "RADIUS Secret" -primary-retry-timeout 20  
-secondary-server 10.17.80.6 -secondary-port remote -secondary-port-number 1912 -secondary-authentication-mode pap  
-secondary-shared-secret "RADIUS Secret1" -secondary-retry-timeout 20
```

5.2 Network Management

This section explains commands related to the following network operations:

- System network configurations
- SNMP configurations
- SMI-S configurations
- Secure server keys

5.2.1 Network Settings

This section explains the commands related to network connectivity.

For the factory default network setting, the default IP address is set for the MNT port of the master CM. If the default setting is used, the following functions are unavailable:

- SNMP Agent basic settings
- E-mail notification settings
- Syslog settings
- RADIUS settings
- Remote support settings (only for ETERNUS Web GUI)
- Network settings update except for the IP address
- Settings for a firmware update from the peer storage system (only for ETERNUS Web GUI)
- SMI-S settings
- AIS Connect settings
- Audit log
- Key management server linkage
- Activation of the NPT in date and time settings
- Firmware hot swapping
- Memory addition
- Hot expansion and hot reduction of the CAs (only for the DX100 S4/DX200 S4, the DX100 S3/DX200 S3, the AF250 S2/AF250, and the DX200F)

To make these functions available, set the network by executing the "set network" command. This releases the factory default network setting. Whether the factory default network setting is set can be determined by executing the "show network" command. If the factory default network setting is set, a message informing that the network setting is required appears when one of the functions above is executed or enabled. A message that prompts the network setting appears at login.

show network

This command displays the network (LAN) configuration parameters.

Syntax

```
show network
```

Parameter

No parameters.

Output

Item name	Description
MNT port	Maintenance port (MNT port) name
RMT port	Remote port (RMT port) name
FST port	Field support port (FST port) name (only for the DX500 S4/DX600 S4, the DX500 S3/DX600 S3, the DX8100 S3/DX8700 S3/DX8900 S3, and the AF650 S2/AF650)
Ipv4	Indicates whether IPv4 settings are enabled or disabled (Enable/Disable/Factory Default). (When the factory default network setting is set, this information is displayed as "Factory Default" for the MNT port.)
Master IP Address	IP address of the maintenance port on master CM (IPv4)
Slave IP Address	IP address of the maintenance port on slave CM (IPv4)
Subnet Mask	Subnet mask of the maintenance port (IPv4)
Gateway	Gateway IP address (IPv4 and IPv6) of the maintenance port
Primary DNS	Primary DNS IP address (IPv4 and IPv6)
Secondary DNS	Secondary DNS IP address (IPv4 and IPv6)
Speed and Duplex	Connection speed of the maintenance port (IPv4 and IPv6)
Allowable IP Address List	List of allowed IP addresses
NO.	Allowable IP address number
IP Address	Allowable IP address (IPv4)
Subnet Mask	Subnet mask (IPv4)
Connect IP Address	Connect IP Address and mask length (IPv6)
Wake on LAN	Indicates whether the Wake on LAN function is enabled on the maintenance port.
Ipv6	Indicates whether IPv6 settings are enabled or disabled (Enable/Disable/Factory Default). (When the factory default network setting is set, this information is displayed as "Factory Default" for the MNT port.)
Master Link Local IP Address	Link local IP address (Master) (IPv6)
Master Connect IP Address	Connect IP address (Master) (IPv6)
Slave Link Local IP Address	Link local IP address (Slave) (IPv6)
Slave Connect IP Address	Connect IP address (Slave) (IPv6)
Length of Subnet Prefix	Prefix length (IPv6)
MAC Address	The MAC address of all the controller modules that are installed A hyphen (-) is displayed in the field of CM#1 for an ETERNUS DX/AF with a single controller.

■ Example(s)

The following example displays the network (LAN) configuration parameters (for the DX60 S4/DX100 S4/DX200 S4, the DX500 S4/DX600 S4, the DX60 S3/DX100 S3/DX200 S3, the DX500 S3/DX600 S3, the DX8100 S3, the AF250 S2/AF650 S2, the AF250/AF650, and the DX200F):

```
CLI> show network
MNT Port
<IPv4 Information>
Ipv4 [Enable]
Master IP Address [192.168.1.1]
Slave IP Address [192.168.1.2]
Subnet Mask [255.255.255.0]
Gateway [192.168.1.250]
Primary DNS [192.168.1.253]
Secondary DNS [192.168.1.254]
Speed and Duplex [Auto Negotiation]
Wake on LAN [Disable]
<Allowable IP Address List>
  NO. IP Address Subnet Mask
  ----
  1 192.180.1.0 255.255.255.0
  2 10.21.138.0 255.255.255.0
  3 1.2.3.0 255.255.255.0
  4 10.10.10.10 255.255.0.0
<IPv6 Information>
Ipv6 [Enable]
Master Link Local IP Address [fe80:2:3:4:5:6:7:8]
Master Connect IP Address [1:2:3::6:7:8]
Slave Link Local IP Address [fe80:b:c:d:e:f:10:11]
Slave Connect IP Address [a:b:c:d::]
Length of Subnet Prefix [64]
Gateway [c0:a8:1:fa:ff:ff:ff:0]
Primary DNS [c0:a8:1:fd::]
Secondary DNS [c0:a8:1:fe::]
<Allowable IP Address List>
  NO. Connect IP Address
  ----
  0 2001:0db8:bd05:01d2:288a:1fc0:0001:10ee/64
  1 c0:c8:2::/64
<MAC Address>
CM#0 [01:02:03:04:05:06]
CM#1 [11:12:13:14:15:16]
RMT Port
<IPv4 Information>
Ipv4 [Enable]
Master IP Address [192.168.128.1]
Slave IP Address [192.168.128.2]
Subnet Mask [255.255.255.0]
Gateway [192.168.128.250]
Primary DNS [192.168.128.253]
Secondary DNS [192.168.128.254]
Speed and Duplex [Auto Negotiation]
Wake on LAN [Disable]
<Allowable IP Address List>
  NO. IP Address Subnet Mask
  ----
  1 192.180.1.0 255.255.255.0
  2 10.21.138.0 255.255.255.0
  3 1.2.3.0 255.255.255.0
  4 10.10.10.10 255.255.0.0
<IPv6 Information>
Ipv6 [Enable]
Master Link Local IP Address [fe80:2:3:4:5:6:7:8]
Master Connect IP Address [1:2:3::6:7:8]
Slave Link Local IP Address [fe80:b:c:d:e:f:10:11]
Slave Connect IP Address [a:b:c:d::]
Length of Subnet Prefix [64]
Gateway [c0:a8:1:fa:ff:ff:ff:0]
Primary DNS [c0:a8:1:fd::]
Secondary DNS [c0:a8:1:fe::]
```

```

<Allowable IP Address List>
NO. Connect IP Address
-----
 0 2001:0db8:bd05:01d2:288a:1fc0:0001:10ee/64
 1 c0:c8:2::/64

<MAC Address>
CM#0 [21:22:23:24:25:26]
CM#1 [31:32:33:34:35:36]

FST Port
<Port Information>
Ipv4 [Enable]
Master IP Address [192.168.134.1]
Slave IP Address [192.168.134.2]
Subnet Mask [255.255.255.0]
Speed and Duplex [Auto Negotiation]

<MAC Address>
CM#0 [41:42:43:44:45:46]
CM#1 [51:52:53:54:55:56]
  
```

The following example displays the network (LAN) configuration parameters (for the DX8700 S3/DX8900 S3):

```

CLI> show network
MNT Port
<IPv4 Information>
Ipv4 [Enable]
Master IP Address [192.168.1.1]
Slave IP Address [192.168.1.2]
Subnet Mask [255.255.255.0]
Gateway [192.168.1.250]
Primary DNS [192.168.1.253]
Secondary DNS [192.168.1.254]
Speed and Duplex [Auto Negotiation]
Wake on LAN [Disable]
<Allowable IP Address List>
NO. IP Address Subnet Mask
-----
 1 192.180.1.0 255.255.255.0
 2 10.21.138.0 255.255.255.0
 3 1.2.3.0 255.255.255.0
 4 10.10.10.10 255.255.0.0

<IPv6 Information>
Ipv6 [Enable]
Master Link Local IP Address [fe80:2:3:4:5:6:7:8]
Master Connect IP Address [1:2:3::6:7:8]
Slave Link Local IP Address [fe80:b:c:d:e:f:10:11]
Slave Connect IP Address [a:b:c:d::]
Length of Subnet Prefix [64]
Gateway [c0:a8:1:fa:ff:ff:ff:0]
Primary DNS [c0:a8:1:fd::]
Secondary DNS [c0:a8:1:fe::]
<Allowable IP Address List>
NO. Connect IP Address
-----
 0 2001:0db8:bd05:01d2:288a:1fc0:0001:10ee/64
 1 c0:c8:2::/64

<MAC Address>
CE#0 CM#0 [00:01:02:03:04:05]
CE#0 CM#1 [00:01:02:03:04:06]
CE#1 CM#0 [00:01:02:03:04:07]
CE#1 CM#1 [00:01:02:03:04:08]
CE#2 CM#0 [00:01:02:03:04:09]
CE#2 CM#1 [00:01:02:03:04:0A]
CE#3 CM#0 [00:01:02:03:04:0B]
CE#3 CM#1 [00:01:02:03:04:0C]
RMT Port
  
```



```
<IPv4 Information>
Ipv4 [Enable]
Master IP Address [192.168.128.1]
Slave IP Address [192.168.128.2]
Subnet Mask [255.255.255.0]
Gateway [192.168.128.250]
Primary DNS [192.168.128.253]
Secondary DNS [192.168.128.254]
Speed and Duplex [Auto Negotiation]
Wake on LAN [Disable]
<Allowable IP Address List>
  NO. IP Address Subnet Mask
  -----
  1 192.180.1.0 255.255.255.0
  2 10.21.138.0 255.255.255.0
  3 1.2.3.0 255.255.255.0
  4 10.10.10.10 255.255.0.0

<IPv6 Information>
Ipv6 [Enable]
Master Link Local IP Address [fe80:2:3:4:5:6:7:8]
Master Connect IP Address [1:2:3::6:7:8]
Slave Link Local IP Address [fe80:b:c:d:e:f:10:11]
Slave Connect IP Address [a:b:c:d::]
Length of Subnet Prefix [64]
Gateway [c0:a8:1:fa:ff:ff:ff:0]
Primary DNS [c0:a8:1:fd::]
Secondary DNS [c0:a8:1:fe::]
<Allowable IP Address List>
  NO. Connect IP Address
  -----
  0 2001:0db8:bd05:01d2:288a:1fc0:0001:10ee/64
  1 c0:c8:2::/64

<MAC Address>
CE#0 CM#0 [01:01:02:03:04:05]
CE#0 CM#1 [01:01:02:03:04:06]
CE#1 CM#0 [01:01:02:03:04:07]
CE#1 CM#1 [01:01:02:03:04:08]
CE#2 CM#0 [01:01:02:03:04:09]
CE#2 CM#1 [01:01:02:03:04:0A]
CE#3 CM#0 [01:01:02:03:04:0B]
CE#3 CM#1 [01:01:02:03:04:0C]

FST Port
<Port Information>
Ipv4 [Enable]
Master IP Address [192.168.134.1]
Slave IP Address [192.168.134.2]
Subnet Mask [255.255.255.0]
Speed and Duplex [Auto Negotiation]

<MAC Address>
CE#0 CM#0 [02:01:02:03:04:05]
CE#0 CM#1 [02:01:02:03:04:06]
CE#1 CM#0 [02:01:02:03:04:07]
CE#1 CM#1 [02:01:02:03:04:08]
CE#2 CM#0 [02:01:02:03:04:09]
CE#2 CM#1 [02:01:02:03:04:0A]
CE#3 CM#0 [02:01:02:03:04:0B]
CE#3 CM#1 [02:01:02:03:04:0C]
```

set network

This command sets up parameters for the Ethernet network, and checks the consistency of parameters. If the system detects an inconsistency between the parameters, the command is terminated abnormally.

- If the factory default network setting is used, make sure to set the "-master-ip" parameter with the MNT port first.

Caution

This command releases the factory default network setting. If settings other than the MNT port are configured first, a confirmation message is displayed to continue the process because connections to the MNT port become unavailable.

- An IPv4 address can be deleted by specifying it as "0.0.0.0", and an IPV6 address can be deleted by specifying it as "0".
- For the DX60 S4/DX100 S4/DX200 S4, the DX60 S3/DX100 S3/DX200 S3, the AF250 S2/AF250, and the DX200F, an IP address that is used to connect to the MNT port on the master controller module (CM) cannot be deleted.
- For the DX500 S4/DX600 S4, the DX500 S3/DX600 S3, the DX8100 S3/DX8700 S3/DX8900 S3, and the AF650 S2/AF650, both the IP address that is used to connect to the MNT port on the master controller module (CM), and the IP address that is used to connect to the RMT port cannot be disabled.
- When critical changes are made (such as changing a subnet address), all of the network parameters should be reconfigured.
- When the command is executed, the CLI session is logged off automatically.
- When "fst" is specified for "-port", gateway, DNSs and IP addresses cannot be set.
- When "fst" is specified for "-port", IPv6 addresses cannot be set.

Syntax

```
set network -port {maintenance | remote | fst} [-ip-format {v4 | v6}] [-ipv6-set-auto {disable | enable}]
[-master-ip ip_address] [-slave-ip ip_address] [-master-link-local-ip ip_address]
[-slave-link-local-ip ip_address] [-master-connect-ip ip_address] [-slave-connect-ip ip_address]
[-netmask netmask] [-subnet-prefix-length length] [-gateway gateway]
[-allow-ip1 ip_address,netmask] [-allow-ip2 ip_address,netmask] [-allow-ip3 ip_address,netmask]
[-allow-ip4 ip_address,netmask] [-allow-ip5 ip_address,netmask] [-allow-ip6 ip_address,netmask]
[-allow-ip7 ip_address,netmask] [-allow-ip8 ip_address,netmask] [-allow-ip9 ip_address,netmask]
[-allow-ip10 ip_address,netmask] [-allow-ip11 ip_address,netmask] [-allow-ip12 ip_address,netmask]
[-allow-ip13 ip_address,netmask] [-allow-ip14 ip_address,netmask] [-allow-ip15 ip_address,netmask]
[-allow-ip16 ip_address,netmask] [-speed {1000 | 100full | 100half | 10full | 10half | auto}]
[-primary-dns-ip ip_address] [-secondary-dns-ip ip_address] [-wake-on-lan {enable | disable}]
```

Parameter

-port	This parameter specifies the Ethernet port.
maintenance	Maintenance port (MNT port)
remote	Remote port (RMT port)
fst	FST port (DX500 S4/DX600 S4, DX500 S3/DX600 S3, DX8100 S3/DX8700 S3/DX8900 S3, and AF650 S2/AF650 only)
-ip-format	Optional. This parameter specifies the format of the IP address that is to be set. If omitted, IPv4 is selected. This parameter can be specified when "maintenance" or "remote" is specified for the "-port" parameter.

v4 The IPv4 setting is performed.
v6 The IPv6 setting is performed.

-ipv6-set-auto

Optional. When "enable" is selected, the link local IP address, the connect IP address, and gateway are set automatically. If omitted, it is handled as if "disable" is selected. This parameter can only be specified when "v6" is specified for the "-ip-format" parameter.

enable IPv6 automatic setting is performed.
disable IPv6 automatic setting is not performed.

-master-ip

Optional. This parameter specifies the IP address of the master CM. The format is IPv4 standard notation (a base 256 "d.d.d.d" string). If omitted, the existing setting is not changed. This parameter can only be specified when "v4" is specified for the "-ip-format" parameter.

Example: -master-ip 192.168.1.1

 **Caution**

- If the slave IP address is active, both master/slave IP addresses must belong to the same subnet address.
- When "0.0.0.0" is set, the IPv4 settings for the port are disabled.
- When both IPv4 and IPv6 settings are disabled, the port becomes unavailable. (With the DX60 S4/DX100 S4/DX200 S4, the DX60 S3/DX100 S3/DX200 S3, the AF250 S2/AF250, and the DX200F, if no other ports can be used other than the corresponding port, both IPv4 and IPv6 settings cannot be disabled. Both the maintenance port and the remote port must be enabled for the DX500 S4/DX600 S4, the DX500 S3/DX600 S3, the DX8100 S3/DX8700 S3/DX8900 S3, and the AF650 S2/AF650.)

ip_address IP address of the master CM

-slave-ip

Optional. This parameter specifies the IP address of the slave CM. The format is IPv4 standard notation (a base 256 "d.d.d.d" string). This parameter cannot be specified for the ETERNUS DX/AF with a single controller. If omitted, the existing setting is not changed. This parameter can only be specified when "v4" is specified for the "-ip-format" parameter.

Example: -slave-ip 192.168.1.2

 **Caution**

Both the master/slave IP addresses must belong to the same subnet address.

ip_address IP address of the slave CM

-master-link-local-ip

Optional. This parameter specifies the link local IP address of the master IP. If omitted, the existing setting is not changed. This parameter can only be specified when "v6" is specified for the "-ip-format" parameter and "disable" is specified for the "-ipv6-set-auto" parameter.

Example: -master-link-local-ip fe80::9abd:2df

 **Caution**

- When "0" is set, the IPv6 settings for the port are disabled.
- When both IPv4 and IPv6 settings are disabled, the port becomes unavailable. (With the DX60 S4/DX100 S4/DX200 S4, the DX60 S3/DX100 S3/DX200 S3, the AF250 S2/AF250, and the DX200F, if no other ports can be used other than the corresponding port, both IPv4 and IPv6 settings cannot be disabled. Both the maintenance port and the remote port must be enabled for the DX500 S4/DX600 S4, the DX500 S3/DX600 S3, the DX8100 S3/DX8700 S3/DX8900 S3, and the AF650 S2/AF650.)

ip_address Link local IP address of the master IP

-slave-link-local-ip

Optional. This parameter specifies the link local IP address of the slave IP. If omitted, the existing setting is not changed. This parameter can only be specified when "v6" is specified for the "-ip-format" parameter and "disable" is specified for the "-ipv6-set-auto" parameter.

Example: -slave-link-local-ip fe80::9ab0:2d0

ip_address Link local IP address of the slave IP

-master-connect-ip

Optional. This parameter specifies the connect IP address of the master IP. Global unicast addresses (including 6to4 addresses) and unique local unicast addresses can be specified for the connect IP address. If omitted, the existing setting is not changed. This parameter can only be specified when "v6" is specified for the "-ip-format" parameter and "disable" is specified for the "-ipv6-set-auto" parameter.

Example: -master-connect-ip 2003:12b:84d::87:3e3

ip_address Connect IP address of the master IP

-slave-connect-ip

Optional. This parameter specifies the connect IP address of the slave IP. Global unicast addresses (including 6to4 addresses) and unique local unicast addresses can be specified for the connect IP address. If omitted, the existing setting is not changed. This parameter can only be specified when "v6" is specified for the "-ip-format" parameter and "disable" is specified for the "-ipv6-set-auto" parameter.

Example: -slave-connect-ip 2003:120:84d::7ac:45

ip_address Connect IP address of the slave IP

-netmask

Optional. This parameter specifies the subnet mask for the specified Ethernet port. The format is IPv4 standard notation (a base 256 "d.d.d.d" string) or IPv6 address format. If omitted, the existing setting is not changed. This parameter can only be specified when "v4" is specified for the "-ip-format" parameter.

Example: -netmask 255.255.255.0

netmask Subnet mask

-subnet-prefix-length

Optional. This command specifies the prefix length of the connect IP address. This parameter is used for IPv6 addresses. The prefix length is equivalent to the subnet mask for IPv4 addresses. Specify a value from 3 to 128.

When a global unicast address is specified for the connect IP address, a value from 3 to 128 can be specified. When a unique local unicast address is specified for the connect IP address, a value from 7 to 128 can be specified. (When a 6to4 address is used to specify the global unicast address, a value from 48 to 128 can be specified.) If omitted, the existing setting is not changed. This parameter can only be specified when "v6" is specified for the "-ip-format" parameter and "disable" is specified for the "-ipv6-set-auto" parameter. To delete the prefix length, set "0".

Example: `-subnet-prefix-length 64`

length Prefix length
 For global unicast addresses: 3 – 128
 For global unicast addresses (6to4 addresses): 48 – 128
 For unique local unicast addresses (6to4 addresses): 7 – 128

`-gateway` Optional. This parameter specifies the gateway address for the specified Ethernet port. This setting is required to permit access beyond the local sub-network (the sub-network to which the system network addresses belong). The format is IPv4 standard notation (a base 256 "d.d.d.d" string) or IPv6 address format. The types of IPv6 addresses that can be specified are local link addresses, global unicast addresses (including 6to4 addresses), and unique local unicast addresses. If omitted, the existing setting is not changed. This parameter can only be specified when "v6" is specified for the "-ip-format" parameter and "disable" is specified for the "-ipv6-set-auto" parameter, or when "v4" is specified for the "-ip-format" parameter.

Example: `-gateway 10.1.1.2`
Example: `-gateway 2001:df:a012::3bbd`

gateway Gateway address

`-allow-ip1 . . . -allow-ip16`

Optional. These parameters specify IP addresses or network addresses that are permitted to connect to this system. A maximum of 16 IP addresses can be specified. The types of IPv6 addresses that can be specified are global unicast addresses (including 6to4 addresses) and unique local unicast addresses. If omitted, no changes are made to the table of allowed addresses. This setting is not required to allow connection from the local sub-network (sub-network to which the system network addresses belong). This parameter can only be specified when "v6" is specified for the "-ip-format" parameter and "disable" is specified for the "-ipv6-set-auto" parameter, or when "v4" is specified for the "-ip-format" parameter. This parameter cannot be specified when "-port fst" is specified.

ip_address, netmask IP address or network address

Example: Specify the following parameter to only permit access from a terminal host that has the IP address "192.168.1.2":
`"-allow-ip1 192.168.1.2"`

Example: Specify the following parameter to only permit access from a terminal host that has the IP address "2001:d53:c51::78:332":
`"-allow-ip1 2001:d53:c51::78:332"`

Example: Specify the following parameter to permit access from all terminals where the IP address range is "192.168.3.1" to "192.168.3.254":
`"-allow-ip1 192.168.3.0,255.255.255.0"`

Example: Specify the following parameter to permit access from all terminals that belong to the 2001:d53:c51:78::/64 network address:

```
"-allow-ip1 2001:d53:c51:78::,64"
```

Example: Specify the following parameter to delete an IP address:

```
"-allow-ip1 0.0.0.0" (IPv4)
```

```
"-allow-ip1 0,0" (IPv6)
```

-speed Optional. This parameter specifies the connection speed of the specified Ethernet port. If omitted, the existing setting is not changed.

1000	1Gbit/s
100full	100Mbit/s full-duplex
100half	100Mbit/s half-duplex
10full	10Mbit/s full-duplex
10half	10Mbit/s half-duplex
auto	Auto negotiation

-primary-dns-ip

Optional. This parameter specifies the primary DNS IP address for the Ethernet port. The format is IPv4 standard notation (a base 256 "d.d.d.d" string) or IPv6 format. The types of IPv6 addresses that can be specified are global unicast addresses (including 6to4 addresses) and unique local unicast addresses. This parameter cannot be specified when "-port fst" is specified. If omitted, the existing setting is not changed. When "v4" is specified for the "-ip-format" parameter, the IP addresses must be specified using IPv4 standard notation. When "v6" is specified for the "-ip-format" parameter, the IP addresses must be specified in IPv6 address format. This parameter cannot be specified when "-port fst" is specified.

ip_address Primary DNS IP address

-secondary-dns-ip

Optional. This parameter specifies the secondary DNS IP address for the Ethernet port. The format is IPv4 standard notation (a base 256 "d.d.d.d" string) or IPv6 format. The types of IPv6 addresses that can be specified are global unicast addresses (including 6to4 addresses) and unique local unicast addresses. This parameter cannot be specified when "-port fst" is specified. If omitted, the existing setting is not changed. When "v4" is specified for the "-ip-format" parameter, the IP addresses must be specified using IPv4 standard notation. When "v6" is specified for the "-ip-format" parameter, the IP addresses must be specified in IPv6 address format. This parameter cannot be specified when "-port fst" is specified.

ip_address Secondary DNS IP address

-wake-on-lan

Optional. This parameter specifies whether or not the Wake on LAN (WOL) function is enabled. This function can be independently set for each Ethernet port (MNT/RMT). The initial value is disabled. This parameter cannot be specified when "-port fst" selected. If omitted, the existing setting is not changed. This parameter cannot be specified when "-port fst" is specified.

enable	Wake on LAN is enabled.
disable	Wake on LAN is disabled.

■ Example(s)

The following example sets up network parameters for the Maintenance port (MNT port). The IP address is "192.168.1.100", and the subnet mask is "255.255.255.0":

```
CLI> set network -port maintenance -master-ip 192.168.1.100 -netmask 255.255.255.0
```

The following example sets up network parameters for the Maintenance port (MNT port). The IP address is "10.10.10.1", the subnet mask is "255.255.0.0", and the gateway address is "10.10.10.250"; accessible terminals are all addresses on the "10.11.0.0" network, and the single host address "192.168.1.1":

```
CLI> set network -port maintenance -master-ip 10.10.10.1 -netmask 255.255.0.0 -gateway 10.10.10.250 -allow-ip1 10.11.0.0,255.255.0.0 -allow-ip2 192.168.1.1
```

The following example changes the Ethernet speed of the maintenance port (MNT port) to 100Mbit/s full-duplex:

```
CLI> set network -port maintenance -speed 100full
```

The following example sets the IP address in IPv6 address format:

```
CLI> set network -port maintenance -ip-format v6 -ipv6-set-auto disable -master-link-local-ip fe80:10:20:34:ab::55:234:abde -slave-link-local-ip fe80:20:31:abcf:f3f::78:4fa -master-connect-ip 2010:df:90a::55:33:234 -slave-connect-ip 2011:23:ab:345:77::32:12a -subnet-prefix-length 64 -gateway 2010:df:90a::52:ab:d3e -allow-ip1 2001:ab:df:23f::abc:56:2 -allow-ip2 2001:234::,64 -primary-dns-ip 2011:ab:def:190::900:32:a80 -secondary-dns-ip 2011:91:aa9::7ab:74:dd
```

The following example automatically sets the IP address in IPv6 format:

```
CLI> set network -port maintenance -ip-format v6 -ipv6-set-auto enable
```

show firewall

This command displays the status of each Ethernet application service port.

■ Syntax

```
show firewall
```

■ Parameter

No parameters.

■ Output

Item name	Description
MNT Port	Maintenance port (MNT port) name
RMT Port	Remote port (RMT port) name
FST Port	Field support port (FST port) name (only for the DX500 S4/DX600 S4, the DX500 S3/DX600 S3, the DX8100 S3/DX8700 S3/DX8900 S3, and the AF650 S2/AF650)
http	Indicates whether an http connection is enabled. (open: enabled, close: disabled)
https	Indicates whether an https connection is enabled. (open: enabled, close: disabled)
telnet	Indicates whether a telnet connection is enabled. (open: enabled, close: disabled)
SSH	Indicates whether an SSH connection is enabled. (open: enabled, close: disabled)
Maintenance-Secure	Indicates whether an ETERNUS Maintenance Secure connection is enabled. (open: enabled, close: disabled)
ICMP	Indicates whether an ICMP connection is enabled. (open: enabled, close: disabled)
SNMP	Indicates whether an SNMP connection is enabled. (open: enabled, close: disabled)
RCIL	Indicates whether an RCIL connection is enabled. (open: enabled, close: disabled) (MNT port only)
ETERNUS DX Discovery	Indicates whether ETERNUS DX Discovery is enabled. (open: enabled, close: disabled) (MNT port only)
ICMP Redirect	Indicates whether ICMP Redirect is enabled. (open: enabled, close: disabled) (MNT port only)

■ Example(s)

The following example displays the status of each application service port:

```
CLI> show firewall
MNT Port
http           [Closed]
https          [Closed]
telnet         [Closed]
SSH            [Open  ]
Maintenance-Secure [Closed]
ICMP           [Closed]
SNMP           [Closed]
RCIL           [Closed]
ETERNUS DX Discovery [Open  ]

RMT Port
http           [Closed]
https          [Closed]
telnet         [Closed]
SSH            [Open  ]
Maintenance-Secure [Closed]
ICMP           [Closed]
SNMP           [Closed]

FST Port
http           [Closed]
https          [Closed]
telnet         [Closed]
SSH            [Open  ]
Maintenance-Secure [Closed]
ICMP           [Closed]
```

set firewall

This command is used to enable and disable the individual Ethernet application service ports. The settings listed in the table below must be performed for each Ethernet port.

Protocol	Service type		
http	GUI	Specify "-confirm-close-all yes" to disable all of the service ports for the GUI and CLI connections or both of the service ports for the CLI connection. If this parameter is not specified, the CLI command terminates with an error message.	
https			
telnet	CLI		
SSH			
Proprietary protocol	ETERNUS Maintenance Secure Secure storage platform software (such as monitoring software)		
ICMP	ping		
SNMP	SNMP protocol		
IPMI	RCIL		
Proprietary protocol	ETERNUS DX Discovery		
ICMP Redirect	ICMP Redirect		

Caution

- All the service ports can be disabled by using this command, but all software, CLI, GUI, and external software such as monitoring software will not be able to establish a connection.
 - For the DX60 S4/DX100 S4/DX200 S4, the DX60 S3/DX100 S3/DX200 S3, the AF250 S2/AF250, and the DX200F, the initial state can be restored by pushing the FUNCTION button that is on the front operation panel of the controller enclosure. However, it should be noted that this will also clear all the network information. For further information, refer to "Operation Guide (Basic)" for the target model.
 - For the DX500 S4/DX600 S4, the DX500 S3/DX600 S3, and the AF650 S2/AF650, the initial state can be restored by pushing the IP Reset switch that is on the front operation panel of the controller enclosure. However, it should be noted that this will also clear all the network information. For further information, refer to "Operation Guide (Basic)" for the target model.
 - Contact your maintenance engineer when a DX8100 S3/DX8700 S3/DX8900 S3 is used.
- When any settings except for ICMP are changed, the CLI session is automatically disconnected after the command is executed. Note that the session is disconnected even if a setting value not involved in CLI connections is changed. For example, your system opens SSH and HTTPS ports, and closes all other ports. At that case, if you requests to close only HTTPS port, your connection connected by SSH will be disconnected. After disconnecting the connection, retry to log in the system.
- It can take a little time for the requested changes to be applied. For example, when GUI is used to request the opening of the SSH port, it may take around a minute before an SSH connected CLI session can be initiated.

Syntax

```
set firewall -port {maintenance | remote | fst} [-http {open | close}]
[-https {open | close}] [-telnet {open | close}] [-ssh {open | close}]
[-maintenance-secure {open | close}] [-icmp {open | close}]
[-snmp {open | close}] [-rcil {open | close}]
[-eternus-dx-discovery {open | close}] [-icmp-redirect {open | close}]
[-confirm-close-all {yes | no}]
```

■ Parameter

- port** This parameter specifies the Ethernet port.
- maintenance** Maintenance port (MNT port)
 - remote** Remote port (RMT port)
 - fst** FST port (DX500 S4/DX600 S4, DX500 S3/DX600 S3, DX8100 S3/DX8700 S3/DX8900 S3, and AF650 S2/AF650 only)
- http** Optional. This parameter specifies if the "http" application port is opened or closed. If omitted, the existing setting is not changed. The initial state is "open".
- open** Application port "http" is opened.
 - close** Application port "http" is closed.
- https** Optional. This parameter specifies if the "https" application port is opened or closed. If omitted, the existing setting is not changed. The initial state is "open".
- open** Application port "https" is opened.
 - close** Application port "https" is closed.
- telnet** Optional. This parameter specifies if the "telnet" application port is opened or closed. If omitted, the existing setting is not changed. The initial state is "open".
- open** Application port "telnet" is opened.
 - close** Application port "telnet" is closed.
- ssh** Optional. This parameter specifies if the "SSH" (Secure Shell) application port is opened or closed. If omitted, the existing setting is not changed. The initial state is "open".
- open** Application port "SSH" is opened.
 - close** Application port "SSH" is closed.
- maintenance-secure** Optional. This parameter specifies if the "ETERNUS Maintenance Secure (PCCT Secure)" application port, which is used to connect to the monitoring software, is opened or closed. If omitted, the existing setting is not changed. The initial state is "open".
- open** Application port "ETERNUS Maintenance Secure" is opened.
 - close** Application port "ETERNUS Maintenance Secure" is closed.
- icmp** Optional. This parameter specifies if the "ICMP" (Internet Control Message Protocol) application port is opened or closed. If omitted, the existing setting is not changed. The initial state is "open".
- open** Application port "ICMP" is opened.
 - close** Application port "ICMP" is closed.
- snmp** Optional. This parameter specifies if the "SNMP" application port is opened or closed. If omitted, the existing setting is not changed. This parameter cannot be specified when "fst" is specified for "-port". The initial state is "open".
- open** Application port "SNMP" is opened.
 - close** Application port "SNMP" is closed.

-rcil Optional. This parameter specifies if the "RCIL" application port is opened or closed. If omitted, the existing setting is not changed. This parameter cannot be specified when "remote" or "fst" is specified for "-port". The initial state is "close".

open	Application port "RCIL" is opened.
close	Application port "RCIL" is closed.

-eternus-dx-discovery Optional. This parameter specifies whether to enable the port for connecting to the ETERNUS DX/AF that is connected to the network with the Remote Installation function.

 **Caution**

This parameter can only be used for the MNT port.

open	ETERNUS DX Discovery is enabled.
close	ETERNUS DX Discovery is disabled.

-icmp-redirect Optional. This parameter specifies if the "ICMP Redirect" application port is opened or closed. If omitted, the existing setting is not changed. The initial value is set to "close". This parameter cannot be specified if ICMP Redirect cannot be set. The initial state will be "open".

 **Caution**

- This parameter can only be used for the MNT port.
- This parameter can only be specified by roles with the Maintenance Operation policy.

open	Application port "ICMP Redirect" is opened.
close	Application port "ICMP Redirect" is closed.

-confirm-close-all Optional. Specify "-confirm-close-all yes" to disable all of the service ports for both GUI and CLI connections. This parameter must be specified in either of the following cases:

- When disabling all of the service ports for both GUI and CLI connections (HTTP, HTTPS, telnet, and SSH)
- When disabling both of the service ports for CLI connections (telnet and SSH)

In all other cases, this parameter is ignored. For example, if a command such as "set firewall -port remote -icmp close -confirm-close-all no" is entered, the command is executed with exactly the same result as if the ICMP service protocol was disabled normally.

yes	Only required when all of the GUI and CLI related service ports are disabled.
no	Handled as "no operation".

■ Example(s)

The following example closes all the service ports, except the SSH service for CLI:

```
CLI> set firewall -port remote -http close -https close -telnet close -maintenance-secure close -icmp close -snmp close
CLI> set firewall -port maintenance -http close -https close -telnet close -maintenance-secure close -icmp close -snmp close
CLI> set firewall -port fst -http close -https close -telnet close -maintenance-secure close -icmp close -rcil close
```

The following example closes all the service ports involved in both GUI and CLI connections:

```
CLI> set firewall -port remote -http close -https close -telnet close -ssh close -confirm-close-all yes
CLI> set firewall -port maintenance -http close -https close -telnet close -ssh close -confirm-close-all yes
CLI> set firewall -port fst -http close -https close -telnet close -ssh close -confirm-close-all yes
```

show network-stat

This command displays the network information of the management LAN (routing table information, socket information, and network statistics information) and the hardware device statistics information of the LAN port.

Syntax

```
show network-stat {-mode {routing | socket | statistics} | -port {maintenance | remote | fst}}
```

Parameter

-mode This parameter specifies the display mode of the network information.

 **Caution**

If the "-port" parameter is specified, this parameter cannot be specified.

routing The current routing table information is displayed.

socket The current socket information is displayed.

statistics The network statistics information is displayed.
IP statistics information, ICMP statistics information, UDP statistics information, TCP statistics information, and detailed TCP statistics information are displayed in order.

-port This parameter specifies the LAN port for displaying the hardware device statistics information.

 **Caution**

If the "-mode" parameter is specified, this parameter cannot be specified.

maintenance Maintenance port (MNT port)

remote Remote port (RMT port)

fst FST port (DX500 S4/DX600 S4, DX500 S3/DX600 S3, DX8100 S3/DX8700 S3/DX8900 S3, and AF650 S2/AF650 only)

Output

Item name	Description
Routing Information	Current routing table information (when "-mode routing" is specified)
Socket Information	Current socket information (when "-mode socket" is specified)
Network Statistics Information	Network statistics information (when "-mode statistics" is specified)
IP Statistics	IP related statistics information
ICMP Statistics	ICMP related statistics information
UDP Statistics	UDP related statistics information
TCP Statistics	TCP related statistics information
Detailed TCP Statistics	Detailed TCP statistics information (VxWorks proprietary statistics information and ETERNUS proprietary statistics information)
LAN Port Network Statistics Information	Hardware device statistics information of the specified LAN port (when "-port" is specified)

■ Example(s)

The following example displays the current routing table information:

```

CLI> show network-stat -mode routing
IPv4
Destination          Gateway          Flags    Use    If    Metric
0.0.0.0              192.168.0.254   UGS      34813 MNT   0
127.0.0.1           127.0.0.1      UH       16556 lo0   0
192.168.0.0/24      192.168.0.90   UC       415   MNT   0
192.168.0.90        192.168.0.90   UH      11449 lo0   0
192.168.1.0/24      192.168.1.1    UC        0     RMT   0
192.168.1.1         192.168.1.1    UH        0     lo0   0

IPv6
Destination          Gateway          Flags    Use    If    Metric
::1                  ::1             UH       398   lo0   0
fe80::/64            fe80::ffff:ffff:ffff:fffe UC        0     lo0   0
fe80::ffff:ffff:ffff:fffe fe80::ffff:ffff:ffff:fffe UH        0     lo0   0
    
```

The following example displays the current socket information:

```

CLI> show network-stat -mode socket
INET sockets
Prot Recv-Q Send-Q Local Address          Foreign Address         State
TCP 0 0 0 0.0.0.0.XXX           0.0.0.0.*              LISTEN
TCP 0 0 0 0.0.0.0.XXXX         0.0.0.0.*              LISTEN
TCP 0 0 0 0.0.0.0.XXXX         0.0.0.0.*              LISTEN
UDP 0 0 0 127.0.0.1.20005      127.0.0.1.20004
UDP 0 0 0 0.0.0.0.XX          0.0.0.0.*
UDP 0 0 0 127.0.0.1.20073      127.0.0.1.20072
UDP 0 0 0 0.0.0.0.623         0.0.0.0.*
UDP 0 0 0 0.0.0.0.664         0.0.0.0.*
UDP 0 0 0 0.0.0.0.*           0.0.0.0.*
UDP 0 0 0 0.0.0.0.9686        0.0.0.0.*
UDP 0 0 0 0.0.0.0.161         0.0.0.0.*
UDP 0 0 0 127.0.0.1.20029      127.0.0.1.20028

INET6 sockets
Prot Recv-Q Send-Q Local Address          Foreign Address         State
TCP 0 0 0 ::.XXX              :::*                    LISTEN
TCP 0 0 0 ::.XX               :::*                    LISTEN
TCP 0 0 0 ::.XXXX             :::*                    LISTEN
TCP 0 0 0 ::.XXXXX            :::*                    LISTEN
TCP 0 0 0 ::.80               :::*                    LISTEN
TCP 1 0 0 ::ffff:192.168.0.90.23 ::ffff:192.168.0.254.48404 ESTABLISHED
TCP 0 0 0 ::.22               :::*                    LISTEN
UDP 0 0 0 ::.*                :::*                    LISTEN
UDP 0 0 0 ::.9686             :::*                    LISTEN
UDP 0 0 0 ::.161              :::*                    LISTEN
    
```

The following example displays the network statistics information:

```
CLI> show network-stat -mode statistics
IP Statistics
Total packets received          [1539261]
Forwarded                       [0]
Incoming packets discarded      [9]
Incoming packets delivered     [47346]
Requests sent out              [0]

ICMP Statistics
Messages received              [5]
Input errors                   [0]
Input histogram:
Destination unreachable       [5]
Messages sent                  [5]
Output errors                  [0]
Output histogram:
Destination unreachable       [5]

UDP Statistics
Packets received               [26169]
Packets to unknown port received [5]
Packet receive errors          [0]
Packets sent                   [26148]

TCP Statistics
Active connection openings     [1839]
Passive connection openings    [4486]
Failed connection attempts     [7]
Connection resets received     [1906]
Connections established        [1]
Segments received              [1470826]
Segments send out              [1532390]
Segments retransmitted         [578]
Bad segments received          [0]
Resets sent                    [10]

Detailed TCP Statistics
Segments received              [1470826]
with header truncation        [0]
with bad checksum              [0]
with bad authentication        [0]
:
:
```

The following example displays the hardware device statistics information of the maintenance port (MNT port):

```
CLI> show network-stat -port maintenance
MNT port statistics
Total octets received                [16272824]
Total octets transmitted             [131514]
Good octets received count          [768]
Good octets transmitted count       [774]
Total packets received              [67542]
Total packets transmitted           [635]
Good packets received count         [12]
Good packets transmitted count      [12]
Broadcast packets received count    [0]
Broadcast packets transmitted count [0]
Multicast packets received count    [0]
Multicast packets transmitted count [0]
CRC error count                     [0]
Alignment error count               [0]
Symbol error count                  [0]
RX error count                       [0]
Missed packets count                [0]
Single collision count               [21]
Excessive collisions count           [0]
Multiple collision count             [7]
Late collisions count                [0]
Collision count                     [37]
Defer count                          [3]
Transmit with no CRS                 [635]
Sequence error count                 [0]
Carrier extension error count        [0]
Receive length error count           [0]
XON received count                   [0]
XON transmitted count                [0]
XOFF received count                  [0]
XOFF transmitted count               [0]
FC received unsupported count        [0]
:
:
```

test network

This command checks the network communication of the management LAN.

The network communication can be checked by executing the following functions.

- Converting the specified host name to an IP address
- Executing "ping" for the specified IP address
- Performing a TCP connection for the port of the specified IP address

Syntax

```
test network -function {dns | ping | tcp-connection}
[-port {maintenance | remote}] [-host-name host_name]
[-ip-address ip_address] [-tcp-port tcp_port]
[-auto-routing {yes | no}] [-retry retry-count] [-timeout timeout]
```

Parameter

- function** This parameter specifies the function to use for checking the network communication.
- dns** The specified host name is converted to an IP address and the result is displayed.
 - ping** A "ping" is performed for the specified IP address and the result is displayed.
 - tcp-connection** A TCP connection is performed for the port of the specified IP address and the result is displayed.
- port** Optional. This parameter specifies the LAN port to be used for checking the network communication. If omitted, the maintenance port (MNT port) is used. If automatic routing is set or if the link local address in the IPv6 format is specified, this parameter must be specified.

Note

FST ports cannot be specified.

maintenance Maintenance port (MNT port)

remote Remote port (RMT port)

- host-name** Optional. This parameter specifies the host name when "dns" is specified with the "-function" parameter. The characters that can be used are 1 to 63 alphanumeric characters (US-ASCII codes 0x30 to 0x39, 0x41 to 0x5A, and 0x61 to 0x7A) and symbols (US-ASCII codes 0x2D, 0x2E, and 0x3A). If "ping" or "tcp-connection" is specified with the "-function" parameter, this parameter cannot be specified.

host_name Host name

- ip-address** Optional. This parameter specifies the IP address when "ping" or "tcp-connection" is specified with the "-function" parameter. If "dns" is specified with the "-function" parameter, this parameter cannot be specified.

ip_address IP address (IPv4 or IPv6)

-tcp-port Optional. This parameter specifies the TCP port number within a range of 1 to 65535 when "tcp-connection" is specified with the "-function" parameter. If "dns" or "ping" is specified with the "-function" parameter, this parameter cannot be specified.

tcp_port TCP port number (1 to 65535)

-auto-routing

Optional. This parameter configures automatic routing.

yes Automatic routing is enabled

no Automatic routing is disabled (only routes the addresses listed in the Allowable IP Address List that is configured in the network environment setting)

-retry Optional. This parameter specifies the number of ping retries within a range of 1 to 10 when "ping" is specified with the "-function" parameter. If omitted, the retry count is "1". If "dns" or "tcp-connection" is specified with the "-function" parameter, this parameter cannot be specified.

retry-count Retry count (1 to 10)

-timeout Optional. This parameter specifies the connection timeout if a TCP connection check is executed when "tcp-connection" is specified for the "-function" parameter within a range of 1 to 60. If omitted, the timeout is "5" seconds. If "dns" or "ping" is specified with the "-function" parameter, this parameter cannot be specified.

timeout Timeout during a TCP connection (1 to 60 seconds)

■ Example(s)

The following example converts the host name "test0.fujitsu.co.jp" to an IP address using the maintenance port (MNT port):

```
CLI> test network -function dns -port maintenance -host-name test0.fujitsu.co.jp
LAN Port: MNT
Server: IPv4 Secondary DNS
Name: test0.fujitsu.co.jp
Address: 10.20.30.1
```

The following example executes pings for "192.168.0.51" using the remote port (RMT port):

```
CLI> test network -function ping -port remote -ip-address 192.168.0.51 -auto-routing yes -retry 5
---192.168.0.51 ping statistics ---
5 packets transmitted, 5 received, 0% packet loss, time 5933 ms
rtt min/avg/max = 0/1056/2116 ms
```

The following example executes TCP connections for 192.168.10.5 using the remote port (RMT port):

```
CLI> test network -function tcp-connection -port remote -ip-address 192.168.10.5 -tcp-port 80 -auto-routing yes -timeout 10
TCP connection is successful. time 14 ms
```

5.2.2 SNMP

This section explains the commands that are related to SNMP settings, MIB view controls, community controls, and SNMP trap controls. ETERNUS DX/AF supports SNMP v1, v2c, and v3.

- Setting/Releasing SNMP parameters
- Setting/Releasing SNMP manager
- Creating SNMP MIB view and adding/removing subtrees
- Deleting SNMP MIB view
- Creating/Changing/Deleting SNMP user settings
- Setting/Changing/Deleting SNMP community profiles
- Setting/Deleting SNMP trap and testing the transmission of SNMP trap
- Exporting enhanced SNMP MIB files

show snmp

This command displays the SNMP parameters.

■ Syntax

```
show snmp
```

■ Parameter

No parameters.

■ Output

Item name	Description
SNMP	Indicates whether SNMP functions are enabled.
Port	LAN port to use SNMP functions
Authentication Failure	Indicates whether to notify Authentication Failure by an SNMP trap when the system is accessed from undefined SNMP communities.
Engine ID	Engine identifier. This information is followed by "(Default)" when the "-engine-id default" parameter is specified for the "set snmp" command.
MIB-II RFC Version	Indicates the version of MIB-II that is used by the ETERNUS DX/AF.

■ Example(s)

The following example displays the SNMP parameters:

```
CLI> show snmp
SNMP [Enable]
Port [MNT]
Authentication Failure [Enable]
Engine ID [0x000102030405060708090a0b0c0d0e0f101112131415161718191a1b1c1d1e1f]
MIB-II RFC Version [RFC1213]
```

The following example displays the SNMP parameter that uses the RMT port and the default engine identifier.

```
CLI> show snmp
SNMP [Enable]
Port [RMT]
Authentication Failure [Enable]
Engine ID [0x800000d380500000e0d0401400] (Default)
MIB-II RFC Version [RFC4293]
```

set snmp

This command enables or disables SNMP and specifies the port to be used for SNMP.

■ Syntax

```
set snmp [-function {enable | disable}] [-port {maintenance | remote}]  
[-authentication-failure {enable | disable}] [-engine-id {engine_id | default}]  
[-mib-ii-rfc-version {1213 | 4293}]
```

■ Parameter

- function** Optional. This parameter specifies whether SNMP functions are enabled or not. The initial value is disabled. If omitted, the existing setting is not changed.
- enable Functions of each SNMP are enabled.
 - disable Functions of each SNMP are disabled (default).
- port** Optional. This parameter specifies the SNMP trap sending port. This parameter is only applied when the trap version is V1 and affects all traps. If omitted, the existing setting is not changed. The default is the MNT port.
- maintenance Maintenance port (MNT port) (default)
 - remote Remote port (RMT port)
- authentication-failure** Optional. This parameter specifies if the SNMP authentication failure function is enabled. This function is used to notify the operator of Authentication Failure by an SNMP trap when this system is accessed from a undefined SNMP community. If omitted, the existing setting is not changed. The initial value is enabled.
- enable An SNMP trap is notified when SNMP authentication fails (default).
 - disable An SNMP trap is not notified when SNMP authentication fails.
- engine-id** Optional. This parameter specified the engine identifier. The engine identifier is 12 to 66 characters because of 5 to 32bytes hexadecimal value which followed from the "0x". It is not available which set all of character is "00" and/or "ff". When "default" is specified, the default value is used. If omitted, the existing id or default value is used.
- engine_id* Engine identifier
 - default Default value
- mib-ii-rfc-version** Optional. This parameter specifies the version of MIB-II that is used by the ETERNUS DX/AF. If omitted, the existing setting is not changed.
- 1213 The RFC1213 format is used. (default)
 - 4293 The RFC4293 format is used.

■ Example(s)

The following example disables SNMP functions:

```
CLI> set snmp -function disable
```

The following example uses the Remote port (RMT port) for SNMP:

```
CLI> set snmp -port remote
```

The following example uses the specified engine identifier:

```
CLI> set snmp -engine-id 0x800102030405060708090a0b0c0d0e0f101112131415161718191a1b1c1d1e1f
```

The following example uses the default engine identifier:

```
CLI> set snmp -engine-id default
```

The following example uses MIB-II RFC4293:

```
CLI> set snmp -mib-ii-rfc-version 4293
```

show snmp-manager

This command displays the SNMP manager settings.

■ Syntax

```
show snmp-manager
```

■ Parameter

No parameters.

■ Output

Item name	Description
No.	SNMP manager setting number
IP address	SNMP manager IP address

■ Example(s)

The following example displays the SNMP parameters:

```
CLI> show snmp-manger
No.  IP address
-----
 1   10.0.0.1
 2   fd80::abd0:123:55
 3   192.168.0.21
 5   192.168.10.11
 6   192.168.0.254
```

create snmp-manager

This command sets IP address to receive SNMP traps in the SNMP manager setting. Since the ETERNUS DX/AF has 10 entries, up to 10 settings can be specified. A new SNMP manager setting will be the lowest number.

■ Syntax

```
create snmp-manager -ip-address ip_address
```

■ Parameter

-ip-address This parameter specifies the SNMP manager IP address. To specify the SNMP manager IP address, use IPv4 standard notation (a base 256 "d.d.d.d" string) or the IPv6 format. The SNMP manager IP address cannot be specified with a fully qualified domain name (FQDN). The types of IPv6 addresses that can be specified are global addresses (including 6to4 addresses), link local addresses, and unique local addresses.

Example: -ip-address 192.168.1.20

Example: -ip-address fe80::1b:332f:d0

ip_address SNMP manager IP address

■ Example(s)

The following example creates SNMP manager to set IP address 10.0.0.1:

```
CLI> create snmp-manager -ip-address 10.0.0.1
```

set snmp-manager

This command sets an IP address to the snmp-manager setting.
This command is not available when the set SNMP manager setting is already used for a SNMP community or SNMP trap.

■ Syntax

```
set snmp-manager -manager-number manager-number -ip-address ip_address
```

■ Parameter

-manager-number

This parameter specifies the SNMP manager settings number. This number can be confirmed by using the "show snmp-manager" command.

manager-number Settings number

-ip-address This parameter specifies the SNMP manager IP address. To specify the SNMP manager IP address, use IPv4 standard notation (a base 256 "d.d.d.d" string) or the IPv6 format. The SNMP manager IP address cannot be specified with a fully qualified domain name (FQDN). The types of IPv6 addresses that can be specified are global addresses (including 6to4 addresses), link local addresses, and unique local addresses.

Example: -ip-address 192.168.1.20

Example: -ip-address fe80::1b:332f:d0

ip_address IP address

■ Example(s)

The following example sets SNMP manager number 3 to IP address 192.168.0.254:

```
CLI> set snmp-manager -manager-number 3 -ip-address 192.168.0.254
```

delete snmp-manager

This command deletes the SNMP manager settings.

This command is not available when the SNMP manager setting that is to be deleted is already used for an SNMP community, an SNMP user, or an SNMP trap.

■ Syntax

```
delete snmp-manager -manager-number manager-numbers
```

■ Parameter

-manager-number

This parameter specifies the SNMP manager settings to delete. One or more numbers can be specified by separating them with a comma (,) or a hyphen (-).

Example:

```
-manager-number 1,2,4  
-manager-number 6-9  
manager-numbers Settings number
```

■ Example(s)

The following example deletes the #4 SNMP manager setting:

```
CLI> show snmp-manager  
No.  IP address  
1    10.0.0.1  
2    172.20.235.1  
3    192.168.0.21  
4    172.20.235.1  
5    192.168.10.11  
6    192.168.0.254  
  
CLI> delete snmp-manager -manager-number 4  
  
CLI> show snmp-manager  
No.  IP address  
1    10.0.0.1  
2    172.20.235.1  
3    192.168.0.21  
5    192.168.10.11  
6    192.168.0.254
```

show snmp-view

This command displays a list of the registered SNMP MIB views. If MIB view names are specified, the command displays the associated sub-trees.

Syntax

```
show snmp-view [-view view_names]
```

Parameter

-view Optional. This parameter specifies the MIB view name to display sub-trees. Two or more MIB views can be specified by both a combination of a part of name and asterisk (*), a wildcard at the same time and just scribing names. The wildcard rules are shown below:

Examples are shown below.

*: Correct
part-of-view-name*: Correct
*part-of-view-name: Incorrect
view_names MIB view name

Output

- When the parameter is omitted.

Item name	Description
"xxxxxxx"	MIB view name

- When an SNMP MIB view name is specified.

Item name	Description
View-name	MIB view name
Subtree	Sub-tree information (include/exclude information) and OID format sub-tree

Example(s)

The following example displays a list of all the registered MIB view names:

```
CLI> show snmp-view
"ViewALL"
"View-mib2"
"View-exmib"
"xview4"
"xview5"
```

The following example displays a sub-tree list of the MIB view named "View-exmib":

```
CLI> show snmp-view -view View-exmib
View-name : "View-exmib"
Subtree1  : [Include] 1.3.6.1.4.1.211.1.21.1
```

The following example displays the sub-trees of the MIB views beginning with the name "xview":

```
CLI> show snmp-view -view xview*
View-name : "xview4"
Subtree1  : [Exclude] 1.3.6.1.4.1.211.1.21.1
Subtree2  : [Exclude] 1.3.6.1.4.1.211.1.21.2
Subtree3  : [Include] 1.3.6.1.4.1.211.1.21.3

View-name : "xview5"
Subtree1  : [Include] 1.3.6.1.2.1.1.1
Subtree2  : [Include] 1.3.6.1.2.1.1.2
Subtree3  : [Exclude] 1.3.6.1.2.1.1.3
```

The following example displays all the registered MIB views and their sub-trees:

```
CLI> show snmp-view -view *
View-name : "ViewALL"
Subtree1  : [Include] 1

View-name : "View-mib2"
Subtree1  : [Include] 1.3.6.1.2.1

View-name : "View-exmib"
Subtree1  : [Include] 1.3.6.1.4.1.211.1.21.1

View-name : "xview4"
Subtree1  : [Exclude] 1.3.6.1.4.1.211.1.21.1
Subtree2  : [Exclude] 1.3.6.1.4.1.211.1.21.2
Subtree3  : [Include] 1.3.6.1.4.1.211.1.21.3

View-name : "xview5"
Subtree1  : [Include] 1.3.6.1.2.1.1.1
Subtree2  : [Include] 1.3.6.1.2.1.1.2
Subtree3  : [Exclude] 1.3.6.1.2.1.1.3
```

The following example displays the default MIB view:

```
CLI> show snmp-view -view *
View-name : "ViewALL"
Subtree1  : [Include] 1

View-name : "View-mib2"
Subtree1  : [Include] 1.3.6.1.2.1

View-name : "View-exmib"
Subtree1  : [Include] 1.3.6.1.4.1.211.1.21.1
```

create snmp-view

This command creates an SNMP Management Information Base view (MIB view). A MIB is a data base which has a tree structure, and the MIB view defines a set of sub-trees for a MIB. MIB views are used to define access scope. A maximum of ten MIB views can be created. ETERNUS DX/AF has three default view settings. These entries can also delete and modify as same as other entries. These default values are described in the "show snmp-view" command section.

Caution

Regarding the SNMP sub-trees name, the following rules apply for descriptions.

- Up to 251 characters can be specified.
- Names must be specified as a combination of numbers and periods (.). Example: "1.3.5"
- A combination of numbers and periods (.) must be used. At least one period (.) must be used. Example: "15" is NG.
- The number "0" cannot be specified between period (.) characters. Example: "1.0.1" is NG.
- Numbers that begin with 0 cannot be specified. Example: "1.01.1" is NG.

Syntax

```
create snmp-view -view view_name [-subtree1 {subtree1 | ""}] [-subtree2 {subtree2 | ""}]  
[-subtree3 {subtree3 | ""}] [-subtree4 {subtree4 | ""}] [-subtree5 {subtree5 | ""}]  
[-subtree6 {subtree6 | ""}] [-subtree7 {subtree7 | ""}] [-subtree8 {subtree8 | ""}]  
[-subtree9 {subtree9 | ""}] [-subtree10 {subtree10 | ""}]  
[-include-subtree subtree_numbers] [-exclude-subtree subtree_numbers]
```

Parameter

-view This parameter specifies the MIB view name. A maximum of 10 MIB views can be specified. It is a unique name. Up to 32 characters can be specified for a view name.

view_name MIB view name

-subtree1 . . . -subtree10

Optional. These parameters specify the accessible sub-trees that make up the specified MIB view (up to 10 sub-trees). If this parameter is omitted or a null character ("") is specified, the subtree is deleted. Each subtree must be unique. If duplex is specified, the command terminates with an error.

subtree1 ... *subtree10* Accessible sub-trees

"" The subtree is deleted.

-include-subtree

Optional. This parameter specifies the "include" subtree type. A value between 1 and 10 can be specified for the subtree number. Two or more subtree numbers can be specified by separating them with a comma (,) or a hyphen (-).

If this parameter and the "-exclude-subtree" parameter are omitted, "include" is used as the default for subtree.

The "-include-subtree" and "-exclude-subtree" parameters cannot both be specified for the same subtree.

subtree_numbers "Include" type subtree number (1 - 10)

-exclude-subtree

Optional. This parameter specifies the "exclude" subtree type. A value between 1 and 10 can be specified for the subtree number. Two or more subtree numbers can be specified by separating them with a comma (,) or a hyphen (-).

If this parameter and the "-include-subtree" parameter are omitted, "include" is used as the default for subtree.

subtree_numbers "Exclude" type subtree number (1 – 10)

■ **Example(s)**

The following example creates the MIB view named "1.3". It includes one sub-tree named "1.3.6.1.2.1" in the MIB view.

```
CLI> create snmp-view -view xview4 -subtree1 1.3.6.1.2.1 -include-subtree 1
```

The following example is specified without the "-subtree2" parameter when "-subtree1", "-subtree3", "-include-subtree1", and "-exclude-subtree3" are specified:

```
CLI> create snmp-view -view xview5 -subtree1 1.3.6.1.2.1 -subtree3 1.3.6.1.2.2 -include-subtree 1 -exclude-subtree 3
```

set snmp-view

This command adds or deletes sub-trees to the specified SNMP MIB view. This command is not available when the delete SNMP MIB view setting is already used for a SNMP community, SNMP user or SNMP trap.

Caution

Regarding the SNMP sub-trees name, the following rules apply for descriptions.

- Up to 251 characters can be specified.
- Names must be specified as a combination of numbers and periods (.). Example: "1.3.5"
- A combination of numbers and periods (.) must be used. At least one period (.) must be used. Example: "15" is NG.
- The number "0" cannot be specified between period (.) characters. Example: "1.0.1" is NG.
- Numbers that begin with 0 cannot be specified. Example: "1.01.1" is NG.

Syntax

```
set snmp-view -view view_name [-subtree1 {subtree1 | ""}] [-subtree2 {subtree2 | ""}]  
[-subtree3 {subtree3 | ""}] [-subtree4 {subtree4 | ""}] [-subtree5 {subtree5 | ""}]  
[-subtree6 {subtree6 | ""}] [-subtree7 {subtree7 | ""}] [-subtree8 {subtree8 | ""}]  
[-subtree9 {subtree9 | ""}] [-subtree10 {subtree10 | ""}]  
[-include-subtree subtree_numbers] [-exclude-subtree subtree_numbers]
```

Parameter

-view This parameter specifies the name of the MIB view that will be changed. Only one view can be specified at the same time. Up to 32 characters can be specified for a view name and at least one character must be specified.

view_name MIB view name

-subtree1 . . . -subtree10

Optional. These parameters specify the accessible sub-trees corresponding to the specified MIB view (up to 10 sub-trees). If omitted, the existing setting is not changed. Each sub-tree must be unique. If duplex is specified, the command terminates with an error.

Caution

To delete a subtree, specify a null character ("). When a null character (") is specified, all of the subtrees are relocated. Example: -subtree3 "".

<i>subtree1</i> ... <i>subtree10</i>	Accessible sub-trees
""	The subtree is deleted.

-include-subtree

Optional. This parameter specifies the "include" subtree type. A value between 1 and 10 can be specified for the subtree number. Two or more subtree numbers can be specified by separating them with a comma (,) or a hyphen (-).

If this parameter and the "-exclude-subtree" parameter are omitted, "include" is used as the default for subtree.
The "-include-subtree" and "-exclude-subtree" parameters cannot both be specified for the same subtree.

subtree_numbers "Include" type subtree number

-exclude-subtree

Optional. This parameter specifies the "exclude" subtree type. A value between 1 and 10 can be specified for the subtree number. Two or more subtree numbers can be specified by separating them with a comma (,) or a hyphen (-).

If this parameter and the "-include-subtree" parameter are omitted, "include" is used as the default for subtree.

subtree_numbers "Exclude" type subtree number

■ **Example(s):**

The following example adds the sub-tree named "1.3.6.1.2.8" to the MIB view named "xview4":

```
CLI> set snmp-view -view xview4 -subtree2 1.3.6.1.2.8
```

The following example deletes the sub-tree #1 from the SNMP view named "xview5". For example, sub-tree #2 is newly relocated as sub-tree #1:

```
CLI> set snmp-view -view xview5 -subtree1 ""
```

The following example changes the sub-tree #4 of "xview1" from "include" to "exclude":

```
CLI> set snmp-view -view xview1 -exclude-subtree 4
```

delete snmp-view

This command deletes one or more SNMP MIB views.

This command is not available when the SNMP MIB view setting that is to be deleted is already used for an SNMP community, an SNMP user, or an SNMP trap.

■ Syntax

```
delete snmp-view -view view_names
```

■ Parameter

-view This parameter specifies the MIB view name to be deleted. The wildcard asterisk (*) can be used to specify the view names of two or more MIBs. Specify each part of a view name followed by an asterisk (*) or only use an asterisk. The asterisk cannot be specified before the part of each view name.

Examples are shown below.

*: Correct

part-of-view-name*: Correct

*part-of-view-name: Incorrect

view_names MIB view name

■ Example(s)

The following example deletes the MIB view named "xview4":

```
CLI> delete snmp-view -view xview4
```

The following example deletes the MIB views beginning with the name "xview1":

```
CLI> delete snmp-view -view xview1*
```

The following example deletes all the registered MIB views:

```
CLI> delete snmp-view -view *
```

show snmp-user

This command displays a list of the registered SNMP users.

Syntax

```
show snmp-user [-name user_name | -number numbers]
```

Parameter

-user or -number

Optional. This parameter specifies the user name or user number to display SNMP user entry. When using "-number", one or more users can be specified by separating them with a comma (,) or a hyphen (-). If this parameter is omitted, all the registered SNMP users are listed.

Example:

```
-name Foo  
-number 1  
-number 2,3  
-number 1-4  
user_name  SNMP user name  
numbers    SNMP user number
```

Output

Item name	Description
No.	User number
User name	User name
Authentication	Authentication method or disable
Encryption	Encryption enable or disable (AES, DES, or disable)
MIB-view	MIB view name

Example(s)

The following example displays a list of all the registered SNMP users:

```
CLI> show snmp-user  
No.  User name           Authentication  Encryption  MIB-view  
1    "FooVar1"             MD5           AES         "xview4"  
2    "FooVax"              SHA           disable     "xview5"  
3    "BUZZ"                disable       disable  
4    "snmpuser1"          MD5           DES         "view13"  
5    "snmpuser2"          SHA           DES         "View-exmib"
```

The following example lists the SNMP users named "Buzz":

```
CLI> show snmp-user -user BUZZ  
No.  User name           Authentication  Encryption  MIB-view  
3    "BUZZ"             disable       disable
```

The following example displays the SNMP users numbering from 2 to 4:

```
CLI> show snmp-user -number 2-4
```

No.	User name	Authentication	Encryption	MIB-view
2	"FooVax"	SHA	disable	"view4"
3	"BUZZ"	disable	disable	
4	"snmpuser1"	MD5	AES	"view13"

The following example displays the SNMP users numbering from 1 and 5:

```
CLI> show snmp-user -number 1,5
```

No.	User name	Authentication	Encryption	MIB-view
1	"FooVar1"	MD5	DES	"xview4"
5	"snmpuser2"	SHA	DES	"View-exmib"

create snmp-user

This command creates SNMP user settings.

Note

Depending on the model, the support state of the encryption-related functions may differ.

Syntax

```
create snmp-user -name user_name -view {mib_view_name | ""} [-authentication {enable | disable}]  
[-authentication-method {md5 | sha}] [-encryption {enable | disable}] [-encryption-method {des | aes}]
```

Parameter

- name** This parameter specifies the SNMP user name. Up to 10 SNMP user names can be specified. It is a unique name. Between 8 and 32 characters can be specified for a name.
- user_name* SNMP user name
- view** This parameter specifies the MIB view name. Up to 32 characters can be specified for a view name. Specify a null character ("") to not specify a view name.
- mib_view_name* MIB view name
"" An MIB view name is not specified.
- authentication** Optional. This parameter specifies whether to enable authentication. If it is specified, the "-authentication-method" and "-encryption" options can be specified. In addition, the ETERNUS DX/AF confirms the authentication password. Between 8 and 64 characters can be used for the password. If omitted, it is enabled.
- enable Authentication is enabled (default).
disable Authentication is disabled.
- authentication-method** Optional. This parameter specifies which authentication method is used. One of the following methods can be selected.
- md5 MD5 (default)
sha SHA
- encryption** Optional. This parameter specifies the encryption mode. If this parameter is set to enable, the ETERNUS DX/AF confirms the encryption password. Between 8 and 64 characters can be used for the password.
- enable Encryption is enabled (default).
disable Encryption is disabled.

-encryption-method

Optional. This parameter specifies the encryption method. If this parameter is omitted, the DES method is used as the encryption method.

 **Caution**

This parameter can only be specified when the encryption function is enabled.

des	DES encryption method (Default)
aes	AES encryption method (Default)

■ Example(s)

The following example creates the MIB user named "snmpuser1" with view "view13":

```
CLI> create snmp-user -name snmpuser1 -view view13
Authentication Password:
Confirm Authentication Password:
Encryption Password:
Confirm Encryption Password:
```

The following example creates the MIB user name "FooVar" with view "xview4" and authentication is disabled:

```
CLI> create snmp-user -name FooVar -view xview4 -authentication disable
```

The following example creates the SNMP user name "FooUser" without specifying a view name:

```
CLI> create snmp-user -name FooUser -view ""
```

set snmp-user

This command modifies SNMP user settings.

Note

Depending on the model, the support state of the encryption-related functions may differ.

Syntax

```
set snmp-user {-user user_name | -number number} [-view {mib_view_name | ""}]  
[-authentication {enable | disable}] [-authentication-method {md5 | sha}]  
[-encryption {enable | disable}] [-encryption-method {des | aes}]
```

Parameter

-user or -number

This parameter specifies the SNMP user name or user number.
The user number can be confirmed by using the command "show snmp-user".

user_name SNMP user name
number SNMP user number

-view

Optional. This parameter specifies the name of the MIB view that will be changed. Only one view can be specified at the same time. Up to 32 characters can be specified for a view name. Specify a null character ("") to not specify a view name. If a null character ("") is specified, the associated view is removed from this user setting.

mib_view_name MIB view name
"" An MIB view name is not specified.

-authentication

Optional. This parameter specifies whether to enable authentication. If it is specified, the "-authentication-method" and "-encryption" options can be specified. In addition, the ETERNUS DX/AF confirms the authentication password. Between 8 and 64 characters can be used for the password. If omitted, the existing setting is not changed.

enable Authentication is enabled.
disable Authentication is disabled.

-authentication-method

Optional. This parameter specifies which authentication method is used. One of the following methods can be selected. If omitted, the existing setting is not changed.

md5 MD5 (default)
sha SHA

-encryption

Optional. This parameter specifies the encryption mode. If this parameter is set to enable, the ETERNUS DX/AF confirms the encryption password. Between 8 and 64 characters can be used for the password. If omitted, the existing setting is not changed.

enable Encryption is enabled.
disable Encryption is disabled.

-encryption-method

Optional. This parameter specifies the encryption method. If this parameter is omitted, the DES encryption method is used.

 **Caution**

This parameter can be specified only when the encryption function is enabled.

des DES encryption method (Default)
aes AES encryption method (Default)

■ Example(s)

The following example sets user FooVar to SNMP view "xview4":

```
CLI> set snmp-user -user FooVar -view xview4
```

In the following example, user FooVar is set to SNMP view "xview4", the authentication method is set to MD5, and encryption is enabled:

```
CLI> set snmp-user -user FooVar -view xview4 -authentication enable -authentication-method md5
Current Authentication Password:
New Authentication Password:
Confirm Authentication Password:
Current Encryption Password:
New Encryption Password:
Confirm Encryption Password:
```

delete snmp-user

This command deletes one or more SNMP user settings. This command is not available when the SNMP user setting that is to be deleted is already used for an SNMP community or an SNMP trap.

Syntax

```
delete snmp-user {-user user_name | -number numbers}
```

Parameter

-user or -number

This parameter specifies the user name or user number to delete SNMP user entry. For the "-number" parameter, one or more users can be specified by separating each user number with a comma (,) or a hyphen (-).

When "-number all" is specified, all of the users are deleted. The user number can be confirmed by using the "show snmp-user" command.

Example:

```
-name Foo  
-number 1  
-number 2,3  
-number 1-4  
user_name  SNMP user name  
numbers    SNMP user number
```

Example(s)

The following example deletes the SNMP user named "FooVar":

```
CLI> delete snmp-user -user FooVar
```

The following example deletes SNMP users number 2 and 4:

```
CLI> show snmp-user  
No.  User name      Authentication  Encryption  MIB-view  
1    "FooVar1"        MD5           enable     "xview4"  
2    "FooVax"         SHA           disable    "xview5"  
3    "BUZZ"           disable       disable    "view11"  
4    "snmpuser1"     MD5           enable     "view13"  
  
CLI> delete snmp-user -number 2,4  
  
CLI> show snmp-user  
No.  User name      Authentication  Encryption  MIB-view  
1    "FooVar1"        MD5           enable     "xview4"  
3    "BUZZ"           disable       disable    "view11"
```

show community-profile

This command displays a list of all the registered SNMP community profiles.

Syntax

```
show community-profile [-community community_name]
```

Parameter

-community Optional. This parameter specifies the SNMP community name of the profiles to be displayed. Only one community name can be specified at the same time.

community_name SNMP community name

Output

Item name	Description
No.	Community number
Name	Community name
Manager No.	Manager number
MIB View	MIB view name
Manager list	Manager details
No.	Manager number
IP address	Manager IP address

Example(s)

The following example displays a list of all the registered SNMP community profiles:

```
CLI> show community-profile
No.  Name                               Manager No.                               MIB View
 1  "community100000000000000000000000" 1, 2, 3, 4, 5, 6, 7, 8, 9, 10  "view1"
 2  "community2"                          2,                               "view3"
 3  "community3.141592"                   1, 4, 7, 8, 9                       "view4"
 4  "c4"                                  2, 3, 4, 5,                          "viewC4"
```

The following example displays the SNMP community profiles that is named community2:

```
CLI> show community-profile -community community2
No.  Name                               Manager No.                               MIB View
 2  "community2"                          2,                               6,                               "view3"

<Manager list>
No.  IP address
 2:  17.20.56.101
 6:  144.72.48.100
```

The following example displays an SNMP community profile named community5 with 1, 2, and 3 registered for the manager number that is only used to TRAP:

```
CLI> show community-profile -community community5
No. Name                               Manager No.                               MIB View
-----
 5 "community5"                         1, 2, 3
<Manager list>
No. IP address
-----
 1 192.168.0.10
 2 17.20.56.101
 3 10.0.0.1
```

The following example displays an SNMP community profile name community6 with unlimited access for all managers:

```
CLI> show community-profile -community community6
No. Name                               Manager No.                               MIB View
-----
 6 "community6"                         "xview6"
<Manager list>
No. IP address
-----
```

create community-profile

This command specifies the network scope for SNMP by defining a community profile, which is an association between an SNMP community name, an IP address and a MIB view.

The same community name and IP address cannot be used in more than one profile.

A maximum of 30 profiles can be created.

The SNMP agent of the system permits an access request by an SNMP manager if the request matches the community profile.

A request matches a community profile if the following conditions are met:

- The community name presented by the manager to the agent must match the community name of the profile.
- The IP address of the SNMP manager must also match the address defined in the profile. If the profile contains an IP address that is "0.0.0.0", then all manager IP addresses are matched.

The MIB view associated with a matching profile defines the information that a manager can retrieve from the agent.

Read-Only authority is granted to SNMP manager requests that match a community profile.

It is not possible for a profile to grant any authority other than read-only.

■ Syntax

```
create community-profile -community community_name -view {view_name | ""}  
-manager-number {manager_numbers | none}
```

■ Parameter

-community This parameter specifies the SNMP community name, which can contain up to 32 alphanumeric characters. Only one community name can be specified at the same time.

Caution

If the SNMP community name includes a space (), it must be enclosed by double quotation marks ("). Double quotation marks are included in the character count.

Example: -community "community 001" (using 15 letters)

community_name SNMP community name

-view This parameter specifies the SNMP MIB view name that is accessible by members of the community. If the specified community is set to trap only, specify a null character (") instead of a view name.

view_name SNMP MIB view name

"" The specified community is set to trap only.

-manager-number

This parameter specifies the number of SNMP managers.

Any value between 1 and 10 can be specified. One or more numbers can be specified by separating them with a comma (,) or a hyphen (-). This number can be confirmed by using the "show snmp-manager" command. If unlimited access is specified for the community, specify "none" instead of a manager number.

manager_numbers SNMP manager number (1 – 10)

none Unlimited access is specified for the community.

■ Example(s)

The following example sets the SNMP community. SNMP manager numbers 1 to 10 are specified, and the SNMP MIB view name is "xview4":

```
CLI> create community-profile -community community1 -manager-number 1-10 -view xview4
```

The following example creates the SNMP community in which the SNMP community is named "community2", the SNMP manager number is 2, and the SNMP MIB view is able to access all MIB views:

```
CLI> create community-profile -community community2 -manager-number 2 -view xview5
```

The following example creates an SNMP community that is used only for traps.

```
CLI> create community-profile -community community3 -manager-number 3 -view ""
```

The following example creates an SNMP community for which unlimited access is specified:

```
CLI> create community-profile -community community4 -manager-number none -view xview6
```

set community-profile

This command modifies community profiles to add or to delete SNMP managers.

Syntax

```
set community-profile -community community_name [-name new-community-name]  
[-view {view_name | ""}] [-manager-number {manager_numbers | none}]
```

Parameter

-community This parameter specifies the SNMP community name, which can contain up to 32 alphanumeric characters. Only one community name can be specified at the same time.

Caution

If the SNMP community name includes a space (), it must be enclosed by double quotation marks ("). Double quotation marks are included in the character count.

Example: `-community "community 001"` (using 15 letters)

community_name SNMP community name

-name Optional. This parameter specifies a new community name for a community that already exists.

new-community-name New SNMP community name

-view Optional. This parameter specifies the SNMP MIB view name that is accessible by members of the community. If the specified community is changed to be used for traps only, specify a null character ("") instead of a view name.

view_name SNMP MIB view name

"" The specified community is changed to be used for traps only.

-manager-number

Optional. This parameter specifies the number of SNMP managers.

Any value between 1 and 10 can be specified. This number can be confirmed by using the "show snmp-manager" command. One or more numbers can be specified using "," or "-". If unlimited access is specified for the community, specify "none" instead of a manager number.

manager_numbers SNMP manager number (1 – 10)

none Unlimited access is specified for the community.

Example(s)

The following example sets the SNMP community. SNMP manager numbers 1 to 10 are specified, and the SNMP MIB view name is "xview4":

```
CLI> set community-profile -community community1 -manager-number 1-10 -view xview4
```

The following example sets the SNMP community in which the SNMP community is named "community2", the SNMP manager number is 2, and the SNMP MIB view is able to access all MIB views:

```
CLI> set community-profile -community community2 -manager-number 2 -view xview4
```

The following example sets an SNMP community that is used only for traps.

```
CLI> set community-profile -community community3 -manager-number 3 -view ""
```

The following example sets an SNMP community for which unlimited access is specified:

```
CLI> set community-profile -community community4 -manager-number none -view xview6
```

delete community-profile

This command deletes an SNMP community profile and/or deletes SNMP managers from community profile. This command is not available when the SNMP manager setting that is to be deleted is already used for an SNMP trap.

Caution

- The community-profile "community4" has 3 manager settings #1 – #3.
- When deleting all of the settings using "-manager-numbers 1-3", not only the manager settings on the profile setting, but also the community profile are deleted.
- The result is the same as when "-community community4" is specified.

Syntax

```
delete community-profile -community community_name [-manager-number manager_numbers]
```

Parameter

-community This parameter specifies the SNMP community name of profiles to be deleted. Only one community name can be specified at the same time.

community_name SNMP community name

-manager-number

Optional. This parameter specifies the manager number. Any value between 1 and 10 can be specified. This number can be confirmed by using the "show snmp-manager" command. One or more numbers can be specified by separating them with a comma (,) or a hyphen (-). If omitted, all the profiles that contain the specified SNMP community name are deleted.

manager_numbers SNMP manager number (1 – 10)

Example(s)

The following example deletes all the SNMP community profiles whose name is "community1":

```
CLI> delete community-profile -community community1
```

The following example deletes SNMP manager number 4 from community2:

```
CLI> delete community-profile -community2 -manager-number 4
```

show snmp-trap

This command displays a list of the defined SNMP traps.

■ Syntax

```
show snmp-trap
```

■ Parameter

No parameters.

■ Output

Item name	Description
Trap No.	Number of the entered SNMP traps
SNMP Version	SNMP version (v1/v2c/v3)
Manager Number	Manager number
IP Address	IP address
Community Name	SNMP community name. This is not displayed if the version is not v1 or v2c.
User Name	SNMP user name. This is not displayed if the version is v1 or v2c.
Port Number	Trap sending port number

■ Example(s)

The following example displays a list of all the defined SNMP trap:

```
CLI> show snmp-trap
Trap SNMP Manager IP Community User Port
No. Version Number Address Name Name Number
-----
1 v1 1 1.1.1.1 "community1" 162
1 v1 1 192.168.100.250 "community1" 162
2 v2c 2 fd80::abdd:223:ab "community2" 162
3 v3 3 10.0.0.1 "User1" 162
```

set snmp-trap

This command defines an SNMP trap, which is a definition associating an SNMP community string with an IP address. A maximum of ten SNMP traps can be defined.

■ Syntax

```
set snmp-trap -manager-number manager_number [-version {v1 | v2c | v3}]  
[-community {community_name | ""} | -user {user_name | ""}]  
[-trap-number trap_number] [-port-number port_number]
```

■ Parameter

-manager-number

This parameter specifies the SNMP manager number to send trap. Any value between 1 and 10 can be specified. This number can be confirmed by using the "show snmp-manager" command.

manager_number SNMP manager number

-version

Optional. This parameter specifies the SNMP version. If this parameter is omitted when setting an existing trap, the existing setting for this parameter is not changed.

v1 SNMP version 1.

v2c SNMP version 2c.

v3 SNMP version 3. (default)

-community

Optional. This parameter specifies the SNMP community name, which can contain up to 32 alphanumeric characters. A single command cannot define multiple traps. This should be specified for SNMP version 1 or 2c. This is not necessary for SNMP version 3. If a null character ("") is specified, the associated community is removed from this trap setting.

community_name SNMP community name

"" The associated community is removed from this trap setting.

-user

Optional. This parameter specifies the SNMP user name. This should be specified for SNMP version 3. This is not necessary for SNMP version 1 or 2c. If a null character ("") is specified, the associated user is removed from this trap setting.

user_name SNMP user name

"" The associated user is removed from this trap setting.

-trap-number

This parameter specifies the trap number. The trap number can be confirmed using the "show snmp-trap" command.

trap_number Trap number

-port-number

Optional. This parameter specifies the port number of the manager. If omitted, the previously set port number is used. If no port has been previously set, default port number 162 is used.

port_number Port number

■ Example(s)

The following example sets the SNMP trap corresponding to the SNMP community named "community1" and SNMP manager number 3:

```
CLI> set snmp-trap -community community1 -manager-number 3
```

The following example sets the v3 SNMP trap corresponding to the SNMP user named "user4" and SNMP manager number 3:

```
CLI> set snmp-trap -user user4 -manager-number 3
```

delete snmp-trap

This command deletes the SNMP trap that corresponds to an SNMP community. This command deletes the trap, but does not delete the specified SNMP community.

Syntax

```
delete snmp-trap -trap-number trap_numbers
```

Parameter

-trap-number

This parameter specifies the setting trap number. The trap number can be confirmed using the "show snmp-trap" command. Two or more trap numbers can be specified by separating them with a comma (,) or a hyphen (-).

trap_numbers Trap number

Example(s)

The following example deletes SNMP trap numbers 2-4:

```
CLI> show snmp-trap
Trap  SNMP  Manager  IP          Community  User      Port
No.   Version Number  Address    Name
1     v1       1       192.168.100.250 "community1"
2     v2c     2       192.168.2.1   "community2"
3     v3       3       10.0.0.1     "User1"
4     v3       4       192.168.100.101 "user_four"
5     v3       1       192.168.100.250 "trap_user2"
CLI> delete snmp-trap -trap-number 2-4
CLI> show snmp-trap
Trap  SNMP  Manager  IP          Community  User      Port
No.   Version Number  Address    Name
1     v1       1       192.168.100.250 "community1"
5     v3       1       192.168.100.250 "trap_user2"
```

test snmp-trap

This command sends an SNMP trap to the registered SNMP Manager for testing.

■ Syntax

```
test snmp-trap
```

■ Parameter

No parameters.

■ Example(s)

The following example sends the SNMP trap for testing:

```
CLI> test snmp-trap
```

The following example sends the SNMP trap to the SNMP Managers:

```
CLI> show snmp-trap
Trap No.  SNMP Version  Manager Number  IP Address  Community Name  User Name  Port Number
1      v1        1          1          192.168.100.250  "community1"  "User1"    162
2      v2c       2          2          192.168.2.1     "community2"  "user_four" 8162
3      v3        3          3          10.0.0.1        "community2"  "trap_user2" 162
4      v3        4          4          192.168.100.101  "community2"  "trap_user2" 162
5      v3        1          1          192.168.100.250  "community2"  "trap_user2" 162
CLI> test snmp-trap
```

export enhanced-mib

This command exports the enhanced MIB file in the system to an FTP server.

■ Syntax

```
export enhanced-mib -port {maintenance | remote | fst} -server server_name -user login_user_name  
[-server-view {enable | disable}] [-version {v1 | v2cv3}] [-dir directory] [-filename filename]
```

■ Parameter

- port** This parameter specifies the Ethernet port used to connect to the FTP server. For details, refer to ["1.11 Note for Specifying FTP Server" \(page 54\)](#).
- | | |
|-------------|---|
| maintenance | Maintenance port (MNT port) |
| remote | Remote port (RMT port) |
| fst | FST port (DX500 S4/DX600 S4, DX500 S3/DX600 S3, DX8100 S3/DX8700 S3/DX8900 S3, and AF650 S2/AF650 only) |
- server** This parameter specifies the FTP server name to store the enhanced MIB file. The server name format is IPv4 standard notation (a base 256 "d.d.d.d" string), IPv6 address format, or a fully qualified domain name.
- Example: -server 192.168.1.20
Example: -server fd80::abd0:223:ad
Example: -server foo.bar
- | | |
|--------------------|-----------------|
| <i>server_name</i> | FTP server name |
|--------------------|-----------------|
- user** This parameter specifies the user account name for access to the FTP server. This command displays an FTP server password prompt.
- | | |
|------------------------|-------------------|
| <i>login_user_name</i> | User account name |
|------------------------|-------------------|
- server-view** Optional. This parameter specifies whether a file defined for use by ServerView is included or not. If this parameter is omitted, the file is not included.
- | | |
|---------|--|
| enable | The file defined for ServerView is included. |
| disable | The file defined for ServerView is not included. |
- version** Optional. This parameter specifies the version of an exported MIB file by using the SNMP version. If omitted, the default value "v1" is used.
- | | |
|-------|----------------------------|
| v1 | SNMP version v1. (default) |
| v2cv3 | SNMP version v2c or v3 |
- dir** Optional. This parameter specifies the directory name on the FTP server where the MIB file is to be stored. Since the file name cannot be specified within this string, use the "-filename" parameter to specify the file name.
- | | |
|------------------|----------------|
| <i>directory</i> | Directory name |
|------------------|----------------|

-filename Optional. This parameter specifies the file name to store the MIB file. Since the directory name cannot be specified within this string, use the "-dir" parameter to specify the directory name. If this parameter is omitted, the default file name is "FJDARY-E150.MIB" for the DX60 S4/DX100 S4/DX200 S4, the DX500 S4/DX600 S4, the DX60 S3/DX100 S3/DX200 S3, the DX500 S3/DX600 S3, the AF250 S2/AF650 S2, the AF250/AF650, and the DX200F. And for the DX8700 S3/DX8900 S3, the default file name is "FJDARY-E152.MIB". If the file already exists, it is overwritten.

filename File name

The following conversion specifications, which begin with a percent character, are replaced by their corresponding value at the time of execution. If other conversion strings are specified, this command terminates abnormally with an error message.

%s	Serial number of the system Example: MIB%s-mib.bin -> MIB123456789012-mib.bin
%d	Current date Example: MIB%d-mib.bin -> MIB20080819-mib.bin
%t	Current time Example: MIB%t-mib.bin -> MIB144855-mib.bin
%%	Percent character Example: mib%%.bin -> mib%.bin

■ Example(s)

The following example exports the enhanced MIB to the FTP server named "ftp.a.com". The FTP server login is user "profile1", the stored location is "/temp", the default stored filename "/FJDARY-E150.MIB" is used, and the Ethernet port that is used is the Maintenance port (MNT port).

```
CLI> export enhanced-mib -port maintenance -server ftp.a.com -user profile1 -dir /temp
Password :
exporting /temp/FJDARY-E150.MIB to ftp.a.com
Complete.
```

5.2.3 E-mail Notification

This section explains the commands related to setting up e-mail notification.

show email-notification

This command displays the parameters of E-mail notification functions.

■ Syntax

```
show email-notification
```

■ Parameter

No parameters.

■ Output

Item name	Description
Send E-Mail	E-mail send mode (Enable or Disable)
Port	Ethernet port
SMTP Server	SMTP server name
SMTP Port No	Port number to access an SMTP server
Authentication Method	SMTP authentic method
User Name	User name for SMTP authentication
From	Sender email address
To1 – To5	Receiver addresses of an email that is sent from the system
Text1 – Text10	The fixed messages included in email messages
Retry Count	Retry count
Retry Interval(sec)	Retry interval (seconds)
Response Timeout(sec)	Timeout value for inactive communication that occurs during communication to the mail server (in seconds)
Connection Timeout(sec)	Timeout value for establishment of communication with the mail server (in seconds)
Partial mode	Partial mode
Partial size(KB)	Partial size (KB)
Send Log	E-mail log send mode
I/O Module Log	I/O module log send mode
Customer info	Customer information send mode
SMTP over SSL	Indicates whether the SMTP over SSL is used and the method to be used (Disable, STARTTLS, or SSL/TLS).

■ Example(s)

The following example displays the parameters related to E-mail notification setup:

```
CLI> show email-notification
Send E-Mail           Enable
Port                 MNT
SMTP Server          foo1.bar1
SMTP Port No        25
Authentication Method Auto
User Name            profile
From                 foo2@bar2
To1                  foo1@bar1
To2                  foo2@bar2
To3                  foo3@bar3
To4                  foo4@bar4
To5
Text1                Hello
Text2                This is the ABC.
Text3                Thank you.
Maximum Retries      1
Retry Interval(sec)  4
Connection Timeout(sec) 5
Response Timeout(sec) 30
SMTP over SSL        SSL/TLS
Partial mode         Disable
Partial size(KB)     64
Send Log             Enable
I/O Module Log       Enable
Customer info        Enable
```

set email-notification

This command sets up parameters relating to E-mail notification functions.

Syntax

```
set email-notification [-send {enable | disable}] [-port {maintenance | remote | fst}]  
[-port-number port_number] [-server smtp_server] [-smtp-over-ssl {disable | starttls | ssl-tls}]  
[-authentication {none | auto | cram-md5 | plain | login}] [-user user_name] [-from mail_address]  
[-to1 {address | ""}] [-to2 {address | ""}] [-to3 {address | ""}] [-to4 {address | ""}] [-to5 {address | ""}]  
[-text-count count] [-text1 {strings | ""}] [-text2 {strings | ""}] [-text3 {strings | ""}] [-text4 {strings | ""}]  
[-text5 {strings | ""}] [-text6 {strings | ""}] [-text7 {strings | ""}] [-text8 {strings | ""}] [-text9 {strings | ""}]  
[-text10 {strings | ""}] [-retry-count count] [-retry-interval interval] [-timeout seconds]  
[-connection-timeout seconds] [-partial-mode {enable | disable}] [-partial-size size]  
[-send-log {enable | disable}] [-iom-log {enable | disable}] [-customer-info {enable | disable}]
```

Parameter

- send** Optional. This parameter specifies the E-mail notification mode. It specifies whether the E-mail notification function is enabled or not. If this parameter is omitted, the status is not changed. The initial value is disabled. All necessary parameters to send E-mail must be specified when enabling this parameter.
- | | |
|---------|--|
| enable | E-mail notification is enabled. |
| disable | E-mail notification is disabled (default). |
- port** Optional. This parameter specifies the Ethernet port to connect to an SMTP Server. If omitted, the existing setting is not changed.
- | | |
|-------------|---|
| maintenance | Maintenance port (MNT port) |
| remote | Remote port (RMT port) |
| fst | FST port (DX500 S4/DX600 S4, DX500 S3/DX600 S3, DX8100 S3/DX8700 S3/DX8900 S3, and AF650 S2/AF650 only) |
- port-number** Optional. This parameter specifies the port number to connect to an SMTP server. If omitted, the existing setting is not changed. The initial value is 25.
- | | |
|--------------------|-------------|
| <i>port_number</i> | Port number |
|--------------------|-------------|
- server** Optional. This parameter specifies the SMTP server address. Up to 64 letters can be specified. The server name format is IPv4 standard notation (a base 256 "d.d.d.d" string), IPv6 address format, or a fully qualified domain name. The types of IPv6 addresses that can be specified are global addresses (including 6to4 addresses), link local addresses, and unique local addresses. If omitted, the existing setting is not changed.
- Example: -server 192.168.1.20
Example: -server fd80::abd0:223:ad
Example: -server foo.bar
- smtp_server* SMTP server address

-authentication

Optional. This parameter specifies the authentication method of the SMTP server. If omitted, the existing setting is not changed.

- none** The system connects to the SMTP server without authentication.
- auto** The system connects to the SMTP server using AUTH SMTP authentication and automatically selects the appropriate authentication method from "cram-md5", "plain" or "login".
- cram-md5** The system connects to the SMTP server using AUTH SMTP authentication and uses "cram-md5" as the authentication method.
- plain** The system connects to the SMTP server using AUTH SMTP authentication and uses "plain" as the authentication method.
- login** The system connects to the SMTP server using AUTH SMTP authentication and uses "login" as the authentication method.

-user

Optional. This parameter specifies the user account name to connect to the SMTP server using AUTH SMTP authentication. This command displays a password prompt. When "none" is specified for "-authentication", this parameter is unnecessary. If omitted, the existing setting is not changed.

user_name User account name

-from

Optional. This parameter specifies the "from address" field of E-mail sent from the system. If omitted, the existing setting is not changed.

mail_address Sender email address

- to1**
- to2**
- to3**
- to4**
- to5**

Optional. This parameter specifies up to 5 e-mail addresses sent from the system. If any parameter is omitted, the corresponding value is not changed.

 **Caution**

To delete an address, specify a null character ("").
Example: -to2 ""

-
- address* Receiver email address
 - "" An address is deleted.

-text-count

Optional. This parameter specifies the number of valid message lines. The fixed message is output according to the specified one. Although this command is optional, it must be specified when the fixed message is modified.

 **Caution**

When 0 is specified, the fixed message is deleted.

-
- count* Number of message lines

-text1 . . . -text10

Optional. These parameters specify the fixed lines of the e-mail messages. The maximum number of lines is 10 and the maximum size is a total of 255 bytes. The system sends the message from the "-text1" parameter to the last parameter that is not blank as consecutive messages. If any parameter is omitted, the corresponding value is not changed.

 **Caution**

- The number after "-text" indicates the message line number. For example, "-text5" indicates the 5th line. With the exception of the last line, two bytes of carriage return code (CR) are added to each non-blank line.

Example: -text1 Hello -text2 Hello -text3 Hello
The total number of characters is 19 (5*3 + 2*2)

- The messages must be specified in ascending order beginning at "-text1".

Example: -text1 Hello
-text2 Morning.
-text3 bye.

- A null character ("") indicates a blank line.

Example: -text1 Hello
-text2 ""
-text3 bye

Result of this example:

line1 : Hello

line2 :

line3 : bye

* Line2 is blank.

- If a line includes a blank letter, both ends of the parameter must be enclosed in double quotation marks ("). Double quotation marks are not include in the word count.

Example: -text1 Hello.
-text2 "This is your system." (20 letters)

- To include a double quotation mark, precede it by the back slash character. Back slash characters are not include in the word count.

Example: -text1 abc\"def\"ghi (11 letters)

Result of this example:

abc\"def\"ghi

strings Fixed line of the email message

"" Blank line

-retry-count Optional. This parameter specifies the number of retries that are performed when an e-mail fails to send. Specify a value from 0 to 5 for the retry count. If omitted, the existing setting is not changed. The default value is 0 (no retry).

count Number of retries

-retry-interval

Optional. This parameter specifies the time of the interval to retry sending. Between 1 and 300 seconds should be specified for the value. If omitted, the existing setting is not changed. The default value is 1 (a retry is attempted after a 1 second interval).

interval Retry interval (1 – 300)

-timeout

Optional. This parameter specifies the timeout period for inactive communication that occurs in communication with a mail server. Between 1 and 300 seconds should be specified for the timeout period. A timeout occurs after the period of time that is specified with this parameter elapses when communication becomes inactive during forwarding of an email to the mail server. The default value is five seconds.

 **Caution**

This parameter is mostly used to examine the network environment. Do not change the setting of this parameter for normal operations.

seconds Timeout period for inactive communication (1 – 300)

-connection-timeout

Optional. This parameter specifies the timeout period for the establishment of communication with the mail server. Between 1 and 300 seconds should be specified for the timeout period. A timeout occurs after the period of time that is specified with this parameter elapses when a connection destination is not found or when a connection destination is found but the mail server cannot forward the email. The default value is five seconds.

 **Caution**

This parameter is mostly used to examine the network environment. Do not change the setting of this parameter for normal operations.

seconds Timeout period for the establishment of communication with the mail server (1 – 300)

-smtp-over-ssl

Optional. This parameter specifies whether the SMTP over SSL is used. If the SMTP over SSL is used, the STARTTLS method or the SSL/TLS method can be selected. If this parameter is omitted, SMTP over SSL is not used.

disable SMTP over SSL is not used. (Default)
starttls SMTP over SSL is used with the STARTTLS method.
ssl-tls SMTP over SSL is used with the SSL/TLS method.

-partial-mode

Optional. This parameter specifies whether to divide e-mail into parts when sending. If omitted, the existing setting is not changed. The default value is disabled (e-mails are not divided).

enable Partial e-mail mode is enabled.
disable Partial e-mail mode is disabled (default).

- partial-size** Optional. This parameter specifies the part size of an e-mail. It is available when "-partial-mode" is enabled, and any mode can be specified. Between 64kb and 6400kb should be specified for the value (between 64KB and 6400KB). "kb" must be specified after the number. If omitted, the existing setting is not changed. The ETERNUS DX/AF default value is 64KB (the size of each e-mail is 64KB).
- | | |
|-------------|------------------------|
| <i>size</i> | Part size of an e-mail |
|-------------|------------------------|
- send-log** Optional. This parameter specifies the E-mail log notification mode. This parameter specifies whether the E-mail log notification function is enabled or not. If omitted, the existing setting is not changed. The default value is disable.
- | | |
|---------|---|
| enable | Sending the E-mail log is enabled. |
| disable | Sending the E-mail log is disabled (default). |
- iom-log** Optional. This parameter specifies whether the I/O module logs are included. If omitted, the I/O module logs are included.
- | | |
|---------|---|
| enable | The I/O module log is included (default). |
| disable | The I/O module log is not included. |
- customer-info** Optional. This parameter specifies whether to include customer information in the exported logs. If this parameter is omitted, customer information is included in the logs.
- | | |
|---------|---|
| enable | Customer information is included in the logs (default). |
| disable | Customer information is not included in the logs. |

■ Example(s)

The following example sets up the parameters of the SMTP server. The Ethernet port is the Maintenance port (MNT port), the SMTP server is "foo1.bar1", and the authentication method is "CRAM-MD5". The user name for SMTP authentication is "profile1", the SMTP port number is the default, an e-mail sender address is "foo2@bar2", and the e-mail receiver address is "foo@bar". The SMTP over SSL function is used with the SSL/TLS method. The port number is 465. The fixed message is the following:

```
test-line 1
test-line 2
```

```
CLI> set email-notification -send enable -port maintenance -server foo1.bar1 -authentication cram-md5 -smtp-over-ssl ssl-
tls -port-number 465 -user profile1 -from foo2@bar2 -to1 foo@bar -text-count 2 -text1 "test-line 1" -text2 "test-line 2"
Password :
```

The following example sets up the parameters of the SMTP server. The Ethernet port is remote port (RMT port), SMTP server is "buz.varx". E-mails sent that are larger than 128KB are divided into 128KB parts, other options are not set, and default values are used:

```
CLI> set email-notification -send enable -port remote -server buz.varx -partial-mode enable -partial-size 128kb
```

test email

This command sends an email from the system for testing.

■ Syntax

```
test email
```

■ Parameter

No parameters.

■ Example(s)

The following example tests whether the email can correctly be sent or not:

```
CLI> test email
```

5.2.4 Event Notification

There are three categories of events that can occur; Error, Warning and Information. When an event occurs, a notification can be sent via E-mail, via SNMP, by returning a SCSI sense to the host, or by recording a syslog to syslog server. This section explains the commands to set up event notifications.

show event-notification

This command displays the parameters that have been set for event notification.

Syntax

```
show event-notification
```

Parameter

No parameters.

Output

- When AIS Connect is disabled.

Item name	Description
E-mail	Indicates whether a notification is performed by email. "(HS<0)" also appears when the system has no hot spares.
SNMP	Indicates whether a notification is performed by SNMP trap. "(HS<0)" also appears when the system has no hot spares.
Host	Indicates whether a notification is performed by Host sense. "(HS<0)" also appears when the system has no hot spares. When Host sense operator message (OPMSG) is enabled (the "-host-sense-opmsg" parameter is set to "enable"), "(OPMSG)" is also displayed. The OPMSG setting is only supported in the DX8100 S3/DX8700 S3. For unsupported models, "Notify" or "Notify(HS<0)" is displayed.
REMCS	Indicates whether a notification is performed by REMCS.
syslog	Indicates whether a notification is performed by syslog. "(HS<0)" also appears when the system has no hot spares.

- When AIS Connect is enabled.

Item name	Description
E-mail	Indicates whether a notification is performed by email. "(HS<0)" also appears when the system has no hot spares.
SNMP	Indicates whether a notification is performed by SNMP trap. "(HS<0)" also appears when the system has no hot spares.
Host	Indicates whether a notification is performed by Host sense. "(HS<0)" also appears when the system has no hot spares. When Host sense OPSMG is enabled (the "-host-sense-opmsg" parameter is set to "enable"), "(OPMSG)" is also displayed.
REMCS	Indicates whether a notification is performed by REMCS.
syslog	Indicates whether a notification is performed by syslog. "(HS<0)" also appears when the system has no hot spares.
AIS Connect	Indicates whether a notification is performed by AIS Connect. "(HS<0)" also appears when the system has no hot spares.

■ Example(s)

The following example displays the parameters that have been set for event notification (when AIS connect is disabled):

```

CLI> show event-notification
[Severity: Error Level]
-----
Parts Error          Notify          Notify          Notify (OPMSG)  -          Do not notify
Disk Error          Notify          Notify          Notify          -          Do not notify
Disk Error (HDD Shield) Do not notify Do not notify Do not notify Do not notify Do not notify
Succeed HDD Shield Do not notify Do not notify -          Do not notify
Temperature Error  Notify          Notify          Notify (OPMSG)  -          Do not notify
End of battery life Notify          Notify          Notify (OPMSG)  -          Do not notify
Rebuild/Copyback w/ redundant -          -          Notify (OPMSG)  -          -
Rebuild/Copyback w/o redundant -          -          Notify (OPMSG)  -          -
Complete Redundant Copy (HDD Shield) Do not notify Do not notify Do not notify Do not notify Do not notify
Complete rebuild   Notify          Notify          Notify (OPMSG)  -          Do not notify
Bad data           Notify          Notify          Notify (OPMSG)  -          Do not notify
Pinned data       Notify          Notify          Notify (OPMSG)  -          Do not notify
Not ready          Notify          Notify          Notify (OPMSG)  -          Do not notify
Remote Path Error w transfer Notify          Notify          Notify (OPMSG)  -          Do not notify
Remote Path Error w/o transfer Notify          Notify          Notify (OPMSG)  -          Do not notify
REC Buffer Halt (Path Error) Notify          Notify          -          Notify      Do not notify
REC Buffer Halt (Overload) Notify          Notify          -          Notify      Do not notify
REC Buffer Halt (Other Error) Notify          Notify          -          Notify      Do not notify
Thin Provisioning Pool Rate Notify          Notify          -          -          Do not notify
Redundant Copy Start Finish Notify          Notify          -          -          Do not notify
Copy Session Error Notify          Notify          -          -          Do not notify
SED Network Error  Notify          Notify          -          Do not notify Do not notify
NAS I/O Error       Notify          Notify          -          -          Do not notify
NAS Snapshot Error Notify          Notify          -          -          Do not notify
Disconnect Storage Cluster Controller Notify          Notify          -          Notify      Do not notify
NAS EX System Volume Error Notify          Notify          -          -          Do not notify

[Severity: Warning Level]
-----
Parts Warning       Notify          Notify          Notify          -          Do not notify
Disk Warning        Notify          Notify          Notify          -          Do not notify
Disk Warning (HDD Shield) Do not notify Do not notify Do not notify Do not notify Do not notify
Temperature Warning Notify          Notify          Notify          -          Do not notify
Battery life Warning Notify          Notify          Notify          -          Do not notify
NAS I/O Warning     Notify          Notify          Notify          -          Do not notify
NAS Connection Error Notify          Notify          -          -          Do not notify
Out of NAS Capacity Notify          Notify          -          -          Do not notify
NAS Quota Limit Exceeded Notify          Notify          -          -          Do not notify
NAS EX System Volume Warning Notify          Notify          -          -          Do not notify

[Severity: Information Level]
-----
Recovery module     Do not notify Do not notify -          -          Do not notify
Temperature restoration Do not notify Do not notify -          -          Do not notify
User login/logout   Do not notify Do not notify -          -          Do not notify
Operated RAID Group Do not notify Do not notify -          -          Do not notify
Added/Released Hot Spare Do not notify Do not notify -          -          Do not notify
Operated Volume     Do not notify Do not notify -          -          Do not notify
Power off/on Apply Firmware Do not notify Do not notify -          -          Do not notify
SDP Usage Rate Over Lv1 Do not notify Do not notify -          -          Do not notify
SDP Usage Rate Over Lv2 Do not notify Do not notify -          -          Do not notify
SDP Usage Rate Over Lv3 Do not notify Do not notify -          -          Do not notify
Copy Table Size Usage Rate Over Do not notify Do not notify -          -          Do not notify
Trial copy license expired Notify          Notify          -          -          Do not notify
No Free Space on ODX Volume Do not notify Do not notify -          -          Do not notify
SED Network Error Recovered Notify          Notify          -          -          Do not notify
FC CA Port Link Status Changed Do not notify Do not notify -          -          Do not notify
ISCSI CA Port Link Status Changed Do not notify Do not notify -          -          Do not notify
Host Login Over     Do not notify Do not notify -          -          Do not notify
Remote Path Error Recovered Notify          Do not notify -          Do not notify Do not notify
NAS Connection Status Do not notify Do not notify -          -          Do not notify
Out of NAS Capacity Do not notify Do not notify -          -          Do not notify
Out of NAS File Management Domain Do not notify Do not notify -          -          Do not notify
Succeed NAS Snapshot Do not notify Do not notify -          -          Do not notify
Fall below NAS Quota Limit Do not notify Do not notify -          -          Do not notify
Connect Storage Cluster Controller Notify          Notify          -          -          Do not notify
Automatic Change Storage Cluster State Notify          Notify          -          Notify      Do not notify
Manual Change Storage Cluster State Notify          Notify          -          Notify      Do not notify
NAS CPU Warning     Do not notify Do not notify -          -          Do not notify
NAS CPU Recovered   Do not notify Do not notify -          -          Do not notify
NAS EX System Volume Recovered Notify          Notify          -          -          Do not notify
NAS Multipath Status Do not notify Do not notify -          -          Do not notify
    
```

The following example displays the parameters that have been set for event notification (when AIS connect is enabled):

CLI> show event-notification [Severity: Error Level]	E-Mail	SNMP	Host	REMCS	Syslog	AIS Connect
Parts Error	Notify	Notify	Notify (OPMSG)	-	Do not notify	Notify
Disk Error	Notify	Notify	Notify	-	Do not notify	Notify
Disk Error (HDD Shield)	Do not notify	Do not notify	Do not notify	Do not notify	Do not notify	Do not notify
Succeed HDD Shield	Do not notify	Do not notify	-	Do not notify	Do not notify	Do not notify
Temperature Error	Notify	Notify	Notify (OPMSG)	-	Do not notify	Notify
End of battery life	Notify	Notify	Notify (OPMSG)	-	Do not notify	Notify
Rebuild/Copyback w/ redundant	-	-	Notify (OPMSG)	-	-	-
Rebuild/Copyback w/o redundant	-	-	Notify (OPMSG)	-	-	-
Complete Redundant Copy	Do not notify	Do not notify	Do not notify	Do not notify	Do not notify	Notify
Complete Redundant Copy (HDD Shield)	Do not notify	Do not notify	Do not notify	Do not notify	Do not notify	Notify
Complete rebuild	Notify	Notify	Notify (OPMSG)	-	Do not notify	Notify
Bad data	Notify	Notify	Notify (OPMSG)	-	Do not notify	Notify
Pinned data	Notify	Notify	Notify (OPMSG)	-	Do not notify	Notify
Not ready	Notify	Notify	Notify (OPMSG)	-	Do not notify	Notify
Remote Path Error w transfer	Notify	Notify	Notify (OPMSG)	Notify	Do not notify	Notify
Remote Path Error w/o transfer	Notify	Notify	Notify (OPMSG)	Notify	Do not notify	Notify
REC Buffer Halt (Path Error)	Notify	Notify	Notify	Notify	Do not notify	Notify
REC Buffer Halt (Overload)	Notify	Notify	-	Notify	Do not notify	Notify
REC Buffer Halt (Other Error)	Notify	Notify	-	Notify	Do not notify	Notify
Thin Provisioning Pool Rate	Notify	Notify	-	-	Do not notify	Do not notify
Redundant Copy Start Finish	Notify	Notify	Notify (OPMSG)	Notify	Do not notify	Notify
Copy Session Error	Notify	Notify	Notify	Notify	Do not notify	Notify
SED Network Error	Notify	Notify	-	Do not notify	Do not notify	Notify
NAS I/O Error	Notify	Notify	-	-	Do not notify	Notify
NAS Snapshot Error	Notify	Notify	-	-	Do not notify	Notify
Disconnect Storage Cluster Controller	Notify	Notify	-	Notify	Do not notify	Notify
NAS EX System Volume Error	Notify	Notify	-	-	Do not notify	Notify
[Severity: Warning Level]	E-Mail	SNMP	Host	REMCS	Syslog	AIS Connect
Parts Warning	Notify	Notify	Notify	-	Do not notify	Notify
Disk Warning	Notify	Notify	Notify	-	Do not notify	Notify
Disk Warning (HDD Shield)	Do not notify	Do not notify	Do not notify	Do not notify	Do not notify	Do not notify
Temperature Warning	Notify	Notify	Notify	-	Do not notify	Notify
Battery life Warning	Notify	Notify	Notify	-	Do not notify	Notify
NAS I/O Warning	Notify	Notify	-	-	Do not notify	Notify
NAS Connection Error	Notify	Notify	-	-	Do not notify	Notify
Out of NAS Capacity	Notify	Notify	-	-	Do not notify	Notify
NAS Quota Limit Exceeded	Notify	Notify	-	-	Do not notify	Notify
NAS EX System Volume Warning	Notify	Notify	-	-	Do not notify	-
[Severity: Information Level]	E-Mail	SNMP	Host	REMCS	Syslog	AIS Connect
Recovery module	Do not notify	Do not notify	-	-	Do not notify	Do not notify
Temperature restoration	Do not notify	Do not notify	-	-	Do not notify	Do not notify
User login/logout	Do not notify	Do not notify	-	-	Do not notify	Do not notify
Operated RAID Group	Do not notify	Do not notify	-	-	Do not notify	Do not notify
Added/Released Hot Spare	Do not notify	Do not notify	-	-	Do not notify	Do not notify
Operated Volume	Do not notify	Do not notify	-	-	Do not notify	Do not notify
Power off/on Apply Firmware	Do not notify	Do not notify	-	-	Do not notify	Do not notify
SDP Usage Rate Over Lvl	Do not notify	Do not notify	-	-	Do not notify	Do not notify
SDP Usage Rate Over Lv2	Do not notify	Do not notify	-	-	Do not notify	Do not notify
SDP Usage Rate Over Lv3	Do not notify	Do not notify	-	-	Do not notify	Do not notify
Copy Table Size Usage Rate Over	Do not notify	Do not notify	-	-	Do not notify	Do not notify
Trial copy license expired	Notify	Notify	-	-	Do not notify	Do not notify
No Free Space on ODX Volume	Do not notify	Do not notify	-	-	Do not notify	Do not notify
SED Network Error Recovered	Notify	Notify	-	-	Do not notify	Notify
FC CA Port Link Status Changed	Do not notify	Do not notify	-	-	Do not notify	Notify
ISCSI CA Port Link Status Changed	Do not notify	Do not notify	-	-	Do not notify	Do not notify
Host Login Over	Do not notify	Do not notify	-	-	Do not notify	Notify
Remote Path Error Recovered	Notify	Do not notify	-	Do not notify	Do not notify	Do not notify
NAS Connection Status	Do not notify	Do not notify	-	-	Do not notify	Do not notify
Out of NAS Capacity	Do not notify	Do not notify	-	-	Do not notify	Do not notify
Out of NAS File Management Domain	Do not notify	Do not notify	-	-	Do not notify	Do not notify
Succeed NAS Snapshot	Do not notify	Do not notify	-	-	Do not notify	Do not notify
Fall below NAS Quota Limit	Do not notify	Do not notify	-	-	Do not notify	Do not notify
Connect Storage Cluster Controller	Notify	Notify	-	Notify	Notify	Notify
Automatic Change Storage Cluster State	Notify	Notify	-	Notify	Notify	Notify
Manual Change Storage Cluster State	Notify	Notify	-	Notify	Notify	Notify
NAS CPU Warning	Do not notify	Do not notify	-	-	Do not notify	-
NAS CPU Recovered	Do not notify	Do not notify	-	-	Do not notify	-
NAS EX System Volume Recovered	Notify	Notify	-	-	Do not notify	-
NAS Multipath Status	Do not notify	Do not notify	-	-	Do not notify	-

set event-notification

This command sets up the parameters for event notification, primarily the notification targets such as E-mail, SNMP traps, host sense, REMCS, syslog, and AIS Connect. Notification targets for specific events can be set individually, all events of a particular level can be set to be notified in the same way, or one of two preset options can be selected. When selecting either of the two preset values, other parameters cannot be specified.

■ Syntax

```
set event-notification
{-preset {system-default | remcs-default} |
{-severity {error | warning | information |
e-parts-error | e-disk-error | e-disk-error-hdd-shield | e-succeed-hdd-shield |
e-temperature-error | e-battery-life |
e-rebuild-copyback-with-redundant |
e-rebuild-copyback-without-redundant |
e-complete-redundant-copy | e-complete-redundant-copy-hdd-shield | e-complete-rebuild |
e-bad-data | e-pinned-data | e-not-ready | e-remote-path-with-transfer |
e-remote-path-without-transfer | e-halt-path |
e-halt-overload | e-halt-other | e-tp-pool-ratio |
e-redundant | e-copy-session-error | e-sed-network-error | e-nas-io-error | e-nas-snapshot-error |
e-storage-cluster-controller-disconnected | e-nas-ex-sysvol-error |
w-parts-warning | w-disk-warning | w-disk-warning-hdd-shield | w-temperature-warning |
w-battery-life | w-nas-io-warning | w-nas-connection-error | w-out-of-nas-capacity |
w-nas-quota-limit-exceeded | w-nas-ex-sysvol-warning |
i-recovery-module | i-temperature-restoration | i-user-logon-logoff |
i-operate-raid-group | i-add-release-hot-spare | i-operate-volume | i-power-off-on-cfl |
i-sdp-policy-level1 | i-sdp-policy-level2 | i-sdp-policy-level3 |
i-limit-copy-table | i-expire-trial-copy-license | i-idx | i-sed-network-error-recovered |
i-fc-ca-port-link-status-changed | i-iscsi-ca-port-link-status-changed | i-host-login-over | i-remote-path-recovered |
i-nas-connection-status | i-out-of-nas-capacity | i-out-of-nas-file-management-domain |
i-succeed-nas-snapshot | i-fall-below-nas-quota-limit |
i-storage-cluster-controller-connected | i-storage-cluster-state-auto-changed |
i-storage-cluster-state-manual-changed | i-nas-cpu-warning | i-nas-cpu-recovered | i-nas-ex-sysvol-recovered |
i-nas-multipath-status}}
-method {email | snmp | host | remcs | syslog | ais}
-suppression {enable | disable | disable-when-no-hs}
[-host-sense-opmsg {enable | disable}]}
```

■ Parameter

- preset This parameter specifies preset settings for event notification values. If this parameter is selected, other parameters cannot be specified. The default values are described in the examples below:
- | | |
|----------------|---|
| system-default | Set the system default (Factory shipping default). |
| remcs-default | Set the remote service default (recommended REMCS operation value). |

-severity This parameter specifies the events that will trigger a notification and cannot be specified if the preset function is specified. An operand name starting with "e-" indicates a severity "Error level" event, "w-" indicates a severity "Warning level" event, and "i-" indicates a severity "Information level event". One or more event types can be specified by separating them with a comma (,).

Example: -severity error, w-warning-disk (Specify "error" and "w-warning-disk")
"-suppression disable-when-no-hs" indicates whether the specified event is notified or not when there is no hot spare in the system. It can be specified when "e-broken-disk", "e-rebuild-copyback-without-redundant", "e-redundant", "w-warning-disk", or "w-raid-degrade-event" is specified.

For details about each option for this parameter and the possible combinations that can be specified, refer to ["List of possible combinations that can be specified for "-severity"" \(page 677\)](#).

- | | |
|--------------------------------------|---|
| error | All the Error level events are notified. |
| warning | All the Warning level events are notified. |
| information | All the Information level events are notified. |
| e-parts-error | When modules other than drives are broken, error level events are notified. Host sense, SNMP, E-mail, and syslog may be specified as the notice method. |
| e-disk-error | When a drive that is not a protection (Shield) target is broken, error level events are notified. Host sense, SNMP, E-mail, and syslog may be specified as the notice method. |
| e-disk-error-hdd-shield | When the protection (Shield) target drive fails, error level events are notified. Host sense, SNMP, E-mail, and syslog may be specified as the notice method. |
| e-succeed-hdd-shield | When the failed drive is installed after being determined to be operational as a result of a diagnosis using the protection (Shield) function, error level events are notified. Host sense, SNMP, E-mail, and syslog may be specified as the notice method. |
| e-temperature-error | When the sensor detects an error level temperature, error level events are notified. Host sense, SNMP, E-mail, and syslog may be specified as the notice method. |
| e-battery-life | When battery life expires, error level events are notified. Host sense, SNMP, E-mail, and syslog may be specified as the notice method. |
| e-rebuild-copyback-with-redundant | When rebuild/copyback occurs to a RAID group with redundancy, error level events are notified. Only Host sense may be specified as the notice method. Any notice method may be specified. |
| e-rebuild-copyback-without-redundant | When rebuild/copyback occurs to a RAID group without redundancy, error level events are notified. Only Host sense may be specified as the notice method. Any notice method may be specified. |
| e-complete-redundant-copy | When the redundant copy is complete and the drive that is disconnected from the ETERNUS DX/AF is not a protection (Shield) target, error level events are notified. Any notice method may be specified. |

- e-complete-redundant-copy-hdd-shield**
When the redundant copy is complete and the drive that is disconnected from the ETERNUS DX/AF is a protection (Shield) target, error level events are notified. Any notice method may be specified.
- e-complete-rebuild** When rebuild is finished, error level events are notified. Host sense, SNMP, e-mail, and syslog may be specified as the notice method.
- e-bad-data** When bad data on a track occurs, error level events are notified. Host sense, SNMP, e-mail, and syslog may be specified as the notice method.
- e-pinned-data** When pinned data occurs or disappears, error level events are notified. Host sense, SNMP, e-mail, and syslog may be specified as the notice method. Note that, however, host sense is not used as the notification method when pinned data disappears.
- e-not-ready** When Not-Ready occurs, error level events are notified. Host sense, SNMP, E-mail, and syslog may be specified as the notice method.
- e-remote-path-with-transfer**
When an REC path error (with data transfer) occurs, error level events are notified. Any notice method may be specified.
- e-remote-path-without-transfer**
When an REC path error (without data transfer) occurs, error level events are notified. Any notice method may be specified.
- e-halt-path** When REC path(s) are halted due to a path(s) error, error level events are notified. SNMP, E-mail, and REMCS may be specified as the notice method.
- e-halt-overload** When REC path(s) are halted due to line overload, error level events are notified. SNMP, E-mail, and REMCS may be specified as the notice method.
- e-halt-other** When REC path(s) are halted due to another cause, error level events are notified. SNMP, E-mail, and REMCS may be specified as the notice method.
- e-tp-pool-ratio** When the transition of the thin provisioning pool ratio increases, error level events are notified. SNMP, E-mail and syslog may be specified as the notice method.
- e-redundant** When the redundant copy starts or ends, error level events are notified. Any notice method may be specified.
- e-sed-network-error**
When network connection errors occur with the key server, error level events are notified. SNMP, E-mail, REMCS, syslog, and AIS Connect may be specified as the notice method.
- e-copy-session-error**
When an error occurs for a copy session or an abnormal copy session disappears, error level events are notified. SNMP, E-mail, REMCS, and syslog may be specified as the notice method.
- e-nas-io-error** When NAS I/O is in Error status, error level events are notified. SNMP, E-mail, REMCS, syslog, and AIS Connect may be specified as the notice method. This option can be specified when the NAS function is enabled.

- e-nas-snapshot-error**
When an acquisition of a NAS snapshot fails, error level events are notified. SNMP, E-mail, REMCS, syslog, and AIS Connect may be specified as the notice method.
- e-storage-cluster-controller-disconnected**
When communication with the Storage Cluster Controller is disconnected, error level events are notified. SNMP, E-mail, REMCS, syslog, and AIS Connect may be specified as the notice method.
- e-nas-ex-sysvol-error**
When the NAS expanded system volume is in an abnormal state, error level events are notified. SNMP, E-mail, REMCS, syslog, and AIS Connect may be specified as the notice method.
- w-parts-warning**
When other modules are in a warning condition, warning level events are notified. Host sense, SNMP, E-mail and syslog may be specified as the notice method.
- w-disk-warning**
When the drive that is not a protection (Shield) target is in a warning condition, warning level events are notified. Host sense, SNMP, E-mail and syslog may be specified as the notice method.
- w-disk-warning-hdd-shield**
When the drive that is a protection (Shield) target is in a warning condition, warning level events are notified. Host sense, SNMP, E-mail and syslog may be specified as the notice method.
- w-temperature-warning**
When the sensor detects warning level temperature, warning level events are notified. Host sense, SNMP, E-mail, and syslog may be specified as the notice method.
- w-battery-life**
When battery life will soon expire, warning level events are notified. Host sense, SNMP, E-mail, and syslog may be specified as the notice method. (only for the DX500 S3/ DX600 S3)
- w-nas-io-warning**
When NAS I/O is in Warning status, warning level events are notified. SNMP, E-mail, syslog, and AIS Connect may be specified as the notice method. This option can be specified when the NAS function is enabled.
- w-nas-connection-error**
When the NAS function is in Warning status, warning level events are notified. SNMP, E-mail, syslog, and AIS Connect may be specified as the notice method. This option can be specified when the NAS function is enabled.
- w-out-of-nas-capacity**
When the NAS volume capacity is in Warning status, warning level events are notified. SNMP, E-mail, syslog, and AIS Connect may be specified as the notice method. This option can be specified when the NAS function is enabled.
- w-nas-quota-limit-exceeded**
When the NAS quota has exceeded the threshold, warning level events are notified. SNMP, E-mail, syslog, and AIS Connect may be specified as the notice method. This option can be specified when the NAS function is enabled.

- w-nas-ex-sysvol-warning When the NAS expanded system volume is in a warning state, warning level events are notified. SNMP, E-mail, and syslog may be specified as the notice method.
- i-recovery-module When parts are recovered, information level events are notified. Host sense, SNMP, E-mail, and syslog may be specified as the notice method. When reset groups for host ports are set, only SNMP and E-mail may be specified as the notice method.
- i-temperature-restoration When the temperature sensor detects that the transition of error/warning level to normal level is occurred, information level events are notified. SNMP, E-mail, and syslog may be specified as the notice method.
- i-user-logon-logoff When the user logs on/logs off, information level events are notified. SNMP, E-mail, and syslog may be specified as the notice method.
- i-operate-raid-group When RAID groups are created or deleted, information level events are notified. SNMP, E-mail, and syslog may be specified as the notice method.
- i-add-release-hot-spare When hot spares are added or released, information level events are notified. SNMP, E-mail, and syslog may be specified as the notice method.
- i-operate-volume When volumes are created or deleted, information level events are notified. SNMP, E-mail, and syslog may be specified as the notice method.
- i-power-off-on-cfl When the ETERNUS DX/AF is rebooted or a hot controller firmware update has been executed, information level events are notified. SNMP, E-mail, and syslog may be specified as the notice method.
- i-sdp-policy-level1 When the snap data pool usage reaches the Error level of the Advanced Copy policy, information level events are notified. SNMP, E-mail, and syslog may be specified as the notice method.
- i-sdp-policy-level2 When the snap data pool usage reaches the Warning level of the Advanced Copy policy, information level events are notified. SNMP, E-mail, and syslog can be specified as the notice method. Notifications are sent when the system boot is complete. SNMP and E-mail may be specified as the notice method.
- i-sdp-policy-level3 When the snap data pool usage reaches the Information level of the Advanced Copy policy, information level events are notified. SNMP, E-mail, and syslog may be specified as the notice method.
- i-limit-copy-table When copy table usage reaches the limit, information level events are notified. SNMP, E-mail, and syslog may be specified as the notice method.
- i-expire-trial-copy-license When the trial copy license expires, information level events are notified. SNMP, E-mail, and syslog may be specified as the notice method.
- i-odx When the backup area of the ODX Buffer volume is insufficient, information level events are notified. SNMP, E-mail, and syslog may be specified as the notice method.

- i-sed-network-error-recovered**
When network connection errors with the key server are cleared, information level events are notified. SNMP, E-mail, and syslog may be specified as the notice method.
- i-fc-ca-port-link-status-changed**
When the link status of the FC port is changed, information level events are notified. E-mail, SNMP, syslog, and AIS Connect may be specified as the notice method.
- i-iscsi-ca-port-link-status-changed**
When the link status of the iSCSI port is changed, information level events are notified. E-mail, SNMP, syslog, and AIS Connect may be specified as the notice method.
- i-host-login-over** When the number of hosts that log in exceeds the defined number, information level events are notified. E-mail, SNMP, syslog, and AIS Connect may be specified as the notice method.
- i-remote-path-recovered**
When a remote path error is recovered, information level events are notified. SNMP, E-mail, syslog, AIS Connect, and REMCS may be specified as the notice method.
- i-nas-connection-status**
Information level events about the NAS function are notified. SNMP, E-mail, syslog, and AIS Connect may be specified as the notice method. This option can be specified when the NAS function is enabled.
- i-out-of-nas-capacity**
Information level events about the NAS volume capacity are notified. SNMP, E-mail, syslog, and AIS Connect may be specified as the notice method. This option can be specified when the NAS function is enabled.
- i-out-of-nas-file-management-domain**
Information level events about the NAS directory are notified. SNMP, E-mail, syslog, and AIS Connect may be specified as the notice method. This option can be specified when the NAS function is enabled.
- i-succeed-nas-snapshot**
When an acquisition of a NAS snapshot succeeds, information level events are notified. SNMP, E-mail, REMCS, syslog, and AIS Connect may be specified as the notice method.
- i-fall-below-nas-quota-limit**
When the NAS quota recovers from a state that exceeded the threshold, information level events are notified. SNMP, E-mail, syslog, and AIS Connect may be specified as the notice method. This option can be specified when the NAS function is enabled.
- i-storage-cluster-controller-connected**
When the Storage Cluster controller is recovered, information level events are notified. SNMP, E-mail, REMCS, syslog, and AIS Connect may be specified as the notice method.
- i-storage-cluster-state-auto-changed**
When the status (Active/Standby) of the Storage Cluster TFO group is switched automatically from Standby to Active, or vice versa, information level events are notified. SNMP, E-mail, REMCS, syslog, and AIS Connect may be specified as the notice method.

- i-storage-cluster-state-manual-changed**
When the status (Active/Standby) of the Storage Cluster TFO group is switched manually from Standby to Active, or vice versa, information level events are notified. SNMP, E-mail, REMCS, syslog, and AIS Connect may be specified as the notice method.
- i-nas-cpu-warning** When the NAS CPU is in a warning state, information level events are notified. SNMP, E-mail, and syslog may be specified an the notice method.
- i-nas-cpu-recovered**
When the NAS CPU recovers from the warning state, information level events are notified. SNMP, E-mail, and syslog may be specified an the notice method.
- i-nas-ex-sysvol-recovered**
When the NAS expanded system volume recovers from an abnormal or warning state, information level events are notified. SNMP, E-mail, and syslog may be specified an the notice method.
- i-nas-multipath-status**
When the status of the NAS port that configures the multipath is changed, information level events are notified. SNMP, E-mail, and syslog may be specified an the notice method.
- method** This parameter specifies the notification method. One or more methods can be specified by separating them with a comma (.). However, "remcs" and "ais" cannot be specified simultaneously.
Example: -method email,snmp (Specify "E-mail" and "SNMP")
- | | |
|--------|------------------------|
| email | E-mail |
| snmp | SNMP trap |
| host | Host sense |
| remcs | REMCS (remote support) |
| syslog | syslog |
| ais | AIS Connect |
- suppression** This parameter specifies the suppression mode. It sets whether the specified event level and notice method are notified. This parameter cannot be specified in conjunction with the preset function.

 **Caution**

Set "-suppression on" for events that should not be notified.

enable	Not notified (Suppression is enabled)
disable	Notified
disable-when-no-hs	Notified when no hot spare exists.

-host-sense-opmsg

Optional. This parameter specifies whether to also display the operator message (OPMSG) when notifying with host sense (only supported in the DX8100 S3/DX8700 S3).

This parameter can be specified if "-method" is "host" and "-suppression" is "disable" or "disable-when-on-hs".

enable	OPMSG is notified
disable	OPMSG is not notified

List of possible combinations that can be specified for "-severity"

The possible pattern combinations that can be specified for each model with each option of the "-severity" parameter is shown below.

Option	Model						
	DX60 S4/ DX60 S3	DX100 S4/ DX200 S4/ DX100 S3/ DX200 S3	DX500 S4/ DX600 S4/ DX500 S3/ DX600 S3	DX8100 S3/ DX8700 S3/ DX8900 S3	AF250 S2/ AF250	AF650 S2/ AF650	DX200F
error	x	x	x	x	x	x	x
warning	x	x	x	x	x	x	x
information	x	x	x	x	x	x	x
e-parts-error	x	x	x	x	x	x	x
e-disk-error	x	x	x	x	x	x	x
e-disk-error-hdd-shield	x	x	x	x	x	x	x
e-succeed-hdd-shield	x	x	x	x	x	x	x
e-temperature-error	x	x	x	x	x	x	x
e-battery-life	x (*1)	x (*1)	x	x	x (*1)	x	-
e-rebuild-copyback-with-redundant	x	x	x	x	x	x	x
e-rebuild-copyback-without-redundant	x	x	x	x	x	x	x
e-complete-redundant-copy	x	x	x	x	x	x	x
e-complete-redundant-copy-hdd-shield	x	x	x	x	x	x	x
e-complete-rebuild	x	x	x	x	x	x	x
e-bad-data	x	x	x	x	x	x	x
e-pinned-data	x	x	x	x	x	x	x
e-not-ready	x	x	x	x	x	x	x
e-remote-path-with-transfer	-	x	x	x	x	x	x
e-remote-path-without-transfer	-	x	x	x	x	x	x
e-halt-path	-	x	x	x	x	x	x
e-halt-overload	-	x	x	x	x	x	x
e-halt-other	-	x	x	x	x	x	x
e-tp-pool-ratio	x	x	x	x	x	x	x
e-redundant	x	x	x	x	x	x	x
e-sed-network-error	-	x	x	x	x	x	-
e-copy-session-error	x	x	x	x	x	x	x
e-nas-io-error	-	x	x	-	-	-	-
e-nas-snapshot-error	-	x	x	-	-	-	-
e-storage-cluster-controller-disconnected	-	x	x	x	x	x	x
e-nas-ex-sysvol-error	-	x	x	-	-	-	-
w-parts-warning	x	x	x	x	x	x	x
w-disk-warning	x	x	x	x	x	x	x
w-disk-warning-hdd-shield	x	x	x	x	x	x	x
w-temperature-warning	x	x	x	x	x	x	x
w-battery-life	x (*1)	x (*1)	x	x	x (*1)	x	-
w-nas-io-warning	-	x	x	-	-	-	-
w-nas-connection-error	-	x	x	-	-	-	-

Option	Model						
	DX60 S4/ DX60 S3	DX100 S4/ DX200 S4/ DX100 S3/ DX200 S3	DX500 S4/ DX600 S4/ DX500 S3/ DX600 S3	DX8100 S3/ DX8700 S3/ DX8900 S3	AF250 S2/ AF250	AF650 S2/ AF650	DX200F
w-out-of-nas-capacity	-	x	x	-	-	-	-
w-nas-quota-limit-exceeded	-	x	x	-	-	-	-
w-nas-ex-sysvol-warning	-	x	x	-	-	-	-
i-recovery-module	x	x	x	x	x	x	x
i-temperature-restoration	x	x	x	x	x	x	x
i-user-logon-logoff	x	x	x	x	x	x	x
i-operate-raid-group	x	x	x	x	x	x	x
i-power-off-on-cfl	x	x	x	x	x	x	x
i-add-release-hot-spare	x	x	x	x	x	x	x
i-operate-volume	x	x	x	x	x	x	x
i-sdp-policy-level1	x	x	x	x	x	x	x
i-sdp-policy-level2	x	x	x	x	x	x	x
i-sdp-policy-level3	x	x	x	x	x	x	x
i-limit-copy-table	x	x	x	x	x	x	x
i-expire-trial-copy-license	x	x	x	x	x	x	x
i-odx	x	x	x	x	x	x	x
i-sed-network-error-recovered	-	x	x	x	x	x	-
i-fc-ca-port-link-status-changed	x	x	x	x	x	x	x
i-iscsi-ca-port-link-status-changed	x	x	x	x	x	x	x
i-host-login-over	x	x	x	x	x	x	x
i-remote-path-recovered	-	x	x	x	x	x	x
i-nas-connection-status	-	x	x	-	-	-	-
i-out-of-nas-capacity	-	x	x	-	-	-	-
i-out-of-nas-file-management-domain	-	x	x	-	-	-	-
i-succeed-nas-snapshot	-	x	x	-	-	-	-
i-fall-below-nas-quota-limit	-	x	x	-	-	-	-
i-storage-cluster-controller-connected	-	x	x	x	x	x	x
i-storage-cluster-state-auto-changed	-	x	x	x	x	x	x
i-storage-cluster-state-manual-changed	-	x	x	x	x	x	x
i-nas-cpu-warning	-	x	x	-	-	-	-
i-nas-cpu-recovered	-	x	x	-	-	-	-
i-nas-ex-sysvol-recovered	-	x	x	-	-	-	-
i-nas-multipath-status	-	x	x	-	-	-	-

-: Cannot be specified, x: Can be specified

*1: Cannot be specified for the DX60 S3/DX100 S3/DX200 S3 or the AF250.

■ Example(s)

The following example sets the system default (when AIS Connect is disabled):

```

CLI> set event-notification -preset system-default
CLI> show event-notification
[Severity: Error Level]
-----
Parts Error          Notify          Notify          Notify(OPMSG)   -          Do not notify
Disk Error           Notify          Notify          Notify          -          Do not notify
Disk Error (HDD Shield) Do not notify  Do not notify  Do not notify  Do not notify Do not notify
Succeed HDD Shield  Do not notify  Do not notify  -              Do not notify Do not notify
Temperature Error    Notify          Notify          Notify(OPMSG)   -          Do not notify
End of battery life  Notify          Notify          Notify(OPMSG)   -          Do not notify
Rebuild/Copyback w/o redundant -              -              Notify(OPMSG)   -          Do not notify
Rebuild/Copyback w/o redundant -              -              Notify(OPMSG)   -          Do not notify
Complete Redundant Copy Do not notify  Do not notify  Do not notify  Do not notify Do not notify
Complete Redundant Copy (HDD Shield) Do not notify  Do not notify  Do not notify  Do not notify Do not notify
Complete rebuild     Notify          Notify          Notify(OPMSG)   -          Do not notify
Bad data             Notify          Notify          Notify(OPMSG)   -          Do not notify
Pinned data          Notify          Notify          Notify(OPMSG)   -          Do not notify
Not ready             Notify          Notify          Notify(OPMSG)   -          Do not notify
Remote Path Error w transfer Notify          Notify          Notify(OPMSG)   Notify      Do not notify
Remote Path Error w/o transfer Do not notify  Do not notify  Do not notify  Do not notify Do not notify
REC Buffer Halt (Path Error) Notify          Notify          -              Notify      Do not notify
REC Buffer Halt (Overload) Notify          Notify          -              Notify      Do not notify
REC Buffer Halt (Other Error) Notify          Notify          -              Notify      Do not notify
Thin Provisioning Pool Rate Notify          Notify          -              -          Do not notify
Redundant            Do not notify  Do not notify  Do not notify  Do not notify Do not notify
Copy Session Error   Do not notify  Do not notify  -              Do not notify Do not notify
SED Network Error    Notify          Notify          -              Do not notify Do not notify
NAS I/O Error        Notify          Notify          -              -          Do not notify
Disconnect Storage Cluster Controller Do not notify  Notify          -              Do not notify Do not notify
NAS EX System Volume Error Notify          Notify          -              -          Do not notify
-----
[Severity: Warning Level]
-----
Parts Warning        Notify          Notify          Notify          -          Do not notify
Disk Warning         Notify          Notify          Notify          -          Do not notify
Disk Warning (HDD Shield) Do not notify  Do not notify  Do not notify  Do not notify Do not notify
Temperature Warning  Notify          Notify          Notify          -          Do not notify
Battery life Warning Notify          Notify          Notify          -          Do not notify
NAS I/O Warning      Notify          Notify          Notify          -          Do not notify
NAS Connection Error Notify          Notify          -              -          Do not notify
Out of NAS Capacity  Notify          Notify          -              -          Do not notify
NAS Quota Limit Exceeded Notify          Notify          -              -          Do not notify
NAS EX System Volume Warning Notify          Notify          -              -          Do not notify
-----
[Severity: Information Level]
-----
Recovery module      Do not notify  Do not notify  -              -          Do not notify
Temperature restoration Do not notify  Do not notify  -              -          Do not notify
User login/logout    Do not notify  Do not notify  -              -          Do not notify
Operated RAID Group  Do not notify  Do not notify  -              -          Do not notify
Added/Released Hot Spare Do not notify  Do not notify  -              -          Do not notify
Operated Volume      Do not notify  Do not notify  -              -          Do not notify
Power off/on Apply Firmware Do not notify  Do not notify  -              -          Do not notify
SDP Usage Rate Over Lv1 Do not notify  Do not notify  -              -          Do not notify
SDP Usage Rate Over Lv2 Do not notify  Do not notify  -              -          Do not notify
SDP Usage Rate Over Lv3 Do not notify  Do not notify  -              -          Do not notify
Copy Table Size Usage Rate Over Do not notify  Do not notify  -              -          Do not notify
Trial copy license expired Notify          Notify          -              -          Do not notify
No Free Space on ODX Volume Do not notify  Do not notify  -              -          Do not notify
SED Network Error Recovered Notify          Notify          -              -          Do not notify
FC CA Port Link Status Changed Do not notify  Do not notify  -              -          Do not notify
ISCSI CA Port Link Status Changed Do not notify  Do not notify  -              -          Do not notify
Host Login Over      Do not notify  Do not notify  -              -          Do not notify
Remote Path Error Recovered Do not notify  Do not notify  -              Do not notify Do not notify
NAS Connection Status Do not notify  Do not notify  -              -          Do not notify
Out of NAS Capacity  Do not notify  Do not notify  -              -          Do not notify
Out of NAS File Management Domain Do not notify  Do not notify  -              -          Do not notify
Fall below NAS Quota Limit Do not notify  Do not notify  -              -          Do not notify
Connect Storage Cluster Controller Do not notify  Notify          -              Do not notify Do not notify
Automatic Change Storage Cluster State Notify          Notify          -              Notify      Do not notify
Manual Change Storage Cluster State Do not notify  Notify          -              Do not notify Do not notify
NAS CPU Warning      Do not notify  Do not notify  -              -          Do not notify
NAS CPU Recovered    Do not notify  Do not notify  -              -          Do not notify
NAS EX System Volume Recovered Notify          Notify          -              -          Do not notify
NAS Multipath Status Do not notify  Do not notify  -              -          Do not notify
    
```

The following example sets the system default (when AIS Connect is enabled):

```

CLI> set event-notification -preset system-default
CLI> show event-notification
[Severity: Error Level]
-----
Parts Error          Notify          Notify          Notify(OPMSG)   -          Do not notify   Notify
Disk Error          Notify          Notify          Notify          -          Do not notify   Notify
Disk Error (HDD Shield) Do not notify Do not notify Do not notify   Do not notify Do not notify   Do not notify
Succeed HDD Shield Do not notify Do not notify -              Do not notify Do not notify   Do not notify
Temperature Error  Notify          Notify          Notify(OPMSG)   -          Do not notify   Notify
End of battery life Notify          Notify          Notify(OPMSG)   -          Do not notify   Notify
Rebuild/Copyback w/ redundant -              -              Notify(OPMSG)   -          -              -
Rebuild/Copyback w/o redundant Do not notify Do not notify Do not notify   Do not notify Do not notify   Do not notify
Complete Redundant Copy Do not notify Do not notify Do not notify   Do not notify Do not notify   Do not notify
Complete Redundant Copy (HDD Shield) Notify          Notify          Notify(OPMSG)   -          Do not notify   Notify
Complete rebuild   Do not notify Do not notify Do not notify   Do not notify Do not notify   Do not notify
Bad data           Notify          Notify          Notify(OPMSG)   -          Do not notify   Notify
Pinned data        Notify          Notify          Notify(OPMSG)   -          Do not notify   Notify
Not ready          Notify          Notify          Notify(OPMSG)   -          Do not notify   Notify
Remote Path Error w transfer Do not notify Do not notify Do not notify   Do not notify Do not notify   Do not notify
Remote Path Error w/o transfer Do not notify Do not notify Do not notify   Do not notify Do not notify   Do not notify
REC Buffer Halt (Path Error) Notify          Notify          -              -          Do not notify   Notify
REC Buffer Halt (Overload) Notify          Notify          -              -          Do not notify   Notify
REC Buffer Halt (Other Error) Notify          Notify          -              -          Do not notify   Notify
Thin Provisioning Pool Rate Notify          Notify          -              -          Do not notify   Notify
Redundant          Do not notify Do not notify Do not notify   Do not notify Do not notify   Do not notify
Copy Session Error Do not notify Do not notify -              -          Do not notify   Do not notify
SED Network Error  Notify          Notify          -              -          Do not notify   Do not notify
NAS I/O Error      Notify          Notify          -              -          Do not notify   Notify
Disconnect Storage Cluster Controller Do not notify Do not notify -              -          Do not notify   Do not notify
NAS EX System Volume Error Notify          Notify          -              -          Do not notify   Notify
-----
[Severity: Warning Level]
-----
Parts Warning       Notify          Notify          Notify          -          Do not notify   Notify
Disk Warning        Notify          Notify          Notify          -          Do not notify   Notify
Disk Warning (HDD Shield) Do not notify Do not notify Do not notify   Do not notify Do not notify   Do not notify
Temperature Warning Notify          Notify          Notify          -          Do not notify   Notify
Battery life Warning Notify          Notify          Notify          -          Do not notify   Notify
NAS I/O Warning     Notify          Notify          -              -          Do not notify   Notify
NAS Connection Error Notify          Notify          -              -          Do not notify   Notify
Out of NAS Capacity Notify          Notify          -              -          Do not notify   Notify
NAS Quota Limit Exceeded Notify          Notify          -              -          Do not notify   Notify
NAS EX System Volume Warning Notify          Notify          -              -          Do not notify   -
-----
[Severity: Information Level]
-----
Recovery module     Do not notify Do not notify -              -          Do not notify   Do not notify
Temperature Restoration Do not notify Do not notify -              -          Do not notify   Do not notify
User login/logout   Do not notify Do not notify -              -          Do not notify   Do not notify
Operated RAID Group Do not notify Do not notify -              -          Do not notify   Do not notify
Added/Released Hot Spare Do not notify Do not notify -              -          Do not notify   Do not notify
Operated Volume     Do not notify Do not notify -              -          Do not notify   Do not notify
Power off/on Apply Firmware Do not notify Do not notify -              -          Do not notify   Do not notify
SDP Usage Rate Over Lv1 Do not notify Do not notify -              -          Do not notify   Do not notify
SDP Usage Rate Over Lv2 Do not notify Do not notify -              -          Do not notify   Do not notify
SDP Usage Rate Over Lv3 Do not notify Do not notify -              -          Do not notify   Do not notify
Copy Table Size Usage Rate Over Do not notify Do not notify -              -          Do not notify   Do not notify
Trial copy license expired Notify          Notify          -              -          Do not notify   Do not notify
No Free Space on ODX Volume Do not notify Do not notify -              -          Do not notify   Do not notify
SED Network Error Recovered Notify          Notify          -              -          Do not notify   Do not notify
FC CA Port Link Status Changed Do not notify Do not notify -              -          Do not notify   Do not notify
ISCSI CA Port Link Status Changed Do not notify Do not notify -              -          Do not notify   Do not notify
Host Login Over     Do not notify Do not notify -              -          Do not notify   Do not notify
Remote Path Error Recovered Do not notify Do not notify -              Do not notify Do not notify   Do not notify
NAS Connection Status Do not notify Do not notify -              -          Do not notify   Do not notify
Out of NAS Capacity Do not notify Do not notify -              -          Do not notify   Do not notify
Out of NAS File Management Domain Do not notify Do not notify -              -          Do not notify   Do not notify
Fall below NAS Quota Limit Do not notify Do not notify -              -          Do not notify   Do not notify
Connect Storage Cluster Controller Do not notify Notify          -              Do not notify Do not notify   Do not notify
Automatic Change Storage Cluster State Notify          Notify          -              Notify        Do not notify   Notify
Manual Change Storage Cluster State Do not notify Notify          -              Do not notify Do not notify   Do not notify
NAS CPU Warning     Do not notify Do not notify -              -          Do not notify   -
NAS CPU Recovered   Do not notify Do not notify -              -          Do not notify   -
NAS EX System Volume Recovered Notify          Notify          -              -          Do not notify   -
NAS Multipath Status Do not notify Do not notify -              -          Do not notify   -
    
```

The following example sets the remote service default (when AIS Connect is disabled):

```

CLI> set event-notification -preset remcs-default
CLI> show event-notification
[Severity: Error Level]
-----
Parts Error          Notify          Notify          Notify (OPMSG)  -          Do not notify
Disk Error           Notify (HS<0)  Notify (HS<0)  Do not notify  -          Do not notify
Disk Error (HDD Shield) Do not notify Do not notify  Do not notify  Do not notify Do not notify
Succeed HDD Shield  Do not notify Do not notify  Do not notify  Do not notify Do not notify
Temperature Error   Notify          Notify          Notify (OPMSG)  -          Do not notify
End of battery life Notify          Notify          Notify (OPMSG)  -          Do not notify
Rebuild/Copyback w/ redundant -              -              Do not notify  -          -
Rebuild/Copyback w/o redundant -              -              Notify (HS<0,OPMSG) -          -
Complete Redundant Copy Do not notify Do not notify  Do not notify  Do not notify Do not notify
Complete Redundant Copy (HDD Shield) Do not notify Do not notify  Do not notify  Do not notify Do not notify
Complete rebuild    Notify          Notify          Notify (OPMSG)  -          Do not notify
Bad data            Notify          Notify          Notify (OPMSG)  -          Do not notify
Pinned data         Notify          Notify          Notify (OPMSG)  -          Do not notify
Not ready            Notify          Notify          Notify (OPMSG)  -          Do not notify
Remote Path Error w transfer Notify          Notify          Notify (OPMSG)  Notify      Do not notify
Remote Path Error w/o transfer Do not notify Do not notify  Do not notify  Do not notify Do not notify
REC Buffer Halt (Path Error) Notify          Notify          -              Notify      Do not notify
REC Buffer Halt (Overload) Notify          Notify          -              Notify      Do not notify
REC Buffer Halt (Other Error) Notify          Notify          -              Notify      Do not notify
Thin Provisioning Pool Rate Notify          Notify          -              -          Do not notify
Redundant            Do not notify Do not notify  Do not notify  Do not notify Do not notify
Copy Session Error  Do not notify Do not notify  -              Do not notify Do not notify
SED Network Error   Notify          Notify          -              Do not notify Do not notify
NAS I/O Error        Notify          Notify          -              -          Do not notify
Disconnect Storage Cluster Controller Do not notify Notify          -              Do not notify Do not notify
NAS EX System Volume Error Notify          Notify          -              -          Do not notify

[Severity: Warning Level]
-----
Parts Warning        Do not notify Do not notify  Do not notify  -          Do not notify
Disk Warning         Do not notify Do not notify  Do not notify  -          Do not notify
Disk Warning (HDD Shield) Do not notify Do not notify  Do not notify  Do not notify Do not notify
Temperature Warning  Do not notify Do not notify  Do not notify  -          Do not notify
Battery life Warning Do not notify Do not notify  Do not notify  -          Do not notify
NAS I/O Warning       Do not notify Do not notify  -              -          Do not notify
NAS Connection Error Do not notify Do not notify  -              -          Do not notify
Out of NAS Capacity  Do not notify Do not notify  -              -          Do not notify
NAS Quota Limit Exceeded Do not notify Do not notify  -              -          Do not notify
NAS EX System Volume Warning Notify          Notify          -              -          Do not notify

[Severity: Information Level]
-----
Recovery module      Do not notify Do not notify  -              -          Do not notify
Temperature restoration Do not notify Do not notify  -              -          Do not notify
User login/logout    Do not notify Do not notify  -              -          Do not notify
Operated RAID Group  Do not notify Do not notify  -              -          Do not notify
Added/Released Hot Spare Do not notify Do not notify  -              -          Do not notify
Operated Volume      Do not notify Do not notify  -              -          Do not notify
Power off/on Apply Firmware Do not notify Do not notify  -              -          Do not notify
SDP Usage Rate Over Lv1 Do not notify Do not notify  -              -          Do not notify
SDP Usage Rate Over Lv2 Do not notify Do not notify  -              -          Do not notify
SDP Usage Rate Over Lv3 Do not notify Do not notify  -              -          Do not notify
Copy Table Size Usage Rate Over Do not notify Do not notify  -              -          Do not notify
Trial copy license expired Notify          Notify          -              -          Do not notify
No Free Space on ODX Volume Do not notify Do not notify  -              -          Do not notify
SED Network Error Recovered Notify          Notify          -              -          Do not notify
FC CA Port Link Status Changed Do not notify Do not notify  -              -          Do not notify
ISCSI CA Port Link Status Changed Do not notify Do not notify  -              -          Do not notify
Host Login Over      Do not notify Do not notify  -              -          Do not notify
Remote Path Error Recovered Do not notify Do not notify  -              Do not notify Do not notify
NAS Connection Status Do not notify Do not notify  -              -          Do not notify
Out of NAS Capacity  Do not notify Do not notify  -              -          Do not notify
Out of NAS File Management Domain Do not notify Do not notify  -              -          Do not notify
Fall Below NAS Quota Limit Do not notify Do not notify  -              -          Do not notify
Connect Storage Cluster Controller Do not notify Notify          -              Do not notify Do not notify
Automatic Change Storage Cluster State Notify          Notify          -              Notify      Do not notify
Manual Change Storage Cluster State Do not notify Notify          -              Do not notify Do not notify
NAS CPU Warning       Do not notify Do not notify  -              -          Do not notify
NAS CPU Recovered     Do not notify Do not notify  -              -          Do not notify
NAS EX System Volume Recovered Notify          Notify          -              -          Do not notify
NAS Multipath Status Do not notify Do not notify  -              -          Do not notify
    
```

The following example sets the remote service default (when AIS Connect is enabled):

```

CLI> set event-notification -preset remcs-default
CLI> show event-notification
[Severity: Error Level]
-----
Parts Error          Notify          Notify          Notify(OPMSG)   -          Do not notify   Notify
Disk Error          Notify(HS<0)  Notify(HS<0)   Do not notify  -          Do not notify   Notify(HS<0)
Disk Error (HDD Shield) Do not notify Do not notify Do not notify  Do not notify Do not notify Do not notify
Succeed HDD Shield Do not notify Do not notify -             Do not notify Do not notify Do not notify
Temperature Error  Notify         Notify         Notify(OPMSG)  -          Do not notify   Notify
End of battery life Notify         Notify         Notify(OPMSG)  -          Do not notify   Notify
Rebuild/Copyback w/ redundant -             -             Do not notify -          -              -
Rebuild/Copyback w/o redundant Do not notify Do not notify Notify(HS<0,OPMSG) Do not notify Do not notify Notify
Complete Redundant Copy Do not notify Do not notify Do not notify Do not notify Do not notify Do not notify
Complete Redundant Copy (HDD Shield) Do not notify Do not notify Do not notify Do not notify Do not notify Do not notify
Complete rebuild  Notify         Notify         Notify(OPMSG)  -          Do not notify   Notify
Bad data          Notify         Notify         Notify(OPMSG)  -          Do not notify   Notify
Pinned data       Notify         Notify         Notify(OPMSG)  -          Do not notify   Notify
Not ready         Notify         Notify         Notify(OPMSG)  -          Do not notify   Notify
Remote Path Error w transfer Notify         Notify         Notify(OPMSG)  -          Do not notify   Notify
Remote Path Error w/o transfer Do not notify Do not notify Do not notify Do not notify Do not notify Do not notify
REC Buffer Halt (Path Error) Notify         Notify         -             Notify      Do not notify   Notify
REC Buffer Halt (Overload) Notify         Notify         -             Notify      Do not notify   Notify
REC Buffer Halt (Other Error) Notify         Notify         -             Notify      Do not notify   Notify
Thin Provisioning Pool Rate Notify         Notify         -             -          Do not notify   Do not notify
Redundant         Do not notify Do not notify Do not notify Do not notify Do not notify Do not notify
Copy Session Error Do not notify Do not notify -             Do not notify Do not notify Do not notify
SED Network Error Notify         Notify         -             Do not notify Do not notify Do not notify
NAS I/O Error     Notify         Notify         -             -          Do not notify   Notify
Disconnect Storage Cluster Controller Do not notify Do not notify -             Do not notify Do not notify Do not notify
NAS EX System Volume Error Notify         Notify         -             Do not notify Do not notify Do not notify
-----
[Severity: Warning Level]
-----
Parts Warning       Do not notify Do not notify Do not notify -          Do not notify Do not notify
Disk Warning       Do not notify Do not notify Do not notify -          Do not notify Do not notify
Disk Warning (HDD Shield) Do not notify Do not notify Do not notify Do not notify Do not notify Do not notify
Temperature Warning Do not notify Do not notify Do not notify -          Do not notify Do not notify
Battery life Warning Do not notify Do not notify Do not notify -          Do not notify Do not notify
NAS I/O Warning    Do not notify Do not notify -             -          Do not notify Do not notify
NAS Connection Error Do not notify Do not notify -             -          Do not notify Do not notify
Out of NAS Capacity Do not notify Do not notify -             -          Do not notify Do not notify
NAS Quota Limit Exceeded Do not notify Do not notify -             -          Do not notify Do not notify
NAS EX System Volume Warning Notify         Notify         -             -          Do not notify -
-----
[Severity: Information Level]
-----
Recovery module    Do not notify Do not notify -          -          Do not notify Do not notify
Temperature Restoration Do not notify Do not notify -          -          Do not notify Do not notify
User login/logout  Do not notify Do not notify -          -          Do not notify Do not notify
Operated RAID Group Do not notify Do not notify -          -          Do not notify Do not notify
Added/Released Hot Spare Do not notify Do not notify -          -          Do not notify Do not notify
Operated Volume    Do not notify Do not notify -          -          Do not notify Do not notify
Power off/on Apply Firmware Do not notify Do not notify -          -          Do not notify Do not notify
SDP Usage Rate Over Lv1 Do not notify Do not notify -          -          Do not notify Do not notify
SDP Usage Rate Over Lv2 Do not notify Do not notify -          -          Do not notify Do not notify
SDP Usage Rate Over Lv3 Do not notify Do not notify -          -          Do not notify Do not notify
Copy Table Size Usage Rate Over Do not notify Do not notify -          -          Do not notify Do not notify
Trial copy license expired Notify         Notify         -          -          Do not notify Do not notify
No Free Space on ODX Volume Do not notify Do not notify -          -          Do not notify Do not notify
SED Network Error Recovered Do not notify Do not notify -          -          Do not notify Do not notify
FC CA Port Link Status Changed Do not notify Do not notify -          -          Do not notify Do not notify
ISCSI CA Port Link Status Changed Do not notify Do not notify -          -          Do not notify Do not notify
Host Login Over    Do not notify Do not notify -          -          Do not notify Do not notify
Remote Path Error Recovered Do not notify Do not notify -          Do not notify Do not notify Do not notify
NAS Connection Status Do not notify Do not notify -          -          Do not notify Do not notify
Out of NAS Capacity Do not notify Do not notify -          -          Do not notify Do not notify
Out of NAS File Management Domain Do not notify Do not notify -          -          Do not notify Do not notify
Fall below NAS Quota Limit Do not notify Do not notify -          -          Do not notify Do not notify
Connect Storage Cluster Controller Do not notify Do not notify -          Do not notify Do not notify Do not notify
Automatic Change Storage Cluster State Notify         Notify         -          Do not notify Do not notify Do not notify
Manual Change Storage Cluster State Do not notify Do not notify -          Do not notify Do not notify Do not notify
NAS CPU Warning    Do not notify Do not notify -          -          Do not notify -
NAS CPU Recovered  Do not notify Do not notify -          -          Do not notify -
NAS EX System Volume Recovered Notify         Notify         -          -          Do not notify -
NAS Multipath Status Do not notify Do not notify -          -          Do not notify -
    
```

The following example sets up the parameters for an event notification. The notification method is E-mail. All events with Warning level are notified.

```

CLI> set event-notification -severity warning -method email -suppression disable
    
```

The following example sets up the parameters used for event notification. The notification methods are E-mail and SNMP trap. All events with Warning level or Error level are notified.

```

CLI> set event-notification -severity error,warning -method email,snmp -suppression disable
    
```

show lcd-suppress

This command displays the display suppression state for the LCD message of the operation panel. This command can only be used for the DX8700 S3/DX8900 S3.

Syntax

```
show lcd-suppress
```

Parameter

No parameters.

Output

Item	Description
Parts Error	Indicates whether the error display for the components (other than the drives) is displayed on the LCD. (Display: Displayed, Suppress: Not displayed)
Parts Warning	Indicates whether the warning display for the components (other than the drives) is displayed on the LCD. (Display: Displayed, Suppress: Not displayed)
Disk Error	Indicates whether the error display for the drives is displayed on the LCD. (Display: Displayed, Suppress: Not displayed regardless of the number of hot spares left, Display (HS<0): Not displayed when hot spares are left)
Disk Warning	Indicates whether the warning display for the drives is displayed on the LCD. (Display: Displayed, Suppress: Not displayed regardless of the number of hot spares left, Display (HS<0): Not displayed when hot spares are left)

Example(s)

The following example displays the status of the LCD display suppression:

```
CLI> show lcd-suppress
Parts Error           [Display]
Parts Warning        [Suppress]
Disk Error           [Display (HS<0)]
Disk Warning         [Display]
```

set lcd-suppress

This command sets the display suppression for the LCD message of the control panel. This command can only be used for the DX8700 S3/DX8900 S3.

■ Syntax

```
set lcd-suppress [-parts-error {enable | disable}] [-parts-warning {enable | disable}]  
[-disk-error {enable | disable | disable-when-no-hs}]  
[-disk-warning {enable | disable | disable-when-no-hs}]
```

■ Parameter

- parts-error** Optional. This parameter specifies whether to suppress the error display for the components (other than the drives) on the LCD. If omitted, the existing setting is not changed.
- enable** Error display suppression is set for the components (other than the drives). The error display is not displayed on the LCD.
 - disable** Error display suppression is canceled for the components (other than the drives).
- parts-warning** Optional. This parameter specifies whether to suppress the warning display for the components (other than the drives) on the LCD. If omitted, the existing setting is not changed.
- enable** Warning display suppression is set for the components (other than the drives). The warning display is not displayed on the LCD.
 - disable** Warning display suppression is canceled for the components (other than the drives).
- disk-error** Optional. This parameter specifies whether to suppress the error display for the drives on the LCD. If omitted, the existing setting is not changed.
- enable** Error display suppression is set for the drives. The error display is not displayed on the LCD regardless of the number of hot spares left.
 - disable** Error display suppression is canceled for the drives.
 - disable-when-no-hs** Error display suppression is set for the drives when a hot spare exists. A disk error is displayed on the LCD when no hot spares are left.
- disk-warning** Optional. This parameter specifies whether to suppress the warning display for the drives on the LCD. If omitted, the existing setting is not changed.
- enable** Warning display suppression is set for the drives. The warning display is not displayed on the LCD regardless of the number of hot spares left.
 - disable** Warning display suppression is canceled for the drives.
 - disable-when-no-hs** Error display suppression is set for the drives when a hot spare exists. A disk warning is displayed on the LCD when no hot spares are left.

■ Example(s)

The following example sets LCD display suppression:

```
CLI> set lcd-suppress -parts-error enable -parts-warning enable -disk-error enable -disk-warning enable
```

5.2.5 SMI-S

This section explains the commands relating to the SMI-S function.

show smi-s

This command displays the setting of the SMI-S function and the SMI-S performance information response.

■ Syntax

```
show smi-s
```

■ Parameter

No parameters.

■ Output

Item name	Description
Current	Indicates whether or not all of the SMI-S functions are currently enabled. (Enable / Disable / Error)
Performance Information	Indicates whether or not the SMI-S performance information response is enabled. (Enable / Disable / -) If the SMI-S is in the error state, a hyphen (-) is displayed.

■ Example(s)

The following example displays whether or not the SMI-S function and the SMI-S performance information response are enabled:

```
CLI> show smi-s  
SMI-S [Enable]  
Performance Information [Disable]
```

set smi-s

This command enables or disables the SMI-S function and the SMI-S performance information response.

Caution

The SMI-S setting cannot be changed for the following cases.

- The state of the ETERNUS DX/AF is Not Ready
- There are CMs whose status is not Normal

■ Syntax

```
set smi-s [-function {enable | disable}] [-performance-information {enable | disable}]
```

■ Parameter

-function Optional. This parameter specifies whether all SMI-S functions are enabled or not. The initial value is "disable". If omitted, the existing setting is not changed.

enable Each SMI-S function is enabled.

disable Each SMI-S function is disabled (default).

-performance-information

Optional. This parameter specifies whether to enable the performance information response of SMI-S. If enabled, the performance information can be acquired through SMI-S. The default value is "disable". If omitted, the existing setting is not changed.

Caution

- If the SMI-S function is disabled, this parameter reverts to the initial value (disable).
- If the SMI-S function is "disable", this parameter cannot be changed to "enable".
- If the GS license is registered, this parameter cannot be changed to "enable".
- If the performance information response of SMI-S is enabled, use the "start performance" command to start an acquisition of the performance information.

enable The performance information response is enabled.

disable The performance information response is disabled (default).

■ Example(s)

The following example disables all the SMI-S functions:

```
CLI> set smi-s -function disable
```

5.2.6 SSH/SSL Security Configuration

This section explains the commands related to setting up SSH/SSL security. The following items can be configured:

- Registration of the SSH server key
- Registration of the SSL server key and SSL server certificate
- Exporting the Certificate Signing Request (CSR) and server key file
- Registration of the signed SSL server certificate according to the certification provider

■ Summary of how to register SSL certification

There are two methods for SSL certification; a self-signed certificate and a certificate that is signed by the certificate provider.

The steps involved in registering a certificate that is signed by the certificate provider using CLI are as follows:

Procedure

- 1** Generate and export Certificate Signing Request (CSR).
Use the "create ssl-certificate-request" command to generate and export a CSR for a signed certificate from the certificate provider. This command generates and exports a CSR and a server key. The server key should be hidden from other keys.
- 2** Send CSR to certificate provider and receive signed certificate.
Send the exported CSR to the certificate provider to sign. A signed certificate will be returned from the provider.
- 3** Register the signed certificate.
To register, use the "import ssl-certificate" command to import the received signed certificate and the server key generated in [Step 1](#).

End of procedure

Use the "create ssl-certificate" command to register a self-signed certificate.

The following figure shows how to register the certificate:

Figure 5.2 How to register the SSL certificate

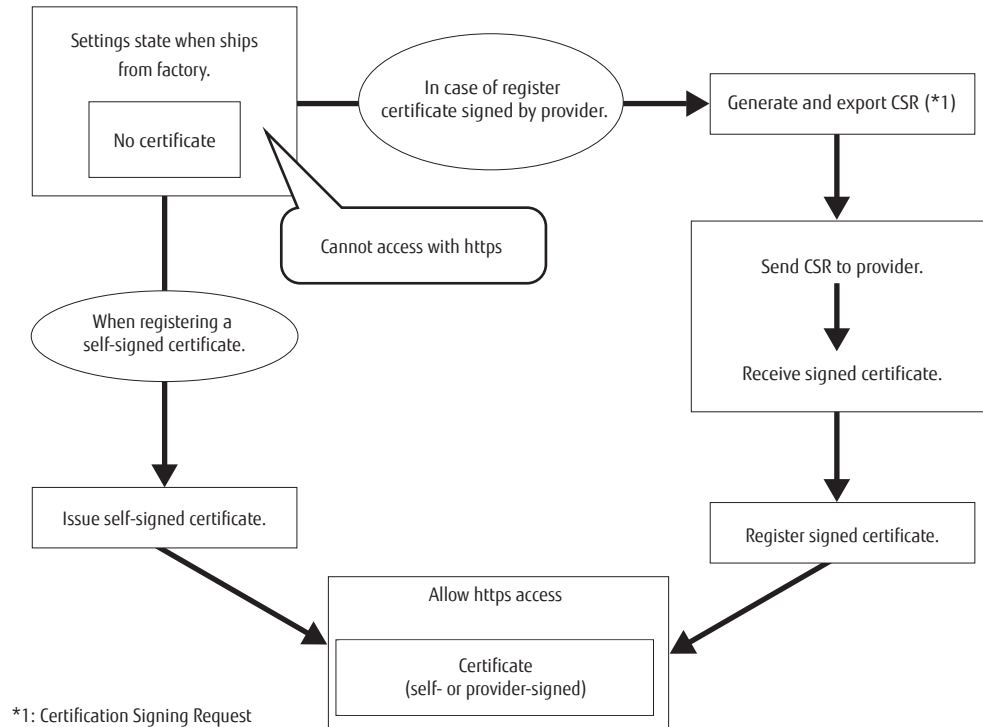

create ssh-server-key

This command renews and registers an SSH (Secure Shell) server key. Once this command is executed, connection via ssh is possible after five minutes have elapsed.

Caution

For controller firmware versions V10L60 and later, because keys that are generated with this command are RSA keys only, "ssh-dss" cannot be used as the host key algorithm. Use "ssh-rsa" instead.

■ Syntax

```
create ssh-server-key [-key-length {1024 | 2048 | 4096}]
```

■ Parameter

-key-length Optional. This parameter specifies the bit length of the generating SSH server key. Only one value can be specified. If this parameter is omitted, 2048 (default value) is used for the key length.

1024	Key length is 1,024bits.
2048	Key length is 2,048bits. (Default value)
4096	Key length is 4,096bits.

■ Example(s)

The following example renews the SSH server key with a key length of 2048bits:

```
CLI> create ssh-server-key -key-length 2048
```

create ssl-certificate

This command renews and registers an SSL (Secure Socket Layer) server key and an SSL server certificate.

■ Syntax

```
create ssl-certificate [-key-length {1024 | 2048 | 4096}]  
-common-name common_name [-subject-alt-name altname1,altname2...]
```

■ Parameter

-key-length Optional. This parameter specifies the bit length of the generating SSL server key. Only one value can be specified.
If this parameter is omitted, 2048 (default value) is used for the key length.

1024	Key length is 1,024bits.
2048	Key length is 2,048bits. (Default value)
4096	Key length is 4,096bits.

-common-name

This parameter specifies an IP address or domain name that accesses HTTPS for the MNT port or the RMT port. The IP address should be written in IPv4 standard notation (a base 256 "d.d.d.d" string) or IPv6 address format. The domain name should be written in full-domain notation (FQDN). Only one value should be specified for this parameter.

Example:

```
foo.var  
192.168.1.1  
2001:1b::430:db0
```

Caution

Abbreviated notations are recommended when inputting an IPv6 address. This is because some browsers support only abbreviated notations.

common_name IP address or domain name that can access HTTPS

-subject-alt-name

Optional. This parameter specifies the IP address and/or domain name that can access HTTPS for the MNT port or the RMT port. The IP address should be written in standard notation (string specified forming d.d.d.d 256base notation) or IPv6 address format. The domain name should be written in full-domain notation (FQDN). The string length of all the FQDNs or IP addresses with these parameters delimiters should be within 511bytes.

Example:

```
foo.var.com (11bytes) Correct  
foo.var.com, 192.168.1.1 ← (11 +1 +11bytes) Correct  
jugemujugem...co.jp ← (511bytes) Correct  
jugemujugemu...co.jp ← (512bytes) Incorrect  
jugemujugem...co.jp, foo.var.com ← (511 +1 +11bytes) Incorrect
```

altname1,altname2 IP address and/or domain name that can access HTTPS

■ Example(s)

The following example renews and registers the SSL server certificate:

```
CLI>create ssl-certificate -key-length 2048 -common-name eternus.example.com -subject-alt-name eternus.example.com,  
eternusmnt.example.com, 172.16.1.11
```

export ssl-certificate-request

This command exports the CSR (Certificate Signing Request) file and server key file that were generated to send to the certificate provider.

■ Syntax

```
export ssl-certificate-request -port {maintenance | remote | fst} -server server_name  
-user login_user_account [-csr-filename csr-filename] [-key-filename key-filename]  
[-key-length {1024 | 2048 | 4096}] -country-name country_name  
-state-province-name state_province_name -locality-name locality_name  
-organization-name organization_name -organization-unit-name organization_unit_name  
-common-name common_name [-subject-alt-name altname1,altname2...]  
[-indicator {enable | disable}]
```

■ Parameter

- port This parameter specifies which Ethernet port is used to connect to the FTP server. For details, refer to ["1.11 Note for Specifying FTP Server" \(page 54\)](#).
- | | |
|-------------|---|
| maintenance | Maintenance port (MNT port) |
| remote | Remote port (RMT port) |
| fst | FST port (DX500 S4/DX600 S4, DX500 S3/DX600 S3, DX8100 S3/DX8700 S3/DX8900 S3, and AF650 S2/AF650 only) |
- server This parameter specifies the name of the FTP server on which the CSR/key file are loaded. The server name should be in IPv4 standard notation (a base 256 "d.d.d.d" string) format, IPv6 address format or a fully qualified domain name (FQDN).
- Example: -server 192.168.1.20
Example: -server fd80::abd0:223:ad
Example: -server foo.bar
- | | |
|--------------------|-----------------|
| <i>server_name</i> | FTP server name |
|--------------------|-----------------|
- user This parameter specifies the user account name for access to the FTP server. This command displays an FTP server password prompt.
- login_user_account* User account name
- csr-filename Optional. This parameter specifies the filename to store the CSR file. If omitted, "server.csr" (default name) is used. If the same filename already exists, it is overwritten.

csr-filename Name of the file to store the CSR file
The following conversion specifications, which begin with a percent character, are replaced by their corresponding values at execution time.
If other conversion strings are specified, this command terminates abnormally with an error message.

%s	Serial number of the system Example: server_%s.csr ® server_123456789012.csr
%d	Current date Example: server_%d.csr ® server_20100316.csr (March 16, 2010)
%t	Current time Example: server_%t.csr ® server_123456.csr (12:34:56)
%%	Percent character Example: server%%.csr ® server%.csr

-key-filename

Optional. This parameter specifies the filename to store the key file. If omitted, "server.key" (default file) is used. If the same filename already exists, it is overwritten.

key-filename Name of the file to store the key file
The following conversion specifications, which begin with a percent character, are replaced by their corresponding value at the time of execution.
If other conversion strings are specified, this command terminates abnormally with an error message.

%s	Serial number of the system Example: server_%s.key ® server_123456789012.key
%d	Current date Example: server_%d.key ® server_20100316.key (March 16, 2010)
%t	Current time Example: server_%t.key ® server_123456.key (12:34:56)
%%	Percent character Example: server%%.key ® server%.key

-key-length Optional. This parameter specifies the bit length of the generating SSL server key. Only one value can be specified. If this parameter is omitted, 2048 (default value) is used for the key length.

1024	Key length is 1,024bits.
2048	Key length is 2,048bits. (Default value)
4096	Key length is 4,096bits.

-country-name

Specify a country using two uppercase characters. "JP" indicates Japan. For other countries, refer to ISO3166-1.

country_name Country name

-state-province-name

Specify the state where the organization is located. Up to 63 characters can be specified.

state_province_name State name

-locality-name

Specify the area where the organization is located. Up to 63 characters can be specified.

locality_name Area name

-organization-name

Specify the organization name. Up to 63 characters can be specified.

organization_name Organization name

-organization-unit-name

Specify the department name of the organization. Up to 63 characters can be specified.

organization_unit_name Department name of the organization.

-common-name

This parameter specifies an IP address or domain name that accesses HTTPS for the MNT port or the RMT port. The IP address should be written in IPv4 standard notation (a base 256 "d.d.d.d" string) or IPv6 address format. The domain name should be written in full-domain notation (FQDN). Only one parameter can be specified.

Example:

foo.var

192.168.1.1

2001:1b::430:db0

common_name IP address or domain name that accesses HTTPS

-subject-alt-name

Optional. This parameter specifies the IP address or domain name that can access HTTPS for the MNT port or the RMT port. To specify the SNMP manager IP address, use IPv4 standard notation (a base 256 "d.d.d.d" string), the IPv6 address format, or fully qualified domain name (FQDN). One or more FQDNs or IP addresses can be specified. The string length of all the FQDNs or IP addresses with this parameter delimiters should be within 511 bytes.

Example:

foo.var.com ← (11 bytes) Correct

foo.var.com, 192.168.1.1 ← (11 + 1 + 11 bytes) Correct

jugemujugem...co.jp ← (511 bytes) Correct

jugemujugemu...co.jp ← (512 bytes) Incorrect

jugemujugem...co.jp, foo.var.com ← (511 + 1 + 11 bytes) Incorrect

altname1, altname2... IP address or domain name that can access HTTPS

-indicator Optional. This parameter specifies whether the progress indicator is displayed. If omitted, the progress indicator is displayed.

 enable Progress indicator is displayed.

 disable Progress indicator is not displayed.

■ Example(s)

The following example generates and exports the CSR and the server key:

```
CLI> export ssl-certificate-request -port maintenance -server ftp.example.com -user tornado -key-length 2048 -country-  
name JP -state-province-name Nagano -locality-name Nagano -organization-name FJL -organization-unit-name Eternus -common-  
name Eternus0001.example.com  
Password :  
exporting ./server.csr to ftp.example.com  
Password :  
exporting ./server.key to ftp.example.com  
complete.
```

import ssl-certificate

This command imports and registers the SSL server certificate that is signed by the certificate provider.

■ Syntax

```
import ssl-certificate -port {maintenance | remote | fst} -server server_name  
-user login_user_account [-cert-filename cert-filename]  
[-key-filename key-filename] [-indicator {enable | disable}]
```

■ Parameter

- port** This parameter specifies which Ethernet port is used to connect to the FTP server. For further information, refer to ["1.11 Note for Specifying FTP Server" \(page 54\)](#).
- | | |
|--------------------|---|
| <i>maintenance</i> | Maintenance port (MNT port) |
| <i>remote</i> | Remote port (RMT port) |
| <i>fst</i> | FST port (DX500 S4/DX600 S4, DX500 S3/DX600 S3, DX8100 S3/DX8700 S3/DX8900 S3, and AF650 S2/AF650 only) |
- server** This parameter specifies the name of the FTP server on which the certificate and key file are stored. The server name should be in IPv4 standard notation (a base 256 "d.d.d.d" string) format, IPv6 address format or a fully qualified domain name (FQDN).
- Example: -server 192.168.1.20
Example: -server fd80::abd0:223:ad
Example: -server foo.bar
- | | |
|--------------------|-----------------|
| <i>server_name</i> | FTP server name |
|--------------------|-----------------|
- user** This parameter specifies a user account name for access to the FTP server. This command displays an FTP server password prompt.
- | | |
|---------------------------|-------------------|
| <i>login_user_account</i> | User account name |
|---------------------------|-------------------|
- cert-filename** Optional. This parameter specifies the filename to load the certificate file. If omitted, "server.crt" (default file) is used. If the same file already exists, it is overwritten.
- | | |
|----------------------|---------------------------------------|
| <i>cert-filename</i> | Filename to load the certificate file |
|----------------------|---------------------------------------|
- key-filename** Optional. This parameter specifies the filename to load the certificate and the key file. If omitted, "server.key" (default file) is used. If the same file already exists, it is overwritten.
- | | |
|---------------------|---|
| <i>key-filename</i> | Filename to load the certificate and the key file |
|---------------------|---|
- indicator** Optional. This parameter specifies whether the progress indicator is displayed. If omitted, the progress indicator is displayed.
- | | |
|----------------|--------------------------------------|
| <i>enable</i> | Progress indicator is displayed. |
| <i>disable</i> | Progress indicator is not displayed. |

■ Example(s)

The following example imports and registers the signed certificate and the server key:

```
CLI> import ssl-certificate -port maintenance -server ftp.example.com -user cli-user -cert-filename server.cert  
-key-filename server.key
```

show ssl-version

This command displays the SSL version that can be used with SSL communication.

■ Syntax

```
show ssl-version
```

■ Parameter

No parameters.

■ Output

Item name	Description
Protocol	Protocol for performing communication with SSL (application service) For Ethernet ports whose connections are set to disable (close) with the firewall setting, regardless of what is displayed by this command, SSL communication cannot be used.
HTTPS(GUI)	SSL version used with Web GUI communication
HTTPS(SMI-S)	SSL version used with SMI-S communication
Maintenance-Secure	SSL version used with ETERNUS SF communication
TLS1.0	Usability of TLS1.0 (Enable / -)
TLS1.1	Usability of TLS1.1 (Enable / -)
TLS1.2	Usability of TLS1.2 (Enable / -)

■ Example(s)

The following example displays the SSL version that can be used with SSL communication:

```
CLI> show ssl-version
Protocol          TLS1.0  TLS1.1  TLS1.2
-----
HTTPS (GUI)      -       -       Enable
HTTPS (SMI-S)   -       Enable  Enable
Maintenance-Secure -       Enable  Enable
```

set ssl-version

This command changes the setting of the SSL version that can be used for SSL communication.

Caution

For Ethernet ports whose connections are set to disable (close) with the firewall setting, regardless of what is displayed by this command, SSL communication cannot be used.

■ Syntax

```
set ssl-version -protocol {https-gui | https-smi-s | maintenance-secure | all}  
-version {tls1.0 | tls1.1 | tls1.2 | all} -enable {yes | no}
```

■ Parameter

-protocol	This parameter specifies the protocol (application service) for changing the SSL version setting. Multiple protocols cannot be specified. To change all the protocol settings together, specify "all".
https-gui	Web GUI
https-smi-s	SMI-S
maintenance-secure	ETERNUS Maintenance Secure (such as monitoring software)
all	All protocols (such as Web GUI, SMI-S, ETERNUS SF)
-version	This parameter specifies the version of the SSL for changing the setting. Multiple versions cannot be specified. To change all the SSL version settings together, specify "all".
tls1.0	TLS1.0
tls1.1	TLS1.1
tls1.2	TLS1.2
all	All versions (TLS1.0, TLS1.1, TLS1.2)
-enable	This parameter specifies the SSL communication usability of the SSL version that is specified with the "-version" parameter.

Caution

If the setting does not allow the use of all SSL versions, SSL communication from the protocol that was set with the "-protocol" parameter becomes unusable.

yes	SSL communication for the specified version can be used.
no	SSL communication for the specified version cannot be used.

■ Example(s)

The following example changes the setting so that only TLS1.2 SSL communication can be used with all protocols:

```
CLI> set ssl-version -protocol all -version all -enable no  
CLI> set ssl-version -protocol all -version tls1.2 -enable yes
```

The following example sets the version of SSL that can be used with Web GUI to TLS1.2 only and sets the version of SSL that can be used with protocols other than Web GUI to TSL1.1 and later:

```
CLI> set ssl-version -protocol all -version all -enable yes
CLI> set ssl-version -protocol https-gui -version tls1.0 -enable no
CLI> set ssl-version -protocol https-gui -version tls1.1 -enable no
CLI> set ssl-version -protocol https-smi-s -version tls1.0 -enable no
CLI> set ssl-version -protocol maintenance-secure -version tls1.0 -enable no
```

5.2.7 AIS Connect Settings

AIS Connect is a remote support service function that monitors/remotely controls the ETERNUS DX/AF storage systems from a remote server (an AIS Connect server). AIS Connect and REMCS cannot be used simultaneously.

Note

When performing the AIS Connect setting for the ETERNUS DX/AF for the first time, agreeing to the terms and conditions must be performed via GUI. This agreement cannot be performed via CLI.

This section explains the commands to set up the AIS Connect function.

- Setting the AIS Connect operating environment
- Setting the AIS Connect remote session
- Checking the connection of the AIS Connect server
- AIS Connect manual log transmission
- AIS Connect test event notification
- Registering the SSL server certification
- Enabling the GUI menu display (REMCS settings and AIS Connect settings)

Switching from AIS Connect operations to REMCS operations

The procedure for switching remote support operations from AIS Connect to REMCS is as follows.

Procedure

- 1 Enable the REMCS menu display with the "set remote-support-mode" command.
- 2 Set AIS Connect to disable with the "set ais-connect" command.
- 3 Configure REMCS using GUI.

 End of procedure

show ais-connect

This command displays the AIS Connect operation environment.

■ Syntax

```
show ais-connect
```

■ Parameter

No parameters.

■ Output

Item name	Description
AIS Connect Function	Indicates whether the AIS Connect function is enabled.
Port	LAN port on the ETERNUS DX/AF that communicates with the AIS Connect server
Automatic Log Transmission	Indicates whether logs are automatically sent.
Country Of Installation	Code and name of the country where the ETERNUS DX/AF is shipped. If it is not set, a hyphen (-) is displayed.
Service Contract Responsibility	Code and name of the country in which the support office for the ETERNUS DX/AF is located. If it is not set, "Undefined" is displayed.
SSL Server Certification	Indicates whether server certification is enabled.
Proxy Server	FQDN or IP address (IPv4) of the proxy server. If it is not set, a hyphen (-) is displayed.
Proxy Port Number	Proxy server port number. If it is not set, a hyphen (-) is displayed.
Proxy Type	Type of communication with the proxy server (HTTP / SOCKS). If it is not set, a hyphen (-) is displayed.
Proxy User Name	User name for proxy authentication
Remote Session	Indicates whether a remote session from the AIS Connect server to the ETERNUS DX/AF is allowed.
Remote Session Timeout(hour)	Timeout interval for remote sessions. A number between 1 to 24 or "Unlimited" is displayed.
Issuer Name	Issuer name
Valid From	Starting date of the validity period
Valid To	Ending date of the validity period

■ Example(s)

The following example displays the operation environment of AIS Connect:

```
CLI> show ais-connect
AIS Connect Function      [Enable]
Port                     [MNT]
Automatic Log Transmission [Enable]
Country Of Installation  [392 (JAPAN)]
Service Contract Responsibility [392 (JAPAN)]
SSL Server Certification  [Use]
Proxy Server              [foo.bar]
Proxy Port Number        [123]
Proxy Type                [HTTP]
Proxy User Name           [User1]
Remote Session            [Permit]
Remote Session Timeout(hour) [3]
<Trusted Root Certification Authorities>
Issuer Name               [Fujitsu Certification Authority]
Valid From                 [2012-08-17 13:04:47]
Valid To                   [2015-08-17 13:04:47]

Issuer Name               [Fujitsu Certification Authority2]
Valid From                 [2012-08-17 13:04:47]
Valid To                   [2015-08-17 13:04:47]
```

set ais-connect

This command sets up the AIS Connect operation environment. If the "REMCS function" is running or "E-mail log send mode" is enabled, the AIS Connect function cannot be enabled.

Syntax

```
set ais-connect  
[-function {enable | disable}] [-port {maintenance | remote}] [-send-log {enable | disable}]  
[-country-code country-code] [-server-certification {enable | disable}] [-proxy-server {proxy-server | ""}]  
[-proxy-port-number proxy-port-number] [-proxy-type {http | socks}] [-user-name {user-name | ""}]
```

Parameter

- function** Optional. This parameter specifies whether to enable the AIS Connect function. If omitted, the existing setting is not changed.
- enabled The AIS Connect function is enabled.
 - disable The AIS Connect function is disabled.
- port** Optional. This parameter specifies which LAN port is used to communicate with the AIS Connect server. This parameter cannot be specified when the AIS Connect function is disabled. If omitted, the existing setting is not changed.
- maintenance Maintenance port (MNT port)
 - remote Remote port (RMT port)
- send-log** Optional. This parameter specifies whether to automatically collect logs and send them to the AIS Connect server when a failure (Error/Warning) occurs. This parameter cannot be specified when the AIS Connect function is disabled or "Undefined" is displayed for "Service Contract Responsibility" (the code of the country in which the support office for the ETERNUS DX/AF is located). If omitted, the existing setting is not changed.
- enabled Logs are automatically sent.
 - disable Logs are not automatically sent.
- country-code** Optional. This parameter specifies the shipment destination of the ETERNUS DX/AF (the country where the ETERNUS DX/AF is located). Specify a value that is listed in ["Country code list"](#). This parameter cannot be specified when the AIS Connect function is disabled. This parameter must be specified when the AIS Connect function is enabled. If omitted, the existing setting is not changed.
- country-code* Country code
- server-certification** Optional. This parameter specifies whether to enable server certification for SSL/TLS communication between the ETERNUS DX/AF and the AIS Connect server. This parameter cannot be specified when the AIS Connect function is disabled. If omitted, the existing setting is not changed.
- enabled Server certification is enabled (default).
 - disable Server certification is disabled.

-proxy-server

Optional. This parameter specifies the proxy server. Only one proxy server can be specified at the same time. The server name format should be either IPv4 standard notation (a base 256 "d.d.d.d" string) or a fully qualified domain name (FQDN). Up to 63 alphanumeric characters can be specified. When a proxy server is not used, specify a null character (""). If consecutive double quotations (""") are specified, the proxy port number, the proxy type, and the user name are initialized. When the AIS Connect function is disabled, only a null character (""") can be specified. If omitted, the existing setting is not changed.

Example: -proxy-server 192.168.1.20

Example: -proxy-server foo.bar

proxy-server Proxy server

"" A proxy server is not used or the AIS Connect function is disabled.

-proxy-port-number

Optional. This parameter specifies the proxy server port number. Specify the port number within 1 to 5 digits. The port number cannot be set above 65535. This parameter cannot be specified when the AIS Connect function is disabled or the proxy server is not set. If omitted, the existing setting is not changed.

proxy-port-number Proxy server port number

-proxy-type Optional. This parameter specifies the type of communication with the proxy server. This parameter cannot be specified when the AIS Connect function is disabled or the proxy server is not set. If omitted, the existing setting is not changed.

http Basic/NTLM HTTP authentication

socks SOCKSv5 authentication

-user-name Optional. This parameter specifies the user name for proxy server authentication. Up to 32 characters can be specified. This parameter cannot be specified when the AIS Connect function is disabled or the proxy server is not set. To delete the user name for proxy server authentication that is already set, specify a null character ("""). If omitted, the existing setting is not changed.

user-name User name for proxy server authentication

"" The user name for proxy server authentication is deleted.

■ **Example(s)**

The following example sets up an AIS Connect operation environment:

```
CLI> set ais-connect -function enable -port maintenance -send-log enable -country-code 392 -server-certification enable  
-proxy-server foo.bar -proxy-port-number 123 -proxy-type http -proxy-user-name User1  
Password :  
Confirm Password :
```

■ Country code list

This list provides the country codes and the country names that are used to specify the shipment destination of the ETERNUS DX/AF.

4	AFGHANISTAN	8	ALBANIA
12	ALGERIA	16	AMERICAN SAMOA
20	ANDORRA	24	ANGOLA
660	ANGUILLA	10	ANTARCTICA
28	ANTIGUA AND BARBUDA	32	ARGENTINA
51	ARMENIA	533	ARUBA
36	AUSTRALIA	40	AUSTRIA
31	AZERBAIJAN	44	BAHAMAS
48	BAHRAIN	50	BANGLADESH
52	BARBADOS	112	BELARUS
56	BELGIUM	84	BELIZE
204	BENIN	60	BERMUDA
64	BHUTAN	68	BOLIVIA
70	BOSNIA AND HERZEGOWINA	72	BOTSWANA
74	BOUVET ISLAND	76	BRAZIL
86	BRITISH INDIAN OCEAN TERRITORY	96	BRUNEI DARUSSALAM
100	BULGARIA	854	BURKINA FASO
108	BURUNDI	116	CAMBODIA
120	CAMEROON	124	CANADA
132	CAPE VERDE	136	CAYMAN ISLANDS
140	CENTRAL AFRICAN REPUBLIC	148	CHAD
152	CHILE	156	CHINA
162	CHRISTMAS ISLAND	166	COCOS VALUES (KEELING) ISLANDS
170	COLOMBIA	174	COMOROS
178	CONGO	184	COOK ISLANDS
188	COSTA RICA	384	COTE D'IVOIRE
191	CROATIA (LOCAL NAME: HRVATSKA)	192	CUBA
196	CYPRUS	203	CZECH REPUBLIC
208	DENMARK	262	DJIBOUTI
212	DOMINICA	214	DOMINICAN REPUBLIC
626	EAST TIMOR	218	ECUADOR
818	EGYPT	222	EL SALVADOR
226	EQUATORIAL GUINEA	232	ERITREA
233	ESTONIA	231	ETHIOPIA
238	FALKLAND ISLANDS VALUES (MALVINAS)	234	FAROE ISLANDS
242	FIJI	246	FINLAND
250	FRANCE	254	FRENCH GUIANA
258	FRENCH POLYNESIA	260	FRENCH SOUTHERN TERRITORIES
266	GABON	270	GAMBIA
268	GEORGIA	276	GERMANY

288	GHANA	292	GIBRALTAR
300	GREECE	304	GREENLAND
308	GRENADA	312	GUADELOUPE
316	GUAM	320	GUATEMALA
324	GUINEA	624	GUINEA-BISSAU
328	GUYANA	332	HAITI
334	HEARD AND MC DONALD ISLANDS	340	HONDURAS
344	HONG KONG	348	HUNGARY
352	ICELAND	356	INDIA
360	INDONESIA	364	IRAN VALUES (ISLAMIC REPUBLIC OF)
368	IRAQ	372	IRELAND
376	ISRAEL	380	ITALY
388	JAMAICA	392	JAPAN
400	JORDAN	398	KAZAKHSTAN
404	KENYA	296	KIRIBATI
408	KOREA, DEMOCRATIC PEOPLES REPUBLIC OF	410	KOREA, REPUBLIC OF
414	KUWAIT	417	KYRGYZSTAN
418	LAO PEOPLES DEMOCRATIC REPUBLIC	428	LATVIA
422	LEBANON	426	LESOTHO
430	LIBERIA	434	LIBYAN ARAB JAMAHIRIYA
438	LIECHTENSTEIN	440	LITHUANIA
442	LUXEMBOURG	446	MACAU
807	MACEDONIA, THE FORMER YUGOSLAV REPUBLIC OF	450	MADAGASCAR
454	MALAWI	458	MALAYSIA
462	MALDIVES	466	MALI
470	MALTA	584	MARSHALL ISLANDS
474	MARTINIQUE	478	MAURITANIA
480	MAURITIUS	175	MAYOTTE
484	MEXICO	583	MICRONESIA, FEDERATED STATES OF
498	MOLDOVA, REPUBLIC OF	492	MONACO
496	MONGOLIA	500	MONTSERRAT
504	MOROCCO	508	MOZAMBIQUE
104	MYANMAR	516	NAMIBIA
520	NAURU	524	NEPAL
528	NETHERLANDS	530	NETHERLANDS ANTILLES
540	NEW CALEDONIA	554	NEW ZEALAND
558	NICARAGUA	562	NIGER
566	NIGERIA	570	NIUE
574	NORFOLK ISLAND	580	NORTHERN MARIANA ISLANDS
578	NORWAY	512	OMAN
586	PAKISTAN	585	PALAU
275	PALESTINIAN TERRITORY, OCCUPIED	591	PANAMA
598	PAPUA NEW GUINEA	600	PARAGUAY

604	PERU	608	PHILIPPINES
612	PITCAIRN	616	POLAND
620	PORTUGAL	630	PUERTO RICO
634	QATAR	638	REUNION
642	ROMANIA	643	RUSSIAN FEDERATION
646	RWANDA	659	SAINT KITTS AND NEVIS
662	SAINT LUCIA	670	SAINT VINCENT AND THE GRENADINES
882	SAMOA	674	SAN MARINO
678	SAO TOME AND PRINCIPE	682	SAUDI ARABIA
686	SENEGAL	688	SERBIA AND MONTENEGRO
690	SEYCHELLES	694	SIERRA LEONE
702	SINGAPORE	703	SLOVAKIA VALUES (SLOVAK REPUBLIC)
705	SLOVENIA	90	SOLOMON ISLANDS
706	SOMALIA	710	SOUTH AFRICA
239	SOUTH GEORGIA AND THE SOUTH SANDWICH ISLANDS	724	SPAIN
144	SRI LANKA	654	ST. HELENA
666	ST. PIERRE AND MIQUELON	736	SUDAN
740	SURINAME	744	SVALBARD AND JAN MAYEN ISLANDS
748	SWAZILAND	752	SWEDEN
756	SWITZERLAND	760	SYRIAN ARAB REPUBLIC
158	TAIWAN	762	TAJIKISTAN
834	TANZANIA, UNITED REPUBLIC OF	764	THAILAND
768	TOGO	772	TOKELAU
776	TONGA	780	TRINIDAD AND TOBAGO
788	TUNISIA	792	TURKEY
795	TURKMENISTAN	796	TURKS AND CAICOS ISLANDS
798	TUVALU	800	UGANDA
804	UKRAINE	784	UNITED ARAB EMIRATES
826	UNITED KINGDOM	840	UNITED STATES
581	UNITED STATES MINOR OUTLYING ISLANDS	858	URUGUAY
860	UZBEKISTAN	548	VANUATU
336	VATICAN CITY STATE VALUES (HOLY SEE)	862	VENEZUELA
704	VIET NAM	92	VIRGIN ISLANDS VALUES (BRITISH)
850	VIRGIN ISLANDS VALUES (U.S.)	876	WALLIS AND FUTUNA ISLANDS
732	WESTERN SAHARA	887	YEMEN
894	ZAMBIA	716	ZIMBABWE

set ais-connect-remote-session

This command permits remote sessions to remotely control the ETERNUS DX/AF from a remote server by using the AIS Connect function.

This command cannot be used when the AIS Connect function is disabled.

■ Syntax

```
set ais-connect-remote-session -session {permit | forbid} [-timeout timeout]
```

■ Parameter

- session This parameter specifies whether remote sessions are permitted to remotely control the ETERNUS DX/AF from the AIS Connect server. When connections of remote sessions are permitted with this option, the setting is automatically reversed if the AIS Connect server does not request remote sessions within the period that is specified for the "-timeout" option.
- permit Connections for remote sessions are permitted.
 - forbid Connections for remote sessions are not permitted.
- timeout Optional, but must be specified when "permit" is specified for the "-session" parameter. This parameter specifies the idle timeout interval for remote sessions. If the AIS Connect server does not request remote sessions within the specified period, the setting that permits connections of remote sessions is automatically reversed. This time period can be specified on an hourly basis by using a number from 0 to 24. If "0" is specified, a timeout does not occur (the idle timeout interval is unlimited).
- timeout* Idle timeout interval for remote sessions (0 – 24)

■ Example(s)

The following example allows connection from the AIS Connect server and sets two hours as the timeout interval:

```
CLI> set ais-connect-remote-session -session permit -timeout 2
```

test ais-connect

This command checks the connections with the AIS Connect server.

■ Syntax

```
test ais-connect
```

■ Parameter

No parameters.

■ Example(s)

The following example checks the connection with the AIS Connect server:

```
CLI> test ais-connect
```

send ais-connect-log

This command is used to manually send logs to the AIS Connect server.

■ Syntax

```
send ais-connect-log
```

■ Parameter

No parameters.

■ Example(s)

The following example manually sends logs to the AIS Connect server:

```
CLI> send ais-connect-log
```

test ais-connect-event-notification

This command is used to test an event notification to the AIS Connect server.

■ Syntax

```
test ais-connect-event-notification
```

■ Parameter

No parameters.

■ Example(s)

The following example tests an event notification to the AIS Connect server:

```
CLI> test ais-connect-event-notification
```

import ais-ssl-certificate

This command imports and registers the SSL server certificate that is signed by the certificate provider.

■ Syntax

```
import ais-ssl-certificate -port {maintenance | remote | fst} -server server_name -user login_user_account  
-filename filename [-indicator {enable | disable}]
```

■ Parameter

- port This parameter specifies which Ethernet port is used to connect to the FTP server. For further information, refer to ["1.11 Note for Specifying FTP Server" \(page 54\)](#).
- | | |
|-------------|---|
| maintenance | Maintenance port (MNT port) |
| remote | Remote port (RMT port) |
| fst | FST port (DX500 S4/DX600 S4, DX500 S3/DX600 S3, DX8100 S3/DX8700 S3/DX8900 S3, and AF650 S2/AF650 only) |
- server This parameter specifies the FTP server name in which the certificate file is to be stored. The server name format is IPv4 standard notation (as a string in the base 256 notation d.d.d.d), IPv6 address format or a fully qualified domain name (FQDN).
- Example: -server 192.168.1.20
Example: -server fd80::abd0:223:ad
Example: -server foo.bar
- server_name* FTP server name
- user This parameter specifies the user name that is to be used to access the FTP server. When this parameter is specified, the command displays an FTP server password prompt.
- login_user_account* User name
- filename This parameter specifies the certificate file name.
- filename* Certificate file name
- indicator Optional. This parameter specifies whether the progress indicator is displayed. If omitted, the progress indicator is displayed.
- | | |
|---------|--------------------------------------|
| enable | Progress indicator is displayed. |
| disable | Progress indicator is not displayed. |

■ Example(s)

The following example imports and registers the signed certificate:

```
CLI> import ais-ssl-certificate -port maintenance -server ftp.example.com -user cli-user filename server.cert  
Password :
```

show ais-communication-log

This command displays the AIS Connect communication log. The log for the startup and shutdown of AIS Connect agent and the most recent TCP connection can be displayed.

Note

If AIS Connect agent is started or restarted (such as with the AIS Connect setting, an ETERNUS DX/AF reboot, a CM reboot, or a switch of the master CM), the log is initialized.

Syntax

```
show ais-communication-log
```

Parameter

No parameters.

Output

No Output.

Example(s)

The following example displays the AIS Connect communication log:

```
CLI> show ais-communication-log
2017-02-20 10:20:30 agent started
2017-02-20 10:20:31 connect to 10.20.30.40:443 (ID:17)
:
:
```

set remote-support-mode

This command enables the GUI menu display (REMCS setting and AIS Connect setting) of the remote support.

Note

- This command can be executed regardless of the set state of REMCS and AIS Connect.
- If the GUI menu display of the REMCS setting and the AIS Connect setting is enabled with this command, the display cannot be disabled.

Syntax

```
set remote-support-mode -mode all
```

Parameter

-mode This parameter enables the GUI menu display of the REMCS setting and the AIS Connect setting.
 all REMCS setting and AIS Connect setting

Example(s)

The following example enables the GUI menu display of the REMCS setting and the AIS Connect setting:

```
CLI> set remote-support-mode -mode all
```

5.3 System Settings

This section explains the commands related to the following miscellaneous functions.

The main functions are as follows:

- Date and time
- NTP
- ETERNUS DX/AF name
- Encryption mode
- Box ID
- Power synchronization
- Self-Encrypting Drive (SED) authentication
- Syslog server
- Audit log
- Key management server linkage
- Power-off/reboot system
- Deduplication/Compression mode
- Unified license
- Non-disruptive Storage Migration

5.3.1 Date, Time and NTP

This section explains the commands related to setting the date and time of the system. The system also supports time correction using the Network Time Protocol (NTP).

show date

This command displays the date and time of the system.

■ Syntax

```
show date
```

■ Parameter

No parameters.

■ Output

Item name	Description
YYYY-MM-DD	Date (YYYY: year, MM: month, DD: day)
hh:mm:ss	Time (hh: hour, mm: minute, ss: second)
GMT	Greenwich Mean Time
DST	Starting date and time and ending date and time (displayed in "MMDDhh" format or "MM,{1st 2nd 3rd 4th last},{sun mon tue wed thu fri sat},hh" format)

■ Example(s)

The following example displays the system date and time:

```
CLI> show date
2008-10-01 10:59:59 GMT+09:00 (Tokyo, Osaka, Kyoto, Fukuoka, Sapporo)
DST [OFF]

CLI> show date
2008-12-31 00:00:03 GMT+03:00 (Nairobi, Moscow)
DST [ON] 06-01 02:00 - 09-30 02:00

CLI> show date
2008-01-01 23:55:00 GMT+01:00 (Paris, Madrid, Stockholm)
DST [ON] 03-last-Sun 01:00 - 10-last-Sun 01:00
```

set date

This command sets the date and time of the system.

Syntax

```
set date [-time YYYYMMDDhhmmss] [-timezone number] [-dst {enable | disable}]
[-from{MMDDhh | MM,{1st | 2nd | 3rd | 4th | last},{sun | mon | tue | wed | thu | fri | sat},hh}]
[-to {MMDDhh | MM,{1st | 2nd | 3rd | 4th | last},{sun | mon | tue | wed | thu | fri | sat},hh}]
```

Parameter

-time Optional. This parameter specifies the date and time. The format is "YYYYMMDDhhmmss": "YYYY" is the year (a four-digit number from 2001 to 2037), "MM" is the number of the month (01-12), "DD" is the number of the day (01-31), "hh" is the hour in 24-hour time (00-23), "mm" is the minute (00-59), and "ss" is the second (00-59). If omitted, the existing setting is not changed.

YYYYMMDDhhmmss Date and time

-timezone Optional. This parameter specifies the time difference from Greenwich Mean Time (GMT). The selectable preset numbers are shown below. If omitted, the existing setting is not changed.

number Time difference from Greenwich Mean Time (GMT)

0	Eniwetok, Kwajalein	-12:00
1	Samoa	-11:00
2	Honolulu	-10:00
3	Alaska	-9:00
4	Los Angels, San Francisco, San Diego	-8:00
5	Arizona	-7:00
6	Chicago, Mexico City	-6:00
7	New York, Bogota	-5:00
8	Caracas	-4:00
9	Newfoundland	-3:30
10	Sao Paulo, Brasilia	-3:00
11	Mid-Atlantic Ocean	-2:00
12	Azores Island, Cape Verde	-1:00
13	Dublin, London, Manchester, Lisbon	0:00
14	Paris, Madrid, Stockholm	+1:00
15	Rome, Vienna, Berlin	+1:00
16	Milan, Amsterdam	+1:00
17	Athens, Helsinki, Cairo	+2:00
18	Beirut, Cape Town	+2:00
19	Nairobi, Moscow	+3:00
20	Abu Dhabi	+4:00
21	Islamabad, Karachi	+5:00

22	New Delhi	+5:30
23	Dhaka	+6:00
24	Bangkok, Jakarta	+7:00
25	Hong Kong, Manila, Singapore	+8:00
26	Beijing, Taipei, Kuala Lumpur, Perth	+8:00
27	Tokyo, Osaka, Kyoto, Fukuoka, Sapporo	+9:00
28	Seoul	+9:00
29	Adelaide	+9:30
30	Guam, Sydney, Melbourne	+10:00
31	Solomon Islands, New Caledonia	+11:00
32	Wellington, Auckland, Fiji	+12:00

-dst Optional. This parameter specifies whether the daylight saving time is enabled or not. If omitted, the existing setting is not changed.

- enable DST is enabled.
- disable DST is disabled.

 **Caution**

- When "enable" is specified, both the starting and the ending information must be specified.
- When "disable" is specified, the starting nor the ending information cannot be specified.

-from Optional. This parameter specifies when DST (daylight saving time) starts, and must be specified when enabling DST. If omitted, the existing setting is not changed.

There are two formats; "MMDDhh" and "MM, {1st | 2nd | 3rd | 4th | last},{sun | mon | tue | wed | thu | fri | sat},hh".

MMDDhh "MM" is the starting month number (01 – 12), "DD" is the starting day number (01 – 31), and "hh" is the starting hour in 24-hour time (00 – 23).

MM, {1st | 2nd | 3rd | 4th | last},{sun | mon | tue | wed | thu | fri | sat},hh
 "MM" is the starting month number (01 – 12). Both "{1st | 2nd | 3rd | 4th | last}" and "{sun | mon | tue | wed | thu | fri | sat}" are pairs, and means the starting day and the starting week. "hh" is the starting hour in 24-hour time (00 – 23).

-to Optional. This parameter specifies when DST (daylight saving time) ends, and must be specified when enabling DST. If omitted, the existing setting is not changed.

There are two formats; "MMDDhh" and "MM, {1st | 2nd | 3rd | 4th | last},{sun | mon | tue | wed | thu | fri | sat},hh".

MMDDhh "MM" is the ending month number (01 – 12), "DD" is the ending day number (01 – 31), and "hh" is the ending hour in 24-hour time (00 – 23).

MM, {1st | 2nd | 3rd | 4th | last},{sun | mon | tue | wed | thu | fri | sat},hh
 "MM" is the ending month number (01 – 12). Both "{1st | 2nd | 3rd | 4th | last}" and "{sun | mon | tue | wed | thu | fri | sat}" are pairs, and means the ending day and the ending week. "hh" is the ending hour in 24-hour time (00 – 23).

■ Example(s)

The following example sets the system date to 11:55 PM on January 12, 2009 GMT:

```
CLI> set date -time 20090112235500
```

The following example sets the system date to 11:55 PM on January 12, 2009 in the New York time zone (GMT -5:00):

```
CLI> set date -time 20090112235500 -timezone 7
```

The following example sets the system date to 12:30 PM on January 1, 2009 in the Honolulu time zone (GMT-10:00). DST is set from 1:00 AM on the last Sunday of March to 1:00 AM on the last Sunday of October:

```
CLI> set date -time 20090101123000 -timezone 2 -dst enable -from 03,last,sun,01 -to 10,last,sun,01
```

The following example sets the system date to 12:30 PM on January 1, 2009. DST is set from 2:00 AM on March 1st and 2:00 AM on October 30th:

```
CLI> set date -time 20090101123000 -timezone 2 -dst enable -from 030102 -to 103002
```

show ntp

This command displays the NTP configuration.

Syntax

```
show ntp
```

Parameter

No parameters.

Output

Item name	Description
NTP	It shows whether the NTP function is enabled, or not.
Primary NTP Server	Primary NTP server name
Primary NTP LAN Port	Ethernet port to connect to primary NTP server
Secondary NTP Server	Secondary NTP server name
Secondary NTP LAN Port	Ethernet port to connect to secondary NTP server (MNT or RMT)
Access Status	Result of synchronization
YYYY-MM-DD hh:mm:ss no date SYNC	No synchronization result can be found.
YYYY-MM-DD hh:mm:ss Primary NTP Server succeeded SYNC	Synchronization with the primary NTP server succeeded.
YYYY-MM-DD hh:mm:ss Secondary NTP Server succeeded SYNC	Synchronization with the secondary NTP server succeeded.
YYYY-MM-DD hh:mm:ss failed SYNC	Synchronization failed.

Example(s)

The following example displays the NTP configuration:

```
CLI> show ntp
NTP [Enable]
Primary NTP Server [10.1.1.100]
Primary NTP LAN Port [RMT]
Secondary NTP Server [10.1.1.200]
Secondary NTP LAN Port [MNT]
Access Status [2008-02-21 08:30:00 Primary NTP Server succeeded SYNC]

CLI> show ntp
NTP [Enable]
Primary NTP Server [fd80::abd0:223:ad]
Primary NTP LAN Port [RMT]
Secondary NTP Server [fe80:0000:0000:0000:0280:0001:fe84:6417]
Secondary NTP LAN Port [MNT]
Access Status [0000-00-00 00:00:00 failed SYNC]

CLI> show ntp
NTP [Disable]
Primary NTP Server [10.1.1.100]
Primary NTP LAN Port [RMT]
Secondary NTP Server [10.1.1.200]
Secondary NTP LAN Port [MNT]
Access Status [0000-00-00 00:00:00 Secondary NTP Server succeeded SYNC]
```

set ntp

The system supports time correction using the Network Time Protocol (NTP) and implements the NTP client functions. This command can set up the NTP environment.

■ Syntax

```
set ntp [-function {enable | disable}] [-primary-server server_address]  
[-primary-port {maintenance | remote}] [-secondary-server server_address]  
[-secondary-port {maintenance | remote}]
```

■ Parameter

-function Optional. This parameter specifies whether the NTP client is enabled or not. If omitted, the existing setting is not changed.

enable NTP is enabled.

disable NTP is disabled.

-primary-server

Optional. This parameter specifies the address of the primary NTP server. Up to 64 characters can be specified. The server name format is IPv4 standard notation (a base 256 "d.d.d.d" string), IPv6 address format, or a fully qualified domain name. The types of IPv6 addresses that can be specified are global addresses (including 6to4 addresses), link local addresses, and unique local addresses. If omitted, the existing setting is not changed.

Example: -primary-server 192.168.1.20

Example: -primary-server fd80::abd0:223:ad

Example: -primary-server foo.bar

server_address Primary NTP server address

-primary-port

Optional. This parameter specifies the Ethernet port to connect to the primary NTP server. If omitted, the existing setting is not changed.

maintenance Maintenance port (MNT port)

remote Remote port (RMT port)

-secondary-server

Optional. This parameter specifies the address of the secondary NTP server. Up to 64 characters can be specified. The server name format is IPv4 standard notation (a base 256 "d.d.d.d" string), IPv6 address format, or a fully qualified domain name. The types of IPv6 addresses that can be specified are global addresses (including 6to4 addresses), link local addresses, and unique local addresses. If omitted, the existing setting is not changed.

Example: -secondary-server 192.168.1.20

Example: -secondary-server fd80::abd0:223:ad

Example: -secondary-server foo.bar

server_address Secondary NTP server address

-secondary-port

Optional. This parameter specifies the Ethernet port to connect to the secondary NTP server. If omitted, the existing setting is not changed.

maintenance	Maintenance port (MNT port)
remote	Remote port (RMT port)

■ **Example(s)**

The following example sets the NTP configuration. The primary NTP server is specified as "ntpserver.com". The MNT port is specified as the Ethernet port for the primary NTP functions.

```
CLI> set ntp -function enable -primary-server ntpserver.com -primary-port maintenance
```

The following example sets the NTP configuration. The secondary NTP server is specified as IP address "10.1.1.100". The RMT port is specified as the Ethernet port for secondary NTP functions.

```
CLI> set ntp -function enable -secondary-server 10.1.1.100 -secondary-port remote
```

The following example disables NTP:

```
CLI> set ntp -function disable
```

5.3.2 ETERNUS DX/AF Name

This section explains the commands used to set the ETERNUS DX/AF name.

show storage-system-name

This command displays the registered ETERNUS DX/AF name.

■ Syntax

```
show storage-system-name
```

■ Parameter

No parameters.

■ Output

Item name	Description
Name	ETERNUS DX/AF name
Installation Site	Installation site
Contact	Contact address
Description	Description of the ETERNUS DX/AF

■ Example(s)

The following example displays the ETERNUS DX/AF name:

```
CLI> show storage-system-name
Name           [DXL-1]
Installation Site [FJ]
Contact        [AVRIL]
Description    [CALC1]
```

set storage-system-name

This command sets the ETERNUS DX/AF information. Note that the Virtual Disk Service (VDS) "Friendly" name corresponds to the ETERNUS DX/AF name.

■ Syntax

```
set storage-system-name [-name name] [-installation-site location]  
[-contact contact] [-description description]
```

■ Parameter

- name** Optional. This parameter specifies the ETERNUS DX/AF name (up to 16 characters). Permitted characters are described in ["1.2.2 Keywords and Parameters" \(page 33\)](#). If omitted, the existing setting is not changed.
- name* ETERNUS DX/AF name
- installation-site** Optional. This parameter specifies the installation site name (up to 50 letters). Permitted characters are described in ["1.2.2 Keywords and Parameters" \(page 33\)](#). If omitted, the existing setting is not changed.
- location* Installation site name
- contact** Optional. This parameter specifies the administrator address (up to 50 characters). Permitted characters are described in ["1.2.2 Keywords and Parameters" \(page 33\)](#). If omitted, the existing setting is not changed.
- contact* Administrator address
- description** Optional. This parameter specifies the description of the ETERNUS DX/AF (up to 50 characters). Permitted characters are described in ["1.2.2 Keywords and Parameters" \(page 33\)](#). If omitted, the existing setting is not changed.
- description* Description of the ETERNUS DX/AF

■ Example(s)

The following example sets the ETERNUS DX/AF name, installation site name, descriptions, and contact address:

```
CLI> set storage-system-name -name E2000-No1 -installation-site FJ -contact AVRIL -description CALC2
```

5.3.3 Encryption Mode

This section explains the commands related to encryption mode functions. Enabling encryption mode makes the encryption mode functions that are performed by a CM available.

 **Caution**

The commands that are described in this section are not supported in the DX60 S4/DX60 S3.

 **Note**

Depending on the model, the support state of the encryption-related functions may differ.

show encryption

This command displays the status of the encryption mode.

Note

Depending on the model, the support state of the encryption-related functions may differ.

Syntax

```
show encryption
```

Parameter

No parameters.

Output

Item name	Description
Encryption Mode	Encryption mode

Example(s)

The following example displays whether the encryption mode is enabled or disabled:

```
CLI> show encryption
Encryption Mode [Fujitsu]

CLI> show encryption
Encryption Mode [AES-128]

CLI> show encryption
Encryption Mode [AES-256]

CLI> show encryption
Encryption Mode [Disable]
```

set encryption

This command specifies whether encryption mode is enabled or disabled. If the encryption mode is enabled, "Fujitsu Original Encryption", "AES-128bit", or "AES-256bit" must be specified for the encryption type. After switching the encryption mode from enabled to disabled, the ETERNUS DX/AF must be rebooted. When switching the encryption mode from disabled to enabled, this operation is not required.

Note

Depending on the model, the support state of the encryption-related functions may differ.

Syntax

```
set encryption -mode {fujitsu | aes | aes128 | aes256 | disable}
```

Parameter

-mode	This parameter specifies encryption mode.
fujitsu	Encryption mode is enabled (Fujitsu Original Encryption).
aes	Encryption mode is enabled (AES-128bit).
aes128	Encryption mode is enabled (AES-128bit). If the controller firmware version is V10L50-3000 or later, V10L52-3000 or later, or V10L53 or later, specify this option when the AES 128bit encryption mode is enabled.
aes256	Encryption mode is enabled (AES-256bit). If the controller firmware version is V10L50-3000 or later, V10L52-3000 or later, or V10L53 or later, specify this option when the AES 256bit encryption mode is enabled.
disable	Encryption mode is disabled.

Example(s)

The following example enables the Fujitsu Original Encryption mode function:

```
CLI> set encryption -mode fujitsu
```

The following example disables the encryption mode.
After that, the ETERNUS DX/AF is rebooted:

```
CLI> set encryption -mode disable  
CLI> shutdown -mode reboot
```

5.3.4 Box ID

This section explains the commands related to the Box ID.

show boxid

This command displays the registered Box ID.

■ Syntax

```
show boxid
```

■ Parameter

No parameters.

■ Output

Item name	Description
Box ID	Registered Box ID

■ Example(s)

The following example displays the registered Box ID:

```
CLI> show boxid  
Box ID [00DXL#####ET06F21AUABCPJ000000#####]
```

set boxid

Box ID is the identification information presented to certain applications. This command sets the Box ID. The series name, the model name, the serial number, and additional fixed characters of the system are set as the default for the Box ID.

■ Syntax

```
set boxid -id box_id
```

■ Parameter

-id This parameter specifies a Box ID. Up to 40 alphanumeric characters, spaces, and hash marks (#) can be specified. Each Box ID must be unique.

● Note

- All alphabetic characters are handled as uppercase.
- The pound key characters (#) are automatically appended when the input characters are less than 40.

box_id Box ID

■ Example(s)

The following example sets the Box ID:

```
CLI> set boxid -id "00DXL#####ET06F21AUABCPJ000000#####"
```

5.3.5 Power Synchronization

This section explains the commands related to power synchronization.

show power-synchronization

This command displays the settings that control how the shutdown function interacts with the external sensor.

■ Syntax

```
show power-synchronization
```

■ Parameter

No parameters.

■ Output

Item name	Description
RCIL	The setting of the power control function that uses an RCIL interface
Auto Power	The setting to turn the system power on when power is supplied
Resume Power	The setting to turn the system power on when power is supplied after the ETERNUS DX/AF is shut down due to a power outage
PWC Port Information	
Controller Module #0	Indicates whether CM#0 is connected to the power synchronized device. (Only for the DX60 S4/DX100 S4/DX200 S4, the DX500 S4/DX600 S4, the DX60 S3/DX100 S3/DX200 S3, the DX500 S3/DX600 S3, the DX8100 S3, the AF250 S2/AF650 S2, the AF250/AF650, and the DX200F)
Controller Module #1	Indicates whether CM#1 is connected to the power synchronized device. (Only for the DX60 S4/DX100 S4/DX200 S4, the DX500 S4/DX600 S4, the DX60 S3/DX100 S3/DX200 S3, the DX500 S3/DX600 S3, the DX8100 S3, the AF250 S2/AF650 S2, the AF250/AF650, and the DX200F)
Service Controller #0	Indicates whether SVC#0 is connected to the power synchronized device. (Only for the DX8700 S3/DX8900 S3)
Service Controller #1	Indicates whether SVC#1 is connected to the power synchronized device. (Only for the DX8700 S3/DX8900 S3)
Waiting Time to Shutdown	The time that starts the ETERNUS DX/AF shutdown when a power outage signal is received from an external sensor device
Type	The reset interface (Power Synchronized Unit, PMAN, or manual). In this output, the preset interface is displayed if the same setup as the preset is set by manual setup.
Power Fail Signal	The signal polarity that controls the input power outage signal when a power supply fails and power is not provided
Low Battery Signal	The signal polarity that controls the battery voltage low signal when the battery usage of a UPS is low
UPS Shutdown Signal	The signal polarity that controls the UPS output stop signal when the shutdown is complete
SCCI/PPC Unit Information (These items are displayed only for the DX8100 S3/DX8700 S3/DX8900 S3.)	
Controller Module #0	Indicates whether CM#0 is connected to the power synchronized device. (Only for the DX8100 S3)
Controller Module #1	Indicates whether CM#1 is connected to the power synchronized device. (Only for the DX8100 S3)

Item name	Description
Service Controller #0	Indicates whether SVC#0 is connected to the power synchronized device. (Only for the DX8700 S3/DX8900 S3)
Service Controller #1	Indicates whether SVC#1 is connected to the power synchronized device. (Only for the DX8700 S3/DX8900 S3)

■ Example(s)

The following example displays the settings that control how the shutdown function interacts with the external sensor (for the DX60 S4/DX100 S4/DX200 S4, the DX500 S4/DX600 S4, the DX60 S3/DX100 S3/DX200 S3, the DX500 S3/DX600 S3, the AF250 S2/AF650 S2, the AF250/AF650, and the DX200F):

```
CLI> show power-synchronization
RCIL [Enable]
Auto Power [Enable]
Resume Power [Disable]
<PWC Port>
  Controller Module #0 [Enable]
  Controller Module #1 [Disable]
  Waiting Time to Shutdown [5 min.]
  Type [Power Synchronized Unit]
  Power Fail Signal [Positive]
  Low Battery Signal [Negative]
  UPS Shutdown Signal [Negative]
```

The following example displays the settings that control how the shutdown function interacts with the external sensor (for the DX8700 S3/DX8900 S3):

```
CLI> show power-synchronization
RCIL [Enable]
Auto Power [Enable]
Resume Power [Disable]
<PWC Port>
  Service Controller #0 [Enable]
  Service Controller #1 [Disable]
  Waiting Time to Shutdown [5 min.]
  Type [Power Synchronized Unit]
  Power Fail Signal [Positive]
  Low Battery Signal [Negative]
  UPS Shutdown Signal [Negative]
<SCCI/PPC Unit>
  Service Controller #0 [Enable]
  Service Controller #1 [Disable]
```

set power-synchronization

This command configures the way in which the shutdown function interacts with the external sensor.

■ Syntax

```
set power-synchronization [-rcil {enable | disable}] [-auto-power {enable | disable}]  
[-resume-power {enable | disable}]  
[-pwc-cm {0 | 1 | all | none}] [-pwc-svc {0 | 1 | all | none}]  
[-scci-ppc-cm {0 | 1 | all | none}] [-scci-ppc-svc {0 | 1 | all | none}]  
[-shutdown-time shutdown_time]  
[-preset {power-sync | pman | manual}] [-power-fail-signal {positive | negative}]  
[-low-battery-signal {positive | negative}] [-ups-shutdown-signal {disable | positive | negative}]
```

■ Parameter

- rcil** Optional. This parameter specifies whether the power synchronization setting using the RCIL.
- | | |
|---------|-----------|
| enable | Enabled. |
| disable | Disabled. |
- auto-power** Optional. If "enable" is specified, the system power is turned on when a power supply is detected. The default value is set to disable.
- | | |
|---------|---------------------|
| enable | Enabled. |
| disable | Disabled. (Default) |
- resume-power** Optional. If "enable" is specified, the system power is turned on when a power supply is detected after the ETERNUS DX/AF is shut down due to a power outage. The default value is set to disable.
- | | |
|---------|---------------------|
| enable | Enabled. |
| disable | Disabled. (Default) |
- pwc-cm** Optional. This parameter specifies the controller module number that connects to the external sensor (only for the DX60 S4/DX100 S4/DX200 S4, the DX500 S4/DX600 S4, the DX60 S3/DX100 S3/DX200 S3, the DX500 S3/DX600 S3, the DX8100 S3, the AF250 S2/AF650 S2, the AF250/AF650, and the DX200F). The connection method conforms to the PWC port (RS-232C standard). If omitted, the existing setting is not changed.
- | | |
|------|---|
| 0 | Controller module #0 |
| 1 | Controller module #1 |
| all | Both controller module #0 and controller module #1 |
| none | No connection. If selected, only "-auto-power" and "-resume-power" from the parameters that follow can be selected. |

- pwc-svc** Optional. This parameter specifies the service controller (SVC) number that connects to the external sensor (only for the DX8700 S3/DX8900 S3).
The connection method conforms to the PWC port (RS-232C standard). If omitted, the existing setting is not changed.
- | | |
|------|---|
| 0 | SVC #0 |
| 1 | SVC #1 |
| all | Both SVC #0 and SVC #1 |
| none | No connection. If selected, only "-auto-power" and "-resume-power" from the parameters that follow can be selected. |
- scci-ppc-cm**
- Optional. This parameter specifies the controller module number that connects to the external sensor (only for the DX8100 S3).
The connection method is SCCI or PPC. If omitted, the existing setting is not changed.
- | | |
|------|--|
| 0 | Controller module #0 |
| 1 | Controller module #1 |
| all | Both controller module #0 and controller module #1 |
| none | No connection. |
- scci-ppc-svc**
- Optional. This parameter specifies the Service Controller (SVC) number that connects to the external sensor (only for the DX8700 S3/DX8900 S3).
The connection method is SCCI or PPC. If omitted, the existing setting is not changed.
- | | |
|------|------------------------|
| 0 | SVC #0 |
| 1 | SVC #1 |
| all | Both SVC #0 and SVC #1 |
| none | No connection. |
- shutdown-time**
- Optional. This parameter specifies the time in minutes between when a power outage signal is received and when a system shutdown begins. If omitted, the existing setting is not changed. Any value between 0 and 15 can be specified.
- | | |
|----------------------|---|
| <i>shutdown_time</i> | Time in minutes between when a power outage signal is received and when a system shutdown begins (0 – 15) |
|----------------------|---|
- preset** Optional. This parameter specifies the preset values for the power synchronization interface. If this parameter is specified, the following "-power-fail-signal" and "-low-battery-signal" parameters cannot be specified. If omitted, the existing setting is not changed. The initial value is set to "pman" for the DX60 S4/DX100 S4/DX200 S4, the DX500 S4/DX600 S4, the DX60 S3/DX100 S3/DX200 S3, the DX500 S3/DX600 S3, the AF250 S2/AF650 S2, the AF250/AF650, and the DX200F. The initial value for the DX8700 S3/DX8900 S3 is "manual".
- | | |
|------------|--|
| power-sync | Power synchronized unit. If this operand is specified, "-power-fail-signal" is assigned as positive and "-low-battery-signal" is assigned as negative. |
|------------|--|

- pman** PMAN (is supported only for the DX60 S4/DX100 S4/DX200 S4, the DX500 S4/DX600 S4, the DX60 S3/DX100 S3/DX200 S3, the DX500 S3/DX600 S3, the DX8100 S3, the AF250 S2/AF650 S2, the AF250/AF650, and the DX200F. Default)
If this operand is specified, "-power-fail-signal" is assigned as positive and "-low-battery-signal" is assigned as positive.
- manual** Manual setting (is the default for the DX8700 S3/DX8900 S3). For this setting, "-power-fail-signal" and "-low-battery-signal" must be specified at the same time.

-power-fail-signal

Optional. This parameter specifies the signal polarity of the power outage signal, which indicates that the power supply has failed. If omitted, the existing setting is not changed. The initial value is set to "positive". This can be set when "manual" is specified for "-preset".

- positive** Positive is set. (Default)
negative Negative is set.

-low-battery-signal

Optional. This parameter specifies the signal polarity of the low battery voltage signal, which indicates that battery power is nearly exhausted. If omitted, the existing setting is not changed. The initial value is set to "positive". This can be set when "manual" is specified for "-preset".

- positive** Positive is set. (Default)
negative Negative is set.

-ups-shutdown-signal

Optional. This parameter specifies the signal polarity of the UPS stop signal when completing shutdown. If omitted, the existing setting is not changed. The initial value is set to "disable".

- positive** Positive is set.
negative Negative is set.
disable The UPS synchronization function is disabled. (Default)

■ **Example(s)**

The following example sets how the shutdown function interacts with the external sensor. Both controller modules are selected, the shutdown time is specified as five minutes, and the input signal that signals power outage is specified as positive.

```
CLI> set power-synchronization -pwc-cm all -shutdown-time 5 -power-fail-signal positive
```

5.3.6 Self-Encrypting Drive (SED) Authentication Settings

This section explains the commands that are related to the Self-Encrypting Drive (SED) authentication settings.

There are two types of authentication keys for SEDs: the common key that is stored in the ETERNUS DX/AF and an SED authentication key that is managed by the key server. Commands for setting the common key are explained in this section. Note that if an SED authentication key is used, the common key must also be set.

 **Caution**

The commands that are described in this section support only models that can be installed with SEDs.

show sed-authentication

This command displays the status of the authentication key registration for SEDs.

■ Syntax

```
show sed-authentication
```

■ Parameter

No parameters.

■ Output

Item name	Description
SED authentication	Indicates whether the SED authentication key is registered.

■ Example(s)

The following example shows the sed-authentication command when the SED authentication key is registered:

```
CLI> show sed-authentication  
SED authentication    [Registered]
```

The following example shows the sed-authentication command when the SED authentication key is not registered:

```
CLI> show sed-authentication  
SED authentication    [Not Registered]
```

set sed-authentication

This command sets the authentication key for SEDs. SEDs are used to prevent the leakage of data in case a drive is stolen or lost.

■ Syntax

```
set sed-authentication -execution {yes | no}
```

■ Parameter

-execution	This parameter sets the authentication key for SEDs.
yes	The authentication key for SEDs is set.
no	The authentication key for SEDs is not set (default).

■ Example(s)

The following example sets the authentication key for an SED:

```
CLI> set sed-authentication -execution yes
```

5.3.7 Syslog Server Settings

Syslog is a protocol that allows a machine to send event notification message. This section explains commands related to the sending settings for the server.

- Displaying the Syslog server settings.
- Setting the Syslog server.

Figure 5.3 Syslog server overview

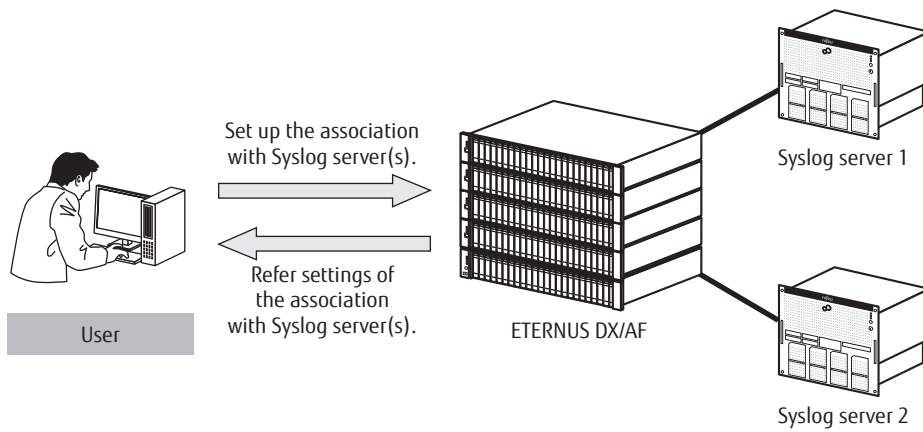

show syslog-notification

This command displays settings of the syslog server association.

Syntax

```
show syslog-notification
```

Parameter

No parameters.

Output

Item name	Description
Server1 function	Indicates whether syslog server 1 is enabled.
Server1	FQDN or IP address (IPv4 or IPv6) of the syslog server 1
Server1 Port Number	UDP port number of the syslog server 1 for the syslog protocol
Server1 Port	Indicates which port is used.
Server2 function	Indicates whether syslog server 2 is enabled.
Server2	FQDN or IP address (IPv4 or IPv6) of the syslog server 2
Server2 Port Number	UDP port number of the syslog server 2 for the syslog protocol
Server2 Port	Indicates which port is used.

Example(s)

The following example displays the settings of the syslog servers:

```
CLI> show syslog-notification
Server1 Function  [Enable (RFC3164)]
Server1          [10.21.134.198]
Server1 Port Number [514]
Server1 Port      [MNT]
Server2 Function  [Enable (RFC5424)]
Server2          [10.17.80.6]
Server2 Port Number [517]
Server2 Port      [RMT]
```

set syslog-notification

This command sets up an association with the syslog server.

■ Syntax

```
set syslog-notification
[-server1-function {disable | rfc3164 | rfc5424}]
[-server1 syslog-server1] [-server1-port-number port_number]
[-server1-port {maintenance | remote}]
[-server2-function {disable | rfc3164 | rfc5424}]
[-server2 syslog-server2]
[-server2-port-number port_number]
[-server2-port {maintenance | remote}]
```

■ Parameter

-server1-function

Optional. This parameter specifies whether to enable syslog server 1. If this parameter is omitted, this setting is not changed.

disable Syslog server 1 is disabled.

rfc3164 Syslog server 1 is enabled and uses message format based on RFC3164.

rfc5424 Syslog server 1 is enabled and uses message format based on RFC5424.

-server1

Optional. This parameter specifies syslog server 1. Only one server can be specified. The server name format should be IPv4 standard notation (a base 256 "d.d.d.d" string), IPv6 address format, or a fully qualified domain name (FQDN). The types of IPv6 addresses that can be specified are global addresses (including 6to4 addresses), link local addresses, and unique local addresses. Up to 63 alphanumeric characters can be specified. If this parameter is omitted, this setting is not changed.

Example: -server1 192.168.1.20

Example: -server1 fd80::abd0:223:ad

Example: -server1 foo.bar

syslog-server1 Server name of syslog server 1

-server1-port-number

Optional. This parameter specifies syslog server 1's UDP port number for the syslog protocol. Specify the port number within 1 to 5 digits. The port number cannot be set above 65535. If omitted, the setting is not changed. The default value is 514.

port_number Syslog server 1's UDP port number

-server1-port

Optional. This parameter specifies syslog server 1's LAN port. If this parameter is omitted, this setting is not changed.

maintenance Maintenance port (MNT port)

remote Remote port (RMT port)

-server2-function

Optional. This parameter specifies whether to enable syslog server 2. If this parameter is omitted, this setting is not changed.

`disable` Syslog server 2 is disabled.

`rfc3164` Syslog server 2 is enabled and uses message format based on RFC3164.

`rfc5424` Syslog server 2 is enabled and uses message format based on RFC5424.

-server2

Optional. This parameter specifies syslog server 2. Only one server can be specified. The server name format should be IPv4 standard notation (a base 256 "d.d.d.d" string), IPv6 address format, or a fully qualified domain name (FQDN). The types of IPv6 addresses that can be specified are global addresses (including 6to4 addresses), link local addresses, and unique local addresses. Up to 63 alphanumeric characters can be specified. If this parameter is omitted, this setting is not changed.

Example: `-server2 192.168.1.20`

Example: `-server2 fd80::abd0:223:ad`

Example: `-server2 foo.bar`

syslog-server2 Server name of syslog server 2

-server2-port-number

Optional. This parameter specifies syslog server 2's UDP port number for the syslog protocol. Specify the port number within 1 to 5 digits. The port number cannot be set above 65535. If omitted, the setting is not changed. The default value is 514.

port_number Syslog server 2's UDP port number

-server2-port

Optional. This parameter specifies syslog server 2's LAN port. If this parameter is omitted, this setting is not changed.

`maintenance` Maintenance port (MNT port)

`remote` Remote port (RMT port)

■ **Example(s)**

The following example sets the syslog server:

```
CLI> set syslog-notification -server1-function rfc3164 -server1 10.21.134.198 -server1-port-number 514  
-server1-port maintenance -server2-function rfc5424 -server2 10.17.80.6 -server2-port-number 517 -server2-lan-port remote
```

5.3.8 Audit Log Settings

Audit logs are audit trail information that records operations that are executed for the system by a system engineer or administrator and the response from the system. Logs are sent to the server by using syslog protocols.

This section explains the following commands related to the audit log settings.

- Displaying the audit log function
- Changing the audit log function settings

Figure 5.4 Audit log function overview

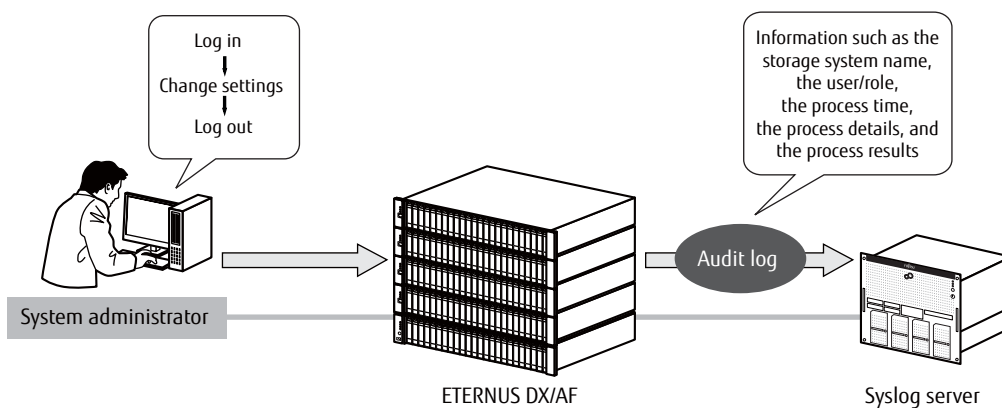

show audit

This command displays the settings of the audit log functions.

Syntax

```
show audit
```

Parameter

No parameters.

Output

Item name	Description
Audit Log	Indicates whether the audit log function is enabled.
Server1 function	Indicates whether syslog server 1 is enabled.
Server1	FQDN or IP address (IPv4 or IPv6) of the syslog server 1
Server1 Port Number	UDP port number of the syslog server 1 for the syslog protocol
Server1 Port	Indicates which port is used.
Server2 function	Indicates whether syslog server 2 is enabled.
Server2	FQDN or IP address (IPv4 or IPv6) of the syslog server 2
Server2 Port Number	UDP port number of the syslog server 2 for the syslog protocol
Server2 Port	Indicates which port is used.

Example(s)

The following example displays the settings of the audit log function:

```
CLI> show audit
Audit Log           [Enable]
Server1 Function    [Enable (RFC3164)]
Server1             [10.21.134.198]
Server1 Port Number [514]
Server1 Port        [MNT]
Server2 Function    [Enable (RFC5424)]
Server2             [10.17.80.6]
Server2 Port Number [517]
Server2 Port        [RMT]
```

set audit

This command changes the general settings of the audit log function. Use the "show audit" command to display the audit log function settings that are configured by this command.

■ Syntax

```
set audit [-mode {enable | disable}]  
[-server1-function {disable | rfc3164 | rfc5424}]  
[-server1 audit_log_server1] [-server1-port-number port_number]  
[-server1-port {maintenance | remote}]  
[-server2-function {disable | rfc3164 | rfc5424}]  
[-server2 audit_log_server2] [-server2-port-number port_number]  
[-server2-port {maintenance | remote}]
```

■ Parameter

-mode Optional. This parameter specifies whether to enable the audit log function.

enable The audit log function is enabled.
disable The audit log function is disabled.

-server1-function

Optional. This parameter specifies whether to enable syslog server 1. If omitted, the existing setting is not changed. If omitted, the existing setting is not changed. This parameter cannot be specified when the audit log function is disabled.

disable Syslog server 1 is disabled.
rfc3164 Syslog server 1 is enabled and uses message format based on RFC3164.
rfc5424 Syslog server 1 is enabled and uses message format based on RFC5424.

-server1 Optional. This parameter specifies syslog server 1. Only one server can be specified. The server name format should be IPv4 standard notation (a base 256 "d.d.d.d" string), IPv6 address format, or a fully qualified domain name (FQDN). The types of IPv6 addresses that can be specified are global addresses (including 6to4 addresses), link local addresses, and unique local addresses. Up to 63 alphanumeric characters can be specified. If omitted, the existing setting is not changed. This parameter cannot be specified when the audit log function is disabled.

Example: **-server1** 192.168.1.20
Example: **-server1** fd80::abd0:223:ad
Example: **-server1** foo.bar

audit_log_server1 Server name of syslog server 1

-server1-port-number

Optional. This parameter specifies syslog server 1's UDP port number for the syslog protocol. Specify the port number within 1 to 5 digits. The port number cannot be set above 65535. If omitted, the setting is not changed.

The default value is 514. This parameter cannot be specified when the audit log function is disabled.

port_number Syslog server 1's UDP port number

-server1-port

Optional. This parameter specifies syslog server 1's LAN port. If omitted, the existing setting is not changed. This parameter cannot be specified when the audit log function is disabled.

maintenance	Maintenance port (MNT port)
remote	Remote port (RMT port)

-server2-function

Optional. This parameter specifies whether to enable syslog server 2. If omitted, the existing setting is not changed. This parameter cannot be specified when the audit log function is disabled.

disable	Syslog server 2 is disabled.
rfc3164	Syslog server 2 is enabled and uses message format based on RFC3164.
rfc5424	Syslog server 2 is enabled and uses message format based on RFC5424.

-server2

Optional. This parameter specifies syslog server 2. Only one server can be specified. The server name format should be IPv4 standard notation (a base 256 "d.d.d.d" string), IPv6 address format, or a fully qualified domain name (FQDN). The types of IPv6 addresses that can be specified are global addresses (including 6to4 addresses), link local addresses, and unique local addresses. Up to 63 alphanumeric characters can be specified. If omitted, the existing setting is not changed. This parameter cannot be specified when the audit log function is disabled.

Example: `-server2 192.168.1.20`
Example: `-server2 fd80::abd0:223:ad`
Example: `-server2 foo.bar`

audit_log_server2 Server name of syslog server 2

-server2-port-number

Optional. This parameter specifies syslog server 2's UDP port number for the syslog protocol. Specify the port number within 1 to 5 digits. The port number cannot be set above 65535. If omitted, the setting is not changed. The default value is 514. This parameter cannot be specified when the audit log function is disabled.

port_number Syslog server 2's UDP port number

-server2-port

Optional. This parameter specifies syslog server 2's LAN port. If omitted, the existing setting is not changed. This parameter cannot be specified when the audit log function is disabled.

maintenance	Maintenance port (MNT port)
remote	Remote port (RMT port)

■ **Example(s)**

The following example sets up the audit log function:

```
CLI> set audit -mode enable -server1-function rfc3164 -server1 10.21.134.198 -server1-port-number 514  
-server1-port maintenance -server2-function rfc5424 -server2 10.17.80.6 -server2-port-number 517 -server2-lan-port remote
```

5.3.9 Key Management Server Linkage Function

The key management server linkage function manages the authentication keys that are used for Self-Encrypting Drives (SED) in the key server.

This section explains the commands to set up the key management server linkage function.

- Setting the key management machine name
 - Setting the key server
 - Registering the SSL/KMIP server certificate
 - Creating/changing/deleting the key group
 - Updating the key
 - Recovery from key group blockage
-

Caution

The commands that are described in this section support only models that can be installed with SEDs.

■ Summary of the key management server linkage function settings

The steps involved in setting the key management server linkage function are provided below.

Procedure

- 1** Register the SED authentication key.
Use the "set sed-authentication" command to register the SED authentication key. After executing this command, use the "show sed-authentication" command to check if the SED authentication key is registered.
 - 2** Create an SSL self-signed certificate.
Use the "create ssl-certificate" command to create a Secure Socket Layer (SSL) server key and an SSL server certificate.
 - 3** Set the key management machine name.
Use the "set sed-key-machine-name" command to set the key management machine name. After executing this command, use the "show sed-key-machine-name" command to check if the key management machine name is set.
 - 4** Add the key servers.
Use the "set sed-key-server" command to set up the key servers.
 - 5** Create a key group.
Use the "create sed-key-group" command to create a key group.
-

Note

- Use the "create sed-key-group" command to change a key group.
 - Use the "delete sed-key-group" command to delete a key group.
-

- 6** Import the SSL/KMIP certificate.
Use the "import ssl-kmip-certificate" command to register the server certificate that is signed by a certificate provider to the ETERNUS DX/AF.

7 Update the SED authentication key.

Use the "change sed-key" command to update the SED authentication key for the key group.

 **Caution**

If no SED authentication key is registered in the key group, an error occurs when the first update of the SED authentication key is performed. In this case, register the SSL self-signed certificate of the ETERNUS DX/AF in the key server, accept access from the ETERNUS DX/AF, and then update the SED authentication key again. The "Key Status" changes to "Normal".

8 Check the key server status.

Use the "show sed-key-groups" command to check the key server status.

9 Set the key group for a RAID group.

Use the "set raid-group" command to enable the key management server linkage function for a RAID group.

End of procedure

show sed-key-machine-name

This command displays the key management machine name for connecting with the key server.

■ Syntax

```
show sed-key-machine-name
```

■ Parameter

No parameters.

■ Output

Item name	Description
Key Machine Name	Key management machine name

■ Example(s)

The following example displays the key management machine name:

```
CLI> show sed-key-machine-name  
Key Machine Name      A0E2000000000_ET06F21AUABCPJ000000
```

set sed-key-machine-name

This command specifies the key management machine name that is used as the machine name for connecting to the key server.

The key management machine name corresponds to the machine ID in the key server.

■ Syntax

```
set sed-key-machine-name -machine-name {machine_name | ""}
```

■ Parameter

-machine-name

This parameter specifies the key management machine name. Up to 48 alphanumeric characters and underscores (_) can be specified. Only an alphabetical character can be specified as the first letter. Specify a null character ("") to disable the specified key management machine name.

machine_name Key management machine name

"" The specified key management machine name is disabled.

■ Example(s)

The following example sets a key management machine name:

```
CLI> set sed-key-machine-name -machine-name A0E200000000_ET06F21AUABCPJ000000
```

show sed-key-servers

This command displays the key server.

Syntax

```
show sed-key-servers [-server-id server_id]
```

Parameter

-server-id Optional. This parameter specifies the key server IDs that are to be displayed. 1 or 2 can be specified. Multiple key server IDs can be specified at the same time. If this parameter is omitted, all of the server information is displayed.

server_id Key server ID

Output

Item name	Description
Server ID	Key server ID
Server	FQDN or IP address (IPv4 or IPv6) of the key server
Port Number	Port number of the key server
Port	Indicates which LAN port is used.

Example(s)

The following example displays the key server information:

```
CLI> show sed-key-servers
Server ID      1
Server        10.21.134.198
Port Number   5696
Port          RMT

Server ID      2
Server        -
Port Number   5696
Port          MNT
```

The following example displays the key server information when the server ID is 1:

```
CLI> show sed-key-servers -server-id 1
Server ID      1
Server        10.21.134.198
Port Number   5696
Port          RMT
```

set sed-key-server

This command sets up the key servers. Up to two key servers can be registered.

■ Syntax

```
set sed-key-server -server-id server_id [-server {server | ""}] [-port-number port_number]  
[-port {maintenance | remote}]
```

■ Parameter

- server-id** This parameter specifies the key server ID that is to be registered. 1 or 2 can be specified.
- server_id* Key server ID
- server** Optional. This parameter specifies the key server. Only one server can be specified. The server name format should be IPv4 standard notation (a base 256 "d.d.d.d" string), IPv6 address format, or a fully qualified domain name (FQDN). Up to 63 alphanumeric characters can be specified. Specify a null character ("") to disable the specified server ID. If omitted, the existing setting is not changed.
- Example: -server 192.168.1.20
Example: -server fd80::abd0:223:ad
Example: -server foo.bar
- server* Key server
"" The specified server ID is disabled.
- port-number** Optional. This parameter specifies the port number of the key server. Specify the port number within 1 to 5 digits. The port number cannot be set above 65535. If omitted, the setting is not changed. The default value is 5696.
- port_number* Port number of the key server
- port** Optional. This parameter specifies the LAN port for the key server. If omitted, the existing setting is not changed.
- maintenance* Maintenance port (MNT port)
remote Remote port (RMT port)

■ Example(s)

The following example sets up the key server:

```
CLI> set sed-key-server -server-id 1 -server 10.21.134.198 -port-number 5696 -port maintenance
```

import ssl-kmip-certificate

This command imports and registers in the ETERNUS DX/AF the server certificate that is signed by a certificate provider.

■ Syntax

```
import ssl-kmip-certificate -port {maintenance | remote | fst} -server server_name  
-user login_user_account -filename filename [-indicator {enable | disable}]
```

■ Parameter

- port** This parameter specifies which Ethernet port is used to connect to the FTP server. For details, refer to ["1.11 Note for Specifying FTP Server" \(page 54\)](#).
- | | |
|--------------------|---|
| <i>maintenance</i> | Maintenance port (MNT port) |
| <i>remote</i> | Remote port (RMT port) |
| <i>fst</i> | FST port (DX500 S4/DX600 S4, DX500 S3/DX600 S3, DX8100 S3/DX8700 S3/DX8900 S3, and AF650 S2/AF650 only) |
- server** This parameter specifies the FTP server name in which the certificate file is to be stored. The server name format is IPv4 standard notation (as a string in the base 256 notation d.d.d.d), IPv6 address format or a fully qualified domain name (FQDN).
- Example: `-server 192.168.1.20`
Example: `-server fd80::abd0:223:ad`
Example: `-server foo.bar`
- server_name* FTP server name
- user** This parameter specifies the user name that is to be used to access the FTP server. When this parameter is specified, the command displays an FTP server password prompt.
- login_user_account* User account name
- filename** This parameter specifies the certificate file name.
- filename* Certificate file name
- indicator** Optional. This parameter specifies whether the progress indicator is displayed. If omitted, the progress indicator is displayed.
- | | |
|----------------|--------------------------------------|
| <i>enable</i> | Progress indicator is displayed. |
| <i>disable</i> | Progress indicator is not displayed. |

■ Example(s)

The following example imports and registers the signed certificate:

```
CLI> import ssl-kmip-certificate -port maintenance -server ftp.example.com -user cli-user filename server.cert
```

show sed-key-groups

This command displays the key group and the server certificate.

■ Syntax

```
show sed-key-groups
```

■ Parameter

No parameters.

■ Output

The following information is displayed when a key group is registered.

Item name	Description
SED Key Group Name	Key group name
Key Expiration Date	Valid period of the key being used. If the key server is inaccessible, "Not Available" is displayed. If a valid period is not set, a hyphen (-) is displayed.
Key Status	Key status
Machine Group Name	Machine group name
Security Level	Security level
Recovery Mode	Recovery mode
Period	Valid period of the key. If a valid period is not set, a hyphen (-) is displayed.
Master Server ID	Master server ID. If it is not set, a hyphen (-) is displayed. This information is followed by the master server status.
Master Server	FQDN or IP address of the master server. If it is not set, a hyphen (-) is displayed.
Slave Server ID	Slave server ID. If it is not set, a hyphen (-) is displayed. This information is followed by the slave server status.
Slave Server	FQDN or IP address of the slave server. If it is not set, a hyphen (-) is displayed.

The following information is displayed when a server certificate is registered.

Item name	Description
Issuer Name	Issuer name
Subject Name	Owner name
Valid From	Starting date of the valid period
Valid To	Ending date of the valid period
Serial Number	Serial number

■ Example(s)

The following example displays the key group information and the server certificate information:

```
CLI> show sed-key-groups
SED Key Group           Key Expiration Key Status
Name                    Date
key_group1             2012-07-27    Normal
<Detail Information>
Machine Group Name     machine_group1
Security Level         High
Recovery Mode          Auto
Period                 7
Master Server ID       1 (Normal)
Master Server          10.21.134.198
Slave Server ID        2 (Normal)
Slave Server           10.21.134.199
<Server Certificate Information>
Issuer Name            Fujitsu Certification Authority
Subject Name           Key Management Server
Valid From             2012-08-17 13:04:47
Valid To               2015-08-17 13:04:47
Serial Number          602199653074063
```

The following example shows when a key group is registered but a server certificate is not registered:

```
CLI> show sed-key-groups
SED Key Group           Key Expiration Key Status
Name                    Date
key_group1             2012-07-27    Normal
<Detail Information>
Machine Group Name     machine_group1
Security Level         High
Recovery Mode          Auto
Period                 7
Master Server ID       1 (Normal)
Master Server          10.21.134.198
Slave Server ID        2 (Normal)
Slave Server           10.21.134.199
```

The following example shows when a key group is not registered but a server certificate is registered:

```
CLI> show sed-key-groups
<Server Certificate Information>
Issuer Name            Fujitsu Certification Authority
Subject Name           Key Management Server
Valid From             2012-08-17 13:04:47
Valid To               2015-08-17 13:04:47
Serial Number          602199653074063
```

create sed-key-group

This command creates a key group.
Only one key group can be created for the ETERNUS DX/AF.

■ Syntax

```
create sed-key-group -name name -machine-group-name machine_group_name  
[-security-level {low | high}] [-recovery-mode {auto | manual}] [-period {period | ""}]  
[-master-server-id {master_server_id | ""}] [-slave-server-id {slave_server_id | ""}]
```

■ Parameter

- name** This parameter specifies the key group name. 1 to 32 alphanumeric characters and underscores (_) can be specified. Only an alphabetical character can be specified as the first letter.
- name* Key group name
- machine-group-name** This parameter specifies the machine group name. Set the same name as the device group name in the key server. 1 to 16 alphanumeric characters and underscores (_) can be specified. Only an alphabetical character can be specified as the first letter.
- machine_group_name* Machine group name
- security-level** Optional. This parameter specifies the security level when communication with the key server is not available during a drive failure or drive maintenance work in a RAID group that uses the key group. If omitted, "high" is set.
- high Rebuild or maintenance cannot be performed.
low Rebuild or maintenance is performed using the common key.
- recovery-mode** Optional. This parameter specifies whether to automatically perform recovery of a drive or a RAID group that cannot be communicated with due to blockage of the key server when the communication recovers. When "manual" is set, recovery work is performed manually by the user from Web GUI or CLI. If omitted, "auto" is set.
- auto Automatic recovery is performed.
manual Automatic recovery is not performed.
- period** Optional. This parameter specifies the valid period of the key. This period can be specified on a monthly basis by using a number from 1 to 12. Specify a null character ("") or omit this parameter to not set this period.
- period* Valid period of the key (1 – 12)
"" The valid period of the key is not set.
- master-server-id** Optional. This parameter specifies the key server ID for the master server. 1 or 2 can be specified. When the master server is not used, specify a null character ("") or omit this parameter. Use the same setting as the master server that is set in the key server.

master_server_id Key server ID for the master server (1 or 2)
"" The key server ID is omitted.

-slave-server-id

Optional. This parameter specifies the key server ID for the slave server. 1 or 2 can be specified. When the slave server is not used, specify a null character (""). If omitted, the slave server is not set. Use the same setting as the slave server that is set in the key server.

slave_server_id Key server ID for the slave server (1 or 2)
"" The key server ID is omitted.

■ Example(s)

The following example sets up the key group:

```
CLI> create sed-key-group -name key-group1 -machine-group-name machine_group1 -security-level high -recovery-mode auto  
-period 6 -master-server-id 1 -slave-server-id 2
```

set sed-key-group

This command modifies the key group.

■ Syntax

```
set sed-key-group [-name name] [-machine-group-name machine_group_name]  
[-security-level {low | high}] [-recovery-mode {auto | manual}] [-period {period | ""}]  
[-master-server-id {master_server_id | ""}] [-slave-server-id {slave_server_id | ""}]
```

■ Parameter

-name Optional. This parameter specifies the key group name. 1 to 32 alphanumeric characters and underscores (_) can be specified. Only an alphabetical character can be specified as the first letter. If omitted, the existing setting is not changed.

name Key group name

-machine-group-name Optional. This parameter specifies the machine group name. Set the same name as the device group name in the key server. 1 to 16 alphanumeric characters and underscores (_) can be specified. Only an alphabetical character can be specified as the first letter. If omitted, the existing setting is not changed.

machine_group_name Machine group name

-security-level Optional. This parameter specifies the security level. If omitted, the existing setting is not changed.

high Rebuild or maintenance cannot be performed when communication with the key server is not available during a drive failure or drive maintenance work in a RAID group that uses the key group.

low Rebuild or maintenance is performed using the common key when communication with the key server is not available during a drive failure or drive maintenance work in a RAID group that uses the key group.

-recovery-mode Optional. This parameter specifies whether to automatically perform recovery of a drive or a RAID group that cannot be communicated with due to blockage of the key server when the communication recovers. When "manual" is set, the recovery work is performed manually by the user from Web GUI or CLI. If omitted, "auto" is set.

auto Automatic recovery is performed.

manual Automatic recovery is not performed.

-period Optional. This parameter specifies the valid period of the key. This period can be specified on a monthly basis by using a number from 1 to 12. Specify a null character ("") or omit this parameter to not set this period. If omitted, the existing setting is not changed.

period Valid period of the key (1 – 12)

"" The valid period of the key is not set.

-master-server-id

Optional. This parameter specifies the key server ID for the master server. 1 or 2 can be specified. When the master server is not used, specify a null character ("). If omitted, the existing setting is not changed. Use the same setting as the master server that is set in the key server.

master_server_id Key server ID for the master server (1 or 2)
" The key server ID is omitted.

-slave-server-id

Optional. This parameter specifies the key server ID for the slave server. 1 or 2 can be specified. When the slave server is not used, specify a null character ("). If omitted, the existing setting is not changed. Use the same setting as the slave server that is set in the key server.

slave_server_id Key server ID for the slave server (1 or 2)
" The key server ID is omitted.

■ Example(s)

The following example modifies the key group:

```
CLI> set sed-key-group -name key-group2 -machine-group-name machine_group2 -security-level low -recovery-mode manual  
-period "" -master-server-id 2 -slave-server-id 1
```

delete sed-key-group

This command deletes the key group.

■ Syntax

```
delete sed-key-group
```

■ Parameter

No parameters.

■ Example(s)

The following example deletes the key group:

```
CLI> delete sed-key-group
```

change sed-key

This command updates the key for the key group.

■ Syntax

```
change sed-key -mode {reuse | delete}
```

■ Parameter

-mode	This parameter specifies the update mode.
reuse	The previously used key is reusable after being switched.
delete	The previously used key is not reusable after being switched.

■ Example(s)

The following example updates the key for the key group:

```
CLI> change sed-key -mode reuse
```

recover sed-key-group

This command recovers a blocked key group.

■ Syntax

```
recover sed-key-group
```

■ Parameter

No parameters.

■ Example(s)

The following example recovers the blocked key group:

```
CLI> recover sed-key-group
```

5.3.10 Power-Off/Reboot System

This section explains the commands related to system power-off or reboot.

shutdown

This command will power off or reboot the system. The CLI session is automatically closed.

Note

- The ETERNUS DX/AF is powered off or rebooted regardless of the power synchronization setting.
- When power synchronization is enabled and the ETERNUS DX/AF is powered off by this command, the ETERNUS DX/AF may automatically reboot according to the power control process of the server.

Syntax

```
shutdown -mode {off | reboot}
```

Parameter

-mode	This parameter specifies the shutdown mode.
off	Power off the system.
reboot	Reboot the system.

Example(s)

The following example powers off the system:

```
CLI> shutdown -mode off
```

The following example reboots the system:

```
CLI> shutdown -mode reboot
```

5.3.11 Deduplication/Compression Mode Setting

This section describes the commands related to the Deduplication/Compression mode setting.

 **Caution**

- To use the Deduplication/Compression function, the Deduplication/Compression mode setting must be enabled in advance.
 - This function is supported in the DX200 S4, the DX500 S4/DX600 S4, the DX200 S3, the DX500 S3/DX600 S3, the AF250 S2/AF650 S2, and the AF250/AF650. However, this function is not supported in the Unified Storage.
-

The functions that are related to the Deduplication/Compression mode setting are as follows.

- Displaying the state of the Deduplication/Compression mode setting
- Configuring the Deduplication/Compression mode setting

show dedup-mode

This command displays the state of the Deduplication/Compression mode setting.

■ Syntax

```
show dedup-mode
```

■ Parameter

No parameters.

■ Output

Item name	Description
Dedup mode	State of the Deduplication/Compression mode setting

■ Example(s)

The following example displays the output when the Deduplication/Compression mode setting is enabled:

```
CLI> show dedup-mode  
Mode                [Enable]
```

The following example displays the output when the Deduplication/Compression mode setting is disabled:

```
CLI> show dedup-mode  
Mode                [Disable]
```

set dedup-mode

This command configures the Deduplication/Compression mode setting. The Deduplication/Compression mode setting enables/disables the Deduplication/Compression function in each ETERNUS DX/AF.

Caution

- This command is not supported in the Unified Storage.
- If the Deduplication/Compression mode setting is changed from "enable" to "disable", the ETERNUS DX/AF must be rebooted. If the mode is changed from "disable" to "enable", the ETERNUS DX/AF does not need to be rebooted.
- For the DX200 S4, the DX500 S4, the DX200 S3, and the DX500 S3, the memory capacity for each CM must be 32GB or more in order to enable the Deduplication/Compression mode setting.
- For the DX600 S4 and the DX600 S3, the memory capacity of each CM must be 32GB or more to enable the Deduplication/Compression mode setting.
- If the ETERNUS DX/AF state is Not Ready, the Deduplication/Compression mode setting cannot be configured.
- The Maintenance Operation policy is required to disable the Deduplication/Compression mode setting.
- The Cache control mode temporarily becomes "Write Through Mode" when the Deduplication/Compression mode setting is enabled. When the Cache control mode is Write Through Mode, the performance of the workload I/O in the entire storage system is reduced. Therefore, use this function when the workload I/O is low. This process may take a maximum of several tens of minutes to complete.

Syntax

```
set dedup-mode -mode {enable | disable}
```

Parameter

-mode	This parameter specifies whether to enable the Deduplication/Compression mode setting. For details on the Deduplication/Compression mode setting, refer to "3.4 Deduplication/Compression" (page 276) .
enable	The Deduplication/Compression mode setting is enabled. (default if Memory Extension is installed)
disable	The Deduplication/Compression mode setting is disabled. (default if Memory Extension is not installed)

Example(s)

The following example enables the Deduplication/Compression mode setting:

```
CLI> set dedup-mode -mode enable
```

5.3.12 Unified License Configuration

For the license registration of the Unified function in the ETERNUS DX/AF, use the "upgrade unified-model" command. The Maintenance Operation policy is required.

5.3.13 Non-disruptive Storage Migration Function

The Non-disruptive Storage Migration function migrates volume data from the migration source storage system (external storage system) to the migration destination storage system (local storage system) without using the host. RAID Migration is used for the data migration.

The logical volumes in the external storage system are imported into the local storage system as External Drives and an External RAID Group is created. Because a logical volume (External Volume) that is created in an External RAID Group inherits the device Information of an External LU, the server recognizes the volume as the same device. Therefore, the server does not need to recognize the migration destination volume and the online data migration is available.

Figure 5.5 Non-disruptive Storage Migration function overview

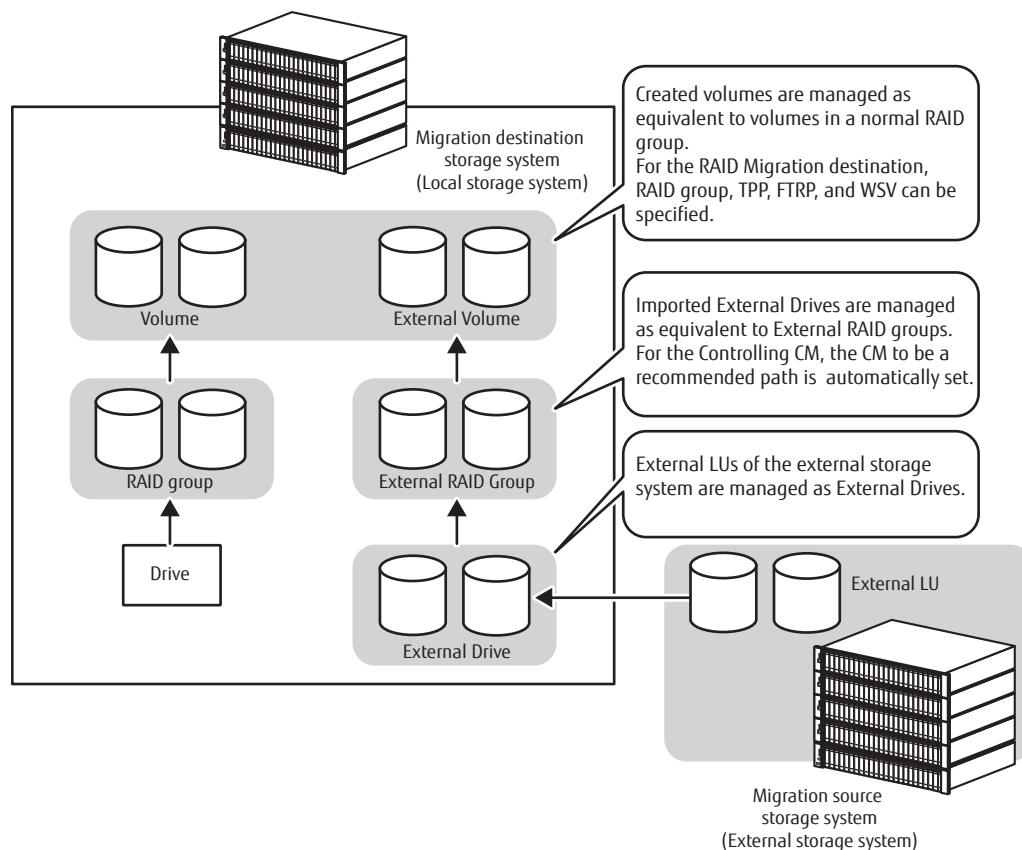

This section explains the following commands related to the Non-disruptive Storage Migration function.

- Registering/displaying the license for the Non-disruptive Storage Migration function
- Displaying external storage systems/External LU list
- Importing External LU (creating an External Drive)
- Displaying/deleting External Drives
- Creating/deleting/displaying External RAID Groups
- Creating an External Volume (*1)
- RAID Migration function (*1)

*1: For details about the operation commands, refer to ["3.2.1 Volume" \(page 148\)](#).

Note

- To use this function, registration of the Non-disruptive Storage Migration License (free of charge) is required.
 - For connection between storage systems, an FC host interface is used. FC ports are connected in the FC-Initiator mode.
 - Up to 32 ports on the external storage system can be connected to one FC-Initiator port.
 - For the RAID Migration destination, RAID group, TPP, FTRP, and WSV can be specified.
The volume type that can be created from the imported External Volume is Standard only.
 - One External Volume can be created from an External RAID Group.
 - Volumes that are migrated to the local storage system respond to the host with information that is equivalent to External Volumes, even after migration is completed.
-

Volume overview

The volumes used for the Non-disruptive Storage Migration function are shown below.

- External LU
General term for migration source LU managed on the external storage system.
- External Drive
General term for migration source LU managed on the local storage system.
Drives specified with "Migration" for "Usage" in the output of the "show external-drive" command.
- External RAID Group
General term for a RAID group created from an External Drive.
RAID groups specified with "Migration" for "Usage" in the output of the "show external-raid-group" command.
- External Volume
Volume created from an External RAID Group.
Volumes specified with "Migration" for "Type" in the output of the "show volumes" command.
- Maximum number of volumes that can be migrated
Data migration (RAID Migration) can be performed for 32 volumes at a time.
- Number of External Drives that can be imported into the local storage system
The number of External Drives that can be imported is shown below for each model.

DX60 S4/DX60 S3: 512
DX100 S4/DX100 S3: 2,048
DX200 S4/DX200 S3: 4,096
DX500 S4/DX500 S3: 8,192
DX600 S4/DX600 S3: 8,192
DX8100 S3/DX8700 S3/DX8900 S3: 16,384
AF250 S2/AF250: 4,096
AF650 S2/AF650: 8,192
DX200F: 4,096

■ Setting the Non-disruptive Storage Migration function

The following procedure explains how to set the Non-disruptive Storage Migration function.

Procedure

- 1 Enable the Non-disruptive Storage Migration function using the "set non-disruptive-storage-migration" command to register the license.
- 2 Connect the external storage system and local storage system in the FC-Initiator mode.
 - 2-1 Use the "set host-port-mode" command to set the operation mode of the host interface port to the Initiator mode.

Caution

Before executing the "set fc-parameters" command, make sure to use the "set host-port-mode" command to switch the port mode. The reason for this operation is that switching the port mode restores some parameters to the default values.

- 2-2 Use the "show host-port-mode" command to check the status.
 - 2-3 Use the "set fc-parameters" command to specify the parameters to control the FC host interface port.
 - 2-4 Use the "show fc-parameters" command to check the status.
- 3 Import the volumes in the external storage system into the local storage system as External Drives.
 - 3-1 Use the "discover external-storage" command to check the external storage system that is connected to the FC-Initiator port.
 - 3-2 Specify the "-serial" option for the "discover external-storage" command to check the External LU of the selected external storage system.
 - 3-3 Use the "create external-drive" command to import the volumes as External Drives. Check the state of the imported External Drive using the "show external-drive" command.
- 4 Create an External RAID Group from the External Drive.
 - 4-1 Use the "create external-raid-group" command to create an External RAID Group.
 - 4-2 Use the "show external-raid-group" command to check the status.
- 5 Create an External Volume in the External RAID Group.
 - 5-1 Using the "create volume" command, specify the "-external-rg-number" or "-external-rg-name" option to create an External Volume.
The created External Volume is not formatted and the stored data is inherited.
 - 5-2 Use the "show volumes" command to check the status.
- 6 Associate the created volume with the server.
 - 6-1 Set host affinity.
For details about host affinity setting, refer to ["3.6 Host Interface Management" \(page 302\)](#).
- 7 Add a multipath to the server.

- 8** Remove the multipath from the server and disconnect the server from the external storage system. The operation switches from the migration source storage system to the migration destination storage system.
- 9** Start data migration (RAID Migration).
 - 9-1** Use the "start migration" command to start data migration.
 - 9-2** Use the "show migration" command to check the status. To stop the data migration, use the "stop migration" command.

Note

When migrating a volume created from an External RAID Group, the encryption function cannot be specified.

- 10** After the migration is completed, delete both the External RAID Group and the External Drive.
 - 10-1** Use the "delete external-raid-group" command to delete the External RAID Groups.
 - 10-2** Use the "delete external-drive" command to delete the External Drives.
- 11** Delete the license for the Non-disruptive Storage Migration function.

End of procedure

Figure 5.6 Structure of the Non-disruptive Storage Migration function

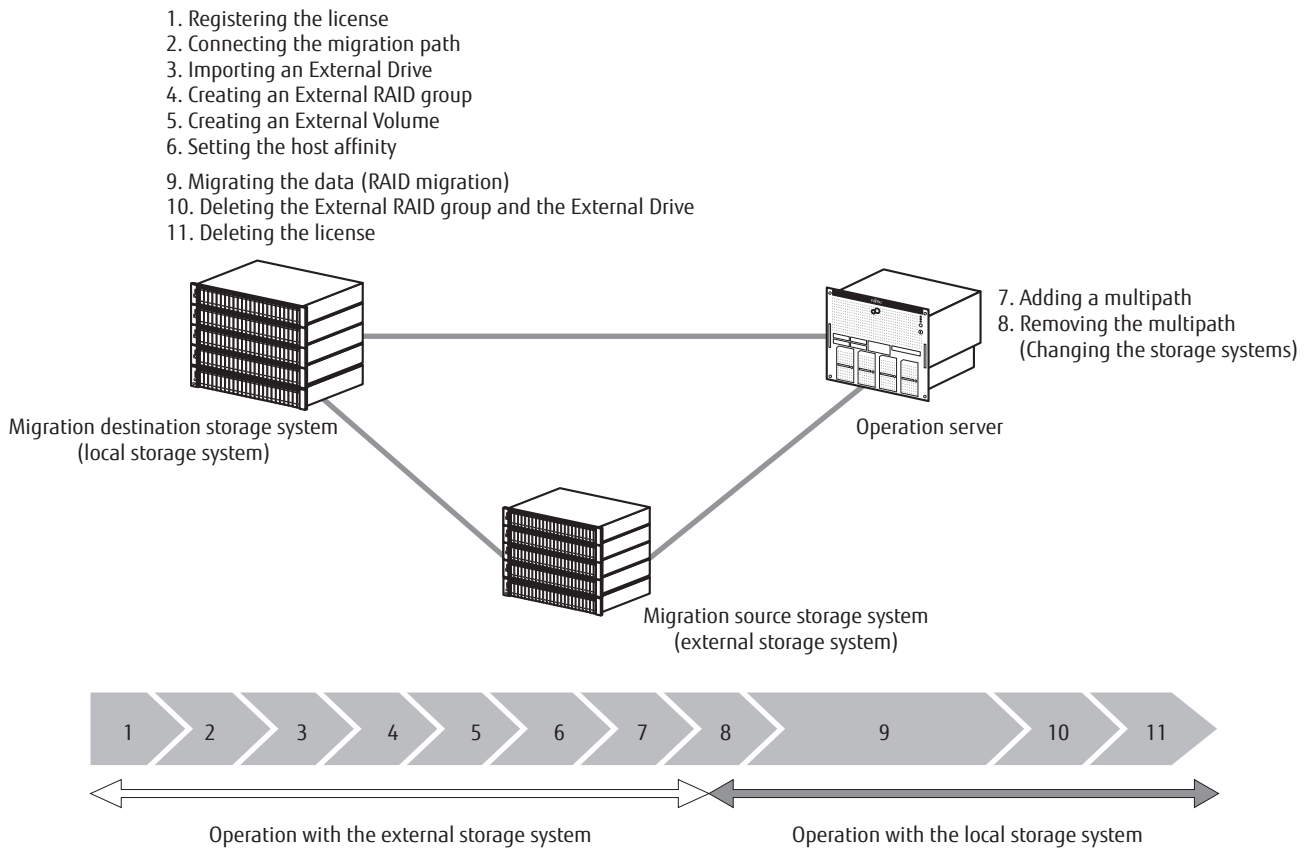

The commands used for the Non-disruptive Storage Migration function are as follows:

Function	Command
Displaying volumes	show volumes
Creating volumes	create volume
Deleting volumes	delete volume
Displaying the Migration	show migration
Starting a RAID Migration	start migration
Stopping a RAID Migration	stop migration
Displaying the registration status of the Non-disruptive Storage Migration License	show non-disruptive-storage-migration
Registering the Non-disruptive Storage Migration License	set non-disruptive-storage-migration
Displaying the external storage system information and External LU Information	discover external-storage
Displaying the External Drive information	show external-drive
Importing the External Drives	create external-drive
Deleting External Drives	delete external-drive
Displaying External RAID Groups	show external-raid-group
Creating an External RAID Group	create external-raid-group
Deleting External RAID Groups	delete external-raid-group
Recovering an External RAID Group	recover external-raid-group

Whether the commands can operate External Volumes is shown below:

Command	External Volume Operation
set volume	x
show volume-progress	x
show volume-mapping	x
format volume	-
expand volume	-
set volume-parameters	N/A
create odx-buffer-volume	N/A
set volume-exc	N/A
set volume-qos	x
create lun-group	x
set lun-group	x
set mapping	x
start advanced-copy	-
create rec-disk-buffer	N/A
show performance	x
set cache-parameters	N/A
show cache-parameters	N/A
release reservation	x

x: Available, -: Unavailable, N/A: The command does not function even if it is specified.

show non-disruptive-storage-migration

This command displays the registration status of the license for the Non-disruptive Storage Migration function.

■ Syntax

```
show non-disruptive-storage-migration
```

■ Parameter

No parameters.

■ Output

Item name	Description
License	Registration status of the license
Registered	The license is registered.
-	The license is not registered.

■ Example(s)

The following example displays the registration status of the Non-disruptive Storage Migration function:

```
CLI> show non-disruptive-storage-migration  
License [Registered]
```

set non-disruptive-storage-migration

This command registers the license for the Non-disruptive Storage Migration function.

Note

To use the Non-disruptive Storage Migration function, register the Non-disruptive Storage Migration License in advance using this command.

Syntax

```
set non-disruptive-storage-migration -key key
```

Parameter

-key This parameter specifies the license key for the function that manages the external storage system. The license key consists of 16 alphanumeric characters (fixed). To delete the license, specify a null character ("").

key License key

Example(s)

The following example registers the license:

```
CLI> set non-disruptive-storage-migration -key 0123456789abcdef
```

The following example deletes the license:

```
CLI> set non-disruptive-storage-migration -key ""
```

discover external-storage

This command displays information of the external storage system that is connected to the local storage system and information of the External LU.

Syntax

```
discover external-storage [ -serial serial_number ]
```

Parameter

- serial** Optional. This parameter specifies the serial number of the external storage system. When a serial number is specified, the External LU Information of the corresponding external storage system is displayed. If omitted, information of external storage system connected to the local storage system is displayed in a list. A maximum of 16 alphanumeric characters (ASCII) can be used. Up to 512 External LUs associated with the specified external storage system can be displayed. Only one serial number can be specified.

serial_number

Serial number

Output

Item name	Description
External Storage	external storage system information
Serial No.	Serial number of the external storage system
Vendor ID	Vendor ID of the external storage system
Product ID	Product ID of the external storage system
External LU Count	Number of External LUs associated with the specified external storage system. Displayed only when the "-serial" parameter is specified.
Connection Path	Connection path information between the external storage system and local storage system
Target WWN	WWN of the external storage system port
Initiator Port	FC-Initiator port of the local storage system connected to the external storage system.
External LU List	External LU list
LUN	LU number of the External LU. If the LUN addressing format is a PRHL/FLAT configuration, the LU number is displayed with a decimal number. If the LUN addressing format is a configuration other than PRHL/FLAT, the LU number is displayed with a hexadecimal number.
UID	GUID of the External LU
Size	Capacity of the External LU. For details about the display format, refer to "1.3 Size of Drives and Logical Units" (page 50) .
LUN Addressing	LUN addressing format of the External LU
PRHL	PRHL configuration
FLAT	FLAT configuration
-	The LUN addressing format is a configuration other than PRHL/FLAT.

■ Example(s)

The following example displays information of all connected external storage systems:

```
CLI> discover external-storage
<External Storage>
Serial No.      [2801FE0006000000]
Vendor ID      [FUJITSU]
Product ID     [ETERNUS_DXL]
<Connection Path>
Target WWN      Initiator Port
-----
0001020304050607 CM#0 CA#0 Port#2
08090A0B0C0D0E0F CM#1 CA#0 Port#1

<External Storage>
Serial No.      [1106A60005000000]
Vendor ID      [FUJITSU]
Product ID     [ETERNUS_DXH]
<Connection Path>
Target WWN      Initiator Port
-----
0001020304050611 CE#0 CM#0 CA#0 Port#2
08090A0B0C0D0F00 CE#0 CM#1 CA#0 Port#1
```

The following example displays the information of the external storage system with a serial number of "2801FE0006000000":

```
CLI> discover external-storage -serial 2801FE0006000000
<External Storage>
Serial No.      [2801FE0006000000]
Vendor ID      [FUJITSU]
Product ID     [ETERNUS_DXL]
External LU Count [2]
<External LU List>
LUN            UID                                Size      LUN Addressing
-----
0 600000E00D2A00000002A0000000000000 4.00 GB PRHL
1 600000E00D2A00000002A0000000F00000 8.00 GB PRHL
```

The following example displays the information of the external storage system that has a LUN whose LUN addressing format is not a PRHL/FLAT configuration:

```
CLI> discover external-storage -serial 2801FE0006000000
<External Storage>
Serial No.      [2801FE0006000000]
Vendor ID      [UNKNOWNVENDOR]
Product ID     [UNKNOWN_PRODUCT_ID]
External LU Count [2]
<External LU List>
LUN            UID                                Size      LUN Addressing
-----
0x8005123456789ABC 0000000000000000000000000000000025 4.00 GB -
0x8006123456789ABC 0000000000000000000000000000000026 4.00 GB -
```

show external-drive

This command displays information of External Drives that are imported into the ETERNUS DX/AF.

■ Syntax

```
show external-drive [ -mode { list | detail } ] [ -external-drive-number numbers | -serial serial_number ]
```

■ Parameter

- mode** Optional. This parameter specifies a display mode.
If omitted, summary information is displayed.
- list** Summary information is displayed.
- detail** Detailed information is displayed.
- external-drive-number**
- Optional. This parameter specifies the External Drive number.
When this parameter is specified, only the External Drive that matches the specified number is displayed.
Multiple numbers can be specified, but duplicate numbers cannot be specified. Multiple numbers can be specified by separating them with a comma (,) or a hyphen (-) (or both).
- numbers** External Drive number
- serial** Optional. This parameter specifies the serial number of the external storage system.
When this parameter is specified, only the External Drives that belong to the specified external storage system are displayed.
A maximum of 16 alphanumeric characters (ASCII) can be used. Only one serial number can be specified.
- serial_number***
- Serial number

■ Output

Item name	Description
External Drive	External Drive information
External Drive No.	External Drive number
Status	Status
Size	Capacity. For details about the display format, refer to " 1.3 Size of Drives and Logical Units " (page 50). When detailed information is displayed, the size in bytes is also displayed. Display example: [131.50GB (141197049856 bytes)]
Usage	Usage of the External LU
Migration	For data migration
External LU Info	Whether the External LU Information is inherited or not
Inherited	External LU Information is inherited.
-	External LU Information is not inherited.
External LU	Information related to External LU
Serial No.	Serial number of the external storage system
Vendor ID	Vendor ID of the external storage system
Product ID	Product ID of the external storage system
UID	GUID of the External LU
LUN	LU number of the External LU. If the LUN addressing format is a PRHL/FLAT configuration, the LU number is displayed with a decimal number. If the LUN addressing format is a configuration other than PRHL/FLAT, the LU number is displayed with a hexadecimal number.
LUN Addressing	LUN addressing format of the External LU
PRHL	PRHL configuration
FLAT	FLAT configuration
-	The LUN addressing format is a configuration other than PRHL/FLAT.
Connection Path	Connection path information between the external storage system and local storage system
Target WWN	WWN of the external storage system port
Initiator Port	FC-Initiator port of the local storage system connected to the external storage system.

■ Example(s)

The following example displays the summary information of all External Drives:

```
CLI> show external-drive
External Drives
No.   Status      Size      Usage      External LU Info  External LUs
-----
0 Available 1023.00 MB Migration Inherited 2801FE0006000000 600000E00D2A0000002A006800000000
1 Available 8.00 GB Migration Inherited 2801FE0007000000 600000E00D2A0000002A006800010000
2 Available 4.00 GB Migration - 2801FE0009000000 600000E00D2B0000002A006800020000
```

The following example displays the detailed information of all External Drives:

```

CLI> show external-drive -mode detail
<External Drive>
External Drive No.  [0]
Status              [Available]
Size                [1023.00 MB (1072693248 Byte)]
Usage              [Migration]
External LU Info    [Inherited]
<External LU>
  Serial No.        [2801FE0006000000]
  Vendor ID         [FUJITSU]
  Product ID        [ETERNUS_DXL]
  UID               [600000E00D2A0000002A000000000000]
  LUN               [0]
  LUN Addressing    [PRHL]
<Connection Path>
  Target WWN        Initiator Port
  -----
  3331020304050607 CM#0 CA#1 Port#2
  44490A0B0C0D0E0F CM#1 CA#0 Port#2

<External Drive>
External Drive No.  [1]
Status              [Available]
Size                [8.00GB (8589934592 Byte)]
Usage              [Migration]
External LU Info    [-]
<External LU>
  Serial No.        [2801FE0007000000]
  Vendor ID         [FUJITSU]
  Product ID        [ETERNUS_DXL]
  UID               [600000E00D2A0000002A0000000F0000]
  LUN               [1]
  LUN Addressing    [PRHL]
<Connection Path>
  Target WWN        Initiator Port
  -----
  1111020304050607 CM#0 CA#0 Port#2
  22290A0B0C0D0E0F CM#1 CA#0 Port#1

<External Drive>
External Drive No.  [2]
Status              [Available]
Size                [4.00GB (4294967296 Byte)]
Usage              [Migration]
External LU Info    [-]
<External LU>
  Serial No.        [2801FE0007000000]
  Vendor ID         [FUJITSU]
  Product ID        [ETERNUS_DXL]
  UID               [600000E00D2A0000002A0000000E0000]
  LUN               [2]
  LUN Addressing    [PRHL]
<Connection Path>
  Target WWN        Initiator Port
  -----
  0001020304050607 CM#0 CA#0 Port#2
  08090A0B0C0D0E0F CM#1 CA#0 Port#2
  
```

The following example displays the summary information of External Drives #0 and #1:

```

CLI> show external-drive -mode list -external-drive-number 0,1
External Drives
No.  Status      Size      Usage      External LU Info  External LUs
-----
  0  Available    1023.00 MB Migration Inherited         2801FE0006000000 600000E00D2A0000002A000000000000
  1  Available      8.00 GB Migration -          2801FE0007000000 600000E00D2A0000002A0000000F0000
  
```

The following example displays the detailed information of the External Drive imported from the external storage system with a serial number of "2801FE0006000000":

```
CLI> show external-drive -mode detail -serial 2801FE0006000000
<External Drive>
External Drive No.  [0]
Status              [Available]
Size                [1023.00 MB (1072693248 Byte)]
Usage               [Migration]
External LU Info    [Inherited]
<External LU>
  Serial No.        [2801FE0006000000]
  Vendor ID         [FUJITSU]
  Product ID        [ETERNUS_DXL]
  UID               [600000E00D2A0000002A000000000000]
  LUN               [0]
  LUN Addressing    [PRHL]
<Connection Path>
  Target WWN        Initiator Port
  -----
  0001020304050607 CM#0 CA#0 Port#1
  08090A0B0C0D0E0F CM#1 CA#0 Port#2
  18191A1B1C1D1E1F CM#1 CA#1 Port#2
```

The following example displays the detailed information of the External Drive if the LUN addressing format is a configuration other than PRHL/FLAT:

```
CLI> show external-drive -mode detail -serial 2801FE0006000000
<External Drive>
External Drive No.  [5]
Status              [Available]
Size                [1023.00 MB (1072693248 Byte)]
Usage               [Migration]
External LU Info    [Inherited]
<External LU>
  Serial No.        [2801FE0006000000]
  Vendor ID         [UNKNOWNVENDOR]
  Product ID        [UNKNOWN_PRODUCT_ID]
  UID               [000000000000000000000000000000000025]
  LUN               [0x8005123456789ABC]
  LUN Addressing    [-]
<Connection Path>
  Target WWN        Initiator Port
  -----
  1122334455667788 CM#0 CA#1 Port#2
  11000000000000088 CM#1 CA#0 Port#0
```

create external-drive

This command imports the External LU of the specified external storage system as an External Drive of the local storage system.

Note

- The External LU of the external storage system that is displayed with the "discover external-storage" command can be imported.
- Before executing this command, use the "discover external-storage" command to check the External LU of the external storage system that can be imported.

Syntax

```
create external-drive -serial serial_number [ -inherit-external-lu-info { yes | no } ] -lun { luns | all }
```

Parameter

- serial** This parameter specifies the serial number of the external storage system. A maximum of 16 alphanumeric characters (ASCII) can be used. Only one serial number can be specified.
- serial_number*
Serial number
- inherit-external-lu-info**
- Optional. This parameter specifies whether the External Drive information is inherited or not. If omitted, the information is inherited.
- yes External LU Information is inherited.
no External LU Information is not inherited.
- lun** This parameter specifies the External LU number. The External LU imported into the ETERNUS DX/AF cannot be imported again. For "*luns*", multiple numbers can be specified but duplicate numbers cannot be specified. If this parameter is specified with decimal numbers (the LUN addressing format is a PRHL/FLAT configuration), up to 512 numbers can be specified. (The settable range is 0 to 4095, numbers only.) Multiple numbers can be specified by separating them with a comma (,) or a hyphen (-) (or both). If this parameter is specified with hexadecimal numbers (the LUN addressing format is a configuration other than PRHL/FLAT), up to 256 numbers can be specified. (Fixed to 18 characters, including numbers, upper case letters from A to F and lower case letters from a to f. The first characters must be 0x.) Multiple numbers can be specified by separating them with a comma (,).
- luns* LU number of the External LU
all All External LUs in the specified external storage system are imported.

■ Example(s)

The following example imports External LU#0 , #1, and #2 of the specified external storage system with External LU Information inherited:

```
CLI> create external-drive -serial 1106A60005000000 -inherit-external-lu-info yes -lun 0-2
```

The following example imports all External LUs of the specified external storage system with no External LU Information inherited:

```
CLI> create external-drive -serial 1106A60008000000 -inherit-external-lu-info no -lun all
```

The following example imports External LUs (whose LUN addressing format is a configuration other than PRHL/FLAT) from the specified external storage system with no External LU Information inherited:

```
CLI> create external-drive -serial 1106A60008000000 -inherit-external-lu-info no -lun  
0x8005123456789abc,0x8006321654987cba
```

delete external-drive

This command deletes External Drives.

Note

External Drives that are in use cannot be deleted. To delete an External Drive, the External RAID Group created from the target External Drive must be deleted.

Syntax

```
delete external-drive { -external-drive-number numbers | -serial serial_number }
```

Parameter

-external-drive-number

This parameter specifies the External Drive number.

Multiple numbers can be specified, but duplicate numbers cannot be specified. Multiple numbers can be specified by separating them with a comma (,) or a hyphen (-) (or both).

numbers External Drive number

-serial

This parameter specifies the serial number of the external storage system.

All imported External Drives are deleted from the external storage system of the specified serial number. If any one of the External Drives is in use, the command terminates with an error.

A maximum of 16 alphanumeric characters (ASCII) can be used. Only one serial number can be specified.

serial_number

Serial number

Example(s)

The following example deletes imported External Drives #0 and #1:

```
CLI> delete external-drive -external-drive-number 0,1
```

The following example deletes all External Drives of the external storage system with a serial number of "2801FE0006000000":

```
CLI> delete external-drive -serial 2801FE0006000000
```

show external-raid-group

This command displays the External RAID Groups imported into the ETERNUS DX/AF.

Syntax

```
show external-raid-group [ -external-rg-number numbers | -external-rg-name name ]
```

Parameter

-external-rg-number or -external-rg-name

Optional. This parameter specifies the identifier of the External RAID Group to display the detailed information.

If omitted, the summary information of all External RAID Groups is displayed.

When the "-external-rg-number *numbers*" parameter is specified, multiple numbers can be specified but duplicate numbers cannot be specified.

When the "-external-rg-name *name*" parameter is specified, only one External RAID Group name can be specified.

numbers External RAID Group number

name External RAID Group name

Output

Item name	Description
External RAID Group Information	External RAID Group identification information
External RAID Group	External RAID Group information
No.	External RAID Group number
Name	External RAID Group name
Usage	Usage of the External LU
Migration	Data migration
External LU Info	Whether the External LU Information is inherited or not
Inherited	External LU Information is inherited.
-	External LU Information is not inherited.
Assigned CM	Associated CM number
Status	External RAID Group status
Total Capacity	Total capacity. For details about the display format, refer to "1.3 Size of Drives and Logical Units" (page 50) . When detailed information is displayed, the size in bytes is also displayed. Display example: [131.50GB (141197049856 bytes)]
Free Capacity	Free capacity. If "0" is displayed, this indicates the state in which the External Volumes are created from the External RAID group. If a number other than "0" is displayed, this indicates the state in which there are no External Volumes in the External RAID group. For details about the display format, refer to "1.3 Size of Drives and Logical Units" (page 50) . When detailed information is displayed, the size in bytes is also displayed. Display example: [131.50GB (141197049856 bytes)]

Item name	Description
External Drive List	External Drive list
No.	External Drive number assigned to the External RAID Group
Status	External Drive status

■ Example(s)

The following example displays the summary information of all External RAID Groups:

```
CLI> show external-raid-group
```

External RAID Group No.	Usage	External LU Info	Assigned CM	Status	Total Capacity	Free Capacity	
1	RAIDGROUP001	Migration	Inherited	CM#0	Available	131.50 GB	129.42 GB
2	RAIDGROUP002	Migration	-	CM#1	Broken	131.50 GB	129.42 GB

The following example displays the detailed information of External RAID Groups #1 and #2:

```
CLI> show external-raid-group -external-rg-number 1,2
<External RAID Group Information>
External RAID Group No. [1]
External RAID Group Name [RAIDGROUP001]
Usage [Migration]
External LU Info [Inherited]
Assigned CM [CM#0]
Status [Available]
Total Capacity [131.50 GB (141197049856 Byte)]
Free Capacity [129.42 GB (138963666862 Byte)]
<External Drive List>
No. Status
-----
0 Available

<External RAID Group Information>
External RAID Group No. [2]
External RAID Group Name [RAIDGROUP002]
Usage [Migration]
External LU Info [-]
Assigned CM [CM#1]
Status [Broken]
Total Capacity [131.50 GB (141197049856 Byte)]
Free Capacity [129.42 GB (138963666862 Byte)]
<External Drive List>
No. Status
-----
1 Broken
```

create external-raid-group

This command creates an External RAID Group. For one External Drive, one External RAID Group is created.

■ Syntax

```
create external-raid-group -name name -external-drive-number { numbers | all }
```

■ Parameter

- name** This parameter specifies an alias for the External RAID Group. For details, refer to ["1.2.10 RAID Group Syntax" \(page 39\)](#). Only one External RAID Group name can be specified. An External RAID Group name is a unique name in the ETERNUS DX/AF. If multiple External Drives are specified for the "-external-drive-number" parameter, the External RAID groups are created by adding an integer in ascending order to the end of the specified name. If the maximum number of characters (16 characters) is exceeded by addition of the above-mentioned integer, the string of characters that exceeds the maximum number is converted to "~".
- Example 1: When two External RAID Groups are created with "-name VLUNAME_abcdefgh" specified, External RAID Groups named "VLUNAME_abcdef~0" and "VLUNAME_abcdef~1" are created.
- Example 2: When two External RAID Groups are created with "-name VLUNAME_abcdefg" specified while 10 External RAID Group names from "VLUNAME_abcdefg0" to "VLUNAME_abcdefg9" exist in the ETERNUS DX/AF, External RAID Groups named "VLUNAME_abcde~10" and "VLUNAME_abcde~11" are created.
- name* External RAID Group name
- external-drive-number** This parameter specifies the External Drive assigned to the External RAID Group. One or more parameters can be specified at the same time.
- For one specified External Drive, one External RAID Group is created.
 - The same number of External RAID Groups is created as the number of specified External Drives.
 - When the specified External Drive does not exist, the command terminates with an error.
 - When the specified External Drive is in use, the command terminates with an error.
 - When "all" is specified, External RAID Groups are created for all unused External Drives.
 - When "all" is specified but no unused External Drives exist, the command terminates with an error.
 - Multiple numbers can be specified, but duplicate numbers cannot be specified. Multiple numbers can be specified by separating them with a comma (,) or a hyphen (-) (or both).
- numbers* External Drive number
- all All External Drives are specified.

■ Example(s)

The following example creates External RAID Groups for External Drives #0 and #20:

```
CLI> create external-raid-group -name VLU -external-drive-number 0,20
```

The following example creates External RAID Groups for all External Drives:

```
CLI> create external-raid-group -name VLU -external-drive-number all
```

delete external-raid-group

This command deletes the specified External RAID Group.

■ Syntax

```
delete external-raid-group { -external-rg-number numbers | -external-rg-name name }
```

■ Parameter

-external-rg-number or -external-rg-name

This parameter specifies the identifier of the External RAID Group to be deleted.

For details, refer to "[1.2.10 RAID Group Syntax](#)" (page 39).

When the "-external-rg-number" parameter is specified, multiple numbers can be specified but duplicate numbers cannot be specified.

When the "-external-rg-name" parameter is specified, only one External RAID Group name can be specified.

numbers External RAID Group number

name External RAID Group name

■ Example(s)

The following example deletes External RAID Groups #0 and #1:

```
CLI> delete external-raid-group -external-rg-number 0,1
```

recover external-raid-group

This command recovers the External RAID Group.

■ Syntax

```
recover external-raid-group { -external-rg-number number | -external-rg-name name }
```

■ Parameter

-external-rg-number or -external-rg-name

This parameter specifies the identifier of the External RAID Group to be recovered. Specify an External RAID Group in Broken status. Multiple groups cannot be specified. For details, refer to ["1.2.10 RAID Group Syntax" \(page 39\)](#).

number External RAID Group number

name External RAID Group name

■ Example(s)

The following example recovers External RAID Group #0:

```
CLI> recover external-raid-group -external-rg-number 0
```

Chapter 6

Information Settings and Display



This chapter explains the commands relating to the various information collected by the system.

6.1 Performance

This section explains performance related commands.

6.1.1 Performance Information

These functions display the performance information that is collected and stored by the system. Information is collected for each volume, each host interface port, each drive, and each controller module. Collection must be enabled before performance information can be displayed.

This section explains the commands for displaying performance information as shown below:

- Starting the performance information acquisition
- Stopping the performance information acquisition

show performance

This command displays the performance information collected and stored by the system. Performance information can be displayed only when the collection of performance information has been started through GUI or CLI.

Syntax

```
show performance  
[-type {host-io [-volume-number volume_numbers | -volume-name volume_names] |  
advanced-copy [-volume-number volume_numbers | -volume-name volume_names] |  
disks [-disks disks] | cm [-cm cm_numbers] | port [-port port_numbers] | pfm  
}]
```

Parameter

-type Optional. This parameter specifies the type of performance information. If omitted, the performance collection status is displayed.

host-io	Host I/O statistics for each volume
advanced-copy	Advanced copy statistics for each volume
disks	Statistics for each drive
cm	Statistics for controller module
port	Statistics for host interface port
pfm	Statistics for each PCIe Flash Module (PFM) (only for the DX500 S4/DX600 S4, the DX500 S3/ DX600 S3, and the DX8700 S3/DX8900 S3)

-volume-number or -volume-name

Optional. This parameter specifies the volume identifiers. This parameter can be specified only when "host-io" or "advanced-copy" is selected for "-type". One or more volumes can be specified at the same time. For details, refer to ["1.2.11 Volume Syntax" \(page 40\)](#). If omitted, the information of all the volumes is listed.

volume_numbers Volume number
volume_names Volume name

-disks Optional. This parameter specifies the volume identifiers. This parameter can be specified only when "disks" is selected for "-type". One or more drives can be specified at the same time. For details, refer to ["1.2.5 Drive Syntax" \(page 35\)](#). If omitted, the information for all drives is listed.

disks Drive

-cm Optional. This parameter specifies the controller module (or the CM number). This parameter can be specified only when "cm" is selected for the "-type" parameter. If omitted, the information for both controller modules is listed.

cm_numbers CM number

- 0 CM#0
(DX60 S4/DX100 S4/DX200 S4, DX500 S4/DX600 S4, DX60 S3/DX100 S3/DX200 S3, DX500 S3/DX600 S3, DX8100 S3, AF250 S2/AF650 S2, AF250/AF650, and DX200F only)
- 1 CM#1
(DX60 S4/DX100 S4/DX200 S4, DX500 S4/DX600 S4, DX60 S3/DX100 S3/DX200 S3, DX500 S3/DX600 S3, DX8100 S3, AF250 S2/AF650 S2, AF250/AF650, and DX200F only)
- wx* CE#w-CM#x (DX8700 S3/DX8900 S3 only)
 "w" is the controller enclosure (CE) number, "x" is the controller module (CM) number.
 Example: "01" indicates CE#0-CM#1
 For the controller enclosure number, the range that the value can be specified with is 0 to b (hex).
 For the controller module number, 0 or 1 can be specified.

-port Optional. This parameter specifies the host interface port number, and can be specified only when "port" is selected for the "-type" parameter. Only one parameter can be specified at the same time. If omitted, all the host interface ports are displayed.

Example: -port 000

For details, refer to ["1.2.15 Host Interface Port Syntax" \(page 44\)](#).

port_numbers Host interface port number

- xyz* "x" is the controller module (CM) number, "y" is the CA number, and "z" is the host port number (DX60 S4/DX100 S4/DX200 S4, DX500 S4/DX600 S4, DX60 S3/DX100 S3/DX200 S3, DX500 S3/DX600 S3, DX8100 S3, AF250 S2/AF650 S2, AF250/AF650, and DX200F only).
 Example: "123" indicates CM#1-CA#2-Port#3
- wxyz* "w" is the controller enclosure (CE) number, "x" is the controller module (CM) number, "y" is the CA number, and "z" is the host port number (DX8700 S3/DX8900 S3 only).
 Example: "0123" indicates CE#0-CM#1-CA#2- Port#3

■ Output

Item name	Description
Status	Indicates whether collection of performance information has started
Interval	The interval time by which performance information is updated
Volume	Volume identifiers
No.	Volume number
Name	Volume name
IOPS(IOPS)	IOPS
Read	Read IOPS
Write	Write IOPS
Transmitted	Transmitted IOPS
Received	Received IOPS
Throughput	Throughput (in MB/s)
Read	Read throughput
Write	Write throughput
Transmitted	Transmitted throughput
Received	Received throughput

Item name	Description
Response Time	Response time (in milliseconds)
Read	Read response time
Write	Write response time
Processing Time	Processing time in the ETERNUS DX/AF of the response times (in milliseconds)
Read	Read processing time
Write	Write processing time
Cache Hit Rate	Cache hit rate (%)
Read	Read cache hit
Write	Write cache hit
Prefetch	Prefetch cache hit
EXC Cache Hit Rate Read	Extreme Cache (EXC) or Extreme Cache Pool cache hit rate (%) This item does not appear when the EXC function or the Extreme Cache Pool function is disabled for the ETERNUS DX/AF. A hyphen (-) appears when the EXC function or the Extreme Cache Pool function is enabled for the ETERNUS DX/AF but disabled for the relevant volume.
Location	Location of the target component in the ETERNUS DX/AF
Busy Rate	Busy rate (%) of the target component
Copy Residual Quantity	Copy residual quantity (MB) A hyphen (-) appears for the CM Core.

The following information only appears for the Unified Storage.

Item name	Description
CPU Busy Rate	CPU usage rate for all the NAS CPU cores (Unit: percentage)
CPU Core#n Busy Rate	CPU core usage rate per NAS CPU core (Unit: percentage) (n: core number)
CPU Core#n Wait Rate	CPU I/O wait ratio per NAS CPU core (Unit: percentage) (n: core number)
I/O CPU Busy Rate	CPU usage rate during I/O requests to the ETERNUS DX/AF (Unit: percentage)
I/O CPU Wait Rate	CPU I/O wait ratio during I/O requests to the ETERNUS DX/AF (Unit: percentage) (n: core number)
I/O Wait Time	Average latency time of I/O requests to the ETERNUS DX/AF (Unit: milliseconds)
NAS Volume Usage Rate	Usage rate of all NAS volumes (Unit: percentage)
NAS Volume Used Amount	Used capacity of all NAS volumes (Unit: KB)
Disk Throughput Read	Read throughput for the drive (Unit: MB/s)
Disk Throughput Write	Write throughput for the drive (Unit: MB/s)
Network Throughput Read	Transmission throughput of all NAS ports (excluding the management LAN) in the target CM (Unit: MB/s)
Network Throughput Write	Receive throughput of all NAS ports (excluding the management LAN) in the target CM (Unit: MB/s)
Samba Operations	Number of processes in Samba per second (Unit: times/second)
NFS Operations	Number of processes in NFS per second (Unit: times/second)
Free Memory	Unused memory capacity (Unit: KB)
Cached Memory	Memory capacity that contains cache data when access to the disk occurs (Unit: KB)

If "cm" is specified for "-type" and NAS user volumes (nas-tpv) exist in the ETERNUS DX/AF, the following information is displayed for each NAS user volume (nas-tpv).

Item name	Description
I/O CPU Busy Rate	CPU usage rate during I/O requests to the NAS volumes (Unit: percentage)
I/O Wait Time	Average wait time of I/O requests to the NAS volumes (Unit: milliseconds)

Item name	Description
Usage Rate	Usage rate of the NAS volumes (Unit: percentage)
Used Amount	Used capacity of the NAS volumes (Unit: KB)
Throughput Read	Read throughput for the NAS volumes (Unit: MB/s)
Throughput Write	Write throughput for the NAS volumes (Unit: MB/s)

■ Example(s)

The following example displays the status of performance information collection:

```
CLI> show performance
Status [ON]
Interval [30sec]
```

The following example displays the performance information when the Host I/O statistics is specified (and when the EXC function is disabled):

```
CLI> show performance -type host-io
Volume
No. Name IOPS(IOPS) Throughput(MB/s) Response Time(msec.) Processing Time(msec.) Cache Hit Rate(%)
Read / Write Read / Write Read / Write Read / Write Read / Write / Prefetch
-----
1 VOL001 6621 5192 589 379 17055 12056 10025 10010 41 37 36
2 VOL002 7791 6608 613 292 12148 11045 10005 10007 41 37 36
```

The following example displays the performance information when the Host I/O statistics is specified (for an ETERNUS DX/AF that has the EXC function enabled, but the EXC setting of the volume unit is disabled):

```
CLI> show performance -type host-io
Volume
No. Name IOPS(IOPS) Throughput(MB/s) Response Time(msec.) Processing Time(msec.) Cache Hit Rate(%) EXC Cache Hit Rate(%)
Read / Write Read / Write Read / Write Read / Write Read / Write / Prefetch Read
-----
1 VOL001 6621 5192 589 379 17055 12056 10025 10010 41 37 36 -
2 VOL002 7791 6608 613 292 12148 11045 10005 10007 41 37 36 -
```

The following example displays the performance information when the Host I/O statistics is specified (for a DX500 S4/DX600 S4 and a DX500 S3/DX600 S3 with a PFM installed, or when the EXC function is enabled in a DX100 S4/DX200 S4):

```
CLI> show performance -type host-io
Volume
No. Name IOPS(IOPS) Throughput(MB/s) Response Time(msec.) Processing Time(msec.) Cache Hit Rate(%) EXC Cache Hit Rate(%)
Read / Write Read / Write Read / Write Read / Write Read / Write / Prefetch Read
-----
1 VOL001 6621 5192 589 379 17055 12056 10025 10010 41 37 36 20
2 VOL002 7791 6608 613 292 12148 11045 10005 10007 41 37 36 21
3 VOL003 6621 5192 589 379 17055 12056 10025 10010 41 37 36 20
4 VOL004 7791 6608 613 292 12148 11045 10005 10007 41 37 36 21
5 VOL005 6621 5192 589 379 17055 12056 10025 10010 41 37 36 20
6 VOL006 7791 6608 613 292 12148 11045 10005 10007 41 37 36 21
7 VOL007 6621 5192 589 379 17055 12056 10025 10010 41 37 36 -
8 VOL008 7791 6608 613 292 12148 11045 10005 10007 41 37 36 -
```

The following example displays the performance information when the Host I/O statistics is specified for the volume named "VOL001":

```
CLI> show performance -type host-io -volume-name VOL001
Volume
No. Name IOPS(IOPS) Throughput(MB/s) Response Time(msec.) Processing Time(msec.) Cache Hit Rate(%)
Read / Write Read / Write Read / Write Read / Write Read / Write / Prefetch
-----
1 VOL001 6621 5192 589 379 17055 12056 10025 10010 41 37 36
```

The following example displays the performance information when the Advanced copy statistics is specified (for a DX500 S4/DX600 S4 and a DX500 S3/DX600 S3 without a PFM installed, or for a DX60 S4/DX100 S4/DX200 S4, a DX60 S3/DX100 S3/DX200 S3, an AF250 S2/AF250, and a DX200F):

```
CLI> show performance -type advanced-copy
Volume
No.  Name
-----
  1  VOL001
  2  VOL002
IOPS (IOPS)          Throughput (MB/s)      Cache Hit Rate(%)
Read / Write        Read / Write            Read / Write / Prefetch
-----
  1  6621  5192          589  379          41  37  36
  2  7791  6608          613  292          41  37  36
```

The following example displays the performance information when the Advanced copy statistics is specified for volume #2:

```
CLI> show performance -type advanced-copy -volume-number 2
Volume
No.  Name
-----
  2  VOL002
IOPS (IOPS)          Throughput (MB/s)      Cache Hit Rate(%)
Read / Write        Read / Write            Read / Write / Prefetch
-----
  2  7791  6608          613  292          41  37  36
```

The following example displays the performance information when the Advanced copy statistics is specified (and when the EXC function is enabled for a DX500 S4/DX600 S4 and a DX500 S3/DX600 S3 with a PFM installed).

```
CLI> show performance -type advanced-copy
Volume
No.  Name
-----
  1  VOL001
  2  VOL002
  3  VOL003
  4  VOL004
  5  VOL005
  6  VOL006
  7  VOL007
  8  VOL008
IOPS (IOPS)          Throughput (MB/s)      Cache Hit Rate(%)      EXC Cache Hit Rate(%)
Read / Write        Read / Write            Read / Write / Prefetch  Read
-----
  1  6621  5192          589  379          41  37  36  20
  2  7791  6608          613  292          41  37  36  21
  3  6621  5192          589  379          41  37  36  20
  4  7791  6608          613  292          41  37  36  21
  5  6621  5192          589  379          41  37  36  20
  6  7791  6608          613  292          41  37  36  21
  7  6621  5192          589  379          41  37  36  -
  8  7791  6608          613  292          41  37  36  -
```

The following example displays the performance information when the drive statistics is specified:

```
CLI> show performance -type disks
Location          Busy Rate(%)
-----
CE-Disk#0         67
CE-Disk#1         66
```

The following example displays the performance information when the drive statistics is specified for drive #0 in the CE:

```
CLI> show performance -type disks -disks 000
Location          Busy Rate(%)
-----
CE-Disk#0         67
```

The following example displays the performance information when the controller module statistics is selected for both CMs (DX100 S3):

```
CLI> show performance -type cm
Location          Busy Rate(%) Copy Residual Quantity(MB)
-----
CM#0              56 55191552
CM#0 CPU Core#0  66 -
CM#0 CPU Core#1  46 -
CM#1              52 55191552
CM#1 CPU Core#0  62 -
CM#1 CPU Core#1  42 -
```

The following example displays the performance information when the controller module statistics is selected (for the DX8900 S3):

```
CLI> show performance -type cm
Location          Busy Rate(%) Copy Residual Quantity(MB)
-----
CE#0 CM#0          35                      0
CE#0 CM#0 CPU Core#0  34                      -
CE#0 CM#0 CPU Core#1  36                      -
CE#0 CM#0 CPU Core#2  40                      -
CE#0 CM#0 CPU Core#3  33                      -
CE#0 CM#0 CPU Core#4  36                      -
CE#0 CM#0 CPU Core#5  33                      -
CE#0 CM#0 CPU Core#6  31                      -
CE#0 CM#0 CPU Core#7  34                      -
CE#0 CM#0 CPU Core#8  34                      -
CE#0 CM#0 CPU Core#9  35                      -
CE#0 CM#1          35                      0
CE#0 CM#1 CPU Core#0  34                      -
CE#0 CM#1 CPU Core#1  36                      -
CE#0 CM#1 CPU Core#2  40                      -
CE#0 CM#1 CPU Core#3  33                      -
CE#0 CM#1 CPU Core#4  36                      -
CE#0 CM#1 CPU Core#5  33                      -
CE#0 CM#1 CPU Core#6  31                      -
CE#0 CM#1 CPU Core#7  34                      -
CE#0 CM#1 CPU Core#8  34                      -
CE#0 CM#1 CPU Core#9  35                      -
```

The following example displays the performance information when the controller module statistics is selected for CM#1 (for the DX100 S3):

```
CLI> show performance -type cm -cm 1
Location          Busy Rate(%) Copy Residual Quantity(MB)
-----
CM#1              52                      55191552
CM#1 CPU Core#0   62                      -
CM#1 CPU Core#1   42                      -
```

The following example displays the performance information when the controller module statistics is selected for CE#0 CM#1 (for the DX8900 S3):

```
CLI> show performance -type cm -cm 01
Location          Busy Rate(%) Copy Residual Quantity(MB)
-----
CE#0 CM#1          35                      0
CE#0 CM#1 CPU Core#0  34                      -
CE#0 CM#1 CPU Core#1  36                      -
CE#0 CM#1 CPU Core#2  40                      -
CE#0 CM#1 CPU Core#3  33                      -
CE#0 CM#1 CPU Core#4  36                      -
CE#0 CM#1 CPU Core#5  33                      -
CE#0 CM#1 CPU Core#6  31                      -
CE#0 CM#1 CPU Core#7  34                      -
CE#0 CM#1 CPU Core#8  34                      -
CE#0 CM#1 CPU Core#9  35                      -
```

The following example displays the performance information when the controller module statistics is selected for CM#1 (and when the NAS function is enabled):

```

CLI> show performance -type cm -cm 1
Location          Busy Rate(%) Copy Residual Quantity(MB)
-----
CM#1              52              55191552
CM#1 CPU Core#0   62              -
CM#1 CPU Core#1   42              -

<CM#1 NAS Performance>
CPU Busy Rate          [50%]
CPU Core#0 Busy Rate   [50%]
CPU Core#0 Wait Rate   [30%]
CPU Core#1 Busy Rate   [50%]
CPU Core#1 Wait Rate   [30%]
I/O CPU Busy Rate     [0%]
I/O CPU Wait Rate     [10%]
I/O Wait Time         [100msec.]
NAS Volume Usage Rate [100%]
NAS Volume Used Amount [100KB]
Disk Throughput Read   [0MB/s]
Disk Throughput Write  [0MB/s]
Network Throughput Read [0MB/s]
Network Throughput Write [123MB/s]
Samba Operations       [456counts/s]
NFS Operations         [789counts/s]
Free Memory            [123KB]
Cached Memory          [456KB]

<CM#1 NAS Volume#12345 Performance>
I/O CPU Busy Rate     [75%]
I/O Wait Time         [123msec.]
Usage Rate            [15%]
Used Amount           [456KB]
Throughput Read       [789MB/s]
Throughput Write      [1234MB/s]

<CM#1 NAS Volume#01234 Performance>
I/O CPU Busy Rate     [75%]
I/O Wait Time         [321msec.]
Usage Rate            [51%]
Used Amount           [654KB]
Throughput Read       [987MB/s]
Throughput Write      [4321MB/s]
  
```

For FC and iSCSI, the following example displays the performance information when the host interface port statistics is specified:

```

CLI> show performance -type port
Location          IOPS (IOPS)          Throughput (MB/s)
                Read      / Write          Read      / Write
-----
CM#0 CA#0 Port#0   6621      5192          589      379
CM#1 CA#1 Port#1   7791      6608          613      292
  
```

The following example displays performance information when the host interface port statistics is selected for CM#0-CA#0-Port#0:

```

CLI> show performance -type port -port 000
CM CA Port Performance Data List
Location          IOPS (IOPS)          Throughput (MB/s)
                Read      / Write          Read      / Write
-----
CM#0 CA#0 Port#0   6621      5192          589      379
  
```

The following example displays performance information when the host interface port statistics is selected for the Fibre channel or iSCSI (for the DX8700 S3/DX8900 S3):

```

CLI> show performance -type port
CM CA Port Performance Data List
Location          IOPS (IOPS)          Throughput (MB/s)
                Read      / Write          Read      / Write
-----
CE#0 CM#0 CA#0 Port#0   0          0          0          0
CE#0 CM#0 CA#0 Port#1   0          0          0          0
CE#0 CM#1 CA#0 Port#0   0          0          0          0
CE#0 CM#1 CA#0 Port#1   0          0          0          0
  
```

The following example displays performance information when the host interface port statistics is specified and the host interface port mode is RA:

```
CLI> show performance -type port
CM RA Port Performance Data List
Location          IOPS (IOPS)
                  Transmitted / Received    Throughput (MB/s)
                  Transmitted / Received
-----
CM#0 CA#0 Port#2      6621      5192      589      379
CM#1 CA#0 Port#0      7791      6608      613      292
CM#1 CA#0 Port#1      6621      5192      589      379
CM#1 CA#0 Port#2      7791      6608      613      292
```

The following example displays performance information when the host interface port statistics is specified for CE#0 CM#1 CA#2 Port#3 (for the DX8700 S3/DX8900 S3):

```
CLI> show performance -type port -port 0123
CM CA Port Performance Data List
Location          IOPS (IOPS)
                  Read / Write      Throughput (MB/s)
                  Read / Write
-----
CE#0 CM#1 CA#2 Port#3 6621      5192      589      379
```

The following example displays performance information when the host interface port statistics is selected and NAS CA is used:

```
CLI> show performance -type port
CM NAS CA Port Performance Data List
Location          Throughput (MB/s)
                  Read / Write
-----
CM#0 CA#0 Port#0      589      379
CM#1 CA#1 Port#1      613      292
```

The following example displays performance information when the host interface port statistics is specified and the host interface ports are a mix of both RA mode and CA mode:

```
CLI> show performance -type port
CA Port Information
Location          IOPS (IOPS)
                  Read / Write      Throughput (MB/s)
                  Read / Write
-----
CM#0 CA#0 Port#0      6621      5192      589      379
CM#0 CA#0 Port#1      7791      6608      613      292
CM#0 CA#0 Port#3      6621      5192      589      379
CM#1 CA#0 Port#3      7791      6608      613      292

RA Port Information
Location          IOPS (IOPS)
                  Transmitted / Received    Throughput (MB/s)
                  Transmitted / Received
-----
CM#0 CA#0 Port#2      6621      5192      589      379
CM#1 CA#0 Port#0      7791      6608      613      292
CM#1 CA#0 Port#1      6621      5192      589      379
CM#1 CA#0 Port#2      7791      6608      613      292
```

The following example displays the performance information when the PFM statistics is specified:

```
CLI> show performance -type pfm
Location          Busy Rate (%)
-----
CM#0 PFM#0        67
CM#0 PFM#1        1
CM#1 PFM#0        35
CM#1 PFM#1        67
```

start performance

This command starts the collection of performance information. If performance information is already being collected, then the command terminates with an error message.

■ Syntax

```
start performance [-interval {30 | 60 | 90 | 120 | 150 | 180 | 210 | 240 | 270 | 300}]
```

■ Parameter

-interval	Optional. This parameter specifies the update interval for performance information. A unit is second. If omitted, the default value (30 seconds) is used.
30	Updated every 30 seconds (default).
60	Updated every 60 seconds.
90	Updated every 90 seconds.
120	Updated every 120 seconds.
150	Updated every 150 seconds.
180	Updated every 180 seconds.
210	Updated every 210 seconds.
240	Updated every 240 seconds.
270	Updated every 270 seconds.
300	Updated every 300 seconds.

■ Example(s)

The following example starts collecting the performance information at 30 seconds intervals:

```
CLI> start performance -interval 30
```

stop performance

This command stops the collection of performance information.

■ Syntax

```
stop performance [-force]
```

■ Parameter

-force Optional. This parameter forcibly stops the collection of performance information.

■ Example(s)

The following example stops the collection of performance information:

```
CLI> stop performance
```

6.1.2 Performance Tuning Parameters

This section explains the commands related to performance tuning parameters. The following items can be tuned:

- Setting the RAID group performance tuning parameter
- Setting the performance tuning parameter for the volume (cache control)

show raid-tuning

This command displays the performance tuning parameters of all the RAID groups.

Syntax

```
show raid-tuning
```

Parameter

No parameters.

Output

Item name	Description
RAID Group	RAID group identifiers
No.	RAID group number
Name	RAID group name
RAID Level	RAID level
Status	RAID group status
DCMF	DCMF (A multiplying factor which issues disk commands to drives)
Rebuild Priority	Rebuild priority
Drive Access Priority	Drive access priority
Disk Tuning	Indicates whether Disk Tuning is enabled.
Throttle	Ratio of command issues to drives
Ordered Cut	Interval for issuing the "Ordered Queue" command to drives

Example(s)

The following example displays the performance tuning parameters of all the RAID groups:

```
CLI> show raid-tuning
RAID Group      RAID   Status
No.  Name      Level
-----
0  RLU#0      RAID1  Available
1  RAIDGROUP001 RAID1+0 Spare in Use
2  RAIDGROUP002 RAID5   Available
3  RAIDGROUP003 RAID5   Available
4  RAIDGROUP004 RAID5   SED Locked

DCMF  Rebuild  Drive Access  Disk  Throttle  Ordered
      Priority Priority  Tuning      Cut
-----
1 Low   Response  Disable     -
4 Low   Response  Enable      80%  1024
2 Middle Throughput Disable     -
3 High  -         Enable      -
2 High  -         Disable     -
```

set raid-tuning

This command the performance tuning parameters for the specified RAID group. For normal operations, the performance tuning parameters do not need to be changed.

Syntax

```
set raid-tuning {-rg-number rg_numbers | -rg-name rg_names}  
[-dcmf {1 | 2 | 3 | 4 | 5 | 6 | 7 | 8 | 9 | 10}] [-rebuild-priority {low | middle | high}]  
[-drive-access-priority {response | throughput}] [-disk-tuning {enable | disable}]  
[-throttle {10 | 20 | 30 | 40 | 50 | 60 | 70 | 80 | 90 | 100}] [-ordered-cut {ordered_cut}]
```

Parameter

-rg-number or -rg-name

This parameter specifies the RAID group identifiers whose tuning parameters are to be set up. One or more parameters can be specified at the same time. For details, refer to ["1.2.10 RAID Group Syntax" \(page 39\)](#).

rg_numbers RAID group number

rg_names RAID group name

-dcmf

Optional. This parameter specifies the value of Disk Command Multiplying Factor (DCMF). DCMF is a coefficient that increases the limit on the number of outstanding disk commands. Increasing the value of DCMF improves sequential write performance. The default value is one. A DCMF value of two results in the limit on the number of outstanding commands by a factor of two from the default.

1 – 10 Value of Disk Command Multiplying Factor (DCMF)

-rebuild-priority

Optional. This parameter specifies the priority for Rebuild of the relevant RAID group. The same priority is set to all of the RAID groups that are specified with the "-rg-number" parameter or the "-rg-name" parameter.

low Low. Normal priority is given for rebuild, copyback, and redundant copy.

middle Middle. Rebuild, copyback, and redundant copy are given the same priority as host access.

high High. Rebuild, copyback, and redundant copy are given priority over host access.

-drive-access-priority

Optional. This parameter specifies the priority for accesses to the drives. The same priority is set to all of the RAID groups that are specified with the "-rg-number" parameter or the "-rg-name" parameter.

response Response priority mode

throughput Throughput priority mode

-disk-tuning

Optional. This parameter specifies whether to enable or disable the tuning settings for disk accesses. If omitted, the existing setting is not changed. When "disable" is specified, the "-throttle" and "-ordered-cut" parameters cannot be specified. If omitted, the existing setting is not changed.

enable The tuning settings are enabled. (default)

disable The tuning settings are disabled.

-throttle Optional. This parameter specifies the ratio of command issues to disks as a percentage value. This parameter can be specified only when "enable" is specified or is already set for the "-disk-tuning" parameter. Between 10 and 100 (in increments of 10) can be specified. If omitted, the existing setting is not changed.

10 – 100 Ratio of command issues to disks

-ordered-cut

Optional. This parameter specifies the interval for issuing the "Ordered Queue" command to disks. This parameter can be specified only when "enable" is specified or is already set for the "-disk-tuning" parameter. Enter a value between 0 and 65535. The initial value is 400. This parameter cannot be specified if the RAID groups that are specified by the "-rg-number" or "-rg-name" parameter include a RAID group that is configured with SSDs. If omitted, the existing setting is not changed.

ordered_cut Interval for issuing the "Ordered Queue" command to disks (0 – 65535)
(initial value is 400)

■ Example(s)

The following example sets the performance tuning parameters for the RAID group named "R1". 10 is specified for DCMF, 80% is specified for throttle, and 1024 is specified for ordered cut:

```
CLI> set raid-tuning -rg-name R1 -dcmf 10 -disk-tuning enable -throttle 80 -ordered-cut 1024
```

The following example sets the value of DCMF to 5 and disables disk tuning for the two RAID group named "R1" and "R2":

```
CLI> set raid-tuning -rg-name R1,R2 -dcmf 5 -disk-tuning disable
```

The following example sets the DCMF to 10, the rebuild priority to "middle", and the drive access priority to the Response priority mode for the RAID group named "R1":

```
CLI> set raid-tuning -rg-name R1 -dcmf 10 -rebuild-priority middle -drive-access-priority response
```

show cache-parameters

This command displays the cache data control parameters for all the volumes.

Syntax

```
show cache-parameters
```

Parameter

No parameters.

Output

Item name	Description
Exclusive Read Cache (%)	Percentage of the read-only area in the cache memory (0 – 30%)
Volume	Volume identifiers
No.	Volume number
Name	Volume name
Type	Volume type
FP	Force Pre-fetch Mode
PL	Pre-fetch limit
MWC(Range)	Multi Write back Count (Selectable range)
PSDC	Number of times data access (Read I/O) is sequentially performed
SDDC	Number of times data access (Write I/O) is sequentially performed
SS	Value of the parameter for determining data access (Read I/O) sequentiality
SDS	Value of the parameter for determining data access (Write I/O) sequentiality
SPMC	Sequential Parallel Multi I/O Count (SPMC) value
Cache Limit Size (MB)	Upper limit value for the cache memory capacity that can be used by a volume

Example(s)

The following example displays the cache control parameters:

```
CLI> show cache-parameters
Exclusive Read Cache (%) [10]

Volume
No.  Name                               Type      FP  PL  MWC (Range)  PSDC  PPC  SDDC  SDPC  SS  SDS  SPMC  Cache Limit
-----
0  LV0000                               Standard  ON   8   4 (1-4)     4    3   5    6   128  128  6    -
3  LogicalVolume003                     SDV      OFF  9   1 (1-1)     4    3   5    6   128  128  6   2080
4  LogicalVolume004                     MVV      OFF  9   1 (1-1)     4    3   5    6   128  128  6   32.5
```

set cache-parameters

This command sets up the cache control conditions, which are performance tuning parameters, for the specified volume(s). For normal operations, the cache control conditions do not need to be changed.

■ Syntax

```
set cache-parameters
{{-volume-number volume_numbers | -volume-name volume_names}
{-pool-number pool_numbers | -pool-name pool_names}
[-fp {enable | disable}] [-pl pre_fetch] [-mwc multi_writeback_counter]
[-psdc pre_fetch_sequential_detect_count] [-sddc sequential_dirty_detect_count]
[-ss sequential_slope] [-sds sequential_dirty_slope]
[-cache-limit {off | 32.5mb | 65mb | 130mb | 260mb | 520mb | 1040mb | 2080mb}]
[-sPMC sPMC_value] | {[-exclusive-read-cache {0 | 5 | 10 | 15 | 20 | 25 | 30}]}
```

■ Parameter

-volume-number or -volume-name

This parameter specifies the volume identifiers whose performance tuning parameters are to be set up. One or more parameters can be specified at the same time. However, if the specified volume has a UID (or LUN ID) that is inherited from an External LU or an External Volume, the setting cannot be changed. For details, refer to ["1.2.11 Volume Syntax" \(page 40\)](#).

volume_numbers Volume number
volume_names Volume name

-pool-number or -pool-name

This parameter specifies the Thin Provisioning Pool identifiers or Flexible Tier Sub Pool identifiers for the performance tuning parameter. One or more identifiers can be specified. For details, refer to ["1.2.7 Thin Provisioning Pool Syntax" \(page 36\)](#).

pool_numbers Thin Provisioning Pool number
pool_names Thin Provisioning Pool name

-fp Optional. This parameter specifies the Force Pre-fetch (FP) mode. If this parameter is omitted, the mode is not changed.

enable Force Pre-fetch mode is enabled.
disable Force Pre-fetch mode is disabled.

-pl Optional. This parameter specifies the Pre-fetch Limit value. If this parameter is omitted, the value is not changed.

pre_fetch Pre-fetch Limit value

- mwc Optional. This parameter specifies the Multi Write Back Counter (MWC). Increasing the MWC value improves sequential write performance. If this parameter is omitted, the value is not changed. The applicable range of MWC values depends on the type of RAID group to which the volume belongs. In addition, the value that can be specified in MWC differs depending on the RAID level, the drive configuration, and the Stripe Depth. The allowed range of MWC values can be displayed by using the "show cache-parameters" command.
- multi_writeback_counter* Multi Write Back Counter (MWC)
- psdc Optional. This parameter specifies the number of times data access (Read I/O) is sequentially performed (Prefetch Sequential Detect Count). If omitted, then this parameter is not changed.
- pre_fetch_sequential_detect_count* Number of times data access (Read I/O) is sequentially performed
- sddc Optional. This parameter specifies the number of times data access (Write I/O) is sequentially performed (Sequential Dirty Detect Count). If omitted, then this parameter is not changed.
- sequential_dirty_detect_count* Number of times data access (Write I/O) is sequentially performed
- ss Optional. This parameter specifies the parameter for determining data access (Read I/O) sequentiality (Sequential Slope). If omitted, then this parameter is not changed.
- sequential_slope* Parameter for determining data access (Read I/O) sequentiality
- sds Optional. This parameter specifies the parameter for determining data access (Write I/O) sequentiality (Sequential Dirty Slope). If omitted, then this parameter is not changed.
- sequential_dirty_slope* Parameter for determining data access (Write I/O) sequentiality
- cache-limit Optional. This parameter specifies the upper limit value for the cache memory capacity that can be used by a volume. If omitted, then this parameter is not changed. Thin Provisioning Pools cannot be specified. In addition, for the DX8100 S3/DX8700 S3, this parameter cannot be used when the Bind-in-Cache capacity is set in the ETERNUS DX/AF.
- Volumes that are not LUN Concatenation Volumes and that are the following types can also be specified:
- Standard
 - SDV
 - SDPV
 - MVV (DX8700 S3 only)
- | | |
|--------|--|
| off | No upper limit is set. |
| 32.5mb | Up to 32.5MB can be used. |
| 65mb | Up to 65MB can be used. |
| 130mb | Up to 130MB can be used. |
| 260mb | Up to 260MB can be used. |
| 520mb | Up to 520MB can be used. |
| 1040mb | Up to 1,040MB can be used. (this cannot be set for the DX60 S4/DX60 S3) |
| 2080mb | Up to 2,080MB can be used. (this cannot be set for the DX60 S4/DX100 S4 or the DX60 S3/DX100 S3) |
- sPMC Optional. This parameter specifies the Sequential Parallel Multi I/O Count (SPMC) value. This parameter is used for determining sequential access. The settable range is 0 to 32. Determining sequential access becomes more efficient when the value is bigger.

spm_c_value Sequential Parallel Multi I/O Count (SPMC) value (0 - 32)

-exclusive-read-cache

Optional. This parameter specifies the percentage of the read-only area in the cache memory. Between 0 and 30 percent can be specified. The area that is set as the read-only area will not be usable as write cache. This parameter cannot be specified with other parameters.

0	A read-only area is not set.
5	The read-only area is set to 5%.
10	The read-only area is set to 10%.
15	The read-only area is set to 15%.
20	The read-only area is set to 20%.
25	The read-only area is set to 25%.
30	The read-only area is set to 30%.

■ **Example(s)**

The following example sets the Pre-fetch Limit to 20 for the volumes with consecutively numbered identifiers #1 – #8:

```
CLI> set cache-parameters -volume-number 1-8 -pl 20
```

6.2 Event Log Information



This section explains the commands for displaying information on events that have occurred in the system.

show events

This command displays event information which has occurred in the system. The events displayed can be narrowed down by specifying various parameters. If all the parameters are omitted, all events are displayed. If multiple parameters are specified, the events displayed function according to the parameters that are set.

Syntax

```
show events [-severity {information | warning | error}] [-cm cm_number] [-count count]
```

Parameter

-severity Optional. This parameter specifies the severity of the event level. When severity is specified, the display is restricted to information about events of the specified severity level. Only one level can be specified at the same time. If omitted, all the events of the severity levels are displayed.

information Information level
 warning Warning level
 error Error level

-cm Optional. This parameter specifies the controller module (CM) number. Only events for the specified CM are displayed. If omitted, all the events of all CMs are displayed.

cm_number CM number

0 CM#0
 (DX60 S4/DX100 S4/DX200 S4, DX500 S4/DX600 S4, DX60 S3/DX100 S3/DX200 S3, DX500 S3/DX600 S3, DX8100 S3, AF250 S2/AF650 S2, AF250/AF650, and DX200F only)

1 CM#1
 (DX60 S4/DX100 S4/DX200 S4, DX500 S4/DX600 S4, DX60 S3/DX100 S3/DX200 S3, DX500 S3/DX600 S3, DX8100 S3, AF250 S2/AF650 S2, AF250/AF650, and DX200F only)

wx CE#w-CM#x (DX8700 S3/DX8900 S3 only)
 "w" is the controller enclosure (CE) number, "x" is the controller module (CM) number
 Example: "01" indicates CE#0-CM#1
 For the controller enclosure number, the range that the value can be specified with is 0 to b (hex).
 For the controller module number, 0 or 1 can be specified.

-count Optional. This parameter limits how many events are displayed, selecting from the latest event and working backward. If omitted, all the events are displayed.

count Number of events that are displayed

Output

Item name	Description
YYYY-MM-DD hh:mm:ss	The date and time which the events have occurred
Information, Warning, or Error	Event severity and event details For the event details, an abbreviation of the event type (T: Test I: Information J/W: Warning P/E: Error M: Maintenance R: Recovery), the event code (fixed eight-digit code), and the event message are displayed.

■ Example(s)

The following example displays the event information for Error level:

```
CLI> show events -level error
2008-01-01 12:00:05   Error           P 01000000 Controller module #0 Fault
```

delete events

This command deletes all the events that have been recorded in the system.

■ Syntax

```
delete events
```

■ Parameter

No parameters.

■ Example(s)

The following example deletes all the event information:

```
CLI> delete events
```

6.3 Environment Information



This section explains the commands that are related to displaying the environment information for the ETERNUS DX/AF.

show power-consumption

This command displays power consumption information of the ETERNUS DX/AF.
When the update process for the power consumption information is performed in the ETERNUS DX/AF, this command finishes successfully without displaying an output. Wait for a while and retry the command.

Syntax

```
show power-consumption [-csv]
```

Parameter

-csv Optional. This parameter is used to display the power consumption information in a CSV format.

Note

Information that was output in the CSV format cannot be specified for setup commands (or command names that start with "create" or "set").

Output

Item name	Description
Location	Display target of the power consumption information System, CE#x, FE, and DE#xx are displayed for the DX8700 S3/DX8900 S3. For all other models, System, CE, and DE#xx are displayed. However, for models that do not support DEs, DE#xx is not displayed.
1-min avg.	Average power consumption for the last minute (unit: W)
1-hour avg.	Average power consumption for the last hour (unit: W)

Example(s)

The following example shows information when parameters are omitted (for the DX60 S4/DX100 S4/DX200 S4, the DX500 S4/DX600 S4, the DX60 S3/DX100 S3/DX200 S3, the DX500 S3/DX600 S3, the DX8100 S3, and the AF650 S2/AF650).

```
CLI> show power-consumption
Location 1-min avg.(W) 1-hour avg.(W)
-----
System          460          520
CE               255          310
DE#00           105          110
```

The following example shows information when parameters are omitted (for the DX8700 S3/DX8900 S3).

```
CLI> show power-consumption
Location 1-min avg.(W) 1-hour avg.(W)
-----
System          460          520
CE#0            255          310
CE#1            256          309
FE              300          350
DE#00           105          110
DE#10           250          320
```

The following example shows information that is displayed when "-csv" is specified (for the DX100 S4/DX200 S4, the DX500 S4/DX600 S4, the DX100 S3/DX200 S3, the DX500 S3/DX600 S3, and the DX8100 S3).

The values for [Location], [1-min avg.(W)] and [1-hour avg.(W)] are displayed in a CSV format.

```
CLI> show power-consumption -csv
[Location],[1-min avg.(W)],[1-hour avg.(W)]
System,460,520
CE,255,310
DE#00,105,110
```

The following example shows information that is displayed when "-csv" is specified (for the DX8700 S3/DX8900 S3).

The values for [Location], [1-min avg.(W)] and [1-hour avg.(W)] are displayed in a CSV format.

```
CLI> show power-consumption -csv
[Location],[1-min avg.(W)],[1-hour avg.(W)]
System,460,520
CE#0,255,310
CE#1,256,309
FE,300,350
DE#00,105,110
DE#10,250,320
```

6.4 Maintenance Operation and Maintenance Information

This section explains the commands that are related to displaying the maintenance operation and maintenance information for the device.

6.4.1 Hardware Maintenance

This section explains the commands that are related to the hot maintenance of the ETERNUS DX/AF.

■ Adding drive enclosures

The steps involved for adding drive enclosures are as follows. An addition is performed in each SAS cascade. For details, refer to "Installing Additional Drive Enclosures" in "Operation Guide (Basic)" of each model.

● Hot expansion when drive enclosures are not installed

Procedure

- 1 Install a drive enclosure to be added in the rack.
Check to make sure that the IOMs and the PSUs of the drive enclosure are installed successfully. For high-density drive enclosures, check to make sure that FEMs are also installed successfully.
- 2 Connect IOM#0 of the added drive enclosure to CM#0 with the SAS cable (mini SAS HD cable between enclosures).
- 3 Connect power cables to each PSU.
- 4 Execute the "hot expansion" command with "-type de" or "-type deX".
- 5 Connect IOM#1 of the added drive enclosure to CM#1 with the SAS cable (mini SAS HD cable between enclosures).
- 6 After the work is completed, enter "c".
Wait for the operation to finish.

End of procedure

- Hot expansion when existing drive enclosures exist (including multiple specifications)

Procedure

- 1 Install all of the drive enclosures to be added in the rack.
Check to make sure that the IOMs and the PSUs of all the drive enclosures are installed successfully. For high-density drive enclosures, check to make sure that FEMs are also installed successfully.
- 2 Connect from the IOM#0 DI (OUT) port of the largest existing drive enclosure number to the IOM#0 DI (IN) port of the drive enclosure to be added with the SAS cable (mini SAS HD cable between enclosures).
When adding multiple drive enclosures, connect from the IOM#1 DI (OUT) port of the largest drive enclosure number among the drive enclosures to add to the IOM#1 DI (IN) port of the drive enclosure one number before in sequence with the SAS cable (mini SAS HD cable between enclosures).
- 3 Connect power cables to each PSU.
- 4 Execute the "hot expansion" command with "-type de", "-type deX", or "-type deY".
- 5 Remove the SAS cable (mini SAS HD cable between enclosures) connecting the IOM#1 DI (IN) port of the largest existing drive enclosure number and the CM#1 DI (OUT) port.
- 6 Connect from the CM#1 DI (OUT) port to the IOM#1 DI (IN) port of the largest drive enclosure number among the drive enclosures to add with the SAS cable (mini SAS HD cable between enclosures).
- 7 After the work is completed, enter "c".
Wait for the operation to finish.

End of procedure

- Cold expansion (including multiple specifications)

Procedure

- 1 Install all of the drive enclosures to be added in the rack.
Check to make sure that the IOMs and the PSUs of all the drive enclosures are installed successfully. For high-density drive enclosures, check to make sure that FEMs are also installed successfully.
- 2 Connect IOM#0 and IOM#1 of all the added drive enclosures with SAS cables (mini SAS HD cables between enclosures).
- 3 Connect power cables to each PSU.
Wait about 10 minutes until each IOM is integrated in the ETERNUS DX/AF.
- 4 Execute the "hot expansion" command with "-type de", "-type deX", or "-type deY".
Wait for the operation to finish.

End of procedure

hot expansion

This command adds and enables a component while the ETERNUS DX/AF is running.

Caution

This command is not supported in the DX8100 S3/DX8700 S3/DX8900 S3.

■ Syntax

```
hot expansion -type type_name [-mode {hot | cold}]
```

■ Parameter

-type This parameter specifies the name of the component to add. When specifying the drive enclosure number, multiple numbers can be specified simultaneously.

Caution

When executing this parameter in the DX500 S4/DX600 S4, the DX500 S3/DX600 S3, and the AF650 S2/AF650, the Maintenance Operation policy is required.

type_name Component Name

de	Drive enclosure (DX60 S4/DX100 S4/DX200 S4, DX60 S3/DX100 S3/DX200 S3, and AF250 S2/AF250 only). Drive enclosure numbers are automatically allocated by the ETERNUS DX/AF.
deX	Drive enclosure number.
deXX	The specifiable range of drive enclosure numbers for each model is shown below. DX60 S4: 01 to 03 DX100 S4/DX200 S4: 01 to 0a DX60 S3: 01 to 03 DX100 S3/DX200 S3: 01 to 0a AF250 S2/AF250: 01

-mode Optional. This parameter specifies whether to hot add the component. If omitted, "hot" is set.

hot	The component is hot added.
cold	The component is cold added.

■ Example(s)

The following example adds DE#02:

```
CLI> hot expansion -type de02
CLI> Please perform the following task(s).
CLI> Please input "c", if task(s) finishes.
CLI> "Workflow Sequence"
CLI> 1. Please detach the cable from the port.
CLI> Connection Source : CM#1 DI(OUT) Port / Connection Destination : DE#01 IOM#1 DI(IN) Port
CLI> 2. Please connect the SAS cable to the port.
CLI> Connection Source : DE#02 IOM#1 DI(OUT) Port / Connection Destination : DE#01 IOM#1 DI(IN) Port
CLI> > c
CLI> Expansion of Drive Enclosure have been normally completed.
```

6.4.2 Remote Directory

This section explains the commands related to displaying a directory in an FTP server.

show remote-dir

This command displays a list of files on the specified FTP server. A user account is required to access the FTP server.

Syntax

```
show remote-dir -port {maintenance | remote} -server server_name  
-user login_user-account -dir dir_path
```

Parameter

- port** This parameter specifies which Ethernet port is used to connect to the FTP server. For details, refer to ["1.11 Note for Specifying FTP Server" \(page 54\)](#).
 - maintenance* Maintenance port (MNT port)
 - remote* Remote port (RMT port)
- server** This parameter specifies the FTP server name to display a directory. The server name format is IPv4 standard notation (a base 256 "d.d.d.d" string) or a fully qualified domain name (FQDN).
 - Example: -server 192.168.1.20
 - Example: -server foo.bar
 - server_name* FTP server name
- user** This parameter specifies the user name that can access the FTP server. This command displays a password prompt.
 - login_user-account* User name
- dir** This parameter specifies the directory path name to be displayed.
 - dir_path* Directory path name

Output

Item name	Description
xxxxxxxxxxxxxxxxxx	File name
YYYY-MM-DD hh:mm:ss	Created date
yyyyyyyyy	File size

Note

The output form depends on the FTP server environment.

■ Example(s)

The following example displays the file list of the directory named "/tmp" on the server named "ftp.a.com" that is connected via the maintenance port (MNT port). The user name for the FTP server is "profile1":

```
CLI> show remote-dir -port maintenance -server ftp.a.com -dir /tmp -user profile1
Password :
v10110-0000.01.bin 2011-01-10 10:20:30 1048756
v10110-0000.02.bin 2011-01-10 10:20:30 1048756
```

6.4.3 Controller Firmware

This section explains the commands related to the maintenance of controller firmware.

show firmware-version

This command displays the controller firmware version registered in the system.

Syntax

```
show firmware-version
```

Parameter

No parameters.

Output

Item name	Description
Version	Controller firmware version
Date	Created date For the current firmware that is running, "Current" is also displayed. For the reserved controller firmware at the next booting, "Next" is also displayed.

Example(s)

The following examples display the controller firmware version:

```
CLI> show firmware-version
  Version      Date
 1 V10L10-0000 2011-06-01
 2 V10L20-0000 2011-09-01 Current

CLI> show firmware-version
  Version      Date      Next
 1 V10L30-0000 2011-12-09
 2 V10L20-0000 2011-09-01 Current
```

6.4.4 Log

Various incidents are recorded in the system logs (component failures, environment conditions, user operations warning incidents etc.). This section explains the commands related to exporting logs.

export log

This command exports the log files that are stored in the system to the specified FTP server.

Syntax

```
export log -port {maintenance | remote | fst}
-server server_name -user login_user_account -filename filename
[-starting-time YYYYMMDD-hhmmss -ending-time YYYYMMDD-hhmmss | -last-24h {enable | disable} |
-last {24h | week | month}]
[-only-disk-log {enable | disable}]
[-iom-log {enable | disable}] [-nas-log {enable | disable}]
[-customer-info {enable | disable}] [-indicator {enable | disable}]
```

Parameter

- port** This parameter specifies which Ethernet port is used to connect to the FTP server. For details, refer to ["1.11 Note for Specifying FTP Server" \(page 54\)](#).
- | | |
|--------------------|---|
| <i>maintenance</i> | Maintenance port (MNT port) |
| <i>remote</i> | Remote port (RMT port) |
| <i>fst</i> | FST port (DX500 S4/DX600 S4, DX500 S3/DX600 S3, DX8100 S3/DX8700 S3/DX8900 S3, and AF650 S2/AF650 only) |
- server** This parameter specifies the name of the FTP server that will receive the logs. The server name format is IPv4 standard notation (a base 256 "d.d.d.d" string) or a fully qualified domain name (FQDN).
- Example: -server 192.168.1.20
Example: -server foo.bar
- | | |
|--------------------|-----------------|
| <i>server_name</i> | FTP server name |
|--------------------|-----------------|
- user** This parameter specifies the user name that can access the FTP server. This command displays a password prompt.
- | | |
|---------------------------|-----------|
| <i>login_user_account</i> | User name |
|---------------------------|-----------|
- filename** This parameter specifies the name of the log file to be stored on the FTP server. If the same filename already exists, it is overwritten.
- | | |
|-----------------|---------------|
| <i>filename</i> | Log file name |
|-----------------|---------------|
- The following conversion specifications, which begin with a percent character, are replaced with their corresponding values during file creation. If other conversion strings are specified, this command terminates abnormally with an error message.
- | | |
|----|---|
| %s | Serial number of the system
Example:
/tmp/%s-log.bin -> /tmp/123456789012-log.bin |
| %d | Current date
Example:
/tmp/%d-log.bin -> /tmp/20080819-log.bin |

`%t` Current time
 Example:
`/tmp/%t-log.bin -> /tmp/144855-log.bin`

`%%` Percent character
 Example:
`/tmp/log%%.bin -> /tmp/log%.bin`

-starting-time

Optional. Log entries can be restricted to a specific time range. This parameter specifies the starting time. The format is "YYYYMMDD-hhmmss". "YYYY" is the number of the year (a four-digit number), "MM" is the number of the month (01 – 12), "DD" is the number of the day (01 – 31), "hh" is the hour in 24-hour time (00 – 23), "mm" is the minute (00 – 59), and "ss" is the second (00 – 59). If omitted, the start time is the earliest entry (except when the "-last-24h" parameter is specified).

Note that both the starting time and ending time must be specified. If these parameters are specified, the "-last-24h" parameter and the "-last" parameter cannot be specified.

YYYYMMDD-hhmmss Starting time of the log entries

-ending-time

Optional. Log entries can be restricted to a specific time range. This parameter specifies the ending time. The format is "YYYYMMDD-hhmmss". "YYYY" is the number of the year (a four-digit number), "MM" is the number of the month (01 – 12), "DD" is the number of the day (01 – 31), "hh" is the hour in 24-hour time (00 – 23), "mm" is the minute (00 – 59), and "ss" is the second (00 – 59). If omitted, the start time is the latest entry (except when the "-last-24h" parameter is specified).

Note that both the starting time and ending time must be specified. If these parameters are specified, the "-last-24h" parameter and the "-last" parameter cannot be specified.

YYYYMMDD-hhmmss Ending time of the log entries

-last-24h

Optional. Log entries can be restricted to the last 24 hours. If this parameter is specified, the "-starting-time" parameter, the "-ending-time" parameter, and the "-last" parameter cannot be specified. If this parameter is omitted, this function is not used.

`enable` Log entries are restricted to the last 24 hours.

`disable` Log entries are not restricted to the last 24 hours.

-last

Optional. Log entries can be restricted to the log with most recent command execution. If this parameter is specified, the "-starting-time" parameter, the "-ending-time" parameter, and the "-last-24h" parameter cannot be specified. If this parameter is omitted, this function is not used.

`24h` Log entries are restricted to the last 24 hours. This is the same as if "-last-24h enable" is specified.

`week` Log entries are restricted to the last week.

`month` Log entries are restricted to the last month.

-only-disk-log

Optional. Log entries are restricted to drive (disk and SSD) related items. The file size of the log can be kept small by specifying this parameter only when drive related logs are required. The default value is "disable".

enable Log entries other than for the I/O module and the NAS engine are restricted to drive related items. The I/O module log and the NAS engine log depend on the specification of the "-iom-log" parameter and the "-nas-log" parameter.

disable Log entries are not restricted to drive related items (default).

-iom-log

Optional. This parameter specifies whether the I/O module logs are included. If omitted, I/O module logs are included.

enable The I/O module logs are included.

disable The I/O module logs are not included.

-nas-log

Optional. This parameter specifies whether to include the NAS Engine logs. If omitted, the NAS Engine logs are included.

This parameter is ignored when specified with an ETERNUS DX/AF that does not have a NAS engine.

enable The NAS Engine logs are included.

disable The NAS Engine logs are not included.

-customer-info

Optional. This parameter specifies whether to include customer information in the exported logs. If this parameter is omitted, customer information is included in the logs.

enable Customer information is included in the logs.

disable Customer information is excluded from the logs.

 **Caution**

When "disable" is specified, logs for the NAS function are not exported.

-indicator

Optional. This parameter specifies whether the progress indicator is displayed. If omitted, this function is enabled.

enable Progress indicator is displayed.

disable Progress indicator is not displayed.

■ Example(s)

The following example exports logs to the FTP server named "ftp.a.com" using the maintenance port (MNT port). The user name is "profile1" and the output filename is "/tmp/log".

The entered password in "Password :" is not displayed:

```
CLI> export log -port maintenance -server ftp.a.com -user profile1 -filename /tmp/log
Password :
exporting /tmp/log to ftp.a.com
complete
```

The following example is the same as above, except that the progress indicator is not displayed.

The entered password in "Password :" is not displayed:

```
CLI> export log -port maintenance -server ftp.a.com -user profile1 -filename /tmp/log -indicator disable
Password :
```

6.4.5 Panic Dump

The system stores a panic dump when crashing. This section explains the commands related to exporting the panic dump.

show panic-dump

This command displays a list of the panic dumps that are stored in the system.

Caution

When "NAS Engine Panic" is displayed for "Panic Message", the panic dump number is not fixed. Deleting the panic dump may change the panic dump number.

■ Syntax

```
show panic-dump
```

■ Parameter

No parameters.

■ Output

Item name	Description
No.	Panic dump number
Module	Panic dump module name
Panic Date	Panic date
Panic Code	Panic code
Data Size	Panic dump size (unit: byte)
Panic Message	Messages
Error Code	Error code for the error that occurred when panic dump information is displayed. (When no error occurs, a hyphen [-] is displayed.)

■ Example(s)

The following example displays a list of the panic dumps:

```
CLI> show panic-dump
No. Module      Panic Date      Panic Code Data Size   Panic Message  Error Code
-----
 1 CM#0          2008-07-10 12:15:10 0x12345678   286331153 EXC:Data Abort -
 2 CM#1          2008-07-14 12:35:10 0x12345678   286331153 EXC:Data Abort -
 3 CM#1 CA#0      2009-01-23 12:34:10 0x12345678   134217728 EXC:Data Abort -
```

The following example displays a list of the panic dumps (for the DX8700 S3/DX8900 S3):

```
CLI> show panic-dump
No. Module      Panic Date      Panic Code Data Size   Panic Message  Error Code
-----
 1 CE#0 CM#0      2008-07-10 12:15:10 0x12345678   286331153 EXC:Data Abort -
 2 CE#3 CM#1      2008-07-14 12:35:10 0x12345678   286331153 EXC:Data Abort -
 3 CE#3 CM#2 CA#3    2009-01-23 12:34:10 0x12345678   134217728 EXC:Data Abort -
```

export panic-dump

This command exports a panic dump file stored in the system to the specified FTP server. The panic dump information, including the panic dump number, can be displayed by using the "show panic-dump" command.

Syntax

```
export panic-dump -port {maintenance | remote | fst} -server server_name
-user login_user_account -filename filename -dump-number dump_number [-indicator {enable | disable}]
```

Parameter

- port** This parameter specifies which Ethernet port is used to connect to the FTP server. For details, refer to ["1.11 Note for Specifying FTP Server" \(page 54\)](#).
- | | |
|-------------|---|
| maintenance | Maintenance port (MNT port) |
| remote | Remote port (RMT port) |
| fst | FST port (DX500 S4/DX600 S4, DX500 S3/DX600 S3, DX8100 S3/DX8700 S3/DX8900 S3, and AF650 S2/AF650 only) |
- server** This parameter specifies the FTP server name which will store the panic dump. The server name format is IPv4 standard notation (a base 256 "d.d.d.d" string) or a fully qualified domain name (FQDN).
- Example: -server 192.168.1.20
Example: -server foo.bar
- server_name* FTP server name
- user** This parameter specifies the user name that can access the FTP server. This command displays a password prompt.
- login_user_account* User name
- filename** This parameter specifies the name of the panic dump file to be stored on the FTP server. If the same filename already exists, it is overwritten.
- filename* Panic dump file name
- The following conversion specifications, which begin with a percent character, are replaced with their corresponding values during file creation. If other conversion strings are specified, this command terminates abnormally with an error message.
- | | |
|----|---|
| %s | Serial number of the system
Example:
/tmp/%s-log.zlg -> /tmp/123456789012-log.zlg |
| %d | Current date
Example:
/tmp/%d-log.zlg -> /tmp/20080819-log.zlg |

%t	Current time Example: /tmp/%t-log.zlg -> /tmp/144855-log.zlg
%%	Percent character Example: /tmp/log%%.zlg -> /tmp/log%.zlg

-dump-number

One or more panic dumps can be stored in the system. They can be displayed by using the "show panic-dump" command. This parameter specifies the panic dump number to be exported.

dump_number Panic dump number

-indicator Optional. This parameter specifies whether the progress indicator is displayed. If omitted, this function is enabled.

enable Progress indicator is displayed.

disable Progress indicator is not displayed.

■ Example(s)

The following example exports panic dump #1 to the FTP server named "ftp.a.com" using the maintenance port (MNT port).

The user name is "profile1" and the output filename is "/tmp/dump.zlg".

The entered password in "Password :" is not displayed:

```
CLI> export panic-dump -port maintenance -server ftp.a.com -user profile1 -filename /tmp/dump.zlg -dump-number 1
Password :
Panic Dump No.1 CM#0 2008-07-10 12:15:10 0x12345678 286331153 EXC:Data Abort
selected panic dump details in the same format as "show panic-dump" command.
exporting /tmp/dump.zlg to ftp.a.com
complete.
```

The following example is the same as above, except that the progress indicator is not displayed.

The entered password in "Password :" is not displayed:

```
CLI> export panic-dump -port maintenance -server ftp.a.com -user profile1 -filename /tmp/dump.zlg -dump-number 1 -indicator disable
Password :
```

6.4.6 Configuration Information

Configuration information can be stored externally in a file. This section explains the commands related to manipulating configuration information.

show config-information

This command displays a list of the configuration information that is stored in the system.

■ Syntax

```
show config-information
```

■ Parameter

No parameters.

■ Output

Item name	Description
Information	Configuration information
Date	Configuration date (yyyy-mm-dd hh:mm:ss) If the system has no configuration information, a hyphen (-) is displayed here.
Note	Other information

■ Example(s)

The following example displays a list of the configuration information:

```
CLI > show config-information
Information      Date          Note
-----
Two Time Before -          -
One Time Before 2008-07-20 23:11:00 aabbccdd
Latest          2008-07-22 15:26:45 -
```

export config-information

This command exports the configuration information stored in the system to the specified FTP server.

Syntax

```
export config-information -port {maintenance | remote | fst} -server server_name
-user login_user_account -filename filename -data {latest | one-before | two-before}
[-indicator {enable | disable}]
```

Parameter

- port** This parameter specifies which Ethernet port is used to connect to the FTP server. For details, refer to ["1.11 Note for Specifying FTP Server" \(page 54\)](#).
- | | |
|--------------------|---|
| <i>maintenance</i> | Maintenance port (MNT port) |
| <i>remote</i> | Remote port (RMT port) |
| <i>fst</i> | FST port (DX500 S4/DX600 S4, DX500 S3/DX600 S3, DX8100 S3/DX8700 S3/DX8900 S3, and AF650 S2/AF650 only) |
- server** This parameter specifies the FTP server name that will store the configuration information. The server name format is IPv4 standard notation (a base 256 "d.d.d.d" string) or a fully qualified domain name (FQDN).
- Example: -server 192.168.1.20
Example: -server foo.bar
- | | |
|--------------------|-----------------|
| <i>server_name</i> | FTP server name |
|--------------------|-----------------|
- user** This parameter specifies the user name that can access the FTP server. This command displays a password prompt.
- | | |
|---------------------------|-----------|
| <i>login_user_account</i> | User name |
|---------------------------|-----------|
- filename** This parameter specifies configuration information filename to be stored. If the same filename already exists, it is overwritten.
- | | |
|-----------------|------------------------------------|
| <i>filename</i> | Configuration information filename |
|-----------------|------------------------------------|
- The following conversion specifications, which begin with a percent character, are replaced with their corresponding value at the time of execution. If other conversion strings are specified, this command terminates abnormally with an error message.
- | | |
|----|---|
| %s | Serial number of the system
Example:
/tmp/%s-log.cfg -> /tmp/123456789012-log.cfg |
| %d | Current date
Example:
/tmp/%d-log.cfg -> /tmp/20080819-log.cfg |
| %t | Current time
Example:
/tmp/%t-log.cfg -> /tmp/144855-log.cfg |

%% Percent character
 Example:
 /tmp/log%%.cfg -> /tmp/log%.cfg

- data** This parameter specifies which configuration information will be exported.
- latest** This parameter specifies the latest configuration information in the system.
- one-before** This parameter specifies the second-latest configuration information in the system.
- two-before** This parameter specifies the third-latest configuration information in the system.
- indicator** Optional. This parameter specifies whether the progress indicator is displayed. If omitted, this function is enabled.
- enable** Progress indicator is displayed.
- disable** Progress indicator is not displayed.

■ Example(s)

The following example exports the latest configuration information to the FTP server named "ftp.a.com" using the maintenance port (MNT port). The user name for the FTP server is "profile1" and the filename is "/tmp/config.cfg".

The entered password in "Password :" is not displayed:

```
CLI> export config-information -port maintenance -server ftp.a.com -user profile1 -filename /tmp/config.cfg -data latest
Password :
exporting /tmp/config.cfg to ftp.a.com
complete.
```

The following example is the same as above, except that the progress indicator is not displayed.

The entered password in "Password :" is not displayed:

```
CLI> export config-information -port maintenance -server ftp.a.com -user profile1 -filename /tmp/config.cfg -data latest
-indicator disable
Password :
```

6.4.7 Error Information

This section explains the commands related to the error information of disks and ports.

show disk-error

This command displays the details of disk errors.

Syntax

```
show disk-error
```

Parameter

No parameters.

Output

Item name	Description
E	An error sign (*). This shows that there are some errors for both ports.
Disk Location	Disk number
Status	Disk status
Port	Disk port number
Media Error	Media error count
Drive Error	Drive error count
Drive-Recovered Error	Drive recovered error count
SMART Error	SMART event count
I/O Timeout	I/O timeout count
Link Error	Link error count
Check-Code Error	Check code error count

Example(s)

The following example displays the disk error information:

```

CLI> show disk-error
E Disk      Status
  Location
-----
* CE-Disk#0  Rebuild/Copyback
  Port#0      0      0      0      0      0      0      0
  Port#1      0      0      0      0      0      0      0
* CE-Disk#1  Available(Predictive Failure)
  Port#0      2      0      0      1      0      0      0
  Port#1      0      0      0      0      0      0      0
DE#4-Disk#0  Rebuild/Copyback
  Port#0      0      0      0      0      0      0      0
  Port#1      0      0      0      0      0      0      0

```

clear disk-error

This command clears the disk error information. It is possible to clear the error information of specific disks.

■ Syntax

```
clear disk-error [-disks disks]
```

■ Parameter

-disks Optional. This parameter specifies the disks to clear the error information from. One or more disks can be specified at the same time. For details, refer to ["1.2.5 Drive Syntax" \(page 35\)](#). If this parameter is omitted, the error information for all the disks is cleared.

disks Disk

■ Example(s)

The following example clears the error information for all the disks:

```
CLI> clear disk-error
```

The following example clears only the error information for disk#1 in the CE:

```
CLI> clear disk-error -disks 001
```

show port-error

This command displays the error details of the SAS expander ports (the interfaces linking controllers and drive enclosures). There are three ports for each expander module and four PHYs for each port.

For SAS host interfaces, the port state can be checked with the "show fru-ce" command.

■ Syntax

```
show port-error
```

■ Parameter

No parameters.

■ Output

Item name	Description
Expander	Expander type
Port	Port number
PHY	PHY number
Status	Link status
Invalid Dword	Invalid Dword count
Disparity Error	Disparity Error count
Loss of Dword Synchronization	Loss of Dword Synchronization count
PHY Reset Problem	PHY Reset Problem count

■ Example(s)

The following example displays the error details of the SAS expander ports (for models other than the DX8700 S3/DX8900 S3).

- The Status of CM#x EXP Port#0,#1 PHY#2,#3 is displayed as N/A for the DX60 S4/DX100 S4/DX200 S4, the DX60 S3/DX100 S3/DX200 S3, and the AF250 S2/AF250.
- The Status of CM#x IOC#y Port#z PHY#2,#3 is displayed as N/A for the DX60 S4/DX100 S4/DX200 S4, the DX60 S3/DX100 S3/DX200 S3, and the AF250 S2/AF250.
- CM#x EXP Port#4 to #7 is only displayed for the DX600 S4, the DX600 S3, and the AF650 S2/AF650.
- CM#x IOC#1 Port#z is only displayed for the DX600 S4, the DX600 S3, and the AF650 S2/AF650.
- DE#x IOM#y Port#2,#3 is only displayed for high-density drive enclosures.
- DE#x FEM#y EXP#z Port is only displayed for high-density drive enclosures.
- DE#x FEM#1 is displayed regardless of the number of CMs.

```

CLI> show port-error

```

Expander	Port	PHY	Status	Invalid Dword	Disparity Error	Loss of Dword Synchronization	PHY Reset Problem
CM#0 EXP	Port#0	PHY#0	Link Up	0	0	0	0
		PHY#1	Link Up	0	0	0	0
		PHY#2	N/A	-	-	-	-
		PHY#3	N/A	-	-	-	-
	Port#1	PHY#0	Link Up	0	0	0	0
		PHY#1	Link Up	0	0	0	0
		PHY#2	Link Up	0	0	0	0
		PHY#3	Link Up	0	0	0	0
	Port#2	PHY#0	Link Up	0	0	0	0
		PHY#1	Link Up	0	0	0	0
		PHY#2	N/A	-	-	-	-
	Port#3	PHY#0	Link Up	0	0	0	0
		PHY#1	Link Up	0	0	0	0
		PHY#2	Link Up	-	-	-	-
	Port#4	PHY#0	Link Up	0	0	0	0
		PHY#1	Link Up	0	0	0	0
		PHY#2	Link Up	0	0	0	0
		PHY#3	Link Up	0	0	0	0
	Port#5	PHY#0	Link Up	0	0	0	0
		PHY#1	Link Up	0	0	0	0
		PHY#2	N/A	-	-	-	-
	Port#6	PHY#0	Link Up	0	0	0	0
		PHY#1	Link Up	0	0	0	0
		PHY#2	N/A	-	-	-	-
	Port#7	PHY#0	Link Up	0	0	0	0
		PHY#1	Link Up	0	0	0	0
		PHY#2	N/A	-	-	-	-
		PHY#3	N/A	-	-	-	-
CM#0 IOC#0	Port#0	PHY#0	Link Up	0	0	0	0
		PHY#1	Link Up	0	0	0	0
		PHY#2	N/A	-	-	-	-
		PHY#3	N/A	-	-	-	-
	Port#1	PHY#0	Link Up	0	0	0	0
		PHY#1	Link Up	0	0	0	0
		PHY#2	Link Up	0	0	0	0
		PHY#3	Link Up	0	0	0	0
CM#0 IOC#1	Port#0	PHY#0	Link Up	0	0	0	0
		PHY#1	Link Up	0	0	0	0
		PHY#2	N/A	-	-	-	-
		PHY#3	N/A	-	-	-	-
	Port#1	PHY#0	Link Up	0	0	0	0
		PHY#1	Link Up	0	0	0	0
		PHY#2	Link Up	0	0	0	0
		PHY#3	Link Up	0	0	0	0

DE#1 IOM#0	Port#0	PHY#0	Link Up	0	0	0	0	
		PHY#1	Link Up	0	0	0	0	
		PHY#2	Link Up	0	0	0	0	
		PHY#3	Link Up	0	0	0	0	
	Port#1	PHY#0	Link Down	-	-	-	-	
		PHY#1	Link Down	-	-	-	-	
		PHY#2	Link Down	-	-	-	-	
		PHY#3	Link Down	-	-	-	-	
	Port#2	PHY#0	Link Up	0	0	0	0	
		PHY#1	Link Up	0	0	0	0	
		PHY#2	Link Up	0	0	0	0	
		PHY#3	Link Up	0	0	0	0	
		PHY#4	Link Up	0	0	0	0	
		PHY#5	Link Up	0	0	0	0	
		PHY#6	Link Up	0	0	0	0	
		PHY#7	Link Up	0	0	0	0	
		PHY#8	Link Up	0	0	0	0	
		PHY#9	Link Up	0	0	0	0	
		PHY#10	Link Up	0	0	0	0	
	Port#3	PHY#11	Link Up	0	0	0	0	
		PHY#0	Link Up	0	0	0	0	
		PHY#1	Link Up	0	0	0	0	
		PHY#2	Link Up	0	0	0	0	
		PHY#3	Link Up	0	0	0	0	
		PHY#4	Link Up	0	0	0	0	
		PHY#5	Link Up	0	0	0	0	
		PHY#6	Link Up	0	0	0	0	
		PHY#7	Link Up	0	0	0	0	
		PHY#8	Link Up	0	0	0	0	
		PHY#9	Link Up	0	0	0	0	
	DE#1 IOM#1	Port#0	PHY#10	Link Up	0	0	0	0
			PHY#11	Link Up	0	0	0	0
			PHY#2	Link Up	0	0	0	0
PHY#3			Link Up	0	0	0	0	
Port#1		PHY#0	Link Down	-	-	-	-	
		PHY#1	Link Down	-	-	-	-	
		PHY#2	Link Down	-	-	-	-	
		PHY#3	Link Down	-	-	-	-	
Port#2		PHY#0	Link Up	0	0	0	0	
		PHY#1	Link Up	0	0	0	0	
		PHY#2	Link Up	0	0	0	0	
		PHY#3	Link Up	0	0	0	0	
	PHY#4	Link Up	0	0	0	0		
	PHY#5	Link Up	0	0	0	0		
	PHY#6	Link Up	0	0	0	0		
	PHY#7	Link Up	0	0	0	0		
	PHY#8	Link Up	0	0	0	0		
	PHY#9	Link Up	0	0	0	0		
	PHY#10	Link Up	0	0	0	0		
Port#3	PHY#11	Link Up	0	0	0	0		
	PHY#0	Link Up	0	0	0	0		
	PHY#1	Link Up	0	0	0	0		
	PHY#2	Link Up	0	0	0	0		
	PHY#3	Link Up	0	0	0	0		
	PHY#4	Link Up	0	0	0	0		
	PHY#5	Link Up	0	0	0	0		
	PHY#6	Link Up	0	0	0	0		
	PHY#7	Link Up	0	0	0	0		
	PHY#8	Link Up	0	0	0	0		
	PHY#9	Link Up	0	0	0	0		
DE#1 FEM#0 EXP#0	Port	PHY#10	Link Up	0	0	0	0	
		PHY#11	Link Up	0	0	0	0	
		PHY#0	Link Up	0	0	0	0	
		PHY#1	Link Up	0	0	0	0	
		PHY#2	Link Up	0	0	0	0	
		PHY#3	Link Up	0	0	0	0	
		PHY#4	Link Up	0	0	0	0	
		PHY#5	Link Up	0	0	0	0	
		PHY#6	Link Up	0	0	0	0	
		PHY#7	Link Up	0	0	0	0	
		PHY#8	Link Up	0	0	0	0	
		PHY#9	Link Up	0	0	0	0	

DE#1 FEM#0 EXP#1	Port	PHY#0	Link Down	-	-	-	-
		PHY#1	Link Down	-	-	-	-
		PHY#2	Link Down	-	-	-	-
		PHY#3	Link Down	-	-	-	-
		PHY#4	Link Up	0	0	0	0
		PHY#5	Link Up	0	0	0	0
		PHY#6	Link Up	0	0	0	0
		PHY#7	Link Up	0	0	0	0
		PHY#8	Link Up	0	0	0	0
		PHY#9	Link Up	0	0	0	0
		PHY#10	Link Up	0	0	0	0
DE#1 FEM#1 EXP#0	Port	PHY#0	Link Up	0	0	0	0
		PHY#1	Link Up	0	0	0	0
		PHY#2	Link Up	0	0	0	0
		PHY#3	Link Up	0	0	0	0
		PHY#4	Link Up	0	0	0	0
		PHY#5	Link Up	0	0	0	0
		PHY#6	Link Up	0	0	0	0
		PHY#7	Link Up	0	0	0	0
		PHY#8	Link Up	0	0	0	0
		PHY#9	Link Up	0	0	0	0
		PHY#10	Link Up	0	0	0	0
DE#1 FEM#1 EXP#1	Port	PHY#0	Link Down	-	-	-	-
		PHY#1	Link Down	-	-	-	-
		PHY#2	Link Down	-	-	-	-
		PHY#3	Link Down	-	-	-	-
		PHY#4	Link Up	0	0	0	0
		PHY#5	Link Up	0	0	0	0
		PHY#6	Link Up	0	0	0	0
		PHY#7	Link Up	0	0	0	0
		PHY#8	Link Up	0	0	0	0
		PHY#9	Link Up	0	0	0	0
		PHY#10	Link Up	0	0	0	0
PHY#11	Link Up	0	0	0	0		

The following example displays the error details of the SAS expander ports (for the DX8700 S3/DX8900 S3):

```

CLI> show port-error
Expander      Port  PHY  Status  Invalid  Disparity  Loss of Dword  PHY Reset
-----  -----  ---  -----  -----  -----  -----  -----
CE#0 CM#0 EXP  Port#0  PHY#0  Link Up    0         0         0         0
              PHY#1  Link Up    0         0         0         0
              PHY#2  N/A       -         -         -         -
              PHY#3  N/A       -         -         -         -
              Port#1  PHY#0  Link Up    0         0         0         0
              PHY#1  Link Up    0         0         0         0
              PHY#2  Link Up    0         0         0         0
              PHY#3  Link Up    0         0         0         0
              Port#2  PHY#0  Link Up    0         0         0         0
              PHY#1  Link Up    0         0         0         0
              PHY#2  N/A       -         -         -         -
              PHY#3  N/A       -         -         -         -
              Port#3  PHY#0  Link Up    0         0         0         0
              PHY#1  Link Up    0         0         0         0
              PHY#2  Link Up    0         0         0         0
              PHY#3  Link Up    0         0         0         0
    
```

CE#0 CM#1 EXP	Port#0	PHY#0	Link Up	0	0	0	0	
		PHY#1	Link Up	0	0	0	0	
		PHY#2	N/A	-	-	-	-	
		PHY#3	N/A	-	-	-	-	
	Port#1	PHY#0	Link Up	0	0	0	0	
		PHY#1	Link Up	0	0	0	0	
		PHY#2	Link Up	0	0	0	0	
		PHY#3	Link Up	0	0	0	0	
	Port#2	PHY#0	Link Up	0	0	0	0	
		PHY#1	Link Up	0	0	0	0	
		PHY#2	N/A	-	-	-	-	
		PHY#3	N/A	-	-	-	-	
Port#3	PHY#0	Link Up	1	0	0	0		
	PHY#1	Link Up	1	0	0	0		
	PHY#2	Link Up	1	0	0	0		
	PHY#3	Link Up	1	0	0	0		
DE#1 IOM#0	Port#0	PHY#0	Link Up	0	0	0	0	
		PHY#1	Link Up	0	0	0	0	
		PHY#2	Link Up	0	0	0	0	
		PHY#3	Link Up	0	0	0	0	
	Port#1	PHY#0	Link Down	-	-	-	-	
		PHY#1	Link Down	-	-	-	-	
		PHY#2	Link Down	-	-	-	-	
		PHY#3	Link Down	-	-	-	-	
	Port#2	PHY#0	Link Up	0	0	0	0	
		PHY#1	Link Up	0	0	0	0	
		PHY#2	Link Up	0	0	0	0	
		PHY#3	Link Up	0	0	0	0	
		PHY#4	Link Up	0	0	0	0	
		PHY#5	Link Up	0	0	0	0	
		PHY#6	Link Up	0	0	0	0	
		PHY#7	Link Up	0	0	0	0	
		PHY#8	Link Up	0	0	0	0	
		PHY#9	Link Up	0	0	0	0	
		PHY#10	Link Up	0	0	0	0	
	Port#3	PHY#0	Link Up	0	0	0	0	
		PHY#1	Link Up	0	0	0	0	
		PHY#2	Link Up	0	0	0	0	
		PHY#3	Link Up	0	0	0	0	
		PHY#4	Link Up	0	0	0	0	
		PHY#5	Link Up	0	0	0	0	
		PHY#6	Link Up	0	0	0	0	
		PHY#7	Link Up	0	0	0	0	
		PHY#8	Link Up	0	0	0	0	
		PHY#9	Link Up	0	0	0	0	
		PHY#10	Link Up	0	0	0	0	
	DE#1 IOM#1	Port#0	PHY#0	Link Up	0	0	0	0
			PHY#1	Link Up	0	0	0	0
			PHY#2	Link Up	0	0	0	0
			PHY#3	Link Up	0	0	0	0
		Port#1	PHY#0	Link Down	-	-	-	-
			PHY#1	Link Down	-	-	-	-
PHY#2			Link Down	-	-	-	-	
PHY#3			Link Down	-	-	-	-	
Port#2		PHY#0	Link Up	0	0	0	0	
		PHY#1	Link Up	0	0	0	0	
		PHY#2	Link Up	0	0	0	0	
	PHY#3	Link Up	0	0	0	0		
	PHY#4	Link Up	0	0	0	0		
	PHY#5	Link Up	0	0	0	0		
	PHY#6	Link Up	0	0	0	0		
	PHY#7	Link Up	0	0	0	0		
	PHY#8	Link Up	0	0	0	0		
	PHY#9	Link Up	0	0	0	0		
	PHY#10	Link Up	0	0	0	0		
Port#3	PHY#0	Link Up	0	0	0	0		
	PHY#1	Link Up	0	0	0	0		
	PHY#2	Link Up	0	0	0	0		
	PHY#3	Link Up	0	0	0	0		
	PHY#4	Link Up	0	0	0	0		
	PHY#5	Link Up	0	0	0	0		
	PHY#6	Link Up	0	0	0	0		
	PHY#7	Link Up	0	0	0	0		
	PHY#8	Link Up	0	0	0	0		
	PHY#9	Link Up	0	0	0	0		
	PHY#10	Link Up	0	0	0	0		
PHY#11	Link Up	0	0	0	0			

DE#1 FEM#0 EXP#0	Port	PHY#0	Link Up	0	0	0	0
		PHY#1	Link Up	0	0	0	0
		PHY#2	Link Up	0	0	0	0
		PHY#3	Link Up	0	0	0	0
		PHY#4	Link Up	0	0	0	0
		PHY#5	Link Up	0	0	0	0
		PHY#6	Link Up	0	0	0	0
		PHY#7	Link Up	0	0	0	0
		PHY#8	Link Up	0	0	0	0
		PHY#9	Link Up	0	0	0	0
		PHY#10	Link Up	0	0	0	0
		PHY#11	Link Up	0	0	0	0
DE#1 FEM#0 EXP#1	Port	PHY#0	Link Down	-	-	-	-
		PHY#1	Link Down	-	-	-	-
		PHY#2	Link Down	-	-	-	-
		PHY#3	Link Down	-	-	-	-
		PHY#4	Link Up	0	0	0	0
		PHY#5	Link Up	0	0	0	0
		PHY#6	Link Up	0	0	0	0
		PHY#7	Link Up	0	0	0	0
		PHY#8	Link Up	0	0	0	0
		PHY#9	Link Up	0	0	0	0
		PHY#10	Link Up	0	0	0	0
		PHY#11	Link Up	0	0	0	0
DE#1 FEM#1 EXP#0	Port	PHY#0	Link Up	0	0	0	0
		PHY#1	Link Up	0	0	0	0
		PHY#2	Link Up	0	0	0	0
		PHY#3	Link Up	0	0	0	0
		PHY#4	Link Up	0	0	0	0
		PHY#5	Link Up	0	0	0	0
		PHY#6	Link Up	0	0	0	0
		PHY#7	Link Up	0	0	0	0
		PHY#8	Link Up	0	0	0	0
		PHY#9	Link Up	0	0	0	0
		PHY#10	Link Up	0	0	0	0
		PHY#11	Link Up	0	0	0	0
DE#1 FEM#1 EXP#1	Port	PHY#0	Link Down	-	-	-	-
		PHY#1	Link Down	-	-	-	-
		PHY#2	Link Down	-	-	-	-
		PHY#3	Link Down	-	-	-	-
		PHY#4	Link Up	0	0	0	0
		PHY#5	Link Up	0	0	0	0
		PHY#6	Link Up	0	0	0	0
		PHY#7	Link Up	0	0	0	0
		PHY#8	Link Up	0	0	0	0
		PHY#9	Link Up	0	0	0	0
		PHY#10	Link Up	0	0	0	0
		PHY#11	Link Up	0	0	0	0

6.4.8 Bad Data Information in Volumes

This section explains the commands for resolving the bad data information of volumes.

show bad-data-info

This command displays either the bad data information for all of the volumes or for the specified volume(s).

Syntax

```
show bad-data-info [{-volume-number volume_numbers | -volume-name volume_names}]
```

Parameter

-volume-number or -volume-name

Optional. This parameter specifies the volume identifiers to display bad data. One or more parameters can be specified. For details, refer to "[1.2.11 Volume Syntax](#)" (page 40).

volume_numbers Volume number

volume_names Volume name

Output

Item name	Description
Volume	Volume identifiers
No.	Volume number
Name	Volume name
Volume Type	Volume type
Error LBA	Start offset LBA of the bad data
LBA Count	Number of LBAs of the bad data
Error Type	Error type

Example(s)

The following example displays bad data information for volume number #1:

```
CLI> show bad-data-info -volume-number 1
Volume                               Volume Type  Error LBA      LBA Count      Error Type
No.  Name
-----
  1  VOL001                Standard    0x0123456789ABCDEF  0xFEDCBA9876543210  Contiguity
```

The following example displays bad data information for the volumes named "VOL001" and "VOL012":

```
CLI> show bad-data-info -volume-name VOL001, VOL012
Volume                               Volume Type  Error LBA      LBA Count      Error Type
No.  Name
-----
  1  VOL001                Standard    0x0123456789ABCDEF  0xFEDCBA9876543210  Contiguity
 12  VOL012                Standard    0x0000000076543210  0x0000000089ABCDEF  Dispersion
```

The following example displays all the volumes with bad data information:

```
CLI> show bad-data-info
Volume                               Volume Type  Error LBA      LBA Count      Error Type
No.  Name
-----
  1  VOL001                Standard    0x0123456789ABCDEF  0xFEDCBA9876543210  Contiguity
  3  VOL003                MVV        0x0000000089ABCDEF  0x0000000076543210  Contiguity
 10  VOL010                Standard    0x0000000076543210  0x0000000089ABCDEF  Dispersion
```

6.5 Utility

This section explains commands related to miscellaneous system utility functions.

6.5.1 Diagnostic Utilities

This section explains the commands related to system diagnostics.

show diagnosis

This command displays the results of the diagnostic tests that have been run on the disks or RAID groups.

■ Syntax

```
show diagnosis -type {disks [-disks {all | disks}] |  
raid-groups [-rg-number rg_numbers | -rg-name rg_names]}
```

■ Parameter

-type This parameter specifies the type of diagnostic results to be displayed. Only one type can be displayed by a single command.

disks The diagnostic results of disks

raid-groups The diagnostic results of RAID groups

-rg-number or -rg-name

Optional. This parameter specifies the RAID group identifiers to be displayed and "raid-groups" must be specified together with "-type". One or more RAID groups can be specified at the same time. For details, refer to ["1.2.10 RAID Group Syntax" \(page 39\)](#). If omitted, all the RAID groups are selected.

rg_numbers RAID group number

rg_names RAID group name

-disks Optional. This parameter specifies the disks to display more detailed diagnostic results of the disks and "raid-groups" must be specified together with "-type". One or more disks can be specified at the same time. For details, refer to ["1.2.5 Drive Syntax" \(page 35\)](#). If omitted, a summary list of all the disks is displayed.

all All the disks

disks Disk

■ Output

- Summary results of the disk diagnosis

Item name	Description
Diagnosis Status	Diagnosis status
Progress	Diagnosis progress
Method	Diagnosis mode
Diagnosis Count	Loop count for diagnosis
Location	Disk number
Diagnosis Status	Executing status
Result	Diagnosis result

- Summary results of the RAID diagnosis

Item name	Description
Diagnosis Status	Diagnosis status
Progress	Diagnosis progress

Item name	Description
Recovery Mode	Diagnosis mode
ON	Auto Error Recovery
OFF	No Recovery
RAID Group	RAID group identifiers
No.	RAID group number
Name	RAID group name
Diagnosis Status	Executing status
Result	Diagnosis result

- Details of the disk diagnosis

Item name	Description
Location	Disk number
Diagnosis Status	Executing status
Result	Diagnosis result
Progress	Diagnosis progress
Diagnosed Disk LBA Count	Diagnosed LBA
Total Disk LBA Count	Total LBAs of the disks

- Error Information

Item name	Description
Hard Error Count	Detected hard error count
SMART Error Count	Detected SMART count
Compare Error Count	Detected data compare error count
Medium Error Count	Detected medium error count
Recovered Error Count	Detected recovered error count
No Sense Error Count	Detected no sense error count
Interface Error Count	Detected interface error count
Other Error Count	Detected other error count

- Medium Error Details

Item name	Description
Head#0-#7	Detected medium error in the head#0 - #7 (except SENSE=01/0300 and 01/1501)
Other Error Count	Detected recovered error in others (target is SENSE=01/0300 and 01/1501)

- Recovered Error Details

Item name	Description
Head#0-#7	Detected recovered error in the head#0 - #7 (except SENSE=03/1100 and 01/1300)
Other Error Count	Detected recovered error in others (target is SENSE=03/1100 and 01/1300)

- Details of the RAID diagnosis

Item name	Description
RAID Group Number	RAID group number
RAID Group Name	RAID group name
Recovery Mode	Diagnosis mode
ON	Auto Error Recovery
OFF	No Recovery
Diagnosis Status	Executing status
Result	Diagnosis result
Progress	Diagnosis progress
Diagnosed RAID Group LBA Count	Diagnosed LBA
Total RAID Group LBA Count	Total LBAs of the disks

- Error Information

(Succeeded / Failed in Restoration)

Item name	Description
Compare Error	Compare error counts for restoration succeeded and restoration failed cases
Medium Error	Medium error counts for restoration succeeded and restoration failed cases
CRC Error	CRC error counts for restoration succeeded and restoration failed cases
Block ID Error Count	Block ID error counts for restoration succeeded and restoration failed cases
Bad Data Flag Error	Bad data flag error counts for restoration succeeded and restoration failed cases

- Error Details

(Detailed error information for cases when a restoration fails)

Item name	Description
Volume Number	The volume number in which errors occurred.
Volume Name	The volume name in which errors occurred.
Status	Recovering status (Error status). Medium Error, CRC Error, etc.
Volume LBA	The LBA of the volume in which errors occurred
RAID Group LBA	The LBA of the RAID group in which errors occurred
Error Stripe No.	The stripe number in which errors occurred
Location	The disk number in which errors occurred
Error Disk LBA	The LBA of the disk in which errors occurred

■ Example(s)

The following example displays the summary results of the disk diagnosis:

```
CLI>show diagnosis -type disks
Disk Diagnosis
Diagnosis Status : Diagnosing
Progress         : 90%
Method          : Read Only
Diagnosis Count : 5/10

Disk List
Location      Diagnosis Status  Result
CE-Disk#0     Complete          Normal
DE#1-Disk#0   Complete          Normal
DE#1-Disk#10  Diagnosing        Normal
```

The following example displays the summary results of the RAID diagnosis:

```
CLI> show diagnosis -type raid-groups
RAID Group Diagnosis
Diagnosis Status : Diagnosing
Progress         : 90%
Recovery Mode    : Enable(Except compare error)

RAID Group List
RAID Group      Diagnosis      Result
No.  Name        Status
-----
  1  RLU#1        Diagnosing    Normal
  1  RLU000       Complete     Normal
 12  RLU002       Complete     Normal
 13  RLU003       Complete     Normal
 14  RLU004       Diagnosing    Normal
```

The following example displays the detailed results of the disk diagnosis:

```
CLI>show diagnosis -type disks -disks 100
Location      : DE#1-Disk#0
Diagnosis Status : Diagnosing
Result        : Normal
Progress      : 10%
Diagnosed Disk LBA Count : 0x0000000008803072
Total Disk LBA Count   : 0x0000000025182720

Error Information
Hard Error Count      : 0
SMART Error Count    : 0
Compare Error Count   : 0
Medium Error Count    : 0
Recovered Error Count : 0
No Sense Count       : 0
Interface Error Count : 0
Other Error Count     : 0

Medium Error Detail Information
Head#0 Head#1 Head#3 Head#4 Head#5 Head#6 Head#7 Other Error Count
  0      0      0      0      0      0      0      0

Recovered Error Detail Information
Head#0 Head#1 Head#3 Head#4 Head#5 Head#6 Head#7 Other Error Count
  0      0      0      0      0      0      0      0
```

The following example displays the detailed results of the RAID diagnosis:

```
CLI> show diagnosis -type raid-group -rg-name RGP001
RAID Group Number      : 0
RAID Group Name        : RGP001
Recovery Mode          : ON
Diagnosis Status       : Diagnosing
Result                 : Normal
Progress               : 34%
Diagnosed RAID Group LBA Count : 0x0000000008803072
Total RAID Group LBA Count   : 0x0000000025182720
Succeeded in Restoration   : 0
Failed in Restoration     : 0

Error Information
Error                Succeeded / Failed (in Restoration)
Compare Error       :          0 /          0
Medium Error        :          0 /          1
CRC Error           :          0 /          0
Block ID Error      :          0 /          0
Bad Data Flag Error :          0 /          0

Error Detail Information(1/1)
Volume Number       : 1023
Volume Name        : VOL-001
Status             : Recovered Medium Error
Volume LBA         : 0x0000000010000000
RAID Group LBA     : 0x0000000010000000
Error Strip No.    : 0x00000000
Location           : DE#1-Disk#10
Error Disk LBA     : 0x00000100
```

6.5.2 LED

This section explains the commands related to the control of the LEDs.

show led

This command displays the status of the LEDs in each enclosure and each module.

Syntax

```
show led
```

Parameter

No parameters.

Output

Item name	Description
Controller Enclosure Panel	LED status of the CE panel-unit
Controller Enclosure Controller Module	LED status of the CM#x
System Operation Panel	LED status of the FE operation panel (only for the DX8700 S3/DX8900 S3)
Front End Router	LED status of the FRT (only for the DX8700 S3/DX8900 S3)
Drive Enclosure Panel	LED status of the DE panel-unit
Drive Enclosure I/O Module	LED status of the IOM#x
Drive Enclosure Fan Expander Module	LED status of the FEM#x (The LED state for FEM#1 is shown regardless of the number of CMs)
CE-Disk	LED status of the CE-Disk#y
DE#x-Disk	LED status of the DE#x-Disk#y

Example(s)

The following example displays the status of the LEDs for all components (for the DX60 S4/DX60 S3):

```
CLI> show led
Controller Enclosure
Panel [OFF]
Controller Module #0 [OFF]
Controller Module #1 [ON ]
Drive Enclosure #10
Panel [OFF]
I/O Module #0 [OFF]
I/O Module #1 [OFF]
CE-Disk #0 [ON ] #1 [ON ] #2 [OFF] #3 [OFF] #4 [ - ] #5 [ - ] #6 [ - ] #7 [ - ] #8 [ - ] #9 [ - ] #10[ - ] #11[ - ]
DE#1-Disk #0 [ON ] #1 [ON ] #2 [ON ] #3 [OFF] #4 [ON ] #5 [ - ] #6 [ - ] #7 [ - ] #8 [ - ] #9 [ - ] #10[ - ] #11[ - ]
```

The following example displays the status of the LEDs for all components (for the DX100 S4/DX200 S4 and the DX100 S3/DX200 S3):

```
CLI> show led
Controller Enclosure
Panel [OFF]
Controller Module #0 [OFF]
Controller Module #1 [ON ]
Drive Enclosure #10
Panel [OFF]
I/O Module #0 [OFF]
I/O Module #1 [OFF]
CE-Disk #0 [ON ] #1 [ON ] #2 [OFF] #3 [OFF] #4 [ - ] #5 [ - ] #6 [ - ] #7 [ - ] #8 [ - ] #9 [ - ] #10[ - ] #11[ - ]
DE#1-Disk #0 [ON ] #1 [ON ] #2 [ON ] #3 [OFF] #4 [ON ] #5 [ - ] #6 [ - ] #7 [ - ] #8 [ - ] #9 [ - ] #10[ - ] #11[ - ]
#12[ON ] #13[OFF] #14[ON ] #15[ON ] #16[ - ] #17[ - ] #18[ - ] #19[ - ] #20[ - ] #21[ - ] #22[ - ] #23[OFF]
```

The following example displays the status of the LEDs for all components (for the DX500 S4/DX600 S4 and the DX500 S3/DX600 S3):

```
CLI> show led
Controller Enclosure
Panel [OFF]
Controller Module #0 [OFF]
Controller Module #1 [ON ]
Drive Enclosure #00
Panel [ON ]
I/O Module #0 [ON ]
I/O Module #1 [ON ]
Drive Enclosure #10
Panel [OFF]
I/O Module #0 [OFF]
I/O Module #1 [OFF]
DE#00-Disk #0 [ON ] #1 [ON ] #2 [OFF] #3 [OFF] #4 [ - ] #5 [ - ] #6 [ - ] #7 [ - ] #8 [ - ] #9 [ - ] #10 [ - ] #11 [ - ]
DE#10-Disk #0 [ON ] #1 [ON ] #2 [ON ] #3 [OFF] #4 [ON ] #5 [ - ] #6 [ - ] #7 [ - ] #8 [ - ] #9 [ - ] #10 [ - ] #11 [ - ]
           #12 [ON ] #13 [OFF] #14 [ON ] #15 [ON ] #16 [ - ] #17 [ - ] #18 [ - ] #19 [ - ] #20 [ - ] #21 [ - ] #22 [ - ] #23 [OFF]
```

The following example displays the status of the LEDs of all components (when a high-density drive enclosure is installed):

```
CLI> show led
Controller Enclosure
Panel [OFF]
Controller Module #0 [OFF]
Controller Module #1 [ON ]
Drive Enclosure #00
Panel [OFF]
I/O Module #0 [OFF]
I/O Module #1 [OFF]
Fan Expander Module #0 [OFF]
Fan Expander Module #1 [OFF]
DE#00-Disk #0 [ON ] #1 [ON ] #2 [ON ] #3 [OFF] #4 [ON ] #5 [ - ] #6 [ - ] #7 [ - ] #8 [ - ] #9 [ - ] #10 [ - ] #11 [ - ]
           #12 [ON ] #13 [OFF] #14 [ON ] #15 [ON ] #16 [ - ] #17 [ - ] #18 [ - ] #19 [ - ] #20 [ - ] #21 [ - ] #22 [ - ] #23 [OFF]
           #24 [ON ] #25 [OFF] #26 [ON ] #27 [ON ] #28 [ - ] #29 [ - ] #30 [ - ] #31 [ - ] #32 [ - ] #33 [ - ] #34 [ - ] #35 [OFF]
           #36 [ON ] #37 [OFF] #38 [ON ] #39 [ON ] #40 [ - ] #41 [ - ] #42 [ - ] #43 [ - ] #44 [ - ] #45 [ - ] #46 [ - ] #47 [OFF]
           #48 [ON ] #49 [OFF] #50 [ON ] #51 [ON ] #52 [ - ] #53 [ - ] #54 [ - ] #55 [ - ] #56 [ - ] #57 [ - ] #58 [ - ] #59 [OFF]
```

The following example displays the status of the LEDs of all components (for the DX8700 S3/DX8900 S3):

```
CLI> show led
Controller Enclosure #0
Panel [ON ]
Controller Module #0 [ON ]
Controller Module #1 [ON ]
Controller Enclosure #1
Panel [ON ]
Controller Module #0 [ON ]
Controller Module #1 [ON ]
Frontend Enclosure
System Operation Panel [ON ]
Front End Router #0 [ON ]
Front End Router #1 [ON ]
Front End Router #2 [OFF]
Front End Router #3 [ON ]
Drive Enclosure #00
Panel [OFF]
I/O Module #0 [OFF]
I/O Module #1 [OFF]
Drive Enclosure #10
Panel [OFF]
I/O Module #0 [OFF]
I/O Module #1 [OFF]
DE#00-Disk #0 [ON ] #1 [ON ] #2 [OFF] #3 [OFF] #4 [ - ] #5 [ - ] #6 [ - ] #7 [ - ] #8 [ - ] #9 [ - ] #10 [ - ] #11 [ - ]
DE#10-Disk #0 [ON ] #1 [ON ] #2 [ON ] #3 [OFF] #4 [ON ] #5 [ - ] #6 [ - ] #7 [ - ] #8 [ - ] #9 [ - ] #10 [ - ] #11 [ - ]
           #12 [ON ] #13 [OFF] #14 [ON ] #15 [ON ] #16 [ - ] #17 [ - ] #18 [ - ] #19 [ - ] #20 [ - ] #21 [ - ] #22 [ - ] #23 [OFF]
```

set led

This command turns the specified LED(s) either on or off.

Syntax

```
set led -target {ce | fe | frt | opnl | de | disk}  
[-ce enclosure_number | -frt frt_number | -de enclosure_number | -disks disks] -led {on | off}
```

Parameter

- target** This parameter specifies which enclosure will have all of the LEDs turned on or off. When "-target disks" is specified, the "-disks" parameter must also be specified.
- ce** All components in the controller enclosure (CE)
 - opnl** System operation panel (DX8700 S3/DX8900 S3 only)
 - fe** All components in the frontend enclosure (FE) (DX8700 S3/DX8900 S3 only)
 - frt** Front End Router (FRT) (DX8700 S3/DX8900 S3 only)
 - de** All components in the drive enclosure
 - disk** Only the specified drives
- ce** Optional. This parameter specifies the controller enclosure for turning all the LEDs on or off (and is only supported in the DX8700 S3/DX8900 S3). Only one controller enclosure can be specified. For details, refer to ["1.2.3 Controller Enclosure Syntax" \(page 34\)](#). If "ce" is specified in "-target", this parameter must be specified.
- enclosure_number* Controller enclosure number
- frt** Optional. This parameter specifies the Front End Router (FRT) with a range of 0 to 3 for turning all the LEDs on or off (and is only supported in the DX8700 S3/DX8900 S3). Only one FRT can be specified. If "frt" is specified in "-target", this parameter must be specified.
- frt_number* Front End Router number
- de** Optional. This parameter specifies the drive enclosure for turning all the LEDs on or off. Only one drive enclosure can be specified. For details, refer to ["1.2.4 Drive Enclosure Syntax" \(page 34\)](#). This parameter must be specified when "de" is specified for the "-target" parameter.
- enclosure_number* Drive enclosure number
- disks** Optional. This parameter specifies which drives LED are turned on or off. Multiple drives can be specified at the same time. For details, refer to ["1.2.5 Drive Syntax" \(page 35\)](#). This parameter must be specified when "disk" is specified for the "-target" parameter.
- disks* Drive

-led This parameter specifies whether the specified LEDs are turned on or off.

on	Turn on the LED
off	Turn off the LED

■ Example(s)

The following example turns on the LEDs of disk#1 and disk#2 in DE#1:

```
CLI> set led -target disk -disks 001,002 -led on
```

The following example turns on the LEDs of all the components in DE#1:

```
CLI> set led -target de -de 1 -led on
```

The following example turns on the LEDs of all the components in the FE (for the DX8700 S3/DX8900 S3):

```
CLI> set led -target fe
```

6.5.3 Other Notification

This section explains the commands used for setting parameters regarding other event notification functions.

show event-parameters

This command displays the parameters set by the "set event-parameters" command.

■ Syntax

```
show event-parameters
```

■ Parameter

No parameters.

■ Output

Item name	Description
Blink Panel Fault LED	Indicates whether the Panel Fault LED is blinked when the system status is warning
Redundant Copy Fault LED	Indicates whether the Fault LED lights up when the redundant copy is complete

■ Example(s)

The following example displays the event parameters:

```
CLI> show event-parameters  
Blink Panel Fault LED [Enable ]  
Redundant Copy Fault LED [Enable ]
```

set event-parameters

This command specifies the notifications of an event other than the notifications specified in the "set event-notification" command.

■ Syntax

```
set event-parameters [-blink-panel-led {enable | disable}] [-redundant-copy-led {enable | disable}]
```

■ Parameter

-blink-panel-led

Optional. This parameter specifies whether the Panel FAULT LED will blink when the system is in "warning" status.

enable The Panel FAULT LED will blink.

disable The Panel FAULT LED will not blink.

-redundant-copy-led

Optional. This parameter specifies whether the FAULT LED will turn on after the redundant copy is complete.

enable The Fault LED will turn on after the redundant copy is complete.

disable The Fault LED will not turn on after the redundant copy is complete.

■ Example(s)

The following example sets the event parameters:

```
CLI> set event-parameters -blink-panel-led enable -redundant-copy-led enable
```

6.5.4 Subsystem Parameters

This section explains the commands used to set and check the subsystem parameters.

show subsystem-parameters

This command displays the subsystem parameters.

Syntax

```
show subsystem-parameters
```

Parameter

No parameters.

Output

Item name	Description
Load Balance	Indicates whether controlling load balance of the system is enabled.
Reject INQUIRY from Unauthorized Host	Indicates whether an INQUIRY command that is issued from an unauthorized host is accepted. (When an INQUIRY command is set to be not accepted, the operation is the same as the response to an INQUIRY command with an Affinity Error.)
Thin Provisioning Allocation Mode	Indicates whether the current setting of the Thin Provisioning Allocation mode is enabled.
Checkcode Enforcement Mode	Indicates whether the current setting of the Checkcode Enforcement Mode is enabled.
Copybackless	Indicates whether the Copybackless function is enabled.
Turbo Mode	Indicates whether the Turbo mode is enabled.
Dedup Data Compare Mode	Indicates whether the Data Compare mode is enabled. (If the Deduplication/Compression mode setting is disabled, this item is not displayed)
Optimize for Advanced Format SSD	Advanced Format (AF)-supported item. Indicates whether the ETERNUS DX/AF responds to the host so that access for RAID groups or pools that include SSDs can be performed with a 4k sector alignment.
Expand Volume Mode	Indicates whether the Expand Volume Mode is enabled. (Displayed only for the DX100 S4/DX200 S4 and the DX100 S3/DX200 S3)
Expand Host Mode	Indicates whether the Expand Host Mode is enabled. (Displayed only for the DX500 S4/DX600 S4, the DX500 S3/DX600 S3, and the AF650 S2/AF650)
ESF WWN Mode	Indicates the WWPN generation mode of the FC interface port that is to be used in the software.
Writeback Limit Count	Indicates the number of process commands that are issued during Writeback (writes data back to the drive).

Example(s)

The following example displays the subsystem parameters (for the DX60 S4/DX60 S3, the DX8100 S3/DX8700 S3/DX8900 S3, the AF250 S2/AF250, and the DX200F):

```
CLI> show subsystem-parameters
Load Balance [Disable ]
Reject INQUIRY from Unauthorized Host [Enable ]
Thin Provisioning Allocation Mode [TPP balancing]
Checkcode Enforcement Mode [Enable ]
Copybackless [Enable ]
Turbo Mode [Disable ]
Dedup Data Compare Mode [Disable ]
Optimize for Advanced Format SSD [Enable ]
ESF WWN Mode [Enable ]
Writeback Limit Count [ 512]
```

The following example displays the subsystem parameters (for the DX100 S4/DX200 S4 and the DX100 S3/DX200 S3):

```
CLI> show subsystem-parameters
Load Balance [Disable ]
Reject INQUIRY from Unauthorized Host [Enable ]
Thin Provisioning Allocation Mode [TPP balancing]
Checkcode Enforcement Mode [Enable ]
Copybackless [Enable ]
Turbo Mode [Disable ]
Dedup Data Compare Mode [Disable ]
Optimize for Advanced Format SSD [Enable ]
Expand Volume Mode [Enable ]
ESF WWN Mode [Enable ]
Writeback Limit Count [ 512]
```

The following example displays the subsystem parameters (for the DX500 S4/DX600 S4, the DX500 S3/DX600 S3, and the AF650 S2/AF650):

```
CLI> show subsystem-parameters
Load Balance [Disable ]
Reject INQUIRY from Unauthorized Host [Enable ]
Thin Provisioning Allocation Mode [TPP balancing]
Checkcode Enforcement Mode [Enable ]
Copybackless [Enable ]
Turbo Mode [Disable ]
Dedup Data Compare Mode [Disable ]
Optimize for Advanced Format SSD [Enable ]
Expand Host Mode [Enable ]
ESF WWN Mode [Enable ]
Writeback Limit Count [ 512]
```

set subsystem-parameters

This command sets up the storage unit subsystem parameters.

■ Syntax

```
set subsystem-parameters [-load-balance {enable | disable}]  
[-reject-inquiry {enable | disable}]  
[-tp-alloc-mode {tpp-balancing | tpv-balancing}]  
[-enforce-checkcode {enable | disable}]  
[-copybackless{enable | disable}]  
[-turbo-mode {enable | disable}]  
[-dedup-data-cmp {enable | disable}]  
[-optimize-af-ssd {enable | disable}]  
[-expand-host-mode {enable | disable}]  
[-expand-volume-mode {enable | disable}]  
[-esf-wwn-mode {enable | disable}]  
[-writeback-limit-count {128 | 256 | 512 | 1024 | 2048 | 3072 | 6144}]
```

■ Parameter

-load-balance

Optional. This parameter specifies if the controlling load balance of the system is enabled. This function will allow the system to return sense information to the host even if the I/O traffic for the overall system is overloaded. If omitted, the existing setting is not changed. The initial value is set to "enable".

▶ Caution

Disable the load balance when the ETERNUS DX/AF is connected to hosts that are running HP-UX. If the load balance is enabled, incorrect logs may be recorded in the host.

enable	Load balance control is enabled.
disable	Load balance control is disabled.

-reject-inquiry

Optional. This parameter specifies whether an INQUIRY command that is issued from an unauthorized host is rejected. Enable this parameter when VERITAS Volume Manager Dynamic Multi-Pathing (VxVM DMP) is used. If omitted, the existing settings are not changed. The default value is disabled.

enable	An Affinity Error is returned for an INQUIRY command that is issued from an unauthorized host.
disable	A normal response is returned for an INQUIRY command that is issued from an unauthorized host.

-tp-alloc-mode

Optional. This parameter specifies how to allocate the physical drive area when a write process is performed for an area in a Thin Provisioning Volume to which physical drive area is not allocated.

tpp-balancing	The physical drive area is allocated so that each TPP is evenly used.
tpv-balancing	The physical drive area is allocated so that the physical drive area for a TPV is evenly allocated to each RAID group in the TPP.

-enforce-checkcode

Optional. This parameter specifies whether the Checkcode Enforcement Mode is enabled. If this parameter is enabled, the error detection mechanism inside the device intensifies. During write data duplication, check codes for all the blocks are checked. If omitted, the value of this parameter will not change. The default value is "enable".

enable	Checkcode Enforcement Mode is enabled.
disable	Checkcode Enforcement Mode is disabled.

-copybackless

Optional. This parameter specifies whether the copybackless function is enabled. When this function is enabled, the configuration of the relevant RAID group is changed to add the hot spare to the RAID group after a rebuild operation is complete. A copyback operation is not performed after a failed drive is replaced. When this function is disabled, the configuration of the relevant RAID group remains unchanged after a rebuild operation is complete. A copyback operation is performed after a failed drive is replaced. The default value is "enable".

 **Note**

The copybackless function operates if a hot spare is registered with the same drive type (*1) as the target drive.

*1: The same drive type refers to a drive that has all of the same attributes (Online / Nearline / SSD / Online SED / Nearline SED / SSD SED), SSD type, capacity, and rotational speed.

enable	The copybackless function is enabled.
disable	The copybackless function is disabled.

-turbo-mode

Optional. This parameter specifies whether to enable or disable the Turbo mode. The Turbo mode is a function that makes processors work at a higher frequency than the rated frequency to improve performance. This function is also called Intel® Turbo Boost Technology.

 **Caution**

This parameter cannot be specified for the DX60 S4/DX100 S4, the DX60 S3/DX100 S3/DX200 S3, and the DX200F.

enable	The Turbo mode is enabled.
disable	The Turbo mode is disabled.

-dedup-data-cmp

Optional. This parameter specifies whether to enable the Data Compare mode (all byte comparison) if the same hash value is detected when the Deduplication/Compression function is used. The default value is "disable".

 **Caution**

- This parameter cannot be specified for models that do not support the Deduplication/Compression function.
- This parameter cannot be specified if the Deduplication/Compression function (Deduplication/Compression mode setting) of the ETERNUS DX/AF is disabled.
- This parameter can be changed only if there are no Deduplication/Compression Volumes (dedup-tpv).

enable	The Data Compare mode (all byte comparison) is enabled.
disable	The Data Compare mode (all byte comparison) is disabled.

-optimize-af-ssd

Optional. This parameter specifies whether Advanced Format (AF) is supported in SSDs. This parameter specifies whether the ETERNUS DX/AF responds to the host so that access for RAID groups or pools that are configured with SSDs can be performed with a 4k sector alignment. Setting this parameter promotes access efficiency.

 **Caution**

This parameter cannot be specified for models that cannot be installed with SSDs.

enable	The ETERNUS DX/AF responds to the host.
disable	The ETERNUS DX/AF does not respond to the host.

-expand-host-mode

Optional. This parameter specifies whether to expand the maximum number of host registrations (per ETERNUS DX/AF) and the maximum number of LUN group registrations (per ETERNUS DX/AF). The default value is "disable".

 **Note**

This parameter can be specified for the DX500 S4/DX600 S4, the DX500 S3/DX600 S3, and the AF650 S2/AF650.

 **Caution**

- To change the setting of this parameter, stop all port I/O in advance. If the setting of this parameter is changed, all the ports are reset.
- If the number of hosts, the number of LUN groups, the host number, or the LUN group number is 1,025 or higher, the Expand Host Mode cannot be changed from "enable" to "disable".
- This parameter does not expand the number of Host-LU QoS (maximum of 1,024).

enable	The Expand Host Mode is enabled. The maximum number of host registrations (per ETERNUS DX/AF) is 4,096 and the maximum number of LUN group registrations (per ETERNUS DX/AF) is 2,048.
disable	The Expand Host Mode is disabled. The maximum number of host registrations (per ETERNUS DX/AF) is 1,024 and the maximum number of LUN group registrations (per ETERNUS DX/AF) is 1,024.

-expand-volume-mode

Optional. This parameter specifies whether to expand the maximum number of volume registrations (per ETERNUS DX/AF) and the maximum number of copy session registrations (per ETERNUS DX/AF and includes WVOL copy sessions). The default value is "disable".

 **Note**

This parameter can be specified for the DX100 S4/DX200 S4 and the DX100 S3/DX200 S3.

 **Caution**

- If the settings of this parameter is changed, the ETERNUS DX/AF must be rebooted. By rebooting the ETERNUS DX/AF, the setting of this parameter is reflected.
- If the volume number is 2,048 or higher for the DX100 S4/DX100 S3, and 4,096 or higher for the DX200 S4/DX200 S3, or if the number of copy sessions is 1,025 or higher for the DX100 S4/DX100 S3, and 2,049 or higher for the DX200 S4/DX200 S3, the Expand Volume Mode cannot be changed from "enable" to "disable".
- If the error message "EB334" or "EB907" is displayed, after contacting a maintenance engineer, delete the resource that is indicated by the maintenance engineer.

Examples:

- Delete the volumes, copy sessions, Thin Provisioning pools, or REC disk buffers if they were created after the Expand Volume Mode was enabled.
 - Disable the Flexible Tier mode if it was enabled after the Expand Volume Mode was enabled.
-

enable	The Expand Volume Mode is enabled. The maximum number of volume registrations (per ETERNUS DX/AF) and the maximum number of copy sessions (per ETERNUS DX/AF) are as follows: DX100 S4: the maximum number of volume registrations is 4,096 and the maximum number of copy sessions is 2,048 DX200 S4: the maximum number of volume registrations is 8,192 and the maximum number of copy sessions is 4,096 DX100 S3: the maximum number of volume registrations is 4,096 and the maximum number of copy sessions is 2,048 DX200 S3: the maximum number of volume registrations is 8,192 and the maximum number of copy sessions is 4,096
disable	The Expand Volume Mode is disabled. The maximum number of volume registrations (per ETERNUS DX/AF) and the maximum number of copy sessions (per ETERNUS DX/AF) are as follows: DX100 S4: the maximum number of volume registrations is 2,048 and the maximum number of copy sessions is 1,024 DX200 S4: the maximum number of volume registrations is 4,096 and the maximum number of copy sessions is 2,048 DX100 S3: the maximum number of volume registrations is 2,048 and the maximum number of copy sessions is 1,024 DX200 S3: the maximum number of volume registrations is 4,096 and the maximum number of copy sessions is 2,048

-esf-wwn-mode

Optional. This parameter specifies the WWPn generation mode of the FC interface port that is to be used in the software. The default value is "disable".

Note

This parameter can be set with the Storage Management policy and the Maintenance Operation policy.

- enable The WWPN is generated by masking bit6 to 7 of the ETERNUS DX/AF WWN.
- disable The WWPN is generated by holding bit6 to 7 of the ETERNUS DX/AF WWN.

-writeback-limit-count

Optional. This parameter specifies the number of process commands that are issued during Writeback (writes data back to the drive). The bigger the Writeback Limit Count is, the more the resources that are used for the write process becomes. Cache hits for the write process also become more likely to occur. The smaller the Writeback Limit Count is, the less the resources that are used for the write process becomes. However, it is more likely to cause a write cache miss.

The default value is 512.

- 128 The Writeback Limit Count is set to 128.
- 256 The Writeback Limit Count is set to 256.
- 512 The Writeback Limit Count is set to 512.
- 1024 The Writeback Limit Count is set to 1024.
- 2048 The Writeback Limit Count is set to 2048. (This cannot be set for the DX60 S4/DX60 S3.)
- 3072 The Writeback Limit Count is set to 3072. (This cannot be set for the DX60 S4/DX100 S4/DX200 S4, the DX60 S3/DX100 S3/DX200 S3, the AF250 S2/AF250, and the DX200F.)
- 6144 The Writeback Limit Count is set to 6144. (This cannot be set for the DX60 S4/DX100 S4/DX200 S4, the DX500 S4, the DX60 S3/DX100 S3/DX200 S3, the DX500 S3, the DX8100 S3, the AF250 S2/AF250, and the DX200F.)

■ Example(s)

The following example sets up the subsystem parameter:

```
CLI> set subsystem-parameters -load-balance enable -tp-alloc-mode tpp-balancing
```

The following example enables the Data Compare mode:

```
CLI> set subsystem-parameters -dedup-data-cmp enable
```

6.5.5 Reservations

This section explains the commands related to the persistent reservation status of the volumes.

show reservation

This command displays the reservation status of the volumes.

Syntax

```
show reservation [-volume-number volume_numbers | -volume-name volume_names]
```

Parameter

-volume-number or -volume-name

This parameter specifies the volume identifiers to be released. One or more volumes can be specified at the same time. For details, refer to ["1.2.11 Volume Syntax" \(page 40\)](#).

volume_numbers Volume number

volume_names Volume name

Output

- When volume identifiers are omitted

Item name	Description
Volume	Volume identifiers
No.	Volume number
Name	Volume name
LUN	Logical unit number associated with the target volume
Port	When Host Affinity Mode is disabled, the host interface port number assigning to the host mapping is displayed
LUN Group	LUN group identifiers (this information appears when the Host Affinity Mode is enabled).
No.	LUN group number that belongs to the volume
Name	LUN group name that belongs to the volume
Registrant Count	Number of reservation key registrations
Reservation Type	Type of the persistent reservation
Persistent	Status of the persistent reservation
APTPL	Indicates whether the reservation information is kept for the reboot that occurred.

- When volume identifiers are specified

Item name	Description
Volume	Volume identifiers
No.	Volume number
Name	Volume name
Host	Host identifiers
No.	Host number
Name	Host name

Item name	Description
Reservation Key	Reservation key (Identifier information used for the persistent reservation)
Hold Reservation	Reservation status of a volume by a reservation key

■ Example(s)

The following example displays a list of the reserved volumes:

```
CLI> show reservation
Volume
No.  Name                LUN  Port                LUN Group          Registrant  Reservation  Persistent  APTPL
-----
 1 LogicalVolume1        11  CM#0 CA#0 Port#0    - -           32 WE         Yes         Yes
 12 LV12                 222 CM#1 CA#0 Port#1    - -           1 EA-RO      Yes         No
 13 LV13                 13  - CM#1 CA#0 Port#1    1 Affinity-Group#1  10 -         No         No
111 LogicalVolume111    - CM#1 CA#0 Port#0    - -           10 -         -         No
```

The following example displays a list of the reserved volumes (for the DX8700 S3/DX8900 S3):

```
CLI> show reservation
Volume
No.  Name                LUN  Port                LUN Group          Registrant  Reservation  Persistent  APTPL
-----
 1 LogicalVolume1        11  CE#1 CM#0 CA#0 Port#0 - -           32 WE         Yes         Yes
 12 LV12                 222 CE#1 CM#1 CA#0 Port#1 - -           1 EA-RO      Yes         No
 13 LV13                 13  - CM#1 CA#0 Port#1    1 Affinity-Group#1  10 -         No         No
111 LogicalVolume111    - CE#3 CM#1 CA#0 Port#0 - -           10 -         -         No
```

The following example displays information about all the hosts with volume #1 reserved. In the host information, the reservation key and the reservation status of the volume corresponding to the reservation key are displayed:

```
CLI> show reservation -volume-number 1
Volume
No.  Name                Host                Reservation          Hold
-----
 1 Volume#1          0 Host-name-0000    0123456789abcdef    Yes
                   1 Host-name-0001    00123efa30939000    Yes
                   2 Host-name-0002    00133495828492A3    No
```

release reservation

This command releases the volumes that have been reserved by host servers (persistent reservation). The reservation key is also deleted.

■ Syntax

```
release reservation {-volume-number volume_numbers | -volume-name volume_names}
```

■ Parameter

-volume-number or -volume-name

This parameter specifies the volume identifiers to be released. One or more volumes can be specified at the same time. For details, refer to ["1.2.11 Volume Syntax" \(page 40\)](#).

volume_numbers Volume number

volume_names Volume name

■ Example(s)

The following example releases the volume named "VOL001" that has been reserved by the host servers:

```
CLI > release reservation -volume-name VOL001
```

The following example releases volume numbers #5 to #25 that have been reserved by the host servers:

```
CLI > release reservation -volume-number 5-25
```

6.5.6 Cache Utilities

This section explains the commands related to cache control utilities.

show pinned-data

If certain failure events have occurred when writing data, data cannot be written back to the drive(s) (volumes) from the cache data area. The data that cannot be written back to the drive is retained in the cache data area and is called pinned data (PIN). This command displays a list of all the pinned data.

Syntax

```
show pinned-data
```

Parameter

No parameters.

Output

Item name	Description
Volume	Volume identifiers
No.	Volume number
Name	Volume name
LBA	Logical block address (LBA of volume in which pinned data is retained)
RC	Cause of pinned data (Reason Code)
SK	Sense key
ASC	Additional sense code
ASCQ	Additional sense code qualifier

Example(s)

The following example displays a list of all the pinned data:

```
CLI> show pinned-data
Volume
No.   Name
-----
 1 VolumeNumber0001
 1 VolumeNumber0001
 3 Vol13
 4 Vol14
 4 Vol14
11 Vol11
LBA
0x0000000000000000
0x0000000000000100
0x0000000000000000
0x0000000000000000
0x0000000000001000
0x0000000000000000
RC
0x00
0x00
0x00
0x00
0x00
0x00
SK
0x00
0x00
0x00
0x00
0x00
0x00
ASC
0x00
0x00
0x00
0x00
0x00
0x00
ASCQ
0x00
0x00
0x00
0x00
0x00
0x00
```

6.5.7 Disk Patrol

This section explains the commands related to the disk patrol function.

The disk patrol function is a function that performs diagnostic tests on the disks without affecting the host I/O performance. This function detects and corrects any disk problems if possible before a disk error occurs.

A disk error can cause data loss or data corruption if there is a double error of the disks or if a block error occurs during rebuild operations. The disk patrol function checks the hot spares to ensure that they have no errors before they are used during Rebuild or Redundant copy operations.

In addition, the disk patrol function can disconnect a disk with an error being detected if necessary.

External Drives are not supported. Disk patrol for the External Drives is performed in the external storage systems.

show disk-patrol

This command displays the disk patrol function settings.

■ Syntax

```
show disk-patrol
```

■ Parameter

No parameters.

■ Output

Item name	Description
Disk Patrol	Indicates whether the disk patrol function is enabled for the ETERNUS DX/AF.

■ Example(s)

The following example displays the disk patrol function settings:

```
CLI> show disk-patrol  
Disk Patrol      Enable
```

set disk-patrol

This command sets up the disk patrol function.

■ Syntax

```
set disk-patrol [-mode {enable | disable}]
```

■ Parameter

-mode	Optional. This parameter specifies whether to enable or disable the disk patrol function for the ETERNUS DX/AF.
enable	The disk patrol function is enabled.
disable	The disk patrol function is disabled.

■ Example(s)

The following example enables the disk patrol function:

```
CLI> set disk-patrol -mode enable
```

Chapter 7

NAS Function Setting and Display

This chapter describes the commands that are related to the NAS functions for managing the NAS system. For information about operating the NAS functions, refer to "FUJITSU Storage ETERNUS DX S4/S3 series Hybrid Storage Systems Configuration Guide (NAS)".

Caution

- The NAS function is not supported by the ETERNUS DX/AF storage systems with a single controller.
- NAS setting related commands are unavailable if one of the CMs in the ETERNUS DX/AF is in abnormal status.
- If an abnormal termination occurs with the configuration command, follow the instructions in the error message to deal with the issue, and make sure to execute the command again. If the command is not executed again, the process may not behave normally the next time.
- The NAS function is not supported by the DX60 S4/DX60 S3, the DX8100 S3/DX8700 S3/DX8900 S3, the AF250 S2/AF650 S2, the AF250/AF650, and the DX200F.

■ Volume and area of the NAS system

- NAS system volume (\$SYSVOL1, \$SYSVOL2, and \$SYSVOL3)
A NAS system volume is configured from three volumes and has a total capacity of 17GB. Volume names of NAS system volumes cannot be changed.

Volume names and capacities of NAS system volumes are as follows.

Volume name	Displayed "Usage Details" of the "show volumes" command	Capacity
\$SYSVOL1	NAS FS Management	1GB
\$SYSVOL2	NAS CM#0 System	8GB
\$SYSVOL3	NAS CM#1 System	8GB

- NAS expansion system volume (cm0-nas-ex-sysvol and cm1-nas-ex-sysvol)
NAS expansion system volumes are areas for saving the NAS audit logs. The volume name can be set freely.

Purposes and capacities of NAS expansion volumes are as follows.

Displayed "Usage Details" of the "show volumes" command	Purpose	Capacity
NAS CM#0 EX System	For storing the audit logs of CM#0	1GB to 4TB
NAS CM#1 EX System	For storing the audit logs of CM#1	1GB to 4TB

- NAS system management area
In NAS volumes, each volume must have a system management area of approximately 300GB. This area is a metadata area used by the system for managing file system information.

■ NAS volume

- NAS user volume (nas-tpv)
A NAS operation volume to be used for business.
- NAS backup volume (nas-tpv-backup)
A NAS backup volume to be used for backups.

■ NAS volume creation

The procedure for creating volumes and making these volumes accessible from a host is provided below.

Procedure

1 Create NAS volumes.

Create NAS user volumes (nas-tpv) with the "create volume" command.

When the first volume is created, the following three system volumes are also created within the same TPP for the ETERNUS DX/AF. The capacity of the system volumes totals 17GB.

```
$SYSVOL1
$SYSVOL2
$SYSVOL3
```

If system volumes are not created, the NAS function cannot be used. In addition, the volume name of the system volume cannot be changed.

Note

- To check the status of the volumes, use the "show volumes" command. To change the settings of an already created volume, use the "set volume" command.
- The status of the NAS Engine is "Maintenance" until the system volume is generated. The status of the NAS Engine becomes "Normal" when the NAS volume is created and the system volume is generated.
- The status of the NAS Engine becomes "Maintenance" after the system volume is deleted. To recreate a NAS volume (or system volume), wait until the NAS Engine has started. The status of the NAS Engine becomes "[Maintenance / 0xE000]" after the NAS Engine has started. To check whether the NAS Engine has started, use the "show fru-ce" command.
- To delete a NAS volume, use the "delete volume" command.
- To expand a NAS volume, use the "expand volume" command.
- If the following functions are used, NAS user volumes (NAS TPV [nas-tpv]) that are created with controller firmware versions earlier than the supported versions must be reconfigured (or perform a format conversion) using the "reconfigure nas-fs" command. The format conversion process can take up to 15 minutes.
 - Capacity expansion
Controller firmware version V10L21 or later
 - Quota setting for each shared folder
Controller firmware version V10L51 or later
- Even when creating NAS backup volumes (nas-tpv-backup), use the "create volume" command.

2 Create NAS shared folders.

Create shared folders for the NAS.

Create shared folders that are configured with NAS user volumes (nas-tpv) with the "create nas-share" command.

Note

- To check the status of the shared folders, use the "show nas-share" command. To change the settings after a shared folder is created, use the "set nas-share" command.
 - To delete a shared folder, use the "delete nas-share" command.
-

3 Set up the NAS network.

Assign an IP address to the CA port for NAS (NAS port) with the "create nas-interface" command.

Note

- To check the status of the network settings, use the "show nas-interface" command. To change the settings after a network setting is created, use the "set nas-interface" command.
 - To delete a network setting, use the "delete nas-interface" command.
-

End of procedure

 **Caution**

- The NAS function cannot be used when no system volumes exist. To check whether system volumes exist, use the "show volumes" command.

```

CLI> show volumes -type tpv
Volume
No.   Name                Status           Usage Details      NAS Volume
                                Format Status
0     $SYSVOL1             Available        NAS CM#0 System    Not Process
1     $SYSVOL2             Available        NAS CM#1 System    Creating filesystem
2     $SYSVOL3             Available        NAS FS Management  Mounting

```

System volumes are automatically created when NAS user volumes (nas-tpv) are created. To create NAS user volumes (nas-tpv), use the "create volume" command.

The system volumes are listed below. System volumes are required to control the NAS function.

```

$SYSVOL1
$SYSVOL2
$SYSVOL3

```

- After performing [Step 3](#), set up the authentication server to connect to it. To set up a NAS network, use the "create nas-interface" command.
- The following operations cannot be performed for NAS user volumes (nas-tpv) in which a shared folder exists.
 - Volume deletion
 - Volume formatting
- Do not perform Zero Reclamation for NAS user volumes (nas-tpv), NAS backup volumes (nas-tpv-backup), or NAS system volumes.
- When an abnormality is occurring in the NAS port, the following commands cannot perform a configuration change for the relevant port.
 - set nas-port
 - create nas-interface
 - set nas-interface
 - set nas-bonding
 - set nas-multipath
 - set nas-route
 - set nas-route6
- Even if an Eco-mode schedule is set in a TPP where a system volume exists, the Eco-mode function does not operate. When using the Eco-mode function, migrate the system volume to a different TPP by executing a RAID Migration.

7.1 Shared Folders

This section describes the commands that are related to the management of NAS shared folders. The control functions for NAS shared folders are as follows:

- Displaying NAS shared folders
- Creating NAS shared folders
- Changing the NAS shared folder settings
- Deleting NAS shared folders
- Deleting all the data under the NAS shared folders
- Displaying the NAS shared folders while the NAS data deletion process is executing
- Displaying the user home directory
- Deleting the user home directory

■ Access privileges of the user and group

The relationship between the parameter settings that are related to the privileges of the NAS shared folder and the access privileges that are actually granted to the user and group is shown.

The following example sets the parameters to UserA (who belongs to GroupA) and UserB (who belongs to GroupB).

Parameters for the "create nas-share" command and the "set nas-share" command					Privileges that are to be set to the NAS shared folder					Reference
-access	-cifs-user-access		-cifs-group-access		GroupA		GroupB		All other users	
	-r	-rw	-r	-rw	UserA	Other users	UserB	Other users		
r	-	-	-	-	R	R	R	R	R	(*1)
	-	-	-	everyone	RW	RW	RW	RW	RW	(*2)
	-	UserA	-	-	RW	x	x	x	x	(*3)
	-	-	-	GroupA	RW	RW	x	x	x	(*3)
	-	UserA	-	GroupB	RW	x	RW	RW	x	
rw	-	-	-	-	RW	RW	RW	RW	RW	(*1)
	-	-	everyone	-	R	R	R	R	R	(*2)
	UserB	-	-	-	x	x	R	x	x	(*3)
	-	-	GroupA	-	R	R	x	x	x	(*3)
	UserB	-	-	GroupA	RW	RW	R	x	x	
	-	UserA	GroupA	-	RW	R	x	x	x	(*4)
	UserA	-	-	GroupA	RW	RW	x	x	x	(*4)
	UserA	-	-	everyone	RW	RW	RW	RW	RW	(*4)
-	UserA	everyone	-	RW	R	R	R	R	(*4)	

-: parameter unspecified, x: no access

R: Read-only privileges, RW: Read-Write privileges

*1: When only "-access" is specified, the access privileges that are specified with "-access" are available.

*2: If "everyone" is specified, the specified privileges are set to all authorized users in the ETERNUS DX/AF.

*3: If the user ("-cifs-user-access-r" or "-cifs-user-access-rw") or group ("cifs-group-access-r" or "-cifs-group-access-rw") is specified, the access privileges are set only for the specified user and group. All other users are denied access.

*4: If the user is specified with "R" ("-cifs-user-access-r") and the group in which the user belongs to is specified with "RW" ("-cifs-group-access-rw"), because the "RW" privilege takes precedence, the user is set with "RW".

■ Home directory function

The home directory function is a function that can acquire user exclusive NAS shared folders (or user home directories) when the user is connected with CIFS. This function can be used with Active Directory authentication or local user authentication.

With the "create nas-share -home-directory" command, the folder "homes", which stores the user home directory, is created and the home directory function becomes usable. When the user connects with CIFS, the user home directory is created under the "homes" folder. In addition, the "homes" folder is an exclusive folder for storing user home directories. It cannot be used as a normal NAS shared folder.

For CLI operations, the homes folder is treated as a NAS shared folder. Operations for the "homes" folder are performed with the same commands as normal NAS shared folders. However, compared to operations for normal NAS shared folders, there are some restrictions for the parameters that can be specified.

- Examples of the used commands
 - Creating a folder
"create nas-share" command
 - Changing the settings of a folder
"set nas-share" command
 - Deleting the data under a folder
"clear nas-data" command
 - Deleting a folder
"delete nas-share" command
 - Setting a quota
"set nas-quota" command

The following commands are used to operate (display or delete) the user home directory under the "homes" folder.

- Displaying the user home directory
"show nas-home-directory" command
- Deleting the user home directory
"delete nas-home-directory" command

● Note

- Access to user home directories from FTP is not available.
 - For volumes under the user home directory, the snapshot function can be used in the same way as a normal NAS volume.
 - The deletion of an Active Directory user or a local user has no correlation with the deletion of the user home directory. The user and the corresponding user home directory must be deleted individually.
-

show nas-share

This command displays information about the NAS shared folder that is registered in the ETERNUS DX/AF.

▶ Caution

When the NAS shared folder identifier or the volume identifier is selected, detailed NAS shared folder information is displayed. If omitted, an overview of the NAS shared folder is displayed in a list.

● Note

Depending on the model, the support state of the encryption-related functions may differ.

■ Syntax

```
show nas-share [{-share-name share_name | -share-number share_numbers |  
-volume-name volume_name | -volume-number volume_numbers}]
```

■ Parameter

-share-name or -share-number

Optional. This parameter specifies a NAS shared folder identifier to be displayed. When using a name, only one name can be specified. When using a number, multiple numbers can be specified.

▶ Caution

- After performing a restoration (*1) from a NAS backup volume (nas-tpv-backup), the share-number of the NAS shared folder for the restoration target will be reset. After the restoration, check the share-number of the restored NAS shared folder before use.
Note, the share-number of a NAS shared folder that is not a restoration target is retained.
*1: Backup and restore are controlled from the software.
- If the NAS shared folder name includes multibyte characters, specify the NAS shared folder with the "-share-number" parameter.

<i>share_name</i>	NAS shared folder name
<i>share_numbers</i>	NAS shared folder numbers

-volume-name or -volume-number

Optional. This parameter specifies a volume identifier. When using a name, only one name can be specified. When using a number, multiple numbers can be specified.

<i>volume_name</i>	Volume name
<i>volume_numbers</i>	Volume number

■ Output

Item name	Description
Share	Identifier of the NAS shared folder
No.	NAS shared folder number
Name	NAS shared folder name
Volume No.	Volume number
Volume Name	Volume name
Share	Status of sharing (Active or Inactive)
Service	File system (NFS, CIFS, or NFS-CIFS)
NFS Export Path	A directory path that can be exported to the NFS connection host
Access	Access privileges (Read or Read-Write) of the shared folder
Oplocks	Indicates whether the Oplocks function is set to Enable or Disable. (A hyphen [-] appears when the protocol is NFS.)
SMB Encryption	Indicates whether the SMB encryption function is enabled (Enable or Disable). (A hyphen [-] appears when the protocol is NFS.)
ABE	Indicates whether the Access-Based Enumeration (ABE) function is enabled (Enable or Disable). (A hyphen [-] appears when the protocol is NFS.)
Owner	Owner of the shared folder
Group	Group of the shared folder
Allow NFS Hosts	Information on hosts to which access is allowed (This information only appears when NFS or NFS/CIFS is used as the protocol.)
No Root Squash NFS Hosts	Information on hosts to which root squash is disabled (This information only appears when NFS or NFS/CIFS is used as the protocol.)
Allow CIFS Hosts	Information on hosts to which access is allowed (This information only appears when CIFS or NFS/CIFS is used as the protocol.)
Deny CIFS Hosts	Information on hosts to which access is denied (This information only appears when CIFS or NFS/CIFS is used as the protocol.)
CIFS Access Users(r)	Information on users to which CIFS access is allowed (Read only) (A hyphen [-] is displayed for NFS.)
CIFS Access Users(rw)	Information on users to which CIFS access is allowed (Read-Write) (A hyphen [-] is displayed for NFS.)
CIFS Access Groups(r)	Information on groups to which CIFS access is allowed (Read only) (A hyphen [-] is displayed for NFS.)
CIFS Access Groups(rw)	Information on groups to which CIFS access is allowed (Read-Write) (A hyphen [-] is displayed for NFS.)
Audit Log	Displays whether the NAS audit log function is enabled or disabled (Enable, Disable) (A hyphen [-] is displayed for NFS.)

■ Example(s)

The following example shows settings when an option is omitted:

```
CLI> show nas-share
Share
No.   Name
-----
  0   NAS-SHARE#0
  1   NAS-SHARE#1
  2   NAS-SHARE#2
  3   NAS-SHARE#3
  4   NAS-SHARE#4
```

The following example shows a detailed view when "Volume No. 25" is specified:

```
CLI> show nas-share -volume-number 25
<NAS Share Information>
Share No.           [0]
Share Name          [NAS-SHARE#0]
Volume No.          [25]
Volume Name         [NAS-VOL#0]
Share               [Active]
Service             [NFS-CIFS]
NFS Export Path     [/mnt/nas/nv25/data/NAS-SHARE#0]
Access              [READ]
Oplocks             [Enable]
SMB Encryption     [Disable]
ABE                 [Disable]
Owner               [root]
Group               [Root]
Allow CIFS Hosts    [10.21.13.1,@group,*.fujitsu.com,10.21.13.0/255.255.255.0]
Deny CIFS Hosts    [10.21.13.1,@group,*.fujitsu.com,10.21.13.0/255.255.255.0]
Allow NFS Hosts     [10.21.13.1,@group,*.fujitsu.com,10.21.13.0/255.255.255.0]
No Root Squash NFS Hosts [10.21.13.1]
CIFS Access Users (r) [userA,userB]
CIFS Access Users (rw) [userC,userD]
CIFS Access Groups (r) [groupA,groupB]
CIFS Access Groups (rw) [groupC,groupD]
Audit Log           [Disable]

<NAS Share Information>
Share No.           [4]
Share Name          [NAS-SHARE#4]
Volume No.          [25]
Volume Name         [NAS-VOL#0]
Share               [Active]
Service             [CIFS]
NFS Export Path     [-]
Access              [READ-WRITE]
Oplocks             [Enable]
SMB Encryption     [Disable]
ABE                 [Disable]
Owner               [root]
Group               [Root]
Allow CIFS Hosts    [10.21.13.1,@group,*.fujitsu.com,10.21.13.0/255.255.255.0]
Deny CIFS Hosts    [10.21.13.1,@group,*.fujitsu.com,10.21.13.0/255.255.255.0]
Allow NFS Hosts     [-]
No Root Squash NFS Hosts [-]
CIFS Access Users (r) [userA]
CIFS Access Users (rw) []
CIFS Access Groups (r) [groupA,groupB]
CIFS Access Groups (rw) [everyone]
Audit Log           [Disable]
```

The following example shows a detailed view when the "NAS-SHARE#2" NAS shared folder is specified:

```
CLI> show nas-share -share-name NAS-SHARE#2
<NAS Share Information>
Share No.                [2]
Share Name               [NAS-SHARE#2]
Volume No.              [26]
Volume Name             [NAS-VOL#1]
Share                   [Inactive]
Service                 [NFS]
NFS Export Path         [:/mnt/nas/nv2/data/NAS-SHARE#2]
Access                  [READ-WRITE]
Oplocks                 [-]
SMB Encryption         [-]
ABE                    [-]
Owner                   [root]
Group                   [Root]

Allow CIFS Hosts       [-]
Deny CIFS Hosts       [-]
Allow NFS Hosts        [10.21.13.1,@group,*.fujitsu.com,10.21.13.0/255.255.255.0]
No Root Squash NFS Hosts [10.21.13.1]
CIFS Access Users (r)  [-]
CIFS Access Users (rw) [-]
CIFS Access Groups (r) [-]
CIFS Access Groups (rw) [-]
Audit Log              [-]
```

create nas-share

This command creates a NAS shared folder. The maximum number of shared folders that can be registered in the ETERNUS DX/AF is 256.

Caution

When using an authentication server, both CMs must be ready to communicate with the authentication server. For each CM, the following requirements must be met.

- Using the "create nas-interface" command, an IP address is assigned to one or more ports.
- Using the port above, the CM is in a state capable of communicating with the authentication server.

If the above requirements are not met and the command fails, fulfill the requirements, and execute the command again.

Note

Depending on the model, the support state of the encryption-related functions may differ.

Syntax

```
create nas-share {-name name | -home-directory}
{-volume-number volume_number | -volume-name volume_name}
-service {cifs | nfs | nfs-cifs} [-access {r | rw}] [-oplocks {enable | disable}]
[-smb-encryption {enable | disable}] [-abe {enable | disable}]
[-owner owner] [-group group] [-share {active | inactive}]
[-nfs-allow-host {allow-host}] [-nfs-no-root-squash-host {no-root-squash-host}]
[-cifs-allow-host {allow-host}] [-cifs-deny-host {deny-host}]
[-cifs-user-access-r users] [-cifs-user-access-rw users]
[-cifs-group-access-r groups] [-cifs-group-access-rw groups]
[-audit-log {enable | disable}]
```

Parameter

-name This parameter specifies the name of the shared folder to be created using up to 76 characters. For details, refer to ["1.2.21 Shared Folder Syntax" \(page 48\)](#).

Caution

This parameter cannot be specified at the same time as the "-home-directory" parameter. In addition, if the "-home-directory" parameter is omitted, this parameter must be set.

name This parameter specifies the NAS shared folder name.

-home-directory This parameter enables the home directory function by creating the user-specific folder "homes" for storing the user home directory.

Caution

- This parameter can only be specified if the used protocol is CIFS.
- This parameter cannot be specified at the same time as the "-name" parameter. In addition, if the "-name" parameter is omitted, this parameter must be set.

-volume-number or -volume-name

This parameter specifies the NAS user volume (nas-tpv) in which the target shared folder is to be created. Only one volume identifier can be specified simultaneously. For details, refer to "[1.2.11 Volume Syntax](#)" ([page 40](#)).

 **Caution**

Only NAS user volumes (nas-tpv) can be specified.

<i>volume_number</i>	NAS user volume number
<i>volume_name</i>	NAS user volume name

-service This parameter specifies the protocol of the file system to be used. If the "-home-directory" parameter is specified, only "cifs" can be specified.

cifs	Windows CIFS is used.
nfs	UNIX NFS is used.
nfs-cifs	Both UNIX NFS and Windows CIFS are used.

-access Optional. This parameter specifies privileges to write data to the shared folder. If this parameter is omitted, "rw" is specified. If the "-home-directory" parameter is specified, only "rw" can be specified.

 **Caution**

- The Write privilege of the NAS shared folder is set with this parameter only if the "-cifs-user-access-r", "-cifs-user-access-rw", "-cifs-group-access-r", or "-cifs-group-access-rw" parameter is not specified.
- The value of this parameter is ignored if the "-cifs-user-access-r", "-cifs-user-access-rw", "-cifs-group-access-r", or "-cifs-group-access-rw" parameter is specified.
- All users are given the Read-Write privilege if this parameter and the "-cifs-user-access-r", "-cifs-user-access-rw", "-cifs-group-access-r", and "-cifs-group-access-rw" parameters are not specified. For details, refer to "[Access privileges of the user and group](#)" ([page 890](#)) of "[7.1 Shared Folders](#)" ([page 890](#)).

r	Privileges to read data only
rw	Privileges to read and write data

-oplocks Optional. This parameter specifies whether the shared folder locks the files by using the Opportunistic locking (Oplocks) function to avoid conflicts. If this parameter is omitted, "disable" is specified.

 **Caution**

- When Alternate Data Streams (ADS) is used, do not set this parameter to "enable".
- This parameter can be specified only when CIFS or NFS/CIFS is used as the protocol.

enable	The Oplocks function is used.
disable	The Oplocks function is not used.

-smb-encryption

Optional. This parameter specifies whether the SMB encryption function is enabled. When the SMB encryption function is enabled, file access communication is encrypted based on the SMB protocol. This parameter can only be specified when "cifs" or "nfs-cifs" is specified for the "-service" parameter. If omitted, "disable" is set.

enable The SMB encryption function is enabled.
disable The SMB encryption function is disabled. (default)

-abe

Optional. This parameter specifies whether the Access-Based Enumeration (ABE) function is enabled. When the ABE function is enabled, files and folders that are set without access privileges can be hidden if the shared folders are accessed with CIFS. This parameter can only be specified when "cifs" or "nfs-cifs" is specified for the "-service" parameter. If omitted, "disable" is set.
If the "-home-directory" parameter is specified, only "disable" can be specified.

enable The ABE function is enabled.
disable The ABE function is disabled (default).

-owner

Optional. This parameter specifies the name of the owner of the shared folder. For details, refer to ["1.2.22 Shared Folder Owner Name or Group Name Syntax" \(page 48\)](#).

If this parameter is omitted, "root" is specified.

 **Caution**

- When this parameter is specified, the "-group" parameter must be set. Both parameters must be specified.
- If root is specified for both this parameter and the "-group" parameter, or if the specification is omitted for both parameters, file access is possible with root privileges for all NFS connection hosts. To allow file access with root privileges only for specific NFS connection hosts, specify the target NFS connection host in the "-nfs-no-root-squash-host" parameter.

owner Name of the owner of the shared folder

-group

Optional. This parameter specifies the group name of the shared folder. For details, refer to ["1.2.22 Shared Folder Owner Name or Group Name Syntax" \(page 48\)](#).

If this parameter is omitted, "root" is specified.

 **Caution**

- When this parameter is specified, the "-owner" parameter must be set. Both parameters must be specified.
- If root is specified for both the "-owner" parameter and this parameter, or if the specification is omitted for both parameters, file access is possible with root privileges for all NFS connection hosts. To allow file access with root privileges only for specific NFS connection hosts, specify the target NFS connection host in the "-nfs-no-root-squash-host" parameter.

group Group name of the shared folder

-share Optional. This parameter specifies whether to enable the shared folder that is created. If this parameter is omitted, "active" is specified.

active The shared folder will be enabled.

inactive The shared folder will be disabled.

-nfs-allow-host

Optional. This parameter specifies the hosts that are allowed to access the shared folder. For details, refer to ["1.2.23 NFS Connection Host, CIFS Connection Host, or NFS/CIFS Connection Host Syntax" \(page 49\)](#).

If omitted, access is allowed from all hosts. This parameter can be specified only when NFS or NFS/CIFS is used as the protocol.

 **Caution**

- Specify the hosts, including ones that have already been set.
- The consecutive spaces before and after the host name are ignored and the trimmed character string is reflected.
- If multiple hosts are specified for this parameter and the "-nfs-no-root-squash-host" parameter, the order of priority for application differs depending on the specified format and the specified order of this parameter.
The order of priority is based on the following list (priority is listed from highest [1] to lowest [4]).

(1) FQDN

(2) IP address, IP network (Example: 192.168.10.0/255.255.255.0)

(3) Something other than "*" is specified (Example: FQDN that includes a host name or "*")

(4) *

If the order of priority is the same, the host described first (or on the left side) is given priority. For example, if "192.168.10.10,192.168.10.0/255.255.255.0" is specified, "192.168.10.10" is given priority.

If multiple corresponding NFS connection hosts are specified for this parameter, the possibility of file access with root privileges is determined by whether or not the "-nfs-no-root-squash-host" parameter is specified for the host that has the highest priority.

Note

Specification examples for this parameter and the "-nfs-no-root-squash-host" parameter are indicated below.

- When the specification of an FQDN is mixed with an IP network

- Example in which file access is possible with root privileges

If the IP address of the FQDN specification "fqdn.example.co.jp" is "192.168.10.100", by performing the following setting, when files are accessed from the NFS connection host "192.168.10.100", the "fqdn.example.co.jp" specification with the highest priority is applied.

Because the "-nfs-no-root-squash-host" parameter is specified for "fqdn.example.co.jp", file access is possible with root privileges.

```
-nfs-allow-host 192.168.10.0/255.255.255.0,fqdn.example.co.jp -nfs-no-root-squash-host fqdn.example.co.jp
```

- When the specification of an IP address is mixed with an IP network

- Example in which file access is possible with root privileges

If the following setting is performed, file access is possible with root privileges from IP address "192.168.10.100" of the NFS connection host.

Because the specification "192.168.10.100" which is described first with this parameter is applied, the "-nfs-no-root-squash-host" parameter is specified for "192.168.10.100".

```
-nfs-allow-host 192.168.10.100,192.168.10.0/255.255.255.0 -nfs-no-root-squash-host 192.168.10.100
```

- Example in which file access is not possible with root privileges

If the following setting is performed, file access is not possible with root privileges from IP address "192.168.10.100" of the NFS connection host.

Even if "192.168.10.100" is specified with the "-nfs-no-root-squash-host" parameter, because the specification "192.168.10.0/255.255.255.0" is described first with this parameter, it has the higher priority.

```
-nfs-allow-host 192.168.10.0/255.255.255.0,192.168.10.100 -nfs-no-root-squash-host 192.168.10.100
```

The following formats are available:

- single host
Example: 10.123.123.123
IP network
Example: 10.123.123.0/255.255.255.0
Example: 10.123.123.0/24
- FQDN

allow-host Host that is allowed to access the shared folder

-nfs-no-root-squash-host

Optional. This parameter specifies the host in which root squash is to be disabled. For details, refer to ["1.2.23 NFS Connection Host, CIFS Connection Host, or NFS/CIFS Connection Host Syntax" \(page 49\)](#).

If root squash is disabled, because root access from the NFS connection host is treated as root access on the NAS shared folder, root of the specified host can change all the files on the NAS shared folder.

If omitted, this parameter is not changed. This parameter can be specified only when NFS or NFS/CIFS is used as the protocol. This parameter cannot be specified if the "-home-directory" parameter is specified.

Hosts specified with this parameter must be specified with the same character string (case sensitive) as the hosts specified for the "-nfs-allow-host" parameter. The following example specification is not permitted.

Example: -nfs-allow-host *.fujitsu.com -nfs-no-root-squash-host www.fujitsu.com

Specify the same character string to both the "-nfs-allow-host" parameter and this parameter as shown below.

Example: -nfs-allow-host www.fujitsu.com, *.fujitsu.com -nfs-no-root-squash-host www.fujitsu.com

Caution

- Specify the hosts, including ones that have already been set.
- The consecutive spaces before and after the host name are ignored and the trimmed character string is reflected.
- If multiple hosts are specified for the "-nfs-allow-host" parameter and this parameter, the order of priority for application differs depending on the specified format and the specified order of the "-nfs-allow-host" parameter.

The order of priority is based on the following list (priority is listed from highest [1] to lowest [4]).

(1) FQDN

(2) IP address, IP network (Example: 192.168.10.0/255.255.255.0)

(3) Something other than "*" is specified (Example: FQDN that includes a host name or "*")

(4) *

If the order of priority is the same, the host described first (or on the left side) is given priority. For example, if "192.168.10.10,192.168.10.0/255.255.255.0" is specified, "192.168.10.10" is given priority.

If multiple corresponding NFS connection hosts are specified for the "-nfs-allow-host" parameter, the possibility of file access with root privileges is determined by whether or not this parameter is specified for the host that has the highest priority.

 **Note**

Specification examples for the "-nfs-allow-host" parameter and this parameter are indicated below.

- When the specification of an FQDN is mixed with an IP network

- Example in which file access is possible with root privileges

If the IP address of the FQDN specification "fqdn.example.co.jp" is "192.168.10.100", by performing the following setting, when files are accessed from the NFS connection host "192.168.10.100", the "fqdn.example.co.jp" specification with the highest priority is applied. Because this parameter is specified for "fqdn.example.co.jp", file access is possible with root privileges.

```
-nfs-allow-host 192.168.10.0/255.255.255.0,fqdn.example.co.jp -nfs-no-root-squash-host  
fqdn.example.co.jp
```

- When the specification of an IP address is mixed with an IP network

- Example in which file access is possible with root privileges

If the following setting is performed, file access is possible with root privileges from IP address "192.168.10.100" of the NFS connection host.

Because the specification "192.168.10.100" which is described first with the "-nfs-allow-host" parameter is applied, this parameter is specified for "192.168.10.100".

```
-nfs-allow-host 192.168.10.100,192.168.10.0/255.255.255.0 -nfs-no-root-squash-host  
192.168.10.100
```

- Example in which file access is not possible with root privileges

If the following setting is performed, file access is not possible with root privileges from IP address "192.168.10.100" of the NFS connection host.

Even if "192.168.10.100" is specified with this parameter, because the specification "192.168.10.0/255.255.255.0" is described first with the "-nfs-allow-host" parameter, it has the higher priority.

```
-nfs-allow-host 192.168.10.0/255.255.255.0,192.168.10.100 -nfs-no-root-squash-host  
192.168.10.100
```

The following formats are available:

- single host
Example: 10.123.123.123
- IP network
Example: 10.123.123.0/255.255.255.0
Example: 10.123.123.0/24
FQDN

no-root-squash-host Host in which root squash is to be disabled

-cifs-allow-host

Optional. This parameter specifies the host that is allowed to access the shared folder. For details, refer to ["1.2.23 NFS Connection Host, CIFS Connection Host, or NFS/CIFS Connection Host Syntax" \(page 49\)](#).

If omitted, access is allowed from all hosts. This parameter can be specified only when CIFS or NFS/CIFS is used as the protocol.

 **Caution**

Specify the hosts, including ones that have already been allowed.

The following formats are available:

- single host
Example: 10.123.123.123
- IP network
Example: 10.123.123.0/255.255.255.0
Example: 10.123.123.0/24
- EXCEPT
Only the specific hosts can be excepted from access using "EXCEPT" (based on the format of Samba).
Example: 150.203.* EXCEPT 150.203.6.66
- FQDN

allow-host Host that is allowed to access the shared folder

-cifs-deny-host

Optional. This parameter specifies the host that is denied access to the shared folder. For details, refer to ["1.2.23 NFS Connection Host, CIFS Connection Host, or NFS/CIFS Connection Host Syntax" \(page 49\)](#).

This parameter can be specified only when CIFS or NFS/CIFS is used as the protocol.

 **Caution**

Specify the hosts, including ones that have already been denied access.

The following formats are available:

- single host
Example: 10.123.123.123
- IP network
Example: 10.123.123.0/255.255.255.0
Example: 10.123.123.0/24
- FQDN

deny-host Host that is denied access to the shared folder

-cifs-user-access-r

Optional. This parameter specifies the CIFS user with the Read-only privilege. For details, refer to ["1.2.24 CIFS User Name or CIFS Group Name Syntax" \(page 49\)](#).

If the "-home-directory" parameter is specified, this parameter cannot be specified.

If the "-service nfs" parameter is specified, this parameter cannot be specified.

This parameter cannot be specified for a duplicate user with the "-cifs-user-access-rw" parameter.

For example, CIFS connection privilege can be specified as follows.

- If the NAS shared folder is created by specifying "-cifs-user-access-r userA,userB" and by omitting the other parameters (-cifs-user-access-rw, -cifs-group-access-r, -cifs-group-access-rw)
Read-only privilege: userA and userB
No access: All users other than userA and userB

 **Caution**

CIFS connections are unavailable to all unspecified users or groups if one of the following parameters is specified: "-cifs-user-access-r", "-cifs-user-access-rw", "-cifs-group-access-r", or "-cifs-group-access-rw". Privileges for the NFS connection follows the settings of the "-access" parameter. For details, refer to ["Access privileges of the user and group" \(page 890\)](#) of ["7.1 Shared Folders" \(page 890\)](#).

users Read-only user names

-cifs-user-access-rw

Optional. This parameter specifies the CIFS user with the Read-Write privilege. For details, refer to ["1.2.24 CIFS User Name or CIFS Group Name Syntax" \(page 49\)](#).

If the "-home-directory" parameter is specified, this parameter cannot be specified.

If the "-service nfs" parameter is specified, this parameter cannot be specified.

This parameter cannot be specified for a duplicate user with the "-cifs-user-access-r" parameter.

For example, CIFS connection privilege can be specified as follows.

- If the NAS shared folder is created by specifying "-cifs-user-access-rw userA,userB" and by omitting the other parameters (-cifs-user-access-r, -cifs-group-access-r, -cifs-group-access-rw)
Read-Write privilege: userA and userB
No access: All users other than userA and userB
-

 **Caution**

CIFS connections are unavailable to all unspecified users or groups if one of the following parameters is specified: "-cifs-user-access-r", "-cifs-user-access-rw", "-cifs-group-access-r", or "-cifs-group-access-rw". For details, refer to ["Access privileges of the user and group" \(page 890\)](#) of ["7.1 Shared Folders" \(page 890\)](#).

users Read-Write user names

-cifs-group-access-r

Optional. This parameter specifies the CIFS group with the Read-only privilege. For details, refer to ["1.2.24 CIFS User Name or CIFS Group Name Syntax" \(page 49\)](#).

The CIFS group name can be specified with "everyone".

If the "-home-directory" parameter is specified, this parameter cannot be specified.

If the "-service nfs" parameter is specified, this parameter cannot be specified.

This parameter cannot be specified for a duplicate user with the "-cifs-user-access-rw" parameter.

For example, CIFS connection privilege can be specified as follows.

- If the NAS shared folder is created by specifying "-cifs-group-access-r groupA,groupB" and by omitting the other parameters (-cifs-user-access-r, -cifs-user-access-rw, -cifs-group-access-rw)
Read-only privilege: groupA and groupB
No access: All users who do not belong to groupA and groupB.
- If the NAS shared folder is created by specifying "-cifs-group-access-r everyone" and by omitting the other parameters (-cifs-user-access-r, -cifs-user-access-rw, -cifs-group-access-rw)
Read-only privilege: All users
- If the NAS shared folder is created by specifying "-cifs-user-access-rw userA -cifs-group-access-r everyone" and by omitting the other parameters (-cifs-user-access-r, -cifs-group-access-rw)
Read-Write privilege: userA
Read-only privilege: All users other than userA
- If the NAS shared folder is created by specifying "-cifs-user-access-rw userA -cifs-group-access-r groupA" (where userA belongs to groupA) and by omitting the other parameters (-cifs-user-access-r, -cifs-group-access-rw)
Read-Write privilege: userA
Read-only privilege: All users who belongs to groupA other than the userA
No access: All users who do not belong to groupA

 **Caution**

- CIFS connections are unavailable to all unspecified users or groups if one of the following parameters is specified: "-cifs-user-access-r", "-cifs-user-access-rw", "-cifs-group-access-r", or "-cifs-group-access-rw". For details, refer to ["Access privileges of the user and group" \(page 890\)](#) of ["7.1 Shared Folders" \(page 890\)](#).
- All users are given the Read-only privilege if "-cifs-group-access-r everyone" is specified, and "-cifs-user-access-rw" and "-cifs-group-access-rw" are not specified.
- If "-cifs-group-access-r everyone" is specified, and "-cifs-user-access-rw" and "-cifs-group-access-rw" are specified, the specified user and group is given the Read-Write privilege and the other users are given Read-only privileges.
- If the user is specified with the Read-Write privilege and the group where the user belongs is specified with the Read-only privilege, the specified user is given the Read-Write privilege and the other users that belong to the group are given the Read-only privilege.

groups Read-Only group names

-cifs-group-access-rw

Optional. This parameter specifies the CIFS group with the Read-Write privilege. For details, refer to ["1.2.24 CIFS User Name or CIFS Group Name Syntax" \(page 49\)](#).

The CIFS group name can be specified with "everyone".

If the "-home-directory" parameter is specified, this parameter cannot be specified.

If the "-service nfs" parameter is specified, this parameter cannot be specified.

This parameter cannot be specified for a duplicate user with the "-cifs-user-access-r" parameter.

For example, CIFS connection privilege can be specified as follows.

- If the NAS shared folder is created by specifying "-cifs-group-access-rw groupA,groupB" and by omitting the other parameters (-cifs-user-access-r, -cifs-user-access-rw, -cifs-group-access-r)
Read-Write privilege: groupA and groupB
No access: All users who do not belong to groupA and groupB
- If the NAS shared folder is created by specifying "-cifs-group-access-rw everyone" and by omitting the other parameters (-cifs-user-access-r, -cifs-user-access-rw, -cifs-group-access-r)
Read-Write privilege: All users
- If the NAS shared folder is created by specifying "-cifs-user-access-r userA -cifs-group-access-rw everyone" and by omitting the other parameters (-cifs-user-access-rw, -cifs-group-access-r)
Read-Write privilege: All users (including userA)
- If the NAS shared folder is created by specifying "-cifs-user-access-r userA -cifs-group-access-rw groupA" (where userA belongs to groupA) and by omitting the other parameters (-cifs-user-access-rw, -cifs-group-access-r)
Read-Write privilege: userA
Read-only privilege: All users who belongs to groupA (including userA)
No access: All users who do not belong to groupA

 **Caution**

- CIFS connections are unavailable to all unspecified users or groups if one of the following parameters is specified: "-cifs-user-access-r", "-cifs-user-access-rw", "-cifs-group-access-r", or "-cifs-group-access-rw". For details, refer to ["Access privileges of the user and group" \(page 890\)](#) of ["7.1 Shared Folders" \(page 890\)](#).
- If "-cifs-group-access-rw everyone" is specified, all users are given Read-Write access regardless of the other specified parameters (-cifs-user-access-r, -cifs-user-access-rw, -cifs-group-access-r).
- If the user is specified with the Read-only privilege and the group where the user belongs is specified with the Read-Write privilege, the specified user is given the Read-Write privilege because the Read-Write privilege takes precedence.

groups Read-Write group names

-audit-log Optional. This parameter specifies whether to enable the NAS audit log function of the NAS shared folder. If the NAS audit log function is enabled, the audit log is recorded in the NAS expanded system volume. If omitted, "disable" is set. This parameter cannot be specified if the "-service nfs" parameter is specified.

enable The NAS audit log function is enabled.

disable The NAS audit log function is disabled (default).

■ Example(s)

The following example shows the creation of a CIFS protocol-based shared folder using NAS volume #2:

```
CLI> create nas-share -name NewFolder -volume-number 2 -service cifs -access rw -oplocks disable -owner root -group root  
-share active -cifs-allow-host 192.0.2.128,server.hq.example.com -cifs-deny-host 2001:db8::32:1
```

The following example shows the creation of an NFS protocol-based shared folder using the NAS volume named "NAS_1":

```
CLI> create nas-share -name NewFolder -volume-name NAS_1 -service nfs -access r -owner root -group root -share inactive
```

The following example specifies the CIFS connection privileges and the creation of a NAS shared folder. The Read-only privilege is given to "userA", "userB", "groupA", and "groupB", the Read-Write privilege is given to "userC" and "groupC", and all other users and groups are denied access:

```
CLI> create nas-share -name NewFolder -volume-name NAS_1 -service cifs -access r -owner root -group root -share active  
-cifs-user-access-r userA,userB -cifs-user-access-rw userC -cifs-group-access-r groupA,groupB -cifs-group-access-rw groupC
```

set nas-share

This command changes NAS shared folder settings. If internal resources become insufficient due to a change in settings, a change error occurs.

Caution

When using an authentication server, both CMs must be ready to communicate with the authentication server. For each CM, the following requirements must be met.

- Using the "create nas-interface" command, an IP address is assigned to one or more ports.
- Using the port above, the CM is in a state capable of communicating with the authentication server.

If the above requirements are not met and the command fails, fulfill the requirements, and execute the command again.

Note

Depending on the model, the support state of the encryption-related functions may differ.

Syntax

```
set nas-share
{-share-number share_number | -share-name share_name | -all}
[-access {r | rw}] [-oplocks {enable | disable}]
[-smb-encryption {enable | disable}] [-abe {enable | disable}]
[-owner owner] [-group group] [-share {active | inactive}]
[-nfs-allow-host {allow-host | ""}] [-nfs-no-root-squash-host {no-root-squash-host | ""}]
[-cifs-allow-host {allow-host | ""}] [-cifs-deny-host {deny-host | ""}]
[-cifs-user-access-r {users | ""}] [-cifs-user-access-rw {users | ""}]
[-cifs-group-access-r {groups | ""}] [-cifs-group-access-rw {groups | ""}]
[-audit-log {enable | disable}]
```

Parameter

-share-number, -share-name, or -all

This parameter specifies a NAS shared folder to be changed. When the "-share-number" parameter is used, multiple numbers can be specified by inserting a hyphen (-) or a comma (,) between them as a delimiter. When the "-share-name" parameter is used, only one NAS shared folder can be specified. For details on how to specify names, refer to ["1.2.21 Shared Folder Syntax" \(page 48\)](#).

Caution

- A NAS shared folder that does not exist cannot be specified.
- If the NAS shared folder name includes multibyte characters, specify the NAS shared folder with the "-share-number" parameter.

<i>share_number</i>	NAS shared folder number
<i>share_name</i>	NAS shared folder name
-all	All NAS shared folders

-access Optional. This parameter specifies privileges to write data to the shared folder. If omitted, this parameter is not changed.

 **Caution**

- The Write privilege of the NAS shared folder is set with this parameter only if the "-cifs-user-access-r", "-cifs-user-access-rw", "-cifs-group-access-r", or "-cifs-group-access-rw" parameter is not specified.
- The value of this parameter is ignored if the "-cifs-user-access-r", "-cifs-user-access-rw", "-cifs-group-access-r", or "-cifs-group-access-rw" parameter is specified (excluding "").
- All users inherit the Read-Write privilege if this parameter and the "-cifs-user-access-r", "-cifs-user-access-rw", "-cifs-group-access-r", and "-cifs-group-access-rw" parameters are not specified. For details, refer to ["Access privileges of the user and group" \(page 890\)](#) of ["7.1 Shared Folders" \(page 890\)](#).

For example, for the NAS shared folder with CIFS access privileges where only userA has the Read-Write privilege, CIFS connection privileges can be set as follows.

- If the NAS shared folder settings are changed by specifying '-access r -cifs-user-access-rw "" ' and by omitting the other parameters (-cifs-user-access-r, -cifs-group-access-r, -cifs-group-access-rw)
Read-only privilege: All users
- If the NAS shared folder settings are changed by specifying "-access r -cifs-user-access-r userB" and by omitting the other parameters (-cifs-user-access-rw, -cifs-group-access-r, -cifs-group-access-rw)
Read-Write privilege: userA
Read only privilege: userB
No access: All users other than userA and userB
- If the NAS shared folder settings are changed by omitting all the parameters (-access, -cifs-user-access-r, -cifs-user-access-rw, -cifs-group-access-r, -cifs-group-access-rw)
Read-Write privilege: userA
No access: All users other than userA

If "homes" is specified with the "-share-name" parameter or if the folder number of the user-specific folder "homes" is specified with the "-share-number" parameter, only "rw" can be specified.

r Privileges to read data only
rw Privileges to read and write data

-oplocks Optional. This parameter specifies whether the shared folder locks the files by using the Opportunistic locking (Oplocks) function to avoid conflicts. If omitted, this parameter is not changed.

 **Caution**

This parameter can be specified only when CIFS or NFS/CIFS is used as the protocol.

enable The Oplocks function is used.
disable The Oplocks function is not used.

-smb-encryption

Optional. This parameter specifies whether the SMB encryption function is enabled. When the SMB encryption function is enabled, file access communication is encrypted based on the SMB protocol. This parameter can only be specified when "cifs" or "nfs-cifs" is specified for the "-service" parameter. If omitted, the existing setting is not changed.

enable The SMB encryption function is enabled.
disable The SMB encryption function is disabled.

-abe Optional. This parameter specifies whether the Access-Based Enumeration (ABE) function is enabled. When the ABE function is enabled, files and folders that are set without access privileges can be hidden if the shared folders are accessed with CIFS. This parameter can only be specified when "cifs" or "nfs-cifs" is specified for the "-service" parameter.
If "homes" is specified with the "-share-name" parameter or if the folder number of the user-specific folder "homes" is specified with the "-share-number" parameter, only "disable" can be specified. If omitted, this parameter is not changed.

enable The ABE function is enabled.
disable The ABE function is disabled.

-owner Optional. This parameter specifies the name of the owner of the shared folder. For details, refer to ["1.2.22 Shared Folder Owner Name or Group Name Syntax" \(page 48\)](#).

If omitted, this parameter is not changed.

 **Caution**

- When this parameter is specified, the "-group" parameter must be set. Both parameters must be specified.
- If root is specified for both this parameter and the "-group" parameter, or if the specification is omitted for both parameters, file access is possible with root privileges for all NFS connection hosts. To allow file access with root privileges only for specific NFS connection hosts, specify the target NFS connection host in the "-nfs-no-root-squash-host" parameter.

owner Name of the owner of the shared folder

-group Optional. This parameter specifies the group name of the shared folder. For details, refer to ["1.2.22 Shared Folder Owner Name or Group Name Syntax" \(page 48\)](#).

If omitted, this parameter is not changed.

 **Caution**

- When this parameter is specified, the "-owner" parameter must be set. Both parameters must be specified.
- If root is specified for both the "-owner" parameter and this parameter, or if the specification is omitted for both parameters, file access is possible with root privileges for all NFS connection hosts. To allow file access with root privileges only for specific NFS connection hosts, specify the target NFS connection host in the "-nfs-no-root-squash-host" parameter.

group Group name of the shared folder

-share Optional. This parameter specifies whether to enable the shared folder that is created. If omitted, this parameter is not changed.

 **Caution**

If the values that are not "enable" in parameters such as "-owner", "-group", and "-nfs-allow-host" are set when the "inactive" state is changed to "active", an error occurs and changing to "active" may not be possible. Check the settings according to the generated error.

active	The shared folder will be enabled.
inactive	The shared folder will be disabled.

-nfs-allow-host

Optional. This parameter specifies the hosts that are allowed to access the shared folder. For details, refer to ["1.2.23 NFS Connection Host, CIFS Connection Host, or NFS/CIFS Connection Host Syntax" \(page 49\)](#).

If omitted, this parameter is not changed. This parameter can be specified only when NFS or NFS/CIFS is used as the protocol.

 **Caution**

- Specify the hosts, including ones that have already been set.
- The consecutive spaces before and after the host name are ignored and the trimmed character string is reflected.
- If multiple hosts are specified for this parameter and the "-nfs-no-root-squash-host" parameter, the order of priority for application differs depending on the specified format and the specified order of this parameter.
The order of priority is based on the following list (priority is listed from highest [1] to lowest [4]).

(1) FQDN

(2) IP address, IP network (Example: 192.168.10.0/255.255.255.0)

(3) Something other than "*" is specified (Example: FQDN that includes a host name or "*")

(4) *

If the order of priority is the same, the host described first (or on the left side) is given priority. For example, if "192.168.10.10,192.168.10.0/255.255.255.0" is specified, "192.168.10.10" is given priority.

If multiple corresponding NFS connection hosts are specified for this parameter, the possibility of file access with root privileges is determined by whether or not the "-nfs-no-root-squash-host" parameter is specified for the host that has the highest priority.

Note

Specification examples for this parameter and the "-nfs-no-root-squash-host" parameter are indicated below.

- When the specification of an FQDN is mixed with an IP network

- Example in which file access is possible with root privileges

If the IP address of the FQDN specification "fqdn.example.co.jp" is "192.168.10.100", by performing the following setting, when files are accessed from the NFS connection host "192.168.10.100", the "fqdn.example.co.jp" specification with the highest priority is applied. Because the "-nfs-no-root-squash-host" parameter is specified for "fqdn.example.co.jp", file access is possible with root privileges.

```
-nfs-allow-host 192.168.10.0/255.255.255.0,fqdn.example.co.jp -nfs-no-root-squash-host fqdn.example.co.jp
```

- When the specification of an IP address is mixed with an IP network

- Example in which file access is possible with root privileges

If the following setting is performed, file access is possible with root privileges from IP address "192.168.10.100" of the NFS connection host.

Because the specification "192.168.10.100" which is described first with this parameter is applied, the "-nfs-no-root-squash-host" parameter is specified for "192.168.10.100".

```
-nfs-allow-host 192.168.10.100,192.168.10.0/255.255.255.0 -nfs-no-root-squash-host 192.168.10.100
```

- Example in which file access is not possible with root privileges

If the following setting is performed, file access is not possible with root privileges from IP address "192.168.10.100" of the NFS connection host.

Even if "192.168.10.100" is specified with the "-nfs-no-root-squash-host" parameter, because the specification "192.168.10.0/255.255.255.0" is described first with this parameter, it has the higher priority.

```
-nfs-allow-host 192.168.10.0/255.255.255.0,192.168.10.100 -nfs-no-root-squash-host 192.168.10.100
```

The following formats are available:

- single host
Example: 10.123.123.123
- IP network
Example: 10.123.123.0/255.255.255.0
Example: 10.123.123.0/24
- FQDN

To delete a setting, specify the NULL character (""). If this parameter is specified with the NULL character string (""), and the "-nfs-no-root-squash-host" parameter is not specified, the deletion target host is also deleted from No Root Squash NFS Hosts if registered.

allow-host Host that is allowed to access the shared folder

"" The setting is deleted.

-nfs-no-root-squash-host

Optional. This parameter specifies the host in which root squash is to be disabled. For details, refer to ["1.2.23 NFS Connection Host, CIFS Connection Host, or NFS/CIFS Connection Host Syntax" \(page 49\)](#).

If root squash is disabled, because root access from the NFS connection host is treated as root access on the NAS shared folder, root of the specified host can change all the files on the NAS shared folder.

If omitted, this parameter is not changed. This parameter can be specified only when NFS or NFS/CIFS is used as the protocol.

Hosts specified with this parameter must be specified with the same character string (case sensitive) as the hosts specified for the "-nfs-allow-host" parameter. The following example specification is not permitted.

Example: -nfs-allow-host *.fujitsu.com -nfs-no-root-squash-host www.fujitsu.com

Specify the same character string to both the "-nfs-allow-host" parameter and this parameter as shown below.

Example: -nfs-allow-host www.fujitsu.com, *.fujitsu.com -nfs-no-root-squash-host www.fujitsu.com

Caution

- Specify the hosts, including ones that have already been set.
- The consecutive spaces before and after the host name are ignored and the trimmed character string is reflected.
- If multiple hosts are specified for the "-nfs-allow-host" parameter and this parameter, the order of priority for application differs depending on the specified format and the specified order of the "-nfs-allow-host" parameter.

The order of priority is based on the following list (priority is listed from highest [1] to lowest [4]).

(1) FQDN

(2) IP address, IP network (Example: 192.168.10.0/255.255.255.0)

(3) Something other than "*" is specified (Example: FQDN that includes a host name or "*")

(4) *

If the order of priority is the same, the host described first (or on the left side) is given priority. For example, if "192.168.10.10,192.168.10.0/255.255.255.0" is specified, "192.168.10.10" is given priority.

If multiple corresponding NFS connection hosts are specified for the "-nfs-allow-host" parameter, the possibility of file access with root privileges is determined by whether or not this parameter is specified for the host that has the highest priority.

Note

Specification examples for the "-nfs-allow-host" parameter and this parameter are indicated below.

- When the specification of an FQDN is mixed with an IP network

- Example in which file access is possible with root privileges

If the IP address of the FQDN specification "fqdn.example.co.jp" is "192.168.10.100", by performing the following setting, when files are accessed from the NFS connection host "192.168.10.100", the "fqdn.example.co.jp" specification with the highest priority is applied. Because this parameter is specified for "fqdn.example.co.jp", file access is possible with root privileges.

```
-nfs-allow-host 192.168.10.0/255.255.255.0,fqdn.example.co.jp -nfs-no-root-squash-host  
fqdn.example.co.jp
```

- When the specification of an IP address is mixed with an IP network

- Example in which file access is possible with root privileges

If the following setting is performed, file access is possible with root privileges from IP address "192.168.10.100" of the NFS connection host.

Because the specification "192.168.10.100" which is described first with the "-nfs-allow-host" parameter is applied, this parameter is specified for "192.168.10.100".

```
-nfs-allow-host 192.168.10.100,192.168.10.0/255.255.255.0 -nfs-no-root-squash-host  
192.168.10.100
```

- Example in which file access is not possible with root privileges

If the following setting is performed, file access is not possible with root privileges from IP address "192.168.10.100" of the NFS connection host.

Even if "192.168.10.100" is specified with this parameter, because the specification "192.168.10.0/255.255.255.0" is described first with the "-nfs-allow-host" parameter, it has the higher priority.

```
-nfs-allow-host 192.168.10.0/255.255.255.0,192.168.10.100 -nfs-no-root-squash-host  
192.168.10.100
```

The following formats are available:

- single host
Example: 10.123.123.123
- IP network
Example: 10.123.123.0/255.255.255.0
Example: 10.123.123.0/24
- FQDN

To delete a setting, specify the NULL character ("").

<i>no-root-squash-host</i>	Host in which root squash is to be disabled
""	All existing settings are deleted.

-cifs-allow-host

Optional. This parameter specifies the host that is allowed to access the shared folder. For details on how to specify hosts, refer to ["1.2.23 NFS Connection Host, CIFS Connection Host, or NFS/CIFS Connection Host Syntax" \(page 49\)](#).

If omitted, this parameter is not changed. This parameter can be specified only when CIFS or NFS/CIFS is used as the protocol.

 **Caution**

- Specify the hosts, including ones that have already been allowed.
- If an allowed host is set or the setting is changed, the setting for the connected host is enabled after a reconnection.

The following formats are available:

- single host
Example: 10.123.123.123
- IP network
Example: 10.123.123.0/255.255.255.0
Example: 10.123.123.0/24
- EXCEPT
Only the specific hosts can be excepted from access using "EXCEPT" (based on the format of Samba).
Example: 150.203.* EXCEPT 150.203.6.66
- FQDN

To delete a setting, specify a null character ("").

allow-host Host that is allowed to access the shared folder

"" The setting is deleted.

-cifs-deny-host

Optional. This parameter specifies the host that is denied access to the shared folder. For details on how to specify hosts, refer to ["1.2.23 NFS Connection Host, CIFS Connection Host, or NFS/CIFS Connection Host Syntax" \(page 49\)](#).

If omitted, this parameter is not changed. This parameter can be specified only when CIFS or NFS/CIFS is used as the protocol.

 **Caution**

- Specify the hosts, including ones that have already been denied access.
- If a denied host is set or the setting is changed, the setting for the connected host is enabled after a reconnection.

The following formats are available:

- single host
Example: 10.123.123.123
- IP network
Example: 10.123.123.0/255.255.255.0
Example: 10.123.123.0/24
- FQDN

To delete a setting, specify a null character ("").

deny-host Host that is denied access to the shared folder

"" The setting is deleted.

-cifs-user-access-r

Optional. This parameter specifies the CIFS user with the Read-only privilege. For details on how to specify CIFS users, refer to ["1.2.23 NFS Connection Host, CIFS Connection Host, or NFS/CIFS Connection Host Syntax" \(page 49\)](#).

If the "nas-share" parameter is specified with a single value and the NFS protocol is used, this parameter cannot be specified.

The settings can be changed only if the "nas-share" parameter is specified with multiple values or "all" and the NAS shared folder is CIFS or NFS/CIFS common.

If "homes" is specified with the "-share-name" parameter or if the folder number of the user-specific folder "homes" is specified with the "-share-number" parameter, this parameter cannot be specified.

This parameter cannot be specified for a duplicate user with the "-cifs-user-access-rw" parameter.

For the user name that is already registered with the "-cifs-user-access-rw" parameter, this parameter may not be used for specifying as long as the user name is not deleted from the "-cifs-user-access-rw" parameter.

For example, CIFS connection privilege can be specified as follows.

- If "-cifs-user-access-r userA,userB" is specified for a NAS shared folder that is not set with the "-cifs-user-access-r", "-cifs-user-access-rw", "-cifs-group-access-r", or "-cifs-group-access-rw" parameter
Read-only privilege: userA and userB
No access: All users other than userA and userB
- If "-cifs-user-access-r userA,userB,userC" is specified to the above NAS shared folder
Read-only privilege: userA, userB, and userC
No access: All users other than userA, userB, and userC

 **Caution**

- CIFS connections are unavailable to all unspecified users or groups if one of the following parameters is specified: "-cifs-user-access-r", "-cifs-user-access-rw", "-cifs-group-access-r", or "-cifs-group-access-rw". For details, refer to ["Access privileges of the user and group" \(page 890\)](#) of ["7.1 Shared Folders" \(page 890\)](#).
- When a user that is allowed access is added, users that were already set must also be included in the specification.

<i>users</i>	Read-only user names
""	The existing settings are all deleted.

-cifs-user-access-rw

Optional. This parameter specifies the CIFS user with the Read-Write privilege. For details on how to specify CIFS users, refer to ["1.2.23 NFS Connection Host, CIFS Connection Host, or NFS/CIFS Connection Host Syntax" \(page 49\)](#).

If the "nas-share" parameter is specified with a single value and the NFS protocol is used, this parameter cannot be specified.

The settings can be changed only if the "nas-share" parameter is specified with multiple values or "all" and the NAS shared folder is CIFS or NFS/CIFS common.

If "homes" is specified with the "-share-name" parameter or if the folder number of the user-specific folder "homes" is specified with the "-share-number" parameter, this parameter cannot be specified.

This parameter cannot be specified for a duplicate user with the "-cifs-user-access-r" parameter.

For the user name that is already registered with the "-cifs-user-access-r" parameter, this parameter may not be used for specifying as long as the user name is not deleted from the "-cifs-user-access-r" parameter.

For example, CIFS connection privilege can be specified as follows.

- If "-cifs-user-access-rw userA,userB" is specified for a NAS shared folder that is not set with the "-cifs-user-access-r", "-cifs-user-access-rw", "-cifs-group-access-r", or "-cifs-group-access-rw" parameter
Read-Write privilege: userA and userB
No access: All users other than userA and userB
- If "-cifs-user-access-rw userA,userB,userC" is specified to the above NAS shared folder
Read-Write privilege: userA, userB, and userC
No access: All users other than userA, userB, and userC

 **Caution**

- CIFS connections are unavailable to all unspecified users or groups if one of the following parameters is specified: "-cifs-user-access-r", "-cifs-user-access-rw", "-cifs-group-access-r", or "-cifs-group-access-rw". For details, refer to ["Access privileges of the user and group" \(page 890\)](#) of ["7.1 Shared Folders" \(page 890\)](#).
- When a user that is allowed access is added, users that were already set must also be included in the specification.

<i>users</i>	Read-Write user names
""	The existing settings are all deleted.

-cifs-group-access-r

Optional. This parameter specifies the CIFS group with the Read-only privilege. For details on how to specify CIFS groups, refer to ["1.2.23 NFS Connection Host, CIFS Connection Host, or NFS/CIFS Connection Host Syntax" \(page 49\)](#).

The CIFS group name can be specified with "everyone".

If the "nas-share" parameter is specified with a single value and the NFS protocol is used, this parameter cannot be specified.

The settings can be changed only if the "nas-share" parameter is specified with multiple values or "all" and the NAS shared folder is CIFS or NFS/CIFS common.

If "homes" is specified with the "-share-name" parameter or if the folder number of the user-specific folder "homes" is specified with the "-share-number" parameter, this parameter cannot be specified.

This parameter cannot be specified for a duplicate user with the "-cifs-group-access-r" parameter.

For the group name that is already registered with the "-cifs-group-access-r" parameter, this parameter may not be used for specifying as long as the group name is not deleted from the "-cifs-group-access-r" parameter. If omitted, the existing setting is not changed.

For example, CIFS connection privilege can be specified as follows.

- If "-cifs-group-access-r groupA,groupB" is specified to the NAS shared folder that is not set with the "-cifs-user-access-r", "-cifs-user-access-rw", "-cifs-group-access-r", or "-cifs-group-access-rw" parameters
Read-only privilege: groupA and groupB
No access: All users who do not belong to groupA and groupB
- If "-cifs-group-access-r groupA,groupB,groupC" is specified to the above NAS shared folder
Read-only privilege: groupA, groupB, and groupC
No access: All users who do not belong to groupA, groupB, and groupC

- If "-cifs-group-access-r everyone" is specified to the NAS shared folder where only userA has the Read-Write privilege
Read-Write privilege: userA
Read-only privilege: All users other than userA
- If "-cifs-group-access-r groupA" is specified to the NAS shared folder where only userA has the Read-Write privilege
Read-Write privilege: userA
Read-only privilege: All users who belongs to groupA other than userA
No access: All users who do not belong to groupA

 **Caution**

- CIFS connections are unavailable to all unspecified users or groups if one of the following parameters is specified: "-cifs-user-access-r", "-cifs-user-access-rw", "-cifs-group-access-r", or "-cifs-group-access-rw". Privileges for the NFS connection follows the settings of the "-access" parameter. For details, refer to ["Access privileges of the user and group" \(page 890\)](#) of ["7.1 Shared Folders" \(page 890\)](#).
- When a group that is allowed access is added, groups that were already set must also be included in the specification.
- If "-cifs-group-access-r everyone" is specified, the existing access privilege settings of the "-cifs-user-access-rw" and "-cifs-group-access-rw" parameters are retained and the other users are given Read-only privileges.
- If the user is specified with the Read-Write privilege and the group where the user belongs is specified with the Read-only privilege, the specified user is given the Read-Write privilege and the other users that belong to the group are given the Read-only privilege.

<i>groups</i>	Read-only group names
""	The existing settings are all deleted.

-cifs-group-access-rw

Optional. This parameter specifies the CIFS group with the Read-Write privilege. For details on how to specify CIFS groups, refer to ["1.2.23 NFS Connection Host, CIFS Connection Host, or NFS/CIFS Connection Host Syntax" \(page 49\)](#).

The CIFS group name can be specified with "everyone".

If the "nas-share" parameter is specified with a single value and the NFS protocol is used, this parameter cannot be specified.

The settings can be changed only if the "nas-share" parameter is specified with multiple values or "all" and the NAS shared folder is CIFS or NFS/CIFS common.

If "homes" is specified with the "-share-name" parameter or if the folder number of the user-specific folder "homes" is specified with the "-share-number" parameter, this parameter cannot be specified.

This parameter cannot be specified for a duplicate user with the "-cifs-group-access-rw" parameter.

For the group name that is already registered with the "-cifs-group-access-rw" parameter, this parameter may not be used for specifying as long as the group name is not deleted from the "-cifs-group-access-rw" parameter. If omitted, the existing setting is not changed.

For example, CIFS connection privilege can be specified as follows.

- If "-cifs-group-access-rw groupA,groupB" is specified to the NAS shared folder that is not set with the "-cifs-user-access-r", "-cifs-user-access-rw", "-cifs-group-access-r", or "-cifs-group-access-rw" parameters
Read-Write privilege: groupA and groupB
No access: All users who do not belong to groupA and groupB

- If "-cifs-group-access-rw groupA,groupB,groupC" is specified to the above NAS shared folder.
Read-Write privilege: groupA, groupB, and groupC
No access: All users who do not belong to groupA, groupB, and groupC
- If "-cifs-group-access-rw everyone" is specified to the NAS shared folder where only userA has the Read-Write privilege
Read-Write privilege: All users (including userA)
- If "-cifs-group-access-rw groupA" is specified to the NAS shared folder where only userA (who belongs to groupA) has the Read-Write privilege
Read-Write privilege: All users who belongs to groupA (including userA)
No access: All users who do not belong to groupA

 **Caution**

- CIFS connections are unavailable to all unspecified users or groups if one of the following parameters is specified: "-cifs-user-access-r", "-cifs-user-access-rw", "-cifs-group-access-r", or "-cifs-group-access-rw". For details, refer to ["Access privileges of the user and group" \(page 890\)](#) of ["7.1 Shared Folders" \(page 890\)](#).
- When a group that is allowed access is added, groups that were already set must also be included in the specification.
- If "-cifs-group-access-rw everyone" is specified, all users are given Read-Write access regardless of the other specified parameters (-cifs-user-access-r, -cifs-user-access-rw, -cifs-group-access-r).
- If the user is specified with the Read-only privilege and the group where the user belongs is specified with the Read-Write privilege, the specified user is given the Read-Write privilege because the Read-Write privilege takes precedence.

groups Read-Write group names
"" The existing settings are all deleted.

-audit-log Optional. This parameter specifies whether to enable the NAS audit log function of the NAS shared folder. If the NAS audit log function is enabled, the audit log is recorded in the NAS expanded system volume. This parameter cannot be specified if the NFS protocol is used. The settings can be changed only if the NAS shared folder is CIFS or NFS/CIFS common. If omitted, this parameter is not changed.

enable The NAS audit log function is enabled.
disable The NAS audit log function is disabled.

■ Example(s)

The following example shows settings for changing the access privileges of shared folders #2 and #4 to Read only:

```
CLI> set nas-share -share-number 2,4 -access r
```

The following example shows settings for unsharing the "NewFolder" shared folder:

```
CLI> set nas-share -share-name NewFolder -share inactive
```

The following examples show settings for changing the CIFS connection privileges of the NAS shared folder.

- Before changes

```
CLI> create nas-share -share-number 2 -name NewFolder -volume-name NAS_1 -service cifs -cifs-user-access-r userA  
-cifs-user-access-rw userB -cifs-group-access-r groupB -cifs-group-access-rw groupC
```

The Read-only privilege is given to userA and groupB, the Read-Write privilege is given to userB and groupC, and the other users and groups are denied access.

- After changes

```
CLI> set nas-share -share-number 2 -cifs-user-access-r userA,userC -cifs-user-access-rw userD  
-cifs-group-access-rw ""
```

The Read-only privilege is given to userA, userC and groupB, the Read-Write privilege is given to userD, and the other users and groups are denied access. (userC is given the Read-only privilege, userD is added with the Read-Write privilege, access privilege settings for userB and group C are deleted, and the access privilege (Read-only privilege) of groupB is retained).

delete nas-share

This command deletes a NAS shared folder.

Note

If the shared folder cannot be deleted with this command due to data remaining in the shared folder, use the "clear nas-data" command to delete all the data.

Syntax

```
delete nas-share {-share-number share_number | -share-name share_name | -all} [-force]
```

Parameter

-share-number, -share-name, or -all

This parameter specifies a NAS shared folder to be deleted. When the "-share-number" parameter is used, multiple numbers up to 128 can be specified at the same time by inserting a hyphen (-) or a comma (,) between them as a delimiter. When the "-share-name" parameter is used, only one NAS shared folder can be specified. For details on how to specify names, refer to "[1.2.21 Shared Folder Syntax](#)" (page 48). When the "-all" parameter is used, all the NAS shared folders in the ETERNUS DX/AF are deleted.

Caution

- If files and folders (including hidden files and hidden folders) exist in the specified NAS shared folder, the NAS shared folder cannot be deleted. Delete the files and folders that exist in the NAS shared folder in advance.
- A NAS shared folder that does not exist cannot be specified.
- When the NAS shared folder name includes multibyte characters, specify the number with the "-share-number" parameter.
- If the specified shared folder is set with a quota, the quota is deleted when the shared folder is deleted. If the deletion of the quota setting fails, the deletion process of the shared folder does not execute.
- If the shared folder is deleted, the NAS audit log file and the NAS audit log folder of the specified shared folder are deleted at the same time. In addition, if the FTP publishing setting information is in the specified shared folder, the FTP publishing information is also deleted.

<i>share_number</i>	NAS shared folder number
<i>share_name</i>	NAS shared folder name
-all	All NAS shared folders

-force Optional. This parameter forcibly deletes the specified shared folder.

Caution

Do not use this parameter. When restoring the NAS function by deleting the NAS volume, use this parameter in order to delete the shared folder by force.

■ Example(s)

The following example shows settings for deleting shared folders #2, #3, and #4:

```
CLI> delete nas-share -share-number 2-4
```

The following example shows settings for deleting shared folders #2 and #5:

```
CLI> delete nas-share -share-number 2,5
```

The following example shows settings for deleting the "NewFolder" shared folder:

```
CLI> delete nas-share -share-name NewFolder
```

clear nas-data

This command deletes all data under the specified NAS shared folder.

Note

- This command prompt is immediately returned and the deletion process is executed in the background.
- If the deletion data is large, the deletion process takes time.
- If a deletion is executing in the background, a new deletion request cannot be performed. In addition, the running process can be referenced using the "show nas-share-progress" command.
- If the ETERNUS DX/AF is shut down while a deletion is executing in the background, this command must be re-executed.
- If the NAS shared folder is accessed during a data deletion, files may remain in the NAS shared folder.

Syntax

```
clear nas-data {-share-number share_numbers | -share-name share_name}
```

Parameter

-share-number or -share-name

This parameter specifies a NAS shared folder for deleting the data. When using a name, only one name can be specified. When using a number, multiple numbers can be specified.

Caution

- NAS shared folders that do not exist cannot be specified.
- If multiple NAS shared folders are specified, the deletion process is performed in ascending order of the NAS shared folder number. The order for deleting the data cannot be specified.
- When the NAS shared folder name includes multibyte characters, specify the number with the "-share-number" parameter.

share_numbers NAS shared folder numbers

share_name NAS shared folder name

Example(s)

The following example deletes the data of NAS shared folder numbers 2, 3, and 4:

```
CLI> clear nas-data -share-number 2-4
```

The following example deletes the data of NAS shared folder numbers 2 and 5:

```
CLI> clear nas-data -share-number 2,5
```

The following example deletes the data of the NAS shared folder name "NewFolder":

```
CLI> clear nas-data -share-name NewFolder
```

show nas-share-progress

This command displays the progress of the processes for the data deletion of the NAS shared folder, the initialization of the ACL information, the deletion of the user home directories, or the running inflation process.

Syntax

```
show nas-share-progress
```

Parameter

No parameters.

Output

Item name	Description
The list of shared folders during deletion	Displayed when a data deletion of the NAS shared folder is being executed.
Share	List of executing deletions among the NAS shared folders that are specified with the "clear nas-data" command. NAS shared folders in which the deletion completed or failed are not displayed.
No.	NAS shared folder number of the NAS data deletion that is being executed.
Name	NAS shared folder name of the NAS data deletion that is being executed.
Initializing ACL Progress Information	Displayed when the ACL information is being initialized.
Share No.	NAS shared folder number of the ACL information that is being initialized
Share Name	NAS shared folder name of the ACL information that is being initialized
Completed Object Count	The number of targets in which the initialization of the ACL information is completed. If the total number of ACL information initialization targets is being calculated, a hyphen (-) is displayed.
Total Object Count	Total number of ACL information initialization targets the moment the process starts. If the process targets increased or decreased due to access after the process started, the actual number of process targets may differ from the number displayed. When the total number of ACL information initialization targets is being calculated, "Calculating" is displayed.
File Inflate Progress Information	Displayed when an inflation process is running.
Share No.	Shared folder number of the running inflation process
Share Name	Shared folder name of the running inflation process
File Path	Sparse file path of the running inflation process (relative path of the NAS shared folder set as the root folder)
Provisioned Size (KB)	Provisioning size of the Sparse file of the running inflation process (logical size)
Inflate Progress	Displays the allocated capacity ratio (= allocated capacity / provisioning size) of the Sparse file of the running inflation process. For "Overwrite", the process begins from the numerical value that is dependent on the existing allocation capacity, but the process itself is performed for the entire file so some time may pass until the numerical value begins to increase. If the inflation process completes normally, because a process that becomes 100% is complete, this command does not display that process. After the process is complete, check the File Allocation Status by specifying the target file with the "show nas-file-inflate" command.

Item name	Description
The list of user home directories under deletion	Displayed when deleting user home directories.
User home directories	Name of the user home directory currently being deleted

■ Example(s)

The following information is displayed when the data of NAS shared folder numbers "0" to "4" is deleted:

```
CLI> show nas-share-progress
<The list of shared folders during deletion>
Share
No.   Name
-----
  0 NAS-SHARE#0
  1 NAS-SHARE#1
  2 NAS-SHARE#2
  3 NAS-SHARE#3
  4 NAS-SHARE#4
```

The following information is displayed when calculating the total number of initialization targets with the initialization process of the ACL information for NAS shared folder number "0":

```
CLI> show nas-share-progress
<Initializing ACL Progress Information>
Share No.           [0]
Share Name          [Share#0]
Completed Object Count [-]
Total Object Count  [Calculating]
```

The following information is shown when the ACL information of NAS shared folder number "0" is being initialized:

```
CLI> show nas-share-progress
<Initializing ACL Progress Information>
Share No.           [0]
Share Name          [Share#0]
Completed Object Count [1000]
Total Object Count  [100000000]
```

The following information is displayed when data is being deleted for NAS shared folder number "0" to "2", the ACL information of NAS shared folder number "4" is being initialized, and an inflate process is being performed for NAS shared folder number "5":

```
CLI> show nas-share-progress
<The list of shared folders during deletion>
Share
No.   Name
-----
  0 NAS-SHARE#0
  1 NAS-SHARE#1
  2 NAS-SHARE#2

<Initializing ACL Progress Information>
Share No.           [4]
Share Name          [Share#4]
Completed Object Count [1000]
Total Object Count  [100000000]

<File Inflate Progress Information>
Share No.           [5]
Share Name          [SHARE#5]
File Path           [vm/myvm-flat.vmdk]
Provisioned Size(KB) [104857600]
Inflate Progress    [56%]
```

The following information is displayed when user home directories are being deleted:

```
CLI> show nas-share-progress
<The list of user home directories under deletion>
domainA\userA
domainB\userB
userA
userB
```

show nas-home-directory

This command displays user home directories.

Note

- The display format and the display content differ depending on the number of specified users and the search result. The size of the user home directory is displayed when all of the following conditions are satisfied.
 - Only one user is specified
 - The specified character string does not include an asterisk (*)
 - The search result is only one user home directory
- If all the parameters are omitted, all existing user home directories are displayed. If the number of user home directories of the display target exceeds 5,000, after displaying 5,000 user home directories the following message is displayed.
"The number of user home directories exceeds the maximum of displayable items."
- A timeout may occur when searching the user home directories. A timeout period is five minutes. If a timeout occurs, the following message is displayed.
"A timeout occurred while searching for home directories."

Syntax

```
show nas-home-directory [-user user_names | -base64-user base64_users]
```

Parameter

-user Optional. This parameter specifies the username of the user home directory that is to be displayed. Alphanumeric characters and symbols (US-ASCII code 0x20 to 0x7E) can be used. However, the following characters cannot be used:

```
"" , "+" , "/" , ":" , ";" , "<" , "=" , ">" , "?" , "@" , "[" , "]" , "|"
```

The characters are case insensitive. A wildcard (*) can be specified. Multiple usernames can be specified by separating them with a comma (.). Up to 2,048 characters can be entered.

When specifying a user that is managed with Active Directory, specify with the following format.

```
netbios domain name\username
```

Example: domain\user1

```
user_names Usernames
```

-base64-user Optional. This parameter specifies the username of the user home directory that is to be displayed in the Base64 format.

 **Caution**

The Base64 encoding format complies with RFC4648. However, there is no newline character.

- The characters after encoding are as follows.
ABCDEFGHIJKLMNOPQRSTUVWXYZabcdefghijklmnopqrstuvwxyz0123456789+/
• The padding character is "=".
- There is no newline character.
- Only the specified characters can be used.
- There is no line checksum.

A wildcard (*) can be specified. Specify the asterisk (*) in the Base64 format. Multiple user names can be specified by separating them with a comma (,). Specify the comma (,) in the Base64 format.

Usernames with a size that exceeds 2,048 Bytes before the character string is encoded with the Base64 format cannot be specified. After the character string is decoded, only UTF-8 is accepted as the character code. When specifying multi-byte character usernames, convert the username (UTF-8) that is to be specified to the Base64 format so that it can be specified as a parameter of this option.

The character string before encoding to the Base64 format is case insensitive.

When specifying a user that is managed with Active Directory, specify with the following format.

netbios domain name\username

Example: domain\user1

base64_user_names Usernames (post-Base64 encoding)

■ **Output**

Item name	Description
User home directory	User home directory
Size (KB)	Size of the user home directory

■ **Example(s)**

The following example displays all user home directories:

```
CLI> show nas-home-directory
domainA\userA
domainA\userAA
domainA\userAAA
domainB\userA
domainB\userB
userA
userB
BASICuserABC
```

The following example shows the output when the user home directories that are to be displayed exceeds 5,000:

```
CLI> show nas-home-directory
domainA\userA
domainA\userAA
domainA\userAAA
domainB\userA
domainB\userB
userA
userB
BASICuserABC
.....
.....
The number of user home directories exceeds the maximum of displayable items.
```

The following example shows the output when one user (userA who is managed by domainA) is specified:

```
CLI> show nas-home-directory -user domainA\userA
<User Home Directory Information>
User home directory [domainA\userA]
Size (KB)           [3072]
```

The following example shows the output when multiple users (userA and userB) are specified:

```
CLI> show nas-home-directory -user userA,userB
userA
userB
domainA\userA
domainB\userB
```

The following example shows the output when userA and userAA who are managed by domainA are specified:

```
CLI> show nas-home-directory -user domain\userA,domain\userAA
domainA\userA
domainA\userAA
```

The following example displays all the user home directories that are managed by domainA:

```
CLI> show nas-home-directory -user domainA\*
domainA\userX
domainA\userY
domainA\userZ
```

The following example displays all the user home directories when "-user *" is specified.
The result is the same as when no parameters are specified:

```
CLI> show nas-home-directory -user *
domainA\userA
domainA\userAA
domainA\userAAA
domainB\userA
BASICuserABC
```

The following example displays all the user home directories which include the character string "userA":

```
CLI> show nas-home-directory -user *userA*
domainA\userA
domainA\userAA
domainA\userAAA
domainB\userA
BASICuserABC
```

The following example shows the output when a timeout occurs during a search process for user home directories and a partial search result is displayed:

```
CLI> show nas-home-directory
domainA\userA
domainA\userAA
domainA\userAAA
domainB\userA
BASICuserABC

A timeout occurred while searching for home directories.
```

The following example shows the output when a timeout occurs during a search process for user home directories and no search results are displayed:

```
CLI> show nas-home-directory

A timeout occurred while searching for home directories.
```

delete nas-home-directory

This command deletes user home directories.

The progress for the deletion process of the user home directories can be checked with the "show nas-share-progress" command.

Note

To confirm whether the user home directory was deleted properly, first make sure the user home directory of the running deletion process no longer exists with the "show nas-share-progress" command, and then make sure the deleted user home directory is no longer displayed with the "show nas-home-directory" command.

Syntax

```
delete nas-home-directory {-user user_names | -base64-user base64_user_names}
```

Parameter

-user This parameter specifies the user name of the user home directory that is to be deleted. Alphanumeric characters and symbols (US-ASCII code 0x20 to 0x7E) can be used. However, the following characters cannot be used:

```
"" , "*" , "+" , "/" , ":" , ";" , "<" , "=" , ">" , "?" , "@" , "[" , "]" , "|"
```

The characters are case insensitive. Multiple user names can be specified by separating them with a comma (.). Duplicate users cannot be specified. Up to 2,048 characters can be entered.

When specifying a user that is managed with Active Directory, specify with the following format.

```
netbios domain name\username
```

Example: domain\user1

```
user_names User names
```

-base64-user This parameter specifies the user name of the user home directory that is to be deleted in the Base64 format.

Caution

The Base64 encoding format complies with RFC4648. However, there is no newline character.

- The characters after encoding are as follows.
ABCDEFGHIJKLMNOPQRSTUVWXYZabcdefghijklmnopqrstuvwxyz0123456789+/
• The padding character is "=".
- There is no newline character.
- Only the specified characters can be used.
- There is no line checksum.

Multiple user names can be specified by separating them with a comma (,). Duplicate users cannot be specified. Specify the comma (,) in the Base64 format.

Usernames with a size that exceeds 2,048 Bytes before the character string is encoded with the Base64 format cannot be specified. After the character string is decoded, only UTF-8 is accepted as the character code. When specifying multi-byte character usernames, convert the username (UTF-8) that is to be specified to the Base64 format so that it can be specified as a parameter of this option.

The character string before encoding to the Base64 format is case insensitive.

When specifying a user that is managed with Active Directory, specify with the following format.

netbios domain name\username

Example: domain\user1

base64_user_names User names (post-Base64 encoding)

■ Example(s)

The following example deletes the user home directories of userA and userB:

```
CLI> delete nas-home-directory -user userA,userB
```

The following example deletes the user home directories of userA who is managed by domainA and userB who is managed by domainB:

```
CLI> delete nas-home-directory -user domainA\userA,domainB\userB
```

7.2 Network Interface

This section describes the commands that are related to management of the NAS network interface. The functions that control the NAS network interface are as follows:

- Displaying the NAS network interface
- Creating the NAS network interface
- Changing NAS network interface settings
- Deleting the NAS network interface

show nas-interface

This command displays information about the NAS interface that is registered in the ETERNUS DX/AF.

Caution

If the NAS interface identifier is specified, information is displayed only for the specified NAS interface or port. If omitted, an overview of the NAS interface is displayed in a list.

■ Syntax

```
show nas-interface [-nas-if-number nas-if-number] [-port port]
```

■ Parameter

-nas-if-number

Optional. This parameter specifies the NAS interface number to be displayed. When the "-nas-if-number" parameter is used, multiple numbers can be specified by inserting a hyphen (-) or a comma (,) between them as a delimiter.

nas-if-number NAS interface number

-port

Optional. This parameter specifies the NAS port to be displayed. Only the NAS interface that is assigned to the specified NAS port is displayed. Multiple ports can be specified by inserting a hyphen (-) or a comma (,) between them as a delimiter.

Example: -port 000,001

For details, refer to "[1.2.15 Host Interface Port Syntax](#)" (page 44).

Caution

A non-NAS port or a member port for bonding is ignored if specified.

port NAS port

■ Output

Item name	Description
NAS Interface No.	NAS interface number
Port	Port number
VLAN ID	VLAN ID. If no value is specified, a hyphen (-) is displayed.
RIP	Indicates whether to receive routing information using Routing Information Protocol (RIP) (Enable or Disable).
IP Address	IPv4 address. If no value is specified, a hyphen (-) is displayed.
Subnet Mask	IPv4 subnet mask. If no value is specified, a hyphen (-) is displayed.
Gateway IP Address	IPv4 gateway address. If no value is specified, a hyphen (-) is displayed.
Link Local Address	IPv6 link local address. If no value is specified, a hyphen (-) is displayed.

Item name	Description
Connect IP Address or Subnet Prefix Length	IPv6 global address, unique local IP address, or IPv6 subnet prefix length. If no value is specified, a hyphen (-) is displayed.
IPv6 Gateway IP Address	IPv6 gateway address. If no value is specified, a hyphen (-) is displayed.

■ Example(s)

The following example shows settings when no option is specified:

```
CLI> show nas-interface
<NAS Interface Information>
NAS Interface No.      [25]
Port                  [CM#0 CA#0 Port#0]
VLAN ID               [4090]
RIP                   [Enable]
IP Address             [192.168.2.64]
Subnet Mask            [255.255.255.0]
Gateway IP Address    [0.0.0.0]
Link Local Address    [-]
Connect IP Address    [-]
IPv6 Gateway IP Address [-]
```

```
<NAS Interface Information>
NAS Interface No.      [20]
Port                  [CM#0 CA#0 Port#1]
VLAN ID               [4080]
RIP                   [Disable]
IP Address             [-]
Subnet Mask            [-]
Gateway IP Address    [-]
Link Local Address    [FE80::290:CCFF:FEA4:3A49]
Connect IP Address    [2001:DB8::8:800:200C:417A/7]
IPv6 Gateway IP Address [FE80::2AA:FF:FE9A:21B8]
```

The following example shows settings when the NAS interface number is specified:

```
CLI> show nas-interface -nas-if-number 25
<NAS Interface Information>
NAS Interface No.      [25]
Port                  [CM#0 CA#0 Port#0]
VLAN ID               [4090]
RIP                   [Enable]
IP Address             [192.168.2.64]
Subnet Mask            [255.255.255.0]
Gateway IP Address    [0.0.0.0]
Link Local Address    [-]
Connect IP Address    [-]
IPv6 Gateway IP Address [-]
```

The following example shows settings when the NAS port is specified:

```
CLI> show nas-interface -port 001
<NAS Interface Information>
NAS Interface No.      [20]
Port                  [CM#0 CA#0 Port#1]
VLAN ID               [4080]
RIP                   [Disable]
IP Address             [-]
Subnet Mask            [-]
Gateway IP Address    [-]
Link Local Address    [FE80::290:CCFF:FEA4:3A49]
Connect IP Address    [2001:DB8::8:800:200C:417A/7]
IPv6 Gateway IP Address [FE80::2AA:FF:FE9A:21B8]
```

create nas-interface

This parameter creates a NAS network interface. In the NAS interface definition, at least one valid IP address (the "-ip" parameter, the "-link-local-ip" parameter, or the "-connect-ip" parameter) must be specified. A maximum of 160 network interfaces can be created per ETERNUS DX/AF.

Syntax

```
create nas-interface [-port port] [-rip {enable | disable}]  
[-vlan-id vlanid] [-ip ip_address -netmask netmask] [-gateway gateway_address]  
[-link-local-ip link_local_address]  
[-connect-ip ip_address -subnet-prefix-length prefix_length]  
[-ipv6-gateway gateway_address]
```

Parameter

-port Optional. This parameter specifies the port to which the NAS interface is to be assigned.

Caution

- Only NAS ports can be specified.
- A port that is set as a member port for bonding cannot be specified.
- When VLANID is not specified, multiple NAS interface cannot be assigned to each NAS port.
- When VLANID is specified, up to 160 NAS interfaces can be assigned to each NAS port.
- When VLANID is specified, the same VLANID cannot be assigned multiple times to each NAS port.

port Port to which the NAS interface is assigned
Example: -port 100

-rip Optional. This parameter specifies whether to receive routing information using the Routing Information Protocol (RIP). The RIP supports receive processing, but does not support send processing.

enable Routing information is received using RIP (default)
disable Routing information is not received using RIP

-vlan-id Optional. This parameter specifies a VLAN ID between 0 and 4094. When "0" is specified, VLAN is disabled.

vlanid VLAN ID (0 to 4094)

-ip Optional. This parameter specifies the IPv4 address of the NAS interface.

Caution

- An address that conflicts with that of another NAS interface cannot be specified.
- The "-netmask" parameter must be set.

ip_address IPv4 address of the NAS interface
Example: 192.168.0.100

-netmask Optional. This parameter specifies the subnet mask of the IPv4 address between 192.0.0.0 and 255.255.255.252.

 **Caution**

The "-ip" parameter must be set.

netmask Subnet mask of IPv4 address (192.0.0.0 to 255.255.255.252)

-gateway Optional. This parameter specifies the IPv4 gateway address.

 **Caution**

- The address of a different subnet cannot be specified.
- The "-ip" parameter must be set.

gateway_address IPv4 gateway address.
Example: 192.168.0.1

-link-local-ip Optional. This parameter specifies the IPv6 link local address of the NAS interface.

 **Caution**

- An address that conflicts with that of another NAS interface cannot be specified.
- Only a link local address can be specified.

link_local_address IPv6 link local address of the NAS interface
Example: fe80::0123:4567:89ab:cdef

-connect-ip Optional. This parameter specifies the IPv6 global address or unique local address of the NAS interface.

 **Caution**

- An address that conflicts with that of another NAS interface cannot be specified.
- Only a global address or unique local address can be specified.
- The "-subnet-prefix-length" parameter must be set.

ip_address IPv6 global address or unique local address of the NAS interface
Example: 2001:db8:20:3:1000:100:20:3

-subnet-prefix-length Optional. This parameter specifies the subnet prefix length of the NAS interface between 3 and 128.

prefix_length Subnet prefix length of the NAS interface (3 to 128)

-ipv6-gateway Optional. This parameter specifies the IPv6 gateway address.

 **Caution**

- The address of a different subnet cannot be specified.
 - A link local address can be specified.
 - The "-connect-ip" parameter must be set.
-

gateway_address IPv6 gateway address
Example: 2001:db8::1234:0:0:9abc

■ Example(s)

The following example shows the settings for creating a NAS interface with an IPv4 address. The created NAS interface is then assigned to CM#0 CA#0 Port#0.

```
CLI> create nas-interface -port 000 -ip 192.168.0.100 -netmask 255.255.255.0 -gateway 192.168.0.1
```

The following example shows the settings for creating a NAS interface with an IPv6 address. The created NAS interface is then assigned to CM#0 CA#0 Port#1.

```
CLI> create nas-interface -port 001 -link-local-ip fe80::0123:4567:89ab:cdef -connect-ip 2001:db8:20:3:1000:100:20:3  
-subnet-prefix-length 64 -ipv6-gateway 2001:db8:20:3:1000:100:20:1
```

set nas-interface

This command changes NAS network interface settings. In the NAS interface definition, at least one valid IP address (the "-ip" parameter, the "-link-local-ip" parameter, or the "-connect-ip" parameter) must be specified. A maximum of 160 network interfaces can be created per ETERNUS DX/AF.

Syntax

```
set nas-interface -nas-if-number nas-if-number  
[-port {port | ""}] [-rip {enable | disable}]  
[-ip {ip_address | "" | 0.0.0.0} -netmask {netmask | "" | 0.0.0.0}]  
[-gateway {gateway_address | "" | 0.0.0.0}]  
[-link-local-ip {link_local_address | "" | ::}] [-connect-ip {ip_address | "" | ::}]  
[-subnet-prefix-length {prefix_length}] [-ipv6-gateway {gateway_address | "" | ::}]
```

Parameter

-nas-if-number

This parameter specifies one target NAS interface.

Caution

- A NAS interface that does not exist cannot be specified.
- Only users with Software roles can specify multiple NAS interfaces by separating the numbers with a comma (-).
 - The "-port" parameter must be specified.
 - Parameters other than "-port" are ignored even if they are specified.

nas-if-number NAS interface number

-port

Optional. This parameter specifies the port to which the NAS interface is to be assigned. To delete a port, specify a null character ("").

Caution

- Only NAS ports can be specified.
- A port that is set as a member port for bonding cannot be specified.
- When VLANID is not specified, only one NAS interface can be assigned to each NAS port.
- When VLANID is specified, up to 160 NAS interfaces can be assigned to each NAS port.
- The same VLANID NAS interface cannot be assigned multiple times to a single NAS port.

port Port to be assigned
Example: -port 100

"" The port to which the NAS interface is to be assigned is deleted.

-rip

Optional. This parameter specifies whether to receive routing information using the Routing Information Protocol (RIP). The RIP supports receive processing, but does not support send processing.

enable Routing information is received using RIP.

disable Routing information is not received using RIP

-ip Optional. This parameter specifies the IPv4 address of the NAS interface. To delete the IPv4 address, specify a null character ("") or "0.0.0.0".

 **Caution**

- An address that conflicts with that of another NAS interface cannot be specified.
- The "-netmask" parameter must be set.

ip_address IPv4 address of the NAS interface
Example: 192.168.0.100

"" or 0.0.0.0 The IPv4 address of the NAS interface is deleted.

-netmask Optional. This parameter specifies the subnet mask of the IPv4 address between 192.0.0.0 and 255.255.255.252. To delete the subnet mask of the IPv4 address, specify a null character ("") or "0.0.0.0".

 **Caution**

The "-ip" parameter must be set.

netmask Subnet mask of IPv4 address
(192.0.0.0 – 255.255.255.252)

"" or 0.0.0.0 The subnet mask of the IPv4 address is deleted.

-gateway Optional. This parameter specifies the IPv4 gateway address. To delete the IPv4 gateway address, specify a null character ("") or "0.0.0.0".

 **Caution**

- The address of a different subnet cannot be specified.
- The "-ip" parameter must be set.

gateway_address IPv4 gateway address.
Example: 192.168.0.1

"" or 0.0.0.0 The IPv4 gateway address is deleted.

-link-local-ip Optional. This parameter specifies the IPv6 link local address of the NAS interface. To delete the IPv6 link local address, specify a null character ("") or two colons (::).

 **Caution**

- An address that conflicts with that of another NAS interface cannot be specified.
- Only a link local address can be specified.

link_local_address IPv6 link local address of the NAS interface
Example: fe80::0123:4567:89ab:cdef

"" or :: The IPv6 link local address of the NAS interface is deleted.

-connect-ip Optional. This parameter specifies the IPv6 global address or unique local address of the NAS interface. To delete the IPv6 global address or the unique local address, specify a null character ("") or two colons (::).

 **Caution**

- An address that conflicts with that of another NAS interface cannot be specified.
- Only a global address or unique local address can be specified.
- The "-subnet-prefix-length" parameter must be set.

ip_address IPv6 global address or unique local address of the NAS interface
Example: 2001:db8:20:3:1000:100:20:3

"" or :: The IPv6 global address or unique local address of the NAS interface is deleted.

-subnet-prefix-length

Optional. This parameter specifies the subnet prefix length of the NAS interface between 3 and 128.

 **Caution**

- The "-connect-ip" parameter must be set.
- If the setting of the "-connect-ip" parameter is deleted, the setting of the "-subnet-prefix-length" parameter is also deleted.

prefix_length Subnet prefix length of the NAS interface (3 to 128)

-ipv6-gateway

Optional. This parameter specifies the IPv6 gateway address. To delete the IPv6 gateway address, specify a null character ("") or two colons (::).

 **Caution**

- The address of a different subnet cannot be specified.
- A link local address can be specified.
- The "-connect-ip" parameter must be set.

gateway_address IPv6 gateway address
Example: 2001:db8::1234:0:0:9abc

"" or :: The IPv6 gateway address is deleted.

■ Example(s)

The following example shows settings for changing the IPv4 address of NAS interface #0:

```
CLI> set nas-interface -nas-if-number 0 -ip 192.168.0.101
```

The following example shows settings for changing the IPv6 address of NAS interface #1:

```
CLI> create nas-interface -nas-if-number 1 -connect-ip 2001:db8:20:3:1000:100:20:4
```

delete nas-interface

This command deletes a NAS interface.

Syntax

```
delete nas-interface {-nas-if-number nas-if-number | -all}
```

Parameter

-nas-if-number or -all

This parameter specifies the NAS interface to be deleted. When the "nas-if-number" parameter is used, multiple numbers can be specified by inserting a hyphen (-) or a comma (,) between them as a delimiter. When the "-all" parameter is used, all the NAS interfaces on the ETERNUS DX/AF are deleted.

Caution

A NAS interface that does not exist cannot be specified.

<i>nas-if-number</i>	NAS interface number
-all	All NAS interfaces

Example(s)

The following example shows settings for deleting NAS interfaces #2, #3, and #4:

```
CLI> delete nas-interface -nas-if-number 2-4
```

The following example shows settings for deleting NAS interfaces #2 and #5:

```
CLI> delete nas-interface -nas-if-number 2,5
```

The following example shows settings for deleting NAS interface #1:

```
CLI> delete nas-interface -nas-if-number 1
```

The following example shows settings for deleting NAS interfaces of all numbers:

```
CLI> delete nas-interface -all
```

7.3 Network Interface Bonding Settings

This section describes the commands that are related to management of the NAS network interface bonding settings. The functions that control the NAS network interface bonding settings are as follows:

- Displaying the NAS network interface bonding settings
- Configuring the NAS network interface bonding settings
- Canceling the NAS network interface bonding settings

show nas-bonding

This command displays the NAS port bonding settings.

Syntax

```
show nas-bonding
```

Parameter

No parameters.

Output

Item name	Description
Master Port	Master port number
Member Port	Member port number
Bonding Mode	Bonding mode (balance-rr, active-backup, balance-or, 802.3ad, balance-tlb, and balance-alb)
Hash Policy	Hash policy (L2, L23, L34)

Example(s)

The following example shows the NAS port Bonding settings:

```
CLI> show nas-bonding
<Bonding Information>
Master Port      [CM#0 CA#0 Port#0]
Member Port      [CM#0 CA#1 Port#0, CM#0 CA#1 Port#1]
Bonding Mode     [balance-xor]
Hash Policy      [L2]

<Bonding Information>
Master Port      [CM#1 CA#0 Port#0]
Member Port      [CM#1 CA#1 Port#0, CM#1 CA#1 Port#1]
Bonding Mode     [balance-xor]
Hash Policy      [L2]
```

set nas-bonding

This command configures NAS port bonding settings. Up to 15 member ports can be assigned to a single master port.

Syntax

```
set nas-bonding -master-port port1 [-member-port port2,port3,...]  
[-mode {0 | 1 | 2 | 4 | 5 | 6}] [-hash-policy {L2 | L23 | L34}]
```

Parameter

-master-port

This parameter specifies the port that is to be set as the master port.

Caution

- The following ports cannot be specified:
 - Ports other than the NAS port
 - Ports that are already specified as a member port
 - Ports with multipath settings
- When performing new bonding settings, the NAS interface port setting that is set to the specified port is deleted.
When a master port that has already been set with bonding settings is specified, the NAS interface port setting is preserved.

port1 Master port
Example: -master-port 001

-member-port

Optional. This parameter specifies the ports that are to be set as member ports. Multiple member ports can be specified by inserting a comma (,) between them as a delimiter.
To add a member port, specify only the target port. If a port that has already been assigned to a member port of the target master port is specified, it does not cause an error.

Caution

- The following ports cannot be specified:
 - Ports other than the NAS port
 - Ports that are specified as a master port
 - Ports that are specified as a member port for other master ports
 - Ports with multipath settings
 - Ports with different CMs from the master port
- The settings of the NAS interface port that is assigned to the member port are deleted.

port2,port3,... Member port
Example: -member-port 100,101

-mode Optional. This parameter specifies the bonding mode.

0	balance-rr
1	active-backup
2	balance-xor
4	802.3ad
5	balance-tlb
6	balance-alb

-hash-policy Optional. This parameter specifies the hash policy. If omitted, this parameter is set to L2 or equivalent.

 **Caution**

This setting is only enabled when "-mode" is "2 (balance-xor)" or "4 (802.3ad)". Note that specifying this parameter is available for other "-mode" settings.

L2	Layer2 (Default)
L23	Layer2+3
L34	Layer3+4

■ Example(s)

The following example shows settings for assigning CM#1 CA#0 Port#0 to a master port and assigning CM#1 CA#0 Port#1 and CM#1 CA#1 Port#1 to member ports:

```
CLI> set nas-bonding -master-port 100 -member-port 101,111 -mode 1
```

The following example shows settings for adding CM#1 CA#0 Port#1 to the master port CM#1 CA#1 Port#1 as a member port:

```
CLI> set nas-bonding -master-port 111 -member-port 101 -mode 2 -hash-policy L23
```

delete nas-bonding

This command cancels the NAS port bonding settings.

Syntax

```
delete nas-bonding -master-port port1 [-member-port port2,port3,...]
```

Parameter

-master-port

This parameter specifies the master port to be canceled.

Caution

- A port for which no bonding settings are configured as a master port cannot be specified.
- If the bonding settings are canceled, the NAS interface port setting that was set is deleted.
- The port that is set in the multipath cannot be specified.

port1 Master port to be canceled
Example: -master-port 001

-member-port

Optional. This parameter specifies the member port to be canceled. Multiple member ports can be specified by inserting a comma (,) between them as a delimiter.
If this parameter is omitted, bonding of the master port that is specified by the "-master-port" parameter is canceled. If this parameter is specified, only bonding of the specified port is canceled. However, if canceling bonding of the specified member port eliminates all of the member ports of the master port, bonding of the master port is canceled.

Caution

A port for which no bonding settings are configured as a member port cannot be specified.

port2,port3,... Member port to be canceled
Example: -member-port 100,101

Example(s)

The following example shows settings for canceling bonding settings of member ports, CM#0 CA#1 Port#0 and CM#0 CA#1 Port#1, of the master port, CM#0 CA#0 Port#0:

```
CLI> show nas-bonding
<Bonding Information>
Master Port            [CM#0 CA#0 Port#0]
Member Port            [CM#0 CA#1 Port#0,CM#0 CA#1 Port#1,,,,,]
Bonding Mode           [balance-xor]
Hash Policy            [L2]

CLI> delete nas-bonding -master-port 000

CLI> show nas-bonding
```

The following example shows settings for canceling bonding settings of CM#0 CA#1 Port#0 from member ports, CM#0 CA#1 Port#0 and CM#0 CA#1 Port#1, of the master port, CM#0 CA#0 Port#0:

```
CLI> show nas-bonding
<Bonding Information>
Master Port      [CM#0 CA#0 Port#0]
Member Port      [CM#0 CA#1 Port#0,CM#0 CA#1 Port#1,,,,,]
Bonding Mode     [balance-xor]
Hash Policy      [L2]

CLI> delete nas-bonding -master-port 000 -member-port 010

CLI> show nas-bonding
<Bonding Information>
Master Port      [CM#0 CA#0 Port#0]
Member Port      [CM#0 CA#1 Port#1,,,,,]
Bonding Mode     [balance-xor]
Hash Policy      [L2]
```

The following example shows settings for canceling bonding settings of CM#0 CA#1 Port#0 and CM#0 CA#1 Port#1 from member ports, CM#0 CA#1 Port#0 and CM#0 CA#1 Port#1, of the master port, CM#0 CA#0 Port#0:

```
CLI> show nas-bonding
<Bonding Information>
Master Port      [CM#0 CA#0 Port#0]
Member Port      [CM#0 CA#1 Port#0,CM#0 CA#1 Port#1,,,,,]
Bonding Mode     [balance-xor]
Hash Policy      [L2]

CLI> delete nas-bonding -master-port 000 -member-port 010,011

CLI> show nas-bonding
```

7.4 Network Interface Multipath Configuration

This section describes the commands that are related to a multipath configuration of the NAS network interface. The functions that control a NAS network interface multipath configuration are as follows:

- Displaying the NAS network interface multipath configuration
- Configuring the NAS network interface multipath
- Deleting the NAS network interface multipath configuration

show nas-multipath

This command displays the NAS port multipath configuration.

Syntax

```
show nas-multipath
```

Parameter

No parameters.

Output

Item name	Description
CM#x CA#y Port#z <-> CM#x CA#y Port#z	Port numbers for which a multipath is configured

Example(s)

The following example displays the port that is configured with multipath:

```
CLI> show nas-multipath
CM#0 CA#0 Port#0 <-> CM#1 CA#0 Port#0 (Normal)
CM#0 CA#0 Port#1 <-> CM#1 CA#0 Port#1 (Normal)
CM#0 CA#1 Port#0 <-> CM#1 CA#1 Port#0 (Normal)
CM#0 CA#1 Port#1 <-> CM#1 CA#1 Port#1 (Normal)
```

The following example displays the port that is configured with multipath (when only one of the ports for configuring the multipath is used):

```
CLI> show nas-multipath
CM#0 CA#0 Port#0 <-> CM#1 CA#0 Port#0 (CM#0 CA#0 Port#0 is currently inactive)
CM#0 CA#0 Port#1 <-> CM#1 CA#0 Port#1 (CM#1 CA#0 Port#1 is currently inactive)
CM#0 CA#1 Port#0 <-> CM#1 CA#1 Port#0 (Normal)
CM#0 CA#1 Port#1 <-> CM#1 CA#1 Port#1 (Normal)
```

set nas-multipath

This parameter sets a multipath configuration for NAS ports.

■ Syntax

```
set nas-multipath -port port1,port2
```

■ Parameter

-port This parameter specifies the ports that are paired in the multipath configuration. Insert a comma (,) between each of the ports as a delimiter.

Caution

The following ports cannot be specified:

- Ports other than the NAS port
- Ports that are paired with another port
- Ports that are already specified as a member port
- Ports in the same CM
- Ports in different subnet addresses

port1,port2 Ports that are to be paired
Example: -port 001,101

■ Example(s)

The following example shows the settings to set CM#0 CA#0 Port#1 and CM#1 CA#0 Port#1 as a pair:

```
CLI> set nas-multipath -port 001,101
```

delete nas-multipath

This parameter cancels a multipath configuration for NAS ports.

■ Syntax

```
delete nas-multipath -port port1,port2
```

■ Parameter

-port This parameter specifies the ports for which the multipath setting is canceled. Insert a comma (,) between each of the ports as a delimiter.

 **Caution**

Ports without a multipath configuration cannot be specified.

port1,port2 Ports that are to be paired
Example: -port 001,101

■ Example(s)

The following example shows the settings to cancel the pairing of CM#0 CA#0 Port#1 and CM#1 CA#0 Port#1:

```
CLI> delete nas-multipath -port 001,101
```

7.5 Network Settings

This section describes the commands that are related to management of the NAS network connection. The functions that control the NAS network connection are as follows:

- Displaying the NAS network interface port settings
- Configuring the NAS network interface port
- Displaying the DNS server
- Adding the DNS server
- Deleting the DNS server
- Displaying the IPv4 route of the NAS interface
- Adding the IPv4 static route of the NAS interface
- Deleting the IPv4 route of the NAS interface
- Displaying the IPv6 route of the NAS interface
- Adding the IPv6 static route of the NAS interface
- Deleting the IPv6 route of the NAS interface

show nas-port

This command displays information of the parameters that are used to control NAS ports.

Syntax

```
show nas-port [-port ports]
```

Parameter

-port Optional. This parameter specifies the NAS port of which information is to be displayed based on the format of the host interface. Multiple member ports can be specified by inserting a comma (,) between them as a delimiter.

Caution

If a non-NAS port is specified, the target port information is not displayed.

ports NAS port
Example: -port 000,001

Output

Item name	Description
Location	NAS port number of which information is to be displayed
MAC Address	MAC address
Transfer Rate	The transfer rate and the communication method (bandwidth) setting of the NAS port
MTU	MTU (Jumbo Frame) size setting
CIFS	CIFS connection firewall setting
NFS	NFS connection firewall setting
FTP	FTP connection firewall setting
FXP	FXP connection firewall setting
RIP	RIP connection firewall setting
ICMP	ICMP connection firewall setting
PRIMECLUSTER	PRIMECLUSTER connection firewall setting
Local User Password	Firewall setting value of the port for changing normal user passwords in the local user authentication Displayed only for the Security Setting policy
Link detected	Current link status
Speed	Transfer rate of the current link
Duplex	Communication method (bandwidth) of the current link

■ Example(s)

The following example shows the output when the parameters are omitted:

```
CLI> show nas-port
<NAS Port Information>
Location          [CM#0 CA#0 Port#0]
MAC Address       [F8-0F-41-29-EF-7B]
Transfer Rate     [10Gbps]
MTU               [5000]
CIFS              [Open]
NFS               [Open]
FTP              [Open]
FXP              [Open]
RIP              [Open]
ICMP             [Open]
PRIMECLUSTER     [Open]
Local User Password [Open]
Link detected     [Yes]
Speed            [1Gbps]
Duplex           [Full]

<NAS Port Information>
Location          [CM#0 CA#0 Port#1]
MAC Address       [F8-0F-41-29-EF-7C]
Transfer Rate     [10Gbps]
MTU               [5000]
CIFS              [Open]
NFS               [Open]
FTP              [Open]
FXP              [Open]
RIP              [Open]
ICMP             [Open]
PRIMECLUSTER     [Open]
Local User Password [Close]
Link detected     [No]
Speed            [-]
Duplex           [-]
```

set nas-port

This command configures the parameters that control NAS ports.

Caution

- When Bonding ports, the contents that were set with this command operate as the set value of the master port.
- When deleting the Bonding, the master port and member port values that became active during the Bonding configuration are maintained.

Syntax

```
set nas-port -port ports  
[-mtu mtu_size] [-rate {auto | 1g | 100mfull}] [-cifs {open | close}] [-nfs {open | close}]  
[-rip {open | close}] [-icmp {open | close}] [-primecluster {open | close}]  
[-ftp {open | close}] [-fxp {open | close}] [-local-user-password {open | close}]
```

Parameter

-port This parameter specifies the NAS port to be configured based on the format of the host interface port. Multiple ports can be specified by inserting a comma (,) between them as a delimiter.

Caution

- Only NAS ports can be specified.
- If a port bonding setting is configured, member ports cannot be specified.

<i>ports</i>	NAS port Example: -port 000,001
-mtu	Optional. This parameter specifies the MTU size between 576 and 9000. If omitted, this parameter is not changed. The default value is 1500. <i>mtu_size</i> MTU size (576 to 9000)
-rate	Optional. This parameter specifies the transfer rate of the NAS port. If omitted, this parameter is not changed. The default value is "auto" (1Gbit/s for 1Gbit/s NAS ports and 10Gbit/s for 10Gbit/s NAS ports). However, only "auto" can be specified for 10Gbit/s NAS ports. auto Automatic 1g 1Gbit/s (1Gbit/s NAS ports only) 100mfull 100Mbit/s Full Duplex (Full duplication) (1Gbit/s NAS ports only)
-cifs	Optional. This parameter specifies whether the CIFS connection is enabled or disabled. If omitted, this parameter is not changed. The default value is "open". open The CIFS connection is enabled. close The CIFS connection is disabled.
-nfs	Optional. This parameter specifies whether the NFS connection is enabled or disabled. If omitted, this parameter is not changed. The default value is "open".

- open The NFS connection is enabled.
 - close The NFS connection is disabled.
- rip Optional. This parameter specifies whether the RIP connection is enabled or disabled. If omitted, this parameter is not changed. The default value is "open".
- open The RIP connection is enabled.
 - close The RIP connection is disabled.
- icmp Optional. This parameter specifies whether the ICMP connection is enabled or disabled. If omitted, this parameter is not changed. The default value is "open".
- open The ICMP connection is enabled.
 - close The ICMP connection is disabled.
- primecluster
- Optional. This parameter specifies whether the PRIMECLUSTER connection is enabled or disabled. If omitted, this parameter is not changed. The default value is "close".
- open The PRIMECLUSTER connection is enabled.
 - close The PRIMECLUSTER connection is disabled.
- ftp Optional. This parameter specifies whether to enable or disable the FTP connection. If omitted, the existing setting is not changed. The default value is "close".
- open The FTP connection is enabled.
 - close The FTP connection is disabled.
- fxp Optional. This parameter specifies whether to enable or disable the FXP connection. If omitted, the existing setting is not changed. The default value is "close".
- open The FXP connection is enabled.
 - close The FXP connection is disabled.
- local-user-password
- Optional. The Security Settings policy is required. This parameter specifies whether to open the port (TCP port 30022) for changing passwords of the local user authentication. If omitted, the existing setting is not changed. the default value is "close".

If the port for changing passwords is opened, the password of the local user who is logged into that port with SSH can be changed.

For example, if local user UserA is logged into the port for changing passwords with SSH, only the password of UserA can be changed. The passwords of other local users such as UserB cannot be changed.

 **Caution**

While the port for changing passwords is open, the following commands cannot be executed.

- create nas-local-user
- create nas-local-group
- set nas-local-user
- delete nas-local-user
- delete nas-local-group

open	The port for changing passwords of the local user authentication is opened.
close	The port for changing passwords of the local user authentication is closed.

■ Example(s)

The following example shows settings for assigning the transfer rate to 1Gbit/s and the MTU size to 9000 for the NAS port at CM#0 CA#0 Port#0:

```
CLI> set nas-port -port 000 -mtu 9000 -rate 1g
```

show nas-dns

This command displays the DNS server settings.

■ Syntax

```
show nas-dns
```

■ Parameter

No parameters.

■ Output

Item name	Description
Primary(IPv4)	Primary IPv4 address for the DNS server
Secondary(IPv4)	Secondary IPv4 address for the DNS server
Primary(IPv6)	Primary IPv6 global address or unique local address of the DNS server
Secondary(IPv6)	Secondary IPv6 global address or unique local address of the DNS server

■ Example(s)

The following example shows settings for displaying the DNS server settings.

```
CLI> show nas-dns
Primary (IPv4)      [10.23.4.3]
Secondary (IPv4)   [10.0.8.3]
Primary (IPv6)     [-]
Secondary (IPv6)   [-]
```

set nas-dns

This command configures the DNS server.

Syntax

```
set nas-dns [-primary-ip {ip_address | ""}] [-secondary-ip {ip_address | ""}]  
[-primary-ipv6 {ipv6_address | ""}] [-secondary-ipv6 {ipv6_address | ""}]
```

Parameter

-primary-ip Optional. This parameter specifies the primary IPv4 address of the DNS server. To delete a setting, specify a null character (""). If omitted, this parameter is not changed.

Caution

- The primary DNS server cannot be set with the same IP address as the secondary DNS server.
- If the secondary IPv4 addresses have been specified, the primary IPv4 addresses cannot be deleted.

ip_address Primary IPv4 address
"" The primary IPv4 address is deleted.

-secondary-ip Optional. This parameter specifies the secondary IPv4 address of the DNS server. To delete a setting, specify a null character (""). If omitted, this parameter is not changed.

Caution

- The secondary DNS server cannot be set with the same IP address as the primary DNS server.
- If the primary IPv4 addresses have not been specified, the secondary IPv4 addresses cannot be set.

ip_address Secondary IPv4 address
"" The secondary IPv4 address is deleted.

-primary-ipv6 Optional. This parameter specifies the primary IPv6 global address or unique local address of the DNS server. To delete a setting, specify a null character (""). If omitted, this parameter is not changed.

Caution

- The primary DNS server cannot be set with the same IP address as the secondary DNS server.
- If the secondary IPv6 global addresses or the unique local address have been specified, the primary IPv6 global addresses or the unique local address cannot be deleted.

ip_address Primary IPv6 global address or unique local address
"" The primary IPv6 global address or unique local address is deleted.

-secondary-ipv6 Optional. This parameter specifies the secondary IPv6 global address or unique local address of the DNS server. To delete a setting, specify a null character (""). If omitted, this parameter is not changed.

 **Caution**

- The secondary DNS server cannot be set with the same IP address as the primary DNS server.
- If the primary IPv6 global addresses or the unique local address have not been specified, the secondary IPv6 global addresses or the unique local address cannot be set.

ip_address Secondary IPv6 global address or unique local address

"" The secondary IPv6 global address or unique local address is deleted.

■ Example(s)

The following example shows the settings for a DNS server.

```
CLI> set nas-dns -primary-ip 10.20.30.40 -secondary-ip 20.30.40.50
```

show nas-route

This command displays IPv4 route information of the NAS interface.

■ Syntax

```
show nas-route [-mode {startup | current}]
```

■ Parameter

- mode Optional. This parameter specifies route information to be displayed.
- startup Information is displayed regarding the static route that is to be specified when the system starts (default).
- current The current IP routing table is displayed for each CM.

■ Output

- When the "startup" option is specified.

Item name	Description
Target	Indicates whether the target is a network or host.
Destination	IP address of the target network or host
Gateway	Gateway address
Netmask	Netmask of the target network
NAS Interface No.	NAS interface number

- When the "current" option is specified.

Item name	Description
Destination	IP address of the target network or host
Gateway	Gateway address
Netmask	Netmask of the target network
Flags	Routing flag
Iface	NAS interface number

■ Example(s)

The following example shows settings when "startup" is specified:

```
CLI> show nas-route -mode startup
<IP Route Information>
Target          [Network]
Destination     [192.168.0.10]
Gateway        [192.168.0.100]
Netmask        [255.255.255.0]
NAS Interface No. [0]

Target          [Host]
Destination     [192.168.0.10]
Gateway        [192.168.0.110]
Netmask        [-]
NAS Interface No. [0]
```

The following example shows settings when "current" is specified:

```
CLI> show nas-route -mode current
<CM#0 IP Routing Table>
Destination      Gateway          Genmask          Iface
192.168.4.0     0.0.0.0         255.255.255.0   2
192.168.2.0     0.0.0.0         255.255.255.0   0
169.254.0.0     0.0.0.0         255.255.0.0     0
169.254.0.0     0.0.0.0         255.255.0.0     2

<CM#1 IP Routing Table>
Destination      Gateway          Genmask          Iface
192.168.5.0     0.0.0.0         255.255.255.0   3
192.168.2.0     0.0.0.0         255.255.255.0   1
169.254.0.0     0.0.0.0         255.255.0.0     3
169.254.0.0     0.0.0.0         255.255.0.0     1
```

set nas-route

This command adds the IPv4 static route of the NAS interface. The specified route remains enabled, unless it is deleted, even after the system is rebooted. If a NAS interface setting is changed or deleted, the route may be deleted automatically. The specified route can be checked by using the "-mode startup" parameter of the "show nas-route" command.

Syntax

```
set nas-route {{-host host_ip_address -gw gateway_address -nas-if-number nas-if-number} |  
{-net net_ip_address -gw gateway_address -netmask netmask -nas-if-number nas-if-number}}
```

Parameter

- host This parameter specifies the IP address of the destination host in the route in IPv4 format. If the network is selected as the destination, specify the target with the "-net" parameter.
- host_ip_address* IP address of destination host (IPv4 format)
Example: -host 192.168.2.10
- net This parameter specifies the IP address of the destination network in the route in IPv4 format. If the host is selected as the destination, specify the target with the "-host" parameter.
- net_ip_address* IP address of destination network (IPv4 format)
Example: -net 192.168.2.0
- gw This parameter specifies the gateway IP address that is to be used by the route in IPv4 format.
- gateway_address* Gateway IP address (IPv4 format)
Example: -gw 192.168.0.1
- netmask This parameter specifies the netmask of the destination network in IPv4 format. From 192.0.0.0 to 255.255.255.252 can be specified for the netmask with this parameter.
- netmask* Netmask (IPv4 format) (192.0.0.0 to 255.255.255.252)
Example: -netmask 255.255.255.0
- nas-if-number This parameter specifies one NAS interface that is to be used by the route.

Caution

- A NAS interface number that does not exist cannot be specified.
- If the specified NAS interface number is assigned to the port that configures the multipath, both CMs must be set with the same route.
If the route on both CMs are set differently, the route information is not set correctly when a line failure occurs and the CM communications path is switched.

nas-if-number NAS interface number

■ Example(s)

The following example shows settings for assigning a static route to network 192.168.2.0:

```
CLI> set nas-route -net 192.168.2.0 -gw 192.168.0.1 -netmask 255.255.255.0 -nas-if-number 1
```

The following example shows settings for assigning a static route to host 192.168.2.10:

```
CLI> set nas-route -host 192.168.2.10 -gw 192.168.0.1 -nas-if-number 1
```

delete nas-route

This command deletes an IPv4 static route that has been set using the "set nas-route" command. The static routes that can be deleted by this command are the routes that can be displayed by with the "-mode startup" parameter of the "show nas-route" command.

Syntax

```
delete nas-route {{-host host_ipaddress -gw gateway_address -nas-if-number nas-if-number} |  
{-net net_ip_address -gw gateway_address -netmask netmask -nas-if-number nas-if-number} | -all}
```

Parameter

- host** This parameter specifies the IP address of the destination host in the route, that is to be deleted, in IPv4 format.
- host_ip_address* IP address of destination host (IPv4 format)
Example: -host 192.168.2.10
- net** This parameter specifies the IP address of the destination network in the route, that is to be deleted, in IPv4 format.
- net_ip_address* IP address of destination network (IPv4 format)
Example: -net 192.168.2.0
- gw** This parameter specifies the gateway IP address, that is to be deleted, in IPv4 format. However, if the "-all" parameter is specified, the "-gw" parameter is optional.
- gateway_address* Gateway IP address (IPv4 format)
Example: -gw 192.168.0.1
- netmask** This parameter specifies the netmask of the destination network, that is to be deleted, in IPv4 format.
- netmask* Netmask (IPv4 format)
Example: -netmask 255.255.255.0
- nas-if-number** This parameter specifies one NAS interface that is used by the route to be deleted.

Caution

- A NAS interface number that does not exist cannot be specified.
- If the specified NAS interface number is assigned to the port that configures the multipath, both CMs must be set with the same route.
If the route on both CMs are set differently, the route information is not set correctly when a line failure occurs and the communications path is switched.

nas-if-number NAS interface number

- all** This parameter deletes all routes that can be deleted.
- all* All routes

■ Example(s)

The following example shows settings for deleting a static route to network 192.168.2.0:

```
CLI> delete nas-route -net 192.168.2.0 -gw 192.168.0.1 -netmask 255.255.255.0 -nas-if-number 1
```

The following example shows settings for deleting a static route to host 192.168.2.10:

```
CLI> delete nas-route -host 192.168.2.10 -gw 192.168.0.1 -nas-if-number 1
```

show nas-route6

This command displays IPv6 route information of the NAS interface.

Syntax

```
show nas-route6 [-mode {current | startup}]
```

Parameter

- mode Optional. This parameter specifies route information to be displayed.
- current The current IP routing table is displayed for each CM.
 - startup Information is displayed for the static route that is to be specified when the system starts (default).

Output

- When the "startup" option is specified.

Item name	Description
Destination	IP address of the target network or host
Prefix length	Prefix length of the target network
Gateway	Gateway address
NAS Interface No.	NAS interface name

- When the "current" option is specified.

Item name	Description
Destination	IP address of the target network or host
Gateway	Gateway address
If	NAS interface name

Example(s)

The following example shows settings when "startup" is specified:

```
CLI> show nas-route6 -mode startup
<IP Route Information>
Destination        [2001:db8:1:1::]
Prefix length     [64]
Gateway           [::]
NAS Interface No. [0]
```

The following example shows settings when "current" is specified:

```
CLI> show nas-route6 -mode current
<CM#0 IP Routing Table>
Destination      Next Hop      Iface
fe80::/64       ::           0
fe80::/64       ::           2
ff00::/8        ::           0
ff00::/8        ::           2

<CM#1 IP Routing Table>
Destination      Next Hop      Iface
fe80::/64       ::           1
ff00::/8        ::           1
```

set nas-route6

This parameter adds the IPv6 static route of the NAS interface. The specified route remains enabled, unless it is deleted, even after the system is rebooted. If a NAS interface setting is changed or deleted, the route may be deleted automatically. The specified route can be checked by using the "-mode startup" parameter of the "show nas-route6" command.

Syntax

```
set nas-route6 -ip target_ipv6_address [-subnet-prefix-length prefix_length]  
-gw gateway_address -nas-if-number nas-if-number
```

Parameter

-ip This parameter specifies the destination IPv6 address in the route.

target_ipv6_address IP address (IPv6 format)
Example: -ip 2001:db8::/32

Caution

Specify an IP address on the subnet different from the IP address specified with the "-gw" parameter.

-subnet-prefix-length

Optional. This parameter specifies the subnet prefix length between 3 and 128. If this parameter is omitted, "128" is specified.

prefix_length Subnet prefix length (3 to 128)

-gw This parameter specifies the gateway IP address that is used by the route.

gateway_address Gateway IP address (IPv6 format)
Example: -gw fe80::250:56ff:feaa:2c1b

Caution

Specify an IP address on the same subnet as the NAS interface.

-nas-if-number

This parameter specifies one NAS interface that is to be used by the route.

Caution

- A NAS interface number that does not exist cannot be specified.
- If the specified NAS interface number is assigned to the port that configures the multipath, both CMs must be set with the same route.
If the route on both CMs are set differently, the route information is not set correctly when a line failure occurs and the CM communications path is switched.

nas-if-number NAS interface number

■ Example(s)

The following example shows settings for assigning a static route to fe80::250:56ff:feaa:2c1b:

```
CLI> set nas-route6 2001:db8:: -subnet-prefix-length 32 -gw fe80::250:56ff:feaa:2c1b -nas-if-number 1
```

delete nas-route6

This command deletes an IPv6 static route that has been set using the "set nas-route6" command. The static routes that can be deleted by this command are the routes that can be displayed by with the "-mode startup" parameter of the "show nas-route6" command.

Syntax

```
delete nas-route6 {{-ip target_ipv6_address [-subnet-prefix-length prefix_length]  
-gw gateway_address -nas-if-number nas-if-number} | -all}
```

Parameter

- ip** This parameter specifies the destination IPv6 address in the route to be deleted.
target_ipv6_address IP address (IPv6 format)
Example: -ip 2001:db8::/32
- subnet-prefix-length** Optional. This parameter specifies the subnet prefix length that is to be deleted between 3 and 128.
prefix_length Subnet prefix length (3 to 128)
- gw** This parameter specifies the gateway IP address that is used by the route to be deleted. However, if the "-all" parameter is specified, the "-gw" parameter is optional.
gateway_address Gateway IP address (IPv6 format)
Example: -gw fe80::250:56ff:feaa:2c1b
- nas-if-number** This parameter specifies one NAS interface that is to be used by the route.

Caution

- A NAS interface number that does not exist cannot be specified.
- If the specified NAS interface number is assigned to the port that configures the multipath, both CMs must be set with the same route.
If the route on both CMs are set differently, the route information is not set correctly when a line failure occurs and the CM communications path is switched.

-
- nas-if-number* NAS interface number
- all** This parameter deletes all routes that can be deleted.
-all All routes

Example(s)

The following example shows settings for deleting a route to fe80::250:56ff:feaa:2c1b:

```
CLI> delete nas-route6 2001:db8:: -nas-if-number 1
```

7.6 NAS Server Configuration

This section describes the commands that are related to management of the NAS Server configuration. The functions that control the NAS Server configuration are as follows:

- Displaying the NAS Server configuration
- NAS Server configuration
- Executing the meta cache distribution
- Displaying the initial distribution and the current location of the meta cache

■ Meta cache distribution function

The meta cache distribution function is a function that reverts the meta cache location to the initial distribution when the NAS cache (or meta cache) location is biased towards one CM.

Meta cache exists in NAS user volume (nas-tpv) units and NAS backup volume (nas-tpv-backup) units. The meta cache is automatically configured to have no bias between CMs when a NAS volume is created. However, if a failover occurs due to a file system blockage or an unmount, there are cases when the meta cache becomes biased towards one CM. If the meta cache location is in a biased state, the memory resources of one CM will be insufficient or the access performance from the CM without the meta cache will be reduced. If a bias occurs in the meta cache location, insufficient memory resources or reduced access performance can be prevented by reverting the meta cache location to the CM of the initial distribution by using the meta cache distribution function.

The meta cache distribution function can be executed automatically or manually.

- Automatic execution
Enable the automatic meta cache distribution function with the "set nas-server" command.
If enabled, the meta cache location is checked every half hour on the hour whether it has deviated from the initial distribution for all NAS volumes. If the current distribution of the meta cache differs from the initial distribution, a redistribution is executed to automatically revert back to the initial location.
The process to return to the initial location takes a maximum of two minutes. For automatic executions, meta cache distribution is executed regardless of I/O access so there may be cases when the I/O response is delayed for a maximum of two minutes.
Meta cache distribution cannot be executed during a hot maintenance of the controller firmware.
- Manual execution
Use the "initialize nas-cache-distribution" command.
For selected NAS volumes, execute the meta cache distribution function at any time to revert the meta cache location back to the initial distribution.
The initial distribution and the current distribution of the meta cache location can be checked with the "show nas-cache-distribution" command.
The process to revert back to the initial distribution takes a maximum of two minutes per volume.

 **Note**

- While meta cache distribution is running, the response for operations of the target NAS volumes (such as creation / deletion of shared folders for NAS volumes and deletion / mounting / unmounting of NAS volumes) may be delayed for a maximum of two minutes.
 - Automatic execution of the meta cache distribution, snapshot acquisition, and NAS volume expansion have an exclusive relationship. They each wait until the previously running process is complete. If the previous process is not complete even after five minutes have passed, it terminates with an error. Similarly, automatic snapshot acquisition, manual execution of the meta cache distribution, and NAS volume expansion also have an exclusive relationship. For this case, they also wait until the previously running process is complete. If the previous process is not complete even after five minutes have passed, it terminates with an error.
-

show nas-server

This command displays the information of the NAS Server configuration.

■ Syntax

```
show nas-server
```

■ Parameter

No parameters.

■ Output

Item name	Description
Server name	Server name
Server SID	Server security ID (if unset, "-" is displayed)
Service Priority	Services processed on a priority basis (This item always displays "Default" because it is not used.)
NFSv4	Displays whether the NFS version 4 protocol is enabled or disabled (Enable, Disable).
SMB version	SMB protocol version
FXP	Displays whether the FXP is enabled or disabled (Enable, Disable).
Auto initialize cache distribution	Displays whether the automatic meta cache distribution function is enabled or disabled (Enable, Disable).
Show CIFS ADS files	Displays whether the Alternate Data Streams (ADS) file is displayed or not displayed on the client side (Yes, No).
CIFS restrict anonymous	Displays whether access is restricted for anonymous users. This item is displayed only if the users have the Security Setting policy.

■ Example(s)

The following example shows the information of the NAS Server configuration (with the Security Setting policy and without the Maintenance Operation policy):

```
CLI> show nas-server
Server name           [FOOSERVER]
Server SID            [-]
Service Priority      [Default]
NFSv4                 [Enable]
SMB version           [3]
FXP                   [Enable]
Auto initialize cache distribution [Enable]
Show CIFS ADS files  [No]
CIFS restrict anonymous [Yes]
```

set nas-server

This command configures the NAS Server.

Syntax

```
set nas-server [-server-name server_name] [-server-sid security_sid]  
[-nfsv4 {enable | disable}]  
[-smb-version {1 | 2 | 3}] [-fxp {enable | disable}] [-auto-initialize-cache-distribution {enable | disable}]  
[-show-cifs-ads-files {yes | no}] [-cifs-restrict-anonymous {yes | no}]
```

Parameter

-server-name

Optional. This parameter specifies the server name using 1-15 characters.
Alphanumeric characters and symbols can be used.

- Alphanumeric characters
Alphanumeric characters corresponding to US-ASCII code 0x30 to 0x39, 0x41 to 0x5A, and 0x61 to 0x7A.
- Hyphen
The hyphen (-) character corresponding to US-ASCII Code 0x2D.
However, a hyphen (-) cannot be used as the first and/or the last character of the server name.

To reset the server name back to the default value, use the NULL character ("). The default value is a string of characters that starts with "DX" followed by the serial number of the device (10 digit).

server_name Sets the server name.

" Resets the server name to the default values.

-server-sid Optional. This parameter specifies the security ID (SID) for the CIFS service when used with local user authentication.

Specify SIDs in the following format.

S-1-5-21-x-x-x

- Specify 14 to 41 characters.
- The value "S-1-5-21-" is fixed (S is a capital letter).
- For "x" in "x-x-x", specify a number 0 to 4294967295.

If omitted, the system generated SID is used.

Caution

If a new SID is set or the SID setting is changed while the CIFS service is used with local user authentication, the access authority of every user may become lost, and access to files or folders will not be possible. In this case, initialization of the access authority will be required.

-nfsv4 Optional. This parameter specifies whether to enable the NFS version 4 protocol. In order to reflect the settings, the ETERNUS DX/AF must be rebooted. The settings are reflected in the established session after the ETERNUS DX/AF reboots.

 **Caution**

Make sure to reboot the ETERNUS DX/AF after changing the setting. If the operation is started without a reboot, access may stop when a failover or a failback is performed due to failures in, for example, the controller.

enable	The NFS version 4 protocol is enabled.
disable	The NFS version 4 protocol is disabled (default).

-smb-version Optional. This parameter specifies the version of the SMB protocol. If omitted, the existing setting is not changed.

1	SMB protocol version 1
2	SMB protocol version 2
3	SMB protocol version 3 (default)

-fxp Optional. This parameter specifies whether to enable the File eXchange Protocol (FXP).

enable	FXP is enabled.
disable	FXP is disabled (default).

-auto-initialize-cache-distribution Optional. This parameter specifies whether to enable the automatic meta cache distribution function. If omitted, the existing setting is not changed.

 **Caution**

While an automatic meta cache distribution is running, responses for operations (such as shared folder creation/deletion for NAS volumes and NAS volume expansion/deletion/mounting/unmounting/snapshot acquisition) to the target NAS volumes may be delayed for a maximum of two minutes.

enable	The automatic meta cache distribution function is enabled.
disable	The automatic meta cache distribution function is disabled (default).

-show-cifs-ads-files Optional. This parameter specifies whether to display the Alternate Data Streams (ADS) file. If omitted, this parameter is not changed.

 **Caution**

Only users with the Security Setting policy can specify this parameter.

yes	The ADS file is displayed.
no	The ADS file is not displayed.

-cifs-restrict-anonymous

Optional. This parameter specifies whether to restrict access from anonymous users.
If omitted, this parameter is not changed.

 **Caution**

Only users with the Security Setting policy can specify this parameter.

yes	Access from anonymous users is restricted.
no	Access from anonymous users is not restricted.

■ Example(s)

The following example shows settings for assigning the server name to FOOSERVER:

```
CLI> set nas-server -server-name FOOSERVER
```

The following example shows settings for resetting the server name to the default values:

```
CLI> set nas-server -server-name ""
```

The following example shows the setting for enabling the NFS version 4 protocol:

```
CLI> set nas-server -nfsv4 enable
```

The following example shows how to set the SMB protocol to version 1:

```
CLI> set nas-server -smb-version 1
```

The following example shows setting for enabling FXP:

```
CLI> set nas-server -fxp enable
```

The following example enables the automatic meta cache distribution function:

```
CLI> set nas-server -auto-initialize-cache-distribution enable
```

show nas-cache-distribution

This command displays the initial meta cache locations and the current meta cache locations of all NAS user volumes (nas-tpv) and all NAS backup volumes (nas-tpv-backup).

Syntax

```
show nas-cache-distribution
```

Parameter

No parameters.

Output

Item name	Description
Volume	Volume identifier
No.	Volume number
Name	Volume name
Cache Location	Meta cache location
Initial	Initial meta cache location For volumes in which the meta cache location cannot be acquired, a hyphen (-) is displayed.
Current	Current meta cache location For volumes in which the meta cache location cannot be acquired, a hyphen (-) is displayed.

Example(s)

The following example shows the meta cache location of all NAS user volumes (nas-tpv) and all NAS backup volumes (nas-tpv-backup):

```
CLI> show nas-cache-distribution
Volume
No.   Name                Cache Location
      Current  Initial
-----
 3 NAS_VOL#0             CM#0    CM#0
 4 NAS_VOL#1             CM#1    CM#1
 5 NAS_VOL_BK#0         CM#1    CM#0
 6 NAS_VOL_BK#1         CM#1    CM#1
```

The following example shows the output when the meta cache location of NAS_VOL#1 cannot be acquired:

```
CLI> show nas-cache-distribution
Volume
No.   Name                Cache Location
      Current  Initial
-----
 3 NAS_VOL#0             CM#0    CM#0
 4 NAS_VOL#1             -        -
 5 NAS_VOL_BK#0         CM#1    CM#0
 6 NAS_VOL_BK#1         CM#1    CM#1
```

initialize nas-cache-distribution

This command manually executes the meta cache distribution.

Note

- Check the meta cache location with the "show nas-cache-distribution" command and if the meta cache location differs from the initial distribution state, the meta cache location can be reverted to the initial distribution by executing this command.
- If a conflict occurs such as when acquiring a snapshot, the acquisition time of the snapshot may deviate.
- If the error message "ED74C" is output by executing this command, the ETERNUS DX/AF may have been temporarily in a high load state. Wait for a while and try again. In addition, even if the high load state is resolved, there are cases when this error code continues to be output for a maximum of 30 minutes. In that case, try again after approximately 30 minutes.

Syntax

```
initialize nas-cache-distribution  
{-volume-number volume_number | -volume-name volume_name | -all}
```

Parameter

-volume-number, -volume-name, or -all

This parameter specifies the NAS user volume (*nas-tpv*) or the NAS backup volume (*nas-tpv-backup*) to revert the meta cache location to the CM of the initial distribution. Multiple volumes cannot be specified with numbers or names. To specify all NAS user volumes (*nas-tpv*) and all NAS backup volumes (*nas-tpv-backup*), specify "-all".

For details on the specification methods, refer to ["1.2.11 Volume Syntax" \(page 40\)](#).

volume_number NAS user volume number or NAS backup volume number

volume_name NAS user volume name or NAS backup volume name

-all All NAS user volumes and all NAS backup volumes

Example(s)

The following example reverts the meta cache location of NAS user volume NAS_VOL#0 to the initial distribution:

```
CLI> initialize nas-cache-distribution -volume-name NAS_VOL#0
```

The following example reverts the meta cache location of NAS user volume #4 to the initial distribution:

```
CLI> initialize nas-cache-distribution -volume-number 4
```

The following example reverts the meta cache location of all NAS user volumes and all NAS backup volumes to the initial distribution:

```
CLI> initialize nas-cache-distribution -all
```

7.7 Authentication Settings

This section describes the commands that are related to management of the NAS authentication settings. Active Directory authentication/LDAP authentication cannot be used at the same time as the local user authentication. If one of the settings is performed, delete all the other settings.

The functions that control the NAS authentication settings are as follows:

- Displaying the Active Directory settings
- Configuring the Active Directory settings
- Displaying the LDAP settings
- Configuring the LDAP settings
- Displaying the local user
- Creating the local user
- Changing the settings of the local user
- Deleting the local user
- Displaying the local group
- Creating the local group
- Deleting the local group

■ Local user authentication

The local user authentication function is a function that creates, deletes, and displays the local users/local groups that can be used with CIFS authentication and FTP authentication. Access privileges of directories and files on the NAS shared folders can be determined based on the local user/local group. In addition, local users can only access files for which they have access privileges.

The owner of a file that is created by a local user becomes the local user. The primary group of the local user becomes the group.

If local user authentication is used with CIFS operations, the local user settings are enabled after a CIFS reconnection.

Local users/local groups have the following special user and special groups.

● Special user

- shareuser\$ (user ID: 450)

The local user who is used for authenticating with firmware versions earlier than V10L53 if an authentication server is not used.

For firmware versions V10L53 and later, displaying, creating, and deleting the local user, and changing the groups to which the user belongs can be performed from CLI.

● Special group

- shareuser\$ (group ID: 450)

The local group that is used for authenticating with firmware versions earlier than V10L53 if an authentication server is not used.

For firmware versions V10L53 and later, displaying, creating, and deleting the local group can be performed from CLI.

- sharegroup\$ (group ID: 451)

If a local user is created without specifying a primary group, this group is registered as the primary group. The group sharegroup\$ is automatically created and automatically deleted. It cannot be created or deleted from CLI.

- BUILTIN groups

They are local groups that are set in advance with fixed privileges. They can be registered as the secondary group of the local users, but they cannot be registered as the primary group.

For firmware versions V10L53 and later, because the BUILTIN groups are registered in the ETERNUS DX/AF, they cannot be created or deleted from CLI.

The following three groups are available for BUILTIN groups.

- BUILTIN_Administrators (group ID: 1002)
Has full control privileges.
- BUILTIN_Users (group ID: 1003)
Has privileges to perform mostly basic operations.
- BUILTIN_BackupOperators (group ID: 1004)
Has privileges to backup and restore all files regardless of access permissions.

The available operations or settings for each special group are as follows:

Operation	shareuser\$	sharegroup\$	BUILTIN group
Creation	Manual creation	Automatic creation (if a local user is created without specifying a primary group)	Not available (registered)
Deletion	Manual deletion	Automatic deletion (if the member user is deleted)	Not available
Group ID settings	450 (fixed)	451 (fixed)	1002 to 1004
Primary Group ID setting	Available	Available	Not available
Secondary Group ID setting	Available	Available	Available

show nas-ad

This command displays the information of the Active Directory authentication settings. When the authentication is not set, nothing is displayed.

Caution

This command cannot be executed if local groups other than BUILTIN and local users exist.

■ Syntax

```
show nas-ad
```

■ Parameter

No parameters.

■ Output

Item name	Description
Server 1 to Server 3	IP address or host name of the Active Directory authentication server
Domain	Domain name of the Active Directory authentication server
User	Active Directory domain administrator ID

■ Example(s)

The following example shows the settings when Active Directory authentication is set.

```
CLI> show nas-ad
Server1      [10.21.138.254]
Server2      [example2]
Server3      [-]
Domain       [example.domain]
User         [example_user]
```

The following example shows the settings when Active Directory authentication is not set. Nothing is displayed.

```
CLI> show nas-ad
Server1      [-]
Server2      [-]
Server3      [-]
Domain       [-]
User         [-]
```

set nas-ad

This command configures settings for performing authentication using Active Directory.

Caution

- Kerberos authentication is used by default.
- This command is available only in the shared folder that uses CIFS or NFS/CIFS.
- When using an authentication server, both CMs must be ready to communicate with the authentication server. For each CM, the following requirements must be met.
 - Using the "create nas-interface" command, an IP address is assigned to one or more ports.
 - Using the port above, the CM is in a state capable of communicating with the authentication server.If the above requirements are not met and the command fails, fulfill the requirements, and execute the command again.
- If the setting for the authentication server did not end successfully, execute the command again after the system status becomes normal.
- When this command ends successfully, the NAS Engine restarts.
- If a setting is reconfigured after it was deleted, the previous setting value is not held.
- To create a new setting, the "-server1" parameter (or the "-server2" parameter or the "-server3" parameter), the "-domain" parameter, and the "-user" parameter must be specified.
- If the host name is specified, the IP address is internally referenced from DNS. If the DNS settings are changed, a reconfiguration may be required using this command.
- To delete a setting, the server IP address, the host name settings, the setting value for "-domain", and the setting value for "-user" must be deleted. To delete the values for each of these settings, specify a null character ("").
- If a null character ("") is not used for the "-user" parameter, a password must be entered after the command is executed.
- If the usable NAS interface is not configured, this command can be only used to delete the settings.
- The time must be synchronized between the ETERNUS DX/AF and the Active Directory authentication server. NTP's automatic time correction is recommended.
- This command cannot be executed if local groups other than BUILTIN and local users exist.

Syntax

```
set nas-ad [-server1 {ip_address | host_name | ""}]  
[-server2 {ip_address | host_name | ""}] [-server3 {ip_address | host_name | ""}]  
[-domain {domain_name | ""}] [-user {user_id | ""}]
```

Parameter

-server1 This parameter specifies the character string that is used for the IP address or host name of the Active Directory authentication server. For details, refer to ["1.2.19 Server Syntax" \(page 47\)](#).
-server2
-server3

To delete a setting, specify a null character (""). When any of the options (the "-server1" parameter, the "-server2" parameter, or the "-server3" parameter) has been set, the "-domain" parameter and the "-user" parameter must be set. If omitted, this parameter is not changed.

ip_address IP address
host_name Host name
"" The setting is deleted.

-domain This parameter specifies the character string that is used for the domain name of the Active Directory authentication server. For details, refer to ["1.2.20 Domain Syntax" \(page 47\)](#).

To delete a setting, specify a null character (""). If omitted, this parameter is not changed.

domain_name Domain name
Example: -domain example.domain
"" The setting is deleted.

-user This parameter specifies the character string that is used for the user ID of the Active Directory domain administrator. For details, refer to ["1.2.20 Domain Syntax" \(page 47\)](#).

To delete a setting, specify a null character (""). If omitted, this parameter is not changed.

user_id User ID
Example: -user example-id
"" The setting is deleted.

■ Example(s)

The following example shows settings for creating a new setting value:

```
CLI> set nas-ad -server1 10.21.138.254 -user example_user -domain example.domain
```

The following examples shows settings for deleting a setting value:

```
CLI> set nas-ad -server1 "" -server2 "" -server3 "" -user "" -domain ""
```

show nas-ldap

This command displays the information of the LDAP (such as OpenLDAP) authentication settings. When the authentication is not set, nothing is displayed.

Caution

This command cannot be executed if local groups other than BUILTIN and local users exist.

■ Syntax

```
show nas-ldap
```

■ Output

Item name	Description
Server 1 to Server 3	IP address or host name of the LDAP authentication server
Domain	Domain name of the LDAP authentication server
User	LDAP domain administrator ID

■ Example(s)

The following example shows the settings when LDAP authentication is set:

```
CLI> show nas-ldap
Server1      [10.21.138.254]
Server2      [example2]
Server3      [-]
Domain       [example.domain]
User         [example_user]
```

The following example shows the settings when LDAP authentication is not set. Nothing is displayed:

```
CLI> show nas-ldap
Server1      [-]
Server2      [-]
Server3      [-]
Domain       [-]
User         [-]
```

set nas-ldap

This command configures settings for performing authentication using LDAP (such as OpenLDAP).

Caution

- This command is available only in the shared folder that uses NFS or NFS/CIFS.
- To create a new setting, the "-server1" parameter (or the "-server2" parameter or the "-server3" parameter), the "-domain" parameter, and the "-user" parameter must be specified.
- To delete a setting, the server IP address, the host name settings, the "-domain" parameter, and the "-user" parameter settings must be deleted. To delete the values for each of these settings, specify a null character ("").
- If a setting is reconfigured after it was deleted, the previous setting value is not held.
- If a null character ("" is not used for the "-user" parameter, a password must be entered after the command is executed.
- When using an authentication server, both CMs must be ready to communicate with the authentication server. For each CM, the following requirements must be met.
 - Using the "create nas-interface" command, an IP address is assigned to one or more ports.
 - Using the port above, the CM is in a state capable of communicating with the authentication server.
- If the above requirements are not met and the command fails, fulfill the requirements, and execute the command again.
- If the usable NAS interface is not configured, this command can be only used to delete the settings.
- This command cannot be executed if local groups other than BUILTIN and local users exist.

Syntax

```
set nas-ldap [-server1 {ip_address | host_name | ""}] [-server2 {ip_address | host_name | ""}]  
[-server3 {ip_address | host_name | ""}] [-domain {domain_name | ""}] [-user {user_id | ""}]
```

Parameter

-server1 This parameter specifies the character string that is used for the IP address or host name of the LDAP authentication server. For details, refer to ["1.2.19 Server Syntax" \(page 47\)](#).
-server2
-server3

To delete a setting, specify a null character (""). When any of the options (the "-server1" parameter, the "-server2" parameter, or the "-server3" parameter) has been set, the "-domain" parameter and the "-user" parameter must be set. If omitted, this parameter is not changed.

ip_address IP address
host_name Host name
"" The setting is deleted.

-domain This parameter specifies the character string that is used for the domain name of the LDAP authentication server. For details, refer to ["1.2.20 Domain Syntax" \(page 47\)](#).

To delete a setting, specify a null character (""). If omitted, this parameter is not changed.

domain_name Domain name
Example: -domain example.domain
"" The setting is deleted.

-user This parameter specifies the character string that is used for the user ID of the LDAP domain administrator. For details, refer to ["1.2.19 Server Syntax" \(page 47\)](#).

To delete a setting, specify a null character ("). If omitted, this parameter is not changed.

 **Caution**

Specify the user ID (account) registered in the LDAP authentication server that can manage the target directory and subdirectory trees.
This user ID differs from the "Directory Server Manager (the account that was specified with Directory Manager DN)" that was registered when installing the 389 Directory Server package.

<i>user_id</i>	User ID Example: -user example-id
"	The setting is deleted.

■ Example(s)

The following example shows settings for creating a new setting value:

```
CLI> set nas-ldap -server1 10.21.138.254,example -user example_user -domain example.example
```

The following examples shows settings for deleting a setting value:

```
CLI> set nas-ldap -server1 "" -server2 "" -server3 "" -user "" -domain ""
```

show nas-local-user

This command displays the detailed information of the local users.

Caution

- This command cannot be executed if an Active Directory authentication server or an LDAP authentication server is registered. After deleting all Active Directory authentication servers and all LDAP authentication servers, try again.
- If all parameters are omitted, the information of all local users is displayed.
- If unregistered local users or local groups are specified for the "-uid" or "-gid" parameters, the detailed information of those local users is not displayed.

■ Syntax

```
show nas-local-user  
[-user user_names | -uid user_ids | -group group_names | -gid group_ids]
```

■ Parameter

-user or -uid

Optional. This parameter specifies the local user for displaying the detailed information. Multiple local users can be specified by separating them with a comma (.). If local user names are specified, a range of names cannot be specified. In addition, local users who do not exist cannot be specified. If local user IDs are specified, a range of IDs can be specified. Specify with a range of 450 to 999.

Examples:

```
-user user00  
-user user00,user01  
-uid 501  
-uid 500-750  
-uid 450,500,999
```

user_names Local user names

user_ids Local user IDs

-group or -gid

Optional. This parameter specifies the local group (primary or secondary) to which the local user whose detailed information is to be displayed belongs. Multiple local groups can be specified by separating them with a comma (.). If local group names are specified, a range of names cannot be specified. In addition, local groups that do not exist cannot be specified. If local group IDs are specified, a range of IDs can be specified. Specify with a range of 450 to 1004.

Examples:

```
-group user00  
-group user00,user01  
-gid 501  
-gid 600-1004  
-gid 450,500,999
```

group_names Local group names

group_ids Local group IDs

■ Output

Item name	Description
NAS local user Information	Local user information
User	Local user identification information
ID	Local user ID
Name	Local user name
Primary Group	Primary group identification information
ID	Primary group ID
Name	Primary group name Displayed only if the "-user" parameter or the "-uid" parameter is specified.
Secondary Group	Secondary group identification information If the secondary group is not registered, a hyphen (-) is displayed.
ID	Secondary group ID If there are multiple secondary groups, they are displayed separated by a comma (,).
Name	Secondary group name Displayed only if the "-user" parameter or the "-uid" parameter is specified.

■ Example(s)

The following example shows the information of all local users:

```
CLI> show nas-local-user
User
ID  Name                               Group ID
                                Primary Secondary
-----
450 shareuser$                         451 -
500 user00                             500 501,502,503,504,505,506,507,508,509,510,511,512,513,514,515,516
501 User01                             500 501,599
502 User02                             510 511,512,513,514,515,516,517,518,519,520,521,522,523,1002,1003,1004
999 user99                             599 666,777
```

The following example shows the information of local user whose name is "user00":

```
CLI> show nas-local-user -user user00
<NAS Local User Information>
User ID [500]
User Name [user00]
Primary Group ID / Name [500 / Group000]
Secondary Group ID / Name [501 / Group001]
[502 / Group002]
[503 / Group003]
[504 / Group004]
[505 / Group005]
[506 / Group006]
[507 / Group007]
[508 / Group008]
[509 / Group009]
[510 / Group010]
[511 / Group011]
[512 / Group012]
[513 / Group013]
[514 / Group014]
[515 / Group015]
[516 / group_xxx]
```

The following example shows the information of local users whose IDs are 999 and 450:

```
CLI> show nas-local-user -uid 999,450
<NAS Local User Information>
User ID [450]
User Name [shareuser$]
Primary Group ID / Name [451 / sharegroup$]
Secondary Group ID / Name [- / -]

<NAS Local User Information>
User ID [999]
User Name [user99]
Primary Group ID / Name [599 / group_bcc]
Secondary Group ID / Name [666 / Group066]
[777 / Group081]
```

The following example shows the information of local users in local group name group_bcc (group ID: 599) and group_xxx (group ID: 516):

```
CLI> show nas-local-user -group group_bcc,group_xxx
User Group ID
ID Name Primary Secondary
-----
500 user00 500 501,502,503,504,505,506,507,508,509,510,511,512,513,514,515,516
501 User01 500 501,599
502 User02 510 511,512,513,514,515,516,517,518,519,520,521,522,523,1002,1003,1004
599 User99 599 666,777
```

The following example shows the information of local users in local group ID 501:

```
CLI> show nas-local-user -gid 501
User Group ID
ID Name Primary Secondary
-----
500 user00 500 501,502,503,504,505,506,507,508,509,510,511,512,513,514,515,516
501 User01 500 501,599
```

create nas-local-user

This command creates a local user to perform the local user authentication access.

The created local user can access files for which the local user itself and the local groups (primary and secondary) have access privileges.

Caution

- This command cannot be executed if an Active Directory authentication server or an LDAP authentication server is registered. After deleting all Active Directory authentication servers and all LDAP authentication servers, try again.
- The maximum number of local users that can be created is 100.
- If the port for changing passwords of the local user authentication is set to open, this command cannot be executed. Close the port with the "set nas-port" command and try again.
- Enter the password in the password prompt after entering the command. The characters that can be used for the password are alphanumeric characters and symbols (US-ASCII code 0x20 to 0x7E), 8 to 32 characters in length.

Syntax

```
create nas-local-user -name user_name  
[-uid user_id] [-primary-group group_name | -primary-gid group_id]  
[-secondary-group group_names | -secondary-gid group_ids]
```

Parameter

-name This parameter specifies the local user name that is to be created with 1 to 32 characters. Multiple names cannot be specified. The characters that can be used are alphanumeric characters (US-ASCII code 0x30 to 0x39, 0x41 to 0x5A, and 0x61 to 0x7A), hyphen (-), underscore (_), and dollar sign (\$). However, the dollar sign (\$) can only be specified as the last character of the name. The beginning of the name can be specified with alphanumeric characters or an underscore (_). The characters are case insensitive.

Caution

- The name that is used with the NAS engine user function cannot be specified.
- Local user names that already exist cannot be specified.
- Because the following character strings are special reserved words, they cannot be specified as the local user name.
adm, audio, bin, cdrom, cgroup, daemon, dialout, dip, disk, everyone, floppy, ftp, games, gopher, halt, kmem, ldap, lock, lp, mail, mailnull, man, mem, nfsnobody, nobody, nscd, nslcd, ntp, operator, oprofile, root, rpc, rpcuser, saslauth, shutdown, smmsp, sshd, sync, sys, tape, tcpdump, tty, users, utempter, utmp, uucp, vcsa, video, wheel

user_name Local user name

-uid Optional. This parameter specifies the local user ID that is to be created with the number 450 or a number from 500 to 999. Multiple IDs cannot be specified. If omitted, unused numbers are set in ascending order starting from 500.

 **Caution**

- If shareuser\$ is set for the "-name" parameter, the "-uid" parameter can only be set with the local user ID "450".
- If the "-name" parameter is set with a name other than shareuser\$, the "-uid" parameter cannot be set with the local user ID "450".
- If shareuser\$ is set for the "-name" parameter and the "-uid" parameter is omitted, "450" is set for the local user ID.
- Local user IDs that already exist cannot be specified.

user_id Local user ID

-primary-group or -primary-gid

Optional. This parameter specifies the primary group to which the local user belongs. Multiple groups cannot be specified. If the primary group ID is specified, 450 (shareuser\$), 451 (sharegroup\$), or a number 500 to 999 can be specified.

 **Caution**

- The "-primary-group" parameter cannot be specified at the same time as the "-primary-gid" parameter.
- If the "-primary-group" parameter and the "-primary-gid" parameter are both omitted, sharegroup\$ (group ID: 451) is automatically set. If sharegroup\$ does not exist, it is automatically created.
- The same local group that is specified for the "-secondary-group" parameter or the "-secondary-gid" parameter cannot be specified.
- Local groups that do not exist cannot be specified.

group_name Primary group name

group_id Primary group ID

-secondary-group or -secondary-gid

Optional. This parameter specifies the secondary group to which the local user belongs. Up to 16 groups can be specified at the same time. Multiple groups can be specified by separating them with a comma (,). Duplicate groups cannot be specified. If the secondary group ID is specified, 450 (shareuser\$), 451 (sharegroup\$), a number 500 to 999, 1002 (BUILTIN_Administrators), 1003 (BUILTIN_Users), or 1004 (BUILTIN_BackupOperators) can be specified.

Examples:

-secondary-group groupA,groupB
-secondary-gid 500,501,502

 **Caution**

- The "-secondary-group" parameter cannot be specified at the same time as the "-secondary-gid" parameter.
 - If the "-secondary-group" parameter and the "-secondary-gid" parameter are both omitted, a local group is not registered to the secondary group.
 - The same local group that is specified for the "-primary-group" parameter or the "-primary-gid" parameter cannot be specified.
 - Even if the specified local group is registered as the primary group of other local users, it can be registered to the secondary group.
 - Local groups that do not exist cannot be specified.
-

group_names Secondary group name
group_ids Secondary group ID

■ Example(s)

The following example creates a local user with a local user name "UserA", local user ID "501", primary group ID "600", and secondary group IDs "601" and "602".

The password entered in "Password:" and "Confirm Password:" is not displayed:

```
CLI> create nas-local-user -name UserA -uid 501 -primary-gid 600 -secondary-gid 601,602  
Password:  
Confirm Password:
```

The following example creates a local user with a user name "UserA".

The primary group is set with sharegroup\$ (group ID: 451) and a secondary group is not registered.

The password entered in "Password:" and "Confirm Password:" is not displayed:

```
CLI> create nas-local-user -name UserA  
Password:  
Confirm Password:
```

set nas-local-user

This command changes the local user settings.

Caution

- This command cannot be executed if an Active Directory authentication server or an LDAP authentication server is registered. After deleting all Active Directory authentication servers and all LDAP authentication servers, try again.
- The name and ID of the local user cannot be changed. To change the name or ID, first delete the local user with the "delete nas-local-user" command and then recreate the local user with the "create nas-loca-user" command.
- If all the local users that belong to the sharegroup\$ group (group ID: 451) are deleted by executing this command, the sharegroup\$ group is deleted. Other than sharegroup\$, local groups are not deleted.
- If the port for changing passwords of the local user authentication is set to open, this command cannot be executed. Close the port with the "set nas-port" command and try again.

Syntax

```
set nas-local-user {-user user_name | -uid user_id}  
[-primary-group group_name | -primary-gid group_id]  
[-secondary-group {group_names | ""} | -secondary-gid {group_ids | ""}]  
[-set-password]
```

Parameter

-user or -uid

This parameter specifies the local user whose settings are to be changed. Multiple users cannot be specified. If the local user ID is specified, 450 (shareuser\$) or a number 500 to 999 can be specified.

Caution

Local users that do not exist cannot be specified.

user_name Local user name

user_id Local user ID

-primary-group or -primary-gid

Optional. This parameter specifies the primary group to which the local user belongs. Multiple groups cannot be specified. If the primary group ID is specified, 450 (shareuser\$), 451 (sharegroup\$), or a number 500 to 999 can be specified.

 **Caution**

- The "-primary-group" parameter cannot be specified at the same time as the "-primary-gid" parameter.
- If the "-primary-group" parameter and the "-primary-gid" parameter are both omitted, the settings cannot be changed.
- The same local group as the secondary group cannot be specified.
- If a local group that is registered to the secondary group of the local user whose settings are to be changed is specified, the registration is automatically released from the secondary group. Specifying the "-secondary-group" parameter or the "-secondary-gid" parameter is not required for releasing the registration.
- Local groups that do not exist cannot be specified.

group_name Primary group name
group_id Primary group ID

-secondary-group or -secondary-gid

Optional. This parameter specifies the secondary group to which the local user belongs. Up to 16 groups can be specified at the same time. Multiple groups can be specified by separating them with a comma (.). If the secondary group ID is specified, 450 (shareuser\$), 451 (sharegroup\$), a number 500 to 999, 1002 (BUILTIN Administrators), 1003 (BUILTIN Users), or 1004 (BUILTIN BackupOperators) can be specified.

 **Caution**

- The "-secondary-group" parameter cannot be specified at the same time as the "-secondary-gid" parameter.
- If the "-secondary-group" parameter and the "-secondary-gid" parameter are both omitted, the settings cannot be changed.
- The same local group as the primary group cannot be specified.
- The specified secondary group can be specified as the primary group of other local users.
- If a secondary group is added, specify by including the already configured secondary groups.
- Local groups that do not exist cannot be specified.

group_names Secondary group name
group_ids Secondary group ID
"" All secondary group registrations of the specified local user are released.

-set-password

Optional. This parameter changes the password of the local user. If omitted, the password remains unchanged. If this parameter is specified, enter a new password in the password prompt that is displayed after issuing this command.

 **Note**

The characters that can be used for the password are alphanumeric characters and symbols (US-ASCII code 0x20 to 0x7E), 8 to 32 characters in length.

■ Example(s)

The following example changes the primary group, the secondary group, and the password of local user whose name is "UserA".

The password entered in "Password:" and "Confirm Password:" is not displayed.

- Before changes
Primary group: sharegroup\$ (group ID: 451)
Secondary group: GroupA (group ID: 500) and GroupB (group ID: 501)
- After changes
Primary group: GroupC (group ID: 502)
Secondary group: GroupA (group ID: 500), GroupB (group ID: 501), and GroupD (group ID: 503)

```
CLI> set nas-local-user -user UserA -primary-gid 502 -secondary-gid 500,501,503 -set-password  
Password:  
Confirm Password:
```

The following example changes the secondary group "GroupB" of user "UserA" to the primary group:

- Before changes
Primary group: GroupA
Secondary group: GroupB, GroupC, GroupD, GroupE
- After changes
Primary group: GroupB
Secondary group: GroupC, GroupD, GroupE

```
CLI> set nas-local-user -user UserA -primary-group GroupB
```

The following example releases all secondary group registrations of local user whose name is "UserA". The primary group and password are not changed:

```
CLI> set nas-local-user -user UserA -secondary-gid ""
```

delete nas-local-user

This command deletes the local user.

Caution

- This command cannot be executed if an Active Directory authentication server or an LDAP authentication server is registered. After deleting all Active Directory authentication servers and all LDAP authentication servers, try again.
- The user home directory of the specified local user cannot be deleted with this command. For deletion methods of the user home directory, refer to "[delete nas-home-directory](#)" (page 931).
- Even if a local user is deleted with this command, the data of the corresponding user within the user home directory cannot be deleted.
- If all the local users that belong to the sharegroup\$ group (group ID: 451) are deleted by executing this command, the sharegroup\$ group is deleted. Other than sharegroup\$, local groups are not deleted.
- If the port for changing passwords of the local user authentication is set to open, this command cannot be executed. Close the port with the "set nas-port" command and try again.

■ Syntax

```
delete nas-local-user {-user user_name | -uid user_id}
```

■ Parameter

-user or -uid

This parameter specifies the local user who is to be deleted. Multiple users cannot be specified. If the local user ID is specified, 450 (shareuser\$) or a number 500 to 999 can be specified.

Caution

Local users that do not exist cannot be specified.

user_name Local user name

user_id Local user ID

■ Example(s)

The following example deletes the local user whose local user name is "UserA":

```
CLI> delete nas-local-user -user UserA
```

The following examples deletes the local user whose local user ID is "500":

```
CLI> delete nas-local-user -uid 500
```

show nas-local-group

This command displays the local group information.

Local user information that is registered in the local group can be checked with "show nas-local-user".

Caution

- This command cannot be executed if an Active Directory authentication server or an LDAP authentication server is registered. After deleting all Active Directory authentication servers and all LDAP authentication servers, try again.
- If the parameters are not specified, all local group information is displayed.
- If the "-group" parameter or the "-gid" parameter is specified, the specified local group information is displayed.
- If an unregistered local group is specified in the "-gid" parameter, that local group information is not displayed.

■ Syntax

```
show nas-local-group [-group group_names | -gid group_ids]
```

■ Parameter

-group or -gid

Optional. This parameter specifies the local group whose information is to be displayed. Multiple groups can be specified by separating them with a comma (,). Duplicate groups cannot be specified. If local group names are specified, a range of names cannot be specified. In addition, local groups that do not exist cannot be specified. If local group IDs are specified, a range of IDs can be specified. Specify with a range of 450 to 1004.

Examples:

```
-group group00  
-group group00,group01  
-gid 501  
-gid 700-1004  
-gid 450,500,700
```

group_names Local group name

group_ids Local group ID

■ Example(s)

The following example displays all local group information:

```
CLI > show nas-local-group  
Group ID Group Name  
-----  
450 shareuser$  
451 sharegroup$  
500 Group0  
501 Group1  
502 Group2  
1002 BUILTIN_Administrators  
1003 BUILTIN_Users  
1004 BUILTIN_BackupOperators
```

The following example displays the local group information of the local groups whose names are "Group0" and "Group1":

```
CLI > show nas-local-group -group Group0,Group1
Group ID Group Name
-----
    500 Group0
    501 Group1
```

The following example displays the local group information of the local group whose ID is "501":

```
CLI > show nas-local-group -gid 501
Group ID Group Name
-----
    501 Group1
```

create nas-local-group

This command creates local groups.

Caution

- This command cannot be executed if an Active Directory authentication server or an LDAP authentication server is registered. After deleting all Active Directory authentication servers and all LDAP authentication servers, try again.
- The maximum number of local groups, which includes sharegroup\$ and BUILTIN groups, that can be created is 100.
- Because the following local groups are automatically created, they cannot be created with this command.
 - sharegroup\$ (group ID: 451)
 - BUILTIN groups
BUILTIN_Administrators (group ID: 1002), BUILTIN_Users (group ID: 1003),
BUILTIN_BackupOperators (group ID: 1004)
- To change the group name and group ID of a created local group, first delete the local group and then recreate it.
- If the port for changing passwords of the local user authentication is set to open, this command cannot be executed. Close the port with the "set nas-port" command and try again.

Syntax

```
create nas-local-group -name group_name [-gid group_id]
```

Parameter

-name This parameter specifies the local group name that is to be created with 1 to 32 characters. Multiple names cannot be specified. The characters that can be used are alphanumeric characters (US-ASCII code 0x30 to 0x39, 0x41 to 0x5A, and 0x61 to 0x7A), hyphen (-), underscore (_), and dollar sign (\$). However, the dollar sign (\$) can only be specified as the last character of the name. The beginning of the name can be specified with alphanumeric characters or an underscore (_). The characters are case insensitive. In addition, names with only numbers cannot be specified.

Caution

- The BUILTIN groups and sharegroup\$ cannot be created.
- The name that is used with the NAS engine user function cannot be specified.
- Local group names that already exist cannot be specified.
- Because the following character strings are special reserved words, they cannot be specified as the local group name.
adm, audio, bin, cdrom, cgroup, daemon, dialout, dip, disk, everyone, floppy, ftp, games, gopher, halt, kmem, ldap, lock, lp, mail, mailnull, man, mem, nfsnobody, nobody, nscd, nslcd, ntp, operator, oprofile, root, rpc, rpcuser, saslauth, shutdown, smmsp, sshd, sync, sys, tape, tcpdump, tty, users, utempter, utmp, uucp, vcsa, video, wheel

group_name Local group name

-gid Optional. This parameter specifies the local group ID that is to be created with the number 450 or a number from 500 to 999. Multiple IDs cannot be specified. If omitted, unused numbers are set in ascending order starting from 500.

 **Caution**

- If shareuser\$ is set for the "-name" parameter, the "-gid" parameter can only be set with the local group ID "450".
- If the "-name" parameter is set with a name other than shareuser\$, the "-gid" parameter cannot be set with the local group ID "450".
- If shareuser\$ is set for the "-name" parameter and the "-gid" parameter is omitted, "450" is set for the local group ID.
- Local group IDs that already exist cannot be specified.

group_id Local group ID

■ **Example(s)**

The following example creates a local group with a local group name "group" and a local group ID "650":

```
CLI > create nas-local-group -name group -gid 650
```

The following example creates a local group specified with "group2" in the local group name and by omitting the group ID:

```
CLI > create nas-local-group -name group2
```

delete nas-local-group

This command deletes the local group.

Caution

- This command cannot be executed if an Active Directory authentication server or an LDAP authentication server is registered. After deleting all Active Directory authentication servers and all LDAP authentication servers, try again.
- The local group that is used as the primary group of the local user cannot be deleted.
- The local group that is used as the secondary group of the local user is deleted from the secondary group of the local user.
- The automatically created sharegroup\$ and BUILTIN groups cannot be deleted with this command.
- If the port for changing passwords of the local user authentication is set to open, this command cannot be executed. Close the port with the "set nas-port" command and try again.

Syntax

```
delete nas-local-group {-group group_name | -gid group_id}
```

Parameter

-group or -gid

This parameter specifies the local group that is to be deleted. Multiple groups cannot be specified. If local group IDs are specified, 450 (shareuser\$) or a number 500 to 999 can be specified.

Caution

- The BUILTIN groups (group ID: 1002 to 1004) and sharegroup\$ (group ID: 451) cannot be deleted.
- Local groups that do not exist cannot be specified.

group_name Local group name

group_id Local group ID

Example(s)

The following example deletes the local group with the local group name "group650":

```
CLI > delete nas-local-group -group group650
```

The following example deletes the local group with the local group ID "650":

```
CLI > delete nas-local-group -gid 650
```

7.8 FTP/FXP Function

This section describes the commands related to the FTP/FXP function.

For the shared folder, access via File Transfer Protocol (FTP) and File eXchange Protocol (FXP) is possible.

To access with FTP/FXP, user authentication via an authentication server (Active Directory authentication server or LDAP authentication server) or via local user authentication is required.

The firewall setting of FTP/FXP for each CA port for NAS (NAS port) can be configured. This is configured from the "set nas-port" command.

Use the "set nas-server" command to enable/disable the FXP function.

For information about how to use the FTP/FXP function, refer to "FUJITSU Storage ETERNUS DX S4/S3 series Hybrid Storage Systems Configuration Guide (NAS)".

Operations of the shared folders that are to be published using FTP/FXP are as follows:

- Displaying the NAS shared folder that is published to FTP
- Setting the NAS shared folder that is to be published to FTP
- Deleting the settings of the NAS shared folder that is published to FTP

Caution

- Encrypted communication (FTPS/SFTP/FXSP) is not supported.
 - Because the connection may be cut if a failover or a failback occurs during an FTP session, re-establishing the connection from the FTP client is required.
-

show nas-ftp

This command displays the NAS shared folder that is published to FTP.

■ Syntax

```
show nas-ftp
```

■ Parameter

No parameters.

■ Output

Item name	Description
Share No.	NAS shared folder number
Share Name	NAS shared folder name

■ Example(s)

The following example displays the NAS shared folder that is to be published to FTP:

```
CLI> show nas-ftp
<FTP Publishing Setting Information>
Share No. [1]
Share Name[NAS-SHARE#1]
<FTP Publishing Setting Information>
Share No. [2]
Share Name[NAS-SHARE#2]
<FTP Publishing Setting Information>
Share No. [3]
Share Name[NAS-SHARE#3]
```

set nas-ftp

This command sets the NAS shared folder that is to be published to FTP. The maximum number of NAS shared folders that can be published to FTP for each ETERNUS DX/AF is five.

■ Syntax

```
set nas-ftp {-share-number share_numbers | -share-name share_name}
```

■ Parameter

-share-number or -share-name

This parameter specifies the NAS shared folder that is to be published to FTP. For number specifications, multiple numbers can be specified by separating them with a comma (,) or a hyphen (-). For name specifications, only one name can be specified.

When the NAS shared folder name includes multibyte characters, specify the NAS shared folder with the "-share-number" parameter.

Caution

The folder number or folder name of the user-specific folder "homes" cannot be specified.

<i>share_numbers</i>	NAS shared folder numbers
<i>share_name</i>	NAS shared folder name

■ Example(s)

The following example publishes NAS shared folder #1 with FTP:

```
CLI> set nas-ftp -share-number 1
```

The following example publishes NAS shared folder name NAS_1 with FTP:

```
CLI> set nas-ftp -share-name NAS_1
```

delete nas-ftp

This command deletes the settings of the NAS shared folder that is published to FTP.

■ Syntax

```
delete nas-ftp {-share-number share_numbers | -share-name share_name}
```

■ Parameter

-share-number or -share-name

This parameter deletes the settings of the NAS shared folder that is published to FTP. For number specifications, multiple numbers can be specified by separating them with a comma (,) or a hyphen (-). For name specifications, only one name can be specified.

When the NAS shared folder name includes multibyte characters, specify the NAS shared folder with the "-share-number" parameter.

share_numbers NAS shared folder numbers

share_name NAS shared folder name

■ Example(s)

The following example deletes the settings of NAS shared folder #1 that is published to FTP:

```
CLI> delete nas-ftp -share-number 1
```

The following example deletes the settings of NAS shared folder name NAS_1 that is published to FTP:

```
CLI> delete nas-ftp -share-name NAS_1
```

7.9 Network Connection Testing

This section describes the commands that are related to management of the NAS network connection test. The functions that control the NAS network connection test are as follows:

- Checking the IPv4 route (ping)
- Checking the IPv6 route (ping)
- Displaying the IPv4 route information (traceroute)
- Displaying the IPv6 route information (traceroute)

test nas-ping

This command checks the network connection between an ETERNUS DX/AF and the remote host (IPv4).

Syntax

```
test nas-ping -host {ip_address | host_name} -nas-if-number nas-if-number
```

Parameter

-host This parameter specifies the target host, in which the connection is to be checked, using the IP address or the host name.

ip_address IP address
Example: -host 10.20.30.40

host_name Host name
Example: -host www.example.com

-nas-if-number

This parameter specifies the interface from which packets are to be sent.

nas-if-number Existing NAS interface number

Example(s)

The following example checks the network communication between the ETERNUS DX/AF and the remote host (for IPv4):

```
CLI> test nas-ping -host 10.17.78.15 -nas-if-number 0
PING 10.17.78.15 (10.17.78.15) 56(84) bytes of data.
64 bytes from 10.17.78.15: icmp_seq=1 ttl=123 time=1.00 ms
64 bytes from 10.17.78.15: icmp_seq=2 ttl=123 time=0.997 ms
64 bytes from 10.17.78.15: icmp_seq=3 ttl=123 time=0.993 ms
64 bytes from 10.17.78.15: icmp_seq=4 ttl=123 time=1.01 ms
64 bytes from 10.17.78.15: icmp_seq=5 ttl=123 time=0.979 ms

--- 10.17.78.15 ping statistics ---
5 packets transmitted, 5 received, 0% packet loss, time 3999ms
rtt min/avg/max/mdev = 0.979/0.997/1.016/0.030 ms
```

test nas-ping6

This command checks the network connection between an ETERNUS DX/AF and the remote host (IPv6).

■ Syntax

```
test nas-ping6 -host {ip_address | host_name} -nas-if-number nas-if-number
```

■ Parameter

-host This parameter specifies the target host, in which the connection is to be checked, using the IP address or the host name.

ip_address IP address
Example: -host fe80::4456:d2a:53f5:fd9

host_name Host name
Example: -host www.example.com

-nas-if-number

This parameter specifies the interface from which packets are to be sent.

nas-if-number Existing NAS interface number

■ Example(s)

The following example checks the network communication between the ETERNUS DX/AF and the remote host (for IPv6):

```
CLI> test nas-ping -host6 fe80::4456:d2a:53f5:fd9 -nas-if-number 0
PING fe80::4456:d2a:53f5:fd9(fe80::4456:d2a:53f5:fd9) from fe80::226:2dff:fe05:10b2 eth0: 56 data bytes
From fe80::226:2dff:fe05:10b2 icmp_seq=1 ttl=123 time=1.00 ms
From fe80::226:2dff:fe05:10b2 icmp_seq=2 ttl=123 time=1.01 ms
From fe80::226:2dff:fe05:10b2 icmp_seq=3 ttl=123 time=0.99 ms

--- fe80::4456:d2a:53f5:fd9 ping statistics ---
3 packets transmitted, 3 received, 0% packet loss, time 3.00ms
```

test nas-traceroute

This command displays a packet route to the host (for IPv4).

■ Syntax

```
test nas-traceroute -host {ip_address | host_name} -nas-if-number nas-if-number
```

■ Parameter

-host This parameter specifies the target host, in which the connection is to be checked, using the IP address or the host name.

ip_address IP address
Example: -host 10.20.30.40

host_name Host name
Example: -host www.example.com

-nas-if-number

This parameter specifies the interface from which packets are to be sent.

nas-if-number Existing NAS interface number

■ Example(s)

The following example shows the packet route to the host (for IPv4):

```
CLI> test nas-traceroute -host 10.17.78.15 -nas-if-number 0
traceroute to 10.17.78.15 (10.17.78.15), 30 hops max, 40 byte packets
 1 10.21.157.1 (10.21.157.1) 0.525 ms 0.677 ms 0.850 ms
 2 10.21.191.1 (10.21.191.1) 0.447 ms 0.904 ms 1.097 ms
 3 10.16.8.1 (10.16.8.1) 0.310 ms 0.398 ms 0.431 ms
 4 10.16.2.2 (10.16.2.2) 0.404 ms 0.485 ms 0.573 ms
 5 10.16.106.2 (10.16.106.2) 0.467 ms 0.984 ms 1.189 ms
 6 HOST-PC.g01.fujitsu.local (10.17.78.15) 0.755 ms * *
```

test nas-traceroute6

This command displays a packet route to the host (for IPv6).

Syntax

```
test nas-traceroute6 -host {ip_address | host_name} -nas-if-number nas-if-number
```

Parameter

-host This parameter specifies the target host, in which the connection is to be checked, using the IP address or the host name.

ip_address IP address
Example: -host fe80::4456:d2a:53f5:fd9

host_name Host name
Example: -host www.example.com

-nas-if-number

This parameter specifies the interface from which packets are to be sent.

nas-if-number Existing NAS interface number

Example(s)

The following example shows the packet route to the host (for IPv6):

```
CLI> test nas-traceroute6 -host fe80::4456:d2a:53f5:fd9 -nas-if-number 1
traceroute to fe80::4456:d2a:53f5:fd9 (fe80::4456:d2a:53f5:fd9), 30 hops max, 40 byte packets
 1 fe80::4456:d2a:53f5:fda (fe80::4456:d2a:53f5:fda) 0.525 ms 0.677 ms 0.850 ms
 2 fe80::4456:d2a:53f5:fdc (fe80::4456:d2a:53f5:fdc) 0.447 ms 0.904 ms 1.097 ms
 3 HOST-PC.g01.fujitsu.local (fe80::4456:d2a:53f5:fd9) 0.755 ms * *
```

7.10 File System Maintenance

This section describes the commands that are related to the maintenance of the NAS file system.
The NAS file system maintenance functions are as follows:

- Displaying the usage status of the file system
- Displaying the mount information of the file system
- Displaying the status of the file system management server and file system management client
- Reconfiguring of a file system for supporting additional functions

show nas-df

This command displays the usage status of the file system.

■ Syntax

```
show nas-df {-volume-number volume-numbers | -volume-name volume-name}
```

■ Parameter

-volume-number or -volume-name

This parameter specifies the target NAS user volume (NAS TPV [nas-tpv]) or NAS backup volume (nas-tpv-backup). Only a single volume can be specified. However, when the firmware version is V10L21 or later, multiple volumes can be specified by using the "-volume-number" parameter. For details, refer to ["1.2.11 Volume Syntax" \(page 40\)](#).

Caution

If the specified volume does not exist or if the volumes are not NAS TPVs or NAS backup destination Thin Provisioning Volumes, no items are displayed or "count 0" is displayed. In these cases, an error does not occur.

Also, when specifying multiple volume numbers with firmware version V10L21 or later, only existing NAS TPVs or NAS backup destination Thin Provisioning Volumes are displayed.

However, if the target volume does not exist when the "-volume-name" parameter is specified, it causes an error.

volume-number Volume number

volume-name Volume name

■ Output

Item name	Description
Message	Information of the file system
Volume No.	Volume number
Volume Name	Volume name
Total Disk Space(KB)	Total capacity of the file system (unit: KB)
Used Disk Space(KB)	Used capacity of the file system (unit: KB)
Available Disk Space(KB)	Available capacity of the file system (unit: KB)

■ Example(s)

The following example shows the settings for displaying the usage status of volume #2:

```
CLI> show nas-df -volume-number 2
Volume No.           [2]
Volume Name          [NAS-VOL]
Total Disk Space(KB) [361240]
Used Disk Space(KB)  [8]
Available Disk Space(KB) [361232]
```

The following example displays multiple usage states for volume numbers 2 and 3. (only for firmware version V10L21 or later):

```
CLI> show nas-df -volume-number 2,3
<usage status>
Volume No.           [2]
Volume Name          [NAS-VOL]
Total Disk Space(KB) [361240]
Used Disk Space(KB)  [8]
Available Disk Space(KB) [361232]
<usage status>
Volume No.           [3]
Volume Name          [NAS-VOL2]
Total Disk Space(KB) [361240]
Used Disk Space(KB)  [8]
Available Disk Space(KB) [361232]
```

show nas-fsstat

This command displays the statistics of the file system.

Syntax

```
show nas-fsstat {-volume-number volume-number | -volume-name volume-name}
```

Parameter

-volume-number or -volume-name

This parameter specifies the target NAS user volume (NAS TPV [nas-tpv]). Only a single volume can be specified.

Caution

- If the specified volume does not exist or if the volumes are not NAS TPVs, no items are displayed or "count 0" is displayed. In these cases, an error does not occur. However, if the specified volume does not exist when the "-volume-name" parameter is specified, it causes an error.
- If the specified volume is not mounted, this command terminates with an error.

volume-number Volume number
volume-name Volume name

Output

Item name	Description
Message	Displays the file system information

Example(s)

The following example shows the settings for displaying the statistics of volume #3:

```
CLI> show nas-fsstat -volume-number 3
bufalloc dbufalloc dbufsleep
0 0 0
Filesystem:/mnt/nas/nv3 Thu Nov 7 20:39:45 JST 2013
eviction nornode vacated
2 0 0
vget getattr vacated
0 0 0
open close gattr gattrc gattrn gattrv
1873 1955 0 0 0 0
rlink rlinkc fsync rdir rdirc rdirn
0 0 1994 764 382 0
open close map read write frlock vacated
0 0 0 0 0 6069822 0
utime uattr cattr csize truncg truncs truncv extg extv
0 1269 0 0 0 0 0 1012297 106
dirr dirw dirrblk dirwblk dirr-n dirw-n dirrflsh dirwflsh
0 0 0 0 0 0 0 0
send rcv timeout
6081539 6081490 0
... (snip)
```

show nas-fsmntstat

This command displays the mount state of the file system.

Syntax

```
show nas-fsmntstat {-volume-number volume-number | -volume-name volume-name}
```

Parameter

-volume-number or -volume-name

This parameter specifies the target NAS user volume (NAS TPV [*nas-tpv*]). Only a single volume can be specified.

Caution

- Only NAS TPVs can be specified.
- If the specified volume is not mounted, this command terminates with an error.

volume-number	Volume number
volume-name	Volume name

Output

Item name	Description
Message	Displays the file system information

Example(s)

The following example shows the mount state of volume #3:

```
CLI> show nas-fsmntstat -volume-number 3
MountPoint /mnt/nas/nv3
Device /dev/disk/by-id/scsi-1FUJITSU_300000370106
SV MDS localhost 29000 Active
SV MDS node2INTNET 29000 Standby
SV AC node2INTNET Normal
CL AC node1INTNET Normal
```

reconfigure nas-fs

This command reconfigures (or performs a format conversion of) a file system that supports capacity expansions and quota settings for each shared folder.

Caution

If the following functions are used, NAS user volumes (NAS TPV [nas-tpv]) that are created with controller firmware versions earlier than the supported versions must be reconfigured (or perform a format conversion). The format conversion process can take up to 15 minutes.

- Capacity expansion
Controller firmware version V10L21 or later
- Quota setting for each shared folder
Controller firmware version V10L51 or later

Perform a CIFS and NFS unmount from the client before reconfiguring. In addition, if the currently used controller firmware version is V10L31 or later, because the file lock state is release for all file systems, stop operations in all the file systems. Back up the NAS volume data to a different area. If the backup was not performed, after a failed reconfiguration, the data cannot be restored.

Do not restore backup data that was collected before the reconfiguration for the reconfigured NAS volume or the newly created NAS volume. After reconfiguring the NAS volume, collect the backup data.

■ Syntax

```
reconfigure nas-fs {-volume-number volume-number | -volume-name volume-name}
```

■ Parameter

-volume-number or -volume-name

This parameter specifies the target NAS user volume (NAS TPV [nas-tpv]) for reconfiguration. Only a single volume can be specified. For details, refer to ["1.2.11 Volume Syntax" \(page 40\)](#).

Caution

Only NAS TPVs can be specified.

volume-number	Volume number
volume-name	Volume name

■ Example(s)

The following example reconfigures the file system for NAS volume1:

```
CLI> reconfigure nas-fs -volume-number 1
```

The following example reconfigures the file system for NAS volume NAS_VOL#0:

```
CLI> reconfigure nas-fs -volume-name NAS_VOL#0
```

7.11 Snapshot

This section describes the commands that are related to the management of the NAS Snapshot function. This function performs an automatic Snapshot acquisition according to the schedule management. Snapshot uses SnapOPC+ of the Advanced Copy function. Snapshot storage destinations differ from NAS backup volumes (nas-tpv-backup).

The NAS Snapshot functions are as follows:

- Displaying the Snapshot setting information
- Creating Snapshot related settings
- Deleting Snapshot related settings
- Starting the scheduled operation for Snapshot
- Stopping the scheduled operation for Snapshot

■ Preparations for Snapshot Acquisitions

The settings necessary for Snapshot acquisitions are shown below.

Procedure

- 1** Create the snapshot destination volume (SDPV).
Create the snapshot destination volume (SDPV) by using the "create volume" command.
- 2** Create the snapshot destination volume (SDV).
Create the snapshot destination volume (SDV) by using the "set nas-snapshot" command.
- 3** Settings that are related to the Snapshot copy operation.
Configure copy operation related settings by using the "set advanced-copy-parameters" command.

Note

Snapshot shares resources with Advanced Copy. For that reason, the setting and session for the copy table size, and the volume and amount used for the copy operation are affected mutually.

End of procedure

show nas-snapshot

This command displays the Snapshot setting information.

Syntax

```
show nas-snapshot  
{-volume-number volume_numbers | -volume-name volume_name}
```

Parameter

-volume-number or -volume-name

This parameter specifies the NAS volume for displaying the Snapshot setting information. When specifying a number, multiple numbers can be specified. If this parameter is not specified, information for all volumes that are setup with Snapshot is displayed. For details, refer to ["1.2.11 Volume Syntax" \(page 40\)](#).

Caution

Only NAS user volumes (nas-tpv) can be specified.

volume_numbers NAS Thin Provisioning Volume number

volume_name NAS Thin Provisioning Volume name

Output

Item name	Description
Volume Number	NAS volume number
Volume Name	NAS volume name
Snapshot Status	Summary of the SnapOPC+ states for the NAS volumes (Even if only one generation is Error Suspend, Error is displayed.)
-	The snapshot is not collected in all the NAS snapshot volumes.
Normal	The snapshot is operating normally.
Error	A snapshot that terminated abnormally exists.
Schedule	Status of the scheduled operation for Snapshot (A hyphen [-] is displayed for the manual collection mode)
Active	Operating
Inactive	Stopped
Mode	Snapshot collection mode
Auto	Automatic collection mode
Manual	Manual collection mode
Day	Snapshot schedule type (A hyphen [-] is displayed for the manual collection mode)
Daily	Daily acquisition
Sun,Mon,Tue,Wed,Thu, Fri,Sat	Acquisition per day (shown separated by a comma [,])
Time	Snapshot scheduled times (0-23) (Shown separated with a comma [,]. A hyphen [-] is displayed for the manual collection mode.)

Item name	Description
Generation Count	Snapshot generation count
RAID Group Number	RAID group number of the Snapshot destination
RAID Group Name	RAID group name of the Snapshot destination
Volume	Snapshot volume identifier
Number	Snapshot volume number
Name	Snapshot volume name
Snapshot Date	The time snapshots were acquired Example: 2014-02-07 09:00 (If a Snapshot was not acquired, a hyphen [-] is displayed. Volumes are displayed in descending order from the newest by using the time that the Snapshot was acquired. In addition, volumes for unacquired Snapshots are shown last.)
Session Status	Status of the session for NAS snapshot volumes
-	The snapshot is not collected.
Normal	The snapshot is operating normally.
Error	The snapshot is interrupted due to abnormalities.

■ Example(s)

The following example shows the setting information for all volumes that are setup with Snapshot in the ETERNUS DX/AF (for the automatic collection mode):

```

CLI> show nas-snapshot
<Snapshot Setting Information>
Volume Number      [0]
Volume Name        [NAS_VOL#0]
Snapshot status    [Normal]
Schedule           [Active]
Mode               [Auto]
Day               [Mon,Wed]
Time              [1,13]
Generation Count   [8]
<Snapshot Volume Information>
RAID Group Number  [1]
RAID Group Name    [RG#1]
Volume            Snapshot      Session
No.   Name        Date          Status
-----
  1   NAS_VOL#0_1   2014-05-14 13:00 Normal
  2   NAS_VOL#0_2   2014-05-14 01:00 Normal
  3   NAS_VOL#0_3   2014-05-12 13:00 Normal
  4   NAS_VOL#0_4   2014-05-12 01:00 Normal
  5   NAS_VOL#0_5   2014-05-07 13:00 Normal
  6   NAS_VOL#0_6   2014-05-07 01:00 Normal
  7   NAS_VOL#0_7   2014-05-05 13:00 Normal
  8   NAS_VOL#0_8   -              -
  
```

The following example shows the setting information for all volumes that are setup with Snapshot in the ETERNUS DX/AF (for the manual collection mode):

```
CLI> show nas-snapshot
<Snapshot Setting Information>
Volume Number      [0]
Volume Name        [NAS_VOL#0]
Snapshot status    [Normal]
Schedule           [-]
Mode               [Manual]
Day                [-]
Time               [-]
Generation Count   [8]
<Snapshot Volume Information>
RAID Group Number [1]
RAID Group Name   [RG#1]
Volume
No.   Name                               Snapshot           Session
-----
1 NAS_VOL#0_1 2014-05-14 13:00 Normal
2 NAS_VOL#0_2 2014-05-14 01:00 Normal
3 NAS_VOL#0_3 2014-05-12 13:00 Normal
4 NAS_VOL#0_4 2014-05-12 01:00 Normal
5 NAS_VOL#0_5 2014-05-07 13:00 Normal
6 NAS_VOL#0_6 2014-05-07 01:00 Normal
```

The example below shows the setting information for all volumes if all generations of Snapshot are Error Suspend. For SnapOPC+ in Error Suspend, "Date" displays the time when the status changed to Error Suspend. All generations earlier than the generation in the Error Suspend state are displayed as Error Suspend. However, if a Snapshot is acquired after all generations are in the Error Suspend state, only the latest generation may be displayed as Normal.

```
CLI> show nas-snapshot
<Snapshot Setting Information>
Volume Number      [0]
Volume Name        [NAS_VOL#0]
Snapshot status    [Error]
Schedule           [Active]
Mode               [Auto]
Day                [Mon,Wed]
Time               [1,13]
Generation Count   [8]
<Snapshot Volume Information>
RAID Group Number [1]
RAID Group Name   [RG#1]
Volume
No.   Name                               Snapshot           Session
-----
1 NAS_VOL#0_1 2014-05-14 13:00 Normal
2 NAS_VOL#0_2 2014-05-14 01:00 Error
3 NAS_VOL#0_3 2014-05-14 01:00 Error
4 NAS_VOL#0_4 2014-05-14 01:00 Error
5 NAS_VOL#0_5 2014-05-14 01:00 Error
6 NAS_VOL#0_6 2014-05-14 01:00 Error
7 NAS_VOL#0_7 2014-05-14 01:00 Error
8 NAS_VOL#0_8 2014-05-14 01:00 Error
```

set nas-snapshot

This command performs Snapshot related settings.

Caution

For snapshot storage, snapshot destination volumes (SDVs) for the required number of generations are automatically created. Creating the snapshot destination volume (SDPV) by using the "create volume" command is required in advance.

Syntax

```
set nas-snapshot  
{-volume-number volume_number | -volume-name volume_name}  
[-name name]  
[-rg-number rg_number | -rg-name rg_name]  
[-generation generation]  
[-day {daily | {sun | mon | tue | wed | thu | fri | sat}}]  
[-time time][-mode {auto | manual}]
```

Parameter

-volume-number or -volume-name

This parameter specifies the NAS volume for setting Snapshot. Only a single volume can be specified. For details, refer to ["1.2.11 Volume Syntax" \(page 40\)](#).

Caution

Only NAS user volumes (nas-tpv) can be specified.

volume_number NAS Thin Provisioning Volume number
volume_name NAS Thin Provisioning Volume name

-name Optional. This parameter specifies the character string using a 1-16 character range for the volume name of the automatically created NAS snapshot volume. For volume names that are actually created, "\$snap_*N*" (*N* is a number greater than or equal to 0) is added to the end of the specified name. Characters that can be specified are the same as the "-volume-name" parameter (for details on the usable characters, refer to ["1.2.11 Volume Syntax" \(page 40\)](#)).

Caution

- When setting the specified NAS volume for the first time, this parameter must be specified. An error occurs when specifying this parameter other than the first time.
- If this parameter is omitted, the NAS volume name (maximum length 16 characters) that was specified with the "-volume-number" or "-volume-name" parameter is treated as the specified name.
- During a generation expansion, the NAS Snapshot volume name used is the same as during the initial setting (only N changes).

name NAS Snapshot volume name (1-16 characters)

-rg-number or -rg-name

Optional. This parameter specifies the RAID group where Snapshot is created. Only one RAID group can be specified.

 **Caution**

- When setting the specified NAS volume for the first time, this parameter must be specified. When changing settings, this parameter cannot be specified.
- The following RAID groups cannot be specified:
 - RAID groups that are registered in a TPP or an FTRP
 - RAID groups that are registered as REC Disk Buffers
 - RAID groups that are registered as Extreme Cache Pools

rg_number RAID group number

rg_name RAID group name

-generation Optional. This parameter specifies the number of Snapshot generations using a range of 1-128.

 **Caution**

When setting the specified NAS volume for the first time, this parameter must be specified. When changing settings, the Snapshot volume is automatically created or deleted depending on the new number of generations.

generation The number of Snapshot generations (1-128)

-day Optional. This parameter specifies the Snapshot schedule type. Multiple parameters can be specified by separating with a comma (,).

 **Caution**

- When setting the specified NAS volume for the first time, this parameter must be specified. If "daily" is included in the specification, specifying other parameters will result in an error.
- This parameter cannot be specified if "-mode manual" is specified.

daily	Acquires a snapshot every day
sun	Acquires a snapshot every Sunday
mon	Acquires a snapshot every Monday
tue	Acquires a snapshot every Tuesday
wed	Acquires a snapshot every Wednesday
thu	Acquires a snapshot every Thursday
fri	Acquires a snapshot every Friday
sat	Acquires a snapshot every Saturday

-time Optional. This parameter specifies the Snapshot schedule time with a range of 0-23. Multiple parameters can be specified by separating with a comma (,).

 **Caution**

- When setting the specified NAS volume for the first time, this parameter must be specified.
- This parameter cannot be specified if "-mode manual" is specified.

time Snapshot schedule time (0-23)

-mode Optional. This parameter specifies whether to automatically collect according to the schedule, or manually collect the snapshot.

 **Caution**

- When the specified NAS volume is set for the first time, this parameter must be specified. When the settings of the specified NAS volume is changed, this parameter cannot be specified.
- During the initial setting of the specified NAS volume, either "auto" (automatic collection) or "manual" (manual collection) can be specified. If this parameter is omitted, "auto" is set.

auto Automatic collection mode

manual Manual collection mode

■ Example(s)

The following example performs a Snapshot setting that acquires a Snapshot at 9:00 and 15:00 every Tuesday and Thursday for 8 generation in Snapshot creation RAID group number 1 as Snapshot volume name NAS_VOL#0 in NAS volume NAS_VOL#0:

```
CLI> set nas-snapshot -volume-name NAS_VOL#0 -generation 8 -rg-number 1 -name NAS_VOL#0 -day tue,thu -time 9,15
```

The following example expands the number of generations to 128 in NAS volume NAS_VOL#0:

```
CLI> set nas-snapshot -volume-name NAS_VOL#0 -generation 128
```

delete nas-snapshot

This command deletes Snapshot related settings.

Caution

This command automatically deletes Snapshot volumes proportional to the number of generations.

■ Syntax

```
delete nas-snapshot  
{-volume-number volume_numbers | -volume-name volume_name}
```

■ Parameter

-volume-number or -volume-name

This parameter specifies the NAS volume for deleting Snapshot. When specifying numbers, by separating with a comma (,) or hyphen (-), multiple numbers can be specified. When specifying names, only one can be specified. For details, refer to "[1.2.11 Volume Syntax](#)" (page 40).
Even if a NAS volume that has not been configured with Snapshot is specified, an error will not occur.

Caution

Only the NAS user volumes (nas-tpv) can be specified.

<i>volume_numbers</i>	NAS Thin Provisioning Volume number
<i>volume_name</i>	NAS Thin Provisioning Volume name

■ Example(s)

The following example deletes the Snapshot settings for NAS volume name NAS_VOL#0:

```
CLI> delete nas-snapshot -volume-name NAS_VOL#0
```

The following example deletes the Snapshot settings for NAS volume number 1 and 2:

```
CLI> delete nas-snapshot -volume-number 1,2
```

start nas-snapshot

This command starts the scheduled operation for Snapshot.

Caution

- Snapshot settings must be in the specified NAS volume in advance.
- This command cannot be executed for manual collection mode schedules.
- If this command is executed at the same time as a snapshot acquisition, the scheduled operation is not started immediately. Because of that, execute this command a few minutes before the snapshot acquisition. Even if the scheduled operation is started after the acquisition period, a snapshot of that period is not acquired.

■ Syntax

```
start nas-snapshot  
{-volume-number volume_numbers | -volume-name volume_name}
```

■ Parameter

-volume-number or -volume-name

This parameter specifies the NAS volume for starting the Snapshot scheduled operation. When specifying numbers, by separating with a comma (,) or hyphen (-), multiple numbers can be specified. When specifying names, only one can be specified. For details, refer to "[1.2.11 Volume Syntax](#)" (page 40). Even if a NAS volume that is already running a scheduled operation is specified, this parameter is ignored without an error.

Caution

Only the NAS user volumes (nas-tpv) can be specified.

<i>volume_numbers</i>	NAS Thin Provisioning Volume number
<i>volume_name</i>	NAS Thin Provisioning Volume name

■ Example(s)

The following example starts the Snapshot scheduled operation for NAS volume NAS_VOL#0:

```
CLI> start nas-snapshot -volume-name NAS_VOL#0
```

The following example starts the Snapshot scheduled operation for NAS volume number 1 and 2:

```
CLI> start nas-snapshot -volume-number 1,2
```

stop nas-snapshot

This command stops the scheduled operation for Snapshot.

Caution

- Snapshot must be set in the specified NAS volume in advance. Even if the operation is stopped, Snapshot settings and Snapshot volumes are preserved.
- This command cannot be executed for manual collection mode schedules.
- If this command is executed at the same time as a snapshot acquisition, the scheduled operation is not stopped immediately. Because of that, execute this command a few minutes before the snapshot acquisition. Even if the scheduled operation is stopped during a snapshot acquisition, the acquisition is not suspended.

Syntax

```
stop nas-snapshot  
{-volume-number volume_numbers | -volume-name volume_name}
```

Parameter

-volume-number or -volume-name

This parameter specifies the NAS volume for stopping the Snapshot scheduled operation. When specifying numbers, by separating with a comma (,) or hyphen (-), multiple numbers can be specified. When specifying names, only one can be specified. For details, refer to "[1.2.11 Volume Syntax](#)" (page 40). Even if a NAS volume that has already stopped a scheduled operation is specified, this parameter is ignored without an error.

Caution

Only the NAS user volumes (nas-tpv) can be specified.

<i>volume_numbers</i>	NAS Thin Provisioning Volume number
<i>volume_name</i>	NAS Thin Provisioning Volume name

Example(s)

The following example stops the Snapshot scheduled operation for NAS volume name NAS_VOL#0:

```
CLI> stop nas-snapshot -volume-name NAS_VOL#0
```

The following example stops the Snapshot scheduled operation for NAS volume number 1 and 2:

```
CLI> stop nas-snapshot -volume-number 1,2
```

7.12 Quota

This section describes the commands that are related to the NAS quota setting.

By using this function, each user, group, or shared folder can be limited on the number of possible directories and files that can be created, and the drive usage amount by volume unit.

The NAS quota setting functions are as follows:

- Displaying the NAS quota settings
- Creating the NAS quota settings
- Changing the NAS quota settings
- Deleting the NAS quota settings

Caution

- Quota settings are configured for users and groups that are registered in the authentication server. When using this function, registering the users or groups in the authentication server in advance is necessary.
- Depending on the controller firmware version, the type of quota that can be used differs. Quotas can be used for each user and group if the controller firmware version is V10L21 or later. Quotas can be used for each shared folder if the controller firmware version is V10L51 or later. If a TPV that was created with a controller firmware earlier than the corresponding version of the various quotas is used, a format conversion is required before the quota setting. The format conversion procedure is as follows.

- (1) Reconfigure the target NAS volume using the "reconfigure nas-fs" command.
- (2) Unmount the target NAS volume from both CMs using the "forced nas-fsunmount" command.
- (3) Perform a format conversion of the file system using the "start nas-fsck -mode repair" command.
- (4) Remount the file system using the "forced nas-fsmount".

If the NAS volume is unmounted, the management information of the CIFS server and the NFS server is cleared. Because of that, unmount the NAS volume after CIFS and NFS are unmounted from the client. In addition, if the currently used controller firmware version is V10L31 or later, stop operations in all file systems since the file lock states are released in all file systems.

- When inconsistencies in the quota information occur, restore the quota information by executing the "start nas-fsck" command.
- If a NAS volume is deleted, quota settings assigned to that volume are also deleted at the same time.
- If the shared folder is deleted, the quota setting that was assigned to that shared folder is also deleted at the same time.

show nas-quota

This command displays the NAS quota settings.

Caution

If the drive usage reaches the limit value, "Exceeded" will be displayed, but an error message or event notification that indicates that the limit has been exceeded is not reported at this point. A notification is reported when a file operation has failed because the limit has been exceeded.

■ Syntax

```
show nas-quota  
[{-quota-number quota_numbers | -volume-number volume_numbers  
 | -volume-name volume_name}]
```

■ Parameter

-quota-number, -volume-number, or -volume-name

This parameter specifies the identifier of the volume associated with the quota setting or the quota number for displaying the setting. When specifying quota numbers or volume numbers, by separating with a comma (,) or hyphen (-), multiple numbers can be specified. When specifying volume names, only one can be specified.

<i>quota_numbers</i>	Quota number
<i>volume_numbers</i>	Volume number (Displays all the quota setting information associated with the specified volume number.)
<i>volume_name</i>	Volume name (Displays all the quota setting information associated with the specified volume number.)

■ Output

Item name	Description
Quota No.	Identification number of the NAS quota setting
State	Quota state
Normal	Normal
Warning	Exceeds the warning value (usage>warning value)
Exceeded	Limit value has been reached (usage≥limit value)
Unknown	Due to a mistake in the usage acquisition, the quota state is not identifiable.
Volume No.	Volume number associated with the quota setting
Volume Name	Volume name associated with the quota setting
User	User associated with the quota setting (displayed only when the quota setting is associated with the user)
Group	Group associated with the quota setting (displayed only when the quota setting is associated with the group)

Item name	Description
Share No.	NAS shared folder number associated with the quota setting (displayed only when the quota setting is associated with the NAS shared folder)
Share Name	NAS shared folder name associated with the quota setting (displayed only when the quota setting is associated with the NAS shared folder)
Used Disk Space (KB)	Currently used space for users, groups, or NAS shared folders that are set with a quota (units: KB) (If the acquisition of the current value fails for reasons such as users, groups, or NAS shared folders being deleted from the authentication server, a hyphen [-] is displayed.)
Limit Disk Space (KB)	Usage limit capacity of the user, group, or NAS shared folder that is set with a quota (unit: KB) (when unlimited, "0" is displayed)
Warning Disk Space (KB)	Usage warning capacity of the user, group, or NAS shared folder that is set with a quota (unit: KB) (when unlimited, "0" is displayed)
Numbers of files	The number of files created by users, groups, or NAS shared folders that are set with a quota (If the acquisition of the current value fails for reasons such as users or groups being deleted from the authentication server, a hyphen [-] is displayed.)
File Limit	The file limit number for users, groups, or NAS shared folders that are set with a quota (when unlimited, "0" is displayed)
File Warning	The file warning number for users, groups, or NAS shared folders that are set with a quota (when unlimited, "0" is displayed)

■ Example(s)

The following example displays all quota setting information that exists in the ETERNUS DX/AF:

```
CLI> show nas-quota
<Quota Setting Information>
Quota No.          [0]
State              [Normal]
Volume No.         [4]
Volume Name        [NAS_VOL#0]
User               [root]
Used Disk Space(KB) [5023240]
Limit Disk Space(KB) [10485760]
Warning Disk Space(KB) [8388608]
Numbers of files   [21]
File Limit         [256]
File Warning       [128]

<Quota Setting Information>
Quota No.          [1]
State              [Warning]
Volume No.         [4]
Volume Name        [NAS_VOL#0]
Group              [Root]
Used Disk Space(KB) [9000000]
Limit Disk Space(KB) [10485760]
Warning Disk Space(KB) [8388608]
Numbers of files   [43]
File Limit         [256]
File Warning       [128]

<Quota Setting Information>
Quota No.          [2]
State              [Exceeded]
Volume No.         [5]
Volume Name        [NAS_VOL#1]
User               [root]
Used Disk Space(KB) [310482]
Limit Disk Space(KB) [10485760]
Warning Disk Space(KB) [8388608]
Numbers of files   [256]
File Limit         [256]
File Warning       [128]

<Quota Setting Information>
Quota No.          [3]
State              [Exceeded]
Volume No.         [6]
Volume Name        [NAS_VOL#2]
Share No.          [2]
Share Name         [Share#0]
Used Disk Space(KB) [310482]
Limit Disk Space(KB) [10485760]
Warning Disk Space(KB) [8388608]
Numbers of files   [256]
File Limit         [256]
File Warning       [128]
```

create nas-quota

This command creates NAS quota settings.

If a NAS volume is specified, a quota setting is created for the user or group that uses the specified NAS volume.

If a NAS shared folder is specified, a quota setting is created for each NAS shared folder regardless of the user or group that is using it.

A maximum of 20,000 quota settings can be created.

Caution

- When specifying multiple users or groups, create the same number of quota settings proportional to the number of users or groups that have the same limit value or the same warning value.
- The drive space can be used if the limit value has been exceeded but within the range of the "drive usage limit value + 2GB".
- The number of files cannot exceed the specified threshold.
- Do not perform a quota setting for the administrative user (root).
- Sparse files that are inflated with the "start nas-file-inflate" command are not targets of the quota function limit. Because of that, there may be cases where the drive usage capacity can be used beyond the limit value.

Syntax

```
create nas-quota  
{-volume-number volume_number | -volume-name volume_name | -share-name share_name  
 | -share-number share_numbers} [-user users] [-group groups]  
[-disk-limit disk_limit{mb | gb | tb}] [-disk-warning disk_warning{mb | gb | tb}]  
[-file-limit file_limit] [-file-warning file_warning]
```

Parameter

-volume-number or -volume-name

Optional. This parameter specifies the NAS volume for setting the quota. Only a single volume can be specified. For details, refer to "[1.2.11 Volume Syntax](#)" (page 40).

Caution

- Only NAS user volumes (nas-tpv) can be specified.
- If this parameter is omitted, the "-share-number" parameter or the "-share-name" parameter must be specified. If both parameters are omitted, an error occurs.

<i>volume_number</i>	NAS Thin Provisioning Volume number
<i>volume_name</i>	NAS Thin Provisioning Volume name

-share-name or -share-number

Optional. This parameter specifies the NAS shared folder for setting the quota. For number specifications, multiple numbers can be specified by inserting a comma (,) or a hyphen (-) between them as a delimiter. For name specifications, only a single name can be specified. Up to 76 characters can be entered.

 **Caution**

- Only NAS shared folders can be specified.
- If this parameter is omitted, the "-volume-number" parameter or the "-volume-name" parameter must be specified. If both parameters are omitted, an error occurs.
- When the NAS shared folder name includes multibyte characters, specify the NAS shared folder with the "-share-number" parameter.

share_name NAS shared folder name
share_numbers NAS shared folder numbers

-user Optional. This parameter specifies the user for setting the quota.
Alphanumeric characters and symbols (US-ASCII code 0x20 to 0x7E) can be used.
However, "?" (US-ASCII code 0x3F) and "\" (US-ASCII code 0x5C) cannot be used.

Multiple user names can be specified by separating with a comma (,). Up to 2048 characters can be entered.

 **Caution**

- If the "-volume-number" parameter or the "-volume-name" parameter is specified and this parameter is omitted, specifying "-group" described below is required.
When the "-volume-number" parameter or the "-volume-name" parameter is specified, if neither "-user" nor "-group" is specified, an error will occur.
If the "-share-name" parameter or the "-share-number" parameter is specified, this parameter cannot be specified.
- Because the following character strings are reserved words, even if they are registered in the authentication server, they cannot be specified as the owner of the quota.
"shareuser\$", "bin", "daemon", "adm", "lp", "sync", "shutdown", "halt", "mail", "uucp", "operator", "games", "gopher", "ftp", "nobody", "vcsa", "rpc", "nscd", "ntp", "sasauth", "mailnull", "smmsp", "rpcuser", "nfsnobody", "sshd", "nslcd", "tcpdump", and "oprofile"

users User name for setting the quota

-group Optional. This parameter specifies the group for setting the quota.
Alphanumeric characters and symbols (US-ASCII code 0x20 to 0x7E) can be used.
However, "?" (US-ASCII code 0x3F) and "\" (US-ASCII code 0x5C) cannot be used.

Multiple group names can be specified by separating with a comma (,). Up to 2048 characters can be entered.

 **Caution**

- If the "-volume-number" parameter or the "-volume-name" parameter is specified and this parameter is omitted, specifying "-user" described above is required.
When the "-volume-number" parameter or the "-volume-name" parameter is specified, if neither "-user" nor "-group" is specified, an error will occur.
If the "-share-name" parameter or the "-share-number" parameter is specified, this parameter cannot be specified.

- Because the following character strings are reserved words, even if they are registered in the authentication server, they cannot be specified as the group of the quota.
"shareuser\$", "bin", "daemon", "sys", "adm", "tty", "disk", "lp", "mem", "kmem", "wheel", "mail", "uucp", "man", "games", "gopher", "video", "dip", "ftp", "lock", "audio", "nobody", "users", "utmp", "utempter", "floppy", "vcsa", "rpc", "nscd", "cdrom", "tape", "dialout", "ntp", "saslauth", "mailnull", "smmosp", "rpcuser", "nfsnobody", "sshd", "ldap", "tcpdump", and "oprofile"

groups Group name for setting the quota

-disk-limit Optional. This parameter specifies the drive usage limit value. With a drive capacity range of 0-128TB, the capacity unit can be specified from MB, GB and TB. When "0" is specified, drive usage becomes unlimited.

Example: -disk-limit 100gb (limited to 100GB)

Example: -disk-limit 0gb (unlimited. 0mb and 0tb will also have the same result)

The drive usage limit value and the specified NAS volume capacity are unrelated.

If omitted, this parameter becomes unlimited.

 **Caution**

At least one parameter must be specified among the "-disk-limit", "-disk-warning", "-file-limit", or "-file-warning" parameters. If all the parameters are omitted, an error will occur.

disk_limit{mb | gb | tb} Drive usage limit value (units: mb [MB], gb [GB], tb [TB])
(0-128TB)

-disk-warning

Optional. This parameter specifies the drive usage warning value. With a drive capacity range of 0-128TB, the capacity unit can be specified from MB, GB and TB. When "0" is specified, drive usage becomes unlimited.

Example: -disk-warning 100gb (limited to 100GB)

Example: -disk-warning 0gb (unlimited. 0mb and 0tb will also have the same result)

The drive usage limit value and the specified NAS volume capacity are unrelated.

If a value larger than "-disk-limit" is specified, an error will occur. If omitted, this parameter becomes unlimited.

 **Caution**

At least one parameter must be specified among the "-disk-limit", "-disk-warning", "-file-limit", or "-file-warning" parameters. If all the parameters are omitted, an error will occur.

disk_warning{mb | gb | tb} Drive usage warning value (units: mb [MB], gb [GB], tb [TB])
(0-128TB)

-file-limit

Optional. This parameter specifies the limit value for the number of files that can be created. Specify with a range of 0 - 134,217,723. When "0" is specified, file creation becomes unlimited. If omitted, this parameter becomes unlimited.

 **Caution**

At least one parameter must be specified among the "-disk-limit", "-disk-warning", "-file-limit", or "-file-warning" parameters. If all the parameters are omitted, an error will occur.

file_limit Limit value for the number of files that can be created
(0 - 134,217,723)

-file-warning

Optional. This parameter specifies the warning value for the number of files that can be created. Specify with a range of 0 - 134,217,723. When "0" is specified, file creation becomes unlimited. If a value larger than "-file-limit" is specified, an error will occur. If omitted, this parameter becomes unlimited.

Caution

At least one parameter must be specified among the "-disk-limit", "-disk-warning", "-file-limit", or "-file-warning" parameters. If all the parameters are omitted, an error will occur.

<i>file_warning</i>	Warning value for the number of files that can be created (0 - 134,217,723)
---------------------	--

■ Example(s)

The following example creates a quota setting that limits the number of creatable files to 300 and drive usage to 100GB for users USER#0 and USER#1 in NAS volume NAS_VOL.

```
CLI> create nas-quota -volume-name NAS_VOL -user USER#0,USER#1 -disk-limit 100gb -file-limit 300
```

The following example creates a quota setting that sets the drive usage warning value to 1800GB and limits the drive usage to 1TB for user USER#0, and groups GROUP#0 and GROUP#1 in NAS volume NAS_VOL.

```
CLI> create nas-quota -volume-name NAS_VOL -user USER#0 -group GROUP#0,GROUP#1 -disk-limit 2tb -disk-warning 1800gb
```

The following example displays a partial failure when creating a quota setting with a user or group. (A situation in which the creation of a quota setting for group GROUP#1 succeeded, but the quota setting for user USER#0 and group GROUP#0 failed):

```
CLI> create nas-quota -volume-name NAS_VOL -user USER#0 -group GROUP#0,GROUP#1 -disk-limit 2tb -disk-warning 1800gb
Creation of quota setting failed partially.
<Failed User/Group List>
User:USER#0
Group:GROUP#0
```

The following example creates a quota setting that limits the drive usage capacity to 100GB and the number of created files to 300 for NAS shared folder SHARE#0:

```
CLI> create nas-quota -share-name SHARE#0 -disk-limit 100gb -file-limit 300
```

The following example creates a quota setting that limits the drive usage capacity to 100GB and the number of created files to 300 for NAS shared folder #1 to #3:

```
CLI> create nas-quota -share-number 1,2,3 -disk-limit 100gb -file-limit 300
```

set nas-quota

This command changes the NAS quota settings.

Caution

Sparse files that are inflated with the "start nas-file-inflate" command are not targets of the quota function limit. Because of that, there may be cases where the drive usage capacity can be used beyond the limit value.

■ Syntax

```
set nas-quota -quota-number quota_number  
[-disk-limit disk_limit{mb | gb | tb}] [-disk-warning disk_warning{mb | gb | tb}]  
[-file-limit file_limit] [-file-warning file_warning]
```

■ Parameter

-quota-number

This parameter specifies the quota number for changing the quota settings. Only one number can be specified.

Caution

An error will occur if a non-existent quota number is specified.

quota_number Quota number

-disk-limit

Optional. This parameter specifies the drive usage limit value. With a drive capacity range of 0-128TB, the capacity unit can be specified from MB, GB and TB. When "0" is specified, drive usage becomes unlimited.

Example: -disk-limit 100gb (limited to 100GB)

Example: -disk-limit 0gb (unlimited. 0mb and 0tb will also have the same result)

The drive usage limit value and the specified NAS volume capacity are unrelated.

If omitted, the existing setting is not changed.

Caution

At least one parameter must be specified among the "-disk-limit", "-disk-warning", "-file-limit", or "-file-warning" parameters. If all the parameters are omitted, an error will occur.

disk_limit{mb | gb | tb} Drive usage limit value (units: mb [MB], gb [GB], tb [TB])
(0-128TB)

-disk-warning

Optional. This parameter specifies the drive usage warning value. With a drive capacity range of 0-128TB, the capacity unit can be specified from MB, GB and TB. When "0" is specified, drive usage becomes unlimited.

Example: -disk-warning 100gb (limited to 100GB)

Example: -disk-warning 0gb (unlimited. 0mb and 0tb will also have the same result)

The drive usage limit value and the specified NAS volume capacity are unrelated.

If a value larger than "-disk-limit" is specified, an error will occur. If omitted, the existing setting is not changed.

 **Caution**

At least one parameter must be specified among the "-disk-limit", "-disk-warning", "-file-limit", or "-file-warning" parameters. If all the parameters are omitted, an error will occur.

disk_warning{mb | gb | tb} Drive usage warning value (units: mb [MB], gb [GB], tb [TB])
(0-128TB)

-file-limit Optional. This parameter specifies the limit value for the number of files that can be created. Specify with a range of 0 - 134,217,723. When "0" is specified, file creation becomes unlimited. If omitted, the existing setting is not changed.

 **Caution**

At least one parameter must be specified among the "-disk-limit", "-disk-warning", "-file-limit", or "-file-warning" parameters. If all the parameters are omitted, an error will occur.

file_limit Limit value for the number of files that can be created
(0 - 134,217,723)

-file-warning Optional. This parameter specifies the warning value for the number of files that can be created. Specify with a range of 0 - 134,217,723. When "0" is specified, file creation becomes unlimited. If a value larger than "-file-limit" is specified, an error will occur. If omitted, the existing setting is not changed.

 **Caution**

At least one parameter must be specified among the "-disk-limit", "-disk-warning", "-file-limit", or "-file-warning" parameters. If all the parameters are omitted, an error will occur.

file_warning Warning value for the number of files that can be created
(0 - 134,217,723)

■ Example(s)

The following example changes the drive limit to unlimited and the usable file limit number to 1000 for the quota settings of quota number 1.

```
CLI> set nas-quota -quota-number 1 -disk-limit 0mb -file-limit 1000
```

delete nas-quota

This command deletes the NAS quota settings.

■ Syntax

```
delete nas-quota {-quota-number quota_numbers | -all}
```

■ Parameter

-quota-number or -all

This parameter specifies the quota for deleting the setting. When specifying numbers, by separating with a comma (,) or hyphen (-), multiple numbers can be specified. If "-all" is specified, all quota settings are deleted.

<i>quota_numbers</i>	Quota setting number
-all	All quota settings

■ Example(s)

The following example deletes the quota settings for quota numbers 1-10.

```
CLI> delete nas-quota -quota-number 1-10
```

The following example deletes all quota settings.

```
CLI> delete nas-quota -all
```

The following example displays the quota setting deletion that has partially failed.

```
CLI> delete nas-quota -quota-number 1-10
Deletion of quota setting failed partially.
<Failed Quota Setting Number List>
1
3
```

7.13 NAS Packet Capture

This section describes the commands related to capturing the NAS packet.
For information about capturing packets, refer to "FUJITSU Storage ETERNUS DX S4/S3 series Hybrid Storage Systems Configuration Guide (NAS)".

Note

Collected packet capture information is saved in the system volume.
The collected packet capture can be collected with FTP through the CA port for NAS (NAS port). In that case, a user account for the investigation log FTP is required.

The functions that control capturing the NAS packet are as follows.

Function	Command
Displaying the startup state of the packet capture	show nas-pcap
Starting the packet capture	start nas-pcap
Stopping the packet capture	stop nas-pcap
Creating an account for the audit log	create nas-engine-user
Deleting the capture file of the packet capture	clear nas-pcap

■ Creating an account for the investigation log

Create a user account for the investigation log FTP using the "create nas-engine-user" command.

- To delete the account, use the "delete nas-engine-user" command.
- To display the account information, use the "show nas-engine-user" command.

show nas-pcap

This command displays the startup status of the packet capture according to "packet capture".

Syntax

```
show nas-pcap
```

Parameter

No parameters.

Output

Item name	Description
Free Space (MB)	Free space of SYSVOL that can be used with "packet capture"
NAS Interface No	NAS port number (or NAS Interface No) of the executing packet capture If the executing NAS port number (or NAS Interface No) does not exist, a hyphen (-) is displayed.

Example(s)

The following information is displayed when a packet capture is running in CM#0 and a packet capture is not running in CM#1:

```
CLI> show nas-pcap
<CM#0 Packet Capture Information>
Free Space (MB)      [5000]
NAS Interface No     [0,2,4]

<CM#1 Packet Capture Information>
Free Space (MB)      [6000]
NAS Interface No     [-]
```

start nas-pcap

This command starts a packet capture. The captured data is split into multiple files and created cyclically.

Caution

By outputting the packet capture file, the SYSVOL capacity may become depleted. Take care not to deplete the capacity. The free space of SYSVOL can be checked from the "show nas-pcap" command. In addition, if the packet capture collection is complete, delete the capture information file from the "clear nas-pcap" command.

■ Syntax

```
start nas-pcap -nas-if-number nas_if_number [-file-size file_size] [-file-count file_count]  
[-packet-length packet_length] [-string string]
```

■ Parameter

-nas-if-number

This parameter specifies the NAS port number (or NAS interface number) for executing the packet capture. Multiple NAS port numbers cannot be specified.

nas_if_number NAS port number (or NAS interface number)

-file-size

Optional. This parameter specifies the maximum size of each output file with a range of 50 to 1024. The unit is in MBs (1MB = 1,000,000 bytes). If omitted, 100 is set.

file_size Maximum size of each output file (50 to 1024, unit: MB)

-file-count

Optional. This parameter specifies the maximum number of splits for the output file with a range of 2 to 10. If omitted, 10 is set.

The captured data is output to the first file if the maximum number is exceeded.

For example, if a packet is captured up to the 10th capture and the captures for #0 to #9 are complete, when the 11th packet is captured, the data for #0 is deleted and overwritten by the data for #10. The data for #1 to #9 remain without being deleted.

file_count Maximum number of splits for the output file (2 to 10)

-packet-length

Optional. This parameter specifies the maximum data length of the packet that is output with a range of 1 to 9014. The unit is in bytes. If omitted, 192 is set.

packet_length Maximum data length of the packet that is output (1 to 9014, unit: byte)

■ Example(s)

The following example starts a packet capture:

```
CLI> start nas-pcap -nas-if-number 0 -file-size 100 -file-count 10 -packet-length 100
```

stop nas-pcap

This command stops all packet captures that are started with the "start nas-pcap" command.

■ Syntax

```
stop nas-pcap
```

■ Parameter

No parameters.

■ Example(s)

The following example stops all packet captures:

```
CLI> stop nas-pcap
```

clear nas-pcap

This command deletes all the packet capture information files in both controller modules (CM).

Note

- When this command terminates abnormally, the packet capture file of only one CM may be deleted.
- If a packet capture is executing, this command terminates with an error.

Syntax

```
clear nas-pcap
```

Parameter

No parameters.

Example(s)

The following example stops all packet captures:

```
CLI> clear nas-pcap
```

7.14 NAS Audit Log

This section describes the commands that are related to the configuration of the NAS audit log function.

For information about the NAS audit log function, refer to "FUJITSU Storage ETERNUS DX S4/S3 series Hybrid Storage Systems Configuration Guide (NAS)".

Note

- The target of the NAS audit log is CIFS access only. NAS audit logs for NFS access cannot be acquired.
- The NAS audit log can be enabled/disabled for each NAS shared folder name.
- The output destination of the NAS audit log is the NAS expanded system volumes.
- The output NAS audit log can be collected with FTP through the CA port for NAS. In that case, a user account for the audit log FTP is required.

NAS audit log functions are as follows.

Function	Command
Creating NAS expanded system volumes	create volume
Displaying the configuration of the NAS audit log function (per ETERNUS DX/AF)	show nas-audit
Changing the configuration of the NAS audit log function (per ETERNUS DX/AF)	set nas-audit
Configuring the NAS audit logs (shared folder)	create nas-share
Changing the settings of the NAS audit log (shared folder)	set nas-share
Displaying the settings of the NAS audit log (shared folder)	show nas-share
Creating an account for the NAS audit log	create nas-engine-user
Displaying the account information for the NAS audit log	show nas-engine-user
Deleting an account for the NAS audit log	delete nas-engine-user
Displaying the NAS audit log file information	show nas-audit-log-information
Deleting the NAS audit log file	clear nas-audit-log
Checking the integrity of the NAS expanded system volume	start nas-fsck -mode

Account creation for the audit log

Create a user account for the audit log FTP using the "create nas-engine-user" command.

- To delete the account, use the "delete nas-engine-user" command.
- To display the account information, use the "show nas-engine-user" command.

show nas-audit

This command displays the settings of the NAS audit log function.

■ Syntax

```
show nas-audit
```

■ Parameter

No parameters.

■ Output

Item name	Description
Mode	Displays whether the NAS audit log function is enabled or disabled. (Enable/Disable)
Rotate Count	Generation number of the audit log file that is to be stored. If the NAS audit log function is disabled, a hyphen (-) is displayed.

■ Example(s)

The following information is displayed when the NAS audit log function is enabled:

```
CLI> show nas-audit
Mode                [Enable]
Rotate Count        [365]
```

The following information is displayed when the NAS audit log function is disabled:

```
CLI> show nas-audit
Mode                [Disable]
Rotate Count        [-]
```

set nas-audit

This command enables/disables the NAS audit log function and sets the number of generations for storing the audit log file.

Note

- By enabling the NAS audit log function of each NAS shared folder and by enabling the NAS audit log function with this command, the audit log control is enabled.
- When access occurs in NAS volumes where the audit log control is enabled, the accessed information is recorded in the audit log file.
- Audit log files are created in each NAS shared folder and switches to new files once a day (between 3 a.m. to 4 a.m.).
- If the number of files to be stored exceeds the number of set generations, the oldest generation file is deleted.
- There is no limit for the file size. However, if the free space of the NAS expanded system volume for saving the file is insufficient, the audit log is not recorded in the file.

Syntax

```
set nas-audit [-mode {enable | disable}] [-rotate-count rotate_count]
```

Parameter

-mode Optional. This parameter specifies whether to enable/disable the NAS audit log function. If omitted, this parameter is not changed.

enable The NAS audit log function is enabled.

disable The NAS audit log function is disabled.

-rotate-count

Optional. This parameter specifies the number of generations to be stored with a range of 1 to 365 for the rotated audit log files.

When the NAS audit log function is changed from disable to enable using the "-mode" parameter, 30 is set if this parameter is omitted.

Caution

The settings can be changed while the NAS audit log function is operating. If this is set to a value smaller than the number of audit log files that are stored, when the file of the current day is saved, the files are deleted in order from the oldest generation.

rotate_count Number of generations for storing the audit log files (1 to 365)

Example(s)

The following example enables the NAS audit log function:

```
CLI> set nas-audit -mode enable -rotate-count 1
```

show nas-audit-log-information

This command displays the file information of the NAS audit log.

Syntax

```
show nas-audit-log-information [-share-number share_number] -share-name share_name]
```

Parameter

-share-number or -share-name

Optional. This parameter specifies the NAS shared folder to display the file information of the NAS audit log. If omitted, the file information of the NAS audit log for all NAS shared folders is displayed. Multiple NAS shared folders cannot be specified.

When the NAS shared folder name includes multibyte characters, specify the NAS shared folder with the "-share-number" parameter.

Caution

If a NAS shared folder that does not exist is specified, or if the NFS NAS shared folder is specified by Service, nothing is displayed.

share_number NAS shared folder number

share_name NAS shared folder name

Output

Item name	Description
Share No.	NAS shared folder number Only displayed if the NAS shared folder Service is CIFS or NFS/CIFS common.
Share Name	NAS shared folder name Only displayed if the NAS shared folder Service is CIFS or NFS/CIFS common.
Audit Log	Displays whether the NAS audit log function is enabled or disabled. (Enable/Disable) Only displayed if the NAS shared folder Service is CIFS or NFS/CIFS common.
CM#XFile Size(MB)	Total size of the audit log files for each NAS shared folder Only displayed if the NAS shared folder Service is CIFS or NFS/CIFS common. CM#X is the controller module (CM) number. Displays the total size of the audit log files for each CM number where the audit log files are collected. Displays a hyphen (-) if the audit log file does not exist. Displays "Unknown" if the available audit log file information cannot be acquired.
CM#XFile Count	Number of audit log files for each NAS shared folder Only displayed if the NAS shared folder Service is CIFS or NFS/CIFS common. CM#X is the controller module (CM) number. Displays the number of audit log files for each CM number where the audit log files are collected. Displays a hyphen (-) if the audit log file does not exist. Displays "Unknown" if the available audit log file information cannot be acquired.

■ Example(s)

The following example displays the audit log file information for all NAS shared folders:

```
CLI> show nas-audit-log-information
<NAS Audit Log Information>
Share No.          [0]
Share Name         [NAS-SHARE#0]
Audit Log          [Enable]
CM#0 File Size(MB) [1024]
CM#0 File Count    [365]
CM#1 File Size(MB) [1]
CM#1 File Count    [1]

<NAS Audit Log Information>
Share No.          [1]
Share Name         [NAS-SHARE#1]
Audit Log          [Disable]
CM#0 File Size(MB) [1]
CM#0 File Count    [1]
CM#1 File Size(MB) [2]
CM#1 File Count    [2]
```

The following example displays the audit log file information for NAS shared folder #1:

```
CLI> show nas-audit-log-information -share-number 1
<NAS Audit Log Information>
Share No.          [1]
Share Name         [NAS-SHARE#1]
Audit Log          [Enable]
CM#0 File Size(MB) [1024]
CM#0 File Count    [365]
CM#1 File Size(MB) [1]
CM#1 File Count    [1]
```

The following information is displayed when there is no audit log file in the specified NAS shared folder:

```
CLI> show nas-audit-log-information
<NAS Audit Log Information>
Share No.          [0]
Share Name         [NAS-SHARE#0]
Audit Log          [Enable]
CM#0 File Size(MB) [-]
CM#0 File Count    [-]
CM#1 File Size(MB) [-]
CM#1 File Count    [-]
```

The following information is displayed when the available audit log file information cannot be acquired:

```
CLI> show nas-audit-log-information
<NAS Audit Log Information>
Share No.          [0]
Share Name         [NAS-SHARE#0]
Audit Log          [Enable]
CM#0 File Size(MB) [Unknown]
CM#0 File Count    [Unknown]
CM#1 File Size(MB) [Unknown]
CM#1 File Count    [Unknown]
```

clear nas-audit-log

This command deletes the NAS audit log file.

Note

Depending on whether the NAS audit log function is enabled/disabled, deletion of the audit log files differs as shown below.

- If the NAS audit log function is disabled
All the audit log files in the NAS shared folder are deleted.
- If the NAS audit log function is enabled
All the audit log files other than the one currently being collected are deleted.

Syntax

```
clear nas-audit-log {-share-number share_number | -share-name share_name | -all}
```

Parameter

-share-number, -share-name, or -all

This parameter specifies the NAS shared folders for deleting the NAS audit log files. Multiple NAS shared folders cannot be specified with numbers or names. Specify the "-all" option for specifying all the NAS shared folders.

When the NAS shared folder name includes multibyte characters, specify the NAS shared folder with the "-share-number" parameter.

<i>share_number</i>	NAS shared folder number
<i>share_name</i>	NAS shared folder name
-all	All NAS shared folders

Example(s)

The following example deletes the NAS audit log file of NAS shared folder #0:

```
CLI> clear nas-audit-log -share-number 0
```

7.15 NAS Engine User Setting

This section describes the commands related to the NAS Engine user setting for operating the audit logs and the investigation logs.

The functions that control the NAS Engine user settings are as follows.

- Displaying the information of the NAS Engine login user
- Creating the user for logging in to the NAS Engine
- Deleting the user for logging in to the NAS Engine

show nas-engine-user

This command displays all the information of the user for logging in to the NAS Engine.

Syntax

```
show nas-engine-user
```

Parameter

No parameters.

Output

Item name	Description
Audit User	Audit user name If the Audit user (or the user for the audit log FTP) does not exist, a hyphen (-) is displayed.
Dump User	Dump user name If the Dump user (or the user for the investigation log FTP) does not exist, a hyphen (-) is displayed.

Example(s)

The following example displays the information of the user for logging in to the NAS Engine:

```
CLI> show nas-engine-user
<CM#0 NAS engine user information>
Audit User      [User1]
Dump User       [User2]

<CM#1 NAS engine user information>
Audit User      [User1]
Dump User       [-]
```

create nas-engine-user

This command creates the user for logging in to the NAS Engine with the specified user type.

Note

- For the FTP user that collects the dump, the account is registered to the NAS Engine with an expiration date.
- Only one user can be registered for each user type. If a user type that is already registered with a user is specified, the user information is re-registered.
- If this command is used to create a user, a group with the same name as the user is automatically created.
- For the dump user, the password may be invalidated due to a NAS Engine restart. With the main cause being, such as, a controller module reboot, the dump user may unintentionally be invalidated. This can be checked with the "show nas-engine-user" command. If the password has been invalidated, re-registering the user with this command is required.
- Enter a password in the password prompt after entering the command. The characters that can be used for the password are alphanumeric characters and symbols (US-ASCII code 0x20 to 0x7E), 8 to 32 characters in length.

Syntax

```
create nas-engine-user -type {audit | dump} -name name [-expiry expiry]
```

Parameter

-type This parameter specifies the user type. The number of users that can be created with the same user type is only one.

audit User for the audit log FTP

dump User for the investigation log FTP

-name This parameter specifies the user name that is to be created with 1 to 19 characters. The characters that can be used are alphanumeric characters (US-ASCII code 0x30 to 0x39, 0x41 to 0x5A, and 0x61 to 0x7A). The same user name cannot be specified with different user types. In addition, there are some user names that cannot be used. These include, but are not limited to, user names that are the same as users for the internal management of the ETERNUS DX/AF.

Caution

The user name and the group name that are used with the local user authentication function cannot be specified.

name User name that is to be created

-expiry Optional. This parameter specifies the expiration date of the password within a range of 1 to 24. (Unit: Hours)

Caution

- If the "-type" parameter is "dump", this parameter must be specified.
- If the "-type" parameter is "audit", this parameter cannot be specified. There is no expiration date for Audit type accounts.

expiry Expiration date of the password

■ Example(s)

The following example is for creating the Dump user.
The entered passwords in "Password ::" and "Confirm Password:" are not displayed:

```
CLI> create nas-engine-user -type dump -name dumpuser -expiry 4  
Password:  
Confirm Password:
```

delete nas-engine-user

This command deletes the user for logging in to the NAS Engine with the specified user type.

■ Syntax

```
delete nas-engine-user -type {audit | dump}
```

■ Parameter

-type This parameter specifies the user type that is to be deleted.

 audit User for the audit log FTP

 dump User for the investigation log FTP

■ Example(s)

The following example deletes the Dump user:

```
CLI> delete nas-engine-user -type dump
```

7.16 NAS Function Restoration

This section describes the commands that are related to the restoration of NAS.

When trouble occurs in a NAS function, the commands described in this section are used. If a suspicious failure occurs during operation, request for your maintenance engineer to investigate the issue.

Caution

The NAS function is not supported by the DX60 S4/DX60 S3, the DX8100 S3/DX8700 S3/DX8900 S3, the AF250 S2/AF650 S2, the AF250/AF650, and the DX200F.

- Mounting the file system
- Unmounting the file system
- Setting the file system offline
- Setting the file system online
- Displaying the check process result of the file system
- Starting the file system check
- Lock operation of the file system
- NAS Engine recovery
- Bringing components (NAS Engine and NAS System Volume) online
- Displaying the NAS Engine log settings
- Changing the NAS Engine log settings
- Displaying the host that has a locked NAS file
- Releasing the NAS file lock
- Displaying the inflation information of the Sparse file
- Starting the inflation process of the Sparse file
- Stopping the inflation process of the Sparse file

The following operations can be performed on a NAS volume.

- Deleting a NAS Volume
For details refer to ["delete volume" \(page 174\)](#) in ["3.2 Volume Management"](#).
- Formatting a NAS volume
For details refer to ["format volume" \(page 178\)](#) in ["3.2 Volume Management"](#).

■ Sparse file inflation function

The Sparse file inflation function performs a continuous inflation (zero initialization) of the disk area for the specified Sparse file. By executing this function before operation, the access performance degradation of the Sparse file can be prevented.

As an example of a Sparse file, there are Thin virtual disks that are a type of VMware virtual disk.

For details, refer to "FUJITSU Storage ETERNUS DX S4/S3 series Hybrid Storage Systems Configuration Guide (NAS)".

The Sparse file inflation function is executed using the following procedure.

Procedure

- 1** Starting the inflation
Specify the path of the target Sparse file by using the "start nas-file-inflate" command to start the inflation.
- 2** Acquiring the inflation information
Acquire the inflation information by using the "show nas-file-inflate" command. If the inflation process is complete, "Full" is displayed in the File Allocation Status.
If the inflation process is running, the progress of the inflation process can be checked using the "show nas-share-progress" command.

End of procedure

Note

- While waiting until the command prompt is returned after the "start nas-file-inflate" command is executed, if the "show nas-file-inflate" command or the "show nas-share-progress" command is executed in another terminal, the correct results may not be displayed. Make sure to execute the "show nas-file-inflate" command or the "show nas-share-progress" command after the inflation process is complete.
- If the inflation process is abnormally terminated, "Partial" is displayed in the File Allocation Status of the "show nas-file-inflate" command. For abnormal terminations, after the error state is resolved, the inflation process must be restarted by specifying the "-overwrite-whole-file" parameter of the "start nas-file-inflate" command.

forced nas-fsmount

This command performs a mount of the file system.

Caution

- When unmounting the NAS volume, the management information of the CIFS and NFS server is cleared. For that reason, unmounting the NAS volume after unmounting CIFS and NFS from the client is required.
- If the Active Directory authentication setting is set, the target CM must be able to communicate with the authentication server.

The target CM must satisfy both of the following conditions:

- One or more ports have been assigned with an IP address using the "create nas-interface" command.
- Communication is possible with the authentication servers using the above-mentioned ports.

If the command fails without satisfying the above-mentioned conditions, re-execute the command after satisfying the conditions.

- If an integrity check or a repair is being executed for any volume using the "start nas-fsck" command, execute this command after the process is completed.

Syntax

```
forced nas-fsmount -cm {0 | 1} {-volume-number volume-number | -volume-name volume-name}
```

Parameter

-cm This parameter specifies the target controller module.

0 Controller module#0

1 Controller module#1

-volume-number or -volume-name

This parameter specifies the target NAS user volume (NAS TPV [*nas-tpv*]). Only a single volume can be specified.

Caution

- Only NAS TPVs can be specified.
- If the specified volume is mounted, this command terminates with an error.

volume-number Volume number

volume-name Volume name

■ Example(s)

The following example shows settings for mounting NAS TPV#1 in CM#0.

```
CLI> forced nas-fsmount -cm 0 -volume-number 1
```

The following example shows settings for mounting NAS TPV in CM#1.

```
CLI> forced nas-fsmount -cm 1 -volume-name NAS_TPV
```

forced nas-fsunmount

This command performs an unmount of the file system.

Caution

When unmounting the NAS volume, the management information of the CIFS and NFS server is cleared. For that reason, unmount the NAS volume after unmounting CIFS and NFS from the client. In addition, if the currently used controller firmware version is V10L31 or later, because the file lock state is release for all file systems, stop operations in all the file systems.

■ Syntax

```
forced nas-fsunmount -cm {0 | 1} {-volume-number volume-number | -volume-name volume-name}
```

■ Parameter

-cm This parameter specifies the target controller module.

0	Controller module#0
1	Controller module#1

-volume-number or -volume-name

This parameter specifies the target NAS user volume (NAS TPV [*nas-tpv*]). Only a single volume can be specified.

Caution

- Only NAS TPVs can be specified.
- If the specified volume is unmounted, this command terminates with an error.

<i>volume-number</i>	Volume number
<i>volume-name</i>	Volume name

■ Example(s)

This command unmounts NAS TPV#1 from CM#0.

```
CLI> forced nas-fsunmount -cm 0 -volume-number 1
```

This command unmounts NAS TPV from CM#1.

```
CLI> forced nas-fsunmount -cm 1 -volume-name NAS_TPV
```

forced nas-fsoffline

This command performs a forcible stop of the file system.

Syntax

```
forced nas-fsoffline -cm {0 | 1} {-volume-number volume-number | -volume-name volume-name}
```

Parameter

-cm This parameter specifies the target controller module.

0	Controller module#0
1	Controller module#1

-volume-number or -volume-name

This parameter specifies the target NAS user volume (NAS TPV [*nas-tpv*]). Only a single volume can be specified.

Caution

- Only NAS TPVs can be specified.
- Unmount the target volume in advance.

<i>volume-number</i>	Volume number
<i>volume-name</i>	Volume name

Example(s)

The following example shows settings for forcibly stopping NAS TPV#1 in CM#0.

```
CLI> forced nas-fsoffline -cm 0 -volume-number 1
```

The following example shows settings for forcibly stopping NAS TPV in CM#1.

```
CLI> forced nas-fsoffline -cm 1 -volume-name NAS_TPV
```

forced nas-fsonline

This command performs a forcible start of the file system.

■ Syntax

```
forced nas-fsonline -cm {0 | 1} {-volume-number volume-number | -volume-name volume-name}
```

■ Parameter

-cm This parameter specifies the target controller module.

0	Controller module#0
1	Controller module#1

-volume-number or -volume-name

This parameter specifies the target NAS user volume (NAS TPV [*nas-tpv*]). Only a single volume can be specified.

Caution

- Only NAS TPVs can be specified.
- Unmount the target volume in advance.

<i>volume-number</i>	Volume number
<i>volume-name</i>	Volume name

■ Example(s)

The following example shows settings for forcibly starting NAS TPV#1 in CM#0.

```
CLI> forced nas-fsonline -cm 0 -volume-number 1
```

The following example shows settings for forcibly starting NAS TPV in CM#1.

```
CLI> forced nas-fsonline -cm 1 -volume-name NAS_TPV
```

show nas-fsck

This example shows the result of an integrity check for the file system that is started by executing the "start nas-fsck" command.

Syntax

```
show nas-fsck
```

Parameter

No parameters.

Output

Item name	Description
Volume No.	The volume number that is undergoing an integrity check
Volume Name	The name of the volume that is undergoing an integrity check
Message	Progress or check result

Example(s)

The following example shows the settings when checking NAS TPV #1.

```
CLI> show nas-fsck
Volume No.      [1]
Volume Name    [NAS_TPV]
<Message>
/dev/disk/by-id/scsi-3600000e00d2800000028000000030000-part1 (NO WRITE)
/dev/disk/by-id/scsi-3600000e00d2800000028000000030000-part1 is clean
```

The following example shows the settings when the check result for NAS TPV #2 is displayed.

```
CLI> show nas-fsck
Volume No.      [2]
Volume Name    [NAS_TPV]
<Message>
/dev/disk/by-id/scsi-3600000e00d2800000028000000030000-part1 (NO WRITE)
/dev/disk/by-id/scsi-3600000e00d2800000028000000030000-part1 is clean
pdfsck end.
```

start nas-fsck

This command performs an integrity check of and repairs the file system. The process takes a maximum of 15 minutes. To review the check results, use the "show nas-fsck" command.

Caution

- Disable the NAS audit log function in advance before executing this command.
 - When authentication servers are used, both CMs must be able to communicate with the authentication server. Each CM must satisfy both of the following conditions:
 - One or more ports have been assigned with an IP address using the "create nas-interface" command.
 - Communication is possible with the authentication servers using the above-mentioned ports.
- If the command fails without satisfying the above-mentioned conditions, re-execute the command after satisfying the conditions.

■ Syntax

```
start nas-fsck -mode {report | check | repair | force-repair}  
{-volume-number volume-number | -volume-name volume-name}
```

■ Parameter

- mode** This parameter specifies the integrity check mode.
If a NAS expanded system volume (cm0-nas-ex-sysvol, cm1-nas-ex-sysvol) is specified for "-volume-number" or "-volume-name", only "report" or "force-repair" can be specified for "-mode".
- | | |
|--------------|--|
| report | Performs a check. Does not repair inconsistencies. |
| check | Performs a check. Does not repair severe inconsistencies. |
| repair | Performs checks as well as repairs inconsistencies. |
| force-repair | Performs checks as well as repairs inconsistencies without using the update log. |

-volume-number or -volume-name

This parameter specifies the target NAS user volume (NAS TPV [nas-tpv]) or a NAS expanded system volume (cm0-nas-ex-sysvol, cm1-nas-ex-sysvol). Only a single volume can be specified.

Caution

Unmount the target volume in advance.

<i>volume-number</i>	Volume number
<i>volume-name</i>	Volume name

■ Example(s)

The following example shows when NAS TPV #1 is checked with "check" mode.

```
CLI> start nas-fsck -volume-number 1 -mode check
```

The following example shows when NAS TPV is forcibly checked with "repair" mode.

```
CLI> start nas-fsck -volume-name NAS_TPV -mode repair
```

forced nas-fslock

This command locks or unlocks the writing process for the file system.

■ Syntax

```
forced nas-fslock -mode {lock | unlock}  
{-volume-number volume-number | -volume-name volume-name}
```

■ Parameter

-mode This parameter specifies the locks or unlocks of the writing process.

lock	Locks the writing process.
unlock	Unlocks the writing process.

-volume-number or -volume-name

This parameter specifies the target NAS user volume (NAS TPV [*nas-tpv*]). Only a single volume can be specified.

Caution

- Only NAS TPVs can be specified.
- If the specified volume is unmounted, this command terminates with an error.

<i>volume-number</i>	Volume number
<i>volume-name</i>	Volume name

■ Example(s)

The following example shows settings for locking the writing process for NAS TPV#1.

```
CLI> forced nas-fslock -mode lock -volume-number 1
```

The following example shows settings for unlocking the writing process for NAS TPV.

```
CLI> forced nas-fslock -mode unlock -volume-name NAS_TPV
```

recover nas-engine

This command performs a recovery process when a problem occurs in the NAS Engine.

Caution

Execute this command according to the instructions given by your maintenance engineer.

■ Syntax

```
recover nas-engine -arg argument
```

■ Parameter

-arg This parameter specifies the recovery argument. Based on the Support Department instructions, specify the necessary value.
argument Recovery argument

■ Example(s)

This command executes the recovery process.

```
CLI> recover nas-engine -arg test
```

forced online

This command will attempt to bring the component online without replacing it.

Caution

- Without a Maintenance Operation policy, only "cmX-nas-engine" or "cmX-nas-sysvol" can be selected.
- Execute this command according to the instructions given by your maintenance engineer.

■ Syntax

```
forced online -type type_name
```

■ Parameter

-type This parameter specifies the name of the component to be forced online. Only one component can be specified at the same time.

cm0-nas-engine or cm1-nas-engine

NAS Engine. This option can only be specified when the NAS function is enabled. This option enables the specified NAS Engine.

cm0-nas-sysvol or cm1-nas-sysvol

NAS System Volume. This option can only be specified when the NAS function is enabled. After a System Volume (Root FS) of the NAS Engine is recovered, the specified NAS Engine is enabled.

■ Example(s)

The following example forcibly brings the NAS Engine in CM#0 online:

```
CLI> forced online -type cm0-nas-engine
```

The following example forcibly brings the NAS System Volume in CM#1 online:

```
CLI> forced online -type cm1-nas-sysvol
```

show nas-log-info

This command displays the log settings of the NAS Engine.

■ Syntax

```
show nas-log-info
```

■ Parameter

No parameters.

■ Output

Item name	Description
Samba Log Level	Samba log level 0 to 10 (if the value is increased, the log is output in greater detail. Displayed in a format of [Log level of CM0/Log level of CM1].)
Samba Log Size (KB)	Samba log size (Unit: KB) (Displayed in a format of [Log size of CM0/Log size of CM1].)
CTDB Log Level	Cluster Trivial Database (CTDB) log level 0 to 7 (displayed in a format of [Log level of CM0/Log level of CM1].)
CTDB Log Size (KB)	CTDB log size (Unit: KB) (Displayed in a format of [Log size of CM0/Log size of CM1].)

■ Example(s)

The following example shows the log settings of the NAS Engine:

```
CLI> show nas-log-info
Samba Log Level      [2/2]
Samba Log Size (KB)  [32/32]
CTDB Log Level       [3/3]
CTDB Log Size (KB)   [1024/1024]
```

set nas-log-info

This command changes the log settings of the NAS Engine.

Caution

- If this command is used to set a larger log level or log size, return the setting back to the default value immediately after collecting the logs that are necessary.
- When performing this command, the changes are reflected on all the CMs. However, for CMs where errors have occurred, the changes may not have been applied. After changing the settings, make sure to use the "show nas-log-info" command and check the set value.

■ Syntax

```
set nas-log-info -module {samba | ctddb} [-level level] [-size size]
```

■ Parameter

- module** This parameter specifies the log setting to be changed.
- | | |
|-------|---|
| samba | The samba log setting is changed. |
| ctddb | The Cluster Trivial Database (CTDB) log setting is changed. |
- level** Optional. This parameter specifies the log level. If omitted, this parameter remains unchanged.
- The specifiable range differs with Samba and CTDB.
For Samba, the specifiable range is 0 to 10 (with a default of 2).
For CTDB, the specifiable range is 0 to 7 (with a default of 3).
If the value is increased, the log is output in greater detail.
- | | |
|--------------|-----------|
| <i>level</i> | Log level |
|--------------|-----------|
- size** Optional. This parameter specifies the total size of the logs for each CM. The unit is KB. If omitted, this parameter remains unchanged.
- The specifiable range differs with Samba and CTDB.
For Samba, the specifiable range is 1 to 1024 (with a default of 32).
For CTDB, the specifiable range is 1 to 10240 (with a default of 1024).
- | | |
|-------------|---------------------|
| <i>size</i> | Log size (Unit: KB) |
|-------------|---------------------|

■ Example(s)

The following example changes the Samba log settings to a log level of "2" and a log size of 32KB:

```
CLI> set nas-log-info -module samba -level 2 -size 32
```

The following example changes the CTDB log settings to a log level of "3" and a log size of 1024KB:

```
CLI> set nas-log-info -module ctdb -level 3 -size 1024
```

show nas-lock

This command displays a list of clients that can lock the NAS files or displays whether the specified client has locked the NAS files. This information can be displayed for any protocol being used (NFS or CIFS).

Syntax

```
show nas-lock  
[-cm cm_number]  
[-ip ip_address]
```

Parameter

-cm Optional. This parameter specifies the controller module (CM) number to be displayed. Multiple CMs cannot be specified. If omitted, all the CMs are displayed.

cm_number CM number

-ip Optional. This parameter specifies the IP address of the client to check whether the NAS file is locked. An IPv4 format or an IPv6 format can be specified. A fully qualified domain name format (FQDN) cannot be specified. Multiple IP addresses cannot be specified. If omitted, all the clients are displayed.

Example: -ip 192.168.0.100

Example: -ip 2001:db8:20:3:1000:100:20:3

Example: -ip 2001:db8:20::3

ip_address IP address of the client (IPv4 or IPv6)

Output

Item name	Description
CM#n	Controller module (CM) number This item displays the IP address of the client that is locking the NAS file or displays whether there are any locked NAS files.

Example(s)

The following example shows the output when parameters are omitted (if the NAS file is locked):

```
CLI> show nas-lock  
<CM#0>  
192.168.1.100  
192.168.1.2  
  
<CM#1>  
192.168.1.3  
192.168.1.4
```

The following example shows the output when parameters are omitted (if the NAS file is not locked or the NAS Engine is not started):

```
CLI> show nas-lock
<CM#0>
clients have no locks

<CM#1>
clients have no locks
```

The following example shows the output when the CM number is specified (if the NAS file is locked):

```
CLI> show nas-lock -cm 0
<CM#0>
192.168.1.100
192.168.1.2
```

The following example shows the output when the CM number is specified (if the NAS file is not locked or the NAS Engine is not started):

```
CLI> show nas-lock -cm 0
<CM#0>
clients have no locks
```

The following example shows the output when the IP address is specified (if the NAS file is locked):

```
CLI> show nas-lock -ip 192.168.1.100
<CM#0>
client may have locks
<CM#1>
client has no locks
```

The following example shows the output when the IP address is specified (if the NAS file is not locked or the NAS Engine is not started):

```
CLI>show nas-lock -ip 192.168.1.100
<CM#0>
client has no locks
<CM#1>
client has no locks
```

The following example shows the output when the CM number and the IP address are specified (if the NAS file is locked):

```
CLI>show nas-lock -cm 0 -ip 192.168.1.100
<CM#0>
client may have locks
```

The following example shows the output when the CM number and the IP address are specified (if the NAS file is not locked or the NAS Engine is not started):

```
CLI>show nas-lock -cm 0 -ip 192.168.1.100
<CM#0>
client has no locks
```

delete nas-lock

This command releases the NAS file lock in the host of the specified IP address if the NAS file is locked. If this command is executed by specifying a host where the NAS file is not locked, the setting remains unchanged. The NAS file lock can be released for both the NFS and CIFS protocols.

This command is executed asynchronously. For that reason, even if this command is executed, there are cases when the NAS file lock is not removed. By using the "show nas-lock" command, check whether the NAS file lock was removed in the host of the specified IP address.

Syntax

```
delete nas-lock  
-ip ip_address  
[-cm cm_number]
```

Parameter

-ip This parameter specifies the IP address of the client that locks the NAS file. An IPv4 format or an IPv6 format can be specified. A fully qualified domain name format (FQDN) cannot be specified. Multiple IP addresses cannot be specified.

Example: -ip 192.168.0.100

Example: -ip 2001:db8:20:3:1000:100:20:3

Example: -ip 2001:db8:20::3

ip_address IP address of the client (IPv4 or IPv6)

-cm Optional. This parameter specifies the controller module (CM) number where the lock is to be removed. Multiple CMs cannot be specified. If omitted, the NAS file locks in all the CMs are removed.

cm_number CM number

Output

Item name	Description
CM#n	Controller module (CM) number This item displays whether the locks are released from the NAS files.

Example(s)

The following example removes the NAS file lock of the specified client IP address:

```
CLI> delete nas-lock -ip 192.168.1.100  
<CM#0>  
client locks will be deleted  
  
<CM#1>  
client has no locks
```

The following example removes the NAS file lock of the specified client IP address (if the specified client does not exist, the locked NAS file does not exist, or the NAS Engine is not started):

```
CLI> delete nas-lock -ip 192.168.1.100
<CM#0>
client has no locks

<CM#1>
client has no locks
```

The following example removes the NAS file lock of the specified client IP address and CM number:

```
CLI> delete nas-lock -ip 192.168.1.100 -cm 0
<CM#0>
client locks will be deleted
```

The following example removes the NAS file lock of the specified client IP address and CM number (if the specified client does not exist, the locked NAS file does not exist, or the NAS Engine is not started):

```
CLI> delete nas-lock -ip 192.168.1.100 -cm 0
<CM#0>
client has no locks
```

show nas-file-inflate

This command displays the inflation information of the NAS file.

Check for the existence of an operating inflation process with the "show nas-share-progress" command.

Syntax

```
show nas-file-inflate [-share-number share-number | -share-name share_name]  
{-path path | -base64-path base64_path}
```

Parameter

-share-number or -share-name

This parameter specifies the NAS shared folder in which the NAS file exists to display the inflation information. Multiple folders cannot be specified. If a NAS shared folder name is specified, up to 76 characters can be entered.

Caution

When the NAS shared folder name includes multibyte characters, specify the NAS shared folder with the "-share-number" parameter.

share_number NAS shared folder number

share_name NAS shared folder name

-path

Optional. This parameter specifies the NAS file with the path to display the inflation information. A path (including the file name) that exceeds 1,023 Bytes cannot be specified.

Caution

- For the "-path" parameter, specify the absolute path or the relative path of the NAS shared folder that is specified with the "-share-name" parameter or the "-share-number" parameter as the root folder.
- Paths and folders that do not exist cannot be specified.
- This parameter cannot be specified at the same time as the "-base64-path" parameter. In addition, if the "-base64-path" parameter is omitted, this parameter must be set.

If a file with the extension ".vmdk" is specified, the corresponding file that has "-flat" just before the extension becomes the inflation target. For example, if "-path foo/bar.vmdk" is specified, the inflation information of "foo/bar-flat.vmdk" is displayed.

path NAS file path

-base64-path

Optional. This parameter specifies the NAS file with the path to display the inflation information using a character string that is encoded in the Base64 format.

A path (including the file name) with a character string size that exceeds 1,023 Bytes before being encoded with the Base64 format cannot be specified. After the character string is decoded, only UTF-8 is accepted as the character code.

When creating a multi-byte character path (including the file name), convert the path (UTF-8) that is to be created to the Base64 format so that it can be specified as a parameter of this option.

 **Caution**

- For the "-base64-path" parameter, specify the absolute path or the relative path of the NAS shared folder that is specified with the "-share-name" parameter or the "-share-number" parameter as the root folder.
- Paths and folders that do not exist cannot be specified.
- This parameter cannot be specified at the same time as the "-path" parameter. In addition, if the "-path" parameter is omitted, this parameter must be set.
- The Base64 encoding format complies with RFC4648. However, there is no newline character.

If a file with the extension ".vmdk" is specified, the corresponding file that has "-flat" just before the extension becomes the display targets. For example, if "-base64-path foo/bar.vmdk" is specified, the inflation information of "foo/bar-flat.vmdk" is displayed.

base64_path NAS file path (Base64 format)

■ Output

Item name	Description
Share	NAS shared folder identification
No.	NAS shared folder number
Name	NAS shared folder name
File Path	NAS file path (relative path from the NAS shared folder)
Provisioned Size (KB)	NAS file provisioning size (logical size)
File Allocation Status	Capacity allocation state for the NAS file
Full	Full capacity allocated
Empty	Unallocated (allocated size = 0)
Inflating	Inflating (can be checked with "Inflate Progress")
Partial	Partial allocation (unallocated areas exist)
Inflate Progress	Displays the allocated capacity ratio (=allocated capacity / provisioning size) of the inflating NAS file. A hyphen (-) is displayed if an inflation process is not running. For "Overwrite", the process begins from the numerical value that is dependent on the existing assigned capacity, but the process itself is performed for the entire file so some time may pass until the numerical value begins to increase.

■ Example(s)

The following example displays the inflation information of the inflating file in shared folder #0 when specified with an absolute path:

```
CLI> show nas-file-inflate -share-number 0 -path /vm/myvm.vmdk
<File Inflate Information>
Share No.           [0]
Share Name         [SHARE#0]
File Path          [/vm/myvm-flat.vmdk]
Provisioned Size(KB) [104857600]
File Allocation Status [Inflating]
Inflate Progress   [56%]
```

The following example displays the inflation information of the Sparse file that has an allocated size of "0" (zero) in shared folder SHARE#2 when specified with a relative path:

```
CLI> show nas-file-inflate -share-name SHARE#2 -path vm/myvm.vmdk
<File Inflate Information>
Share No.          [2]
Share Name         [SHARE#2]
File Path          [vm/myvm-flat.vmdk]
Provisioned Size (KB) [32869]
File Allocation Status [Empty]
Inflate Progress   [-]
```

The following example displays the inflation information of the file that completed the inflation process in shared folder SHARE#3 when specified with an absolute path:

```
CLI> show nas-file-inflate -share-name SHARE#3 -path /vm/myvm.vmdk
<File Inflate Information>
Share No.          [3]
Share Name         [SHARE#3]
File Path          [/vm/myvm-flat.vmdk]
Provisioned Size (KB) [131584]
File Allocation Status [Full]
Inflate Progress   [-]
```

start nas-file-inflate

This command starts the inflation process.

Only one inflation process can be executed at a time in the ETERNUS DX/AF. If the inflation process is required for multiple files, wait until the currently running inflation process completes and then perform the inflation process for each file, one at a time.

In addition, an inflation process is stopped by powering off the ETERNUS DX/AF or by rebooting the controller. If the inflation process is stopped, start the inflation process again if necessary. If the inflation process is restarted, specifying the "-overwrite-whole-file" parameter is required.

Caution

- If the TPP is in an over provisioning state, depending on the usage state of the TPP, the physical area of the NAS volume cannot be ensured during an inflation process and the NAS engine may degrade.
- If the "-overwrite-whole-file" parameter is omitted when the allocated size of the specified file is not "0" (zero), this command terminates with an error.
- If the provisioning size (or logical size) is specified with a small file (100MB), this command terminates with an error.
- Sparse files that are inflated with this command are not targets of the quota function limit. Because of that, there may be cases where the drive usage capacity can be used beyond the limit value.

■ Syntax

```
start nas-file-inflate {-share-number share-number | -share-name share_name}  
{-path path | -base64-path base64_path}  
[-overwrite-whole-file]
```

■ Parameter

-share-number or -share-name

This parameter specifies the NAS shared folder in which the Sparse file exists to perform the inflation process. Multiple folders cannot be specified. If a NAS shared folder name is specified, up to 76 characters can be entered.

Caution

When the NAS shared folder name includes multibyte characters in the name, specify the "-share-number" parameter.

share_number NAS shared folder number

share_name NAS shared folder name

-path Optional. This parameter specifies the Sparse file with the path to perform the inflation process. A path (including the file name) that exceeds 1,023 Bytes cannot be specified.

 **Caution**

- For the "-path" parameter, specify the absolute path or the relative path of the NAS shared folder that is specified with the "-share-name" parameter or the "-share-number" parameter as the root folder.
- Paths and folders that do not exist cannot be specified.
- This parameter cannot be specified at the same time as the "-base64-path" parameter. In addition, if the "-base64-path" parameter is omitted, this parameter must be set.

If a file with the extension ".vmdk" is specified, the corresponding file that has "-flat" just before the extension becomes the inflation target. For example, if "-path foo/bar.vmdk" is specified, "foo/bar-flat.vmdk" becomes the inflation target.

path Sparse file path

-base64-path

Optional. This parameter specifies the Sparse file with the path using a character string that is encoded in the Base64 format.

A path (including the file name) with a character string size that exceeds 1,023 Bytes before being encoded with the Base64 format cannot be specified. After the character string is decoded, only UTF-8 is accepted as the character code.

When creating a multi-byte character path (including the file name), convert the path (UTF-8) that is to be created to the Base64 format so that it can be specified as a parameter of this option.

 **Caution**

- For the "-base64-path" parameter, specify the absolute path or the relative path of the NAS shared folder that is specified with the "-share-name" parameter or the "-share-number" parameter as the root folder.
- Paths and folders that do not exist cannot be specified.
- This parameter cannot be specified at the same time as the "-path" parameter. In addition, if the "-path" parameter is omitted, this parameter must be set.
- The Base64 encoding format complies with RFC4648. However, there is no newline character.

If a file with the extension ".vmdk" is specified, the corresponding file that has "-flat" just before the extension becomes the inflation target. For example, if "-base64-path foo/bar.vmdk" is specified, "foo/bar-flat.vmdk" becomes the inflation target.

base64_path Sparse file path (Base64 format)

-overwrite-whole-file

Optional. If this parameter is specified, regardless of the allocated size of the specified file, the entire file is overwritten with zeros and the allocated size is expanded if necessary. If the "-overwrite-whole-file" parameter is omitted when the allocated size of the specified file is not "0" (zero), this command terminates with an error.

■ Example(s)

The following example writes zeros to the entire file by expanding the allocated size of the file that has an allocation size of "0" (zero) in shared folder #0 (when specified with an absolute path):

```
CLI> start nas-file-inflate -share-number 0 -path /vm/myvm.vmdk
```

The following example writes zeros to the entire file by expanding the allocated size of the file that has an allocation size of "0" (zero) in shared folder SHARE#2 (when specified with a relative path):

```
CLI> start nas-file-inflate -share-name SHARE#2 -path vm/myvm.vmdk
```

The following example overwrites the entire file with zeros by expanding the allocated size of the file that does not have an allocation size of "0" (zero) in shared folder SHARE#3 (when specified with an absolute path):

```
CLI> start nas-file-inflate -share-name SHARE#3 -path /vm/myvm.vmdk -overwrite-whole-file
```

stop nas-file-inflate

This command stops the inflation process that was started with the "start nas-file-inflate" command.

Even if there are no inflation processes running, this command completes normally. Check for the existence of an operating inflation process with the "show nas-progress" command.

■ Syntax

```
stop nas-file-inflate -execution {yes | no}
```

■ Parameter

-execution	Optional. This parameter specifies the execution mode. If "yes" is specified, the operating inflation process is stopped.
yes	The operating inflation process is stopped.
no	The inflation process is not stopped.

■ Example(s)

The following example stops the operating inflation process:

```
CLI> stop nas-file-inflate -execution yes
```

Chapter 8

Storage Cluster Management

This chapter explains the commands related to the management of the Storage Cluster functions. When installing the Storage Cluster, performing a configuration from ETERNUS SF Storage Cruiser's ETERNUS SF Web Console is required.

Caution

- The commands that are described in this chapter are not supported in the DX60 S4/DX60 S3.
 - The host interface type of the local storage system and the remote storage system must be the same. FC cannot be mixed with iSCSI.
 - External Volumes and volumes with a UID (or LUN ID) that is inherited from an External LU are not supported by this function.
-

■ TFOV

Transparent Failover Volume (TFOV) is a volume in which the Storage Cluster setting is performed.

■ TFO group

A Transparent Failover (TFO) group is the operations unit for a failover in a single ETERNUS DX/AF, and a Storage Cluster failover is performed for each TFO group.

■ TFO pair port (CA port pair)

With the Storage Cluster function, a failover can be performed by controlling the Link status of each CA port in the two ETERNUS DX/AF storage systems. A single CA port assigned to a TFO group that is used as the Primary and a single CA port assigned to a TFO group that is used as the Secondary are paired to make up TFO pair ports (CA port pair).

■ TFO pair

In the Storage Cluster function, TFO pairs are a combination of TFOVs that consists of pairs. In addition, this also refers to the paired state.

8.1 Storage Cluster

This section explains the details of the commands that are related to the management of the Storage Cluster.

Caution

When installing Storage Cluster, performing a configuration from ETERNUS SF Web Console that is in ETERNUS SF Storage Cruiser is required. For information about operating Storage Cluster, refer to "FUJITSU Storage ETERNUS SF Storage Cruiser Operation Guide".

The control functions for Storage Cluster that are supported by CLI are listed in the following table:

Function	Command
Displaying the registration status of the Storage Cluster license	show storage-cluster-license
Setting the maximum value of the volume for the Storage Cluster function	set storage-cluster-license
Deleting the Storage Cluster license	delete storage-cluster-license
Displaying the settings of a TFO group	show tfo-groups
Registering a TFO group	create tfo-group
Changing the settings of a TFO group	set tfo-group
Deleting the settings of a TFO group	delete tfo-group
Displaying TFO pair ports	show tfo-pair
Setting TFO pair ports	set tfo-pair
Releasing TFO pairs	release tfo-pair
Restoring TFO pairs	recover tfo-pair
Activating TFO groups	forced tfo-group-activate
Displays the list or UID for the volume that belongs in the TFO group	show volumes
Changing the UID or initializing the UID	set volume
Displaying the transfer mode of the Storage Cluster	show fc-parameters show iscsi-parameters
Configuring the transfer mode of the Storage Cluster	set fc-parameters set iscsi-parameters
Stopping the copy session	stop advanced-copy

■ Recovery during a RAID failure (releasing and recovering TFO pairs between TFOVs)

The recovery procedure during a RAID failure in the primary storage is shown below.

Procedure

- 1** Release the TFO pair
In the secondary storage, by using the "release tfo-pair" command, mirror pair relationships between cabinets of the target TFOV are released.
- 2** Maintain the primary storage RAID
Contact a maintenance engineer.
- 3** Recover the TFO pair
In the secondary storage, by using the "recover tfo-pair" command, reconfigure the mirror pair relationships between the cabinets of the target TFOV in the direction of the primary storage from the secondary storage.

End of procedure

■ Reinitialization of the TFOV UID, serial number, and product ID

For continuous operations with the secondary storage after the primary storage becomes unrecoverable, volumes in the secondary storage continue to use the same volume information (UID, serial number, and product ID) even after the volumes become out of sync due to an operation such as TFO group removal. When volumes in the secondary storage are used as a different type of volume after the volumes are made out of sync, the volume information must be reinitialized.

▶ Caution

If a host recognizes multiple volumes with identical volume information, the unforeseen circumstances will occur such as data destruction.

After the volume information is initialized, have the host re-recognize the devices.

The reinitialization procedure for the TFOV UID, serial number, and product ID is shown below.

Procedure

- 1** Reinitialization of the TFOV UID, serial number, and product ID.
Perform a reinitialization using the "set volume" command.

End of procedure

show storage-cluster-license

This command displays the registration status of the Storage Cluster license key.

Syntax

```
show storage-cluster-license
```

Parameter

No parameters.

Output

Item name	Description
Storage Cluster License	Registration status of the Storage Cluster license
Maximum TFO capacity	Maximum total capacity of the volumes for each ETERNUS DX/AF that can be used in the Storage Cluster If the Storage Cluster license is not registered, a hyphen (-) is displayed.

Example(s)

The following example shows the output when the Storage Cluster license has been registered:

```
CLI> show storage-cluster-license
Storage Cluster License [Registered]
Maximum TFO capacity   [16 PB]
```

The following example shows the output when the Storage Cluster license has not been registered:

```
CLI> show storage-cluster-license
Storage Cluster License [-]
Maximum TFO capacity   [-]
```

set storage-cluster-license

This command sets the maximum total capacity of the volumes for each ETERNUS DX/AF that can be used in the Storage Cluster.

Note

The license key for the Storage Cluster function is set from the software.

Syntax

```
set storage-cluster-license  
[-max-tfo-capacity {128tb | 256tb | 384tb | 768tb | 1pb | 2pb | 3pb | 4pb | 8pb | 16pb}]
```

Parameter

-max-tfo-capacity

Optional. This parameter specifies the maximum total capacity of the volumes for each ETERNUS DX/AF that can be used in the Storage Cluster. If omitted, this parameter remains unchanged.

The values for each model are indicated below.

DX100 S4/DX100 S3: 256tb (default), 1pb, 2pb
DX200 S4/DX200 S3: 256tb (default), 1pb, 2pb
DX500 S4/DX500 S3: 384tb (default), 1pb, 2pb, 3pb
DX600 S4/DX600 S3: 768tb (default), 1pb, 2pb, 4pb, 8pb
DX8100 S3: 128tb (default), 1pb
DX8700 S3/DX8900 S3: 1pb (default), 2pb, 4pb, 8pb, 16pb
AF250 S2/AF250: 256tb (default), 1pb, 2pb
AF650 S2/AF650: 768tb (default), 1pb, 2pb, 4pb, 8pb
DX200F: 256tb (default), 1pb, 2pb

Caution

- If the maximum total capacity is reduced, all TFO sessions must be deleted.
- If the maximum total capacity is expanded, the expanded portion uses the shared area of the cache memory. If the installed memory is insufficient, the maximum total capacity cannot be expanded.
- To downgrade the firmware to a version earlier than V10L70, the maximum total capacity of the volume must be returned to the initial value.

128tb	The maximum total capacity is specified as 128TB.
256tb	The maximum total capacity is specified as 256TB.
384tb	The maximum total capacity is specified as 384TB.
768tb	The maximum total capacity is specified as 768TB.
1pb	The maximum total capacity is specified as 1PB.
2pb	The maximum total capacity is specified as 2PB.
3pb	The maximum total capacity is specified as 3PB.
4pb	The maximum total capacity is specified as 4PB.
8pb	The maximum total capacity is specified as 8PB.
16pb	The maximum total capacity is specified as 16PB.

■ Example(s)

The following example sets the maximum total capacity of the volumes for each ETERNUS DX/AF that can be used in the Storage Cluster to 1PB:

```
CLI> set storage-cluster-license -max-tfo-capacity 1pb
```

delete storage-cluster-license

This command deletes the registered Storage Cluster license.

■ Syntax

```
delete storage-cluster-license -execution {yes | no}
```

■ Parameter

- execution This parameter specifies the execution mode. The registered Storage Cluster license is deleted when "yes" is specified.
- | | |
|-----|--|
| yes | The registered Storage Cluster license is deleted. |
| no | The registered Storage Cluster license is not deleted. |

■ Example(s)

The following example deletes the registered Storage Cluster license:

```
CLI> delete storage-cluster-license -execution yes
```

show tfo-groups

This command displays the status of TFO groups, and TFO pair port settings (combination of local and remote ports).

Syntax

```
show tfo-groups [-tfo-number tfog_numbers]
```

Parameter

-tfo-number

Optional. This parameter specifies the TFO group number. The specifiable range is "0" to "31". Multiple TFO group numbers can be specified by separating multiple numbers with a comma (,) or a hyphen (-). If omitted, all TFO group states and TFO pair port settings are displayed.

Example: -tfo-number 0

Example: -tfo-number 0,1

Example: -tfo-number 0-1

tfog_numbers TFO group number

Output

Item name	Description
TFO Group No.	TFO group number
TFO Group Name	TFO group name
Type	TFO group type (Primary or Secondary)
Status	TFO group status (Active or Standby)
Phase	TFO group settings (Disabled, Initial, Maintenance, Failovered, Copying Back, Failback Ready, Failbacked, Normal, Copying, Failed)
Condition	TFO group condition (Disabled, Halt, Normal) When the condition is "Halt", a Halt reason (None, TFO Group Disconnected, Version Mismatch, TFO Group Setting Missing, TFO Group Setting Mismatch, Monitoring Server Disconnected) is also displayed.
Failback Mode	Failback mode of the TFO group (Auto or Manual)
Failover Mode	Failover mode of the TFO group (Auto or Manual)
Failover in CA Port Link Down	Displays whether automatic failover is executed when a CA port Link Down is detected.
On (Enable)	Executes automatic failover when a CA port Link Down is detected.
On (Disable)	Does not execute automatic failover even if the failover setting during a CA port Link Down is set to auto. (Cannot be executed for failover mode [Manual] or failback mode [Auto])
Off	Does not execute automatic failover when a CA port Link Down is detected.
Split Mode	Write permission (Read/Write or Read Only)
Monitor Interval	Interval for monitoring whether failover has completed (Normal [10 seconds or less], Long [20 seconds or less]). A hyphen (-) is displayed when the "Failover Mode" is not "Auto".

Item name	Description
Pair Box ID	Box ID of the remote storage system
Own <-> Pair Port	Combination of the port number for the local storage system and the port number for the Pair to be. The controller enclosure number is displayed in the port number for the Pair to be (or "CE#0" for the DX100 S4/DX200 S4, the DX500 S4/DX600 S4, the DX100 S3/DX200 S3, the DX500 S3/DX600 S3, the DX8100 S3, the AF250 S2/AF650 S2, the AF250/AF650, and the DX200F).

■ Example(s)

The following example shows TFO group #0:

```

CLI> show tfo-groups
TFO Group No.          [0]
TFO Group Name        [TFOG#0]
Type                  [Primary]
Status                [Active]
Phase                 [Normal]
Condition              [Halt (Version Mismatch)]
Failback Mode         [Manual]
Failover Mode         [Auto]
Failover in CA Port Link Down [On (Disable)]
Split Mode            [Read/Write]
Monitor Interval      [normal]
Pair Box ID           [00DXL#####ET06F21AUABCPJ000000#####]
Own <-> Pair Port     [CM#0 CA#0 Port#0 <-> CE#0 CM#0 CA#1 Port#0]
                     [CM#0 CA#0 Port#1 <-> CE#b CM#0 CA#1 Port#1]
  
```

create tfo-group

This command registers TFO groups and configures TFO pair port. The smallest number among the unused numbers is assigned as the TFO group number.

■ Syntax

```
create tfo-group
-name name
-type {primary | secondary}
-pair-box-id pair_box_id
[-failback {auto | manual}]
[-failover {auto | manual}]
[-failover-ca-port-linkdown {on | off}]
[-split-mode {rw | r}]
[-monitor-interval {normal | long}]
-own-port port_numbers -pair-port port_numbers
```

■ Parameter

-name This parameter specifies the TFO group name. Up to 16 characters can be specified. For details on how to specify this parameter, refer to ["1.2.6 Alias Name Syntax" \(page 35\)](#).

name TFO Name of the group

-type This parameter specifies the type for the TFO group.

primary Primary TFO group

secondary Secondary TFO group

-pair-box-id This parameter specifies the Box ID for the storage system that will become the pair.

▶ Caution

- Up to 40 alphanumeric characters (US-ASCII code 0x30 to 0x39, 0x41 to 0x5A, and 0x61 to 0x7A), spaces, and pound signs (#) can be specified.
- All alphabetic characters are handled as capital letters.
- The pound sign characters (#) are automatically appended when the input characters are less than 40.

pair_box_id Box ID of the remote storage system

-failback Optional. This parameter specifies the failback mode setting. If omitted, "manual" is set.

auto Automatic failback

manual Manual failback (default)

-failover Optional. This parameter specifies the failover mode setting. If omitted, "auto" is set. Automatic failover is available if the monitoring server exists.

auto Automatic failover (default)

manual Manual failover

-failover-ca-port-linkdown

Optional. This parameter specifies whether to execute automatic failover when a CA port Link Down is detected.
If omitted, "on" is set.

 **Note**

For manual failover or automatic failback, even if "on" is set, automatic failover is not executed.

on	Automatic failover is executed when a CA port Link Down is detected. (Default)
off	Automatic failover is not executed when a CA port Link Down is detected.

-split-mode Optional. This parameter specifies the access permission for the TFO volume when the copy path is disconnected. If omitted, readable/writable is set for the access permission.

rw	Readable/writable (default)
r	Readable only

-monitor-interval

Optional. This parameter sets the interval for monitoring whether a failover has completed. This parameter is specified if the "-failover" parameter is specified as "auto" or if the "-failover" parameter is omitted.

 **Caution**

The Maintenance Operation policy is required.

normal	The monitor interval is set to 10 seconds or less (default: when the iSCSI port is not included in the REC path between storage systems)
long	The monitor interval is set to 20 seconds or less (default: when the iSCSI port is included in the REC path between storage systems)

-own-port This parameter specifies the CA port number of the local storage system that configures the TFO pair port. The port mode of the port that is to be specified must be in the CA mode. Multiple port numbers can be specified. For details on how to specify this parameter, refer to ["1.2.15 Host Interface Port Syntax" \(page 44\)](#). The number of specified port numbers must be the same as the "-pair-port" parameter.

Example: -own-port 000,001 (for the DX100 S4/DX200 S4, the DX500 S4/DX600 S4, the DX100 S3/DX200 S3, the DX500 S3/DX600 S3, the DX8100 S3, the AF250 S2/AF650 S2, the AF250/AF650, and the DX200F)

Example: -own-port 000,1010 (for the DX8700 S3/DX8900 S3)

port_numbers CA port number of the local storage system that configures the TFO pair port

- pair-port This parameter specifies the CA port number of the remote storage system that configures the TFO pair port. The port mode of the port that is to be specified must be in the CA mode. Multiple port numbers can be specified. For details on how to specify this parameter, refer to "[1.2.15 Host Interface Port Syntax](#)" (page 44). The number of specified port numbers must be the same as the "-own-port" parameter.

For CA port numbers, specify with a 3-digit or 4-digit number.

- When specifying with a 3-digit number
The usable ports are up to an 8CM, 4CA, 4Port.
If the remote device is a DX8700 S3/DX8900 S3, when specifying CM#2 to CM#7, the CM of CE#1 to CE#3 are set.
 - CE number
The value (or quotient) of the CM number X divided by 2.
 - CM number
The value (or remainder) of the CM number X divided by 2.
Example: If CM#2 was specified, the result is CE#1CM#0 ($2 / 2 = 1$ with a remainder of 0)
Example: If CM#7 was specified, the result is CE#3CM#1 ($7 / 2 = 3$ with a remainder of 1)
- When specifying with a 4-digit number
The usable ports are up to a 4CE, 2CM, 4CA, 4Port.

Example: -pair-port 000,001,0120,3130

port_numbers CA port number of the remote storage system that configures the TFO pair port

■ Example(s)

The following example creates a TFO group:

```
CLI> create tfo-group -name TFOG#0 -type primary -pair-box-id 00DXL#####ET06F21AUABCPJ000000##### -own-port 000  
-pair-port 100
```

set tfo-group

This command changes the settings of a TFO group and configures a TFO pair port.

■ Syntax

```
set tfo-group -tfog-number tfog_number  
[-name name]  
[-failback {auto | manual}]  
[-failover {auto | manual}]  
[-failover-ca-port-linkdown {on | off}]  
[-split-mode {rw | r}]  
[-monitor-interval {normal | long}]  
[-own-port port_numbers]  
[-pair-port port_numbers]
```

■ Parameter

-tfog-number

This parameter specifies the number of the TFO group to change the settings. Only one number can be specified for the TFO group number. The specifiable range is "0" to "31".
Example: -tfog-number 0

tfog_number TFO group number

-name

Optional. This parameter specifies the TFO group name. Up to 16 characters can be specified. For details on how to specify the TFO group name, refer to ["1.2.6 Alias Name Syntax" \(page 35\)](#). If omitted, the TFO group name is not changed.

name TFO group name

-failback

Optional. This parameter specifies the failback mode setting. If omitted, the existing setting is not changed.

auto Automatic failover
manual Manual failover (default)

-failover

Optional. This parameter specifies the failover mode setting. If omitted, the existing setting is not changed. Automatic failover is available if the monitoring server exists.

auto Automatic failover
manual Manual failover (default)

-failover-ca-port-linkdown

Optional. This parameter specifies whether to execute automatic failover when a CA port Link Down is detected.
If omitted, this parameter remains unchanged.

 **Note**

For manual failover or automatic failback, even if "on" is set, automatic failover is not executed.

on	Automatic failover is executed when a CA port Link Down is detected.
off	Automatic failover is not executed when a CA port Link Down is detected.

-split-mode Optional. This parameter specifies the access permission for the TFO volume when the copy path is disconnected. If omitted, the existing setting is not changed.

rw	Readable/writable
r	Readable only

-monitor-interval

Optional. This parameter sets the interval for monitoring whether failover has completed. This parameter can be specified if "auto" is specified for the "-failover" parameter. If omitted, the monitoring interval is not changed.

 **Caution**

The Maintenance Operation policy is required.

normal	Sets the interval for monitoring whether failover has completed to 10 seconds or less (default)
long	Sets the interval for monitoring whether failover has completed to 20 seconds or less

-own-port Optional. This parameter specifies the CA port number of the local storage system that configures the TFO pair port to be added. The port mode of the port that is to be specified must be in the CA mode. Multiple port numbers can be specified. For details on how to specify this parameter, refer to ["1.2.15 Host Interface Port Syntax" \(page 44\)](#).

The number of specified port numbers must be the same as the "-pair-port" parameter.

Example: -own-port 000,001 (for the DX100 S4/DX200 S4, the DX500 S4/DX600 S4, the DX100 S3/DX200 S3, the DX500 S3/DX600 S3, the DX8100 S3, the AF250 S2/AF650 S2, the AF250/AF650, and the DX200F)

Example: -own-port 0000,1010 (for the DX8700 S3/DX8900 S3)

<i>port_number</i>	CA port number of the local storage system that configures the TFO pair port
--------------------	--

-pair-port Optional. This parameter specifies the CA port number of the remote storage system that configures the TFO pair port to be added. The port mode of the port that is to be specified must be in the CA mode. Multiple port numbers can be specified. For details on how to specify this parameter, refer to "[1.2.15 Host Interface Port Syntax](#)" (page 44).

The number of specified port numbers must be the same as the "-own-port" parameter.

For CA port numbers, specify with a 3-digit or 4-digit number.

- When specifying with a 3-digit number

The usable ports are up to an 8CM, 4CA, 4Port.

If the remote device is a DX8700 S3/DX8900 S3, when specifying CM#2 to CM#7, the CM of CE#1 to CE#3 are set.

- CE number

The value (or quotient) of the CM number X divided by 2.

- CM number

The value (or remainder) of the CM number X divided by 2.

Example: If CM#2 was specified, the result is CE#1CM#0 ($2 / 2 = 1$ with a remainder of 0)

Example: If CM#7 was specified, the result is CE#3CM#1 ($7 / 2 = 3$ with a remainder of 1)

- When specifying with a 4-digit number

The usable ports are up to a 4CE, 2CM, 4CA, 4Port.

Example: -pair-port 000,001

Example: -pair-port 0011,3111

port_numbers CA port number of the remote storage system that configures the TFO pair port

■ Example(s)

The following example changes the settings for TFO group #0:

```
CLI> set tfo-group -tfo-number 0 -name TFOG#000 -failover auto
```

delete tfo-group

This command deletes TFO groups as well as removing TFO pair port settings. When all the ports configured in the specified TFO group are removed, that TFO group is deleted.

Syntax

```
delete tfo-group  
-tfo-number tfo_group_number  
[-own-port {port_numbers}]  
[-port-wwn-mode {keep | original}]
```

Parameter

-tfo-number

This parameter specifies the number of the TFO group for deletion, or the number of the TFO group for removing the TFO pair port setting. Only one number can be specified for the TFO group number. "0" or "31" can be specified. If the "-own-port" parameter or the "-port-wwn-mode" parameter is omitted, the specified TFO group is deleted.

Example: -tfo-number 0

tfo_group_number TFO group number

-own-port

Optional. This parameter specifies the CA port number of the local storage system for removing the TFO pair port setting. The port mode of the port that is to be specified must be in the CA mode. Multiple port numbers can be specified. For details on how to specify this parameter, refer to ["1.2.15 Host Interface Port Syntax" \(page 44\)](#). If omitted, the TFO pair port settings are removed for all the local storage systems port numbers of the specified TFO group, and that TFO group is deleted. This parameter cannot be specified with the "-port-wwn-mode" parameter. If this parameter is specified, the WWPN of the relevant FC port will be reverted to the initial setting.

Example: -own-port 000,001 (for the DX100 S4/DX200 S4, the DX500 S4/DX600 S4, the DX100 S3/DX200 S3, the DX500 S3/DX600 S3, the DX8100 S3, the AF250 S2/AF650 S2, the AF250/AF650, and the DX200F)

Example: -own-port 0000,1010 (for the DX8700 S3/DX8900 S3)

port_numbers The CA port number of the local storage system for removing the TFO pair port setting.

-port-wwn-mode

Optional. This parameter specifies whether to return the WWPN of the FC port to the initial setting if a TFO group is deleted. For the secondary TFO group, this parameter can be specified. For iSCSI ports, this parameter is ignored.

This parameter cannot be specified with the "-own-port" parameter.

keep The WWPN of the port is maintained (default).

original The WWPN of the port is reverted to the original setting.

■ Example(s)

The following example deletes TFO group #0 and returns the WWPN of the port to the original setting:

```
CLI> delete tfo-group -tfog-number 0 -port-wwn-mode original
```

The following example removes TFO pair port settings for TFO group #0:

```
CLI> delete tfo-group -tfog-number 0 -own-port 000
```

show tfo-pair

This command displays TFO pair port status, TFO volume information, and TFO session information.

Syntax

```
show tfo-pair [-tfog-number tfog_number] [-session-id id]
```

Parameter

-tfog-number

Optional. This parameter specifies the number of the TFO groups to display the information. Multiple TFO group numbers can be specified. "0" or "31" can be specified. This parameter cannot be specified with the "-session-id" parameter.

Example: -tfog-number 0
Example: -tfog-number 0,1
Example: -tfog-number 0-1

tfog_number TFO group number

-session-id Optional. This parameter specifies the ID of the session to display the information. Multiple session IDs can be specified. This parameter cannot be specified with the "-tfog-number" parameter.

Example: -session-id 0
Example: -session-id 10,20
Example: -session-id 0-5

id Session ID

Output

- If all the parameters are omitted, the following items are displayed.

Item name	Description
TFO Group No.	The TFO group number of the local storage system
TFO Group Name	The TFO group name of the local storage system
Port	The port number of the local storage system
Host No.	The host number of the local storage system
Host Name	The host name of the local storage system

- When the TFO group number is specified, the following items are displayed.

Item name	Description
TFO Group No.	The TFO group number of the local storage system
TFO Group Name	The TFO group name of the local storage system
Port	The port number of the local storage system
Host No.	The host number of the local storage system
Host Name	The host name of the local storage system
Own Volume No.	The TFO volume number of the local storage system
Own Volume Name	The TFO volume name of the local storage system

Item name	Description
Pair Volume No.	The TFO volume number that will be paired. A hyphen (-) is displayed if the TFO session does not exist in the relevant volume of the local storage system or if the session status is "Idle" or "Reserve".
SID	The session ID of the local storage system. A hyphen (-) is displayed if the TFO session does not exist in the relevant volume of the local storage system (TFO sessions in "Idle" or "Reserve" status are also regarded as not existing).
Status	The status of the TFO session (Active, Error Suspend, Suspend, or Halt). A hyphen (-) is displayed if the TFO session does not exist in the relevant volume of the local storage system (TFO sessions in "Idle" or "Reserve" status are also regarded as not existing).
Phase	The phase of the TFO session (Copying or Equivalent). A hyphen (-) is displayed if the TFO session does not exist in the relevant volume of the local storage system (TFO sessions in "Idle" or "Reserve" status are also regarded as not existing).
Error Code	Error codes are displayed as two-digit hexadecimal numbers. If "Status" is a hyphen (-), a hyphen (-) is displayed. A hyphen (-) is displayed if the TFO session does not exist in the relevant volume of the local storage system (TFO sessions in "Idle" or "Reserve" status are also regarded as not existing).

- When the session ID is specified, the following items are displayed.

Item name	Description
SID	Session ID of the local storage system
Own Volume No.	TFO volume number of the local storage system A hyphen (-) is displayed if the session status is "Idle" or "Reserve".
Own Volume Name	TFO volume name of the local storage system A hyphen (-) is displayed if the session status is "Idle" or "Reserve".
Pair Volume No.	The TFO volume number that will be paired A hyphen (-) is displayed if the session status is "Idle" or "Reserve".
Status	The status of the TFO session (Active, Error Suspend, Suspend, or Halt) A hyphen (-) is displayed if the session status is "Idle" or "Reserve".
Phase	The phase of the TFO session (Copying, Equivalent) A hyphen (-) is displayed if the session status is "Idle" or "Reserve".
Error Code	Error codes are displayed as two-digit hexadecimal numbers A hyphen (-) is displayed if the session status is "Idle" or "Reserve".
Source Block Address	The copy source start Logical Block Address (LBA) is displayed as a 16-digit hexadecimal number A hyphen (-) is displayed if the session status is "Idle" or "Reserve".
Destination Block Address	The copy destination start Logical Block Address (LBA) is displayed as a 16-digit hexadecimal number A hyphen (-) is displayed if the session status is "Idle" or "Reserve".
Total Data Size	Total copy data block A hyphen (-) is displayed if the session status is "Idle" or "Reserve".
Copied Data Size	Completed copy data block A hyphen (-) is displayed if the session status is "Idle" or "Reserve".
Direction	Displays the roles of this system in the copy session (From Local/To Remote: copy source, From Remote/To Local: copy destination) A hyphen (-) is displayed if the session status is "Idle" or "Reserve".
Sync	The operation mode (Sync) of the session A hyphen (-) is displayed if the session status is "Idle" or "Reserve".
Recovery Mode	The recovery mode (Automatic) of the session "Automatic" is the mode that automatically resumes the copy when the REC copy path is recovered from an abnormal state. A hyphen (-) is displayed if the session status is "Idle" or "Reserve".

Item name	Description
Split Mode	The split mode of the session is displayed in the following way: Automatic: The mode that authorizes write I/O access to the copy source when the REC copy path is in an abnormal state. Manual: The mode that authorizes write I/O access to the copy source when the REC copy path is in an abnormal state. The specified sense information is transmitted to the host. A hyphen (-) is displayed if the session status is "Idle" or "Reserve".
Remote Session-ID	The session ID of another system connected remotely to this system A hyphen (-) is displayed if the session status is "Idle" or "Reserve".
Remote Box-ID	The identifier of another system connected remotely to this system A hyphen (-) is displayed if the session status is "Idle" or "Reserve".
Time Stamp	Time stamp Displays the local time. The time stamp just before a backup is displayed when the status is "Active" or "Suspend". The time stamp the moment a problem occurs is displayed when the status is "Error Suspend" or "Halt". A hyphen (-) is displayed if the session status is "Idle" or "Reserve".
Elapsed Time	The elapsed time from the start of the session (combination of days, hours, minutes, and seconds) A hyphen (-) is displayed if the session status is "Idle" or "Reserve".
Copy Range	Copy range (Total, Extent) A hyphen (-) is displayed if the session status is "Idle" or "Reserve".
Secondary Access Permission	Possibility of host access to the area of the Secondary storage while the status is "Active" (Read Only at Equivalency, No Read/Write) A hyphen (-) is displayed if the session status is "Idle" or "Reserve".
Concurrent Suspend Status	Concurrent Suspend transition state (Normal, Exec, Error, Unknown) A hyphen (-) is displayed if the session status is "Idle" or "Reserve".

■ Example(s)

The following example shows information when parameters are omitted. A list of all TFO pair ports is displayed:

```
CLI> show tfo-pair
TFO Group      Port                Host
No.  Name            No.  Name
-----
0  TFOG#0          CM#0 CA#0 Port#0    0  Host#0
0  TFOG#0          CM#0 CA#0 Port#1    10 Host#10
0  TFOG#0          CM#0 CA#1 Port#0    7  Host#7
0  TFOG#0          CM#0 CA#1 Port#1    16 Host#16
1  TFOG#1          CM#0 CA#0 Port#2    3  Host#3
1  TFOG#1          CM#0 CA#0 Port#3    1  Host#1
```

The following example shows information when parameters are omitted (for the DX8700 S3/DX8900 S3). A list of all TFO pair ports is displayed:

```
CLI> show tfo-pair
TFO Group      Port                Host
No.  Name            No.  Name
-----
0  TFOG#0          CE#0 CM#0 CA#0 Port#0    0  Host#0
0  TFOG#0          CE#0 CM#0 CA#0 Port#1    10 Host#10
0  TFOG#0          CE#0 CM#0 CA#1 Port#0    7  Host#7
0  TFOG#0          CE#0 CM#0 CA#1 Port#1    16 Host#16
1  TFOG#1          CE#0 CM#0 CA#0 Port#2    3  Host#3
1  TFOG#1          CE#0 CM#0 CA#0 Port#3    1  Host#1
```

The following example shows information for TFO group #0 and TFO group #1:

```

CLI> show tfo-pair -tfog-number 0,1
<TFO Group Info #0>
TFO Group Name [TFO#0]

<Port Info CM#0 CA#0 Port#0>
Host No. [0]
Host Name [HOST#0]

Own Volume          Pair Volume SID  Status      Phase      Error
No.  Name          No.          -  -  -  -  -  -
-----
0  VOLUME00000000000000000000000000000000  0  0  Active  Copying  0x00
1  VOLUME00000000000000000000000000000001  1  1  Active  Copying  0x00
2  VOLUME00000000000000000000000000000002  -  -  -  -  -

<Port Info CM#0 CA#0 Port#1>
Host No. [10]
Host Name [HOST#10]

Own Volume          Pair Volume SID  Status      Phase      Error
No.  Name          No.          -  -  -  -  -  -
-----
3  VOLUME000000000003  3  3  Active  Copying  0x00
4  VOLUME000000000004  4  4  Active  Copying  0x00

<Port Info CM#0 CA#1 Port#0>
Host No. [7]
Host Name [HOST#7]

Own Volume          Pair Volume SID  Status      Phase      Error
No.  Name          No.          -  -  -  -  -  -
-----
5  VOLUME000000000005  5  5  Active  Copying  0x00
6  VOLUME000000000006  6  6  Active  Copying  0x00

<Port Info CM#0 CA#1 Port#1>
Host No. [16]
Host Name [HOST#16]

Own Volume          Pair Volume SID  Status      Phase      Error
No.  Name          No.          -  -  -  -  -  -
-----
7  VOLUME000000000007  7  7  Active  Copying  0x00
8  VOLUME000000000008  8  8  Active  Copying  0x00

<TFO Group Info #1>
TFO Group Name [TFO#1]

<Port Info CM#0 CA#0 Port#2>
Host No. [3]
Host Name [HOST#3]

Own Volume          Pair Volume SID  Status      Phase      Error
No.  Name          No.          -  -  -  -  -  -
-----
10 VOLUME00000000000000000000000000000010  10 10  Active  Copying  0x00
11 VOLUME00000000000000000000000000000011  11 11  Active  Copying  0x00

<Port Info CM#0 CA#0 Port#3>
Host No. [1]
Host Name [HOST#1]

Own Volume          Pair Volume SID  Status      Phase      Error
No.  Name          No.          -  -  -  -  -  -
-----
12 VOLUME00000000000000000000000000000012  12 12  Active  Copying  0x00
13 VOLUME00000000000000000000000000000013  13 13  Active  Copying  0x00
  
```

The following example shows the session information for session ID #0 and session ID #2:

```
CLI> show tfo-pair -session-id 0,2
<Session Info #10>
Own Volume No.           [0]
Own Volume Name          [VOLUME000000000000000000000000]
Pair Volume No.         [0]
Status                   [Active]
Phase                    [Copying]
Error Code               [0x00]
Source Block Address     [0x1234567890123456LBA]
Destination Block Address [0x1234567890123456LBA]
Total Data Size          [1024MB]
Copied Data Size         [512MB]
Direction                [From Local/To Remote]
Sync                     [Sync]
Recovery Mode            [Automatic]
Split Mode               [Manual]
Remote Session-ID       [10]
Remote Box-ID           [00DXL#####ET06F21AUABCPJ000000#####]
Time Stamp               [2010-11-17 18:30:00]
Elapsed Time             [1 day 1 hour 32 min 35 sec]
Copy Range               [Extent]
Secondary Access Permission [No Read/Write]
Concurrent Suspend Status [Normal]

<Session Info #2>
Own Volume No.          [-]
Own Volume Name         [-]
Pair Volume No.        [-]
Status                  [-]
Phase                   [-]
Error Code              [-]
Source Block Address    [-]
Destination Block Address [-]
Total Data Size         [-]
Copied Data Size        [-]
Direction               [-]
Sync                    [-]
Recovery Mode           [-]
Split Mode              [-]
Remote Session-ID       [-]
Remote Box-ID           [-]
Time Stamp              [-]
Elapsed Time            [-]
Copy Range              [-]
Secondary Access Permission [-]
Concurrent Suspend Status [-]
```

set tfo-pair

This command configures TFO pair ports for each host affinity unit.

■ Syntax

```
set tfo-pair  
-port port_number  
{-host-number host_number | -host-name host_name}
```

■ Parameter

-port This parameter specifies the CA port number of the local storage system that configures the TFO pair port. Only one port number can be specified. For details on how to specify this parameter, refer to ["1.2.15 Host Interface Port Syntax" \(page 44\)](#).

Example: -port 000 (for the DX100 S4/DX200 S4, the DX500 S4/DX600 S4, the DX100 S3/DX200 S3, the DX500 S3/DX600 S3, the DX8100 S3, the AF250 S2/AF650 S2, the AF250/AF650, and the DX200F)
Example: -port 1010 (for the DX8700 S3/DX8900 S3)

port_number Port number

-host-number or -host-name

This parameter specifies the host number or host name to associate with the TFO pair port. Only one host number or host name can be specified. For details on how to specify this parameter, refer to ["1.2.12 Host Syntax" \(page 41\)](#). For host number or host name association, perform with the "set host-affinity" command.

host_number Host number

host_name Host name

■ Example(s)

The following example sets affinity for host #0 with CM#0 CA#0 Port#0:

```
CLI> set tfo-pair -port 000 -host-number 0
```

The following example sets affinity for host #0 with CE#0 CM#0 CA#0 Port#0 (for the DX8700 S3/DX8900 S3):

```
CLI> set tfo-pair -port 0000 -host-number 0
```

release tfo-pair

This command releases TFO pairs.

Syntax

```
release tfo-pair
-port port_number
{-host-number host_number | -host-name host_name}
[-volume-number volume_numbers | -volume-name volume_names]
[-volume-uid-mode {keep | original}]
```

Parameter

-port This parameter specifies the port number associated with the TFO volume to release the pairing. Only one port number can be specified. For details on how to specify this parameter, refer to ["1.2.15 Host Interface Port Syntax" \(page 44\)](#).

Example: -port 000 (for the DX100 S4/DX200 S4, the DX500 S4/DX600 S4, the DX100 S3/DX200 S3, the DX500 S3/DX600 S3, the DX8100 S3, the AF250 S2/AF650 S2, the AF250/AF650, and the DX200F)
Example: -port 1010 (for the DX8700 S3/DX8900 S3)

port_number Port number

-host-number or -host-name

This parameter specifies the host number or host name associated with the TFO volume to release the pairing. Only one host number or host name can be specified. For details on how to specify this parameter, refer to ["1.2.12 Host Syntax" \(page 41\)](#).

host_number Host number

host_name Host name

-volume-number or -volume-name

Optional. This parameter specifies the number or name of the TFO volume to release the pairing. Multiple TFO volume numbers or names can be specified. For details on how to specify this parameter, refer to ["1.2.11 Volume Syntax" \(page 40\)](#). If this parameter is specified, the UID will remain as the Pair TFO volume UID. If omitted, all TFO volume pairings that belongs to the target LUN group will be released. This parameter cannot be specified with the "-volume-uid-mode" parameter.

volume_numbers TFO volume number

volume_names TFO volume name

-volume-uid-mode

This parameter specifies whether to return the TFO volume UID to the original UID after the pairing is released. This parameter cannot be specified with the "-volume-number" parameter or the "-volume-name" parameter.

keep Maintain the TFO volume UID (default)

original Return the TFO volume UID back to the original UID

■ Example(s)

The following example releases TFO Pairs for all the TFO volumes that are associated with CM#0 CA#0 Port#0 and host #0 affinity:

```
CLI> release tfo-pair -port 000 -host-number 0 -volume-uid-mode original
```

The following example releases TFO Pairs for all the TFO volumes that are associated with CE#0 CM#0 CA#0 Port#0 and host #0 affinity (for the DX8700 S3/DX8900 S3):

```
CLI> release tfo-pair -port 0000 -host-number 0 -volume-uid-mode original
```

The following example releases TFO Pairs for TFO volume #0 that is associated with CM#0 CA#0 Port#0 and host #0 affinity:

```
CLI> release tfo-pair -port 000 -host-number 0 -volume-number 0
```

recover tfo-pair

This command recovers TFO pairs.

■ Syntax

```
recover tfo-pair
-port port_number
{-host-number host_number | -host-name host_name}
[-volume-number volume_numbers | -volume-name volume_names]
-recovery-target {primary | secondary}
```

■ Parameter

-port This parameter specifies the port number associated with the TFO volume for the recovery. Only one port number can be specified. For details on how to specify this parameter, refer to ["1.2.15 Host Interface Port Syntax" \(page 44\)](#).

Example: -port 000 (for the DX100 S4/DX200 S4, the DX500 S4/DX600 S4, the DX100 S3/DX200 S3, the DX500 S3/DX600 S3, the DX8100 S3, the AF250 S2/AF650 S2, the AF250/AF650, and the DX200F)
Example: -port 1010 (for the DX8700 S3/DX8900 S3)

port_number Port number

-host-number or **-host-name**

This parameter specifies the host number or host name associated with the TFO volume for the recovery. Only one host number or host name can be specified. For details on how to specify this parameter, refer to ["1.2.12 Host Syntax" \(page 41\)](#).

host_number Host number

host_name Host name

-volume-number or **-volume-name**

Optional. This parameter specifies the TFO volume number or TFO volume name for the recovery. Multiple TFO volume numbers or TFO volume names can be specified. For details on how to specify this parameter, refer to ["1.2.11 Volume Syntax" \(page 40\)](#). If omitted, all TFO volumes that belong to the target LUN group will be recovered.

volume_numbers TFO volume number

volume_names TFO volume name

-recovery-target

This parameter specifies the TFO group type that the TFO volume will belong to for the recovery.

primary Recovers (Copyback) the TFO volume that belongs to the Primary TFO group

secondary Recovers (Rebuild) the TFO volume that belongs to the Secondary TFO group

■ Example(s)

The following example recovers all the TFO volumes that are associated with CM#0 CA#0 Port#0 and host #0 affinity:

```
CLI> recover tfo-pair -port 000 -host-number 0 -recovery-target primary
```

The following example recovers all the TFO volumes that are associated with CE#0 CM#0 CA#0 Port#0 and host #0 affinity (for the DX8700 S3/DX8900 S3):

```
CLI> recover tfo-pair -port 0000 -host-number 0 -recovery-target primary
```

The following example recovers TFO volume #0 that is associated with CM#0 CA#0 Port#0 and host #0 affinity:

```
CLI> recover tfo-pair -port 000 -host-number 0 -volume-number 0 -recovery-target secondary
```

forced tfo-group-activate

This command activates TFO groups.

■ Syntax

```
forced tfo-group-activate -tfog-number tfog_number  
{-active-mode {manual-failover | manual-failback} |  
-forced-mode {primary-active | secondary-active}}
```

■ Parameter

-tfog-number

This parameter specifies the number of the TFO group to be activated. Only one number can be specified for the TFO group number. "0" or "31" can be specified.

Example: -tfog-number 0

tfog_number TFO group number

-active-mode

This parameter specifies whether to implement manual failover or manual failback. This parameter cannot be specified with the "-forced-mode" parameter. This parameter must be specified when the "-forced-mode" parameter is omitted.

manual-failover Manual failover

manual-failback Manual failback

-forced-mode

This parameter specifies whether to forcibly activate the Primary storage TFO group or the Secondary storage TFO group. This parameter cannot be specified with the "-active-mode" parameter. This parameter must be specified when the "-active-mode" parameter is omitted.

Caution

For the "primary-active" setting, the Maintenance Operation policy is required.

primary-active The primary storage TFO group is activated.

secondary-active The secondary storage TFO group is activated.

■ Example(s)

The following example activates TFO group #0:

```
CLI> forced tfo-group-activate -tfog-number 0 -active-mode concurrent-failover
```

Chapter 9

CLI Original Function



This section explains the commands related specifically to the CLI environment itself.

9.1 CLI Environment

This section explains the commands relating specifically to the CLI environment itself.

- Forcibly releasing the resources that CLI and the controller firmware control
- Idle timeout interval
- Logoff
- Viewing help

set clienv-force-unlock

Multiple sessions may compete for exclusive resources. One session can execute commands, but commands issued by the other session(s) are abnormally terminated with an error message. In this case, wait for the session to complete processing, and then retry the failed command. Or, use this command to forcibly release exclusive resources. This is useful when access is lost due to unexpected errors, such as a terminal disconnecting suddenly. This command forcibly releases resources on which CLI and RAID controller firmware have an exclusive hold.

Caution

Do not use this command while settings are being performed by another session of Web GUI, CLI, or monitoring software.

■ Syntax

```
set clienv-force-unlock
```

■ Parameter

No parameters.

■ Example(s)

The following example forcibly releases exclusive resources:

```
CLI> set clienv-force-unlock
```

set clienv-idle-timeout

This command changes the timeout related value of the CLI session. The time can be set to automatically log off idle CLI sessions. The idle timeout interval applies to sessions that are created after the timeout interval is set. The timeout interval that is set by this command is shared in the ETERNUS DX/AF. In addition, if all the parameters are omitted, the current value is displayed.

■ Syntax

```
set clienv-idle-timeout [-timeout minute]
```

■ Parameter

-timeout Optional. This parameter specifies the idle timeout interval in minutes until an idle status CLI session is automatically logged off. Any value from 5 minutes to 60 minutes can be specified. If omitted, the current idle timeout interval is displayed.

minute Idle timeout interval until an idle status CLI session is automatically logged off
(5 – 60)

■ Example(s)

The following example sets the idle timeout interval to 60 minutes:

```
CLI> set clienv-idle-timeout -timeout 60
```

The following example displays the current idle timeout interval for the ETERNUS DX/AF:

```
CLI> set clienv-idle-timeout  
CLI Idle Timeout (minute) [60]
```

logoff/logout/exit

These commands exit the CLI session. All of these commands have the same effect.

■ Syntax

```
logoff  
logout  
exit
```

■ Parameter

No parameters.

■ Example(s)

Any of the following commands exit a CLI session:

```
CLI> logoff  
CLI> logout  
CLI> exit
```

help

This command displays brief descriptions for all the command names supported by CLI.

■ Syntax

```
help [command_name]
```

■ Parameter

command_name

Optional. This parameter specifies the CLI command name. Either the verb section (the first part of the CLI command name) or the complete command name can be specified. If omitted, all the CLI command names are listed.

Examples of correct parameter specifications are as follows:

- CLI> help (no parameter)
- CLI> help show (verb section only)
- CLI> help show mapping (complete command)
- CLI> help show ma (incomplete command but OK)

● Note

- The only complete command that matches this is "show mapping".
- An incomplete command that can be uniquely identified is treated as a complete command.

Examples of incorrect parameter specifications are as follows:

- CLI> help mapping (object section only)
- CLI> help sh (incomplete verb section of command)
- CLI> help show m (incomplete object section of command)

● Note

"show mapping" and "show migration" are complete commands that match the help string. In this case, CLI cannot identify a unique command.

■ Example(s)

The following example has no parameter. Brief descriptions for all the command names are displayed:

```
CLI> help
copy host-affinity      - Copy host affinity group associations from a host interface port to other ports.
copy mapping            - Copy the LUN mapping definitions from a specified host interface port to one or more host interface ports.
create community-profile - Create a SNMP community profile.
create eco-schedule     - Create one ECO schedule and only one ECO schedule event.
... (snip)
```

The following example shows when "create" (the verb section or first part of the CLI command name) is specified as the command parameter for the help command. Brief descriptions of all the command names beginning with the word "create" are output:

```
CLI> help create
create community-profile - Create a SNMP community profile.
create eco-schedule      - Create one ECO schedule and only one ECO schedule event.
create host-wwn-name     - Create a host identifier and alias for an FC host port.
create raid-group        - Create a RAID group with the specified RAID group name, RAID level and disks.
create snmp-view         - Create an SNMP Management Information Base view (MIB view).
create ssl-certificate   - Re-create a server key and a server certificate for network security using SSH/SSL.
create user              - A new user name of profile
create volume            - Create one or more volumes on a specified RAID group.
```

The following example displays a detailed description of the "create raid-group" command:

```
CLI> help create raid-group
Descriptions:
  Create a RAID group with the specified RAID group name, RAID level and disks.
Syntax:
  create raid-group -name alias_name -disks disks -level {0|1|5|6|10|50} [-assigned-cm {0|1|auto}]
Parameter description(s):
  -name
    Name of a RAID group
  -disks
    Disk drives to use in the RAID group
  -level
    RAID level
      0 : RAID0
      1 : RAID1
      5 : RAID5
      6 : RAID6
      10 : RAID1+0
      50 : RAID5+0
  -assigned-cm
    Assigned controller for the RAID group
      0 : Controller Module #0
      1 : Controller Module #1
      auto : Automatically (default)
```

Appendix A

Error Messages/Error Codes

This appendix provides descriptions for the error messages and error codes that the CLI outputs.

A.1 Error Messages

This section explains error message numbers, and messages output to the CLI, as well as recommended actions. Refer to ["1.7 Error Message Format" \(page 53\)](#) (in the overview section of this manual) for a detailed explanation on CLI error messages.

If an error occurs with a NAS function operation, refer to "FUJITSU Storage ETERNUS DX S4/S3 series Hybrid Storage Systems Configuration Guide (NAS)" for additional troubleshooting information.

Table A.1 List of error messages

Message number	Message Countermeasure for the error
E0001	Bad value.
	The operand of the specified parameter is incorrect. Check the parameters identified in the details of this message.
E0002	Value out of range.
	The operand of the specified parameter is out of the correct range. Check the parameters identified in the details of this message.
E0003	Too many parameters.
	Too many parameters were specified. Check the parameters identified in the details of this message.
E0004	Missing parameter.
	Too few parameters were specified. Check the parameters identified in the details of this message.
E0005	Incorrect parameter combination.
	The combination of the parameters specified is incorrect. Check the parameters identified in the details of this message.
E0006	Inconsistent status.
	The status of the object specified is inappropriate for the operation requested. Check the status of the object identified in the details of this message.
E0007	Inconsistent usage.
	The usage requested is incorrect for the specified object. Check the permitted usage of the object identified in the details of this message.
E0008	Inconsistent size.
	The size requested does not correspond with the current size. Check the size of the object identified in the details of this message.
E0009	Inconsistent RAID level.
	The operation is not appropriate for the RAID level of the specified RAID group. Check the RAID level of the group identified in the details of this message.

Message number	Message Countermeasure for the error
E0010	Inconsistent model type of device.
	The specified operation is not appropriate for the type of device. Check the type of device identified in the details of this message.
E0011	Inconsistent network setup.
	This message indicates that the network settings are incorrect. Check the network settings by using the "show network" command.
E0012	Inconsistent e-mail setup.
	This message indicates that the e-mail settings are incorrect. Check the e-mail settings by using the "show email-notification" command.
E0014	Inconsistent disk status.
	Cannot execute the specified command because the drive is not in an appropriate state. Check the status of the drives identified in the details of this message.
E0015	Inconsistent enclosure status.
	Cannot execute the specified command because the enclosure is not in an appropriate state. Check the status of the drives identified in the details of this message.
E0019	Inconsistent parameter.
	The specified parameter does not correspond with the command. Check the parameters indicated in the details of this message.
E0020	Internal error.
	An internal error has occurred. Retry the command, and if unsuccessful, contact the support department.
E0021	The requested operation has failed.
	The specified command process has failed. If this error continues to recur even after numerous command retries, the specified command cannot be executed for an unknown reason.
E0030	Command not supported.
	This command is not supported. Check the execution conditions (Example: model type, host interface type [FC/SAS/iSCSI], and firmware levels).
E0031	Reserved keyword is used.
	Reserved keyword cannot be used. Use another name.
E0032	Controller firmware cannot be downgraded.
	Reverting to an earlier version is not allowed for the hot application mode. Confirm the controller firmware version by using the "show firmware" command, and use the cold application mode if necessary.
E0033	Not applicable to this target.
	The specified resource cannot be applied to the specified command process. Check the specified resource.
E0034	Mainframe resources.
	The specified Mainframe resource cannot be applied to the specified command process. Check the specified resource.
E0035	Disk firmware can only be upgraded.
	Confirm the firmware version that is registered in the ETERNUS DX/AF and the firmware version that has been applied to the disks. The disk firmware that is currently being used can only be upgraded to a newer version.
E0041	Incorrect password syntax.
	The syntax of the specified password is incorrect. Check that the length and characters of the passwords are acceptable.
E0042	Incorrect password.
	The password entered is incorrect. Check and then re-enter the password.
E0050	Incorrect file.
	The specified file format is incorrect. Check the format of the file identified in the details of this message.

Message number	Message Countermeasure for the error
E0051	Incorrect license key.
	The specified license key is incorrect. Check the license key shown in the details of this message.
E0052	File access failure.
	Unable to access the specified file. Possible causes include file restrictions or a lack of free space when creating a file.
E0053	Remote server access failure.
	Access to the remote server failed.
	Check the ETERNUS DX/AF's network setting, the remote server setting, or the network environment's status.
E0060	Resource locked.
	The resource is being used by another session. Wait for a while and retry the command. If this error message continues to recur even after numerous command retries, a resource can be forcibly released by using the "set clienv-force-unlock" command (do not use this command while settings are being performed by another session of Web GUI, CLI, or monitoring software).
E0061	Lock was relinquished to another user.
	The process privilege is taken by another user (GUI, CLI, or monitoring software). Wait for a while and try again.
E0070	Resource busy.
	Resources corresponding to the specified parameter are used by another process. Check the working status of the resources identified in the details of this message.
E0071	Resource is linked to the other resource.
	The specified parameter is associated with other resources. Confirm the associated status of the specified parameter (Example: host mappings, ECO definitions, etc.). Release the association if necessary and try again. For example, host mappings can be released by using the "release host-affinity" command and/or the "release mapping" command, and Eco-mode definitions can be deleted by using the "release eco-raid-group" command.
E0072	Resource is temporarily insufficient.
	Could not execute because the required resource is temporarily insufficient. Wait for a while and retry the command.
E0073	Drive is currently Busy. Wait a while, and then retry.
	A timeout occurred while performing an internal retry. Wait for a while and retry the command.
E0080	Resource limited.
	A resource has reached its limit. Confirm the limit and the status of the specified parameter/function.
E0081	Number of active disks has reached the system limit.
	The drives or volumes have reached the specified upper limit. Check either the specified parameter or the system's upper limit value.
E0089	Not available under current Advanced Copy usable mode conditions.
	The current Advanced Copy mode does not permit this operation. Use the "show advanced-copy-parameters" command to check the Advanced Copy usable mode.
	The Advanced Copy usable mode can be canceled by using the "set advanced-copy-parameters" command if necessary.
E0090	Not available under current system status conditions.
	The current system status does not permit this operation. Check the status of the ETERNUS DX/AF using the "show status" command or the "show enclosure-status" command.
E0091	Not available under current SNMP settings.
	The current SNMP mode does not permit this operation. Check the SNMP mode by using the "show snmp" command. The SNMP mode can be changed by using the "set snmp" command if necessary.

Message number	Message Countermeasure for the error
E0092	Not available under current operation mode conditions.
	The current operation mode does not permit this operation. Check the operation mode by using the "show enclosure-status" command. The operation mode can be set by using the "start maintenance" command or canceled by using the "stop maintenance" command if necessary.
E0093	Not available under current host affinity mode conditions.
	The current host affinity mode does not permit this operation. Check the host affinity mode by using the "show fc-parameters" command, the "show sas-parameters" command, or the "show iscsi-parameters" command. The host affinity mode can be set or canceled by using the "set fc-parameters" command, the "set sas-parameters" command, or the "set iscsi-parameters" command if necessary.
E0094	Not available under current encryption status conditions.
	The current encryption mode does not permit this operation. Check the encryption mode or the encryption state using the "show encryption" command or the "show volumes" command. The encryption mode can be set or canceled by using the "set encryption" command if necessary.
E0095	Not available under current e-mailing conditions.
	The current e-mail send condition does not permit this operation. Confirm whether the e-mail send condition is enabled by using the "show email-notification" command. Set the e-mail environment by using the "set email-notification" command if necessary.
E0097	Not available under master controller module.
	Could not execute this command from the master controller module. Try again from the slave controller module, which can be accessed by the redundant IP address. For details, refer to the "show network" command.
E0098	Not available under slave controller module.
	Could not execute this command from the slave controller module. Try again from the master controller module.
E0099	Not available under current system configuration.
	The operation cannot be performed because of inconsistency with the system configuration. The setting operation cannot be performed because the configuration is not applied. Reboot the ETERNUS DX/AF.
E0100	No space.
	Resources corresponding to the specified parameter have insufficient space. Check the resources associated with the object that was identified in the details of this message.
E0101	No memory.
	Could not allocate working memory. Close other sessions and try again.
E0102	Not available under system disk status.
	This message indicates that the execution condition does not match with the BUD (Bootup and Utility Device) status. Confirm the BUD status by using the "show disks" command.
E0110	Resource does not exist.
	Resources corresponding to the specified parameter do not exist. Check the resources associated with the object identified in the details of this message.
E0111	Resource is not reserved.
	Resources corresponding to the specified parameter are not reserved. Check the status of resources associated with the object identified in the details of this message.
E0113	No SNMP trap information.
	Could not execute because SNMP trap information is not registered. Check the SNMP trap information by using the "show snmp-trap" command. Create SNMP trap information by using the "create snmp-trap" command if necessary.

Message number	Message Countermeasure for the error
E0114	No volumes in the RAID Group / Thin provisioning pool.
	There are no volumes in the specified RAID group or Thin Provisioning Pool. Check the number of volumes in the specified RAID group or Thin Provisioning Pool by using the "show raid-groups" command or the "show thin-pro-pools" command.
E0115	Performance monitor has not started.
	Collecting performance information has not started. Start collecting performance information by using the "start performance" command.
E0116	The system disks are included in the RAID group.
	System drives exist in the RAID group.
E0117	No target disks.
	The target drives do not exist. Confirm the drive status or details by using the "show disks" command.
E0118	Remote Copy target is not supported model.
	The specified storage system is not supported for Remote Equivalent Copy. Check whether or not to specify an appropriate storage system.
E0120	Already registered.
	The resource is already registered. Check the status of the object shown in the details of this message.
E0122	Closure of all CLI and GUI ports requires confirmation.
	Displayed when all the connections methods for both the CLI and GUI are to be disabled. If this is intentional, retry the command with the "-confirm-close-all yes" parameter specified to make the storage system inaccessible via CLI or GUI.
E0123	Closure of all CLI ports requires confirmation.
	Displayed when all the CLI connection methods are to be disabled. If this is intentional, retry the command with the "-confirm-close-all yes" parameter specified to make the storage system inaccessible via CLI.
E0131	Already unmapped.
	Resources corresponding to the specified parameter are already unmapped. Check the resources identified in the details of this message.
E0132	Already stopped.
	Resources corresponding to the specified parameter are already stopped. Check the resources identified in the details of this message.
E0133	Already running for expanding others.
	The relevant operation has been already executed with another resource.
E0140	One or more components have failed.
	One or more components have failed during the maintenance operation. Check the reason for the failure or take log files and ask the support department to investigate.
E0141	At least one resource is required.
	At least one or more resources are required. Check the specification.
E0142	One or more encrypted volumes exist.
	Cannot execute this command because encrypted volumes exist. Please check the status of volumes by using the "show volumes" command.
E0143	Unexpected error occurred during operator intervention.
	During operator intervention, an unexpected error occurred (Example: the terminal session was suddenly disconnected). Try the operation again.
E0145	Advanced Copy table exists.
	Advanced Copy table has already been defined in the system. Check the Advanced Copy table size by using the "show advanced-copy-parameters" command. The table size should be zero. Set the Advanced Copy table size to 0 by using the "set advanced-copy-parameters" command if necessary.

Message number	Message Countermeasure for the error
E0146	RAID group contains a temporary volume.
	Could not execute because a temporary volume exists in the RAID group. If necessary, retry the command after deleting the temporary volume.
E0150	Collecting performance data.
	Performance data is currently being collected. Wait for a while and retry the command.
E0151	Power-off or power-on in process.
	Could not execute while the system is turning on or turning off. Try again after the system has completed powering-on.
E0152	Volumes formatting in process.
	Could not execute while volumes are formatting. Check the progress status of the volumes using the "show volume-progress" command. Try again after formatting is complete.
E0153	Encryption or decryption of volumes in process.
	Could not execute while volumes are being encrypted or decrypted. Please check the progress of volumes operations by using the "show volume-progress" command. Try again after volume encryption or decryption is complete.
E0154	Advanced Copy session active.
	Could not execute while Advanced Copy sessions are processing. Check the status by using the "show advanced-copy-sessions" command and wait for the session to complete before retrying the command. Try again after the Advanced Copy sessions starts up.
E0155	Volumes migration in process.
	Could not execute while volumes are being migrated. Check the progress status of volumes by using the "show volume-progress" command.
E0156	RAID group expansion in process.
	Could not execute while a RAID group is being expanded. Check the progress status of RAID group operations by using the "show raid-group-progress" command.
E0157	Remote Copy session active.
	Could not execute while Remote Copy sessions are processing. Check the status using ETERNUS Web GUI or ETERNUS SF AdvancedCopy Manager (ACM).
E0158	Controller firmware update in process.
	Could not execute while controller firmware update is processing. Wait for a while and retry the command after the controller firmware update is complete.
E0159	Remote maintenance in process.
	Could not execute while remote maintenance is processing. Wait for a while and retry the command after remote maintenance is complete.
E0160	Competing with background process.
	Some operations are being performed by another process. Wait for a while and try again.
E0161	Competing with disk diagnosis running in background process.
	Disk diagnosis is being performed by another process. Wait for a while and try again or stop the disk diagnosis.
E0162	Competing with RAID group diagnosis running in background process.
	RAID group diagnosis is being performed by another process. Wait for a while and try again.
E0163	Competing with hot update of firmware in background process.
	A hot controller firmware update is being performed by another process. Wait for a while and try again.
E0164	Competing with cold update of firmware in background process.
	A cold controller firmware update is being performed by another process. Wait for a while and try again.

Message number	Message Countermeasure for the error
E0165	Competing with update of disk firmware in background process.
	Disk firmware is being updated by another process. Wait for a while and try again.
E0166	Competing with quick formatting of volume in background process.
	Quick formatting of a volume is running in other process. Wait for a while and try again.
E0167	Competing with changing Advanced Copy parameters in background process.
	Advanced Copy parameters are being changed by another process. Wait for a while and try again.
E0168	Competing with allocating remote copy buffer in background process.
	A remote copy buffer is being allocated by another process. Wait for a while and try again.
E0169	Competing with preparing firmware update in background process.
	A firmware update is being prepared by another process. Wait for a while and try again.
E0170	Competing with setting cache control in background process.
	Cache control parameters are being set by another process. Wait for a while and try again.
E0171	Competing with reassigning RAID group controller in background process.
	A RAID group is being reassigned to a different controller by another process. Wait for a while and try again.
E0172	Competing with initializing volume in background process.
	A volume is being initialized by another process. Wait for a while and try again.
E0173	Competing with encrypting or decrypting volume in background process.
	A volume is being encrypted or decrypted by another process. Please wait for a while and try again.
E0174	Competing with registering RAID group in background process.
	A RAID group is being registered by another process. Wait for a while and try again.
E0175	Competing with deleting RAID group in background process.
	A RAID group is being deleted by another process. Wait for a while and try again.
E0176	Competing with registering volume in background process.
	A volume is being registered by another process. Wait for a while and try again.
E0177	Competing with deleting volume in background process.
	A volume is being deleted by another process. Wait for a while and try again.
E0178	Competing with registering global hot spare in background process.
	A global hot spare is being registered by another process. Wait for a while and try again.
E0179	Competing with changing maintenance mode in background process.
	The maintenance mode is being changed by another process. Wait for a while and try again.
E0180	Competing with moving volume in background process.
	A volume is being moved by another process. Wait for a while and try again.
E0181	Competing with expanding RAID group in background process.
	A RAID group is being expanded by another process. Wait for a while and try again.
E0182	Competing with collecting G-List information in background process.
	G-List information is being collected by another process. Wait for a while and try again.
E0183	Competing with setting ECO mode in background process.
	An Eco-mode is being set by another process. Wait for a while and try again.
E0184	Competing with assigning ECO schedule in background process.
	An Eco-mode schedule is being assigned by another process. Wait for a while and try again.

Message number	Message Countermeasure for the error
E0185	Competing with setting ECO schedule in background process.
	An Eco-mode schedule is being set by another process. Wait for a while and try again.
E0186	Competing with setting date and time in background process.
	Date and time are being set by another process. Wait for a while and try again.
E0187	Competing with expanding volume in background process.
	A volume is being expanded by another process. Wait for a while and try again.
E0188	Competing with deleting Advanced Copy session in background process.
	An Advanced Copy session is being deleted by another process. Wait for a while and try again.
E0190	Competing with registering dedicated hot spare in background process.
	A dedicated hot spare is being registered by another process. Wait for a while and try again.
E0191	Competing with releasing dedicated hot spare in background process.
	A dedicated hot spare is being released by another process. Wait for a while and try again.
E0192	Competing with collecting event information in background process.
	Event information is being collected by another process. Wait for a while and try again.
E0193	Competing with deleting snap data volume in background process.
	A Snap Data Volume is being deleted by another process. Wait for a while and try again.
E0194	Reclamation of Thin Provisioning Volume is in progress.
	A Thin Reclamation process is being performed. Wait for a while and try again.
E0195	Rebuild or Copyback in process.
	Rebuild or Copyback is being performed. Wait for a while and try again.
E0196	Competing with storage migration in background process.
	Storage Migration is being performed by another process. Wait for a while and try again.
E0197	Quick Unmap in process.
	Quick UNMAP (releasement of physical area) is being performed. Wait for a while and try again.
E0198	Flexible tier migration in process.
	Flexible Tier Migration is being performed. Wait for a while and try again.
E0200	Competing with setting Flexible tier mode in background process.
	The Flexible Tier mode is being set by another process. Wait for a while and try again.
E0201	Competing with deleting Flexible tier pool in background process.
	A Flexible Tier Pool is being deleted by another process. Wait for a while and try again.
E0202	Competing with formatting Flexible tier pool in background process.
	A Flexible Tier Pool is being formatted by another process. Wait for a while and try again.
E0203	Competing with registering Flexible tier volume in background process.
	A Flexible Tier Volume is being registered by another process. Wait for a while and try again.
E0204	Competing with setting Flexible tier sub pool priority in background process.
	The Flexible Tier Sub Pool Priority is being set by another process. Wait for a while and try again.
E0205	Competing with setting Flexible tier pool parameters in background process.
	The Flexible Tier Pool parameters are being set by another process. Wait for a while and try again.
E0206	Competing with Flexible tier migration in background process.
	Flexible Tier Migration is being started or stopped by another process. Wait for a while and try again.

Message number	Message Countermeasure for the error
E0207	Competing with registering Thin Provisioning Pool in background process.
	A Thin Provisioning Pool is being registered by another process. Wait for a while and try again.
E0208	Competing with deleting Thin Provisioning Volume in background process.
	A Thin Provisioning Pool is being deleted by another process. Wait for a while and try again.
E0209	Competing with formatting Thin Provisioning Volume in background process.
	A Thin Provisioning Pool is being formatted by another process. Wait for a while and try again.
E0210	Competing with setting Thin Provisioning Volume parameters in background process.
	The Thin Provisioning Pool parameters are being set by another process. Wait for a while and try again.
E0211	Competing with registering REC Disk Buffer Volume in background process.
	An REC disk buffer volume is being registered by another process. Wait for a while and try again.
E0212	Competing with deleting REC Disk Buffer Volume in background process.
	An REC disk buffer volume is being deleted by another process. Wait for a while and try again.
E0213	Competing with inhibiting copy destination volume in background process.
	A copy destination volume is being protected by another process. Wait for a while and try again.
E0214	Competing with Thin Provisioning Pool migration in background process.
	Thin Provisioning Pool Migration is being performed by another process. Wait for a while and try again.
E0215	Competing with setting cache size limit to volume in background process.
	The cache size limit is being set by another process. Wait for a while and try again.
E0216	Competing with setting Offloaded Data Transfer Mode in background process.
	The ODX mode is being set by another process. Wait for a while and try again.
E0217	Competing with setting Key management group ID in background process.
	The ID of the key management group is being set as a background process.
E0218	Competing with changing Key in background process.
	The key of the key management group is being changed as a background process.
E0300	Syntax error in REC path information. (Incorrect file header)
	A syntax error was detected in the specified REC path information file. Specifically, the header identifier is incorrect. Check the output line given in the details of this message and amend the header identifier.
E0301	Syntax error in REC path information. (Version mismatch)
	A syntax error was detected in the specified REC path information file. Specifically, the version information is mismatched. Check the output line given in the details of this message and amend the version information.
E0302	Syntax error in REC path information. (Incorrect label)
	A syntax error was detected in the specified REC path information file. Specifically, the label name is incorrect. Check the output line given in the details of this message and amend the label name.
E0303	Syntax error in REC path information. (Incorrect operand)
	A syntax error was detected in the specified REC path information file. Specifically, the operand name is incorrect. Check the output line given in the details of this message and amend the operand name.
E0304	Syntax error in REC path information. (Duplicate definition)
	A syntax error was detected in the specified REC path information file. Specifically, the specified definitions are duplicated. Check the output line given in the details of this message and amend the incorrect definition.
E0305	Syntax error in REC path information. (Missing label)
	A syntax error was detected in the specified REC path information file. Specifically, the required label names are missing. Check the output line given in the details of this message and add the required label names.

Message number	Message Countermeasure for the error
E0306	Syntax error in REC path information. (Too many labels)
	A syntax error was detected in the specified REC path information file. Specifically, unnecessary label names exist. Check the output line given in the details of this message and delete any unnecessary label names.
E0307	Syntax error in REC path information. (Missing double quotes)
	A syntax error was detected in the specified REC path information file. Specifically, the specified operand name is not enclosed in double quotations. Check the output line given in the details of this message.
E0308	Syntax error in REC path information. (Unexpected label)
	A syntax error was detected in the specified REC path information file. Specifically, the specified label names are mismatched. Check the output line given in the details of this message and amend it to the correct label.
E0309	Syntax error in REC path information. (Undefined information)
	A syntax error was detected in the specified REC path information file. Specifically, undefined information was found. Check the output line given in the details of this message and amend it to match the defined information.
E0311	Syntax error in REC path information. (Too many lines)
	A syntax error was detected in the specified REC path information file. Specifically, the number of lines used has reached its limit. Delete unnecessary lines.
E0312	Syntax error in REC path information. (Overlong line)
	A syntax error was detected in the specified REC path information file. Specifically, the number of characters used has reached its limit. Begin on a newline.
E0313	Syntax error in REC path information. (WWN does not match actual)
	A syntax error was detected in the specified REC path information file. Specifically, an inappropriate WWN was used. Check the output line given in the details of this message and amend it to the appropriate WWN.
E0314	Syntax error in REC path information. (Host port mode does not match actual)
	A syntax error was detected in the specified REC path information file. Specifically, an inappropriate host interface port mode was used. Check the output line given in the details of this message and amend it to the appropriate host interface port mode.
E0315	Syntax error in REC path information. (Number of storage-links for one storage system over upper limit)
	A syntax error was detected in the specified REC path information file. Specifically, the number of path information definitions for one storage system has reached its limit. Check the output line given in the details of this message.
E0316	Syntax error in REC path information. (Number of storage-links between one pair of storage systems over upper limit.)
	A syntax error was detected in the specified REC path information file. Specifically, the number of path information definitions between one pair of storage systems has reached its upper limit. Check the output line given in the details of this message.
E0317	Syntax error in REC path information. (Number of port-links for one host interface port over upper limit)
	A syntax error was detected in the specified REC path information file. Specifically, the number of path information definitions for one host interface port has reached its limit. Check the output line given in the details of this message.
E0318	Syntax error in REC path information. (Number of host interface ports for one storage system over upper limit)
	A syntax error was detected in the specified REC path information file. Specifically, the number of host interface port definitions for one storage system has reached its limit. Check the output line given in the details of this message.
E0319	Syntax error in REC path information. (Total number of storage systems over upper limit)
	A syntax error was detected in the specified REC path information file. Specifically, the number of storage system definitions has reached its limit. Check the output line given in the details of this message.
E0320	Syntax error in REC path information. (Total number of links over upper limit)
	A syntax error was detected in the specified REC path information file. Specifically, the total number of linkages has reached its limit. Refine the result to obtain the necessary information.

Message number	Message Countermeasure for the error
E0321	Syntax error in REC path information. (CA type or IP version do not match)
	A syntax error was detected in the specified REC path information file. The CA type or IP version is not the same.
E0330	Flexible tier mode has already been valid.
	The Flexible Tier mode is already enabled.
E0331	Flexible tier mode is not valid.
	The Flexible Tier mode is disabled.
E0332	One or more flexible tier pools exist.
	Flexible Tier Pools exist. Check whether Flexible Tier Pools exist by using the "show flexible-tier-pools" command.
E0333	Cannot format Flexible Tier Pool.
	The specified Flexible Tier Pool cannot be formatted. Check the Flexible Tier Pool by using the "show flexible-tier-pools" command.
E0334	RAID Migration cannot be set to the specified volume.
	RAID Migration cannot be set for the specified volume. Check the volume by using the "show volumes" command.
E0335	RAID Migration cannot be set to the specified Flexible Tier Pool.
	RAID Migration cannot be set for the specified Flexible Tier Pool volume. Check the Flexible Tier Pool by using the "show flexible-tier-pools" command.
E0336	Migration failed because of insufficient free space of the destination pool.
	The migration failed because the free space in the migration destination pool is insufficient.
E0337	The specified Flexible Tier Pool does not have a Flexible Tier Sub Pool.
	A Flexible Tier Sub Pool does not exist in the specified Flexible Tier Pool. Check whether Flexible Tier Sub Pools exist by using the "show flexible-tier-pools" command.
E0342	The time out occurred.
	A timeout occurred during AIS Connect processing. Check the network status.
E0343	The network is not normal.
	The AIS Connect network is not in normal status. Check the network status.
E0344	The time out occurred in the network.
	A timeout occurred in the AIS Connect network. Check the network status.
E0345	The network of IDM server is unreachable.
	The network of the AIS Connect server cannot be accessed. Check the network status.
E0346	The IDM server is unreachable.
	The AIS Connect server cannot be accessed. Check the network status.
E0347	The IDM server refused the connection.
	The AIS Connect server refused the connection. Check the network status.
E0348	The IDM server reset the connection.
	The AIS Connect server reset the connection. Check the network status.
E0349	The SSL communication fault occurred.
	An SSL communication error occurred. Check the network status.
E0350	The name resolution of the host name failed.
	Name resolution of the host name failed. Check the network status.
E0351	It failed in the HTTP authentication.
	HTTP authentication failed. Check the authentication setting.

Message number	Message Countermeasure for the error
E0352	The HTTP authentic method does not correspond.
	HTTP authentication is not supported. Check the authentication setting.
E0353	It failed in the SOCKS authentication.
	SOCKS authentication for the proxy server failed. Check the authentication setting.
E0354	The SOCKS authentic method does not correspond.
	SOCKS authentication is not supported. Check the authentication setting.
E0355	Export log in process.
	A log is already being exported. Wait for a while and retry the command.
E0356	AIS Connect or AIS Connect server authentication is enabled.
	AIS Connect function is enabled. Disable the AIS Connect function, and then retry the command.
E0357	AIS Connect is disabled.
	AIS Connect function is disabled. Enable the AIS Connect function, and then retry the command.
E0358	REMCS is enabled.
	REMCS function is enabled. Disable the REMCS function, and then retry the command.
E0359	Log Transmission of E-Mail Notification is enabled.
	Log transmission via email notification is enabled. Disable the log transmission, and then retry the command.
E0360	AIS SSL certificate is not registered.
	A proper root certificate is not registered. Register a proper root certificate.
E0361	AIS SSL certificate is invalid.
	The root certificate is invalid or has expired. Register a proper root certificate.
E0362	Log transmission of E-Mail notification and AIS connect cannot be enabled simultaneously.
	The log transmission of the E-mail notification and AIS Connect cannot be enabled simultaneously.
E0390	Backup REC Path information does not exist.
	A backup file does not exist in the system. This also means a path information file has not been set for the system yet.
E0391	Round trip time measurement has failed.
	Measuring the round trip time has failed for any reason. Confirm the environment between the ETERNUS DX/AF storage systems.
E0392	Unsupported path type.
	Could not execute due to the path type. Confirm the path type by using the "show rec-path" command.
E0393	Syntax error in REC path information. (iSCSI parameter(s) do not match actual)
	A syntax error occurred for the specified path information file. Check the iSCSI parameter and correct the syntax.
E0394	Failed to access the server.
	Access to the server failed.
E0395	The object cannot be operated.
	The target object cannot be operated.
E0396	A part of SpinUp/Down failed.
	Some of the spinup/spindown operations failed.
E0397	All SpinUp/Down failed.
	All of the spinup/spindown operations failed.
E0399	Syntax error in REC path information.
	A syntax error was detected in the specified REC path information file. Check the output line given in the details of this message.

Message number	Message Countermeasure for the error
E5000	Parameter not supported.
	The specified parameter is not supported. Check the parameter that was specified.
E5001	User authority to use the parameter is improper.
	The specified parameter cannot be used with the current policy.
E5002	Authority of security is necessary for data decryption.
	The data cannot be decrypted because the user does not have the required privilege.
E5003	The user authority to use the command is improper.
	The specified command cannot be executed with the current policy.
E5010	The volume encryption is specified for SED disk.
	Volume encryption cannot be performed for a RAID group that is configured with SEDs.
E5033	Cannot Warm Boot CFL.
	A warm boot cannot be performed because a hot controller firmware update is currently being executed.
E5034	Cannot Hard Boot CFL.
	A hard boot cannot be performed because a hot controller firmware update is currently being executed.
E5081	Abnormal pinned CBE error.
	Formatting cannot be performed because Pin exists.
E5084	System not ready.
	The status of the ETERNUS DX/AF is "Not Ready".
E5100	Thin Provisioning mode is invalid.
	The Thin Provisioning function is disabled.
E5101	Check thin-pro-pool Status.
	The Thin Provisioning Pool cannot be formatted. Check the status of the Thin Provisioning Pool by using the "show thin-pro-pools" command.
E5102	Migration session count is limit.
	The number of sessions (including balancing sessions) has reached the maximum number of sessions that can run in an ETERNUS DX/AF.
E5104	Thin Provisioning Pool capacity is limit.
	The TPP capacity exceeds the maximum TPP capacity that can be created in an ETERNUS DX/AF.
E5105	Not exist unused disk enough
	The number of unused drives is insufficient.
E5106	RAID or Volume is insufficient.
	The number of RAID groups or volumes is insufficient.
E5107	RAID type is temporary.
	The RAID group is temporarily being used.
E5108	Volume type is not Thin Provisioning Volume.
	The volume type is not TPV.
E5109	RAID group belong to thin-provisioning-pool/flexible-tier-pool.
	The RAID group belongs to a Thin Provisioning Pool or a Flexible Tier Pool.
E5110	Thin Provisioning Volume count is limit.
	The maximum number of volumes has been registered in the ETERNUS DX/AF.
E5200	No copy license.
	No copy license is registered.

Message number	Message Countermeasure for the error
E5201	Invalid copy phase
	The current phase of the copy session is incorrect. Check the session phase by using the "show advanced-copy-sessions" command.
E5202	Exist SDV / SDPV.
	SDVs or SDPVs exist.
E5203	Exist REC disk buffer.
	REC disk buffer volumes exist.
E5204	Exist REC buffer.
	The REC buffer is set.
E5205	Exist REC path setting.
	The REC path is set.
E5206	Exist any of copy session(s).
	Copy sessions exist. Check the sessions by using the "show advanced-copy-sessions" command. Wait until the copy sessions finish, and then try again.
E5207	Exist volume(s) of protection from copy destination.
	Copy destination volumes with protection settings exist.
E5208	Copy license information updating due to trial license expired.
	The copy license information is being updated. Wait for a while and try again.
E5209	Not support E6K to target of REC.
	An REC session cannot be established because the connection destination storage system does not support REC or there is another cause.
E5210	Data in disk buffer.
	Data exists in the disk buffer. Check the disk buffer by using the "show rec-buffer" command.
E5211	The raid group is for REC disk buffer.
	The specified RAID group is configured with an REC disk buffer. Check the RAID group by using the "show rec-disk-buffer" command.
E5212	Source and destination RA type is not match.
	The RA type does not match for the copy source and copy destination devices in the REC path settings. Check the contents of the settings for the path information file.
E5213	The times registering trial license has been reached the system limit.
	The limit for the number of times that the trial license can be registered has been reached.
E5214	Exist RA.
	The RA is set. Check the RA by using the "show host-port-mode" command.
E5215	Result string is too long.
	The CLI execution result in the remote terminal exceeds the predetermined size.
E5216	Compete for the affinity path.
	A conflict occurred in an affinity port.
E5217	The specified multiplicity or priority level mismatch connect mode (Direct/Switched) of the REC path.
	The connected path type is different from the specified condition of the parameter.
E5300	An error occurred in the copy path connection.
	An error (timeout or blockage) occurred during communication between the ETERNUS DX/AF storage systems.
E5301	An unsupported command was issued by the remote storage.
	The remote ETERNUS storage system issued a command that the local ETERNUS DX/AF does not support.

Message number	Message Countermeasure for the error
E5302	The specified volume number is not correct (exceeding the maximum volume number).
	A number that is larger than the maximum value for the configuration is specified for the LU.
E5303	The specified volume is not supported.
	The LU type of the specified volume is not supported.
E5304	Advanced copy cannot be set to the specified volume.
	A copy session cannot be set for the LU.
E5305	There is "Bad Sector" in the copy source volume.
	The copy source volume contains a bad sector.
E5306	Encryption settings of copy source volume and copy destination volume are different.
	The encryption settings of the copy source LU and the copy destination LU are different.
E5307	The copy source volume and copy destination volume don't belong to the same resource domain.
	The resource domain number for the copy source LU and the copy destination LU are different.
E5308	The specified volume is a "Temporary".
	The LU is a dummy volume. A dummy volume is a volume that remains after RAID Migration fails.
	A restoration copy cannot be set for a session that is to be restored because the session will be deleted.
E5309	Disk failure occurred while the relevant copy session is in "Suspend" state. The copy session turns into "Error" state.
	The session transitioned to error status because the drive in Suspend status failed.
E5310	Parameter error occurred.
	Parameter error (incorrect settings).
E5311	Source volume whose capacity is larger than destination volume's cannot be specified.
	The copy source LU is larger than the copy destination LU for all of the copy sessions.
E5312	It failed to reverse the copy session.
	The relevant session could not be reversed or its mode could not be changed.
E5313	Copy range conflicts with the existing RAID migration session.
	The scope of the copy session overlaps the scope of the existing RAID Migration session.
E5314	The specified copy range of the copy source volume is overlap with the copy range in an existing session (excluding cascade and restore).
	The copy source LU area is the same as the copy destination LU area for the existing copy session (excluding cascade copy sessions and restoration copy sessions).
E5315	The specified copy range of the copy destination volume is overlap with the copy range in an existing session (excluding cascade and restore copy).
	The copy destination LU area is the same as the copy source LU area for the existing copy session (excluding cascade copy sessions and restoration copy sessions).
E5316	The specified cascade copy cannot be done.
	The scope for the cascade copy is out of the allowed range.
E5317	The copy session which is in progress of restoring was specified.
	A restoration copy session is attempted to be restored.
E5318	The number of cascades exceeds the maximum.
	The number of cascades exceeds the upper limit.
E5319	An "Error Suspend" session was specified.
	The restoration copy is attempted with Concurrent OPC and the session that is specified for this restoration copy is in ErrorSuspend state or in the Readying phase.

Message number	Message Countermeasure for the error
E5320	Multiple copy sessions in REC Consistency mode cannot operate in a single storage.
	A multiple copy in REC Consistency mode is attempted in a single ETERNUS DX/AF (this type of multiple copy is allowed when one of the copy sessions is suspended).
E5321	The state of the specified session is not correct.
	The relevant session has been deleted.
	The status of the QuickOPC session is not Active or Copying when the session restarts.
	The SUSPEND command is issued when the status of the relevant session is not Active/Equivalent. (This does not apply when an REC session is forcibly specified.)
E5322	The SUSPEND command is issued when the status of the relevant (REC) session is ErrorSuspend or Halt and when the status of the REC buffer is Buffering (this also applies when an REC session is forcibly specified).
	The CHANGE command is issued when the status of the relevant session is not Suspend.
E5323	A command was issued while processing CONCURRENT SUSPEND command.
	A command is issued while the CONCURRENT SUSPEND command transitions the asynchronous session status to Suspend.
E5324	The specified operation is not a "Force specify".
	The session cannot be transitioned to Suspend status or cannot be deleted because it is not forcibly specified. A STOP command is issued to a session that is not the oldest for a SnapOPC+ operation without specifying the session forcibly.
E5325	There is no path to access to the copy source volume or copy destination volume.
	The RAID group for the copy source LU or the copy destination LU is blocked.
E5326	The specified volume is an Advanced Copy read-only volume. It cannot be set as copy destination volume.
	The copy destination LU is write-protected.
E5327	The STOP command was issued to a SnapOPC/SnapOPC+ session which is in progress of restoring.
	A STOP command is issued to a SnapOPC session that is being restored.
E5328	REC buffer transfer is not complete in time or buffer recovery is processing under SUSPEND command process. SUSPEND command cannot be done.
	The REC buffer transfer did not complete within a certain period of time. A buffer recovery is performed while the SUSPEND command is being processed (the SUSPEND command cannot be executed because untransferred data is recovered).
E5329	REC buffer data transfer is under monitoring. The specified session cannot be reversed.
	The session cannot be reversed because the untransferred REC buffer is being monitored.
E5330	It will lead to EC/REC cascade copy session that is not in "Suspend" state but has cascade source volume.
	The session cannot be reversed because it is the cascade source for an EC/REC that is not in Suspend status.
E5331	The copy session has already been reversed.
	The session cannot be reversed because it has been already reversed.
E5332	The number of copy sessions exceeds the allowable maximum copy sessions for this storage.
	The number of sessions exceeds the maximum number in a single ETERNUS DX/AF.
E5333	The copy license is not valid.
	The copy license is invalid.
E5334	The number of copy sessions exceeds the allowable maximum copy sessions for each copy source volume.
	The number of sessions exceeds the maximum number for a copy source LU in a single ETERNUS DX/AF.
E5335	The number of copy sessions exceeds the allowable maximum copy sessions for each copy destination volume.
	The number of sessions exceeds the maximum number for a copy destination LU in a single ETERNUS DX/AF.
E5335	The number of SnapOPC+ copy session generations exceeds the maximum for a copy source volume.
	The number of SnapOPC+ generations exceeds the maximum number for a copy source LU.

Message number	Message Countermeasure for the error
E5336	Copy area of copy source volumes in monitoring copy sessions is overlap.
	The copy source LU areas of some monitoring sessions overlap.
E5337	The new copy session settings are the same with an existing one's. The new copy session cannot be started.
	The scope of the new copy session and the existing copy session are identical (excluding the case when these sessions are OPC sessions or QuickOPC sessions and these session restart in Copying status) or the copy destination areas of the new copy session and the existing copy overlap each other.
E5338	Copy destination volume and cascade copy destination volume in the copy session is overlap.
	The copy destination for the relevant session overlaps the cascade linkage destination.
E5339	It will lead to copy destination volumes overlap. EC/REC cascade copy session cannot be reversed.
	The copy destinations of some sessions overlap each other because the EC/REC session that is cascaded is reversed.
E5340	SDV is being initialized.
	An SDV is being initialized.
E5341	There is already a copy session where the specified SDV was set as copy destination.
	A session for which the copy destination is an SDV exists.
E5342	The copy session has already been set.
	The copy session has already been set.
E5343	The copy session has already been deleted.
	The copy session has already been deleted.
E5344	The copy session is in progress of transition to "Suspend" state asynchronously or has already been in "Suspend" state.
	The session to which the SUSPEND command is issued is being asynchronously transitioned to Suspend status.
	The session has been transitioned to Suspend status.
E5345	The state of the session is already Active.
	The session is already in Active status.
E5346	The copy table has not been set yet.
	The copy table has not been set yet.
E5347	Copy table size is not sufficient.
	The size of the copy bitmap is not sufficient.
E5348	REC buffer is not in "Active" state.
	The REC buffer is not in Active status.
E5349	Copy source and copy destination, usage (sending or receiving) of REC buffer settings after resuming copy sessions don't match the original settings.
	The copy source and the copy destination do not correspond with the sender and receiver targets of the REC buffer after the copy session is reversed.
E5350	REC buffer setting is being changed or REC buffer related functions are in progress.
	The REC buffer setting is being changed. An REC buffer operation is running with ETERNUS Web GUI or ETERNUS CLI.
E5351	Copy source and copy destination, usage (sending or receiving) of REC buffer settings after reversing copy sessions don't match the original settings.
	The REC buffer setting is being changed. An REC buffer operation is running with ETERNUS Web GUI or ETERNUS CLI.
E5352	The disk configured the RAID group of the specified volume is in motor OFF state due to ECO-mode.
	The specified LU cannot be copied because the drive motor is turned off (this applies for OPC sessions).
E5353	The specified BoxID cannot be found.
	The specified Box ID information cannot be found in the configuration information.

Message number	Message Countermeasure for the error
E5354	The copy path is not in "Normal" state. Copy sessions in this storage were deleted but copy sessions in the remote storage still exist.
	The session could be deleted in the local ETERNUS DX/AF but could not be deleted in the remote ETERNUS DX/AF because of an error in the path status.
E5355	Firmware update is in progress. The specified operation cannot be done.
	The command cannot be processed because a hot controller firmware update is currently being executed.
E5356	Advanced copy resolution settings of the local storage and remote storage are different.
	The storage system resolution is not the same between the copy source and the copy destination.
E5357	SDV was specified as a copy destination volume where the copy session is not SnapOPC+.
	An SDV is specified for the copy destination of the non-SnapOPC copy session.
E5358	SDV was specified as a copy source volume in SnapOPC+.
	An SDV is specified for the copy source of the SnapOPC copy session.
E5359	A standard volume was specified as copy destination volume in SnapOPC+.
	A volume is specified for the copy destination of the SnapOPC copy session.
E5360	An error, which can be recovered by retry, occurred.
	An error that is recoverable with a retry has occurred. Try again.
E5361	The storage is in "Not Ready" or internal error state.
	The ETERNUS DX/AF is in a Not Ready status or an error event occurred in the firmware.
E5362	The specified volume is currently configured with Bind-in-Cache extent. RAID Migration cannot apply to this volume.
	RAID Migration cannot be performed for the specified LU because Bind-in-Cache is running for the LU.
E5363	The previous generation session is Readyng
	The latest generation was attempted to be set for the SnapOPC+ session with a generation in Readyng Session status.
E5364	The restore OPC can not start by using concurrent OPC.
	A restoration OPC session was attempted to be set with Concurrent OPC.
E5365	The restore OPC of readyng session can not start.
	A restoration session was attempted to be set for a Readyng session.
E5366	The specified copy range is overlap with the copy range in an existing xcopy session.
	The copy destination area of a new session that is cascaded with a XCOPY session overlaps the copy destination area of an existing XCOPY session or an XCOPY session that is to be restored.
E5367	The specified copy range is overlap with the copy range in an existing Readyng or Copying OPC session.
	The Concurrent OPC command attempted to overwrite an existing OPC session in Copying status or the normal OPC start command attempted to overwrite an existing OPC session in Readyng status.
E5368	The specified session can not restart because it is under restore.
	A QuickOPC session that is being restored was attempted to be restarted with Concurrent OPC.
E5369	The specified remote box id is not support the out of band copy.
	The ETERNUS storage system that is connected to start the REC does not support copying via a LAN (Support is only available for connections between two ETERNUS DX S2 series systems or later).
E5370	In the remote old model storage, the specified volume is invalid.
	An invalid volume is specified in the connection destination ETERNUS storage system that is an older model.
E5371	In the remote old model storage, parameter error occurred.
	A command parameter error occurred in the connection destination ETERNUS storage system that is an older model.

Message number	Message Countermeasure for the error
E5372	In the remote old model storage, the specified copy range is overlap with the copy range in an existing session.
	The scope of some sessions overlap each other in the connection destination ETERNUS storage system that is an older model.
E5373	In the remote old model storage, status of session or status of volume is error.
	The session status or the LU status is not normal in the connection destination ETERNUS storage system that is an older model.
E5374	In the remote old model storage, the number of copy sessions exceeds the allowable maximum copy sessions.
	The number of sessions exceeds the maximum number in the connection destination ETERNUS storage system that is an older model.
E5375	In the remote old model storage, the new copy session overlap with the existing one's. The new copy session cannot be started.
	The copy destination of a new session overlaps the copy destination of an existing session in the connection destination ETERNUS storage system that is an older model.
E5376	In the remote old model storage, error occurred about setting of the copy table or status of REC Buffer.
	The copy table setting or the REC buffer status is not normal in the connection destination ETERNUS storage system that is an older model.
E5377	In the remote old model storage, the specified copy volume is a "SDV".
	An SDV is specified for the copy volume in the connection destination ETERNUS storage system that is an older model.
E5378	In the remote old model storage, an error occurred in the copy path connection.
	A communication error between the ETERNUS storage systems occurred in the connection destination ETERNUS storage system that is an older model.
E5379	An unsupported command was issued by the remote old model storage.
	An unsupported command for communication between ETERNUS storage systems is issued from the connection destination ETERNUS storage system that is an older model.
E5380	In the remote old model storage, copy session has been already set.
	The session is already set in the connection destination ETERNUS storage system that is an older model.
E5381	In the remote old model storage, copy session has been already deleted.
	The session is already deleted in the remote ETERNUS storage system that is an older model.
E5382	In the remote old model storage, copy session is already in "Suspend" status or changing to be "Suspend" status.
	An asynchronous session is being transitioned to Suspend status or the session is in Suspend status in the connection destination ETERNUS storage system that is an older model.
E5383	In the remote old model storage, copy session status is already in "Active" status.
	The session is in Active status in the connection destination ETERNUS storage system that is an older model.
E5384	In the remote old model storage, no copy license.
	No copy license is registered in the connection destination ETERNUS storage system that is an older model.
E5385	In the remote old model storage configuration, the specified BoxID cannot be found.
	The specified Box ID information cannot be found in the connection destination ETERNUS storage system that is an older model.
E5386	The copy path is not in "Normal" state. Copy sessions in this storage were deleted but copy sessions in the remote old model storage still exist.
	A session could be deleted in the local ETERNUS DX/AF but could not be deleted in the remote ETERNUS DX/AF that is an older model because of an error in the path status.
E5387	In the remote old model storage, firmware update is in progress. The specified operation cannot be done.
	The command cannot be processed in the connection destination ETERNUS storage system that is an older model because a hot controller firmware update is currently being executed.

Message number	Message Countermeasure for the error
E5388	Copy resolution settings of the local storage and remote old model storage are different.
	The storage system resolution is not the same between the copy source (older model) and the copy destination.
E5389	In the remote old model storage, an error, which can be recovered by retry, occurred.
	An error that is recoverable with a retry has occurred in the old model of the connection destination. Try again.
E5390	The remote old model storage is in "Not Ready" or internal error state.
	The connection destination ETERNUS storage system that is an older model is in a Not Ready status or an error event occurred in the firmware of the connection destination ETERNUS storage system that is an older model.
E5391	There is not the certification of consistency.
	The Concurrent OPC error recovered (this does not guarantee data integrity).
E5392	Multiple copy source storage exists.
	The copy destination to which the command was issued has multiple copy source ETERNUS storage systems.
E5393	The certification of consistency is unknown.
	The Concurrent OPC warning recovered (this may or may not guarantee data integrity).
E5394	The copy source storage is not support this command.
	The command that was issued to the copy destination is not supported by the copy source firmware.
E5395	Controller Module failed.
	Copy session control failed because a CM degraded.
E5396	The remote storage is not support this function.
	The firmware of the remote ETERNUS storage system does not support REC.
E5400	The same command that was issued by specifying by start has already been processed.
	The same command that is specified by start is already being processed.
E5401	The same command that was issued by specifying by restart has already been processed.
	The same command that is specified by restart is already being processed.
E5402	REC transfer mode which specified by Start or Resume command is invalid at all RA ports which configure path.
	The REC transfer mode that is specified by the Start command or the Resume command is invalid for all of the RA ports that configure the path.
E5501	iSNS server cannot be connected from the specified iSCSI CA port.
	The iSNS server is not set for the specified iSCSI CA port.
E5502	CLI cannot change the host or port parameter setting created by GUI.
	A host name and port setting that are created with GUI cannot be changed by CLI.
E5503	The Multiple VLAN setting of a specified port is invalid.
	The multiple VLAN setting of the specified port is invalid.
E5504	The specified Additional IP Information setting is invalid.
	The specified virtual port setting is invalid.
E5601	The automatic setup of IPv6 address cannot be performed.
	The setup of automatic IPv6 address typing cannot be performed.
E5701	The factory setup is not done.
	The factory settings have not been performed.
E5900	Command error.
	Common MMI error.
E6000	Advanced Copy session that covers the entire volume is active.
	An Advanced Copy session that affects the entire volume is being performed.

Message number	Message Countermeasure for the error
E6001	The specified volume is ODX Buffer Volume.
	The specified volume is an ODX Buffer volume.
E6002	The specified volume is volume during Zero Reclamation execution.
	The specified volume is a volume that is currently undergoing Zero Reclamation.
E6003	Offloaded Data Transfer Mode is valid.
	The Offloaded Data Transfer mode is enabled.
E6004	Offloaded Data Transfer Mode is not valid.
	The Offloaded Data Transfer mode is disabled.
E6005	ODX Buffer Volume exist.
	ODX Buffer volumes exist.
E6006	The specified volume is not ODX Buffer Volume.
	The specified volume is not an ODX Buffer volume.
E6007	Offloaded Data Transfer in process.
	An Offloaded Data Transfer is in progress.
E6008	The specified volume is not volume during Zero Reclamation execution.
	The specified volume is a volume that is currently not undergoing Zero Reclamation.
E6009	Not available under operating Bind-in-Cache.
	The specified command cannot be executed because Bind-in-Cache is set.
E6010	Current cache page size is over specified cache limit size.
	The cache capacity that is being used by the Write process has exceeded the specified cache capacity limit.
E6011	Not available under cache limit settings.
	The cache memory cannot be used because its capacity is set to be limited.
E6012	The RAID migration from which a security level differs requires security authority.
	The Security Setting policy is required to perform RAID Migration with a different security level.
E6201	The specified RAID Group does not consist of SED.
	The specified RAID group does not consist of SEDs.
E7001	SED authentication key is not registered.
	The SED authentication key is not registered.
E7002	The master server is not registered in the key management group.
	The master server is not registered in the key management group.
E7003	Rejected by the server. Please try again to be accepted on the server.
	The server rejected the relevant operation. Set the server to accept the operation and try again.
E7004	The key which can be changed is not in the server.
	The server contains no keys that can be changed.
E7005	Abnormal state of the key.
	The key state is not normal.
E7006	The key is not acquired.
	The key is not acquired.
E7007	The key management group is not registered.
	The key management group is not registered.

Message number	Message Countermeasure for the error
E7100	The specified Flexible Tier Pool has Flexible Tier Volume(s) which is balancing.
	The specified Flexible Tier Pool has Flexible Tier Volumes that are being balanced.
E7101	There is no free OLU or SLU to create destination LUN.
	There is no free volume to create a destination LUN.
E7102	It is in the process of deleting source Thin Provisioning Volume internally which is done after migration.
	A source Thin Provisioning Volume is internally being deleted after migration.
E7103	Number of migration sessions has reached the system limit.
	The number of migration sessions has reached the system limit.
E7104	The source LUN has already using for migrated.
	The source LUN is already being used for a migration session.
E7105	The source LUN has already using at other session.
	The source LUN is already being used for another session.
E7106	The resource in the internal is depleted.
	All of the internal resources are already been used.
E7107	State of source volume or destination volume is error.
	An error has occurred in the source volume or the destination volume.
E7108	The specified volume don't have migration session during startup.
	A migration session is not running for the specified volume.
E7109	The specified volume is currently configured with Bind-in-Cache extent.
	Bind-in-Cache is set for the specified volume.
E7110	Logical capacity which can be migrate is over.
	The logical capacity that can be migrated exceeds the maximum capacity.
E7111	Physical capacity of destination pool is error.
	The physical capacity of the destination pool is abnormal.
E7112	There is not enough free space to create the pool in the device.
	There is not enough free space to create the pool in the ETERNUS DX/AF.
E7113	Balancing cannot be executed because there is not enough free space in the pool.
	Balancing cannot be executed because there is not enough free space in the pool.
E7114	Balancing cannot be executed because the device is in error state.
	Balancing cannot be executed because the ETERNUS DX/AF is in error state.
E8000	Undefined command.
	Undefined command.
E8001	Undefined parameter.
	Undefined parameter.
E8002	Another user is performing an operation.
	Another user is performing an operation.
E8003	The lock session ID cannot be obtained.
	The lock session ID cannot be obtained.
E8004	The value cannot be specified under current user authority.
	The specified parameter includes a parameter that cannot be specified with the current user policy.

Message number	Message Countermeasure for the error
E8005	The specified user account does not exist.
	The specified user account does not exist.
E8006	Because there will be no user account that can configure user account or role, the specified operation cannot be done.
	There are no user accounts with the User Management policy.
E8007	Your password has expired. You must change your password and log in again.
	A disabled command was executed using an account with an expired password.
E8008	Password policy and Lockout policy cannot be enforced on a user account with the Software role.
	The password policy and the account lockout policy cannot be applied to user accounts with the Software role.
E8100	The syntax is incorrect.
	The syntax is incorrect.
E8101	An unusable character is specified.
	An unusable character is specified.
E8102	The parameter is out of the allowed range.
	The parameter is out of the allowed range.
E8103	An unnecessary parameter is specified.
	An unnecessary parameter is specified.
E8104	The required parameter is not specified.
	The required parameter is not specified.
E8105	The number of specified values is too many.
	The number of specified values is too many.
E8106	The number of specified values is not enough.
	The number of specified values is not enough.
E8107	The number of specified characters is too many.
	The number of specified characters is too many.
E8108	The number of specified characters is not enough.
	The number of specified characters is not enough.
E8109	The combination of the parameters or values is incorrect.
	The combination of the parameters or values is incorrect.
E810A	A value that is not a multiple of 100GB is specified for the Extreme Cache capacity.
	A value that is not a multiple of 100GB is specified for the Extreme Cache capacity.
E810B	The specified value does not match the current setting value.
	The specified value does not match the current setting value. Check the current setting value.
E810C	The specified value is not supported by the device model.
	The specified value is not supported by the ETERNUS DX/AF.
E810D	No values are specified.
	No values are specified.
E810E	The format of the value is incorrect.
	The format of the value is incorrect.
E810F	The password is incorrect.
	The password is incorrect.

Message number	Message Countermeasure for the error
E8800	Unable to resolve destination address.
	The address resolution failed.
E8801	The route addition failed. Check the network address of the destination and the src port.
	The route configuration failed.
E8802	Cannot connect to the server.
	Connecting to the host failed.
E8803	Login incorrect.
	The login failed.
E8804	The processing status of packet capture is invalid.
	The packet capture process state is invalid.
E8805	Detected an error during ftp command establishment.
	An error was detected while preparing to execute the FTP command.
E8806	Detected an error during ftp command execution. Maybe incorrect the file name or permission settings are the cause of the error.
	An error was detected while executing the FTP command.
E8807	Detect FTP Connection Failure.
	The connection to the FTP server failed.
E8808	Reading data from the FTP server failed.
	Reading data from the FTP server failed.
E8809	Writing data to the FTP server failed.
	Writing data from the FTP server failed.
E9000	The device model does not support the command.
	The ETERNUS DX/AF model does not support the command.
E9001	The command cannot be executed because the device is in "Not Ready" status.
	The command cannot be executed because the ETERNUS DX/AF is in Not Ready status.
E9002	The storage cluster license is not registered.
	The Storage Cluster license is not registered.
E9003	The storage cluster license is already registered.
	The Storage Cluster license is already registered.
E9004	The copy license and storage cluster license is not registered.
	Both the copy license and the Storage Cluster license are not registered.
E9006	The command cannot be executed because the device is not in "Normal" status.
	The command cannot be executed because the ETERNUS DX/AF is not in Normal status.
E9007	The GS license is registered.
	The GS license is registered.
E9008	The Advanced Copy license is not registered.
	The Advanced Copy license is not registered.
E9009	The Non-disruptive Storage Migration license is not registered.
	The Non-disruptive Storage Migration License is not registered.
E900A	The Non-disruptive Storage Migration license is already registered.
	The Non-disruptive Storage Migration License is already registered.

Message number	Message Countermeasure for the error
E9200	The Extreme Cache function is not enabled.
	The Extreme Cache function is not enabled for the ETERNUS DX/AF.
E9201	The Flexible Tier mode is enabled.
	The Flexible Tier mode is enabled. Disable the Flexible Tier mode.
E9202	The Thin Provisioning allocation mode is TPV balancing.
	The Thin Provisioning allocation mode is TPV balancing. Change the Thin Provisioning allocation mode to TPP balancing.
E9203	Disk Patrol is disabled.
	Disk Patrol is disabled.
E9204	The device contains pinned data.
	The ETERNUS DX/AF contains pinned data.
E9205	The command cannot be executed because the network setting is the factory default setting.
	The command cannot be executed because the network setting is the factory default setting.
E9206	The Extreme Cache function is enabled.
	The Extreme Cache function is enabled.
E9207	The operation mode is not "Maintenance Mode".
	The operation mode is not Maintenance Mode.
E9208	SMI-S server is already enabled.
	The SMI-S function is enabled.
E9209	SMI-S server is already disabled.
	The SMI-S function is disabled.
E920A	SMI-S server is work in progress for changing the state.
	The operational state of the SMI-S function is currently being modified.
E920B	The WOL function is not enabled.
	The WOL function is not enabled.
E920C	The Extreme Cache Pool function is not enabled.
	The Extreme Cache Pool function is not enabled.
E920D	The Extreme Cache function and Extreme Cache Pool function is not enabled.
	The Extreme Cache function and the Extreme Cache Pool function are not enabled.
E920E	The encryption mode is disabled.
	The command cannot be executed due to an inconsistency between the encryption mode and the parameter.
E920F	It is necessary to disable the EXC or EXC Pool function before enable the EXC or EXC Pool function.
	The Extreme Cache function or the Extreme Cache Pool function must be disabled before enabling.
E9210	Collecting performance data is already running.
	A performance information acquisition is already in progress.
E9211	Collecting performance data has been started by Storage Cruiser.
	A performance information acquisition has been started from Storage Cruiser.
E9212	The Deduplication/Compression mode is not enabled.
	The Deduplication/Compression mode setting is not enabled for the ETERNUS DX/AF.
E9213	The NAS audit log is enabled.
	The NAS audit log is enabled.

Message number	Message Countermeasure for the error
E9214	The NAS audit log is disabled.
	The NAS audit log is disabled.
E9215	The Deduplication/Compression mode is enabled.
	The Unified license cannot be registered in an ETERNUS DX/AF that has the Deduplication/Compression mode setting enabled.
E9219	The current default chunk size of the device is different from one or more existing Flexible Tier Pools.
	Because the ETERNUS DX/AF has FTRPs with chunk sizes that are different from the current default chunk size, the chunk sizes within the ETERNUS DX/AF may differ.
E9300	Competing with cold update of firmware in background process.
	A cold controller firmware update is currently being executed. Wait for a while and try again.
E9301	Competing with hot update of firmware in background process.
	A hot controller firmware update is currently being executed. Wait for a while and try again.
E9302	Competing with update of disk firmware in background process.
	Disk firmware is being updated. Wait for a while and try again.
E9303	Competing with diagnosing RAID groups.
	The RAID group is being diagnosed. Wait for a while and try again.
E9304	Competing with diagnosing Disks.
	The drive is being diagnosed. Wait for a while and try again.
E9305	Competing with quick formatting of volume in background process.
	The QF Bit Map is being obtained. Wait for a while and try again.
E9306	Competing with changing Advanced Copy parameters in background process.
	The copy table size is being changed. Wait for a while and try again.
E9307	Competing with allocating remote copy buffer in background process.
	The REC buffer is being obtained. Wait for a while and try again.
E9308	Competing with preparing firmware update in background process.
	The EC is being switched. Wait for a while and try again.
E9309	Competing with setting cache control in background process.
	Bind-in-Cache is being set. Wait for a while and try again.
E930A	Competing with reassigning RAID group controller in background process.
	The assigned CM for the RAID group is being changed. Wait for a while and try again.
E930B	Competing with initializing volume in background process.
	The Snap Data Volume is being initialized. Wait for a while and try again.
E930C	Competing with encrypting or decrypting volume in background process.
	An encryption process or a decryption process is running. Wait for a while and try again.
E930D	Competing with registering RAID group in background process.
	A RAID group is being registered. Wait for a while and try again.
E930E	Competing with deleting RAID group in background process.
	A RAID group is being deleted. Wait for a while and try again.
E930F	Competing with registering volume in background process.
	An LU is being registered. Wait for a while and try again.
E9310	Competing with deleting volume in background process.
	An LU is being deleted. Wait for a while and try again.

Message number	Message Countermeasure for the error
E9311	Competing with registering global hot spare in background process.
	A hot spare is being registered. Wait for a while and try again.
E9312	Competing with changing maintenance mode in background process.
	A maintenance operation is being started or terminated. Wait for a while and try again.
E9313	Competing with expanding RAID group in background process.
	LDE is being performed. Wait for a while and try again.
E9314	Competing with collecting G-List information in background process.
	G-List information is being collected. Wait for a while and try again.
E9315	Competing with setting ECO mode in background process.
	An Eco-mode operation is being set. Wait for a while and try again.
E9316	Competing with assigning ECO schedule in background process.
	An Eco-mode operation is being set for each RAID group. Wait for a while and try again.
E9317	Competing with setting ECO schedule in background process.
	An Eco-mode schedule is being set. Wait for a while and try again.
E9318	Competing with setting date and time in background process.
	Date and time are being set. Wait for a while and try again.
E9319	Competing with expanding volume in background process.
	LUN Concatenation is being performed. Wait for a while and try again.
E931A	Competing with deleting Advanced Copy session in background process.
	An EC/REC session is being deleted. Wait for a while and try again.
E931B	Competing with deleting Advanced Copy session in background process.
	An OPC session is being deleted. Wait for a while and try again.
E931C	Competing with storage migration in background process.
	Data migration is being performed in an open system. Wait for a while and try again.
E931D	Competing with storage migration in background process.
	Data migration is being performed in a Mainframe system. Wait for a while and try again.
E931E	Competing with deleting snap data volume in background process.
	An SDPV is being deleted. Wait for a while and try again.
E931F	Competing with changing Advanced Copy parameters in background process.
	The SDPV resolution is being changed. Wait for a while and try again.
E9320	Competing with searching target WWNs.
	The target WWN is being obtained. Wait for a while and try again.
E9321	Competing with collecting disk performance information.
	Drive performance error information is being obtained. Wait for a while and try again.
E9322	Competing with checking file of storage migration path information.
	A data migration file is being confirmed in an open system. Wait for a while and try again.
E9323	Competing with checking file of storage migration path information.
	A data migration file is being confirmed in a Mainframe system. Wait for a while and try again.
E9324	Competing with registering Thin Provisioning Pool in background process.
	A pool is being registered. Wait for a while and try again.

Message number	Message Countermeasure for the error
E9325	Competing with deleting Thin Provisioning Pool in background process.
	A pool is being deleted. Wait for a while and try again.
E9326	Competing with formatting Thin Provisioning Pool in background process.
	A pool is being formatted Wait for a while and try again.
E9327	Competing with registering Thin Provisioning Volume in background process.
	A pool volume is being registered. Wait for a while and try again.
E9328	Competing with deleting Thin Provisioning Volume in background process.
	A pool volume is being deleted. Wait for a while and try again.
E9329	Competing with formatting Thin Provisioning Volume in background process.
	A pool volume is being formatted. Wait for a while and try again.
E932A	Competing with setting Thin Provisioning pool parameters in background process.
	The pool parameters are being set. Wait for a while and try again.
E932B	Competing with setting Thin Provisioning Volume parameters in background process.
	The pool volume parameters are being set. Wait for a while and try again.
E932C	Competing with setting Thin Provisioning mode in background process.
	A pool is being set. Wait for a while and try again.
E932D	Competing with assigning ECO schedule in background process.
	An Eco-mode operation is being set for a Thin Provisioning Pool. Wait for a while and try again.
E932E	Competing with registering REC Disk Buffer Volume in background process.
	An REC disk buffer volume is being registered. Wait for a while and try again.
E932F	Competing with deleting REC Disk Buffer Volume in background process.
	An REC disk buffer volume is being deleted. Wait for a while and try again.
E9330	Competing with inhibiting copy destination volume in background process.
	An operation to specify a copy destination is being suppressed. Wait for a while and try again.
E9331	Competing with moving volume in background process.
	Thin Provisioning or RAID Migration is being performed. Wait for a while and try again.
E9332	Competing with balancing Thin Provisioning Pool or Flexible Tier Pool data in background process.
	Thin Provisioning data or Flexible Tier data is being balanced. Wait for a while and try again.
E9333	Competing with registering dedicated hot spare in background process.
	A dedicated hot spare is being registered. Wait for a while and try again.
E9334	Competing with releasing dedicated hot spare in background process.
	A dedicated hot spare is being released. Wait for a while and try again.
E9335	Competing with collecting event information in background process.
	An event message log is being collected. Wait for a while and try again.
E9336	Competing with controlling advanced copy session.
	An EC session is being controlled. Wait for a while and try again.
E9337	Competing with controlling advanced copy session.
	An REC session is being controlled. Wait for a while and try again.
E9338	Competing with controlling advanced copy session.
	An OPC session is being controlled. Wait for a while and try again.

Message number	Message Countermeasure for the error
E9339	Competing with controlling advanced copy session.
	A monitoring session is being controlled. Wait for a while and try again.
E933A	Competing with setting Flexible tier mode in background process.
	The Flexible Tier mode is being set. Wait for a while and try again.
E933B	Competing with deleting Flexible tier pool in background process.
	A Flexible Tier Pool is being deleted. Wait for a while and try again.
E933C	Competing with formatting Flexible tier pool in background process.
	A Flexible Tier Pool is being formatted. Wait for a while and try again.
E933D	Competing with registering Flexible tier volume in background process.
	A Flexible Tier Volume is being registered. Wait for a while and try again.
E933E	Competing with setting Flexible tier sub pool priority in background process.
	The Flexible Tier Sub Pool Priority is being set. Wait for a while and try again.
E933F	Competing with setting Flexible tier pool parameters in background process.
	The Flexible Tier Pool parameter (threshold) are being set. Wait for a while and try again.
E9340	Flexible tier migration in process.
	Flexible Tier Migration is being started or stopped. Wait for a while and try again.
E9341	Competing with setting cache size limit to volume in background process.
	The cache LUN size limit is being set. Wait for a while and try again.
E9342	Competing with setting Offloaded Data Transfer Mode in background process.
	The Offloaded Data Transfer mode is being set. Wait for a while and try again.
E9343	Competing with setting Key management group ID in background process.
	The ID of the key management group is being set. Wait for a while and try again.
E9344	Competing with changing Key in background process.
	The key for the key management group is being changed. Wait for a while and try again.
E9345	NAS configuration process is in progress.
	The NAS setting is being changed. Wait for a while and try again.
E9346	Storage cluster license configuration process is in progress.
	The Storage Cluster license process is running. Wait for a while and try again.
E9347	TFO group configuration process is in progress.
	The TFO Group configuration process is running. Wait for a while and try again.
E9348	TFOV configuration process is in progress.
	The TFOV configuration process is running. Wait for a while and try again.
E9349	TFO group activate process is in progress.
	The TFO Group activation process is running. Wait for a while and try again.
E934A	TFO pair configuration process is in progress.
	The TFO Pair configuration process is running. Wait for a while and try again.
E934B	WVol mode setting process is in progress.
	The WVOL mode configuration process is running.
E934D	System cache function setting process is in progress.
	The configuration process of the function for acquiring the active table is running.

Message number	Message Countermeasure for the error
E934E	Starting SSD sanitization process is in progress.
	An SSD sanitization startup process is running.
E9380	The Storage migration is in progress.
	The storage migration process is running.
E9400	No memory.
	No resources can be obtained. Wait for a while and try again.
E9401	No message queue.
	No resources can be obtained. Wait for a while and try again.
E9402	No semaphore.
	No resources can be obtained. Wait for a while and try again.
E9403	CLI session limit reached.
	No resources can be obtained. Wait for a while and try again.
EA000	The CM status is not normal.
	The CM status is not normal. Wait for a while and try again.
EA200	The CA port type is incorrect.
	The CA port type is incorrect.
EA201	The specified CA port does not exist.
	The specified CA port does not exist.
EA202	The relevant operation cannot be executed because all of the CAs are NAS CAs.
	The relevant operation cannot be executed because all of the CAs are NAS CAs.
EA203	Host port mode of the CA port is incorrect.
	The port mode of the CA port is incorrect.
EA204	The WWPN/WWNN has not been changed.
	WWPN/WWNN has not been changed.
EA205	The CA Port status is not normal.
	The CA port state is abnormal.
EA400	The number of maximum disk slots is exceeded.
	The number of drives exceeds the maximum slot number. The drive cannot be added.
EA401	Cannot add Drive Enclosure any more.
	The drive enclosure cannot be added because the number of drive enclosures has reached the maximum number of drive enclosure.
EA402	The Drive Enclosure type does not support.
	The drive enclosure type is not supported.
EA600	No PFM is installed in the device.
	A PFM is not installed in the ETERNUS DX/AF.
EA601	A PFM is not installed in some of the CMs in the device.
	A PFM is not installed in some of the CMs in the ETERNUS DX/AF.
EA602	The PFM status is not normal.
	The PFM status is not normal.
EA603	The number of PFMs is different between the CMs.
	The number of PFMs is different between the CMs.

Message number	Message Countermeasure for the error
EA604	The specified disk does not exist.
	The specified drive does not exist.
EA605	The disk type is incorrect.
	The drive type is incorrect.
EA606	The capacity of the specified disk is insufficient.
	The capacity of the specified drive is insufficient.
EA607	The specified disk is not available as a member disk.
	The specified drive cannot be used as a member drive.
EA608	One or more specified disks are installed in the CE different from the specified assigned CM.
	The specified drive is installed to a controller enclosure that is different from the controller enclosure that the assigned CM belongs to.
EA609	SED and non-SED cannot be specified at the same time.
	SEDs and non-SEDs cannot be specified together.
EA60A	The drive is being used.
	The drive is currently being used.
EA60B	The drive status is incorrect.
	The status of the specified drive is incorrect.
EA800	The maintenance target is inconsistent status.
	The status of the maintenance target is inconsistent.
EA801	Not available under current system status conditions.
	Under the current system condition, this is not available.
EB000	The specified Flexible tier sub pool does not exist.
	The specified Flexible Tier Sub Pool does not exist.
EB001	One or more TPP or FTSP exists in the device.
	A TPP or an FTSP exists in the ETERNUS DX/AF. Delete the TPP or the FTSP.
EB002	The Fast Recovery RAID Group cannot be specified.
	The Fast Recovery RAID group cannot be specified.
EB003	The specified RAID Group does not exist.
	The specified RAID group does not exist.
EB004	The specified RAID Group status is not normal.
	The status of the RAID group is incorrect.
EB005	The specified RAID Group are already used.
	The specified RAID Group is currently in use for another purpose.
EB006	The number of volumes exceeds the maximum number of registrations in the RAID Group.
	The number of registered volumes has reached the maximum number for the RAID group.
EB007	The free capacity of the RAID Group is insufficient.
	The remaining capacity of the RAID group is insufficient.
EB008	One or more VWOLs exist in the specified Flexible tier pool.
	A VWOL exists in the specified Flexible Tier Pool.
EB009	The RAID Group used for the Extreme Cache Pool cannot be specified.
	An Extreme Cache Pool dedicated RAID group is specified.

Message number	Message Countermeasure for the error
EB00A	The Extreme Cache Pool already exists for the specified CM.
	An Extreme Cache Pool dedicated RAID group has already been specified in the same assigned CM.
EB00B	The Extreme Cache Pool does not exist for the specified CM.
	Extreme Cache Pool does not exist in the specified CM.
EB00C	The specified disk is already used.
	The specified drive is already being used for an existing RAID group.
EB00D	One or more Deduplication/Compression volumes exist in the specified pool.
	The specified pool has Deduplication/Compression Volumes.
EB00E	Deduplication and/or Compression is not enabled on the specified pool.
	The Deduplication/Compression setting is disabled in the specified pool.
EB00F	Extreme Cache Pool exists.
	An Extreme Cache Pool exists.
EB010	Not allowed to configure this RAID Level with the specified disks.
	The specified drive does not match the RAID level.
EB011	The free capacity of the pool is insufficient.
	The free space of the TPP or FTRP is insufficient.
EB012	The pool status is not normal.
	The pool is not in a normal state.
EB013	The flexible tier pool status is not normal.
	The FTRP is not in a normal state.
EB014	A volume for WVOL metadata exists in the specified pool.
	A WVOL Metadata exclusive FTV exist in the specified pool.
EB015	There are one or more pools enabled for Deduplication and/or Compression.
	A pool that has the Deduplication/Compression setting enabled exists.
EB016	Encryption option cannot be used for Extreme Cache Pool composed of SED-SSDs.
	An attempt was made to set the firmware encryption for an Extreme Cache Pool that is configured with SED SSDs.
EB017	ECO schedule is assigned to the specified pool.
	The ECO mode schedule is assigned to the specified pool.
EB018	Deduplication and/or Compression is enabled on the specified pool.
	The Deduplication/Compression setting is enabled for the specified pool.
EB02A	The specified RAID Group is not in use for Flexible Tier Pool.
	The specified RAID group is not used in the FTRP.
EB02B	The specified Thin Provisioning Pool is not applicable for Deduplication or Compression.
	The Deduplication/Compression setting cannot be enabled for the specified pool.
EB02C	The specified chunk size exceeds the current default chunk size of the device.
	The specified chunk size exceeds the current default chunk size of the ETERNUS DX/AF.
EB300	This command is not available for the type or usage of the specified volume.
	The volume type is incorrect.
EB301	The volume status is not normal.
	The volume status is incorrect.

Message number	Message Countermeasure for the error
EB302	The type of drive that configures the RLU or the TPP that the volume belongs to is incorrect.
	The type of drive that configures the RAID group or the TPP that the volume belongs to is incorrect.
EB303	The specified volume does not exist.
	The specified volume does not exist.
EB304	An incorrect UID is specified.
	An incorrect UID is specified.
EB305	The cache size limit is set.
	The cache size limit is set.
EB306	The volume in Fast Recovery RAID Group cannot be specified.
	The volume in Fast Recovery RAID group cannot be specified.
EB307	One or more VVols exist in the device.
	A WVOL exists in the ETERNUS DX/AF.
EB308	The number of volumes exceeds the maximum number of registrations.
	The number of registered volumes has reached the maximum number for the system.
EB309	The specified volume is being used as a VVOL.
	The specified volume is used for VVOLs.
EB30A	The specified volume's data integrity is T10-DIF.
	T10-DIF is set for the specified volume.
EB30B	The specified volume is thick provisioning volume.
	The allocation setting of the specified volume is Thick Provisioning.
EB30C	One or more Deduplication/Compression volumes exist.
	Deduplication/Compression Volumes exist.
EB30D	Zero Reclamation is running.
	Zero Reclamation is being performed on the specified volume.
EB30E	The WVOL cannot be specified with the other resources.
	A WVOL cannot be specified more than once.
EB30F	Data migration is running.
	A migration is being performed on the specified volume.
EB31A	Balancing process is running.
	A balancing process is being performed on the specified volume.
EB31B	The specified volume has no error data.
	Data errors do not exist in the specified volume.
EB31C	The specified volume has too many error data.
	The specified volume has too many data errors.
EB31D	The volume for WVOL metadata already exists.
	The WVOL Metadata exclusive FTV already exists in the ETERNUS DX/AF.
EB31E	The specified volume is being used as a volume for WVOL metadata.
	The specified volume is a WVOL Metadata exclusive FTV.
EB31F	The Deduplication/Compression System volume status is not normal.
	The status of the DEDUP_SYS Volume is not normal.

Message number	Message Countermeasure for the error
EB320	One or more NAS volumes exist.
	NAS volumes exist.
EB334	The resource, which can be used only in expand volume mode, exists.
	A volume that can only be used when the Expand Volume Mode is enabled exists.
EB339	The Deduplication/Compression volume is being used.
	If a copy session or a migration is running in the Deduplication/Compression Volume, the DEDUP_SYS Volume cannot be formatted.
EB500	Number of iSNS server has reached the iSCSI CA port limit.
	The number of iSNS servers has reached the maximum number for the specified iSCSI CA port.
EB501	The specified port belongs to a port group.
	The specified port belongs to a port group.
EB502	The lun group, which is set in specified host affinity and port, specify volume does not exist.
	The specified volume does not exist in the LUN group where affinity is configured with the specified port and/or host.
EB505	Host affinity mode is inconsistent.
	Host affinity mode is inconsistent.
EB506	The host specified does not exist.
	The specified host does not exist.
EB507	The specified port and host is not affinity setting.
	The specified port and host are not configured with affinity.
EB508	The specified port is affinity setting.
	The target port has been configured with affinity.
EB509	The specified lun group are already used in the host affinity.
	The LUN group is already using host affinity.
EB50A	The specified lun group are already used in the TFO group.
	The LUN group is already used in the TFO group.
EB50B	The specified volume are already used in the host affinity.
	The specified volume is already used in the host affinity.
EB50C	The specified volume are already used in the TFO group.
	The specified volume is already used in the TFO group.
EB50D	The specified volume is already used in other TFO group.
	The specified volume is already used in another TFO group.
EB510	TFO pair does not exist in the volume of all of the lun group that has been set affinity in the specified host and port specified.
	A volume with a TFO pair does not exist in the LUN group where affinity is configured with the specified port and/or host.
EB511	The specified host is already used in the host affinity that includes the lun mask group.
	The specified host is already being used with host affinity in the LUN mask group.
EB512	The specified host belongs to a host group.
	The specified host belongs to a host group.
EB513	The specified lun mask group are already used in the host affinity.
	The specified LUN mask group has been set with host affinity.

Message number	Message Countermeasure for the error
EB514	The lun mask group which can be affinity setting does not exist.
	A LUN mask group that can be set with host affinity does not exist.
EB515	The source port is already used in the host affinity that includes the lun mask group.
	The copy source port configures host affinity with the LUN mask group.
EB516	The destination port is already used in the host affinity that includes the lun mask group.
	The copy destination port configures host affinity with the LUN mask group.
EB517	Host number or lun group number, which can be used only in expand host mode, exists.
	The host number or the LUN group number that can be used only when the Expand Host Mode is enabled already exists.
EB518	The number of hosts exceeds the maximum number of hosts which can be registered if expand host mode is disabled.
	The number of hosts that can be registered when the Expand Host Mode is disabled has exceeded the maximum.
EB519	The iSCSI hosts, which have the same iSCSI name but one of them has no IP address configuration, cannot be used for the same CA port in host affinity setting.
	Host affinity cannot be set for the iSCSI host interface accessed by both an iSCSI host with a random IP address and an iSCSI host with a specific IP address that have the same iSCSI name.
EB51A	The iSCSI hosts, which have the same iSCSI name but one of them has no IP address configuration, cannot be used for the same host group.
	If an iSCSI host group is created or if an iSCSI host is added to an iSCSI host group, the host group cannot have both an iSCSI host with a random IP address and an iSCSI host with a specific IP address that have the same iSCSI name.
EB51B	The specified iSCSI Name cannot be used because it causes a conflict in host affinity setting at a CA port in which a host with the same iSCSI Name has already been used.
	The iSCSI name cannot be changed, because by changing the iSCSI name, the iSCSI host with a random IP address that has the same name as the iSCSI host with a specific IP address becomes the target of the host affinity setting in the same iSCSI interface port.
EB51C	The specified iSCSI Name cannot be used because it causes a conflict in host group setting in which a host with the same iSCSI Name has already been used.
	The iSCSI name cannot be changed, because by changing the iSCSI name, the iSCSI host with a random IP address that has the same name as the iSCSI host with a specific IP address becomes the target of the registration in the same host group.
EB900	REC path is not set.
	A REC path is not set.
EB901	REC path is not normal.
	An error is detected in the REC path.
EB902	REC Buffer is mirror recovery status.
	The REC buffer is in mirror recovery status.
EB903	CFL is canceled because REC session is not continuable state.
	A hot controller firmware update was suspended because the remote copy session is in a state where continuation is not possible. Take one of the following actions: <ul style="list-style-type: none"> • Recover the Advanced Copy path. • Set the concurrent loading (path switching linkage) mode to "Manual (Operator linkage)" and try again. • Suspend REC sessions that are not in "Suspend" status, "Error Suspend" status, or "Halt" status by using the software that started these REC sessions.
EB904	REC path is set in this device.
	A REC path has been configured.

Message number	Message Countermeasure for the error
EB905	REC path using iSCSI interface exists.
	A REC path of the iSCSI interface exists.
EB906	There are CA port that port mode is CA/RA or RA is exists.
	An RA mode port or an RA/CA mode port exists.
EB907	The resource, which can be used only in expand volume mode, exists.
	A copy session that can only be used when the Expand Volume Mode is enabled exists.
EB909	The specified RA path does not exist.
	The specified connection path does not exist.
EBD02	The controller firmware is being received from the REMCS center.
	The controller firmware is being received from the REMCS center.
EBD03	The specified generation is not in valid status.
	The controller firmware of the specified generation is not valid.
EBD04	The specified controller firmware is already registered.
	An archive of the same version has already been registered.
EBD05	The specified generation is already registered on the Flash memory.
	The controller firmware of the specified generation has already been registered to the flash memory.
EBD06	Not available under current system status conditions.
	Under the current system condition, this is not available.
EBD07	The "hot-auto" application type cannot be executed in current configuration.
	A hot application cannot be performed automatically (without cooperation).
EBD08	The "hot-manual" application type cannot be executed in current configuration.
	A hot application cannot be performed manually (with operator cooperation).
EBD09	One or more components have failed when applying the firmware.
	The process failed due to a built-in process associated with applying the firmware.
EBD0A	An internal process failed.
	The ETERNUS DX/AF status is not normal.
EBD0B	An error occurred in Master CM but the controller firmware has been applied.
	An error occurred in the master CM but the hot controller firmware update has completed.
EBD0C	An error occurred in Master CM and the controller firmware has not been applied.
	The hot controller firmware update has failed because an error occurred in the master CM.
EBD0D	The hot application failed because the system is under heavy I/O load.
	The hot controller firmware update has failed because the system is under heavy I/O load.
EBD0E	The hot application failed because the pinned data exists.
	The hot controller firmware update has failed because pinned data exists.
EBD0F	The Data migration is in progress.
	A data migration is running.
EBD10	A conflict exists between the specified application type and the Advanced Copy Session.
	A conflict exists between the copy session and the hot controller firmware update.
EBD11	There is no redundant path available for accessing the external storage device(s).
	There is no redundant path available to access the external storage system.

Message number	Message Countermeasure for the error
EBE00	The specified volume is being used as a NAS volume.
	The specified volume is being used as a NAS volume.
EBE01	This operation is not applicable to the specified object.
	Advanced copy cannot be executed for the specified volume.
EBE02	The NAS function is not available.
	The NAS function is not available.
EBE03	The number of NAS-TPVs exceeds the maximum number of registrations.
	The number of NAS-TPVs exceeds the maximum number of registrations.
EBE04	The number of NAS-TPVs (Backup) exceeds the maximum number of registrations.
	The number of NAS-TPVs (Backup) exceeds the maximum number of registrations.
EBE05	Number of NAS System Volume has reached the system limit.
	The number of registered SYSVOLs or SYSVOLs that are to be created has reached the maximum number of registrations.
EBE06	Capacity of NAS System Volume has reached the system limit.
	The logical capacity of registered SYSVOLs or SYSVOLs that are to be created has reached the maximum capacity of registrations.
EBE07	An error was detected in NAS Engine.
	An error was detected in the NAS Engine.
EBE08	NAS system volume does not exist.
	The NAS system volume is not registered.
EBE09	NAS system volume is not writable.
	The NAS system volume is not writable.
EBE0A	The firmware does not support NAS.
	The firmware does not support NAS.
EBE0B	This operation is not applicable to the Unified Storage.
	The executed operation is not supported in the Unified Storage.
EB017	ECO schedule is assigned to the specified pool.
	The Eco-mode schedule has been assigned to the specified pool.
EBE20	Specified NAS share does not exist.
	The specified NAS share folder does not exist.
EBE21	The number of NAS share exceeds the maximum number of registrations.
	The number of NAS share folders exceeds the maximum number of registrations.
EBE22	Specified NAS share name already exists.
	The specified NAS share folder name is already registered.
EBE23	Insufficient NAS share resources.
	The NAS share folder information capacity has reached the upper limit (10MB).
EBE24	[-force] option is only used for the NAS Volume whose status is "Readying".
	The status of the NAS volume is not "Readying".
EBE25	R and RW cannot be set to the same user or group.
	The same user name or the same group name cannot be specified with both Read-Only privilege (R) and Read-Write privilege (RW) at the same time.

Message number	Message Countermeasure for the error
EBE26	Specified host is not registered in the Allow NFS Hosts.
	The specified host is not included in "NFS access allowed hosts" (or NFS Allow Host).
EBE27	Specified NAS share does not support CIFS service.
	The specified folder does not support CIFS.
EBE28	Home directory function is already enabled.
	The "create nas-share -home-directory" command was executed while the home directory function was already enabled.
EBE29	The specified NAS share is used for home directory function.
	The specified NAS shared folder is the "homes" folder that is used with the home directory function.
EBE30	Specified NAS interface does not exist.
	The specified NAS interface does not exist.
EBE31	The number of NAS interfaces exceeds the maximum number of registrations.
	The number of NAS interfaces exceeds the maximum number of registrations.
EBE32	Another non-VLAN IP address has been registered with this port.
	The specified port is already set for a non-VLAN interface.
EBE33	The specified IPv4 address is already registered.
	The specified IPv4 address is already registered.
EBE34	The specified IPv6 link local address is already registered.
	The specified IPv6 link local address is already registered.
EBE35	The specified IPv6 address is already registered.
	The specified IPv6 address is already registered.
EBE36	No valid IP address exists.
	No valid IP address exists.
EBE37	The VLAN ID setting is incorrect.
	The VLAN ID setting is incorrect.
EBE38	The IPv4 address is incorrect.
	The IPv4 address is incorrect.
EBE39	The subnet mask setting is incorrect.
	The subnet mask setting is incorrect.
EBE3A	The gateway address is incorrect.
	The specified gateway address is incorrect.
EBE3B	The IPv4 host address should be non-zero.
	The specified IPv4 address is incorrect.
EBE3C	The specified IPv6 link local address is incorrect.
	The specified IPv6 link local address is incorrect.
EBE3D	The specified IPv6 global address is incorrect.
	The specified IPv6 global address is incorrect.
EBE3E	The IPv6 prefix length should be 3-128.
	The specified prefix length is incorrect.
EBE3F	The IPv6 gateway address should be same subnet or have other interface ID.
	The specified IPv6 gateway address is incorrect.

Message number	Message Countermeasure for the error
EBE40	The specified IPv6 address is not a link local address or a global address.
	The specified IPv6 address is not a link local address or a global address.
EBE41	The specified IP address already exists.
	The specified IP address already exists.
EBE42	The primary DNS server information is not set.
	The primary DNS server information is not set.
EBE43	Specified NAS interface is not assigned to port.
	The specified NAS interface is not assigned to a port.
EBE44	The same VLAN ID has been registered to this port.
	The same VLAN ID interface has already been set for the specified port.
EBE45	The specified NAS interface is used by multi-path.
	The specified NAS interface cannot be changed because it is being used by the multipath setting.
EBE70	The specified port is the master port for the bonding.
	The specified port is the master port for the bonding process.
EBE71	The specified port is the member port for the bonding.
	The specified port is the member port for the bonding process.
EBE72	The specified port is not the master port for the bonding.
	The specified port is not the master port for the bonding process.
EBE73	The specified port is not the member port for the bonding.
	The specified port is not the member port for the bonding process.
EBE74	The specified port is on a different CM.
	The specified port is a port on a different CM.
EBE75	The number of member ports exceeds the maximum number of registrations.
	The number of member ports exceeds the maximum number of registrations.
EBE76	Cannot delete the bond because the multi-path is enabled.
	Multipath has been set. Bonding cannot be deleted.
EBE80	The specified port belong to the multi-path.
	The specified port is set for a multipath.
EBE81	The specified port is not multi-path pair.
	The specified port is not set for a multipath.
EBE82	The specified port is installed in the same CM.
	The specified port is a port in the same CM.
EBE83	The IP address of the NAS interface under the multi-path ports has to have the same network address.
	The IP address that is being set as the multipath must be on the same network address.
EBE90	The server settings conflicted.
	The server settings are duplicated.
EBE91	Some required settings are not specified.
	Some required settings are not specified.
EBE92	Available NAS interface not exist.
	An available NAS interface does not exist.

Message number	Message Countermeasure for the error
EBE93	One or more NAS AD/LDAP servers are registered.
	An Active Directory authentication server or an LDAP authentication server is registered.
EBE94	The same local group cannot be set to both Primary and Secondary groups.
	The primary group and the secondary group cannot be set with the same local group.
EBE95	The specified local user name or ID is already registered.
	The specified local user name or local user ID is already registered.
EBE96	The specified local group does not exist.
	The specified local group does not exist.
EBE97	The specified local user does not exist.
	The specified local user does not exist.
EBE98	The specified local group name or ID is already registered.
	The specified local group name or local group ID is already registered.
EBE99	The specified local group is used as Primary group.
	The specified local group is registered as the primary group.
EBE9A	One or more local users or groups are registered.
	A local user or a local group is already registered.
EBE9B	The number of local users exceeds the maximum number of registrations.
	The registered number of local users has reached the maximum number.
EBE9C	The number of local groups exceeds the maximum number of registrations.
	The registered number of local groups has reached the maximum number.
EBE9D	BUILTIN Group can be used only for Secondary group.
	BUILTIN groups can only be used as a secondary group.
EBE9E	Specified group name is incorrect.
	The specified local group name is not correct.
EBEA0	The specified route is already registered.
	The specified route is already registered.
EBEA1	The specified route is not registered.
	The specified route is not registered.
EBEA2	The specified gateway cannot be accessed.
	The specified gateway cannot be accessed.
EBEA3	The host address or the interface ID portion of the IP address should be zero.
	The host address portion or interface ID portion of the IP address is not zero.
EBEA4	The destination address is the same as the interface address.
	The target address is the same as the interface address.
EBEA5	The gateway address is the same as the interface address.
	The gateway address is the same as the interface address.
EBEA6	The specified destination address is incorrect.
	The specified destination address is incorrect.
EBEB0	The number of NAS snapshot volumes exceeds the maximum number of registrations.
	The number of NAS Snapshot generations has reached the maximum number for the system.

Message number	Message Countermeasure for the error
EBEB1	The specified NAS snapshot configurations not exist.
	The specified NAS Snapshot setting does not exist.
EBEB2	The NAS snapshot configurations is set to specified volume.
	Snapshot has been set to the specified volume.
EBEB3	The Snap Data Pool Volume which is match the encryption status of the specified volume, does not exist.
	The SDPV that corresponds the encryption state of the specified volume does not exist.
EBEB4	The NAS snapshot configurations is the manual collecting mode.
	The NAS snapshot configuration is set to the manual acquisition mode.
EBEC0	The number of NAS quota settings exceeds the maximum number of registrations.
	The number of registered quota settings has reached the maximum number for the system.
EBEC1	A NAS quota setting associated with specified volume and group/user already exists.
	The quota settings related to the specified volume and specified group or user already exists.
EBEC2	Warning value larger than limit value is specified.
	The warning value has been specified with a larger value than the limit value.
EBEC3	Specified NAS quota setting does not exist.
	The specified NAS quota setting does not exist.
EBEC4	Deletion of the quota setting associated with specified volume failed.
	Deletion of the quota setting that is related to the specified volume has failed.
EBEC5	All of quota setting failed. Specified user or group may not exist.
	All the quota settings have failed. The specified user or group may not have been registered in the authentication server.
EBEC6	Deletion of the quota setting associated with specified NAS share failed.
	Deletion of the quota setting that is related to the specified shared folder has failed.
EBEE0	The specified NAS share has already been configured for FTP service.
	FTP has already been configured for the specified shared folder.
EBEE1	The number of NAS share folders for FTP service exceeds the allowable maximum.
	The number of shared folders that are to be published via FTP has exceeded the limit.
EBEE2	The specified NAS share has not been configured for FTP service.
	With the settings of the shared folder that is to be published via FTP deleted, FTP is not set for the specified shared folder.
EBF00	The number of registered TFO group has exceeded maximum in this device.
	The number of registered TFO groups has exceeded the maximum number set in the ETERNUS DX/AF.
EBF01	TFO group is exist.
	TFO Groups exist.
EBF02	TFO group does not exist.
	TFO groups do not exist.
EBF03	The specified TFO group name is already registered.
	The specified TFO group name has already been registered.
EBF04	The specified CA Port is not in the specified TFO group.
	The target port is not included in the specified TFO group.
EBF05	The specified TFO group is primary.
	The TFO group that is specified is the primary.

Message number	Message Countermeasure for the error
EBF06	The specified port is not TFO port.
	The specified port is not a TFO pair port.
EBF07	The specified port is already TFO pair port configured.
	The specified port is already configured in the TFO pair port.
EBF08	Different types of CA ports cannot be used in TFO group.
	Different types of interface ports cannot be used in the TFO group.
EBF09	The maximum TFO capacity cannot be decreased when TFO pair exists.
	If a TFO session exists, a value smaller than the current value cannot be set for the maximum capacity of the specified TFOV.
EBF0A	The specified volume is not in process of TFO pair.
	The TFO pair does not exist in the specified volume.
EBF0B	The TFO group is primary.
	The command was executed on the primary TFO group.
EBF0C	The specified volume is in process of TFO pair.
	The TFO pair is configured in the specified volume.
EBF0D	There is a volume what is in process of TFO pair.
	The volume that has been configured with the TFO pair exists in the specified pool.
EBF0E	The specified volume is configured TFOV.
	The specified volume is configured as the TFOV.
EBF10	Change of size was specified volume is TFOV.
	Changing the size was specified by the TFOV.
EBF11	The parameter needs storage cluster license.
	The Storage Cluster license is not registered. The specified parameter cannot be used.
EBF12	The destination port belongs to TFO group.
	The copy destination port belongs to the TFO Group.
EBF13	The source port belongs to TFO group.
	The copy source port belongs to the TFO Group.
EBF15	The specified port has been changed WWPN/WWNN.
	The WWPN/WWNN of the specified port has been changed.
EBF16	TFO group is set to manual failover.
	For the TFO group that is configured to manual failover, the monitoring interval is specified until the failover completes.
EC000	VVol Fault : ActivateProviderFailed
	Activation of Provider has failed.
EC001	VVol Fault : InactiveProvider
	Provider has not been activated.
EC002	VVol Fault : IncompatibleVolume
	There is no compatibility in the volume.
EC003	VVol Fault : IncorrectSite
	The site is incorrect.
EC004	VVol Fault : InvalidArgument
	The value of the specified parameter is not defined (the value does not exist). Verify the entered parameter.

Message number	Message Countermeasure for the error
EC005	VVol Fault : InvalidCertificate
	The certificate is invalid.
EC006	VVol Fault : InvalidLogin
	The login is invalid.
EC007	VVol Fault : InvalidProfile
	The profile is invalid.
EC008	VVol Fault : InvalidSession
	The session is invalid.
EC009	VVol Fault : InvalidStatisticsContext
	The source context is invalid.
EC00A	The specified VVol copy session does not exist.
	The VVol copy session does not exist.
EC010	VVol Fault : LostAlarm
	The alarm was lost.
EC011	VVol Fault : LostEvent
	The event was lost.
EC012	VVol Fault : NotCancellable
	The specified target is not in a cancellable state.
EC013	VVol Fault : NotFound
	The value of the specified parameter does not exist or is already processing. Verify the entered parameter.
EC014	VVol Fault : NotImplemented
	Not implemented.
EC015	VVol Fault : NotSupported
	Not supported.
EC016	VVol Fault : OutOfResource
	The specified parameter is has reached the defined upper limit or the value of the specified parameter is outside the defined range. Verify the upper limit value or the entered parameter.
EC017	VVol Fault : PermissionDenied
	Permission was denied.
EC018	VVol Fault : ResourceInUse
	The target of the specified parameter is currently being used or is in an unspecifiable state.
EC019	VVol Fault : SnapshotTooMany
	There are too many snapshots.
EC020	VVol Fault : StorageFault
	The VVOL function is disabled, there is an error with the value of the specified parameter, or there is an error in the combination of the specified parameters.
EC021	VVol Fault : Timeout
	A timeout has occurred.
EC022	VVol Fault : TooMany
	The specified parameter has exceeded the number of defined events. Verify the entered parameter.
EC100	One or more external drives exist.
	One or more External Drives exist in the ETERNUS DX/AF.

Message number	Message Countermeasure for the error
EC101	The specified external storage devices do not exist.
	The specified external storage does not exist.
EC102	The number of external drives exceeds the maximum number of registrations.
	The number of External Drives exceeds the maximum number that can be created.
EC103	External LUs do not exist.
	External LUs do not exist.
EC104	External drives do not exist.
	External Drives do not exist.
EC105	External drives are already used.
	External Drives are used for an External RAID Group.
EC106	The status of external drives is not normal.
	The status of External Drives is not normal.
EC107	The specified external RAID Group does not exist.
	The specified External RAID Group does not exist.
EC108	External RAID Groups are already used.
	External RAID Groups are used for volumes for Non-disruptive Storage Migration.
EC109	The specified external RAID Group is not in "Broken" state.
	The specified External RAID Group is not in "Broken" state.
EC10A	The number of external RAID Groups exceeds the maximum number of registrations.
	The number of External RAID Groups exceeds the maximum number that can be created.
EC10B	The status of external RAID Groups is not normal.
	The status of External RAID Groups is not normal.
EC10C	The specified external RAID Group name has already been used.
	The specified External RAID Group name has already been registered.
EC10D	External LUs are not accessible.
	The External RAID Group is blocked.
ED000	Send failed internal command.
	An internal error has occurred. If this error persists, request your maintenance engineer to investigate the error.
ED001	Receive failed internal command response.
	An internal error has occurred. If this error persists, request your maintenance engineer to investigate the error.
ED002	Internal command retry timeout.
	An internal error has occurred. If this error persists, request your maintenance engineer to investigate the error.
ED003	Internal command progress retry timeout.
	An internal error has occurred. If this error persists, request your maintenance engineer to investigate the error.
ED180	Flexible Tier Migration is running.
	Flexible Tier Migration is running. Wait for a while and try again.
ED181	Quick UNMAP is being performed.
	Quick UNMAP is being performed. Wait for a while and try again.
ED182	The cache LUN size limit is being set.
	The cache LUN size limit is being set. Wait for a while and try again.

Message number	Message Countermeasure for the error
ED183	Because EC is being executed, the processing was discontinued.
	A complete EC is running. Wait for a while and try again.
ED184	Because OPC is being executed, the processing was discontinued.
	A complete OPC is running. Wait for a while and try again.
ED185	Because REC is being executed, the processing was discontinued.
	A complete REC is running. Wait for a while and try again.
ED186	Offloaded Data Transfer is being performed.
	An Offloaded Data Transfer is being performed. Wait for a while and try again.
ED187	The REC disk buffer volume is associated.
	The REC disk buffer volume is associated. Wait for a while and try again.
ED190	The internal resources are insufficient.
	The internal resources are insufficient. Wait for a while and try again.
ED191	The internal resources are insufficient.
	The internal resources are insufficient. Wait for a while and try again.
ED192	The internal resources are insufficient.
	The memory area is insufficient. Wait for a while and try again.
ED193	A non-master-CM component received a command.
	A non-master-CM component received a command. Wait for a while and try again.
ED194	The internal resources are insufficient.
	The dynamic allocating memory is insufficient. Wait for a while and try again.
ED195	Internal processes are running. Wait for a while and try again.
	An internal process is being performed. Wait for a while and try again.
ED196	The internal resources are insufficient.
	The internal resources are insufficient. Wait for a while and try again.
ED197	Number of the processing request is reached the limit.
	The internal resources are insufficient. Wait for a while and try again.
ED198	Process is timeout.
	An internal process is being performed. Wait for a while and try again. If the result is the same even after performing a retry, request your maintenance engineer to investigate the error.
ED199	The process terminated with an error because pinned data existed.
	The process terminated with an error because pinned data was detected. Wait for a while and try again.
ED19A	The key management server responded with an error.
	The key management server responded with an error.
ED19B	An error occurred during communication with the key management server.
	An error occurred during communication with the key management server.
ED19C	The key management server contains no keys that can be changed.
	The key management server contains no keys that can be changed.
ED19F	The command process is being canceled.
	The command process is being canceled. Wait for a while and try again.
ED1A0	Another process is running.
	Another process is running. Wait for a while and try again.

Message number	Message Countermeasure for the error
ED1A1	EC is running.
	An EC is running. Wait for a while and try again.
ED1A2	OPC is running.
	An OPC is running. Wait for a while and try again.
ED1A3	REC is running.
	An REC is running. Wait for a while and try again.
ED1A4	ROPC is running.
	ROPC is running. Wait for a while and try again.
ED1A5	CCP is running.
	CCP is running. Wait for a while and try again.
ED1A6	Quick Format is running.
	Quick Format is running. Wait for a while and try again.
ED1A7	Rebuild operation is running.
	A Rebuild operation is running. Wait for a while and try again.
ED1A8	There is no redundancy.
	There is no redundancy.
ED1A9	A DE is being rebooted.
	A DE is being rebooted. Wait for a while and try again.
ED1AA	CFL is running.
	A hot controller firmware update is currently being executed. Wait for a while and try again.
ED1AB	CFD is running.
	A cold controller firmware update is currently being executed. Wait for a while and try again.
ED1AC	Operations associated with Log file, Panic Dump or Event information are being processed.
	The information for the log, panic dump, or event is being deleted or retrieved. Wait for a while and try again.
ED1AD	The hot spare is in use.
	The hot spare is in use.
ED1AE	Upgrade Dirty Recovery is running.
	An Upgrade Dirty Recovery is running. Wait for a while and try again.
ED1AF	Degrade Dirty Recovery is running.
	A Degrade Dirty Recovery is running. Wait for a while and try again.
ED1B0	Remote Maintenance is running.
	Remote Maintenance is running. Wait for a while and try again.
ED1B1	Command Lock is being processed.
	An internal process is being performed. Wait for a while and try again.
ED1B2	The configuration is being changed.
	The configuration is being changed. Wait for a while and try again.
ED1B3	Bind In Cache (Extent) is set.
	Bind-in-Cache is set. (Extent)
ED1B4	Data Migration is running.
	Data Migration is running. Wait for a while and try again.

Message number	Message Countermeasure for the error
ED1B5	Logical Device Expansion is running.
	Logical Device Expansion is running. Wait for a while and try again.
ED1B6	Write Through is running.
	Write Through is running. Wait for a while and try again.
ED1B7	An encryption process or a decryption process is running.
	An encryption process or a decryption process is running. Wait for a while and try again.
ED1B8	Bind In Cache is set.
	Bind-in-Cache is set.
ED1B9	Some of the spinup or spindown operations failed.
	Some of the spinup or spindown operations failed. Wait for a while and try again.
ED1BA	Eco-mode schedule suspension timeout occurred.
	An Eco-mode schedule suspension timeout occurred. Wait for a while and try again.
ED1BB	All of the spinup and spindown operations failed.
	All of the spinup and spindown operations failed. Wait for a while and try again.
ED1BC	There is an encryption volume.
	There is an encrypted volume.
ED1BD	Operation Mode is not in "Maintenance Mode".
	The Maintenance mode is not set.
ED1BE	A Storage Migration path is set or Storage Migration is running.
	A Storage Migration path is set or Storage Migration is running.
ED1BF	Extended Copy is running.
	An Extended Copy is running. Wait for a while and try again.
ED1C0	An error occurred in the module.
	An error occurred in the module. Check the module status.
ED1C1	An error occurred in the CM.
	An error occurred in the CM.
ED1C2	An error occurred in the CA.
	An error occurred in the CA.
ED1C3	An error occurred in the BRT.
	An error occurred in the BRT.
ED1C4	An error occurred in the SVC.
	An error occurred in the SVC.
ED1C5	An error occurred in the RSP.
	An error occurred in the RSP.
ED1C6	An error occurred in the FRT.
	An error occurred in the FRT.
ED1C7	An error occurred in the PBC.
	An error occurred in the PBC.
ED1C8	An error occurred in the battery.
	An error occurred in the battery.

Message number	Message Countermeasure for the error
ED1C9	An error occurred in the DE.
	An error occurred in the DE.
ED1CA	An error occurred in the DE path.
	An error occurred in the DE path.
ED1CB	An error occurred in the user drive.
	An error occurred in the user drive.
ED1CC	An error occurred in the system drive.
	An error occurred in the system drive.
ED1CD	An error occurred in the Flash-ROM.
	An error occurred in the Flash-ROM.
ED1CE	An error occurred in the FE Expander.
	An error occurred in the FE Expander.
ED1CF	An error occurred in the BE Expander.
	An error occurred in the BE Expander.
ED1D0	An error occurred in the EXP.
	An error occurred in the EXP.
ED1D1	An error occurred in the drive path.
	An error occurred in the drive path.
ED1D2	An error occurred in the drive.
	An error occurred in the drive.
ED1D3	Unable to retrieve data from NAS Engine. Please check the status of the NAS Engine.
	Data from the NAS engine cannot be retrieved. Check the status of the NAS engine.
ED1E0	Power-on has not been performed yet or power-off is being performed.
	Power-on has not been performed yet or power-off is being performed. Wait for a while and try again.
ED1E1	Zero is specified for the module ID in the transmitter.
	Zero is specified for the module ID in the transmitter. Wait for a while and try again.
ED1E2	The lock has been acquired.
	The lock has been acquired. Wait for a while and try again.
ED1E3	Locking has not been performed.
	Locking has not been performed. Wait for a while and try again.
ED1E4	An unsupported command was specified.
	An unsupported command was specified.
ED1E5	The parameter length is incorrect.
	The parameter length is incorrect. Check the input content.
ED1E6	The specified parameter is incorrect.
	The specified parameter is incorrect. Wait for a while and try again. Check the input content.
ED1E7	The data length is incorrect.
	The data length is incorrect. Check the input content.
ED1E8	The specified data is incorrect.
	The specified data is incorrect. Check the input content.

Message number	Message Countermeasure for the error
ED1E9	The execution of the command is requested while this command is already being performed.
	The execution of the command is requested while this command is already being performed. Wait for a while and try again.
ED1EA	The target object cannot be operated.
	The target object cannot be operated. Check the input content or the device status.
ED1EB	An internal process failed.
	An internal process failed to complete successfully. Request your maintenance engineer to investigate the error.
ED1EC	Because Storage Cluster is being executed, the processing was discontinued.
	The Storage Cluster is running. Wait for a while and try again.
ED1ED	The Flexible Tier Pool shrinking is in process.
	A Flexible Tier Pool shrinking is running.
ED200	The user name or password is incorrect.
	The user name or password is incorrect. Check the input content.
ED201	The user name is duplicated.
	The user name is duplicated. Check the input content.
ED202	The number of registered users has reached the limit.
	The number of registered users has reached the limit. Check the input content.
ED203	This user has already registered the User Key. The process was aborted.
	Deleting of a user with a registered user key is attempted. Check the input content.
ED204	The specified role name is not registered.
	The specified role name is not registered in the ETERNUS DX/AF. Check the input content.
ED205	An internal process failed.
	Execution is not possible due to other factors. Wait for a while and try again.
ED206	The login request exceeds the allowable maximum number of login process.
	The number of issuances exceeds the maximum number for simultaneous issuances. Wait for a while and try again.
ED207	The specified process cannot be performed because a process that the Virtual Disk Service issued is already running.
	The specified process cannot be performed because a process that the Virtual Disk Service issued is already running.
ED208	The specified RAID Group is not in "Available" state.
	The RAID group is not in Available status.
ED209	An error has occurred in a communication path.
	An error has occurred in a communication path.
ED20B	The source volume of migration is being deleted by internal process after completed migration.
	The migration source Thin Provisioning Volume is internally being deleted after migration is complete. Wait for a while and try again.
ED20C	The cache memory size is insufficient for Bind-in-Cache.
	The cache memory size that is allocated for Bind-in-Cache is insufficient.
ED20D	No response is received.
	No response is received. Wait for a while and try again.
ED20E	iSNS server is not set.
	An iSNS server is not set.

Message number	Message Countermeasure for the error
ED20F	The installation type information for the DE that is to be added is insufficient.
	The installation type information for the DE that is to be added is insufficient. Check the input content or the device status.
ED210	Maintenance mode start or maintenance mode end is being executed by operation.
	Maintenance is being started or being terminated due to a Maintenance SW.
ED211	The license information is being updated because the trial license expired.
	The license information is being updated because the trial license expired. Wait for a while and try again.
ED212	The Bitmap is being acquired.
	The Bitmap is being acquired. Wait for a while and try again.
ED213	The storage is not in "Not Ready" state.
	The ETERNUS DX/AF is in Not Ready status. Check the device status.
ED214	The Not Ready factor is not Machine Down Recovery failed.
	The cause of Not Ready status is not Machine Down Recovery Fail. Check the device status.
ED215	(if processing mode is 0x00) CM with the following status exists among defined CM: Status other than Online - This CM is not included in the Cyclic composition.
	The status of the CM is not Online or the CM is not included in the Cyclic configuration.
ED216	The device is a busy state. Please wait for a while.
	Two internal processes are running. Wait for a while and try again.
ED217	Storage Cruiser is being used. The process was aborted.
	A process (collecting performance information) that was started from ETERNUS SF Storage Cruiser is currently being performed. Wait for a while and try again.
ED218	Command executed from except Storage Cruiser. The process was aborted.
	A process (collecting performance information) that was started from software other than ETERNUS SF Storage Cruiser is currently being performed. Wait for a while and try again.
ED219	Reading all BUDs failed.
	Reading of all the BUDs failed. Wait for a while and try again.
ED21A	No BUDs are accessible.
	No BUDs are accessible. Wait for a while and try again.
ED21B	Writing all BUDs failed.
	Writing of all the BUDs failed. Wait for a while and try again.
ED21C	All of the BUD capacity is used.
	All of the BUD capacity is used. Wait for a while and try again.
ED21D	A timeout occurred during firmware registration.
	A timeout occurred during firmware registration.
ED21E	A checksum error occurred.
	A checksum error occurred.
ED21F	The size of the archive in the header is not corresponding to the size of the forwarding archive.
	The size of the archive in the header is not the same as the size of the forwarding archive.
ED220	The disk where the archive that tries to be registered can be applied doesn't exist in the device.
	The ETERNUS DX/AF contains no drives that the target archive for registration can be applied to.
ED221	The archive that tries to be registered is unsupported firmware.
	The archive that is to be registered is unsupported firmware.

Message number	Message Countermeasure for the error
ED222	Reading the history data failed.
	Reading of the history data failed.
ED223	Reading the composition data failed.
	Reading of the configuration data failed.
ED224	Writing the history data failed.
	Writing of the history data failed.
ED225	Keeping the composition data failed.
	Writing of the configuration data failed.
ED226	Keeping the newest composition data failed.
	Writing of the "newest" configuration data failed.
ED227	The configuration is internally being updated.
	The configuration is internally being updated. Wait for a while and try again.
ED228	Reading from a BUD failed.
	Reading from a BUD failed. Wait for a while and try again.
ED229	The BUD doesn't exist.
	The BUD does not exist. Wait for a while and try again.
ED22A	The target module does not exist.
	The target module does not exist. Check the input content.
ED22B	The process cannot be performed because another function is being executed.
	The process cannot be performed because another function is being executed. Wait for a while and try again.
ED22C	The revision that changes the Advanced Copy version cannot be performed because an EC, an OPC, or a REC is running.
	The revision that changes the Advanced Copy version cannot be performed because an EC, an OPC, or an REC is running.
ED22D	The execution was canceled because an error occurred during communication with the CM.
	The execution was canceled because an error occurred during communication with the CM.
ED22E	The firmware application or EC switch has not executed.
	The firmware is not applied or the EC is not switched.
ED22F	The free capacity of the Flexible Tier Pool is insufficient.
	The FTRP size is insufficient.
ED230	The EC switching operation that changes the Advanced Copy version is attempted while an EC, an OPC, or a REC is running.
	The EC switching operation that changes the Advanced Copy version is attempted while an EC, an OPC, or an REC is running.
ED231	Distribution of the control domain failed.
	Distribution of the control domain failed. Wait for a while and try again.
ED232	The storage is not in "Normal" state.
	The ETERNUS DX/AF status is not normal. Request your maintenance engineer to investigate the error.
ED233	The version is not normal.
	The version is not normal.
ED234	A remote copy is running.
	A remote copy is running. Wait for a while and try again.

Message number	Message Countermeasure for the error
ED235	Reclamation of Thin Provisioning Volume is in progress.
	A hot controller firmware update cannot be executed due to a Reclamation factor.
ED236	Not all batteries are in "Full Charge" state.
	A hot controller firmware update cannot be executed because the battery charge is insufficient.
ED237	Controller Firmware is not registered.
	The target module does not exist in the BUD.
ED238	CFL is not executed yet.
	A hot controller firmware update has not been executed yet.
ED239	Because the numbers of connections to the specified device reached the maximum number, it is not possible to connect it. Please wait for a while.
	The number of connections exceeds the maximum number.
ED23A	The firmware distribution function between devices of the specified device doesn't have interchangeability with this device.
	The function levels do not match.
ED23B	The firmware types do not match.
	The firmware types do not match.
ED23C	The error occurred by the communication with the specified device.
	The model types do not match.
ED23D	Powering off is being performed.
	Powering off is being performed.
ED23E	CFL is running.
	A hot controller firmware update is currently being executed. Wait for a while and try again.
ED23F	The firmware is being downloaded.
	The firmware is being downloaded. Wait for a while and try again.
ED240	Gateway is not set though the specified device is set outside the subnet.
	The gateway is not set for the specified device that is outside of the subnet.
ED241	Duplicated IP address between the specified device and used LAN port.
	The IP addresses of the specified device and the LAN port that is used are duplicated.
ED242	The specified device is in the subnet of unused LAN port.
	The specified device is in the subnet of an unused LAN port.
ED243	Duplicated IP address between the specified device and allowed IP of unused LAN port.
	The IP addresses of the specified device and the LAN port that is not used are duplicated.
ED244	Group IDs of the specified storage and the current storage are different.
	The group IDs of the specified ETERNUS DX/AF and the current ETERNUS DX/AF are different.
ED245	IP address of DNS is not valid.
	The IP address of the DNS is invalid.
ED246	Acceptable IP addresses from other subnet have been specified but Gateway has not been set.
	A communication destination that is outside of the subnet is set but the gateway is not set.
ED247	The port specified for used LAN port of a remote support is not set.
	The specified port is not set to the LAN port that is used.
ED248	Gateway is not set though DNS is set outside of the subnet.
	A DNS that is outside of the subnet is set but the gateway is not set.

Message number	Message Countermeasure for the error
ED249	Gateway is not set though the PROXY server is set outside of the subnet.
	A proxy server that is outside of the subnet is set but the gateway is not set.
ED24A	Gateway is not set though the HTTP server is set outside of the subnet.
	An http server that is outside of the subnet is set but the gateway is not set.
ED24B	Gateway is not set though the SMTP server is set outside of the subnet.
	An SMTP server that is outside of the subnet is set but the gateway is not set.
ED24C	Gateway is not set though the POP server is set outside of the subnet.
	A POP server that is outside of the subnet is set but the gateway is not set.
ED24D	Gateway is not set though the NTP server is set outside of the subnet.
	An NTP server that is outside of the subnet is set but the gateway is not set.
ED24E	DNS server to resolve server name is not specified.
	A DNS is not set for the name resolution.
ED24F	Please export the log, and contact the person in charge of maintenance.
	Export the log and then request your maintenance engineer to investigate the error.
ED250	The name resolution of the proxy server failed.
	The name resolution of the proxy server failed.
ED251	The name resolution of the http server failed.
	The name resolution of the http server failed.
ED252	The name resolution of the SMTP server failed.
	The name resolution of the SMTP server failed.
ED253	The name resolution of the POP server failed.
	The name resolution of the POP server failed.
ED254	The name resolution of the NTP server failed.
	The name resolution of the NTP server failed.
ED255	Even though the command terminated successfully, the name resolution of the primary DNS failed. The secondary DNS is used instead.
	Even though the command terminated successfully, the name resolution of the primary DNS failed. The secondary DNS is used instead (this message is a warning message).
ED256	The name resolution succeeded by the IPv6 Primary DNS server.
	The command terminated successfully (the name resolution succeeded with the IPv6 primary DNS).
ED257	The name resolution succeeded by the IPv6 Secondary DNS server.
	The command terminated successfully (the name resolution succeeded with the IPv6 secondary DNS).
ED258	The name resolution succeeded by the IPv4 Primary DNS server.
	The command terminated successfully (the name resolution succeeded with the IPv4 primary DNS).
ED259	The name resolution succeeded by the IPv4 Secondary DNS server.
	The command terminated successfully (the name resolution succeeded with the IPv4 secondary DNS).
ED25A	Login to the POP server is impossible because the user name or password is incorrect.
	Logging in to the POP server is not possible because the user name or password is incorrect.
ED25B	Error occurred in authentication with AUTH.
	An error occurred during AUTH authentication
ED25C	Error occurred in communication with SMTP server.
	An error occurred during communication with the MTP server.

Message number	Message Countermeasure for the error
ED25D	Error occurred in communication with HTTP server.
	An error occurred during communication with the http server.
ED25E	Error occurred in communication with PROXY server.
	An error occurred during communication with the proxy server.
ED25F	Error occurred in communication with POP server.
	An error occurred during communication with the POP server.
ED260	Time out occurred in communication with SMTP server.
	A timeout occurred during communication with the SMTP server.
ED261	Time out occurred in communication with HTTP server.
	A timeout occurred during communication with the http server.
ED262	Time out occurred in communication with PROXY server.
	A timeout occurred during communication with the proxy server.
ED263	Time out occurred in communication with POP server.
	A timeout occurred during communication with the POP server.
ED264	Error occurred in sending data to SMTP server.
	An error occurred during communication with the SMTP server.
ED265	Error occurred in sending data to HTTP server.
	An error occurred while sending data to the http server.
ED266	Error occurred in sending data to PROXY server.
	An error occurred while sending data to the proxy server.
ED267	Error occurred in sending data to POP server.
	An error occurred while sending data to the POP server.
ED268	Error occurred in receiving data from SMTP server.
	An error occurred while receiving data from the SMTP server.
ED269	Error occurred in receiving data from HTTP server.
	An error occurred while receiving data from the http server.
ED26A	Error occurred in receiving data from PROXY server.
	An error occurred while receiving data from the proxy server.
ED26B	Error occurred in receiving data from POP server.
	An error occurred while receiving data from the POP server.
ED26C	Duplicated IP address between DNS server and used LAN port.
	The IP address of the DNS is the same as the IP address of the LAN port that is used.
ED26D	The IP address for DNS server is in the subnet of unused LAN port.
	The DNS is in the subnet of the LAN port that is not used.
ED26E	Duplicated IP address between DNS server and allowed IP of unused LAN port.
	The IP address of the DNS is the same as the IP address of the LAN port that is not used.
ED26F	Duplicated IP address between PROXY server and used LAN port.
	The IP address of the proxy server is the same as the IP address of the LAN port that is used.
ED270	Duplicated IP address between HTTP server and used LAN port.
	The IP address of the http server is the same as the IP address of the LAN port that is used.

Message number	Message Countermeasure for the error
ED271	Duplicated IP address between SMTP server and used LAN port.
	The IP address of the SMTP server is the same as the IP address of the LAN port that is used.
ED272	Duplicated IP address between POP server and used LAN port.
	The IP address of the POP server is the same as the IP address of the LAN port that is used.
ED273	Duplicated IP address between NTP server and used LAN port.
	The IP address of the NTP server is the same as the IP address of the LAN port that is used.
ED274	The IP address for the PROXY server is in the subnet of unused LAN port.
	The proxy server is in the subnet of the LAN port that is not used.
ED275	The IP address for the HTTP server is in the subnet of unused LAN port.
	The http server is in the subnet of the LAN port that is not used.
ED276	The IP address for the SMTP server is in the subnet of unused LAN port.
	The SMTP server is in the subnet of the LAN port that is not used.
ED277	The IP address for the POP server is in the subnet of unused LAN port.
	The POP server is in the subnet of the LAN port that is not used.
ED278	The IP address for the NTP server is in the subnet of unused LAN port.
	The NTP server is in the subnet of the LAN port that is not used.
ED279	Duplicated IP address between PROXY server and allowed IP of unused LAN port.
	The IP address of the proxy server is the same as the IP address of the LAN port that is not used.
ED27A	The Flexible Tier Pool is in "Broken" state.
	The FTRP state is "Broken".
ED27B	The ODX Buffer volume exists.
	The ODX Buffer volume exists.
ED27C	The Flexible Tier Pool balancing is in process.
	An FTRP balancing is running.
ED27D	Online Storage Migration is in process.
	An Online Storage Migration is running.
ED27E	Freeing up space in the Flexible Tier Pool is in process.
	An FTRP UNMAP is running.
ED27F	The last RAID Group in the Flexible Tier Pool cannot be deleted.
	The last RAID group within the FTRP cannot be deleted.
ED280	The RAID Group is being deleted by internal process after Flexible Tier Pool shrinking.
	An internally executed deletion process for a RAID group is running after the process of the Flexible Tier Pool shrinking.
ED281	Duplicated IP address between HTTP server and allowed IP of unused LAN port.
	The IP address of the http server is the same as the IP address of the LAN port that is not used.
ED282	Duplicated IP address between SMTP server and allowed IP of unused LAN port.
	The IP address of the SMTP server is the same as the IP address of the LAN port that is not used.
ED283	Duplicated IP address between POP server and allowed IP of unused LAN port.
	The IP address of the POP server is the same as the IP address of the LAN port that is not used.
ED284	Duplicated IP address between NTP server and allowed IP of unused LAN port.
	The IP address of the NTP server is the same as the IP address of the LAN port that is not used.

Message number	Message Countermeasure for the error
ED285	The Flexible Tier Pool shrinking is in process.
	A Flexible Tier Pool shrinking is running.
ED286	Failed to start SSD sanitization.
	The SSD sanitization startup process failed.
ED287	The Flexible Tier Pool shrinking is in process.
	The RAID group currently reserved for deletion is specified by starting the Flexible Tier Pool shrinking.
ED288	The Flexible Tier Pool shrinking is not in process.
	A RAID group that is not currently reserved for deletion is specified by stopping the Flexible Tier Pool shrinking.
ED289	The password cannot be set. (Minimum password age policy violation)
	The password cannot be changed due to the minimum password age.
ED28A	The device is not registered.
	The ETERNUS DX/AF is not registered.
ED28B	The password cannot be set. (Password history policy violation)
	The password cannot be changed because previously used passwords cannot be specified again.
ED28C	No BUDs are available.
	No BUDs are available.
ED28D	The password cannot be set. (Minimum password length policy violation)
	The password cannot be set due to an incorrect password length.
ED28E	The remote support center is busy.
	The remote support center is busy.
ED28F	The network information is being set.
	The network information is being set. Wait for a while and try again.
ED290	No controller firmware can be downloaded.
	No controller firmware can be downloaded.
ED291	The information of the device is being sent again because outdated information is registered in the remote support center. Wait approximately ten minutes and try again.
	The information of the ETERNUS DX/AF is being sent again because outdated information is registered in the remote support center. Wait approximately 10 minutes and try again.
ED292	An error occurred during HTTP communication.
	An error occurred during http communication.
ED293	An error occurred during SMTP communication.
	An error occurred during SMTP communication.
ED294	A communication error occurred.
	A communication error occurred.
ED295	No log files exist.
	No log files exist (the timeout interval for this error is five minutes.)
ED296	The specified SLU does not exist.
	A volume number that is not configured is specified.
ED297	Data cannot be obtained because of a cache miss.
	Data cannot be obtained because of a cache miss.
ED298	The cache data cannot be obtained because the specified mirror cache does not exist.
	The cache data cannot be obtained because the specified mirror cache does not exist.

Message number	Message Countermeasure for the error
ED299	The cache data cannot be obtained because the cache of the drive that is specified contains dirty data.
	The cache data cannot be obtained because the cache of the specified drive contains dirty data.
ED29B	Specified Head Number is invalid.
	The specified Head value is incorrect.
ED29E	The storage is in "Machine Down" state.
	The ETERNUS DX/AF is in Machine Down status.
ED29F	Status of target RAID Group is not Broken.
	The specified RAID group is not in Broken status.
ED2A0	The access path to the specified RAID group is not normal.
	The access path to the specified RAID group is not normal.
ED2A1	There is no access path to the target RAID Group.
	The specified RAID group is blocked.
ED2A2	The password cannot be set. (Password complexity policy violation)
	The password cannot be set because it does not satisfy the password complexity policy.
ED2A4	The specified Role name has already been used.
	The specified Role name has already been used.
ED2A5	The number of roles has reached the maximum number of registrations.
	The number of roles has reached the maximum number of registrations.
ED2A6	Deletion of a role that is assigned to a user is attempted.
	Deletion of a role that is assigned to a user is attempted.
ED2A8	The specified Snap Data Pool Volume does not exist.
	The specified SDPV does not exist.
ED2A9	The Copy Bitmap is insufficient.
	All of the Copy Bitmap has been used.
ED2AA	Processing was interrupted because it reached max copy session count or copy function is not enable.
	The number of sessions exceeds the maximum number for operation.
ED2AB	The specified volume is in process of copy session or RAID Migration.
	A session is running for the specified LU.
ED2AC	An invalid LU is specified.
	An invalid LU is specified.
ED2AD	Because specified session is not the oldest one, the processing was not performed.
	The session is not in the correct status (a generation that is not the oldest is specified).
ED2AE	The specified volume is being initialized.
	The specified SDV is being initialized.
ED2AF	The encryption settings of the copy source and the copy destination are different.
	The encryption settings of the copy source and the copy destination are different.
ED2B0	The drive motor is stopped for either the copy source or the copy destination due to an Eco-mode schedule.
	The drive motor is stopped for either the copy source or the copy destination due to an Eco-mode schedule.
ED2B1	The specified destination volume is being used by another session.
	A copy scope overlap occurs in the specified SDV.

Message number	Message Countermeasure for the error
ED2B2	The Thin Provisioning function is disabled.
	The Thin Provisioning function is disabled.
ED2B3	Slave CM: Execution was discontinued for the other command accepted.
	In the Slave CM, the configuration management received a command because a passage occurs (this is an error).
ED2B4	Slave CM: Error occurred in receiving data from Master CM.
	In the Slave CM, a reception error occurred during communication between the CMs for receiving the response from the master CM.
ED2B5	Master CM: Error occurred in sending data from Slave CM.
	In the Master CM, a transmission error occurred during communication between the CMs for obtaining command data from the Slave CM.
ED2B6	Master CM: Error occurred in receiving data from Slave CM.
	In the Master CM, a reception error occurred during communication between the CMs for obtaining command data from the Slave CM.
ED2B7	Bind-in-Cache Memory Size has already been set. Cache Parameters cannot be changed.
	The Bind-in-Cache memory capacity is set.
ED2B8	The specified resource number exceeds the maximum value for the allowed range.
	The specified resource number exceeds the maximum value for the allowed range.
ED2B9	Incorrect parameter combination.
	Some of the specified parameters are incorrect.
ED2BA	The specified license key is incorrect.
	The specified license key is incorrect. Check the input content.
ED2BB	The specified User Public Key file is not correct.
	The specified key file is incorrect.
ED2BC	The specified SSL Server Key file does not match the SSL Server Certificate file.
	The specified key or certificate file is incorrect.
ED2BD	No session is running.
	No session is running.
ED2BE	Access to the BUD is being suppressed.
	Access to the BUD is being suppressed.
ED2BF	The pool capacity that can be created in the device exceeds the maximum pool capacity.
	The maximum pool capacity that can be created in the ETERNUS DX/AF exceeds the maximum pool capacity.
ED2C0	The number of unused disks is insufficient.
	The number of unused drives is insufficient.
ED2C1	RLU/DLU/SLU are insufficient.
	The number of RAID groups or volumes is insufficient.
ED2C2	The Flexible Tier function is disabled.
	The Flexible Tier function is disabled.
ED2C6	The SSL/KMIP certificate file is not normal.
	The certificate file is not normal.
ED2C7	The process has failed. It failed in some CA port(s).
	Some of the CA ports failed to be started or stopped.

Message number	Message Countermeasure for the error
ED2C8	The process has failed. It failed in all CA ports.
	All of the CA ports failed to be started or stopped.
ED2C9	The specified TPPE ID does not exist.
	The specified TPPE ID does not exist.
ED2CA	The trial license key is incorrect.
	The trial license key is incorrect.
ED2CB	The trial license key has reached the registration limit number of times.
	The number of times the trial license is set exceeds the limit.
ED2CC	Competing with AIS connect operation in background process.
	The specified AIS Connect process is internally being performed.
ED2CD	Competing with AIS connect send log operation in background process.
	An AIS Connect log transmission is internally being performed.
ED2CE	Volume Type which is the Migration destination is different.
	The volume type of the migration destination differs from the volume type of the migration source.
ED2CF	Another Deduplication/Compression check already in progress.
	A Deduplication/Compression check is running.
ED2D0	Displaying Snap OPC restore size is not supported.
	The estimated amount of SDP used by SnapOPC+ restore cannot be obtained.
ED2D1	Recovery process is running. Wait for a while and try again.
	A recovery process is running.
ED2D2	The installed memory is insufficient.
	The installed memory is insufficient.
ED2D3	The WVOL function is not disabled.
	The setting cannot be changed because the WVOL function is enabled.
ED500	An error occurred in the Deduplication/Compression Process.
	An error was detected during the Deduplication/Compression process.
ED506	The usable capacity of the Deduplication/Compression Map volume is insufficient temporarily. Please wait for a while and retry.
	The usable capacity of the DEDUP_MAP Volume is temporarily low. Wait a while and try again.
ED507	The system is in high-load state. Please wait for a while.
	The ETERNUS DX/AF is in a high-load state. Wait a while and try again.
ED508	The specified external LU has already been registered.
	The specified External LU has already been imported.
ED509	The access path of the external storage device is not normal.
	The access path of the specified External RAID Group is not normal.
ED50A	The number of drives that is used exceeds the maximum number.
	The number of drives that is used exceeds the maximum number.
ED50B	The target mapping table number exceeds the maximum number in the allowed range.
	The target mapping table number exceeds the allowed range.
ED50C	The target OLU already exists in the same mapping table.
	The target volume already exists in the same mapping table.

Message number	Message Countermeasure for the error
ED50D	Incorrect parameter combination.
	Some of the specified parameters are incorrect.
ED50E	The specified host number exceeds the maximum number in the allowed range.
	The specified host number exceeds the maximum number in the allowed range.
ED50F	The WWN that is to be registered is duplicated.
	The WWN that is to be registered is duplicated.
ED510	The specified external RAID Group cannot be recovered.
	Recovery for the specified External RAID Group is not supported.
ED511	CA port is overlapping in group.
	The settings are duplicated for a single CA port of a single host.
ED512	The External LU information is not consistent. Please refer to ETERNUS CLI User's Guide for more details.
	The External LU information is not consistent between the target ports.
	<ul style="list-style-type: none"> • There may be an error in the mapping setting of the target port. Check the mapping setting of the target port in the external storage system. • A connection to an incorrect target port may exist. Check the connection destination target port.
ED513	The specified LCU number exceeds the maximum number in the allowed range.
	The specified LCU number exceeds the maximum number in the allowed range.
ED514	The specified host response number exceeds the maximum number in the allowed range.
	The specified host response number exceeds the maximum number in the allowed range.
ED515	The external storage device responded with an error.
	The external storage system responded with an error.
ED516	An error occurred in accessing the external storage device.
	An error occurred in issuing I/Os to the external storage system.
ED517	A copy session is running.
	A copy session is running.
ED518	The connected device does not support this function.
	The ETERNUS DX/AF that is connected is not supported.
ED519	The forwarding interval cannot be specified when the ETERNUS6000 is connected.
	The forwarding interval cannot be specified when the ETERNUS6000 is connected.
ED51A	The buffer size exceeds the maximum size for the device.
	The buffer size exceeds the maximum size for the ETERNUS DX/AF.
ED51B	REC Buffer has already been configured. The process was aborted.
	The REC buffer setting has already been applied.
ED51C	The storage is in "Not Ready" state. The process was aborted.
	The ETERNUS DX/AF is in Not Ready status.
ED51D	The REC disk buffer contains some data.
	The REC disk buffer contains some data.
ED51E	Some REC Consistency sessions are not in Suspend status.
	Some REC Consistency sessions are not in Suspend status.
ED523	The number of migration sessions has reached the maximum number for operations in the device.
	The number of migration sessions has reached the maximum number for operations in an ETERNUS DX/AF.

Message number	Message Countermeasure for the error
ED524	The migration source LUN is being used by another migration process.
	The migration source LUN is being used by another migration process. Wait for a while and try again.
ED525	The migration source LUN is being used by another copy session.
	The migration source LUN is being used by another copy session. Wait for a while and try again.
ED526	All of the internal resources have already been used.
	All of the internal resources have already been used. Wait for a while and try again.
ED527	The status of the volume in the migration source or the migration destination is not normal.
	The status of the volume in the migration source or the migration destination is not normal.
ED528	No migration sessions are running for the specified OLU.
	No migration sessions are running for the specified volume.
ED529	Bind-in-Cache is set for the specified OLU.
	Bind-in-Cache is set for the specified volume.
ED52A	The migration capacity exceeds the maximum logical capacity that can be migrated.
	The migration capacity exceeds the maximum logical capacity that can be migrated.
ED52B	There is not enough free space in the specified destination pool.
	An error occurred while checking the physical pool capacity in the migration destination.
ED52C	The total capacity of pool is not enough in the storage system. The process was aborted.
	The pool capacity that can be created in the ETERNUS DX/AF is insufficient.
ED52F	Enough work capacity for Balancing Thin Provisioning Volume or Balancing Flexible Tier Pool does not exist. This function cannot be executed.
	No unused volume numbers are available to create a migration destination LUN.
ED531	The necessary LU resources are insufficient.
	The necessary LU resources are insufficient.
ED53A	Communication to other device is failure.
	Communication between the ETERNUS DX/AF storage systems failed.
ED53B	TFO group status is inconsist.
	The status of the TFO group is inconsistent.
ED53C	TFO group phase is inconsist.
	The command cannot be executed with the current TFO group Phase.
ED53D	The specified TFO group has no volume.
	The specified volume in the TFO group does not exist.
ED53E	Capacity of volume differs with in the secondary and primary.
	The volume sizes for the Primary storage and Secondary storage are inconsistent.
ED53F	The volume is used TFO group already.
	A pairing was performed on a volume that has already been paired.
ED540	Firmware of the other storage does not support the Storage Cluster.
	The operation firmware of the remote storage system does not support the Storage Cluster.
ED541	The specified type of TFO group is already registered.
	A TFO group for the specified type is already registered.
ED542	Box ID is inconsistent.
	The Box ID is inconsistent.

Message number	Message Countermeasure for the error
ED543	The TFO group is inconsistent of pair port configuration between primary and secondary.
	The pair port configuration between the Primary storage and Secondary storage is inconsistent.
ED544	Volume that can not be use in TFO pair port exists.
	A volume that cannot configure a TFO pair port exists.
ED545	Failover mode or Split mode does not match between the secondary and primary.
	The operation mode (Failover Mode, Split Mode) in the Primary storage and the Secondary storage does not match.
ED546	Copy session exists in the volume.
	The copy session exists in the volume.
ED548	Volume UID differs with in the secondary and primary.
	The UID in the Primary storage and Secondary storage is inconsistent.
ED549	Can not to delete TFO group that is changed WWN in the standby state.
	For TFO groups in a Standby state, WWPN was deleted permanently.
ED54A	Volume of primary paired with specified volume is not exist.
	The volume that will be paired with the specified volume in the Primary storage does not exist.
ED54B	TFO group activation was specified for incorrect device.
	An ETERNUS DX/AF (Primary storage or Secondary storage) that has no relevance was specified for activation.
ED54C	Port of primary paired is not affinity setting.
	The primary pair port is not set with host affinity.
ED54D	Storage Cluster data transfer feature is disabled in all RA ports constituting the copy path.
	For all RA ports that constitute the copy path, the data transfer for the Storage Cluster function is set to disable.
ED54E	TFO pair is active.
	The TFO pair exists.
ED54F	Device of manual failover is inappropriate TFO group condition.
	The manual failover target storage system is in an inappropriate TFO group state.
ED550	The volume cannot be set the copy.
	The LU for the copy source or copy destination is in a state in which the copy session cannot be set.
ED551	There is "Bad Sector" in the copy source volume.
	A bad sector exists in the copy source LU.
ED552	The number of copy sessions exceeds the allowable maximum copy sessions for this storage.
	The maximum number of sessions per copy source or copy destination ETERNUS DX/AF storage systems has been exceeded.
ED553	The number of copy sessions exceeds the allowable maximum copy sessions for each copy source volume.
	The maximum number of sessions per copy source LU has been exceeded.
ED554	The number of copy sessions exceeds the allowable maximum copy sessions for each copy destination volume.
	The maximum number of sessions per copy destination LU has been exceeded.
ED555	Firmware update is in progress. The specified operation cannot be done.
	The command cannot be executed because a hot controller firmware update is currently being executed in the copy source or copy destination.
ED556	VVOL session is active.
	The VVOL session exists.
ED557	The free capacity of the pool is insufficient.
	The free space in the TPP or FTRP is insufficient.

Message number	Message Countermeasure for the error
ED558	Process to free up space in the TPP from a host is running.
	The allocation mode cannot be changed from "Thin" to "Thick" because the area is currently being released from the server.
ED700	The free capacity of the NAS volumes is insufficient.
	The free capacity of the NAS volumes is insufficient.
ED701	The free capacity of the NAS system volumes is insufficient.
	The free capacity of the NAS system volumes is insufficient.
ED702	Filesystem check is required.
	The NAS file system needs to be checked.
ED703	Full filesystem check is required.
	The NAS file system needs to be completely checked.
ED704	The mounting status of the NAS file system is incorrect.
	The mounting status of the NAS file system is not normal.
ED705	Maintenance of the filesystem is required.
	Maintenance of the NAS file system is required.
ED706	DNS lookup failure.
	The name resolution with the DNS in the NAS failed.
ED707	The VLAN setting for the NAS is incorrect.
	The VLAN setting for the NAS is incorrect.
ED708	The NAS bonding setting is incorrect.
	The NAS bonding setting is incorrect.
ED709	The network setting for the NAS is incorrect.
	The network setting for the NAS is incorrect.
ED70A	An I/O error occurs in the NAS system.
	An I/O error is detected in the NAS system.
ED70B	The authentication process via the authentication server failed.
	The authentication process via the authentication server failed. Check the server settings, wait a while, and try again. If the result is the same even after performing a retry, request your maintenance engineer to investigate the error.
ED70C	Filesystem version error.
	The NAS file system version is incompatible. Perform a file system reconfiguration (format conversion process).
ED70D	NAS interface failover is currently active.
	Failover is operating by using the multipath.
ED70E	Before setting NAS quota, it is necessary to run filesystem check.
	The NAS quota settings cannot be performed since a file system check has not been executed.
ED710	An internal error occurs in the NAS system.
	An error was detected in the NAS system. If the result is the same even after performing a retry, request your maintenance engineer to investigate the error. However, if the error involves volume creation or expansion, there may be insufficient free space in the Thin Provisioning pool (TPP). Check the free space of the TPP.
ED720	Filesystem check is already running.
	The NAS file system is already being checked.

Message number	Message Countermeasure for the error
ED721	Invalid operation.
	There was an error in the operating procedure or the access frequency to the drive is temporarily high. If there is no operating procedure error, wait a while and try again.
ED722	NAS engine is not started.
	The NAS engine is not started. The status of the NAS engine is "Ready" (no system volume).
ED723	The Volume not mounted.
	The NAS volume is being unmounted.
ED724	Failed to connect to the other CM.
	Abnormal transmissions between the NAS engines have occurred.
ED725	The NAS Snapshot is currently busy.
	The NAS Snapshot is in a busy state.
ED726	The free capacity of the storage pool is insufficient.
	Acquisition of a NAS volume management area has failed.
ED727	Domain join error.
	A domain join error.
ED728	Server connection error.
	An authentication server connection error.
ED729	Clock skew too great.
	A time error.
ED72A	Improper user or group.
	A user name or group name parameter error.
ED72B	User or group does not exists.
	The user name or group name does not exist.
ED72C	Improper allow host address.
	Allowed host error.
ED72D	Authority error.
	LDAP authority error.
ED72E	Filesystem is being accessed.
	The target file system is being accessed.
ED72F	Nas quota setting failed partially.
	The NAS quota setting has partially failed.
ED733	The files or folders exist in this shared folder. Please delete it first.
	Files or folders exist in the specified NAS shared folder. When retrying the command, the corresponding files and folders in the NAS shared folder must be deleted.
ED734	NAS data deletion process is running.
	A deletion process for the NAS data is running.
ED735	NAS extension system volume does not exist.
	The NAS expanded system volume does not exist.
ED736	The snap data volume is being used.
	The NAS snapshot volume is being used.
ED737	Consistency check of NAS extension system volume is in progress.
	A consistency check of the NAS expanded system volume is in progress.

Message number	Message Countermeasure for the error
ED738	NAS extension system volume is not normal.
	The NAS expanded system volume is not normal.
ED739	One or more clients have connected to this shared folder. Please disconnect it first.
	A client is connected to the specified NAS shared folder. Re-execute the command in a state in which there are no client connections.
ED73A	Improper path.
	The parameter of the specified path (file or folder) is improper.
ED73B	Path does not exist.
	The specified path (file or folder) does not exist.
ED73C	Packet capture is in progress at the specified NAS interface.
	A packet capture is running.
ED73D	Specified user name is incorrect.
	The specified user name is not correct.
ED73E	FTP connection session exists.
	Logging in to the FTP service.
ED73F	The Access Control List is being initialized.
	The ACL information is being deleted.
ED740	The free file system space is insufficient.
	The free space in the file system is insufficient.
ED741	The specified file has non-empty data. Overwriting is required.
	The allocated size of the specified file is not "0" (zero). In order to overwrite the entire file with zeros, the "-overwrite-whole-file" parameter must be specified.
ED742	The file inflating process is running.
	An inflation process is currently running (one process is executable per system).
ED743	Specified group name is incorrect.
	The specified local group name is not correct.
ED744	Snapshot or NAS cache distribution process is running.
	A Snapshot or a meta cache distribution process is currently running.
ED745	The user is already registered.
	The local user is already registered.
ED746	The group is already registered.
	The local group is already registered.
ED747	The provisioned file size is too small to inflate.
	Because the provisioned size of the specified file is too small (100MB or less), an inflation process cannot be executed.
ED748	The user cannot be deleted because it is currently being used to access to a shared folder.
	The specified local user cannot be deleted because it is currently accessing the NAS shared folder.
ED749	User home directory deletion process is running.
	The user's home directory is currently being deleted.
ED74A	Cannot start to inflate the specified file because it is in use.
	The inflation process cannot start because a conflicting Write access has been detected.

Message number	Message Countermeasure for the error
ED74B	Firewall setting for secure connection to change local user password is configured as "open" for some NAS ports. Please change the setting of these ports to "close".
	The port for changing passwords of the local user authentication is open. Close the port and try again.
ED74C	Initializing NAS cache distribution failed. The storage system might be in high-load temporarily. Please wait for a while and retry.
	The meta cache distribution failed. Because the ETERNUS DX/AF may be overloaded, wait a while and try again. Even if the overload in the ETERNUS DX/AF is resolved, there are cases when this error code is continuously notified for a maximum of 30 minutes. In that case, wait 30 minutes and try again.
ED800	Stack suspend timeout.
	A timeout error occurred because monitoring of the Asynchronous Stack mode with the timer is suspended.
ED801	Cascade copy session exist.
	The cascade destination copy session uses the data in the specified copy session.
ED802	Cascade local copy session exist.
	An OPC, QuickOPC, SnapOPC, or SnapOPC+ session is set in the cascade destination.
ED803	Cascade EC/REC session is not suspended.
	The EC/REC in the cascade destination is not in Suspend status.
ED805	Started of advanced copy session which uses TFOV to unsupported volume type.
	An Advanced Copy session using TFOV started for an unsupported combination.
ED806	Copy of an illegal combination with TFO pair.
	A copy started for an illegal case combined with a TFO pair.
ED807	Copy of an illegal combination with storage cluster continuous copy session.
	A copy session that is illegally combined with the Storage Cluster continuous copy session was started.
ED808	Illegal copy session has been specified for the TFO port.
	An illegal copy session has been specified for the TFO pair port.
ED809	Illegal combination with Online Storage Migration.
	A combination with Online Storage Migration is illegal.
EF000	Internal Error Occurred.
	An internal error occurred.

A.2 Error Codes

This section explains error codes.

A.2.1 Copy Session Error Codes

Table A.2 List of copy session error codes

Error code	Description
0x10 – 0x1F	An error that is caused by a copy source volume occurs. Some copy source volumes cannot be accessed because a failure has occurred in a component (e.g. drives and drive enclosures).
0x20 – 0x2F	An error that is caused by a copy destination volume occurs. Some copy destination volumes cannot be accessed because a failure has occurred in a component (e.g. drives and drive enclosures).
0x30 – 0x3F	An error occurred due to a copy path or an REC buffer HALT occurred.
0xBA	Bad data exists.
0xBB	SDV/SDP capacity is insufficient.
0xBD	Overload status is detected in a copy destination volume or a copy destination storage system.
0xBE	A copy path has failed. Data is stored in the REC Buffer. This error is displayed only when the "Type" is "REC".
0xBF	A copy path has failed. Data is stored in the REC Disk Buffer. This error is displayed only when the "Type" is "REC".
Error codes other than above	An error other than the ones listed above occurs.

Appendix B

List of Supported Commands

This appendix provides a list of supported commands. An "x" mark indicates that the command is supported. For details on the latest support status, refer to "Design Guide (Basic)" of each model.

B.1 List of Supported Commands (of the Target Model)

Commands that are supported are shown by model.

Table B.1 List of supported commands for status display (of the target model)

Command name	Target model																Remarks	
	DX60 S4	DX100 S4	DX200 S4	DX500 S4	DX600 S4	DX60 S3	DX100 S3	DX200 S3	DX500 S3	DX600 S3	DX8100 S3	DX8700 S3	DX8900 S3	AF250 S2	AF650 S2	AF250		AF650
Storage System Status																		
show status	x	x	x	x	x	x	x	x	x	x	x	x	x	x	x	x	x	x
show enclosure-status	x	x	x	x	x	x	x	x	x	x	x	x	x	x	x	x	x	x
show fru-ce	x	x	x	x	x	x	x	x	x	x	x	x	x	x	x	x	x	x
show fru-fe												x	x					
show fru-de	x	x	x	x	x	x	x	x	x	x	x	x	x	x	x	x	x	
show disks	x	x	x	x	x	x	x	x	x	x	x	x	x	x	x	x	x	x
show hardware-information	x	x	x	x	x	x	x	x	x	x	x	x	x	x	x	x	x	x

Table B.2 List of supported commands for RAID group management (of the target model)

Command name	Target model																Remarks	
	DX60 S4	DX100 S4	DX200 S4	DX500 S4	DX600 S4	DX60 S3	DX100 S3	DX200 S3	DX500 S3	DX600 S3	DX8100 S3	DX8700 S3	DX8900 S3	AF250 S2	AF650 S2	AF250		AF650
RAID Group																		
show raid-groups	x	x	x	x	x	x	x	x	x	x	x	x	x	x	x	x	x	x
show raid-group-progress	x	x	x	x	x	x	x	x	x	x	x	x	x	x	x	x	x	x
create raid-group	x	x	x	x	x	x	x	x	x	x	x	x	x	x	x	x	x	x
set raid-group	x	x	x	x	x	x	x	x	x	x	x	x	x	x	x	x	x	x
delete raid-group	x	x	x	x	x	x	x	x	x	x	x	x	x	x	x	x	x	x
expand raid-group	x	x	x	x	x	x	x	x	x	x	x	x	x	x	x	x	x	x

Appendix B List of Supported Commands
 B.1 List of Supported Commands (of the Target Model)

Command name	Target model																Remarks	
	DX60 S4	DX100 S4	DX200 S4	DX500 S4	DX600 S4	DX60 S3	DX100 S3	DX200 S3	DX500 S3	DX600 S3	DX8100 S3	DX8700 S3	DX8900 S3	AF250 S2	AF650 S2	AF250		AF650
Hot Spares																		
set global-spare	x	x	x	x	x	x	x	x	x	x	x	x	x	x	x	x	x	
release global-spare	x	x	x	x	x	x	x	x	x	x	x	x	x	x	x	x	x	
set dedicated-spare	x	x	x	x	x	x	x	x	x	x	x	x	x	x	x	x	x	
release dedicated-spare	x	x	x	x	x	x	x	x	x	x	x	x	x	x	x	x	x	
Eco-mode Management																		
show eco-mode	x	x	x	x	x	x	x	x	x	x	x	x	x					
set eco-mode	x	x	x	x	x	x	x	x	x	x	x	x	x					
show eco-schedule	x	x	x	x	x	x	x	x	x	x	x	x	x					
create eco-schedule	x	x	x	x	x	x	x	x	x	x	x	x	x					
set eco-schedule	x	x	x	x	x	x	x	x	x	x	x	x	x					
delete eco-schedule	x	x	x	x	x	x	x	x	x	x	x	x	x					
show eco-raid-group	x	x	x	x	x	x	x	x	x	x	x	x	x					
set eco-raid-group	x	x	x	x	x	x	x	x	x	x	x	x	x					
release eco-raid-group	x	x	x	x	x	x	x	x	x	x	x	x	x					

Table B.3 List of supported commands for volume management (of the target model)

Command name	Target model																Remarks	
	DX60 S4	DX100 S4	DX200 S4	DX500 S4	DX600 S4	DX60 S3	DX100 S3	DX200 S3	DX500 S3	DX600 S3	DX8100 S3	DX8700 S3	DX8900 S3	AF250 S2	AF650 S2	AF250		AF650
Volume																		
show volumes	x	x	x	x	x	x	x	x	x	x	x	x	x	x	x	x	x	
show volume-progress	x	x	x	x	x	x	x	x	x	x	x	x	x	x	x	x	x	
show volume-mapping	x	x	x	x	x	x	x	x	x	x	x	x	x	x	x	x	x	
create volume	x	x	x	x	x	x	x	x	x	x	x	x	x	x	x	x	x	
set volume	x	x	x	x	x	x	x	x	x	x	x	x	x	x	x	x	x	
delete volume	x	x	x	x	x	x	x	x	x	x	x	x	x	x	x	x	x	
delete all-volumes	x	x	x	x	x	x	x	x	x	x	x	x	x	x	x	x	x	
format volume	x	x	x	x	x	x	x	x	x	x	x	x	x	x	x	x	x	
expand volume	x	x	x	x	x	x	x	x	x	x	x	x	x	x	x	x	x	
set volume-parameters	x	x	x	x	x	x	x	x	x	x	x	x	x	x	x	x	x	
show migration	x	x	x	x	x	x	x	x	x	x	x	x	x	x	x	x	x	
start migration	x	x	x	x	x	x	x	x	x	x	x	x	x	x	x	x	x	
stop migration	x	x	x	x	x	x	x	x	x	x	x	x	x	x	x	x	x	
show balancing-thin-pro-volumes	x	x	x	x	x	x	x	x	x	x	x	x	x	x	x	x	x	
start balancing-thin-pro-volume	x	x	x	x	x	x	x	x	x	x	x	x	x	x	x	x	x	
stop balancing-thin-pro-volume	x	x	x	x	x	x	x	x	x	x	x	x	x	x	x	x	x	

Appendix B List of Supported Commands
 B.1 List of Supported Commands (of the Target Model)

Command name	Target model																Remarks		
	DX60 S4	DX100 S4	DX200 S4	DX500 S4	DX600 S4	DX60 S3	DX100 S3	DX200 S3	DX500 S3	DX600 S3	DX8100 S3	DX8700 S3	DX8900 S3	AF250 S2	AF650 S2	AF250		AF650	DX200F
start zero-reclamation	x	x	x	x	x	x	x	x	x	x	x	x	x	x	x	x	x	x	
stop zero-reclamation	x	x	x	x	x	x	x	x	x	x	x	x	x	x	x	x	x	x	
Volume (QoS)																			
show volume-qos		x	x	x	x		x	x	x	x	x	x	x	x	x	x	x	x	
set volume-qos		x	x	x	x		x	x	x	x	x	x	x	x	x	x	x	x	
Flexible Tier Volume																			
create flexible-tier-volume		x	x	x	x		x	x	x	x	x	x	x	x	x	x	x	x	
set flexible-tier-volume		x	x	x	x		x	x	x	x	x	x	x	x	x	x	x	x	
format flexible-tier-volume		x	x	x	x		x	x	x	x	x	x	x	x	x	x	x	x	
expand flexible-tier-volume		x	x	x	x		x	x	x	x	x	x	x	x	x	x	x	x	
delete flexible-tier-volume		x	x	x	x		x	x	x	x	x	x	x	x	x	x	x	x	
delete all-flexible-tier-volumes		x	x	x	x		x	x	x	x	x	x	x	x	x	x	x	x	
start flexible-tier-migration		x	x	x	x		x	x	x	x	x	x	x	x	x	x	x	x	
ODX Buffer Volume																			
show odx-mode	x	x	x	x	x	x	x	x	x	x	x	x	x	x	x	x	x	x	
set odx-mode	x	x	x	x	x	x	x	x	x	x	x	x	x	x	x	x	x	x	
create odx-buffer-volume	x	x	x	x	x	x	x	x	x	x	x	x	x	x	x	x	x	x	
set odx-buffer-volume	x	x	x	x	x	x	x	x	x	x	x	x	x	x	x	x	x	x	
delete odx-buffer-volume	x	x	x	x	x	x	x	x	x	x	x	x	x	x	x	x	x	x	
Extreme Cache																			
show extreme-cache				x	x				x	x		x	x						
set extreme-cache				x	x				x	x		x	x						
set volume-exc				x	x				x	x		x	x						
show extreme-cache-pool		x	x	x	x		x	x	x	x		x	x						
create extreme-cache-pool		x	x	x	x		x	x	x	x		x	x						
delete extreme-cache-pool		x	x	x	x		x	x	x	x		x	x						
WVOL																			
show wvol-mode		x	x	x	x		x	x	x	x	x	x	x	x	x	x	x	x	
set wvol-mode		x	x	x	x		x	x	x	x	x	x	x	x	x	x	x	x	
show wvol-task		x	x	x	x		x	x	x	x	x	x	x	x	x	x	x	x	

Table B.4 List of supported commands for Thin Provisioning Pool management (of the target model)

Command name	Target model																Remarks	
	DX60 S4	DX100 S4	DX200 S4	DX500 S4	DX600 S4	DX60 S3	DX100 S3	DX200 S3	DX500 S3	DX600 S3	DX8100 S3	DX8700 S3	DX8900 S3	AF250 S2	AF650 S2	AF250		AF650
Thin Provisioning Pool																		
show thin-provisioning	x	x	x	x	x	x	x	x	x	x	x	x	x	x	x	x	x	
set thin-provisioning	x	x	x	x	x	x	x	x	x	x	x	x	x	x	x	x	x	
show thin-pro-pools	x	x	x	x	x	x	x	x	x	x	x	x	x	x	x	x	x	
show thin-pro-pool-progress	x	x	x	x	x	x	x	x	x	x	x	x	x	x	x	x	x	
create thin-pro-pool	x	x	x	x	x	x	x	x	x	x	x	x	x	x	x	x	x	
set thin-pro-pool	x	x	x	x	x	x	x	x	x	x	x	x	x	x	x	x	x	
delete thin-pro-pool	x	x	x	x	x	x	x	x	x	x	x	x	x	x	x	x	x	
expand thin-pro-pool	x	x	x	x	x	x	x	x	x	x	x	x	x	x	x	x	x	
format thin-pro-pool	x	x	x	x	x	x	x	x	x	x	x	x	x	x	x	x	x	
Thin Provisioning Pool Eco-mode Management																		
show eco-thin-pro-pool	x	x	x	x	x	x	x	x	x	x	x	x	x					
set eco-thin-pro-pool	x	x	x	x	x	x	x	x	x	x	x	x	x					
release eco-thin-pro-pool	x	x	x	x	x	x	x	x	x	x	x	x	x					

Table B.5 List of supported commands for Flexible Tier management (of the target model)

Command name	Target model																Remarks	
	DX60 S4	DX100 S4	DX200 S4	DX500 S4	DX600 S4	DX60 S3	DX100 S3	DX200 S3	DX500 S3	DX600 S3	DX8100 S3	DX8700 S3	DX8900 S3	AF250 S2	AF650 S2	AF250		AF650
Flexible Tier Pool																		
show flexible-tier-mode		x	x	x	x		x	x	x	x	x	x	x	x	x	x	x	
show flexible-tier-pools		x	x	x	x		x	x	x	x	x	x	x	x	x	x	x	
show flexible-tier-pool-progress		x	x	x	x		x	x	x	x	x	x	x	x	x	x	x	
delete flexible-tier-pool		x	x	x	x		x	x	x	x	x	x	x	x	x	x	x	
show flexible-tier-sub-pools		x	x	x	x		x	x	x	x	x	x	x	x	x	x	x	
set flexible-tier-sub-pool		x	x	x	x		x	x	x	x	x	x	x	x	x	x	x	
stop shrinking-flexible-tier-pool		x	x	x	x		x	x	x	x	x	x	x	x	x	x	x	
FTRPE Migration																		
show ftrpe-migration		x	x	x	x		x	x	x	x	x	x	x	x	x	x	x	
FTRP Balancing																		
show balancing-flexible-tier-pools		x	x	x	x		x	x	x	x	x	x	x	x	x	x	x	
start balancing-flexible-tier-pool		x	x	x	x		x	x	x	x	x	x	x	x	x	x	x	
stop balancing-flexible-tier-pool		x	x	x	x		x	x	x	x	x	x	x	x	x	x	x	

Table B.6 List of supported commands for host interface management (of the target model)

Command name	Target model																	Remarks	
	DX60 S4	DX100 S4	DX200 S4	DX500 S4	DX600 S4	DX60 S3	DX100 S3	DX200 S3	DX500 S3	DX600 S3	DX8100 S3	DX8700 S3	DX8900 S3	AF250 S2	AF650 S2	AF250	AF650		DX200F
Host Interface Port Parameters																			
show fc-parameters	x	x	x	x	x	x	x	x	x	x	x	x	x	x	x	x	x	x	
set fc-parameters	x	x	x	x	x	x	x	x	x	x	x	x	x	x	x	x	x	x	
show sas-parameters	x	x	x			x	x	x											
set sas-parameters	x	x	x			x	x	x											
show iscsi-parameters	x	x	x	x	x	x	x	x	x	x	x	x	x	x	x	x	x	x	
set iscsi-parameters	x	x	x	x	x	x	x	x	x	x	x	x	x	x	x	x	x	x	
show fcoe-parameters							x	x	x	x	x	x	x						
set fcoe-parameters							x	x	x	x	x	x	x						
Host Identifiers (Host Alias)																			
show host-wwn-names	x	x	x	x	x	x	x	x	x	x	x	x	x	x	x	x	x	x	
create host-wwn-name	x	x	x	x	x	x	x	x	x	x	x	x	x	x	x	x	x	x	
set host-wwn-name	x	x	x	x	x	x	x	x	x	x	x	x	x	x	x	x	x	x	
delete host-wwn-name	x	x	x	x	x	x	x	x	x	x	x	x	x	x	x	x	x	x	
discover host-wwn-names	x	x	x	x	x	x	x	x	x	x	x	x	x	x	x	x	x	x	
show host-sas-addresses	x	x	x			x	x	x											
create host-sas-address	x	x	x			x	x	x											
set host-sas-address	x	x	x			x	x	x											
delete host-sas-address	x	x	x			x	x	x											
discover host-sas-addresses	x	x	x			x	x	x											
show host-iscsi-names	x	x	x	x	x	x	x	x	x	x	x	x	x	x	x	x	x	x	
create host-iscsi-name	x	x	x	x	x	x	x	x	x	x	x	x	x	x	x	x	x	x	
set host-iscsi-name	x	x	x	x	x	x	x	x	x	x	x	x	x	x	x	x	x	x	
delete host-iscsi-name	x	x	x	x	x	x	x	x	x	x	x	x	x	x	x	x	x	x	
discover host-iscsi-names	x	x	x	x	x	x	x	x	x	x	x	x	x	x	x	x	x	x	
Mapping (when LUN Groups are Used)																			
show host-affinity	x	x	x	x	x	x	x	x	x	x	x	x	x	x	x	x	x	x	
set host-affinity	x	x	x	x	x	x	x	x	x	x	x	x	x	x	x	x	x	x	
copy host-affinity	x	x	x	x	x	x	x	x	x	x	x	x	x	x	x	x	x	x	
release host-affinity	x	x	x	x	x	x	x	x	x	x	x	x	x	x	x	x	x	x	
Mapping (when Host Affinity Mode is Not Used)																			
show mapping	x	x	x	x	x	x	x	x	x	x	x	x	x	x	x	x	x	x	
set mapping	x	x	x	x	x	x	x	x	x	x	x	x	x	x	x	x	x	x	
copy mapping	x	x	x	x	x	x	x	x	x	x	x	x	x	x	x	x	x	x	
release mapping	x	x	x	x	x	x	x	x	x	x	x	x	x	x	x	x	x	x	

Appendix B List of Supported Commands
 B.1 List of Supported Commands (of the Target Model)

Command name	Target model																	Remarks	
	DX60 S4	DX100 S4	DX200 S4	DX500 S4	DX600 S4	DX60 S3	DX100 S3	DX200 S3	DX500 S3	DX600 S3	DX8100 S3	DX8700 S3	DX8900 S3	AF250 S2	AF650 S2	AF250	AF650		DX200F
Host Groups																			
show host-groups	x	x	x	x	x	x	x	x	x	x	x	x	x	x	x	x	x	x	
create host-group	x	x	x	x	x	x	x	x	x	x	x	x	x	x	x	x	x	x	
set host-group	x	x	x	x	x	x	x	x	x	x	x	x	x	x	x	x	x	x	
delete host-group	x	x	x	x	x	x	x	x	x	x	x	x	x	x	x	x	x	x	
Port Groups																			
show port-groups	x	x	x	x	x	x	x	x	x	x	x	x	x	x	x	x	x	x	
create port-group	x	x	x	x	x	x	x	x	x	x	x	x	x	x	x	x	x	x	
set port-group	x	x	x	x	x	x	x	x	x	x	x	x	x	x	x	x	x	x	
delete port-group	x	x	x	x	x	x	x	x	x	x	x	x	x	x	x	x	x	x	
LUN Groups																			
show lun-groups	x	x	x	x	x	x	x	x	x	x	x	x	x	x	x	x	x	x	
create lun-group	x	x	x	x	x	x	x	x	x	x	x	x	x	x	x	x	x	x	
set lun-group	x	x	x	x	x	x	x	x	x	x	x	x	x	x	x	x	x	x	
copy lun-group	x	x	x	x	x	x	x	x	x	x	x	x	x	x	x	x	x	x	
delete lun-group	x	x	x	x	x	x	x	x	x	x	x	x	x	x	x	x	x	x	
show host-path-state	x	x	x	x	x	x	x	x	x	x	x	x	x	x	x	x	x	x	
set host-path-state	x	x	x	x	x	x	x	x	x	x	x	x	x	x	x	x	x	x	
LUN Groups (Host LU QoS)																			
show host-lu-qos-performance		x	x	x	x		x	x	x	x	x	x	x	x	x	x	x	x	
start host-lu-qos-performance		x	x	x	x		x	x	x	x	x	x	x	x	x	x	x	x	
stop host-lu-qos-performance		x	x	x	x		x	x	x	x	x	x	x	x	x	x	x	x	
Host Response																			
show host-response	x	x	x	x	x	x	x	x	x	x	x	x	x	x	x	x	x	x	
set host-response	x	x	x	x	x	x	x	x	x	x	x	x	x	x	x	x	x	x	
delete host-response	x	x	x	x	x	x	x	x	x	x	x	x	x	x	x	x	x	x	
Host Sense Conversion																			
show host-sense	x	x	x	x	x	x	x	x	x	x	x	x	x	x	x	x	x	x	
set host-sense	x	x	x	x	x	x	x	x	x	x	x	x	x	x	x	x	x	x	
delete host-sense	x	x	x	x	x	x	x	x	x	x	x	x	x	x	x	x	x	x	
Reset Group for Host Interface Port																			
show ca-reset-group	x	x	x	x	x	x	x	x	x	x	x	x	x	x	x	x	x	x	
set ca-reset-group	x	x	x	x	x	x	x	x	x	x	x	x	x	x	x	x	x	x	
Ping Command for iSCSI Hosts																			
test iscsi-ping	x	x	x	x	x	x	x	x	x	x	x	x	x	x	x	x	x	x	

Appendix B List of Supported Commands
 B.1 List of Supported Commands (of the Target Model)

Command name	Target model																Remarks	
	DX60 S4	DX100 S4	DX200 S4	DX500 S4	DX600 S4	DX60 S3	DX100 S3	DX200 S3	DX500 S3	DX600 S3	DX8100 S3	DX8700 S3	DX8900 S3	AF250 S2	AF650 S2	AF250		AF650
Host LU QoS																		
show qos-mode		x	x	x	x		x	x	x	x	x	x	x	x	x	x	x	
set qos-mode		x	x	x	x		x	x	x	x	x	x	x	x	x	x	x	
show lu-qos-groups		x	x	x	x		x	x	x	x	x	x	x	x	x	x	x	
set lu-qos-group		x	x	x	x		x	x	x	x	x	x	x	x	x	x	x	
delete lu-qos-group		x	x	x	x		x	x	x	x	x	x	x	x	x	x	x	
show host-lu-qos		x	x	x	x		x	x	x	x	x	x	x	x	x	x	x	
set host-lu-qos		x	x	x	x		x	x	x	x	x	x	x	x	x	x	x	
show qos-schedule		x	x	x	x		x	x	x	x	x	x	x	x	x	x	x	
set qos-schedule		x	x	x	x		x	x	x	x	x	x	x	x	x	x	x	
delete all-qos-setting		x	x	x	x		x	x	x	x	x	x	x	x	x	x	x	
Login Host Display																		
show ca-port-login-host	x	x	x	x	x	x	x	x	x	x	x	x	x	x	x	x	x	

Table B.7 List of supported commands for Advanced Copy management (of the target model)

Command name	Target model																Remarks	
	DX60 S4	DX100 S4	DX200 S4	DX500 S4	DX600 S4	DX60 S3	DX100 S3	DX200 S3	DX500 S3	DX600 S3	DX8100 S3	DX8700 S3	DX8900 S3	AF250 S2	AF650 S2	AF250		AF650
Copy Session Management																		
show advanced-copy-license	x	x	x	x	x	x	x	x	x	x	x	x	x	x	x	x	x	
set advanced-copy-license	x	x	x	x	x	x	x	x	x	x	x	x	x	x	x	x	x	
delete advanced-copy-license	x	x	x	x	x	x	x	x	x	x	x	x	x	x	x	x	x	
show advanced-copy-policy	x	x	x	x	x	x	x	x	x	x	x	x	x	x	x	x	x	
set advanced-copy-policy	x	x	x	x	x	x	x	x	x	x	x	x	x	x	x	x	x	
show advanced-copy-parameters	x	x	x	x	x	x	x	x	x	x	x	x	x	x	x	x	x	
set advanced-copy-parameters	x	x	x	x	x	x	x	x	x	x	x	x	x	x	x	x	x	
show snap-data-volume	x	x	x	x	x	x	x	x	x	x	x	x	x	x	x	x	x	
initialize snap-data-volume	x	x	x	x	x	x	x	x	x	x	x	x	x	x	x	x	x	
show snap-data-pool	x	x	x	x	x	x	x	x	x	x	x	x	x	x	x	x	x	
delete snap-data-pool-volume	x	x	x	x	x	x	x	x	x	x	x	x	x	x	x	x	x	
show advanced-copy-sessions	x	x	x	x	x	x	x	x	x	x	x	x	x	x	x	x	x	
start advanced-copy	x	x	x	x	x	x	x	x	x	x	x	x	x	x	x	x	x	
stop advanced-copy	x	x	x	x	x	x	x	x	x	x	x	x	x	x	x	x	x	

Appendix B List of Supported Commands
 B.1 List of Supported Commands (of the Target Model)

Command name	Target model																Remarks	
	DX60 S4	DX100 S4	DX200 S4	DX500 S4	DX600 S4	DX60 S3	DX100 S3	DX200 S3	DX500 S3	DX600 S3	DX8100 S3	DX8700 S3	DX8900 S3	AF250 S2	AF650 S2	AF250		AF650
Remote Equivalent Copy Management																		
show host-port-mode	x	x	x	x	x	x	x	x	x	x	x	x	x	x	x	x	x	
set host-port-mode	x	x	x	x	x	x	x	x	x	x	x	x	x	x	x	x	x	
show rec-path			x	x	x			x	x	x	x	x	x	x	x	x	x	
import rec-path			x	x	x			x	x	x	x	x	x	x	x	x	x	
show backup-rec-path-information			x	x	x			x	x	x	x	x	x	x	x	x	x	
export backup-rec-path			x	x	x			x	x	x	x	x	x	x	x	x	x	
convert rec-path			x	x	x			x	x	x	x	x	x	x	x	x	x	
measure rec-round-trip-time			x	x	x			x	x	x	x	x	x	x	x	x	x	
set rec-round-trip-time			x	x	x			x	x	x	x	x	x	x	x	x	x	
set rec-multiplicity			x	x	x			x	x	x	x	x	x	x	x	x	x	
show rec-buffer			x	x	x			x	x	x	x	x	x	x	x	x	x	
set rec-buffer			x	x	x			x	x	x	x	x	x	x	x	x	x	
delete rec-buffer			x	x	x			x	x	x	x	x	x	x	x	x	x	
show rec-disk-buffer			x	x	x			x	x	x	x	x	x	x	x	x	x	
create rec-disk-buffer			x	x	x			x	x	x	x	x	x	x	x	x	x	
set rec-disk-buffer			x	x	x			x	x	x	x	x	x	x	x	x	x	
delete rec-disk-buffer			x	x	x			x	x	x	x	x	x	x	x	x	x	
format rec-disk-buffer			x	x	x			x	x	x	x	x	x	x	x	x	x	
release rec-disk-buffer			x	x	x			x	x	x	x	x	x	x	x	x	x	
set rec-path-qos			x	x	x			x	x	x	x	x	x	x	x	x	x	

Table B.8 List of supported commands for user management (of the target model)

Command name	Target model																Remarks	
	DX60 S4	DX100 S4	DX200 S4	DX500 S4	DX600 S4	DX60 S3	DX100 S3	DX200 S3	DX500 S3	DX600 S3	DX8100 S3	DX8700 S3	DX8900 S3	AF250 S2	AF650 S2	AF250		AF650
Role																		
show role	x	x	x	x	x	x	x	x	x	x	x	x	x	x	x	x	x	
create role	x	x	x	x	x	x	x	x	x	x	x	x	x	x	x	x	x	
set role	x	x	x	x	x	x	x	x	x	x	x	x	x	x	x	x	x	
delete role	x	x	x	x	x	x	x	x	x	x	x	x	x	x	x	x	x	
User Policy Setting																		
show user-policy	x	x	x	x	x	x	x	x	x	x	x	x	x	x	x	x	x	
set user-policy	x	x	x	x	x	x	x	x	x	x	x	x	x	x	x	x	x	
show users	x	x	x	x	x	x	x	x	x	x	x	x	x	x	x	x	x	
create user	x	x	x	x	x	x	x	x	x	x	x	x	x	x	x	x	x	
set user	x	x	x	x	x	x	x	x	x	x	x	x	x	x	x	x	x	

Appendix B List of Supported Commands
 B.1 List of Supported Commands (of the Target Model)

Command name	Target model																	Remarks	
	DX60 S4	DX100 S4	DX200 S4	DX500 S4	DX600 S4	DX60 S3	DX100 S3	DX200 S3	DX500 S3	DX600 S3	DX8100 S3	DX8700 S3	DX8900 S3	AF250 S2	AF650 S2	AF250	AF650		DX200F
delete user	X	X	X	X	X	X	X	X	X	X	X	X	X	X	X	X	X	X	
show login-users	X	X	X	X	X	X	X	X	X	X	X	X	X	X	X	X	X	X	
set password	X	X	X	X	X	X	X	X	X	X	X	X	X	X	X	X	X	X	
initialize all-users	X	X	X	X	X	X	X	X	X	X	X	X	X	X	X	X	X	X	
import ssh-public-key	X	X	X	X	X	X	X	X	X	X	X	X	X	X	X	X	X	X	
delete ssh-public-key	X	X	X	X	X	X	X	X	X	X	X	X	X	X	X	X	X	X	
show maintenance-key	X	X	X	X	X	X	X	X	X	X	X	X	X	X	X	X	X	X	
RADIUS Server Settings																			
show radius	X	X	X	X	X	X	X	X	X	X	X	X	X	X	X	X	X	X	
set radius	X	X	X	X	X	X	X	X	X	X	X	X	X	X	X	X	X	X	

Table B.9 List of supported commands for network management (of the target model)

Command name	Target model																	Remarks	
	DX60 S4	DX100 S4	DX200 S4	DX500 S4	DX600 S4	DX60 S3	DX100 S3	DX200 S3	DX500 S3	DX600 S3	DX8100 S3	DX8700 S3	DX8900 S3	AF250 S2	AF650 S2	AF250	AF650		DX200F
Network Settings																			
show network	X	X	X	X	X	X	X	X	X	X	X	X	X	X	X	X	X	X	
set network	X	X	X	X	X	X	X	X	X	X	X	X	X	X	X	X	X	X	
show firewall	X	X	X	X	X	X	X	X	X	X	X	X	X	X	X	X	X	X	
set firewall	X	X	X	X	X	X	X	X	X	X	X	X	X	X	X	X	X	X	
show network-stat	X	X	X	X	X	X	X	X	X	X	X	X	X	X	X	X	X	X	
test network	X	X	X	X	X	X	X	X	X	X	X	X	X	X	X	X	X	X	
SNMP																			
show snmp	X	X	X	X	X	X	X	X	X	X	X	X	X	X	X	X	X	X	
set snmp	X	X	X	X	X	X	X	X	X	X	X	X	X	X	X	X	X	X	
show snmp-manager	X	X	X	X	X	X	X	X	X	X	X	X	X	X	X	X	X	X	
create snmp-manager	X	X	X	X	X	X	X	X	X	X	X	X	X	X	X	X	X	X	
set snmp-manager	X	X	X	X	X	X	X	X	X	X	X	X	X	X	X	X	X	X	
delete snmp-manager	X	X	X	X	X	X	X	X	X	X	X	X	X	X	X	X	X	X	
show snmp-view	X	X	X	X	X	X	X	X	X	X	X	X	X	X	X	X	X	X	
create snmp-view	X	X	X	X	X	X	X	X	X	X	X	X	X	X	X	X	X	X	
set snmp-view	X	X	X	X	X	X	X	X	X	X	X	X	X	X	X	X	X	X	
delete snmp-view	X	X	X	X	X	X	X	X	X	X	X	X	X	X	X	X	X	X	
show snmp-user	X	X	X	X	X	X	X	X	X	X	X	X	X	X	X	X	X	X	
create snmp-user	X	X	X	X	X	X	X	X	X	X	X	X	X	X	X	X	X	X	
set snmp-user	X	X	X	X	X	X	X	X	X	X	X	X	X	X	X	X	X	X	
delete snmp-user	X	X	X	X	X	X	X	X	X	X	X	X	X	X	X	X	X	X	

Appendix B List of Supported Commands
 B.1 List of Supported Commands (of the Target Model)

Command name	Target model																	Remarks	
	DX60 S4	DX100 S4	DX200 S4	DX500 S4	DX600 S4	DX60 S3	DX100 S3	DX200 S3	DX500 S3	DX600 S3	DX8100 S3	DX8700 S3	DX8900 S3	AF250 S2	AF650 S2	AF250	AF650		DX200F
show community-profile	x	x	x	x	x	x	x	x	x	x	x	x	x	x	x	x	x	x	
create community-profile	x	x	x	x	x	x	x	x	x	x	x	x	x	x	x	x	x	x	
set community-profile	x	x	x	x	x	x	x	x	x	x	x	x	x	x	x	x	x	x	
delete community-profile	x	x	x	x	x	x	x	x	x	x	x	x	x	x	x	x	x	x	
show snmp-trap	x	x	x	x	x	x	x	x	x	x	x	x	x	x	x	x	x	x	
set snmp-trap	x	x	x	x	x	x	x	x	x	x	x	x	x	x	x	x	x	x	
delete snmp-trap	x	x	x	x	x	x	x	x	x	x	x	x	x	x	x	x	x	x	
test snmp-trap	x	x	x	x	x	x	x	x	x	x	x	x	x	x	x	x	x	x	
export enhanced-mib	x	x	x	x	x	x	x	x	x	x	x	x	x	x	x	x	x	x	
E-mail Notification																			
show email-notification	x	x	x	x	x	x	x	x	x	x	x	x	x	x	x	x	x	x	
set email-notification	x	x	x	x	x	x	x	x	x	x	x	x	x	x	x	x	x	x	
test email	x	x	x	x	x	x	x	x	x	x	x	x	x	x	x	x	x	x	
Event Notification																			
show event-notification	x	x	x	x	x	x	x	x	x	x	x	x	x	x	x	x	x	x	
set event-notification	x	x	x	x	x	x	x	x	x	x	x	x	x	x	x	x	x	x	
show lcd-suppress													x	x					
set lcd-suppress													x	x					
SMI-S																			
show smi-s	x	x	x	x	x	x	x	x	x	x	x	x	x	x	x	x	x	x	
set smi-s	x	x	x	x	x	x	x	x	x	x	x	x	x	x	x	x	x	x	
SSH/SSL Security Configuration																			
create ssh-server-key	x	x	x	x	x	x	x	x	x	x	x	x	x	x	x	x	x	x	
create ssl-certificate	x	x	x	x	x	x	x	x	x	x	x	x	x	x	x	x	x	x	
export ssl-certificate-request	x	x	x	x	x	x	x	x	x	x	x	x	x	x	x	x	x	x	
import ssl-certificate	x	x	x	x	x	x	x	x	x	x	x	x	x	x	x	x	x	x	
show ssl-version	x	x	x	x	x	x	x	x	x	x	x	x	x	x	x	x	x	x	
set ssl-version	x	x	x	x	x	x	x	x	x	x	x	x	x	x	x	x	x	x	

Appendix B List of Supported Commands
 B.1 List of Supported Commands (of the Target Model)

Command name	Target model																Remarks	
	DX60 S4	DX100 S4	DX200 S4	DX500 S4	DX600 S4	DX60 S3	DX100 S3	DX200 S3	DX500 S3	DX600 S3	DX8100 S3	DX8700 S3	DX8900 S3	AF250 S2	AF650 S2	AF250		AF650
AIS Connect Settings																		
show ais-connect	x	x	x	x	x	x	x	x	x	x	x	x	x	x	x	x	x	(*1)
set ais-connect	x	x	x	x	x	x	x	x	x	x	x	x	x	x	x	x	x	(*1)
set ais-connect-remote-session	x	x	x	x	x	x	x	x	x	x	x	x	x	x	x	x	x	(*1)
test ais-connect	x	x	x	x	x	x	x	x	x	x	x	x	x	x	x	x	x	(*1)
send ais-connect-log	x	x	x	x	x	x	x	x	x	x	x	x	x	x	x	x	x	(*1)
test ais-connect-event-notification	x	x	x	x	x	x	x	x	x	x	x	x	x	x	x	x	x	(*1)
import ais-ssl-certificate	x	x	x	x	x	x	x	x	x	x	x	x	x	x	x	x	x	(*1)
show ais-communication-log	x	x	x	x	x	x	x	x	x	x	x	x	x	x	x	x	x	(*1)
set remote-support-mode	x	x	x	x	x	x	x	x	x	x	x	x	x	x	x	x	x	(*1)

*1: The command cannot be used with Japanese models.

Table B.10 List of supported commands for system management (of the target model)

Command name	Target model																Remarks	
	DX60 S4	DX100 S4	DX200 S4	DX500 S4	DX600 S4	DX60 S3	DX100 S3	DX200 S3	DX500 S3	DX600 S3	DX8100 S3	DX8700 S3	DX8900 S3	AF250 S2	AF650 S2	AF250		AF650
Date, Time, and NTP																		
show date	x	x	x	x	x	x	x	x	x	x	x	x	x	x	x	x	x	
set date	x	x	x	x	x	x	x	x	x	x	x	x	x	x	x	x	x	
show ntp	x	x	x	x	x	x	x	x	x	x	x	x	x	x	x	x	x	
set ntp	x	x	x	x	x	x	x	x	x	x	x	x	x	x	x	x	x	
ETERNUS DX/AF Name																		
show storage-system-name	x	x	x	x	x	x	x	x	x	x	x	x	x	x	x	x	x	
set storage-system-name	x	x	x	x	x	x	x	x	x	x	x	x	x	x	x	x	x	
Encryption Mode																		
show encryption		x	x	x	x		x	x	x	x	x	x	x	x	x	x	x	
set encryption		x	x	x	x		x	x	x	x	x	x	x	x	x	x	x	
Box ID																		
show boxid	x	x	x	x	x	x	x	x	x	x	x	x	x	x	x	x	x	
set boxid	x	x	x	x	x	x	x	x	x	x	x	x	x	x	x	x	x	
Power Synchronization																		
show power-synchronization	x	x	x	x	x	x	x	x	x	x	x	x	x	x	x	x	x	
set power-synchronization	x	x	x	x	x	x	x	x	x	x	x	x	x	x	x	x	x	
Self-Encrypting Drive (SED) Authentication Settings																		
show sed-authentication		x	x	x	x		x	x	x	x	x	x	x	x	x	x	x	
set sed-authentication		x	x	x	x		x	x	x	x	x	x	x	x	x	x	x	

Appendix B List of Supported Commands
 B.1 List of Supported Commands (of the Target Model)

Command name	Target model																Remarks	
	DX60 S4	DX100 S4	DX200 S4	DX500 S4	DX600 S4	DX60 S3	DX100 S3	DX200 S3	DX500 S3	DX600 S3	DX8100 S3	DX8700 S3	DX8900 S3	AF250 S2	AF650 S2	AF250		AF650
Syslog Server Settings																		
show syslog-notification	x	x	x	x	x	x	x	x	x	x	x	x	x	x	x	x	x	
set syslog-notification	x	x	x	x	x	x	x	x	x	x	x	x	x	x	x	x	x	
Audit Log Settings																		
show audit	x	x	x	x	x	x	x	x	x	x	x	x	x	x	x	x	x	
set audit	x	x	x	x	x	x	x	x	x	x	x	x	x	x	x	x	x	
Key Management Server Linkage Function																		
show sed-key-machine-name		x	x	x	x		x	x	x	x	x	x	x	x	x	x	x	
set sed-key-machine-name		x	x	x	x		x	x	x	x	x	x	x	x	x	x	x	
show sed-key-servers		x	x	x	x		x	x	x	x	x	x	x	x	x	x	x	
set sed-key-server		x	x	x	x		x	x	x	x	x	x	x	x	x	x	x	
import ssl-kmip-certificate		x	x	x	x		x	x	x	x	x	x	x	x	x	x	x	
show sed-key-groups		x	x	x	x		x	x	x	x	x	x	x	x	x	x	x	
create sed-key-group		x	x	x	x		x	x	x	x	x	x	x	x	x	x	x	
set sed-key-group		x	x	x	x		x	x	x	x	x	x	x	x	x	x	x	
delete sed-key-group		x	x	x	x		x	x	x	x	x	x	x	x	x	x	x	
change sed-key		x	x	x	x		x	x	x	x	x	x	x	x	x	x	x	
recover sed-key-group		x	x	x	x		x	x	x	x	x	x	x	x	x	x	x	
Power-Off/Reboot System																		
shutdown	x	x	x	x	x	x	x	x	x	x	x	x	x	x	x	x	x	
Deduplication/Compression Mode Setting																		
show dedup-mode			x	x	x			x	x	x				x	x	x	x	
set dedup-mode			x	x	x			x	x	x				x	x	x	x	
Non-disruptive Storage Migration Function																		
show non-disruptive-storage-migration	x	x	x	x	x	x	x	x	x	x	x	x	x	x	x	x	x	
set non-disruptive-storage-migration	x	x	x	x	x	x	x	x	x	x	x	x	x	x	x	x	x	
discover external-storage	x	x	x	x	x	x	x	x	x	x	x	x	x	x	x	x	x	
show external-drive	x	x	x	x	x	x	x	x	x	x	x	x	x	x	x	x	x	
create external-drive	x	x	x	x	x	x	x	x	x	x	x	x	x	x	x	x	x	
delete external-drive	x	x	x	x	x	x	x	x	x	x	x	x	x	x	x	x	x	
show external-raid-group	x	x	x	x	x	x	x	x	x	x	x	x	x	x	x	x	x	
create external-raid-group	x	x	x	x	x	x	x	x	x	x	x	x	x	x	x	x	x	
delete external-raid-group	x	x	x	x	x	x	x	x	x	x	x	x	x	x	x	x	x	
recover external-raid-group	x	x	x	x	x	x	x	x	x	x	x	x	x	x	x	x	x	

Table B.11 List of supported commands for performance management (of the target model)

Command name	Target model																Remarks	
	DX60 S4	DX100 S4	DX200 S4	DX500 S4	DX600 S4	DX60 S3	DX100 S3	DX200 S3	DX500 S3	DX600 S3	DX8100 S3	DX8700 S3	DX8900 S3	AF250 S2	AF650 S2	AF250		AF650
Performance Information																		
show performance	x	x	x	x	x	x	x	x	x	x	x	x	x	x	x	x	x	
start performance	x	x	x	x	x	x	x	x	x	x	x	x	x	x	x	x	x	
stop performance	x	x	x	x	x	x	x	x	x	x	x	x	x	x	x	x	x	
Performance Tuning Parameters																		
show raid-tuning	x	x	x	x	x	x	x	x	x	x	x	x	x	x	x	x	x	
set raid-tuning	x	x	x	x	x	x	x	x	x	x	x	x	x	x	x	x	x	
show cache-parameters	x	x	x	x	x	x	x	x	x	x	x	x	x	x	x	x	x	
set cache-parameters	x	x	x	x	x	x	x	x	x	x	x	x	x	x	x	x	x	

Table B.12 List of supported commands for event log information management (of the target model)

Command name	Target model																Remarks	
	DX60 S4	DX100 S4	DX200 S4	DX500 S4	DX600 S4	DX60 S3	DX100 S3	DX200 S3	DX500 S3	DX600 S3	DX8100 S3	DX8700 S3	DX8900 S3	AF250 S2	AF650 S2	AF250		AF650
Event Log Information																		
show events	x	x	x	x	x	x	x	x	x	x	x	x	x	x	x	x	x	
delete events	x	x	x	x	x	x	x	x	x	x	x	x	x	x	x	x	x	

Table B.13 List of supported commands for environmental information management (of the target model)

Command name	Target model																Remarks	
	DX60 S4	DX100 S4	DX200 S4	DX500 S4	DX600 S4	DX60 S3	DX100 S3	DX200 S3	DX500 S3	DX600 S3	DX8100 S3	DX8700 S3	DX8900 S3	AF250 S2	AF650 S2	AF250		AF650
Environmental Information																		
show power-consumption	x	x	x	x	x	x	x	x	x	x	x	x	x		x		x	

Table B.14 List of supported commands for maintenance operation and maintenance information management (of the target model)

Command name	Target model																Remarks	
	DX60 S4	DX100 S4	DX200 S4	DX500 S4	DX600 S4	DX60 S3	DX100 S3	DX200 S3	DX500 S3	DX600 S3	DX8100 S3	DX8700 S3	DX8900 S3	AF250 S2	AF650 S2	AF250		AF650
Hardware Maintenance																		
hot expansion	x	x	x	x	x	x	x	x	x	x				x	x	x	x	

Appendix B List of Supported Commands
 B.1 List of Supported Commands (of the Target Model)

Command name	Target model																Remarks	
	DX60 S4	DX100 S4	DX200 S4	DX500 S4	DX600 S4	DX60 S3	DX100 S3	DX200 S3	DX500 S3	DX600 S3	DX8100 S3	DX8700 S3	DX8900 S3	AF250 S2	AF650 S2	AF250		AF650
Remote Directory																		
show remote-dir	x	x	x	x	x	x	x	x	x	x	x	x	x	x	x	x	x	x
Controller Firmware																		
show firmware-version	x	x	x	x	x	x	x	x	x	x	x	x	x	x	x	x	x	x
Log																		
export log	x	x	x	x	x	x	x	x	x	x	x	x	x	x	x	x	x	x
Panic Dump																		
show panic-dump	x	x	x	x	x	x	x	x	x	x	x	x	x	x	x	x	x	x
export panic-dump	x	x	x	x	x	x	x	x	x	x	x	x	x	x	x	x	x	x
Configuration Information																		
show config-information	x	x	x	x	x	x	x	x	x	x	x	x	x	x	x	x	x	x
export config-information	x	x	x	x	x	x	x	x	x	x	x	x	x	x	x	x	x	x
Error Information																		
show disk-error	x	x	x	x	x	x	x	x	x	x	x	x	x	x	x	x	x	x
clear disk-error	x	x	x	x	x	x	x	x	x	x	x	x	x	x	x	x	x	x
show port-error	x	x	x	x	x	x	x	x	x	x	x	x	x	x	x	x	x	x
Bad Data Information in Volumes																		
show bad-data-info	x	x	x	x	x	x	x	x	x	x	x	x	x	x	x	x	x	x

Table B.15 List of supported commands for utility management (of the target model)

Command name	Target model																Remarks	
	DX60 S4	DX100 S4	DX200 S4	DX500 S4	DX600 S4	DX60 S3	DX100 S3	DX200 S3	DX500 S3	DX600 S3	DX8100 S3	DX8700 S3	DX8900 S3	AF250 S2	AF650 S2	AF250		AF650
Diagnostic Utilities																		
show diagnosis	x	x	x	x	x	x	x	x	x	x	x	x	x	x	x	x	x	x
LED																		
show led	x	x	x	x	x	x	x	x	x	x	x	x	x	x	x	x	x	x
set led	x	x	x	x	x	x	x	x	x	x	x	x	x	x	x	x	x	x
Other Notification																		
show event-parameters	x	x	x	x	x	x	x	x	x	x	x	x	x	x	x	x	x	x
set event-parameters	x	x	x	x	x	x	x	x	x	x	x	x	x	x	x	x	x	x
Subsystem Parameters																		
show subsystem-parameters	x	x	x	x	x	x	x	x	x	x	x	x	x	x	x	x	x	x
set subsystem-parameters	x	x	x	x	x	x	x	x	x	x	x	x	x	x	x	x	x	x
Reservations																		
show reservation	x	x	x	x	x	x	x	x	x	x	x	x	x	x	x	x	x	x
release reservation	x	x	x	x	x	x	x	x	x	x	x	x	x	x	x	x	x	x

Appendix B List of Supported Commands
 B.1 List of Supported Commands (of the Target Model)

Command name	Target model																Remarks	
	DX60 S4	DX100 S4	DX200 S4	DX500 S4	DX600 S4	DX60 S3	DX100 S3	DX200 S3	DX500 S3	DX600 S3	DX8100 S3	DX8700 S3	DX8900 S3	AF250 S2	AF650 S2	AF250		AF650
Cache Utilities																		
show pinned-data	x	x	x	x	x	x	x	x	x	x	x	x	x	x	x	x	x	x
Disk Patrol																		
show disk-patrol	x	x	x	x	x	x	x	x	x	x	x	x	x	x	x	x	x	x
set disk-patrol	x	x	x	x	x	x	x	x	x	x	x	x	x	x	x	x	x	x

Table B.16 List of supported commands for NAS function management (of the target model)

Command name	Target model																Remarks	
	DX60 S4	DX100 S4	DX200 S4	DX500 S4	DX600 S4	DX60 S3	DX100 S3	DX200 S3	DX500 S3	DX600 S3	DX8100 S3	DX8700 S3	DX8900 S3	AF250 S2	AF650 S2	AF250		AF650
NAS Shared Folder																		
show nas-share		x	x	x	x		x	x	x	x								(*1)
create nas-share		x	x	x	x		x	x	x	x								(*1)
set nas-share		x	x	x	x		x	x	x	x								(*1)
delete nas-share		x	x	x	x		x	x	x	x								(*1)
clear nas-data		x	x	x	x		x	x	x	x								(*1)
show nas-share-progress		x	x	x	x		x	x	x	x								(*1)
show nas-home-directory		x	x	x	x		x	x	x	x								(*1)
delete nas-home-directory		x	x	x	x		x	x	x	x								(*1)
NAS Network Interface																		
show nas-interface		x	x	x	x		x	x	x	x								(*1)
create nas-interface		x	x	x	x		x	x	x	x								(*1)
set nas-interface		x	x	x	x		x	x	x	x								(*1)
delete nas-interface		x	x	x	x		x	x	x	x								(*1)
NAS Network Interface Bonding Settings																		
show nas-bonding		x	x	x	x		x	x	x	x								(*1)
set nas-bonding		x	x	x	x		x	x	x	x								(*1)
delete nas-bonding		x	x	x	x		x	x	x	x								(*1)
NAS Network Interface Multipath Settings																		
show nas-multipath		x	x	x	x		x	x	x	x								(*1)
set nas-multipath		x	x	x	x		x	x	x	x								(*1)
delete nas-multipath		x	x	x	x		x	x	x	x								(*1)
NAS Network Settings																		
show nas-port		x	x	x	x		x	x	x	x								(*1)
set nas-port		x	x	x	x		x	x	x	x								(*1)
show nas-dns		x	x	x	x		x	x	x	x								(*1)
set nas-dns		x	x	x	x		x	x	x	x								(*1)

Appendix B List of Supported Commands
 B.1 List of Supported Commands (of the Target Model)

Command name	Target model																Remarks		
	DX60 S4	DX100 S4	DX200 S4	DX500 S4	DX600 S4	DX60 S3	DX100 S3	DX200 S3	DX500 S3	DX600 S3	DX8100 S3	DX8700 S3	DX8900 S3	AF250 S2	AF650 S2	AF250		AF650	DX200F
show nas-route		x	x	x	x		x	x	x	x									(*1)
set nas-route		x	x	x	x		x	x	x	x									(*1)
delete nas-route		x	x	x	x		x	x	x	x									(*1)
show nas-route6		x	x	x	x		x	x	x	x									(*1)
set nas-route6		x	x	x	x		x	x	x	x									(*1)
delete nas-route6		x	x	x	x		x	x	x	x									(*1)
NAS Server Configurations																			
show nas-server		x	x	x	x		x	x	x	x									(*1)
set nas-server		x	x	x	x		x	x	x	x									(*1)
show nas-cache-distribution		x	x	x	x		x	x	x	x									(*1)
initialize nas-cache-distribution		x	x	x	x		x	x	x	x									(*1)
NAS Authentication Settings																			
show nas-ad		x	x	x	x		x	x	x	x									(*1)
set nas-ad		x	x	x	x		x	x	x	x									(*1)
show nas-ldap		x	x	x	x		x	x	x	x									(*1)
set nas-ldap		x	x	x	x		x	x	x	x									(*1)
show nas-local-user		x	x	x	x		x	x	x	x									(*1)
create nas-local-user		x	x	x	x		x	x	x	x									(*1)
set nas-local-user		x	x	x	x		x	x	x	x									(*1)
delete nas-local-user		x	x	x	x		x	x	x	x									(*1)
show nas-local-group		x	x	x	x		x	x	x	x									(*1)
create nas-local-group		x	x	x	x		x	x	x	x									(*1)
delete nas-local-group		x	x	x	x		x	x	x	x									(*1)
FTP/FXP Functions																			
show nas-ftp		x	x	x	x		x	x	x	x									(*1)
set nas-ftp		x	x	x	x		x	x	x	x									(*1)
delete nas-ftp		x	x	x	x		x	x	x	x									(*1)
NAS Network Connection Testing																			
test nas-ping		x	x	x	x		x	x	x	x									(*1)
test nas-ping6		x	x	x	x		x	x	x	x									(*1)
test nas-traceroute		x	x	x	x		x	x	x	x									(*1)
test nas-traceroute6		x	x	x	x		x	x	x	x									(*1)
File System Management																			
show nas-df		x	x	x	x		x	x	x	x									(*1)
show nas-fsstat		x	x	x	x		x	x	x	x									(*1)
show nas-fsmntstat		x	x	x	x		x	x	x	x									(*1)
reconfigure nas-fs		x	x	x	x		x	x	x	x									(*1)

Appendix B List of Supported Commands
 B.1 List of Supported Commands (of the Target Model)

Command name	Target model															Remarks			
	DX60 S4	DX100 S4	DX200 S4	DX500 S4	DX600 S4	DX60 S3	DX100 S3	DX200 S3	DX500 S3	DX600 S3	DX8100 S3	DX8700 S3	DX8900 S3	AF250 S2	AF650 S2		AF250	AF650	DX200F
Snapshot																			
show nas-snapshot		x	x	x	x		x	x	x	x									(*1)
set nas-snapshot		x	x	x	x		x	x	x	x									(*1)
delete nas-snapshot		x	x	x	x		x	x	x	x									(*1)
start nas-snapshot		x	x	x	x		x	x	x	x									(*1)
stop nas-snapshot		x	x	x	x		x	x	x	x									(*1)
Quota																			
show nas-quota		x	x	x	x		x	x	x	x									(*1)
create nas-quota		x	x	x	x		x	x	x	x									(*1)
set nas-quota		x	x	x	x		x	x	x	x									(*1)
delete nas-quota		x	x	x	x		x	x	x	x									(*1)
NAS Packet Capture																			
show nas-pcap		x	x	x	x		x	x	x	x									(*1)
start nas-pcap		x	x	x	x		x	x	x	x									(*1)
stop nas-pcap		x	x	x	x		x	x	x	x									(*1)
clear nas-pcap		x	x	x	x		x	x	x	x									(*1)
NAS Audit Log																			
show nas-audit		x	x	x	x		x	x	x	x									(*1)
set nas-audit		x	x	x	x		x	x	x	x									(*1)
show nas-audit-log-information		x	x	x	x		x	x	x	x									(*1)
clear nas-audit-log		x	x	x	x		x	x	x	x									(*1)
NAS Engine User Settings																			
show nas-engine-user		x	x	x	x		x	x	x	x									(*1)
create nas-engine-user		x	x	x	x		x	x	x	x									(*1)
delete nas-engine-user		x	x	x	x		x	x	x	x									(*1)
NAS Function Restoration																			
forced nas-fsmount		x	x	x	x		x	x	x	x									(*1)
forced nas-fsunmount		x	x	x	x		x	x	x	x									(*1)
forced nas-fsoffline		x	x	x	x		x	x	x	x									(*1)
forced nas-fsonline		x	x	x	x		x	x	x	x									(*1)
show nas-fsck		x	x	x	x		x	x	x	x									(*1)
start nas-fsck		x	x	x	x		x	x	x	x									(*1)
forced nas-fslock		x	x	x	x		x	x	x	x									(*1)
recover nas-engine		x	x	x	x		x	x	x	x									(*1)
forced online		x	x	x	x		x	x	x	x									(*1)
show nas-log-info		x	x	x	x		x	x	x	x									(*1)
set nas-log-info		x	x	x	x		x	x	x	x									(*1)
show nas-lock		x	x	x	x		x	x	x	x									(*1)

Appendix B List of Supported Commands
 B.1 List of Supported Commands (of the Target Model)

Command name	Target model															Remarks				
	DX60 S4	DX100 S4	DX200 S4	DX500 S4	DX600 S4	DX60 S3	DX100 S3	DX200 S3	DX500 S3	DX600 S3	DX8100 S3	DX8700 S3	DX8900 S3	AF250 S2	AF650 S2		AF250	AF650	DX200F	
delete nas-lock		x	x	x	x		x	x	x	x										(*1)
show nas-file-inflate		x	x	x	x		x	x	x	x										(*1)
start nas-file-inflate		x	x	x	x		x	x	x	x										(*1)
stop nas-file-inflate		x	x	x	x		x	x	x	x										(*1)

*1: Supports unified storage only.

Table B.17 List of supported commands for Storage Cluster management (of the target model)

Command name	Target model															Remarks			
	DX60 S4	DX100 S4	DX200 S4	DX500 S4	DX600 S4	DX60 S3	DX100 S3	DX200 S3	DX500 S3	DX600 S3	DX8100 S3	DX8700 S3	DX8900 S3	AF250 S2	AF650 S2		AF250	AF650	DX200F
Storage Cluster																			
show storage-cluster-license			x	x	x			x	x	x	x	x	x	x	x	x	x	x	
set storage-cluster-license			x	x	x			x	x	x	x	x	x	x	x	x	x	x	
delete storage-cluster-license			x	x	x			x	x	x	x	x	x	x	x	x	x	x	
show tfo-groups			x	x	x			x	x	x	x	x	x	x	x	x	x	x	
create tfo-group			x	x	x			x	x	x	x	x	x	x	x	x	x	x	
set tfo-group			x	x	x			x	x	x	x	x	x	x	x	x	x	x	
delete tfo-group			x	x	x			x	x	x	x	x	x	x	x	x	x	x	
show tfo-pair			x	x	x			x	x	x	x	x	x	x	x	x	x	x	
set tfo-pair			x	x	x			x	x	x	x	x	x	x	x	x	x	x	
release tfo-pair			x	x	x			x	x	x	x	x	x	x	x	x	x	x	
recover tfo-pair			x	x	x			x	x	x	x	x	x	x	x	x	x	x	
forced tfo-group-activate			x	x	x			x	x	x	x	x	x	x	x	x	x	x	

Table B.18 List of supported commands for CLI original function management (of the target model)

Command name	Target model															Remarks			
	DX60 S4	DX100 S4	DX200 S4	DX500 S4	DX600 S4	DX60 S3	DX100 S3	DX200 S3	DX500 S3	DX600 S3	DX8100 S3	DX8700 S3	DX8900 S3	AF250 S2	AF650 S2		AF250	AF650	DX200F
CLI Environment																			
set clienv-force-unlock	x	x	x	x	x	x	x	x	x	x	x	x	x	x	x	x	x	x	
set clienv-idle-timeout	x	x	x	x	x	x	x	x	x	x	x	x	x	x	x	x	x	x	
logoff/logout/exit	x	x	x	x	x	x	x	x	x	x	x	x	x	x	x	x	x	x	
help	x	x	x	x	x	x	x	x	x	x	x	x	x	x	x	x	x	x	

B.2 List of Supported Commands (Policies)

This section shows the policies for each command.

Table B.19 List of supported commands (policies)

Command name	Policy													
	Status	RAID Group Management	Volume - Create / Modify	Volume - Delete / Format	NAS Management	Host Interface Management	Advanced Copy Management	Copy Session Management	Storage Management	User Management	Authentication / Role	Security Setting	Maintenance Information	Firmware Management
Storage System Status														
show status	x													
show enclosure-status	x													
show fru-ce	x													
show fru-fe	x													
show fru-de	x													
show disks	x	x											x	
show hardware-information	x													
RAID Group Management														
show raid-groups	x	x	x											
show raid-group-progress	x	x	x											
create raid-group		x												
set raid-group		x									x (*1)			
delete raid-group		x												
expand raid-group		x												
set global-spare		x												
release global-spare		x												
set dedicated-spare		x												
release dedicated-spare		x												
show eco-mode	x	x												
set eco-mode		x												
show eco-schedule	x	x												
create eco-schedule		x												
set eco-schedule		x												
delete eco-schedule		x												
show eco-raid-group	x	x												
set eco-raid-group		x												

Appendix B List of Supported Commands
 B.2 List of Supported Commands (Policies)

Command name	Policy													
	Status	RAID Group Management	Volume - Create / Modify	Volume - Delete / Format	NAS Management	Host Interface Management	Advanced Copy Management	Copy Session Management	Storage Management	User Management	Authentication / Role	Security Setting	Maintenance Information	Firmware Management
release eco-raid-group		x												
Volume Management														
show volumes	x		x	x		x		x				x		
show volume-progress	x		x	x		x						x		
show volume-mapping	x		x	x		x		x				x		
create volume			x											
set volume			x											
delete volume				x										
delete all-volumes				x										
format volume				x										
expand volume			x											
set volume-parameters			x											
show migration	x		x	x		x						x		
start migration			x									x (*1)		
stop migration			x											
show balancing-thin-pro-volumes	x		x											
start balancing-thin-pro-volume			x											
stop balancing-thin-pro-volume			x											
start zero-reclamation			x											
stop zero-reclamation			x											
show volume-qos	x		x											
set volume-qos			x											
create flexible-tier-volume			x											
set flexible-tier-volume			x											
format flexible-tier-volume				x										
expand flexible-tier-volume			x											
delete flexible-tier-volume				x										
delete all-flexible-tier-volumes				x										
start flexible-tier-migration			x									x		
show odx-mode									x					
set odx-mode									x					
create odx-buffer-volume			x											
set odx-buffer-volume			x											

Appendix B List of Supported Commands
 B.2 List of Supported Commands (Policies)

Command name	Policy													
	Status	RAID Group Management	Volume - Create / Modify	Volume - Delete / Format	NAS Management	Host Interface Management	Advanced Copy Management	Copy Session Management	Storage Management	User Management	Authentication / Role	Security Setting	Maintenance Information	Firmware Management
delete odx-buffer-volume				X										
show extreme-cache	X		X						X					
set extreme-cache									X					
set volume-exc			X						X					
show extreme-cache-pool	X		X						X					
create extreme-cache-pool									X					
delete extreme-cache-pool									X					
WVOL														
show wvol-mode	X								X					
set wvol-mode									X					
show wvol-task									X					
Thin Provisioning Pool Management														
show thin-provisioning		X							X					
set thin-provisioning									X					
show thin-pro-pools	X	X	X	X										
show thin-pro-pool-progress	X	X	X											
create thin-pro-pool		X												
set thin-pro-pool		X												
delete thin-pro-pool		X												
expand thin-pro-pool		X												
format thin-pro-pool		X												
show eco-thin-pro-pool	X	X												
set eco-thin-pro-pool		X												
release eco-thin-pro-pool		X												
Flexible Tier Management														
show flexible-tier-mode		X							X					
show flexible-tier-pools	X	X	X	X										
show flexible-tier-pool-progress	X	X	X											
delete flexible-tier-pool		X												
show flexible-tier-sub-pools	X	X	X	X										
set flexible-tier-sub-pool		X												
stop shrinking-flexible-tier-pool		X												
show ftrpe-migration	X		X	X		X						X		
show balancing-flexible-tier-pools	X		X											

Appendix B List of Supported Commands
 B.2 List of Supported Commands (Policies)

Command name	Policy													
	Status	RAID Group Management	Volume - Create / Modify	Volume - Delete / Format	NAS Management	Host Interface Management	Advanced Copy Management	Copy Session Management	Storage Management	User Management	Authentication / Role	Security Setting	Maintenance Information	Firmware Management
start balancing-flexible-tier-pool			x											
stop balancing-flexible-tier-pool			x											
Host Interface Management														
show fc-parameters	x					x								
set fc-parameters						x								
show sas-parameters	x					x								
set sas-parameters						x								
show iscsi-parameters	x					x								
set iscsi-parameters						x								
show fcoe-parameters	x					x								
set fcoe-parameters						x								
show host-wwn-names	x					x								
create host-wwn-name						x								
set host-wwn-name						x								
delete host-wwn-name						x								
discover host-wwn-names						x								
show host-sas-addresses	x					x								
create host-sas-address						x								
set host-sas-address						x								
delete host-sas-address						x								
discover host-sas-addresses						x								
show host-iscsi-names	x					x								
create host-iscsi-name						x								
set host-iscsi-name						x								
delete host-iscsi-name						x								
discover host-iscsi-names						x								
show host-affinity	x					x								
set host-affinity						x								
copy host-affinity						x								
release host-affinity						x								
show mapping	x					x								
set mapping						x								
copy mapping						x								
release mapping						x								

Appendix B List of Supported Commands
 B.2 List of Supported Commands (Policies)

Command name	Policy													
	Status	RAID Group Management	Volume - Create / Modify	Volume - Delete / Format	NAS Management	Host Interface Management	Advanced Copy Management	Copy Session Management	Storage Management	User Management	Authentication / Role	Security Setting	Maintenance Information	Firmware Management
show host-groups	x					x								
create host-group						x								
set host-group						x								
delete host-group						x								
show port-groups	x					x								
create port-group						x								
set port-group						x								
delete port-group						x								
show lun-groups						x								
create lun-group						x								
set lun-group						x								
copy lun-group						x								
delete lun-group						x								
show host-path-state	x					x								
set host-path-state						x								
show host-lu-qos-performance						x								
start host-lu-qos-performance						x								
stop host-lu-qos-performance						x								
show host-response	x					x								
set host-response						x								
delete host-response						x								
show host-sense						x								
set host-sense						x								
delete host-sense						x								
show ca-reset-group	x					x								
set ca-reset-group						x								
test iscsi-ping						x								
show qos-mode	x					x								
set qos-mode						x								
show lu-qos-groups	x					x								
set lu-qos-group						x								
delete lu-qos-group						x								
show host-lu-qos	x					x								
set host-lu-qos						x								

Appendix B List of Supported Commands
 B.2 List of Supported Commands (Policies)

Command name	Policy													
	Status	RAID Group Management	Volume - Create / Modify	Volume - Delete / Format	NAS Management	Host Interface Management	Advanced Copy Management	Copy Session Management	Storage Management	User Management	Authentication / Role	Security Setting	Maintenance Information	Firmware Management
show qos-schedule	x					x								
set qos-schedule						x								
delete all-qos-setting				x		x								
show ca-port-login-host	x					x								
Advanced Copy Management														
show advanced-copy-license	x						x	x	x					
set advanced-copy-license									x					
delete advanced-copy-license									x					
show advanced-copy-policy	x													
set advanced-copy-policy							x							
show advanced-copy-parameters	x						x	x	x					
set advanced-copy-parameters							x							
show snap-data-volume	x													
initialize snap-data-volume			x											
show snap-data-pool	x						x							
delete snap-data-pool-volume			x											
show advanced-copy-sessions	x							x						
start advanced-copy								x						
stop advanced-copy								x						
show host-port-mode						x								
set host-port-mode						x								
show rec-path	x						x							
import rec-path							x							
show backup-rec-path-information	x													
export backup-rec-path							x							
convert rec-path							x							
measure rec-round-trip-time							x							
set rec-round-trip-time							x							
set rec-multiplicity							x							
show rec-buffer	x						x							
set rec-buffer							x							
delete rec-buffer							x							
show rec-disk-buffer	x						x							
create rec-disk-buffer							x							

Appendix B List of Supported Commands
 B.2 List of Supported Commands (Policies)

Command name	Policy													
	Status	RAID Group Management	Volume - Create / Modify	Volume - Delete / Format	NAS Management	Host Interface Management	Advanced Copy Management	Copy Session Management	Storage Management	User Management	Authentication / Role	Security Setting	Maintenance Information	Firmware Management
set rec-disk-buffer							X							
delete rec-disk-buffer							X							
format rec-disk-buffer							X							
release rec-disk-buffer							X							
set rec-path-qos							X							
User Management														
show role										X	X			
create role											X			
set role											X			
delete role											X			
show user-policy										X	X			
set user-policy										X				
show users										X	X			
create user										X				
set user										X				
delete user										X				
show login-users										X	X			
set password	X	X	X	X	X	X	X	X	X	X	X	X	X	X
initialize all-users										X				
import ssh-public-key										X				
delete ssh-public-key										X				
show maintenance-key										X				
show radius											X			
set radius											X			
Network Management														
show network	X									X				
set network										X				
show firewall										X				
set firewall										X				
show network-stat										X				
test network										X				
show snmp	X									X				
set snmp										X				
show snmp-manager										X				

Appendix B List of Supported Commands
 B.2 List of Supported Commands (Policies)

Command name	Policy												
	Status	RAID Group Management	Volume - Create / Modify	Volume - Delete / Format	NAS Management	Host Interface Management	Advanced Copy Management	Copy Session Management	Storage Management	User Management	Authentication / Role	Security Setting	Maintenance Information
create snmp-manager									x				
set snmp-manager									x				
delete snmp-manager									x				
show snmp-view									x				
create snmp-view									x				
set snmp-view									x				
delete snmp-view									x				
show snmp-user									x				
create snmp-user									x				
set snmp-user									x				
delete snmp-user									x				
show community-profile									x				
create community-profile									x				
set community-profile									x				
delete community-profile									x				
show snmp-trap									x				
set snmp-trap									x				
delete snmp-trap									x				
test snmp-trap									x				
export enhanced-mib									x				
show email-notification	x								x				
set email-notification									x				
test email									x				
show event-notification									x				
set event-notification									x				
show lcd-suppress									x				
set lcd-suppress									x				
show smi-s									x				
set smi-s									x				
create ssh-server-key									x				
create ssl-certificate									x				
export ssl-certificate-request									x				
import ssl-certificate									x				
show ssl-version									x				

Appendix B List of Supported Commands
 B.2 List of Supported Commands (Policies)

Command name	Policy													
	Status	RAID Group Management	Volume - Create / Modify	Volume - Delete / Format	NAS Management	Host Interface Management	Advanced Copy Management	Copy Session Management	Storage Management	User Management	Authentication / Role	Security Setting	Maintenance Information	Firmware Management
set ssl-version								x						
show ais-connect								x					x	
set ais-connect								x					x	
set ais-connect-remote-session								x						
test ais-connect								x						
send ais-connect-log								x						
test ais-connect-event-notification								x						
import ais-ssl-certificate								x						
show ais-communication-log								x						
set remote-support-mode								x						
System Settings														
show date	x						x	x				x		
set date								x						
show ntp	x							x						
set ntp								x						
show storage-system-name	x						x	x				x		
set storage-system-name								x						
show encryption							x	x				x		
set encryption												x		
show boxid							x							
set boxid							x							
show power-synchronization								x						
set power-synchronization								x						
show sed-authentication	x						x	x				x		
set sed-authentication												x		
show syslog-notification	x							x						
set syslog-notification								x						
show audit	x											x		
set audit												x		
show sed-key-machine-name	x						x	x				x		
set sed-key-machine-name												x		
show sed-key-servers	x						x	x				x		
set sed-key-server												x		
import ssl-kmip-certificate												x		

Appendix B List of Supported Commands
 B.2 List of Supported Commands (Policies)

Command name	Policy													
	Status	RAID Group Management	Volume - Create / Modify	Volume - Delete / Format	NAS Management	Host Interface Management	Advanced Copy Management	Copy Session Management	Storage Management	User Management	Authentication / Role	Security Setting	Maintenance Information	Firmware Management
show sed-key-groups	x						x		x			x		
create sed-key-group												x		
set sed-key-group												x		
delete sed-key-group												x		
change sed-key												x		
recover sed-key-group		x (*2)										x		
shutdown									x					
show dedup-mode	x								x					
set dedup-mode									x					
show non-disruptive-storage-migration	x								x					
set non-disruptive-storage-migration									x					
discover external-storage		x												
show external-drive	x	x												
create external-drive		x												
delete external-drive		x												
show external-raid-group	x	x												
create external-raid-group		x												
delete external-raid-group		x												
recover external-raid-group		x												
Performance														
show performance	x													
start performance									x					
stop performance									x					
show raid-tuning	x	x												
set raid-tuning		x												
show cache-parameters			x											
set cache-parameters			x											
Event Log Information														
show events													x	
delete events													x	
Environmental Information														
show power-consumption	x													

Appendix B List of Supported Commands
 B.2 List of Supported Commands (Policies)

Command name	Policy													
	Status	RAID Group Management	Volume - Create / Modify	Volume - Delete / Format	NAS Management	Host Interface Management	Advanced Copy Management	Copy Session Management	Storage Management	User Management	Authentication / Role	Security Setting	Maintenance Information	Firmware Management
Maintenance Operation and Maintenance Information														
hot expansion									X					
show remote-dir	X													
show firmware-version	X													
export log	X												X	
show panic-dump													X	
export panic-dump													X	
show config-information													X	
export config-information													X	
show disk-error													X	
clear disk-error													X	
show port-error													X	
show bad-data-info	X													
Utility														
show diagnosis	X													
show led	X													
set led	X													
show event-parameters								X						
set event-parameters								X						
show subsystem-parameters								X						
set subsystem-parameters								X						
show reservation	X					X								
release reservation						X								
show pinned-data	X													
show disk-patrol								X						
set disk-patrol								X						
NAS Shared Folder														
show nas-share	X				X									
create nas-share					X									
set nas-share					X									
delete nas-share					X									
clear nas-data					X									
show nas-share-progress	X				X									
show nas-home-directory	X				X									

Appendix B List of Supported Commands
 B.2 List of Supported Commands (Policies)

Command name	Policy													
	Status	RAID Group Management	Volume - Create / Modify	Volume - Delete / Format	NAS Management	Host Interface Management	Advanced Copy Management	Copy Session Management	Storage Management	User Management	Authentication / Role	Security Setting	Maintenance Information	Firmware Management
delete nas-home-directory					x									
NAS Network Interface														
show nas-interface	x				x									
create nas-interface					x									
set nas-interface					x									
delete nas-interface					x									
NAS Network Interface Bonding Settings														
show nas-bonding	x				x									
set nas-bonding					x									
delete nas-bonding					x									
NAS Network Interface Multipath Configuration														
show nas-multipath	x				x									
set nas-multipath					x									
delete nas-multipath					x									
NAS Network Settings														
show nas-port	x				x									
set nas-port					x									
show nas-dns	x				x									
set nas-dns					x									
show nas-route	x				x									
set nas-route					x									
delete nas-route					x									
show nas-route6	x				x									
set nas-route6					x									
delete nas-route6					x									
NAS Server Configuration														
show nas-server	x				x							x		
set nas-server					x							x		
show nas-cache-distribution	x				x									
initialize nas-cache-distribution					x									
NAS Authentication Settings														
show nas-ad					x									
set nas-ad					x									
show nas-ldap					x									

Appendix B List of Supported Commands
 B.2 List of Supported Commands (Policies)

Command name	Policy													
	Status	RAID Group Management	Volume - Create / Modify	Volume - Delete / Format	NAS Management	Host Interface Management	Advanced Copy Management	Copy Session Management	Storage Management	User Management	Authentication / Role	Security Setting	Maintenance Information	Firmware Management
set nas-ldap					x									
show nas-local-user	x											x		
create nas-local-user												x		
set nas-local-user												x		
delete nas-local-user												x		
show nas-local-group	x											x		
create nas-local-group												x		
delete nas-local-group												x		
FTP/FXP Functions														
show nas-ftp	x				x									
set nas-ftp					x									
delete nas-ftp					x									
NAS Network Connection Testing														
test nas-ping					x									
test nas-ping6					x									
test nas-traceroute					x									
test nas-traceroute6					x									
NAS File System Management														
show nas-df	x				x									
show nas-fsstat	x				x									
show nas-fsmntstat	x				x									
reconfigure nas-fs					x									
NAS Snapshot														
show nas-snapshot	x				x									
set nas-snapshot					x									
delete nas-snapshot					x									
start nas-snapshot					x									
stop nas-snapshot					x									
NAS Quota														
show nas-quota	x				x									
create nas-quota					x									
set nas-quota					x									
delete nas-quota					x									

Appendix B List of Supported Commands
 B.2 List of Supported Commands (Policies)

Command name	Policy													
	Status	RAID Group Management	Volume - Create / Modify	Volume - Delete / Format	NAS Management	Host Interface Management	Advanced Copy Management	Copy Session Management	Storage Management	User Management	Authentication / Role	Security Setting	Maintenance Information	Firmware Management
NAS Packet Capture														
show nas-pcap	x				x									
start nas-pcap					x									
stop nas-pcap					x									
clear nas-pcap					x									
NAS Audit Log														
show nas-audit	x				x									
set nas-audit					x									
show nas-audit-log-information	x				x									
clear nas-audit-log					x									
NAS Engine User Settings														
show nas-engine-user	x				x									
create nas-engine-user					x									
delete nas-engine-user					x									
NAS Function Restoration														
forced nas-fsmount					x									
forced nas-fsunmount					x									
forced nas-fsoffline					x									
forced nas-fsonline					x									
show nas-fsck	x				x									
start nas-fsck					x									
forced nas-fslock					x									
recover nas-engine					x									
forced online					x									
show nas-log-info													x	
set nas-log-info													x	
show nas-lock	x				x									
delete nas-lock					x									
show nas-file-inflate	x				x									
start nas-file-inflate					x									
stop nas-file-inflate					x									
Storage Cluster														
show storage-cluster-license	x								x					
set storage-cluster-license									x					

Appendix B List of Supported Commands
 B.2 List of Supported Commands (Policies)

Command name	Policy													
	Status	RAID Group Management	Volume - Create / Modify	Volume - Delete / Format	NAS Management	Host Interface Management	Advanced Copy Management	Copy Session Management	Storage Management	User Management	Authentication / Role	Security Setting	Maintenance Information	Firmware Management
delete storage-cluster-license									x					
show tfo-groups	x					x								
create tfo-group						x								
set tfo-group						x								
delete tfo-group						x								
show tfo-pair	x					x								
set tfo-pair						x								
release tfo-pair						x								
recover tfo-pair						x								
forced tfo-group-activate						x								
CLI Environment														
set clienv-force-unlock	x													
set clienv-idle-timeout								x						
logoff/logout/exit	x	x	x	x	x	x	x	x	x	x	x	x	x	x
help	x	x	x	x	x	x	x	x	x	x	x	x	x	x

*1: Policies that are required to set some parameters.

*2: Both the RAID Group Management policy and the Security Setting policy are required to execute this command.

B.3 List of Supported Commands (Default Roles)

This section shows the default role of each command.

Table B.20 List of supported commands (default roles)

Command name	Default role					
	Monitor	Admin	Storage Admin	Account Admin	Security Admin	Maintainer
Storage System Status						
show status	x	x	x		x	x
show enclosure-status	x	x	x		x	x
show fru-ce	x	x	x		x	x
show fru-fe	x	x	x		x	x
show fru-de	x	x	x		x	x
show disks	x	x	x		x	x
show hardware-information	x	x	x		x	x
RAID Group Management						
show raid-groups	x	x	x		x	x
show raid-group-progress	x	x	x		x	x
create raid-group		x	x			x
set raid-group		x	x			x
delete raid-group		x	x			x
expand raid-group		x	x			x
set global-spare		x	x			x
release global-spare		x	x			x
set dedicated-spare		x	x			x
release dedicated-spare		x	x			x
show eco-mode	x	x	x		x	x
set eco-mode		x	x			x
show eco-schedule	x	x	x		x	x
create eco-schedule		x	x			x
set eco-schedule		x	x			x
delete eco-schedule		x	x			x
show eco-raid-group	x	x	x		x	x
set eco-raid-group		x	x			x
release eco-raid-group		x	x			x
Volume Management						
show volumes	x	x	x		x	x
show volume-progress	x	x	x		x	x
show volume-mapping	x	x	x		x	x
create volume		x	x			x
set volume		x	x			x
delete volume		x	x			x
delete all-volumes		x	x			x
format volume		x	x			x

Appendix B List of Supported Commands
 B.3 List of Supported Commands (Default Roles)

Command name	Default role					
	Monitor	Admin	Storage Admin	Account Admin	Security Admin	Maintainer
expand volume		x	x			x
set volume-parameters		x	x			x
show migration	x	x	x		x	x
start migration		x	x			x
stop migration		x	x			x
show balancing-thin-pro-volumes	x	x	x		x	x
start balancing-thin-pro-volume		x	x			x
stop balancing-thin-pro-volume		x	x			x
start zero-reclamation		x	x			x
stop zero-reclamation		x	x			x
show volume-qos	x	x	x		x	x
set volume-qos		x	x			x
create flexible-tier-volume		x	x			x
set flexible-tier-volume		x	x			x
format flexible-tier-volume		x	x			x
expand flexible-tier-volume		x	x			x
delete flexible-tier-volume	x	x	x		x	x
delete all-flexible-tier-volumes	x	x	x		x	x
start flexible-tier-migration	x	x	x		x	x
show odx-mode		x				x
set odx-mode		x				x
create odx-buffer-volume		x	x			x
set odx-buffer-volume		x	x			x
delete odx-buffer-volume		x	x			x
show extreme-cache	x	x	x			x
set extreme-cache		x				x
set volume-exc		x	x			x
show extreme-cache-pool	x	x	x			x
create extreme-cache-pool		x				x
delete extreme-cache-pool		x				x
WVOL						
show vvol-mode	x	x	x		x	x
set vvol-mode		x				x
show vvol-task		x				x
Thin Provisioning Pool Management						
show thin-provisioning		x	x			x
set thin-provisioning		x				x
show thin-pro-pools	x	x	x		x	x
show thin-pro-pool-progress	x	x	x		x	x
create thin-pro-pool		x	x			x
set thin-pro-pool		x	x			x
delete thin-pro-pool		x	x			x
expand thin-pro-pool		x	x			x

Appendix B List of Supported Commands
 B.3 List of Supported Commands (Default Roles)

Command name	Default role					
	Monitor	Admin	Storage Admin	Account Admin	Security Admin	Maintainer
format thin-pro-pool		x	x			x
show eco-thin-pro-pool	x	x	x		x	x
set eco-thin-pro-pool		x	x			x
release eco-thin-pro-pool		x	x			x
Flexible Tier Management						
show flexible-tier-mode		x	x			x
show flexible-tier-pools	x	x	x		x	x
show flexible-tier-pool-progress		x	x			x
delete flexible-tier-pool	x	x	x		x	x
show flexible-tier-sub-pools	x	x	x		x	x
set flexible-tier-sub-pool		x	x			x
stop shrinking-flexible-tier-pool		x	x			x
show ftrpe-migration	x	x	x		x	x
show balancing-flexible-tier-pools	x	x	x		x	x
start balancing-flexible-tier-pool		x	x			x
stop balancing-flexible-tier-pool		x	x			x
Host Interface Management						
show fc-parameters	x	x	x		x	x
set fc-parameters		x	x			x
show sas-parameters	x	x	x		x	x
set sas-parameters		x	x			x
show iscsi-parameters	x	x	x		x	x
set iscsi-parameters		x	x			x
show fcoe-parameters	x	x	x		x	x
set fcoe-parameters		x	x			x
show host-wwn-names	x	x	x		x	x
create host-wwn-name		x	x			x
set host-wwn-name		x	x			x
delete host-wwn-name		x	x			x
discover host-wwn-names		x	x			x
show host-sas-addresses	x	x	x		x	x
create host-sas-address		x	x			x
set host-sas-address		x	x			x
delete host-sas-address		x	x			x
discover host-sas-addresses		x	x			x
show host-iscsi-names	x	x	x		x	x
create host-iscsi-name		x	x			x
set host-iscsi-name		x	x			x
delete host-iscsi-name		x	x			x
discover host-iscsi-names		x	x			x
show host-affinity	x	x	x		x	x
set host-affinity		x	x			x
copy host-affinity		x	x			x

Appendix B List of Supported Commands
 B.3 List of Supported Commands (Default Roles)

Command name	Default role					
	Monitor	Admin	Storage Admin	Account Admin	Security Admin	Maintainer
release host-affinity		x	x			x
show mapping	x	x	x		x	x
set mapping		x	x			x
copy mapping		x	x			x
release mapping		x	x			x
show host-groups	x	x	x		x	x
create host-group		x	x			x
set host-group		x	x			x
delete host-group		x	x			x
show port-groups	x	x	x		x	x
create port-group		x	x			x
set port-group		x	x			x
delete port-group		x	x			x
show lun-groups		x	x			x
create lun-group		x	x			x
set lun-group		x	x			x
copy lun-group		x	x			x
delete lun-group		x	x			x
show host-path-state	x	x	x		x	x
set host-path-state		x	x			x
show host-lu-qos-performance		x	x			x
start host-lu-qos-performance		x	x			x
stop host-lu-qos-performance		x	x			x
show host-response	x	x	x		x	x
set host-response		x	x			x
delete host-response		x	x			x
show host-sense		x	x			x
set host-sense		x	x			x
delete host-sense		x	x			x
show ca-reset-group	x	x	x		x	x
set ca-reset-group		x	x			x
test iscsi-ping		x	x			x
show qos-mode	x	x	x		x	x
set qos-mode		x	x			x
show lu-qos-groups	x	x	x		x	x
set lu-qos-group		x	x			x
delete lu-qos-group		x	x			x
show host-lu-qos	x	x	x		x	x
set host-lu-qos		x	x			x
show qos-schedule	x	x	x		x	x
set qos-schedule		x	x			x
delete all-qos-setting		x	x			x
show ca-port-login-host	x	x	x		x	x

Appendix B List of Supported Commands
 B.3 List of Supported Commands (Default Roles)

Command name	Default role					
	Monitor	Admin	Storage Admin	Account Admin	Security Admin	Maintainer
Advanced Copy Management						
show advanced-copy-license	x	x	x		x	x
set advanced-copy-license		x				x
delete advanced-copy-license		x				x
show advanced-copy-policy	x	x	x		x	x
set advanced-copy-policy		x	x			x
show advanced-copy-parameters	x	x	x		x	x
set advanced-copy-parameters		x	x			x
show snap-data-volume	x	x	x		x	x
initialize snap-data-volume		x	x			x
show snap-data-pool	x	x	x		x	x
delete snap-data-pool-volume		x	x			x
show advanced-copy-sessions	x	x	x		x	x
start advanced-copy		x	x			x
stop advanced-copy		x	x			x
show host-port-mode		x	x			x
set host-port-mode		x	x			x
show rec-path	x	x	x		x	x
import rec-path		x	x			x
show backup-rec-path-information	x	x	x		x	x
export backup-rec-path		x	x			x
convert rec-path		x	x			x
measure rec-round-trip-time		x	x			x
set rec-round-trip-time		x	x			x
set rec-multiplicity		x	x			x
show rec-buffer	x	x	x		x	x
set rec-buffer		x	x			x
delete rec-buffer		x	x			x
show rec-disk-buffer	x	x	x		x	x
create rec-disk-buffer		x	x			x
set rec-disk-buffer		x	x			x
delete rec-disk-buffer		x	x			x
format rec-disk-buffer		x	x			x
release rec-disk-buffer		x	x			x
set rec-path-qos		x	x			x
User Management						
show role		x		x		
create role		x		x		
set role		x		x		
delete role		x		x		
show user-policy		x		x		
set user-policy		x		x		
show users		x		x		

Appendix B List of Supported Commands
 B.3 List of Supported Commands (Default Roles)

Command name	Default role					
	Monitor	Admin	Storage Admin	Account Admin	Security Admin	Maintainer
create user		x		x		
set user		x		x		
delete user		x		x		
show login-users		x		x		
set password	x	x	x	x	x	x
initialize all-users		x		x		
import ssh-public-key		x		x		
delete ssh-public-key		x		x		
show maintenance-key		x		x		
show radius		x		x		
set radius		x		x		
Network Management						
show network	x	x	x		x	x
set network		x				x
show firewall		x				x
set firewall		x				x
show network-stat		x				x
test network		x				x
show snmp	x	x	x		x	x
set snmp		x				x
show snmp-manager		x				x
create snmp-manager		x				x
set snmp-manager		x				x
delete snmp-manager		x				x
show snmp-view		x				x
create snmp-view		x				x
set snmp-view		x				x
delete snmp-view		x				x
show snmp-user		x				x
create snmp-user		x				x
set snmp-user		x				x
delete snmp-user		x				x
show community-profile		x				x
create community-profile		x				x
set community-profile		x				x
delete community-profile		x				x
show snmp-trap		x				x
set snmp-trap		x				x
delete snmp-trap		x				x
test snmp-trap		x				x
export enhanced-mib		x				x
show email-notification	x	x	x		x	x
set email-notification		x				x

Appendix B List of Supported Commands
 B.3 List of Supported Commands (Default Roles)

Command name	Default role					
	Monitor	Admin	Storage Admin	Account Admin	Security Admin	Maintainer
test email		x				x
show event-notification		x				x
set event-notification		x				x
show lcd-suppress		x				x
set lcd-suppress		x				x
show smi-s		x				x
set smi-s		x				x
create ssh-server-key		x				x
create ssl-certificate		x				x
export ssl-certificate-request		x				x
import ssl-certificate		x				x
show ssl-version		x				x
set ssl-version		x				x
show ais-connect		x				x
set ais-connect		x				x
set ais-connect-remote-session		x				x
test ais-connect		x				x
send ais-connect-log		x				x
test ais-connect-event-notification		x				x
import ais-ssl-certificate		x				x
show ais-communication-log		x				x
set remote-support-mode		x				x
System Settings						
show date	x	x	x		x	x
set date		x				x
show ntp	x	x	x		x	x
set ntp		x				x
show storage-system-name	x	x	x		x	x
set storage-system-name		x				x
show encryption		x	x		x	x
set encryption		x			x	
show boxid		x	x			x
set boxid		x	x			x
show power-synchronization		x				x
set power-synchronization		x				x
show sed-authentication	x	x	x		x	x
set sed-authentication		x			x	
show syslog-notification	x	x	x		x	x
set syslog-notification		x				x
show audit	x	x	x		x	x
set audit					x	
show sed-key-machine-name	x	x	x		x	x
set sed-key-machine-name		x			x	

Appendix B List of Supported Commands
 B.3 List of Supported Commands (Default Roles)

Command name	Default role					
	Monitor	Admin	Storage Admin	Account Admin	Security Admin	Maintainer
show sed-key-servers	x	x	x		x	x
set sed-key-server		x			x	
import ssl-kmip-certificate		x			x	
show sed-key-groups	x	x	x		x	x
create sed-key-group		x			x	
set sed-key-group		x			x	
delete sed-key-group		x			x	
change sed-key		x			x	
recover sed-key-group		x			x	
shutdown		x				x
show dedup-mode	x	x	x		x	x
set dedup-mode		x				x
show non-disruptive-storage-migration	x	x	x		x	x
set non-disruptive-storage-migration		x				x
discover external-storage		x	x			x
show external-drive	x	x	x		x	x
create external-drive		x	x			x
delete external-drive		x	x			x
show external-raid-group	x	x	x		x	x
create external-raid-group		x	x			x
delete external-raid-group		x	x			x
recover external-raid-group		x	x			x
Performance						
show performance	x	x	x		x	x
start performance		x				x
stop performance		x				x
show raid-tuning	x	x	x		x	x
set raid-tuning		x	x			x
show cache-parameters		x	x			x
set cache-parameters		x	x			x
Event Log Information						
show events		x			x	x
delete events		x			x	x
Environmental Information						
show power-consumption	x	x	x		x	x
Maintenance Operation and Maintenance Information						
hot expansion		x				x
show remote-dir	x	x	x		x	x
show firmware-version	x	x	x		x	x
export log	x	x	x		x	x
show panic-dump		x			x	x
export panic-dump		x			x	x
show config-information		x			x	x

Appendix B List of Supported Commands
 B.3 List of Supported Commands (Default Roles)

Command name	Default role					
	Monitor	Admin	Storage Admin	Account Admin	Security Admin	Maintainer
export config-information		x			x	x
show disk-error		x			x	x
clear disk-error		x			x	x
show port-error		x			x	x
show bad-data-info	x	x	x		x	x
Utility						
show diagnosis	x	x	x		x	x
show led	x	x	x		x	x
set led	x	x	x		x	x
show event-parameters		x				x
set event-parameters		x				x
show subsystem-parameters		x				x
set subsystem-parameters		x				x
show reservation	x	x	x		x	x
release reservation		x	x			x
show pinned-data	x	x	x		x	x
show disk-patrol		x				x
set disk-patrol		x				x
NAS Shared Folder						
show nas-share	x	x	x		x	x
create nas-share		x	x			x
set nas-share		x	x			x
delete nas-share		x	x			x
clear nas-data		x	x			x
show nas-share-progress	x	x	x		x	x
show nas-home-directory	x	x	x		x	x
delete nas-home-directory		x	x			x
NAS Network Interface						
show nas-interface	x	x	x		x	x
create nas-interface		x	x			x
set nas-interface		x	x			x
delete nas-interface		x	x			x
NAS Network Interface Bonding settings						
show nas-bonding	x	x	x		x	x
set nas-bonding		x	x			x
delete nas-bonding		x	x			x
NAS Network Interface Multipath Configuration						
show nas-multipath	x	x	x		x	x
set nas-multipath		x	x			x
delete nas-multipath		x	x			x
NAS Network Settings						
show nas-port	x	x	x		x	x
set nas-port		x	x			x

Appendix B List of Supported Commands
 B.3 List of Supported Commands (Default Roles)

Command name	Default role					
	Monitor	Admin	Storage Admin	Account Admin	Security Admin	Maintainer
show nas-dns	x	x	x			x
set nas-dns		x	x			x
show nas-route		x	x		x	x
set nas-route		x	x		x	x
delete nas-route	x	x	x			x
show nas-route6	x	x	x			x
set nas-route6	x	x	x		x	x
delete nas-route6	x	x	x		x	x
NAS Server Configuration						
show nas-server	x	x	x		x	x
set nas-server		x	x		x	x
show nas-cache-distribution	x	x	x		x	x
initialize nas-cache-distribution		x	x			x
NAS Authentication Settings						
show nas-ad		x	x			x
set nas-ad		x	x			x
show nas-ldap		x	x			x
set nas-ldap		x	x			x
show nas-local-user	x	x	x		x	x
create nas-local-user		x			x	
set nas-local-user		x			x	
delete nas-local-user		x			x	
show nas-local-group	x	x	x		x	x
create nas-local-group		x			x	
delete nas-local-group		x			x	
FTP/FXP Functions						
show nas-ftp	x	x	x			x
set nas-ftp		x	x			x
delete nas-ftp		x	x			x
NAS Network Connection Testing						
test nas-ping		x	x		x	x
test nas-ping6		x	x		x	x
test nas-traceroute		x	x		x	x
test nas-traceroute6		x	x			x
NAS File System Management						
show nas-df	x	x	x			x
show nas-fsstat		x	x			x
show nas-fsmntstat		x	x		x	x
reconfigure nas-fs		x	x			x
NAS Snapshot						
show nas-snapshot	x	x	x		x	x
set nas-snapshot		x	x			x
delete nas-snapshot		x	x			x

Appendix B List of Supported Commands
 B.3 List of Supported Commands (Default Roles)

Command name	Default role					
	Monitor	Admin	Storage Admin	Account Admin	Security Admin	Maintainer
start nas-snapshot		x	x			x
stop nas-snapshot		x	x			x
NAS Quota						
show nas-quota	x	x	x		x	x
create nas-quota		x	x			x
set nas-quota		x	x			x
delete nas-quota		x	x			x
NAS Packet Capture						
show nas-pcap	x	x	x			x
start nas-pcap		x	x			x
stop nas-pcap		x	x			x
clear nas-pcap		x	x			x
NAS Audit Log						
show nas-audit	x	x	x			x
set nas-audit		x	x			x
show nas-audit-log-information	x	x	x			x
clear nas-audit-log		x	x			x
NAS Engine User Settings						
show nas-engine-user	x	x	x			x
create nas-engine-user		x	x			x
delete nas-engine-user		x	x			x
NAS Function Restoration						
forced nas-fsmount		x	x			x
forced nas-fsunmount		x	x			x
forced nas-fsoffline		x	x			x
forced nas-fsonline		x	x			x
show nas-fsck	x	x	x			x
start nas-fsck		x	x			x
forced nas-fslock		x	x			x
recover nas-engine		x	x			x
forced online		x	x			x
show nas-log-info		x			x	x
set nas-log-info		x			x	x
show nas-lock	x	x	x		x	x
delete nas-lock		x	x			x
show nas-file-inflate	x	x	x		x	x
start nas-file-inflate		x	x			x
stop nas-file-inflate		x	x			x
Storage Cluster						
show storage-cluster-license	x	x	x		x	x
set storage-cluster-license		x				x
delete storage-cluster-license		x				x
show tfo-groups	x	x	x		x	x

Appendix B List of Supported Commands
 B.3 List of Supported Commands (Default Roles)

Command name	Default role					
	Monitor	Admin	Storage Admin	Account Admin	Security Admin	Maintainer
create tfo-group		x	x			x
set tfo-group		x	x			x
delete tfo-group		x	x			x
show tfo-pair	x	x	x		x	x
set tfo-pair		x	x			x
release tfo-pair		x	x			x
recover tfo-pair		x	x			x
forced tfo-group-activate		x	x			x
CLI Environment						
set clienv-force-unlock	x	x	x		x	x
set clienv-idle-timeout		x				x
logoff/logout/exit	x	x	x	x	x	x
help	x	x	x	x	x	x

Appendix C

Firmware Version Support for Commands

This appendix provides a list of firmware versions that support CLI commands. An "x" mark indicates that the command is supported by this firmware or later.

Caution

- Some parameters of a command may be supported by a firmware version that is different from the firmware version that supports the command.
- Depending on the model, the supported firmware version varies.

List of firmware version support for commands

Command name	Firmware version														
	V10L10	V10L13	V10L16	V10L20	V10L21	V10L30	V10L32	V10L33	V10L40	V10L50	V10L51	V10L53	V10L60	V10L70	V10L80
Storage System Status															
show status	x														
show enclosure-status	x														
show fru-ce	x														
show fru-fe									x						
show fru-de	x														
show disks	x														
show hardware-information	x														
RAID Group Management															
show raid-groups	x														
show raid-group-progress	x														
create raid-group	x														
set raid-group	x														
delete raid-group	x														
expand raid-group	x														
set global-spare	x														
release global-spare	x														
set dedicated-spare	x														
release dedicated-spare	x														
show eco-mode	x														
set eco-mode	x														
show eco-schedule	x														
create eco-schedule	x														
set eco-schedule	x														
delete eco-schedule	x														

Command name	Firmware version														
	V10L10	V10L13	V10L16	V10L20	V10L21	V10L30	V10L32	V10L33	V10L40	V10L50	V10L51	V10L53	V10L60	V10L70	V10L80
show eco-raid-group	x														
set eco-raid-group	x														
release eco-raid-group	x														
Volume Management															
show volumes	x														
show volume-progress	x														
show volume-mapping	x														
create volume	x														
set volume	x														
delete volume	x														
delete all-volumes	x														
format volume	x														
expand volume	x														
set volume-parameters						x									
show migration	x														
start migration	x														
stop migration	x														
show balancing-thin-pro-volumes	x														
start balancing-thin-pro-volume	x														
stop balancing-thin-pro-volume	x														
start zero-reclamation	x														
stop zero-reclamation	x														
show volume-qos				x											
set volume-qos				x											
create flexible-tier-volume	x														
set flexible-tier-volume	x														
format flexible-tier-volume	x														
expand flexible-tier-volume	x														
delete flexible-tier-volume	x														
delete all-flexible-tier-volumes	x														
start flexible-tier-migration	x														
show odx-mode	x														
set odx-mode	x														
create odx-buffer-volume	x														
set odx-buffer-volume	x														
delete odx-buffer-volume	x														
show extreme-cache	x														
set extreme-cache	x														
set volume-exc	x														

Command name	Firmware version														
	V10L10	V10L13	V10L16	V10L20	V10L21	V10L30	V10L32	V10L33	V10L40	V10L50	V10L51	V10L53	V10L60	V10L70	V10L80
show extreme-cache-pool						x									
create extreme-cache-pool						x									
delete extreme-cache-pool						x									
WVOL															
show wvol-mode							x								
set wvol-mode							x								
show wvol-task										x					
Thin Provisioning Pool Management															
show thin-provisioning	x														
set thin-provisioning	x														
show thin-pro-pools	x														
show thin-pro-pool-progress	x														
create thin-pro-pool	x														
set thin-pro-pool	x														
delete thin-pro-pool	x														
expand thin-pro-pool	x														
format thin-pro-pool	x														
show eco-thin-pro-pool	x														
set eco-thin-pro-pool	x														
release eco-thin-pro-pool	x														
Flexible Tier Management															
show flexible-tier-mode	x														
show flexible-tier-pools	x														
show flexible-tier-pool-progress	x														
delete flexible-tier-pool	x														
show flexible-tier-sub-pools	x														
set flexible-tier-sub-pool	x														
stop shrinking-flexible-tier-pool													x		
show ftrpe-migration	x														
show balancing-flexible-tier-pools	x														
start balancing-flexible-tier-pool	x														
stop balancing-flexible-tier-pool	x														
Host Interface Management															
show fc-parameters	x														
set fc-parameters	x														
show sas-parameters	x														
set sas-parameters	x														
show iscsi-parameters	x														
set iscsi-parameters	x														

Command name	Firmware version														
	V10L10	V10L13	V10L16	V10L20	V10L21	V10L30	V10L32	V10L33	V10L40	V10L50	V10L51	V10L53	V10L60	V10L70	V10L80
show fcoe-parameters	x														
set fcoe-parameters	x														
show host-wwn-names	x														
create host-wwn-name	x														
set host-wwn-name	x														
delete host-wwn-name	x														
discover host-wwn-names	x														
show host-sas-addresses	x														
create host-sas-address	x														
set host-sas-address	x														
delete host-sas-address	x														
discover host-sas-addresses	x														
show host-iscsi-names	x														
create host-iscsi-name	x														
set host-iscsi-name	x														
delete host-iscsi-name	x														
discover host-iscsi-names	x														
show host-affinity	x														
set host-affinity	x														
copy host-affinity	x														
release host-affinity	x														
show mapping	x														
set mapping	x														
copy mapping	x														
release mapping	x														
show host-groups	x														
create host-group	x														
set host-group	x														
delete host-group	x														
show port-groups	x														
create port-group	x														
set port-group	x														
delete port-group	x														
show lun-groups	x														
create lun-group	x														
set lun-group	x														
copy lun-group	x														
delete lun-group	x														
show host-path-state	x														

Command name	Firmware version														
	V10L10	V10L13	V10L16	V10L20	V10L21	V10L30	V10L32	V10L33	V10L40	V10L50	V10L51	V10L53	V10L60	V10L70	V10L80
set host-path-state	x														
show host-lu-qos-performance	x														
start host-lu-qos-performance	x														
stop host-lu-qos-performance	x														
show host-response	x														
set host-response	x														
delete host-response	x														
show host-sense	x														
set host-sense	x														
delete host-sense	x														
show ca-reset-group	x														
set ca-reset-group	x														
test iscsi-ping	x														
show qos-mode	x														
set qos-mode	x														
show lu-qos-groups	x														
set lu-qos-group	x														
delete lu-qos-group	x														
show host-lu-qos	x														
set host-lu-qos	x														
show qos-schedule	x														
set qos-schedule	x														
delete all-qos-setting				x											
show ca-port-login-host															x
Advanced Copy Management															
show advanced-copy-license	x														
set advanced-copy-license	x														
delete advanced-copy-license	x														
show advanced-copy-policy	x														
set advanced-copy-policy	x														
show advanced-copy-parameters	x														
set advanced-copy-parameters	x														
show snap-data-volume	x														
initialize snap-data-volume	x														
show snap-data-pool	x														
delete snap-data-pool-volume	x														
show advanced-copy-sessions	x														
start advanced-copy	x														
stop advanced-copy	x														

Command name	Firmware version														
	V10L10	V10L13	V10L16	V10L20	V10L21	V10L30	V10L32	V10L33	V10L40	V10L50	V10L51	V10L53	V10L60	V10L70	V10L80
show host-port-mode	x														
set host-port-mode	x														
show rec-path	x														
import rec-path	x														
show backup-rec-path-information	x														
export backup-rec-path	x														
convert rec-path	x														
measure rec-round-trip-time	x														
set rec-round-trip-time	x														
set rec-multiplicity	x														
show rec-buffer	x														
set rec-buffer	x														
delete rec-buffer	x														
show rec-disk-buffer	x														
create rec-disk-buffer	x														
set rec-disk-buffer	x														
delete rec-disk-buffer	x														
format rec-disk-buffer	x														
release rec-disk-buffer	x														
set rec-path-qos						x									
User Management															
show role	x														
create role	x														
set role	x														
delete role	x														
show user-policy														x	
set user-policy														x	
show users	x														
create user	x														
set user	x														
delete user	x														
show login-users	x														
set password	x														
initialize all-users	x														
import ssh-public-key	x														
delete ssh-public-key	x														
show maintenance-key										x					
show radius	x														
set radius	x														

Command name	Firmware version														
	V10L10	V10L13	V10L16	V10L20	V10L21	V10L30	V10L32	V10L33	V10L40	V10L50	V10L51	V10L53	V10L60	V10L70	V10L80
Network Management															
show network	x														
set network	x														
show firewall	x														
set firewall	x														
show network-stat														x	
test network														x	
show snmp	x														
set snmp	x														
show snmp-manager	x														
create snmp-manager	x														
set snmp-manager	x														
delete snmp-manager	x														
show snmp-view	x														
create snmp-view	x														
set snmp-view	x														
delete snmp-view	x														
show snmp-user	x														
create snmp-user	x														
set snmp-user	x														
delete snmp-user	x														
show community-profile	x														
create community-profile	x														
set community-profile	x														
delete community-profile	x														
show snmp-trap	x														
set snmp-trap	x														
delete snmp-trap	x														
test snmp-trap	x														
export enhanced-mib	x														
show email-notification	x														
set email-notification	x														
test email	x														
show event-notification	x														
set event-notification	x														
show lcd-suppress									x						
set lcd-suppress									x						
show smi-s	x														
set smi-s	x														

Command name	Firmware version														
	V10L10	V10L13	V10L16	V10L20	V10L21	V10L30	V10L32	V10L33	V10L40	V10L50	V10L51	V10L53	V10L60	V10L70	V10L80
create ssh-server-key	x														
create ssl-certificate	x														
export ssl-certificate-request	x														
import ssl-certificate	x														
show ssl-version														x	
set ssl-version														x	
show ais-connect	x														
set ais-connect	x														
set ais-connect-remote-session	x														
test ais-connect	x														
send ais-connect-log	x														
test ais-connect-event-notification	x														
import ais-ssl-certificate	x														
show ais-communication-log														x	
set remote-support-mode													x		
System Settings															
show date	x														
set date	x														
show ntp	x														
set ntp	x														
show storage-system-name	x														
set storage-system-name	x														
show encryption	x														
set encryption	x														
show boxid	x														
set boxid	x														
show power-synchronization	x														
set power-synchronization	x														
show sed-authentication	x														
set sed-authentication	x														
show syslog-notification	x														
set syslog-notification	x														
show audit	x														
set audit	x														
show sed-key-machine-name	x														
set sed-key-machine-name	x														
show sed-key-servers	x														
set sed-key-server	x														
import ssl-kmip-certificate	x														

Command name	Firmware version														
	V10L10	V10L13	V10L16	V10L20	V10L21	V10L30	V10L32	V10L33	V10L40	V10L50	V10L51	V10L53	V10L60	V10L70	V10L80
show sed-key-groups	x														
create sed-key-group	x														
set sed-key-group	x														
delete sed-key-group	x														
change sed-key	x														
recover sed-key-group	x														
shutdown	x														
show dedup-mode													x		
set dedup-mode													x		
show non-disruptive-storage -migration															x
set non-disruptive-storage -migration															x
discover external-storage															x
show external-drive															x
create external-drive															x
delete external-drive															x
show external-raid-group															x
create external-raid-group															x
delete external-raid-group															x
recover external-raid-group															x
Performance															
show performance	x														
start performance	x														
stop performance	x														
show raid-tuning	x														
set raid-tuning	x														
show cache-parameters	x														
set cache-parameters	x														
Event Log Information															
show events	x														
delete events	x														
Environment Information															
show power-consumption						x									
Maintenance Information															
hot expansion						x									
show remote-dir	x														
show firmware-version	x														
export log	x														
show panic-dump	x														

Command name	Firmware version														
	V10L10	V10L13	V10L16	V10L20	V10L21	V10L30	V10L32	V10L33	V10L40	V10L50	V10L51	V10L53	V10L60	V10L70	V10L80
export panic-dump	x														
show config-information	x														
export config-information	x														
show disk-error	x														
clear disk-error	x														
show port-error	x														
show bad-data-info	x														
Utility															
show diagnosis	x														
show led	x														
set led	x														
show event-parameters	x														
set event-parameters	x														
show subsystem-parameters	x														
set subsystem-parameters	x														
show reservation	x														
release reservation	x														
show pinned-data	x														
show disk-patrol	x														
set disk-patrol	x														
NAS Shared Folder															
show nas-share	x														
create nas-share	x														
set nas-share	x														
delete nas-share	x														
clear nas-data											x				
show nas-share-progress											x				
show nas-home-directory												x			
delete nas-home-directory												x			
NAS Network Interface															
show nas-interface	x														
create nas-interface	x														
set nas-interface	x														
delete nas-interface	x														
NAS Network Interface Bonding Settings															
show nas-bonding	x														
set nas-bonding	x														
delete nas-bonding	x														

Command name	Firmware version														
	V10L10	V10L13	V10L16	V10L20	V10L21	V10L30	V10L32	V10L33	V10L40	V10L50	V10L51	V10L53	V10L60	V10L70	V10L80
NAS Network Interface Multipath Configuration															
show nas-multipath	x														
set nas-multipath	x														
delete nas-multipath	x														
NAS Network Settings															
show nas-port	x														
set nas-port	x														
show nas-dns	x														
set nas-dns	x														
show nas-route	x														
set nas-route	x														
delete nas-route	x														
show nas-route6	x														
set nas-route6	x														
delete nas-route6	x														
NAS Server Configuration															
show nas-server		x													
set nas-server		x													
show nas-cache-distribution												x			
initialize nas-cache-distribution												x			
NAS Authentication Settings															
show nas-ad	x														
set nas-ad	x														
show nas-ldap	x														
set nas-ldap	x														
show nas-local-user												x			
create nas-local-user												x			
set nas-local-user												x			
delete nas-local-user												x			
show nas-local-group												x			
create nas-local-group												x			
delete nas-local-group												x			
FTP/FXP Functions															
show nas-ftp											x				
set nas-ftp											x				
delete nas-ftp											x				
NAS Network Connection Testing															
test nas-ping	x														
test nas-ping6	x														

Command name	Firmware version														
	V10L10	V10L13	V10L16	V10L20	V10L21	V10L30	V10L32	V10L33	V10L40	V10L50	V10L51	V10L53	V10L60	V10L70	V10L80
test nas-traceroute	x														
test nas-traceroute6	x														
NAS File System Maintenance															
show nas-df	x														
show nas-fsstat	x														
show nas-fsmntstat	x														
reconfigure nas-fs					x										
NAS Snapshot															
show nas-snapshot					x										
set nas-snapshot					x										
delete nas-snapshot					x										
start nas-snapshot					x										
stop nas-snapshot					x										
NAS Quota															
show nas-quota					x										
create nas-quota					x										
set nas-quota					x										
delete nas-quota					x										
NAS Packet Capture															
show nas-pcap											x				
start nas-pcap											x				
stop nas-pcap											x				
clear nas-pcap											x				
NAS Audit Log															
show nas-audit											x				
set nas-audit											x				
show nas-audit-log-information											x				
show nas-audit-log											x				
NAS Engine User Settings															
show nas-engine-user											x				
create nas-engine-user											x				
delete nas-engine-user											x				
NAS Function Restoration															
forced nas-fsmount			x												
forced nas-fsunmount			x												
forced nas-fsoffline			x												
forced nas-fsonline			x												
show nas-fsck	x														
start nas-fsck			x												

Command name	Firmware version														
	V10L10	V10L13	V10L16	V10L20	V10L21	V10L30	V10L32	V10L33	V10L40	V10L50	V10L51	V10L53	V10L60	V10L70	V10L80
forced nas-fslock			x												
recover nas-engine			x												
forced online			x												
show nas-log-info								x							
set nas-log-info								x							
show nas-lock								x							
delete nas-lock								x							
show nas-file-inflate												x			
start nas-file-inflate												x			
stop nas-file-inflate												x			
Storage Cluster															
show storage-cluster-license						x									
set storage-cluster-license														x	
delete storage-cluster-license						x									
show tfo-groups						x									
create tfo-group						x									
set tfo-group						x									
delete tfo-group						x									
show tfo-pair						x									
set tfo-pair						x									
release tfo-pair						x									
recover tfo-pair						x									
forced tfo-group-activate						x									
CLI Environment															
set clienv-force-unlock	x														
set clienv-idle-timeout	x														
logoff/logout/exit	x														
help	x														

Appendix D

Basic Setting Examples

This appendix explains the basic procedures for creating volumes and make them accessible to hosts.

Note that the following procedures are also explained. For more details, refer to the pages listed below.

- Procedures for various host accesses
- Procedures for resetting settings

D.1 Settings When Using Volumes

This section explains how to create Standard volumes and make them accessible to hosts.

An outline of the settings is provided below.

(1) RAID Configuration Settings ("[D.1.1 RAID Configuration Setting Procedure](#)" (page 1245))

Create a RAID group and a volume.

- Creating RAID groups
Specify a drive to create a RAID group.
- Creating volumes
Create a volume in a RAID group.

(2) Host Access Settings ("[D.1.2 Host Access Setting Procedure](#)" (page 1246))

The security of data when multiple hosts are connected can be guaranteed by allocating a host interface port that can be accessed by the host and a volume that can be recognized by the host. This is why the host affinity setting is performed.

- Setting host affinity with a host group, a port group, and a LUN group.
 - Set the parameter to control the host interface port.
 - Register a host that can be used to identify the HBA (Hot Bus Adapter).
 - Create a host group (*1).
 - Create a port group (*2).
 - Create a LUN group (*3).
 - Set the relationship between a host group, port group, and LUN group.

*1: Host group

A host group is a group of hosts (HBAs) that have the same interface and access the same LUN groups. Multiple hosts (HBAs) can be set to one host group. Once the host group is created, the settings of the hosts (HBAs) can be changed when changing the settings of the host group. The required settings for each host (HBAs) are simplified and usability is enhanced.

*2: Port group

A port group is a group of ports that have the same port settings. Ports that access the same LUN group, such as the ports that use multipath connections to servers and the ports that connect servers that configure a cluster, are set to a single port group. The single port group can be allocated to multiple host groups. Once the port group is created, all of the ports can be selected at the same time. The required settings for each port are simplified and usability is enhanced.

*3: LUN group

A LUN group is a group of LUNs that are accessed from the same host group and port group.

D.1.1 RAID Configuration Setting Procedure

(1) Creating RAID groups

An example of creating a RAID group is shown below. For more details, refer to ["3.1 RAID Group Management" \(page 114\)](#).

Procedure

- 1 Specify 004 and 005 for the drive numbers, and create a RAID group that is named r1 (RAID1).

```
CLI> create raid-group -name r1 -level 1 -disks 004,005
```

End of procedure

(2) Creating volumes

An example of creating volumes is shown below. For more details, refer to ["3.2 Volume Management" \(page 148\)](#).

Procedure

- 1 Create volumes "v0", "v1", and "v2" in RAID group "r1".

```
CLI> create volume -name v -count 3 -rg-name r1 -type standard -size 512mb
```

End of procedure

D.1.2 Host Access Setting Procedure

This section is an example of how to set up host access. For more details, refer to ["3.6 Host Interface Management" \(page 302\)](#).

The following configuration example is used to explain the procedure.

Figure D.1 Host connection example

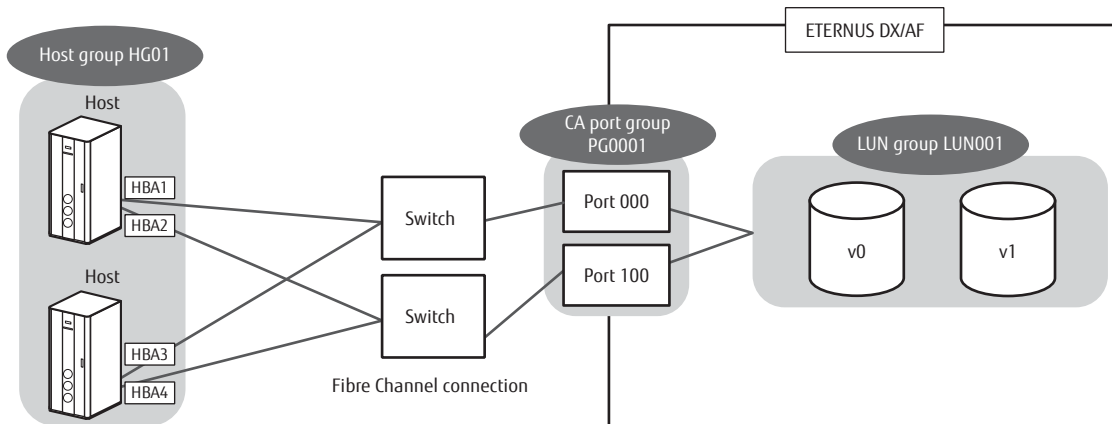

A relationship is set between port group PG0001, LUN group LUN001, and host group HG01.

Procedure

- 1 Change the connection topology of host interface ports 000 and 100 to fabric.

```
CLI> set fc-parameters -port 000,100 -connect fabric
```

- 2 Register a host WWN.

In this example, host WWNs named HBA1, HBA2, HBA3, and HBA4 are registered.

```
CLI> create host-wwn-name -wwn 40000000abc80e38 -name HBA1  
CLI> create host-wwn-name -wwn 40000000abc80e00 -name HBA2  
CLI> create host-wwn-name -wwn 40000000abc80e01 -name HBA3  
CLI> create host-wwn-name -wwn 40000000abc80e02 -name HBA4
```

- 3 Group HBA1, HBA2, HBA3, and HBA4 together, and create a host group named HG01.

```
CLI> create host-group -name HG01 -host-type fc -host-name HBA1,HBA2,HBA3,HBA4
```

- 4 Group host interface ports 000 and 100 together, and create a port group named PG0001.

```
CLI> create port-group -name PG0001 -port 000,100
```

5 Map a volume with LUNs and create a LUN group named LUN001.

```
CLI> create lun-group -name LUN001 -volume-name v0,v1 -lun 0-1
```

In this example, volumes are mapped as follows:

- Volume v0 is paired with LUN 0.
- Volume v1 is paired with LUN 1.

6 Set the relationship between port group PG0001, LUN group LUN001, and host group HG01.

```
CLI> set host-affinity -port-group-name PG0001 -lg-name LUN001 -host-group-name HG01
```

End of procedure

D.2 Settings for Various Host Accesses

This section describes host access settings that are not covered in ["D.1.2 Host Access Setting Procedure" \(page 1246\)](#).

An outline of these settings is provided below.

- Specifying a host and performing mapping (host affinity mode) (["D.2.1 Specifying a Host and Performing Mapping \(Host Affinity Mode\)" \(page 1248\)](#))
 - (1) Enable the host affinity mode of the host interface port.
 - (2) Set the parameter that controls the host interface port.
 - (3) Register a host that is used to identify the HBAs (Host Bus Adapter).
 - (4) Create a LUN group.
 - (5) Set the relationship between the host, host interface ports, and LUN group.
- Specifying a port group and performing LUN mapping (["D.2.2 Specifying a Port Group and Performing LUN Mapping" \(page 1249\)](#))
 - (1) Set the parameter that controls the host interface port.
 - (2) Set a host response.
 - (3) Create a port group.
 - (4) Create a LUN group.
 - (5) Set the relationship between the port group, LUN group, and host response.

- Specifying a port and performing LUN mapping (["D.2.3 Specifying a Port and Setting LUN Mapping" \(page 1249\)](#))
 - (1) Disable the host affinity mode of the host interface port.
 - (2) Set the parameter that controls the host interface port.
 - (3) Set the relationship between the host interface ports, the volumes, and the LUNs.

D.2.1 Specifying a Host and Performing Mapping (Host Affinity Mode)

An example of setting up host access is shown below. For more details, refer to ["3.6 Host Interface Management" \(page 302\)](#).

The example below is for a Fibre Channel interface.

Procedure

- 1 Enable the host affinity mode of host interface port 001.

```
CLI> set fc-parameters -port 001 -host-affinity enable
```

- 2 Set the connection of the host interface port 001 to fabric.

```
CLI> set fc-parameters -port 001 -connect fabric
```

- 3 Register a host WWN named HBA5.

```
CLI> create host-wwn-name -wwn 40000000abc80e03 -name HBA5
```

- 4 Map a volume with a LUN and create a LUN group named LUN002.

```
CLI> create lun-group -name LUN002 -volume-name v2 -lun 0
```

In this example, volume v2 and LUN 0 are mapped.

- 5 Set the relationship between host interface port 001, LUN group LUN002, and host identifier HBA5.

```
CLI> set host-affinity -port 001 -lg-name LUN002 -host-name HBA5
```

End of procedure

D.2.2 Specifying a Port Group and Performing LUN Mapping

An example of setting up host access is shown below. For more details, refer to ["3.6 Host Interface Management" \(page 302\)](#).

The example shown below is the case for the Fibre Channel interface.

Procedure

- 1 Set the connection of host interface ports 000 and 100 to fabric.
The following example shows the case for the Fibre Channel interface.

```
CLI> set fc-parameters -port 000,100 -connect fabric
```

- 2 Group host interface ports 000 and 100 together, and create a port group named PG0001.

```
CLI> create port-group -name PG0001 -port 000,100
```

- 3 Map a volume with a LUN, and create a LUN group named LUN002.

```
CLI> create lun-group -name LUN002 -volume-name v2 -lun 0
```

In this example, volume v2 and LUN 0 are mapped.

- 4 Set the relationship between port group PG0001, LUN group LUN002, and host response number 0.

```
CLI> set host-affinity -port-group-name PG0001 -lg-name LUN002 -host-response-number 0
```

End of procedure

D.2.3 Specifying a Port and Setting LUN Mapping

An example of creating host access is shown below. For more details, refer to ["3.6 Host Interface Management" \(page 302\)](#).

The example shown below is the case for the Fibre Channel interface.

Procedure

- 1 Disable the host affinity mode of host interface ports 000 and 001.

```
CLI> set fc-parameters -port 000,001 -host-affinity disable
```

- 2 Set the connection topology of host interface ports 000 and 001 to fabric.

```
CLI> set fc-parameters -port 000,001 -connect fabric
```

- 3 Set the relationship between host interface ports 000 and 001, volumes v0, v1, and v2, and LUNs 0, 1, and 2.

```
CLI> set mapping -volume-name v0,v1,v2 -lun 0-2 -port 000,001
```

End of procedure

D.3 Setting Cancellation

This section explains how to cancel the settings that are described in ["D.1 Settings When Using Volumes" \(page 1244\)](#).

An outline for canceling settings is shown below.

- (1) Canceling mapping (["D.3.1 Canceling Mapping" \(page 1251\)](#))
Cancel the set mapping (host affinity) or LUN mapping.
- (2) Deleting LUN groups, port groups, host groups, or registered host
 - ["D.3.2 Deleting LUN Groups" \(page 1251\)](#)
 - ["D.3.3 Deleting Port Groups" \(page 1252\)](#)
 - ["D.3.4 Deleting Host Groups" \(page 1252\)](#)
 - ["D.3.5 Deleting Registered Hosts" \(page 1252\)](#)
Delete created LUN groups, port groups, host groups, or registered hosts.
- (3) Deleting volumes (["D.3.6 Deleting Volumes" \(page 1253\)](#))
Delete created volumes. All mappings associated with the host need to be disabled before deleting volumes.
- (4) Deleting RAID groups (["D.3.7 Deleting RAID Groups" \(page 1253\)](#))
Delete created RAID groups. All the volumes in a RAID group need to be deleted before deleting the RAID group.

D.3.1 Canceling Mapping

■ Releasing mapping (host affinity)

An example of deleting host affinity is shown below. For more details, refer to ["3.6 Host Interface Management" \(page 302\)](#).

Procedure

- 1 Cancel all of the host affinity settings for port group PG0001.

```
CLI> release host-affinity -port-group-name PG0001
```

End of procedure

■ Releasing LUN mapping

An example of deleting LUN mapping is shown below. For more details, refer to ["3.6 Host Interface Management" \(page 302\)](#).

Procedure

- 1 Cancel all of the mapping definitions for host interface ports 000 and 001.

```
CLI> release mapping -port 000,001
```

End of procedure

D.3.2 Deleting LUN Groups

An example of deleting a LUN group is shown below. For more details, refer to ["3.6 Host Interface Management" \(page 302\)](#).

Procedure

- 1 Delete LUN group LUN001.

```
CLI> delete lun-group -lg-name LUN001
```

End of procedure

D.3.3 Deleting Port Groups

An example of deleting a port group is shown below. For more details, refer to ["3.6 Host Interface Management" \(page 302\)](#).

Procedure

- 1 Delete port group PG0001.

```
CLI> delete port-group -port-group-name PG0001
```

End of procedure

D.3.4 Deleting Host Groups

An example of deleting a host group is shown below. For more details, refer to ["3.6 Host Interface Management" \(page 302\)](#).

Procedure

- 1 Delete host group HG01.

```
CLI> delete host-group -host-group-name HG01
```

End of procedure

D.3.5 Deleting Registered Hosts

An example of deleting registered hosts is shown below. For more details, refer to ["3.6 Host Interface Management" \(page 302\)](#).

Procedure

- 1 Delete hosts HBA1, HBA2, and HBA4.

```
CLI> delete host-wwn-name -host-name HBA1, HBA2, HBA4
```

End of procedure

D.3.6 Deleting Volumes

An example of deleting volumes is shown below. For more details, refer to ["3.2 Volume Management" \(page 148\)](#).

Procedure

- 1 Delete volumes v0, v1, and v2.

```
CLI> delete volume -volume-name v0,v1,v2
```

End of procedure

D.3.7 Deleting RAID Groups

An example of deleting a RAID group is shown below. For more details, refer to ["3.1 RAID Group Management" \(page 114\)](#).

Procedure

- 1 Delete the RAID group named r1.

```
CLI> delete raid-group -rg-name r1
```

End of procedure

Appendix E

Status List

This appendix describes status meanings.

E.1 General Status

The meaning of each general status is described below.

Table E.1 List of general statuses

Status	Description
Empty	The ETERNUS DX/AF is not defined or is not installed.
Normal	The ETERNUS DX/AF is in normal state.
Pinned Data	Pinned data exists.
Unused	A component is undefined.
Warning	A component requires preventive maintenance.
Maintenance	The ETERNUS DX/AF is under maintenance.
Error	A component with an error exists.
Loop Down	The ETERNUS DX/AF is in BackEnd Down status.
Not Ready	A failure is detected in the ETERNUS DX/AF. I/O from the host cannot be received normally.
Subsystem Down	The ETERNUS DX/AF is cannot be used.
Change Assigned CM	Hot expansion and recovery of the CM is required.
Unknown	A status other than the ones listed above.

E.2 Component Status

The meaning of each component status is described below.

Table E.2 List of component statuses

Status	Description
Normal	The component is operating normally.
Warning	The component requires preventive maintenance.
Maintenance	The component is under maintenance.
Error	An error has occurred in the component.
Normal (Inside unused parts)	There is an unused component that is installed in the ETERNUS DX/AF.
Check1	The component is being rebooted.

Status	Description
Undefined	The component is installed, but not used.
Unknown	A status other than the ones listed above.

E.3 Drive Status

The meaning of each drive status is described below.

Table E.3 List of drive statuses

Status	Description
Available	The drive is in normal status. The drive is used in the RAID group.
Available (Predictive Failure)	SMART occurred in a user data drive.
Spare	The drive is an unused hot spare.
Present	The drive is not used (not registered as a RAID group or hot spare), or is waiting for rebuild/copy back.
Readying	The drive is starting up.
Rebuild/Copyback	Rebuild or copy back is being performed in the drive.
Redundant Copy	A Redundant copy is being performed in the drive.
Not Supported	The drive is not supported. [Example] Drive capacity is insufficient.
Not Exist	The drive cannot be recognized.
Failed Usable	An error involving RAID group failure has occurred in the drive.
Broken	An error has occurred in the drive.
Not Available	The drive is not defined or has not been installed.
Formatting	Quick formatting has just started in the drive.
Not Format	The drive is not formatted.
Unknown	A status other than the ones listed above.

E.4 Volume Status

The meaning of each volume status is described below.

Table E.4 List of volume statuses

Status	Description
Available	The volume is in normal status.
Spare in Use	The RAID group that contains the relevant volume manages redundancy by using the hot spare.
Readying	The volume is not formatted.

Status	Description
Rebuild	Rebuilding from a failed data disk to the hot spare or to the replaced drive is being performed in the RAID group to which the volume belongs.
Copyback	Copyback is being performed from the hot spare to the new data drive in the RAID group to which the volume belongs.
Redundant Copy	Redundant copy to the hot spare is being performed in the RAID group to which the volume belongs.
Partially Exposed Rebuild	Rebuilding from the first failed data drive to the hot spare or to the replaced disk is being performed in the RAID group to which the volume belongs. This status is displayed only when the RAID type of the RAID group to which the volume belongs is "High Reliability (RAID6)".
Exposed	The RAID group to which the volume belongs lost redundancy due to drive failure.
Partially Exposed	One of the drive that configure the RAID group to which the volume belongs has failed. This status is displayed only when the type of the RAID group to which the volume belongs is "High Reliability (RAID6)".
Not Ready	The RAID group to which the volume belongs is blocked.
Broken	The volume is broken.
Data Lost	Data in the volume is lost. Reading or writing of data cannot be performed.
Not Available	The volume is not defined or has not been installed.
Unknown	A status other than the ones listed above.

E.5 Pool Status (TPP/FTRP/FTSP Status)

The meaning of each pool status is described below.

Table E.5 List of pool statuses

Status	Description
Available	The pool is operating normally.
Maintenance	Forcible recovery of the pool is being performed.
Readying	All the physical area in the pool is not formatted.
Part Readying	Some parts of the physical area in the pool are not formatted.
Exposed	The pool is available. The "Exposed" status of the pool is displayed not only when the RAID group that configures the pool has lost redundancy and is in "Exposed" status, but also when the RAID group maintains redundancy in "Spare in Use" status. The "Exposed" status of pool indicates that the RAID group in the pool is not in normal status because of any causes such as the drive failure.
Broken	The pool is broken.
Data Lost	Data in the pool is lost. Reading or writing of data cannot be performed.
Unknown	A status other than the ones listed above.

E.6 RAID Group Status

The meaning of each RAID group status is described below.

Table E.6 List of RAID group statuses

Status	Description
Available	The RAID group is operating normally.
Spare in Use	Rebuilding to the hot spare is complete. The RAID group manages redundancy by using the hot spare.
Readying	The RAID group that is registered as an REC Disk Buffer is not formatted. This status is displayed only for a RAID group that is registered as an REC Disk Buffer.
Rebuild	Rebuilding from a failed data drive to the hot spare or to the replaced drive is being performed in the RAID group.
Copyback	Copyback from the hot spare to the new data drive is being performed in the RAID group.
Redundant Copy	Redundant copy to the hot spare is being performed in the RAID group.
Partially Exposed Rebuild	Rebuilding from the first failed data drive to the hot spare or to the replaced drive is being performed in the RAID group. This status is displayed only when the RAID type of the RAID group is "High Reliability (RAID6)".
Exposed Rebuild	Two of the data drive for the RAID group have failed. Rebuilding from the first failed data drive to the hot spare or to the replaced drive is being performed. In addition, all the hot spares have already been used. As a result, the second failed data drive is waiting for the hot spare to become available. This status is displayed only when the RAID type of the RAID group is "High Reliability (RAID6)".
Exposed	The RAID group lost redundancy due to drive failure.
Partially Exposed	One of the drive that configure the RAID group has failed. This status is displayed only when the type of the RAID group is "High Reliability (RAID6)".
No Disk Path	The RAID group is blocked.
SED Locked	The RAID group is blocked. If an SED authentication key cannot be obtained from the key server, "SED Locked" is displayed.
Broken	The RAID group is broken.
Unknown	A status other than the ones listed above.

E.7 Key Status

The meaning of each key status is described below.

Table E.7 List of key statuses

Status	Description
Normal	A valid key is registered for the SEDs. The key is in normal state.
Expiration	An expired key is registered in the SED. The key has expired, but a new key can be obtained from the server.

Status	Description
Not Acquired	The required key for starting key server management is not obtained. The allocation of the Master server and the Slave server to the key group has been deleted.
Key Server Error	The network between the ETERNUS DX/AF and the key server is in normal status, but no SED key is stored in the key server.
Network Error	The key cannot be obtained due to a network error between the ETERNUS DX/AF and the key server.
Modifying	A RAID group in which the key is being modified exists in the key group. "RAID group of which key is modifying" indicates the following conditions: <ul style="list-style-type: none"> • The key is being updated manually from GUI or CLI • The key is automatically being updated because it expired • Updating of the key stopped due to an error • SEDs are maintained while a network error occurs when the security level is "Low"
Unregistered Server Certificate	The "SSL / KMIP Certificate" (key server certification) is not registered in the ETERNUS DX/AF. Communication between the ETERNUS DX/AF and the key server cannot be performed.
Expired Server Certificate	The "SSL / KMIP Certificate" (key server certification) has expired. Communication between the ETERNUS DX/AF and the key server cannot be performed.
No SSL Certificate	An SSL certificate (*1) for the ETERNUS DX/AF has not been created. Communication between the ETERNUS DX/AF and the key server cannot be performed.

*1: "Self-signed SSL certificate" or "SSL server certificate"

E.8 Key Server Status

The meaning of each key server status is described below.

Table E.8 List of key server statuses

Status	Description
Normal	The communication between the ETERNUS DX/AF and the key server is normal. The key can be obtained successfully. The key server is in normal state.
Setting	"Setting" indicates the following conditions: <ul style="list-style-type: none"> • The "SSL / KMIP Certificate" (key server certification) or SSL certificate (*1) is not registered. • The network between the ETERNUS DX/AF and the key server is normal, but connection to the key server is forbidden.
Network Error	The network between the ETERNUS DX/AF and the key server is not connected normally.
Key Acquisition Failure	The key that is requested from the ETERNUS DX/AF does not exist in the key server.
Key Server Error	An error due to a failure other than key acquisition failure is detected.
Internal Error	Communication to the key server could not be performed due to an internal failure of the ETERNUS DX/AF.

*1: "Self-signed SSL certificate" or "SSL server certificate"

Appendix F

Default Value List

The default values for commands are shown below.

Table F.1 List of the default values for RAID group management commands

Command	Parameter	Default value
RAID group		
create raid-group	assigned-cm	auto
Eco-mode management		
set eco-mode	mode	disable
create eco-schedule	event-type	every-day

Table F.2 List of the default values for volume management commands

Command	Parameter	Default value
Volume		
create volume	attention	80%
	exc	<ul style="list-style-type: none">When the volume type is Open, Standard, WSV, TPV (including nas-tpv and nas-tpv-backup), "enable"When the volume type is sdv or sdpv, or when RAID group or pool is configured with the SSD, "disable"
	allocation	thin
set volume	alua	follow-host-response
Flexible Tier Volume		
create flexible-tier-volume	attention	80%
	allocation	thin
	type	default
set flexible-tier-volume	alua	follow-host-response
ODX Buffer Volume		
create odx-buffer-volume	attention	80%
	allocation	thin
Extreme Cache		
set extreme-cache	initial-caching-threshold	1
	caching-threshold	5
	monitoring-io	read
create extreme-cache-pool	encryption	disable

Table F.3 List of the default values for Thin Provisioning management commands

Command	Parameter	Default value
Thin Provisioning Pool		
set thin-provisioning	max-pool-capacity	<ul style="list-style-type: none"> For the ETERNUS DX60 S4/DX100 S4/DX200 S4, "32TB" For the ETERNUS DX500 S4, "64TB" For the ETERNUS DX600 S4, "128TB" For the ETERNUS DX60 S3/DX100 S3/DX200 S3, "32TB" For the ETERNUS DX500 S3, "64TB" For the ETERNUS DX600 S3, "128TB" For the ETERNUS DX8100 S3, "64TB" For the ETERNUS DX8700 S3/DX8900 S3, "256TB" For the ETERNUS AF250 S2/AF250, "32TB" For the ETERNUS AF650 S2/AF650, "128TB" For the ETERNUS DX200F, "32TB"
create thin-pro-pool	warning	90%
	attention	75%
	assigned-cm	auto
	encryption	disable
expand thin-pro-pool	assigned-cm	auto

Table F.4 List of the default values for Flexible Tier management commands

Command	Parameter	Default value
Flexible Tier Pool		
set flexible-tier-sub-pool	assigned-cm	auto

Table F.5 List of the default values for host interface management commands

Command	Parameter	Default value
Host Interface Port Parameters		
set fc-parameters	host-affinity	disable
	connect	loop
	rate	auto
	loop-id-assign	manual
	loop-id	0x00
	frame-size	2048
	reset-scope	initiator-lun
	reserve-cancel	disable
	rec-line-no	0
	rec-transfer-sync	enable
	rec-transfer-stack	enable
	rec-transfer-consistency	enable
	rec-transfer-through	enable
tfo-transfer-mode	enable	

Command	Parameter	Default value
set sas-parameters	host-affinity	disable
	rate	auto
	reset-scope	initiator-lun
	reserve-cancel	disable
set iscsi-parameters	multiple-vlan	disable
	additional-ip-function	enable
	host-affinity	disable
	reset-scope	initiator-lun
	reserve-cancel	disable
	ipv4-flag	enable
	ipv6-flag	disable
	link-local-ip	The IP address that is generated from the ETERNUS DX/AF WWN
	tcp-port	3260
	tcp-window-scale	2
	isns-server	disable
	isns-server-port	3205
	chap	disable
	header-digest	disable
	data-digest	disable
	jumbo-frame	disable
	rate	<ul style="list-style-type: none"> • For 1Gbit/s iSCSI, "1gauto" • For 10Gbit/s iSCSI, "10gauto"
	cmds-n-count	unlimited
	vlan-id	disable
	vlan-id-value	0
	mtu	1300
	bandwidth	400 Mbit/s
	chap-ca	disable
	chap-ra	disable
	rec-line-no	0
	rec-transfer-sync	enable
rec-transfer-stack	enable	
rec-transfer-consistency	enable	
rec-transfer-through	enable	
tfo-transfer-mode	enable	

Command	Parameter	Default value
set fcoe-parameters	host-affinity	disable
	rate	10Gbit/s
	frame-size	2048
	reset-scope	initiator-lun
	reserve-cancel	disable
	fcf-vlan-id	disable
	fcf-vlan-id-value	0
	fcf-fabric-name	disable
	fcf-fabric-name-value	0
set host-response	lun-address	prhl-dev
	lun-expand-mode	disable
	symmetric	<ul style="list-style-type: none"> For the DX8700 S3/DX8900 S3, "active" For the DX60 S4/DX100 S4/DX200 S4, the DX500 S4/DX600 S4, the DX60 S3/DX100 S3/DX200 S3, the DX500 S3/DX600 S3, the AF250 S2/AF650 S2, the AF250/AF650, and the DX200F, "passive"
	tpgs	enable
	tpg-referrals	disable
	prhl-dev-type	no-dev-type
	flat-prhl-dev-type	no-dev-type
	scsi-version	6
	naca	off
	dev-id-type	type3
	product-id	default
	rsv-rsp-status	disable
	lun-mapping	enable
	lun-capacity	enable
	vendor-unique-sense	disable
	monitor-time	25 seconds
	load-balance-rsp-status	unit-attention
	iscsi-disc-rsp	all
	iscsi-rsv-range	system
	rsv-mode-sense	conflict
Host Sense Conversion		
set host-sense	preset	no-conversion
Host Interface Port Reset Group		
set ca-reset-group	group	A reset group is set for all of the host interface ports.

Table F.6 List of the default values for Advanced Copy management commands

Command	Parameter	Default value
Copy Session Management		
set advanced-copy-policy	threshold	information : 50%
		warning : 70%
		error : 99%
set advanced-copy-parameters	resolution	<ul style="list-style-type: none"> For the DX60 S4/DX100 S4/DX200 S4, the DX60 S3/DX100 S3/DX200 S3, the AF250 S2/AF250, and the DX200F, "x16" For the the DX500 S4/DX600 S4, DX500 S3/DX600 S3, the DX8100 S3/DX8700 S3/DX8900 S3, and the AF650 S2/AF650, "x1"
		table-size
	sdpe	1GB
	ec-opc-priority	auto
	warning	80%
	copy-schedule-mode	session-balancing
	Remote Equivalent Copy Management	
import rec-path	indicator	enable
export backup-rec-path	indicator	enable
convert rec-path	indicator	enable
set rec-multiplicity	multiplicity	auto
	priority-level	auto
	copy-schedule-mode	session-balancing
set rec-buffer	buffer-size	128MB
	forwarding-interval	1 second
	halt-wait-timer	15 seconds
	monitoring-time	5 minutes
	io-response-mode	enable
	immed-halt-mode	enable
	high-bandwidth-mode	enable
create rec-disk-buffer	encryption	disable
	assigned-cm	auto
	stripe-depth	64kb

Table F.7 List of the default values for user management commands

Command	Parameter	Default value
User Policy Settings		
set user-policy	password-length	4
	password-complexity	disable
	password-history	0
	password-min-age	0
	password-max-age	0
	lockout-threshold	0
	lockout-duration	30
create user	function	enable
	enforce-password-policy	no
	enforce-lockout-policy	no
set user	function	enable
	enforce-password-policy	no
	enforce-lockout-policy	no
RADIUS Server Settings		
set radius	primary-port-number	1812
	primary-authentication-mode	chap
	primary-retry-timeout	30 seconds
	secondary-port-number	1812
	secondary-authentication-mode	chap
	secondary-retry-timeout	30 seconds

Table F.8 List of the default values for network management commands

Command	Parameter	Default value
Network Settings		
set network	ip-format	IPv4
	ipv6-set-auto	disable
	master-ip	<ul style="list-style-type: none"> For MNT ports, "the address assigned by the DHCP server" For RMT and FST ports, "192.168.1.1"
	slave-ip	Not specified
	master-link-local-ip	The WWN base link local address of the ETERNUS DX/AF
	netmask	<ul style="list-style-type: none"> For MNT ports, "the address assigned by the DHCP server" For RMT and FST ports, "255.255.255.0"
	wake-on-lan	disable

Command	Parameter	Default value
set firewall	http	open
	https	open
	telnet	open
	ssh	open
	maintenance-secure	open
	icmp	open
	snmp	open
	rcil	close
	icmp-redirect	close
test network	port	maintenance
	retry	1
	timeout	5
SNMP		
set snmp	function	disable
	port	maintenance
	authentication-failure	enable
	engine-id	default
	mib-ii-rfc-version	1213
create snmp-user	authentication	enable
	authentication-method	md5
	encryption	enable
	encryption-method	des
set snmp-user	authentication	disable
	authentication-method	md5
	encryption	disable
	encryption-method	des
set snmp-trap	version	v3
	port-number	162
export enhanced-mib	version	v1

Command	Parameter	Default value
E-mail Notifications		
set email-notification	send	disable
	port	maintenance
	port-number	25
	authentication	none
	retry-count	0
	retry-interval	1 second
	timeout	5 seconds
	connection-timeout	5 seconds
	smtp-over-ssl	disable
	partial-mode	disable
	partial-size	64KB
	send-log	disable
	iom-log	enable
customer-info	enable	
Event Notifications		
set event-notification	preset	system-default
set lcd-suppress	parts-error	enable
	parts-warning	enable
	disk-error	disable-when-no-hs
	disk-warning	disable-when-no-hs
SMI-S		
set smi-s	function	disable
	performance-information	disable
SSH/SSL Security		
create ssh-server-key	key-length	2048
create ssl-certificate	key-length	2048
export ssl-certificate-request	csr-filename	server.crt
	key-filename	server.key
	key-length	2048
	indicator	enable
import ssl-certificate	cert-filename	server.crt
	key-filename	server.key
	indicator	enable
AIS connect Settings		
set ais-connect	server-certification	enable

Table F.9 List of the default values for system management commands

Command	Parameter	Default value
Encryption Mode		
set encryption	mode	disable
Power Synchronization		
set power-synchronization	auto-power	disable
	resume-power	disable
	preset	<ul style="list-style-type: none"> For the DX60 S4/DX100 S4/DX200 S4, the DX500 S4/DX600 S4, the DX60 S3/DX100 S3/DX200 S3, the DX500 S3/DX600 S3, the DX8100 S3, the AF250 S2/AF650 S2, the AF250/AF650, and the DX200F, "pman" For the DX8700 S3/DX8900 S3, "manual"
	power-fail-signal	positive
	low-battery-signal	positive
	ups-shutdown-signal	negative
	ups-shutdown	disable
Self-Encrypting Drive (SED) Authentication Setting		
set sed-authentication	execution	no
Syslog Server Settings		
set syslog-notification	server1-function	disable
	server1-port-number	514
	server1-port	maintenance
	server2-function	disable
	server2-port-number	514
	server2-port	maintenance
Audit Log Function Settings		
set audit	server1-port-number	514
	server2-port-number	514
Key Management Server Link Function		
create sed-key-group	security-level	high
	recovery-mode	auto
set sed-key-server	port-number	5696
	port	maintenance
Deduplication/Compression Mode Setting		
set dedup-mode	mode	<ul style="list-style-type: none"> If Memory Extension is installed, "enable" If Memory Extension is not installed, "disable"
Non-disruptive Storage Migration Function		
create external-drive	inherit-external-lu-info	yes

Table F.10 List of the default values for performance management commands

Command	Parameter	Default value
Performance Information		
start performance	interval	30 seconds
Performance Tuning Parameters		
set raid-tuning	dcmf	1
	disk-tuning	enable
	ordered-cut	400
set cache-parameters	fp	disable
	pl	8
	mwc	-
	psdc	5
	sddc	5
	ss	128
	sds	128
	cache-limit	off
	spmc	<ul style="list-style-type: none"> • For the DX60 S4/DX60 S3, "1" • For the DX100 S4/DX100 S3, "2" • For the DX200 S4/DX200 S3, "6" • For the DX500 S4/DX500 S3, "6" • For the DX600 S4/DX600 S3, "10" • For the DX8100 S3, "6" • For the DX8700 S3, "6" • For the DX8900 S3, "10" • For the AF250 S2/AF250, "6" • For the AF650 S2/AF650, "10" • For the DX200F, "6"
	exclusive-read-cache	0

Table F.11 List of the default values for maintenance operation/information management commands

Command	Parameter	Default value
Hardware Maintenance		
hot expansion	mode	hot
Log		
export log	only-disk-log	disable

Table F.12 List of the default values for utility management commands

Command	Parameter	Default value
Other Notifications		
set event-parameters	blink-panel-led	enable
	redundant-copy-led	disable
Subsystem Parameters		
set subsystem-parameters	load-balance	enable
	reject-inquiry	disable
	tp-alloc-mode	tpp-balancing
	enforce-checkcode	enable
	copybackless	enable
	turbo-mode	<ul style="list-style-type: none"> • For the DX60 S4, "-" • For the DX100 S4, "-" • For the DX200 S4, "disable" • For the DX500 S4/DX600 S4, "enable" • For the DX60 S3/DX100 S3/DX200 S3, "-" • For the DX500 S3/DX600 S3, "disable" • For the DX8100 S3/DX8700 S3/DX8900 S3, "disable" • For the AF250 S2/AF650 S2, "enable" • For the AF250/AF650, "disable" • For the DX200F, "-"
	dedup-data-cmp	disable
	optimize-af-ssd	<ul style="list-style-type: none"> • When shipped from the factory, "enable" • If the existing firmware version was upgraded to V10L30 or later, "disable"
	writeback-limit-count	512
	expand-host-mode	disable
	expand-volume-mode	disable
esf-wwn-mode	disable	

Table F.13 List of the default values for NAS function management commands

Command	Parameter	Default value
NAS Shared Folder		
create nas-share	access	rw
	oplocks	disable
	smb-encryption	disable
	abe	disable
	owner	root
	group	root
	share	active
NAS Network Interface		
create nas-interface	rip	enable
	ip	Not specified
	netmask	Not specified
	gateway	Not specified
	link-local-ip	Not specified
	connect-ip	Not specified
	subnet-prefix-length	Not specified
	ipv6-gateway	Not specified
NAS Network Interface Bonding Settings		
set nas-bonding	hash-policy	L2
NAS Network Settings		
set nas-port	mtu	1500
	rate	auto
	cifs	open
	nfs	open
	rip	open
	icmp	open
	primecluster	close
	ftp	close
	fxp	close
	local-user-password	close
set nas-route6	subnet-prefix-length	128
NAS Server Configuration		
set nas-server	server-name	String of characters that starts with "DX" followed by the serial number of the ETERNUS DX/AF (10 digit)
	nfsv4	disable
	smb-version	3
	fxp	disable
	auto-initialize-cache-distribution	disable
	show-cifs-ads-files	no
	cifs-restrict-anonymous	yes

Command	Parameter	Default value
NAS Function Restoration		
set nas-log-info	level	<ul style="list-style-type: none"> • For Samba, "2" • For CTDB, "3"
	size	<ul style="list-style-type: none"> • For Samba, "32" • For CTDB, "1024"

Table F.14 List of the default values for Storage Cluster management commands

Command	Parameter	Default value
Storage Cluster		
set storage-cluster-license	max-tfo-capacity	<ul style="list-style-type: none"> • For the DX100 S4/DX100 S3, "256tb" • For the DX200 S4/DX200 S3, "256tb" • For the DX500 S4/DX500 S3, "384tb" • For the DX600 S4/DX600 S3, "768tb" • For the DX8100 S3, "128tb" • For the DX8700 S3/DX8900 S3, "1pb" • For the AF250 S2/AF250, "256tb" • For the AF650 S2/AF650, "768tb" • For the DX200F, "256tb"
	create tfo-group	failback
	failover	auto
	failover-cap-port-linkdown	on
	split-mode	rw
	monitor-interval	<ul style="list-style-type: none"> • For firmware versions earlier than V10L60, "normal" • For firmware versions V10L60 and later <ul style="list-style-type: none"> - If iSCSI ports are not included in the REC paths between cabinets, "normal" - If iSCSI ports are included in the REC paths between cabinets, "long"
release tfo-pair	volume-uid-mode	keep

Table F.15 List of the default values for management commands for CLI original functions

Command	Parameter	Default value
CLI Environment		
set clienv-idle-timeout	timeout	30 minutes

FUJITSU Storage
ETERNUS DX S4/S3 series Hybrid Storage Systems,
ETERNUS AF series, ETERNUS DX200F All-Flash Arrays

ETERNUS CLI User's Guide

P2X0-1210-24ENZO

Date of issuance: April 2018
Issuance responsibility: FUJITSU LIMITED

- The content of this manual is subject to change without notice.
- This manual was prepared with the utmost attention to detail. However, Fujitsu shall assume no responsibility for any operational problems as the result of errors, omissions, or the use of information in this manual.
- Fujitsu assumes no liability for damages to third party copyrights or other rights arising from the use of any information in this manual.
- The content of this manual may not be reproduced or distributed in part or in its entirety without prior permission from Fujitsu.

FUJITSU