

**CARLO GAVAZZI**  
Automation Components



**Our Products**

## Sensors

Photoelectric sensors	8
Capacitive sensors	35
Inductive sensors	52
Ultrasonic sensors	90
Conductive level sensors	99
Magnetic sensors	103
Safety	110
Connectivity	129
Wind sensors	132

## Switches

Solid state relays	136
Solid state relays accessories	173
Soft starters	178
Variable frequency drives	183
Electromechanical relays	187
Sockets for electromechanical relays	192
Switching power supplies	193

# Controls

Digital panel meters	210
Energy/Power analyzers	214
Current transformers	224
Data aggregation solutions	233
PV monitoring solutions	238
Building automation	242
Parking guidance system	261
DuplineSafe	265
Fieldbuses	269
Monitoring relays	281
Timers	294
Counters	299





## A complete product range

### ABOUT CARLO GAVAZZI

Carlo Gavazzi Automation is a multinational electronics group active in the design, manufacture and marketing of electronic equipment targeted at the global markets of industrial and building automation.

Our history is full of firsts and our products are installed in a huge number of applications all over the world. With more than 80 years of successful operation, our experience is unparalleled.

We have our headquarters in Europe and numerous offices around the world.

Our R&D competence centres and production sites are located in Denmark, Italy, Lithuania, Malta and the People's Republic of China.

We operate worldwide through 22 of our own sales companies and also selected representatives in more than 65 countries, from the United States in the West to the Pacific Rim in the East.

Our core competence in automation spans three product lines: Sensors, Switches and Controls.

Our wide array of products includes sensors, monitoring relays, timers, energy management systems, solid state relays, safety devices and fieldbus systems.

We focus our expertise on offering state-of-the-art product solutions in selected market segments.

Our customers include original equipment manufacturers of packaging machines, plastic-injection moulding machines, food and beverage production machines, conveying and materials handling equipment, door and entrance control systems, lifts and escalators, as well as heating, ventilation and air-conditioning devices.





## A guarantee of reliability

Carlo Gavazzi products earned the independent approval of the relevant bodies which govern our industry and the many markets we serve.

They are developed and manufactured in full compliance with the most important international standard regulations.

Carlo Gavazzi manufacturing facilities operates in line with the requirements of ISO9001:2015 Quality Management Systems and ISO14001:2015 Environmental Management System standard.



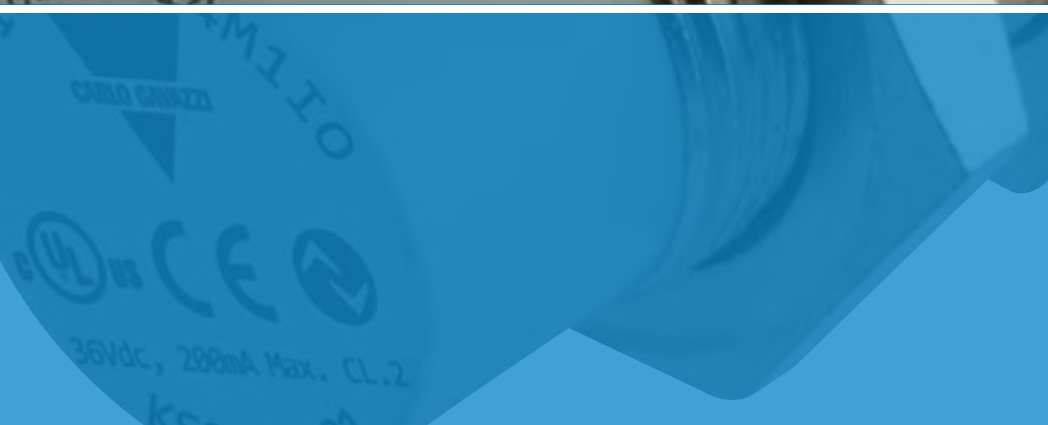





# Sensors



Photoelectric sensors	8
Capacitive sensors	35
Inductive sensors	52
Ultrasonic sensors	90
Conductive level sensors	99
Magnetic sensors	103
Safety	110
Connectivity	129
Wind sensors	132





# Photoelectric sensors

	M18, DC, axial type		M18, DC, radial type	
Types	PA18CA.	PA18CA.	PA18CR.	PA18CR.
Connections	2 m cable	M12 connector	2 m cable	M12 connector
				
Dimensions (mm)	M18 x 40	M18 x 44	M18 x 50	M18 x 54
<b>Diffuse reflective</b>				
Sensing distance (Sn)	50 - 1000 mm	50 - 1000 mm	50 - 800 mm	50 - 800 mm
NPN NO+NC	PA18CAD10NASA	PA18CAD10NAM1SA	PA18CRD08NASA	PA18CRD08NAM1SA
PNP NO+NC	PA18CAD10PASA	PA18CAD10PAM1SA	PA18CRD08PASA	PA18CRD08PAM1SA
<b>Diffuse reflective WS</b>				
Sensing distance (Sn)	0 - 400 mm	0 - 400 mm		
NPN NO+NC	PA18CAD04NAWS	PA18CAD04NAM1WS		
PNP NO+NC	PA18CAD04PAWS	PA18CAD04PAM1WS		
<b>Retro reflective polarized</b>				
Sensing distance (Sn)	5 - 500 cm	5 - 500 cm	5 - 400 cm	5 - 400 cm
NPN NO+NC	PA18CAP50NASA	PA18CAP50NAM1SA	PA18CRP40NASA	PA18CRP40NAM1SA
PNP NO+NC	PA18CAP50PASA	PA18CAP50PAM1SA	PA18CRP40PASA	PA18CRP40PAM1SA
<b>Retro reflective</b>				
Sensing distance (Sn)	5 - 650 cm	5 - 650 cm	5 - 500 cm	5 - 500 cm
NPN NO+NC	PA18CAR65NASA	PA18CAR65NAM1SA	PA18CRR50NASA	PA18CRR50NAM1SA
PNP NO+NC	PA18CAR65PASA	PA18CAR65PAM1SA	PA18CRR50PASA	PA18CRR50PAM1SA
<b>Through-beam emitter (E)</b>				
Sensing distance (Sn)	1 - 20 m	1 - 20 m	1 - 16 m	1 - 16 m
	PA18CAT20	PA18CAT20M1	PA18CRT16	PA18CRT16M1
<b>Through-beam receiver (R)</b>				
Sensing distance (Sn)	1 - 20 m	1 - 20 m	1 - 16 m	1 - 16 m
NPN NO+NC	PA18CAT20NASA	PA18CAT20NAM1SA	PA18CRT16NASA	PA18CRT16NAM1SA
PNP NO+NC	PA18CAT20PASA	PA18CAT20PAM1SA	PA18CRT16PASA	PA18CRT16PAM1SA
<b>Background suppression (BGS)</b>				
Sensing distance (Sn)	10 - 200 mm	10 - 200 mm		
NPN NO+NC	PA18CAB20NASA	PA18CAB20NAM1SA		
PNP NO+NC	PA18CAB20PASA	PA18CAB20PAM1SA		
<b>Specifications</b>				
Operating frequency	500 Hz	500 Hz	500 Hz	500 Hz
Rated operating voltage	10 - 30 VDC	10 - 30 VDC	10 - 30 VDC	10 - 30 VDC
Voltage drop	≤ 2.0 VDC @ 100 mA	≤ 2.0 VDC @ 100 mA	≤ 2.0 VDC @ 100 mA	≤ 2.0 VDC @ 100 mA
Degree of protection	IP 67 + IP 69K	IP 67 + IP 69K	IP 67 + IP 69K	IP 67 + IP 69K
Protection short-circuit (S)				
Reverse polarity (P)	SPT	SPT	SPT	SPT
Transients (T)				
Supply current	≤ 25 mA @ 24 VDC	≤ 25 mA @ 24 VDC	≤ 25 mA @ 24 VDC	≤ 25 mA @ 24 VDC
BGS, E + R	≤ 40 mA @ 24 VDC	≤ 40 mA @ 24 VDC	≤ 40 mA @ 24 VDC	≤ 40 mA @ 24 VDC
Housing material	ABS, PMMA, PBTB	ABS, PMMA, PBTB	ABS, PMMA, PBTB	ABS, PMMA, PBTB
Operating temperature	-25°C to +60°C	-25°C to +60°C	-25°C to +60°C	-25°C to +60°C
LED colour	Yellow, Green	Yellow, Green	Yellow, Green	Yellow, Green
Approvals/Marks	CE - cULus - ECOLAB	CE - cULus - ECOLAB	CE - cULus - ECOLAB	CE - cULus - ECOLAB

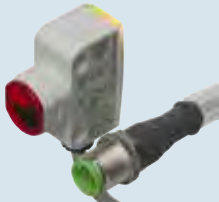

# Photoelectric sensors

## M18, DC, square type

Types	PH18.	PH18.	PH18.
Connections	2 m cable	M12 connector	Pigtail M12
			
Dimensions (mm)	15 x 21 (31.5) x 35	15 x 21 (31.5) x 35	15 x 21 (31.5) x 35
<b>Diffuse reflective</b>			
Sensing distance (Sn)	50 - 1000 mm	50 - 1000 mm	50 - 1000 mm
NPN NO+NC	<b>PH18CND10NASA</b>	<b>PH18CND10NAM1SA</b>	<b>PH18CND10NAT1SA</b>
PNP NC+NC	<b>PH18CND10PASA</b>	<b>PH18CND10PAM1SA</b>	<b>PH18CND10PAT1SA</b>
<b>Retro reflective polarized</b>			
Sensing distance (Sn)	5 - 500 cm	5 - 500 cm	5 - 500 cm
NPN NO+NC	<b>PH18CNP50NASA</b>	<b>PH18CNP50NAM1SA</b>	<b>PH18CNP50NAT1SA</b>
PNP NO+NC	<b>PH18CNP50PASA</b>	<b>PH18CNP50PAM1SA</b>	<b>PH18CNP50PAT1SA</b>
<b>Retro reflective</b>			
Sensing distance (Sn)	5 - 650 cm	5 - 650 cm	5 - 650 cm
NPN NO+NC	<b>PH18CNR65NASA</b>	<b>PH18CNR65NAM1SA</b>	<b>PH18CNR65NAT1SA</b>
PNP NO+NC	<b>PH18CNR65PASA</b>	<b>PH18CNR65PAM1SA</b>	<b>PH18CNR65PAT1SA</b>
<b>Through-beam emitter (E)</b>			
Sensing distance (Sn)	1 - 20 m	1 - 20 m	1 - 20 m
	<b>PH18CNT20</b>	<b>PH18CNT20M1</b>	<b>PH18CNT20T1</b>
<b>Through-beam receiver (R)</b>			
Sensing distance (Sn)	1 - 20 m	1 - 20 m	1 - 20 m
NPN NO+NC	<b>PH18CNT20NASA</b>	<b>PH18CNT20NAM1SA</b>	<b>PH18CNT20NAT1SA</b>
PNP NO+NC	<b>PH18CNT20PASA</b>	<b>PH18CNT20PAM1SA</b>	<b>PH18CNT20PAT1SA</b>
<b>Background suppression (BGS)</b>			
Sensing distance (Sn)	8 - 200 mm	8 - 200 mm	8 - 200 mm
NPN NO+NC	<b>PH18CNB20NASA</b>	<b>PH18CNB20NAM1SA</b>	<b>PH18CNB20NAT1SA</b>
PNP NO+NC	<b>PH18CNB20PASA</b>	<b>PH18CNB20PAM1SA</b>	<b>PH18CNB20PAT1SA</b>
<b>Specifications</b>			
Operating frequency	500 Hz	500 Hz	500 Hz
Rated operating voltage	10 - 30 VDC	10 - 30 VDC	10 - 30 VDC
Voltage drop	≤ 2.0 VDC @ 100 mA	≤ 2.0 VDC @ 100 mA	≤ 2.0 VDC @ 100 mA
Degree of protection	IP 67 + IP 69K	IP 67 + IP 69K	IP 67 + IP 69K
Protection short-circuit (S)			
Reverse polarity (P)	SPT	SPT	SPT
Transients (T)			
Supply current	≤ 25 mA @ 24 VDC	≤ 25 mA @ 24 VDC	≤ 25 mA @ 24 VDC
BGS, E + R	≤ 40 mA @ 24 VDC	≤ 40 mA @ 24 VDC	≤ 40 mA @ 24 VDC
Housing material	ABS, PMMA	ABS, PMMA	ABS, PMMA
Operating temperature	-25°C to +60°C	-25°C to +60°C	-25°C to +60°C
LED colour	Yellow, Green	Yellow, Green	Yellow, Green
Approvals/Marks	CE - cULus - ECOLAB	CE - cULus - ECOLAB	CE - cULus - ECOLAB



# Photoelectric sensors

## M18 metal, DC, integrated amplifier

Types	E.18..	E.18..-1
Connections	2 m cable	M12 connector
		
Dimensions (mm)	M18 x 55	M18 x 67
<b>Diffuse reflective</b>		
Operating frequency	120 Hz	120 Hz
Sensing distance (Sn)	400 mm, adjustable	400 mm, adjustable
NPN NO+NC	<b>EO1804NPAS</b>	<b>EO1804NPAS-1</b>
PNP NC+NC	<b>EO1804PPAS</b>	<b>EO1804PPAS-1</b>
<b>Retro reflective polarized</b>		
Operating frequency	100 Hz	100 Hz
Sensing distance (Sn)	2 m, adjustable	2 m, adjustable
NPN NO+NC	<b>EP1820NPAS</b>	<b>EP1820NPAS-1</b>
PNP NO+NC	<b>EP1820PPAS</b>	<b>EP1820PPAS-1</b>
<b>Retro reflective</b>		
Operating frequency	120 Hz	120 Hz
Sensing distance (Sn)	3 m, adjustable	3 m, adjustable
NPN NO+NC	<b>ER1830NPAS</b>	<b>ER1830NPAS-1</b>
PNP NO+NC	<b>ER1830PPAS</b>	<b>ER1830PPAS-1</b>
<b>Through-beam emitter</b>		
Sensing distance (Sn)	20 m <b>ET1820</b>	20 m <b>ET1820-1</b>
<b>Through-beam receiver</b>		
Operating frequency	170 Hz	170 Hz
Sensing distance (Sn)	20 m, adjustable	20 m, adjustable
NPN NO+NC	<b>ET1820NPAS</b>	<b>ET1820NPAS-1</b>
PNP NO+NC	<b>ET1820PPAS</b>	<b>ET1820PPAS-1</b>
<b>Fiber optic</b>		
Operating frequency	120 Hz	120 Hz
Sensing distance (Sn)	Fiber dependent	Fiber dependent
NPN NO+NC	<b>EF1801NPAS</b>	<b>EF1801NPAS-1</b>
PNP NO+NC	<b>EF1801PPAS</b>	<b>EF1801PPAS-1</b>
<b>Specifications</b>		
Rated operating voltage	10 - 40 VDC	10 - 40 VDC
Voltage drop	≤ 2.5 VDC	≤ 2.5 VDC
Degree of protection	IP 67	IP 67
Protection short-circuit (S)		
Reverse polarity (P)	SPT	SPT
Transients (T)		
Load current	< 200 mA	< 200 mA
Housing material	Nickel-plated brass	Nickel-plated brass
Operating temperature	-20°C to +60°C	-20°C to +60°C
LED colour	Yellow	Yellow
Approvals/Marks	CE	CE





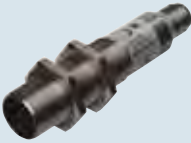

# Photoelectric sensors







	M18 plastic, AC, integrated amplifier		M18 metal, AC, integrated amplifier	
Types	PA18CL	PA18CL.M6	PA18AL	PA18AL..M6
Connections	2 m cable	M12 connector	2 m cable	M12 connector
				
Dimensions (mm)	M18 x 71.5	M18 x 83.5	M18 x 71.5	M18 x 83.5
<b>Diffuse reflective</b>				
Operating frequency	20 Hz	20 Hz	20 Hz	20 Hz
Sensing distance (Sn)	100 mm, fixed	100 mm, fixed		
Thyristor (SCR) NC	PA18CLD01TC	PA18CLD01TCM6		
Thyristor (SCR) NO	PA18CLD01TO	PA18CLD01TOM6		
Sensing distance (Sn)	200 mm, fixed	200 mm, fixed		
Thyristor (SCR) NC	PA18CLD02TC	PA18CLD02TCM6		
Thyristor (SCR) NO	PA18CLD02TO	PA18CLD02TOM6		
Sensing distance (Sn)	400 mm, fixed	400 mm, fixed		
Thyristor (SCR) NC	PA18CLD04TC	PA18CLD04TCM6		
Thyristor (SCR) NO	PA18CLD04TO	PA18CLD04TOM6		
Sensing distance (Sn)	400 mm, adjustable	400 mm, adjustable	400 mm, adjustable	400 mm, adjustable
Thyristor (SCR) NC	PA18CLD04TCSA	PA18CLD04TCM6SA	PA18ALD04TCSA	PA18ALD04TCM6SA
Thyristor (SCR) NO	PA18CLD04TOSA	PA18CLD04TOM6SA	PA18ALD04TOSA	PA18ALD04TOM6SA
<b>Retro reflective polarized</b>				
Operating frequency	25 Hz	25 Hz	25 Hz	25 Hz
Sensing distance (Sn)	2 m, fixed	2 m, fixed	2 m, adjustable	2 m, adjustable
Thyristor (SCR) NC	PA18CLP20TC	PA18CLP20TCM6	PA18ALP20TCSA	PA18ALP20TCM6SA
Thyristor (SCR) NO	PA18CLP20TO	PA18CLP20TOM6	PA18ALP20TOSA	PA18ALP20TOM6SA
<b>Retro reflective</b>				
Operating frequency	20 Hz	20 Hz	20 Hz	20 Hz
Sensing distance (Sn)	3 m, fixed	3 m, fixed	3 m, adjustable	3 m, adjustable
Thyristor (SCR) NC	PA18CLR30TC	PA18CLR30TCM6	PA18ALR30TCSA	PA18ALR30TCM6SA
Thyristor (SCR) NO	PA18CLR30TO	PA18CLR30TOM6	PA18ALR30TOSA	PA18ALR30TOM6SA
<b>Specifications</b>				
Rated operating voltage	20 - 250 VAC	20 - 250 VAC	20 - 250 VAC	20 - 250 VAC
Voltage drop	≤ 10 VAC	≤ 10 VAC	≤ 10 VAC	≤ 10 VAC
Off state current	≤ 5 mA AC	≤ 5 mA AC	≤ 5 mA AC	≤ 5 mA AC
Degree of protection	IP 67	IP 67	IP 67	IP 67
Protection short-circuit (S)				
Reverse polarity (P)	PT	PT	PT	PT
Transients (T)				
Load current	< 500 mA	< 500 mA	< 500 mA	< 500 mA
Housing material	Polyester (PBTP)	Polyester (PBTP)	Nickel-plated brass	Nickel-plated brass
Operating temperature	-20°C to +60°C	-20°C to +60°C	-20°C to +60°C	-20°C to +60°C
LED colour	Yellow	Yellow	Yellow	Yellow
Approvals/Marks	CE - UL - CSA	CE - UL - CSA	CE - UL - CSA	CE - UL - CSA

# Photoelectric sensors

## Integrated amplifier

Types	PD30 Stainless steel AISI 316L		PD30 ABS housing Back potentiometer	
Connections	2 m cable	M8 connector	2 m cable	M8 connector
				
Dimensions (mm)	11 x 31.5 x 21	11 x 31.5 x 21	10 x 30 x 20	10 x 30 x 20
<b>Diffuse reflective</b>				
Operating frequency / Sensing distance (Sn)	1000 Hz / 1 m	1000 Hz / 1 m	1000 Hz / 1 m	1000 Hz / 1 m
NPN NO+NC	<b>PD30ETD10NASA</b>	<b>PD30ETD10NAM5SA</b>	<b>PD30CND10NASA</b>	<b>PD30CND10NAM5SA</b>
PNP NO+NC	<b>PD30ETD10PASA</b>	<b>PD30ETD10PAM5SA</b>	<b>PD30CND10PASA</b>	<b>PD30CND10PAM5SA</b>
<b>Diffuse reflective, extremely wide angle, infrared light</b>				
Operating frequency / Sensing distance (Sn)	1000 Hz / 200 mm	1000 Hz / 200 mm	1000 Hz / 200 mm	1000 Hz / 200 mm
NPN NO+NC	<b>PD30ETD02NAWE</b>	<b>PD30ETD02NAM5WE</b>		
PNP NO+NC	<b>PD30ETD02PAWE</b>	<b>PD30ETD02PAM5WE</b>		
<b>Diffuse reflective background suppression, red light</b>				
Operating frequency / Sensing distance (Sn)	500 Hz / 200 mm	500 Hz / 200 mm	500 Hz / 200 mm	500 Hz / 200 mm
NPN NO+NC	<b>PD30ETB20NASA</b>	<b>PD30ETB20NAM5SA</b>	<b>PD30CNB20NASA</b>	<b>PD30CNB20NAM5SA</b>
PNP NO+NC	<b>PD30ETB20PASA</b>	<b>PD30ETB20PAM5SA</b>	<b>PD30CNB20PASA</b>	<b>PD30CNB20PAM5SA</b>
<b>Diffuse reflective background suppression, infrared light</b>				
Operating frequency / Sensing distance (Sn)	500 Hz / 200 mm	500 Hz / 200 mm	500 Hz / 200 mm	500 Hz / 200 mm
NPN NO+NC	<b>PD30ETB20NAIS</b>	<b>PD30ETB20NAM5IS</b>	<b>PD30CNB20NAIS</b>	<b>PD30CNB20NAM5IS</b>
PNP NO+NC	<b>PD30ETB20PAIS</b>	<b>PD30ETB20PAM5IS</b>	<b>PD30CNB20PAIS</b>	<b>PD30CNB20PAM5IS</b>
<b>Retro reflective</b>				
Operating frequency / Sensing distance (Sn)	1000 Hz / 6 m	1000 Hz / 6 m	1000 Hz / 6 m	1000 Hz / 6 m
NPN NO+NC	<b>PD30ETR60NASA</b>	<b>PD30ETR60NAM5SA</b>	<b>PD30CNR60NASA</b>	<b>PD30CNR60NAM5SA</b>
PNP NO+NC	<b>PD30ETR60PASA</b>	<b>PD30ETR60PAM5SA</b>	<b>PD30CNR60PASA</b>	<b>PD30CNR60PAM5SA</b>
<b>Retro reflective polarized</b>				
Operating frequency / Sensing distance (Sn)	1000 Hz / 6 m	1000 Hz / 6 m	1000 Hz / 6 m	1000 Hz / 6 m
NPN NO+NC	<b>PD30ETP60NASA</b>	<b>PD30ETP60NAM5SA</b>	<b>PD30CNP60NASA</b>	<b>PD30CNP60NAM5SA</b>
PNP NO+NC	<b>PD30ETP60PASA</b>	<b>PD30ETP60PAM5SA</b>	<b>PD30CNP60PASA</b>	<b>PD30CNP60PAM5SA</b>
<b>Through-beam emitter</b>				
Sensing distance (Sn)	15 m	15 m	15 m	15 m
	<b>PD30ETT15</b>	<b>PD30ETT15M5</b>	<b>PD30CNT15</b>	<b>PD30CNT15M5</b>
<b>Through-beam receiver</b>				
Operating frequency / Sensing distance (Sn)	500 Hz / 15 m	500 Hz / 15 m	500 Hz / 15 m	500 Hz / 15 m
NPN NO/NC	<b>PD30ETT15NASA</b>	<b>PD30ETT15M5NASA</b>	<b>PD30CNT15NASA</b>	<b>PD30CNT15NAM5SA</b>
PNP NO/NC	<b>PD30ETT15PASA</b>	<b>PD30ETT15M5PASA</b>	<b>PD30CNT15PASA</b>	<b>PD30CNT15PAM5SA</b>
<b>Specifications</b>				
Rated operating voltage	10 - 30 VDC	10 - 30 VDC	10 - 30 VDC	10 - 30 VDC
Voltage drop	≤ 2.0 VDC @ 100 mA	≤ 2.0 VDC @ 100 mA	≤ 2.0 VDC @ 100 mA	≤ 2.0 VDC @ 100 mA
Degree of protection	IP 68, IP69K	IP 68, IP69K	IP 67	IP 67
Protection short-circuit (S)				
Reverse polarity (P)	SPT	SPT	SPT	SPT
Transients (T)				
Load current	≤ 100 mA	≤ 100 mA	≤ 100 mA	≤ 100 mA
Housing material	Stainless steel AISI 316L	Stainless steel AISI 316L	ABS	ABS
Operating temperature	-40 (-25)°C to +60°C	-40 (-25)°C to +60°C	-25°C to +60°C	-25°C to +60°C
LED colour	Yellow + Green	Yellow + Green	Yellow + Green	Yellow + Green
Approvals/Marks UL508	CE - cULus - ECOLAB	CE - cULus - ECOLAB	CE - cULus	CE - cULus

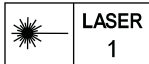
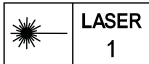
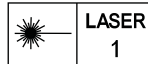

# Photoelectric Time of Flight (ToF) sensors with IO-Link

Integrated amplifier				
Types	LD30 Stainless steel AISI 316L		LD30 ABS housing Back potentiometer	
Connections	2 m cable	M8 connector	2 m cable	M8 connector
				
Dimensions (mm)	11 x 31.5 x 21	11 x 31.5 x 21	10 x 30 x 20	10 x 30 x 20
<b>Diffuse reflective background suppression, Infrared Laser - Class 1</b>				
Operating frequency / Sensing distance (Sn)	5 Hz / 1 m	5 Hz / 1 m	5 Hz / 1 m	5 Hz / 1 m
	<b>LD30ETB110BPA2IO</b>	<b>LD30ETB110BPM5IO</b>	<b>LD30CTB110BPA2IO</b>	<b>LD30CTB110BPM5IO</b>
<b>Specifications</b>				
Detection function	2 separate function, Single mode, Windows Mode, Two-point Mode	2 separate function, Single mode, Windows Mode, Two-point Mode	2 separate function, Single mode, Windows Mode, Two-point Mode	2 separate function, Single mode, Windows Mode, Two-point Mode
Sensing Principle	Time Of Flight detection (TOF)	Time Of Flight detection (TOF)	Time Of Flight detection (TOF)	Time Of Flight detection (TOF)
Light source	Infrared Laser - Class 1	Infrared Laser - Class 1	Infrared Laser - Class 1	Infrared Laser - Class 1
Analogue output	Via IO-Link	Via IO-Link	Via IO-Link	Via IO-Link
Selectable function output 1	NPN, PNP or Push-Pull	NPN, PNP or Push-Pull	NPN, PNP or Push-Pull	NPN, PNP or Push-Pull
Selectable function output 2	NPN, PNP, Push-Pull, External input or External teach	NPN, PNP, Push-Pull, External input or External teach	NPN, PNP, Push-Pull, External input or External teach	NPN, PNP, Push-Pull, External input or External teach
Diagnostic	Operation hours, Power cycles, Detection cycles max. and min. Temperatures, Short-circuit, Maintenance, No of Parameter change	Operation hours, Power cycles, Detection cycles max. and min. Temperatures, Short-circuit, Maintenance, No of Parameter change	Operation hours, Power cycles, Detection cycles max. and min. Temperatures, Short-circuit, Maintenance, No of Parameter change	Operation hours, Power cycles, Detection cycles max. and min. Temperatures, Short-circuit, Maintenance, No of Parameter change
Logic functions	AND, OR, X-OR, Gated SR-FF	AND, OR, X-OR, Gated SR-FF	AND, OR, X-OR, Gated SR-FF	AND, OR, X-OR, Gated SR-FF
Timer functions	ON delay, OFF delay, ON+OFF delay and One shot	ON delay, OFF delay, ON+OFF delay and One shot	ON delay, OFF delay, ON+OFF delay and One shot	ON delay, OFF delay, ON+OFF delay and One shot
Rated operating voltage	10 - 30 VDC	10 - 30 VDC	10 - 30 VDC	10 - 30 VDC
Voltage drop	≤ 1.0 VDC	≤ 1.0 VDC	≤ 1.0 VDC	≤ 1.0 VDC
No load supply current (I <sub>o</sub> )	≤ 20 mA	≤ 20 mA	≤ 20 mA	≤ 20 mA
Protection short-circuit (S)				
Reverse polarity (P)	SPT	SPT	SPT	SPT
Transients (T)				
Output current	< 100 mA	< 100 mA	< 100 mA	< 100 mA
Housing material	Stainless steel AISI 316L	Stainless steel AISI 316L	ABS	ABS
Operating temperature	-25°C to +50°C	-25°C to +50°C	-25°C to +50°C	-25°C to +50°C
Degree of protection	IP 68, IP69K	IP 68, IP69K	IP 67	IP 67
LED colour	Yellow + Green	Yellow + Green	Yellow + Green	Yellow + Green
Communication interface	IO-Link	IO-Link	IO-Link	IO-Link
Transmission type	COM2 (38,4 kBaud)	COM2 (38,4 kBaud)	COM2 (38,4 kBaud)	COM2 (38,4 kBaud)
IO-Link revision	1.1	1.1	1.1	1.1
SDCI standard	IEC 61131-9	IEC 61131-9	IEC 61131-9	IEC 61131-9
Profiles	Smart Sensor: Process Data Variable; Device Identification	Smart Sensor: Process Data Variable; Device Identification	Smart Sensor: Process Data Variable; Device Identification	Smart Sensor: Process Data Variable; Device Identification
SIO mode	Yes	Yes	Yes	Yes
Required master port type	A	A	A	A
Min. process cycle time [ms]	5	5	5	5
Approvals/Marks	CE - cULus - ECOLAB Class 1 laser according to IEC 60825-1:2014	CE - cULus - ECOLAB Class 1 laser according to IEC 60825-1:2014	CE - cULus Class 1 laser according to IEC 60825-1:2014	CE - cULus Class 1 laser according to IEC 60825-1:2014
				







# Photoelectric sensors

## Integrated amplifier



Types	PD30 PointSpot Back potentiometer		PD30 Top potentiometer
Connections	2 m cable	M8 connector	2 m cable
			
Dimensions (mm)	10 x 30 x 20	10 x 30 x 20	10 x 30 x 20
<b>Diffuse reflective</b>			
Operating frequency / Sensing distance (Sn)			1000 Hz / 1 m
NPN NO+NC			<b>PD30CTD10NASA</b>
PNP NO+NC			<b>PD30CTD10PASA</b>
<b>Diffuse reflective, extremely wide angle, infrared light</b>			
Operating frequency / Sensing distance (Sn)			1000 Hz / 200 mm
NPN NO+NC			<b>PD30CTD02NAWE</b>
PNP NO+NC			<b>PD30CTD02PAWE</b>
<b>Diffuse reflective background suppression, red light</b>			
Operating frequency / Sensing distance (Sn)	500 Hz / 250 mm	500 Hz / 250 mm	500 Hz / 200 mm
NPN NO+NC	<b>PD30CNB25NAPS</b>	<b>PD30CNB25NAM5PS</b>	<b>PD30CTB20NASA</b>
PNP NO+NC	<b>PD30CNB25PAPS</b>	<b>PD30CNB25PAM5PS</b>	<b>PD30CTB20PASA</b>
<b>Diffuse reflective background suppression, infrared light</b>			
Operating frequency / Sensing distance (Sn)			500 Hz / 200 mm
NPN NO+NC			<b>PD30CTB20NAIS</b>
PNP NO+NC			<b>PD30CTB20PAIS</b>
<b>Retro reflective polarized</b>			
Operating frequency / Sensing distance (Sn)	1000 Hz / 5 m	1000 Hz / 5 m	
NPN NO+NC	<b>PD30CNP50NAPS</b>	<b>PD30CNP50NAM5PS</b>	
PNP NO+NC	<b>PD30CNP50PAPS</b>	<b>PD30CNP50PAM5PS</b>	
<b>Specifications</b>			
Rated operating voltage	10 - 30 VDC	10 - 30 VDC	10 - 30 VDC
Voltage drop	≤ 2.0 VDC @ 100 mA	≤ 2.0 VDC @ 100 mA	≤ 2.0 VDC @ 100 mA
Degree of protection	IP 67	IP 67	IP 67
Protection short-circuit (S)			
Reverse polarity (P)	SPT	SPT	SPT
Transients (T)			
Load current	≤ 100 mA	≤ 100 mA	≤ 100 mA
Housing material	ABS	ABS	ABS
Operating temperature	-25°C to +60°C	-25°C to +60°C	-25°C to +60°C
LED colour	Yellow + Green	Yellow + Green	Yellow + Green
Approvals/Marks UL508	CE - cULus	CE - cULus	CE - cULus

# Photoelectric sensors

## Integrated amplifier





Types	PD30 - Advanced with teach-in			
Connections	2 m cable	M8 connector	2 m cable	M8 connector
				
Dimensions (mm)	10 x 30 x 20	10 x 30 x 20	10 x 30 x 20	10 x 30 x 20
<b>Retro reflective</b>		<b>Retro reflective - transparent objects</b>		
Operating frequency / Sensing distance (Sn)	1000 Hz / 6 m, Teach-in	1000 Hz / 6 m, Teach-in	1000 Hz / 2 m, Teach-in	1000 Hz / 2 m, Teach-in
Mute NPN NO/NC	PD30CNR06NPMU	PD30CNR06NPM5MU	PD30CNG02NPMU	PD30CNG02NPM5MU
Mute PNP NO/NC	PD30CNR06PPMU	PD30CNR06PPM5MU	PD30CNG02PPMU	PD30CNG02PPM5MU
Dust NPN NO/NC	PD30CNR06NPDU	PD30CNR06NPM5DU		
Dust PNP NO/NC	PD30CNR06PPDU	PD30CNR06PPM5DU		
Remote NPN NO/NC	PD30CNR06NPRT	PD30CNR06NPM5RT	PD30CNG02NPRT	PD30CNG02NPM5RT
Remote PNP NO/NC	PD30CNR06PPRT	PD30CNR06PPM5RT	PD30CNG02PPRT	PD30CNG02PPM5RT
<b>Retro reflective polarized</b>		<b>Diffuse reflective</b>		
Operating frequency / Sensing distance (Sn)	1000 Hz / 6 m, Teach-in	1000 Hz / 6 m, Teach-in	1000 Hz / 1 m, Teach-in	1000 Hz / 1 m, Teach-in
Mute NPN NO/NC	PD30CNP06NPMU	PD30CNP06NPM5MU		
Mute PNP NO/NC	PD30CNP06PPMU	PD30CNP06PPM5MU		
Dust NPN NO/NC	PD30CNP06NPDU	PD30CNP06NPM5DU	PD30CND10NPDU	PD30CND10NPM5DU
Dust PNP NO/NC	PD30CNP06PPDU	PD30CNP06PPM5DU	PD30CND10PPDU	PD30CND10PPM5DU
Remote NPN NO/NC	PD30CNP06NPRT	PD30CNP06NPM5RT	PD30CND10NPRT	PD30CND10NPM5RT
Remote PNP NO/NC	PD30CNP06PPRT	PD30CNP06PPM5RT	PD30CND10PPRT	PD30CND10PPM5RT
<b>Through-beam emitter</b>				
Sensing distance (Sn)	15 m, Teach-in	15 m, Teach-in		
NPN	PD30CNT15NMU	PD30CNT15NM5MU		
PNP	PD30CNT15PMU	PD30CNT15PM5MU		
<b>Through-beam receiver mute function</b>		<b>Diffuse reflective background suppression</b>		
Operating frequency / Sensing distance (Sn)	1000 Hz / 15 m, Teach-in	1000 Hz / 15 m, Teach-in	1000 Hz / 150 mm, Teach-in	1000 Hz / 150 mm, Teach-in
Remote NPN NO/NC	PD30CNT15NPRT	PD30CNT15NPM5RT	PD30CNB15NPRT	PD30CNB15NPM5RT
Remote PNP NO/NC	PD30CNT15PPRT	PD30CNT15PPM5RT	PD30CNB15PPRT	PD30CNB15PPM5RT
Dust NPN NO/NC	PD30CNT15NPDU	PD30CNT15NPM5DU		
Dust PNP NO/NC	PD30CNT15PPDU	PD30CNT15PPM5DU		
<b>Specifications</b>				
Rated operating voltage	10 - 30 VDC	10 - 30 VDC	10 - 30 VDC	10 - 30 VDC
Voltage drop	≤ 2.4 VDC @ 100 mA	≤ 2.4 VDC @ 100 mA	≤ 2.4 VDC @ 100 mA	≤ 2.4 VDC @ 100 mA
Degree of protection	IP 67	IP 67	IP 67	IP 67
Protection short-circuit (S)				
Reverse polarity (P)	SPT	SPT	SPT	SPT
Transients (T)				
Load current	≤ 100 mA	≤ 100 mA	≤ 100 mA	≤ 100 mA
Housing material	ABS	ABS	ABS	ABS
Operating temperature	-25°C to +55°C	-25°C to +55°C	-25°C to +55°C	-25°C to +55°C
LED colour	Yellow + Green	Yellow + Green	Yellow + Green	Yellow + Green
Approvals/Marks UL508	CE - cULus	CE - cULus	CE - cULus	CE - cULus

# Photoelectric sensors

	Fiber optic sensor	Integrated amplifier colour sensors
<b>Types</b>	<b>FA1</b>	<b>PD12CNC..BPT</b>
<b>Connections</b>	<b>2 m cable</b>	<b>M12 connector</b>
		
Dimensions (mm)	10 x 33 x 80	61 x 26 x 115
<b>Diffuse reflective</b>		
Operating frequency	200, 500, 1000, 5000 $\mu$ S	500 Hz
Sensing distance (Sn)	Fiber dependent	2 to 60 mm (fiber dependent)
NPN NO+NC	<b>FA1-N</b>	
PNP NO+NC	<b>FA1-P</b>	
NPN/PNP NO+PC		<b>PD12CNC01BPM1T 1 Output</b>
NPN/PNP NO+PC		<b>PD12CNC04BPM1T 4 Output</b>
<b>Accessories: fibers</b>		
Dist. 18 mm		<b>FPDC 01 SCC 100</b>
Dist. 40-60 mm		<b>FPDC 02 SCC 100</b>
Dist. 4-6 mm		<b>FPDC 03 SCC 100</b>
Dist. 2-6 mm		<b>FPDC 04 SCC 100</b>
Dist. 4 mm		<b>FPDC 05 SCC 100</b>
<b>Specifications</b>		
Rated operating voltage	12 to 24 VDC	24 VDC
Voltage drop	$\leq 1.5$ VDC	$\leq 2.2$ VDC
Degree of protection	IP 40	IP 65
Protection short-circuit (S)		
Reverse polarity (P)	SPT	SPT
Transients (T)		
Load current	$\leq 100$ mA	$< 100$ mA
Housing material	ABS	Polycarbonate
Operating temperature	0°C to +60°C	0°C to +40°C
LED colour	Red + Green	Yellow + Green
Approvals/Marks	CE	CE - cUL
UL508	cULus (UL508)	
Light source	Red LED 660 nm	
Plastic fiber unit	FUR (reflective) & FUT (through beam) series. Please refer to FUR FUT specifications datasheets	

# Photoelectric sensors

## Through-beam, transistor output

Types	PB10..	PA12	PB18..	PE12..
Connections	5 m cable	M12 connector	5 m cable	5 m cable
				
Dimensions (mm)	Ø10	M12	Ø18	Ø12
<b>Through-beam emitter</b>				
Sensing distance (Sn)	20 m	20 m	15 m	15 m
Single channel	<b>PB10CNT20</b>	<b>PA12BNT20</b>	<b>PB18CNT15</b>	<b>PE12CNT15</b>
Channel 1	<b>PB10C1T20</b>	<b>PA12B1T20</b>		<b>PE12C1T15</b>
Channel 2	<b>PB10C2T20</b>	<b>PA12B2T20</b>		<b>PE12C2T15</b>
Channel 3	<b>PB10C3T20</b>	<b>PA12B3T20</b>		<b>PE12C3T15</b>
<b>Through-beam receiver</b>				
Operating frequency	100 Hz (for 3 ch 30 Hz)	100 Hz (for 3 ch 30 Hz)	100 Hz	100 Hz
Sensing distance (Sn)	20 m	20 m	15 m	15 m
NPN NO Single channel	<b>PB10CNT20NO</b>	<b>PA12BNT20NO</b>	<b>PB18CNT15NO</b>	<b>PE12CNT15NO</b>
NPN NC Single channel	<b>PB10CNT20NC</b>	<b>PA12BNT20NC</b>	<b>PB18CNT15NC</b>	<b>PE12CNT15NC</b>
PNP NO Single channel	<b>PB10CNT20PO</b>	<b>PA12BNT20PO</b>	<b>PB18CNT15PO</b>	<b>PE12CNT15PO</b>
PNP NC Single channel	<b>PB10CNT20PC</b>	<b>PA12BNT20PC</b>	<b>PB18CNT15PC</b>	<b>PE12CNT15PC</b>
NPN NO Channel 1	<b>PB10C1T20NO</b>	<b>PA12B1T20NO</b>		<b>PE12C1T15NO</b>
NPN NC Channel 1	<b>PB10C1T20NC</b>	<b>PA12B1T20NC</b>		<b>PE12C1T15NC</b>
PNP NO Channel 1	<b>PB10C1T20PO</b>	<b>PA12B1T20PO</b>		<b>PE12C1T15PO</b>
PNP NC Channel 1	<b>PB10C1T20PC</b>	<b>PA12B1T20PC</b>		<b>PE12C1T15PC</b>
NPN NO Channel 2	<b>PB10C2T20NO</b>	<b>PA12B2T20NO</b>		<b>PE12C2T15NO</b>
NPN NC Channel 2	<b>PB10C2T20NC</b>	<b>PA12B2T20NC</b>		<b>PE12C2T15NC</b>
PNP NO Channel 2	<b>PB10C2T20PO</b>	<b>PA12B2T20PO</b>		<b>PE12C2T15PO</b>
PNP NC Channel 2	<b>PB10C2T20PC</b>	<b>PA12B2T20PC</b>		<b>PE12C2T15PC</b>
NPN NO Channel 3	<b>PB10C3T20NO</b>	<b>PA12B3T20NO</b>		<b>PE12C3T15NO</b>
NPN NC Channel 3	<b>PB10C3T20NC</b>	<b>PA12B3T20NC</b>		<b>PE12C3T15NC</b>
PNP NO Channel 3	<b>PB10C3T20PO</b>	<b>PA12B3T20PO</b>		<b>PE12C3T15PO</b>
PNP NC Channel 3	<b>PB10C3T20PC</b>	<b>PA12B3T20PC</b>		<b>PE12C3T15PC</b>
<b>Specifications</b>				
Rated operating voltage	10 - 30 VDC	10 - 30 VDC	10 - 30 VDC	10 - 30 VDC
Voltage drop	≤ 1.5 VDC	≤ 1.5 VDC	≤ 1.5 VDC	≤ 1.5 VDC
Degree of protection	IP 67	IP 67	IP 67	IP 67
Protection short-circuit (S)				
Reverse polarity (P)	SPT	SPT	SPT	SPT
Transients (T)				
Load current	≤ 100 mA	≤ 100 mA	≤ 100 mA	≤ 100 mA
Housing material	PC	PC	PTE	PC
Operating temperature	-20°C to +50°C	-20°C to +50°C	-20°C to +50°C	-20°C to +50°C
LED colour	Green (E), Yellow (R)	Green (E), Yellow (R)		Green (E), Yellow (R)
Approvals/Marks	CE	CE	CE	CE
UL 508	cULus	UL - cUL	cULus	cULus
UL 325	cURus	UR - cURus	cURus	cURus

NB! For pig-tail connector versions add C2 after the part number



# Photoelectric sensors

## DC, integrated amplifier

Types	PD70	PD112	PA.	PB.
Connections	2 m cable or connector		2 m cable or connector	
				

Dimensions (mm)	11.6 x 11.6 x 70	112 x 45 x 25	36 x 18 x 63	18 x 75 x 36
-----------------	------------------	---------------	--------------	--------------

### Diffuse reflective background suppression

Operating frequency		Door mode 16.7 Hz Industry mode 250 Hz	1000 Hz	1000 Hz
Sensing distance (Sn)		2.5 m, adjustable	150 mm, adjustable	150 mm, adjustable
Cable		2 m	2 m	2 m
NPN/PNP, NO+NC		-	PA15INPA/PA15IPPA	PB15INPA/PB15IPPA
NPN+PNP, NO/NC		PD112CNB25BP	-	-
Connector		M12	M12	M12
NPN/PNP, NO+NC		-	PA15INPA-1/PA15IPPA-1	PB15INPA-1/PB15IPPA-1
NPN+PNP, NO/NC		PD112CNB25BPM1		

### Retro reflective polarized

Operating frequency			1000 Hz	1000 Hz
Sensing distance (Sn)			3 m, adjustable	3 m, adjustable
Cable			2 m	2 m
NPN/PNP, NO+NC			PA3PNPA/PA3PPPA	PB3PNPA/PB3PPPA
Connector			M12	M12
NPN/PNP, NO+NC			PA3PNPA-1/PA3PPPA-1	PB3PNPA-1/PB3PPPA-1

### Through-beam



Operating frequency	100 Hz			
Sensing distance (Sn)	12 m, adjustable			
Cable	2 m			
NPN NO (Receiver)	PD70CNT12NO			
NPN NC (Receiver)	PD70CNT12NC			
PNP NO (Receiver)	PD70CNT12PO			
PNP NC (Receiver)	PD70CNT12PC			
Mute High (Emitter)	PD70CNT12MH			
Mute Low (Emitter)	PD70CNT12ML			
Connector	M8			
NPN NO (Receiver)	PD70CNT12NOM5			
NPN NC (Receiver)	PD70CNT12NCM5			
PNP NO (Receiver)	PD70CNT12POM5			
PNP NC (Receiver)	PD70CNT12PCM5			
Mute High (Emitter)	PD70CNT12M5MH			
Mute Low (Emitter)	PD70CNT12M5ML			

### Specifications





Rated operating voltage	10 - 30 VDC	10 - 30 VDC	10 - 30 VDC	10 - 30 VDC
Voltage drop	≤ 1.8 VDC	≤ 2.5 VDC	≤ 2.5 VDC	≤ 2.5 VDC
Degree of protection	IP 67	IP 67	IP 67	IP 67
Protection short-circuit (S)				
Reverse polarity (P)	SPT	SPT	SPT	SPT
Transients (T)				
Load current	≤ 100 mA	< 200 mA	< 200 mA	< 200 mA
Housing material	PC Black	PC Black	Aluminium	Reinforced ABS
Operating temperature	-25°C to +55°C	-25°C to +55°C	-25°C to +60°C	-25°C to +60°C
LED colour	Yellow, Receiver output Green, Emitter power ON	Yellow, Output Green, Power ON	Yellow	Yellow
Approvals/Marks	CE - cURus	CE - cULus	CE	CE

# Photoelectric sensors





## Integrated amplifier

Types	PC50	PC50..M1	PC50
Connections	2 m cable	M12 connector	2 m cable
			
Dimensions (mm)	17 x 50 x 50	17 x 50 x 50	17 x 50 x 50
<b>Diffuse reflective</b>			
Operating frequency	500 Hz	500 Hz	20 Hz
Sensing distance (Sn)	1 m, adjustable	1 m, adjustable	
NPN/PNP NO+NC	<b>PC50CND10BA</b>	<b>PC50CND10BAM1</b>	
Sensing distance (Sn)	2 m, adjustable	2 m, adjustable	
NPN/PNP NO+NC	<b>PC50CND20BA</b>	<b>PC50CND20BAM1</b>	
Sensing distance (Sn)			1 m, adjustable
Relay SPDT Multivoltage			<b>PC50CND10RP</b>
Sensing distance (Sn)			2 m, adjustable
Relay SPDT Multivoltage			<b>PC50CND20RP</b>
<b>Diffuse reflective background suppression</b>			
Operating frequency	250 Hz	250 Hz	
Sensing distance (Sn)	500 mm, adjustable	500 mm, adjustable	
NPN/PNP NO+NC	<b>PC50CNB50BA</b>	<b>PC50CNB50BAM1</b>	
<b>Retro reflective polarized</b>			
Operating frequency	500 Hz	500 Hz	20 Hz
Sensing distance (Sn)	6 m, adjustable	6 m, adjustable	6 m, adjustable
NPN/PNP NO+NC	<b>PC50CNP06BA</b>	<b>PC50CNP06BAM1</b>	
Mute High	<b>PC50CNP06BAMH</b>	<b>PC50CNP06BAM1MH</b>	
Mute Low	<b>PC50CNP06BAML</b>	<b>PC50CNP06BAM1ML</b>	
Relay SPDT Multivoltage			<b>PC50CNP06RP</b>
<b>Retro reflective</b>			
Operating frequency	500 Hz	500 Hz	20 Hz
Sensing distance (Sn)	10 m, adjustable	10 m, adjustable	10 m, adjustable
NPN/PNP NO+NC	<b>PC50CNR10BA</b>	<b>PC50CNR10BAM1</b>	
Relay SPDT Multivoltage			<b>PC50CNR10RP</b>
<b>Through-beam emitter</b>			
Sensing distance (Sn)	20 m	20 m	20 m
	<b>PC50CNT20B</b>	<b>PC50CNT20BAM1</b>	<b>PC50CNT20R</b>
<b>Through-beam receiver</b>			
Operating frequency	500 Hz	500 Hz	20 Hz
Sensing distance (Sn)	20 m, adjustable	20 m, adjustable	20 m, adjustable
NPN/PNP NO+NC	<b>PC50CNT20BA</b>	<b>PC50CNT20BAM1</b>	-
Relay SPDT Multivoltage			<b>PC50CNT20RP</b>
<b>Specifications</b>			
Rated operating voltage	10 - 30 VDC	10 - 30 VDC	12 - 240 VDC / 24 - 240 VAC
Voltage drop	≤ 2.5 VDC	≤ 2.5 VDC	Relay SPDT
Degree of protection	IP 67	IP 67	IP 67
Protection short-circuit (S)			
Reverse polarity (P)	SPT	SPT	PT
Transients (T)			
Load current	≤ 200 mA	≤ 200 mA	≤ 3 mA
Housing material	Reinforced ABS/PC	Reinforced ABS/PC	Reinforced ABS/PC
Operating temperature	-20°C to +60°C	-20°C to +60°C	-20°C to +60°C
LED colour	Yellow + Green	Yellow + Green	Yellow + Green
Approvals/Marks	CE - UL - CSA	CE - UL - CSA	CE - UL - CSA

# Photoelectric sensors

	Integrated amplifier		Fork sensor	
Types	PD60..	PD60..M5	PF80..	PF74..
Connections	2 m cable	M8 connector	M8 connector	5 m cable
				
Dimensions (mm)	13 x 30 x 60	13 x 30 x 60	12 x 37.5 x 80	15 x 60 x 74
<b>Contrast sensor</b>				
Operating frequency	20 kHz	20 kHz		
Sensing distance (Sn)	18 mm (fibre depend.)	18 mm (fibre depend.)		
NPN/PNP NO+NC	<b>PD60CNK18BPT</b>	<b>PD60CNK18BPM5T</b>		
<b>Fork sensor</b>				
Operating frequency			10 kHz	≤ 1100 Hz
Sensing distance (Sn)			3 mm, slot width	30 mm, slot width
NPN/PNP NO+NC			<b>PF80FNT03BPM5T</b>	
PNP NO, NPN NC				<b>PF74CNT30BC</b>
PNP NC, NPN NO				<b>PF74CNT30BO</b>
<b>General specifications</b>				
Rated operating voltage	10 - 30 VDC	10 - 30 VDC	10 - 30 VDC	19.2 - 28.8 VDC
Voltage drop	≤ 2.0 VDC	≤ 2.0 VDC	≤ 2.0 VDC @ 100 mA ≤ 1.0 VDC @ 10 mA	≤ 1.5 VDC @ 100 mA
Degree of protection	IP 65	IP 65	IP 65	IP 65
Protection short-circuit (S)				
Reverse polarity (P)	SPT	SPT	ST	SPT
Transients (T)				
Load current	≤ 100 mA	≤ 100 mA	≤ 40 mA	≤ 30 mA
Housing material	PC	PC	Aluminium, black	PC, black
Operating temperature	0°C to +60°C	0°C to +60°C	-20°C to +60°C	-25°C to +60°C
LED colour	Red	Red	Yellow + Red	Yellow + Green
Approvals/Marks	CE - UL - cUL	CE - UL - cUL	CE	CE



# Photoelectric sensors

	Integrated amplifier relay output			Through-beam relay output
Types	PM..	PM..	PD86	PD98
Connections	Terminals single relay	Terminal block mute input	Terminal block mute input	Terminal block mute input
				
Dimensions (mm)	25 x 65 x 81	25 x 65 x 81	86 x 44 x 39	98 x 56 x 37
<b>Diffuse reflective</b>				
Oper. freq. / Sens. dist. (Sn)	20 Hz			
Sensing distance (Sn)	0.8 m, adjustable			
Relay SPDT Multivoltage	<b>PMD8RG / RGT</b> <b>PMD8RI / RIT</b>			
<b>Retro reflective polarized</b>				
Oper. freq. / Sens. dist. (Sn)	20 Hz / 12 m, fixed	20 Hz / 12 m, fixed	20 Hz / 12 m, fixed	
Relay SPDT Multivoltage	<b>PMP12RG / PMP12RI</b>		<b>PD86CNP12QPMU</b>	
Relay SPST (PC)		<b>PMP12RGM / PMP12RIM</b>	<b>PD86HNP12QPMU-01C</b>	
Relay SPST (ZAMAK)				
<b>Retro reflective</b>				
Oper. freq. / Sens. dist. (Sn)	20 Hz / 10 m, fixed			
Relay SPDT Multivoltage	<b>PMR10RG / RGT</b>			
Relay SPST	<b>PMR10RI / RIT</b>			
<b>Through-beam emitter</b>				
Sensing distance (Sn)	20 m	20 m		30 m (15 m default)
	<b>PMT20G / PMT20I</b>	<b>PMT20GM / PMT20IM</b>		<b>PD98CNT30QMU*</b>
<b>Through-beam receiver</b>				
Oper. freq. / Sens. dist. (Sn)	20 Hz / 20 m, fixed	20 Hz / 20 m, fixed		25 Hz / 30 m (15 m default)
Relay SPDT Multivoltage	<b>PMT20RG / RGT</b> <b>PMT20RI / RIT</b>			
Relay SPST				
<b>General specifications</b>				
Rated operating voltage	12 - 240 VDC / 24 - 240 VAC	24 VAC/DC ±20%	24 VAC/DC ±20%	12 V to 24 VAC/DC
Voltage drop	Relay SPDT	Relay SPST	Relay SPST	Relay DPDT
Degree of protection	IP 67	IP 67	IP 66	IP 54
Protection short-circuit (S)				
Reverse polarity (P)	PT	PT	PT	PT
Transients (T)				
Load current	≤ 3 A	≤ 3 A	1 A (AC), 0.5 A (DC)	1 A (AC), 0.5 A (DC)
Housing material	PC/ABS	PC/ABS	PD86C.. : PC + PMMA PD86H.. : ZAMAK + PMMA	PC/ABS
Operating temperature	-25°C to +55°C	-25°C to +55°C	-25°C to +60°C	-25°C to +60°C
LED colour	Yellow	Yellow	Yellow + Green	Yellow (receiver)
Approvals/Marks	CE - UL - CSA	CE - UL325 - UL508	CE - UL325 - UL508	CE - UL325
Remarks	G = PG 13.5 Outlet I = ½"NPT Outlet T = Timer	G = PG 13.5 Outlet I = ½"NPT Outlet Mute input	Mute input	Mute input





\* Item number set, emitter + receiver.



# Photoelectric sensors

	Heavy duty infrared barrier	Through-beam relay output
Types	PD140	PD180
Connections	Terminal block	Terminal block
		
Dimensions (mm)	140 x 51 x 46	180 x 51 x 49
<b>Through-beam range</b>		
Indoor sensing distance (max)	60 m outdoor	15 / 30 m
<b>General specifications</b>		
Technology	Infrared	Infrared
Supply voltage receiver or emitter	12...24 VAC/VDC	12 + 24 VAC/DC
Battery supply emitter		2 x 3,6 VDC, 2100 mAh Lithium batteries size AA
Consumption	155 mA to 24 VAC (Emitter and receiver)	35 mA DC (55 mA DC with low battery alarm)
Output	SPDT	2 x SPST
Contact rating	1 A /@ 30 VDC, 0.5 A @ 50 VAC (resistive load)	1 A @ 30 VDC, 0.5 A @ 30 VAC (resistive load)
Approvals	CE - UL325 - UL508	CE - UL325 - CSA
Conformity	EN 12445, EN 12453, EN12978, EN/ISO 13849-1 ESPE2, RoHS	EN 12445, EN12453, EN12978, EN/ISO 13849-1 ESPE2, RoHS
Test input	Emitter test input	Emitter test input
<b>Environmental specifications</b>		
Wavelength	850 nm	850 nm
Operating temperature	-20°C to +60°C	-25°C to +55°C
Degree of protection	IP 65	IP 55
<b>Mechanical specifications</b>		
LED transmitter	Power signal	None (energy saving)
LED receiver	Signal for alignment with transmitter	Power ON - Green LED Output - Yellow LED
Optical adjustment	Horizontal 200° Vertical ±15°	Horizontal 200° Vertical ±30°
Mounting	Wall mounted type	Wall mounted type
Material	Aluminium, PC	PC
Weight	460 g (set)	Emitter 270 g Receiver 230 g
Comments	ESPE Category 2, EN 61496-2 Accessory: Laser alignment tool	ESPE Category 2, EN 61496-2 Emitter is supplied with 2 x 3.6 VDC 2100 mAh lithium batteries
Accessories	APD140-LA01 APD140-LA02 APD140-TC01	

# Photoelectric sensors

	Sensors	Amplifier 1-channel	Amplifier 2-channel	Amplifier 3-channel
<b>Types</b>	<b>MPF..</b>	<b>MPF1..</b>	<b>MPF2..</b>	<b>MPF3..</b>
<b>Connections</b>	<b>10 m cable</b>	<b>Terminals</b>	<b>Terminals</b>	<b>Terminals</b>
				
<b>Dimensions (mm)</b>	See sensor type	70 x 57 x 86	70 x 57 x 86	70 x 57 x 86
<b>Amplifier</b>				
		1-Channel	2-Channel	3-Channel
12-24 VAC/DC ±15%		<b>MPF1-912RSL</b>	<b>MPF2-912RSL</b>	<b>MPF3-912RSL</b>
Low current		<b>MPF1-912RS</b>	<b>MPF2-912RS</b>	<b>MPF3-912RS</b>
12-24 VAC/DC ±15%		<b>MPF1-115RS</b>	<b>MPF2-115RS</b>	<b>MPF3-115RS</b>
115 VAC ±15%		<b>MPF1-230RS</b>	<b>MPF2-230RS</b>	<b>MPF3-230RS</b>
230 VAC ±15%				
<b>Through-beam emitter</b>		<b>Output and function selection</b>		
Sensing distance (Sn)	15 m	No Dist Adjust		Dist Adjust
Ø12 x 20	<b>MPFT15-4 (C)</b>	Normal Mute	Inverted Mute	Normal Mute
D11 x 24.5	<b>MPFT15-D11-4</b>			
D18 x 25	<b>MPFT15-D18-4 (C)</b>	RS	RSI	RSA
M14 x 23	<b>MPFT15-M14-4 (C)</b>	RSL	RSLI	RSLAI
<b>Through-beam receiver</b>				
Sensing distance (Sn)	15 m			
Ø12 x 20	<b>MPFR-4 (C)</b>			
D11 x 24.5	<b>MPFR-D11-4</b>			
D18 x 25	<b>MPFR-D18-4 (C)</b>			
M14 x 23	<b>MPFR-M14-4 (C)</b>			
<b>General specifications</b>				
Rated operating voltage	Powered by amplifier	See amplifier reference	See amplifier reference	See amplifier reference
Output		1 x 2 SPST in series	2 x 2 SPST in series	3 x 2 SPST in series
Low current resistive load		RS type: 2 A @ 240 VAC / 30 VDC RSL type: 0.5 A @ 50 VAC / 30 VAC	RS type: 2 A @ 240 VAC / 30 VDC RSL type: 0.5 A @ 50 VAC / 30 VAC	RS type: 2 A @ 240 VAC / 30 VDC RSL type: 0.5 A @ 50 VAC / 30 VAC
Operating frequency	Amplifier dependent	10 Hz	10 Hz	10 Hz
Degree of protection	IP 67	IP 40	IP 40	IP 40
Protection short-circuit (S)				
Reverse polarity (P)	SPT	PT	PT	PT
Transients (T)				
Housing material				
-Amplifier		PC	PC	PC
-Sensor Ø12+D11+D18	PC + ABS			
-Sensor	PC + Stainless steel			
Operating temperature	-20°C to +60°C	-20°C to +60°C	-20°C to +60°C	-20°C to +60°C
LED colour		Yellow	Yellow	Yellow
Approvals/Marks	CE - UL325 - UL508	CE - UL325 - UL508	CE - UL325 - UL508	CE - UL325 - UL508
Remarks	C = Pigtail connector version			
Optical angle (degrees)	±5			

# Photoelectric sensors

## Sensors for amplifiers

Types	MOF..	MOF.. ATEX	MNF..	MDF..
Connections	10 m cable	Terminals	Terminals	Terminals
				

Dimensions (mm)	Ø 10 x 42	Ø 10 x 42	Ø 20 x 80	Ø 13.5 x 55
-----------------	-----------	-----------	-----------	-------------

### Through-beam emitter

Sensing distance (Sn)	20 m	20 m		
Max. ±2° optical angle	<b>MOFT20</b> <b>MOFT20-M12-2</b>	<b>MOFT20AX</b> <b>MOFT20-M12-2AX</b>		
Sensing distance (Sn)	50 m			
Max. ±2° optical angle	<b>MOFT50</b> <b>MOFT50-M12-2</b>			
Sensing distance (Sn)	20 m	20 m		
Max. ±5° optical angle	<b>MOFT20-5</b> <b>MOFT20-M12-5</b>	<b>MOFT20-5AX</b> <b>MOFT20-M12-5AX</b>		
Sensing distance (Sn)	20 m	20 m	15 m	30 m
Max. ±8° optical angle	<b>MOFT20-8</b> <b>MOFT20-M12-8</b> <b>MOFT20-M14-8</b>	<b>MOFT20-8AX</b> <b>MOFT20-M12-8AX</b> <b>MOFT20-M14-8AX</b>	<b>MNFT15</b>	<b>MDFT30</b>



### Through-beam receiver

Operating frequency	Amplifier dependent	Amplifier dependent	Amplifier dependent	Amplifier dependent
Sensing distance (Sn)	See emitter	See emitter	See emitter	See emitter
Max. ±2° optical angle	<b>MOFR</b> <b>MOFR-M12-2</b>	<b>MOFRAX</b> <b>MOFR-M12-2AX</b>		
Max. ±5° optical angle	<b>MOFR-5</b> <b>MOFR-M12-5</b>	<b>MOFR-5AX</b> <b>MOFR-M12-5AX</b>		
Max. ±8° optical angle	<b>MOFR-8</b> <b>MOFR-M12-8</b> <b>MOFR-M14-8</b>	<b>MOFR-8AX</b> <b>MOFR-M12-8AX</b> <b>MOFR-M14-8AX</b>	<b>MNFR15</b>	<b>MDFR30</b>

### General specifications





Rated operating voltage	Powered by Amplifier	Powered by Amplifier	Powered by Amplifier	Powered by Amplifier
Output	On Amplifier	On Amplifier	On Amplifier	On Amplifier
Operating frequency	See Amplifier type: S142.. - S143.. - PAM..	See Amplifier type: S142.. - S143.. - PAM..	See Amplifier type: S142.. - S143.. - PAM..	See Amplifier type: S142.. - S143.. - PAM..
Degree of protection	IP 66 - IP 67	IP 66 - IP 67	IP 67	IP 67
Protection short-circuit (S)				
Reverse polarity (P)	SPT	SPT	SPT	SPT
Transients (T)				
Housing material sensor	Ø10: PC M14 + M14: PC + SS	Ø10: PC M14 + M14: PC + SS	PC M14 + M14: PC + SS	Acetal, glass reinforced
Operating temperature	-20°C to +60°C	-20°C to +60°C	-20°C to +60°C	-20°C to +60°C
LED colour	None	None	None	None
Approvals/Marks	CE	CE - ATEX	CE	CE

# Photoelectric sensors



Types	Amplifiers for sensors		
Connections	11-pole plug	11-pole plug	11-pole plug
			
Dimensions (mm)	35 x 80 x 81.5	35 x 80 x 81.5	35 x 80 x 81.5
Description	Standard amplifier with Sensor diagnostics and adjustable sensing distance	As S142A but with adjustable time delay	As S142A but with Master / Slave function for high neighbour immunity
<b>References amplifier</b>			
1 x SPDT relay	<b>S142ARNN924</b>	<b>S142BRNN924</b>	
1 x NPN output	<b>S142ARNO24</b>	<b>S142BRNO24</b>	
1 x NPN alarm output	<b>S142ARNN115</b> <b>S142ARNN230</b>	<b>S142BRNN115</b> <b>S142BRNN230</b>	
1 x SPDT relay	<b>S142ARNT924</b>	<b>S142BRNT924</b>	
1 x NPN output or alarm	<b>S142ARNT024</b>		
1 x Emitter mute input	<b>S142ARNT115</b> <b>S142ARNT230</b>	<b>S142BRNT115</b> <b>S142BRNT230</b>	
1 x PNP output	<b>S142APPT924</b>	<b>S142BPPT924</b>	
1 x PNP alarm output	<b>S142APPT115</b>	<b>S142BPPT115</b>	
1 x Emitter mute input	<b>S142APPT230</b>	<b>S142BPPT230</b>	
1 x SPDT relay			<b>S142CRXA924</b>
A - Auto distance adjustment			<b>S142CRXA115</b> <b>S142CRXA230</b>
M - Manual distance adjustment			<b>S142CRXM924</b> <b>S142CRXM115</b> <b>S142CRXM230</b>
<b>General specifications</b>			
Rated operating voltage			
924	24 VAC/DC	24 VAC/DC	24 VAC/DC
115	115 VAC	115 VAC	115 VAC
230	230 VAC	230 VAC	230 VAC
Relay load current resistive load	10 A @ 250 VAC / 25 VDC SPD	10 A @ 250 VAC / 25 VDC SPD	10 A @ 250 VAC / 25 VDC SPD
Transistor load current	100 mA 40 VDC	100 mA 40 VDC	
Operation frequency	20 Hz	20 Hz, no timer	15 Hz @ 2 systems 4 Hz @ 6 systems
Degree of protection	IP 20	IP 20	IP 20
Protection short-circuit (S)			
Reverse polarity (P)	SPT	SPT	S
Transients (T)			
Housing material	Noryl SE1, Light grey	Noryl SE1, Light grey	Noryl SE1, Light grey
Operating temperature	-20°C to +50°C	-20°C to +50°C	-20°C to +50°C
Approvals/Marks	CE - UL - CSA	CE - UL - CSA	CE - UL - CSA



# Photoelectric sensors

Types	S1430 UAP..	S1430 RAL..	S1430 ROS..	PAM...
Connections	1 1-pole plug	11-pole plug	11-pole plug	Terminals
				
Dimensions (mm)	35 x 80 x 81.5	35 x 80 x 81.5	35 x 80 x 81.5	2, 3, 4, 5, 6 DIN housing
Description	3 inputs 3 transistors outputs	3 inputs 3 transistors outputs	3 inputs 3 double relay outputs	2-4-6-8 or 10 channels modular system
<b>References amplifier</b>				
12-30 VAC/DC ±15%	<b>S1430UAP912</b>			
15-30 VAC/DC ±10%		<b>S1430RAL915</b>	<b>S1430ROS915</b>	
No. of channels				2 channels
- NPN output, NO				<b>PAM02AN3ANO/NC</b>
- PNP output, NO				<b>PAM02AN3APO/PC</b>
No. of channels				4 channels
- NPN output, NO				<b>PAM04AN3ANO/NC</b>
- PNP output, NO				<b>PAM04AN3APO/PC</b>
No. of channels				6 channels
- NPN output, NO				<b>PAM06AN3ANO/NC</b>
- PNP output, NO				<b>PAM06AN3APO/PC</b>
<b>References extension modules</b>				
No. of channels				2 channels
- NPN output, NO				<b>PAM02CN3ANO</b>
- NPN output, NC				<b>PAM02CN3ANC</b>
- PNP output, NO				<b>PAM02CN3APO</b>
- PNP output, NC				<b>PAM02CN3APC</b>
No. of channels				4 channels
- NPN output, NO				<b>PAM04CN3ANO</b>
- NPN output, NC				<b>PAM04CN3ANC</b>
- PNP output, NO				<b>PAM04CN3APO</b>
- PNP output, NC				<b>PAM04CN3APC</b>
<b>General specifications</b>				
Rated operating voltage	See Amplifier type	See Amplifier type	See Amplifier type	18 - 33 VDC
Output	3 x Transistor NPN/PNP/NO/NC	3 x SPST	3 x SPST	One output per channel
Load current resistive load	100 mA, 40 VDC, NPN	1.5 A @ 100 VAC / 30 VDC	1.5 A @ 100 VAC / 30 VDC	20 mA, 33 VDC, NPN / PNP 8 A @ 250 VAC / 24 VDC SPDT resistive load
Operation frequency	16 Hz	12.5 Hz	12.5 Hz	30 Hz @ 6 channels
Degree of protection	IP 20	IP 20	IP 20	IP 20
Protection short-circuit (S)				
Reverse polarity (P)	SPT	PT	PT	SPT
Transients (T)				
Housing material	Noryl SE1, Light grey	Noryl SE1, Light grey	Noryl SE1, Light grey	
Operating temperature	-20°C to +50°C	-20°C to +50°C	-20°C to +50°C	-20°C to +50°C
LED colour	Yellow + Green + Red	Yellow + Green + Red	Yellow + Green + Red	Yellow + Green + Red
Approvals/Marks	Multiplexed system	Multiplexed system	Multiplexed system	Multiplexed system, test functions, bargraph, mute input etc.

# Photoelectric sensors

Types	Wireless entrapment protection device for industrial doors ESPE		
Connections	Main controller	Subcontroller	PB 11
			
Dimensions (mm)	35 x 35 x 125	26 x 242 x 45	Ø11 x 24.5
Description	The Carlo Gavazzi main controller can control up to 4 subcontrollers	This flexible Carlo Gavazzi subcontroller can handle 2 safety edges and 1 door-in-door limit switch	
References			
Main controller	<b>WSM 2 B A 2 D24</b>		
Subcontroller	<b>WSS 2 B A 2 BAT</b>		
Photoelectric sensor Emitter	<b>PB 11 CNT 15 WE</b>		
Photoelectric sensor Receiver	<b>PB 11 CNT 15 WR</b>		
General specifications			
Rated operating voltage	12 - 24 VAC/DC	1 - 4 Lithium 3.6 VDC size AA batteries	From subcontroller
Supply current	< 50 mA		
Relay load current resistive load	1 A / 30 VDC 0.5 A / 30 VAC		
Communication frequency	2.4 GHz Duplex	2.4 GHz Duplex	
Response time	120 mS	120 mS	
Number of channels	16	16	
Communication distance	10 m wireless	10 m wireless	
Sensing distance			15 m
Subcontroller up-time		10 - 80 sec	
Test input	On main module		
Degree of protection	IP 66	IP 66	IP 67
Protection short-circuit (S) Reverse polarity (P) Transients (T)	PT	P	
Housing material	ABS, Light grey	PC, Light grey	PA6 Glass reinforced
Operating temperature	-25°C to +55°C	-25°C to +55°C	-25°C to +55°C
LED colour	Green, Yellow, Red	Yellow	-
Approvals/Marks	CE - UL - FCC	CE - UL - FCC	CE - UL

# Photoelectric sensors

## Types **Wireless entrapment protection device for industrial gates ESPE**

### Connections **Main controller      Subcontroller      PB 11**



Dimensions (mm)      35 x 35 x 125      26 x 242 x 45      Ø11 x 24.5

Description      The Carlo Gavazzi main controller can control up to 6 subcontrollers      This flexible Carlo Gavazzi subcontroller can handle one opening safety edge and one closing edge





### References

Main controller (N.O. 8.2 kohm output)	<b>WSM6GAOOD24</b>		
Main controller (N.C. output)	<b>WSM6GACCD24</b>		
Subcontroller		<b>WSS2GA2BAT</b>	
Photoelectric sensor Emitter			<b>PB 11 CNT 15 WE</b>
Photoelectric sensor Receiver			<b>PB 11 CNT 15 WR</b>

### General specifications

Rated operating voltage	12 - 24 VAC/DC	1 - 4 Lithium 3.6 VDC size AA batteries	From subcontroller
Supply current	< 50 mA		
Relay load current resistive load	1 A / 30 VDC 0.5 A / 30 VAC		
Communication frequency	2.4 GHz Duplex	2.4 GHz Duplex	
Response time	From 15 to 100 ms	From 15 to 100 ms	
Number of channels	16	16	
Communication distance	15 m wireless	15 m wireless	
Sensing distance			2.5 m
Subcontroller up-time		15 – 105 s, fixed time or infinite	
Test input	On main module		
Degree of protection	IP 66	IP 66	IP 67
Protection short-circuit (S)			
Reverse polarity (P)	PT	P	
Transients (T)			
Housing material	ABS, Light grey	PC, Light grey	PA6 Glass reinforced
Operating temperature	-25°C to +55°C	-25°C to +55°C	-25°C to +55°C
LED colour	Green, Yellow, Red	Yellow	-
Approvals/Marks	CE - UL - FCC - TÜV	CE - UL - FCC - TÜV	CE - UL

# Photoelectric level sensors

Integrated amplifier			
Types	VPO.E.	VP ATEX	VP E.M
Connections	2 m cable	2 m cable	2 m cable
			
Dimensions (mm)	3/8" x 74	3/8" x 74	3/8" x 74
Light type	Unmodulated	Unmodulated	Unmodulated
<b>References optical level sensor</b>			
Operating frequency	30 Hz	30 Hz	30 Hz
Sensing dist. (Sn), Hor.	± 5 mm, fixed	± 5 mm, fixed	± 5 mm, fixed
Sensing dist. (Sn), Ver.	± 2.5 mm, fixed	± 2.5 mm, fixed	± 2.5 mm, fixed
Housing material	Polysulphone	Polysulphone	Polysulphone
NPN NO	<b>VP02E</b>		<b>VP02EM</b>
NPN NC	<b>VP01E</b>		<b>VP01EM</b>
PNP NO	<b>VP02EP</b>	<b>VP02EPAX</b>	<b>VP02EPM</b>
PNP NC	<b>VP01EP</b>	<b>VP01EPAX</b>	<b>VP01EPM</b>
Housing material	Polyamide 12	Polyamide 12	Polyamide 12
NPN NO	<b>VP04E</b>		<b>VP04EM</b>
NPN NC	<b>VP03E</b>		<b>VP03EM</b>
PNP NO	<b>VP04EP</b>	<b>VP04EPAX</b>	<b>VP04EPM</b>
PNP NC	<b>VP03EP</b>	<b>VP03EPAX</b>	<b>VP03EPM</b>
Housing material	Polysulphone		
SCR NO	<b>VP02-110TB</b>		
SCR NC	<b>VP01-110TB</b>		
SCR NO	<b>VP02-230TB</b>		
SCR NC	<b>VP01-230TB</b>		
<b>DC-types</b>			
Rated operating voltage	10 - 40 VDC	10 - 16.8 VDC	10 - 40 VDC
Voltage drop	≤ 1.0 VDC	≤ 1.0 VDC	≤ 1.0 VDC
Off-state current	≤ 12 mA	≤ 12 mA	≤ 12 mA
Load current	< 200 mA	< 50 mA	< 200 mA
<b>AC-types (SCR)</b>			
Rated operating voltage	110 or 230 VAC		
Voltage drop	≤ 9 VAC		
Off-state current	≤ 7 mA		
Load current	< 10 - 100 mA		
<b>General specifications</b>			
Degree of protection	IP 67	IP 67	IP 67
Protection short-circuit (S)			
Reverse polarity (P)	PT	PT	PT
Transients (T)			
Operating temperature	-20°C to +80°C	-20°C to +80°C	-20°C to +80°C
LED colour	Yellow	Yellow	Yellow
Pressure	10 bar @ +60°C	10 bar @ +60°C	10 bar @ +60°C
Approvals/Marks	CE	CE -  - TÜV - ATEX zone 1	CE



# Photoelectric level sensors

## Integrated amplifier

Types	VPA..../VPB....	VPA....-1/VPB....-1
Connections	2 m cable	M12 connector



Dimensions (mm)	3/8" x 70.5	3/8" x 90.5
Light type	Modulated	Modulated

### References optical level sensor

Operating frequency	30 Hz	30 Hz
Sensing dist. (Sn), Hor.	± 5 mm, fixed	± 5 mm, fixed
Sensing dist. (Sn), Ver.	± 2.5 mm, fixed	± 2.5 mm, fixed
Housing material	Stainless steel/polysulphone	Stainless steel/polysulphone
NPN NO+NC	<b>VPA1MNA</b>	<b>VPA1MNA-1</b>
PNP NO+NC	<b>VPA1MPA</b>	<b>VPA1MPA-1</b>
Housing material	Stainless steel and glass	Stainless steel and glass
NPN NO+NC	<b>VPA2MNA</b>	<b>VPA2MNA-1</b>
PNP NO+NC	<b>VPA2MPA</b>	<b>VPA2MPA-1</b>
Housing material	Nickel-pl. brass/polysulphone	Nickel-pl. brass/polysulphone
NPN NO+NC	<b>VPB1MNA</b>	<b>VPB1MNA-1</b>
PNP NO+NC	<b>VPB1MPA</b>	<b>VPB1MPA-1</b>
Housing material	Nickel-plated brass and glass	Nickel-plated brass and glass
NPN NO+NC	<b>VPB2MNA</b>	<b>VPB2MNA-1</b>
PNP NO+NC	<b>VPB2MPA</b>	<b>VPB2MPA-1</b>

### DC-types



Rated operational voltage	10 - 40 VDC	10 - 40 VDC
Voltage drop	≤ 2.5 VDC	≤ 2.5 VDC
Off-state current	≤ 7 mA	≤ 7 mA
Load current	< 200 mA	< 200 mA

### General specifications

Degree of protection	IP 67	IP 67
Protection short-circuit (S)		
Reverse polarity (P)	SPT	SPT
Transients (T)		
Operating temperature	-20°C to +70°C	-20°C to +70°C
LED colour	Yellow	No LED
Pressure	10 bar @ +60°C	10 bar @ +60°C
Approvals/Marks	CE	CE

# Motion and presence sensors

## Combined motion and presence detectors for pedestrian doors

Types	GUARDIAN 1	GUARDIAN 2
Connections	Terminal block	Terminal block
		
Dimensions (mm)	210 x 77 x 58	210 x 77 x 58
Technology	Digital video camera technology 640 x 480	Digital video camera technology 640 x 480
Door types	Straight sliding doors	Curved and straight sliding doors
Features	The Guardian sensor is a unique motion and presence detector that provides maximum safety and protection in pedestrian sliding door installations. Equipped with the latest digital video camera technology, Guardian watches over the entrance and exit area safeguarding people within, while at the same time controlling the doors. Guardian is able to ignore cross traffic, and it has a brilliant capability of self-adjusting to changes in the environment and weather conditions	
<b>Input specifications</b>		
Mounting height	180 cm to 300 cm	180 cm to 300 cm
Motion zone sensing area	Hight 180 cm = 246 x 204 cm Hight 220 cm = 300 x 249 cm Hight 300 cm = 410 x 340 cm	Hight 180 cm = 246 x 204 cm Hight 220 cm = 300 x 249 cm Hight 300 cm = 410 x 340 cm
Presence zone sensing area	Hight 180 cm = 42 cm x door width Hight 220 cm = 51 cm x door width Hight 300 cm = 70 cm x door width	Hight 180 cm = 42 cm x door width Hight 220 cm = 51 cm x door width Hight 300 cm = 70 cm x door width
Maximum door radius vs. Mounting height		Hight 180 cm = Radius 130 cm Hight 220 cm = Radius 170 cm Hight 300 cm = Radius 200 cm
Sensitivity	Adjusting in 7 steps	Adjusting in 7 steps
Presence time	7 step rotary switch: (10, 30 sec.) 1 min, 5 min (not accordance to DIN18650)	7 step rotary switch: (10, 30 sec.) 1 min, 5 min (not accordance to DIN18650)
Ambient light	10 lux - 50.000 lux	10 lux - 50.000 lux
<b>Output specifications</b>		
Output function	Safety and Motion Zone: relay - SPST Common relay data: 1 A DC 30 VDC 600.000 cycles @ 0.5 A, 50 VAC/30 VDC	Safety and Motion Zone: relay - SPST Common relay data: 1 A DC 30 VDC 600.000 cycles @ 0.5 A, 50 VAC/30 VDC
<b>General specifications</b>		
Rated operating voltage	12 - 24 VAC	12 - 24 VAC
No load supply current	Max. 230 mA	Max. 230 mA
Test input. Active high	ON > 9 VAC/VDC OFF < 6 VAC/VDC	ON > 9 VAC/VDC OFF < 6 VAC/VDC
Test input. Active low	ON < 6 VAC/VDC OFF > 9 VAC/VDC	ON < 6 VAC/VDC OFF > 9 VAC/VDC
Type of ESPE	Type 2	Type 2
Degree of protection	IP 64	IP 64
TÜV	In acc. with machinery directive 2006/42/EC, annex I DIN 18650-1 § 5.7.4, edition 2005 (prEN16005), EN13241-1, EN 12978	In acc. with machinery directive 2006/42/EC, annex I DIN 18650-1 § 5.7.4, edition 2005 (prEN16005), EN13241-1, EN 12978
UL-approved	cURus: UL325, CSA-C22.2 No. 247	cURus: UL325, CSA-C22.2 No. 247
Marking	CE	CE
<b>References</b>		
Marking	GUARDIAN 1	GUARDIAN 2

## Photoelectric sensors accessories

### Reflectors, rectangular



Item Number	ER100	ER840	ER681	ER686
Dimensions (mm)	100 x 100 x 9.2	84.5 x 84.5 x 9	52 x 119 x 27	55.3 x 126 x 9
Mounting (screws not incl.)	2 x M3 screws	2 x M3.5 screws	4 x M4 screws	2 x M6 screws
Reduction factor	1.2	0.96	0.92	0.92

### Reflectors, rectangular



Item Number	ER4060	ER5060	ER42182	ER5080
Dimensions (mm)	60 x 41 x 8	55.5 x 61 x 8	186 x 46.5 x 8	80 x 54 x 8
Mounting (screws not incl.)	2 x M3.5 screws	2 x M4 screws	2 x M6 screws	Adhesive
Reduction factor	0.81	0.80	0.65	0.60

### Reflectors, rectangular

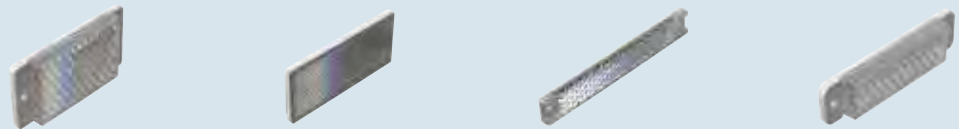

Item Number	ER483	ER8	ER665	ER530
Dimensions (mm)	32.5 x 65 x 8	82 x 37 x 5.5	18.5 x 120 x 65	19 x 72.5 x 8.4
Mounting (screws not incl.)	2 x M3.5 screws	Adhesive	2 x M4 screws	2 x M3.5 screws
Reduction factor	0.55	0.51	0.45	0.45

### Reflectors, rectangular

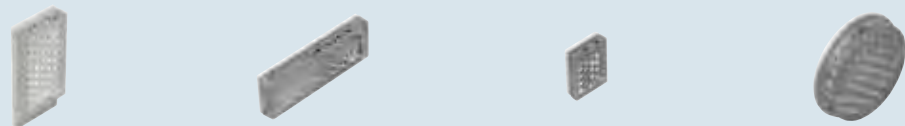

Item Number	ER390	ER1	ER640	ER692
Dimensions (mm)	23.5 x 47.5 x 8	51 x 17.5 x 5	13 x 17 x 5	Ø 35 x 5.5
Mounting (screws not incl.)	2 x M3.5 screws	Adhesive	Adhesive	Adhesive
Reduction factor	1.39	0.20	0.16	0.53

# Photoelectric sensors accessories

## Reflectors, cylindrical

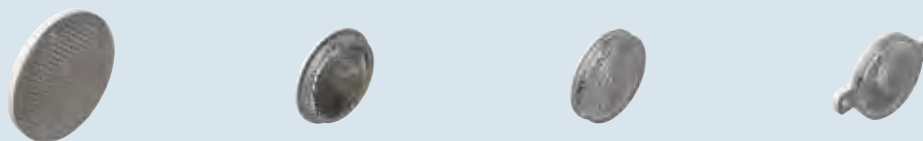

Item Number	<b>ER4</b>	<b>ER460</b>	<b>ER420</b>	<b>ER423</b>
Dimensions (mm)	Ø 84 x 7.4	Ø 46 x 6.5	Ø 42 x 6.3	Ø 41.5 x 6
Mounting (screws not incl.)	1 x M4 screw	Adhesive	Adhesive	2 x M3 screws
Reduction factor	1	0.55	0.54	0.54

## Reflectors, cylindrical

## Micro cube reflectors for LD32

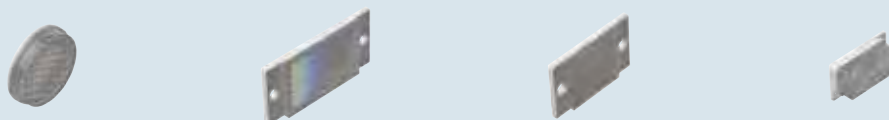

Item Number	<b>ER689</b>	<b>EM 130-20</b>	<b>EM 120-20</b>	<b>EM 123-70</b>
Dimensions (mm)	Ø 25 x 5.5	20 x 43	20 x 32	13.7 x 23
Mounting (screws not incl.)	Adhesive	2 x M3 screws	2 x M3.5 screws	2 x M2 screws
Reduction factor	0.39	1 (Micro Cube)	1 (Micro Cube)	1 (Micro Cube)

## Reflectors, tape

## Micro cube reflectors for LD32

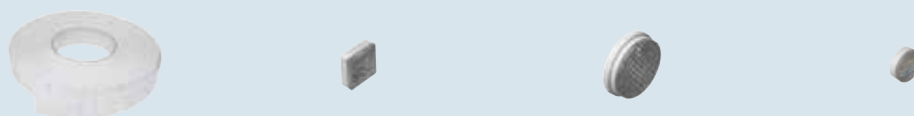

Item Number	<b>ERT25</b>	<b>EM 111-40</b>	<b>EM 121-41</b>	<b>EM 110-40</b>
Dimensions (mm)	25 mm x 45.7 m	10.5 x 10.5	Ø20	Ø10
Mounting (screws not incl.)	Adhesive			
Reduction factor	0.23 (25 x 25 mm)	1 (Micro Cube)	1 (Micro Cube)	1 (Micro Cube)

## Reflectors, tape



## Accessories, photoelectric sensors



Item Number	<b>ERT50</b>	<b>AMPF-MB1</b>	<b>AMPF-MB2</b>	<b>AMPF-MB3</b>
Dimensions (mm)/Used for	50 mm x 45.7 m	MPFT15-4 & MPFR-4	MPFT15-4 & MPFR-4	MPFT15-4 & MPFR-4
Mounting (screws not incl.)	Adhesive			
Reduction factor/ Description	0.34 (50 x 50 mm)	Plastic mounting bracket for wall mounting	Adaptor for fitting to an Ø18 mm rubber profile	Metal mounting bracket for harsh environment



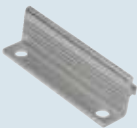

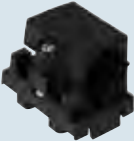
# Photoelectric sensors accessories

## Accessories, photoelectric sensors





				
Item Number	<b>6I0DC</b>	<b>APA3</b>	<b>MB-M01</b>	<b>MB18A</b>
Used for	S1430...	PA.. sensors	MOF.. sensors	M18 sensors
Description	Plug conversion	Mounting bracket in anodized aluminium	Ball mounting bracket for flexible mounting	Mounting bracket in plast

## Accessories, photoelectric sensors

## Brackets





				
Item Number	<b>APA18-MB1</b>	<b>APH18-MB1</b>	<b>APA-2</b>	<b>APB-1</b>
Used for	PA18 sensors	PH18 sensors	PA.. sensors	PB
Description	Mounting bracket in plast	Mounting bracket in plast	Mounting bracket in steel, black	Mounting bracket in steel, black

## Brackets

				
Item Number	<b>MB02</b>	<b>APD32-MB3</b>	<b>APD30 MB1</b>	<b>APD30 MB2</b>
Used for	PM	PD32 - LD32	PD.. sensors	PD.. sensors
Description	Long mounting bracket for wall mounting in steel, chromated	Mounting bracket in steel, chromated	Mounting bracket in steel, chromated	Mounting bracket in steel, chromated

## Brackets

## Alignment tools

				
Item Number	<b>ACP50-1</b>	<b>APD140-LA01</b>	<b>APD140-LA02</b>	<b>APD140-TC01</b>
Used for	PC50.. sensors	PD140.. Heavy duty infrared barrier	PD140.. Heavy duty infrared barrier	PD140.. Heavy duty infrared barrier
Description	Mounting bracket in steel, chromated	Laser alignment tool	Laser alignment tool without batteries (Battery: DL1/3N, CR1/3N 3V - Lithium)	Alignment test cable

# Capacitive proximity sensors, TRIPLESIELD™

**Types** **M18-AC TRIPLESIELD™**

**Connections** **2 m cable** **M12 connector**

**Flush mountable**



Dimensions (mm)	M18 x 71.5	M18 x 83.5
Thread (mm)	M18 x 1 x 46.5	M18 x 1 x 46.5
Operating frequency	10 Hz	10 Hz
Sensing distance (Sn)	3 - 8 mm (adjustable)	3 - 8 mm (adjustable)

**References**

Thyristor (SCR) NO	<b>CA18CLF08TO</b>	<b>CA18CLF08TOM6</b>
Thyristor (SCR) NC	<b>CA18CLF08TC</b>	<b>CA18CLF08TCM6</b>

**Non-flush mountable**



Dimensions (mm)	M18 x 79.5	M18 x 91.5
Thread (mm)	M18 x 1 x 46.5	M18 x 1 x 46.5
Operating frequency	10 Hz	10 Hz
Sensing distance (Sn)	3 - 12 mm (adjustable)	3 - 12 mm (adjustable)

**References**

Thyristor (SCR) NO	<b>CA18CLN12TO</b>	<b>CA18CLN12TOM6</b>
Thyristor (SCR) NC	<b>CA18CLN12TC</b>	<b>CA18CLN12TCM6</b>

**Characteristics flush and non-flush mountable**

Rated operating voltage	20 - 250 VAC	20 - 250 VAC
Voltage drop	≤ 10 VAC	≤ 10 VAC
Degree of protection	IP 67	IP 67
Protection short-circuit (S)		
Reverse polarity (P)	T	T
Transients (T)		
Output current	< 500 mA	< 500 mA
Housing material	Thermoplastic polyester	Thermoplastic polyester
Operating temperature	-25°C to +80°C	-25°C to +80°C
LED colour	Yellow	Yellow
Approvals/Marks	CE - UL - CSA	CE - UL - CSA





## Capacitive proximity sensors, 4<sup>th</sup> Generation TRIPLESIELD™

Types	M18-DC 4 <sup>th</sup> Generation TRIPLESIELD™ Flush mountable		M18-DC 4 <sup>th</sup> Generation TRIPLESIELD™ Non-flush mountable	
Connections	2 m cable	M12 connector	2 m cable	M12 connector
				
Dimensions (mm)	M18 x 70	M18 x 85	M18 x 70	M18 x 85
Thread (mm)	M18 x 1.0 x 55	M18 x 1.0 x 55	M18 x 1.0 x 55	M18 x 1.0 x 55
Operating frequency	50 Hz	50 Hz	50 Hz	50 Hz
Sensing distance (Sn)	8 mm (adjustable 2 - 10 mm)	8 mm (adjustable 2 - 10 mm)	12 mm (adjustable 3 - 15 mm)	12 mm (adjustable 3 - 15 mm)
<b>References</b>				
Standard				
NPN - NO and NC	CA18CAF08NA	CA18CAF08NAM1	CA18CAN12NA	CA18CAN12NAM1
PNP - NO and NC	CA18CAF08PA	CA18CAF08PAM1	CA18CAN12PA	CA18CAN12PAM1
Dust alarm				
PNP - NO	CA18CAF08PODU		CA18CAN12PODU	
PNP - NC	CA18CAF08PCDU		CA30CN25PCDU	
Temperature alarm				
PNP - NO	CA18CAF08POTA		CA18CAN12POTA	
PNP - NC	CA18CAF08PCTA		CA18CAN12PCTA	
<b>Characteristics flush and non-flush mountable</b>				
Rated operating voltage	10 - 40 VDC	10 - 40 VDC	10 - 40 VDC	10 - 40 VDC
Voltage drop	≤ 2.0 VDC	≤ 2.0 VDC	≤ 2.0 VDC	≤ 2.0 VDC
Degree of protection	IP 67, IP 68, IP 69K	IP 67, IP 68, IP 69K	IP 67, IP 68, IP 69K	IP 67, IP 68, IP 69K
Protection short-circuit (S) Reverse polarity (P) Transients (T)	SPT	SPT	SPT	SPT
Output current	< 200 mA	< 200 mA	< 200 mA	< 200 mA
Housing material	PBT	PBT	PBT	PBT
Operating temperature	-30°C to +85°C	-30°C to +85°C	-30°C to +85°C	-30°C to +85°C
LED colour	Yellow and Green	Yellow and Green	Yellow and Green	Yellow and Green
Approvals/Marks	CE - cULus - ECOLAB	CE - cULus - ECOLAB	CE - cULus - ECOLAB	CE - cULus - ECOLAB

# Capacitive proximity sensors, 4<sup>th</sup> Gen. TRIPLESIELD™ with IO-LINK

## M18-DC 4<sup>th</sup> Generation TRIPLESIELD™ with IO-Link

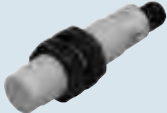
Types	Flush mountable		Non-flush mountable	
Connections	2 m cable	M12 connector 4-pole	2 m cable	M12 connector 4-pole
				
Dimensions (mm)	M18 x 70	M18 x 85	M18 x 70	M18 x 85
Thread (mm)	M18 x 1.0 x 55	M18 x 1.0 x 55	M18 x 1.0 x 55	M18 x 1.0 x 55
Operating frequency	50 Hz	50 Hz	50 Hz	50 Hz
Sensing distance (Sn)	8 mm (adjustable 2 - 10 mm)	8 mm (adjustable 2 - 10 mm)	12 mm (adjustable 3 - 15 mm)	12 mm (adjustable 3 - 15 mm)
<b>References</b>				
	CA18CAF08BPA2IO	CA18CAF08BPM1IO	CA18CAN12BPA2IO	CA18CAN12BPM1IO
<b>Characteristics flush and non-flush mountable</b>				
Selectable function output 1	NPN, PNP or Push-Pull	NPN, PNP or Push-Pull	NPN, PNP or Push-Pull	NPN, PNP or Push-Pull
Selectable function output 2	NPN, PNP, Push-Pull, External input or External teach	NPN, PNP, Push-Pull, External input or External teach	NPN, PNP, Push-Pull, External input or External teach	NPN, PNP, Push-Pull, External input or External teach
Diagnostic	Operation hours, Power cycles, Detection cycles max. and min. Temperatures, Short-circuit, Maintenance, No of Parameter change	Operation hours, Power cycles, Detection cycles max. and min. Temperatures, Short-circuit, Maintenance, No of Parameter change	Operation hours, Power cycles, Detection cycles max. and min. Temperatures, Short-circuit, Maintenance, No of Parameter change	Operation hours, Power cycles, Detection cycles max. and min. Temperatures, Short-circuit, Maintenance, No of Parameter change
Logic functions	AND, OR, X-OR, Gated SR-FF	AND, OR, X-OR, Gated SR-FF	AND, OR, X-OR, Gated SR-FF	AND, OR, X-OR, Gated SR-FF
Timer functions	ON delay, OFF delay, ON+OFF delay and One shot	ON delay, OFF delay, ON+OFF delay and One shot	ON delay, OFF delay, ON+OFF delay and One shot	ON delay, OFF delay, ON+OFF delay and One shot
Rated operating voltage	10 - 40 VDC	10 - 40 VDC	10 - 40 VDC	10 - 40 VDC
Voltage drop	≤ 1.0 VDC	≤ 1.0 VDC	≤ 1.0 VDC	≤ 1.0 VDC
No load supply current (I <sub>o</sub> )	≤ 20 mA	≤ 20 mA	≤ 20 mA	≤ 20 mA
Protection short-circuit (S) Reverse polarity (P) Transients (T)	SPT	SPT	SPT	SPT
Output current	< 200 mA	< 200 mA	< 200 mA	< 200 mA
Housing material	PBT	PBT	PBT	PBT
Operating temperature	-30°C to +85°C (120°C sensor face)	-30°C to +85°C (120°C sensor face)	-30°C to +85°C (120°C sensor face)	-30°C to +85°C (120°C sensor face)
Degree of protection	IP 67, IP 68, IP 69K, NEMA: 1, 2, 4, 4X, 5, 6, 6P, 12	IP 67, IP 68, IP 69K, NEMA: 1, 2, 4, 4X, 5, 6, 6P, 12	IP 67, IP 68, IP 69K, NEMA: 1, 2, 4, 4X, 5, 6, 6P, 12	IP 67, IP 68, IP 69K, NEMA: 1, 2, 4, 4X, 5, 6, 6P, 12
LED colour	Yellow and Green	Yellow and Green	Yellow and Green	Yellow and Green
Communication interface	IO-Link	IO-Link	IO-Link	IO-Link
Transmission type	COM2 (38,4 kBaud)	COM2 (38,4 kBaud)	COM2 (38,4 kBaud)	COM2 (38,4 kBaud)
IO-Link revision	1.1	1.1	1.1	1.1
SDCI standard	IEC 61131-9	IEC 61131-9	IEC 61131-9	IEC 61131-9
Profiles	Smart Sensor: Process Data Variable; Device Identification	Smart Sensor: Process Data Variable; Device Identification	Smart Sensor: Process Data Variable; Device Identification	Smart Sensor: Process Data Variable; Device Identification
SIO mode	Yes	Yes	Yes	Yes
Required master port type	A	A	A	A
Min. process cycle time [ms]	5	5	5	5
Approvals/Marks	CE - cULus - ECOLAB	CE - cULus - ECOLAB	CE - cULus - ECOLAB	CE - cULus - ECOLAB

# Capacitive proximity sensors, TRIPLESIELD™

## Types

### M30-DC TRIPLESIELD™

#### Connections

#### 2 m cable

#### M12 connector

#### Flush mountable



Dimensions (mm)	M30 x 63.6	M30 x 63.6
Thread (mm)	M30 x 1.5 x 50	M30 x 1.5 x 50
Operating frequency	50 Hz	50 Hz
Sensing distance (Sn)	2 - 16 mm (adjustable)	2 - 16 mm (adjustable)

#### References

NPN - NO and NC	EC3016NPASL	EC3016NPASL-1
PNP - NO and NC	EC3016PPASL	EC3016PPASL-1

#### Non-flush mountable



Dimensions (mm)	M30 x 75.6	M30 x 75.6
Thread (mm)	M30 x 1.5 x 50	M30 x 1.5 x 50
Operating frequency	50 Hz	50 Hz
Sensing distance (Sn)	4 - 25 mm (adjustable)	4 - 25 mm (adjustable)

#### References

NPN - NO and NC	EC3025NPASL	EC3025NPASL-1
PNP - NO and NC	EC3025PPASL	EC3025PPASL-1

#### Characteristics flush and non-flush mountable

Rated operating voltage	10 - 40 VDC	10 - 40 VDC
Voltage drop	≤ 2.5 VDC	≤ 2.5 VDC
Degree of protection	IP 67	IP 67
Protection short-circuit (S)		
Reverse polarity (P)	SPT	SPT
Transients (T)		
Output current	< 200 mA	< 200 mA
Housing material	Stainless steel	Stainless steel
Operating temperature	-25°C to +80°C	-25°C to +80°C
LED colour	Yellow	Yellow
Approvals/Marks	CE - UL - CSA	CE - UL - CSA

# Capacitive proximity sensors, 4<sup>th</sup> Generation TRIPLESIELD™

## M30-DC 4<sup>th</sup> Generation TRIPLESIELD™

Types	Flush mountable		Non-flush mountable	
	2 m cable	M12 connector	2 m cable	M12 connector
Connections				

Dimensions (mm)	M30 x 81	M30 x 74	M30 x 81	M30 x 74
Thread (mm)	M30 x 1.5 x 59.5	M30 x 1.5 x 59.5	M30 x 1.5 x 45.5	M30 x 1.5 x 45.5
Operating frequency	50 Hz	50 Hz	50 Hz	50 Hz
Sensing distance (Sn)	16 mm (adjustable 2 - 20 mm)	16 mm (adjustable 2 - 20 mm)	25 mm (adjustable 4 - 30 mm)	25 mm (adjustable 4 - 30 mm)

### References





Standard				
NPN - NO and NC	CA30CAF16NA	CA30CAF16NAM1	CA30CAN25NA	CA30CAN25NAM1
PNP - NO and NC	CA30CAF16PA	CA30CAF16PAM1	CA30CAN25PA	CA30CAN25PAM1
Dust alarm				
PNP - NO	CA30CAF16PODU		CA30CAN25PODU	
PNP - NC	CA30CAF16PCDU		CA30CAN25PCDU	
Temperature alarm				
PNP - NO	CA30CAF16POTA		CA30CAN25POTA	
PNP - NC	CA30CAF16PCTA		CA30CAN25PCTA	

### Characteristics flush and non-flush mountable





Rated operating voltage	10 - 40 VDC	10 - 40 VDC	10 - 40 VDC	10 - 40 VDC
Voltage drop	≤ 2.0 VDC	≤ 2.0 VDC	≤ 2.0 VDC	≤ 2.0 VDC
Degree of protection	IP 67, IP 68, IP 69K	IP 67, IP 68, IP 69K	IP 67, IP 68, IP 69K	IP 67, IP 68, IP 69K
Protection short-circuit (S)				
Reverse polarity (P)	SPT	SPT	SPT	SPT
Transients (T)				
Output current	< 200 mA	< 200 mA	< 200 mA	< 200 mA
Housing material	PBT	PBT	PBT	PBT
Operating temperature	-30°C to +85°C	-30°C to +85°C	-30°C to +85°C	-30°C to +85°C
LED colour	Yellow and Green	Yellow and Green	Yellow and Green	Yellow and Green
Approvals/Marks	CE - cULus - ECOLAB	CE - cULus - ECOLAB	CE - cULus - ECOLAB	CE - cULus - ECOLAB





# Capacitive proximity sensors, 4<sup>th</sup> Gen. TRIPLESIELD™ with IO-Link

## M30-DC 4<sup>th</sup> Generation TRIPLESIELD™ with IO-Link

Types	Flush mountable		Non-flush mountable	
	2 m cable	M12 connector	2 m cable	M12 connector
Connections				
Dimensions (mm)	M30 x 81	M30 x 74	M30 x 81	M30 x 74
Thread (mm)	M30 x 1.5 x 59.5	M30 x 1.5 x 59.5	M30 x 1.5 x 45.5	M30 x 1.5 x 45.5
Operating frequency	50 Hz	50 Hz	50 Hz	50 Hz
Sensing distance (Sn)	16 mm (adjustable 2 - 20 mm)	16 mm (adjustable 2 - 20 mm)	25 mm (adjustable 4 - 30 mm)	25 mm (adjustable 4 - 30 mm)
<b>References</b>				
	<b>CA30CAF16BPA2IO</b>	<b>CA30CAF16BPM1IO</b>	<b>CA30CAN25BPA2IO</b>	<b>CA30CAN25BPM1IO</b>
<b>Characteristics flush and non-flush mountable</b>				
Selectable function output 1	NPN, PNP or Push-Pull	NPN, PNP or Push-Pull	NPN, PNP or Push-Pull	NPN, PNP or Push-Pull
Selectable function output 2	NPN, PNP, Push-Pull, External input or External teach	NPN, PNP, Push-Pull, External input or External teach	NPN, PNP, Push-Pull, External input or External teach	NPN, PNP, Push-Pull, External input or External teach
Diagnostic	Operation hours, Power cycles, Detection cycles max. and min. Temperatures, Short-circuit, Maintenance, No of Parameter change	Operation hours, Power cycles, Detection cycles max. and min. Temperatures, Short-circuit, Maintenance, No of Parameter change	Operation hours, Power cycles, Detection cycles max. and min. Temperatures, Short-circuit, Maintenance, No of Parameter change	Operation hours, Power cycles, Detection cycles max. and min. Temperatures, Short-circuit, Maintenance, No of Parameter change
Logic functions	AND, OR, X-OR, Gated SR-FF	AND, OR, X-OR, Gated SR-FF	AND, OR, X-OR, Gated SR-FF	AND, OR, X-OR, Gated SR-FF
Timer functions	ON delay, OFF delay, ON+OFF delay and One shot	ON delay, OFF delay, ON+OFF delay and One shot	ON delay, OFF delay, ON+OFF delay and One shot	ON delay, OFF delay, ON+OFF delay and One shot
Rated operating voltage	10 - 40 VDC	10 - 40 VDC	10 - 40 VDC	10 - 40 VDC
Voltage drop	≤ 1.0 VDC	≤ 1.0 VDC	≤ 1.0 VDC	≤ 1.0 VDC
No load supply current (I <sub>o</sub> )	≤ 20 mA	≤ 20 mA	≤ 20 mA	≤ 20 mA
Protection short-circuit (S) Reverse polarity (P) Transients (T)	SPT	SPT	SPT	SPT
Output current	< 200 mA	< 200 mA	< 200 mA	< 200 mA
Housing material	PBT	PBT	PBT	PBT
Operating temperature	-30°C to +85°C (120°C sensor face)	-30°C to +85°C (120°C sensor face)	-30°C to +85°C (120°C sensor face)	-30°C to +85°C (120°C sensor face)
Degree of protection	IP 67, IP 68, IP 69K, NEMA:1,2,4,4X,5,6,6P,12	IP 67, IP 68, IP 69K, NEMA:1,2,4,4X,5,6,6P,12	IP 67, IP 68, IP 69K, NEMA:1,2,4,4X,5,6,6P,12	IP 67, IP 68, IP 69K, NEMA:1,2,4,4X,5,6,6P,12
LED colour	Yellow and Green	Yellow and Green	Yellow and Green	Yellow and Green
Communication interface	IO-Link	IO-Link	IO-Link	IO-Link
Transmission type	COM2 (38,4 kBaud)	COM2 (38,4 kBaud)	COM2 (38,4 kBaud)	COM2 (38,4 kBaud)
IO-Link revision	1.1	1.1	1.1	1.1
SDCI standard	IEC 61131-9	IEC 61131-9	IEC 61131-9	IEC 61131-9
Profiles	Smart Sensor: Process Data Variable; Device Identification	Smart Sensor: Process Data Variable; Device Identification	Smart Sensor: Process Data Variable; Device Identification	Smart Sensor: Process Data Variable; Device Identification
SIO mode	Yes	Yes	Yes	Yes
Required master port type	A	A	A	A
Min. process cycle time [ms]	5	5	5	5
Approvals/Marks	CE - cULus - ECOLAB	CE - cULus - ECOLAB	CE - cULus - ECOLAB	CE - cULus - ECOLAB

# Capacitive proximity sensors, TRIPLESIELD™

Types		M30-AC TRIPLESIELD™			
Connections	2 m cable	M12 connector	2 m cable	M12 connector	
<b>Flush mountable</b>					
Dimensions (mm)	M30 x 63.6	M30 x 63.6	M30 x 63.6	M30 x 63.6	
Thread (mm)	M30 x 1.5 x 50	M30 x 1.5 x 50	M30 x 1.5 x 50	M30 x 1.5 x 50	
Operating frequency	10 Hz	10 Hz	10 Hz	10 Hz	
Sensing distance (Sn)	2 - 16 mm (adjustable)	2 - 16 mm (adjustable)	2 - 16 mm (adjustable)	2 - 16 mm (adjustable)	
<b>References</b>					
Thyristor (SCR) NO or NC	<b>EC3016TBAPL</b>	<b>EC3016TBAPL-6</b>	<b>EC3016TBASL</b>	<b>EC3016TBASL-6</b>	

<b>Non-flush mountable</b>				
Dimensions (mm)	M30 x 75.6	M30 x 75.6	M30 x 75.6	M30 x 75.6
Thread (mm)	M30 x 1.5 x 50	M30 x 1.5 x 50	M30 x 1.5 x 50	M30 x 1.5 x 50
Operating frequency	10 Hz	10 Hz	10 Hz	10 Hz
Sensing distance (Sn)	4 - 25 mm (adjustable)	4 - 25 mm (adjustable)	4 - 25 mm (adjustable)	4 - 25 mm (adjustable)
<b>References</b>				
Thyristor (SCR) NO or NC	<b>EC3025TBAPL</b>	<b>EC3025TBAPL-6</b>	<b>EC3025TBASL</b>	<b>EC3025TBASL-6</b>

<b>Characteristics flush and non-flush mountable</b>				
Rated operating voltage	20 - 250 VAC	20 - 250 VAC	20 - 250 VAC	20 - 250 VAC
Voltage drop	< 10 VAC	< 10 VAC	< 10 VAC	< 10 VAC
Degree of protection	IP 67	IP 67	IP 67	IP 67
Protection short-circuit (S)				
Reverse polarity (P)	T	T	T	T
Transients (T)				
Output current	< 500 mA	< 500 mA	< 500 mA	< 500 mA
Housing material	Thermoplastic polyester	Thermoplastic polyester	Stainless steel	Stainless steel
Operating temperature	-25°C to +80°C	-25°C to +80°C	-25°C to +80°C	-25°C to +80°C
LED colour	Yellow	Yellow	Yellow	Yellow
Approvals/Marks	CE - UL - CSA	CE - UL - CSA	CE - UL - CSA	CE - UL - CSA



# Capacitive proximity sensors, TRIPLESIELD™

Types	M12 Teach-in TRIPLESIELD™		M18 Teach-in TRIPLESIELD™	
Connections	2 m cable	M12 connector	2 m cable	M12 connector

**Flush mountable**



Dimensions (mm)	M12 x 82.4	M12 x 84.7	M18 x 89.55	M18 x 89.2
Thread (mm)	M12 x 1 x 50	M12 x 1 x 50	M18 x 1 x 50	M18 x 1 x 50
Operating frequency	15 Hz	15 Hz	15 Hz	15 Hz
Sensing distance (Sn)	0.5 - 8 mm (Teach-in)	0.5 - 8 mm (Teach-in)	0.2 - 12 mm (Teach-in)	0.2 - 12 mm (Teach-in)



## References

NPN/PNP, NO/NC	CA12CLC08BP	CA12CLC08BPM1	CA18CLC12BP	CA18CLC12BPM1
----------------	-------------	---------------	-------------	---------------

## Characteristics flush and non-flush mountable

Rated operating voltage	10 - 40 VDC	10 - 40 VDC	10 - 40 VDC	10 - 40 VDC
Voltage drop	< 2.5 VDC	< 2.5 VDC	< 2.5 VDC	< 2.5 VDC
Degree of protection	IP 68	IP 68	IP 68	IP 68
Protection short-circuit (S) Reverse polarity (P) Transients (T)	SPT	SPT	SPT	SPT
Output current	< 250 mA	< 250 mA	< 250 mA	< 250 mA
Housing material	Thermoplastic polyester	Thermoplastic polyester	Thermoplastic polyester	Thermoplastic polyester
Operating temperature	-25°C to +85°C	-25°C to +85°C	-25°C to +85°C	-25°C to +85°C
Special features	Teach-in, humidity compensation NPN/PNP auto detection, remote setup, alarm output. On request: dirt and moisture compensation	Teach-in, humidity compensation NPN/PNP auto detection, remote setup, alarm output. On request: dirt and moisture compensation	Teach-in, humidity compensation NPN/PNP auto detection, remote setup, alarm output. On request: dirt and moisture compensation	Teach-in, humidity compensation NPN/PNP auto detection, remote setup, alarm output. On request: dirt and moisture compensation
Approvals/Marks	CE - UL - CSA	CE - UL - CSA	CE - UL - CSA	CE - UL - CSA

# Capacitive proximity sensors, TRIPLESIELD™

Types	M30 Teach-in TRIPLESIELD™		M30 AC/DC TRIPLESIELD™	
Connections	2 m cable	M12 connector	2 m cable	M12 connector
<b>Flush mountable</b>				
Dimensions (mm)	M30 x 99.2	M30 x 90.45	M30 x 63.6	M30 x 75.6
Thread (mm)	M30 x 1.5 x 50	M30 x 1.5 x 50	M30 x 1.5 x 50	M30 x 1.5 x 50
Operating frequency	15 Hz	15 Hz	10 Hz	10 Hz
Sensing distance (Sn)	0.5 - 30 mm (adjustable)	0.5 - 30 mm (adjustable)	2 - 16 mm (adjustable)	2 - 16 mm (adjustable)
<b>References</b>				
NPN/PNP, NO/NC	CA30CLC30BP	CA30CLC30BPM1		
Power MOFSET			CA30CLF16CP	CA30CLF16CPM6
<b>Non-flush mountable</b>				
Dimensions (mm)			M30 x 71.6	M30 x 83.6
Thread (mm)			M30 x 1.5 x 50	M30 x 1.5 x 50
Operating frequency			10 Hz	10 Hz
Sensing distance (Sn)			2 - 25 mm (adjustable)	2 - 25 mm (adjustable)
<b>References</b>				
Power MOFSET			CA30CLN25CP	CA30CLN25CPM6
<b>Characteristics flush and non-flush mountable</b>				
Rated operating voltage	10 - 40 VDC	10 - 40 VDC	20 - 250 VAC/DC	20 - 250 VAC/DC
Voltage drop	< 2.5 VDC	< 2.5 VDC	< 5.5 VAC/DC	< 5.5 VAC/DC
Degree of protection	IP 68	IP 68	IP 67	IP 67
Protection short-circuit (S)			PT	PT
Reverse polarity (P)	SPT	SPT		
Transients (T)				
Output current	< 250 mA	< 250 mA	< 250 mA DC < 350 mA AC	< 250 mA DC < 350 mA AC
Housing material	Thermoplastic polyester	Thermoplastic polyester	Thermoplastic polyester	Thermoplastic polyester
Operating temperature	-20°C to +85°C	-20°C to +85°C	-25°C to +80°C	-25°C to +80°C
LED colour	Yellow	Yellow	Yellow	Yellow
Special features	Teach-in, humidity compensation NPN/PNP auto detection, remote setup, alarm output. On request: dirt and moisture compensation	Teach-in, humidity compensation NPN/PNP auto detection, remote setup, alarm output. On request: dirt and moisture compensation		
Approvals/Marks	CE - UL - CSA	CE - UL - CSA	CE - UL - CSA	CE - UL - CSA

## Capacitive proximity sensors, TRIPLESIELD™

### Types

### M18 TRIPLESIELD™, chemical resistant

#### Connections

2 m cable

2 m cable

2 m cable

#### Flush mountable



Dimensions (mm)	M18 x 71.5	M18 x 71.5	M18 x 71.5
Thread (mm)	M18 x 1 x 46.5	M18 x 1 x 46.5	M18 x 1 x 46.5
Operating frequency	30 Hz	30 Hz	30 Hz
Sensing distance (Sn)	3 - 8 mm (adjustable)	3 - 8 mm (adjustable)	3 - 8 mm (adjustable)

#### References

NPN-NO/NC	CA18HLF08NA	CA18GLF08NA	CA18FLF08NA
PNP-NO/NC	CA18HLF08PA	CA18GLF08PA	CA18FLF08PA

#### Non-flush mountable



Dimensions (mm)	M18 x 71.5
Thread (mm)	M18 x 1 x 46.5
Operating frequency	30 Hz
Sensing distance (Sn)	3 - 12 mm (adjustable)





#### References

NPN-NO/NC	CA18HLN12NA
PNP-NO/NC	CA18HLN12PA



#### Characteristics flush and non-flush mountable

Rated operating voltage	10 - 40 VDC	10 - 40 VDC	10 - 40 VDC
Voltage drop	≤ 2.5 VDC	≤ 2.5 VDC	≤ 2.5 VDC
Degree of protection	IP 67	IP 67	IP 67
Protection short-circuit (S)	SPT	SPT	SPT
Reverse polarity (P)			
Transients (T)			
Output current	< 200 mA	< 200 mA	< 200 mA
Housing material	Polypropylene	PVC	Teflon
Operating temperature	-25°C to +80°C	-25°C to +80°C	-25°C to +80°C
LED colour	Yellow	Yellow	Yellow
Approvals/Marks	CE	CE	CE



## Capacitive proximity sensors, TRIPLESIELD™

Types	VC5510	VC5510 Time delay	CD50	
Connections	1.5 m cable	1.5 m cable	2 m cable	2 m cable
Flush mountable				
Dimensions (mm)	55 x 35 x 15	55 x 35 x 15	50 x 30 x 7	50 x 30 x 7
Operating frequency	> 15 Hz	> 0.1 Hz	10 Hz	10 Hz
Sensing distance (Sn)	10 mm	10 mm	6 mm	5 mm
<b>References</b>				
NPN - NO	VC5510NNOP	VC5510NNOPT	CD50CNF06NO	CD50CNF05NO
NPN - NC	VC5510NNCP	VC5510NNCPT		
PNP - NO	VC5510PNOP	VC5510PNOPT		
PNP - NC	VC5510PNCP	VC5510PNCPT		
Sensing distance (Sn)			7 mm	
PNP - NO			CD50CNF07PO	
NPN - NC			CD50CNF07NC	
Sensing distance (Sn)			10 mm	
PNP - NO			CD50CNF10PO	
NPN - NC			CD50CNF10NC	
<b>Characteristics flush and non-flush mountable</b>				
Rated operating voltage	5 - 30 VDC	5 - 30 VDC	10 - 30 VDC	5 VDC
Voltage drop	≤ 1.5 VDC	≤ 1.5 VDC	≤ 1.5 V	≤ 1.5 V
Degree of protection	IP65	IP 65	IP 67	IP 67
Output current	≤ 100 mA	≤ 100 mA	≤ 50 mA	≤ 50 mA
Housing material	PC/ABS	PC/ABS	Noryl, grey	Noryl, grey
Operating temperature	0°C to +50°C	0°C to +50°C	0°C to +60°C	0°C to +60°C
LED colour	Red	Red		
Approvals/Marks	CE - UL	CE - UL	CE	CE

## Capacitive proximity sensors, TRIPLESIELD™

Types	CD46 Teach-in TRIPLESIELD™	EC 5525 TRIPLESIELD™	
Connections	2 m cable	2 m cable	M12 connector
Flush or Non-flush mountable			
	Dimensions short body (mm)	46 x 28 x 5.5	55 x 35 x 15
Operating frequency	10 Hz	50 Hz	50 Hz
Sensing distance (Sn)	1.0 - 10 mm (Teach-in)	4 - 25 mm	4 - 25 mm
<b>References</b>			
NPN-NO/NC	CD46CNC10NP	EC5525NPAP	EC5525NPAP-1
PNP-NO/NC	CD46CNC10PP	EC5525PPAP	EC5525PPAP-1
<b>Characteristics flush and non-flush mountable</b>			
Rated operating voltage	10 - 30 VDC	10 - 40 VDC	10 - 40 VDC
Voltage drop	≤ 2.5 VDC	≤ 2.5 VDC	≤ 2.5 VDC
Degree of protection	IP 68	IP 67	IP 67
Protection short-circuit (S) Reverse polarity (P) Transients (T)	SPT	SPT	SPT
Output current	≤ 200 mA	≤ 200 mA	≤ 200 mA
Housing material	PBT	Polycarbonate	Polycarbonate
Operating temperature	-25°C to +80°C	-25°C to +80°C	-25°C to +80°C
LED colour	Yellow, Green	Yellow	Yellow
Special features	Teach-in, remote setup, alarm output		
Approvals/Marks	CE - UL - CSA	CE - UL - CSA	CE - UL - CSA

## Capacitive proximity sensors, TRIPLESIELD™

Types	M18 Teach-in TRIPLESIELD™		M30 Teach-in TRIPLESIELD™	
Connections	2 m cable	M12 connector	2 m cable	M12 connector
<b>Flush or Non-flush mountable</b>				
Dimensions (mm)	M18 x 89.55	M18 x 89.2	M30 x 99.2	M30 x 99.45
Thread (mm)	M18 x 1 x 50	M18 x 1 x 50	M30 x 1.5 x 50	M30 x 1.5 x 50
Operating frequency	5 Hz	5 Hz	5 Hz	5 Hz
Sensing distance (Sn)	0.5 - 12 mm (Teach-in)	0.5 - 12 mm (Teach-in)	0.5 - 30 mm (Teach-in)	0.5 - 30 mm (Teach-in)
<b>References</b>				
NPN/PNP, NO/NC	CA18CLL12BP	CA18CLL12BPM1	CA30CLL30BP	CA30CLL30BPM1
<b>Characteristics flush and non-flush mountable</b>				
Rated operating voltage	10 - 40 VDC	10 - 40 VDC	10 - 40 VDC	10 - 40 VDC
Voltage drop	≤ 2.5 VDC	≤ 2.5 VDC	≤ 2.5 VDC	≤ 2.5 VDC
Degree of protection	IP 68	IP 68	IP 68	IP 68
Output current	≤ 250 mA	≤ 250 mA	≤ 250 mA	≤ 250 mA
Housing material	Thermoplastic polyester	Thermoplastic polyester	Thermoplastic polyester	Thermoplastic polyester
Operating temperature	-20°C to +85°C	-20°C to +85°C	-20°C to +85°C	-20°C to +85°C
Max. temperature on sensing face	120°C (248°F)	120°C (248°F)	120°C (248°F)	120°C (248°F)
LED colour	Yellow	Yellow	Yellow	Yellow
Special features	Single-step Teach-in, humidity compensation NPN/PNP auto detection, remote setup, alarm output. On request: dirt and moisture compensation	Single-step Teach-in, humidity compensation NPN/PNP auto detection, remote setup, alarm output. On request: dirt and moisture compensation	Single-step Teach-in, humidity compensation NPN/PNP auto detection, remote setup, alarm output. On request: dirt and moisture compensation	Single-step Teach-in, humidity compensation NPN/PNP auto detection, remote setup, alarm output. On request: dirt and moisture compensation
Approvals/Marks	CE - UL - CSA	CE - UL - CSA	CE - UL - CSA	CE - UL - CSA



# Capacitive level sensors

## Types

## Capacitive liquid level sensors

### Connections

### 2 m cable

### M8, 4-pin pig-tail



Dimensions (mm)	34 x 16 x 8 mm	34 x 16 x 8 mm
Operating frequency	10 Hz	10 Hz
Tank wall thickness (out-of-the-box)	0.5 to 6 mm plastic, 0.5 to 4 mm glass	0.5 to 6 mm plastic, 0.5 to 4 mm glass
Teach-in	Empty or full tank	Empty or full tank
<b>References</b>		
NPN - NC	<b>CD34CNFLNCP2</b>	<b>CD34CNFLNCT5</b>
NPN - NO	<b>CD34CNFLNOP2</b>	<b>CD34CNFLNOT4</b>
PNP - NC	<b>CD34CNFLPCP2</b>	<b>CD34CNFLPCT5</b>
PNP - NO	<b>CD34CNFLPOP2</b>	<b>CD34CNFLPOT5</b>
<b>Specifications</b>		
Rated operating voltage	10 - 30 VDC	10 - 30 VDC
Voltage drop	≤ 1.5 VDC	≤ 1.5 VDC
Degree of protection	IP 65, IP 66, IP 67, IP 68 (1.3 m @ 24h), IP 69K NEMA 1, 2, 4, 4X, 5, 12	IP 65, IP 66, IP 67, IP 68 (1.3 m @ 24h), IP 69K NEMA 1, 2, 4, 4X, 5, 12
Protection short-circuit (S) Reverse polarity (P) Transients (T)	SPT	SPT
Output current	< 100 mA	< 100 mA
Housing material	PBT	PBT
Operating temperature	-25°C to +80°C	-25°C to +80°C
LED colour	Yellow and Green	Yellow and Green
Special features	Designed to eliminate tank walls and build-up foam or film on tank walls. Detection liquids: water-based liquids such as water, milk, syrup, milkshakes, lubricants, acids, alkaline, body fluids and highly conductive liquids up to 50 ms	Designed to eliminate tank walls and build-up foam or film on tank walls. Detection liquids: water-based liquids such as water, milk, syrup, milkshakes, lubricants, acids, alkaline, body fluids and highly conductive liquids up to 50 ms
Approvals/Marks	CE - cULus - ECOLAB	CE - cULus - ECOLAB
Accessories	Mounting Bracket ACD34-MB01	Mounting Bracket ACD34-MB01

# Capacitive level sensors

**Types** Capacitive level sensors for solid, fluid and granulated substances

**Connections** 2 m cable 2 m cable 2 m cable 2 m cable



Dimensions (mm)	Ø32 x 101	Ø32 x 101	Ø32 x 101	M30 x 101
Thread	Smooth	Smooth	Smooth	M30 (with 2 nuts)
Operating frequency	1 Hz	1 Hz	1 Hz	1 Hz
Sensing distance (Sn)	4 - 12 mm (adjustable)	4 - 12 mm (adjustable)	4 - 12 mm (adjustable)	4 - 12 mm (adjustable)

## References with ON delay

Time delay	1 s - 10 m			1 s - 10 m
120 VAC	<b>VC11RT12010M</b>			
230 VAC	<b>VC11RT23010M</b>			
24 VAC/DC	<b>VC11RT92410M</b>			
24-230 VAC/DC	<b>VC11RTM2410M</b>			<b>CA30CLN12MU10M</b>

## References with OFF delay

Time delay		1 s - 10 m		1 s - 10 m
120 VAC		<b>VC12RT12010M</b>		
230 VAC		<b>VC12RT23010M</b>		
24 VAC/DC		<b>VC12RT92410M</b>		
24-230 VAC/DC		<b>VC12RTM2410M</b>		<b>CA30CLN12MV10M</b>

## References without delay

120 VAC			<b>VC12RN120</b>	
230 VAC			<b>VC12RN230</b>	
24 VAC/DC			<b>VC12RN924</b>	
24-230 VAC/DC			<b>VC12RNM24</b>	<b>CA30CLN12MT</b>

## Specifications

Consumption	≤ 1.5 W	≤ 1.5 W	≤ 1.5 W	≤ 2.5 W
Consumption M24 versions	≤ 2.5 W	≤ 2.5 W	≤ 2.5 W	
Hysteresis	1.5 mm at 7 mm sensing distance	1.5 mm at 7 mm sensing distance	1.5 mm at 7 mm sensing distance	3 - 20%
Output	Relay SPDT 2 A / 240 VAC	Relay SPDT 2 A / 240 VAC	Relay SPDT 2 A / 240 VAC	Relay SPDT 2 A / 240 VAC
Degree of protection	IP 67	IP 67	IP 67	IP 67
Housing material	Thermoplastic polyester	Thermoplastic polyester	Thermoplastic polyester	PBTP, grey
Operating temperature	-20°C to +70°C	-20°C to +70°C	-20°C to +70°C	-20°C to +70°C
LED colour	Red	Red	Red	Yellow
Approvals/Marks UL508 NEMA	CE cULus (M24 versions)	CE - CSA cULus (M24 versions)	CE cULus (M24 versions)	CE, CSA cULus 1, 2, 4, 4X, 5, 6, 6P, 12

## Capacitive level sensors

	Ø18 Sensors for solid, fluid and granulated substances		Ø32 Sensors
Types	2-wire, AC	3-wire, DC	2-wire, AC
Connections	2 m cable	2 m cable	2 m cable
			
Dimensions (mm)	Ø18 x 86	Ø18 x 86	Ø32 x 101
Thread	Smooth	Smooth	Smooth
Operating frequency	10 Hz	30 Hz	10 Hz
Sensing distance (Sn)	3 - 12 mm (adjustable)	3 - 12 mm (adjustable)	2 - 20 mm (adjustable)
<b>References</b>			
Thyristor (SCR) NO	<b>CB18CLN12TOFT</b>		
Thyristor (SCR) NO ATEX	<b>CB18CLN12TOFTAX</b>		
Thyristor (SCR) NC	<b>CB18CLN12TCFT</b>		
Thyristor (SCR) NC ATEX	<b>CB18CLN12TCFTAX</b>		
NPN - NO/NC		<b>CB18CLN12NA</b>	
NPN - NO/NC ATEX		<b>CB18CLN12NAAX</b>	
PNP - NO/NC		<b>CB18CLN12PA</b>	
PNP - NO/NC ATEX		<b>CB18CLN12PAAX</b>	
ON-delay			No
Thyristor (SCR) NO			<b>CB32CLN20TO</b>
Thyristor (SCR) NO ATEX			<b>CB32CLN20TOAX</b>
Thyristor (SCR) NC			<b>CB32CLN20TC</b>
Thyristor (SCR) NC ATEX			<b>CB32CLN20TCAX</b>
ON-delay			Yes
Thyristor (SCR) NO			<b>CB32CLN20TOFT</b>
Thyristor (SCR) NO ATEX			<b>CB32CLN20TOFTAX</b>
Thyristor (SCR) NC			<b>CB32CLN20TCFT</b>
Thyristor (SCR) NC ATEX			<b>CB32CLN20TCFTAX</b>
<b>Specifications</b>			
Rated operating voltage	20 - 250 VAC	10 - 40 VDC	20 - 250 VAC
Voltage drop	≤ 10 VAC	≤ 10 VAC	≤ 10 VAC
Time delay	30 s ON-delay		30 s ON-delay
Degree of protection	IP 67	IP 67	IP 67
Protection short-circuit (S)			
Reverse polarity (P)	T	SPT	T
Transients (T)			
Output current	≤ 500 mA	≤ 200 mA	≤ 500 mA
Housing material	Thermoplastic polyester	Thermoplastic polyester	Thermoplastic polyester
Operating temperature	-25°C to +80°C	-25°C to +80°C	-20°C to +70°C
LED colour	Yellow	Yellow	Yellow
Approvals/Marks	CE - UL - CSA - ATEX	CE - UL - CSA - ATEX	CE - UL - CSA - ATEX

# Capacitive level sensors

## Types Ø32 Level sensors TRIPLESIELD™ - ATEX

Connections	With ON delay	With OFF delay	Without time delay
-------------	---------------	----------------	--------------------



Dimensions (mm)	Ø32 x 101	Ø32 x 101	Ø32 x 101
Thread	Smooth	Smooth	Smooth
Operating frequency	5 Hz	5 Hz	5 Hz
Sensing distance (Sn)	4 - 20 mm (adjustable)	4 - 20 mm (adjustable)	4 - 20 mm (adjustable)





### References

Cable length	2 m	2 m	2 m
120 VAC	<b>CB32CLN20SUAX</b>	<b>CB32CLN20SVAX</b>	<b>CB32CLN20STAX</b>
230 VAC	<b>CB32CLN20RUAX</b>	<b>CB32CLN20RVAX</b>	<b>CB32CLN20RTAX</b>
24 VAC/DC	<b>CB32CLN20QUAX</b>	<b>CB32CLN20QVAX</b>	<b>CB32CLN20QTAX</b>
Cable length	5 m	5 m	5 m
120 VAC	<b>CB32CLN20SUAX5M</b>	<b>CB32CLN20SVAX5M</b>	<b>CB32CLN20STAX5M</b>
230 VAC	<b>CB32CLN20RUAX5M</b>	<b>CB32CLN20RVAX5M</b>	<b>CB32CLN20RTAX5M</b>
24 VAC/DC	<b>CB32CLN20QUAX5M</b>	<b>CB32CLN20QVAX5M</b>	<b>CB32CLN20QTAX5M</b>
Cable length	10 m	10 m	10 m
120 VAC	<b>CB32CLN20SUAX10M</b>	<b>CB32CLN20SVAX10M</b>	<b>CB32CLN20STAX10M</b>
230 VAC	<b>CB32CLN20RUAX10M</b>	<b>CB32CLN20RVAX10M</b>	<b>CB32CLN20RTAX10M</b>
24 VAC/DC	<b>CB32CLN20QUAX10M</b>	<b>CB32CLN20QVAX10M</b>	<b>CB32CLN20QTAX10M</b>

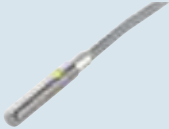

### Specifications

Consumption	< 1.5 W	< 1.5 W	< 1.5 W
Hysteresis	3 to 20% of sensing distance	3 to 20% of sensing distance	3 to 20% of sensing distance
Output	Relay SPDT, 2 A / 240 VAC	Relay SPDT, 2 A / 240 VAC	Relay SPDT, 2 A / 240 VAC
Time delay	1 s - 10 m	1 s - 10 m	
Degree of protection	IP 67	IP 67	IP 67
Housing material	PBT	PBT	PBT
Operating temperature	-20°C to +70°C	-20°C to +70°C	-20°C to +70°C
LED colour	Yellow	Yellow	Yellow
Approvals/Marks	CE - ATEX	CE - ATEX	CE - ATEX

# Inductive proximity sensors, 3-wire, DC, IO-Link

Types	Ø4 IO-Link - Short body		M5 IO-Link - Short body	
Connections	2 m cable	M8 connector	2 m cable	M8 connector
<b>Flush mountable</b>				
Dimensions (mm)	Ø4 x 28.2	Ø4 x 38.2	M5 x 28.2	M5 x 38.2
Thread (mm)	-	-	M5 x 0.5 x 23	M5 x 0.5 x 23
Operating frequency	4.5 kHz (extended range) 6 kHz (standard range)	4.5 kHz (extended range) 6 kHz (standard range)	4.5 kHz (extended range) 6 kHz (standard range)	4.5 kHz (extended range) 6 kHz (standard range)
Sensing distance (Sn)	0.8 or 1.3 mm (adjustable)	0.8 or 1.3 mm (adjustable)	0.8 or 1.3 mm (adjustable)	0.8 or 1.3 mm (adjustable)
<b>References</b>	<b>IBS04SF15A2IO</b>	<b>IBS04SF15M5IO</b>	<b>ICS05S23F15A2IO</b>	<b>ICS05S23F15M5IO</b>
<b>Characteristics</b>				
Output configuration	NPN, PNP or push-pull NO or NC	NPN, PNP or push-pull NO or NC	NPN, PNP or push-pull NO or NC	NPN, PNP or push-pull NO or NC
Adjustable hysteresis	Standard or increased value	Standard or increased value	Standard or increased value	Standard or increased value
Timer functions	ON delay, OFF delay, ON + OFF delay and one shot	ON delay, OFF delay, ON + OFF delay and one shot	ON delay, OFF delay, ON + OFF delay and one shot	ON delay, OFF delay, ON + OFF delay and one shot
Switchpoint mode	Single point, two point or window	Single point, two point or window	Single point, two point or window	Single point, two point or window
Advanced functions	RPM counter, rotational speed monitoring	RPM counter, rotational speed monitoring	RPM counter, rotational speed monitoring	RPM counter, rotational speed monitoring
Diagnostic functions	Underrun and overrun temperature events, frequency monitoring	Underrun and overrun temperature events, frequency monitoring	Underrun and overrun temperature events, frequency monitoring	Underrun and overrun temperature events, frequency monitoring
Communication interface	IO-Link (V 1.1)	IO-Link (V 1.1)	IO-Link (V 1.1)	IO-Link (V 1.1)
Rated operating voltage	10 - 30 VDC	10 - 30 VDC	10 - 30 VDC	10 - 30 VDC
Voltage drop	max. 1.2 VDC (@ 100 mA)	max. 1.2 VDC (@ 100 mA)	max. 1.2 VDC (@ 100 mA)	max. 1.2 VDC (@ 100 mA)
Degree of protection	IP 67	IP 67	IP 67	IP 67
Protection short-circuit (S) Reverse polarity (P) Transients (T)	SPT	SPT	SPT	SPT
Output current	≤ 100 mA	≤ 100 mA	≤ 100 mA	≤ 100 mA
Housing material	Stainless steel	Stainless steel	Stainless steel	Stainless steel
Operating temperature	-25°C to +70°C	-25°C to +70°C	-25°C to +70°C	-25°C to +70°C
LED colour	Yellow	Yellow	Yellow	Yellow
Approvals/Marks	CE - UL - CSA	CE - UL - CSA	CE - UL - CSA	CE - UL - CSA

# Inductive proximity sensors, 3-wire, DC, IO-Link

Types	M8 IO-Link - Short body		M8 IO-Link - Long body	
Connections	2 m cable	M8 connector	2 m cable	M8 connector
<b>Flush mountable</b>				
Dimensions (mm)	M8 x 31	M8 x 40	M8 x 46	M8 x 55
Thread (mm)	M8 x 1 x 30	M8 x 1 x 29	M8 x 1 x 45	M8 x 1 x 44
Operating frequency	2 kHz	2 kHz	2 kHz	2 kHz
Sensing distance (Sn)	1 or 2 mm (adjustable)	1 or 2 mm (adjustable)	1 or 2 mm (adjustable)	1 or 2 mm (adjustable)
<b>References</b>	<b>ICS08S30F20A2IO</b>	<b>ICS08S30F20M5IO</b>	<b>ICS08L45F20A2IO</b>	<b>ICS08L45F20M5IO</b>

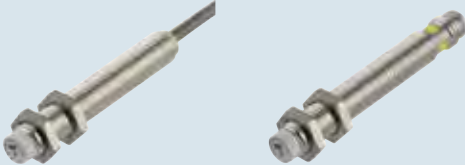



<b>Non-flush mountable</b>				
Dimensions (mm)	M8 x 34	M8 x 43	M8 x 49	M8 x 58
Thread (mm)	M8 x 1 x 30	M8 x 1 x 29	M8 x 1 x 45	M8 x 1 x 44
Operating frequency	2 kHz	2 kHz	2 kHz	2 kHz
Sensing distance (Sn)	2 or 4 mm (adjustable)	2 or 4 mm (adjustable)	2 or 4 mm (adjustable)	2 or 4 mm (adjustable)
<b>References</b>	<b>ICS08S30N40A2IO</b>	<b>ICS08S30N40M5IO</b>	<b>ICS08L45N40A2IO</b>	<b>ICS08L45N40M5IO</b>





## Characteristics flush and non-flush mountable

Output configuration	NPN, PNP or push-pull NO or NC	NPN, PNP or push-pull NO or NC	NPN, PNP or push-pull NO or NC	NPN, PNP or push-pull NO or NC
Adjustable hysteresis	Standard or increased value	Standard or increased value	Standard or increased value	Standard or increased value
Timer functions	ON delay, OFF delay, ON + OFF delay and one shot	ON delay, OFF delay, ON + OFF delay and one shot	ON delay, OFF delay, ON + OFF delay and one shot	ON delay, OFF delay, ON + OFF delay and one shot
Switchpoint mode	Single point, two point or window	Single point, two point or window	Single point, two point or window	Single point, two point or window
Advanced functions	RPM counter, rotational speed monitoring	RPM counter, rotational speed monitoring	RPM counter, rotational speed monitoring	RPM counter, rotational speed monitoring
Diagnostic functions	Underrun and overrun temperature events, frequency monitoring	Underrun and overrun temperature events, frequency monitoring	Underrun and overrun temperature events, frequency monitoring	Underrun and overrun temperature events, frequency monitoring
Communication interface	IO-Link (V 1.1)	IO-Link (V 1.1)	IO-Link (V 1.1)	IO-Link (V 1.1)
Rated operating voltage	10 - 30 VDC	10 - 30 VDC	10 - 30 VDC	10 - 30 VDC
Voltage drop	max. 1.2 VDC (@ 100 mA)	max. 1.2 VDC (@ 100 mA)	max. 1.2 VDC (@ 100 mA)	max. 1.2 VDC (@ 100 mA)
Degree of protection	IP 67	IP 67	IP 67	IP 67
Protection short-circuit (S) Reverse polarity (P) Transients (T)	SPT	SPT	SPT	SPT
Output current	≤ 100 mA	≤ 100 mA	≤ 100 mA	≤ 100 mA
Housing material	Stainless steel	Stainless steel	Stainless steel	Stainless steel
Operating temperature	-25°C to +80°C	-25°C to +80°C	-25°C to +80°C	-25°C to +80°C
LED colour	Yellow	Yellow	Yellow	Yellow
Approvals/Marks	CE - UL - CSA	CE - UL - CSA	CE - UL - CSA	CE - UL - CSA



# Inductive proximity sensors, 3-wire, DC, IO-Link





Types	M12 IO-Link - Short body		M12 IO-Link - Long body	
Connections	2 m cable	M12 connector	2 m cable	M12 connector
<b>Flush mountable</b>				
Dimensions (mm)	M12 x 32	M12 x 50.2	M12 x 52	M12 x 70.2
Thread (mm)	M12 x 1 x 30	M12 x 1 x 30	M12 x 1 x 50	M12 x 1 x 50
Operating frequency	2 kHz	2 kHz	2 kHz	2 kHz
Sensing distance (Sn)	33%, 50%, 75% or 100% of 4 mm	33%, 50%, 75% or 100% of 4 mm	33%, 50%, 75% or 100% of 4 mm	33%, 50%, 75% or 100% of 4 mm
<b>References</b>	<b>ICB12S30F04A2IO</b>	<b>ICB12S30F04M1IO</b>	<b>ICB12L50F04A2IO</b>	<b>ICB12L50F04M1IO</b>





<b>Non-flush mountable</b>				
Dimensions (mm)	M12 x 36	M12 x 54.2	M12 x 56	M12 x 74.2
Thread (mm)	M12 x 1 x 30	M12 x 1 x 30	M12 x 1 x 50	M12 x 1 x 50
Operating frequency	2 kHz	2 kHz	2 kHz	2 kHz
Sensing distance (Sn)	33%, 50%, 75% or 100% of 8 mm	33%, 50%, 75% or 100% of 8 mm	33%, 50%, 75% or 100% of 8 mm	33%, 50%, 75% or 100% of 8 mm
<b>References</b>	<b>ICB12S30N08A2IO</b>	<b>ICB12S30N08M1IO</b>	<b>ICB12L50N08A2IO</b>	<b>ICB12L50N08M1IO</b>

## Characteristics flush and non-flush mountable

Output configuration	NPN, PNP or push-pull NO or NC	NPN, PNP or push-pull NO or NC	NPN, PNP or push-pull NO or NC	NPN, PNP or push-pull NO or NC
Adjustable hysteresis	Standard or increased value	Standard or increased value	Standard or increased value	Standard or increased value
Timer functions	ON delay, OFF delay, ON + OFF delay and one shot	ON delay, OFF delay, ON + OFF delay and one shot	ON delay, OFF delay, ON + OFF delay and one shot	ON delay, OFF delay, ON + OFF delay and one shot
Switchpoint mode	Single point, two point or window	Single point, two point or window	Single point, two point or window	Single point, two point or window
Advanced functions	RPM counter, rotational speed monitoring	RPM counter, rotational speed monitoring	RPM counter, rotational speed monitoring	RPM counter, rotational speed monitoring
Diagnostic functions	Underrun and overrun temperature events, frequency monitoring	Underrun and overrun temperature events, frequency monitoring	Underrun and overrun temperature events, frequency monitoring	Underrun and overrun temperature events, frequency monitoring
Communication interface	IO-Link (V 1.1)	IO-Link (V 1.1)	IO-Link (V 1.1)	IO-Link (V 1.1)
Rated operating voltage	10 - 36 VDC	10 - 36 VDC	10 - 36 VDC	10 - 36 VDC
Voltage drop	max. 2.5 VDC @ 200 mA	max. 2.5 VDC @ 200 mA	max. 2.5 VDC @ 200 mA	max. 2.5 VDC @ 200 mA
Degree of protection	IP 67	IP 67	IP 67	IP 67
Protection short-circuit (S) Reverse polarity (P) Transients (T)	SPT	SPT	SPT	SPT
Output current	≤ 200 mA	≤ 200 mA	≤ 200 mA	≤ 200 mA
Housing material	Nickel-plated brass	Nickel-plated brass	Nickel-plated brass	Nickel-plated brass
Operating temperature	-25°C to +70°C	-40°C to +70°C	-25°C to +70°C	-40°C to +70°C
LED colour	Yellow and Green	Yellow and Green	Yellow and Green	Yellow and Green
Approvals/Marks	CE - cULus	CE - cULus	CE - cULus	CE - cULus





# Inductive proximity sensors, 3-wire, DC, IO-Link





Types	M18 IO-Link - Short body		M18 IO-Link - Long body	
Connections	2 m cable	M12 connector	2 m cable	M12 connector
<b>Flush mountable</b>				
Dimensions (mm)	M18 x 32	M18 x 54	M18 x 52	M18 x 74
Thread (mm)	M18 x 1 x 30	M18 x 1 x 30	M18 x 1 x 50	M18 x 1 x 50
Operating frequency	1.5 kHz		1.5 kHz	
Sensing distance (Sn)	33%, 50%, 75% or 100% of 8 mm		33%, 50%, 75% or 100% of 8 mm	
<b>References</b>	<b>ICB18S30F08A2IO</b>	<b>ICB18S30F08M1IO</b>	<b>ICB18L50F08A2IO</b>	<b>ICB18L50F08M1IO</b>

<b>Non-flush mountable</b>				
Dimensions (mm)	M18 x 42	M18 x 64	M18 x 62	M18 x 84
Thread (mm)	M18 x 1 x 30	M18 x 1 x 30	M18 x 1 x 50	M18 x 1 x 50
Operating frequency	1.5 kHz		1.5 kHz	
Sensing distance (Sn)	33%, 50%, 75% or 100% of 14 mm		33%, 50%, 75% or 100% of 14 mm	
<b>References</b>	<b>ICB18S30N14A2IO</b>	<b>ICB18S30N14M1IO</b>	<b>ICB18L50N14A2IO</b>	<b>ICB18L50N14M1IO</b>

<b>Characteristics flush and non-flush mountable</b>				
Output configuration	NPN, PNP or push-pull NO or NC	NPN, PNP or push-pull NO or NC	NPN, PNP or push-pull NO or NC	NPN, PNP or push-pull NO or NC
Adjustable hysteresis	Standard or increased value	Standard or increased value	Standard or increased value	Standard or increased value
Timer functions	ON delay, OFF delay, ON + OFF delay and one shot	ON delay, OFF delay, ON + OFF delay and one shot	ON delay, OFF delay, ON + OFF delay and one shot	ON delay, OFF delay, ON + OFF delay and one shot
Switchpoint mode	Single point, two point or window	Single point, two point or window	Single point, two point or window	Single point, two point or window
Advanced functions	RPM counter, rotational speed monitoring	RPM counter, rotational speed monitoring	RPM counter, rotational speed monitoring	RPM counter, rotational speed monitoring
Diagnostic functions	Underrun and overrun temperature events, frequency monitoring	Underrun and overrun temperature events, frequency monitoring	Underrun and overrun temperature events, frequency monitoring	Underrun and overrun temperature events, frequency monitoring
Communication interface	IO-Link (V 1.1)	IO-Link (V 1.1)	IO-Link (V 1.1)	IO-Link (V 1.1)
Rated operating voltage	10 - 36 VDC	10 - 36 VDC	10 - 36 VDC	10 - 36 VDC
Voltage drop	max. 2.5 VDC @ 200 mA	max. 2.5 VDC @ 200 mA	max. 2.5 VDC @ 200 mA	max. 2.5 VDC @ 200 mA
Degree of protection	IP 67	IP 67	IP 67	IP 67
Protection short-circuit (S) Reverse polarity (P) Transients (T)	SPT	SPT	SPT	SPT
Output current	≤ 200 mA	≤ 200 mA	≤ 200 mA	≤ 200 mA
Housing material	Nickel-plated brass	Nickel-plated brass	Nickel-plated brass	Nickel-plated brass
Operating temperature	-25°C to +70°C	-40°C to +70°C	-25°C to +70°C	-40°C to +70°C
LED colour	Yellow and Green	Yellow and Green	Yellow and Green	Yellow and Green
Approvals/Marks	CE - cULus	CE - cULus	CE - cULus	CE - cULus

# Inductive proximity sensors, 3-wire, DC, IO-Link

Types	M30 IO-Link - Short body		M30 IO-Link - Long body	
Connections	2 m cable	M12 connector	2 m cable	M12 connector
<b>Flush mountable</b>				
Dimensions (mm)	M30 x 32	M30 x 55	M30 x 52	M30 x 85
Thread (mm)	M30 x 1.5 x 30	M30 x 1.5 x 30	M30 x 1.5 x 50	M30 x 1.5 x 50
Operating frequency	1 kHz	1 kHz	1 kHz	1 kHz
Sensing distance (Sn)	33%, 50%, 75% or 100% of 15 mm	33%, 50%, 75% or 100% of 15 mm	33%, 50%, 75% or 100% of 15 mm	33%, 50%, 75% or 100% of 15 mm
<b>References</b>	<b>ICB30S30F15A2IO</b>	<b>ICB30S30F15M1IO</b>	<b>ICB30L50F15A2IO</b>	<b>ICB30L50F15M1IO</b>

<b>Non-flush mountable</b>				
Dimensions (mm)	M30 x 44	M30 x 67	M30 x 64	M30 x 87
Thread (mm)	M30 x 1.5 x 30	M30 x 1.5 x 30	M30 x 1.5 x 50	M30 x 1.5 x 50
Operating frequency	1 kHz	1 kHz	1 kHz	1 kHz
Sensing distance (Sn)	33%, 50%, 75% or 100% of 22 mm	33%, 50%, 75% or 100% of 22 mm	33%, 50%, 75% or 100% of 22 mm	33%, 50%, 75% or 100% of 22 mm
<b>References</b>	<b>ICB30S30N22A2IO</b>	<b>ICB30S30N22M1IO</b>	<b>ICB30L50N22A2IO</b>	<b>ICB30L50N22M1IO</b>

<b>Characteristics flush and non-flush mountable</b>				
Output configuration	NPN, PNP or push-pull NO or NC	NPN, PNP or push-pull NO or NC	NPN, PNP or push-pull NO or NC	NPN, PNP or push-pull NO or NC
Adjustable hysteresis	Standard or increased value	Standard or increased value	Standard or increased value	Standard or increased value
Timer functions	ON delay, OFF delay, ON + OFF delay and one shot	ON delay, OFF delay, ON + OFF delay and one shot	ON delay, OFF delay, ON + OFF delay and one shot	ON delay, OFF delay, ON + OFF delay and one shot
Switchpoint mode	Single point, two point or window	Single point, two point or window	Single point, two point or window	Single point, two point or window
Advanced functions	RPM counter, rotational speed monitoring	RPM counter, rotational speed monitoring	RPM counter, rotational speed monitoring	RPM counter, rotational speed monitoring
Diagnostic functions	Underrun and overrun temperature events, frequency monitoring	Underrun and overrun temperature events, frequency monitoring	Underrun and overrun temperature events, frequency monitoring	Underrun and overrun temperature events, frequency monitoring
Communication interface	IO-Link (V 1.1)	IO-Link (V 1.1)	IO-Link (V 1.1)	IO-Link (V 1.1)
Rated operating voltage	10 - 36 VDC	10 - 36 VDC	10 - 36 VDC	10 - 36 VDC
Voltage drop	max. 2.5 VDC @ 200 mA	max. 2.5 VDC @ 200 mA	max. 2.5 VDC @ 200 mA	max. 2.5 VDC @ 200 mA
Degree of protection	IP 67	IP 67	IP 67	IP 67
Protection short-circuit (S) Reverse polarity (P) Transients (T)	SPT	SPT	SPT	SPT
Output current	≤ 200 mA	≤ 200 mA	≤ 200 mA	≤ 200 mA
Housing material	Nickel-plated brass	Nickel-plated brass	Nickel-plated brass	Nickel-plated brass
Operating temperature	-25°C to +70°C	-40°C to +70°C	-25°C to +70°C	-40°C to +70°C
LED colour	Yellow and Green	Yellow and Green	Yellow and Green	Yellow and Green
Approvals/Marks	CE - cULus	CE - cULus	CE - cULus	CE - cULus

# Inductive proximity sensors, 3-wire, DC

Types	M12 Standard - Short body		M12 Standard - Long body	
Connections	2 m cable	M12 connector	2 m cable	M12 connector
<b>Flush mountable</b>				

Dimensions (mm)	M12 x 47	M12 x 50	M12 x 67	M12 x 70
Thread (mm)	M12 x 1 x 30	M12 x 1 x 30	M12 x 1 x 50	M12 x 1 x 50
Operating frequency	2 kHz	2 kHz	2 kHz	2 kHz
Sensing distance (Sn)	2 mm	2 mm	2 mm	2 mm

## References

NPN-NO	ICB12S30F02NO	ICB12S30F02NOM1	ICB12L50F02NO	ICB12L50F02NOM1
PNP-NO	ICB12S30F02PO	ICB12S30F02POM1	ICB12L50F02PO	ICB12L50F02POM1
NPN-NC	ICB12S30F02NC	ICB12S30F02NCM1	ICB12L50F02NC	ICB12L50F02NCM1
PNP-NC	ICB12S30F02PC	ICB12S30F02PCM1	ICB12L50F02PC	ICB12L50F02PCM1

<b>Non-flush mountable</b>				
----------------------------	---	---	--	---

Dimensions (mm)	M12 x 51	M12 x 54	M12 x 71	M12 x 74
Thread (mm)	M12 x 1 x 30	M12 x 1 x 30	M12 x 1 x 50	M12 x 1 x 50
Operating frequency	2 kHz	2 kHz	2 kHz	2 kHz
Sensing distance (Sn)	4 mm	4 mm	4 mm	4 mm



## References



NPN-NO	ICB12S30N04NO	ICB12S30N04NOM1	ICB12L50N04NO	ICB12L50N04NOM1
PNP-NO	ICB12S30N04PO	ICB12S30N04POM1	ICB12L50N04PO	ICB12L50N04POM1
NPN-NC	ICB12S30N04NC	ICB12S30N04NCM1	ICB12L50N04NC	ICB12L50N04NCM1
PNP-NC	ICB12S30N04PC	ICB12S30N04PCM1	ICB12L50N04PC	ICB12L50N04PCM1

## Characteristics flush and non-flush mountable

Rated operating voltage	10 - 36 VDC	10 - 36 VDC	10 - 36 VDC	10 - 36 VDC
Voltage drop	≤ 2.5 VDC @ 200 mA	≤ 2.5 VDC @ 200 mA	≤ 2.5 VDC @ 200 mA	≤ 2.5 VDC @ 200 mA
Degree of protection	IP 67	IP 67	IP 67	IP 67
Protection short-circuit (S)				
Reverse polarity (P)	SPT	SPT	SPT	SPT
Transients (T)				
Output current	< 200 mA @ 50°C ≤ 150 mA @ 50-70°C	< 200 mA @ 50°C ≤ 150 mA @ 50-70°C	< 200 mA @ 50°C ≤ 150 mA @ 50-70°C	< 200 mA @ 50°C ≤ 150 mA @ 50-70°C
Housing material	Nickel-plated brass	Nickel-plated brass	Nickel-plated brass	Nickel-plated brass
Operating temperature	-25°C to +70°C	-25°C to +70°C	-25°C to +70°C	-25°C to +70°C
LED colour	Yellow	Yellow	Yellow	Yellow
Approvals/Marks	CE - cULus - Cl. I Div. 2	CE - cULus - Cl. I Div. 2	CE - cULus - Cl. I Div. 2	CE - cULus - Cl. I Div. 2

# Inductive proximity sensors, 3-wire, DC, extended range









Types	M12 Extended - Extra-short body	M12 Extended - Extra-short body
Connections	2 m cable	M12 connector
<b>Flush mountable</b>		
Dimensions (mm)	M12 x 25	M12 x 40
Thread (mm)	M12 x 1 x 23	M12 x 1 x 23
Operating frequency	2 kHz	2 kHz
Sensing distance (Sn)	4 mm	4 mm
<b>References</b>		
NPN-NO	ICB12S23F04A2NO	ICB12S23F04M1NO
PNP-NO	ICB12S23F04A2PO	ICB12S23F04M1PO
NPN-NC	ICB12S23F04A2NC	ICB12S23F04M1NC
PNP-NC	ICB12S23F04A2PC	ICB12S23F04M1PC

<b>Non-flush mountable</b>		
Dimensions (mm)	M12 x 29	M12 x 44
Thread (mm)	M12 x 1 x 23	M12 x 1 x 23
Operating frequency	2 kHz	2 kHz
Sensing distance (Sn)	8 mm	8 mm
<b>References</b>		
NPN-NO	ICB12S23N08A2NO	ICB12S23N08M1NO
PNP-NO	ICB12S23N08A2PO	ICB12S23N08M1PO
NPN-NC	ICB12S23N08A2NC	ICB12S23N08M1NC
PNP-NC	ICB12S23N08A2PC	ICB12S23N08M1PC

## Characteristics quasi-flush and non-flush mountable

Rated operating voltage	10 - 36 VDC	10 - 36 VDC
Voltage drop	≤ 2.5 VDC @ 200 mA	≤ 2.5 VDC @ 200 mA
Degree of protection	IP 67	IP 67
Protection short-circuit (S) Reverse polarity (P) Transients (T)	SPT	SPT
Output current	≤ 200 mA	≤ 200 mA
Housing material	Nickel-plated brass	Nickel-plated brass
Operating temperature	-25°C to +80°C	-25°C to +80°C
LED colour	Yellow	Yellow
Approvals/Marks	CE - cULus	CE - cULus

# Inductive proximity sensors, 3-wire, DC, extended range

Types	M12 Extended - Short body		M12 Extended - Long body	
Connections	2 m cable	M12 connector	2 m cable	M12 connector
<b>Flush mountable</b>				
Dimensions (mm)	M12 x 47	M12 x 50	M12 x 67	M12 x 70
Thread (mm)	M12 x 1 x 30	M12 x 1 x 30	M12 x 1 x 50	M12 x 1 x 50
Operating frequency	2 kHz	2 kHz	2 kHz	2 kHz
Sensing distance (Sn)	4 mm	4 mm	4 mm	4 mm
<b>References</b>				
NPN-NO	ICB12S30F04NO	ICB12S30F04NOM1	ICB12L50F04NO	ICB12L50F04NOM1
PNP-NO	ICB12S30F04PO	ICB12S30F04POM1	ICB12L50F04PO	ICB12L50F04POM1
NPN-NC	ICB12S30F04NC	ICB12S30F04NCM1	ICB12L50F04NC	ICB12L50F04NCM1
PNP-NC	ICB12S30F04PC	ICB12S30F04PCM1	ICB12L50F04PC	ICB12L50F04PCM1
<b>Non-flush mountable</b>				
Dimensions (mm)	M12 x 51	M12 x 54	M12 x 71	M12 x 74
Thread (mm)	M12 x 1 x 30	M12 x 1 x 30	M12 x 1 x 50	M12 x 1 x 50
Operating frequency	2 kHz	2 kHz	2 kHz	2 kHz
Sensing distance (Sn)	8 mm	8 mm	8 mm	8 mm
<b>References</b>				
NPN-NO	ICB12S30N08NO	ICB12S30N08NOM1	ICB12L50N08NO	ICB12L50N08NOM1
PNP-NO	ICB12S30N08PO	ICB12S30N08POM1	ICB12L50N08PO	ICB12L50N08POM1
NPN-NC	ICB12S30N08NC	ICB12S30N08NCM1	ICB12L50N08NC	ICB12L50N08NCM1
PNP-NC	ICB12S30N08PC	ICB12S30N08PCM1	ICB12L50N08PC	ICB12L50N08PCM1
<b>Characteristics flush and non-flush mountable</b>				
Rated operating voltage	10 - 36 VDC	10 - 36 VDC	10 - 36 VDC	10 - 36 VDC
Voltage drop	≤ 2.5 VDC @ 200 mA	≤ 2.5 VDC @ 200 mA	≤ 2.5 VDC @ 200 mA	≤ 2.5 VDC @ 200 mA
Degree of protection	IP 67	IP 67	IP 67	IP 67
Protection short-circuit (S) Reverse polarity (P) Transients (T)	SPT	SPT	SPT	SPT
Output current	≤ 200 mA @ 50°C ≤ 150 mA @ 50-70°C	≤ 200 mA @ 50°C ≤ 150 mA @ 50-70°C	≤ 200 mA @ 50°C ≤ 150 mA @ 50-70°C	≤ 200 mA @ 50°C ≤ 150 mA @ 50-70°C
Housing material	Nickel-plated brass	Nickel-plated brass	Nickel-plated brass	Nickel-plated brass
Operating temperature	-25°C to +70°C	-25°C to +70°C	-25°C to +70°C	-25°C to +70°C
LED colour	Yellow	Yellow	Yellow	Yellow
Approvals/Marks	CE - cULus - Cl. I Div. 2	CE - cULus - Cl. I Div. 2	CE - cULus - Cl. I Div. 2	CE - cULus - Cl. I Div. 2

## Inductive proximity sensors, 3-wire, DC, increased range

Types	M12 Increased - Short body		M12 Increased - Long body	
Connections	2 m cable	M12 connector	2 m cable	M12 connector

### Quasi-flush mountable



Dimensions (mm)	M12 x 48	M12 x 51	M12 x 68	M12 x 71
Thread (mm)	M12 x 1 x 30	M12 x 1 x 30	M12 x 1 x 50	M12 x 1 x 50
Operating frequency	2 kHz	2 kHz	2 kHz	2 kHz
Sensing distance (Sn)	6 mm	6 mm	6 mm	6 mm

### References

NPN-NO	ICB12S30F06NO	ICB12S30F06NOM1	ICB12L50F06NO	ICB12L50F06NOM1
PNP-NO	ICB12S30F06PO	ICB12S30F06POM1	ICB12L50F06PO	ICB12L50F06POM1
NPN-NC	ICB12S30F06NC	ICB12S30F06NCM1	ICB12L50F06NC	ICB12L50F06NCM1
PNP-NC	ICB12S30F06PC	ICB12S30F06PCM1	ICB12L50F06PC	ICB12L50F06PCM1

### Non-flush mountable



Dimensions (mm)	M12 x 51	M12 x 54	M12 x 71	M12 x 74
Thread (mm)	M12 x 1 x 30	M12 x 1 x 30	M12 x 1 x 50	M12 x 1 x 50
Operating frequency	2 kHz	2 kHz	2 kHz	2 kHz
Sensing distance (Sn)	10 mm	10 mm	10 mm	10 mm

### References





NPN-NO	ICB12S30N10NO	ICB12S30N10NOM1	ICB12L50N10NO	ICB12L50N10NOM1
PNP-NO	ICB12S30N10PO	ICB12S30N10POM1	ICB12L50N10PO	ICB12L50N10POM1
NPN-NC	ICB12S30N10NC	ICB12S30N10NCM1	ICB12L50N10NC	ICB12L50N10NCM1
PNP-NC	ICB12S30N10PC	ICB12S30N10PCM1	ICB12L50N10PC	ICB12L50N10PCM1





### Characteristics quasi-flush and non-flush mountable

Rated operating voltage	10 - 36 VDC	10 - 36 VDC	10 - 36 VDC	10 - 36 VDC
Voltage drop	≤ 2.5 VDC @ 200 mA	≤ 2.5 VDC @ 200 mA	≤ 2.5 VDC @ 200 mA	≤ 2.5 VDC @ 200 mA
Degree of protection	IP 67	IP 67	IP 67	IP 67
Protection short-circuit (S) Reverse polarity (P) Transients (T)	SPT	SPT	SPT	SPT
Output current	≤ 200 mA @ 50°C ≤ 150 mA @ 50-70°C	≤ 200 mA @ 50°C ≤ 150 mA @ 50-70°C	≤ 200 mA @ 50°C ≤ 150 mA @ 50-70°C	≤ 200 mA @ 50°C ≤ 150 mA @ 50-70°C
Housing material	Nickel-plated brass	Nickel-plated brass	Nickel-plated brass	Nickel-plated brass
Operating temperature	-25°C to +70°C	-25°C to +70°C	-25°C to +70°C	-25°C to +70°C
LED colour	Yellow	Yellow	Yellow	Yellow
Approvals/Marks	CE - cULus - Cl. I Div. 2	CE - cULus - Cl. I Div. 2	CE - cULus - Cl. I Div. 2	CE - cULus - Cl. I Div. 2



# Inductive proximity sensors, 3-wire, DC





Types	M18 Standard - Short body		M18 Standard - Long body	
Connections	2 m cable	M12 connector	2 m cable	M12 connector
<b>Flush mountable</b>				
Dimensions (mm)	M18 x 53	M18 x 54	M18 x 73	M18 x 74
Thread (mm)	M18 x 1 x 30	M18 x 1 x 30	M18 x 1 x 50	M18 x 1 x 50
Operating frequency	1.5 kHz	1.5 kHz	1.5 kHz	1.5 kHz
Sensing distance (Sn)	5 mm	5 mm	5 mm	5 mm
<b>References</b>				
NPN-NO	ICB18S30F05NO	ICB18S30F05NOM1	ICB18L50F05NO	ICB18L50F05NOM1
PNP-NO	ICB18S30F05PO	ICB18S30F05POM1	ICB18L50F05PO	ICB18L50F05POM1
NPN-NC	ICB18S30F05NC	ICB18S30F05NCM1	ICB18L50F05NC	ICB18L50F05NCM1
PNP-NC	ICB18S30F05PC	ICB18S30F05PCM1	ICB18L50F05PC	ICB18L50F05PCM1





<b>Non-flush mountable</b>				
Dimensions (mm)	M18 x 63	M18 x 64	M18 x 83	M18 x 84
Thread (mm)	M18 x 1 x 30	M18 x 1 x 30	M18 x 1 x 50	M18 x 1 x 50
Operating frequency	1.5 kHz	1.5 kHz	1.5 kHz	1.5 kHz
Sensing distance (Sn)	8 mm	8 mm	8 mm	8 mm
<b>References</b>				
NPN-NO	ICB18S30N08NO	ICB18S30N08NOM1	ICB18L50N08NO	ICB18L50N08NOM1
PNP-NO	ICB18S30N08PO	ICB18S30N08POM1	ICB18L50N08PO	ICB18L50N08POM1
NPN-NC	ICB18S30N08NC	ICB18S30N08NCM1	ICB18L50N08NC	ICB18L50N08NCM1
PNP-NC	ICB18S30N08PC	ICB18S30N08PCM1	ICB18L50N08PC	ICB18L50N08PCM1

<b>Characteristics flush and non-flush mountable</b>				
Rated operating voltage	10 - 36 VDC	10 - 36 VDC	10 - 36 VDC	10 - 36 VDC
Voltage drop	≤ 2.5 VDC @ 200 mA	≤ 2.5 VDC @ 200 mA	≤ 2.5 VDC @ 200 mA	≤ 2.5 VDC @ 200 mA
Degree of protection	IP 67	IP 67	IP 67	IP 67
Protection short-circuit (S)				
Reverse polarity (P)	SPT	SPT	SPT	SPT
Transients (T)				
Output current	≤ 200 mA @ 50°C ≤ 150 mA @ 50-70°C	≤ 200 mA @ 50°C ≤ 150 mA @ 50-70°C	≤ 200 mA @ 50°C ≤ 150 mA @ 50-70°C	≤ 200 mA @ 50°C ≤ 150 mA @ 50-70°C
Housing material	Nickel-plated brass	Nickel-plated brass	Nickel-plated brass	Nickel-plated brass
Operating temperature	-25°C to +70°C	-25°C to +70°C	-25°C to +70°C	-25°C to +70°C
LED colour	Yellow	Yellow	Yellow	Yellow
Approvals/Marks	CE - cULus - Cl. I Div. 2	CE - cULus - Cl. I Div. 2	CE - cULus - Cl. I Div. 2	CE - cULus - Cl. I Div. 2



## Inductive proximity sensors, 3-wire, DC, extended range

Types	M18 Extended - Short body		M18 Extended - Long body	
Connections	2 m cable	M12 connector	2 m cable	M12 connector
<b>Flush mountable</b>				
Dimensions (mm)	M18 x 53	M18 x 54	M18 x 73	M18 x 74
Thread (mm)	M18 x 1 x 30	M18 x 1 x 30	M18 x 1 x 50	M18 x 1 x 50
Operating frequency	1.5 kHz	1.5 kHz	1.5 kHz	1.5 kHz
Sensing distance (Sn)	8 mm	8 mm	8 mm	8 mm
<b>References</b>				
NPN-NO	ICB18S30F08NO	ICB18S30F08NOM1	ICB18L50F08NO	ICB18L50F08NOM1
PNP-NO	ICB18S30F08PO	ICB18S30F08POM1	ICB18L50F08PO	ICB18L50F08POM1
NPN-NC	ICB18S30F08NC	ICB18S30F08NCM1	ICB18L50F08NC	ICB18L50F08NCM1
PNP-NC	ICB18S30F08PC	ICB18S30F08PCM1	ICB18L50F08PC	ICB18L50F08PCM1

<b>Non-flush mountable</b>				
Dimensions (mm)	M18 x 63	M18 x 64	M18 x 83	M18 x 84
Thread (mm)	M18 x 1 x 30	M18 x 1 x 30	M18 x 1 x 50	M18 x 1 x 50
Operating frequency	1.5 kHz	1.5 kHz	1.5 kHz	1.5 kHz
Sensing distance (Sn)	14 mm	14 mm	14 mm	14 mm
<b>References</b>				
NPN-NO	ICB18S30N14NO	ICB18S30N14NOM1	ICB18L50N14NO	ICB18L50N14NOM1
PNP-NO	ICB18S30N14PO	ICB18S30N14POM1	ICB18L50N14PO	ICB18L50N14POM1
NPN-NC	ICB18S30N14NC	ICB18S30N14NCM1	ICB18L50N14NC	ICB18L50N14NCM1
PNP-NC	ICB18S30N14PC	ICB18S30N14PCM1	ICB18L50N14PC	ICB18L50N14PCM1

<b>Characteristics flush and non-flush mountable</b>				
Rated operating voltage	10 - 36 VDC	10 - 36 VDC	10 - 36 VDC	10 - 36 VDC
Voltage drop	≤ 2.5 VDC @ 200 mA	≤ 2.5 VDC @ 200 mA	≤ 2.5 VDC @ 200 mA	≤ 2.5 VDC @ 200 mA
Degree of protection	IP 67	IP 67	IP 67	IP 67
Protection short-circuit (S) Reverse polarity (P) Transients (T)	SPT	SPT	SPT	SPT
Output current	≤ 200 mA @ 50°C ≤ 150 mA @ 50-70°C	≤ 200 mA @ 50°C ≤ 150 mA @ 50-70°C	≤ 200 mA @ 50°C ≤ 150 mA @ 50-70°C	≤ 200 mA @ 50°C ≤ 150 mA @ 50-70°C
Housing material	Nickel-plated brass	Nickel-plated brass	Nickel-plated brass	Nickel-plated brass
Operating temperature	-25°C to +70°C	-25°C to +70°C	-25°C to +70°C	-25°C to +70°C
LED colour	Yellow	Yellow	Yellow	Yellow
Approvals/Marks	CE - cULus - Cl. I Div. 2	CE - cULus - Cl. I Div. 2	CE - cULus - Cl. I Div. 2	CE - cULus - Cl. I Div. 2

# Inductive proximity sensors, 3-wire, DC, increased range

Types	M18 Increased - Short body		M18 Increased - Long body	
Connections	2 m cable	M12 connector	2 m cable	M12 connector



Dimensions (mm)	M18 x 54	M18 x 55	M18 x 74	M18 x 75
Thread (mm)	M18 x 1 x 30	M18 x 1 x 30	M18 x 1 x 50	M18 x 1 x 50
Operating frequency	1 kHz	1 kHz	1 kHz	1 kHz
Sensing distance (Sn)	12 mm	12 mm	12 mm	12 mm

**References**

NPN-NO	ICB18S30F12NO	ICB18S30F12NOM1	ICB18L50F12NO	ICB18L50F12NOM1
PNP-NO	ICB18S30F12PO	ICB18S30F12POM1	ICB18L50F12PO	ICB18L50F12POM1
NPN-NC	ICB18S30F12NC	ICB18S30F12NCM1	ICB18L50F12NC	ICB18L50F12NCM1
PNP-NC	ICB18S30F12PC	ICB18S30F12PCM1	ICB18L50F12PC	ICB18L50F12PCM1



Dimensions (mm)	M18 x 63	M18 x 64	M18 x 83	M18 x 84
Thread (mm)	M18 x 1 x 30	M18 x 1 x 30	M18 x 1 x 50	M18 x 1 x 50
Operating frequency	1 kHz	1 kHz	1 kHz	1 kHz
Sensing distance (Sn)	20 mm	20 mm	20 mm	20 mm









**References**

NPN-NO	ICB18S30N20NO	ICB18S30N20NOM1	ICB18L50N20NO	ICB18L50N20NOM1
PNP-NO	ICB18S30N20PO	ICB18S30N20POM1	ICB18L50N20PO	ICB18L50N20POM1
NPN-NC	ICB18S30N20NC	ICB18S30N20NCM1	ICB18L50N20NC	ICB18L50N20NCM1
PNP-NC	ICB18S30N20PC	ICB18S30N20PCM1	ICB18L50N20PC	ICB18L50N20PCM1





**Characteristics quasi-flush and non-flush mountable**





Rated operating voltage	10 - 36 VDC	10 - 36 VDC	10 - 36 VDC	10 - 36 VDC
Voltage drop	≤ 2.5 VDC @ 200 mA	≤ 2.5 VDC @ 200 mA	≤ 2.5 VDC @ 200 mA	≤ 2.5 VDC @ 200 mA
Degree of protection	IP 67	IP 67	IP 67	IP 67
Protection short-circuit (S)				
Reverse polarity (P)	SPT	SPT	SPT	SPT
Transients (T)				
Output current	≤ 200 mA @ 50°C ≤ 150 mA @ 50-70°C	≤ 200 mA @ 50°C ≤ 150 mA @ 50-70°C	≤ 200 mA @ 50°C ≤ 150 mA @ 50-70°C	≤ 200 mA @ 50°C ≤ 150 mA @ 50-70°C
Housing material	Nickel-plated brass	Nickel-plated brass	Nickel-plated brass	Nickel-plated brass
Operating temperature	-25°C to +70°C	-25°C to +70°C	-25°C to +70°C	-25°C to +70°C
LED colour	Yellow	Yellow	Yellow	Yellow
Approvals/Marks	CE - cULus - Cl. I Div. 2	CE - cULus - Cl. I Div. 2	CE - cULus - Cl. I Div. 2	CE - cULus - Cl. I Div. 2

## Inductive proximity sensors, 3-wire, DC

Types	M30 Standard - Short body		M30 Standard - Long body	
Connections	2 m cable	M12 connector	2 m cable	M12 connector
<b>Flush mountable</b>				
Dimensions (mm)	M30 x 43.6	M30 x 55	M30 x 63.6	M30 x 75
Thread (mm)	M30 x 1.5 x 30	M30 x 1.5 x 30	M30 x 1.5 x 50	M30 x 1.5 x 50
Operating frequency	1 kHz	1 kHz	1 kHz	1 kHz
Sensing distance (Sn)	10 mm	10 mm	10 mm	10 mm
<b>References</b>				
NPN-NO	ICB30S30F10NO	ICB30S30F10NOM1	ICB30L50F10NO	ICB30L50F10NOM1
PNP-NO	ICB30S30F10PO	ICB30S30F10POM1	ICB30L50F10PO	ICB30L50F10POM1
NPN-NC	ICB30S30F10NC	ICB30S30F10NCM1	ICB30L50F10NC	ICB30L50F10NCM1
PNP-NC	ICB30S30F10PC	ICB30S30F10PCM1	ICB30L50F10PC	ICB30L50F10PCM1
<b>Non-flush mountable</b>				
Dimensions (mm)	M30 x 55.6	M30 x 67	M30 x 75.6	M30 x 87
Thread (mm)	M30 x 1.5 x 30	M30 x 1.5 x 30	M30 x 1.5 x 50	M30 x 1.5 x 50
Operating frequency	1 kHz	1 kHz	1 kHz	1 kHz
Sensing distance (Sn)	15 mm	15 mm	15 mm	15 mm
<b>References</b>				
NPN-NO	ICB30S30N15NO	ICB30S30N15NOM1	ICB30L50N15NO	ICB30L50N15NOM1
PNP-NO	ICB30S30N15PO	ICB30S30N15POM1	ICB30L50N15PO	ICB30L50N15POM1
NPN-NC	ICB30S30N15NC	ICB30S30N15NCM1	ICB30L50N15NC	ICB30L50N15NCM1
PNP-NC	ICB30S30N15PC	ICB30S30N15PCM1	ICB30L50N15PC	ICB30L50N15PCM1
<b>Characteristics flush and non-flush mountable</b>				
Rated operating voltage	10 - 36 VDC	10 - 36 VDC	10 - 36 VDC	10 - 36 VDC
Voltage drop	≤ 2.5 VDC @ 200 mA	≤ 2.5 VDC @ 200 mA	≤ 2.5 VDC @ 200 mA	≤ 2.5 VDC @ 200 mA
Degree of protection	IP 67	IP 67	IP 67	IP 67
Protection short-circuit (S) Reverse polarity (P) Transients (T)	SPT	SPT	SPT	SPT
Output current	≤ 200 mA @ 50°C ≤ 150 mA @ 50-70°C	≤ 200 mA @ 50°C ≤ 150 mA @ 50-70°C	≤ 200 mA @ 50°C ≤ 150 mA @ 50-70°C	≤ 200 mA @ 50°C ≤ 150 mA @ 50-70°C
Housing material	Nickel-plated brass	Nickel-plated brass	Nickel-plated brass	Nickel-plated brass
Operating temperature	-25°C to +70°C	-40°C to +70°C	-25°C to +70°C	-40°C to +70°C
LED colour	Yellow	Yellow	Yellow	Yellow
Approvals/Marks	CE - cULus - Cl. I Div. 2	CE - cULus - Cl. I Div. 2	CE - cULus - Cl. I Div. 2	CE - cULus - Cl. I Div. 2

# Inductive proximity sensors, 3-wire, DC, extended range

Types	M30 Extended - Short body		M30 Extended - Long body	
Connections	2 m cable	M12 connector	2 m cable	M12 connector
<b>Flush mountable</b>				
Dimensions (mm)	M30 x 43.6	M30 x 55	M30 x 63.6	M30 x 75
Thread (mm)	M30 x 1.5 x 30	M30 x 1.5 x 30	M30 x 1.5 x 50	M30 x 1.5 x 50
Operating frequency	1 kHz	1 kHz	1 kHz	1 kHz
Sensing distance (Sn)	15 mm	15 mm	15 mm	15 mm
<b>References</b>				
NPN-NO	ICB30S30F15NO	ICB30S30F15NOM1	ICB30L50F15NO	ICB30L50F15NOM1
PNP-NO	ICB30S30F15PO	ICB30S30F15POM1	ICB30L50F15PO	ICB30L50F15POM1
NPN-NC	ICB30S30F15NC	ICB30S30F15NCM1	ICB30L50F15NC	ICB30L50F15NCM1
PNP-NC	ICB30S30F15PC	ICB30S30F15PCM1	ICB30L50F15PC	ICB30L50F15PCM1

<b>Non-flush mountable</b>				
Dimensions (mm)	M30 x 55.6	M30 x 67	M30 x 75.6	M30 x 87
Thread (mm)	M30 x 1.5 x 30	M30 x 1.5 x 30	M30 x 1.5 x 50	M30 x 1.5 x 50
Operating frequency	1 kHz	1 kHz	1 kHz	1 kHz
Sensing distance (Sn)	22 mm	22 mm	22 mm	22 mm
<b>References</b>				
NPN-NO	ICB30S30N22NO	ICB30S30N22NOM1	ICB30L50N22NO	ICB30L50N22NOM1
PNP-NO	ICB30S30N22PO	ICB30S30N22POM1	ICB30L50N22PO	ICB30L50N22POM1
NPN-NC	ICB30S30N22NC	ICB30S30N22NCM1	ICB30L50N22NC	ICB30L50N22NCM1
PNP-NC	ICB30S30N22PC	ICB30S30N22PCM1	ICB30L50N22PC	ICB30L50N22PCM1

<b>Characteristics flush and non-flush mountable</b>				
Rated operating voltage	10 - 36 VDC	10 - 36 VDC	10 - 36 VDC	10 - 36 VDC
Voltage drop	≤ 2.5 VDC @ 200 mA	≤ 2.5 VDC @ 200 mA	≤ 2.5 VDC @ 200 mA	≤ 2.5 VDC @ 200 mA
Degree of protection	IP 67	IP 67	IP 67	IP 67
Protection short-circuit (S)				
Reverse polarity (P)	SPT	SPT	SPT	SPT
Transients (T)				
Output current	≤ 200 mA @ 50°C ≤ 150 mA @ 50-70°C	≤ 200 mA @ 50°C ≤ 150 mA @ 50-70°C	≤ 200 mA @ 50°C ≤ 150 mA @ 50-70°C	≤ 200 mA @ 50°C ≤ 150 mA @ 50-70°C
Housing material	Nickel-plated brass	Nickel-plated brass	Nickel-plated brass	Nickel-plated brass
Operating temperature	-25°C to +70°C	-40°C to +70°C	-25°C to +70°C	-40°C to +70°C
LED colour	Yellow	Yellow	Yellow	Yellow
Approvals/Marks	CE - cULus - Cl. I Div. 2	CE - cULus - Cl. I Div. 2	CE - cULus - Cl. I Div. 2	CE - cULus - Cl. I Div. 2

## Inductive proximity sensors, 3-wire, DC, increased range

Types	M30 Increased - Short body		M30 Increased - Long body	
Connections	2 m cable	M12 connector	2 m cable	M12 connector

### Quasi-flush mountable



Dimensions (mm)	M30 x 35	M30 x 60	M30 x 50	M30 x 75
Thread (mm)	M30 x 1.5 x 35	M30 x 1.5 x 35	M30 x 1.5 x 50	M30 x 1.5 x 50
Operating frequency	100 Hz	100 Hz	100 Hz	100 Hz
Sensing distance (Sn)	22 mm	22 mm	22 mm	22 mm

### References

NPN-NO	ICB30S35F22NO	ICB30S35F22NOM1	ICB30L50F22NO	ICB30L50F22NOM1
PNP-NO	ICB30S35F22PO	ICB30S35F22POM1	ICB30L50F22PO	ICB30L50F22POM1
NPN-NC	ICB30S35F22NC	ICB30S35F22NCM1	ICB30L50F22NC	ICB30L50F22NCM1
PNP-NC	ICB30S35F22PC	ICB30S35F22PCM1	ICB30L50F22PC	ICB30L50F22PCM1

### Non-flush mountable



Dimensions (mm)	M30 x 47	M30 x 72	M30 x 62	M30 x 87
Thread (mm)	M30 x 1.5 x 35	M30 x 1.5 x 35	M30 x 1.5 x 50	M30 x 1.5 x 50
Operating frequency	100 Hz	100 Hz	100 Hz	100 Hz
Sensing distance (Sn)	40 mm	40 mm	40 mm	40 mm

### References

NPN-NO	ICB30S35N40NO	ICB30S35N40NOM1	ICB30L50N40NO	ICB30L50N40NOM1
PNP-NO	ICB30S35N40PO	ICB30S35N40POM1	ICB30L50N40PO	ICB30L50N40POM1
NPN-NC	ICB30S35N40NC	ICB30S35N40NCM1	ICB30L50N40NC	ICB30L50N40NCM1
PNP-NC	ICB30S35N40PC	ICB30S35N40PCM1	ICB30L50N40PC	ICB30L50N40PCM1





### Characteristics quasi-flush and non-flush mountable

Rated operating voltage	10 - 36 VDC	10 - 36 VDC	10 - 36 VDC	10 - 36 VDC
Voltage drop	≤ 2.5 VDC @ 200 mA	≤ 2.5 VDC @ 200 mA	≤ 2.5 VDC @ 200 mA	≤ 2.5 VDC @ 200 mA
Degree of protection	IP 67	IP 67	IP 67	IP 67
Protection short-circuit (S) Reverse polarity (P) Transients (T)	SPT	SPT	SPT	SPT
Output current	≤ 200 mA @ 50°C ≤ 150 mA @ 50-70°C	≤ 200 mA @ 50°C ≤ 150 mA @ 50-70°C	≤ 200 mA @ 50°C ≤ 150 mA @ 50-70°C	≤ 200 mA @ 50°C ≤ 150 mA @ 50-70°C
Housing material	Nickel-plated brass	Nickel-plated brass	Nickel-plated brass	Nickel-plated brass
Operating temperature	-25°C to +70°C	-25°C to +70°C	-25°C to +70°C	-25°C to +70°C
LED colour	Yellow	Yellow	Yellow	Yellow
Approvals/Marks	CE - cULus - Cl. I Div. 2	CE - cULus - Cl. I Div. 2	CE - cULus - Cl. I Div. 2	CE - cULus - Cl. I Div. 2

# Inductive proximity sensors, 3-wire, DC, washdown IP69K

Types	M12 Standard - Long body	M12 Extended - Long body	M18 Standard - Long body	M18 Extended - Long body
-------	--------------------------	--------------------------	--------------------------	--------------------------

Connections	M12 connector	M12 connector	M12 connector	M12 connector
-------------	---------------	---------------	---------------	---------------

<b>Flush mountable</b>				
	Dimensions (mm)	M12 x 64.8	M12 x 64.8	M18 x 63
	Thread (mm)	M12 x 1 x 38.7	M12 x 1 x 38.7	M12 x 1 x 35
	Operating frequency	2 kHz	2 kHz	1.5 kHz
Sensing distance (Sn)	2 mm	4 mm	5 mm	8 mm

References				
NPN-NO	ICS12LF02NOM1-FB	ICS12LF04NOM1-FB	ICS18LF05NOM1-FB	ICS18LF08NOM1-FB
PNP-NO	ICS12LF02POM1-FB	ICS12LF04POM1-FB	ICS18LF05POM1-FB	ICS18LF08POM1-FB
NPN-NC	ICS12LF02NCM1-FB	ICS12LF04NCM1-FB	ICS18LF05NCM1-FB	ICS18LF08NCM1-FB
PNP-NC	ICS12LF02PCM1-FB	ICS12LF04PCM1-FB	ICS18LF05PCM1-FB	ICS18LF08PCM1-FB

<b>Non-flush mountable</b>				
	Dimensions (mm)	M12 x 64.8	M12 x 64.8	M18 x 63
	Thread (mm)	M12 x 1 x 32.5	M12 x 1 x 32.5	M12 x 1 x 27
	Operating frequency	2 kHz	2 kHz	1.5 kHz
Sensing distance (Sn)	4 mm	8 mm	8 mm	12 mm

Dimensions (mm)	M12 x 64.8	M12 x 64.8	M18 x 63	M18 x 63
Thread (mm)	M12 x 1 x 32.5	M12 x 1 x 32.5	M12 x 1 x 27	M12 x 1 x 27
Operating frequency	2 kHz	2 kHz	1.5 kHz	1.5 kHz
Sensing distance (Sn)	4 mm	8 mm	8 mm	12 mm

References				
NPN-NO	ICS12LN04NOM1-FB	ICS12LN08NOM1-FB	ICS18LN08NOM1-FB	ICS18LN12NOM1-FB
PNP-NO	ICS12LN04POM1-FB	ICS12LN08POM1-FB	ICS18LN08POM1-FB	ICS18LN12POM1-FB
NPN-NC	ICS12LN04NCM1-FB	ICS12LN08NCM1-FB	ICS18LN08NCM1-FB	ICS18LN12NCM1-FB
PNP-NC	ICS12LN04PCM1-FB	ICS12LN08PCM1-FB	ICS18LN08PCM1-FB	ICS18LN12PCM1-FB

Characteristics flush and non-flush mountable				
Rated operating voltage	10 - 36 VDC	10 - 36 VDC	10 - 36 VDC	10 - 36 VDC
Voltage drop	≤ 2.5 VDC @ 200 mA	≤ 2.5 VDC @ 200 mA	≤ 2.5 VDC @ 200 mA	≤ 2.5 VDC @ 200 mA
Degree of protection	IP 67, IP 68, IP 69K	IP 67, IP 68, IP 69K	IP 67, IP 68, IP 69K	IP 67, IP 68, IP 69K
Protection short-circuit (S)	SPT	SPT	SPT	SPT
Reverse polarity (P)				
Transients (T)				
Output current	≤ 200 mA @ 50°C ≤ 150 mA @ 50-80°C	≤ 200 mA @ 50°C ≤ 150 mA @ 50-80°C	≤ 200 mA @ 50°C ≤ 150 mA @ 50-80°C	≤ 200 mA @ 50°C ≤ 150 mA @ 50-80°C
Housing material	Stainless steel (AISI 316L)	Stainless steel (AISI 316L)	Stainless steel (AISI 316L)	Stainless steel (AISI 316L)
Front cap material	PPS grey - FDA certified	PPS grey - FDA certified	PPS grey - FDA certified	PPS grey - FDA certified
Operating temperature	-40°C to +80°C	-40°C to +80°C	-40°C to +80°C	-40°C to +80°C
LED colour	Yellow	Yellow	Yellow	Yellow
Approvals/Marks	CE - cULus - ECOLAB - Cl. I Div. 2	CE - cULus - ECOLAB - Cl. I Div. 2	CE - cULus - ECOLAB - Cl. I Div. 2	CE - cULus - ECOLAB - Cl. I Div. 2

## Inductive proximity sensors, 3-wire, DC, washdown IP69K

Types	M30 Standard		M30 Extended	
	Short body	Long body	Short body	Long body

Connections	M12 connector	M12 connector	M12 connector	M12 connector
-------------	---------------	---------------	---------------	---------------



### Flush mountable

Dimensions (mm)	M30 x 47	M30 x 67.5	M30 x 47	M30 x 67.5
Thread (mm)	M30 x 1.5 x 30	M30 x 1.5 x 50	M30 x 1.5 x 30	M30 x 1.5 x 50
Operating frequency	1 kHz	1 kHz	1 kHz	1 kHz
Sensing distance (Sn)	10 mm	10 mm	15 mm	15 mm

### References

NPN-NO	ICS30SF10NOM1-FB	ICS30LF10NOM1-FB	ICS30SF15NOM1-FB	ICS30LF15NOM1-FB
PNP-NO	ICS30SF10POM1-FB	ICS30LF10POM1-FB	ICS30SF15POM1-FB	ICS30LF15POM1-FB
NPN-NC	ICS30SF10NCM1-FB	ICS30LF10NCM1-FB	ICS30SF15NCM1-FB	ICS30LF15NCM1-FB
PNP-NC	ICS30SF10PCM1-FB	ICS30LF10PCM1-FB	ICS30SF15PCM1-FB	ICS30LF15PCM1-FB



### Non-flush mountable

Dimensions (mm)	M30 x 59.5	M30 x 79.5	M30 x 59.5	M30 x 79.5
Thread (mm)	M30 x 1.5 x 30	M30 x 1.5 x 50	M30 x 1.5 x 30	M30 x 1.5 x 50
Operating frequency	1 kHz	1 kHz	1 kHz	1 kHz
Sensing distance (Sn)	15 mm	15 mm	22 mm	22 mm

### References









NPN-NO	ICS30SN15NOM1-FB	ICS30LN15NOM1-FB	ICS30SN22NOM1-FB	ICS30LN22NOM1-FB
PNP-NO	ICS30SN15POM1-FB	ICS30LN15POM1-FB	ICS30SN22POM1-FB	ICS30LN22POM1-FB
NPN-NC	ICS30SN15NCM1-FB	ICS30LN15NCM1-FB	ICS30SN22NCM1-FB	ICS30LN22NCM1-FB
PNP-NC	ICS30SN15PCM1-FB	ICS30LN15PCM1-FB	ICS30SN22PCM1-FB	ICS30LN22PCM1-FB

### Characteristics flush and non-flush mountable

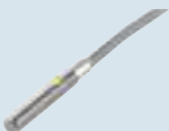
Rated operating voltage	10 - 36 VDC	10 - 36 VDC	10 - 36 VDC	10 - 36 VDC
Voltage drop	≤ 2 VDC @ 200 mA	≤ 2 VDC @ 200 mA	≤ 2 VDC @ 200 mA	≤ 2 VDC @ 200 mA
Degree of protection	IP 67, IP 68, IP 69K	IP 67, IP 68, IP 69K	IP 67, IP 68, IP 69K	IP 67, IP 68, IP 69K
Protection short-circuit (S)	SPT	SPT	SPT	SPT
Reverse polarity (P)	SPT	SPT	SPT	SPT
Transients (T)	SPT	SPT	SPT	SPT
Output current	≤ 200 mA @ 50°C ≤ 150 mA @ 50-80°C ≤ 100 mA @ 80-85°C	≤ 200 mA @ 50°C ≤ 150 mA @ 50-80°C ≤ 100 mA @ 80-85°C	≤ 200 mA @ 50°C ≤ 150 mA @ 50-80°C ≤ 100 mA @ 80-85°C	≤ 200 mA @ 50°C ≤ 150 mA @ 50-80°C ≤ 100 mA @ 80-85°C
Housing material	Stainless steel (AISI 316L)	Stainless steel (AISI 316L)	Stainless steel (AISI 316L)	Stainless steel (AISI 316L)
Front cap material	PPS grey - FDA certified	PPS grey - FDA certified	PPS grey - FDA certified	PPS grey - FDA certified
Operating temperature	-40°C to +85°C	-40°C to +85°C	-40°C to +85°C	-40°C to +85°C
LED colour	Yellow	Yellow	Yellow	Yellow
Approvals/Marks	CE - cULus - ECOLAB - Cl. I Div. 2	CE - cULus - ECOLAB - Cl. I Div. 2	CE - cULus - ECOLAB - Cl. I Div. 2	CE - cULus - ECOLAB - Cl. I Div. 2

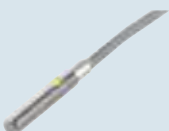

# Inductive proximity sensors, 3-wire, DC

Types	Ø4 Standard & Extended Short body		M5 Standard & Extended Short body	
	2 m cable	M8 connector	2 m cable	M8 connector
<b>Flush mountable - Standard</b>				
Dimensions (mm)	Ø4 x 28.2	Ø4 x 38.2	M5 x 28.2	M5 x 38.2
Thread (mm)	-	-	M5 x 0.5 x 23	M5 x 0.5 x 23
Operating frequency	6 kHz	6 kHz	6 kHz	6 kHz
Sensing distance (Sn)	0.8 mm	0.8 mm	0.8 mm	0.8 mm
<b>References</b>				
NPN-NO	IBS04SF08A2NO	IBS04SF08M5NO	ICS05S23F08A2NO	ICS05S23F08M5NO
PNP-NO	IBS04SF08A2PO	IBS04SF08M5PO	ICS05S23F08A2PO	ICS05S23F08M5PO
NPN-NC	IBS04SF08A2NC	IBS04SF08M5NC	ICS05S23F08A2NC	ICS05S23F08M5NC
PNP-NC	IBS04SF08A2PC	IBS04SF08M5PC	ICS05S23F08A2PC	ICS05S23F08M5PC
<b>Flush mountable - Extended</b>				
Dimensions (mm)	Ø4 x 28.2	Ø4 x 38.2	M5 x 28.2	M5 x 38.2
Thread (mm)	-	-	M5 x 0.5 x 23	M5 x 0.5 x 23
Operating frequency	4.5 kHz	4.5 kHz	4.5 kHz	4.5 kHz
Sensing distance (Sn)	1.3 mm	1.3 mm	1.3 mm	1.3 mm
<b>References</b>				
NPN-NO	IBS04SF15A2NO	IBS04SF15M5NO	ICS05S23F15A2NO	ICS05S23F15M5NO
PNP-NO	IBS04SF15A2PO	IBS04SF15M5PO	ICS05S23F15A2PO	ICS05S23F15M5PO
NPN-NC	IBS04SF15A2NC	IBS04SF15M5NC	ICS05S23F15A2NC	ICS05S23F15M5NC
PNP-NC	IBS04SF15A2PC	IBS04SF15M5PC	ICS05S23F15A2PC	ICS05S23F15M5PC
<b>Characteristics</b>				
Rated operating voltage	10 - 30 VDC	10 - 30 VDC	10 - 30 VDC	10 - 30 VDC
Voltage drop	max. 1.2 VDC (@ 100 mA)	max. 1.2 VDC (@ 100 mA)	max. 1.2 VDC (@ 100 mA)	max. 1.2 VDC (@ 100 mA)
Degree of protection	IP 67	IP 67	IP 67	IP 67
Protection short-circuit (S)				
Reverse polarity (P)	SPT	SPT	SPT	SPT
Transients (T)				
Output current	≤ 100 mA	≤ 100 mA	≤ 100 mA	≤ 100 mA
Housing material	Stainless steel	Stainless steel	Stainless steel	Stainless steel
Operating temperature	-25°C to +70°C	-25°C to +70°C	-25°C to +70°C	-25°C to +70°C
LED colour	Yellow	Yellow	Yellow	Yellow
Approvals/Marks	CE - UL - CSA	CE - UL - CSA	CE - UL - CSA	CE - UL - CSA



## Inductive proximity sensors, 3-wire, DC

Types	M8 Extended - Short body		M8 Extended - Long body	
Connections	2 m cable	M8 connector	2 m cable	M8 connector

### Flush mountable



Dimensions (mm)	M8 x 31	M8 x 40	M8 x 46	M8 x 55
Thread (mm)	M8 x 1 x 30	M8 x 1 x 29	M8 x 1 x 45	M8 x 1 x 44
Operating frequency	2 kHz	2 kHz	2 kHz	2 kHz
Sensing distance (Sn)	2 mm	2 mm	2 mm	2 mm

### References

NPN-NO	ICS08S30F20A2NO	ICS08S30F20M5NO	ICS08L45F20A2NO	ICS08L45F20M5NO
PNP-NO	ICS08S30F20A2PO	ICS08S30F20M5PO	ICS08L45F20A2PO	ICS08L45F20M5PO
NPN-NC	ICS08S30F20A2NC	ICS08S30F20M5NC	ICS08L45F20A2NC	ICS08L45F20M5NC
PNP-NC	ICS08S30F20A2PC	ICS08S30F20M5PC	ICS08L45F20A2PC	ICS08L45F20M5PC

### Non-flush mountable



Dimensions (mm)	M8 x 34	M8 x 43	M8 x 49	M8 x 58
Thread (mm)	M8 x 1 x 30	M8 x 1 x 29	M8 x 1 x 45	M8 x 1 x 44
Operating frequency	2 kHz	2 kHz	2 kHz	2 kHz
Sensing distance (Sn)	4 mm	4 mm	4 mm	4 mm





### References





NPN-NO	ICS08S30N40A2NO	ICS08S30N40M5NO	ICS08L45N40A2NO	ICS08L45N40M5NO
PNP-NO	ICS08S30N40A2PO	ICS08S30N40M5PO	ICS08L45N40A2PO	ICS08L45N40M5PO
NPN-NC	ICS08S30N40A2NC	ICS08S30N40M5NC	ICS08L45N40A2NC	ICS08L45N40M5NC
PNP-NC	ICS08S30N40A2PC	ICS08S30N40M5PC	ICS08L45N40A2PC	ICS08L45N40M5PC

### Characteristics flush and non-flush mountable

Rated operating voltage	10 - 30 VDC	10 - 30 VDC	10 - 30 VDC	10 - 30 VDC
Voltage drop	max. 1.2 VDC (@ 100 mA)	max. 1.2 VDC (@ 100 mA)	max. 1.2 VDC (@ 100 mA)	max. 1.2 VDC (@ 100 mA)
Degree of protection	IP 67	IP 67	IP 67	IP 67
Protection short-circuit (S)				
Reverse polarity (P)	SPT	SPT	SPT	SPT
Transients (T)				
Output current	≤ 100 mA	≤ 100 mA	≤ 100 mA	≤ 100 mA
Housing material	Stainless steel	Stainless steel	Stainless steel	Stainless steel
Operating temperature	-25°C to +80°C	-25°C to +80°C	-25°C to +80°C	-25°C to +80°C
LED colour	Yellow	Yellow	Yellow	Yellow
Approvals/Marks	CE - UL - CSA	CE - UL - CSA	CE - UL - CSA	CE - UL - CSA

# Inductive proximity sensors, 4-wire, DC, extended range





Types	M8 Extended - Short body		M8 Extended - Long body	
Connections	2 m cable	M8 connector	2 m cable	M8 connector
<b>Flush mountable</b>				
Dimensions (mm)	M8 x 31	M8 x 40	M8 x 46	M8 x 55
Thread (mm)	M8 x 1 x 30	M8 x 1 x 29	M8 x 1 x 45	M8 x 1 x 44
Operating frequency	2 kHz	2 kHz	2 kHz	2 kHz
Sensing distance (Sn)	2 mm	2 mm	2 mm	2 mm
<b>References</b>				
NPN-NO+NC	ICS08S30F02NA	ICS08S30F02NAM5	ICS08L45F02NA	ICS08L45F02NAM5
PNP-NO+NC	ICS08S30F02PA	ICS08S30F02PAM5	ICS08L45F02PA	ICS08L45F02PAM5





<b>Non-flush mountable</b>				
Dimensions (mm)	M8 x 34	M8 x 43	M8 x 49	M8 x 58
Thread (mm)	M8 x 1 x 30	M8 x 1 x 29	M8 x 1 x 45	M8 x 1 x 44
Operating frequency	2 kHz	2 kHz	2 kHz	2 kHz
Sensing distance (Sn)	4 mm	4 mm	4 mm	4 mm
<b>References</b>				
NPN-NO+NC	ICS08S30N04NA	ICS08S30N04NAM5	ICS08L45N04NA	ICS08L45N04NAM5
PNP-NO+NC	ICS08S30N04PA	ICS08S30N04PAM5	ICS08L45N04PA	ICS08L45N04PAM5

## Characteristics flush and non-flush mountable

Rated operating voltage	10 - 36 VDC	10 - 36 VDC	10 - 36 VDC	10 - 36 VDC
Voltage drop	≤ 1.6 VDC @ 200 mA	≤ 1.6 VDC @ 200 mA	≤ 1.6 VDC @ 200 mA	≤ 1.6 VDC @ 200 mA
Degree of protection	IP 67	IP 67	IP 67	IP 67
Protection short-circuit (S)				
Reverse polarity (P)	SPT	SPT	SPT	SPT
Transients (T)				
Output current	≤ 200 mA @ 50°C ≤ 150 mA @ 50-70°C	≤ 200 mA @ 50°C ≤ 150 mA @ 50-70°C	≤ 200 mA @ 50°C ≤ 150 mA @ 50-70°C	≤ 200 mA @ 50°C ≤ 150 mA @ 50-70°C
Housing material	Stainless steel (AISI304)	Stainless steel (AISI304)	Stainless steel (AISI304)	Stainless steel (AISI304)
Operating temperature	-25°C to +80°C	-25°C to +80°C	-25°C to +80°C	-25°C to +80°C
LED colour	Yellow	Yellow	Yellow	Yellow
Approvals/Marks	CE - cULus	CE - cULus	CE - cULus	CE - cULus

## Inductive proximity sensors, 4-wire, DC

Types	M12 Standard - Short body		M12 Standard - Long body	
Connections	2 m cable	M12 connector	2 m cable	M12 connector
<b>Flush mountable</b>				
Dimensions (mm)	M12 x 47	M12 x 50	M12 x 67	M12 x 70
Thread (mm)	M12 x 1 x 30	M12 x 1 x 30	M12 x 1 x 50	M12 x 1 x 50
Operating frequency	2 kHz	2 kHz	2 kHz	2 kHz
Sensing distance (Sn)	2 mm	2 mm	2 mm	2 mm
<b>References</b>				
NPN-NO+NC	ICB12S30F02NA	ICB12S30F02NAM1	ICB12L50F02NA	ICB12L50F02NAM1
PNP-NO+NC	ICB12S30F02PA	ICB12S30F02PAM1	ICB12L50F02PA	ICB12L50F02PAM1





<b>Non-flush mountable</b>				
Dimensions (mm)	M12 x 51	M12 x 54	M12 x 71	M12 x 74
Thread (mm)	M12 x 1 x 30	M12 x 1 x 30	M12 x 1 x 50	M12 x 1 x 50
Operating frequency	2 kHz	2 kHz	2 kHz	2 kHz
Sensing distance (Sn)	4 mm	4 mm	4 mm	4 mm
<b>References</b>				
NPN-NO+NC	ICB12S30N04NA	ICB12S30N04NAM1	ICB12L50N04NA	ICB12L50N04NAM1
PNP-NO+NC	ICB12S30N04PA	ICB12S30N04PAM1	ICB12L50N04PA	ICB12L50N04PAM1

### Characteristics flush and non-flush mountable

Rated operating voltage	10 - 36 VDC	10 - 36 VDC	10 - 36 VDC	10 - 36 VDC
Voltage drop	≤ 2.5 VDC @ 200 mA	≤ 2.5 VDC @ 200 mA	≤ 2.5 VDC @ 200 mA	≤ 2.5 VDC @ 200 mA
Degree of protection	IP 67	IP 67	IP 67	IP 67
Protection short-circuit (S)				
Reverse polarity (P)	SPT	SPT	SPT	SPT
Transients (T)				
Output current	< 200 mA @ 50°C ≤ 150 mA @ 50-70°C	< 200 mA @ 50°C ≤ 150 mA @ 50-70°C	< 200 mA @ 50°C ≤ 150 mA @ 50-70°C	< 200 mA @ 50°C ≤ 150 mA @ 50-70°C
Housing material	Nickel-plated brass	Nickel-plated brass	Nickel-plated brass	Nickel-plated brass
Operating temperature	-25°C to +70°C	-25°C to +70°C	-25°C to +70°C	-25°C to +70°C
LED colour	Yellow	Yellow	Yellow	Yellow
Approvals/Marks	CE - cULus	CE - cULus	CE - cULus	CE - cULus





# Inductive proximity sensors, 4-wire, DC, extended range





Types	M12 Extended - Short body		M12 Extended - Long body	
Connections	2 m cable	M12 connector	2 m cable	M12 connector
<b>Flush mountable</b>				
Dimensions (mm)	M12 x 47	M12 x 50	M12 x 67	M12 x 70
Thread (mm)	M12 x 1 x 30	M12 x 1 x 30	M12 x 1 x 50	M12 x 1 x 50
Operating frequency	2 kHz	2 kHz	2 kHz	2 kHz
Sensing distance (Sn)	4 mm	4 mm	4 mm	4 mm
<b>References</b>				
NPN-NO+NC	ICB12S30F04NA	ICB12S30F04NAM1	ICB12L50F04NA	ICB12L50F04NAM1
PNP-NO+NC	ICB12S30F04PA	ICB12S30F04PAM1	ICB12L50F04PA	ICB12L50F04PAM1

<b>Non-flush mountable</b>				
Dimensions (mm)	M12 x 51	M12 x 54	M12 x 71	M12 x 74
Thread (mm)	M12 x 1 x 30	M12 x 1 x 30	M12 x 1 x 50	M12 x 1 x 50
Operating frequency	2 kHz	2 kHz	2 kHz	2 kHz
Sensing distance (Sn)	8 mm	8 mm	8 mm	8 mm
<b>References</b>				
NPN-NO+NC	ICB12S30N08NA	ICB12S30N08NAM1	ICB12L50N08NA	ICB12L50N08NAM1
PNP-NO+NC	ICB12S30N08PA	ICB12S30N08PAM1	ICB12L50N08PA	ICB12L50N08PAM1

<b>Characteristics flush and non-flush mountable</b>				
Rated operating voltage	10 - 36 VDC	10 - 36 VDC	10 - 36 VDC	10 - 36 VDC
Voltage drop	≤ 2.5 VDC @ 200 mA	≤ 2.5 VDC @ 200 mA	≤ 2.5 VDC @ 200 mA	≤ 2.5 VDC @ 200 mA
Degree of protection	IP 67	IP 67	IP 67	IP 67
Protection short-circuit (S)				
Reverse polarity (P)	SPT	SPT	SPT	SPT
Transients (T)				
Output current	≤ 200 mA @ 50°C ≤ 150 mA @ 50-70°C	≤ 200 mA @ 50°C ≤ 150 mA @ 50-70°C	≤ 200 mA @ 50°C ≤ 150 mA @ 50-70°C	≤ 200 mA @ 50°C ≤ 150 mA @ 50-70°C
Housing material	Nickel-plated brass	Nickel-plated brass	Nickel-plated brass	Nickel-plated brass
Operating temperature	-25°C to +70°C	-25°C to +70°C	-25°C to +70°C	-25°C to +70°C
LED colour	Yellow	Yellow	Yellow	Yellow
Approvals/Marks	CE - cULus	CE - cULus	CE - cULus	CE - cULus

## Inductive proximity sensors, 4-wire, DC





Types	M18 Standard - Short body		M18 Standard - Long body	
Connections	2 m cable	M12 connector	2 m cable	M12 connector
<b>Flush mountable</b>				
Dimensions (mm)	M18 x 53	M18 x 54	M18 x 73	M18 x 74
Thread (mm)	M18 x 1 x 30	M18 x 1 x 30	M18 x 1 x 50	M18 x 1 x 50
Operating frequency	1.5 kHz	1.5 kHz	1.5 kHz	1.5 kHz
Sensing distance (Sn)	5 mm	5 mm	5 mm	5 mm
<b>References</b>				
NPN-NO+NC	ICB18S30F05NA	ICB18S30F05NAM1	ICB18L50F05NA	ICB18L50F05NAM1
PNP-NO+NC	ICB18S30F05PA	ICB18S30F05PAM1	ICB18L50F05PA	ICB18L50F05PAM1





<b>Non-flush mountable</b>				
Dimensions (mm)	M18 x 63	M18 x 64	M18 x 83	M18 x 84
Thread (mm)	M18 x 1 x 30	M18 x 1 x 30	M18 x 1 x 50	M18 x 1 x 50
Operating frequency	1.5 kHz	1.5 kHz	1.5 kHz	1.5 kHz
Sensing distance (Sn)	8 mm	8 mm	8 mm	8 mm
<b>References</b>				
NPN-NO+NC	ICB18S30N08NA	ICB18S30N08NAM1	ICB18L50N08NA	ICB18L50N08NAM1
PNP-NO+NC	ICB18S30N08PA	ICB18S30N08PAM1	ICB18L50N08PA	ICB18L50N08PAM1

### Characteristics flush and non-flush mountable

Rated operating voltage	10 - 36 VDC	10 - 36 VDC	10 - 36 VDC	10 - 36 VDC
Voltage drop	≤ 2.5 VDC @ 200 mA	≤ 2.5 VDC @ 200 mA	≤ 2.5 VDC @ 200 mA	≤ 2.5 VDC @ 200 mA
Degree of protection	IP 67	IP 67	IP 67	IP 67
Protection short-circuit (S)				
Reverse polarity (P)	SPT	SPT	SPT	SPT
Transients (T)				
Output current	≤ 200 mA @ 50°C ≤ 150 mA @ 50-70°C	≤ 200 mA @ 50°C ≤ 150 mA @ 50-70°C	≤ 200 mA @ 50°C ≤ 150 mA @ 50-70°C	≤ 200 mA @ 50°C ≤ 150 mA @ 50-70°C
Housing material	Nickel-plated brass	Nickel-plated brass	Nickel-plated brass	Nickel-plated brass
Operating temperature	-25°C to +70°C	-25°C to +70°C	-25°C to +70°C	-25°C to +70°C
LED colour	Yellow	Yellow	Yellow	Yellow
Approvals/Marks	CE - cULus	CE - cULus	CE - cULus	CE - cULus



# Inductive proximity sensors, 4-wire, DC, extended range

Types	M18 Extended - Short body		M18 Extended - Long body	
Connections	2 m cable	M12 connector	2 m cable	M12 connector
<b>Quasi-flush mountable</b>				
Dimensions (mm)	M18 x 53	M18 x 54	M18 x 73	M18 x 74
Thread (mm)	M18 x 1 x 30	M18 x 1 x 30	M18 x 1 x 50	M18 x 1 x 50
Operating frequency	1.5 kHz	1.5 kHz	1.5 kHz	1.5 kHz
Sensing distance (Sn)	8 mm	8 mm	8 mm	8 mm
<b>References</b>				
NPN-NO+NC	ICB18S30F08NA	ICB18S30F08NAM1	ICB18L50F08NA	ICB18L50F08NAM1
PNP-NO+NC	ICB18S30F08PA	ICB18S30F08PAM1	ICB18L50F08PA	ICB18L50F08PAM1





<b>Non-flush mountable</b>				
Dimensions (mm)	M18 x 63	M18 x 64	M18 x 83	M18 x 84
Thread (mm)	M18 x 1 x 30	M18 x 1 x 30	M18 x 1 x 50	M18 x 1 x 50
Operating frequency	1.5 kHz	1.5 kHz	1.5 kHz	1.5 kHz
Sensing distance (Sn)	14 mm	14 mm	14 mm	14 mm
<b>References</b>				
NPN-NO+NC	ICB18S30N14NA	ICB18S30N14NAM1	ICB18L50N14NA	ICB18L50N14NAM1
PNP-NO+NC	ICB18S30N14PA	ICB18S30N14PAM1	ICB18L50N14PA	ICB18L50N14PAM1





<b>Characteristics quasi-flush and non-flush mountable</b>				
Rated operating voltage	10 - 36 VDC	10 - 36 VDC	10 - 36 VDC	10 - 36 VDC
Voltage drop	≤ 2.5 VDC @ 200 mA	≤ 2.5 VDC @ 200 mA	≤ 2.5 VDC @ 200 mA	≤ 2.5 VDC @ 200 mA
Degree of protection	IP 67	IP 67	IP 67	IP 67
Protection short-circuit (S)				
Reverse polarity (P)	SPT	SPT	SPT	SPT
Transients (T)				
Output current	≤ 200 mA @ 50°C ≤ 150 mA @ 50-70°C	≤ 200 mA @ 50°C ≤ 150 mA @ 50-70°C	≤ 200 mA @ 50°C ≤ 150 mA @ 50-70°C	≤ 200 mA @ 50°C ≤ 150 mA @ 50-70°C
Housing material	Nickel-plated brass	Nickel-plated brass	Nickel-plated brass	Nickel-plated brass
Operating temperature	-25°C to +70°C	-25°C to +70°C	-25°C to +70°C	-25°C to +70°C
LED colour	Yellow	Yellow	Yellow	Yellow
Approvals/Marks	CE - cULus	CE - cULus	CE - cULus	CE - cULus

## Inductive proximity sensors, 4-wire, DC

Types	M30 Standard - Short body		M30 Standard - Long body	
Connections	2 m cable	M12 connector	2 m cable	M12 connector
<b>Flush mountable</b>				
Dimensions (mm)	M30 x 43.6	M30 x 55	M30 x 63.6	M30 x 75
Thread (mm)	M30 x 1.5 x 30	M30 x 1.5 x 30	M30 x 1.5 x 50	M30 x 1.5 x 50
Operating frequency	1 kHz	1 kHz	1 kHz	1 kHz
Sensing distance (Sn)	10 mm	10 mm	10 mm	10 mm
<b>References</b>				
NPN-NO+NC	ICB30S30F10NA	ICB30S30F10NAM1	ICB30L50F10NA	ICB30L50F10NAM1
PNP-NO+NC	ICB30S30F10PA	ICB30S30F10PAM1	ICB30L50F10PA	ICB30L50F10PAM1
<b>Non-flush mountable</b>				
Dimensions (mm)	M30 x 55.6	M30 x 67	M30 x 75.6	M30 x 87
Thread (mm)	M30 x 1.5 x 30	M30 x 1.5 x 30	M30 x 1.5 x 50	M30 x 1.5 x 50
Operating frequency	1 kHz	1 kHz	1 kHz	1 kHz
Sensing distance (Sn)	15 mm	15 mm	15 mm	15 mm
<b>References</b>				
NPN-NO+NC	ICB30S30N15NA	ICB30S30N15NAM1	ICB30L50N15NA	ICB30L50N15NAM1
PNP-NO+NC	ICB30S30N15PA	ICB30S30N15PAM1	ICB30L50N15PA	ICB30L50N15PAM1
<b>Characteristics flush and non-flush mountable</b>				
Rated operating voltage	10 - 36 VDC	10 - 36 VDC	10 - 36 VDC	10 - 36 VDC
Voltage drop	≤ 2.5 VDC @ 200 mA	≤ 2.5 VDC @ 200 mA	≤ 2.5 VDC @ 200 mA	≤ 2.5 VDC @ 200 mA
Degree of protection	IP 67	IP 67	IP 67	IP 67
Protection short-circuit (S)				
Reverse polarity (P)	SPT	SPT	SPT	SPT
Transients (T)				
Output current	≤ 200 mA @ 50°C ≤ 150 mA @ 50-70°C	≤ 200 mA @ 50°C ≤ 150 mA @ 50-70°C	≤ 200 mA @ 50°C ≤ 150 mA @ 50-70°C	≤ 200 mA @ 50°C ≤ 150 mA @ 50-70°C
Housing material	Nickel-plated brass	Nickel-plated brass	Nickel-plated brass	Nickel-plated brass
Operating temperature	-25°C to +70°C	-40°C to +70°C	-25°C to +70°C	-40°C to +70°C
LED colour	Yellow	Yellow	Yellow	Yellow
Approvals/Marks	CE - cULus	CE - cULus	CE - cULus	CE - cULus

# Inductive proximity sensors, 4-wire, DC, extended range





Types	M30 Extended - Short body		M30 Extended - Long body	
Connections	2 m cable	M12 connector	2 m cable	M12 connector
<b>Flush mountable</b>				
Dimensions (mm)	M30 x 43.6	M30 x 55	M30 x 63.6	M30 x 75
Thread (mm)	M30 x 1.5 x 30	M30 x 1.5 x 30	M30 x 1.5 x 50	M30 x 1.5 x 50
Operating frequency	1 kHz	1 kHz	1 kHz	1 kHz
Sensing distance (Sn)	15 mm	15 mm	15 mm	15 mm
<b>References</b>				
NPN-NO+NC	ICB30S30F15NA	ICB30S30F15NAM1	ICB30L50F15NA	ICB30L50F15NAM1
PNP-NO+NC	ICB30S30F15PA	ICB30S30F15PAM1	ICB30L50F15PA	ICB30L50F15PAM1





<b>Non-flush mountable</b>				
Dimensions (mm)	M30 x 55.6	M30 x 67	M30 x 75.6	M30 x 87
Thread (mm)	M30 x 1.5 x 30	M30 x 1.5 x 30	M30 x 1.5 x 50	M30 x 1.5 x 50
Operating frequency	1 kHz	1 kHz	1 kHz	1 kHz
Sensing distance (Sn)	22 mm	22 mm	22 mm	22 mm
<b>References</b>				
NPN-NO+NC	ICB30S30N22NA	ICB30S30N22NAM1	ICB30L50N22NA	ICB30L50N22NAM1
PNP-NO+NC	ICB30S30N22PA	ICB30S30N22PAM1	ICB30L50N22PA	ICB30L50N22PAM1

<b>Characteristics flush and non-flush mountable</b>				
Rated operating voltage	10 - 36 VDC	10 - 36 VDC	10 - 36 VDC	10 - 36 VDC
Voltage drop	≤ 2.5 VDC @ 200 mA	≤ 2.5 VDC @ 200 mA	≤ 2.5 VDC @ 200 mA	≤ 2.5 VDC @ 200 mA
Degree of protection	IP 67	IP 67	IP 67	IP 67
Protection short-circuit (S)				
Reverse polarity (P)	SPT	SPT	SPT	SPT
Transients (T)				
Output current	≤ 200 mA @ 50°C ≤ 150 mA @ 50-70°C	≤ 200 mA @ 50°C ≤ 150 mA @ 50-70°C	≤ 200 mA @ 50°C ≤ 150 mA @ 50-70°C	≤ 200 mA @ 50°C ≤ 150 mA @ 50-70°C
Housing material	Nickel-plated brass	Nickel-plated brass	Nickel-plated brass	Nickel-plated brass
Operating temperature	-25°C to +70°C	-40°C to +70°C	-25°C to +70°C	-40°C to +70°C
LED colour	Yellow	Yellow	Yellow	Yellow
Approvals/Marks	CE - cULus	CE - cULus	CE - cULus	CE - cULus











## Inductive proximity sensors, high temperature

Types	M5	M8	M12	
Connections	2 m cable	2 m cable	2 m cable or M12 connector	
Flush or non-flush mountable				
Dimensions (mm)	M5 x 30	M8 x 45	M12 x 40	M12 x 40
Thread (mm)	M5 x 0.5 x 25	M8 x 1 x 40	M12 x 1 x 40	M12 x 1 x 34
Sensing distance (Sn)	0.8 mm	1 mm	2 mm	4 mm
Output	≤ 5 mA	≤ 5 mA	≤ 20 mA	≤ 20 mA
<b>References</b>				
NPN-NO Cable	IA05BSF08NOHT-K	IA08BSF10NOHT-K		
PNP-NO Cable	IA05BSF08POHT-K	IA08BSF10POHT-K	IA12ASF02POHT-K	IA12ASN04POHT-K
PNP-NO Plug			IA12ASF02POM1HT-K	IA12ASN04POM1HT-K
<b>Specifications</b>				
Rated operating voltage	10 - 30 VDC	10 - 30 VDC	10 - 30 VDC	10 - 30 VDC
Degree of protection	IP 67	IP 67	IP 67	IP 67
Protection short-circuit (S) Reverse polarity (P) Transients (T)	SP	SP	S	S
Housing material	Stainless steel	Stainless steel	Nickel-plated brass	Nickel-plated brass
Operating temperature	-25°C to +120°C	-25°C to +120°C	-40°C to +100°C	-40°C to +100°C
Approvals/Marks	CE	CE	CE	CE

Types	M18		M30	
Connections	2 m cable or M12 connector		2 m cable or M12 connector	
Flush or non-flush mountable				
Dimensions (mm)	M18 x 40	M18 x 40	M30 x 40	M30 x 40
Thread (mm)	M18 x 1 x 40	M18 x 1 x 32	M30 x 1.5 x 40	M30 x 1.5 x 28
Sensing distance (Sn)	5 mm	8 mm	10 mm	15 mm
Output	≤ 25 mA	≤ 25 mA	≤ 25 mA	≤ 25 mA
<b>References</b>				
PNP-NO Cable	IA18ASF05POHT-K	IA18ASN08POHT-K	IA30ASF10POHT-K	
PNP-NO Plug	IA18ASF05POM1HT-K	IA18ASN08POM1HT-K	IA30ASF10POM1HT-K	IA30ASN15POM1HT-K
<b>Characteristics flush and non-flush mountable</b>				
Rated operating voltage	10 - 30 VDC	10 - 30 VDC	10 - 30 VDC	10 - 30 VDC
Degree of protection	IP 67	IP 67	IP 67	IP 67
Protection short-circuit (S) Reverse polarity (P) Transients (T)	S	S	S	S
Housing material	Nickel-plated brass	Nickel-plated brass	Nickel-plated brass	Nickel-plated brass
Operating temperature	-40°C to +100°C	-40°C to +100°C	-40°C to +100°C	-40°C to +100°C
Approvals/Marks	CE	CE	CE	CE

# Inductive proximity sensors, NAMUR, DC

Types	M12		M18	
Housing	Steel	Plastic	Steel	Plastic
<b>Flush mountable</b>				
Dimensions short body (mm)	Cable: M12 x 41 Plug (M12): M12 x 54.5	Cable: M12 x 41 Plug (M12): M12 x 54.5	Cable: M18 x 41.6 Plug (M12): M18 x 55	Cable: M18 x 41.6 Plug (M12): M18 x 55
Dimensions long body (mm)	Cable: M12 x 61 Plug (M12): M12 x 74.5	Cable: M12 x 61 Plug (M12): M12 x 74.5	Cable: M18 x 61.6 Plug (M12): M18 x 75	Cable: M18 x 61.6 Plug (M12): M18 x 75
Thread (mm)	Short: M12 x 1 x 30 Long: M12 x 1 x 50	Short: M12 x 1 x 30 Long: M12 x 1 x 50	Short: M18 x 1 x 30 Long: M18 x 1 x 50	Short: M18 x 1 x 30 Long: M18 x 1 x 50
Operating frequency	1.4 kHz	1.4 kHz	500 Hz	500 Hz
Sensing distance (Sn)	2 mm	2 mm	5 mm	5 mm
<b>References</b>				
Short body cable	<b>IA12ESF02UC</b>	<b>IA12CSF02UC</b>	<b>IA18ESF05UC</b>	<b>IA18CSF05UC</b>
Long body cable	<b>IA12ELF02UC</b>	<b>IA12CLF02UC</b>	<b>IA18ELF05UC</b>	<b>IA18CLF05UC</b>
Short body plug	<b>IA12ESF02UCM1</b>	<b>IA12CSF02UCM1</b>	<b>IA18ESF05UCM1</b>	<b>IA18CSF05UCM1</b>
Long body plug	<b>IA12ELF02UCM1</b>	<b>IA12CLF02UCM1</b>	<b>IA18ELF05UCM1</b>	<b>IA18CLF05UCM1</b>

<b>Non-flush mountable</b>				
Dimensions short body (mm)	Cable: M12 x 45 Plug (M12): M12 x 58.5	Cable: M12 x 45 Plug (M12): M12 x 58.5	Cable: M18 x 49.6 Plug (M12): M18 x 63	Cable: M18 x 49.6 Plug (M12): M18 x 63
Dimensions long body (mm)	Cable: M12 x 65 Plug (M12): M12 x 78.5	Cable: M12 x 65 Plug (M12): M12 x 78.5	Cable: M18 x 69.6 Plug (M12): M18 x 83	Cable: M18 x 69.6 Plug (M12): M18 x 83
Thread (mm)	Short: M12 x 1 x 30 Long: M12 x 1 x 50	Short: M12 x 1 x 30 Long: M12 x 1 x 50	Short: M18 x 1 x 30 Long: M18 x 1 x 50	Short: M18 x 1 x 30 Long: M18 x 1 x 50
Operating frequency	1.2 kHz	1.2 kHz	200 Hz	200 Hz
Sensing distance (Sn)	4 mm	4 mm	8 mm	8 mm
<b>References</b>				
Short body cable	<b>IA12ESN04UC</b>	<b>IA12CSN04UC</b>	<b>IA18ESN08UC</b>	<b>IA18CSN08UC</b>
Long body cable	<b>IA12ELN04UC</b>	<b>IA12CLN04UC</b>	<b>IA18ELN08UC</b>	<b>IA18CLN08UC</b>
Short body plug	<b>IA12ESN04UCM1</b>	<b>IA12CSN04UCM1</b>	<b>IA18ESN08UCM1</b>	<b>IA18CSN08UCM1</b>
Long body plug	<b>IA12ELN04UCM1</b>	<b>IA12CLN04UCM1</b>	<b>IA18ELN08UCM1</b>	<b>IA18CLN08UCM1</b>

<b>Characteristics flush and non-flush mountable</b>				
Rated operating voltage	7 - 9 VDC	7 - 9 VDC	7 - 9 VDC	7 - 9 VDC
Degree of protection	IP 67	IP 67	IP 67	IP 67
Housing material	Stainless steel	Thermoplastic polyester	Stainless steel	Thermoplastic polyester
Operating temperature	-25°C to +70°C	-25°C to +70°C	-25°C to +70°C	-25°C to +70°C
LED colour	Yellow	Yellow	Yellow	Yellow
Approvals/Marks	CE - UL - CSA	CE - UL - CSA	CE - UL - CSA	CE - UL - CSA

# Inductive proximity sensors, NAMUR, DC

## Types

M30

### Housing

Steel

Plastic

### Flush mountable



Dimensions short body (mm)	Cable: M30 x 43.6 Plug (M12): M30 x 55.5	Cable: M30 x 43.6 Plug (M12): M30 x 55.5
Dimensions long body (mm)	Cable: M30 x 63.6 Plug (M12): M30 x 75.5	Cable: M30 x 63.6 Plug (M12): M30 x 75.5
Thread (mm)	Short: M30 x 1.5 x 30 Long: M30 x 1.5 x 50	Short: M30 x 1.5 x 30 Long: M30 x 1.5 x 50
Operating frequency	300 Hz	300 Hz
Sensing distance (Sn)	10 mm	10 mm

### References

Short body cable	<b>IA30ESF10UC</b>	<b>IA30CSF10UC</b>
Long body cable	<b>IA30ELF10UC</b>	<b>IA30CLF10UC</b>
Short body plug	<b>IA30ESF10UCM1</b>	<b>IA30CSF10UCM1</b>
Long body plug	<b>IA30ELF10UCM1</b>	<b>IA30CLF10UCM1</b>

### Non-flush mountable



Dimensions short body (mm)	Cable: M30 x 55.6 Plug (M12): M30 x 67.5	Cable: M30 x 55.6 Plug (M12): M30 x 67.5
Dimensions long body (mm)	Cable: M30 x 75.6 Plug (M12): M30 x 87.5	Cable: M30 x 75.6 Plug (M12): M30 x 87.5
Thread (mm)	Short: M30 x 1.5 x 30 Long: M30 x 1.5 x 50	Short: M30 x 1.5 x 30 Long: M30 x 1.5 x 50
Operating frequency	100 Hz	100 Hz
Sensing distance (Sn)	15 mm	15 mm



### References



Short body cable	<b>IA30ESN15UC</b>	<b>IA30CSN15UC</b>
Long body cable	<b>IA30ELN15UC</b>	<b>IA30CLN15UC</b>
Short body plug	<b>IA30ESN15UCM1</b>	<b>IA30CSN15UCM1</b>
Long body plug	<b>IA30ELN15UCM1</b>	<b>IA30CLN15UCM1</b>

### Characteristics flush and non-flush mountable

Rated operating voltage	7 - 9 VDC	7 - 9 VDC
Degree of protection	IP 67	IP 67
Housing material	Stainless steel	Thermoplastic polyester
Operating temperature	-25°C to +70°C	-25°C to +70°C
LED colour	Yellow	Yellow
Approvals/Marks	CE - UL - CSA	CE - UL - CSA

## Inductive proximity sensors, 2-wire, DC, extended range

Types	M8 Extended Short body	M12 Extended - Short body	
Connections	2 m cable	2 m cable	M12 connector
<b>Flush mountable</b>			
Dimensions (mm)	M8 x 30	M12 x 49	M12 x 63
Thread (mm)	M8 x 1 x 30	M12 x 1 x 38	M12 x 1 x 38
Operating frequency	2 kHz	1 kHz	1 kHz
Sensing distance (Sn)	2 mm	4 mm	4 mm
<b>References</b>			
NO	IA08BSF02DO	IA12DSF04DO	IA12ASF04DOM1
NC	IA08BSF02DC	IA12DSF04DC	IA12ASF04DCM1

<b>Non-flush mountable</b>			
Dimensions (mm)	M8 x 30	M12 x 53	M12 x 67
Thread (mm)	M8 x 1 x 26	M12 x 1 x 38	M12 x 1 x 38
Operating frequency	2 kHz	800 Hz	800 Hz
Sensing distance (Sn)	4 mm	8 mm	8 mm
<b>References</b>			
NO	IA08BSN04DO	IA12DSN08DO	IA12ASN08DOM1
NC	IA08BSN04DC	IA12DSN08DC	IA12ASN08DCM1

<b>Characteristics flush and non-flush mountable</b>			
Rated operating voltage	10 - 30 VDC	10 - 40 VDC	10 - 40 VDC
Voltage drop	≤ 8 VDC @ max. load	≤ 3 VDC @ max. load	≤ 3 VDC @ max. load
Degree of protection	IP 67	IP 67	IP 67
Protection short-circuit (S)			
Reverse polarity (P)	SPT	SPT	SPT
Transients (T)			
Output current	3 - 100 mA	5 - 100 mA	5 - 100 mA
Housing material	Stainless steel	Nickel-plated brass	Nickel-plated brass
Operating temperature	-25°C to +70°C	-25°C to +70°C	-25°C to +70°C
LED colour	Yellow	Yellow	Yellow
Approvals/Marks	CE - CSA	CE - UL - CSA	CE - UL - CSA

## Inductive proximity sensors, 2-wire, DC, extended range

Types	M18 Extended - Short body		M30 Extended - Short body	
Connections	2 m cable	M12 connector	2 m cable	M12 connector

### Flush mountable



Dimensions (mm)	M18 x 42	M18 x 55	M30 x 44	M30 x 55
Thread (mm)	M18 x 1 x 30	M18 x 1 x 30	M30 x 1.5 x 30	M30 x 1.5 x 30
Operating frequency	500 Hz	500 Hz	400 Hz	400 Hz
Sensing distance (Sn)	8 mm	8 mm	15 mm	15 mm

### References

NO	IA18DSF08DO	IA18ASF08DOM1	IA30DSF15DO	IA30ASF15DOM1
NC	IA18DSF08DC	IA18ASF08DCM1	IA30DSF15DC	IA30ASF15DCM1

### Non-flush mountable



Dimensions (mm)	M18 x 50	M18 x 63	M30 x 56	M30 x 67
Thread (mm)	M18 x 1 x 30	M18 x 1 x 30	M30 x 1.5 x 30	M30 x 1.5 x 30
Operating frequency	400 Hz	400 Hz	200 Hz	200 Hz
Sensing distance (Sn)	14 mm	14 mm	22 mm	22 mm



### References



NO	IA18DSN14DO	IA18ASN14DOM1	IA30DSN22DO	IA30ASN22DOM1
NC	IA18DSN14DC	IA18ASN14DCM1	IA30DSN22DC	IA30ASN22DCM1

### Characteristics flush and non-flush mountable

Rated operating voltage	10 - 40 VDC	10 - 40 VDC	10 - 40 VDC	10 - 40 VDC
Voltage drop	≤ 3 VDC @ max. load	≤ 3 VDC @ max. load	≤ 3 VDC @ max. load	≤ 3 VDC @ max. load
Degree of protection	IP 67	IP 67	IP 67	IP 67
Protection short-circuit (S)				
Reverse polarity (P)	SPT	SPT	SPT	SPT
Transients (T)				
Output current	5 - 100 mA	5 - 100 mA	5 - 100 mA	5 - 100 mA
Housing material	Nickel-plated brass	Nickel-plated brass	Nickel-plated brass	Nickel-plated brass
Operating temperature	-25°C to +70°C	-25°C to +70°C	-25°C to +70°C	-25°C to +70°C
LED colour	Yellow	Yellow	Yellow	Yellow
Approvals/Marks	CE - UL - CSA	CE - UL - CSA	CE - UL - CSA	CE - UL - CSA









# Inductive proximity sensors, 2-wire, AC

Types	M12 Standard - Long body	
Connections	2 m cable	M12 connector
<b>Flush mountable</b>		
Dimensions (mm)	M12 x 66	M12 x 74.5
Thread (mm)	M12 x 1 x 50	M12 x 1 x 50
Operating frequency	25 Hz	25 Hz
Sensing distance (Sn)	2 mm	2 mm
<b>References</b>		
SCR-NO	EI1202TBOSL	EI1202TBOSL-6
SCR-NC	EI1202TBOSL	

<b>Non-flush mountable</b>		
Dimensions (mm)	M12 x 70	M12 x 78.5
Thread (mm)	M12 x 1 x 50	M12 x 1 x 50
Operating frequency	25 Hz	25 Hz
Sensing distance (Sn)	4 mm	4 mm
<b>References</b>		
SCR-NO	EI1204TBOSL	EI1204TBOSL-6
SCR-NC	EI1204TBOSL	

<b>Characteristics flush and non-flush mountable</b>		
Rated operating voltage	20 - 265 VAC	20 - 265 VAC
Voltage drop	≤ 8 VAC	≤ 8 VAC
Degree of protection	IP 67	IP 67
Protection short-circuit (S)		
Reverse polarity (P)	T	T
Transients (T)		
Output current	< 500 mA	< 500 mA
Housing material	Stainless steel	Stainless steel
Operating temperature	-25°C to +70°C	-25°C to +70°C
LED colour	Yellow	Yellow
Approvals/Marks	CE - UL - CSA	CE - UL - CSA

## Inductive proximity sensors, 2-wire, AC

Types	M18 Standard - Short body		M18 Standard - Long body	
Connections	2 m cable	M12 connector	2 m cable	M12 connector
<b>Flush mountable</b>				
Dimensions (mm)	M18 x 57	M18 x 55	M18 x 77	M18 x 75
Thread (mm)	M18 x 1 x 30	M18 x 1 x 30	M18 x 1 x 50	M18 x 1 x 50
Operating frequency	25 Hz	25 Hz	25 Hz	25 Hz
Sensing distance (Sn)	5 mm	5 mm	5 mm	5 mm
<b>References</b>				
SCR-NO	EI1805TBOSS	EI1805TBOSS-6	EI1805TBOSL	EI1805TBOSL-6
SCR-NC	EI1805TBCSS		EI1805TBCSL	
<b>Non-flush mountable</b>				
Dimensions (mm)	M18 x 65	M18 x 63	M18 x 85	M18 x 83
Thread (mm)	M18 x 1 x 30	M18 x 1 x 30	M18 x 1 x 50	M18 x 1 x 50
Operating frequency	25 Hz	25 Hz	25 Hz	25 Hz
Sensing distance (Sn)	8 mm	8 mm	8 mm	8 mm
<b>References</b>				
SCR-NO	EI1808TBOSS	EI1808TBOSS-6	EI1808TBOSL	EI1808TBOSL-6
SCR-NC	EI1808TBCSS		EI1808TBCSL	EI1808TBCSL-6
<b>Characteristics flush and non-flush mountable</b>				
Rated operating voltage	20 - 265 VAC	20 - 265 VAC	20 - 265 VAC	20 - 265 VAC
Voltage drop	≤ 8 VAC	≤ 8 VAC	≤ 8 VAC	≤ 8 VAC
Degree of protection	IP 67	IP 67	IP 67	IP 67
Protection short-circuit (S)				
Reverse polarity (P)	T	T	T	T
Transients (T)				
Output current	< 500 mA	< 500 mA	< 500 mA	< 500 mA
Housing material	Stainless steel	Stainless steel	Stainless steel	Stainless steel
Operating temperature	-25°C to +70°C	-25°C to +70°C	-25°C to +70°C	-25°C to +70°C
LED colour	Yellow	Yellow	Yellow	Yellow
Approvals/Marks	CE - UL - CSA	CE - UL - CSA	CE - UL - CSA	CE - UL - CSA

# Inductive proximity sensors, 2-wire, AC

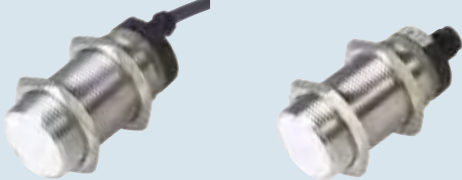

Types	M30 Standard - Short body		M30 Standard - Long body	
Connections	2 m cable	M12 connector	2 m cable	M12 connector
<b>Flush mountable</b>				
Dimensions (mm)	M30 x 59		M30 x 79	M30 x 75.5
Thread (mm)	M30 x 1.5 x 30		M30 x 1.5 x 50	M30 x 1.5 x 50
Operating frequency	25 Hz		25 Hz	25 Hz
Sensing distance (Sn)	10 mm		10 mm	10 mm
<b>References</b>				
SCR-NO	EI3010TBOSS		EI3010TBOSL	EI3010TBOSL-6
SCR-NC	EI3010TBCSS		EI3010TBCSL	



<b>Non-flush mountable</b>				
Dimensions (mm)	M30 x 87.5	M30 x 67.5	M30 x 91	M30 x 71
Thread (mm)	M30 x 1.5 x 30	M30 x 1.5 x 30	M30 x 1.5 x 50	M30 x 1.5 x 50
Operating frequency	25 Hz	25 Hz	25 Hz	25 Hz
Sensing distance (Sn)	15 mm	15 mm	15 mm	15 mm
<b>References</b>				
SCR-NO	EI3015TBOSS	EI3015TBOSS-6	EI3015TBOSL	EI3015TBOSL-6
SCR-NC	EI3015TBCSS		EI3015TBCSL	

<b>Characteristics flush and non-flush mountable</b>				
Rated operating voltage	20 - 265 VAC	20 - 265 VAC	20 - 265 VAC	20 - 265 VAC
Voltage drop	≤ 8 VAC	≤ 8 VAC	≤ 8 VAC	≤ 8 VAC
Degree of protection	IP 67	IP 67	IP 67	IP 67
Protection short-circuit (S)				
Reverse polarity (P)	T	T	T	T
Transients (T)				
Output current	< 500 mA	< 500 mA	< 500 mA	< 500 mA
Housing material	Stainless steel	Stainless steel	Stainless steel	Stainless steel
Operating temperature	-25°C to +70°C	-25°C to +70°C	-25°C to +70°C	-25°C to +70°C
LED colour	Yellow	Yellow	Yellow	Yellow
Approvals/Marks	CE - UL - CSA	CE - UL - CSA	CE - UL - CSA	CE - UL - CSA



## Inductive proximity sensors, 2-wire, AC

Types	M18 Standard Short body	M18 Standard - Long body		M30 Standard Long body
Connections	2 m cable	2 m cable	M12 connector	2 m cable
<b>Flush mountable</b>				
Dimensions (mm)	M18 x 57	M18 x 77		M30 x 79
Thread (mm)	M18 x 1 x 30	M18 x 1 x 50		M30 x 1.5 x 50
Operating frequency	25 Hz	25 Hz		25 Hz
Sensing distance (Sn)	5 mm	5 mm		10 mm
<b>References</b>				
SCR-NO	EI1805TBOPS	EI1805TBOPL		EI3010TBOPL

<b>Non-flush mountable</b>				
Dimensions (mm)		M18 x 85	M18 x 83	M30 x 91
Thread (mm)		M18 x 1 x 50	M18 x 1 x 50	M30 x 1.5 x 50
Operating frequency		25 Hz	25 Hz	25 Hz
Sensing distance (Sn)		8 mm	8 mm	15 mm
<b>References</b>				
SCR-NO		EI1808TBOPL		EI3015TBOPL
SCR-NC		EI1808TBCPL	EI1808TBCPL-6	

### Characteristics flush and non-flush mountable

Rated operating voltage	20 - 265 VAC	20 - 265 VAC	20 - 265 VAC	20 - 265 VAC
Voltage drop	≤ 8 VAC	≤ 8 VAC	≤ 8 VAC	≤ 8 VAC
Degree of protection	IP 67	IP 67	IP 67	IP 67
Protection short-circuit (S)				
Reverse polarity (P)	T	T	T	T
Transients (T)				
Output current	< 500 mA	< 500 mA	< 500 mA	< 500 mA
Housing material	Thermoplastic polyester	Thermoplastic polyester	Thermoplastic polyester	Thermoplastic polyester
Operating temperature	-25°C to +70°C	-25°C to +70°C	-25°C to +70°C	-25°C to +70°C
LED colour	Yellow	Yellow	Yellow	Yellow
Approvals/Marks	CE - UL - CSA	CE - UL - CSA	CE - UL - CSA	CE - UL - CSA

# Inductive proximity sensors, micro switch 2-wire DC

**Types** Micro switch

**Connections** 2 m cable



**Dimensions body (mm)** 30 x 19 x 15

**Thread (mm)** Ø 12 x 16

**Sensing distance (Sn)** 1 kHz

**Output** 4 mm

## References

**NO** IG12FSF04DO

**NC** IG12FSF04DC

## Specifications

**Rated operating voltage** 10 to 40 VDC

**Voltage drop** ≤ 3 VDC at max. load

**Degree of protection** IP67

**Protection short-circuit (S)** SPT

**Reverse polarity (P)**

**Transients (T)**



**Output current** ≤ 5 - 100 mA

**Housing material** Anodized aluminium





**Operating temperature** -25°C to +70°C

**Approvals/Marks** CE

## Inductive proximity sensors, switch, polyester housing

Types	Transistor NPN/PNP		Power MOSFET output AC/DC	
Connections	Terminals		Terminals	Terminals
<b>Non-flush mountable</b>				
Dimensions (mm)	40 x 40 x 118		40 x 40 x 118	40 x 40 x 118
Operating frequency	≤ 100 Hz		≤ 25 Hz AC; 40 Hz DC	≤ 25 Hz
Sensing distance (Sn)	30 mm		30 mm	30 mm
<b>References</b>				
NPN - NO / NC	<b>IC40CNN30NAT1</b>			
PNP - NO / NC	<b>IC40CNN30PAT1</b>			
AC / DC - NO			<b>IC40CNN30COT1</b>	
AC / DC - NC			<b>IC40CNN30CCT1</b>	
AC - NO / NC				<b>IC40CNN30TAT1</b>
<b>Specifications</b>				
Rated operating voltage	10 - 30 VDC		20 - 250 VAC/DC	20 - 250 VAC
Degree of protection	IP 67		IP 67	IP 67
Protection short-circuit (S) Reverse polarity (P) Transients (T)	SP		S	
Output current	≤ 200 mA		5 - 200 mA @ 25°C	5 - 200 mA @ 25°C
Housing material	Thermoplastic polyester		Thermoplastic polyester	Thermoplastic polyester
Operating temperature	-25°C to +70°C		-25°C to +70°C	-25°C to +70°C
LED colour	Red, Green		Red, Green	Red, Green
Approvals/Marks	CE		CE	CE

## Inductive proximity sensors, loop detector

Types	Single loop	Dual loop	Single loop	Dual loop
Connections	Plug 11 pin circular	Plug 11 pin circular	DIN rail	DIN rail
				
Dimensions HxWxD (mm)	81 x 35.5 x 60.2	81 x 35.5 x 60.2	84 x 22 x 99	84 x 22 x 99
Adjustment	Auto	Auto	Auto	Auto
Adjustable sensitivity via potentiometer	0.01% to 1.00%	0.01% to 1.00%	0.01% to 1.00%	0.01% to 1.00%
Loop inductance	20-1000 µH	20-1000 µH	20-1000 µH	20-1000 µH
Input	1 Loop	2 Loop	1 Loop	2 Loop
Output	2 x SPDT, relay output	2 x SPDT, relay output	2 x SPDT, relay output	2 x SPDT, relay output
<b>References</b>				
24-240 VAC / VDC	<b>LDP1PA2DU24</b>	<b>LDP2PA2DU24</b>	<b>LDD1PA2DU24</b>	<b>LDD2PA2DU24</b>
<b>Main features</b>				
Automatic sensitivity boost (ASB)	Yes	Yes	Yes	Yes
Automatic loop frequency tuning	Yes	Yes	Yes	Yes
4 adjustable loop frequency channels	Yes	Yes	Yes	Yes
Selectable fail safe / fail secure mode	Yes	Yes	Yes	Yes
Multicolor LED for easy setup and advanced diagnostic	Yes	Yes	Yes	Yes
Directional logic	No	Yes	No	Yes
<b>Specifications</b>				
Operating temperature	-40°C to +70°C	-40°C to +70°C	-40°C to +70°C	-40°C to +70°C
Degree of protection	IP 30	IP 30	IP 20	IP 20
Mounting	11 pin circular plug	11 pin circular plug	DIN rail	DIN rail
Approvals/Marks	CE - UL - CSA	CE - UL - CSA	CE - cULus	CE - cULus

## Ultrasonic sensors, 1 x digital output - Short body

Types	UA18CSD..TI	UA18CSD..M1TI	UA18ESD..TI	UA18ESD..M1TI
Connections	2 m cable	M12 connector	2 m cable	M12 connector
				
Dimensions (mm)	M18 x 53	M18 x 60	M18 x 53	M18 x 60
<b>References</b>				
Sensing distance (Sn)	40 - 300 mm	40 - 300 mm	40 - 300 mm	40 - 300 mm
Operating frequency	≤ 8 Hz	≤ 8 Hz	≤ 8 Hz	≤ 8 Hz
Blind zone	≤ 40 mm	≤ 40 mm	≤ 40 mm	≤ 40 mm
1 x NPN	<b>UA18CSD03NPTI</b>	<b>UA18CSD03NPM1TI</b>	<b>UA18ESD03NPTI</b>	<b>UA18ESD03NPM1TI</b>
1 x PNP	<b>UA18CSD03PPTI</b>	<b>UA18CSD03PPM1TI</b>	<b>UA18ESD03PPTI</b>	<b>UA18ESD03PPM1TI</b>
Sensing distance (Sn)	80 - 800 mm	80 - 800 mm	80 - 800 mm	80 - 800 mm
Operating frequency	≤ 5 Hz	≤ 5 Hz	≤ 5 Hz	≤ 5 Hz
Blind zone	≤ 80 mm	≤ 80 mm	≤ 80 mm	≤ 80 mm
1 x NPN	<b>UA18CSD08NPTI</b>	<b>UA18CSD08NPM1TI</b>	<b>UA18ESD08NPTI</b>	<b>UA18ESD08NPM1TI</b>
1 x PNP	<b>UA18CSD08PPTI</b>	<b>UA18CSD08PPM1TI</b>	<b>UA18ESD08PPTI</b>	<b>UA18ESD08PPM1TI</b>
<b>Specifications</b>				
Rated operating voltage	10 - 30 VDC	10 - 30 VDC	10 - 30 VDC	10 - 30 VDC
Voltage drop	≤ 2.2 VDC	≤ 2.2 VDC	≤ 2.2 VDC	≤ 2.2 VDC
Degree of protection	IP 67	IP 67	IP 67	IP 67
Protection short-circuit (S) Reverse polarity (P) Transients (T)	SPT	SPT	SPT	SPT
Load current	< 100 mA	< 100 mA	< 100 mA	< 100 mA
Housing material	PBT	PBT	Stainless steel AISI 316L	Stainless steel AISI 316L
Operating temperature	-20°C to +60°C	-20°C to +60°C	-20°C to +60°C	-20°C to +60°C
LED colour	Yellow (output), Green (Echo ON)	Yellow (output), Green (Echo ON)	Yellow (output), Green (Echo ON)	Yellow (output), Green (Echo ON)
Approvals/Marks	CE - cULus	CE - cULus	CE - cULus	CE - cULus

## Ultrasonic sensors, analogue output - Short body

Types	UA18CSD..TI	UA18CSD..MITI	UA18ESD..TI	UA18ESD..MITI
Connections	2 m cable	M12 connector	2 m cable	M12 connector



Dimensions (mm)	M18 x 53	M18 x 60	M18 x 53	M18 x 60
-----------------	----------	----------	----------	----------

### References

Sensing distance (Sn)	40 - 300 mm	40 - 300 mm	40 - 300 mm	40 - 300 mm
Response time	≤ 400 mS	≤ 400 mS	≤ 400 mS	≤ 400 mS
Blind zone	≤ 40 mm	≤ 40 mm	≤ 40 mm	≤ 40 mm
4-20 mA	<b>UA18CSD03AGTI</b>	<b>UA18CSD03AGM1TI</b>	<b>UA18ESD03AGTI</b>	<b>UA18ESD03AGM1TI</b>
0-10 V	<b>UA18CSD03AKTI</b>	<b>UA18CSD03AKM1TI</b>	<b>UA18ESD03AKTI</b>	<b>UA18ESD03AKM1TI</b>
Sensing distance (Sn)	80 - 800 mm	80 - 800 mm	80 - 800 mm	80 - 800 mm
Response time	≤ 400 mS	≤ 400 mS	≤ 400 mS	≤ 400 mS
Blind zone	≤ 80 mm	≤ 80 mm	≤ 80 mm	≤ 80 mm
4-20 mA	<b>UA18CSD08AGTI</b>	<b>UA18CSD08AGM1TI</b>	<b>UA18ESD08AGTI</b>	<b>UA18ESD08AGM1TI</b>
0-10 V	<b>UA18CSD08AKTI</b>	<b>UA18CSD08AKM1TI</b>	<b>UA18ESD08AKTI</b>	<b>UA18ESD08AKM1TI</b>



### Specifications

Rated operating voltage NG or PG NK or PK	10 - 30 VDC	10 - 30 VDC	10 - 30 VDC	10 - 30 VDC
Degree of protection	IP 67	IP 67	IP 67	IP 67
Protection short-circuit (S) Reverse polarity (P) Transients (T)	Supply: PT Analogue output: P	Supply: PT Analogue output: P	Supply: PT Analogue output: P	Supply: PT Analogue output: P
Housing material	PBT	PBT	Stainless steel AISI 316L	Stainless steel AISI 316L
Operating temperature	-20°C to +60°C	-20°C to +60°C	-20°C to +60°C	-20°C to +60°C
LED colour	Yellow (output), Green (Echo ON)	Yellow (output), Green (Echo ON)	Yellow (output), Green (Echo ON)	Yellow (output), Green (Echo ON)
Approvals/Marks	CE - cULus	CE - cULus	CE - cULus	CE - cULus

## Ultrasonic sensors, 2 x digital outputs

Types	UA18CAD..TI	UA18CAD..MITI	UA30CAD35..TI	UA30CAD35..MITI
Connections	2 m cable	M12 connector	2 m cable	M12 connector
				
Dimensions (mm)	M18 x 85	M18 x 85	M30 x 90	M30 x 90
<b>References</b>				
Sensing distance (Sn)	50 - 400 mm	50 - 400 mm	250 - 3500 mm	250 - 3500 mm
Operating frequency	≤ 10 Hz	≤ 10 Hz	≤ 2 Hz	≤ 2 Hz
Blind zone	≤ 50 mm	≤ 50 mm	≤ 250 mm	≤ 250 mm
2 x NPN	<b>UA18CAD04NPTI</b>	<b>UA18CAD04NPM1TI</b>	<b>UA30CAD35NPTI</b>	<b>UA30CAD35NPM1TI</b>
2 x PNP	<b>UA18CAD04PPTI</b>	<b>UA18CAD04PPM1TI</b>	<b>UA30CAD35PPTI</b>	<b>UA30CAD35PPM1TI</b>
Sensing distance (Sn)	100 - 900 mm	100 - 900 mm		
Operating frequency	≤ 4 Hz	≤ 4 Hz		
Blind zone	≤ 100 mm	≤ 100 mm		
2 x NPN	<b>UA18CAD09NPTI</b>	<b>UA18CAD09NPM1TI</b>		
2 x PNP	<b>UA18CAD09PPTI</b>	<b>UA18CAD09PPM1TI</b>		
Sensing distance (Sn)	200 - 2200 mm	200 - 2200 mm		
Operating frequency	≤ 1 Hz	≤ 1 Hz		
Blind zone	≤ 200 mm	≤ 200 mm		
2 x NPN	<b>UA18CAD22NPTI</b>	<b>UA18CAD22NPM1TI</b>		
2 x PNP	<b>UA18CAD22PPTI</b>	<b>UA18CAD22PPM1TI</b>		
<b>Specifications</b>				
Rated operating voltage	15 - 30 VDC	15 - 30 VDC	12 - 30 VDC	12 - 30 VDC
Voltage drop	≤ 2.2 VDC	≤ 2.2 VDC	≤ 2.2 VDC	≤ 2.2 VDC
Degree of protection	IP 67	IP 67	IP 67	IP 67
Protection short-circuit (S) Reverse polarity (P) Transients (T)	SPT	SPT	SPT	SPT
Load current	< 500 mA	< 500 mA	< 300 mA	< 300 mA
Load current - UL	< 100 mA	< 100 mA	< 100 mA	< 100 mA
Housing material	PBT	PBT	PBT	PBT
Operating temperature	-20°C to +60°C	-20°C to +60°C	-20°C to +70°C	-20°C to +70°C
LED colour	Yellow	Yellow	Yellow, Green	Yellow, Green
Approvals/Marks	CE - cULus	CE - cULus	CE - cULus	CE - cULus

## Ultrasonic sensors, 2 x digital outputs

Types	UA30CAD60..TI	UA30CAD60..MITI
Connections	2 m cable	M12 connector
		
Dimensions (mm)	M30 (Ø40) x 90	M30 (Ø40) x 90
<b>References</b>		
Sensing distance (Sn)	350 - 6000 mm	350 - 6000 mm
Operating frequency	≤ 1 Hz	≤ 1 Hz
Blind zone	≤ 350 mm	≤ 350 mm
2 x NPN	<b>UA30CAD60NPTI</b>	<b>UA30CAD60NPM1TI</b>
2 x PNP	<b>UA30CAD60PPTI</b>	<b>UA30CAD60PPM1TI</b>
<b>Specifications</b>		
Rated operating voltage	12 - 30 VDC	12 - 30 VDC
Voltage drop	≤ 2.2 VDC	≤ 2.2 VDC
Degree of protection	IP 67	IP 67
Protection short-circuit (S) Reverse polarity (P) Transients (T)	SPT	SPT
Load current	< 300 mA	< 300 mA
Load current - UL	< 100 mA	< 100 mA
Housing material	PBT	PBT
Operating temperature	-20°C to +70°C	-20°C to +70°C
LED colour	Yellow, Green	Yellow, Green
Approvals/Marks	CE - cULus	CE - cULus





## Ultrasonic sensors, 2 x digital outputs

Types	UA18EAD..TI	UA18EAD..MITI	UA30EAD35..TI	UA30EAD35..MITI
Connections	2 m cable	M12 connector	2 m cable	M12 connector
				
Dimensions (mm)	M18 x 85	M18 x 85	M30 x 90	M30 x 90
<b>References</b>				
Sensing distance (Sn)	50 - 400 mm	50 - 400 mm	350 - 3500 mm	350 - 3500 mm
Operating frequency	≤ 10 Hz	≤ 10 Hz	≤ 2 Hz	≤ 2 Hz
Blind zone	≤ 50 mm	≤ 50 mm	≤ 350 mm	≤ 350 mm
2 x NPN	<b>UA18EAD04NPTI</b>	<b>UA18EAD04NPM1TI</b>	<b>UA30EAD35NPTI</b>	<b>UA30EAD35NPM1TI</b>
2 x PNP	<b>UA18EAD04PPTI</b>	<b>UA18EAD04PPM1TI</b>	<b>UA30EAD35PPTI</b>	<b>UA30EAD35PPM1TI</b>
Sensing distance (Sn)	100 - 900 mm	100 - 900 mm		
Operating frequency	≤ 4 Hz	≤ 4 Hz		
Blind zone	≤ 100 mm	≤ 100 mm		
2 x NPN	<b>UA18EAD09NPTI</b>	<b>UA18EAD09NPM1TI</b>		
2 x PNP	<b>UA18EAD09PPTI</b>	<b>UA18EAD09PPM1TI</b>		
Sensing distance (Sn)	200 - 1500 mm	200 - 1500 mm		
Operating frequency	≤ 1 Hz	≤ 1 Hz		
Blind zone	≤ 200 mm	≤ 200 mm		
2 x NPN	<b>UA18EAD15NPTI</b>	<b>UA18EAD15NPM1TI</b>		
2 x PNP	<b>UA18EAD15PPTI</b>	<b>UA18EAD15PPM1TI</b>		
<b>Specifications</b>				
Rated operating voltage	15 - 30 VDC	15 - 30 VDC	12 - 30 VDC	12 - 30 VDC
Voltage drop	≤ 2.2 VDC	≤ 2.2 VDC	≤ 2.2 VDC	≤ 2.2 VDC
Degree of protection	IP 67	IP 67	IP 67	IP 67
Protection short-circuit (S) Reverse polarity (P) Transients (T)	SPT	SPT	SPT	SPT
Load current	< 500 mA	< 500 mA	< 300 mA	< 300 mA
Load current - UL	< 100 mA	< 100 mA	< 100 mA	< 100 mA
Housing material	AISI 316L	AISI 316L	AISI 316L	AISI 316L
Operating temperature	-20°C to +60°C	-20°C to +60°C	-20°C to +70°C	-20°C to +70°C
LED colour	Yellow	Yellow	Yellow, Green	Yellow, Green
Approvals/Marks	CE - cULus	CE - cULus	CE - cULus	CE - cULus

## Ultrasonic sensors, analogue and digital output

Types	UA18CAD..TI	UA18CAD..MITI	UA30CAD35..TI	UA30CAD35..MITI
Connections	2 m cable	M12 connector	2 m cable	M12 connector
				
Dimensions (mm)	M18 x 85	M18 x 85	M30 x 90	M30 x 90
<b>References</b>				
Sensing distance (Sn)	50 - 400 mm	50 - 400 mm	250 - 3500 mm	250 - 3500 mm
Operating frequency	≤ 10 Hz	≤ 10 Hz	≤ 2 Hz	≤ 2 Hz
Blind zone	≤ 50 mm	≤ 50 mm	≤ 250 mm	≤ 250 mm
NPN, 4-20 mA	<b>UA18CAD04NGTI</b>	<b>UA18CAD04NGM1TI</b>	<b>UA30CAD35NGTI</b>	<b>UA30CAD35NGM1TI</b>
PNP, 4-20 mA	<b>UA18CAD04PGTI</b>	<b>UA18CAD04PGM1TI</b>	<b>UA30CAD35PGTI</b>	<b>UA30CAD35PGM1TI</b>
NPN, 0-10 V	<b>UA18CAD04NKTI</b>	<b>UA18CAD04NKM1TI</b>	<b>UA30CAD35NKTI</b>	<b>UA30CAD35NKM1TI</b>
PNP, 0-10 V	<b>UA18CAD04PKTI</b>	<b>UA18CAD04PKM1TI</b>	<b>UA30CAD35PKTI</b>	<b>UA30CAD35PKM1TI</b>
Sensing distance (Sn)	100 - 900 mm	100 - 900 mm		
Operating frequency	≤ 4 Hz	≤ 4 Hz		
Blind zone	≤ 100 mm	≤ 100 mm		
NPN, 4-20 mA	<b>UA18CAD09NGTI</b>	<b>UA18CAD09NGM1TI</b>		
PNP, 4-20 mA	<b>UA18CAD09PGTI</b>	<b>UA18CAD09PGM1TI</b>		
NPN, 0-10 V	<b>UA18CAD09NKTI</b>	<b>UA18CAD09NKM1TI</b>		
PNP, 0-10 V	<b>UA18CAD09PKTI</b>	<b>UA18CAD09PKM1TI</b>		
Sensing distance (Sn)	200 - 2200 mm	200 - 2200 mm		
Operating frequency	≤ 1 Hz	≤ 1 Hz		
Blind zone	≤ 200 mm	≤ 200 mm		
NPN, 4-20 mA	<b>UA18CAD22NGTI</b>	<b>UA18CAD22NGM1TI</b>		
PNP, 4-20 mA	<b>UA18CAD22PGTI</b>	<b>UA18CAD22PGM1TI</b>		
NPN, 0-10 V	<b>UA18CAD22NKTI</b>	<b>UA18CAD22NKM1TI</b>		
PNP, 0-10 V	<b>UA18CAD22PKTI</b>	<b>UA18CAD22PKM1TI</b>		
<b>Specifications</b>				
Rated operating voltage NG or PG NK or PK	15 - 30 VDC 15 - 30 VDC	15 - 30 VDC 15 - 30 VDC	12 - 30 VDC 15 - 30 VDC	12 - 30 VDC 15 - 30 VDC
Voltage drop	≤ 2.2 VDC	≤ 2.2 VDC	≤ 2.2 VDC	≤ 2.2 VDC
Degree of protection	IP 67	IP 67	IP 67	IP 67
Protection short-circuit (S) Reverse polarity (P) Transients (T)	Digital output: SPT Supply: PT Analogue output: P	Digital output: SPT Supply: PT Analogue output: P	Digital output: SPT Supply: PT Analogue output: P	Digital output: SPT Supply: PT Analogue output: P
Load current	< 500 mA	< 500 mA	< 100 mA	< 100 mA
Load current - UL	< 100 mA	< 100 mA	< 100 mA	< 100 mA
Housing material	PBT	PBT	PBT	PBT
Operating temperature	-20°C to +60°C	-20°C to +60°C	-20°C to +70°C	-20°C to +70°C
LED colour	Yellow	Yellow	Yellow, Green	Yellow, Green
Approvals/Marks	CE - cULus	CE - cULus	CE - cULus	CE - cULus



## Ultrasonic sensors, analogue and digital output

Types	UA30CAD60..TI	UA30CAD60..MITI
Connections	2 m cable	M12 connector
		
Dimensions (mm)	M30 (Ø40) x 90	M30 (Ø40) x 90
<b>References</b>		
Sensing distance (Sn)	350 - 6000 mm	350 - 6000 mm
Operating frequency	≤ 1 Hz	≤ 1 Hz
Blind zone	≤ 350 mm	≤ 350 mm
NPN, 4-20 mA	<b>UA30CAD60NGTI</b>	<b>UA30CAD60NGM1TI</b>
PNP, 4-20 mA	<b>UA30CAD60PGTI</b>	<b>UA30CAD60PGM1TI</b>
NPN, 0-10 V	<b>UA30CAD60NKTI</b>	<b>UA30CAD60NKM1TI</b>
PNP, 0-10 V	<b>UA30CAD60PKTI</b>	<b>UA30CAD60PKM1TI</b>
<b>Specifications</b>		
Rated operating voltage NG or PG NK or PK	12 - 30 VDC 15 - 30 VDC	12 - 30 VDC 15 - 30 VDC
Voltage drop	≤ 2.2 VDC	≤ 2.2 VDC
Degree of protection	IP 67	IP 67
Protection short-circuit (S) Reverse polarity (P) Transients (T)	Digital output: SPT Supply: PT Analogue output: P	Digital output: SPT Supply: PT Analogue output: P
Load current	< 100 mA	< 100 mA
Load current - UL	< 100 mA	< 100 mA
Housing material	PBT	PBT
Operating temperature	-20°C to +70°C	-20°C to +70°C
LED colour	Yellow, Green	Yellow, Green
Approvals/Marks	CE - cULus	CE - cULus

## Ultrasonic sensors, analogue and digital output

Types	UA18EAD..TI	UA18EAD..MITI	UA30EAD35..TI	UA30EAD35..MITI
Connections	2 m cable	M12 connector	2 m cable	M12 connector
				
Dimensions (mm)	M18 x 85	M18 x 85	M30 x 93	M30 x 100
<b>References</b>				
Sensing distance (Sn)	50 - 400 mm	50 - 400 mm	350 - 3500 mm	350 - 3500 mm
Operating frequency	≤ 10 Hz	≤ 10 Hz	≤ 2 Hz	≤ 2 Hz
Blind zone	≤ 50 mm	≤ 50 mm	≤ 350 mm	≤ 350 mm
NPN, 4-20 mA	<b>UA18EAD04NGTI</b>	<b>UA18EAD04NGM1TI</b>	<b>UA30EAD35NGTI</b>	<b>UA30EAD35NGM1TI</b>
PNP, 4-20 mA	<b>UA18EAD04PGTI</b>	<b>UA18EAD04PGM1TI</b>	<b>UA30EAD35PGTI</b>	<b>UA30EAD35PGM1TI</b>
NPN, 0-10 V	<b>UA18EAD04NKTI</b>	<b>UA18EAD04NKM1TI</b>	<b>UA30EAD35NKTI</b>	<b>UA30EAD35NKM1TI</b>
PNP, 0-10 V	<b>UA18EAD04PKTI</b>	<b>UA18EAD04PKM1TI</b>	<b>UA30EAD35PKTI</b>	<b>UA30EAD35PKM1TI</b>
Sensing distance (Sn)	100 - 900 mm	100 - 900 mm		
Operating frequency	≤ 4 Hz	≤ 4 Hz		
Blind zone	≤ 100 mm	≤ 100 mm		
NPN, 4-20 mA	<b>UA18EAD09NGTI</b>	<b>UA18EAD09NGM1TI</b>		
PNP, 4-20 mA	<b>UA18EAD09PGTI</b>	<b>UA18EAD09PGM1TI</b>		
NPN, 0-10 V	<b>UA18EAD09NKTI</b>	<b>UA18EAD09NKM1TI</b>		
PNP, 0-10 V	<b>UA18EAD09PKTI</b>	<b>UA18EAD09PKM1TI</b>		
Sensing distance (Sn)	200 - 1500 mm	200 - 1500 mm		
Operating frequency	≤ 1 Hz	≤ 1 Hz		
Blind zone	≤ 200 mm	≤ 200 mm		
NPN, 4-20 mA	<b>UA18EAD15NGTI</b>	<b>UA18EAD15NGM1TI</b>		
PNP, 4-20 mA	<b>UA18EAD15PGTI</b>	<b>UA18EAD15PGM1TI</b>		
NPN, 0-10 V	<b>UA18EAD15NKTI</b>	<b>UA18EAD15NKM1TI</b>		
PNP, 0-10 V	<b>UA18EAD15PKTI</b>	<b>UA18EAD15PKM1TI</b>		
<b>Specifications</b>				
Rated operating voltage NG or PG NK or PK	15 - 30 VDC 15 - 30 VDC	15 - 30 VDC 15 - 30 VDC	12 - 30 VDC 15 - 30 VDC	12 - 30 VDC 15 - 30 VDC
Voltage drop	≤ 2.2 VDC	≤ 2.2 VDC	≤ 2.2 VDC	≤ 2.2 VDC
Degree of protection	IP 67	IP 67	IP 67	IP 67
Protection short-circuit (S) Reverse polarity (P) Transients (T)	Digital output: SPT Supply: PT Analogue output: P	Digital output: SPT Supply: PT Analogue output: P	Digital output: SPT Supply: PT Analogue output: P	Digital output: SPT Supply: PT Analogue output: P
Load current	< 100 mA	< 100 mA	< 100 mA	< 100 mA
Load current - UL	< 100 mA	< 100 mA	< 100 mA	< 100 mA
Housing material	AISI 316L	AISI 316L	AISI 316L	AISI 316L
Operating temperature	-20°C to +60°C	-20°C to +60°C	-20°C to +70°C	-20°C to +70°C
LED colour	Yellow	Yellow	Yellow, Green	Yellow, Green
Approvals/Marks	CE - cULus	CE - cULus	CE - cULus	CE - cULus

## Ultrasonic sensors, DC, analogue, remote teach

	Programmable RS232	Integrated amplifier
<b>Types</b>	<b>UA30CLD..M7</b>	<b>UA12BLD..M1TR</b>
<b>Connections</b>	<b>M16 connector</b>	<b>M12 connector</b>
		
Dimensions (mm)	M30 x 136	M12 x 79
<b>References diffuse reflective</b>		
Operating frequency	5 - 30 Hz programmable	20 Hz
Sensing distance (Sn)	150 - 1500 mm adj.	25 - 200 mm adj.
0-10 VDC	<b>UA30CLD15FKM7</b>	
4-20 mA	<b>UA30CLD15FGM7</b>	
NPN-NO/NC		<b>UA12BLD02NPM1TR</b>
PNP-NO/NC		<b>UA12BLD02PPM1TR</b>
Sensing distance (Sn)	250 - 2000 mm adj.	
0-10 VDC	<b>UA30CLD20FKM7</b>	
4-20 mA	<b>UA30CLD20FGM7</b>	
Sensing distance (Sn)	350 - 3500 mm adj.	
0-10 VDC	<b>UA30CLD35FKM7</b>	
4-20 mA	<b>UA30CLD35FGM7</b>	
<b>Specifications</b>		
Rated operating voltage	19 - 30 VDC	10 - 30 VDC
Voltage drop	≤ 2.5 VDC	≤ 4.5 V
Degree of protection	IP 67	IP 65
Protection short-circuit (S)		
Reverse polarity (P)	SPT	SPT
Transients (T)		
Load current	< 100 mA Analogue see type	< 100 mA
Housing material	PBTB	Stainless steel
Operating temperature	-15°C to +70°C	-20°C to +70°C
LED colour	Yellow + Green	
Remarks	Hold/sync. input RS232	
Approvals/Marks	CE - UL - cUL	CE
<b>Adapters</b>		
<b>Types</b>	<b>AUA - RT</b>	
<b>Connections</b>	<b>M12 connector</b>	
		
Dimensions (mm)	17 x 56	
<b>Specifications</b>		
Programming adapter for remote teach sensors ending with "RT"		

# Conductive level sensors

Types	VN / VNI	VNY / VNYI	VPC	VPP
-------	----------	------------	-----	-----



Electrodes				
Number of electrodes	1, 2, 3 or 4	1, 2, 3 or 4	1, 2 or 3	1, 2 or 3
Diameter/length (mm)	D5/1000	D5/1000	D4/500	D4/500
Material	Stainless steel	Stainless steel	Stainless steel	Stainless steel
Isolation of electrodes	Yes (VNI)	Yes (VNYI)	Yes	Yes
Isolation	Polyethylene	Polyethylene	Polyethylene	PVDF

Housing				
Pipe thread	1½"	1½"	½" [VPC x05] or 1" [VPC x10]	½" [VPC x05] or 1" [VPC x10]
Material	Nylon 6	Nylon 6	PVC	Polypropylene

References								
1 electrode	<b>VN1</b>	<b>VNI1</b>	<b>VNY1</b>	<b>VNYI1</b>	<b>VPC105</b>	<b>VPC110</b>	<b>VPP105</b>	<b>VPP110</b>
2 electrodes	<b>VN2</b>	<b>VNI2</b>	<b>VNY2</b>	<b>VNYI2</b>	<b>VPC205</b>	<b>VPC210</b>	<b>VPP205</b>	<b>VPP210</b>
3 electrodes	<b>VN3</b>	<b>VNI3</b>	<b>VNY3</b>	<b>VNYI3</b>		<b>VPC310</b>		<b>VPP310</b>
4 electrodes	<b>VN4</b>	<b>VNI4</b>	<b>VNY4</b>	<b>VNYI4</b>				

Specifications				
Degree of protection	IP 67	IP 67	IP 67	IP 67
Operating temperature	0°C to +90°C	0°C to +90°C	0°C to +60°C	0°C to +100°C
Approvals/Marks	CE	CE	CE	CE



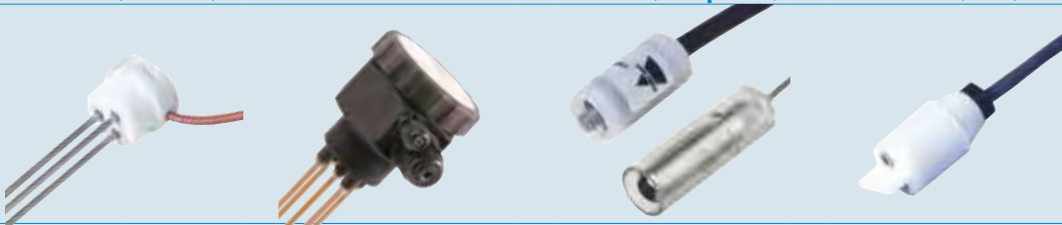

## Conductive level sensors

Types	VT / VTI		CLH	VH	A 94-10
Connections	Cable (Silicone)		Screw connection	Cable (Neoprene)	Cable (PVC)
					
<b>Electrodes</b>					
Number of electrodes	1, 2, 3 or 4		2 or 4 + reference	1 (hanging)	2 (hanging)
Diameter/length (mm)	D5/1000		D4	D18/36.5 or D32/75.5	D22/75.0
Material	Stainless steel		Stainless steel	Stainless steel	Stainless steel
Isolation of electrodes	Yes [VTI]		Yes	No [VH1, VH3, VH4] - Yes [VH2]	No
Isolation	Teflon		Kynar, Polyolefine	Nylon 6	
<b>Housing</b>					
Pipe thread	1½"		1½"		
Material	Teflon		Polypropylene	Nylon 6 [VH1, VH2] Polycarbonate [VH3, VH4]	Polyester
<b>References</b>					
1 electrode	<b>VT1</b>	<b>VTI1</b>			
1 electrode with Neoprene cable				<b>VH1 or VH2</b>	
1 electrode with UV resistant PVC cable				<b>VH3</b>	
1 electrode without cable				<b>VH4</b>	
2 electrodes	<b>VT2</b>	<b>VTI2</b>			<b>A 94-10</b>
3 electrodes	<b>VT3</b>	<b>VTI3</b>	<b>CLH3*</b>		
4 electrodes	<b>VT4</b>	<b>VTI4</b>			
5 electrodes			<b>CLH5*</b>		
<b>Specifications</b>					
Degree of protection	IP 67		IP 65	IP 67	IP 67
Operating temperature	0°C to +145°C		-20°C to +90°C	0°C to +90°C	0°C to +60°C
Approvals/Marks	CE		CE	CE	CE
<b>Electrodes</b> (Stainless steel ANSI316)					
No Insulation					
1 m			<b>CLE1</b>		
2 m			<b>CLE2</b>		
Extension 1 m			<b>CLE1X</b>		
Kynar (DVDP) insulation					
1 m			<b>CLE1K</b>		
2 m			<b>CLE2K</b>		
Extension 1 m			<b>CLE1KX</b>		
Polyolefine insulation					
1 m			<b>CLE1P</b>		
2 m			<b>CLE2P</b>		
Extension 1 m			<b>CLE1PX</b>		

\* Electrodes shall be ordered separately





# Conductive level sensors

## Level controller



Types	CLD1	CLD2	CLP2 Basic	CLP2
Connections	DIN-rail	DIN-rail	Plug 11 pin circular	Plug 11 pin circular
				
Function	Filling or emptying. Selectable by rotary switches. Conductive liquids	Filling or emptying. Selectable by rotary switches. Conductive liquids	Filling or emptying. Selectable by rotary switches. Conductive liquids	Filling or emptying. Selectable by rotary switches. Conductive liquids
Adjustable	Yes, Potentiometer	Yes, Potentiometer	Yes, Potentiometer	Yes, Potentiometer
Sensitivity	5 K $\Omega$ to 150 K $\Omega$	250 $\Omega$ to 500 K $\Omega$	5 K $\Omega$ to 150 K $\Omega$	250 $\Omega$ to 500 K $\Omega$
Functions switch	- Timer 1 to 30 sec. delay on filling or/and emptying	- Filling / Emptying - 3-levels: Low, Standard and High	- Filling / Emptying	- Filling / Emptying - 3-levels: Low, Standard and High
Input	1 + reference	2 + reference	2 + reference	2 + reference
Output	8 A / 250 VAC SPST	8 A / 250 VAC SPDT	8 A / 250 VAC SPDT	8 A / 250 VAC DPDT
Power Supply	24 V AC/DC	24 - 240 VAC/DC	24 VDC, 24 VAC, 115 VAC or 230 VAC	24 VAC/DC, 115 VAC or 230 VAC
<b>References</b>				
24 240 VAC/DC		<b>CLD2EB1BU24</b>		
24 VDC			<b>CLP2EB1B724</b>	
24 VAC			<b>CLP2EB1B024</b>	
24 VAC/DC	<b>CLD1EA1CM24</b>			<b>CLP2EA1CM24</b>
115 VAC			<b>CLP2EB1B115</b>	<b>CLP2EA1C115</b>
230 VAC			<b>CLP2EB1B230</b>	<b>CLP2EA1C230</b>
<b>Specifications</b>				
Time delay	< 300 mS	< 2S	< 2S	< 300 mS
Housing material	ABS VO	PA66	NORYL PPO	NORYL PPO
Operating temperature	-20°C to +50°C	-20°C to +50°C	-20°C to +50°C	-20°C to +50°C
Output LED colour	Yellow	Yellow	Yellow	Yellow
Power LED colour	Green	Green	Green	Green
Approvals/Marks	CE - cURus - CSA	CE - cULus	CE - cURus - CSA	CE - cURus - CSA



## Conductive level sensors

Level controller				
Types	CLD2	CLP2 Master-Slave	CLD4	CLP4
Connections	DIN-rail	Plug 11 pin circular	DIN-rail	Plug 11 pin circular
				
Function	Filling or emptying. Selectable by rotary switches. Conductive liquids	Filling or emptying. Selectable by rotary switches. Conductive liquids Master - Slave system	Filling, emptying or combinations. Selectable by rotary switches. Conductive liquids	Filling, emptying or combinations. Selectable by rotary switches. Conductive liquids
Adjustable	Yes, Potentiometer	Yes, Potentiometer	Yes, Potentiometer	Yes, Potentiometer
Sensitivity	250 Ω to 500 KΩ	250 Ω to 500 KΩ	250 Ω to 500 KΩ	250 Ω to 500 KΩ
Functions switch	- Filling / Emptying - 3-levels: Low, Standard and High	- Filling / Emptying - 3-levels: Low, Standard and High	- Tank - well - Direct in to out 2 probe - Low and High alarm - 2 system in one, filling and/ or emptying - 3-levels: Low, Standard and High	- Tank - well - Direct in to out 2 probe - Low and High alarm - 2 system in one, filling and/ or emptying - 3-levels: Low, Standard and High
Input	2 + reference	2 + reference	2 to 4 + reference	2 to 4 + reference
Output	8 A / 250 VAC DPDT	8 A / 250 VAC SPDT	8 A / 250 VAC SPDT, SPST	8 A / 250 VAC 2 X SPST
Power Supply	24 VAC/DC, 115 VAC or 230 VAC	24 VAC/DC, 115 VAC or 230 VAC	24 VAC/DC, 115 VAC or 230 VAC	24 VAC/DC, 115 VAC or 230 VAC
<b>References</b>				
24 VAC/DC	<b>CLD2EA1CM24</b>	<b>CLP2FA1BM24</b>	<b>CLD4MA2DM24</b>	<b>CLP4MA2AM24</b>
115 VAC	<b>CLD2EA1C115</b>	<b>CLP2FA1B115</b>	<b>CLD4MA2D115</b>	<b>CLP4MA2A115</b>
230 VAC	<b>CLD2EA1C230</b>	<b>CLP2FA1B230</b>	<b>CLD4MA2D230</b>	<b>CLP4MA2A230</b>
<b>Specifications</b>				
Time delay	< 300 mS	< 300 mS	< 300 mS	< 300 mS
Housing material	ABS VO	NORYL PPO	ABS VO	NORYL PPO
Operating temperature	-20°C to +50°C	-20°C to +50°C	-20°C to +50°C	-20°C to +50°C
Output LED colour	Yellow	Yellow	Yellow	Yellow
Power LED colour	Green	Green	Green	Green
Approvals/Marks	CE - cURus - CSA	CE - cURus - CSA	CE - cURus - CSA	CE - cURus - CSA

# Proximity magnetic sensors, rectangular

Rectangular			
Types	S series	SPB2 series	SPA1 series
			
Dimensions (mm)	11.5 x 79 x 21.2	25.5 x 85 x 24	16 x 90 x 20
<b>Electrical specifications</b>			
Max. switch. voltage contact	250 VAC [SA / SC 2, SB2 / -S5] 1500 VAC [SA / SC 8] 230 VAC [SS2, S.BS.2]	250 VAC	24 VDC [output 1 and 2]
Max. switch. current contact	1 A [SS2, S.BS.2] 3 A [SA2, SC2, SB2, SB2S5, SA8, SC8]	3 A	0.5 A [output 1] 4 A [output 2]
Max. switch. power contact	100 VA [SA / SC 2, SB2 / -S5] 120 VA [SA / SC 8] 60 VA [SS2, S.BS.2]	100 VA	5 VA [output 1] 100 VA [output 2]
Power supply			24 VDC
<b>General specifications</b>			
Operating distance	5 - 32 mm	5 - 30 mm	12 mm
Output connection	PVC cable, 0.5 m (0.24 m Type S5)	Faston [SPB2] 2 m PVC Cable [SPB22MT]	PVC cable, 19 cm Pig-tail
Degree of protection	IP 67	IP 67 [SPB22MT] IP 65 [SPB2]	IP 67
Operating temperature	-25°C to +75°C	-25°C to +75°C	-25°C to +80°C
Housing material	Plastic	Plastic	ABS class V0
<b>References</b>			
Normally open	SA2 SA8		
Normally closed	SC2 SC8		
Change - Over	SS2		
Bistable	SB2 SB2S5	SPB2 SPB22MT	
Bistable CO	S.BS.2		
Normally closed, 2 outputs			SPA1S2 SPA1S3

# Proximity magnetic sensors, rectangular

## Rectangular

### Types

### M and MS series

### MM series

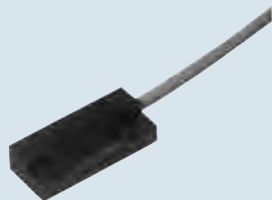

Dimensions (mm)

8.3 x 37 x 16

6.1 x 23.5 x 14 [A6]  
7 x 27 x 11 [A3, S1]

### Electrical specifications

Max. switch. voltage contact

100 VAC [MS1]  
230 VAC [MSA1]  
500 VAC [MA3, MC3]

100 VAC [S1, A6]  
500 VAC [A3]

Max. switch. current contact

0.25 A [MS1]  
0.5 A [MA3, MC3]  
0.75 A [MSA1]

0.25 A [S1]  
0.5 A [A3, A6]

Max. switch. power contact

5 VA [MS1]  
10 VA [MSA1, MA3, MC3]

5 VA [S1]  
10 VA [A3, A6]

### General specifications

Operating distance

7 - 35 mm

10 - 40 mm

Output connection

PVC cable, 0.5 m  
(2 m, Type MSA1)

PVC cable [A3, S1]  
Twin lead cable [A6]

Degree of protection

IP 67

IP 67

Operating temperature

-25°C to +75°C

-25°C to +75°C

Housing material

Plastic

Plastic

### References

Normally open

**MSA1**  
**MA3**

**MMA3**  
**MMA6**

Normally closed



**MC3**

Change - Over

**MS1**

**MMS1**

# Proximity magnetic sensors, cylindrical

Cylindrical			
Types	FM... series	FMM... series	FMMP... series
			

Dimensions (mm)	Ø 9.3 [A3, C3, S1] M10 x 0.75 [A3S5, A6] M12 x 1 [C3S1, A9S1]	M8 x 1	Ø 6 x 25 [L25] Ø 6 x 33 [L33] Ø 6 x 38 [L38]
-----------------	---	--------	--

## Electrical specifications

Max. switch. voltage contact	100 VAC [S1, A6] 230 VAC [A9S1] 500 VAC [A3, C3, A3S5, C3S1]	100 VAC [A6, S1] 500 VAC [A3]	140 VAC
Max. switch. current contact	0.25 A [S1] 0.5 A [A3, C3, A6, A3S5, C3S1] 3 A [A9S1]	0.25 A [S1] 0.5 A [A3, A6]	1 A
Max. switch. power contact	5 VA [A3, C3, A3S5, C3S1] 60 VA [A9S1] 100 VA [S1, A6]	5 VA [S1] 10 VA [A3, A6]	10 VA
Max carry current			1.2 A

## General specifications





Operating distance	5 - 36 mm	8 - 27 mm	> 8 mm
Output connection	PVC cable 0.5 m for Ø 9.3 2 m for M10 and M12	PVC cable, 2 m	Twin lead cable, 0.5 m
Degree of protection	IP 67	IP 67	IP 67
Operating temperature	-25°C to +75°C	-25°C to +70°C	-20°C to +75°C
Housing material	Plastic [A3, C3, S1] Nickel plated brass [A6] Brass [A3S5, C3S1, A9S1]	Stainless steel [A3, S1] Nickel plated brass [A6]	Plastic

## References

Normally open	<b>FMA3</b> <b>FMA3S5</b> <b>FMA6</b> <b>FMA9S1</b>	<b>FMMA3</b> <b>FMMA6</b>	<b>FMMPA7L25</b> <b>FMMPA7L33</b> <b>FMMPA7L38</b>
Normally closed	<b>FMC3</b> <b>FMC3S1</b>		
Change - Over	<b>FMS1</b>	<b>FMMS1</b>	



# Proximity magnetic sensors, cylindrical

## Cylindrical

Types	FMP... series	FS... series	FSLP... series	FSM... series
				
Dimensions (mm)	M12 x 1 x 100	Ø 13.5 [A2, A8, C2, C8, S2] M10 x 1.25 [A2S3, S2S1] M12 x 1 [A2S4, S2S4] M16 x 1.5 [B2]	Ø 16	M12 x 1 [A2, A7, S2] M16 x 1 [S2S2AT]
<b>Electrical specifications</b>				
Max. switch. voltage contact	120 VAC / DC [C7] 175 VDC, 120 VAC [S1] 200 VDC, 140 VAC [A7] 230 VAC / DC [A9, C9, A9S1] 250 VAC / DC [B2]	230 VAC [S2, S2S1, S2S4] 250 VAC [A2, B2, C2, A2S3, A2S4] 1500 VAC [A8, C8]	100 VAC [A7] 250 VAC [B2]	24 VDC [A7] 230 VAC [S2, S2S2AT] 250 VAC [A2]
Max. switch. current contact	0.25 A [S1] 0.5 A [C7] 1 A [A7] 3 A [B2, A9, C9, A9S1]	1 A [S2, S2S4, S2S1] 3 A [A2, B2, C2, A8, C8, A2S3, A2S4]	0.4 A [A7] 3 A [B2]	0.5 A [S2S2AT] 1 A [S2] 3 A [A2] 50 mA [A7]
Max. switch. power contact	5 VA [S1] 10 VA [A7, C7] 60 VA [A9, C9, A9S1] 120 VA [B2]	60 VA [S2S1, S2S4, S2] 100 VA [A2, B2, C2, A2S3, A2S4] 120 VA [A8, C8]	10 VA [A7] 120 VA [B2]	30 VA [S2S2AT] 60 VA [S2] 100 VA [A2] (A7 negligible)
<b>General specifications</b>				
Operating distance	7 - 26 mm	3 - 32 mm	18 - 25 mm (front); >10 - >15 mm (side)	2 - 19 mm
Output connection	PVC cable, 2 m	PVC cable, 2 m 0.5 m for Ø 13.5	PVC cable, 2 m	Silicone cable, 2 m [A7] Silicone cable, 0.5 m [S2S2AT] PVC cable, 2 m [A2, S2]
Degree of protection	IP 67	IP 67	IP 67	IP 67
Operating temperature	-25°C to +75°C	-25°C to +75°C	-30°C to +80°C	-25°C to +75°C [A2, A7, S2] -20°C to +150°C [S2S2AT]
Housing material	Plastic	Plastic [A2, A8, C2, C8, S2, B2] Brass [A2S3 / S4, S2S1 / S4]	Plastic	Brass [S2S2, S2S2AT] Nickel plated brass [A2, A7, S2]
<b>References</b>				
Normally open	FMPA7 [black] FMPA9 [black] FMPA9S1 [black]	FSA2 FSA8 FSA2S32MT FSA2S42MT	FSLPA7	FSMA2 FSMA7
Normally closed	FMPC7 [red] FMPC9 [red]	FSC2 FSC8		
Change - Over	FMPS1 [blue]	FSS2 FSS2S12MT FSS2S42MT		FSMS2 FSMS2S2AT
Bistable	FMPB2 [grey]	FSB22MT	FSLPB2	

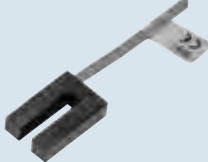
# Proximity magnetic sensors, slot



Slot		
Types	ISY series	IM series
		
Dimensions (mm)	10 x 45 x 37	7 x 28 x 18.5
<b>Electrical specifications</b>		
Max. switch. voltage contact	100 VAC [S1] 500 VAC [C3]	100 VAC [S1] 500 VAC [C3]
Max. switch. current contact	0.25 A [S1] 0.5 A [C3]	0.25 A [S1] 0.5 A [C3]
Max. switch. power contact	5 VA [S1] 10 VA [C3]	5 VA [S1] 10 VA [C3]
<b>General specifications</b>		
Output connection	PVC cable, 0.5 m	PVC cable, 0.5 m
Degree of protection	IP 67	IP 67
Operating temperature	-25°C to +75°C	-25°C to +75°C
Housing materials	Plastic	Plastic
<b>References</b>		
Normally closed	ISYC3	IMC3
Change - Over	ISYS1	IMS1

Types	Magnetic units CL series		
Shapes	Rectangular	Trapezoidal	Cylindrical
			

<b>General specifications</b>						
Minimum separation:	Dimensions (mm)	References				
10	25 x 14 x 8	CL1				
20	44.5 x 12 x 9	CL2				
30	59 x 18 x 9	CL3				
50	76 x 25 x 18	CL4				
Not mandatory	Dimensions (mm)	References	Dimensions (mm)	References		
	90 x 31 x 22.5	CL90	Ø 9.3 x 32	CL10		
			Ø 13.5 x 65	CL11		
			Ø 18 x 6	CL18		
			Ø 23 x 9	CL23		
			Ø 31 x 10	CL31		
			Ø 20 x 10	CL20S1		
			Ø 22.1 x 11.3	CL20S3		

# Level magnetic sensors

## Cylindrical

Types	ILM series	ILMM series	ILMP series
			

Float Diameter (mm)	Ø 53	Ø 28	Ø 25
---------------------	------	------	------

### Output functions

Normally open,  
Normally closed [2, 8]  
Change-over [S2]

Normally open and normally closed  
[5, 590, 5ATS1]  
Normally open [5S1]  
Normally closed [5S2, 5S2AT]

Normally open, normally closed

### Electrical specifications

Max. switch. voltage contact	230 VAC [S2] - 250 VAC [2] 1500 VAC [8]	240 VAC, 220 VDC	240 VAC, 200 VDC
Max. switch. current contact	1 A [S2] 3 A [2, 8]	0.5 A	0.5 A
Max. switch. power contact	60 VA [S2] - 100 VA [2] 120 VA [8]	50 VA	50 VA

### General specifications

Output connection	Silicone cable, 0.5 m	XLPE cable, 0.3 m 1,1 m [ATS1]	PVC cable, 0.3 m
Min. liquid specific gravity	0.75 kg / dm <sup>3</sup>	0.75 kg / dm <sup>3</sup>	
Max. pressure	20 kg / cm <sup>2</sup>	10 kg / cm <sup>2</sup>	2 kg / cm <sup>2</sup>
Degree of protection	IP 67	IP 67	IP 67
Operating temperature	-25°C to +120°C [2, 8, S2]	-10°C to +120°C [5, 590] -10°C to +200°C [5ATS1, 5S2AT] -20°C to +120°C [5S1, 5S2]	-20°C to +80°C
Housing materials	AISI 316 stainless steel	AISI 304 stainless steel [5, 590 5ATS1] AISI316 stainless steel [5S2AT, 5S1, 5S2]	Plastic

### References

Normally open / Normally closed	<b>ILM.2</b> <b>ILM8</b>	<b>ILMM5</b> <b>ILMM590</b> <b>ILMM5ATS1</b>	<b>ILMP5</b> <b>ILMP5P</b>
Change - Over	<b>ILMS2</b>		
Normally closed		<b>ILMM5S2AT</b> <b>ILMM5S2</b>	
Normally open		<b>ILMM5S1</b>	





# Level magnetic sensors

				Cylindrical		
Types	ILMPU - ILU - ILMU series		ILSP series	FLM series - Flux Sensors		
						
Float Diameter (mm)	Ø 17.5 [ILMPU] Ø 31 [ILMU] Ø 45 [ILU]		Ø 44	Ø 20		
<b>Electrical specifications</b>						
Max. switch. voltage contact	230 VAC [ILUS2] 240 VAC, 200 VDC [ILMPU5, ILMU5] 250 VAC [ILU2] 1000 VAC [ILU8]		230 VAC [S2] 250 VAC [2] 1500 VAC [8]	100 VAC		
Max. switch. current contact	0.5 A [ILMP, ILM] 1 A [ILUS2] 3 A [ILU2, ILU8]		1 A [S2] 3 A [2, 8]	0.4 A		
Max. switch. power contact	50 VA [ILMP, ILM] 60 VA [ILUS2] 100 VA [ILU2] 120 VA [ILU8]		60 VA [S2] 100 VA [2] 120 VA [8]	10 VA		
<b>General specifications</b>						
Output connection	XLPE cable, 0.3 m [ILMPU5] PVC cable, 0.3 m [ILMU5] Silicone cable, 0.5 m [ILU2, ILU8, ILUS2]		Silicone cable, 0.5 m	HT105 PVC cable ended with 6.35 mm female faston		
Operating distance $D_{on}$				+5 mm		
Release distance $D_{off}$				$D_{on} - 2$ mm		
Min. liquid specific gravity	0.70 kg / dm <sup>3</sup> [ILMPU, ILMU] 0.75 kg / dm <sup>3</sup> [ILU]		0.75 kg / dm <sup>3</sup>			
Max. pressure	2 kg / cm <sup>2</sup> [ILMPU, ILMU] 100 kg / cm <sup>2</sup> [ILU]		0.6 kg / cm <sup>2</sup>			
Degree of protection	IP 68		IP 67	IP 67		
Operating temperature	-20°C to +80°C [ILMPU, ILMU] -25°C to +100°C [ILU]		-25°C to +100 °C	-30°C to +105°C		
Housing materials	Non toxic polypropylene or plastic		Plastic	Stainless steel		
<b>References</b>						
Normally open / Normally closed	<b>ILMPU5</b> <b>ILMU5</b>		<b>ILSP2</b> <b>ILSP8</b>			
Normally open	<b>ILU2</b> <b>ILU8</b>			<b>FLMA1S1</b>		
Change - Over	<b>ILUS2</b>		<b>ILSPS2</b>			







# Safety magnetic sensors

## Compact safety magnetic sensors

Types	MC 36C... Left exit		MC 36C... Right exit		
	Connections	2 m cable	M8 connector	2 m cable	M8 connector
					
Dimensions (mm)	36 x 26 x 13	36 x 26 x 13	36 x 26 x 13	36 x 26 x 13	
Operating frequency	100 Hz	100 Hz	100 Hz	100 Hz	
Assured switching distance (Sao)	5 mm (with MC36CM)	5 mm (with MC36CM)	5 mm (with MC36CM)	5 mm (with MC36CM)	
Assured switch-off distance (Sar)	15 mm (with MC36CM)	15 mm (with MC36CM)	15 mm (with MC36CM)	15 mm (with MC36CM)	
<b>Electrical specifications</b>					
Rated operating voltage	12-24 VAC/DC	12-24 VAC/DC	12-24 VAC/DC	12-24 VAC/DC	
Rated operating current	0.25 A (resistive load)	0.25 A (resistive load)	0.25 A (resistive load)	0.25 A (resistive load)	
Maximum switching load	6 W (resistive load)	6 W (resistive load)	6 W (resistive load)	6 W (resistive load)	
<b>General specifications</b>					
Rated insulation voltage	120 V AC	60 V AC / 75 V DC	120 V AC	60 V AC / 75 V DC	
Degree of protection	IP 67	IP 67	IP 67	IP 67	
Reverse polarity protection	Yes	Yes	Yes	Yes	
Housing material	PBT red	PBT red	PBT red	PBT red	
Operating temperature	-25°C to +80°C	-25°C to +80°C	-25°C to +80°C	-25°C to +80°C	
Output connection	2 m PVC cable 4 x 0.25 mm <sup>2</sup>	M8 4-pin connector	2 m PVC cable 4 x 0.25 mm <sup>2</sup>	M8 4-pin connector	
Vibration resistance	10 g (10...150 Hz)	10 g (10...150 Hz)	10 g (10...150 Hz)	10 g (10...150 Hz)	
Shock resistance	30 g (11 ms)	30 g (11 ms)	30 g (11 ms)	30 g (11 ms)	
Approvals/Marks	CE - cULus	CE - cULus	CE - cULus	CE - cULus	
<b>References - versions without LED</b>					
2 NO outputs	<b>MC36CH2OLA2</b>	<b>MC36CH2OLM5</b>	<b>MC36CH2ORA2</b>	<b>MC36CH2ORM5</b>	
1 NO + 1 NC outputs	<b>MC36CH1O1CLA2</b>	<b>MC36CH1O1CLM5</b>	<b>MC36CH1O1CRA2</b>	<b>MC36CH1O1CRM5</b>	
<b>References - versions with LED</b>					
2 NO outputs	<b>MC36CH2OLA2L</b>	<b>MC36CH2OLM5L</b>	<b>MC36CH2ORA2L</b>	<b>MC36CH2ORM5L</b>	
1 NO + 1 NC outputs	<b>MC36CH1O1CLA2L</b>	<b>MC36CH1O1CLM5L</b>	<b>MC36CH1O1CRA2L</b>	<b>MC36CH1O1CRM5L</b>	
LED color	Yellow	Yellow	Yellow	Yellow	
<b>Actuator</b>					
Dimensions (mm)	36 x 26 x 13	36 x 26 x 13	36 x 26 x 13	36 x 26 x 13	
References	<b>MC36CM</b>	<b>MC36CM</b>	<b>MC36CM</b>	<b>MC36CM</b>	

# Safety magnetic sensors

## Safety magnetic sensors

Types	SMS...	CLS...
	 	 

### Electrical specifications

Max. switch. voltage	100 VAC
Max. switch. power	5 VA
Max. switch. current	0.25 A

### General specifications













External dimensions (mm)	88 x 25 x 13; M18x1 SMSA2; M30x1.5 SMSA3P	
Suitable magnetic unit	CLS; CLSA2 (SMSA2P); CLSA2M (SMSA2M); CLSA3 (SMSA3P)	
Output connection	Cable (PVC, AWG 22 to 26, L=2 m.); pig tail with M12 connector, L=0.3 m	
Degree of protection	IP 67	IP 67
Operating temperature	-25°C to +70°C	
Housing material	Plastic; PBT + 30 % glass (SMSA2P and SMSA3P); Stainless steel (SMSA2M)	Plastic (CLS, CLSA2, CLS3); Stainless steel (CLSA2M)
Approvals/Marks	CE - (UL version is available for some items with different codification)	CE - (UL version is available for some items with different codification)

### References

	Safety Outputs	Aux. Outputs	REFERENCES	Dimensions	REFERENCES
Housing type: Rectangular Material: Plastic	1NO		<b>SMS10</b>	88 x 25 x 13	<b>CLS</b>
	1NO	1NC	<b>SMS10NC</b>		
	1NO	1NC	<b>SMS10NCM1</b> 0.3 m cable with M12 conn.		
	1NO+1NC		<b>SMS01</b>		
	1NO+1NC		<b>SMS02</b>		
	1NO+1NC		<b>SMS02LD</b> LED on NC contact		
	1NO+1NC		<b>SMS02S1</b> Resistor on NO contact		
	2NO		<b>SMS03</b>		
	2NO		<b>SMS03+ CM1A4/O3MT</b> 0.3 m cable with M12 conn.		
	2NO	1NC	<b>SMS03NC</b>		
Housing type: Cylindrical Material: Plastic	1NO+1NC		<b>SMSA2P02</b>	Ø25.1 x 9.3	<b>CLSA2</b>
	1NO+1NC		<b>SMSA2P02LD</b> LED on NC contact		
	2NO		<b>SMSA2P03</b>		
	1NO		<b>SMSA2P10</b>		
	2NO		<b>SMSA2P30</b>	Ø30 x 16	<b>CLSA3</b>
	1NO+1NC		<b>SMSA3P02</b>		
	2NO		<b>SMSA3P03</b>		
	2NO		<b>SMSA3P30</b>		
Housing type: Cylindrical Material: Stainless steel	1NO+1NC		<b>SMSA2M02</b>	Ø25.1 x 9.3	<b>CLSA2M</b>
	1NO		<b>SMSA2M10</b>		

# Intrinsic safety

## Explosion proof sensors

Types	Cylindrical series FSQ	Rectangular series MQ	Level series ILM
			
Exter. Dimensions (mm) Float Dimensions (mm)	Ø16 x 110	37 x 16 x 8.3	Spherical Ø 53 [S], Cylindrical Ø 45x55 [C]
Category	2G, 2D	2G, 2D [MQx1EX] 1G, 1D [MQA0EX]	2G, 2D [ILMx2] 1G, 1D [ILMx0]
EX Identification	 II2GExmbIICT5Gb  II2DExmbIICT100°CDBIP67	 II2GExmbIICT5Gb [MQx1EX]  II2DExmbIICT100°CDBIP67 [MQx1EX]  II1GExialICT6Gα [MQA0EX]  II1DExialICT100°CDBIP67 [MQA0EX]	 II2GExmbIICT5Gb [ILMx2]  II2DExmbIICT100°CDBIP67 [ILMx2]  II1GExialICT6Gα [ILMx0]  II1DExialICT100°CDBIP67 [ILMx0]





## General specifications

Max. switch. voltage contact	250 VAC	230 VAC/DC [MQA1EX, MQC1EX] 30 VAC/DC [MQA0EX] 150 VAC/DC [MQS1EX]	250 VAC/DC [ILMA2] 230 VAC/DC [ILMS2] 30 VAC/DC [ILMx0]
Max. switch. current contact	3 A	0.25 to 0.75 A [MQx1EX] 120 mA [MQA0EX]	3 A [ILMA2]; 1A [ILMS2] 120 mA [ILMx0]
Max. switch. power contact	100 VA	5 to 10 VA [MQx1EX] - [MQA0EX]	100 VA [ILMA2] 60 VA [ILMS2]
Operating distance	8 - 30 mm	10 - 35 mm	-
Degree of protection	IP 67 IP66 (FSQA2HFEX)	IP 67	IP 67
Temperature Class	T5	T5 [MQx1EX] T6 [MQA0EX]	T5 [ILMx2] T6 [ILMx0]
Body material	Stainless steel AISI 303	Self-exting. PP + 30% glass fiber	Stainless steel AISI 316
Approvals/Mark	CE - TÜV Sud	CE - TÜV Sud	CE - TÜV Sud

## References



Normally open	<b>FSQA2B01SLEX</b> <b>FSQA2HFEX</b>	<b>MQA1EX</b> <b>MQA0EX</b>	<b>ILMA2SSLEX</b> <b>ILMA2CSLEX</b> <b>ILMAOSSLEX</b> <b>ILMAOCSLEX</b>
Normally closed		<b>MQC1EX</b>	
Change - Over		<b>MQS1EX</b>	<b>ILMS2SEX</b> <b>ILMS2CEX</b> <b>ILMSOSEX</b> <b>ILMSOCEX</b>

# Safety modules





	Emergency stop, safety gates, lift levelling, interlocks		Safety gates	Two hand control
Types	SMS20	SMS31	SMSA31	SM2H21
				
Dimensions HxWxD (mm)	110,8 x 17.5 x 121,1	110,8 x 17.5 x 121,1	110,8 x 17.5 x 121,1	110,8 x 17.5 x 121,1
Safety category	Category 4	Category 4	Category 4	Category 4
Performance Level	PL e (EN ISO 13849-1)	PL e (EN ISO 13849-1)	PL e (EN ISO 13849-1)	PL e (EN ISO 13849-1)
Function	Category 0 emergency stop module, safety gates, safety magnetic switches, interlocks, lift levelling	Category 0 emergency stop module, safety gates, safety magnetic switches, interlocks, lift levelling	Safety gates, safety magnetic switches in antivalent mode	Two hand control Type IIIC
<b>Output specifications</b>				
	2 x NO safety relay	3 x NO safety relay + 1 NC relay	3 x NO safety relay + 1 NC relay	2 x NO safety relay + 1 NC relay, 1 NO PNP
Max. load AC1	6 A @ 250 VAC	6 A @ 250 VAC	6 A @ 250 VAC	6 A @ 250 VAC
Max. load DC1	6 A @ 24 VDC	6 A @ 24 VDC	6 A @ 24 VDC	6 A @ 24 VDC
Electrical life	> 10 <sup>5</sup> operations	> 10 <sup>5</sup> operations	> 10 <sup>5</sup> operations	> 10 <sup>5</sup> operations
<b>Input specifications</b>				
Type	2 x NO, voltage free	2 x NO, voltage free	1 x NO + 1 x NC, voltage free	2 x NO, 2 x NC, voltage free
<b>General specifications</b>				
Power supply	24 VDC -10% +10% 24 VAC -15% +10%	24 VDC -10% +10% 24 VAC -15% +10%	24 VDC -10% +10% 24 VAC -15% +10%	24 VDC -10% +10% 24 VAC -15% +10%
Screw terminals	Detachable	Detachable	Detachable	Detachable
Start	Automatic, Manual and Monitored manual	Automatic, Manual and Monitored manual	Automatic, Manual and Monitored manual	Automatic
Approvals/Marks	CE - UL - TÜV - RoHS - EN 81-20, EN 81-50	CE - UL - TÜV - RoHS - EN 81-20, EN 81-50	CE - UL - TÜV - RoHS	CE - UL - TÜV - RoHS
<b>References</b>				
	SMS20	SMS31	SMSA31	SM2H21

# Safety modules

## Multifunction safety modules

Types	Delayed outputs	Instantaneous outputs	Lift levelling
			
Dimensions HxWxD (mm)	90 x 18 x 63	90 x 18 x 63	90 x 18 x 63
Safety Integrity Level (EN 62061)	SIL CL 3	SIL CL 3	SIL CL 3
Safety Integrity Level (EN 61058)	SIL 3	SIL 3	SIL 3
Performance Level (EN ISO 13849-1:2015)	Cat 4, PL e	Cat 4, PL e	Cat 4, PL e
Lift Standards	-	-	EN 81-20 EN 81-50
Function	Selectable delay time. Can be easily set-up through the hex-switch, selected from a choice of 15 pre-set configurations, from 0 to 30 sec. 4 LEDs on the front panel indicate the status and any errors during operation	The correct opening and closing of the safety function OSSD is tested automatically. 4 LEDs on the front panel indicate the status and any errors during operation	The correct opening and closing of the safety function OSSD is tested automatically. 4 LEDs on the front panel indicate the status and any errors during operation
			Control of levelling, re-levelling and preliminary operation with doors not closed and locked
<b>Output specifications</b>			
Safety Output / Auxiliary Output	2 x OSSD direct + 2 x OSSD delayed	4 x OSSD (NO)	3 x OSSD (NO) + 1 OSSD Auxiliary (1 NC)
Max. load DC24	≤400 mA	≤400 mA	≤400 mA
<b>Input specifications</b>			
Type	Certus modules can be connected with different types of input: E-stop, E-gate, limit switch, non-contact switch, safety light curtains (ESPE Type 4, Type 2), safety light beam (single beam), safety mat, levelling	Certus modules can be connected with different types of input: E-stop, E-gate, limit switch, non-contact switch, safety light curtains (ESPE Type 4, Type 2), safety light beam (single beam), safety mat, levelling	Certus modules can be connected with different types of input: E-stop, E-gate, limit switch, non-contact switch, safety light curtains (ESPE Type 4, Type 2), safety light beam (single beam), safety mat, levelling
			Possibility of connecting mechanical or magnetic switches (reed contact)
<b>General specifications</b>			
Power supply	24 VDC ± 20%	24 VDC ± 20%	24 VDC ± 20%
Screw terminals	Fixed	Fixed	Fixed
Start	Manual or automatic start selectable	Manual or automatic start selectable	Manual or automatic start selectable
Approvals/Marks	CE - TÜV - cULus - RoHS	CE - TÜV - cULus - RoHS	CE - TÜV - cULus - RoHS
<b>References</b>			
	<b>CM22D0A</b>	<b>CM40D0A</b>	<b>CM30D1A</b>
			<b>CL20D2A</b>

# Safety modules

	Safety expansion unit	Safety mat & edge		Safety light curtains
Types	SME41	NSE02C	NST02C	NLG02D/NLG13D
				
Dimensions HxWxD (mm)	110,8 x 17,5 x 121,1	84 x 22,5 x 100	84 x 22,5 x 100	99 x 22,5 x 114
Safety category	Category 4	Category 3 (EN ISO 13849-1)	Category 3 (EN ISO 13849-1)	Category 4 (EN ISO 13849-1)
Performance Level	PL e (EN ISO 13849-1)	PL d (EN ISO 13849-1)	PL d (EN ISO 13849-1)	PL e (EN ISO 13849-1)
Function	Safety expansion relay unit	Safety mat & edge module	Safety mat module	Light curtains safety modules
<b>Output specifications</b>				
	4 x NO safety relay + 1 x NC relay	2 x NO safety relay	2 x NO safety relay	2 x NO safety relay [NLG02] 3 x NO safety relay + 1 NC relay [NLG13]
Max. load AC1	6 A @ 250 VAC	5 A @ 230 VAC	5 A @ 230 VAC	6 A @ 230 VAC
Max. load DC1	6 A @ 24 VDC	5 A @ 24 VDC	5 A @ 24 VDC	6 A @ 24 VDC
Electrical life	> 10 <sup>5</sup> operations	> 10 <sup>5</sup> operations	> 10 <sup>5</sup> operations	> 10 <sup>5</sup> operations
<b>Input specifications</b>				
Type	2 x NO, voltage free or OSSD	2-wire mats or safety edges	4-wire mats	2 x NO min 10 mA / 17 V max 60 mA / 38 V [NLG02] max 30 mA / 38 V
<b>General specifications</b>				
Power supply	24 VDC -10% +10% 24 VAC -15% +10%	24 VAC/DC ±15%	24 VAC/DC ±15%	24 VDC - 15% +10%
Screw terminals	Detachable	Fixed	Fixed	Fixed [SA, SC] Detachable [DA, DC]
Start	-	Automatic / Manual [SA] Monitored manual [SC]	Automatic / Manual [SA] Monitored manual [SC]	Automatic / Manual [SA, DA] Monitored manual [SC, DC]
Approvals/Marks	CE - UL - TÜV - RoHS	CE - TÜV - RoHS	CE - TÜV - RoHS	CE - UL - TÜV - RoHS
<b>References</b>				
	<b>SME41</b>	<b>NSE02CB24SA</b> <b>NSE02CB24SC</b>	<b>NST02CB24SA</b> <b>NST02CB24SC</b>	<b>NLG02D724SA</b> <b>NLG02D724SC</b> <b>NLG02D724DA</b> <b>NLG02D724DC</b> <b>NLG13D724SA</b> <b>NLG13D724SC</b> <b>NLG13D724DA</b> <b>NLG13D724DC</b>

# Configurable safety modules

## Types

## Configurable master module

### CMM



Dimensions HxWxD (mm)	108 x 22.5 x 114.5
Safety Level	Safety Integrity Level SIL 3, according to EN 61508 Safety Integrity Level SIL CL 3, according to EN 62061 Performance Level PL e and Cat. 4, according to EN ISO 13489-1
Function	Can stand-alone managing and monitoring different safety sensors and commands at the same time. Manages up to 14 expansion units leaving out C2 R/C4 R modules

### Safety inputs and outputs specifications

CMM as a stand alone unit	- 8 digital inputs, PNP active high according to EN 61131-2 - 2 pairs of solid state programmable safety outputs (OSSD), PNP active high 400 mA at 24 VDC max
Max. digital inputs with expansion modules	128
Max. digital outputs with expansion modules	16 pairs (OSSD)
Max. n° of expansion modules	14, leaving out C2 R/C4 R modules

### Non-Safety inputs and outputs specifications

Test outputs	4
Programmable digital signal outputs	2
Input for Start/Restart interlock and EDM	2

### General specifications

Rated voltage	24 VDC ±20% / supply from Class II
Digital inputs	PNP active high, according to EN 61131-2
OSSD	PNP active high - 400 mA @ 24 VDC (every OSSD)
Enclosure protection class	IP 20
Terminal blocks protection class	IP 2x

## Types

## I/O Expansion modules

### C 8I 20

### C 8I / C 16I

### C 12I 8TO





Dimensions HxWxD (mm)	108 x 22.5 x 114.5	108 x 22.5 x 114.5	108 x 22.5 x 114.5
Performance Level	Cat. 4, PL e (EN ISO 13849-1)	Cat. 4, PL e (EN ISO 13849-1)	Cat. 4, PL e (EN ISO 13849-1)
Safety Integrity Level	SIL 3 (EN 61508)	SIL 3 (EN 61508)	SIL 3 (EN 61508)
Function	Expansion modules	Expansion modules	Expansion modules

### General specifications

PFHd (IEC 61508:1998)	5.72E-9	5.75E-9 [C 8I] 7.09E-9 [C 16I]	3.24E-9
Rated voltage	24 VDC ±20%	24 VDC ±20%	24 VDC ±20%
Dissipated power	3 W max	3 W max	3 W max
Digital inputs	8 / PNP active high according to EN 61131-2 [C 8I 20]	PNP active high according to EN 61131-2 8 [C 8I] / 16 [C 16I]	12 / PNP active high according to EN 61131-2 [C 12I 8TO]
Digital output	2 OSSD pairs with 400 mA output current		
Test output	4 for sensor monitoring and checking short-circuits and overloads	4 for sensor monitoring and checking short-circuits and overloads	8 for sensor monitoring and checking short-circuits and overloads



## Configurable safety modules

	OSSD	Relay expansion modules
Types	C 2OSSD / C 4OSSD	C 2R / C 4R
		
Dimensions HxWxD (mm)	108 x 22.5 x 114.5	108 x 22.5 x 114.5
Performance Level	Cat. 4, PL e (EN ISO 13849-1)	Cat. 4, PL e (EN ISO 13849-1)
Safety Integrity Level	SIL 3 (EN 61508)	SIL 3 (EN 61508)
Rated volatge	24 VDC ±20%	24 VDC ±20%
Function	Expansion modules	Expansion modules

### General specifications

PHFd (IEC 61508:1998)	3.16E-9 [C 2OSSD] / 3.44E-9 [C 4OSSD]	
Dissipated power	3 W max	3 W max
Digital output	PNP active high 2 [C 2OSSD]; PNP active high 4 [C 4OSSD]	
Switching voltage		240 VAC
Switching current		6 A max
Contacts		2 NO + 1 NC [C 2R] connectable to 1 OSSD pair 4 NO + 2 NC [C 4R] connectable to 2 OSSD pairs
Feedback contacts		1 NC [C 2R] / 2 NC [C 4R]

### Speed monitoring modules



	C PSS	C ES1 / C ES2
		
Dimensions HxWxD (mm)	108 x 22.5 x 114.5	108 x 22.5 x 114.5
Performance Level	Cat. 4, PL e (EN ISO 13849-1)	Cat. 4, PL e (EN ISO 13849-1)
Safety Integrity Level	SIL 3 (EN 61508)	SIL 3 (EN 61508)
Rated volatge	24 VDC ±20%	24 VDC ±20%
Function	Can be used to control the following: <ul style="list-style-type: none"> <li>• Zero speed, Max. speed, Speed range;</li> <li>• Direction of movement, rotation/translation;</li> </ul> Up to 4 speed thresholds can be set for each logic output (axis). Each unit incorporates two logic outputs that can be configured using the software and is thus capable of controlling up to two independent axes	Can be used to control the following: <ul style="list-style-type: none"> <li>• Zero speed, Max. speed, Speed range;</li> <li>• Direction of movement, rotation/translation;</li> </ul> Up to 4 speed thresholds can be set for each logic output (axis). Each unit incorporates two logic outputs that can be configured using the software and is thus capable of controlling up to two independent axes

### General specifications

Dissipated power	3 W max	3 W max
Max number of axis	2	2
2 proximity inputs	2 axis Sin/Cos + 1 or 2 proximity [C PSS]	
1 encoder e 2 proximity inputs		1 encoder TTL 5V + 1 or 2 proximity [C ES1T] 1 encoder HTL + 1 or 2 proximity [C ES1H]
2 encoder e 2 proximity inputs		2 encoder TTL + 1 o 2 proximity [C ES2T] 2 encoder HTL + 1 o 2 proximity [C ES2H] 2 encoder Sin/Cos + 1 o 2 proximity [C ES2S]



# Configurable safety modules

	Data and diagnostics communication modules	Bus transfer expansion modules
Types	C DDC	C BT
		
Dimensions HxWxD (mm)	108 x 22.5 x 114.5	108 x 22.5 x 114.5
Performance Level	Cat. 4, PL e (EN ISO 13849-1)	Cat. 4, PL e (EN ISO 13849-1)
Safety Integrity Level	SIL 3 (EN 61508)	SIL 3 (EN 61508)
Rated voltage	24 VDC ±20%	24 VDC ±20%
Function	Communication with most common industrial fieldbus system	Interface expansion module allowing the connection of remote expansions. Ideal solution for the interconnection of the safety functions of several machines in a production line
<b>General specifications</b>		
Connection		Shielded cable compatible with RS485
Max connection distance		50 m
Max number of CBT modules per system		6
References	Profibus [C PFBUS] DeviceNET [C DNET] CANopen [C CAN] Ethernet IP [C EIP] EtherCAT [C ECAT] PROFINET [C PFNET] Universal Serial Bus [C OMMS]	1 connection (1 input or 1 output) [C BT1] 2 connections (1 input and 1 output) [C BT2]  The C BT1 is placed at the beginning or at the end of the network connected with a single cable, whilst the C BT2 goes in the middle.

# Safety switches - Electromagnetic safety interlock

## Interlock types

### Electrical

### Mechanical



## Family: ESI

	ESI Electrical Interlock	ESI Mechanical Interlock
Material body	Polimeric	Polimeric
Dimensions WxHxD (mm)	40 x 190 x 42	40 x 190 x 42
<b>References contact block</b>		
1NO + 2NC (Coil) + 1NC (Actuator)	<b>ESI31xE024</b>	<b>ESI31xM024</b>
1NO + 2NC (Coil) + 1NO (Actuator)	<b>ESI22xE024</b>	<b>ESI22xM024</b>
2NC (Coil) + 1NO + 1NC (Actuator)	<b>ESI13xE024</b>	<b>ESI13xM024</b>
1NO + 2NC (Coil) + 1NC (Actuator)	<b>ESI31xE120</b>	<b>ESI31xM120</b>
1NO + 2NC (Coil) + 1NO (Actuator)	<b>ESI22xE120</b>	<b>ESI22xM120</b>
2NC (Coil) + 1NO + 1NC (Actuator)	<b>ESI13xE120</b>	<b>ESI13xM120</b>
1NO + 2NC (Coil) + 1NC (Actuator)	<b>ESI31xE230</b>	<b>ESI31xM230</b>
1NO + 2NC (Coil) + 1NO (Actuator)	<b>ESI22xE230</b>	<b>ESI22xM230</b>
2NC (Coil) + 1NO + 1NC (Actuator)	<b>ESI13xE230</b>	<b>ESI13xM230</b>
<b>General specifications (for all types)</b>		
Conformance	Low Voltage Directive 2014/35/EU in accordance with EN/IEC 60947-5-1	Low Voltage Directive 2014/35/EU in accordance with EN/IEC 60947-5-1
	Machinery Directive 2006/42/CE in accordance with EN ISO 14119	Machinery Directive 2006/42/CE in accordance with EN ISO 14119
	SILCL 3 in accordance with EN 62061	SILCL 3 in accordance with EN 62061
	PL e in accordance with EN ISO 13849-1	PL e in accordance with EN ISO 13849-1
	Interlock type 2 in accordance with EN ISO 14119	Interlock type 2 in accordance with EN ISO 14119
Max actuating speed	20 m/min	20 m/min
Switching frequency	600 cycles/h	600 cycles/h
Load factor	0.5	0.5
Retention force at locked actuator	1200 N	1200 N
Mechanical durability	1,000,000 operations	1,000,000 operations
B10d	4,000,000 operations	4,000,000 operations
Rated operating current AC-15	24 V - 10 A	24 V - 10 A
Rated operating current AC-15	230 V - 4 A	230 V - 4 A
Rated operating current DC-13	24 V - 4 A	24 V - 4 A

X must be replaced depending on the head orientation:  
1: 0° 2: 90° 3: 180° 4: 270°

CARLO GAVAZZI Automation Components. Specifications are subject to change without notice. Illustrations are for example only.

# Limit switches - Safety type

## Head types

Key Actuator 90° adj. head (key must be ordered separately)



### Family: S

	PS21	PS42	PS31	PS43
	Thermoplastic*	Thermoplastic*	Thermoplastic*	Metal
Dimensions WxHxD (mm)	30.3 x 90 x 30	57 x 83 x 33	41.3 x 109.5 x 41	43 x 104.5 x 66
<b>References contact block</b>				
Snap 1NO+1NC	PS21S-PS1105-T00	PS42S-PS1105-T00	PS31S-PS1105-T00	PS43S-PS1105-Y00
Snap 2NC	PS21S-PS0205-T00	PS42S-PS0205-T00	PS31S-PS0205-T00	PS43S-PS0205-Y00
Slow 1NO+1NC	PS21S-PT1105-T00	PS42S-PT1105-T00	PS31S-PT1105-T00	PS43S-PT1105-Y00
Slow Ov.**1NO+1NC	PS21S-PO1105-T00	PS42S-PO1105-T00	PS31S-PO1105-T00	PS43S-PO1105-Y00
Slow 2NC	PS21S-PT0205-T00	PS42S-PT0205-T00	PS31S-PT0205-T00	PS43S-PT0205-Y00
Slow 2NO+1NC			PS31S-PT2105-T00	PS43S-PT2105-Y00
Slow 1NO+2NC			PS31S-PT1205-T00	PS43S-PT1205-Y00
Slow 3NC			PS31S-PT0305-T00	PS43S-PT0305-Y00

## Head types

Key actuator fully turnable head (key must be ordered separately)

Hinge Switch Operated lever\*



### Family: S / H

	PS21	PS42	PS21	PS42
	Thermoplastic*	Thermoplastic*	Thermoplastic*	Thermoplastic*
Dimensions WxHxD (mm)	30.3 x 98.6 x 30	57 x 91.5 x 33	30.3 x 157 x 42	57 x 150 x 42
<b>References contact block</b>				
Snap 1NO+1NC	PS21S-PS1109-T00	PS42S-PS1109-T00	PS21H-PS11HC-T00	PS42H-PS11HC-T00
Snap 2NC	PS21S-PS0209-T00	PS42S-PS0209-T00	PS21H-PS02HC-T00	PS42H-PS02HC-T00
Slow 1NO+1NC	PS21S-PT1109-T00	PS42S-PT1109-T00	PS21H-PT11HC-T00	PS42H-PT11HC-T00
Slow Ov.**1NO+1NC	PS21S-PO1109-T00	PS42S-PO1109-T00	PS21H-PO11HC-T00	PS42H-PO11HC-T00
Slow 2NC	PS21S-PT0209-T00	PS42S-PT0209-T00	PS21H-PT02HC-T00	PS42H-PT02HC-T00

## Head types

Hinge shaft Zinc plated steel

Hinge Shaft Stainless steel



### Family: H

	PS21	PS42	PS21	PS42
	Thermoplastic*	Thermoplastic*	Thermoplastic*	Thermoplastic*
Dimensions WxHxD (mm)	30.3 x 79.5 x 51.2	57 x 72.5 x 52.5	30.3 x 79.5 x 51.2	30.3 x 72.5 x 52.5
<b>References contact block</b>				
Snap 1NO+1NC	PS21H-PS11HZ-T00	PS42H-PS11HZ-T00	PS21H-PS11HS-T00	PS42H-PS11HS-T00
Snap 2NC	PS21H-PS02HZ-T00	PS42H-PS02HZ-T00	PS21H-PS02HS-T00	PS42H-PS02HS-T00
Slow 1NO+1NC	PS21H-PT11HZ-T00	PS42H-PT11HZ-T00	PS21H-PT11HS-T00	PS42H-PT11HS-T00
Slow Ov.**1NO+1NC	PS21H-PO11HZ-T00	PS42H-PO11HZ-T00	PS21H-PO11HS-T00	PS42H-PO11HS-T00
Slow 2NC	PS21H-PT02HZ-T00	PS42H-PT02HZ-T00	PS21H-PT02HS-T00	PS42H-PT02HS-T00

### General specifications (for all types)

Degree of protection	IP 65 (plastic body) IP 66 (metal body)	Rated operational current	
Rated insulation voltage plastic body	(U <sub>i</sub> )	le/AC-15 230 VAC	3.1 A
according to IEC 60947-1 and EN 60947-1	500 V	le/DC-13 24 VDC	2.8 A
according to UL 508, CSA C22-2 n°14	A 600, Q 600	Electrical durability (according to IEC 60947-5-1 annex C)	
Rated insulation voltage metal body	(U <sub>i</sub> )	max. switching frequency Cycles/h	3600
according to IEC 60947-1 and EN 60947-1	400 V (PS21, PS42)	load factor	0.5
	500 V (PS31, PS43)	Air temperature near the device	
according to UL 508, CSA C22-2 n°14	A 300, Q 300 (PS21, PS42)	during operation	-25 to +70°C
	A 600, Q 600 (PS31, PS43)	for storage	-30 to +80°C
Rated impulse withstand voltage U <sub>imp</sub>	6 kV	Approvals	CE - UL - CSA

\* also available in metal (M type) \*\* Ov.: overlapping travel paths

CARLO GAVAZZI Automation Components. Specifications are subject to change without notice. Illustrations are for example only.

# Limit switches - Safety type

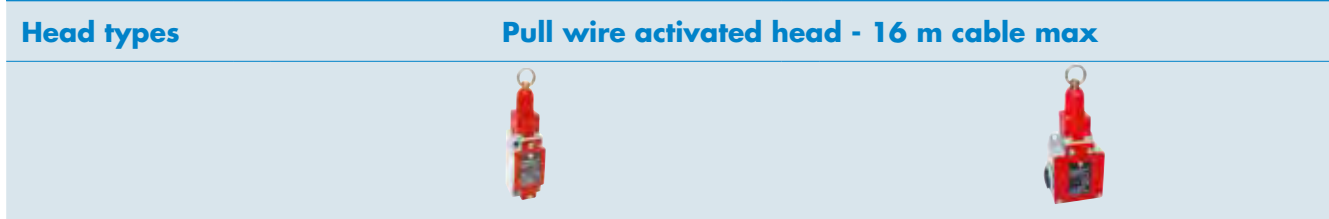

**Family: R**

	<b>PS31</b> Metal	<b>PS43</b> Metal
Dimensions WxHxD (mm)	40 x 162.75 x 43	63 x 158.25 x 43.3

**References contact block**

	<b>PS31R-PS11N7-Y00</b>	<b>PS43R-PS11N7-Y00</b>
Snap 1NO+1NC	PS31R-PS02N7-Y00	PS43R-PS02N7-Y00
Snap 2NC	PS31R-PT11N7-Y00	PS43R-PT11N7-Y00
Slow 1NO+1NC	PS31R-PO11N7-Y00	PS43R-PO11N7-Y00
Slow Ov.**1NO+1NC	PS31R-PT02N7-Y00	PS43R-PT02N7-Y00
Slow 2NC	PS31R-PT21N7-Y00	PS43R-PT21N7-Y00
Slow 2NO+1NC	PS31R-PT12N7-Y00	PS43R-PT12N7-Y00
Slow 1NO+2NC	PS31R-PT03N7-Y00	PS43R-PT03N7-Y00
Slow 3NC		

**Head types** **Pull wire activated head with pull button reset - 16 m cable max**

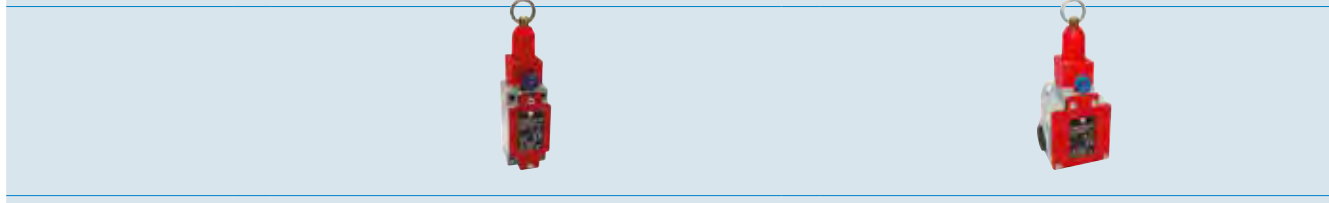

**Family: H**

	<b>PS31</b> Metal	<b>PS43</b> Metal
Dimensions WxHxD (mm)	40 x 162.75 x 43	63 x 158.25 x 44

**References contact block**

	<b>PS31R-PS11N7-YK0</b>	<b>PS43R-PS11N7-YK0</b>
Snap 1NO+1NC	PS31R-PS02N7-YK0	PS43R-PS02N7-YK0
Snap 2NC	PS31R-PT11N7-YK0	PS43R-PT11N7-YK0
Slow 1NO+1NC	PS31R-PO11N7-YK0	PS43R-PO11N7-YK0
Slow Ov.**1NO+1NC	PS31R-PT02N7-YK0	PS43R-PT02N7-YK0
Slow 2NC	PS31R-PT21N7-YK0	PS43R-PT21N7-YK0
Slow 2NO+1NC	PS31R-PT12N7-YK0	PS43R-PT12N7-YK0
Slow 1NO+2NC	PS31R-PT03N7-YK0	PS43R-PT03N7-YK0
Slow 3NC		

**General specifications (for all types)**

Degree of protection	IP 65 (plastic body) IP 66 (metal body)	Rated operational current	
Rated insulation voltage plastic body	(Ui)	le/AC-15 230 VAC	3.1 A
according to IEC 60947-1 and EN 60947-1	500 V	le/DC-13-24 VDC	2.8 A
according to UL 508, CSA C22-2 n°14	A 600, Q 600	Electrical durability (according to IEC 60947-5-1 annex C)	
Rated insulation voltage metal body	(Ui)	max. switching frequency Cycles/h	3600
according to IEC 60947-1 and EN 60947-1	400 V (PS21, PS42) 500 V (PS31, PS43)	load factor	0.5
according to UL 508, CSA C22-2 n°14	A 300, Q 300 (PS21, PS42) A 600, Q 600 (PS31, PS43)	Air temperature near the device	
Rated impulse withstand voltage Uimp	6 kV	during operation	-25 to +70°C
		for storage	-30 to +80°C
		Approvals	CE - UL - CSA

\* also available in metal (Y type) \*\* Ov.: overlapping travel paths  
 CARLO GAVAZZI Automation Components. Specifications are subject to change without notice. Illustrations are for example only.

# Limit switches - Safety type with pull button reset

## Head Types

**PO**  
Steel plunger

**PR** Steel plunger  
with nylon roller

**R3** Plastic roller lever  
on metal plunger

**RT** Lever with  
nylon roller



## Family: K

	PS21	PS21	PS21	PS21
	Thermoplastic*	Thermoplastic*	Thermoplastic*	Thermoplastic*
Dimensions WxHxD (mm)	30.3 x 88 x 36.5	30.3 x 99 x 36.5	30.3 x 107 x 36.5	39 x 106 x 45

## References contact block

Snap 1NO+1NC	⊕	PS21K-PS11PO-T00	PS21K-PS11PR-T00	PS21K-PS11R3-T00	PS21K-PS1105-T00
Snap 2NC	⊕	PS21K-PS02PO-T00	PS21K-PS02PR-T00	PS21K-PS02R3-T00	PS21K-PS0205-T00
Slow 1NO+1NC	⊕	PS21K-PT11PO-T00	PS21K-PT11PR-T00	PS21K-PT11R3-T00	PS21K-PT1105-T00
Slow 2NC	⊕	PS21K-PT02PO-T00	PS21K-PT02PR-T00	PS21K-PT02R3-T00	PS21K-PT02RT-T00



## Family: K

	PS42	PS42	PS42	PS42
	Thermoplastic*	Thermoplastic*	Thermoplastic*	Thermoplastic*
Dimensions WxHxD (mm)	57 x 81 x 36.5	57 x 92 x 36.5	57 x 100 x 36.5	57 x 99 x 45

## References contact block

Snap 1NO+1NC	⊕	PS42K-PS11PO-T00	PS42K-PS11PR-T00	PS42K-PS11R3-T00	PS42K-PS11RT-T00
Snap 2NC	⊕	PS42K-PS02PO-T00	PS42K-PS02PR-T00	PS42K-PS02R3-T00	PS42K-PS02RT-T00
Slow 1NO+1NC	⊕	PS42K-PT11PO-T00	PS42K-PT11PR-T00	PS42K-PT11R3-T00	PS42K-PT11RT-T00
Slow 2NC	⊕	PS42K-PT02PO-T00	PS42K-PT02PR-T00	PS42K-PT02R3-T00	PS42K-PT02RT-T00

## Head Types

**R4** Roller Lever,  
external side actuation

**LR** Roller Lever Ø22,  
side actuation



## Family: K

	PS21	PS42
	Thermoplastic*	Thermoplastic*
Dimensions WxHxD (mm)	44 x 107 x 36.5	57 x 112 x 36.5

## References contact block

Snap 1NO+1NC	⊕	PS21K-PS11R4-T00	PS42K-PS11LR-T00
Snap 2NC	⊕	PS21K-PS02R4-T00	PS42K-PS02LR-T00
Slow 1NO+1NC	⊕	PS21K-PT11R4-T00	PS42K-PT11LR-T00
Slow 2NC	⊕	PS21K-PT02R4-T00	PS42K-PT02LR-T00



## General specifications (for all types)

Degree of protection	IP 65	Rated operational current	
Rated insulation voltage plastic body	(U <sub>i</sub> )	I <sub>e</sub> /AC-15 230 VAC	3.1 A
according to IEC 60947-1 and EN 60947-1	500 V	I <sub>e</sub> /DC-13-24 VDC	2.8 A
according to UL 508, CSA C22-2 n°14	A 600, Q 600	Electrical durability (according to IEC 60947-5-1 annex C)	
Rated insulation voltage metal body	(U <sub>i</sub> )	max. switching frequency Cycles/h	3600
according to IEC 60947-1 and EN 60947-1	400 V	load factor	0.5
	500 V	Air temperature near the device	
according to UL 508, CSA C22-2 n°14	A 300, Q 300 (PS21, PS42)	during operation	-25 to +70°C
	A 600, Q 600 (PS31, PS43)	for storage	-30 to +80°C
Rated impulse withstand voltage U <sub>imp</sub>	6 kV	Approvals	CE - UL - CSA



\* Also available in metal (Y type) other types available

CARLO GAVAZZI Automation Components. Specifications are subject to change without notice. Illustrations are for example only.

## Limit switches - Safety hinge

Head types	Safety hinge	Safety hinge	Safety hinge
			
<b>Family: PS38H</b>			
	PS38H M12 connector	PS38H 2 m cable	PS38H 2 m cable back output
Material body	Thermoplastic	Thermoplastic	Thermoplastic
Dimensions WxHxD (mm)	60 x 110 x 15	60 x 110 x 15	60 x 110 x 15
<b>References contact block</b>			
Slow action T22: 2NO + 2NC	<b>PS38H-IT2205-T01</b>	<b>PS38H-CT2205-T01</b>	<b>PS38H-CT2205-T02</b>
Slow action T13: 1NO + 3NC	<b>PS38H-IT1305-T01</b>	<b>PS38H-CT1305-T01</b>	<b>PS38H-CT1305-T02</b>
<b>General specifications (for all types)</b>			
Conformance	IEC 947-5-1 and European EN 60947-5-1 standards. Safety system of machinery up to SIL 3 or PLe according to EN ISO 13849-1	IEC 947-5-1 and European EN 60947-5-1 standards. Safety system of machinery up to SIL 3 or PLe according to EN ISO 13849-1	IEC 947-5-1 and European EN 60947-5-1 standards. Safety system of machinery up to SIL 3 or PLe according to EN ISO 13849-1
Air temperature near the device	Operation - 20°C to + 80°C Storage - 20°C to + 80°C	Operation - 20°C to + 80°C Storage - 20°C to + 80°C	Operation - 20°C to + 80°C Storage - 20°C to + 80°C
Degree of protection	IP 67	IP 67	IP 67
Mechanical durability	1,000,000 operations	1,000,000 operations	1,000,000 operations
Operation frequency	1,200 cycles/h	1,200 cycles/h	1,200 cycles/h
B10d	2,000,000 cycles	2,000,000 cycles	2,000,000 cycles
Positive opening operation (according to IEC 947-5-1)	All NC contacts are positive opening operation (min. actuating torque 0.5 Nm)	All NC contacts are positive opening operation (min. actuating torque 0.5 Nm)	All NC contacts are positive opening operation (min. actuating torque 0.5 Nm)
Rated insulation voltage Ui	30 V	400 V	400 V
Protection against electrical shocks (according to IEC 536)	Class II	Class II	Class II
Thermal current Ith	2 A	4 A	4 A
Rated operational current	24 VDC - 2 A	24 - 120 - 250 - 400 VCA 4 A 24 VDC 2 A / 125 VDC 0.4 A / 250 VDC 0.3 A	24 - 120 - 250 - 400 VAC 4 A 24 VDC 2 A / 125 VDC 0.4 A / 250 VDC 0.3 A
Approvals	CE - UL - CSA	CE - UL - CSA	CE - UL - CSA

# Limit switches - Miniature type

Head Types	<b>PO</b> Plain plunger	<b>PY</b> Nylon roller plunger	<b>P8</b> Cross nylon roller plunger	<b>RT</b> Ø14 Nylon roller lever
				

Dimensions WxHxD (mm)	35 x 60 x 16 1 m PVC cable	35 x 70 x 16 1 m PVC cable	35 x 70 x 16 1 m PVC cable	35 x 92 x 29.5 1 m PVC cable
-----------------------	-------------------------------	-------------------------------	-------------------------------	---------------------------------

## PS31M (metal\*) References contact block

Snap 1NO+1NC	⊕	<b>PS31M-CS11PO-M00</b>	<b>PS31M-CS11PY-M00</b>	<b>PS31M-CS11P8-M00</b>	<b>PS31M-CS11RT-M00</b>
Slow 1NO+1NC	⊕	<b>PS31M-CT11PO-M00</b>	<b>PS31M-CT11PY-M00</b>	<b>PS31M-CT11P8-M00</b>	<b>PS31M-CT11RT-M00</b>



Dimensions WxHxD (mm)	31.5 x 60 x 16 1 m PVC cable	31.5 x 70 x 16 1 m PVC cable	31.5 x 70 x 16 1 m PVC cable	31.5 x 92 x 29.5 1 m PVC cable
-----------------------	---------------------------------	---------------------------------	---------------------------------	-----------------------------------

## PS21M (metal\*) References contact block

Snap 1NO+1NC	⊕	<b>PS21M-CS11PO-M00</b>	<b>PS21M-CS11PY-M00</b>	<b>PS21M-CS11P8-M00</b>	<b>PS21M-CS11RT-M00</b>
Slow 1NO+1NC	⊕	<b>PS21M-CT11PO-M00</b>	<b>PS21M-CT11PY-M00</b>	<b>PS21M-CT11P8-M00</b>	<b>PS21M-CT11RT-M00</b>

Head Types	Plain plunger with fixing nuts	Roller plunger with fixing nuts	Cross roller plunger with fixing nuts	<b>R1</b> Adjustable lever with Ø18 nylon roller
------------	-----------------------------------	------------------------------------	--	---



Dimensions (mm) WxHxD	35 x 74 x 16 1 m PVC cable	35 x 84.8 x 16 1 m PVC cable	35 x 84.8 x 16 1 m PVC cable	35 x 86...158 x 38.9 1 m PVC cable
-----------------------	-------------------------------	---------------------------------	---------------------------------	---------------------------------------

## PS31M (metal\*) References contact block

Snap 1NO+1NC	⊕	<b>PS31M-CS11PO-MOL</b>	<b>PS31M-CS11PY-MOL</b>	<b>PS31M-CS11P8-MOL</b>	<b>PS31M-CS11RT-MOL</b>
Slow 1NO+1NC	⊕	<b>PS31M-CT11PO-MOL</b>	<b>PS31M-CT11PY-MOL</b>	<b>PS31M-CT11P8-MOL</b>	<b>PS31M-CT11RT-MOL</b>



Dimensions WxHxD (mm)	31.5 x 74 x 16 1 m PVC cable	31.5 x 84.8 x 16 1 m PVC cable	31.5 x 84.8 x 16 1 m PVC cable	31.5 x 86...158 x 38.9 1 m PVC cable
-----------------------	---------------------------------	-----------------------------------	-----------------------------------	---

## PS21M (metal\*) References contact block

Snap 1NO+1NC	⊕	<b>PS21M-CS11PO-MOL</b>	<b>PS21M-CS11PY-MOL</b>	<b>PS21M-CS11P8-MOL</b>	<b>PS21M-CS11RT-MOL</b>
Slow 1NO+1NC	⊕	<b>PS21M-CT11PO-MOL</b>	<b>PS21M-CT11PY-MOL</b>	<b>PS21M-CT11P8-MOL</b>	<b>PS21M-CT11RT-MOL</b>

## General specifications (for all types)

Mechanical life	>10 000 000 cycles	Rated thermal current (I <sub>th</sub> )	10 A (IEC947-5-1)
Operating frequency	3600 cycles/h	Rated insulation voltage (U <sub>i</sub> )	400 VAC (IEC947-5-1)
Rated operating current (I <sub>e</sub> )	1.5 A/230 V (Cat. AC15)	Degree of protection	IP 67
	1.1 A/24 V (Cat. DC13)	Approvals	CE - UL (upon request)

\* Also available in thermoplastic (T type)

# Limit switches - Limit type

Head Types	PO Plain plunger	PR Roller plunger	RH Plastic roller plunger	RT Nylon roller lever
------------	---------------------	----------------------	------------------------------	--------------------------

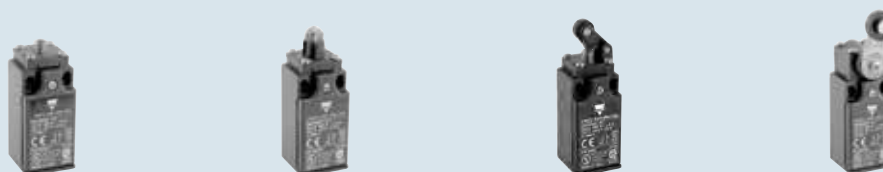

## Family: L

	PS21	PS21	PS21	PS21
	Thermoplastic*	Thermoplastic*	Thermoplastic*	Thermoplastic*
Dimensions WxHxD (mm)	30.3 x 73 x 30	30.3 x 84 x 30	30.3 x 92 x 30	30.3 x 106 x 45

## References contact block

Snap 1NO+1NC	⊕	PS21L-PS11P0-T00	PS21L-PS11PR-T00	PS21L-PS11RH-T00	PS21L-PS11RT-T00
Slow 1NO+1NC	⊕	PS21L-PT11P0-T00	PS21L-PT11PR-T00	PS21L-PT11RH-T00	PS21L-PT11RT-T00
Slow Ov.**1NO+1NC	⊕	PS21L-PO11P0-T00	PS21L-PO11PR-T00	PS21L-PO11RH-T00	PS21L-PO11RT-T00
Slow 2NO		PS21L-PT20P0-T00	PS21L-PT20PR-T00	PS21L-PT20RH-T00	PS21L-PT20RT-T00
Slow 2NC	⊕	PS21L-PT02P0-T00	PS21L-PT02PR-T00	PS21L-PT02RH-T00	PS21L-PT02RT-T00
Snap 2NC	⊕	PS21L-PS02P0-T00	PS21L-PS02PR-T00	PS21L-PS02RH-T00	PS21L-PS02RT-T00

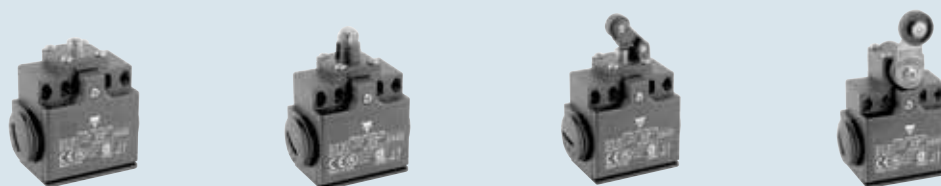

## Family: L

	PS42	PS42	PS42	PS42
	Thermoplastic*	Thermoplastic*	Thermoplastic*	Thermoplastic*
Dimensions WxHxD (mm)	57 x 66 x 33	57 x 77 x 33	57 x 85 x 33	57 x 99 x 45

## References contact block

Snap 1NO+1NC	⊕	PS42L-PS11P0-T00	PS42L-PS11PR-T00	PS42L-PS11RH-T00	PS42L-PS11RT-T00
Slow 1NO+1NC	⊕	PS42L-PT11P0-T00	PS42L-PT11PR-T00	PS42L-PT11RH-T00	PS42L-PT11RT-T00
Slow Ov.**1NO+1NC	⊕	PS42L-PO11P0-T00	PS42L-PO11PR-T00	PS42L-PO11RH-T00	PS42L-PO11RT-T00
Slow 2NO		PS42L-PT20P0-T00	PS42L-PT20PR-T00	PS42L-PT20RH-T00	PS42L-PT20RT-T00
Slow 2NC	⊕	PS42L-PT02P0-T00	PS42L-PT02PR-T00	PS42L-PT02RH-T00	PS42L-PT02RT-T00
Snap 2NC	⊕	PS42L-PS02P0-T00	PS42L-PS02PR-T00	PS42L-PS02RH-T00	PS42L-PS02RT-T00

## General specifications (for all types)

Degree of protection	IP 65 (plastic body) IP 66 (metal body)	Rated operational current	
Rated insulation voltage plastic body	(Ui)	le/AC-15 230 VAC	3.1 A
	according to IEC 60947-1 and EN 60947-1	le/DC-13-24 VDC	2.8 A
	according to UL 508, CSA C22-2 n°14	Electrical durability (according to IEC 60947-5-1 annex C)	
Rated insulation voltage metal body	(Ui)	max. switching frequency Cycles/h	3600
	according to IEC 60947-1 and EN 60947-1	load factor	0.5
	400 V (PS21, PS42)	Air temperature near the device	
	500 V (PS31, PS43)	during operation	-25 to +70°C
	according to UL 508, CSA C22-2 n°14	for storage	-30 to +80°C
Rated impulse withstand voltage U <sub>imp</sub>	6 kV	Approvals	CE - UL - CSA

\* also available in metal (V type)    \*\* Ov.: overlapping travel paths



# Limit switches - Limit type

## Head types

**W1** Adjustable lever with Ø50 rubber roller

**R1** Adjustable lever with Ø18 nylon roller

**BE** Ø18 nylon roller lever

**LW** Stainless steel spring cat whisker



## Family: L

	PS21	PS21	PS21	PS21
	Thermoplastic*	Thermoplastic*	Thermoplastic*	Thermoplastic*
Dimensions WxHxD (mm)	30.3 x (126.5-186.5) x 52	30.3 x (98.5-170.5) x 45.5	30.3 x 114 x 33	30.3 x 188 x 30

## References contact block

Snap 1NO+1NC	⊕	PS21L-PS11W1-T00	PS21L-PS11R1-T00	PS21L-PS11BE-T00	PS21L-PS11LW-T00
Slow 1NO+1NC	⊕	PS21L-PT11W1-T00	PS21L-PT11R1-T00	PS21L-PT11BE-T00	PS21L-PT11LW-T00
Slow Ov.**1NO+1NC	⊕	PS21L-PO11W1-T00	PS21L-PO11R1-T00	PS21L-PO11BE-T00	PS21L-PO11LW-T00
Slow 2NO		PS21L-PT20W1-T00	PS21L-PT20R1-T00	PS21L-PT20BE-T00	PS21L-PT20LW-T00
Slow 2NC	⊕	PS21L-PT02W1-T00	PS21L-PT02R1-T00	PS21L-PT02BE-T00	PS21L-PT02LW-T00
Snap 2NC	⊕	PS21L-PS02W1-T00	PS21L-PS02R1-T00	PS21L-PS02BE-T00	PS21L-PS02LW-T00



## Family: L

	PS42	PS42	PS42	PS42
	Thermoplastic*	Thermoplastic*	Thermoplastic*	Thermoplastic*
Dimensions WxHxD (mm)	57 x (118.5-177) x 33	57 x (91.5-163.5) x 33	57 x 107 x 33	57 x 181 x 45

## References contact block

Snap 1NO+1NC	⊕	PS42L-PS11W1-T00	PS42L-PS11R1-T00	PS42L-PS11BE-T00	PS42L-PS11LW-T00
Slow 1NO+1NC	⊕	PS42L-PT11W1-T00	PS42L-PT11R1-T00	PS42L-PT11BE-T00	PS42L-PT11LW-T00
Slow Ov.**1NO+1NC	⊕	PS42L-PO11W1-T00	PS42L-PO11R1-T00	PS42L-PO11BE-T00	PS42L-PO11LW-T00
Slow 2NO		PS42L-PT20W1-T00	PS42L-PT20R1-T00	PS42L-PT20BE-T00	PS42L-PT20LW-T00
Slow 2NC	⊕	PS42L-PT02W1-T00	PS42L-PT02R1-T00	PS42L-PT02BE-T00	PS42L-PT02LW-T00
Snap 2NC	⊕	PS42L-PS02W1-T00	PS42L-PS02R1-T00	PS42L-PS02BE-T00	PS42L-PS02LW-T00

## General specifications (for all types)

Degree of protection	IP 65 (plastic body) IP 66 (metal body)	Rated operational current	
Rated insulation voltage plastic body	(U <sub>i</sub> )	le/AC-15 230 VAC	3.1 A
according to IEC 60947-1 and EN 60947-1	500 V	le/AC-13 24 VDC	2.8 A
according to UL 508, CSA C22-2 n°14	A 600, Q 600	Electrical durability (according to IEC 60947-5-1 annex C)	
Rated insulation voltage metal body	(U <sub>i</sub> )	max. switching frequency Cycles/h	3600
according to IEC 60947-1 and EN 60947-1	400 V (plastic body)	load factor	0.5
	500 V (PS31, PS43)	Air temperature near the device	
according to UL 508, CSA C22-2 n°14	A 300, Q 300 (PS21, PS42)	during operation	-25 to +70°C
	A 600, Q 600 (PS31, PS43)	for storage	-30 to +80°C
Rated impulse withstand voltage U <sub>imp</sub>	6 kV	Approvals	CE - UL - CSA

\* also available in metal (M type) \*\* Ov.: overlapping travel paths

# Limit switches - Limit type

Head types	PO Plain plunger	PR Roller plunger	RH Plastic roller lever	RT Nylon roller lever
				

## Family: L

	PS43 Metal	PS43 Metal	PS43 Metal	PS43 Metal
Dimensions WxHxD (mm)	66 x 102.5 x 43	66 x 115.5 x 43	67 x 129.5 x 43	66 x 128.5 x 61.5

## References contact block

Snap 1NO+1NC	↔	PS43L-PS11PO-M00	PS43L-PS11PR-M00	PS43L-PS11RH-M00	PS43L-PS11RT-M00
Slow 1NO+1NC	↔	PS43L-PT11PO-M00	PS43L-PT11PR-M00	PS43L-PT11RH-M00	PS43L-PT11RT-M00
Slow Ov.**1NO+1NC	↔	PS43L-PO11PO-M00	PS43L-PO11PR-M00	PS43L-PO11RH-M00	PS43L-PO11RT-M00
Slow 2NO	↔	PS43L-PT20PO-M00	PS43L-PT20PR-M00	PS43L-PT20RH-M00	PS43L-PT20RT-M00
Slow 2NC	↔	PS43L-PT02PO-M00	PS43L-PT02PR-M00	PS43L-PT02RH-M00	PS43L-PT02RT-M00
Snap 2NC	↔	PS43L-PS02PO-M00	PS43L-PS02PR-M00	PS43L-PS02RH-M00	PS43L-PS02RT-M00
Slow 1NO+2NC	↔	PS43L-PT12PO-M00	PS43L-PT12PR-M00	PS43L-PT12RH-M00	PS43L-PT12RT-M00
Slow 2NO+1NC	↔	PS43L-PT21PO-M00	PS43L-PT21PR-M00	PS43L-PT21RH-M00	PS43L-PT21RT-M00
Slow 3NC	↔	PS43L-PT03PO-M00	PS43L-PT03PR-M00	PS43L-PT03RH-M00	PS43L-PT03RT-M00
Slow 3NO	↔	PS43L-PT30PO-M00	PS43L-PT30PR-M00	PS43L-PT30RH-M00	PS43L-PT30RT-M00



## Family: L

	PS31 Thermoplastic*	PS31 Thermoplastic*	PS31 Thermoplastic*	PS31 Thermoplastic*
Dimensions WxHxD (mm)	41 x 104 x 40.5	41 x 117 x 40.5	41 x 121 x 40.5	41 x 130 x 59

## References contact block

Snap 1NO+1NC	↔	PS31L-PS11PO-T00	PS31L-PS11PR-T00	PS31L-PS11RH-T00	PS31L-PS11RT-T00
Slow 1NO+1NC	↔	PS31L-PT11PO-T00	PS31L-PT11PR-T00	PS31L-PT11RH-T00	PS31L-PT11RT-T00
Slow Ov.**1NO+1NC	↔	PS31L-PO11PO-T00	PS31L-PO11PR-T00	PS31L-PO11RH-T00	PS31L-PO11RT-T00
Slow 2NO	↔	PS31L-PT20PO-T00	PS31L-PT20PR-T00	PS31L-PT20RH-T00	PS31L-PT20RT-T00
Slow 2NC	↔	PS31L-PT02PO-T00	PS31L-PT02PR-T00	PS31L-PT02RH-T00	PS31L-PT02RT-T00
Snap 2NC	↔	PS31L-PS02PO-T00	PS31L-PS02PR-T00	PS31L-PS02RH-T00	PS31L-PS02RT-T00
Slow 1NO+2NC	↔	PS31L-PT12PO-T00	PS31L-PT12PR-T00	PS31L-PT12RH-T00	PS31L-PT12RT-T00
Slow 2NO+1NC	↔	PS31L-PT21PO-T00	PS31L-PT21PR-T00	PS31L-PT21RH-T00	PS31L-PT21RT-T00
Slow 3NC	↔	PS31L-PT03PO-T00	PS31L-PT03PR-T00	PS31L-PT03RH-T00	PS31L-PT03RT-T00
Slow 3NO	↔	PS31L-PT30PO-T00	PS31L-PT30PR-T00	PS31L-PT30RH-T00	PS31L-PT30RT-T00

## General specifications (for all types)

Degree of protection	IP 65 (plastic body) IP 66 (metal body)	Rated operational current	
Rated insulation voltage plastic body	(U <sub>i</sub> )	I <sub>e</sub> /AC-15 230 VAC	3.1 A
according to IEC 60947-1 and EN 60947-1	500 V	I <sub>e</sub> /DC-13-24 VDC	2.8 A
according to UL 508, CSA C22-2 n°14	A 600, Q 600	Electrical durability (according to IEC 60947-5-1 annex C)	
Rated insulation voltage metal body	(U <sub>i</sub> )	max. switching frequency Cycles/h	3600
according to IEC 60947-1 and EN 60947-1	400 V (PS21, PS42)	load factor	0.5
	500 V (PS31, PS43)	Air temperature near the device	
according to UL 508, CSA C22-2 n°14	A 300, Q 300 (PS21, PS42)	during operation	-25 to +70°C
	A 600, Q 600 (PS31, PS43)	for storage	-30 to +80°C
Rated impulse withstand voltage U <sub>imp</sub>	6 kV	Approvals	CE - UL - CSA

\* also available in metal (M type) \*\* Ov.: overlapping travel paths

CARLO GAVAZZI Automation Components. Specifications are subject to change without notice. Illustrations are for example only.

# Limit switches - Limit type

## Head types

**W1** Adjustable lever with Ø50 rubber roller

**R1** Adjustable lever with Ø18 nylon roller

**BE** Ø50 nylon roller lever

**LW** Stainless steel spring cat whisker



## Family: L

	PS43 Metal	PS43 Metal	PS43 Metal	PS43 Metal
Dimensions WxHxD (mm)	62 x (147.5-203.5) x 62.5	62 x (133.5-189.5) x 60	62 x 142.5 x 66	62 x 195,5 x 43

## References contact block

Snap 1NO+1NC	⊕	PS43L-PS11W1-M00	PS43L-PS11R1-M00	PS43L-PS11W0-M00	PS43L-PS11LW-M00
Slow 1NO+1NC	⊕	PS43L-PT11W1-M00	PS43L-PT11R1-M00	PS43L-PT11W0-M00	PS43L-PT11LW-M00
Slow Ov.**1NO+1NC	⊕	PS43L-PO11W1-M00	PS43L-PO11R1-M00	PS43L-PO11W0-M00	PS43L-PO11LW-M00
Slow 2NO		PS43L-PT20W1-M00	PS43L-PT20R1-M00	PS43L-PT20W0-M00	PS43L-PT20LW-M00
Slow 2NC	⊖	PS43L-PT02W1-M00	PS43L-PT02R1-M00	PS43L-PT02W0-M00	PS43L-PT02LW-M00
Snap 2NC	⊖	PS43L-PS02W1-M00	PS43L-PS02R1-M00	PS43L-PS02W0-M00	PS43L-PS02LW-M00
Slow 1NO+2NC	⊕	PS43L-PT12W1-M00	PS43L-PT12R1-M00	PS43L-PT12W0-M00	PS43L-PT12LW-M00
Slow 2NO+1NC	⊕	PS43L-PT21W1-M00	PS43L-PT21R1-M00	PS43L-PT21W0-M00	PS43L-PT21LW-M00
Slow 3NC	⊖	PS43L-PT03W1-M00	PS43L-PT03R1-M00	PS43L-PT03W0-M00	PS43L-PT03LW-M00
Slow 3NO		PS43L-PT30W1-M00	PS43L-PT30R1-M00	PS43L-PT30W0-M00	PS43L-PT30LW-M00

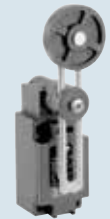

## Family: L

	PS31 Thermoplastic*	PS31 Thermoplastic*	PS31 Thermoplastic*	PS31 Thermoplastic*
Dimensions WxHxD (mm)	50 x (149-205) x 65	41 x (135-191) x 60	50 x 144 x 64.5	41 x 195 x 40.5

## References contact block

Snap 1NO+1NC	⊕	PS31L-PS11W1-T00	PS31L-PS11R1-T00	PS31L-PS11W0-T00	PS31L-PS11LW-T00
Slow 1NO+1NC	⊕	PS31L-PT11W1-T00	PS31L-PT11R1-T00	PS31L-PT11W0-T00	PS31L-PT11LW-T00
Slow Ov.**1NO+1NC	⊕	PS31L-PO11W1-T00	PS31L-PO11R1-T00	PS31L-PO11W0-T00	PS31L-PO11LW-T00
Slow 2NO		PS31L-PT20W1-T00	PS31L-PT20R1-T00	PS31L-PT20W0-T00	PS31L-PT20LW-T00
Slow 2NC	⊖	PS31L-PT02W1-T00	PS31L-PT02R1-T00	PS31L-PT02W0-T00	PS31L-PT02LW-T00
Snap 2NC	⊖	PS31L-PS02W1-T00	PS31L-PS02R1-T00	PS31L-PS02W0-T00	PS31L-PS02LW-T00
Slow 1NO+2NC	⊕	PS31L-PT12W1-T00	PS31L-PT12R1-T00	PS31L-PT12W0-T00	PS31L-PT12LW-T00
Slow 2NO+1NC	⊕	PS31L-PT21W1-T00	PS31L-PT21R1-T00	PS31L-PT21W0-T00	PS31L-PT21LW-T00
Slow 3NC	⊖	PS31L-PT03W1-T00	PS31L-PT03R1-T00	PS31L-PT03W0-T00	PS31L-PT03LW-T00
Slow 3NO	⊖	PS31L-PT30W1-T00	PS31L-PT30R1-T00	PS31L-PT30W0-T00	PS31L-PT30LW-T00

## General specifications (for all types)

Degree of protection	IP 65 (plastic body) IP 66 (metal body)	Rated operational current	
Rated insulation voltage plastic body	(U <sub>i</sub> )	le/AC-15 230 VAC	3.1 A
according to IEC 60947-1 and EN 60947-1	500 V	le/DC-13-24 VDC	2.8 A
according to UL 508, CSA C22-2 n°14	A 600, Q 600	Electrical durability (according to IEC 60947-5-1 annex C)	
Rated insulation voltage metal body	(U <sub>i</sub> )	max. switching frequency Cycles/h	3600
according to IEC 60947-1 and EN 60947-1	400 V (PS21, PS42)	load factor	0.5
according to UL 508, CSA C22-2 n°14	500 V (PS31, PS43)	Air temperature near the device	
	A 300, Q 300 (PS21, PS42)	during operation	-25 to +70°C
	A 600, Q 600 (PS31, PS43)	for storage	-30 to +80°C
Rated impulse withstand voltage U <sub>imp</sub>	6 kV	Approvals	CE - UL - CSA

\* also available in metal (M type) \*\* Ov.: overlapping travel paths

# Connectivity

## SCTL55

### Function Smart configurator for IO-Link sensors



Dimensions (mm)	62 x 222 x 90
Description	Portable self-powered device for an easy control, diagnosis and parameterization of IO-Link sensors
Function	<p>Intuitive GUI with dedicated App for a simplified user experience.</p> <p>Access to an advanced diagnostic with the possibility to verify operating hours, number of detections, operating cycles, alarms and quality of run of the sensor connected.</p> <p>Easy management of operating parameters such as switchpoint mode, logic and timing functions, sensing distance, output configuration (PNP/NPN/push-pull, NO/NC).</p>
Housing type	Handheld
<b>IO-Link interface</b>	
Supply voltage	24 VDC $\pm$ 20%
Maximum load	80 mA/Short circuit protected
Incorrect polarity protection	Yes
Connectors to sensor	Plug type: M8 3-wire, M8 4-wire and M12
IO-Link protocol support	IO-Link v1.1
<b>IO-Link file administration</b>	
Wi-Fi	Automatic download of IODD file via Configure App
Micro SD card	Import and save IODD file from/to Micro SD card (not included)
<b>Electrical ratings and battery information</b>	
Standard charger via micro USB	5 V/1 A or PC USB port
Battery type	High capacity LI-ION rechargeable battery
Operating time (with sensor connected)	Full operation: > 5 hours; Screen off: > 22 hours
Standby time	Device completely off: 6 months
<b>General specifications</b>	
User interface	High definition 5.5" touchscreen display, 720 x 1280 pixel
Indication	5 LED for main battery status LEDs for Power, IO-Link, Error, SIO2 and USB
Degree of protection	IP 30
Pollution degree	2
Ambient air temperature	Charging: 10°C to +35°C; Operating: 0°C to +40°C
Storage temperature	0°C to +50°C
Ambient humidity range	Operating: 0 to 90% non condensing; Storage: 0 to +90% non condensing
Operating system	Carlo Gavazzi Store with dedicated Apps
Memory	Large internal memory, expandible with Micro SD card
App	"Configure" App with customized home page for each Carlo Gavazzi sensors family
Approvals/Marks	CE - RoHS - FCC - IC
<b>Accessories</b>	
Included accessories	Protective holster. Extension cable: 0.5 m M12 to 4 hooks for cable type sensors. Lanyard.
<b>References</b>	
5.5" touch screen display	SCTL55

# Connectivity

## Cordsets



Dimensions (mm)	Straight M8 connector PVC cable	Angled M8 connector PVC cable	Straight M8 connector PVC cable	Angled M8 connector PVC cable
Used for	3-wire DC sensors	3-wire DC sensors	4-wire DC sensors	4-wire DC sensors
2 m cable	<b>CONB53NF-S2</b>	<b>CONB53NF-A2</b>	<b>CONB54NF-S2</b>	<b>CONB54NF-A2</b>
5 m cable	<b>CONB53NF-S5</b>	<b>CONB53NF-A5</b>	<b>CONB54NF-S5</b>	<b>CONB54NF-A5</b>
10 m cable	<b>CONB53NF-S10</b>	<b>CONB53NF-A10</b>	<b>CONB54NF-S10</b>	<b>CONB54NF-A10</b>
15 m cable	<b>CONB53NF-S15</b>	<b>CONB53NF-A15</b>	<b>CONB54NF-S15</b>	<b>CONB54NF-A15</b>
Degree of protection	IP 67	IP 67	IP 67	IP 67
PUR version	Add "P" at the end of the part number	Add "P" at the end of the part number	Add "P" at the end of the part number	Add "P" at the end of the part number



Dimensions (mm)	Straight M12 connector TPE cable	Angled M12 connector TPE cable	Straight M12 connector PVC cable	Angled M12 connector PVC cable
Used for	4-wire DC	4-wire DC	3-, 4- or 5-wire DC	3-, 4- or 5-wire DC
2 m cable, 3-pin			<b>CONB13NF-S2</b>	<b>CONB13NF-A2</b>
5 m cable, 3-pin			<b>CONB13NF-S5</b>	<b>CONB13NF-A5</b>
10 m cable, 3-pin			<b>CONB13NF-S10</b>	<b>CONB13NF-A10</b>
15 m cable, 3-pin			<b>CONB13NF-S15</b>	<b>CONB13NF-A15</b>
2 m cable, 4-pin	<b>CONB14NF-S2W</b>	<b>CONB14NF-A2W</b>	<b>CONB14NF-S2</b>	<b>CONB14NF-A2</b>
5 m cable, 4-pin	<b>CONB14NF-S5W</b>	<b>CONB14NF-A5W</b>	<b>CONB14NF-S5</b>	<b>CONB14NF-A5</b>
10 m cable, 4-pin			<b>CONB14NF-S10</b>	<b>CONB14NF-A10</b>
15 m cable, 4-pin			<b>CONB14NF-S15</b>	<b>CONB14NF-A15</b>
2 m cable, 5-pin			<b>CONB15NF-S2</b>	<b>CONB15NF-A2</b>
5 m cable, 5-pin			<b>CONB15NF-S5</b>	<b>CONB15NF-A5</b>
10 m cable, 5-pin			<b>CONB15NF-S10</b>	<b>CONB15NF-A10</b>
15 m cable, 5-pin			<b>CONB15NF-S15</b>	<b>CONB15NF-A15</b>
Degree of protection	IP69K	IP69K	IP 67	IP 67
PUR version			Add "P" at the end of the part number	Add "P" at the end of the part number

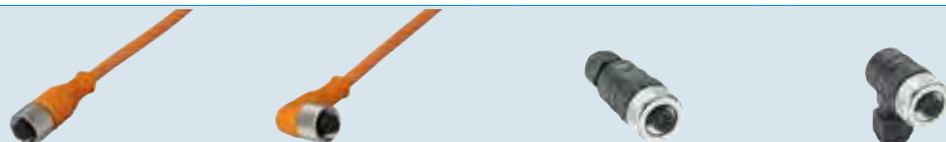

Dimensions (mm)	Straight M12 connector PVC cable	Angled M12 connector PVC cable	Straight M12 connector Terminal connection	Angled M12 connector Terminal connection
Used for	2-wire AC	2-wire AC	4-wire DC	4-wire DC
2 m cable, 3-pin	<b>CONH6A-S2</b>	<b>CONH6A-A2</b>		
5 m cable, 3-pin	<b>CONH6A-S5</b>	<b>CONH6A-A5</b>		
No cable 4-pin			<b>CONB14NF-S</b>	<b>CONB14NF-A</b>
Degree of protection	IP67	IP67	IP 67	IP 67

# Connectivity

## Brackets angled

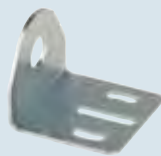

Steel, galvanized	<b>AMB8-A</b>	<b>AMB12-A</b>	<b>AMB18-A</b>	<b>AMB30-A</b>
Stainless steel AISI316L	-	<b>AMB12-A316L</b>	<b>AMB18-A316L</b>	-
Used for	M8 sensors	M12 sensors	M18 sensors	M30 sensors
Description	Mounting bracket	Mounting bracket	Mounting bracket	Mounting bracket

## Brackets straight



Steel, galvanized	<b>AMB8-S</b>	<b>AMB12-S</b>	<b>AMB18-S</b>	<b>AMB30-S</b>
Stainless steel AISI316L	-	<b>AMB12-S316L</b>	<b>AMB18-S316L</b>	-
Used for	M8 sensors	M12 sensors	M18 sensors	M30 sensors
Description	Mounting bracket	Mounting bracket	Mounting bracket	Mounting bracket

## General accessories



Dimensions (mm)	-	65 x 27 x 130
Used for	Cylindrical 4 - 30 mm sensor	Testing sensor
Item number	<b>AMB4-30</b>	<b>ST-03</b>
Description	Universal sensor mounting bracket	Sensor tester for: NAMUR and 2-, 3- or 4-wire DC NPN/PNP and NO/NC with LED and Buzzer

## Wind sensors

### Wind vane

#### Types

**DWS-D-D...**



Dimensions (mm)

207 x 174

Function

Wind direction

#### References wind vane

Wind indication

0° and 90° intervals  
**DWS-D-DAC13**

Wind indication

±7° and left/right  
**DWS-D-DDC13**

#### General specifications

Electrical connections

2 m cable

Rated operating voltage

12 - 24 VDC

Voltage drop

Typ. 4.9 VDC

Degree of protection

IP 54

Signal

NPN/PNP square wave 12.5 mA ± 2 mA

Housing material

Body: black PVC  
Rotor: stainless steel

Approvals/Marks

CE

#### References

For ordering key details, please refer to [www.gavazziautomation.com](http://www.gavazziautomation.com)

# Wind sensors

## Cup anemometer

### Types

**DWS-V-D...**



Dimensions (mm)	183 x 145
Function	Wind speed

### References cup anemometer

Operating temperature	-20°C to 60°C
Heating	Yes
Air velocity	From 1.5 m/s to 30 m/s <b>DWS-V-DAC13</b>
Operating temperature	0°C to 60°C
Heating	No
Air velocity	From 1.5 m/s to 30 m/s <b>DWS-V-DBC05</b>

### General specifications

Electrical connections	2 m cable
Rated operating voltage	12 - 24 VDC
Voltage drop	Typ. 4.9 VDC
Degree of protection	IP 54
Output frequency	10 Hz pr. m/s
Housing material	Body: black PVC Rotor: stainless steel
Approvals/Marks	CE

### References

For ordering key details, please refer to [www.gavazziautomation.com](http://www.gavazziautomation.com)



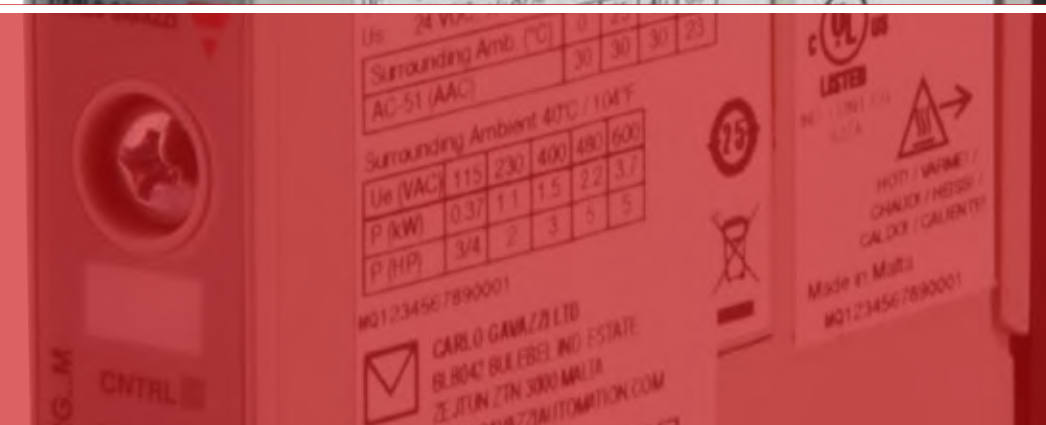

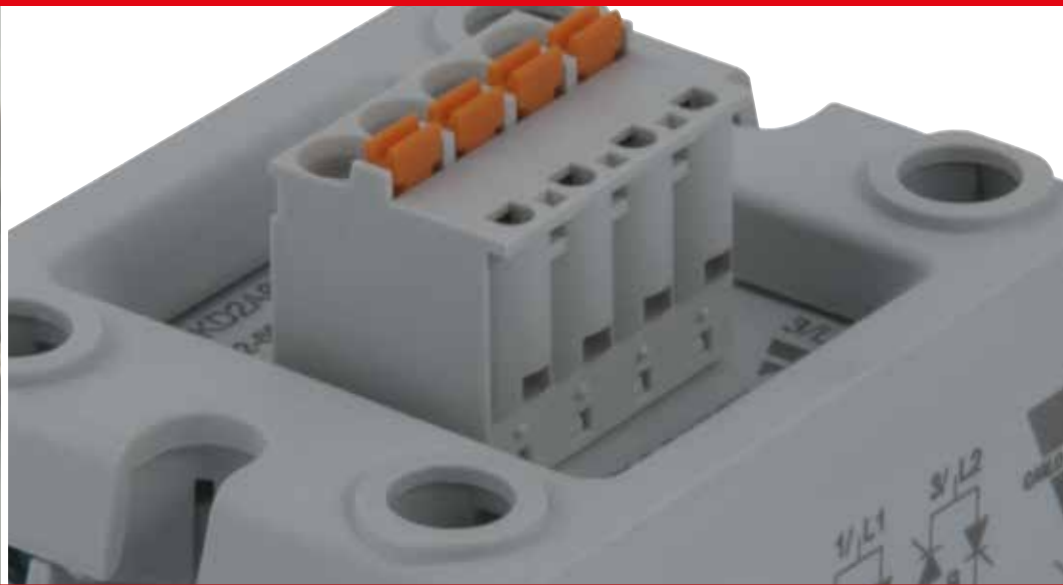

# Switches



Solid state relays	136
Solid state relays accessories	173
Soft starters	178
Variable frequency drives	183
Electromechanical relays	187
Sockets for electromechanical relays	192
Switching power supplies	193



# Solid state relays PCB type, 1-phase

	AC output		DC output
Types	RP1A - RP1B 3/5/5.5 AAC	RP.10 10 AAC	RP1D 1/4/8 ADC
PCB mounting SSRs, AC and DC operating. Rated isolation voltage $\geq 4000$ Vrms.			
Dimensions HxWxD (mm)	25.4 x 43 x 10.5	37 x 43 x 22	25.4 x 43 x 10.5
Features	Standard AC switching SSR	With integral heatsink	DC switching SSR
<b>Input specifications</b>			
Control input range	3-32 VDC [RP1A23..] 3-32 VDC [RP1A40..] 4-32 VDC [RP1A48..] 15-32 VAC [RP1A23A6]	3-32 VDC [RP1A23..] 4-32 VDC [RP1A40..] 4-32 VDC [RP1A48..]	4.5 - 32 VDC
Max. input current	10 mA	10 mA	15 mA
<b>Output specifications</b>			
Rated operational current			DC1: 1/4/8 ADC
AC 51 @ Ta=25°C	3 A [RP1...3] 5 A [RP1...5] 5.5 A [RP1...6]	10 A	
AC 53a @ Ta=25°C	2 A [RP1...3] 3 A [RP1...5] 5 A [RP1...6]	7 A	
Min. operational current	20 mA	10 mA	1 mADC
Non rep. surge current (t=20 ms)	65 A <sub>p</sub> [RP1...3] 80 A <sub>p</sub> [RP1...5] 250 A <sub>p</sub> [RP1...6]	250 A <sub>p</sub>	
Off-state leakage current	$\leq 1$ mA	$\leq 3$ mA	0.01 mADC
I <sup>2</sup> t for fusing (t=10 ms)	20 A <sup>2</sup> s [RP1...3] 50 A <sup>2</sup> s [RP1...5] 340 A <sup>2</sup> s [RP1...6]	340 A <sup>2</sup> s	
Critical dV/dt off-state	250 V/ $\mu$ s [RP1...3] 500 V/ $\mu$ s [RP1...5] 500 V/ $\mu$ s [RP1...6]	1000 V/ $\mu$ s	
<b>General specifications</b>			
Operational voltage range	12-265 Vrms [RP1A23..] 20-440 Vrms [RP1A40..] 20-530 Vrms [RP1A48..]	12-265 Vrms [RP1A23..] 20-440 Vrms [RP1A40..] 20-530 Vrms [RP1A48..]	1- 60 VDC [RP1D060...] 1 - 350 VDC [RP1D350...]
Blocking voltage	650 V <sub>p</sub> [RP1A23..] 850 V <sub>p</sub> [RP1A40..] 1000 V <sub>p</sub> [RP1A48..]	650 V <sub>p</sub> [RP1A23..] 850 V <sub>p</sub> [RP1A40..] 1000 V <sub>p</sub> [RP1A48..]	
Power factor	0.5	0.5	0.5
Operating temperature	-20°C to +70°C	-30°C to +80°C	-20°C to +80°C
Terminals	4 pins x $\varnothing$ 0.1 mm	4 pins x $\varnothing$ 0.1 mm	4 pins x $\varnothing$ 0.1 mm
Approvals/Marks	CE - UR - cUR - EAC - VDE	CE - UR - cUR - EAC	CE - UR - cUR - EAC
<b>References</b>			
	3 A	10 A	1 A
	RP1A23D3	RP1A23D10	RP1D350D1
	RP1A40D3	RP1A40D10	
	RP1A48D3	RP1A48D10	4 A
	5 A		RP1D060D4
	RP1A23D5		
	RP1A40D5		8 A
	RP1A48D5		RP1D060D8
	5.5 A		
	RP1A23D6		
	RP1A23A6		
	RP1A40D6		
	RP1A48D6		

\* Other options available on request: Instant-on switching (RP1B..), see Accessories for DIN-rail adaptor.  
CARLO GAVAZZI Automation Components. Specifications are subject to change without notice. Illustrations are for example only.

# Solid state relays, 1-phase



## Slimline - AC output

Types	<b>RGS1A..KKE</b> 25/50/75/90 AAC	<b>RGS1A..KGE</b> 50/90 AAC	<b>RGS1A..MKE</b> 25/50/90 AAC
Single-phase, chassis mounting with LED for control status indication, IP20 protection, 45-65 Hz operating frequency, $\geq 4000$ VACrms isolation voltage, 100 kArms short circuit current rating, certified motor ratings.			
Dimensions HxWxD (mm)	90 x 17.8 x 50.6	90 x 17.8 x 50.6	90 x 17.8 x 63.6
Features	17.8 mm wide solid state relay with integrated varistor on output, AC or DC control range, screw terminals with captivated clamp for power and control connections, E-type layout	17.8 mm wide solid state relay with integrated varistor on output, AC or DC control range, box clamp for power connections (up to 25 mm <sup>2</sup> /AWG3), screw for control connections, E-type layout	17.8 mm wide solid state relay with integrated varistor on output, AC or DC control range, screw terminals with captivated clamp for power connections and pluggable spring for control, E-type layout
<b>Input specifications</b>			
Control input range	3-32 VDC [RG.23D.] / 4-32 VDC [RG.60D.] 20-275 VAC, 24-190 VDC [RG..A.]	4-32 VDC [RG..D.] 20-275 VAC, 24-190 VDC [RG..A.]	3-32 VDC [RG..23D..], 4-32 VDC [RG..60D..] 20-275 VAC, 24-190 VDC [RG..A.]
Max. input current	11 mADC [RG..D.] 30 mAAC [RG..A.]	11 mADC [RG..D.] 30 mAAC [RG..A.]	11 mADC [RG..D.] 30 mAAC [RG..A.]
<b>Output specifications</b>			
Rated operational current AC-51 @ Ta=40°C	25 AAC [RG..25] / 50 AAC [RG..50/51] 75 AAC [RG..75] / 90 AAC [RG..90/91/92]	50 AAC [RG..50] 90 AAC [RG..92]	25 AAC [RG..25] / 50 AAC [RG..50] 90 AAC [RG..90/92]
AC-53a @ Ta=40°C	5 AAC [RG..25] / 10 AAC [RG..50/51] 14.8 AAC [RG..75] / 18 AAC [RG..90/91/92]	10 AAC [RG..50] 18 AAC [RG..92]	5 AAC [RG..25] / 10 AAC [RG..50] 18 AAC [RG..90/92]
Min. operational current	150 mAAC [RG..25] / 250 mAAC [RG..50/51] 400 mAAC [RG..75] / 500 mAAC [RG..90/91/92]	250 mAAC [RG..50] 500 mAAC [RG..92]	150 mAAC [RG..25] / 250 mAAC [RG..50] 500 mAAC [RG..90/92]
Non rep. surge current (t=10 ms)	325 Ap [RG..25] / 600 Ap [RG..50/51] 800 Ap [RG..75] / 1150 Ap [RG..90/91] 1900 Ap [RGS..92]	600 Ap [RG..50] 1900 Ap [RG..92]	325 Ap [RG..25] / 600 Ap [RG..50] 1150 Ap [RG..90] / 1900 Ap [RG..92]
Max. Off-state leak current	3 mAAC	3 mAAC	3 mAAC
I <sup>2</sup> t for fusing (t=10 ms)	525 A <sup>2</sup> s [RG..25] / 1800 A <sup>2</sup> s [RG..50/51] 3200 A <sup>2</sup> s [RG..75] / 6600 A <sup>2</sup> s [RG..90/91] 18000 A <sup>2</sup> s [RGS..92]	1800 A <sup>2</sup> s [RG..50] 18000 A <sup>2</sup> s [RG..92]	525 A <sup>2</sup> s [RG..25] / 1800 A <sup>2</sup> s [RG..50] 6600 A <sup>2</sup> s [RG..90] / 18000 A <sup>2</sup> s [RG..92]
Critical dV/dt (@ Tj init=40°C)	1000 V/μs	1000 V/μs	1000 V/μs
<b>General specifications</b>			
Operational voltage range	24-240 VAC +10% [RG.23..] 42-600 VAC +10% [RG.60..] 42-690 VAC + 10% [RG..69..]*	42-600 VAC +10%	24-240 VAC +10% [RG..23..] 42-600 VAC +10% [RG..60..]
Blocking voltage	800 Vp [RG..23..] 1200 Vp [RG..60..] 1600 Vp [RG..60..51/91]	1200 Vp	800 Vp [RG..23..] 1200 Vp [RG..60..]
Power factor	$\geq 0.5$ at rated voltage	$\geq 0.5$ at rated voltage	$\geq 0.5$ at rated voltage
Operating temperature	-40°C to +80°C	-40°C to +80°C	-40°C to +80°C
Approvals/Marks	CE - cURus - CSA - EAC - VDE	CE - cURus - CSA - EAC - VDE	CE - cURus - CSA - EAC - VDE
<b>References</b>			
230 VAC, 800 Vp	25 AAC: <b>RGS1A23X25KKE</b>		25 AAC: <b>RGS1A23X25MKE</b>
	50 AAC: <b>RGS1A23X50KKE</b>		50 AAC: <b>RGS1A23X50MKE</b>
600 VAC, 1200 Vp	25 AAC: <b>RGS1A60X25KKE</b>		25 AAC: <b>RGS1A60X25MKE</b>
	50 AAC: <b>RGS1A60X50KKE</b>	50 AAC: <b>RGS1A60X50KGE</b>	50 AAC: <b>RGS1A60X50MKE</b>
	75 AAC: <b>RGS1A60X75KKE</b>		
	90 AAC: <b>RGS1A60X90KKE</b>		90 AAC: <b>RGS1A60X90MKE</b>
600 VAC, 1600 Vp	90 AAC: <b>RGS1A60X92KKE</b>	90 AAC: <b>RGS1A60X92KGE</b>	90 AAC: <b>RGS1A60X92MKE</b>
	50 AAC: <b>RGS1A60X51KKE</b>		
690 VAC, 1600 Vp	90 AAC: <b>RGS1A60X91KKE</b>		
	90 AAC: <b>RGS1A69X91KKE*</b>		

X must be replaced with D for DC control 3-32 VDC, 4-32 VDC (for 600 VAC versions)  
 X must be replaced with A for AC control 20-275 VAC, 24-190 VDC  
 RGS1B.. models for Instant On (Random) switching are available on request  
 \*690 VAC variants are CE marked only and do not include a varistor across the output

# Solid state relays, 1-phase

## Slimline - AC output

Types	<b>RGS1A..MGE</b> 50/90 AAC	<b>RGS1A..KGU</b> 30 AAC	<b>RGS1A..DIN</b> 10/12 AAC
Single-phase, chassis mounting with LED for control status indication, IP20 protection, 45-65 Hz operating frequency, ≥4000 VACrms isolation voltage, 100 kArms short circuit current rating, certified motor ratings.			
Dimensions HxWxD (mm)	90 x 17.8 x 63.6	90 x 17.8 x 50.6	106 x 17.8 x 65
Features	17.8 mm wide solid state relay with integrated varistor on output, AC or DC control range, box clamps for power connections (25 mm <sup>2</sup> / AWG3) and pluggable spring for control, E-type layout	17.8 mm wide solid state relay with integrated varistor on output, AC or DC control range, box clamps for power and control connections, U-type layout	17.8 mm wide solid state relay mounted on DIN mountable module

## Input specifications

Control input range	4-32 VDC [RG..D..] 20-275 VAC, 24-190 VDC [RG..A..]	4-32 VDC [RG..D..] 20-275 VAC, 24-190 VDC [RG..A..]	3-32 VDC [RG..23D..] 4-32 VDC [RG..60D..] 20-275 VAC, 24-190 VDC [RG..A..]
Max. input current	11 mADC [RG..D..] 30 mAAC [RG..A..]	11 mADC [RG..D..] 30 mAAC [RG..A..]	11 mADC [RG..D..] 30 mAAC [RG..A..]

## Output specifications

Rated operational current AC-51 @ Ta=40°C	50 AAC [RG..50] 90 AAC [RG..92]	30 AAC	10 AAC [RG..20/25..DIN] 12 AAC [RG..50/90..DIN]
AC-53a @ Ta=40°C	10 AAC [RG..50] 18 AAC [RG..92]	8 AAC	5 AAC [RG..20/25..DIN] 5 AAC [RG..50/90..DIN]
Min. operational current	250 mAAC [RG..50] 500 mAAC [RG..92]	250 mAAC	150 mAAC [RG..20/25..DIN] 250 mAAC [RG..50..DIN] 400 mAAC [RG..90..DIN]
Non rep. surge current (t=10 ms)	600 Ap [RG..50] 1900 Ap [RG..92]	600 Ap	325 Ap [RG..20/25..DIN] 600 Ap [RG..50..DIN] 1150 Ap [RG..90..DIN]
Max. Off-state leak current	3 mAAC	3 mAAC	3 mAAC
I <sup>2</sup> t for fusing (t=10 ms)	1800 A <sup>2</sup> s [RG..50] 18000 A <sup>2</sup> s [RG..92]	1800 A <sup>2</sup> s	525 A <sup>2</sup> s [RG..20/25..DIN] 1800 A <sup>2</sup> s [RG..50..DIN] 6600 A <sup>2</sup> s [RG..90..DIN]
Critical dV/dt (@ Tj init=40°C)	1000 V/μs	1000 V/μs	1000 V/μs

## General specifications

Operational voltage range	42-600 VAC +10%	42-600 VAC +10%	24-240 VAC +10% [RG..23..] 42-600 VAC +10% [RG..60..]
Blocking voltage	1200 Vp	1200 Vp	800 Vp [RG..23..] 1200 Vp [RG..60..]
Power factor	≥ 0.5 at rated voltage	≥ 0.5 at rated voltage	≥ 0.5 at rated voltage
Operating temperature	-40°C to +80°C	-40°C to +80°C	-40°C to +80°C
Approvals/Marks	CE - cURus - CSA - EAC - VDE	CE - cURus - CSA - EAC - VDE	CE - cURus - CSA - EAC - VDE

## References

230 VAC, 800 Vp, E-type		10 AAC: <b>RGS1A23X25KKEDIN</b> 12 AAC: <b>RGS1A23X50KKEDIN</b>
600 VAC, 1200 Vp, E-type	50 AAC: <b>RGS1A60X50MGE</b> 90 AAC: <b>RGS1A60X92MGE</b>	10 AAC: <b>RGS1A60X25KKEDIN</b> 12 AAC: <b>RGS1A60X50KKEDIN</b> 12 AAC: <b>RGS1A60D90KKEDIN</b>
600 VAC, 1200 Vp, U-type		30 AAC: <b>RGS1A60X30KGU</b> 10 AAC: <b>RGS1A60D20KGUDIN</b>



X must be replaced with D for DC control 3-32 VDC, 4-32 VDC (for 600 VAC versions)  
X must be replaced with A for AC control 20-275 VAC, 24-190 VDC  
RGS1B.. models for Instant On (Random) switching are available on request



# Solid state relays, 1-phase

## Slimline - DC output

## Slimline - AC output, Integrated monitoring

Types	<b>RGSD1..KKE</b> 15/25 ADC	<b>RGSA..KEM</b> 25/50/90 AAC	<b>RGSA..GEM</b> 90 AAC
Single-phase, chassis mounting industrial relays with LED for control status indication and IP20 protection, rated isolation voltage $\geq 4000$ Vrms, 100 kArms short circuit current rating for AC switching versions.			
Dimensions HxWxD (mm)	90 x 17.8 x 50.6	90 x 17.8 x 82	90 x 17.8 x 82
Features	17.8 mm wide solid state relay with IGBT output, integrated free wheeling diode, DC control voltage, screw terminals with captivated clamp, E-type layout	17.8 mm wide solid state relay, integrated monitoring for SSR and load malfunction, integrated varistor, DC control and supply, transistor output for remote alarm signalling	17.8 mm wide solid state relay, integrated monitoring for SSR and load malfunction, integrated varistor, DC control and supply, transistor output for remote alarm signalling
<b>Input specifications</b>			
Control input range	4.5-32 VDC	4-32 VDC	4-32 VDC
Max. input current		0.5 mADC at 24 VDC	0.5 mADC at 24 VDC
Supply voltage		19.2 - 28.8 VDC	19.2 - 28.8 VDC
Max. supply current	13.7 mADC	40 mA	40 mA
<b>Alarm specifications</b>			
Output type		Transistor, NC, NO max. 35 VDC/100 mA	Transistor, NC, NO max. 35 VDC/100 mA
Alarm indication		Mains loss, load loss, SSR open and short cct, SSR internal error, supply out of range	Mains loss, load loss, SSR open and short cct, SSR internal error, supply out of range
<b>Output specifications</b>			
Rated operational current AC-51 @ $T_a=40^\circ\text{C}$		25 AAC [RGSA..25] 50 AAC [RGSA..50] 90 AAC [RGSA..92]	90 AAC
DC Rated operational current	15 ADC [RGSD1..15.] 25 ADC [RGSD1..25.]		
Minimum operational current	20 mA	150 mAAC [RGSA..25] 250 mAAC [RGSA..50] 500 mAAC [RGSA..92]	500 mAAC
Non rep. surge current ( $I_{tsm}$ ) ( $t=10$ ms)	200 ADC [10 $\mu$ s]	325 A <sub>p</sub> [RGSA..25] 600 A <sub>p</sub> [RGSA..50] 1900 A <sub>p</sub> [RGSA..92]	1900 A <sub>p</sub>
Max. Off-state leak current	1.5 mADC	5 mAAC	5 mAAC
$I^2t$ for fusing ( $t=10$ ms)		525 A <sup>2</sup> s [RGSA..25] 1800 A <sup>2</sup> s [RGSA..50] 18000 A <sup>2</sup> s [RGSA..92]	18000 A <sup>2</sup> s
Critical dV/dt (@ $T_j$ init= $40^\circ\text{C}$ )		1000 V/ $\mu$ s	1000 V/ $\mu$ s
<b>General specifications</b>			
Operational voltage range	24-1000 VDC [CE] 24-600 VDC [UL508]	42-265 VAC [RGSA23..] 150-660 VAC [RGSA60..]	150-660 VAC
Blocking voltage	1200 VDC	800 V <sub>p</sub> [RGSA23..] 1200 V <sub>p</sub> [RGSA60..]	1200 V <sub>p</sub>
Power factor		$\geq 0.9$ at rated voltage	$\geq 0.9$ at rated voltage
Operating temperature	-40°C to +80°C	-20°C to +65°C	-20°C to +65°C
Approvals/Marks	CE - cURus - CSA - EAC	CE - cURus - CSA - EAC	CE - cURus - CSA - EAC
<b>References</b>			
1000 VDC	15 ADC: <b>RGSD1000D15KKE</b> 25 ADC: <b>RGSD1000D25KKE</b>		
230 VAC, 800 V <sub>p</sub> , 525 A <sup>2</sup> s, Screw		25 AAC: <b>RGSA23D25KEM</b>	
600 VAC, 1200 V <sub>p</sub> , 525 A <sup>2</sup> s, Screw		25 AAC: <b>RGSA60D25KEM</b>	
600 VAC, 1200 V <sub>p</sub> , 1800 A <sup>2</sup> s, Screw		50 AAC: <b>RGSA60D50KEM</b>	
600 VAC, 1200 V <sub>p</sub> , 18000 A <sup>2</sup> s, Screw		90 AAC: <b>RGSA60D92KEM</b>	
600 VAC, 1200 V <sub>p</sub> , 18000 A <sup>2</sup> s, Box			90 AAC: <b>RGSA60D92GEM</b>

KK = screws for control terminals, screws for power terminals  
 GK = box clamps for control terminals, screws for power terminals  
 GG = box clamps for control terminals, box clamps for power terminals

CARLO GAVAZZI Automation Components. Specifications are subject to change without notice. Illustrations are for example only.

# Solid state relays, 1-phase

## Slimline - AC output, integrated current measurement

Types	RGS1S..EP 30/90 AAC	RGS1S..UP 65 AAC
-------	------------------------	---------------------

Single-phase, chassis mounting industrial relays with LED for control status indication and IP20 protection, rated isolation voltage  $\geq 4000$  Vrms, 100 kArms short circuit current rating for AC switching versions.



Dimensions HxWxD (mm)	90 x 22.5 x 78	90 x 35.6 x 78
-----------------------	----------------	----------------

Features	22.5 mm wide solid-state relay with thyristor output, integrated varistor, DC control, local or remote TEACH, detection of partial load failure (1/6), SSR and load malfunction, SSR overheat protection.	35 mm wide solid-state relay with thyristor output, integrated varistor, DC control, local or remote TEACH, detection of partial load failure (1/6), SSR and load malfunction, SSR overheat protection.
----------	---	---

### Input specifications

Control input range	4-32 VDC	4-32 VDC
Max. input current	10 mADC at 24 VDC	10 mADC at 24 VDC
Supply voltage	24 VDC -15%, +20%	24 VDC -15%, +20%
Max. supply current	50 mADC	50 mADC

### Alarm specifications

Output type	NC PNP open collector max. 35 VDC / 50 mA	NC PNP open collector max. 35 VDC / 50 mA
Alarm indication	Red LED (flash rate)	Red LED (flash rate)

### Output specifications

Rated operational current AC-51 @ Ta=40°C	30 AAC [RGS1S..30] 90 AAC [RGS1S..92]	65 AAC
Minimum TEACH / operational current	1.2 AAC [RGS1S..30] 5 AAC [RGS1S..92]	5 AAC
Minimum partial load current	0.2 AAC [RGS1S..30] 0.83 AAC [RGS1S..92]	0.83 AAC
Detectable partial load failure	> 16.67% from current setpoint	> 16.67% from current setpoint
Non rep. surge current (I <sub>tsm</sub> ) (t=10 ms)	600 A <sub>p</sub> [RGS1S..30] 1900 A <sub>p</sub> [RGS1S..92]	1900 A <sub>p</sub>
Max. Off-state leak current	3 mAAC	3 mAAC
I <sup>2</sup> t for fusing (t=10 ms)	1800 A <sup>2</sup> s [RGS1S..30] 18000 A <sup>2</sup> s [RGS1S..92]	18000 A <sup>2</sup> s
Critical dV/dt (@ T <sub>j</sub> init=40°C)	1000 V/μs	1000 V/μs

### General specifications

Operational voltage range	42-600 VAC +10%	42-600 VAC +10%
Blocking voltage	1200 V <sub>p</sub>	1200 V <sub>p</sub>
Power factor	≥ 0.9 at rated voltage	≥ 0.9 at rated voltage
Operating temperature	-25°C to +70°C	-25°C to +70°C
Approvals/Marks	CE - cURus - CSA - EAC	CE - cURus - CSA - EAC

### References

600 VAC, 1800 A <sup>2</sup> s, E-type	30 AAC: RGS1S60D30GKEP	
600 VAC, 18000 A <sup>2</sup> s, E-type	90 AAC: RGS1S60D92GGEP	
600 VAC, 18000 A <sup>2</sup> s, U-type		65 AAC: RGS1S60D61GGUP

GK = box clamps for control terminals, screws for power terminals  
GG = box clamps for control terminals, box clamps for power terminals

# Solid state relays, 1-phase

## Slimline - Soft start switching

## Slimline - Proportional controllers

Types	RGS1P..K.. 50 AAC	RGS1P..K.. 90 AAC	RGS1P..AA.. / V.. 50 AAC	RGS1P..AA.. / V.. 90 AAC
Single-phase, chassis mounting industrial relays with integrated overvoltage protection, LED for control and load status indication, IP20 protection, rated isolation voltage $\geq 4000$ Vrms, 100 kArms short circuit current rating.				

Dimensions HxWxD (mm)	90 x 35.8 x 51	90 x 35.8 x 51	90 x 35.8 x 51	90 x 35.8 x 51
Features	DC control input solid state relay with soft starting feature for short wave infrared heaters	DC control input solid state relay with soft starting feature for short wave infrared heaters	Analogue input (current or voltage), selectable modes for output switching - phase angle, full cycle distributed firing, advanced full cycle and soft starting	Analogue input (current or voltage), selectable modes for output switching - phase angle, full cycle distributed firing, advanced full cycle and soft starting

### Supply specifications

Supply voltage	24 VDC -15%, +20% 24 VAC -15%, +15%	24 VDC -15%, +20% 24 VAC -15%, +15%	24 VDC -15%, +20% (RG..V..ED) 24 VAC -15%, +15% (RG..V..ED) 90-250 VAC (RG..V..EA)	24 VDC -15%, +20% (RG..V..ED) 24 VAC -15%, +15% (RG..V..ED) 90-250 VAC (RG..V..EA)
Max. supply current	30 mA	30 mA	30 mA (RG..V..ED) 14 mA (RG..V..EA)	30 mA (RG..V..ED) 14 mA (RG..V..EA)

### Control specifications

Control input range	19.2 - 28.8 VDC	19.2 - 28.8 VDC	4-20 mA (RG..AA..) 0-10 V, 0-5 V, 1-5 V, POT (RG..V..)	4-20 mA (RG..AA..) 0-10 V, 0-5 V, 1-5 V, POT (RG..V..)
Input impedance	100 k $\Omega$	100 k $\Omega$	500 $\Omega$ (RG..AA..) 100 k $\Omega$ (RG..V..)	500 $\Omega$ (RG..AA..) 100 k $\Omega$ (RG..V..)

### Output specifications

Rated operational current AC-51 @ 40°C	50 AAC	90 AAC	50 AAC	90 AAC
Minimum operational current	250 mAAC	500 mAAC	250 mAAC	500 mAAC
Non rep. surge current (I <sub>sm</sub> ) (t=10 ms)	600 A <sub>p</sub>	1900 A <sub>p</sub>	600 A <sub>p</sub>	1900 A <sub>p</sub>
I <sup>2</sup> t for fusing (t=10 ms)	1800 A <sup>2</sup> s	18000 A <sup>2</sup> s	1800 A <sup>2</sup> s	18000 A <sup>2</sup> s
Max. Off-state leakage current	5 mAAC	5 mAAC	5 mAAC	5 mAAC
Critical dV/dt (@ T <sub>j</sub> init=40°C)	1000 V/ $\mu$ s	1000 V/ $\mu$ s	1000 V/ $\mu$ s	1000 V/ $\mu$ s

### General specifications

Operational voltage range	85 - 265 VAC (RGS1P23..) 190 - 550 VAC (RGS1P48..) 410 - 660 VAC (RGS1P60..)	85 - 265 VAC (RGS1P23..) 190 - 550 VAC (RGS1P48..) 410 - 660 VAC (RGS1P60..)	85 - 265 VAC (RGS1P23..) 190 - 550 VAC (RGS1P48..) 410 - 660 VAC (RGS1P60..)	85 - 265 VAC (RGS1P23..) 190 - 550 VAC (RGS1P48..) 410 - 660 VAC (RGS1P60..)
Blocking voltage	800 V <sub>p</sub> (RGS1P23..) 1200 V <sub>p</sub> (RGS1P48..) 1200 V <sub>p</sub> (RGS1P60..)	800 V <sub>p</sub> (RGS1P23..) 1200 V <sub>p</sub> (RGS1P48..) 1200 V <sub>p</sub> (RGS1P60..)	800 V <sub>p</sub> (RGS1P23..) 1200 V <sub>p</sub> (RGS1P48..) 1200 V <sub>p</sub> (RGS1P60..)	800 V <sub>p</sub> (RGS1P23..) 1200 V <sub>p</sub> (RGS1P48..) 1200 V <sub>p</sub> (RGS1P60..)
Power factor	> 0.7	> 0.7	> 0.7	> 0.7
Terminals	Screw with captive clamp	Box clamp	Screw with captive clamp	Box clamp
Operating temperature	-40°C to +70°C	-40°C to +70°C	-40°C to +70°C	-40°C to +70°C
Approvals/Marks	CE - cURus - CSA - EAC	CE - cURus - CSA - EAC	CE - cURus - CSA - EAC	CE - cURus - CSA - EAC

### References





External supply 24 VDC/AC				
Operational output 85 - 265 VAC	<b>RGS1P23K50ED</b>	<b>RGS1P23K92ED</b>		
Operational output 190 - 550 VAC	<b>RGS1P48K50ED</b>	<b>RGS1P48K92ED</b>		
Operational output 410 - 660 VAC	<b>RGS1P60K50ED</b>	<b>RGS1P60K92ED</b>		
Control input				
4-20 mA			<b>RGS1PxxAA50E</b>	<b>RGS1PxxAA92E</b>
0-10 VDC, 0-5 VDC, 1-5 VDC, POT				
External supply 24 VDC/AC			<b>RGS1PxxV50ED</b>	<b>RGS1PxxV92ED</b>
External supply 90-250 VAC			<b>RGS1PxxV50EA</b>	<b>RGS1PxxV92EA</b>

xx = 23 for operational voltage range 85 - 265 VAC  
 xx = 48 for operational voltage range 190 - 550 VAC  
 xx = 60 for operational voltage range 410 - 660 VAC



# Solid state relays, 1-phase

## Industrial housing - AC output

Types	RF1A 25 AAC	RS1A 10/25/40 AAC	RAM1A 25/50/75/100/125 AAC	RAM1A..G 25/50/100/125 AAC
Single-phase, chassis mounting, industrial relays with LED status indication and IP20 protection. AC operating frequency range 45-65 Hz. Rated isolation voltage ≥4000 Vrms.				
Dimensions HxWxD (mm)	36 x 21 x 24	58.2 x 44.8 x 28.8	58.2 x 44.8 x 28.8	58.2 x 44.8 x 28.8
Features	Zero Cross or Instant ON, Built-in transistor, VDE, Glow wire acc. to IEC/EN 60335-1	Zero Cross, Ideal for Ohmic loads	Zero Cross or Instant ON, Built-in snubber, VDE	Zero Cross, Built-in varistor, VDE, Glow wire acc. to IEC/EN 60335-1

### Input specifications

Control input range	4.25 - 9 VDC [RF1A..L] 9 - 18 VDC [RF1A..M] 18 - 28.8 VDC [RF1A..D]	3-32 VDC [RS1A23D] 4-32 VDC [RS1A....D] 18-36 VAC/DC [RS1A...LA] 80-130 VAC [RS1A..A1-] 200-260 VAC [RS1A..A2-] 360-440 VAC [RS1A..A4-]	3-32 VDC [RAM1A23D..] 4-32 VDC [RAM1A60D..] 20-280 VAC / 22-48 VDC [RAM1A..A.]	3-32 VDC [RAM1A23D..] 4-32 VDC [RAM1A60D..] 20-280 VAC / 22-48 VDC [RAM1A..A.]
Max. input current	15 mA [RF1A..L] 12 mA [RF1A..M] 12.5 mA [RF1A..D]	12 mA [RS1A..D] 15 mA [RS1A..LA] 13 mA [RS1A...A1-/A2-/A4-]	12 mA [RAM1A..D.] 20 mA [RAM1A..A.]	12 mA [RAM1A..D.] 20 mA [RAM1A..A.]

### Output specifications

	RF1A	RS1A..10 / 25 / 40	RAM1A..25 / 50 / 75 / 100 / 125	RAM1A..25/50/51/100/125
Rated operational current				
AC 51 @ Ta=25°C	25 AAC	10 / 25 / 40 AAC	25 / 50 / 75 / 100 / 125 AAC	25 / 50 / 50 / 100 / 125 AAC
AC 53a @ Ta=25°C			5 / 15 / 17 / 20 / 30 AAC	5 / 15 / 15 / 20 / 30 AAC
Min. operational current	150 mAAC	150 / 150 / 250 mAAC	150 / 250 / 400 / 400 / 500 mAAC	150 / 250 / 400 / 400 / 500 mAAC
Non rep. surge current (t=10 ms)	325 Ap	100 / 325 / 600 Ap	325 / 600 / 800 / 1150 / 1900 Ap	325 / 600 / 800 / 1150 / 1900 Ap
Off-state leakage current	< 3 mA	< 3 mA	< 3 mA	< 3 mA
I <sup>2</sup> t for fusing (t=10 ms)	525 A <sup>2</sup> s	50 / 525 / 1800 A <sup>2</sup> s	525 / 1800 / 3200 / 6600 / 18000 A <sup>2</sup> s	525 / 1800 / 3200 / 6600 / 18000 A <sup>2</sup> s
Critical dv/dt	1000 V/μs	500 V/μs	1000 V/μs	1000 V/μs

### General specifications

Operational voltage range	24 - 280 VAC	42-265 VAC [RS1A23..] 42-440 VAC [RS1A40..] 42-530 VAC [RS1A48..]	24-265 VAC [RAM1A23..] 42-660 VAC [RAM1A60..] 42-760 VAC [RAM1A69..]	24-265 VAC [RAM1A23..] 42-660 VAC [RAM1A60..]
Blocking voltage	600Vp	650 Vp [RS1A23..] 850 Vp [RS1A40..] 1200 Vp [RS1A48..]	650 Vp [RAM1A23..] 1200 Vp [RAM1A60..] 1600 Vp [RAM1A69..]	650 Vp [RAM1A23..] 1200 Vp [RAM1A60..]
Power factor	≥ 0.9	≥ 0.95	≥ 0.5	≥ 0.5
Operating temperature	-30°C to +80°C	-20°C to +70°C	-40°C to +80°C	-40°C to +80°C
Terminals	FASTONS	Screw type with clamp	Screw type with clamp	Screw type with clamp
Approvals/Marks	CE - UR - CSA - VDE - EAC	CE - UR - CSA - EAC	CE - UR - CSA - CCC - VDE* - EAC	CE - UR - CSA - CCC - VDE - EAC

### References

	RF1A	RS1A	RAM1A	RAM1A..G
230 VAC	25 AAC <b>RF1A23L25</b> <b>RF1A23M25</b> <b>RF1A23D25</b>	10 / 25 / 40 AAC <b>RS1A23X10</b> (X = D, LA only) <b>RS1A23X25</b> <b>RS1A23X40</b>	25 / 50 / 75 / 100 / 125 AAC <b>RAM1A23DY</b> <b>RAM1A23AY</b>	25 / 50 / 100 / 125 AAC <b>RAM1A23DYYG</b> <b>RAM1A23AYYG</b>
400 VAC		<b>RS1A40X10</b> (X = D, LA only) <b>RS1A40X25</b> <b>RS1A40X40</b>		
480 VAC		<b>RS1A48X10</b> (X = D, LA only) <b>RS1A48X25</b> (X = D, LA only) <b>RS1A48X40</b> (X = D, LA only)		
600 VAC			<b>RAM1A60DY</b> <b>RAM1A60AY</b> <b>RAM1A69DY</b> <b>RAM1A69AY</b>	<b>RAM1A60DYYG</b> <b>RAM1A60AYYG</b>
690 VAC				



RF1B.., RAM1B.. Instant On switching versions available on request.  
\* 690 VAC CE marked only.

X = D for DC control = 3-32 VDC (RS1A23..), 4-32 VDC (RS1A40.., RS1A48..)  
X = LA for AC control = 18-36 VAC/DC  
X = A1- for AC control = 80-130 VAC (not available for RS1A40..)

X = A2- for AC control = 200-260 VAC  
X = A4- for AC control = 360-440 VAC  
YY = 25 for 25 AAC  
YY = 50 for 50 AAC

YY = 51 for 50 AAC high I<sup>2</sup>t (RAM1A60..G only)  
YY = 75 for 75 AAC  
YY = 100 for 100 AAC (not available for RAM1A23..G)  
YY = 125 for 125 AAC (not available for RAM1A23..G)

# Solid state relays, 1-phase

	Industrial housing - AC output	Industrial housing - peak switching	Industrial housing - phase angle switching
Types	RM1A 25/50/75/100 AAC	RM1C 25/50/75/100 AAC	RM1E 25/50/100/125 AAC
Single-phase, chassis mounting, industrial relays with LED status indication and IP20 protection AC operating frequency range 45-65 Hz. Rated isolation voltage $\geq 4000$ Vrms.			
Dimensions HxWxD (mm)	58.2 x 44.8 x 28.8	58.2 x 44.8 x 28.8	58.2 x 44.8 x 28.8
Features	Zero Cross or Instant ON, Built-in varistor	Ideal for transformers	Analogue phase-angle control

## Input specifications

Control input range	3-32 VDC [RM1A23D.] 4-32 VDC [RM1A60D.] 20-280 VAC / 22-48 VDC [RM1A..A.] 4.25-36 VDC / 4.25-27 VAC [RM1A..M.]	4.25-32 VDC	4-20 mA [RM1E..AA.] 0-10 VDC [RM1E..V.]
Max. input current	12 mA [RM1A..D.] 20 mA [RM1A..A.] 18 mA [RM1A..M.]	18 mA	0.15 mA [RM1E..V.]
Supply voltage range			24 VDC [RM1E..V.]
Max. supply input current			20 mA [RM1E..V.]

## Output specifications

	RM1A..25 / 50 / 75 / 100	RM1C..25 / 50 / 75 / 100	RM1E..25 / 50 / 100 / 125
Rated operational current			
AC 51 @ $T_a=25^\circ\text{C}$	25 / 50 / 75 / 100 AAC	25 / 50 / 75 / 100 AAC	25 / 50 / 100 / 125 AAC
AC 53a @ $T_a=25^\circ\text{C}$	5 / 15 / 20 / 30 AAC		5 / 15 / 20 / 30 AAC
AC 56a @ $T_a=25^\circ\text{C}$		10 / 20 / 25 / 30 AAC	
Min. operational current	150 / 250 / 400 / 500 mAAC	150 / 250 / 400 / 500 mAAC	150 / 250 / 400 / 500 mAAC
Non rep. surge current (t=10 ms)	325 / 600 / 1150 / 1900 A <sub>p</sub>	325 / 600 / 1150 / 1900 A <sub>p</sub>	325 / 600 / 1150 / 1900 A <sub>p</sub>
Off-state leakage current	< 3 mA	< 3 mA	< 3 mA
I <sup>2</sup> t for fusing (t=10 ms)	525 / 1800 / 6600 / 18000 A <sup>2</sup> s	525 / 1800 / 6600 / 18000 A <sup>2</sup> s	525 / 1800 / 6600 / 18000 A <sup>2</sup> s

## General specifications

Operational voltage range	24-265 VAC [RM1A23..] 42-440 VAC [RM1A40..] 42-530 VAC [RM1A48..] 42-660 VAC [RM1A60..]	100-440 VAC [RM1C40D.] 340-660 VAC [RM1C60D.]	90-280 VAC [RM1E23AA..] 90-265 VAC [RM1E23V..] 340-460 VAC [RM1E40AA..] 200-550 VAC [RM1E48AA/V..] 410-660 VAC [RM1E60AA/V..]
Blocking voltage	650 V <sub>p</sub> [RM1A23..] 850 V <sub>p</sub> [RM1A40..] 1200 V <sub>p</sub> [RM1A48..] 1400 V <sub>p</sub> [RM1A60..]	850 V <sub>p</sub> [RM1C40D..] 1400 V <sub>p</sub> [RM1C60D..]	650 V <sub>p</sub> [RM1E23..] 850 V <sub>p</sub> [RM1E40..] 1200 V <sub>p</sub> [RM1E48..] 1400 V <sub>p</sub> [RM1E60..]
Power factor	$\geq 0.5$	$\geq 0.5$	$\geq 0.75$
Operating temperature	-20°C to +70°C	-30°C to +80°C	-20°C to +70°C
Terminals	Screw type with clamp	Screw type with clamp	Screw type with clamp
Approvals/Marks	CE - UR - CSA - CCC - EAC	CE - UR - CSA - EAC	CE - UR - CSA - EAC



## References 1-phase:

230 Vrms	25 / 50 / 75 / 100 AAC RM1A23XY	25 / 50 / 75 / 100 AAC	25 / 50 / 100 / 125 AAC RM1E23X25 (X = AA or V) RM1E23X50 (X = AA or V) RM1E23X100 (X = AA or V) RM1E23X125 (X = AA or V)
400 Vrms	RM1A40XY	RM1C40D25 RM1C40D50 RM1C40D75	RM1E40AA25 RM1E40AA50 RM1E40AA100
480 Vrms	RM1A48XY		RM1E48X25 (X = AA or V) RM1E48X50 (X = AA or V) RM1E48X100 (X = AA or V) RM1E48X125 (X = AA or V)
600 Vrms	RM1A60XY	RM1C60D25 RM1C60D50 RM1C60D100	RM1E60X25 (X = AA or V) RM1E60X50 (X = AA or V) RM1E60X100 (X = AA or V)

RM1B.. Instant On switching versions available on request X = D for DC control = 3-32 VDC (RM1A23..), 4-32 VDC (RM1A40.., RM1A48.., RM1A60..) Y = M for low AC control = 4.25-36 VDC / 4.25-27 VAC YY = 75 for 75 AAC  
YY = 25 for 25 AAC YY = 50 for 50 AAC YY = 100 for 100 AAC  
X = A for AC control = 20-280 VAC / 22-48 VDC YY = 25 for 25 AAC YY = 50 for 50 AAC YY = 100 for 100 AAC

# Solid state relays, 1-phase

## Industrial housing - AC output

Types	RA 25/50/90/110 AAC	RA Sense 25/50/90/110 AAC	RA Low Noise 10/25 AAC
Single-phase relays, chassis mounting, variants with special functions. 2-phase industrial relays.			
Dimensions HxWxD (mm)	58.2 x 44.8 x 28.8	58.2 x 44.8 x 28.8	58.2 x 44.8 x 28.8
Features	General purpose	Detects supply and load failure	Complies with EN55022

### Input specifications

Control input range	3-32 VDC [RA..D..] 10-90 VAC / DC [RA..LA..] 90-280 VAC / DC [RA..HA..]	7-32 VDC	3-32 VDC
Max. input current	22 mA [RA..D..] 17 mA [RA..LA..] 6.5 mA [RA..HA..]	4 mA	32 mA
Control supply		20-32 VDC (40 mA)	
Alarm output	PNP NPN	VCC - 2 VDC (100 mA) 2 VDC (100 mA)	

### Output specifications

Rated operational current			
AC 51 @ Ta=25°C	25 / 50 / 90 / 110 AAC	25 / 50 / 90 / 110 AAC	10 / 25 AAC
AC 53a @ Ta=25°C	5/15/ 20/30 AAC		
Min. operational current	20 mA	200 mArms	2 Arms
Non rep. surge current (t=10 ms)	325 Ap [RA..25.] 600 Ap [RA..50.] 1150 Ap [RA..90.] 1900 Ap [RA..110.]	325 Ap [RA..25..S] 600 Ap [RA..50..S] 1150 Ap [RA..90..S] 1900 Ap [RA..110..S]	90 Ap, t=20 ms [RA..10..L] 200 Ap, t=20 ms [RA..25..L]
Off-state leakage current	< 3 mA	< 6 mArms	< 1 mArms
I <sup>2</sup> t for fusing (t=10 ms)	<525 A <sup>2</sup> s [RA..25.] <1800 A <sup>2</sup> s [RA..50.] <6600 A <sup>2</sup> s [RA..90.] <18000 A <sup>2</sup> s [RA..110.]	525 A <sup>2</sup> s [RA..25..S] 1800A <sup>2</sup> s [RA..50..S] 6600 A <sup>2</sup> s [RA..90..S] 18000 A <sup>2</sup> s [RA..110..S]	120 A <sup>2</sup> s [RA..10..L] 200 A <sup>2</sup> s [RA..25..L]

### General specifications

Operational voltage range	24-280 Vrms [RA24.06..] 42-480 Vrms [RA44.08..] 42-530 Vrms [RA48.12..] 24-690 Vrms [RA60.16..]	60-140 Vrms [RA12..S] 170-250 Vrms [RA23..S] 150-440 Vrms [RA40..S] 180-530 Vrms [RA48..S]	180-265 Vrms [RA24..L] 340-530 Vrms [RA40..L]
Blocking voltage	<650 Vp [RA24.06..] <850 Vp [RA44.08..] <1200 Vp [RA48.12..] <1600 Vp [RA60.16..]	650 Vp [RA12..S] 650 Vp [RA23..S] 1000 Vp [RA40..S] 1200 Vp [RA48..S]	650 Vp [RA24..L] 850 Vp [RA40..L]
Power factor	≥ 0.5	≥ 0.5	1
Operating temperature	-20°C to +70°C	-20°C to +70°C	-20°C to +70°C
Terminals	Screw type with clamp	Screw / 5 way plug	Screw type with clamp
Approvals/Marks	CE - UR - CSA - EAC	CE - UR - CSA - EAC	CE - UR - CSA

### References

	25 / 50 / 90 / 110 AAC	25 / 50 / 90 / 110 AAC	10 / 25 AAC
120 Vrms		RA12..06..S	
230 Vrms	RA24..D..	RA23..06..S	RA2410-D06L
	RA24..LA..		RA2425-D06L
	RA24..HA..		
400 Vrms	RA44..D..	RA40..10..S	RA4010-D08L
	RA44..LA..		RA4025-D08L
	RA44..HA..		
480 Vrms	RA48..D..	RA48..12..S	
	RA48..LA..		
	RA48..HA..		
600 Vrms	RA60..D..		

# Solid state relays, 1 / 3-phase

## Industrial housing - DC output

## Industrial housing - AC output, 3 poles

Types	<b>RM1D</b> 10/20/50/100 ADC	<b>RZ3A</b> 25/55/75 AAC
Single-phase and 3-phase industrial relays		

Dimensions HxWxD (mm)	58.2 x 44.8 x 29.5	74 x 103 x 41
-----------------------	--------------------	---------------

Features	DC switching SSR, 4 kV isolation between input and output, fast response times	3-phase switching, integrated overvoltage protection
----------	--	--

### Input specifications

Control input range	4-32 VDC	4-32 VDC [RZ3A..D.] 24-275 VAC [RZ3A..A.]
Max. input current	15 mA	23 mA [RZ3A..D.] 15 mA [RZ3A..A.]
Max. switching frequency	1000 Hz	

### Output specifications

Rated operational current		
@ Ta=25°C	DC1: 10 / 20 / 50 / 100 A	AC51: 25 / 55 / 75 AAC AC53a: 5 / 15 / 20 AAC
Min. operational current	5 mA	150 mAAC [RZ3..25] 250 mAAC [RZ3..55] 400 mAAC [RZ3..75]
Non rep. surge current (t=10 ms)		325 Ap [RZ3A..25..] 600 Ap [RZ3A..55..] 1150 Ap [RZ3A..75..]
Off-state leakage current	0.1 mADC	< 3 mA
I <sup>2</sup> t for fusing (t=10 ms)		525 A <sup>2</sup> s [RZ3A..25..] 1800 A <sup>2</sup> s [RZ3A..55..] 6600 A <sup>2</sup> s [RZ3A..75..]

### General specifications

Operational voltage range	1-60 VDC	24-440 VAC [RZ3A40.] 42-530 VAC [RZ3A48.] 42-660 VAC [RZ3A60.] 42-750 VAC [RZ3A69.]
Blocking voltage	-	<850 VP [RZ3A40..] <1200 VP [RZ3A48..] <1600 VP [RZ3A60..] <1600 VP [RZ3A69.]
Operating temperature	-20°C to +80°C	-30°C to +80°C
Terminals	Screw type with clamp	Screw type with clamp
Approvals/Marks	CE - UR - cUR - EAC	CE - UR - CSA - EAC





### References

DC output voltage:		25 / 55 / 75 AAC per pole
60 VDC	10 A: <b>RM1D060D10</b> 20 A: <b>RM1D060D20</b> 50 A: <b>RM1D060D50</b> 100 A: <b>RM1D060D100</b>	
AC output voltage:		
400 VAC		<b>RZ3A40DYY*</b> <b>RZ3A40AYY*</b>
480 VAC		<b>RZ3A48DYY*</b> <b>RZ3A48AYY*</b>
600 VAC		<b>RZ3A60DYY*</b> <b>RZ3A60AYY*</b>
690 VAC		<b>RZ3A69D75**</b> <b>RZ3A69A75**</b>

\* Add suffix 'P' for additional integrated Over Temperature Protection, \*\* CE only  
YY = 25 for 25 AAC, YY = 55 for 55 AAC, YY = 75 for 75 AAC

# Solid state relays, 2-poles

## Industrial housing - AC output

Types	<b>RA2A</b> 25/40 AAC	<b>RA2A..C</b> 25/40 AAC	<b>RKD2..C</b> <b>RK2..C</b> 50/75 AAC	<b>RKD2..P</b> <b>RK2..P</b> 50/75 AAC
2-pole industrial solid state relays.				
Dimensions HxWxD (mm)	57.8 x 44.5 x 31.7	57.8 x 44.5 x 34.8	53 x 44.5 x 33	58 x 44.5 x 33 (w/o plug) 58 x 44.5 x 44 (incl. plug)
Features	Two independent poles, RA2A..M for inductive loads	Two independent poles with integrated varistor on output	2-poles with independent control (RKD2) or common control (RK2), control connection via connector pins	2-poles with independent control (RKD2) or common control (RK2), control connection via provided spring plug

### Input specifications

Control input range	4.5-32 VDC	4.5-32 VDC	4-32 VDC	4-32 VDC
Max. input current	2 x 10 mA	2x 10 mA	2 x 12 mA [RKD2..] 1 x 24 mA [RK2..]	2 x 12 mA [RKD2..] 1 x 24 mA [RK2..]

### Output specifications

Rated operational current				
AC 51 @ Ta=25°C	25 / 40 AAC per pole	25 / 40 AAC per pole	50 AAC per pole [RK..50/51] 75 AAC per pole [RK..75]	50 AAC per pole [RK..50/51] 75 AAC per pole [RK..75]
AC 53a @ Ta=25°C	5 / 15 AAC per pole [RA2A..M]		12 AAC	12 AAC
Min. operational current	150 mArms [RA2A...25] 250 mArms [RA2A...40]	150 mArms [RA2A...25C] 250 mArms [RA2A...40C]	250 mArms [RK..50] 400 mArms [RK..51/75]	250 mArms [RK..50] 400 mArms [RK..51/75]
Non rep. surge current (t=10 ms)	325 A <sub>p</sub> [RA2A..25] 600 A <sub>p</sub> [RA2A..40]	325 A <sub>p</sub> [RA2A...25C] 600 A <sub>p</sub> [RA2A...40C]	500 A <sub>p</sub> [RK..50] 775 A <sub>p</sub> [RK..51] 1400 A <sub>p</sub> [RK..75]	500 A <sub>p</sub> [RK..50] 775 A <sub>p</sub> [RK..51] 1400 A <sub>p</sub> [RK..75]
Off-state leakage current	<3 mArms	<3 mArms	≤3 mArms	≤3 mArms
I <sup>2</sup> t for fusing (t=10 ms)	525 A <sup>2</sup> s [RA2A..25] 1800 A <sup>2</sup> s [RA2A..40]	525 A <sup>2</sup> s [RA2A..25C] 1800 A <sup>2</sup> s [RA2A..40C]	1500 A <sup>2</sup> s [RK..50] 3000 A <sup>2</sup> s [RK..51] 9800 A <sup>2</sup> s [RK..75]	1500 A <sup>2</sup> s [RK..50] 3000 A <sup>2</sup> s [RK..51] 9800 A <sup>2</sup> s [RK..75]

### General specifications

Operational voltage range	24-265 Vrms [RA2A23..] 42-530 Vrms [RA2A48..] 42-660 Vrms [RA2A60..]	24-265 Vrms [RA2A23..] 42-660 Vrms [RA2A60..]	24-265 Vrms [RK..23..] 42-660 Vrms [RK..60]	24-265 Vrms [RK..23] 42-660 Vrms [RK..60]
Blocking voltage	650 V <sub>p</sub> [RA2A23..] 1200 V <sub>p</sub> [RA2A48..] 1200 V <sub>p</sub> [RA2A60..]	650 V <sub>p</sub> [RA2A23..] 1200 V <sub>p</sub> [RA2A60..]	600 V <sub>p</sub> [RK..23..] 1200 V <sub>p</sub> [RK..60..]	600 V <sub>p</sub> [RK..23..] 1200 V <sub>p</sub> [RK..60..]
Power factor	≥0.95 [RA2A...]/ ≥0.50 [RA2A...M]	≥0.95	≥0.5	≥0.5
Operating temperature	-20°C to +70°C	-20°C to +70°C	-40°C to +80°C	-40°C to +80°C
Terminals	FASTONS 6.35 mm	FASTONS 6.35 mm / 4 way plug	M4 screw / Control pins	M4 screw / Plug terminal
Approvals/Marks	CE - UR - CSA - EAC	CE - cURus - EAC	CE - UR - CSA - VDE - EAC	CE - UR - CSA - VDE - EAC





### References

	25 / 40 AAC per pole	25 / 40 AAC per pole	50 / 75 AAC per pole	50 / 75 AAC per pole
230 Vrms	25 AAC: <b>RA2A23D25</b>	25 AAC: <b>RA2A23D25C</b>	50 AAC: <b>RKD2A23D50C</b>	50 AAC: <b>RKD2A23D50P</b>
	<b>RA2A23D25M</b>	40 AAC: <b>RA2A23D40C</b>	50 AAC: <b>RKD2A23D51C</b>	50 AAC: <b>RKD2A23D51P</b>
	40 AAC: <b>RA2A23D40</b>		75 AAC: <b>RKD2A23D75C</b>	75 AAC: <b>RKD2A23D75P</b>
480 Vrms	<b>RA2A23D40M</b>			
	25 AAC: <b>RA2A48D25</b>			
	<b>RA2A48D25M</b>			
600 Vrms	40 AAC: <b>RA2A48D40</b>			
	<b>RA2A48D40M</b>			
	25 AAC: <b>RA2A60D25</b>	25 AAC: <b>RA2A60D25C</b>	50 AAC: <b>RKX2Y60D50C</b>	50 AAC: <b>RKX2Y60D50P</b>
	<b>RA2A60D25M</b>	40 AAC: <b>RA2A60D40C</b>	50 AAC: <b>RKX2A60D51C</b>	50 AAC: <b>RKX2A60D51P</b>
	40 AAC: <b>RA2A60D40</b>		75 AAC: <b>RKX2Y60D75C</b>	75 AAC: <b>RKX2Y60D75P</b>
	<b>RA2A60D40M</b>			

X = must be replaced with 'D' for dual control, blank for common control  
Y = must be replaced with 'A' for zero cross switching, 'B' for instant on switching

# Solid state contactors, 1-phase

Slimline, DIN-rail mounting - AC output

Types	<b>RGC..15KKE</b> 20 AAC	<b>RGC..25KKE</b> <b>RGC..32KKE</b> 25/30 AAC	<b>RGC..32KGE</b> 37 AAC	<b>RGC..30KKE</b> 30 AAC
Single-phase, semiconductor contactors with integrated heatsink, LED indication and IP20 protection, AC operating frequency 45-65 Hz, rated isolation voltage $\geq 4000$ Vrms, 100 kArms short circuit current rating, motor ratings according to UL508, integrated varistor on output.				
Dimensions HxWxD (mm)	110 x 17.8 x 103.5	110 x 17.8 x 103.5	110 x 17.8 x 103.5	110 x 22.5 x 141
Features	17.8 mm wide solid state contactor, DC or AC control voltage, screw terminals for power and control, E-type layout	17.8 mm wide solid state contactor, DC or AC control voltage, screw terminals for power and control, E-type layout	17.8 mm wide solid state contactor, DC control voltage, box clamps for power terminals and screw terminals for control, E-type layout	22.5 mm wide solid state contactor, DC or AC control voltage, screw terminals for power and control, E-type layout
<b>Input specifications</b>				
Control input range	3-32 VDC [RG.23D.] 4-32 VDC [RG.60D.] 20-275 VAC, 24-190 VDC [RG..A.]	3-32 VDC [RG.23D.] 4-32 VDC [RG.60D.] 20-275 VAC, 24-190 VDC [RG..A.]	4-32 VDC	3-32 VDC [RG.23D.] 4-32 VDC [RG.60D.] 20-275 VAC, 24-190 VDC [RG..A.]
Max. input current	11 mADC [RG..D.] 30 mAAC [RG..A.]	11 mADC [RG..D.] 30 mAAC [RG..A.]	11 mADC	11 mADC [RG..D.] 30 mAAC [RG..A.]
<b>Output specifications</b>				
Rated operational current AC 51 @ $T_a=40^\circ\text{C}$	20 AAC	25 AAC [RGC..25.] 30 AAC [RGC..32.]	37 AAC	30 AAC
AC 53a @ $T_a=40^\circ\text{C}$	5 AAC	5 AAC	5 AAC	8 AAC
Min. operational current	150 mA	250 mA [RGC..25.] 500 mA [RGC..32.]	500 mA	250 mA
Non rep. surge current ( $t=10$ ms)	325 A <sub>p</sub>	600 A <sub>p</sub> [RGC..25.] 1900 A <sub>p</sub> [RGC..32.]	1150 A <sub>p</sub>	600 A <sub>p</sub>
Off-state leakage current	3 mAAC	3 mAAC	3 mAAC	3 mAAC
$I^2t$ for fusing ( $t=10$ ms)	525 A <sup>2</sup> s	1800 A <sup>2</sup> s [RGC..25.] 18000 A <sup>2</sup> s [RGC..32.]	18000 A <sup>2</sup> s	1800 A <sup>2</sup> s
Critical $dV/dt$ (@ $T_j$ init= $40^\circ\text{C}$ )	1000 V/ $\mu\text{s}$	1000 V/ $\mu\text{s}$	1000 V/ $\mu\text{s}$	1000 V/ $\mu\text{s}$
<b>General specifications</b>				
Operational voltage range	24-240 VAC +10% [RG.23..] 42-600 VAC +10% [RG.60..]	24-240 VAC +10% [RG.23..] 42-600 VAC +10% [RG.60..]	42-600 VAC +10%	24-240 VAC +10% [RG.23..] 42-600 VAC +10% [RG.60..]
Blocking voltage	800 V <sub>p</sub> [RGC.23.] 1200 V <sub>p</sub> [RGC.60.]	800 V <sub>p</sub> [RGC.23.] 1200 V <sub>p</sub> [RGC.60.]	1200 V <sub>p</sub>	800 V <sub>p</sub> [RGC.23.] 1200 V <sub>p</sub> [RGC.60.]
Power factor	$\geq 0.5$ at rated voltage	$\geq 0.5$ at rated voltage	$\geq 0.5$ at rated voltage	$\geq 0.5$ at rated voltage
Operating temperature	-40°C to +80°C	-40°C to +80°C	-40°C to +80°C	-40°C to +80°C
Approvals/Marks	CE - cULus - VDE - EAC - GL	CE - cULus - VDE* - EAC - GL*	CE - cULus - EAC	CE - cULus - VDE - EAC - GL
<b>References</b>				
DC control voltage				
230 VAC, 800 V <sub>p</sub>	20 AAC: <b>RGCI A23D15KKE</b>	25 AAC: <b>RGCI A23D25KKE</b>		30 AAC: <b>RGCI A23D30KKE</b>
600 VAC, 1200 V <sub>p</sub>	20 AAC: <b>RGCI A60D15KKE</b>	25 AAC: <b>RGCI A60D25KKE</b>		30 AAC: <b>RGCI A60D30KKE</b>
600 VAC, 1200 V <sub>p</sub> , 18000 A <sup>2</sup> s		30 AAC: <b>RGCI A60D32KKE</b>	37 AAC: <b>RGCI A60D32KGE</b>	
AC/DC control voltage				
230 VAC, 800 V <sub>p</sub>	20 AAC: <b>RGCI A23A15KKE</b>	25 AAC: <b>RGCI A23A25KKE</b>		30 AAC: <b>RGCI A23A30KKE</b>
600 VAC, 1200 V <sub>p</sub>	20 AAC: <b>RGCI A60A15KKE</b>	25 AAC: <b>RGCI A60A25KKE</b>		30 AAC: <b>RGCI A60A30KKE</b>

Instant On (Random) Switching available on request (RGC1B60D...)





\* not applicable to RGC..32

CARLO GAVAZZI Automation Components. Specifications are subject to change without notice. Illustrations are for example only.



# Solid state contactors, 1-phase

Slimline, DIN-rail mounting - AC output

Types	RGC..15MKE 20 AAC	RGC..25MKE RGC..32MKE 25/30 AAC	RGC..32MGE 37 AAC	RGC..30MKE 30 AAC
Single-phase, semiconductor contactors with integrated heatsink, LED indication and IP20 protection, AC operating frequency 45-65 Hz, rated isolation voltage $\geq 4000$ Vrms, 100 kArms short circuit current rating, motor ratings according to UL508, integrated varistor on output.				
Dimensions HxWxD (mm)	110 x 17.8 x 114.5	110 x 17.8 x 114.5	110 x 17.8 x 114.5	110 x 22.5 x 152
Features	17.8 mm wide solid state contactor, DC or AC control voltage range, screw terminals with captivated clamp for power terminals and spring plug for control, E-type layout	17.8 mm wide solid state contactor, DC or AC control voltage range, screw terminals with captivated clamp for power terminals and spring plug for control, E-type layout	17.8 mm wide solid state contactor, DC control voltage range, box clamps for power terminals and spring plug for control, E-type layout	22.5 mm wide solid state contactor, DC or AC control voltage range, screw terminals with captivated clamp for power terminals and spring plug for control, E-type layout

## Input specifications

Control input range	3-32 VDC [RG.23D.] / 4-32 VDC [RG.60D.] 20-275 VAC, 24-190 VDC [RG..A.]	3-32 VDC [RG.23D.] / 4-32 VDC [RG.60D.] 20-275 VAC, 24-190 VDC [RG..A.]	4-32 VDC	3-32 VDC [RG.23D.] / 4-32 VDC [RG.60D.] 20-275 VAC, 24-190 VDC [RG..A.]
Max. input current	11 mADC [RG..D.] 30 mAAC [RG..A.]	11 mADC [RG..D.] 30 mAAC [RG..A.]	11 mADC	11 mADC [RG..D.] 30 mAAC [RG..A.]

## Output specifications

Rated operational current				
AC 51 @ Ta=40°C	20 AAC	25 AAC [RGC..25.] 30 AAC [RGC..32.]	37 AAC	30 AAC
AC 53a @ Ta=40°C	5 AAC	5 AAC	5 AAC	8 AAC
Min. operational current	150 mA	250 mA [RGC..25.] 500 mA [RGC..32.]	500 mA	250 mA
Non rep. surge current (t=10 ms)	325 Ap	600 Ap [RGC..25.] 1900 Ap [RGC..32.]	1900 Ap	600 Ap
Off-state leakage current	3 mAAC	3 mAAC	3 mAAC	3 mAAC
I <sup>2</sup> t for fusing (t=10 ms)	525 A <sup>2</sup> s	1800 A <sup>2</sup> s [RGC..25.] 18000 A <sup>2</sup> s [RGC..32.]	18000 A <sup>2</sup> s	1800 A <sup>2</sup> s
Critical dV/dt (@ Tj init=40°C)	1000 V/μs	1000 V/μs	1000 V/μs	1000 V/μs

## General specifications

Operational voltage range	24-240 VAC +10% [RG.23..] 42-600 VAC +10% [RG.60..]	24-240 VAC +10% [RG.23..] 42-600 VAC +10% [RG.60..]	42-600 VAC +10%	24-240 VAC +10% [RG.23..] 42-600 VAC +10% [RG.60..]
Blocking voltage	800 Vp [RGC.23.] 1200 Vp [RGC.60.]	800 Vp [RGC.23.] 1200 Vp [RGC.60.]	1200 Vp	800 Vp [RGC.23.] 1200 Vp [RGC.60.]
Power factor	$\geq 0.5$ at rated voltage	$\geq 0.5$ at rated voltage	$\geq 0.5$ at rated voltage	$\geq 0.5$ at rated voltage
Operating temperature	-40°C to +80°C	-40°C to +80°C	-40°C to +80°C	-40°C to +80°C
Approvals/Marks	CE - cULus - VDE - EAC - GL	CE - cULus - VDE* - EAC - GL*	CE - cULus - EAC	CE - cULus - VDE - EAC - GL



## References

DC control voltage				
230 VAC, 800 Vp	20 AAC: RGC1A23D15MKE	25 AAC: RGC1A23D25MKE		30 AAC: RGC1A23D30MKE
600 VAC, 1200 Vp	20 AAC: RGC1A60D15MKE	25 AAC: RGC1A60D25MKE		30 AAC: RGC1A60D30MKE
600 VAC, 1200 Vp, 18000 A <sup>2</sup> s		30 AAC: RGC1A60D32MKE	37 AAC: RGC1A60D32MGE	
AC/DC control voltage				
230 VAC, 800 Vp	20 AAC: RGC1A23A15MKE	25 AAC: RGC1A23A25MKE		30 AAC: RGC1A23A30MKE
600 VAC, 1200 Vp	20 AAC: RGC1A60A15MKE	25 AAC: RGC1A60A25MKE		30 AAC: RGC1A60A30MKE

Instant On (Random) Switching available on request (RGC1B60D...)  
\* not applicable to RGC.32

# Solid state contactors, 1-phase

Slimline, DIN-rail mounting - AC output

Types	RGC..15KGU 20 AAC	RGC..25KGU 25 AAC	RGC..30KGU 30 AAC
Single-phase, semiconductor contactors with integrated heatsink, LED indication and IP20 protection, AC operating frequency 45-65 Hz, rated isolation voltage $\geq 4000$ Vrms, 100 kArms short circuit current rating, motor ratings according to UL508.			
Dimensions HxWxD (mm)	110 x 17.8 x 103.5	110 x 17.8 x 103.5	110 x 22.5 x 141
Features	17.8 mm wide solid state contactor, integrated varistor for overvoltage protection, DC or AC control voltage range, screw terminals with captivated clamp for connection of control terminals and box clamps for power terminals, U-type layout	17.8 mm wide solid state contactor, integrated varistor for overvoltage protection, DC or AC control voltage range, screw terminals with captivated clamp for connection of control terminals and box clamps for power terminals, U-type layout	22.5 mm wide solid state contactor, integrated varistor for overvoltage protection, DC or AC control voltage range, screw terminals with captivated clamp for connection of control terminals and box clamps for power terminals, U-type layout
<b>Input specifications</b>			
Control input range	3-32 VDC [RG.23D.] 4-32 VDC [RG.60D.] 20-275 VAC, 24-190 VDC [RG..A.]	3-32 VDC [RG.23D.] 4-32 VDC [RG.60D.] 20-275 VAC, 24-190 VDC [RG..A.]	3-32 VDC [RG.23D.] 4-32 VDC [RG.60D.] 20-275 VAC, 24-190 VDC [RG..A.]
Max. input current	11 mADC [RG..D.] 30 mAAC [RG..A.]	11 mADC [RG..D.] 30 mAAC [RG..A.]	11 mADC [RG..D.] 30 mAAC [RG..A.]
<b>Output specifications</b>			
Rated operational current			
AC 51 @ $T_a=40^\circ\text{C}$	20 AAC	25 AAC	30 AAC
AC 53a @ $T_a=40^\circ\text{C}$	5 AAC	5 AAC	8 AAC
Min. operational current	150 mA	250 mA	250 mA
Non rep. surge current (t=10 ms)	325 Ap	600 Ap	600 Ap
Off-state leakage current	3 mAAC	3 mAAC	3 mAAC
I <sup>2</sup> t for fusing (t=10 ms)	525 A <sup>2</sup> s	1800 A <sup>2</sup> s	1800 A <sup>2</sup> s
Critical dV/dt (@ $T_j$ init=40°C)	1000 V/ $\mu$ s	1000 V/ $\mu$ s	1000 V/ $\mu$ s
<b>General specifications</b>			
Operational voltage range	24-240 VAC +10% [RG.23..] 42-600 VAC +10% [RG.60..]	24-240 VAC +10% [RG.23..] 42-600 VAC +10% [RG.60..]	24-240 VAC +10% [RG.23..] 42-600 VAC +10% [RG.60..]
Blocking voltage	800 Vp [RGC.23.] 1200 Vp [RGC.60.]	800 Vp [RGC.23.] 1200 Vp [RGC.60.]	800 Vp [RGC.23.] 1200 Vp [RGC.60.]
Power factor	$\geq 0.5$ at rated voltage	$\geq 0.5$ at rated voltage	$\geq 0.5$ at rated voltage
Operating temperature	-40°C to +80°C	-40°C to +80°C	-40°C to +80°C
Approvals/Marks	CE - cULus - VDE - EAC - GL	CE - cULus - VDE - EAC - GL	CE - cULus - VDE - EAC - GL
<b>References</b>			
DC control voltage			
230 VAC, 800 Vp	20 AAC: RGC1A23D15KGU	25 AAC: RGC1A23D25KGU	30 AAC: RGC1A23D30KGU
600 VAC, 1200 Vp	20 AAC: RGC1A60D15KGU	25 AAC: RGC1A60D25KGU	30 AAC: RGC1A60D30KGU
AC/DC control voltage			
230 VAC, 800 Vp	20 AAC: RGC1A23A15KGU	25 AAC: RGC1A23A25KGU	30 AAC: RGC1A23A30KGU
600 VAC, 1200 Vp	20 AAC: RGC1A60A15KGU	25 AAC: RGC1A60A20KGU	30 AAC: RGC1A60A30KGU





Instant On (Random) Switching available on request (RGC1B60D...)

CARLO GAVAZZI Automation Components. Specifications are subject to change without notice. Illustrations are for example only.



# Solid state contactors, 1-phase

## Slimline, DIN-rail mounting - AC output

Types	RGC..40/42KGE 40/43 AAC	RGC..40/42MGE 40/43 AAC	RGC..60/62KGE 60/65 AAC	RGC..62MGE 65 AAC
Single-phase, semiconductor contactors with integrated heatsink, LED indication and IP20 protection, AC operating frequency 45-65 Hz, rated isolation voltage $\geq 4000$ Vrms, 100 kArms short circuit current rating, motor ratings according to UL508.				
Dimensions HxWxD (mm)	110 x 35.6 x 141	110 x 35.6 x 152	110 x 69.1 x 141	110 x 69.1 x 152
Features	35 mm wide solid state contactor, integrated varistor, DC or AC control voltage, screw terminals for control, box clamp for power terminals, E-type layout	35 mm wide solid state contactor, integrated varistor, DC or AC control voltage, spring plug for control, box clamp for power terminals, E-type layout	70 mm wide solid state contactor, integrated varistor, DC or AC control voltage, screw terminals for control, box clamp for power terminals, E-type layout	70 mm wide solid state contactor, integrated varistor, DC or AC control voltage, spring plug for control, box clamp for power terminals, E-type layout

### Input specifications

Control input range	3-32 VDC [RG..23D..] 4-32 VDC [RG..60D..] 20-275 VAC, 24-190 VDC [RG..A..]	4-32 VDC [RG..D..] 20-275 VAC, 24-190 VDC [RG..A..]	3-32 VDC [RG..23D..] 4-32 VDC [RG..60D..] 20-275 VAC, 24-190 VDC [RG..A..]	4-32 VDC [RG..D..] 20-275 VAC, 24-190 VDC [RG..A..]
Max. input current	11 mA DC [RG..D..] 30 mA AC [RG..A..]	11 mA DC [RG..D..] 30 mA AC [RG..A..]	11 mA DC [RG..D..] 30 mA AC [RG..A..]	11 mA DC [RG..D..] 30 mA AC [RG..A..]

### Output specifications

Rated operational current AC 51 @ Ta=40°C	40 AAC [RGC..40] 43 AAC [RGC..42]	40 AAC [RGC..40] 43 AAC [RGC..42]	60 AAC [RGC..60] 65 AAC [RGC..62]	65 AAC
AC 53a @ Ta=40°C	13 AAC [RGC..40] 16 AAC [RGC..42]	13 AAC [RGC..40] 16 AAC [RGC..42]	14.8 AAC [RGC..60] 20 AAC [RGC..62]	20 AAC
Min. operational current	400 mA AC [RGC..40] 500 mA AC [RGC..42]	400 mA AC [RGC..40] 500 mA AC [RGC..42]	400 mA AC [RGC..60] 500 mA AC [RGC..62]	500 mA AC
Non rep. surge current (t=10 ms)	800 Ap [RGC..40] 1900 Ap [RGC..42]	800 Ap [RGC..40] 1900 Ap [RGC..42]	800 Ap [RGC..60] 1900 Ap [RGC..62]	1900 Ap
Off-state leakage current	3 mA AC	3 mA AC	3 mA AC	3 mA AC
I <sup>2</sup> t for fusing (t=10 ms)	3200 A <sup>2</sup> s [RGC..40] 18000 A <sup>2</sup> s [RGC..42]	3200 A <sup>2</sup> s [RGC..40] 18000 A <sup>2</sup> s [RGC..42]	3200 A <sup>2</sup> s [RGC..60] 18000 A <sup>2</sup> s [RGC..62]	18000 A <sup>2</sup> s
Critical dV/dt (@ Tj init=40°C)	1000 V/μs	1000 V/μs	1000 V/μs	1000 V/μs

### General specifications

Operational voltage range	24-240 VAC +10% [RG..23..] 42-600 VAC +10% [RG..60..]	42-600 VAC +10%	24-240 VAC +10% [RG..23..] 42-600 VAC +10% [RG..60..]	42-600 VAC +10%
Blocking voltage	800 Vp [RGC..23..] 1200 Vp [RGC..60..]	1200 Vp	800 Vp [RGC..23..] 1200 Vp [RGC..60..]	1200 Vp
Power factor	$\geq 0.5$ at rated voltage	$\geq 0.5$ at rated voltage	$\geq 0.5$ at rated voltage	$\geq 0.5$ at rated voltage
Operating temperature	-40°C to +80°C	-40°C to +80°C	-40°C to +80°C	-40°C to +80°C
Approvals/Marks	CE - cULus - VDE - EAC	CE - cULus - VDE - EAC	CE - cULus - VDE - EAC	CE - cULus - VDE - EAC



### References

230 VAC, 800 Vp, 3200 A <sup>2</sup> s	40 AAC: RGC1A23X40KGE		60 AAC: RGC1A23X60KGE	
230 VAC, 800 Vp, 18000 A <sup>2</sup> s	43 AAC: RGC1A23X42KGE		65 AAC: RGC1A23X62KGE	
600 VAC, 1200 Vp, 3200 A <sup>2</sup> s	40 AAC: RGC1A60X40KGE	40 AAC: RGC1A60X40MGE	60 AAC: RGC1A60X60KGE	
600 VAC, 1200 Vp, 18000 A <sup>2</sup> s	43 AAC: RGC1A60X42KGE	43 AAC: RGC1A60X42MGE	65 AAC: RGC1A60X62KGE	65 AAC: RGC1A60X62MGE

X must be replaced with D for DC control 3-32 VDC, 4-32 VDC (for 600 VAC versions)  
 X must be replaced with A for AC control 20-275 VAC, 24-190 VDC  
 RGC1B.. models for Instant On (Random) switching are available on request  
 \*690 VAC variants are CE marked only and do not include a varistor across the output

# Solid state contactors, 1-phase

## Slimline, DIN-rail mounting - AC output





Types	<b>RGC..40/42KGU</b> 40/43 AAC	<b>RGC..60/62KGU</b> 60/65 AAC
Single-phase, semiconductor contactors with integrated heatsink, LED indication and IP20 protection, rated isolation voltage $\geq 4000$ Vrms, 100 kArms short circuit current rating and motor ratings according to UL508 for AC output switching.		
Dimensions HxWxD (mm)	110 x 35.6 x 141	110 x 69.1 x 141
Features	35 mm wide solid state contactor, integrated varistor, DC or AC control voltage, screw terminals for control, box clamp for power terminals, U-type layout	70 mm wide solid state contactor, integrated varistor, DC or AC control voltage, screw terminals for control, box clamp for power terminals, U-type layout
<b>Input specifications</b>		
Control input range	4-32 VDC [RG..D..] 20-275 VAC, 24-190 VDC [RG..A..]	4-32 VDC [RG..D..] 20-275 VAC, 24-190 VDC [RG..A..]
Max. input current	11 mADC [RG..D..] 30 mAAC [RG..A..]	11 mADC [RG..D..] 30 mAAC [RG..A..]
<b>Output specifications</b>		
Rated operational current		
AC-51 @ $T_a=40^\circ\text{C}$	40 AAC [RGC..40] 43 AAC [RGC..42]	60 AAC [RGC..60] 65 AAC [RGC..62]
AC-53a @ $T_a=40^\circ\text{C}$	13 AAC [RGC..40] 16 AAC [RGC..42]	14.8 AAC [RGC..60] 20 AAC [RGC..62]
Min. operational current	400 mAAC [RGC..40] 500 mAAC [RGC..42]	400 mAAC [RGC..60] 500 mAAC [RGC..62]
Non rep. surge current (t=10 ms)	800 Ap [RGC..40] 1900 Ap [RGC..42]	800 Ap [RGC..60] 1900 Ap [RGC..62]
Off-state leakage current	3 mAAC	3 mAAC
$I^2t$ for fusing (t=10 ms)	3200 A <sup>2</sup> s [RGC..40] 18000 A <sup>2</sup> s [RGC..42]	3200 A <sup>2</sup> s [RGC..60] 18000 A <sup>2</sup> s [RGC..62]
Critical dV/dt (@ $T_j$ init= 40°C)	1000 V/ $\mu$ s	1000 V/ $\mu$ s
<b>General specifications</b>		
Operational voltage range	42-600 VAC +10%	42-600 VAC +10%
Blocking voltage	1200 Vp	1200 Vp
Power factor	$\geq 0.5$ at rated voltage	$\geq 0.5$ at rated voltage
Operating temperature	-40°C to +80°C	-40°C to +80°C
Approvals/Marks	CE - cULus - VDE - EAC	CE - cULus - VDE - EAC
<b>References</b>		
600 VAC, 1200 Vp, 3200 A <sup>2</sup> s	40 AAC: <b>RGC1A60X40KGU</b>	60 AAC: <b>RGC1A60X60KGU</b>
600 VAC, 1200 Vp, 18000 A <sup>2</sup> s	43 AAC: <b>RGC1A60X42KGU</b>	65 AAC: <b>RGC1A60X62KGU</b>

X must be replaced with D for DC control 4-32 VDC. X must be replaced with A for AC control 20-275 VAC, 24-190 VDC  
 RGC1B.. models for Instant On (Random) switching are available on request

CARLO GAVAZZI Automation Components. Specifications are subject to change without notice. Illustrations are for example only.

# Solid state contactors, 1-phase

Slimline, DIN-rail mounting - AC output, high blocking voltage

Types	RGH..15KKE 23 AAC	RGH..31KKE 30 AAC	RGH..41KGE RGH..41KGU 40 AAC	RGH..60KGE RGH..60KGU 60 AAC
Single-phase, semiconductor contactors with integrated heatsink, LED indication and IP20 protection, AC operating frequency 45-65 Hz, rated isolation voltage $\geq 4000$ Vrms, 100 kArms short circuit current rating, motor ratings according to UL508.				
Dimensions HxWxD (mm)	110 x 17.8 x 103.5	110 x 22.5 x 141	110 x 35.6 x 141	110 x 69.1 x 141
Features	17.8 mm wide solid state contactor, integrated varistor, DC or AC control voltage, screw terminals for control and power terminals, E-type layout	22.5 mm wide solid state contactor, integrated varistor, DC or AC control voltage, screw terminals for control and power terminals, E-type layout	35 mm wide solid state contactor, integrated varistor, DC or AC control voltage, screw terminals for control and box clamps for power terminals, E-type or U-type layout	70 mm wide solid state contactor, integrated varistor, DC or AC control voltage, screw terminals for control and box clamps for power terminals, E-type or U-type layout

## Input specifications

Control input range	4-32 VDC [RG..D..] 20-275 VAC, 24-190 VDC [RG..A..]	4-32 VDC [RG..D..] 20-275 VAC, 24-190 VDC [RG..A..]	4-32 VDC [RG..D..] 20-275 VAC, 24-190 VDC [RG..A..]	4-32 VDC [RG..D..] 20-275 VAC, 24-190 VDC [RG..A..]
Max. input current	11 mADC [RG..D..] 30 mAAC [RG..A..]	11 mADC [RG..D..] 30 mAAC [RG..A..]	11 mADC [RG..D..] 30 mAAC [RG..A..]	11 mADC [RG..D..] 30 mAAC [RG..A..]

## Output specifications

Rated operational current AC 51 @ Ta=40°C	23 AAC	30 AAC	40 AAC	60 AAC
AC 53a @ Ta=40°C	5 AAC	10 AAC	13 AAC	18 AAC
Min. operational current	400 mAAC	400 mAAC	400 mAAC	400 mAAC
Non rep. surge current (t=10 ms)	1150 Ap	1150 Ap	1150 Ap	1150 Ap
Off-state leakage current	3 mAAC	3 mAAC	3 mAAC	3 mAAC
I <sup>2</sup> t for fusing (t=10 ms)	6600 A <sup>2</sup> s	6600 A <sup>2</sup> s	6600 A <sup>2</sup> s	6600 A <sup>2</sup> s
Critical dV/dt (@ Tj init=40°C)	1000 V/μs	1000 V/μs	1000 V/μs	1000 V/μs

## General specifications

Operational voltage range	42-600 VAC +10%	42-600 VAC +10%	42-600 VAC +10% [RG..60..] 42-690 VAC +10% [RG..69..]*	42-600 VAC +10% [RG..60..] 42-690 VAC +10% [RG..69..]*
Blocking voltage	1600 Vp	1600 Vp	1600 Vp	1600 Vp
Power factor	$\geq 0.5$ at rated voltage	$\geq 0.5$ at rated voltage	$\geq 0.5$ at rated voltage	$\geq 0.5$ at rated voltage
Operating temperature	-40°C to +80°C	-40°C to +80°C	-40°C to +80°C	-40°C to +80°C
Approvals/Marks	CE - cULus - VDE - EAC	CE - cULus - VDE - EAC	CE - cULus - VDE - EAC	CE - cULus - VDE - EAC



## References

E-type				
600 VAC, 1600 Vp, DC control	23 AAC: RGH1A60D15KKE	30 AAC: RGH1A60D31KKE	40 AAC: RGH1A60D41KGE	60 AAC: RGH1A60D60KGE
600 VAC, 1600 Vp, AC control	23 AAC: RGH1A60A15KKE	30 AAC: RGH1A60A31KKE	40 AAC: RGH1A60A41KGE	60 AAC: RGH1A60A60KGE
690 VAC, 1600 Vp, DC control			40 AAC: RGH1A69D41KGE*	60 AAC: RGH1A69D60KGE*
690 VAC, 1600 Vp, AC control			40 AAC: RGH1A69A41KGE*	60 AAC: RGH1A69A60KGE*
U-type				
600 VAC, 1600 Vp, DC control			40 AAC: RGH1A60D41KGU	60 AAC: RGH1A60D60KGU
600 VAC, 1600 Vp, AC control			40 AAC: RGH1A60A41KGU	60 AAC: RGH1A60A60KGU

\*690 VAC variants are CE marked only and do not include a varistor across the output

# Solid state contactors, 1-phase

Slimline, DIN-rail mounting - AC output, high blocking voltage

Types	<b>RGH..15MKE</b> 23 AAC	<b>RGH..31MKE</b> 30 AAC	<b>RGH..41MGE</b> 40 AAC
Single-phase, semiconductor contactors with integrated heatsink, LED indication and IP20 protection, AC operating frequency 45-65 Hz, rated isolation voltage $\geq 4000$ Vrms, 100 kArms short circuit current rating, motor ratings according to UL508.			
Dimensions HxWxD (mm)	110 x 17.8 x 114.5	110 x 22.5 x 152	110 x 35.6 x 152
Features	17.8 mm wide solid state contactor, integrated varistor, DC or AC control voltage, spring plug for control and screw terminals for power, E-type layout	22.5 mm wide solid state contactor, integrated varistor, DC or AC control voltage, spring plug for control and screw terminals for power, E-type layout	35 mm wide solid state contactor, integrated varistor, DC or AC control voltage, spring plug for control and box clamps for power terminals, E-type layout

## Input specifications

Control input range	4-32 VDC [RG..D..] 20-275 VAC, 24-190 VDC [RG..A..]	4-32 VDC [RG..D..] 20-275 VAC, 24-190 VDC [RG..A..]	4-32 VDC [RG..D..] 20-275 VAC, 24-190 VDC [RG..A..]
Max. input current	11 mA DC [RG..D..] 30 mA AC [RG..A..]	11 mA DC [RG..D..] 30 mA AC [RG..A..]	11 mA DC [RG..D..] 30 mA AC [RG..A..]

## Output specifications

Rated operational current AC 51 @ $T_a=40^\circ\text{C}$	23 AAC	30 AAC	40 AAC
AC 53a @ $T_a=40^\circ\text{C}$	5 AAC	10 AAC	13 AAC
Min. operational current	400 mA AC	400 mA AC	400 mA AC
Non rep. surge current (t=10 ms)	1150 A <sub>p</sub>	1150 A <sub>p</sub>	1150 A <sub>p</sub>
Off-state leakage current	3 mA AC	3 mA AC	3 mA AC
I <sup>2</sup> t for fusing (t=10 ms)	6600 A <sup>2</sup> s	6600 A <sup>2</sup> s	6600 A <sup>2</sup> s
Critical dV/dt (@ T <sub>j</sub> init=40°C)	1000 V/ $\mu$ s	1000 V/ $\mu$ s	1000 V/ $\mu$ s

## General specifications





Operational voltage range	42-600 VAC +10%	42-600 VAC +10%	42-600 VAC +10%
Blocking voltage	1600 V <sub>p</sub>	1600 V <sub>p</sub>	1600 V <sub>p</sub>
Power factor	$\geq 0.5$ at rated voltage	$\geq 0.5$ at rated voltage	$\geq 0.5$ at rated voltage
Operating temperature	-40°C to +80°C	-40°C to +80°C	-40°C to +80°C
Approvals/Marks	CE - cULus - VDE - EAC	CE - cULus - VDE - EAC	CE - cULus - VDE - EAC

## References

600 VAC, 1600 V <sub>p</sub> , DC control	23 AAC: <b>RGH1A60D15MKE</b>	30 AAC: <b>RGH1A60D31MKE</b>	40 AAC: <b>RGH1A60D41MGE</b>
600 VAC, 1600 V <sub>p</sub> , AC control	23 AAC: <b>RGH1A60A15MKE</b>	30 AAC: <b>RGH1A60A31MKE</b>	40 AAC: <b>RGH1A60A41MGE</b>

# Solid state contactors, 1-phase

## DIN-rail mounting - AC output with over temperature protection

Types	RG..30..P 30 AAC	RG..40/42..P 40/43 AAC	RG..60/62..P 60/65 AAC	RG..90/92..P 85 AAC
Single-phase, semiconductor contactors with integrated heatsink, LED indication and IP20 protection, AC operating frequency 45-65 Hz, rated isolation voltage $\geq 4000$ Vrms, 100 kArms short circuit current rating, motor ratings according to UL508.				
Dimensions HxWxD (mm)	110 x 22.5 x 168	110x 35.6 x 168	110 x 69.1 x 168	126 x 69.1 x 168 (with fan)
Features	Integrated over temperature for protection against over heating, screw terminals with captivated clamp for connection of power terminals and box clamps for control terminals	Integrated over temperature for protection against over heating, box clamps for connection of power and control terminals	Integrated over temperature for protection against over heating, box clamps for connection of power and control terminals	Integrated over temperature for protection against over heating, box clamps for connection of power and control terminals

### Input specifications

Control input range	5-32 VDC [RG.D.] 20-275 VAC, 24-190 VDC [RG.A.]	5-32 VDC [RG.D.] 20-275 VAC, 24-190 VDC [RG.A.]	5-32 VDC [RG.D.] 20-275 VAC, 24-190 VDC [RG.A.]	5-32 VDC [RG.D.] 20-275 VAC, 24-190 VDC [RG.A.]
Max. input current	24 mA DC [RG..D.] 35 mA AC [RG..A.]	24 mA DC [RG..D.] 35 mA AC [RG..A.]	23 mA DC [RG..D.] 35 mA AC [RG..A.]	23 mA DC [RG..D.] 35 mA AC [RG..A.]

### Supply voltage

Rated supply voltage	24 VDC -15%, +20%	24 VDC -15%, +20%	24 VDC -15%, +20%	24 VDC -15%, +20%
Max. current rating	50 mA DC	50 mA DC	50 mA DC	50 mA DC (fan rating 24 VDC/50 mA)

### Over temperature alarm

Alarm output	PNP open collector normally closed, max. 24 VDC / 50 mA [RGC.D.P] Potential free normally closed, max. 24 VDC / 50 mA [RGC.A.P]	PNP open collector normally closed, max. 24 VDC / 50 mA [RGC.D.P] Potential free normally closed, max. 24 VDC / 50 mA [RGC.A.P]	PNP open collector normally closed, max. 24 VDC / 50 mA [RGC.D.P] Potential free normally closed, max. 24 VDC / 50 mA [RGC.A.P]	PNP open collector normally closed, max. 24 VDC / 50 mA [RGC.D.P] Potential free normally closed, max. 24 VDC / 50 mA [RGC.A.P]
--------------	--	--	--	--

### Output specifications

Rated operational current				
AC 51 @ Ta=40°C	30 AAC	40 AAC [RGC..40], 43 AAC [RGC..42]	60 AAC [RGC..60] 65 AAC [RGC..62]	85 AAC
AC 53a @ Ta=40°C	8 AAC	13 AAC [RGC..40], 16 AAC [RGC..42]	14.8 AAC [RGC..60] 20 AAC [RGC..62]	18 AAC [RGC..90] 20 AAC [RGC..92]
Min. operational current	250 mA	400 mA [RGC..40], 500 mA AC [RGC..42]	400 mA [RGC..60] 500 mA [RGC..62]	400 mA [RGC..90] 500 mA [RGC..92]
Non rep. surge current (t=10 ms)	600 A <sub>p</sub>	800 A <sub>p</sub> [RGC..40] 1900 A <sub>p</sub> [RGC..42]	800 A <sub>p</sub> [RGC..60] 1900 A <sub>p</sub> [RGC..62]	1150 A <sub>p</sub> [RGC..90] 1900 A <sub>p</sub> [RGC..92]
Off-state leakage current	3 mA AC	3 mA AC	3 mA AC	3 mA AC
I <sup>2</sup> t for fusing (t=10 ms)	1800 A <sup>2</sup> s	3200 A <sup>2</sup> s [RGC..40], 18000 A <sup>2</sup> s [RGC..42]	3200 A <sup>2</sup> s [RGC..60] 18000 A <sup>2</sup> s [RGC..62]	6600 A <sup>2</sup> s [RGC..90] 18000 A <sup>2</sup> s [RGC..92]
Critical dV/dt off-state (@ T <sub>j</sub> init=40°C)	1000 V/μs	1000 V/μs	1000 V/μs	1000 V/μs



### General specifications

Operational voltage range	42-600 VAC +10%	42-600 VAC +10%	42-600 VAC +10%	42-600 VAC +10%
Blocking voltage	1200 V <sub>p</sub>	1200 V <sub>p</sub>	1200 V <sub>p</sub>	1200 V <sub>p</sub>
Power factor	$\geq 0.5$ at rated voltage	$\geq 0.5$ at rated voltage	$\geq 0.5$ at rated voltage	$\geq 0.5$ at rated voltage
Operating temperature	-40°C to +70°C	-40°C to +70°C	-40°C to +70°C	-40°C to +70°C
Approvals/Marks	CE - cULus - VDE - EAC	CE - cULus - VDE - EAC	CE - cULus - VDE - EAC	CE - cULus - VDE - EAC

### References

DC control voltage				
600 VAC, 1200 V <sub>p</sub> , U-type		40 AAC: RGC1A60D40GGUP	60 AAC: RGC1A60D60GGUP	85 AAC: RGC1A60D90GGUP
600 VAC, 1200 V <sub>p</sub> , E-type	30 AAC: RGC1A60D30GKEP	43 AAC: RGC1A60D42GGEP	65 AAC: RGC1A60D62GGEP	85 AAC: RGC1A60D90GGEP
600 VAC, 1200 V <sub>p</sub> , E-type, high I <sup>2</sup> t				85 AAC: RGC1A60D92GGEP
AC/DC control voltage				
600 VAC, 1200 V <sub>p</sub> , U-type		40 AAC: RGC1A60A40GGUP	60 AAC: RGC1A60A60GGUP	85 AAC: RGC1A60A90GGUP
600 VAC, 1200 V <sub>p</sub> , E-type	30 AAC: RGC1A60A30GKEP	43 AAC: RGC1A60A42GGEP	65 AAC: RGC1A60A62GGEP	85 AAC: RGC1A60A90GGEP
600 VAC, 1200 V <sub>p</sub> , E-type, high I <sup>2</sup> t				85 AAC: RGC1A60A92GGEP





# Solid state contactors, 1-phase

	DIN-rail mounting		
	DC output	AC output with integrated fuse	AC output with integrated fuse and monitoring
Types	RGC1D..15KKE 15 ADC	RGC1FA 20/30/40 AAC	RGC1FS 20/30/40 AAC
Single-phase, semiconductor contactors with integrated heatsink, LED indication and IP20 protection, rated isolation voltage $\geq 4000$ Vrms, 100 kArms short circuit current rating, motor ratings according to UL508.			
Dimensions HxWxD (mm)	110 x 17.8 x 141	110 x 35.6 x 168	110 x 35.6 x 168
Features	17.8 mm wide solid state contactor for DC switching with integrated free wheeling diode, DC control, screw terminals for power and control, E-type layout	35 mm wide solid state contactor with integrated fuse, DC control voltage range, box clamps for connection of power & control terminals	35 mm wide solid state contactor with integrated fuse, monitoring for SSR, load & fuse failure detection, DC control voltage range, box clamps for connection of power & control terminals
<b>Input specifications</b>			
Control input range	4.5-32 VDC	3-32 VDC [RGC1F..23.] 4.5-32 VDC [RGC1F..60.]	3-32 VDC [RGC1F..23.] 4.5-32 VDC [RGC1F..60.]
Max. input current	13.7 mADC	12 mADC	12 mADC
<b>Supply voltage</b>			
Rated supply voltage			24 VDC -15%, +20%
Max. current rating			80 mADC
<b>Over temperature alarm</b>			
Alarm output			PNP open collector normally closed, max. 24 VDC / 50 mA
<b>Output specifications</b>			
Rated operational current			
AC 51 @ Ta=40°C		20 AAC [RGC1F..20.] 30 AAC [RGC1F..30.] 40 AAC [RGC1F..40.]	20 AAC [RGC1F..20.] 30 AAC [RGC1F..30.] 40 AAC [RGC1F..40.]
AC 53a @ Ta=40°C		4.7 AAC [RGC1F..20.] 6 AAC [RGC1F..30.] 8 AAC [RGC1F..40.]	4.7 AAC [RGC1F..20.] 6 AAC [RGC1F..30.] 8 AAC [RGC1F..40.]
DC 1 @ 40°C	15 ADC		
Min. operational current	20 mADC	200 mAAC	200 mAAC
Non rep. surge current (I <sub>sm</sub> ) (t=10 ms)	200 ADC (10us)	Integrated fuse	Integrated fuse
Off-state leakage current	1.5 mADC		
I <sup>2</sup> t for fusing (t=10 ms)		Fuse - 740 A <sup>2</sup> s [RGC1F..20.] Fuse - 1400 A <sup>2</sup> s [RGC1F..30.] Fuse - 3100 A <sup>2</sup> s [RGC1F..40.]	Fuse - 740 A <sup>2</sup> s [RGC1F..20.] Fuse - 1400 A <sup>2</sup> s [RGC1F..30.] Fuse - 3100 A <sup>2</sup> s [RGC1F..40.]
Critical dV/dt off-state (@ T <sub>j</sub> init=40°C)		1000 V/μs	1000 V/μs
<b>General specifications</b>			
Operational voltage range	24-1000 VDC [CE] 24-600 VDC [UL508]	42-600 VAC +10%	42-600 VAC +10%
Blocking voltage	1200 V <sub>p</sub>	1200 V <sub>p</sub>	1200 V <sub>p</sub>
Power factor		$\geq 0.5$ at rated voltage	$\geq 0.5$ at rated voltage
Operating temperature	-40°C to +80°C	-40°C to +70°C	-40°C to +70°C
Approvals/Marks	CE - EAC - cULus	CE - EAC - cULus (up to 30 AAC)	CE - EAC - cULus (up to 30 AAC)
<b>References</b>			
DC control voltage 600 VAC, 1200 V <sub>p</sub>		20 AAC: RGC1FA60D20GGE 30 AAC: RGC1FA60D30GGE 40 AAC: RGC1FA60D40GGE	20 AAC: RGC1FS60D20GGE 30 AAC: RGC1FS60D30GGE 40 AAC: RGC1FS60D40GGE
1000 VDC	15 ADC: RGC1D1000D15KKE		





# Solid state contactors, 1-phase

## DIN-rail mounting - AC output, integrated system monitoring

Types	<b>RGCTA..15/25/31KEM</b> 20/25/30 AAC	<b>RGCTA..30KEM</b> 30 AAC	<b>RGCTA..42GEM</b> 43 AAC	<b>RGCTA..62GEM</b> 65 AAC
Single-phase, semiconductor contactors with integrated monitoring, E-type configuration, LED indication and IP20 protection, AC operating frequency 45-65 Hz, rated isolation voltage $\geq 4000$ Vrms, 100 kArms short circuit current rating.				
Dimensions HxWxD (mm)	110 x 17.8 x 134	110 x 22.5 x 171.5	110 x 35.6 x 171.5	110 x 70 x 171.5
Features	17.8 mm wide solid state contactor, integrated monitoring for SSR and load malfunction, integrated varistor, DC control and supply, transistor output for remote alarm signalling	22.5 mm wide solid state contactor, integrated monitoring for SSR and load malfunction, integrated varistor, DC control and supply, transistor output for remote alarm signalling	35 mm wide solid state contactor, integrated monitoring for SSR and load malfunction, integrated varistor, DC control and supply, transistor output for remote alarm signalling	70 mm wide solid state contactor, integrated monitoring for SSR and load malfunction, integrated varistor, DC control and supply, transistor output for remote alarm signalling
<b>Input specifications</b>				
Control input range	4-32 VDC	4-32 VDC	4-32 VDC	4-32 VDC
Max. input current	0.5 mADC at 24 VDC	0.5 mADC at 24 VDC	0.5 mADC at 24 VDC	0.5 mADC at 24 VDC
<b>Supply voltage</b>				
Rated supply voltage	19.2-28.8 VDC	19.2-28.8 VDC	19.2-28.8 VDC	19.2-28.8 VDC
Max. current rating	40 mA	40 mA	40 mA	40 mA
<b>Alarm specifications</b>				
Output type	Transistor, NC, NO max. 35 VDC/100 mA	Transistor, NC, NO max. 35 VDC/100 mA	Transistor, NC, NO max. 35 VDC/100 mA	Transistor, NC, NO max. 35 VDC/100 mA
Alarm Condition	Mains loss, load loss, SSR open and short cct, SSR internal error, supply out of range	Mains loss, load loss, SSR open and short cct, SSR internal error, supply out of range	Mains loss, load loss, SSR open and short cct, SSR internal error, supply out of range	Mains loss, load loss, SSR open and short cct, SSR internal error, supply out of range
<b>Output specifications</b>				
Rated operational current AC 51 @ Ta=40°C	20 AAC [RGC..15] 25 AAC [RGC..25] 30 AAC [RGC..31]	30 AAC	43 AAC	65 AAC
Minimum operational current	150 mAAC [RGC..15] 250 mAAC [RGC..25] 400 mAAC [RGC..31]	250 mAAC	500 mAAC	500 mAAC
Non. rep. surge current I <sub>tsm</sub> (t=10ms)	325 A <sub>p</sub> [RGC..15] 600 A <sub>p</sub> [RGC..25] 1150 A <sub>p</sub> [RGC..31]	600 A <sub>p</sub>	1900 A <sub>p</sub>	1900 A <sub>p</sub>
Max. off state leakage current	5 mAAC	5 mAAC	5 mAAC	5 mAAC
I <sup>2</sup> t for fusing (t=10ms)	525 A <sup>2</sup> s [RGC..15] 1800 A <sup>2</sup> s [RGC..25] 6600 A <sup>2</sup> s [RGC..31]	1800 A <sup>2</sup> s	18000 A <sup>2</sup> s	18000 A <sup>2</sup> s
Critical dV/dt (@ T <sub>j</sub> init=40°C)	1000 V/μs	1000 V/μs	1000 V/μs	1000 V/μs
<b>General specifications</b>				
Operational voltage range	42-265 VAC [RGCTA23..] 150-660 VAC [RGCTA60..]	150-660 VAC	150-660 VAC	150-660 VAC
Blocking voltage	800 V <sub>p</sub> [RGCTA23..] 1200 V <sub>p</sub> [RGCTA60..]	1200 V <sub>p</sub>	1200 V <sub>p</sub>	1200 V <sub>p</sub>
Power factor	$\geq 0.9$ at rated voltage	$\geq 0.9$ at rated voltage	$\geq 0.9$ at rated voltage	$\geq 0.9$ at rated voltage
Operating temperature	-20°C to +65°C	-20°C to +65°C	-20°C to +65°C	-20°C to +65°C
Approvals/Marks	CE - cULus - EAC	CE - cULus - EAC	CE - cULus - EAC	CE - cULus - EAC
<b>References</b>				
230 VAC, 800 V <sub>p</sub> , 525A <sup>2</sup> s	20 AAC: <b>RGCTA23D15KEM</b>			
230 VAC, 800 V <sub>p</sub> , 6600 A <sup>2</sup> s	30 AAC: <b>RGCTA23D31KEM</b>			
600 VAC, 1200 V <sub>p</sub> , 525 A <sup>2</sup> s	20 AAC: <b>RGCTA60D15KEM</b>			
600 VAC, 1200 V <sub>p</sub> , 1800 A <sup>2</sup> s	25 AAC: <b>RGCTA60D25KEM</b>	30 AAC: <b>RGCTA60D30KEM</b>		
600 VAC, 1200 V <sub>p</sub> , 6600 A <sup>2</sup> s	30 AAC: <b>RGCTA60D31KEM</b>			
600 VAC, 1200 V <sub>p</sub> , 18000 A <sup>2</sup> s			43 AAC: <b>RGCTA60D42GEM</b>	65 AAC: <b>RGCTA60D62GEM</b>

# Solid state contactors, 1-phase

## DIN-rail mounting - AC output, integrated current measurement

Types	RGC1S..20/30/31GKEP 23/30 AAC	RGC1S..25GKEP 25 AAC	RGC1S..26GGEP 25 AAC
Single-phase, semiconductor contactors with integrated current measurement, E-type configuration, LED indication and IP20 protection, AC operating frequency 45-65 Hz, rated isolation voltage $\geq 4000$ Vrms, 100 kArms short circuit current rating.			
Dimensions HxWxD (mm)	110 x 22.5 x 163	110 x 22.5 x 126	110 x 22.5 x 126
Features	22.5 mm wide solid state contactor, integrated varistor, DC control, local or remote TEACH, detection of partial load failure (1/6), SSR and load malfunction, SSR overheat protection	22.5 mm wide solid state contactor, integrated varistor, DC control, local or remote TEACH, detection of partial load failure (1/6), SSR and load malfunction, SSR overheat protection	22.5 mm wide solid state contactor, integrated varistor, DC control, local or remote TEACH, detection of partial load failure (1/6), SSR and load malfunction, SSR overheat protection
<b>Input specifications</b>			
Control input range	4-32 VDC	4-32 VDC	4-32 VDC
Max. input current	10 mA <sub>DC</sub> at 24 VDC	10 mA <sub>DC</sub> at 24 VDC	10 mA <sub>DC</sub> at 24 VDC
<b>Supply voltage</b>			
Rated supply voltage	24 VDC -15%, +20%	24 VDC -15%, +20%	24 VDC -15%, +20%
Max. current rating	50 mA <sub>DC</sub>	50 mA <sub>DC</sub>	50 mA <sub>DC</sub>
<b>Alarm specifications</b>			
Output type	NC PNP open collector max. 35 VDC/50 mA	NC PNP open collector max. 35 VDC/50 mA	NC PNP open collector max. 35 VDC/50 mA
Alarm Indication	Red LED (flash rate)	Red LED (flash rate)	Red LED (flash rate)
<b>Output specifications</b>			
Rated operational current			
AC 51 @ T <sub>a</sub> =40°C	23 AAC [RGC1S..20] 30 AAC [RGC1S..30] 30 AAC [RGC1S..31]	25 AAC	25 AAC
Minimum TEACH / operational current	1.2 AAC	1.2 AAC	1.2 AAC
Minimum partial load current	0.2 AAC	0.2 AAC	0.2 AAC
Detectable partial load failure	>16.67% from current setpoint	>16.67% from current setpoint	>16.67% from current setpoint
Non. rep. surge current I <sub>sm</sub> (t=10ms)	325 A <sub>p</sub> [RGC1S..20] 600 A <sub>p</sub> [RGC1S..30] 1150 A <sub>p</sub> [RGC1S..31]	600 A <sub>p</sub>	1900 A <sub>p</sub>
Max. off state leakage current	3 mA <sub>AC</sub>	3 mA <sub>AC</sub>	3 mA <sub>AC</sub>
I <sup>2</sup> t for fusing (t=10ms)	525 A <sup>2</sup> s [RGC1S..20] 1800 A <sup>2</sup> s [RGC1S..30] 6600 A <sup>2</sup> s [RGC1S..31]	1800 A <sup>2</sup> s	18000 A <sup>2</sup> s
Critical dV/dt (@ T <sub>j</sub> init=40°C)	1000 V/μs	1000 V/μs	1000 V/μs
<b>General specifications</b>			
Operational voltage range	42-600 VAC +10%	42-600 VAC +10%	42-600 VAC +10%
Blocking voltage	1200 V <sub>p</sub>	1200 V <sub>p</sub>	1200 V <sub>p</sub>
Power factor	$\geq 0.9$ at rated voltage	$\geq 0.9$ at rated voltage	$\geq 0.9$ at rated voltage
Operating temperature	-25°C to +70°C	-25°C to +70°C	-25°C to +70°C
Approvals/Marks	CE - cULus - EAC	CE - cULus - EAC	CE - cULus - EAC
<b>References</b>			
600 VAC, 1200 V <sub>p</sub> , 525A <sup>2</sup> s	23 AAC: <b>RGC1S60D20GKEP</b>		
600 VAC, 1200 V <sub>p</sub> , 1800A <sup>2</sup> s	30 AAC: <b>RGC1S60D30GKEP</b>	25 AAC: <b>RGC1S60D25GKEP</b>	
600 VAC, 1200 V <sub>p</sub> , 6600A <sup>2</sup> s	30 AAC: <b>RGC1S60D31GKEP</b>		
600 VAC, 1200 V <sub>p</sub> , 18000A <sup>2</sup> s			25 AAC: <b>RGC1S60D26GGEP</b>

GK = screws for control terminals, box clamps for power terminals  
GG = box clamps for control terminals, box clamps for power terminals

CARLO GAVAZZI Automation Components. Specifications are subject to change without notice. Illustrations are for example only.



# Solid state contactors, 1-phase

DIN-rail mounting - AC output, integrated current measurement

Types	RGC1S..41GG.P 43 AAC	RGC1S..61GG.P 65 AAC	RGC1S..90GGEP 85 AAC
-------	-------------------------	-------------------------	-------------------------

Single-phase, semiconductor contactors with integrated heatsink, LED indication and IP20 protection, AC operating frequency 45-65 Hz, Rated isolation voltage  $\geq 4000$  Vrms, 100 kArms short circuit current rating, motor ratings according to UL508.



Dimensions HxWxD (mm)	110 x 35.6 x 163	110 x 69.1 x 163	126 x 69.1 x 163 (with fan)
Features	35 mm wide solid-state contactor, integrated varistor, DC control, local or remote TEACH, detection of partial load failure (1/6), SSR and load malfunction, SSR overheat protection	70 mm wide solid-state contactor, integrated varistor, DC control, local or remote TEACH, detection of partial load failure (1/6), SSR and load malfunction, SSR overheat protection	70 mm wide solid-state contactor with, integrated varistor, DC control, local or remote TEACH, detection of partial load failure (1/6), SSR and load malfunction, SSR overheat protection

## Input specifications

Control input range	4-32 VDC	4-32 VDC	4-32 VDC
Max. input current	10 mADC at 24 VDC	10 mADC at 24 VDC	10 mADC at 24 VDC

## Supply voltage

Supply voltage	24 VDC -15%, +20%	24 VDC -15%, +20%	24 VDC -15%, +20%
Max. current rating	50 mADC	50 mADC	50 mADC (fan rating 24 VDC / 50 mA)

## Alarm specifications

Output type	NC PNP open collector max. 35 VDC / 50 mA	NC PNP open collector max. 35 VDC / 50 mA	NC PNP open collector max. 35 VDC / 50 mA
Alarm Indication	Red LED (flash rate)	Red LED (flash rate)	Red LED (flash rate)

## Output specifications

Rated operational current			
AC 51 @ Ta=40°C	43 AAC	65 AAC	85 AAC
Minimum TEACH / operational current	1.2 AAC	5 AAC	5 AAC
Minimum partial load current	0.2 AAC	0.83 AAC	0.83 AAC
Detectable partial load failure	>16.67% from current setpoint	>16.67% from current setpoint	>16.67% from current setpoint
Non. rep. surge current I <sub>sm</sub> (t=10ms)	1900 Ap	1900 Ap	1900 Ap
Max. off state leakage current	3 mAAC	3 mAAC	3 mAAC
I <sup>2</sup> t for fusing (t=10 ms)	18000 A <sup>2</sup> s	18000 A <sup>2</sup> s	18000 A <sup>2</sup> s
Critical dV/dt (@ T <sub>j</sub> init=40°C)	1000 V/μs	1000 V/μs	1000 V/μs

## General specifications



Operational voltage range	42-600 VAC +10%	42-600 VAC +10%	42-600 VAC +10%
Blocking voltage	1200 V <sub>P</sub>	1200 V <sub>P</sub>	1200 V <sub>P</sub>
Power factor	$\geq 0.9$ at rated voltage	$\geq 0.9$ at rated voltage	$\geq 0.9$ at rated voltage
Operating temperature	-25°C to +70°C	-25°C to +70°C	-25°C to +70°C
Approvals/Marks	CE - cULus - EAC	CE - cULus - EAC	CE - cULus - EAC

## References

600 VAC, 1200 V <sub>P</sub> , E-type	43 AAC: RGC1S60D41GGEP	65 AAC: RGC1S60D61GGEP	85 AAC: RGC1S60D90GGEP
600 VAC, 1200 V <sub>P</sub> , U-type	43 AAC: RGC1S60D41GGUP	65 AAC: RGC1S60D61GGUP	

# Solid state contactors, 1-phase

## DIN-rail mounting - Soft start switching

Types	RGC1P..K.. 30 AAC	RGC1P..K.. 43 AAC	RGC1P..K.. 63 AAC
Single-phase, solid state relay with integrated heatsink, with integrated overvoltage protection, LED for control and load status indication, IP20 protection, Rated isolation voltage $\geq 4000$ Vrms, 100 kArms short circuit current rating.			
Dimensions HxWxD (mm)	110 x 35.8 x 104	110 x 35.8 x 104	110 x 72 x 126
Features	DC control input solid state contactor with soft starting feature for short wave infrared heaters	DC control input solid state contactor with soft starting feature for short wave infrared heaters	DC control input solid state contactor with soft starting feature for short wave infrared heaters
<b>Supply specifications</b>			
Supply voltage	24 VDC -15%, +20% 24 VAC -15%, +15%	24 VDC -15%, +20% 24 VAC -15%, +15%	24 VDC -15%, +20% 24 VAC -15%, +15%
Max. supply current	30 mA	30 mA	30 mA
<b>Control specifications</b>			
Control input	19.2 - 28.8 VDC	19.2 - 28.8 VDC	19.2 - 28.8 VDC
Input impedance	100 k $\Omega$	100 k $\Omega$	100 k $\Omega$
<b>Output specifications</b>			
Rated operational current AC-51 @ 40°C	30 AAC	43 AAC	63 AAC
Minimum operational current	250 mAAC	500 mAAC	500 mAAC
Non rep. surge current (I <sub>tsm</sub> ) (t=10 ms)	600 Ap	1900 Ap	1900 Ap
I <sup>2</sup> t for fusing (t=10 ms)	1800 A <sup>2</sup> s	18000 A <sup>2</sup> s	18000 A <sup>2</sup> s
Max. Off-state leakage current	5 mAAC	5 mAAC	5 mAAC
Critical dV/dt (@ T <sub>j</sub> init=40°C)	1000 V/ $\mu$ s	1000 V/ $\mu$ s	1000 V/ $\mu$ s
<b>General specifications</b>			
Operational voltage range	85 - 265 VAC [RGC1P23..] 190 - 550 VAC [RGC1P48..] 410 - 660 VAC [RGC1P60..]	85 - 265 VAC [RGC1P23..] 190 - 550 VAC [RGC1P48..] 410 - 660 VAC [RGC1P60..]	85 - 265 VAC [RGC1P23..] 190 - 550 VAC [RGC1P48..] 410 - 660 VAC [RGC1P60..]
Blocking voltage	800 V <sub>P</sub> [RGC1P23..] 1200 V <sub>P</sub> [RGC1P48..] 1200 V <sub>P</sub> [RGC1P60..]	800 V <sub>P</sub> [RGC1P23..] 1200 V <sub>P</sub> [RGC1P48..] 1200 V <sub>P</sub> [RGC1P60..]	800 V <sub>P</sub> [RGC1P23..] 1200 V <sub>P</sub> [RGC1P48..] 1200 V <sub>P</sub> [RGC1P60..]
Power factor	> 0.7	> 0.7	> 0.7
Terminals	Screw with captive clamp	Box clamp	Box clamp
Operating temperature	-40°C to +70°C	-40°C to +70°C	-40°C to +70°C
Approvals/Marks	CE - UL - cUL - EAC	CE - UL - cUL - EAC	CE - UL - cUL - EAC
<b>References</b>			
External supply 24 VDC/AC			
Operational output 85 - 265 VAC	<b>RGC1P23K30ED</b>	<b>RGC1P23K42ED</b>	<b>RGC1P23K62ED</b>
Operational output 190 - 550 VAC	<b>RGC1P48K30ED</b>	<b>RGC1P48K42ED</b>	<b>RGC1P48K62ED</b>
Operational output 410 - 660 VAC	<b>RGC1P60K30ED</b>	<b>RGC1P60K42ED</b>	<b>RGC1P60K62ED</b>

# Solid state contactors, 1-phase

## DIN-rail mounting - Proportional controllers

Types	RGC1P..AA.. / V.. 12 AAC	RGC1P..AA.. / V.. 30 AAC	RGC1P..AA.. / V.. 43 AAC	RGC1P..AA.. / V.. 50 / 63 AAC
Single-phase, solid state relay with integrated heatsink, with integrated overvoltage protection, LED for control and load status indication, IP20 protection, rated isolation voltage $\geq 4000$ Vrms, 100 kArms short circuit current rating.				

Dimensions HxWxD (mm)	106 x 35.8 x 65	110 x 35.8 x 104	110 x 35.8 x 104	110 x 72 x 126
Features	Analogue input (current or voltage), selectable modes for output switching - phase angle, full cycle distributed firing, advanced full cycle and soft starting	Analogue input (current or voltage), selectable modes for output switching - phase angle, full cycle distributed firing, advanced full cycle and soft starting	Analogue input (current or voltage), selectable modes for output switching - phase angle, full cycle distributed firing, advanced full cycle and soft starting	Analogue input (current or voltage), selectable modes for output switching - phase angle, full cycle distributed firing, advanced full cycle and soft starting

### Supply specifications

Supply voltage	24 VDC -15%, +20% [RG..V.ED] 24 VAC -15%, +15% [RG..V.ED] 90-250 VAC [RG..V.EA]	24 VDC -15%, +20% [RG..V.ED] 24 VAC -15%, +15% [RG..V.ED] 90-250 VAC [RG..V.EA]	24 VDC -15%, +20% [RG..V.ED] 24 VAC -15%, +15% [RG..V.ED] 90-250 VAC [RG..V.EA]	24 VDC -15%, +20% [RG..V.ED] 24 VAC -15%, +15% [RG..V.ED] 90-250 VAC [RG..V.EA]
Max. supply current	30 mA [RG..V.ED] 14 mA [RG..V.EA]	30 mA [RG..V.ED] 14 mA [RG..V.EA]	30 mA [RG..V.ED] 14 mA [RG..V.EA]	30 mA [RG..V.ED] 14 mA [RG..V.EA]

### Control specifications

Control input range	4-20 mA (RG..AA.) 0-10 V, 0-5 V, 1-5 V, POT (RG..V..)	4-20 mA (RG..AA.) 0-10 V, 0-5 V, 1-5 V, POT (RG..V..)	4-20 mA (RG..AA.) 0-10 V, 0-5 V, 1-5 V, POT (RG..V..)	4-20 mA (RG..AA.) 0-10 V, 0-5 V, 1-5 V, POT (RG..V..)
Input impedance	500 $\Omega$ (RG..AA.) 100 k $\Omega$ (RG..V..)	500 $\Omega$ (RG..AA.) 100 k $\Omega$ (RG..V..)	500 $\Omega$ (RG..AA.) 100 k $\Omega$ (RG..V..)	500 $\Omega$ (RG..AA.) 100 k $\Omega$ (RG..V..)

### Output specifications

Rated operational current AC-51 @ 40°C	15 AAC	30 AAC	43 AAC	50 AAC [RG..50] 63 AAC [RG..62]
Minimum operational current	250 mAAC	250 mAAC	500 mAAC	500 mAAC
Non rep. surge current (I <sub>tsm</sub> ) (t=10 ms)	600 A <sub>p</sub>	600 A <sub>p</sub>	1900 A <sub>p</sub>	800 A <sub>p</sub> [RG..50] 1900 A <sub>p</sub> [RG..62]
I <sup>2</sup> t for fusing (t=10 ms)	1800 A <sup>2</sup> s	1800 A <sup>2</sup> s	18000 A <sup>2</sup> s	3200 A <sup>2</sup> s [RG..50] 18000 A <sup>2</sup> s [RG..62]
Max. Off-state leakage current	5 mAAC	5 mAAC	5 mAAC	5 mAAC
Critical dV/dt (@ T <sub>j</sub> init=40°C)	1000 V/ $\mu$ s	1000 V/ $\mu$ s	1000 V/ $\mu$ s	1000 V/ $\mu$ s

### General specifications



Operational voltage range	85 - 265 VAC [RGC1P23..] 190 - 550 VAC [RGC1P48..]	85 - 265 VAC [RGC1P23..] 190 - 550 VAC [RGC1P48..] 410 - 660 VAC [RGC1P60..]	85 - 265 VAC [RGC1P23..] 190 - 550 VAC [RGC1P48..] 410 - 660 VAC [RGC1P60..]	85 - 265 VAC [RGC1P23..] 190 - 550 VAC [RGC1P48..] 410 - 660 VAC [RGC1P60..]
Blocking voltage	800 V <sub>p</sub> [RGC1P23..] 1200 V <sub>p</sub> [RGC1P48..]	800 V <sub>p</sub> [RGC1P23..] 1200 V <sub>p</sub> [RGC1P48..] 1200 V <sub>p</sub> [RGC1P60..]	800 V <sub>p</sub> [RGC1P23..] 1200 V <sub>p</sub> [RGC1P48..] 1200 V <sub>p</sub> [RGC1P60..]	800 V <sub>p</sub> [RGC1P23..] 1200 V <sub>p</sub> [RGC1P48..] 1200 V <sub>p</sub> [RGC1P60..]
Power factor	> 0.7	> 0.7	> 0.7	> 0.7
Terminals	Screw with captive clamp	Screw with captive clamp	Box clamp	Box clamp
Operating temperature	-40°C to +70°C	-40°C to +70°C	-40°C to +70°C	-40°C to +70°C
Approvals/Marks	CE - UL - cUL - EAC	CE - UL - cUL - EAC	CE - UL - cUL - EAC	CE - UL - cUL - EAC

### References

Control input				
4-20 mA	RGC1PyyAA12E	RGC1PxxAA30E	RGC1PxxAA42E	50 AAC: RGC1PyyAA50E 63 AAC: RGC1PxxAA62E
0-10 VDC, 0-5 VDC, 1-5 VDC, POT	RGC1PyyV12ED	RGC1PxxV30ED	RGC1PxxV42ED	50 AAC: RGC1PyyV50ED 63 AAC: RGC1PxxV62ED
External supply 24 VDC/AC				
External supply 90-250 VAC	RGC1PyyV12EA	RGC1PxxV30EA	RGC1PxxV42EA	63 AAC: RGC1PxxV62EA

xx = 23 for operational voltage range 85 - 265 VAC  
48 for operational voltage range 190 - 550 VAC  
60 for operational voltage range 410 - 660 VAC  
yy = 23 for operational voltage range 85 - 265 VAC  
48 for operational voltage range 190 - 550 VAC

# Solid state relays with fieldbus, 1-phase

	NRG controller	NRG BUS cables
<b>Types</b>	<b>NRGC</b>	<b>RCRGN..</b>
Solid state solutions with real-time monitoring. The NRG controller and NRG BUS cables are required for the operation of the NRG solid state relays.		
Dimensions HxWxD (mm)	90 x 38.5 x 64 (without plugs) 107 x 38.5 x 64 (with plugs)	
	Controller of the NRG BUS chain with Modbus RTU over RS485 interface connected to the PLC of the system. The NRGC is the master of the BUS chain when configuration is required for the NRG solid state relays. It acts as a gateway when the PLC needs to access the NRG solid state relays. Each NRGC can handle a maximum of 48 NRG solid state relays	Terminated proprietary cables for the NRG internal BUS connecting respective RG..N solid state relays and RG..N solid state relays to the NRG controller. The BUS terminator terminates the internal BUS
<b>Supply specifications</b>		
Supply voltage	19.2 - 32 VDC	
Power consumption	<12 W	
<b>Auxiliary output specifications</b>		
Relay output	EMR, 3 pins (1 Form C)	
Relay output function	Configurable as an auxiliary output or an alarm output. Default is set as an alarm output (operates in case of NRGC related alarms)	
Relay output ratings	2 A, 250 VAC / 30 VDC	
<b>Alarm specifications</b>		
Alarm output	Red LED, Relay output if set to operate as an alarm output, status register of the NRGC	
<b>General specifications</b>		
Communication protocol	Modbus RTU, 2-wire half duplex	
Baud rate	Baudrate: 115200 bits/s (selectable 9600, 19200, 38400, 57600)	
Modbus physical interface	2x RJ45 plugs	
Approvals/Marks	CE - cULus - EAC	
<b>References</b>		
NRG controller	<b>NRGC</b>	
NRG BUS cables	10 cm: <b>RCRGN-010-2</b> 75 cm: <b>RCRGN-075-2</b> 150 cm: <b>RCRGN-150-2</b> 350 cm: <b>RCRGN-350-2</b> 500 cm: <b>RCRGN-500-2</b>	
NRG internal BUS termination	<b>RGN-TERMRES*</b>	

\* 1x RGN-TERMRES is provided with each NRGC

# Solid state relays with fieldbus, 1-phase

## NRG Solid state relays

Types	RGS..N 50/90 AAC	RGC..N 25/30/37 AAC	RGC..N 43/65 AAC
-------	---------------------	------------------------	---------------------

Switching components within the NRG system; Single-phase, AC operating frequency 45-65 Hz, rated isolation  $\geq 4000$  Vrms, IP20 protection, 100 kArms short circuit current rating according to UL508, integrated varistor on output.



Dimensions HxWxD (mm)	90 x 17.8 x 82	110 x 17.8 x 134	110 x 35 x 172 [RGC..42..] 110 x 70 x 172 [RGC..62..]
-----------------------	----------------	------------------	--

Features Solid state relays with integrated monitoring and a communication interface to provide real time data through an internal BUS: Current, Voltage, Frequency, Power, Energy consumption, SSR running hours and Load running hours. Interface to the PLC is done through the **NRGC**. RG..D..N versions are switched via an external voltage. A max. of 48 RG..D..Ns can be connected to 1x NRGC. RG..CM..N versions can be switched via the BUS as default or through an external voltage. RG..CM..N allows selection of switching mode in ON/OFF, Full cycle, Advanced full cycle or Burst. A max. of 32 RG..CM..Ns can be connected to 1x NRGC.

### Control specifications

Control input range	4-32 VDC	4-32 VDC	4-32 VDC
Max. input current	12.5 mA	12.5 mA	12.5 mA

### Supply specifications

Supply voltage Provided through internal BUS using cables RCRGN...

### Alarm specifications

Alarm output Red LED on the RG..N, alarm presence is identified through the status register of the solid state relay. Alarms that can be detected include: load deviation, system failure (mains loss, load loss, SSR open circuit), SSR short circuit, current out of range, voltage out of range, frequency out of range, over-temperature protection, communication and internal errors.

### Output specifications

Rated operational current			
AC 51 @ Ta=40°C	50 AAC [RGS..50..] 90 AAC [RGS..92..]	25 AAC [RGC..25KEN] 30 AAC [RGC..32KEN] 37 AAC [RGC..32GEN]	43 AAC [RGC..42..] 65 AAC [RGC..62..]
Min. operational current	250 mAAC [RGS..50..] 500 mAAC [RGS..92..]	250 mAAC [RGC..25..] 500 mAAC [RGC..32..]	500 mAAC
Non-rep. surge current (t=10 ms)	600 Ap [RGS..50..] 1900 Ap [RGS..92..]	600 Ap [RGC..25..] 1900 Ap [RGC..32..]	1900 Ap
Off-state leakage current	< 5 mAAC	< 5 mAAC	< 5 mAAC
I <sup>2</sup> t for fusing (t=10 ms)	1800 A <sup>2</sup> s [RGS..50..] 18000 A <sup>2</sup> [RGS..92..]	1800 A <sup>2</sup> s [RGC..25..] 18000 A <sup>2</sup> s [RGC..32..]	18000 A <sup>2</sup> s
Critical dV/dt off-state	1000 V/μs	1000 V/μs	1000 V/μs

### General specifications

Operational voltage range	42 - 600 VAC +10%	42 - 600 VAC +10%	42 - 600 VAC +10%
Blocking voltage	1200 Vr	1200 Vr	1200 Vr
Power factor	$\geq 0.9$	$\geq 0.9$	$\geq 0.9$
Operating temperature	-20°C to +65°C	-20°C to +65°C	-20°C to +65°C
Output terminals	Screw [RG..KEN] Box clamp [RG..GEN]	Screw [RG..KEN] Box clamp [RG..GEN]	Box clamp
Approvals/Marks	CE - UR - CSA - EAC	CE - cULus - EAC	CE - cULus - EAC

### References

600 VAC, 1200 Vr, Screw	50 AAC: RGS1A60X50KEN	25 AAC: RGC1A60X25KEN	
	90 AAC: RGS1A60X92KEN	30 AAC: RGC1A60X32KEN	
600 VAC, 1200 Vr, Box clamps	90 AAC: RGS1A60X92GEN	37 AAC: RGC1A60X32GEN	43 AAC: RGC1A60X42GEN
			65 AAC: RGC1A60X62GEN

X = 'D' for versions with external control only

X = 'CM' for versions that can be switched via the communication interface or optionally through external control

CARLO GAVAZZI Automation Components. Specifications are subject to change without notice. Illustrations are for example only.

# Solid state contactors, 45 mm, 3-phase

DIN-rail mounting - AC output, 3 poles

## Types

**RGCM3A..15..**  
15 AAC / 2.2 kW

Semiconductor contactors with integrated heatsink.  
AC operating frequency range 45-65 Hz.  
Rated isolation voltage  $\geq 4000$  Vrms.



Dimensions HxWxD (mm)

105 x 45 x 105

Features

45 mm solid state contactor, enclosed heatsink, integrated varistors for over-voltage protection, 5 kArms SCCR, screw with clamp for power connection

## Control specifications

Control input range

5-32 VDC [RGC..D.]  
20-275 VAC, 24-190 VDC [RGC..A.]

Input current @ max. control voltage

31.5 mA DC [RG..D.]  
19 mA AC [RG..A.]

## Output specifications

Rated operational current AC-51 @  $T_a=40^\circ\text{C}$

15.5 AAC

AC-53a @  $T_a=40^\circ\text{C}$

5.8 AAC

Motor rating

2.2 kW @ 400 VAC  
3 HP @ 600 VAC

Minimum operational current

250 mA AC

Non. rep. surge current  $I_{tsm}$  ( $t=10$  ms)

600 Ap

$I^2t$  for fusing ( $t=10$  ms)

1800 A<sup>2</sup>s

Off-state leakage current

3 mA AC

Critical dV/dt (@  $T_j$  init= $40^\circ\text{C}$ )

1000 V/ $\mu$ s

## General specifications

Operational voltage range

42-600 VAC +10%

Blocking voltage

1200 Vp

Power factor

$\geq 0.5$  at rated voltage

Operating temperature

$-40^\circ\text{C}$  to  $+70^\circ\text{C}$

Approvals/Marks

CE - cULus - EAC

## References

DC control voltage





**RGCM3A60D15GKE**

AC control voltage

**RGCM3A60A15GKE**

# Solid state contactors, 3-phase



DIN-rail mounting - AC output, 2 + 1 poles

Types	RGC2A..10.. 10 AAC	RGC2A..25.. 27 AAC	RGC2A..40.. 40 AAC	RGC2A..75..F 75 AAC
Semiconductor contactors with integrated heatsink, AC operating frequency range 45-65 Hz. Rated isolation voltage 4000 Vrms.				
Dimensions HxWxD (mm)	106 x 54 x 65	110 x 54 x 103	110 x 72 x 126	141 x 72 x 141 (with fan)
Features	54 mm solid state contactor, integrated varistors for over-voltage protection, 100 kArms SCCR, screw with clamp for power connection	54 mm solid state contactor, integrated varistors for over-voltage protection, 100 kArms SCCR, screw with clamp for power connection	72 mm solid state contactor, integrated varistors for over-voltage protection, 100 kArms SCCR, box clamp for power connection	72 mm solid state contactor, integrated overheat protection with EMR alarm output, 100 kArms SCCR, box clamp for power connection
<b>Input specifications</b>				
Control input range	5-32 VDC [RGC..D.] 20-275 VAC 24-190 VDC [RGC..A.]	5-32 VDC [RGC..D.] 20-275 VAC 24-190 VDC [RGC..A.]	5-32 VDC [RGC..D.] 20-275 VAC 24-190 VDC [RGC..A.]	5-32 VDC [RG..D..DF] 5-32 VDC [RG..D..AF] 20-275 VAC [RG..A..AF]
Input current @ max. control voltage	31.5 mADC [RG..D.] 19 mAAC [RG..A.]	31.5 mADC [RG..D.] 19 mAAC [RG..A.]	31.5 mADC [RG..D.] 19 mAAC [RG..A.]	12.5 mADC [RG..D..DF] 5.5 mADC [RG..D..AF] 4.3 mAAC [RG..A..AF]
External supply voltage				24 VDC [RG..D..DF] 90-250 VAC [RG..D..AF] 90-250 VAC [RG..A..AF]
Max. supply current				150 mADC [RG..D..DF] 80 mADC [RG..D..AF] 80 mAAC [RG..A..AF]
<b>Alarm specifications</b>				
Alarm output				EMR: 2 A 230 VAC / 30 VDC
Alarm condition				Over Temperature
<b>Output specifications</b>				
Rated operational current AC-51 @ Ta=40°C	10 AAC	27 AAC	40 AAC	75 AAC
AC-53a @ Ta=40°C	5 AAC	11.5 AAC	16.5 AAC	28 AAC
Motor rating	1.5 kW @ 400 VAC 3 HP @ 600 VAC VAC	5.5 kW @ 400 VAC 10 HP @ 600 VAC	7.5 kW @ 400 VAC 15 HP @ 600 VAC	11 kW @ 400 VAC 25 HP @ 600 VAC
Minimum operational current	250 mAAC	250 mAAC	400 mAAC	500 mAAC
Non. rep. surge current Iism (t=10 ms)	600 Ap	600 Ap	1150 Ap	1750 Ap
I <sup>2</sup> t for fusing (t=10 ms)	1800 A <sup>2</sup> s	1800 A <sup>2</sup> s	6600 A <sup>2</sup> s	15000 A <sup>2</sup> s
<b>General specifications</b>				
Operational voltage range	42-600 VAC +10%	42-220 VAC +10% [RG..22.] 42-600 VAC +10% [RG..60.]	42-600 VAC +10%	42-600 VAC +10%
Blocking voltage	1200 Vp	800 Vp [RG..22.] 1200 Vp [RG..60.]	1200 Vp	1200 Vp
Power factor	≥ 0.5 at rated voltage	≥ 0.5 at rated voltage	≥ 0.5 at rated voltage	≥ 0.5 at rated voltage
Operating temperature	-40°C to +80°C	-40°C to +80°C	-40°C to +80°C	-40°C to +70°C [RG..DF] -40°C to +60°C [RG...AF]
Approvals/Marks	CE - cULus - EAC - VDE - CCC	CE - cULus - EAC - CCC	CE - cULus - EAC - CCC	CE - cULus - EAC - CCC
<b>References</b>				
DC control voltage				
220 VAC, 800 Vp		RGC2A22D25KKE		
600 VAC, 1200 Vp	RGC2A60D10KKE	RGC2A60D25KKE	RGC2A60D40KGE	
AC/DC control voltage				
220 VAC, 800 Vp		RGC2A22A25KKE		
600 VAC, 1200 Vp	RGC2A60A10KKE	RGC2A60A25KKE	RGC2A60A40KGE	
DC control voltage, DC external supply				RGC2A60D75GGEDF
DC control voltage, AC external supply				RGC2A60D75GGEAF
AC control voltage, AC external supply				RGC2A60A75GGEAF



# Solid state contactors, 3-phase



## DIN-rail mounting - AC output with monitoring, 2 + 1 poles

Types	<b>RGC2A..25..M</b> 27 AAC	<b>RGC2A..40..M</b> 40 AAC	<b>RGC2A..75..FM</b> 75 AAC
Semiconductor contactors with integrated heatsink, AC operating frequency 45-65 Hz. Rated isolation voltage output to heatsink of 4000 Vrms, 100 kArms Short Circuit Current Rating.			
Dimensions HxWxD (mm)	110 x 54 x 118	110 x 72 x 141	141 x 72 x 141 (with fan)
Features	54 mm solid state contactor, EMR alarm output and electronic auxiliary output, screw with clamp for power connection	72 mm solid state contactor, EMR alarm output and electronic auxiliary output, box clamp for power connection	72 mm solid state contactor, EMR alarm output and electronic auxiliary output, box clamp for power connection
<b>Input specifications</b>			
Control input range	5-32 VDC [RG..D..DM] 5-32 VDC [RG..D..AM] 20-275 VAC [RG..A..AM]	5-32 VDC [RG..D..DM] 5-32 VDC [RG..D..AM] 20-275 VAC [RG..A..AM]	5-32 VDC [RG..D..DFM] 5-32 VDC [RG..D..AFM] 20-275 VAC [RG..A..AFM]
Control current @ max. control voltage	12.5 mADC [RG..D..DM] 5.5 mADC [RG..D..AM] 4.3 mAAC [RG..A..AM]	12.5 mADC [RG..D..DM] 5.5 mADC [RG..D..AM] 4.3 mAAC [RG..A..AM]	12.5 mADC [RG..D..DFM] 5.5 mADC [RG..D..AFM] 4.3 mAAC [RG..A..AFM]
External supply voltage	24 VDC [RG..D..DM] 90-250 VAC [RG..D..AM] 90-250 VAC [RG..A..AM]	24 VDC [RG..D..DM] 90-250 VAC [RG..D..AM] 90-250 VAC [RG..A..AM]	24 VDC [RG..D..DFM] 90-250 VAC [RG..D..AFM] 90-250 VAC [RG..A..AFM]
Max. supply current	60 mADC [RG..D..DM] 60 mAAC [RG..D..AM] 60 mAAC [RG..A..AM]	60 mADC [RG..D..DM] 60 mAAC [RG..D..AM] 60 mAAC [RG..A..AM]	150 mADC [RG..D..DFM] 80 mAAC [RG..D..AFM] 80 mAAC [RG..A..AFM]
<b>Alarm specifications</b>			
Alarm output	EMR; 2 A 250 VAC / 30 VDC	EMR; 2 A 250 VAC / 30 VDC	EMR; 2 A 250 VAC / 30 VDC
Alarm condition	Mains loss, Load loss, SSR open cct., SSR short cct., SSR over temperature	Mains loss, Load loss, SSR open cct., SSR short cct., SSR over temperature	Mains loss, Load loss, SSR open cct., SSR short cct., SSR over temperature
<b>Output specifications</b>			
Rated operational current AC-51 @ Ta=40°C	27 AAC	40 AAC	75 AAC
Minimum operational current	250 mAAC	400 mAAC	500 mAAC
Non. rep. surge current I <sub>tsm</sub> (t=10 ms)	600 A <sub>p</sub>	1150 A <sub>p</sub>	1750 A <sub>p</sub>
I <sup>2</sup> t for fusing (t=10 ms)	1800 A <sup>2</sup> s	6600 A <sup>2</sup> s	15000 A <sup>2</sup> s
Off-state leakage current	5 mAAC	5 mAAC	5 mAAC
<b>General specifications</b>			
Operational voltage range	90-600 VAC +10%	90-600 VAC +10%	90-600 VAC +10%
Blocking voltage	1200 V <sub>p</sub>	1200 V <sub>p</sub>	1200 V <sub>p</sub>
Operating temperature	-40°C to +80°C [RG...DM] -40°C to +60°C [RG...AM]	-40°C to +80°C [RG...DM] -40°C to +60°C [RG...AM]	-40°C to +70°C [RG...DFM] -40°C to +60°C [RG...AFM]
Approvals/Marks	CE - cULus - EAC - CCC	CE - cULus - EAC - CCC	CE - cULus - EAC - CCC
<b>References</b>			
600 VAC, 1200 V <sub>p</sub>			
DC control voltage, DC external supply	<b>RGC2A60D25GKEDM</b>	<b>RGC2A60D40GGEDM</b>	<b>RGC2A60D75GGEDFM</b>
DC control voltage, AC external supply	<b>RGC2A60D25GKEAM</b>	<b>RGC2A60D40GGEAM</b>	<b>RGC2A60D75GGEAFM</b>
AC control voltage, AC external supply	<b>RGC2A60A25GKEAM</b>	<b>RGC2A60A40GGEAM</b>	<b>RGC2A60A75GGEAFM</b>





# Solid state contactors, 3-phase

## DIN-rail mounting - AC output, 3 poles

Types	RGC3A..10.. 10 AAC	RGC3A..20.. 20 AAC	RGC3A..25.. / 30.. 28/30 AAC
Semiconductor contactors with integrated heatsink, AC operating frequency 45-65 Hz. Rated isolation voltage output to heatsink of 4000 Vrms.			
Dimensions HxWxD (mm)	110 x 54 x 63.5	110 x 54 x 103	110 x 72 x 126
Features	54 mm solid state contactor, integrated varistors for over-voltage protection, 100 kArms SCCR, screw with clamp for power connection	54 mm solid state contactor, integrated varistors for over-voltage protection, 100 kArms SCCR, screw with clamp for power connection	72 mm solid state contactor, integrated varistors for over-voltage protection, 100 kArms SCCR, screw with clamp or box clamp for power connection
<b>Input specifications</b>			
Control input range	5-32 VDC [RGC..D.] 20-275 VAC, 24-190 VDC [RGC..A.]	5-32 VDC [RGC..D.] 20-275 VAC, 24-190 VDC [RGC..A.]	5-32 VDC [RGC..D.] 20-275 VAC, 24-190 VDC [RGC..A.]
Input current @ max. control voltage	31.5 mADC [RG..D.] 19 mAAC [RG..A.]	31.5 mADC [RG..D.] 19 mAAC [RG..A.]	31.5 mADC [RG..D.] 19 mAAC [RG..A.]
<b>Output specifications</b>			
Rated operational current AC-51 @ Ta=40°C	10 AAC	20 AAC	28 AAC [RGC3..25] 30 AAC [RGC3..30]
AC-53a @ Ta=40°C	5 AAC	10 AAC	11 AAC [RGC3..25] 14 AAC [RGC3..30]
Motor rating	1.5 kW @ 400 VAC 3 HP @ 600 VAC	4 kW @ 400 VAC 10 HP @ 600 VAC	4 kW @ 400 VAC [RGC3..25] 5.5 kW @ 400 VAC [RGC3..30] 10 HP @ 600 VAC [RGC3..25] 15 HP @ 600 VAC [RGC3..30]
Minimum operational current	250 mAAC	250 mAAC	250 mAAC [RGC3..25] 400 mAAC [RGC3..30]
Non. rep. surge current I <sub>tsm</sub> (t=10 ms)	600 A <sub>p</sub>	600 A <sub>p</sub>	600 A <sub>p</sub> [RGC3..25] 1150 A <sub>p</sub> [RGC3..30]
I <sup>2</sup> t for fusing (t=10 ms)	1800 A <sup>2</sup> s	1800 A <sup>2</sup> s	1800 A <sup>2</sup> s [RGC3..25] 6600 A <sup>2</sup> s [RGC3..30]
Off-state leakage current	5 mAAC	5 mAAC	5 mAAC
Critical dV/dt (@ T <sub>j</sub> init=40°C)	1000 V/μs	1000 V/μs	1000 V/μs
<b>General specifications</b>			
Operational voltage range	42-220 VAC + 10% [RG..22.] 42-600 VAC +10% [RG..60.]	42-220 VAC + 10% [RG..22.] 42-600 VAC +10% [RG..60.]	42-600 VAC +10%
Blocking voltage	800 V <sub>p</sub> [RG..22.] 1200 V <sub>p</sub> [RG..60.]	800 V <sub>p</sub> [RG..22.] 1200 V <sub>p</sub> [RG..60.]	1200 V <sub>p</sub>
Power factor	≥ 0.5 at rated voltage	≥ 0.5 at rated voltage	≥ 0.5 at rated voltage
Operating temperature	-40°C to +80°C	-40°C to +80°C	-40°C to +80°C
Approvals/Marks	CE - cULus - EAC - VDE - CCC	CE - cULus - EAC - CCC	CE - cULus - EAC - CCC
<b>References</b>			
DC control voltage			
220 VAC, 800 V <sub>p</sub>	RGC3A22D10KKE	RGC3A22D20KKE	
600 VAC, 1200 V <sub>p</sub>	RGC3A60D10KKE	RGC3A60D20KKE	28 AAC: RGC3A60D25KKE 30 AAC: RGC3A60D30KGE
AC/DC control voltage			
220 VAC, 800 V <sub>p</sub>	RGC3A22A10KKE	RGC3A22A20KKE	
600 VAC, 1200 V <sub>p</sub>	RGC3A60A10KKE	RGC3A60A20KKE	28 AAC: RGC3A60A25KKE 30 AAC: RGC3A60A30KGE

# Solid state contactors, 3-phase

	DIN-rail mounting - AC output, 3 poles		Panel mounting - AC output, 3 poles
Types	RGC3A..40..F 42 AAC	RGC3A..65..F 66 AAC	RGC3A..48 48 AAC
Semiconductor contactors with integrated heatsink, AC operating frequency 45-65 Hz. Rated isolation voltage output to heatsink of 4000 Vrms, 100 kArms short circuit current rating.			
Dimensions HxWxD (mm)	135 x 54 x 118 (with fan)	141 x 72 x 141 (with fan)	175 x 157 x 119
Features	54 mm solid state contactor + fan, integrated overheat protection with EMR alarm output, box clamp for power connection	72 mm solid state contactor + fan, integrated overheat protection with EMR alarm output, box clamp for power connection	157 mm solid state contactor, integrated varistors for over-voltage protection, 100 kArms SCCR, box clamp for power connection
<b>Input specifications</b>			
Control input range	5-32 VDC [RG..D..DF] 20-275 VAC [RG..A..AF]	5-32 VDC [RG..D..DF] 5-32 VDC [RG..D..AF] 20-275 VAC [RG..A..AF]	5-32 VDC [RG..D] 20-275 VAC, 24-190 VDC [RG..A]
Input current @ max. control voltage	12.5 mADC [RG..D..DF] 4.3 mAAC [RG..A..AF]	12.5 mADC [RG..D..DF] 5.5 mADC [RG..D..AF] 4.3 mAAC [RG..A..AF]	31.5 mADC [RG..D] 19 mAAC [RG..A]
External supply voltage	24 VDC [RG..D..DF] 90-250 VAC [RG..A..AF]	24 VDC [RG..D..DF] 90-250 VAC [RG..D..AF] 90-250 VAC [RG..A..AF]	
Max. supply current	150 mADC [RG..D..DF] 80 mAAC [RG..A..AF]	150 mADC [RG..D..DF] 80 mAAC [RG..D..AF] 80 mAAC [RG..A..AF]	
<b>Alarm specifications</b>			
Alarm output	EMR; 2 A 250 VAC / 30 VDC	EMR; 2 A 250 VAC / 30 VDC	
Alarm condition	SSR Over temperature	SSR Over temperature	
<b>Output specifications</b>			
Rated operational current AC-51 @ Ta=40°C	42 AAC	66 AAC	48 AAC
AC-53a @ Ta=40°C	17 AAC	25 AAC	23 AAC
Motor rating	7.5 kW @ 400 VAC 15 HP @ 600 VAC	11 kW @ 400 VAC 25 HP @ 600 VAC	11 kW @ 400 VAC 25 HP @ 600 VAC
Minimum operational current	400 mAAC	500 mAAC	500 mAAC
Non. rep. surge current I <sub>tsm</sub> (t=10 ms)	1150 A <sub>p</sub>	1750 A <sub>p</sub>	1750 A <sub>p</sub>
I <sup>2</sup> t for fusing (t=10 ms)	6600 A <sup>2</sup> s	15000 A <sup>2</sup> s	15000 A <sup>2</sup> s
Off-state leakage current	5 mAAC	5 mAAC	5 mAAC
Critical dV/dt (@ T <sub>j</sub> init=40°C)	1000 V/μs	1000 V/μs	1000 V/μs
<b>General specifications</b>			
Operational voltage range	42-600 VAC +10%	42-600 VAC +10%	42-600 VAC +10%
Blocking voltage	1200 V <sub>p</sub>	1200 V <sub>p</sub>	1200 V <sub>p</sub>
Power factor	≥ 0.5 at rated voltage	≥ 0.5 at rated voltage	≥ 0.5 at rated voltage
Operating temperature	-40°C to +70°C [RG..D..DF] -40°C to +60°C [RG..A..AF]	-40°C to +70°C [RG..D..DF] -40°C to +60°C [RG..A..AF]	-40°C to +80°C
Approvals/Marks	CE - cULus - EAC - CCC	CE - cULus - EAC - CCC	CE - cULus - EAC
<b>References</b>			
600 VAC, 1200 V <sub>p</sub>			
DC control voltage, DC external supply	RGC3A60D40GGEDF	RGC3A60D65GGEDF	
DC control voltage, AC external supply		RGC3A60D65GGEAF	
AC control voltage, AC external supply	RGC3A60A40GGEAF	RGC3A60A65GGEAF	
DC control voltage			RGC3A60D48KGE
AC control voltage			RGC3A60A48KGE

# Solid state contactors, 3-phase

**DIN-rail mounting -  
AC output with monitoring, 3 poles**

**Panel mounting -  
AC output with  
monitoring, 3 poles**

**Types**

**RGC3A..20..M**  
20 AAC

**RGC3A..25/30..M**  
28/30 AAC

**RGC3A..65..FM**  
66 AAC

**RGC3A..48..M**  
48 AAC

Semiconductor contactors with integrated heatsink, AC operating frequency 45-65 Hz. Rated isolation voltage output to heatsink of 4000 Vrms, 100 kArms SCCR.



Dimensions HxWxD (mm)

110 x 54 x 118

110 x 72 x 141

141 x 72 x 141 (with fan)

175 x 157 x 119

Features

54 mm solid state contactor, EMR alarm output and electronic auxiliary output, screw with clamp for power connection

72 mm solid state contactor, EMR alarm output and electronic auxiliary output, screw with clamp or box clamp for power connection

72 mm solid state contactor + fan, EMR alarm output and electronic auxiliary output, box clamp for power connection

157 mm solid state contactor, EMR alarm output and electronic auxiliary output, box clamp for power connection

## Input specifications

Control input range	5-32 VDC [RG..D..DM] 5-32 VDC [RG..D..AM] 20-275 VAC [RG..A..AM]	5-32 VDC [RG..D..DM] 5-32 VDC [RG..D..AM] 20-275 VAC [RG..A..AM]	5-32 VDC [RG..D..DFM] 5-32 VDC [RG..D..AFM] 20-275 VAC [RG..A..AFM]	5-32 VDC [RG..D..D] 20-275 VAC [RG..A..A]
Control current @ max. control voltage	12.5 mADC [RG..D..DM] 5.5 mADC [RG..D..AM] 4.3 mAAC [RG..A..AM]	12.5 mADC [RG..D..DM] 5.5 mADC [RG..D..AM] 4.3 mAAC [RG..A..AM]	12.5 mADC [RG..D..DFM] 5.5 mADC [RG..D..AFM] 4.3 mAAC [RG..A..AFM]	12.5 mADC [RG..D..D] 4.3 mAAC [RG..A..A]
External supply voltage	24 VDC [RG..D..DM] 90-250 VAC [RG..D..AM] 90-250 VAC [RG..A..AM]	24 VDC [RG..D..DM] 90-250 VAC [RG..D..AM] 90-250 VAC [RG..A..AM]	24 VDC [RG..D..DFM] 90-250 VAC [RG..D..AFM] 90-250 VAC [RG..A..AFM]	24 VDC [RG..D..D] 90-250 VAC [RG..A..A]
Max. supply current	80 mADC [RG..D..DM] 60 mAAC [RG..D..AM] 60 mAAC [RG..A..AM]	80 mADC [RG..D..DM] 60 mAAC [RG..D..AM] 60 mAAC [RG..A..AM]	150 mADC [RG..D..DFM] 80 mAAC [RG..D..AFM] 80 mAAC [RG..A..AFM]	80 mADC [RG..D..D] 60 mAAC [RG..A..A]

## Alarm specifications

Alarm output	EMR; 2 A 250 VAC / 30 VDC	EMR; 2 A 250 VAC / 30 VDC	EMR; 2 A 250 VAC / 30 VDC	EMR; 2 A 250 VAC / 30 VDC
Alarm condition	Mains loss, Load loss, SSR open cct., SSR short cct., SSR over temperature	Mains loss, Load loss, SSR open cct., SSR short cct., SSR over temperature	Mains loss, Load loss, SSR open cct., SSR short cct., SSR over temperature	Mains loss, Load loss, SSR Open cct., SSR Short cct., SSR Over temperature

## Output specifications

Rated operational current AC-51 @ Ta=40°C	20 AAC	28 AAC [RGC3..25] 30 AAC [RGC3..30]	66 AAC	48 AAC
Minimum operational current	250 mAAC	250 mAAC [RGC3..25] 400 mAAC [RGC3..30]	500 mAAC	500 mAAC
Non. rep. surge current I <sub>tsm</sub> (t=10 ms)	600 A <sub>p</sub>	600 A <sub>p</sub> [RGC3..25] 1150 A <sub>p</sub> [RGC3..30]	1750 A <sub>p</sub>	1750 A <sub>p</sub>
Off-state leakage current	5 mAAC	5 mAAC	5 mAAC	5 mAAC
I <sup>2</sup> t for fusing (t=10 ms)	1800 A <sup>2</sup> s	1800 A <sup>2</sup> s [RGC3..25] 6600 A <sup>2</sup> s [RGC3..30]	15000 A <sup>2</sup> s	15000 A <sup>2</sup> s
Critical dV/dt (@ T <sub>j</sub> init=40°C)	1000 V/μs	1000 V/μs	1000 V/μs	1000 V/μs

## General specifications



Operational voltage range	90-600 VAC +10%	90-600 VAC +10%	90-600 VAC +10%	90-600 VAC +10%
Blocking voltage	1200 V <sub>p</sub>	1200 V <sub>p</sub>	1200 V <sub>p</sub>	1200 V <sub>p</sub>
Operating temperature	-40°C to +80°C [RG...DM] -40°C to +60°C [RG...AM]	-40°C to +80°C [RG...DM] -40°C to +60°C [RG...AM]	-40°C to +70°C [RG...DFM] -40°C to +60°C [RG...AFM]	-40°C to +80°C [RG...DM] -40°C to +60°C [RG...AM]
Approvals/Marks	CE - cULus - EAC - CCC	CE - cULus - EAC - CCC	CE - cULus - EAC - CCC	CE - cULus - EAC

## References

DC control voltage, DC external supply	<b>RGC3A60D20GKEDM</b>	28 AAC: <b>RGC3A60D25GKEDM</b> 30 AAC: <b>RGC3A60D30GGEDM</b>	<b>RGC3A60D65GGEDFM</b>	<b>RGC3A60D48GGEDM</b>
DC control voltage, AC external supply	<b>RGC3A60D20GKEAM</b>	28 AAC: <b>RGC3A60D25GKEAM</b> 30 AAC: <b>RGC3A60D30GGEAM</b>	<b>RGC3A60D65GGEAFM</b>	
AC control voltage, AC external supply	<b>RGC3A60A20GKEAM</b>	28 AAC: <b>RGC3A60A25GKEAM</b> 30 AAC: <b>RGC3A60A30GGEAM</b>	<b>RGC3A60A65GGEAFM</b>	<b>RGC3A60A48GGEAM</b>



# Solid state contactors, 3-phase

## 4-20 mA Proportional controllers, 2 + 1 poles

Types	<b>RGC2P60AA15C1</b> 15 AAC	<b>RGC2P60AA25C1</b> 27 AAC	<b>RGC2P60AA40C1</b> 40 AAC
3-phase semiconductor proportional controllers with integrated heatsink, AC operating frequency range 45-65 Hz. Rated isolation voltage 4000 Vrms, 100 kArms short circuit current rating.			
Dimensions HxWxD (mm)	110 x 54 x 103	110 x 54 x 103	110 x 72 x 126
Features	54 mm solid state contactor with integrated varistors for over-voltage protection, screw with clamp for power connection	54 mm solid state contactor with integrated varistors for over-voltage protection, screw with clamp for power connection	72 mm solid state contactor, integrated varistors for over-voltage protection, box clamp for power connection
<b>Input specifications</b>			
Control input	4-20 mADC	4-20 mADC	4-20 mADC
Voltage drop	<10 VDC @ 20 mADC	<10 VDC @ 20 mADC	<10 VDC @ 20 mADC
<b>Types</b>			
Switching mode	1 Full Cycle [RGC..C1..]	1 Full Cycle [RGC..C1..]	1 Full Cycle [RGC..C1..]
<b>Output specifications</b>			
Rated operational current AC-51 @ Ta=40°C	15 AAC	27 AAC	40 AAC
Minimum operational current	500 mAAC	500 mAAC	500 mAAC
Non. rep. surge current I <sub>tsm</sub> (t=10 ms)	600 Ap	600 Ap	1150 Ap
I <sup>2</sup> t for fusing (t=10 ms)	1800 A <sup>2</sup> s	1800 A <sup>2</sup> s	6600 A <sup>2</sup> s
Off-state leakage current	5 mAAC	5 mAAC	5 mAAC
Critical dV/dt (@ T <sub>j</sub> init=40°C)	1000 V/μs	1000 V/μs	1000 V/μs
<b>General specifications</b>			
Operational voltage range	180-600 VAC +10%	180-600 VAC +10%	180-600 VAC +10%
Blocking voltage	1200 V <sub>P</sub>	1200 V <sub>P</sub>	1200 V <sub>P</sub>
Power factor	≥ 0.7 at rated voltage	≥ 0.7 at rated voltage	≥ 0.7 at rated voltage
Operating temperature	-40°C to +70°C	-40°C to +70°C	-40°C to +70°C
Approvals/Marks	CE - cULus - EAC -CCC	CE - cULus - EAC -CCC	CE - cULus - EAC -CCC
<b>References</b>			
Control Input:	4-20 mADC	4-20 mADC	4-20 mADC
1 Full Cycle	<b>RGC2P60AA15C1</b>	<b>RGC2P60AA25C1</b>	<b>RGC2P60AA40C1</b>



# Solid state contactors, 3-phase

## Proportional controllers with monitoring, 2 + 1 poles

Types	<b>RGC2P..25..M</b> 27 AAC	<b>RGC2P..40..M</b> 40 AAC	<b>RGC2P..75..FM</b> 75 AAC
Semiconductor contactors with integrated heatsink, AC operating frequency 45-65 Hz. Rated isolation voltage output to heatsink of 4000 Vrms, 100 kArms short circuit current rating.			
Dimensions HxWxD (mm)	110 x 54 x 118	110 x 72 x 141	141 x 72 x 141 (with fan)
Features	54 mm solid state contactor with integrated varistors for over-voltage protection, system monitoring, screw with clamp for power connection	72 mm solid state contactor with integrated varistors for over-voltage protection, system monitoring, box clamp for power connection	72 mm solid state contactor with fan and system monitoring, integrated varistors for over-voltage protection, box clamp for power connection
<b>Input specifications</b>			
Control input	0-20, 4-20, 12-20 mADC [RGC..I..] 0-10, 0-5, 1-5 VDC [RGC..V..] External potentiometer [RGC..V..]	0-20, 4-20, 12-20 mADC [RGC..I..] 0-10, 0-5, 1-5 VDC [RGC..V..] External potentiometer [RGC..V..]	0-20, 4-20, 12-20 mADC [RGC..I..] 0-10, 0-5, 1-5 VDC [RGC..V..] External potentiometer [RGC..V..]
Input impedance	<250 ohms [RGC..I..] 100k ohms [RGC..V..]	<250 ohms [RGC..I..] 100k ohms [RGC..V..]	<250 ohms [RGC..I..] 100k ohms [RGC..V..]
External supply voltage	24 VDC/AC	24 VDC/AC	24 VDC/AC [RGC..DFM] 90-250 VAC [RGC..AFM]
Max. supply current	90 mADC/AC	90 mADC/AC	175 mADC/AC [RGC..DFM] 60 mAAC [RGC..AFM]
<b>Alarm specifications</b>			
Alarm output	EMR; 2 A 250 VAC / 30 VDC	EMR; 2 A 250 VAC / 30 VDC	EMR; 2 A 250 VAC / 30 VDC
Alarm condition	Mains loss, Load loss, SSR open cct., SSR short cct., SSR over temperature	Mains loss, Load loss, SSR open cct., SSR short cct., SSR over temperature	Mains loss, Load loss, SSR open cct., SSR short cct., SSR over temperature
<b>Types</b>			
Switching mode	1 Full Cycle [RGC..C1..] 4 Full Cycles [RGC..C4..]	1 Full Cycle [RGC..C1..] 4 Full Cycles [RGC..C4..]	1 Full Cycle [RGC..C1..] 4 Full Cycles [RGC..C4..]
<b>Output specifications</b>			
Rated operational current AC-51 @ Ta=40°C	27 AAC	40 AAC	75 AAC
Minimum operational current	500 mAAC	500 mAAC	500 mAAC
Non. rep. surge current I <sub>sm</sub> (t=10 ms)	600 Ap	1150 Ap	1750 Ap
I <sup>2</sup> t for fusing (t=10 ms)	1800 A <sup>2</sup> s	6600 A <sup>2</sup> s	15000 A <sup>2</sup> s
Off-state leakage current	5 mAAC	5 mAAC	5 mAAC
Critical dV/dt (@ T <sub>j</sub> init=40°C)	1000 V/μs	1000 V/μs	1000 V/μs
<b>General specifications</b>			
Operational voltage range	180-600 VAC +10%	180-600 VAC +10%	180-600 VAC +10%
Blocking voltage	1200 Vp	1200 Vp	1200 Vp
Power factor	≥ 0.7 at rated voltage	≥ 0.7 at rated voltage	≥ 0.7 at rated voltage
Operating temperature	-40°C to +70°C max. +60°C for 24 VAC supply	-40°C to +70°C max. +60°C for 24 VAC supply	-40°C to +70°C max. +60°C for 24 VAC supply
Approvals/Marks	CE - cULus - EAC - CCC	CE - cULus - EAC - CCC	CE - cULus - EAC - CCC
<b>References</b>			
Control Input:	0-20, 4-20, 12-20 mADC	0-20, 4-20, 12-20 mADC	0-20, 4-20, 12-20 mADC
1 Full Cycle, DC external supply	<b>RGC2P60I25C1DM</b>	<b>RGC2P60I40C1DM</b>	<b>RGC2P60I75C1DFM</b>
1 Full Cycle, AC external supply			<b>RGC2P60I75C1AFM</b>
4 Full Cycles, DC external supply	<b>RGC2P60I25C4DM</b>	<b>RGC2P60I40C4DM</b>	<b>RGC2P60I75C4DFM</b>
4 Full Cycles, AC external supply			<b>RGC2P60I75C4AFM</b>
Control Input:	0-10, 0-5, 1-5 VDC, Pot	0-10, 0-5, 1-5 VDC, Pot	0-10, 0-5, 1-5 VDC, Pot
1 Full Cycle, DC external supply	<b>RGC2P60V25C1DM</b>	<b>RGC2P60V40C1DM</b>	<b>RGC2P60V75C1DFM</b>
1 Full Cycle, AC external supply			<b>RGC2P60V75C1AFM</b>

# Solid state contactors, 3-phase



## 4-20 mA Proportional controllers, 3 poles

Types	<b>RGC3P60AA20..</b> 20 AAC	<b>RGC3P60AA30..</b> 30 AAC
3-phase semiconductor proportional controllers with integrated heatsink, AC operating frequency range 45-65 Hz. Rated isolation voltage 4000 Vrms, 100 kArms short circuit current rating.		
Dimensions HxWxD (mm)	110 x 54 x 103	110 x 72 x 126
Features	54 mm solid state contactor with integrated varistors for over-voltage protection, screw with clamp for power connection	72 mm solid state contactor, integrated varistors for over-voltage protection, box clamp for power connection
<b>Input specifications</b>		
Control input	4-20 mADC	4-20 mADC
Voltage drop	<10 VDC @ 20 mADC	<10 VDC @ 20 mADC
<b>Types</b>		
Switching mode	Phase Angle [RGC..E] 1 Full Cycle [RGC..C1]	Phase Angle [RGC..E] 1 Full Cycle [RGC..C1]
<b>Output specifications</b>		
Rated operational current AC-51 @ Ta=40°C	20 AAC	30 AAC
Minimum operational current	500 mAAC	500 mAAC
Non. rep. surge current I <sub>sm</sub> (t=10 ms)	600 A <sub>p</sub>	1150 A <sub>p</sub>
I <sup>2</sup> t for fusing (t=10 ms)	1800 A <sup>2</sup> s	6600 A <sup>2</sup> s
Off-state leakage current	5 mAAC	5 mAAC
Critical dV/dt (@ T <sub>j</sub> init=40°C)	1000 V/μs	1000 V/μs
<b>General specifications</b>		
Operational voltage range	180-600 VAC +10%	180-600 VAC +10%
Blocking voltage	1200 V <sub>p</sub>	1200 V <sub>p</sub>
Power factor	≥ 0.7 at rated voltage	≥ 0.7 at rated voltage
Operating temperature	-40°C to +70°C	-40°C to +70°C
Approvals/Marks	CE - cULus - EAC - CCC	CE - cULus - EAC - CCC
<b>References</b>		
Control Input:	4-20 mADC	4-20 mADC
Phase Angle	<b>RGC3P60AA20E</b>	<b>RGC3P60AA30E</b>
1 Full Cycle	<b>RGC3P60AA20C1</b>	<b>RGC3P60AA30C1</b>



# Solid state contactors, 3-phase

## Proportional controllers with monitoring, 3 poles





Types	RGC3P..20..EP RGC3P..20..M 20 AAC	RGC3P..30..EP RGC3P..30..M 30 AAC	RGC3P..65..EPF RGC3P..65..FM 66 AAC
Semiconductor contactors with integrated heatsink, AC operating frequency 45-65 Hz. Rated isolation voltage output to heatsink of 4000 Vrms, 100 kArms short circuit current rating.			
Dimensions HxWxD (mm)	110 x 54 x 118	110 x 72 x 141	141 x 72 x 141 (with fan)
Features	54 mm solid state contactor with integrated varistors for over-voltage protection, system monitoring, screw with clamp for power connection	72 mm solid state contactor with integrated varistors for over-voltage protection, system monitoring, box clamp for power connection	72 mm solid state contactor with fan and system monitoring, integrated varistors for over-voltage protection, box clamp for power connection
<b>Input specifications</b>			
Control input	0-20, 4-20, 12-20 mADC [RGC..I..] 0-10, 0-5, 1-5 VDC [RGC..V..] External potentiometer [RGC..V..]	0-20, 4-20, 12-20 mADC [RGC..I..] 0-10, 0-5, 1-5 VDC [RGC..V..] External potentiometer [RGC..V..]	0-20, 4-20, 12-20 mADC [RGC..I..] 0-10, 0-5, 1-5 VDC [RGC..V..] External potentiometer [RGC..V..]
Input impedance	<250 ohms [RGC..I..] 100k ohms [RGC..V..]	<250 ohms [RGC..I..] 100k ohms [RGC..V..]	<250 ohms [RGC..I..] 100k ohms [RGC..V..]
External supply voltage	24 VDC/AC [RGC..DM] 90-250 VAC [RGC..AM]	24 VDC/AC [RGC..DM] 90-250 VAC [RGC..AM]	24 VDC/AC [RGC..DFM] 90-250 VAC [RGC..AFM]
Max. supply current	90 mADC/AC [RGC..DM] 30 mAAC [RGC..AM]	90 mADC/AC [RGC..DM] 30 mAAC [RGC..AM]	175 mADC/AC [RGC..DFM] 60 mAAC [RGC..AFM]
<b>Alarm specifications</b>			
Alarm output	EMR; 2 A 250 VAC / 30 VDC	EMR; 2 A 250 VAC / 30 VDC	EMR; 2 A 250 VAC / 30 VDC
Alarm condition	Mains loss, Load loss, SSR open cct., SSR short cct., SSR over temperature	Mains loss, Load loss, SSR open cct., SSR short cct., SSR over temperature	Mains loss, Load loss, SSR open cct., SSR short cct., SSR over temperature
<b>Types</b>			
Switching mode	Phase Angle [RGC..E..] 1 Full Cycle [RGC..C1..] 4 Full Cycles [RGC..C4..] 16 Full Cycles [RGC..C16..] Softstart [RGC..S..]	Phase Angle [RGC..E..] 1 Full Cycle [RGC..C1..] 4 Full Cycles [RGC..C4..] 16 Full Cycles [RGC..C16..] Softstart [RGC..S..]	Phase Angle [RGC..E..] 1 Full Cycle [RGC..C1..] 4 Full Cycles [RGC..C4..] 16 Full Cycles [RGC..C16..] Softstart [RGC..S..]
<b>Output specifications</b>			
Rated operational current AC-51 @ Ta=40°C	20 AAC	30 AAC	66 AAC
Minimum operational current	500 mAAC	500 mAAC	500 mAAC
Non. rep. surge current I <sub>tsm</sub> (t=10ms)	600 Ap	1150 Ap	1750 Ap
I <sup>2</sup> t for fusing (t=10 ms)	1800 A <sup>2</sup> s	6600 A <sup>2</sup> s	15000 A <sup>2</sup> s
Off-state leakage current	5 mAAC	5 mAAC	5 mAAC
Critical dV/dt (@ Tj init=40°C)	1000 V/μs	1000 V/μs	1000 V/μs
<b>General specifications</b>			
Operational voltage range	180-600 VAC +10%	180-600 VAC +10%	180-600 VAC +10%
Blocking voltage	1200 Vr	1200 Vr	1200 Vr
Power factor	≥ 0.7 at rated voltage	≥ 0.7 at rated voltage	≥ 0.7 at rated voltage
Operating temperature	-40°C to +70°C max. +60°C for 24 VAC supply	-40°C to +70°C max. +60°C for 24 VAC supply	-40°C to +70°C max. +60°C for 24 VAC supply
Approvals/Marks	CE - eULus - EAC - CCC	CE - eULus - EAC - CCC	CE - eULus - EAC - CCC
<b>References</b>			
Phase Angle, DC external supply	RGC3P60Y20EDP	RGC3P60Y30EDP	RGC3P60Y65EDFP
Phase Angle, AC external supply	RGC3P60Y20EAP	RGC3P60Y30EAP	RGC3P60Y65EAFP
X Full Cycle, DC external supply	RGC3P60Y20CXDM (X = 1/4/16)	RGC3P60Y30CXDM (X = 1/4/16)	RGC3P60Y65CXDFM (X = 1/4/16)
X Full Cycle, AC external supply	RGC3P60Y20CXAM (X = 1/4/16)	RGC3P60Y30CXAM (X = 1/4/16)	RGC3P60Y65CXAFM (X = 1/4/16)
Softstart + 16 Full Cycles, DC external supply	RGC3P60V20S16DM	RGC3P60V30S16DM	RGC3P60V65S16DFM
Digital Control Input (5-10 VDC):	5-10 VDC	5-10 VDC	5-10 VDC
Softstart + ON/OFF, DC external supply	RGC3P60V20SDM	RGC3P60V30SDM	RGC3P60V65SDFM

Y = 'I' for 0-20 mA, 4-20 mA or 12-20 mA or 'V' for 0-10 V, 0-5 V, 1-5 V or pot

CARLO GAVAZZI Automation Components. Specifications are subject to change without notice. Illustrations are for example only.





# Solid state relays accessories

## General accessories

Types	RPM1	RPM1P	RPM1V	RPM2
				
Dimensions HxWxD (mm)	84 x 12.5 x 42	84 x 12.5 x 42	84 x 12.5 x 42	82 x 25 x 39
Description	Din-rail adaptor for PCB relays. (Relay excluded)	Din-rail adaptor with sockets for plug-in PCB relays. (Relay excluded)	DIN-rail adaptor for PCB relays with LED and varistor across output terminals. (Relay excluded)	Din-rail adaptor for PCB relays with an operational voltage $\geq 230$ V. (Relay excluded)
Pack quantity	1	1	1	2
<b>References</b>	<b>RPM1</b>	<b>RPM1P</b> (no LED) <b>RPM1PD</b> (with LED)	<b>RPM1V</b>	<b>RPM2</b>



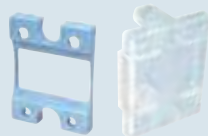

## Selection guide for SSR assemblies\*

	<b>RP...M1</b>	<b>RP...M1P</b> (no LED) <b>RP...M1PD</b> (with LED)	<b>RP...M1V</b>	<b>RP...M2</b>
--	----------------	---	-----------------	----------------

Types	DIN adaptor	DIN adaptor RG	Protection cover RM/RA/RK	Tamper proof cover RGS1P, RGC1P
				
Dimensions HxWxD (mm)	81 x 44 x 13.5	106 x 17.8 x 14	58 x 45 x 9 / 26	59 x 45 x 25.5
Description	DIN-rail adaptor for 1-phase SSR & heatsink assemblies. Integrated in heatsink kits	DIN-rail adaptor for RGS relays	Clip-on IP20 protection Cover	Tamper proof protection cover for RGS1P, RGC1P
Pack quantity	1	1	10 (RK)/20 (RMIP20)/25 (BBR..)	5
<b>References</b>	<b>RHS00</b>	<b>RGS1DIN</b>	<b>RMIP20</b> (for RM, RS, RAM series) <b>RKIP20</b> (for RK series) <b>BBR</b> (for RA, RD series) <b>BBR-S</b> (for RA..S series)	<b>RGTMP</b>

## Selection guide for SSR assemblies\*

	<b>R...H8</b>	<b>RGS...DIN</b>
--	---------------	------------------

Types	Thermal paste	Thermal pad Slim SSRs	Thermal pad RM, RA	Thermal pad RZ3
				
Dimensions HxWxD (mm)		34.6 x 14 x 0.13 (RG) 21 x 19 x 0.13 (RF)	42 x 35 x 0.25	70 x 77 x 0.25
Description	2 ml syringe silicon based thermal compound	Thermal pad for RG and RF series	Graphite thermal pad for RA, RD, RM, RAM, RS series	Graphite thermal pad for RZ3 series
Pack quantity	1	10	50	10
<b>References</b>	<b>HTS02S</b>	<b>RGHT</b> (for RG series) <b>RFHT</b> (for RF series)	<b>KK071 CUT</b>	<b>RZHT</b>





\* Conditions may apply. Please ask your Sales representative for further details.





CARLO GAVAZZI Automation Components. Specifications are subject to change without notice. Illustrations are for example only.







# Solid state relays accessories





## General accessories

Types	RM fork terminal	RM FASTON terminals	RM spacers	Overload relay adaptor
				
Dimensions HxWxD (mm)	35 x 16.5 x 25 / 29	4.8 / 6.3	M3 x 12	
Description	RM, RS, RK and RAM terminal adaptor for 16 mm <sup>2</sup> and 35 mm <sup>2</sup> cable	Screw FASTON terminals, flat or 45° angled for output (6.3 mm) and input (4.8 mm) RM, RS, RAM terminals	Standoff spacer for RM, RS, RAM series M3 control terminals	Overload Relay Adaptor for REC and RGCM3 series
Pack quantity	10	20	20	5
<b>References</b>				
	<b>RM625FK</b> (16 mm <sup>2</sup> )	<b>RM48FO</b> (4.8 mm, flat)	<b>RMSP03</b>	<b>REC3ADAPTOR</b>
	<b>RM635FK</b> (35 mm <sup>2</sup> )	<b>RM48F4</b> (4.8 mm, 45°)		
	<b>RM635FKP</b> (35 mm <sup>2</sup> )	<b>RM63FO</b> (6.3 mm, flat)		
		<b>RM63F4</b> (6.3 mm, 45°)		





Types	RG plug terminals	RGCM plug terminals	RK plug terminals	RG..M plug terminals
				
Description	2-pole spring loaded plug terminal, 2.5 mm <sup>2</sup> for RG series	3 way, 2-pole box clamp plug terminal, 2.5 mm <sup>2</sup> for RGCM3 series	4 way, 4-pole/2-pole spring loaded plug terminal, 5.08 mm for RK series	3-pole spring loaded plug terminal, 5.00 mm for RG..M series
Pack quantity	10	10	10	10
<b>References</b>				
	<b>RGM25</b>	<b>RG3G25</b>	<b>RK4MT</b> (4 way, 4-pole)	<b>RG3M15AL</b> (labelled 'NC NO COM')
	<b>RGMREF</b> (for RG..N)		<b>RK2MT</b> (4 way, 2-pole)	<b>RG3M15CTR</b> (labelled 'A1+ A2- Us+')



Types	Cables	Termination resistor	Fans	Screw kits
				
Dimensions HxWxD (mm)			40 x 40 x 20 (RHSF40) 60 x 60 x 20 (RHSF60) 120 x 120 x 38 (RHS301F)	
Description	Cable for RM1E...V, RA2A...C, RK...C and RA...S models with one-end terminated with a female plug for mounting on the SSR	Termination resistor to be fitted on the last RG..N on the NRG bus chain	RHSF40-24 to be mounted with RHS45C, RHS45B, RHS540, RHS542 RHSF60-24/240 to be mounted with RHS90A, RHS112A, RHS703 RHS301F115/230 to be mounted with RHS301 incl. bracket	Screw kits for assembling SSRs to heatsinks. M5 x 10 mm to be used with RA, RD, RM, RAM, RS, RK and RZ3 series. M4 x 15 mm used for RHS38AD heatsink. M5 x 23 / 30 mm to be used with RG series
	1		1	20
<b>References</b>				
	<b>RCS3-100-1</b> [RM1E..V]	<b>RGN-TERMRES</b>	<b>RHSF40-24</b> (24 VDC)	<b>SRWKITM5X10MM</b>
	<b>RCS4-100-1</b> [RA2A..C]		<b>RHSF60-24</b> (24 VDC)	<b>SRWKITM4X15MM</b>
	<b>RCS4-400-1</b> [RA2A..C]		<b>RHSF60-230</b> (240 VAC)	<b>SRWKITM5X23MM</b>
	<b>RCS5-200-1</b> [RA..S]		<b>RHS301F115</b> (115 VAC)	<b>SRWKITM5X30MM</b>
	<b>RCK4-100-1</b> [RKD2..C]		<b>RHS301F230</b> (230 VAC)	
	<b>RCK2-100-1</b> [RK2..C]			

# Solid state relays accessories

General accessories		DIN mount heatsinks for solid state relays		
Types	Varistors	Temperature limit switches	RHS300	RHS37A
				
Dimensions HxWxD (mm) (SSR not included)		6.5 x 5.5 x 3	105 x 82 x 20	18 x 110 x 52
Description	Surge / transient voltage protection for SSRs	Temperature limit switches that may be fitted in the RZ3 housing between SSR and heatsink	Heatsink for 1x 3-phase RZ3 series	Heatsink for 1x 1-phase RG series
Pack quantity	10	1		

Thermal resistance**				
Without fan	-	-	5.40°C/W (>30 W)	4.00°C/W (>20 W)
References / Selection guide for heatsink assemblies*				
	275 V: <b>RV02</b>	420 V: <b>RV04</b>	<b>UP62-70</b>	
	510 V: <b>RV05</b>	625 V: <b>RV06</b>	<b>UP62-80</b>	
	680 V: <b>RV07</b>		<b>UP62-90</b>	
Without fan			<b>R...H1</b>	<b>R...H51</b>

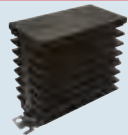
DIN mount heatsinks for solid state relays				
Types	RHS10015	RHS100	RHS45C	RHS52A
				
Dimensions HxWxD (mm) (SSR not included)	100 x 82 x 29	44 x 82 x 48	45 x 103 x 55	22.5 x 110 x 90
Description	Heatsink for max. 2x 1-phase RA, RD, RM, RAM, RS and RK series	Heatsink for 1x 1-phase RA, RD, RM, RAM, RS and RK series	Heatsink for 1x 1-phase RA, RD, RM, RAM, RS and RK series	Heatsink for 1x 1-phase RG series
Thermal resistance**				
Without fan	4.00°C/W (>30 W)	3.10°C/W (>25 W)	2.20°C/W (>45 W)	2.00°C/W (>45 W)
Selection guide for heatsink assemblies*				
Without fan	<b>R...H47</b>	<b>R...H0</b>	<b>R...H15</b>	<b>R...H61</b>









Types	RHS45B	RHS54..	RHS703..	RHS90A
				
Dimensions HxWxD (mm) (SSR not included)	45 x 103 x 80	54 x 110 x 51	72 x 110 x 75	90 x 103 x 80
Description	Heatsink for 1x 1-phase RA, RD, RM, RAM, RS and RK series	Heatsink for max. 3x 1-phase RG series, 1x 1-phase RA, RD, RM, RAM, RS and RK series: <b>RHS540</b> Heatsink for max. 2x 1-phase RG series: <b>RHS542</b>	Heatsink for max. 3x 1-phase RG series, 1x 1-phase RA, RD, RM, RAM, RS and RK series	Heatsink for 1x 1-phase RA, RD, RM, RAM, RS and RK series
Thermal resistance**				
Without fan	1.85°C/W (>50 W)	1.85°C/W (>60 W)	1.10°C/W (>60 W)	0.97°C/W (>60 W)
Selection guide for heatsink assemblies*				
Without fan	<b>R...H5</b>	<b>R...H65 [RHS540]</b> <b>R...H66 [RHS542]</b>	<b>R...H75 [RHS703]</b>	<b>R...H16</b>

\* Conditions may apply. Please ask your Sales representative for further details.

\*\* Refer to specific heatsink datasheet for further details on heatsink characteristics and assemblies.

# Solid state relays accessories

## DIN mount heatsinks for solid state relays

Types	RHS301..	RHS1 12A..	RHS1 1267DIND
			
Dimensions HxWxD (mm) (SSR not included)	119 x 82 x 94	112 x 103 x 80	119 x 125 x 94
Description	Heatsink for 1x 3-phase RZ3, 2x 1-phase RA, RD, RM, RAM, RS and RK series: <b>RHS301</b>	Heatsink for 1x 3-phase RZ3, 2x 1-phase RA, RD, RM, RAM, RS and RK series: <b>RHS1 12A</b>	Heatsink for 1x 3-phase RZ3 series, max 3x 1-phase RG series, 2x 1-phase RA, RD, RM, RAM, RS and RK series
<b>Thermal resistance**</b>			
Without fan	0.82°C/W (> 80 W)	0.76°C/W (>100 W)	0.54°C/W (>150 W)
<b>Selection guide for heatsink assemblies*</b>			
Without fan	<b>R...H2</b> [RHS301]	<b>R...H17</b>	<b>R...H78D</b>
Types	RHS54..F	RHS703..F	RHS301..F
			
Dimensions HxWxD (mm) (SSR not included)	54 x 135 x 51	72 x 141 x 75	124 x 146 x 122
Description	Heatsink for max. 3x 1-phase RG series, 1x 1-phase RA, RD, RM, RAM, RS and RK series: <b>RHS540F40-24</b> (24 VDC fan) Heatsink for max. 2x 1-phase RG series: <b>RHS542F40-24</b> (24 VDC fan)	Heatsink for max. 3x 1-phase RG series, 1x 1-phase RA, RD, RM, RAM, RS and RK series: <b>RHS703F60-24</b> (24 VDC fan) <b>RHS703F60-230</b> (240 VAC fan)	Heatsink for 1x 3-phase RZ3, 2x 1-phase RA, RD, RM, RAM, RS and RK series: <b>RHS301F115C</b> [115 VAC fan] <b>RHS301F230C</b> [230 VAC fan]
<b>Thermal resistance**</b>			
With fan	0.65°C/W	0.37°C/W	0.28°C/W
<b>Selection guide for heatsink assemblies*</b>			
With fan	<b>R...H67</b> [RHS540F40-24] <b>R...H68</b> [RHS542F40-24]	<b>R...H76</b> [RHS703F60-24] <b>R...H77</b> [RHS703F60-230]	<b>R...H10</b> [RHS301F115C] <b>R...H12</b> [RHS301F230C]
Types	RHS 1 12A..F	RHS28009F80-24P	RHS28011F80-24P
			
Dimensions HxWxD (mm) (SSR not included)	112 x 103 x 80 112 x 120 x 80 (with fan)	280 x 87 x 122	280 x 87 x 122
Description	Heatsink for 1x 3-phase RZ3, 2x 1-phase RA, RD, RM, RAM, RS and RK series: <b>RHS1 12AF60-24</b> [24 VDC fan] <b>RHS1 12AF60-230</b> [230 VAC fan]	Heatsink for max. 9x 1-phase RG series or 4x 1-phase RA, RD, RM, RAM, RS and RK series with integrated fan and overtemperature protection	Heatsink for max. 11x 1-phase RG series or 3x 1-phase RA, RD, RM, RAM, RS and RK series with integrated fan and overtemperature protection
<b>Thermal resistance**</b>			
With fan	0.35°C/W	0.12°C/W (24 VDC)	0.12°C/W (24 VDC)
<b>Selection guide for heatsink assemblies*</b>			
With fan	<b>R...H18</b> [RHS1 12AF60-24] <b>R...H52</b> [RHS1 12AF60-230]	<b>R...H41</b>	<b>R...H44</b>





\* Conditions may apply. Please ask your Sales representative for further details.

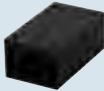
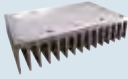
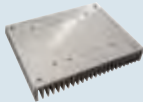
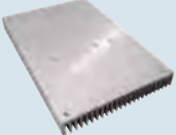

\*\* Refer to specific heatsink datasheet for further details on heatsink characteristics and assemblies.

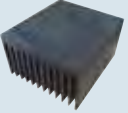
# Solid state relays accessories

## Thru wall mount heatsinks for solid state relays

Types	RHS38ARFD	RHS10025D	RHS16225D	RHS16225LD
				
Dimensions HxWxD (mm) (SSR not included)	46 x 76 x 33	100 x 100 x 25	162 x 100 x 25	162 x 250 x 25
Description	Heatsink for 1x 1-phase RF series	Heatsink for max. 3x 1-phase RG series, 1x 1-phase RA, RD, RM, RAM, RS and RK series	Heatsink for 1x 3-phase RZ3 series, max. 3x 1-phase RA, RD, RM, RAM, RS, RK and RG series	Heatsink for 1x 3-phase RZ3 series, max. 3x 1-phase RA, RD, RM, RAM, RS, RK and RG series
<b>Thermal resistance**</b>				
Without fan	2.85°C/W (>40 W)	1.85°C/W (>60 W)	1.30°C/W (>90 W)	0.84°C/W (>120 W)
<b>References / Selection guide for heatsink assemblies*</b>				
Without fan	R...H53	R...H49	R...H55	R...H55L

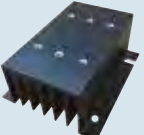
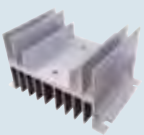
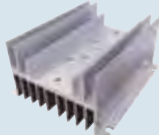
Thru wall mount heatsinks for solid state relays		Panel mount heatsinks for solid state relays		
Types	RHS11267D	RHS30040D	RHS5050..	RHS38A..
				
Dimensions HxWxD (mm) (SSR not included)	112 x 125 x 67	300 x 200 x 40	80 x 50 x 51	46 x 76 x 33
Description	Heatsink for max. 3x 1-phase RG series or 1x 1-phase RA, RD, RM, RAM, RS and RK series	Heatsink for max. 12x 1-phase RG series or 8x 1-phase RA, RD, RM, RAM, RS and RK series	<b>RHS5050D:</b> Heatsink for 1x 1-phase RA, RD, RM, RAM, RS and RK series <b>RHS5050RFD:</b> Heatsink for 1x 1-phase RF series	<b>RHS38AD:</b> Heatsink for 1x 1-phase RA, RD, RM, RAM, RS and RK series <b>RHS38ARFD:</b> Heatsink for 1x 1-phase RF series
<b>Thermal resistance**</b>				
Without fan	0.54°C/W (>150 W)	0.40°C/W (>180 W)	3.50°C/W (>25 W)	2.85°C/W (>40 W)
<b>Selection guide for heatsink assemblies*</b>				
Without fan	R...H78	R...H57	R...H60	R...H53

Panel mount heatsinks for solid state relays				
Types	RHS5840D	RHS10067D	RHS10067LD	RHS320
				
Dimensions HxWxD (mm) (SSR not included)	81 x 100 x 40	121 x 76 x 67	121 x 140 x 67	240 x 100 x 93
Description	Heatsink for max. 3x 1-phase RG series, 1x 1-phase RA, RD, RM, RAM, RS and RK series	Heatsink for 1x 1-phase RA, RD, RM, RAM, RS and RK series	Heatsink for 2x 1-phase RA, RD, RM, RAM, RS, RK and RG series	Heatsink for 1x 3-phase RZ3 series, max. 3x 1-phase RA, RD, RM, RAM, RS, RK and RG series
<b>Thermal resistance**</b>				
Without fan	1.80°C/W (>60 W)	1.70°C/W (>20 W)	0.88°C/W (>80 W)	0.40°C/W (>120 W)
<b>Selection guide for heatsink assemblies*</b>				
Without fan	R...H48	R...H58	R...H58L	R...H13

\* Conditions may apply. Please ask your Sales representative for further details.

\*\* Refer to specific heatsink datasheet for further details on heatsink characteristics and assemblies.

# Soft starters

## Scroll compressor soft starters

**Types** **RSBS** **RSBD 45 & 75 mm** **RSBT 45 & 120 mm**

Soft starting of 1-phase (RSBS) and 3-phase (RSBD, RSBT) scroll compressors



Dimensions (mm)

70.6 x 137 x 81.4

12 A to 45 A:  
106 x 45 x 125  
55 A to 95 A:  
150 x 75 x 170

16 A to 32 A (no relay output):  
81 x 45 x 125  
16 A to 32 A (with relay output):  
97.5 x 45 x 125  
55 A to 95 A:  
150 x 120 x 170

Features

Internally bypassed, current limit start, auxiliary relay output, HP algorithm for high pressure starts, Option for external start capacitor

Compact 2-phase (RSBD) controlled soft starter for scroll compressors. Patented auto-adapt function for reduction of inrush current and for current balancing. No user settings required with HP algorithm optimised for multi-compressor systems

3-phase (RSBT) Controlled solution with internal bypass. Patented self-learning algorithm for optimal current reduction. Compliant to Class B (residential limits) for EMC emissions (16 A to 32 A). Optional serial communication for energy variables, alarms, start/stop

### Control specifications

Control input range

230 VAC

Option E: 110 - 400 VAC  
Option F: 24 VAC / DC

Option E: 110 - 400 VAC [RSBT 45 mm]  
Option C: 24 VAC / DC & 110-400 VAC [RSBT 120 mm]

Controlled phases

1

2

3

### Output specifications

Rated operational current (I<sub>e</sub>)

32 A

RSBD 45 mm: 12/16/25/32/37/45 A  
RSBD 75 mm: 55/70/95 A

RSBT 45 mm: 16/25/32 A  
RSBT 120 mm: 55/70/95 A

Operational voltage

230 VAC (-15%, +10%)

RSBD 45 mm: 220 - 400 VAC (-15%, +10%)  
RSBD 75 mm: 220 - 600 VAC (-15%, +10%)

RSBT 45 mm: 220/400 VAC (-15%, +10%)  
RSBT 120 mm: 220 - 480 VAC (-15%, +10%)

Number of starts per hour

10 (evenly distributed)

12 (evenly distributed)

12 (evenly distributed)

Assigned compressor rating @ 400 V

4 kW (5 HP) [ @ 230 V ]

RSBD 45 mm:  
5.5 kW (5 HP) to 22 kW (25 HP)  
RSBD 75 mm:  
30 kW (30 HP) to 55 kW (50 HP)

RSBT 45 mm:  
7.5 kW (7.5 HP) to 15 kW (15 HP)  
RSBT 120 mm:  
22 kW (30 HP) to 45 kW (50 HP)

### General specifications

Internally bypassed

Yes

Yes

Yes

Operational frequency

50/60 Hz ±10%

50/60 Hz ±10 Hz

50/60 Hz ±10 Hz

Ramp up/Ramp down

< 1 s / 0 s

< 1 s / 0 s

< 1 s / 0 s

Default Current limit

45 Arms  
(80 Arms in HP mode)

3.5xI<sub>e</sub>

RSBT 45 mm  
RSBT.16: 40 A,  
RSBT.25: 90 A,  
RSBT.32: 110 A  
RSBT 120 mm: 3.5xI<sub>e</sub>

Operating temperature

-20°C to +65°C (-4°F to +149°F)

-20°C to +60°C (-4°F to +140°F)

-20°C to +60°C (-4°F to +140°F)

Storage temperature

-30°C to +70°C (-22°F to +158°F)

-40°C to +80°C (-40°F to +176°F)

-40°C to +85°C (-40°F to +185°F)

Wrong phase sequence indication

N/A

Yes

Yes

Degree of protection

IP 20

RSBD 45 mm: IP 20  
RSBD 75 mm: IP 20 (Housing) /  
IP 10 (Terminals)

RSBT 45 mm: IP 20  
RSBT 120 mm: IP 20 (Housing) /  
IP 10 (Terminals)

Approvals

CE - (UL - cUL pending)



RSBD 45 mm: CE - cULus - CCC - EAC  
RSBD 75 mm: CE - cULus - CCC - EAC

RSBT 45 mm: CE - cULus\*\* - VDE\*\*\* - CCC  
RSBT 120 mm: CE - cULus - CCC

\* For RSBS23...V22... auxiliary terminal is 10.5 mm protruding  
\*\* For options V50 / V51 / V61  
\*\*\* Up to 15 AAC (Up to 32 AAC for RSBT.HPV models only)  
\*\*\*\* Assigned compressor rating @ 230 V

# Soft starters

## Centrifugal pump and ventilators soft starters

Types	RSWT 45 mm	RSWT 75 & 120 mm
Soft-starters with dedicated, self-learning algorithm for centrifugal pumps.		
Dimensions (mm)	RSWT4012/RSWT4016: 130 x 45 x 125 RSWT4025: 157 x 45 x 125	RSWT 75 mm: 177 x 75 x 206 RSWT 120 mm: 177 x 120 x 206
Features	3-phase controlled, internally bypassed. Self-learning algorithm dedicated to centrifugal pumps and ventilators. Integrated overload protection (Class 10). RSWT40 versions - internally supplied	3-phase controlled and internally bypassed. Integrated overload protection, PTC i/p, remote alarm reset. RSWT40 versions - internally supplied. 3 output relays for alarm, top of ramp and run indication
<b>Control specifications</b>		
Control input range	Option E: 110 - 400 VAC [RSWT40...] Option F: 24 VAC/DC [RSWT40...] Option GG: 100 - 240 VAC [RSWT60...] Option FF: 24 VAC/DC [RSWT60..]	Option E: 110 - 400 VAC [RSWT40...] Option F: 24 VAC/DC [RSWT40...] Option GG: 100 - 240 VAC [RSWT60...] Option FF: 24 VAC/DC [RSWT60..]
Controlled phases	3	3
<b>Output specifications</b>		
Rated operational current AC 53b	12/16/25 A	32/37/45/55/70/90 A
Operational voltage	RSWT40: 220 - 400 VAC (-15%, +10%) RSWT60: 220 - 600 VAC (-15%, +10%)	RSWT40: 220 - 400 VAC (-15%, +10%) RSWT60: 220 - 600 VAC (-15%, +10%)
Number of starts per hour @ 40°C	20	20
Assigned motor rating @ 400 V	RSWTxx12: 5.5 kW (5 HP) RSWTxx16: 7.5 kW (7.5 HP) RSWTxx25: 11 kW (10 HP)	RSWTxx32: 15 kW (20 HP) RSWTxx37: 18.5 kW (25 HP) RSWTxx45: 22 kW (30 HP) RSWTxx55: 25 kW (35 HP) RSWTxx70: 37 kW (40 HP) RSWTxx90: 45 kW (50 HP)
<b>General specifications</b>		
Internally bypassed	Yes	Yes
Operational frequency	50/60 Hz ±10%	50/60 Hz ±10%
Ramp up/Ramp down	1-20 s / 0-20 s	1-20 s / 0-20 s
Initial torque	Self-adjusted by RSWT	Self-adjusted by RSWT
Operating temperature	-20°C to 60°C (-4°F to +140°F)	-20°C to 60°C (-4°F to +140°F)
Storage temperature	-40°C to +80°C (-40°F to +176°F)	-40°C to +80°C (-40°F to +176°F)
Integrated overload protection	Yes	Yes
Degree of protection	IP 20	IP 20 (control circuit) IP 10 (power terminals)
Approvals	CE - cULus - CCC - EAC	CE - cULus - CCC - EAC

xx = 40 or 60

CARLO GAVAZZI Automation Components. Specifications are subject to change without notice. Illustrations are for example only.

# Soft starters

## General purpose soft starters

### Types

### RSGD 45 mm

### RSGD 75 mm

Soft starting and stopping of 3-phase motors. Self-learning algorithms on RSGD series for better ease of use.



### Dimensions (mm)

106 x 45 x 125 [RSGD..VD2.0]  
137 x 45 x 137 [RSGD..VX2.0]

177 x 75 x 206 [RSGD..55.. - RSGD..85..]  
177 x 75 x 221 [RSGD..100..]

### Features

Self-learning 2-phase controlled general purpose soft starter. Improved current reduction capability. 2-relay outputs for top of ramp and alarm indication. Optional motor overload protection (Class 10). QR code for quicker troubleshooting

Self-learning 2-phase controlled general purpose soft starter. Intergrated motor overload protection (Class 10) and serial communication (Modbus RS485)

## Control specifications

### Control input range

Option E0: 110 - 400 VAC [RSGD40..]  
Option F0: 24 VAC/DC [RSGD40..]  
Option GG: 100 - 240 VAC [RSGD60..]

Option E0: 110 - 400 VAC [RSGD40..]  
Option F0: 24 VAC/DC [RSGD40..]  
Option FF: 24 VAC/DC [RSGD60..]  
Option GG: 100 - 240 VAC [RSGD60..]

### Controlled phases

2

2

## Output specifications

### Rated operational current AC 53b

12/16/25/32/45 A

55/70/85/100 A

### Operational voltage

RSGD40: 220 - 400 VAC (-15%, +10%)  
RSGD60: 220 - 600 VAC (-15%, +10%)

RSGD40: 220 - 400 VAC (-15%, +10%)  
RSGD60: 220 - 600 VAC (-15%, +10%)

### Number of starts per hour @ 40°C

20 - [RSGD..12, RSGD..16, RSGD..25..VX210, RSGD..32]  
10 - [RSGD..25..VD200, RSGD..45]

10

### Assigned motor rating @ 400 V

RSGD..12: 5.5 kW/5 HP  
RSGD..16: 7.5 kW/7.5 HP  
RSGD..25: 11 kW/10 HP  
RSGD..32: 15 kW/15 HP  
RSGD..45: 22 kW/25 HP

RSGD..55: 30 kW/30 HP  
RSGD..70: 37 kW/40 HP  
RSGD..85: 45 kW/50 HP  
RSGD..100: 55 kW/50 HP

## General specifications

### Internally bypassed

Yes

Yes

### Operational frequency

50/60 Hz ±10%

50/60 Hz ±10%

### Ramp up/Ramp down

1 - 20 s / 0 - 20 s

1 - 30 s / 0 - 30 s

### Initial torque

Not required

Not required

### Operating temperature

-20°C to 60°C (-4°F to +140°F)

-20°C to 60°C (-4°F to +140°F)

### Storage temperature

-40°C to +80°C (-40°F to +176°F)

-40°C to +80°C (-40°F to +176°F)

### Wrong phase sequence indication

Yes

Yes

### Motor overload protection

V.200: No  
V.210: Yes (Class 10)

Yes (Class 10)

### PTC input

No

Yes

### Degree of protection

IP 20

IP 20 (control circuit)  
IP 10 (power terminals)

### Approvals



CE - cULus - CCC - EAC

CE - cULus - CCC - EAC



# Soft starters

## Solid state soft starters and motor reversing

Types	RGTS 1-phase	RR2A Reversing
Single and three phase solid state solutions for motor control		
Dimensions (mm)	113 x 54 x 110	41 x 103 x 74
Features	Single phase solid state soft starter. Wide operational voltage range. 100 kArms short circuit current rating	Reversing with built-in interlock, optoisolation 2-pole change-over, built-in transient overvoltage protection, LED status indication
<b>Control specifications</b>		
Control input range	No control signal required (starts as soon as mains voltage is present)	10 - 40 VDC [RR2A..D...] 90 - 140 VAC [RR2A..LA...] 180 - 265 VAC [RR2A..HA...]
Controlled phases	1	2
<b>Output specifications</b>		
Rated operational current AC 53a	12 A [RGTS2412...] 16 A [RGTS2416...] 25 A [RGTS2425...]	5 A [RR2A40D150/RR2A48D220] 11 A [RR2A40D400/RR2A48D550]
Operational voltage	100 - 240 VAC	40 - 440 VAC [RR2A40D...] 40 - 530 VAC [RR2A48D...]
Number of starts per hour @40°C	10	60 - [RR2A..150/RR2A..220] 40 - [RR2A..400/RR2A..550]
Assigned motor rating @ 400 V	RGTS2412...: 1.1 kW / 2 HP	RR2A..150: 1.5kW / 2 HP
Assigned motor rating @ 230 V (for RGTS only)	RGTS2416...: 1.5 kW / 2 HP RGTS2425...: 3.0 kW / 3 HP	RR2A..220: 2.2kW / 3 HP RR2A..400: 4.0 kW / 5 HP RR2A..550: 5.5 kW / 7.5 HP
<b>General specifications</b>		
Internally bypassed	No	No
Operational frequency	50/60 Hz ±10%	50/60 Hz ±10%
Rampup/Ramp down	0.5 - 5 s/0 s	No ramp-up/ramp-down
Initial torque	10 - 80 %	Not applicable
Operating temperature	-40°C to +60°C (-40°F to +140°F)	-20°C to +80°C
Storage temperature	-40°C to +100°C (-40°F to +212°F)	-40°C to +100°C
Wrong phase sequence indication	No	No
Motor overload protection	No	No
PTC input	No	No
Degree of protection	IP 20	IP 20
Approvals	CE - cULus	CE - UL - cUL



# Soft starters

## Dynamic motor starter

### Types

### HDMS

Single phase motor starter for scroll compressors and submersible pumps



Dimensions (mm)

153 x 85.6 x 86.7

Features

Eliminates the start capacitor  
Self-learning algorithm  
Tool-free terminals  
NFC & Modbus interface  
Coated PCBs

### Control specifications

Control input range

110 - 230 VAC

Controlled phases

1

### Output specifications

Rated operational current AC 53b

12, 25, 32, 37 AAC

Operational voltage

110 - 230 VAC

Number of starts per hour @40°C

10

Assigned motor rating @ 110 VAC

HDMS2312...: 0.56 kW / 0.75 HP  
HDMS2325...: 1.1 kW / 2 HP  
HDMS2332...: 1.5 kW / 2 HP  
HDMS2337...: 2.2 kW / 3 HP

Assigned motor rating @ 230 VAC

HDMS2312...: 1.5 kW / 2 HP  
HDMS2325...: 3.7 kW / 5 HP  
HDMS2332...: 4 kW / 5.5 HP  
HDMS2337...: 5.5 kW / 7.5 HP

### General specifications

Internally bypassed

Yes

Operational frequency

50/60 Hz ±10%

Ramp up/Ramp down

< 1 s / 0 s

Initial torque

Automatically adjusted

Operating temperature

-20°C to +65°C (-4°F to +149°F)

Storage temperature

-40°C to +80°C (-40°F to +176°F)

Wrong phase sequence indication

No

Motor overload protection

Yes

Communication interface

NFC, Modbus RTU

Degree of protection

IP 00

Approvals

CE - cULus

# Variable frequency drives

## VariFlex<sup>3</sup> variable frequency drives - RVL series

Types	Size A	Size B	Size C	Size D
Drives, Inverters				

Dimensions HxWxD (mm)	141 x 72 x 139	144 x 118 x 147	197 x 129 x 148	273 x 187 x 190
-----------------------	----------------	-----------------	-----------------	-----------------

Features	V/F and Sensorless vector control algorithm. Conform to EMC standard EN 61800-3. In-built PTC and PID functions. In-built RJ45 for Modbus and BACnet communication. Additional communication protocol via add-on modules.			
----------	---	--	--	--

### Technical specifications

AC Supply voltage	1-ph: 100 - 120 VAC 1-ph: 200 - 240 VAC 3-ph: 200 - 240 VAC	1-ph: 200 - 240 VAC 3-ph: 200 - 240 VAC 3-ph: 380 - 480 VAC	3-ph: 380 - 480 VAC	3-ph: 380 - 480 VAC
AC Supply frequency	50 - 60 Hz	50 - 60 Hz	50 - 60 Hz	50 - 60 Hz
Output voltage	3-ph: 0 - 240 VAC [RVLFA1../RVLFA320..]	3-ph: 0 - 240 VAC [RVLFB1../RVLFB320..] 3-ph: 0 - 480 VAC [RVLFB340..]	3-ph: 0 - 480 VAC [RVLFC340..]	3-ph: 0 - 480 VAC [RVLFD340..]
Output frequency	0.01 - 599 Hz	0.01 - 599 Hz	0.01 - 599 Hz	0.01 - 599 Hz
Rated output current	2.6 A [RVLFA..040..] 4.3 A [RVLFA..075..] 7.5 A [RVLFA..150..]	7.5 A [RVLFB..150..] 10.5 A [RVLFB..220..] 2.3 A [RVLFB34..075..] 3.8 A [RVLFB34..150..] 5.2 A [RVLFB34..220..]	9.2 A [RVLFB34..370..] 13.0 A [RVLFB34..550..]	17.5 A [RVLFB34..750..] 24.0 A [RVLFB34..1100..]
Allowable momentary power loss	1.0 s	2.0 s	2.0 s	2.0 s

### General specifications

Operating temperature	-10°C to +50°C	-10°C to +50°C	-10°C to +50°C	-10°C to +50°C
Storage temperature	-20°C to +60°C	-20°C to +60°C	-20°C to +60°C	-20°C to +60°C
Digital inputs	5	5	5	5
Digital outputs	1 (Programmable)	1 (Programmable)	1 (Programmable)	1 (Programmable)
Analogue inputs	2 (0 - 10 VDC, 0 - 20 mA)	2 (0 - 10 VDC, 0 - 20 mA)	2 (0 - 10 VDC, 0 - 20 mA)	2 (0 - 10 VDC, 0 - 20 mA)
Analogue outputs	1 (0 - 10 VDC)	1 (0 - 10 VDC)	1 (0 - 10 VDC)	1 (0 - 10 VDC)
Mounting	Panel mount DIN-rail (with accessory)	Panel mount DIN-rail (with accessory)	Panel mount	Panel mount
Integrated cooling fan	No	No	Yes	Yes
Switching frequency	1 to 16 kHz	1 to 16 kHz	1 to 16 kHz	1 to 16 kHz
Approvals	CE - cULus	CE - cULus	CE - cULus	CE - cULus

### References

100 - 120 VAC, 1-phase	<b>RVLFA110040A</b> [0.4kW] <b>RVLFA110075A</b> [0.75kW]			
200 - 240 VAC, 1-phase	<b>RVLFA120040FA</b> [0.4kW] <b>RVLFA120075FA</b> [0.75kW]	<b>RVLFB120150FA</b> [1.5kW] <b>RVLFB120220FA</b> [2.2kW]		
200 - 240 VAC, 3-phase	<b>RVLFA320040A</b> [0.4kW] <b>RVLFA320075A</b> [0.75kW]	<b>RVLFB320150A</b> [1.5kW] <b>RVLFB320220A</b> [2.2kW]		
380 - 480 VAC, 3-phase		<b>RVLFB340075FA</b> [0.75kW] <b>RVLFB340150FA</b> [1.5kW] <b>RVLFB340220FA</b> [2.2kW]	<b>RVLFC340370FA</b> [3.7kW] <b>RVLFC340550FA</b> [5.5kW]	<b>RVLFC340750FA</b> [7.5kW] <b>RVLFC3401100FA</b> [11kW]

# Variable frequency drives

## VariFlex<sup>3</sup> variable frequency drives - RVFF series

Types	Size A	Size B	Size C
Drives, Inverters			

Dimensions HxWxD (mm)	385 x 140 x 177	416 x 210 x 215	500 x 265 x 225
Features	V/F control, SLV, PM SLV with PWM mode, 32 bit processor, overload 120% for 60 sec, built-in filter (up to 55 kw), simple PLC capability, 2 sets of PID functions, multi-pumps control, 6 multi-functions DI, 3 multi-functions relay outputs, 2 analogue inputs and 2 analogue outputs, built-in RS485 modbus communication.		

### Technical specifications

AC supply voltage	3-ph: 380-480 VAC	3-ph: 380-480 VAC	3-ph: 380-480 VAC
AC supply frequency	50/60 Hz	50/60 Hz	50/60 Hz
Output voltage	3-ph: 380-480 VAC	3-ph: 380-480 VAC	3-ph: 380-480 VAC
Output frequency	0.1 ~ 400.0 Hz	0.1 ~ 400.0 Hz	0.1 ~ 400.0 Hz
100% RMS output current	9.2 A [RVFFA3400400F] 12.1 A [RVFFA3400550F] 17.5 A [RVFFA3400750F]	23 A [RVFFB3401100F] 31 A [RVFFB3401500F]	38 A [RVFFC3401850F] 44 A [RVFFC3402200F] 54 A [RVFFC3403000F]

### General specifications

Operating temperature	-10°C to +50°C	-10°C to +50°C	-10°C to +50°C
Storage temperature	-20°C to +70°C	-20°C to +70°C	-20°C to +70°C
Digital inputs	6	6	6
Digital outputs	3 (Programmable)	3 (Programmable)	3 (Programmable)
Analogue inputs	2 (0 - 10 VDC/0-20 mA, 4-20 mA)	2 (0 - 10 VDC/0-20 mA, 4-20 mA)	2 (0 - 10 VDC/0-20 mA, 4-20 mA)
Analogue outputs	2 (0-10 VDC, 4-20 mA)	2 (0-10 VDC, 4-20 mA)	2 (0-10 VDC, 4-20 mA)
Mounting	Panel mounting	Panel mounting	Panel mounting
Integrated cooling fan	Yes	Yes	Yes
Switching frequency	2 to 16 kHz	2 to 16 kHz	2 to 16 kHz
Approvals	CE - cULus	CE - cULus	CE - cULus

### References

380 - 480 VAC, 3-phase	<b>RVFFA3400400F</b> [4 kW - 5 HP] <b>RVFFA3400400F</b> [5.5 kW - 7.5 HP] <b>RVFFA3400750F</b> [7.5 kW - 10 HP]	<b>RVFFB3401100F</b> [11 kW - 15 HP] <b>RVFFB3401500F</b> [15 kW - 20 HP]	<b>RVFFC3401850F</b> [18.5 kW - 25 HP] <b>RVFFC3402200F</b> [22 kW - 30 HP] <b>RVFFC3403000F</b> [30 kW - 40 HP]
------------------------	---	--	--

# Variable frequency drives

## VariFlex<sup>3</sup> variable frequency drives - RVFF series

Types	Size D	Size E	Size F
Drives, Inverters			

Dimensions HxWxD (mm)	679 x 284 x 252	740 x 349 x 300	1105 x 463 x 325
Features	V/F control, SLV, PM SLV with PWM mode, 32 bit processor, overload 120% for 60 sec, built-in filter (up to 55 kw), simple PLC capability, 2 sets of PID functions, multi-pumps control, 6 multi-functions DI, 3 multi-functions relay outputs, 2 analogue inputs and 2 analogue outputs, built-in RS485 modbus communication.		

### Technical specifications

AC supply voltage	3-ph: 380 - 480 VAC;	3-ph: 380 - 480 VAC;	3-ph: 380 - 480 VAC;
AC supply frequency	50/60 Hz	50/60 Hz	50/60 Hz
Output voltage	3-ph: 380 - 480 VAC	3-ph: 380 - 480 VAC	3-ph: 380 - 480 VAC
Output frequency	0.1 ~ 400.0 Hz	0.1 ~ 400.0 Hz	0.1 ~ 400.0 Hz
100% RMS output current	73 A [RVFFD3403700F] 88 A [RVFFD3404500F] 103 A [RVFFD3405500F]	145 A [RVFFE3407500] 168 A [RVFFE3409000]	208 A [RVFFF34011000] 250 A [RVFFF34013200] 296 A [RVFFF34016000]

### General specifications





Operating temperature	-10°C to +50°C	-10°C to +50°C	-10°C to +50°C
Storage temperature	-20°C to +70°C	-20°C to +70°C	-20°C to +70°C
Digital inputs	6	6	6
Digital outputs	3 (Programmable)	3 (Programmable)	3 (Programmable)
Analogue inputs	2 (0 - 10 VDC/0-20 mA, 4-20 mA)	2 (0 - 10 VDC/0-20 mA, 4-20 mA)	2 (0 - 10 VDC/0-20 mA, 4-20 mA)
Analogue outputs	2 (0-10 VDC, 4-20 mA)	2 (0-10 VDC, 4-20 mA)	2 (0-10 VDC, 4-20 mA)
Mounting	Panel mounting	Panel mounting	Panel mounting
Integrated cooling fan	Yes	Yes	Yes
Switching frequency	2 to 16 kHz	2 to 16 kHz	2 to 16 kHz
Approvals	CE - cULus	CE - cULus	CE - cULus

### References



380 - 480 VAC, 3-phase	<b>RVFFD3403700F</b> [37 kW - 50 HP] <b>RVFFD3404500F</b> [45 kW - 60 HP] <b>RVFFD3405500F</b> [55 kW - 75 HP]	<b>RVFFE3407500</b> [75 kW - 100 HP] <b>RVFFE3409000</b> [90 kW - 125 HP]	<b>RVFFF34011000</b> [110 kW - 150 HP] <b>RVFFF34013200</b> [132 kW - 175 HP] <b>RVFFF34016000</b> [160 kW - 215 HP]
------------------------	--	--	--

## Variable frequency drives





### Accessories

Types	DNET Module	Profibus Module	CAN Module	TCP-IP Module
				
Dimensions HxWxD (mm)	106 x 38 x 59.3	106 x 38 x 59.3	106 x 38 x 59.3	106 x 38 x 59.3
Features	DeviceNET communication module	Profibus communication module	CANopen communication module	TCP-IP communication module
<b>Technical specifications</b>				
Supply voltage	24 VDC, 50 mA	24 VDC, 50 mA	24 VDC, 50 mA	24 VDC, 50 mA
<b>General specifications</b>				
Operating temperature	-10°C to +50°C	-10°C to +50°C	-10°C to +50°C	-10°C to +50°C
Storage temperature	-20°C to +70°C	-20°C to +70°C	-20°C to +70°C	-20°C to +70°C
Degree of protection	IP 20	IP 20	IP 20	IP 20
Connections	Screw terminals	Screw terminals	Screw terminals	Screw terminals
Mounting	DIN-rail or panel mounting	DIN-rail or panel mounting	DIN-rail or panel mounting	DIN-rail or panel mounting
<b>References</b>				
	<b>RV-DNET</b>	<b>RV-PDP</b>	<b>RV-CAN</b>	<b>RV-TCPIP</b>

### Accessories

Types	Multi-pump card	Copy module
		
Dimensions HxWxD (mm)		85 x 62 x 14.2
Features	Controls up to 8 DO for multi pump/fan control	Use to duplicate parameters settings
<b>General specifications</b>		
Operating temperature	-10°C to +50°C	-10°C to +50°C
Storage temperature	-20°C to +70°C	-20°C to +70°C
Degree of protection	IP00	IP20
Connection	Plug-in to RVFF	RJ-45
<b>References</b>		
	<b>RV-IO-8DO</b>	<b>RV-CU</b>

# Industrial and Midi industrial relays

	Industrial relays		Midi industrial relays	
Types	RCP 8 (2 Poles)	RCP 11 (3 Poles)	RMI 2-10 (2 Poles)	RMI 4-5 (4 Poles)
				
Dimensions HxWxD (mm)	56 x 35.5 x 35.5	56 x 35.5 x 35.5	37 x 21.5 x 28	37 x 21.5 x 28
No. of Contacts	2 Change-over (octal)	3 Change-over (undecal)	2 Change-over	4 Change-over
Contact rating	10 A	10 A	10 A	6 A
Features	Test button / Flag / LED	Test button / Flag / LED	Test button / Flag / LED	Test button / Flag / LED

## Output specifications

Max. load AC1	12 A / 250 VAC	12 A / 250 VAC	12 A / 250 VAC	6 A / 250 VAC
Min. load	100 mA / 12 VDC	100 mA / 125 VDC	100 mA / 5 VDC	100 mA / 5 VDC
Electrical life	> 100.000 cycles	> 100.000 cycles	> 100.000 cycles	> 100.000 cycles
Switching power	2500 VA (resistive)	2500 VA (resistive)	2500 VA (resistive)	1250 VA (resistive)

## General specifications

Voltage ranges VDC	6 - 12 - 24 - 48 - 60 - 110	6 - 12 - 24 - 48 - 60 - 110	12 - 24 - 48 - 60 - 110	12 - 24 - 48 - 60 - 110
Voltage ranges VAC	6 - 12 - 24 - 48 - 115/120 - 230	6 - 12 - 24 - 48 - 115/120 - 230	12 - 24 - 48 - 115/120 - 230	12 - 24 - 48 - 115/120 - 230
Insulation according to	EN 61810-1	EN 61810-1	EN 61810-1	EN 61810-1
Consumption	1.5 W DC-2.5 VA AC	1.5 W DC-2.5 VA AC	1 W DC-1.4 VA AC	1 W DC-1.4 VA AC
Approvals / Conformity	cURus - CSA - IMQ - RINA	cURus - CSA - IMQ - RINA	cURus - CSA - IMQ - RINA	cURus - CSA - IMQ - RINA

## References

6 VDC	RCP80026 VDC	RCP110036 VDC		
12 VDC	RCP800212 VDC	RCP1100312 VDC	RMIA21012 VDC	RMIA4512 VDC
24 VDC	RCP800224 VDC	RCP1100324 VDC	RMIA21024 VDC	RMIA4524 VDC
48 VDC	RCP800248 VDC	RCP1100348 VDC	RMIA21048 VDC	RMIA4548 VDC
60 VDC	RCP800260 VDC	RCP1100360 VDC	RMIA21060 VDC	RMIA4560 VDC
100 VDC	RCP8002100 VDC	RCP11003100 VDC		
11 0VDC	RCP8002110 VDC	RCP11003110 VDC	RMIA210110 VDC	RMIA45110 VDC
6 VAC	RCP80026 VAC	RCP110036 VAC		
12 VAC	RCP800212 VAC	RCP1100312 VAC	RMIA21012 VAC	RMIA4512 VAC
24 VAC	RCP800224 VAC	RCP1100324 VAC	RMIA21024 VAC	RMIA4524 VAC
48 VAC	RCP800248 VAC	RCP1100348 VAC	RMIA21048 VAC	RMIA4548 VAC
115/120 VAC	RCP8002115/120 VAC	RCP11003115/120 VAC	RMIA210115/120 VAC	RMIA45115/120 VAC
230 VAC	RCP8002230 VAC	RCP11003230 VAC	RMIA210230 VAC	RMIA45230 VAC
Options	Consult your Carlo Gavazzi partner or distributor			

	Industrial relays sockets		Midi industrial relays sockets	
Types	ZPD 8XA ZPD 11XA	ZPD 8A ZPD 11A	ZMI 2NA ZMI 4NA	ZMI 2 / 3 / 4SA
				

## General specifications





Dimensions HxWxD (mm)	65 x 27 x 38	65 x 27 x 38	42.5 x 75 x 27	42.5 x 75 x 27
Rated volt. / Rated curr.	10 A @ 400 VAC	10 A @ 400 VAC	10 A @ 300 VAC	10/12 A @ 300 VAC
Insulation voltage	> 3 kV	> 3 kV	> 4 kV	> 4 kV
Socket material	Self-ext. PA6 + GF (V1)	Self-ext. PA6 + GF (V1)	Self-ext. PA6 + GF (V2)	Self-ext. PA6 + GF (V2)
Mounting	DIN-rail	DIN-rail	DIN-rail	DIN-rail
Degree of protection	IP 20	IP 20	IP 20	IP 20
Approvals	CE - cURus - CSA (10 A 300 VAC)	CE - cURus - CSA - IMQ	CE - cURus - CSA	CE - cURus - CSA

## References



For RCP 8 / RCP 11	ZPD 8XA / ZPD 11XA	ZPD 8A / ZPD 11A		
For RMI2-10 / RMI4-5			ZMI 2NA / ZMI 4NA	ZMI 2 / 3 / 4SA

# Midi industrial relays

## Midi industrial relays



Types	RPY 1	RPY 2	RPY 3	RPY 4
				
Dimensions HxWxD (mm)	36 x 21.5 x 28	36 x 21.5 x 28	36 x 31.5 x 28	36 x 41.5 x 28
No. of Contacts	1 Change-over	2 Change-over	3 Change-over	4 Change-over
Contact rating	16 A	10 A	10 A	10 A
Terminal types	Faston or PCB	Faston or PCB	Faston or PCB	Faston or PCB
<b>Output specifications</b>				
Max. load AC1	16 A	10 A	10 A	10 A
Electrical life	1 x 10 <sup>5</sup>	1 x 10 <sup>5</sup>	1 x 10 <sup>5</sup>	1 x 10 <sup>5</sup>
Switching power	1 HP at 240 VAC 1/2 HP at 120 VAC	3/4 HP at 240 VAC 1/3 HP at 120 VAC	3/4 HP at 240 VAC 1/3 HP at 120 VAC	3/4 HP at 240 VAC 1/3 HP at 120 VAC
<b>General specifications</b>				
Voltage ranges VDC	6 - 12 - 24 - 36 - 48 - 110	6 - 12 - 24 - 36 - 48 - 110	6 - 12 - 24 - 36 - 48 - 110	6 - 12 - 24 - 36 - 48 - 110 - 220
Voltage ranges VAC	6 - 12 - 24 - 120 - 230	6 - 12 - 24 - 120 - 230	6 - 12 - 24 - 120 - 230	6 - 12 - 24 - 120 - 230
Insulation Coil / Contact	2000/1200 VAC	2000/1200 VAC	2000/1200 VAC	2000/1200 VAC
Consumption	DC=0.9 W - AC=1.2 VA	DC=0.9 W - AC=1.2 VA	DC=1.4 W - AC=2 VA	DC=1.5 W - AC=2.5 VA
Approvals / Conformity	cURus - CSA - TÜV	cURus - CSA - TÜV	cURus - CSA - TÜV	cURus - CSA - TÜV
<b>References</b>				
6 VDC	RPYA0016	RPYA0026	RPYA0036	RPYA0046
12 VDC	RPYA00112	RPYA00212	RPYA00312	RPYA00412
24 VDC	RPYA00124	RPYA00224	RPYA00324	RPYA00424
36 VDC	RPYA00136	RPYA00236	RPYA00336	RPYA00436
48 VDC	RPYA00148	RPYA00248	RPYA00348	RPYA00448
110 VDC	RPYA001110	RPYA002110	RPYA003110	RPYA004110
6 VAC	RPYA001A6	RPYA002A6	RPYA003A6	RPYA004A6
12 VAC	RPYA001A12	RPYA002A12	RPYA003A12	RPYA004A12
24 VAC	RPYA001A24	RPYA002A24	RPYA003A24	RPYA004A24
120 VAC	RPYA001A120	RPYA002A120	RPYA003A120	RPYA004A120
230 VAC	RPYA001A230	RPYA002A230	RPYA003A230	RPYA004A230
Options	Consult your Carlo Gavazzi partner or distributor			

## Midi industrial relays sockets



Types	ZPY08A	ZPY11A	ZPY14A
			
<b>General specifications</b>			
Dimensions HxWxD (mm)	27.8 x 30 x 69.8	27.8 x 40 x 69.8	27.8 x 50.5 x 69.8
Rated volt. / Rated curr.	10 A @ 300 VAC	10 A @ 300 VAC	10 A @ 300 VAC
Insulation voltage	> 4 kW	> 4 kW	> 4 kW
Socket material	PA6 - V2	PA6 - V2	PA6 - V2
Mounting	DIN-rail	DIN-rail	DIN-rail
Degree of protection	IP 00	IP 00	IP 00
Approvals	cURus - CSA	cURus - CSA	cURus - CSA
<b>References</b>			
Consult your Carlo Gavazzi Partner or Distributor	For Relays: RPYA 001 and RPYA 002	For Relays: RPYA 003	For Relays: RPYA 004

# Slim industrial relays

## Slim industrial relays

Types	RSLM100	RSLM001
		
Dimensions HxWxD (mm)	15 x 28 x 5	15 x 28 x 5
No. of Contacts	1 Normally open	1 Change-over
Contact rating	6 A	6 A
<b>Output specifications</b>		
Max. load AC1	6 A / 250 VAC	6 A / 250 VAC
Min. load	170 mW / 24 VDC 210 mW / 48~60 VDC	170 mW / 24 VDC 210 mW / 48~60 VDC
Mechanical endurance	> 100,000 cycles	> 100,000 cycles
Switching power	1500 VA	1500 VA
<b>General specifications</b>		
Voltage ranges VDC	12 - 24 - 48 - 60	12 - 24 - 48 - 60
Consumption	170 mW ~ 210 mW	170 mW ~ 210 mW
Approvals / Conformity	cURus - CSA - VDE - CQC	cURus - CSA - VDE - CQC
<b>References</b>		
12 VDC	RSLM100012	RSLM001012
24 VDC	RSLM100024	RSLM001024
48 VDC	RSLM100048	RSLM001048
60 VDC	RSLM100060	RSLM001060

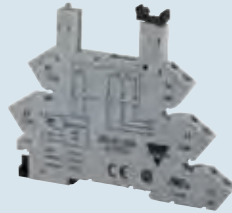
## Slim relay sockets

Types	ZRLS1.NA	ZRLS1.GA	ZRLP
			
<b>General specifications</b>			
Dimensions HxWxD (mm)	88 x 55 x 6	101 x 80 x 6	33 x 30 x 6
Rated volt. / Rated curr.	6 A @ 300 VAC	6 A @ 300 VAC	6 A @ 300 VAC
Insulation voltage	> 3 kV	> 3 kV	> 3 kV
Socket material	PA66 + GF (V0)	PA66 + GF (V0)	PA66 + GF (V0)
Mounting	DIN-rail	DIN-rail	PCB
Terminal Type	Screw cage	Spring loaded	
Approvals	CE - cURus - CSA	CE - cURus - CSA	CSA - cURus
<b>References</b>			
Input Voltage 6~24 VAC/VDC	ZRLS12NA	ZRLS12GA	
Input Voltage 48~60 VAC/VDC	ZRLS13NA	ZRLS13GA	
Input Voltage 110~125 VAC/VDC	ZRLS14NA	ZRLS14GA	
Input Voltage 220~240 VAC/VDC	ZRLS15NA	ZRLS15GA	
			ZRLP



# Power relays

## Power relays

**Types** **NB** (1/2 Poles) **NF** (1/2 Poles) **NP** (1/2 Poles)



Dimensions HxWxD (mm)	55 x 50.5 x 54.5	36 x 50.5 x 54.5	36 x 50.5 x 33.5
No. of Contacts	1 Normally open 2 Normally open	1 Normally open 2 Normally open	1 Normally open 2 Normally open
Contact rating	30 A	30 A	30 A
Terminal types	Bolt	Faston	PCB

### Output specifications

Max. load AC1	30 A (1NO) - 25 A (2NO)	30 A (1NO) - 25 A (2NO)	30 A (1NO) - 25 A (2NO)
Electrical life	1 x 10 <sup>5</sup>	1 x 10 <sup>5</sup>	1 x 10 <sup>5</sup>
Switching power	7500 VA / 840 W	7500 VA / 840 W	7500 VA / 840 W

### General specifications

Voltage ranges VDC	6 - 12 - 24 - 48 - 100 - 110	6 - 12 - 24 - 48 - 100 - 110	6 - 12 - 24 - 48 - 100 - 110
Voltage ranges VAC	12 - 24 - 48 - 115 - 230	12 - 24 - 48 - 115 - 230	12 - 24 - 48 - 115 - 230
Insulation according to	4000 VAC	4000 VAC	4000 VAC
Consumption	DC=1.9 W - AC=2.7 VA	DC=1.9 W - AC=2.7 VA	DC=1.9 W - AC=2.7 VA
Approvals / Conformity	cURus	cURus	cURus

### References

	1NO Contact	2NO Contact	1NO Contact	2NO Contact	1NO Contact	2NO Contact
6 VDC	<b>NBD 100 6</b>	<b>NBD 200 6</b>	<b>NFD 100 6</b>	<b>NFD 200 6</b>	<b>NPD 100 6</b>	<b>NPD 200 6</b>
12 VDC	<b>NBD 100 12</b>	<b>NBD 200 12</b>	<b>NFD 100 12</b>	<b>NFD 200 12</b>	<b>NPD 100 12</b>	<b>NPD 200 12</b>
24 VDC	<b>NBD 100 24</b>	<b>NBD 200 24</b>	<b>NFD 100 24</b>	<b>NFD 200 24</b>	<b>NPD 100 24</b>	<b>NPD 200 24</b>
48 VDC	<b>NBD 100 48</b>	<b>NBD 200 48</b>	<b>NFD 100 48</b>	<b>NFD 200 48</b>	<b>NPD 100 48</b>	<b>NPD 200 48</b>
100 VDC	<b>NBD 100 100</b>	<b>NBD 200 100</b>	<b>NFD 100 100</b>	<b>NFD 200 100</b>	<b>NPD 100 100</b>	<b>NPD 200 100</b>
12 VAC	<b>NBA 100 12</b>	<b>NBA 200 12</b>	<b>NFA 100 12</b>	<b>NFA 200 12</b>	<b>NPA 100 12</b>	<b>NPA 200 12</b>
24 VAC	<b>NBA 100 24</b>	<b>NBA 200 24</b>	<b>NFA 100 24</b>	<b>NFA 200 24</b>	<b>NPA 100 24</b>	<b>NPA 200 24</b>
48 VAC	<b>NBA 100 48</b>	<b>NBA 200 48</b>	<b>NFA 100 48</b>	<b>NFA 200 48</b>	<b>NPA 100 48</b>	<b>NPA 200 48</b>
115 VAC	<b>NBA 100 115</b>	<b>NBA 200 115</b>	<b>NFA 100 115</b>	<b>NFA 200 115</b>	<b>NPA 100 115</b>	<b>NPA 200 115</b>
230 VAC	<b>NBA 100 230</b>	<b>NBA 200 230</b>	<b>NFA 100 230</b>	<b>NFA 200 230</b>	<b>NPA 100 230</b>	<b>NPA 200 230</b>
Options	Consult your Carlo Gavazzi partner or distributor					

# Power relays

## Power relays

### CF (2 Poles)



### CS (2 Poles)



Dimensions (mm) WxHxD	26.42 x 68.58 x 34.54	26.42 x 52.32 x 34.54
No. of Contacts	2 Normally open 2 Change-over	2 Normally open 2 Change-over
Contact rating	30 A	30 A
Terminal types	Faston	PCB
<b>Output specifications</b>		
Max. load AC1	30 A (2NO) - 30 A (2CO)	30 A (2NO) - 30 A (2CO)
Electrical life	1 x 10 <sup>5</sup>	1 x 10 <sup>5</sup>
Switching power	8310 VA / 840 W	8310 VA / 840 W
<b>General specifications</b>		
Voltage ranges VDC	5 - 6 - 12 - 24 - 48 - 110	5 - 6 - 12 - 24 - 48 - 110
Voltage ranges VAC	24 - 120 - 208 - 240 - 277	24 - 120 - 208 - 240 - 277
Insulation according to	4000 VAC	4000 VAC
Consumption	DC=1.7 W - AC=4 VA	DC=1.7 W - AC=4 VA
Approvals / Conformity	cURus	cURus

### References

	2NO Contact	2CO Contact	2NO Contact	2CO Contact
5 VDC	<b>CF30 D2005</b>	<b>CF30 D0025</b>	<b>CS30 D2005</b>	<b>CS30 D0025</b>
6 VDC	<b>CF30 D2006</b>	<b>CF30 D0026</b>	<b>CS30 D2006</b>	<b>CS30 D0026</b>
12 VDC	<b>CF30 D20012</b>	<b>CF30 D00212</b>	<b>CS30 D20012</b>	<b>CS30 D00212</b>
24 VDC	<b>CF30 D20024</b>	<b>CF30 D00224</b>	<b>CS30 D20024</b>	<b>CS30 D00224</b>
48 VDC	<b>CF30 D20048</b>	<b>CF30 D00248</b>	<b>CS30 D20048</b>	<b>CS30 D00248</b>
110 VDC	<b>CF30 D200110</b>	<b>CF30 D002110</b>	<b>CS30 D200110</b>	<b>CS30 D002110</b>
24 VAC	<b>CF30 A20024</b>	<b>CF30 A00224</b>	<b>CS30 A20024</b>	<b>CS30 A00224</b>
120 VAC	<b>CF30 A200120</b>	<b>CF30 A002120</b>	<b>CS30 A200120</b>	<b>CS30 A002120</b>
208 VAC (only 60Hz)	<b>CF30 A200208</b>	<b>CF30 A002208</b>	<b>CS30 A200208</b>	<b>CS30 A002208</b>
220 VAC (only 50Hz)	<b>CF30 A200220</b>	<b>CF30 A002220</b>	<b>CS30 A200220</b>	<b>CS30 A002220</b>
240 VAC	<b>CF30 A200240</b>	<b>CF30 A002240</b>	<b>CS30 A200240</b>	<b>CS30 A002240</b>
277 VAC	<b>CF30 A200277</b>	<b>CF30 A002277</b>	<b>CS30 A200277</b>	<b>CS30 A002277</b>
Options	Consult your Carlo Gavazzi partner or distributor			

# Sockets for electromechanical relays

## Types

ZD 35/2A

ZD 50/2A

ZD 35/3A

ZD 50/3A

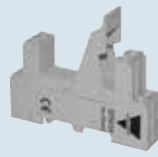
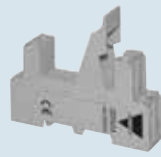

## General specifications

Rated volt. / Rated curr.	12 A @ 300 VAC	12 A @ 300 VAC	12 A @ 300 VAC	12 A @ 300 VAC
Insulation voltage	> 5 kV	> 5 kV	> 5 kV	> 5 kV
Socket material	Self-ext. PA6 + GF (V1)	Self-ext. PA6 + GF (V1)	Self-ext. PA6 + GF (V1)	Self-ext. PA6 + GF (V1)
Mounting	DIN-rail	DIN-rail	DIN-rail	DIN-rail
Degree of protection	IP 20	IP 20	IP 20	IP 20
Approvals	CE - cURus - CSA (12 A, 300 VAC)	CE - cURus - CSA (12 A, 300 VAC)	CE - cURus - CSA (12 A, 300 VAC)	CE - cURus - CSA (12 A, 300 VAC)

## References

For relay:	MZ 1P 5/10 A	MZ B 1P 5/10 A	MZ 1P 5/10 A	MZ B 1P 5/10 A
	M15 M 8 A	MZ 2P 5/10 A	M15 M 8 A	MZ 2P 5/10 A
	M25 1P 12 A	MZ 1P 16 A	M25 1P 12 A	MZ 1P 16 A
	LC 10 A	M15 M 8 A	LC 10 A	M15 M 8 A
		M25 1P 16 A		M25 1P 16 A
		M25 2P 8 A		M25 2P 8 A
	LC 5/16 A		LC 5/16 A	

For detailed informations consult your Carlo Gavazzi Partner or Distributor

Hold down spring to be ordered separately:  
 • SZD15 for M15/M25 relays  
 • SZD20 for LC relays  
 • SZD25 for MZ relays

Hold down spring to be ordered separately:  
 • SZD15 for M15/M25 relays  
 • SZD20 for LC relays  
 • SZD25 for MZ relays

Hold down spring to be ordered separately:  
 • SZD15 for M15/M25 relays  
 • SZD20 for LC relays  
 • SZD25 for MZ relays

Hold down spring to be ordered separately:  
 • SZD15 for M15/M25 relays  
 • SZD20 for LC relays  
 • SZD25 for MZ relays

## Types

### Additional modules for ZMI and ZD sockets



## General specifications

Dimensions (mm) WxHxD	23 x 12.5 x 8.5
Terminal material	CuSn
Degree of protection	IP 40
Operating temperature	-40°C to +70°C
Ambient humidity	85RH non condensing
Approvals / Conformity	No approvals

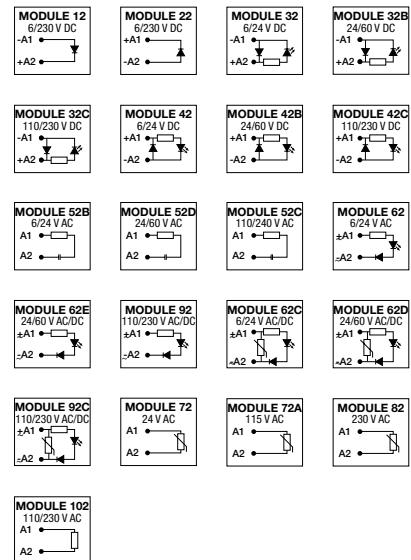

## References

Consult your Carlo Gavazzi Partner or Distributor





# Switching power supplies

## Single-phase switching power supplies

Types	SPD 5 / 10 / 18 W				SPD 30 / 60 W			SPD 90 / 100 W		
										
Dimensions HxWxD (mm)	90 x 22.5 x 114				90 x 40.5 x 114			90 x 54 x 114		
<b>Output specifications</b>										
Voltage	5 VDC	12 VDC	15 VDC	24 VDC	12 VDC	24 VDC	48 VDC	12 VDC	24 VDC	48 VDC
Current SPD 5 W	1 A	420 mA	340 mA	210 mA						
Current SPD 10 W	2 A	840 mA	670 mA	420 mA						
Current SPD 18 W	3 A	1.5 A	1.2 A	750 mA						
Current SPD 30 W					2.5 A	1.25 A	625 mA			
Current SPD 60 W					5 A	2.5 A	1.25 A			
Current SPD 90 W										3.8 A
Current SPD 100 W								8.4 A	4.2 A	2.1 A
Line regulation		±1%				±0.5%			±1%	
Load regulation		±2%				±0.5%			±1%	
Efficiency	75%	77%	77%	77%	86%	89%	89%			85%
<b>Input specifications</b>										
Voltage range	Multi voltage: 90 to 265 VAC or 120 to 370 VDC				Multi voltage: 85 to 264 VAC or 90 to 375 VDC			Multi voltage: 90 to 264 VAC or 120 to 375 VDC		
Frequency range	47 to 63 Hz				47 to 63 Hz			47 to 63 Hz		
<b>General specifications</b>										
Ambient temperature	-40°C to +71°C				-40°C to +71°C			-35°C to +71°C		
Storage	-40°C to +85°C				-40°C to +85°C			-40°C to +85°C		
Derating (>60°C)	3 % / °C				2.5 % / °C			2.5 % / °C		
Approvals/Marks	cULus - TÜV - CE - UL Class 2 - Class I Div 2				cULus - TÜV - CE - UL Class 2 - Class I Div 2			cULus - TÜV - CE - UL Class 2 (90 W) - Class I Div 2		
Installation	DIN-rail				DIN-rail			DIN-rail		
Connection	Screw terminals / Spring terminals (B)				Screw terminals / Spring terminals (B)			Screw terminals / Spring terminals (B)		
<b>Main features</b>										
	Adjustable output voltage. Internal noise filter. Short circuit protection. Overload protection (110-135%)				Adjustable output voltage. Internal noise filter. Short circuit protection. Overload protection (110-135%). Output "Power ready" signal VDC (only model 24 VDC)			Adjustable output voltage. Internal noise filter. Short circuit protection. Overload protection (102-108%), PFC. Overvoltage protection (102-106%). Output "Power ready" signal VDC		
LED indicator for "power on"	Yes				Yes			Yes		
LED indicator for DC "too low"	Yes				No - SPD24 with transistor output			Yes with relay output		
<b>References</b>										
<b>5 VDC</b>										
Screw terminals	SPD05051 / SPD05101 SPD05181									
Spring terminals	SPD05051B / SPD05101B SPD05181B									
<b>12 VDC</b>										
Screw terminals	SPD12051 / SPD12101 SPD12181				SPD12301 / SPD12601			SPD121001		
Spring terminals	SPD12051B / SPD12101B SPD12181B				SPD12301B / SPD12601B					
<b>24 VDC</b>										
Screw terminals	SPD24051 / SPD24101 SPD24181				SPD24301 / SPD24601			SPD24901L / SPD241001		
Spring terminals	SPD24051B / SPD24101B SPD24181B				SPD24301B / SPD24601B					
<b>48 VDC</b>										
Screw terminals					SPD48301 / SPD48601			SPD481001		
Spring terminals					SPD48301B / SPD48601B					

# Switching power supplies

## Single-phase switching power supplies

Types	SPD 120 W(N)			SPD 240 W		SPD 300 W	
							
Dimensions HxWxD (mm)	124.5 x 64 x 123.6			124.5 x 83.5 x 123.6		124.5 x 83.5 x 123.6	
<b>Output specifications</b>							
Voltage	12 VDC	24 VDC	48 VDC	24 VDC	48 VDC	24 VDC	48 VDC
Current	10 A	5 A	2.5 A	10 A	5 A	12.5 A	6.25 A
Line regulation		±0.5%	±0.5%		±0.5%		±0.5%
Load regulation		±1%	±1%		±1%		±1%
Efficiency	84%	86%	86%	89%	90%	89%	90%
<b>Input specifications</b>							
Voltage range	Autoselect: 90 to 132 VAC, 180 to 264 VAC, 120 to 375 VDC			Autoselect: 90 to 132 VAC, 180 to 264 VAC, 120 to 375 VDC		Autoselect: 90 to 132 VAC, 180 to 264 VAC, 120 to 375 VDC	
Frequency range	47 to 63 Hz			47 to 63 Hz		47 to 63 Hz	
PFC	0.7			0.75		0.75	
<b>General specifications</b>							
Ambient temperature	-35°C to +71°C			-40°C to +71°C		-30°C to +71°C	
Storage	-40°C to +85°C			-40°C to +85°C		-40°C to +85°C	
Derating (>60°C)	2.5 % / °C			2.5 % / °C		2.5 % / °C	
Approvals/Marks	cULus - TÜV - CE - Class I Div 2			cULus - TÜV - CE - Class I Div 2		cULus - TÜV - CE - Class I Div 2	
Installation	DIN-rail			DIN-rail		DIN-rail	
Connection	Screw terminals / Detach screw terminals (B)			Screw terminals / Detach screw terminals (B)		Screw terminals / Detach screw terminals (B)	
<b>Main features</b>							
	Adjustable output voltage. Internal noise filter. Short circuit protection. Overload protection (110-145%). Parallel connection up to 3 supplies and PFC function on (N) model only			Adjustable output voltage. Internal noise filter. Short circuit protection. Overload protection (110-145%). Parallel connection up to 3 supplies standard. PFC function integrated		Parallel function, PFC and Output ready	
LED indicator for "power on"	Yes			Yes		Yes, 24 V with output ready	
LED indicator for DC "too low"	Yes - with relay output (SPD24 only)			Yes - with relay output (SPD24 only)		Yes	
<b>References</b>							
<b>12 VDC</b>							
Screw terminals	SPD121201N						
Detach. screw terminals	SPD121201BN						
<b>24 VDC</b>							
Screw terminals	SPD241201N		SPD242401		SPD243001		
Detach. screw terminals	SPD241201BN		SPD242401B		SPD243001B		
<b>48 VDC</b>							
Screw terminals	SPD481201N		SPD482401		SPD483001		
Detach. screw terminals	SPD481201BN		SPD482401B		SPD483001B		

# Switching power supplies

## Single-phase switching power supplies

## Bi-phase switching power supplies

### Types

**SPD 480 W**
**SPD 100 W**

**Dimensions HxWxD (mm)**

124.5 x 175.5 x 123.6

90 x 54 x 114

### Output specifications

	SPD 480 W		SPD 100 W		
Voltage	24 VDC	48 VDC	12 VCC	24 VCC	48 VCC
Current	20 A	10 A	8.4 A	4.2 A	2.1 A
Line regulation	±0.5%		±1.0%		
Load regulation	±1%		±1.0%		
Efficiency (typ)	89%	90%	86%	87%	89%

### Input specifications

	SPD 480 W	SPD 100 W
Voltage range	Autoselect: 90 to 132 VAC, 186 to 264 VAC, 120 to 370 VDC	340 to 575 VAC, 480 to 820 VAC
Frequency range	47 to 63 Hz	47 to 63 Hz
PFC	0.99	0.55

### General specifications

	SPD 480 W	SPD 100 W
Ambient temperature	-40°C to +71°C	-40°C to +71°C
Storage	-40°C to +85°C	-40°C to +85°C
Derating (>60°C)	2.5 % / °C > 56°C	2.5% / °C
Approvals/Marks	cULus - TÜV - CE - Class I Div 2	cULus - TÜV - CE - Class I Div 2
Installation	DIN-rail	DIN-rail
Connection	Screw terminals / Detach screw terminals (B)	Screw terminal

### Main features

Adjustable output voltage.  
Internal noise filter.  
Short circuit protection.  
Overload protection (120-140%).  
Parallel connection up to 3 supplies standard.  
PFC function integrated

Parallel function, PFC and Output ready

LED indicator for "power on"	Yes	Yes - with relay output (SPD24 only)
LED indicator for DC "too low"	Yes - with relay output (SPD24 only)	Yes

### References

12 VDC		
Screw terminals		SPD 121002
24 VDC		
Screw terminals	SPD244801	SPD 241002
Detach. screw terminals	SPD244801B	
48 VDC		
Screw terminals	SPD482401	SPD 481002
Detach. screw terminals	SPD482401B	

# Switching power supplies

## Three-phase switching power supplies

Types	SPD 120 W 3-ph	SPD 240 W 3-ph	SPD 480 W 3-ph	SPD 960 W 3-ph
-------	----------------	----------------	----------------	----------------



Dimensions HxWxD (mm)	124 x 74.3 x 118.8	124 x 89.0 x 118.8	124 x 150 x 118.8	126.2 x 275.8 x 118.8
-----------------------	--------------------	--------------------	-------------------	-----------------------

### Output specifications

Voltage	12 VDC	24 VDC	24 VDC	48 VDC	24 VDC	48 VDC	24 VDC	48 VDC
Current	10 A	5 A	10 A	5 A	20 A	10 A	40 A	20 A
Line regulation	±1%		±1%		±1%		±1%	
Load regulation	±1%		±1%		±1%		±1%	
Efficiency	87%	89%	90%	91%	90%	91%	92%	93%

### Input specifications

Voltage range	340 to 575 VAC 480 to 820 VDC	340 to 575 VAC 480 to 820 VDC	340 to 575 VAC 480 to 820 VDC	340 to 575 VAC 480 to 820 VDC
Frequency range	47 to 63 Hz	47 to 63 Hz	47 to 63 Hz	47 to 63 Hz
PFC	0.55	0.55	0.65	0.80

### General specifications

Ambient temperature	-40°C to +71°C	-25°C to +71°C	-30°C to +71°C	-40°C to +71°C
Storage	-40°C to +85°C	-25°C to +85°C	-40°C to +85°C	-40°C to +85°C
Derating	2.5 % / °C > 61°C	2.5 % / °C > 61°C	2.5 % / °C > 61°C	3.5 % / °C > 61°C
Approvals/Marks	cULus - TÜV - CE - Class I Div 2	cULus - TÜV - CE - Class I Div 2	cULus - TÜV - CE - Class I Div 2	cULus - TÜV - CE - Class I Div 2
Installation	DIN-rail	DIN-rail	DIN-rail	DIN-rail
Connection	Screw terminals	Screw terminals	Screw terminals / Detach conn.	Screw terminals

### Main features





	Can be used as Bi or Three-phase, Parallel function and PFC	Can be used as Bi or Three-phase, Parallel function and PFC	Can be used as Bi or Three-phase, Parallel function and PFC	Can be used as Bi or Three-phase. Active parallel function and PFC
LED indicator for "power on"	Yes, 24 V with output ready	Yes, 24 V with output ready	Yes, 24 V with output ready	Yes, 24 V with output ready
LED indicator for DC "too low"	Yes	Yes	Yes	Yes

### References

<b>12 VDC</b>				
Screw terminals	<b>SPD121203</b>			
<b>24 VDC</b>				
Screw terminals	<b>SPD241203</b>	<b>SPD242403</b>	<b>SPD244803</b>	<b>SPD249603</b> <b>SPD249603L</b> (without parallel function and output ready)
<b>48 VDC</b>				
Screw terminals	<b>SPD482403</b>		<b>SPD484803</b>	<b>SPD489603</b>

# Switching power supplies

## Low profile DIN-rail mounting

Types	<b>SPM 1</b> 7.5 W to 10 W	<b>SPM 3</b> 15 W to 30 W	<b>SPM 4</b> 35 W to 60 W	<b>SPM 5</b> 60 W to 100 W
				
Dimensions HxWxD (mm)	91 x 18 x 55.5	91 x 52 x 55.5	91 x 71 x 55.5	91 x 90 x 55.5
<b>Output specifications</b>				
Voltage	5 VDC, 12 VDC, 15 VDC, 24 VDC	5 VDC, 12 VDC, 15 VDC, 24 VDC	5 VDC, 12 VDC, 15 VDC, 24 VDC	5 VDC, 12 VDC, 15 VDC, 24 VDC, 24 VDC (S ver.)
Current	1.5 A - 0.83 A 0.67 A - 0.42 A	3.0 A - 2.1 A 2.0 A - 1.3 A	7.0 A - 4.5 A 4.0 A - 2.5 A	12 A - 6 A - 5 A 4.2 A - 3.8 A
Output Power	5 V - 7.5 W 12 V, 15 V, 24 V - 10 W	5 V - 15 W 12 V - 25 W 15 V, 24 V - 30 W	5 V - 35 W 12 V - 54 W 15 V, 24 V - 60 W	5 V - 60 W 12 V - 72 W 15 V - 75 W 24 V - 100 W or 24 V - 91 W (for class 2 compliance)
Line regulation	±1%	±1%	±1%	±1%
Load regulation	±1%	±1%	±1%	±1%
<b>Input specifications</b>				
Voltage range	90 to 264 VAC, 120 to 370 VDC	90 to 264 VAC, 120 to 370 VDC	90 to 264 VAC, 120 to 370 VDC	90 to 264 VAC, 120 to 370 VDC
Frequency range	47 to 63 Hz	47 to 63 Hz	47 to 63 Hz	47 to 63 Hz
<b>General specifications</b>				
Ambient temperature	-25°C to +71°C	-25°C to +71°C	-25°C to +71°C	-25°C to +71°C
Storage	-25°C to +85°C	-25°C to +85°C	-25°C to +85°C	-25°C to +85°C
Derating (>60°C)	2.5 % / °C	2.5 % / °C	2.5 % / °C	2.5 % / °C
Approvals/Marks	cULus - TÜV - CE - UL Class 2 - Class 1 Div 2	cULus - TÜV - CE - UL Class 2 - Class 1 Div 2	cULus - TÜV - CE - UL Class 2 - Class 1 Div 2	cULus - TÜV - CE - UL Class 2 (up to 91 W) - Class 1 Div 2
Installation	DIN-rail	DIN-rail	DIN-rail	DIN-rail
Connection	Screw terminals	Screw terminals	Screw terminals	Screw terminals
<b>Main features</b>				
		Adjustable output voltage	Adjustable output voltage	Adjustable output voltage
LED indicator for "power on"	Yes	Yes	Yes	Yes
LED indicator for DC "too low"	Yes	Yes	Yes	Yes
<b>References</b>				
5 VDC	<b>SPM1051</b>	<b>SPM3051</b>	<b>SPM4051</b>	<b>SPM5051</b>
12 VDC	<b>SPM1121</b>	<b>SPM3121</b>	<b>SPM4121</b>	<b>SPM5121</b>
15 VDC	<b>SPM1151</b>	<b>SPM3151</b>	<b>SPM4151</b>	<b>SPM5151</b>
24 VDC	<b>SPM1241</b>	<b>SPM3241</b>	<b>SPM4241</b>	<b>SPM5241</b>
24 VDC (Not UL Class 2)				<b>SPM5241S</b>



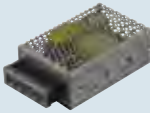
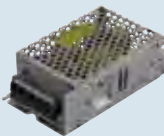
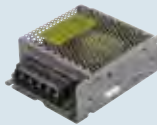
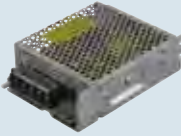

# Switching power supplies

## Enclosed switching power supplies

Types	SPPC 25 W	SPPC 35 W	SPPC 50 W	SPPC 75 W
				
Dimensions HxWxD (mm)	79 x 51 x 28.8	101.6 x 63.5 x 33	99 x 82 x 35	129 x 98 x 38
<b>Output specifications</b>				
Voltage	5 V, 12 V, 24 V	5 V, 12 V, 24 V	5 V, 12 V, 15 V, 24 V, 48 V	5 V, 12 V, 24 V, 48 V
Current	5 A, 2.1 A, 1.1 A	6 A, 3 A, 1.5 A	8 A, 4.2 A, 3.4 A, 2.2 A, 1.12 A	12 A, 6 A, 3.2 A, 1.62 A
Line regulation	±0.5%	±0.5%	±0.5%	±0.5%
Load regulation	±2.0%, ±1.0%, ±1.0%	±1.0%	±1.0%	±2.0%
Efficiency (typ)	115 VAC 230 VAC	76%, 80%, 84% 78%, 82%, 85%	79%, 83%, 86% 80%, 84%, 87%	79%, 84%, 87%, 88% 80%, 85%, 88%, 89%
<b>Input specifications</b>				
Voltage range	90 to 264 VAC 127 to 370 VDC	90 to 264 VAC 127 to 370 VDC	90 to 264 VAC 127 to 370 VDC	90 to 264 VAC 127 to 370 VDC
Frequency range	47 to 63 Hz	47 to 63 Hz	47 to 63 Hz	47 to 63 Hz
<b>General specifications</b>				
Ambient temperature	-25°C to +70°C	-25°C to +70°C	-25°C to +70°C	-25°C to +70°C
Storage	-40°C to +85°C	-40°C to +85°C	-40°C to +85°C	-40°C to +85°C;
Derating (>50°C)	2% / °C	2% / °C	1.5% / °C	1.5% / °C
Cooling	Free air convection	Free air convection	Free air convection	Free air convection
Approvals/Marks	CE - cURus	CE - cURus	CE - cURus	CE - cURus
Installation	Screw terminal	Screw terminal	Screw terminal	Screw terminal
<b>Main features</b>				
Mounting	Horizontal and vertical (DIN-rail mounting accessories available)	Horizontal and vertical (DIN-rail mounting accessories available)	Horizontal and vertical (DIN-rail mounting accessories available)	Horizontal and vertical (DIN-rail mounting accessories available)
<b>References</b>				
5 VDC	SPPC 525 1	SPPC 535 1	SPPC 550 1	SPPC 575 1
12 VDC	SPPC 1225 1	SPPC 1235 1	SPPC 1250 1	SPPC 1275 1
15 VDC			SPPC 1550 1	
24 VDC	SPPC 2425 1	SPPC 2435 1	SPPC 2450 1	SPPC 2475 1
48 VDC			SPPC 4850 1	SPPC 4875 1



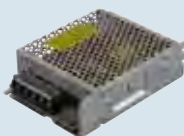
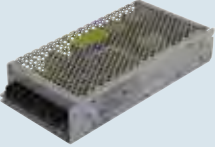

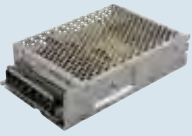
# Switching power supplies

## Compact enclosed switching power supplies

Types	SPPC 100 W	SPPC 150 W	SPPC 150 W (PFC) Power Factor Correction	SPPC 150 W PFC Compact
				
Dimensions HxWxD (mm)	129 x 98 x 38	199 x 98 x 38	194 x 99 x 50	160 x 98 x 38
<b>Output specifications</b>				
Voltage	5 V, 12 V, 24 V, 48 V	5 VDC, 12 VDC, 15 VDC, 24 VDC, 48 VDC	5 VDC, 12 VDC, 15 VDC, 24 VDC, 48 VDC	5 VDC, 12 VDC, 15 VDC, 24 VDC, 48 VDC
Current	20 A, 8.5 A, 4.2 A, 2.2 A	26 A, 12.5 A, 10 A, 6.5 A, 3.3 A	30 A, 12.5 A, 10 A, 6.3 A, 3.2 A	12.5 A, 10 A, 6.3 A, 3.2 A
Line regulation	±0.5%	±0.5%	±0.5%	±0.5%
Load regulation	±2% (5, 12 V) ±1% (24, 48 V)	±1%	±1%	±2%, ±2%, ±1%, ±1%
Efficiency (typ)	84%, 87%, 88%, 88%	up to 85%	up to 87%	86%, 87%, 87%, 88%
Built-in active PFC			PFC > 0.98 @ 115 VAC; PFC > 0.95 @ 230 VAC	Active PFC, PF > 0.95
<b>Input specifications</b>				
Voltage range	90 to 264 VAC 127 to 370 VDC	88 to 132 VAC 176 to 264 VAC 124 to 186 VDC 248 to 370 VDC	88 to 264 VAC 124 to 370 VDC	90 to 264 VAC 120 to 370 VDC
Frequency range	47 to 63 Hz	47 to 63 Hz	47 to 63 Hz	47 - 63 VAC
<b>General specifications</b>				
Ambient temperature	-25°C to +70°C	-25°C to +70°C	-25°C to +70°C	- 20° C to +70°C
Storage	-40°C to +85°C;	-40°C to +85°C	-30°C to +85°C	- 30° C to +85°C
Output short circuit		Long-term, auto recovery	Long-term, auto recovery	Long-term, auto recovery
Derating (>50°C)	See derating curve	2.5% / °C	2.5% / °C	Refer to derating diagram
Cooling	Free air convection	Free air convection	Free air convection	Free air convection
Approvals/Marks	CE - cURus	CE - cURus	CE - cURus	CE - cURus
Installation	Screw terminal	Screw terminal	Screw terminal	Screw terminal
<b>Main features</b>				
Mounting	Horizontal and vertical (DIN-rail mounting accessories available)	Horizontal and vertical (DIN-rail mounting accessories available)	Horizontal and vertical (DIN-rail mounting accessories available)	Horizontal and vertical (DIN-rail mounting accessories available)
<b>References</b>				
5 VDC	SPPC5100 1	SPPC5150 1	SPPC5150 1F	
12 VDC	SPPC12100 1	SPPC12150 1	SPPC12150 1F	SPPC12150 1FC
15 VDC		SPPC15150 1	SPPC15150 1F	SPPC15150 1FC
24 VDC	SPPC24100 1	SPPC24150 1	SPPC24150 1F	SPPC24150 1FC
48 VDC	SPPC48100 1	SPPC48150 1	SPPC48150 1F	SPPC48150 1FC



# Switching power supplies

## Compact enclosed switching power supplies

Types	SPPC 200 W	SPPC 240 W	SPPC 320 W	SPPC 480 W
				
Dimensions HxWxD (mm)	199 x 99 x 50	199 x 99 x 50	199 x 99 x 50	218 x 116.5 x 41
<b>Output specifications</b>				
Voltage	5 V, 12 V, 24 V, 48 V	12 V, 24 V	5 V, 12 V, 24 V, 48 V	12 V, 24 V, 36 V, 48 V
Current	40 A, 16.7 A, 8.4 A, 4.2 A	20 A, 10 A	55 A, 25 A, 13 A, 6.7 A	34 A, 22 A, 14 A, 11 A
Line regulation	±0.5%	±0.5%	±0.5%	±0.5%, ±0.5%, ±0.5%, ±0.2%
Load regulation	±1.0%	±1.0%	±1.0%	±1.0%
Efficiency (typ)	79%, 84%, 86%, 87.5%	84%, 86%	79%, 84.5%, 87%, 87.5%	88%, 89%, 90%, 90%
Built-in active PFC	(115 VAC): PF>0.98 (230 VAC): PF>0.96	(115 VAC): PF>0.98 (230 VAC): PF>0.96	(115 VAC): PF>0.98 (230 VAC): PF>0.96	(115 VAC): PF>0.98 (230 VAC): PF>0.96
<b>Input specifications</b>				
Voltage range	85 to 264 VAC 120 to 370 VDC	85 to 264 VAC 120 to 370 VDC	85 to 264 VAC 120 to 370 VDC	90 to 264 VAC 127 to 370 VAC
Frequency range	47 to 63 Hz	47 to 63 Hz	47 to 63 Hz	47 to 63 Hz
<b>General specifications</b>				
Ambient temperature	-25°C to +70°C	-25°C to +70°C	-25°C to +70°C	-30°C to +70°C
Storage	-40°C to +85°C	-40°C to +85°C	-40°C to +85°C	-40°C to +85°C
Output short circuit	Long-term, auto recovery	Long-term, auto recovery		
Derating (>50°C)	2% / °C	2% / °C	2% / °C	2% / °C
Cooling	Forced air (built-in DC fan controlled by load and internal temperature)	Forced air (built-in DC fan controlled by load and internal temperature)	Forced air (built-in DC fan controlled by load and internal temperature)	Forced air (built-in DC fan controlled by load and internal temperature)
Approvals/Marks	CE - cURus	CE - cURus	CE - cURus	CE - cURus
Installation	Screw terminal	Screw terminal	Screw terminal	Screw terminal
<b>Main features</b>				
Mounting	Horizontal and vertical (DIN-rail mounting accessories available)	Horizontal and vertical (DIN-rail mounting accessories available)	Horizontal and vertical (DIN-rail mounting accessories available)	Horizontal and vertical (DIN-rail mounting accessories available)
<b>References</b>				
5 VDC	SPPC5200 1FC		SPPC5320 1FC	
12 VDC	SPPC12200 1FC	SPPC12240 1FC	SPPC12320 1FC	SPPC12480 1FC
15 VDC				SPPC24480 1FC
24 VDC	SPPC24200 1FC	SPPC24240 1FC	SPPC24320 1FC	SPPC36480 1FC
48 VDC	SPPC48200 1FC		SPPC48320 1FC	SPPC48480 1FC

# Switching power supplies

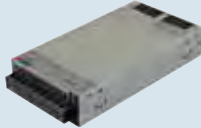
## Compact enclosed switching power supplies

Types	SPPC 600 W	SPPC 800 W
		
Dimensions HxWxD (mm)	218 x 116.5 x 41	226 x 116.5 x 41
<b>Output specifications</b>		
Voltage	12 V, 24 V, 36 V, 48 V	24 V, 48 V
Current	(100 to 127 VAC): 34 A, 22 A, 14 A, 11 A (128 to 264 VAC): 42 A, 26.5 A, 17.5 A, 13.6 A	(100 to 127 VAC): 27 A, 14 A (128 to 264 VAC): 33 A, 16.5 A
Line regulation	±0.5%	±0.5%
Load regulation	±1.0%	±1.0%
Efficiency (typ)	88%, 89%, 90%, 90%	88%, 89%
Built-in active PFC	(115 VAC): PF>0.98 (230 VCA): PF>0.96	(115 VAC): PF>0.98 (230 VAC): PF>0.96
<b>Input specifications</b>		
Voltage range	90 to 264 VAC 127 to 370 VAC	90 to 264 VAC 127 to 370 VAC
Frequency range	47 to 63 Hz	47 to 63 Hz
<b>General specifications</b>		
Ambient temperature	-30°C to +70°C	-30°C to +70°C
Storage	-40°C to +85°C	-40°C to +85°C
Output short circuit	Yes	Yes
Derating (>50°C)	2% / °C	2% / °C
Cooling	Forced air (built-in DC fan controlled by load and internal temperature)	Forced air (built-in DC fan controlled by load and internal temperature)
Approvals/Marks	CE - cURus	CE - cURus
Installation	Screw terminal	Screw terminal
<b>Main features</b>		
Mounting	Horizontal and vertical (DIN-rail mounting accessories available)	Horizontal and vertical (DIN-rail mounting accessories available)
<b>References</b>		
12 VDC	SPPC12600 1FC	
15 VDC	SPPC24600 1FC	SPPC 24800 1FC
24 VDC	SPPC36600 1FC	
48 VDC	SPPC48600 1FC	SPPC 48800 1FC

# Switching power supplies

## Compact DIN-rail power supplies

### Types

### SPDM 30 W

### SPDM 50 W

### SPDM 75 W



Dimensions HxWxD (mm)	90 x 22.4 x 100	90 x 30 x 100	90 x 40.5 x 100
-----------------------	-----------------	---------------	-----------------

### Output specifications

Voltage	12 V, 24 V	12 V, 24 V	12 V, 24 V
Current	2 A (12 V) 1.25 A (24 V)	4 A (12 V) 2.1 A (24 V)	5.5 A (12 V) 3 A (24 V)
Line regulation	±1.0%	±1.0%	±1.0%
Load regulation	±1.0%	±1.0%	±1.0%
Efficiency (typ)	85% to 89%	85% to 89%	85% to 89%

### Input specifications

Voltage range	85 to 264 VAC 120 to 375 VDC	85 to 264 VAC 120 to 375 VDC	85 to 264 VAC 120 to 375 VDC
Frequency range	47 to 63 Hz	47 to 63 Hz	47 to 63 Hz

### General specifications

Ambient temperature	-25°C to +70°C	-25°C to +70°C	-25°C to +70°C
Storage	-40°C to +85°C	-40°C to +85°C	-40°C to +85°C
Output short circuit	Yes	Yes	Yes
Derating (>50°C)	Refer to datasheet	Refer to datasheet	Refer to datasheet
Cooling	Natural air convection	Natural air convection	Natural air convection
Approvals/Marks	CE - cULus - cURus - UL Class 2	CE - cULus - cURus - UL Class 2	CE - cULus - cURus - UL Class 2 <small>Class 2 only for 24 VDC models (SPDM24751 and SPDM24751B)</small>
Installation	DIN-rail	DIN-rail	DIN-rail
Connection	Screw or Spring terminals	Screw or Spring terminals	Screw or Spring terminals

### Main features

LED indicator for "DC OK"	Yes	Yes	Yes
---------------------------	-----	-----	-----

### References

#### 12 VDC



Screw terminals	SPDM12301	SPDM12501	SPDM12751 (Not UL Class 2)
Spring terminals	SPDM12301B	SPDM12501B	SPDM12751B (Not UL Class 2)

#### 24 VDC

Screw terminals	SPDM24301	SPDM24501	SPDM24751
Spring terminals	SPDM24301B	SPDM24501B	SPDM24751B



# Switching power supplies

## Compact DIN-rail power supplies

Types	SPDM 120 W	SPDM 240 W
		
Dimensions HxWxD (mm)	124 x 45 x 119	124 x 70 x 127
<b>Output specifications</b>		
Voltage	12 V, 24 V, 48 V	24 V, 48 V
Current	10 A (12 V) 5 A (24 V) 2.5 A (48 V)	10 A (24 V) 5 A (48 V)
Line regulation	±0.5%	±0.5%
Load regulation	±1.0%	±1.0%
Efficiency (typ)	85% (12 V) 88% (24 V) 89% (48 V)	87% (24 V) 88% (48 V)
<b>Input specifications</b>		
Voltage range	90 to 264 VAC 127 to 370 VDC	90 to 264 VAC 127 to 370 VDC
Frequency range	47 to 63 Hz	47 to 63 Hz
<b>General specifications</b>		
Ambient temperature	-20°C to +70°C	-20°C to +70°C
Storage	-40°C to +85°C	-40°C to +85°C
Output short circuit	Yes	Yes
Derating (>50°C)	Refer to datasheet	Refer to datasheet
Cooling	Natural air convection	Natural air convection
Approvals/Marks	CE - cURus - cULus	CE
Installation	DIN-rail	DIN-rail
Connection	Screw terminals	Screw terminals
<b>Main features</b>		
LED indicator for "DC OK"	Yes	Yes
<b>References</b>		
12 VDC	<b>SPDM121201</b>	
24 VDC	<b>SPDM241201</b>	<b>SPDM242401</b>
48 VDC	<b>SPDM481201</b>	<b>SPDM482401</b>



# Switching power supplies

## High compactness DIN-rail power supplies

Types	SPDC 120 W	SPDC 240 W	SPDC 480 W
			
Dimensions HxWxD (mm)	124 x 32 x 119	124 x 45 x 119	124 x 70 x 127
<b>Output specifications</b>			
Voltage	12 V, 24 V	24 V	24 V, 48 V
Current	10 A, 5 A	10 A	20 A, 10 A
Line regulation	±0.5%	±0.5%	±0.5%
Load regulation	±1.0%	±1.0%	±1.0%
Efficiency (typ)	From 89.5% to 91%	88.00%	93.80%
Built-in active PFC	>0.95	>0.95	>0.95
<b>Input specifications</b>			
Rated input voltage	100 VAC - 240 VAC	100 VAC - 240 VAC	100 VAC - 240 VAC
Voltage range	85 to 264 VAC 127 to 360 VDC	85 to 264 VAC 127 to 375 VDC	85 to 264 VAC 130 to 350 VDC
Frequency range	47 to 63 Hz	47 to 63 Hz	47 to 63 Hz
<b>General specifications</b>			
Ambient temperature	-25°C to 70°C	-25°C to 70°C	-25°C to 70°C
Storage	-40°C to 85°C	-40°C to 85°C	-40°C to 85°C
Output short circuit	Yes	Yes	Yes
Derating (>50°C)	Refer to datasheet diagram	Refer to datasheet diagram	Refer to datasheet diagram
Cooling	Free air convection	Free air convection	Free air convection
Approvals/Marks	CE - cURus - cULus	CE - cURus - cULus	CE - cURus - cULus
Installation	DIN-rail	DIN-rail	DIN-rail
Connection	Screw terminals	Screw terminal	Screw terminal
<b>Main features</b>			
DC OK Out	SPST relay	SPST relay	SPST relay
<b>References</b>			
12 VDC	<b>SPDC121201</b>		
24 VDC	<b>SPDC241201</b>	<b>SPDC242401</b>	<b>SPDC244801</b>
48 VDC			<b>SPDC484801</b>



# Switching power supplies, redundancy modules

## Redundancy modules

Types	SPD Redundancy module	SPM Redundancy module
		
Dimensions HxWxD (mm)	90 x 54 x 114	91 x 35 x 56
<b>Output specifications</b>		
Voltage	24 VDC	24 VDC
Current	20 A	10 A
<b>Input specifications</b>		
Voltage range	21 to 28 VDC	21 to 48 VDC
<b>General specifications</b>		
Ambient temperature	-40°C to +71°C	
Storage	-40°C to +85°C	
Approvals/Marks	cULus - TÜV - CE	CE
Installation	DIN-rail	DIN-rail
Connection	Screw terminals	Screw terminals
<b>Main features</b>		
LED indicator for "power on"	Yes - with relay output (SPD24 only)	
Features	2 Relay outputs for remote monitoring	
<b>References</b>		
24 VDC	SPD24RM20	SPM2RM2410



# Switching power supplies, backup systems

	UPS controller	Switching power supply and UPS
Types	SPUC	SPUBC
		
Dimensions HxWxD (mm)	90 x 54 x 114	115 x 65 x 135
<b>Output specifications</b>		
Voltage	12 / 24 VDC	24 VDC
Charging voltage	12 V Model: Min. 9.1 VDC ~ 13.75 VDC Max. 24 V Model: Min. 18.7 VDC ~ 28 VDC Max.	27.5 VDC (Std.), 28.8 VDC (Boost)
Power supply current	30 A	5 A + 5 A with battery charged + 5 A for 4 s
Charging current max	2.5 A	5 A
<b>Input specifications</b>		
Rated voltage input	12 / 24 VDC	115 VAC, 230 VAC, 277 VAC
Voltage range	12 V Model: 11 VDC to 14 VDC 24 V Model: 22.5 VDC to 28 VDC	90 to 305 VAC
Frequency range		47 to 63 Hz
<b>General specifications</b>		
Ambient temperature	-40°C to +71°C	-25°C to +70°C
Storage	-40°C to +85°C	-40°C to +85°C
Derating (+51°C to +70°C)	2.5% /°C	Refer to datasheet diagram
Cooling	Free air convection	Free air convection
Approvals/Marks	CE - cURus - TÜV	CE - cURus
Installation	Screw terminal	Screw terminal
<b>Main features</b>		
Mounting	DIN-rail mounting	DIN-rail mounting
Battery diagnosis	No	Yes
DC OK Out	Yes	Yes
Battery OK Out	Yes	Yes
Mains / Backup Out	Yes	Yes
<b>References</b>		
12 V 30 A max	<b>SPUC12360</b>	
24 V 30 A max	<b>SPUC24720</b>	
PS + UPS 24 V 120 W		<b>SPUBC24120</b>

# Switching power supplies, backup systems

## Low profile DIN battery charger

## Battery racks for UPS and chargers

### Types

#### SPM5BC

#### SPUBAT 24V



Dimensions HxWxD (mm)

91 x 90 x 57

175 x 62 x 120  
200 x 82 x 160  
210 x 145 x 130  
210 x 210 x 210

### Output specifications

Voltage	12 V / 24 V	24 VDC
Charging voltage	13.6 VDC / 27.2 VDC	
Power supply current	30 W / 60 W	
Charging current max	1.25 A - 2.5 A 30 W / 2.5 A - 5 A 60 W	120 mA, 320 mA, 720 mA, 1.2 A
Battery capacity		1.2 / 3.2 / 7.2 / 12 Ah
Battery type		AGM VRLA

### Input specifications

Rated voltage input	110 VAC / 240 VAC	24 V
Voltage range	90 to 264 VAC 120 to 375 VDC	27.5 @ 20°C 26.8 @ 30°C 26.1 @ 40°C VDC End of charge voltage (trickle)
Frequency range	47 to 63 Hz	
Max charging current		0.36 / 0.9 / 2.16 A

### General specifications

Ambient temperature	-40°C to +51°C	0°C to +40°C
Storage	-40°C to +85°C	0°C to +40°C
Derating (+51°C to +70°C)	Refer to datasheet diagram	
Cooling	Free air convection	Free air convection
Approvals/Marks	CE -TÜV	CE
Installation	Screw terminal	Screw terminal

### Main features

Mounting	Horizontal and vertical (DIN-rail mounting accessories available)	Wall / DIN-rail mounting
Battery diagnosis	No	
DC OK Out	No	
Battery OK Out	No	
Mains / Backup Out	Yes	

### References

12 V 30 W	SPM5BC 1230	
24 V 30 W	SPM5BC 2430	
12 V 60 W	SPM5BC 1260	
24 V 60 W	SPM5BC 2460	
24 V 1.2 Ah Battery		SPUBAT241A2
24 V 3.2 Ah Battery		SPUBAT243A2
24 V 7.2 Ah Battery		SPUBAT247A2
24 V 12 Ah Battery		SPUBAT2412A

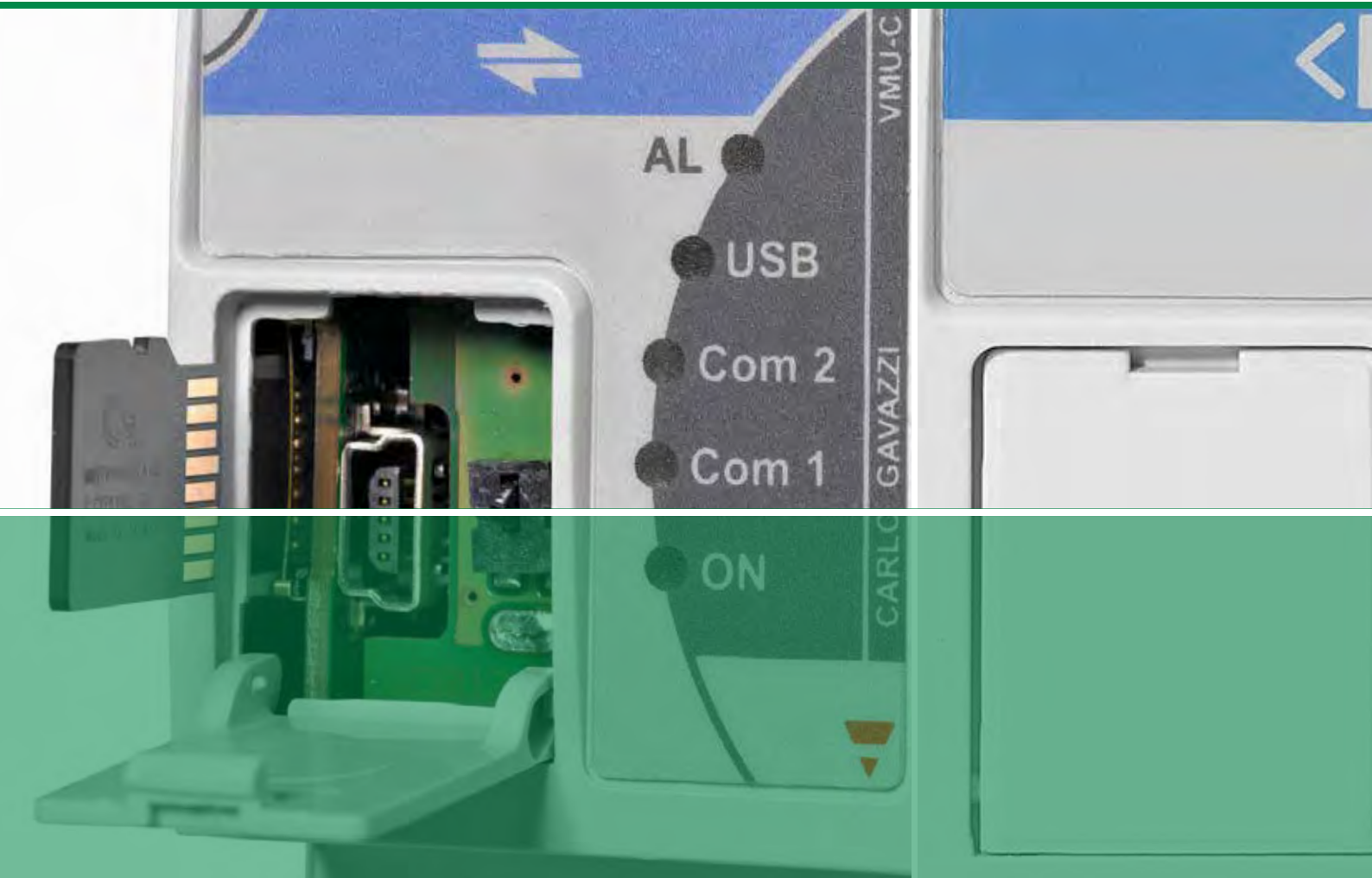



# Controls





Digital panel meters	210
Energy/Power analyzers	214
Current transformers	224
Data aggregation solutions	233
PV monitoring solutions	238
Building automation	242
Parking guidance system	261
DuplineSafe	265
Fieldbuses	269
Monitoring relays	281
Timers	294
Counters	299

# Digital panel meters

## Ammeters, voltmeters and frequency meters



Types	DI3 DIN	DI3 72	LDI 3
			
Dimensions HxWxD (mm)	89 x 52.5 x 58.5	72 x 72 x 75.5	48 x 96 x 83
Function	3-digit meter. 1-phase AC, DC. Voltmeter, ammeter frequency meter	Microprocessor based indicator. AC / DC ammeter, voltmeter. Freq. meter 3-digit display red LED. Height: 14.2 mm	Microprocessor based indicator. AC / DC ammeter, voltmeter. Freq. meter 3-digit display
<b>Input specifications</b>			
Range code	1 A / 100 VAC [AV1] 5 A / 500 VAC [AV5] 1 A / 60 mV / 100 V / 500 VDC [AV6] 1 Hz to 1000 Hz [F1K]	[AV1]: 1 AAC / 100 VAC [AV5]: 5 AAC / 500 VAC [AV6]: 1 ADC / 60 mV / 100 V / 500 VDC	[AV1]: 1 AAC / 100 VAC [AV5]: 5 AAC / 500 VAC [AV6]: 1 ADC / 60 mV / 100 V / 500 VDC [F1K]: 1 to 1000 Hz
Accuracy	0.5% FS (0.1% FS frequency meter)	±0.5% FS	±0.5% FS (±0.3% FS frequency meter)
Indication	Max.	999 [AV1 / AV5]	999
	Min.	000 [AV1 / AV5] -99 [AV6]	000 [AV1 / AV5] -99 [AV6]
Range selection / decimal point pos.	Selectable by DIP-switch	Selectable by DIP-switch	Selectable by DIP-switch
Display refresh time	1 time/s	1 time/s	1 time/s
<b>General specifications</b>			
Power supply	24 VAC [A] 48 VAC [B] 115 VAC [C] 230 VAC [D]	24 VAC [A], 48 VAC [B], 115 VAC [C], 230 VAC [D]	24 VAC [A], 48 VAC [B], 115 VAC [C], 230 VAC [D]
Option		IP65[EX]	IP65[IX], tropicalization [XT]
Safety Standards	EN 61010-1, IEC 61010-1, VDE0411	EN 61010-1, IEC 61010-1, VDE0411	EN 61010-1, IEC 61010-1, VDE0411
Approvals/Marks	CE - CSA	CE - CSA	CE - c CSA us
<b>References</b>			
For ordering key details, please refer to <a href="http://www.gavazziautomation.com">www.gavazziautomation.com</a>			

# Digital panel meters

	Ammeters and voltmeters		Thermometer and ohmmeter
Types	LDI 35 AV0	LDI 35 AV2	LDI 35 CF
			
Dimensions HxWxD (mm)	48 x 96 x 83	48 x 96 x 83	48 x 96 x 83
Function	Microprocessor based indicator/controller, AC / DC ammeter, voltmeter, 3½-digit or 3-digit + dummy zero display	Microprocessor based indicator/controller, AC / DC ammeter, voltmeter, 3½-digit or 3-digit + dummy zero display	Microprocessor based indicator/controller, Temperature resistance Measur. in °C or °F, 3½-digit or 3-digit + dummy zero display
<b>Input specifications</b>			
Range code	Current: 2 mA DC, 20 mA DC Voltage: 200 mV DC, 20 VDC, 200 VDC [AV0]	Current: 2 AAC/DC, 5 AAC/DC Voltage: 200 VAC/DC, 500 VAC/DC [AV2]	Pt100, Ni100 [CFX]; Pt1000 [CFP]; TC-J-LK-S-T [CFX/CFP]; 200.0Ω [CFX]; 2000Ω [CFP]
Accuracy	±0.3% FS	DC: ±0.3% FS, AC: ±0.5% FS	TC, PT100/1000, resistance ±0.3% FS, Ni 100 ±0.5% FS
Indication	Max.	3½-dgt: 1999, 3+0-dgt: 9990	Depending on range and type of the temperature probe
	Min.	3½-dgt: -1999, 3+0-dgt: -1990	
Resistance			0 to 200 Ω (2000 Ω)
Range election / decimal point pos.	Programmable	Programmable	Programmable
Display refresh time	4 times/s	4 times/s	4 times/s
<b>Functions</b>			
	Password protection. Scaling factor. Diagnostics. Digital filter programm. Max. data hold.	Password protection. Scaling factor. Diagnostics. Digital filter programm. Max. data hold.	Password protection. Scaling factor. Diagnostics. Digital filter programm. Max. data hold.
<b>Output specifications</b>			
Setpoints	1 optional alarm [1] 5 A / 250 VAC / DC Excit. output 40 mA / 15 VDC [AX]	1 optional alarm [1] 5 A / 250 VAC / DC Excit. output 40 mA / 15 VDC [AX]	1 optional alarm [1] 5 A / 250 VAC / DC Excit. output 40 mA / 15 VDC [AX]
<b>General specifications</b>			
Power supply	120 [E], 230 [D], 240 [F], 24 [A], 48 [B], 115 [C] VAC, 9 - 32 [3] VDC, 40 - 150 [6] VDC	120 [E], 230 [D], 240 [F], 24 [A], 48 [B], 115 [C] VAC, 9 - 32 [3] VDC, 40-150 [6] VDC	120 [E], 230 [D], 240 [F], 24 [A], 48 [B], 115 [C] VAC, 9 - 32 [3] VDC, 40-150 [6] VDC
Option	IP65[IX], excit. out [AX], tropicalization [XT]	IP65[IX], excit. out [AX], tropicalization [XT]	IP65[IX], excit. out [AX], tropicalization [XT]
Safety Standards	EN 61010-1, IEC 61010-1, VDE0411	EN 61010-1, IEC 61010-1, VDE0411	EN 61010-1, IEC 61010-1, VDE0411
Approvals/Marks	CE - c CSA us	CE - c CSA us	CE - c CSA us
<b>References</b>			
For ordering key details, please refer to <a href="http://www.gavazziautomation.com">www.gavazziautomation.com</a>			

# Digital panel meters

## Ammeters and voltmeters

Types	LDM 30	LDM 35 H	LDM 40
			
Dimensions HxWxD (mm)	48 x 96 x 83	48 x 96 x 83	48 x 96 x 83
Function	3-DGT + dummy 0 $\mu$ P-based indicator, red LED display	3 1/2-DGT $\mu$ P-based indicator and controller, 3 1/2-DGT or 3-DGT + dummy 0 red LED display	4-DGT $\mu$ P-based indicator and controller
<b>Input specifications</b>			
Range code	1 A / 100 VAC [AV1]; 5 A / 500 VAC [AV5]	(0.2-2-20 mA, 0.2-2-20 V) [LSE]; (0.2- 2-5 A, 20-200-500 V) [HSX]; DC and AC TRMS	(0.2-2-20 mA, 0.2-2-20 V) [LSE]; (0.2- 2-5 A, 20-200-500 V) [HSX]; DC and AC TRMS
Accuracy	$\pm 0.5\%$ FS, $\pm 1$ -DGT	DC: $\pm(0.3\%$ RDG + 3-DGT) AC: $\pm(0.5\%$ RDG + 3-DGT)	DC: $\pm(0.1\%$ RDG + 2-DGT) AC: $\pm(0.3\%$ RDG + 2-DGT)
Indication	Max.	9990	9999
	Min.	000	0 (AC) -9999 (DC) 4-DGT LED red
Range selection / decimal point pos.	Selectable by dipswitch	Programmable	Programmable
Display refresh time	2 times/s	5 times/s	5 times/s
<b>Functions</b>			
		Signal / display scaling. Digital filter. Peak and valley.	Signal / display scaling. Digital filter. Peak and valley.
<b>Output specifications</b>			
		Up to 2 Alarm relay, [1-2]	Up to 2 Alarm relay, [1-2], Analogue 0 to 20 mA, 0 to 10 V [AV], RS485
<b>General specifications</b>			
Power supply	24 / 48 VAC [B], 115 / 230 VAC [D]	90 to 260 VAC / DC [H], 18 to 60 VAC / DC [L]	90 to 260 VAC / DC [H], 18 to 60 VAC / DC [L]
Option	Tropicalization [XT], IP 65 [IX]	Tropicalization [TX]	Tropicalization [T]
Safety Standards	EN61010-1 IEC61010-1	EN61010-1 IEC61010-1	EN61010-1 IEC61010-1
Approvals/Marks	CE - cURus - cCSAus	CE - cURus - cCSAus	CE - cURus - cCSAus
<b>References</b>			
For ordering key details, please refer to <a href="http://www.gavazziautomation.com">www.gavazziautomation.com</a>			



# Digital panel meters

## Modular meter and conditioner

Types	UDM 35	UDM 40	USC
			

Dimensions HxWxD (mm)	48 x 96 x 105	48 x 96 x 105	44 x 113 x 107
Function	MODULAR Microprocessor-based indicator / controller AC/DC Ammeter / Voltmeter / Resistance / temperature measurement	MODULAR Microprocessor-based indicator / controller AC/DC Ammeter / Voltmeter / Resistance / temperature measurement	MODULAR Microprocessor-based converter / controller AC/DC Ammeter / Voltmeter / Resistance / temperature measurement

Input specifications				
Range code	0.2-2-20 mA DC/AC 0.2-2-20 VDC/AC [LSX] + AUX 13 VDC [LSE] or 25 VDC [LSF]; 0.2-2-5 A DC/AC; 20-200-500 V DC/AC [HSX]; TC: J-K-S-T-E, Pt100-250-500- 1000 [TRX]; 0.02-0.2-2-20 kΩ [TRX] 0.001 Hz to 50 Hz for DC signal [TF1] 0.001 Hz to 50 Hz for AC signal [TF2]	0.2-2-20 mA DC/AC 0.2-2-20 VDC/AC [LSX] + AUX 13 VDC [LSE] or 25 VDC [LSF]; 0.2-2-5 A DC/AC; 20-200-500 VDC/AC [HSX]; TC: J-K-S-T-E, Pt100-250-500- 1000 [TRX]; 0.02-0.2-2-20 kΩ [TRX] 0.001 Hz to 50 Hz for DC signal [TF1] 0.001 Hz to 50 Hz for AC signal [TF2]	0.2-2-20 mA DC/AC 0.2-2-20 VDC/AC [LSX] + AUX 13 VDC [LSE] or 25 VDC [LSF]; 0.2-2-5 A DC/AC; 20-200-500 VDC/AC [HSX]; TC: J-K-S-T-E, Pt100-250-500- 1000 [TRX]; 0.02-0.2-2-20 kΩ [TRX] 0.001 Hz to 50 Hz for DC signal [TF1] 0.001 Hz to 50 Hz for AC signal [TF2]	
Accuracy	0.1% RDG	0.1% RDG	0.1% RDG	
Indication	Max.	1999	9999	
	Min.	0 (AC) -1999 (DC), 3 ½-DGT LED red	0 (AC) -9999 (DC), 4-DGT LED. Colours: red, green, orange	
Range election / decimal	Programmable	Programmable		
Display refresh time	5 times/s	5 times/s	5 times/s	

Functions			
	Password protection. Scaling factor. Min Max data storage. Programmable digital filter Analog signal re-transmission Range selection. Programmable via PC.	Password protection. Scaling factor. Min Max data storage. 16 linearization points. Programm. digital filter. Analog signal re-transmission Range selection. Programmable via PC.	Password protection. Scaling factor. Min Max data storage. 16 linearization points. Programm. digital filter. Analog signal re-transmission Range selection. Programmable via PC.

Output specifications			
Setpoints	Analogue 0 to 20 mA, 0 to 10 V [AV] Serial RS485 [SX], Serial RS232 [SY], Single relay output [R1], Dual relay output [R2], Dual relay + dual open coll. output [R4], Four relay output [R5]	Analogue 0 to 20 mA, 0 to 10 V [AV] Serial RS485 [SX], Serial RS232 [SY], Single relay output [R1], Dual relay output [R2], Dual relay + dual open coll. output [R4], Four relay output [R5]	Analogue 0 to 20 mA, 0 to 10 V [AV] Serial RS485 [SX], Serial RS232 [SY], Single relay output [R1], Dual relay output [R2], Dual relay + dual open coll. output [R4], Four relay output [R5]

General specifications			
Power supply	90 to 260 AC/DC [H], 18 to 60 VAC/DC [L] 10 to 28 VDC [3]	90 to 260 AC/DC [H], 18 to 60 VAC/DC [L] 10 to 28 VDC [3]	90 to 260 AC/DC [H], 18 to 60 VAC/DC [L] 10 to 28 VDC [3]
Option	Tropicalization [TX]	Tropicalization [TX]	Tropicalization [TX]
Safety Standards	EN 61010-1, IEC 61010-1	EN 61010-1, IEC 61010-1	EN 61010-1, IEC 61010-1
Approvals/Marks	CE - cURus - cCSAus	CE - cURus - cCSAus	CE - cURus - cCSAus



### References

For ordering key details, please refer to [www.gavazziautomation.com](http://www.gavazziautomation.com)





# Energy analyzers

## Energy analyzers





Types	EM110	EM111	EM112
			
Dimensions HxWxD (mm)	90 x 18 x 63	90 x 18 x 63	90 x 36 x 63
Description	1-phase kWh meter 1-DIN module	1-phase energy analyzer with Touch Tech technology 1-DIN module	1-phase energy analyzer with Touch Tech technology 2-DIN modules
Function	kWh	VLN, A, Hz, $\pm W$ , $W_{dmd}$ , $W_{dmd\ max}$ , $\pm var$ , PF, $\pm kWh$ , $\pm kvarh$ , kWh+ by tariff (2) TRMS method	VLN, A, Hz, $\pm W$ , $W_{dmd}$ , $W_{dmd\ max}$ , $\pm var$ , PF, $\pm kWh$ , $\pm kvarh$ , kWh+ by tariff (2) TRMS method
<b>Input specifications</b>			
Range code	120 VAC [AV7] 230 VAC [AV8] Ib: 5 A, I <sub>max</sub> : 45 AAC; 1-phase	120 VAC [AV7] 230 VAC [AV8] Ib: 5 A; Inom: 32 A; I <sub>max</sub> : 45 AAC; 1-phase	120 VAC [AV1] 230 VAC [AV0] Ib: 5 A, I <sub>max</sub> : 100 AAC; 1-phase
Accuracy	n.a.	$\pm 0.5\%$ RDG (V, A)	$\pm 0.5\%$ RDG (V, A)
Active energy	Class 1 (EN62053-21) Class B (EN50470-3)	Class 1 (EN62053-21) Class B (EN50470-3)	Class 1 (EN62053-21) Class B (EN50470-3)
Reactive energy	n.a.	Class 2 (EN62053-23)	Class 2 (EN62053-23)
Display	Electromechanical 6+1 DGT (energy)	Backlit LCD with touch keypad 4 DGT (inst. variables) 5+2, 6+1, 7 DGT (energies)	Backlit LCD with touch keypad and supercapacitor backup (up to 48h) up to 2 x 4 DGT (inst. variables) 6+2, 7+1, 8 DGT (energies)
<b>Output specifications</b>			
Pulse output	1-open collector [O1]	1-open collector [O1]	1-open collector [O1]
Alarm output			
Communication		Modbus RTU [S1] M-bus [M1]	Modbus RTU [S1] M-bus [M1]
Inputs		1 (dual tariff management)	1 (dual tariff management)
<b>General specifications</b>			
Power supply	Self power supply [X]	Self power supply [X]	Self power supply [X]
Approvals/Marks	CE - MID - cULus [AV7 only]	CE - MID - cULus [AV7 only]	CE - MID - cULus [AV1 only]
<b>References</b>			
For ordering key details, please refer to <a href="http://www.gavazziautomation.com">www.gavazziautomation.com</a>			

For ordering key details, please refer to [www.gavazziautomation.com](http://www.gavazziautomation.com)

# Energy analyzers

Energy analyzers			
Types	EM330	EM340	EM24 DIN
			
Dimensions HxWxD (mm)	90 x 54 x 63	90 x 54 x 63	90 x 72 x 67
Description	3-phase energy analyzer with Touch Tech technology and wrong connection detection 3-DIN modules	3-phase energy analyzer with Touch Tech technology and wrong connection detection 3-DIN modules	3-phase energy analyzer 4 DIN modules
Function	System: $\pm kWh$ , $\pm kvarh$ , $kWh+$ by tariff (2), $V_{LN}$ , $V_{LL}$ , PF, Hz, $\pm W$ , $W_{dmd}$ , $W_{dmd\ max}$ , $\pm var$ , VA, h Single-phase: kWh, $V_{LN}$ , $V_{LL}$ , A, PF, W, var, VA TRMS method	System: $\pm kWh$ , $\pm kvarh$ , $kWh+$ by tariff (2), $V_{LN}$ , $V_{LL}$ , PF, Hz, $\pm W$ , $W_{dmd}$ , $W_{dmd\ max}$ , $\pm var$ , VA Single-phase: kWh, $V_{LN}$ , $V_{LL}$ , A, PF, W, var, VA TRMS method	System: $\pm kWh$ , $\pm kvarh$ , $V_{LN}$ , $V_{LL}$ , var, VA, $W_{dmd}$ , W, $VA_{dmd}$ , Hz, hour counter, gas and water Max: $A_{dmd}$ , $W_{dmd}$ , $VA_{dmd}$ Single-phase: $V_{LL}$ , $V_{LN}$ , A, W, var, VA, PF, kWh, kvarh TRMS method
Input specifications			
Range code	3-phase 400-480 $V_{LL}$ AC [AV5] Ib: 5 A, I <sub>max</sub> : 6 AAC; 3-phase	3-phase 208-400 $V_{LL}$ ac [AV2] Ib: 5 A, I <sub>max</sub> : 65 AAC; 3-phase	120 / 208 $V_{LL}$ [AV6]; 400 $V_{LL}$ [AV5] In: 1 / 5 A, I <sub>max</sub> : 10 AAC [AV5 and AV6]; 208/400 $V_{LL}$ [AV2] Ib: 10 A, I <sub>max</sub> : 65 AAC [AV2]
Accuracy	$\pm 0.5\%$ RDG (V, A)	$\pm 0.5\%$ RDG (V, A)	$\pm 0.5\%$ RDG (V, A)
Active energy	Class 1 (EN62053-21) Class B (EN50470-3)	Class 1 (EN62053-21) Class B (EN50470-3)	Class 1 (EN62053-21) Class B (EN50470-3)
Reactive energy	Class 2 (EN62053-23)	Class 2 (EN62053-23)	Class 2 (EN62053-23)
Display	Backlit LCD with touch keypad 3x 4 DGT (inst. variables) 3x 6+2, 7+1, 8 DGT (energies)	Backlit LCD with touch keypad 3x 4 DGT (inst. variables) 3x 6+2, 7+1, 8 DGT (energies)	LCD 3x 4 DGT (inst. variables) 6+2, 7+1, 8 DGT (energies)
Output specifications			
Pulse output	1-open collector [O1]	1-open collector [O1]	2-open collector [O2]; Relay [R2]
Alarm output			2-open collector [O2]; Relay [R2]
Communication	Modbus RTU [S1] M-bus [M1]	Modbus RTU [S1] M-bus [M1]	Modbus RTU [IS] Modbus Ethernet [E1] M-BUS [Mx] Wireless M-BUS [W1] Dupline [DP]
Inputs	1 (dual tariff management)	1 (dual tariff management)	3 digital input [IS]
General specifications			
Power supply	90 to 260 VAC/DC [H]	Self power supply [X]	Self power supply [X]. Auxiliary power supply: 18 to 60 VAC/DC [L], 115 / 230 VAC [D], according to the model [AV5, AV6]
Approvals/Marks	CE - cULus - MID	CE - MID	CE - cULus [AV5 and AV6] - MID [X..PF.]
References			
For ordering key details, please refer to <a href="http://www.gavazziautomation.com">www.gavazziautomation.com</a>			

# Energy analyzers

Energy transducers				Compact transducers
Types	ET112	ET330	ET340	CPT DIN Basic and Advanced
				
Dimensions HxWxD (mm)	90 x 36 x 63	90 x 54 x 63	90 x 54 x 63	83.5 x 45 x 98.5
Description	1-phase energy transducer 2-DIN modules	3-phase energy transducer with wrong connection detection 3-DIN modules	3-phase energy transducer with wrong connection detection 3-DIN modules	3-phase compact power transducer
Function	$V_{LN}, A, Hz, \pm W, W_{dmd}, W_{dmd} \max, \pm var, PF, \pm kWh, \pm kvarh, kWh+$ by tariff (2) TRMS method	System: $\pm kWh, \pm kvarh, kWh+$ by tariff (2), $V_{LN}, V_{LL}, PF, Hz, \pm W, W_{dmd}, W_{dmd} \max, \pm var, VA$ Single-phase: $kWh, V_{LN}, V_{LL}, A, PF, W, var, VA$ , TRMS method	System: $\pm kWh, \pm kvarh, kWh+$ by tariff (2), $V_{LN}, V_{LL}, PF, Hz, \pm W, W_{dmd}, W_{dmd} \max, \pm var, VA$ Single-phase: $kWh, V_{LN}, V_{LL}, A, PF, W, var, VA$ , TRMS method	4-digit data format instantaneous variable, 8+1-digit format energies, 5+2-digit format hours TRMS method System: $kWh, kvarh, V_{LN}, V_{LL}, An, PF, W, var, VA, W_{dmd}, VA_{dmd}, Hz$ , hour meter Max: $W_{dmd}, VA_{dmd}$ [Adv] Single-phase: $V_{LN}, V_{LL}, A, A_{dmd}, PF, W, var, VA, THD (A, V)$ [Adv] Max [Adv]: $V_{LN}, A, A_{dmd}, W$ Min [Adv]: $V_{LN}, A, PF$
<b>Input specifications</b>				
Range code	120 VAC [AV1] 230 VAC [AV0] Ib: 5 A, I <sub>max</sub> : 100 AAC; 1-phase	3-phase 400-480 V <sub>LL</sub> AC [AV5] Ib: 5 A, I <sub>max</sub> : 6 AAC; 3-phase	3-phase 208-400 V <sub>LL</sub> AC [AV2] Ib: 5 A, I <sub>max</sub> : 65 AAC; 3-phase	120 / 208 VAC [AV6], 400 / 690 VAC [AV5], 1 AAC and 5 AAC
Accuracy	$\pm 0.5\%$ RDG (V, A)	$\pm 0.2\%$ RDG (V, A)	$\pm 0.5\%$ RDG (V, A)	$\pm 0.5\%$ RDG (A, V)
Active energy	Class 1 (EN62053-21)	Class 0.5S (EN62053-22)	Class 1 (EN62053-21)	kWh: Class 1 (EN62053-21)
Reactive energy	Class 2 (EN62053-23)	Class 2 (EN62053-23)	Class 2 (EN62053-23)	kvarh: Class 2 (EN62053-23)
<b>Output specifications</b>				
Pulse output				2 (open collector) [O2 Advanced]
Alarm output				2 (relays) with PLC-type control function on 16 variables (AND / OR) [R2 Advanced]
Analogue output				Up to 3: 20 mA [A1-3 Advanced], 10 VDC [V1-3 Advanced]
Communication	Modbus RTU [S1]	Modbus RTU [S1]	Modbus RTU [S1]	RS422/485 [S1], RS232 [S2]
Inputs	1 (dual tariff management)	1 (dual tariff management)	1 (dual tariff management)	
<b>General specifications</b>				
Power supply	Self power supply [X]	Self power supply [X]	Self power supply [X]	18 to 60 VAC/DC [L], 90 to 260 VAC/DC [H]
Approvals/Marks	CE	CE - cULus	CE	CE - cURus - CSA
<b>References</b>				
For ordering key details, please refer to <a href="http://www.gavazziautomation.com">www.gavazziautomation.com</a>				

# Energy analyzers

## Energy meters

## Energy analyzers

### Types

### EM21 72R

### EM210 AV

### EM210 MV



Dimensions HxWxD (mm)	72 x 72 x 65	72 x 72 x 65	72 x 72 x 65
Description	3-phase energy meter 4-DIN modules and 72 x 72 panel mounting	3-phase energy analyzer 4-DIN modules and 72 x 72 panel mounting	3-phase energy analyzer 4-DIN modules and 72 x 72 panel mounting
Function	System: kWh, kvarh, W, var, PF, Hz, Phase sequence Single-phase: V <sub>LN</sub> , V <sub>LL</sub> , A, PF TRMS method	System: ±kWh, kvarh, W, var, PF, An and h-meter (only [X]), Phase-sequence Single-phase: V <sub>LL</sub> , V <sub>LN</sub> , A, PF, THD (V, A, up to 15th H. THD only [X]) TRMS method	System: ±kWh, kvarh, W, var, PF, An, h-meter, Phase-sequence Single-phase: V <sub>LL</sub> , V <sub>LN</sub> , A, PF, THD (V, A, up to 15th H.) TRMS method

### Input specifications

Range code	120 / 230 VAC, 400 VAC 3-phase current input by included current sensors (three ranges available: 90 A - 150 A - 250 A)	120 / 230 VAC, 400 VAC In: 5 A; I <sub>max</sub> : 6 A (current connection by CT)	120 / 230 VAC, 400 VAC By 333 mV CT [CTV] or by Rogowski sensors [ROG4K]
Accuracy	±0.5% RDG (V) ±1% RDG (A)	±0.5% RDG (V, A)	±0.5% RDG (V, A)
Active energy	Class 2 (EN62053-21)	Class 1 (EN62053-21) Class B (EN50470-3)	Class 1 (EN62053-21)
Reactive energy		Class 2 (EN62053-23)	Class 2 (EN62053-23)
Display	LCD 3 DGT (inst. variables) 6+1, 7 DGT (energies)	LCD 3 DGT (inst. variables) 5+2, 6+1, 7 DGT (energies)	LCD 3 DGT (inst. variables) 5+2, 6+1, 7 DGT (energies)

### Output specifications

Pulse output	1 static opto-mosfet	1 static opto-mosfet	1 static opto-mosfet
Communication	RS485 (2-wire, Modbus) M-BUS by means of VMU-B	RS485 (2-wire, Modbus)	RS485 (2-wire, Modbus)



### General specifications

Power supply	Self power supply	Self power supply [X] Universal power supply 90-260 VAC/DC [H] (MID version)	Self power supply
Approvals/Marks	CE - cULus	CE - cULus - MID [PF]	CE - cULus





### References

For ordering key details, please refer to [www.gavazziautomation.com](http://www.gavazziautomation.com)



# Quick-fit energy meters

	Quick-fit dual energy meters	3-phase current transformers	Panel adapter for energy meters
Types	EM270	TCD X	EM200-96 Adapter
			
Dimensions HxWxD (mm)	72 x 72 x 65	TCD1X: 72 x 75 x 66.8 TCD2X: 72 x 105 x 50 TCD3X: 78 x 135 x 50	96 x 96 x 41.4
Description	3-phase energy meter 4-DIN modules and 72 x 72 panel mounting	3-phase current transformers for EM270 quick fit meter. Connection to the meter by means of RJ11 connector (included).	Adapter frame from 72 x 72 mm to 96 x 96 mm panel mounting. Installation by fixing brackets included in the meter.
Function	System: kWh, kvarh, kW, kvar Single-phase: kWh, W, W <sub>dmd</sub> , W <sub>dmd max</sub> , A, V <sub>LL</sub> , V <sub>LN</sub> Virtual sum of the two 3-phase or six 1-phase loads TRMS method	Suitable to be installed downstream the circuit breakers (same width). Automatic setting of the CT ratio in the meter	Suitable for EM210, EM270, EM271, EM280, EM21-72D, EM21-72R, EM21-72V
<b>Input specifications</b>			
Range	120 / 230 VAC, 400 VAC In: from 160 to 630 A by TCD X	TCD1X: 160 A TCD2X: 250 A TCD3X: 630 A	
Accuracy	±0.5% RDG (V, A)	Equivalent to Class 0.5 (IEC61869-2)	
Active energy	Equivalent to Class 1 (EN62053-21)		
Reactive energy	Equivalent to Class 2 (EN62053-23)		
Display	LCD 3 DGT (inst. variables) 6+1, 7 DGT (energies)		
<b>Output specifications</b>			
Pulse output	2 static opto-mosfet		
Communication	RS485 (2-wire, Modbus) M-BUS by means of VMU-BM2...B		
<b>General specifications</b>			
Power supply	Self power supply	n.a.	
Approvals/Marks	CE - cULus	CE - cULus (with EM 270)	CE
<b>References</b>			
For ordering key details, please refer to <a href="http://www.gavazziautomation.com">www.gavazziautomation.com</a>			

## Quick-fit energy meters





	Quick-fit dual energy meters	3-phase current transformers	Quick-fit 6-channel energy meters	6-channel current transformer blocks
Types	EM271	TCD M	EM280	TCD06B
				
Dimensions HxWxD (mm)	72 x 72 x 65	TCD0M: 3 by 26 x 40 x 26, hole 9.6 TCD1M: 3 by 31 x 46 x 31, hole 15.7 TCD2M: 3 by 41 x 66 x 38, hole 15.5 TCD3M: 3 by 50 x 78 x 39, hole 20.5	72 x 72 x 65	TCD06BX (solid core): 118 x 53 x 34, hole 7.0, hole centre distance 17.5  TCD06BS (split core): 118 x 45 x 59, hole 8.5, hole centre distance 17.5
Description	Quick-fit energy meter with daisy chaining of voltage and serial connections and fast RJ connection of TCD M 3-phase split-core current sensors, for retrofit applications. Managing of two 3-phase or six 1-phase loads. 4-DIN modules and 72 x 72 panel mounting	TCD M: 3-phase split core current sensors for EM271 quick-fit meter. Connection to the meter by means of RJ11 connector (included). TCDMM: adaptor for 3 CT by 333 mV up to 10000 A	Quick-fit energy meter with daisy chaining of voltage and serial connections and fast RJ connection of TCD06B 6-channel current transformer block. Managing of two 3-phase or six 1-phase loads. 4-DIN modules and 72 x 72 panel mounting	6-channel current transformer blocks with hole centre distance 17.5 mm (same of miniature circuit breakers) for EM280 quick-fit meter. Connection to the meter by means of RJ11 connector (included)
Function	System: kWh, kvarh, kW, kvar Single-phase: kWh, W, W <sub>dmd</sub> , W <sub>dmd max</sub> , A, V <sub>LL</sub> , V <sub>LN</sub> Virtual sum of the two 3-phase or six 1-phase loads TRMS method	Suitable to be installed in any existing installation. Automatic setting of the CT ratio in the meter	System: kWh, kvarh, kW, kvar Single-phase: kWh, W, W <sub>dmd</sub> , W <sub>dmd max</sub> , A, V <sub>LL</sub> , V <sub>LN</sub> Virtual sum of the two 3-phase or six 1-phase loads TRMS method	Suitable to be installed in any new and existing installation. Automatic setting of the CT ratio in the meter
<b>Input specifications</b>				
Range	120 / 230 VAC, 400 VAC In: from 60 to 400 A by TCD M	TCD0M: 60 A TCD1M: 100 A TCD2M: 200 A TCD3M: 400 A TCDMM: suitable to be connected to standard CT up to 10 kA	120 / 230 VAC, 400 VAC In: 32 A by TCD06BX and TCD06BS	TCD06B: 32 A
Accuracy	±0.5% RDG (V, A)	Equivalent to Class 1 (IEC61869-2)	±0.5% RDG (V, A)	Equivalent to Class 0.5 (IEC61869-2)
Active energy	Equivalent to Class 1 (EN62053-21)		Equivalent to Class 1 (EN62053-21)	
Reactive energy	Equivalent to Class 2 (EN62053-23)		Equivalent to Class 2 (EN62053-23)	
Display	LCD 3 DGT (inst. variables) 6+1, 7 DGT (energies)		LCD 3 DGT (inst. variables) 6+1, 7 DGT (energies)	
<b>Output specifications</b>				
Pulse output	2 static opto-mosfet		2 static opto-mosfet	
Communication	RS485 (2-wire, Modbus)		RS485 (2-wire, Modbus)	
<b>General specifications</b>				
Power supply	Self power supply		Self power supply	
Approvals/Marks	CE - cULus	CE - cULus (with EM271)	CE - cULus	CE - cULus (with EM280)
<b>References</b>				
For ordering key details, please refer to <a href="http://www.gavazziautomation.com">www.gavazziautomation.com</a>				

# Power analyzers

	Self-addressing Quick-fit energy transducers	Multifunction meters	Power analyzers
Types	ET272	WM12-DIN	WM14-DIN
			
Dimensions HxWxD (mm)	72 x 72 x 65	90 x 108 x 64.5 [DIN]	90 x 108 x 64.5 [DIN]
Description	Self-addressing quick-fit energy transducer with fast RJ connection of TCD M 3-phase split-core current sensors, for retrofit or new applications. Managing of two 3-phase or six 1-phase loads. 4-DIN modules mounting	3-phase multifunction meter 6-DIN modules [DIN]	3-phase multifunction meter 6-DIN modules [DIN]
Function	Innovative self-addressing Modbus function (it requires VMU-C EM) System: kWh, kvarh, kW, kvar Single-phase: kWh, W, W <sub>dmd</sub> , W <sub>dmd max</sub> , A, V <sub>LL</sub> , V <sub>LN</sub> Virtual sum of the two 3-phase or six 1-phase loads TRMS method	System: V <sub>LL</sub> , V <sub>LN</sub> , A, An, VA, VA <sub>dmd</sub> , W, W <sub>dmd</sub> , var, PF, Hz Max: A, W <sub>dmd</sub> Single-phase: V <sub>LL</sub> , V <sub>LN</sub> , A, VA, W, var, PF	System: kWh, kvarh, V <sub>LL</sub> , V <sub>LN</sub> , An, PF, W, var, VA, W <sub>dmd</sub> , VA <sub>dmd</sub> , Hz, hour meter Max: A, A <sub>dmd</sub> , W <sub>dmd</sub> Single-phase: V <sub>LL</sub> , V <sub>LN</sub> , A, A <sub>dmd</sub> , PF, W, var, VA
<b>Input specifications</b>			
Range code	230 VAC, 400 VAC In: from 60 to 400 A by TCD M up to 10000 A by TCDMM	400 / 660 V <sub>LL</sub> AC 5(6) AAC [AV5], 100 / 208 V <sub>LL</sub> AC 5(6) AAC [AV6] (current connection by CT)	400 / 660 V <sub>LL</sub> AC 5(6) AAC [AV5], 100 / 208 V <sub>LL</sub> AC 5(6) AAC [AV6] (current connection by CT)
Accuracy	±0.5% RDG (V, A)		
Active energy	Equivalent to Class 1 (EN62053-21)		Class 1
Reactive energy	Equivalent to Class 2 (EN62053-23)		Class 2
Display		LED 3x 3 DGT	LED 3x 3-DGT 8+1 DGT (energies)
<b>Output specifications</b>			
Communication	RS485 (2-wire, Modbus)	RS485 port [S]	RS485 port [S]
<b>General specifications</b>			
Power supply	Self power supply	24 VAC [A] 48 VAC [B] 115 VAC [C] 230 VAC [D] 18 to 60 VDC [3]	24 VAC [A] 48 VAC [B] 115 VAC [C] 230 VAC [D] 18 to 60 VDC [3] 90 to 260 AC/DC [H DG]
Approvals/Marks	CE - cULus	CE - cULus	CE - cULus
<b>References</b>			
For ordering key details, please refer to <a href="http://www.gavazziautomation.com">www.gavazziautomation.com</a>			



# Power analyzers

	Power analyzers	Modular power analyzers	Modular power quality analyzers	
Types	WM15 96	WM20 96	WM30 96	WM40 96
				
Dimensions HxWxD (mm)	96 x 96 x 59	96 x 96 x 50	96 x 96 x 50	96 x 96 x 50
Description	3-phase power analyzer 96 x 96 panel mounting	3-phase modular power quality analyzer 96 x 96 panel mounting	3-phase modular power quality analyzer 96 x 96 panel mounting	3-phase modular power quality analyzer 96 x 96 panel mounting
Function	System: $\pm$ kWh, $\pm$ kvarh, $V_{LL}$ , $V_{LN}$ , var, VA, W, $W_{dmd}$ , $VA_{dmd}$ , VA, PF, Hz, THD, $\pm$ hour counter Max: $A_{dmd}$ , $W_{dmd}$ , $VA_{dmd}$ Single-phase: $V_{LL}$ , $V_{LN}$ , A, W, var, VA, PF, $A_{dmd}$ , kWh TRMS method	System: total/partial $\pm$ kWh and $\pm$ kvarh, $V_{LN}$ , $V_{LL}$ , VA, W, var, PF, Hz, THD (V,A) Single-phase: $V_{LN}$ , $V_{LL}$ , VA, A, An, W, var, PF, THD Phase-sequence-asymmetry loss	System: total/partial $\pm$ kWh and $\pm$ kvarh, $V_{LN}$ , $V_{LL}$ , VA, W, var, PF, Hz, THD (V,A) Single-phase: $V_{LN}$ , $V_{LL}$ , VA, A, An, W, var, PF, THD Phase-sequence-asymmetry loss	System: Total/partial $\pm$ kWh and $\pm$ kvarh (multi-tariff), $V_{LN}$ , $V_{LL}$ , VA, W, var, PF, Hz, THD, K-factor Single-phase: $V_{LN}$ , $V_{LL}$ , VA, A, An (calculated or measured), W, var, PF, THD, TDD; Phase sequence-asymmetry-loss Load profile, event stamping, data logger, utility and hour counters

## Input specifications

Range code	277 / 415 V <sub>LL</sub> AC [X], 347 / 600 V <sub>LL</sub> AC [H], In: 5 A, I <sub>max</sub> : 6 A <sub>CA</sub>	400 / 690 V <sub>LL</sub> AC 1(2) AAC [AV4] 400 / 690 V <sub>LL</sub> AC 5(6) AAC [AV5] 100 / 208 V <sub>LL</sub> AC 5(6) AAC [AV6] 100 / 208 V <sub>LL</sub> AC 1(2) AAC [AV7]	400 / 690 V <sub>LL</sub> AC 1(2) AAC [AV4] 400 / 690 V <sub>LL</sub> AC 5(6) AAC [AV5] 100 / 208 V <sub>LL</sub> AC 5(6) AAC [AV6] 100 / 208 V <sub>LL</sub> AC 1(2) AAC [AV7]	400 / 690 V <sub>LL</sub> AC 1(2) AAC [AV4] 400 / 690 V <sub>LL</sub> AC 5(6) AAC [AV5] 100 / 208 V <sub>LL</sub> AC 5(6) AAC [AV6] 100 / 208 V <sub>LL</sub> AC 1(2) AAC [AV7]
Accuracy	$\pm$ 0.5% RDG (V, A)	$\pm$ 0.2% RDG (V, A)	$\pm$ 0.2% RDG (V, A)	$\pm$ 0.2% RDG (V, A)
Active energy	Class 1 (EN62053-21)	Class 0.5S according to EN62053-22	Class 0.5S according to EN62053-22	Class 0.5S according to EN62053-22
Reactive energy	Class 2 (EN62053-23)	Class 2 according to EN62053-23	Class 2 according to EN62053-23	Class 2 according to EN62053-23
Display	Matrix LCD backlight up to 4x 4 DGT (inst. variables) 3x 8+2 DGT (energies)	LCD backlight 3x 4 DGT (inst. variables) 8+2, 9+1, 10 DGT (energies)	LCD backlight 4x 4 DGT (inst. variables) 8+2, 9+1, 10 DGT (energies)	LCD backlight 4x 4 DGT (inst. variables) 8+2, 9+1, 10 DGT (energies)

## Output specifications

Pulse output	1 open collector [OX or OS]	Up to 2 digital outputs	Up to 2 digital outputs	Up to 8 digital outputs
Alarm output	1 open collector [OX or OS]	Up to 2 freely configuration virtual alarms	Up to 4 freely configuration virtual alarms	Up to 16 freely configuration virtual alarms
Communication	RS485 (2-wire) [OS] M-BUS by means of VMU-B	Optical port Modbus RS485/232 port, BACnet SMTP [B3], Modbus TCP Ethernet port [E2], BACnet-IP [B1], Profibus [P1]	Optical port Modbus RS485/232 port, BACnet SMTP [B3], Modbus TCP Ethernet port [E2], BACnet-IP [B1], Ethernet/IP [E6], Profibus [P1]	Optical port Modbus RS485/232 port, BACnet SMTP [B3], Modbus TCP Ethernet port [E2], BACnet-IP [B1], Ethernet/IP [E6], Profibus [P1]
Analogue output			Up to 2	Up to 4
Inputs				Up to 6 digital inputs

## General specifications





Power supply	Self power supply [X] 120 to 240 VAC/DC [H]	18 to 60 VAC/DC [L] 90 to 260 VAC/DC [H]	18 to 60 VAC/DC [L] 90 to 260 VAC/DC [H]	18 to 60 VAC/DC [L] 90 to 260 VAC/DC [H]
Approvals/Marks	CE - cULus - MID [X power supply]	CE - cULus	CE - cULus	CE - cULus

## References

For ordering key details, please refer to [www.gavazziautomation.com](http://www.gavazziautomation.com)



# Power analyzers

	Modular branch circuit analyzers	12-channel current transformer blocks	Wiring system for WM50	Optical communication interface
Types	WM50 96	TCD12 BS	TCD12 WS	OPTOPROG
				
Dimensions HxWxD (mm)	96 x 96 x 50	221 x 58 x 49,50		52 x 17.5 x 50.8
Description	96-channel branch circuit analyzer 96 x 96 panel mounting	Split-core CT block for WM50: hole 8.5, hole centre distance 17.5	Wires system for WM50 branch circuit monitoring system	
Function	Mains power analysis and single branch circuit measurement Mains, system: Total/partial $\pm$ kWh and $\pm$ kvarh (multi-tariff), $V_{LN}$ , $V_{LL}$ , $V_A$ , $W$ , var, PF, Hz, THD, K-factor Mains, Single-phase: $V_{LN}$ , $V_{LL}$ , $V_A$ , $A_{L1}$ , $A_{L2}$ (calculated or measured), $W$ , var, PF, THD, TDD; Phase sequence-asymmetry-loss, event stamping, utility and hour counters Single branch channels: $A$ , $W$ , var, $V_A$ , PF, kWh, THD (A), daily min and max for 1 of the above variables	12-channel current transformer blocks with hole centre distance 17.5 mm (same of miniature circuit breakers) for WM50 branch circuit analyzer. Connection to the meter by means of dedicated cable [TCD12WS]	Set of cables to connect WM50 with TCD12BS and 2 consecutive TCD12BS <sup>1)</sup>	Bluetooth and USB interface for meters and analysers with optical port

## Input specifications

Range code	208..480 $V_{LL}$ AC 5(6) AAC [AV5]	Nominal 32 AAC (max 65 AAC)	[030]: 30 cm length cable [050]: 50 cm length cable [100]: 100 cm length cable [200]: 200 cm length cable [500]: 500 cm length cable
Accuracy	$\pm 0.2\%$ RDG (V, A), mains	$\pm 0.5\%$ RDG (A), branch channels	
Active energy	Mains: Class 0.5S according to EN62053-22 Branch channels: Class 2 according to EN62053-21		
Reactive energy	Class 2 according to EN62053-23		
Display	LCD backlight 4x 4 DGT (inst. variables) 8+2, 9+1, 10 DGT (energies), only mains		

## Output specifications

Pulse output	Up to 6 digital outputs		
Alarm output	Up to 16 freely configuration virtual alarms		
Communication	Optical port Modbus RS485/232 port [S1], Modbus TCP Ethernet port [E2]	High speed communication to WM50	
Inputs	Up to 6 digital inputs		

## Port

Port 1 - connections		Bluetooth, Micro-USB
Port 2 - connections		Optical



## General specifications

Power supply	100 to 277 VAC/DC	Power supply from WM50	Battery
Approvals/Marks	CE - cULus	CE - cULus (with WM50)	CE, FCC, IC, Bluetooth 4.0

## References



For ordering key details, please refer to [www.gavazziautomation.com](http://www.gavazziautomation.com)

# DC Energy meters

	Contactless power analyzers		Energy analyzers	
Types	CPA050/CPA300	CPA300-V	VMU-E	VMU-X
				
Dimensions HxWxD (mm)	CPA050 63 x 46 x 25 (without connectors) CPA300 99 x 89 x 30 (without connectors)	99 x 89 x 30 (without connectors)	1-DIN module	1-DIN module
Description	Contactless power analyzers	Contactless current transducer for PV installations up to 1500 VDC	DC energy analyzer: V, A, W, kWh	Power supply and communication module for VMU-E unit
Function	CPA monitors electrical variables (V, A, W, var, VA, kWh, PF, HZ, THD) in 1-phase AC (from 1 to 400 Hz) or DC systems	CPA monitors electrical variables (A,Ah) in 1-phase AC (from 1 to 400 Hz) or DC systems		
<b>Input specifications</b>				
Range code	One current input (Hall effect): 50 AAC/50 ADC [CPA300] 300 AAC/400 ADC One voltage input: 800 VAC/1000 VDC	One current input (Hall effect): 300 AAC/400 ADC	400 VDC 20 ADC [AV00] (up 1000 ADC by external shunt 120 mV) 400 VDC 1000 ADC [AV10] (by 10 VDC current sensor)	
Accuracy	±0.5%F.S. (V, A, W)	±0.5%F.S. (A)	±0.5% RDG (V, A)	
Active energy			Class 1	
Display	Front LED to show the Power-ON status of the device	Front LED to show the Power-ON status of the device	LCD 6 DGT	
<b>Output specifications</b>				
Pulse output			1 opto-mosfet through VMU-X unit [X]	1 opto-mosfet
Alarm output	Virtual alarm detection of voltage over-range and current over-range	Virtual alarm detection of current over-range	1 opto-mosfet through VMU-X unit [X]	1 opto-mosfet
Communication	RS485 Modbus RTU	RS485 Modbus RTU	RS485 Modbus RTU through VMU-X unit [X]	RS485 Modbus RTU
Analogue output		Programmable scale 0-10 Vdc		
<b>General specifications</b>				
Power supply	9 to 30 VDC power supply	9 to 30 VDC power supply	Self power supply through VMU-X unit [X]	38 to 265 VAC/DC [U]
Approvals/Marks	CE - cURus	CE - cURus	CE	CE
<b>References</b>				
For ordering key details, please refer to <a href="http://www.gavazziautomation.com">www.gavazziautomation.com</a>				

# Current transformers

## Current transformers

Types	CTD 1Z	TADK	TADK2
			

Dimensions HxWxD (mm)	76 x 44 x 31	115.5 x 75 x 44	115.5 x 75 x 44
-----------------------	--------------	-----------------	-----------------

### Input specifications

	Current transformer 1-phase AC	Current transformer 1-phase AC	Current transformer 1-phase AC
Operating frequency	48 to 62 Hz	48 to 62 Hz	48 to 62 Hz
Max. system voltage	0.72 kV	0.72 kV	0.72 kV
Rated insulation level	3 kV/1 min @ 50 Hz	3 kV/1 min @ 50 Hz	3 kV/1 min @ 50 Hz
Security factor	≤ 5	≤ 5	≤ 5

### Output specifications

Secondary current	5 A	5 A standard (1 A on request)	5 A standard (1 A on request)
-------------------	-----	----------------------------------	----------------------------------

### General specifications

Class	1 / 3	0.5	0.5
Bus-bar size (mm) [diameter]	[22]	no (wounded primary)	25 x 5 (fixed bar)
Standards	EN 61869-2	IEC 60185	IEC 60185





### Primary current

	Burden (VA)		Burden (VA)		Burden (VA)		
	Class	1	3	Class	0.5	Class	0.5
Accuracy class depending on the burden of the secondary circuit	50 A		1.5	1 A	10	1 A	10
	100 A	2.5		5 A	10	5 A	10
	125 A	2.5		10 A	10	10 A	10
	150 A	2.5		15 A	10	15 A	10
	200 A	3.75		25 A	10	25 A	10
				40 A	10	40 A	10
						50 A	10
						60 A	10
						80 A	10
						100 A	10
						150 A	10
						200 A	10
						250 A	10

### References

For ordering key details, please refer to [www.gavazziautomation.com](http://www.gavazziautomation.com)

# Current transformers



Current transformers															
Types	CTD 1X			CTD 2X			CTD 3X			CTD 4X					
															
Dimensions HxWxD (mm)	66 x 46 x 30			86 x 56 x 42			109 x 77 x 42			113 x 90 x 42					
<b>Input specifications</b>															
	Current transformer 1-phase AC			Current transformer 1-phase AC			Current transformer 1-phase AC			Current transformer 1-phase AC					
Operating frequency	48 to 62 Hz			48 to 62 Hz			48 to 62 Hz			48 to 62 Hz					
Max. system voltage	0.72 kV			0.72 kV			0.72 kV			0.72 kV					
Rated insulation level	3 kV/1 min @ 50 Hz			3 kV/1 min @ 50 Hz			3 kV/1 min @ 50 Hz			3 kV/1 min @ 50 Hz					
Security factor	≤ 5			≤ 5			≤ 5			≤ 5					
<b>Output specifications</b>															
Secondary current	5 A 1 A			5 A 1 A			5 A 1 A			5 A 1 A					
<b>General specifications</b>															
Class	0.5 / 1 / 3			0.5 / 1 / 3			0.5 / 1 / 3			0.5 / 1 / 3 / 5P5					
Bus-bar size (mm) [diameter]	20 x 5 [23]			32 x 5 / 30 x 10 / 25 x 20 / 25 x 12 [24]			51 x 15 / 40 x 20 / 32 x 32 / 40 x 20 [41]			64 x 20 / 51 x 43 / [51]					
Standards	EN 61869-2, cURus			EN 61869-2, cURus			EN 61869-2, cURus			EN 61869-2, cURus					
<b>Primary current</b>															
Accuracy class depending on the burden of the secondary circuit	Burden (VA)			Burden (VA)			Burden (VA)			Burden (VA)					
	Class	0.5	1	3	Class	0.5	1	3	Class	0.5	1	3			
	50 A		1	1.25	40 A			1.25	50 A		1.75	150 A	2.5	5	
	60 A		1	1.25	50 A			1.5	60 A		2	200 A	3.25	6	
	70 A		1.5	1.75	60 A			2	70 A		2.25	250 A	2.5	4.5	
	75 A	1	1.25	1.75	70 A			2.5	75 A		3	300 A	3	4	
	80 A	1.25	1.5	2	75 A		1.75	2.5	80 A		3	400 A	6	9	
	100 A	1.5	1.75	2.25	80 A		2	2.75	100 A		2	3.5	500 A	10	12.5
	120 A	1.75	2	2.5	100 A		2.5	3	120 A		2.25	4	600 A	11	13.5
	125 A	2	2.25	2.75	120 A		2.75	3.75	125 A		2.5	4.5	700 A	12.5	15
	150 A	2.25	2.5	3	125 A	2	2.75	3.75	150 A	2.25	3	6	750 A	13	15.5
	160 A	2.5	2.75	3.25	150 A	3	4	5	160 A	2.5	3.5	6.5	800 A	14	16.5
	200 A	3	3.25	3.75	160 A	3	4	5	200 A	3	4.5	8.5	1000 A	17.5	20
	250 A	4.5	4.75	5.25	200 A	4	5	6.5	250 A	3.5	6.5	10.5	1200 A	20	22.5
	300 A	5	5.5	6	250 A	5.5	7	8	300 A	7	10	13	1250 A	20	22.5
				300 A	7	8.5	9.5	400 A	9	14	17	1500 A	27.5	30	
				400 A	12	13.5	14.5	500 A	14	18	21	1600 A	27.5	30	
				500 A	14	15.5	16.5	600 A	17	21	24				
				600 A	17.5	19	20	700 A	22	26	29				
								750 A	24	28	31				
								800 A	25	29	32				

## References

For ordering key details, please refer to [www.gavazziautomation.com](http://www.gavazziautomation.com)

# Current transformers

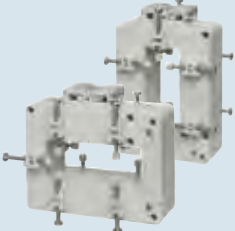
## Current transformers

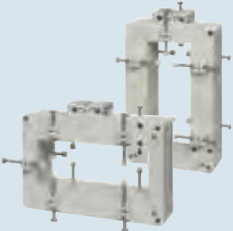
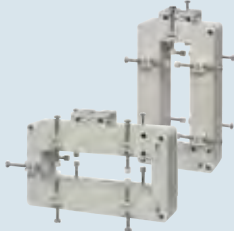
Types	CTD 8V CTD 8H	CTD 8Q	CTD 9V CTD 9H	CTD 10V CTD 10H
				
Dimensions HxWxD (mm)	133 x 87 x 40 104 x 117 x 40	144 x 129 x 40	178 x 92 x 40 109 x 162 x 40	178 x 107 x 40 124 x 162 x 40

### Input specifications

	Current transformer 1-phase AC	Current transformer 1-phase AC	Current transformer 1-phase AC	Current transformer 1-phase AC
Operating frequency	48 to 62 Hz	48 to 62 Hz	48 to 62 Hz	48 to 62 Hz
Max. system voltage	0.72 kV	0.72 kV	0.72 kV	0.72 kV
Rated insulation level	3 kV/1 min @ 50 Hz	3 kV <sub>RMS</sub> , 50 Hz, 1 min	3 kV / 1 min @ 50 Hz	3 kV / 1 min @ 50 Hz
Security factor	≤ 5	≤ 5	≤ 5	≤ 5

### Output specifications

Secondary current	5 A 1 A	5 A 1 A	5 A 1 A	5 A 1 A
-------------------	------------	------------	------------	------------

### General specifications

Class	0.5 / 1 / 3	0.5	0.5 / 1 / 3	0.5 / 1 / 3
Bus-bar size (mm) [diameter]	80 X 30	55 x 100	125 x 35	125 x 50
Standards	EN 61869-2, cURus	EN 60044-1	EN 61869-2, cURus	EN 61869-2, cURus

### Primary current

	Burden (VA)				Burden (VA)				Burden (VA)				Burden (VA)			
	Class	0.5	1	3	Class	0.5			Class	0.5	1	3	Class	0.50	1	3
150 A				2	1000 A	15			400 A		3	6	400 A	1	7	10
200 A				4	1500 A	15			500 A	2	4	8	500 A	3	10	14
250 A				5	2000 A	15			600 A	4	6	10	600 A	5	12	17
300 A		2	6		2500 A	15			700 A	4	8	10	700 A	8	15	20
400 A	3	5	8		3000 A	15			750 A	4	8	10	750 A	10	15	20
500 A	5	7	10		4000 A	15			800 A	4	8	10	800 A	10	15	20
600 A	6	10	12						1000 A	6	10	13	1000 A	12	20	25
700 A	6	10	12						1200 A	8	12	15	1200 A	15	25	30
750 A	8	12	15						1250 A	8	12	15	1250 A	15	25	30
800 A	8	12	15						1500 A	10	15	18	1500 A	20	30	40
1000 A	10	15	20						1600 A	10	15	18	1600 A	20	30	40
1200 A	12	15	20						2000 A	15	20	24	2000 A	25	40	50
1250 A	12	15	20						2500 A	20	25	30	2500 A	30	50	60
1500 A	15	20	25						3000 A	25	30	35	3000 A	30	50	60
1600 A	15	20	25						3200 A	25	30	35	3200 A	30	50	60
2000 A	20	25	30													
2500 A	25	30	40													

Accuracy class depending on the burden of the secondary circuit

### References

For ordering key details, please refer to [www.gavazziautomation.com](http://www.gavazziautomation.com)

# Current transformers

	Current transformers		Split core current transformers	
--	----------------------	--	---------------------------------	--

Types	CTD 11V CTD 11H	CTD 12V CTD 12H	CTD 5S	CTD 6S
-------	--------------------	--------------------	--------	--------



Dimensions HxWxD (mm)	178 x 98 x 40 115 x 160 x 40	178 x 125 x 40 140 x 157 x 40	94 x 83 x 40	114 x 107 x 40
-----------------------	---------------------------------	----------------------------------	--------------	----------------

### Input specifications

	Current transformer 1-phase AC	Current transformer 1-phase AC	Split core current transformer 1-phase AC	Split core current transformer 1-phase AC
Operating frequency	48 to 62 Hz	48 to 62 Hz	48 to 62 Hz	48 to 62 Hz
Max. system voltage	0.72 kV	0.72 kV	0.72 kV	0.72 kV
Rated insulation level	3 kV <sub>RMS</sub> , 50 Hz	3 kV <sub>RMS</sub> , 50 Hz	3 kV <sub>RMS</sub> , 50 Hz, 1 min	3 kV <sub>RMS</sub> , 50 Hz, 1 min
Security factor	≤ 5	≤ 5	≤ 5	≤ 5

### Output specifications

Secondary current	5 A 1 A	5 A 1 A	5 A 1 A	5 A 1 A
-------------------	------------	------------	------------	------------

### General specifications

Class	0.5	0.5	1	1
Bus-bar size (mm)	125 x 37	125 x 53	27 x 32	52 x 51
Standards	EN 60044-1	EN 60044-1	EN 61869-2, cURus	EN 61869-2, cURus





### Primary current

	Burden (VA)		Burden (VA)		Burden (VA)			Burden (VA)		
	Class	0.5	Class	0.5	Class	1	3	Class	1	3
	Accuracy class depending on the burden of the secondary circuit	1000 A	15	1000 A	15	100 A	1.5	1.5	150 A	1.5
	1500 A	15	1500 A	15	125 A	1.5	1.5	200 A	1.5	2
	2000 A	15	2000 A	15	150 A	1.5	2.5	250 A	1.5	3.75
	2500 A	15	2500 A	15	200 A	1.5	5	300 A	1.5	5
	3000 A	15	3000 A	15	250 A	1.5	5	400 A	2.5	5
	4000 A	15	4000 A	15	300 A	2.5	7.5	500 A	5	10
					400 A	5	10	600 A	7.5	15
								700 A	7.5	15
								750 A	7.5	15
								800 A	10	15
								1000 A	10	15

### References

For ordering key details, please refer to [www.gavazziautomation.com](http://www.gavazziautomation.com)

# Current transformers

	Split core current transformers			Active current sensor
Types	CTD 8S	CTD 9S	CTD 10S	ROG 400
				

Dimensions HxWxD (mm)	133 x 87 x 40	178 x 92 x 40	178 x 107 x 40	54 x 29 x 17
-----------------------	---------------	---------------	----------------	--------------

## Input specifications

	Split core current transformer 1-phase AC	Split core current transformer 1-phase AC	Split core current transformer 1-phase AC	Split core AC current sensor 1-phase AC
Operating frequency	48 to 62 Hz	48 to 62 Hz	48 to 62 Hz	45 to 65 Hz
Max. system voltage	0.72 kV	0.72 kV	0.72 kV	
Rated insulation level	3 kV <sub>RMS</sub> , 50 Hz, 1 min	3 kV <sub>RMS</sub> , 50 Hz, 1 min	3 kV <sub>RMS</sub> , 50 Hz, 1 min	3 kV <sub>RMS</sub> , 50 Hz
Security factor	≤ 5	≤ 5	≤ 5	

## Output specifications

Secondary current	5 A 1 A	5 A 1 A	5 A 1 A	4 to 20 mA DC
-------------------	------------	------------	------------	---------------

## General specifications

Class	1	1	1	
Bus-bar size (mm)	81 x 31	125 x 35	125 x 50	[40]
Standards	EN 61869-2, cURus	EN 61869-2, cURus	EN 61869-2, cURus	

## Primary current

	Burden (VA)			Burden (VA)			Burden (VA)		
	Class	1	3	Class	1	3	Class	1	3
150 A			1.5	400 A		3	400 A	1	7
200 A			1.5	500 A	2	4	500 A	3	10
250 A			2	600 A	4	6	600 A	5	12
300 A			2	700 A	4	8	700 A	8	15
400 A	3	5		750 A	4	8	750 A	10	15
500 A	5	7		800 A	4	8	800 A	10	15
600 A	6	10		1000 A	6	10	1000 A	12	20
700 A	6	10		1200 A	8	12	1200 A	15	25
750 A	8	12		1250 A	8	12	1250 A	15	25
800 A	8	12		1500 A	10	15	1500 A	20	30
1000 A	10	15		1600 A	10	15	1600 A	20	30
1200 A	12	15		2000 A	15	20	2000 A	25	40
1250 A	12	15		2500 A	20	25	2500 A	30	50
1500 A	15	20		3000 A	25	30	3000 A	30	50
1600 A	15	20		3200 A	25	30	3200 A	30	50
2000 A	20	25							
2500 A	25	30							

Accuracy class depending on the burden of the secondary circuit





400 AAC



## References

For ordering key details, please refer to [www.gavazziautomation.com](http://www.gavazziautomation.com)

# Current transformers

## Split core and Rogowski current sensors for EM210\_MV

Types	CTV-1X	CTV-2X	CTV-3X	CTV-4X
				
<b>Input / output specifications</b>				
Primary current 50/60 Hz	60 A	100 A	200 A	200 or 400 A
Secondary output	333 mV	333 mV	333 mV	333 mV
<b>General specifications</b>				
Accuracy	1%	1%	1%	1%
Linearity	0.5%	0.5%	0.5%	0.5%
Phase error at nominal current	≤4°	≤2°	≤2°	≤2°
Max. system voltage	660 V	660 V	660 V	660 V
Opening angle	180°	180°	180°	180°
Certifications	CE - cURus	CE - cURus	CE - cURus	CE - cURus
<b>References</b>				
	CTV1X60A333MV	CTV2x100A333MV	CTV3X200A333MX	CTV4X200A333MV CTV4X400A333MV

Types	CTV-6X	CTV-8X	ROG4K
			
<b>Input / output specifications</b>			
Primary current 50/60 Hz	400 A	800 A	4000 A
Secondary output	333 mV	333 mV	
<b>General specifications</b>			
Accuracy	1,00%	1%	1%
Linearity	0.5%		
Phase error at nominal current	≤2°	≤2°	
Max. system voltage	660 V	660 V	600 V (cat III)
Opening angle	180°		
Coil length			400, 600 or 900 [XXX]
Certifications	CE - cURus	CE - cURus	CE - cURus
<b>References</b>			
	CTV6X400A333MV	CTV8X800A333MV	ROG4K1002M [XXX] 3X



# Current transformers

## Split core current transformers

### Types

#### CTA-5X



#### CTA-6X



### Input/Output specifications

Primary current 50/60 Hz	100 to 300 A	200 to 600 A
Secondary output	5 A	5 A

### General specifications

Accuracy	cl. 1 or 3	cl. 1 or 3
Max. rated system voltage	600 V	600 V
Rated insulation level	0.72 kV AC, dielectric strength 3 kV AC for 1 min	0.72 kV AC, dielectric strength 3 kV AC for 1 min
Insulation class	B	B
Opening angle	180°	180°
Certifications	CE - cURus	CE - cURus

### References

CTA5XxxxA5A

CTA6XxxxA5A

# Current transformers

## Current transformers for monitoring relays

Types	MI	MP	A 82	E 83
				

Dimensions HxWxD (mm)	45 x 52 x 16 [5 / 20] 67.5 x 95 x 20 [100 / 500]	45 x 120 x 16 [5 / 20] 114 x 150 x 23 [100 / 500]	67.5 x 95 x 20	56 x 22.5 x 49
Function	1-phase AC. Output voltage. Cable hole.	3-phase AC. Output voltage. Cable hole.	1-phase AC. Output 0 / 4-20 mA DC, 0-10 VDC (A82-30). Cable hole. Led indication.	1-phase AC. Output 4-20 mA DC. Cable hole. DIN-rail mounting.

### Input specifications

Input current	0.5 - 5 AAC [5] 2 - 20 AAC [20] 10 - 100 AAC [100] 50 - 500 AAC [500]	0.5 - 5 AAC [5] 2 - 20 AAC [20] 10 - 100 AAC [100] 50 - 500 AAC [500]	0 - 25 AAC [25] 0 - 50 AAC [50] 0 - 100 AAC [100] 0 - 250 AAC [250] 0 - 500 AAC [500]	0 - 5 AAC 0 - 10 AAC 0 - 15 AAC 0 - 20 AAC 0 - 25 AAC 0 - 30 AAC 0 - 50 AAC
Max. current continuously	20 AAC [5] 50 AAC [20] 250 AAC [100] 750 AAC [500]	20 AAC [5] 50 AAC [20] 250 AAC [100] 750 AAC [500]	600 AAC	100 AAC
Dielectric voltage	6 kV ACrms	6 kV ACrms	6 kV ACrms	

### Output specifications

Output value	0.4 - 4 Vp The output voltage is proportional to the input current	0.4 - 4 Vp The output voltage is proportional to the highest current value in the 3 conductors which are drawn through the holes of the current metering transformer	A82 - 10: 0-20 mA DC A82 - 20: 4-20 mA DC A82 - 30: 0-10 VDC The output current (A82-10, A82-20) and voltage (A82-30) are proportional to the input current	4 - 20 mA DC The output current is proportional to the input current
Output tolerance	± 5% @ In	± 5% @ In	± 2% @ 50 Hz	± 2% @ 50 Hz
Rated insulation voltage (cable)	250 VACrms	250 VACrms	250 VACrms	

### General specifications

Cable hole diameter	10.5 mm [5 / 20] 27 mm [100 / 500]	3 x 12 mm [5 / 20] 3 x 27 mm [100 / 500]	27 mm	12 mm
Connection cable	2 m PVC 2 x 0.5 mm <sup>2</sup>	2 m PVC 2 x 0.5 mm <sup>2</sup>	A82-10, A82-30: 2 m, 3x0.25 m <sup>2</sup> A82-20: 2 m, 2x0.25 m <sup>2</sup>	Screw terminal 2 x 1.5 mm <sup>2</sup>
Operating temperature	-20°C to +60°C	-20°C to +60°C	-20°C to +50°C	-20°C to +50°C

### References

	<b>MI 5</b>	<b>MP 3005</b>	<b>A 82-XX 25</b>	<b>E 83-20 50</b>
	<b>MI 20</b>	<b>MP 3020</b>	<b>A 82-XX 50</b>	
	<b>MI 100</b>	<b>MP 3100</b>	<b>A 82-XX 100</b>	
	<b>MI 500</b>	<b>MP 3500</b>	<b>A 82-XX 250</b>	
			<b>A 82-XX 500</b>	
			XX = 10: 0-20 mA DC = 20: 4-20 mA DC = 30: 0-10 VDC	

# Current transformers

## Core balance transformers

### Types

### CTG



Dimensions HxWxD (mm)

Hole Ø 35, 50, 70, 120, 160 or 210 mm

Function

Zero current transformer for DEA71 and DEB71

### Input specifications

Input type	1-phase 3-phase 3-phase + N
Max. Input voltage	750 VAC
Operating frequency	50 Hz - 60 Hz
Dielectric voltage	3 kV ACrms

### Output specifications

Reduction ratio	1:1000
Output type	Bi-polar
Output terminals	Screw connector



### General specifications

Cable hole diameter	From 35 mm to 210 mm
Connection	2.5 mm <sup>2</sup>
Operating temperature	-5°C to +55°C



### References

CTG035  
CTG050  
CTG070  
CTG120  
CTG160  
CTG210

# Data aggregation solutions



	Web-server	Web-server
Types	UWP 3.0	VMU-C EM
		
Dimensions HxWxD (mm)	2-DIN module	2-DIN module
Description	Web-Server, gateway and controller for energy efficiency management and building automation; compatible with Carlo Gavazzi meters, analyzers and building automation solutions it provides easy integration with local or remote SCADA/Server solutions and a configurable Web interface for analysis, alerting and reporting	Web-server for datacenter applications which controls and supervises any electrical installation acquiring information from energy meters, power analyzers and VMU I/O modules. It provides information via Internet, so data are available anywhere
Type	Micro PC	Micro PC
Storage memory	4 GB	4 GB
Back-up memory	Micro-SD / Micro-SDHC / USB	Micro-SD / Micro-SDHC / USB
<b>LED</b>		
Status and colour	One LED with different colours for BUS communication, communication ports, status and power supply	One LED with different colours for internal BUS communication, communication ports, alarms and power supply
<b>Communication port and Output specifications</b>		
RS485	2 ports for power analyzers, energy meters and Modbus devices	1 port for VMU I/O modules, 1 port for power analyzers, energy meters and Modbus devices
Ethernet	1 port for Internet / LAN connection, BACnet clients and Modbus/TCP devices	1 port for Internet / LAN connection and Modbus/TCP devices
USB	1 USB "mini-A" (service port)	1 USB "A" (for USB stick) and 1 USB "mini-A" (service port)
<b>Connections</b>		
RS485	3 screw terminals per port	3 screw terminals per port
Ethernet	RJ-45 connector (10 / 100 Base-T)	RJ-45 connector (10 / 100 Base-T)
USB	High Speed USB 2.0	High Speed USB 2.0
<b>General specifications</b>		
Voltage supply	From 12 to 28 VDC	From 12 to 28 VDC
Power consumption	≤ 5 W	≤ 5 W
Approvals/Marks	CE - cULus listed	CE - cULus listed
<b>References</b>		
For ordering key details, please refer to <a href="http://www.gavazziautomation.com">www.gavazziautomation.com</a>		

## Data aggregation solutions



	USB dongle connection module	Wireless endpoint gateway	Wireless master gateway
Types	VMU-D	UWP-A	UWP-M
			
Dimensions HxWxD (mm)	2-DIN module	2-DIN module	2-DIN module
Description	Accessory module for connecting third party USB dongle modems (3G or 4G) approved by Carlo Gavazzi to VMU-C systems	RS485 to long range wireless, LoRaWAN® adapter converting a CG meter or power analyzer into a wireless endpoint	Long range wireless concentrator to connect multiple UWP A endpoints to the UWP 3.0 controller
Type	USB dongle connection module	Gateway	Gateway
<b>Remote communication specifications</b>			
SIM card	Mobile, SIM Card	Long range wireless, LoRaWAN® (868 MHz, Europe only)	Long range wireless (868 MHz, Europe only)
Compatibility	Compatible with USB modems (3G or 4G) approved by Carlo Gavazzi	CG Meters and analyzers	UWP 3.0
Supported services	Internet communication; SMS		
<b>LED</b>			
Status and colour	Single colour green for power supply status	Power ON, bus communication, diagnostics	Power ON, bus communication, diagnostics
<b>Communication port and Output specifications</b>			
RS485		1 port for one power analyzer or energy meter	
USB	1 USB "A" (for USB dongle modem connection)	1 USB for Set-up via UCS software	
<b>Antenna</b>			
Connector	Depending on the modem unit	SMA	SMA
Type	Depending on the modem unit	High performance antenna 868 MHz	High performance antenna 868 MHz
<b>Connections</b>			
RS485		3 screw terminals per port	
Ethernet			
USB		High Speed USB 3.0/2.0	
<b>General specifications</b>			
Voltage supply	From 12 to 28 VDC	24 VDC, 115-240 VAC	24 VDC, 115-240 VAC
Power consumption	IN/OUT connection to supply also the VMU-C / VMU-Y unit; consumption depending on the connected optional modules (range: from 8.6 W to 18.6 W)		1.3 W max
Approvals/Marks	CE - cULus listed	CE - LoRaWAN®	CE
<b>References</b>			
For ordering key details, please refer to <a href="http://www.gavazziautomation.com">www.gavazziautomation.com</a>			

# Data aggregation solutions





## VMU I/O optional modules for VMU-C EM

Types	VMU-M EM	VMU-P EM	VMU-O EM
			
Dimensions	1-DIN module	1-DIN module	1-DIN module
Description	Master unit 6-DGT readout	Environment variable measurement unit	Inputs / outputs unit
Function	VMU-M performs the local bus management of VMU-P both measuring units and VMU-O I/O unit	2 temperatures, 1 analogue and 1 pulse rate output	VMU-O allows to add, for every single unit, available in the local bus two digital inputs and two relay outputs
<b>Input specifications</b>			
Range code	2 Pt100 or Pt1000, 3-wires (-50.0 to +200.0°C) or one digital input and one pulse input, for local management	2 Pt100 or Pt1000, 3-wires 1 analogue input (20 mA or 120 mV). 1 pulse rate input (0 to 1000 Hz max.) [2TIW]	2 digital inputs for Protection trip detection or others"
Accuracy	±(0.5%RDG + 5DGT)	±(0.2%RDG + 1DGT)	
<b>Output specifications</b>			
Alarm	Real and virtual alarm management of all variables coming from VMU-M and VMU-P with local event logging		2 digital outputs for alarm notification of local alarms or as a digital input status changing. SPST relay type
Serial communication	Local bus: up to 1 VMU-P and 3 VMU-O units RS485 communication port (Modbus)	Local bus: one VMU-P unit per bus	Local bus: up to 3 VMU-O units
Others		Front multicolour LED to show the status of the unit	Front multicolour LED to show the status of the unit
<b>General specifications</b>			
Power supply	12 to 28 VDC power supply	Self-power supply from VMU-M unit	Self-power supply from VMU-M unit
Approvals/Marks	cULus approved	cULus approved	cULus approved
<b>References</b>			
For ordering key details, please refer to <a href="http://www.gavazziautomation.com">www.gavazziautomation.com</a>			

# Data aggregation solutions



	Pulse counters concentrators		Aggregation server
Types	VMU-MC	VMU-OC	Em <sup>2</sup> -Server
			
Dimensions	1-DIN module	1-DIN module	
Description	Pulse counter concentrator	Pulse input extender	Em <sup>2</sup> -Server is a cloud solution capable of aggregating information from up to 100 installations powered by UWP 3.0 or VMU-C EM units. Data from the plants are transmitted through Internet, stored inside the embedded database and presented by the integrated web interface. Em <sup>2</sup> -Server + UWP 3.0 or VMU-C EM is a solid, reliable and plug'n play architecture aimed at managing multiple sites projects
Function	VMU-MC concentrates 2 pulse counter inputs (up to 11 with optional VMU-OC extender), and makes the relevant totalizers available via Modbus/RTU	3 additional SO pulse counter inputs	
Type			Virtual Machine Software
<b>Input specifications</b>			
Range code	2 SO inputs (either pulse for pulse counting or ON/OFF status monitoring)	3 SO inputs (either pulse for pulse counting or ON/OFF status monitoring)	
Pulse frequency	Max 100 Hz	Max 100 Hz	
<b>Output specifications</b>			
Serial communication	Local bus: up to 3 VMU-OC units RS485 communication port (Modbus)	Local bus: up to 3 VMU-OC units	
Others	LCD for Status, totalizers, active tariff display Front multicolour LED for power, MODBUS communication, local bus alert	Front multicolour LED to show the status of the unit	
<b>Compatibility</b>			
Host operating system			Operating system compatible with VMWARE 64 bit technology
Virtual Machine compatibility			VMWARE 64 bit
Hardware compatibility			64 bit architecture compatible with VMWARE 64 bit
Cloud compatibility			Hosting providers compatible with VMWARE technology
<b>Software/Firmware specification</b>			
Data acquisition			By means of Carlo Gavazzi's DP (Data push) protocol
Integrated operating system			64 bit Linux
Integrated data base			Industrial class SQL relational database
User interface			Integrated multi-user, multilingual web interface
<b>General specifications</b>			
Power supply	15 to 24 VDC power supply	Self-power supply from VMU-MC unit	
Approvals/Marks	cULus approved	cULus approved	
Managed UWP 3.0 or VMU-C EM units			From 20 to 100
Software installation			By DVD or USB stick containing the Em <sup>2</sup> -Server Virtual machine
Licensing			Perpetual license based on connected UWP 3.0 or VMU-C EM units
<b>References</b>			
For ordering key details, please refer to <a href="http://www.gavazziautomation.com">www.gavazziautomation.com</a>			

# Data aggregation solutions

	Serial converter	Ethernet gateway	M-Bus and wireless M-Bus to MODBUS/TCP gateways	M-bus converter	Optical communication interface
Types	SIU-PC3	SIU-TCP	SIU-MBM	VMU-B	OPTOPROG
					
Dimensions HxWxD (mm)	Front: 60 x 37.5	Front: 78 x 65	Front: 95 x 71	Front: 90 x 17.5	52 x 17.5 x 50.8
Function	RS422 / RS485 to USB converter	[SIU TCP2] RS232 / 485 to Ethernet Gateway [SIU TCP3] RS232 / 485 to Ethernet Modbus Gateway	Wireless M-Bus [only SIU-MBM-02] and M-Bus to Modbus/TCP gateway	Modbus to M-bus converter	Bluetooth and USB interface for meters and analysers with optical port
<b>Port 1</b>					
Port connections	USB type A	Ethernet, 10 / 100 Mbps RJ45	Ethernet, 10 / 100 Mbps RJ45	RS485	Bluetooth, Micro-USB
Baud rate	Max 961.6 kBaud	Max 230400 Baud			
<b>Port 2</b>					
Port connections	RS232, RS485 2-wire communication	[SIU TCP2] RS232, RS485 2-wire and 4-wire communication [SIU TCP3] RS232, RS485 2-wire communication	M-Bus, [SIU-MBM-02] wireless M-Bus (EU868MHz)	M-bus	Optical
<b>General specifications</b>					
Power supply	Self supplied by USB port	9 to 30 VDC AD5V1A: AC / DC power supply adapter (on request)	15 to 21 VAC; 18 to 35 VDC	18 to 260 VAC/DC	Battery
Approvals/Marks	CE - FCC	CE	CE	CE	CE - FCC - IC - Bluetooth 4.0
<b>References</b>					
	SIU PC3	SIU TCP2	SIU-MBM-01 SIU-MBM-01-160 (M-Bus)	VMUBM2US1B1A (for EM210, EM26)	OPTOPROG
		SIU TCP3	SIU-MBM-02 (M-Bus and wireless M-Bus)	VMUBM2US1B1B (for EM27x, EM280)	
				VMUBM2US1B1C (for WM15)	



## PV monitoring solutions

	Web-server	USB dongle connection module
Types	VMU-C PV	VMU-D
		
Dimensions HxWxD (mm)	2-DIN module	2-DIN module
Description	VMU-C is a Web-server which controls and supervises a photovoltaic installation acquiring information from Eos-Array groups, inverters and energy meters. The VMU-C provides information via Internet so data are available wherever you are. VMU-C is also capable of M2M communication by scheduling FTP uploads or by interacting with its HTTP API	Accessory module for connecting third party USB dongle modems (3G or 4G) approved by Carlo Gavazzi to VMU-C systems
Type	Micro PC	USB dongle connection module
Storage memory	4 GB	
Back-up memory	Micro-SD / Micro-SDHC / USB	
<b>Mobile communication specifications</b>		
SIM card		Depending on the modem unit
Compatibility		Compatible with USB modems (3G or 4G) approved by Carlo Gavazzi
Supported services		Internet communication; SMS
<b>LED</b>		
Status and colour	One led with different colors for internal BUS communication, communication ports, alarms and power supply	Single colour green for power supply status
<b>Communication port and output specifications</b>		
RS485	1 port for Eos-Arrays, 1 port for inverters and energy meters	
Ethernet	1 port for Internet / LAN connection	
USB	1 USB "A" (for USB stick) and 1 USB "mini-A" (service port)	1 USB "A" (for USB dongle modem connection)
<b>Antenna</b>		
Connector		Depending on the modem unit
Type		Depending on the modem unit
<b>Connections</b>		
RS485	3 screw terminals per port	
Ethernet	RJ-45 connector (10 / 100 Base-T)	
USB	High Speed USB 2.0	
<b>General specifications</b>		
Voltage supply	From 12 to 28 VDC	From 12 to 28 VDC
Power consumption	≤ 5 W	IN/OUT connection to supply also the VMU-C unit; consumption depending on the connected optional modules (range: from 8.6 W to 18.6 W)
Approvals/Marks	CE - cULus listed	CE - cULus listed
<b>References</b>		
For ordering key details, please refer to <a href="http://www.gavazziautomation.com">www.gavazziautomation.com</a>		

# PV monitoring solutions

## EOS-Array solar control solution

Types	VMU-M	VMU-S	VMU-P	VMU-O
				

Dimensions HxWxD (mm)	1-DIN module	1-DIN module	1-DIN module	1-DIN module
Description	Master unit 6-DGT readout	String unit, with built-in protection fuseholder	Environment variable measurement unit	Inputs/outputs unit
Function	VMU-M performs the local bus management of VMU-S, VMU-P both measuring units and VMU-O I/O unit	Variables measuring unit, DC current, voltage, power and energy metering. String control and efficiency measurement	PV module temperature, air temperature, sun irradiance and wind speed metering	VMU-O allows to add, for every single unit, available in the local bus two digital inputs and two relay outputs

### Input specifications

Range code	2 Pt100 or Pt1000, 3-wire (-50.0°C to +200.0°C) or one digital input and one pulse input. [T2]	Direct connections 16 A / 1000 VDC [AV10]. Measurements: V, A, W, Wh	2 Pt100 or Pt1000, 3-wire (PV and air temperature). 1 irradiance input (up to 120 mV [2TIW] or 4-20 mA [2TCW]). 1 wind speed input (0 to 1000 Hz max.)	2 digital inputs for "Protection trip detection or others" [I2]
Accuracy	±(0.5% RDG + 5DGT)	±(0.5% RDG + 2DGT)	±(0.2% RDG + 1DGT)	

### Output specifications

Alarm	Real and virtual alarm management of all variables coming from VMU-M, VMU-S, and VMU-P with event logging			2 digital outputs for alarm notification as string alarm or as a digital input status changing. SPST relay type. [R2]
Serial communication	Local bus: up to 15 mixed VMU-S, VMU-P and VMU-O units RS485 communication port (Modbus) [S1]	Local bus: up to 15 VMU-S units in the same bus [S]	Local bus: one VMU-P unit per bus [S]	Local bus: up to 7 VMU-O units
Others	Data logger (V, A, W, PV cell and air temperature, irradiation, wind speed) DC/AC efficiency	Diagnostics functions: antitheft control, fuse blow detection, wrong PV panel connection. Front multicolour LED to show the status of the unit	Front multicolour LED to show the status of the unit	Front multicolour LED to show the status of the unit

### General specifications

Power supply	12 to 28 VDC power supply [A]	Self-power supply from VMU-M unit [X]	Self-power supply from VMU-M unit [X]	Self-power supply from VMU-M unit [X]
Approvals/Marks	CE - cULus Listed	CE - cULus Listed	CE - cULus Listed	CE - cULus Listed

### References

For ordering key details, please refer to [www.gavazziautomation.com](http://www.gavazziautomation.com)

# PV monitoring solutions

## EOS-Array Lite solar control solution

### Types

#### VMU-ML

#### VMU-S0

#### VMU-P



Dimensions HxWxD (mm)	1-DIN module	1-DIN module	1-DIN module
Description	Master unit 6-DGT readout	String unit, with built-in protection fuseholder	Environment variable measurement unit
Function	VMU-ML performs the local bus management of VMU-S0, VMU-P both measuring units and VMU-O output unit	Variables measuring unit, DC current and voltage	PV module temperature, air temperature, sun irradiance

### Input specifications

Range code		Direct connections 16 A / 1000 VDC [AV10]. Measurements: V, A	1 Pt100 or Pt1000, 3-wire (PV and air temperature). 1 irradiation input (up to 120 mV [1TI] or 4 - 20 mA [2TCW])
Accuracy		$\pm(0.5\%RDG + 2DGT)$	$\pm(0.2\%RDG + 1DGT)$

### Output specifications

Alarm	Single real or virtual alarm management of all variables coming from VMU-ML, VMU-S0, and VMU-P		
Serial communication	Local bus: up to 15 mixed VMU-S0, VMU-P and VMU-O units RS485 communication port (Modbus) [S1]	Local bus: up to 15 VMU-S0 units in the same bus [S]	Local bus: one VMU-P unit per bus [S]
Others	Front dual colour LED to show the status of the unit	Diagnostics functions: wrong PV panel connection	Front multicolor LED to show the status of the unit



### General specifications

Power supply	12 to 28 VDC power supply [A]	Self-power supply from VMU-ML unit [X]	Self-power supply from VMU-ML unit [X]
Approvals/Marks	CE - cULus Listed	CE - cULus Listed	CE - cULus Listed



### References

For ordering key details, please refer to [www.gavazziautomation.com](http://www.gavazziautomation.com)

# PV monitoring solutions

	Solar irradiance sensor		Pyranometer
Types	PVS-1V	PVS-1A	PVS-2A
			
Dimensions (mm)	57 x 48 x 15 (not including clamp)	62 x 48 x 15 (not including clamp)	162 x 215 x 40
Description	Solar irradiance sensor based on photovoltaic technology built with a solid aluminium case and anti-UV encapsulating resin	Solar irradiance sensor based on photovoltaic technology built with a solid aluminium case and anti-UV encapsulating resin	Global solar radiation sensor based on a thermopile transducer compliant with WMO (World Meteorological Organization) standards for environmental monitoring, provided with worldwide valid calibration certificate
<b>Environmental specifications</b>			
Operating temperature	-10°C to 80°C	-10°C to 80°C	-40°C to 80°C
Degree of protection	IP 67	IP 67	IP 67
<b>General specifications</b>			
Technology	Crystalline calibrated cell	Crystalline calibrated cell	2 <sup>nd</sup> Class Thermopile Pyranometer according to ISO9060
Output	80 mV @ 1000 W/m <sup>2</sup> STC	4-20 mA	4-20 mA
Calibration	According to IEC 60904-2 and 60904-4 (calibration certificate as option)	According to IEC 60904-2 and 60904-4 (calibration certificate as option)	According to ISO9847 (calibration certificate included)
Solar irradiance range	0-1250 W/m <sup>2</sup>	0-1250 W/m <sup>2</sup>	0-2000 W/m <sup>2</sup>
Connector	3 PIN Phoenix M8 IP67 connector (male and female included)	3 PIN Phoenix M8 IP67 connector (male and female included)	7 pin IP68 connector (male, female and 10 meters cable included)
Housing material	Aluminium	Aluminium	Aluminium
Power supply	Self-powered	Powered by VMU-P module through the 4-20 mA current loop	10-28 VDC, power consumption < 0.1 W
Approvals/Marks	CE	CE	CE
<b>References</b>			
For ordering key details, please refer to <a href="http://www.gavazziautomation.com">www.gavazziautomation.com</a>			



# Building automation

	Automation server	Controllers	
Function	Building	Building	Hotel/Home
			
Dimensions HxWxD (mm)	2-DIN module	2-DIN module	2-DIN module
Description	It is an automation server, a powerful IIoT gateway and a programmable unit for building automation functions. It is empowered by a configurable web interface which makes it an outstanding HMI without screen. It integrates the standard IEC 61131 PLC (Codesys), so that any building automation function can be programmed by means of a standard and well-known tool	Controller for energy efficiency management and building automation, web-server and gateway; compatible with Carlo Gavazzi meters, analyzers and building automation solutions. It provides easy integration with local or remote SCADA/Server solutions and a configurable Web interface for control, analysis, alerting and reporting	Room controller for hotel and home application. Programmable light functions to control DALI lamps
Type	Micro PC	Micro PC	Micro PC
Storage memory	4 GB	4 GB	4 GB
Back-up memory	Micro-SD / Micro-SDHC / USB	Micro-SD / Micro-SDHC / USB	Micro-SD / Micro-SDHC / USB
<b>LED</b>			
Status and colour		One LED with different colours for BUS communication, communication ports, status and power supply	One LED with different colours for internal BUS communication, communication ports, alarms and power supply
<b>Communication port and output specifications</b>			
RS485	1 port for power analyzers, energy meters and Modbus devices	2 ports for power analyzers, energy meters and Modbus devices	
Ethernet	1 port for Internet / LAN connection, IoT, BACnet, Modbus, KNX IP	1 port for Internet / LAN connection, Bacnet clients and Modbus/TCP devices	1 port for Internet / LAN connection and Modbus/TCP devices
USB	1 USB "A" (for USB stick)	1 USB "mini-A" (service port)	1 USB "A" (for USB stick) and 1 USB "mini-A" (service port)
<b>Connections</b>			
RS485	3 screw terminals per port	3 screw terminals per port	
Ethernet	RJ-45 connector (10 / 100 Base-T)	RJ-45 connector (10 / 100 Base-T)	RJ-45 connector (10 / 100 Base-T)
USB	High Speed USB 2.0	High Speed USB 2.0	High Speed USB 2.0
<b>General specifications</b>			
Voltage supply	From 10 to 32 VDC	From 12 to 28 VDC	From 12 to 28 VDC
Power consumption	≤ 9 W	≤ 5 W	≤ 5 W
Approvals/Marks	CE - cULus listed	CE - cULus listed	CE - cULus listed
<b>References</b>			
	<b>XAP10RSEXX</b>	<b>UWP30RSEXXX</b>	<b>SA2WEB24</b>





# Building automation

Bus generators		
Function	Wired	Wired
		
Dimensions (mm)	2-DIN module	2-DIN module
Functions	Smart Dupline® generator	Dupline® generator
<b>Electrical specifications</b>		
Power supply	24 VDC ± 20%	24 VDC ± 20%
<b>General specifications</b>		
LEDs	Green, yellow	Green, yellow
Mounting	DIN-rail (2 modules)	DIN-rail (2 modules)
Degree of protection	Front: IP 40, Screw terminal: IP 20	Front: IP 40, Screw terminal: IP 20
Pollution degree	2 (IEC 60664-1, par. 4.6.2)	2 (IEC 60664-1, par. 4.6.2)
Operating temperature	-20°C to +50°C	-20°C to +50°C
Storage temperature	-50°C to +85°C	-50°C to +85°C
Humidity (non condensing)	20 to 80 %	20 to 80 %
Main features	Smart Dupline® bus generator. Connection of up to 250 slave modules	Dupline® bus generator
<b>References</b>		
	SH2MCG24	SH2DUG24

# Building automation



		Bus generators		
Function	Wireless	DALI Master	DALI ballast	
				
Dimensions (mm)	2-DIN module	2-DIN module	210 x 50 x 32	
Functions	Wireless base unit for generating wireless network	DALI Master and DALI Power supply	DALI driver for DT6 and DT8 LEDs	
<b>Electrical specifications</b>				
Power supply	24 VDC, 115-240 VAC	230 VAC	230 VAC	
<b>General specifications</b>				
LEDs	Green, yellow, blue	Green, yellow, yellow		
Mounting	DIN-rail (2 modules)		DIN-rail (2 modules)	
Degree of protection	Front: IP 40, Screw terminal: IP 20	Front: IP 40, Screw terminal: IP 20	IP 20	
Pollution degree	2 (IEC 60664-1, par. 4.6.2)		2 (IEC 60664-1, par. 4.6.2)	
Operating temperature	-20°C to +50°C	-20°C to +50°C	-20°C to +45°C	
Storage temperature	-50°C to +85°C	-40°C to +70°C	-40°C to +80°C	
Humidity (non condensing)	20 to 80 %		10 to 95 %	
Main features	Wireless bus generator. Connection of up to 250 slave modules. Based on IEEE 802.15.4, @ 2.4 GHz Range up to 700 m	Acts as a gateway between Smart Dupline® and DALI. Enables the use of DALI lighting actuators in the system - Tunable white management		DALI approved driver for standard and tunable white LEDs. It controls warm white and cool white output via a single DALI address, providing high power factor and efficiency. The output current is programmed by means of dip-switches, while the address can be assigned either by a DALI master or manually by means of the push-button
<b>References</b>				
	SH2WBU230N	SB2DALIT8230	SBBADT8CCT	

# Building automation

	Network module	USB dongle connection module	Relay modules	
Function	Repeater		SPST relay	Bistable relay
				
Dimensions (mm)	2-DIN module	2-DIN module	2-DIN module	2-DIN module
Functions	Repeater and isolator	Remote access by Internet when a wired connection is not available Plug'n'play configuration SMS alerting SMS commands Email alertin	Four-relay output module	Four-relay output module
<b>Electrical specifications</b>				
Outputs			4	4
Power supply	230 VAC	12 to 28 VDC	24 VDC	Bus
<b>General specifications</b>				
LEDs	Green, yellow, yellow	Green	Green, yellow, red	Green, yellow, red
Mounting	DIN-rail (2 modules)	DIN-rail (2 modules)	DIN-rail (2 modules)	DIN-rail (2 modules)
Degree of protection	Front: IP 40, Screw terminal: IP 20	Front: IP 40, Screw terminal: IP 20	Front: IP 40, Screw terminal: IP 20	Front: IP 40, Screw terminal: IP 20
Pollution degree	2 (IEC 60664-1, par. 4.6.2)		2 (IEC 60664-1, par. 4.6.2)	2 (IEC 60664-1, par. 4.6.2)
Operating temperature	0°C to +50°C	-25°C to +65°C	-20°C to +50°C	-20°C to +50°C
Storage temperature	-50°C to +85°C	-30°C to +70C	-50°C to +85°C	-50°C to +85°C
Humidity (non condensing)	20 to 90 %		20 to 80 %	20 to 80 %
Main features	Extends the transmission distance by regenerating the carrier signal and providing 300 mA bus output. Acts as an isolator between primary and secondary Dupline®	Compatible with Sx2WEB system Mobile Internet connection Compatible with USB dongle modems. Watchdog features to prevent common mobile network hassles	Load: 5 A, voltage free x 4 Local bus	Load: 16 A, 230 VAC x 4 Local bus
<b>References</b>				
	<b>SB2REP230</b>	<b>SH2DSP24</b>	<b>SH2RE1A424</b>	<b>SH2RE16A4</b>





## Building automation

Relay modules			
Output type	Bistable relay	Bistable relay	Wireless relay
			
Dimensions (mm)	2-DIN module	26 x 39 x 17	40 x 45 x 31
Functions	Two-relay output module with energy measurement	Small sized remote relay output	Wireless relay output module with energy measurement
Electrical specifications			
Outputs	2	1	1
Power supply	230 VAC	Bus	230/110 VAC
General specifications			
LEDs	Green, yellow, red		Green, blue
Mounting	DIN-rail (2 modules)	Decentralized	
Degree of protection	Front: IP 40, Screw terminal: IP 20		
Pollution degree	2 (IEC 60664-1, par. 4.6.2)	3 (IEC 60664)	2 (IEC 60664-1, par. 4.6.2)
Operating temperature	-20°C to +50°C	-20°C to +50°C	-20°C to +50°C
Storage temperature	-50°C to +85°C	-50°C to +85°C	-50°C to +85°C
Humidity (non condensing)	20 to 80 %	20 to 80 %	20 to 80 %
Main features	Load: 16 A, 230 VAC x 2 Energy reading, Local bus	Load: 13 A, 250 VAC	Load: 10 A, 250 VAC Energy reading, Wireless
References			
	<b>SH2RE16A2E230</b>	<b>BDA-RE13A-U</b>	
230 VAC			<b>SHJWRE10AE230</b>
115 VAC			<b>SHJWRE10AE115</b>
Capacitive push buttons			<b>SHJWRE10AExLS230</b>

# Building automation

## Roller blind modules

Output type	SPST relay	SPST relay	SPST relay
			

Dimensions (mm)	50 x 50 x 30	2-DIN module	2-DIN module
Functions	Decentralized module for up/down control of one rollerblind motor	Relay output module for up/down control of two AC rollerblind motors	Relay output module for up/down control of two DC rollerblind motors

### Electrical specifications

Outputs	1 SPST relay & 1 SPDT relay	2 SPST + 2 SPDT relay	2 SPST + 2 SPDT relay
Inputs	AC	AC	DC
Power supply	230 VAC ± 15%	24 VDC ± 20%	24 VDC ± 20%

### General specifications





LEDs		Green, yellow, red	Green, yellow, red
Mounting	Eurobox	DIN-rail (2 modules)	DIN-rail (2 modules)
Degree of protection		Front: IP 40, Screw terminal: IP 20	Front: IP 40, Screw terminal: IP 20
Pollution degree	3 (IEC 60664)	2 (IEC 60664-1, par. 4.6.2)	2 (IEC 60664-1, par. 4.6.2)
Operating temperature	-20°C to +50°C	-20°C to +50°C	-20°C to +50°C
Storage temperature	-50°C to +85°C	-50°C to +85°C	-50°C to +85°C
Humidity (non condensing)	20 to 80 %	20 to 80 %	20 to 80 %

Main features	Up/down control, tilting, local bus	Up/down control, tilting, local bus	Up/down control, tilting, local bus
---------------	-------------------------------------	-------------------------------------	-------------------------------------





### References

	<b>SHDRODC230</b>	<b>SH2ROAC224</b>	<b>SH2RODC224</b>
--	-------------------	-------------------	-------------------





# Building automation

	Dimmer modules			Output modules
Output type	Power mosfet	Wireless dimmer	1 to 10 V output	Solid state relay
				
Dimensions (mm)	2-DIN module	40 x 45 x 31	2-DIN module	2-DIN module
Functions	Power dimmer up to 500 W for R, L, C load and LED lamps	Power dimmer up to 200 W for R, L, C load and LED lamps	Analogue output dimmer for adjustable ballast with 1 to 10 V input	Four-solid-state relay output module
<b>Electrical specifications</b>				
Outputs	1	1	4	4
Power supply	230 VAC	230/110 VAC	24 VDC ± 20%	24 VDC ± 20%
<b>General specifications</b>				
LEDs	Green, yellow, red	Green, blue	Green, yellow, red	Green, yellow, red
Mounting	DIN-rail (2 modules)		DIN-rail (2 modules)	DIN-rail (2 modules)
Degree of protection	Front: IP 40, Screw terminal: IP 20		Front: IP 40, Screw terminal: IP 20	Front: IP 40, Screw terminal: IP 20
Pollution degree	2 (IEC 60664-1, par. 4.6.2)	2 (IEC 60664-1, par. 4.6.2)	2 (IEC 60664-1, par. 4.6.2)	2 (IEC 60664-1, par. 4.6.2)
Operating temperature	-20°C to +50°C	-20°C to +50°C	-20°C to +50°C	-20°C to +50°C
Storage temperature	-50°C to +85°C	-50°C to +85°C	-50°C to +85°C	-50°C to +85°C
Humidity (non condensing)	20 to 80 %	20 to 80 %	20 to 80 %	20 to 80 %
Main features	Local bus / Energy reading	Wireless universal dimmer with energy reading		Load: 10 W x 4 Local bus
<b>References</b>				
With energy reading	<b>SH2D500WE230</b>			
Without energy reading	<b>SH2D500W1230</b>			
230 VAC	<b>SHJWD200WE230</b>			
115 VAC	<b>SHJWD200WE115</b>			
Capacitive push buttons	<b>SHJWD200WExLS230</b>			
			<b>SH2D10V424</b>	<b>SH2SSTRI424</b>

# Building automation

Function	Energy meter modules		Digital input module	Fire damper
	Dupline® connection	Wireless	4 inputs	I/O module
				
Dimensions (mm)	2-DIN module	40 x 45 x 31	2-DIN module	150 x 110 x 70
Functions	Energy meter with direct connection up to 16 A	Energy meter with direct connection up to 16 A	Input module, configurable as contact or pulse counter	I/O-module for control of two fire dampers
<b>Electrical specifications</b>				
Inputs			4	4
Outputs				2 (T6 ONL)
Power supply	115...240 VAC	115...240 VAC	24 VDC ± 20%	24...230 VAC
<b>General specifications</b>				
LEDs	Green, yellow, red	Green, blue	Green, yellow, red	Green, yellow (3)
Mounting	DIN-rail (2 modules)		DIN-rail (2 modules)	Box ready for wall mounting
Degree of protection	Front: IP 40, Screw terminal: IP 20		Front: IP 40, Screw terminal: IP 20	IP55
Pollution degree	2 (IEC 60664-1, par. 4.6.2)	2 (IEC 60664-1, par. 4.6.2)	2 (IEC 60664-1, par. 4.6.2)	2 (IEC 60664-1, par. 4.6.2)
Operating temperature	-20°C to +50°C	-20°C to +50°C	-20°C to +50°C	0°C to +50°C
Storage temperature	-50°C to +85°C	-50°C to +85°C	-50°C to +85°C	-50°C to +85°C
Humidity (non condensing)	20 to 80 %	20 to 80 %	20 to 80 %	20 to 90 %
Main features	Values readout: A, V, W, Wdmd, VA, var, PF, kWh	Values readout: A, V, W, Wdmd, VA, var, PF, kWh	Voltage free, NPN, PNP, counter	Box ready for decentral mounting near dampers
<b>References</b>				
			<b>SH2INDI424</b>	
115...230 VAC	<b>SH2EM16A230</b>			
230 VAC		<b>SHJWEM16A230</b>		<b>SBB4I2O230T6</b>
115 VAC		<b>SHJWEM16A115</b>		
24 VAC				<b>SBB4I2O24T6</b>
Bus powered				<b>SBB4I</b>

## Building automation

	Transparent module	Analogue output modules	Analogue input modules	
Function		0 to 10 V output	Input module	Pulse counter
				
Dimensions (mm)	8.5 x 90 x 67	50 x 30 x 18	50 x 30 x 18	28 x 14 x 10
Functions	Transparent module for simplifying the wiring of the home installation	Output module with 2 analogue outputs	Input module with 2 analogue inputs	Decentral 4 input pulse counter module
<b>Electrical specifications</b>				
Inputs			2 x 0-20 / 4-20 mA inputs	
Outputs		2 x 0-10 VDC		
Power supply	No power supply needed	24 VDC	24 VDC	Powered by bus
<b>General specifications</b>				
Mounting	DIN-rail	Inside wall box or environmental sensor housings	Inside wall box or environmental sensor housings	Small sized plug-in
Degree of protection	Front: IP 40 Screw terminal: IP 20	IP 20	IP 20	IP 20
Pollution degree	2 (IEC 60664-1, par. 4.6.2)	2 (IEC 60664-1, par. 4.6.2)	2 (IEC 60664-1, par. 4.6.2)	
Operating temperature	-20°C to +50°C	0°C to +50°C	0°C to +50°C	0°C to +50°C
Storage temperature	-30°C to +70°C	-50°C to +85°C	-50°C to +85°C	-50°C to +70°C
Humidity (non condensing)	20 to 80 %	20 to 90 %	20 to 90 %	20 to 90%
<b>References</b>				
	<b>SH1DUPFT</b>	<b>SHPOUTV224</b>	<b>SHPINA224</b>	
50 inputs				<b>SHPINCTS04</b>
Contact inputs				<b>SHPINCNT4</b>

# Building automation

## Analogue input modules

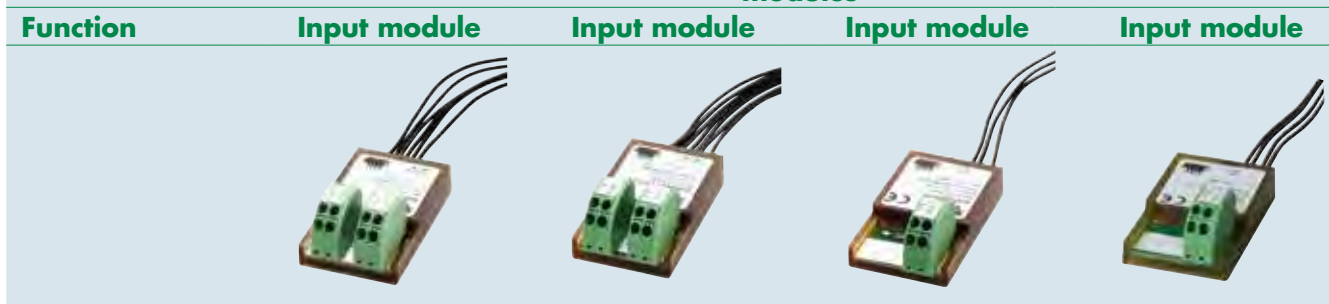

Dimensions (mm)	50 x 30 x 18	50 x 30 x 18	50 x 30 x 18	50 x 30 x 18
Functions	Input module with 3 analogue inputs	Input module with 4 analogue inputs	Input module with 2 analogue inputs	Input module with 2 analogue inputs

### Electrical specifications

Inputs	3 x 0-10 VDC	2 x 0-10 VDC, 1 x thermistor 10K3 input 1 x variable resistor 1-11 KΩ	1 x thermistor 10K3 1 x variable resistor 1-11 KΩ	2* Ni1000/Pt1000 inputs
Power supply	24 VDC	24 VDC	Bus	Bus

### General specifications

Mounting	Inside wall box or environmental sensor housings	Inside wall box or environmental sensor housings	Inside wall box or environmental sensor housings	Inside wall box or environmental sensor housings
Degree of protection	IP 20	IP 20	IP 20	IP 20
Pollution degree	2 (IEC 60664-1, par. 4.6.2)	2 (IEC 60664-1, par. 4.6.2)	2 (IEC 60664-1, par. 4.6.2)	2 (IEC 60664-1, par. 4.6.2)
Operating temperature	0°C to +50°C	0°C to +50°C	0°C to +50°C	0°C to +50°C
Storage temperature	-50°C to +85°C	-50°C to +85°C	-50°C to +85°C	-50°C to +85°C
Humidity (non condensing)	20 to 90 %	20 to 90 %	20 to 90 %	20 to 90 %

References				
	<b>SHPINV324</b>	<b>SHPINV2T1P124</b>	<b>SHPINT1P1</b>	<b>SHPINNI2</b>

# Building automation

## Light switch interfaces

### Function

### Input module

### Input / output



Dimensions (mm)

28 x 28 x 10

28 x 28 x 10

Functions

Input module for voltage free outputs

Input / output module for voltage free outputs and PNP transistor inputs

### Electrical specifications

Inputs

4/8

4

Outputs

4 PNP

Power supply

Powered by bus

Powered by bus

### General specifications

LEDs

Mounting

In a junction box or behind a switch/pushbutton input

In a junction box or behind a switch/pushbutton input

Degree of protection

IP 20

IP 20

Operating temperature

0°C to +50°C

0°C to +50°C

Storage temperature

-20°C to +70°C

-20°C to +70°C

Humidity (non condensing)

20 to 80%

20 to 80%

### References

4 contacts

**BDB-INCON4-U**

8 contacts

**BDB-INCON8-U**



Output voltage 3.3 V

**BDB-IOCP8-U**

Output voltage 8 V

**BDB-IOCP8A-U**



# Building automation

Input modules			
Function	Digital	Voltage	Wireless
			
Dimensions (mm)	89 x 66 x 29	28 x 28 x 10	40 x 45 x 31
Functions	Input module for voltage free outputs or NPN transistor outputs	Opto-isolated input voltage module, 90-265 VAC	Decentral 4 input and pulse counter module. Operating distance 700 m open space
Electrical specifications			
Inputs	4-contact or NPN transistor inputs	90 - 265 VAC	
Power supply	Powered by bus	Powered by bus	115...240 VAC
General specifications			
LEDs	Green, yellow, red		Green, blue
Degree of protection	IP 20	IP 20	
Pollution degree		3 (IEC 60664)	2 (IEC 60664-1, par. 4.6.2)
Operating temperature	-20°C to +50°C	-20°C to +50°C	-20°C to +50°C
Storage temperature	-50°C to +85°C	-50° to +70°C	-50°C to +85°C
Humidity (non condensing)	20 to 80%	20 to 80%	20 to 80 %
References			
	<b>BDD-INCON4-U</b>	<b>BDA-INVOL-U</b>	
4 contacts			SHJWINS04230, SHJWINS04115



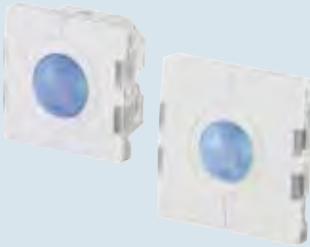

# Building automation

## Light switches

Function	4 pushbutton	4 pushbutton	4 pushbutton + PIR + Luxmeter
			
Dimensions (mm)	44 x 44 / 55 x 55	44 x 44 / 55 x 55	44 x 44 / 55 x 55
Functions	Light switch for building automation applications	Wireless light switch for building automation applications	Light switch and PIR sensor for detecting presence and/or movement in indoor installations
<b>Electrical specifications</b>			
Number of switches	4	4	4
Power supply	Powered by bus	Supplied by battery, type Lithium button 2450 3 V	Powered by bus
<b>General specifications</b>			
Colour	Black/white	Black/white	Black/white
LEDs	White/blue	Red/blue	White/blue
Mounting	Compatible with many types of wall boxes see datasheet	Compatible with many types of wall boxes see datasheet	Compatible with many types of wall boxes see datasheet
Degree of protection	IP 20	IP 20	IP 20
Pollution degree	3 (IEC 60664)	3 (IEC 60664)	3 (IEC 60664)
Operating temperature	-20°C to +50°C	-20°C to +50°C	0°C to +50°C
Storage temperature	-30°C to +60°C	-30°C to +60°C	-20°C to +70°C
Humidity (non condensing)	20 to 80%	20 to 80%	20 to 80%
Other functions	Humidity and temperature sensor (...TH)	55x55: Flat design, mountable on any surface, embedded temperature sensor	Operating distance: 8 m Angle: 90°
Remarks	Approved according to UL60950	Approved according to UL60950	Approved according to UL60950
<b>References</b>			
44 x 44 Wallbox Btcino, Niko, Fuga	<b>B4X-LS4-U</b>	<b>SHA4XWLS4</b>	<b>SHA4XLS4P90L</b>
55 x 55 Compatible with many types of wall boxes - see datasheet	<b>B5X-LS4-U</b>	<b>SHE5XWLS4WF</b> <b>SHE5XWLS4BF</b>	<b>SHE5XLS4P90L</b>
55 x 55 Compatible with many types of wall boxes - see datasheet Temperature		<b>SHE5XWLS4WFT</b> <b>SHE5XWLS4BFT</b>	
44 x 44 Wallbox Btcino, Niko, Fuga Temperature and humidity	<b>SHA4XLS4TH</b>		
55 x 55 Compatible with many types of wall boxes - see datasheet Temperature and humidity	<b>SHE5XLS4TH</b>		

# Building automation

	Temperature display	Movement / Presence sensors	
Function		150° PIR/ Luxmeter	90° PIR/ Luxmeter
			
Dimensions (mm)	44 x 44 / 55 x 55	44 x 44 / 55 x 55	44 x 44 / 55 x 55
Functions	Temperature controller with display	PIR sensor for detecting presence and/or movement in indoor installations	PIR sensor for detecting presence and/or movement in indoor installations

## Electrical specifications

Number of switches	4		
Power supply	Powered by bus	Powered by bus	Powered by bus

## General specifications



Colour	White/black	White/black	White/black
LEDs	White/blue	White/blue	White/blue
Mounting	Wallbox Btcino, Niko, Fuga / Elko, Gira, Jung	Wallbox Btcino, Niko, Fuga / Elko, Gira, Jung	Wallbox Btcino, Niko, Fuga / Elko, Gira, Jung
Degree of protection	IP 20	IP 20	IP 20
Pollution degree	3 (IEC 60664)	3 (IEC 60664)	3 (IEC 60664)
Operating temperature	-10°C to +50°C	-20°C to +50°C	0°C to +50°C
Storage temperature	-20°C to +70°C	-30°C to +70°C	-20°C to +70°C
Humidity (non condensing)	20 to 80%	20 to 80%	20 to 80%
Remarks	Approved according to UL60950	Operating distance: 8 m angle: 150°	Operating distance: 8 m Angle: 90°

## References

44 x 44 Wallbox Btcino, Niko, Fuga	<b>SHA4XTEMDIS SHA4XLS2TEMDIS</b>	<b>SHA4XP150/SHA4XP150L</b>	<b>B4X-PIR90-U</b>
55 x 55 Compatible with many types of wall boxes - see datasheet	<b>SHE5XTEMDIS SHE5XLS2TEMDIS</b>	<b>SHE5XP150/SHE5XP150L</b>	<b>B5X-PIR90-U</b>
44 x 44 Wallbox Btcino, Niko, Fuga + luxmeter			<b>SHA4XP90L</b>
55 x 55 Compatible with many types of wall boxes - see datasheet + luxmeter			<b>SHE5XP90L</b>



# Building automation

## Movement / Presence sensors



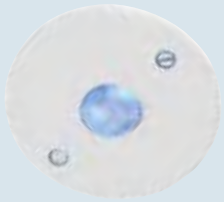
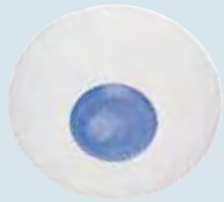

Function	90° PIR/ Luxmeter	90° PIR/ Luxmeter
		
Dimensions (mm)	104 x 55 x 57	67 x 52 x 34
Functions	PIR sensor for detecting presence and/or movement in indoor installations	PIR sensor for detecting presence and/or movement in indoor / outdoor installations
<b>Electrical specifications</b>		
Power supply	Powered by bus	Powered by bus
<b>General specifications</b>		
Colour	White	White
LEDs	Red	Red
Mounting	Wall mounting	Wall mounting
Degree of protection	IP 40	IP 64 / IP 20
Pollution degree	3 (IEC 60664)	3 (IEC 60664)
Operating temperature	0°C to +50°C	-20°C to +50°C
Storage temperature	-20°C to +70°C	-30°C to +70°C
Humidity (non condensing)	20 to 80%	20 to 80%
Main features	Operating distance: 12 m Angle: 90°	Operating distance: 0.5 - 15 m Angle: 90°
<b>References</b>		
	<b>BSD-PIR90-U</b>	
Luxmeter	<b>SHSDP90L</b>	
Outdoor		<b>BSP-PIR90-U</b>
Indoor		<b>BSP-PIR90A-U</b>
Outdoor + luxmeter		<b>SHSPP90L</b>
Indoor + luxmeter		<b>SHSPP90LA</b>

# Building automation

## Movement / Presence sensors

Function	90° PIR/ Luxmeter	360° PIR/ Luxmeter	360° PIR/ Luxmeter
			
Dimensions (mm)	Ø 76 x 25	Ø 90 x 40	Ø 96.5 x 70.6
Functions	PIR sensor for detecting presence and/or movement in indoor installations	PIR sensor for detecting presence and/or movement in indoor installations with a built-in luxmeter	PIR sensor for detecting presence and/or movement in indoor and outdoor installations with a built-in luxmeter
<b>Electrical specifications</b>			
Power supply	Powered by bus	Powered by bus	Powered by bus
<b>General specifications</b>			
Colour	White	White	White
LEDs	Blue	Blue	Blue
Mounting	LK ceilingbox PL52 or PL55	Ceiling mounting	Ceiling mounting
Degree of protection	IP 20	IP 20	IP 20, IP 55
Pollution degree	3 (IEC 60664)	3 (IEC 60664)	3 (IEC 60664)
Operating temperature	0°C to +50°C	0°C to +50°C	0°C to +50°C
Storage temperature	-20°C to +70°C	-20°C to +70°C	-20°C to +70°C
Humidity (non condensing)	20 to 80%	20 to 80%	20 to 80%
Main features	Detection range: ≤ Ø 8 m Angle: 90°	Detection range: ≤ Ø 7.5 m Angle: 360° Lens: dual detecting zones	Detection range: Ø 14 m and Ø 24 m Angle: 360° Detection Area: programmable
<b>References</b>			
	<b>BSB-PIR90-U</b>	<b>SHSQP360L</b>	
Luxmeter	<b>SHSBP90L</b>		
24 m, built-in			<b>SBQP360L24M</b>
14 m, built-in			<b>SHQP360L7M</b>
24 m, surface			<b>SBQP360L24MF</b>
24 m, surface, IP 55			<b>SBQP360L24MFO</b>
14 m, surface			<b>SHQP360L7MF</b>
14 m, surface, IP 55			<b>SHQP360L7MFO</b>

# Building automation

	Touch displays	Environmental sensors		
Function	Graphical display	Display	RGB LED	Blind
				

Dimensions (mm)	187 x 147 / 147 x 107	80 x 90 x 26	80 x 90 x 26	80 x 90 x 26
Functions	High definition 7" and 4.3" colour touchscreens, BACnet, Modbus and KNX gateway	Room sensors for CO <sub>2</sub> temperature and %RH measurement - with display	Room sensors for CO <sub>2</sub> temperature and %RH measurement - with LED indication	Room sensors for CO <sub>2</sub> temperature and %RH measurement

## Electrical specifications

Power supply	24 VDC ± 20%	Bus	Bus	Bus
--------------	--------------	-----	-----	-----





## General specifications

Mounting	Wall mounting	Wall mounting	Wall mounting	Wall mounting
Indication	Display	Display	Red, green, blue	None
Degree of protection	Front: IP 66 Rear: IP 20	IP 20	IP 20	IP 20
Pollution degree		2 (IEC 60664-1, par. 4.6.2)	2 (IEC 60664-1, par. 4.6.2)	2 (IEC 60664-1, par. 4.6.2)
Operating temperature	0°C to +50°C	-20°C to +50°C	-20°C to +50°C	-20°C to +50°C
Storage temperature	-20°C to +70°C	-40°C to +70°C	-40°C to +70°C	-40°C to +70°C
Humidity (non condensing)	5 to 85% RH	0 to 90 %	0 to 90 %	0 to 90 %
Main features	Windows CE, 7", 800 x 480 pixel / 4.3", 480 x 272 pixel, Ethernet port, BACnet, Modbus, KNX, data logging, configurable graphical display and alarms management	CO <sub>2</sub> measuring range: 0 to 2000 ppm CO <sub>2</sub> measurement: Dual source infrared NDIR technology Temperature measuring range: -20°C to +50°C (-4 to 122°F) Humidity measuring range: 0 to 100 %RH	CO <sub>2</sub> measuring range: 0 to 2000 ppm CO <sub>2</sub> measurement: Dual source infrared NDIR technology Temperature measuring range: -20°C to +50°C (-4 to 122°F) Humidity measuring range: 0 to 100 %RH	CO <sub>2</sub> measuring range: 0 to 2000 ppm CO <sub>2</sub> measurement: Dual source infrared NDIR technology Temperature measuring range: -20°C to +50°C (-4 to 122°F) Humidity measuring range: 0 to 100 %RH





## References

7", 800 x 480 pixel	<b>BTM-T7-24</b>			
4.3", 480 x 272 pixel	<b>BTM-T4-24</b>			
Display, CO <sub>2</sub> + temperature		<b>SHSUCOTD</b>		
Display, CO <sub>2</sub> + temperature + humidity		<b>SHSUCOTH</b>		
Display, temperature + humidity		<b>SHSUTH</b>		
Display, temperature		<b>SHSUTD</b>		
RGB Led, CO <sub>2</sub> + temperature			<b>SHSUCOTL</b>	
RGB Led, temperature + humidity			<b>SHSUCOHL</b>	
CO <sub>2</sub> + temperature				<b>SHSUCOT</b>
CO <sub>2</sub> + temperature + humidity				<b>SHSUCOHL</b>
Temperature + humidity				<b>SHSUTH</b>
Temperature				<b>SHSUT</b>





## Building automation

	Smoke	Water	Window	Alarm
Function	Smoke detector	Water sensor	Wireless sensor	Keypad
				
Dimensions (mm)	Ø 100 x 51	70 x 39 x 15.5	Sensor: 60 x 30 x 15.5, Magnet: 32 x 10.2 x 11.5	130 x 50 x 8
Functions	Smoke detector for home/ building applications	Water detection sensor for home/building applications	Wireless, battery powered reed sensor with additional input	Programmable keypad for building access control and alarm control in indoor and outdoor applications
<b>Electrical specifications</b>				
Inputs			Reed, voltage free	12 push buttons
Power supply	Powered by bus / 9 VDC battery	Powered by bus	Battery	9-17 VDC
<b>General specifications</b>				
Colour	White	White	White	Black / white
LEDs	Red		Red / blue	Yellow, red, green, programmable
Mounting	Ceiling mounting	Wall mounting	Wall mounting, screw and double side tape	Wall box mounting
Degree of protection	IP 43	IP 67	IP 20	IP 67
Pollution degree			2 (IEC 60664-1, par. 4.6.2)	
Operating temperature	0°C to +50°C	-20°C to +50°C	-20°C to +50°C	-15°C to +60°C
Storage temperature	-5°C to +85°C	-50°C to +85°C	-30°C to +85°C	-30° to 80°C
Humidity (non condensing)	20 to 80%	20 to 80 %	20 to 80 %	100%
Main features	Detection area: 60 m <sup>2</sup>	Input for Felson probe		28 user-programmable codes, Buzzer output
<b>References</b>				
		<b>BSF-WAT-U</b>		<b>BACC-KEYPAD-DC-U</b>
Battery backup	<b>BSG-SMOA-U</b>			
No battery backup	<b>BSG-SMO-U</b>			
Reed contact			<b>SHDWWISEN</b>	
Reed contact + voltage free			<b>SHDWWISENIN1</b>	

## Building automation



	Environmental sensor		Light	Temperature
Function	Weather station	Anemometer	Luxmeter	Outdoor
				
Dimensions (mm)	96 x 77 x 118	183 x 137 x 145	55 x 53 x 36	67 x 35 x 15
Functions	Weather station for measurement of temperature, wind speed, brightness and precipitation	Anemometer for building automation applications	Luxmeter for indoor / outdoor installations	Temperature sensor for indoor and outdoor applications
<b>Electrical specifications</b>				
Power supply	12 to 40 VDC / 12 to 28 VAC	Powered by bus	Powered by bus	Powered by bus
<b>General specifications</b>				
Colour	White		White	Light grey
Mounting	Wall mounting	Wall mounting	Wall mounting	Direct wall mounting
Connection				Cable / plug
Degree of protection	IP 44	IP 54	IP 44	IP 67
Pollution degree	2 (IEC 60664-1, par. 4.6.2)			
Operating temperature	-30°C to +50°	-20°C to +60°C	-30°C to +60°C	-40°C to +60°C
Storage temperature	-30°C to +70°C	-20°C to +60°C		-55°C to +85°C
Humidity (non condensing)	5 to 95%	20 to 80%		20 to 80%
Main features	GPS receiver	Measuring range: 2 to 25 m/s Heating system	Measuring range: 0 to 20 kLux	
Remarks				Approved according to UL60950
<b>References</b>				
	<b>SHOWEAGPS</b>	<b>BSN-ANE-U</b>	<b>BSH-LUX-U</b>	
Cable, 2 m				<b>BSI-TEMANAB-U</b>
Plug, M12				<b>BSI-TEMANA-U</b>

# Parking guidance system



	<b>Carpark Master generator</b>	<b>Carpark Controller</b>	<b>Carpark Server</b>	<b>Carpark Display interface</b>
<b>Types</b>	<b>SBP2MCG324</b>	<b>UWP30</b>	<b>SBP2CPY24</b>	<b>SBP2DI48524</b>
				
<b>Dimensions</b>	2-DIN module	2-DIN module	2-DIN module	2-DIN module
<b>Functions</b>	The Carpark Master Generator provide 28 VDC power and bus on a 3-wire connection with up to 90 sensors	Programmable controller with functions for parking guidance, booking, energy saving. One controller can manage up to 7 Dupline® networks (630 spaces). Compatible with Carlo Gavazzi meters, analyzers and building automation solutions. It provides easy integration with local or remote SCADA/Server solutions and a configurable Web interface for control, analysis, alerting and reporting	Carpark server to link together up to 10 carpark controllers UWP30 in a TCP/IP network to manage large networks (up to 6300 spaces)	Module which interface between Dupline and Modbus RTU for Carpark displays
<b>Housing type</b>	Mounting on DIN-rail	Mounting on DIN-rail	Mounting on DIN-rail	Mounting on DIN-rail
<b>Electrical specifications</b>				
<b>Features/Signal types</b>	3-wire master generator for carpark sensors and LED indicators. Other smartbuilding components such as PIR, CO sensors and HVAC modules can be connected to the same bus	Various I/O's and function parameters are available as BACnet/IP objects through the Ethernet port, thereby allowing seamless integration with any building management system, thereby allowing energy saving functions for lighting and ventilation	The webserver aggregates data from multiple carpark controllers in a single centralized database, allowing the user to access them as a graphical user interface through a PC with a standard Web-browser	Interface module between Dupline® and Modbus RTU. RS485 to display. Up to 300 m
<b>Power supply</b>	28 VDC	24 VDC	24 VDC	24 VDC
<b>General specifications</b>				
<b>Degree of protection</b>	IP 20	IP 20	IP 20	IP 20
<b>Pollution degree</b>	-20°C to +50°C	-25°C to +50°C	-25°C to +50°C	-20°C to +50°C
<b>Operating temperature</b>	-50°C to +85°C	-30°C to +70°C	-30°C to +70°C	-50°C to +85°C
<b>References</b>				
<b>Carpark master generator</b>	<b>SBP2MCG324</b>			
<b>Carpark controller</b>		<b>UWP30RSEXXX</b>		
<b>Carpark server</b>			<b>SBP2CPY24</b>	
<b>Display interface</b>				<b>SBP2DI48524</b>

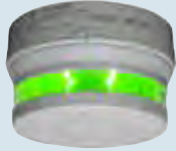



## Parking guidance system

	Sensor	LED indicator	Baseholder
<b>Types</b>	<b>SBPSUSLxx</b>	<b>SBPILED</b>	<b>SBPBASEx</b>
			
<b>Dimensions (mm)</b>	Ø116 x 78	Ø116 x 50	Ø116 x 26 / Ø116 x 44
<b>Functions</b>	Ultrasonic sensors for detection of cars and with RGB LED indication	LED indicator with RGB LED indication	Baseholder for Carpark sensors and LED indicator
<b>Housing type</b>	Direct mounting on base holder to rail, ceiling or conduit/pipe	Direct mounting on base holder to rail, ceiling or conduit/pipe	Direct mounting of base holder on rail, ceiling or conduit/pipe
<b>Electrical specifications</b>			
<b>Features/Signal types</b>	3-wire sensor with built-in RGB LEDs. Programmable from the UWP tool configuration software. Can detect available or occupied spaces or be used in count systems	3-wire LED indicator with built-in RGB LEDs. Programmable from the UWP tool configuration software. To be mounted outside the parking space	Baseholder for sensors and LED indicators. No programming. Only wire connected
<b>Power supply</b>	3-wire system with Dupline <sup>®</sup> and sensor supply	3-wire system with Dupline <sup>®</sup> and sensor supply	
<b>General specifications</b>			
<b>Degree of protection</b>	IP 34	IP 34	IP 34
<b>Operating temperature</b>	-40°C to +70°C	-40°C to +70°C	-40°C to +70°C
<b>Storage temperature</b>	-40°C to +85°C	-50°C to +85°C	-50°C to +85°C
<b>References</b>			
45 degree sensor	<b>SBPSUSL45</b>		
Vertical sensor	<b>SBPSUSL</b>		
Counting sensor	<b>SBPSUSCNT</b>		
LED indicator		<b>SBPILED</b>	
Baseholder for cable tray / conduit			<b>SBPBASEA</b>
Baseholder for ceiling			<b>SBPBASEB</b>



# Parking guidance system

Displays			
Types	DIS A RSE	DIS B RSE	DIS C RSE
			
Dimensions (mm)	260 x 150 x 80	520 x 150 x 80	520 x 250 x 80
Functions	Bright RGB LED matrix <ul style="list-style-type: none"> <li>• Selectable symbols</li> <li>• Visible at a distance of more than 50 m</li> <li>• Brightness control</li> <li>• Settings are configurable from the embedded webserver</li> <li>• Indoor and outdoor use</li> <li>• Extended temperature range down to -30°C</li> <li>• Configuration: up to 4 digits or 2 symbols</li> </ul>	Bright RGB LED matrix <ul style="list-style-type: none"> <li>• Selectable symbols</li> <li>• Visible at a distance of more than 50 m</li> <li>• Brightness control</li> <li>• Settings are configurable from the embedded webserver</li> <li>• Indoor and outdoor use</li> <li>• Extended temperature range down to -30°C</li> <li>• Configuration: up to 4 digits and 2 symbols</li> </ul>	Bright RGB LED matrix <ul style="list-style-type: none"> <li>• Selectable symbols</li> <li>• Visible at a distance of more than 50 m</li> <li>• Brightness control</li> <li>• Settings are configurable from the embedded webserver</li> <li>• Indoor and outdoor use</li> <li>• Extended temperature range down to -30°C</li> <li>• Configuration: up to 4 digits and 2 symbols and running text. Can combine text and digits.</li> </ul>
<b>Electrical specifications</b>			
Power supply	24 VDC	24 VDC	24 VDC
<b>Features</b>			
	Guides the driver by showing moving green arrow or red cross or other symbols as well as number of free spaces for a lane or area in the carpark. RS485 communication	Guides the driver by showing moving green arrow or red cross or other symbols as well as number of free spaces for a lane or area in the carpark. RS485 communication	Shows a running text and a combination with up to 4 digits and two symbols. The text is of costumers own choice. RS485 communication
<b>General specifications</b>			
Degree of protection	IP 24	IP 24	IP 24
Pollution degree	3 (IEC 60664)	3 (IEC 60664)	3 (IEC 60664)
Operating temperature	-30°C to +55°C	-30°C to +55°C	-30°C to +55°C
Humidity	10 to 90% non condensing	10 to 90% non condensing	10 to 90% non condensing
<b>References</b>			
One tile	<b>DISARSE</b>		
Two tiles	<b>DISBRSE</b>		
Four tiles	<b>DISCRSE</b>		

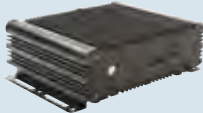

## Parking guidance system

	Carpark LoRa®-based wireless sensor	Carpark NB-IoT wireless sensor	Carpark Concentrator for wireless sensor	Videobox
Types	<b>SBPWSI1</b>	<b>SBPWSI2</b>	<b>SBPCWSI1xxx</b>	<b>SBPVBE</b>
				
Dimensions	91 x 96 x 84 mm	91 x 96 x 84 mm	300 x 175 x 92 mm	160 x 51 x 127 mm
Functions	LoRa® proprietary and LoRaWAN® sensor for smart parking installations	NB-IoT sensor for smart parking installations	Concentrator for proprietary LoRa® wireless sensor	The videobox converts the IP cameras images into occupancy information
Housing type	Recessed	Recessed	Mounting on pole/wall	Mounting on DIN-rail
<b>Electrical specifications</b>				
Features/Signal types	It detects the occupied/free status of the parking bays by using the earth's magnetic field. Operating frequency: 868 MHz. The SBPWSI1 sensor can be configured to transmits the parking bay status to the central gateway SBPCWSI1 using Long Range wireless communication or directly to the LoRaWAN® networks.	It detects the occupied/free status of the parking bays by using the earth's magnetic field. The SBPWSI2 sensor communicate directly to the NB-IoT bridges and then to the cloud.	The SBPCWSI1 is a compact Long Range wireless gateway designed to collect occupancy information from SBPWSI1 sensors. The occupancy information is transmitted to the cloud in real-time by means of the wireless 4G/LTE cellular network or LAN connection and UWP3.0/SBP2CPY platform gathers data by means of the cloud.	The SBPVBE is a small PC to which up to 8 IP cameras can be connected. It works in accordance with the GDPR: after analysing the images, they are automatically destroyed so that there is no trace of sensitive content
Power supply	Battery	Battery	24 VDC/230 VAC	110 VAC/230VAC
<b>General specifications</b>				
Degree of protection	IP 68	IP 68	IP 66	IP 54
Operating temperature	-50°C to +85°C	-30°C to +70°C	-20°C to +60°C	-20°C to +60°C
<b>References</b>				
Wireless sensor	<b>SBPWSI1</b>	<b>SBPWSI2</b>		
Concentrator			<b>SBPCWSI1230</b> <b>SBPCWSI124</b>	
Videobox				<b>SBPVBE</b>





# DuplineSafe

	Input module	Output module
<b>Types</b>	<b>GS7510 2101</b>	<b>GS3830 0143</b>
		
Dimensions (mm)	57.5 x 36.0 x 16.4	144 x 77 x 70
Functions	Bus-powered safety input module	DuplineSafe relay output module. Monitors up to 63 DuplineSafe inputs
Housing type		DIN-rail mounting H8
<b>Electrical specifications</b>		
Number of channels	2	2
Features/Signal types	1 x NC contact	2 x NO Relays Force Guided contact
Power supply	Powered through the Dupline® network	230 VAC ± 15%
<b>General specifications</b>		
Degree of protection	IP 67	IP 20
Pollution degree	3 (IEC 60664)	3 (IEC 60664)
Operating temperature	-40°C to +50°C	-25°C to +50°C
Storage temperature	-40°C to +70°C	-30°C to +70°C
Humidity (non condensing)	20 to 80%	20 to 80%
Remarks	Approved according to IEC/EN 61508, EN 62061 and ISO/EN 13849-1 PL e	Approved according to IEC/EN 61508, EN 62061 and ISO/EN 13849-1 PL e
<b>References</b>		
Cable connection	<b>GS7510 2101</b>	
Cable connection cULus approved	<b>GS7510 2192</b>	
Plug connector	<b>GS7510 2101-1</b>	
Plug connector cULus approved	<b>GS7510 2192-1</b>	
Output relay		<b>GS3830 0143</b>

# DuplineSafe

Gateway / interface			
Types	GS33910060800	GS3891 0125	GSTI 50
			
Dimensions (mm)	90 x 35 x 58.5	144 x 77 x 70	55 x 70 x 15
Functions	Profinet gateway with function as slave. Up to 7 master generators can be connected via the HS RS485 bus. All Dupline® signals from master generators are available on Profinet	Profibus-DP Gateway passive with Safety mapping	Dupline® Modbus interface module with Safety mapping
Housing type	DIN-rail mounting H2	DIN-rail mounting H8	Compact plastic housing
Electrical specifications			
Features/Signal types	Reads/controls up to 7 Dupline networks through Profinet. Miniwebserver for diagnostics of Profinet and Dupline® networks available	Reads/controls up to 128 inputs/outputs through Profibus-DP. Communication speed up to 12 MBaud	
Power supply	24 VDC	115 = 115 VAC 230 = 230 VAC	Powered by the RS485 com port
General specifications			
Degree of protection	IP 20	IP 20	IP 20
Operating temperature	-20°C to +50°C	0°C to +50°C	-20°C to +60°C
Storage temperature	-30°C to +85°C	-20°C to +85°C	-30°C to +85°C
Humidity (non condensing)	20 to 80%	20 to 80%	
Remarks		Certified by PNO	Supports Modbus RTU function code 3 and code 16
References			
	GS33910060800	GS3891 0125	GSTI 50

# DuplineSafe

	Optical fibre converter	Repeater	Configuration tool	
Types	GS3492/GS3493	GS3892 0000	GS7380 0080	GS7380 0081
				
Dimensions (mm)	77 x 72 x 70	77 x 144 x 70	28 x 90 x 145	25 x 50 x 100
Functions	Optical repeater for converting DuplineSafe from electrical to optical transmission media	DuplineSafe signal repeater for extension of transmission distance	Configuration and test unit for DuplineSafe	USB Configuration unit for DuplineSafe
Housing type	DIN-rail, H4	DIN-rail H8	Handheld	Handheld
<b>Electrical specifications</b>				
Number of channels	Adjusts automatically	Adjusts automatically		
Features/Signal types	All Dupline® signal types	Regenerates the Dupline® signal carrier through channel generator output		Windows based programming tool for safety output relay module and safety input modules
Power supply	230 = 115/230 VAC	024 = 024 VAC 115 = 115 VAC 230 = 230 VAC	9 V battery 6LR61	Supplied by the USB port
<b>General specifications</b>				
Degree of protection	IP 20	IP 40	IP 40	IP 40
Pollution degree				3 (IEC 60664)
Operating temperature	0°C to +50°C	0°C to +50°C	0°C to +50°C	0°C to +50°C
Storage temperature	-20°C to +85°C	-50°C to +85°C	-20°C to +70°C	-20°C to +60°C
Remarks	Operates pair-wise. Runs on 50/125, 62.5/125 or 100/140 micro m with STN connectors		Adapt 7380 is included	
<b>References</b>				
		<b>GS3892 0000</b>	<b>GS7380 0080</b>	<b>GS7380 0081</b>
Optical/electrical converter	<b>GS3492 0000</b>			
Electrical/optical converter	<b>GS3493 0000</b>			

# DuplineSafe

## Master generator

### Types



**GS33900000800**



Dimensions (mm)	90 x 35 x 58.5
Functions	Master channel generator which provide Dupline® bus carrier with power and communication for the connected Dupline® units
Housing type	DIN-rail mounting H2
<b>Electrical specifications</b>	
Number of channels	128
Features/Signal types	The unit supports Digital in/out, Analink in/out, Mux BCD in/out, 8 bit in/out and DuplineSafe in High Dupline® current output (450 mA)
Power supply	24 VDC
<b>General specifications</b>	
Degree of protection	IP 20
Operating temperature	-20°C to +50°C
Storage temperature	-50°C to +85°C
Humidity (non condensing)	20 to 80%
<b>References</b>	
Dupline® Master Channel Generator	<b>GS33900000800</b>



# Fieldbuses - Industrial

## Channel generators/interfaces



Types	SD2DUG24	G3496	G3800
			
Dimensions (mm)	35 x 90 x 58,5	77 x 72 x 70	77 x 144 x 70
Functions	Standard channel generator	Plug & Play RS232/RS485 Interface with built-in protocols for specific PLC brands and Modbus	Controller and Modbus Interface with built-in GSM Modem (option) or external Radio Modem Logger (option)
Housing type	DIN-rail, H4	DIN-rail, H4	DIN-rail, H8
<b>Electrical specifications</b>			
Number of channels	Selectable	Selectable	Selectable
Features/Signal types	2 and 3-wire operation with DC-power on the 3 <sup>rd</sup> wire. The unit supports Digital in/out, Analink in/out, Mux BCD in/out, 8 bit in/out and Dupline	Possibility for 3-wire operation with DC-power on the 3 <sup>rd</sup> wire	4 x Contact/PNP input +4 x PNP 10-30 VDC output 2 x RS232+1 x RS485. Possibility for alarms, monitoring and control via SMS messages
Power supply	24 VDC	700 = 20-30 VDC	800 = 10-30 VDC 230 = 115-230 VAC
<b>General specifications</b>			
Degree of protection	IP 20	IP 20	IP 20
Operating temperature	-20°C to +50°C	0°C to +50°C	0°C to +50°C
Storage temperature	-50°C to +85°C	-50°C to +85°C	-20°C to +85°C
Remarks	Modbus gateway, RS485	Built-in protocol for specific PLC brands for easy interfacing	Up to 32 controllers can be networked together via RS485 or Ethernet via converter module
<b>References</b>			
Channel Generator	<b>SD2DUG24</b>		
Mitsubishi	<b>G3496 0003</b>		
Omron	<b>G3496 0004</b>		
Allen-Bradley	<b>G3496 0006</b>		
Schneider	<b>G3496 0007</b>		
Matsushita	<b>G3496 0009</b>		
-GSM Modem, -RS485			<b>G3800 0015</b>
-GSM Modem, +RS485			<b>G3800 0016</b>



# Fieldbuses - Industrial



	Channel generators/interfaces		Digital input modules	
Types	G3891	GTI50	G3410 5501	G3420
				
Dimensions (mm)	77 x 144 x 70	55 x 70 x 15 mm	77 x 72 x 70	77 x 72 x 70
Functions	Gateways to Fieldbus systems (Profibus-DP, DeviceNet etc.)	Dupline® Modbus RTU Interface module for Text Displays and Touch screens	Dupline® powered transmitter with 8 monostable volt-free contacts	Input module for external supply with optoisolated inputs
Housing type	DIN-rail, H8	Closed plastic housing with 25p male sub-D	DIN-rail, H4	DIN-rail, H4
<b>Electrical specifications</b>				
Number of channels	Selectable		8	8
Features/Signal types		Supports Modbus RTU function code 3 and code 16	Volt-free input contacts	Contact/NPN Voltage (6-265 VAC/DC)
Power supply	230 = 115/230 VAC	Powered by RS485 port	Powered by Dupline®	024 = 24 VAC 115 = 115 VAC 230 = 230 VAC 800 = 10-30 VDC
<b>General specifications</b>				
Degree of protection	IP 20	IP 20	IP 20	IP 20
Operating temperature	0°C to +50°C	-20°C to +60°C	-20°C to +50°C	-20°C to +50°C
Storage temperature	-20°C to +85°C	-50°C to +85°C	-50°C to +85°C	-50°C to +85°C
Remarks			Low power consumption	
<b>References</b>				
	<b>GTI50</b>			
Profibus-DP with C. G.	<b>G3891 0020</b>			
Profibus-DP analogue output multiplex	<b>G3891 0021</b>			
DeviceNet	<b>G3891 0050</b>			
Lonworks	<b>G3891 0051</b>			
Modbus/TCP	<b>G3891 0052</b>			
Profibus-DP passive	<b>G3891 0120</b>			
8 channel	<b>G3410 5501</b>			
Contact/NPN	<b>G3420 5501</b>			
Voltage	<b>G3420 5502</b>			

# Fieldbuses - Industrial

	Digital input modules		Digital I/O modules
Types	G5010	G8810 2201	G3440 4443
			
Dimensions (mm)	49 x 22.5 x 56	28 x 14 x 10	77 x 72 x 70
Functions	Dupline® powered single input Module	Small-sized 2-channel monostable transmitter	Combined I/O module for external supply with optoisolated inputs and relay outputs
Housing type	DIN-rail, Mini-E	Plug-in	DIN-rail, H4
<b>Electrical specifications</b>			
Number of channels	1	2	4
Features/Signal types	Contact input	2 contact inputs for push buttons cULus approved	2 x 6-265 VAC/DC inputs +2 x SPST relay outputs
Power supply	Powered through the Dupline® network	Supplied by Dupline®	024 = 24 VAC 115 = 115 VAC 230 = 230 VAC 824 = 15-30 VDC
<b>General specifications</b>			
Degree of protection	IP 20	IP 65	IP 20
Operating temperature	-20°C to +50°C	-40°C to +70°C	-20°C to +50°C
Storage temperature	-50°C to +85°C	-40°C to +70°C	-50°C to +85°C
Remarks		Address coding by GAP 1605	
<b>References</b>			
1 channel	<b>G5010 1106</b>		
2 channels	<b>G5010 2206</b>	<b>G8810 2201</b>	
2 input + 2 output SPST			<b>G3440 4443</b>



# Fieldbuses - Industrial

## Digital output modules





Types	G3430 / G3830	G34305545	G8830 1143
			
Dimensions (mm)	77 x 72 x 70 77 x 144 x 70 (H8)	77 x 72 x 70	26 x 39 x 17
Functions	Output modules for external supply with isolated outputs	Central relay module with 8 x SPST relays for resistive loads	Decentral relay module with 1 x SPST relay for control of lights
Housing type	DIN-rail, H4 DIN-rail, H8 (G3830 5543)	DIN-rail, H4	Compact regular, with solid cables. For decentral installation
<b>Electrical specifications</b>			
Number of channels	1, 2, 4, 8	8	1
Features/Signal types	10 A SPDT relay 10 A SPST relay 0.7 A NPN transistor 0.7 A PNP transistor	8 x 16 A/250 VAC relays Inrush current: <130 A	1 x 13 A/250 VAC relay Inrush current: <130 A
Power supply	024 = 24 VAC 115 = 115 VAC 230 = 230 VAC 800 = 10-30 VDC 824 = 15-30 VDC	024 = 24 VAC 115 = 115 VAC 230 = 230 VAC	Powered through the Dupline® network
<b>General specifications</b>			
Degree of protection	IP 20	IP 20	IP 20
Operating temperature	-20°C to +50°C	-5°C to +50°C	0°C to +50°C
Storage temperature	-50°C to +85°C	-50°C to +85°C	-50°C to +85°C
Remarks		Total module load max. 32 A	Recommended minimum load 100 mA / 12 V
<b>References</b>			
2 x 10 A SPDT	<b>G3430 2249</b>		
4 x 5 A SPST	<b>G3430 4443</b>		
4 x 16 A SPST	<b>G3430 4445</b>		
8 x 5 A SPST	<b>G3830 5543</b>		
8 x 0.7 A NPN	<b>G3430 5511</b>		
8 x 0.7 A PNP	<b>G3430 5521</b>		
8 x 16 A SPST (Max. 32 A)		<b>G3430 5545</b>	
1 x 13 A SPST			<b>G8830 1143</b>

# Fieldbuses - Industrial





## Analogue input modules

Types	G3429 6470	G3210 1161	G3210 1111
			
Dimensions (mm)	77 x 72 x 70	77 x 36 x 70	77 x 36 x 70
Functions	Universal analogue input module for external supply	Analogue input module powered from Dupline® and input signal	Dupline®- powered Analogue input module for Pt100 temperature sensor
Housing type	DIN-rail, H4	DIN-rail, H2	DIN-rail, H2
<b>Electrical specifications</b>			
Number of channels	Selectable	1	1
Features/Signal types	4 x isolated analogue input. Input type individually configurable (0-20 mA, 4-20 mA, 0-10 VDC)	1 x 4-20 mA input	1 x Pt100 3-wire input ranges: (-50°C to +40°C) (+30°C to +120°C) (-10°C to +100°C)
Power supply	024 = 24 VAC 115 = 115 VAC 230 = 230 VAC 800 = 10-30 VDC	Powered through the Dupline® network and 4-20 mA input signal	Powered through the Dupline® network
<b>General specifications</b>			
Degree of protection	IP 20	IP 20	IP 20
Operating temperature	0°C to +50°C	0°C to +50°C	0°C to +50°C
Storage temperature	-20°C to +85°C	-50°C to +85°C	-50°C to +85°C
Remarks	Protocol freely selectable (Analink, Multiplexed BCD or 8-bit)	Uses Analink 8-bit protocol	Uses Analink 8-bit protocol. Built-in cable compensation
<b>References</b>			
Universal analogue output	<b>G3429 6470</b>		
Dupline® powered analogue input +30°C to +120°C		<b>G3210 1161</b>	<b>G3210 1112</b>



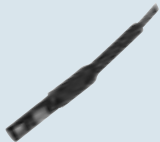

## Fieldbuses - Industrial

	Analogue output modules	Decentral analogue input modules		
Types	G3439 6470	G8810 6265	G8810 6311	G8810 6312
				
Dimensions (mm)	77 x 72 x 70	50 x 30 x 18	50 x 30 x 18	50 x 30 x 18
Functions	Universal analogue output module for external supply	Decentral analogue module with 3 x 0-10 VDC inputs designed for HVAC systems	Decentral analogue module with 2 x 0-10 VDC, 1 x thermistor and 1 x variable resistor inputs designed for HVAC systems	Decentral analogue module with 1 x thermistor and 1 x variable resistor inputs designed for HVAC systems
Housing type	DIN-rail, H4	Compact housing for decentral installation	Compact housing for decentral installation	Compact housing for decentral installation
<b>Electrical specifications</b>				
Number of channels	Selectable	3	4	2
Features/Signal types	4 x analogue outputs. Output type configurable for 0-20 mA, 4-20 mA or 0-10 VDC	3 x 0-10 VDC input	2 x 0-10 VDC input 1 x thermistor 10k3 input 1 x variable resistor 1-11 KΩ input	1 x thermistor 10k3 input 1 x variable resistor 1-11 KΩ input
Power supply	024 = 24 VAC 115 = 115 VAC 230 = 230 VAC 800 = 10-30 VDC	Powered from external 15-30 VDC	Powered from external 15-30 VDC	Dupline® powered
<b>General specifications</b>				
Degree of protection	IP 20	IP 20	IP 20	IP 20
Operating temperature	0°C to +50°C	0°C to +50°C	0°C to +50°C	0°C to +50°C
Storage temperature	-20°C to +85°C	-20°C to +85°C	-20°C to +85°C	-20°C to +85°C
Remarks	Protocol freely selectable (Analink, Multiplexed BCD or 8-bit)	Analink protocol 8 bit resolution	Analink protocol 8 bit resolution	Analink protocol 8 bit resolution
<b>References</b>				
Universal analogue output	<b>G3439 6470</b>			
Decentral 3 x input		<b>G8810 6265</b>		
Decentral 4 x input			<b>G8810 6311</b>	
Decentral 2 x input Bus powered				<b>G8810 6312</b>





## Fieldbuses - Industrial

	Digital sensors	Temperature sensor	Repeater	Converters
<b>Types</b>	<b>G8910 1101</b>	<b>G8911 1010</b>	<b>D3892 0000</b>	<b>G3492 / G3493</b>
				
<b>Dimensions (mm)</b>	Ø11 x 68	67 x 35 x 15	77 x 144 x 70	77 x 72 x 70
<b>Functions</b>	Dupline® powered magnet proximity switch	Temperature sensor for outdoor use. With built-in PT1000 transducer	Dupline® signal Repeater for extension of transmission distance	Optical repeater for converting Dupline® from electrical to optical transmission media
<b>Housing type</b>	Cylindrical	Flat pack sensor housing	DIN-rail, H8	DIN-rail, H4
<b>Electrical specifications</b>				
<b>Number of channels</b>	1	1	Adjusts automatically	Adjusts automatically
<b>Features/Signal types</b>	Detects proximity of magnet	1 x Analink Range: -30°C to +60°C	All Dupline® signal types. Regenerates the Dupline® signal carrier through channel-generator output	All Dupline® signal types
<b>Power supply</b>	Powered through the Dupline® network	Powered through the Dupline® network	024 = 24 VAC 115 = 115 VAC 230 = 230 VAC	230 = 115/230 VAC
<b>General specifications</b>				
<b>Degree of protection</b>	IP 67	IP 67	IP 20	IP 20
<b>Operating temperature</b>	-20°C to +50°C	-25°C to +70°C	0°C to +50°C	0°C to +50°C
<b>Storage temperature</b>	-20°C to +70°C	-55°C to +85°C	-50°C to +85°C	-20°C to +85°C
<b>Remarks</b>	Available in Ø 11 plastic housing or with M14 metal thread	8-bit resolution		Operates pair-wise. Runs on 0/125, 62.5/125 or 100/140 micro m with STN connectors
<b>References</b>				
Ø11	<b>G8910 1101</b>			
M14	<b>G8910 1101-G</b>			
M12 plug		<b>G8911 1010</b>		
Repeater (Booster)			<b>D3892 0000</b>	
Optical/electrical converter				<b>G3492 0000</b>
Electrical/optical converter				<b>G3493 0000</b>

## Fieldbuses - Industrial





Types	Power supply		Accessories	
Housing	G3485 0000	GAP1605	GTU8	G3282 2002 230
				
Dimensions (mm)	77 x 72 x 70	120 x 65 x 22	145 x 90 x 28	77 x 36 x 70
Functions	3-wire power supply, used when multiple Dupline® modules are supplied through a DC-bus	Dupline® coding device for assigning addresses to Dupline® I/O modules and sensors	Dupline® test unit for monitoring and control of Dupline® channels	Dupline® bus separator
Housing type	DIN-rail, H4	Handheld	Handheld	H2 Housing
<b>Electrical specifications</b>				
Number of channels	Selectable	NA	Adjusts automatically	2
Features/Signal types	Supply current ≤ 4 A (up to 25°C) or ≥ 3 A (up to 50°C)		Digital, multiplexed BCD, 8-bit analogue signals and split I/O. Also prepared to calibrate sensors in Carpark system	Disconnect the secondary side of the Dupline® bus when a short-circuit is detected
Power supply	15-30 VDC	9 V battery	Powered through the Dupline® network	230 V
<b>General specifications</b>				
Degree of protection	IP 20	IP 40	IP 40	IP 20
Operating temperature	0°C to +50°C	0°C to +50°C	0°C to +50°C	0°C to +50°C
Storage temperature	-20°C to +85°C	-20°C to +60°C	-20°C to +85°C	-20°C to +85°C
Remarks	Multiple units can be connected in parallel to increase length and size of a Dupline® system		Options for latching digital signals and for reading multiplexed BCD values	
<b>References</b>				
3-wire power supply	<b>G3485 0000 700</b>			
Programmer	<b>GAP1605</b>			
Monitoring and control unit	<b>GTU8</b>			
Bus separator	<b>G3282 2002 230</b>			

# Fieldbuses - Industrial

Accessories				
Types	ADAPT 1605	ANT1	ANT2	DT01/DT02
				
Dimensions (mm)	25 x 50 x 100		15 x 35 x 120	17.5 x 70 x 77
Functions	Codings adaptor between GAP1605 and Dupline® modules without standard connection plug	GSM antenna 900 MHz	Active antenna used for radio controlled clock	Cable termination unit
Housing type	Handheld box		Glued plastic casing	H1 housing
Electrical specifications				
Features/Signal types	4 clip-on terminals for Dupline® modules. Includes a M12 plug for modules like G8911 1010		Input signal is 77.5 kHz	Removes distortion caused by reflection
Power supply		Powered by G3800 XXXX	Powered by G3800 XXXX	No power needed
General specifications				
Degree of protection	IP 20	IP 67	IP 40	IP 20
Operating temperature	0°C to +50°C	-25°C to +60°C	0°C to +50°C	-20°C to +50°C
Storage temperature	-20°C to +60°C	-20°C to +60°C	-20°C to +60°C	-50°C to +85°C
References				
Adaptor	ADAPT 1605			
Antenna		ANT1	ANT2	
Standard Dupline®				DT01
Hi-line Dupline®				DT02





## Fieldbuses - Agriculture

	Digital I/O modules		Converter	Tools
Types	GH3440 4412	GH6440 4412	GH3485 0000	GHTU8
				
Dimensions (mm)	77 x 72 x 70	80 x 77 x 50	77 x 72 x 70	145 x 90 x 28
Functions	I/O module for irrigation valve control	I/O module for irrigation valve control	Dupline® to Hi-Line converter	Dupline® test unit for monitoring and control of Dupline® channels. Used for Hi-line modules
Housing type	DIN-rail, H4	Fully molded housing for under ground installation	DIN-rail, H4	Handheld
<b>Electrical specifications</b>				
Number of channels	4	4	Adjusts automatically	Adjusts automatically
Features/Signal types	2 outputs for control of 3-wire 12 VDC latching valve, and 2 contact inputs	2 outputs for control of 3-wire 12 VDC latching valve, and 2 contact inputs	Converts the Dupline® signal to Hi-Line 28 VDC level for control of irrigation valves (see GH3440 4412 and GH6440 4412)	Digital, multiplexed BCD and 8-bit analogue signals
Power supply	Powered through Hi-Line signal (see GH34850000)	Powered through Hi-Line signal (see GH34850000)	724 = 20-30 VDC	Powered through the Dupline® network
<b>General specifications</b>				
Degree of protection	IP 20	IP 67	IP 20	IP 40
Operating temperature	0°C to +50°C	0°C to +50°C	0°C to +50°C	0°C to +50°C
Storage temperature	-50°C to +85°C	-50°C to +85°C	-50°C to +85°C	-20°C to +85°C
Remarks				Options for latching digital signals and for reading multiplexed BCD values
<b>References</b>				
2 outputs and 2 inputs	<b>GH3440 4412</b>	<b>GH6440 4412</b>		
Converter			<b>GH3485 0000</b>	
Monitoring and control unit				<b>GHTU8</b>

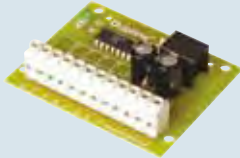
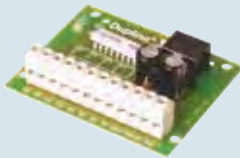
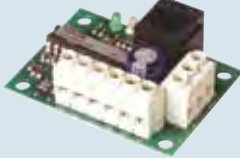
# Fieldbuses - Elevator



	Input module	Output module	Input/output module
<b>Types</b>	<b>G2120</b>	<b>G2130</b>	<b>G2140 4421</b>
			
<b>Dimensions (mm)</b>	Open PCB 72.3 x 59	Open PCB 74 x 59	Open PCB 54 x 40
<b>Functions</b>	8 contact inputs for push buttons or transistors. LED indications for supply and carrier	8 outputs for control of floor indicators and lamps. LED indications for supply and carrier	2 push button inputs. 2 PNP-transistor outputs. LED indications for supply and carrier
<b>Housing type</b>	Snap locks or DIN-rail (vertical or horizontal)	Snap locks or DIN-rail (vertical or horizontal)	Snap locks or DIN-rail (vertical or horizontal)
<b>Electrical specifications</b>			
<b>Number of channels</b>	8	8	4
<b>Features/Signal types</b>	3-wire operation with DC-power on wire 3	3-wire operation with DC-power on wire 3	3-wire operation with DC-power on wire 3
<b>Power supply</b>	700 = 10 - 30 VDC	700 = 10 - 30 VDC	700 = 10 - 30 VDC
<b>General specifications</b>			
<b>Operating temperature</b>	-20°C to +50°C	-20°C to +50°C	-20°C to +50°C
<b>References</b>			
<b>NPN</b>	<b>G2120 5501 700</b>	<b>G2130 5511 700</b>	
<b>PNP</b>	<b>G2120 5502 700</b>	<b>G2130 5521 700</b>	<b>G2140 4421 700</b>

## Fieldbuses - Elevator

	Input/output module	Master modules	
Types	G2140 55.0	G2196	G3496
			
Dimensions (mm)	Open PCB 74 x 59	Open PCB 86 x 54	77 x 72 x 70
Functions	4 push-button inputs 4 transistor outputs LED indications for supply and carrier	128 signals RS 485/RS 232 interface to control system LED indications for supply, carrier and RS485Tx	Plug & Play RS232/RS485 Interface with built-in protocols for specific PLC brands and Modbus
Housing type	Snap locks or DIN-rail (vertical or horizontal)	Snap locks or DIN-rail (vertical or horizontal)	DIN-rail, H4
<b>Electrical specifications</b>			
Number of channels	8	128 inputs and 128 outputs	Selectable
Features/Signal types	3-wire operation with DC-power on 3 wires	3-wire operation with DC-power on 3 wires	Possibility for 3-wire operation with DC-power on 3 wires
Power supply	700 = 10 - 30 VDC	700 = 20 - 30 VDC	700 = 20 - 30 VDC
<b>General specifications</b>			
Degree of protection			IP 20
Operating temperature	-20°C to +50°C	-20°C to +60°C	0°C to +50°C
Storage temperature			-50°C to +85°C
Remarks			Built-in protocol for specific PLC brands for easy interfacing
<b>References</b>			
NPN	<b>G2140 5510 700</b>		
PNP	<b>G2140 5520 700</b>		
Mitsubishi FX & A-series		<b>G2196 0003 700</b>	<b>G3496 0003 700</b>
Omron		<b>G2196 0004 700</b>	<b>G3496 0004 700</b>
Modbus RTU Slave		<b>G2196 0005 700</b>	<b>G3496 0005 700</b>
Allen-Bradley			<b>G3496 0006 700</b>
Matsushita			<b>G3496 0009 700</b>





# Monitoring relays

## Earth Leakage

Types	DEA71	DEB71
		
Dimensions HxWxD (mm) DIN-rail housing	81 x 35.5 x 67.2 [Mini-D]	81 x 35.5 x 67.2 [Mini-D]
Function	Modular residual current monitoring relay, fixed I <sub>Δn</sub> setting, warning output @60% I <sub>Δn</sub> , Alarm @80% I <sub>Δn</sub> , no delay. Operates with CTG series core balance transformers	Modular residual current monitoring relay, adjustable I <sub>Δn</sub> setting, warning output @60% I <sub>Δn</sub> , Alarm @80% I <sub>Δn</sub> , leakage level LED bar, adjustable delay. Operates with CTG series core balance transformers
<b>Input specifications</b>		
Measuring range I <sub>Δn</sub>	30 mA	300 mA
		30 mA to 5 A
		300 mA to 30 A
<b>Output specifications</b>		
Type	2 x SPDT relay	2 x SPDT relay
Max. load AC1	5 A / 250 VAC	5 A / 250 VAC
Max. load DC12	5 A / 24 VDC	5 A / 24 VDC
Electrical life	>1 x 10 <sup>5</sup> operations	>1 x 10 <sup>5</sup> operations
<b>General specifications</b>		
Power supply	24 VAC to 240 VAC	24 VAC to 240 VAC
Approvals/Marks	CE - cULus	CE - cULus
<b>References</b>		
	DEA71DM24A003	DEB71DM24A5
	DEA71DM24A030	DEB71DM24A30

# Monitoring relays

## Current relays

Types	DIA 01 PIA 01	DIA 53	DIB 01 PIB 01	DIB 71
				
Dimensions HxWxD (mm) DIN-rail housing Plug-in housing	80 x 22.5 x 99.5 [D] 80 x 36 x 94 [P]	81 x 17.5 x 67.2 [Mini-D]	80 x 22.5 x 99.5 [D] 80 x 36 x 94 [P]	81 x 35.5 x 67.2 [Mini-D]
Function	Over current monitoring relay. 1-phase AC / DC. Direct input or on CT 5 A. Setpoint adjustable. Hysteresis adjustable.	Over current monitoring relay. 1-phase AC. Setpoint adjustable. 2-wire connection. Reaction time < 50 ms for F versions. 12 mm hole for insulated current carrying wire.	Over or under current monitoring relay. 1-phase AC / DC TRMS. Direct input or on CT 5 A. Setpoint adjustable. Hysteresis adjustable. Delay time adjustable. 12 mm hole for insulated current carrying wire [100 A].	Over or under current monitoring relay. 1-phase AC/DC TRMS. Direct input or on CT 5 A. Setpoint adjustable. Hysteresis adjustable. Delay time adjustable.

## Input specifications

Measuring range	0.5 - 5 AAC/DC	2 - 20 AAC [20 A] 5 - 50 AAC [50 A] 10 - 100 AAC [100 A]	0.1 - 5 mAAC/DC [5 MA] 1 - 50 mAAC/DC [50 MA] 10-500 mAAC/DC [500 MA] 0.1-5 AAC/DC [5 A] 1-10 AAC/DC [10 A] 2-100 AAC [100 A]	0.1 - 5 mAAC/DC [5 MA] 1 - 50 mAAC/DC [50 MA] 10 - 500 mAAC/DC [500 MA] 0.1 - 5 AAC/DC [5 A]
-----------------	----------------	--	--	---

## Output specifications

Type	1 x SPDT relay	Static output	1 x SPDT relay	1 x SPDT relay
Max. load AC1	8 A / 250 VAC		8 A / 250 VAC	5 A / 250 VAC
Max. load DC12	5 A / 24 VDC	100 mA	5 A / 24 VDC	5 A / 24 VDC
Electrical life	>1 x 10 <sup>5</sup> operations		>1 x 10 <sup>5</sup> operations	>1 x 10 <sup>5</sup> operations





## General specifications

Power supply	24-48 VAC/DC [D48] 115 / 230 VAC [B23]	40 VDC max. Powered by the measured current	24-48 VAC/DC [D48] 115 / 230 VAC [B23] 24 VDC / 24-240 VAC [M24]	24 / 48 VAC [B48] 115 / 230 VAC [B23]
Approvals/Marks	CE - UL - CSA	CE - UL - CSA	CE - cULus	CE - UL - CSA

## References





DIA01C D48 5A	DIA53S 724 20A	DIB01C ... 5MA	DIB71C B48 5MA
PIA01C D48 5A	DIA53S 724 50A	DIB01C ... 50MA	DIB71C B48 50MA
DIA01C B23 5A	DIA53S 724 100A	DIB01C ... 500MA	DIB71C B48 500MA
PIA01C B23 5A	DIA53S 724 20A F	DIB01C ... 5A	DIB71C B48 5A
	DIA53S 724 50A F	DIB01C ... 10A	DIB71C B23 5MA
	DIA53S 724 100A F	DIB01C M24 100A	DIB71C B23 50MA
		PIB01C ... 5MA	DIB71C B23 500MA
		PIB01C ... 50MA	DIB71C B23 5A
		PIB01C ... 500MA	
		PIB01C ... 5A	
		PIB01C ... 10A	
		... = insert code for Power Supply	

# Monitoring relays

	Current relays		Voltage relays	
Types	DIB 02 PIB 02	DIC 01 PIC 01	DUA 01 PUA 01	DUA 52
				
Dimensions HxWxD (mm)				
DIN-rail housing	80 x 22.5 x 99.5 [D]	80 x 45 x 99.5 [D]	80 x 22.5 x 99.5 [D]	81 x 17.5 x 67.2 [Mini-D]
Plug-in housing	80 x 36 x 94 [P]	80 x 36 x 94 [P]	80 x 36 x 94 [P]	
Function	Over or under current monitoring relay. 1-phase AC/DC TRMS. Input on shunt or CT MI / MP. Setpoint adjustable. Hysteresis adjustable. Delay time adjustable.	Process signal monitoring relay. 1-phase AC/DC TRMS. Direct input, CT A82 or CT MI / MP. 2 setpoints separately adjustable. Hysteresis adjustable. 2 delay times separately adjustable.	Over current and voltage monitoring relay. 1-phase AC/DC or CT MI / MP. Setpoint adjustable. Hysteresis adjustable.	Under voltage monitoring relay for DC battery. Setpoint adjustable. Hysteresis adjustable. Measures its own power supply.
<b>Input specifications</b>				
Measuring range	6 - 150 mVAC/DC 0.4 - 4 V <sub>P</sub>	0.5 - 20 mAAC/DC 0.1 - 10 VAC/DC 0.4 - 4 V <sub>P</sub>	2 - 500 VAC/DC 0.4 - 4 V <sub>P</sub>	8 - 28 VDC [724] 38 - 58 VDC [748]
<b>Output specifications</b>				
Type	1 x SPDT relay	1 x SPDT relay [P] 2 x SPDT relays [D]	1 x SPDT relay	1 x SPDT relay
Max. load AC1	8 A / 250 VAC	8 A / 250 VAC	8 A / 250 VAC	5 A / 250 VAC
Max. load DC12	5 A / 24 VDC	5 A / 24 VDC	5 A / 24 VDC	5 A / 24 VDC
Electrical life	>1 x 10 <sup>5</sup> operations	>1 x 10 <sup>5</sup> operations	>1 x 10 <sup>5</sup> operations	>1 x 10 <sup>5</sup> operations
<b>General specifications</b>				
Power supply	24 - 48 VAC/DC [D48] 115 / 230 VAC [B23]	24 - 48 VAC/DC [D48] 115 / 230 VAC [B23]	24 - 48 VAC/DC [D48] 115 / 230 VAC [B23]	8 - 28 VDC [724] 38 - 58 VDC [748]
Approvals/Marks	CE - cULus	CE - cULus	CE - UL - CSA	CE - UL - CSA
<b>References</b>				
	DIB02C D48 150MV	DIC01D D48 AV0	DUA01C D48 500V	DUA52 C724
	PIB02C D48 150MV	PIC01C D48 AV0	PUA01C D48 500V	DUA52 C748
	DIB02C B23 150MV	DIC01D B23 AV0	DUA01C B23 500V	
	PIB02C B23 150MV	PIC01C B23 AV0	PUA01C B23 500V	



# Monitoring relays

## Voltage relays

Types	DUA 55	DUB 01 PUB 01	DUB 71	DUB 72
				
Dimensions HxWxD (mm) DIN-rail housing Plug-in housing	81 x 17.5 x 67.2 [Mini-D]	80 x 22.5 x 99.5 [D] 80 x 36 x 94 [P]	81 x 35.5 x 67.2 [Mini-D]	81 x 35.5 x 67.2 [Mini-D]
Function	Over and under voltage monitoring relay. 1-phase (measures its own power supply) AC TRMS.	Over or under voltage monitoring relay. 1-phase AC/DC TRMS. Setpoint adjustable. Hysteresis adjustable. Delay time adjustable.	Over or under voltage monitoring relay. 1-phase AC/DC TRMS. Setpoint adjustable. Hysteresis adjustable. Delay time adjustable.	Double under voltage monitoring relay. 24 VDC. 2 adjustable setpoints + hysteresis. 2 independent relay outputs.
<b>Input specifications</b>				
Measuring range	208 / 220 / 230 / 240 VAC	0.1 - 10 VAC/DC [10 V] 2-500 VAC/DC [500 V]	0.1 - 10 VAC/DC [10 V] 2-500 VAC/DC [500 V]	16 VDC to 30 VDC
<b>Output specifications</b>				
Type	1 x SPDT relay	1 x SPDT relay	1 x SPDT relay	1 x SPST 3 A from A 1 x SPST 20 A from A
Max. load AC1	5 A / 250 VAC	8 A / 250 VAC	5 A / 250 VAC	-
Max. load DC12	5 A / 24 VDC	5 A / 24 VDC	5 A / 24 VDC	-
Electrical life	>1 x 10 <sup>5</sup> operations	>1 x 10 <sup>5</sup> operations	>1 x 10 <sup>5</sup> operations	>1 x 10 <sup>5</sup> operations
<b>General specifications</b>				
Power supply	208 - 480 VAC	24-48 VAC/DC [D48] 115 / 230 VAC [B23]	24/48 VAC [B48] 115 / 230 VAC [B23]	24 VDC
Approvals/Marks	CE - UL - CSA	CE - cULus	CE - UL - CSA	CE- cULus - ISA Class I Div 2
<b>References</b>				
	<b>DUA55 CM44</b>	<b>DUB01C D48 10V</b> <b>DUB01C D48 500V</b> <b>PUB01C D48 10V</b> <b>PUB01C D48 500V</b> <b>DUB01C B23 10V</b> <b>DUB01C B23 500V</b> <b>PUB01C B23 10V</b> <b>PUB01C B23 500V</b>	<b>DUB71C B48 10V</b> <b>DUB71C B48 500V</b> <b>DUB71C B23 10V</b> <b>DUB71C B23 500V</b>	<b>DUB72D724EX</b>

# Monitoring relays





## Voltage relays

Types	DUB 02 PUB 02	DUB 03 PUB 03	DUC 01 PUC 01
			
Dimensions HxWxD (mm)			
DIN-rail housing	80 x 22.5 x 99.5 [D]	80 x 22.5 x 99.5 [D]	80 x 45 x 99.5 [D]
Plug-in housing	80 x 36 x 94 [P]	80 x 36 x 94 [P]	80 x 36 x 94 [P]
Function	Over and under voltage monitoring relay. 1-phase (measures its own power supply) AC TRMS. Over and under voltage setpoints separately adjustable. Hysteresis adjustable. Delay time adjustable (ON/OFF).	Over or under voltage monitoring relay. 1-phase (measures its own power supply) AC/DC TRMS. Setpoint adjustable. Hysteresis adjustable. Delay time adjustable.	Over and under voltage monitoring relay. 1-phase AC/DC TRMS. 2 setpoints separately adjustable. Hysteresis adjustable. 2 delay functions separately adjustable.
<b>Input specifications</b>			
Measuring range	24/115/230 VAC	24/48/115/240 VAC/DC	2 - 500 VAC/DC [500 V]
<b>Output specifications</b>			
Type	1 x SPDT relay	1 x SPDT relay [P]	1 x SPDT relay [C] 2 x SPDT relay [D]
Max. load AC1	8 A / 250 VAC	8 A / 250 VAC	8 A / 250 VAC
Max. load DC12	5 A / 24 VDC	5 A / 24 VDC	5 A / 24 VDC
Electrical life	>1 x 10 <sup>5</sup> operations	>1 x 10 <sup>5</sup> operations	>1 x 10 <sup>5</sup> operations
<b>General specifications</b>			
Power supply	24/115/230 VAC	12 - 240 VAC/DC	24 - 48 VAC/DC [D48] 115 / 230 VAC [B23]
Approvals/Marks	CE - cULus	CE - cULus	CE - cULus
<b>References</b>			
	DUB02C T23	DUB03C W24	DUC01D D48 500V
	PUB02C T23	PUB03C W24	PUC01C D48 500V
			DUC01D B23 500V
			PUC01C B23 500V



# Monitoring relays

## 3-phase voltage relays

Types	DPA 01 PPA 01	DPA 51 DPA 71	DPA52	DPA 03 PPA 03
				
Dimensions HxWxD (mm) DIN-rail housing	80 x 22.5 x 99.5 [D]	81 x 17.5 x 67.2 [Mini-D] 81 x 35.5 x 67.2 [Mini-D]	81 x 17.5 x 67.2 [Mini-D]	80 x 22.5 x 99.5 [D]
Plug-in housing	80 x 36 x 94 [P]			80 x 36 x 94 [P]
Function	Phase sequence, total and partial phase loss monitoring relay. 3-phase AC (measures its own power supply). Regenerated voltage detection.	Phase sequence, total and partial phase loss monitoring relay. 3-phase AC (measures its own power supply). Regenerated voltage detection.	Phase sequence, total and partial phase loss monitoring relay. 3-phase AC TRMS (measures its own power supply), switching power supply. Regenerated voltage detection	Under voltage, phase sequence, total and partial phase loss monitoring relay. 3-phase AC TRMS (measures its own power supply). Regenerated voltage detection.

### Input specifications

Measuring range	208 - 240 VAC [M23] 208 - 415 VAC [P] [M44] 208 - 480 VAC [D] [M44] 380 - 415 VAC [P] [M48] 380 - 480 VAC [D] [M48] 380 - 600 VAC [M60] 380 - 690 VAC [M69]	208 - 240 VAC [M23] 208 - 480 VAC [M44] 380 - 480 VAC [M48]	208 - 480 VAC	208 - 240 VAC [M23] 380 - 415 VAC [P] [M48] 380 - 480 VAC [D] [M48] 600 - 690 VAC [M69]
-----------------	---	---	---------------	--

### Output specifications

Type	1 x SPDT relay [C] 1 x DPDT relay [D]	1 x SPDT relay [C] 1 x DPDT relay [D]	1 x SPDT relay	1 x SPDT relay
Max. load AC1	8 A / 250 VAC	5 A / 250 VAC	5 A / 250 VAC	8 A / 250 VAC
Max. load DC12	5 A / 24 VDC	5 A / 24 VDC	5 A / 24 VDC	5 A / 24 VDC
Electrical life	>1 x 10 <sup>5</sup> operations	>1 x 10 <sup>5</sup> operations	>1 x 10 <sup>5</sup> operations	>1 x 10 <sup>5</sup> operations

### General specifications





Power supply	208 - 240 VAC [M23] 208 - 415 VAC [P] [M44] 208 - 480 VAC [D] [M44] 380 - 415 VAC [P] [M48] 380 - 480 VAC [D] [M48] 380 - 600 VAC [M60] 380 - 690 VAC [M69]	208 - 240 VAC [M23] 208 - 480 VAC [M44] 380 - 480 VAC [M48]	208 - 480 VAC	208 - 240 VAC [M23] 380 - 415 VAC [P] [M48] 380 - 480 VAC [D] [M48] 600 - 690 VAC [M69]
Approvals/Marks	CE - UL - CSA	CE - UL - CSA	CE - cULus - CCC	CE - UL - CSA

### References

	DPA01D M23	DPA51C M44	DPA52CM44	DPA03C M23
	PPA01D M23	DPA71D M23		PPA03C M23
	DPA01C M44	DPA71D M48		DPA03C M48
	PPA01C M44			PPA03C M48
	DPA01D M48			DPA03C M69
	PPA01D M48			
	DPA01C M60			
	DPA01C M69			



# Monitoring relays

## 3-phase voltage relays



Types	DPA 53	DPA 55	DPB 51	DPB52
				
Dimensions HxWxD (mm) DIN-rail housing	81 x 17.5 x 67.2 [Mini-D]	81 x 17.5 x 67.2 [Mini-D]	90 x 17.5 x 67.2 [Mini-D]	81 x 17.5 x 67.2 [Mini-D]
Function	Under voltage, phase sequence, total and partial phase loss monitoring relay. 3-phase AC TRMS (measures its own power supply). Regenerated voltage detection.	Over and under voltage, phase sequence, total and partial phase loss monitoring relay. 3-phase (measures its own power supply) AC TRMS. Two tolerance voltage windows. Regenerated voltage detection.	Over and under voltage monitoring phase sequence, total and partial phase loss, neutral loss monitoring relay. 3-phase+N AC TRMS (measures its own power supply). Regenerated voltage detection 2 setpoints separately adjustable. Delay time adjustable.	Over and under voltage, phase sequence, total and partial phase loss monitoring 3-phase (measures its own power supply), switching power supply. Regenerated voltage detection. 2 setpoints separately adjustable. Delay time adjustable.
<b>Input specifications</b>				
Measuring range	208 - 240 VAC [M23] 380 - 480 VAC [M48]	208 - 480 VAC	208 - 480 VAC	208 - 480 VAC
<b>Output specifications</b>				
Type	1 x SPDT relay	1 x SPDT relay	1 x SPDT relay	1 x SPDT relay
Max. load AC1	5 A / 250 VAC	5 A / 250 VAC	5 A / 250 VAC	5 A / 250 VAC
Max. load DC12	5 A / 24 VDC	5 A / 24 VDC	5 A / 24 VDC	5 A / 24 VDC
Electrical life	>1 x 10 <sup>5</sup> operations	>1 x 10 <sup>5</sup> operations	>1 x 10 <sup>5</sup> operations	>1 x 10 <sup>5</sup> operations
<b>General specifications</b>				
Power supply	208 - 240 VAC [M23] 380 - 480 VAC [M48]	208 - 480 VAC	208 - 480 VAC	208 - 480 VAC
Approvals/Marks	CE - UL - CSA	CE - UL - CSA	CE - UL - CSA	CE - cULus - CCC
<b>References</b>				
	<b>DPA53C M23</b> <b>DPA53C M48</b>	<b>DPA55C M44</b>	<b>DPB51C M44</b>	<b>DPB52CM44</b>

# Monitoring relays

## 3-phase voltage relays

Types	DPB 01 PPB 01	DPB 02 PPB 02
		
Dimensions HxWxD (mm)	80 x 22.5 x 99.5 [D]	80 x 22.5 x 99.5 [D]
DIN-rail housing	80 x 36 x 94 [P]	80 x 36 x 94 [P]
Plug-in housing	80 x 36 x 94 [P]	80 x 36 x 94 [P]
Function	Over and under voltage, phase sequence, total and partial phase loss. 3-phase+N AC TRMS (measures its own power supply). N versions without phase sequence detection. Wide input voltage range, 50 Hz - 400 Hz [M44] 2 setpoints separately adjustable. Delay time adjustable.	Asymmetry monitoring relay, phase sequence, total and partial phase loss monitoring relay. 3-phase +N AC TRMS (measures its own power supply). Wide input voltage range, 50 Hz - 400 Hz [M44] Adjustable asymmetry. Delay time adjustable.
<b>Input specifications</b>		
Measuring range	208 - 240 VAC [M23] 380 - 415 VAC [P] [M48] 380 - 480 VAC [D] [M48] 208 - 480 VAC [M44]	208 - 240 VAC [M23] 380 - 415 VAC [P] [M48] 380 - 480 VAC [D] [M48] 208 - 480 VAC [M44]
<b>Output specifications</b>		
Type	1 x SPDT relay	1 x SPDT relay
Max. load AC1	8 A / 250 VAC	8 A / 250 VAC
Max. load DC12	5 A / 24 VDC	5 A / 24 VDC
Electrical life	>1 x 10 <sup>5</sup> operations	>1 x 10 <sup>5</sup> operations
<b>General specifications</b>		
Power supply	208 - 240 VAC [M23] 380 - 415 VAC [P] [M48] 380 - 480 VAC [D] [M48] [W] 208 - 480 VAC [M44]	208 - 240 VAC [M23] 380 - 415 VAC [P] [M48] 380 - 480 VAC [D] [M48] [W] 208 - 480 VAC [M44]
Approvals/Marks	CE - cULus - CCC	CE - cULus - CCC
<b>References</b>		
	DPB01C M23	DPB02C M23
	PPB01C M23	PPB02C M23
	DPB01C M23 N	DPB02C M44
	PPB01C M23 N	PPB02C M44
	DPB01C M44	DPB02C M48
	PPB01C M44	PPB02C M48
	DPB01C M48	
	PPB01C M48	
	DPB01C M48 W4	
	PPB01C M48 W4	
	DPB01C M48 N	
	PPB01C M48 N	
	DPB01C M48 N W4	
	PPB01C M48 N W4	

# Monitoring relays

	3-phase voltage relays		3-phase multifunction voltage relays
Types	DPC 01 PPC 01	DPC 71 PPC 71	DPC 02
			
			
Dimensions (mm) HxWxD			
DIN-rail housing	80 x 45 x 99.5 [D]	81 x 35.5 x 67.2 [D]	80 x 45 x 99.5 [D]
Plug-in housing	80 x 36 x 94 [P]	81.2 x 35.5 x 75 [P]	
Function	Over and under voltage, asymmetry and tolerance, phase sequence, total and partial phase loss monitoring relay. 3-phase+N AC TRMS (measures its own power supply), 50 Hz - 400 Hz mains. Setpoint separately adjustable by function.	Over and under voltage, asymmetry and tolerance, phase sequence, total and partial phase loss monitoring relay. 3-phase+N AC TRMS (measures its own power supply). Setpoints separately adjustable by function.	Over and under voltage, over and under frequency, phase sequence, total and partial phase loss monitoring relay. 3-phase+N AC TRMS (measures its own power supply). Setpoints separately adjustable. Separately adjustable delay times. Adjustable frequency range.

## Input specifications

Measuring range	208 - 240 VAC [M23] 380 - 415 VAC [P] [M48] 380 - 480 VAC [D] [M48] 600 - 690 VAC [M69] Frequency 50 - 60 Hz 100 - 115 VAC [M11 400Hz] 208 - 240 VAC [M23 400Hz] 380 - 415 VAC [M48 400Hz] 440 - 480 VAC [M49 400Hz] 600 - 690 VAC [M69 400Hz] 208 - 690 VAC [M44] Frequency 50 - 400 Hz	208 - 240 VAC [M23] 380 - 415 VAC [P] [M48] 380 - 480 VAC [D] [M48]	Voltage: 208 - 240 VAC [M23] 380 - 415 VAC [M48] 440 - 480 VAC [M49] 600 - 690 VAC [M69] 208 - 690 VAC [M44] Frequency: 50 / 60 Hz
-----------------	---	---	---

## Output specifications

Type	2 x SPDT relays	2 x SPDT relays	2 x SPDT relays
Max. load AC1	8 A / 250 VAC	5 A / 250 VAC	8 A / 250 VAC
Max. load DC12	5 A / 24 VDC	5 A / 24 VDC	5 A / 24 VDC
Electrical life	>1 x 10 <sup>5</sup> operations	>1 x 10 <sup>5</sup> operations	>1 x 10 <sup>5</sup> operations

## General specifications

Power supply	100 - 115 VAC [M11] 208 - 240 VAC [M23] 380 - 415 VAC [P] [M48] 380 - 480 VAC [D] [M48] 440 - 480 VAC [M49] 600 - 690 VAC [M69] 208 - 690 VAC [M44]	208 - 240 VAC [M23] 380 - 415 VAC [P] [M48] 380 - 480 VAC [D] [M48]	208 - 240 VAC [M23] 380 - 415 VAC [M48] 440 - 480 VAC [M49] 600 - 690 VAC [M69] 208 - 690 VAC [M44]
Approvals/Marks	CE - cULus - CCC - RINA	CE - UL - CSA	CE - cULus - CCC - RINA

## References

DPC01D M23	DPC71D M23	DPC02D M23
PPC01D M23	PPC71D M23	DPC02D M48
DPC01D M44	DPC71D M48	DPC02D M44
DPC01D M48	PPC71D M48	DPC02D M49
PPC01D M48		DPC02D M69
DPC01D M69		
DPC01D M11 400HZ		
DPC01D M23 400HZ		
DPC01D M48 400HZ		
DPC01D M49 400HZ		
DPC01D M69 400HZ		

# Monitoring relays

## 3-phase multifunction voltage relays

## Interface protection relays

### Types

### DPD 02

### DPC 72

### PI-DIN



Dimensions HxWxD (mm)

80 x 22.5 x 99.5

90 x 71.6 x 66.3 [D]

90 x 71.6 x 66.3

Description

Over and under voltage, over and under frequency, asymmetry detection, total and partial phase loss and phase sequence monitoring relay.  
NFC communication 3-phase / 3-phase+N AC TRMS (measures its own power supply).  
Digital settings, setpoints separately adjustable.  
Separately adjustable delay times.  
Adjustable frequency range.

Digital interface protection relay with over and under voltage, over and under frequency, phase sequence, total or partial phase loss.  
Frequency derivative monitoring, voltage quality, RS485 port, event counter, datastamping and auto-test function.  
3-phase (measures its own power supply) AC TRMS.  
Setpoints separately adjustable.  
Separately adjustable delay times.  
Programmable via PC (DpcSoft free configuration software).

1- or 3-phase systems monitoring relay interface protection.

### Measuring input

Voltage range

208 VAC - 480 VAC

380-415 VAC [M48]

230 V<sub>LN</sub>, 400 V<sub>LL</sub>

Frequency range

50 Hz - 400 Hz

45-65 Hz

47.5 to 51.5 Hz

Display

LCD, 2 lines 4 DGT, 1 line 8 DGT

LCD, 2 lines 4 DGT, 1 line 8 DGT

### Signal inputs

VDE-AR-N-4105

2 digitals

CEI 0-21

4 digitals

### Output specifications

Type

2 x SPDT relays

1 x DPDT relays

2 x SPDT relays

Max. load AC1

8 A / 250 VAC

8 A / 250 VAC

8 A @ 250 VAC

Max. load DC12

5 A / 24 VDC

5 A / 24 VDC

5 A / 24 VDC

Electrical life

>1 x 10<sup>5</sup> operations

>1 x 10<sup>5</sup> operations

>1 x 10<sup>5</sup> operations

Serial communication protocol

RS485

RS485

Protocol

Modbus RTU

Modbus RTU

### General specifications

Power supply

208 VAC - 480 VAC ±20%

308 - 415 VAC

115..230 VCA -20% +15%  
(48..62 Hz)  
Option 24 VDC -20% +10%

Approvals/Marks

CE - cULus - CCC - RINA

CE

CE -  
VDE-AR-N4105:2018 -  
CEI-0-21 -  
ER-G98-Issue-1-Am-1 -  
ER-G99-Issue-1-Am-3 -  
Dansk Energi

### References

DPD02D M44  
DPD02D M44B

DPC72D M48

CEI 0-21 (AC aux power)

PIDIN0021HI4R2S1XX

CEI 0-21 (DC aux power)

PIDIN0021LI4R2S1XX

VDE-AR-N 4105:2018;

CEI 0 - 21;

ER G98 Issue 1 Am 1;

ER G99 Issue 1 Am 3;

Dansk Energi (AC aux power)

PIDIN0126HI2R2S1XX

VDE-AR-N 4105:2018;

CEI 0 - 21;



ER G98 Issue 1 Am 1;

ER G99 Issue 1 Am 3;

Dansk Energi (DC aux power)



PIDIN0126LI2R2S1XX

# Monitoring relays

	Frequency relays		Cosφ relays
Types	DFB 01 PFB 01	DFC 01	DWA 01 PWA 01
			
Dimensions HxWxD (mm)			
DIN-rail housing	80 x 22.5 x 99.5 [D]	80 x 45 x 99.5 [D]	80 x 22.5 x 99.5 [D]
Plug-in housing	80 x 36 x 94 [P]		80 x 36 x 94 [P]
Function	Frequency monitoring relay. 1-phase AC (measures its own power supply). 2 setpoints separately adjustable. Delay time adjustable.	Frequency monitoring relay. 1-phase AC (measures its own power supply). 2 setpoints separately adjustable. 2 separately adjustable delay times. 2 separate relay outputs.	Cosφ monitoring relay. 1- or 3-phase AC (measures its own power supply). Direct input or through external CT. Power ON delay adjustable.
<b>Input specifications</b>			
Measuring range	50 / 60 Hz	50 / 60 Hz	cosφ: 0.1-0.99
<b>Output specifications</b>			
Type	1 x SPDT relay	2 x SPDT relay	1 x SPDT relay
Max. load AC1	8 A / 250 VAC	8 A / 250 VAC	8 A / 250 VAC
Max. load DC12	5 A / 24 VDC	5 A / 24 VDC	5 A / 24 VDC
Electrical life	>1 x 10 <sup>5</sup> operations	>1 x 10 <sup>5</sup> operations	>1 x 10 <sup>5</sup> operations
<b>General specifications</b>			
Power supply	24 - 240 VAC	24 - 48 VAC [B48] 115 - 230 VAC [B23]	208 - 240 VAC [M23] 380 - 415 VAC [P] [M48] 380 - 480 VAC [D] [M48]
Approvals/Marks	CE - UL - CSA	CE - UL - CSA	CE - UL - CSA
<b>References</b>			
	<b>DFB01C M24</b>	<b>DFC01D B48</b>	<b>DWA01C M23 5A</b>
	<b>PFB01C M24</b>	<b>DFC01D B23</b>	<b>PWA01C M23 5A</b>
			<b>DWA01C M48 5A</b>
			<b>PWA01C M48 5A</b>

# Monitoring relays

## Power and power factor relays

Types	DWB 01 PWB 01	DWB 02 PWB 02	DWB 03 PWB 03
			
Dimensions HxWxD (mm)	80 x 45 x 99.5 [D]	80 x 45 x 99.5 [D]	80 x 45 x 99.5 [D]
DIN-rail housing	80 x 36 x 94 [P]	80 x 36 x 94 [P]	80 x 36 x 94 [P]
Plug-in housing	80 x 36 x 94 [P]	80 x 36 x 94 [P]	80 x 36 x 94 [P]
Function	Power factor monitoring relay. 1- or 3-phase (measures its own power supply) AC TRMS. Direct input or through external CT. 2 separately adjustable setpoints. Delay time adjustable. Power ON delay adjustable.	Active power monitoring relay. 1- or 3-phase (measures its own power supply) AC TRMS. Direct input or through external CT. 2 separately adjustable setpoints. Delay time adjustable. Power ON delay adjustable.	Active power, with power direction, monitoring relay. 1- or 3-phase AC TRMS (measures its own power supply). Direct input or through external CT. 2 separately adjustable setpoints. Delay time adjustable. Power ON delay adjustable.

### Input specifications

Measuring range	cosφ: 0.1 - 0.99	208 - 690 VAC 0.5 - 5 AAC 1 - 10 AAC 0.4 - 4 Vp	208 - 690 VAC 0.5 - 5 AAC 1 - 10 AAC 0.4 - 4 Vp
-----------------	------------------	--	--

### Output specifications

Type	1 x SPDT relays	1 x SPDT relays	1 x SPDT relays
Max. load AC1	8 A / 250 VAC	8 A / 250 VAC	8 A / 250 VAC
Max. load DC12	5 A / 24 VDC	5 A / 24 VDC	5 A / 24 VDC
Electrical life	>1 x 10 <sup>5</sup> operations	>1 x 10 <sup>5</sup> operations	>1 x 10 <sup>5</sup> operations





### General specifications

Power supply	208 - 240 VAC [M23] 380 - 415 VAC [P] [M48] 380 - 480 VAC [D] [M48] 600 - 690 VAC [M69]	208 - 240 VAC [M23] 380 - 415 VAC [P] [M48] 380 - 480 VAC [D] [M48] 600 - 690 VAC [M69]	208 - 240 VAC [M23] 380 - 415 VAC [P] [M48] 380 - 480 VAC [D] [M48] 600 - 690 VAC [M69]
Approvals/Marks	CE - UL - CSA	CE - UL - CSA	CE - UL - CSA

### References

DWB01C M23 10A	DWB02C M23 10A	DWB03C M23 10A
PWB01C M23 10A	PWB02C M23 10A	PWB03C M23 10A
DWB01C M48 10A	DWB02C M48 10A	DWB03C M48 10A
PWB01C M48 10A	PWB02C M48 10A	PWB03C M48 10A
DWB01C M69 10A	DWB02C M69 10A	DWB03C M69 10A

# Monitoring relays

	Motor thermistor relays			Pump alternating relays
Types	DTA 01 / PTA 01 DTA 02 / PTA 02	DTA 71 DTA 72	DTA 04	DLA 71 DLA 73
				
Dimensions HxWxD (mm)				
DIN-rail housing	80 x 22.5 x 99.5	81 x 35.5 x 67.2 (Mini-D)	80 x 22.5 x 99.5	81 x 35.5 x 67.2 (Mini-D)
Plug-in housing	80 x 36 x 94			
Function	Motor temperature monitoring relays. PTC insulated input. Automatic set-point. Short circuit detection. Latch, test and reset function (DTA02, PTA02).	Motor Thermistor relays. PTC insulated input. Automatic set-point. Short circuit and Open Circuit detection. Automatic Reset (DTA71) Auto or Manual reset, local or remote, test and ready for reset functions (DTA72).	Motor Thermistor relays. PTC insulated input. Automatic set-point. Short circuit and Open Circuit detection. Automatic or manual Reset, test, ready for reset functions.	Pump alternating relay. For 2 or 3 pumps. Differential or sequential mode. Automatic rotation of the pumps. Output relay managed by one independent input contact (DLA73).

## Output specifications

Type	1 x SPDT relay or 1 x SPST relay	1 x SPDT relay [DTA71] 2 x SPDT relay [DTA72]	2 x SPST relays	2 x SPST relay [DLA71] [2P] 3 x SPST relay [DLA71] [3P] 3 x SPST relay [DLA73]
Max. load AC1	8 A / 250 VAC	8 A / 250 VAC	8 A / 250 VAC	5 A / 250 VAC
Max. load DC12	5 A / 24 VDC	5 A / 24 VDC	5 A / 24 VDC	5 A / 24 VDC
Electrical life	>1 x 10 <sup>5</sup> operations	>1 x 10 <sup>5</sup> operations	>1 x 10 <sup>5</sup> operations	>1 x 10 <sup>5</sup> operations

## General specifications

Power supply	24 - 48 VAC/DC [D48] 115 VAC [115] 230 VAC [230]	24 - 240 VAC/DC	24 - 240 VAC/DC	24 / 48 VAC [B48] 115 / 230 VAC [B23]
Approvals/Marks	CE - UL - CSA	CE - cULus	CE - cULus	CE - UL - CSA

## References

DTA01C D48	DTA71CM24	DTA04DM24	DLA71D B48 2P
DTA01C 115	DTA72DM24		DLA71T B48 3P
DTA01C 230			DLA71D B23 2P
DTA02C D48			DLA71T B23 3P
DTA02C 115			DLA73T B23 2P
DTA02C 230			DLA73T B48 2P
PTA01C D48			
PTA01C 115			
PTA01C 230			
PTA02C D48			
PTA02C 115			
PTA02C 230			



# Timers

## Delay on operate

Types	DAA 01 PAA 01	DAA 51 DAA 71	FAA 01 FAA 08
-------	------------------	------------------	------------------



Dimensions HxWxD (mm)			
DIN-rail housing	80 x 22.5 x 99.5 [D] 80 x 36 x 94 [P]	81 x 17.5 x 67.2 [Mini-D] 81 x 35.5 x 67.2 [Mini-D]	
Plug-in housing			48 x 48 x 83.4

Function	Delay on operate (manual start).	Delay on operate (automatic start).	Delay on operate. Symmetrical recycler. Interval. One shot.
----------	----------------------------------	-------------------------------------	--

### Input specifications

Time range	0.1 s - 1 s 1 s - 10 s 6 s - 60 s 60 s - 600 s 0.1 h - 1 h 1 h - 10 h 10 h - 100 h	0.1 s - 1 s 1 s - 10 s 6 s - 60 s 60 s - 600 s 0.1 h - 1 h 1 h - 10 h 10 h - 100 h	Full scale 12 0.02 - 1.2 s 0.2 - 12 s 2 - 120 s 0.2 - 12 m 2 - 120 m 0.2 - 12 h 2 - 120 h	Full scale 30 0.05 - 3 s 0.5 - 30 s 5 - 300 s 0.5 - 30 m 5 - 300 m 0.5 - 30 h 5 - 300 h
------------	--	--	--	--

### Output specifications

	1 x SPDT relay [C] 2 x SPDT relays [D]	1 x SPDT relay [C] 1 x DPDT relay [D]	1 x DPDT relay 11-pin [01] 8-pin [08]
Max. load AC1	8 A / 250 VAC	5 A / 250 VAC	5 A / 250 VAC
Max. load DC12	5 A / 24 VDC	5 A / 24 VDC	5 A / 24 VDC
Electrical life	>1 x 10 <sup>5</sup> operations	>1 x 10 <sup>5</sup> operations	>1 x 10 <sup>5</sup> operations



### General specifications

Power supply	24 VDC / 24 - 240 VAC [C] 24 - 240 VAC/DC [D]	24 VDC / 24-240 VAC [CM24] 24-240 VAC / DC [DM24] 12-240 VAC / DC [DW24]	12-240 VAC / DC
Approvals/Marks	CE - UL - CSA	CE - UL - CSA - RINA [DAA51 only] - CCC [DAA51_B001 only]	CE - UL - CSA





### References

DAA01C M24	DAA51C M24	FAA01D W24
PAA01C M24	DAA71D M24	FAA08D W24
DAA01D M24	DAA71D W24	
PAA01D M24		

# Timers





	Delay on operate	Delay on release	
Types	HAA 08 HAA 14	DBA 02 PBA 02	DBA 52
			
Dimensions HxWxD (mm)			
DIN-rail housing		80 x 22.5 x 99.5 [D]	81 x 17.5 x 67.2 [Mini-D]
Plug-in housing	28 x 21.5 x 64	80 x 36 x 94 [P]	
Function	Delay on operate. Symmetrical recycler with ON or OFF first. Interval.	Delay on release.	Delay on release.
<b>Input specifications</b>			
Time range	0.1 s - 1 s 1 s - 10 s 6 s - 60 s 60 s - 600 s 0.1 h - 1 h 1 h - 10 h 10 h - 100 h	0.1 s - 1 s / 1 s - 10 s 6 s - 60 s / 60 s - 600 s 0.1 h - 1 h / 1 h - 10 h 10 h - 100 h	0.1 s - 1 s / 1 s - 10 s 6 s - 60 s / 60 s - 600 s 0.1 h - 1 h / 1 h - 10 h 10 h - 100 h
<b>Output specifications</b>			
	1 x 4PDT relay [Q] 1 x DPDT relay [D] 14-pin [14] 8-pin [08]	1 x SPDT relay	1 x SPDT relay
Max. load AC1	5 A / 250 VAC	8 A / 250 VAC	5 A / 250 VAC
Max. load DC12	5 A / 24 VDC	5 A / 24 VDC	5 A / 24 VDC
Electrical life	>1 x 10 <sup>5</sup> operations	>1 x 10 <sup>5</sup> operations	>1 x 10 <sup>5</sup> operations
<b>General specifications</b>			
Power supply	24-240 VAC / DC	24 VDC / 24-240 VAC	24 VDC / 24-240 VAC
Approvals/Marks	CE - UL - CSA	CE - UL - CSA	CE - UL - CSA
<b>References</b>			
	HAA14Q M24 HAA08D M24	DBA02C M24 PBA02C M24	DBA52C M24

# Timers

	True delay on release		Recycler		
Types	D/PBB 01 D/PBB 02	DBB 51	DCB 01 PCB 01	DCB 51	
					
Dimensions HxWxD (mm) DIN-rail housing Plug-in housing	80 x 22.5 x 99.5 [D] 80 x 36 x 94 [P]	81 x 17.5 x 67.2 [Mini-D]	80 x 22.5 x 99.5 [D] 80 x 36 x 94 [P]	81 x 17.5 x 67.2 [Mini-D]	
Function	True delay on release.	True delay on release.	Asymmetrical recycler with ON and OFF time first. One shot. Two state delay on operate.	Asymmetrical recycler with ON or OFF first.	
<b>Input specifications</b>					
Time range	D/PBB01: 0.1 s - 1 s / 1 s - 10 s 6 s - 60 s / 60 s - 600 s D/PBB02: 60 s - 600 s / 0.1 h - 1 h 1 h - 10 h	1 s - 10 s [10S] 6 s - 60 s [1M] 60 s - 600 s [10M]	0.1 - 1 s / 1 - 10 s 6 - 60 s / 60 s - 600 s 0.1 h 1 h / 1 h - 10 h 10 h - 100 h	0.1 - 1 s / 1 - 10 s 6 - 60 s / 60 s - 600 s 0.1 h 1 h / 1 h - 10 h 10 h - 100 h	
<b>Output specifications</b>					
	1 x SPDT relay [C] 1 x DPDT relay [D]	1 x SPDT relay	1 x SPDT relay [C] 2 x SPDT relays [D]	1 x SPDT relay	
Max. load AC1	8 A / 250 VAC	5 A / 250 VAC	8 A / 250 VAC	5 A / 250 VAC	
Max. load DC12	5 A / 24 VDC	5 A / 24 VDC	5 A / 24 VDC	5 A / 24 VDC	
Electrical life	>1 x 10 <sup>5</sup> operations	>1 x 10 <sup>5</sup> operations	>1 x 10 <sup>5</sup> operations	>1 x 10 <sup>5</sup> operations	
<b>General specifications</b>					
Power supply	24-240 VAC / DC [M24] 12-24 VDC [724]	24 VDC / 24-240 VAC	24 VDC / 24-240 VAC [C] 24-240 VAC / DC [D]	24 VDC / 24-240 VAC	
Approvals/Marks	CE - UL - CSA	CE - UL - CSA	CE - UL - CSA	CE - UL - CSA	
<b>References</b>					
	<b>DBB01C M24</b>	<b>DBB51C M24 10S</b>	<b>DCB01C M24</b>	<b>DCB51C M24</b>	
	<b>PBB01C M24</b>	<b>DBB51C M24 1M</b>	<b>PCB01C M24</b>		
	<b>DBB01D M24</b>	<b>DBB51C M24 10M</b>	<b>DCB01D M24</b>		
	<b>PBB01D M24</b>		<b>PCB01D M24</b>		
	<b>DBB01C 724</b>				
	<b>PBB01C 724</b>				
	<b>DBB01D 724</b>				
	<b>PBB01D 724</b>				
	<b>DBB02C M24</b>				
	<b>PBB02C M24</b>				
	<b>DBB02D M24</b>				
	<b>PBB02D M24</b>				

# Timers

## Multifunction

Types	DMB 01 PMB 01	DMB 51 DMB 71	FMB 01	DMC 01 PMC 01
				
Dimensions HxWxD (mm) DIN-rail housing	80 x 22.5 x 99.5 [D]	81 x 17.5 x 67.2 [Mini-D] 81 x 35.5 x 67.2 [Mini-D]		80 x 22.5 x 99.5 [D] 80 x 45 x 99.5 [D] 80 x 36 x 94 [P]
Plug-in housing	80 x 36 x 94 [P]		48 x 48 x 83.4	
Function	Multifunction: <ul style="list-style-type: none"> <li>• Delay on operate - manual start</li> <li>• Delay on release</li> <li>• Interval - manual start</li> <li>• Symmetrical recycler</li> <li>• Double interval</li> <li>• Interval on trigger open</li> </ul>	Multifunction: <ul style="list-style-type: none"> <li>• Delay on operate - manual start</li> <li>• Delay on release</li> <li>• Interval - manual start</li> <li>• Symmetrical recycler</li> <li>• Double interval</li> <li>• Interval on trigger open</li> </ul>	Multifunction: (Trigger, Gate and Reset inputs) <ul style="list-style-type: none"> <li>• Delay on operate - manual start</li> <li>• Delay on release</li> <li>• Interval - manual start</li> <li>• Symmetrical recycler</li> <li>• Double interval</li> <li>• Interval on trigger open</li> </ul>	Multifunction: <ul style="list-style-type: none"> <li>• Delay on operate - manual start</li> <li>• Delay on operate - automatic and manual start</li> <li>• Delay on release</li> <li>• Interval - manual start</li> <li>• Interval - automatic and manual start</li> <li>• Interval - manual start with no time reset</li> <li>• Interval - automatic and manual start with no time reset</li> </ul>

## Input specifications

Time range	0.1 s - 1 s / 1 s - 10 s 6 s - 60 s / 60 s - 600 s 0.1 h - 1 h / 1 h - 10 h 10 h - 100 h	0.1 s - 1 s / 1 s - 10 s 6 s - 60 s / 60 s - 600 s 0.1 h - 1 h / 1 h - 10 h 10 h - 100 h	Full scale: 12 0.02 - 1.2 s / 0.2 - 12 m 2 - 120 s / 0.2 - 12 m 2 - 120 m / 0.2 - 12 h 2 - 120 h Full scale: 30 0.05 - 3 s / 0.5 - 30 s 5 - 300 s / 0.5 - 30 m 5 - 300 m / 0.5 - 30 h 5 - 300 h	0.1 s - 1 s / 1 s - 10 s 6 s - 60 s / 60 s - 600 s 0.1 h - 1 h / 1 h - 10 h 10 h - 100 h
------------	---	---	--	---

## Output specifications

	1 x SPDT relay [C] 1 x DPDT relay [D]	1 x SPDT relay [C] 1 x DPDT relay [D]	1 x DPDT relay	1 x SPDT relay [C] 2 x SPDT relay [D]
Max. load AC1	8 A / 250 VAC	5 A / 250 VAC	5 A / 250 VAC	8 A / 250 VAC
Max. load DC12	5 A / 24 VDC	5 A / 24 VDC	5 A / 24 VDC	5 A / 24 VDC
Electrical life	>1 x 10 <sup>5</sup> operations	>1 x 10 <sup>5</sup> operations	>1 x 10 <sup>5</sup> operations	>1 x 10 <sup>5</sup> operations

## General specifications



Power supply	24 VDC & 24-240 VAC [C] 24-240 VAC/DC [D]	24 VDC & 24-240 VAC [M24] 12-240 VAC/DC [W24]	12-240 VAC/DC	24 VDC [724] 24 / 48 VAC [B48] 115 / 230 VAC [B23] 24 VAC [024] 115 VAC [115] 230 VAC [230]
Approvals/Marks	CE - UL - CSA - RINA [DMB01 only]	CE - UL - CSA - RINA [DMB51 only] - CCC [DMB51_B006 only]	CE - UL - CSA	CE - UL - CSA

## References

<b>DMB01C M24</b>	<b>DMB51C M24</b>	<b>FMB01D W24</b>	<b>DMC01C xxx</b>
<b>PMB01C M24</b>	<b>DMB51C W24</b>		<b>PMC01C yyy</b>
<b>DMB01D M24</b>	<b>DMB71D M24</b>		<b>DMC01D xxx</b>
<b>PMB01D M24</b>	<b>DMB71D W24</b>		<b>PMC01D yyy</b>

xxx= 724, B23, B48  
yyy= 724, 024, 115, 230

# Timers

	Mini-E timers	Star delta	
Types	EAS EBS ECS	DAC 01/PAC 01	DAC 51
			
Dimensions HxWxD (mm)	56 x 22.5 x 49 <sup>[Mini-E]</sup>	80 x 22.5 x 99.5 [D]	81 x 17.5 x 67.2 <sup>[Mini-D]</sup>
DIN-rail housing	56 x 22.5 x 44 <sup>[Mini-E]</sup> [F]		
Plug-in housing		80 x 36 x 94 [P]	
Function	EAS - Delay on operate (automatic start). EBS - Interval (automatic start). ECS - Symmetrical recycler (ON/OFF automatic start) thyristor output. Screw or fast-ON connection. DIN-rail or chassis mounting	Star delta	Star delta
<b>Input specifications</b>			
Time range	[10S]: 0.5 s - 10 s [1M]: 0.1 m - 1 m [10M]: 1 m - 10 m	0.1 s - 1 s / 1 s - 10 s 6 s - 60 s / 60 s - 600 s	0.1 s - 1 s / 1 s - 10 s 6 s - 60 s / 60 s - 600 s
Star to delta relay (neutral centre position)		50 - 130 ms between star to delta position	50 - 130 ms between star to delta position
<b>Output specifications</b>			
	Static output 500 mA, 700 mA [F]	1 x SPDT relay (with neutral centre position)	1 x SPDT relay (with neutral centre position)
Max. load AC1		8 A / 250 VAC	5 A / 250 VAC
Max. load DC12		5 A / 24 VDC	5 A / 24 VDC
Electrical life		>1 x 10 <sup>5</sup> operations	>1 x 10 <sup>5</sup> operations
<b>General specifications</b>			
Power supply	24-230 VAC / DC [EAS] 24-230 VAC [EBS], [ECS]	24-240 VAC / DC [M24] 380-415 VAC [M40]	24-240 VAC / DC
Approvals/Marks	CE - UL - CSA	CE - UL - CSA	CE - UL - CSA
<b>References</b>			
	EAS S M23 ...	DAC01C M24	DAC51C M24
	EAS S M23 ... F	PAC01C M24	
	EBS S M23 ...	DAC01C M40	
	EBS S M23 ... F	PAC01C M40	
	ECS S M23 A ...		
	ECS S M23 B ...		
	ECS S M23 A ... F		
	ECS S M23 B ... F		
	... = insert code for Time Range		

# Counters

## Electromechanical counters

Types	EMCT46/EMCT47	E2CT4	E1CT4	ECH4
				

Version	Micro	Mini	Standard	Combination time and energy meter
Dimensions HxWxD (mm)	13.8 x 25 x 35.2 20 x 30 x 36.2	24 x 48 x 53.8	24 x 48 x 49	48 x 48 x 38

### Technical data

Number of digit	6/7	5	6	7/8
Reset	No	Yes	No	No
Digit height, visible (mm)	4 x 1.7 / 4 x 1.2	4 x 1.7	4 x 1.7	4 x 1.7
Panel cut-out (mm)	e.g. 27 x 14	45 x 22 / 31 x 20	45 x 22 / 31 x 20	46 x 46 X Ø50.5
Mounting type	Panel / PCB	Panel / base mount / PCB	Panel / base mount / PCB	Panel / DIN-rail
Degree of protection	up to IP 65	IP 41	IP 41	IP 52 front side
Pulse voltage min. / max.	1.5 to 24 VDC	24 to 230 VAC 12 to 24 VDC	24 to 230 VAC 12 to 24 VDC	0 to 260 VAC 0 to 260 VDC
Max. count frequency	10 Hz	10 Hz	10 Hz	10 Hz
Min. power consumption	70 mW	0.75 VA (115 VAC) 1.5 VA (230 VAC) 130 mW VDC	0.75 VA (115 VAC) 1.5 VA (230 VAC) 50 mW VDC	1 W / 1.43 VA

### References

	EMCT46xxxxxx EMCT47xxxxxx	E2CT4xxxxxx	E1CT4xxxxxx	ECH4
--	------------------------------	-------------	-------------	------

## Electronic counters

Types	FKA	DCT86	DMF861	DMF862
				

Version	LCD-Panel mount	LED-Panel mount	LED-Panel mount	LED-Panel mount
Dimensions HxWxD (mm)	DIN 48 x 24	DIN 48 x 24	DIN 48 x 24	DIN 48 x 24

### Function

Totaliser	Yes			
Pulse counter		Yes	Yes	2 pulse counters, Pulse counter and timer, Pulse and frequency meter or 2 timers
Position display for encoders			Yes	
Frequency meter/Tachometer			Yes	
Timer			Yes	

### Technical data



Number of digit	8	6	6	6
Reset	Manual / Electric	Manual / Electric	Manual / Electric	Manual / Electric
Digit height, visible (mm)	8	8	8	8
Panel cut-out (mm)	45 x 22	45 x 22	45 x 22	45 x 22
Degree of protection	IP 65 front side	IP 65 front side	IP 65 front side	IP 65 front side
Power supply	Lithium battery	10 to 30 VDC	10 to 30 VDC	10 to 30 VDC
Count inputs	NPN/PNP 10 to 260 VAC/DC	NPN/PNP	NPN/PNP	NPN/PNP

### References





	FKAxxxxxx	DCT86xxxxxx	DMF861xxxxxx	DMF862xxxxxx
--	-----------	-------------	--------------	--------------

# Counters



## Digital multifunction

Types	DMF1461	DMF1462
		
Version	LED - Panel mount	LED - Panel mount
Dimensions HxWxD (mm)	DIN 96 x 48	DIN 96 x 48
<b>Function</b>		
Pulse counter	Yes	2 pulse counters, Pulse counter and timer, Pulse and frequency meter or 2 timers
Position display for encoders	Yes	
Frequency meter / Tachometer	Yes	Yes
Timer	Yes	Yes
<b>Technical data</b>		
Number of digit	6	6
Reset	Manual / Electric	Manual / Electric
Preset	-	-
Digit height, visible (mm)	14	14
Panel cut-out (mm)	92 x 45	92 x 45
Degree of protection	IP 65 front side	IP 65 front side
Max. count frequency (Hz)	60000	60000
Supply voltage	90...260 VAC / 10...30 VDC	90...260 VAC / 10...30 VDC
Count inputs	Schmitt-Trigger	Schmitt-Trigger
<b>References</b>		
	DMF1461xxx0	DMF1462xx0

## Hour meter electromechanical

Types	E1HM4	E2HM4	E2HM35	E1HM35
				
Version	Panel mount	Panel mount	Panel mount	DIN-rail
Dimensions HxWxD (mm)	DIN 48 x 24 - DIN 28 x 53	DIN 48 x 48	Ø71.1 - Ø58,7	90 x 36 x 66
<b>Technical data</b>				
Number of digit	7/8	7/8	6	7
Time range	0.01~99999.99h	0.01~99999.99h	0.01~99999.9h	0.01~99999.99h
Digit height, visible (mm)	4	4	3.5	3.5
Panel cut-out (mm)	45 x 22 / 50 x 25	46 x 46	Ø50.08	-
Degree of protection	IP 65 front side	IP 65 front side	IP 65 front side	IP 65 front side
Min. power consumption (W/VA)	0.5 / 1.2	0.5 / 1.2	0.7 / 0.4	1 / 2.5
Voltage range	20...264 VAC 10...130 VDC	20...440 VAC 10...30 VDC	115...230 VAC 10...80 VDC	24 / 115 / 230 VAC 10...27 VDC
<b>References</b>				
	E1HM4xxxxxx	E2HM4xxxxxx	E2HM35xxxxxx	E1HM35xxxxxx

# Counters

	Hour meter electronic LCD		Electronic multifunction counters
Types	FSA01	FSA02	DMF61 / DMF62
			
Version	LCD panel mount	LCD panel mount	LCD panel mount
Dimensions HxWxD (mm)	DIN 24 x 48	DIN 24 x 48	DIN 48 x 48
<b>Technical data</b>			
Number of digit	7	8	2 x 6
Time range	0.01 h; h.min	0.01 h; h.min	
Max. Count frequency (Hz)			50000
Preset			61: 1 / 62: 2
Reset	Manual / Electrical	Manual / Electrical	Electronic
Digit height, visible (mm)	8	8	
Panel cut-out (mm)	45 x 22	45 x 22	45 x 45
Mounting type	Panel mount	Panel mount	Panel mount
Degree of protection	IP 65 front side	IP 65 front side	IP 65 front side
Power supply	Lithium battery (>8 years)	Lithium battery (>8 years)	90 to 260 VAC 10 to 30 VDC
Output			Relay or Optocoupler
Input			2 count inputs, gate, reset, lock, MPI, 4 optional inputs
<b>References</b>			
	FSA01xxxxx	FSA02xxxxx	DMF6101xxxx0 DMF6201xxxx0











## OUR SALES NETWORK IN EUROPE

### AUSTRIA

Carlo Gavazzi GmbH  
Ketzergasse 374,  
A-1230 Wien  
Tel: +43 1 888 4112  
Fax: +43 1 889 10 53  
office@carlogavazzi.at

### BELGIUM

Carlo Gavazzi NV/SA  
Mechelsesteenweg 311,  
B-1800 Vilvoorde  
Tel: +32 2 257 4120  
Fax: +32 2 257 41 25  
sales@carlogavazzi.be

### DENMARK

Carlo Gavazzi Handel A/S  
Over Hadstenevej 40,  
DK-8370 Hadsten  
Tel: +45 89 60 6100  
Fax: +45 86 98 15 30  
handel@gavazzi.dk

### FINLAND

Carlo Gavazzi OY AB  
Ahventie 4 B,  
FI-02170 Espoo  
Tel: +358 9 756 2000  
myynti@gavazzi.fi

### FRANCE

Carlo Gavazzi Sarl  
Zac de Paris Nord II, 69, rue de la Belle Etoile,  
F-95956 Roissy CDG Cedex  
Tel: +33 1 49 38 98 60  
Fax: +33 1 48 63 27 43  
french.team@carlogavazzi.fr

### GERMANY

Carlo Gavazzi GmbH  
Pforstr. 10-14  
D-64293 Darmstadt  
Tel: +49 6151 81000  
Fax: +49 6151 81 00 40  
info@gavazzi.de

### GREAT BRITAIN

Carlo Gavazzi UK Ltd  
4.4 Frimley Business Park,  
Frimley, Camberley, Surrey GU16 7SG  
Tel: +44 1 276 854 110  
Fax: +44 1 276 682 140  
sales@carlogavazzi.co.uk

### ITALY

Carlo Gavazzi SpA  
Via Milano 13,  
I-20020 Lainate  
Tel: +39 02 931 761  
Fax: +39 02 931 763 01  
info@gavazziacbu.it

### NETHERLANDS

Carlo Gavazzi BV  
Wijkermeerweg 23,  
NL-1948 NT Beverwijk  
Tel: +31 251 22 9345  
Fax: +31 251 22 60 55  
info@carlogavazzi.nl

### NORWAY

Carlo Gavazzi AS  
Melkeveien 13,  
N-3919 Porsgrunn  
Tel: +47 35 93 0800  
Fax: +47 35 93 08 01  
post@gavazzi.no

### PORTUGAL

Carlo Gavazzi Lda  
Rua dos Jerónimos 38-B,  
P-1400-212 Lisboa  
Tel: +351 21 361 7060  
Fax: +351 21 362 13 73  
carlogavazzi@carlogavazzi.pt

### SPAIN

Carlo Gavazzi SA  
Avda. Iparraguirre, 80-82,  
E-48940 Leioa (Bizkaia)  
Tel: +34 94 480 4037  
Fax: +34 94 431 6081  
gavazzi@gavazzi.es

### SWEDEN

Carlo Gavazzi AB  
V:a Kyrkogatan 1,  
S-652 24 Karlstad  
Tel: +46 54 85 1125  
Fax: +46 54 85 11 77  
info@carlogavazzi.se

### SWITZERLAND

Carlo Gavazzi AG  
Verkauf Schweiz/Vente Suisse  
Sumpfsstrasse 3,  
CH-6312 Steinhausen  
Tel: +41 41 747 4535  
Fax: +41 41 740 45 40  
info@carlogavazzi.ch

## OUR SALES NETWORK IN THE AMERICAS

### USA

Carlo Gavazzi Inc.  
750 Hastings Lane,  
Buffalo Grove, IL 60089, USA  
Tel: +1 847 465 6100  
Fax: +1 847 465 7373  
sales@carlogavazzi.com

### CANADA

Carlo Gavazzi Inc.  
2660 Meadowvale Boulevard,  
Mississauga, ON L5N 6M6, Canada  
Tel: +1 905 542 0979  
Fax: +1 905 542 22 48  
gavazzi@carlogavazzi.com

### MEXICO

Carlo Gavazzi Mexico S.A. de C.V.  
Circuito Puericultores 22, Ciudad Satelite  
Naucalpan de Juarez, Edo Mex. CP 53100  
Mexico  
T +52 55 5373 7042  
F +52 55 5373 7042  
mexicosales@carlogavazzi.com

### BRAZIL

Carlo Gavazzi Automação Ltda.  
Av. Francisco Matarazzo, 1752  
Conj 2108 - Barra Funda - São Paulo/SP  
Tel: +55 11 3052 0832  
Fax: +55 11 3057 1753  
info@carlogavazzi.com.br

## OUR SALES NETWORK IN ASIA AND PACIFIC

### SINGAPORE

Carlo Gavazzi Automation Singapore Pte. Ltd.  
61 Tai Seng Avenue #05-06  
Print Media Hub @ Paya Lebar iPark  
Singapore 534167  
Tel: +65 67 466 990  
Fax: +65 67 461 980  
info@carlogavazzi.com.sg

### MALAYSIA

Carlo Gavazzi Automation (M) SDN. BHD.  
D12-06-G, Block D12,  
Pusat Perdagangan Dana 1,  
Jalan PJU 1A/46, 47301 Petaling Jaya,  
Selangor, Malaysia.  
Tel: +60 3 7842 7299  
Fax: +60 3 7842 7399  
sales@gavazzi-asia.com

### CHINA

Carlo Gavazzi Automation  
(China) Co. Ltd.  
Unit 2308, 23/F.,  
News Building, Block 1, 1002  
Middle Shennan Zhong Road,  
Shenzhen, China  
Tel: +86 755 83699500  
Fax: +86 755 83699300  
sales@carlogavazzi.cn

### HONG KONG

Carlo Gavazzi Automation  
Hong Kong Ltd.  
Unit No. 16 on 25<sup>th</sup> Floor, One Midtown,  
No. 11 Hoi Shing Road, Tsuen Wan,  
New Territories, Hong Kong  
Tel: +852 26261332 / 26261333  
Fax: +852 26261316

## OUR COMPETENCE CENTRES AND PRODUCTION SITES

### DENMARK

Carlo Gavazzi Industri A/S  
Hadsten

### MALTA

Carlo Gavazzi Ltd  
Zejtun

### ITALY

Carlo Gavazzi Controls SpA  
Belluno

### LITHUANIA

Uab Carlo Gavazzi Industri Kaunas  
Kaunas

### CHINA

Carlo Gavazzi Automation (Kunshan) Co., Ltd.  
Kunshan

## HEADQUARTERS

Carlo Gavazzi Automation SpA  
Via Milano, 13  
I-20020 - Lainate (MI) - ITALY  
Tel: +39 02 931 761  
info@gavazziautomation.com



**CARLO GAVAZZI**  
Automation Components

*Energy to Components!*

[www.gavazziautomation.com](http://www.gavazziautomation.com)



CAT OP ENG REV/27 02/20  
Specifications are subject to change without notice. Illustrations are for example only.