

Continental 
The Future in Motion



Hydraulics Catalog

2015 Hydraulic Hose, Fittings
& Equipment

www.contitech.us

ContiTech

What's New?



Hot Oiler

The Prospector™ Hot Oiler hose was specifically designed to initiate the flow of hot oil (275°F/135°C continuous; 300°F/149°C intermittent) and bring it to the surface. The hose is reinforced with dual-braided, high-tensile steel wire and features an oil- and abrasion-resistant synthetic rubber cover to help get the job done.



Prospector™ BOP 5000

This fire-tested, very high pressure BOP hose acts as a hydraulic control connection that can be critically important to the well control system. The hose is reinforced with up to six layers of spiraled, high-tensile steel wire to handle pressures that can reach 5,000 psi (34.5 MPa).



XCP3

With a special flame- and abrasion-resistant construction, the XCP3 takes on high-pressure hydraulic applications, and is designed to replace the SAE100R1 when a tougher, more flexible hose is required. With 5X the abrasion resistance over our standard cover, it's easy to see why this hose is the go-to choice.



Extended Life XR16SC

When the job requires tight bends, flexibility and abrasion resistance, this high pressure service hose steps up to the task. Using a nitrile inner tube and dual-braided, high-tensile steel wire reinforcement, it can handle 4,500 psi (31 MPa) flows of petroleum- and water-based hydraulic fluids.



DR2SN

The DR2SN high-pressure hose comes into play during construction, machine, tool and agricultural applications where high temperature petroleum- or water-based hydraulic fluids are a factor. The hose features a blue CPE cover, is flame resistant and meets higher EN/DIN pressures.

Table of Contents

Table of Contents

Table of Contents	E
-------------------	---

Product Line Overview

Putting Words to What We Do	J
Staying Connected With You	K
Who We Are	K
Unleash Hydraulics	L-M
Hydraulic Hose Line	N-Q
Hydraulic Fittings, Adapters, Standards & Specs	R-S
Hydraulic Equipment & Accessories	T
Notes	U

Hoses

Hydraulic Hose & Fitting Products	1
Hydraulic Hose Nomenclature	3

Low Pressure

SR6 - SAE 100R6/EN 854 R6	5
HR6 - Desert® SAE 100R6/EN 854 R6	5
HR4 - Desert® SAE 100R4	6
SR3 - SAE 100R3/EN 854 R3	6
IG - Insta-Grip™ 300	7
IGHT - Insta-Grip™ HT 300	7
IGTC - Insta-Grip™ TC	8
IGP - Insta-Grip™ PLUS	8

Medium Pressure

SR1SN - SAE 100R1AT/1SN	9
SFS - SAE 100R1AT/1SN (Fire Suppression)	9
DR1SN - Desert® SAE 100R1AT/1SN	10

High Pressure

SR2SN - SAE 100R2AT/2SN	10
DR2SN - Desert® SAE 100R2AT/2SN	11
LR2SN - Arctic® SAE 100R2AT/2SN	11
SR16SC - SAE 100R16/EN 857 2SC	12
DR16SC - Constant Pressure	12
XR16SC - Extended Life SAE 100R16/EN857 2SC	13
ARC16SC - Armorcoat™ SAE 100R16/EN 857 2SC	13
SCP3 - SAE 100R17	14
XCP3 - Extended Life SAE 100R17	14
ACP3 Armorcoat™ SAE 100R17	15

Very High Pressure

SR12 - SAE 100R12/EN 856 12	15
ARC12 - Armorcoat™ SAE 100R12/856 R12	16
SR13 - SAE 100R13/EN 856 R13	16
ARC13 - Armorcoat™ SAE 100R13/EN 856 R13	17
SR15 - SAE 100R15	17
ARC15 - Armorcoat™ SAE 100R15	18

Very High Pressure (cont'd)

S4SP - EN 856 4SP/DIN 20023 4SP	18
S4SH - EN 856 4SH/DIN 20023 4SH	19

Thermoplastic

SR7 - SAE 100R7/EN 855 R7	19
TR7 - SAE 100R7 (Twin-Line)	20
NR7 - SAE 100R7 (Non-Conductive)	20
BR7 - SAE 100R7 (Twin-Line, Non-Conductive)	21
SR8 - SAE 100R8/EN 855 R8	21
TR8 - SAE 100R8 (Twin-Line)	22
NR8 - SAE 100R8 (Non-Conductive)	22
SR18 - SAE 100R18	23

Special Application

NSFX - Saflex®	23
SHR - Prospector™ Slim-Hole Rotary Hose	24
BOP - Prospector™ BOP 3000	24
BOP - Prospector™ BOP 5000	25
Prospector™ Hot Oiler	25
SGUN - Grease Gun Hose	25
SHJ - Jack Hose	26
SR14A - SAE 100R14A	26

Fleet Application

SR5 - SAE 100R5	27
DR5 - Desert® SAE 100R5	28
SCX5 - SAE 100R5 (Rubber Covered)	29
DUT - Universal Truck SAE J1402 Type A 1	30

Air Conditioning

G4826 - Galaxy® 4826	31
G4867 - Galaxy® 4867	31
G4890 - Galaxy® 4890	32

Military Application

MIL-DTL-13444H Type I	33
MIL-DTL-13444H Type III	33
MIL-DTL-13531 Type II, Class A	34
MIL-DTL-3992 Type I, Class I	34
MIL-DTL-8788	34

Hose Working Pressure Selection Guide	35
Hose Special Attributes	41
Hose Temperature Limits	43

Hose Accessories

Protective Sleeving	44
Protective Wraps	44
Hose Routing Clamps	45

Fittings

Hydraulic Fitting Nomenclature	47
Hydraulic Ferrule Nomenclature	49
Perma-Crimp Fitting Selection	50
Explanation of Fitting Part Number	
Dimensions and Attributes	51

Section 1

(Fittings for hoses: SR1SN, DR1SN, SFS, SR2SN, DR2SN, LR2SN, CR2SN, GR16, GR17, SR16SC, ARC16SC, XCP3, SCP3, XR16SC and ACP3)

How To Use the Fitting Tables	52
JIC 37° Flare (SAE J514)	53
SAE 45° J512 Flare	57
SAE 45° Inverted Flare	58
NPTF	60
NPSM	63
GTF	63
SAE J514 Flareless Tube Fittings	64
Standpipe	64
O-Ring Face Seal (SAE J1453) ORS/ORFS	65
O-Ring Boss Straight Thread (SAE J514)	69
Code 61 Flange (SAE J518)	71
Code 62 Flange (SAE J518)	74
Komatsu® Flange	77
BSPP (British Standard Pipe Parallel)	79
BSPT (British Standard Pipe Tapered)	81
BSP Flat Seat (British Standard Pipe)	81
DIN 24° Light	82
DIN 24° Heavy	84
DIN 60°	86
Japanese Komatsu® 30° Flare With Metric Threads	87
JIS 30° (Parallel Pipe Threads)	88

Section 2

(Fittings for hoses: GR7, TR7, NR7, BR7, GR8, TR8, NR8, GR18)

How To Use the Fitting Tables	89
JIC 37° Flare (SAE J514)	90
SAE 45° Flare J512 Flare	94
SAE 45° Inverted Flare	95
NPTF	96
NPSM	98
SAE J514 Flareless Tube Fittings	99
Standpipe	99
O-Ring Face Seal (SAE J1453) ORS/ORFS	100
O-Ring Boss Straight Thread (SAE J1453)	102
BSPP (British Standard Pipe Parallel)	104
DIN 60°	104
JIS 30° (Parallel Pipe Threads)	105

Section 3

(Fittings for hoses: SR12, ARC12)

How To Use the Fitting Tables	106
JIC 37° Flare (SAE J514)	107
NPTF	111
NPSM	112
O-Ring Face Seal (SAE J1453) ORS/ORFS	112
O-Ring Boss Straight Thread (SAE J514)	115
Code 61 Flange (SAE J518)	116
Code 62 Flange (SAE J518)	120
Caterpillar® Flange	124
Komatsu® Flange	126
BSPP (British Standard Pipe Parallel)	127
BSPT (British Standard Pipe Tapered)	129
DIN 24° Light	129
DIN 24° Heavy	131
Japanese Komatsu® 30° Flare With Metric Threads	133
JIS 30° (Parallel Pipe Threads)	133

Section 4

(Fittings for hoses: SR13, ARC13, SR15, ARC15, S4SP, S4SH)

How To Use the Fitting Tables	134
JIC 37° Flare (SAE J514)	135
JIC 45° Flare J512 Flare	140
SAE 45° Inverted Flare	141
NPTF	144
NPSM	145
SAE J514 Flareless Tube Fittings	145
Standpipe	146
O-Ring Face Seal (SAE J1453) ORS/ORFS	149
O-Ring Boss Straight Thread (SAE J514)	151
Code 61 Flange (SAE J518)	155
Code 62 Flange (SAE J518)	159
Caterpillar® Flange	162
BSPP (British Standard Pipe Parallel)	164
BSPT (British Standard Pipe Tapered)	165
BSP Flat Seat (British Standard Pipe)	165
DIN 24° Light	167
DIN 24° Heavy	167
DIN 60°	169
Japanese Komatsu® 30° Flare With Metric Threads	170
JIS 30° (Parallel Pipe Threads)	171

Section 5**(Fittings for hoses: SR3, HR4, SR6, HR6, SR14A)**

How To Use the Fitting Tables	172
JIC 37° Flare (SAE J514)	173
SAE 45° J512 Flare	176
SAE 45° Inverted Flare	178
NPTF	179
NPSM	181
SAE J514 Flareless Tube Fitting	182
Standpipe	182
O-Ring Face Seal (SAE J1453) ORS/ORFS	183
O-Ring Boss Straight Thread (SAE J514)	186
Code 61 Flange (SAE J518)	188
Code 62 Flange (SAE J518)	191
BSPP (British Standard Pipe Parallel)	192
BSPT (British Standard Pipe Tapered)	194
BSP Flat Seat (British Standard Pipe)	195
DIN 24° Light	195
DIN 24° Heavy	197
DIN 60°	199
Japanese Komatsu® 30° Flare with Metric Threads	200
JIS 30° (Parallel Pipe Threads)	201

Section 6**(Fittings for hoses: SR5, DR5, SCX5)**

How To Use the Fitting Tables	202
JIC 37° Flare (SAE J514)	203
SAE 45° J512 Flare	209
SAE 45° Inverted Flare	211
NPTF	213
NPSM	216
SAE J514 Flareless Tube Fittings	216
Standpipe	217
O-Ring Face Seal (SAE J1453) ORS/ORFS	218
O-Ring Boss Straight Thread (SAE J514)	220
Code 61 Flange (SAE J518)	222
Code 62 Flange (SAE J518)	223
BSPP (British Standard Pipe Parallel)	223
BSPT (British Standard Pipe Tapered)	225
BSP Flat Seat (British Standard Pipe)	225
DIN 24° Light	226
DIN 24° Heavy	228
DIN 60°	229
Japanese Komatsu® 30° Flare with Metric Threads	230
JIS 30° (Parallel Pipe Threads)	231

Section 6A**(Fittings for hoses: DUT)**

How To Use the Fitting Tables	232
JIC 37° Flare (SAE J514)	233
SAE 45° J512 Flare	234
SAE 45° Inverted Flare	235
NPTF	236
SAE J514 Flareless Tube Fittings	237
Flange Engine Oil Connection (Two Bolt)	237
PTT 30°	237

Section 7**(Fittings for hoses: NSF, SHR, SGUN, SHJ, IG, IGHT, IGTC, IGP)**

How To Use the Fitting Tables	238
SF NSF Hose Fittings	239
NPTF	239
O-Ring Boss Straight Thread (SAE J514)	239
SH SHR Hose Fittings	240
NPTF Male API	240
GG SGUN Hose Fittings	240
NPTF	240
B2 SHJ Hose Fittings	240
NPTF	242
PB Push-On Brass Fittings (For use with IG, IGHT, IGTC & IGP Hose)	241
Hose Mender	241
JIC 37° Flare (SAE J514)	241
NPTF	242
SAE 45° Flare J512 Flare	244
SAE 45° Inverted Flare	245

Section 8**(Air Conditioning Fittings and Adapters for hoses: G4826, G4867, G4890)**

A/C Fitting Nomenclature	246
How To Use the Fitting Tables	247
Compressor O-Ring Tube	248
Flareless Tube	249
Hose Mender	250
O-Ring Insert Male	251
O-Ring Tube	253
SAE 45° Flare	258
GC Cool Clip Fittings (For Galaxy Air Conditioning Hose G4890)	260
Compressor Pad Block	260
Compressor O-Ring Tube	261
Flareless Tube	261
Ford Spring Lock	263
Hose Mender	264
O-Ring Face Seal	266
O-Ring Insert Male	266
O-Ring Tube	268
SAE 45° Flare	372
A/C Adapters	375
A/C Fitting Accessories & Assembly Tools	376

Section 9 (Fitting Ferrules)

UNI-CRIMP Ferrules	279
UCF1	279
UCF2	279
UCF3	279
UCF4	279
UCF5	280
UCF6	280
UCF7	280
UCF8	280
UCF9	281
UCF10	281

Section 9 (Fitting Ferrules) Continued

UCF11	281
Dual-Grip™ Ferrules	282
DGF1	283
DGF2	282
Fitting Reference Charts & Accessories	
Choosing the Correct Fittings	283
Working Pressure Charts	284
Thread Reference Chart	285
Fitting Accessories (O-Rings)	287
Split Flanges	289
German Metric Thread ID Template	290
Code 61 / Code 62 / Caterpillar® Flange Identification Template	291
Thread Identification Kit	292

Equipment & Accessories**Crimpers (With Associated Parts)**

PC125M	294
PC125	295
PC150	296
PC150H	297
PC200-P	298
PC400-P	299
PC600L-P	300
PC1000-P	304

Test Benches

PCTB1500	302
PCTB2500	302

Hose Saws

HS150	303
HS301	303
HS303	303
HS501	304
HS503	304
Skiving Tools	304

Fitting Cabinets (With Associated Parts)

CB102	307
CB103	307

Assemblies

Selecting the Proper Hose Assembly, S.T.A.M.P.E.D.	309
Defining Hose and Assembly Length	311
Steps In Hose Assembly	
Ultra-Crimp™ 1-piece Fittings	313
Uni-Crimp® 2-piece Fittings	315
Field-Grip Reusable Fittings	317
Internal and External Skivings	319
GR14A Hose	320
Galaxy® G4890 Air Conditioning Hose with Cool-Clip® Fittings	322
Galaxy® G4826 or G4867 Air Conditioning Hose with A/C Crimp Fittings	323
Notes	325

Installation & Maintenance

Service Life Factors	327
Safety Considerations	328
Proper Installation and Hose Routing	329
Hose Maintenance and Storage	330

Appendix

Fitting Identification by Thread Type	333
Fitting Identification Templates	350
Fitting Nut Types	351
Recommended Torque Values	352
Hose ID Selection Nomograph	354
Hose Pressure Drop	356
Chemical Resistance Tables	358
Temperature Conversion Chart	392
Pressure Conversions	394
Fraction Equivalents	395
Conversion Constants	396
Alphanumeric Part Number Index - Descriptive Numbers	397
Alphanumeric Part Number Index - Product Numbers	404
Notes	409

Putting Words to What We Do

Choose us as your sole supplier for hydraulic assembly components, including hoses, fittings, adapters and the assembly equipment. Because, whatever your application - construction, agriculture, oil and gas, manufacturing, transportation - our broad selection will connect you with a high-quality, reliable hydraulic hose assembly system. And you can trust that our products meet these global performance standards: SAE, DIN, JIS, USCG, ABS and US MSHA.

Not only are our hydraulic hose products designed to make a very literal connection - to each other and to your equipment - our network of distributors is ready to connect with you and your business needs. And we strive to do it all in the most friendly and efficient manner possible.

Being easy to work with can really be a differentiator in the hydraulic hose market. We know this and will always do our best to make sure your business is treated with the attention and care it deserves. That is our commitment to you.



Crimpers

Adapters & Fittings



Hoses



Staying Connected With You



Experienced hydraulic sales specialists



Friendly customer service representatives



Application engineers for technical assistance



Interactive website with important, up-to-date information



OneSource Distribution Network



Local support on a global basis

Who We Are

Continental ContiTech is the authority in elastomer compounding and reinforcement technology. Our history in the business gives us the expertise to not only make reliable products, but also to know the industry and its needs. And we are constantly innovating new ways to better serve our customers.

Under the Continental ContiTech brand, we manufacture a wide assortment of consumer and commercial products. In fact, we are one of the few manufacturers in the world that can offer a full breadth of industrial rubber products including

- › Industrial Hose › Conveyor Belts
- › Power Transmission Belts
- › Hydraulic Hose and Fittings › Air Springs
- › Rubber Track



Unleash Hydraulics

Whether the application is construction, oil and gas, agriculture, mining, manufacturing or transportation, designers and engineers are finding new ways to apply hydraulic power. We have your equipment needs covered with Continental ContiTech hydraulic hoses to meet the demands of the application and the environment. Plus, our hoses meet all major global standards.

Hydraulic Hose Standards & Specs

Continental ContiTech Hydraulic Hoses

- › Are produced to ISO 9001 certification
- › Undergo state-of-the-art manufacturing processes
- › Meet the applied international standards of SAE J517, EN 853, EN 854, EN 855, EN 856, EN 857, DIN 20023

Featuring



Arctic® Low Temperature Hose

- › -67°F (-55°C) low temperature service
- › LR2SN (SAE 100R2AT/2SN) high pressure hydraulic applications



Armorcoat™ Hose Cover

- › Super tough cover for high abrasion applications
- › Can replace protective sleeves
- › Mine Safety and Health Administration (MSHA) rated
- › ARC12 (SAE 100R12/EN 856 R12), ARC13 (SAE100R13/EN 856 R13), ARC15 (SAE 100R15), ARC16SC (SAE 100R16/EN 857 2SC) and ACP3 (SAE 100R17) hydraulic applications



Braided Hose

- › Higher EN / DIN pressures
- › Arctic™, Desert® and Armorcoat™ constructions
- › SR1SN (SAE 100R1AT/1SN), Desert® DR1SN (SAE 100R1AT/1SN), SR2SN (SAE 100R2AT/2SN), Arctic™ LR2SN (SAE 100R2AT/2SN), DR2SN (SAE 100R2AT/2SN), Desert® SR16SC (SAE 100R16/857 2SC), Armorcoat™ ARC16SC (SAE 100R16/857 2SC), SCP3 (SAE 100R17) and Armorcoat™ ACP3 (SAE 100R17), XR16SC
- › SFS (Fire Suppression SAE 100R1AT)
- › XCP3 (Constant Pressure 3000, SAE 100R17)





Desert® High Temperature Hose

- › 275°F (135°C) and 302°F (150°C) high temperature service
- › DR1SN (SAE 100R1AT/1SN), DR2SN (SAE 100R2AT/2SN), HR6 (SAE 100R6/EN 854 R6) hydraulic applications and HR4 (SAE 100R4)
- › DR2SN to 302°F (150°C) service, DR5 (SAE 100R5/J1942), DUT (J1402)



Fleet Applications

- › SR5 (SAE 100R5)
- › DR5 (high temperature service)
- › DUT (SAE J1402 Type A1)
- › Air conditioning hose
- › Military vehicles



High Pressure Hose

- › 4- and 6-spiral hose
- › Armorcoat™ abrasion cover available
- › Very high pressure and high pulsating applications up to 6000 psi
- › MSHA covers
- › SR12 (SAE 100R12/EN 856 R12), SR13 (SAE 100R13/EN 856 R13), SR15 (SAE 100R15), S4SH (EN 856 4SH/DIN 20023 4SH) and S4SP (EN 856 4SP/DIN 20023 4SP) hydraulic applications



Low Pressure Hose

- › 300 - 1250 psi
- › Textile reinforcement
- › SR3 (SAE 100R3), SR6 (SAE 100R6)
- › HR6 (SAE 100R6), HR4 (SAE 100R4)
- › Push-On Hose, Insta-Grip™ 300, Insta-Grip™ HT 300, Insta-Grip™ Plu^s and Insta-Grip™ T^c



Non-Conductive Hose

- › NSFEX (Saflex®) medium pressure hydraulic applications
- › Thermoplastic Hose including NR7 (SAE 100R7), NR8 (SAE 100R8) and BR7 (SAE 100R7)
- › Twin-lines available















Teflon Hose

- › 500°F (206°C) high temperature intermittent service
- › Chemical resistance
- › Stainless steel braided cover
- › SR14A (SAE 100R14)

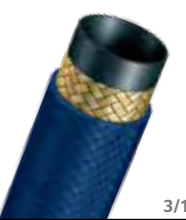
Hydraulic Hose Line

Varied pressures, abrasion levels and temperatures are no match for Continental ContiTech Hydraulic Hoses.

 <p>3/16" - 2"</p>	 <p>1/4" - 2"</p>	 <p>3/16" - 2"</p>	 <p>1/4" - 2"</p>
<p>SR1SN SAE 100R1AT/1SN Hydraulic applications requiring 1-braid hose at higher EN/DIN pressures.</p>	<p>Desert® DR1SN SAE 100R1AT/1SN High temperature, 1-braid hose at EN/DIN pressures.</p>	<p>SR2SN SAE 100R2AT/2SN Hydraulic applications requiring 2-braid hose at higher EN/DIN pressures.</p>	<p>Desert® DR2SN SAE 100R2AT/2SN High temperature 2-braid hose at EN/DIN pressures.</p>
 <p>1/4" - 2"</p>	 <p>1/4" - 1 1/4"</p>	 <p>1/4" - 4"</p>	 <p>3/16" - 1 13/16"</p>
<p>Arctic® LR2SN SAE 100R2AT/2SN High pressure, low temperature hydraulic oil lines.</p>	<p>SR3 SAE 100R3/EN 854 R3 Low pressure, 2 textile braid reinforced hose.</p>	<p>HR4 SAE 100R4 Low pressure, high temperature return line or suction line.</p>	<p>SR5 General purpose, medium pressure applications.</p>
 <p>3/16" - 1 1/2"</p>	 <p>1/4" - 1 1/2"</p>	 <p>3/16" - 1 1/2"</p>	 <p>3/16" - 3/4"</p>
<p>Desert® DR5 SAE 100R5/SAE J1942 Medium pressure, high temperature blue textile cover reinforced with 1-braid steel wire.</p>	<p>SCX5 SAE 100R5-type Rubber covered, USCG approved.</p>	<p>DUT SAE J1402 Type A1 High temperature, medium pressure fleet applications.</p>	<p>SR6 SAE 100R6/854 R6 Low pressure, textile reinforced applications.</p>



1/4" - 3/4"

Desert® HR6

SAE 100R6/854 R6

Low pressure, high temperature textile reinforced applications.



1/8" - 1"

SR7

SAE 100R7/855 R7

Medium pressure, thermoplastic hose with a perforated cover.



3/16" - 1/2"

TR7

SAE 100R7 (Twin-Line)

Medium pressure, twin-line thermoplastic hose with a perforated cover.

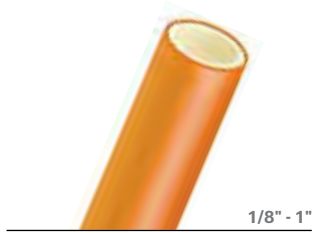

1/8" - 1"

NR7

SAE 100R7 (Non-Conductive)

Medium pressure, thermoplastic hose with a non-perforated cover.

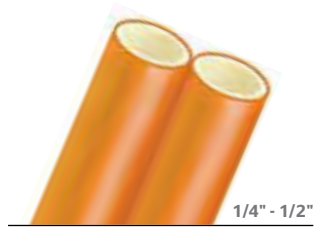

1/4" - 1/2"

BR7

SAE 100R7

(Twin-Line, Non-Conductive)

Medium pressure, twin-line thermoplastic hose with a non-perforated cover.



3/16" - 1/2"

SR8

SAE 100R8/855 R8

High pressure, thermoplastic hose with a perforated cover.



3/8" - 1/2"

TR8

SAE 100R8 (Twin-Line)

High pressure, twin-line, thermoplastic hose with a perforated cover.



1/4" - 1/2"

NR8

SAE 100R8 (Non-Conductive)

High pressure, thermoplastic hose with a non-perforated cover.



1/4" - 1"

S4SP

EN 856 4SP/DIN 20023 4SP

A 4-spiral hydraulic hose for very high pressure applications.



3/4" - 2"

S4SH

EN 856 4SH/DIN 20023 4SH

A 4-spiral hydraulic hose for very high pressure, pulsating applications.



3/8" - 2"

SAE 100R12/856 R12

A 4-spiral hydraulic hose for very high pressure applications subject to surges or flexing.



3/8" - 2"

Armorcoat™ ARC12

SAE 100R12/856 R12

For very high pressure applications subject to surges or flexing and requiring an abrasion-resistant cover.



3/4" - 2"

SR13

SAE 100R13/856 R13

A 4- and 6-spiral hose for very high pressure applications subject to surges or flexing.



3/4" - 2"

Armorcoat™ ARC13

SAE 100R13/856 R13

A 4- and 6-spiral hose for very high pressure applications subject to surges or flexing and requiring maximum abrasion resistance.

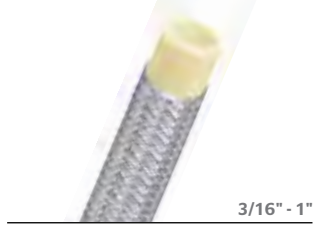

3/16" - 1"

SR14A

SAE 100R14A

PTFE line hose for air compressor discharge, hot oils and fluids, used under demanding physical conditions.



1/2" - 2"

SR15

SAE 100R15

A 4- and 6-spiral hose for severe high pressure applications.



1/2" - 1"

Armorcoat™ ARC15

SAE 100R15

A 4-spiral hose for severe high pressure and abrasive applications.



1/4" - 1/4"

SR16SC

SAE 100R16/857 2SC

For high pressure service with tight bends exceeding SAE 100R2 and SAE 100R16 standards.

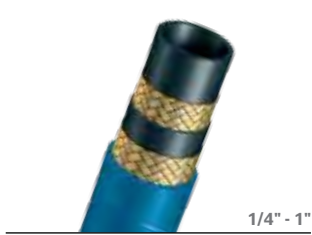

1/4" - 1"

Desert® DR16SC

SAE 100R16

High pressure 2-braid hose with excellent impulse performance and high flexibility.



1/4" - 1"

Armorcoat™ ARC16SC

SAE 100R16/857 2SC

For high pressure service with tight bends requiring ultimate abrasion resistance.



1/4" - 1"

XR16SC

SAE 100R16/857 2SC

For high pressure service with tight bends requiring maximum abrasion resistance.



1/4" - 1"

SCP3

SAE J1942

For high pressure hydraulic applications designed to replace where higher pressures and a more flexible hose are required.



1/4" - 1/2"

Armorcoat™ ACP3

SAE 100R17

For high pressure hydraulic applications requiring greater flexibility and ultimate abrasion resistance.



1/4" - 1"

XCP3

SAE 100R17

For high pressure hydraulic applications replacing SAE 100R17 with greater flexibility and superior abrasion resistance.



1/4" - 1/2"

SR18

SAE 100R18

Thermoplastic hose, highly flexible even in cold temperatures.



1/4" - 1/2"

NSFX

SAFLEX®

Medium pressure, non-conductive applications where shock hazards exist.



1/4" - 1"

SFS

Fire Suppression Hose

Medium pressure fire suppressant applications for mining, forestry and firefighting equipment.



3/16" only

SGUN

Grease Gun Hose

Used as a grease whip hose or general purpose lubrication line.



1/4" - 3/8"

SHJ

Jack Hose

For extreme high pressure hydraulic lines for jacking systems.



1/4" - 1"

Insta-Grip™ 300

Push-On

For use with push-on fittings, 300 psi and applications requiring non-conductivity.



1/4" - 3/4"

Insta-Grip™ HT 300

Push-On

For use with push-on fittings at working pressures up to 300 psi.



3/16" - 1"

Insta-Grip™ Plus 300

Push-On

For use with push-on fittings, 300 psi and applications requiring abrasion-resistant cover.



Insta-Grip™ TC
Push-On
 For low pressure hydraulic and pneumatic systems.



Galaxy® 4890, 4826, 4867
Air Conditioning Hose
 For AC applications requiring Cool Clip™ or Cool Crimp™ fittings.



Prospector™ Slim Hole Rotary
SHR
 For high pressure slim hole, seismograph, work-over or portable drill rigs.

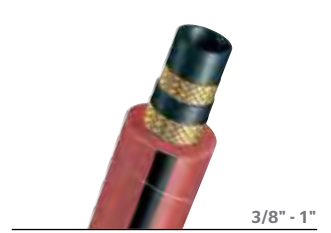

Prospector™ BOP 3000
Blow Out Prevention
 For hydraulic connection between the well control equipment and the control system in oil and gas exploration.



Prospector™ BOP 5000
Blow Out Prevention
 For hydraulic connection between the well control equipment and the control system in oil and gas exploration.



Hot Oiler
Static Pressure
 For initiating the flow of hot oil (275°F/135°C continuous; 300°F/149°C intermittent) and bringing it to the surface.



M-3992 Type I, Class 1
Military
 For low pressure flexible connections in air brake systems.



MIL-DTL-8788
Military
 High pressure hydraulic systems requiring interoperability and compatibility with associated components and equipment.



MIL-DTL-13444H Type I
Military
 Fuel and oil lines in military vehicles.



MIL-DTL-13444H Type III
Military
 For medium pressure hydraulic oil and fuel lines.



MIL-DTL-13531 Type II, Class A
Military
 Medium and high pressure hydraulic systems.

Hydraulic Fittings, Adapters Standards & Specs

Low-, medium- and high-pressure fittings are available for braided, spiral and thermoplastic hose.

Fittings

- › Ultra-Crimp™ (1-Piece)
- › Uni-Crimp® (2-Piece)
- › Dual-Grip® (2-Piece)
- › Field-Grip®
(Re-attachable)
- › Push-On
- › Air Conditioning

Thread-Ends

- › SAE
- › NPTF
- › JIC
- › British Standard
- › DIN
- › JIS
- › API

End Styles

- › Straights
- › Swivels
- › Elbows
- › Flanges

Featuring



Bite-to-Wire

These one-piece crimp fittings provide maximum coupling retention on 1- and 2-braid hoses as well as 4- and 6-spiral hoses. Serrations penetrate the cover with a powerful bite into the wire reinforcement, resulting in even hose compression.



No Skive

Assemblies made faster, with fewer steps and less mess.

Full-Length Crimp

Maximum coupling retention for a safe and longer lasting assembly; easier to crimp with a lower profile.



Zinc Plating

- › Offers corrosion resistance for extended hose assembly and fitting life, easily surpassing the corrosion resistance of SAE J516, ASTM B117.
- › Silver chromium 6
Free plating on Ultra-Crimp™, Uni-Crimp® and Dual-Grip® fittings.



Full Line of High Pressure Spiral Hose Couplings

- › Code 61, Code 62, Cat® Flange and Komatsu® Flange fittings for SAE 100R12 and 100R13
- › Solid one-piece flanged fitting; no braze or weld joints



Field-Grip® Fittings

Non-skive, re-attachable for easy installation



Push-on Fittings

Fittings compatible with push-on hose, including Insta-Grip 300,™ Insta-Grip Plus 300,™ Insta-Grip™ TC and Insta-Grip™ HT 300



A/C Fittings

Cool Clip® and Cool Crimp™ fittings



Adapters

Change existing end styles



Hydraulic Equipment & Accessories

To complete the total assembly solution, look no further than the Continental ContiTech Perma-Crimp® line. In addition to crimpers, we also offer crimper dies, cabinets, pumps, cut-off saws, skivers, hose/fitting pushers and hose assembly test benches.



Perma-Crimp® PC125M

- › Lightweight for portable field use.
- › Three power options. Attach hand, air or electrical pump.
- › Capable of crimping up to 1 ¼" 2-braid and 1 ¼" 4-spiral hose.



Perma-Crimp® PC125

- › Suitable for shop service and bench mounting.
- › Includes 1-HP electric pump on a common base.
- › Capable of crimping up to 1 ¼" 2-braid and 1 ¼" 4-spiral hose.



Perma-Crimp® PSW100 & 101

- › Positive stop crimper conversion kits.
- › Die sets allow you to use existing equipment with Continental ContiTech brand hose.



Perma-Crimp® PC150

- › Stationary crimper with more power to manufacture hose assemblies.
- › Includes 2-HP electric pump on a common base for bench mounting.
- › Capable of crimping up to 1 ½" 2-braid and 4-spiral hose.



Perma-Crimp® PC150H

- › High-volume, stationary crimper.
- › 1-HP power source.
- › Capable of crimping up to 1 ½" 2-braid and 4-spiral hose.



Perma-Crimp® PC200-P

- › High-capacity, stationary, "production" crimper.
- › 7.5-HP power source.
- › Microprocessor control for fast and accurate adjustments.
- › Capable of crimping up to 2" 6-spiral hose.



Perma-Crimp® PC400-P

- › High-capacity, stationary "production" crimper.
- › 7.5-HP power source.
- › Capable of crimping up to 2" 6-spiral hydraulic and 4" industrial hose.



Perma-Crimp® PC600L-P

- › High-volume, high-capacity "production" crimper.
- › 7.5-HP power source, 350 ton cylinder.
- › Fully automated ACT programmable controller.
- › Capable of crimping up to 2 ½" braided spiral hydraulic and up to 6" industrial hose.



Perma-Crimp® PC1000-P

- › High-volume, high-capacity stationary crimper.
- › Fully automatic ACT3™ microprocessor controller.
- › 1,415 crimps per hour with 450 tons of crimping force.

Hydraulic Hose & Fitting Products

Proper Assembly of ContiTech Perma-Crimp® Hose and Fittings.

ContiTech Perma-Crimp® hose, fittings and crimping equipment work together to provide an efficient and reliable hose connection. Hose and fittings are part of an engineered system, and are to be assembled in accordance with ContiTech specifications. Using non-ContiTech components may produce an assembly that does not meet rated performance. **ContiTech does not warrant, expressly or by implication, hose assemblies that do not incorporate ContiTech Perma-Crimp® hose and fittings, or are not crimped in accordance with ContiTech process specifications.**

Buyers may elect to attach additional or non-standard parts or equipment, or to use different manufacturing

specifications, as necessary to meet the requirements of the buyer or customer's application. In such cases, the buyer has sole responsibility to qualify the hose for these applications as necessary to ensure performance capability.

For guidance in the assembly of ContiTech Perma-Crimp® hose and couplings, please refer to the ContiTech Crimp Specifications Manual. Information in this catalog is believed to be accurate, but is not warranted, and is subject to change without prior notice. For the most current available product and crimp specifications information, please check our website: www.contitech.us.





Hoses

Hydraulic Hose Nomenclature



Hose Attribute

First character of Part Number

- H = High Temp (DESERT®), 275°F
- L = Low Temp (ARCTIC®)
- A = Abrasion Cover (ARMORCOAT™)
- N = Non-Conductive
- T = Twin-Line
- B = Both Non-Conductive and Twin-Line
- S = Standard Specification Hose
- D = High Temp (DESERT®), 302°F
- X = Extended Life Abrasion Resistance Cover

Note: Push-On Hose (IG, IGHT, IGTC, UG); Military Hose (MIL, M); and SHR Hose do not have a one-digit Hose Attribute character.

Hose Standard

Next 2-5 characters of Part Number before hyphen

- R1SN = SAE 100R1AT/1SN
- FS = Fire Suppression (SAE 100R1AT/1SN)
- R2SN = SAE 100R2AT/2SN
- R3 = SAE 100R3/EN 854 R3
- R4 = SAE 100R4
- R5 = SAE 100R5
- CX5 = SAE100R5 (Rubber Covered)
- UT = Universal Truck Hose (SAE J1402 A1)
- R6 = SAE 100R6/854 R6
- R7 = SAE 100R7/855 R7
- SFX = SAFLEX®
- R8 = SAE 100R8/855 R8
- 4SH = EN 856 4SH/DIN 20023 4SH
- 4SP = EN 856 4SP/DIN 20023 4SP
- R12 = SAE 100R12/856 R12
- R13 = SAE 100R13/856 R13
- R14A = SAE 100R14A
- R15 = SAE 100R15
- R16SC = SAE 100R16/857 2SC
- CP3 = Constant Pressure 3000 (SAE 100R17)
- R18 = SAE 100R18
- SHR = Prospector™ Slim Hole Rotary
- BOP = Prospector™ BOP 3000, 5000
- GUN = Grease Gun Hose
- HJ = Jack Hose
- 4826 = Galaxy® 4826 (Air Conditioning)
- 4867 = Galaxy® 4867 (Air Conditioning)
- 4890 = Galaxy® 4890 SLE (Air Conditioning)
- IG = Insta-Grip™ 300 (Push-On)
- IGTC = Insta-Grip™ TC (Push-On)
- IGHT = Insta-Grip™ HT 300 (Push-On)
- IGP = Insta-Grip™ Plus (Push-On)
- M or MIL = Military Hose

Hose Dash Size

(Hose Inside Diameter) Last 2 characters of Part Number after hyphen

All hoses except R5, UT and Galaxy®

- 02 = 1/8" (3.3 mm)
- 03 = 3/16" (4.8 mm)
- 04 = 1/4" (6.4 mm)
- 05 = 5/16" (7.9 mm)
- 06 = 3/8" (9.5 mm)
- 08 = 1/2" (12.7 mm)
- 10 = 5/8" (15.9 mm)
- 12 = 3/4" (19 mm)
- 16 = 1" (25.4 mm)
- 20 = 1 1/4" (31.8 mm)
- 24 = 1 1/2" (38.1 mm)
- 32 = 2" (50.8 mm)
- 40 = 2 1/2" (63.5 mm)
- 48 = 3" (76.2 mm)
- 56 = 3 1/2" (89 mm)
- 64 = 4" (101.6 mm)

SAE 100R5, UT and Galaxy® Hose

- 04 = 3/16" (4.8 mm)
- 05 = 1/4" (6.4 mm)
- 06 = 5/16" (7.9 mm)
- 08 = 13/32" (10.3 mm)
- 10 = 1/2" (12.7 mm)
- 12 = 5/8" (15.9 mm)
- 14 = 3/4" (19.1 mm)
- 16 = 7/8" (22.2 mm)
- 20 = 1 1/8" (28.6 mm)
- 24 = 1 3/8" (35 mm)
- 32 = 1 3/4" (46 mm)

Note: Military Hose utilize unique military dash sizes.

Warning - Selection of Hose

Selection of the proper hose for the application is essential to the proper operation and safe use of the hose and related equipment. Inadequate attention to selection of the hose for your application can result in hose leakage, bursting, or other failure, which can cause serious bodily injury or property damage from spraying fluids or flying projectiles. Some of the factors involved in the selection of the proper hose include:

- › Hose Size
- › Fluid Conveyed
- › Hose Pressure
- › Hose Length
- › Bends
- › Static Head Pressure
- › Hose Ends
- › Temperature
- › Installation Design

The above factors and information provided in this catalog should be considered in selecting the proper hose for your application.

Hydraulic Hose Nomenclature

Hydraulic Hose Part Number Designations

Part #	Description	Page #
SR1SN	SAE100R1AT/1SN	9
DR1SN	Desert® SAE 100R1AT/1SN (High Temp)	10
SFS	SAE 100R1AT/1SN (Fire Suppression)	9
SR2SN	SAE 100R2AT/2SN	10
LR2SN	ARCTIC® SAE 100R2AT/2SN (Low Temp)	11
DR2SN	Desert® SAE 100R2AT/2SN (High Temp)	11
SR3	SAE 100R3/EN 854 R3	6
HR4	Desert® SAE 100R4 (High Temp)	6
SR5	SAE 100R5	27
DR5	Desert® SAE 100R5 (High Temp)	28
SCX5	SAE 100R5 (Rubber Covered)	29
DUT	SAE J1402 A1 Universal Truck Hose	30
SR6	SAE 100R6/EN 854 R6	5
HR6	Desert® SAE 100R6/EN 854 R6 (High Temp)	5
SR7	SAE 100R7/EN 855 R7	20
NR7	SAE 100R7 (Non-Conductive)	21
TR7	SAE 100R7 (Twin-Line)	20
BR7	SAE 100R7 (Twin-Line, Non-Conductive)	21
SR8	SAE 100R8/EN855 R8	22
NR8	SAE 100R8 (Non-Conductive)	23
TR8	SAE 100R8 (Twin-Line)	22
S4SH	EN 856 4SH	19
S4SP	EN 856 4SP	19
SR12	SAE 100R12/EN 856 R12	16
ARC12	ARMORCOAT™ SAE 100R12/EN856 R12 (Abrasion Cover)	16

Part #	Description	Page #
SR13	SAE 100R13/EN 856 R13	17
ARC13	ARMORCOAT™ SAE 100R13/EN856 R13 (Abrasion Cover)	17
SR14A	SAE 100R14A (Stainless Steel Cover, Teflon® Tube)	26
SR15	SAE 100R15	18
ARC15	ARMORCOAT™ SAE 100R15 (Abrasion Cover)	18
SR16SC	SAE 100R16/EN 857 2SC	13
DR16SC	Desert® SAE 100R16SC	14
XR16SC	Extended Life SAE 100R16SC	12
ARC16SC	ARMORCOAT™ SAE 100R16/EN857 2SC (Abrasion Cover)	14
SCP3	Constant Pressure SAE 100R17	13
ACP3	ARMORCOAT™ SAE 100R17 (Abrasion Cover)	15
XCP3	Extended Life SAE 100R17 (Constant Pressure 3000 psi)	14
SR18	SAE 100R18	23
NSFX	SAFLEX® (Non-Conductive)	24
SHR	Prospector™ Slim Hole Rotary Hose	24
BOP 3000	Prospector™ BOP 3000 (Blow Out Preventer)	25
BOP 5000	Prospector™ COP 5000 (Blow Out Preventer)	
Hot Oiler	Hot Oiler	
SGUN	Grease Gun Hose	25
SHJ	Jack Hose	26
G4826	Galaxy® 4826 (Air Conditioning)	31
G4867	Galaxy® 4867 (Air Conditioning)	31
G4890	Galaxy® 4890 SLE (Air Conditioning)	32
IG	Insta-Grip™ 300 Push-On (Rubber Cover)	7
IGHT	Insta-Grip™ HT 300 Push-On (High Temp)	7
IGTC	Insta-Grip™ TC Push-On (Textile Cover)	8
IGP	Insta-Grip™ Plus Push-On (Cabryn® Rubber Cover)	8
MIL	Military Hose	33

SR6

SAE 100R6/EN 854 R6 | Low Pressure

**Application**

Low pressure, textile reinforced applications including petroleum and water-based fluids for use as power steering return, lube lines and air lines. Not for brake applications.

Inner Tube

Nitrile

Reinforcement

One textile braid

Cover

Black polychloroprene

Temperature Range

-40°F to 212°F (-40°C to 100°C)

Fitting Reference

All fittings compatible with the SR6 hose family are listed in Section 6 (starting on page 201) of the catalog.

Branding

Example: Continental ContiTech SR6-03 SAE 100R6 R6 3/16" (DN05) W.P. 500 psi (3.4 MPa)

› Meets or exceeds the performance requirements of: SAE 100R6/EN 854 R6.

Descriptive #/ Product #	SAP #	Hose Size ID		Hose OD		Max. Working Pressure		Min. Bend Radius		Min. Burst Pressure		Weight lbs./ft.
		in.	DIN Dash Size	in.	mm	psi	MPa	in.	mm	psi	MPa	
SR6-03	20240277	3/16	05	0.44	11.1	500	3.4	2.0	51	2000	13.8	0.07
SR6-04	20240278	1/4	06	0.50	12.7	400	2.8	2.5	64	1600	11.0	0.09
SR6-05	20240279	5/16	08	0.56	9.1	400	2.8	3.0	76	1600	11.0	0.09
SR6-06	20240280	3/8	10	0.63	15.9	400	2.8	3.0	76	1600	11.0	0.11
SR6-08	20240281	1/2	12	0.78	19.8	400	2.8	4.0	102	1600	11.0	0.16
SR6-10	20240282	5/8	16	0.91	23.0	350	2.4	5.0	127	1400	9.7	0.18
SR6-12	20254775	3/4	19	1.05	26.6	300	2.1	6.0	152	1200	8.3	0.25

Desert® HR6

SAE 100R6/EN 854 R6 | Low Pressure

**Application**

Low pressure, textile reinforced applications including petroleum and water-based fluids for use in power steering return, lube lines and air lines. Not for brake applications.

Inner Tube

Nitrile

Reinforcement

One textile braid

Cover

Black polychloroprene

Temperature Range

-40°F to 275°F (-40°C to 135°C)

Fitting Reference

All fittings compatible with the HR6 hose family are listed in Section 6 (starting on page 201) of the catalog.

Branding

Example: Continental ContiTech DESERT® HR6-04 SAE 100R6/EN 854 R6 (High Temp) 1/4" (DN06) W.P. 400 psi (2.8 MPa)

› Meets or exceeds the performance requirements of: SAE 100R6/EN 854 R6.

› High Temperature

Descriptive #/ Product #	SAP #	Hose Size ID		Hose OD		Max. Working Pressure		Min. Bend Radius		Min. Burst Pressure		Weight lbs./ft.
		in.	DIN Dash Size	in.	mm	psi	MPa	in.	mm	psi	MPa	
HR6-04	20687451	1/4	06	0.51	12.9	400	2.8	2.5	64	1600	11.0	0.09
HR6-05	20239412	5/16	08	0.57	14.5	400	2.8	3.0	76	1600	11.0	0.09
HR6-06	20687409	3/8	10	0.64	16.2	400	2.8	3.0	76	1600	11.0	0.11
HR6-08	20743641	1/2	12	0.77	19.6	400	2.8	4.0	102	1600	11.0	0.16
HR6-10	20616767	5/8	16	0.91	23.2	350	2.4	5.0	127	1400	9.7	0.18
HR6-12	20645813	3/4	19	1.06	26.9	300	2.1	6.0	152	1200	8.3	0.25

Desert® HR4

SAE 100R4 | Low Pressure



1/2 Bend

- › Meets or exceeds the performance requirements of: SAE 100R4
- › High Temperature
- › Meets Flame Resistance USMSHA Designation
- › SAE J1942/ U.S. Coast Guard 

Application

Low pressure, high temperature return line or suction line for petroleum- and water-based hydraulic fluids. Vacuum rating 25 in Hg. HR4 has half the bend radius of typical SAE 100R4.

Inner Tube

Nitrile

Reinforcement

Spiral-plyed synthetic fabric with wire helix

Cover

Black polychloroprene

Temperature Range

-40°F to 275°F (-40°C to 135°C)

Fitting Reference

All fittings compatible with the HR4 hose family are listed in Section 6 (starting on page 201) of the catalog. Note: No Continental ContiTech fitting recommendation on HR4-48 and HR4-64 hose sizes.

Branding

Example: Continental ContiTech DESERT® HR4-12 SAE 100R4 3/4" (19mm) W.P. 300 psi (2.1 MPa) MSHA IC-152/8

Descriptive #/ Product #	SAP #	Hose Size ID		Hose OD		Max. Working Pressure		Min. Bend Radius		Min. Burst Pressure		Weight lbs./ft.	USCG Approved
		in.	mm	in.	mm	psi	MPa	in.	mm	psi	MPa		
HR4-12	20325410	3/4	19.0	1.37	34.9	300	2.1	2.5	64	1200	8.3	0.53	H
HR4-16	20325411	1	25.4	1.63	41.3	250	1.7	3.0	76	1000	6.9	0.65	H
HR4-20	20325412	1¼	31.8	2.00	50.8	200	1.4	4.0	102	800	5.5	0.80	H
HR4-24	20325413	1½	38.1	2.25	57.2	150	1.0	5.0	127	600	4.1	0.91	H
HR4-32	20325414	2	50.8	2.75	69.9	100	0.7	6.0	152	400	2.8	1.18	H
HR4-40	20325415	2½	63.5	3.25	82.6	62	0.4	7.0	188	250	1.7	1.72	H
HR4-48	20325416	3	76.2	3.75	95.3	58	0.4	9.0	229	232	1.6	2.03	
HR4-64	20325418	4	101.6	4.75	120.7	35	0.2	12	305	140	1.0	2.75	

SR3

SAE 100R3/EN 854 R3 | Low Pressure



- › Meets or exceeds the performance requirements of: SAE 100R3/EN 854 R3
- › Meets Flame Resistance USMSHA Designation

Application

Low pressure, textile reinforced hose for petroleum- or water-based hydraulic fluids or pneumatic applications. Not to be used for air brake.

Inner Tube

Nitrile

Reinforcement

Two textile braids

Cover

Black polychloroprene

Temperature Range

-40°F to 212°F (-40°C to 100°C)

Fitting Reference

All fittings compatible with the SR3 hose family are listed in Section 6 (starting on page 201) of the catalog.

Branding

Example: Continental ContiTech SR3-04 SAE 100R3 R3 1/4" (DN06) W.P. 1250 psi (8.6 MPa) MSHA 2G-IC-14C/30

Descriptive #/ Product #	SAP #	Hose Size ID		Hose OD		Max. Working Pressure		Min. Bend Radius		Min. Burst Pressure		Weight lbs./ft.
		in.	DIN Dash Size	in.	mm	psi	MPa	in.	mm	psi	MPa	
SR3-04	20240260	1/4	06	0.56	14.3	1250	8.6	3.0	76	5000	34.5	0.12
SR3-05	20239389	5/16	08	0.68	17.5	1200	8.3	4.0	102	4800	33.1	0.16
SR3-06	20240261	3/8	10	0.75	19.0	1125	7.8	4.0	102	4500	31.0	0.17
SR3-08	20240262	1/2	12	0.94	23.8	1000	6.9	5.0	127	4000	27.6	0.25
SR3-10	20553192	5/8	10	1.06	27.1	884	6.1	5.5	140	3538	24.4	0.31
SR3-12	20240275	3/4	19	1.25	31.8	750	5.2	6.0	152	3000	20.7	0.43
SR3-16	20240276	1	25	1.50	38.1	565	3.9	8.0	203	2260	15.6	0.51
SR3-20	20239390	1¼	31	1.75	44.4	377	2.6	10.0	254	1508	10.4	0.63

IG

INSTA-GRIP™ 300 | Low Pressure Push-On



- › Meets Flame Resistance USMSHA Designation
- › Non-Conductive

Application

For use with push-on fittings at maximum working pressures of 300 psi. For low pressure hydraulic and pneumatic systems such as shop air systems, general industrial, maintenance and automotive applications. Non-conductive, minimum electrical resistance, greater than (1) megohm per inch of hose length at 1000 Volts DC. Note: Insta-Grip™ 300 black cover hose meets USMSHA 2G-1C-14C/33. All others colors meet USMSHA 2G-1C-14C/32.

Inner Tube

Chemivic® oil and heat resistant synthetic rubber (RMA Class A high oil resistance)

Reinforcement

One textile braid

Cover

Black, Blue, Red, Green, Grey (others, contact marketing): weather, abrasion and oil resistant Nitrile synthetic rubber. (RMA Class B medium/high oil resistance)

Temperature Range

-40°F to 190°F (-40°C to 88°C)

Fitting Reference

All fittings compatible with the Insta-Grip™ 300 hose family are listed in Section 8 (starting on page 267) of the catalog.

Branding

Example: Continental ContiTech Insta-Grip™ 1/4" W.P. 300 psi Flame Resistant USMSHA 2G-1C-14C/33 Made in U.S.A..

Descriptive # (***) Insert Color	Product # (***) Insert Color	SAP # (BLK) exc.16 (RED)	Hose Size ID		Hose OD		Max. Working Pressure		Min. Bend Radius		Min. Burst Pressure		Weight	
			in.	mm	in.	mm	psi	MPa	in.	mm	psi	MPa	lbs./ft.	kg/m
(See Legend)	(See Legend)													
IG 300 1/4***	IG***-04	20022636	1/4	6.4	0.54	13.7	300	2.1	2.5	64	1200	8.3	0.09	0.13
IG 300 5/16***	IG***-05	20022641	5/16	7.9	0.62	15.7	300	2.1	3.0	76	1200	8.3	0.12	0.18
IG 300 3/8***	IG***-06	20022644	3/8	9.5	0.69	17.5	300	2.1	3.0	76	1200	8.3	0.14	0.21
IG 300 1/2***	IG***-08	20022648	1/2	12.7	0.81	20.6	300	2.1	5.0	127	1200	8.3	0.16	0.24
IG 300 5/8***	IG***-10	20022651	5/8	15.9	0.93	23.6	300	2.1	6.0	152	1200	8.3	0.20	0.30
IG 300 3/4***	IG***-12	20022653	3/4	19.0	1.07	27.2	300	2.1	7.0	178	1200	8.3	0.25	0.37
IG 300 1***	IG***-16	20136613	1	25.4	1.34	34.0	300	2.1	8.0	203	1200	8.3	0.34	0.51

Colors: Black = BLK, Blue = BLU, Red = RED, Green = GRN, Grey = GRY

IGHT

INSTA-GRIP™ HT 300 | Low Pressure Push-On



- › High Temperature

Application

For lubricating and fuel oils, air and water. Not recommended for applications involving impulse movements or air brake applications. For use with push-on fittings at working pressures up to 300 psi.

Inner Tube

Black CPE Rubber, Meets RMA Class B Oil Resistance

Reinforcement

One synthetic textile braid

Cover

Black CPE rubber, Meets RMA Class B oil resistance

Temperature Range

Petroleum-based hydraulic fluids -40°F to +300°F (-40°C to +150°C)
Water and Air -40°F to 190°F (-40°C to 88°C)

Fitting Reference

All fittings compatible with the Insta-Grip™ HT 300 hose family are listed in Section 8 (starting on page 267) of the catalog.

Branding

Example: Continental ContiTech Insta-Grip™ HT 1/4" 300 psi W.P. Made in U.S.A..

Descriptive #/ Product #	SAP #	Hose Size ID		Hose OD		Max. Working Pressure		Min. Bend Radius		Min. Burst Pressure		Weight lbs./ft.
		in.	mm	in.	mm	psi	MPa	in.	mm	psi	MPa	
IGHT-04	20544196	1/4	6.4	0.51	12.8	300	2.1	2.5	64	1200	8.3	0.09
IGHT-06	20544197	3/8	9.5	0.67	17.0	300	2.1	3.0	76	1200	8.3	0.14
IGHT-08	20544198	1/2	12.7	0.76	19.3	300	2.1	5.0	127	1200	8.3	0.16
IGHT-10	20544199	5/8	15.9	0.93	23.6	300	2.1	6.0	152	1200	8.3	0.20
IGHT-12	20571923	3/4	19.0	1.04	26.5	300	2.1	7.0	178	1200	8.3	0.25

IGTC

INSTA-GRIP™ TC | Low Pressure Push-On



Application

For low pressure hydraulic and pneumatic systems such as shop air systems, general industrial, maintenance and automotive applications.

Inner Tube

Chemivic® oil and heat resistant synthetic rubber (RMA Class A High Oil Resistance)

Reinforcement

One textile braid

Cover

Black dyed textile braid, mildew and oil resistance

Temperature Range

-40°F to 200°F (-40°C to 93°C)

Fitting Reference

All fittings compatible with the Insta-Grip™ TC hose family are listed in Section 8 (starting on page 267) of the catalog.

Branding

Example: Continental ContiTech Insta-Grip™ TC 1/4" W.P. 300 psi Made in U.S.A..

Descriptive #/ Product #	SAP #	Hose Size ID		Hose OD		Max. Working Pressure		Min. Bend Radius		Min. Burst Pressure		Weight	
		in.	mm	in.	mm	psi	MPa	in.	mm	psi	MPa	lbs./ft.	kg/m
IGTC-04	20022593	1/4	6.4	0.50	12.7	300	2.1	2.5	64	1200	8.3	0.08	0.12
IGTC-05	20022595	5/16	7.9	0.56	14.2	300	2.1	3.0	76	1200	8.3	0.09	0.13
IGTC-06	20022597	3/8	9.5	0.64	16.3	300	2.1	3.0	76	1200	8.3	0.11	0.16
IGTC-08	20022600	1/2	12.7	0.75	19.1	300	2.1	5.0	127	1200	8.3	0.13	0.19
IGTC-10	20022602	5/8	15.9	0.91	23.1	300	2.1	6.0	152	1200	8.3	0.19	0.28
IGTC-12	20022604	3/4	19.0	1.03	26.2	300	2.1	7.0	178	1200	8.3	0.21	0.31

IGP

INSTA-GRIP™ PLUS | Low Pressure Push-On



- › Meets Flame Resistance USMSHA Designation
- › Non-Conductive
- › Abrasion Cover

Application

For use with push-on fittings at maximum working pressures of 400 psi. For low pressure hydraulic and pneumatic systems such as robotics, shop air systems, general industrial, maintenance and automotive applications. Non-conductive, minimum electrical resistance, greater than (1) megohm per inch of hose length at 1000 Volts DC.

Inner Tube

Chemivic® oil and heat resistant synthetic rubber (RMA Class A High Oil Resistance)

Reinforcement

One textile braid

Cover

Black, Blue, Red, Green, Grey, White, Brown and Yellow (others, contact marketing): weather-abrasion and oil resistant Carbryn™ rubber. (RMA Class A high oil resistance)

Temperature Range

-40°F to 200°F (-40°C to 93°C)

Fitting Reference

All fittings compatible with the Insta-Grip™ hose family are listed in Section 8 (starting on page 267) of the catalog.

Branding

Example: Continental ContiTech Insta-Grip™ Plus Non-Conductive 3/8" (9.5 mm) W.P. 400 psi (28 bar); Flame Resistant USMSHA 2G-IC-14C / 27 Made in U.S.A..

Descriptive # (***)Insert Color	Product # (***)Insert Color	SAP #	Hose Size ID		Hose OD		Max. Working Pressure		Min. Bend Radius		Min. Burst Pressure		Weight	
(See Legend)	(See Legend)	(BLK)	in.	mm	in.	mm	psi	MPa	in.	mm	psi	MPa	lbs./ft.	kg/m
Insta-Grip Plus 3/16***	IGP***-03	20022699	3/16	4.8	0.36	9.10	400	2.8	2.5	64	1600	11.0	0.04	0.06
Insta-Grip Plus 1/4***	IGP***-04	20022700	1/4	6.4	0.51	13.0	400	2.8	2.5	64	1600	11.0	0.08	0.12
Insta-Grip Plus 3/8***	IGP***-06	20022703	3/8	9.5	0.67	17.0	400	2.8	3.0	76	1600	11.0	0.13	0.19
Insta-Grip Plus 1/2***	IGP***-08	20022706	1/2	12.7	0.76	19.3	400	2.8	5.0	127	1600	11.0	0.14	0.21
Insta-Grip Plus 5/8***	IGP***-10	20022711	5/8	15.9	0.93	23.6	400	2.8	6.0	152	1600	11.0	0.19	0.28
Insta-Grip Plus 3/4***	IGP***-12	20022714	3/4	19.0	1.06	26.9	400	2.8	7.0	178	1600	11.0	0.24	0.36
Insta-Grip Plus 1***	IGP***-16	20141684	1	25.4	1.34	34.0	400	2.8	8.0	203	1600	11.0	0.34	0.51

Colors: Black = BLK, Blue = BLU, Red = RED, Green = GRN, Grey = GRY, White = WHT, Brown = BRN, Yellow = YEL

SR1SN

SAE 100R1AT/1SN | Medium Pressure



Application

Medium pressure hydraulic applications including mobile, machine tool and agricultural applications, using petroleum or water-based hydraulic fluids.

Reinforcement

One braid of high-tensile steel wire

Cover

Black polychloroprene

Temperature Range

-40°F to 212°F (-40°C to 100°C)

Fitting Reference

All fittings compatible with the SR1SN hose family are listed in Section 1 (starting on page 52) of the catalog.

Branding

Example: Continental ContiTech SR1SN-03 SAE 100R1AT/1SN 3/16" (DN05) W.P. 3630 psi (25 MPa) MSHA 2G-14C/12

› Meets or exceeds the performance requirements of: SAE 100R1AT; EN 853 1SN; DIN 20022 1SN.

› Meets Flame Resistance USMSHA Designation

› Meets Higher EN/DIN Pressures

› SAE J1942/U.S. Coast Guard 

Inner Tube

Nitrile

Descriptive #/ Product #	SAP #	Hose Size ID		Hose OD		Max. Working Pressure		Min. Bend Radius		Min. Burst Pressure		Weight lbs./ft.	USCG Approved
		in.	mm	in.	mm	psi	MPa	in.	mm	psi	MPa		
SR1SN-03	20239993	3/16	05	0.47	11.9	3625	25.0	3.5	89	14500	100.0	0.12	HF-A
SR1SN-04	20240216	1/4	06	0.53	13.6	3270	22.5	4.0	102	13080	90.2	0.15	HF-A
SR1SN-05	20240217	5/16	08	0.60	15.1	3120	21.5	4.5	114	12480	86.0	0.17	-
SR1SN-06	20240218	3/8	10	0.69	17.5	2615	18.0	5.0	127	10460	72.1	0.22	HF-A
SR1SN-08	20240219	1/2	12	0.81	20.7	2320	16.0	7.0	178	9280	64.0	0.28	H
SR1SN-10	20240250	5/8	16	0.94	23.8	1890	13.0	8.0	203	7560	52.1	0.33	HF-A
SR1SN-12	20240251	3/4	19	1.10	27.8	1530	10.5	9.5	241	6120	42.2	0.41	HF-A
SR1SN-16	20240252	1	25	1.41	35.8	1280	8.8	12.0	305	5120	35.3	0.62	HF-A
SR1SN-20	20239333	1¼	31	1.70	43.1	920	6.3	16.5	419	3680	25.4	0.84	H
SR1SN-24	20238892	1½	38	1.98	50.3	730	5.0	20.0	508	2920	20.1	1.05	H
SR1SN-32	20239351	2	51	2.51	63.8	580	4.0	25.0	635	2320	16.0	1.48	H

SFS

SAE 100R1AT Fire Suppression | Medium Pressure



Application

Medium pressure hydraulic applications including fire suppression actuation equipment where the red cover allows for easy identification.

Reinforcement

One braid of high-tensile steel wire

Cover

Red nitrile

Temperature Range

-40°F to 212°F (-40°C to 100°C)

Fitting Reference

All fittings compatible with the SFS hose family are listed in Section 1 (starting on page 52) of the catalog.

Branding

Example: Continental ContiTech SFS -12 FIRE SUPPRESSION HOSE 3/4" (19mm) W.P. 1250 psi (8.6 MPa) MSHA 2G-1C-14C/31 MADE IN U.S.A.

› Meets Flame Resistance USMSHA Designation

Inner Tube

Nitrile

Descriptive #/ Product #	SAP #	Hose Size ID		Hose OD		Max. Working Pressure		Min. Bend Radius		Min. Burst Pressure		Weight lbs./ft.
		in.	DIN Dash Size	in.	mm	psi	MPa	in.	mm	psi	MPa	
SFS -04	20276330	1/4	6.4	0.53	13.6	2750	19.0	4	102	11000	75.8	0.15
SFS -06	20276331	3/8	9.5	0.69	17.5	2250	15.5	5	127	9000	62.1	0.22
SFS -08	20276332	1/2	12.7	0.81	20.7	2000	13.8	7	178	8000	55.2	0.28
SFS -12	20276333	3/4	19.0	1.10	27.8	1250	8.6	9.5	241	5000	34.5	0.41
SFS -16	20276334	1	25.4	1.41	35.8	1000	6.9	12	305	4000	27.6	0.62

Desert® DR1SN

SAE 100R1AT/1SN | Medium Pressure



- › Meets or exceeds the performance requirements of: SAE 100R1AT; EN 853 1SN; DIN 20022 1SN.
- › High Temperature
- › Meets Higher EN/DIN Pressures
- › ABS Type Approved through 1"

Application

Medium pressure hydraulic oil lines used in mobile, machine tool and agricultural applications where higher temperature petroleum- or water-based hydraulic fluids are a factor.

Inner Tube

Black CPE

Reinforcement

One braid of high-tensile steel wire

Cover

Blue CPE

Temperature Range

-40°F to 302°F (-40°C to 150°C)

Fitting Reference

All fittings compatible with the DR1SN hose family are listed in Section 1 (starting on page 52) of the catalog.

Branding

Example: Continental ContiTech DESERT® DR1SN-04 SAE 100R1AT/1SN (High temp) 1/4" (DN06) W.P. 3270 psi (22.5 MPa)

Descriptive #/ Product #	SAP #	Hose Size ID		Hose OD		Max. Working Pressure		Min. Bend Radius		Min. Burst Pressure		Weight lbs./ft.
		in.	DIN Dash Size	in.	mm	psi	MPa	in.	mm	psi	MPa	
DR1SN-04	20239353	1/4	06	0.52	13.1	3270	22.5	4.0	102	13080	90.2	0.15
DR1SN-06	20239354	3/8	10	0.67	17.1	2615	18.0	5.0	127	10460	72.1	0.22
DR1SN-08	20239355	1/2	12	0.80	20.3	2320	16.0	7.0	178	9280	64.0	0.28
DR1SN-10	20239356	5/8	16	0.92	23.4	1890	13.0	8.0	203	7560	52.1	0.33
DR1SN-12	20239357	3/4	19	1.08	27.4	1530	10.5	9.5	241	6120	42.2	0.41
DR1SN-16	20239358	1	25	1.39	35.3	1280	8.8	12.0	305	5120	35.3	0.62
DR1SN-20	20239359	1¼	31	1.70	43.1	920	6.3	16.5	419	3680	25.4	0.84
DR1SN-24	20239360	1½	38	1.97	50.1	730	5.0	20.0	508	2920	20.1	1.09
DR1SN-32	20239361	2	51	2.50	63.6	580	4.0	25.0	635	2320	16.0	1.34

SR2SN

SAE 100R2AT/2SN | Medium Pressure



- › Meets or exceeds the performance requirements of: SAE 100R2AT; EN 853 2SN; DIN 20022 2SN.
- › Meets Flame Resistance USMSHA Designation
- › Meets Higher EN/DIN Pressures
- › ABS Type Approved
- › SAE J1942/U.S. Coast Guard

Application

High pressure hydraulic oil lines used in construction, machine tool and agricultural applications using petroleum- or water-based hydraulic fluids. Hose sizes 3/16"- 5/8" have a vacuum rating of 28 in Hg. Hose sizes 3/4"- 1" have a vacuum rating of 24 in Hg.

Inner Tube

Nitrile

Reinforcement

Two braids of high-tensile steel wire

Cover

Black polychloroprene

Temperature Range

-40°F to 212°F (-40°C to 100°C)

Fitting Reference

All fittings compatible with the SR2SN hose family are listed in Section 1 (starting on page 52) of the catalog.

Branding

Example: Continental ContiTech SR2SN-03 SAE 100R2AT/2SN 3/16" (DN05) W.P. 6000 psi (41.4 MPa) MSHA 2G-14C/12

Descriptive #/ Product #	SAP #	Hose Size ID		Hose OD		Max. Working Pressure		Min. Bend Radius		Min. Burst Pressure		Weight lbs./ft.	USCG Approved
		in.	DIN Dash Size	in.	mm	psi	MPa	in.	mm	psi	MPa		
SR2SN-03	20240253	3/16	05	0.48	12.3	6200	41.5	3.5	89	24800	171.0	0.20	-
SR2SN-04	20240254	1/4	06	0.59	15.1	5800	40.0	4.0	102	23200	160.0	0.24	HF-A
SR2SN-06	20276604	3/8	10	0.75	19.1	4800	33.1	5.0	127	19200	132.4	0.34	H
SR2SN-08	20270619	1/2	12	0.88	22.2	4000	27.6	7.0	178	16000	110.3	0.43	HF-A
SR2SN-10	20240257	5/8	16	1.00	25.4	3630	25.0	8.0	203	14520	100.0	0.50	-
SR2SN-12	20240258	3/4	19	1.16	29.4	3120	21.5	9.5	241	12480	86.0	0.61	HF-A
SR2SN-16	20240259	1	25	1.50	38.1	2400	16.5	12.0	305	9600	66.2	0.88	HF-A
SR2SN-20	20239362	1¼	31	1.86	47.2	1820	12.5	16.5	419	7280	50.2	1.53	H
SR2SN-24	20239363	1½	38	2.11	54.1	1310	9.0	20.0	508	5240	36.1	1.64	H
SR2SN-32	20239364	2	51	2.62	66.7	1160	8.0	25.0	635	4640	32.0	2.02	H

Desert® DR2SN

SAE 100R2AT-Type S | High Pressure

**Application**

High pressure hydraulic oil lines used in construction, machine tool and agricultural applications where higher temperature petroleum- or water-based hydraulic fluids are a factor.

Inner Tube

Black CPE

Reinforcement

Two braids of high-tensile steel wire

Cover

Blue CPE

Temperature Range

-40°F to 302°F (-40°C to 150°C)

Fitting Reference

All fittings compatible with the DR2SN hose family are listed in Section 1 (starting on page 52) of the catalog.

Branding

Example: Continental ContiTech DESERT® DR2SN-08 SAE 100R2AT-Type S 1/2" (DN12) 4000 psi (27.6 MPa)

› Meets or exceeds the performance requirements of: SAE 100R2AT-Type S; EN853 2SN-pressures.

› High Temperature

› Meets Higher EN/DIN Pressures

› Meets Flame Resistance USMSHA Designation

› SAE J1942/U.S. Coast Guard 

Descriptive #/ Product #	SAP #	Hose Size ID		Hose OD		Max. Working Pressure		Min. Bend Radius		Min. Burst Pressure		Weight lbs./ft.	USCG Approved
		in.	DIN Dash Size	in.	mm	psi	MPa	in.	mm	psi	MPa		
DR2SN-04	20698338	1/4	08	0.59	15.1	5800	40.0	4.0	102	23200	160.0	0.24	-
DR2SN-06	20698339	3/8	10	0.75	19.1	4800	33.1	5.0	127	19200	132.4	0.34	H
DR2SN-08	20698620	1/2	12	0.88	22.2	4000	27.6	7.0	178	16000	110.3	0.43	H
DR2SN-10	20698621	5/8	16	1	25.4	3630	25.0	8.0	203	14520	100.0	0.50	H
DR2SN-12	20698622	3/4	19	1.16	29.4	3120	21.5	9.5	241	12480	86.0	0.61	H
DR2SN-16	20698623	1	25	1.5	38.1	2400	16.5	12.0	305	9600	66.6	0.88	H

Arctic® LR2SN

SAE 100R2AT/2SN | High Pressure

**Application**

High pressure hydraulic oil lines used in construction, machine tool and agricultural applications where lower temperature petroleum- or water-based hydraulic fluids are a factor.

Inner Tube

Nitrile

Reinforcement

Two braids of high-tensile steel wire

Cover

Black polychloroprene

Temperature Range

-58°F to 212°F (-50°C to 100°C)

Fitting Reference

All fittings compatible with the LR2SN hose family are listed in Section 1 (starting on page 52) of the catalog.

Branding

Example: Continental ContiTech ARCTIC® LR2SN-04 SAE 100R2AT/2SN (Low temp) 1/4" (DN06) W.P. 5800 psi (40 MPa) MSHA IC-152/8

› Meets or exceeds the performance requirements of: SAE 100R2AT; EN 853 2SN; DIN 20022 2SN.

› Meets Flame Resistance USMSHA Designation

› Meets Higher EN/DIN Pressures

› Low Temperature

Descriptive #/ Product #	SAP #	Hose Size ID		Hose OD		Max. Working Pressure		Min. Bend Radius		Min. Burst Pressure		Weight lbs./ft.
		in.	DIN Dash Size	in.	mm	psi	MPa	in.	mm	psi	MPa	
LR2SN-04	20239365	1/4	06	0.58	14.7	5800	40.0	4.0	102	23200	160.0	0.24
LR2SN-06	20728489	3/8	10	0.74	18.7	4800	33.1	5.0	127	19200	132.4	0.34
LR2SN-08	20728510	1/2	12	0.86	21.8	4000	27.6	7.0	178	16000	110.3	0.43
LR2SN-10	20728511	5/8	16	0.99	25.0	3630	25.0	8.0	203	14520	100.0	0.50
LR2SN-12	20728512	3/4	19	1.14	29.0	3120	21.5	9.5	241	12480	86.0	0.61
LR2SN-16	20728513	1	25	1.48	37.6	2400	16.5	12.0	305	9600	66.2	0.88

SR16SC

SAE 100R16/857 2SC | High Pressure



Tight Bends & Flexible

- › Meets or exceeds the performance requirements of: SAE 100R16; EN 857 2SC
- › Meets Flame Resistance USMSHA Designation
- › Meets Higher EN/DIN Pressures
- › SAE J1942/U.S. Coast Guard 

Application

High pressure service with tight bends for petroleum- and water-based hydraulic fluids. Excellent impulse performance and flexibility exceeding SAE 100R2 and SAE 100R16 standards.

Inner Tube

Nitrile

Reinforcement

Two braids of high-tensile steel wire

Cover

Black polychloroprene

Temperature Range

-40°F to 212°F (-40°C to 100°C)

Fitting Reference

All fittings compatible with the SR16SC hose family are listed in Section 1 (starting on page 52) of the catalog.

Branding

Example: Continental ContiTech SR16SC-04 SAE 100R16/EN 857 2SC 1/4" (DN06) W.P. 5800 psi (40 MPa) MSHA 1C-152/8 2 G-14C/12

Descriptive #/ Product #	SAP #	Hose Size ID		Hose OD		Max. Working Pressure		Min. Bend Radius		Min. Burst Pressure		Weight lbs./ft.	USCG Approved
		in.	DIN Dash Size	in.	mm	psi	MPa	in.	mm	psi	MPa		
SR16SC-04	20494340	1/4	06	0.54	13.7	5800	40.0	2.0	51	23200	160.0	0.18	H
SR16SC-06	20436685	3/8	10	0.70	17.7	5000	34.5	2.5	64	20000	137.9	0.27	H
SR16SC-08	20263798	1/2	12	0.81	20.6	4500	31.0	3.5	89	18000	124.1	0.36	H
SR16SC-10	20264959	5/8	16	0.95	24.2	4000	27.6	4.0	102	16000	110.3	0.41	H
SR16SC-12	20239475	3/4	19	1.10	28.0	3500	24.1	5.0	127	14000	96.5	0.55	H
SR16SC-16	20483278	1	25	1.40	35.5	2700	18.6	6.0	152	10800	74.5	0.83	H
SR16SC-20	20666436	1 1/4	31	1.74	44.3	1813	12.5	8.3	210	7252	50.0	1.12	

DR16SC

Constant Pressure | High Pressure



- › Meets or exceeds the performance requirements of: SAE 100R16
- › Meets Flame Resistance USMSHA Designation
- › SAE J1942/U.S. Coast Guard 

Application

High pressure service with tight bends for petroleum- and water-based hydraulic fluids. For high temperature applications.

Inner Tube

Nitrile

Reinforcement

Two braids of high-tensile steel wire

Cover

Blue CPE

Temperature Range

-40°F to 302°F (-40°C to 150°C)

Fitting Reference

All fittings compatible with the DR16SC hose family are listed in Section 1 (starting on page 52) of the catalog.

Descriptive #/ Product #	SAP #	Hose Size ID		Hose OD		Max. Working Pressure		Min. Bend Radius		Weight lbs./ft.
		in.	DIN Dash Size	in.	mm	psi	MPa	in.	lbs./ft.	
DR16SC-04	20778355	1/4	6	0.54	18.8	5075	35	2.0	0.23	
DR16SC-06	20755831	3/8	10	0.70	17.8	5000	34.5	2.5	0.33	
DR16SC-08	20755835	1/2	12	0.82	20.9	4500	31	3.5	0.43	
DR16SC-12	20755850	3/4	19	1.10	28.0	3500	24.1	5.0	0.61	
DR16SC-16	20776987	1	25	1.42	35.9	2700	18.6	6.0	0.94	

Extended Life XR16SC™

SAE 100R16/EN857 2SC | High Pressure



Tight Bends & Flexible

- › Meets or exceeds the performance requirements of: SAE 100R16; EN 857 2SC
- › Meets Flame Resistance USMSHA Designation
- › Meets Higher EN/DIN Pressures
- › SAE J1942/U.S. Coast Guard 

Application

High pressure service needing abrasion resistance, tight bends and flexible. For petroleum- and water-based hydraulic fluids.

Excellent impulse performance and flexibility exceeding SAE 100R2 and SAE 100R16 standards.

Inner Tube

Nitrile

Reinforcement

Two braids of high-tensile steel wire

Cover

Extra abrasion, oil and weather resistant synthetic rubber.

Temperature Range

-40°F to 212°F (-40°C to 100°C)

Fitting Reference

All fittings compatible with the XR16SC™ hose family are listed in Section 1 (starting on page 52) of the catalog.

Branding

Example: Continental ContiTech Extended Life XR16SC™-08 SAE 100R16/EN 857 2SC 1/2" (DN12) W.P. 4500 psi (31 MPa) MSHA 2G 1C-14C/37

Descriptive #/ Product #	SAP #	Hose Size ID		Hose OD		Max. Working Pressure		Min. Bend Radius		Min. Burst Pressure		Weight lbs./ft.	USCG Approved
		in.	DIN Dash Size	in.	mm	psi	MPa	in.	mm	psi	MPa		
XR16SC-04	20693982	1/4	06	0.54	13.70	5800	40.0	2.0	51	23200	160.0	0.18	H
XR16SC-06	20693983	3/8	10	0.70	17.70	5000	34.5	2.5	64	20000	137.9	0.27	H
XR16SC-08	20693984	1/2	12	0.81	20.60	4500	31.0	3.5	89	18000	124.1	0.36	H
XR16SC-10	20693985	5/8	16	0.95	24.20	4000	27.6	4.0	102	16000	110.3	0.41	H
XR16SC-12	20693987	3/4	19	1.10	28.00	3500	24.1	5.0	127	14000	96.5	0.55	H
XR16SC-16	20693988	1	25	1.40	35.50	2700	18.6	6.0	152	10800	74.5	0.83	H

Armorcoat™ ARC16SC

SAE 100R16/857 2SC | High Pressure



- › Meets or exceeds the performance requirements of: SAE 100R16; EN 857 2SC
- › Meets Flame Resistance USMSHA Designation
- › Meets Higher EN/DIN Pressures
- › Abrasion Cover

Application

High pressure service with tight bends for petroleum- and water-based hydraulic fluids where maximum abrasion resistance is required. Excellent impulse performance and flexibility exceeding SAE 100R2 and SAE 100R16 standards.

Inner Tube

Nitrile

Reinforcement

Two braids of high-tensile steel wire

Cover

Black synthetic rubber with ARMORCOAT™

Temperature Range

-40°F to 212°F (-40°C to 100°C)

Fitting Reference

All fittings compatible with the ARC16SC hose family are listed in Section 1 (starting on page 52) of the catalog.

Branding

Example: Continental ContiTech ARMORCOAT™ ARC16SC-04 SAE 100R16/EN 857 2SC (Abrasion cover) 1/4" (DN06) W.P. 5800 psi (40 MPa) MSHA IC-152/7

Descriptive #/ Product #	SAP #	Hose Size ID		Hose OD		Max. Working Pressure		Min. Bend Radius		Min. Burst Pressure		Weight lbs./ft.
		in.	DIN Dash Size	in.	mm	psi	MPa	in.	mm	psi	MPa	
AR16SC-04	20731686	1/4	06	0.52	13.2	5800	40.0	2.0	51	23200	160.0	0.17
AR16SC-06	20731831	3/8	10	0.67	17.0	5000	34.5	2.5	64	20000	137.9	0.26
AR16SC-08	20730593	1/2	12	0.81	20.6	4500	31.0	3.5	89	18000	124.1	0.35
AR16SC-10	20733777	5/8	16	0.92	23.4	4000	27.6	4.0	102	16000	110.3	0.40
AR16SC-12	20733779	3/4	19	1.08	27.4	3500	24.1	5.0	127	14000	96.5	0.54
AR16SC-16	20731853	1	25	1.40	35.5	2700	18.6	6.0	152	10800	74.5	0.83

SCP3

Constant Pressure | High Pressure



- › Meets Flame Resistance USMSHA Designation
- › SAE J1942/U.S. Coast Guard 

Application

High pressure hydraulic applications designed to replace SAE 100R1 where higher pressures and a more flexible hose are required.

Inner Tube

Nitrile

Reinforcement

One braid of high-tensile steel wire. Sizes 5/8", 3/4" and 1" 2-wire braid

Cover

Oil and weather resistant synthetic rubber

Temperature Range

-40°F to 212°F (-40°C to 100°C)

Fitting Reference

All fittings compatible with the SCP3 hose family are listed in Section 1 (starting on page 52) of the catalog.

Descriptive #/ Product #	SAP #	Hose Size ID		Hose OD		Max. Working Pressure		Min. Bend Radius	Min. Burst Pressure		Weight lbs./ft.	USCG Approved
		in.	mm	in.	mm	psi	MPa	in.	psi	MPa		
SCP3-04	20318573	1/4	6.4	0.50	12.7	3000	20.7	2.0	12000	82.7	0.11	H
SCP3-06	20317756	3/8	9.5	0.65	16.5	3000	20.7	2.5	3000	20.7	0.17	HF-A
SCP3-08	20318576	1/2	12.7	0.78	19.8	3000	20.7	3.5	3000	20.7	0.28	HF-A
SCP3-10	20239486	5/8	15.9	0.95	24.1	3000	20.7	4.0	3000	20.7	0.41	H
SCP3-12	20470795	3/4	19	1.13	28.7	3000	20.7	5.0	3000	20.7	0.55	H
SCP3-16	20329003	1	25.4	1.44	36.6	3000	20.7	6.0	3000	20.7	0.82	H

Extended Life XCP3

Constant Pressure | High Pressure



- › Meets or exceeds the performance requirements of: SAE 100R
- › Meets Flame Resistance USMSHA Designation
- › SAE J1942/U.S. Coast Guard 
- › Abrasion Resistant Cover

Application

High pressure hydraulic applications needing abrasion resistance designed to replace SAE 100R1 where higher pressures and a more flexible hose are required.

Inner Tube

Nitrile

Reinforcement

One braid of high-tensile steel wire. Sizes 5/8", 3/4" and 1" 2-wire braid

Cover

Extra Abrasion, Oil & Weather Resistant Synthetic Rubber (More than 5X the Abrasion Resistance over SCP3)

Temperature Range

-40°F to 212°F (-40°C to 100°C)

Fitting Reference

All fittings compatible with the XCP3 hose family are listed in Section 1 (starting on page 52) of the catalog.

Descriptive #/ Product #	SAP #	Hose Size ID		Hose OD		Max. Working Pressure		Min. Bend Radius	Weight lbs./ft.
		in.	mm	in.	mm	psi	MPa	in.	
XCP3-04	20738196	1/4	6.4	0.50	12.7	3000	20.7	2.0	0.11
XCP3-06	20784065	3/8	9.5	0.65	16.5	3000	20.7	2.5	0.17
XCP3-08	20774712	1/2	12.7	0.78	19.8	3000	20.7	3.5	0.28
XCP3-10	20777228	5/8	15.9	0.95	24.1	3000	20.7	4.0	0.41
XCP3-12	20777501	3/4	19.0	1.13	28.7	3000	20.7	5.0	0.55
XCP3-16	20774714	1	25.4	1.44	36.6	3000	20.7	6.0	0.82

Armorcoat™ ACP3

SAE 100R17 | High Pressure



Application

High pressure hydraulic applications designed to replace SAE 100R1 where higher pressures, increased flexibility and maximum abrasion resistance are required.

Inner Tube

Nitrile

Reinforcement

One braid of high-tensile steel wire

Cover

Black Synthetic Rubber with ARMORCOAT™

Temperature Range

-40°F to 212°F (-40°C to 100°C)

Fitting Reference

All fittings compatible with the ACP3 hose family are listed in Section 2 (starting on page 89) of the catalog.

Branding

Example: Continental ContiTech ARMORCOAT™ ACP3-04
SAE 100R17 (Abrasion Cover) 1/4" (6.4mm) W.P. 3000 psi (20.7 MPa)
MSHA IC-152/7

- › Meets or exceeds the performance requirements of: SAE 100R17
- › Meets Flame Resistance USMSHA Designation
- › Abrasion Cover

Descriptive #/ Product #	SAP #	Hose Size ID		Hose OD		Max. Working Pressure		Min. Bend Radius		Min. Burst Pressure		Weight lbs./ft.
		in.	mm	in.	mm	psi	MPa	in.	mm	psi	MPa	
ACP3-04	20706539	1/4	6.6	0.50	12.8	3000	20.7	2.0	51	12000	82.7	0.11
ACP3-06	20706643	3/8	9.7	0.65	16.5	3000	20.7	2.5	64	12000	82.7	0.17
ACP3-08	20706648	1/2	12.9	0.79	19.9	3000	20.7	3.5	89	12000	82.7	0.28

SR12

SAE 100R12/856 R12 | Very High Pressure



1/2 Bend 3/8" - 3/4"

Application

Very high pressure applications subject to surges or flexing such as oil and gas, construction equipment, mining and the high-performance industrial market.

Inner Tube

Polychloroprene

Reinforcement

Four alternating layers of spiralled high-tensile steel wire

Cover

Black Polychloroprene

Temperature Range

-40°F to 250°F (-40°C to 121°C)

Fitting Reference

All fittings compatible with the SR12 hose family are listed in Section 4 (starting on page 135) of the catalog.

Branding

Example: Continental ContiTech SR12-06 SAE 100R12/EN 856 R12 3/8" (DN10) W.P. 4000 psi (27.6 MPa) MSHA IC-152/2

- › Meets or exceeds the performance requirements of: SAE 100R12; EN 856 R12
- › Meets Flame Resistance USMSHA Designation
- › SAE J1942/U.S. Coast Guard 
- › ABS Type Pending

Descriptive #/ Product #	SAP #	Hose Size ID		Hose OD		Max. Working Pressure		Min. Bend Radius		Min. Burst Pressure		Weight lbs./ft.	USCG Approved
		in.	mm	in.	mm	psi	MPa	in.	mm	psi	MPa		
SR12-06	20703115	3/8	10	0.80	20.3	4100	28.3	2.5	65	16400	112	0.40	H
SR12-08	20703046	1/2	12	0.94	23.8	4100	28.3	3.5	90	16400	112	0.52	H
SR12-10	20703117	5/8	16	1.08	27.4	4100	28.3	4.0	100	16400	112	0.70	H
SR12-12	20703048	3/4	19	1.21	30.7	4100	28.3	5.1	130	16400	112	0.81	H
SR12-16	20693294	1	25	1.50	38.0	4100	28.3	11.8	300	16400	112	1.20	H
SR12-20	20703118	1 1/4	31	1.85	47.0	3050	21.0	16.5	420	12200	84	1.70	H
SR12-24	20703119	1 1/2	38	2.10	53.5	2550	17.5	19.7	500	10200	70	2.05	H
SR12-32	20693298	2	51	2.60	66.7	2550	17.5	25.0	635	10200	70	2.82	H

Armorcoat™ ARC12

SAE 100R12/856 R12 | Very High Pressure



1/2 Bend 3/8" - 3/4"

- › Meets or exceeds the performance requirements of: SAE 100R12; EN 856 R12
- › Meets Flame Resistance USMSHA Designation
- › Abrasion Cover

Application

Very high pressure applications subject to surges or flexing such as construction equipment, mining and the high-performance industrial market where maximum abrasion resistance is required.

Inner Tube

Polychloroprene

Reinforcement

Four alternating layers of spiralled high-tensile steel wire

Cover

Black Synthetic Rubber with ARMORCOAT™

Temperature Range

-40°F to 250°F (-40°C to 121°C)

Fitting Reference

All fittings compatible with the ARC12 hose family are listed in Section 4 (starting on page 135) of the catalog.

Branding

Example: Continental ContiTech ARMORCOAT™ ARC12-06
SAE 100R12/EN 856 R12 (Abrasion Cover) 3/8" (DN10) W.P. 4000 psi (27.6 MPa) MSHA IC-152/7

Descriptive #/ Product #	SAP #	Hose Size ID		Hose OD		Max. Working Pressure		Min. Bend Radius		Weight lbs./ft.
		in.	mm	in.	mm	psi	MPa	in.	mm	
ARC12-06	20729168	3/8	10	0.80	20.2	4100	28.3	2.5	64	0.44
ARC12-08	20715104	1/2	12	0.94	23.8	4100	28.3	3.5	90	0.55
ARC12-10	20729176	5/8	16	1.11	28.2	4100	28.3	3.9	100	0.72
ARC12-12	20715106	3/4	19	1.21	30.7	4100	28.3	5.1	30	0.82
ARC12-16	20715107	1	25	1.50	38	4100	28.3	11.8	300	1.21
ARC12-20	20729173	1¼	31	1.85	47	3050	21.0	16.5	420	1.65
ARC12-24	20729174	1½	38	2.10	53.4	2550	17.6	19.7	500	2.19
ARC12-32	20729175	2	51	2.63	66.7	2550	17.6	25.0	635	3.13

SR13

SAE 100R13/856 R13 | Very High Pressure



- › Meets or exceeds the performance requirements of: SAE 100R13; EN 856 R13
- › Meets Flame Resistance USMSHA Designation
- › SAE J1942/U.S. Coast Guard 
- › ABS Type Pending

Application

Very high pressure applications subject to surges or flexing such as construction equipment, mining and the high-performance industrial market.

Inner Tube

Polychloroprene

Reinforcement

Four alternating layers of spiralled high-tensile steel wire (sizes 3/4" and 1") and six alternating layers of spiralled high-tensile steel wire (sizes 1¼", 1½" and 2")

Cover

Black polychloroprene

Temperature Range

-40°F to 250°F (-40°C to 121°C)

Fitting Reference

All fittings compatible with the SR13 hose family are listed in Section 5 (starting on page 163) of the catalog.

Branding

Example: Continental ContiTech SR13-12 SAE 100R13/EN 856 R13 3/4" (DN19) W.P. 5000 psi (34.5 MPa) MSHA IC-152/8

Descriptive #/ Product #	SAP #	Hose Size ID		Hose OD		Max. Working Pressure		Min. Bend Radius		Min. Burst Pressure	Weight lbs./ft.	USCG Approved	
		in.	mm	in.	mm	psi	MPa	in.	mm				
SR13-12	20704441	3/4	19	1.26	32.1	5100	35.0	9.4	240	20400	140.7	1.09	H
SR13-16	20704442	1	25	1.52	38.7	5100	35.0	11.8	300	20400	140.7	1.42	H
SR13-20	20704443	1¼	31	1.96	49.8	5100	35.0	16.5	420	20400	140.7	2.69	H
SR13-24	20704449	1½	38	2.25	57.3	5100	35.0	19.7	500	20400	140.7	3.35	H
SR13-32	20704450	2	51	2.80	71.1	5100	35.0	25.2	640	20400	140.7	4.93	H

Armorcoat™ ARC13

SAE 100R13/856 R13 | Very High Pressure



Application

Very high pressure applications subject to surges or flexing such as construction equipment, mining and the high-performance industrial market where maximum abrasion resistance is required.

Inner Tube

Polychloroprene

Reinforcement

Four alternating layers of spiralled high-tensile steel wire (sizes 5/8", 3/4" and 1") and six alternating layers of spiralled high-tensile steel wire (size 1 1/4", 1 1/2" and 2")

Cover

Black Synthetic Rubber with ARMORCOAT™

Temperature Range

-40°F to 250°F (-40°C to 121°C)

Fitting Reference

All fittings compatible with the ARC13 hose family are listed in Section 5 (starting on page 163) of the catalog. Note: No Continental ContiTech fitting recommendation on ARC13 -10 hose size.

Branding

Example: Continental ContiTech ARMORCOAT™ ARC13 -10 EN 856 R13 (Abrasion Cover) 5/8" (DN16) W.P. 5000 psi (34.5 MPa) MSHA IC-152/7

- › Meets or exceeds the performance requirements of: SAE 100R13 (except size 5/8"); EN 856 R13 (all sizes)
- › Meets Flame Resistance USMSHA Designation
- › Abrasion Cover

Descriptive #/ Product #	SAP #	Hose Size ID		Hose OD		Max. Working Pressure		Min. Bend Radius		Min. Burst Pressure		Weight lbs./ft.
		in.	mm	in.	mm	psi	MPa	in.	mm	psi	MPa	
ARC13-12	20715111	3/4"	19	1.26	32.1	5100	35.2	9.5	240	20400	141	0.97
ARC13-16	20715112	1"	25	1.51	38.5	5100	35.2	11.8	305	20400	141	1.30
ARC13-20	20715113	1 1/4"	31	1.96	49.8	5100	35.2	16.5	420	20400	141	1.73
ARC13-24	20715114	1 1/2"	38	2.26	57.3	5100	35.2	19.7	500	20400	141	3.27
ARC13-32	20715115	2"	51	2.8	71.1	5100	35.2	25.2	640	20400	141	4.43

SR15

SAE 100R15 | Very High Pressure



Application

Designed specifically to handle severe high pressure applications where pressure spikes or constant hydrostatic loads are present.

Inner Tube

Polychloroprene

Reinforcement

Four alternating layers of spiralled high-tensile steel wire (sizes 1/2", 5/8", 3/4" and 1") and six alternating layers of spiralled high-tensile steel wire (sizes 1 1/4", 1 1/2" and 2")

Cover

Black polychloroprene

Temperature Range

-40°F to 250°F (-40°C to 121°C)

Fitting Reference

All fittings compatible with the SR15 hose family are listed in Section 5 (starting on page 163) of the catalog. Note: No Continental ContiTech fitting recommendation on SR15-08 and SR15-10 hose sizes.

Branding

Example: Continental ContiTech SR15-08 SAE 100R15 1/2" (12.7mm) W.P. 6000 psi (41.4 MPa) MSHA IC-152/8

- › Meets or exceeds the performance requirements of: SAE 100R15 (except sizes 5/8" and 2" which are proprietary 6000 psi hoses)
- › Meets Flame Resistance USMSHA Designation
- › SAE J1942/U.S. Coast Guard 
- › ABS Type Pending

Descriptive #/ Product #	SAP #	Hose Size ID		Hose OD		Max. Working Pressure		Min. Bend Radius		Min. Burst Pressure		Weight lbs./ft.	USCG Approved
		in.	mm	in.	mm	psi	MPa	in.	mm	psi	MPa		
SR15-08	20714800	1/2"	12	0.95	24.2	6100	42.0	7.9	200	24400	168.0	0.59	-
SR15-12	20714785	3/4"	19	1.26	32.0	6100	42.0	10.4	265	24400	168.0	1.09	H
SR15-16	20714793	1"	25	1.53	38.8	6100	42.0	13.0	330	24400	168.0	1.46	H
SR15-20	20714794	1 1/4"	32	1.89	48.0	6100	42.0	17.5	445	24400	168.0	2.41	-
SR15-24	20714795	1 1/2"	38	2.23	56.8	6100	42.0	20.9	530	24400	168.0	3.02	-

Armorcoat™ ARC15

SAE 100R15 | Very High Pressure



- › Meets or exceeds the performance requirements of: SAE 100R15
- › Meets Flame Resistance USMSHA Designation
- › Abrasion Cover

Application

Designed specifically to handle severe high pressure applications where pressure spikes or constant hydrostatic loads are present and maximum abrasion resistance is required.

Inner Tube

Polychloroprene

Reinforcement

Four alternating layers of spiralled high-tensile steel wire

Cover

Black Polychloroprene with ARMORCOAT™

Temperature Range

-40°F to 250°F (-40°C to 121°C)

Fitting Reference

All fittings compatible with the ARC15 hose family are listed in Section 5 (starting on page 163) of the catalog. Note: No Continental ContiTech fitting recommendation on ARC15 -08 hose size.

Branding

Example: Continental ContiTech ARMORCOAT™ ARC15 -08 SAE 100R15 (Abrasion Cover) 1/2" (12.7mm) W.P. 6000 psi (41.4 MPa) MSHA IC-152/7

Descriptive #/ Product #	SAP #	Hose Size ID		Hose OD		Max. Working Pressure		Min. Bend Radius		Min. Burst Pressure		Weight lbs./ft.
		in.	mm	in.	mm	psi	MPa	in.	mm	psi	MPa	
ARC15-08	20714906	1/2"	12.7	1.06	26.8	6100	42	8.0	200	24400	168.0	0.59
ARC15-12	20714907	3/4"	19.0	1.27	32.2	6100	42	10.5	265	24400	168.0	1.08
ARC15-16	20714908	1"	25.4	1.53	38.8	6100	42	13.0	330	24400	168.0	1.48

S4SP

EN 856 4SP/DIN 20023 4SP | Very High Pressure



- › Meets or exceeds the performance requirements of: EN 856 4SP; DIN 20023 4SP
- › Meets Flame Resistance USMSHA Designation
- › Meets Higher EN/DIN Pressures
- › ABS Type Pending

Application

Very high pressure applications used for petroleum-based hydraulic fluids..

Inner Tube

Polychloroprene

Reinforcement

Four alternating layers of spiralled high-tensile steel wire

Cover

Black polychloroprene

Temperature Range

-40°F to 212°F (-40°C to 100°C)

Fitting Reference

All fittings compatible with the S4SP hose family are listed in Section 5 (starting on page 163) of the catalog.

Branding

Example: Continental ContiTech S4SP-04 EN 856 4SP 1/4" (DN06) W.P. 6550 psi (45.2 MPa) MSHA IC-152/8

Descriptive #/ Product #	SAP #	Hose Size ID		Hose OD		Max. Working Pressure		Min. Bend Radius		Min. Burst Pressure		Weight lbs./ft.
		in.	mm	in.	mm	psi	MPa	in.	mm	psi	MPa	
S4SP-06	20714777	3/8	10	0.84	21.4	6455	45.0	7.1	180	25820	178	0.51
S4SP-08	20714778	1/2	12	0.97	24.6	6020	41.5	9.0	230	24080	166	0.58
S4SP-10	20714779	5/8	16	1.11	28.2	5075	35.0	9.8	250	20300	140	0.73
S4SP-12	20714771	3/4	19	1.27	32.2	5510	38.0	11.8	300	22040	152	0.98
S4SP-16	20714773	1	25	1.56	39.7	4640	32.0	13.4	340	18560	128	1.30

S4SH

EN 856 4SH/DIN 20023 4SH | Very High Pressure

**Application**

Very high pressure, pulsating applications used for petroleum-based hydraulic fluids.

Inner Tube

Polychloroprene

Reinforcement

Four alternating layers of spiralled high-tensile steel wire

Cover

Black polychloroprene

Temperature Range

-40°F to 212°F (-40°C to 100°C)

Fitting Reference

All fittings compatible with the S4SH hose family are listed in Section 5 (starting on page 163) of the catalog.

Branding

Example: Continental ContiTech S4SH-12 EN 856 4SH 3/4" (DN19) W.P. 6000 psi (41.4 MPa) MSHA IC-152/8

- › Meets or exceeds the performance requirements of: EN 856 4SH; DIN 20023 4SH
- › Meets Flame Resistance USMSHA Designation
- › Meets Higher EN/DIN Pressures
- › ABS Type Pending

Descriptive #/ Product #	SAP #	Hose Size ID		Hose OD		Max. Working Pressure		Min. Bend Radius		Min. Burst Pressure		Weight lbs./ft.
		in.	mm	in.	mm	psi	MPa	in.	mm	psi	MPa	
S4SH-12	20706576	3/4	19	1.27	32.2	6090	42.0	11.0	280	24360	168.0	1.09
S4SH-16	20706577	1	25	1.52	38.7	5510	38.0	13.4	340	22040	152.0	1.42
S4SH-20	20706723	1 1/4	31	1.79	45.5	5080	35.0	17.9	455	20320	140.0	1.71
S4SH-24	20706724	1 1/2	38	2.11	53.5	4205	29.0	22.0	560	16820	116.0	2.19
S4SH-32	20706725	2	51	2.68	68.1	3650	25.0	28.0	710	14600	100.7	3.31

SR7

SAE 100R7/855 R7 | Thermoplastic



Exceeds SAE Min. Bend Radius

Application

Medium pressure thermoplastic hose with a perforated cover. Compatible with petroleum-, water- and synthetic-based fluids for mobile equipment, lube lines, blowout preventers, hydraulic lifts and construction machinery.

Inner Tube

Nylon

Reinforcement

Synthetic fiber

Cover

Black urethane, perforated

Temperature Range

-40°F to 200°F (-40°C to 93°C)
Note: Max temperature for water-based and fire-resistant fluids is 150°F (66°C).

Fitting Reference

All fittings compatible with the SR7 hose family are listed in Section 3 (starting on page 118) of the catalog.

Branding

Example: Continental ContiTech SR7-02 SAE 100R7/EN855 R7 1/8" (DN03) W.P. 2500 psi (17.2 MPa)

- › Meets or exceeds the performance requirements of: SAE 100R7; EN 855 R7

Descriptive #/ Product #	SAP #	Hose Size ID		Hose OD		Max. Working Pressure		Min. Bend Radius		Min. Burst Pressure		Weight lbs./ft.
		in.	mm	in.	mm	psi	MPa	in.	mm	psi	MPa	
SR7-02	20243607	1/8	03	0.34	8.5	2500	17.2	0.5	13	10000	68.9	0.03
SR7-03	20243608	3/16	05	0.43	10.8	3000	20.7	0.8	20	12000	82.7	0.05
SR7-04	20243609	1/4	06	0.51	13.0	3000	20.7	1.3	33	12000	82.7	0.06
SR7-05	20243650	5/16	08	0.59	15.1	2500	17.2	1.8	46	10000	68.9	0.07
SR7-06	20243651	3/8	10	0.67	17.0	2250	15.5	2.0	51	9000	62.1	0.10
SR7-08	20243652	1/2	12	0.82	20.7	2000	13.8	3.0	76	8000	55.2	0.14
SR7-12	20243653	3/4	19	1.07	27.1	1250	8.6	5.0	127	5000	34.5	0.19
SR7-16	20243654	1	25	1.34	34.0	1000	6.9	8.0	203	4000	27.6	0.26

TR7

SAE 100R7 (Twin-Line) | Thermoplastic



- › Meets or exceeds the performance requirements of: SAE 100R7;
- › Twin-Line

Application

Medium pressure, twin-line thermoplastic hose with a perforated cover. Compatible with petroleum-, water- and synthetic-based fluids for mobile equipment, lube lines, blowout preventers, hydraulic lifts and construction machinery.

Inner Tube

Nylon

Reinforcement

Synthetic fiber

Cover

Black urethane, perforated

Temperature Range

-40°F to 200°F (-40°C to 93°C)
 Note: Max temperature for water-based and fire-resistant fluids is 150°F (66°C).

Fitting Reference

All fittings compatible with the TR7 hose family are listed in Section 3 (starting on page 118) of the catalog.

Branding

Example: Continental ContiTech TR7-03 SAE 100R7 3/16" (4.8mm) W.P. 3000 psi (20.7 MPa)

Descriptive #/ Product #	SAP #	Hose Size ID		Hose OD		Max. Working Pressure		Min. Bend Radius		Min. Burst Pressure		Weight lbs./ft.
		in.	mm	in.	mm	psi	MPa	in.	mm	psi	MPa	
TR7-03	20243663	3/16	4.8	0.43	10.8	3000	20.7	0.8	20	12000	82.7	0.09
TR7-04	20243664	1/4	6.4	0.51	13.0	3000	20.7	1.3	33	12000	82.7	0.11
TR7-05	20243665	5/16	7.9	0.59	15.1	2500	17.2	1.8	46	10000	68.9	0.14
TR7-06	20243666	3/8	9.5	0.67	17.0	2250	15.5	2.0	51	9000	62.1	0.19
TR7-08	20243667	1/2	12.7	0.82	20.7	2000	13.8	3.0	76	8000	55.2	0.28

NR7

SAE 100R7 (Non-Conductive) | Thermoplastic



- › Meets or exceeds the performance requirements of: SAE 100R7;
- › Non-Conductive

Application

Medium pressure thermoplastic hose with a non-perforated cover. Compatible with petroleum-, water- and synthetic-based fluids for mobile equipment, lube lines, blowout preventers, hydraulic lifts and construction machinery requiring SAE 100R7 non-conductivity standards.

Inner Tube

Polyester

Reinforcement

Synthetic fiber

Cover

Orange urethane

Temperature Range

-65°F to 200°F (-54°C to 93°C)
 Note: Temperature range is -40°F to 200°F (-40°C to 93°C) for sizes 1/8", 3/4" and 1". Max. temperature for water-based and fire-resistant fluids is 140°F (60°C).

Fitting Reference

All fittings compatible with the NR7 hose family are listed in Section 3 (starting on page 118) of the catalog.

Branding

Example: Continental ContiTech NR7-02 SAE 100R7 (Non-Conductive) 1/8" (3.3mm) W.P. 2500 psi (17.2 MPa)

Descriptive #/ Product #	SAP #	Hose Size ID		Hose OD		Max. Working Pressure		Min. Bend Radius		Min. Burst Pressure		Weight lbs./ft.
		in.	mm	in.	mm	psi	MPa	in.	mm	psi	MPa	
NR7-02	20243655	1/8	3.3	0.34	8.5	2500	17.2	0.5	13	10000	68.9	0.03
NR7-03	20243656	3/16	4.8	0.43	10.8	3000	20.7	0.8	20	12000	82.7	0.05
NR7-04	20243657	1/4	6.4	0.49	12.3	2750	19.0	1.3	33	11000	75.8	0.06
NR7-05	20243658	5/16	7.9	0.58	14.7	2500	17.2	1.8	46	10000	68.9	0.08
NR7-06	20243659	3/8	9.5	0.64	16.1	2250	15.5	2.0	51	9000	62.1	0.10
NR7-08	20243660	1/2	12.7	0.82	20.7	2250	15.5	3.0	76	9000	62.1	0.14
NR7-12	20243661	3/4	19.0	1.07	27.1	1250	8.6	5.0	127	5000	34.5	0.19
NR7-16	20243662	1	25.4	1.34	34.0	1000	6.9	8.0	203	4000	27.6	0.26

BR7

SAE 100R7 (Twin-Line, Non-Conductive) | Thermoplastic

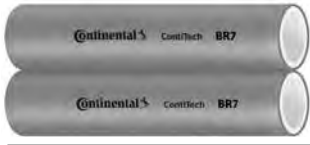
**Application**

Medium pressure, twin-line thermoplastic hose with a non-perforated cover. Compatible with petroleum-, water- and synthetic-based fluids for mobile equipment, lube lines, blowout preventers, hydraulic lifts and construction machinery requiring SAE 100R7 non-conductivity standards.

Inner Tube

Nylon

Reinforcement

Synthetic fiber

Cover

Orange urethane

Temperature Range

-65°F to 200°F (-54°C to 93°C)
Note: Max temperature for water-based and fire-resistant fluids is 150°F (66°C).

Fitting Reference

All fittings compatible with the BR7 hose family are listed in Section 3 (starting on page 118) of the catalog.

Branding

Example: Continental ContiTech BR7-04 SAE 100R7 (Non-Conductive) 1/4" (6.4mm) W.P. 2750 psi (19 MPa)

- › Meets or exceeds the performance requirements of: SAE 100R7;
- › Twin-Line
- › Non-Conductive

Descriptive #/ Product #	SAP #	Hose Size ID		Hose OD		Max. Working Pressure		Min. Bend Radius		Min. Burst Pressure		Weight lbs./ft.
		in.	mm	in.	mm	psi	MPa	in.	mm	psi	MPa	
BR7-04	20243684	1/4	6.4	0.49	12.3	2750	19.0	1.3	33	11000	75.8	0.12
BR7-05	20243685	5/16	7.9	0.58	14.7	2500	17.2	1.8	46	10000	68.9	0.15
BR7-06	20243686	3/8	9.5	0.64	16.1	2250	15.5	2.0	51	9000	62.1	0.19
BR7-08	20243687	1/2	12.7	0.82	20.7	2250	15.5	3.0	76	9000	62.1	0.29

SR8

SAE 100R8/855 R8 | Thermoplastic



Exceeds SAE Min. Bend Radius

- › Meets or exceeds the performance requirements of: SAE 100R8; EN 855 R8

Application

High pressure thermoplastic hose with a perforated cover for petroleum-, water- and synthetic-based fluids for mobile equipment, lube lines, blowout preventers, hydraulic lifts and construction machinery.

Inner Tube

Nylon

Reinforcement

Synthetic fiber

Cover

Black urethane, perforated

Temperature Range

-40°F to 200°F (-40°C to 93°C)
Note: Max temperature for water-based and fire-resistant fluids is 150°F (66°C).

Fitting Reference

All fittings compatible with the SR8 hose family are listed in Section 3 (starting on page 118) of the catalog.

Branding

Example: Continental ContiTech SR8-03 SAE 100R8/EN 855 R8 3/16" (DN05) W.P. 5000 psi (34.5 MPa)

Descriptive #/ Product #	SAP #	Hose Size ID		Hose OD		Max. Working Pressure		Min. Bend Radius		Min. Burst Pressure		Weight lbs./ft.
		in.	mm	in.	mm	psi	MPa	in.	mm	psi	MPa	
SR8-03	20243672	3/16	05	0.52	13.1	5000	34.5	1.5	38	20000	137.9	0.08
SR8-04	20243673	1/4	06	0.63	15.9	5000	34.5	2.0	51	20000	137.9	0.12
SR8-06	20243674	3/8	10	0.77	19.4	4000	27.6	2.5	64	16000	110.3	0.15
SR8-08	20243675	1/2	12	0.89	22.7	3500	24.1	4.0	102	14000	96.5	0.19

TR8

SAE 100R8 (Twin-Line) | Thermoplastic



- › Meets or exceeds the performance requirements of: SAE 100R8;
- › Twin-Line

Application

High pressure, twin-line thermoplastic hose with a perforated cover. Compatible with petroleum-, water- and synthetic-based fluids for mobile equipment, lube lines, blowout preventers, hydraulic lifts and construction machinery.

Inner Tube

Nylon

Reinforcement

Synthetic fiber

Cover

Black urethane, perforated

Temperature Range

-40°F to 200°F (-40°C to 93°C)
Note: Max temperature for water-based and fire-resistant fluids is 150°F (66°C).

Fitting Reference

All fittings compatible with the TR8 hose family are listed in Section 3 (starting on page 118) of the catalog.

Branding

Example: Continental ContiTech TR8-06 SAE 100R8 3/8" (9.5mm) W.P. 4000 psi (27.6 MPa)

Descriptive #/ Product #	SAP #	Hose Size ID		Hose OD		Max. Working Pressure		Min. Bend Radius		Min. Burst Pressure		Weight lbs./ft.
		in.	mm	in.	mm	psi	MPa	in.	mm	psi	MPa	
TR8-06	20243679	3/8	9.5	0.77	19.4	4000	27.6	2.5	64	16000	110.3	0.30
TR8-08	20416222	1/2	12.7	0.89	22.7	3500	24.1	4.0	102	14000	96.5	0.38

NR8

SAE 100R8 (Non-Conductive) | Thermoplastic



- › Meets or exceeds the performance requirements of: SAE 100R8;
- › Non-Conductive

Application

High pressure thermoplastic hose with a non-perforated cover. Compatible with petroleum-, water- and synthetic-based fluids for mobile equipment, lube lines, blowout preventers, hydraulic lifts and construction machinery requiring SAE 100R8 non-conductivity standards.

Inner Tube

Nylon

Reinforcement

Synthetic fiber

Cover

Orange urethane

Temperature Range

-40°F to 200°F (-40°C to 93°C)
Note: Max temperature for water-based and fire-resistant fluids is 150°F (66°C).

Fitting Reference

All fittings compatible with the NR8 hose family are listed in Section 3 (starting on page 118) of the catalog.

Branding

Example: Continental ContiTech NR8-04 SAE 100R8 (Non-conductive) 1/4" (6.4mm) W.P. 5000 psi (34.5 MPa)

Descriptive #/ Product #	SAP #	Hose Size ID		Hose OD		Max. Working Pressure		Min. Bend Radius		Min. Burst Pressure		Weight lbs./ft.
		in.	mm	in.	mm	psi	MPa	in.	mm	psi	MPa	
NR8-04	20243676	1/4	6.4	0.63	15.9	5000	34.5	2.0	51	20000	137.9	0.12
NR8-06	20243677	3/8	9.5	0.77	19.4	4000	27.6	2.5	64	16000	110.3	0.15
NR8-08	20243678	1/2	12.7	0.89	22.7	3500	24.1	4.0	102	14000	96.5	0.19

SR18

SAE 100R18 | Thermoplastic



Flexible at Low Temp

- › Meets or exceeds the performance requirements of: SAE 100R18;
- › Low Temperature

Application

Thermoplastic hose, highly flexible even in cold temperatures. Compact size with a small OD and lightweight yet rugged construction. Applications for this hose include forklifts, construction equipment, general hydraulic applications, chemical and gas transfer, agricultural equipment, material handling, freezer applications, machine tools and robotics, lubrication equipment and portable hydraulic tools.

Inner Tube

Polyester

Reinforcement

Synthetic fiber

Cover

Polyester

Temperature Range

-65°F to 199°F (-54°C to 93°C)

Fitting Reference

All fittings compatible with the SR18 hose family are listed in Section 3 (starting on page 118) of the catalog.

Branding

Example: Continental ContiTech SR18-04 SAE 100R18 1/4" (6.4mm) W.P. 3000 psi (20.7 MPa)

Descriptive #/ Product #	SAP #	Hose Size ID		Hose OD		Max. Working Pressure		Min. Bend Radius		Min. Burst Pressure		Weight lbs./ft.
		in.	mm	in.	mm	psi	MPa	in.	mm	psi	MPa	
SR18-04	20243680	1/4	6.4	0.49	12.3	3000	20.7	1.3	32	12000	82.7	0.06
SR18-05	20243681	5/16	7.9	0.61	15.5	3000	20.7	1.5	38	12000	82.7	0.08
SR18-06	20243682	3/8	9.5	0.66	16.8	3000	20.7	2.0	51	12000	82.7	0.12
SR18-08	20243683	1/2	12.7	0.85	21.6	3000	20.7	3.5	89	12000	82.7	0.15

NSFX

SAFLEX® | Special Application



- › Non-Conductive

Application

Medium pressure applications where shock hazards exist and non-conductivity is required. Meets max leakage of 100 microamps/ft at 75 KV for 3 minutes.

Inner Tube

Polychloroprene

Reinforcement

Two textile braids

Cover

Orange nitrile

Temperature Range

-40°F to 212°F (-40°C to 100°C)

Fitting Reference

All fittings compatible with the NSFX hose family are listed in Section 8 (starting on page 267) of the catalog.

Branding

Example: Continental ContiTech NSFX-04 SAFLEX® (Non-conductive) 1/4" (6.4mm) W.P. 2750 psi (19 MPa)

Descriptive #/ Product #	SAP #	Hose Size ID		Hose OD		Max. Working Pressure		Min. Bend Radius		Min. Burst Pressure		Weight lbs./ft.
		in.	mm	in.	mm	psi	MPa	in.	mm	psi	MPa	
NSFX-04	20240283	1/4	6.4	0.56	14.2	2750	19.0	3.5	89	11000	75.8	0.11
NSFX-06	20240284	3/8	9.5	0.75	19.0	2250	15.5	4.0	102	9000	62.1	0.19
NSFX-08	20240285	1/2	12.7	0.94	23.7	2000	13.8	6.0	152	8000	55.2	0.27

Prospector™ SHR

Slim-Hole Rotary Hose | Special Application



› Meets Flame Resistance USMSHA Designation

Application

High pressure, rotary hose for slim-hole, seismograph, work-over or portable drilling rigs. For use with small- to medium-blast, water-well or shot-hole drilling applications. Used in hydraulic oil, mud or air applications or where pulsating pump is required.

Inner Tube

Polychloroprene

Reinforcement

Four alternating layers of spiralled high-tensile steel wire for the

SHR5000-16 (1") and SHR3650-32 (2"). Six alternating layers of spiralled high-tensile steel wire for the SHR5000-20 (1 1/4") through SHR5000-32 (2")

Cover

Polychloroprene, Pin Pricked

Temperature Range

When conveying air: -40°F to 158°F (-40°C to 70°C). When conveying fluids: -40°F to 250°F (-40°C to 121°C). When conveying fluids for SHR3650-32 : -40°F to 212°F (-40°C to 100°C)

Fitting Reference

All fittings compatible with the Prospector™ Slim-Hole Rotary hose family are listed in Section 8 (starting on page 267) of the catalog.

Branding

Example: Continental ContiTech Prospector™ Slim-Hole Rotary 1" 5000 psi W.P. Flame Resistant MSHA IC-152/8. Made in Italy.

Safety Factor

4:1 Safety Factor, except 2400-48 which is 2.5:1

Descriptive #/ Product #	SAP #	Hose Size ID		Hose OD		Max. Working Pressure		Min. Bend Radius		Min. Burst Pressure		Weight lbs./ft.
		in.	mm	in.	mm	psi	MPa	in.	mm	psi	MPa	
SHR2400-48	20613761	3"	76	3.94	100.1	2400	16.5	36.0	914	6000	41.4	4.50
SHR3000-32	20749438	2"	50.8	2.69	68.3	3000	20.7	25.0	635	12000	82.7	1.34
SHR3650-32	20714905	2"	50.8	2.74	69.7	3650	25.2	28.0	710	14600	100.7	2.40
SHR5000-16	20714808	1"	25.4	1.57	39.8	5100	35.2	11.8	300	20400	140.7	3.35
SHR5000-20	20714890	1 1/4"	31.8	2.02	51.3	5100	35.2	16.5	420	20400	140.7	4.38
SHR5000-24	20714903	1 1/2"	38.1	2.31	58.8	5100	35.2	19.7	500	20400	140.7	3.13
SHR5000-32	20714904	2"	50.8	2.9	72.7	5100	35.2	24.8	630	20400	140.7	4.27

Prospector™ BOP 3000

Special Application



Fire Tested

Application

BOP hose is a hydraulic control connection that is used in the well control system

Inner Tube

Black nitrile

Reinforcement

2-Wire braid steel

Cover

Pink polychloroprene, wrapped finish

Temperature Range

-40°F to 212°F (-40°C to 100°C)

Verification

Independently tested as per test requirements specified by "Lloyd's

Register Fire Tests for Flexible Hoses on Offshore Installations" (OD/1000/499-29th June, 1992) and EUB (Directive 036)

Fitting Reference

Special assembly procedure required. Contact Continental ContiTech for details.

Descriptive #/ Product #	SAP #	Hose Size ID		Hose OD		Max. Working Pressure		Min. Bend Radius		Min. Burst Pressure		Weight lbs./ft.
		in.	mm	in.	mm	psi	MPa	in.	mm	psi	MPa	
BOP-06	20613999	3/8	9.5	1.11	28.2	3000	20.7	6.0	152	12000	82.7	0.75
BOP-08	20614010	1/2	12.7	1.19	30.2	3000	20.7	8.0	203	12000	82.7	0.81
BOP-12	20614011	3/4	19.1	1.49	37.8	3000	20.7	11.0	279	12000	82.7	1.22
BOP-16	20614012	1	25.4	1.84	46.7	3000	20.7	15.0	381	12000	82.7	1.74

Prospector™ BOP 5000

Very High Pressure



Fire Tested

Application

BOP hose is a hydraulic control connection that is used in the well control system

Inner Tube

Polychloroprene

Reinforcement

Four alternating layers of spiral

high-tensile steel wire (size 3/8", 1/2", 3/4", 1", 1 1/4") and six alternating layers of spiraled hightensile steel wire (size 1 1/2" and 2")

Cover

Pink polychloroprene, wrapped finish

Temperature Range

-40°F to 212°F (-40°C to 100°C)

Branding

Example: Continental ContiTech BOP 5000 3/8" (9.5mm) W.P. 5000 psi (34.5 MPa)

Fitting Reference

Special assembly procedure required. Contact Continental ContiTech

Descriptive #/ Product #	SAP #	Hose Size ID		Hose OD		Max. Working Pressure		Min. Bend Radius		Min. Burst Pressure		Weight lbs./ft.
		in.	mm	in.	mm	psi	MPa	in.	mm	psi	MPa	
BOP5000-06	20715121	3/8	10.0	1.14	29.0	5000	34.5	7.1	180	20000	138.0	0.80
BOP5000-08	20715122	1/2	12.5	1.24	31.6	5000	34.5	9.0	230	20000	138.0	0.90
BOP5000-12	20715123	3/4	19.0	1.58	40.1	5000	34.5	11.8	300	20000	138.0	1.60
BOP5000-16	20715124	1	25.0	1.85	46.9	5000	34.5	13.4	340	20000	138.0	2.00
BOP5000-20	20715125	1 1/4	31.5	2.10	53.4	5000	34.5	18.1	460	20000	138.0	2.40
BOP5000-24	20715126	1 1/2	38.0	2.59	65.9	5000	34.5	19.7	500	20000	138.0	4.10
BOP5000-32	20715127	2	51.0	3.14	79.7	5000	34.5	24.8	630	20000	138.0	5.50

Prospector™ Hot Oiler

Grease Gun Hose | Special Application



Meets Flame Resistance USMSHA Designation

Application

Static pressure, hot oiler applications. Designed specifically to handle the transfer of hot oil at 275F continuous, 300F intermittent to clear the paraffin around the casing to help start the flow of oil to the surface.

Inner Tube

Black, oil resistant, synthetic rubber.

Reinforcement

Two braids of high-tensile steel wire

Cover

Black, oil and abrasion resistant, synthetic rubber.

Temperature Range

-40F to +275F (-40C to +135C)

Fitting Reference

S4-NPMAPI-2424 SAP#20636530

Branding

Continental ContiTech HOT OILER

Descriptive #/ Product #	SAP #	Hose Size ID		Hose OD		Max. Working Pressure		Min. Bend Radius		Min. Burst Pressure		Weight lbs./ft.
		in.	mm	in.	mm	psi	MPa	in.	mm	psi	MPa	
Hot Oiler	20739314	1.5	38.0	2.16	54.8	2500	17.2	20.0	508	8125	56.0	1.64

SGUN

Grease Gun Hose | Special Application



Meets Flame Resistance USMSHA Designation

Application

Used as a grease whip hose or general purpose lubrication line. To be used with hand grease guns only. Not for powered units.

Inner Tube

Nitrile

Reinforcement

One braid of high-tensile steel wire

Cover

Black polychloroprene

Temperature Range

-40°F to 212°F (-40°C to 100°C)

Fitting Reference

All fittings compatible with the SGUN hose family are listed in Section 8 (starting on page 267) of the catalog.

Branding

Example: Continental ContiTech SGUN-03 Grease Gun Hose 3/16" (4.8mm) W.P. 3000 psi (20.7 MPa) MSHA 2G-14C/12

Descriptive #/ Product #	SAP #	Hose Size ID		Hose OD		Max. Working Pressure		Min. Bend Radius		Min. Burst Pressure		Weight lbs./ft.
		in.	mm	in.	mm	psi	MPa	in.	mm	psi	MPa	
SGUN-03	20240286	3/16	4.8	0.41	10.4	3000	20.7	NA	NA	12000	82.7	0.09

SHJ

Jack Hose | Special Application



- › Meets Flame Resistance USMSHA Designation

Application

Extreme high pressure hydraulic lines for jacking systems.

Inner Tube

Nitrile

Reinforcement

Two braids of high-tensile steel wire

Cover

Black polychloroprene

Temperature Range

-40°F to 212°F (-40°C to 100°C)

Fitting Reference

All fittings compatible with the SHJ hose family are listed in Section 8 (starting on page 267) of the catalog.

Branding

Example: Continental ContiTech SHJ-04 Jack Hose 1/4" (6.4mm) W.P. 10000 psi (68.9 MPa) MSHA 2G-14C/12

Descriptive #/ Product #	SAP #	Hose Size ID		Hose OD		Max. Working Pressure		Min. Bend Radius		Min. Burst Pressure		Weight lbs./ft.
		in.	mm	in.	mm	psi	MPa	in.	mm	psi	MPa	
SHJ-04	20319601	1/4	6.4	0.58	14.7	10000	68.9	4.0	102	20000	137.9	0.24
SHJ-06	20319602	3/8	9.5	0.74	18.7	10000	68.9	5.0	127	20000	137.9	0.30

SR14A

SAE 100R14A | Fleet & Special Application



- › Meets or exceeds the performance requirements of: SAE 100R14A; FDA 21 CFR 177, 1500 Specifications
- › High Temperature
- › Chemical Resistant

Application

Medium pressure hydraulic applications including truck, bus, industrial and aerospace. Compatible with air, fuel, lubricants, high temp oil and some chemical applications.

Inner Tube

Polytetrafluoroethylene

Reinforcement

Synthetic fiber

Cover

304 stainless steel wire braid

Temperature Range

-65°F to 450°F (-54°C to 232°C) continuous -100°F to 500°F (-73°C to 260°C) intermittent

Fitting Reference

Hose utilizes UCF9 ferrules with Continental ContiTech Uni-Crimp® stems, Section 6 (starting on page 201) of the catalog.

Branding

N/A

Descriptive #/ Product #	SAP #	Hose Size ID		Hose OD		Max. Working Pressure		Min. Bend Radius		Min. Burst Pressure		Weight lbs./ft.
		in.	mm	in.	mm	psi	MPa	in.	mm	psi	MPa	
SR14A-03	20303683	3/16	4.8	0.31	7.9	3000	20.7	2.0	51	12000	82.7	0.06
SR14A-04	20303665	1/4	6.4	0.38	9.5	3000	20.7	3.0	76	12000	82.7	0.08
SR14A-05	20303667	5/16	7.9	0.45	11.3	2500	17.2	4.0	102	10000	69.0	0.09
SR14A-06	20303669	3/8	9.5	0.50	12.8	2250	15.5	4.5	114	9000	62.1	0.11
SR14A-08	20303691	1/2	12.7	0.65	16.5	1500	10.3	6.5	165	6000	41.4	0.15
SR14A-10	20303693	5/8	15.9	0.78	19.8	1200	8.3	7.7	196	4800	33.1	0.19
SR14A-12	20303695	3/4	19.1	0.89	22.5	1100	7.6	8.2	208	4400	30.3	0.21
SR14A-16	20303697	1	25.4	1.14	28.8	900	6.2	10.0	254	3600	24.8	0.32

SR5

SAE 100R5 | Fleet Application

**Application**

General purpose, medium pressure hose, for use in air brakes, power steering, turbo oil lines, tilt cab cylinders, transmission coolant and filtration lines. Compatible with petroleum based hydraulic fluids, air, water, gasoline and diesel fuel (GR-04 thru-20 only), lubricating oils and coolants.

Note: Not recommended for under-the-hood, automotive and truck fuel line applications. Only hoses designed and tested to meet SAE fuel line standards should be used for these applications

Note: Sizes 7/8", 1 1/8", 1 3/8" and 1 13/16" do not meet SAE J1402 Type AII & DOT FMVSS 106 Type AII because these sizes are not listed in the referenced specifications.

Inner Tube

Nitrile for 3/16" - 1 1/8" IDs
polychloroprene for 1 3/8" - 1 13/16" IDs

Reinforcement

One braid of high-tensile steel wire

Cover

Black impregnated textile braid

Temperature Range

-40°F to 212°F (-40°C to 100°C)

Fitting Reference

All fittings compatible*** with the SR5 hose family are listed in Section 7 (starting on page 231) of the catalog.

Branding

Example: Continental ContiTech SR5-04 5 mm (3/16") SAE 100R5 (DOT FMVSS 106 AII, J1402 Air Brake) 20.7 MPa (3000 psi) W.P. GY Made in U.S.A..

› Meets or exceeds the performance requirements of: SAE 100R5; DOT FMVSS 106 All and SAE J1402 (sizes 3/16", 1/4", 5/16", 13/32", 1/2" and 5/8")

› SAE J1942/U.S. Coast Guard 

Descriptive #/ Product #	SAP #	Hose Size ID		Hose OD		Max. Working Pressure		Min. Bend Radius		Min. Burst Pressure		Weight lbs./ft.	USCG Approved
		in.	Mm	in.	Mm	Psi	MPa	in.	Mm	Psi	MPa		
SR5-04	20324155	3/16	4.8	0.52	13.2	3000	20.7	3.0	76	12000	82.7	0.15	H
SR5-05	20416026	1/4	6.4	0.58	14.8	3000	20.7	3.4	86	12000	82.7	0.18	H
SR5-06	20324042	5/16	7.9	0.68	17.1	2250	15.5	4.0	102	9000	62.1	0.22	H
SR5-08	20324041	13/32	10.3	0.77	19.5	2000	13.8	4.6	117	8000	55.2	0.30	H
SR5-10	20326081	1/2	12.7	0.92	23.4	1750	12.1	5.5	140	7000	48.3	0.37	H
SR5-12	20455110	5/8	15.9	1.08	27.4	1500	10.3	6.5	165	6000	41.4	0.45	H
SR5-16	20340597	7/8	22.2	1.24	31.4	800	5.5	7.4	187	3200	22.1	0.47	H
SR5-20	20239407	1 1/8	28.6	1.50	38.1	625	4.3	9.0	229	2500	17.2	0.58	H
SR5-24	20239408	1 3/8	35.0	1.75	44.4	500	3.4	10.5	267	2000	13.8	0.73	H
SR5-32	20239409	1 13/16	46.0	2.22	56.4	350	2.4	13.3	337	1400	9.7	0.90	H

***Note: Assemblies made with Continental ContiTech's SR5 hose and Continental ContiTech's Field-Grip® or Uni-Crimp® fittings meet SAE J1402 and DOT FMVSS 571.106 specifications. Assemblies made with Uni-Crimp fittings also meet SAE J517 100R5 assembly requirements. USCG rating "H" requires GTEX protective sleeving. Federal law requires registration with the Department of Transportation for anyone producing air brake hose assemblies.

Desert® DR5

SAE 100R5 | Fleet Application



- › Meets or exceeds the performance requirements of: SAE 100R5; SAE J1402 Type All, DOT FMVSS 106 Type All
- › High Temperature
- › SAE J1942/U.S. Coast Guard 

Application

High temperature, medium pressure hose for use in applications including turbocharger oil lines, tilt cab cylinder and air brake lines, transmission coolant and filtration lines. Compatible with petroleum oil and phosphate ester-based hydraulic fluids, air, water, diesel fuel, petroleum based lubricating oils and coolants.

Note: Not recommended for under-the-hood, automotive and truck fuel line applications. Only hoses designed and tested to meet SAE fuel line standards should be used for these applications

Note: Sizes 7/8" (-16) and 1 1/8" (-20) do not meet SAE J1402 Type All & DOT FMVSS 106 Type All because these sizes are not listed in the referenced specifications.

Inner Tube

CPE

Reinforcement

One braid textile, one braid steel

Cover

Blue impregnated textile braid

Temperature Range

SAE 100R5 Hydraulic Applications: -40°F to 302°F (-40°C to 150°C)

Air Brake Applications: -40°F to 200°F (-40°C to 93°C)
 General Hot Oil Applications: -40°F to 300°F (-40°C to 150°C)
 General Air Applications: -40°F to 200°F (-40°C to 93°C)
 Water Applications: -40°F to 212°F (-40°C to 100°C)

Fitting Reference

All fittings compatible*** with the DR5 hose family are listed in Section 7 (starting on page 231) of the catalog.

Branding

Example: Continental ContiTech DR5-06 SAE 8 mm (5/16") SAE 100R5 (DOT FMVSS 106 All, J1402 AIR BRAKE) 15.5 MPa (2250 psi) W.P. GY Made in U.S.A..

Descriptive #/ Product #	SAP #	Hose Size ID		Hose OD		Max. Working Pressure		Min. Bend Radius		Min. Burst Pressure		Weight lbs./ft.	USCG Approved
		in.	mm	in.	mm	psi	MPa	in.	mm	psi	MPa		
DR5-04	20340705	3/16	4.8	0.52	13.2	3000	20.7	3.0	76	12000	82.7	0.15	H
DR5-05	20341023	1/4	6.4	0.58	14.8	3000	20.7	3.4	86	12000	82.7	0.18	H
DR5-06	20340706	5/16	7.9	0.68	17.1	2250	15.5	4.0	102	9000	62.1	0.22	H
DR5-08	20340707	13/32	10.3	0.77	19.5	2000	13.8	4.5	117	8000	55.2	0.30	H
DR5-10	20340708	1/2	12.7	0.92	23.4	1750	12.1	5.5	140	7000	48.3	0.37	H
DR5-12	20341025	5/8	15.9	1.08	27.4	1500	10.3	6.5	165	6000	41.4	0.45	H
DR5-16	20340709	7/8	22.2	1.24	31.4	800	5.5	7.4	187	3200	22.1	0.47	H
DR5-20	20368015	1 1/8	28.6	1.50	38.1	625	4.3	9.0	229	2500	17.2	0.58	H

***Note: Assemblies made with Continental ContiTech's DR5 hose and Continental ContiTech' Field Grip® or Uni-Crimp® fittings meet SAE J1402 and DOT FMVSS 571.106 specifications. For high pressure hydraulic applications use the Uni-Crimp® fitting which meets SAE J517 100R5 assembly requirements. Federal law requires registration with the Department of Transportation for anyone producing air brake hose assemblies.

SCX5

Fleet Application

**Application**

For use with medium-pressure applications including water, gasoline, diesel, lubricating oils and petroleum-based hydraulic oils.

Inner Tube

Nitrile

Reinforcement

One braid steel wire and one braid textile

Cover

Black polychloroprene

Temperature Range

-40°F to 212°F (-40°C to 100°C)

Fitting Reference

The SCX5 hose family utilizes the UC Crimp Fittings listed in Section 7 (starting on page 231) of the catalog.

Branding

Example: Continental ContiTech SCX5-05 1/4" (6.4 mm) 3000 psi W.P (20.7 MPa) MSHA 2G-14C/12 Made in U.S.A..

- › Meets or exceeds the performance requirements of: SAE 100R5
- › Meets Flame Resistance USMSHA Designation
- › SAE J1942/U.S. Coast Guard 

Descriptive #/ Product #	SAP #	Hose Size ID		Hose OD		Max. Working Pressure		Min. Bend Radius		Min. Burst Pressure		Weight lbs./ft.	USCG Approved
		in.	mm	in.	mm	psi	MPa	in.	mm	psi	MPa		
SCX5-05	20608834	1/4	6.4	0.58	14.8	3000	20.7	3.4	86	12000	82.7	0.18	H
SCX5-06	20608835	5/16	7.9	0.68	17.3	2250	15.5	4.0	102	9000	62.1	0.22	H
SCX5-08	20608836	13/32	10.3	0.78	19.8	2000	13.8	4.6	117	8000	55.2	0.23	H
SCX5-10	20608837	1/2	12.7	0.91	23.0	1750	12.1	5.5	140	7000	48.3	0.34	H
SCX5-12	20608838	5/8	15.9	1.08	27.4	1500	10.3	6.5	165	6000	41.4	0.41	H
SCX5-16	20608839	7/8	22.2	1.23	31.3	800	5.5	7.4	188	3200	22.1	0.44	H
SCX5-20	20608890	1"	28.6	1.50	38.1	625	4.3	9.0	229	2500	17.2	0.53	H



DUT

Universal Truck | Fleet Application



- › Meets or exceeds the performance requirements of: SAE J1402 Type A1 DOT FMVSS 106 Type A1
- › High Temperature

Application

High temperature, medium pressure hose for use in applications including turbocharger oil lines, tilt cab cylinder and air brake lines, transmission coolant and filtration lines. Compatible with petroleum oil and phosphate ester based hydraulic fluids, air, water, diesel fuel, petroleum based lubricating oils and coolants.

Note: Not recommended for under-the-hood, automotive and truck fuel line applications. Only hoses designed and tested to meet SAE fuel line standards should be used for these applications.

Note: Sizes 7/8" (-16) and 1 1/8" (-20) do not meet SAE J1402 Type A1 & DOT FMVSS 106 Type A1 because these sizes are not listed in the referenced specifications.

Inner Tube

CPE

Reinforcement

One braid textile, one braid steel

Cover

Blue impregnated textile braid

Temperature Range

Air Brake Applications: -40°F to 200°F (-40°C to 93°C)

General Hot Oil Applications: -40°F to 302°F (-40°C to 150°C)
 General Air Applications: -40°F to 200°F (-40°C to 93°C)
 Water Applications: -40°F to 212°F (-40°C to 100°C)

Fitting Reference

All fittings compatible with the DUT hose family are listed in Section 7A (starting on page 261) of the catalog.

Branding

Example: Continental ContiTech DUT-06 SAE J1402 Type A1 Air Brake DOT FMVSS 106 A1 5/16" (7.9mm) W.P. 1500 psi (10.3 MPa)

Descriptive #/ SAP # Product #	SAP #	Hose Size ID		Hose OD		Max. Working Pressure		Min. Bend Radius		Min. Burst Pressure		Weight lbs./ft.
		in.	mm	in.	mm	psi	MPa	in.	mm	psi	MPa	
DUT-04	20367570	3/16	4.8	0.49	12.4	2000	13.8	2.0	51	8000	55.2	0.12
DUT-05	20367574	1/4	6.4	0.55	14.0	1500	10.3	2.5	64	6000	41.4	0.14
DUT-06	20367576	5/16	7.9	0.62	15.7	1500	10.3	3.0	76	6000	41.4	0.17
DUT-08	20367577	13/32	10.3	0.74	18.8	1250	8.6	3.5	89	5000	34.5	0.20
DUT-10	20367578	1/2	12.7	0.83	21.1	1000	6.9	4.0	102	4000	27.6	0.22
DUT-12	20367579	5/8	15.9	0.96	24.4	750	5.2	4.5	114	3000	20.7	0.24
DUT-16	20424721	7/8	22.2	1.21	30.7	400	2.8	5.0	127	1600	11.0	0.30
DUT-20	20424722	1 1/8	28.6	1.49	37.8	300	2.1	5.5	140	1200	8.3	0.44

Note: Federal law requires registration with the Department of Transportation for anyone producing air brake hose assemblies.

Galaxy® G4826

SAE J2064 | Air Conditioning

**Application**

Recommended for R134a and R12 refrigerants in automotive, heavy-duty truck, construction and agricultural air conditioning systems.

Inner Tube

Chloroprene

Barrier

Nylon

Reinforcement

Two-spiral polyester

Cover

Black EPDM

Temperature Range

-22°F to 257°F (-30°C to 125°C)

Fitting Reference

All fittings compatible with the G4826 hose family are listed in Section 9 (starting on page 275) of the catalog.

Branding

Example: Galaxy® by Continental ContiTech SAE J2064 Type C Class II 13/32" ID (10mm) 4826 - Size 8

› Meets or exceeds the performance requirements of: SAE J2064, Type C Class 11

Descriptive #/ Product #	SAP #	Hose Size ID		Hose OD		Max. Working Pressure		Min. Bend Radius		Min. Burst Pressure		Weight lbs./ft.
		in.	mm	in.	mm	psi	MPa	in.	mm	psi	MPa	
G4826-06	20290026	5/16	7.9	0.75	19.1	500	3.4	0.6	16	2000	13.8	0.20
G4826-08	20290027	13/32	10.3	0.91	23.0	500	3.4	1.0	25	2000	13.8	0.28
G4826-10	20290028	1/2	12.7	1.00	25.4	500	3.4	1.3	32	2000	13.8	0.33
G4826-12	20290029	5/8	15.9	1.13	28.6	350	2.4	2.0	50	1750	12.1	0.38

Galaxy® G4867

SAE J2064 | Air Conditioning

**Application**

Recommended for R134a, refrigerant blends and compressor lubricants as a suction line in air conditioning systems for heavy-duty truck.

Inner Tube

Chloroprene

Barrier

Nylon

Reinforcement

Single-braid polyester

Cover

Black chlorobutyl

Temperature Range

-22°F to 257°F (-30°C to 125°C)

Fitting Reference

All fittings compatible with the G4867 hose family are listed in Section 9 (starting on page 275) of the catalog.

Branding

Example: Galaxy® by Continental ContiTech SAE J2064 Type C Class II 13/32" ID (10mm) 4826 - Size 8

› Meets or exceeds the performance requirements of: SAE J2064, Type C Class 1

Descriptive #/ Product #	SAP #	Hose Size ID		Hose OD		Max. Working Pressure		Min. Bend Radius		Min. Burst Pressure		Weight lbs./ft.
		in.	mm	in.	mm	psi	MPa	in.	mm	psi	MPa	
G4867-14	20306586	3/4	19.0	1.13	28.6	350	2.4	6.3	160	1750	12.1	0.26

Galaxy® SLE G4890

SAE J2064 | Air Conditioning



› Meets or exceeds the performance requirements of: SAE J2064, Type C Class 1

Application

Recommended for R134a, R1234yf and most refrigerant blends and compressor lubricants in automotive and heavy-duty truck air conditioning systems where significant reduction in permeation and moisture ingress is desired.

Inner Tube

Chloroprene

Barrier

Nylon

Reinforcement

Single-braid polyester

Cover

Black chlorobutyl

Temperature Range

-40°F to 275°F (-40°C to 135°C)

Fitting Reference

All fittings compatible with the G4890 hose family are listed in Section 9 (starting on page 275) of the catalog.

Branding

Example: Galaxy® by Continental ContiTech SAE J2064 Type C Class I 5/16" ID (8mm) 4890 - Size 6

Descriptive #/ Product #	SAP #	Hose Size ID		Hose OD		Max. Working Pressure		Min. Bend Radius		Min. Burst Pressure		Weight lbs./ft.
		in.	mm	in.	mm	psi	MPa	in.	mm	psi	MPa	
G4890-06	20306246	5/16	7.9	0.56	14.7	500	3.4	1.0	25	2000	13.8	0.09
G4890-08	20306247	13/32	10.3	0.69	17.3	500	3.4	1.5	38	2000	13.8	0.12
G4890-10	20306248	1/2	12.7	0.75	19.4	500	3.4	2.5	63	2000	13.8	0.13
G4890-12	20306249	5/8	15.9	0.94	23.6	350	2.4	4.0	104	1750	12.1	0.20

MIL-DTL-13444H

TYPE I | Military Application



Application

Fuel and oil lines in military vehicles and other military applications.

Reinforcement

Single fabric braid

Qualification

QPL-13444 Type I approved for bulk hose. QPL-13444 Type I approved for permanent UC fittings with UCF2 Ferrules on factory assemblies. Distributor-made assemblies must seek DSCC approval.

Inner Tube

Nitrile

Cover

Polychloroprene

Temperature Range

-65°F to 250°F (-53.89°C to 121.1°C)

› Meets or exceeds the performance requirements of: MIL-DTL-13444H Type I

Descriptive #/ Product #	SAP #	Hose Size ID		Hose OD		Max. Working Pressure		Min. Bend Radius		Min. Burst Pressure		Weight lbs./ft.
		in.	Military Dash Size	in.	mm	psi	MPa	in.	mm	psi	MPa	
MIL-H-13444-I-3	20472785	3/16	3	0.44	11.1	425	2.9	2.00	50.80	1700	11.7	.070
MIL-H-13444-I-4	20468052	1/4	4	0.50	12.7	300	2.0	2.25	57.15	1250	8.6	.090
MIL-H-13444-I-5	20470472	5/16	5	0.56	14.3	275	1.9	2.75	69.85	1100	7.6	.100
MIL-H-13444-I-6	20472786	3/8	6	0.63	15.9	250	1.7	3.00	76.20	1000	6.9	.110
MIL-H-13444-I-8	20485914	1/2	8	0.78	19.8	200	1.4	3.75	95.25	750	5.2	.170
MIL-H-13444-I-10	20490906	5/8	10	0.97	25.6	175	1.2	4.75	120.65	700	4.8	.220
MIL-H-13444-I-12	20493008	3/4	12	1.09	27.8	125	0.9	5.50	139.70	500	3.4	.260

MIL-DTL-13444H

TYPE III | Military Application



Application

Medium-pressure hydraulic oil and fuel lines. Used in military vehicles and other support equipment.

Reinforcement

White textile braid and 1-wire steel braid

Qualification

QPL-13444 Type III approved for bulk hose. QPL-13444 Type III approved for permanent UC fittings with UCF6 Ferrules on factory assemblies. Distributor-made assemblies must seek DSCC approval.

Inner Tube

Nitrile

Cover

Black impregnated textile braid

Temperature Range

-55°F to 300°F (-48.33°C to 148.89°C)

› Meets or exceeds the performance requirements of: MIL-DTL-13444H Type III

Descriptive #/ Product #	SAP #	Hose Size ID		Hose OD		Max. Working Pressure		Min. Bend Radius		Min. Burst Pressure		Weight lbs./ft.
		in.	Military Dash Size	in.	mm	psi	MPa	in.	mm	psi	MPa	
MIL-H-13444-III-4	20474735	3/16	4	0.49	12.5	1500	10.3	0.75	19.05	6000	41.4	0.29
MIL-H-13444-III-5	20479489	1/4	5	0.55	14.1	1500	10.3	1.00	25.40	6000	41.4	0.28
MIL-H-13444-III-6	20476712	5/16	6	0.62	15.7	1000	6.8	1.25	31.75	4000	27.5	0.39
MIL-H-13444-III-8	20477294	13/32	8	0.74	18.7	1000	6.8	1.75	44.45	4000	27.5	0.47
MIL-H-13444-III-10	20488137	1/2	10	0.83	21.1	875	6.0	2.25	31.75	3500	24.1	0.47
MIL-H-13444-III-12	20494896	5/8	12	0.96	24.3	750	5.1	2.75	69.85	3000	20.7	0.32
MIL-H-13444-III-16	20524468	7/8	16	1.21	30.6	375	2.6	3.50	88.90	1500	10.3	0.44
MIL-H-13444-III-20	20597709	1 1/8	20	1.49	37.8	300	2.0	4.50	114.3	1250	8.6	0.50

MIL-DTL-13531

TYPE II, Class A | Military Application



Application

Medium and high pressure hydraulic systems.

Reinforcement

2 braids of high-tensile steel wire

Qualification

QPL-13531 approved for bulk hose. QPL-13531 approved for permanent UC fittings with UCF2 Ferrules on factory hose assemblies. Distributor-made assemblies must seek DSCC approval.

Inner Tube

Nitrile

Cover

Black polychloroprene

Temperature Range

-65°F to 200°F (-53.89°C to 93.33°C)

› Meets or exceeds the performance requirements of: MIL-DTL-13531 Type II, Class A

Descriptive #/ Product #	SAP #	Hose Size ID		Hose OD		Max. Working Pressure		Min. Bend Radius		Min. Burst Pressure		Weight lbs./ft.
		in.	Military Dash Size	in.	mm	psi	MPa	in.	mm	psi	MPa	
M13531-B3A	20441525	3/16	3	0.63	15.9	5000	34.47	4.0	101.6	20000	137.9	0.26
M13531-B4A	20441526	1/4	4	0.69	17.5	5000	34.47	4.0	101.6	20000	137.9	0.31
M13531-B5A	20441527	5/16	5	0.75	19.1	4250	29.30	4.5	114.3	17000	117.2	0.33
M13531-B6A	20441528	3/8	6	0.84	21.4	4000	27.57	5.0	127.0	16000	110.3	0.41
M13531-B8A	20441529	1/2	8	0.97	24.6	3500	24.13	7.0	117.8	14000	96.5	0.50
M13531-B10A	20442170	5/8	10	1.09	27.8	2750	18.96	8.5	215.9	11000	75.8	0.59
M13531-B12A	20442171	3/4	12	1.25	31.8	2250	15.51	9.5	241.3	9000	62.1	0.72
M13531-B14A	20442172	7/8	14	1.38	34.9	2000	13.78	10.5	266.7	8000	55.2	0.81
M13531-B16A	20442173	1	16	1.56	39.7	2000	13.78	11.0	279.4	8000	55.2	1.01

MIL-DTL-3992

TYPE I, Class 1 | Military Application



Application

Low pressure hose for flexible connections in air brake systems on automotive vehicles.

Inner Tube

Nitrile

Cover

Black polychloroprene

Reinforcement

2 textile braids

Temperature Range

-60°F to 200°F (-51°C to 93°C)

› Meets or exceeds the performance requirements of: MIL-DTL-39921

Descriptive #/ Product #	SAP #	Hose Size ID		Hose OD		Max. Working Pressure		Min. Bend Radius		Min. Burst Pressure		Weight lbs./ft.
		in.	mm	in.	mm	psi	MPa	in.	mm	psi	MPa	
M3992-B0112	20024160	3/8	9.53	0.75	19.1	200	1.38	3.5	88.9	900	6.2	0.18
M3992-B0116	20568988	1/2	12.7	0.88	22.2	200	1.38	4.0	101.6	900	6.2	0.21

MIL-DTL-8788

Hydraulic Hose | Military Application



Application

High pressure hydraulic systems requiring interoperability and compatibility with associated components and equipment.

Inner Tube

Nitrile

Cover

Black polychloroprene

Reinforcement

2 braids of high-tensile steel wire

Temperature Range

-65°F to 160°F (-54°C to 71°C)

› Meets or exceeds the performance requirements of: MIL-DTL-8788

Descriptive #/ Product #	SAP #	Hose Size ID		Hose OD		Max. Working Pressure		Min. Bend Radius		Min. Burst Pressure		Weight lbs./ft.
		in.	mm	in.	mm	psi	MPa	in.	mm	psi	MPa	
M8788-4	20024593	0.22	5.6	0.625	15.88	3000	20.68	3.00	76.20	12000	82.8	0.27
M8788-5	20024596	0.28	7.1	0.703	17.86	3000	20.68	3.38	85.85	12000	82.8	0.32
M8788-6	20024600	0.34	8.7	0.766	19.46	3000	20.68	5.00	127.00	12000	82.8	0.37
M8788-8	20024604	0.44	11.1	0.859	21.82	3000	20.68	5.75	146.05	12000	82.8	0.44
M8788-10	20024613	0.56	14.3	1.031	26.19	3000	20.68	6.50	165.10	12000	82.8	0.57
M8788-12	20024616	0.69	17.5	1.219	30.96	3000	20.68	7.75	196.85	12000	82.8	0.76
M8788-16	20024619	0.88	22.2	1.500	38.10	3000	20.68	9.63	244.60	12000	82.8	1.32

Hose Working Pressure Selection Guide

Hose dash size and recommended working pressures

This table is to be used as a guide in the selection of hose by maximum working pressure. The recommended maximum working pressure should not be the only factor in hose selection. Final selection of the hose is further dependent on fluid and ambient temperatures, concentration of the fluid, and intermittent or continuous exposure.

			Dash Size							
Pressure Range	Family Part #	Hose Description	02	03	04	05	06	08	10	12
			Hose ID							
			1/8" (3.3 mm)	3/16" (4.8 mm)	1/4" (6.4 mm) R5, UT: 3/16" (4.8 mm)	5/16" (7.9 mm) R5, UT: 1/4" (6.4 mm)	3/8" (9.5 mm) R5: 5/16" (7.9 mm)	1/2" (12.7 mm) R5, UT, AC: 13/32" (10.3 mm)	5/8" (15.9 mm) R5, UT, AC: 1/2" (12.7 mm)	3/4" (19 mm) R5, UT, AC: 5/8" (15.9 mm)
Low Pressure	SR6	SAE 100R6/EN 854 R6		500	400	400	400	400	350	300
	HR6	Desert® SAE 100R6/EN 854 R6 (High Temp)			400	400	400	400	350	300
	HR4	Desert® SAE 100R4								300
	SR3	SAE 100R3/EN 854 R3			1250	1200	1125	1000		750
Low Pressure Push-On	IG	Insta-Grip™ 300 (Non-Conductive)			300	300	300	300	300	300
	IGHT	Insta-Grip™ HT 300 (High Temp)			300		300	300	300	300
	IGTC	Insta-Grip™ TC			300	300	300	300	300	300
	IGP	Insta-Grip™ Plus		400	400		400	400	400	400
Medium Pressure	SR1SN	SAE 100R1AT/1SN		3625	3260	3120	2615	2320	1890	1530
	DR1SN	Desert® SAE 100R1AT/1SN (High Temp)			3270		2615	2320	1890	1530
	SFS	SAE 100R1AT (Fire Suppression)			2750		2250	2000		1250
High Pressure	SR2SN	SAE 100R2AT/2SN		6200	5800		4800	4000	3630	3120
	DR2SN	Desert® SAE 100R2AT/2SN (High Temp)			5800		4800	4000	3630	3120
	XR16SC	SAE 100R16/EN 857 2SC			5800		5000	4500	4000	3500
	LR2SN	ARCTIC™ SAE 100R2AT/2SN (Low Temp)			5800		4800	4000	3630	3120
	DR16SC	SAE 100R16/EN 857 2SC			5075		5000	4500		3500
	SR16SC	SAE 100R16/EN 857 2SC			5800		5000	4500	4000	3500
	ARC16SC	ARMORCOAT™ SAE 100R16/EN 857 2SC (Abrasion Cover)			5800		5000	4500	4000	3500
	XCP3	SAE 100R17 (Constant Pressure)			3000		3000	3000	3000	3000
	SCP3	(Constant Pressure)			3000		3000	3000	3000	3000
	ACP3	ARMORCOAT™ SAE 100R17 (Abrasion Cover)			3000		3000	3000		

Fittings

Equipment & Accessories

Assemblies

Installation & Maintenance

Appendix

			Dash Size								
Pressure Range	Family Part #	Hose Description	14	16	20	24	32	40	48	56	64
			Hose ID								
			7/8" (22.2mm) UT, AC: 3/4" (19mm)	1" (25.4 mm) R5, UT: 7/8" (22.2 mm)	1 1/4" (31.8 mm) R5, UT: 1 1/8" (28.6 mm)	1 1/2" (38.1 mm) R5: 1 3/8" (35 mm)	2" (50.8 mm) R5: 1 3/8" (46 mm)	2 1/2" (63.5 mm)	3" (76.2 mm)	3 1/2" (89 mm)	4" (101.6 mm)
Low Pressure	SR6	SAE 100R6/EN 854 R6									
	HR6	Desert® SAE 100R6/EN 854 R6 (High Temp)									
	HR4	Desert® SAE 100R4		250	200	150	100	62	56	45	35
	SR3	SAE 100R3/EN 854 R3		565	377				58		
Low Pressure Push-On	IG	Insta-Grip™ 300 (Non-Conductive)		300							
	IGHT	Insta-Grip™ HT 300 (High Temp)									
	IGTC	Insta-Grip™ TC									
	IGP	Insta-Grip™ Plus		400							
Medium Pressure	SR1SN	SAE 100R1AT/1SN		1280	920	730	580				
	DR1SN	Desert® SAE 100R1AT/1SN (High Temp)		1280	920	730	580				
	SFS	SAE 100R1AT (Fire Suppression)		1000							
High Pressure	SR2SN	SAE 100R2AT/2SN		2400	1820	1310	1160				
	DR2SN	Desert® SAE 100R2AT/2SN (High Temp)		2400							
	XR16SC	SAE 100R16/EN 857 2SC		2700							
	LR2SN	ARCTIC™ SAE 100R2AT/2SN (Low Temp)		2400	1820		1160				
	DR16SC	SAE 100R16/EN 857 2SC		2700							
	SR16SC	SAE 100R16/EN 857 2SC		2700	1813						
	ARC16SC	ARMORCOAT™ SAE 100R16/EN 857 2SC (Abrasion Cover)		2700							
	XCP3	SAE 100R17 (Constant Pressure)		3000							
	SCP3	(Constant Pressure)		3000							
	ACP3	ARMORCOAT™ SAE 100R17 (Abrasion Cover)									

Hose Working Pressure Selection Guide

Continued

Fittings

Equipment & Accessories

Assemblies

Installation & Maintenance

Appendix

Pressure Range	Family Part #	Hose Description	Dash Size									
			02	03	04	05	06	08	10	12		
			Hose ID									
			1/8" (3.3 mm)	3/16" (4.8 mm)	1/4" (6.4 mm) R5, UT: 3/16" (4.8 mm)	5/16" (7.9 mm) R5, UT: 1/4" (6.4 mm)	3/8" (9.5 mm) R5: 5/16" (7.9 mm)	1/2" (12.7 mm) R5, UT, AC: 13/32" (10.3 mm)	5/8" (15.9 mm) R5, UT, AC: 1/2" (12.7 mm)	3/4" (19 mm) R5, UT, AC: 5/8" (15.9 mm)		
Very High Pressure	SR12	SAE 100R12/EN 856 R12					4100	4100	4100	4100		
	ARC12	ARMORCOAT™ SAE 100R12/EN 856 R12 (Abrasion Cover)					4100	4100	4100	4100		
	SR13	SAE 100R13/EN 856 R13								5100		
	ARC13	ARMORCOAT™ SAE 100R13/EN 856 R13 (Abrasion Cover)								5100		
	SR15	SAE 100R15						6100		6100		
	ARC15	ARMORCOAT™ SAE 100R15 (Abrasion Cover)						6100		6100		
	S4SP	EN 856 4SP					6455	6020	5075	5510		
	S4SH	EN 856 4SH								6090		
Thermoplastic	SR7	SAE 100R7/EN 855 R7	2500	3000	3000	2500	2250	2000		1250		
	TR7	SAE 100R7 (Twin-Line)		3000	3000	2500	2250	2000				
	NR7	SAE 100R7 (Non-Conductive)	2500	3000	2750	2500	2250	2250		1250		
	BR7	SAE 100R7 (Twin-Line, Non-Conductive)			2750	2500	2250	2250				
	SR8	SAE 100R8/EN 855 R8		5000	5000		4000	3500				
	TR8	SAE 100R8 (Twin-Line)					4000	3500				
	NR8	SAE 100R8 (Non-Conductive)			5000		4000	3500				
	SR18	SAE 100R18			3000	3000	3000	3000				
Special Application	NSFX	SAFLEX® (Non-conductive)			2750		2250	2000				
	SHR	Prospector™ SHR (Slim-Hole Rotary)										
	BOP	Prospector™ BOP (Blow Out Preventor)					3000/5000	3000/5000		3000/5000		
	SGUN	Grease Gun Hose		3000								
	SHJ	Jack Hose			10000		10000					
	Hot Oiler	Prospector (Hot Oiler)										

			Dash Size								
Pressure Range	Family Part #	Hose Description	14	16	20	24	32	40	48	56	64
			Hose ID								
			7/8" (22.2mm) UT, AC: 3/4" (19mm)	1" (25.4 mm) R5, UT: 7/8" (22.2 mm)	1 1/4" (31.8 mm) R5, UT: 1 1/8" (28.6 mm)	1 1/2" (38.1 mm) R5: 1 3/8" (35 mm)	2" (50.8 mm) R5: 1 3/16" (46 mm)	2 1/2" (63.5 mm)	3" (76.2 mm)	3 1/2" (89 mm)	4" (101.6 mm)
Very High Pressure	SR12	SAE 100R12/EN 856 R12		4100	3050	2550	2550				
	ARC12	ARMORCOAT™ SAE 100R12/EN 856 R12 (Abrasion Cover)		4100	3050	2550	2550				
	SR13	SAE 100R13/EN 856 R13		5100	5100	5100	5100				
	ARC13	ARMORCOAT™ SAE 100R13/EN 856 R13 (Abrasion Cover)		5100	5100	5100	5100				
	SR15	SAE 100R15		6100	6100	6100					
	ARC15	ARMORCOAT™ SAE 100R15 (Abrasion Cover)		6100							
	S4SP	EN 856 4SP		4640							
	S4SH	EN 856 4SH		5510	5080	4205	3650				
Thermoplastic	SR7	SAE 100R7/EN 855 R7		1000							
	TR7	SAE 100R7 (Twin-Line)									
	NR7	SAE 100R7 (Non-Conductive)		1000							
	BR7	SAE 100R7 (Twin-Line, Non-Conductive)									
	SR8	SAE 100R8/EN 855 R8									
	TR8	SAE 100R8 (Twin-Line)									
	NR8	SAE 100R8 (Non-Conductive)									
	SR18	SAE 100R18									
Special Application	NSFX	SAFLEX® (Non-conductive)									
	SHR	Prospector™ SHR (Slim-Hole Rotary)		5100	5100	5100	5100/ 3650/ 3000		2400		
	BOP	Prospector™ BOP (Blow Out Preventor)		3000/ 5000	5000	5000	5000				
	SGUN	Grease Gun Hose									
	SHJ	Jack Hose									
	Hot Oiler	Prospector (Hot Oiler)				2500					

Hose Working Pressure Selection Guide

Continued

Fittings

Equipment & Accessories

Assemblies

Installation & Maintenance

Appendix

			Dash Size							
Pressure Range	Family Part #	Hose Description	02	03	04	05	06	08	10	12
			Hose ID							
			1/8" (3.3 mm)	3/16" (4.8 mm)	1/4" (6.4 mm)	5/16" (7.9 mm)	3/8" (9.5 mm)	1/2" (12.7 mm)	5/8" (15.9 mm)	3/4" (19 mm)
					R5, UT: 3/16" (4.8 mm)	R5, UT: 1/4" (6.4 mm)	R5: 5/16" (7.9 mm)	R5, UT, AC: 13/32" (10.3 mm)	R5, UT, AC: 1/2" (12.7 mm)	R5, UT, AC: 5/8" (15.9 mm)
Fleet Application	SR14A	SAE 100R14A		3000	3000	2500	2250	1500	1200	1100
	SR5	SAE 100R5			3000	3000	2250	2000	1750	1500
	DR5	Desert® SAE 100R5 (High Temp)			3000	3000	2250	2000	1750	1500
	SCX5	SAE 100R5 (Rubber Covered)				3000	2250	2000	1750	1500
	DUT	Universal Truck			2000	1500	1500	1250	1000	750
Air Conditioning	G4826	Air Conditioning SAE J2064 Type C Class II					500	500	500	350
	G4867	Air Conditioning SAE J2064 Type C Class II								
	G4890	Air Conditioning SAE J2064 Type C Class I					500	500	500	350
Military Application	MIL-H-13444-I	MIL-DTL-13444H Type I		425	300	275	250	200	175	125
	MIL-H-13444-III	MIL-DTL-13444H Type III			1500	1500	1000	1000	875	750
	M13531-BA	MIL-DTL-13531 Type II, Class A		5000	5000	4250	4000	3500	2750	2250
	MIL-3992	MIL-DTL-39921 Type I, Class 1					200		200	
	M8788	MIL-DTL-8788			3000	3000	3000	3000	3000	3000

			Dash Size									
Pressure Range	Family Part #	Hose Description	14	16	20	24	32	40	48	56	64	
			Hose ID									
			7/8" (22.2mm) UT, AC: 3/4" (19mm)	1" (25.4 mm) R5, UT: 7/8" (22.2 mm)	1¼" (31.8 mm) R5, UT: 1½" (28.6 mm)	1½" (38.1 mm) R5: 1⅝" (35 mm)	2" (50.8 mm) R5: 1¾" (46 mm)	2½" (63.5 mm)	3" (76.2 mm)	3½" (89 mm)	4" (101.6 mm)	
Fleet Application	SR14A	SAE 100R14A		900								
	SR5	SAE 100R5		800	625	500	350					
	DR5	Desert® SAE 100R5 (High Temp)		800	625							
	SCX5	SAE 100R5 (Rubber Covered)		800	625							
	DUT	Universal Truck		400	300							
Air Conditioning	G4826	Air Conditioning SAE J2064 Type C Class II										
	G4867	Air Conditioning SAE J2064 Type C Class II	350									
	G4890	Air Conditioning SAE J2064 Type C Class I										
Military Application	MIL-H-13444-I	MIL-DTL-13444H Type I										
	MIL-H-13444-III	MIL-DTL-13444H Type III			375	300						
	M13531-BA	MIL-DTL-13531 Type II, Class A		2000	2000							
	MIL-3992	MIL-DTL-39921 Type I, Class 1										
	M8788	MIL-DTL-8788			3000							

Hydraulic Hose Special Attributes

Fittings

Equipment & Accessories

Assemblies

Installation & Maintenance

Appendix

Family Part #	Hose Description	Meets Flame Resistance USMSHA Designation	Meets Higher DIN/EN Pressure	USCG Approved	ABS Approved	Higher Temp Hose	Low Temp Hose	Abrasion Cover Hose	Twin-Line Hose	Non-Conductive Hose	Fire Tested	SAE J1402/ DOT
SR1SN	SAE 100R1AT/1SN											
Desert® DR1SN	SAE 100R1AT/1SN											
SFS	SAE 100R1AT/1SN (Fire Suppression)											
SR2SN	SAE 100R2AT/2SN											
ARCTIC™ LR2SN	SAE 100R2AT/2SN											
DR16SC	SAE 100R16-EN 8572SC											
Desert® DR2SN	SAE 100R2AT/2SN											
SR3	SAE 100R3/EN 854 R3											
Desert® HR4	SAE 100R4											
SR5	SAE 100R5											
Desert® DR5	SAE 100R5											
SCX5	SAE 100R5 Working Pressure (Rubber Covered)											
DUT	SAE J1402 A1 (Universal Truck)											
SR6	SAE 100R6/ EN 854 R6											
Desert® HR6	SAE 100R6/ EN 854 R6											
SR7	SAE 100R7/ EN 855 R7											
NR7	SAE 100R7 (Non-Conductive)											
NSFX	SAFLEX™ (Non-Conductive)											
TR7	SAE 100R7 (Twin-Line)											
BR7	SAE 100R7 (Twin-Line, Non-Conductive)											
SR8	SAE 100R8/ EN 855 R8											
NR8	SAE 100R8 (Non-Conductive)											
TR8	SAE 100R8 (Twin-Line)											
S4SH	EN 856 4SH/ DIN 20023 4SH											
S4SP	EN 856 4SP/ DIN 20023 4SP											
SR12	SAE 100R12/ EN 856 R12											

USCG - Hose and hose assemblies meet requirements of SAE J1492. Hose fittings meet requirements of SAE J1475

Family Part #	Hose Description	Meets Flame Resistance USMSHA Designation	Meets Higher Pressure DIN/EN	USCG Approved	ABS Approved	Higher Temp Hose	Low Temp Hose	Abrasion Cover Hose	Twin-Line Hose	Non-Conductive Hose	Fire Tested	SAE J1402/ DOT
ARMORCOAT™ ARC12	SAE 100R12/ EN 856 R12	Yes	Yes					Yes				
SR13	SAE 100R13/ EN 856 R13	Yes	Yes	Yes	Pending							
ARMORCOAT™ ARC13	SAE 100R13/ EN 856 R13	Yes	Yes					Yes				
SR14A	SAE 100R14A					Yes	Yes					
SR15	SAE 100R15	Yes		Yes	Pending							
ARMORCOAT™ ARC15	SAE 100R15	Yes						Yes				
SR16SC	SAE 100R16/ 857 2SC	Yes	Yes	Yes								
XR16SC	SAE 100R16/ 857 2SC	Yes	Yes	Yes				Yes				
ARMORCOAT™ ARC16SC	SAE 100R16/ 857 2SC	Yes	Yes					Yes				
SCP3	SAE 100R17	Yes		Yes								
ARMORCOAT™ ACP3	SAE 100R17	Yes						Yes				
XCP3	SAE 100R17	Yes		Yes				Yes				
SR18	SAE 100R18						Yes					
SHR	Prospector™ SHR (Slim-Hole Rotary)	Yes										
BOP	Prospector™ BOP (Blow-Out Preventor)										Yes	
SGUN	Grease Gun Hose	Yes										
SHJ	Jack Hose	Yes										
IG	Insta-Grip™ 300 (Push-On)	Yes								Yes		
IGHT	Insta-Grip™ HT 300 (Push-On, High Temp)					Yes						
IGTC	Insta-Grip™ TC (Push-On, Textile Cover)											
IGP	Insta-Grip™ Plus (Push-On)	Yes						Yes		Yes		
MIL-H-13444-I	MIL-DTL-13444H Type I (Military)						Yes					
MIL-H-13444-III	MIL-DTL-13444H Type III (Military)					Yes	Yes					
M13531-BA	MIL-DTL-13531 Type II, Class A (Military)						Yes					
MIL-3992	MIL-DTL-39921 Type I, Class 1 (Military)						Yes					
M8788	MIL-DTL-8788 (Military)						Yes					

Fittings

Equipment & Accessories

Assemblies

Installation & Maintenance

Appendix

Hose Temperature Limits

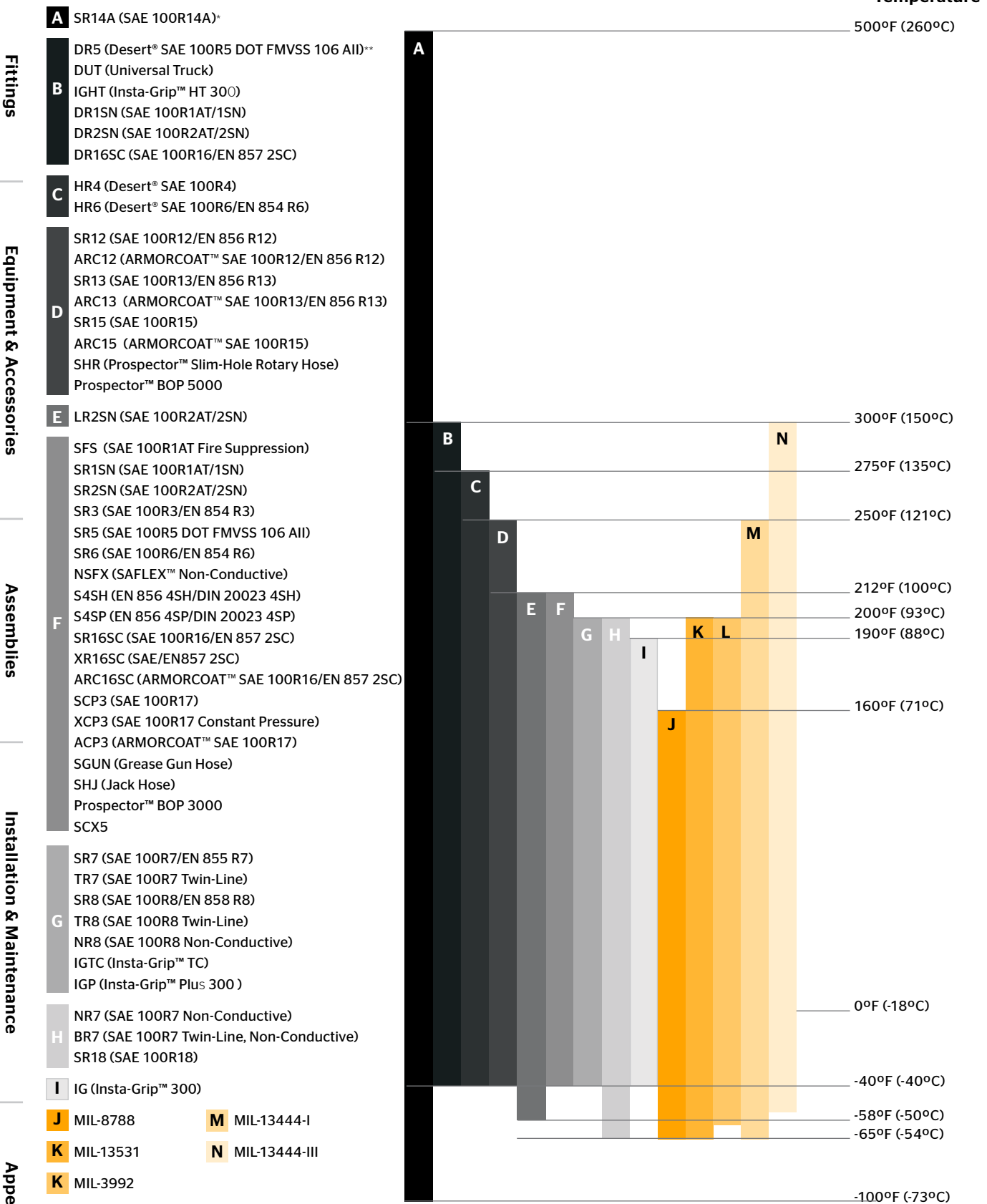

*Intermittent Service

**Hot Oil / Hydraulic Application

Hose Accessories

Protective Sleeving



Application

Extends hose life by protecting hose covers from abrasion typically found in industries such as agricultural, logging, construction and mining. Protective sleeving can also be useful in bundling hose assemblies, making it easier to handle multiple hoses.

Features

- › Abrasion resistant
- › MSHA approved
- › Good resistance to sun, atmospheric agents and aging

Temperature Range

-40°F to 340°F (-40°C to 171.1°C)

Material

Polyamide 6 (nylon)

Color

Black

Available Lengths

Continuous 100 ft. rolls

Descriptive #	Product #	SAP #	ID	Flat Width	Weight
			in.	in.	lbs./ft.
GTEXS20	60200-0020	20243598	0.79	1.34	.02
GTEXS25	60200-0025	20243599	0.98	1.65	.03
GTEXS27	60200-0027	20243600	1.06	1.77	.03
GTEXS31	60200-0031	20243601	1.22	2.05	.04
GTEXS36	60200-0036	20243602	1.42	2.24	.04
GTEXS40	60200-0040	20243603	1.57	2.60	.05
GTEXS44	60200-0044	20243604	1.73	2.83	.06
GTEXS55	60200-0055	20243605	2.17	3.50	.07

Hose Accessories

Protective Wrap



Application

Extends hose life by offering resistance to kinking and cover abrasion. The Protective wrap may also be used for the bundling of hose lines for easier handling.

Features

- › Can be installed without disconnecting hose
- › Can be overlapped for greater protection
- › Light weight

Temperature Range

-30°F to 185°F (-34°C to 85°C)

Material

Cellulose acetate (thermoplastic)

Color

Black

Available Lengths

Continuous 66-ft. rolls

Descriptive #	Product #	SAP #	ID	Flat Width	Weight
			in.	in.	lbs./ft.
HWRAP-12	60210-0012	20243592	0.50	.07	.05
HWRAP-16	60210-0016	20243593	0.63	.07	.06
HWRAP-19	60210-0019	20243594	0.75	.09	.08
HWRAP-25	60210-0025	20243595	1.00	.09	.12
HWRAP-35	60210-0035	20243596	1.38	.09	.17
HWRAP-47	60210-0047	20243597	1.85	.15	.28

*Extruded spiral will have +/- 4% variation in thickness and weight.

Hose Accessories

Hose Routing Clamps



Application

Used for support for long hose lengths. Also aids proper hose routing where abrasion or heat exists.

Material

Steel with 1/32" thick black vinyl cushion

Descriptive #	Product #	SAP #	Clamping Diameter	Bolt Hole
			in.	in.
HRC-0413	60300-0413	20539632	3/16	1/4
HRC-0509	60300-0509	20539633	1/4	9/32
HRC-0709	60300-0709	20431807	3/8	9/32
HRC-0809	60300-0809	20431808	7/16	9/32
HRC-0913	60300-0913	20431809	1/2	13/32
HRC-1013	60300-1013	20431810	9/16	13/32
HRC-1113	60300-1113	20431811	5/8	13/32
HRC-1213	60300-1213	20431812	11/16	13/32
HRC-1313	60300-1313	20431813	3/4	13/32
HRC-1413	60300-1413	20431814	13/16	13/32
HRC-1513	60300-1513	20431815	7/8	13/32
HRC-1613	60300-1613	20431816	15/16	13/32
HRC-1713	60300-1713	20431817	1	13/32
HRC-1813	60300-1813	20431818	1 1/16	13/32
HRC-1913	60300-1913	20431819	1 1/8	13/32
HRC-2017	60300-2017	20431820	1 3/16	17/32
HRC-2117	60300-2117	20431821	1 1/4	17/32
HRC-2317	60300-2317	20431822	1 3/8	17/32
HRC-2517	60300-2517	20431823	1 1/2	17/32
HRC-2617	60300-2617	20431824	1 9/16	17/32
HRC-2917	60300-2917	20431825	1 3/4	17/32
HRC-3117	60300-3117	20431826	1 7/8	17/32
HRC-3217	60300-3217	20431827	1 15/16	17/32
HRC-3317	60300-3317	20431828	2	17/32
HRC-3417	60300-3417	20431829	2 5/32	17/32
HRC-3817	60300-3817	20431830	2 21/32	17/32



Fittings

Hydraulic Fitting Nomenclature

Example: **B2 - JCFX45 - 0608**

Fitting Family	Thread Description	Hose Dash Size	Thread Dash Size
First 2 characters	Next 2-7 characters	Next 2 characters	Last 2 characters
B1 B2 S4 Ultra-Crimp™ 1-piece fitting S6 S6X SH	Refer to the next page for detailed information. For AC and GC fittings see Fittings Section 9.	All hoses except R5, DUT and Galaxy® 02 = 1/8" (3.2 mm) 03 = 3/16" (4.8 mm) 04 = 1/4" (6.4 mm) 05 = 5/16" (7.9 mm) 06 = 3/8" (9.5 mm) 08 = 1/2" (12.7 mm) 10 = 5/8" (15.9 mm) 12 = 3/4" (19 mm) 16 = 1" (25.4 mm) 20 = 1 1/4" (31.8 mm) 24 = 1 1/2" (38.1 mm) 32 = 2" (50.8 mm) 40 = 2 1/2" (63.5 mm)	02 03 04 05 06 08 10 12 14 15 16 18 20 22 24 26 28 30 32 33 36 40 42 45 52
T7 Thermoplastic 1-piece fitting T8			See "Thread Reference Chart" on page 314 for crossing over dash size to thread sizes.
FG = Field-Grip™ 1-piece reattachable fitting UT = DUT Hose 1-piece reattachable fitting			
UC Uni-Crimp™ Stem (2-piece)			
DG Dual-Grip™ Stem (2-piece internal and external skive fitting) SHDG		SAE 100R5, DUT and Galaxy Hose 04 = 3/16" (4.8 mm) 05 = 1/4" (6.4 mm) 06 = 5/16" (7.9 mm) 08 = 13/32" (10.3 mm) 10 = 1/2" (12.7 mm) 12 = 5/8" (15.9 mm) 14 = 3/4" (19.1 mm) 16 = 7/8" (22.2 mm) 20 = 1 1/8" (28.6 mm) 24 = 1 3/8" (35 mm) 32 = 1 13/16" (46 mm)	
PB = Push-On Brass (1-piece fitting) SF = SAFLEX™ (1-piece fitting) GG = Grease Gun (1-piece fitting) AC = Air Conditioning (1-piece crimp fitting) GC = Cool Clip™ (air conditioning clip fitting)			

Warning - Selection of Fitting

Selection of the proper fittings for the application is essential to the proper operation and safe use of the hose and related equipment. Inadequate attention to the selection of the hose fitting for the application can result in hose leakage, bursting or other failures, which can cause serious bodily injury or property damage from spraying fluids or flying projectiles. Some of the factors involved in the selection of the proper hose ends are:

- › Fluid Compatibility
- › Pressure
- › Temperature
- › Installation Design
- › Hose Size
- › Corrosion Requirements

If there are any questions as to what fitting should be used, Continental ContiTech recommends that you consult the Continental ContiTech Hydraulics Application Group for assistance.

Proper Assembly of Continental ContiTech Perma-Crimp™ Hose and Fittings

Continental ContiTech Perma-Crimp™ hose, fittings and crimping equipment work together to provide an efficient and reliable hose connection. Continental ContiTech hose and fittings are part of an engineered system and are to be assembled in accordance with Continental ContiTech specifications. Using non-Continental ContiTech components may produce an assembly that does not meet rated performance. Continental ContiTech DOES NOT WARRANT, EXPRESSLY OR BY IMPLICATION, HOSE ASSEMBLIES THAT DO NOT INCORPORATE Continental ContiTech PERMA-CRIMP HOSE AND FITTINGS, OR ARE NOT CRIMPED in. ACCORDANCE WITH Continental ContiTech's PROCESS SPECIFICATIONS. Buyers may elect to attach additional or non-standard parts or equipment, or to use different manufacturing specifications, as necessary to meet the requirements of the buyer or customer's application. In such cases, the buyer has sole responsibility to qualify the hose for these applications as necessary to ensure performance capability.

For guidance in the assembly of Continental ContiTech Perma-Crimp™ hose and couplings, please refer to the Continental ContiTech Crimp Specifications Manual. Information in this catalog is believed to be accurate, but is not warranted, and is subject to change without prior notice. For the most current available product information, check www.contitech.us.

Hydraulic Fitting Nomenclature

Thread	Thread Description	Gender	Swivel	Elbow
JC FX		Female	Swivel	
JC FX45		Female	Swivel	45° Elbow
JC FX90		Female	Swivel	90° Elbow
JC FX90L	JIC 37° Flare (SAE J514)	Female	Swivel	90° Elbow (Long Drop-Tube)
JC FX90S		Female	Swivel	90° Elbow (Short Drop-Tube)
JC M		Male		
SF FX		Female	Swivel	
SF FX45		Female	Swivel	45° Elbow
SF FX90		Female	Swivel	90° Elbow
SF FX90L	SAE 45° J512 Flare	Female	Swivel	90° Elbow (Long Drop-Tube)
SF FX90S		Female	Swivel	90° Elbow (Short Drop-Tube)
SF M		Male		
SI F		Female		
SI M		Male		
SI MX	SAE 45° Inverted Flare	Male	Swivel	
SI MX45		Male	Swivel	45° Elbow
SI MX90		Male	Swivel	90° Elbow
NP F		Female		
NP FX		Female	Swivel	
NP M		Male		
NP M90	NPTF	Male		90° Elbow
NP MX		Male	Swivel	90° Elbow
NP MX90B		Male	Swivel	(Block)
NP MAPI	NPTF - Oil Field Connection	Male		
HM	Hose Mender			
NS FX	NPSM	Female	Swivel	
FT M	SAE J514 Flareless Tube Fittings	Male		
GT F	Grease Tap	Female		
SP	Standpipe			
SP 45				45° Elbow

Hydraulic Fitting Nomenclature

Thread	Thread Description	Gender	Swivel	Elbow
OF FX		Female	Swivel	
OF FX45		Female	Swivel	45° Elbow
OF FX90		Female	Swivel	90° Elbow
OF FX90L	O-Ring Face Seal (SAE J1453 ORS/ORFS)	Female	Swivel	90° Elbow (Long Drop-Tube)
OF FX90S		Female	Swivel	90° Elbow (Short Drop-Tube)
OF M		Male		
OB M	O-Ring Boss Straight Thread	Male		
OB MX	(SAE J514)	Male	Swivel	90° Elbow
OB MX90B		Male	Swivel	(Black)
FL				
FL 22				22.5° Elbow
FL 30				30° Elbow
FL 45	Code 61 Flange			45° Elbow
FL 60	(SAE J518)			60° Elbow
FL 67				67° Elbow
FL 90				90° Elbow
FL 110				110° Elbow
FL 135				135° Elbow
FL 90EOC	Engine Oil Connection			90° Elbow
FH				
FH 22				22.5° Elbow
FH 30				30° Elbow
FH 45	Code 62 Flange			45° Elbow
FH 60	(SAE J518)			60° Elbow
FH 67				67° Elbow
FH 90				90° Elbow

Hydraulic Fitting Nomenclature (Continued on page 45)

Fittings

Hydraulic Fitting Nomenclature (Continued)

Thread	Thread Description	Gender	Swivel	Elbow
CF				
CF 22				22.5° Elbow
CF 30				30° Elbow
CF 45	Caterpillar® Flange			45° Elbow
CF 60				60° Elbow
CF 67				67° Elbow
CF 90				90° Elbow
KF				
KF 45	Komatsu® Flange			45° Elbow
KF 90				90° Elbow
BP FX		Female	Swivel	
BP FX45	BSPP (British Standard Pipe Parallel)	Female	Swivel	45° Elbow
BP FX90		Female	Swivel	90° Elbow
BP M		Male		
BT M	BSPT (British Standard Pipe Tapered)	Male		
BF FX	BSP Flat Seat (British Standard Pipe)	Female	Swivel	
DL FX		Female	Swivel	
DL FX45	DIN 24° Light	Female	Swivel	45° Elbow
DL FX90		Female	Swivel	90° Elbow
DL M		Male		
DH FX		Female	Swivel	
DH FX45	DIN 24° Heavy	Female	Swivel	45° Elbow
DH FX90		Female	Swivel	90° Elbow
DH M		Male		
DN FX45	DIN 60°	Female	Swivel	45° Elbow
DN FX90		Female	Swivel	90° Elbow
KM FX	Japanese Komatsu® 30° Flare with Metric Threads	Female	Swivel	
KM FX45		Female	Swivel	45° Elbow
KM FX90		Female	Swivel	90° Elbow
JS FX	JIS 30° (Parallel Pipe Threads)	Female	Swivel	
PTT FX	PTT 30° (for DUT Hose)	Female	Swivel	

Hydraulic Ferrule Nomenclature

Example: **UCF3 - 08**



Ferrule Family

First 4 characters of Part Number

UCF1
UCF2
UCF3
UCF4
UCF5
UCF6
UCF7
UCF8
UCF9
UCF10
UCF11

DGF1 Dual-Grip™ Ferrules,
DGF2 to be used only with
Dual-Grip™ stems.

Thread Dash Size

Last 2 characters of Part Number

03 = 3/16" (4.8 mm)
04 = 1/4" (6.4 mm)
05 = 5/16" (7.9 mm)
06 = 3/8" (9.5 mm)
08 = 1/2" (12.7 mm)
10 = 5/8" (15.9 mm)
12 = 3/4" (19 mm)
16 = 1" (25.4 mm)
20 = 1 1/4" (31.8 mm)
24 = 1 1/2" (38.1 mm)
32 = 2" (50.8 mm)
40 = 2 1/2" (63.5 mm)

Perma-Crimp™ Fitting Selection

Using The Quick-Find™ Fitting Tables

Continental ContiTech Brand Quick-Find hydraulic hose and fitting catalog makes Perma-Crimp™ fitting selection very easy with a 5 step process.

Step 1 - Choose the Hose Type

The first step in choosing the correct fitting is to first select the hose type. The fitting catalog and product line is broken up into 11 sections. The 11 sections are based on hose type.

Hose Family

Section 1	Section 2	Section 3	Section 4	Section 5	Section 6	Section 6A	Section 7	Section 8	Section 9
SR1SN	GR7	SR12	SR13	SR3	SR5	DUT	NSFX	Galaxy®	Ferrules
DR1SN	TR7	ARC12	ARC13	GR4	DR5		SHR	G4826	
SFS	NR7		SR15	SR4	GCX5		SGUN	G4867	
SR2SN	BR7		ARC15	SR6			GHJ	G4890	
HR2SN	GR8		S4SP	HR6			IG		
LR2SN	TR8		S4SH	SR14A			IGHT		
CR2SN	NR8			HR4			IGTC		
GR16	GR18						IGP		
SR16SC									
AR16SC									
ACP3									
XCP3									
GR17									

Step 2 - Choose the Fitting Description

Once the hose type has been identified, go to the correct section (Sections 1 to 9) and view the available fittings for that particular hose. Within the content of each section there is a table for each fitting. The Fitting Description at the top of each table describes the fitting. The Fitting Description consists of the following elements

Fitting Description Example

JIC 37° Flare (SAE J514)	Female	45° Elbow	Swivel
Thread Description	Gender	Elbow	Swivel or Non-swivel

Reference Thread Descriptions under Fitting Nomenclature at the beginning of this section. The other attributes of the Fitting Description, including Gender, Elbow and Swivel/Non-swivel, will be found in the fitting table.

Step 3 - Choose Hose I.D. and Thread Size

Choose the correct fitting selected in Step 2 based on the Hose I.D. and Thread Size. In some cases, a fitting may be available in several thread sizes. As an example, a JIC 37° Flare (SAE J514) Female Swivel is available for a hose I.D. of 3/8" and thread sizes 9/16-18 and 3/4-16.

Step 4 - Determine Availability for Hose Type

With the desired fitting identified by Hose I.D. and Thread Size in Step 3, confirm the fitting is compatible for a particular Hose Type by reading to the right of the product table. A "Y" indicates the fitting is an Ultra-Crimp™, 1-piece fitting and compatible with the hose. A part number would indicate the fitting is a 2-piece fitting, either Uni-Crimp™ or Dual-Grip™, requiring a ferrule. The ferrule part number is required to make an assembly. A blank in the compatibility chart would indicate a fitting is not compatible with a particular hose.

Step 5 - Note the Part Number

The fitting part number can now be noted. The part number is found on the left side of the chart. If a ferrule is required, that part number is found on the right side of the chart under hose compatibility (Step 4).

Explanation of Fitting Part Number, Dimensions and Attributes

Explanation of Part Number

The Continental ContiTech Perma-Crimp™ fitting can be described through its functional part number.

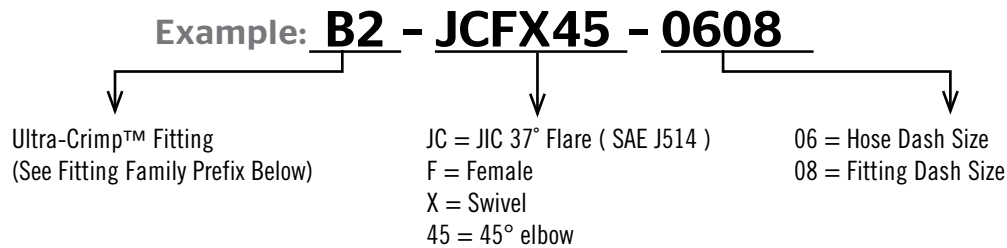

The following prefix will be used in the fitting part number to indicate the Fitting Family.

Fitting Family Prefix	ID
B1, B2, S4, S6, S6X, SH	Ultra-Crimp™ 1-piece fitting
FG, T8	Field-Grip™ 1-piece reattachable fitting
FG	Field-Grip™ 1-piece reattachable fitting
UT	DUT Hose 1-piece reattachable fitting
UC	Uni-Crimp™ Stem (2-piece fitting)
DG, SHDG	Dual-Grip™ Stem (2-piece internal and external skive fitting)
PB	Push-On Brass (1-piece fitting)
SF	SAFLEX® (1-piece fitting)
GG	Grease Gun (1-piece fitting)
AC	Air Conditioning (1-piece crimp fitting)
GC	Cool Clip™ (air conditioning clip fitting)

For the additional breakdown of part number attributes, see Fitting Nomenclature at the beginning of this section.

Fitting Dimensions and Attributes

Within the product tables, you will find the fitting dimensions or attributes.

Hose I.D. - The compatible hose I.D.

Thread Size - The thread size or sizes available for a particular fitting dash size.

Hex Size - The wrench size for one or both nuts on the fitting.

Drop - The drop or "D" dimension describes the length of the elbow.

Cut-Off - The "C" dimension is the amount of hose to be cut for a correct assembly length.

Length - The "L" dimension is the overall length of the fitting.

Tables will also indicate whether the fitting is a skive or non-skive type. Tables will also indicate whether the fitting is an Ultra-Crimp™, indicated with a "Y" and the correct hose compatibility. In some cases, the fitting might be a Uni-Crimp™, or two-piece fitting, requiring a ferrule. The ferrule will be denoted for each type of hose applicable.

Continental ContiTech Brand Quick-Find™ catalog is easy to use, with 5 steps in selecting a Perma-Crimp™ fitting. Knowing the hose type and thread style will lead you to the desired part number.

How to Use the Fitting Tables

This section lists ALL fittings that are compatible with the following hoses:

Hose Family	Hose Description
SR1SN	SAE 100R1AT/1SN
DR1SN	SAE 100R1AT/1SN (High Temp)
SFS	SAE 100R1AT (Fire Suppression)
SR2SN	SAE 100R2AT/2SN
HR2SN	SAE 100R2AT/2SN (High Temp)
LR2SN	SAE 100R2AT/2SN (Low Temp)
CR2SN	SAE 100R2AT/2SN (High Temp, Abrasion Cover)
GR16	SAE 100R16
SR16SC	SAE 100R16/EN 857 2SC
AR16SC	SAE 100R16/EN 857 2SC (Abrasion Cover)
XCP3	SAE 100R17 (Constant Pressure)
ACP3	SAE 100R17 (Abrasion Cover)
GR17	SAE 100R17

Fitting Description

Fitting Type

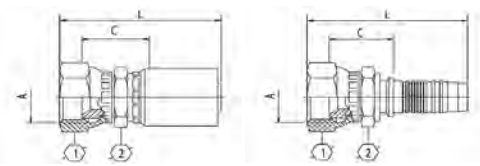

S=Skive
NS=Non-Skive
DG=Dual-Grip™

Descriptive #	Product #	SAP #	Hose Size ID		Thread Size (A)		Hex-1 Wrench Size		Hex-2 Wrench Size		Cut-Off (C)		Length (L)		Skive Type	SR1SN DR1SN SFS	SR2SN HR2SN LR2SN CR2SN	GR16 SR16SC AR16SC	ACP3 XCP3 GR17
			in.	mm	in.	mm	in.	mm	in.	mm	in.	mm	in.	mm					
UC-JCFX-0304	36400-0304	20557173	3/16	4.8	7/16-20	9/16	14	1/2	12	0.71	18.1	1.93	49.0	S		UCF1-03	UCF2-03		Y
B2-JCFX-0403	14400-0403	20289599	1/4	6.4	3/8-24	9/16	14	1/2	12	0.78	19.8	2.05	52.0	NS	Y	Y	Y	Y	Y
B2-JCFX-0404	14400-0404	20293262	1/4	6.4	7/16-20	5/8	16	9/16	14	0.77	19.6	2.09	53.1	NS	Y	Y	Y	Y	Y

Choose fittings carefully considering the working pressure of both hose and fitting. The maximum working pressure of the hose assembly is the lesser of the rated working pressure of the hose and the fitting. See page 313 for working pressure.

A **Part Number (Ferrule)** in the hose compatibility columns indicates that the fitting is a **Uni-Crimp™** style. The fitting, along with the Ferrule shown, work together as a unit for that particular hose.

A **“Y”** in the hose compatibility columns indicates that the fitting is an **Ultra-Crimp™** style fitting and that it works for that particular hose.

A **blank space** in the hose compatibility columns indicates that the fitting **DOES NOT** work for that particular hose.

JIC 37° Flare (SAE J514)

Female | Swivel

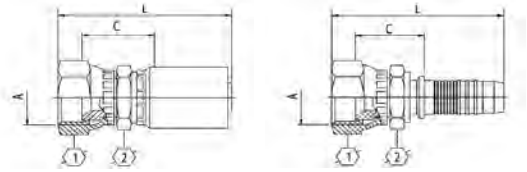

S=Skive
NS=Non-Skive
DG=Dual-Grip™

Description #	Product #	SAP #	Hose Size ID		Thread Size (A)		Hex-1 Wrench Size		Hex-2 Wrench Size		Cut-Off (C)		Length (L)		Skive Type	SR15N DR15N SFS	SR25N HR25N LR25N CR25N	GR16 SR16SC AR16SC	ACP3 XCP3 GR17
			in.	mm	in.	mm	in.	mm	in.	mm	in.	mm	in.	mm					
UC-JCFX-0304	36400-0304	20557173	3/16	4.8	7/16-20	9/16	14	1/2	12	0.71	18.1	1.93	49.0	S	UCF1-03	UCF2-03			
B2-JCFX-0403	14400-0403	20293242	1/4	6.4	3/8-24	9/16	14	1/2	12	0.78	19.8	2.05	52.0	NS	Y	Y	Y	Y	
B2-JCFX-0404	14400-0404	20242031	1/4	6.4	7/16-20	5/8	16	9/16	14	0.77	19.6	2.09	53.1	NS	Y	Y	Y	Y	
B2-JCFX-0404S	14400-0404S	20286835	1/4	6.4	7/16-20	5/8	16	9/16	14	0.77	19.6	2.09	53.1	NS	Y	Y	Y	Y	
B2-JCFX-0405	14400-0405	20242032	1/4	6.4	1/2-20	11/16	17	9/16	14	0.80	20.3	2.15	54.6	NS	Y	Y	Y	Y	
B2-JCFX-0406	14400-0406	20242029	1/4	6.4	9/16-18	3/4	19	9/16	14	0.80	20.3	2.15	54.6	NS	Y	Y	Y	Y	
B2-JCFX-0406S	14400-0406S	20286836	1/4	6.4	9/16-18	3/4	19	9/16	14	0.80	20.3	2.15	54.6	NS	Y	Y	Y	Y	
B2-JCFX-0505	14400-0505	20242038	5/16	7.9	1/2-20	11/16	17	9/16	14	0.80	20.3	2.15	54.6	NS	Y				
B2-JCFX-0506	14400-0506	20242037	5/16	7.9	9/16-18	3/4	19	9/16	14	0.80	20.3	2.15	54.6	NS	Y				
B2-JCFX-0604	14400-0604	20265707	3/8	9.5	7/16-20	5/8	16	11/16	17	0.81	20.6	2.20	56.0	NS	Y	Y	Y	Y	
B2-JCFX-0606	14400-0606	20242041	3/8	9.5	9/16-18	3/4	19	11/16	17	0.84	21.3	2.26	57.5	NS	Y	Y	Y	Y	
B2-JCFX-0606S	14400-0606S	20286837	3/8	9.5	9/16-18	3/4	19	11/16	17	0.84	21.3	2.26	57.5	NS	Y	Y	Y	Y	
B2-JCFX-0608	14400-0608	20242050	3/8	9.5	3/4-16	1	25	3/4	19	0.98	24.8	2.45	62.2	NS	Y	Y	Y	Y	
B2-JCFX-0608S	14400-0608S	20286838	3/8	9.5	3/4-16	1	25	3/4	19	0.98	24.8	2.45	62.2	NS	Y	Y	Y	Y	
B2-JCFX-0610	14400-0610	20242043	3/8	9.5	7/8-14	1 1/16	27	7/8	22	1.02	25.8	2.57	65.2	NS	Y	Y	Y	Y	
B2-JCFX-0612	14400-0612	20293243	3/8	9.5	1 1/16-12	1 1/4	32	1	25	1.07	27.3	2.69	68.3	NS	Y	Y	Y	Y	
B2-JCFX-0806	14400-0806	20242034	1/2	12.7	9/16-18	3/4	19	3/4	19	0.91	23.1	2.52	64.1	NS	Y	Y	Y	Y	
B2-JCFX-0806S	14400-0806S	20424925	1/2	12.7	9/16-18	3/4	19	3/4	19	0.91	23.1	2.52	64.1	NS	Y	Y	Y	Y	
B2-JCFX-0808	14400-0808	20242008	1/2	12.7	3/4-16	1	25	3/4	19	1.01	25.6	2.67	67.8	NS	Y	Y	Y	Y	
B2-JCFX-0808S	14400-0808S	20286839	1/2	12.7	3/4-16	1	25	3/4	19	1.01	25.6	2.67	67.8	NS	Y	Y	Y	Y	
B2-JCFX-0810	14400-0810	20242036	1/2	12.7	7/8-14	1 1/16	27	7/8	22	1.05	26.6	2.79	70.8	NS	Y	Y	Y	Y	
B2-JCFX-0810S	14400-0810S	20286840	1/2	12.7	7/8-14	1 1/16	27	7/8	22	1.05	26.6	2.79	70.8	NS	Y	Y	Y	Y	
B2-JCFX-0812	14400-0812	20241925	1/2	12.7	1 1/16-12	1 1/4	32	1	25	1.11	28.1	2.91	73.9	NS	Y	Y	Y	Y	
B2-JCFX-0816	14400-0816	20293244	1/2	12.7	1 5/16-12	1 1/2	38	1 1/4	32	1.24	31.6	3.08	78.2	NS	Y	Y	Y	Y	
B2-JCFX-1008	14400-1008	20242005	5/8	15.9	3/4-16	1	5	15/16	24	1.05	26.6	2.82	71.6	NS	Y	Y	Y	Y	
B2-JCFX-1010	14400-1010	20242004	5/8	15.9	7/8-14	1 1/16	27	15/16	24	1.09	27.6	2.94	74.6	NS	Y	Y	Y	Y	
B2-JCFX-1010S	14400-1010S	20286841	5/8	15.9	7/8-14	1 1/16	27	15/16	24	1.09	27.6	2.94	74.6	NS	Y	Y	Y	Y	
B2-JCFX-1012	14400-1012	20242026	5/8	15.9	1 1/16-12	1 1/4	32	1	25	1.11	28.1	3.02	76.7	NS	Y	Y	Y	Y	
B2-JCFX-1210	14400-1210	20242047	3/4	19.0	7/8-14	1 1/4	32	1 1/16	27	1.11	28.1	3.20	81.4	NS	Y	Y	Y	Y	
B2-JCFX-1212	14400-1212	20242025	3/4	19.0	1 1/16-12	1 1/4	32	1 1/16	27	1.13	28.6	3.24	82.4	NS	Y	Y	Y	Y	
B2-JCFX-1212S	14400-1212S	20286842	3/4	19.0	1 1/16-12	1 1/4	32	1 1/16	27	1.13	28.6	3.24	82.4	NS	Y	Y	Y	Y	
B2-JCFX-1214	14400-1214	20242049	3/4	19.0	1 3/16-12	1 7/16	36	1 1/4	32	1.18	29.9	3.31	84.1	NS	Y	Y	Y	Y	
B2-JCFX-1216	14400-1216	20242046	3/4	19.0	1 5/16-12	1 1/2	38	1 1/4	32	1.26	32.1	3.41		NS	Y	Y	Y	Y	

Continued on next page

JIC 37° Flare (SAE J514)

Continued

Description #	Product #	SAP #	Hose Size ID		Thread Size (A)		Hex-1 Wrench Size		Hex-2 Wrench Size		Cut-Off (C)		Length (L)		Skive Type	SR1SN DR1SN SFS	SR2SN HR2SN LR2SN CR2SN	GR16 SR16SC AR16SC	ACP3 XCP3 GR17
			in.	mm	in.	mm	in.	mm	in.	mm	in.	mm	in.	mm					
B2-JCFX-1612	14400-1612	20241921	1	25.4	1 1/16-12	1 1/4	32	1 1/4	32	1.24	31.4	3.56	90.3	NS	Y	Y	Y	Y	
B2-JCFX-1616	14400-1616	20241916	1	25.4	1 5/16-12	1 1/2	38	1 1/4	32	1.30	32.9	3.65	92.6	NS	Y	Y	Y	Y	
B2-JCFX-1616 ^S	14400-1616 ^S	20286843	1	25.4	1 5/16-12	1 1/2	38	1 1/4	32	1.30	32.9	3.65	92.6	NS	Y	Y	Y	Y	
B2-JCFX-1620 ^T	14400-1620	20241919	1	25.4	1 5/8-12	2	50	1 5/8	41	1.48	37.5	3.86	98.0	NS	Y	Y	Y	Y	
S4-JCFX-2020 ^T	28400-2020	20241915	1 1/4	31.8	1 5/8-12	2	50	1 5/8	41	1.54	39.1	4.21	107.0	NS	Y	Y	Y	Y	
S4-JCFX-2020 ST	28400-2020 ^S	20289599	1 1/4	31.8	1 5/8-12	2	50	1 5/8	41	1.54	39.1	4.21	107.0	NS	Y	Y	Y	Y	
S4-JCFX-2024 ^T	28400-2024	20293262	1 1/4	31.8	1 7/8-12	2 3/16	55	2	50	1.71	43.4	4.49	114.0	NS	Y	Y	Y	Y	
S4-JCFX-2424 ^T	28400-2424	20241928	1 1/2	38.1	1 7/8-12	2 3/16	55	2	50	1.71	43.4	4.76	121.0	NS	Y	Y	Y	Y	
S4-JCFX-2424 ST	28400-2424 ^S	20289598	1 1/2	38.1	1 7/8-12	2 3/16	55	2	50	1.71	43.4	4.76	121.0	NS	Y	Y	Y	Y	
S4-JCFX-3232 ^T	28400-3232	20242028	2	50.8	2 1/2-12	70 mm	70	2 3/16	65	1.93	49.0	5.71	145.0	NS	Y	Y	Y	Y	

T: Thrust-Wire Nut S: Stainless Steel (see 'Fitting Identification' in Appendix for details)

JIC 37° Flare (SAE J514)

Female 45° Elbow | Swivel

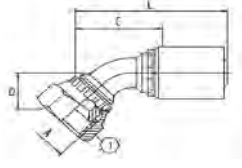

S=Skive
NS=Non-Skive
DG=Dual-Grip™

Description #	Product #	SAP #	Hose Size ID		Thread Size (A)		Drop (D)		Cut-Off (C)		Length (L)		Skive Type	SR1SN DR1SN SFS	SR2SN HR2SN LR2SN CR2SN	GR16 SR16SC AR16SC	ACP3 XCP3 GR17	
			in.	mm	in.	mm	in.	mm	in.	mm	in.	mm						
B2-JCFX45-0404	14420-0404	20241948	1/4	6.4	7/16-20	5/8	16	0.39	10	1.46	37.0	2.40	61.0	NS	Y	Y	Y	Y
B2-JCFX45-0405	14420-0405	20241962	1/4	6.4	1/2-20	11/16	17	0.47	12	1.46	37.0	2.44	62.0	NS	Y	Y	Y	Y
B2-JCFX45-0406	14420-0406	20241949	1/4	6.4	9/16-18	3/4	19	0.43	11	1.54	39.0	2.52	64.0	NS	Y	Y	Y	Y
B2-JCFX45-0606	14420-0606	20241950	3/8	9.5	9/16-18	3/4	19	0.43	11	1.81	46.0	2.87	73.0	NS	Y	Y	Y	Y
B2-JCFX45-0608	14420-0608	20241954	3/8	9.5	3/4-16	1	25	0.59	15	1.85	47.0	2.91	74.0	NS	Y	Y	Y	Y
B2-JCFX45-0808	14420-0808	20241963	1/2	12.7	3/4-16	1	25	0.59	15	2.05	52.0	3.27	83.0	NS	Y	Y	Y	Y
B2-JCFX45-0810	14420-0810	20241965	1/2	12.7	7/8-14	1 1/16	27	0.63	16	2.01	51.0	3.23	82.0	NS	Y	Y	Y	Y
B2-JCFX45-1010	14420-1010	20241980	5/8	15.9	7/8-14	1 1/16	27	0.75	19	2.44	62.0	3.78	96.0	NS	Y	Y	Y	Y
B2-JCFX45-1012	14420-1012	20241967	5/8	15.9	1 1/16-12	1 1/4	32	0.83	21	2.72	69.0	4.06	103.0	NS	Y	Y	Y	Y
B2-JCFX45-1212	14420-1212	20241951	3/4	19.0	1 1/16-12	1 1/4	32	0.83	21	2.64	67.0	4.21	107.0	NS	Y	Y	Y	Y
B2-JCFX45-1216	14420-1216	20241953	3/4	19.0	1 5/16-12	1 1/2	38	1.02	26	2.80	71.0	4.37	111.0	NS	Y	Y	Y	Y
B2-JCFX45-1612	14420-1612	20293221	1	25.4	1 1/16-12	1 1/4	32	1.18	30	2.76	70.0	4.53	115.0	NS	Y	Y	Y	Y
B2-JCFX45-1616	14420-1616	20241957	1	25.4	1 5/16-12	1 1/2	38	0.94	24	3.11	79.0	4.88	124.0	NS	Y	Y	Y	Y
S4-JCFX45-2020 ^T	28420-2020	20241961	1 1/4	31.8	1 5/8-12	2	50	1.46	37	3.82	97.0	6.18	157.0	NS	Y	Y	Y	Y
S4-JCFX45-2424 ^T	28420-2424	20241960	1 1/2	38.1	1 7/8-12	2 3/16	55	1.69	43	4.45	113.0	7.15	181.5	NS	Y	Y	Y	Y

T: Thrust-Wire Nut (see 'Fitting Identification' in Appendix for details)

JIC 37° Flare (SAE J514)

Female 90° Elbow | Swivel

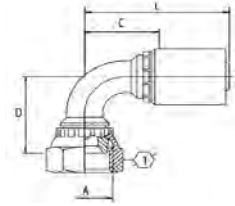

Elbow Type:
LT=Long Tube
ST=Short Tube

S=Skive
NS=Non-Skive
DG=Dual-Grip™

Descriptive #	Product #	SAP #	Hose Size ID		Thread Size (A)		Hex-1 Wrench Size		Elbow Type	Drop (D)		Cut-Off (C)		Length (L)		Skive Type	SR1SN DR1SN SFS	SR2SN HR2SN LR2SN CR2SN	GR16 SR16SC AR16SC	ACP3 XCP3 GR17
			in.	mm	in.	mm	in.	mm		in.	mm	in.	mm	in.	mm					
B2-JCFX90-0404	14425-0404	20241909	1/4	6.4	7/16-20	5/8	16			1.26	32.0	1.34	34.0	2.32	59.0	NS	Y	Y	Y	Y
B2-JCFX90L-0404	14440-0404	20241985	1/4	6.4	7/16-20	5/8	16	LT		1.81	46.0	1.22	31.0	2.20	56.0	NS	Y	Y	Y	Y
B2-JCFX90S-0404	14445-0404	20241929	1/4	6.4	7/16-20	5/8	16	ST		0.83	21.0	1.06	27.0	2.05	52.0	NS	Y	Y	Y	Y
B2-JCFX90-0405	14425-0405	20241913	1/4	6.4	1/2-20	11/16	17			1.18	30.0	1.02	26.0	1.97	50.0	NS	Y	Y	Y	Y
B2-JCFX90L-0405	14440-0405	20241988	1/4	6.4	1/2-20	11/16	17	LT		1.77	45.0	1.22	31.0	2.20	56.0	NS	Y	Y	Y	Y
B2-JCFX90S-0405	14445-0405	20241938	1/4	6.4	1/2-20	11/16	17	ST		0.93	23.5	1.02	26.0	2.01	51.0	NS	Y	Y	Y	Y
B2-JCFX90-0406	14425-0406	20241896	1/4	6.4	9/16-18	3/4	19			1.50	38.0	1.10	28.0	2.09	53.0	NS	Y	Y	Y	Y
B2-JCFX90L-0406	14440-0406	20241970	1/4	6.4	9/16-18	3/4	19	LT		2.13	54.0	1.34	34.0	2.32	59.0	NS	Y	Y	Y	Y
B2-JCFX90S-0406	14445-0406	20241939	1/4	6.4	9/16-18	3/4	19	ST		0.91	23.0	1.22	31.0	2.20	56.0	NS	Y	Y	Y	Y
B2-JCFX90-0604	14425-0604	20293223	3/8	9.5	7/16-20	5/8	16			1.26	32.0	1.38	35.0	2.44	62.0	NS	Y	Y	Y	Y
B2-JCFX90L-0604	14440-0604	20293222	3/8	9.5	7/16-20	5/8	16	LT		1.81	46.0	1.22	31.0	2.28	58.0	NS	Y	Y	Y	Y
B2-JCFX90S-0604	14445-0604	20265709	3/8	9.5	7/16-20	5/8	16	ST		0.83	21.0	1.10	28.0	2.17	55.0	NS	Y	Y	Y	Y
B2-JCFX90-0606	14425-0606	20241902	3/8	9.5	9/16-18	3/4	19			1.38	35.0	1.22	31.0	2.28	58.0	NS	Y	Y	Y	Y
B2-JCFX90L-0606	14440-0606	20241974	3/8	9.5	9/16-18	3/4	19	LT		2.13	54.0	1.69	43.0	2.76	70.0	NS	Y	Y	Y	Y
B2-JCFX90S-0606	14445-0606	20241944	3/8	9.5	9/16-18	3/4	19	ST		0.91	23.0	1.65	42.0	2.72	69.0	NS	Y	Y	Y	Y
B2-JCFX90-0608	14425-0608	20241895	3/8	9.5	3/4-16	1	25			1.61	41.0	1.54	39.0	2.60	66.0	NS	Y	Y	Y	Y
B2-JCFX90L-0608	14440-0608	20241973	3/8	9.5	3/4-16	1	25	LT		2.52	64.0	1.85	47.0	2.91	74.0	NS	Y	Y	Y	Y
B2-JCFX90S-0608	14445-0608	20241943	3/8	9.5	3/4-16	1	25	ST		1.14	29.0	1.93	49.0	2.99	76.0	NS	Y	Y	Y	Y
B2-JCFX90-0808	14425-0808	20241914	1/2	12.7	3/4-16	1	25			1.57	40.0	1.46	37.0	2.72	69.0	NS	Y	Y	Y	Y
B2-JCFX90L-0808	14440-0808	20241978	1/2	12.7	3/4-16	1	25	LT		2.52	64.0	1.97	50.0	3.19	81.0	NS	Y	Y	Y	Y
B2-JCFX90S-0808	14445-0808	20241936	1/2	12.7	3/4-16	1	25	ST		1.14	29.0	1.81	46.0	3.07	78.0	NS	Y	Y	Y	Y
B2-JCFX90-0810	14425-0810	20241911	1/2	12.7	7/8-14	1 1/16	27			1.85	47.0	1.69	43.0	2.95	75.0	NS	Y	Y	Y	Y
B2-JCFX90L-0810	14440-0810	20241987	1/2	12.7	7/8-14	1 1/16	27	LT		2.56	65.0	1.46	37.0	2.72	69.0	NS	Y	Y	Y	Y
B2-JCFX90S-0810	14445-0810	20241946	1/2	12.7	7/8-14	1 1/16	27	ST		1.26	32.0	1.81	46.0	3.03	77.0	NS	Y	Y	Y	Y
B2-JCFX90-0812	14425-0812	20241908	1/2	12.7	1 1/16-12	1 1/4	32			1.81	46.0	1.46	37.0	2.72	69.0	NS	Y	Y	Y	Y
B2-JCFX90-1010	14425-1010	20241932	5/8	15.9	7/8-14	1 1/16	27			1.89	48.0	1.93	49.0	3.31	84.0	NS	Y	Y	Y	Y
B2-JCFX90L-1010	14440-1010	20241976	5/8	15.9	7/8-14	1 1/16	27	LT		2.56	65.0	1.97	50.0	3.31	84.0	NS	Y	Y	Y	Y
B2-JCFX90S-1010	14445-1010	20241923	5/8	15.9	7/8-14	1 1/16	27	ST		1.26	32.0	1.43	36.2	2.78	70.5	NS	Y	Y	Y	Y
B2-JCFX90-1012	14425-1012	20241930	5/8	15.9	1 1/16-12	1 1/4	32			2.28	58.0	1.89	48.0	3.23	82.0	NS	Y	Y	Y	Y
B2-JCFX90S-1012	14445-1012	20241945	5/8	15.9	1 1/16-12	1 1/4	32	ST		1.89	48.0	1.89	48.0	3.23	82.0	NS	Y	Y	Y	Y
B2-JCFX90S-1208	14445-1208	20265741	3/4	19.0	3/4-16	1	25	ST		1.14	29.0	1.65	42.0	3.23	82.0	NS	Y	Y	Y	Y
B2-JCFX90-1210	14425-1210	20293224	3/4	19.0	7/8-14	1 1/16	27			1.89	48.0	1.97	50.0	3.50	89.0	NS	Y	Y	Y	Y
B2-JCFX90-1212	14425-1212	20241897	3/4	19.0	1 1/16-12	1 1/4	32			2.13	54.0	2.05	52.0	3.62	92.0	NS	Y	Y	Y	Y
B2-JCFX90L-1212	14440-1212	20241971	3/4	19.0	1 1/16-12	1 1/4	32	LT		3.74	95.0	2.13	54.0	3.70	94.0	NS	Y	Y	Y	Y
B2-JCFX90S-1212	14445-1212	20241940	3/4	19.0	1 1/16-12	1 1/4	32	ST		1.81	46.0	2.28	58.0	3.82	97.0	NS	Y	Y	Y	Y
B2-JCFX90S-1214	14445-1214	20241942	3/4	19.0	1 3/16-12	1 7/16	36	ST		2.07	52.5	1.93	49.0	3.50	89.0	NS	Y	Y	Y	Y
B2-JCFX90-1216	14425-1216	20241900	3/4	19.0	1 5/16-12	1 1/2	38			2.83	72.0	2.09	53.0	3.62	92.0	NS	Y	Y	Y	Y
B2-JCFX90-1616	14425-1616	20241977	1	25.4	1 5/16-12	1 1/2	38			2.81	71.5	2.87	73.0	4.61	117.0	NS	Y	Y	Y	Y
B2-JCFX90L-1616	14440-1616	20241983	1	25.4	1 5/16-12	1 1/2	38	LT		4.49	114.0	3.11	79.0	4.84	123.0	NS	Y	Y	Y	Y
B2-JCFX90S-1616	14445-1616	20241934	1	25.4	1 5/16-12	1 1/2	38	ST		2.20	56.0	2.91	74.0	4.69	119.0	NS	Y	Y	Y	Y
S4-JCFX90-2020T	28425-2020	20241906	1 1/4	31.8	1 5/8-12	2	50			3.07	78.0	3.23	82.0	5.28	134.0	NS	Y	Y	Y	Y
S4-JCFX90-2024T	28425-2024	20432492	1 1/4	31.8	1 7/8-12	2 3/16	55			3.23	82.0	3.43	87.0	5.47	139.0	NS	Y	Y	Y	Y
S4-JCFX90-2424T	28425-2424	20241904	1 1/2	38.1	1 7/8-12	2 3/16	55			3.62	92.0	3.74	95.0	6.06	154.0	NS	Y	Y	Y	Y

T: Thrust-Wire Nut S: Stainless Steel (see 'Fitting Identification' in Appendix for details)

JIC 37° Flare (SAE J514)

Male

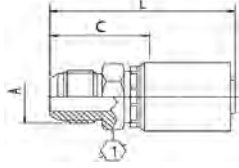

S=Skive
NS=Non-Skive
DG=Dual-Grip™

Descriptive #	Product #	SAP #	Hose Size ID		Thread Size (A)		Cut-Off (C)		Length (L)		Skive Type	SR1SN DR1SN SFS	SR2SN HR2SN LR2SN CR2SN	GR16 SR16SC AR16SC	ACP3 XCP3 GR17	
			in.	mm	in.	mm	in.	mm	in.	mm						
B2-JCM-0404	14450-0404	20241990	1/4	6.4	7/16-20	1/2	12	0.96	24.3	1.93	49.1	NS	Y	Y	Y	Y
B2-JCM-0405	14450-0405	20241991	1/4	6.4	1/2-20	9/16	14	1.00	25.3	1.97	50.1	NS	Y	Y	Y	Y
B2-JCM-0406	14450-0406	20241995	1/4	6.4	9/16-18	11/16	17	1.04	26.3	2.01	51.1	NS	Y	Y	Y	Y
B2-JCM-0506	14450-0506	20242012	5/16	7.9	9/16-18	11/16	17	1.04	26.3	2.01	51.1	NS	Y	Y	Y	Y
B2-JCM-0606	14450-0606	20242014	3/8	9.5	9/16-18	11/16	17	1.04	26.3	2.09	53.0	NS	Y	Y	Y	Y
B2-JCM-0608	14450-0608	20242007	3/8	9.5	3/4-16	3/4	19	1.17	29.8	2.22	56.5	NS	Y	Y	Y	Y
B2-JCM-0610	14450-0610	20242024	3/8	9.5	7/8-14	15/16	24	1.33	33.8	2.38	60.5	NS	Y	Y	Y	Y
B2-JCM-0808	14450-0808	20241994	1/2	12.7	3/4-16	3/4	19	1.20	30.6	2.44	62.1	NS	Y	Y	Y	Y
B2-JCM-0810	14450-0810	20241993	1/2	12.7	7/8-14	15/16	24	1.36	34.6	2.60	66.1	NS	Y	Y	Y	Y
B2-JCM-0812	14450-0812	20241997	1/2	12.7	1 1/16-12	1 1/16	27	1.46	37.1	2.70	68.6	NS	Y	Y	Y	Y
B2-JCM-1008	14450-1008	20441227	5/8	15.9	3/4-16	15/16	24	1.24	31.6	2.59	65.9	NS	Y	Y	Y	Y
B2-JCM-1010	14450-1010	20242010	5/8	15.9	7/8-14	15/16	24	1.36	34.6	2.71	68.9	NS	Y	Y	Y	Y
B2-JCM-1012	14450-1012	20242011	5/8	15.9	1 1/16-12	1 1/16	27	1.46	37.1	2.81	71.4	NS	Y	Y	Y	Y
B2-JCM-1210	14450-1210	20293165	3/4	19.0	7/8-14	1 1/16	27	1.38	35.1	2.94	74.6	NS	Y	Y	Y	Y
B2-JCM-1212	14450-1212	20242022	3/4	19.0	1 1/16-12	1 1/16	27	1.48	37.6	3.04	77.1	NS	Y	Y	Y	Y
B2-JCM-1214	14450-1214	20242020	3/4	19.0	1 3/16-12	1 1/4	32	1.58	40.1	3.13	79.6	NS	Y	Y	Y	Y
B2-JCM-1216	14450-1216	20242018	3/4	19.0	1 5/16-12	1 1/16	36	1.68	42.6	3.23	82.1	NS	Y	Y	Y	Y
B2-JCM-1616	14450-1616	20242002	1	25.4	1 5/16-12	1 7/16	36	1.71	43.4	3.46	88.0	NS	Y	Y	Y	Y
B2-JCM-1620	14450-1620	20242016	1	25.4	1 5/8-12	1 13/16	46	1.85	46.9	3.60	91.5	NS	Y	Y	Y	Y
S4-JCM-2020	28450-2020	20241999	1 1/4	31.8	1 5/8-12	1 13/16	46	1.91	48.5	3.96	100.5	NS	Y	Y	Y	Y
S4-JCM-2024	28450-2024	20241998	1 1/4	31.8	1 7/8-12	2	50	2.07	52.5	4.11	104.5	NS	Y	Y	Y	Y
S4-JCM-2424	28450-2424	20242027	1 1/2	38.1	1 7/8-12	2	50	2.07	52.5	4.39	111.5	NS	Y	Y	Y	Y
S4-JCM-3232	28450-3232	20242023	2	50.8	2 1/2-12	2 9/16	65	2.44	62.0	5.28	134.0	NS	Y	Y	Y	Y

SAE 45° J512 Flare

Female | Swivel

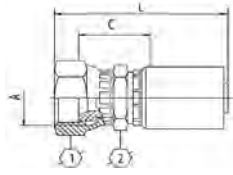

S=Skive
NS=Non-Skive
DG=Dual-Grip™

Descriptive #	Product #	SAP #	Hose Size ID		Thread Size (A)		Hex-1 Wrench Size		Hex-2 Wrench Size		Cut-Off (C)		Length (L)		Skive Type	SR1SN DR1SN SFS	SR2SN HR2SN LR2SN CR2SN	GR16 SR16SC AR16SC	ACP3 XCP3 GR17
			in.	mm	in.	mm	in.	mm	in.	mm	in.	mm	in.	mm					
B2-SFFX-0606	14775-0606	20241706	3/8	9.5	5/8-18	7/8	22	3/4	19	0.92	23.3	2.38	60.5	NS	Y	Y	Y	Y	
B2-SFFX-0608	14775-0608	20293245	3/8	9.5	3/4-16	1	25	3/4	19	0.98	24.8	2.45	62.2	NS	Y	Y	Y	Y	
B2-SFFX-0810	14775-0810	20293246	1/2	12.7	7/8-14	1 1/16	27	7/8	22	1.05	26.6	2.79	70.8	NS	Y	Y	Y	Y	
B2-SFFX-1212	14775-1212	20241707	3/4	19.0	1 1/16-14	1 1/4	32	1 1/16	27	1.13	28.6	3.23	82.1	NS	Y	Y	Y	Y	

SAE 45° J512 Flare

Female 45° Elbow | Swivel

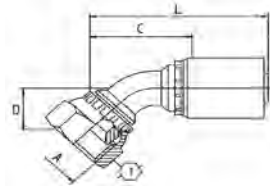

S=Skive
NS=Non-Skive
DG=Dual-Grip™

Descriptive #	Product #	SAP #	Hose Size D		Thread Size (A)		Hex-1 Wrench Size		Hex-2 Wrench Size		Cut-Off (C)		Length (L)		Skive Type	SR1SN DR1SN SFS	SR2SN HR2SN LR2SN CR2SN	GR16 SR16SC AR16SC	ACP3 XCP3 GR17
			in.	mm	in.	mm	in.	mm	in.	mm	in.	mm	in.	mm					
B2-SFFX45-0606	14777-0606	20293247	3/8	9.5	5/8-18	7/8	22	0.47	12	1.81	46.0	2.87	73.0	NS	Y	Y	Y	Y	
B2-SFFX45-0808	14777-0808	20293248	1/2	12.7	3/4-16	1	25	0.59	15	2.05	52.0	3.27	83.0	NS	Y	Y	Y	Y	
B2-SFFX45-1212	14777-1212	20441271	3/4	19.0	1 1/16-14	1 1/4	32	0.83	21.0	2.68	68.0	4.49	114.0	NS	Y	Y	Y	Y	

SAE 45° J512 Flare

Female 90° Elbow | Swivel

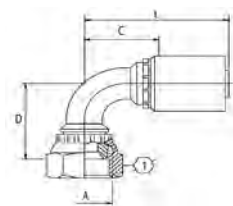

S=Skive
NS=Non-Skive
DG=Dual-Grip™

Descriptive #	Product #	SAP #	Hose Size ID		Thread Size (A)		Drop (D)		Cut-Off (C)		Length (L)		Skive Type	SR1SN DR1SN SFS	SR2SN HR2SN LR2SN CR2SN	GR16 SR16SC AR16SC	ACP3 XCP3 GR17	
			in.	mm	in.	mm	in.	mm	in.	mm	in.	mm						
B2-SFFX90-0606	14780-0606	20293249	3/8	9.5	5/8-18	7/8	22	0.94	24.0	1.65	42.0	2.72	69.0	NS	Y	Y	Y	Y
B2-SFFX90L-0606	14781-0606	20293250	3/8	9.5	5/8-18	7/8	22	2.19	55.5	1.69	43.0	2.76	70.0	NS	Y	Y	Y	Y
B2-SFFX90S-0808	14783-0808	20293251	1/2	12.7	3/4-16	1	25	1.14	29.0	1.81	46.0	3.07	78.0	NS	Y	Y	Y	Y
B2-SFFX90-1212	14780-1212	20441304	3/4	19.0	1 1/16-14	1 1/4	32	2.13	54.0	2.05	52.0	3.62	92.0	NS	Y	Y	Y	Y

SAE 45° J512 Flare

Male

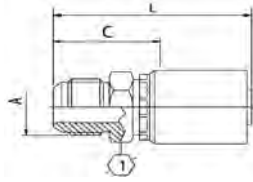

S=Skive
NS=Non-Skive
DG=Dual-Grip™

Descriptive #	Product #	SAP #	Hose Size ID		Thread Size (A)		Hex-1 Wrench Size		Cut-Off (C)		Length (L)		Skive Type	SR1SN DR1SN SFS	SR2SN HR2SN LR2SN CR2SN	GR16 SR16SC AR16SC	ACP3 XCP3 GR17
			in.	mm	in.	mm	in.	mm	in.	mm	in.	mm					
B2-SFM-0606	14785-0606	20293213	3/8	9.5	5/8-18	5/8	16	0.93	23.7	2.15	54.7	NS	Y	Y	Y	Y	
B2-SFM-0608	14785-0608	20293214	3/8	9.5	3/4-16	3/4	19	1.10	28.0	2.32	59.0	NS	Y	Y	Y	Y	
B2-SFM-0808	14785-0808	20293215	1/2	12.7	3/4-16	3/4	19	1.10	28.0	2.54	64.6	NS	Y	Y	Y	Y	
B2-SFM-1212	14785-1212	20293216	3/4	19.0	1 1/8-14	1 1/8	27	1.61	41.0	3.17	80.5	NS	Y	Y	Y	Y	

SAE 45° Inverted Flare

Male | Swivel

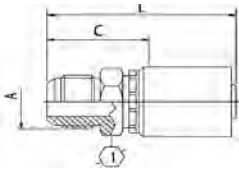

S=Skive
NS=Non-Skive
DG=Dual-Grip™

Descriptive #	Product #	SAP #	Hose Size ID		Thread Size (A)		Hex-1 Wrench Size		Cut-Off (C)		Length (L)		Skive Type	SR1SN DR1SN SFS	SR2SN HR2SN LR2SN CR2SN	GR16 SR16SC AR16SC	ACP3 XCP3 GR17
			in.	mm	in.	mm	in.	mm	in.	mm	in.	mm					
B2-SIMX-0403	14800-0403	20293166	1/4	6.4	3/8-24	1/2	12	1.22	30.9	2.19	55.7	NS	Y	Y	Y	Y	
B2-SIMX-0404	14800-0404	20293167	1/4	6.4	7/16-24	1/2	12	1.22	30.9	2.19	55.7	NS	Y	Y	Y	Y	
B2-SIMX-0405	14800-0405	20293168	1/4	6.4	1/2-20	9/16	14	1.26	32.0	2.24	56.8	NS	Y	Y	Y	Y	
B2-SIMX-0605	14800-0605	20293169	3/8	9.5	1/2-20	9/16	14	1.29	32.8	2.34	59.5	NS	Y	Y	Y	Y	
B2-SIMX-0606	14800-0606	20293170	3/8	9.5	5/8-18	11/16	17	1.43	36.3	2.48	63.0	NS	Y	Y	Y	Y	
B2-SIMX-0607	14800-0607	20293171	3/8	9.5	11/16-18	3/4	19	1.45	36.8	2.50	63.5	NS	Y	Y	Y	Y	
B2-SIMX-0808	14800-0808	20293172	1/2	12.7	3/4-18	3/4	19	1.54	39.2	2.78	70.7	NS	Y	Y	Y	Y	
B2-SIMX-0810	14800-0810	20293173	1/2	12.7	7/8-18	15/16	24	1.60	40.7	2.84	72.2	NS	Y	Y	Y	Y	

SAE 45° Inverted Flare

Male 45° Elbow | Swivel

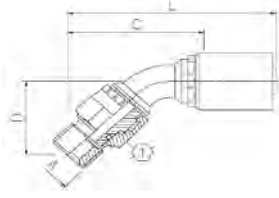

S=Skive
NS=Non-Skive
DG=Dual-Grip™

Descriptive #	Product #	SAP #	Hose Size ID		Thread Size (A)	Hex-1 Wrench Size		Drop (D)		Cut-Off (C)		Length (L)		Skive Type	SR1SN DR1SN SFS	SR2SN HR2SN LR2SN CR2SN	GR16 SR16SC AR16SC	ACP3 XCP3 GR17
			in.	mm		in.	mm	in.	mm	in.	mm	in.	mm					
B2-SIMX45-0403	14810-0403	20293174	1/4	6.4	3/8-24	1/2	12	1.24	31.5	2.68	68.0	3.62	92.0	NS	Y	Y	Y	Y
B2-SIMX45-0404	14810-0404	20293175	1/4	6.4	7/16-24	1/2	12	1.24	31.5	2.68	68.0	3.62	92.0	NS	Y	Y	Y	Y
B2-SIMX45-0604	14810-0604	20293382	3/8	9.5	7/16-24	1/2	12	1.57	40.0	2.95	75.0	4.02	102.0	NS	Y	Y	Y	Y
B2-SIMX45-0605	14810-0605	20293177	3/8	9.5	1/2-20	9/16	14	1.50	38.0	2.99	76.0	4.06	103.0	NS	Y	Y	Y	Y
B2-SIMX45-0606	14810-0606	20293178	3/8	9.5	5/8-18	11/16	17	1.50	38.0	2.99	76.0	4.06	103.0	NS	Y	Y	Y	Y
B2-SIMX45-0607	14810-0607	20293179	3/8	9.5	11/16-18	3/4	19	1.50	38.0	2.99	76.0	4.06	103.0	NS	Y	Y	Y	Y

SAE 45° Inverted Flare

Male 90° Elbow | Swivel

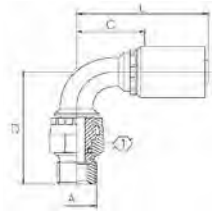

S=Skive
NS=Non-Skive
DG=Dual-Grip™

Descriptive #	Product #	SAP #	Hose Size ID		Thread Size (A)	Hex-1 Wrench Size		Drop (D)		Cut-Off (C)		Length (L)		Skive Type	SR1SN DR1SN SFS	SR2SN HR2SN LR2SN CR2SN	GR16 SR16SC AR16SC	ACP3 XCP3 GR17
			in.	mm		in.	mm	in.	mm	in.	mm	in.	mm					
B2-SIMX90-0403	14815-0403	20293180	1/4	6.4	3/8-24	1/2	12	1.97	50.0	1.38	35.0	2.32	59.0	NS	Y	Y	Y	Y
B2-SIMX90-0404	14815-0404	20293181	1/4	6.4	7/16-24	1/2	12	2.05	52.0	1.30	33.0	2.24	57.0	NS	Y	Y	Y	Y
B2-SIMX90-0405	14815-0405	20293182	1/4	6.4	1/2-20	9/16	14	1.96	49.8	1.52	38.5	2.49	63.3	NS	Y	Y	Y	Y
B2-SIMX90-0604	14815-0604	20293183	3/8	9.5	7/16-24	1/2	12	2.44	62.0	1.34	34.0	2.36	60.0	NS	Y	Y	Y	Y
B2-SIMX90-0605	14815-0605	20293184	3/8	9.5	1/2-20	9/16	14	2.44	62.0	1.38	35.0	2.44	62.0	NS	Y	Y	Y	Y
B2-SIMX90-0606	14815-0606	20293185	3/8	9.5	5/8-18	11/16	17	2.44	62.0	1.38	35.0	2.44	62.0	NS	Y	Y	Y	Y
B2-SIMX90-0607	14815-0607	20293186	3/8	9.5	11/16-18	3/4	19	2.44	62.0	1.38	35.0	2.44	62.0	NS	Y	Y	Y	Y
B2-SIMX90-0808	14815-0808	20293187	1/2	12.7	3/4-18	3/4	19	2.32	59.0	2.13	54.0	3.35	85.0	NS	Y	Y	Y	Y

NPTF

Female

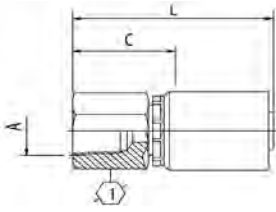

S=Skive
NS=Non-Skive
DG=Dual-Grip™

Descriptive #	Product #	SAP #	Hose Size ID		Thread Size (A)		Hex-1 Wrench Size		Cut-Off (C)		Length (L)		Skive Type	SR1SN DR1SN SFS	SR2SN HR2SN LR2SN CR2SN	GR16 SR16SC AR16SC	ACP3 XCP3 GR17
			in.	mm	in.	mm	in.	mm	in.	mm							
B2-NPF-0402	14600-0402	20293225	1/4	6.4	1/8-27	9/16	14	0.88	22.3	1.85	47.1	NS	Y	Y	Y	Y	
B2-NPF-0404	14600-0404	20242105	1/4	6.4	1/4-18	3/4	19	1.09	27.8	2.07	52.6	NS	Y	Y	Y	Y	
B2-NPF-0604	14600-0604	20293226	3/8	9.5	1/4-18	3/4	19	1.09	27.8	2.15	54.5	NS	Y	Y	Y	Y	
B2-NPF-0606	14600-0606	20242103	3/8	9.5	3/8-18	7/8	22	1.13	28.8	2.19	55.5	NS	Y	Y	Y	Y	
B2-NPF-0808	14600-0808	20242106	1/2	12.7	1/2-14	1	25	1.40	35.6	2.64	67.1	NS	Y	Y	Y	Y	
B2-NPF-1212	14600-1212	20242104	3/4	19.0	3/4-14	1 1/4	32	1.50	38.1	3.06	77.6	NS	Y	Y	Y	Y	

NPTF

Female | Swivel

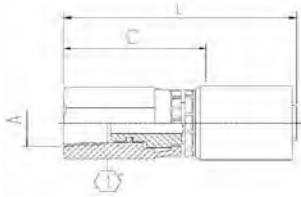

S=Skive
NS=Non-Skive
DG=Dual-Grip™

Descriptive #	Product #	SAP #	Hose Size ID		Thread Size (A)		Hex-1 Wrench Size		Cut-Off (C)		Length (L)		Skive Type	SR1SN DR1SN SFS	SR2SN HR2SN LR2SN CR2SN	GR16 SR16SC AR16SC	ACP3 XCP3 GR17
			in.	mm	in.	mm	in.	mm	in.	mm							
B2-NPFX-0606	14605-0606	20293227	3/8	9.5	3/8-18	7/8	22	2.05	52.0	3.10	78.7	NS	Y	Y	Y	Y	
B2-NPFX-1616	14605-1616	20293228	1	25.4	1-11 1/2	1 1/2	38	2.87	72.9	4.63	117.5	NS	Y	Y	Y	Y	

NPTF

Male

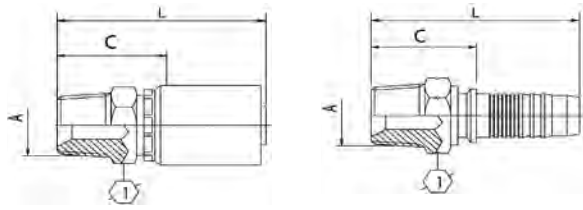

S=Skive
NS=Non-Skive
DG=Dual-Grip™

Descriptive #	Product #	SAP #	Hose Size ID		Thread Size (A)	Hex-1 Wrench Size		Cut-Off (C)		Length (L)		Skive Type	SR1SN DR1SN SFS	SR2SN HR2SN LR2SN CR2SN	GR16 SR16SC AR16SC	ACP3 XCP3 GR17
			in.	mm		in.	mm	in.	mm	in.	mm					
UC-NPM-0302	36615-0302	20242703	3/16	4.8	1/8-27	1/2	12	0.82	20.8	1.69	43.0	S	UCF1-03	UCF2-03		
B2-NPM-0402	14615-0402	20242110	1/4	6.4	1/8-27	9/16	14	0.84	21.3	1.81	46.1	NS	Y	Y	Y	Y
B2-NPM-0404	14615-0404	20242111	1/4	6.4	1/4-18	11/16	17	1.06	26.8	2.03	51.6	NS	Y	Y	Y	Y
B2-NPM-0404 ^S	14615-0404 ^S	20286649	1/4	6.4	1/4-18	11/16	17	1.06	26.8	2.03	51.6	NS	Y	Y	Y	Y
B2-NPM-0406	14615-0406	20242109	1/4	6.4	3/8-18	3/4	19	1.09	27.8	2.07	52.6	NS	Y	Y	Y	Y
B2-NPM-0408	14615-0408	20242115	1/4	6.4	1/2-14	7/8	22	1.23	31.3	2.21	56.1	NS	Y	Y	Y	Y
B2-NPM-0604	14615-0604	20242067	3/8	9.5	1/4-18	11/16	17	1.06	26.8	2.11	53.5	NS	Y	Y	Y	Y
B2-NPM-0606	14615-0606	20242069	3/8	9.5	3/8-18	3/4	19	1.09	27.8	2.15	54.5	NS	Y	Y	Y	Y
B2-NPM-0606 ^S	14615-0606 ^S	20286830	3/8	9.5	3/8-18	3/4	19	1.09	27.8	2.15	54.5	NS	Y	Y	Y	Y
B2-NPM-0608	14615-0608	20242079	3/8	9.5	1/2-14	7/8	22	1.23	31.3	2.28	58.0	NS	Y	Y	Y	Y
B2-NPM-0806	14615-0806	20242113	1/2	12.7	3/8-18	3/4	19	1.13	28.6	2.37	60.1	NS	Y	Y	Y	Y
B2-NPM-0808	14615-0808	20242093	1/2	12.7	1/2-14	7/8	22	1.26	32.1	2.50	63.6	NS	Y	Y	Y	Y
B2-NPM-0808 ^S	14615-0808 ^S	20286831	1/2	12.7	1/2-14	7/8	22	1.26	32.1	2.50	63.6	NS	Y	Y	Y	Y
B2-NPM-0812	14615-0812	20242116	1/2	12.7	3/4-14	1 1/16	27	1.34	34.1	2.58	65.6	NS	Y	Y	Y	Y
B2-NPM-1008	14615-1008	20242071	5/8	15.9	1/2-14	15/16	24	1.30	33.1	2.65	67.4	NS	Y	Y	Y	Y
B2-NPM-1008 ^S	14615-1008 ^S	20286832	5/8	15.9	1/2-14	15/16	24	1.30	33.1	2.65	67.4	NS	Y	Y	Y	Y
B2-NPM-1012	14615-1012	20242066	5/8	15.9	3/4-14	1 1/16	27	1.34	34.1	2.69	68.4	NS	Y	Y	Y	Y
B2-NPM-1208	14615-1208	20242078	3/4	19.0	1/2-14	1 1/16	27	1.32	33.6	2.88	73.1	NS	Y	Y	Y	Y
B2-NPM-1212	14615-1212	20242076	3/4	19.0	3/4-14	1 1/16	27	1.36	34.6	2.92	74.1	NS	Y	Y	Y	Y
B2-NPM-1212 ^S	14615-1212 ^S	20286833	3/4	19.0	3/4-14	1 1/16	27	1.36	34.6	2.92	74.1	NS	Y	Y	Y	Y
B2-NPM-1216	14615-1216	20242077	3/4	19.0	1-11 1/2	1 1/16	36	1.72	43.6	3.27	83.1	NS	Y	Y	Y	Y
B2-NPM-1612	14615-1612	20242107	1	25.4	3/4-14	1 7/16	36	1.55	39.4	3.31	84.0	NS	Y	Y	Y	Y
B2-NPM-1616	14615-1616	20242099	1	25.4	1-11 1/2	1 7/16	36	1.75	44.4	3.50	89.0	NS	Y	Y	Y	Y
B2-NPM-1616 ^S	14615-1616 ^S	20286834	1	25.4	1-11 1/2	1 7/16	36	1.75	44.4	3.50	89.0	NS	Y	Y	Y	Y
B2-NPM-1620	14615-1620	20242092	1	25.4	1 1/4-11 1/2	1 13/16	46	1.87	47.4	3.62	92.0	NS	Y	Y	Y	Y
S4-NPM-2020	28615-2020	20242094	1 1/4	31.8	1 1/4-11 1/2	1 13/16	46	1.93	49.0	3.98	101.0	NS	Y	Y	Y	
S4-NPM-2024	28615-2024	20242095	1 1/4	31.8	1 1/2-11 1/2	2	50	1.99	50.5	4.04	102.5	NS	Y	Y	Y	
S4-NPM-2424	28615-2424	20242102	1 1/2	38.1	1 1/2-11 1/2	2	50	1.99	50.5	4.31	109.5	NS	Y	Y		
S4-NPM-3232	28615-3232	20242108	2	50.8	2-11 1/2	2 9/16	65	2.13	54.2	4.97	126.2	NS	Y	Y		

S: Stainless Steel

NPTF

Male | Swivel

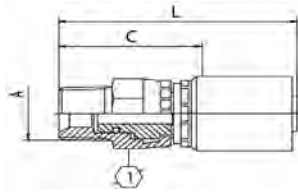

S=Skive
NS=Non-Skive
DG=Dual-Grip™

Descriptive #	Product #	SAP #	Hose Size ID		Thread Size (A)		Hex-1 Wrench Size		Cut-Off (C)		Length (L)		Skive Type	SR1SN DR1SN SFS	SR2SN HR2SN LR2SN CR2SN	GR16 SR16SC AR16SC	ACP3 XCP3 GR17
			in.	mm	in.	mm	in.	mm	in.	mm							
B2-NPMX-0402	14645-0402	20435592	1/4	6.4	1/8-27	5/8	16	1.34	34.0	2.31	58.8	NS	Y	Y	Y	Y	
B2-NPMX-0404	14645-0404	20242087	1/4	6.4	1/4-18	11/16	17	1.48	37.6	2.46	62.4	NS	Y	Y	Y	Y	
B2-NPMX-0406	14645-0406	20242086	1/4	6.4	3/8-18	7/8	22	1.56	39.5	2.53	64.3	NS	Y	Y	Y	Y	
B2-NPMX-0604	14645-0604	20242082	3/8	9.5	1/4-18	11/16	17	1.56	39.6	2.61	66.3	NS	Y	Y	Y	Y	
B2-NPMX-0606	14645-0606	20242081	3/8	9.5	3/8-18	7/8	22	1.48	37.5	2.53	64.2	NS	Y	Y	Y	Y	
B2-NPMX-0608	14645-0608	20242083	3/8	9.5	1/2-14	1	25	1.71	43.5	2.76	70.2	NS	Y	Y	Y	Y	
B2-NPMX-0804	14645-0804	20293188	1/2	12.7	1/4-18	11/16	17	1.59	40.4	2.83	71.9	NS	Y	Y	Y	Y	
B2-NPMX-0806	14645-0806	20242088	1/2	12.7	3/8-18	7/8	22	1.51	38.3	2.75	69.8	NS	Y	Y	Y	Y	
B2-NPMX-0808	14645-0808	20242074	1/2	12.7	1/2-14	1	25	1.67	42.3	2.91	73.8	NS	Y	Y	Y	Y	
B2-NPMX-1212	14645-1212	20242091	3/4	19.0	3/4-14	1 1/4	32	1.97	50.1	3.53	89.6	NS	Y	Y	Y	Y	
B2-NPMX-1616	14645-1616	20242085	1	25.4	1-11 1/2	1 5/8	41	2.28	57.9	4.04	102.5	NS	Y	Y	Y	Y	

NPTF

Male 90° Elbow (Block) | Swivel



S=Skive
NS=Non-Skive
DG=Dual-Grip™

Descriptive #	Product #	SAP #	Hose Size ID		Thread Size (A)		Hex-1 Wrench Size	Drop (D)		Cut-Off (C)		Length (L)		Skive Type	SR1SN DR1SN SFS	SR2SN HR2SN LR2SN CR2SN	GR16 SR16SC AR16SC	ACP3 XCP3 GR17
			in.	mm	in.	mm		in.	mm	in.	mm	in.	mm					
B2-NPMX90B-0404	14650-0404	20293189	1/4	6.4	1/4-18	11/16	17	1.54	39.0	0.67	17.0	1.65	41.8	NS	Y	Y	Y	Y
B2-NPMX90B-0604	14650-0604	20293190	3/8	9.5	1/4-18	11/16	17	1.61	41.0	0.79	20.0	1.84	46.7	NS	Y	Y	Y	Y
B2-NPMX90B-0606	14650-0606	20293191	3/8	9.5	3/8-18	7/8	22	1.61	41.0	0.79	20.0	1.84	46.7	NS	Y	Y	Y	Y
B2-NPMX90B-0806	14650-0806	20441228	1/2	12.7	3/8-18	7/8	22	1.61	41.0	0.83	21.0	2.07	52.5	NS	Y	Y	Y	Y
B2-NPMX90B-0808	14650-0808	20293192	1/2	12.7	1/2-14	1	25	1.89	48.0	0.91	23.0	2.15	54.5	NS	Y	Y	Y	Y
B2-NPMX90B-1212	14650-1212	20293193	3/4	19.0	3/4-14	1 1/4	32	2.40	61.0	1.06	27.0	2.62	66.5	NS	Y	Y	Y	Y

NPSM

Female | Swivel

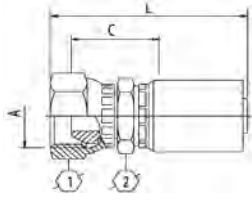

S=Skive
NS=Non-Skive
DG=Dual-Grip™

Descriptive #	Product #	SAP #	Hose Size I.D.		Thread Size (A)		Hex-1 Wrench Size		Hex-2 Wrench Size		Cut-Off (C)		Length (L)		Skive Type	GRS DR1SN SFS	SR2SN LR2SN CR2SN	GR16 AR16SC	ACP3 XCP3 GR17
			in.	mm	in.	mm	in.	mm	in.	mm	in.	mm	in.	mm					
B2-NSFX-0404	14655-0404	20242064	1/4	6.4	1/4-18	3/4	19	11/16	17	0.96	24.3	2.17	55.1	NS	Y	Y	Y	Y	
B2-NSFX-0606	14655-0606	20242065	3/8	9.5	3/8-18	7/8	22	3/4	19	0.98	24.8	2.27	57.7	NS	Y	Y	Y	Y	
B2-NSFX-0808	14655-0808	20242063	1/2	12.7	1/2-14	11/16	27	7/8	22	1.05	26.6	2.54	64.6	NS	Y	Y	Y	Y	
B2-NSFX-1212	14655-1212	20293252	3/4	19.0	3/4-14	1 1/4	32	1 3/16	30	1.13	28.6	3.02	76.6	NS	Y	Y	Y	Y	
B2-NSFX-1616	14655-1616	20293253	1	25.4	1-11 1/2	1 1/2	38	1 7/16	36	1.39	35.4	3.54	90.0	NS	Y	Y	Y	Y	
S4-NSFX-2020	28655-2020	20293263	1 1/4	31.8	1 1/4-11 1/2	2	50	1 5/8	41	2.05	52.0	4.09	104.0	NS	Y	Y	Y	Y	

GTF

Female

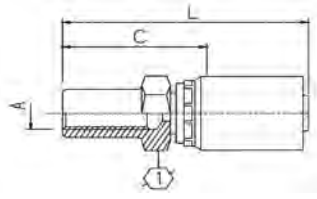

S=Skive
NS=Non-Skive
DG=Dual-Grip™

Descriptive #	Product #	SAP #	Hose Size D		Thread Size (A)	Hex-1 Wrench Size	Cut-Off (C)		Length (L)		Skive Type	SR1SN DR1SN SFS	SR2SN LR2SN CR2SN	GR16 AR16SC	ACP3 XCP3 GR17	
			in.	mm			in.	mm	in.	mm						in.
B2-GTF-0404	14370-0404	20293254	1/4	6.4	.511-27	3/4	19	0.92	23.3	1.89	48.1	NS	Y	Y	Y	Y

SAE J514 Flareless Tube Fittings

Male

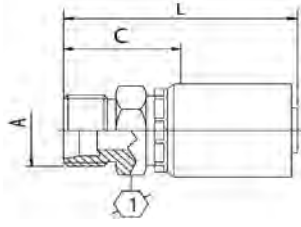

S=Skive
NS=Non-Skive
DG=Dual-Grip™

Descriptive #	Product #	SAP #	Hose Size ID		Thread		Hex-1 Wrench Size		Cut-Off (C)		Length (L)		Skive Type	SR1SN DR1SN SFS	SR2SN HR2SN LR2SN CR2SN	GR16 SR16SC AR16SC	ACP3 XCP3 GR17
			in.	mm	in.	mm	in.	mm	in.	mm	in.	mm					
B2-FTM-0404	14360-0404	20286101	1/4	6.4	7/16-20	1/2	12	0.86	21.8	1.83	46.6	NS	Y	Y	Y	Y	
B2-FTM-0405	14360-0405	20294798	1/4	6.4	1/2-20	9/16	14	0.90	22.8	1.87	47.6	NS	Y	Y	Y	Y	
B2-FTM-0605	14360-0605	20294799	3/8	9.5	1/2-20	5/8	16	0.94	23.8	1.99	50.5	NS	Y	Y	Y	Y	
B2-FTM-0606	14360-0606	20286102	3/8	9.5	9/16-18	5/8	16	0.95	24.2	2.00	50.9	NS	Y	Y	Y	Y	
B2-FTM-0808	14360-0808	20286103	1/2	12.7	3/4-16	7/8	22	1.12	28.4	2.36	59.9	NS	Y	Y	Y	Y	
B2-FTM-0810	14360-0810	20294860	1/2	12.7	7/8-14	15/16	24	1.22	31.0	2.46	62.5	NS	Y	Y	Y	Y	
B2-FTM-1212	14360-1212	20294861	3/4	19.0	1 1/16-12	1 3/16	30	1.30	33.1	2.86	72.6	NS	Y	Y	Y	Y	
B2-FTM-1616	14360-1616	20294862	1	25.4	1 5/16-12	1 7/16	36	1.49	37.9	3.25	82.5	NS	Y	Y	Y	Y	

Standpipe

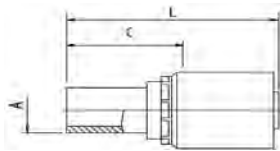

S=Skive
NS=Non-Skive
DG=Dual-Grip™

Descriptive #	Product #	SAP #	Hose Size ID		Tube O.D. (A)	Cut-Off (C)		Length (L)		Skive Type	SR1SN DR1SN SFS	SR2SN HR2SN LR2SN CR2SN	GR16 SR16SC AR16SC	ACP3 XCP3 GR17
			in.	mm		mm	in.	mm	in.					
B2-SP-0406	14825-0406	20441305	1/4	6.4	6	1.11	28.3	2.09	53.1	NS	Y	Y	Y	Y
B2-SP-0408	14825-0408	20241714	1/4	6.4	8	1.19	30.2	2.17	55.0	NS	Y	Y	Y	Y
B2-SP-0410	14825-0410	20241710	1/4	6.4	10	1.27	32.2	2.24	57.0	NS	Y	Y	Y	Y
B2-SP-0610	14825-0610	20241712	3/8	9.5	10	1.19	30.3	2.24	57.0	NS	Y	Y	Y	Y
B2-SP-0612	14825-0612	20241711	3/8	9.5	12	1.15	29.3	2.20	56.0	NS	Y	Y	Y	Y
B2-SP-0815	14825-0815	20241717	1/2	12.7	15	1.26	32.1	2.50	63.6	NS	Y	Y	Y	Y
B2-SP-0816	14825-0816	20241716	1/2	12.7	16	1.46	37.1	2.70	68.6	NS	Y	Y	Y	Y
B2-SP-1018	14825-1018	20241715	5/8	15.9	18	1.35	34.2	2.70	68.5	NS	Y	Y	Y	Y
B2-SP-1020	14825-1020	20241720	5/8	15.9	20	1.74	44.2	3.09	78.5	NS	Y	Y	Y	Y
B2-SP-1222	14825-1222	20241713	3/4	19.0	22	1.44	36.5	2.99	76.0	NS	Y	Y	Y	Y
B2-SP-1628	14825-1628	20241718	1	25.4	28	1.59	40.4	3.35	85.0	NS	Y	Y	Y	Y

Standpipe

45° Elbow

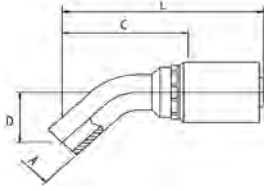

S=Skive
NS=Non-Skive
DG=Dual-Grip™

Descriptive #	Product #	SAP #	Hose Size I.D.		Tube O.D. (A)		Hex-1 Wrench Size		Drop (D)		Length (L)		Skive Type	SR1SN DR1SN SFS	SR2SN HR2SN LR2SN CR2SN	GR16 SR16SC AR16SC	ACP3 XCP3 GR17
			in.	mm	mm	in.	mm	in.	mm	in.	mm						
B2-SP45-0408	14830-0408	20241719	1/4	6.4	8	0.91	23	1.69	43.0	2.68	68.0	NS	Y	Y	Y	Y	

O-Ring Face Seal (SAE J1453) ORS/ORFS

Female | Swivel

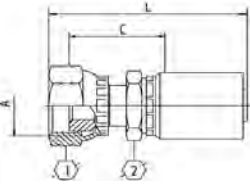

S=Skive
NS=Non-Skive
DG=Dual-Grip™

Descriptive #	Product #	SAP #	Hose Size I.D.		Thread Size (A)	Hex-1 Wrench Size		Hex-2 Wrench Size		Cut-Off (C)		Length (L)		Skive Type	SR1SN DR1SN SFS	SR2SN HR2SN LR2SN CR2SN	GR16 SR16SC AR16SC	ACP3 XCP3 GR17
			in.	mm		in.	mm	in.	mm	in.	mm	in.	mm					
B2-OFFX-0404	14700-0404	20242188	1/4	6.4	9/16-18	11/16	17	9/16	14	1.07	27.3	2.37	60.3	NS	Y	Y	Y	Y
B2-OFFX-0406	14700-0406	20242141	1/4	6.4	11/16-16	7/8	22	11/16	17	1.19	30.3	2.54	64.6	NS	Y	Y	Y	Y
B2-OFFX-0408	14700-0408	20242148	1/4	6.4	13/16-16	15/16	24	7/8	22	1.39	35.3	2.80	71.1	NS	Y	Y	Y	Y
B2-OFFX-0604	14700-0604	20293218	3/8	9.5	9/16-18	11/16	17	11/16	17	1.11	28.3	2.49	63.2	NS	Y	Y	Y	Y
B2-OFFX-0606	14700-0606	20242196	3/8	9.5	11/16-16	7/8	22	11/16	17	1.19	30.3	2.62	66.5	NS	Y	Y	Y	Y
B2-OFFX-0608	14700-0608	20242198	3/8	9.5	13/16-16	15/16	24	7/8	22	1.39	35.3	2.87	73.0	NS	Y	Y	Y	Y
B2-OFFX-0806	14700-0806	20242143	1/2	12.7	11/16-16	7/8	22	3/4	19	1.26	32.1	2.88	73.1	NS	Y	Y	Y	Y
B2-OFFX-0808	14700-0808	20242149	1/2	12.7	13/16-16	15/16	24	7/8	22	1.42	36.1	3.09	78.6	NS	Y	Y	Y	Y
B2-OFFX-0810	14700-0810	20242144	1/2	12.7	1-14	1 3/16	30	15/16	24	1.56	39.6	3.31	84.1	NS	Y	Y	Y	Y
B2-OFFX-0812	14700-0812	20242136	1/2	12.7	1 3/16-12	1 7/16	36	1 3/16	30	1.66	42.1	3.47	88.1	NS	Y	Y	Y	Y
B2-OFFX-1010	14700-1010	20242178	5/8	15.9	1-14	1 3/16	30	15/16	24	1.56	39.6	3.39	86.1	NS	Y	Y	Y	Y
B2-OFFX-1012	14700-1012	20242199	5/8	15.9	1 3/16-12	1 7/16	36	1 3/16	30	1.66	42.1	3.58	90.9	NS	Y	Y	Y	Y
B2-OFFX-1210	14700-1210	20242201	3/4	19.0	1-14	1 3/16	30	1 1/16	27	1.58	40.1	3.65	92.6	NS	Y	Y	Y	Y
B2-OFFX-1212	14700-1212	20242189	3/4	19.0	1 3/16-12	1 7/16	36	1 3/16	30	1.68	42.6	3.80	96.6	NS	Y	Y	Y	Y
B2-OFFX-1216	14700-1216	20242169	3/4	19.0	1 7/16-12	1 5/8	41	1 7/16	36	1.91	48.6	4.05	102.9	NS	Y	Y	Y	Y
B2-OFFX-1612	14700-1612	20242159	1	25.4	1 3/16-12	1 7/16	36	1 1/4	32	1.79	45.4	4.11	104.5	NS	Y	Y	Y	Y
B2-OFFX-1616	14700-1616	20242142	1	25.4	1 7/16-12	1 5/8	41	1 7/16	36	1.94	49.4	4.28	108.8	NS	Y	Y	Y	Y
B2-OFFX-1620	14700-1620	20242164	1	25.4	1 11/16-12	2	50	1 5/8	41	1.98	50.4	4.32	109.8	NS	Y	Y	Y	Y
S4-OFFX-2020	28700-2020	20242137	1 1/4	31.8	1 11/16-12	2	50	1 5/8	41	2.05	52.0	4.68	118.8	NS	Y	Y	Y	Y
S4-OFFX-2424	28700-2424	20242138	1 1/2	38.1	2-12	2 3/8	60	2	50	2.22	56.5	5.18	131.5	NS	Y	Y	Y	Y

O-Ring Face Seal (SAE J1453) ORS/ORFS

Female 45° Elbow | Swivel

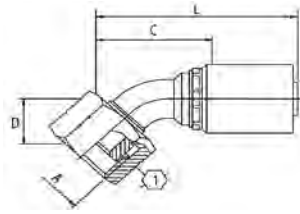

S=Skive
NS=Non-Skive
DG=Dual-Grip™

Descriptive #	Product #	SAP #	Hose Size ID		Thread Size (A)		Hex-1 Wrench Size		Drop (D)		Cut-Off (C)		Length (L)		Skive Type	SR1SN DR1SN SFS	SR2SN HR2SN LR2SN CR2SN	GR16 SR16SC AR16SC	ACP3 XCP3 GR17
			in.	mm	in.	mm	in.	mm	in.	mm	in.	mm	in.	mm					
B2-OFFX45-0404	14710-0404	20242231	1/4	6.4	9/16-18	11/16	17	0.43	11.0	1.61	41.0	2.60	66.0	NS	Y	Y	Y	Y	
B2-OFFX45-0406	14710-0406	20242230	1/4	6.4	11/16-16	7/8	22	0.43	11.0	1.81	46.0	2.80	71.0	NS	Y	Y	Y	Y	
B2-OFFX45-0606	14710-0606	20242204	3/8	9.5	11/16-16	7/8	22	0.47	12.0	1.85	47.0	2.91	74.0	NS	Y	Y	Y	Y	
B2-OFFX45-0608	14710-0608	20242206	3/8	9.5	13/16-16	15/16	24	0.59	15.0	2.01	51.0	3.07	78.0	NS	Y	Y	Y	Y	
B2-OFFX45-0808C	14710-0808	20242228	1/2	12.7	13/16-16	15/16	24	0.63	16.0	1.85	47.0	3.11	79.0	NS	Y	Y	Y	Y	
B2-OFFX45-0810	14710-0810	20242225	1/2	12.7	1-14	1 3/16	30	0.65	16.5	1.97	50.0	3.23	82.0	NS	Y	Y	Y	Y	
B2-OFFX45-1010	14710-1010	20242217	5/8	15.9	1-14	1 3/16	30	0.67	17.0	2.28	58.0	3.62	92.0	NS	Y	Y	Y	Y	
B2-OFFX45-1012	14710-1012	20242207	5/8	15.9	1 3/16-12	1 7/16	36	0.83	21.0	2.48	63.0	3.82	97.0	NS	Y	Y	Y	Y	
B2-OFFX45-1210	14710-1210	20293219	3/4	19.0	1-14	1 3/16	30	0.79	20.0	2.09	53.0	3.66	93.0	NS	Y	Y	Y	Y	
B2-OFFX45-1212	14710-1212	20242232	3/4	19.0	1 3/16-12	1 7/16	36	0.83	21.0	2.48	63.0	4.06	103.0	NS	Y	Y	Y	Y	
B2-OFFX45-1216	14710-1216	20242208	3/4	19.0	1 7/16-12	1 5/8	41	0.94	24.0	2.80	71.0	4.33	110.0	NS	Y	Y	Y	Y	
B2-OFFX45-1616	14710-1616	20242219	1	25.4	1 7/16-12	1 5/8	41	1.02	26.0	3.23	82.0	5.00	127.0	NS	Y	Y	Y	Y	
S4-OFFX45-2020	28710-2020	20242223	1 1/4	31.8	1 11/16-12	2	50	1.02	26.0	3.82	97.0	6.16	156.5	NS	Y	Y	Y	Y	
S4-OFFX45-2024	28710-2024	20242224	1 1/4	31.8	2-12	2 3/8	60	1.10	28.0	3.98	101.0	6.34	161.0	NS	Y	Y	Y	Y	
S4-OFFX45-2424	28710-2424	20242222	1 1/2	38.1	2-12	2 3/8	60	1.10	28.0	4.13	105.0	6.77	172.0	NS	Y	Y	Y	Y	

O-Ring Face Seal (SAE J1453) ORS/ORFS

Female 90° Elbow | Swivel

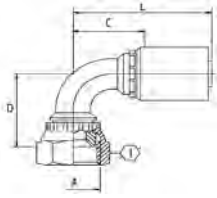

Elbow Type:
LT=Long Tube
ST=Short Tube

S=Skive
NS=Non-Skive
DG=Dual-Grip™

Descriptive #	Product #	SAP #	Hose Size ID		Thread Size (A)		Hex-1 Wrench Size	Elbow Type	Drop (D)		Cut-Off (C)		Length (L)			Skive Type	SR15N SFS	SR25N LR25N CR25N	GR16 SR16SC AR16SC	ACP3 XCP3 GR17
			in.	mm	in.	mm			in.	mm	in.	mm	in.	mm	in.					
B2-OFFX90-0404	14715-0404	20242236	1/4	6.4	9/16-18	11/16	17		1.26	32.0	1.18	30.0	2.17	55.0	NS	Y	Y	Y	Y	
B2-OFFX90L-0404	14720-0404	20242254	1/4	6.4	9/16-18	11/16	17	LT	1.81	46.0	1.30	33.0	2.28	58.0	NS	Y	Y	Y	Y	
B2-OFFX90S-0404	14725-0404	20242152	1/4	6.4	9/16-18	11/16	17	ST	0.83	21.0	1.10	28.0	2.09	53.0	NS	Y	Y	Y	Y	
B2-OFFX90-0406	14715-0406	20242243	1/4	6.4	11/16-16	7/8	22		1.50	38.0	1.46	37.0	2.44	62.0	NS	Y	Y	Y	Y	
B2-OFFX90L-0406	14720-0406	20242250	1/4	6.4	11/16-16	7/8	22	LT	2.13	54.0	1.38	35.0	2.36	60.0	NS	Y	Y	Y	Y	
B2-OFFX90S-0406	14725-0406	20242151	1/4	6.4	11/16-16	7/8	22	ST	0.91	23.0	1.26	32.0	2.24	57.0	NS	Y	Y	Y	Y	
B2-OFFX90S-0604	14725-0604	20591895	3/8	9.5	9/16-18	11/16	17	ST	0.94	24.0	1.65	42.0	2.72	69.0	NS	Y	Y	Y	Y	
B2-OFFX90-0606	14715-0606	20242239	3/8	9.5	11/16-16	7/8	22		1.50	38.0	1.65	42.0	2.72	69.0	NS	Y	Y	Y	Y	
B2-OFFX90L-0606	14720-0606	20241694	3/8	9.5	11/16-16	7/8	22	LT	2.13	54.0	1.65	42.0	2.72	69.0	NS	Y	Y	Y	Y	
B2-OFFX90S-0606	14725-0606	20242158	3/8	9.5	11/16-16	7/8	22	ST	0.98	25.0	1.65	42.0	2.72	69.0	NS	Y	Y	Y	Y	
B2-OFFX90-0608	14715-0608	20242252	3/8	9.5	13/16-16	15/16	24		1.61	41.0	1.73	44.0	2.80	71.0	NS	Y	Y	Y	Y	
B2-OFFX90L-0608	14720-0608	20241705	3/8	9.5	13/16-16	15/16	24	LT	2.52	64.0	1.85	47.0	2.91	74.0	NS	Y	Y	Y	Y	
B2-OFFX90S-0608	14725-0608	20242160	3/8	9.5	13/16-16	15/16	24	ST	1.14	29.0	1.65	42.0	2.72	69.0	NS	Y	Y	Y	Y	
B2-OFFX90S-0806	14725-0806	20441217	1/2	12.7	11/16-16	7/8	22	ST	0.98	25.0	1.73	44.0	2.99	76.0	NS	Y	Y	Y	Y	
B2-OFFX90-0808 ^c	14715-0808	20241704	1/2	12.7	13/16-16	15/16	24		1.65	42.0	1.38	35.0	2.60	66.0	NS	Y	Y	Y	Y	
B2-OFFX90L-0808 ^c	14720-0808	20242216	1/2	12.7	13/16-16	15/16	24	LT	2.52	64.0	1.50	38.0	2.76	70.0	NS	Y	Y	Y	Y	
B2-OFFX90S-0808 ^c	14725-0808	20242226	1/2	12.7	13/16-16	15/16	24	ST	1.14	29.0	1.57	40.0	2.80	71.0	NS	Y	Y	Y	Y	
B2-OFFX90-0810	14715-0810	20241703	1/2	12.7	1-14	1 3/8	30		1.85	47.0	1.89	48.0	3.15	80.0	NS	Y	Y	Y	Y	
B2-OFFX90L-0810	14720-0810	20242214	1/2	12.7	1-14	1 3/8	30	LT	2.76	70.0	1.81	46.0	3.07	78.0	NS	Y	Y	Y	Y	
B2-OFFX90S-0810	14725-0810	20242249	1/2	12.7	1-14	1 3/8	30	ST	1.28	32.5	1.81	46.0	3.07	78.0	NS	Y	Y	Y	Y	
B2-OFFX90S-0812	14725-0812	20293220	1/2	12.7	1 3/8-12	1 7/8	36	ST	2.01	51.0	2.20	56.0	3.46	88.0	NS	Y	Y	Y	Y	
B2-OFFX90-1010	14715-1010	20242242	5/8	15.9	1-14	1 3/8	30		1.73	44.0	2.17	55.0	3.54	90.0	NS	Y	Y	Y	Y	
B2-OFFX90L-1010	14720-1010	20241696	5/8	15.9	1-14	1 3/8	30	LT	2.76	70.0	2.17	55.0	3.54	90.0	NS	Y	Y	Y	Y	
B2-OFFX90S-1010	14725-1010	20242162	5/8	15.9	1-14	1 3/8	30	ST	1.28	32.5	2.05	52.0	3.43	87.0	NS	Y	Y	Y	Y	
B2-OFFX90S-1012	14725-1012	20242161	5/8	15.9	1 3/8-12	1 7/8	36	ST	1.93	49.0	2.17	55.0	3.54	90.0	NS	Y	Y	Y	Y	
B2-OFFX90S-1210	14725-1210	20242167	3/4	19.0	1-14	1 3/8	30	ST	1.26	32.0	1.75	44.5	3.31	84.0	NS	Y	Y	Y	Y	
B2-OFFX90-1212	14715-1212	20242237	3/4	19.0	1 3/8-12	1 7/8	36		2.28	58.0	2.44	62.0	3.98	101.0	NS	Y	Y	Y	Y	
B2-OFFX90L-1212	14720-1212	20242255	3/4	19.0	1 3/8-12	1 7/8	36	LT	3.78	96.0	2.44	62.0	3.98	101.0	NS	Y	Y	Y	Y	
B2-OFFX90S-1212	14725-1212	20242153	3/4	19.0	1 3/8-12	1 7/8	36	ST	2.01	51.0	2.40	61.0	3.94	100.0	NS	Y	Y	Y	Y	
B2-OFFX90S-1216	14725-1216	20242155	3/4	19.0	1 3/8-12	1 5/8	41	ST	2.80	71.0	2.60	66.0	4.13	105.0	NS	Y	Y	Y	Y	
B2-OFFX90S-1612	14725-1612	20441218	1	25.4	1 3/8-12	1 7/8	36	ST	2.01	51.0	2.17	55.0	3.90	99.0	NS	Y	Y	Y	Y	
B2-OFFX90-1616	14715-1616	20241698	1	25.4	1 7/8-12	1 5/8	41		2.60	66.0	3.27	83.0	5.00	127.0	NS	Y	Y	Y	Y	
B2-OFFX90L-1616	14720-1616	20242202	1	25.4	1 7/8-12	1 5/8	41	LT	4.49	114.0	3.27	83.0	5.00	127.0	NS	Y	Y	Y	Y	
B2-OFFX90S-1616	14725-1616	20242244	1	25.4	1 7/8-12	1 5/8	41	ST	2.28	58.0	3.27	83.0	5.00	127.0	NS	Y	Y	Y	Y	
B2-OFFX90-1620	14715-1620	20242253	1	25.4	1 1/2-12	2	50		3.07	78.0	3.27	83.0	5.00	127.0	NS	Y	Y	Y	Y	
B2-OFFX90S-1620	14725-1620	20242235	1	25.4	1 1/2-12	2	50	ST	2.52	64.0	3.27	83.0	5.00	127.0	NS	Y	Y	Y	Y	
S4-OFFX90-2020	28715-2020	20241702	1 1/4	31.8	1 1/2-12	2	50		3.07	78.0	3.82	97.0	5.87	149.0	NS	Y	Y	Y	Y	
S4-OFFX90L-2020	28720-2020	20242212	1 1/4	31.8	1 1/2-12	2	50	LT	5.08	129.0	3.82	97.0	5.87	149.0	NS	Y	Y	Y	Y	
S4-OFFX90S-2020	28725-2020	20242247	1 1/4	31.8	1 1/2-12	2	50	ST	2.68	68.0	3.74	95.0	5.79	147.0	NS	Y	Y	Y	Y	
S4-OFFX90L-2024	28720-2024	20242213	1 1/4	31.8	2-12	2 3/8	60	LT	5.55	141.0	4.02	102.0	6.06	154.0	NS	Y	Y	Y	Y	
S4-OFFX90S-2024	28725-2024	20242248	1 1/4	31.8	2-12	2 3/8	60	ST	2.72	69.0	4.02	102.0	6.06	154.0	NS	Y	Y	Y	Y	
S4-OFFX90-2424	28715-2424	20241701	1 1/2	38.1	2-12	2 3/8	60		3.43	87.0	4.25	108.0	6.57	167.0	NS	Y	Y	Y	Y	
S4-OFFX90L-2424	28720-2424	20441321	1 1/2	38.1	2-12	2 3/8	60	LT	5.55	141.0	4.37	111.0	6.69	170.0	NS	Y	Y	Y	Y	
S4-OFFX90S-2424	28725-2424	20242246	1 1/2	38.1	2-12	2 3/8	60	ST	3.07	78.0	4.02	102.0	6.34	161.0	NS	Y	Y	Y	Y	

C: Crimp Nut (see "Fitting Identification" in Appendix for details)

O-Ring Face Seal (SAE J1453) ORS/ORFS

Male

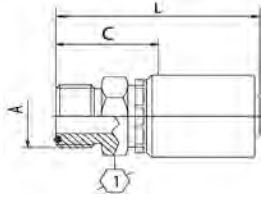

S=Skive
NS=Non-Skive
DG=Dual-Grip™

Descriptive #	Product #	SAP #	Hose Size ID		Thread Size (A)		Hex-1 Wrench Size		Cut-Off (C)		Length (L)		Skive Type	SR1SN SFS	SR2SN HR2SN LR2SN CR2SN	GR16 AR16SC	ACP3 XCP3 GR17
			in.	mm	in.	mm	in.	mm	in.	mm	in.	mm					
B2-OFM-0404	14730-0404	20242187	1/4	6.4	9/16-18	11/16	17	0.88	22.3	1.85	47.1	NS	Y	Y	Y	Y	
B2-OFM-0406	14730-0406	20441219	1/4	6.4	11/16-16	3/4	19	0.96	24.3	1.93	49.1	NS	Y	Y	Y	Y	
B2-OFM-0606	14730-0606	20242181	3/8	9.5	11/16-16	3/4	19	0.96	24.3	2.01	51.0	NS	Y	Y	Y	Y	
B2-OFM-0608	14730-0608	20242183	3/8	9.5	13/16-16	7/8	22	1.04	26.3	2.09	53.0	NS	Y	Y	Y	Y	
B2-OFM-0808	14730-0808	20242174	1/2	12.7	13/16-16	7/8	22	1.07	27.1	2.31	58.6	NS	Y	Y	Y	Y	
B2-OFM-0810	14730-0810	20242173	1/2	12.7	1-14	1 1/16	27	1.20	30.6	2.44	62.1	NS	Y	Y	Y	Y	
B2-OFM-0812	14730-0812	20242172	1/2	12.7	1 3/16-12	1 1/4	32	1.34	34.1	2.58	65.6	NS	Y	Y	Y	Y	
B2-OFM-1010	14730-1010	20242186	5/8	15.9	1-14	1 1/16	27	1.20	30.6	2.56	64.9	NS	Y	Y	Y	Y	
B2-OFM-1012	14730-1012	20242185	5/8	15.9	1 3/16-12	1 1/4	32	1.34	34.1	2.69	68.4	NS	Y	Y	Y	Y	
B2-OFM-1212	14730-1212	20242177	3/4	19.0	1 3/16-12	1 1/4	32	1.36	34.6	2.92	74.1	NS	Y	Y	Y	Y	
B2-OFM-1216	14730-1216	20242179	3/4	19.0	1 7/16-12	1 5/8	41	1.50	38.1	3.06	77.6	NS	Y	Y	Y	Y	
B2-OFM-1616	14730-1616	20242194	1	25.4	1 7/16-12	1 1/2	38	1.49	37.9	3.25	82.5	NS	Y	Y	Y	Y	
S4-OFM-2020	28730-2020	20242171	1 1/4	31.8	1 11/16-12	1 13/16	46	1.63	41.5	3.68	93.5	NS	Y	Y	Y	Y	

O-Ring Boss Straight Thread (SAE J514)

Male

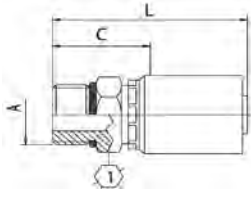

S=Skive
NS=Non-Skive
DG=Dual-Grip™

Descriptive #	Product #	SAP #	Hose Size ID		Thread Size (A)		Hex-1 Wrench Size		Cut-Off (C)		Length (L)		Skive Type	SR1SN DR1SN SFS	SR2SN HR2SN LR2SN CR2SN	GR16 SR16SC AR16SC	ACP3 XCP3 GR17
			in.	mm	in.	mm	in.	mm	in.	mm							
B2-OBM-0404	14670-0404	20242133	1/4	6.4	7/16-20	9/16	14	0.80	20.3	1.78	45.1	NS	Y	Y	Y	Y	
B2-OBM-0405	14670-0405	20242132	1/4	6.4	1/2-20	5/8	16	0.83	21.2	1.81	46.1	NS	Y	Y	Y	Y	
B2-OBM-0406	14670-0406	20242129	1/4	6.4	9/16-18	11/16	17	0.88	22.3	1.85	47.1	NS	Y	Y	Y	Y	
B2-OBM-0408	14670-0408	20297678	1/4	6.4	3/4-16	7/8	22	0.96	24.3	1.93	49.1	NS	Y	Y	Y	Y	
B2-OBM-0606	14670-0606	20242122	3/8	9.5	9/16-18	3/4	19	0.92	23.3	1.97	50.0	NS	Y	Y	Y	Y	
B2-OBM-0608	14670-0608	20242121	3/8	9.5	3/4-16	7/8	22	0.96	24.3	2.01	51.0	NS	Y	Y	Y	Y	
B2-OBM-0610	14670-0610	20242117	3/8	9.5	7/8-14	1 1/16	27	1.06	26.8	2.11	53.5	NS	Y	Y	Y	Y	
B2-OBM-0808	14670-0808	20242134	1/2	12.7	3/4-16	7/8	22	0.99	25.1	2.23	56.6	NS	Y	Y	Y	Y	
B2-OBM-0810	14670-0810	20242131	1/2	12.7	7/8-14	1 1/16	27	1.09	27.6	2.33	59.1	NS	Y	Y	Y	Y	
B2-OBM-0812	14670-0812	20242128	1/2	12.7	1 1/16-12	1 1/4	32	1.26	32.1	2.50	63.6	NS	Y	Y	Y	Y	
B2-OBM-1008	14670-1008	20293194	5/8	15.9	3/4-16	15/16	24	1.03	26.1	2.38	60.4	NS	Y	Y	Y	Y	
B2-OBM-1010	14670-1010	20293195	5/8	15.9	7/8-14	15/16	24	1.09	27.6	2.44	61.9	NS	Y	Y	Y	Y	
B2-OBM-1012	14670-1012	20242123	5/8	15.9	1 1/16-12	1 1/4	32	1.26	32.1	2.61	66.4	NS	Y	Y	Y	Y	
B2-OBM-1210	14670-1210	20242120	3/4	19.0	7/8-14	1 1/16	27	1.11	28.1	2.66	67.6	NS	Y	Y	Y	Y	
B2-OBM-1212	14670-1212	20242126	3/4	19.0	1 1/16-12	1 1/4	32	1.28	32.6	2.84	72.1	NS	Y	Y	Y	Y	
B2-OBM-1216	14670-1216	20242118	3/4	19.0	1 5/16-12	1 1/2	38	1.36	34.6	2.92	74.1	NS	Y	Y	Y	Y	
B2-OBM-1616	14670-1616	20242127	1	25.4	1 5/16-12	1 1/2	38	1.39	35.4	3.15	80.0	NS	Y	Y	Y	Y	
S4-OBM-2020	28670-2020	20293258	1 1/4	31.8	1 5/8-12	1 3/4	46	1.54	39.0	3.58	91.0		Y	Y	Y		

O-Ring Boss Straight Thread (SAE J514)

Male | Swivel

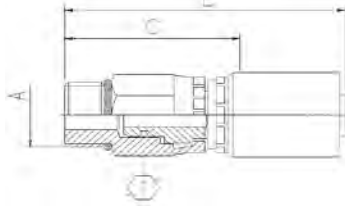

S=Skive
NS=Non-Skive
DG=Dual-Grip™

Descriptive #	Product #	SAP #	Hose Size ID		Thread Size (A)		Cut-Off (C)		Length (L)		Skive Type	SR1SN DR1SN SFS	SR2SN HR2SN LR2SN CR2SN	GR16 SR16SC AR16SC	ACP3 XCP3 GR17	
			in.	mm	in.	mm	in.	mm	in.	mm						
B2-OBMX-0404	14680-0404	20293196	1/4	6.4	7/16-20	11/16	17	1.30	33.1	2.28	57.9	NS	Y	Y	Y	Y
B2-OBMX-0406	14680-0406	20441229	1/4	6.4	9/16-18	7/8	22	1.67	42.5	2.65	67.3	NS	Y	Y	Y	Y
B2-OBMX-0606	14680-0606	20293197	3/8	9.5	9/16-18	7/8	22	1.59	40.5	2.65	67.2	NS	Y	Y	Y	Y
B2-OBMX-0608	14680-0608	20293198	3/8	9.5	3/4-16	1	25	1.71	43.5	2.76	70.2	NS	Y	Y	Y	Y
B2-OBMX-0808	14680-0808	20293199	1/2	12.7	3/4-16	1	25	1.67	42.3	2.91	73.8	NS	Y	Y	Y	Y
B2-OBMX-0810	14680-0810	20293200	1/2	12.7	7/8-14	1	25	1.72	43.8	2.96	75.3	NS	Y	Y	Y	Y
B2-OBMX-1212	14680-1212	20293201	3/4	19.0	1 1/16-12	1 1/4	32	1.95	49.6	3.51	89.1	NS	Y	Y	Y	Y

O-Ring Boss Straight Thread (SAE J514)

Male 90° Elbow (Block) | Swivel

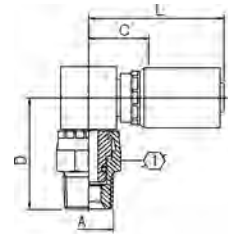

S=Skive
NS=Non-Skive
DG=Dual-Grip™

Descriptive #	Product #	SAP #	Hose Size ID		Thread Size (A)		Drop (D)		Cut-Off (C)		Length (L)		Skive Type	SR1SN DR1SN SFS	SR2SN HR2SN LR2SN CR2SN	GR16 SR16SC AR16SC	ACP3 XCP3 GR17	
			in.	mm	in.	mm	in.	mm	in.	mm	in.	mm						
B2-OBMX90B-0405	14685-0405	20293202	1/4	6.4	1/2-20	11/16	17	1.38	35.0	0.67	17.0	1.65	41.8	NS	Y	Y	Y	Y
B2-OBMX90B-0406	14685-0406	20441270	1/4	6.4	9/16-18	7/8	22	1.65	42.0	0.75	19.0	1.72	43.8	NS	Y	Y	Y	Y
B2-OBMX90B-0606	14685-0606	20293203	3/8	9.5	9/16-18	7/8	22	1.73	44.0	0.79	20.0	1.84	46.7	NS	Y	Y	Y	Y
B2-OBMX90B-0608	14685-0608	20293204	3/8	9.5	3/4-16	1	25	1.77	45.0	0.87	22.0	1.92	48.7	NS	Y	Y	Y	Y
B2-OBMX90B-0808	14685-0808	20293205	1/2	12.7	3/4-16	1	25	1.89	48.0	0.91	23.0	2.15	54.5	NS	Y	Y	Y	Y
B2-OBMX90B-0810	14685-0810	20293206	1/2	12.7	7/8-14	1	25	1.97	50.0	0.91	23.0	2.15	54.5	NS	Y	Y	Y	Y
B2-OBMX90B-1012	14685-1012	20294829	5/8	15.9	1 1/16-12	1 1/4	32	2.36	60.0	1.06	27.0	2.41	61.3	NS	Y	Y	Y	Y
B2-OBMX90B-1212	14685-1212	20293207	3/4	19.0	1 1/16-12	1 1/4	32	2.36	60.0	1.06	27.0	2.62	66.5	NS	Y	Y	Y	Y

Code 61 Flange (SAE J518)

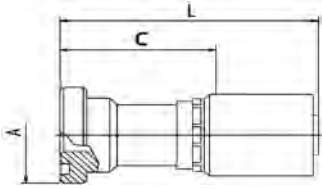

S=Skive
NS=Non-Skive
DG=Dual-Grip™

Descriptive #	Product #	SAP #	Hose Size ID		Flange Size		Flange Diameter		Cut-Off (C)		Length (L)		Skive Type	SR1SN DR1SN SFS	SR2SN HR2SN LR2SN CR2SN	GR16 SR16SC AR16SC	ACP3 XCP3 GR17
			in.	mm	in.	mm	in.	mm	in.	mm	in.	mm					
B2-FL-0808	14320-0808	20242908	1/2	12.7	1/2	1.19	30.2	1.61	41.0	2.85	72.5	NS	Y	Y	Y	Y	
B2-FL-0812	14320-0812	20242906	1/2	12.7	3/4	1.50	38.1	1.65	42.0	2.89	73.5	NS	Y	Y	Y	Y	
B2-FL-1012	14320-1012	20242899	5/8	15.9	3/4	1.50	38.1	1.66	42.2	3.01	76.5	NS	Y	Y	Y	Y	
B2-FL-1212	14320-1212	20242901	3/4	19.0	3/4	1.50	38.1	1.67	42.5	3.23	82.0	NS	Y	Y	Y	Y	
B2-FL-1216	14320-1216	20242903	3/4	19.0	1	1.75	44.5	1.99	50.5	3.54	90.0	NS	Y	Y	Y	Y	
B2-FL-1616	14320-1616	20242879	1	25.4	1	1.75	44.5	2.02	51.4	3.78	96.0	NS	Y	Y	Y	Y	
B2-FL-1620	14320-1620	20242902	1	25.4	1¼	2.00	50.8	2.12	53.9	3.88	98.5	NS	Y	Y	Y	Y	
S4-FL-2020	28320-2020	20242909	1¼	31.8	1¼	2.00	50.8	2.19	55.5	4.23	107.5	NS	Y	Y	Y		
S4-FL-2024	28320-2024	20242910	1¼	31.8	1½	2.37	60.3	2.30	58.5	4.35	110.5	NS	Y	Y	Y		
S4-FL-2424	28320-2424	20242886	1½	38.1	1½	2.37	60.3	2.31	58.8	4.63	117.5	NS	Y	Y			
S4-FL-2432	28320-2432	20242911	1½	38.1	2	2.81	71.4	2.76	70.0	5.08	129.0	NS	Y	Y			
S4-FL-3232	28320-3232	20242895	2	50.8	2	2.81	71.4	2.76	70.0	5.59	142.0	NS	Y	Y			

Code 61 Flange (SAE J518)

22.5° Elbow

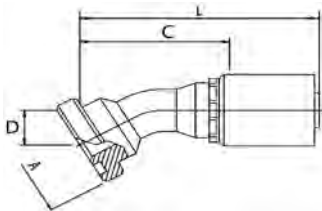

S=Skive
NS=Non-Skive
DG=Dual-Grip™

Descriptive #	Product #	SAP #	Hose Size ID		Flange Size		Drop (D)		Cut-Off (C)		Length (L)		Skive Type	SR1SN DR1SN SFS	SR2SN HR2SN LR2SN CR2SN	GR16 SR16SC AR16SC	ACP3 XCP3 GR17	
			in.	mm	in.	mm	in.	mm	in.	mm	in.	mm						in.
B2-FL22-1616	14330-1616	20242939	1	25.4	1	1.75	44.5	0.47	12.0	3.66	93.0	5.39	137.0	NS	Y	Y	Y	Y
S4-FL22-2020	28330-2020	20242928	1¼	31.8	1¼	2.00	50.8	0.63	16.0	4.49	114.0	6.54	166.0	NS	Y	Y	Y	
S4-FL22-2024	28330-2024	20293266	1¼	31.8	1½	2.37	60.3	0.81	20.5	4.53	115.0	6.57	167.0	NS	Y	Y	Y	
S4-FL22-2424	28330-2424	20242923	1½	38.1	1½	2.37	60.3	0.65	16.5	5.16	131.0	7.48	190.0	NS	Y	Y		
S4-FL22-3232	28330-3232	20293267	2	50.8	2	2.81	71.4	0.87	22.0	6.02	153.0	8.86	225.0	NS	Y	Y		

Code 61 Flange (SAE J518)

30° Elbow

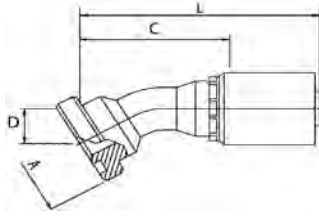

S=Skive
NS=Non-Skive
DG=Dual-Grip™

Descriptive #	Product #	SAP #	Hose Size ID		Flange Size	Flange Diameter		Drop (D)		Cut-Off (C)		Length (L)		Skive Type	SR1SN DR1SN SFS	SR2SN HR2SN LR2SN CR2SN	GR16 SR16SC AR16SC	ACP3 XCP3 GR17
			in.	mm		in.	mm	in.	mm	in.	mm	in.	mm					
B2-FL30-1616	14335-1616	20242927	1	25.4	1	1.75	44.5	0.83	21.0	3.54	90.0	5.28	134.0	NS	Y	Y	Y	Y
S4-FL30-2020	28335-2020	20242922	1¼	31.8	1¼	2.00	50.8	0.98	25.0	4.02	102.0	6.06	154.0	NS	Y	Y	Y	Y
S4-FL30-2024	28335-2024	20242913	1¼	31.8	1½	2.37	60.3	1.06	27.0	4.41	112.0	6.46	164.0	NS	Y	Y	Y	Y
S4-FL30-2424	28335-2424	20242924	1½	38.1	1½	2.37	60.3	0.91	23.0	5.35	136.0	7.68	195.0	NS	Y	Y	Y	Y
S4-FL30-2432	28335-2432	20293269	1½	38.1	2	2.81	71.4	1.44	36.5	5.91	150.0	8.23	209.0	NS	Y	Y	Y	Y
S4-FL30-3232	28335-3232	20293270	2	50.8	2	2.81	71.4	1.18	30.0	5.87	149.0	8.70	221.0	NS	Y	Y	Y	Y

Code 61 Flange (SAE J518)

45° Elbow

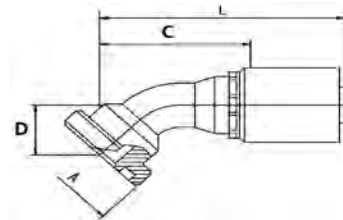

S=Skive
NS=Non-Skive
DG=Dual-Grip™

Descriptive #	Product #	SAP #	Hose Size ID		Flange Size	Flange Diameter		Drop (D)		Cut-Off (C)		Length (L)		Skive Type	SR1SN DR1SN SFS	SR2SN HR2SN LR2SN CR2SN	GR16 SR16SC AR16SC	ACP3 XCP3 GR17
			in.	mm		in.	mm	in.	mm	in.	mm	in.	mm					
B2-FL45-0808	14340-0808	20242949	1/2	12.7	1/2	1.19	30.2	0.87	22.0	2.09	53.0	3.31	84.0	NS	Y	Y	Y	Y
B2-FL45-0812	14340-0812	20242947	1/2	12.7	3/4	1.50	38.1	1.02	26.0	2.36	60.0	3.62	92.0	NS	Y	Y	Y	Y
B2-FL45-1212	14340-1212	20242942	3/4	19.0	3/4	1.50	38.1	1.26	32.0	2.91	74.0	4.45	113.0	NS	Y	Y	Y	Y
B2-FL45-1216	14340-1216	20242944	3/4	19.0	1	1.75	44.5	1.14	29.0	3.07	78.0	4.61	117.0	NS	Y	Y	Y	Y
B2-FL45-1616	14340-1616	20242919	1	25.4	1	1.75	44.5	1.32	33.5	3.27	83.0	5.00	127.0	NS	Y	Y	Y	Y
B2-FL45-1620	14340-1620	20242917	1	25.4	1¼	2.00	50.8	1.42	36.0	3.23	82.0	5.00	127.0	NS	Y	Y	Y	Y
S4-FL45-2020	28340-2020	20242934	1¼	31.8	1¼	2.00	50.8	1.48	37.5	3.74	95.0	5.79	147.0	NS	Y	Y	Y	Y
S4-FL45-2024	28340-2024	20242921	1¼	31.8	1½	2.37	60.3	1.57	40.0	4.09	104.0	6.14	156.0	NS	Y	Y	Y	Y
S4-FL45-2424	28340-2424	20242915	1½	38.1	1½	2.37	60.3	1.89	48.0	4.61	117.0	6.93	176.0	NS	Y	Y	Y	Y
S4-FL45-2432	28340-2432	20242914	1½	38.1	2	2.81	71.4	2.19	55.5	5.35	136.0	7.68	195.0	NS	Y	Y	Y	Y
S4-FL45-3232	28340-3232	20242945	2	50.8	2	2.81	71.4	1.87	47.5	5.55	141.0	8.39	213.0	NS	Y	Y	Y	Y

Code 61 Flange (SAE J518)

60° Elbow

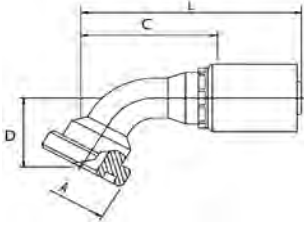

S=Skive
NS=Non-Skive
DG=Dual-Grip™

Descriptive #	Product #	SAP #	Hose Size D		Flange Size	Flange Diameter (A)		Drop (D)		Cut-Off (C)		Length (L)		Skive Type	SR1SN DR1SN SFS	SR2SN HR2SN LR2SN CR2SN	GR16 SR16SC AR16SC	ACP3 XCP3 GR17
			in.	mm		in.	mm	in.	mm	in.	mm	in.	mm					
B2-FL60-1212	14345-1212	20242938	3/4	19.0	3/4	1.50	38.1	1.46	37.0	3.39	86.0	4.92	125.0	NS	Y	Y	Y	Y
B2-FL60-1216	14345-1216	20242936	3/4	19.0	1	1.75	44.5	1.73	44.0	4.02	102.0	5.57	141.5	NS	Y	Y	Y	Y
B2-FL60-1616	14345-1616	20293255	1	25.4	1	1.75	44.5	1.85	47.0	3.98	101.0	5.73	145.6	NS	Y	Y	Y	Y
S4-FL60-2020	28345-2020	20242937	1/4	31.8	1/4	2.00	50.8	2.22	56.5	5.10	129.5	7.15	181.5	NS	Y	Y	Y	
S4-FL60-2024	28345-2024	20293271	1/4	31.8	1/2	2.37	60.3	2.28	58.0	5.31	135.0	7.36	187.0	NS	Y	Y	Y	
S4-FL60-2424	28345-2424	20293272	1/2	38.1	1/2	2.37	60.3	2.24	57.0	5.98	152.0	8.31	211.0	NS	Y	Y		
S4-FL60-2432	28345-2432	20293273	1/2	38.1	2	2.81	71.4	3.05	77.5	6.52	165.5	8.84	224.5	NS	Y	Y		
S4-FL60-3232	28345-3232	20293274	2	50.8	2	2.81	71.4	3.62	92.0	6.81	173.0	9.65	245.0	NS	Y	Y		

Code 61 Flange (SAE J518)

67° Elbow

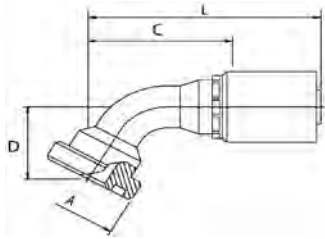

S=Skive
NS=Non-Skive
DG=Dual-Grip™

Description #	Product #	SAP #	Hose Size ID		Flange Size	Flange Diameter (A)		Drop (D)		Cut-Off (C)		Length (L)		Skive Type	SR1SN DR1SN SFS	SR2SN HR2SN LR2SN CR2SN	GR16 SR16SC AR16SC	ACP3 XCP3 GR17
			in.	MM		in.	MM	in.	MM	in.	MM	in.	MM					
B2-FL67-1616	14347-1616	20293256	1	25.4	1	1.75	44.5	1.95	49.5	3.68	93.4	5.43	138.0	NS	Y	Y	Y	Y
S4-FL67-2020	28347-2020	20293278	1/4	31.8	1/4	2.00	50.8	2.46	62.5	4.72	120.0	6.77	172.0	NS	Y	Y	Y	
S4-FL67-2424	28347-2424	20293280	1/2	38.1	1/2	2.37	60.3	2.58	65.5	5.33	135.5	7.66	194.5	NS	Y	Y		
S4-FL67-2432	28347-2432	20293281	1/2	38.1	2	2.81	71.4	3.46	88.0	5.55	141.0	7.87	200.0	NS	Y	Y		
S4-FL67-3232	28347-3232	20293282	2	50.8	2	2.81	71.4	3.76	95.5	7.05	179.0	9.88	251.0	NS	Y	Y		

Code 61 Flange (SAE J518)

90° Elbow

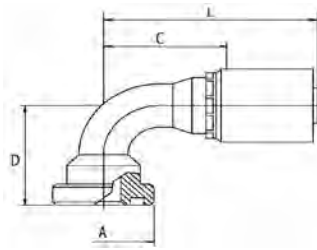

S=Skive
NS=Non-Skive
DG=Dual-Grip™

Descriptive #	Product #	SAP #	Hose Size ID		Flange Size	Flange Diameter (A)		Drop (D)		Cut-Off (C)		Length (L)		Skive Type	SR1SN DR1SN SFS	SR2SN HR2SN LR2SN CR2SN	GR16 SR16SC AR16SC	ACP3 XCP3 GR17
			in.	mm		in.	mm	in.	mm	in.	mm	in.	mm					
B2-FL90-0808	14350-0808	20242888	1/2	12.7	1/2	1.19	30.2	1.65	42.0	1.81	46.0	3.03	77.0	NS	Y	Y	Y	Y
B2-FL90-0812	14350-0812	20242877	1/2	12.7	3/4	1.50	38.1	2.01	51.0	1.77	45.0	3.03	77.0	NS	Y	Y	Y	Y
B2-FL90-1212	14350-1212	20242881	3/4	19.0	3/4	1.50	38.1	2.36	60.0	2.28	58.0	3.82	97.0	NS	Y	Y	Y	Y
B2-FL90-1216	14350-1216	20242883	3/4	19.0	1	1.75	44.5	2.54	64.5	2.60	66.0	4.17	106.0	NS	Y	Y	Y	Y
B2-FL90-1616	14350-1616	20242930	1	25.4	1	1.75	44.5	2.64	67.0	2.80	71.0	4.53	115.0	NS	Y	Y	Y	Y
B2-FL90-1620	14350-1620	20242893	1	25.4	1 1/4	2.00	50.8	2.80	71.0	2.91	74.0	4.65	118.0	NS	Y	Y	Y	Y
S4-FL90-2016	28350-2016	20242897	1 1/4	31.8	1	1.75	44.5	2.56	65.0	3.70	94.0	5.75	146.0	NS	Y	Y	Y	
S4-FL90-2020	28350-2020	20242931	1 1/4	31.8	1 1/4	2.00	50.8	3.31	84.0	3.46	88.0	5.51	140.0	NS	Y	Y	Y	
S4-FL90-2024	28350-2024	20242889	1 1/4	31.8	1 1/2	2.37	60.3	3.44	87.5	3.58	91.0	5.63	143.0	NS	Y	Y	Y	
S4-FL90-2424	28350-2424	20242891	1 1/2	38.1	1 1/2	2.37	60.3	3.58	91.0	4.13	105.0	6.46	164.0	NS	Y	Y		
S4-FL90-2432	28350-2432	20242890	1 1/2	38.1	2	2.81	71.4	4.53	115.0	4.13	105.0	6.46	164.0	NS	Y	Y		
S4-FL90-3232	28350-3232	20242894	2	50.8	2	2.81	71.4	5.12	130.0	5.08	129.0	7.91	201.0	NS	Y	Y		

Code 62 Flange (SAE J518)

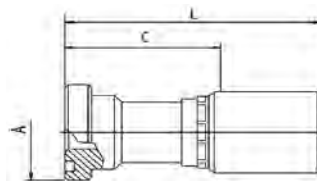

S=Skive
NS=Non-Skive
DG=Dual-Grip™

Descriptive #	Product #	SAP #	Hose Size I.D.		Flange Size	Flange Diameter (A)		Cut-Off (C)		Length (L)		Skive Type	GRS DR1SN SFS	SR2SN HR2SN LR2SN CR2SN	GR16 SR16SC AR16SC	ACP3 XCP3 GR17
			in.	mm		in.	mm	in.	mm	in.	mm					
B2-FH-1212	14300-1212	20241745	3/4	19.0	3/4	1.63	41.3	2.07	52.5	3.62	92.0	NS	Y	Y	Y	Y
B2-FH-1616	14300-1616	20242954	1	25.4	1	1.87	47.6	2.22	56.4	3.98	101.0	NS	Y	Y	Y	Y
B2-FH-1620	14300-1620	20242951	1	25.4	1 1/4	2.13	54.0	2.50	63.4	4.25	108.0	NS	Y	Y	Y	Y
S4-FH-2016	28300-2016	20441292	1 1/4	31.8	1	1.87	47.6	3.27	83.0	5.31	135.0	NS	Y	Y	Y	
S4-FH-2020	28300-2020	20241752	1 1/4	31.8	1 1/4	2.13	54.0	3.27	83.0	5.31	135.0	NS	Y	Y	Y	
S4-FH-2024	28300-2024	20241754	1 1/4	31.8	1 1/2	2.50	63.5	2.80	71.0	4.84	123.0	NS	Y	Y	Y	
S4-FH-2424	28300-2424	20241751	1 1/2	38.1	1 1/2	2.50	63.5	3.74	95.0	6.06	154.0	NS	Y	Y		
S4-FH-2432	28300-2432	20241757	1 1/2	38.1	2	3.13	79.4	2.99	76.0	5.31	135.0	NS	Y	Y		
S4-FH-3232	28300-3232	20241759	2	50.8	2	3.13	79.4	2.99	76.0	5.83	148.0	NS	Y	Y		

Code 62 Flange (SAE J518)

22.5° Elbow

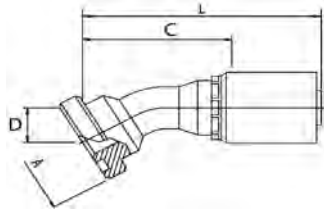

S=Skive
NS=Non-Skive
DG=Dual-Grip™

Descriptive #	Product #	SAP #	Hose Size ID		Flange Size		Flange Diameter		Drop (D)		Cut-Off (C)		Length (L)		Skive Type	SR1SN DR1SN SFS	SR2SN HR2SN LR2SN CR2SN	GR16 SR16SC AR16SC	ACP3 XCP3 GR17
			in.	mm	in.	mm	in.	mm	in.	mm	in.	mm	in.	mm					
S4-FH22-2020	28303-2020	20293291	1/4	31.8	1/4	2.13	54.0	0.69	17.5	4.72	120.0	6.77	172.0	NS	Y	Y	Y		
S4-FH22-2024	28303-2024	20293292	1/4	31.8	1/2	2.50	63.5	0.81	20.5	5.04	128.0	7.09	180.0	NS	Y	Y	Y		

Code 62 Flange (SAE J518)

30° Elbow

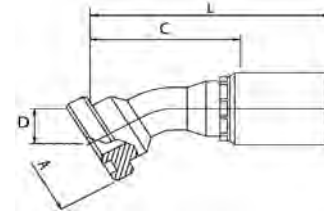

S=Skive
NS=Non-Skive
DG=Dual-Grip™

Descriptive #	Product #	SAP #	Hose Size ID		Flange Size		Flange Diameter		Drop (D)		Cut-Off (C)		Length (L)		Skive Type	SR1SN DR1SN SFS	SR2SN HR2SN LR2SN CR2SN	GR16 SR16SC AR16SC	ACP3 XCP3 GR17
			in.	mm	in.	mm	in.	mm	in.	mm	in.	mm	in.	mm					
S4-FH30-2020	28305-2020	20293295	1/4	31.8	1/4	2.13	54.0	0.96	24.5	4.61	117.0	6.65	169.0	NS	Y	Y	Y		
S4-FH30-2024	28305-2024	20293296	1/4	31.8	1/2	2.50	63.5	1.12	28.5	4.90	124.5	6.95	176.5	NS	Y	Y	Y		
S4-FH30-2424	28305-2424	20293297	1/2	38.1	1/2	2.50	63.5	1.08	27.5	5.22	132.5	7.54	191.5	NS	Y	Y			
S4-FH30-3232	28305-3232	20293298	2	50.8	2	3.13	79.4	1.44	36.5	6.65	169.0	9.49	241.0	NS	Y	Y			

Code 62 Flange (SAE J518)

45° Elbow

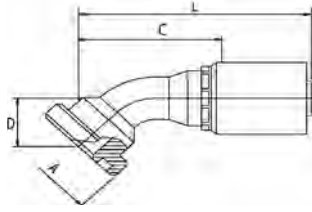

S=Skive
NS=Non-Skive
DG=Dual-Grip™

Descriptive #	Product #	SAP #	Hose Size ID		Flange Size		Flange Diameter		Drop (D)		Cut-Off (C)		Length (L)		Skive Type	GR1S DR1SN SFS	SR2SN HR2SN LR2SN CR2SN	GR16 SR16SC AR16SC	ACP3 XCP3 GR17
			in.	mm	in.	mm	in.	mm	in.	mm	in.	mm	in.	mm					
B2-FH45-1212	14310-1212	20241791	3/4	19.0	3/4	1.63	41.3	1.22	31.0	3.31	84.0	4.88	124.0	NS	Y	Y	Y	Y	
B2-FH45-1616	14310-1616	20241775	1	25.4	1	1.87	47.6	1.42	36.0	3.82	97.0	5.55	141.0	NS	Y	Y	Y	Y	
B2-FH45-1620	14310-1620	20241772	1	25.4	1 1/4	2.13	54.0	1.54	39.0	3.78	96.0	5.55	141.0	NS	Y	Y	Y	Y	
S4-FH45-2020	28310-2020	20241764	1 1/4	31.8	1 1/4	2.13	54.0	1.57	40.0	4.29	109.0	6.34	161.0	NS	Y	Y	Y		
S4-FH45-2024	28310-2024	20241765	1 1/4	31.8	1 1/2	2.50	63.5	1.79	45.5	4.53	115.0	6.57	167.0	NS	Y	Y	Y		
S4-FH45-2424	28310-2424	20241769	1 1/2	38.1	1 1/2	2.50	63.5	1.77	45.0	4.84	123.0	7.17	182.0	NS	Y	Y			
S4-FH45-2432	28310-2432	20241776	1 1/2	38.1	2	3.13	79.4	2.26	57.5	5.24	133.0	7.56	192.0	NS	Y	Y			
S4-FH45-3232	28310-3232	20241767	2	50.8	2	3.13	79.4	2.36	60.0	6.18	157.0	9.02	229.0	NS	Y	Y			

Code 62 Flange (SAE J518)

60° Elbow

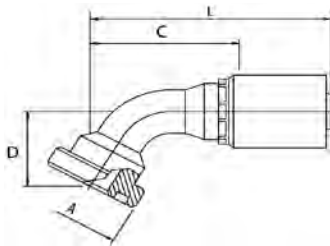

S=Skive
NS=Non-Skive
DG=Dual-Grip™

Descriptive #	Product #	SAP #	Hose Size ID		Flange Size		Flange Diameter		Drop (D)		Cut-Off (C)		Length (L)		Skive Type	SR1SN DR1SN SFS	SR2SN HR2SN LR2SN CR2SN	GR16 SR16SC AR16SC	ACP3 XCP3 GR17
			in.	mm	in.	mm	in.	mm	in.	mm	in.	mm	in.	mm					
S4-FH60-2020	28312-2020	20293301	1 1/4	31.8	1 1/4	2.13	54.0	2.32	59.0	5.26	133.5	7.30	185.5	NS	Y	Y	Y		
S4-FH60-2024	28312-2024	20293302	1 1/4	31.8	1 1/2	2.50	63.5	2.48	63.0	5.49	139.5	7.54	191.5	NS	Y	Y	Y		

Code 62 Flange (SAE J518)

90° Elbow

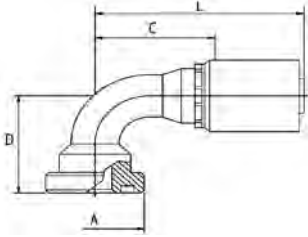

S=Skive
NS=Non-Skive
DG=Dual-Grip™

Descriptive #	Product #	SAP #	Hose Size D		Flange Size		Flange Diameter		Drop (D)		Cut-Off (C)		Length (L)		Skive Type	SR1SN DR1SN SFS	SR2SN HR2SN LR2SN CR2SN	GR16 SR16SC AR16SC	ACP3 XCP3 GR17
			in.	mm	in.	mm	in.	mm	in.	mm	in.	mm	in.	mm					
B2-FH90-0808	14315-0808	20241744	1/2	12.7	1/2	1.25	31.8	1.81	46.0	1.89	48.0	3.11	79.0	NS	Y	Y	Y	Y	
B2-FH90-1212	14315-1212	20241732	3/4	19.0	3/4	1.63	41.3	2.40	61.0	2.48	63.0	4.06	103.0	NS	Y	Y	Y	Y	
B2-FH90-1616	14315-1616	20241788	1	25.4	1	1.87	47.6	2.97	75.5	2.95	75.0	4.65	118.0	NS	Y	Y	Y	Y	
B2-FH90-1620	14315-1620	20241785	1	25.4	1 1/4	2.13	54.0	3.07	78.0	3.07	78.0	4.80	122.0	NS	Y	Y	Y	Y	
S4-FH90-2016	28315-2016	20441315	1 1/4	31.8	1	1.87	47.6	2.83	72.0	3.35	85.0	5.39	137.0	NS	Y	Y	Y	Y	
S4-FH90-2020	28315-2020	20241780	1 1/4	31.8	1 1/4	2.13	54.0	3.50	89.0	3.82	97.0	5.87	149.0	NS	Y	Y	Y	Y	
S4-FH90-2024	28315-2024	20241781	1 1/4	31.8	1 1/2	2.50	63.5	3.70	94.0	3.86	98.0	5.91	150.0	NS	Y	Y	Y	Y	
S4-FH90-2424	28315-2424	20241771	1 1/2	38.1	1 1/2	2.50	63.5	4.13	105.0	4.45	113.0	6.77	172.0	NS	Y	Y	Y	Y	
S4-FH90-2432	28315-2432	20241777	1 1/2	38.1	2	3.13	79.4	4.84	123.0	4.45	113.0	6.77	172.0	NS	Y	Y	Y	Y	
S4-FH90-3232	28315-3232	20241740	2	50.8	2	3.13	79.4	5.20	132.0	5.63	143.0	8.46	215.0	NS	Y	Y	Y	Y	

Komatsu® Flange

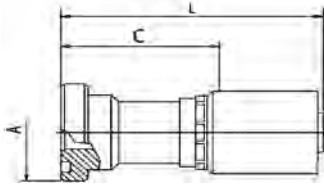

S=Skive
NS=Non-Skive
DG=Dual-Grip™

Descriptive #	Product #	SAP #	Hose Size ID		Flange Size		Flange Diameter		Cut-Off (C)		Length (L)		Skive Type	SR1SN DR1SN SFS	SR2SN HR2SN LR2SN CR2SN	GR16 SR16SC AR16SC	ACP3 XCP3 GR17
			in.	mm	in.	mm	in.	mm	in.	mm							
B2-KF-0810	14530-0810	20293257	1/2	12.7	5/8	1.34	34.0	1.84	46.7	3.08	78.2	NS	Y	Y	Y	Y	
B2-KF-1010	14530-1010	20242060	5/8	15.9	5/8	1.34	34.0	1.84	46.7	3.19	81.0	NS	Y	Y	Y	Y	

Komatsu® Flange

45° Elbow

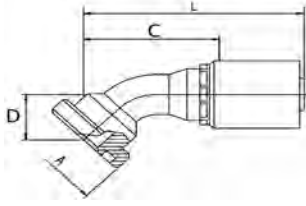

S=Skive
NS=Non-Skive
DG=Dual-Grip™

Descriptive Number	Product Number	SAP Number	Hose Size I.D.		Flange Size		Flange Diameter		Drop (D)		Cut-Off (C)		Length (L)		Skive Type	SR1SN, DR1SN, SFS	SR2SN, HR2SN, LR2SN, CR2SN	GR16, SR16SC, AR16SC	ACP3, XCP3, GR17
			in.	mm	in.	mm	in.	mm	in.	mm	in.	mm	in.	mm					
B2-KF45-1010	14535-1010	20242061	5/8	15.9	5/8	1.34	34.0	0.98	25.0	2.32	59.0	3.66	93.0	NS	Y	Y	Y	Y	

Komatsu® Flange

90° Elbow

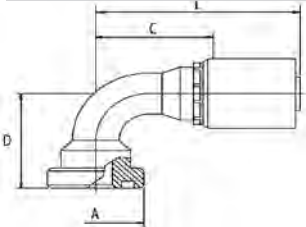

S=Skive
NS=Non-Skive
DG=Dual-Grip™

Descriptive Number	Product Number	SAP Number	Hose Size I.D.		Flange Size		Flange Diameter		Drop (D)		Cut-Off (C)		Length (L)		Skive Type	SR1SN, DR1SN, SFS	SR2SN, HR2SN, LR2SN, CR2SN	GR16, SR16SC, AR16SC	ACP3, XCP3, GR17
			in.	mm	in.	mm	in.	mm	in.	mm	in.	mm	in.	mm					
B2-KF90-1010	14540-1010	20242062	5/8	15.9	5/8	1.34	34.0	2.01	51.0	1.97	50.0	3.35	85.0	NS	Y	Y	Y	Y	

BSPB (British Standard Pipe Parallel)

Female | Swivel

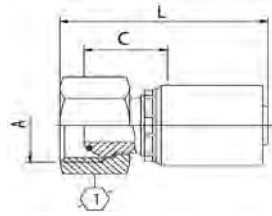

S=Skive
NS=Non-Skive
DG=Dual-Grip™

Descriptive #	Product #	SAP #	Hose Size ID		Hex-1 Wrench Size	Cut-Off (C)		Length (L)		Skive Type	SR1SN DR1SN SFS	SR2SN HR2SN LR2SN CR2SN	GR16 SR16SC AR16SC	ACP3 XCP3 GR17	
			in.	mm		mm	in.	mm	in.						mm
B2-BPFX-0404	14105-0404	20242821	1/4	6.4	1/4-19	19	0.82	20.8	1.94	49.2	NS	Y	Y	Y	Y
B2-BPFX-0406	14105-0406	20242820	1/4	6.4	3/8-19	22	0.92	23.3	2.11	53.6	NS	Y	Y	Y	Y
B2-BPFX-0606	14105-0606	20242834	3/8	9.5	3/8-19	22	0.92	23.3	2.19	55.5	NS	Y	Y	Y	Y
B2-BPFX-0608	14105-0608	20242822	3/8	9.5	1/2-14	27	0.96	24.3	2.24	56.9	NS	Y	Y	Y	Y
B2-BPFX-0808	14105-0808	20242826	1/2	12.7	1/2-14	27	0.99	25.1	2.46	62.5	NS	Y	Y	Y	Y
B2-BPFX-0810	14105-0810	20242823	1/2	12.7	5/8-14	27	1.12	28.4	2.74	69.6	NS	Y	Y	Y	Y
B2-BPFX-1010 ^C	14105-1010	20242824	5/8	15.9	5/8-14	27	0.67	17.1	2.41	61.1	NS	Y	Y	Y	Y
B2-BPFX-1012	14105-1012	20242839	5/8	15.9	3/4-14	32	1.14	29.0	2.83	71.9	NS	Y	Y	Y	Y
B2-BPFX-1212 ^C	14105-1212	20242818	3/4	19.0	3/4-14	32	0.81	20.6	2.72	69.1	NS	Y	Y	Y	Y
B2-BPFX-1616 ^C	14105-1616	20242862	1	25.4	1-11	38	0.94	23.9	3.11	79.0	NS	Y	Y	Y	Y
S4-BPFX-2020 ^T	28105-2020	20242842	1 1/4	31.8	1 1/4-11	50	1.26	32.0	3.70	94.0	NS	Y	Y	Y	
S4-BPFX-2424 ^T	28105-2424	20242860	1 1/2	38.1	1 1/2-11	55	1.33	33.8	4.13	105.0	NS	Y	Y		
S4-BPFX-3232 ^T	28105-3232	20242819	2	50.8	2-11	70	1.34	34.0	4.80	122.0	NS	Y	Y		

C: Crimp Nut T: Thrust-Wire Nut (see 'Fitting Identification' in Appendix for details)

BSPB (British Standard Pipe Parallel)

Female 45° Elbow | Swivel

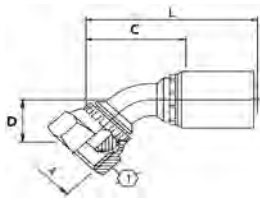

S=Skive
NS=Non-Skive
DG=Dual-Grip™

Descriptive #	Product #	SAP #	Hose Size ID		Hex-1 Wrench Size	Drop (D)		Cut-Off (C)		Length (L)		Skive Type	SR1SN DR1SN SFS	SR2SN HR2SN LR2SN CR2SN	GR16 SR16SC AR16SC	ACP3 XCP3 GR17	
			in.	mm		mm	in.	mm	in.	mm	in.						mm
B2-BPFX45-0404 ^S	14115-0404	20242851	1/4	6.4	1/4-19	19	0.59	15.0	1.81	46.0	2.76	70.0	NS	Y	Y	Y	Y
B2-BPFX45-0606 ^S	14115-0606	20242847	3/8	9.5	3/8-19	22	0.81	20.5	1.97	50.0	3.03	77.0	NS	Y	Y	Y	Y
B2-BPFX45-0808 ^S	14115-0808	20242853	1/2	12.7	1/2-14	27	0.83	21.0	2.17	55.0	3.43	87.0	NS	Y	Y	Y	Y
B2-BPFX45-1010	14115-1010	20242846	5/8	15.9	5/8-14	27	0.85	21.5	2.52	64.0	3.86	98.0	NS	Y	Y	Y	Y
B2-BPFX45-1212	14115-1212	20242849	3/4	19.0	3/4-14	32	1.10	28.0	2.76	70.0	4.33	110.0	NS	Y	Y	Y	Y
B2-BPFX45-1616	14115-1616	20242850	1	25.4	1-11	38	1.34	34.0	3.31	84.0	5.04	128.0	NS	Y	Y	Y	Y
S4-BPFX45-2020 ^T	28115-2020	20242854	1 1/4	31.8	1 1/4-11	50	1.57	40.0	3.98	101.0	6.22	158.0	NS	Y	Y	Y	
S4-BPFX45-2424 ^T	28115-2424	20242855	1 1/2	38.1	1 1/2-11	55	1.81	46.0	4.57	116.0	7.13	181.0	NS	Y	Y		
S4-BPFX45-3232 ^T	28115-3232	20242841	2	50.8	2-11	70	2.36	60.0	5.98	152.0	9.13	232.0	NS	Y	Y		

T: Thrust-Wire Nut S: Slip Nut (see 'Fitting Identification' in Appendix for details)

BSPB (British Standard Pipe Parallel)

Female 90° Elbow | Swivel

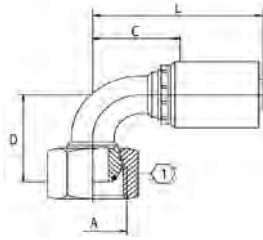

S=Skive
NS=Non-Skive
DG=Dual-Grip™

Descriptive #	Product #	SAP #	Hose Size ID		Thread Size (A)	Hex-1 Wrench Size	Drop (D)		Cut-Off (C)		Length (L)		Skive Type	SR1SN DR1SN SFS	SR2SN HR2SN LR2SN CR2SN	GR16 SR16SC AR16SC	ACP3 XCP3 GR17
			in.	mm			in.	mm	in.	mm	in.	mm					
B2-BPFX90-0404	14120-0404	20242868	1/4	6.4	1/4-19	19	1.14	29.0	1.14	29.0	2.13	54.0	NS	Y	Y	Y	Y
B2-BPFX90-0606	14120-0606	20242864	3/8	9.5	3/8-19	22	1.65	42.0	1.38	35.0	2.44	62.0	NS	Y	Y	Y	Y
B2-BPFX90-0608	14120-0608	20242859	3/8	9.5	1/2-14	27	1.40	35.5	1.34	34.0	2.40	61.0	NS	Y	Y	Y	Y
B2-BPFX90-0808	14120-0808	20242870	1/2	12.7	1/2-14	27	1.61	41.0	1.42	36.0	2.64	67.0	NS	Y	Y	Y	Y
B2-BPFX90-1010 ^C	14120-1010	20242863	5/8	15.9	5/8-14	27	1.85	47.0	1.89	48.0	3.23	82.0	NS	Y	Y	Y	Y
B2-BPFX90-1212 ^C	14120-1212	20242866	3/4	19.0	3/4-14	32	2.09	53.0	1.93	49.0	3.50	89.0	NS	Y	Y	Y	Y
B2-BPFX90-1616 ^C	14120-1616	20242845	1	25.4	1-11	38	2.72	69.0	2.95	75.0	4.72	120.0	NS	Y	Y	Y	Y
S4-BPFX90-2020 ^T	28120-2020	20242848	1 1/4	31.8	1 1/4-11	50	3.27	83.0	3.23	82.0	5.28	134.0	NS	Y	Y	Y	
S4-BPFX90-2424 ^T	28120-2424	20242843	1 1/2	38.1	1 1/2-11	55	3.78	96.0	3.78	96.0	6.10	155.0	NS	Y	Y		
S4-BPFX90-3232 ^T	28120-3232	20242867	2	50.8	2-11	70	5.35	136.0	5.04	128.0	7.87	200.0	NS	Y	Y		

C: Crimp Nut T: Thrust-Wire Nut (see 'Fitting Identification' in Appendix for details)

BSPB (British Standard Pipe Parallel)

Male

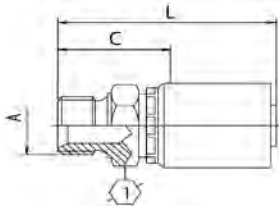

S=Skive
NS=Non-Skive
DG=Dual-Grip™

Descriptive #	Product #	SAP #	Hose Size ID		Thread Size (A)	Hex-1 Wrench Size	Cut-Off (C)		Length (L)		Skive Type	SR1SN DR1SN SFS	SR2SN HR2SN LR2SN CR2SN	GR16 SR16SC AR16SC	ACP3 XCP3 GR17
			in.	mm			in.	mm	in.	MM					
B2-BPM-0404	14130-0404	20242840	1/4	6.4	1/4-19	19	1.04	26.3	2.01	51.1	NS	Y	Y	Y	Y
B2-BPM-0606	14130-0606	20242829	3/8	9.5	3/8-19	22	1.09	27.8	2.15	54.5	NS	Y	Y	Y	Y
B2-BPM-0608	14130-0608	20242830	3/8	9.5	1/2-14	27	1.23	31.3	2.28	58.0	NS	Y	Y	Y	Y
B2-BPM-0806	14130-0806	20242835	1/2	12.7	3/8-19	22	1.13	28.6	2.37	60.1	NS	Y	Y	Y	Y
B2-BPM-0808	14130-0808	20242827	1/2	12.7	1/2-14	27	1.26	32.1	2.50	63.6	NS	Y	Y	Y	Y
B2-BPM-1010	14130-1010	20242828	5/8	15.9	5/8-14	30	1.34	34.1	2.69	68.4	NS	Y	Y	Y	Y
B2-BPM-1212	14130-1212	20242832	3/4	19.0	3/4-14	32	1.44	36.6	3.00	76.1	NS	Y	Y	Y	Y
B2-BPM-1616	14130-1616	20242838	1	25.4	1-11	41	1.61	41.0	3.43	87.0	NS	Y	Y	Y	Y
S4-BPM-2020	28130-2020	20242836	1 1/4	31.8	1 1/4-11	50	1.89	48.0	3.94	100.0	NS	Y	Y	Y	
S4-BPM-2424	28130-2424	20242837	1 1/2	38.1	1 1/2-11	55	2.01	51.0	4.33	110.0	NS	Y	Y		
S4-BPM-3232	28130-3232	20242833	2	50.8	2-11	70	2.22	56.5	5.06	128.5	NS	Y	Y		

BSPT (British Standard Pipe Tapered)

Male

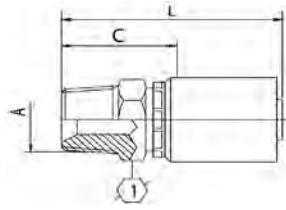

S=Skive
NS=Non-Skive
DG=Dual-Grip™

Descriptive #	Product #	SAP #	Hose Size ID		Thread Size (A)	Hex-1 Wrench Size	Cut-Off (C)		Length (L)		Skive Type	SR1SN DR1SN SFS	SR2SN HR2SN LR2SN CR2SN	GR16 SR16SC AR16SC	ACP3 XCP3 GR17
			in.	mm			in.	mm	in.	mm					
B2-BTM-0404	14170-0404	20242873	1/4	6.4	1/4-19	17	1.06	26.8	2.03	51.6	NS	Y	Y	Y	Y
B2-BTM-0606	14170-0606	20242872	3/8	9.5	3/8-19	19	1.09	27.8	2.15	54.5	NS	Y	Y	Y	Y
B2-BTM-0808	14170-0808	20242871	1/2	12.7	1/2-14	22	1.30	33.1	2.54	64.6	NS	Y	Y	Y	Y
B2-BTM-1212	14170-1212	20242876	3/4	19.0	3/4-14	27	1.36	34.6	2.92	74.1	NS	Y	Y	Y	Y
B2-BTM-1616	14170-1616	20242874	1	25.4	1-11	36	1.75	44.4	3.50	89.0	NS	Y	Y	Y	Y

BSP Flat Seat (British Standard Pipe)

Female | Swivel

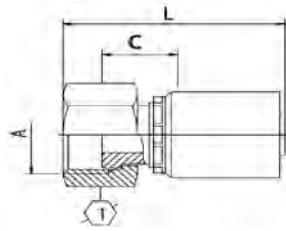

S=Skive
NS=Non-Skive
DG=Dual-Grip™

Descriptive #	Product #	SAP #	Hose Size ID		Thread Size (A)	Hex-1 Wrench Size	Cut-Off (C)		Length (L)		Skive Type	SR1SN DR1SN SFS	SR2SN HR2SN LR2SN CR2SN	GR16 SR16SC AR16SC	ACP3 XCP3 GR17
			in.	mm			in.	mm	in.	mm					
B2-BFFX-0606	14100-0606	20242815	3/8	9.5	3/8-19	22	0.80	20.3	2.22	56.3	NS	Y	Y	Y	Y
B2-BFFX-0608	14100-0608	20242814	3/8	9.5	1/2-14	27	0.82	20.8	2.28	57.9	NS	Y	Y	Y	Y
B2-BFFX-0808	14100-0808	20242816	1/2	12.7	1/2-14	27	0.85	21.6	2.50	63.5	NS	Y	Y	Y	Y
B2-BFFX-0812	14100-0812	20242812	1/2	12.7	3/4-14	32	0.97	24.6	2.70	68.6	NS	Y	Y	Y	Y
B2-BFFX-1212 ^C	14100-1212	20242813	3/4	19.0	3/4-14	32	0.71	18.1	2.72	69.1	NS	Y	Y	Y	Y

C: Crimp Nut (see 'Fitting Identification' in Appendix for details)

DIN 24° Light

Female | Swivel

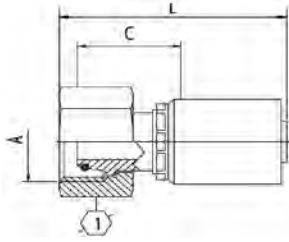

S=Skive
NS=Non-Skive
DG=Dual-Grip™

Descriptive #	Product #	SAP #	Hose Size ID		Thread Size (A)	Hex-1 Wrench Size	Cut-Off (C)		Length (L)		Skive Type	SR1SN DR1SN SFS	SR2SN HR2SN LR2SN CR2SN	GR16 SR16SC AR16SC	ACP3 XCP3 GR17
			in.	mm			in.	mm	in.	mm					
B2-DLFX-0412T	14240-0412	20241852	1/4	6.4	12 x 1½	14	0.98	24.8	1.99	50.6	NS	Y	Y	Y	Y
B2-DLFX-0414	14240-0414	20241837	1/4	6.4	14 x 1½	17	0.96	24.4	1.98	50.2	NS	Y	Y	Y	Y
B2-DLFX-0416	14240-0416	20241845	1/4	6.4	16 x 1½	19	1.00	25.4	2.04	51.9	NS	Y	Y	Y	Y
B2-DLFX-0616	14240-0616	20241842	3/8	9.5	16 x 1½	19	1.10	28.0	2.28	58.0	NS	Y	Y	Y	Y
B2-DLFX-0618	14240-0618	20241843	3/8	9.5	18 x 1½	22	1.00	25.4	2.10	53.3	NS	Y	Y	Y	Y
B2-DLFX-0822	14240-0822	20241859	1/2	12.7	22 x 1½	27	1.11	28.2	2.43	61.8	NS	Y	Y	Y	Y
B2-DLFX-1026	14240-1026	20241844	5/8	15.9	26 x 1½	32	1.15	29.2	2.58	65.6	NS	Y	Y	Y	Y
B2-DLFX-1230	14240-1230	20241840	3/4	19.0	30 x 2	36	1.25	31.7	2.93	74.5	NS	Y	Y	Y	Y
B2-DLFX-1636	14240-1636	20241871	1	25.4	36 x 2	41	1.32	33.6	3.25	82.5	NS	Y	Y	Y	Y
S4-DLFX-2045	28240-2045	20241857	1¼	31.8	45 x 2	50	1.58	40.1	3.78	95.9		Y	Y	Y	
S4-DLFX-2452	28240-2452	20441314	1½	38.1	52 x 2	60	1.59	40.5	4.05	102.8		Y	Y		

T: Thrust-Wire Nut (see 'Fitting Identification' in Appendix for details)

DIN 24° Light

Female 45° Elbow | Swivel

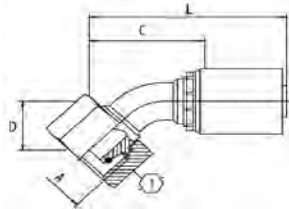

S=Skive
NS=Non-Skive
DG=Dual-Grip™

Descriptive #	Product #	SAP #	Hose Size ID		Thread Size (A)	Hex-1 Wrench Size	Drop (D)		Cut-Off (C)		Length (L)		Skive Type	SR1SN DR1SN SFS	SR2SN HR2SN LR2SN CR2SN	GR16 SR16SC AR16SC	ACP3 XCP3 GR17
			in.	mm			in.	mm	in.	mm	in.	mm					
B2-DLFX45-0414	14245-0414	20241855	1/4	6.4	14 x 1½	17	0.69	17.5	1.69	43.0	2.68	68.0	NS	Y	Y	Y	Y
B2-DLFX45-0416	14245-0416	20241860	1/4	6.4	16 x 1½	19	0.79	20.0	1.65	42.0	2.64	67.0	NS	Y	Y	Y	Y
B2-DLFX45-0616	14245-0616	20441216	3/8	9.5	16 x 1½	19	0.71	18.0	1.73	44.0	2.91	74.0	NS	Y	Y	Y	Y
B2-DLFX45-0618	14245-0618	20241862	3/8	9.5	18 x 1½	22	0.77	19.5	1.85	47.0	2.96	75.2	NS	Y	Y	Y	Y
B2-DLFX45-0822	14245-0822	20241858	1/2	12.7	22 x 1½	27	0.83	21.0	2.17	55.0	3.50	89.0	NS	Y	Y	Y	Y
B2-DLFX45-1026	14245-1026	20241863	5/8	15.9	26 x 1½	32	0.94	24.0	2.56	65.0	4.02	102.0	NS	Y	Y	Y	Y
B2-DLFX45-1230	14245-1230	20241861	3/4	19.0	30 x 2	36	1.26	32.0	2.72	69.0	4.42	112.3	NS	Y	Y	Y	Y
B2-DLFX45-1636	14245-1636	20241856	1	25.4	36 x 2	41	1.26	32.0	3.58	91.0	5.35	136.0	NS	Y	Y	Y	Y
S4-DLFX45-2452	28245-2452	20588801	1½	38.1	52 x 2	60	1.85	47.0	4.49	114.0	6.82	173.2	NS	Y	Y		

DIN 24° Light

Female 90° Elbow | Swivel

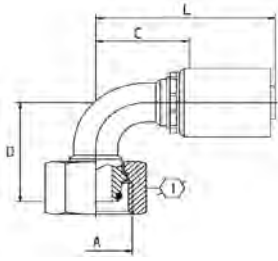

S=Skive
NS=Non-Skive
DG=Dual-Grip™

Descriptive #	Product #	SAP #	Hose Size ID		Thread Size (A)	Hex-1 Wrench Size	Drop (D)		Cut-Off (C)		Length (L)		Skive Type	SR1SN	SR2SN	GR16	ACP3
			in.	mm			in.	mm	in.	mm	in.	mm		DR1SN SFS	HR2SN LR2SN CR2SN	SR16SC AR16SC	XCP3 GR17
B2-DLFX90-0412	14250-0412	20241866	1/4	6.4	12 x 1½	14	1.02	26.0	1.14	29.0	2.13	54.0	NS	Y	Y	Y	Y
B2-DLFX90-0414	14250-0414	20241867	1/4	6.4	14 x 1½	17	1.28	32.5	1.10	28.0	2.09	53.0	NS	Y	Y	Y	Y
B2-DLFX90-0416	14250-0416	20241868	1/4	6.4	16 x 1½	19	1.28	32.5	1.10	28.0	2.09	53.0	NS	Y	Y	Y	Y
B2-DLFX90-0616	14250-0616	20289910	3/8	9.5	16 x 1½	19	1.42	36.0	1.18	30.0	2.36	60.0	NS	Y	Y	Y	Y
B2-DLFX90-0618	14250-0618	20241870	3/8	9.5	18 x 1½	22	1.54	39.0	1.30	33.0	2.36	60.0	NS	Y	Y	Y	Y
B2-DLFX90-0822	14250-0822	20241865	1/2	12.7	22 x 1½	27	1.59	40.5	1.57	40.0	2.80	71.0	NS	Y	Y	Y	Y
B2-DLFX90-1026	14250-1026	20241853	5/8	15.9	26 x 1½	32	1.89	48.0	2.01	51.0	3.39	86.0	NS	Y	Y	Y	Y
B2-DLFX90-1230	14250-1230	20241869	3/4	19.0	30 x 2	36	2.32	59.0	2.05	52.0	3.62	92.0	NS	Y	Y	Y	Y
B2-DLFX90-1636	14250-1636	20241864	1	25.4	36 x 2	41	2.68	68.0	3.07	78.0	4.80	122.0	NS	Y	Y	Y	Y
S4-DLFX90-2045	28250-2045	20241872	1¼	31.8	45 x 2	50	3.50	89.0	3.54	90.0	5.59	142.0	NS	Y	Y	Y	Y
S4-DLFX90-2452	28250-2452	20588800	1½	38.1	52 x 2	60	3.84	97.5	4.21	107.0	6.54	166.1	NS	Y	Y		

DIN 24° Light

Male

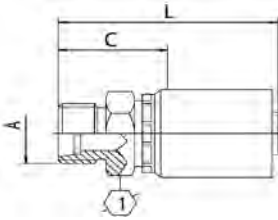

S=Skive
NS=Non-Skive
DG=Dual-Grip™

Descriptive #	Product #	SAP #	Hose Size ID		Thread Size (A)	Hex-1 Wrench Size	Cut-Off (C)		Length (L)		Skive Type	SR1SN	SR2SN	GR16	ACP3
			in.	mm			in.	mm	in.	mm		DR1SN SFS	HR2SN LR2SN CR2SN	SR16SC AR16SC	XCP3 GR17
B2-DLM-0412	14255-0412	20241847	1/4	6.4	12 x 1½	14	0.84	21.3	1.81	46.1	NS	Y	Y	Y	Y
B2-DLM-0414	14255-0414	20241848	1/4	6.4	14 x 1½	14	0.84	21.3	1.81	46.1	NS	Y	Y	Y	Y
B2-DLM-0416	14255-0416	20241849	1/4	6.4	16 x 1½	17	0.92	23.3	1.89	48.1	NS	Y	Y	Y	Y
B2-DLM-0616	14255-0616	20241850	3/8	9.5	16 x 1½	17	0.92	23.3	1.89	50.0	NS	Y	Y	Y	Y
B2-DLM-0618	14255-0618	20241838	3/8	9.5	18 x 1½	19	0.96	24.3	2.01	51.0	NS	Y	Y	Y	Y
B2-DLM-0622	14255-0622	20274103	3/8	9.5	22 x 1½	22	1.04	26.3	2.05	52.0	NS	Y	Y	Y	Y
B2-DLM-0822	14255-0822	20241846	1/2	12.7	22 x 1½	22	1.03	26.1	2.27	57.6	NS	Y	Y	Y	Y
B2-DLM-1026	14255-1026	20241851	5/8	15.9	26 x 1½	27	1.07	27.1	2.42	61.4	NS	Y	Y	Y	Y
B2-DLM-1230	14255-1230	20241854	3/4	19.0	30 x 2	32	1.24	31.6	2.80	71.1	NS	Y	Y	Y	Y
B2-DLM-1636	14255-1636	20241839	1	25.4	36 x 2	36	1.35	34.4	3.11	79.0	NS	Y	Y	Y	Y

DIN 24° Heavy

Female | Swivel

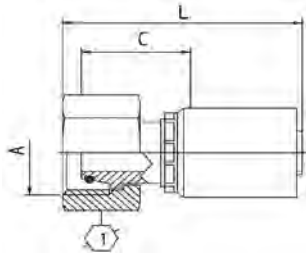

S=Skive
NS=Non-Skive
DG=Dual-Grip™

Descriptive #	Product #	SAP #	Hose Size ID		Thread Size (A)	Hex-1 Wrench Size	Cut-Off (C)		Length (L)		Skive Type	SR1SN DR1SN SFS	SR2SN HR2SN LR2SN CR2SN	GR16 SR16SC AR16SC	ACP3 XCP3 GR17
			in.	mm			in.	mm	in.	mm					
B2-DHFX-0416	14210-0416	20241801	1/4	6.4	16 x 1½	19	1.09	27.7	2.12	53.8	NS	Y	Y	Y	Y
B2-DHFX-0418	14210-0418	20241805	1/4	6.4	18 x 1½	22	1.09	27.6	2.11	53.6	NS	Y	Y	Y	Y
B2-DHFX-0618	14210-0618	20293217	3/8	9.5	18 x 1½	22	1.09	27.6	2.35	59.8	NS	Y	Y	Y	Y
B2-DHFX-0620	14210-0620	20241796	3/8	9.5	20 x 1½	24	1.09	27.6	2.25	57.1	NS	Y	Y	Y	Y
B2-DHFX-0622	14210-0622	20241803	3/8	9.5	22 x 1½	27	1.22	31.1	2.44	62.1	NS	Y	Y	Y	Y
B2-DHFX-0820	14210-0820	20441214	1/2	12.7	20 x 1½	24	1.12	28.4	2.41	61.1	NS	Y	Y	Y	Y
B2-DHFX-0824	14210-0824	20241815	1/2	12.7	24 x 1½	30	1.25	31.7	2.67	67.7	NS	Y	Y	Y	Y
B2-DHFX-1030	14210-1030	20241807	5/8	15.9	30 x 2	36	1.44	36.5	2.93	74.3	NS	Y	Y	Y	Y
B2-DHFX-1230T	14210-1230	20241800	3/4	19.0	30 x 2	36	1.46	37.0	3.13	79.5	NS	Y	Y	Y	Y
B2-DHFX-1236	14210-1236	20241799	3/4	19.0	36 x 2	46	1.58	40.2	3.39	86.2	NS	Y	Y	Y	Y
B2-DHFX-1642	14210-1642	20241830	1	25.4	42 x 2	50	1.70	43.1	3.65	92.7	NS	Y	Y	Y	Y
S4-DHFX-2042	28210-2042	20241721	1¼	31.8	42 x 2	50	1.76	44.7	4.00	101.7	NS	Y	Y	Y	
S4-DHFX-2052	28210-2052	20241818	1¼	31.8	52 x 2	60	1.89	48.1	4.18	106.1	NS	Y	Y	Y	

DIN 24° Heavy

Female 45° Elbow | Swivel

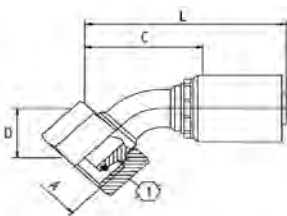

S=Skive
NS=Non-Skive
DG=Dual-Grip™

Descriptive #	Product #	SAP #	Hose Size ID		Thread Size (A)	Hex-1 Wrench Size	Drop (D)		Cut-Off (C)		Length (L)		Skive Type	SR1SN DR1SN SFS	SR2SN HR2SN LR2SN CR2SN	GR16 SR16SC AR16SC	ACP3 XCP3 GR17
			in.	mm			in.	mm	in.	mm	in.	mm					
B2-DHFX45-0416	14215-0416	20441303	1/4	6.4	16 x 1½	19	0.63	16.0	1.93	49.0	2.87	73.0	NS	Y	Y	Y	Y
B2-DHFX45-0418	14215-0418	20241817	1/4	6.4	18 x 1½	22	0.75	19.0	1.69	43.0	2.68	68.0	NS	Y	Y	Y	Y
B2-DHFX45-0620	14215-0620	20241821	3/8	9.5	20 x 1½	24	0.79	20.0	2.01	51.0	3.03	77.0	NS	Y	Y	Y	Y
B2-DHFX45-0622	14215-0622	20241822	3/8	9.5	22 x 1½	27	0.83	21.0	2.09	53.0	3.15	80.0	NS	Y	Y	Y	Y
B2-DHFX45-0824	14215-0824	20241819	1/2	12.7	24 x 1½	30	0.85	21.5	2.20	56.0	3.43	87.0	NS	Y	Y	Y	Y
B2-DHFX45-1030	14215-1030	20241823	5/8	15.9	30 x 2	36	1.18	30.0	2.60	66.0	3.98	101.0	NS	Y	Y	Y	Y
B2-DHFX45-1236	14215-1236	20241820	3/4	19.0	36 x 2	46	1.30	33.0	2.72	69.0	4.29	109.0	NS	Y	Y	Y	Y
B2-DHFX45-1642	14215-1642	20241828	1	25.4	42 x 2	50	1.59	40.5	4.33	110.0	6.10	155.0	NS	Y	Y	Y	Y

DIN 24° Heavy

Female 90° Elbow | Swivel

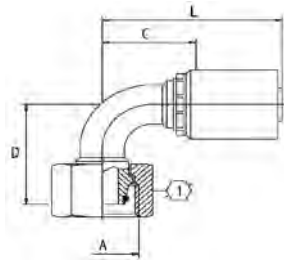

S=Skive
NS=Non-Skive
DG=Dual-Grip™

Descriptive #	Product #	SAP #	Hose Size ID		Thread Size (A)	Hex-1 Wrench Size	Drop (D)		Cut-Off (C)		Length (L)		Skive Type	SR1SN	SR2SN	GR16	ACP3
			in.	mm			in.	mm	in.	mm	in.	mm		in.	mm	DR1SN SFS	HR2SN LR2SN CR2SN
B2-DHFX90-0416	14220-0416	20477376	1/4	6.4	16 x 1½	19	1.30	33.0	1.06	27.0	2.05	52.0	NS	Y	Y	Y	Y
B2-DHFX90-0418	14220-0418	20241829	1/4	6.4	18 x 1½	22	1.34	34.0	1.06	27.0	2.05	52.0	NS	Y	Y	Y	Y
B2-DHFX90-0618	14220-0618	20441215	3/8	9.5	18 x 1½	22	1.34	34.0	1.18	30.0	2.36	60.0	NS	Y	Y	Y	Y
B2-DHFX90-0620	14220-0620	20241797	3/8	9.5	20 x 1½	24	1.52	38.5	1.34	34.0	2.40	61.0	NS	Y	Y	Y	Y
B2-DHFX90-0622	14220-0622	20241835	3/8	9.5	22 x 1½	27	1.59	40.5	1.34	34.0	2.40	61.0	NS	Y	Y	Y	Y
B2-DHFX90-0824	14220-0824	20241825	1/2	12.7	24 x 1½	30	1.63	41.5	1.57	40.0	2.80	71.0	NS	Y	Y	Y	Y
B2-DHFX90-1030	14220-1030	20241832	5/8	15.9	30 x 2	36	2.17	55.0	1.89	48.0	3.23	82.0	NS	Y	Y	Y	Y
B2-DHFX90-1236	14220-1236	20241836	3/4	19.0	36 x 2	46	2.34	59.5	2.01	51.0	3.54	90.0	NS	Y	Y	Y	Y
B2-DHFX90-1642	14220-1642	20241824	1	25.4	42 x 2	50	3.11	79.0	2.99	76.0	4.72	120.0	NS	Y	Y	Y	Y
S4-DHFX90-2052	28220-2052	20265706	1¼	31.8	52 x 2	60	3.62	92.0	3.70	94.0	5.75	146.0	NS	Y	Y	Y	Y

DIN 24° Heavy

Male

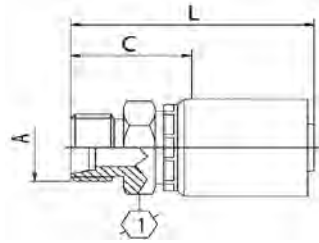

S=Skive
NS=Non-Skive
DG=Dual-Grip™

Descriptive #	Product #	SAP #	Hose Size ID		Thread Size (A)	Hex-1 Wrench Size	Cut-Off (C)		Length (L)		Skive Type	SR1SN	SR2SN	GR16	ACP3
			in.	mm			in.	mm	in.	mm		DR1SN SFS	HR2SN LR2SN CR2SN	SR16SC AR16SC	XCP3 GR17
B2-DHM-0416	14225-0416	20241810	1/4	6.4	16 x 1½	17	0.96	24.3	1.93	49.1	NS	Y	Y	Y	Y
B2-DHM-0418	14225-0418	20241811	1/4	6.4	18 x 1½	19	1.00	25.3	1.97	50.1	NS	Y	Y	Y	Y
B2-DHM-0620	14225-0620	20241813	3/8	9.5	20 x 1½	22	1.00	25.3	2.05	52.0	NS	Y	Y	Y	Y
B2-DHM-0622	14225-0622	20241804	3/8	9.5	22 x 1½	22	1.07	27.3	2.13	54.0	NS	Y	Y	Y	Y
B2-DHM-0824	14225-0824	20241809	1/2	12.7	24 x 1½	24	1.15	29.1	2.39	60.6	NS	Y	Y	Y	Y
B2-DHM-1030	14225-1030	20241814	5/8	15.9	30 x 2	32	1.30	33.1	2.65	67.4	NS	Y	Y	Y	Y
B2-DHM-1230	14225-1230	20241812	3/4	19.0	30 x 2	32	1.32	33.6	2.88	73.1	NS	Y	Y	Y	Y
B2-DHM-1236	14225-1236	20241816	3/4	19.0	36 x 2	36	1.48	37.6	3.04	77.1	NS	Y	Y	Y	Y
B2-DHM-1642	14225-1642	20241808	1	25.4	42 x 2	46	1.67	42.4	3.43	87.0	NS	Y	Y	Y	Y

DIN 60°

Female 45° Elbow | Swivel

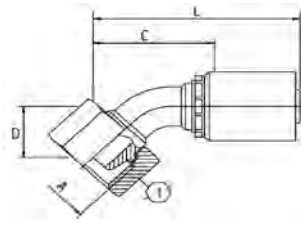

S=Skive
NS=Non-Skive
DG=Dual-Grip™

Descriptive #	Product #	SAP #	Hose Size ID		Thread Size (A)	Hex-1 Wrench Size	Drop (D)		Cut-Off (C)		Length (L)		Skive Type	SR1SN	SR2SN	GR16	ACP3
			in.	mm			in.	mm	in.	mm	in.	mm					
B2-DNFX45-0414	14275-0414	20241882	1/4	6.4	14 x 1½	17	0.63	16.0	1.38	35.0	2.54	64.5	NS	Y	Y	Y	Y
B2-DNFX45-0416	14275-0416	20241881	1/4	6.4	16 x 1½	19	0.67	17.0	1.42	36.0	2.58	65.5	NS	Y	Y	Y	Y
B2-DNFX45-0618	14275-0618	20241873	3/8	9.5	18 x 1½	22	0.77	19.5	1.69	43.0	2.76	70.0	NS	Y	Y	Y	Y
B2-DNFX45-0822	14275-0822	20241879	1/2	12.7	22 x 1½	27	0.79	20.0	2.17	55.0	3.39	86.0	NS	Y	Y	Y	Y
B2-DNFX45-1026	14275-1026	20241880	5/8	15.9	26 x 1½	32	1.02	26.0	2.44	62.0	3.90	99.0	NS	Y	Y	Y	Y

DIN 60°

Female 90° Elbow | Swivel

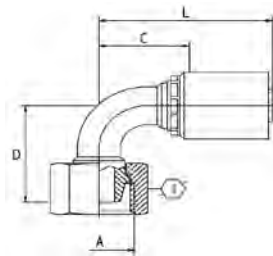

S=Skive
NS=Non-Skive
DG=Dual-Grip™

Descriptive #	Product #	SAP #	Hose Size ID		Thread Size (A)	Hex-1 Wrench Size	Drop (D)		Cut-Off (C)		Length (L)		Skive Type	SR1SN	SR2SN	GR16	ACP3
			in.	mm			in.	mm	in.	mm	in.	mm					
B2-DNFX90-0414	14280-0414	20241878	1/4	6.4	14 x 1½	17	1.12	28.5	1.18	30.0	2.17	55.0	NS	Y	Y	Y	Y
B2-DNFX90-0416	14280-0416	20241877	1/4	6.4	16 x 1½	19	1.28	32.5	1.10	28.0	2.09	53.0	NS	Y	Y	Y	Y
B2-DNFX90-0616	14280-0616	20241876	3/8	9.5	16 x 1½	19	1.26	32.0	1.18	30.0	2.36	60.0	NS	Y	Y	Y	Y
B2-DNFX90-0618	14280-0618	20241875	3/8	9.5	18 x 1½	22	1.46	37.0	1.30	33.0	2.36	60.0	NS	Y	Y	Y	Y
B2-DNFX90-0822	14280-0822	20241883	1/2	12.7	22 x 1½	27	1.57	40.0	1.57	40.0	2.80	71.0	NS	Y	Y	Y	Y
B2-DNFX90-1026	14280-1026	20241874	5/8	15.9	26 x 1½	32	1.85	47.0	2.05	52.0	3.39	86.0	NS	Y	Y	Y	Y

Japanese Komatsu® 30° Flare with Metric Threads

Female | Swivel

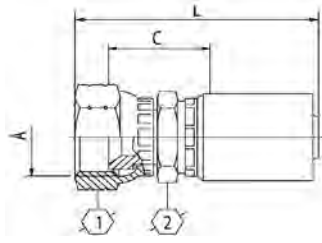

S=Skive
NS=Non-Skive
DG=Dual-Grip™

Descriptive #	Product #	SAP #	Hose Size ID		Thread Size (A)	Hex-1 Wrench Size	Hex-2 Wrench Size	Cut-Off (C)		Length (L)		Skive Type	SR1SN DR1SN SFS	SR2SN HR2SN LR2SN CR2SN	GR16 SR16SC AR16SC	ACP3 XCP3 GR17
			in.	mm				mm	mm	in.	mm					
B2-KMFX-0414	14545-0414	20241888	1/4	6.4	14 x 1.5	19	17	0.82	20.8	2.19	55.6	NS	Y	Y	Y	Y
B2-KMFX-0618	14545-0618	20241894	3/8	9.5	18 x 1.5	22	19	0.86	21.8	2.30	58.5	NS	Y	Y	Y	Y
B2-KMFX-0822	14545-0822	20241891	1/2	12.7	22 x 1.5	27	22	0.93	23.6	2.62	66.6	NS	Y	Y	Y	Y
B2-KMFX-1024	14545-1024	20241886	5/8	15.9	24 x 1.5	32	30	1.07	27.1	3.01	76.4	NS	Y	Y	Y	Y
B2-KMFX-1230	14545-1230	20241884	3/4	19.0	30 x 1.5	36	30	1.09	27.6	3.35	85.1	NS	Y	Y	Y	Y
B2-KMFX-1633	14545-1633	20241893	1	25.4	33 x 1.5	41	36	1.41	35.7	4.03	102.3	NS	Y	Y	Y	Y
S4-KMFX-2036	28545-2036	20241889	1¼	31.8	36 x 1.5	46	46	1.71	43.5	4.63	117.5	NS	Y	Y	Y	
S4-KMFX-2442	28545-2442	20241890	1½	38.1	42 x 1.5	55	55	1.73	44.0	5.04	128.0	NS	Y	Y		

Japanese Komatsu® 30° Flare with Metric Threads

Female 45° Elbow | Swivel

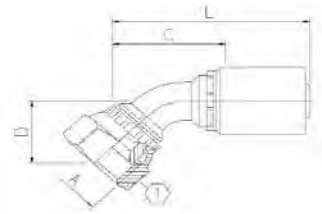

S=Skive
NS=Non-Skive
DG=Dual-Grip™

Descriptive #	Product #	SAP #	Hose Size ID		Thread Size (A)	Hex-1 Wrench Size	Drop (D)		Cut-Off (C)		Length (L)		Skive Type	SR1SN DR1SN SFS	SR2SN HR2SN LR2SN CR2SN	GR16 SR16SC AR16SC	ACP3 XCP3 GR17
			in.	mm			mm	in.	mm	in.	mm	in.					
B2-KMFX45-0414	14548-0414	20293383	1/4	6.4	14 x 1.5	19	0.61	15.5	1.50	38.0	2.48	63.0	NS	Y	Y	Y	Y
B2-KMFX45-0618	14548-0618	20293384	3/8	9.5	18 X 1.5	22	0.71	18.0	1.73	44.0	2.76	70.0	NS	Y	Y	Y	Y
B2-KMFX45-1024	14548-1024	20293386	5/8	15.9	24 x 1.5	32	1.32	33.5	2.72	69.0	4.06	103.0	NS	Y	Y	Y	Y
B2-KMFX45-1230	14548-1230	20293387	3/4	19.0	30 x 1.5	36	1.67	42.5	3.11	79.0	4.65	118.0	NS	Y	Y	Y	Y
B2-KMFX45-1633	14548-1633	20293388	1	25.4	33 x 1.5	41	2.52	64.0	4.69	119.0	6.46	164.0	NS	Y	Y	Y	Y

Japanese Komatsu® 30° Flare with Metric Threads

Female 90° Elbow | Swivel

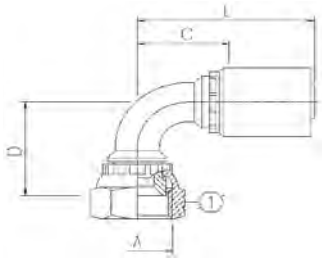

S=Skive
NS=Non-Skive
DG=Dual-Grip™

Descriptive #	Product #	SAP #	Hose Size ID		Thread Size (A)	Hex-1 Wrench Size	Drop (D)		Cut-Off (C)		Length (L)		Skive Type	SR1SN DR1SN SFS	SR2SN HR2SN LR2SN CR2SN	GR16 SR16SC AR16SC	ACP3 XCP3 GR17
			in.	mm			in.	mm	in.	mm	in.	mm					
B2-KMFX90-0414	14550-0414	20293389	1/4	6.4	14 x 1.5	19	1.16	29.5	1.30	33.0	2.28	58.0	NS	Y	Y	Y	Y
B2-KMFX90-0618	14550-0618	20293390	3/8	9.5	18 x 1.5	22	1.40	35.5	1.42	36.0	2.44	62.0	NS	Y	Y	Y	Y
B2-KMFX90-0822	14550-0822	20293391	1/2	12.7	22 x 1.5	27	2.09	53.0	1.46	37.0	2.68	68.0	NS	Y	Y	Y	Y
B2-KMFX90-1024	14550-1024	20293392	5/8	15.9	24 x 1.5	32	2.44	62.0	1.97	50.0	3.31	84.0	NS	Y	Y	Y	Y
B2-KMFX90-1230	14550-1230	20293393	3/4	19.0	30 x 1.5	36	2.99	76.0	2.05	52.0	3.62	92.0	NS	Y	Y	Y	Y
B2-KMFX90-1633	14550-1633	20293394	1	25.4	33 x 1.5	41	4.49	114.0	3.11	79.0	4.84	123.0	NS	Y	Y	Y	Y

JIS 30° (Parallel Pipe Threads)

Female | Swivel

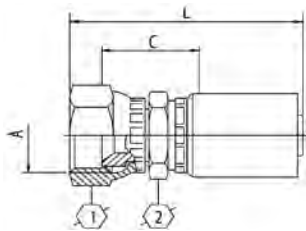

S=Skive
NS=Non-Skive
DG=Dual-Grip™

Descriptive #	Product #	SAP #	Hose Size ID		Thread Size (A)	Hex-1 Wrench Size	Hex-2 Wrench Size	Cut-Off (C)		Length (L)		Skive Type	SR1SN DR1SN SFS	SR2SN HR2SN LR2SN CR2SN	GR16 SR16SC AR16SC	ACP3 XCP3 GR17
			in.	mm				in.	mm	in.	mm					
B2-JSFX-0404	14520-0404	20242055	1/4	6.4	1/4-19	19	17	0.82	20.8	2.19	55.6	NS	Y	Y	Y	Y
B2-JSFX-0606	14520-0606	20242058	3/8	9.5	3/8-19	22	19	0.86	21.8	2.30	58.5	NS	Y	Y	Y	Y
B2-JSFX-0808	14520-0808	20242057	1/2	12.7	1/2-14	27	22	0.93	23.6	2.62	66.6	NS	Y	Y	Y	Y
B2-JSFX-1012	14520-1012	20293229	5/8	15.9	3/4-14	36	30	1.05	26.6	2.91	73.9	NS	Y	Y	Y	Y
B2-JSFX-1212	14520-1212	20242054	3/4	19.0	3/4-14	36	30	1.07	27.1	3.13	79.6	NS	Y	Y	Y	Y
B2-JSFX-1616	14520-1616	20242052	1	25.4	1-11	41	36	1.30	32.9	3.64	92.5	NS	Y	Y	Y	Y
S4-JSFX-2020 ^T	28520-2020	20241722	1 1/4	31.8	1 1/4-11	50	46	1.56	39.5	4.21	107.0	NS	Y	Y	Y	

C: Crimp Nut T: Thrust-Wire Nut (see 'Fitting Identification' in Appendix for details)

How to Use the Fitting Tables

This section lists ALL fittings that are compatible with the following hoses:

Hose Family	Hose Description
GR7	SAE 100R7/EN 855 R7
TR7	SAE 100R7 (Twin-Line)
NR7	SAE 100R7 (Non-Conductive)
BR7	SAE 100R7 (Twin-Line, Non-Conductive)
GR8	SAE 100R8/EN 855 R8
TR8	SAE 100R8 (Twin-Line)
NR8	SAE 100R8 (Non-Conductive)
GR18	SAE 100R18

Fitting Description

Fitting Type

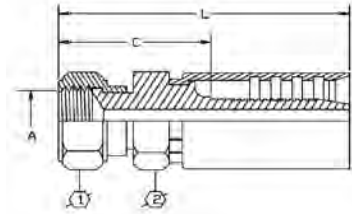

Descriptive #	Product #	SAP #	Hose Size ID		Thread Size (A)	Hex-1 Wrench Size	Hex-2 Wrench Size	Cut-Off (C)		Length (L)		Hose Family		
			in.	mm				in.	mm	in.	mm	in.	mm	GR7
T7-JCFX-0204	32400-0204	20243997	1/8	3.2	7/16-20	5/8	1/2	1.06	27.0	1.71	43.5	Y		Y
T7-JCFX-0303	32400-0303	20243995	3/16	4.8	3/8-24	9/16	9/16	1.31	33.3	2.21	56.2	Y		
T7-JCFX-0304	32400-0304	20243994	3/16	4.8	7/16-20	5/8	9/16	1.38	34.9	2.16	54.8	Y		

Choose fittings carefully considering the working pressure of both hose and fitting. The maximum working pressure of the hose assembly is the lesser of the rated working pressure of the hose and the fitting. See page 313 for working pressure.

A "Y" in the hose compatibility columns indicates that the fitting is an **Ultra-Crimp™** style fitting and that it works for that particular hose.

A **blank space** in the hose compatibility columns indicates that the fitting **DOES NOT** work for that particular hose.

JIC 37° Flare (SAE J514)

Female | Swivel

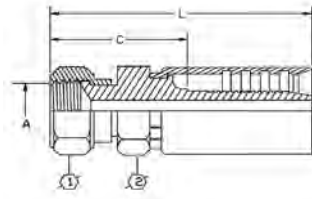

Descriptive #	Product #	SAP #	Hose Size ID		Thread Size (A)	Hex-1 Wrench Size	Hex-2 Wrench Size	Cut-Off (C)		Length (L)		GR7 TR7 NR7 BR7	GR8 TR8 NR8	GR18
			in.	mm				in.	mm	in.	mm			
T7-JCFX-0204	32400-0204	20243997	1/8	3.2	7/16-20	5/8	1/2	1.06	27.0	1.71	43.5	Y		Y
T7-JCFX-0303	32400-0303	20243995	3/16	4.8	3/8-24	9/16	9/16	1.31	33.3	2.21	56.2	Y		
T7-JCFX-0304	32400-0304	20243994	3/16	4.8	7/16-20	5/8	9/16	1.38	34.9	2.16	54.8	Y		
T8-JCFX-0304	34400-0304	20243993	3/16	4.8	7/16-20	5/8	9/16	1.38	34.9	2.16	54.8		Y	
T7-JCFX-0305	32400-0305	20243996	3/16	4.8	1/2-20	3/4	9/16	1.38	34.9	2.16	54.8	Y		
T8-JCFX-0305	34400-0305	20243999	3/16	4.8	1/2-20	3/4	9/16	1.38	34.9	2.16	54.8		Y	
T7-JCFX-0404	32400-0404	20244000	1/4	6.4	7/16-20	5/8	5/8	1.44	36.5	2.53	64.3	Y		Y
T7-JCFX-0404 ^S	32400-0404 ^S	20298359	1/4	6.4	7/16-20	5/8	5/8	1.44	36.5	2.53	64.3	Y		Y
T8-JCFX-0404	34400-0404	20243991	1/4	6.4	7/16-20	5/8	5/8	1.44	36.5	2.53	64.3		Y	
T8-JCFX-0404 ^S	34400-0404 ^S	20435884	1/4	6.4	7/16-20	5/8	5/8	1.44	36.5	2.53	64.3		Y	
T7-JCFX-0405	32400-0405	20244002	1/4	6.4	1/2-20	3/4	5/8	1.44	36.5	2.53	64.3	Y		Y
T8-JCFX-0405	34400-0405	20244001	1/4	6.4	1/2-20	3/4	5/8	1.44	36.5	2.53	64.3		Y	
T7-JCFX-0406	32400-0406	20244007	1/4	6.4	9/16-18	3/4	5/8	1.44	36.5	2.53	64.3	Y		Y
T8-JCFX-0406	34400-0406	20243998	1/4	6.4	9/16-18	3/4	5/8	1.44	36.5	2.53	64.3		Y	
T7-JCFX-0505	32400-0505	20244010	5/16	7.9	1/2-20	3/4	5/8	1.25	31.8	2.53	64.3	Y		Y
T7-JCFX-0506	32400-0506	20244009	5/16	7.9	9/16-18	3/4	5/8	1.38	34.9	2.53	64.3	Y		Y
T7-JCFX-0604	32400-0604	20244015	3/8	9.5	7/16-20	5/8	13/16	1.25	31.8	2.69	68.3	Y		Y
T8-JCFX-0604	34400-0604	20244014	3/8	9.5	7/16-20	5/8	13/16	1.25	31.8	2.69	68.3		Y	
T7-JCFX-0606	32400-0606	20244011	3/8	9.5	9/16-18	3/4	3/4	1.50	38.1	2.81	71.5	Y		Y
T8-JCFX-0606	34400-0606	20244008	3/8	9.5	9/16-18	3/4	3/4	1.38	34.9	2.81	71.5		Y	
T7-JCFX-0608	32400-0608	20244017	3/8	9.5	3/4-16	15/16	3/4	1.38	34.9	2.81	71.5	Y		Y
T8-JCFX-0608	34400-0608	20244018	3/8	9.5	3/4-16	15/16	3/4	1.38	34.9	2.81	71.5		Y	
T7-JCFX-0610	32400-0610	20244013	3/8	9.5	7/8-14	1 1/16	7/8	1.50	38.1	2.97	75.4	Y		Y
T8-JCFX-0610	34400-0610	20244012	3/8	9.5	7/8-14	1 1/16	7/8	1.50	38.1	2.97	75.4		Y	
T7-JCFX-0808	32400-0808	20243932	1/2	12.7	3/4-16	15/16	7/8	1.62	41.3	3.16	80.2	Y		Y
T8-JCFX-0808	34400-0808	20244006	1/2	12.7	3/4-16	15/16	7/8	1.62	41.3	3.16	80.2		Y	
T7-JCFX-0810	32400-0810	20244005	1/2	12.7	7/8-14	1 1/16	7/8	1.62	41.3	3.16	80.2	Y		Y
T8-JCFX-0810	34400-0810	20244004	1/2	12.7	7/8-14	1 1/16	7/8	1.62	41.3	3.16	80.2		Y	
T7-JCFX-0812	32400-0812	20243934	1/2	12.7	1 1/16-12	1 1/4	1 1/8	1.62	41.3	3.25	82.6	Y		Y
T8-JCFX-0812	34400-0812	20243935	1/2	12.7	1 1/16-12	1 1/4	1 1/8	1.62	41.3	3.25	82.6		Y	
T7-JCFX-1210	32400-1210	20244016	3/4	19.0	7/8-14	1 1/16	1 1/8	1.62	41.3	3.44	87.3	Y		
T7-JCFX-1212	32400-1212	20243992	3/4	19.0	1 1/16-12	1 1/4	1 1/8	1.62	41.3	3.44	87.3	Y		
T7-JCFX-1216	32400-1216	20244019	3/4	19.0	1 5/16-12	1 1/2	1 3/8	1.69	42.9	3.50	88.9	Y		
T7-JCFX-1616	32400-1616	20243933	1	25.4	1 5/16-12	1 1/2	1 3/8	1.69	42.9	4.06	103.2	Y		

S: Stainless Steel

JIC 37° Flare (SAE J514)

Female 45° Elbow | Swivel

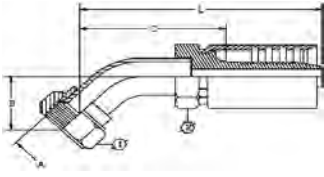

Descriptive #	Product #	SAP #	Hose Size ID		Thread Size (A)	Hex-1 Wrench Size	Hex-2 Wrench Size	Drop (D)		Cut-Off (C)		Length (L)		GR7 TR7 NR7 BR7	GR8 TR8 NR8	GR18
			in.	mm				in.	mm	in.	mm	in.	mm			
T7-JCFX45-0404	32420-0404	20243938	1/4	6.4	7/16-20	9/16	5/8	0.47	11.9	1.50	38.1	2.55	64.9	Y		Y
T8-JCFX45-0404	34420-0404	20243939	1/4	6.4	7/16-20	9/16	5/8	0.47	11.9	1.50	38.1	2.55	64.9		Y	
T7-JCFX45-0405	32420-0405	20243942	1/4	6.4	1/2-20	5/8	5/8	0.53	13.4	1.62	41.3	2.73	69.4	Y		Y
T8-JCFX45-0405	34420-0405	20243950	1/4	6.4	1/2-20	5/8	5/8	0.53	13.4	1.56	39.7	2.64	67.2		Y	
T7-JCFX45-0406	32420-0406	20243940	1/4	6.4	9/16-18	11/16	5/8	0.39	9.9	1.94	49.2	3.04	77.3	Y		Y
T8-JCFX45-0406	34420-0406	20243941	1/4	6.4	9/16-18	11/16	5/8	0.59	14.9	1.69	42.9	2.73	69.3		Y	
T7-JCFX45-0506	32420-0506	20243965	5/16	7.9	9/16-18	11/16	5/8	0.39	9.9	1.94	49.2	3.11	79.0	Y		Y
T7-JCFX45-0606	32420-0606	20243936	3/8	9.5	9/16-18	11/16	3/4	0.39	9.9	1.94	49.2	3.30	83.8	Y		Y
T8-JCFX45-0606	34420-0606	20243945	3/8	9.5	9/16-18	11/16	3/4	0.39	9.9	1.94	49.2	3.30	83.8		Y	
T7-JCFX45-0608	32420-0608	20243943	3/8	9.5	3/4-16	7/8	3/4	0.55	14.0	2.25	57.2	3.54	89.9	Y		Y
T8-JCFX45-0608	34420-0608	20243944	3/8	9.5	3/4-16	7/8	3/4	0.55	14.0	2.25	57.2	3.54	89.9		Y	
T7-JCFX45-0808	32420-0808	20243949	1/2	12.7	3/4-16	7/8	7/8	0.71	18.1	1.62	41.3	3.28	83.4	Y		Y
T8-JCFX45-0808	34420-0808	20243947	1/2	12.7	3/4-16	7/8	7/8	0.71	18.1	1.62	41.3	3.28	83.4		Y	
T7-JCFX45-0810	32420-0810	20243951	1/2	12.7	7/8-14	1	7/8	0.84	21.3	1.88	47.6	3.91	99.3	Y		Y
T8-JCFX45-0810	34420-0810	20243952	1/2	12.7	7/8-14	1	7/8	0.63	16.0	2.25	57.2	3.91	99.3		Y	
T7-JCFX45-1212	32420-1212	20243946	3/4	19.0	1 1/16-12	1 1/4	1 1/8	0.63	16.0	2.25	57.2	4.33	110.0	Y		
T7-JCFX45-1616	32420-1616	20243948	1	25.4	1 5/16-12	1 1/2	1 3/8	1.15	29.1	2.62	66.7	5.02	127.5	Y		

JIC 37° Flare (SAE J514)

Female 90° Elbow | Swivel

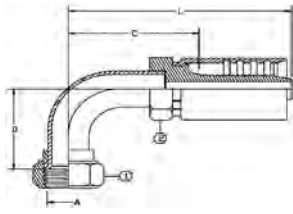

Elbow Type:
LT=Long Tube
ST=Short Tube

Descriptive #	Product #	SAP #	Hose Size ID		Thread Size (A)	Hex-1 Wrench Size	Hex-2 Wrench Size	Elbow Type	Drop (D)		Cut-Off (C)		Length (L)		GR7 TR7 NR7 BR7	GR8 TR8 NR8	GR18
			in.	mm					in.	mm	in.	mm	in.	mm			
T7-JCFX90-0404	32425-0404	20243919	1/4	6.4	7/16-20	9/16	5/8		0.68	17.3	1.69	42.9	2.76	70.0	Y		Y
T8-JCFX90-0404	34425-0404	20243931	1/4	6.4	7/16-20	9/16	5/8		0.68	17.3	1.69	42.9	2.76	70.0		Y	
T7-JCFX90L-0404	32440-0404	20243958	1/4	6.4	7/16-20	9/16	5/8	LT	1.80	45.7	1.25	31.8	2.31	58.7	Y		Y
T8-JCFX90L-0404	34440-0404	20243957	1/4	6.4	7/16-20	9/16	5/8	LT	1.80	45.7	1.25	31.8	2.31	58.7		Y	
T7-JCFX90-0405	32425-0405	20243929	1/4	6.4	1/2-20	5/8	5/8		1.00	25.4	1.31	33.3	2.38	60.3	Y		Y
T8-JCFX90-0405	34425-0405	20243930	1/4	6.4	1/2-20	5/8	5/8		1.00	25.4	1.31	33.3	2.38	60.3		Y	
T7-JCFX90L-0405	32440-0405	20243968	1/4	6.4	1/2-20	5/8	5/8	LT	1.77	45.0	1.30	32.9	2.38	60.3	Y		Y
T8-JCFX90L-0405	34440-0405	20243969	1/4	6.4	1/2-20	5/8	5/8	LT	1.77	45.0	1.31	33.3	2.38	60.3		Y	
T7-JCFX90-0406	32425-0406	20243927	1/4	6.4	9/16-18	11/16	5/8		1.12	28.6	1.94	49.2	3.25	82.6	Y		Y
T8-JCFX90-0406	34425-0406	20243916	1/4	6.4	9/16-18	11/16	5/8		1.12	28.6	1.31	33.3	2.41	61.1		Y	
T7-JCFX90L-0406	32440-0406	20243954	1/4	6.4	9/16-18	11/16	5/8	LT	2.18	55.4	1.19	30.2	2.44	61.9	Y		Y
T8-JCFX90L-0406	34440-0406	20243955	1/4	6.4	9/16-18	11/16	5/8	LT	2.18	55.4	1.19	30.2	2.44	61.9		Y	
T7-JCFX90-0505	32425-0505	20243922	5/16	7.9	1/2-20	5/8	5/8		1.00	25.4	1.12	28.6	2.38	60.3	Y		Y
T7-JCFX90-0506	32425-0506	20243937	5/16	7.9	9/16-18	11/16	5/8		0.85	21.6	1.88	47.6	3.06	77.7	Y		Y
T7-JCFX90L-0506	32440-0506	20243960	5/16	7.9	9/16-18	11/16	5/8	LT	2.18	55.4	1.19	30.2	2.44	61.9	Y		Y
T7-JCFX90-0606	32425-0606	20243920	3/8	9.5	9/16-18	11/16	3/4		0.85	21.6	1.94	49.2	3.25	82.6	Y		Y
T8-JCFX90-0606	34425-0606	20243921	3/8	9.5	9/16-18	11/16	3/4		0.85	21.6	1.94	49.2	3.25	82.6		Y	
T7-JCFX90L-0606	32440-0606	20243953	3/8	9.5	9/16-18	11/16	3/4	LT	2.18	55.4	1.94	49.2	3.24	82.3	Y		Y
T8-JCFX90L-0606	34440-0606	20243959	3/8	9.5	9/16-18	11/16	3/4	LT	2.18	55.4	1.94	49.2	3.24	82.3		Y	
T7-JCFX90-0608	32425-0608	20243923	3/8	9.5	3/4-16	7/8	3/4		1.09	27.7	2.00	50.8	3.34	84.8	Y		Y
T8-JCFX90-0608	34425-0608	20243918	3/8	9.5	3/4-16	7/8	3/4		1.09	27.7	2.00	50.8	3.34	84.8		Y	
T7-JCFX90L-0608	32440-0608	20243956	3/8	9.5	3/4-16	7/8	3/4	LT	2.43	61.7	1.31	33.3	2.75	69.9	Y		Y
T8-JCFX90L-0608	34440-0608	20243962	3/8	9.5	3/4-16	7/8	3/4	LT	2.43	61.7	1.31	33.3	2.75	69.9		Y	
T7-JCFX90-0808	32425-0808	20243925	1/2	12.7	3/4-16	7/8	7/8		1.09	27.7	1.94	49.2	3.53	89.7	Y		Y
T8-JCFX90-0808	34425-0808	20243926	1/2	12.7	3/4-16	7/8	7/8		1.09	27.7	1.94	49.2	3.53	89.7		Y	
T7-JCFX90L-0808	32440-0808	20243970	1/2	12.7	3/4-16	7/8	7/8	LT	2.43	61.7	1.31	33.3	2.94	74.6	Y		Y
T8-JCFX90L-0808	34440-0808	20243964	1/2	12.7	3/4-16	7/8	7/8	LT	2.43	61.7	1.31	33.3	2.94	74.6		Y	
T7-JCFX90-0810	32425-0810	20243924	1/2	12.7	7/8-14	1	7/8		1.23	31.2	2.19	55.6	3.74	95.0	Y		Y
T8-JCFX90-0810	34425-0810	20243928	1/2	12.7	7/8-14	1	7/8		1.23	31.2	2.19	55.6	3.74	95.0		Y	
T7-JCFX90L-0810	32440-0810	20243966	1/2	12.7	7/8-14	1	7/8	LT	2.57	65.3	2.19	55.6	3.77	95.8	Y		Y
T8-JCFX90L-0810	34440-0810	20243967	1/2	12.7	7/8-14	1	7/8	LT	2.57	65.3	2.19	55.6	3.77	95.8		Y	
T7-JCFX90-1212	32425-1212	20243917	3/4	19.0	1 1/16-12	1 1/4	1 1/8		2.31	58.7	2.06	52.4	3.88	98.4	Y		
T7-JCFX90-1616	32425-1616	20243961	1	25.4	1 5/16-12	1 1/2	1 3/8		2.50	63.5	2.94	74.6	4.75	120.7	Y		
T7-JCFX90L-1616	32440-1616	20243963	1	25.4	1 5/16-12	1 1/2	1 3/8	LT	4.33	110.0	2.31	58.7	4.69	119.1	Y		

JIC 37° Flare (SAE J514)

Male

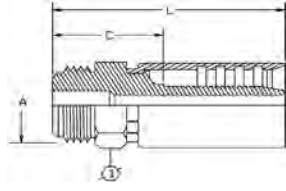

Descriptive #	Product #	SAP #	Hose Size ID		Thread Size (A)	Hex-1 Wrench Size	Cut-Off (C)		Length (L)		GR7 TR7 NR7 BR7	GR8 TR8 NR8	GR18
			in.	mm			in.	in.	mm	in.			
T7-JCM-0304	32450-0304	20243990	3/16	4.8	7/16-20	9/16	1.25	31.8	2.05	52.1	Y		
T8-JCM-0304	34450-0304	20243989	3/16	4.8	7/16-20	9/16	1.25	31.8	2.05	52.1		Y	
T7-JCM-0404	32450-0404	20243973	1/4	6.4	7/16-20	5/8	1.25	31.8	2.30	58.4	Y		Y
T8-JCM-0404	34450-0404	20243972	1/4	6.4	7/16-20	5/8	1.25	31.8	2.30	58.4		Y	
T7-JCM-0405	32450-0405	20243975	1/4	6.4	1/2-20	5/8	1.25	31.8	2.30	58.4	Y		Y
T8-JCM-0405	34450-0405	20243974	1/4	6.4	1/2-20	5/8	1.25	31.8	2.30	58.4		Y	
T7-JCM-0406	32450-0406	20243985	1/4	6.4	9/16-18	3/4	1.32	33.5	2.40	61.0	Y		Y
T8-JCM-0406	34450-0406	20243978	1/4	6.4	9/16-18	3/4	1.31	33.3	2.40	61.0		Y	
T7-JCM-0505	32450-0505	20243982	5/16	7.9	1/2-20	5/8	1.06	27.0	2.36	60.0	Y		Y
T7-JCM-0506	32450-0506	20243981	5/16	7.9	9/16-18	11/16	1.31	33.3	2.30	58.4	Y		Y
T7-JCM-0606	32450-0606	20243984	3/8	9.5	9/16-18	3/4	1.38	34.9	2.59	65.7	Y		Y
T8-JCM-0606	34450-0606	20243983	3/8	9.5	9/16-18	3/4	1.12	28.6	2.59	65.7		Y	
T7-JCM-0608	32450-0608	20243987	3/8	9.5	3/4-16	13/16	1.38	34.9	2.69	68.3	Y		Y
T8-JCM-0608	34450-0608	20243986	3/8	9.5	3/4-16	13/16	1.25	31.8	2.69	68.3		Y	
T7-JCM-0808	32450-0808	20243979	1/2	12.7	3/4-16	7/8	1.44	36.5	2.88	73.1	Y		Y
T8-JCM-0808	34450-0808	20243971	1/2	12.7	3/4-16	7/8	1.25	31.8	2.88	73.1		Y	
T7-JCM-0810	32450-0810	20243977	1/2	12.7	7/8-14	15/16	1.44	36.5	3.10	78.8	Y		Y
T8-JCM-0810	34450-0810	20243976	1/2	12.7	7/8-14	15/16	1.50	38.1	3.10	78.8		Y	
T7-JCM-1212	32450-1212	20243988	3/4	19.0	1 1/16-12	1 1/8	1.50	38.1	3.32	84.4	Y		
T7-JCM-1616	32450-1616	20243980	1	25.4	1 5/16-12	1 3/8	1.62	41.3	3.94	100.1	Y		

SAE 45° J512 Flare

Female | Swivel

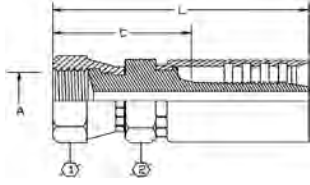

Descriptive #	Product #	SAP #	Hose Size ID		Thread Size (A)	Hex-1 Wrench Size	Hex-2 Wrench Size	Cut-Off (C)		Length (L)		GR7 TR7 NR7 BR7	GR8 TR8 NR8	GR18
			in.	mm				in.	mm	in.	mm			
T7-SFFX-0404	32775-0404	20244137	1/4	6.4	7/16-20	5/8	5/8	1.44	36.5	2.53	64.3	Y		Y
T8-SFFX-0404	34775-0404	20244136	1/4	6.4	7/16-20	5/8	5/8	1.45	36.7	2.53	64.3		Y	
T7-SFFX-0405	32775-0405	20244140	1/4	6.4	1/2-20	3/4	5/8	1.45	36.7	2.53	64.3	Y		Y
T8-SFFX-0405	34775-0405	20244139	1/4	6.4	1/2-20	3/4	5/8	1.45	36.7	2.53	64.3		Y	
T7-SFFX-0406	32775-0406	20244138	1/4	6.4	5/8-18	13/16	5/8	1.44	36.5	2.53	64.3	Y		Y
T8-SFFX-0406	34775-0406	20244145	1/4	6.4	5/8-18	13/16	5/8	1.44	36.5	2.53	64.3		Y	
T7-SFFX-0506	32775-0506	20244132	5/16	7.9	5/8-18	13/16	5/8	1.25	31.8	2.53	64.3	Y		Y
T7-SFFX-0606	32775-0606	20244134	3/8	9.5	5/8-18	13/16	3/4	1.38	34.9	2.81	71.5	Y		Y
T8-SFFX-0606	34775-0606	20244133	3/8	9.5	5/8-18	13/16	3/4	1.38	34.9	2.81	71.5		Y	
T7-SFFX-0808	32775-0808	20244142	1/2	12.7	3/4-16	15/16	7/8	1.66	42.1	3.15	80.0	Y		Y
T8-SFFX-0808	34775-0808	20244141	1/2	12.7	3/4-16	15/16	7/8	1.66	42.1	3.15	80.0		Y	
T7-SFFX-1212	32775-1212	20244135	3/4	19.0	1 1/16-14	1 1/4	1 1/8	1.62	41.3	3.44	87.3	Y		

SAE 45° J512 Flare

Female 90° Elbow | Swivel

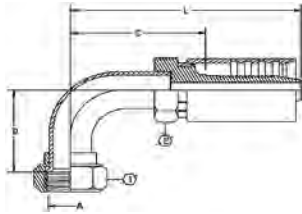

Descriptive #	Product #	SAP #	Hose Size ID		Thread Size (A)	Hex-1 Wrench Size	Hex-2 Wrench Size	Drop (D)		Cut-Off (C)		Length (L)		GR7 TR7 NR7 BR7	GR8 TR8 NR8	GR18
			in.	mm				in.	mm	in.	mm	in.	mm			
T7-SFFX90-0606	32780-0606	20244144	3/8	9.5	5/8-18	3/4	3/4	1.12	28.6	1.19	30.2	2.63	66.8	Y		Y
T8-SFFX90-0606	34780-0606	20244143	3/8	9.5	5/8-18	3/4	3/4	1.12	28.6	1.19	30.2	2.63	66.8		Y	

SAE 45° Inverted Flare

Male | Swivel

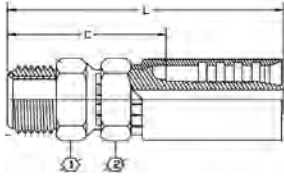

Descriptive #	Product #	SAP #	Hose Size ID		Thread Size (A)	Hex-1 Wrench Size	Hex-2 Wrench Size	Cut-Off (C)		Length (L)		GR7 TR7 NR7 BR7	GR8 TR8 NR8	GR18
			in.	mm				in.	mm	in.	mm			
T7-SIMX-0404	32800-0404	20244127	1/4	6.4	7/16-24	7/16	5/8	1.64	41.6	2.72	69.1	Y		Y
T7-SIMX-0405	32800-0405	20244128	1/4	6.4	1/2-20	1/2	5/8	1.69	42.9	2.78	70.6	Y		Y

SAE 45° Inverted Flare

Male 45° Elbow | Swivel

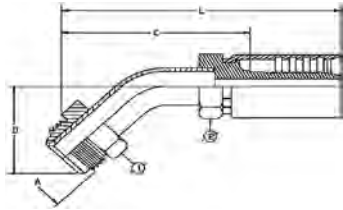

Descriptive #	Product #	SAP #	Hose Size ID		Thread Size (A)	Hex-1 Wrench Size	Hex-2 Wrench Size	Drop (D)		Cut-Off (C)		Length (L)		GR7 TR7 NR7 BR7	GR8 TR8 NR8	GR18
			in.	mm				in.	mm	in.	mm	in.	mm			
T8-SIMX45-0606	34810-0606	20244130	3/8	9.5	5/8-18	5/8	3/4	0.96	24.5	1.88	47.6	3.30	83.8		Y	

SAE 45° Inverted Flare

Male 90° Elbow | Swivel

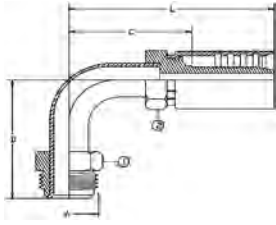

Descriptive #	Product #	SAP #	Hose Size ID		Thread Size (A)	Hex-1 Wrench-Size	Hex-2 Wrench-Size	Drop (D)		Cut-Off (C)		Length (L)		GR7 TR7 NR7 BR7	GR8 TR8 NR8	GR18
			in.	mm				in.	mm	in.	mm	in.	mm			
T7-SIMX90-0404	32815-0404	20244129	1/4	6.4	7/16-24	7/16	9/16	1.31	33.3	1.23	31.3	2.31	58.7	Y		Y
T7-SIMX90-0606	32815-0606	20244131	3/8	9.5	5/8-18	5/8	3/4	1.66	42.2	1.19	30.2	2.62	66.7	Y		Y
T8-SIMX90-0606	34815-0606	20244126	3/8	9.5	5/8-18	5/8	3/4	1.66	42.2	1.19	30.2	2.63	66.8		Y	

NPTF

Female

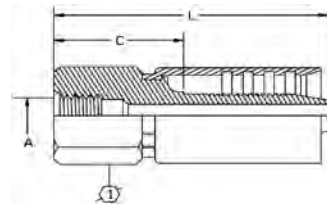

Descriptive #	Product #	SAP #	Hose Size ID		Thread Size (A)	Hex-1 Wrench Size	Cut-Off (C)		Length (L)		GR7 TR7 NR7 BR7	GR8 TR8 NR8	GR18
			in.	mm			in.	mm	in.	mm			
T7-NPF-0404	32600-0404	20244060	1/4	6.4	1/4-18	3/4	1.25	31.8	2.34	59.5	Y		Y
T8-NPF-0404	34600-0404	20244059	1/4	6.4	1/4-18	3/4	1.25	31.8	2.34	59.5		Y	
T7-NPF-0604	32600-0604	20244058	3/8	9.5	1/4-18	3/4	1.06	27.0	2.53	64.3	Y		Y
T7-NPF-0606	32600-0606	20244057	3/8	9.5	3/8-18	7/8	1.19	30.2	2.63	66.7	Y		Y
T8-NPF-0606	34600-0606	20244056	3/8	9.5	3/8-18	7/8	1.19	30.2	2.63	66.7		Y	
T7-NPF-0808	32600-0808	20244062	1/2	12.7	1/2-14	1 1/16	1.31	33.3	3.03	77.0	Y		Y
T8-NPF-0808	34600-0808	20244061	1/2	12.7	1/2-14	1 1/16	1.31	33.3	3.03	77.0		Y	

NPTF

Male

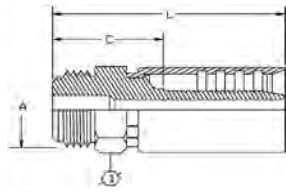

Descriptive #	Product #	SAP #	Hose Size ID		Thread Size (A)	Hex-1 Wrench Size	Cut-Off (C)		Length (L)		GR7 TR7 NR7 BR7	GR8 TR8 NR8	GR18
			in.	mm			in.	mm	in.	mm			
T7-NPM-0202	32615-0202	20244064	1/8	3.2	1/8-27	1/2	0.75	19.1	1.34	34.1	Y		
T7-NPM-0302	32615-0302	20244065	3/16	4.8	1/8-27	9/16	1.06	27.0	1.88	47.8	Y		
T8-NPM-0302	34615-0302	20244055	3/16	4.8	1/8-27	9/16	1.06	27.0	1.88	47.8		Y	
T7-NPM-0304	32615-0304	20244067	3/16	4.8	1/4-18	11/16	1.25	31.8	2.06	52.3	Y		
T8-NPM-0304	34615-0304	20244066	3/16	4.8	1/4-18	11/16	1.25	31.8	2.06	52.3		Y	
T7-NPM-0306	32615-0306	20244052	3/16	4.8	3/8-18	3/4	1.38	34.9	2.15	54.7	Y		
T8-NPM-0306	34615-0306	20244038	3/16	4.8	3/8-18	3/4	1.38	34.9	2.15	54.7		Y	
T7-NPM-0402	32615-0402	20244072	1/4	6.4	1/8-27	5/8	1.06	27.0	2.13	54.1	Y		Y
T8-NPM-0402	34615-0402	20244071	1/4	6.4	1/8-27	5/8	1.06	27.0	2.13	54.1		Y	
T7-NPM-0404	32615-0404	20244078	1/4	6.4	1/4-18	11/16	1.25	31.8	2.31	58.7	Y		Y
T8-NPM-0404	34615-0404	20244079	1/4	6.4	1/4-18	11/16	1.25	31.8	2.31	58.7		Y	
T7-NPM-0406	32615-0406	20244070	1/4	6.4	3/8-18	3/4	1.31	33.3	2.40	61.1	Y		Y
T8-NPM-0406	34615-0406	20244069	1/4	6.4	3/8-18	3/4	1.31	33.3	2.40	61.1		Y	
T7-NPM-0408	32615-0408	20244076	1/4	6.4	1/2-14	15/16	1.56	39.7	2.66	67.5	Y		Y
T8-NPM-0408	34615-0408	20244077	1/4	6.4	1/2-14	15/16	1.56	39.7	2.66	67.5		Y	
T7-NPM-0504	32615-0504	20244032	5/16	7.9	1/4-18	11/16	1.12	28.6	2.31	58.8	Y		Y
T7-NPM-0604	32615-0604	20244033	3/8	9.5	1/4-18	3/4	1.31	33.3	2.59	65.8	Y		Y
T8-NPM-0604	34615-0604	20244030	3/8	9.5	1/4-18	3/4	1.31	33.3	2.59	65.8		Y	
T7-NPM-0606	32615-0606	20244028	3/8	9.5	3/8-18	3/4	1.31	33.3	2.59	65.8	Y		Y
T8-NPM-0606	34615-0606	20244029	3/8	9.5	3/8-18	3/4	1.31	33.3	2.59	65.8		Y	
T7-NPM-0608	32615-0608	20244031	3/8	9.5	1/2-14	15/16	1.56	39.7	2.84	72.2	Y		Y
T8-NPM-0608	34615-0608	20244035	3/8	9.5	1/2-14	15/16	1.56	39.7	2.84	72.2		Y	
T7-NPM-0806	32615-0806	20244073	1/2	12.7	3/8-18	7/8	1.28	32.5	2.78	70.7	Y		Y
T8-NPM-0806	34615-0806	20244075	1/2	12.7	3/8-18	7/8	1.25	31.8	2.78	70.7		Y	
T7-NPM-0808	32615-0808	20244054	1/2	12.7	1/2-14	15/16	1.50	38.1	3.03	77.0	Y		Y
T8-NPM-0808	34615-0808	20244053	1/2	12.7	1/2-14	15/16	1.50	38.1	3.03	77.0		Y	
T7-NPM-0812	32615-0812	20244068	1/2	12.7	3/4-14	1 1/8	1.50	38.1	3.04	77.1	Y		Y
T8-NPM-0812	34615-0812	20244074	1/2	12.7	3/4-14	1 1/8	1.50	38.1	3.09	78.6		Y	
T7-NPM-1208	32615-1208	20244037	3/4	19.0	1/2-14	1 1/8	1.44	36.5	3.22	81.8	Y		
T7-NPM-1212	32615-1212	20244036	3/4	19.0	3/4-14	1 1/8	1.38	34.9	3.22	81.8	Y		
T7-NPM-1616	32615-1616	20244063	1	25.4	1-11 1/2	1 3/8	1.62	41.3	3.97	100.8	Y		

NPTF

Male | Swivel

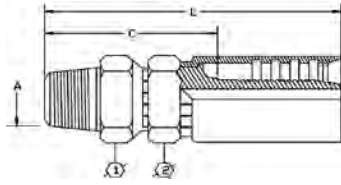

Descriptive #	Product #	SAP #	Hose Size ID		Thread Size (A)	Hex-1 Wrench Size	Hex-2 Wrench Size	Cut-Off (C)		Length (L)		GR7 TR7 NR7 BR7	GR8 TR8 NR8	GR18
			in.	mm				in.	in.	in.	mm			
T7-NPMX-0202	32645-0202	20598101	1/8	3.2	1/8-27	1/2	1/2	1.33	33.8	1.90	48.2	Y		
T7-NPMX-0304	32645-0304	20244047	3/16	4.8	1/4-18	11/16	5/8	1.81	46.0	2.64	67.0	Y		
T8-NPMX-0304	34645-0304	20244039	3/16	4.8	1/4-18	11/16	5/8	1.81	46.0	2.64	67.0		Y	
T7-NPMX-0404	32645-0404	20244050	1/4	6.4	1/4-18	11/16	5/8	1.81	46.0	2.87	73.0	Y		Y
T8-NPMX-0404	34645-0404	20244049	1/4	6.4	1/4-18	11/16	5/8	1.81	46.0	2.87	73.0		Y	
T7-NPMX-0406	32645-0406	20244048	1/4	6.4	3/8-18	3/4	5/8	1.93	49.0	3.02	76.7	Y		Y
T7-NPMX-0504	32645-0504	20244040	5/16	7.9	1/4-18	11/16	5/8	1.62	41.3	2.87	73.0	Y		Y
T7-NPMX-0606	32645-0606	20244042	3/8	9.5	3/8-18	3/4	3/4	1.69	42.9	3.15	80.0	Y		Y
T8-NPMX-0606	34645-0606	20244041	3/8	9.5	3/8-18	3/4	3/4	1.69	42.9	3.15	80.0		Y	
T7-NPMX-0608	32645-0608	20244044	3/8	9.5	1/2-14	7/8	3/4	1.88	47.6	3.38	85.7	Y		Y
T8-NPMX-0608	34645-0608	20244043	3/8	9.5	1/2-14	7/8	3/4	1.88	47.6	3.31	84.2		Y	
T7-NPMX-0808	32645-0808	20244045	1/2	12.7	1/2-14	15/16	7/8	1.94	49.2	3.61	91.7	Y		Y
T8-NPMX-0808	34645-0808	20244051	1/2	12.7	1/2-14	15/16	7/8	1.94	49.2	3.61	91.7		Y	
T7-NPMX-1212	32645-1212	20244046	3/4	19.0	3/4-14	1 1/8	1 1/8	2.00	50.8	3.84	97.5	Y		
T7-NPMX-1616	32645-1616	20244034	1	25.4	1-11 1/2	1 1/2	1 3/8	2.31	58.7	4.65	118.1	Y		

NPSM

Female | Swivel

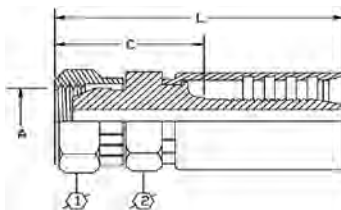

Descriptive #	Product #	SAP #	Hose Size ID		Thread Size (A)	Hex-1 Wrench Size	Hex-2 Wrench Size	Cut-Off (C)		Length (L)		GR7 TR7 NR7 BR7	GR8 TR8 NR8	GR18
			in.	mm				in.	in.	in.	mm			
T7-NSFX-0808	32655-0808	20244026	1/2	12.7	1/2-14	1	1	1.38	34.9	3.06	77.8	Y		Y
T8-NSFX-0808	34655-0808	20244027	1/2	12.7	1/2-14	1	1	1.38	34.9	3.06	77.8		Y	

SAE J514 Flareless Tube Fittings

Male

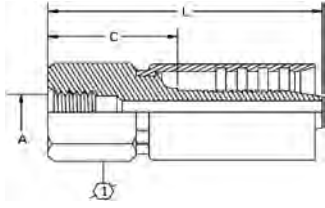

Descriptive #	Product #	SAP #	Hose Size ID		Thread Size (A)	Hex-1 Wrench Size	Cut-Off (C)		Length (L)		GR7 TR7 NR7 BR7	GR8 TR8 NR8	GR18
			in.	mm			in.	mm	in.	mm			
T7-FTM-0606	32360-0606	20244148	3/8	9.5	9/16-18	3/4	1.06	27.0	2.50	63.4	Y		Y
T8-FTM-0606	34360-0606	20244147	3/8	9.5	9/16-18	3/4	1.06	26.9	2.50	63.5		Y	
T7-FTM-0808	32360-0808	20244146	1/2	12.7	3/4-16	7/8	1.16	29.4	2.78	70.6	Y		Y

Standpipe

45° Elbow

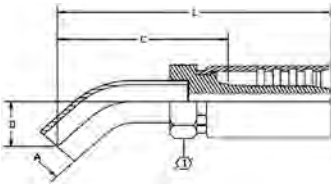

Descriptive #	Product #	SAP #	Hose Size ID			Hex-1 Wrench Size	Drop (D)			Cut-Off (C)		Length (L)		GR7 TR7 NR7 BR7	GR8 TR8 NR8	GR18
			in.	mm	mm		in.	in.	mm	in.	mm	in.	mm			
T7-SP45-0408	32830-0408	20244149	1/4	6.4	8	5/8	0.75	19.0	1.77	45.0	2.80	71.0	Y		Y	
T8-SP45-0408	34830-0408	20244150	1/4	6.4	8	5/8	0.75	19.0	1.77	45.0	2.80	71.0		Y		

O-Ring Face Seal (SAE J1453) ORS/ORFS

Female | Swivel

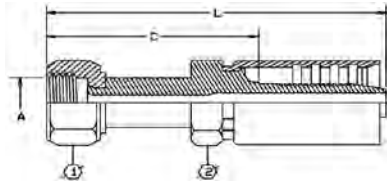

Descriptive #	Product #	SAP #	Hose Size ID		Thread Size (A)	Hex-1 Wrench Size	Hex-2 Wrench Size	Cut-Off (C)		Length (L)		GR7 TR7 NR7 BR7	GR8 TR8 NR8	GR18
			in.	mm				in.	mm	in.	mm			
T7-OFFX-0404	32700-0404	20244101	1/4	6.4	9/16-18	11/16	5/8	1.50	38.1	2.60	66.0	Y		Y
T8-OFFX-0404	34700-0404	20244105	1/4	6.4	9/16-18	11/16	5/8	1.50	38.1	2.60	66.0		Y	
T7-OFFX-0506	32700-0506	20244108	5/16	7.9	11/16-16	13/16	5/8	1.56	39.7	2.74	69.7	Y		Y
T7-OFFX-0606	32700-0606	20244103	3/8	9.5	11/16-16	7/8	3/4	1.44	36.5	2.75	69.9	Y		Y
T8-OFFX-0606	34700-0606	20244106	3/8	9.5	11/16-16	7/8	3/4	1.44	36.5	2.75	69.9		Y	
T7-OFFX-0608	32700-0608	20244107	3/8	9.5	13/16-16	15/16	3/4	1.88	47.6	3.22	81.8	Y		Y
T7-OFFX-0808	32700-0808	20244097	1/2	12.7	13/16-16	15/16	7/8	1.56	39.7	3.12	79.4	Y		Y
T8-OFFX-0808	34700-0808	20244098	1/2	12.7	13/16-16	15/16	7/8	1.69	42.9	3.28	83.4		Y	
T8-OFFX-0810	34700-0810	20244096	1/2	12.7	1-14	1 1/8	7/8	1.88	47.6	3.39	86.1		Y	
T7-OFFX-1212	32700-1212	20244104	3/4	19.0	1 3/16-12	1 3/8	1 1/8	2.12	54.0	3.88	98.7	Y		
T7-OFFX-1616	32700-1616	20244095	1	25.4	1 7/16-12	1 5/8	1 3/8	2.12	54.0	4.36	110.7	Y		

O-Ring Face Seal (SAE J1453) ORS/ORFS

Female 45° Elbow | Swivel

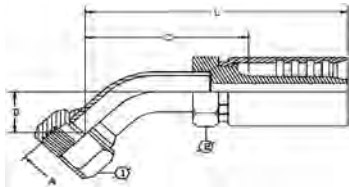

Descriptive #	Product #	SAP #	Hose Size ID		Thread Size (A)	Hex-1 Wrench-Size	Hex-2 Wrench Size	Drop (D)		Cut-Off (C)		Length (L)		GR7 TR7 NR7 BR7	GR8 TR8 NR8	GR18
			in.	mm				in.	mm	in.	mm	in.	mm			
T7-OFFX45-0404	32710-0404	20244116	1/4	6.4	9/16-18	11/16	5/8	0.41	10.4	1.50	38.1	2.55	64.8	Y		Y
T8-OFFX45-0404	34710-0404	20244117	1/4	6.4	9/16-18	11/16	5/8	0.41	10.4	1.50	38.1	2.55	64.8		Y	
T7-OFFX45-0506	32710-0506	20244111	5/16	7.9	11/16-16	13/16	5/8	0.43	10.9	1.50	38.1	2.63	66.9	Y		Y
T7-OFFX45-0606	32710-0606	20244109	3/8	9.5	11/16-16	13/16	3/4	0.43	10.9	1.50	38.1	2.82	71.8	Y		Y
T8-OFFX45-0606	34710-0606	20244110	3/8	9.5	11/16-16	13/16	3/4	0.43	10.9	1.50	38.1	2.82	71.8		Y	
T7-OFFX45-0608	32710-0608	20268564	3/8	9.5	13/16-16	15/16	3/4	0.47	11.9	1.65	41.9	3.12	79.2	Y		Y
T7-OFFX45-0808	32710-0808	20244115	1/2	12.7	13/16-16	15/16	7/8	0.59	15.0	1.75	44.5	3.32	84.2	Y		Y
T8-OFFX45-0808	34710-0808	20244114	1/2	12.7	13/16-16	15/16	7/8	0.59	15.0	1.75	44.5	3.32	84.2		Y	

O-Ring Face Seal (SAE J1453) ORS/ORFS

Female 90° Elbow | Swivel

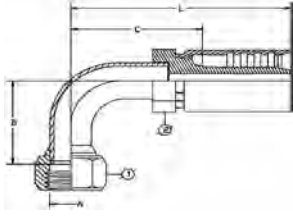

Elbow Type:
LT=Long Tube
ST=Short Tube

Descriptive #	Product #	SAP #	Hose Size ID		Thread Size (A)	Hex-1 Wrench Size	Hex-2 Wrench Size	Elbow Type	Drop (D)		Cut-Off (C)		Length (L)		GR7 TR7 NR7 BR7	GR8 TR8 NR8	GR18
			in.	mm					in.	mm	in.	mm	in.	mm			
T7-OFFX90-0404	32715-0404	20244118	1/4	6.4	9/16-18	11/16	5/8		0.78	19.8	1.25	31.8	2.31	58.8	Y		Y
T8-OFFX90-0404	34715-0404	20244123	1/4	6.4	9/16-18	11/16	5/8		0.78	19.8	1.25	31.8	2.31	58.8		Y	
T7-OFFX90-0506	32715-0506	20244100	5/16	7.9	11/16-16	13/16	3/4		0.90	22.9	1.94	49.2	3.10	78.7	Y		Y
T7-OFFX90-0606	32715-0606	20244119	3/8	9.5	11/16-16	13/16	3/4		0.90	22.9	2.00	50.8	3.30	83.8	Y		Y
T8-OFFX90-0606	34715-0606	20244120	3/8	9.5	11/16-16	13/16	3/4		0.90	22.9	2.00	50.8	3.30	83.8		Y	
T7-OFFX90L-0606	32720-0606	20244121	3/8	9.5	11/16-16	13/16	3/4	LT	2.13	54.1	1.44	36.5	2.74	69.6	Y		Y
T8-OFFX90L-0606	34720-0606	20244122	3/8	9.5	11/16-16	13/16	3/4	LT	2.13	54.1	1.44	36.5	2.74	69.6		Y	
T7-OFFX90-0808	32715-0808	20244124	1/2	12.7	13/16-16	15/16	7/8		1.15	29.2	1.50	38.1	3.04	77.3	Y		Y
T8-OFFX90-0808	34715-0808	20244125	1/2	12.7	13/16-16	15/16	7/8		1.15	29.2	1.50	38.1	3.04	77.3		Y	
T7-OFFX90L-0808	32720-0808	20244112	1/2	12.7	13/16-16	15/16	7/8	LT	2.51	63.8	1.56	39.7	3.16	80.3	Y		Y
T8-OFFX90L-0808	34720-0808	20244113	1/2	12.7	13/16-16	15/16	7/8	LT	2.51	63.8	1.56	39.7	3.16	80.3		Y	
T7-OFFX90-1212	32715-1212	20244099	3/4	19.0	1 3/16-12	1 3/8	1 1/8		1.88	47.8	2.75	69.9	4.47	113.7	Y		

O-Ring Face Seal (SAE J1453) ORS/ORFS

Male

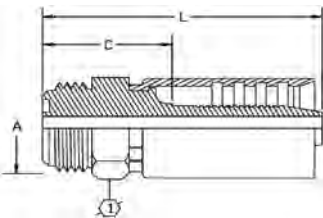

Descriptive #	Product #	SAP #	Hose Size ID		Thread Size (A)	Hex-1 Wrench Size	Cut-Off (C)		Length (L)		GR7 TR7 NR7 BR7	GR8 TR8 NR8	GR18
			in.	mm			in.	mm	in.	mm			
T7-OFM-0404	32730-0404	20244102	1/4	6.4	9/16-18	5/8	1.06	27.0	2.13	54.1	Y		Y

O-Ring Boss Straight Thread (SAE J1453)

Male

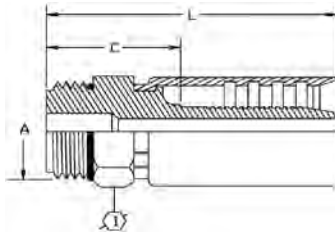

Descriptive #	Product #	SAP #	Hose Size ID		Thread Size (A)	Hex-1 Wrench Size	Cut-Off (C)		Length (L)		GR7 TR7 NR7 BR7	GR8 TR8 NR8	GR18
			in.	mm			in.	mm	in.	mm			
T7-OBM-0406	32670-0406	20244092	1/4	6.4	9/16-18	11/16	1.06	27.0	2.14	54.4	Y		Y
T8-OBM-0406	34670-0406	20244093	1/4	6.4	9/16-18	11/16	1.06	27.0	2.14	54.4		Y	
T7-OBM-0606	32670-0606	20244083	3/8	9.5	9/16-18	3/4	1.00	25.4	2.42	61.5	Y		Y
T8-OBM-0606	34670-0606	20244084	3/8	9.5	9/16-18	3/4	1.00	25.4	2.42	61.5		Y	
T7-OBM-0608	32670-0608	20244081	3/8	9.5	3/4-16	7/8	1.03	26.2	2.47	62.7	Y		Y
T8-OBM-0608	34670-0608	20244082	3/8	9.5	3/4-16	7/8	1.03	26.2	2.47	62.7		Y	
T7-OBM-0808	32670-0808	20244090	1/2	12.7	3/4-16	15/16	1.09	27.8	2.78	70.7	Y		Y
T8-OBM-0808	34670-0808	20244091	1/2	12.7	3/4-16	15/16	1.09	27.8	2.78	70.7		Y	

O-Ring Boss Straight Thread (SAE J1453)

Male | Swivel

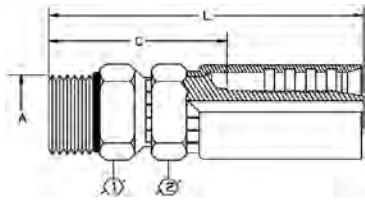

Descriptive #	Product #	SAP #	Hose Size ID		Thread Size (A)	Hex-1 Wrench Size	Hex-2 Wrench Size	Cut-Off (C)		Length (L)		GR7 TR7 NR7 BR7	GR8 TR8 NR8	GR18
			in.	mm				in.	mm	in.	mm			
T7-OBMX-0606	32680-0606	20244080	3/8	9.5	9/16-18	3/4	3/4	1.50	38.1	2.97	75.4	Y		Y
T8-OBMX-0606	34680-0606	20244086	3/8	9.5	9/16-18	3/4	3/4	1.50	38.1	2.97	75.4		Y	

O-Ring Boss Straight Thread (SAE J1453)

Male 90° Elbow (Block) | Swivel

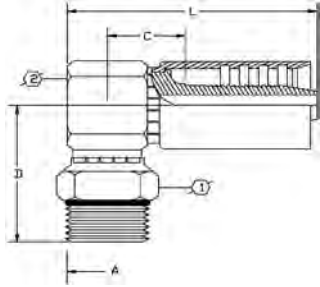

Elbow Type:
BE=Block Elbow

Descriptive #	Product #	SAP #	Hose Size ID		Thread Size (A)		Hex-1 Wrench Size	Hex-2 Wrench Size	Elbow Type	Drop (D)		Cut-Off (C)		Length (L)		GR7	GR8	GR18
			in.	mm	in.	in.	in.	mm		in.	mm	in.	mm	in.	mm	TR7	TR8	NR7
T7-OBMX90B-0608	32685-0608	20244088	3/8	9.5	3/4-16	7/8	13/16	BE	1.11	28.1	0.88	22.2	2.63	66.8	Y		Y	
T8-OBMX90B-0608	34685-0608	20244094	3/8	9.5	3/4-16	7/8	13/16	BE	1.11	28.1	0.88	22.2	2.63	66.8		Y		

O-Ring Face Seal (SAE J1453) ORS/ORFS

Female | Swivel

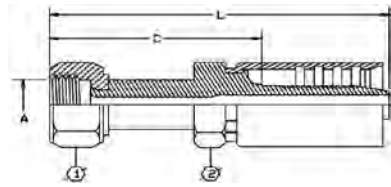

Descriptive #	Product #	SAP #	Hose Size ID		Thread Size (A)		Hex-1 Wrench Size	Hex-2 Wrench Size	Cut-Off (C)	Length (L)		GR7	GR8	GR18			
			in.	mm	in.	mm	in.	mm		in.	mm	in.	mm	TR7	TR8	NR7	NR8
T7-BPFX-0404	32105-0404	20243906	1/4	6.4	1/4-19	3/4	19	9/16	14	1.29	32.8	2.31	58.8	Y		Y	
T8-BPFX-0404	34105-0404	20243903	1/4	6.4	1/4-19	3/4	19	9/16	14	1.29	32.8	2.31	58.8		Y		
T7-BPFX-0606	32105-0606	20243907	3/8	9.5	3/8-19	7/8	22	11/16	17	1.41	35.8	2.67	67.8	Y		Y	
T8-BPFX-0606	34105-0606	20243908	3/8	9.5	3/8-19	7/8	22	11/16	17	1.41	35.8	2.67	67.8		Y		
T7-BPFX-0608	32105-0608	20243902	3/8	9.5	1/2-14	1 1/16	27		18	1.59	40.5	2.85	72.5	Y		Y	
T8-BPFX-0608	34105-0608	20243901	3/8	9.5	1/2-14	1 1/16	27		18	1.59	40.5	2.85	72.5		Y		
T7-BPFX-0806	32105-0806	20243904	1/2	12.7	5/8-14	7/8	22	1 1/4	22	1.74	44.1	3.23	82.1	Y		Y	
T8-BPFX-0806	34105-0806	20243900	1/2	12.7	5/8-14	7/8	22	1 1/4	22	1.74	44.1	3.23	82.1		Y		
T7-BPFX-0808	32105-0808	20243909	1/2	12.7	1/2-14	1 1/16	27	1 1/4	22	1.55	39.4	3.05	77.4	Y		Y	
T8-BPFX-0808	34105-0808	20243905	1/2	12.7	1/2-14	1 1/16	27	1 1/4	22	1.55	39.4	3.05	77.4		Y		
T7-BPFX-1616	32105-1616	20243910	1	25.4	1-11	1 5/8	41	1 7/16	36	1.76	44.7	4.00	101.7	Y			

BSPB (British Standard Pipe Parallel)

Female 90° Elbow | Swivel

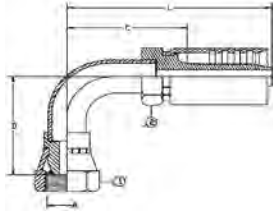

Descriptive #	Product #	SAP #	Hose Size ID		Thread Size (A)	Hex-1 Wrench Size	Hex-2 Wrench Size	Drop (D)		Cut-Off (C)		Length (L)		GR7	GR8	GR18		
			in.	mm	in.	in.	in.	mm	in.	mm	in.	mm	in.	mm	TR7	TR8	NR7	NR8
T7-BPFX90-0606	32120-0606	20243911	3/8	9.5	3/8-19	7/8	22	11/16	17	1.50	38.0	1.57	40.0	2.83	72.0	Y		Y
T8-BPFX90-0606	34120-0606	20243914	3/8	9.5	3/8-19	7/8	22	11/16	17	1.50	38.0	1.57	40.0	2.83	72.0		Y	
T7-BPFX90-0808	32120-0808	20243913	1/2	12.7	1/2-14	1 1/8	27	7/8	22	1.67	42.5	1.65	42.0	3.15	80.0	Y		Y
T8-BPFX90-0808	34120-0808	20243912	1/2	12.7	1/2-14	1 1/8	27	7/8	22	1.67	42.5	1.65	42.0	3.15	80.0		Y	

DIN 60°

Female 90° Elbow | Swivel

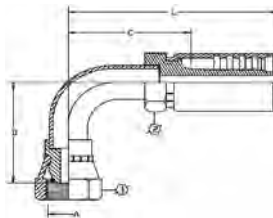

Descriptive #	Product #	SAP #	Hose Size ID		Thread Size (A)	Hex-1 Wrench Size	Hex-2 Wrench Size	Drop (D)		Cut-Off (C)		Length (L)		GR7	GR8	GR18
			in.	mm	in.	in.	in.	mm	in.	mm	in.	mm	in.	mm	TR7	TR8
T8-DNFX90-0418	34280-0418	20243915	1/4	6.4	18 x 1 1/2	22	17	1.40	35.5	1.30	33.0	2.32	59.0		Y	

JIS 30° (Parallel Pipe Threads)

Female | Swivel

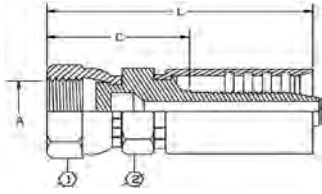

Descriptive #	Product #	SAP #	Hose Size ID		Thread Size (A)		Hex-1 Wrench Size		Hex-2 Wrench Size		Cut-Off (C)		Length (L)		GR7 TR7 NR7 BR7	GR8 TR8 NR8	GR18
			in.	mm	in.	mm	in.	mm	in.	mm	in.	mm	in.	mm			
T7-JSFX-0404	32520-0404	20244023	1/4	6.4	1/4-19	3/4	19	13/16	19	1.38	34.9	2.46	62.6	Y		Y	
T8-JSFX-0404	34520-0404	20244020	1/4	6.4	1/4-19	3/4	19	13/16	19	1.38	34.9	2.46	62.6		Y		
T7-JSFX-0606	32520-0606	20244022	3/8	9.5	3/8-19	7/8	22	7/8	22	1.56	39.7	2.82	71.6	Y		Y	
T8-JSFX-0606	34520-0606	20244021	3/8	9.5	3/8-19	7/8	22	7/8	22	1.56	39.7	2.82	71.6		Y		
T7-JSFX-0808	32520-0808	20244025	1/2	12.7	1/2-14	1 1/16	27	7/8	22	1.69	42.9	3.32	84.4	Y		Y	
T8-JSFX-0808	34520-0808	20244024	1/2	12.7	1/2-14	1 1/16	27	7/8	22	1.69	42.9	3.32	84.4		Y		

How to Use the Fitting Tables

This section lists ALL fittings that are compatible with the following hoses:

Hose Family	Hose Description
SR12	SAE 100R12/EN 856 R12
ARC12	SAE 100R12/EN 856 R12 (Abrasion Cover)

Fitting Description

Fitting Type

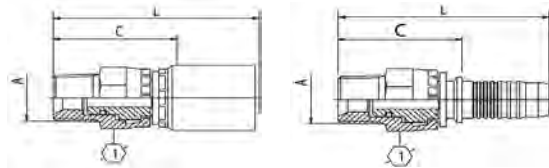

S=Skive,
NS=Non-Skive,
DG=Dual-Grip™

Description #	Product #	SAP #	Hose Size ID		Thread Size (A)	Hex-1 Wrench Size		Cut-Off (C)		Length (L)		Skive Type	SR12 ARC12
			in.	mm		in.	mm	in.	mm	in.	mm		
S4-NPMX-0606	28645-0606	20242080	3/8	9.5	3/8-18	7/8	22	1.48	37.5	2.53	64.2	NS	Y
S4-NPMX-0808	28645-0808	20242089	1/2	12.7	1/2-14	1	25	1.67	42.3	2.91	73.8	NS	Y
S4-NPMX-1212	28645-1212	20242084	3/4	19.0	3/4-14	1 1/4	32	1.97	50.1	3.53	89.6	NS	Y
UC-NPMX-1616	36645-1616	20242739	1	25.4	1-11 1/2	1 5/8	41	2.28	57.9	4.04	102.5	NS	UCF7-16

Choose fittings carefully considering the working pressure of both hose and fitting. The maximum working pressure of the hose assembly is the lesser of the rated working pressure of the hose and the fitting. See page 313 for working pressure.

A "Y" in the hose compatibility columns indicates that the fitting is an **Ultra-Crimp** style fitting and that it works for that particular hose.

A **Part Number (Ferrule)** in the hose compatibility columns indicates that the fitting is a **Uni-Crimp** style. The fitting, along with the Ferrule shown, work together as a unit for that particular hose.

JIC 37° Flare (SAE J514)

Female | Swivel

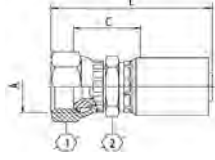

S=Skive
NS=Non-Skive
DG=Dual-Grip™

Description #	Product #	SAP #	Hose Size ID		Thread Size (A)	Hex-1 Wrench Size		Hex-2 Wrench Size		Cut-Off (C)		Length (L)		Skive Type	SR12 ARC12
			in.	mm		in.	mm	in.	mm	in.	mm	in.	mm		
S4-JCFX-0606	28400-0606	20242039	3/8	9.5	9/16-18	3/4	19	11/16	17	0.84	21.3	2.26	57.5	NS	Y
S4-JCFX-0608	28400-0608	20242051	3/8	9.5	3/4-16	1	25	3/4	19	0.98	24.8	2.45	62.2	NS	Y
S4-JCFX-0806	28400-0806	20242033	1/2	12.7	9/16-18	3/4	19	3/4	19	0.91	23.1	2.52	64.1	NS	Y
S4-JCFX-0808	28400-0808	20241956	1/2	12.7	3/4-16	1	25	3/4	19	1.01	25.6	2.67	67.8	NS	Y
S4-JCFX-0810	28400-0810	20242035	1/2	12.7	7/8-14	1 1/16	27	7/8	22	1.05	26.6	2.79	70.8	NS	Y
S4-JCFX-0812	28400-0812	20241926	1/2	12.7	1 1/16-12	1 1/4	32	1	25	1.11	28.1	2.91	73.9	NS	Y
S4-JCFX-1008	28400-1008	20449625	5/8	15.9	3/4-16	1	25	15/16	24	1.05	26.6	2.82	71.6	NS	Y
S4-JCFX-1010	28400-1010	20242003	5/8	15.9	7/8-14	1 1/16	27	15/16	24	1.09	27.6	2.94	74.6	NS	Y
S4-JCFX-1010 ^S	28400-1010S	20424907	5/8	15.9	7/8-14	1 1/16	27	15/16	24	1.09	27.6	2.94	74.6	NS	Y
S4-JCFX-1012	28400-1012	20241989	5/8	15.9	1 1/16-12	1 1/4	32	1	25	1.11	28.1	3.02	76.7	NS	Y
S4-JCFX-1210	28400-1210	20242048	3/4	19.0	7/8-14	1 1/16	27	1 1/16	27	0.79	20.1	2.85	72.3	NS	Y
S4-JCFX-1212	28400-1212	20242030	3/4	19.0	1 1/16-12	1 1/4	32	1 1/16	27	1.13	28.6	3.24	82.4	NS	Y
S4-JCFX-1212 ^S	28400-1212S	20424909	3/4	19.0	1 1/16-12	1 1/4	32	1 1/16	27	1.13	28.6	3.24	82.4	NS	Y
S4-JCFX-1214	28400-1214	20242045	3/4	19.0	1 3/16-12	1 7/16	36	1 1/4	32	0.78	19.9	2.92	74.1	NS	Y
S4-JCFX-1216	28400-1216	20242044	3/4	19.0	1 5/16-12	1 1/2	38	1 1/4	32	1.26	32.1	3.41	86.7	NS	Y
S4-JCFX-1612	28400-1612	20241937	1	25.4	1 1/16-12	1 1/4	32	1 1/4	32	1.24	31.4	3.56	90.3	NS	Y
S4-JCFX-1616	28400-1616	20241917	1	25.4	1 5/16-12	1 1/2	38	1 1/4	32	1.30	32.9	3.65	92.6	NS	Y
S4-JCFX-1616 ^S	28400-1616S	20424920	1	25.4	1 5/16-12	1 1/2	38	1 1/4	32	1.30	32.9	3.65	92.6	NS	Y
S4-JCFX-1620 ^T	28400-1620	20241920	1	25.4	1 5/8-12	2	50	1 5/8	41	1.48	37.5	3.86	98.0	NS	Y
S4-JCFX-2020 ^T	28400-2020	20241915	1 1/4	31.8	1 5/8-12	2	50	1 5/8	41	1.54	39.1	4.21	107.0	NS	Y
S4-JCFX-2020 ^S	28400-2020S	20289599	1 1/4	31.8	1 5/8-12	2	50	1 5/8	41	1.54	39.1	4.21	107.0	NS	Y
S4-JCFX-2024 ^T	28400-2024	20293262	1 1/4	31.8	1 7/8-12	2 3/16	55	2	50	1.71	43.4	4.49	114.0	NS	Y
S4-JCFX-2424 ^T	28400-2424	20241928	1 1/2	38.1	1 7/8-12	2 3/16	55	2	50	1.71	43.4	4.76	121.0	NS	Y
S4-JCFX-2424 ^S	28400-2424S	20289598	1 1/2	38.1	1 7/8-12	2 3/16	55	2	50	1.71	43.4	4.76	121.0	NS	Y
S4-JCFX-3232 ^T	28400-3232	20242028	2	50.8	2 1/2-12	70 mm	70	2 5/16	65	1.93	49.0	5.71	145.0	NS	Y

T: Thrust-Wire Nut (see "Fitting Identification" in Appendix for details)

S: Stainless Steel

JIC 37° Flare (SAE J514)

Female 45° | Swivel

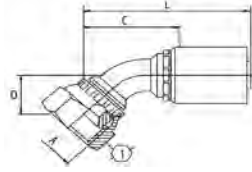

S=Skive
NS=Non-Skive
DG=Dual-Grip™

Description #	Product #	SAP #	Hose Size ID		Thread Size (A)		Hex-1 Wrench Size		Drop (D)		Cut-Off (C)		Length (L)		Skive Type	SR12 ARC12
			in.	mm	in.	mm	in.	mm	in.	mm	in.	mm	in.	mm		
S4-JCFX45-0606	28420-0606	20241969	3/8	9.5	9/16-18	3/4	19	0.43	11.0	1.81	46.0	2.87	73.0	NS	Y	
S4-JCFX45-0608	28420-0608	20241955	3/8	9.5	3/4-16	1	25	0.59	15.0	1.85	47.0	2.91	74.0	NS	Y	
S4-JCFX45-0808	28420-0808	20241964	1/2	12.7	3/4-16	1	25	0.59	15.0	2.05	52.0	3.27	83.0	NS	Y	
S4-JCFX45-0810	28420-0810	20241966	1/2	12.7	7/8-14	1 1/16	27	0.63	16.0	2.01	51.0	3.23	82.0	NS	Y	
S4-JCFX45-1010	28420-1010	20428863	5/8	15.9	7/8-14	1 1/16	27	0.75	19.0	2.44	62.0	3.78	96.0	NS	Y	
S4-JCFX45-1212	28420-1212	20241947	3/4	19.0	1 1/16-12	1 1/4	32	0.83	21.0	2.64	67.0	4.21	107.0	NS	Y	
S4-JCFX45-1616	28420-1616	20241958	1	25.4	1 1/8-12	1 1/2	38	0.94	24.0	3.11	79.0	4.88	124.0	NS	Y	
S4-JCFX45-1620	28420-1620	20293259	1	25.4	1 5/8-12	2	50	1.46	37.0	3.37	85.5	5.47	139.0	NS	Y	
S4-JCFX45-2020 ^T	28420-2020	20241961	1 1/4	31.8	1 5/8-12	2	50	1.46	37.0	3.82	97.0	6.18	157.0	NS	Y	
S4-JCFX45-2424 ^T	28420-2424	20241960	1 1/2	38.1	1 7/8-12	2 3/16	55	1.69	43.0	4.45	113.0	7.15	181.5	NS	Y	

T: Thrust-Wire Nut (see "Fitting Identification" in Appendix for details)

JIC 37° Flare (SAE J514)

Female 90° Elbow | Swivel

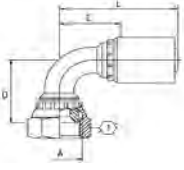

LT=Long Tube
ST=Short Tube

S=Skive
NS=Non-Skive
DG=Dual-Grip™

Description #	Product #	SAP #	Hose Size ID		Thread Size (A)		Hex-1 Wrench Size		Drop (D)		Cut-Off (C)		Length (L)		Skive Type	SR12 ARC12
			in.	mm	in.	mm	in.	mm	in.	mm	in.	mm	in.	mm		
S4-JCFX90-0606	28425-0606	20241903	3/8	9.5	9/16-18	3/4	19		1.38	35.0	1.22	31.0	2.28	58.0	NS	Y
S4-JCFX90L-0606	28440-0606	20241975	3/8	9.5	9/16-18	3/4	19	LT	2.13	54.0	1.69	43.0	2.76	70.0	NS	Y
S4-JCFX90-0808	28425-0808	20241910	1/2	12.7	3/4-16	1	25		1.57	40.0	1.46	37.0	2.72	69.0	NS	Y
S4-JCFX90L-0808	28440-0808	20241986	1/2	12.7	3/4-16	1	25	LT	2.52	64.0	1.97	50.0	3.19	81.0	NS	Y
S4-JCFX90-0810	28425-0810	20241912	1/2	12.7	7/8-14	1 1/16	27		1.85	47.0	1.69	43.0	2.95	75.0	NS	Y
S4-JCFX90L-0810	28440-0810	20293261	1/2	12.7	7/8-14	1 1/16	27	LT	2.56	65.0	1.46	37.0	2.72	69.0	NS	Y
S4-JCFX90-1010	28425-1010	20241933	5/8	15.9	7/8-14	1 1/16	27		1.89	48.0	1.93	49.0	3.31	84.0	NS	Y
S4-JCFX90-1012	28425-1012	20241931	5/8	15.9	1 1/16-12	1 1/4	32		2.28	58.0	1.89	48.0	3.23	82.0	NS	Y
S4-JCFX90-1210	28425-1210	20457475	3/4	19.0	7/8-14	1 1/16	27		1.89	48.0	1.97	50.0	3.50	89.0	NS	Y
S4-JCFX90-1212	28425-1212	20241898	3/4	19.0	1 1/16-12	1 1/4	32		2.13	54.0	2.05	52.0	3.62	92.0	NS	Y
S4-JCFX90L-1212	28440-1212	20241972	3/4	19.0	1 1/16-12	1 1/4	32	LT	3.74	95.0	2.13	54.0	3.70	94.0	NS	Y
S4-JCFX90S-1212	28445-1212	20241941	3/4	19.0	1 1/16-12	1 1/4	32	ST	1.81	46.0	2.28	58.0	3.82	97.0	NS	Y
S4-JCFX90-1216	28425-1216	20241901	3/4	19.0	1 5/16-12	1 1/2	38		2.83	72.0	2.09	53.0	3.62	92.0	NS	Y
S4-JCFX90-1616	28425-1616	20241979	1	25.4	1 5/16-12	1 1/2	38		2.81	71.5	2.87	73.0	4.61	117.0	NS	Y
S4-JCFX90L-1616	28440-1616	20241984	1	25.4	1 5/16-12	1 1/2	38	LT	4.49	114.0	3.11	79.0	4.84	123.0	NS	Y
S4-JCFX90S-1616	28445-1616	20241935	1	25.4	1 5/16-12	1 1/2	38	ST	2.20	56.0	2.91	74.0	4.69	119.0	NS	Y
S4-JCFX90-1620	28425-1620	20432491	1	25.4	1 5/8-12	2	50		3.07	78.0	2.87	73.0	4.61	117.0	NS	Y
S4-JCFX90-2020 ^T	28425-2020	20241906	1 1/4	31.8	1 5/8-12	2	50		3.07	78.0	3.23	82.0	5.28	134.0	NS	Y
S4-JCFX90-2024 ^T	28425-2024	20432492	1 1/4	31.8	1 7/8-12	2 3/16	55		3.23	82.0	3.43	87.0	5.47	139.0	NS	Y
S4-JCFX90-2424 ^T	28425-2424	20241904	1 1/2	38.1	1 7/8-12	2 3/16	55		3.62	92.0	3.74	95.0	6.06	154.0	NS	Y

T: Thrust-Wire Nut (see "Fitting Identification" in Appendix for details)

JIC 37° Flare (SAE J514)

Male

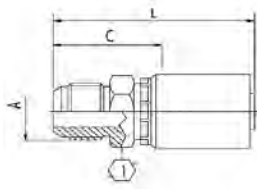

S=Skive
NS=Non-Skive
DG=Dual-Grip™

Description #	Product #	SAP #	Hose Size ID		Thread Size (A)	Hex-1 Wrench Size		Cut-Off (C)		Length (L)		Skive Type	SR12 ARC12
			in.	mm		in.	mm	in.	mm	in.	mm		
S4-JCM-0606	28450-0606	20242013	3/8	9.5	9/16-18	11/16	17	1.04	26.3	2.09	53.0	NS	Y
S4-JCM-0608	28450-0608	20242015	3/8	9.5	3/4-16	3/4	19	1.17	29.8	2.22	56.5	NS	Y
S4-JCM-0808	28450-0808	20242006	1/2	12.7	3/4-16	3/4	19	1.20	30.6	2.44	62.1	NS	Y
S4-JCM-0810	28450-0810	20241992	1/2	12.7	7/8-14	15/16	24	1.36	34.6	2.60	66.1	NS	Y
S4-JCM-0812	28450-0812	20241996	1/2	12.7	1 1/16-12	1 1/16	27	1.46	37.1	2.70	68.6	NS	Y
S4-JCM-1010	28450-1010	20242009	5/8	15.9	7/8-14	15/16	24	1.36	34.6	2.71	68.9	NS	Y
S4-JCM-1212	28450-1212	20242021	3/4	19.0	1 1/16-12	1 1/16	27	1.48	37.6	3.04	77.1	NS	Y
S4-JCM-1214	28450-1214	20242019	3/4	19.0	1 3/16-12	1 1/4	32	1.58	40.1	3.13	79.6	NS	Y
S4-JCM-1216	28450-1216	20242017	3/4	19.0	1 5/16-12	1 7/16	36	1.68	42.6	3.23	82.1	NS	Y
S4-JCM-1616	28450-1616	20242001	1	25.4	1 5/16-12	1 7/16	36	1.71	43.4	3.46	88.0	NS	Y
S4-JCM-1620	28450-1620	20242000	1	25.4	1 5/8-12	1 13/16	46	1.85	46.9	3.60	91.5	NS	Y
S4-JCM-2020	28450-2020	20241999	1 1/4	31.8	1 5/8-12	1 13/16	46	1.91	48.5	3.96	100.5	NS	Y
S4-JCM-2024	28450-2024	20241998	1 1/4	31.8	1 7/8-12	2	50	2.07	52.5	4.11	104.5	NS	Y
S4-JCM-2424	28450-2424	20242027	1 1/2	38.1	1 7/8-12	2	50	2.07	52.5	4.39	111.5	NS	Y
S4-JCM-3232	28450-3232	20242023	2	50.8	2 1/2-12	2 9/16	65	2.44	62.0	5.28	134.0	NS	Y

NPTF

Male

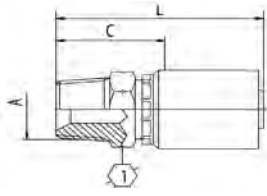

S=Skive
NS=Non-Skive
DG=Dual-Grip™

Description #	Product #	SAP #	Hose Size ID		Thread Size (A)	Hex-1 Wrench Size		Cut-Off (C)		Length (L)		Skive Type	SR12 ARC12
			in.	mm		in.	mm	in.	mm	in.	mm		
S4-NPM-0604	28615-0604	20242068	3/8	9.5	1/4-18	11/16	17	1.06	26.8	2.11	53.5	NS	Y
S4-NPM-0606	28615-0606	20242070	3/8	9.5	3/8-18	3/4	19	1.09	27.8	2.15	54.5	NS	Y
S4-NPM-0608	28615-0608	20242073	3/8	9.5	1/2-14	7/8	22	1.23	31.3	2.28	58.0	NS	Y
S4-NPM-0806	28615-0806	20242114	1/2	12.7	3/8-18	3/4	19	1.13	28.6	2.37	60.1	NS	Y
S4-NPM-0808	28615-0808	20242100	1/2	12.7	1/2-14	7/8	22	1.26	32.1	2.50	63.6	NS	Y
S4-NPM-0812	28615-0812	20242112	1/2	12.7	3/4-14	1 1/16	27	1.34	34.1	2.58	65.6	NS	Y
S4-NPM-1012	28615-1012	20242072	5/8	15.9	3/4-14	1 1/16	27	1.34	34.1	2.69	68.4	NS	Y
S4-NPM-1208	28615-1208	20242090	3/4	19.0	1/2-14	1 1/16	27	1.32	33.6	2.88	73.1	NS	Y
S4-NPM-1212	28615-1212	20242075	3/4	19.0	3/4-14	1 1/16	27	1.36	34.6	2.92	74.1	NS	Y
S4-NPM-1212S	28615-1212S	20424928	3/4	19.0	3/4-14	1 1/16	27	1.36	34.6	2.92	74.1	NS	Y
S4-NPM-1216	28615-1216	20242097	3/4	19.0	1-11 1/2	1 7/16	36	1.72	43.6	3.27	83.1	NS	Y
S4-NPM-1612	28615-1612	20242096	1	25.4	3/4-14	1 7/16	36	1.55	39.4	3.31	84.0	NS	Y
S4-NPM-1616	28615-1616	20242098	1	25.4	1-11 1/2	1 7/16	36	1.75	44.4	3.50	89.0	NS	Y
S4-NPM-1616S	28615-1616S	20424929	1	25.4	1-11 1/2	1 7/16	36	1.75	44.4	3.50	89.0	NS	Y
S4-NPM-1620	28615-1620	20242101	1	25.4	1 1/4-11 1/2	1 13/16	46	1.87	47.4	3.62	92.0	NS	Y
S4-NPM-2020	28615-2020	20242094	1 1/4	31.8	1 1/4-11 1/2	1 13/16	46	1.93	49.0	3.98	101.0	NS	Y
S4-NPM-2020S	28615-2020S	20424930	1 1/4	31.8	1 1/4-11 1/2	1 13/16	46	1.93	49.0	3.98	101.0	NS	Y
S4-NPM-2024	28615-2024	20242095	1 1/4	31.8	1 1/2-11 1/2	2	50	1.99	50.5	4.04	102.5	NS	Y
S4-NPM-2424	28615-2424	20242102	1 1/2	38.1	1 1/2-11 1/2	2	50	1.99	50.5	4.31	109.5	NS	Y
S4-NPM-2424S	28615-2424S	20424931	1 1/2	38.1	1 1/2-11 1/2	2	50	1.99	50.5	4.31	109.5	NS	Y
S4-NPM-3232	28615-3232	20242108	2	50.8	2-11 1/2	2 9/16	65	2.13	54.2	4.97	126.2	NS	Y

NPTF

Male | Swivel

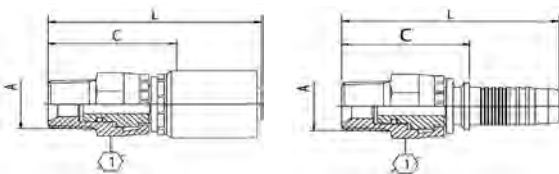

S=Skive
NS=Non-Skive
DG=Dual-Grip™

Description #	Product #	SAP #	Hose Size ID		Thread Size (A)	Hex-1 Wrench Size		Cut-Off (C)		Length (L)		Skive Type	SR12 ARC12
			in.	mm		in.	mm	in.	mm	in.	mm		
S4-NPMX-0606	28645-0606	20242080	3/8	9.5	3/8-18	7/8	22	1.48	37.5	2.53	64.2	NS	Y
S4-NPMX-0808	28645-0808	20242089	1/2	12.7	1/2-14	1	25	1.67	42.3	2.91	73.8	NS	Y
S4-NPMX-1212	28645-1212	20242084	3/4	19.0	3/4-14	1 1/4	32	1.97	50.1	3.53	89.6	NS	Y
S4-NPMX-1616	28645-1616	20242739	1	25.4	1-11 1/2	1 5/8	41	2.28	57.9	4.04	102.5	NS	UCF7-16

NPSM

Female | Swivel

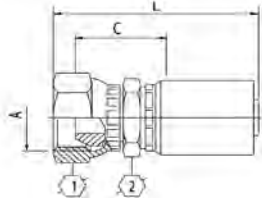

S=Skive
NS=Non-Skive
DG=Dual-Grip™

Description #	Product #	SAP #	Hose Size ID		Thread Size (A)	Hex-1 Wrench Size		Hex-2 Wrench Size		Cut-Off (C)		Length (L)		Skive Type	SR12 ARC12
			in.	mm		in.	mm	in.	mm	in.	mm	in.	mm		
S4-NSFX-2020	28655-2020	20293263	1¼	31.8	1¼-11½	2	50	1 5/8	41	1.73	52.0	3.78	104.0	NS	Y

O-Ring Face Seal (SAE J1453) ORS/ORFS

Female | Swivel

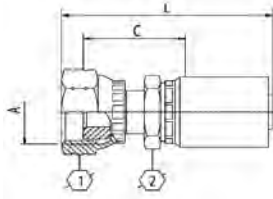

S=Skive
NS=Non-Skive
DG=Dual-Grip™

Description #	Product #	SAP #	Hose Size ID		Thread Size (A)	Hex-1 Wrench Size		Hex-2 Wrench Size		Cut-Off (C)		Length (L)		Skive Type	SR12 ARC12
			in.	mm		in.	mm	in.	mm	in.	mm	in.	mm		
S4-OFFX-0606	28700-0606	20242197	3/8	9.5	11/16-16	7/8	22	11/16	17	1.19	30.3	2.62	66.5	NS	Y
S4-OFFX-0808	28700-0808	20242147	1/2	12.7	13/16-16	15/16	24	7/8	22	1.42	36.1	3.09	78.6	NS	Y
S4-OFFX-0810	28700-0810	20242145	1/2	12.7	1-14	1¾	30	15/16	24	1.56	39.6	3.31	84.1	NS	Y
S4-OFFX-0812	28700-0812	20242135	1/2	12.7	1¾-12	17/16	36	1¾	30	1.66	42.1	3.47	88.1	NS	Y
S4-OFFX-1010	28700-1010	20242176	5/8	15.9	1-14	1¾	30	15/16	24	1.56	39.6	3.39	86.1	NS	Y
S4-OFFX-1012	28700-1012	20242200	5/8	15.9	1¾-12	17/16	36	1¾	30	1.66	42.1	3.58	90.9	NS	Y
S4-OFFX-1210	28700-1210	20242195	3/4	19.0	1-14	1¾	30	11/16	27	1.58	40.1	3.65	92.6	NS	Y
S4-OFFX-1212	28700-1212	20242190	3/4	19.0	1¾-12	17/16	36	1¾	30	1.68	42.6	3.80	96.6	NS	Y
S4-OFFX-1216	28700-1216	20242193	3/4	19.0	17/16-12	15/8	41	17/16	36	1.91	48.6	4.05	102.9	NS	Y
S4-OFFX-1612	28700-1612	20242146	1	25.4	1¾-12	17/16	36	1¼	32	1.79	45.4	4.11	104.5	NS	Y
S4-OFFX-1616	28700-1616	20242140	1	25.4	17/16-12	15/8	41	17/16	36	1.94	49.4	4.28	108.8	NS	Y
S4-OFFX-1620	28700-1620	20242165	1	25.4	11¼-12	2	50	15/8	41	1.98	50.4	4.32	109.8	NS	Y
S4-OFFX-2020	28700-2020	20242137	1¼	31.8	11¼-12	2	50	15/8	41	2.05	52.0	4.68	118.8	NS	Y
S4-OFFX-2424	28700-2424	20242138	1½	38.1	2-12	2¾	60	2	50	2.22	56.5	5.18	131.5	NS	Y

O-Ring Face Seal (SAE J1453) ORS/ORFS

Female 45° Elbow | Swivel

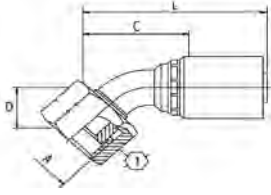

S=Skive
NS=Non-Skive
DG=Dual-Grip™

Description #	Product #	SAP #	Hose Size ID		Thread Size (A)		Hex-1 Wrench Size		Drop (D)		Cut-Off (C)		Length (L)		Skive Type	SR12 ARC12
			in.	mm	in.	mm	in.	mm	in.	mm	in.	mm	in.	mm		
S4-OFFX45-0606	28710-0606	20242205	3/8	9.5	11/16-16	7/8	22	0.47	12.0	1.85	47.0	2.91	74.0	NS	Y	
S4-OFFX45-0808 ^C	28710-0808	20242229	1/2	12.7	13/16-16	15/16	24	0.63	16.0	1.85	47.0	3.11	79.0	NS	Y	
S4-OFFX45-0810	28710-0810	20242234	1/2	12.7	1-14	1 3/16	30	0.65	16.5	1.97	50.0	3.23	82.0	NS	Y	
S4-OFFX45-1010	28710-1010	20242209	5/8	15.9	1-14	1 3/16	30	0.67	17.0	2.28	58.0	3.62	92.0	NS	Y	
S4-OFFX45-1212	28710-1212	20242233	3/4	19.0	1 3/16-12	1 7/16	36	0.83	21.0	2.48	63.0	4.06	103.0	NS	Y	
S4-OFFX45-1616	28710-1616	20242220	1	25.4	1 7/16-12	1 5/8	41	1.02	26.0	3.23	82.0	5.00	127.0	NS	Y	
S4-OFFX45-1620	28710-1620	20242218	1	25.4	1 1/4-12	2	50	1.02	26.0	3.35	85.0	5.41	137.5	NS	Y	
S4-OFFX45-2020	28710-2020	20242223	1 1/4	31.8	1 1/4-12	2	50	1.02	26.0	3.82	97.0	6.16	156.5	NS	Y	
S4-OFFX45-2024	28710-2024	20242224	1 1/4	31.8	2-12	2 3/8	60	1.10	28.0	3.98	101.0	6.34	161.0	NS	Y	
S4-OFFX45-2424	28710-2424	20242222	1 1/2	38.1	2-12	2 3/8	60	1.10	28.0	4.13	105.0	6.77	172.0	NS	Y	

C: Crimp Nut (see "Fitting Identification" in Appendix for details)

O-Ring Face Seal (SAE J1453) ORS/ORFS

Female 90° Elbow | Swivel

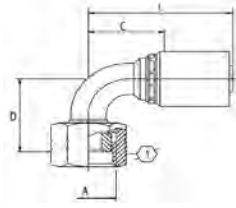

LT=Long Tube
ST=Short Tube

S=Skive
NS=Non-Skive
DG=Dual-Grip™

Description #	Product #	SAP #	Hose Size ID		Thread Size (A)	Hex-1 Wrench Size		Elbow Type	Drop (D)		Cut-Off (C)		Length (L)		Skive Type	SR12 ARC12
			in.	mm		in.	mm		in.	mm	in.	mm	in.	mm		
S4-OFFX90-0606	28715-0606	20242240	3/8	9.5	11/16-16	7/8	22		1.50	38.0	1.65	42.0	2.72	69.0	NS	Y
S4-OFFX90L-0606	28720-0606	20241695	3/8	9.5	11/16-16	7/8	22	LT	2.13	54.0	1.65	42.0	2.72	69.0	NS	Y
S4-OFFX90S-0606	28725-0606	20242210	3/8	9.5	11/16-16	7/8	22	ST	0.98	25.0	1.65	42.0	2.72	69.0	NS	Y
S4-OFFX90-0808 ^C	28715-0808	20241697	1/2	12.7	13/16-16	15/16	24		1.65	42.0	1.38	35.0	2.60	66.0	NS	Y
S4-OFFX90L-0808 ^C	28720-0808	20242203	1/2	12.7	13/16-16	15/16	24	LT	2.52	64.0	1.50	38.0	2.76	70.0	NS	Y
S4-OFFX90S-0808 ^C	28725-0808	20242192	1/2	12.7	13/16-16	15/16	24	ST	1.14	29.0	1.57	40.0	2.80	71.0	NS	Y
S4-OFFX90L-0810	28720-0810	20242215	1/2	12.7	1-14	13/16	30	LT	2.76	70.0	1.81	46.0	3.07	78.0	NS	Y
S4-OFFX90S-0810	28725-0810	20242241	1/2	12.7	1-14	13/16	30	ST	1.28	32.5	1.81	46.0	3.07	78.0	NS	Y
S4-OFFX90S-1010	28725-1010	20242163	5/8	15.9	1-14	13/16	30	ST	1.73	44.0	2.17	55.0	3.54	90.0	NS	Y
S4-OFFX90S-1210 ^C	28725-1210	20241723	3/4	19.0	1-14	13/16	30	ST	1.26	32.0	1.75	44.5	3.31	84.0	NS	Y
S4-OFFX90L-1212	28720-1212	20241693	3/4	19.0	1 3/16-12	1 7/16	36	LT	3.78	96.0	2.44	62.0	3.98	101.0	NS	Y
S4-OFFX90S-1212	28725-1212	20242154	3/4	19.0	1 3/16-12	1 7/16	36	ST	2.01	51.0	2.40	61.0	3.94	100.0	NS	Y
S4-OFFX90S-1216	28725-1216	20242156	3/4	19.0	1 7/16-12	1 5/8	41	ST	2.80	71.0	2.60	66.0	4.13	105.0	NS	Y
S4-OFFX90-1616	28715-1616	20241699	1	25.4	1 7/16-12	1 5/8	41		2.60	66.0	3.27	83.0	5.00	127.0	NS	Y
S4-OFFX90L-1616	28720-1616	20242211	1	25.4	1 7/16-12	1 5/8	41	LT	4.49	114.0	3.27	83.0	5.00	127.0	NS	Y
S4-OFFX90S-1616	28725-1616	20242245	1	25.4	1 7/16-12	1 5/8	41	ST	2.28	58.0	3.27	83.0	5.00	127.0	NS	Y
S4-OFFX90-2020	28715-2020	20241702	1 1/4	31.8	1 11/16-12	2	50		3.07	78.0	3.82	97.0	5.87	149.0	NS	Y
S4-OFFX90L-2020	28720-2020	20242212	1 1/4	31.8	1 11/16-12	2	50	LT	5.08	129.0	3.82	97.0	5.87	149.0	NS	Y
S4-OFFX90S-2020	28725-2020	20242247	1 1/4	31.8	1 11/16-12	2	50	ST	2.68	68.0	3.74	95.0	5.79	147.0	NS	Y
S4-OFFX90L-2024	28720-2024	20242213	1 1/4	31.8	2-12	2 3/8	60	LT	5.55	141.0	4.02	102.0	6.06	154.0	NS	Y
S4-OFFX90S-2024	28725-2024	20242248	1 1/4	31.8	2-12	2 3/8	60	ST	2.72	69.0	4.02	102.0	6.06	154.0	NS	Y
S4-OFFX90-2424	28715-2424	20241701	1 1/2	38.1	2-12	2 3/8	60		3.43	87.0	4.25	108.0	6.57	167.0	NS	Y
S4-OFFX90L-2424	28720-2424	20441321	1 1/2	38.1	2-12	2 3/8	60	LT	5.55	141.0	4.37	111.0	6.69	170.0	NS	Y
S4-OFFX90S-2424	28725-2424	20242246	1 1/2	38.1	2-12	2 3/8	60	ST	3.07	78.0	4.02	102.0	6.34	161.0	NS	Y

C: Crimp Nut (see "Fitting Identification" in Appendix for details)

O-Ring Face Seal (SAE J1453) ORS/ORFS

Male

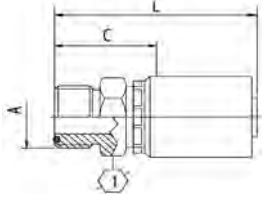

S=Skive
NS=Non-Skive
DG=Dual-Grip™

Description #	Product #	SAP #	Hose Size ID		Thread Size (A)	Hex-1 Wrench Size		Cut-Off (C)		Length (L)		Skive Type	SR12 ARC12
			in.	mm		in.	mm	in.	mm	in.	mm		
S4-OFM-0606	28730-0606	20242182	3/8	9.5	11/16-16	3/4	19	0.96	24.3	2.01	51.0	NS	Y
S4-OFM-0608	28730-0608	20242184	3/8	9.5	13/16-16	7/8	22	1.04	26.3	2.09	53.0	NS	Y
S4-OFM-0808	28730-0808	20242175	1/2	12.7	13/16-16	7/8	22	1.07	27.1	2.31	58.6	NS	Y
S4-OFM-1212	28730-1212	20242168	3/4	19.0	1 3/16-12	1 1/4	32	1.36	34.6	2.92	74.1	NS	Y
S4-OFM-1216	28730-1216	20242180	3/4	19.0	1 7/16-12	1 5/8	41	1.50	38.1	3.06	77.6	NS	Y
S4-OFM-1616	28730-1616	20242170	1	25.4	1 7/16-12	1 1/2	38	1.49	37.9	3.25	82.5	NS	Y
S4-OFM-2020	28730-2020	20242171	1 1/4	31.8	1 11/16-12	1 3/4	46	1.63	41.5	3.68	93.5	NS	Y

O-Ring Boss Straight Thread (SAE J514)

Male

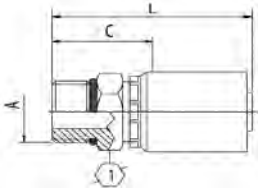

S=Skive
NS=Non-Skive
DG=Dual-Grip™

Description #	Product #	SAP #	Hose Size ID		Thread Size (A)	Hex-1 Wrench Size		Cut-Off (C)		Length (L)		Skive Type	SR12 ARC12
			in.	mm		in.	mm	in.	mm	in.	mm		
S4-OBM-0808	28670-0808	20242130	1/2	12.7	3/4-16	7/8	22	0.99	25.1	2.23	56.6	NS	Y
S4-OBM-1212	28670-1212	20242124	3/4	19.0	1 1/16-12	1 1/4	32	1.28	32.6	2.84	72.1	NS	Y
S4-OBM-1216	28670-1216	20242119	3/4	19.0	1 5/16-12	1 1/2	38	1.36	34.6	2.92	74.1	NS	Y
S4-OBM-1616	28670-1616	20242125	1	25.4	1 5/16-12	1 1/2	38	1.39	35.4	3.15	80.0	NS	Y
S4-OBM-2020	28670-2020	20293258	1 1/4	31.8	1 5/8-12	1 3/4	46	1.54	39.0	3.58	91.0	NS	Y

Code 61 Flange (SAE J518)

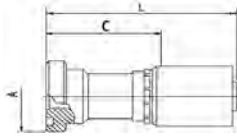

S=Skive
NS=Non-Skive
DG=Dual-Grip™

Description #	Product #	SAP #	Hose Size ID		Flange Size (A)	Flange Diameter (A)		Cut-Off (C)		Length (L)		Skive Type	SR12 ARC12
			in.	mm		in.	mm	in.	mm	in.	mm		
S4-FL-0808	28320-0808	20242907	1/2	12.7	1/2	1.19	30.2	1.61	41.0	2.85	72.5	NS	Y
S4-FL-0812	28320-0812	20242905	1/2	12.7	3/4	1.50	38.1	1.65	42.0	2.89	73.5	NS	Y
S4-FL-1012	28320-1012	20242898	5/8	15.9	3/4	1.50	38.1	1.66	42.2	3.01	76.5	NS	Y
S4-FL-1212	28320-1212	20242900	3/4	19.0	3/4	1.50	38.1	1.67	42.5	3.23	82.0	NS	Y
S4-FL-1216	28320-1216	20242912	3/4	19.0	1	1.75	44.5	1.99	50.5	3.54	90.0	NS	Y
S4-FL-1220	28320-1220	20441320	3/4	19.0	1 1/4	2.00	50.8	2.09	53.0	3.64	92.5	NS	Y
S4-FL-1616	28320-1616	20242878	1	25.4	1	1.75	44.5	2.02	51.4	3.78	96.0	NS	Y
S4-FL-1620	28320-1620	20242904	1	25.4	1 1/4	2.00	50.8	2.12	53.9	3.88	98.5	NS	Y
S4-FL-1624	28320-1624	20293264	1	25.4	1 1/2	2.37	60.3	2.24	57.0	4.00	101.5	NS	Y
S4-FL-2020	28320-2020	20242909	1 1/4	31.8	1 1/4	2.00	50.8	2.19	55.5	4.23	107.5	NS	Y
S4-FL-2024	28320-2024	20242910	1 1/4	31.8	1 1/2	2.37	60.3	2.30	58.5	4.35	110.5	NS	Y
S4-FL-2424	28320-2424	20242886	1 1/2	38.1	1 1/2	2.37	60.3	2.31	58.8	4.63	117.5	NS	Y
S4-FL-2432	28320-2432	20242911	1 1/2	38.1	2	2.81	71.4	2.76	70.0	5.08	129.0	NS	Y
S4-FL-3232	28320-3232	20242895	2	50.8	2	2.81	71.4	2.76	70.0	5.59	142.0	NS	Y

Code 61 Flange (SAE J518)

22.5° Elbow

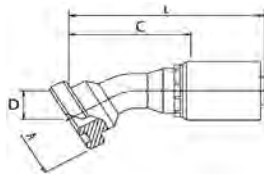

S=Skive
NS=Non-Skive
DG=Dual-Grip™

Description #	Product #	SAP #	Hose Size ID		Flange Size (A)	Flange Diameter (A)		Drop (D)		Cut-Off (C)		Length (L)		Skive Type	SR12 ARC12
			in.	mm		in.	mm	in.	mm	in.	mm	in.	mm		
S4-FL22-0808	28330-0808	20441293	1/2	12.7	1/2	1.19	30.2	0.35	9.0	2.32	59.0	3.58	91.0	NS	Y
S4-FL22-1212	28330-1212	20441202	3/4	19.0	3/4	1.50	38.1	0.83	21.0	3.90	99.0	5.47	139.0	NS	Y
S4-FL22-1216	28330-1216	20441276	3/4	19.0	1	1.75	44.5	0.51	13.0	3.39	86.0	4.96	126.0	NS	Y
S4-FL22-1616	28330-1616	20242929	1	25.4	1	1.75	44.5	0.47	12.0	3.66	93.0	5.39	137.0	NS	Y
S4-FL22-1620	28330-1620	20293265	1	25.4	1 1/4	2.00	50.8	0.63	16.0	3.62	92.0	5.39	137.0	NS	Y
S4-FL22-2020	28330-2020	20242928	1 1/4	31.8	1 1/4	2.00	50.8	0.63	16.0	4.49	114.0	6.54	166.0	NS	Y
S4-FL22-2024	28330-2024	20293266	1 1/4	31.8	1 1/2	2.37	60.3	0.81	20.5	4.53	115.0	6.57	167.0	NS	Y
S4-FL22-2424	28330-2424	20242923	1 1/2	38.1	1 1/2	2.37	60.3	0.65	16.5	5.16	131.0	7.48	190.0	NS	Y
S4-FL22-3232	28330-3232	20293267	2	50.8	2	2.81	71.4	0.87	22.0	6.02	153.0	8.86	225.0	NS	Y

Code 61 Flange (SAE J518)

30° Elbow

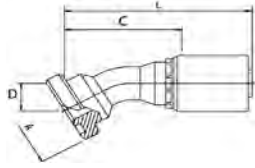

S=Skive
NS=Non-Skive
DG=Dual-Grip™

Description #	Product #	SAP #	Hose Size ID		Flange Size (A)	Flange Diameter (A)		Drop (D)		Cut-Off (C)		Length (L)		Skive Type	SR12 ARC12
			in.	mm		in.	mm	in.	mm	in.	mm	in.	mm		
S4-FL30-1212	28335-1212	20242920	3/4	19.0	3/4	1.50	38.1	0.75	19.0	3.19	81.0	4.72	120.0	NS	Y
S4-FL30-1216	28335-1216	20242932	3/4	19.0	1	1.75	44.5	0.75	19.0	3.31	84.0	4.84	123.0	NS	Y
S4-FL30-1616	28335-1616	20242926	1	25.4	1	1.75	44.5	0.83	21.0	3.54	90.0	5.28	134.0	NS	Y
S4-FL30-1620	28335-1620	20242925	1	25.4	1¼	2.00	50.8	0.87	22.0	3.54	90.0	5.31	135.0	NS	Y
S4-FL30-1624	28335-1624	20293268	1	25.4	1½	2.37	60.3	1.06	27.0	4.13	105.0	5.87	149.0	NS	Y
S4-FL30-2020	28335-2020	20242922	1¼	31.8	1¼	2.00	50.8	0.98	25.0	4.02	102.0	6.06	154.0	NS	Y
S4-FL30-2024	28335-2024	20242913	1¼	31.8	1½	2.37	60.3	1.06	27.0	4.41	112.0	6.46	164.0	NS	Y
S4-FL30-2424	28335-2424	20242924	1½	38.1	1½	2.37	60.3	0.91	23.0	5.35	136.0	7.68	195.0	NS	Y
S4-FL30-2432	28335-2432	20293269	1½	38.1	2	2.81	71.4	1.44	36.5	5.91	150.0	8.23	209.0	NS	Y
S4-FL30-3232	28335-3232	20293270	2	50.8	2	2.81	71.4	1.18	30.0	5.87	149.0	8.70	221.0	NS	Y

Code 61 Flange (SAE J518)

45° Elbow

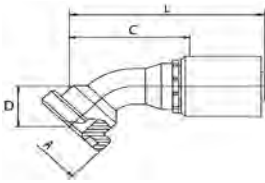

S=Skive
NS=Non-Skive
DG=Dual-Grip™

Description #	Product #	SAP #	Hose Size ID		Flange Size (A)	Flange Diameter (A)		Drop (D)		Cut-Off (C)		Length (L)		Skive Type	SR12 ARC12
			in.	mm		in.	mm	in.	mm	in.	mm	in.	mm		
S4-FL45-0808	28340-0808	20242950	1/2	12.7	1/2	1.19	30.2	0.87	22.0	2.09	53.0	3.31	84.0	NS	Y
S4-FL45-0812	28340-0812	20242946	1/2	12.7	3/4	1.50	38.1	1.02	26.0	2.36	60.0	3.62	92.0	NS	Y
S4-FL45-1012	28340-1012	20441203	5/8	15.9	3/4	1.50	38.1	1.02	26.0	2.56	65.0	3.90	99.0	NS	Y
S4-FL45-1212	28340-1212	20242948	3/4	19.0	3/4	1.50	38.1	1.26	32.0	2.91	74.0	4.45	113.0	NS	Y
S4-FL45-1216	28340-1216	20242943	3/4	19.0	1	1.75	44.5	1.14	29.0	3.07	78.0	4.61	117.0	NS	Y
S4-FL45-1616	28340-1616	20242918	1	25.4	1	1.75	44.5	1.32	33.5	3.27	83.0	5.00	127.0	NS	Y
S4-FL45-1620	28340-1620	20242916	1	25.4	1¼	2.00	50.8	1.42	36.0	3.23	82.0	5.00	127.0	NS	Y
S4-FL45-2020	28340-2020	20242934	1¼	31.8	1¼	2.00	50.8	1.48	37.5	3.74	95.0	5.79	147.0	NS	Y
S4-FL45-2024	28340-2024	20242921	1¼	31.8	1½	2.37	60.3	1.57	40.0	4.09	104.0	6.14	156.0	NS	Y
S4-FL45-2424	28340-2424	20242915	1½	38.1	1½	2.37	60.3	1.89	48.0	4.61	117.0	6.93	176.0	NS	Y
S4-FL45-2432	28340-2432	20242914	1½	38.1	2	2.81	71.4	2.19	55.5	5.35	136.0	7.68	195.0	NS	Y
S4-FL45-3232	28340-3232	20242945	2	50.8	2	2.81	71.4	1.87	47.5	5.55	141.0	8.39	213.0	NS	Y

Code 61 Flange (SAE J518)

60° Elbow

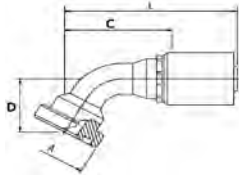

S=Skive
NS=Non-Skive
DG=Dual-Grip™

Description #	Product #	SAP #	Hose Size ID		Flange Size (A)	Flange Diameter (A)		Drop (D)		Cut-Off (C)		Length (L)		Skive Type	SR12 ARC12
			in.	mm		in.	mm	in.	mm	in.	mm	in.	mm		
S4-FL60-1212	28345-1212	20242935	3/4	19.0	3/4	1.50	38.1	1.46	37.0	3.39	86.0	4.92	125.0	NS	Y
S4-FL60-1216	28345-1216	20242940	3/4	19.0	1	1.75	44.5	1.73	44.0	4.02	102.0	5.57	141.5	NS	Y
S4-FL60-1616	28345-1616	20242941	1	25.4	1	1.75	44.5	1.85	47.0	3.98	101.0	5.73	145.6	NS	Y
S4-FL60-1620	28345-1620	20242933	1	25.4	1 1/4	2.00	50.8	1.71	43.5	4.20	106.6	5.95	151.2	NS	Y
S4-FL60-2020	28345-2020	20242937	1 1/4	31.8	1 1/4	2.00	50.8	2.22	56.5	5.10	129.5	7.15	181.5	NS	Y
S4-FL60-2024	28345-2024	20293271	1 1/4	31.8	1 1/2	2.37	60.3	2.28	58.0	5.31	135.0	7.36	187.0	NS	Y
S4-FL60-2424	28345-2424	20293272	1 1/2	38.1	1 1/2	2.37	60.3	2.24	57.0	5.98	152.0	8.31	211.0	NS	Y
S4-FL60-2432	28345-2432	20293273	1 1/2	38.1	2	2.81	71.4	3.05	77.5	6.52	165.5	8.84	224.5	NS	Y
S4-FL60-3232	28345-3232	20293274	2	50.8	2	2.81	71.4	3.62	92.0	6.81	173.0	9.65	245.0	NS	Y

Code 61 Flange (SAE J518)

67° Elbow

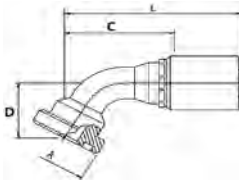

S=Skive
NS=Non-Skive
DG=Dual-Grip™

Description #	Product #	SAP #	Hose Size ID		Flange Size (A)	Flange Diameter (A)		Drop (D)		Cut-Off (C)		Length (L)		Skive Type	SR12 ARC12
			in.	mm		in.	mm	in.	mm	in.	mm	in.	mm		
S4-FL67-1212	28347-1212	20293275	3/4	19	3/4	1.5	38.1	1.79	45.5	3.09	78.5	4.65	118	NS	Y
S4-FL67-1216	28347-1216	20441294	3/4	19	1	1.75	44.4	2.01	51	3.46	88	5	127	NS	Y
S4-FL67-1616	28347-1616	20293276	1	25.4	1	1.75	44.4	1.95	49.5	3.68	93.4	5.43	138	NS	Y
S4-FL67-1620	28347-1620	20293277	1	25.4	1 1/4	2	50.8	2.11	53.5	3.88	98.5	5.63	143	NS	Y
S4-FL67-2020	28347-2020	20293278	1 1/4	31.8	1 1/4	2	50.8	2.46	62.5	4.72	120	6.77	172	NS	Y
S4-FL67-2024	28347-2024	20293280	1 1/2	38.1	1 1/2	2.37	60.3	2.58	65.5	5.33	135.5	7.66	194.5	NS	Y
S4-FL67-2424	28347-2424	20293281	1 1/2	38.1	2	2.81	71.4	3.46	88	5.55	141	7.87	200	NS	Y
S4-FL67-2432	28347-2432	20293282	2	50.8	2	2.81	71.4	3.76	99.5	7.05	179	9.88	251	NS	Y

Code 61 Flange (SAE J518)

90° Elbow

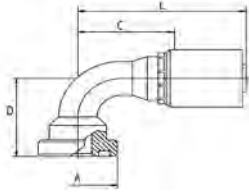

S=Skive
NS=Non-Skive
DG=Dual-Grip™

Description #	Product #	SAP #	Hose Size ID		Flange Size (A)	Flange Diameter (A)		Drop (D)		Cut-Off (C)		Length (L)		Skive Type	SR12 ARC12
			in.	mm		in.	mm	in.	mm	in.	mm	in.	mm		
S4-FL90-0808	28350-0808	20242887	1/2	12.7	1/2	1.19	30.2	1.65	42.0	1.81	46.0	3.03	77.0	Y	
S4-FL90-0812	28350-0812	20242885	1/2	12.7	3/4	1.50	38.1	2.01	51.0	1.77	45.0	3.03	77.0	Y	
S4-FL90-1212	28350-1212	20242880	3/4	19.0	3/4	1.50	38.1	2.36	60.0	2.28	58.0	3.82	97.0	Y	
S4-FL90-1216	28350-1216	20242882	3/4	19.0	1	1.75	44.5	2.54	64.5	2.60	66.0	4.17	106.0	Y	
S4-FL90L-1216*	28352-1216	20293284	3/4	19.0	1	1.75	44.5	3.15	80.0	2.60	66.0	4.17	106.0	Y	
S4-FL90-1612	28350-1612	20293285	1	25.4	3/4	1.50	38.1	2.17	55.0	2.64	67.0	4.41	112.0	Y	
S4-FL90-1616	28350-1616	20242896	1	25.4	1	1.75	44.5	2.64	67.0	2.80	71.0	4.53	115.0	Y	
S4-FL90L-1616	28352-1616	20293286	1	25.4	1	1.75	44.5	4.92	125.0	2.95	75.0	4.69	119.0	Y	
S4-FL90-1620	28350-1620	20242892	1	25.4	1 1/4	2.00	50.8	2.80	71.0	2.91	74.0	4.65	118.0	Y	
S4-FL90-1624	28350-1624	20293287	1	25.4	1 1/2	2.37	60.3	2.95	75.0	3.66	93.0	5.43	138.0	Y	
S4-FL90-2016	28350-2016	20242897	1 1/4	31.8	1	1.75	44.5	2.56	65.0	3.70	94.0	5.75	146.0	Y	
S4-FL90-2020	28350-2020	20242931	1 1/4	31.8	1 1/4	2.00	50.8	3.31	84.0	3.46	88.0	5.51	140.0	Y	
S4-FL90-2024	28350-2024	20242889	1 1/4	31.8	1 1/2	2.37	60.3	3.44	87.5	3.58	91.0	5.63	143.0	Y	
S4-FL90-2424	28350-2424	20242891	1 1/2	38.1	1 1/2	2.37	60.3	3.58	91.0	4.13	105.0	6.46	164.0	Y	
S4-FL90-2432	28350-2432	20242890	1 1/2	38.1	2	2.81	71.4	4.53	115.0	4.13	105.0	6.46	164.0	Y	
S4-FL90-3232	28350-3232	20242894	2	50.8	2	2.81	71.4	5.12	130.0	5.08	129.0	7.91	201.0	Y	

*Drop Length does not meet SAE long drop dimensions

Code 61 Flange (SAE J518)

110° Elbow

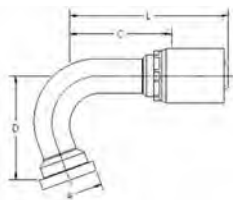

S=Skive
NS=Non-Skive
DG=Dual-Grip™

Description #	Product #	SAP #	Hose Size ID		Flange Size (A)	Flange Diameter (A)		Drop (D)		Cut-Off (C)		Length (L)		Skive Type	SR12 ARC12
			in.	mm		in.	mm	in.	mm	in.	mm				
S4-FL110-1212	28354-1212	20441316	3/4	19.0	3/4	1.50	38.1	2.76	70.0	2.44	62.0	4.02	102.0	NS	Y
S4-FL110-1216	28354-1216	20441317	3/4	19.0	1	1.75	44.5	2.91	74.0	2.24	57.0	3.82	97.0	NS	Y
S4-FL110-1616	28354-1616	20441318	1	25.4	1	1.75	44.5	3.11	79.0	3.74	95.0	5.51	140.0	NS	Y
S4-FL110-2424	28354-2424	20441319	1 1/2	38.1	1 1/2	2.37	60.3	4.33	110.0	3.74	95.0	6.06	154.0	NS	Y

Code 61 Flange (SAE J518)

135° Elbow

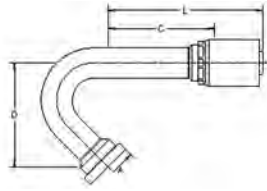

S=Skive
NS=Non-Skive
DG=Dual-Grip™

Description #	Product #	SAP #	Hose Size ID		Flange Size (A)	Flange Diameter (A)		Drop (D)		Cut-Off (C)		Length (L)		Skive Type	SR12 ARC12
			in.	mm		in.	mm	in.	mm	in.	mm	in.	mm		
S4-FL135-1212	28355-1212	20477377	3/4	19.0	3/4	1.50	38.1	3.15	80.0	2.95	75.0	4.49	114.0	NS	Y

Code 62 Flange (SAE J518)

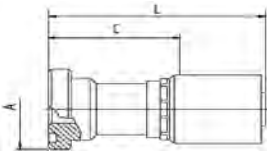

S=Skive
NS=Non-Skive
DG=Dual-Grip™

Description #	Product #	SAP #	Hose Size ID		Flange Size (A)	Flange Diameter (A)		Cut-Off (C)		Length (L)		Skive Type	SR12 ARC12
			in.	mm		in.	mm	in.	mm	in.	mm		
S4-FH-0808	28300-0808	20241741	1/2	12.7	1/2	1.25	31.8	1.85	47.0	3.09	78.5	NS	Y
S4-FH-0812	28300-0812	20241750	1/2	12.7	3/4	1.63	41.3	2.05	52.0	3.29	83.5	NS	Y
S4-FH-1212	28300-1212	20241753	3/4	19.0	3/4	1.63	41.3	2.07	52.5	3.62	92.0	NS	Y
S4-FH-1216	28300-1216	20241747	3/4	19.0	1	1.87	47.6	2.19	55.5	3.74	95.0	NS	Y
S4-FH-1612	28300-1612	20293288	1	25.4	3/4	1.63	41.3	2.22	56.4	3.98	101.0	NS	Y
S4-FH-1616	28300-1616	20241730	1	25.4	1	1.87	47.6	2.22	56.4	3.98	101.0	NS	Y
S4-FH-1620	28300-1620	20241218	1	25.4	1 1/4	2.13	54.0	2.50	63.4	4.25	108.0	NS	Y
S4-FH-2016	28300-2016	20441292	1 1/4	31.8	1	1.87	47.6	3.27	83.0	5.31	135.0	NS	Y
S4-FH-2020	28300-2020	20241752	1 1/4	31.8	1 1/4	2.13	54.0	3.27	83.0	5.31	135.0	NS	Y
S4-FH-2024	28300-2024	20241754	1 1/4	31.8	1 1/2	2.50	63.5	2.80	71.0	4.84	123.0	NS	Y
S4-FH-2424	28300-2424	20241751	1 1/2	38.1	1 1/2	2.50	63.5	3.74	95.0	6.06	154.0	NS	Y
S4-FH-2432	28300-2432	20241757	1 1/2	38.1	2	3.13	79.4	2.99	76.0	5.31	135.0	NS	Y
S4-FH-3232	28300-3232	20241759	2	50.8	2	3.13	79.4	2.99	76.0	5.83	148.0	NS	Y

Code 62 Flange (SAE J518)

22.5° Elbow

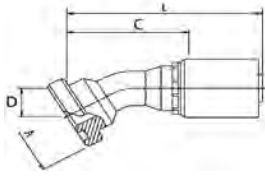

S=Skive
NS=Non-Skive
DG=Dual-Grip™

Description #	Product #	SAP #	Hose Size ID		Flange Size (A)	Flange Diameter (A)		Drop (D)		Cut-Off (C)		Length (L)		Skive Type	SR12 ARC12
			in.	mm		in.	mm	in.	mm	in.	mm	in.	mm		
S4-FH22-1212	28303-1212	20293289	3/4	19.0	3/4	1.63	41.3	0.55	14.0	3.66	93.0	5.22	132.5	NS	Y
S4-FH22-1616	28303-1616	20293290	1	25.4	1	1.87	47.6	0.63	16.0	4.19	106.5	5.94	151.0	NS	Y
S4-FH22-2020	28303-2020	20293291	1¼	31.8	1¼	2.13	54.0	0.69	17.5	4.72	120.0	6.77	172.0	NS	Y
S4-FH22-2024	28303-2024	20293292	1¼	31.8	1½	2.50	63.5	0.81	20.5	5.04	128.0	7.09	180.0	NS	Y

Code 62 Flange (SAE J518)

30° Elbow

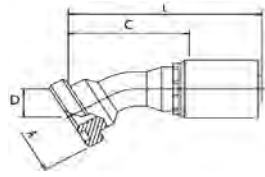

S=Skive
NS=Non-Skive
DG=Dual-Grip™

Description #	Product #	SAP #	Hose Size ID		Flange Size (A)	Flange Diameter (A)		Drop (D)		Cut-Off (C)		Length (L)		Skive Type	SR12 ARC12
			in.	mm		in.	mm	in.	mm	in.	mm	in.	mm		
S4-FH30-1212	28305-1212	20293293	3/4	19.0	3/4	1.63	41.3	0.77	19.5	3.48	88.5	5.04	128.0	NS	Y
S4-FH30-1616	28305-1616	20293294	1	25.4	1	1.87	47.6	0.89	22.5	4.11	104.5	5.87	149.0	NS	Y
S4-FH30-2020	28305-2020	20293295	1¼	31.8	1¼	2.13	54.0	0.96	24.5	4.61	117.0	6.65	169.0	NS	Y
S4-FH30-2024	28305-2024	20293296	1¼	31.8	1½	2.50	63.5	1.12	28.5	4.90	124.5	6.95	176.5	NS	Y
S4-FH30-2424	28305-2424	20293297	1½	38.1	1½	2.50	63.5	1.08	27.5	5.22	132.5	7.54	191.5	NS	Y
S4-FH30-3232	28305-3232	20293298	2	50.8	2	3.13	79.4	1.44	36.5	6.65	169.0	9.49	241.0	NS	Y

Code 62 Flange (SAE J518)

45° Elbow

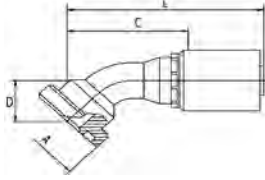

S=Skive
NS=Non-Skive
DG=Dual-Grip™

Description #	Product #	SAP #	Hose Size ID		Flange Size (A)	Flange Diameter (A)		Drop (D)		Cut-Off (C)		Length (L)		Skive Type	SR12 ARC12
			in.	mm		in.	mm	in.	mm	in.	mm	in.	mm		
S4-FH45-0808	28310-0808	20241762	1/2	12.7	1/2	1.25	31.8	0.91	23.0	2.24	57.0	3.46	88.0	NS	Y
S4-FH45-0812	28310-0812	20241761	1/2	12.7	3/4	1.63	41.3	1.20	30.5	3.15	80.0	4.37	111.0	NS	Y
S4-FH45-1212	28310-1212	20241790	3/4	19.0	3/4	1.63	41.3	1.22	31.0	3.31	84.0	4.88	124.0	NS	Y
S4-FH45-1216	28310-1216	20241794	3/4	19.0	1	1.87	47.6	1.32	33.5	3.15	80.0	4.72	120.0	NS	Y
S4-FH45-1616	28310-1616	20241774	1	25.4	1	1.87	47.6	1.42	36.0	3.82	97.0	5.55	141.0	NS	Y
S4-FH45-1620	28310-1620	20241778	1	25.4	1 1/4	2.13	54.0	1.54	39.0	3.78	96.0	5.55	141.0	NS	Y
S4-FH45-2020	28310-2020	20241764	1 1/4	31.8	1 1/4	2.13	54.0	1.57	40.0	4.29	109.0	6.34	161.0	NS	Y
S4-FH45-2024	28310-2024	20241765	1 1/4	31.8	1 1/2	2.50	63.5	1.79	45.5	4.53	115.0	6.57	167.0	NS	Y
S4-FH45-2424	28310-2424	20241769	1 1/2	38.1	1 1/2	2.50	63.5	1.77	45.0	4.84	123.0	7.17	182.0	NS	Y
S4-FH45-2432	28310-2432	20241776	1 1/2	38.1	2	3.13	79.4	2.26	57.5	5.24	133.0	7.56	192.0	NS	Y
S4-FH45-3232	28310-3232	20241767	2	50.8	2	3.13	79.4	2.36	60.0	6.18	157.0	9.02	229.0	NS	Y

Code 62 Flange (SAE J518)

60° Elbow

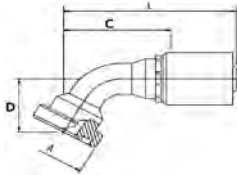

S=Skive
NS=Non-Skive
DG=Dual-Grip™

Description #	Product #	SAP #	Hose Size ID		Flange Size (A)	Flange Diameter (A)		Drop (D)		Cut-Off (C)		Length (L)		Skive Type	SR12 ARC12
			in.	mm		in.	mm	in.	mm	in.	mm	in.	mm		
S4-FH60-1212	28312-1212	20293299	3/4	19.0	3/4	1.63	41.3	1.61	41.0	3.56	90.5	5.12	130.0	NS	Y
S4-FH60-1616	28312-1616	20293300	1	25.4	1	1.87	47.6	1.99	50.5	4.21	107.0	5.96	151.5	NS	Y
S4-FH60-2020	28312-2020	20293301	1 1/4	31.8	1 1/4	2.13	54.0	2.32	59.0	5.26	133.5	7.30	185.5	NS	Y
S4-FH60-2024	28312-2024	20293302	1 1/4	31.8	1 1/2	2.50	63.5	2.48	63.0	5.49	139.5	7.54	191.5	NS	Y

Code 62 Flange (SAE J518)

67° Elbow

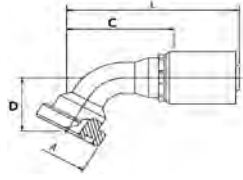

S=Skive
NS=Non-Skive
DG=Dual-Grip™

Description #	Product #	SAP #	Hose Size ID		Flange Size (A)	Flange Diameter (A)		Drop (D)		Cut-Off (C)		Length (L)		Skive Type	SR12 ARC12
			in.	mm		in.	mm	in.	mm	in.	mm	in.	mm		
S4-FH67-1616	28313-1616	20293304	1	25.4	1	1.87	47.6	2.24	57.0	3.94	100.0	5.68	144.2	NS	Y

Code 62 Flange (SAE J518)

90° Elbow

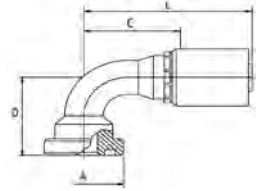

S=Skive
NS=Non-Skive
DG=Dual-Grip™

Description #	Product #	SAP #	Hose Size ID		Flange Size (A)	Flange Diameter (A)		Drop (D)		Cut-Off (C)		Length (L)		Skive Type	SR12 ARC12
			in.	mm		in.	mm	in.	mm	in.	mm	in.	mm		
S4-FH90-0808	28315-0808	20241739	1/2	12.7	1/2	1.25	31.8	1.81	46.0	1.89	48.0	3.11	79.0	NS	Y
S4-FH90-0812	28315-0812	20241737	1/2	12.7	3/4	1.63	41.3	2.13	54.0	1.89	48.0	3.11	79.0	NS	Y
S4-FH90-1012	28315-1012	20242953	5/8	15.9	3/4	1.63	41.3	2.17	55.0	1.97	50.0	3.31	84.0	NS	Y
S4-FH90-1212	28315-1212	20241731	3/4	19.0	3/4	1.63	41.3	2.40	61.0	2.48	63.0	4.06	103.0	NS	Y
S4-FH90-1216	28315-1216	20241734	3/4	19.0	1	1.87	47.6	2.60	66.0	2.48	63.0	4.06	103.0	NS	Y
S4-FH90-1612	28315-1612	20293303	1	25.4	3/4	1.63	41.3	2.40	61.0	2.87	73.0	4.61	117.0	NS	Y
S4-FH90-1616	28315-1616	20241787	1	25.4	1	1.87	47.6	2.95	75.0	2.91	74.0	4.65	118.0	NS	Y
S4-FH90-1620	28315-1620	20241743	1	25.4	1 1/4	2.13	54.0	3.07	78.0	3.07	78.0	4.80	122.0	NS	Y
S4-FH90-2016	28315-2016	20441315	1 1/4	31.8	1	1.87	47.6	2.83	72.0	3.35	85.0	5.39	137.0	NS	Y
S4-FH90-2020	28315-2020	20241780	1 1/4	31.8	1 1/4	2.13	54.0	3.50	89.0	3.70	94.0	5.75	146.0	NS	Y
S4-FH90-2024	28315-2024	20241781	1 1/4	31.8	1 1/2	2.50	63.5	3.70	94.0	3.86	98.0	5.91	150.0	NS	Y
S4-FH90-2424	28315-2424	20241771	1 1/2	38.1	1 1/2	2.50	63.5	4.13	105.0	3.94	100.0	6.26	159.0	NS	Y
S4-FH90-2432	28315-2432	20241777	1 1/2	38.1	2	3.13	79.4	4.84	123.0	4.53	115.0	6.85	174.0	NS	Y
S4-FH90-3232	28315-3232	20241740	2	50.8	2	3.13	79.4	5.20	132.0	5.63	143.0	8.46	215.0	NS	Y

Caterpillar Flange

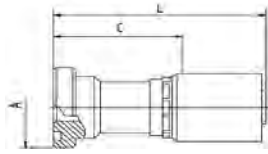

S=Skive
NS=Non-Skive
DG=Dual-Grip™

Description #	Product #	SAP #	Hose Size ID		Flange Size (A)	Flange Diameter (A)		Cut-Off (C)		Length (L)		Skive Type	SR12 ARC12
			in.	mm		in.	mm	in.	mm	in.	mm		
S4-CF-1212	28185-1212	20293305	3/4	19.0	3/4	1.63	41.3	3.46	88.0	5.02	127.5	NS	Y
S4-CF-1216	28185-1216	20441277	3/4	19.0	1	1.87	47.6	3.52	89.5	5.08	129.0	NS	Y
S4-CF-1612	28185-1612	20441322	1	25.4	3/4	1.63	41.3	3.48	88.4	5.24	133.0	NS	Y
S4-CF-1616	28185-1616	20293306	1	25.4	1	1.87	47.6	3.54	90.0	5.30	134.6	NS	Y
S4-CF-1620	28185-1620	20441278	1	25.4	1 1/4	2.13	54.0	3.66	93.0	5.42	137.6	NS	Y
S4-CF-2020	28185-2020	20441206	1 1/4	31.8	1 1/4	2.13	54.0	3.43	87.0	5.47	139.0	NS	Y
S4-CF-2024	28185-2024	20441279	1 1/4	31.8	1 1/2	2.50	63.5	3.58	91.0	5.63	143.0	NS	Y
S4-CF-2424	28185-2424	20293307	1 1/2	38.1	1 1/2	2.50	63.5	3.31	84.0	5.63	143.0	NS	Y
S4-CF-2432	28185-2432	20441323	1 1/2	38.1	2	3.13	79.4	3.86	98.0	6.18	157.0	NS	Y
S4-CF-3232	28185-3232	20293308	2	50.8	2	3.13	79.4	4.33	110.0	7.17	182.0	NS	Y

Caterpillar Flange

22.5° Elbow

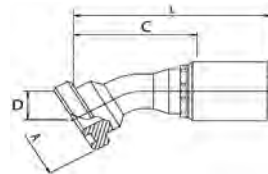

S=Skive
NS=Non-Skive
DG=Dual-Grip™

Description #	Product #	SAP #	Hose Size ID		Flange Size (A)	Flange Diameter (A)		Drop (D)		Cut-Off (C)		Length (L)		Skive Type	SR12 ARC12
			in.	mm		in.	mm	in.	mm	in.	mm	in.	mm		
S4-CF22-1212	28187-1212	20441272	3/4	19.0	3/4	1.63	41.3	0.63	16.0	3.78	96.0	5.35	136.0	NS	Y
S4-CF22-1616	28187-1616	20441280	1	25.4	1	1.87	47.6	0.71	18.0	4.33	110.0	6.10	155.0	NS	Y
S4-CF22-1620	28187-1620	20441306	1	25.4	1 1/4	2.13	54.0	0.71	18.0	4.29	109.0	6.06	154.0	NS	Y
S4-CF22-2020	28187-2020	20441307	1 1/4	31.8	1 1/4	2.13	54.0	0.77	19.5	4.80	122.0	6.85	174.0	NS	Y
S4-CF22-2024	28187-2024	20441281	1 1/4	31.8	1 1/2	2.50	63.5	0.91	23.0	5.12	130.0	7.17	182.0	NS	Y

Caterpillar Flange

30° Elbow

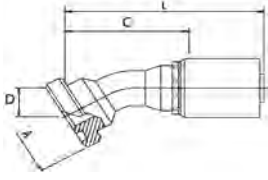

S=Skive
NS=Non-Skive
DG=Dual-Grip™

Description #	Product #	SAP #	Hose Size ID		Flange Size (A)	Flange Diameter (A)		Drop (D)		Cut-Off (C)		Length (L)		Skive Type	SR12 ARC12
			in.	mm		in.	mm	in.	mm	in.	mm	in.	mm		
S4-CF30-1216	28188-1216	20441324	3/4	19.0	1	1.87	47.6	0.87	22.0	3.82	97.0	5.39	137.0	NS	Y

Caterpillar Flange

45° Elbow

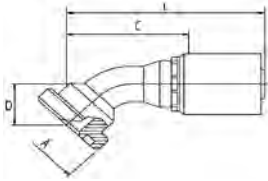

S=Skive
NS=Non-Skive
DG=Dual-Grip™

Description #	Product #	SAP #	Hose Size ID		Flange Size (A)	Flange Diameter (A)		Drop (D)		Cut-Off (C)		Length (L)		Skive Type	SR12 ARC12
			in.	mm		in.	mm	in.	mm	in.	mm	in.	mm		
S4-CF45-1212	28190-1212	20441282	3/4	19.0	3/4	1.63	41.3	1.34	34.0	3.39	86.0	4.96	126.0	NS	Y
S4-CF45-1216	28190-1216	20441308	3/4	19.0	1	1.87	47.6	1.34	34.0	3.54	90.0	5.08	129.0	NS	Y
S4-CF45-1616	28190-1616	20441283	1	25.4	1	1.87	47.6	1.57	40.0	3.90	99.0	5.63	143.0	NS	Y
S4-CF45-1620	28190-1620	20441284	1	25.4	1/4	2.13	54.0	1.57	40.0	3.86	98.0	5.59	142.0	NS	Y
S4-CF45-2020	28190-2020	20441285	1/4	31.8	1/4	2.13	54.0	1.69	43.0	4.33	110.0	6.38	162.0	NS	Y
S4-CF45-2024	28190-2024	20441286	1/4	31.8	1/2	2.50	63.5	1.95	49.5	4.57	116.0	6.61	168.0	NS	Y
S4-CF45-2424	28190-2424	20441325	1/2	38.1	1/2	2.50	63.5	1.89	48.0	7.01	178.0	9.33	237.0	NS	Y

Caterpillar Flange

60° Elbow

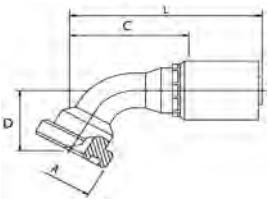

S=Skive
NS=Non-Skive
DG=Dual-Grip™

Description #	Product #	SAP #	Hose Size ID		Flange Size (A)	Flange Diameter (A)		Drop (D)		Cut-Off (C)		Length (L)		Skive Type	SR12 ARC12
			in.	mm		in.	mm	in.	mm	in.	mm	in.	mm		
S4-CF60-1616	28192-1616	20441287	1	25.4	1	1.87	47.6	2.09	53.0	4.61	117.0	6.34	161.0	NS	Y
S4-CF60-1620	28192-1620	20441288	1	25.4	1/4	2.13	54.0	2.24	57.0	4.45	113.0	6.18	157.0	NS	Y
S4-CF60-2020	28192-2020	20441289	1/4	31.8	1/4	2.13	54.0	2.52	64.0	5.2	132.0	7.24	184.0	NS	Y
S4-CF60-2024	28192-2024	20441290	1/4	31.8	1/2	2.50	63.5	2.76	70.0	5.35	136.0	7.40	188.0	NS	Y
S4-CF60-2432	28192-2432	20441326	1/2	38.1	2	3.13	79.4	3.35	85.0	5.47	139.0	7.80	198.0	NS	Y

Caterpillar Flange

67° Elbow

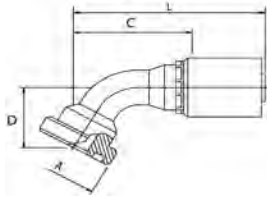

S=Skive
NS=Non-Skive
DG=Dual-Grip™

Description #	Product #	SAP #	Hose Size ID		Flange Size (A)	Flange Diameter (A)		Drop (D)		Cut-Off (C)		Length (L)		Skive Type	SR12 ARC12
			in.	mm		in.	mm	in.	mm	in.	mm	in.	mm		
S4-CF67-2020	28194-2020	20441327	1¼	31.8	1¼	2.13	54.0	2.76	70.0	4.92	125.0	6.97	177.0	NS	Y
S4-CF67-2024	28194-2024	20441328	1¼	31.8	1½	2.50	63.5	3.07	78.0	5.04	128.0	7.09	180.0	NS	Y

Caterpillar Flange

90° Elbow

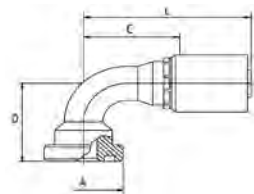

S=Skive
NS=Non-Skive
DG=Dual-Grip™

Description #	Product #	SAP #	Hose Size ID		Flange Size (A)	Flange Diameter (A)		Drop (D)		Cut-Off (C)		Length (L)		Skive Type	SR12 ARC12
			in.	mm		in.	mm	in.	mm	in.	mm	in.	mm		
S4-CF90-1212	28195-1212	20293309	¾	19.0	¾	1.63	41.3	2.64	67.0	2.60	66.0	4.17	106.0	NS	Y
S4-CF90-1216	28195-1216	20441291	¾	19.0	1	1.87	47.6	2.76	70.0	2.68	68.0	4.21	107.0	NS	Y
S4-CF90-1616	28195-1616	20293310	1	25.4	1	1.87	47.6	3.11	79.0	3.27	83.0	5.00	127.0	NS	Y
S4-CF90-1620	28195-1620	20441273	1	25.4	1¼	2.13	54.0	3.25	82.5	3.07	78.0	4.80	122.0	NS	Y
S4-CF90-2020	28195-2020	20441274	1¼	31.8	1¼	2.13	54.0	3.66	93.0	3.62	92.0	5.67	144.0	NS	Y
S4-CF90-2024	28195-2024	20441275	1¼	31.8	1½	2.50	63.5	3.98	101.0	3.70	94.0	5.75	146.0	NS	Y
S4-CF90-2424	28195-2424	20441332	1½	38.1	1½	2.50	63.5	4.29	109.0	4.41	112.0	6.73	171.0	NS	Y

Komatsu® Flange

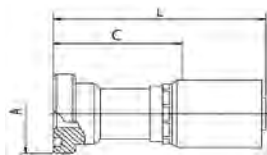

S=Skive
NS=Non-Skive
DG=Dual-Grip™

Description #	Product #	SAP #	Hose Size ID		Flange Size (A)	Flange Diameter (A)		Cut-Off (C)		Length (L)		Skive Type	SR12 ARC12
			in.	mm		in.	mm	in.	mm	in.	mm		
S4-KF-0810	28530-0810	20441211	1/2	12.7	5/8	1.34	34.0	1.84	46.7	3.08	78.2	NS	Y
S4-KF-1010	28530-1010	20441212	5/8	15.9	5/8	1.34	34.0	1.84	46.7	3.19	81.0	NS	Y
S4-KF-1210	28530-1210	20441295	¾	19.0	5/8	1.34	34.0	1.99	50.5	3.54	90.0	NS	Y

Komatsu® Flange

45° Elbow

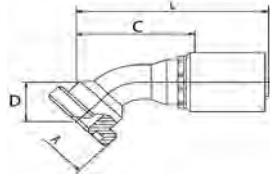

S=Skive
NS=Non-Skive
DG=Dual-Grip™

Description #	Product #	SAP #	Hose Size ID		Flange Size	Flange Diameter (A)		Drop (D)		Cut-Off (C)		Length (L)		Skive Type	SR12 ARC12
			in.	mm		in.	mm	in.	mm	in.	mm	in.	mm		
S4-KF45-1010	28535-1010	20441204	5/8	15.9	5/8	1.34	34.0	0.98	25.0	2.32	59.0	3.66	93.0	NS	Y

Komatsu® Flange

90° Elbow

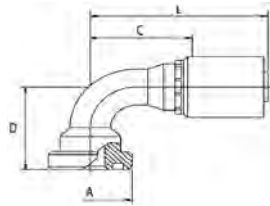

S=Skive
NS=Non-Skive
DG=Dual-Grip™

Description #	Product #	SAP #	Hose Size ID		Flange Size	Flange Diameter (A)		Drop (D)		Cut-Off (C)		Length (L)		Skive Type	SR12 ARC12
			in.	mm		in.	mm	in.	mm	in.	mm	in.	mm		
S4-KF90-1010	28540-1010	20441205	5/8	15.9	5/8	1.34	34.0	2.01	51.0	1.97	50.0	3.35	85.0	NS	Y
S4-KF90-1210	28540-1210	20441296	3/4	19.0	5/8	1.34	34.0	2.01	51.0	2.17	55.0	3.74	95.0	NS	Y

BSPB (British Standard Pipe Parallel)

Female | Swivel

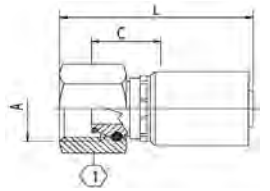

S=Skive
NS=Non-Skive
DG=Dual-Grip™

Description #	Product #	SAP #	Hose Size ID		Thread Size	Hex-1 Wrench Size		Cut-Off (C)		Length (L)		Skive Type	SR12 ARC12
			in.	mm		in.	mm	in.	mm	in.	mm		
S4-BPFX-0606 ^S	28105-0606	20242857	3/8	9.5	3/8-19	7/8	22	0.92	23.3	2.19	55.5	NS	Y
S4-BPFX-0808 ^S	28105-0808	20242825	1/2	12.7	1/2-14	1 1/16	27	0.99	25.1	2.46	62.5	NS	Y
S4-BPFX-1212 ^C	28105-1212	20242817	3/4	19.0	3/4-14	1 1/4	32	0.81	20.6	2.72	69.1	NS	Y
S4-BPFX-1616 ^C	28105-1616	20242861	1	25.4	1-11	1 1/2	38	0.94	23.9	3.11	79.0	NS	Y
S4-BPFX-2020	28105-2020	20242842	1 1/4	31.8	1 1/4-11	2	50	1.26	32.0	3.70	94.0	NS	Y
S4-BPFX-2424	28105-2424	20242860	1 1/2	38.1	1 1/2-11	2 3/16	55	1.33	33.8	4.13	105.0	NS	Y
S4-BPFX-3232	28105-3232	20242819	2	50.8	2-11	70 mm	70	1.34	34.0	4.80	122.0	NS	Y

C: Crimp Nut

S: Slip Nut (see "Fitting Identification" in Appendix for details)

BSPB (British Standard Pipe Parallel)

Female 45° Elbow | Swivel

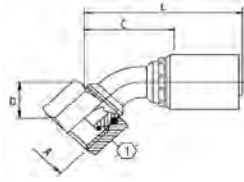

S=Skive
NS=Non-Skive
DG=Dual-Grip™

Description #	Product #	SAP #	Hose Size ID		Thread Size (A)	Hex-1 Wrench Size		Drop (D)		Cut-Off (C)		Length (L)		Skive Type	SR12 ARC12
			in.	mm		in.	mm	in.	mm	in.	mm	in.	mm		
S4-BPFX45-0808 ^S	28115-0808	20242852	1/2	12.7	1/2-14	1 1/16	27	0.83	21.0	2.17	55.0	3.43	87.0	NS	Y
S4-BPFX45-1212 ^C	28115-1212	20242858	3/4	19.0	3/4-14	1 1/4	32	1.10	28.0	2.76	70.0	4.33	110.0	NS	Y
S4-BPFX45-1616 ^C	28115-1616	20242856	1	25.4	1-11	1 1/2	38	1.34	34.0	3.31	84.0	5.04	128.0	NS	Y
S4-BPFX45-2020	28115-2020	20242854	1 1/4	31.8	1 1/4-11	2	50	1.57	40.0	3.98	101.0	6.22	158.0	NS	Y
S4-BPFX45-2424	28115-2424	20242855	1 1/2	38.1	1 1/2-11	2 3/16	55	1.81	46.0	4.57	116.0	7.13	181.0	NS	Y
S4-BPFX45-3232	28115-3232	20242841	2	50.8	2-11	70 mm	70	2.36	60.0	5.98	152.0	9.13	232.0	NS	Y

C: Crimp Nut
S: Slip Nut (see "Fitting Identification" in Appendix for details)

BSPB (British Standard Pipe Parallel)

Female 90° Elbow | Swivel

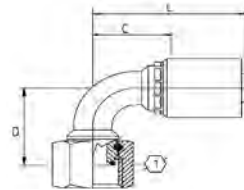

S=Skive
NS=Non-Skive
DG=Dual-Grip™

Description #	Product #	SAP #	Hose Size ID		Thread Size (A)	Hex-1 Wrench Size		Drop (D)		Cut-Off (C)		Length (L)		Skive Type	SR12 ARC12
			in.	mm		in.	mm	in.	mm	in.	mm	in.	mm		
S4-BPFX90-0808 ^S	28120-0808	20242869	1/2	12.7	1/2-14	1 1/16	27	1.61	41	1.42	36.0	2.64	67.0	NS	Y
S4-BPFX90-1212 ^C	28120-1212	20242865	3/4	19.0	3/4-14	1 1/4	32	2.09	53	1.93	49.0	3.50	89.0	NS	Y
S4-BPFX90-1616 ^C	28120-1616	20242844	1	25.4	1-11	1 1/2	38	2.72	69	2.95	75.0	4.72	120.0	NS	Y
S4-BPFX90-2020	28120-2020	20242848	1 1/4	31.8	1 1/4-11	2	50	3.27	83	3.23	82.0	5.28	134.0	NS	Y
S4-BPFX90-2424	28120-2424	20242843	1 1/2	38.1	1 1/2-11	2 3/16	55	3.78	96	3.78	96.0	6.10	155.0	NS	Y
S4-BPFX90-3232	28120-3232	20242867	2	50.8	2-11	70 mm	70	5.35	136	5.04	128.0	7.87	200.0	NS	Y

C: Crimp Nut
S: Slip Nut (see "Fitting Identification" in Appendix for details)

BSPB (British Standard Pipe Parallel)

Male

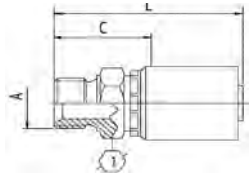

S=Skive
NS=Non-Skive
DG=Dual-Grip™

Description #	Product #	SAP #	Hose Size ID		Thread Size	Hex-1 Wrench Size		Cut-Off (C)		Length (L)		Skive Type	SR12 ARC12
			in.	mm		in.	mm	in.	mm	in.	mm		
S4-BPM-1212	28130-1212	20242831	3/4	19.0	3/4-14	1 1/4	32	1.44	36.6	3.00	76.1	NS	Y
S4-BPM-2020	28130-2020	20242836	1 1/4	31.8	1 1/4-11	2	50	1.89	48.0	3.94	100.0	NS	Y
S4-BPM-2424	28130-2424	20242837	1 1/2	38.1	1 1/2-11	2 3/16	55	2.01	51.0	4.33	110.0	NS	Y
S4-BPM-3232	28130-3232	20242833	2	50.8	2-11	70 mm	70	2.22	56.5	5.06	128.5	NS	Y

BSPT (British Standard Pipe Tapered)

Male

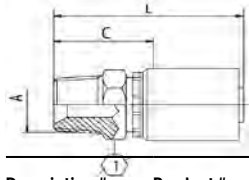

S=Skive
NS=Non-Skive
DG=Dual-Grip™

Description #	Product #	SAP #	Hose Size ID		Thread Size	Hex-1 Wrench Size		Cut-Off (C)		Length (L)		Skive Type	SR12 ARC12
			in.	mm		in.	mm	in.	mm	in.	mm		
S4-BTM-1616	28170-1616	20242875	1	25.4	1-11	1 7/16	36	1.75	44.4	3.50	89.0	NS	Y

DIN 24° Light

Female | Swivel

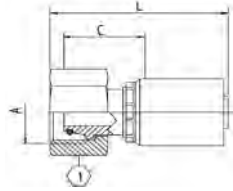

S=Skive
NS=Non-Skive
DG=Dual-Grip™

Description #	Product #	SAP #	Hose Size ID		Thread Size	Hex-1 Wrench Size	Cut-Off (C)		Length (L)		Skive Type	SR12 ARC12
			in.	mm			in.	mm	in.	mm		
S4-DLFX-0618	28240-0618	20441313	3/8	9.5	18 x 1 1/2	22	1.00	25.4	2.10	53.3	NS	Y
S4-DLFX-0822	28240-0822	20441207	1/2	12.7	22 x 1 1/2	27	1.11	28.2	2.43	61.8	NS	Y
S4-DLFX-1026	28240-1026	20441200	5/8	15.9	26 x 1 1/2	32	1.15	29.2	2.58	65.6	NS	Y
S4-DLFX-1230	28240-1230	20241841	3/4	19	30 x 2	36	1.25	31.7	2.93	74.5	NS	Y
S4-DLFX-1236	28240-1236	20441208	3/4	19	36 x 2	41	1.29	32.8	3.02	76.6	NS	Y
S4-DLFX-1636	28240-1636	20441209	1	25.4	36 x 2	41	1.32	33.6	3.25	82.5	NS	Y
S4-DLFX-2045	28240-2045	20241857	1 1/4	31.8	45 x 2	50	1.58	40.1	3.78	95.9	NS	Y
S4-DLFX-2452	28240-2452	20441314	1 1/2	38.1	52 x 2	60	1.59	40.5	4.05	102.8	NS	Y

DIN 24° Light

Female 45° Elbow | Swivel

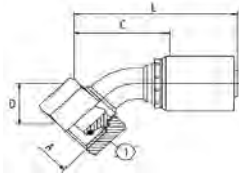

S=Skive
NS=Non-Skive
DG=Dual-Grip™

Description #	Product #	SAP #	Hose Size ID		Thread Size (A)	Hex-1 Wrench Size	Drop (D)		Cut-Off (C)		Length (L)		Skive Type	SR12 ARC12
			in.	mm			in.	mm	in.	mm	in.	mm		
S4-DLFX45-2452	28245-2452	20588801	1½	38.1	52 x 2.0	60	1.85	47.0	4.49	114.0	6.82	173.2	NS	Y

DIN 24° Light

Female 90° Elbow | Swivel

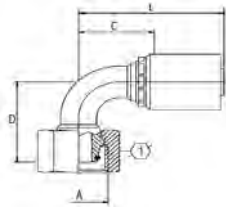

S=Skive
NS=Non-Skive
DG=Dual-Grip™

Description #	Product #	SAP #	Hose Size ID		Thread Size (A)	Hex-1 Wrench Size	Drop (D)		Cut-Off (C)		Length (L)		Skive Type	SR12 ARC12
			in.	mm			in.	mm	in.	mm	in.	mm		
S4-DLFX90-1230	28250-1230	20441210	3/4	19	30 x 2	36	2.32	59.0	2.05	52.0	3.62	92.0	NS	Y
S4-DLFX90-1636	28250-1636	20441201	1	25.4	36 x 2	41	2.68	68.0	3.07	78.0	4.80	122.0	NS	Y
S4-DLFX90-2045	28250-2045	20241872	1¼	31.8	45 x 2	50	3.50	89.0	3.54	90.0	5.59	142.0	NS	Y
S4-DLFX90-2452	28250-2452	20588800	1½	38.1	52 x 2	60	3.84	97.5	4.21	107.0	6.54	166.1	NS	Y

DIN 24° Heavy

Female | Swivel

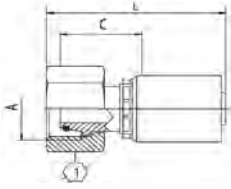

S=Skive
NS=Non-Skive
DG=Dual-Grip™

Description #	Product #	SAP #	Hose Size ID		Thread Size	Hex-1 Wrench Size	Cut-Off (C)		Length (L)		Skive Type	SR12 ARC12
			in.	mm			in.	mm	in.	mm		
S4-DHFX-0620	28210-0620	20241795	3/8	9.5	20 x 1½	24	1.09	27.6	2.25	57.1	NS	Y
S4-DHFX-0622	28210-0622	20241806	3/8	9.5	22 x 1½	27	1.22	31.1	2.44	62.1	NS	Y
S4-DHFX-0824	28210-0824	20241802	1/2	12.7	24 x 1½	30	1.25	31.7	2.67	67.7	NS	Y
S4-DHFX-1030	28210-1030	20441177	5/8	15.9	30 x 2	36	1.44	36.5	2.93	74.3	NS	Y
S4-DHFX-1230	28210-1230	20441178	3/4	19	30 x 2	36	1.46	37.0	3.13	79.5	NS	Y
S4-DHFX-1236	28210-1236	20241798	3/4	19	36 x 2	46	1.58	40.2	3.39	86.2	NS	Y
S4-DHFX-1636	28210-1636	20441309	1	25.4	36 x 2	46	1.61	41.0	3.63	92.1	NS	Y
S4-DHFX-1642	28210-1642	20241827	1	25.4	42 x 2	50	1.70	43.1	3.65	92.7	NS	Y
S4-DHFX-2042	28210-2042	20241721	1¼	31.8	42 x 2	50	1.76	44.7	4.00	101.7	NS	Y
S4-DHFX-2052	28210-2052	20241818	1¼	31.8	52 x 2	60	1.89	48.1	4.18	106.1	NS	Y

DIN 24° Heavy

Female 45° Elbow | Swivel

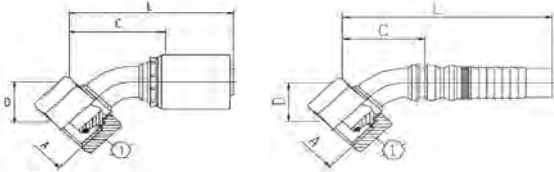

S=Skive
NS=Non-Skive
DG=Dual-Grip™

Description #	Product #	SAP #	Hose Size ID		Thread Size (A)	Hex-1 Wrench Size	Drop (D)		Cut-Off (C)		Length (L)		Skive Type	SR12 ARC12
			in.	mm			in.	mm	in.	mm	in.	mm		
S4-DHFX45-1236	28215-1236	20441179	3/4	19.0	36 x 2	46	1.30	33.0	2.72	69.0	4.29	109.0	NS	Y
DG-DHFX45-1642	16215-1642	20242311	1	25.4	42 x 2	50	1.97	50.0	3.81	96.8	6.92	175.8	DG	DGF1-16

DIN 24° Heavy

Female 90° Elbow | Swivel

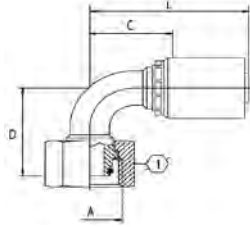

S=Skive
NS=Non-Skive
DG=Dual-Grip™

Description #	Product #	SAP #	Hose Size ID		Thread Size (A)	Hex-1 Wrench Size	Drop (D)		Cut-Off (C)		Length (L)		Skive Type	SR12 ARC12
			in.	mm			in.	mm	in.	mm	in.	mm		
S4-DHFX90-0620	28220-0620	20241834	3/8	9.5	20 x 1½	24	1.52	38.5	1.34	34.0	2.40	61.0	NS	Y
S4-DHFX90-0622	28220-0622	20241833	3/8	9.5	22 x 1½	27	1.59	40.5	1.34	34.0	2.40	61.0	NS	Y
S4-DHFX90-0824	28220-0824	20241826	1/2	12.7	24 x 1½	30	1.63	41.5	1.57	40.0	2.80	71.0	NS	Y
S4-DHFX90-1030	28220-1030	20241831	5/8	15.9	30 x 2	36	2.17	55.0	1.89	48.0	3.23	82.0	NS	Y
S4-DHFX90-1230	28220-1230	20441310	3/4	19.0	30 x 2	36	2.28	58.0	2.01	51.0	3.54	90.0	NS	Y
S4-DHFX90-1236	28220-1236	20441311	3/4	19.0	36 x 2	46	2.34	59.5	2.01	51.0	3.54	90.0	NS	Y
S4-DHFX90-1642	28220-1642	20441312	1	25.4	42 x 2	50	3.11	79.0	2.99	76.0	4.72	120.0	NS	Y
S4-DHFX90-2052	28220-2052	20265706	1¼	31.8	52 x 2	60	3.62	92.0	3.70	94.0	5.75	146.0	NS	Y

DIN 24° Heavy

Male

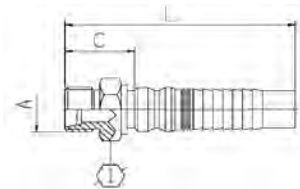

S=Skive
NS=Non-Skive
DG=Dual-Grip™

Description #	Product #	SAP #	Hose Size ID		Thread Size (A)	Hex-1 Wrench Size	Drop (D)		Cut-Off (C)		Length (L)		Skive Type	SR12 ARC12
			in.	mm			in.	mm	in.	mm	in.	mm		
DG-DHM-1236	16225-1236	20242327	3/4	19.0	36 x 2	36	1.14	29.0	3.90	99.0	DG	DGF1-12NS	Y	
DG-DHM-1642	16225-1642	20242384	1	25.4	42 x 2	46	1.26	32.0	4.59	116.5	DG	DGF1-12DG	DGF1-16	

Japanese Komatsu® 30° Flare with Metric Threads

Female | Swivel

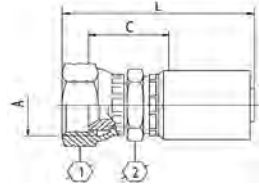

S=Skive
NS=Non-Skive
DG=Dual-Grip™

Description #	Product #	SAP #	Hose Size ID		Thread Size (A)	Hex-1 Wrench Size	Hex-2 Wrench Size	Cut-Off (C)		Length (L)		Skive Type	SR12 ARC12
			in.	mm				in.	mm	in.	mm		
S4-KMFX-0822	28545-0822	20241885	1/2	12.7	22 X 1.5	27	22	0.93	23.6	2.62	66.6	NS	Y
S4-KMFX-1024	28545-1024	20441213	5/8	15.9	24 x 1.5	32	30	1.07	27.1	3.01	76.4	NS	Y
S4-KMFX-1230	28545-1230	20241887	3/4	19.0	30 X 1.5	36	30	1.09	27.6	3.35	85.1	NS	Y
S4-KMFX-1633	28545-1633	20241892	1	25.4	33 X 1.5	41	36	1.41	35.7	4.03	102.3	NS	Y
S4-KMFX-2036	28545-2036	20241889	1¼	31.8	36 X 1.5	46	46	1.71	43.5	4.63	117.5	NS	Y
S4-KMFX-2442	28545-2442	20241890	1½	38.1	42 X 1.5	55	55	1.73	44.0	5.04	128.0	NS	Y

JIS 30° (Parallel Pipe Threads)

Female | Swivel

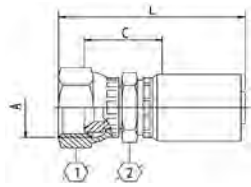

S=Skive
NS=Non-Skive
DG=Dual-Grip™

Description #	Product #	SAP #	Hose Size ID		Thread Size (A)	Hex-1 Wrench Size	Hex-2 Wrench Size	Cut-Off (C)		Length (L)		Skive Type	SR12 ARC12
			in.	mm				in.	mm	in.	mm		
S4-JSFX-0808	28520-0808	20242056	1/2	12.7	1/2-14	27	22	0.93	23.6	2.62	66.6	NS	Y
S4-JSFX-1212	28520-1212	20242053	3/4	19.0	3/4-14	36	30	1.07	27.1	3.13	79.6	NS	Y
S4-JSFX-1616	28520-1616	20242059	1	25.4	1-11	41	36	1.30	32.9	3.64	92.5	NS	Y
S4-JSFX-2020 ^T	28520-2020	20241722	1¼	31.8	1¼-11	50	46	1.56	39.5	4.21	107.0	NS	Y

T: Thrust-Wire Nut (see "Fitting Identification" in Appendix for details)

How to Use the Fitting Tables

This section lists ALL fittings that are compatible with the following hoses:

Hose Family	Hose Description
SR13	SAE 100R13/EN 856 R13
ARC13	SAE 100R13/EN 856 R13 (Abrasion Cover)
SR15	SAE 100R15
ARC15	SAE 100R15 (Abrasion Cover)
S4SP	EN 856 4SP
S4SH	EN 856 4SH

Fitting Description

Fitting Type

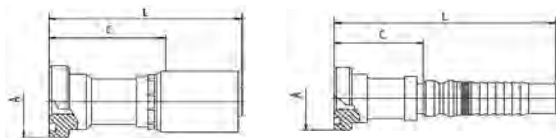

S=Skive
NS=Non-Skive
DG=Dual-Grip™

Description #	Product #	SAP #	Hose Size ID		Flange Size		Flange Dia (A)		Cut-Off (C)		Length (L)		Skive Type	SR13 ARC13	SR15 ARC15	S4SP	S4SH
			in.	mm	in.	mm	in.	mm	in.	mm	in.	mm					
DG-FH-1212	16300-1212	20254304	3/4	19.0	3/4	1.63	41.3	1.73	44.0	4.49	114.0	DG	DGF1-12	DGF1-12	DGF1-12	DGF1-12	
S6-FH-1212	30300-1212	20241742	3/4	19.0	3/4	1.63	41.3	2.11	53.5	4.27	108.5	NS	Y				Y
UC-FH-1212	36300-1212	20242607	3/4	19.0	3/4	1.63	41.3	2.07	52.5	3.62	92.0	S			UCF2-12		

Choose fittings carefully considering the working pressure of both hose and fitting. The maximum working pressure of the hose assembly is the lesser of the rated working pressure of the hose and the fitting. See page 313 for working pressure.

A "Y" in the hose compatibility columns indicates that the fitting is an **Ultra-Crimp™** style fitting and that it works for that particular hose.

A **blank space** in the hose compatibility columns indicates that the fitting **DOES NOT** work for that particular hose.

A **Part Number (Ferrule)** in the hose compatibility columns indicates that the fitting is a **Uni-Crimp™** style. The fitting, along with the ferrule shown, work together as a unit for that particular hose.

JIC 37° Flare (SAE J514)

Female | Swivel

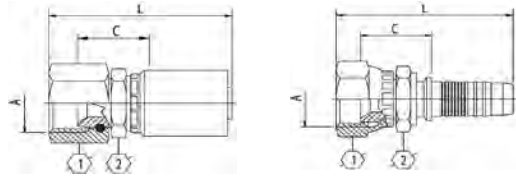

S=Skive
NS=Non-Skive
DG=Dual-Grip™

Description #	Product #	SAP #	Hose Size ID		Thread Size (A)	Hex-1 Wrench Size		Hex-2 Wrench Size		Cut-Off (C)		Length (L)		Skive Type	SR13 ARC13	SR15 ARC15	S4SP	S4SH
			in.	mm		in.	mm	in.	mm	in.	mm	in.	mm					
UC-JCFX-0404	36400-0404	20242786	1/4	6.4	7/16-20	5/8	16	9/16	14	0.77	19.6	2.09	53.1	S			UCF3-04	
UC-JCFX-0404S	36400-0404S	20540685	1/4	6.4	7/16-20	5/8	16	9/16	14	0.77	19.6	2.09	53.1	S			UCF3-04	
UC-JCFX-0405	36400-0405	20242746	1/4	6.4	1/2-20	1 1/16	17	9/16	14	0.80	20.3	2.15	54.6	S			UCF3-04	
UC-JCFX-0406	36400-0406	20242778	1/4	6.4	9/16-18	3/4	19	9/16	14	0.80	20.3	2.15	54.6	S			UCF3-04	
UC-JCFX-0606	36400-0606	20242787	3/8	9.5	9/16-18	3/4	19	1 1/16	17	0.84	21.3	2.26	57.5	S			UCF3-06	
UC-JCFX-0606S	36400-0606S	20540686	3/8	9.5	9/16-18	3/4	19	1 1/16	17	0.84	21.3	2.26	57.5	S			UCF3-06	
UC-JCFX-0608	36400-0608	20242779	3/8	9.5	3/4-16	1	25	3/4	19	0.98	24.8	2.46	62.5	S			UCF3-06	
UC-JCFX-0610	36400-0610	20242708	3/8	9.5	7/8-14	1 1/16	27	7/8	22	1.02	25.8	2.57	65.2	S			UCF3-06	
UC-JCFX-0806	36400-0806	20242666	1/2	12.7	9/16-18	3/4	19	3/4	19	0.91	23.1	2.52	64.1	S			UCF2-08	
UC-JCFX-0808	36400-0808	20242785	1/2	12.7	3/4-16	1	25	3/4	19	1.01	25.6	2.67	67.8	S			UCF2-08	
UC-JCFX-0808S	36400-0808S	20540687	1/2	12.7	3/4-16	1	25	3/4	19	1.01	25.6	2.67	67.8	S			UCF2-08	
UC-JCFX-0810	36400-0810	20242772	1/2	12.7	7/8-14	1 1/16	27	7/8	22	1.05	26.6	2.79	70.8	S			UCF2-08	
UC-JCFX-0812	36400-0812	20242727	1/2	12.7	1 1/16-12	1 1/4	32	1	25	1.11	28.1	2.91	73.9	S			UCF2-08	
UC-JCFX-1008	36400-1008	20242399	5/8	15.9	3/4-16	1	25	15/16	24	1.05	26.6	2.82	71.6	S			UCF2-10	
UC-JCFX-1010	36400-1010	20242774	5/8	15.9	7/8-14	1 1/16	27	15/16	24	1.09	27.6	2.94	74.6	S			UCF2-10	
UC-JCFX-1010S	36400-1010S	20540688	5/8	15.9	7/8-14	1 1/16	27	15/16	24	1.09	27.6	2.94	74.6	S			UCF2-10	
UC-JCFX-1012	36400-1012	20242580	5/8	15.9	1 1/16-12	1 1/4	32	1	25	1.11	28.1	3.02	76.7	S			UCF2-10	
UC-JCFX-1210	36400-1210	20242694	3/4	19.0	7/8-14	1 3/16	30	1 1/16	27	1.11	28.1	3.20	81.4	S			UCF2-12	
DG-JCFX-1212 ^{TDG1}	16400-1212	20254271	3/4	19.0	1 1/16-12	1 1/4	32			0.74	18.7	3.82	97.0	DG	DGF1-12	DGF1-12	DGF1-12	DGF1-12
S6-JCFX-1212	30400-1212	20242042	3/4	19.0	1 1/16-12	1 1/4	32	1 1/16	27	1.19	30.2	3.92	99.5	NS	Y			Y
UC-JCFX-1212	36400-1212	20242783	3/4	19.0	1 1/16-12	1 1/4	32	1 1/16	27	1.13	28.6	3.24	82.4	S			UCF2-12	
UC-JCFX-1212S	36400-1212S	20540689	3/4	19.0	1 1/16-12	1 1/4	32	1 1/16	27	1.13	28.6	3.24	82.4	S			UCF2-12	
UC-JCFX-1214	36400-1214	20242613	3/4	19.0	1 3/16-12	1 7/16	36	1 1/4	32	1.18	29.9	3.31	84.1	S			UCF2-12	
UC-JCFX-1216	36400-1216	20242719	3/4	19.0	1 5/16-12	1 1/2	38	1 1/4	32	1.26	32.1	3.41	86.7	S			UCF2-12	
UC-JCFX-1612	36400-1612	20242702	1	25.4	1 1/16-12	1 1/4	32	1 1/4	32	1.24	31.4	3.56	90.3	S			UCF2-16	
DG-JCFX-1616 ^{TDG1}	16400-1616	20242491	1	25.4	1 5/16-12	1 1/2	38			0.89	22.5	4.49	114.0	DG	DGF1-16	DGF1-16	DGF1-16	DGF1-16
S6-JCFX-1616	30400-1616	20241918	1	25.4	1 5/16-12	1 1/2	38	1 7/16	36	1.50	38.0	4.61	117.0	NS	Y			Y
UC-JCFX-1616	36400-1616	20242784	1	25.4	1 5/16-12	1 1/2	38	1 1/4	32	1.30	32.9	3.65	92.6	S			UCF2-16	
UC-JCFX-1616S	36400-1616S	20540690	1	25.4	1 5/16-12	1 1/2	38	1 1/4	32	1.30	32.9	3.65	92.6	S			UCF2-16	
UC-JCFX-1620	36400-1620	20242711	1	25.4	1 5/8-12	2	50	1 5/8	41	1.48	37.5	3.86	98.0	S			UCF2-16	
DG-JCFX-2020 ^{TDG1}	16400-2020	20242398	1 1/4	31.8	1 5/8-12	2	50			1.01	25.7	5.06	128.5	DG	DGF2-20	DGF2-20		DGF1-20
S6-JCFX-2020	30400-2020	20241924	1 1/4	31.8	1 5/8-12	2	50	1 5/8	41	1.70	43.1	5.31	135.0	NS	Y			
S6X-JCFX-2020*	30400-2020X	20577099	1 1/4	31.8	1 5/8-12	2	50	1 5/8	41	1.70	43.1	6.08	154.5	NS	Y			Y
DG-JCFX-2424 ^{TDG1}	16400-2424	20242432	1 1/2	38.1	1 7/8-12	2 3/16	55			1.14	29.0	5.47	139.0	DG	DGF2-24	DGF2-24		
S6-JCFX-2424	30400-2424	20241922	1 1/2	38.1	1 7/8-12	2 3/16	55	2	50	1.94	49.4	5.94	151.0	NS	Y			Y
DG-JCFX-3232 ^{TDG1}	16400-3232	20254272	2	50.8	2 1/2-12	70 mm	70			1.34	34.0	6.10	155.0	DG	DGF2-32	DGF2-32		DGF1-32

*One piece, no skive fitting solution. In development, check with Customer Service regarding availability for specific thread types.

T: Thrust-Wire Nut (See "Fitting Identification" in Appendix for details)

DG: Part listed is Dual-Grip™ style (image is Uni-Crimp™ style)

1: Single Hex

JIC 37° Flare (SAE J514)

Female 45° Elbow | Swivel

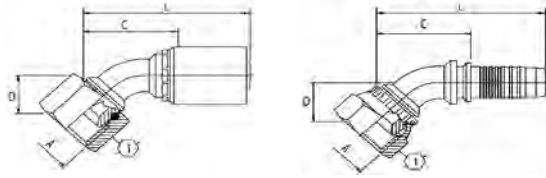

S=Skive
NS=Non-Skive
DG=Dual-Grip™

Description #	Product #	SAP #	Hose Size		Thread Size (A)	Hex-1 Wrench Size		Drop (D)		Cut-Off (C)		Length (L)		Skive Type	SR13 ARC13	SR15 ARC15	S4SP	S4SH
			in.	mm		in.	mm	in.	mm	in.	mm	in.	mm					
UC-JCFX45-0404	36420-0404	20242725	1/4	6.4	7/16-20	5/8	16	0.39	10.0	1.46	37.0	2.40	61.0	S			UCF3-04	
UC-JCFX45-0405	36420-0405	20242628	1/4	6.4	1/2-20	11/16	17	0.47	12.0	1.46	37.0	2.44	62.0	S			UCF3-04	
UC-JCFX45-0406	36420-0406	20242629	1/4	6.4	9/16-18	3/4	19	0.43	11.0	1.54	39.0	2.52	64.0	S			UCF3-04	
UC-JCFX45-0606	36420-0606	20242743	3/8	9.5	9/16-18	3/4	19	0.43	11.0	1.81	46.0	2.87	73.0	S			UCF3-06	
UC-JCFX45-0608	36420-0608	20242698	3/8	9.5	3/4-16	1	25	0.59	15.0	1.85	47.0	2.91	74.0	S			UCF3-06	
UC-JCFX45-0808	36420-0808	20242729	1/2	12.7	3/4-16	1	25	0.59	15.0	2.05	52.0	3.27	83.0	S			UCF2-08	
UC-JCFX45-0810	36420-0810	20242675	1/2	12.7	7/8-14	1 1/16	27	0.63	16.0	2.01	51.0	3.23	82.0	S			UCF2-08	
UC-JCFX45-1010	36420-1010	20242345	5/8	15.9	7/8-14	1 1/16	27	0.75	19.0	2.44	62.0	3.78	96.0	S			UCF2-10	
UC-JCFX45-1012	36420-1012	20242344	5/8	15.9	1 1/16-12	1 1/4	32	0.83	21.0	2.72	69.0	4.06	103.0	S			UCF2-10	
DG-JCFX45-1212	16420-1212	20254273	3/4	19.0	3/4-16	1 1/4	32	1.08	27.5	2.60	66.0	5.40	137.2	DG	DGF1-12	DGF1-12	DGF1-12	DGF1-12
S6-JCFX45-1212	30420-1212	20241952	3/4	19.0	1 1/16-12	1 1/4	32	1.08	27.5	2.76	70.0	5.20	132.2	NS	Y			Y
UC-JCFX45-1212	36420-1212	20242721	3/4	19.0	1 1/16-12	1 1/4	32	0.83	21.0	2.64	67.0	4.21	107.0	S			UCF2-12	
UC-JCFX45-1216	36420-1216	20242343	3/4	19.0	1 5/16-12	1 1/2	38	1.02	26.0	2.80	71.0	4.37	111.0	S			UCF2-12	
DG-JCFX45-1616	16420-1616	20254274	1	25.4	1 5/16-12	1 1/2	38	1.22	31.0	3.15	80.0	6.46	164.0	DG	DGF1-16	DGF1-16	DGF1-16	DGF1-16
S6-JCFX45-1616	30420-1616	20241959	1	25.4	1 5/16-12	1 1/2	38	1.22	31.0	3.35	85.0	6.16	156.5	NS	Y			Y
UC-JCFX45-1616	36420-1616	20242742	1	25.4	1 5/16-12	1 1/2	38	0.94	24.0	3.11	79.0	4.88	124.0	S			UCF2-16	
DG-JCFX45-2020	16420-2020	20254275	1 1/4	31.8	1 5/8-12	2	50	1.46	37.0	3.66	93.0	7.39	187.8	DG	DGF2-20	DGF2-20		DGF1-20
S6-JCFX45-2020	30420-2020	20241968	1 1/4	31.8	1 5/8-12	2	50	1.46	37.0	3.90	99.0	7.22	183.5	NS	Y			
S6X-JCFX45-2020*	30420-2020X	20577100	1 1/4	31.8	1 5/8-12	2	50	1.46	37.0	3.90	99.0	7.99	203.0	NS	Y			Y
S6-JCFX45-2424	30420-2424	20424976	1 1/2	38.1	1 7/8-12	2 3/16	55	1.71	43.5	4.65	118.0	8.64	219.5	NS	Y			Y

*One piece, no skive fitting solution. In development, check with Customer Service regarding availability for specific thread types.

JIC 37° Flare (SAE J514)

Female 90° Elbow | Swivel

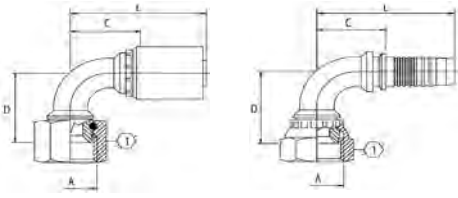

Elbow Type
 LT=Long Tube
 ST=Short Tube

S=Skive
 NS=Non-Skive
 DG=Dual-Grip™

Description #	Product #	SAP #	Hose Size ID		Thread Size (A)	Hex-1 Wrench Size		Elbow Type	Drop (D)		Cut-Off (C)		Length (L)		Skive Type	SR13 ARC13	SR15 ARC15	S4SP	S4SH
			in.	mm		in.	mm		in.	mm	in.	mm	in.	mm					
UCJCFX90-0404	36425-0404	20242770	1/4	6.4	7/16-20	5/8	16		1.26	32.0	1.34	34.0	2.32	59.0	S			UCF3-04	
UCJCFX90L-0404	36440-0404	20242662	1/4	6.4	7/16-20	5/8	16	LT	1.81	46.0	1.22	31.0	2.20	56.0	S			UCF3-04	
UCJCFX90S-0404	36445-0404	20242430	1/4	6.4	7/16-20	5/8	16	ST	0.83	21.0	1.06	27.0	2.05	52.0	S			UCF3-04	
UCJCFX90-0405	36425-0405	20242657	1/4	6.4	1/2-20	11/16	17		1.18	30.0	1.02	26.0	1.97	50.0	S			UCF3-04	
UCJCFX90L-0405	36440-0405	20242473	1/4	6.4	1/2-20	11/16	17	LT	1.77	45.0	1.22	31.0	2.20	56.0	S			UCF3-04	
UCJCFX90S-0405	36445-0405	20242396	1/4	6.4	1/2-20	11/16	17	ST	0.93	23.5	1.02	26.0	2.01	51.0	S			UCF3-04	
UCJCFX90-0406	36425-0406	20242718	1/4	6.4	9/16-18	3/4	19		1.50	38.0	1.10	28.0	2.09	53.0	S			UCF3-04	
UCJCFX90L-0406	36440-0406	20242474	1/4	6.4	9/16-18	3/4	19	LT	2.13	54.0	1.34	34.0	2.32	59.0	S			UCF3-04	
UCJCFX90S-0406	36445-0406	20242397	1/4	6.4	9/16-18	3/4	19	ST	0.91	23.0	1.22	31.0	2.20	56.0	S			UCF3-04	
UCJCFX90-0604	36425-0604	20318323	3/8	9.5	7/16-20	5/8	16		1.26	32.0	1.38	35.0	2.44	62.0	S			UCF3-06	
UCJCFX90L-0604	36440-0604	20318322	3/8	9.5	7/16-20	5/8	16	LT	1.81	46.0	1.22	31.0	2.28	58.0	S			UCF3-06	
UCJCFX90-0606	36425-0606	20242776	3/8	9.5	9/16-18	3/4	19		1.38	35.0	1.22	31.0	2.28	58.0	S			UCF3-06	
UCJCFX90L-0606	36440-0606	20242720	3/8	9.5	9/16-18	3/4	19	LT	2.13	54.0	1.69	43.0	2.76	70.0	S			UCF3-06	
UCJCFX90S-0606	36445-0606	20242475	3/8	9.5	9/16-18	3/4	19	ST	0.91	23.0	1.65	42.0	2.72	69.0	S			UCF3-06	
UCJCFX90-0608	36425-0608	20242753	3/8	9.5	3/4-16	1	25		1.61	41.0	1.54	39.0	2.60	66.0	S			UCF3-06	
UCJCFX90L-0608	36440-0608	20242587	3/8	9.5	3/4-16	1	25	LT	2.52	64.0	1.85	47.0	2.91	74.0	S			UCF3-06	
UCJCFX90S-0608	36445-0608	20242431	3/8	9.5	3/4-16	1	25	ST	1.14	29.0	1.93	49.0	2.99	76.0	S			UCF3-06	
UCJCFX90-0808	36425-0808	20242764	1/2	12.7	3/4-16	1	25		1.57	40.0	1.46	37.0	2.72	69.0	S			UCF2-08	
UCJCFX90L-0808	36440-0808	20242688	1/2	12.7	3/4-16	1	25	LT	2.52	64.0	1.97	50.0	3.19	81.0	S			UCF2-08	
UCJCFX90S-0808	36445-0808	20242429	1/2	12.7	3/4-16	1	25	ST	1.14	29.0	1.81	46.0	3.07	78.0	S			UCF2-08	
UCJCFX90-0810	36425-0810	20242706	1/2	12.7	7/8-14	1 1/8	27		1.85	47.0	1.69	43.0	2.95	75.0	S			UCF2-08	
UCJCFX90L-0810	36440-0810	20242584	1/2	12.7	7/8-14	1 1/8	27	LT	2.56	65.0	1.46	37.0	2.72	69.0	S			UCF2-08	
UCJCFX90S-0810	36445-0810	20242395	1/2	12.7	7/8-14	1 1/8	27	ST	1.26	32.0	1.81	46.0	3.03	77.0	S			UCF2-08	
UCJCFX90-0812	36425-0812	20242349	1/2	12.7	1 1/8-12	1 1/4	32		1.81	46.0	1.46	37.0	2.72	69.0	S			UCF2-08	
UCJCFX90-1010	36425-1010	20242749	5/8	15.9	7/8-14	1 1/8	27		1.89	48.0	1.93	49.0	3.31	84.0	S			UCF2-10	
UCJCFX90L-1010	36440-1010	20242346	5/8	15.9	7/8-14	1 1/8	27	LT	2.56	65.0	1.97	50.0	3.31	84.0	S			UCF2-10	
UCJCFX90S-1010	36445-1010	20591962	5/8	15.9	7/8-14	1 1/8	27	ST	1.26	32.0	1.43	36.2	2.78	70.5	S			UCF2-10	
UCJCFX90-1012	36425-1012	20242350	5/8	15.9	1 1/8-12	1 1/4	32		2.28	58.0	1.89	48.0	3.23	82.0	S			UCF2-10	
UCJCFX90L-1012	36440-1012	20283400	5/8	15.9	1 1/8-12	1 1/4	32	LT	3.78	96.0	2.13	54.0	3.31	84.0	S			UCF2-10	
UCJCFX90L-1210	36440-1210	20613763	3/4	19.0	7/8-14	1 1/8	27	LT	3.78	96.0	1.97	50.0	3.50	89.0	S			UCF2-12	
UCJCFX90S-1210	36445-1210	20613762	3/4	19.0	7/8-14	1 1/8	27	ST	1.26	32.0	1.97	50.0	3.52	89.5	S	UCF2-12			
DGJCFX90-1212	16425-1212	20254276	3/4	19.0	1 1/8-12	1 1/4	32		2.24	57.0	1.77	45.0	4.29	109.0	DG	DGF1-12	DGF1-12	DGF1-12	DGF1-12
S6JCFX90-1212	30425-1212	20241899	3/4	19.0	1 1/8-12	1 1/4	32		2.24	57.0	2.32	59.0	4.49	114.0	NS	Y			Y
UCJCFX90-1212	36425-1212	20242756	3/4	19.0	1 1/8-12	1 1/4	32		2.13	54.0	2.05	52.0	3.62	92.0	S			UCF2-12	
UCJCFX90L-1212	36440-1212	20242674	3/4	19.0	1 1/8-12	1 1/4	32	LT	3.74	95.0	2.13	54.0	3.70	94.0	S			UCF2-12	
UCJCFX90S-1212	36445-1212	20591963	3/4	19.0	1 1/8-12	1 1/4	32	ST	1.81	46.0	2.28	58.0	3.82	97.0	S			UCF2-12	
UCJCFX90-1216	36425-1216	20242579	3/4	19.0	1 5/8-12	1 1/2	38		2.83	72.0	2.09	53.0	3.62	92.0	S			UCF2-12	

JIC 37° Flare (SAE J514)

Female 90° Elbow | Swivel (continued)

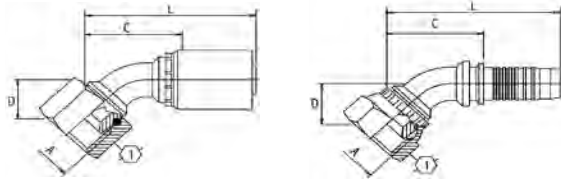

Elbow Type
 LT=Long Tube
 ST=Short Tube

S=Skive
 NS=Non-Skive
 DG=Dual-Grip™

Description #	Product #	SAP #	Hose Size ID		Thread Size (A)		Hex-1 Wrench Size		Elbow Drop (D)		Cut-Off (C)		Length (L)		Skive Type	SR13 ARC13	SR15 ARC15	S4SP	S4SH
			in.	mm	in.	mm	in.	mm	in.	mm	in.	mm	in.	mm					
DG-JCFX90-1616 ^T DG	16425-1616	20242347	1	25.4	1 ¹ / ₁₆ -12	1 ¹ / ₂	38		2.64	67.0	2.80	71.0	5.83	148.0	DG	DGF1-16	DGF1-16	DGF1-16	DGF1-16
S6-JCFX90-1616	30425-1616	20241927	1	25.4	1 ¹ / ₁₆ -12	1 ¹ / ₂	38		2.64	67.0	2.99	76.0	5.51	140.0	NS	Y			Y
UC-JCFX90-1616	36425-1616	20242758	1	25.4	1 ¹ / ₁₆ -12	1 ¹ / ₂	38		2.81	71.5	2.87	73.0	4.61	117.0	S			UCF2-16	
UC-JCFX90L-1616	36440-1616	20242651	1	25.4	1 ¹ / ₁₆ -12	1 ¹ / ₂	38	LT	4.49	114.0	3.11	79.0	4.84	123.0	S			UCF2-16	
UC-JCFX90S-1616	36445-1616	20591964	1	25.4	1 ¹ / ₁₆ -12	1 ¹ / ₂	38	ST	2.20	56.0	2.91	74.0	4.69	119.0	S			UCF2-16	
DG-JCFX90-2020 ^T DG	16425-2020	20242348	1 ¹ / ₄	31.8	1 ¹ / ₈ -12	2	50		3.07	78.0	3.11	79.0	6.50	165.0	DG	DGF2-20	DGF2-20		DGF1-20
S6-JCFX90-2020	30425-2020	20241907	1 ¹ / ₄	31.8	1 ¹ / ₈ -12	2	50		3.07	78.0	3.31	84.0	6.32	160.5	NS	Y			
S6X-JCFX90-2020*	30425-2020X	20577101	1 ¹ / ₄	31.8	1 ¹ / ₈ -12	2	50		3.07	78.0	3.31	84.0	7.09	180.0	NS	Y			Y
DG-JCFX90-2424 ^T DG	16425-2424	20254277	1 ¹ / ₂	38.1	1 ¹ / ₈ -12	2 ³ / ₁₆	55		3.62	92.0	3.70	94.0	7.28	185.0	DG	DGF2-24	DGF2-24		
S6-JCFX90-2424	30425-2424	20241905	1 ¹ / ₂	38.1	1 ¹ / ₈ -12	2 ³ / ₁₆	55		3.62	92.0	4.13	105.0	7.40	188.0	NS	Y			Y

*One piece, no skive fitting solution. In development, check with Customer Service regarding availability for specific thread types.

T: Thrust-Wire Nut (see "Fitting Identification" in Appendix for details)

DG: Part listed is Dual-Grip™ style (image is Uni-Crimp™ style)

JIC 37° Flare (SAE J514)

Male

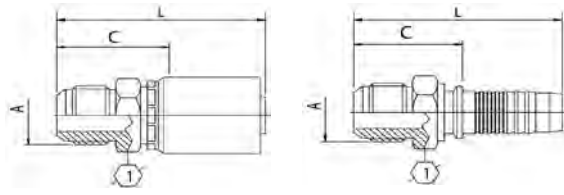

S=Skive
NS=Non-Skive
DG=Dual-Grip™

Description #	Product #	SAP #	Hose Size ID		Thread Size (A)		Hex-1 Wrench Size		Cut-Off (C)		Length (L)		Skive Type	SR13 ARC13	SR15 ARC15	S4SP	S4SH
			in.	mm	in.	mm	in.	mm	in.	mm	in.	mm					
UCJCM-0404	36450-0404	20242728	1/4	6.4	7/16-20	1/2	12	0.96	24.3	1.93	49.1	S				UCF3-04	
UCJCM-0405	36450-0405	20242664	1/4	6.4	1/2-20	9/16	14	1.00	25.3	1.97	50.1	S				UCF3-04	
UCJCM-0406	36450-0406	20242687	1/4	6.4	9/16-18	11/16	17	1.04	26.3	2.01	51.1	S				UCF3-04	
UCJCM-0606	36450-0606	20242759	3/8	9.5	9/16-18	11/16	17	1.04	26.3	2.09	53.0	S				UCF3-06	
UCJCM-0608	36450-0608	20242755	3/8	9.5	3/4-16	3/4	19	1.17	29.8	2.22	56.5	S				UCF3-06	
UCJCM-0610	36450-0610	20242630	3/8	9.5	7/8-14	15/16	24	1.33	33.8	2.38	60.5	S				UCF3-06	
UCJCM-0808	36450-0808	20242736	1/2	12.7	3/4-16	3/4	19	1.20	30.6	2.44	62.1	S				UCF2-08	
UCJCM-0810	36450-0810	20242716	1/2	12.7	7/8-14	15/16	24	1.36	34.6	2.60	66.1	S				UCF2-08	
UCJCM-0812	36450-0812	20242670	1/2	12.7	1 1/8-12	1 1/8	27	1.46	37.1	2.70	68.6	S				UCF2-08	
UCJCM-1010	36450-1010	20242435	5/8	15.9	7/8-14	15/16	24	1.36	34.6	2.71	68.9	S				UCF2-10	
UCJCM-1012	36450-1012	20242400	5/8	15.9	1 1/8-12	1 1/8	27	1.46	37.1	2.81	71.4	S				UCF2-10	
S6JCM-1212	30450-1212	20424978	3/4	19.0	1 1/8-12	1 1/8	27	1.52	38.5	3.68	93.5	NS	Y				Y
UCJCM-1212	36450-1212	20242732	3/4	19.0	1 1/8-12	1 1/8	27	1.48	37.6	3.04	77.1	S				UCF2-12	
UCJCM-1214	36450-1214	20242542	3/4	19.0	1 3/8-12	1 1/4	32	1.58	40.1	3.13	79.6	S				UCF2-12	
UCJCM-1216	36450-1216	20242634	3/4	19.0	1 7/8-12	1 7/8	36	1.68	42.6	3.23	82.1	S				UCF2-12	
DGJCM-1616 ^{DG}	16450-1616	20242351	1	25.4	1 5/8-12	1 7/8	36	1.30	33.0	4.63	117.5	DG	DGF1-16	DGF1-16		DGF1-16	DGF1-16
S6JCM-1616	30450-1616	20424979	1	25.4	1 5/8-12	1 7/8	36	1.79	45.5	4.31	109.5	NS	Y				Y
UCJCM-1616	36450-1616	20242747	1	25.4	1 5/8-12	1 7/8	36	1.71	43.4	3.46	88.0	S				UCF2-16	
UCJCM-1620	36450-1620	20242433	1	25.4	1 5/8-12	1 3/8	46	1.85	46.9	3.60	91.5	S				UCF2-16	
DGJCM-2020 ^{DG}	16450-2020	20242353	1 1/4	31.8	1 5/8-12	1 3/8	46	1.39	35.3	5.22	132.5	DG	DGF2-20	DGF2-20			DGF1-20
S6JCM-2020	30450-2020	20424980	1 1/4	31.8	1 5/8-12	1 3/8	46	2.03	51.5	5.02	127.5	NS	Y				
S6XJCM-2020*	30450-2020X	20563020	1 1/4	31.8	1 5/8-12	1 3/8	46	2.03	51.5	5.79	147.0	NS	Y				Y
DGJCM-2424 ^{DG}	16450-2424	20242352	1 1/2	38.1	1 7/8-12	2	50	1.54	39.0	5.57	141.5	DG	DGF2-24	DGF2-24			
S6JCM-2424	30450-2424	20424981	1 1/2	38.1	1 7/8-12	2	50	2.26	57.5	5.53	140.5	NS	Y				Y

*One piece, no skive fitting solution. In development, check with Customer Service regarding availability for specific thread types.
DG: Part listed is Dual-Grip™ style (image is Uni-Crimp™ style)

JIC 45° J512 Flare

Female | Swivel

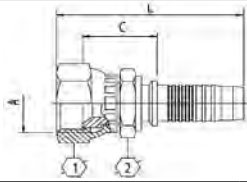

S=Skive
NS=Non-Skive
DG=Dual-Grip™

Description #	Product #	SAP #	Hose Size ID		Thread Size (A)		Hex-1 Wrench Size		Hex-2 Wrench Size		Cut-Off (C)		Length (L)		Skive Type	SR13 ARC13	SR15 ARC15	S4SP	S4SH
			in.	mm	in.	mm	in.	mm	in.	mm	in.	mm	in.	mm					
UC-SFFX-0606	36775-0606	20242760	3/8	9.5	5/8-18	7/8	22	3/4	19	0.92	23.3	2.38	60.5	S				UCF3-06	
UC-SFFX-0608	36775-0608	20318359	3/8	9.5	3/4-16	1	25	3/4	19	0.98	24.8	2.45	62.2	S				UCF3-06	
UC-SFFX-1212	36775-1212	20242652	3/4	19.0	1 1/4-14	1 1/4	32	1 1/16	27	1.13	28.6	3.23	82.1	S				UCF2-12	

JIC 45° J512 Flare

Female 45° Elbow | Swivel

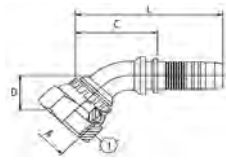

S=Skive
NS=Non-Skive
DG=Dual-Grip™

Description #	Product #	SAP #	Hose Size ID		Thread Size (A)		Hex-1 Wrench Size		Drop (D)		Cut-Off (C)		Length (L)		Skive Type	SR13 ARC13	SR15 ARC15	S4SP	S4SH
			in.	mm	in.	mm	in.	mm	in.	mm	in.	mm							
UC-SFFX45-0606	36777-0606	20318360	3/8	9.5	5/8-18	7/8	22	0.47	12	1.81	46	2.87	73	S				UCF3-06	

JIC 45° J512 Flare

Female 90° Elbow | Swivel

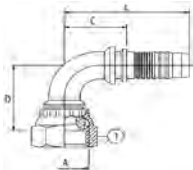

S=Skive
NS=Non-Skive
DG=Dual-Grip™

Description #	Product #	SAP #	Hose Size ID		Thread Size (A)		Hex-1 Wrench Size		Hex-2 Wrench Size		Cut-Off (C)		Length (L)		Skive Type	SR13 ARC13	SR15 ARC15	S4SP	S4SH
			in.	mm	in.	mm	in.	mm	in.	mm	in.	mm							
UC-SFFX90-0606	36780-0606	20318325	3/8	9.5	5/8-18	7/8	22	0.94	24.0	1.65	42.0	2.72	69.0	S				UCF3-06	
UC-SFFX90L-0606	36781-0606	20318362	3/8	9.5	5/8-18	7/8	22	2.19	55.5	1.69	43.0	2.76	70.0	S				UCF3-06	

JIC 45° J512 Flare

Male

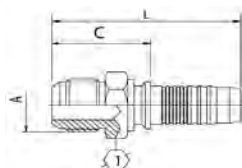

S=Skive
NS=Non-Skive
DG=Dual-Grip™

Description #	Product #	SAP #	Hose Size ID		Thread Size (A)		Hex-1 Wrench Size		Cut-Off (C)		Length (L)		Skive Type	SR13 ARC13	SR15 ARC15	S4SP	S4SH
			in.	mm	in.	mm	in.	mm	in.	mm							
UC-SFM-0606	36785-0606	20318320	3/8	9.5	5/8-18	5/8	16	0.93	23.7	2.15	54.7	S				UCF3-06	

SAE 45° Inverted Flare

Male | Swivel

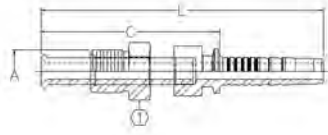

S=Skive
NS=Non-Skive
DG=Dual-Grip™

Description #	Product #	SAP #	Hose Size ID		Thread Size (A)		Hex-1 Wrench Size		Cut-Off (C)		Length (L)		Skive Type	SR13 ARC13	SR15 ARC15	S4SP	S4SH
			in.	mm	in.	mm	in.	mm	in.	mm	in.	mm					
UC-SIMX-0403	36800-0403	20318328	1/4	6.4	3/8-24	1/2	12	1.22	30.9	2.19	55.7	S				UCF3-04	
UC-SIMX-0404	36800-0404	20318329	1/4	6.4	7/16-24	1/2	12	1.22	30.9	2.19	55.7	S				UCF3-04	
UC-SIMX-0405	36800-0405	20318330	1/4	6.4	1/2-20	9/16	14	1.26	32.0	2.24	56.8	S				UCF3-04	
UC-SIMX-0605	36800-0605	20318331	3/8	9.5	1/2-20	9/16	14	1.29	32.8	2.34	59.5	S				UCF3-06	
UC-SIMX-0606	36800-0606	20318332	3/8	9.5	5/8-18	11/16	17	1.43	36.3	2.48	63.0	S				UCF3-06	
UC-SIMX-0607	36800-0607	20318333	3/8	9.5	11/16-18	3/4	19	1.45	36.8	2.50	63.5	S				UCF3-06	
UC-SIMX-0808	36800-0808	20318334	1/2	12.7	3/4-18	3/4	19	1.54	39.2	2.78	70.7	S				UCF2-08	
UC-SIMX-0810	36800-0810	20318335	1/2	12.7	7/8-18	15/16	24	1.60	40.7	2.84	72.2	S				UCF2-08	

SAE 45° Inverted Flare

Male 45° Elbow | Swivel

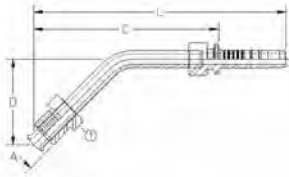

S=Skive
NS=Non-Skive
DG=Dual-Grip™

Description #	Product #	SAP #	Hose Size ID		Thread Size (A)		Hex-1 Wrench Size		Drop (D)		Cut-Off (C)		Length (L)		Skive Type	SR13 ARC13	SR15 ARC15	S4SP	S4SH
			in.	mm	in.	mm	in.	mm	in.	mm	in.	mm	in.	mm					
UC-SIMX45-0403	36810-0403	20318336	1/4	6.4	3/8-24	1/2	12	1.24	31.5	2.68	68.0	3.62	92.0	S				UCF3-04	
UC-SIMX45-0404	36810-0404	20318337	1/4	6.4	7/16-24	1/2	12	1.24	31.5	2.68	68.0	3.62	92.0	S				UCF3-04	
UC-SIMX45-0604	36810-0604	20318338	3/8	9.5	7/16-24	1/2	12	1.57	40.0	2.95	75.0	4.02	102.0	S				UCF3-06	
UC-SIMX45-0605	36810-0605	20318339	3/8	9.5	1/2-20	9/16	14	1.50	38.0	2.99	76.0	4.06	103.0	S				UCF3-06	
UC-SIMX45-0606	36810-0606	20318340	3/8	9.5	5/8-18	11/16	17	1.50	38.0	2.99	76.0	4.06	103.0	S				UCF3-06	
UC-SIMX45-0607	36810-0607	20318341	3/8	9.5	11/16-18	3/4	19	1.50	38.0	2.99	76.0	4.06	103.0	S				UCF3-06	

SAE 45° Inverted Flare

Male 90° Elbow | Swivel

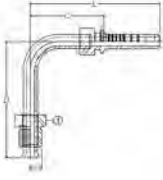

S=Skive
NS=Non-Skive
DG=Dual-Grip™

Description #	Product #	SAP #	Hose Size ID		Thread Size (A)		Hex-1 Wrench Size		Drop (D)		Cut-Off (C)		Length (L)		Skive Type	SR13 ARC13	SR15 ARC15	S4SP	S4SH
			in.	mm	in.	mm	in.	mm	in.	mm	in.	mm	in.	mm					
UC-SIMX90-0403	36815-0403	20318342	1/4	6.4	3/8-24	1/2	12	1.97	50.0	1.38	35.0	2.32	59.0	S				UCF3-04	
UC-SIMX90-0404	36815-0404	20318343	1/4	6.4	7/16-24	1/2	12	2.05	52.0	1.30	33.0	2.24	57.0	S				UCF3-04	
UC-SIMX90-0405	36815-0405	20318344	1/4	6.4	1/2-20	9/16	14	1.96	49.8	1.52	38.5	2.49	63.3	S				UCF3-04	
UC-SIMX90-0604	36815-0604	20318345	3/8	9.5	7/16-24	1/2	12	2.44	62.0	1.34	34.0	2.36	60.0	S				UCF3-06	
UC-SIMX90-0605	36815-0605	20318346	3/8	9.5	1/2-20	9/16	14	2.44	62.0	1.38	35.0	2.44	62.0	S				UCF3-06	
UC-SIMX90-0606	36815-0606	20318347	3/8	9.5	5/8-18	11/16	17	2.44	62.0	1.38	35.0	2.44	62.0	S				UCF3-06	
UC-SIMX90-0607	36815-0607	20318348	3/8	9.5	11/16-18	3/4	19	2.44	62.0	1.38	35.0	2.44	62.0	S				UCF3-06	
UC-SIMX90-0808	36815-0808	20318349	1/2	12.7	3/4-18	3/4	19	2.32	59.0	2.13	54.0	3.35	85.0	S				UCF2-08	

NPTF

Female

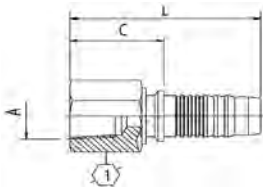

S=Skive
NS=Non-Skive
DG=Dual-Grip™

Description #	Product #	SAP #	Hose Size ID		Thread Size (A)		Hex-1 Wrench Size		Cut-Off (C)		Length (L)		Skive Type	SR13 ARC13	SR15 ARC15	S4SP	S4SH
			in.	mm	in.	mm	in.	mm	in.	mm	in.	mm					
UC-NPF-0404	36600-0404	20242660	1/4	6.4	1/4-18	3/4	19	1.09	27.8	2.07	52.6	S					UCF3-04
UC-NPF-0606	36600-0606	20242656	3/8	9.5	3/8-18	7/8	22	1.13	28.8	2.19	55.5	S					UCF3-06
UC-NPF-0808	36600-0808	20242622	1/2	12.7	1/2-14	1	25	1.40	35.6	2.64	67.1	S					UCF2-08
UC-NPF-1212	36600-1212	20242548	3/4	19.0	3/4-14	1 1/4	32	1.50	38.1	3.06	77.6	S					UCF2-12

NPTF

Male

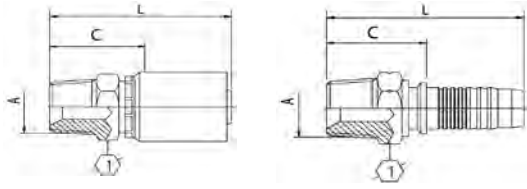

S=Skive
NS=Non-Skive
DG=Dual-Grip™

Description #	Product #	SAP #	Hose Size ID		Thread Size (A)		Hex-1 Wrench Size		Cut-Off (C)		Length (L)		Skive Type	SR13 ARC13	SR15 ARC15	S4SP	S4SH
			in.	mm	in.	mm	in.	mm	in.	mm	in.	mm					
UC-NPM-0402	36615-0402	20242766	1/4	6.4	1/8-27	9/16	14	0.84	21.3	1.81	46.1	S				UCF3-04	
UC-NPM-0404	36615-0404	20242780	1/4	6.4	1/4-18	11/16	17	1.06	26.8	2.03	51.6	S				UCF3-04	
UC-NPM-0404S	36615-0404S	20540691	1/4	6.4	1/4-18	11/16	17	1.06	26.8	2.03	51.6	S				UCF3-04	
UC-NPM-0406	36615-0406	20242748	1/4	6.4	3/8-18	3/4	19	1.09	27.8	2.07	52.6	S				UCF3-04	
UC-NPM-0408	36615-0408	20242661	1/4	6.4	1/2-14	7/8	22	1.23	31.3	2.21	56.1	S				UCF3-04	
UC-NPM-0604	36615-0604	20242761	3/8	9.5	1/4-18	11/16	17	1.06	26.8	2.11	53.5	S				UCF3-06	
UC-NPM-0606	36615-0606	20242782	3/8	9.5	3/8-18	3/4	19	1.09	27.8	2.15	54.5	S				UCF3-06	
UC-NPM-0606S	36615-0606S	20540693	3/8	9.5	3/8-18	3/4	19	1.09	27.8	2.15	54.5	S				UCF3-06	
UC-NPM-0608	36615-0608	20242767	3/8	9.5	1/2-14	7/8	22	1.23	31.3	2.28	58.0	S				UCF3-06	
UC-NPM-0806	36615-0806	20242722	1/2	12.7	3/8-18	3/4	19	1.13	28.6	2.37	60.1	S				UCF2-08	
UC-NPM-0808	36615-0808	20242775	1/2	12.7	1/2-14	7/8	22	1.26	32.1	2.50	63.6	S				UCF2-08	
UC-NPM-0808S	36615-0808S	20540694	1/2	12.7	1/2-14	7/8	22	1.26	32.1	2.50	63.6	S				UCF2-08	
UC-NPM-0812	36615-0812	20242679	1/2	12.7	3/4-14	1 1/16	27	1.34	34.1	2.58	65.6	S				UCF2-08	
UC-NPM-1012	36615-1012	20274105	5/8	15.9	3/4-14	1 1/16	27	1.34	34.1	2.69	68.4	S				UCF2-10	
UC-NPM-1208	36615-1208	20242689	3/4	19.0	1/2-14	1 1/16	27	1.32	33.6	2.88	73.1	S				UCF2-12	
DG-NPM-1212 ^{DG}	16615-1212	20242574	3/4	19.0	3/4-14	1 1/16	27	1.02	26.0	3.78	96.0	DG	DGF1-12	DGF1-12	DGF1-12	DGF1-12	DGF1-12
S6-NPM-1212	30615-1212	20385938	3/4	19.0	3/4-14	1 1/16	27	1.40	35.5	3.56	90.5	NS	Y			Y	
UC-NPM-1212	36615-1212	20242771	3/4	19.0	3/4-14	1 1/16	27	1.36	34.6	2.92	74.1	S				UCF2-12	
UC-NPM-1212S	36615-1212S	20540695	3/4	19.0	3/4-14	1 1/16	27	1.36	34.6	2.92	74.1	S				UCF2-12	
UC-NPM-1216	36615-1216	20242649	3/4	19.0	1-11 1/2	1 7/16	36	1.72	43.6	3.27	83.1	S				UCF2-12	
UC-NPM-1612	36615-1612	20242684	1	25.4	3/4-14	1 7/16	36	1.55	39.4	3.31	84.0	S				UCF2-16	
DG-NPM-1616 ^{DG}	16615-1616	20242518	1	25.4	1-11 1/2	1 7/16	36	1.34	34.0	4.67	118.5	DG	DGF1-16	DGF1-16	DGF1-16	DGF1-16	DGF1-16
S6-NPM-1616	30615-1616	20293311	1	25.4	1-11 1/2	1 7/16	36	1.83	46.5	4.35	110.5	NS	Y			Y	
UC-NPM-1616	36615-1616	20242769	1	25.4	1-11 1/2	1 7/16	36	1.75	44.4	3.50	89.0	S				UCF2-16	
UC-NPM-1616S	36615-1616S	20540696	1	25.4	1-11 1/2	1 7/16	36	1.75	44.4	3.50	89.0	S				UCF2-16	
UC-NPM-1620	36615-1620	20242638	1	25.4	1 1/4-11 1/2	1 9/16	46	1.87	47.4	3.62	92.0	S				UCF2-16	
DG-NPM-2020 ^{DG}	16615-2020	20242437	1 1/4	31.8	1 1/4-11 1/2	1 9/16	46	1.41	35.8	5.24	133.0	DG	DGF2-20	DGF2-20			DGF1-20
S6-NPM-2020	30615-2020	20293312	1 1/4	31.8	1 1/4-11 1/2	1 9/16	46	2.05	52.0	5.04	128.0	NS	Y				
S6X-NPM-2020*	30615-2020X	20577103	1 1/4	31.8	1 1/4-11 1/2	1 9/16	46	2.05	52.0	5.81	147.5	NS	Y				Y
DG-NPM-2424 ^{DG}	16615-2424	20242354	1 1/2	38.1	1 1/2-11 1/2	2	50	1.56	39.5	5.49	139.5	DG	DGF2-24	DGF2-24			
S6-NPM-2424	30615-2424	20293313	1 1/2	38.1	1 1/2-11 1/2	2	50	2.19	55.5	5.45	138.5	NS	Y				Y
DG-NPM-3232 ^{DG}	16615-3232	20242401	2	50.8	2-11 1/2	2 9/16	65	1.54	39.2	5.91	150.2	DG	DGF2-32	DGF2-32			DGF1-32

*One piece, no skive fitting solution. In development, check with Customer Service regarding availability for specific thread types.
DG: Part listed is Dual-Grip™ style (image is Uni-Crimp™ style)

NPTF

Male | Swivel

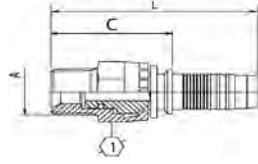

S=Skive
NS=Non-Skive
DG=Dual-Grip™

Description #	Product #	SAP #	Hose Size ID		Thread Size (A)		Hex-1 Wrench Size		Cut-Off (C)		Length (L)		Skive Type	SR13 ARC13	SR15 ARC15	S4SP	S4SH
			in.	mm	in.	mm	in.	mm	in.	mm	in.	mm					
UC-NPMX-0404	36645-0404	20242757	1/4	6.4	1/4-18	11/16	17	1.48	37.6	2.46	62.4	S				UCF3-04	
UC-NPMX-0406	36645-0406	20242519	1/4	6.4	3/8-18	7/8	22	1.56	39.5	2.53	64.3	S				UCF3-04	
UC-NPMX-0604	36645-0604	20242745	3/8	9.5	1/4-18	11/16	17	1.56	39.6	2.61	66.3	S				UCF3-06	
UC-NPMX-0606	36645-0606	20242777	3/8	9.5	3/8-18	7/8	22	1.48	37.5	2.53	64.2	S				UCF3-06	
UC-NPMX-0608	36645-0608	20242751	3/8	9.5	1/2-14	1	25	1.71	43.5	2.76	70.2	S				UCF3-06	
UC-NPMX-0806	36645-0806	20242503	1/2	12.7	3/8-18	7/8	22	1.51	38.3	2.75	69.8	S				UCF2-08	
UC-NPMX-0808	36645-0808	20242762	1/2	12.7	1/2-14	1	25	1.67	42.3	2.91	73.8	S				UCF2-08	
UC-NPMX-1212	36645-1212	20242730	3/4	19.0	3/4-14	1 1/4	32	1.97	50.1	3.53	89.6	S				UCF2-12	
UC-NPMX-1616	36645-1616	20242739	1	25.4	1-11 1/2	1 3/4	41	2.28	57.9	4.04	102.5	S				UCF2-16	

NPTF

Male 90° Elbow (Block) | Swivel

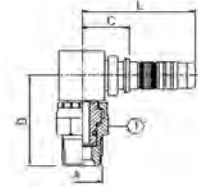

S=Skive
NS=Non-Skive
DG=Dual-Grip™

Description #	Product #	SAP #	Hose Size ID		Thread Size (A)		Hex-1 Wrench Size		Drop (D)		Cut-Off (C)		Length (L)		Skive Type	SR13 ARC13	SR15 ARC15	S4SP	S4SH
			in.	mm	in.	mm	in.	mm	in.	mm	in.	mm	in.	mm					
UC-NPMX90B-0404	36650-0404	20318350	1/4	6.4	1/4-18	11/16	17	1.54	39.0	0.67	17.0	1.65	41.8	S				UCF3-04	
UC-NPMX90B-0604	36650-0604	20318351	3/8	9.5	1/4-18	11/16	17	1.61	41.0	0.79	20.0	1.84	46.7	S				UCF3-06	
UC-NPMX90B-0606	36650-0606	20318352	3/8	9.5	3/8-18	7/8	22	1.61	41.0	0.79	20.0	1.84	46.7	S				UCF3-06	
UC-NPMX90B-0808	36650-0808	20318353	1/2	12.7	1/2-14	1	25	1.89	48.0	0.91	23.0	2.15	54.5	S				UCF2-08	

NPSM

Female | Swivel

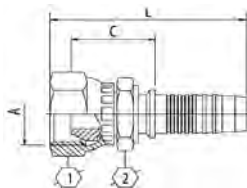

S=Skive
NS=Non-Skive
DG=Dual-Grip™

Description #	Product #	SAP #	Hose Size ID		Thread Size (A)		Hex-1 Wrench Size		Hex-2 Wrench Size		Cut-Off (C)		Length (L)		Skive Type	SR13 ARC13	SR15 ARC15	S4SP	S4SH
			in.	mm	in.	mm	in.	mm	in.	mm	in.	mm	in.	mm					
UC-NSFX-0404	36655-0404	20242668	1/4	6.4	1/4-18	3/4	19	11/16	17	0.96	24.3	2.17	55.1	S				UCF3-04	
UC-NSFX-0606	36655-0606	20242669	3/8	9.5	3/8-18	7/8	22	3/4	19	0.98	24.8	2.27	57.7	S				UCF3-06	
UC-NSFX-0808	36655-0808	20242654	1/2	12.7	1/2-14	1 1/4	27	7/8	22	1.05	26.6	2.54	64.6	S				UCF2-08	

SAE J514 Flareless Tube Fittings

Male

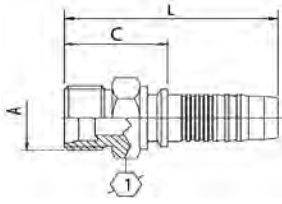

S=Skive
NS=Non-Skive
DG=Dual-Grip™

Description #	Product #	SAP #	Hose Size ID		Thread Size (A)		Hex-1 Wrench Size		Cut-Off (C)		Length (L)		Skive Type	SR13 ARC13	SR15 ARC15	S4SP	S4SH
			in.	mm	in.	mm	in.	mm	in.	mm	in.	mm					
UCFTM-0404	36360-0404	20286107	1/4	6.4	7/16-20	1/2	12	0.86	21.8	1.83	46.6	S				UCF3-04	
UCFTM-0606	36360-0606	20286108	3/8	9.5	9/16-18	5/8	16	0.95	24.2	2.00	50.9	S				UCF3-06	

*All Fittings come with Nut and Sleeve

Standpipe

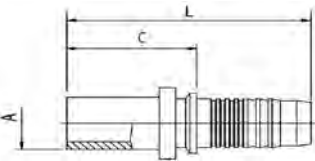

S=Skive
NS=Non-Skive
DG=Dual-Grip™

Description #	Product #	SAP #	Hose Size ID		Tube OD (A)	Cut-Off (C)		Length (L)		Skive Type	SR13 ARC13	SR15 ARC15	S4SP	S4SH
			in.	mm		in.	mm	in.	mm					
UC-SP-0410	36825-0410	20242461	1/4	6.4	10	1.27	32.2	2.24	57.0	S				UCF3-04
UC-SP-0610	36825-0610	20242555	3/8	9.5	10	1.19	30.3	2.24	57.0	S				UCF3-06
UC-SP-0612	36825-0612	20242576	3/8	9.5	12	1.15	29.3	2.20	56.0	S				UCF3-06
UC-SP-0815	36825-0815	20242372	1/2	12.7	15	1.26	32.1	2.50	63.6	S				UCF2-08
UC-SP-0816	36825-0816	20242482	1/2	12.7	16	1.46	37.1	2.70	68.6	S				UCF2-08
UC-SP-1222	36825-1222	20242373	3/4	19	22	1.44	36.5	2.99	76.0	S				UCF2-12
UC-SP-1628	36825-1628	20242371	1	25.4	28	1.59	40.4	3.35	85.0	S				UCF2-16

Standpipe

45° Elbow

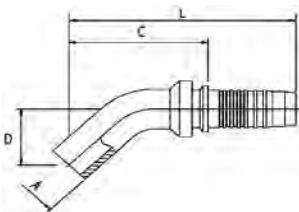

S=Skive
NS=Non-Skive
DG=Dual-Grip™

Description #	Product #	SAP #	Hose Size ID		Tube OD (A)	Drop (D)	Cut-Off (C)		Length (L)		Skive Type	SR13 ARC13	SR15 ARC15	S4SP	S4SH
			in.	mm			mm	in.	mm	in.					
UC-SP45-0408	36830-0408	20242370	1/4	6.4	8	0.91	23.0	1.69	43.0	2.68	68.0	S			UCF3-04

O-Ring Face Seal (SAE J1453) ORS/ORFS

Female | Swivel

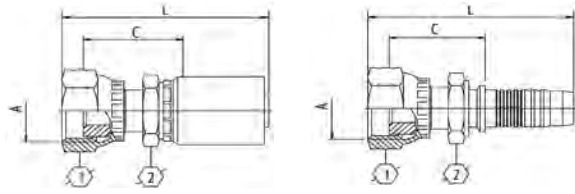

S=Skive
NS=Non-Skive
DG=Dual-Grip™

Description #	Product #	SAP #	Hose Size ID		Thread Size (A)		Hex-1 Wrench Size		Hex-2 Wrench Size		Cut-Off (C)		Length (L)		Skive Type	SR13 ARC13	SR15 ARC15	S4SP	S4SH
			in.	mm	in.	mm	in.	mm	in.	mm	in.	mm	in.	mm					
UC-OFFX-0404	36700-0404	20242723	1/4	6.4	9/16-18	11/16	17	9/16	14	1.07	27.3	2.37	60.3	S			UCF3-04		
UC-OFFX-0406	36700-0406	20242655	1/4	6.4	11/16-16	7/8	22	11/16	17	1.19	30.3	2.54	64.6	S			UCF3-04		
UC-OFFX-0408	36700-0408	20242441	1/4	6.4	13/16-16	15/16	24	7/8	22	1.39	35.3	2.80	71.1	S			UCF3-04		
UC-OFFX-0604	36700-0604	20612477	3/8	9.5	9/16-18	11/16	17	11/16	17	1.11	28.3	2.49	63.2	S			UCF3-06		
UC-OFFX-0606	36700-0606	20242763	3/8	9.5	11/16-16	7/8	22	11/16	17	1.19	30.3	2.62	66.5	S			UCF3-06		
UC-OFFX-0608	36700-0608	20242691	3/8	9.5	13/16-16	15/16	24	7/8	22	1.39	35.3	2.87	73.0	S			UCF3-06		
UC-OFFX-0806	36700-0806	20242552	1/2	12.7	11/16-16	7/8	22	3/4	19	1.26	32.1	2.88	73.1	S			UCF2-08		
UC-OFFX-0808	36700-0808	20242733	1/2	12.7	13/16-16	15/16	24	7/8	22	1.42	36.1	3.09	78.6	S			UCF2-08		
UC-OFFX-0810	36700-0810	20242704	1/2	12.7	1-14	1 3/8	30	15/16	24	1.56	39.6	3.31	84.1	S			UCF2-08		
UC-OFFX-0812	36700-0812	20242551	1/2	12.7	1 3/8-12	1 7/8	36	1 3/8	30	1.66	42.1	3.47	88.1	S			UCF2-08		
UC-OFFX-1010	36700-1010	20242442	5/8	15.9	1-14	1 3/8	30	15/16	24	1.56	39.6	3.39	86.1	S			UCF2-10		
UC-OFFX-1012	36700-1012	20242367	5/8	15.9	1 3/8-12	1 7/8	36	1 3/8	30	1.66	42.1	3.58	90.9	S			UCF2-10		
UC-OFFX-1210	36700-1210	20242553	3/4	19.0	1-14	1 3/8	30	1 1/8	27	1.58	40.1	3.65	92.6	S			UCF2-12		
DG-OFFX-1212	16700-1212	20254278	3/4	19.0	1 3/8-12	1 7/8	36	1 3/8	30	1.57	40.0	4.67	118.5	DG	DGF1-12	DGF1-12	DGF1-12	DGF1-12	
S6-OFFX-1212	30700-1212	20242191	3/4	19.0	1 3/8-12	1 7/8	36	1 3/8	30	1.75	44.5	4.49	114.0	NS	Y			Y	
UC-OFFX-1212	36700-1212	20242741	3/4	19.0	1 3/8-12	1 7/8	36	1 3/8	30	1.68	42.6	3.80	96.6	S			UCF2-12		
DG-OFFX-1216	16700-1216	20254279	3/4	19.0	1 7/8-12	1 5/8	41	1 7/8	36	1.69	43.0	4.80	121.8	DG	DGF1-12	DGF1-12	DGF1-12	DGF1-12	
S6-OFFX-1216	30700-1216	20242150	3/4	19.0	1 7/8-12	1 5/8	41	1 7/8	36	1.79	45.5	4.54	115.3	NS	Y			Y	
UC-OFFX-1216	36700-1216	20242646	3/4	19.0	1 7/8-12	1 5/8	41	1 7/8	36	1.91	48.6	4.05	102.9	S			UCF2-12		
UC-OFFX-1612	36700-1612	20242521	1	25.4	1 3/8-12	1 7/8	36	1 1/4	32	1.79	45.4	4.11	104.5	S			UCF2-16		
DG-OFFX-1616 ^{DG}	16700-1616	20242458	1	25.4	1 7/8-12	1 5/8	41	1 7/8	36	1.85	47.0	5.44	138.3	DG	DGF1-16	DGF1-16	DGF1-16	DGF1-16	
S6-OFFX-1616	30700-1616	20242139	1	25.4	1 7/8-12	1 5/8	41	1 7/8	36	1.95	49.5	5.05	128.3	NS	Y			Y	
UC-OFFX-1616	36700-1616	20242734	1	25.4	1 7/8-12	1 5/8	41	1 7/8	36	1.94	49.4	4.28	108.8	S			UCF2-16		
DG-OFFX-1620 ^{DG}	16700-1620	20242366	1	25.4	1 1/8-12	2	50	1 3/8	46	1.93	49.0	5.52	140.3	DG	DGF1-16	DGF1-16	DGF1-16	DGF1-16	
S6-OFFX-1620	30700-1620	20242166	1	25.4	1 1/8-12	2	50	1 5/8	41	1.91	48.4	5.01	127.2	NS	Y			Y	
UC-OFFX-1620	36700-1620	20242505	1	25.4	1 1/8-12	2	50	1 5/8	41	1.98	50.4	4.32	109.8	S			UCF2-16		
DG-OFFX-2020 ^{DG}	16700-2020	20242534	1 1/4	31.8	1 1/8-12	2	50	1 3/8	46	1.86	47.2	5.86	148.9	DG	DGF2-20	DGF2-20		DGF1-20	
S6-OFFX-2020	30700-2020	20293315	1 1/4	31.8	1 1/8-12	2	50	1 5/8	41	2.20	56.0	5.78	146.8	NS	Y				
S6X-OFFX-2020*	30700-2020X	20577104	1 1/4	31.8	1 1/8-12	2	50	1 5/8	41	2.20	56.0	6.55	166.3	NS	Y			Y	
DG-OFFX-2424	16700-2424	20297682	1 1/2	38.1	1 7/8-12	2 3/8	60	2	50	2.05	52.0	6.28	159.5	DG	DGF2-24	DGF2-24			
S6-OFFX-2424	30700-2424	20297684	1 1/2	38.1	1 7/8-12	2 3/8	60	2	50	2.46	62.5	6.36	161.5	NS	Y			Y	

*One piece, no skive fitting solution. In development, check with Customer Service regarding availability for specific thread types.
DG: Part listed is Dual-Grip™ style (image is Uni-Crimp™ style)

O-Ring Face Seal (SAE J1453) ORS/ORFS

Female 45° Elbow | Swivel

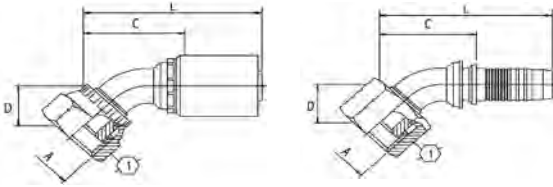

S=Skive
NS=Non-Skive
DG=Dual-Grip™

Description #	Product #	SAP #	Hose Size ID		Hex-1 Wrench Size (A)		Drop (D)		Cut-Off (C)		Length (L)		Skive Type	SR13 ARC13	SR15 ARC15	S4SP	S4SH	
			in.	mm	in.	mm	in.	mm	in.	mm	in.	mm						
UC-OFFX45-0404	36710-0404	20242631	1/4	6.4	9/16-18	11/16	17	0.43	11.0	1.61	41.0	2.60	66.0	S			UCF3-04	
UC-OFFX45-0406	36710-0406	20242549	1/4	6.4	11/16-16	7/8	22	0.43	11.0	1.81	46.0	2.80	71.0	S			UCF3-04	
UC-OFFX45-0606	36710-0606	20242683	3/8	9.5	11/16-16	7/8	22	0.47	12.0	1.85	47.0	2.91	74.0	S			UCF3-06	
UC-OFFX45-0608	36710-0608	20242593	3/8	9.5	13/16-16	15/16	24	0.59	15.0	2.01	51.0	3.07	78.0	S			UCF3-06	
UC-OFFX45-0808 ^C	36710-0808	20242637	1/2	12.7	13/16-16	15/16	24	0.63	16.0	1.85	47.0	3.11	79.0	S			UCF2-08	
UC-OFFX45-0810	36710-0810	20242532	1/2	12.7	1-14	13/16	30	0.65	16.5	1.97	50.0	3.23	82.0	S			UCF2-08	
DG-OFFX45-1212	16710-1212	20254300	3/4	19.0	13/16-12	17/16	36	1.02	26.0	3.07	78.0	5.89	149.5	DG	DGF1-12	DGF1-12	DGF1-12	DGF1-12
S6-OFFX45-1212	30710-1212	20242251	3/4	19.0	13/16-12	17/16	36	1.02	26.0	3.19	81.0	5.73	145.5	NS	Y			Y
UC-OFFX45-1212	36710-1212	20242681	3/4	19.0	13/16-12	17/16	36	0.83	21.0	2.48	63.0	4.06	103.0	S			UCF2-12	
DG-OFFX45-1216	16710-1216	20254301	3/4	19.0	17/16-12	15/8	41	1.10	28.0	2.68	68.0	5.49	139.5	DG	DGF1-12	DGF1-12	DGF1-12	DGF1-12
S6-OFFX45-1216	30710-1216	20242227	3/4	19.0	17/16-12	15/8	41	1.10	28.0	3.19	81.0	5.65	143.5	NS	Y			Y
UC-OFFX45-1216	36710-1216	20242359	3/4	19.0	17/16-12	15/8	41	0.94	24.0	2.80	71.0	4.33	110.0	S			UCF2-12	
DG-OFFX45-1616 ^{CDG}	16710-1616	20242356	1	25.4	17/16-12	15/8	41	1.10	28.0	4.49	114.0	7.80	198.0	DG	DGF1-16	DGF1-16	DGF1-16	DGF1-16
S6-OFFX45-1616	30710-1616	20242221	1	25.4	17/16-12	15/8	41	1.10	28.0	3.70	94.0	6.52	165.5	NS	Y			Y
UC-OFFX45-1616 ^C	36710-1616	20242643	1	25.4	17/16-12	15/8	41	1.02	26.0	3.23	82.0	5.00	127.0	S			UCF2-16	
UC-OFFX45-1620C	36710-1620	20242355	1	25.4	11/16-12	2	50	1.02	26.0	3.35	85.0	5.41	137.5	S			UCF2-16	
DG-OFFX45-2020 ^{CDG}	16710-2020	20242358	1 1/4	31.8	11/16-12	2	50	1.30	33.0	3.98	101.0	7.70	195.5	DG	DGF2-20	DGF2-20		DGF1-20
S6-OFFX45-2020	30710-2020	20424985	1 1/4	31.8	11/16-12	2	50	1.44	36.5	4.33	110.0	7.60	193.0	NS	Y			
S6X-OFFX45-2020*	30710-2020X	20577105	1 1/4	31.8	11/16-12	2	50	1.44	36.5	4.33	110.0	8.37	212.5	NS	Y			Y
S6-OFFX45-2424	30710-2424	20424986	1 1/2	38.1	17/8-12	2 3/8	60	1.46	37.0	4.57	116.0	8.15	207.0	NS	Y			Y

*One piece, no skive fitting solution. In development, check with Customer Service regarding availability for specific thread types.
C: Crimp Nut (see "Fitting Identification" in Appendix for details)
DG: Part listed is Dual-Grip™ style (Image is Uni-Crimp™ style)

O-Ring Face Seal (SAE J1453) ORS/ORFS

Female 90° Elbow | Swivel

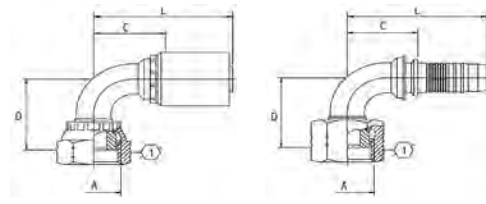

Elbow Type
 LT=Long Tube
 ST=Short Tube

S=Skive
 NS=Non-Skive
 DG=Dual-Grip™

Description#	Product #	SAP #	Hose Size ID		Thread Size (A)	Hex-1 Wrench Size		Elbow Type	Drop (D)		Cut-Off (C)		Length (L)		Skive Type	SR13 ARC13	SR15 ARC15	S4SP	S4SH
			in.	mm		in.	mm		in.	mm	in.	mm	in.	mm					
UC-OFFX90-0404	36715-0404	20242602	1/4	6.4	9/16-18	11/16	17	_____	1.26	32.0	1.18	30.0	2.17	55.0	S			UCF3-04	
UC-OFFX90L-0404	36720-0404	20242533	1/4	6.4	9/16-18	11/16	17	LT	1.81	46.0	1.30	33.0	2.28	58.0	S			UCF3-04	
UC-OFFX90S-0404	36725-0404	20242682	1/4	6.4	9/16-18	11/16	17	ST	0.83	21.0	1.10	28.0	2.09	53.0	S			UCF3-04	
UC-OFFX90-0406	36715-0406	20242479	1/4	6.4	11/16-16	7/8	22	_____	1.50	38.0	1.46	37.0	2.44	62.0	S			UCF3-04	
UC-OFFX90L-0406	36720-0406	20242492	1/4	6.4	11/16-16	7/8	22	LT	2.13	54.0	1.38	35.0	2.36	60.0	S			UCF3-04	
UC-OFFX90S-0406	36725-0406	20242598	1/4	6.4	11/16-16	7/8	22	ST	0.91	23.0	1.26	32.0	2.24	57.0	S			UCF3-04	
UC-OFFX90-0606	36715-0606	20242633	3/8	9.5	11/16-16	7/8	22	_____	1.50	38.0	1.65	42.0	2.72	69.0	S			UCF3-06	
UC-OFFX90L-0606	36720-0606	20242615	3/8	9.5	11/16-16	7/8	22	LT	2.13	54.0	1.65	42.0	2.72	69.0	S			UCF3-06	
UC-OFFX90S-0606	36725-0606	20242717	3/8	9.5	11/16-16	7/8	22	ST	0.98	25.0	1.65	42.0	2.72	69.0	S			UCF3-06	
UC-OFFX90-0608	36715-0608	20242480	3/8	9.5	13/16-16	15/16	24	_____	1.61	41.0	1.73	44.0	2.80	71.0	S			UCF3-06	
UC-OFFX90L-0608	36720-0608	20242493	3/8	9.5	13/16-16	15/16	24	LT	2.52	64.0	1.85	47.0	2.91	74.0	S			UCF3-06	
UC-OFFX90S-0608	36725-0608	20242620	3/8	9.5	13/16-16	15/16	24	ST	1.14	29.0	1.65	42.0	2.72	69.0	S			UCF3-06	
UC-OFFX90-0808 ^C	36715-0808	20242571	1/2	12.7	13/16-16	15/16	24	_____	1.65	42.0	1.38	35.0	2.60	66.0	S			UCF2-08	
UC-OFFX90L-0808 ^C	36720-0808	20242566	1/2	12.7	13/16-16	15/16	24	LT	2.52	64.0	1.50	38.0	2.76	70.0	S			UCF2-08	
UC-OFFX90S-0808 ^C	36725-0808	20242663	1/2	12.7	13/16-16	15/16	24	ST	1.14	29.0	1.57	40.0	2.80	71.0	S			UCF2-08	
UC-OFFX90-0810	36715-0810	20242363	1/2	12.7	1-14	1 3/16	30	_____	1.85	47.0	1.89	48.0	3.15	80.0	S			UCF2-08	
UC-OFFX90L-0810	36720-0810	20242438	1/2	12.7	1-14	1 3/16	30	LT	2.76	70.0	1.81	46.0	3.07	78.0	S			UCF2-08	
UC-OFFX90S-0810	36725-0810	20242550	1/2	12.7	1-14	1 3/16	30	ST	1.28	32.5	1.81	46.0	3.07	78.0	S			UCF2-08	
UC-OFFX90-1010	36715-1010	20242403	5/8	15.9	1-14	1 3/16	30	_____	1.73	44.0	2.17	55.0	3.54	90.0	S			UCF2-10	
UC-OFFX90S-1010	36725-1010	20242365	5/8	15.9	1-14	1 3/16	30	ST	1.28	32.5	2.05	52.0	3.43	87.0	S			UCF2-10	
UC-OFFX90S-1012	36725-1012	20242364	5/8	15.9	1 3/16-12	1 7/8	36	ST	1.93	49.0	2.17	55.0	3.54	90.0	S			UCF2-10	
UC-OFFX90S-1210	36725-1210	20242457	3/4	19.0	1-14	1 3/16	30	ST	1.26	32.0	1.75	44.5	3.31	84.0	S			UCF2-12	
DG-OFFX90-1212	16715-1212	20254302	3/4	19.0	1 3/16-12	1 7/8	36	_____	2.28	58.0	2.52	64.0	5.04	128.0	DG	DGF1-12	DGF1-12	DGF1-12	DGF1-12
S6-OFFX90-1212	30715-1212	20242238	3/4	19.0	1 3/16-12	1 7/8	36	_____	2.28	58.0	2.68	68.0	4.84	123.0	NS	Y			Y
UC-OFFX90-1212	36715-1212	20242439	3/4	19.0	1 3/16-12	1 7/8	36	_____	2.28	58.0	2.44	62.0	3.98	101.0	S			UCF2-12	
UC-OFFX90L-1212	36720-1212	20242514	3/4	19.0	1 3/16-12	1 7/8	36	LT	3.78	96.0	2.44	62.0	3.98	101.0	S			UCF2-12	
UC-OFFX90S-1212	36725-1212	20242680	3/4	19.0	1 3/16-12	1 7/8	36	ST	2.01	51.0	2.40	61.0	3.94	100.0	S			UCF2-12	
DG-OFFX90-1216	16715-1216	20254303	3/4	19.0	1 7/8-12	1 5/8	41	_____	2.28	58.0	2.60	66.0	5.12	130.0	DG	DGF1-12	DGF1-12	DGF1-12	DGF1-12
S6-OFFX90S-1216	30725-1216	20242157	3/4	19.0	1 7/8-12	1 5/8	41	ST	2.28	58.0	2.76	70.0	4.92	125.0	NS	Y			Y
UC-OFFX90S-1216	36725-1216	20242481	3/4	19.0	1 7/8-12	1 5/8	41	ST	2.80	71.0	2.60	66.0	4.13	105.0	S			UCF2-12	
DG-OFFX90-1616 ^{CDG}	16715-1616	20242361	1	25.4	1 7/8-12	1 5/8	41	_____	2.60	66.0	2.95	75.0	5.98	152.0	DG	DGF1-16	DGF1-16	DGF1-16	DGF1-16
S6-OFFX90-1616	30715-1616	20241700	1	25.4	1 7/8-12	1 5/8	41	_____	2.60	66.0	3.15	80.0	5.67	144.0	NS	Y			Y
UC-OFFX90-1616	36715-1616	20242478	1	25.4	1 7/8-12	1 5/8	41	_____	2.60	66.0	3.27	83.0	5.00	127.0	S			UCF2-16	
UC-OFFX90L-1616	36720-1616	20242504	1	25.4	1 7/8-12	1 5/8	41	LT	4.49	114.0	3.27	83.0	5.00	127.0	S			UCF2-16	
UC-OFFX90S-1616	36725-1616	20242690	1	25.4	1 7/8-12	1 5/8	41	ST	2.28	58.0	3.27	83.0	5.00	127.0	S			UCF2-16	
UC-OFFX90-1620	36715-1620	20242360	1	25.4	1 1/2-12	2	50	_____	3.07	78.0	3.27	83.0	5.00	127.0	S			UCF2-16	
UC-OFFX90S-1620	36725-1620	20242440	1	25.4	1 1/2-12	2	50	ST	2.52	64.0	3.27	83.0	5.00	127.0	S			UCF2-16	
DG-OFFX90-2020 ^{CDG}	16715-2020	20242362	1 1/4	31.8	1 1/2-12	2	50	_____	3.19	81.0	3.62	92.0	7.01	178.0	DG	DGF2-20	DGF2-20		DGF1-20
S6-OFFX90-2020	30715-2020	20392702	1 1/4	31.8	1 1/2-12	2	50	_____	3.19	81.0	4.02	102.0	7.03	178.5	NS	Y			
S6X-OFFX90-2020*	30715-2020X	20577106	1 1/4	31.8	1 1/2-12	2	50	_____	3.19	81.0	4.02	102.0	7.80	198.0	NS	Y			Y
DG-OFFX90-2424 ^{CDG}	16715-2424	20297683	1 1/2	38.1	1 7/8-12	2 3/8	60	_____	3.31	84.0	3.90	99.0	7.52	191.0	DG	DGF2-24	DGF2-24		
S6-OFFX90-2424	30715-2424	20297685	1 1/2	38.1	1 7/8-12	2 3/8	60	_____	3.80	96.5	5.12	130.0	8.39	213.0	NS	Y			Y

*One piece, no skive fitting solution. In development, check with Customer Service regarding availability for specific thread types.
 C: Crimp Nut (see "Fitting Identification" in Appendix for details)
 DG: Part listed is Dual-Grip™ style (image is Uni-Crimp™ style)

O-Ring Face Seal (SAE J1453) ORS/ORFS

Male

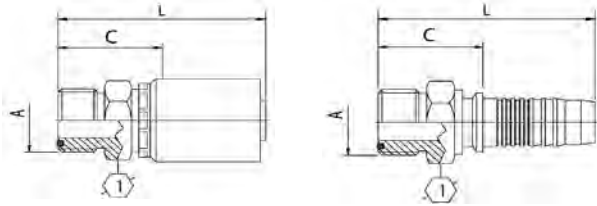

S=Skive
NS=Non-Skive
DG=Dual-Grip™

Description #	Product #	SAP #	Hose Size ID		Thread Size (A)		Hex-1 Wrench Size		Cut-Off (C)		Length (L)		Skive Type	SR13 ARC13	SR15 ARC15	S4SP	S4SH
			in.	mm	in.	mm	in.	mm	in.	mm	in.	mm					
UC-OFM-0404	36730-0404	20242567	1/4	6.4	9/16-18	11/16	17	0.88	22.3	1.85	47.1	S				UCF3-04	
UC-OFM-0606	36730-0606	20242596	3/8	9.5	11/16-16	3/4	19	0.96	24.3	2.01	51.0	S				UCF3-06	
UC-OFM-0608	36730-0608	20242575	3/8	9.5	13/16-16	7/8	22	1.04	26.3	2.09	53.0	S				UCF3-06	
UC-OFM-0808	36730-0808	20242545	1/2	12.7	13/16-16	7/8	22	1.07	27.1	2.31	58.6	S				UCF2-08	
UC-OFM-0810	36730-0810	20242369	1/2	12.7	1-14	1 1/16	27	1.20	30.6	2.44	62.1	S				UCF2-08	
UC-OFM-0812	36730-0812	20242368	1/2	12.7	1 3/16-12	1 1/4	32	1.34	34.1	2.58	65.6	S				UCF2-08	
S6-OFM-1212	30730-1212	20424990	3/4	19.0	1 3/16-12	1 1/4	32	1.42	36.0	3.62	92.0	NS	Y			Y	
UC-OFM-1212	36730-1212	20242535	3/4	19.0	1 3/16-12	1 1/4	32	1.36	34.6	2.92	74.1	S				UCF2-12	
UC-OFM-1216	36730-1216	20242443	3/4	19.0	1 7/8-12	1 5/8	41	1.50	38.1	3.06	77.6	S				UCF2-12	
S6-OFM-1616	30730-1616	20424991	1	25.4	1 7/8-12	1 1/2	38	1.57	40.0	4.09	104.0	NS	Y			Y	
UC-OFM-1616	36730-1616	20242459	1	25.4	1 7/8-12	1 1/2	38	1.49	37.9	3.25	82.5	S				UCF2-16	
S6X-OFM-2020*	30730-2020X	20424992	1 1/4	31.8	1 1/4-12	1 3/8	46	1.75	44.5	5.51	140.0	NS	Y			Y	
S6-OFM-2424	30730-2424	20424993	1 1/2	38.1	2-12	2 3/16	55	1.91	48.5	5.18	131.5	NS	Y			Y	

*One piece, no skive fitting solution. In development, check with Customer Service regarding availability for specific thread types.

O-Ring Boss Straight Thread (SAE J514)

Male

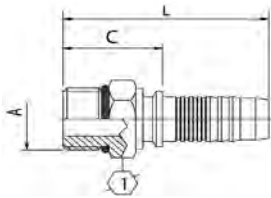

S=Skive
NS=Non-Skive
DG=Dual-Grip™

Description #	Product #	SAP #	Hose Size ID		Thread Size (A)		Hex-1 Wrench Size		Cut-Off (C)		Length (L)		Skive Type	SR13 ARC13	SR15 ARC15	S4SP	S4SH
			in.	mm	in.	mm	in.	mm	in.	mm	in.	mm					
UC-OBM-0404	36670-0404	20242597	1/4	6.4	7/16-20	9/16	14	0.80	20.3	1.78	45.1	S				UCF3-04	
UC-OBM-0405	36670-0405	20242531	1/4	6.4	1/2-20	5/8	16	0.83	21.2	1.81	46.1	S				UCF3-04	
UC-OBM-0406	36670-0406	20242591	1/4	6.4	9/16-18	11/16	17	0.88	22.3	1.85	47.1	S				UCF3-04	
UC-OBM-0606	36670-0606	20242677	3/8	9.5	9/16-18	3/4	19	0.92	23.3	1.97	50.0	S				UCF3-06	
UC-OBM-0608	36670-0608	20242672	3/8	9.5	3/4-16	7/8	22	0.96	24.3	2.01	51.0	S				UCF3-06	
UC-OBM-0610	36670-0610	20242614	3/8	9.5	7/8-14	1 1/16	27	1.06	26.8	2.11	53.5	S				UCF3-06	
UC-OBM-0808	36670-0808	20242665	1/2	12.7	3/4-16	7/8	22	0.99	25.1	2.23	56.6	S				UCF2-08	
UC-OBM-0810	36670-0810	20242595	1/2	12.7	7/8-14	1 1/16	27	1.09	27.6	2.33	59.1	S				UCF2-08	
UC-OBM-0812	36670-0812	20242476	1/2	12.7	1 1/16-12	1 1/4	32	1.26	32.1	2.50	63.6	S				UCF2-08	
UC-OBM-1210	36670-1210	20242520	3/4	19.0	7/8-14	1 1/16	27	1.11	28.1	2.66	67.6	S				UCF2-12	
UC-OBM-1212	36670-1212	20242592	3/4	19.0	1 1/16-12	1 1/4	32	1.28	32.6	2.84	72.1	S				UCF2-12	
UC-OBM-1216	36670-1216	20242455	3/4	19.0	1 5/8-12	1 1/2	38	1.36	34.6	2.92	74.1	S				UCF2-12	
UC-OBM-1616	36670-1616	20242589	1	25.4	1 5/8-12	1 1/2	38	1.39	35.4	3.15	80.0	S				UCF2-16	

O-Ring Boss Straight Thread (SAE J514)

Male | Swivel

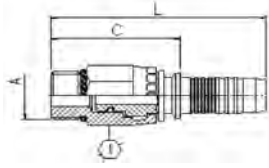

S=Skive
NS=Non-Skive
DG=Dual-Grip™

Description #	Product #	SAP #	Hose Size ID		Thread Size (A)	Hex-1 Wrench Size		Cut-Off (C)		Length (L)		Skive Type	SR13 ARC13	SR15 ARC15	S4SP	S4SH
			in.	mm		in.	mm	in.	mm	in.	mm					
UC-OBMX-0608	36680-0608	20318237	3/8	9.5	3/4-16	1	25	1.71	43.5	2.76	70.2	S				UCF3-06
UC-OBMX-0808	36680-0808	20318238	1/2	12.7	3/4-16	1	25	1.67	42.3	2.91	73.8	S				UCF2-08
UC-OBMX-0810	36680-0810	20318239	1/2	12.7	7/8-14	1	25	1.72	43.8	2.96	75.3	S				UCF2-08

O-Ring Boss Straight Thread (SAE J514)

Male 90° Elbow (Block) | Swivel

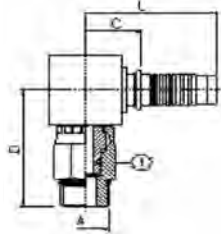

S=Skive
NS=Non-Skive
DG=Dual-Grip™

Description #	Product #	SAP #	Hose Size ID		Thread Size (A)	Hex-1 Wrench Size		Drop (D)		Cut-Off (C)		Length (L)		Skive Type	SR13 ARC13	SR15 ARC15	S4SP	S4SH
			in.	mm		in.	mm	in.	mm	in.	mm	in.	mm					
UC-OBMX90B-0405	36685-0405	20318354	1/4	6.4	1/2-20	11/16	17	1.38	35.0	0.67	17.0	1.65	41.8	S				UCF3-04
UC-OBMX90B-0606	36685-0606	20318355	3/8	9.5	9/16-18	7/8	22	1.73	44.0	0.79	20.0	1.84	46.7	S				UCF3-06
UC-OBMX90B-0608	36685-0608	20318356	3/8	9.5	3/4-16	1	25	1.77	45.0	0.87	22.0	1.92	48.7	S				UCF3-06
UC-OBMX90B-0808	36685-0808	20318357	1/2	12.7	3/4-16	1	25	1.89	48.0	0.91	23.0	2.15	54.5	S				UCF2-08
UC-OBMX90B-0810	36685-0810	20318358	1/2	12.7	7/8-14	1	25	1.97	50.0	0.91	23.0	2.15	54.5	S				UCF2-08

Code 61 Flange (SAE J518)

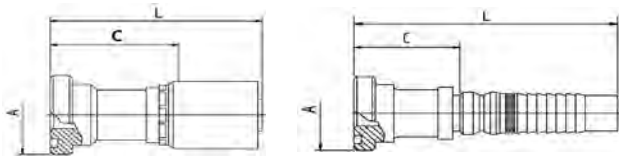

S=Skive
NS=Non-Skive
DG=Dual-Grip™

Description #	Product #	SAP #	Hose Size ID		Flange Size		Flange Dia (A)		Cut-Off (C)		Length (L)		Skive Type	SR13, ARC13	SR15, ARC15	S4SP	S4SH
			in.	mm	in.	mm	in.	mm	in.	mm	in.	mm					
UC-FL-0808 ^{UC}	36320-0808	20242569	1/2	12.7	1/2	1.19	30.2	1.61	41.0	2.85	72.5	S				UCF2-08	
UC-FL-0812 ^{UC}	36320-0812	20242300	1/2	12.7	3/4	1.50	38.1	1.65	42.0	2.89	73.5	S				UCF2-08	
DG-FL-1212	16320-1212	20242452	3/4	19.0	3/4	1.50	38.1	1.34	34.0	4.09	104.0	DG	DGF1-12	DGF1-12	DGF1-12	DGF1-12	
S6-FL-1212	30320-1212	20307981	3/4	19.0	3/4	1.50	38.1	1.71	43.5	3.88	98.5	NS	Y				Y
UC-FL-1212 ^{UC}	36320-1212	20242707	3/4	19.0	3/4	1.50	38.1	1.67	42.5	3.23	82.0	S				UCF2-12	
DG-FL-1216	16320-1216	20242382	3/4	19.0	1	1.75	44.5	1.65	42.0	4.41	112.0	DG	DGF1-12	DGF1-12	DGF1-12	DGF1-12	
UC-FL-1216 ^{UC}	36320-1216	20242650	3/4	19.0	1	1.75	44.5	1.99	50.5	3.54	90.0	S				UCF2-12	
DG-FL-1616	16320-1616	20242619	1	25.4	1	1.75	44.5	1.61	41.0	4.94	125.5	DG	DGF1-16	DGF1-16	DGF1-16	DGF1-16	
S6-FL-1616	30320-1616	20307982	1	25.4	1	1.75	44.5	2.11	53.5	4.63	117.5	NS	Y				Y
UC-FL-1616 ^{UC}	36320-1616	20242744	1	25.4	1	1.75	44.5	2.02	51.4	3.78	96.0	S				UCF2-16	
DG-FL-1620	16320-1620	20242416	1	25.4	1 1/4	2.00	50.8	1.71	43.5	5.04	128.0	DG	DGF1-16	DGF1-16	DGF1-16	DGF1-16	
UC-FL-1620 ^{UC}	36320-1620	20242697	1	25.4	1 1/4	2.00	50.8	2.12	53.9	3.88	98.5	S				UCF2-16	
S6-FL-1624	30320-1624	20293317	1	25.4	1 1/2	2.37	60.3	2.32	59.0	4.84	123.0	NS	Y				Y
DG-FL-2020	16320-2020	20242451	1 1/4	31.8	1 1/4	2.00	50.8	1.67	42.3	5.49	139.5	DG	DGF2-20	DGF2-20			DGF1-20
S6-FL-2020	30320-2020	20307983	1 1/4	31.8	1 1/4	2.00	50.8	2.30	58.5	5.30	134.5	NS	Y				
S6X-FL-2020*	30320-2020X	20577095	1 1/4	31.8	1 1/4	2.00	50.8	2.30	58.5	6.06	154.0	NS	Y				Y
DG-FL-2024	16320-2024	20242299	1 1/4	31.8	1 1/2	2.37	60.3	1.78	45.3	5.61	142.5	DG	DGF2-20	DGF2-20			DGF1-20
DG-FL-2424	16320-2424	20242554	1 1/2	38.1	1 1/2	2.37	60.3	1.77	45.0	5.81	147.5	DG	DGF2-24	DGF2-24			
S6-FL-2424	30320-2424	20307984	1 1/2	38.1	1 1/2	2.37	60.3	2.50	63.5	5.77	146.5	NS	Y				Y
DG-FL-2432	16320-2432	20242298	1 1/2	38.1	2	2.81	71.4	2.22	56.5	6.26	159.0	DG	DGF2-24	DGF2-24			
DG-FL-3232	16320-3232	20242526	2	50.8	2	2.81	71.4	2.17	55.0	6.54	166.0	DG	DGF2-32	DGF2-32			DGF1-32

*One piece, no skive fitting solution. In development, check with Customer Service regarding availability for specific thread types.
UC. Part listed is Uni-Crimp™ style (image is Dual-Grip™ style)

Code 61 Flange (SAE J518)

22.5° Elbow

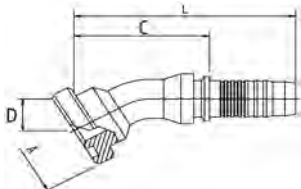

S=Skive
NS=Non-Skive
DG=Dual-Grip™

Description #	Product #	SAP #	Hose Size ID		Flange Size		Drop (D)		Cut-Off (C)		Length (L)		Skive Type	SR13, ARC13	SR15, ARC15	S4SP	S4SH
			in.	mm	in.	mm	in.	mm	in.	mm	in.	mm					
UC-FL22-1616	36330-1616	20242623	1	25.4	1	1.75	44.5	0.47	12.0	3.66	93.0	5.39	137.0	S			UCF2-16

Code 61 Flange (SAE J518)

30° Elbow

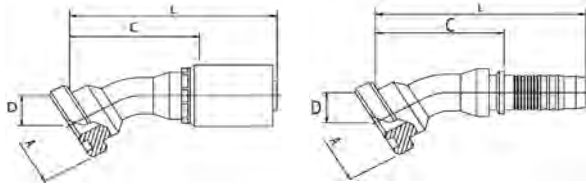

S=Skive
NS=Non-Skive
DG=Dual-Grip™

Description #	Product #	SAP #	Hose Size ID		Flange Size		Flange Dia (A)		Drop (D)		Cut-Off (C)		Length (L)		Skive Type	SR13 ARC13	SR15 ARC15	S4SP	S4SH
			in.	mm	in.	mm	in.	mm	in.	mm	in.	mm	in.	mm					
UC-FL30-1212	36335-1212	20242577	3/4	19.0	3/4	1.50	38.1	0.75	19.0	3.19	81.0	4.72	120.0	S				UCF2-12	
UC-FL30-1216	36335-1216	20242379	3/4	19.0	1	1.75	44.5	0.75	19.0	3.31	84.0	4.84	123.0	S				UCF2-12	
UC-FL30-1616	36335-1616	20242497	1	25.4	1	1.75	44.5	0.83	21.0	3.54	90.0	5.28	134.0	S				UCF2-16	
UC-FL30-1620	36335-1620	20242498	1	25.4	1¼	2.00	50.8	0.87	22.0	3.54	90.0	5.31	135.0	S				UCF2-16	
S6-FL30-1624	30335-1624	20293318	1	25.4	1½	2.37	60.3	1.06	27.0	4.21	107.0	6.73	171.0	NS	Y				Y
DG-FL30-3232	16335-3232	20297539	2	50.8	2	2.81	71.4	1.28	32.5	5.87	149.0	9.69	246.0	DG	DGF2-32	DGF2-32			DGF1-32

Code 61 Flange (SAE J518)

45° Elbow

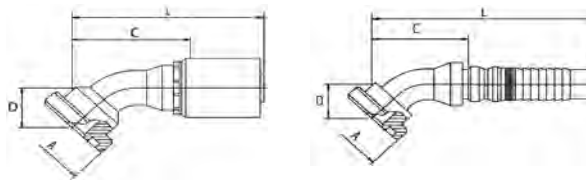

S=Skive
NS=Non-Skive
DG=Dual-Grip™

Description #	Product #	SAP #	Hose Size ID		Flange Size		Flange Dia (A)		Drop (D)		Cut-Off (C)		Length (L)		Skive Type	SR13 ARC13	SR15 ARC15	S4SP	S4SH
			in.	mm	in.	mm	in.	mm	in.	mm	in.	mm	in.	mm					
UC-FL45-0808 ^{UC}	36340-0808	20242508	1/2	12.7	1/2	1.19	30.2	0.87	22.0	2.09	53.0	3.31	84.0	S				UCF2-08	
UC-FL45-0812 ^{UC}	36340-0812	20242293	1/2	12.7	3/4	1.50	38.1	1.02	26.0	2.36	60.0	3.62	92.0	S				UCF2-08	
DG-FL45-1212	16340-1212	20242450	3/4	19.0	3/4	1.50	38.1	0.98	25.0	2.72	69.0	5.24	133.0	DG	DGF1-12	DGF1-12	DGF1-12	DGF1-12	
S6-FL45-1212	30340-1212	20242497	3/4	19.0	3/4	1.50	38.1	1.10	28.0	2.80	71.0	4.96	126.0	NS	Y				Y
UC-FL45-1212 ^{UC}	36340-1212	20242678	3/4	19.0	3/4	1.50	38.1	1.26	32.0	2.91	74.0	4.45	113.0	S				UCF2-12	
UC-FL45-1216	36340-1216	20242617	3/4	19.0	1	1.75	44.5	1.14	29.0	3.07	78.0	4.61	117.0	S				UCF2-12	
DG-FL45-1616	16340-1616	20242558	1	25.4	1	1.75	44.5	1.38	35.0	3.27	83.0	6.30	160.0	DG	DGF1-16	DGF1-16	DGF1-16	DGF1-16	
S6-FL45-1616	30340-1616	20307986	1	25.4	1	1.75	44.5	1.38	35.0	3.46	88.0	5.98	152.0	NS	Y				Y
UC-FL45-1616	36340-1616	20242700	1	25.4	1	1.75	44.5	1.32	33.5	3.27	83.0	5.00	127.0	S				UCF2-16	
DG-FL45-1620	16340-1620	20242291	1	25.4	1¼	2.00	50.8	1.18	30.0	3.78	96.0	6.77	172.0	DG	DGF1-16	DGF1-16	DGF1-16	DGF1-16	
UC-FL45-1620 ^{UC}	36340-1620	20242653	1	25.4	1¼	2.00	50.8	1.42	36.0	3.23	82.0	5.00	127.0	S				UCF2-16	
DG-FL45-2020	16340-2020	20242414	1¼	31.8	1¼	2.00	50.8	1.28	32.5	3.98	101.0	7.40	188.0	DG	DGF2-20	DGF2-20			DGF1-20
S6-FL45-2020	30340-2020	20307987	1¼	31.8	1¼	2.00	50.8	1.52	38.5	4.09	104.0	7.11	180.5	NS	Y				
S6X-FL45-2020*	30340-2020X	20568985	1¼	31.8	1¼	2.00	50.8	1.52	38.5	4.09	104.0	7.87	200.0	NS	Y				Y
DG-FL45-2024	16340-2024	20242292	1¼	31.8	1½	2.37	60.3	1.57	40.0	3.66	93.0	7.09	180.0	DG	DGF2-20	DGF2-20			DGF1-20
DG-FL45-2424	16340-2424	20242449	1½	38.1	1½	2.37	60.3	1.69	43.0	4.09	104.0	7.68	195.0	DG	DGF2-24	DGF2-24			
S6-FL45-2424	30340-2424	20307988	1½	38.1	1½	2.37	60.3	1.69	43.0	4.37	111.0	7.64	194.0	NS	Y				Y
DG-FL45-3232	16340-3232	20242294	2	50.8	2	2.81	71.4	2.13	54.0	5.43	138.0	9.25	235.0	DG	DGF2-32	DGF2-32			DGF1-32

*One piece, no skive fitting solution. In development, check with Customer Service regarding availability for specific thread types.
UC: Part listed is Uni-Crimp™ style (image is Dual-Grip™ style)

Code 61 Flange (SAE J518)

60° Elbow

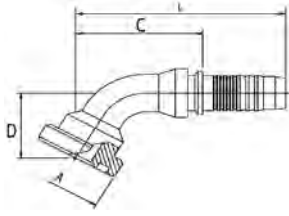

S=Skive
NS=Non-Skive
DG=Dual-Grip™

Description #	Product #	SAP #	Hose Size ID		Flange Dia (A)		Drop (D)		Cut-Off (C)		Length (L)		Skive Type	SR13 ARC13	SR15 ARC15	S4SP	S4SH
			in.	mm	in.	mm	in.	mm	in.	mm	in.	mm					
UC-FL60-1212	36345-1212	20242516	3/4	19.0	3/4	1.50	38.1	1.46	37.0	3.39	86.0	4.92	125.0	S			UCF2-12
UC-FL60-1216	36345-1216	20242499	3/4	19.0	1	1.75	44.5	1.73	44.0	4.02	102.0	5.57	141.5	S			UCF2-12
UC-FL60-1616	36345-1616	20242510	1	25.4	1	1.75	44.5	1.85	47.0	3.98	101.0	5.73	145.6	S			UCF2-16
UC-FL60-1620	36345-1620	20242560	1	25.4	1 1/4	2.00	50.8	1.71	43.5	4.20	106.6	5.95	151.2	S			UCF2-16

Code 61 Flange (SAE J518)

67° Elbow

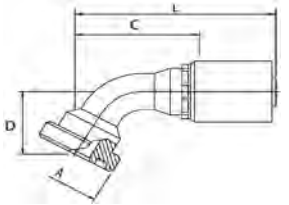

S=Skive
NS=Non-Skive
DG=Dual-Grip™

Description #	Product #	SAP #	Hose Size ID		Flange Dia (A)		Drop (D)		Cut-Off (C)		Length (L)		Skive Type	SR13 ARC13	SR15 ARC15	S4SP	S4SH
			in.	mm	in.	mm	in.	mm	in.	mm	in.	mm					
S6-FL67-1212	30347-1212	20293319	3/4	19.0	3/4	1.50	38.1	1.79	45.5	3.19	81.0	5.35	136.0	NS	Y		Y
S6-FL67-1616	30347-1616	20293320	1	25.4	1	1.75	44.5	1.89	48.0	3.56	90.5	6.08	154.5	NS	Y		Y
S6-FL67-2020	30347-2020	20293321	1 1/4	31.8	1 1/4	2.00	50.8	2.34	59.5	5.12	130.0	7.34	186.5	NS	Y		
S6X-FL67-2020*	30347-2020X	20577097	1 1/4	31.8	1 1/4	2.00	50.8	2.34	59.5	5.12	130.0	8.11	206.0	NS	Y		Y

*One piece, no skive fitting solution. In development, check with Customer Service regarding availability for specific thread types.

Code 61 Flange (SAE J518)

90° Elbow

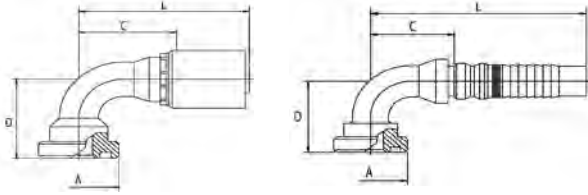

S=Skive
NS=Non-Skive
DG=Dual-Grip™

Description #	Product #	SAP #	Hose Size ID		Flange Size		Flange Dia (A)		Drop (D)		Cut-Off (C)		Length (L)		Skive Type	SR13, ARC13	SR15, ARC15	S4SP	S4SH
			in.	mm	in.	mm	in.	mm	in.	mm	in.	mm	in.	mm					
UC-FL90-0808 ^{UC}	36350-0808	20242537	1/2	12.7	1/2	1.19	30.2	1.65	42.0	1.81	46.0	3.03	77.0	S				UCF2-08	
UC-FL90-0812 ^{UC}	36350-0812	20242381	1/2	12.7	3/4	1.50	38.1	2.01	51.0	1.77	45.0	3.03	77.0	S				UCF2-08	
DG-FL90-1212	16350-1212	20242486	3/4	19.0	3/4	1.50	38.1	2.17	55.0	2.48	63.0	5.00	127.0	DG	DGF1-12	DGF1-12	DGF1-12	DGF1-12	DGF1-12
S6-FL90-1212	30350-1212	20307989	3/4	19.0	3/4	1.50	38.1	2.28	58.0	2.56	65.0	4.72	120.0	NS	Y				Y
UC-FL90-1212 ^{UC}	36350-1212	20242696	3/4	19.0	3/4	1.50	38.1	2.36	60.0	2.28	58.0	3.82	97.0	S				UCF2-12	
DG-FL90-1216	16350-1216	20242297	3/4	19.0	1	1.75	44.5	2.32	59.0	2.52	64.0	5.04	128.0	DG	DGF1-12	DGF1-12	DGF1-12	DGF1-12	DGF1-12
UC-FL90-1216 ^{UC}	36350-1216	20242667	3/4	19.0	1	1.75	44.5	2.54	64.5	2.60	66.0	4.17	106.0	S				UCF2-12	
S6-FL90-1612	30350-1612	20293323	1	25.4	3/4	1.50	38.1	2.17	55.0	2.72	69.0	5.24	133.0	NS	Y				Y
DG-FL90-1616	16350-1616	20242603	1	25.4	1	1.75	44.5	2.52	64.0	2.83	72.0	5.87	149.0	DG	DGF1-16	DGF1-16	DGF1-16	DGF1-16	DGF1-16
S6-FL90-1616	30350-1616	20308020	1	25.4	1	1.75	44.5	2.52	64.0	3.07	78.0	5.59	142.0	NS	Y				Y
UC-FL90-1616 ^{UC}	36350-1616	20242740	1	25.4	1	1.75	44.5	2.64	67.0	2.80	71.0	4.53	115.0	S				UCF2-16	
DG-FL90-1620	16350-1620	20242295	1	25.4	1 1/4	2.00	50.8	2.72	69.0	2.76	70.0	5.79	147.0	DG	DGF1-16	DGF1-16	DGF1-16	DGF1-16	DGF1-16
UC-FL90-1620 ^{UC}	36350-1620	20242701	1	25.4	1 1/4	2.00	50.8	2.80	71.0	2.91	74.0	4.65	118.0	S				UCF2-16	
S6-FL90-1624	30350-1624	20293324	1	25.4	1 1/2	2.37	60.3	2.95	75.0	3.74	95.0	6.26	159.0	NS	Y				Y
DG-FL90-2020	16350-2020	20242415	1 1/4	31.8	1 1/4	2.00	50.8	3.19	81.0	3.39	86.0	6.81	173.0	DG	DGF2-20	DGF2-20		DGF1-20	
S6-FL90-2020	30350-2020	20308021	1 1/4	31.8	1 1/4	2.00	50.8	3.19	81.0	3.62	92.0	6.59	167.5	NS	Y				
S6X-FL90-2020*	30350-2020X	20577098	1 1/4	31.8	1 1/4	2.00	50.8	3.19	81.0	3.62	92.0	7.36	187.0	NS	Y				Y
DG-FL90-2024	16350-2024	20242296	1 1/4	31.8	1 1/2	2.37	60.3	3.35	85.0	3.19	81.0	6.61	168.0	DG	DGF2-20	DGF2-20		DGF1-20	
DG-FL90-2424	16350-2424	20242524	1 1/2	38.1	1 1/2	2.37	60.3	3.66	93.0	3.78	96.0	7.36	187.0	DG	DGF2-24	DGF2-24			
S6-FL90-2424	30350-2424	20308022	1 1/2	38.1	1 1/2	2.37	60.3	3.66	93.0	4.06	103.0	7.32	186.0	NS	Y				Y
DG-FL90-3232	16350-3232	20242525	2	50.8	2	2.81	71.4	5.12	130.0	5.28	134.0	9.09	231.0	DG	DGF2-32	DGF2-32		DGF1-32	

*One piece, no skive fitting solution. In development, check with Customer Service regarding availability for specific thread types.
UC: Part listed is Uni-Crimp™ style (image is Dual-Grip™ style)

Code 62 Flange (SAE J518)

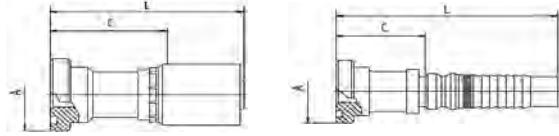

S=Skive
NS=Non-Skive
DG=Dual-Grip™

Description #	Product #	SAP #	Hose Size ID		Flange Size		Flange Dia (A)		Cut-Off (C)		Length (L)		Skive Type	SR13 ARC13	SR15 ARC15	S4SP	S4SH
			in.	mm	in.	mm	in.	mm	in.	mm	in.	mm					
DG-FH-1212	16300-1212	20254304	3/4	19.0	3/4	1.63	41.3	1.73	44.0	4.49	114.0	DG	DGF1-12	DGF1-12	DGF1-12	DGF1-12	
S6-FH-1212	30300-1212	20241742	3/4	19.0	3/4	1.63	41.3	2.11	53.5	4.27	108.5	NS	Y			Y	
UC-FH-1212	36300-1212	20242607	3/4	19.0	3/4	1.63	41.3	2.07	52.5	3.62	92.0	S			UCF2-12		
DG-FH-1216	16300-1216	20254305	3/4	19.0	1	1.87	47.6	1.85	47.0	4.61	117.0	DG	DGF1-12	DGF1-12	DGF1-12	DGF1-12	
S6-FH-1216	30300-1216	20241746	3/4	19.0	1	1.87	47.6	2.22	56.5	4.39	111.5	NS	Y			Y	
UC-FH-1216	36300-1216	20242467	3/4	19.0	1	1.87	47.6	2.19	55.5	3.74	95.0	S			UCF2-12		
S6-FH-1612	30300-1612	20293325	1	25.4	3/4	1.63	41.3	2.30	58.5	4.82	122.5	NS	Y			Y	
DG-FH-1616	16300-1616	20242528	1	25.4	1	1.87	47.6	1.81	46.0	5.14	130.5	DG	DGF1-16	DGF1-16	DGF1-16	DGF1-16	
S6-FH-1616	30300-1616	20241219	1	25.4	1	1.87	47.6	2.30	58.5	4.82	122.5	NS	Y			Y	
UC-FH-1616	36300-1616	20242647	1	25.4	1	1.87	47.6	2.22	56.4	3.98	101.0	S			UCF2-16		
DG-FH-1620	16300-1620	20242307	1	25.4	1/4	2.13	54.0	2.09	53.0	5.41	137.5	DG	DGF1-16	DGF1-16	DGF1-16	DGF1-16	
S6-FH-1620	30300-1620	20241736	1	25.4	1/4	2.13	54.0	2.58	65.5	5.10	129.5	NS	Y			Y	
UC-FH-1620	36300-1620	20242572	1	25.4	1/4	2.13	54.0	2.50	63.4	4.25	108.0	S			UCF2-16		
DG-FH-2016	16300-2016	20242797	1/4	31.8	1	1.87	47.6	2.75	69.8	6.57	167.0	DG	DGF2-20	DGF2-20		DGF1-20	
DG-FH-2020	16300-2020	20242309	1/4	31.8	1/4	2.13	54.0	2.04	51.8	5.87	149.0	DG	DGF2-20	DGF2-20		DGF1-20	
S6-FH-2020	30300-2020	20241738	1/4	31.8	1/4	2.13	54.0	2.52	64.0	5.51	140.0	NS	Y				
S6X-FH-2020*	30300-2020X	20577082	1/4	31.8	1/4	2.13	54.0	2.52	64.0	6.28	159.5	NS	Y			Y	
DG-FH-2024	16300-2024	20254306	1/4	31.8	1/2	2.50	63.5	2.28	57.8	6.10	155.0	DG	DGF2-20	DGF2-20		DGF1-20	
S6-FH-2024	30300-2024	20241749	1/4	31.8	1/2	2.50	63.5	2.91	74.0	5.91	150.0	NS	Y				
S6X-FH-2024*	30300-2024X	20577083	1/4	31.8	1/2	2.50	63.5	2.91	74.0	6.67	169.5	NS	Y			Y	
DG-FH-2424	16300-2424	20242308	1/2	38.1	1/2	2.50	63.5	2.26	57.5	6.30	160.0	DG	DGF2-24	DGF2-24			
S6-FH-2424	30300-2424	20241758	1/2	38.1	1/2	2.50	63.5	2.99	76.0	6.26	159.0	NS	Y			Y	
DG-FH-2432	16300-2432	20242796	1/2	38.1	2	3.13	79.4	2.74	69.5	6.77	172.0	DG	DGF2-24	DGF2-24			
S6-FH-2432	30300-2432	20241756	1/2	38.1	2	3.13	79.4	3.46	88.0	6.73	171.0	NS	Y			Y	
DG-FH-3232	16300-3232	20254307	2	50.8	2	3.13	79.4	2.87	73.0	7.24	184.0	DG	DGF2-32	DGF2-32		DGF1-32	

*One piece, no skive fitting solution. In development, check with Customer Service regarding availability for specific thread types.

Code 62 Flange (SAE J518)

22.5° Elbow

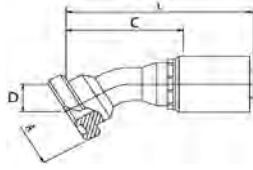

S=Skive
NS=Non-Skive
DG=Dual-Grip™

Description #	Product #	SAP #	Hose Size ID		Flange Size		Flange Dia (A)		Drop (D)		Cut-Off (C)		Length (L)		Skive Type	SR13 ARC13	SR15 ARC15	S4SP	S4SH
			in.	mm	in.	mm	in.	mm	in.	mm	in.	mm	in.	mm					
S6-FH22-1216	30303-1216	20293326	3/4	19.0	1	1.87	47.6	0.59	15.0	3.52	89.5	5.69	144.5	NS	Y				Y
S6-FH22-1616	30303-1616	20293327	1	25.4	1	1.87	47.6	0.61	15.5	4.29	109.0	6.81	173.0	NS	Y				Y
S6-FH22-2020	30303-2020	20293328	1¼	31.8	1¼	2.13	54.0	0.73	18.5	4.57	116.0	6.79	172.5	NS	Y				
S6X-FH22-2020*	30303-2020X	20577084	1¼	31.8	1¼	2.13	54.0	0.73	18.5	4.57	116.0	7.56	192.0	NS	Y				Y
S6-FH22-2024	30303-2024	20293329	1¼	31.8	1½	2.50	63.5	0.85	21.5	5.18	131.5	7.40	188.0	NS	Y				
S6X-FH22-2024*	30303-2024X	20577085	1¼	31.8	1½	2.50	63.5	0.85	21.5	5.18	131.5	8.17	207.5	NS	Y				Y

*One piece, no skive fitting solution. In development, check with Customer Service regarding availability for specific thread types.

Code 62 Flange (SAE J518)

30° Elbow

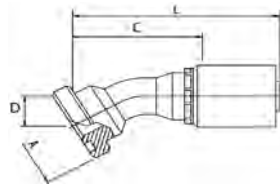

S=Skive
NS=Non-Skive
DG=Dual-Grip™

Description #	Product #	SAP #	Hose Size ID		Flange Size		Flange Dia (A)		Drop (D)		Cut-Off (C)		Length (L)		Skive Type	SR13 ARC13	SR15 ARC15	S4SP	S4SH
			in.	mm	in.	mm	in.	mm	in.	mm	in.	mm	in.	mm					
S6-FH30-1212	30305-1212	20293330	3/4	19.0	3/4	1.63	41.3	0.75	19.0	3.23	82.0	5.39	137.0	NS	Y				Y
S6-FH30-1616	30305-1616	20293331	1	25.4	1	1.87	47.6	0.96	24.5	4.17	106.0	6.69	170.0	NS	Y				Y
S6-FH30-2020	30305-2020	20293332	1¼	31.8	1¼	2.13	54.0	1.00	25.5	4.43	112.5	6.65	169.0	NS	Y				
S6X-FH30-2020*	30305-2020X	20577086	1¼	31.8	1¼	2.13	54.0	1.00	25.5	4.43	112.5	7.42	188.5	NS	Y				Y
S6-FH30-2024	30305-2024	20293333	1¼	31.8	1½	2.50	63.5	1.18	30.0	5.04	128.0	7.26	184.5	NS	Y				
S6X-FH30-2024*	30305-2024X	20577087	1¼	31.8	1½	2.50	63.5	1.18	30.0	5.04	128.0	8.03	204.0	NS	Y				Y
S6-FH30-2424	30305-2424	20293334	1½	38.1	1½	2.50	63.5	1.16	29.5	6.06	154.0	9.33	237.0	NS	Y				Y

*One piece, no skive fitting solution. In development, check with Customer Service regarding availability for specific thread types.

Code 62 Flange (SAE J518)

45° Elbow

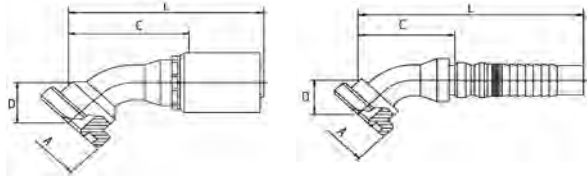

S=Skive
NS=Non-Skive
DG=Dual-Grip™

Description #	Product #	SAP #	Hose Size ID		Flange Size		Flange Dia (A)		Drop (D)		Cut-Off (C)		Length (L)		Skive Type	SR13 ARC13	SR15 ARC15	S4SP	S4SH
			in.	mm	in.	mm	in.	mm	in.	mm	in.	mm	in.	mm					
DG-FH45-1212	16310-1212	20254308	3/4	19.0	3/4	1.63	41.3	1.18	30.0	2.83	72.0	5.35	136.0	DG	DGF1-12	DGF1-12	DGF1-12	DGF1-12	
S6-FH45-1212	30310-1212	20241789	3/4	19.0	3/4	1.63	41.3	1.18	30.0	2.95	75.0	5.12	130.0	NS	Y			Y	
UC-FH45-1212	36310-1212	20242570	3/4	19.0	3/4	1.63	41.3	1.22	31.0	3.31	84.0	4.88	124.0	S			UCF2-12		
DG-FH45-1216	16310-1216	20254309	3/4	19.0	1	1.87	47.6	1.30	33.0	3.03	77.0	5.55	141.0	DG	DGF1-12	DGF1-12	DGF1-12	DGF1-12	
S6-FH45-1216	30310-1216	20241786	3/4	19.0	1	1.87	47.6	1.30	33.0	3.15	80.0	5.31	135.0	NS	Y			Y	
DG-FH45-1616	16310-1616	20242417	1	25.4	1	1.87	47.6	1.38	35.0	3.74	95.0	6.73	171.0	DG	DGF1-16	DGF1-16	DGF1-16	DGF1-16	
S6-FH45-1616	30310-1616	20241773	1	25.4	1	1.87	47.6	1.38	35.0	3.86	98.0	6.38	162.0	NS	Y			Y	
UC-FH45-1616	36310-1616	20242618	1	25.4	1	1.87	47.6	1.42	36.0	3.82	97.0	5.55	141.0	S			UCF2-16		
DG-FH45-1620	16310-1620	20242301	1	25.4	1 1/4	2.13	54.0	1.73	44.0	3.58	91.0	6.61	168.0	DG	DGF1-16	DGF1-16	DGF1-16	DGF1-16	
S6-FH45-1620	30310-1620	20241770	1	25.4	1 1/4	2.13	54.0	1.73	44.0	3.78	96.0	6.30	160.0	NS	Y			Y	
UC-FH45-1620	36310-1620	20242527	1	25.4	1 1/4	2.13	54.0	1.54	39.0	3.78	96.0	5.55	141.0	S			UCF2-16		
DG-FH45-2020	16310-2020	20242303	1 1/4	31.8	1 1/4	2.13	54.0	1.56	39.5	4.02	102.0	7.44	189.0	DG	DGF2-20	DGF2-20		DGF1-20	
S6-FH45-2020	30310-2020	20241763	1 1/4	31.8	1 1/4	2.13	54.0	1.61	41.0	4.06	103.0	7.07	179.5	NS	Y				
S6X-FH45-2020*	30310-2020X	20577088	1 1/4	31.8	1 1/4	2.13	54.0	1.61	41.0	4.06	103.0	7.83	199.0	NS	Y			Y	
S6-FH45-2024	30310-2024	20293336	1 1/4	31.8	1 1/2	2.50	63.5	1.89	48.0	4.61	117.0	7.62	193.5	NS	Y				
S6X-FH45-2024*	30310-2024X	20577089	1 1/4	31.8	1 1/2	2.50	63.5	1.89	48.0	4.61	117.0	8.39	213.0	NS	Y			Y	
DG-FH45-2424	16310-2424	20242302	1 1/2	38.1	1 1/2	2.50	63.5	1.89	48.0	5.35	136.0	8.98	228.0	DG	DGF2-24	DGF2-24			
S6-FH45-2424	30310-2424	20241768	1 1/2	38.1	1 1/2	2.50	63.5	1.89	48.0	5.67	144.0	8.94	227.0	NS	Y			Y	
DG-FH45-2432	16310-2432	20242795	1 1/2	38.1	2	3.13	79.4	2.17	55.0	5.08	129.0	8.70	221.0	DG	DGF2-24	DGF2-24			
S6-FH45-2432	30310-2432	20241766	1 1/2	38.1	2	3.13	79.4	2.17	55.0	5.39	137.0	8.66	220.0	NS	Y			Y	
DG-FH45-3232	16310-3232	20254310	2	50.8	2	3.13	79.4	2.48	63.0	6.34	161.0	10.16	258.0	DG	DGF2-32	DGF2-32		DGF1-32	

*One piece, no skive fitting solution. In development, check with Customer Service regarding availability for specific thread types.

Code 62 Flange (SAE J518)

60° Elbow

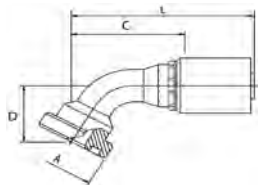

S=Skive
NS=Non-Skive
DG=Dual-Grip™

Description #	Product #	SAP #	Hose Size ID		Flange Size		Flange Dia (A)		Drop (D)		Cut-Off (C)		Length (L)		Skive Type	SR13 ARC13	SR15 ARC15	S4SP	S4SH
			in.	mm	in.	mm	in.	mm	in.	mm	in.	mm	in.	mm					
S6-FH60-1212	30312-1212	20293337	3/4	19.0	3/4	1.63	41.3	1.71	43.5	3.66	93.0	5.83	148.0	NS	Y			Y	
S6-FH60-1616	30312-1616	20293338	1	25.4	1	1.87	47.6	1.87	47.5	4.21	107.0	6.73	171.0	NS	Y			Y	
S6-FH60-2020	30312-2020	20293339	1 1/4	31.8	1 1/4	2.13	54.0	2.54	64.5	5.20	132.0	8.21	208.5	NS	Y				
S6X-FH60-2020*	30312-2020X	20577090	1 1/4	31.8	1 1/4	2.13	54.0	2.54	64.5	5.20	132.0	8.98	228.0	NS	Y			Y	
S6-FH60-2024	30312-2024	20293340	1 1/4	31.8	1 1/2	2.50	63.5	2.74	69.5	5.71	145.0	7.93	201.5	NS	Y				
S6X-FH60-2024*	30312-2024X	20577091	1 1/4	31.8	1 1/2	2.50	63.5	2.74	69.5	5.71	145.0	8.70	221.0	NS	Y			Y	

*One piece, no skive fitting solution. In development, check with Customer Service regarding availability for specific thread types.

Code 62 Flange (SAE J518)

67° Elbow

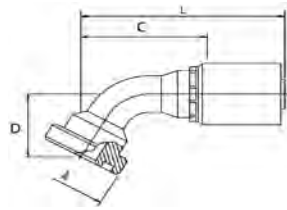

S=Skive
NS=Non-Skive
DG=Dual-Grip™

Description #	Product #	SAP #	Hose Size ID		Flange Size		Flange Dia (A)		Drop (D)		Cut-Off (C)		Length (L)		Skive Type	SR13 ARC13	SR15 ARC15	S4SP	S4SH
			in.	mm	in.	mm	in.	mm	in.	mm	in.	mm	in.	mm					
S6-FH67-1616	30315-1616	20293344	1	25.4	1	1.87	47.6	2.40	61.0	4.04	102.5	6.56	166.5	NS	Y				Y

Code 62 Flange (SAE J518)

90° Elbow

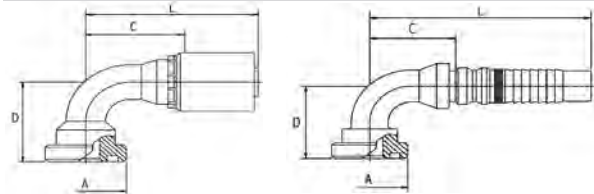

Elbow Type
LT=Long Tube
ST=Short Tube

S=Skive
NS=Non-Skive
DG=Dual-Grip™

Description #	Product #	SAP #	Hose Size ID		Thread Size (A)		Hex-1 Size Wrench Size		Elbow Type	Drop (D)		Cut-Off (C)		Length (L)		Skive Type	SR13 ARC13	SR15 ARC15	S4SP	S4SH
			in.	mm	in.	mm	in.	mm		in.	mm	in.	mm	in.	mm					
UC-FH90-0808 ^{UC}	36315-0808	20242306	1/2	12.7	1/2	1.25	31.8		1.81	46.0	1.89	48.0	3.11	79.0	S				UCF2-08	
DG-FH90-1212	16315-1212	20254311	3/4	19.0	3/4	1.63	41.3		2.52	64.0	2.40	61.0	4.92	125.0	DG	DGF1-12	DGF1-12	DGF1-12	DGF1-12	
S6-FH90-1212	30315-1212	20242952	3/4	19.0	3/4	1.63	41.3		2.52	64.0	2.56	65.0	4.72	120.0	NS	Y			Y	
UC-FH90-1212	36315-1212	20242621	3/4	19.0	3/4	1.63	41.3		2.40	61.0	2.48	63.0	4.06	103.0	S				UCF2-12	
DG-FH90-1216	16315-1216	20254312	3/4	19.0	1	1.87	47.6		2.60	66.0	2.40	61.0	4.92	125.0	DG	DGF1-12	DGF1-12	DGF1-12	DGF1-12	
S6-FH90-1216	30315-1216	20241733	3/4	19.0	1	1.87	47.6		2.60	66.0	2.56	65.0	4.72	120.0	NS	Y			Y	
UC-FH90-1216	36315-1216	20242511	3/4	19.0	1	1.87	47.6		2.60	66.0	2.48	63.0	4.06	103.0	S				UCF2-12	
S6-FH90-1612	30315-1612	20293341	1	25.4	3/4	1.63	41.3		2.40	61.0	2.95	75.0	5.47	139.0	NS	Y			Y	
DG-FH90-1616	16315-1616	20242604	1	25.4	1	1.87	47.6		2.91	74.0	2.76	70.0	5.79	147.0	DG	DGF1-16	DGF1-16	DGF1-16	DGF1-16	
S6-FH90-1616	30315-1616	20241792	1	25.4	1	1.87	47.6		2.91	74.0	2.95	75.0	5.47	139.0	NS	Y			Y	
UC-FH90-1616	36315-1616	20242673	1	25.4	1	1.87	47.6		2.95	75.0	2.91	74.0	4.65	118.0	S				UCF2-16	
DG-FH90-1620	16315-1620	20242466	1	25.4	1 1/4	2.13	54.0		3.15	80.0	3.03	77.0	6.06	154.0	DG	DGF1-16	DGF1-16	DGF1-16	DGF1-16	
S6-FH90-1620	30315-1620	20241784	1	25.4	1 1/4	2.13	54.0		3.35	85.0	3.11	79.0	5.63	143.0	NS	Y			Y	
UC-FH90-1620	36315-1620	20242585	1	25.4	1 1/4	2.13	54.0		3.07	78.0	3.07	78.0	4.80	122.0	S				UCF2-16	
DG-FH90-2020	16315-2020	20242305	1 1/4	31.8	1 1/4	2.13	54.0		3.58	91.0	3.46	88.0	6.89	175.0	DG	DGF2-20	DGF2-20		DGF1-20	
S6-FH90-2020	30315-2020	20241760	1 1/4	31.8	1 1/4	2.13	54.0		3.58	91.0	3.78	96.0	6.79	172.5	NS	Y				
S6X-FH90-2020*	30315-2020X	20577092	1 1/4	31.8	1 1/4	2.13	54.0		3.58	91.0	3.78	96.0	7.56	192.0	NS	Y			Y	
S6-FH90L-2020	30317-2020	20293342	1 1/4	31.8	1 1/4	2.13	54.0	LT	4.72	120.0	3.66	93.0	6.67	169.5	NS	Y				
S6X-FH90L-2020*	30317-2020X	20577094	1 1/4	31.8	1 1/4	2.13	54.0	LT	4.72	120.0	3.66	93.0	7.44	189.0	NS	Y			Y	
DG-FH90-2024	16315-2024	20254313	1 1/4	31.8	1 1/2	2.50	63.5		4.07	103.5	3.66	93.0	7.09	180.0	DG	DGF2-20	DGF2-20		DGF1-20	
S6-FH90-2024	30315-2024	20241793	1 1/4	31.8	1 1/2	2.50	63.5		4.07	103.5	3.90	99.0	6.87	174.5	NS	Y				
S6X-FH90-2024*	30315-2024X	20577093	1 1/4	31.8	1 1/2	2.50	63.5		4.07	103.5	3.90	99.0	7.64	194.0	NS	Y			Y	
S6-FH90-2420	30315-2420	20241782	1 1/2	38.1	1 1/4	2.13	54.0		3.35	85.0	4.41	112.0	7.68	195.0	NS	Y			Y	
DG-FH90-2424	16315-2424	20242304	1 1/2	38.1	1 1/2	2.50	63.5		4.29	109.0	4.17	106.0	7.80	198.0	DG	DGF2-24	DGF2-24			
S6-FH90-2424	30315-2424	20241783	1 1/2	38.1	1 1/2	2.50	63.5		4.29	109.0	4.49	114.0	7.76	197.0	NS	Y			Y	
S6-FH90-2432	30315-2432	20293343	1 1/2	38.1	2	3.13	79.4		4.78	121.5	4.65	118.0	7.91	201.0	NS	Y			Y	
DG-FH90-3232	16315-3232	20254314	2	50.8	2	3.13	79.4		5.45	138.5	5.87	149.0	9.69	246.0	DG	DGF2-32	DGF2-32		DGF1-32	

*One piece, no skive fitting solution. In development, check with Customer Service regarding availability for specific thread types.
UC: Part listed is Uni-Crimp™ style (image is Dual-Grip™ style)

Caterpillar® Flange

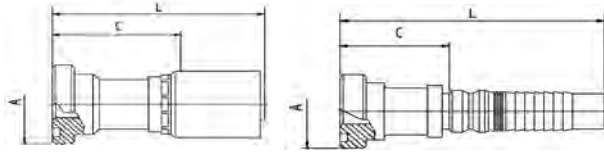

S=Skive
NS=Non-Skive
DG=Dual-Grip™

Description #	Product #	SAP #	Hose Size ID		Flange Size		Flange Dia (A)		Cut-Off (C)		Length (L)		Skive Type	SR13 ARC13	SR15 ARC15	S4SP	S4SH
			in.	mm	in.	mm	in.	mm	in.	mm	in.	mm					
DG-CF-1212	16185-1212	20242290	3/4	19.0	3/4	1.63	41.3	2.99	76.0	5.75	146.0	DG	DGF1-12	DGF1-12	DGF1-12	DGF1-12	
S6-CF-1212	30185-1212	20293345	3/4	19.0	3/4	1.63	41.3	3.37	85.5	5.53	140.5	NS	Y			Y	
DG-CF-1216	16185-1216	20242794	3/4	19.0	1	1.87	47.6	2.99	76.0	5.75	146.0	DG	DGF1-12	DGF1-12	DGF1-12	DGF1-12	
DG-CF-1616	16185-1616	20242413	1	25.4	1	1.87	47.6	3.23	82.0	6.56	166.5	DG	DGF1-16	DGF1-16	DGF1-16	DGF1-16	
S6-CF-1616	30185-1616	20293346	1	25.4	1	1.87	47.6	3.72	94.5	6.24	158.5	NS	Y			Y	
DG-CF-1620	16185-1620	20242447	1	25.4	1 1/4	2.13	54.0	3.23	82.0	6.56	166.5	DG	DGF1-16	DGF1-16	DGF1-16	DGF1-16	
DG-CF-2020	16185-2020	20242448	1 1/4	31.8	1 1/4	2.13	54.0	2.98	75.8	6.81	173.0	DG	DGF2-20	DGF2-20		DGF1-20	
S6-CF-2020	30185-2020	20424960	1 1/4	31.8	1 1/4	2.13	54.0	3.62	92.0	6.61	168.0	NS	Y				
S6X-CF-2020*	30185-2020X	20577069	1 1/4	31.8	1 1/4	2.13	54.0	3.62	92.0	7.38	187.5	NS	Y			Y	
DG-CF-2024	16185-2024	20242289	1 1/4	31.8	1 1/2	2.50	63.5	2.87	72.8	6.69	170.0	DG	DGF2-20	DGF2-20		DGF1-20	
S6X-CF-2024*	30185-2024X	20551648	1 1/4	31.8	1 1/2	2.50	63.5	3.43	87.0	7.19	182.5	NS	Y			Y	
S6-CF-2424	30185-2424	20293347	1 1/2	38.1	1 1/2	2.50	63.5	3.50	89.0	6.77	172.0	NS	Y			Y	

*One piece, no skive fitting solution. In development, check with Customer Service regarding availability for specific thread types.

Caterpillar® Flange

22.5° Elbow

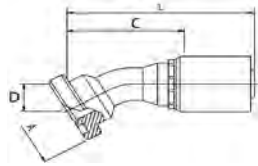

S=Skive
NS=Non-Skive
DG=Dual-Grip™

Description #	Product #	SAP #	Hose Size ID		Flange Size		Flange Dia (A)		Drop (D)		Cut-Off (C)		Length (L)		Skive Type	SR13 ARC13	SR15 ARC15	S4SP	S4SH
			in.	mm	in.	mm	in.	mm	in.	mm	in.	mm	in.	mm					
S6-CF22-2020	30187-2020	20293349	1 1/4	31.8	1 1/4	2.13	54.0	0.79	20.0	6.42	163.0	8.64	219.5	NS	Y				
S6X-CF22-2020*	30187-2020X	20577070	1 1/4	31.8	1 1/4	2.13	54.0	0.79	20.0	6.42	163.0	9.41	239.0	NS	Y			Y	
S6-CF22-2024	30187-2024	20441333	1 1/4	31.8	1 1/2	2.50	63.5	0.87	22.0	6.69	170.0	9.70	246.5	NS	Y				
S6X-CF22-2024*	30187-2024X	20545212	1 1/4	31.8	1 1/2	2.50	63.5	0.87	22.0	6.69	170.0	10.47	266.0	NS	Y			Y	

*One piece, no skive fitting solution. In development, check with Customer Service regarding availability for specific thread types.

Caterpillar® Flange

30° Elbow

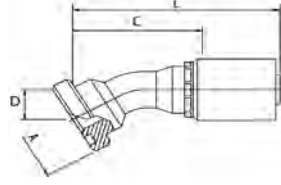

S=Skive
NS=Non-Skive
DG=Dual-Grip™

Description #	Product #	SAP #	Hose Size ID		Flange Size	Flange Dia (A)		Drop (D)		Cut-Off (C)		Length (L)		Skive Type	SR13 ARC13	SR15 ARC15	S4SP	S4SH
			in.	mm		in.	mm	in.	mm	in.	mm	in.	mm					
S6-CF30-1216	30188-1216	20441334	3/4	19.0	1	1.87	47.6	1.04	26.5	4.65	118.0	6.81	173.0	NS	Y			Y
S6-CF30-2020	30188-2020	20293350	1 1/4	31.8	1 1/4	2.13	54.0	1.10	28.0	5.96	151.5	8.19	208.0	NS	Y			
S6X-CF30-2020*	30188-2020X	20577072	1 1/4	31.8	1 1/4	2.13	54.0	1.10	28.0	5.96	151.5	8.96	227.5	NS	Y			Y
S6-CF30-2024	30188-2024	20293351	1 1/4	31.8	1 1/2	2.50	63.5	1.20	30.5	6.57	167.0	8.80	223.5	NS	Y			
S6X-CF30-2024*	30188-2024X	20577073	1 1/4	31.8	1 1/2	2.50	63.5	1.20	30.5	6.57	167.0	9.57	243.0	NS	Y			Y

*One piece, no skive fitting solution. In development, check with Customer Service regarding availability for specific thread types.

Caterpillar® Flange

45° Elbow

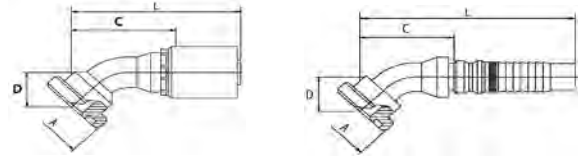

S=Skive
NS=Non-Skive
DG=Dual-Grip™

Description #	Product #	SAP #	Hose Size ID		Flange Size	Flange Dia (A)		Drop (D)		Cut-Off (C)		Length (L)		Skive Type	SR13 ARC13	SR15 ARC15	S4SP	S4SH
			in.	mm		in.	mm	in.	mm	in.	mm	in.	mm					
DG-CF45-1212	16190-1212	20242376	3/4	19.0	3/4	1.63	41.3	1.34	34.0	3.27	83.0	5.79	147.0	DG	DGF1-12	DGF1-12	DGF1-12	DGF1-12
S6-CF45-1212	30190-1212	20424961	3/4	19.0	3/4	1.63	41.3	1.34	34.0	4.06	103.0	6.22	158.0	NS	Y			Y
DG-CF45-1216	16190-1216	20242792	3/4	19.0	1	1.87	47.6	1.34	34.0	3.43	87.0	5.94	151.0	DG	DGF1-12	DGF1-12	DGF1-12	DGF1-12
DG-CF45-1616	16190-1616	20242410	1	25.4	1	1.87	47.6	1.57	40.0	3.70	94.0	6.69	170.0	DG	DGF1-16	DGF1-16	DGF1-16	DGF1-16
S6-CF45-1616	30190-1616	20424952	1	25.4	1	1.87	47.6	1.46	37.0	4.98	126.6	7.50	190.6	NS	Y			Y
DG-CF45-1620	16190-1620	20242446	1	25.4	1 1/4	2.13	54.0	1.57	40.0	3.74	95.0	6.77	172.0	DG	DGF1-16	DGF1-16	DGF1-16	DGF1-16
DG-CF45-2020	16190-2020	20242485	1 1/4	31.8	1 1/4	2.13	54.0	1.69	43.0	4.09	104.0	7.48	190.0	DG	DGF2-20	DGF2-20		DGF1-20
S6-CF45-2020	30190-2020	20424963	1 1/4	31.8	1 1/4	2.13	54.0	1.77	45.0	5.59	142.0	7.81	198.5	NS	Y			
S6X-CF45-2020*	30190-2020X	20577074	1 1/4	31.8	1 1/4	2.13	54.0	1.77	45.0	5.59	142.0	8.58	218.0	NS	Y			Y
DG-CF45-2024	16190-2024	20242810	1 1/4	31.8	1 1/2	2.50	63.5	1.95	49.5	4.33	110.0	7.76	197.0	DG	DGF2-20	DGF2-20		DGF1-20
S6-CF45-2424	30190-2424	20424964	1 1/2	38.1	1 1/2	2.50	63.5	2.05	52.0	7.13	181.0	10.39	264.0	NS	Y			Y

*One piece, no skive fitting solution. In development, check with Customer Service regarding availability for specific thread types.

Caterpillar® Flange

60° Elbow

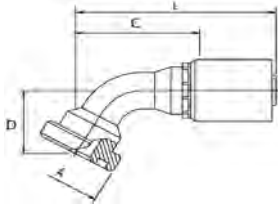

S=Skive
NS=Non-Skive
DG=Dual-Grip™

Description #	Product #	SAP #	Hose Size ID		Flange Size		Flange Dia (A)		Drop (D)		Cut-Off (C)		Length (L)		Skive Type	SR13, ARC13	SR15, ARC15	S4SP	S4SH
			in.	mm	in.	mm	in.	mm	in.	mm	in.	mm	in.	mm					
S6-CF60-1616	30192-1616	20293352	1	25.4	1	1.87	47.6	2.32	59.0	4.65	118.0	7.17	182.0	NS	Y				Y
S6-CF60-1620	30192-1620	20293353	1	25.4	1¼	2.13	54.0	2.24	57.0	4.65	118.0	7.17	182.0	NS	Y				Y
S6-CF60-2020	30192-2020	20293354	1¼	31.8	1¼	2.13	54.4	2.56	65.0	5.31	135.0	8.29	210.5	NS	Y				
S6X-CF60-2020*	30192-2020X	20577075	1¼	31.8	1¼	2.13	54.4	2.56	65.0	5.31	135.0	9.06	230.0	NS	Y				Y
S6-CF60-2024	30192-2024	20293355	1¼	31.8	1½	2.50	63.5	2.66	67.5	5.57	141.5	7.80	198.0	NS	Y				
S6X-CF60-2024*	30192-2024X	20577076	1¼	31.8	1½	2.50	63.5	2.66	67.5	5.57	141.5	8.56	217.5	NS	Y				Y
S6-CF60-2424	30192-2424	20441299	1½	38.1	1½	2.50	63.5	2.85	72.5	6.46	164.0	9.76	248.0	NS	Y				Y
S6-CF60-2432	30192-2432	20441335	1½	38.1	2	3.13	79.4	3.35	85.0	5.71	145.0	8.98	228.0	NS	Y				Y

*One piece, no skive fitting solution. In development, check with Customer Service regarding availability for specific thread types.

Caterpillar® Flange

67° Elbow

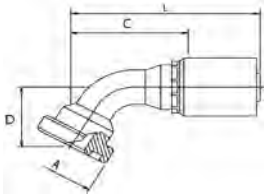

S=Skive
NS=Non-Skive
DG=Dual-Grip™

Description #	Product #	SAP #	Hose Size ID		Flange Size		Flange Dia (A)		Drop (D)		Cut-Off (C)		Length (L)		Skive Type	SR13, ARC13	SR15, ARC15	S4SP	S4SH
			in.	mm	in.	mm	in.	mm	in.	mm	in.	mm	in.	mm					
S6-CF67-2020	30194-2020	20441336	1¼	31.8	1¼	2.13	54.4	2.76	70.0	5.04	128.0	8.05	204.5	NS	Y				
S6X-CF67-2020*	30194-2020X	20545210	1¼	31.8	1¼	2.13	54.4	2.76	70.0	5.04	128.0	8.82	224.0	NS	Y				Y
S6-CF67-2024	30194-2024	20441337	1¼	31.8	1½	2.50	63.5	3.03	77.0	5.20	132.0	8.17	207.5	NS	Y				
S6X-CF67-2024*	30194-2024X	20545211	1¼	31.8	1½	2.50	63.5	3.03	77.0	5.20	132.0	8.94	227.0	NS	Y				Y

*One piece, no skive fitting solution. In development, check with Customer Service regarding availability for specific thread types.

Caterpillar® Flange

90° Elbow

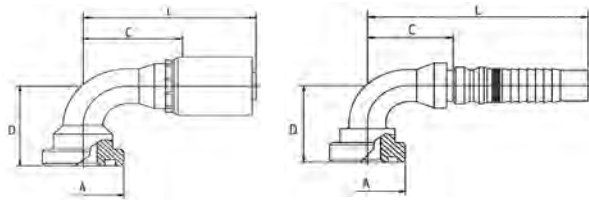

Elbow Type
LT=Long Tube
ST=Short Tube

S=Skive
NS=Non-Skive
DG=Dual-Grip™

Description #	Product #	SAP #	Hose Size ID		Thread Size (A)		Hex-1 Wrench Size	Elbow Type	Drop (D)		Cut-Off (C)		Length (L)		Skive Type	SR13 ARC13	SR15 ARC15	S4SP	S4SH
			in.	mm	in.	mm			in.	mm	in.	mm	in.	mm					
DG-CF90-1212	16195-1212	20242377	3/4	19.0	3/4	1.63	41.3		2.64	67.0	2.52	64.0	5.04	128.0	DG	DGF1-12	DGF1-12	DGF1-12	DGF1-12
S6-CF90-1212	30195-1212	20293356	3/4	19.0	3/4	1.63	41.3		2.64	67.0	2.64	67.0	4.80	122.0	NS	Y			Y
DG-CF90-1216	16195-1216	20242793	3/4	19.0	1	1.87	47.6		2.76	70.0	2.56	65.0	5.08	129.0	DG	DGF1-12	DGF1-12	DGF1-12	DGF1-12
DG-CF90-1616	16195-1616	20242411	1	25.4	1	1.87	47.6		3.11	79.0	3.15	80.0	6.18	157.0	DG	DGF1-16	DGF1-16	DGF1-16	DGF1-16
S6-CF90-1616	30195-1616	20293357	1	25.4	1	1.87	47.6		3.11	79.0	3.35	85.0	5.87	149.0	NS	Y			Y
S6-CF90L-1616	30197-1616	20293358	1	25.4	1	1.87	47.6	LT	5.20	132.0	3.35	85.0	5.87	149.0	NS	Y			Y
DG-CF90-1620	16195-1620	20242811	1	25.4	1¼	2.13	54.0		3.25	82.5	2.95	75.0	5.98	152.0	DG	DGF1-16	DGF1-16	DGF1-16	DGF1-16
DG-CF90-2020	16195-2020	20242288	1¼	31.8	1¼	2.13	54.0		3.66	93.0	3.50	89.0	6.93	176.0	DG	DGF2-20	DGF2-20		DGF1-20
S6-CF90-2020	30195-2020	20424953	1¼	31.8	1¼	2.13	54.0		3.66	93.0	3.82	97.0	6.83	173.5	NS	Y			
S6X-CF90-2020*	30195-2020X	20577079	1¼	31.8	1¼	2.13	54.0		3.66	93.0	3.82	97.0	7.60	193.0	NS	Y			Y
DG-CF90-2024	16195-2024	20242412	1¼	31.8	1½	2.50	63.5		3.98	101.0	3.58	91.0	7.01	178.0	DG	DGF2-20	DGF2-20		DGF1-20
S6-CF90-2424	30195-2424	20424954	1 1/2	38.1	1½	2.50	63.5		4.29	109.0	4.61	117.0	7.87	200.0	NS	Y			Y

*One piece, no skive fitting solution. In development, check with Customer Service regarding availability for specific thread types.

BSPB (British Standard Pipe Parallel)

Female | Swivel

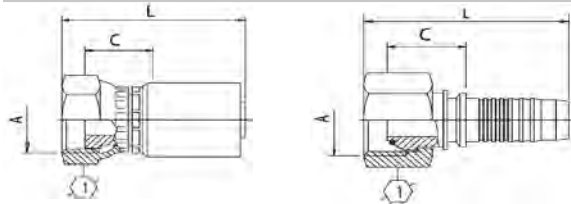

S=Skive
NS=Non-Skive
DG=Dual-Grip™

Description #	Product #	SAP #	Hose Size ID		Thread Size (A)	Hex-1 Wrench Size	Cut-Off (C)		Length (L)		Skive Type	SR13 ARC13	SR15 ARC15	S4SP	S4SH
			in.	mm			in.	mm	in.	mm					
UC-BPFX-0404	36105-0404	20242738	1/4	6.4	1/4-19	19	0.82	20.8	1.94	49.2	S			UCF3-04	
UC-BPFX-0406	36105-0406	20242462	1/4	6.4	3/8-19	22	0.92	23.3	2.11	53.6	S			UCF3-04	
UC-BPFX-0606	36105-0606	20242731	3/8	9.5	3/8-19	22	0.92	23.3	2.19	55.5	S			UCF3-06	
UC-BPFX-0608	36105-0608	20242557	3/8	9.5	1/2-14	27	0.96	24.3	2.24	56.9	S			UCF3-06	
UC-BPFX-0808	36105-0808	20242715	1/2	12.7	1/2-14	27	0.99	25.1	2.46	62.5	S			UCF2-08	
UC-BPFX-0810	36105-0810	20242406	1/2	12.7	5/8-14	27	1.12	28.4	2.74	69.6	S			UCF2-08	
DG-BPFX-1212 ^{TDG}	16105-1212	20242375	3/4	19.0	3/4-14	32	0.89	22.5	3.75	95.2	DG	DGF1-12	DGF1-12	DGF1-12	DGF1-12
S6-BPFX-1212	30105-1212	20424839	3/4	19.0	3/4-14	32	0.99	25.2	3.50	89.0	NS	Y			Y
UC-BPFX-1212	36105-1212	20242626	3/4	19.0	3/4-14	32	0.81	20.6	2.72	69.1	S			UCF2-12	
S6-BPFX-1616	30105-1616	20424940	1	25.4	1-11	38	1.22	31.0	4.15	105.5	NS	Y			Y
UC-BPFX-1616	36105-1616	20242627	1	25.4	1-11	38	0.94	23.9	3.11	79.0	S			UCF2-16	
S6-BPFX-2020	30105-2020	20424941	1¼	31.8	1¼-11	50	1.38	35.0	4.76	121.0	NS	Y			
S6X-BPFX-2020*	30105-2020X	20577065	1¼	31.8	1¼-11	50	1.38	35.0	5.53	140.5	NS	Y			Y
DG-BPFX-3232 ^{TDG}	16105-3232	20242791	2	50.8	2-11	70	1.30	33.0	5.75	146.1	DG	DGF2-32	DGF2-32		DGF1-32

*One piece, no skive fitting solution. In development, check with Customer Service regarding availability for specific thread types.

T: Thrust-Wire Nut (see "Fitting Identification" in Appendix for details)
DG: Part listed is Dual-Grip™ style (image is Uni-Crimp™ style)

BSPB (British Standard Pipe Parallel)

Female 45° Elbow | Swivel

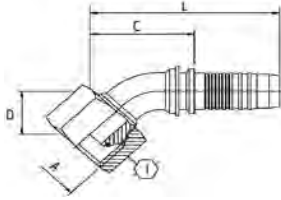

S=Skive
NS=Non-Skive
DG=Dual-Grip™

Description #	Product #	SAP #	Hose Size ID		Thread Size	Hex-1 Wrench Size	Drop (D)		Cut-Off (C)		Length (L)		Skive Type	SR13 ARC13	SR15 ARC15	S4SP	S4SH
			in.	mm			in.	mm	in.	mm	in.	mm					
UC-BPFX45-0404	36115-0404	20242444	1/4	6.4	1/4-19	19	0.59	15.0	1.81	46.0	2.76	70.0	S				UCF3-04
UC-BPFX45-0606	36115-0606	20242496	3/8	9.5	3/8-19	22	0.81	20.5	1.97	50.0	3.03	77.0	S				UCF3-06
UC-BPFX45-0808	36115-0808	20242803	1/2	12.7	1/2-14	27	0.83	21.0	2.17	55.0	3.43	87.0	S				UCF2-08
UC-BPFX45-1212	36115-1212	20242445	3/4	19.0	3/4-14	32	1.10	28.0	2.76	70.0	4.33	110.0	S				UCF2-12
DG-BPFX45-1616 ^T DG	16115-1616	20242802	1	25.4	1-11	38	1.34	34.0	3.19	81.0	6.43	163.3	DG	DGF1-16	DGF1-16	DGF1-16	DGF1-16
UC-BPFX45-1616	36115-1616	20242801	1	25.4	1-11	38	1.34	34.0	3.31	84.0	5.04	128.0	S				UCF2-16
DG-BPFX45-2020 ^T DG	16115-2020	20242287	1 1/4	31.8	1 1/4-11	50	1.57	40.0	3.82	97.0	7.44	189.0	DG	DGF2-20	DGF2-20		DGF1-20
DG-BPFX45-2424 ^T DG	16115-2424	20242286	1 1/2	38.1	1 1/2-11	55	1.81	46.0	4.45	113.0	8.29	210.6	DG	DGF2-24	DGF2-24		
DG-BPFX45-3232 ^T DG	16115-3232	20242788	2	50.8	2-11	70	2.36	60.0	5.94	151.0	10.08	256.0	DG	DGF2-32	DGF2-32		DGF1-32

T: Thrust-Wire Nut (see "Fitting Identification" in Appendix for details)
DG: Part listed is Dual-Grip™ style (image is Uni-Crimp™ style)

BSPB (British Standard Pipe Parallel)

Female 90° Elbow | Swivel

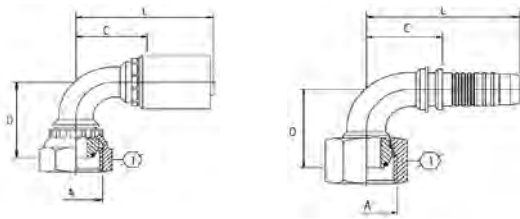

S=Skive
NS=Non-Skive
DG=Dual-Grip™

Description #	Product #	SAP #	Hose Size ID		Thread Size	Hex-1 Wrench Size	Drop (D)		Cut-Off (C)		Length (L)		Skive Type	SR13 ARC13	SR15 ARC15	S4SP	S4SH
			in.	mm			in.	mm	in.	mm	in.	mm					
UC-BPFX90-0404	36120-0404	20242496	1/4	6.4	1/4-19	19	1.14	29.0	1.14	29.0	2.13	54.0	S				UCF3-04
UC-BPFX90-0606	36120-0606	20242803	3/8	9.5	3/8-19	22	1.65	42.0	1.38	35.0	2.44	62.0	S				UCF3-06
UC-BPFX90-0608	36120-0608	20242445	3/8	9.5	1/2-14	27	1.40	35.5	1.34	34.0	2.40	61.0	S				UCF3-06
UC-BPFX90-0808	36120-0808	20242556	1/2	12.7	1/2-14	27	1.61	41.0	1.42	36.0	2.64	67.0	S				UCF2-08
S6-BPFX90-1212	30120-1212	20424914	3/4	19.0	3/4-14	32	2.40	61.0	2.32	59.0	4.49	114.0	NS	Y			Y
UC-BPFX90-1212	36120-1212	20242546	3/4	19.0	3/4-14	32	2.09	53.0	1.93	49.0	3.50	89.0	S				UCF2-12
DG-BPFX90-1616 ^C DG	16120-1616	20242804	1	25.4	1-11	38	2.80	71.0	2.95	75.0	5.94	151.0	DG	DGF1-16	DGF1-16	DGF1-16	DGF1-16
S6-BPFX90-1616	30120-1616	20424915	1	25.4	1-11	38	2.80	71.0	2.91	74.0	5.43	138.0	NS	Y			Y
UC-BPFX90-1616	36120-1616	20242515	1	25.4	1-11	38	2.72	69.0	2.95	75.0	4.72	120.0	S				UCF2-16
S6-BPFX90-2020	30120-2020	20424916	1 1/4	31.8	1 1/4-11	50	3.27	83.0	3.31	84.0	5.53	140.5	NS	Y			
S6X-BPFX90-2020*	30120-2020X	20577067	1 1/4	31.8	1 1/4-11	50	3.27	83.0	3.31	84.0	6.30	160.0	NS	Y			Y
DG-BPFX90-2424 ^T DG	16120-2424	20242789	1 1/2	38.1	1 1/2-11	55	3.78	96.0	3.66	93.0	7.28	185.0	DG	DGF2-24	DGF2-24		
DG-BPFX90-3232 ^T DG	16120-3232	20242790	2	50.8	2-11	70	4.92	125.0	5.47	139.0	9.29	236.0	DG	DGF2-32	DGF2-32		DGF1-32

*One piece, no skive fitting solution. In development, check with Customer Service regarding availability for specific thread types.

C: Crimp Nut; T: Thrust-Wire Nut (see "Fitting Identification" in Appendix for details)

DG: Part listed is Dual-Grip™ style (image is Uni-Crimp™ style)

BSPP (British Standard Pipe Parallel)

Male

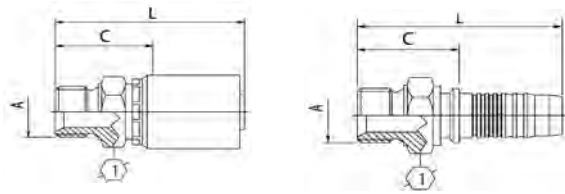

S=Skive
NS=Non-Skive
DG=Dual-Grip™

Description #	Product #	SAP #	Hose Size ID		Thread Size (A)	Hex-1 Wrench Size	Cut-Off (C)		Length (L)		Skive Type	SR13 ARC13	SR15 ARC15	S4SP	S4SH
			in.	mm			mm	in.	mm	in.					
UC-BPM-0404	36130-0404	20242484	1/4	6.4	1/4-19	19	1.04	26.3	2.01	51.1	S			UCF3-04	
UC-BPM-0606	36130-0606	20242581	3/8	9.5	3/8-19	22	1.09	27.8	2.15	54.5	S			UCF3-06	
UC-BPM-0608	36130-0608	20242464	3/8	9.5	1/2-14	27	1.23	31.3	2.28	58.0	S			UCF3-06	
UC-BPM-0806	36130-0806	20242809	1/2	12.7	3/8-19	22	1.13	28.6	2.37	60.1	S			UCF2-08	
UC-BPM-0808	36130-0808	20242463	1/2	12.7	1/2-14	27	1.26	32.1	2.50	63.6	S			UCF2-08	
S6-BPM-1212	30130-1212	20424918	3/4	19.0	3/4-14	32	1.48	37.5	3.64	92.5	NS	Y			Y
UC-BPM-1212	36130-1212	20242407	3/4	19.0	3/4-14	32	1.44	36.6	3.00	76.1	S			UCF2-12	
S6-BPM-1616	30130-1616	20424919	1	25.4	1-11	41	1.75	44.5	4.27	108.5	NS	Y			Y
UC-BPM-1616	36130-1616	20242807	1	25.4	1-11	41	1.67	42.4	3.43	87.0	S			UCF2-16	
S6-BPM-2020	30130-2020	20424950	1 1/4	31.8	1 1/4-11	50	2.01	51.0	5.00	127.0	NS	Y			
S6X-BPM-2020*	30130-2020X	20577068	1 1/4	31.8	1 1/4-11	50	2.01	51.0	5.77	146.5	NS	Y			Y

*One piece, no skive fitting solution. In development, check with Customer Service regarding availability for specific thread types.

BSPT (British Standard Pipe Tapered)

Male

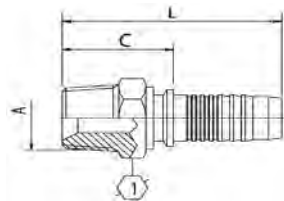

S=Skive
NS=Non-Skive
DG=Dual-Grip™

Description #	Product #	SAP #	Hose Size ID		Thread Size (A)	Hex-1 Wrench Size	Cut-Off (C)		Length (L)		Skive Type	SR13 ARC13	SR15 ARC15	S4SP	S4SH
			in.	mm			mm	in.	mm	in.					
UC-BTM-0404	36170-0404	20242611	1/4	6.4	1/4-19	17	1.06	26.8	2.03	51.6	S			UCF3-04	
UC-BTM-0606	36170-0606	20242612	3/8	9.5	3/8-19	19	1.09	27.8	2.15	54.5	S			UCF3-06	
UC-BTM-0808	36170-0808	20242507	1/2	12.7	1/2-14	22	1.30	33.1	2.54	64.6	S			UCF2-08	
UC-BTM-1212	36170-1212	20242409	3/4	19.0	3/4-14	27	1.36	34.6	2.92	74.1	S			UCF2-12	
UC-BTM-1616	36170-1616	20242408	1	25.4	1-11	36	1.75	44.4	3.50	89.0	S			UCF2-16	

*One piece, no skive fitting solution. In development, check with Customer Service regarding availability for specific thread types.

BSP Flat Seat (British Standard Pipe)

Female | Swivel

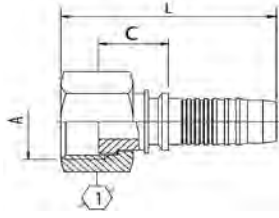

S=Skive
NS=Non-Skive
DG=Dual-Grip™

Description #	Product #	SAP #	Hose Size ID		Thread Size (A)	Hex-1 Wrench Size	Cut-Off (C)		Length (L)		Skive Type	SR13 ARC13	SR15 ARC15	S4SP	S4SH
			in.	mm			mm	in.	mm	in.					
UC-BFFX-0606	36100-0606	20242800	3/8	9.5	3/8-19	22	0.80	20.3	2.22	56.3	S			UCF3-06	
UC-BFFX-0608	36100-0608	20242799	3/8	9.5	1/2-14	27	0.82	20.8	2.28	57.9	S			UCF3-06	
UC-BFFX-0808	36100-0808	20242798	1/2	12.7	1/2-14	27	0.85	21.6	2.50	63.5	S			UCF2-08	
UC-BFFX-0812	36100-0812	20242285	1/2	12.7	3/4-14	32	0.97	24.6	2.70	68.6	S			UCF2-08	

DIN 24° Light

Female | Swivel

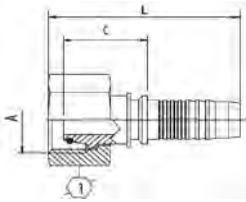

S=Skive
NS=Non-Skive
DG=Dual-Grip™

Description #	Product #	SAP #	Hose Size ID		Thread Size (A)	Hex-1 Wrench Size	Cut-Off (C)		Length (L)		Skive Type	SR13, ARC13	SR15 ARC15	S4SP	S4SH
			in.	mm			mm	in.	mm	in.					
UC-DLFX-0412 ^T	36240-0412	20242540	1/4	6.4	12 x 1½	14	0.98	24.8	1.99	50.6	S			UCF3-04	
UC-DLFX-0414	36240-0414	20242594	1/4	6.4	14 x 1½	17	0.96	24.4	1.98	50.2	S			UCF3-04	
UC-DLFX-0416	36240-0416	20242471	1/4	6.4	16 x 1½	19	1.00	25.4	2.04	51.9	S			UCF3-04	
UC-DLFX-0616	36240-0616	20242658	3/8	9.5	16 x 1½	19	1.00	25.4	2.22	56.4	S			UCF3-06	
UC-DLFX-0618	36240-0618	20242641	3/8	9.5	18 x 1½	22	1.00	25.4	2.10	53.3	S			UCF3-06	
UC-DLFX-0822	36240-0822	20242586	1/2	12.7	22 x 1½	27	1.11	28.2	2.43	61.8	S			UCF2-08	
UC-DLFX-1230	36240-1230	20242501	3/4	19.0	30 x 2	36	1.25	31.7	2.93	74.5	S			UCF2-12	
UC-DLFX-1636	36240-1636	20242453	1	25.4	36 x 2	41	1.32	33.6	3.25	82.5	S			UCF2-16	

T: Thrust-Wire Nut (see "Fitting Identification" in Appendix for details)

DIN 24° Light

Female 45° Elbow | Swivel

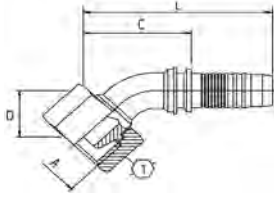

S=Skive
NS=Non-Skive
DG=Dual-Grip™

Description #	Product #	SAP #	Hose Size ID		Thread Size	Hex-1 Wrench Size	Drop (D)		Cut-Off (C)		Length (L)		Skive Type	SR13, ARC13	SR15, ARC15	S4SP	S4SH
			in.	mm			in.	mm	in.	mm	in.	mm					
UC-DLFX45-0414	36245-0414	20242385	1/4	6.4	14 x 1½	17	0.69	17.5	1.69	43.0	2.68	68.0	S				UCF3-04
UC-DLFX45-0416	36245-0416	20242386	1/4	6.4	16 x 1½	19	0.79	20.0	1.65	42.0	2.64	67.0	S				UCF3-04
UC-DLFX45-0618	36245-0618	20242387	3/8	9.5	18 x 1½	22	0.77	19.5	1.85	47.0	2.91	74.0	S				UCF3-06
UC-DLFX45-0822	36245-0822	20242329	1/2	12.7	22 x 1½	27	0.83	21.0	2.17	55.0	3.43	87.0	S				UCF2-08
UC-DLFX45-1230	36245-1230	20242330	3/4	19.0	30 x 2	36	1.26	32.0	2.72	69.0	4.37	111.0	S				UCF2-12
UC-DLFX45-1636	36245-1636	20242328	1	25.4	36 x 2	41	1.26	32.0	3.58	91.0	5.35	136.0	S				UCF2-16

DIN 24° Light

Female 90° Elbow | Swivel

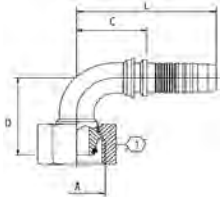

S=Skive
NS=Non-Skive
DG=Dual-Grip™

Description #	Product #	SAP #	Hose Size ID		Thread Size	Hex-1 Wrench Size	Drop (D)		Cut-Off (C)		Length (L)		Skive Type	SR13, ARC13	SR15, ARC15	S4SP	S4SH
			in.	mm			in.	mm	in.	mm	in.	mm					
UC-DLFX90-0412	36250-0412	20242390	1/4	6.4	12 x 1½	14	1.02	26.0	1.16	29.5	2.31	58.6	S				UCF3-04
UC-DLFX90-0414	36250-0414	20242425	1/4	6.4	14 x 1½	17	1.28	32.5	1.10	28.0	2.09	53.0	S				UCF3-04
UC-DLFX90-0416	36250-0416	20242391	1/4	6.4	16 x 1½	19	1.28	32.5	1.10	28.0	2.09	53.0	S				UCF3-04
UC-DLFX90-0618	36250-0618	20242488	3/8	9.5	18 x 1½	22	1.54	39.0	1.30	33.0	2.36	60.0	S				UCF3-06
UC-DLFX90-0822	36250-0822	20242389	1/2	12.7	22 x 1½	27	1.59	40.5	1.57	40.0	2.80	71.0	S				UCF2-08
UC-DLFX90-1230	36250-1230	20242332	3/4	19.0	30 x 2	36	2.32	59.0	2.05	52.0	3.62	92.0	S				UCF2-12
UC-DLFX90-1636	36250-1636	20242331	1	25.4	36 x 2	41	2.68	68.0	3.07	78.0	4.80	122.0	S				UCF2-16

DIN 24° Light

Male

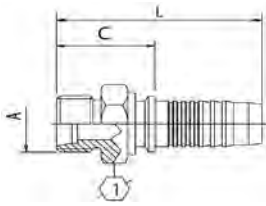

S=Skive
NS=Non-Skive
DG=Dual-Grip™

Description #	Product #	SAP #	Hose Size ID		Thread Size (A)	Hex-1 Wrench Size	Cut-Off (C)		Length (L)		Skive Type	SR13, ARC13	SR15 ARC15	S4SP	S4SH
			in.	mm			mm	in.	mm	in.					
UC-DLM-0412	36255-0412	20242334	1/4	6.4	12 x 1½	14	0.84	21.3	1.81	46.1	S			UCF3-04	
UC-DLM-0414	36255-0414	20242393	1/4	6.4	14 x 1½	14	0.84	21.3	1.81	46.1	S			UCF3-04	
UC-DLM-0416	36255-0416	20242335	1/4	6.4	16 x 1½	17	0.92	23.3	1.89	48.1	S			UCF3-04	
UC-DLM-0616	36255-0616	20242426	3/8	9.5	16 x 1½	17	0.92	23.3	1.97	50.0	S			UCF3-06	
UC-DLM-0618	36255-0618	20242513	3/8	9.5	18 x 1½	19	0.96	24.3	2.01	51.0	S			UCF3-06	
UC-DLM-0822	36255-0822	20242392	1/2	12.7	22 x 1½	22	1.03	26.1	2.27	57.6	S			UCF2-08	
UC-DLM-1230	36255-1230	20242336	3/4	19.0	30 x 2	32	1.24	31.6	2.80	71.1	S			UCF2-12	
UC-DLM-1636	36255-1636	20242333	1	25.4	36 x 2	36	1.35	34.4	3.11	79.0	S			UCF2-16	

DIN 24° Heavy

Female | Swivel

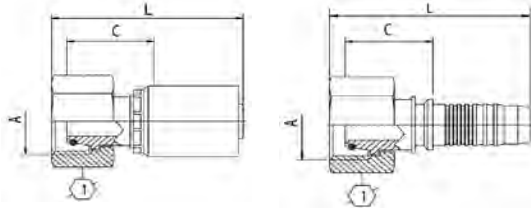

S=Skive
NS=Non-Skive
DG=Dual-Grip™

Description #	Product #	SAP #	Hose Size ID		Thread Size (A)	Hex-1 Wrench Size	Cut-Off (C)		Length (L)		Skive Type	SR13, ARC13	SR15 ARC15	S4SP	S4SH
			in.	mm			mm	in.	mm	in.					
UC-DHFX-0416	36210-0416	20242538	1/4	6.4	16 x 1½	19	1.09	27.7	2.07	52.5	S			UCF3-04	
UC-DHFX-0418	36210-0418	20242529	1/4	6.4	18 x 1½	22	1.09	27.8	2.07	52.6	S			UCF3-04	
UC-DHFX-0620	36210-0620	20242624	3/8	9.5	20 x 1½	24	1.09	27.6	2.25	57.1	S			UCF3-06	
UC-DHFX-0622	36210-0622	20242562	3/8	9.5	22 x 1½	27	1.22	31.1	2.44	62.1	S			UCF3-06	
UC-DHFX-0824	36210-0824	20242561	1/2	12.7	24 x 1½	30	1.25	31.7	2.67	67.7	S			UCF2-08	
DG-DHFX-1230 ^T DG	16210-1230	20242320	3/4	19.0	30 x 2	36	1.47	37.3	4.17	106.0	DG	DGF1-12	DGF1-12	DGF1-12	DGF1-12
S6-DHFX-1230	30210-1230	20424955	3/4	19.0	30 x 2	36	1.45	36.8	3.80	96.5	NS	Y			Y
UC-DHFX-1230	36210-1230	20242319	3/4	19.0	30 x 2	36	1.46	37.0	3.13	79.5	S			UCF2-12	
UC-DHFX-1236	36210-1236	20242530	3/4	19.0	36 x 2	46	1.58	40.2	3.39	86.2	S			UCF2-12	
UC-DHFX-1236S	36210-1236S	20608762	3/4	19.0	36 x 2	46	1.58	40.2	3.39	86.2	S			UCF2-12	
DG-DHFX-1642 ^{DG}	16210-1642	20242422	1	25.4	42 x 2	50	1.78	45.3	4.99	126.8	DG	DGF1-16	DGF1-16	DGF1-16	DGF1-16
S6-DHFX-1642	30210-1642	20424956	1	25.4	42 x 2	50	1.78	45.2	4.50	114.2	NS	Y			Y
UC-DHFX-1642	36210-1642	20242500	1	25.4	42 x 2	50	1.70	43.1	3.65	92.7	S			UCF2-16	
DG-DHFX-2052 ^{DG}	16210-2052	20242423	1¼	31.8	52 x 2	60	1.78	45.3	5.60	142.2	DG	DGF2-20	DGF2-20		DGF1-20
S6-DHFX-2052	30210-2052	20424957	1¼	31.8	52 x 2	60	2.01	51.1	5.39	137.0	NS	Y			
S6X-DHFX-2052*	30210-2052X	20577080	1¼	31.8	52 x 2	60	2.01	51.1	6.16	156.5	NS	Y			Y

*One piece, no skive fitting solution. In development, check with Customer Service regarding availability for specific thread types.
T: Thrust-Wire Nut (see "Fitting Identification" in Appendix for details)
DG: Part listed is Dual-Grip™ style (image is Uni-Crimp™ style)

DIN 24° Heavy

Female 45° Elbow | Swivel

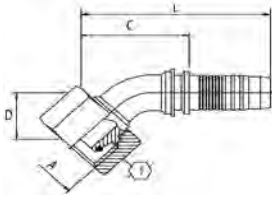

S=Skive
NS=Non-Skive
DG=Dual-Grip™

Description #	Product #	SAP #	Hose Size ID		Thread Size	Hex-1 Wrench Size	Drop (D)		Cut-Off (C)		Length (L)		Skive Type	SR13, ARC13	SR15, ARC15	S4SP	S4SH
			in.	mm			in.	mm	in.	mm	in.	mm					
UC-DHFX45-0418	36215-0418	20242313	1/4	6.4	18 x 1½	22	0.75	19.0	1.69	43.0	2.68	68.0	S				UCF3-04
UC-DHFX45-0620	36215-0620	20242315	3/8	9.5	20 x 1½	24	0.79	20.0	2.01	51.0	3.03	77.0	S				UCF3-06
UC-DHFX45-0622	36215-0622	20242316	3/8	9.5	22 x 1½	27	0.83	21.0	2.09	53.0	3.15	80.0	S				UCF3-06
UC-DHFX45-0824	36215-0824	20242312	1/2	12.7	24 x 1½	30	0.85	21.5	2.20	56.0	3.43	87.0	S				UCF2-08
DG-DHFX45-1236 ^{DG}	16215-1236	20298071	3/4	19.0	36 x 2	46	1.42	36.0	3.07	78.1	5.72	145.4	DG	DGF1-12	DGF1-12	DGF1-12	DGF1-12
UC-DHFX45-1236	36215-1236	20242314	3/4	19.0	36 x 2	46	1.30	33.0	2.72	69.0	4.29	109.0	S				UCF2-12
DG-DHFX45-1642 ^{DG}	16215-1642	20242311	1	25.4	42 x 2	50	1.97	50.0	3.81	96.8	6.92	175.8	DG	DGF1-16	DGF1-16	DGF1-16	DGF1-16
UC-DHFX45-1642	36215-1642	20242310	1	25.4	42 x 2	50	1.59	40.5	4.33	110.0	6.10	155.0	S				UCF2-16

DG: Part listed is Dual-Grip™ style (image is Uni-Crimp™ style)

DIN 24° Heavy

Female 90° Elbow | Swivel

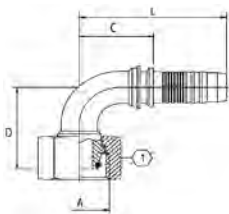

S=Skive
NS=Non-Skive
DG=Dual-Grip™

Description #	Product #	SAP #	Hose Size ID		Thread Size	Hex-1 Wrench Size	Drop (D)		Cut-Off (C)		Length (L)		Skive Type	SR13, ARC13	SR15, ARC15	S4SP	S4SH
			in.	mm			in.	mm	in.	mm	in.	mm					
UC-DHFX90-0418	36220-0418	20242421	1/4	6.4	18 x 1½	22	1.34	34.0	1.06	27.0	2.05	52.0	S				UCF3-04
UC-DHFX90-0620	36220-0620	20242563	3/8	9.5	20 x 1½	24	1.52	38.5	1.34	34.0	2.40	61.0	S				UCF3-06
UC-DHFX90-0622	36220-0622	20242469	3/8	9.5	22 x 1½	27	1.59	40.5	1.34	34.0	2.40	61.0	S				UCF3-06
UC-DHFX90-0824	36220-0824	20242468	1/2	12.7	24 x 1½	30	1.63	41.5	1.57	40.0	2.80	71.0	S				UCF2-08
DG-DHFX90-1236 ^{DG}	16220-1236	20242318	3/4	19.0	36 x 2	46	2.56	65.0	2.44	62.0	4.96	126.0	DG	DGF1-12	DGF1-12	DGF1-12	DGF1-12
UC-DHFX90-1236	36220-1236	20242317	3/4	19.0	36 x 2	46	2.34	59.5	2.01	51.0	3.54	90.0	S				UCF2-12
UC-DHFX90-1236S	36220-1236S	20608763	3/4	19.0	36 x 2	46	2.34	59.5	2.01	51.0	3.54	90.0	S				UCF2-12
UC-DHFX90-1642	36220-1642	20242420	1	25.4	42 x 2	50	3.11	79.0	2.99	76.0	4.72	120.0	S				UCF2-16

DG: Part listed is Dual-Grip™ style (image is Uni-Crimp™ style)

DIN 24° Heavy

Male

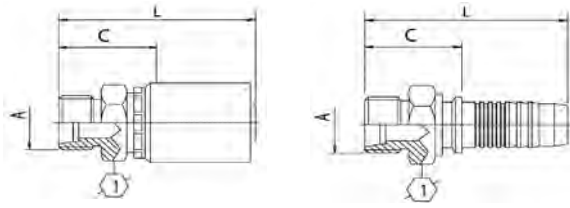

S=Skive
NS=Non-Skive
DG=Dual-Grip™

Description #	Product #	SAP #	Hose Size ID		Thread Size (A)	Hex-1 Wrench Size	Cut-Off (C)		Length (L)		Skive Type	SR13 ARC13	SR15 ARC15	S4SP	S4SH
			in.	mm			mm	in.	mm	in.					
UC-DHM-0416	36225-0416	20242323	1/4	6.4	16 x 1½	17	0.96	24.3	1.93	49.1	S			UCF3-04	
UC-DHM-0418	36225-0418	20242324	1/4	6.4	18 x 1½	19	1.00	25.3	1.97	50.1	S			UCF3-04	
UC-DHM-0620	36225-0620	20242424	3/8	9.5	20 x 1½	22	1.00	25.3	2.05	52.0	S			UCF3-06	
UC-DHM-0622	36225-0622	20242470	3/8	9.5	22 x 1½	22	1.07	27.3	2.13	54.0	S			UCF3-06	
UC-DHM-0824	36225-0824	20242322	1/2	12.7	24 x 1½	24	1.15	29.1	2.39	60.6	S			UCF2-08	
S6-DHM-1230	30225-1230	20424958	3/4	19.0	30 x 2	32	1.36	34.5	3.52	89.5	NS	Y			Y
UC-DHM-1230	36225-1230	20242325	3/4	19.0	30 x 2	32	1.32	33.6	2.88	73.1	S			UCF2-12	
DG-DHM-1236 ^{DG}	16225-1236	20242327	3/4	19.0	36 x 2	36	1.14	29.0	3.90	99.0	DG	DGF1-12	DGF1-12	DGF1-12	DGF1-12
UC-DHM-1236	36225-1236	20242326	3/4	19.0	36 x 2	36	1.48	37.6	3.04	77.1	S			UCF2-12	
DG-DHM-1642 ^{DG}	16225-1642	20242384	1	25.4	42 x 2	46	1.26	32.0	4.59	116.5	DG	DGF1-16	DGF1-16	DGF1-16	DGF1-16
S6-DHM-1642	30225-1642	20424959	1	25.4	42 x 2	46	1.59	40.5	4.11	104.5	NS	Y			Y
UC-DHM-1642	36225-1642	20242321	1	25.4	42 x 2	46	1.67	42.4	3.43	87.0	S			UCF2-16	
S6-DHM-2052	30225-2052	20424971	1¼	31.8	52 x 2	55	2.01	51.0	5.00	127.0	NS	Y			
S6X-DHM-2052*	30225-2052X	20577081	1¼	31.8	52 x 2	55	2.01	51.0	5.77	146.5	NS	Y			Y

*One piece, no skive fitting solution. In development, check with Customer Service regarding availability for specific thread types.
DG: Part listed is Dual-Grip™ style (image is Uni-Crimp™ style)

DIN 60°

Female 45° Elbow | Swivel

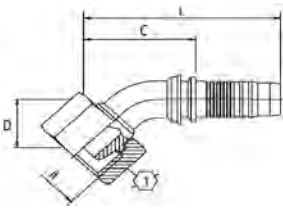

S=Skive
NS=Non-Skive
DG=Dual-Grip™

Description #	Product #	SAP #	Hose Size ID		Thread Size	Hex-1 Wrench Size	Drop (D)	Cut-Off (C)		Length (L)		Skive Type	SR13 ARC13	SR15 ARC15	S4SP	S4SH
			in.	mm				mm	in.	mm	in.					
UC-DNFX45-0414	36275-0414	20242338	1/4	6.4	14 x 1½	17	0.63	16.0	1.38	35.0	2.56	65.0	S			UCF3-04
UC-DNFX45-0416	36275-0416	20242339	1/4	6.4	16 x 1½	19	0.67	17.0	1.42	36.0	2.60	66.0	S			UCF3-04
UC-DNFX45-0618	36275-0618	20242340	3/8	9.5	18 x 1½	22	0.77	19.5	1.69	43.0	2.76	70.0	S			UCF3-06
UC-DNFX45-0822	36275-0822	20242337	1/2	12.7	22 x 1½	27	0.79	20.0	2.17	55.0	3.39	86.0	S			UCF2-08

DIN 60°

Female 90° Elbow | Swivel

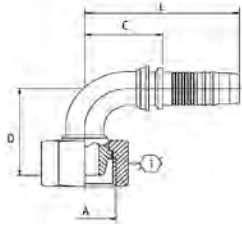

S=Skive
NS=Non-Skive
DG=Dual-Grip™

Description #	Product #	SAP #	Hose Size ID		Thread Size	Hex-1 Wrench Size	Drop (D)		Cut-Off (C)		Length (L)		Skive Type	SR13 ARC13	SR15 ARC15	S4SP	S4SH
			in.	mm			in.	mm	in.	mm	in.	mm					
UC-DNFX90-0414	36280-0414	20242428	1/4	6.4	14 x 1½	17	1.12	28.5	1.18	30.0	2.17	55.0	S				UCF3-04
UC-DNFX90-0416	36280-0416	20242341	1/4	6.4	16 x 1½	19	1.28	32.5	1.10	28.0	2.09	53.0	S				UCF3-04
UC-DNFX90-0616	36280-0616	20242342	3/8	9.5	16 x 1½	19	1.14	29.0	1.02	26.0	2.09	53.0	S				UCF3-06
UC-DNFX90-0618	36280-0618	20242472	3/8	9.5	18 x 1½	22	1.46	37.0	1.30	33.0	2.36	60.0	S				UCF3-06
UC-DNFX90-0822	36280-0822	20242427	1/2	12.7	22 x 1½	27	1.57	40.0	1.57	40.0	2.80	71.0	S				UCF2-08

Japanese Komatsu® 30° Flare with Metric Threads

Female | Swivel

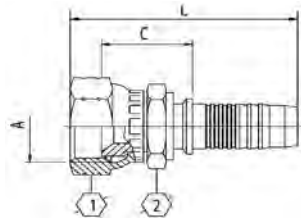

S=Skive
NS=Non-Skive
DG=Dual-Grip™

Description #	Product #	SAP #	Hose Size ID		Thread Size	Hex-1 Wrench Size	Hex-2 Wrench Size	Cut-Off (C)		Length (L)		Skive Type	SR13 ARC13	SR15 ARC15	S4SP	S4SH
			in.	mm				in.	mm	in.	mm					
UC-KMFX-0414	36545-0414	20242590	1/4	6.4	14 x 1.5	19	17	0.82	20.8	2.19	55.6	S				UCF3-04
UC-KMFX-0618	36545-0618	20242636	3/8	9.5	18 x 1.5	22	19	0.86	21.8	2.30	58.5	S				UCF3-06
UC-KMFX-0822	36545-0822	20242573	1/2	12.7	22 x 1.5	27	22	0.93	23.6	2.62	66.6	S				UCF2-08
UC-KMFX-1024	36545-1024	20283390	5/8	15.9	24 x 1.5	32	30	1.07	27.1	3.01	76.4	S				UCF2-10
UC-KMFX-1230	36545-1230	20242541	3/4	19.0	30 x 1.5	36	30	1.09	27.6	3.35	85.1	S				UCF2-12
UC-KMFX-1633	36545-1633	20242564	1	25.4	33 x 1.5	41	36	1.41	35.7	4.03	102.3	S				UCF2-16

Japanese Komatsu® 30° Flare with Metric Threads Female 45° Elbow | Swivel

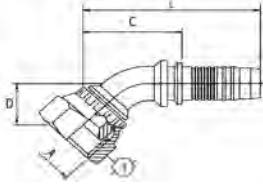

S=Skive
NS=Non-Skive
DG=Dual-Grip™

Description #	Product #	SAP #	Hose Size ID		Thread Size	Hex-1 Wrench Size	Drop (D)		Cut-Off (C)		Length (L)		Skive Type	SR13 ARC13	SR15 ARC15	S4SP	S4SH
			in.	mm			in.	mm	in.	mm	in.	mm					
UC-KMFX45-0414	36548-0414	20318233	1/4	6.4	14 x 1.5	19	0.61	15.5	1.50	38.0	2.48	63.0	S				UCF3-04
UC-KMFX45-0618	36548-0618	20318234	3/8	9.5	18 x 1.5	22	0.71	18.0	1.73	44.0	2.76	70.0	S				UCF3-06
UC-KMFX45-0822	36548-0822	20318235	1/2	12.7	22 x 1.5	27	1.16	29.5	2.20	56.0	3.43	87.0	S				UCF2-08

Japanese Komatsu® 30° Flare with Metric Threads Female 90° Elbow | Swivel

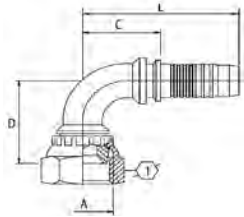

S=Skive
NS=Non-Skive
DG=Dual-Grip™

Description #	Product #	SAP #	Hose Size ID		Thread Size	Hex-1 Wrench Size	Drop (D)		Cut-Off (C)		Length (L)		Skive Type	SR13 ARC13	SR15 ARC15	S4SP	S4SH
			in.	mm			in.	mm	in.	mm	in.	mm					
UC-KMFX90-0414	36550-0414	20318236	1/4	6.4	14 x 1.5	19	1.16	29.5	1.30	33.0	2.28	58.0	S				UCF3-04
UC-KMFX90-0618	36550-0618	20318326	3/8	9.5	18 x 1.5	22	1.40	35.5	1.42	36.0	2.44	62.0	S				UCF3-06
UC-KMFX90-0822	36550-0822	20318327	1/2	12.7	22 x 1.5	27	2.09	53.0	1.46	37.0	2.68	68.0	S				UCF2-08

JIS 30° (Parallel Pipe Threads) Female | Swivel

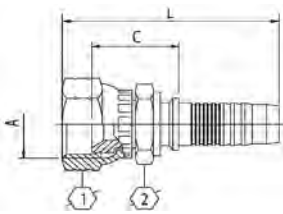

S=Skive
NS=Non-Skive
DG=Dual-Grip™

Description #	Product #	SAP #	Hose Size ID		Thread Size	Hex-1 Wrench Size	Hex-2 Wrench Size	Cut-Off (C)		Length (L)		Skive Type	SR13 ARC13	SR15 ARC15	S4SP	S4SH
			in.	mm				in.	mm	in.	mm					
UC-JSFX-0404	36520-0404	20242644	1/4	6.4	1/4-19	19	17	0.82	20.8	2.19	55.6	S				UCF3-04
UC-JSFX-0606	36520-0606	20242699	3/8	9.5	3/8-19	22	19	0.86	21.8	2.30	58.5	S				UCF3-06
UC-JSFX-0808	36520-0808	20242606	1/2	12.7	1/2-14	27	22	0.93	23.6	2.62	66.6	S				UCF2-08
UC-JSFX-1212	36520-1212	20242543	3/4	19.0	3/4-14	36	30	1.07	27.1	3.13	79.6	S				UCF2-12
UC-JSFX-1616	36520-1616	20242502	1	25.4	1-11	41	36	1.30	32.9	3.64	92.5	S				UCF2-16

How to Use the Fitting Tables

This section lists ALL fittings that are compatible with the following hoses:

Hose Family	Hose Description
SR3	SAE 100R3/EN 854 R3
GR4	SAE 100R4
SR4	SAE 100R4 (High Temp)
SR6	SAE 100R6/EN 854 R6
HR6	SAE 100R6/EN 854 R6 (High Temp)
SR14A	SAE 100R14A

Fitting Description

Fitting Type

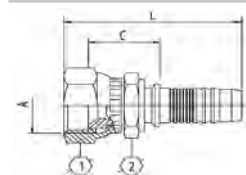

S=Skive
NS=Non-Skive
DG=Dual-Grip™

Descriptive #	Product #	SAP #	Hose Size ID		Thread Size (A)		Hex-1 Wrench Size		Hex-2 Wrench Size		Cut-Off (C)		Length (L)		Skive Type	SR3	SR4 HR4	SR6 HR6	SR14A
			in.	mm	in.	mm	in.	mm	in.	mm	in.	mm	in.	mm					
UC-JCFX-0304	36400-0304	20557173	3/16	4.8	7/16-20	9/16	14	1/2	12	0.71	18.1	1.93	49.0					UCF2-03	UCF9-03
UC-JCFX-0404	36400-0404	20242786	1/4	6.4	7/16-20	5/8	16	9/16	14	0.77	19.6	2.09	53.1		UCF6-04			UCF2-04	UCF9-04
UC-JCFX-0404S	36400-0404S	20540685	1/4	6.4	7/16-20	5/8	16	9/16	14	0.77	19.6	2.09	53.1		UCF6-04			UCF2-04	UCF9-04

Choose fittings carefully considering the working pressure of both hose and fitting. The maximum working pressure of the hose assembly is the lesser of the rated working pressure of the hose and the fitting. See page 313 for working pressure.

A **blank space** in the hose compatibility columns indicates that the fitting **DOES NOT** work for that particular hose.

A **Part Number (Ferrule)** in the hose compatibility columns indicates that the fitting is a **Uni-Crimp™** style. The fitting, along with the ferrule shown, work together as a unit for that particular hose.

JIC 37° Flare (SAE J514)

Female | Swivel

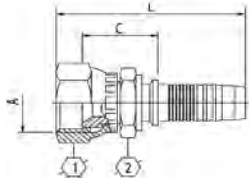

S=Skive
NS=Non-Skive
DG=Dual-Grip™

Descriptive #	Product #	SAP #	Hose Size ID		Thread Size (A)		Hex-1 Wrench Size		Hex-2 Wrench Size		Cut-Off (C)		Length (L)		Skive Type	SR3	SR4 HR4	SR6 HR6	SR14A
			in.	mm	in.	mm	in.	mm	in.	mm	in.	mm	in.	mm					
UCJCFX-0304	36400-0304	20557173	3/16	4.8	7/16-20	9/16	14	1/2	12	0.71	18.1	1.93	49.0	NS			UCF2-03	UCF9-03	
UCJCFX-0404	36400-0404	20242786	1/4	6.4	7/16-20	5/8	16	9/16	14	0.77	19.6	2.09	53.1	NS	UCF6-04		UCF2-04	UCF9-04	
UCJCFX-0404 ^S	36400-0404S	20540685	1/4	6.4	7/16-20	5/8	16	9/16	14	0.77	19.6	2.09	53.1	NS	UCF6-04		UCF2-04	UCF9-04	
UCJCFX-0405	36400-0405	20242746	1/4	6.4	1/2-20	11/16	17	9/16	14	0.80	20.3	2.15	54.6	NS	UCF6-04		UCF2-04	UCF9-04	
UCJCFX-0406	36400-0406	20242778	1/4	6.4	9/16-18	3/4	19	9/16	14	0.80	20.3	2.15	54.6	NS	UCF6-04		UCF2-04	UCF9-04	
UCJCFX-0505	36400-0505	20242676	5/16	7.9	1/2-20	11/16	17	9/16	14	0.80	20.3	2.15	54.6	NS	UCF6-05		UCF2-05	UCF9-05	
UCJCFX-0506	36400-0506	20242765	5/16	7.9	9/16-18	3/4	19	9/16	14	0.80	20.3	2.15	54.6	NS	UCF6-05		UCF2-05	UCF9-05	
UCJCFX-0606	36400-0606	20242787	3/8	9.5	9/16-18	3/4	19	11/16	17	0.84	21.3	2.26	57.5	NS	UCF6-06		UCF2-06	UCF9-06	
UCJCFX-0606 ^S	36400-0606S	20540686	3/8	9.5	9/16-18	3/4	19	11/16	17	0.84	21.3	2.26	57.5	NS	UCF6-06		UCF2-06	UCF9-06	
UCJCFX-0608	36400-0608	20242779	3/8	9.5	3/4-16	1	25	3/4	19	0.98	24.8	2.45	62.2	NS	UCF6-06		UCF2-06	UCF9-06	
UCJCFX-0610	36400-0610	20242708	3/8	9.5	7/8-14	1 1/16	27	7/8	22	1.02	25.8	2.57	65.2	NS	UCF6-06		UCF2-06	UCF9-06	
UCJCFX-0806	36400-0806	20242666	1/2	12.7	9/16-18	3/4	19	3/4	19	0.91	23.1	2.52	64.1	NS	UCF6-08		UCF2-08	UCF9-08	
UCJCFX-0808	36400-0808	20242785	1/2	12.7	3/4-16	1	25	3/4	19	1.01	25.6	2.67	67.8	NS	UCF6-08		UCF2-08	UCF9-08	
UCJCFX-0808 ^S	36400-0808S	20540687	1/2	12.7	3/4-16	1	25	3/4	19	1.01	25.6	2.67	67.8	NS	UCF6-08		UCF2-08	UCF9-08	
UCJCFX-0810	36400-0810	20242772	1/2	12.7	7/8-14	1 1/16	27	7/8	22	1.05	26.6	2.79	70.8	NS	UCF6-08		UCF2-08	UCF9-08	
UCJCFX-0812	36400-0812	20242727	1/2	12.7	1 1/16-12	1 1/4	32	1	25	1.11	28.1	2.91	73.9	NS	UCF6-08		UCF2-08	UCF9-08	
UCJCFX-1008	36400-1008	20242399	5/8	15.9	3/4-16	1	25	15/16	24	1.05	26.6	2.82	71.6	NS			UCF2-10	UCF9-10	
UCJCFX-1010	36400-1010	20242774	5/8	15.9	7/8-14	1 1/16	27	15/16	24	1.09	27.6	2.94	74.6	NS			UCF2-10	UCF9-10	
UCJCFX-1010 ^S	36400-1010S	20540688	5/8	15.9	7/8-14	1 1/16	27	15/16	24	1.09	27.6	2.94	74.6	NS			UCF2-10	UCF9-10	
UCJCFX-1012	36400-1012	20242580	5/8	15.9	1 1/16-12	1 1/4	32	1	25	1.11	28.1	3.02	76.7	NS			UCF2-10	UCF9-10	
UCJCFX-1210	36400-1210	20242694	3/4	19.0	7/8-14	1 1/4	32	1 1/16	27	1.11	28.1	3.20	81.4	NS	UCF6-12	UCF6-12	UCF2-12	UCF9-12	
UCJCFX-1212	36400-1212	20242783	3/4	19.0	1 1/16-12	1 1/4	32	1 1/16	27	1.13	28.6	3.24	82.4	NS	UCF6-12	UCF6-12	UCF2-12	UCF9-12	
UCJCFX-1212 ^S	36400-1212S	20540689	3/4	19.0	1 1/16-12	1 1/4	32	1 1/16	27	1.13	28.6	3.24	82.4	NS	UCF6-12	UCF6-12	UCF2-12	UCF9-12	
UCJCFX-1214	36400-1214	20242613	3/4	19.0	1 3/16-12	1 7/16	36	1 1/4	32	1.18	29.9	3.31	84.1	NS	UCF6-12	UCF6-12	UCF2-12	UCF9-12	
UCJCFX-1216	36400-1216	20242719	3/4	19.0	1 5/16-12	1 1/2	38	1 1/4	32	1.26	32.1	3.41	86.7	NS	UCF6-12	UCF6-12	UCF2-12	UCF9-12	
UCJCFX-1612	36400-1612	20242702	1	25.4	1 1/16-12	1 1/4	32	1 1/4	32	1.24	31.4	3.56	90.3	NS	UCF6-16	UCF6-16		UCF9-16	
UCJCFX-1616	36400-1616	20242784	1	25.4	1 5/16-12	1 1/2	38	1 1/4	32	1.30	32.9	3.65	92.6	NS	UCF6-16	UCF6-16		UCF9-16	
UCJCFX-1616 ^S	36400-1616S	20540690	1	25.4	1 5/16-12	1 1/2	38	1 1/4	32	1.30	32.9	3.65	92.6	NS	UCF6-16	UCF6-16		UCF9-16	
UCJCFX-1620 ^T	36400-1620	20242711	1	25.4	1 5/8-12	2	50	1 5/8	41	1.48	37.5	3.86	98.0	NS	UCF6-16	UCF6-16		UCF9-16	
UCJCFX-2020 ^T	36400-2020	20242781	1 1/4	31.8	1 5/8-12	2	50	1 5/8	41	1.54	39.1	4.21	107.0	NS	UCF6-20	UCF6-20			
UCJCFX-2420	36400-2420	20591960	1 1/2	38.1	1 5/8-12	2	50	2	50	1.62	41.1	4.57	116.0	NS			UCF6-24		
UCJCFX-2424 ^T	36400-2424	20242768	1 1/2	38.1	1 7/8-12	2 3/16	55	2	50	1.71	43.4	4.76	121.0	NS			UCF6-24		
UCJCFX-3232 ^T	36400-3232	20242754	2	50.8	2 1/2-12	70mm	70	2 3/16	65	1.93	49.0	5.71	145.0	NS			UCF6-32		

T: Thrust-Wire Nut (see "Fitting Identification" in Appendix for details)

S: Stainless Steel

JIC 37° Flare (SAE J514)

Female 45° Elbow | Swivel

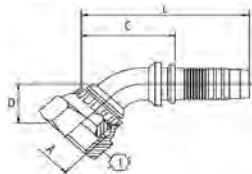

S=Skive
NS=Non-Skive
DG=Dual-Grip™

Descriptive #	Product #	SAP #	Hose Size ID		Thread Size (A)	Hex-1 Wrench Size		Drop (D)		Cut-Off (C)		Length (L)		Skive Type	SR3	SR4 HR4	SR6 HR6	SR14A
			in.	mm		in.	mm	in.	mm	in.	mm	in.	mm					
UC-JCFX45-0404	36420-0404	20242725	1/4	6.4	7/16-20	5/8	16	0.39	10.0	1.46	37.0	2.40	61.0	NS	UCF6-04		UCF2-04	UCF9-04
UC-JCFX45-0405	36420-0405	20242628	1/4	6.4	1/2-20	11/16	17	0.47	12.0	1.46	37.0	2.44	62.0	NS	UCF6-04		UCF2-04	UCF9-04
UC-JCFX45-0406	36420-0406	20242629	1/4	6.4	9/16-18	3/4	19	0.43	11.0	1.54	39.0	2.52	64.0	NS	UCF6-04		UCF2-04	UCF9-04
UC-JCFX45-0506	36420-0506	20242489	5/16	7.9	9/16-18	3/4	19	0.47	12.0	1.69	43.0	2.87	73.0	NS	UCF6-05		UCF2-05	UCF9-05
UC-JCFX45-0606	36420-0606	20242743	3/8	9.5	9/16-18	3/4	19	0.43	11.0	1.81	46.0	2.87	73.0	NS	UCF6-06		UCF2-06	UCF9-06
UC-JCFX45-0608	36420-0608	20242698	3/8	9.5	3/4-16	1	25	0.59	15.0	1.85	47.0	2.91	74.0	NS	UCF6-06		UCF2-06	UCF9-06
UC-JCFX45-0808	36420-0808	20242729	1/2	12.7	3/4-16	1	25	0.59	15.0	2.05	52.0	3.27	83.0	NS	UCF6-08		UCF2-08	UCF9-08
UC-JCFX45-0810	36420-0810	20242675	1/2	12.7	7/8-14	1 1/16	27	0.63	16.0	2.01	51.0	3.23	82.0	NS	UCF6-08		UCF2-08	UCF9-08
UC-JCFX45-1010	36420-1010	20242345	5/8	15.9	7/8-14	1 1/16	27	0.75	19.0	2.44	62.0	3.78	96.0	NS			UCF2-10	UCF9-10
UC-JCFX45-1012	36420-1012	20242344	5/8	15.9	1 1/16-12	1 1/4	32	0.83	21.0	2.72	69.0	4.06	103.0	NS			UCF2-10	UCF9-10
UC-JCFX45-1212	36420-1212	20242721	3/4	19.0	1 1/16-12	1 1/4	32	0.83	21.0	2.64	67.0	4.21	107.0	NS	UCF6-12	UCF6-12	UCF2-12	UCF9-12
UC-JCFX45-1216	36420-1216	20242343	3/4	19.0	1 5/16-12	1 1/2	38	1.02	26.0	2.80	71.0	4.37	111.0	NS	UCF6-12	UCF6-12	UCF2-12	UCF9-12
UC-JCFX45-1616	36420-1616	20242742	1	25.4	1 5/16-12	1 1/2	38	0.94	24.0	3.11	79.0	4.88	124.0	NS	UCF6-16	UCF6-16		UCF9-16
UC-JCFX45-2020 ^T	36420-2020	20242710	1 1/4	31.8	1 5/8-12	2	50	1.46	37.0	3.82	97.0	6.18	157.0	NS	UCF6-20	UCF6-20		
UC-JCFX45-2424 ^T	36420-2424	20242632	1 1/2	38.1	1 7/8-12	2 3/16	55	1.69	43.0	4.45	113.0	7.15	181.5	NS			UCF6-24	
UC-JCFX45-3232 ^T	36420-3232	20269237	2	50.8	2 1/2-12	70mm	70	2.64	67.0	6.30	160.0	9.61	244.0	NS			UCF6-32	

T: Thrust-Wire Nut (see "Fitting Identification" in Appendix for details)

JIC 37° Flare (SAE J514)

Female 90 ° Elbow | Swivel

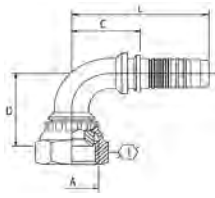

Elbow Type:
LT=Long Tube
ST=Short Tube

S=Skive
NS=Non-Skive
DG=Dual-Grip™

Descriptive#	Product #	SAP #	Hose Size ID		Thread Size (A)		Hex-1 Wrench Size	Elbow Type	Drop (D)		Cut-Off (C)		Length (L)		Skive Type	SR3	SR4 HR4	SR6 HR6	SR14A
			in.	mm	in.	mm			in.	mm	in.	mm	in.	mm					
UCJCFX90-0304	36425-0304	20269250	3/16	4.8	7/16-20	5/8	16		1.26	32.0	1.30	33.0	2.20	56.0	NS			UCF2-03	UCF9-03
UCJCFX90-0404	36425-0404	20242770	1/4	6.4	7/16-20	5/8	16		1.26	32.0	1.34	34.0	2.32	59.0	NS	UCF6-04		UCF2-04	UCF9-04
UCJCFX90L-0404	36440-0404	20242662	1/4	6.4	7/16-20	5/8	16	LT	1.81	46.0	1.22	31.0	2.20	56.0	NS	UCF6-04		UCF2-04	UCF9-04
UCJCFX90S-0404	36445-0404	20242430	1/4	6.4	7/16-20	5/8	16	ST	0.83	21.0	1.06	27.0	2.05	52.0	NS	UCF6-04		UCF2-04	UCF9-04
UCJCFX90-0405	36425-0405	20242657	1/4	6.4	1/2-20	11/16	17		1.18	30.0	1.02	26.0	1.97	50.0	NS	UCF6-04		UCF2-04	UCF9-04
UCJCFX90L-0405	36440-0405	20242473	1/4	6.4	1/2-20	11/16	17	LT	1.77	45.0	1.22	31.0	2.20	56.0	NS	UCF6-04		UCF2-04	UCF9-04
UCJCFX90S-0405	36445-0405	20242396	1/4	6.4	1/2-20	11/16	17	ST	0.93	23.5	1.02	26.0	2.01	51.0	NS	UCF6-04		UCF2-04	UCF9-04
UCJCFX90-0406	36425-0406	20242718	1/4	6.4	9/16-18	3/4	19		1.50	38.0	1.10	28.0	2.09	53.0	NS	UCF6-04		UCF2-04	UCF9-04
UCJCFX90L-0406	36440-0406	20242474	1/4	6.4	9/16-18	3/4	19	LT	2.13	54.0	1.34	34.0	2.32	59.0	NS	UCF6-04		UCF2-04	UCF9-04
UCJCFX90S-0406	36445-0406	20242397	1/4	6.4	9/16-18	3/4	19	ST	0.91	23.0	1.22	31.0	2.20	56.0	NS	UCF6-04		UCF2-04	UCF9-04
UCJCFX90-0504	36425-0504	20612476	5/16	7.9	7/16-20	5/8	16		1.26	32.0	1.97	50.0	3.52	89.5	NS	UCF6-05		UCF2-05	UCF9-05
UCJCFX90-0505	36425-0505	20242565	5/16	7.9	1/2-20	3/4	17		1.38	35.0	1.34	34.0	2.32	59.0	NS	UCF6-05		UCF2-05	UCF9-05
UCJCFX90-0506	36425-0506	20242490	5/16	7.9	9/16-18	3/4	19		1.38	35.0	1.30	33.0	2.28	58.0	NS	UCF6-05		UCF2-05	UCF9-05
UCJCFX90L-0506	36440-0506	20242454	5/16	7.9	9/16-18	3/4	19	LT	2.13	54.0	1.42	36.0	2.40	61.0	NS	UCF6-05		UCF2-05	UCF9-05
UCJCFX90-0604	36425-0604	20318323	3/8	9.5	7/16-20	5/8	16		1.26	32.0	1.38	35.0	2.44	62.0	NS	UCF6-06		UCF2-06	UCF9-06
UCJCFX90L-0604	36440-0604	20318322	3/8	9.5	7/16-20	5/8	16	LT	1.81	46.0	1.22	31.0	2.28	58.0	NS	UCF6-06		UCF2-06	UCF9-06
UCJCFX90-0606	36425-0606	20242776	3/8	9.5	9/16-18	3/4	19		1.38	35.0	1.22	31.0	2.28	58.0	NS	UCF6-06		UCF2-06	UCF9-06
UCJCFX90L-0606	36440-0606	20242720	3/8	9.5	9/16-18	3/4	19	LT	2.13	54.0	1.69	43.0	2.76	70.0	NS	UCF6-06		UCF2-06	UCF9-06
UCJCFX90S-0606	36445-0606	20242475	3/8	9.5	9/16-18	3/4	19	ST	0.91	23.0	1.65	42.0	2.72	69.0	NS	UCF6-06		UCF2-06	UCF9-06
UCJCFX90-0608	36425-0608	20242753	3/8	9.5	3/4-16	1	25		1.61	41.0	1.54	39.0	2.60	66.0	NS	UCF6-06		UCF2-06	UCF9-06
UCJCFX90L-0608	36440-0608	20242587	3/8	9.5	3/4-16	1	25	LT	2.52	64.0	1.85	47.0	2.91	74.0	NS	UCF6-06		UCF2-06	UCF9-06
UCJCFX90S-0608	36445-0608	20242431	3/8	9.5	3/4-16	1	25	ST	1.14	29.0	1.93	49.0	2.99	76.0	NS	UCF6-06		UCF2-06	UCF9-06
UCJCFX90-0808	36425-0808	20242764	1/2	12.7	3/4-16	1	25		1.57	40.0	1.46	37.0	2.72	69.0	NS	UCF6-08		UCF2-08	UCF9-08
UCJCFX90L-0808	36440-0808	20242688	1/2	12.7	3/4-16	1	25	LT	2.52	64.0	1.97	50.0	3.19	81.0	NS	UCF6-08		UCF2-08	UCF9-08
UCJCFX90S-0808	36445-0808	20242429	1/2	12.7	3/4-16	1	25	ST	1.14	29.0	1.81	46.0	3.07	78.0	NS	UCF6-08		UCF2-08	UCF9-08
UCJCFX90-0810	36425-0810	20242706	1/2	12.7	7/8-14	1 1/8	27		1.85	47.0	1.69	43.0	2.95	75.0	NS	UCF6-08		UCF2-08	UCF9-08
UCJCFX90L-0810	36440-0810	20242584	1/2	12.7	7/8-14	1 1/8	27	LT	2.56	65.0	1.46	37.0	2.72	69.0	NS	UCF6-08		UCF2-08	UCF9-08
UCJCFX90S-0810	36445-0810	20242395	1/2	12.7	7/8-14	1 1/8	27	ST	1.26	32.0	1.81	46.0	3.03	77.0	NS	UCF6-08		UCF2-08	UCF9-08
UCJCFX90-0812	36425-0812	20242349	1/2	12.7	1 1/8-12	1 1/4	32		1.81	46.0	1.46	37.0	2.72	69.0	NS	UCF6-08		UCF2-08	UCF9-08
UCJCFX90-1010	36425-1010	20242749	5/8	15.9	7/8-14	1 1/8	27		1.89	48.0	1.93	49.0	3.31	84.0	NS			UCF2-10	UCF9-10
UCJCFX90L-1010	36440-1010	20242346	5/8	15.9	7/8-14	1 1/8	27	LT	2.56	65.0	1.97	50.0	3.31	84.0	NS			UCF2-10	UCF9-10
UCJCFX90S-1010	36445-1010	20591962	5/8	15.9	7/8-14	1 1/8	27	ST	1.26	32.0	1.43	36.2	2.78	70.5	NS			UCF2-10	UCF9-10
UCJCFX90-1012	36425-1012	20242350	5/8	15.9	1 1/8-12	1 1/4	32		2.28	58.0	1.89	48.0	3.23	82.0	NS			UCF2-10	UCF9-10
UCJCFX90L-1012	36440-1012	20283400	5/8	15.9	1 1/8-12	1 1/4	32	LT	3.78	96.0	1.97	50.0	3.31	84.0	NS			UCF2-10	UCF9-10
UCJCFX90L-1210	36440-1210	20613763	3/4	19.0	7/8-14	1 1/8	27	LT	3.78	96.0	1.97	50.0	3.50	89.0	NS	UCF6-12	UCF6-12	UCF2-12	UCF9-12
UCJCFX90S-1210	36445-1210	20613762	3/4	19.0	7/8-14	1 1/8	27	ST	1.26	32.0	1.97	50.0	3.52	89.5	NS	UCF6-12	UCF6-12	UCF2-12	UCF9-12
UCJCFX90-1212	36425-1212	20242756	3/4	19.0	1 1/8-12	1 1/4	32		2.13	54.0	2.05	52.0	3.62	92.0	NS	UCF6-12	UCF6-12	UCF2-12	UCF9-12
UCJCFX90L-1212	36440-1212	20242674	3/4	19.0	1 1/8-12	1 1/4	32	LT	3.74	95.0	2.13	54.0	3.70	94.0	NS	UCF6-12	UCF6-12	UCF2-12	UCF9-12
UCJCFX90S-1212	36445-1212	20591963	3/4	19.0	1 1/8-12	1 1/4	32	ST	1.81	46.0	2.28	58.0	3.82	97.0	NS	UCF6-12	UCF6-12	UCF2-12	UCF9-12
UCJCFX90-1216	36425-1216	20242579	3/4	19.0	1 3/8-12	1 1/2	38		2.83	72.0	2.09	53.0	3.62	92.0	NS	UCF6-12	UCF6-12	UCF2-12	UCF9-12
UCJCFX90-1616	36425-1616	20242758	1	25.4	1 3/8-12	1 1/2	38		2.81	71.5	2.87	73.0	4.61	117.0	NS	UCF6-16	UCF6-16		UCF9-16
UCJCFX90L-1616	36440-1616	20242651	1	25.4	1 3/8-12	1 1/2	38	LT	4.49	114.0	3.11	79.0	4.84	123.0	NS	UCF6-16	UCF6-16		UCF9-16
UCJCFX90S-1616	36445-1616	20591964	1	25.4	1 3/8-12	1 1/2	38	ST	2.20	56.0	2.91	74.0	4.69	119.0	NS	UCF6-16	UCF6-16		UCF9-16
UCJCFX90-2020 ^T	36425-2020	20242752	1 1/4	31.8	1 3/8-12	2	50		3.07	78.0	3.23	82.0	5.28	134.0	NS	UCF6-20	UCF6-20		
UCJCFX90S-2020 ^T	36445-2020	20591967	1 1/4	31.8	1 3/8-12	2	50	ST	2.52	64.0	3.23	82.0	5.28	134.0	NS			UCF6-20	UCF6-20
UCJCFX90-2424 ^T	36425-2424	20242645	1 1/2	38.1	1 3/8-12	2 3/8	55		3.62	92.0	3.74	95.0	6.06	154.0	NS			UCF6-24	
UCJCFX90-3232 ^T	36425-3232	20269239	2	50.8	2 1/2-12	70mm	70		5.51	140.0	5.08	129.0	7.91	201.0	NS			UCF6-32	

T: Thrust-Wire Nut (see "Fitting Identification" in Appendix for details)

JIC 37° Flare (SAE J514)

Male

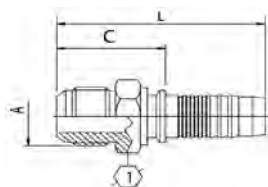

S=Skive
NS=Non-Skive
DG=Dual-Grip™

Descriptive #	Product #	SAP #	Hose Size ID		Thread Size (A)		Hex-1 Wrench Size		Cut-Off (C)		Length (L)		Skive Type	SR3	SR4 HR4	SR6 HR6	SR14A
			in.	mm	in.	mm	in.	mm	in.	mm	in.	mm					
UC-JCM-0404	36450-0404	20242728	1/4	6.4	7/16-20	1/2	12	0.96	24.3	1.93	49.1	NS	UCF6-04		UCF2-04	UCF9-04	
UC-JCM-0405	36450-0405	20242664	1/4	6.4	1/2-20	9/16	14	1.00	25.3	1.97	50.1	NS	UCF6-04		UCF2-04	UCF9-04	
UC-JCM-0406	36450-0406	20242687	1/4	6.4	9/16-18	11/16	17	1.04	26.3	2.01	51.1	NS	UCF6-04		UCF2-04	UCF9-04	
UC-JCM-0505	36450-0505	20242588	5/16	7.9	1/2-20	9/16	14	1.00	25.3	1.97	50.1	NS	UCF6-05		UCF2-05	UCF9-05	
UC-JCM-0506	36450-0506	20242434	5/16	7.9	9/16-18	11/16	17	1.04	26.3	2.01	51.1	NS	UCF6-05		UCF2-05	UCF9-05	
UC-JCM-0606	36450-0606	20242759	3/8	9.5	9/16-18	11/16	17	1.04	26.3	2.09	53.0	NS	UCF6-06		UCF2-06	UCF9-06	
UC-JCM-0608	36450-0608	20242755	3/8	9.5	3/4-16	3/4	19	1.17	29.8	2.22	56.5	NS	UCF6-06		UCF2-06	UCF9-06	
UC-JCM-0610	36450-0610	20242630	3/8	9.5	7/8-14	15/16	24	1.33	33.8	2.38	60.5	NS	UCF6-06		UCF2-06	UCF9-06	
UC-JCM-0808	36450-0808	20242736	1/2	12.7	3/4-16	3/4	19	1.20	30.6	2.44	62.1	NS	UCF6-08		UCF2-08	UCF9-08	
UC-JCM-0810	36450-0810	20242716	1/2	12.7	7/8-14	15/16	24	1.36	34.6	2.60	66.1	NS	UCF6-08		UCF2-08	UCF9-08	
UC-JCM-0812	36450-0812	20242670	1/2	12.7	1 1/8-12	1 1/8	27	1.46	37.1	2.70	68.6	NS	UCF6-08		UCF2-08	UCF9-08	
UC-JCM-1010	36450-1010	20242435	5/8	15.9	7/8-14	1 5/16	24	1.36	34.6	2.71	68.9	NS			UCF2-10	UCF9-10	
UC-JCM-1012	36450-1012	20242400	5/8	15.9	1 1/8-12	1 1/8	27	1.46	37.1	2.81	71.4	NS			UCF2-10	UCF9-10	
UC-JCM-1212	36450-1212	20242732	3/4	19.0	1 1/8-12	1 1/8	27	1.48	37.6	3.04	77.1	NS	UCF6-12	UCF6-12	UCF2-12	UCF9-12	
UC-JCM-1214	36450-1214	20242542	3/4	19.0	1 3/8-12	1 1/4	32	1.58	40.1	3.13	79.6	NS	UCF6-12	UCF6-12	UCF2-12	UCF9-12	
UC-JCM-1216	36450-1216	20242634	3/4	19.0	1 5/8-12	1 7/8	36	1.68	42.6	3.23	82.1	NS	UCF6-12	UCF6-12	UCF2-12	UCF9-12	
UC-JCM-1616	36450-1616	20242747	1	25.4	1 5/8-12	1 7/8	36	1.71	43.4	3.46	88.0	NS	UCF6-16	UCF6-16		UCF9-16	
UC-JCM-1620	36450-1620	20242433	1	25.4	1 5/8-12	1 3/8	46	1.85	46.9	3.60	91.5	NS	UCF6-16	UCF6-16		UCF9-16	
UC-JCM-2020	36450-2020	20242712	1 1/4	31.8	1 5/8-12	1 3/8	46	1.91	48.5	3.96	100.5	NS	UCF6-20	UCF6-20			
UC-JCM-2024	36450-2024	20242608	1 1/4	31.8	1 7/8-12	2	50	2.07	52.5	4.11	104.5	NS	UCF6-20	UCF6-20			
UC-JCM-2424	36450-2424	20242625	1 1/2	38.1	1 7/8-12	2	50	2.07	52.5	4.39	111.5	NS		UCF6-24			
UC-JCM-3232	36450-3232	20242547	2	50.8	2 1/2-12	2 9/16	65	2.44	62.0	5.28	134.0	NS		UCF6-32			

SAE 45° Flare (J512)

Female | Swivel

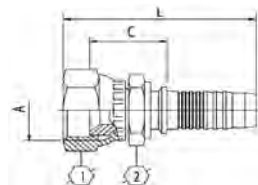

S=Skive
NS=Non-Skive
DG=Dual-Grip™

Descriptive #	Product #	SAP #	Hose Size ID		Thread Size (A)		Hex-1 Wrench Size		Hex-2 Wrench Size		Cut-Off (C)		Length (L)		Skive Type	SR3	SR4 HR4	SR6 HR6	SR14A
			in.	mm	in.	mm	in.	mm	in.	mm	in.	mm	in.	mm					
UC-SFFX-0606	36775-0606	20242760	3/8	9.5	5/8-18	7/8	22	3/4	19	0.92	23.3	2.38	60.5	NS	UCF6-06		UCF2-06	UCF9-06	
UC-SFFX-0608	36775-0608	20318359	3/8	9.5	3/4-16	1	25	3/4	19	0.98	24.8	2.45	62.2	NS	UCF6-06		UCF2-06	UCF9-06	
UC-SFFX-1212	36775-1212	20242652	3/4	19.0	1 1/8-14	1 1/4	32	1 1/8	27	1.13	28.6	3.23	82.1	NS	UCF6-12	UCF6-12	UCF2-12	UCF9-12	

SAE 45° Flare (J512)

Female 45° Elbow | Swivel

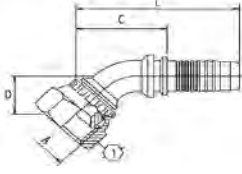

S=Skive
NS=Non-Skive
DG=Dual-Grip™

Descriptive #	Product #	SAP #	Hose Size ID		Thread Size (A)		Hex-1 Wrench Size		Drop (D)		Cut-Off (C)		Length (L)		Skive Type	SR3	SR4 HR4	SR6 HR6	SR14A
			in.	mm	in.	mm	in.	mm	in.	mm	in.	mm							
UCSFFX45-0606	36777-0606	20318360	3/8	9.5	5/8-18	7/8	22	0.47	12.0	1.81	46.0	2.87	73.0	NS	UCF6-06		UCF2-06	UCF9-06	

SAE 45° Flare (J512)

Female 90° Elbow | Swivel

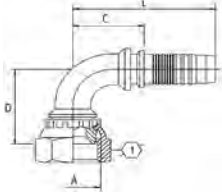

S=Skive
NS=Non-Skive
DG=Dual-Grip™

Descriptive #	Product #	SAP #	Hose Size ID		Thread Size (A)		Hex-1 Wrench Size		Drop (D)		Cut-Off (C)		Length (L)		Skive Type	SR3	SR4 HR4	SR6 HR6	SR14A
			in.	mm	in.	mm	in.	mm	in.	mm	in.	mm							
UCSFFX90-0606	36780-0606	20318325	3/8	9.5	5/8-18	7/8	22	0.94	24.0	1.65	42.0	2.72	69.0	NS	UCF6-06		UCF2-06	UCF9-06	
UCSFFX90L-0606	36781-0606	20318362	3/8	9.5	5/8-18	7/8	22	2.19	55.5	1.69	43.0	2.76	70.0	NS	UCF6-06		UCF2-06	UCF9-06	
UCSFFX90S-0808	36783-0808	20318363	1/2	12.7	3/4-16	1	25	1.14	29.0	1.81	46.0	3.07	78.0	NS	UCF6-08		UCF2-08	UCF9-08	

SAE 45° Flare (J512)

Male

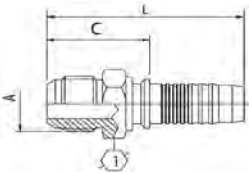

S=Skive
NS=Non-Skive
DG=Dual-Grip™

Descriptive #	Product #	SAP #	Hose Size ID		Thread Size (A)		Hex-1 Wrench Size		Cut-Off (C)		Length (L)		Skive Type	SR3	SR4 HR4	SR6 HR6	SR14A
			in.	mm	in.	mm	in.	mm	in.	mm							
UCSFM-0606	36785-0606	20318320	3/8	9.5	5/8-18	5/8	16	0.93	23.7	2.15	54.7	NS	UCF6-06		UCF2-06	UCF9-06	

SAE 45° Inverted Flare

Male | Swivel

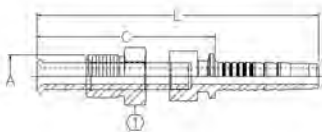

S=Skive
NS=Non-Skive
DG=Dual-Grip™

Descriptive #	Product #	SAP #	Hose Size ID		Thread Size (A)		Hex-1 Wrench Size		Cut-Off (C)		Length (L)		Skive Type	SR3	SR4 HR4	SR6 HR6	SR14A
			in.	mm	in.	mm	in.	mm	in.	mm	in.	mm					
UC-SIMX-0403	36800-0403	203183328	1/4	6.4	3/8-24	1/2	12	1.22	30.9	2.19	55.7	NS	UCF6-04		UCF2-04	UCF9-04	
UC-SIMX-0404	36800-0404	203183329	1/4	6.4	7/16-24	1/2	12	1.22	30.9	2.19	55.7	NS	UCF6-04		UCF2-04	UCF9-04	
UC-SIMX-0405	36800-0405	203183330	1/4	6.4	1/2-20	9/16	14	1.26	32.0	2.24	56.8	NS	UCF6-04		UCF2-04	UCF9-04	
UC-SIMX-0605	36800-0605	203183331	3/8	9.5	1/2-20	9/16	14	1.29	32.8	2.34	59.5	NS	UCF6-06		UCF2-06	UCF9-06	
UC-SIMX-0606	36800-0606	203183332	3/8	9.5	5/8-18	11/16	17	1.43	36.3	2.48	63.0	NS	UCF6-06		UCF2-06	UCF9-06	
UC-SIMX-0607	36800-0607	203183333	3/8	9.5	11/16-18	3/4	19	1.45	36.8	2.50	63.5	NS	UCF6-06		UCF2-06	UCF9-06	
UC-SIMX-0808	36800-0808	203183334	1/2	12.7	3/4-18	3/4	19	1.54	39.2	2.78	70.7	NS	UCF6-08		UCF2-08	UCF9-08	
UC-SIMX-0810	36800-0810	203183335	1/2	12.7	7/8-18	15/16	24	1.60	40.7	2.84	72.2	NS	UCF6-08		UCF2-08	UCF9-08	

SAE 45° Inverted Flare

Male 45° Elbow | Swivel

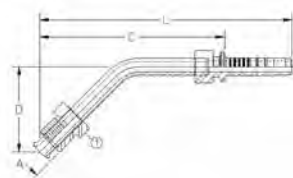

S=Skive
NS=Non-Skive
DG=Dual-Grip™

Descriptive #	Product #	SAP #	Hose Size ID		Thread Size (A)		Drop (D)		Cut-Off (C)		Length (L)		Skive Type	SR3	SR4 HR4	SR6 HR6	SR14A	
			in.	mm	in.	mm	in.	mm	in.	mm	in.	mm						
UC-SIMX45-0403	36810-0403	203183336	1/4	6.4	3/8-24	1/2	12	1.24	31.5	2.68	68.0	3.62	92.0	NS	UCF6-04		UCF2-04	UCF9-04
UC-SIMX45-0404	36810-0404	203183337	1/4	6.4	7/16-24	1/2	12	1.24	31.5	2.68	68.0	3.62	92.0	NS	UCF6-04		UCF2-04	UCF9-04
UC-SIMX45-0604	36810-0604	203183338	3/8	9.5	7/16-24	1/2	12	1.57	40.0	2.95	75.0	4.02	102.0	NS	UCF6-06		UCF2-06	UCF9-06
UC-SIMX45-0605	36810-0605	203183339	3/8	9.5	1/2-20	9/16	14	1.50	38.0	2.99	76.0	4.06	103.0	NS	UCF6-06		UCF2-06	UCF9-06
UC-SIMX45-0606	36810-0606	203183340	3/8	9.5	5/8-18	11/16	17	1.50	38.0	2.99	76.0	4.06	103.0	NS	UCF6-06		UCF2-06	UCF9-06
UC-SIMX45-0607	36810-0607	203183341	3/8	9.5	11/16-18	3/4	19	1.50	38.0	2.99	76.0	4.06	103.0	NS	UCF6-06		UCF2-06	UCF9-06

SAE 45° Inverted Flare

Male 90° Elbow | Swivel

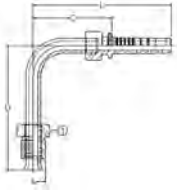

S=Skive
NS=Non-Skive
DG=Dual-Grip™

Descriptive #	Product #	SAP #	Hose Size ID		Thread Size (A)		Hex-1 Wrench Size		Drop (D)		Cut-Off (C)		Length (L)		Skive Type	SR3	SR4 HR4	SR6 HR6	SR14A
			in.	mm	in.	mm	in.	mm	in.	mm	in.	mm	in.	mm					
UC-SIMX90-0403	36815-0403	20318342	1/4	6.4	3/8-24	1/2	12	1.97	50.0	1.38	35.0	2.32	59.0	NS	UCF6-04		UCF2-04	UCF9-04	
UC-SIMX90-0404	36815-0404	20318343	1/4	6.4	7/16-24	1/2	12	2.05	52.0	1.30	33.0	2.24	57.0	NS	UCF6-04		UCF2-04	UCF9-04	
UC-SIMX90-0405	36815-0405	20318344	1/4	6.4	1/2-20	9/16	14	1.96	49.8	1.52	38.5	2.49	63.3	NS	UCF6-04		UCF2-04	UCF9-04	
UC-SIMX90-0604	36815-0604	20318345	3/8	9.5	7/16-24	1/2	12	2.44	62.0	1.34	34.0	2.36	60.0	NS	UCF6-06		UCF2-06	UCF9-06	
UC-SIMX90-0605	36815-0605	20318346	3/8	9.5	1/2-20	9/16	14	2.44	62.0	1.38	35.0	2.44	62.0	NS	UCF6-06		UCF2-06	UCF9-06	
UC-SIMX90-0606	36815-0606	20318347	3/8	9.5	5/8-18	11/16	17	2.44	62.0	1.38	35.0	2.44	62.0	NS	UCF6-06		UCF2-06	UCF9-06	
UC-SIMX90-0607	36815-0607	20318348	3/8	9.5	11/16-18	3/4	19	2.44	62.0	1.38	35.0	2.44	62.0	NS	UCF6-06		UCF2-06	UCF9-06	
UC-SIMX90-0808	36815-0808	20318349	1/2	12.7	3/4-18	3/4	19	2.32	59.0	2.13	54.0	3.35	85.0	NS	UCF6-08		UCF2-08	UCF9-08	

NPTF

Female

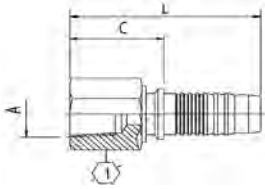

S=Skive
NS=Non-Skive
DG=Dual-Grip™

Descriptive #	Product #	SAP #	Hose Size ID		Thread Size (A)		Hex-1 Wrench Size		Cut-Off (C)		Length (L)		Skive Type	SR3	SR4 HR4	SR6 HR6	SR14A
			in.	mm	in.	mm	in.	mm	in.	mm							
UC-NPF-0404	36600-0404	20242660	1/4	6.4	1/4-18	3/4	19	1.09	27.8	2.07	52.6	NS	UCF6-04		UCF2-04	UCF9-04	
UC-NPF-0606	36600-0606	20242656	3/8	9.5	3/8-18	7/8	22	1.13	28.8	2.19	55.5	NS	UCF6-06		UCF2-06	UCF9-06	
UC-NPF-0808	36600-0808	20242622	1/2	12.7	1/2-14	1	25	1.40	35.6	2.64	67.1	NS	UCF6-08		UCF2-08	UCF9-08	
UC-NPF-1212	36600-1212	20242548	3/4	19.0	3/4-14	1 1/4	32	1.50	38.1	3.06	77.6	NS	UCF6-12	UCF6-12	UCF2-12	UCF9-12	

NPTF

Male

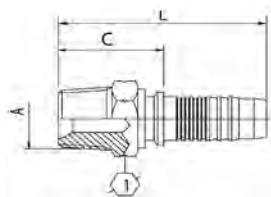

S=Skive
NS=Non-Skive
DG=Dual-Grip™

Descriptive #	Product #	SAP #	Hose Size ID		Thread Size (A)		Hex-1 Wrench Size		Cut-Off (C)		Length (L)		Skive Type	SR3	SR4 HR4	SR6 HR6	SR14A
			in.	mm	in.	mm	in.	mm	in.	mm	in.	mm					
UC-NPM-0302	36615-0302	20242703	3/16	4.8	1/8-27	1/2	12	0.82	20.8	1.69	43.0	NS				UCF2-03	UCF9-03
UC-NPM-0402	36615-0402	20242766	1/4	6.4	1/8-27	9/16	14	0.84	21.3	1.81	46.1	NS	UCF6-04			UCF2-04	UCF9-04
UC-NPM-0404	36615-0404	20242780	1/4	6.4	1/4-18	11/16	17	1.06	26.8	2.03	51.6	NS	UCF6-04			UCF2-04	UCF9-04
UC-NPM-0404 ^S	36615-0404S	20540691	1/4	6.4	1/4-18	11/16	17	1.06	26.8	2.03	51.6	NS	UCF6-04			UCF2-04	UCF9-04
UC-NPM-0406	36615-0406	20242748	1/4	6.4	3/8-18	3/4	19	1.09	27.8	2.07	52.6	NS	UCF6-04			UCF2-04	UCF9-04
UC-NPM-0408	36615-0408	20242661	1/4	6.4	1/2-14	7/8	22	1.23	31.3	2.21	56.1	NS	UCF6-04			UCF2-04	UCF9-04
UC-NPM-0504	36615-0504	20283392	5/16	7.9	1/4-18	11/16	17	1.06	26.8	2.03	51.6	NS	UCF6-05			UCF2-05	UCF9-05
UC-NPM-0504 ^S	36615-0504S	20540692	5/16	7.9	1/4-18	11/16	17	1.06	26.8	2.03	51.6	NS	UCF6-05			UCF2-05	UCF9-05
UC-NPM-0506	36615-0506	20283396	5/16	7.9	3/8-18	3/4	19	1.09	27.8	2.07	52.6	NS	UCF6-05			UCF2-05	UCF9-05
UC-NPM-0604	36615-0604	20242761	3/8	9.5	1/4-18	11/16	17	1.06	26.8	2.11	53.5	NS	UCF6-06			UCF2-06	UCF9-06
UC-NPM-0606	36615-0606	20242782	3/8	9.5	3/8-18	3/4	19	1.09	27.8	2.15	54.5	NS	UCF6-06			UCF2-06	UCF9-06
UC-NPM-0606 ^S	36615-0606S	20540693	3/8	9.5	3/8-18	3/4	19	1.09	27.8	2.15	54.5	NS	UCF6-06			UCF2-06	UCF9-06
UC-NPM-0608	36615-0608	20242767	3/8	9.5	1/2-14	7/8	22	1.23	31.3	2.28	58.0	NS	UCF6-06			UCF2-06	UCF9-06
UC-NPM-0806	36615-0806	20242722	1/2	12.7	3/8-18	3/4	19	1.13	28.6	2.37	60.1	NS	UCF6-08			UCF2-08	UCF9-08
UC-NPM-0808	36615-0808	20242775	1/2	12.7	1/2-14	7/8	22	1.26	32.1	2.50	63.6	NS	UCF6-08			UCF2-08	UCF9-08
UC-NPM-0808 ^S	36615-0808S	20540694	1/2	12.7	1/2-14	7/8	22	1.26	32.1	2.50	63.6	NS	UCF6-08			UCF2-08	UCF9-08
UC-NPM-0812	36615-0812	20242679	1/2	12.7	3/4-14	1 1/16	27	1.34	34.1	2.58	65.6	NS	UCF6-08			UCF2-08	UCF9-08
UC-NPM-1012	36615-1012	20274105	5/8	15.9	3/4-14	1 1/16	27	1.34	34.1	2.69	68.4	NS				UCF2-10	UCF9-10
UC-NPM-1208	36615-1208	20242689	3/4	19.0	1/2-14	1 1/16	27	1.32	33.6	2.88	73.1	NS	UCF6-12	UCF6-12	UCF2-12	UCF9-12	
UC-NPM-1212	36615-1212	20242771	3/4	19.0	3/4-14	1 1/16	27	1.36	34.6	2.92	74.1	NS	UCF6-12	UCF6-12	UCF2-12	UCF9-12	
UC-NPM-1212 ^S	36615-1212S	20540695	3/4	19.0	3/4-14	1 1/16	27	1.36	34.6	2.92	74.1	NS	UCF6-12	UCF6-12	UCF2-12	UCF9-12	
UC-NPM-1216	36615-1216	20242649	3/4	19.0	1-11 1/2	1 7/16	36	1.72	43.6	3.27	83.1	NS	UCF6-12	UCF6-12	UCF2-12	UCF9-12	
UC-NPM-1612	36615-1612	20242684	1	25.4	3/4-14	1 7/16	36	1.55	39.4	3.31	84.0	NS	UCF6-16	UCF6-16		UCF9-16	
UC-NPM-1616	36615-1616	20242769	1	25.4	1-11 1/2	1 7/16	36	1.75	44.4	3.50	89.0	NS	UCF6-16	UCF6-16		UCF9-16	
UC-NPM-1616 ^S	36615-1616S	20540696	1	25.4	1-11 1/2	1 7/16	36	1.75	44.4	3.50	89.0	NS	UCF6-16	UCF6-16		UCF9-16	
UC-NPM-1620	36615-1620	20242638	1	25.4	1 1/4-11 1/2	1 13/16	46	1.87	47.4	3.62	92.0	NS	UCF6-16	UCF6-16		UCF9-16	
UC-NPM-2020	36615-2020	20242773	1 1/4	31.8	1 1/4-11 1/2	1 13/16	46	1.93	49.0	3.98	101.0	NS	UCF6-20	UCF6-20			
UC-NPM-2424	36615-2424	20242685	1 1/2	38.1	1 1/2-11 1/2	2	50	1.99	50.5	4.31	109.5	NS		UCF6-24			
UC-NPM-3232	36615-3232	20242642	2	50.8	2-11 1/2	2 9/16	65	2.13	54.2	4.97	126.2	NS		UCF6-32			

S: Stainless Steel

NPTF

Male | Swivel

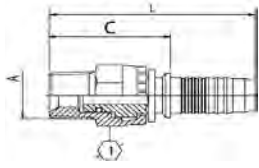

S=Skive
NS=Non-Skive
DG=Dual-Grip™

Descriptive #	Product #	SAP #	Hose Size ID		Thread Size (A)		Hex-1 Wrench Size		Cut-Off (C)		Length (L)		Skive Type	SR3	SR4 HR4	SR6 HR6	SR14A
			in.	mm	in.	mm	in.	mm	in.	mm	in.	mm					
UC-NPMX-0404	36645-0404	20242757	1/4	6.4	1/4-18	11/16	17	1.48	37.6	2.46	62.4	NS	UCF6-04		UCF2-04	UCF9-04	
UC-NPMX-0406	36645-0406	20242519	1/4	6.4	3/8-18	7/8	22	1.56	39.5	2.53	64.3	NS	UCF6-04		UCF2-04	UCF9-04	
UC-NPMX-0604	36645-0604	20242745	3/8	9.5	1/4-18	11/16	17	1.56	39.6	2.61	66.3	NS	UCF6-06		UCF2-06	UCF9-06	
UC-NPMX-0606	36645-0606	20242777	3/8	9.5	3/8-18	7/8	22	1.48	37.5	2.53	64.2	NS	UCF6-06		UCF2-06	UCF9-06	
UC-NPMX-0608	36645-0608	20242751	3/8	9.5	1/2-14	1	25	1.71	43.5	2.76	70.2	NS	UCF6-06		UCF2-06	UCF9-06	
UC-NPMX-0806	36645-0806	20242503	1/2	12.7	3/8-18	7/8	22	1.51	38.3	2.75	69.8	NS	UCF6-08		UCF2-08	UCF9-08	
UC-NPMX-0808	36645-0808	20242762	1/2	12.7	1/2-14	1	25	1.67	42.3	2.91	73.8	NS	UCF6-08		UCF2-08	UCF9-08	
UC-NPMX-1212	36645-1212	20242730	3/4	19.0	3/4-14	1 1/4	32	1.97	50.1	3.53	89.6	NS	UCF6-12	UCF6-12	UCF2-12	UCF9-12	
UC-NPMX-1616	36645-1616	20242739	1	25.4	1-11 1/2	1 3/8	41	2.28	57.9	4.04	102.5	NS	UCF6-16	UCF6-16		UCF9-16	

NPTF

Male 90° Elbow (Block) | Swivel



S=Skive
NS=Non-Skive
DG=Dual-Grip™

Descriptive #	Product #	SAP #	Hose Size ID		Thread Size (A)		Hex-1 Wrench Size		Drop (D)		Cut-Off (C)		Length (L)		Skive Type	SR3	SR4 HR4	SR6 HR6	SR14A
			in.	mm	in.	mm	in.	mm	in.	mm	in.	mm	in.	mm					
UC-NPMX90B-0404	36650-0404	20318350	1/4	6.4	1/4-18	11/16	17	1.54	39.0	0.67	17.0	1.65	41.8	NS	UCF6-04		UCF2-04	UCF9-04	
UC-NPMX90B-0604	36650-0604	20318351	3/8	9.5	1/4-18	11/16	17	1.61	41.0	0.79	20.0	1.84	46.7	NS	UCF6-06		UCF2-06	UCF9-06	
UC-NPMX90B-0606	36650-0606	20318352	3/8	9.5	3/8-18	7/8	22	1.61	41.0	0.79	20.0	1.84	46.7	NS	UCF6-06		UCF2-06	UCF9-06	
UC-NPMX90B-0808	36650-0808	20318353	1/2	12.7	1/2-14	1	25	1.89	48.0	0.91	23.0	2.15	54.5	NS	UCF6-08		UCF2-08	UCF9-08	

NPSM

Female | Swivel

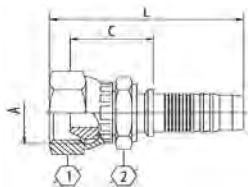

S=Skive
NS=Non-Skive
DG=Dual-Grip™

Descriptive #	Product #	SAP #	Hose Size ID		Thread Size (A)		Hex-1 Wrench Size		Hex-2 Wrench Size		Cut-Off (C)		Length (L)		Skive Type	SR3	SR4 HR4	SR6 HR6	SR14A
			in.	mm	in.	mm	in.	mm	in.	mm	in.	mm							
UC-NSFX-0404	36655-0404	20242668	1/4	6.4	1/4-18	3/4	19	11/16	17	0.96	24.3	2.17	55.1	NS	UCF6-04		UCF2-04	UCF9-04	
UC-NSFX-0606	36655-0606	20242669	3/8	9.5	3/8-18	7/8	22	3/4	19	0.98	24.8	2.27	57.7	NS	UCF6-06		UCF2-06	UCF9-06	
UC-NSFX-0808	36655-0808	20242654	1/2	12.7	1/2-14	1 1/8	27	7/8	22	1.05	26.6	2.54	64.6	NS	UCF6-08		UCF2-08	UCF9-08	

Flareless Tube Fittings (SAE J514)

Male

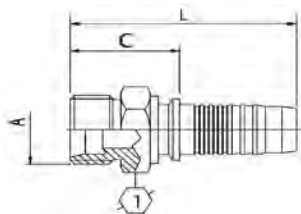

S=Skive
NS=Non-Skive
DG=Dual-Grip™

Descriptive #	Product #	SAP #	Hose Size ID		Thread Size (A)	Hex-1 Wrench Size	Cut-Off (C)		Length (L)		Skive Type	SR3	SR4 HR4	SR6 HR6	SR14A
			in.	mm			in.	mm	in.	mm					
UC-FTM-0404	36360-0404	20286107	1/4	6.4	7/16-20	1/2	12	0.86	21.8	1.83	46.6	NS	UCF6-04	UCF2-04	UCF9-04
UC-FTM-0506	36360-0506	20295568	5/16	7.9	9/16-18	5/8	16	0.95	24.2	1.93	49.0	NS	UCF6-05	UCF2-05	UCF9-05
UC-FTM-0606	36360-0606	20286108	3/8	9.5	9/16-18	5/8	16	0.95	24.2	2.00	50.9	NS	UCF6-06	UCF2-06	UCF9-06

* All Fittings come with Nut and Sleeve

Standpipe

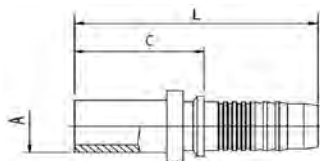

S=Skive
NS=Non-Skive
DG=Dual-Grip™

Descriptive #	Product #	SAP #	Hose Size ID			Tube OD (A)		Cut-Off (C)		Length (L)		Skive Type	SR3	SR4 HR4	SR6 HR6	SR14A
			in.	mm	mm	in.	mm	in.	mm							
UC-SP-0408	36825-0408	20242506	1/4	6.4	8	1.19	30.2	2.17	55.0	NS	UCF6-04		UCF2-04	UCF9-04		
UC-SP-0410	36825-0410	20242461	1/4	6.4	10	1.27	32.2	2.24	57.0	NS	UCF6-04		UCF2-04	UCF9-04		
UC-SP-0610	36825-0610	20242555	3/8	9.5	10	1.19	30.3	2.24	57.0	NS	UCF6-06		UCF2-06	UCF9-06		
UC-SP-0612	36825-0612	20242576	3/8	9.5	12	1.15	29.3	2.20	56.0	NS	UCF6-06		UCF2-06	UCF9-06		
UC-SP-0815	36825-0815	20242372	1/2	12.7	15	1.26	32.1	2.50	63.6	NS	UCF6-08		UCF2-08	UCF9-08		
UC-SP-0816	36825-0816	20242482	1/2	12.7	16	1.46	37.1	2.70	68.6	NS	UCF6-08		UCF2-08	UCF9-08		
UC-SP-1222	36825-1222	20242373	3/4	19.0	22	1.44	36.5	2.99	76.0	NS	UCF6-12	UCF6-12	UCF2-12	UCF9-12		
UC-SP-1628	36825-1628	20242371	1	25.4	28	1.59	40.4	3.35	85.0	NS	UCF6-16	UCF6-16		UCF9-16		

Standpipe

45° Elbow

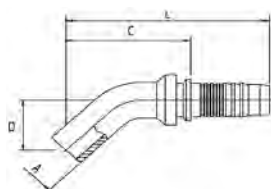

S=Skive
NS=Non-Skive
DG=Dual-Grip™

Descriptive #	Product #	SAP #	Hose Size ID			Tube OD (A)	Drop (D)	Cut-Off (C)		Length (L)		Skive Type	SR3	GR4 HR4	SR6 HR6	SR14A
			in.	mm	mm			in.	mm	in.	mm					
UC-SP45-0408	36830-0408	20242370	1/4	6.4	8	0.91	23.0	1.69	43.0	2.68	68.0	NS	UCF6-04		UCF2-04	UCF9-04

O-Ring Face Seal (SAE J1453) ORS/ORFS

Female | Swivel

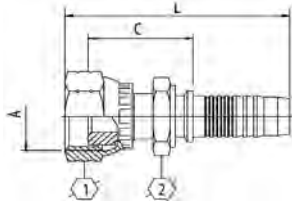

S=Skive
NS=Non-Skive
DG=Dual-Grip™

Descriptive #	Product #	SAP #	Hose Size ID		Thread Size (A)		Hex-1 Wrench Size		Hex-2 Wrench Size		Cut-Off (C)		Length (L)		Skive Type	SR3	SR4 HR4	SR6 HR6	SR14A
			in.	mm	in.	mm	in.	mm	in.	mm	in.	mm	in.	mm					
UC-OFFX-0404	36700-0404	20242723	1/4	6.4	9/16-18	11/16	17	9/16	14	1.07	2.37	60.3	NS	UCF6-04		UCF2-04	UCF9-04		
UC-OFFX-0406	36700-0406	20242655	1/4	6.4	11/16-16	7/8	22	11/16	17	1.19	30.3	2.54	64.6	NS	UCF6-04		UCF2-04	UCF9-04	
UC-OFFX-0408	36700-0408	20242441	1/4	6.4	13/16-16	15/16	24	7/8	22	1.39	35.3	2.80	71.1	NS	UCF6-04		UCF2-04	UCF9-04	
UC-OFFX-0506	36700-0506	20242544	5/16	7.9	11/16-16	7/8	22	11/16	17	1.19	30.3	2.54	64.6	NS	UCF6-05		UCF2-05	UCF9-05	
UC-OFFX-0604	36700-0604	20612477	3/8	9.5	9/16-18	11/16	17	11/16	17	1.11	28.3	2.49	63.2	NS	UCF6-06		UCF2-06	UCF9-06	
UC-OFFX-0606	36700-0606	20242763	3/8	9.5	11/16-16	7/8	22	11/16	17	1.19	30.3	2.62	66.5	NS	UCF6-06		UCF2-06	UCF9-06	
UC-OFFX-0608	36700-0608	20242691	3/8	9.5	13/16-16	15/16	24	7/8	22	1.39	35.3	2.87	73.0	NS	UCF6-06		UCF2-06	UCF9-06	
UC-OFFX-0806	36700-0806	20242552	1/2	12.7	11/16-16	7/8	22	3/4	19	1.26	32.1	2.88	73.1	NS	UCF6-08		UCF2-08	UCF9-08	
UC-OFFX-0808	36700-0808	20242733	1/2	12.7	13/16-16	15/16	24	7/8	22	1.42	36.1	3.09	78.6	NS	UCF6-08		UCF2-08	UCF9-08	
UC-OFFX-0810	36700-0810	20242704	1/2	12.7	1-14	13/16	30	15/16	24	1.56	39.6	3.31	84.1	NS	UCF6-08		UCF2-08	UCF9-08	
UC-OFFX-0812	36700-0812	20242551	1/2	12.7	13/16-12	17/16	36	13/16	30	1.66	42.1	3.47	88.1	NS	UCF6-08		UCF2-08	UCF9-08	
UC-OFFX-1010	36700-1010	20242442	5/8	15.9	1-14	13/16	30	15/16	24	1.56	39.6	3.39	86.1	NS			UCF2-10	UCF9-10	
UC-OFFX-1012	36700-1012	20242367	5/8	15.9	13/16-12	17/16	36	13/16	30	1.66	42.1	3.58	90.9	NS			UCF2-10	UCF9-10	
UC-OFFX-1210	36700-1210	20242553	3/4	19.0	1-14	13/16	30	11/16	27	1.58	40.1	3.65	92.6	NS	UCF6-12	UCF6-12	UCF2-12	UCF9-12	
UC-OFFX-1212	36700-1212	20242741	3/4	19.0	13/16-12	17/16	36	13/16	30	1.68	42.6	3.80	96.6	NS	UCF6-12	UCF6-12	UCF2-12	UCF9-12	
UC-OFFX-1216	36700-1216	20242646	3/4	19.0	17/16-12	15/8	41	17/16	36	1.91	48.6	4.05	102.9	NS	UCF6-12	UCF6-12	UCF2-12	UCF9-12	
UC-OFFX-1612	36700-1612	20242521	1	25.4	13/16-12	17/16	36	11/4	32	1.79	45.4	4.11	104.5	NS	UCF6-16	UCF6-16		UCF9-16	
UC-OFFX-1616	36700-1616	20242734	1	25.4	17/16-12	15/8	41	17/16	36	1.94	49.4	4.28	108.8	NS	UCF6-16	UCF6-16		UCF9-16	
UC-OFFX-1620	36700-1620	20242505	1	25.4	11/16-12	2	50	15/8	41	1.98	50.4	4.32	109.8	NS	UCF6-16	UCF6-16		UCF9-16	
UC-OFFX-2020	36700-2020	20242692	11/4	31.8	11/16-12	2	50	15/8	41	2.05	52.0	4.68	118.8	NS	UCF6-20	UCF6-20			
UC-OFFX-2424	36700-2424	20242495	11/2	38.1	2-12	2 3/8	60	2	50	2.22	56.5	5.18	131.5	NS		UCF6-24			

O-Ring Face Seal (SAE J1453) ORS/ORFS

Female 45° Elbow | Swivel

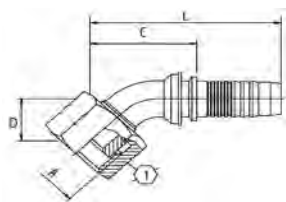

S=Skive
NS=Non-Skive
DG=Dual-Grip™

Descriptive #	Product #	SAP #	Hose Size ID		Thread Size (A)		Hex-1 Wrench Size		Hex-2 Wrench Size		Cut-Off (C)		Length (L)		Skive Type	SR3	SR4 HR4	SR6 HR6	SR14A
			in.	mm	in.	mm	in.	mm	in.	mm	in.	mm	in.	mm					
UC-OFFX45-0404	36710-0404	20242631	1/4	6.4	9/16-18	11/16	17	0.43	11.0	1.61	41.0	2.60	66.0	NS	UCF6-04		UCF2-04	UCF9-04	
UC-OFFX45-0406	36710-0406	20242549	1/4	6.4	11/16-16	7/8	22	0.43	11.0	1.81	46.0	2.80	71.0	NS	UCF6-04		UCF2-04	UCF9-04	
UC-OFFX45-0506	36710-0506	20242456	5/16	7.9	11/16-16	7/8	22	0.47	12.0	1.81	46.0	2.99	76.0	NS	UCF6-05		UCF2-05	UCF9-05	
UC-OFFX45-0606	36710-0606	20242683	3/8	9.5	11/16-16	7/8	22	0.47	12.0	1.85	47.0	2.91	74.0	NS	UCF6-06		UCF2-06	UCF9-06	
UC-OFFX45-0608	36710-0608	20242593	3/8	9.5	13/16-16	15/16	24	0.59	15.0	2.01	51.0	3.07	78.0	NS	UCF6-06		UCF2-06	UCF9-06	
UC-OFFX45-0808 ^C	36710-0808	20242637	1/2	12.7	13/16-16	15/16	24	0.63	16.0	1.85	47.0	3.11	79.0	NS	UCF6-08		UCF2-08	UCF9-08	
UC-OFFX45-0810	36710-0810	20242532	1/2	12.7	1-14	1 3/8	30	0.65	16.5	1.97	50.0	3.23	82.0	NS	UCF6-08		UCF2-08	UCF9-08	
UC-OFFX45-1212	36710-1212	20242681	3/4	19.0	1 3/8-12	1 7/8	36	0.83	21.0	2.48	63.0	4.06	103.0	NS	UCF6-12	UCF6-12	UCF2-12	UCF9-12	
UC-OFFX45-1216	36710-1216	20242359	3/4	19.0	1 7/8-12	1 5/8	41	0.94	24.0	2.80	71.0	4.33	110.0	NS	UCF6-12	UCF6-12	UCF2-12	UCF9-12	
UC-OFFX45-1616	36710-1616	20242643	1	25.4	1 7/8-12	1 5/8	41	1.02	26.0	3.23	82.0	5.00	127.0	NS	UCF6-16	UCF6-16		UCF9-16	
UC-OFFX45-1620	36710-1620	20242355	1	25.4	1 1/2-12	2	50	1.02	26.0	3.35	85.0	5.41	137.5	NS	UCF6-16	UCF6-16		UCF9-16	
UC-OFFX45-2020	36710-2020	20242609	1 1/4	31.8	1 1/2-12	2	50	1.02	26.0	3.82	97.0	6.16	156.5	NS	UCF6-20	UCF6-20			
UC-OFFX45-2024	36710-2024	20242477	1 1/4	31.8	2-12	2 3/8	60	1.10	28.0	3.98	101.0	6.34	161.0	NS	UCF6-20	UCF6-20			
UC-OFFX45-2424	36710-2424	20242357	1 1/2	38.1	2-12	2 3/8	60	1.10	28.0	4.13	105.0	6.77	172.0	NS		UCF6-24			

C: Crimp Nut (see "Fitting Identification" in Appendix for details)

O-Ring Face Seal (SAE J1453) ORS/ORFS

Female 90° Elbow | Swivel

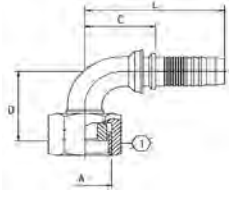

Elbow Type:
LT=Long Tube
ST=Short Tube

S=Skive
NS=Non-Skive
DG=Dual-Grip™

Descriptive #	Product #	SAP #	Hose Size ID		Thread Size (A)		Hex-1 Wrench Size	Elbow Type	Drop (D)		Cut-Off (C)		Length (L)		Skive Type	SR3	SR4 HR4	SR6 HR6	SR14A
			in.	mm	in.	mm			in.	mm	in.	mm	in.	mm					
UC-OFFX90-0404	36715-0404	20242602	1/4	6.4	9/16-18	11/16	17		1.26	32.0	1.18	30.0	2.17	55.0	NS	UCF6-04		UCF2-04	UCF9-04
UC-OFFX90L-0404	36720-0404	20242533	1/4	6.4	9/16-18	11/16	17	LT	1.81	46.0	1.30	33.0	2.28	58.0	NS	UCF6-04		UCF2-04	UCF9-04
UC-OFFX90S-0404	36725-0404	20242682	1/4	6.4	9/16-18	11/16	17	ST	0.83	21.0	1.10	28.0	2.09	53.0	NS	UCF6-04		UCF2-04	UCF9-04
UC-OFFX90-0406	36715-0406	20242479	1/4	6.4	11/16-16	7/8	22		1.50	38.0	1.46	37.0	2.44	62.0	NS	UCF6-04		UCF2-04	UCF9-04
UC-OFFX90L-0406	36720-0406	20242492	1/4	6.4	11/16-16	7/8	22	LT	2.13	54.0	1.38	35.0	2.36	60.0	NS	UCF6-04		UCF2-04	UCF9-04
UC-OFFX90S-0406	36725-0406	20242598	1/4	6.4	11/16-16	7/8	22	ST	0.91	23.0	1.26	32.0	2.24	57.0	NS	UCF6-04		UCF2-04	UCF9-04
UC-OFFX90S-0506	36725-0506	20242494	5/16	7.9	11/16-16	7/8	22	ST	1.34	34.0	1.61	41.0	2.60	66.0	NS	UCF6-05		UCF2-05	UCF9-05
UC-OFFX90-0606	36715-0606	20242633	3/8	9.5	11/16-16	7/8	22		1.50	38.0	1.65	42.0	2.72	69.0	NS	UCF6-06		UCF2-06	UCF9-06
UC-OFFX90L-0606	36720-0606	20242615	3/8	9.5	11/16-16	7/8	22	LT	2.13	54.0	1.65	42.0	2.72	69.0	NS	UCF6-06		UCF2-06	UCF9-06
UC-OFFX90S-0606	36725-0606	20242717	3/8	9.5	11/16-16	7/8	22	ST	0.98	25.0	1.65	42.0	2.72	69.0	NS	UCF6-06		UCF2-06	UCF9-06
UC-OFFX90-0608	36715-0608	20242480	3/8	9.5	13/16-16	15/16	24		1.61	41.0	1.73	44.0	2.80	71.0	NS	UCF6-06		UCF2-06	UCF9-06
UC-OFFX90L-0608	36720-0608	20242493	3/8	9.5	13/16-16	15/16	24	LT	2.52	64.0	1.85	47.0	2.91	74.0	NS	UCF6-06		UCF2-06	UCF9-06
UC-OFFX90S-0608	36725-0608	20242620	3/8	9.5	13/16-16	15/16	24	ST	1.14	29.0	1.65	42.0	2.72	69.0	NS	UCF6-06		UCF2-06	UCF9-06
UC-OFFX90-0808 ^C	36715-0808	20242571	1/2	12.7	13/16-16	15/16	24		1.65	42.0	1.38	35.0	2.60	66.0	NS	UCF6-08		UCF2-08	UCF9-08
UC-OFFX90L-0808 ^C	36720-0808	20242566	1/2	12.7	13/16-16	15/16	24	LT	2.52	64.0	1.50	38.0	2.76	70.0	NS	UCF6-08		UCF2-08	UCF9-08
UC-OFFX90S-0808 ^C	36725-0808	20242663	1/2	12.7	13/16-16	15/16	24	ST	1.14	29.0	1.57	40.0	2.80	71.0	NS	UCF6-08		UCF2-08	UCF9-08
UC-OFFX90-0810	36715-0810	20242363	1/2	12.7	1-14	1 3/8	30		1.85	47.0	1.89	48.0	3.15	80.0	NS	UCF6-08		UCF2-08	UCF9-08
UC-OFFX90L-0810	36720-0810	20242438	1/2	12.7	1-14	1 3/8	30	LT	2.76	70.0	1.81	46.0	3.07	78.0	NS	UCF6-08		UCF2-08	UCF9-08
UC-OFFX90S-0810	36725-0810	20242550	1/2	12.7	1-14	1 3/8	30	ST	1.28	32.5	1.81	46.0	3.07	78.0	NS	UCF6-08		UCF2-08	UCF9-08
UC-OFFX90S-0812	36725-0812	20318321	1/2	12.7	1 3/8-12	1 7/8	36	ST	2.01	51.0	2.20	56.0	3.46	88.0	NS	UCF6-08		UCF2-08	UCF9-08
UC-OFFX90-1010	36715-1010	20242403	5/8	15.9	1-14	1 3/8	30		1.73	44.0	2.17	55.0	3.54	90.0	NS			UCF2-10	UCF9-10
UC-OFFX90S-1010	36725-1010	20242365	5/8	15.9	1-14	1 3/8	30	ST	1.28	32.5	2.05	52.0	3.43	87.0	NS			UCF2-10	UCF9-10
UC-OFFX90S-1012	36725-1012	20242364	5/8	15.9	1 3/8-12	1 7/8	36	ST	1.93	49.0	2.17	55.0	3.54	90.0	NS			UCF2-10	UCF9-10
UC-OFFX90S-1210	36725-1210	20242457	3/4	19.0	1-14	1 3/8	30	ST	1.54	39.0	1.75	44.5	3.31	84.0	NS	UCF6-12	UCF6-12	UCF2-12	UCF9-12
UC-OFFX90-1212	36715-1212	20242439	3/4	19.0	1 3/8-12	1 7/8	36		2.28	58.0	2.44	62.0	3.98	101.0	NS	UCF6-12	UCF6-12	UCF2-12	UCF9-12
UC-OFFX90L-1212	36720-1212	20242514	3/4	19.0	1 3/8-12	1 7/8	36	LT	3.78	96.0	2.44	62.0	3.98	101.0	NS	UCF6-12	UCF6-12	UCF2-12	UCF9-12
UC-OFFX90S-1212	36725-1212	20242680	3/4	19.0	1 3/8-12	1 7/8	36	ST	2.01	51.0	2.40	61.0	3.94	100.0	NS	UCF6-12	UCF6-12	UCF2-12	UCF9-12
UC-OFFX90S-1216	36725-1216	20242481	3/4	19.0	1 7/8-12	1 5/8	41	ST	2.80	71.0	2.60	66.0	4.13	105.0	NS	UCF6-12	UCF6-12	UCF2-12	UCF9-12
UC-OFFX90-1616	36715-1616	20242478	1	25.4	1 7/8-12	1 5/8	41		2.60	66.0	3.27	83.0	5.00	127.0	NS	UCF6-16	UCF6-16		UCF9-16
UC-OFFX90L-1616	36720-1616	20242504	1	25.4	1 7/8-12	1 5/8	41	LT	4.49	114.0	3.27	83.0	5.00	127.0	NS	UCF6-16	UCF6-16		UCF9-16
UC-OFFX90S-1616	36725-1616	20242690	1	25.4	1 7/8-12	1 5/8	41	ST	2.28	58.0	3.27	83.0	5.00	127.0	NS	UCF6-16	UCF6-16		UCF9-16
UC-OFFX90-1620	36715-1620	20242360	1	25.4	1 1/8-12	2	50		3.07	78.0	3.27	83.0	5.00	127.0	NS	UCF6-16	UCF6-16		UCF9-16
UC-OFFX90S-1620	36725-1620	20242440	1	25.4	1 1/8-12	2	50	ST	2.52	64.0	3.27	83.0	5.00	127.0	NS	UCF6-16	UCF6-16		UCF9-16
UC-OFFX90S-2020	36725-2020	20242671	1 1/4	31.8	1 1/8-12	2	50	ST	2.68	68.0	3.74	95.0	5.79	147.0	NS	UCF6-20	UCF6-20		
UC-OFFX90L-2024	36720-2024	20242402	1 1/4	31.8	2-12	2 3/8	60	LT	5.55	141.0	4.02	102.0	6.06	154.0	NS	UCF6-20	UCF6-20		
UC-OFFX90S-2024	36725-2024	20242405	1 1/4	31.8	2-12	2 3/8	60	ST	2.72	69.0	4.02	102.0	6.06	154.0	NS	UCF6-20	UCF6-20		
UC-OFFX90S-2424	36725-2424	20242404	1 1/2	38.1	2-12	2 3/8	60	ST	3.07	78.0	4.02	102.0	6.34	161.0	NS		UCF6-24		

C: Crimp Nut (see "Fitting Identification" in Appendix for details)

O-Ring Face Seal (SAE J1453) ORS/ORFS

Male

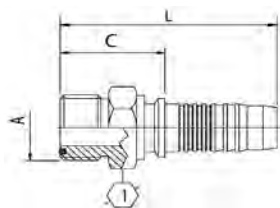

S=Skive
NS=Non-Skive
DG=Dual-Grip™

Descriptive #	Product #	SAP #	Hose Size ID		Thread Size (A)		Hex-1 Wrench Size		Cut-Off (C)		Length (L)		Skive Type	SR3	SR4 HR4	SR6 HR6	SR14A
			in.	mm	in.	mm	in.	mm	in.	mm	in.	mm					
UC-OFM-0404	36730-0404	20242567	1/4	6.4	9/16-18	11/16	17	0.88	22.3	1.85	47.1	NS	UCF6-04		UCF2-04	UCF9-04	
UC-OFM-0606	36730-0606	20242596	3/8	9.5	11/16-16	3/4	19	0.96	24.3	2.01	51.0	NS	UCF6-06		UCF2-06	UCF9-06	
UC-OFM-0608	36730-0608	20242575	3/8	9.5	13/16-16	7/8	22	1.04	26.3	2.09	53.0	NS	UCF6-06		UCF2-06	UCF9-06	
UC-OFM-0808	36730-0808	20242545	1/2	12.7	13/16-16	7/8	22	1.07	27.1	2.31	58.6	NS	UCF6-08		UCF2-08	UCF9-08	
UC-OFM-0810	36730-0810	20242369	1/2	12.7	1-14	1 1/16	27	1.20	30.6	2.44	62.1	NS	UCF6-08		UCF2-08	UCF9-08	
UC-OFM-0812	36730-0812	20242368	1/2	12.7	1 3/16-16	1 1/4	32	1.34	34.1	2.58	65.6	NS	UCF6-08		UCF2-08	UCF9-08	
UC-OFM-1212	36730-1212	20242535	3/4	19.0	1 3/16-12	1 1/4	32	1.36	34.6	2.92	74.1	NS	UCF6-12	UCF6-12	UCF2-12	UCF9-12	
UC-OFM-1216	36730-1216	20242443	3/4	19.0	1 7/16-12	1 5/8	41	1.50	38.1	3.06	77.6	NS	UCF6-12	UCF6-12	UCF2-12	UCF9-12	
UC-OFM-1616	36730-1616	20242459	1	25.4	1 7/16-12	1 1/2	38	1.49	37.9	3.25	82.5	NS	UCF6-16	UCF6-16		UCF9-16	
UC-OFM-2020	36730-2020	20242460	1 1/4	31.8	1 11/16-12	1 3/4	46	1.63	41.5	3.68	93.5	NS	UCF6-20	UCF6-20			

O-Ring Boss Straight Thread (SAE J514)

Male

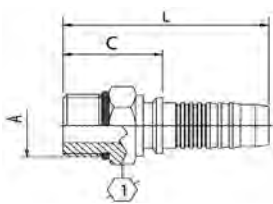

S=Skive
NS=Non-Skive
DG=Dual-Grip™

Descriptive #	Product #	SAP #	Hose Size ID		Thread Size (A)		Hex-1 Wrench Size		Cut-Off (C)		Length (L)		Skive Type	SR3	SR4 HR4	SR6 HR6	SR14A
			in.	mm	in.	mm	in.	mm	in.	mm	in.	mm					
UC-OBM-0404	36670-0404	20242597	1/4	6.4	7/16-20	9/16	14	0.80	20.3	1.78	45.1	NS	UCF6-04		UCF2-04	UCF9-04	
UC-OBM-0405	36670-0405	20242531	1/4	6.4	1/2-20	5/8	16	0.83	21.2	1.81	46.1	NS	UCF6-04		UCF2-04	UCF9-04	
UC-OBM-0406	36670-0406	20242591	1/4	6.4	9/16-18	11/16	17	0.88	22.3	1.85	47.1	NS	UCF6-04		UCF2-04	UCF9-04	
UC-OBM-0606	36670-0606	20242677	3/8	9.5	9/16-18	3/4	19	0.92	23.3	1.97	50.0	NS	UCF6-06		UCF2-06	UCF9-06	
UC-OBM-0608	36670-0608	20242672	3/8	9.5	3/4-16	7/8	22	0.96	24.3	2.01	51.0	NS	UCF6-06		UCF2-06	UCF9-06	
UC-OBM-0610	36670-0610	20242614	3/8	9.5	7/8-14	1 1/16	27	1.06	26.8	2.11	53.5	NS	UCF6-06		UCF2-06	UCF9-06	
UC-OBM-0808	36670-0808	20242665	1/2	12.7	3/4-16	7/8	22	0.99	25.1	2.23	56.6	NS	UCF6-08		UCF2-08	UCF9-08	
UC-OBM-0810	36670-0810	20242595	1/2	12.7	7/8-14	1 1/16	27	1.09	27.6	2.33	59.1	NS	UCF6-08		UCF2-08	UCF9-08	
UC-OBM-0812	36670-0812	20242476	1/2	12.7	1 1/16-12	1 1/4	32	1.26	32.1	2.50	63.6	NS	UCF6-08		UCF2-08	UCF9-08	
UC-OBM-1210	36670-1210	20242520	3/4	19.0	7/8-14	1 1/16	27	1.11	28.1	2.66	67.6	NS	UCF6-12	UCF6-12	UCF2-12	UCF9-12	
UC-OBM-1212	36670-1212	20242592	3/4	19.0	1 1/16-12	1 1/4	32	1.28	32.6	2.84	72.1	NS	UCF6-12	UCF6-12	UCF2-12	UCF9-12	
UC-OBM-1216	36670-1216	20242455	3/4	19.0	1 5/16-12	1 1/2	38	1.36	34.6	2.92	74.1	NS	UCF6-12	UCF6-12	UCF2-12	UCF9-12	
UC-OBM-1616	36670-1616	20242589	1	25.4	1 5/16-12	1 1/2	38	1.39	35.4	3.15	80.0	NS	UCF6-16	UCF6-16		UCF9-16	

O-Ring Boss Straight Thread (SAE J514)

Male | Swivel

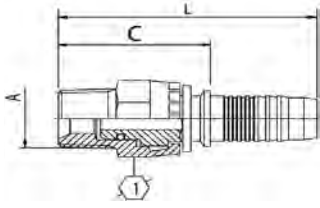

S=Skive
NS=Non-Skive
DG=Dual-Grip™

Descriptive #	Product #	SAP #	Hose Size ID		Thread Size (A)	Hex-1 Wrench Size	Cut-Off (C)		Length (L)		Skive Type	SR3	SR4 HR4	SR6 HR6	SR14A
			in.	mm			in.	mm	in.	mm					
UC-OBMX-0608	36680-0608	20318237	3/8	9.5	3/4-16	1	25	1.71	43.5	2.76	70.2	NS	UCF6-06	UCF2-06	UCF9-06
UC-OBMX-0808	36680-0808	20318238	1/2	12.7	3/4-16	1	25	1.67	42.3	2.91	73.8	NS	UCF6-08	UCF2-08	UCF9-08
UC-OBMX-0810	36680-0810	20318239	1/2	12.7	7/8-14	1	25	1.72	43.8	2.96	75.3	NS	UCF6-08	UCF2-08	UCF9-08

O-Ring Boss Straight Thread (SAE J514)

Male 90° Elbow (Block) | Swivel

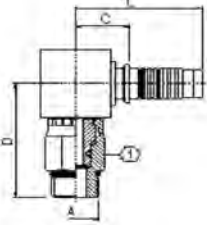

S=Skive
NS=Non-Skive
DG=Dual-Grip™

Descriptive #	Product #	SAP #	Hose Size ID		Thread Size (A)	Hex-1 Wrench Size	Drop (D)		Cut-Off (C)		Length (L)		Skive Type	SR3	SR4 HR4	SR6 HR6	SR14A
			in.	mm			in.	mm	in.	mm	in.	mm					
UC-OBMX90B-0405	36685-0405	20318354	1/4	6.4	1/2-20	11/16	17	1.38	35.0	0.67	17.0	1.65	41.8	NS	UCF6-04	UCF2-04	UCF9-04
UC-OBMX90B-0606	36685-0606	20318355	3/8	9.5	9/16-18	7/8	22	1.73	44.0	0.79	20.0	1.84	46.7	NS	UCF6-06	UCF2-06	UCF9-06
UC-OBMX90B-0608	36685-0608	20318356	3/8	9.5	3/4-16	1	25	1.77	45.0	0.87	22.0	1.92	48.7	NS	UCF6-06	UCF2-06	UCF9-06
UC-OBMX90B-0808	36685-0808	20318357	1/2	12.7	3/4-16	1	25	1.89	48.0	0.91	23.0	2.15	54.5	NS	UCF6-08	UCF2-08	UCF9-08
UC-OBMX90B-0810	36685-0810	20318358	1/2	12.7	7/8-14	1	25	1.97	50.0	0.91	23.0	2.15	54.5	NS	UCF6-08	UCF2-08	UCF9-08

Code 61 Flange (SAE J518)

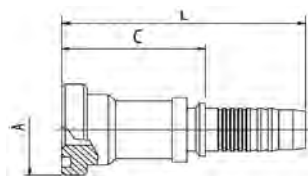

S=Skive
NS=Non-Skive
DG=Dual-Grip™

Descriptive #	Product #	SAP #	Hose Size ID		Flange Size	Flange Diameter (A)		Cut-Off (C)		Length (L)		Skive Type	SR3	SR4 HR4	SR6 HR6	SR14A
			in.	mm		in.	mm	in.	mm	in.	mm					
UC-FL-0808	36320-0808	20242569	1/2	12.7	1/2	1.19	30.2	1.61	41.0	2.85	72.5	NS	UCF6-08		UCF2-08	UCF9-08
UC-FL-0812	36320-0812	20242300	1/2	12.7	3/4	1.50	38.1	1.65	42.0	2.89	73.5	NS	UCF6-08		UCF2-08	UCF9-08
UC-FL-1212	36320-1212	20242707	3/4	19.0	3/4	1.50	38.1	1.67	42.5	3.23	82.0	NS	UCF6-12	UCF6-12	UCF2-12	UCF9-12
UC-FL-1216	36320-1216	20242650	3/4	19.0	1	1.75	44.5	1.99	50.5	3.54	90.0	NS	UCF6-12	UCF6-12	UCF2-12	UCF9-12
UC-FL-1616	36320-1616	20242744	1	25.4	1	1.75	44.5	2.02	51.4	3.78	96.0	NS	UCF6-16	UCF6-16		UCF9-16
UC-FL-1620	36320-1620	20242697	1	25.4	1 1/4	2.00	50.8	2.12	53.9	3.88	98.5	NS	UCF6-16	UCF6-16		UCF9-16
UC-FL-2020	36320-2020	20242750	1 1/4	31.8	1 1/4	2.00	50.8	2.19	55.5	4.23	107.5	NS	UCF6-20	UCF6-20		
UC-FL-2024	36320-2024	20242695	1 1/4	31.8	1 1/2	2.37	60.3	2.30	58.5	4.35	110.5	NS	UCF6-20	UCF6-20		
UC-FL-2424	36320-2424	20242726	1 1/2	38.1	1 1/2	2.37	60.3	2.30	58.5	4.63	117.5	NS		UCF6-24		
UC-FL-2432	36320-2432	20242605	1 1/2	38.1	2	2.81	71.4	2.76	70.0	5.08	129.0	NS		UCF6-24		
UC-FL-3232	36320-3232	20242693	2	50.8	2	2.81	71.4	2.76	70.0	5.59	142.0	NS		UCF6-32		
UC-FL-4040	36320-4040	20242599	2 1/2	63.5	2 1/2	3.31	84.1	2.24	57.0	5.49	139.5	NS		UCF6-40		

Code 61 Flange (SAE J518)

22.5° Elbow

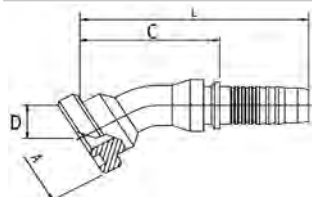

S=Skive
NS=Non-Skive
DG=Dual-Grip™

Descriptive #	Product #	SAP #	Hose Size ID		Flange Size	Flange Diameter (A)		Drop (D)	Cut-Off (C)		Length (L)		Skive Type	SR3	SR4 HR4	SR6 HR6	SR14A
			in.	mm		in.	mm		in.	mm	in.	mm					
UC-FL22-1616	36330-1616	20242623	1	25.4	1	1.75	44.5	0.47	12.0	3.66	93.0	5.39	137.0	NS	UCF6-16	UCF6-16	UCF9-16
UC-FL22-2020	36330-2020	20242568	1 1/4	31.8	1 1/4	2.00	50.8	0.63	16.0	4.49	114.0	6.54	166.0	NS	UCF6-20	UCF6-20	
UC-FL22-2424	36330-2424	20242465	1 1/2	38.1	1 1/2	2.37	60.3	0.65	16.5	5.16	131.0	7.48	190.0	NS		UCF6-24	

Code 61 Flange (SAE J518)

30° Elbow

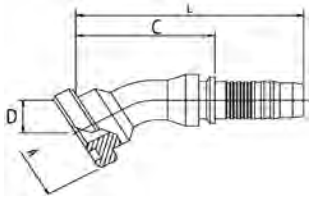

S=Skive
NS=Non-Skive
DG=Dual-Grip™

Descriptive #	Product #	SAP #	Hose Size ID		Flange Size		Flange Diameter (A)		Drop (D)		Cut-Off (C)		Length (L)		Skive Type	SR3	SR4 HR4	SR6 HR6	SR14A
			in.	mm	in.	mm	in.	mm	in.	mm	in.	mm	in.	mm					
UC-FL30-1212	36335-1212	20242577	3/4	19.0	3/4	1.50	38.1	0.75	19.0	3.19	81.0	4.72	120.0	NS	UCF6-12	UCF6-12	UCF2-12	UCF9-12	
UC-FL30-1216	36335-1216	20242379	3/4	19.0	1	1.75	44.5	0.75	19.0	3.31	84.0	4.84	123.0	NS	UCF6-12	UCF6-12	UCF2-12	UCF9-12	
UC-FL30-1616	36335-1616	20242497	1	25.4	1	1.75	44.5	0.83	21.0	3.54	90.0	5.28	134.0	NS	UCF6-16	UCF6-16		UCF9-16	
UC-FL30-1620	36335-1620	20242498	1	25.4	1/4	2.00	50.8	0.87	22.0	3.54	90.0	5.31	135.0	NS	UCF6-16	UCF6-16		UCF9-16	
UC-FL30-2020	36335-2020	20242616	1/4	31.8	1/4	2.00	50.8	0.98	25.0	4.02	102.0	6.06	154.0	NS	UCF6-20	UCF6-20			
UC-FL30-2024	36335-2024	20242378	1/4	31.8	1/2	2.37	60.3	1.06	27.0	4.41	112.0	6.46	164.0	NS	UCF6-20	UCF6-20			
UC-FL30-2424	36335-2424	20242582	1/2	38.1	1/2	2.37	60.3	0.91	23.0	5.35	136.0	7.68	195.0	NS		UCF6-24			

Code 61 Flange (SAE J518)

45° Elbow

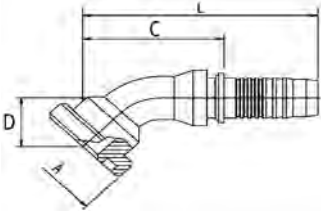

S=Skive
NS=Non-Skive
DG=Dual-Grip™

Descriptive #	Product #	SAP #	Hose Size ID		Flange Size		Flange Diameter (A)		Drop (D)		Cut-Off (C)		Length (L)		Skive Type	SR3	SR4 HR4	SR6 HR6	SR14A
			in.	mm	in.	mm	in.	mm	in.	mm	in.	mm	in.	mm					
UC-FL45-0808	36340-0808	20242508	1/2	12.7	1/2	1.19	30.2	0.87	22.0	2.09	53.0	3.31	84.0	NS	UCF6-08		UCF2-08	UCF9-08	
UC-FL45-0812	36340-0812	20242293	1/2	12.7	3/4	1.50	38.1	1.02	26.0	2.36	60.0	3.62	92.0	NS	UCF6-08		UCF2-08	UCF9-08	
UC-FL45-1212	36340-1212	20242678	3/4	19.0	3/4	1.50	38.1	1.26	32.0	2.91	74.0	4.45	113.0	NS	UCF6-12	UCF6-12	UCF2-12	UCF9-12	
UC-FL45-1216	36340-1216	20242617	3/4	19.0	1	1.75	44.5	1.14	29.0	3.07	78.0	4.61	117.0	NS	UCF6-12	UCF6-12	UCF2-12	UCF9-12	
UC-FL45-1616	36340-1616	20242700	1	25.4	1	1.75	44.5	1.32	33.5	3.27	83.0	5.00	127.0	NS	UCF6-16	UCF6-16		UCF9-16	
UC-FL45-1620	36340-1620	20242653	1	25.4	1/4	2.00	50.8	1.42	36.0	3.23	82.0	5.00	127.0	NS	UCF6-16	UCF6-16		UCF9-16	
UC-FL45-2020	36340-2020	20242705	1/4	31.8	1/4	2.00	50.8	1.48	37.5	3.74	95.0	5.79	147.0	NS	UCF6-20	UCF6-20			
UC-FL45-2024	36340-2024	20242648	1/4	31.8	1/2	2.37	60.3	1.57	40.0	4.09	104.0	6.14	156.0	NS	UCF6-20	UCF6-20			
UC-FL45-2424	36340-2424	20242686	1/2	38.1	1/2	2.37	60.3	1.89	48.0	4.61	117.0	6.93	176.0	NS		UCF6-24			
UC-FL45-3232	36340-3232	20242640	2	50.8	2	2.81	71.4	1.87	47.5	5.55	141.0	8.39	213.0	NS		UCF6-32			
UC-FL45-4040	36340-4040	20242509	2 1/2	63.5	2 1/2	3.31	84.1	2.09	53.0	5.47	139.0	8.74	222.0	NS		UCF6-40			

Code 61 Flange (SAE J518)

60° Elbow

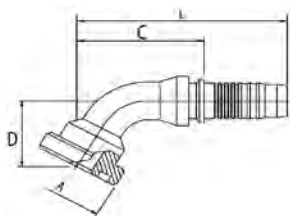

S=Skive
NS=Non-Skive
DG=Dual-Grip™

Descriptive #	Product #	SAP #	Hose Size ID		Flange Size		Flange Diameter (A)		Drop (D)		Cut-Off (C)		Length (L)		Skive Type	SR3	SR4 HR4	SR6 HR6	SR14A
			in.	mm	in.	mm	in.	mm	in.	mm	in.	mm	in.	mm					
UC-FL60-1212	36345-1212	20242516	3/4	19.0	3/4	1.50	38.1	1.46	37.0	3.39	86.0	4.92	125.0	NS	UCF6-12	UCF6-12	UCF2-12	UCF9-12	
UC-FL60-1216	36345-1216	20242499	3/4	19.0	1	1.75	44.5	1.73	44.0	4.02	102.0	5.57	141.5	NS	UCF6-12	UCF6-12	UCF2-12	UCF9-12	
UC-FL60-1616	36345-1616	20242510	1	25.4	1	1.75	44.5	1.85	47.0	3.98	101.0	5.73	145.6	NS	UCF6-16	UCF6-16		UCF9-16	
UC-FL60-1620	36345-1620	20242560	1	25.4	1 1/4	2.00	50.8	1.71	43.5	4.20	106.6	5.95	151.2	NS	UCF6-16	UCF6-16		UCF9-16	
UC-FL60-2020	36345-2020	20242523	1 1/4	31.8	1 1/4	2.00	50.8	2.22	56.5	5.10	129.5	7.15	181.5	NS	UCF6-20	UCF6-20			
UC-FL60-2424	36345-2424	20242380	1 1/2	38.1	1 1/2	2.37	60.3	2.24	57.0	5.98	152.0	8.31	211.0	NS		UCF6-24			

Code 61 Flange (SAE J518)

90° Elbow

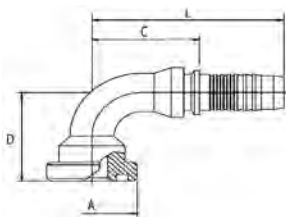

S=Skive
NS=Non-Skive
DG=Dual-Grip™

Descriptive #	Product #	SAP #	Hose Size ID		Flange Size		Flange Diameter (A)		Drop (D)		Cut-Off (C)		Length (L)		Skive Type	SR3	SR4 HR4	SR6 HR6	SR14A
			in.	mm	in.	mm	in.	mm	in.	mm	in.	mm	in.	mm					
UC-FL90-0808	36350-0808	20242537	1/2	12.7	1/2	1.19	30.2	1.65	42.0	1.81	46.0	3.03	77.0	NS	UCF6-08		UCF2-08	UCF9-08	
UC-FL90-0812	36350-0812	20242381	1/2	12.7	3/4	1.50	38.1	2.01	51.0	1.77	45.0	3.03	77.0	NS	UCF6-08		UCF2-08	UCF9-08	
UC-FL90-1212	36350-1212	20242696	3/4	19.0	3/4	1.50	38.1	2.36	60.0	2.28	58.0	3.82	97.0	NS	UCF6-12	UCF6-12	UCF2-12	UCF9-12	
UC-FL90-1216	36350-1216	20242667	3/4	19.0	1	1.75	44.5	2.54	64.5	2.60	66.0	4.17	106.0	NS	UCF6-12	UCF6-12	UCF2-12	UCF9-12	
UC-FL90-1616	36350-1616	20242740	1	25.4	1	1.75	44.5	2.64	67.0	2.80	71.0	4.53	115.0	NS	UCF6-16	UCF6-16		UCF9-16	
UC-FL90-1620	36350-1620	20242701	1	25.4	1 1/4	2.00	50.8	2.80	71.0	2.91	74.0	4.65	118.0	NS	UCF6-16	UCF6-16		UCF9-16	
UC-FL90-2016	36350-2016	20242583	1 1/4	31.8	1	1.75	44.5	2.56	65.0	3.70	94.0	5.75	146.0	NS	UCF6-20	UCF6-20			
UC-FL90-2020	36350-2020	20242735	1 1/4	31.8	1 1/4	2.00	50.8	3.31	84.0	3.46	88.0	5.51	140.0	NS	UCF6-20	UCF6-20			
UC-FL90-2024	36350-2024	20242713	1 1/4	31.8	1 1/2	2.37	60.3	3.44	87.5	3.58	91.0	5.63	143.0	NS	UCF6-20	UCF6-20			
UC-FL90-2424	36350-2424	20242714	1 1/2	38.1	1 1/2	2.37	60.3	3.58	91.0	4.13	105.0	6.46	164.0	NS		UCF6-24			
UC-FL90-2432	36350-2432	20242724	1 1/2	38.1	2	2.81	71.4	4.53	115.0	4.13	105.0	6.46	164.0	NS		UCF6-24			
UC-FL90-3224	36350-3224	20588738	2	50.8	1 1/2	2.37	60.3	5.24	133.0	5.24	133.0	8.07	205.0	NS		UCF6-32			
UC-FL90-3232	36350-3232	20242737	2	50.8	2	2.81	71.4	5.12	130.0	5.08	129.0	7.91	201.0	NS		UCF6-32			
UC-FL90-4040	36350-4040	20245157	2 1/2	63.5	2 1/2	3.31	84.1	4.92	125.0	5.39	137.0	8.64	219.5	NS		UCF6-40			

Code 62 Flange (SAE J518)

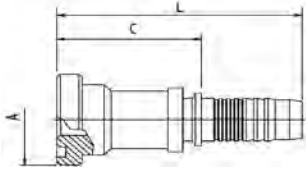

S=Skive
NS=Non-Skive
DG=Dual-Grip™

Descriptive #	Product #	SAP #	Hose Size ID		Flange Diameter (A)		Cut-Off (C)		Length (L)		Skive Type	SR3	SR4 HR4	SR6 HR6	SR14A	
			in.	mm	in.	mm	in.	mm	in.	mm						
UC-FH-1212	36300-1212	20242607	3/4	19.0	3/4	1.63	41.3	2.07	52.5	3.62	92.0	NS	UCF6-12	UCF6-12	UCF2-12	UCF9-12
UC-FH-1216	36300-1216	20242467	3/4	19.0	1	1.87	47.6	2.19	55.5	3.74	95.0	NS	UCF6-12	UCF6-12	UCF2-12	UCF9-12
UC-FH-1616	36300-1616	20242647	1	25.4	1	1.87	47.6	2.22	56.4	3.98	101.0	NS	UCF6-16	UCF6-16		UCF9-16
UC-FH-1620	36300-1620	20242572	1	25.4	1/4	2.13	54.0	2.50	63.4	4.25	108.0	NS	UCF6-16	UCF6-16		UCF9-16
UC-FH-2020	36300-2020	20242659	1/4	31.8	1/4	2.13	54.0	3.27	83.0	5.31	135.0	NS	UCF6-20	UCF6-20		
UC-FH-2024	36300-2024	20242419	1/4	31.8	1/2	2.50	63.5	2.80	71.0	4.84	123.0	NS	UCF6-20	UCF6-20		
UC-FH-2424	36300-2424	20242601	1/2	38.1	1/2	2.50	63.5	3.74	95.0	6.06	154.0	NS		UCF6-24		
UC-FH-3232	36300-3232	20242512	2	50.8	2	3.13	79.4	2.99	76.0	5.83	148.0	NS		UCF6-32		

Code 62 Flange (SAE J518)

45° Elbow

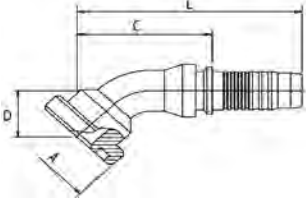

S=Skive
NS=Non-Skive
DG=Dual-Grip™

Descriptive #	Product #	SAP #	Hose Size ID		Flange Diameter (A)		Drop (D)		Cut-Off (C)		Length (L)		Skive Type	SR3	SR4 HR4	SR6 HR6	SR14A	
			in.	mm	in.	mm	in.	mm	in.	mm	in.	mm						
UC-FH45-1212	36310-1212	20242570	3/4	19.0	3/4	1.63	41.3	1.22	31.0	3.31	84.0	4.88	124.0	NS	UCF6-12	UCF6-12	UCF2-12	UCF9-12
UC-FH45-1616	36310-1616	20242618	1	25.4	1	1.87	47.6	1.42	36.0	3.82	97.0	5.55	141.0	NS	UCF6-16	UCF6-16		UCF9-16
UC-FH45-1620	36310-1620	20242527	1	25.4	1/4	2.13	54.0	1.54	39.0	3.78	96.0	5.55	141.0	NS	UCF6-16	UCF6-16		UCF9-16
UC-FH45-2020	36310-2020	20242600	1/4	31.8	1/4	2.13	54.0	1.57	40.0	4.29	109.0	6.34	161.0	NS	UCF6-20	UCF6-20		
UC-FH45-2424	36310-2424	20242517	1/2	38.1	1/2	2.50	63.5	1.77	45.0	4.84	123.0	7.17	182.0	NS		UCF6-24		
UC-FH45-3232	36310-3232	20242383	2	50.8	2	3.13	79.4	2.36	60.0	6.18	157.0	9.02	229.0	NS		UCF6-32		

Code 62 Flange (SAE J518)

90° Elbow

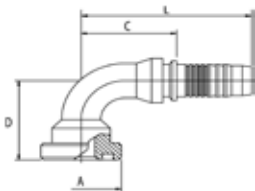

S=Skive
NS=Non-Skive
DG=Dual-Grip™

Descriptive #	Product #	SAP #	Hose Size ID		Flange Size		Flange Diameter (A)		Drop (D)		Cut-Off (C)		Length (L)		Skive Type	SR3	SR4 HR4	SR6 HR6	SR14A
			in.	mm	in.	mm	in.	mm	in.	mm	in.	mm	in.	mm					
UC-FH90-0808	36315-0808	20242306	1/2	12.7	1/2	1.25	31.8	1.81	46.0	1.89	48.0	3.11	79.0	NS	UCF6-08		UCF2-08	UCF9-08	
UC-FH90-1212	36315-1212	20242621	3/4	19.0	3/4	1.63	41.3	2.40	61.0	2.48	63.0	4.06	103.0	NS	UCF6-12	UCF6-12	UCF2-12	UCF9-12	
UC-FH90-1216	36315-1216	20242511	3/4	19.0	1	1.87	47.6	2.60	66.0	2.48	63.0	4.06	103.0	NS	UCF6-12	UCF6-12	UCF2-12	UCF9-12	
UC-FH90-1616	36315-1616	20242673	1	25.4	1	1.87	47.6	2.95	75.0	2.91	74.0	4.65	118.0	NS	UCF6-16	UCF6-16		UCF9-16	
UC-FH90-1620	36315-1620	20242585	1	25.4	1 1/4	2.13	54.0	3.07	78.0	3.07	78.0	4.80	122.0	NS	UCF6-16	UCF6-16		UCF9-16	
UC-FH90-2020	36315-2020	20242635	1 1/4	31.8	1 1/4	2.13	54.0	3.50	89.0	3.70	94.0	5.75	146.0	NS	UCF6-20	UCF6-20			
UC-FH90-2024	36315-2024	20242418	1 1/4	31.8	1 1/2	2.50	63.5	3.70	94.0	3.86	98.0	5.91	150.0	NS	UCF6-20	UCF6-20			
UC-FH90-2424	36315-2424	20242578	1 1/2	38.1	1 1/2	2.50	63.5	4.13	105.0	3.94	100.0	6.26	159.0	NS		UCF6-24			
UC-FH90-3232	36315-3232	20242487	2	50.8	2	3.13	79.4	5.20	132.0	5.63	143.0	8.46	215.0	NS		UCF6-32			

BSPB (British Standard Pipe Parallel)

Female | Swivel

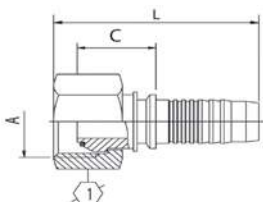

S=Skive
NS=Non-Skive
DG=Dual-Grip™

Descriptive #	Product #	SAP #	Hose Size ID		Thread Size (A)	Hex-1 Wrench Size	Cut-Off (C)		Length (L)		Skive Type	SR3	SR4 HR4	SR6 HR6	SR14A
			in.	mm	mm	in.	mm	in.	mm						
UC-BPFX-0404	36105-0404	20242738	1/4	6.4	1/4-19	19	0.82	20.8	1.94	49.2		UCF6-04		UCF2-04	UCF9-04
UC-BPFX-0406	36105-0406	20242462	1/4	6.4	3/8-19	22	0.92	23.3	2.11	53.6		UCF6-04		UCF2-04	UCF9-04
UC-BPFX-0606	36105-0606	20242731	3/8	9.5	3/8-19	22	0.92	23.3	2.19	55.5		UCF6-06		UCF2-06	UCF9-06
UC-BPFX-0608	36105-0608	20242557	3/8	9.5	1/2-14	27	0.96	24.3	2.24	56.9		UCF6-06		UCF2-06	UCF9-06
UC-BPFX-0808	36105-0808	20242715	1/2	12.7	1/2-14	27	0.99	25.1	2.46	62.5		UCF6-08		UCF2-08	UCF9-08
UC-BPFX-0810	36105-0810	20242406	1/2	12.7	5/8-14	27	1.12	28.4	2.74	69.6		UCF6-08		UCF2-08	UCF9-08
UC-BPFX-1212 ^c	36105-1212	20242626	3/4	19.0	3/4-14	32	0.81	20.6	2.72	69.1		UCF6-12	UCF6-12	UCF2-12	UCF9-12
UC-BPFX-1616 ^c	36105-1616	20242627	1	25.4	1-11	38	0.94	23.9	3.11	79.0		UCF6-16	UCF6-16		UCF9-16
UC-BPFX-2020 ^f	36105-2020	20242483	1 1/4	31.8	1 1/4-11	50	1.26	32.0	3.70	94.0		UCF6-20	UCF6-20		
UC-BPFX-2424 ^f	36105-2424	20242806	1 1/2	38.1	1 1/2-11	55	1.33	33.8	4.13	105.0			UCF6-24		
UC-BPFX-3232	36105-3232	20310550	2	50.8	2-11	70	1.34	34.0	4.80	122.0			UCF6-32		

C: Crimp Nut; T: Thrust-Wire Nut (see "Fitting Identification" in Appendix for details)

BSPB (British Standard Pipe Parallel)

Female 45° Elbow | Swivel

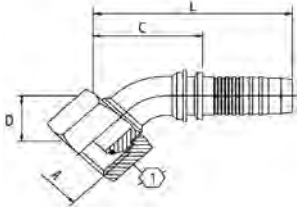

S=Skive
NS=Non-Skive
DG=Dual-Grip™

Descriptive #	Product #	SAP #	Hose Size ID		Thread Size (A)	Hex-1 Wrench Size	Drop (D)		Cut-Off (C)		Length (L)		Skive Type	SR3	SR4 HR4	SR6 HR6	SR14A
			in.	mm			mm	in.	mm	in.	mm	in.					
UC-BPFX45-0404	36115-0404	20242444	1/4	6.4	1/4-19	19	0.59	15.0	1.81	46.0	2.76	70.0	NS	UCF6-04		UCF2-04	UCF9-04
UC-BPFX45-0606	36115-0606	20242496	3/8	9.5	3/8-19	22	0.81	20.5	1.97	50.0	3.03	77.0	NS	UCF6-06		UCF2-06	UCF9-06
UC-BPFX45-0808	36115-0808	20242803	1/2	12.7	1/2-14	27	0.83	21.0	2.17	55.0	3.43	87.0	NS	UCF6-08		UCF2-08	UCF9-08
UC-BPFX45-1212 ^C	36115-1212	20242445	3/4	19.0	3/4-14	32	1.10	28.0	2.76	70.0	4.33	110.0	NS	UCF6-12	UCF6-12	UCF2-12	UCF9-12
UC-BPFX45-1616 ^C	36115-1616	20242801	1	25.4	1-11	38	1.34	34.0	3.31	84.0	5.04	128.0	NS	UCF6-16	UCF6-16		UCF9-16

C: Crimp Nut (see "Fitting Identification" in Appendix for details)

BSPB (British Standard Pipe Parallel)

Female 90° Elbow | Swivel

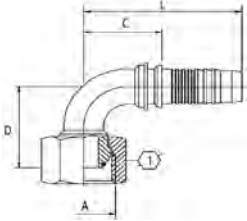

S=Skive
NS=Non-Skive
DG=Dual-Grip™

Descriptive #	Product #	SAP #	Hose Size ID		Thread Size (A)	Hex-1 Wrench Size	Drop (D)		Cut-Off (C)		Length (L)		Skive Type	SR3	SR4 HR4	SR6 HR6	SR14A
			in.	mm			mm	in.	mm	in.	mm	in.					
UC-BPFX90-0404	36120-0404	20242536	1/4	6.4	1/4-19	19	1.14	29.0	1.14	29.0	2.13	54.0	NS	UCF6-04		UCF2-04	UCF9-04
UC-BPFX90-0606	36120-0606	20242610	3/8	9.5	3/8-19	22	1.65	42.0	1.38	35.0	2.44	62.0	NS	UCF6-06		UCF2-06	UCF9-06
UC-BPFX90-0608	36120-0608	20242805	3/8	9.5	1/2-14	27	1.40	35.5	1.34	34.0	2.40	61.0	NS	UCF6-06		UCF2-06	UCF9-06
UC-BPFX90-0808	36120-0808	20242556	1/2	12.7	1/2-14	27	1.61	41.0	1.42	36.0	2.64	67.0	NS	UCF6-08		UCF2-08	UCF9-08
UC-BPFX90-1212 ^C	36120-1212	20242546	3/4	19.0	3/4-14	32	2.09	53.0	1.93	49.0	3.50	89.0	NS	UCF6-12	UCF6-12	UCF2-12	UCF9-12
UC-BPFX90-1616 ^C	36120-1616	20242515	1	25.4	1-11	38	2.72	69.0	2.95	75.0	4.72	120.0	NS	UCF6-16	UCF6-16		UCF9-16
UC-BPFX90-2020 ^T	36120-2020	20242374	1 1/4	31.8	1 1/4-11	50	3.27	83.0	3.23	82.0	5.28	134.0	NS	UCF6-20	UCF6-20		

C: Crimp Nut (see "Fitting Identification" in Appendix for details)

BSPP (British Standard Pipe Parallel)

Male

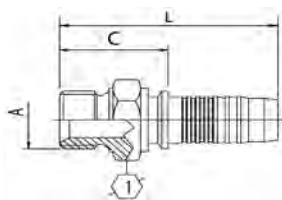

S=Skive
NS=Non-Skive
DG=Dual-Grip™

Descriptive #	Product #	SAP #	Hose Size ID		Thread Size (A)	Hex-1 Wrench Size	Cut-Off (C)		Length (L)		Skive Type	SR3	SR4 HR4	SR6 HR6	SR14A
			in.	mm			mm	in.	mm	in.					
UC-BPM-0404	36130-0404	20242484	1/4	6.4	1/4-19	19	1.04	26.3	2.01	51.1	NS	UCF6-04		UCF2-04	UCF9-04
UC-BPM-0606	36130-0606	20242581	3/8	9.5	3/8-19	22	1.09	27.8	2.15	54.5	NS	UCF6-06		UCF2-06	UCF9-06
UC-BPM-0608	36130-0608	20242464	3/8	9.5	1/2-14	27	1.23	31.3	2.28	58.0	NS	UCF6-06		UCF2-06	UCF9-06
UC-BPM-0806	36130-0806	20242809	1/2	12.7	3/8-19	22	1.13	28.6	2.37	60.1	NS	UCF6-08		UCF2-08	UCF9-08
UC-BPM-0808	36130-0808	20242463	1/2	12.7	1/2-14	27	1.26	32.1	2.50	63.6	NS	UCF6-08		UCF2-08	UCF9-08
UC-BPM-1212	36130-1212	20242407	3/4	19.0	3/4-14	32	1.44	36.6	3.00	76.1	NS	UCF6-12	UCF6-12	UCF2-12	UCF9-12
UC-BPM-1616	36130-1616	20242807	1	25.4	1-11	41	1.67	42.4	3.43	87.0	NS	UCF6-16	UCF6-16		UCF9-16
UC-BPM-2020	36130-2020	20242808	1 1/4	31.8	1 1/4-11	50	1.89	48.0	3.94	100.0	NS	UCF6-20	UCF6-20		

C: Crimp Nut (see "Fitting Identification" in Appendix for details)

BSPT (British Standard Pipe Tapered)

Male

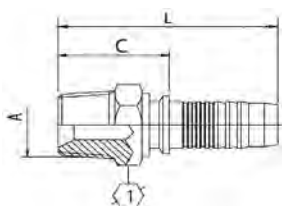

S=Skive
NS=Non-Skive
DG=Dual-Grip™

Descriptive #	Product #	SAP #	Hose Size ID		Thread Size (A)	Hex-1 Wrench Size	Cut-Off (C)		Length (L)		Skive Type	SR3	SR4 HR4	SR6 HR6	SR14A
			in.	mm			mm	in.	mm	in.					
UC-BTM-0404	36170-0404	20242611	1/4	6.4	1/4-19	17	1.06	26.8	2.03	51.6	NS	UCF6-04		UCF2-04	UCF9-04
UC-BTM-0606	36170-0606	20242612	3/8	9.5	3/8-19	19	1.09	27.8	2.15	54.5	NS	UCF6-06		UCF2-06	UCF9-06
UC-BTM-0808	36170-0808	20242507	1/2	12.7	1/2-14	22	1.30	33.1	2.54	64.6	NS	UCF6-08		UCF2-08	UCF9-08
UC-BTM-1212	36170-1212	20242409	3/4	19.0	3/4-14	27	1.36	34.6	2.92	74.1	NS	UCF6-12	UCF6-12	UCF2-12	UCF9-12
UC-BTM-1616	36170-1616	20242408	1	25.4	1-11	36	1.75	44.4	3.50	89.0	NS	UCF6-16	UCF6-16		UCF9-16

BSP Flat Seat (British Standard Pipe)

Female | Swivel

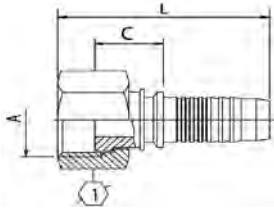

S=Skive
NS=Non-Skive
DG=Dual-Grip™

Descriptive #	Product #	SAP #	Hose Size ID		Thread Size (A)	Hex-1 Wrench Size	Cut-Off (C)		Length (L)		Skive Type	SR3	SR4 HR4	SR6 HR6	SR14A
			in.	mm			mm	in.	mm	in.					
UC-BFFX-0606	36100-0606	20242800	3/8	9.5	3/8-19	22	0.80	20.3	2.22	56.3	NS	UCF6-06		UCF2-06	UCF9-06
UC-BFFX-0608	36100-0608	20242799	3/8	9.5	1/2-14	27	0.82	20.8	2.28	57.9	NS	UCF6-06		UCF2-06	UCF9-06
UC-BFFX-0808	36100-0808	20242798	1/2	12.7	1/2-14	27	0.85	21.6	2.50	63.5	NS	UCF6-08		UCF2-08	UCF9-08
UC-BFFX-0812	36100-0812	20242285	1/2	12.7	3/4-14	32	0.97	24.6	2.70	68.6	NS	UCF6-08		UCF2-08	UCF9-08

DIN 24° Light

Female | Swivel

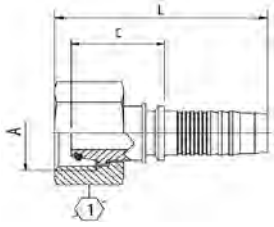

S=Skive
NS=Non-Skive
DG=Dual-Grip™

Descriptive #	Product #	SAP #	Hose Size ID		Thread Size (A)	Hex-1 Wrench Size	Cut-Off (C)		Length (L)		Skive Type	SR3	SR4 HR4	SR6 HR6	SR14A
			in.	mm			mm	in.	mm	in.					
UC-DLFX-0412 ^T	36240-0412	20242540	1/4	6.4	12 x 1.5	14	0.98	24.8	1.99	50.6	NS	UCF6-04		UCF2-04	UCF9-04
UC-DLFX-0414	36240-0414	20242594	1/4	6.4	14 x 1.5	17	0.96	24.4	1.98	50.2	NS	UCF6-04		UCF2-04	UCF9-04
UC-DLFX-0416	36240-0416	20242471	1/4	6.4	16 x 1.5	19	1.00	25.4	2.04	51.9	NS	UCF6-04		UCF2-04	UCF9-04
UC-DLFX-0616	36240-0616	20242658	3/8	9.5	16 x 1.5	19	1.00	25.4	2.22	56.4	NS	UCF6-06		UCF2-06	UCF9-06
UC-DLFX-0618	36240-0618	20242641	3/8	9.5	18 x 1.5	22	1.00	25.4	2.10	53.3	NS	UCF6-06		UCF2-06	UCF9-06
UC-DLFX-0822	36240-0822	20242586	1/2	12.7	22 x 1.5	27	1.11	28.2	2.43	61.8	NS	UCF6-08		UCF2-08	UCF9-08
UC-DLFX-1230	36240-1230	20242501	3/4	19.0	30 x 2.0	36	1.25	31.7	2.93	74.5	NS	UCF6-12	UCF6-12	UCF2-12	UCF9-12
UC-DLFX-1636	36240-1636	20242453	1	25.4	36 x 2.0	41	1.32	33.6	3.25	82.5	NS	UCF6-16	UCF6-16		UCF9-16
UC-DLFX-2045	36240-2045	20242539	1 1/4	31.8	45 x 2.0	50	1.58	40.1	3.78	95.9	NS	UCF6-20	UCF6-20		

T: Thrust-Wire Nut (see "Fitting Identification" in Appendix for details)

DIN 24° Light

Female 45° Elbow | Swivel

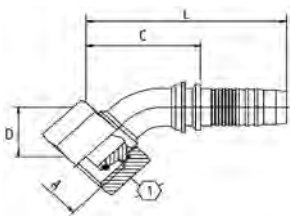

S=Skive
NS=Non-Skive
DG=Dual-Grip™

Descriptive #	Product #	SAP #	Hose Size ID		Thread Size (A)	Hex-1 Wrench Size	Drop (D)		Cut-Off (C)		Length (L)		Skive Type	SR3	SR4 HR4	SR6 HR6	SR14A
			in.	mm			mm	in.	mm	in.	mm	in.					
UC-DLFX45-0414 ^T	36245-0414	20242385	1/4	6.4	14 x 1.5	17	0.69	1.75	1.69	43.0	2.68	68.0	NS	UCF6-04		UCF2-04	UCF9-04
UC-DLFX45-0416	36245-0416	20242386	1/4	6.4	16 x 1.5	19	0.79	2.00	1.65	42.0	2.64	67.0	NS	UCF6-04		UCF2-04	UCF9-04
UC-DLFX45-0618	36245-0618	20242387	3/8	9.5	18 x 1.5	22	0.77	1.95	1.85	47.0	2.91	74.0	NS	UCF6-06		UCF2-06	UCF9-06
UC-DLFX45-0822	36245-0822	20242329	1/2	12.7	22 x 1.5	27	0.83	2.10	2.17	55.0	3.43	87.0	NS	UCF6-08		UCF2-08	UCF9-08
UC-DLFX45-1230	36245-1230	20242330	3/4	19.0	30 x 2.0	36	1.26	3.20	2.72	69.0	4.42	112.3	NS	UCF6-12	UCF6-12	UCF2-12	UCF9-12
UC-DLFX45-1636	36245-1636	20242328	1	25.4	36 x 2.0	41	1.26	3.20	3.58	91.0	5.35	136.0	NS	UCF6-16	UCF6-16		UCF9-16

T: Thrust-Wire Nut (see "Fitting Identification" in Appendix for details)

DIN 24° Light

Female 90° Elbow | Swivel

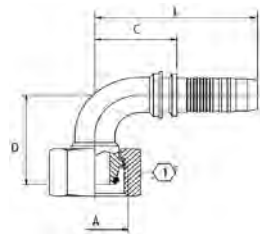

S=Skive
NS=Non-Skive
DG=Dual-Grip™

Descriptive #	Product #	SAP #	Hose Size ID		Thread Size (A)	Hex-1 Wrench Size	Drop (D)		Cut-Off (C)		Length (L)		Skive Type	SR3	SR4 HR4	SR6 HR6	SR14A
			in.	mm			mm	in.	mm	in.	mm	in.					
UC-DLFX90-0412	36250-0412	20242390	1/4	6.4	12 x 1.5	14	1.02	2.60	1.14	29.0	2.13	54.0	NS	UCF6-04		UCF2-04	UCF9-04
UC-DLFX90-0414	36250-0414	20242425	1/4	6.4	14 x 1.5	17	1.28	3.25	1.10	28.0	2.09	53.0	NS	UCF6-04		UCF2-04	UCF9-04
UC-DLFX90-0416	36250-0416	20242391	1/4	6.4	16 x 1.5	19	1.28	3.25	1.10	28.0	2.09	53.0	NS	UCF6-04		UCF2-04	UCF9-04
UC-DLFX90-0618	36250-0618	20242488	3/8	9.5	18 x 1.5	22	1.54	3.90	1.30	33.0	2.36	60.0	NS	UCF6-06		UCF2-06	UCF9-06
UC-DLFX90-0822	36250-0822	20242389	1/2	12.7	22 x 1.5	27	1.59	4.05	1.57	40.0	2.80	71.0	NS	UCF6-08		UCF2-08	UCF9-08
UC-DLFX90-1230	36250-1230	20242332	3/4	19.0	30 x 2.0	36	2.32	5.90	2.05	52.0	3.62	92.0	NS	UCF6-12	UCF6-12	UCF2-12	UCF9-12
UC-DLFX90-1636	36250-1636	20242331	1	25.4	36 x 2.0	41	2.68	6.80	3.07	78.0	4.80	122.0	NS	UCF6-16	UCF6-16		UCF9-16
UC-DLFX90-2045	36250-2045	20242388	1 1/4	31.8	45 x 2.0	50	3.50	8.90	3.54	90.0	5.59	142.0	NS	UCF6-20	UCF6-20		

DIN 24° Light

Male

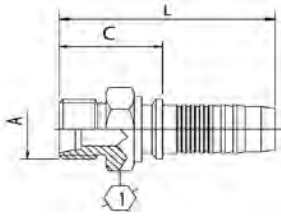

S=Skive
NS=Non-Skive
DG=Dual-Grip™

Descriptive #	Product #	SAP #	Hose Size ID		Thread Size (A)	Hex-1 Wrench Size	Cut-Off (C)		Length (L)		Skive Type	SR3	SR4 HR4	SR6 HR6	SR14A
			in.	mm			mm	in.	mm	in.					
UC-DLM-0412	36255-0412	20242334	1/4	6.4	12 x 1.5	14	0.84	21.3	1.81	46.1	NS	UCF6-04		UCF2-04	UCF9-04
UC-DLM-0414	36255-0414	20242393	1/4	6.4	14 x 1.5	14	0.84	21.3	1.81	46.1	NS	UCF6-04		UCF2-04	UCF9-04
UC-DLM-0416	36255-0416	20242335	1/4	6.4	16 x 1.5	17	0.92	23.3	1.89	48.1	NS	UCF6-04		UCF2-04	UCF9-04
UC-DLM-0616	36255-0616	20242426	3/8	9.5	16 x 1.5	17	0.92	23.3	1.97	50.0	NS	UCF6-06		UCF2-06	UCF9-06
UC-DLM-0618	36255-0618	20242513	3/8	9.5	18 x 1.5	19	0.96	24.3	2.01	51.0	NS	UCF6-06		UCF2-06	UCF9-06
UC-DLM-0822	36255-0822	20242392	1/2	12.7	22 x 1.5	22	1.03	26.1	2.27	57.6	NS	UCF6-08		UCF2-08	UCF9-08
UC-DLM-1230	36255-1230	20242336	3/4	19.0	30 x 2.0	32	1.24	31.6	2.80	71.1	NS	UCF6-12	UCF6-12	UCF2-12	UCF9-12
UC-DLM-1636	36255-1636	20242333	1	25.4	36 x 2.0	36	1.35	34.4	3.11	79.0	NS	UCF6-16	UCF6-16		UCF9-16

DIN 24° Heavy

Female | Swivel

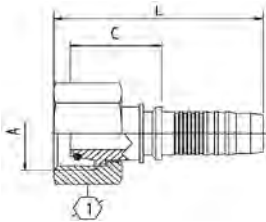

S=Skive
NS=Non-Skive
DG=Dual-Grip™

Descriptive #	Product #	SAP #	Hose Size ID		Thread Size (A)	Hex-1 Wrench Size	Cut-Off (C)		Length (L)		Skive Type	SR3	SR4 HR4	SR6 HR6	SR14A
			in.	mm			mm	in.	mm	in.					
UC-DHFX-0416	36210-0416	20242538	1/4	6.4	16 x 1.5	19	1.09	27.7	2.07	52.5	NS	UCF6-04		UCF2-04	UCF9-04
UC-DHFX-0418	36210-0418	20242529	1/4	6.4	18 x 1.5	22	1.09	27.8	2.07	52.6	NS	UCF6-04		UCF2-04	UCF9-04
UC-DHFX-0620	36210-0620	20242624	3/8	9.5	20 x 1.5	24	1.09	27.6	2.25	57.1	NS	UCF6-06		UCF2-06	UCF9-06
UC-DHFX-0622	36210-0622	20242562	3/8	9.5	22 x 1.5	27	1.22	31.1	2.44	62.1	NS	UCF6-06		UCF2-06	UCF9-06
UC-DHFX-0824	36210-0824	20242561	1/2	12.7	24 x 1.5	30	1.25	31.7	2.67	67.7	NS	UCF6-08		UCF2-08	UCF9-08
UC-DHFX-1230 ^T	36210-1230	20242319	3/4	19.0	30 x 2.0	36	1.46	37.0	3.13	79.5	NS	UCF6-12	UCF6-12	UCF2-12	UCF9-12
UC-DHFX-1236	36210-1236	20242530	3/4	19.0	36 x 2.0	46	1.58	40.2	3.39	86.2	NS	UCF6-12	UCF6-12	UCF2-12	UCF9-12
UC-DHFX-1236S	36210-1236S	20608762	3/4	19.0	36 x 2.0	46	1.58	40.2	3.39	86.2	NS	UCF6-12	UCF6-12	UCF2-12	UCF9-12
UC-DHFX-1642	36210-1642	20242500	1	25.4	42 x 2.0	50	1.70	43.1	3.65	92.7	NS	UCF6-16	UCF6-16		UCF9-16

T: Thrust-Wire Nut (see "Fitting Identification" in Appendix for details)

DIN 24° Heavy

Female 45° Elbow | Swivel

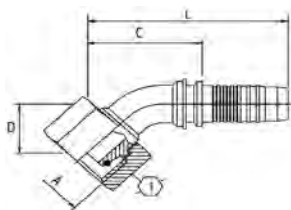

S=Skive
NS=Non-Skive
DG=Dual-Grip™

Descriptive #	Product #	SAP #	Hose Size ID		Thread Size (A)	Hex-1 Wrench Size	Drop (D)		Cut-Off (C)		Length (L)		Skive Type	SR3	SR4 HR4	SR6 HR6	SR14A
			in.	mm			mm	in.	mm	in.	mm	in.					
UC-DHFX45-0418	36215-0418	20242313	1/4	6.4	18 x 1.5	22	0.75	19.0	1.69	43.0	2.68	68.0	NS	UCF6-04		UCF2-04	UCF9-04
UC-DHFX45-0620	36215-0620	20242315	3/8	9.5	20 x 1.5	24	0.79	20.0	2.01	51.0	3.03	77.0	NS	UCF6-06		UCF2-06	UCF9-06
UC-DHFX45-0622	36215-0622	20242316	3/8	9.5	22 x 1.5	27	0.83	21.0	2.09	53.0	3.15	80.0	NS	UCF6-06		UCF2-06	UCF9-06
UC-DHFX45-0824	36215-0824	20242312	1/2	12.7	24 x 1.5	30	0.85	21.5	2.20	56.0	3.43	87.0	NS	UCF6-08		UCF2-08	UCF9-08
UC-DHFX45-1236	36215-1236	20242314	3/4	19.0	36 x 2.0	46	1.30	33.0	2.72	69.0	4.29	109.0	NS	UCF6-12	UCF6-12	UCF2-12	UCF9-12
UC-DHFX45-1642	36215-1642	20242310	1	25.4	42 x 2.0	50	1.59	40.5	4.33	110.0	6.10	155.0	NS	UCF6-16	UCF6-16		UCF9-16

DIN 24° Heavy

Female 90° Elbow | Swivel

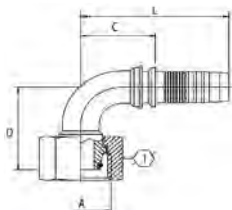

S=Skive
NS=Non-Skive
DG=Dual-Grip™

Descriptive #	Product #	SAP #	Hose Size ID		Thread Size (A)	Hex-1 Wrench Size	Drop (D)		Cut-Off (C)		Length (L)		Skive Type	SR3	SR4 HR4	SR6 HR6	SR14A
			in.	mm			mm	in.	mm	in.	mm	in.					
UC-DHFX90-0418	36220-0418	20242421	1/4	6.4	18 x 1.5	22	1.34	34.0	1.06	27.0	2.05	52.0	NS	UCF6-04		UCF2-04	UCF9-04
UC-DHFX90-0620	36220-0620	20242563	3/8	9.5	20 x 1.5	24	1.52	38.5	1.34	34.0	2.40	61.0	NS	UCF6-06		UCF2-06	UCF9-06
UC-DHFX90-0622	36220-0622	20242469	3/8	9.5	22 x 1.5	27	1.59	40.5	1.34	34.0	2.40	61.0	NS	UCF6-06		UCF2-06	UCF9-06
UC-DHFX90-0824	36220-0824	20242468	1/2	12.7	24 x 1.5	30	1.63	41.5	1.57	40.0	2.80	71.0	NS	UCF6-08		UCF2-08	UCF9-08
UC-DHFX90-1236	36220-1236	20242317	3/4	19.0	36 x 2.0	46	2.34	59.5	2.01	51.0	3.54	90.0	NS	UCF6-12	UCF6-12	UCF2-12	UCF9-12
UC-DHFX90-1236S	36220-1236S	20608763	3/4	19.0	36 x 2.0	46	2.34	59.5	2.01	51.0	3.54	90.0	NS	UCF6-12	UCF6-12	UCF2-12	UCF9-12
UC-DHFX90-1642	36220-1642	20242420	1	25.4	42 x 2.0	50	3.11	79.0	2.99	76.0	4.72	120.0	NS	UCF6-16	UCF6-16		UCF9-16

DIN 24° Heavy

Male

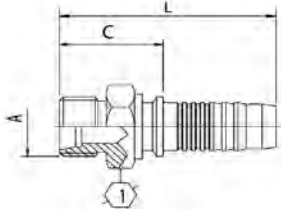

S=Skive
NS=Non-Skive
DG=Dual-Grip™

Descriptive #	Product #	SAP #	Hose Size ID		Thread Size (A)	Hex-1 Wrench Size	Cut-Off (C)		Length (L)		Skive Type	SR3	SR4 HR4	SR6 HR6	SR14A
			in.	mm			in.	mm	in.	mm					
UC-DHM-0416	36225-0416	20242323	1/4	6.4	16 x 1.5	17	0.96	24.3	1.93	49.1		UCF6-04		UCF2-04	UCF9-04
UC-DHM-0418	36225-0418	20242324	1/4	6.4	18 x 1.5	19	1.00	25.3	1.97	50.1		UCF6-04		UCF2-04	UCF9-04
UC-DHM-0620	36225-0620	20242424	3/8	9.5	20 x 1.5	22	1.00	25.3	2.05	52.0		UCF6-06		UCF2-06	UCF9-06
UC-DHM-0622	36225-0622	20242470	3/8	9.5	22 x 1.5	22	1.07	27.3	2.13	54.0		UCF6-06		UCF2-06	UCF9-06
UC-DHM-0824	36225-0824	20242322	1/2	12.7	24 x 1.5	24	1.15	29.1	2.39	60.6		UCF6-08		UCF2-08	UCF9-08
UC-DHM-1230	36225-1230	20242325	3/4	19.0	30 x 2.0	32	1.32	33.6	2.88	73.1		UCF6-12	UCF6-12	UCF2-12	UCF9-12
UC-DHM-1236	36225-1236	20242326	3/4	19.0	36 x 2.0	36	1.48	37.6	3.04	77.1		UCF6-12	UCF6-12	UCF2-12	UCF9-12
UC-DHM-1642	36225-1642	20242321	1	25.4	42 x 2.0	46	1.67	42.4	3.43	87.0		UCF6-16	UCF6-16		UCF9-16

DIN 60°

Female 45° Elbow | Swivel

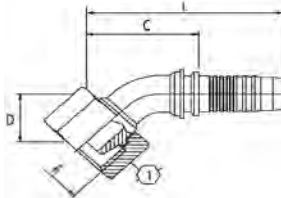

S=Skive
NS=Non-Skive
DG=Dual-Grip™

Descriptive #	Product #	SAP #	Hose Size ID		Thread Size (A)	Hex-1 Wrench Size	Drop (D)	Cut-Off (C)		Length (L)		Skive Type	SR3	SR4 HR4	SR6 HR6	SR14A	
			in.	mm				in.	mm	in.	mm						
UC-DNFX45-0414	36275-0414	20242338	1/4	6.4	14 x 1.5	17	0.63	16.0	1.38	35.0	2.56	65.0	NS	UCF6-04		UCF2-04	UCF9-04
UC-DNFX45-0416	36275-0416	20242339	1/4	6.4	16 x 1.5	19	0.67	17.0	1.42	36.0	2.60	66.0	NS	UCF6-04		UCF2-04	UCF9-04
UC-DNFX45-0618	36275-0618	20242340	3/8	9.5	18 x 1.5	22	0.77	19.5	1.69	43.0	2.76	70.0	NS	UCF6-06		UCF2-06	UCF9-06
UC-DNFX45-0822	36275-0822	20242337	1/2	12.7	22 x 1.5	27	0.79	20.0	2.17	55.0	3.39	86.0	NS	UCF6-08		UCF2-08	UCF9-08

DIN 60°

Female 90° Elbow | Swivel

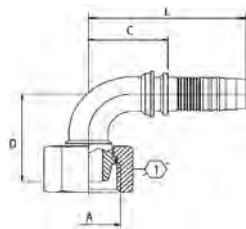

S=Skive
NS=Non-Skive
DG=Dual-Grip™

Descriptive #	Product #	SAP #	Hose Size ID		Thread Size (A)		Hex-1 Wrench Size		Drop (D)		Cut-Off (C)		Length (L)		Skive Type	SR3	SR4 HR4	SR6 HR6	SR14A
			in.	mm	mm.	mm.	in.	mm	in.	mm	in.	mm							
UC-DNFX90-0414	36280-0414	20242428	1/4	6.4	14 x 1.5	17	1.12	28.5	1.18	30.0	2.17	55.0	NS	UCF6-04		UCF2-04	UCF9-04		
UC-DNFX90-0416	36280-0416	20242341	1/4	6.4	16 x 1.5	19	1.28	32.5	1.10	28.0	2.09	53.0	NS	UCF6-04		UCF2-04	UCF9-04		
UC-DNFX90-0616	36280-0616	20242342	3/8	9.5	16 x 1.5	19	1.26	32.0	1.18	30.0	2.36	60.0	NS	UCF6-06		UCF2-06	UCF9-06		
UC-DNFX90-0618	36280-0618	20242472	3/8	9.5	18 x 1.5	22	1.46	37.0	1.30	33.0	2.36	60.0	NS	UCF6-06		UCF2-06	UCF9-06		
UC-DNFX90-0822	36280-0822	20242427	1/2	12.7	22 x 1.5	27	1.57	40.0	1.57	40.0	2.80	71.0	NS	UCF6-08		UCF2-08	UCF9-08		

Japanese Komatsu® 30° Flare with Metric Threads

Female | Swivel

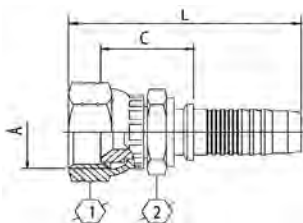

S=Skive
NS=Non-Skive
DG=Dual-Grip™

Descriptive #	Product #	SAP #	Hose Size ID		Thread Size (A)		Hex-1 Wrench Size		Hex-2 Wrench Size		Cut-Off (C)		Length (L)		Skive Type	SR3	SR4 HR4	SR6 HR6	SR14A
			in.	mm	mm	mm	in.	in.	mm	in.	mm								
UC-KMFX-0414	36545-0414	20242590	1/4	6.4	14 X 1.5	19	17	0.82	20.8	2.19	55.6	NS	UCF6-04		UCF2-04	UCF9-04			
UC-KMFX-0618	36545-0618	20242636	3/8	9.5	18 X 1.5	22	19	0.86	21.8	2.30	58.5	NS	UCF6-06		UCF2-06	UCF9-06			
UC-KMFX-0822	36545-0822	20242573	1/2	12.7	22 X 1.5	27	22	0.93	23.6	2.62	66.6	NS	UCF6-08		UCF2-08	UCF9-08			
UC-KMFX-1024	36545-1024	20283390	5/8	15.9	24 x 1.5	32	30	1.07	27.1	3.01	76.4	NS			UCF2-10	UCF9-10			
UC-KMFX-1230	36545-1230	20242541	3/4	19.0	30 X 1.5	36	30	1.09	27.6	3.35	85.1	NS	UCF6-12	UCF6-12	UCF2-12	UCF9-12			
UC-KMFX-1633	36545-1633	20242564	1	25.4	33 X 1.5	41	36	1.41	35.7	4.03	102.3	NS	UCF6-16	UCF6-16		UCF9-16			
UC-KMFX-2036	36545-2036	20242394	1 1/4	31.8	36 X 1.5	46	46	1.71	43.5	4.63	117.5	NS	UCF6-20	UCF6-20					

Japanese Komatsu® 30° Flare with Metric Threads Female 45° Elbow | Swivel

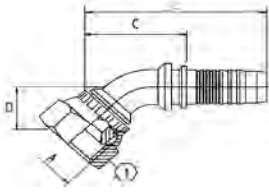

S=Skive
NS=Non-Skive
DG=Dual-Grip™

Descriptive #	Product #	SAP #	Hose Size ID		Thread Size (A)	Hex-1 Wrench Size	Drop (D)		Cut-Off (C)		Length (L)		Skive Type	SR3	SR4 HR4	SR6 HR6	SR14A
			in.	mm			mm	in.	mm	in.	mm	in.					
UC-KMFX45-0414	36548-0414	20318233	1/4	6.4	14 X 1.5	19	0.61	15.5	1.50	38.0	2.48	63.0	NS	UCF6-04		UCF2-04	UCF9-04
UC-KMFX45-0618	36548-0618	20318234	3/8	9.5	18 X 1.5	22	0.71	18.0	1.73	44.0	2.76	70.0	NS	UCF6-06		UCF2-06	UCF9-06
UC-KMFX45-0822	36548-0822	20318235	1/2	12.7	22 X 1.5	27	1.16	29.5	2.20	56.0	3.43	87.0	NS	UCF6-08		UCF2-08	UCF9-08

Japanese Komatsu® 30° Flare with Metric Threads Female 90° Elbow | Swivel

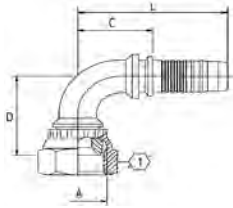

S=Skive
NS=Non-Skive
DG=Dual-Grip™

Descriptive #	Product #	SAP #	Hose Size ID		Thread Size (A)	Hex-1 Wrench Size	Drop (D)		Cut-Off (C)		Length (L)		Skive Type	SR3	SR4 HR4	SR6 HR6	SR14A
			in.	mm			mm	in.	mm	in.	mm	in.					
UC-KMFX90-0414	36550-0414	20318236	1/4	6.4	14 X 1.5	19	1.16	29.5	1.30	33.0	2.28	58.0	NS	UCF6-04		UCF2-04	UCF9-04
UC-KMFX90-0618	36550-0618	20318326	3/8	9.5	18 X 1.5	22	1.40	35.5	1.42	36.0	2.44	62.0	NS	UCF6-06		UCF2-06	UCF9-06
UC-KMFX90-0822	36550-0822	20318327	1/2	12.7	22 X 1.5	27	2.09	53.0	1.46	37.0	2.68	68.0	NS	UCF6-08		UCF2-08	UCF9-08

JIS 30° (Parallel Pipe Threads)

Female | Swivel

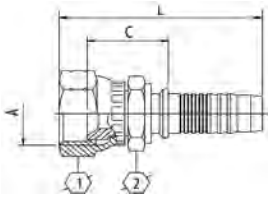

S=Skive
NS=Non-Skive
DG=Dual-Grip™

Descriptive #	Product #	SAP #	Hose Size ID		Thread Size (A)	Hex-1 Wrench Size	Hex-2 Wrench Size	Cut-Off (C)		Length (L)		Skive Type	SR3	SR4 HR4	SR6 HR6	SR14A
			in.	mm				mm	in.	in.	mm					
UC-JSFX-0404	36520-0404	20242644	1/4	6.4	1/4-19	19	17	0.82	20.8	2.19	55.6	NS	UCF6-04		UCF2-04	UCF9-04
UC-JSFX-0606	36520-0606	20242699	3/8	9.5	3/8-19	22	19	0.86	21.8	2.30	58.5	NS	UCF6-06		UCF2-06	UCF9-06
UC-JSFX-0808	36520-0808	20242606	1/2	12.7	1/2-14	27	22	0.93	23.6	2.62	66.6	NS	UCF6-08		UCF2-08	UCF9-08
UC-JSFX-1212	36520-1212	20242543	3/4	19.0	3/4-14	36	30	1.07	27.1	3.13	79.6	NS	UCF6-12	UCF6-12	UCF2-12	UCF9-12
UC-JSFX-1616	36520-1616	20242502	1	25.4	1-11	41	36	1.30	32.9	3.64	92.5	NS	UCF6-16	UCF6-16		UCF9-16
UC-JSFX-2020 ^T	36520-2020	20242436	1 1/4	31.8	1 1/4-11	50	46	1.56	39.5	4.21	107.0	NS	UCF6-20	UCF6-20		

T: Thrust-Wire Nut (see "Fitting Identification" in Appendix for details)

How to Use the Fitting Tables

This section lists ALL fittings that are compatible with the following hoses:

Hose Family	Hose Descriptive
SR5	SAE 100R5
DR5	SAE 100R5 (High Temp)
SCX5	SAE 100R5 (Rubber Covered)

Fitting Description

Fitting Type

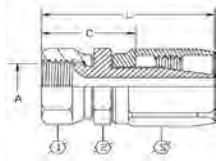

Descriptive #	Product #	SAP #	Hose Size ID		Thread Size (A)	Hex-1 Wrench Size	Hex-2 Wrench Size	Socket (S) Wrench Size	Cut-Off (C)		Length (L)		SR5 DR5
			in.	mm					in.	mm	in.	mm	
FG-JCFX-0404	18400-0404	20245798	3/16	4.8	7/16-20	9/16	9/16	5/8	1.19	30.2	1.94	49.2	Y
FG-JCFX-0505	18400-0505	20245799	1/4	6.4	1/2-20	5/8	5/8	11/16	1.30	32.9	2.08	52.8	Y
FG-JCFX-0606	18400-0606	20245800	5/16	7.9	9/16-18	11/16	11/16	13/16	1.41	35.7	2.31	58.7	Y

A "Y" in the hose compatibility columns indicates that the fitting is an **Field Grip™** style fitting and that it works for that particular hose.

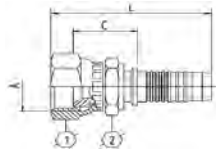

Descriptive #	Product #	SAP #	Hose Size ID		Thread Size (A)	Hex-1 Wrench Size	Hex-2 Wrench Size	Socket (S) Wrench Size	Cut-Off (C)	Length (L)		SR5 DR5 SCX5			
			in.	mm						in.	mm				
UC-JCFX-0304	36400-0304	20557173	3/16	4.8	7/16-20	9/16	14	1/2	12	N/A	0.71	18.1	1.93	49.0	UCF6-03
UC-JCFX-0404	36400-0404	20242786	1/4	6.4	7/16-20	5/8	16	9/16	14	N/A	0.77	19.6	2.09	53.1	UCF6-04
UC-JCFX-0404S	36400-0404S	20540685	1/4	6.4	7/16-20	5/8	16	9/16	14	N/A	0.77	19.6	2.09	53.1	UCF6-04

Choose fittings carefully considering the working pressure of both hose and fitting. The maximum working pressure of the hose assembly is the lesser of the rated working pressure of the hose and the fitting. See page 313 for working pressure.

A **Part Number (Ferrule)** in the hose compatibility columns indicates that the fitting is a **Uni-Crimp™** or **Dual Grip™** style. The fitting, along with the Ferrule shown, work together as a unit for that particular hose.

JIC 37° Flare (SAE J514)

Female | Swivel

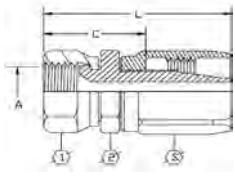

Descriptive #	Product #	SAP #	Hose Size ID		Thread Size (A)	Hex-1 Wrench Size	Hex-2 Wrench Size	Socket (S) Wrench Size	Cut-Off (C)		Length (L)		SR5 DR5
			in.	mm					in.	mm	in.	mm	
FG-JCFX-0404	18400-0404	20245798	3/16	4.8	7/16-20	9/16	9/16	5/8	1.19	30.2	1.94	49.2	Y
FG-JCFX-0505	18400-0505	20245799	1/4	6.4	1/2-20	5/8	5/8	11/16	1.30	32.9	2.08	52.8	Y
FG-JCFX-0606	18400-0606	20245800	5/16	7.9	9/16-18	11/16	11/16	13/16	1.41	35.7	2.31	58.7	Y
FG-JCFX-0808	18400-0808	20245801	13/32	10.3	3/4-16	7/8	7/8	15/16	1.58	40.1	2.68	68.1	Y
FG-JCFX-1010	18400-1010	20245792	1/2	12.7	7/8-14	1	1	1 1/8	1.67	42.5	3.06	77.8	Y
FG-JCFX-1212	18400-1212	20245793	5/8	15.9	1 1/16-12	1 1/4	1 1/4	1 1/4	1.92	48.8	3.50	88.9	Y
FG-JCFX-1616	18400-1616	20245794	7/8	22.2	1 5/16-12	1 1/2	1 1/2	1 7/16	1.92	48.8	3.19	81.0	Y
FG-JCFX-2020	18400-2020	20245795	1 1/8	28.6	1 5/8-12	2	2	1 3/4	2.50	63.5	3.38	85.7	Y
FG-JCFX-2424	18400-2424	20245796	1 3/8	34.9	1 7/8-12	2 1/4	2 1/4	2	2.23	56.8	3.66	92.9	Y
FG-JCFX-3232	18400-3232	20245797	1 13/16	46.0	2 1/2-12	2 7/8	2 7/8	2 1/2	2.58	65.5	4.44	112.7	Y

Continued on next page

JIC 37° Flare (SAE J514)

Female | Swivel (Continued)

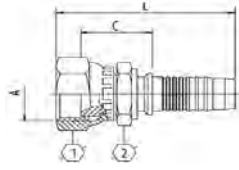

Descriptive #	Product #	SAP #	Hose Size ID		Thread Size (A)	Hex-1 Wrench Size		Hex-2 Wrench Size		Socket (S) Wrench Size	Cut-Off (C)		Length (L)		SR5 DR5 SCX5
			in.	mm		in.	mm	in.	mm		in.	mm	in.	mm	
UC-JCFX-0304	36400-0304	20557173	3/16	4.8	7/16-20	9/16	14	1/2	12	N/A	0.71	18.1	1.93	49.0	UCF6-03
UC-JCFX-0404	36400-0404	20242786	1/4	6.4	7/16-20	5/8	16	9/16	14	N/A	0.77	19.6	2.09	53.1	UCF6-04
UC-JCFX-0404S	36400-0404S	20540685	1/4	6.4	7/16-20	5/8	16	9/16	14	N/A	0.77	19.6	2.09	53.1	UCF6-04
UC-JCFX-0405	36400-0405	20242746	1/4	6.4	1/2-20	11/16	17	9/16	14	N/A	0.80	20.3	2.15	54.6	UCF6-04
UC-JCFX-0406	36400-0406	20242778	1/4	6.4	9/16-18	3/4	19	9/16	14	N/A	0.80	20.3	2.15	54.6	UCF6-04
UC-JCFX-0505	36400-0505	20242676	5/16	7.9	1/2-20	11/16	17	9/16	14	N/A	0.80	20.3	2.15	54.6	UCF6-05
UC-JCFX-0506	36400-0506	20242765	5/16	7.9	9/16-18	3/4	19	9/16	14	N/A	0.80	20.3	2.15	54.6	UCF6-05
UC-JCFX-0606	36400-0606	20242787	13/32	10.3	9/16-18	3/4	19	11/16	17	N/A	0.84	21.3	2.26	57.5	UCF6-06
UC-JCFX-0606S	36400-0606S	20540686	13/32	10.3	9/16-18	3/4	19	11/16	17	N/A	0.84	21.3	2.26	57.5	UCF6-06
UC-JCFX-0608	36400-0608	20242779	13/32	10.3	3/4-16	1	25	3/4	19	N/A	0.98	24.8	2.45	62.2	UCF6-06
UC-JCFX-0610	36400-0610	20242708	13/32	10.3	7/8-14	1 1/16	27	7/8	22	N/A	1.02	25.8	2.57	65.2	UCF6-06
UC-JCFX-0806	36400-0806	20242666	1/2	12.7	9/16-18	3/4	19	3/4	19	N/A	0.91	23.1	2.52	64.1	UCF6-08
UC-JCFX-0808	36400-0808	20242785	1/2	12.7	3/4-16	1	25	3/4	19	N/A	1.01	25.6	2.67	67.8	UCF6-08
UC-JCFX-0808S	36400-0808S	20540687	1/2	12.7	3/4-16	1	25	3/4	19	N/A	1.01	25.6	2.67	67.8	UCF6-08
UC-JCFX-0810	36400-0810	20242772	1/2	12.7	7/8-14	1 1/16	27	7/8	22	N/A	1.05	26.6	2.79	70.8	UCF6-08
UC-JCFX-0812	36400-0812	20242727	1/2	12.7	1 1/16-12	1 1/4	32	1	25	N/A	1.11	28.1	2.91	73.9	UCF6-08
UC-JCFX-1008	36400-1008	20242399	5/8	15.9	3/4-16	1	25	15/16	24	N/A	1.05	26.6	2.82	71.6	UCF6-10
UC-JCFX-1010	36400-1010	20242774	5/8	15.9	7/8-14	1 1/16	27	15/16	24	N/A	1.09	27.6	2.94	74.6	UCF6-10
UC-JCFX-1010S	36400-1010S	20540688	5/8	15.9	7/8-14	1 1/16	27	15/16	24	N/A	1.09	27.6	2.94	74.6	UCF6-10
UC-JCFX-1012	36400-1012	20242580	5/8	15.9	1 1/16-12	1 1/4	32	1	25	N/A	1.11	28.1	3.02	76.7	UCF6-10
UC-JCFX-1416	36400-1416	20283395	7/8	22.2	1 5/16-12	1 1/2	38	1 1/4	32	N/A	1.26	32.1	3.41	86.6	UCF6-12
UC-JCFX-1820	36400-1820	20283399	1 1/8	28.6	1 5/16-12	2	50	1 5/8	41	N/A	1.48	37.5	3.86	98.0	UCF6-16
UC-JCFX-2224	36400-2224	20283397	1 3/8	34.9	1 7/8-12	2 3/16	55	2	50	N/A	1.71	43.4	4.49	114.0	UCF6-20
UC-JCFX-2932	36400-2932	20283398	1 3/16	46.0	2 1/2-12	70mm	70	2 9/16	65	N/A	1.93	49.0	5.71	145.0	UCF8-32

JIC 37° Flare (SAE J514)

Female 45° Elbow | Swivel

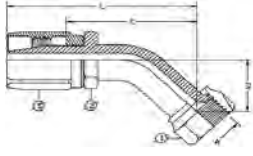

Descriptive #	Product #	SAP #	Hose Size ID		Thread Size (A)	Hex-1 Wrench Size		Hex-2 Wrench Size		Socket (S) Wrench Size		Drop (D)		Cut-Off (C)		Length (L)		SR5 DR5
			in.	mm		in.	in.	in.	in.	in.	mm	in.	mm	in.	mm			
FG-JCFX45-0404	18420-0404	20245820	3/16	4.8	7/16-20	9/16	9/16	5/8	0.33	8.3	1.11	28.2	1.84	46.8	Y			
FG-JCFX45-0505	18420-0505	20245821	1/4	6.4	1/2-20	9/16	5/8	11/16	0.36	9.1	1.28	32.5	1.06	27.0	Y			
FG-JCFX45-0606	18420-0606	20245822	5/16	7.9	9/16-18	9/16	11/16	13/16	0.39	9.9	1.33	33.7	2.23	56.8	Y			
FG-JCFX45-0808	18420-0808	20245823	13/32	10.3	3/4-16	11/16	7/8	15/16	0.55	13.9	1.84	46.8	2.98	75.8	Y			
FG-JCFX45-1010	18420-1010	20245817	1/2	12.7	7/8-14	7/8	1	1 1/8	0.62	15.9	1.95	49.6	3.23	82.2	Y			
FG-JCFX45-1212	18420-1212	20245818	5/8	15.9	1 1/16-12	1 1/8	1 1/4	1 1/4	0.77	19.5	2.22	56.4	3.78	96.0	Y			
FG-JCFX45-1616	18420-1616	20245819	7/8	22.2	1 5/16-12	1 3/8	1 1/2	1 7/16	0.89	22.6	2.23	56.8	3.56	90.5	Y			

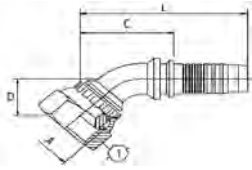

Descriptive #	Product #	SAP #	Hose Size ID		Thread Size (A)	Hex-1 Wrench Size		Hex-2 Wrench Size		Socket (S) Wrench Size	Drop (D)		Cut-Off (C)		Length (L)		SR5 DR5 SCX5
			in.	mm		in.	mm	in.	mm		in.	mm	in.	mm			
UC-JCFX45-0404	36420-0404	20242725	1/4	6.4	7/16-20	5/8	16	N/A		0.39	10.0	1.46	37.0	2.40	61.0	UCF6-04	
UC-JCFX45-0405	36420-0405	20242628	1/4	6.4	1/2-20	11/16	17	N/A		0.47	12.0	1.46	37.0	2.44	62.0	UCF6-04	
UC-JCFX45-0406	36420-0406	20242629	1/4	6.4	9/16-18	3/4	19	N/A		0.43	11.0	1.54	39.0	2.52	64.0	UCF6-04	
UC-JCFX45-0506	36420-0506	20242489	5/16	7.9	9/16-18	3/4	19	N/A		0.47	12.0	1.69	43.0	2.87	73.0	UCF6-05	
UC-JCFX45-0606	36420-0606	20242743	13/32	10.3	9/16-18	3/4	19	N/A		0.43	11.0	1.81	46.0	2.87	73.0	UCF6-06	
UC-JCFX45-0608	36420-0608	20242698	13/32	10.3	3/4-16	1	25	N/A		0.59	15.0	1.85	47.0	2.91	74.0	UCF6-06	
UC-JCFX45-0808	36420-0808	20242729	1/2	12.7	3/4-16	1	25	N/A		0.59	15.0	2.05	52.0	3.27	83.0	UCF6-08	
UC-JCFX45-0810	36420-0810	20242675	1/2	12.7	7/8-14	1 1/16	27	N/A		0.63	16.0	2.01	51.0	3.23	82.0	UCF6-08	
UC-JCFX45-1010	36420-1010	20242345	5/8	15.9	7/8-14	1 1/16	27	N/A		0.75	19.0	2.44	62.0	3.78	96.0	UCF6-10	
UC-JCFX45-1012	36420-1012	20242344	5/8	15.9	1 1/16-12	1 1/4	32	N/A		0.83	21.0	2.72	69.0	4.06	103.0	UCF6-10	
UC-JCFX45-1820	36420-1820	20367919	1 1/8	28.6	1 5/8-12	2	50	N/A		1.52	38.5	3.43	87.0	5.33	135.5	UCF6-16	

JIC 37° Flare (SAE J514)

Female 90° Elbow | Swivel

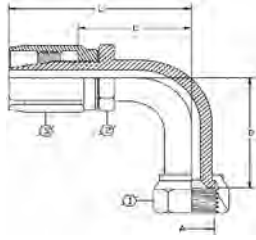

Elbow Type
 LT=Long Tube
 ST=Short Tube

Descriptive #	Product #	SAP #	Hose Size ID		Thread Size (A)	Hex-1 Wrench Size	Hex-2 Wrench Size	Socket (S) Wrench Size	Elbow Type	Drop (D)		Cut-Off (C)		Length (L)		SR5 DR5
			in.	mm						in.	mm	in.	mm	in.	mm	
FG-JCFX90-0404	18425-0404	20245827	3/16	4.8	7/16-20	9/16	9/16	5/8		0.69	17.5	1.00	25.4	1.75	44.5	Y
FG-JCFX90L-0404	18440-0404	20245834	3/16	4.8	7/16-20	9/16	9/16	5/8	LT	1.80	45.6	1.00	25.4	1.75	44.5	Y
FG-JCFX90-0505	18425-0505	20245828	1/4	6.4	1/2-20	9/16	5/8	11/16		0.77	19.5	1.19	30.2	1.97	50.0	Y
FG-JCFX90L-0505	18440-0505	20245835	1/4	6.4	1/2-20	9/16	5/8	11/16	LT	1.78	45.2	1.19	30.2	1.97	50.0	Y
FG-JCFX90-0606	18425-0606	20245829	5/16	7.9	9/16-18	11/16	11/16	13/16		0.84	21.4	1.23	31.4	2.12	54.0	Y
FG-JCFX90L-0606	18440-0606	20245836	5/16	7.9	9/16-18	11/16	11/16	13/16	LT	2.19	55.6	1.23	31.4	2.12	54.0	Y
FG-JCFX90-0808	18425-0808	20245830	13/32	10.3	3/4-16	7/8	7/8	15/16		1.09	27.8	1.61	40.9	2.75	69.9	Y
FG-JCFX90L-0808	18440-0808	20245837	13/32	10.3	3/4-16	7/8	7/8	15/16	LT	2.44	61.9	1.61	40.9	2.75	69.9	Y
FG-JCFX90-1010	18425-1010	20245824	1/2	12.7	7/8-14	1 1/16	1	1 1/8		1.23	31.4	1.66	42.1	2.94	74.6	Y
FG-JCFX90L-1010	18440-1010	20245831	1/2	12.7	7/8-14	1 1/16	1	1 1/8	LT	2.56	65.1	1.66	42.1	2.94	74.6	Y
FG-JCFX90-1212	18425-1212	20245825	5/8	15.9	1 1/16-12	1 1/4	1 1/4	1 1/4		1.81	46.0	2.17	55.2	3.75	95.3	Y
FG-JCFX90L-1212	18440-1212	20245832	5/8	15.9	1 1/16-12	1 1/4	1 1/4	1 1/4	LT	3.73	94.9	2.17	55.2	3.75	95.3	Y
FG-JCFX90-1616	18425-1616	20245826	7/8	22.2	1 5/16-12	1 1/2	1 1/2	1 7/16		2.14	54.4	2.28	57.9	3.55	90.1	Y
FG-JCFX90L-1616	18440-1616	20245833	7/8	22.2	1 5/16-12	1 1/2	1 1/2	1 7/16	LT	4.33	109.9	2.28	57.9	3.55	90.1	Y

JIC 37° Flare (SAE J514)

Female 90° Elbow | Swivel

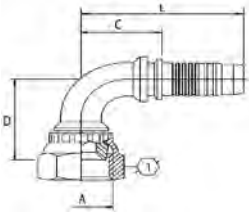

Elbow Type
 LT=Long Tube
 ST=Short Tube

Descriptive #	Product #	SAP #	Hose Size ID		Thread Size (A)	Hex-1 Wrench Size	Hex-2 Wrench Size	Socket (S) Wrench Size	Elbow Type	Drop (D)		Cut-Off (C)		Length (L)		SR5 DR5 SXCS
			in.	mm						in.	mm	in.	mm	in.	mm	
UC-JCFX90-0304	36425-0304	20269250	3/16	4.8	7/16-20	5/8	16	N/A		1.26	32.0	1.30	33.0	2.20	56.0	UCF6-03
UC-JCFX90-0404	36425-0404	20242770	1/4	6.4	7/16-20	5/8	16	N/A		1.26	32.0	1.34	34.0	2.32	59.0	UCF6-04
UC-JCFX90L-0404	36440-0404	20242662	1/4	6.4	7/16-20	5/8	16	N/A	LT	1.81	46.0	1.22	31.0	2.20	56.0	UCF6-04
UC-JCFX90S-0404	36445-0404	20242430	1/4	6.4	7/16-20	5/8	16	N/A	ST	0.83	21.0	1.06	27.0	2.05	52.0	UCF6-04
UC-JCFX90-0405	36425-0405	20242657	1/4	6.4	1/2-20	11/16	17	N/A		1.18	30.0	1.02	26.0	1.97	50.0	UCF6-04
UC-JCFX90L-0405	36440-0405	20242473	1/4	6.4	1/2-20	11/16	17	N/A	LT	1.77	45.0	1.22	31.0	2.20	56.0	UCF6-04
UC-JCFX90S-0405	36445-0405	20242396	1/4	6.4	1/2-20	11/16	17	N/A	ST	0.93	23.5	1.02	26.0	2.01	51.0	UCF6-04
UC-JCFX90-0406	36425-0406	20242718	1/4	6.4	9/16-18	3/4	19	N/A		1.50	38.0	1.10	28.0	2.09	53.0	UCF6-04
UC-JCFX90L-0406	36440-0406	20242474	1/4	6.4	9/16-18	3/4	19	N/A	LT	2.13	54.0	1.34	34.0	2.32	59.0	UCF6-04
UC-JCFX90S-0406	36445-0406	20242397	1/4	6.4	9/16-18	3/4	19	N/A	ST	0.91	23.0	1.22	31.0	2.20	56.0	UCF6-04
UC-JCFX90-0504	36425-0504	20612476	5/16	7.9	7/16-20	5/8	16	N/A		1.26	32.0	1.34	34.0	2.32	58.9	UCF6-05
UC-JCFX90-0505	36425-0505	20242565	5/16	7.9	1/2-20	11/16	17	N/A		1.38	35.0	1.34	34.0	2.32	59.0	UCF6-05
UC-JCFX90-0506	36425-0506	20242490	5/16	7.9	9/16-18	3/4	19	N/A		1.38	35.0	1.30	33.0	2.28	58.0	UCF6-05
UC-JCFX90L-0506	36440-0506	20242454	5/16	7.9	9/16-18	3/4	19	N/A	LT	2.13	54.0	1.42	36.0	2.40	61.0	UCF6-05
UC-JCFX90-0604	36425-0604	20318323	13/32	10.3	7/16-20	5/8	16	N/A		1.26	32.0	1.38	35.0	2.44	62.0	UCF6-06
UC-JCFX90L-0604	36440-0604	20318322	13/32	10.3	7/16-20	5/8	16	N/A	LT	1.81	46.0	1.22	31.0	2.28	58.0	UCF6-06
UC-JCFX90-0606	36425-0606	20242776	13/32	10.3	9/16-18	3/4	19	N/A		1.38	35.0	1.22	31.0	2.28	58.0	UCF6-06
UC-JCFX90L-0606	36440-0606	20242720	13/32	10.3	9/16-18	3/4	19	N/A	LT	2.13	54.0	1.69	43.0	2.76	70.0	UCF6-06
UC-JCFX90S-0606	36445-0606	20242475	13/32	10.3	9/16-18	3/4	19	N/A	ST	0.91	23.0	1.65	42.0	2.72	69.0	UCF6-06
UC-JCFX90-0608	36425-0608	20242753	13/32	10.3	3/4-16	1	25	N/A		1.61	41.0	1.54	39.0	2.60	66.0	UCF6-06
UC-JCFX90L-0608	36440-0608	20242587	13/32	10.3	3/4-16	1	25	N/A	LT	2.52	64.0	1.85	47.0	2.91	74.0	UCF6-06
UC-JCFX90S-0608	36445-0608	20242431	13/32	10.3	3/4-16	1	25	N/A	ST	1.14	29.0	1.93	49.0	2.99	76.0	UCF6-06
UC-JCFX90-0808	36425-0808	20242764	1/2	12.7	3/4-16	1	25	N/A		1.57	40.0	1.46	37.0	2.72	69.0	UCF6-08
UC-JCFX90L-0808	36440-0808	20242688	1/2	12.7	3/4-16	1	25	N/A	LT	2.52	64.0	1.97	50.0	3.19	81.0	UCF6-08
UC-JCFX90S-0808	36445-0808	20242429	1/2	12.7	3/4-16	1	25	N/A	ST	1.14	29.0	1.81	46.0	3.07	78.0	UCF6-08
UC-JCFX90-0810	36425-0810	20242706	1/2	12.7	7/8-14	1 1/16	27	N/A		1.85	47.0	1.69	43.0	2.95	75.0	UCF6-08
UC-JCFX90L-0810	36440-0810	20242584	1/2	12.7	7/8-14	1 1/16	27	N/A	LT	2.56	65.0	1.46	37.0	2.72	69.0	UCF6-08
UC-JCFX90S-0810	36445-0810	20242395	1/2	12.7	7/8-14	1 1/16	27	N/A	ST	1.26	32.0	1.81	46.0	3.03	77.0	UCF6-08
UC-JCFX90-0812	36425-0812	20242349	1/2	12.7	1 1/16-12	1 1/4	32	N/A		1.81	46.0	1.46	37.0	2.72	69.0	UCF6-08
UC-JCFX90-1010	36425-1010	20242749	5/8	15.9	7/8-14	1 1/16	27	N/A		1.89	48.0	1.93	49.0	3.31	84.0	UCF6-10
UC-JCFX90L-1010	36440-1010	20242346	5/8	15.9	7/8-14	1 1/16	27	N/A	LT	2.56	65.0	1.97	50.0	3.31	84.0	UCF6-10
UC-JCFX90S-1010	36445-1010	20591962	5/8	15.9	7/8-14	1 1/16	27	N/A	ST	1.26	32.0	1.43	36.2	2.78	70.5	UCF6-10
UC-JCFX90-1012	36425-1012	20242350	5/8	15.9	1 1/16-12	1 1/4	32	N/A		2.28	58.0	1.89	48.0	3.23	82.0	UCF6-10
UC-JCFX90L-1012	36440-1012	20283400	5/8	15.9	1 1/16-12	1 1/4	32	N/A	LT	3.78	96.0	1.97	50.0	3.31	84.0	UCF6-10

JIC 37° Flare (SAE J514)

Male

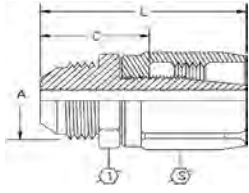

Descriptive #	Product #	SAP #	Hose Size ID		Thread Size (A)	Hex-1 Wrench Size		Socket (S) Wrench Size		Cut-Off (C)		Length (L)		SR5 DR5
			in.	mm		in.	in.	in.	mm	in.	mm			
FG-JCM-0404	18450-0404	20245775	3/16	4.8	7/16-20	1/2	5/8	1.09	27.8	1.84	46.8	Y		
FG-JCM-0505	18450-0505	20245776	1/4	6.4	1/2-20	9/16	11/16	1.17	29.8	1.95	49.6	Y		
FG-JCM-0606	18450-0606	20245777	5/16	7.9	9/16-18	5/8	13/16	1.22	31.0	2.12	54.0	Y		
FG-JCM-0808	18450-0808	20245778	13/32	10.3	3/4-16	13/16	15/16	1.31	33.3	2.56	65.1	Y		
FG-JCM-1010	18450-1010	20245770	1/2	12.7	7/8-14	15/16	1 1/8	1.50	38.1	2.89	73.4	Y		
FG-JCM-1212	18450-1212	20245771	5/8	15.9	1 1/8-12	1 1/8	1 1/4	1.78	45.2	3.34	84.9	Y		
FG-JCM-1616	18450-1616	20245772	7/8	22.2	1 5/8-12	1 3/8	1 7/16	1.69	42.9	2.94	74.6	Y		
FG-JCM-2020	18450-2020	20245773	1 1/8	28.6	1 5/8-12	1 3/4	1 3/4	1.77	44.9	3.12	79.4	Y		
FG-JCM-2424	18450-2424	20245774	1 3/8	35.0	1 7/8-12	2	2	1.97	50.0	3.42	86.9	Y		

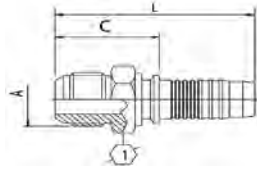

Descriptive #	Product #	SAP #	Hose Size ID		Thread Size (A)	Hex-1 Wrench Size		Socket (S) Wrench Size	Cut-Off (C)		Length (L)		SR5 DR5 SCX5
			in.	mm		in.	mm		in.	in.	mm	in.	
UC-JCM-0404	36450-0404	20242728	1/4	6.4	7/16-20	1/2	12	N/A	0.96	24.3	1.93	49.1	UCF6-04
UC-JCM-0405	36450-0405	20242664	1/4	6.4	1/2-20	9/16	14	N/A	1.00	25.3	1.97	50.1	UCF6-04
UC-JCM-0406	36450-0406	20242687	1/4	6.4	9/16-18	11/16	17	N/A	1.04	26.3	2.01	51.1	UCF6-04
UC-JCM-0505	36450-0505	20242588	5/16	7.9	1/2-20	9/16	14	N/A	1.00	25.3	1.97	50.1	UCF6-05
UC-JCM-0506	36450-0506	20242434	5/16	7.9	9/16-18	11/16	17	N/A	1.04	26.3	2.01	51.1	UCF6-05
UC-JCM-0606	36450-0606	20242759	13/32	10.3	9/16-18	11/16	17	N/A	1.04	26.3	2.09	53.0	UCF6-06
UC-JCM-0608	36450-0608	20242755	13/32	10.3	3/4-16	3/4	19	N/A	1.17	29.8	2.22	56.5	UCF6-06
UC-JCM-0610	36450-0610	20242630	13/32	10.3	7/8-14	15/16	24	N/A	1.33	33.8	2.38	60.5	UCF6-06
UC-JCM-0808	36450-0808	20242736	1/2	12.7	3/4-16	3/4	19	N/A	1.20	30.6	2.44	62.1	UCF6-08
UC-JCM-0810	36450-0810	20242716	1/2	12.7	7/8-14	15/16	24	N/A	1.36	34.6	2.60	66.1	UCF6-08
UC-JCM-0812	36450-0812	20242670	1/2	12.7	1 1/8-12	1 1/8	27	N/A	1.46	37.1	2.70	68.6	UCF6-08
UC-JCM-1010	36450-1010	20242435	5/8	15.9	7/8-14	15/16	24	N/A	1.36	34.6	2.71	68.9	UCF6-10
UC-JCM-1012	36450-1012	20242400	5/8	15.9	1 1/8-12	1 1/8	27	N/A	1.46	37.1	2.81	71.4	UCF6-10

SAE 45° Flare (J512)

Female | Swivel

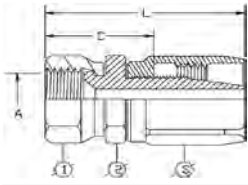

Descriptive #	Product #	SAP #	Hose Size ID		Thread Size (A)	Hex-1 Wrench Size	Hex-2 Wrench Size	Socket (S) Wrench Size	Cut-Off (C)		Length (L)		SR5 DR5
			in.	mm					in.	mm	in.	mm	
FG-SFFX-0404	18775-0404	20245814	3/16	4.8	7/16-20	9/16	9/16	5/8	1.19	30.2	1.94	49.2	Y
FG-SFFX-0505	18775-0505	20245815	1/4	6.4	1/2-20	5/8	5/8	11/16	1.30	32.9	2.08	52.8	Y
FG-SFFX-0606	18775-0606	20245816	5/16	7.9	5/8-18	3/4	3/4	13/16	1.44	36.5	2.34	59.5	Y
FG-SFFX-0808	18775-0808	20291192	13/32	10.3	3/4-16	7/8	7/8	7/8	1.60	40.6	2.70	68.6	Y
FG-SFFX-1010	18775-1010	20245812	1/2	12.7	7/8-14	1	1	1 1/8	1.67	42.5	3.06	77.8	Y
FG-SFFX-1212	18775-1212	20245813	5/8	15.9	1 1/16-14	1 1/4	1 1/4	1 1/4	1.92	48.8	3.50	88.9	Y

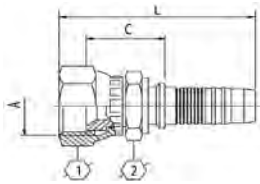

Descriptive #	Product #	SAP #	Hose Size ID		Thread Size (A)	Hex-1 Wrench Size		Hex-2 Wrench Size		Socket (S) Wrench Size	Cut-Off (C)		Length (L)		SR5 DR5 SCX5
			in.	mm		in.	mm	in.	mm		in.	mm	in.	mm	
UC-SFFX-0606	36775-0606	20242760	13/32	10.3	5/8-18	7/8	22	7/8	19	N/A	0.92	23.3	2.38	60.5	UCF6-06
UC-SFFX-0608	36775-0608	20318359	13/32	10.3	3/4-16	1	25	13/16	19	N/A	0.98	24.8	2.45	62.2	UCF6-06

SAE 45° Flare (J512)

Female 45° Elbow | Swivel

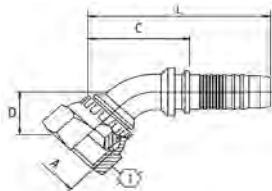

Descriptive #	Product #	SAP #	Hose Size ID		Thread Size (A)	Hex-1 Wrench Size		Drop (D)		Cut-Off (C)	Length (L)		SR5 DR5 SCX5	
			in.	mm		in.	mm	in.	mm		in.	mm		
UC-SFFX45-0606	36777-0606	20318360	13/32	10.3	5/8-18	7/8	22	0.47	12.0	1.81	46.0	2.87	73.0	UCF6-06

SAE 45° Flare (J512)

Female 90° Elbow | Swivel

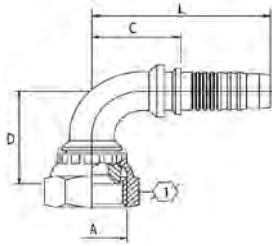

Descriptive #	Product #	SAP #	Hose Size ID		Thread Size (A)		Hex-1 Wrench Size		Drop (D)		Cut-Off (C)		Length (L)		SR5 DR5 SCX5
			in.	mm	in.	mm	in.	mm	in.	mm	in.	mm	in.	mm	
UC-SFFX90-0606	36780-0606	20318325	13/32	10.3	5/8-18	7/8	22	0.94	24.0	1.65	42.0	2.72	69.0	UCF6-06	
UC-SFFX90L-0606	36781-0606	20318362	13/32	10.3	5/8-18	7/8	22	2.19	55.5	1.69	43.0	2.76	70.0	UCF6-06	

SAE 45° Flare (J512)

Male

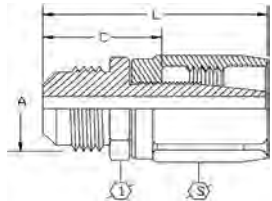

Descriptive #	Product #	SAP #	Hose Size ID		Thread Size (A)	Hex-1 Wrench Size	Socket (S) Wrench Size	Cut-Off (C)		Length (L)		SR5 DR5
			in.	mm				in.	mm	in.	mm	
FG-SFM-0404	18785-0404	20245626	3/16	4.8	7/16-20	1/2	5/8	1.03	26.2	1.80	45.6	Y
FG-SFM-0505	18785-0505	20245627	1/4	6.4	1/2-20	9/16	11/16	1.19	30.2	1.97	50.0	Y
FG-SFM-0606	18785-0606	20245628	5/16	7.9	5/8-18	11/16	13/16	1.28	32.5	2.19	55.6	Y
FG-SFM-0808	18785-0808	20245629	13/32	10.3	3/4-16	13/16	15/16	1.41	35.7	2.66	67.5	Y
FG-SFM-1010	18785-1010	20245624	1/2	12.7	7/8-14	15/16	1 1/8	1.59	40.5	3.00	76.2	Y
FG-SFM-1212	18785-1212	20245625	5/8	15.9	1 1/16-14	1 1/8	1 1/4	1.81	46.0	3.50	88.9	Y

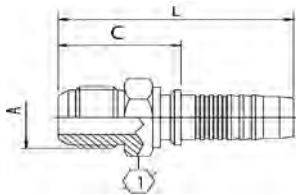

Descriptive #	Product #	SAP #	Hose Size ID		Thread Size (A)	Hex-1 Wrench Size	Cut-Off (C)		Length (L)		SR5 DR5 SCX5	
			in.	mm			in.	mm	in.	mm		
UC-SFM-0606	36785-0606	20318320	13/32	10.3	5/8-18	5/8	16	0.93	23.7	2.15	54.7	UCF6-06

SAE 45° Inverted Flare

Male | Swivel

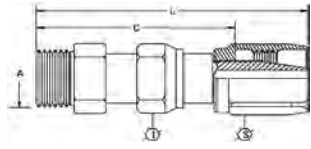

Descriptive #	Product #	SAP #	Hose Size ID		Thread Size (A)	Hex-1 Wrench Size	Socket (S) Wrench Size	Cut-Off (C)		Length (L)		SR5 DR5
			in.	mm				in.	mm	in.	mm	
FG-SIMX-0404	18800-0404	20245779	3/16	4.8	7/16-24	3/8	5/8	1.72	43.7	2.47	62.7	Y
FG-SIMX-0505	18800-0505	20245780	1/4	6.4	1/2-20	7/16	11/16	1.84	46.8	2.62	66.7	Y
FG-SIMX-0606	18800-0606	20245781	5/16	7.9	5/8-18	1/2	13/16	1.81	46.0	2.72	69.1	Y
FG-SIMX-0808	18800-0808	20245782	13/32	10.3	3/4-18	5/8	15/16	1.98	50.4	3.12	79.4	Y

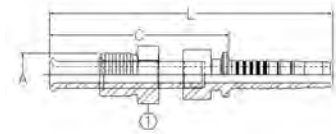

Descriptive #	Product #	SAP #	Hose Size ID		Thread Size (A)	Hex-1 Wrench Size	Cut-Off (C)		Length (L)		SR5 DR5 SCX5	
			in.	mm			in.	mm	in.	mm		
UC-SIMX-0403	36800-0403	20318328	1/4	6.4	3/8-24	1/2	12	1.22	30.9	2.19	55.7	UCF6-04
UC-SIMX-0404	36800-0404	20318329	1/4	6.4	7/16-24	1/2	12	1.22	30.9	2.19	55.7	UCF6-04
UC-SIMX-0405	36800-0405	20318330	1/4	6.4	1/2-20	9/16	14	1.26	32.0	2.24	56.8	UCF6-04
UC-SIMX-0605	36800-0605	20318331	13/32	10.3	1/2-20	9/16	14	1.29	32.8	2.34	59.5	UCF6-06
UC-SIMX-0606	36800-0606	20318332	13/32	10.3	5/8-18	11/16	17	1.43	36.3	2.48	63.0	UCF6-06
UC-SIMX-0607	36800-0607	20318333	13/32	10.3	11/16-18	3/4	19	1.45	36.8	2.50	63.5	UCF6-06
UC-SIMX-0808	36800-0808	20318334	1/2	12.7	3/4-18	3/4	19	1.54	39.2	2.78	70.7	UCF6-08
UC-SIMX-0810	36800-0810	20318335	1/2	12.7	7/8-18	15/16	24	1.60	40.7	2.84	72.2	UCF6-08

SAE 45° Inverted Flare

Male 45° Elbow | Swivel

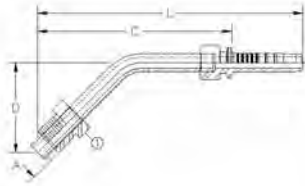

Descriptive #	Product #	SAP #	Hose Size ID		Thread Size (A)	Hex-1 Wrench Size		Drop (D)		Cut-Off (C)		Length (L)		SR5 DR5 SCX5
			in.	mm		in.	mm	in.	mm	in.	mm	in.	mm	
UC-SIMX45-0403	36810-0403	20318336	1/4	6.4	3/8-24	1/2	12	1.24	31.5	2.68	68.0	3.62	92.0	UCF6-04
UC-SIMX45-0404	36810-0404	20318337	1/4	6.4	7/16-24	1/2	12	1.24	31.5	2.68	68.0	3.62	92.0	UCF6-04
UC-SIMX45-0604	36810-0604	20318338	13/32	10.3	7/16-24	1/2	12	1.57	40.0	2.95	75.0	4.02	102.0	UCF6-06
UC-SIMX45-0605	36810-0605	20318339	13/32	10.3	1/2-20	9/16	14	1.50	38.0	2.99	76.0	4.06	103.0	UCF6-06
UC-SIMX45-0606	36810-0606	20318340	13/32	10.3	5/8-18	11/16	17	1.50	38.0	2.99	76.0	4.06	103.0	UCF6-06
UC-SIMX45-0607	36810-0607	20318341	13/32	10.3	11/16-18	3/4	19	1.50	38.0	2.99	76.0	4.06	103.0	UCF6-06

SAE 45° Inverted Flare

Male 90° Elbow | Swivel

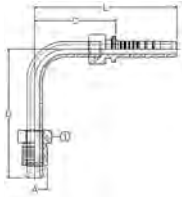

Descriptive #	Product #	SAP #	Hose Size ID		Thread Size (A)	Hex-1 Wrench Size		Drop (D)		Cut-Off (C)		Length (L)		SR5 DR5 SCX5
			in.	mm		in.	mm	in.	mm	in.	mm			
UC-SIMX90-0403	36815-0403	20318342	1/4	6.4	3/8-24	1/2	12	1.97	50.0	1.38	35.0	2.32	59.0	UCF6-04
UC-SIMX90-0404	36815-0404	20318343	1/4	6.4	7/16-24	1/2	12	2.05	52.0	1.30	33.0	2.24	57.0	UCF6-04
UC-SIMX90-0405	36815-0405	20318344	1/4	6.4	1/2-20	9/16	14	1.96	49.8	1.52	38.5	2.49	63.3	UCF6-04
UC-SIMX90-0604	36815-0604	20318345	13/32	10.3	7/16-24	1/2	12	2.44	62.0	1.34	34.0	2.36	60.0	UCF6-06
UC-SIMX90-0605	36815-0605	20318346	13/32	10.3	1/2-20	9/16	14	2.44	62.0	1.38	35.0	2.44	62.0	UCF6-06
UC-SIMX90-0606	36815-0606	20318347	13/32	10.3	5/8-18	11/16	17	2.44	62.0	1.38	35.0	2.44	62.0	UCF6-06
UC-SIMX90-0607	36815-0607	20318348	13/32	10.3	11/16-18	3/4	19	2.44	62.0	1.38	35.0	2.44	62.0	UCF6-06
UC-SIMX90-0808	36815-0808	20318349	1/2	12.7	3/4-18	3/4	19	2.32	59.0	2.13	54.0	3.35	85.0	UCF6-08

NPTF

Female

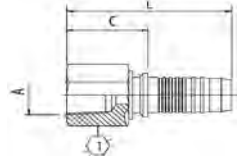

Descriptive #	Product #	SAP #	Hose Size ID		Thread Size (A)	Hex-1 Wrench Size		Cut-Off (C)		Length (L)		SR5 DR5 SCX5
			in.	mm		in.	mm	in.	mm	in.	mm	
UC-NPF-0404	36600-0404	20242660	1/4	6.4	1/4-18	3/4	19	1.09	27.8	2.07	52.6	UCF6-04
UC-NPF-0606	36600-0606	20242656	13/32	10.3	3/8-18	7/8	22	1.13	28.8	2.19	55.5	UCF6-06
UC-NPF-0808	36600-0808	20242622	1/2	12.7	1/2-14	1	25	1.40	35.6	2.64	67.1	UCF6-08

NPTF

Male

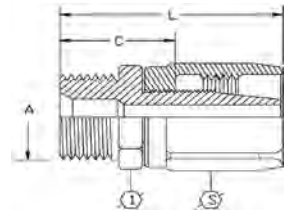

Descriptive #	Product #	SAP #	Hose Size ID		Thread Size (A)	Hex-1 Wrench Size	Socket (S) Wrench Size	Cut-Off (C)		Length (L)		SR5 DR5
			in.	mm				in.	mm	in.	mm	
FG-NPM-0402	18615-0402	20245804	3/16	4.8	1/8-27	9/16	5/8	0.92	23.4	1.67	42.5	Y
FG-NPM-0404	18615-0404	20245805	3/16	4.8	1/4-18	9/16	5/8	1.11	28.2	1.86	47.2	Y
FG-NPM-0504	18615-0504	20245806	1/4	6.4	1/4-18	9/16	11/16	1.19	30.2	1.97	50.0	Y
FG-NPM-0604	18615-0604	20245807	5/16	7.9	1/4-18	9/16	13/16	1.23	31.4	2.17	55.2	Y
FG-NPM-0606	18615-0606	20245808	5/16	7.9	3/8-18	11/16	13/16	1.27	32.2	2.20	56.0	Y
FG-NPM-0806	18615-0806	20245809	13/32	10.3	3/8-18	11/16	15/16	1.33	33.7	2.48	63.1	Y
FG-NPM-0808	18615-0808	20245811	13/32	10.3	1/2-14	7/8	15/16	1.56	39.7	2.72	69.1	Y
FG-NPM-1008	18615-1008	20245810	1/2	12.7	1/2-14	7/8	1 1/8	1.59	40.5	2.86	72.6	Y
FG-NPM-1012	18615-1012	20245802	1/2	12.7	3/4-14	1 1/16	1 1/8	1.66	42.1	2.91	73.8	Y
FG-NPM-1212	18615-1212	20245803	5/8	15.9	3/4-14	1 1/16	1 1/4	1.67	42.5	3.20	81.4	Y
FG-NPM-1612	18615-1612	20245842	7/8	22.2	3/4-14	1 3/8	1 7/16	1.53	38.9	2.80	71.0	Y
FG-NPM-1616	18615-1616	20245841	7/8	22.2	1-11 1/2	1 3/8	1 7/16	1.72	43.7	2.98	75.8	Y
FG-NPM-2020	18615-2020	20245838	1 1/8	28.6	1 1/4-11 1/2	1 3/4	1 3/4	1.83	46.4	3.19	81.0	Y
FG-NPM-2424	18615-2424	20245840	1 3/8	34.9	1 1/2-11 1/2	2	2	1.92	48.8	3.36	85.3	Y
FG-NPM-3232	18615-3232	20245839	1 13/16	46.0	2-11 1/2	2 1/2	2 1/2	2.06	52.4	3.91	99.2	Y

Continued on next page

NPTF

Male (Continued)

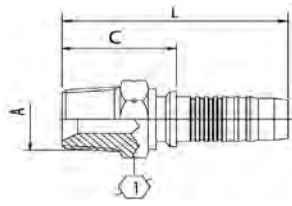

Descriptive #	Product #	SAP #	Hose Size ID		Thread Size (A)	Hex-1 Wrench Size		Cut-Off (C)		Length (L)		SR5 DR5 SCX5
			in.	mm		in.	mm	in.	mm	in.	mm	
UC-NPM-0302	36615-0302	20242703	3/16	4.8	1/8-27	1/2	12	0.82	20.8	1.69	43.0	UCF6-03
UC-NPM-0402	36615-0402	20242766	1/4	6.4	1/8-27	9/16	14	0.84	21.3	1.81	46.1	UCF6-04
UC-NPM-0404	36615-0404	20242780	1/4	6.4	1/4-18	11/16	17	1.06	26.8	2.03	51.6	UCF6-04
UC-NPM-0404S	36615-0404S	20540691	1/4	6.4	1/4-18	11/16	17	1.06	26.8	2.03	51.6	UCF6-04
UC-NPM-0406	36615-0406	20242748	1/4	6.4	3/8-18	3/4	19	1.09	27.8	2.07	52.6	UCF6-04
UC-NPM-0408	36615-0408	20242661	1/4	6.4	1/2-14	7/8	22	1.23	31.3	2.21	56.1	UCF6-04
UC-NPM-0504	36615-0504	20283392	5/16	7.9	1/4-18	11/16	17	1.06	26.8	2.03	51.6	UCF6-05
UC-NPM-0504S	36615-0504S	20540692	5/16	7.9	1/4-18	11/16	17	1.06	26.8	2.03	51.6	UCF6-05
UC-NPM-0506	36615-0506	20283396	5/16	7.9	3/8-18	3/4	19	1.09	27.8	2.07	52.6	UCF6-05
UC-NPM-0604	36615-0604	20242761	13/32	10.3	1/4-18	11/16	17	1.06	26.8	2.11	53.5	UCF6-06
UC-NPM-0606	36615-0606	20242782	13/32	10.3	3/8-18	3/4	19	1.09	27.8	2.15	54.5	UCF6-06
UC-NPM-0606S	36615-0606S	20540693	13/32	10.3	3/8-18	3/4	19	1.09	27.8	2.15	54.5	UCF6-06
UC-NPM-0608	36615-0608	20242767	13/32	10.3	1/2-14	7/8	22	1.23	31.3	2.28	58.0	UCF6-06
UC-NPM-0806	36615-0806	20242722	1/2	12.7	3/8-18	3/4	19	1.13	28.6	2.37	60.1	UCF6-08
UC-NPM-0808	36615-0808	20242775	1/2	12.7	1/2-14	7/8	22	1.26	32.1	2.50	63.6	UCF6-08
UC-NPM-0808S	36615-0808S	20540694	1/2	12.7	1/2-14	7/8	22	1.26	32.1	2.50	63.6	UCF6-08
UC-NPM-0812	36615-0812	20242679	1/2	12.7	3/4-14	1 1/16	27	1.34	34.1	2.58	65.6	UCF6-08
UC-NPM-1012	36615-1012	20274105	5/8	15.9	3/4-14	1 1/16	27	1.34	34.1	2.69	68.4	UCF6-10
UC-NPM-1416	36615-1416	20269531	7/8	22.2	1-11 1/2	1 7/16	36	1.72	43.6	3.27	83.1	UCF6-12
UC-NPM-1820	36615-1820	20283394	1 1/8	28.6	1 1/4-11 1/2	1 13/16	46	1.87	47.4	3.62	92.0	UCF6-16
UC-NPM-2224	36615-2224	20283393	1 3/8	34.9	1 1/2-11 1/2	2	50	1.99	50.5	4.04	102.5	UCF6-20
UC-NPM-2932	36615-2932	20269535	1 13/16	46.0	2-11 1/2	2 9/16	65	2.13	54.2	4.97	126.2	UCF8-32

NPTF

Male | Swivel

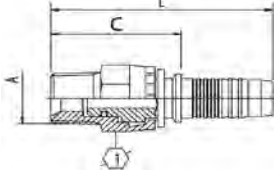

Descriptive #	Product #	SAP #	Hose Size ID		Thread Size (A)	Hex-1 Wrench Size		Cut-Off (C)		Length (L)		SR5 DR5 SCX5
			in.	mm		in.	mm	in.	mm	in.	mm	
UC-NPMX-0404	36645-0404	20242757	1/4	6.4	1/4-18	11/16	17	1.48	37.6	2.46	62.4	UCF6-04
UC-NPMX-0406	36645-0406	20242519	1/4	6.4	3/8-18	7/8	22	1.56	39.5	2.53	64.3	UCF6-04
UC-NPMX-0604	36645-0604	20242745	13/32	10.3	1/4-18	11/16	17	1.56	39.6	2.61	66.3	UCF6-06
UC-NPMX-0606	36645-0606	20242777	13/32	10.3	3/8-18	7/8	22	1.48	37.5	2.53	64.2	UCF6-06
UC-NPMX-0608	36645-0608	20242751	13/32	10.3	1/2-14	1	25	1.71	43.5	2.76	70.2	UCF6-06
UC-NPMX-0806	36645-0806	20242503	1/2	12.7	3/8-18	7/8	22	1.51	38.3	2.75	69.8	UCF6-08
UC-NPMX-0808	36645-0808	20242762	1/2	12.7	1/2-14	1	25	1.67	42.3	2.91	73.8	UCF6-08

NPTF

Male 90° Elbow (Block) | Swivel

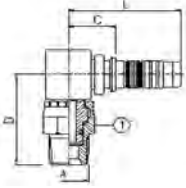

Descriptive #	Product #	SAP #	Hose Size ID		Thread Size (A)	Hex-1 Wrench Size		Drop (D)		Cut-Off (C)		Length (L)		SR5 DR5 SCX5
			in.	mm		in.	mm	in.	mm	in.	mm			
UC-NPMX90B-0404	36650-0404	20318350	1/4	6.4	1/4-18	11/16	17	1.54	39.0	0.67	17.0	1.65	41.8	UCF6-04
UC-NPMX90B-0604	36650-0604	20318351	13/32	10.3	1/4-18	11/16	17	1.61	41.0	0.79	20.0	1.84	46.7	UCF6-06
UC-NPMX90B-0606	36650-0606	20318352	13/32	10.3	3/8-18	7/8	22	1.61	41.0	0.79	20.0	1.84	46.7	UCF6-06
UC-NPMX90B-0808	36650-0808	20318353	1/2	12.7	1/2-14	1	25	1.89	48.0	0.91	23.0	2.15	54.5	UCF6-08

NPSM

Female | Swivel

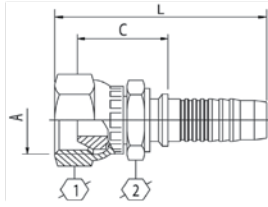

Descriptive #	Product #	SAP #	Hose Size ID		Thread Size (A)	Hex-1 Wrench Size		Hex-2 Wrench Size		Cut-Off (C)		Length (L)		SR5 DR5 SCX5
			in.	mm		in.	mm	in.	mm	in.	mm	in.	mm	
UC-NSFX-0404	36655-0404	20242668	1/4	6.4	1/4-18	3/4	19	11/16	17	0.96	24.3	2.17	55.1	UCF6-04
UC-NSFX-0606	36655-0606	20242669	13/32	10.3	3/8-18	7/8	22	3/4	19	0.98	24.8	2.27	57.7	UCF6-06
UC-NSFX-0808	36655-0808	20242654	1/2	12.7	1/2-14	1 1/16	27	7/8	22	1.05	26.6	2.54	64.6	UCF6-08

SAE J514 Flareless Tube Fittings

Male

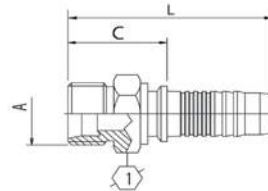

Descriptive #	Product #	SAP #	Hose Size ID		Thread Size (A)	Hex-1 Wrench Size	Cut-Off (C)		Length (L)		SR5 DR5 SCX5	
			in.	mm			in.	mm	in.	mm		
UC-FTM-0404	36360-0404	20286107	1/4	6.4	7/16-20	1/2	12	0.86	21.8	1.83	46.6	UCF6-04
UC-FTM-0506	36360-0506	20295568	5/16	7.9	9/16-18	5/8	16	0.95	24.2	1.93	49.0	UCF6-05
UC-FTM-0606	36360-0606	20286108	13/32	10.3	9/16-18	5/8	16	0.95	24.2	2.00	50.9	UCF6-06

*All fittings come with Nut and Sleeve

Standpipe

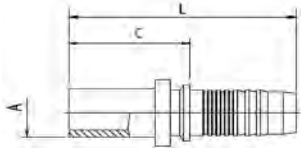

Descriptive #	Product #	SAP #	Hose Size ID		Tube OD (A)	Cut-Off (C)		Length (L)		SR5 DR5 SCX5
			in.	mm		in.	mm	in.	mm	
UC-SP-0410	36825-0410	20242461	1/4	6.4	10	1.27	32.2	2.24	57.0	UCF6-04
UC-SP-0610	36825-0610	20242555	13/32	10.3	10	1.19	30.3	2.24	57.0	UCF6-06
UC-SP-0612	36825-0612	20242576	13/32	10.3	12	1.15	29.3	2.20	56.0	UCF6-06
UC-SP-0815	36825-0815	20242372	1/2	12.7	15	1.26	32.1	2.50	63.6	UCF6-08
UC-SP-0816	36825-0816	20242482	1/2	12.7	16	1.46	37.1	2.70	68.6	UCF6-08

Standpipe

45° Elbow

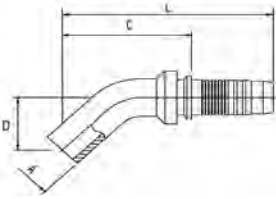

Descriptive #	Product #	SAP #	Hose Size ID		Tube OD (A)	Drop (D)		Cut-Off (C)		Length (L)		SR5 DR5 SCX5
			in.	mm		in.	mm	in.	mm	in.	mm	
UC-SP45-0408	36830-0408	20242370	1/4	6.4	8	0.91	23.0	1.69	43.0	2.68	68.0	UCF6-04

O-Ring Face Seal (SAE J1453) ORS/ORFS

Female | Swivel

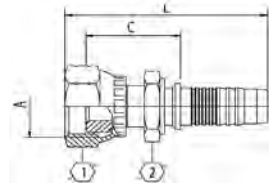

Descriptive #	Product #	SAP #	Hose Size ID		Thread Size (A)	Hex-1 Wrench Size		Hex-2 Wrench Size		Cut-Off (C)		Length (L)		SR5 DR5 SCX5
			in.	mm		in.	mm	in.	mm	in.	mm	in.	mm	
UC-OFFX-0404	36700-0404	20242723	1/4	6.4	9/16-18	11/16	17	9/16	14	1.07	27.3	2.37	60.3	UCF6-04
UC-OFFX-0406	36700-0406	20242655	1/4	6.4	11/16-16	7/8	22	11/16	17	1.19	30.3	2.54	64.6	UCF6-04
UC-OFFX-0408	36700-0408	20242441	1/4	6.4	13/16-16	15/16	24	7/8	22	1.39	35.3	2.80	71.1	UCF6-04
UC-OFFX-0506	36700-0506	20242544	5/16	7.9	11/16-16	7/8	22	11/16	17	1.19	30.3	2.54	64.6	UCF6-05
UC-OFFX-0604	36700-0604	20612477	13/32	10.3	9/16-18	11/16	17	11/16	17	1.11	28.3	2.49	63.2	UCF6-06
UC-OFFX-0606	36700-0606	20242763	13/32	10.3	11/16-16	7/8	22	11/16	17	1.19	30.3	2.62	66.5	UCF6-06
UC-OFFX-0608	36700-0608	20242691	13/32	10.3	13/16-16	15/16	24	7/8	22	1.39	35.3	2.87	73.0	UCF6-06
UC-OFFX-0806	36700-0806	20242552	1/2	12.7	11/16-16	7/8	22	3/4	19	1.26	32.1	2.88	73.1	UCF6-08
UC-OFFX-0808	36700-0808	20242733	1/2	12.7	13/16-16	15/16	24	7/8	22	1.42	36.1	3.09	78.6	UCF6-08
UC-OFFX-0810	36700-0810	20242704	1/2	12.7	1-14	13/16	30	15/16	24	1.56	39.6	3.31	84.1	UCF6-08
UC-OFFX-0812	36700-0812	20242551	1/2	12.7	13/16-12	17/16	36	13/16	30	1.66	42.1	3.47	88.1	UCF6-08
UC-OFFX-1010	36700-1010	20242442	5/8	15.9	1-14	13/16	30	15/16	24	1.56	39.6	3.39	86.1	UCF6-10
UC-OFFX-1012	36700-1012	20242367	5/8	15.9	13/16-12	17/16	36	13/16	30	1.66	42.1	3.58	90.9	UCF6-10

O-Ring Face Seal (SAE J1453) ORS/ORFS

Female 45° Elbow | Swivel

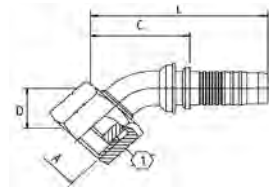

Descriptive #	Product #	SAP #	Hose Size ID		Thread Size (A)	Hex-1 Wrench Size		Drop (D)		Cut-Off (C)		Length (L)		SR5 DR5 SCX5
			in.	mm		in.	mm	in.	mm	in.	mm	in.	mm	
UC-OFFX45-0404	36710-0404	20242631	1/4	6.4	9/16-18	11/16	17	0.43	11.0	1.61	41.0	2.60	66.0	UCF6-04
UC-OFFX45-0406	36710-0406	20242549	1/4	6.4	11/16-16	7/8	22	0.43	11.0	1.81	46.0	2.80	71.0	UCF6-04
UC-OFFX45-0506	36710-0506	20242456	5/16	7.9	11/16-16	7/8	22	0.47	12.0	1.81	46.0	2.99	76.0	UCF6-05
UC-OFFX45-0606	36710-0606	20242683	13/32	10.3	11/16-16	7/8	22	0.47	12.0	1.85	47.0	2.91	74.0	UCF6-06
UC-OFFX45-0608	36710-0608	20242593	13/32	10.3	13/16-16	15/16	24	0.59	15.0	2.01	51.0	3.07	78.0	UCF6-06
UC-OFFX45-0808 ^C	36710-0808	20242637	1/2	12.7	13/16-16	15/16	24	0.63	16.0	1.85	47.0	3.11	79.0	UCF6-08
UC-OFFX45-0810	36710-0810	20242532	1/2	12.7	1-14	13/16	30	0.65	16.5	1.97	50.0	3.23	82.0	UCF6-08

C: Crimp Nut (see "Fitting Identification" in Appendix for details)

O-Ring Face Seal (SAE J1453) ORS/ORFS

Female 90° Elbow | Swivel

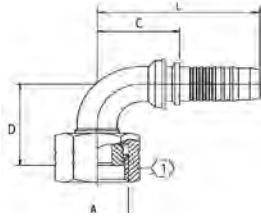

Elbow Type
 LT=Long Tube
 ST=Short Tube

Descriptive #	Product #	SAP #	Hose Size ID		Thread Size (A)		Hex-1 Wrench Size		Elbow Type	Drop (D)		Cut-Off (C)		Length (L)		SR5 DR5 SCX5
			in.	mm	in.	mm	in.	mm		in.	mm	in.	mm	in.	mm	
UC-OFFX90-0404	36715-0404	20242602	1/4	6.4	9/16-18	11/16	17			1.26	32.0	1.18	30.0	2.17	55.0	UCF6-04
UC-OFFX90L-0404	36720-0404	20242533	1/4	6.4	9/16-18	11/16	17	LT		1.81	46.0	1.30	33.0	2.28	58.0	UCF6-04
UC-OFFX90S-0404	36725-0404	20242682	1/4	6.4	9/16-18	11/16	17	ST		0.83	21.0	1.10	28.0	2.09	53.0	UCF6-04
UC-OFFX90-0406	36715-0406	20242479	1/4	6.4	11/16-16	7/8	22			1.50	38.0	1.46	37.0	2.44	62.0	UCF6-04
UC-OFFX90L-0406	36720-0406	20242492	1/4	6.4	11/16-16	7/8	22	LT		2.13	54.0	1.38	35.0	2.36	60.0	UCF6-04
UC-OFFX90S-0406	36725-0406	20242598	1/4	6.4	11/16-16	7/8	22	ST		0.91	23.0	1.26	32.0	2.24	57.0	UCF6-04
UC-OFFX90S-0506	36725-0506	20242494	5/16	7.9	11/16-16	7/8	22	ST		1.34	34.0	1.61	41.0	2.60	66.0	UCF6-05
UC-OFFX90-0606	36715-0606	20242633	13/32	10.3	11/16-16	7/8	22			1.50	38.0	1.65	42.0	2.72	69.0	UCF6-06
UC-OFFX90L-0606	36720-0606	20242615	13/32	10.3	11/16-16	7/8	22	LT		2.13	54.0	1.65	42.0	2.72	69.0	UCF6-06
UC-OFFX90S-0606	36725-0606	20242717	13/32	10.3	11/16-16	7/8	22	ST		0.98	25.0	1.65	42.0	2.72	69.0	UCF6-06
UC-OFFX90-0608	36715-0608	20242480	13/32	10.3	13/16-16	15/16	24			1.61	41.0	1.73	44.0	2.80	71.0	UCF6-06
UC-OFFX90L-0608	36720-0608	20242493	13/32	10.3	13/16-16	15/16	24	LT		2.52	64.0	1.85	47.0	2.91	74.0	UCF6-06
UC-OFFX90S-0608	36725-0608	20242620	13/32	10.3	13/16-16	15/16	24	ST		1.14	29.0	1.65	42.0	2.72	69.0	UCF6-06
UC-OFFX90-0808 ^C	36715-0808	20242571	1/2	12.7	13/16-16	15/16	24			1.65	42.0	1.38	35.0	2.60	66.0	UCF6-08
UC-OFFX90L-0808 ^C	36720-0808	20242566	1/2	12.7	13/16-16	15/16	24	LT		2.52	64.0	1.50	38.0	2.76	70.0	UCF6-08
UC-OFFX90S-0808 ^C	36725-0808	20242663	1/2	12.7	13/16-16	15/16	24	ST		1.14	29.0	1.57	40.0	2.80	71.0	UCF6-08
UC-OFFX90-0810	36715-0810	20242363	1/2	12.7	1-14	13/16	30			1.85	47.0	1.89	48.0	3.15	80.0	UCF6-08
UC-OFFX90L-0810	36720-0810	20242438	1/2	12.7	1-14	13/16	30	LT		2.76	70.0	1.81	46.0	3.07	78.0	UCF6-08
UC-OFFX90S-0810	36725-0810	20242550	1/2	12.7	1-14	13/16	30	ST		1.28	32.5	1.81	46.0	3.07	78.0	UCF6-08
UC-OFFX90-1010	36715-1010	20242403	5/8	15.9	1-14	13/16	30			1.73	44.0	2.17	55.0	3.54	90.0	UCF6-10
UC-OFFX90S-1010	36725-1010	20242365	5/8	15.9	1-14	13/16	30	ST		1.28	32.5	2.05	52.0	3.43	87.0	UCF6-10
UC-OFFX90S-1012	36725-1012	20242364	5/8	15.9	13/16-12	17/16	36	ST		1.93	49.0	2.17	55.0	3.54	90.0	UCF6-10

C: Crimp Nut (see "Fitting Identification" in Appendix for details)

O-Ring Face Seal (SAE J1453) ORS/ORFS

Male - SCXS

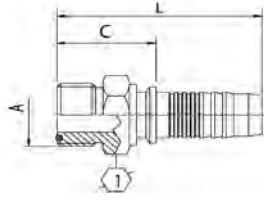

Descriptive #	Product #	SAP #	Hose Size ID		Thread Size (A)	Hex-1 Wrench Size		Cut-Off (C)		Length (L)		SR5 DR5 SCX5
			in.	mm		in.	mm	in.	mm	in.	mm	
UC-OFM-0404	36730-0404	20242567	1/4	6.4	9/16-18	11/16	17	0.88	22.3	1.85	47.1	UCF6-04
UC-OFM-0606	36730-0606	20242596	13/32	10.3	11/16-16	3/4	19	0.96	24.3	2.01	51.0	UCF6-06
UC-OFM-0608	36730-0608	20242575	13/32	10.3	13/16-16	7/8	22	1.04	26.3	2.09	53.0	UCF6-06
UC-OFM-0808	36730-0808	20242545	1/2	12.7	13/16-16	7/8	22	1.07	27.1	2.31	58.6	UCF6-08
UC-OFM-0810	36730-0810	20242369	1/2	12.7	1-14	1 1/16	27	1.20	30.6	2.44	62.1	UCF6-08
UC-OFM-0812	36730-0812	20242368	1/2	12.7	1 3/16-12	1 1/4	32	1.34	34.1	2.58	65.6	UCF6-08

O-Ring Boss Straight Thread (SAE J514)

Male

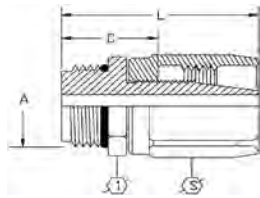

Descriptive #	Product #	SAP #	Hose Size ID		Thread Size (A)	Hex-1 Wrench Size	Socket (S) Wrench Size	Cut-Off (C)		Length (L)		SR5 DR5
			in.	mm				in.	mm	in.	mm	
FG-OBM-0404	18670-0404	20245788	3/16	4.8	7/16-20	9/16	5/8	0.89	22.6	1.64	41.7	Y
FG-OBM-0505	18670-0505	20245789	1/4	6.4	1/2-20	5/8	11/16	0.97	24.6	1.75	44.5	Y
FG-OBM-0606	18670-0606	20245790	5/16	7.9	9/16-18	11/16	13/16	1.03	26.2	1.94	49.2	Y
FG-OBM-0808	18670-0808	20245791	13/32	10.3	3/4-16	7/8	15/16	1.09	27.8	2.34	59.5	Y
FG-OBM-1010	18670-1010	20245783	1/2	12.7	7/8-14	1	1 1/8	1.23	31.4	2.62	66.7	Y
FG-OBM-1212	18670-1212	20245784	5/8	15.9	1 1/16-12	1 1/4	1 1/4	1.53	38.9	3.09	78.6	Y
FG-OBM-1616	18670-1616	20245785	7/8	22.2	1 5/16-12	1 1/2	1 7/16	1.39	35.3	2.66	67.5	Y
FG-OBM-2020	18670-2020	20245786	1 1/8	28.6	1 5/8-12	1 7/8	1 3/4	1.39	35.3	2.75	69.9	Y
FG-OBM-2424	18670-2424	20245787	1 3/8	34.9	1 7/8-12	2 1/8	2	1.39	35.3	2.84	72.2	Y

Continued on next page

O-Ring Boss Straight Thread (SAE J514)

Male (Continued)

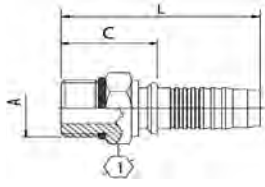

Descriptive #	Product #	SAP #	Hose Size ID		Thread Size (A)		Hex-1 Wrench Size		Cut-Off (C)		Length (L)		SR5 DR5 SCX5
			in.	mm	in.	mm	in.	mm	in.	mm	in.	mm	
UC-OBM-0404	36670-0404	20242597	1/4	6.4	7/16-20	9/16	14	0.80	20.3	1.78	45.1	UCF6-04	
UC-OBM-0405	36670-0405	20242531	1/4	6.4	1/2-20	5/8	16	0.83	21.2	1.81	46.1	UCF6-04	
UC-OBM-0406	36670-0406	20242591	1/4	6.4	9/16-18	11/16	17	0.88	22.3	1.85	47.1	UCF6-04	
UC-OBM-0606	36670-0606	20242677	13/32	10.3	9/16-18	3/4	19	0.92	23.3	1.97	50.0	UCF6-06	
UC-OBM-0608	36670-0608	20242672	13/32	10.3	3/4-16	7/8	22	0.96	24.3	2.01	51.0	UCF6-06	
UC-OBM-0610	36670-0610	20242614	13/32	10.3	7/8-14	1 1/16	27	1.06	26.8	2.11	53.5	UCF6-06	
UC-OBM-0808	36670-0808	20242665	1/2	12.7	3/4-16	7/8	22	0.99	25.1	2.23	56.6	UCF6-08	
UC-OBM-0810	36670-0810	20242595	1/2	12.7	7/8-14	1 1/16	27	1.09	27.6	2.33	59.1	UCF6-08	
UC-OBM-0812	36670-0812	20242476	1/2	12.7	1 1/16-12	1 1/4	32	1.26	32.1	2.50	63.6	UCF6-08	

O-Ring Boss Straight Thread (SAE J514)

Male | Swivel

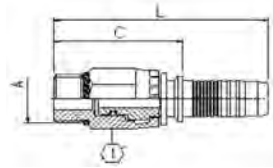

Descriptive #	Product #	SAP #	Hose Size ID		Thread Size (A)		Hex-1 Wrench Size		Cut-Off (C)		Length (L)		SR5 DR5 SCX5
			in.	mm	in.	mm	in.	mm	in.	mm			
UC-OBMX-0608	36680-0608	20318237	13/32	10.3	3/4-16	1	25	1.71	43.5	2.76	70.2	UCF6-06	
UC-OBMX-0808	36680-0808	20318238	1/2	12.7	3/4-16	1	25	1.67	42.3	2.91	73.8	UCF6-08	
UC-OBMX-0810	36680-0810	20318239	1/2	12.7	7/8-14	1	25	1.72	43.8	2.96	75.3	UCF6-08	

O-Ring Boss Straight Thread (SAE J514) Male 90° Elbow (Block) | Swivel

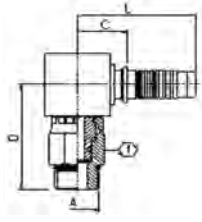

Descriptive #	Product #	SAP #	Hose Size ID		Thread Size (A)		Hex-1 Wrench Size		Drop (D)		Cut-Off (C)		Length (L)		SR5 DR5 SCX5
			in.	mm	in.	mm	in.	mm	in.	mm	in.	mm	in.	mm	
UC-OBMX90B-0405	36685-0405	20318354	1/4	6.4	1/2-20	11/16	17	1.38	35.0	0.67	17.0	1.65	41.8	UCF6-04	
UC-OBMX90B-0606	36685-0606	20318355	13/32	10.3	9/16-18	7/8	22	1.73	44.0	0.79	20.0	1.84	46.7	UCF6-06	
UC-OBMX90B-0608	36685-0608	20318356	13/32	10.3	3/4-16	1	25	1.77	45.0	0.87	22.0	1.92	48.7	UCF6-06	
UC-OBMX90B-0808	36685-0808	20318357	1/2	12.7	3/4-16	1	25	1.89	48.0	0.91	23.0	2.15	54.5	UCF6-08	
UC-OBMX90B-0810	36685-0810	20318358	1/2	12.7	7/8-14	1	25	1.97	50.0	0.91	23.0	2.15	54.5	UCF6-08	

Code 61 Flange (SAE J518)

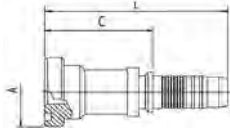

Descriptive #	Product #	SAP #	Hose Size ID		Flange Size	Cut-Off (C)		Length (L)		SR5 DR5 SCX5
			in.	mm		in.	mm	in.	mm	
UC-FL-0808	36320-0808	20242569	1/2	12.7	1/2	1.61	41.0	2.85	72.5	UCF6-08
UC-FL-0812	36320-0812	20242300	1/2	12.7	3/4	1.65	42.0	2.89	73.5	UCF6-08

Code 61 Flange (SAE J518)

45° Elbow

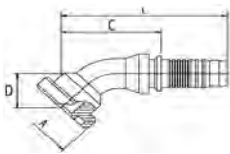

Descriptive #	Product #	SAP #	Hose Size ID		Flange Size	Drop (D)		Cut-Off (C)		Length (L)		SR5 DR5 SCX5
			in.	mm		in.	mm	in.	mm	in.	mm	
UC-FL45-0808	36340-0808	20242508	1/2	12.7	1/2	0.87	22.0	2.09	53.0	3.31	84.0	UCF6-08
UC-FL45-0812	36340-0812	20242293	1/2	12.7	3/4	1.02	26.0	2.36	60.0	3.62	92.0	UCF6-08

Code 61 Flange (SAE J518)

90° Elbow

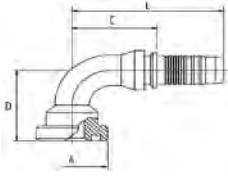

Descriptive #	Product #	SAP #	Hose Size ID		Flange Size	Drop (D)		Cut-Off (C)		Length (L)		SR5 DR5 SCX5
			in.	mm		in.	mm	in.	mm	in.	mm	
UC-FL90-0808	36350-0808	20242537	1/2	12.7	1/2	1.65	42.0	1.81	46.0	3.03	77.0	UCF6-08
UC-FL90-0812	36350-0812	20242381	1/2	12.7	3/4	2.01	51.0	1.77	45.0	3.03	77.0	UCF6-08

Code 62 Flange (SAE J518)

90° Elbow

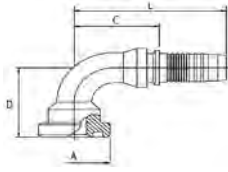

Descriptive #	Product #	SAP #	Hose Size ID		Flange Size	Drop (D)		Cut-Off (C)		Length (L)		SR5 DR5 SCX5
			in.	mm		in.	mm	in.	mm	in.	mm	
UC-FH90-0808	36315-0808	20242306	1/2	12.7	1/2	1.81	46.0	1.89	48.0	3.11	79.0	UCF6-08

BSPB (British Standard Pipe Parallel)

Female | Swivel

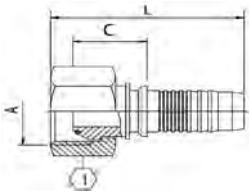

Descriptive #	Product #	SAP #	Hose Size ID		Thread Size (A)	Hex-1 Wrench Size		Cut-Off (C)		Length (L)		SR5 DR5 SCX5
			in.	mm		in.	mm	in.	mm	in.	mm	
UC-BPFX-0404	36105-0404	20242738	1/4	6.4	1/4-19	3/4	19	0.82	20.8	1.94	49.2	UCF6-04
UC-BPFX-0406	36105-0406	20242462	1/4	6.4	3/8-19	7/8	22	0.92	23.3	2.11	53.6	UCF6-04
UC-BPFX-0606	36105-0606	20242731	13/32	10.3	3/8-19	7/8	22	0.92	23.3	2.19	55.5	UCF6-06
UC-BPFX-0608	36105-0608	20242557	13/32	10.3	1/2-14	1 1/16	27	0.96	24.3	2.24	56.9	UCF6-06
UC-BPFX-0808	36105-0808	20242715	1/2	12.7	1/2-14	1 1/16	27	0.99	25.1	2.46	62.5	UCF6-08
UC-BPFX-0810	36105-0810	20242406	1/2	12.7	5/8-14	1 1/16	27	1.12	28.4	2.74	69.6	UCF6-08

BSPB (British Standard Pipe Parallel)

Female 45° Elbow | Swivel

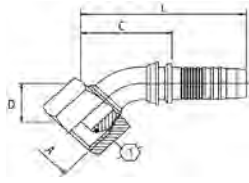

Descriptive #	Product #	SAP #	Hose Size ID		Thread Size (A)		Hex-1 Wrench Size		Drop (D)		Cut-Off (C)		Length (L)		SR5 DR5 SCX5
			in.	mm	in.	mm	in.	mm	in.	mm	in.	mm	in.	mm	
UC-BPFX45-0404	36115-0404	20242444	1/4	6.4	1/4-19	3/4	19	0.59	15.0	1.81	46.0	2.76	70.0	UCF6-04	
UC-BPFX45-0606	36115-0606	20242496	13/32	10.3	3/8-19	7/8	22	0.81	20.5	1.97	50.0	3.03	77.0	UCF6-06	
UC-BPFX45-0808	36115-0808	20242803	1/2	12.7	1/2-14	1 1/16	27	0.83	21.0	2.17	55.0	3.43	87.0	UCF6-08	

BSPB (British Standard Pipe Parallel)

Female 90° Elbow | Swivel

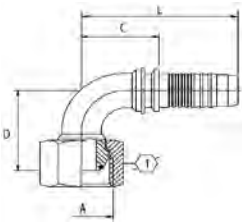

Descriptive #	Product #	SAP #	Hose Size ID		Thread Size (A)		Hex-1 Wrench Size		Drop (D)		Cut-Off (C)		Length (L)		SR5 DR5 SCX5
			in.	mm	in.	mm	in.	mm	in.	mm	in.	mm	in.	mm	
UC-BPFX90-0404	36120-0404	20242536	1/4	6.4	1/4-19	3/4	19	1.14	29.0	1.14	29.0	2.13	54.0	UCF6-04	
UC-BPFX90-0606	36120-0606	20242610	13/32	10.3	3/8-19	7/8	22	1.65	42.0	1.38	35.0	2.44	62.0	UCF6-06	
UC-BPFX90-0608	36120-0608	20242805	13/32	10.3	1/2-14	1 1/16	27	1.40	35.5	1.34	34.0	2.40	61.0	UCF6-06	
UC-BPFX90-0808	36120-0808	20242556	1/2	12.7	1/2-14	1 1/16	27	1.61	41.0	1.42	36.0	2.64	67.0	UCF6-08	

BSPP (British Standard Pipe Parallel)

Male

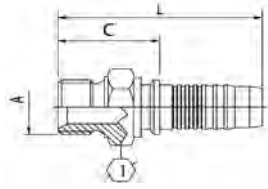

Descriptive #	Product #	SAP #	Hose Size ID		Thread Size (A)		Hex-1 Wrench Size		Cut-Off (C)		Length (L)		SR5 DR5 SCX5
			in.	mm	in.	mm	in.	mm	in.	mm			
UC-BPM-0404	36130-0404	20242484	1/4	6.4	1/4-19	3/4	19	1.04	26.3	2.01	51.1	UCF6-04	
UC-BPM-0606	36130-0606	20242581	13/32	10.3	3/8-19	7/8	22	1.09	27.8	2.15	54.5	UCF6-06	
UC-BPM-0608	36130-0608	20242464	13/32	10.3	1/2-14	1 1/16	27	1.23	31.3	2.28	58.0	UCF6-06	
UC-BPM-0806	36130-0806	20242809	1/2	12.7	3/8-19	7/8	22	1.13	28.6	2.37	60.1	UCF6-08	
UC-BPM-0808	36130-0808	20242463	1/2	12.7	1/2-14	1 1/16	27	1.26	32.1	2.50	63.6	UCF6-08	

BSPT (British Standard Pipe Tapered)

Male

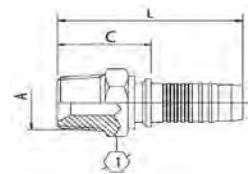

Descriptive #	Product #	SAP #	Hose Size ID		Thread Size (A)		Hex-1 Wrench Size		Cut-Off (C)		Length (L)		SR5 DR5 SCX5
			in.	mm	in.	mm	in.	mm	in.	mm			
UC-BTM-0404	36170-0404	20242611	1/4	6.4	1/4-19	11/16	17	1.06	26.8	2.03	51.6	UCF6-04	
UC-BTM-0606	36170-0606	20242612	13/32	10.3	3/8-19	3/4	19	1.09	27.8	2.15	54.5	UCF6-06	
UC-BTM-0808	36170-0808	20242507	1/2	12.7	1/2-14	7/8	22	1.30	33.1	2.54	64.6	UCF6-08	

BSP Flat Seat (British Standard Pipe)

Female | Swivel

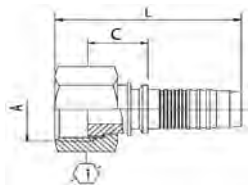

Descriptive #	Product #	SAP #	Hose Size ID		Thread Size (A)		Hex-1 Wrench Size		Cut-Off (C)		Length (L)		SR5 DR5 SCX5
			in.	mm	in.	mm	in.	mm	in.	mm			
UC-BFFX-0606	36100-0606	20242800	13/32	10.3	3/8-19	7/8	22	0.80	20.3	2.22	56.3	UCF6-06	
UC-BFFX-0608	36100-0608	20242799	13/32	10.3	1/2-14	1 1/16	27	0.82	20.8	2.28	57.9	UCF6-06	
UC-BFFX-0808	36100-0808	20242798	1/2	12.7	1/2-14	1 1/16	27	0.85	21.6	2.50	63.5	UCF6-08	
UC-BFFX-0812	36100-0812	20242285	1/2	12.7	3/4-14	1 1/4	32	0.97	24.6	2.70	68.6	UCF6-08	

DIN 24° Light

Female | Swivel

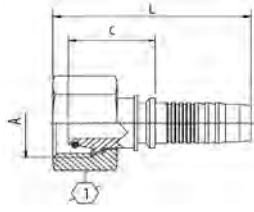

Descriptive #	Product #	SAP #	Hose Size ID		Thread Size (A)	Hex-1 Wrench Size	Cut-Off (C)		Length (L)		SR5 DR5 SCX5
			in.	mm			in.	mm	in.	mm	
UC-DLFX-0412 ^T	36240-0412	20242540	1/4	6.4	12 x 1.5	14	0.98	24.8	1.99	50.6	UCF6-04
UC-DLFX-0414	36240-0414	20242594	1/4	6.4	14 x 1.5	17	0.96	24.4	1.98	50.2	UCF6-04
UC-DLFX-0416	36240-0416	20242471	1/4	6.4	16 x 1.5	19	1.00	25.4	2.04	51.9	UCF6-04
UC-DLFX-0616	36240-0616	20242658	13/32	10.3	16 x 1.5	19	1.10	28.0	2.28	58.0	UCF6-06
UC-DLFX-0618	36240-0618	20242641	13/32	10.3	18 x 1.5	22	1.00	25.4	2.10	53.3	UCF6-06
UC-DLFX-0822	36240-0822	20242586	1/2	12.7	22 x 1.5	27	1.11	28.2	2.43	61.8	UCF6-08

T: Thrust-Wire Nut (see "Fitting Identification" in Appendix for details)

DIN 24° Light

Female 45° Elbow | Swivel

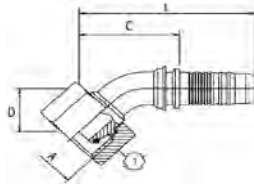

Descriptive #	Product #	SAP #	Hose Size ID		Thread Size (A)	Hex-1 Wrench Size	Drop (D)		Cut-Off (C)		Length (L)		SR5 DR5 SCX5
			in.	mm			in.	mm	in.	mm	in.	mm	
UC-DLFX45-0414	36245-0414	20242385	1/4	6.4	14 x 1.5	17	0.69	17.5	1.69	43.0	2.68	68.0	UCF6-04
UC-DLFX45-0416	36245-0416	20242386	1/4	6.4	16 x 1.5	19	0.79	20.0	1.65	42.0	2.64	67.0	UCF6-04
UC-DLFX45-0618	36245-0618	20242387	13/32	10.3	18 x 1.5	22	0.77	19.5	1.85	47.0	2.96	75.2	UCF6-06
UC-DLFX45-0822	36245-0822	20242329	1/2	12.7	22 x 1.5	27	0.83	21.0	2.17	55.0	3.50	89.0	UCF6-08

DIN 24° Light

Female 90° Elbow | Swivel

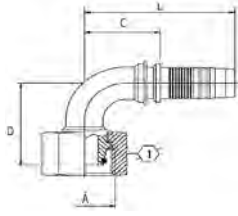

Descriptive #	Product #	SAP #	Hose Size ID		Thread Size (A)	Hex-1 Wrench Size	Drop (D)		Cut-Off (C)		Length (L)		SR5 DR5 SCX5
			in.	mm			in.	mm	in.	mm	in.	mm	
UC-DLFX90-0412	36250-0412	20242390	1/4	6.4	12 x 1.5	14	1.02	26.0	1.14	29.0	2.13	54.0	UCF6-04
UC-DLFX90-0414	36250-0414	20242425	1/4	6.4	14 x 1.5	17	1.28	32.5	1.10	28.0	2.09	53.0	UCF6-04
UC-DLFX90-0416	36250-0416	20242391	1/4	6.4	16 x 1.5	19	1.28	32.5	1.10	28.0	2.09	53.0	UCF6-04
UC-DLFX90-0618	36250-0618	20242488	13/32	10.3	18 x 1.5	22	1.54	39.0	1.30	33.0	2.36	60.0	UCF6-06
UC-DLFX90-0822	36250-0822	20242389	1/2	12.7	22 x 1.5	27	1.59	40.5	1.57	40.0	2.80	71.0	UCF6-08

DIN 24° Light

Male

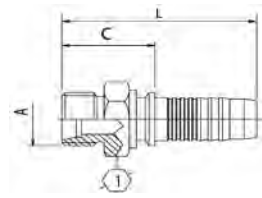

Descriptive #	Product #	SAP #	Hose Size ID		Thread Size (A)	Hex-1 Wrench Size	Cut-Off (C)		Length (L)		SR5 DR5 SCX5
			in.	mm			in.	mm	in.	mm	
UC-DLM-0412	36255-0412	20242334	1/4	6.4	12 x 1.5	14	0.84	21.3	1.81	46.1	UCF6-04
UC-DLM-0414	36255-0414	20242393	1/4	6.4	14 x 1.5	14	0.84	21.3	1.81	46.1	UCF6-04
UC-DLM-0416	36255-0416	20242335	1/4	6.4	16 x 1.5	17	0.92	23.3	1.89	48.1	UCF6-04
UC-DLM-0616	36255-0616	20242426	13/32	10.3	16 x 1.5	17	0.92	23.3	1.97	50.0	UCF6-06
UC-DLM-0618	36255-0618	20242513	13/32	10.3	18 x 1.5	19	0.96	24.3	2.01	51.0	UCF6-06
UC-DLM-0822	36255-0822	20242392	1/2	12.7	22 x 1.5	22	1.03	26.1	2.27	57.6	UCF6-08

DIN 24° Heavy

Female | Swivel

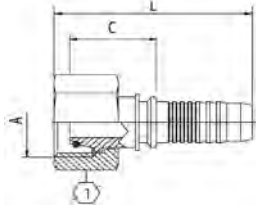

Descriptive #	Product #	SAP #	Hose Size ID		Thread Size (A)	Hex-1 Wrench Size	Cut-Off (C)		Length (L)		SR5 DR5 SCX5
			in.	mm			in.	mm	in.	mm	
UC-DHFX-0416	36210-0416	20242538	1/4	6.4	16 x 1.5	19	1.09	27.7	2.07	52.5	UCF6-04
UC-DHFX-0418	36210-0418	20242529	1/4	6.4	18 x 1.5	22	1.09	27.8	2.07	52.6	UCF6-04
UC-DHFX-0620	36210-0620	20242624	13/32	10.3	20 x 1.5	24	1.09	27.6	2.25	57.1	UCF6-06
UC-DHFX-0622	36210-0622	20242562	13/32	10.3	22 x 1.5	27	1.22	31.1	2.44	62.1	UCF6-06
UC-DHFX-0824	36210-0824	20242561	1/2	12.7	24 x 1.5	30	1.25	31.7	2.67	67.7	UCF6-08

DIN 24° Heavy

Female 45° Elbow | Swivel

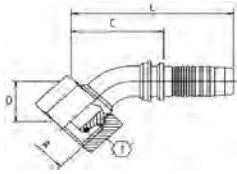

Descriptive #	Product #	SAP #	Hose Size ID		Thread Size (A)	Hex-1 Wrench Size	Drop (D)		Cut-Off (C)		Length (L)		SR5 DR5 SCX5
			in.	mm			in.	mm	in.	mm	in.	mm	
UC-DHFX45-0418	36215-0418	20242313	1/4	6.4	18 x 1.5	22	0.75	19.0	1.69	43.0	2.68	68.0	UCF6-04
UC-DHFX45-0620	36215-0620	20242315	13/32	10.3	20 x 1.5	24	0.79	20.0	2.01	51.0	3.03	77.0	UCF6-06
UC-DHFX45-0622	36215-0622	20242316	13/32	10.3	22 x 1.5	27	0.83	21.0	2.09	53.0	3.15	80.0	UCF6-06
UC-DHFX45-0824	36215-0824	20242312	1/2	12.7	24 x 1.5	30	0.85	21.5	2.20	56.0	3.43	87.0	UCF6-08

DIN 24° Heavy

Female 90° Elbow | Swivel

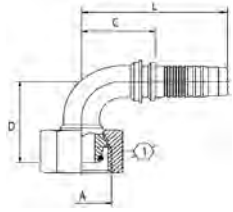

Descriptive #	Product #	SAP #	Hose Size ID		Thread Size (A)	Hex-1 Wrench Size	Drop (D)		Cut-Off (C)		Length (L)		SR5 DR5 SCX5
			in.	mm			in.	mm	in.	mm	in.	mm	
UC-DHFX90-0418	36220-0418	20242421	1/4	6.4	18 x 1.5	22	1.34	34.0	1.06	27.0	2.05	52.0	UCF6-04
UC-DHFX90-0620	36220-0620	20242563	13/32	10.3	20 x 1.5	24	1.52	38.5	1.34	34.0	2.40	61.0	UCF6-06
UC-DHFX90-0622	36220-0622	20242469	13/32	10.3	22 x 1.5	27	1.59	40.5	1.34	34.0	2.40	61.0	UCF6-06
UC-DHFX90-0824	36220-0824	20242468	1/2	12.7	24 x 1.5	30	1.63	41.5	1.57	40.0	2.80	71.0	UCF6-08

DIN 24° Heavy

Male

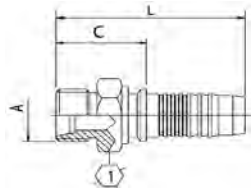

Descriptive #	Product #	SAP #	Hose Size ID		Thread Size (A)	Hex-1 Wrench Size	Cut-Off (C)		Length (L)		SR5 DR5 SCX5
			in.	mm			in.	mm	in.	mm	
UC-DHM-0416	36225-0416	20242323	1/4	6.4	16 x 1.5	17	0.96	24.3	1.93	49.1	UCF6-04
UC-DHM-0418	36225-0418	20242324	1/4	6.4	18 x 1.5	19	1.00	25.3	1.97	50.1	UCF6-04
UC-DHM-0620	36225-0620	20242424	13/32	10.3	20 x 1.5	22	1.00	25.3	2.05	52.0	UCF6-06
UC-DHM-0622	36225-0622	20242470	13/32	10.3	22 x 1.5	22	1.07	27.3	2.13	54.0	UCF6-06
UC-DHM-0824	36225-0824	20242322	1/2	12.7	24 x 1.5	24	1.15	29.1	2.39	60.6	UCF6-08

DIN 60°

Female 45° Elbow | Swivel

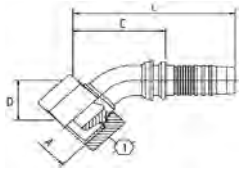

Descriptive #	Product #	SAP #	Hose Size ID		Thread Size (A)	Hex-1 Wrench Size	Drop (D)		Cut-Off (C)		Length (L)		SR5 DR5 SCX5
			in.	mm			in.	mm	in.	mm	in.	mm	
UC-DNFX45-0414	36275-0414	20242338	1/4	6.4	14 x 1.5	17	0.63	16.0	1.38	35.0	2.54	64.5	UCF6-04
UC-DNFX45-0416	36275-0416	20242339	1/4	6.4	16 x 1.5	19	0.67	17.0	1.42	36.0	2.58	65.5	UCF6-04
UC-DNFX45-0618	36275-0618	20242340	13/32	10.3	18 x 1.5	22	0.77	19.5	1.69	43.0	2.76	70.0	UCF6-06
UC-DNFX45-0822	36275-0822	20242337	1/2	12.7	22 x 1.5	27	0.79	20.0	2.17	55.0	3.39	86.0	UCF6-08

DIN 60°

Female 90° Elbow | Swivel

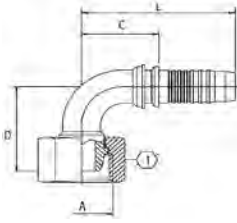

Descriptive #	Product #	SAP #	Hose Size ID		Thread Size (A)	Hex-1 Wrench Size	Drop (D)		Cut-Off (C)		Length (L)		SR5 DR5 SCX5
			in.	mm			in.	mm	in.	mm	in.	mm	
UC-DNFX90-0414	36280-0414	20242428	1/4	6.4	14 x 1.5	17	1.12	28.5	1.18	30.0	2.17	55.0	UCF6-04
UC-DNFX90-0416	36280-0416	20242341	1/4	6.4	16 x 1.5	19	1.28	32.5	1.10	28.0	2.09	53.0	UCF6-04
UC-DNFX90-0616	36280-0616	20242342	13/32	10.3	16 x 1.5	19	1.26	32.0	1.18	30.0	2.36	60.0	UCF6-06
UC-DNFX90-0618	36280-0618	20242472	13/32	10.3	18 x 1.5	22	1.46	37.0	1.30	33.0	2.36	60.0	UCF6-06
UC-DNFX90-0822	36280-0822	20242427	1/2	12.7	22 x 1.5	27	1.57	40.0	1.57	40.0	2.80	71.0	UCF6-08

Japanese Komatsu® 30° Flare with Metric Threads

Female | Swivel

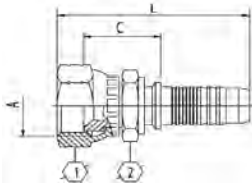

Descriptive #	Product #	SAP #	Hose Size ID		Thread Size (A)	Hex-1 Wrench Size	Hex-2 Wrench Size	Cut-Off (C)		Length (L)		SR5 DR5 SCX5
			in.	mm				in.	mm	in.	mm	
UC-KMFX-0414	36545-0414	20242590	1/4	6.4	14 X 1.5	19	17	0.82	20.8	2.19	55.6	UCF6-04
UC-KMFX-0618	36545-0618	20242636	13/32	10.3	18 X 1.5	22	19	0.86	21.8	2.30	58.5	UCF6-06
UC-KMFX-0822	36545-0822	20242573	1/2	12.7	22 X 1.5	27	22	0.93	23.6	2.62	66.6	UCF6-08
UC-KMFX-1024	36545-1024	20283390	5/8	15.9	24 X 1.5	32	30	1.07	27.1	3.01	76.4	UCF6-10

Japanese Komatsu® 30° Flare with Metric Threads

Female 45° Elbow | Swivel

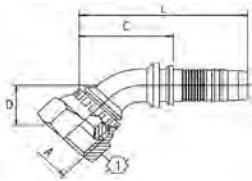

Descriptive #	Product #	SAP #	Hose Size ID		Thread Size (A)	Hex-1 Wrench Size	Drop (D)		Cut-Off (C)		Length (L)		SR5 DR5 SCX5
			in.	mm			in.	mm	in.	mm	in.	mm	
UC-KMFX45-0414	36548-0414	20318233	1/4	6.4	14 X 1.5	19	0.61	15.5	1.50	38.0	2.48	63.0	UCF6-04
UC-KMFX45-0618	36548-0618	20318234	13/32	10.3	18 X 1.5	22	0.71	18.0	1.73	44.0	2.76	70.0	UCF6-06
UC-KMFX45-0822	36548-0822	20318235	1/2	12.7	22 X 1.5	27	1.16	29.5	2.20	56.0	3.43	87.0	UCF6-08

Japanese Komatsu® 30° Flare with Metric Threads

Female 90° Elbow | Swivel

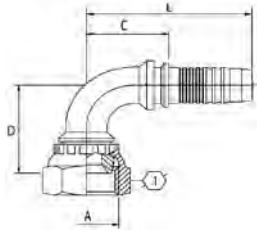

Descriptive #	Product #	SAP #	Hose Size ID		Thread Size (A)	Hex-1 Wrench Size	Drop (D)		Cut-Off (C)		Length (L)		SR5 DR5 SCX5
			in.	mm			in.	mm	in.	mm	in.	mm	
UC-KMFX90-0414	36550-0414	20318236	1/4	6.4	14 X 1.5	19	1.16	29.5	1.30	33.0	2.28	58.0	UCF6-04
UC-KMFX90-0618	36550-0618	20318326	13/32	10.3	18 X 1.5	22	1.40	35.5	1.42	36.0	2.44	62.0	UCF6-06
UC-KMFX90-0822	36550-0822	20318327	1/2	12.7	22 X 1.5	27	2.09	53.0	1.46	37.0	2.68	68.0	UCF6-08

JIS 30° (Parallel Pipe Threads)

Female | Swivel

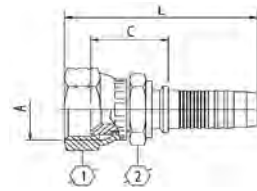

Descriptive #	Product #	SAP #	Hose Size ID		Thread Size (A)	Hex-1 Wrench Size		Hex-2 Wrench Size		Cut-Off (C)		Length (L)		SR5 DR5 SCX5
			in.	mm		in.	mm	in.	mm	in.	mm			
UC-JSFX-0404	36520-0404	20242644	1/4	6.4	1/4-19	3/4	19	11/16	17	0.82	20.8	2.19	55.6	UCF6-04
UC-JSFX-0606	36520-0606	20242699	13/32	10.3	3/8-19	7/8	22	3/4	19	0.86	21.8	2.30	58.5	UCF6-06
UC-JSFX-0808	36520-0808	20242606	1/2	12.7	1/2-14	1 1/16	27	7/8	22	0.93	23.6	2.62	66.6	UCF6-08

How to Use the Fitting Tables

This section lists ALL fittings that are compatible with the following hoses:

Hose Family	Hose Descriptive
DUT	Universal Truck (SAE J1402 Type A1)

Fitting Description

Fitting Type

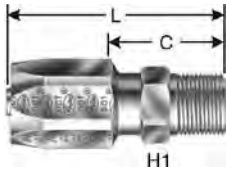

Descriptive #	Product #	SAP #	Hose Size ID		Thread Size	Hex-1 Wrench Size		Hex-2 Wrench Size		Socket Hex (S) Wrench Size	Cut-Off (C)		Length (L)		DUT
			in.	mm	in.	mm	in.	mm	in.	mm	in.	mm	in.	mm	
UT-JCFX-0404 ^{DS}	38400-0404	20419786	3/16	4.8	7/16-20	1/2	12.7	9/16	14.3	9/16	1.10	27.9	1.82	46.2	Y
UT-JCFX-0505 ^{DS}	38400-0505	20419787	1/4	6.4	1/2-20	1/2	12.7	11/16	17.5	5/8	1.21	30.7	2.00	50.8	Y
UT-JCFX-0606	38400-0606	20419788	5/16	7.9	9/16-18	3/4	19.1	3/4	19.1	3/4	1.19	30.2	2.04	51.8	Y

DS: Dual Seat - Connects to either SAE 45° or JIC 37° male fitting*

Choose fittings carefully considering the working pressure of both hose and fitting. The maximum working pressure of the hose assembly is the lesser of the rated working pressure of the hose and the fitting. See page 313 for working pressure.

A "Y" in the hose compatibility columns indicates that the fitting is a "UT" style fitting and that it works for that particular hose.

JIC 37° Flare (SAE J514)

Female | Swivel

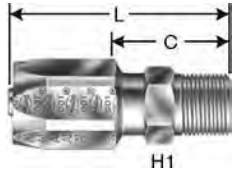

Descriptive #	Product #	SAP #	Hose Size ID		Thread Size	Hex-1 Wrench Size		Hex-2 Wrench Size		Socket (S) Wrench Size	Cut-Off (C)		Length (L)		DUT
			in.	mm		in.	mm	in.	mm		in.	mm	in.	mm	
UT-JCFX-0404 ^{DS}	38400-0404	20419786	3/16	4.8	7/16-20	1/2	12.7	9/16	14.3	9/16	1.10	27.9	1.82	46.2	Y
UT-JCFX-0505 ^{DS}	38400-0505	20419787	1/4	6.4	1/2-20	1/2	12.7	11/16	17.5	5/8	1.21	30.7	2.00	50.8	Y
UT-JCFX-0606	38400-0606	20419788	5/16	7.9	9/16-18	3/4	19.1	3/4	19.1	3/4	1.19	30.2	2.04	51.8	Y
UT-JCFX-0808 ^{DS}	38400-0808	20419789	13/32	10.3	3/4-16	7/8	22.2	7/8	22.2	7/8	1.45	36.8	2.45	62.2	Y
UT-JCFX-1010 ^{DS}	38400-1010	20419801	1/2	12.7	7/8-14	1 1/16	27.0	1 1/16	27.0	1	1.65	41.9	2.72	69.1	Y
UT-JCFX-1212	38400-1212	20419803	5/8	15.9	1 1/16-12	1 1/4	31.8	1 1/4	31.8	1 1/8	1.78	45.2	2.92	74.2	Y
UT-JCFX-1616	38400-1616	20419804	7/8	22.2	1 5/16-12	1 1/2	38.1	1 1/2	38.1	1 3/8	1.84	46.7	2.90	73.7	Y
UT-JCFX-2020	38400-2020	20419806	1 1/8	28.6	1 7/8-12	1 9/16	39.7	2	50.8	1 5/8	2.20	55.9	3.34	84.8	Y

DS: Dual Seat - Connects to either SAE 45° or JIC 37° male fitting

JIC 37° Flare (SAE J514)

Female 45° Elbow | Swivel

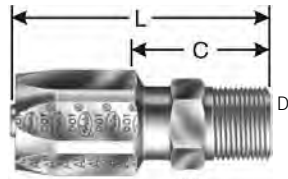

Descriptive #	Product #	SAP #	Hose Size ID		Thread Size	Hex-1 Wrench Size		Hex-2 Wrench Size		Socket (S) Wrench Size	Drop (D)		Cut-Off (C)		Length (L)		DUT
			in.	mm		in.	mm	in.	mm		in.	mm	in.	mm	in.	mm	
UT-JCFX45-0404 ^{DS}	38420-0404	20419746	3/16	4.8	7/16-20	1/2	12.7	9/16	14.3	9/16	0.34	8.6	1.20	30.5	1.92	48.8	Y
UT-JCFX45-0606	38420-0606	20419747	5/16	7.9	9/16-18	1/2	12.7	11/16	17.5	3/4	0.41	10.4	1.48	37.6	2.33	59.2	Y
UT-JCFX45-0808 ^{DS}	38420-0808	20419749	13/32	10.3	3/4-16	11/16	17.5	7/8	22.2	7/8	0.56	14.2	1.73	43.9	2.73	69.3	Y
UT-JCFX45-1010 ^{DS}	38420-1010	20419750	1/2	12.7	7/8-14	3/4	19.1	1	25.4	1	0.63	16.0	2.11	53.6	3.17	80.5	Y
UT-JCFX45-1212	38420-1212	20419751	5/8	15.9	1 1/16-12	7/8	22.2	1 1/4	31.8	1 1/8	0.78	19.8	2.49	63.2	3.63	92.2	Y

DS: Dual Seat - Connects to either SAE 45° or JIC 37° male fitting

JIC 37° Flare (SAE J514)

Female 90° Elbow | Swivel

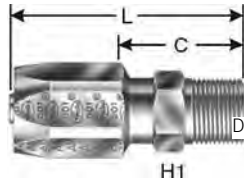

Descriptive #	Product #	SAP #	Hose Size ID		Thread Size	Hex-1 Wrench Size		Hex-2 Wrench Size		Socket (S) Wrench Size	Drop (D)		Cut-Off (C)		Length (L)		DUT
			in.	mm		in.	mm	in.	mm		in.	mm	in.	mm	in.	mm	
UT-JCFX90-0404 ^{DS}	38425-0404	20419742	3/16	4.8	7/16-20	1/2	12.7	9/16	14.3	9/16	0.69	17.5	1.00	25.4	1.72	43.7	Y
UT-JCFX90-0606	38425-0606	20419538	5/16	7.9	9/16-18	1/2	12.7	11/16	17.5	3/4	0.84	21.3	1.36	34.5	2.21	56.1	Y
UT-JCFX90-0808 ^{DS}	38425-0808	20419743	13/32	10.3	3/4-16	11/16	17.5	7/8	22.2	7/8	1.09	27.7	1.54	39.1	2.54	64.5	Y
UT-JCFX90-1010 ^{DS}	38425-1010	20419744	1/2	12.7	7/8-14	3/4	19.1	1	25.4	1	1.25	31.8	1.91	48.5	2.97	75.4	Y
UT-JCFX90-1212	38425-1212	20419535	5/8	15.9	1 1/16-12	7/8	22.2	1 1/4	31.8	1 1/8	1.81	46.0	2.44	62.0	3.58	90.9	Y
UT-JCFX90-1616	38425-1616	20419537	7/8	22.2	1 5/16-12	1 1/4	31.8	1 1/2	38.1	1 3/8	2.16	54.9	2.66	67.6	3.72	94.5	Y

DS: Dual Seat - Connects to either SAE 45° or JIC 37° male fitting

SAE 45° Flare (J512)

Female | Swivel

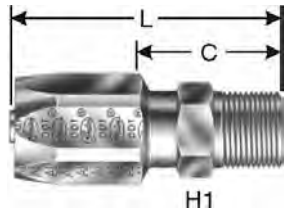

Descriptive #	Product #	SAP #	Hose Size ID		Thread Size	Hex-1 Wrench Size		Hex-2 Wrench Size		Socket (S) Wrench Size	Cut-Off (C)		Length (L)		DUT
			in.	mm		in.	mm	in.	mm		in.	mm	in.	mm	
UT-SFFX-0606	38775-0606	20419782	5/16	7.9	5/8-18	3/4	19.1	3/4	19.1	3/4	1.28	32.5	2.13	54.1	Y
UT-SFFX-1212	38775-1212	20419784	5/8	15.9	1 1/16-14	1 1/4	31.8	1 1/4	31.8	1 1/8	1.80	45.7	2.94	74.7	Y

JIC 37° Flare (SAE J514)

Female 45° Elbow | Swivel



Descriptive #	Product #	SAP #	Hose Size ID		Thread Size	Hex-1 Wrench Size		Hex-2 Wrench Size		Socket (S) Wrench Size	Drop (D)		Cut-Off (C)		Length (L)		DUT
			in.	mm		in.	mm	in.	mm		in.	mm	in.	mm			
UT-SFFX45-0606	38777-0606	20419748	5/16	7.9	5/8-18	1/2	12.7	3/4	19.1	3/4	0.41	10.4	1.48	37.6	2.33	59.2	Y
UT-SFFX45-1212	38777-1212	20419752	5/8	15.9	1 1/16-14	7/8	22.2	1 1/4	31.8	1 1/8	0.78	19.8	2.49	63.2	3.63	92.2	Y

SAE 45° J512 Flare

Female 90° Elbow | Swivel

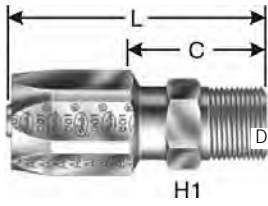

Descriptive #	Product #	SAP #	Hose Size ID		Thread Size	Hex-1 Wrench Size		Hex-2 Wrench Size		Socket (S) Wrench Size	Drop (D)		Cut-Off (C)		Length (L)		DUT
			in.	mm		in.	mm	in.	mm		in.	mm	in.	mm	in.	mm	
UT-SFFX90-0606	38780-0606	20419539	5/16	7.9	5/8-18	1/2	12.7	3/4	19.1	3/4	0.84	21.3	1.36	34.5	2.21	56.1	Y
UT-SFFX90-1212	38780-1212	20419536	5/8	15.9	1 1/16-14	7/8	22.2	1 1/4	31.8	1 1/8	1.81	46.0	2.44	62.0	3.58	90.9	Y

SAE 45° Inverted Flare

Male | Swivel

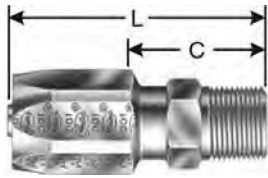

Descriptive #	Product #	SAP #	Hose Size ID		Thread Size	Hex-1 Wrench Size		Hex-2 Wrench Size		Socket (S) Wrench Size	Cut-Off (C)		Length (L)		DUT
			in.	mm		in.	mm	in.	mm		in.	mm	in.	mm	
UT-SIMX-0404	38800-0404	20419716	3/16	4.8	7/16-24	1/2	12.7	7/16	11.1	9/16	1.33	33.8	2.05	52.1	Y
UT-SIMX-0505	38800-0505	20419717	1/4	6.4	1/2-20	1/2	12.7	1/2	12.7	5/8	1.45	36.8	2.26	57.4	Y
UT-SIMX-0605	38800-0605	20419718	5/16	7.9	1/2-20	1/2	12.7	1/2	12.7	3/4	1.54	39.1	2.39	60.7	Y
UT-SIMX-0606	38800-0606	20419719	5/16	7.9	5/8-18	1/2	12.7	5/8	15.9	3/4	1.86	47.2	2.71	68.8	Y
UT-SIMX-0808	38800-0808	20419740	13/32	10.3	3/4-18	11/16	17.5	3/4	19.1	7/8	2.24	56.9	3.24	82.3	Y

SAE 45° Inverted Flare

Male 45° Elbow | Swivel

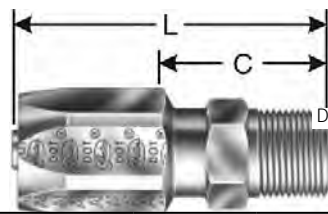

Descriptive #	Product #	SAP #	Hose Size ID		Thread Size	Hex-1 Wrench Size		Hex-2 Wrench Size		Socket (S) Wrench Size	Drop (D)		Cut-Off (C)		Length (L)		DUT
			in.	mm		in.	mm	in.	mm		in.	mm	in.	mm	in.	mm	
UT-SIMX45-0606	38810-0606	20419640	5/16	7.9	5/8-18	1/2	12.7	5/8	15.9	3/4	0.84	21.3	2.94	74.7	3.79	96.3	Y
UT-SIMX45-0808	38810-0808	20419741	13/32	10.3	3/4-18	11/16	17.5	3/4	19.1	7/8	1.09	27.7	3.24	82.3	4.24	107.7	Y

SAE 45° Inverted Flare

Male 90° Elbow | Swivel

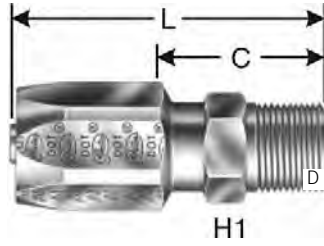

Descriptive #	Product #	SAP #	Hose Size ID		Thread Size	Hex-1 Wrench Size		Hex-2 Wrench Size		Socket (S) Wrench Size	Drop (D)		Cut-Off (C)		Length (L)		DUT
			in.	mm		in.	mm	in.	mm		in.	mm	in.	mm	in.	mm	
UT-SIMX90-0404	38815-0404	20419641	3/16	4.8	7/16-24	1/2	12.7	7/16	11.1	9/16	1.25	31.8	1.33	33.8	2.05	52.1	Y
UT-SIMX90-0505	38815-0505	20419642	1/4	6.4	1/2-20	1/2	12.7	1/2	12.7	5/8	1.50	38.1	1.46	37.1	2.25	57.2	Y
UT-SIMX90-0605	38815-0605	20419643	5/16	7.9	1/2-20	1/2	12.7	1/2	12.7	3/4	1.50	38.1	1.54	39.1	2.39	60.7	Y
UT-SIMX90-0606	38815-0606	20419644	5/16	7.9	5/8-18	1/2	12.7	5/8	15.9	3/4	1.63	41.4	1.86	47.2	2.71	68.8	Y
UT-SIMX90-0808	38815-0808	20419714	13/32	10.3	3/4-18	11/16	17.5	3/4	19.1	7/8	2.00	50.8	2.24	56.9	3.24	82.3	Y

NPTF

Male

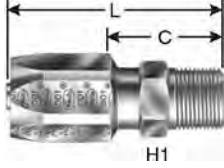

Descriptive #	Product #	SAP #	Hose Size ID		Thread Size	Hex-1 Wrench Size		Socket (S) Wrench Size	Cut-Off (C)		Length (L)		DUT
			in.	mm		in.	mm		in.	mm	in.	mm	
UT-NPM-0402	38615-0402	20419753	3/16	4.8	1/8-27	1/2	12.7	9/16	0.81	20.6	1.53	38.9	Y
UT-NPM-0404	38615-0404	20419754	3/16	4.8	1/4-18	9/16	14.3	9/16	1.03	26.2	1.75	44.5	Y
UT-NPM-0504	38615-0504	20419755	1/4	6.4	1/4-18	9/16	14.3	5/8	0.96	24.4	1.76	44.7	Y
UT-NPM-0604	38615-0604	20419756	5/16	7.9	1/4-18	9/16	14.3	3/4	1.00	25.4	1.85	47.0	Y
UT-NPM-0606	38615-0606	20419757	5/16	7.9	3/8-18	11/16	17.5	3/4	1.04	26.4	1.89	48.0	Y
UT-NPM-0806	38615-0806	20419758	13/32	10.3	3/8-18	11/16	17.5	7/8	1.19	30.2	2.19	55.6	Y
UT-NPM-0808	38615-0808	20419759	13/32	10.3	1/2-14	7/8	22.2	7/8	1.29	32.8	2.29	58.2	Y
UT-NPM-1008	38615-1008	20419770	1/2	12.7	1/2-14	7/8	22.2	1	1.31	33.3	2.38	60.5	Y
UT-NPM-1212	38615-1212	20419771	5/8	15.9	3/4-14	1 1/16	27.0	1 1/8	1.44	36.6	2.59	65.8	Y
UT-NPM-1612	38615-1612	20419773	7/8	22.2	3/4-14	1 1/16	27.0	1 3/8	1.43	36.3	2.49	63.2	Y
UT-NPM-1616	38615-1616	20419772	7/8	22.2	1-11 1/2	1 3/8	34.9	1 3/8	1.74	44.2	2.80	71.1	Y
UT-NPM-2020	38615-2020	20419774	1 1/8	28.6	1 1/4-11 1/2	1 3/4	44.5	1 5/8	1.80	45.7	2.92	74.2	Y

SAE J514 Flareless Tube Fittings

Male

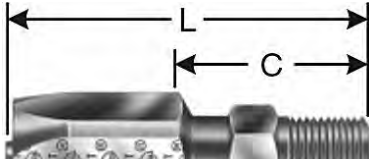

Descriptive #	Product #	SAP #	Hose Size ID		Thread Size	Hex-1 Wrench Size		Hex-2 Wrench Size		Socket (S) Wrench Size	Cut-Off (C)		Length (L)		DUT
			in.	mm		in.	mm	in.	mm		in.	mm	in.	mm	
UT-FTM-0404	38360-0404	20419775	3/16	4.8	7/16-20	1/2	12.7	9/16	14.3	9/16	0.96	24.5	1.68	42.7	Y
UT-FTM-0505	38360-0505	20419777	1/4	6.4	1/2-20	9/16	14.3	5/8	15.9	5/8	0.92	23.4	1.72	43.7	Y
UT-FTM-0604	38360-0604	20419778	5/16	7.9	7/16-20	9/16	14.3	9/16	14.3	3/4	1.01	25.7	2.12	53.8	Y
UT-FTM-0606	38360-0606	20419779	5/16	7.9	5/8-18	5/8	15.9	11/16	17.5	3/4	1.03	26.2	1.87	47.6	Y
UT-FTM-0808	38360-0808	20419780	13/32	10.3	3/4-16	13/16	20.6	7/8	22.2	7/8	1.15	29.2	2.15	54.6	Y
UT-FTM-1010	38360-1010	20419781	1/2	12.7	7/8-14	15/16	23.8	1	25.4	1	1.27	32.3	2.34	59.6	Y

* All Fittings come with Nut and Sleeve

Flange Engine Oil Connection (Two Bolt)

90° Elbow

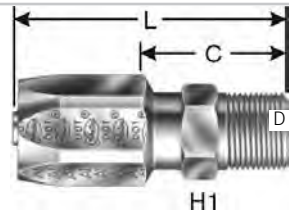

Descriptive #	Product #	SAP #	Hose Size ID		Thread Size	Hex-1 Wrench Size		Socket (S) Wrench Size	Drop (D)		Cut-Off (C)		Length (L)		DUT
			in.	mm		in.	mm		in.	mm	in.	mm	in.	mm	
UT-FL90EOC-2020	38351-2020	20419745	1 1/8	28.6	1/4	1 1/16	39.7	1 1/8	2.50	63.5	3.82	97.0	4.95	125.7	Y

UT-FL90EOC-2020 includes engine connection flange clamp plate

PTT 30°

Female | Swivel

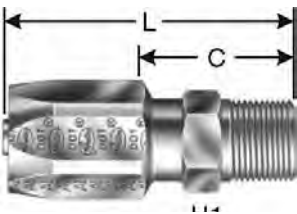

Descriptive #	Product #	SAP #	Hose Size ID		Thread Size	Hex-1 Wrench Size		Hex-2 Wrench Size		Socket (S) Wrench Size	Cut-Off (C)		Length (L)		DUT
			in.	mm		in.	mm	in.	mm		in.	mm	in.	mm	
UT-PTTFX-1616	38745-1616	20419805	7/8	22.2	1 1/16-14	1 1/2	38.1	1 1/2	38.1	1 3/8	1.68	42.7	2.74	69.6	Y

"SF" NSF X Hose Fittings (for use with Saflex® Hose)

NPTF

Male

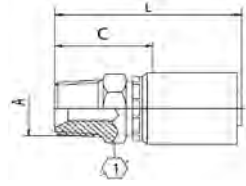

Descriptive #	Product #	SAP #	Hose Size ID		Thread Size (A)	Hex-1 Wrench Size		Cut-Off (C)		Length (L)	
			in.	mm		in.	mm	in.	mm	in.	mm
SF-NPM-0606	26615-0606	20285743	3/8	9.5	3/8-18	3/4	19	1.24	31.5	2.58	65.5
SF-NPM-0608	26615-0608	20413965	3/8	9.5	1/2-14	7/8	22	1.59	40.5	2.86	72.6
SF-NPM-0808	26615-0808	20352115	1/2	12.7	1/2-14	7/8	22	1.57	40.0	3.04	77.2

NPTF

Male | Swivel

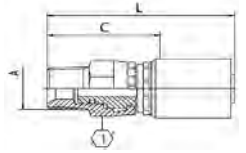

Descriptive #	Product #	SAP #	Hose Size ID		Thread Size (A)	Hex-1 Wrench Size		Cut-Off (C)		Length (L)	
			in.	mm		in.	mm	in.	mm	in.	mm
SF-NPMX-0606	26645-0606	20347559	3/8	9.5	3/8-18	3/4	19	1.83	46.6	3.15	79.9
SF-NPMX-0808	26645-0808	20414341	1/2	12.7	1/2-14	7/8	22	1.76	44.6	3.26	82.8

O-Ring Boss Straight Thread (SAE J514)

Male | Swivel

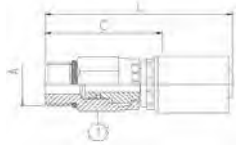

Descriptive #	Product #	SAP #	Hose Size ID		Thread Size (A)	Hex-1 Wrench Size		Cut-Off (C)		Length (L)	
			in.	mm		in.	mm	in.	mm	in.	mm
SF-OBMX-0608	26680-0608	20352114	3/8	9.5	3/4-16	7/8	22	1.73	44.0	3.00	76.3

"SH" SHR Hose Fittings (for use with Prospector™ Slim Hole Rotary Hose)

NPT

Male API

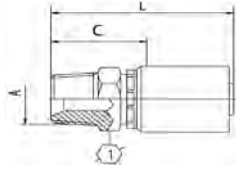

S=Skive
NS=Non-Skive
DG=Dual-Grip™

Descriptive #	Product #	SAP #	Hose Size ID		Thread Size (A)	Hex-1 Wrench Size		Cut-Off (C)		Length (L)		Skive Type	SHR 3600	SHR 5000
			in.	mm		in.	mm	in.	mm	in.	mm			
SH-NPM-API-1616	30617-1616	20466169	1	25.4	1-11½	1⅞	36	2.66	67.5	5.18	131.5	NS	Y	
SH-NPM-API-2020	30617-2020	20466171	1¼	31.8	1¼-11½	1⅞	46	2.94	74.6	6.70	170.1	NS	Y	
SH-NPM-API-2424	30617-2424	20466174	1½	38.1	1½-11½	2	50	3.27	83.0	6.54	166.0	NS	Y	
SHDG-NPM-API-3232	16630-3232	20466175	2	50.8	2-11½	2⅞	65	3.76	95.5	7.58	192.5	DG		DGF2-32
SH-NPM-API-3232	30617-3232	20263241	2	50.8	2-11½	2⅞	65	4.47	113.5	8.19	208.0	NS	Y	

"GG" SGUN Hose Fittings (for use with Grease Gun Hose)

NPT

Male

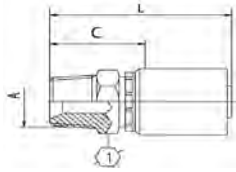

Descriptive #	Product #	SAP #	Hose Size ID		Thread Size (A)	Hex-1 Wrench Size		Cut-Off (C)		Length (L)	
			in.	mm		in.	mm	in.	mm	in.	mm
GG-NPM-0302	20615-0302	20288023	3/16	4.8	1/8-27	5/8	15	0.38	9.65	1.38	35.05

"B2" SHJ Hose Fittings (for use with Jack Hose)

NPT

Male

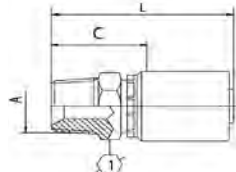

Descriptive #	Product #	SAP #	Hose Size ID		Thread Size (A)	Hex-1 Wrench Size		Cut-Off (C)		Length (L)	
			in.	mm		in.	mm	in.	mm	in.	mm
B2-NPM-0402	14615-0402	20242110	1/4	6.4	1/8-27	9/16	14	0.88	22.30	1.85	47.10
B2-NPM-0404	14615-0404	20242111	1/4	6.4	1/4-18	11/16	17	1.04	26.30	2.01	51.10
B2-NPM-0406	14615-0406	20242109	1/4	6.4	3/8-18	3/4	19	1.04	26.30	2.01	51.10
B2-NPM-0408	14615-0408	20242115	1/4	6.4	1/2-14	7/8	22	1.31	33.30	2.29	58.10
B2-NPM-0604	14615-0604	20242067	3/8	9.5	1/4-18	11/16	17	1.04	26.30	2.09	53.00
B2-NPM-0606	14615-0606	20242069	3/8	9.5	3/8-18	3/4	19	1.04	26.30	2.09	53.00
B2-NPM-0608	14615-0608	20242079	3/8	9.5	1/2-14	7/8	22	1.27	32.30	2.32	59.00

"PB" Push-On Brass Fittings (for use with Insta-Grip™ 300, Insta-Grip™ HT 300, Insta-Grip™ TC & Insta-Grip™ Plus Hose)

Hose Mender

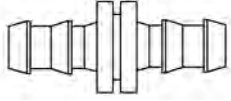

Descriptive #	Product #	SAP #	Hose Size ID		Thread Size (A)	Hex-1 Wrench Size		Cut-Off Length		Overall Length (L)	
			in.	mm		in.	mm	in.	mm	in.	mm
PB-HM-0404	22380-0404	20282715	1/4	6.4				0.06	1.52	1.80	45.72
PB-HM-0808	22380-0505	20282716	5/16	7.9				0.06	1.52	1.80	45.72
PB-HM-0606	22380-0606	20282717	3/8	9.5				0.06	1.52	2.00	50.80
PB-HM-0808	22380-0808	20282718	1/2	12.7				0.06	1.52	2.00	50.80
PB-HM-1010	22380-1010	20283080	5/8	15.9				0.13	3.30	3.03	76.95
PB-HM-1212	22380-1212	20283081	3/4	19.0				0.13	3.30	3.03	76.96

JIC 37° Flare

Female | Swivel

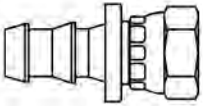

Descriptive #	Product #	SAP #	Hose Size ID		Thread Size (A)	Hex-1 Wrench Size		Cut-Off Length		Overall Length (L)	
			in.	mm		in.	mm	in.	mm	in.	mm
PB-JCFX-0404	22400-0404	20282736	1/4	6.4	7-16-20	9/16	14	0.57	14.47	1.54	39.12
PB-JCFX-0405	22400-0405	20283092	1/4	6.4	1/2-20	5/8	16	0.60	15.11	1.57	39.88
PB-JCFX-0406	22400-0406	20282738	1/4	6.4	9/16-18	3/4	19	0.62	15.76	1.60	40.64
PB-JCFX-0605	22400-0605	20282739	3/8	9.5	1/2-20	5/8	16	0.60	15.11	1.67	42.42
PB-JCFX-0606	22400-0606	20282740	3/8	9.5	9/16-18	3/4	19	0.62	15.76	1.70	43.18
PB-JCFX-0608	22400-0608	20282741	3/8	9.5	3/4-16	7/8	22	0.75	19.00	1.85	46.99
PB-JCFX-0808	22400-0808	20282742	1/2	12.7	3/4-16	7/8	22	0.69	17.49	1.78	45.21
PB-JCFX-0810	22400-0810	20283093	1/2	12.7	7/8-14	1	25	0.74	18.78	1.84	46.74
PB-JCFX-1008	22400-1008	20283094	5/8	15.9	3/4-16	7/8	22	0.70	17.70	2.27	57.66
PB-JCFX-1010	22400-1010	20282745	5/8	15.9	7/8-14	1	25	0.75	19.00	2.33	59.18
PB-JCFX-1212	22400-1212	20283095	3/4	19.0	1 1/16-12	1 1/4	32	0.81	20.51	2.40	60.96
PB-JCFX-1616	22400-1616	20466036	1	25.4	1 5/16-12	1 1/2	38	1.13	28.70	2.57	65.30

JIC 37° Flare

Female 90° Elbow | Swivel

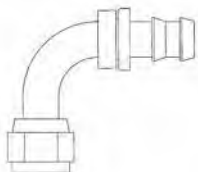

Descriptive #	Product #	SAP #	Hose Size ID		Thread Size (A)	Hex-1 Wrench Size		Cut-Off Length		Overall Length (L)	
			in.	mm		in.	mm	in.	mm	in.	mm
PB-JCFX90-0606	22425-0606	20450811	3/8	9.5	9/16-18	3/4	19	0.87	22.00	1.02	26.00

"PB" Push-On Brass Fittings (for use with Insta-Grip™ 300, Insta-Grip™ HT 300, Insta-Grip™ TC & Insta-Grip™ Plus Hose)

JIC 37° Flare

Male

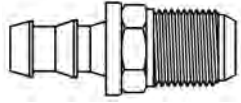

Descriptive #	Product #	SAP #	Hose Size ID		Thread Size (A)	Hex-1 Wrench Size		Cut-Off Length		Overall Length (L)	
			in.	mm		in.	mm	in.	mm	in.	mm
PB-JCM-0404	22450-0404	20282768	1/4	6.4	7/16-20	1/2	13	0.70	17.78	1.57	39.88
PB-JCM-0406	22450-0406	20289525	1/4	6.4	9/16-18	5/8	16	0.77	19.56	1.64	41.66
PB-JCM-0606	22450-0606	20282769	3/8	9.5	9/16-18	5/8	16	0.81	20.57	1.78	45.21
PB-JCM-0808	22450-0808	20282771	1/2	12.7	3/4-16	3/4	19	1.00	25.40	1.97	50.04

NPTF

Female

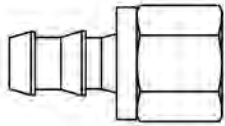

Descriptive #	Product #	SAP #	Hose Size ID		Thread Size (A)	Hex-1 Wrench Size		Cut-Off Length		Overall Length (L)	
			in.	mm		in.	mm	in.	mm	in.	mm
PB-NPF-0402	22600-0402	20289527	1/4	6.4	1/8-27	1/2	13	0.41	10.36	1.35	34.29
PB-NPF-0404	22600-0404	20282772	1/4	6.4	1/4-18	5/8	16	0.54	13.82	1.51	38.35
PB-NPF-0504	22600-0504	20289528	5/16	7.9	1/4-18	5/8	16	0.54	13.82	1.51	38.35
PB-NPF-0604	22600-0604	20283105	3/8	9.5	1/4-18	5/8	16	0.54	13.82	1.61	40.89
PB-NPF-0606	22600-0606	20282774	3/8	9.5	3/8-18	3/4	19	0.56	14.25	1.63	41.40
PB-NPF-0806	22600-0806	20282775	1/2	12.7	3/8-18	3/4	19	0.56	14.25	1.63	41.40
PB-NPF-0808	22600-0808	20282776	1/2	12.7	1/2-14	15/16	24	0.68	17.27	1.77	44.96

"PB" Push-On Brass Fittings (for use with Insta-Grip™ 300, Insta-Grip™ HT 300, Insta-Grip™ TC & Insta-Grip™ Plus Hose)

NPTF

Male

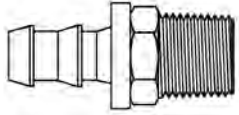

Descriptive #	Product #	SAP #	Hose Size ID		Thread Size (A)	Hex-1 Wrench Size		Cut-Off Length		Overall Length (L)	
			in.	mm		in.	mm	in.	mm	in.	mm
PB-NPM-0402	22615-0402	20283096	1/4	6.4	1/8-27	1/2	13	0.56	14.22	1.43	36.32
PB-NPM-0404	22615-0404	20282748	1/4	6.4	1/4-18	9/16	14	0.79	20.07	1.66	42.16
PB-NPM-0406	22615-0406	20282749	1/4	6.4	3/8-18	11/16	17	0.79	20.07	1.66	42.16
PB-NPM-0504	22615-0504	20289529	5/16	7.9	1/4-18	9/16	14	0.79	20.07	1.66	42.16
PB-NPM-0602	22615-0602	20282750	3/8	9.5	1/8-27	1/2	13	0.56	14.22	1.53	38.86
PB-NPM-0604	22615-0604	20283097	3/8	9.5	1/4-18	9/16	14	0.79	20.07	1.76	44.70
PB-NPM-0606	22615-0606	20282752	3/8	9.5	3/8-18	11/16	17	0.79	20.07	1.76	44.70
PB-NPM-0608	22615-0608	20282753	3/8	9.5	1/2-14	7/8	22	1.00	25.40	1.97	50.04
PB-NPM-0804	22615-0804	20283098	1/2	12.7	1/4-18	11/16	17	0.79	20.07	1.76	44.70
PB-NPM-0806	22615-0806	20282755	1/2	12.7	3/8-18	11/16	17	0.79	20.07	1.76	44.70
PB-NPM-0808	22615-0808	20282756	1/2	12.7	1/2-14	7/8	22	1.00	25.40	1.97	50.04
PB-NPM-0812	22615-0812	20283099	1/2	12.7	3/4-14	1 1/16	27	1.00	25.40	1.97	50.04
PB-NPM-1006	22615-1006	20289540	5/8	15.9	3/8-18	3/4	19	0.89	22.61	2.34	59.44
PB-NPM-1008	22615-1008	20283100	5/8	15.9	1/2-14	7/8	22	1.00	25.40	2.45	62.23
PB-NPM-1012	22615-1012	20282759	5/8	15.9	3/4-14	1 1/16	27	1.00	25.40	2.45	62.23
PB-NPM-1208	22615-1208	20283101	3/4	19.0	1/2-14	7/8	27	1.00	25.40	2.45	62.23
PB-NPM-1212	22615-1212	20283102	3/4	19.0	3/4-14	1 1/16	27	1.00	25.40	2.45	62.23

NPTF

Male 90° Elbow

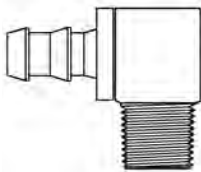

Descriptive #	Product #	SAP #	Hose Size ID		Thread Size (A)	Hex-1 Wrench Size		Cut-Off Length		Drop Length	
			in.	mm		in.	mm	in.	mm	in.	mm
PB-NPM90-0402	22625-0402	20283106	1/4	6.4	1/8-27			0.08	2.10	0.75	19.05
PB-NPM90-0404	22625-0404	20283107	1/4	6.4	1/4-18			0.13	3.24	0.95	24.13
PB-NPM90-0602	22625-0602	20289541	3/8	9.5	1/8-27			0.11	2.67	0.75	19.05
PB-NPM90-0604	22625-0604	20282779	3/8	9.5	1/4-18			0.12	3.05	0.90	22.86
PB-NPM90-0606	22625-0606	20282780	3/8	9.5	3/8-18			0.17	4.19	0.87	22.10
PB-NPM90-0806	22625-0806	20282782	1/2	12.7	3/8-18			0.40	10.10	1.19	30.23
PB-NPM90-0808	22625-0808	20283109	1/2	12.7	1/2-14			0.40	10.10	1.19	30.23
PB-NPM90-1008	22625-1008	20289542	5/8	15.9	1/2-14			0.40	10.10	1.19	30.23
PB-NPM90-1012	22625-1012	20289543	5/8	15.9	3/4-14			0.47	11.81	1.28	32.51
PB-NPM90-1212	22625-1212	20282784	3/4	19.0	3/4-14			0.47	11.81	1.28	32.51

"PB" Push-On Brass Fittings (for use with Insta-Grip™ 300, Insta-Grip™ HT 300, Insta-Grip™ TC & Insta-Grip™ Plus Hose)

NPTF

Male | Swivel

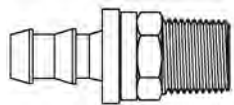

Descriptive #	Product #	SAP #	Hose Size ID		Thread Size (A)	Hex-1 Wrench Size		Cut-Off Length		Overall Length	
			in.	mm		in.	mm	in.	mm	in.	mm
PB-NPMX-0404	22645-0404	20282762	1/4	6.4	1/4-18	9/16	14	1.15	29.21	2.02	51.31
PB-NPMX-0604	22645-0604	20283103	3/8	9.5	1/4-18	9/16	14	1.15	29.21	2.12	53.85
PB-NPMX-0606	22645-0606	20282764	3/8	9.5	3/8-18	11/16	17	1.15	29.21	2.12	53.85
PB-NPMX-0806	22645-0806	20282765	1/2	12.7	3/8-18	11/16	17	1.15	29.21	2.12	53.85
PB-NPMX-0808	22645-0808	20282766	1/2	12.7	1/2-14	7/8	22	1.36	34.54	2.33	59.18
PB-NPMX-1212	22645-1212	20283104	3/4	19.0	3/4-14	1 1/16	27	1.35	34.29	2.80	71.12

SAE 45° Flare

Female | Swivel

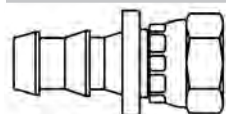

Descriptive #	Product #	SAP #	Hose Size ID		Thread Size (A)	Hex-1 Wrench Size		Cut-Off Length		Drop Length	
			in.	mm		in.	mm	in.	mm	in.	mm
PB-SFFX-0405	22775-0405	20289551	1/4	6.4	1/2-20	5/8	16	0.60	15.11	1.57	39.88
PB-SFFX-0406	22775-0406	20289552	1/4	6.4	5/8-18	3/4	19	0.65	16.41	1.63	41.40
PB-SFFX-0506	22775-0506	20289553	5/16	7.9	5/8-18	3/4	19	0.65	16.41	1.63	41.40
PB-SFFX-0606	22775-0606	20282722	3/8	9.5	5/8-18	3/4	19	0.65	16.41	1.73	43.94
PB-SFFX-0608	22775-0608	20289554	3/8	9.5	3/4-16	7/8	22	0.75	19.00	1.85	46.99
PB-SFFX-0806	22775-0806	20289555	1/2	12.7	5/8-18	7/8	22	0.81	20.51	1.92	48.77
PB-SFFX-0808	22775-0808	20283083	1/2	12.7	3/4-16	7/8	22	0.64	16.19	1.72	43.69
PB-SFFX-0810	22775-0810	20289556	1/2	12.7	7/8-14	1	25	0.74	18.78	1.84	46.74
PB-SFFX-1008	22775-1008	20289557	5/8	15.9	3/4-16	7/8	22	0.70	17.70	2.27	57.66
PB-SFFX-1010	22775-1010	20283084	5/8	15.9	7/8-14	1	25	0.75	19.00	2.33	59.18
PB-SFFX-1212	22775-1212	20282725	3/4	19.0	1 1/16-14	1 1/4	32	0.82	20.94	2.42	61.47

SAE 45° Flare

Male

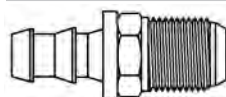

Descriptive #	Product #	SAP #	Hose Size ID		Thread Size (A)	Hex-1 Wrench Size		Cut-Off Length		Overall Length	
			in.	mm		in.	mm	in.	mm	in.	mm
PB-SFM-0606	22785-0606	20282770	3/8	9.5	5/8-18	5/8	16	0.86	21.84	1.83	46.48

"PB" Push-On Brass Fittings (for use with Insta-Grip™ 300, Insta-Grip™ HT 300, Insta-Grip™ TC & Insta-Grip™ Plus Hose)

SAE 45° Inverted Flare

Female

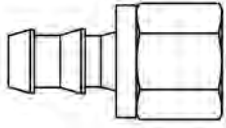

Description #	Product #	SAP #	Hose Size ID		Thread Size (A)	Hex-1 Wrench Size		Cut-Off Length		Overall Length	
			in.	mm		in.	mm	in.	mm	in.	mm
PB-SIF-0403	22790-0403	20289544	1/4	6.4	3/8-24	1/2	13	0.25	6.35	1.12	28.45
PB-SIF-0404	22790-0404	20283090	1/4	6.4	7/16-24	5/8	16	0.23	5.83	1.14	28.96
PB-SIF-0405	22790-0405	20289545	1/4	6.4	1/2-20	9/16	14	0.26	6.69	1.18	29.97
PB-SIF-0605	22790-0605	20289546	3/8	9.5	1/2-20	5/8	16	0.30	7.56	1.32	33.53
PB-SIF-0606	22790-0606	20282734	3/8	9.5	5/8-18	3/4	19	0.32	8.20	1.35	34.29
PB-SIF-0808	22790-0808	20283091	1/2	12.7	3/4-18	7/8	22	0.65	16.41	1.73	43.94

SAE 45° Inverted Flare

Male

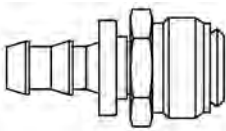

Descriptive #	Product #	SAP #	Hose Size ID		Thread Size (A)	Hex-1 Wrench Size		Cut-Off Length		Overall Length	
			in.	mm		in.	mm	in.	mm	in.	mm
PB-SIM-0403	22795-0403	20289548	1/4	6.4	3/8-24	7/16	11	0.69	17.53	1.56	39.62
PB-SIM-0404	22795-0404	20283085	1/4	6.4	7/16-24	7/16	11	0.69	17.53	1.56	39.62
PB-SIM-0405	22795-0405	20283086	1/4	6.4	1/2-20	1/2	13	0.75	19.05	1.62	41.15
PB-SIM-0505	22795-0505	20283087	5/16	7.9	1/2-20	1/2	13	0.75	19.05	1.62	41.15
PB-SIM-0506	22795-0506	20283088	5/16	7.9	5/8-18	5/8	16	0.76	19.30	1.63	41.40
PB-SIM-0605	22795-0605	20282730	3/8	9.5	1/2-20	1/2	13	0.75	19.05	1.72	43.69
PB-SIM-0606	22795-0606	20282731	3/8	9.5	5/8-18	5/8	16	0.79	20.07	1.76	44.70
PB-SIM-0808	22795-0808	20283089	1/2	12.7	3/4-18	3/4	19	0.87	22.10	1.84	46.74
PB-SIM-1010	22795-1010	20289550	5/8	15.9	7/8-18	1	25	0.90	22.86	2.35	59.69

A/C Fitting Nomenclature

Fitting Style	Family	Fitting Family Description	Gender	Swivel	Valve (V)	Attribute
CB12VS	CB	Compressor Pad Block			R12	S=Single
CB12VSR	CB		R12	SR=Single Reversed		
COTF	COT	Compressor O-Ring Tube	F	Yes		
COTF134V	COT		F	Yes	R134a	
FTBO	FT					BO=Brace On
FTM	FT		M			
F Tmm	FT	Flareless Tube	M			M=Metric
FTN	FT		N=Nut			
FTS	FT					S=Sleeve
FTSM	FT					S=Sleeve, M=Metric
FSLF	FSL	Ford Spring Lock	F			
FSLM	FSL		M			
HM	HM					
HM12V	HM	Hose Mender			R12	
HM134V	HM		R134a			
HMSG	HM					SG=Sight Glass
HMT	HM					T=Tee
ILOTORA	ILOT	Inline Orifice Tube				ORA=Orange
ILOTRED	ILOT		RED=Red			
ILOTBLU	ILOT		BLU=Blue			
ILOTBLK	ILOT		BLK=Black			
ILOTWHI	ILOT		WHI=White			
OFFX	OF	O-Ring Face Seal (SAE J1453 ORS/ORFS)	F	X		
OIM	OI	O-Ring Insert	M			
OIMB	OI		M			B=Bulkhead
OIM134V	OI		M		R134a	
OTF	OT	O-Ring Tube	F	Yes		
OTF12V	OT		F	Yes	R12	
OTF134V	OT		F	Yes	R134a	
OTF134VHS	OT		F	Yes	R134a	HS=High Pressure Side
OTM	OT		M	Yes		
OTMLP	OT		M	Yes		LP=Long Pilot
OTM134V	OT		M	Yes	R134a	
SFFX	SF	SAE 45° J512 Flare	F	X		
SFM	SF		M			
SWA	SW	Sealing Washer				A=Accumulator
SWCN	SW		CN=Compressor Narrow			
SWCW	SW		CW=Compressor Wide			
VC12V	VC	Valve Cap			R12	
VC134VHS	VC		R134a	HS=High Pressure Side		
VC134VLS	VC		R134a	LS=Low Pressure Side		

Additional Prefix & Suffix:

- 45=45° Elbow
- 45B=45° Block Elbow
- 90=90° Elbow
- 90B=90° Block Elbow
- 180=180° Elbow
- A=Aluminum



GC-OTF134V45
 134V=R134a Valve
 45 = 45° Elbow
 OTF = O-Ring Tube Female

How to Use the Fitting Tables

This section lists ALL fittings that are compatible with the following hoses:

Hose Family	Hose Descriptive
G4826	GALAXY® G4826 (SAE J2064)
G4867	GALAXY® G4867 (SAE J2064)
G4890	GALAXY® G4890 (SAE J2064)

For use with Galaxy® G4826 (5/16"-5/8") & G4867 (3/4") Hose

Fitting Description

Fitting Type

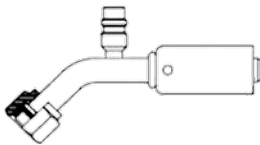

Descriptive #	Product #	SAP #	Hose Size ID		Thread Size	Drop (D)		Cut-Off (R)		Valve (V)	
			in.	mm		in.	mm	in.	mm	in.	mm
AC-OTF134V45-0606	50663-0606	20307056	5/16	7.90	5/8-18	0.55	14	1.61	41	0.63	16
AC-OTF134V45-0808	50663-0808	20306728	13/32	10.30	3/4-16	0.63	16	1.61	41	0.63	16
AC-OTF134V45-1010	50663-1010	20307057	1/2	12.70	7/8-14	0.87	22	1.73	44	0.51	13
AC-OTF134V45-1210	50663-1210	20306729	5/8	15.90	7/8-14	0.94	24	1.89	48	0.51	13
AC-OTF134V45-1212	50663-1212	20307058	5/8	15.90	1 1/16-14	0.94	24	1.89	48	0.51	13
AC-OTF134V45-1412	50663-1412	20307059	3/4	19.05	1 1/16-14	0.94	24	1.89	48	0.51	13

The Continental ContiTech hose, compatible with each fitting style in this section, is shown at the right, above the "Fitting Style" heading.

The fitting styles are different for each hose family. The fittings listed in each "Fitting Style" section are the only approved fittings for the hose shown.

Be sure to use only those fittings shown, for the hose families listed in the heading.

For use with Galaxy® G4826 (5/16"-5/8") & G4867 (3/4") Hose

Compressor O-Ring Tube

Female, 45° Elbow | A/C (Crimp) Fittings

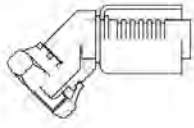

Descriptive #	Product #	SAP #	Hose Size ID		Thread Size (A)	Drop (D)		Cut-Off (R)	
			in.	mm		in.	mm	in.	mm
AC-COTF45-0810	50133-0810	20306551	13/32	10.30	1-14	1.10	28	2.01	51
AC-COTF45-1010	50133-1010	20306545	1/2	12.70	1-14	1.26	32	1.38	35
AC-COTF45-1210	50133-1210	20306546	5/8	15.90	1-14	0.67	17	1.26	32

Compressor O-Ring Tube

Female 90° Elbow | A/C (Crimp) Fittings

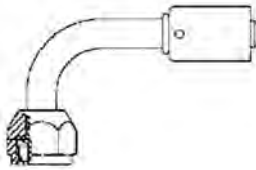

Descriptive #	Product #	SAP #	Hose Size ID		Thread Size (A)	Drop (D)		Cut-Off (R)	
			in.	mm		in.	mm	in.	mm
AC-COTF90-0810	50135-0810	20306547	13/32	10.30	1-14	1.93	49	1.77	45
AC-COTF90-1010	50135-1010	20306548	1/2	12.70	1-14	2.20	56	1.77	45
AC-COTF90-1210	50135-1210	20306549	5/8	15.90	1-14	2.72	69	2.36	60

Compressor O-Ring Tube

Female 90° Block Elbow | A/C (Crimp) Fittings

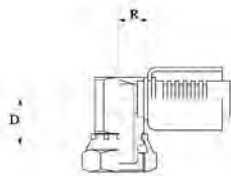

Descriptive #	Product #	SAP #	Hose Size ID		Thread Size (A)	Drop (D)		Cut-Off (R)	
			in.	mm		in.	mm	in.	mm
AC-COTF90B-0810	50137-0810	20306610	13/32	10.30	1-14	0.83	21	0.94	24
AC-COTF90B-1010	50137-1010	20306611	1/2	12.70	1-14	0.83	21	0.94	24
AC-COTF90B-1210	50137-1210	20306612	5/8	15.90	1-14	0.83	21	1.06	27

Compressor O-Ring Tube

Female, R134a Valve, 90° Block Elbow
A/C (Crimp) Fittings

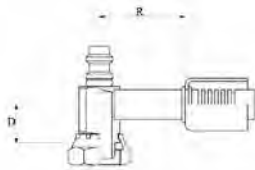

Descriptive #	Product #	SAP #	Hose Size ID		Thread Size (A)	Drop (D)		Cut-Off (R)		Valve	
			in.	mm		in.	mm	in.	mm	in.	mm
AC-COTF134V90B-0810	50145-0810	20306990	13/32	10.30	1-14	0.83	21	0.94	24	0.63	16
AC-COTF134V90B-1010	50145-1010	20306991	1/2	12.70	1-14	0.83	21	0.94	24	0.51	13
AC-COTF134V90B-1210	50145-1210	20306992	5/8	15.90	1-14	0.83	21	1.06	27	0.51	13

For use with Galaxy® G4826 (5/16"-5/8") & G4867 (3/4") Hose

Flareless Tube

Male | A/C (Crimp) Fittings

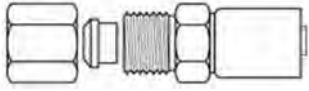

Descriptive #	Product #	SAP	Hose Size ID		Thread Size (A)	Cut-Off (R)	
			in.	mm		in.	mm
AC-FTM-0606	50230-0606	20306613	5/16	7.90	5/8-18	1.46	37
AC-FTM-0608	50230-0608	20306614	5/16	7.90	3/4-16	1.61	41
AC-FTM-0806	50230-0806	20306615	13/32	10.30	5/8-18	1.61	41
AC-FTM-0808	50230-0808	20306616	13/32	10.30	3/4-16	1.61	41
AC-FTM-0810	50230-0810	20306617	13/32	10.30	7/8-14	2.13	54
AC-FTM-1008	50230-1008	20306618	1/2	12.70	3/4-16	2.13	54
AC-FTM-1010	50230-1010	20306619	1/2	12.70	7/8-14	2.13	54
AC-FTM-1210	50230-1210	20306620	5/8	15.90	7/8-14	2.36	60
AC-FTM-1212	50230-1212	20306621	5/8	15.90	1 1/16-14	2.36	60

Flareless Tube

Male, 90° Block Elbow | A/C (Crimp) Fittings

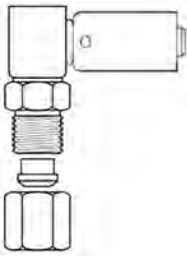

Descriptive #	Product #	SAP #	Hose Size ID		Thread Size (A)	Drop (D)		Cut-Off (R)	
			in.	mm		in.	mm	in.	mm
AC-FTM90B-0606	50235-0606	20306622	5/16	7.90	5/8-18	1.50	38	1.06	27
AC-FTM90B-0808	50235-0808	20306623	13/32	10.30	3/4-16	1.73	44	1.26	32
AC-FTM90B-0810	50235-0810	20306624	13/32	10.30	7/8-14	2.01	51	1.50	38
AC-FTM90B-1008	50235-1008	20306625	1/2	12.70	3/4-16	2.01	51	1.50	38
AC-FTM90B-1010	50235-1010	20306626	1/2	12.70	7/8-14	2.01	51	1.50	38
AC-FTM90B-1210	50235-1210	20306627	5/8	15.90	7/8-14	2.36	60	2.36	60
AC-FTM90B-1212	50235-1212	20306628	5/8	15.90	1 1/16-14	2.36	60	2.36	60

Flareless Tube

Male Metric | A/C (Crimp) Fittings

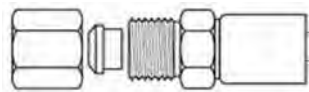

Descriptive #	Product #	SAP #	Hose Size ID		Thread Size (A)	Cut-Off (R)	
			in.	mm		in.	mm
AC-FTmm-0608	50240-0608	20306629	5/16	7.90	5/8-18	1.61	41
AC-FTmm-0812	50240-0812	20306630	13/32	10.30	3/4-16	2.13	54
AC-FTmm-1015	50240-1015	20306631	1/2	12.70	7/8-14	2.36	60

For use with Galaxy® G4826 (5/16"-5/8") & G4867 (3/4") Hose

Hose Mender

A/C (Crimp) Fittings

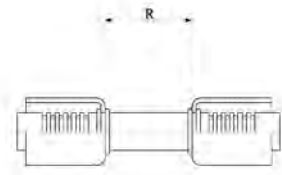

Descriptive #	Product #	SAP #	Hose Size ID		Cut-Off (R)	
			in.	mm	in.	mm
AC-HM-0606	50350-0606	20306643	5/16	7.90	1.73	44
AC-HM-0608	50350-0608	20306644	5/16	7.90	1.73	44
AC-HM-0808	50350-0808	20306645	13/32	10.30	1.61	41
AC-HM-0810	50350-0810	20306646	13/32	10.30	1.73	44
AC-HM-1010	50350-1010	20306647	1/2	12.70	1.73	44
AC-HM-1210	50350-1210	20306648	5/8	15.90	1.73	44
AC-HM-1212	50350-1212	20306649	5/8	15.90	2.01	51

Hose Mender

90° Elbow | A/C (Crimp) Fittings

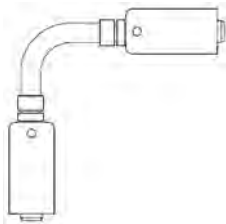

Descriptive #	Product #	SAP #	Hose Size ID		Drop (D)		Cut-Off (R)	
			in.	mm	in.	mm	in.	mm
AC-HM90-0606	50355-0606	20306650	5/16	7.90	0.98	25	0.98	25
AC-HM90-0808	50355-0808	20306651	13/32	10.30	1.73	44	1.73	44
AC-HM90-1010	50355-1010	20306652	1/2	12.70	2.24	57	2.24	57
AC-HM90-1212	50355-1212	20306653	5/8	15.90	2.64	67	2.64	67

Hose Mender

R12 Valve | A/C (Crimp) Fittings

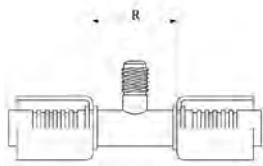

Descriptive #	Product #	SAP #	Hose Size ID		Cut-Off (R)		Valve (V)	
			in.	mm	in.	mm	in.	mm
AC-HM12V-0606	50365-0606	20306658	5/16	7.90	1.61	41	1/4	6.35
AC-HM12V-0808	50365-0808	20306659	13/32	10.30	1.73	44	1/4	6.35
AC-HM12V-1010	50365-1010	20306670	1/2	12.70	1.61	41	1/4	6.35
AC-HM12V-1212	50365-1212	20306671	5/8	15.90	1.73	44	1/4	6.35

Hose Mender

R134a Valve | A/C (Crimp) Fittings

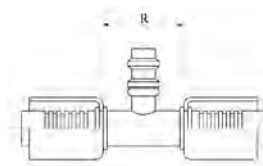

Descriptive #	Product #	SAP #	Hose Size ID		Cut-Off (R)		Valve	
			in.	mm	in.	mm	in.	mm
AC-HM134V-0606	50370-0606	20306672	5/16	7.90	1.73	44	0.63	16
AC-HM134V-0808	50370-0808	20306673	13/32	10.30	1.73	44	0.63	16
AC-HM134V-1010	50370-1010	20306674	1/2	12.70	1.73	44	0.51	13
AC-HM134V-1212	50370-1212	20306675	5/8	15.90	2.01	47	0.51	13

For use with Galaxy® G4826 (5/16"-5/8") & G4867 (3/4") Hose

Hose Mender with Sight Glass

A/C (Crimp) Fittings

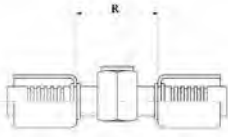

Descriptive #	Product #	SAP #	Hose Size ID		Cut-Off (R)	
			in.	mm	in.	mm
AC-HMSG-0606	50375-0606	20306993	5/16	7.90	1.61	41

Hose Mender, Tee

A/C (Crimp) Fittings

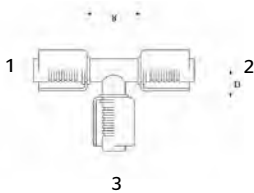

Descriptive #	Product #	SAP #	Hose Size ID		Hose Size ID (3)		Drop (D)		Cut-Off (R)	
			in.	mm	in.	mm	in.	mm	in.	mm
AC-HMT-0606	50380-0606	20306676	5/16	7.90	5/16	7.90	0.98	25	1.93	49
AC-HMT-0808	50380-0808	20306677	13/32	10.30	13/32	10.30	1.26	32	2.05	52
AC-HMT-1010	50380-1010	20306678	1/2	12.70	1/2	12.70	1.26	32	2.24	57
AC-HMT-1210	50380-1210	20306994	5/8	15.90	1/2	12.70	1.38	35	2.05	52
AC-HMT-1212	50380-1212	20306679	5/8	15.90	5/8	15.90	1.26	32	2.05	52

O-Ring Insert

Male | A/C (Crimp) Fittings

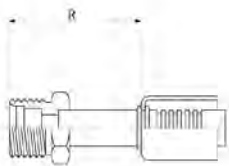

Descriptive #	Product #	SAP #	Hose Size ID		Thread Size	Cut-Off (R)	
			in.	mm		in.	mm
AC-OIM-0606	50500-0606	20306684	5/16	7.90	5/8-18	1.46	37
AC-OIM-0808	50500-0808	20306685	13/32	10.30	3/4-16	1.61	41
AC-OIM-1010	50500-1010	20306686	1/2	12.70	7/8-14	2.13	54
AC-OIM-1210	50500-1210	20306687	5/8	15.90	7/8-14	1.69	43
AC-OIM-1212	50500-1212	20306688	5/8	15.90	1 1/16-14	2.36	60
AC-OIM-1412	50500-1412	20307000	3/4	19.05	1 1/16-14	2.36	60

O-Ring Insert

Male, 45° Elbow | A/C (Crimp) Fittings

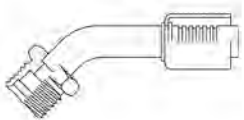

Descriptive #	Product #	SAP #	Hose Size ID (1 & 2)		Thread Size	Drop (D)		Cut-Off (R)	
			in.	mm		in.	mm	in.	mm
AC-OIM45-0606	50503-0606	20307001	5/16	7.90	5/8-18	0.75	19	0.83	21
AC-OIM45-0808	50503-0808	20307002	13/32	10.30	3/4-16	0.98	25	0.94	24
AC-OIM45-1010	50503-1010	20307003	1/2	12.70	7/8-14	1.26	32	1.26	32
AC-OIM45-1212	50503-1212	20307004	5/8	15.90	1 1/16-14	1.38	35	1.50	38
AC-OIM45-1412	50503-1412	20307005	3/4	19.05	1 1/16-14	1.38	35	1.50	38

For use with Galaxy® G4826 (5/16"-5/8") & G4867 (3/4") Hose

O-Ring Insert

Male, 90° Elbow | A/C (Crimp) Fittings

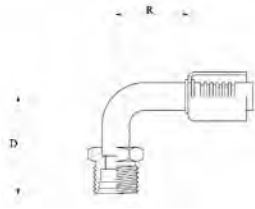

Descriptive #	Product #	SAP #	Hose Size ID		Thread Size	Drop (D)		Cut-Off (R)	
			in.	mm		in.	mm	in.	mm
AC-OIM90-0606	50505-0606	20306689	5/16	7.90	5/8-18	1.50	38	1.06	27
AC-OIM90-0808	50505-0808	20306690	13/32	10.30	3/4-16	1.73	44	1.26	32
AC-OIM90-1010	50505-1010	20306691	1/2	12.70	7/8-14	2.01	51	1.50	38
AC-OIM90-1210	50505-1210	20307006	5/8	15.90	7/8-14	2.17	55	1.97	50
AC-OIM90-1212	50505-1212	20307007	5/8	15.90	1 1/16-14	2.52	64	2.36	60
AC-OIM90-1412	50505-1412	20307008	3/4	19.05	1 1/16-14	2.52	64	2.36	60

O-Ring Insert

Male, Bulkhead | A/C (Crimp) Fittings

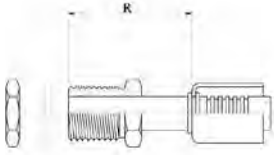

Descriptive #	Product #	SAP #	Hose Size ID		Thread Size	Cut-Off (R)	
			in.	mm		in.	mm
AC-OIMB-0606	50515-0606	20307009	5/16	7.90	5/8-18	2.52	64
AC-OIMB-0808	50515-0808	20307010	13/32	10.30	3/4-16	2.76	70
AC-OIMB-1010	50515-1010	20307011	1/2	12.70	7/8-14	2.95	75

O-Ring Insert

Male, Bulkhead, 90° Elbow | A/C (Crimp) Fittings

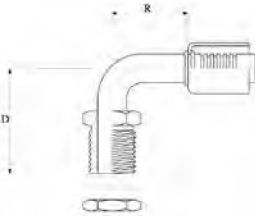

Descriptive #	Product #	SAP #	Hose Size ID		Thread Size	Drop (D)		Cut-Off (R)	
			in.	mm		in.	mm	in.	mm
AC-OIMB90-0606	50520-0606	20307012	5/16	7.90	5/8-18	2.13	54	1.61	41
AC-OIMB90-0808	50520-0808	20307013	13/32	10.30	3/4-16	2.44	62	1.73	44
AC-OIMB90-1010	50520-1010	20307014	5/8	15.90	7/8-14	2.52	64	2.01	51

O-Ring Insert

Male, R134a Valve | A/C (Crimp) Fittings

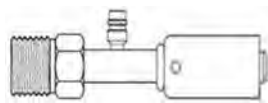

Descriptive #	Product #	SAP #	Hose Size ID		Thread Size	Cut-Off (R)		Valve (V)	
			in.	mm		in.	mm	in.	mm
AC-OIM134V-0606	50530-0606	20307015	5/16	7.90	5/8-18	2.44	62	0.63	16
AC-OIM134V-0808	50530-0808	20307016	13/32	10.30	3/4-16	2.56	65	0.63	16
AC-OIM134V-1010	50530-1010	20307017	1/2	12.70	7/8-14	1.77	45	0.51	13
AC-OIM134V-1212	50530-1212	20307018	5/8	15.90	1 1/16-14	2.95	75	0.51	13

For use with Galaxy® G4826 (5/16"-5/8") & G4867 (3/4") Hose

O-Ring Insert

Male, R134a Valve, 90° Elbow | A/C (Crimp) Fittings

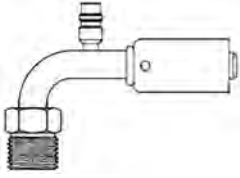

Descriptive #	Product #	SAP #	Hose Size ID		Thread Size (A)	Drop (D)		Cut-Off (R)		Valve (V)	
			in.	mm		in.	mm	in.	mm	in.	mm
AC-OIM134V90-0606	50535-0606	20307019	5/16	7.90	5/8-18	1.61	41	2.13	54	0.63	16
AC-OIM134V90-0808	50535-0808	20307020	13/32	10.30	3/4-16	1.89	48	2.13	54	0.63	16
AC-OIM134V90-1010	50535-1010	20307021	1/2	12.70	7/8-14	2.13	54	2.36	60	0.51	13

O-Ring Tube

Female, Swivel | A/C (Crimp) Fittings

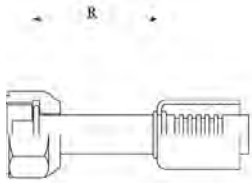

Descriptive #	Product #	SAP #	Hose Size ID		Thread Size	Cut-Off (R)	
			in.	mm		in.	mm
AC-OTF-0605	50600-0605	20307022	5/16	7.90	9/16-18	1.30	33
AC-OTF-0606	50600-0606	20306692	5/16	7.90	5/8-18	1.38	35
AC-OTF-0608	50600-0608	20306693	5/16	7.90	3/4-16	1.50	38
AC-OTF-0806	50600-0806	20307023	13/32	10.30	5/8-18	1.50	38
AC-OTF-0808	50600-0808	20306694	13/32	10.30	3/4-16	1.50	38
AC-OTF-1008	50600-1008	20307024	1/2	12.70	3/4-16	1.69	43
AC-OTF-1010	50600-1010	20306695	1/2	12.70	7/8-14	1.69	43
AC-OTF-1012	50600-1012	20307025	1/2	12.70	1 1/16-14	1.81	46
AC-OTF-1210	50600-1210	20306696	5/8	15.90	7/8-14	1.81	46
AC-OTF-1212	50600-1212	20306697	5/8	15.90	1 1/16-14	1.81	46
AC-OTF-1412	50600-1412	20307026	3/4	19.05	1 1/16-14	1.81	46

O-Ring Tube

Female, Swivel, 45° Elbow | A/C (Crimp) Fittings

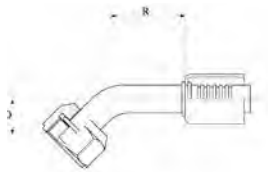

Descriptive #	Product #	SAP #	Hose Size ID		Thread Size	Drop (D)		Cut-Off (R)	
			in.	mm		in.	mm	in.	mm
AC-OTF45-0606	50603-0606	20306698	5/16	7.90	5/8-18	0.55	14	0.83	21
AC-OTF45-0806	50603-0806	20307027	13/32	10.30	5/8-18	0.63	16	0.94	24
AC-OTF45-0808	50603-0808	20306699	13/32	10.30	3/4-16	0.63	16	0.94	24
AC-OTF45-1010	50603-1010	20306700	1/2	12.70	7/8-14	0.87	22	1.26	32
AC-OTF45-1210	50603-1210	20306701	5/8	15.90	7/8-14	0.94	24	1.50	38
AC-OTF45-1212	50603-1212	20306702	5/8	15.90	1 1/16-14	0.94	24	1.50	38
AC-OTF45-1412	50603-1412	20307028	3/4	19.05	1 1/16-14	0.94	24	1.50	38

For use with Galaxy® G4826 (5/16"-5/8") & G4867 (3/4") Hose

O-Ring Tube

Female, Swivel, 90° Elbow | A/C (Crimp) Fittings

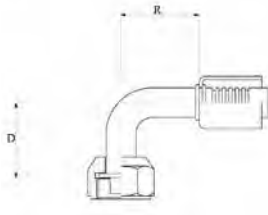

Descriptive #	Product #	SAP #	Hose Size ID		Thread Size	Drop (D)		Cut-Off (R)	
			in.	mm		in.	mm	in.	mm
AC-OTF90-0605	50605-0605	20307029	5/16	7.90	9/16-18	1.10	28	1.26	32
AC-OTF90-0606	50605-0606	20306703	5/16	7.90	5/8-18	1.10	28	1.06	27
AC-OTF90-0608	50605-0608	20306704	5/16	7.90	3/4-16	1.30	33	1.26	32
AC-OTF90-0806	50605-0806	20307030	13/32	10.30	5/8-18	1.30	33	1.26	32
AC-OTF90-0808	50605-0808	20306705	13/32	10.30	3/4-16	1.30	33	1.26	32
AC-OTF90-1008	50605-1008	20307031	1/2	12.70	3/4-16	1.50	38	1.50	38
AC-OTF90-1010	50605-1010	20306706	1/2	12.70	7/8-14	1.50	38	1.50	38
AC-OTF90-1012	50605-1012	20307032	1/2	12.70	1 1/16-14	1.77	45	1.77	45
AC-OTF90-1210	50605-1210	20306707	5/8	15.90	7/8-14	1.77	45	1.77	45
AC-OTF90-1212	50605-1212	20306708	5/8	15.90	1 1/16-14	1.77	45	1.77	45
AC-OTF90-1412	50605-1412	20307033	3/4	19.05	1 1/16-14	1.77	45	1.77	45

O-Ring Tube

Female, Swivel, 90° Block Elbow | A/C (Crimp) Fittings

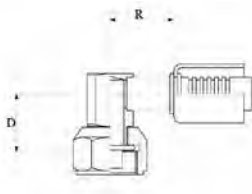

Descriptive #	Product #	SAP #	Hose Size ID		Thread Size	Drop (D)		Cut-Off (R)	
			in.	mm		in.	mm	in.	mm
AC-OTF90B-0808	50610-0808	20306709	13/32	10.30	3/4-16	0.75	19	0.94	24
AC-OTF90B-1010	50610-1010	20306710	1/2	12.70	7/8-14	0.75	19	0.98	25
AC-OTF90B-1210	50610-1210	20306711	5/8	15.90	7/8-14	0.75	19	0.98	25

O-Ring Tube

Female, Swivel, 180° Elbow | A/C (Crimp) Fittings

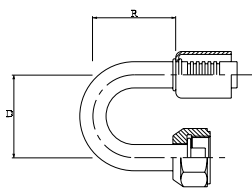

Descriptive #	Product #	SAP #	Hose Size ID		Thread Size	Drop (D)		Cut-Off (R)	
			in.	mm		in.	mm	in.	mm
AC-OTF180-0606	50615-0606	20307034	5/16	7.90	5/8-18	1.61	41	2.01	51
AC-OTF180-0808	50615-0808	20307035	13/32	10.30	3/4-16	1.73	44	2.01	51
AC-OTF180-1212	50615-1212	20307036	5/8	15.90	1 1/16-14	2.13	54	2.99	76

O-Ring Tube

Female, Swivel, Metric | A/C (Crimp) Fittings

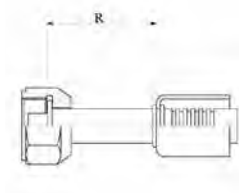

Descriptive #	Product #	SAP #	Hose Size ID		Thread Size	Cut-Off (R)	
			in.	mm		in.	mm
AC-OTFM-0616	50630-0616	20306712	5/16	7.90	16 x 1 1/2	1.54	39
AC-OTFM-0618	50630-0618	20307037	5/16	7.90	18 x 1 1/2	1.54	39
AC-OTFM-0620	50630-0620	20307038	5/16	7.90	20 x 1 1/2	1.54	39
AC-OTFM-0820	50630-0820	20307039	13/32	10.30	20 x 1 1/2	1.69	43
AC-OTFM-1022	50630-1022	20306713	1/2	12.70	22 x 1 1/2	1.69	43
AC-OTFM-1024	50630-1024	20306714	1/2	12.70	24 x 2	1.69	43
AC-OTFM-1227	50630-1227	20306715	5/8	15.90	27 x 2	1.81	46

For use with Galaxy® G4826 (5/16"-5/8") & G4867 (3/4") Hose

O-Ring Tube

Female, Swivel, Metric, 45° Elbow | A/C (Crimp) Fittings

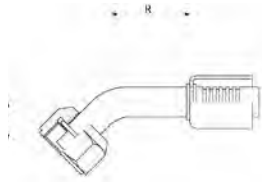

Descriptive #	Product #	SAP #	Hose Size ID		Thread Size	Drop (D)		Cut-Off (R)	
			in.	mm		in.	mm	in.	mm
AC-OTFM45-0614	50633-0614	20307040	5/16	7.90	14 x 1½	0.55	14	0.98	25
AC-OTFM45-0616	50633-0616	20307041	5/16	7.90	16 x 1½	0.55	14	0.98	25
AC-OTFM45-0618	50633-0618	20307042	5/16	7.90	18 x 1½	0.55	14	0.98	25
AC-OTFM45-0620	50633-0620	20307043	5/16	7.90	20 x 1½	0.55	14	0.98	25
AC-OTFM45-0820	50633-0820	20307044	13/32	10.30	20 x 1½	0.63	16	0.98	25
AC-OTFM45-1022	50633-1022	20307045	1/2	12.70	22 x 1½	0.87	22	1.26	32
AC-OTFM45-1024	50633-1024	20307046	1/2	12.70	24 x 2	0.87	22	1.26	32
AC-OTFM45-1227	50633-1227	20307047	5/8	15.90	27 x 2	0.94	24	1.50	38

O-Ring Tube

Female, Swivel, Metric, 90° Elbow | A/C (Crimp) Fittings

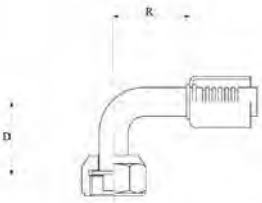

Descriptive #	Product #	SAP #	Hose Size ID		Thread Size	Drop (D)		Cut-Off (R)	
			in.	mm		in.	mm	in.	mm
AC-OTFM90-0616	50635-0616	20306716	5/16	7.90	16 x 1½	1.10	28	1.06	27
AC-OTFM90-0618	50635-0618	20307048	5/16	7.90	18 x 1½	1.10	28	1.06	27
AC-OTFM90-0620	50635-0620	20307049	5/16	7.90	20 x 1½	1.10	28	1.06	27
AC-OTFM90-0820	50635-0820	20307050	13/32	10.30	20 x 1½	1.30	33	1.26	32
AC-OTFM90-1022	50635-1022	20306717	1/2	12.70	22 x 1½	1.50	38	1.50	38
AC-OTFM90-1024	50635-1024	20306718	1/2	12.70	24 x 2	1.50	38	1.50	38
AC-OTFM90-1227	50635-1227	20306719	5/8	15.90	27 x 2	1.77	45	1.77	45

O-Ring Tube

Female, Swivel, R12 Valve | A/C (Crimp) Fittings

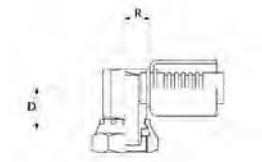

Descriptive #	Product #	SAP #	Hose Size ID		Thread Size	Cut-Off (R)		Valve	
			in.	mm		in.	mm	in.	mm
AC-OTF12V-0606	50650-0606	20307051	5/16	7.90	5/8-18	1.89	48	1/4	6.35
AC-OTF12V-0808	50650-0808	20307052	13/32	10.30	3/4-16	1.89	48	1/4	6.35
AC-OTF12V-1010	50650-1010	20307053	1/2	12.70	7/8-14	2.13	54	1/4	6.35

O-Ring Tube

Female, Swivel, R12 Valve, 90° Elbow | A/C (Crimp) Fittings

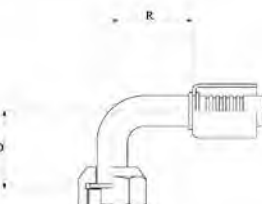

Descriptive #	Product #	SAP #	Hose Size ID		Thread Size	Drop (D)		Cut-Off (R)		Valve (V)	
			in.	mm		in.	mm	in.	mm	in.	mm
AC-OTF12V90-0606	50655-0606	20306720	5/16	7.90	5/8-18	1.10	28	2.13	54	1/4	6.35
AC-OTF12V90-0808	50655-0808	20306721	13/32	10.30	3/4-16	1.30	33	2.13	54	1/4	6.35
AC-OTF12V90-1010	50655-1010	20306722	1/2	12.70	7/8-14	1.50	38	2.36	60	1/4	6.35
AC-OTF12V90-1210	50655-1210	20306723	5/8	15.90	7/8-14	1.73	44	2.68	68	1/4	6.35

For use with Galaxy® G4826 (5/16"-5/8") & G4867 (3/4") Hose

O-Ring Tube

Female, Swivel, R134a Valve | A/C (Crimp) Fittings

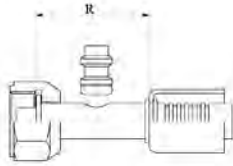

Descriptive #	Product #	SAP #	Hose Size ID		Thread Size	Cut-Off (R)		Valve (V)	
			in.	mm		in.	mm	in.	mm
AC-OTF134V-0606	50660-0606	20306724	5/16	7.90	5/8-18	1.89	48	0.63	16
AC-OTF134V-0808	50660-0808	20306725	13/32	10.30	3/4-16	1.89	48	0.63	16
AC-OTF134V-1010	50660-1010	20306726	1/2	12.70	7/8-14	2.13	54	0.51	13
AC-OTF134V-1210	50660-1210	20306727	5/8	15.90	7/8-14	2.24	57	0.51	13
AC-OTF134V-1212	50660-1212	20307054	5/8	15.90	1 1/16-14	2.24	57	0.51	13
AC-OTF134V-1412	50660-1412	20307055	3/4	19.05	1 1/16-14	2.24	57	0.51	13
AC-OTF134VHS-1010	50675-1010	20307063	1/2	12.70	7/8-14	2.13	54	0.63	16

O-Ring Tube

Female, Swivel, R134a Valve, 45° Elbow | A/C (Crimp) Fittings

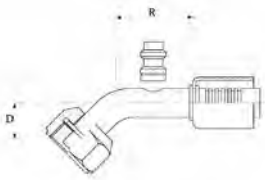

Descriptive #	Product #	SAP #	Hose Size ID		Thread Size	Drop (D)		Cut-Off (R)		Valve (V)	
			in.	mm		in.	mm	in.	mm	in.	mm
AC-OTF134V45-0606	50663-0606	20307056	5/16	7.90	5/8-18	0.55	14	1.61	41	0.63	16
AC-OTF134V45-0808	50663-0808	20306728	13/32	10.30	3/4-16	0.63	16	1.61	41	0.63	16
AC-OTF134V45-1010	50663-1010	20307057	1/2	12.70	7/8-14	0.87	22	1.73	44	0.51	13
AC-OTF134V45-1210	50663-1210	20306729	5/8	15.90	7/8-14	0.94	24	1.89	48	0.51	13
AC-OTF134V45-1212	50663-1212	20307058	5/8	15.90	1 1/16-14	0.94	24	1.89	48	0.51	13
AC-OTF134V45-1412	50663-1412	20307059	3/4	19.05	1 1/16-14	0.94	24	1.89	48	0.51	13

O-Ring Tube

Female, Swivel, R134a Valve, 90° Elbow | A/C (Crimp) Fittings

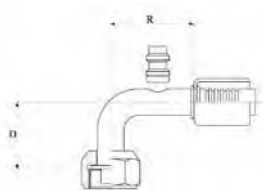

Descriptive #	Product #	SAP #	Hose Size ID		Thread Size	Drop (D)		Cut-Off (R)		Valve (V)	
			in.	mm		in.	mm	in.	mm	in.	mm
AC-OTF134V90-0606	50665-0606	20306730	5/16	7.90	5/8-18	1.10	28	2.13	54	0.63	16
AC-OTF134V90-0806	50665-0806	20307060	13/32	10.30	5/8-18	1.30	33	2.13	54	0.63	16
AC-OTF134V90-0808	50665-0808	20306731	13/32	10.30	3/4-16	1.30	33	2.13	54	0.63	16
AC-OTF134V90-1010	50665-1010	20306732	1/2	12.70	7/8-14	1.50	38	2.36	60	0.51	13
AC-OTF134V90-1210	50665-1210	20306733	5/8	15.90	7/8-14	1.73	44	2.68	68	0.51	13
AC-OTF134V90-1212	50665-1212	20307061	5/8	15.90	1 1/16-14	1.73	44	2.68	68	0.51	13
AC-OTF134V90-1412	50665-1412	20307062	3/4	19.05	1 1/16-14	1.73	44	2.68	68	0.51	13

For use with Galaxy® G4826 (5/16"-5/8") & G4867 (3/4") Hose

O-Ring Tube

Male, Swivel | A/C (Crimp) Fittings

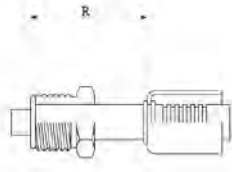

Descriptive #	Product #	SAP #	Hose Size ID		Thread Size	Cut-Off (R)	
			in.	mm		in.	mm
AC-OTM-0606	50700-0606	20306734	5/16	7.90	5/8-18	1.69	43
AC-OTM-0607	50700-0607	20306735	5/16	7.90	11/16-16	1.69	43
AC-OTM-0608	50700-0608	20306736	5/16	7.90	3/4-18	1.77	45
AC-OTM-0808	50700-0808	20306737	13/32	10.30	3/4-18	1.77	45
AC-OTM-1010	50700-1010	20306738	1/2	12.70	7/8-18	1.89	48
AC-OTM-1012	50700-1012	20306739	1/2	12.70	1 1/4-16	2.36	60
AC-OTM-1210	50700-1210	20306740	5/8	15.90	7/8-18	2.36	60
AC-OTM-1212	50700-1212	20306741	5/8	15.90	1 1/4-16	2.36	60

O-Ring Tube

Male, Swivel, 45° Elbow | A/C (Crimp) Fittings

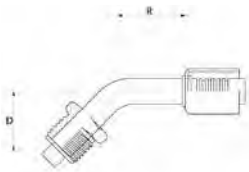

Descriptive #	Product #	SAP #	Hose Size ID		Thread Size	Drop (D)		Cut-Off (R)	
			in.	mm		in.	mm	in.	mm
AC-OTM45-0606	50703-0606	20306742	5/16	7.90	5/8-18	0.87	22	0.83	21
AC-OTM45-0808	50703-0808	20306743	13/32	10.30	3/4-18	0.98	25	0.94	24
AC-OTM45-1010	50703-1010	20306744	1/2	12.70	7/8-18	1.06	27	1.26	32
AC-OTM45-1210	50703-1210	20306745	5/8	15.90	7/8-18	1.18	30	1.50	38
AC-OTM45-1212	50703-1212	20306746	5/8	15.90	1 1/4-16	1.18	30	1.50	38

O-Ring Tube

Male, Swivel, 90° Elbow | A/C (Crimp) Fittings

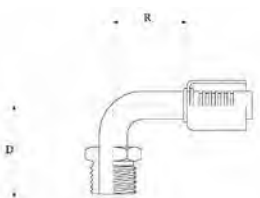

Descriptive #	Product #	SAP #	Hose Size ID		Thread Size	Drop (D)		Cut-Off (R)	
			in.	mm		in.	mm	in.	mm
AC-OTM90-0606	50705-0606	20306747	5/16	7.90	5/8-18	1.61	41	1.06	27
AC-OTM90-0608	50705-0608	20306748	5/16	7.90	3/4-18	1.89	48	1.26	32
AC-OTM90-0806	50705-0806	20306749	13/32	10.30	5/8-18	1.89	48	1.26	32
AC-OTM90-0808	50705-0808	20306750	13/32	10.30	3/4-18	1.89	48	1.26	32
AC-OTM90-1010	50705-1010	20306751	1/2	12.70	7/8-18	2.13	54	1.50	38
AC-OTM90-1012	50705-1012	20306752	1/2	12.70	1 1/4-16	2.24	57	1.77	45
AC-OTM90-1210	50705-1210	20306753	5/8	15.90	7/8-18	2.24	57	1.77	45
AC-OTM90-1212	50705-1212	20306754	5/8	15.90	1 1/4-16	2.24	57	1.77	45

For use with GALAXY® G4826 (5/16"-5/8") & G4867 (3/4") Hose

O-Ring Tube

Male, Swivel, Long Pilot | A/C (Crimp) Fittings

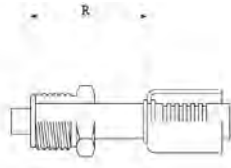

Descriptive #	Product #	SAP #	Hose Size ID		Thread Size	Cut-Off (R)	
			in.	mm		in.	mm
AC-OTMLP-0606	50720-0606	20307064	5/16	7.90	5/8-18	1.06	27
AC-OTMLP-0808	50720-0808	20307065	13/32	10.30	3/4-18	1.26	32
AC-OTMLP-1010	50720-1010	20307066	1/2	12.70	7/8-18	1.50	38
AC-OTMLP-1210	50720-1210	20307067	5/8	15.90	7/8-18	1.77	45

O-Ring Tube

Male, Swivel, R134a Valve | A/C (Crimp) Fittings

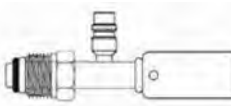

Descriptive #	Product #	SAP #	Hose Size ID		Thread Size	Cut-Off (R)		Valve (V)	
			in.	mm		in.	mm	in.	mm
AC-OTM134V-0606	50730-0606	20307068	5/16	7.90	5/8-18	1.69	43	0.63	16
AC-OTM134V-0808	50730-0808	20307069	13/32	10.30	3/4-18	1.77	45	0.63	16
AC-OTM134V-1010	50730-1010	20307070	1/2	12.70	7/8-18	2.36	60	0.51	13
AC-OTM134V-1210	50730-1210	20306755	5/8	15.90	7/8-18	2.36	60	0.51	13
AC-OTM134V-1212	50730-1212	20307071	5/8	15.90	1 1/16-16	2.52	64	0.51	13

O-Ring Tube

Male, Swivel, R134a Valve, 90° Elbow | A/C (Crimp) Fittings

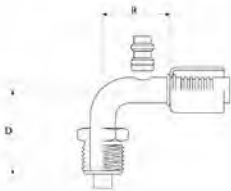

Descriptive #	Product #	SAP #	Hose Size ID		Thread Size	Drop (D)		Cut-Off (R)		Valve	
			in.	mm		in.	mm	in.	mm	in.	mm
AC-OTM134V90-1010	50735-1010	20307072	1/2	12.70	7/8-18	2.13	54	2.36	60	0.51	13
AC-OTM134V90-1210	50735-1210	20306756	5/8	15.90	7/8-18	2.13	54	2.36	60	0.51	13

SAE 45° Flare

Female, Swivel | A/C (Crimp) Fittings

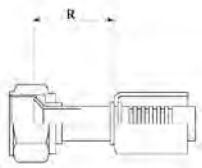

Descriptive #	Product #	SAP #	Hose Size ID		Thread Size	Cut-Off (R)	
			in.	mm		in.	mm
AC-SFFX-0606	50760-0606	20306757	5/16	7.90	5/8-18	1.38	35
AC-SFFX-0608	50760-0608	20306758	5/16	7.90	3/4-16	1.18	30
AC-SFFX-0806	50760-0806	20307073	13/32	10.30	5/8-18	1.18	30
AC-SFFX-0808	50760-0808	20306759	13/32	10.30	3/4-16	1.18	30
AC-SFFX-1008	50760-1008	20307074	1/2	12.70	3/4-16	1.50	38
AC-SFFX-1010	50760-1010	20306760	1/2	12.70	7/8-14	1.50	38
AC-SFFX-1210	50760-1210	20306761	5/8	15.90	7/8-14	1.73	44
AC-SFFX-1212	50760-1212	20306762	5/8	15.90	1 1/16-14	1.73	44

For use with Galaxy® G4826 (5/16"-5/8") & G4867 (3/4") Hose

SAE 45° Flare

Female, Swivel, 45° Elbow | A/C (Crimp) Fittings

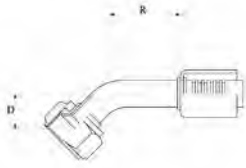

Descriptive #	Product #	SAP #	Hose Size ID		Thread Size	Drop (D)		Cut-Off (R)	
			in.	mm		in.	mm	in.	mm
AC-SFFX45-0606	50763-0606	20306763	5/16	7.90	5/8-18	0.55	14	0.83	21
AC-SFFX45-0608	50763-0608	20306764	5/16	7.90	3/4-16	0.63	16	0.94	24
AC-SFFX45-0806	50763-0806	20307075	13/32	10.30	5/8-18	0.63	16	0.94	24
AC-SFFX45-0808	50763-0808	20306765	13/32	10.30	3/4-16	0.63	16	0.94	24
AC-SFFX45-1008	50763-1008	20307076	1/2	12.70	3/4-16	0.87	22	1.26	32
AC-SFFX45-1010	50763-1010	20306766	1/2	12.70	7/8-14	0.87	22	1.26	32
AC-SFFX45-1210	50763-1210	20306767	5/8	15.90	7/8-14	0.98	25	1.50	38
AC-SFFX45-1212	50763-1212	20306768	5/8	15.90	1 1/16-14	0.98	25	1.50	38

SAE 45° Flare

Female, Swivel, 90° Elbow | A/C (Crimp) Fittings

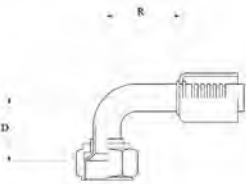

Descriptive #	Product #	SAP #	Hose Size ID		Thread Size	Drop (D)		Cut-Off (R)	
			in.	mm		in.	mm	in.	mm
AC-SFFX90-0606	50765-0606	20306769	5/16	7.90	5/8-18	1.06	27	1.06	27
AC-SFFX90-0608	50765-0608	20306770	5/16	7.90	3/4-16	1.26	32	1.26	32
AC-SFFX90-0806	50765-0806	20307077	13/32	10.30	5/8-18	1.26	32	1.26	32
AC-SFFX90-0808	50765-0808	20306771	13/32	10.30	3/4-16	1.26	32	1.26	32
AC-SFFX90-1008	50765-1008	20307078	1/2	12.70	3/4-16	1.50	38	1.50	38
AC-SFFX90-1010	50765-1010	20306772	1/2	12.70	7/8-14	1.50	38	1.50	38
AC-SFFX90-1210	50765-1210	20306773	5/8	15.90	7/8-14	1.50	38	1.73	44
AC-SFFX90-1212	50765-1212	20306774	5/8	15.90	1 1/16-14	1.50	38	1.73	44

SAE 45° Flare

Male | A/C (Crimp) Fittings

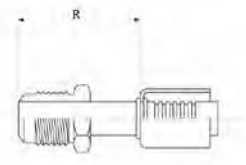

Descriptive #	Product #	SAP #	Hose Size ID		Thread Size	Cut-Off (R)	
			in.	mm		in.	mm
AC-SFM-0606A	50780-0606	20306775	5/16	7.90	5/8-18	1.89	48
AC-SFM-0808A	50780-0808	20306776	13/32	10.30	3/4-16	2.01	51
AC-SFM-1010A	50780-1010	20306777	1/2	12.70	7/8-14	2.32	59
AC-SFM-1212A	50780-1212	20306778	5/8	15.90	1 1/16-14	2.52	64

For use with Galaxy® G4826 (5/16"-5/8") & G4867 (3/4") Hose

SAE 45° Flare

Male, 45° Elbow | A/C (Crimp) Fittings

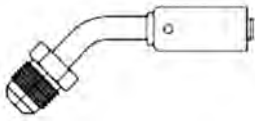

Descriptive #	Product #	SAP #	Hose Size ID		Thread Size	Drop (D)		Cut-Off (R)	
			in.	mm		in.	mm	in.	mm
AC-SFM45-0606A	50783-0606	20306779	5/16	7.90	5/8-18	1.50	38	1.06	27
AC-SFM45-0808A	50783-0808	20306780	13/32	10.30	3/4-16	1.73	44	1.26	32
AC-SFM45-1010A	50783-1010	20306781	1/2	12.70	7/8-14	2.01	51	1.50	38
AC-SFM45-1212A	50783-1212	20306782	5/8	15.90	1 1/16-14	2.52	64	2.36	60

SAE 45° Flare

Male, 90° Elbow | A/C (Crimp) Fittings

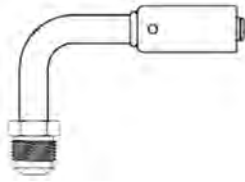

Descriptive #	Product #	SAP #	Hose Size ID		Thread Size	Drop (D)		Cut-Off (R)	
			in.	mm		in.	mm	in.	mm
AC-SFM90-0606A	50785-0606	20306783	5/16	7.90	5/8-18	0.75	19	0.83	21
AC-SFM90-0808A	50785-0808	20306784	13/32	10.30	3/4-16	0.98	25	0.94	24
AC-SFM90-1010A	50785-1010	20306785	1/2	12.70	7/8-14	1.26	32	1.26	32
AC-SFM90-1212A	50785-1212	20306786	5/8	15.90	1 1/16-14	1.38	35	1.50	38

For use with Galaxy® G4890 Hose

Compressor Pad Block

R12 Valve/Switch, 90° Block Elbow | GC Cool Clip™ Fittings

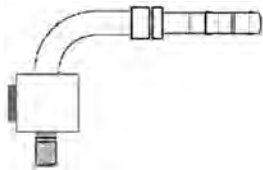

Descriptive #	Product #	SAP #	Hose Size ID		Drop (D)		Cut-Off (R)		Valve (V)	
			in.	mm	in.	mm	in.	mm	in.	mm
GC-CB12VS90-0808	54110-0808	20307089	13/32	10.30	2.63	66.8	3.00	76.2	1/4	6.35
GC-CB12VS90-1008	54110-1008	20307090	1/2	12.70	2.63	66.8	3.00	76.2	1/4	6.35
GC-CB12VS90-1208	54110-1208	20307091	5/8	15.90	2.63	66.8	3.00	76.2	1/4	6.35

Compressor Pad Block

R12 Valve/Switch Reversed, 90° Elbow | GC Cool Clip™ Fittings

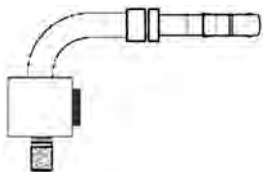

Descriptive #	Product #	SAP #	Hose Size ID		Drop (D)		Cut-Off (R)		Valve (V)	
			in.	mm	in.	mm	in.	mm	in.	mm
GC-CB12VSR90-0808	54112-0808	20307092	13/32	10.30	2.63	66.8	1.88	47.6	1/4	6.35
GC-CB12VSR90-1008	54112-1008	20307093	1/2	12.70	2.63	66.8	1.88	47.6	1/4	6.35
GC-CB12VSR90-1208	54112-1208	20307094	5/8	15.90	2.63	66.8	1.88	47.6	1/4	6.35

For use with Galaxy® G4890 Hose

Compressor O-Ring Tube

Female, 45° Elbow | GC Cool Clip™ Fittings



Descriptive #	Product #	SAP #	Hose Size ID		Thread Size	Drop (D)		Cut-Off (R)	
			in.	mm		in.	mm	in.	mm
GC-COTF45-0810	54133-0810	20306806	13/32	10.30	1-14	0.39	10	2.01	51
GC-COTF45-1010	54133-1010	20306807	1/2	12.70	1-14	0.39	10	2.01	51
GC-COTF45-1210	54133-1210	20306808	5/8	15.90	1-14	0.39	10	2.01	51

Compressor O-Ring Tube

Female, 90° Elbow | GC Cool Clip™ Fittings

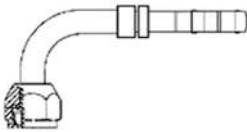

Descriptive #	Product #	SAP #	Hose Size ID		Thread Size	Drop (D)		Cut-Off (R)	
			in.	mm		in.	mm	in.	mm
GC-COTF90-0810	54135-0810	20306809	13/32	10.30	1-14	0.91	23	2.13	54
GC-COTF90-1010	54135-1010	20306810	1/2	12.70	1-14	0.91	23	2.13	54
GC-COTF90-1210	54135-1210	20306811	5/8	15.90	1-14	0.91	23	2.13	54

Compressor O-Ring Tube

Female, 90° Block Elbow | GC Cool Clip™ Fittings

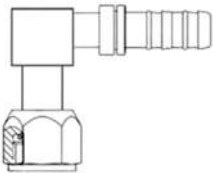

Descriptive #	Product #	SAP #	Hose Size ID		Thread Size	Drop (D)		Cut-Off (R)	
			in.	mm		in.	mm	in.	mm
GC-COTF90B-0810	54137-0810	20306812	13/32	10.30	1-14	0.91	23	2.32	59
GC-COTF90B-1010	54137-1010	20306813	1/2	12.70	1-14	0.91	23	2.32	59
GC-COTF90B-1210	54137-1210	20306814	5/8	15.90	1-14	0.91	23	2.32	59

Compressor O-Ring Tube Female, R134a Valve, 90° Block Elbow | GC Cool Clip™ Fittings

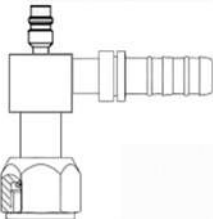

Descriptive #	Product #	SAP #	Hose Size ID		Thread Size	Drop (D)		Cut-Off (R)		Valve	
			in.	mm		in.	mm	in.	mm	in.	mm
GC-COTF134V90B-0810	54145-0810	20307095	13/32	10.30	1-14	0.91	23	2.32	59	0.63	16
GC-COTF134V90B-1010	54145-1010	20307096	1/2	12.70	1-14	0.91	23	2.32	59	0.51	13
GC-COTF134V90B-1210	54145-1210	20307097	5/8	15.90	1-14	0.91	23	2.32	59	0.51	13

Flareless Tube

Braze-On | GC Cool Clip™ Fittings

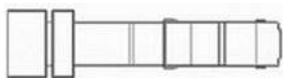

Descriptive #	Product #	SAP #	Hose Size ID		Fitting Size	Cut-Off (R)	
			in.	mm		in.	mm
GC-FTBO-0606	54210-0606	20306815	5/16	7.90	3/8"	1.81	46
GC-FTBO-0808	54210-0808	20306816	13/32	10.30	1/2"	1.81	46
GC-FTBO-1010	54210-1010	20306817	1/2	12.70	5/8"	1.81	46
GC-FTBO-1210	54210-1210	20306818	5/8	15.90	5/8"	1.81	46
GC-FTBO-1212	54210-1212	20306819	5/8	15.90	3/4"	1.81	46

For use with Galaxy® G4890 Hose

Flareless Tube

Male | GC Cool Clip™ Fittings

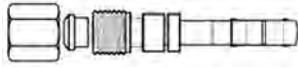

Descriptive #	Product #	SAP #	Hose Size ID		Thread Size	Cut-Off (R)	
			in.	mm		in.	mm
GC-FTM-0606	54230-0606	20306820	5/16	7.90	5/8-18	2.80	71
GC-FTM-0608	54230-0608	20306821	5/16	7.90	3/4-16	2.80	71
GC-FTM-0806	54230-0806	20306822	13/32	10.30	5/8-18	2.80	71
GC-FTM-0808	54230-0808	20306823	13/32	10.30	3/4-16	2.91	74
GC-FTM-0810	54230-0810	20306824	13/32	10.30	7/8-14	2.91	74
GC-FTM-1008	54230-1008	20306825	1/2	12.70	3/4-16	3.15	80
GC-FTM-1010	54230-1010	20306826	1/2	12.70	7/8-14	3.15	80
GC-FTM-1210	54230-1210	20306827	5/8	15.90	7/8-14	3.66	93
GC-FTM-1212	54230-1212	20306828	5/8	15.90	1 1/16-14	3.66	93

Flareless Tube

Male, 90° Block Elbow | GC Cool Clip™ Fittings

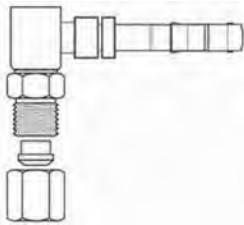

Descriptive #	Product #	SAP #	Hose Size ID		Thread Size	Drop (D)		Cut-Off (R)	
			in.	mm		in.	mm	in.	mm
GC-FTM90B-0606	54235-0606	20306829	5/16	7.90	5/8-18	1.22	31	1.42	36
GC-FTM90B-0608	54235-0608	20307098	5/16	7.90	3/4-16	1.22	31	1.42	36
GC-FTM90B-0806	54235-0806	20307099	13/32	10.30	5/8-18	1.22	31	1.42	36
GC-FTM90B-0808	54235-0808	20306830	13/32	10.30	3/4-16	1.73	44	1.61	41
GC-FTM90B-0810	54235-0810	20306831	13/32	10.30	7/8-14	1.73	44	1.61	41
GC-FTM90B-1008	54235-1008	20306832	1/2	12.70	3/4-16	1.73	44	1.61	41
GC-FTM90B-1010	54235-1010	20306833	1/2	12.70	7/8-14	2.09	53	1.93	49
GC-FTM90B-1210	54235-1210	20306834	5/8	15.90	7/8-14	2.52	64	2.64	67
GC-FTM90B-1212	54235-1212	20306835	5/8	15.90	1 1/16-14	2.52	64	2.64	67

Flareless Tube

Male, Metric | GC Cool Clip™ Fittings

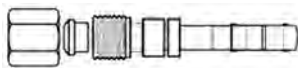

Descriptive #	Product #	SAP #	Hose Size ID		Thread Size	Cut-Off (R)	
			in.	mm		in.	mm
GC-FTmm-0608	54240-0608	20306836	5/16	7.90	5/8-18	2.80	71
GC-FTmm-0812	54240-0812	20306837	13/32	10.30	3/4-16	2.91	74
GC-FTmm-1015	54240-1015	20306838	1/2	12.70	7/8-14	3.66	93

For use with Galaxy® G4890 Hose

Ford Spring Lock

Female | GC Cool Clip™ Fittings

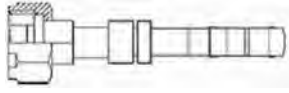

Descriptive #	Product #	SAP #	Hose Size ID		Thread Size	Cut-Off (R)	
			in.	mm		in.	mm
GC-FSLF-0606A	54300-0606A	20306839	5/16	7.90	FSL-06	2.87	73
GC-FSLF-0608A	54300-0608A	20306840	5/16	7.90	FSL-08	2.87	73
GC-FSLF-0808A	54300-0808A	20306841	13/32	10.30	FSL-08	3.11	79
GC-FSLF-1010A	54300-1010A	20306842	1/2	12.70	FSL-10	3.31	84
GC-FSLF-1210A	54300-1210A	20306843	5/8	15.90	FSL-10	3.31	84
GC-FSLF-1212A	54300-1212A	20306844	5/8	15.90	FSL-12	3.31	84

Ford Spring Lock

Female, 45° Elbow | GC Cool Clip™ Fittings

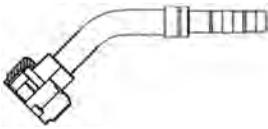

Descriptive #	Product #	SAP #	Hose Size ID		Thread Size	Drop (D)		Cut-Off (R)	
			in.	mm		in.	mm	in.	mm
GC-FSLF45-0606A	54303-0606A	20307100	5/16	7.90	FSL-06	1.30	33	1.85	47
GC-FSLF45-0608A	54303-0608A	20307101	5/16	7.90	FSL-08	1.30	33	1.85	47
GC-FSLF45-0808A	54303-0808A	20307102	13/32	10.30	FSL-08	1.30	33	1.30	33
GC-FSLF45-1210A	54303-1210A	20307104	5/8	15.90	FSL-10	1.42	36	1.61	41
GC-FSLF45-1212A	54303-1212A	20307105	5/8	15.90	FSL-12	1.42	36	1.61	41

Ford Spring Lock

Female, 90° Elbow | GC Cool Clip™ Fittings

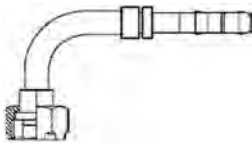

Descriptive #	Product #	SAP #	Hose Size ID		Thread Size	Drop (D)		Cut-Off (R)	
			in.	mm		in.	mm	in.	mm
GC-FSLF90-0606A	54305-0606A	20306845	5/16	7.90	FSL-06	2.13	54	1.97	50
GC-FSLF90-0608A	54305-0608A	20307106	5/16	7.90	FSL-08	2.13	54	1.97	50
GC-FSLF90-0808A	54305-0808A	20306846	13/32	10.30	FSL-08	2.44	62	2.09	53
GC-FSLF90-1010A	54305-1010A	20306847	1/2	12.70	FSL-10	2.52	64	2.36	60
GC-FSLF90-1210A	54305-1210A	20307107	5/8	15.90	FSL-10	2.52	64	2.36	60
GC-FSLF90-1212A	54305-1212A	20306848	5/8	15.90	FSL-12	2.52	64	2.36	60

Ford Spring Lock

Male | GC Cool Clip™ Fittings

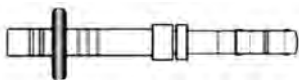

Descriptive #	Product #	SAP #	Hose Size ID		Thread Size	Cut-Off (R)	
			in.	mm		in.	mm
GC-FSLM-0606A	54330-0606A	20306849	5/16	7.90	FSL-06	2.72	69
GC-FSLM-0608A	54330-0608A	20307108	5/16	7.90	FSL-08	2.72	69
GC-FSLM-1010A	54330-1010A	20306851	1/2	12.70	FSL-10	2.99	76
GC-FSLM-1210A	54330-1210A	20306852	5/8	15.90	FSL-10	2.99	76
GC-FSLM-1212A	54330-1212A	20306853	5/8	15.90	FSL-12	3.11	79

For use with Galaxy® G4890 Hose

Ford Spring Lock

Male, 45° Elbow | GC Cool Clip™ Fittings

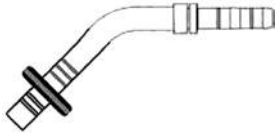

Descriptive #	Product #	SAP #	Hose Size ID		Thread Size	Drop (D)		Cut-Off (R)	
			in.	mm		in.	mm	in.	mm
GC-FSLM45-0606A	54333-0606A	20307109	5/16	7.90	FSL-06	1.30	33	1.85	47
GC-FSLM45-0608A	54333-0608A	20307110	5/16	7.90	FSL-08	1.30	33	1.85	47
GC-FSLM45-0808A	54333-0808A	20307111	13/32	10.30	FSL-08	1.26	32	1.30	33
GC-FSLM45-1010A	54333-1010A	20307112	1/2	12.70	FSL-10	1.42	36	1.61	41
GC-FSLM45-1210A	54333-1210A	20307113	5/8	15.90	FSL-10	1.42	36	1.61	41
GC-FSLM45-1212A	54333-1212A	20307114	5/8	15.90	FSL-12	1.42	36	1.61	41

Ford Spring Lock

Male, 90° Elbow | GC Cool Clip™ Fittings

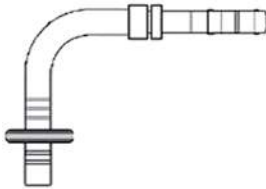

Descriptive #	Product #	SAP #	Hose Size ID		Thread Size	Drop (D)		Cut-Off (R)	
			in.	mm		in.	mm	in.	mm
GC-FSLM90-0606A	54335-0606A	20307115	5/16	7.90	FSL-06	2.13	54	1.97	50
GC-FSLM90-0608A	54335-0608A	20307116	5/16	7.90	FSL-08	2.13	54	1.97	50
GC-FSLM90-0808A	54335-0808A	20307117	13/32	10.30	FSL-08	2.44	62	2.09	53
GC-FSLM90-1010A	54335-1010A	20307118	1/2	12.70	FSL-10	2.52	64	2.36	60
GC-FSLM90-1210A	54335-1210A	20307119	5/8	15.90	FSL-10	2.52	64	2.36	60
GC-FSLM90-1212A	54335-1212A	20307120	5/8	15.90	FSL-12	2.52	64	2.36	60

Hose Mender

GC Cool Clip™ Fittings



Descriptive #	Product #	SAP #	Hose Size ID		Cut-Off (R)	
			in.	mm	in.	mm
GC-HM-0606	54350-0606	20306854	5/16	7.90	2.17	55
GC-HM-0608	54350-0608	20306855	5/16	7.90	2.17	55
GC-HM-0808	54350-0808	20306856	13/32	10.30	2.17	55
GC-HM-0810	54350-0810	20306857	13/32	10.30	2.17	55
GC-HM-1010	54350-1010	20306858	1/2	12.70	2.17	55
GC-HM-1210	54350-1210	20306859	5/8	15.90	2.17	55
GC-HM-1212	54350-1212	20306860	5/8	15.90	2.17	55

Hose Mender

90° Elbow | GC Cool Clip™ Fittings

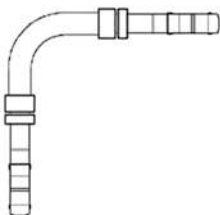

Descriptive #	Product #	SAP #	Hose Size ID		Drop (D)		Cut-Off (R)	
			in.	mm	in.	mm	in.	mm
GC-HM90-0606	54355-0606	20306861	5/16	7.90	0.94	24	0.94	24
GC-HM90-0808	54355-0808	20306862	13/32	10.30	1.14	29	1.14	29
GC-HM90-1010	54355-1010	20306863	1/2	12.70	1.34	34	1.34	34
GC-HM90-1212	54355-1212	20306864	5/8	15.90	1.54	39	1.54	39

For use with Galaxy® G4890 Hose

Hose Mender

180° Elbow | GC Cool Clip™ Fittings

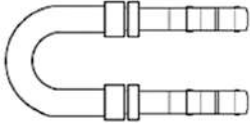

Descriptive #	Product #	SAP #	Hose Size ID		Drop (D)		Cut-Off (R)	
			in.	mm	in.	mm	in.	mm
GC-HM180-0606	54360-0606	20306865	5/16	7.90	1.97	50	2.48	63
GC-HM180-0808	54360-0808	20306866	13/32	10.30	2.36	60	2.48	63
GC-HM180-1010	54360-1010	20306867	1/2	12.70	2.76	70	2.83	72
GC-HM180-1212	54360-1212	20306868	5/8	15.90	3.15	80	3.50	89

Hose Mender

R12 Valve | GC Cool Clip™ Fittings

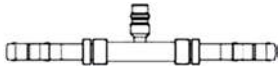

Drawing has R134a Valve
Fittings have R12 Valve

Descriptive #	Product #	SAP #	Hose Size ID		Cut-Off (R)		Valve (V)	
			in.	mm	in.	mm	in.	mm
GC-HM12V-0606	54365-0606	20306869	5/16	7.90	2.17	55	1/4	6.35
GC-HM12V-0808	54365-0808	20306870	13/32	10.30	2.17	55	1/4	6.35
GC-HM12V-1010	54365-1010	20306871	1/2	12.70	2.17	55	1/4	6.35
GC-HM12V-1212	54365-1212	20306872	5/8	15.90	2.17	55	1/4	6.35

Hose Mender

R134a Valve | GC Cool Clip™ Fittings

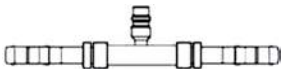

Descriptive #	Product #	SAP #	Hose Size ID		Cut-Off (R)		Valve (V)	
			in.	mm	in.	mm	in.	mm
GC-HM134V-0606	54370-0606	20306873	5/16	7.90	2.17	55	0.63	16
GC-HM134V-0808	54370-0808	20306874	13/32	10.30	2.17	55	0.63	16
GC-HM134V-1010	54370-1010	20306875	1/2	12.70	2.17	55	0.51	13
GC-HM134V-1212	54370-1212	20306876	5/8	15.90	2.17	55	0.51	13

Hose Mender

with Sight Glass | GC Cool Clip™ Fittings

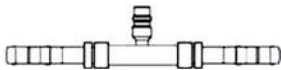

Fitting has sight glass in place of
R134a Valve

Descriptive #	Product #	SAP #	Hose Size ID		Cut-Off (R)	
			in.	mm	in.	mm
GC-HMSG-0606	54375-0606	20307121	5/16	7.90	2.48	63

For use with Galaxy® G4890 Hose

Hose Mender

Tee | GC Cool Clip™ Fittings

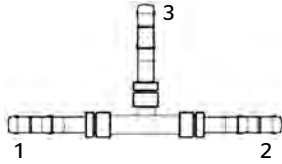

Descriptive #	Product #	SAP #	Hose Size ID (1 & 2)		Hose Size ID (3)		Drop (D)		Cut-Off (R)	
			in.	mm	in.	mm	in.	mm	in.	mm
GC-HMT-0606	54380-0606	20306877	5/16	7.90	5/16	7.90	1.22	31	2.44	62
GC-HMT-0808	54380-0808	20306878	13/32	10.30	13/32	10.30	1.30	33	2.60	66
GC-HMT-1010	54380-1010	20306879	1/2	12.70	1/2	12.70	1.73	44	2.72	69
GC-HMT-1210	54380-1210	20307122	5/8	15.90	1/2	12.70	1.73	44	2.72	69
GC-HMT-1212	54380-1212	20306880	5/8	15.90	5/8	15.90	1.73	44	2.95	75

O-Ring Face Seal

Female, Swivel | GC Cool Clip™ Fittings

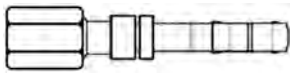

Descriptive #	Product #	SAP #	Hose Size ID		Thread Size	Cut-Off (R)	
			in.	mm		in.	mm
GC-OFFX-0606	54430-0606	20307123	5/16	7.90	11/16-16	1.77	45
GC-OFFX-0808	54430-0808	20307124	13/32	10.30	13/16-16	1.97	50
GC-OFFX-1010	54430-1010	20307125	1/2	12.70	1-14	2.48	63
GC-OFFX-1212	54430-1212	20307126	5/8	15.90	1 3/16-12	2.72	69

O-Ring Face Seal

Female, Swivel, 90° Elbow | GC Cool Clip™ Fittings

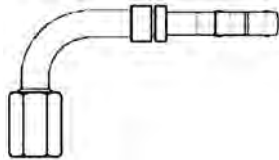

Descriptive #	Product #	SAP #	Hose Size ID		Thread Size	Drop (D)		Cut-Off (R)	
			in.	mm		in.	mm	in.	mm
GC-OFFX90-0606	54435-0606	20306881	5/16	7.90	11/16-16	1.14	29	0.94	24
GC-OFFX90-0808	54435-0808	20306882	13/32	10.30	13/16-16	1.34	34	1.14	29
GC-OFFX90-1010	54435-1010	20307127	1/2	12.70	1-14	1.57	40	1.34	34
GC-OFFX90-1212	54435-1212	20307128	5/8	15.90	1 3/16-12	1.81	46	1.54	39

O-Ring Insert

Male | GC Cool Clip™ Fittings

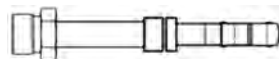

Descriptive #	Product #	SAP #	Hose Size ID		Thread Size	Cut-Off (R)	
			in.	mm		in.	mm
GC-OIM-0606	54500-0606	20306887	5/16	7.90	5/8-18	2.80	71
GC-OIM-0808	54500-0808	20306888	13/32	10.30	3/4-16	2.91	74
GC-OIM-1010	54500-1010	20306889	1/2	12.70	7/8-14	2.13	54
GC-OIM-1210	54500-1210	20306890	5/8	15.90	7/8-14	2.13	54
GC-OIM-1212	54500-1212	20306891	5/8	15.90	1 1/16-14	3.31	84

For use with Galaxy® G4890 Hose

O-Ring Insert

Male, 45° Elbow | GC Cool Clip™ Fittings

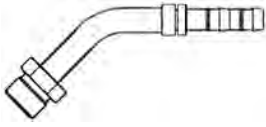

Descriptive #	Product #	SAP #	Hose Size ID		Thread Size	Drop (D)		Cut-Off (R)	
			in.	mm		in.	mm	in.	mm
GC-OIM45-0606	54503-0606	20307130	5/16	7.90	5/8-18	0.75	19	1.18	30
GC-OIM45-0808	54503-0808	20307131	13/32	10.30	3/4-16	0.94	24	1.30	33
GC-OIM45-1010	54503-1010	20307132	1/2	12.70	7/8-14	1.26	32	1.61	41
GC-OIM45-1212	54503-1212	20307133	5/8	15.90	1 1/16-14	1.38	35	1.77	45

O-Ring Insert

Male, 90° Elbow | GC Cool Clip™ Fittings

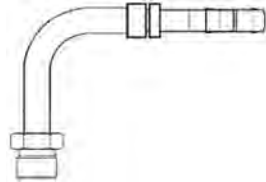

Descriptive #	Product #	SAP #	Hose Size ID		Thread Size	Drop (D)		Cut-Off (R)	
			in.	mm		in.	mm	in.	mm
GC-OIM90-0606	54505-0606	20306892	5/16	7.90	5/8-18	1.38	35	2.13	54
GC-OIM90-0808	54505-0808	20306893	13/32	10.30	3/4-16	1.73	44	1.61	41
GC-OIM90-1010	54505-1010	20306894	1/2	12.70	7/8-14	2.17	55	2.32	59
GC-OIM90-1210	54505-1210	20307134	5/8	15.90	7/8-14	2.17	55	2.32	59
GC-OIM90-1212	54505-1212	20307135	5/8	15.90	1 1/16-14	2.76	70	2.32	59

O-Ring Insert

Male, Bulkhead | GC Cool Clip™ Fittings

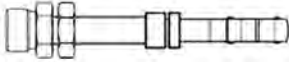

Descriptive #	Product #	SAP #	Hose Size ID		Thread Size	Cut-Off (R)	
			in.	mm		in.	mm
GC-OIMB-0606	54515-0606	20307136	5/16	7.90	5/8-18	3.15	80
GC-OIMB-0808	54515-0808	20307137	13/32	10.30	3/4-16	3.15	80
GC-OIMB-1010	54515-1010	20307138	1/2	12.70	7/8-14	3.15	80

O-Ring Insert

Male, Bulkhead, 90° Elbow | GC Cool Clip™ Fittings

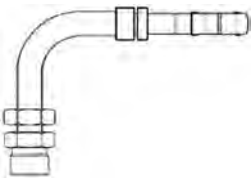

Descriptive #	Product #	SAP #	Hose Size ID		Thread Size	Drop (D)		Cut-Off (R)	
			in.	mm		in.	mm	in.	mm
GC-OIMB90-0606	54520-0606	20307139	5/16	7.90	5/8-18	2.13	54	1.97	50
GC-OIMB90-0808	54520-0808	20307140	13/32	10.30	3/4-16	2.44	62	2.09	53
GC-OIMB90-1010	54520-1010	20307141	5/8	15.90	7/8-14	2.52	64	2.36	60

For use with Galaxy® G4890 Hose

O-Ring Insert

R134a Valve | GC Cool Clip™ Fittings

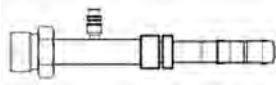

Descriptive #	Product #	SAP #	Hose Size ID		Thread Size	Cut-Off (R)		Valve (V)	
			in.	mm		in.	mm	in.	mm
GC-OIM134V-0606	54530-0606	20307142	5/16	7.90	5/8-18	2.80	71	0.63	16
GC-OIM134V-0808	54530-0808	20307143	13/32	10.30	3/4-16	2.91	74	0.63	16
GC-OIM134V-1010	54530-1010	20307144	1/2	12.70	7/8-14	2.13	54	0.51	13
GC-OIM134V-1212	54530-1212	20307145	5/8	15.90	1 1/16-14	3.31	84	0.51	13

O-Ring Insert

R134a Valve, 90° Elbow | GC Cool Clip™ Fittings

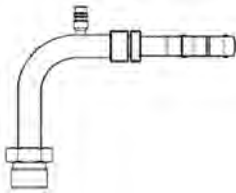

Descriptive #	Product #	SAP #	Hose Size ID		Thread Size	Drop (D)		Cut-Off (R0)		Valve (V)
			in.	mm		in.	mm	in.	mm	
GC-OIM134V90-0606	54535-0606	20307146	5/16	7.90	5/8-18	1.38	35	2.13	54	0.63 16
GC-OIM134V90-0808	54535-0808	20307147	13/32	10.30	3/4-16	1.73	44	1.61	41	0.63 16
GC-OIM134V90-1010	54535-1010	20307148	1/2	12.70	7/8-14	2.17	55	2.32	59	0.51 13

O-Ring Tube

Female, Swivel | GC Cool Clip™ Fittings

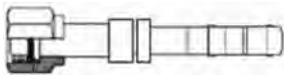

Descriptive #	Product #	SAP #	Hose Size ID		Thread Size	Cut-Off (R)	
			in.	mm		in.	mm
GC-OTF-0605	54600-0605	20307149	5/16	7.90	9/16-18	1.42	36
GC-OTF-0606	54600-0606	20306895	5/16	7.90	5/8-18	1.42	36
GC-OTF-0608	54600-0608	20306896	5/16	7.90	3/4-16	1.57	40
GC-OTF-0806	54600-0806	20307150	13/32	10.30	5/8-18	1.57	40
GC-OTF-0808	54600-0808	20306897	13/32	10.30	3/4-16	1.57	40
GC-OTF-1008	54600-1008	20307151	1/2	12.70	3/4-16	1.57	40
GC-OTF-1010	54600-1010	20306898	1/2	12.70	7/8-14	1.97	50
GC-OTF-1012	54600-1012	20307152	1/2	12.70	1 1/16-14	2.09	53
GC-OTF-1210	54600-1210	20306899	5/8	15.90	7/8-14	1.97	50
GC-OTF-1212	54600-1212	20306900	5/8	15.90	1 1/16-14	2.09	53

O-Ring Tube

Female, Swivel, 45° Elbow | GC Cool Clip™ Fittings



Descriptive #	Product #	SAP #	Hose Size ID		Thread Size	Drop (D)		Cut-Off (R)	
			in.	mm		in.	mm	in.	mm
GC-OTF45-0606	54603-0606	20306901	5/16	7.90	5/8-18	0.55	14	1.02	26
GC-OTF45-0806	54603-0806	20307153	13/32	10.30	5/8-18	0.55	14	1.02	26
GC-OTF45-0808	54603-0808	20306902	13/32	10.30	3/4-16	0.59	15	2.13	54
GC-OTF45-1008	54603-1008	20307154	1/2	12.70	3/4-16	0.59	15	2.13	54
GC-OTF45-1010	54603-1010	20306903	1/2	12.70	7/8-14	0.67	17	2.13	54
GC-OTF45-1210	54603-1210	20306904	5/8	15.90	7/8-14	0.67	17	2.13	54
GC-OTF45-1212	54603-1212	20306905	5/8	15.90	1 1/16-14	1.18	30	2.13	54

For use with Galaxy® G4890 Hose

O-Ring Tube

Female, Swivel, 90° Elbow | GC Cool Clip™ Fittings

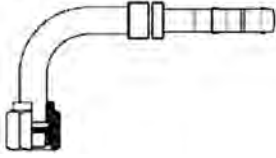

Descriptive #	Product #	SAP #	Hose Size ID		Thread Size	Drop (D)		Cut-Off (R)	
			in.	mm		in.	mm	in.	mm
GC-OTF90-0605	54605-0605	20307155	5/16	7.90	9/16-18	1.26	32	1.46	37
GC-OTF90-0606	54605-0606	20306906	5/16	7.90	5/8-18	1.26	32	1.46	37
GC-OTF90-0608	54605-0608	20306907	5/16	7.90	3/4-16	1.42	36	1.77	45
GC-OTF90-0806	54605-0806	20307156	13/32	10.30	5/8-18	1.65	42	2.17	55
GC-OTF90-0808	54605-0808	20306908	13/32	10.30	3/4-16	1.42	36	1.77	45
GC-OTF90-1008	54605-1008	20307157	1/2	12.70	3/4-16	1.42	36	1.77	45
GC-OTF90-1010	54605-1010	20306909	1/2	12.70	7/8-14	1.65	42	2.17	55
GC-OTF90-1012	54605-1012	20307158	1/2	12.70	1 1/16-14	1.77	45	2.40	61
GC-OTF90-1210	54605-1210	20306910	5/8	15.90	7/8-14	1.65	42	2.17	55
GC-OTF90-1212	54605-1212	20306911	5/8	15.90	1 1/16-14	1.77	45	2.40	61

O-Ring Tube

Female, Swivel, 90° Block Elbow | GC Cool Clip™ Fittings

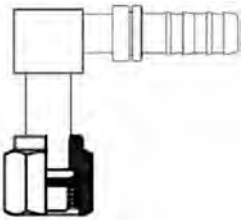

Descriptive #	Product #	SAP #	Hose Size ID		Thread Size	Drop (D)		Cut-Off (R)	
			in.	mm		in.	mm	in.	mm
GC-OTF90B-0808	54610-0808	20306912	13/32	10.30	3/4-16	0.91	23	2.32	59
GC-OTF90B-1010	54610-1010	20306913	1/2	12.70	7/8-14	0.94	24	2.32	59
GC-OTF90B-1210	54610-1210	20306914	5/8	15.90	7/8-14	0.94	24	2.32	59

O-Ring Tube

Female, Swivel, 180° Elbow | GC Cool Clip™ Fittings

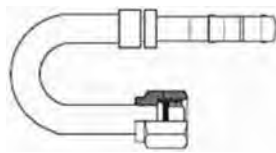

Descriptive #	Product #	SAP #	Hose Size ID		Thread Size	Drop (D)		Cut-Off (R)	
			in.	mm		in.	mm	in.	mm
GC-OTF180-0606	54615-0606	20307159	5/16	7.90	5/8-18	1.97	50	2.48	63
GC-OTF180-0808	54615-0808	20307160	13/32	10.30	3/4-16	2.36	60	2.48	63
GC-OTF180-1212	54615-1212	20307161	5/8	15.90	1 1/16-14	3.15	80	3.50	89

O-Ring Tube

Female, Swivel, R12 Valve | GC Cool Clip™ Fittings

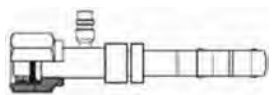

Drawing has R134a Valve
Fittings have R12 Valve

Descriptive #	Product #	SAP #	Hose Size ID		Thread Size	Cut-Off (R)		Valve (V)	
			in.	mm		in.	mm	in.	mm
GC-OTF12V-0606	54650-0606	20307162	5/16	7.90	5/8-18	1.42	36	1/4	6.35
GC-OTF12V-0808	54650-0808	20307163	13/32	10.30	3/4-16	1.57	40	1/4	6.35
GC-OTF12V-1010	54650-1010	20307164	1/2	12.70	7/8-14	1.97	50	1/4	6.35

For use with Galaxy® G4890 Hose

O-Ring Tube

Female, Swivel, R12 Valve, 90° Elbow | GC Cool Clip™ Fittings

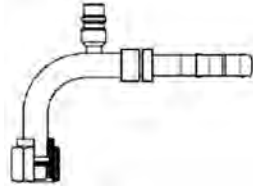

Drawing has R134a Valve
Fittings have R12 Valve

O-Ring Tube

Female, Swivel, R134a Valve | GC Cool Clip™ Fittings

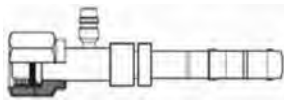

Descriptive #	Product #	SAP #	Hose Size ID		Thread Size	Cut-Off (R)		Valve (V)	
			in.	mm		in.	mm	in.	mm
GC-OTF134V-0606	54660-0606	20306919	5/16	7.90	5/8-18	1.42	36	0.63	16
GC-OTF134V-0808	54660-0808	20306920	13/32	10.30	3/4-16	1.57	40	0.63	16
GC-OTF134V-1010	54660-1010	20306921	1/2	12.70	7/8-14	1.97	50	0.51	13
GC-OTF134V-1210	54660-1210	20306922	5/8	15.90	7/8-14	1.97	50	0.51	13
GC-OTF134V-1212	54660-1212	20307165	5/8	15.90	1 1/16-14	2.09	53	0.51	13
GC-OTF134VHS-1010	54675-1010	20307172	1/2	12.70	7/8-14	1.97	50	0.63	16

O-Ring Tube

Female, Swivel, R134a Valve, 45° Elbow | GC Cool Clip™ Fittings

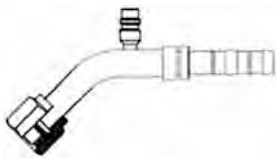

Descriptive #	Product #	SAP #	Hose Size ID		Thread Size	Drop (D)		Cut-Off (R0)		Valve (V)	
			in.	mm		in.	mm	in.	mm	in.	mm
GC-OTF134V45-0606	54663-0606	20307166	5/16	7.90	5/8-18	0.55	14	1.34	34	0.63	16
GC-OTF134V45-0808	54663-0808	20307167	13/32	10.30	3/4-16	0.59	15	1.38	35	0.63	16
GC-OTF134V45-1010	54663-1010	20307168	1/2	12.70	7/8-14	0.67	17	1.42	36	0.51	13
GC-OTF134V45-1210	54663-1210	20306923	5/8	15.90	7/8-14	0.67	17	1.42	36	0.51	13
GC-OTF134V45-1212	54663-1212	20307169	5/8	15.90	1 1/16-14	0.94	24	2.13	54	0.51	13

O-Ring Tube

Female, Swivel, R134a Valve, 90° Elbow | GC Cool Clip™ Fittings

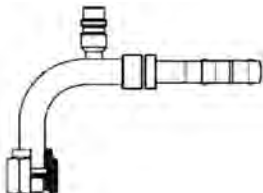

Descriptive #	Product #	SAP #	Hose Size ID		Thread Size	Drop (D)		Cut-Off (R0)		Valve (V)	
			in.	mm		in.	mm	in.	mm	in.	mm
GC-OTF134V90-0606	54665-0606	20306924	5/16	7.90	5/8-18	1.26	32	1.46	37	0.63	16
GC-OTF134V90-0806	54665-0806	20307170	13/32	10.30	5/8-18	1.26	32	1.46	37	0.63	16
GC-OTF134V90-0808	54665-0808	20306925	13/32	10.30	3/4-16	1.42	36	1.77	45	0.63	16
GC-OTF134V90-1010	54665-1010	20306926	1/2	12.70	7/8-14	1.65	42	2.17	55	0.51	13
GC-OTF134V90-1210	54665-1210	20306927	5/8	15.90	7/8-14	1.65	42	2.17	55	0.51	13
GC-OTF134V90-1212	54665-1212	20307171	5/8	15.90	1 1/16-14	1.77	45	2.40	61	0.51	13

For use with Galaxy® G4890 Hose

O-Ring Tube

Male, Swivel | GC Cool Clip™ Fittings

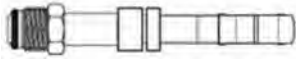

Descriptive #	Product #	SAP #	Hose Size ID		Thread Size	Cut-Off (R)	
			in.	mm		in.	mm
GC-OTM-0606	54700-0606	20306928	5/16	7.90	5/8-18	1.50	38
GC-OTM-0607	54700-0607	20306929	5/16	7.90	11/16-16	1.50	38
GC-OTM-0608	54700-0608	20306930	5/16	7.90	3/4-18	1.54	39
GC-OTM-0806	54700-0806	20307173	13/32	10.30	5/8-18	1.54	39
GC-OTM-0808	54700-0808	20306931	13/32	10.30	3/4-18	2.09	53
GC-OTM-1010	54700-1010	20306932	1/2	12.70	7/8-18	2.17	55
GC-OTM-1012	54700-1012	20306933	1/2	12.70	1 1/16-16	2.17	55
GC-OTM-1210	54700-1210	20306934	5/8	15.90	7/8-18	2.17	55
GC-OTM-1212	54700-1212	20306935	5/8	15.90	1 1/16-16	2.40	61

O-Ring Tube

Male, Swivel, 45° Elbow | GC Cool Clip™ Fittings

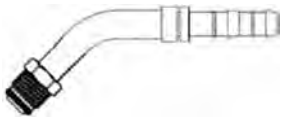

Descriptive #	Product #	SAP #	Hose Size ID		Thread Size	Drop (D)		Cut-Off (R)	
			in.	mm		in.	mm	in.	mm
GC-OTM45-0606	54703-0606	20306936	5/16	7.90	5/8-18	0.87	22	1.14	29
GC-OTM45-0608	54703-0608	20307174	5/16	7.90	3/4-18	0.87	22	1.14	29
GC-OTM45-0806	54703-0806	20307175	13/32	10.30	5/8-18	0.87	22	1.14	29
GC-OTM45-0808	54703-0808	20306937	13/32	10.30	3/4-18	0.98	25	1.42	36
GC-OTM45-1010	54703-1010	20306938	1/2	12.70	7/8-18	1.06	27	1.65	42
GC-OTM45-1210	54703-1210	20306939	5/8	15.90	7/8-18	1.18	30	1.81	46
GC-OTM45-1212	54703-1212	20306940	5/8	15.90	1 1/16-16	1.18	30	1.81	46

O-Ring Tube

Male, Swivel, 90° Elbow | GC Cool Clip™ Fittings

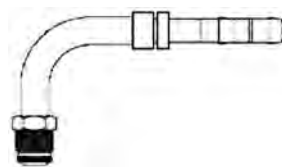

Descriptive #	Product #	SAP #	Hose Size ID		Thread Size	Drop (D)		Cut-Off (R)	
			in.	mm		in.	mm	in.	mm
GC-OTM90-0606	54705-0606	20306941	5/16	7.90	5/8-18	1.46	37	1.38	35
GC-OTM90-0608	54705-0608	20306942	5/16	7.90	3/4-18	1.46	37	1.38	35
GC-OTM90-0806	54705-0806	20306943	13/32	10.30	5/8-18	1.46	37	1.38	35
GC-OTM90-0808	54705-0808	20306944	13/32	10.30	3/4-18	1.77	45	1.69	43
GC-OTM90-1010	54705-1010	20306945	1/2	12.70	7/8-18	2.05	52	2.01	51
GC-OTM90-1012	54705-1012	20306946	1/2	12.70	1 1/16-16	2.05	52	2.01	51
GC-OTM90-1210	54705-1210	20306947	5/8	15.90	7/8-18	2.05	52	2.01	51
GC-OTM90-1212	54705-1212	20306948	5/8	15.90	1 1/16-16	2.36	60	2.24	57

For use with Galaxy® G4890 Hose

O-Ring Tube

Male, Swivel, Long Pilot | GC Cool Clip™ Fittings

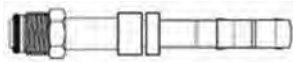

Descriptive #	Product #	SAP #	Hose Size ID		Thread Size	Cut-Off (R)	
			in.	mm		in.	mm
GC-OTMLP-0606	54720-0606	20307176	5/16	7.90	5/8-18	1.50	38
GC-OTMLP-0808	54720-0808	20307177	13/32	10.30	3/4-18	2.09	53
GC-OTMLP-1010	54720-1010	20307178	1/2	12.70	7/8-18	2.17	55
GC-OTMLP-1210	54720-1210	20307179	5/8	15.90	7/8-18	2.17	55

O-Ring Tube

Male, Swivel, R134a Valve | GC Cool Clip™ Fittings

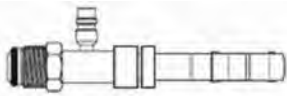

Descriptive #	Product #	SAP #	Hose Size ID		Thread Size	Cut-Off (R)		Valve (V)	
			in.	mm		in.	mm	in.	mm
GC-OTM134V-0606	54730-0606	20307180	5/16	7.90	5/8-18	1.42	36	0.63	16
GC-OTM134V-0808	54730-0808	20307181	13/32	10.30	3/4-18	1.57	40	0.63	16
GC-OTM134V-1010	54730-1010	20307182	1/2	12.70	7/8-18	1.97	50	0.51	13
GC-OTM134V-1210	54730-1210	20306949	5/8	15.90	7/8-18	2.09	53	0.51	13
GC-OTM134V-1212	54730-1212	20307183	5/8	15.90	1 1/16-16	2.09	53	0.51	13

O-Ring Tube

Male, Swivel, R134a Valve, 90° Elbow | GC Cool Clip™ Fittings

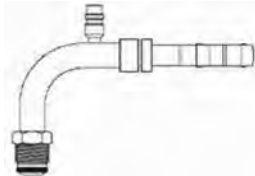

Descriptive #	Product #	SAP #	Hose Size ID		Thread Size	Drop (D)		Cut-Off (R)		Valve (V)	
			in.	mm		in.	mm	in.	mm	in.	mm
GC-OTM134V90-1010	54735-1010	20307184	1/2	12.70	7/8-18	2.05	52	2.01	51	0.51	13
GC-OTM134V90-1210	54735-1210	20306950	5/8	15.90	7/8-18	2.05	52	2.01	51	0.51	13

SAE 45° Flare

Female, Swivel | GC Cool Clip™ Fittings

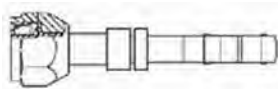

Descriptive #	Product #	SAP #	Hose Size ID		Thread Size	Cut-Off (R)	
			in.	mm		in.	mm
GC-SFFX-0606	54760-0606	20306951	5/16	7.90	5/8-18	1.73	44
GC-SFFX-0608	54760-0608	20306952	5/16	7.90	3/4-16	1.73	44
GC-SFFX-0806	54760-0806	20307185	13/32	10.30	5/8-18	2.13	54
GC-SFFX-0808	54760-0808	20306953	13/32	10.30	3/4-16	2.13	54
GC-SFFX-1008	54760-1008	20307186	1/2	12.70	3/4-16	2.13	54
GC-SFFX-1010	54760-1010	20306954	1/2	12.70	7/8-14	2.32	59
GC-SFFX-1210	54760-1210	20306955	5/8	15.90	7/8-14	2.32	59
GC-SFFX-1212	54760-1212	20306956	5/8	15.90	1 1/16-14	2.52	64

For use with Galaxy® G4890 Hose

SAE 45° Flare

Female, Swivel, 45° Elbow | GC Cool Clip™ Fittings



Descriptive #	Product #	SAP #	Hose Size ID		Thread Size	Drop (D)		Cut-Off (R)	
			in.	mm		in.	mm	in.	mm
GC-SFFX45-0606	54763-0606	20306957	5/16	7.90	5/8-18	0.79	20	2.52	64
GC-SFFX45-0608	54763-0608	20306958	5/16	7.90	3/4-16	0.79	20	2.52	64
GC-SFFX45-0806	54763-0806	20307187	13/32	10.30	5/8-18	0.79	20	2.52	64
GC-SFFX45-0808	54763-0808	20306959	13/32	10.30	3/4-16	0.79	20	2.72	69
GC-SFFX45-1008	54763-1008	20307188	1/2	12.70	3/4-16	0.79	20	2.72	69
GC-SFFX45-1010	54763-1010	20306960	1/2	12.70	7/8-14	0.87	22	2.72	69
GC-SFFX45-1210	54763-1210	20306961	5/8	15.90	7/8-14	0.87	22	2.72	69
GC-SFFX45-1212	54763-1212	20306962	5/8	15.90	1 1/16-14	0.87	22	2.72	69

SAE 45° Flare

Female, Swivel, 90° Elbow | GC Cool Clip™ Fittings

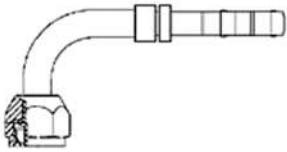

Descriptive #	Product #	SAP #	Hose Size ID		Thread Size	Drop (D)		Cut-Off (R)	
			in.	mm		in.	mm	in.	mm
GC-SFFX90-0606	54765-0606	20306963	5/16	7.90	5/8-18	1.18	30	1.73	44
GC-SFFX90-0608	54765-0608	20306964	5/16	7.90	3/4-16	1.18	30	1.73	44
GC-SFFX90-0806	54765-0806	20307189	13/32	10.30	5/8-18	1.18	30	1.73	44
GC-SFFX90-0808	54765-0808	20306965	13/32	10.30	3/4-16	1.77	45	1.73	44
GC-SFFX90-1008	54765-1008	20307190	1/2	12.70	3/4-16	1.77	45	1.73	44
GC-SFFX90-1010	54765-1010	20306966	1/2	12.70	7/8-14	1.77	45	2.13	54
GC-SFFX90-1210	54765-1210	20306967	5/8	15.90	7/8-14	1.77	45	2.13	54
GC-SFFX90-1212	54765-1212	20306968	5/8	15.90	1 1/16-14	1.77	45	2.13	54

SAE 45° Flare

Male | GC Cool Clip™ Fittings

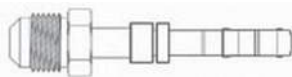

Descriptive #	Product #	SAP #	Hose Size ID		Thread Size	Cut-Off (R)	
			in.	mm		in.	mm
GC-SFM-0606A	54780-0606	20306969	5/16	7.90	5/8-18	1.73	44
GC-SFM-0808A	54780-0808	20306970	13/32	10.30	3/4-16	1.73	44
GC-SFM-1010A	54780-1010	20306971	1/2	12.70	7/8-14	1.85	47
GC-SFM-1212A	54780-1212	20306972	5/8	15.90	1 1/16-14	2.09	53

For use with Galaxy® G4890 Hose

SAE 45° Flare

Male, 45° Elbow | GC Cool Clip™ Fittings

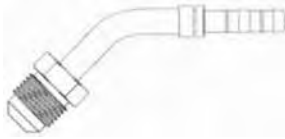

Descriptive #	Product #	SAP #	Hose Size ID		Thread Size	Drop (D)		Cut-Off (R)	
			in.	mm		in.	mm	in.	mm
GC-SFM45-0606A	54783-0606	20306973	5/16	7.90	5/8-18	0.75	19	1.73	44
GC-SFM45-0808A	54783-0808	20306974	13/32	10.30	3/4-16	0.94	24	1.73	44
GC-SFM45-1010A	54783-1010	20306975	1/2	12.70	7/8-14	1.26	32	2.13	54
GC-SFM45-1212A	54783-1212	20306976	5/8	15.90	1 1/16-14	1.38	35	2.13	54

SAE 45° Flare

Male, 90° Elbow | GC Cool Clip™ Fittings

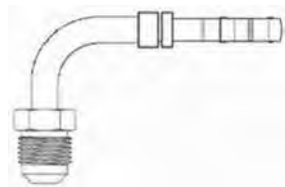

Descriptive #	Product #	SAP #	Hose Size ID		Thread Size	Drop (D)		Cut-Off (R)	
			in.	mm		in.	mm	in.	mm
GC-SFM90-0606A	54785-0606	20306977	5/16	7.90	5/8-18	1.18	30	1.73	44
GC-SFM90-0808A	54785-0808	20306978	13/32	10.30	3/4-16	1.77	45	1.73	44
GC-SFM90-1010A	54785-1010	20306979	1/2	12.70	7/8-14	1.77	45	2.13	54
GC-SFM90-1212A	54785-1212	20306980	5/8	15.90	1 1/16-14	1.77	45	2.13	54

O-Ring Tube Compressor Female to O-Ring Insert

Male, 90° Elbow, with R134a Valve | A/C Adapters

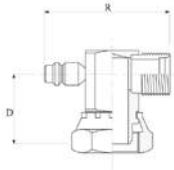

Descriptive #	Product #	SAP #	Thread Size OTCF	Thread Size OIM
AC-OTCF10-OIM08-90-134V	50900-1008	20307079	1-14	3/4-16
AC-OTCF10-OIM10-90-134V	50900-1010	20307080	1-14	7/8-14

O-Ring Tube Female to O-Ring Insert

Male, with R12 Valve | A/C Adapters

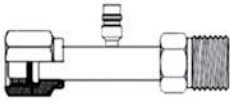

Drawing has R134a Valve
Fittings have R12 Valve

Descriptive #	Product #	SAP #	Thread Size OTCF	Thread Size OIM
AC-OTF06-OIM06-12V	50910-0606	20307081	5/8-18	5/8-18
AC-OTF08-OIM08-12V	50910-0808	20307082	3/4-16	3/4-16
AC-OTF10-OIM10-12V	50910-1010	20307083	7/8-14	7/8-14
AC-OTF12-OIM12-12V	50910-1212	20307084	1 1/16-14	1 1/16-14

O-Ring Tube Female to O-Ring Insert

Male, 90° Elbow, with R12 Valve | A/C Adapters

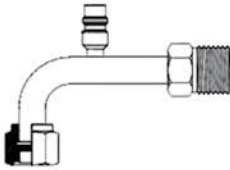

Drawing has R134a Valve
Fittings have R12 Valve

Descriptive #	Product #	SAP #	Thread Size OTCF	Thread Size OIM
AC-OTF06-OIM06-90-12V	50915-0606	20307085	5/8-18	5/8-18
AC-OTF08-OIM08-90-12V	50915-0808	20307086	3/4-16	3/4-16
AC-OTF10-OIM10-90-12V	50915-1010	20307087	7/8-14	7/8-14
AC-OTF12-OIM12-90-12V	50915-1212	20307088	1 1/16-14	1 1/16-14

O-Ring Tube Female to O-Ring Insert

Male, with R134a Valve | A/C Adapters

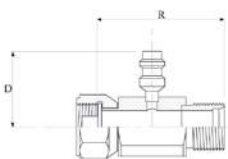

Descriptive #	Product #	SAP #	Thread Size OTCF	Thread Size OIM
AC-OTF06-OIM06-134V	50920-0606	20306798	5/8-18	5/8-18
AC-OTF08-OIM08-134V	50920-0808	20306799	3/4-16	3/4-16
AC-OTF10-OIM10-134V	50920-1010	20306800	7/8-14	7/8-14
AC-OTF12-OIM12-134V	50920-1212	20306801	1 1/16-14	1 1/16-14

O-Ring Tube Female to O-Ring Insert

Male, 90° Elbow, with R134a Valve | A/C Adapters

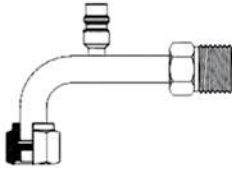

Descriptive #	Product #	SAP #	Thread Size OTF	Thread Size OIM
AC-OTF06-OIM06-90-134V	50925-0606	20306802	5/8-18	5/8-18
AC-OTF08-OIM08-90-134V	50925-0808	20306803	3/4-16	3/4-16
AC-OTF10-OIM10-90-134V	50925-1010	20306804	7/8-14	7/8-14
AC-OTF12-OIM12-90-134V	50925-1212	20306805	1 1/16-14	1 1/16-14

Flareless Tube Nuts

A/C Fitting Accessories

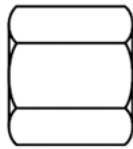

Descriptive #	Product #	SAP #	Thread Size	Tube OD (in.)
AC-FTN-0006	50250-0006	20306632	5/8-18	3/8
AC-FTN-0008	50250-0008	20306633	3/4-16	1/2
AC-FTN-0010	50250-0010	20306634	7/8-14	5/8
AC-FTN-0012	50250-0012	20306635	1 1/16-14	3/4

Flareless Tube Sleeves

A/C Fitting Accessories



Descriptive #	Product #	SAP #	Tube OD (in.)
AC-FTS-0006	50255-0006	20306636	3/8
AC-FTS-0008	50255-0008	20306637	1/2
AC-FTS-0010	50255-0010	20306638	5/8
AC-FTS-0012	50255-0012	20306639	3/4

Flareless Tube Sleeves Metric

A/C Fitting Accessories



Descriptive #	Product #	SAP #	Tube OD (in.)
AC-FTSM-0008	50260-0008	20306640	8.0
AC-FTSM-0012	50260-0012	20306641	12.0
AC-FTSM-0015	50260-0015	20306642	14.5

Inline Orifice Tubes

A/C Fitting Accessories

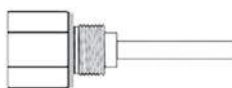

Descriptive #	Product #	SAP #	Orifice Tube OD		Orifice Tube Length		Description
			in.	mm	in.	mm	
AC-ILOTORA-0057	50401-0057	20306995	.057	1.4	3.50	88.9	Inline Orifice Tube, Ford, Orange
AC-ILOTRED-0062	50401-0062	20306996	.062	1.6	3.50	88.9	Inline Orifice Tube, Ford, Red
AC-ILOTBLU-0072	50401-0072	20306997	.072	1.8	3.50	88.9	Inline Orifice Tube, Ford, Blue
AC-ILOTBLK-0072	50402-0072	20306998	.072	1.8	3.50	88.9	Inline Orifice Tube, GM, Black
AC-ILOTWHI-0072	50403-0072	20306999	.072	1.8	3.50	88.9	Inline Orifice Tube, GM, White

O-Ring, for Ford Spring Lock

A/C Fitting Accessories

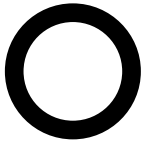

Descriptive #	Product #	SAP #	O-Ring ID	
			in.	mm
GC-OFSL-0006	54450-0006	20306556	3/8	9.5
GC-OFSL-0008	54450-0008	20306557	1/2	12.7
GC-OFSL-0010	54450-0010	20306558	5/8	15.9
GC-OFSL-0012	54450-0012	20306559	3/4	19.1

O-Ring, for Switch

A/C Fitting Accessories

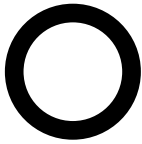

Descriptive #	Product #	SAP #	O-Ring ID	
			in.	mm
GC-OSWCH-0006	54455-0006	20307200	3/8	9.5

O-Ring, for Tube Fittings

A/C Fitting Accessories

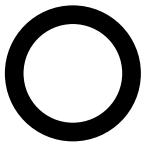

Descriptive #	Product #	SAP #	O-Ring ID		O-Ring Thickness	
			in.	mm	in.	mm
AC-OTUBE-0006	50460-0006	20306552	.30	7.6	0.07	1.8
AC-OTUBE-0008	50460-0008	20306553	.43	10.9	0.07	1.8
AC-OTUBE-0010	50460-0010	20306554	.55	14.0	0.07	1.8
AC-OTUBE-0012	50460-0012	20306555	.68	17.3	0.07	1.8

Sealing Washers

A/C Fitting Accessories

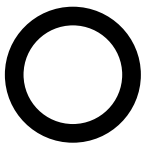

Descriptive #	Product #	SAP #	ID (in.)	Product Description
AC-SWA-0012	50800-0012	20306787	3/4	Sealing Washer, Accumulator
AC-SWCN-0010	50803-0010	20306788	5/8	Sealing Washer, Compressor, Narrow
AC-SWCN-0012	50803-0012	20306789	3/4	Sealing Washer, Compressor, Narrow
AC-SWCW-0010	50805-0010	20306790	5/8	Sealing Washer, Compressor, Wide

Valve Adapters

A/C Fitting Accessories



Descriptive #	Product #	SAP #	R12 Thread Size	R134a (mm)	Product Description
AC-VA12V3/16-134V16	50820-0001	20306791	3/8-24	16	Converts R12 to R134a valve
AC-VA12V1/4-134V13	50820-0002	20306792	7/16-20	13	Converts R12 to R134a valve
AC-VA12V1/4-134V16	50820-0003	20306793	7/16-20	16	Converts R12 to R134a valve

Valve Caps

A/C Fitting Accessories



Descriptive #	Product #	SAP #	Valve Style	Valve Style
AC-VC12V-0001	50830-0001	20306794	R12	1/4"
AC-VC134VHS-0002	50830-0002	20306795	R134a H.S.	16mm
AC-VC134VLS-0003	50830-0003	20306796	R134a L.S.	13mm

Valve Core

A/C Fitting Accessories



Descriptive #	Product #	SAP #	Thread Size
AC-VCORE-0001	50835-0001	20306797	.210x36

Metal Clip

A/C Fitting Accessories



Descriptive #	Product #	SAP #	Hose ID	
			in.	mm
GC-CLIP-0006	54850-0006	20306981	5/16	7.9
GC-CLIP-0008	54850-0008	20306982	13/32	10.3
GC-CLIP-0010	54850-0010	20306983	1/2	12.7
GC-CLIP-0012	54850-0012	20306984	5/8	15.9

Plastic Clip Holder

A/C Fitting Accessories



Descriptive #	Product #	SAP #	Hose ID	
			in.	mm
GC-CLIPHLDR-0006	54855-0006	20306985	5/16	7.9
GC-CLIPHLDR-0008	54855-0008	20306986	13/32	10.3
GC-CLIPHLDR-0010	54855-0010	20306987	1/2	12.7
GC-CLIPHLDR-0012	54855-0012	20306988	5/8	15.9

Clip Pliers

A/C Fitting Accessories



Descriptive #	Product #	SAP #	Product Description
GC-PLIERS-0001	54860-0001	20306989	Clip Pliers for assembly of Cool Clip Fittings

Hose Cutting Tool & Replacement Blades

A/C Fitting Accessories



Descriptive #	Product #	SAP #	Product Description
65090 HCT	65090	20038629	Hose Cutting Tool for G4890 Hose
65091 HCTRB	65091	20052606	Hose Cutting Tool Replacement Blades - 2/Pkg

Uni-Crimp™ and Dual-Grip™ Fitting Ferrules

This section lists dimensions and attributes for 11 Uni-Crimp™ and 2 Dual-Grip™ style ferrules.

The Uni-Crimp™ style ferrules can be non-skive or external skive, depending on the hose family.

Uni-Crimp™ ferrules are to be used only with Uni-Crimp™ style stems.

The Dual-Grip™ style ferrules are external and internal skive and are to be used only with Dual-Grip™ style stems.

Uni-Crimp™ UCF1 Ferrule

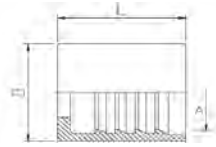

Descriptive/ Product #	SAP #	Hose Size ID		Ferrule Inside Diameter (A)		Ferrule Outside Diameter (B)		Ferrule Length (L)	
		in.	mm	in.	mm	in.	mm	in.	mm
UCF1-03	20242266	3/16	4.8	0.45	11.4	0.67	17.0	1.06	27.0

Uni-Crimp™ UCF2 Ferrule

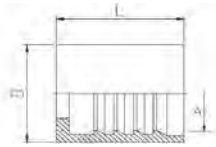

Descriptive/ Product #	SAP #	Hose Size ID		Ferrule Inside Diameter (A)		Ferrule Outside Diameter (B)		Ferrule Length (L)	
		in.	mm	in.	mm	in.	mm	in.	mm
UCF2-03	20242268	3/16	4.8	0.49	12.5	0.75	19.0	0.94	23.8
UCF2-04	20242276	1/4	6.4	0.55	14.0	0.83	21.0	1.04	26.3
UCF2-05	20242272	5/16	7.9	0.62	15.7	0.87	22.0	1.04	26.5
UCF2-06	20242273	3/8	9.5	0.71	18.1	0.98	25.0	1.12	28.5
UCF2-08	20242270	1/2	12.7	0.84	21.4	1.14	29.0	1.37	34.7
UCF2-10	20242275	5/8	15.9	0.98	25.0	1.26	32.0	1.48	37.5
UCF2-12	20242264	3/4	19.0	1.13	28.8	1.42	36.0	1.63	41.5
UCF2-16	20242267	1	25.4	1.44	36.5	1.77	45.0	1.88	47.7
UCF2-32	20309909	2	50.8	2.64	67.1	3.23	82.0	2.96	75.1

Uni-Crimp™ UCF3 Ferrule

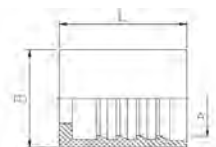

Descriptive/ Product #	SAP #	Hose Size ID		Ferrule Inside Diameter (A)		Ferrule Outside Diameter (B)		Ferrule Length (L)	
		in.	mm	in.	mm	in.	mm	in.	mm
UCF3-04	20241234	1/4	6.4	0.63	16.0	0.87	22.0	1.04	26.3
UCF3-06	20241235	3/8	9.5	0.72	18.4	0.98	25.0	1.12	28.5

Uni-Crimp™ UCF4 Ferrule

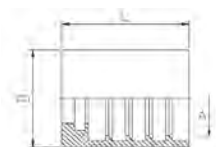

Descriptive/ Product #	SAP #	Hose Size ID		Ferrule Inside Diameter (A)		Ferrule Outside Diameter (B)		Ferrule Length (L)	
		in.	mm	in.	mm	in.	mm	in.	mm
UCF4-20	20241233	1/4	31.8	1.76	44.8	2.17	55.0	1.57	40.0

Uni-Crimp™ UCF5 Ferrule

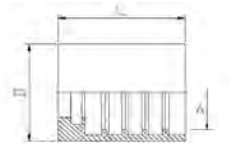

Descriptive/ Product #	SAP #	Hose Size ID		Ferrule Inside Diameter (A)		Ferrule Outside Diameter (B)		Ferrule Length (L)	
		in.	mm	in.	mm	in.	mm	in.	mm
UCF5-04	20242283	1/4	6.4	0.49	12.5	0.75	19.0	1.04	26.3
UCF5-06	20242284	3/8	9.5	0.64	16.3	0.87	22.0	1.07	27.2
UCF5-08	20242281	1/2	12.7	0.78	19.8	0.98	25.0	1.29	32.8
UCF5-10	20304628	5/8	15.9	1.03	26.1	1.34	34.0	1.40	35.6
UCF5-12	20304629	3/4	19.0	1.19	30.2	1.50	38.0	1.52	38.6
UCF5-32	20350849	2	50.8	2.78	70.5	3.23	82.0	2.87	73.0

Uni-Crimp™ UCF6 Ferrule

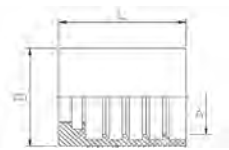

Descriptive/ Product #	SAP #	Hose Size ID		Ferrule Inside Diameter (A)		Ferrule Outside Diameter (B)		Ferrule Length (L)	
		in.	mm	in.	mm	in.	mm	in.	mm
UCF6-03	20288135	3/16	4.8	0.56	14.2	0.79	20.0	0.96	24.3
UCF6-04	20242277	1/4	6.4	0.64	16.2	0.87	22.0	1.04	26.3
UCF6-05	20241236	5/16	7.9	0.71	18.0	0.98	25.0	1.04	26.3
UCF6-06	20242282	3/8	9.5	0.82	20.9	0.98	25.0	1.07	27.2
UCF6-08	20242269	1/2	12.7	0.96	24.4	1.14	29.0	1.29	32.8
UCF6-10	20283401	5/8	15.9	1.09	27.7	1.34	34.0	1.40	35.6
UCF6-12	20242279	3/4	19.0	1.25	31.8	1.50	38.0	1.52	38.6
UCF6-16	20242280	1	25.4	1.65	42.0	1.97	50.0	1.78	45.3
UCF6-20	20242278	1¼	31.8	1.81	46.0	2.01	51.0	1.93	49.0
UCF6-24	20242274	1½	38.1	2.14	54.3	2.37	60.3	2.20	56.0
UCF6-32	20242271	2	50.8	2.72	69.1	3.00	76.1	2.72	69.0
UCF6-40	20242263	2½	63.5	3.19	81.0	3.50	88.9	3.35	85.0

Uni-Crimp™ UCF7 Ferrule

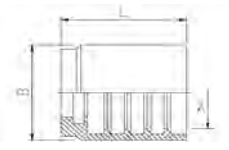

Descriptive/ Product #	SAP #	Hose Size ID		Ferrule Inside Diameter (A)		Ferrule Outside Diameter (B)		Ferrule Length (L)	
		in.	mm	in.	mm	in.	mm	in.	mm
UCF7-08	20263935	1/2	12.7	0.96	24.5	1.34	34.0	1.33	33.9
UCF7-16	20241237	1	25.4	1.54	39.0	1.97	50.0	1.87	47.4
UCF7-20	20318245	1¼	31.8	1.87	47.6	2.28	58.0	2.15	54.6

Uni-Crimp™ UCF8 Ferrule

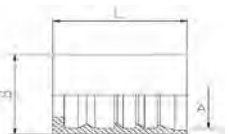

Descriptive/ Product #	SAP #	Hose Size ID		Ferrule Inside Diameter (A)		Ferrule Outside Diameter (B)		Ferrule Length (L)	
		in.	mm	in.	mm	in.	mm	in.	mm
UCF8-32	20289652	2	50.8	2.41	61.3	2.80	71.0	2.50	63.5

Uni-Crimp™ UCF9 Ferrule

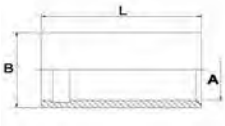

Descriptive/ Product #	SAP #	Hose Size ID		Ferrule Inside Diameter (A)		Ferrule Outside Diameter (B)		Ferrule Length (L)	
		in.	mm	in.	mm	in.	mm	in.	mm
UCF9-03	20318605	3/16	4.8	0.40	10.1	0.56	14.1	0.98	24.9
UCF9-04	20303300	1/4	6.4	0.43	11.0	0.59	15.0	1.14	29.0
UCF9-04S	20540398	1/4	6.4	0.43	11.0	0.59	15.0	1.14	29.0
UCF9-05	20303301	5/16	7.9	0.51	13.0	0.67	17.0	0.79	20.0
UCF9-05S	20540399	5/16	7.9	0.51	13.0	0.67	17.0	0.79	20.0
UCF9-06	20303302	3/8	9.5	0.67	17.0	0.87	22.0	1.22	31.0
UCF9-06S	20540680	3/8	9.5	0.67	17.0	0.87	22.0	1.22	31.0
UCF9-08	20303303	1/2	12.7	0.79	20.0	0.98	25.0	1.34	34.0
UCF9-08S	20540681	1/2	12.7	0.79	20.0	0.98	25.0	1.34	34.0
UCF9-10	20303304	5/8	15.9	0.98	25.0	1.18	30.0	1.42	36.0
UCF9-12	20303305	3/4	19.0	1.17	29.8	1.38	35.0	1.57	40.0
UCF9-12S	20540683	3/4	19.0	1.17	29.8	1.38	35.0	1.57	40.0
UCF9-16	20303306	1	25.4	1.45	36.8	1.65	42.0	1.81	46.0

Uni-Crimp™ UCF10 Ferrule

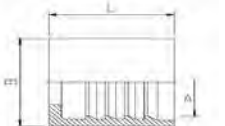

Descriptive/ Product #	SAP #	Hose Size ID		Ferrule Inside Diameter (A)		Ferrule Outside Diameter (B)		Ferrule Length (L)	
		in.	mm	in.	mm	in.	mm	in.	mm
UCF10-06	20479333	3/8	9.5	0.65	16.6	0.91	23.0	1.07	27.2
UCF10-08	20357071	1/2	12.7	0.81	20.7	1.06	27.0	1.29	32.8

Uni-Crimp™ UCF11 Ferrule

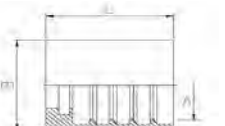

Descriptive/ Product #	SAP #	Hose Size ID		Ferrule Inside Diameter (A)		Ferrule Outside Diameter (B)		Ferrule Length (L)	
		in.	mm	in.	mm	in.	mm	in.	mm
UCF11-04	20369170	1/4	6.4	0.61	15.4	0.87	22.0	1.04	26.3

Dual-Grip™ DGF1 Ferrule

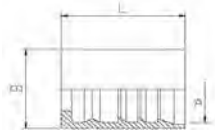

Descriptive / Product #	SAP #	Hose Size ID		Ferrule Inside Diameter (A)		Ferrule Outside Diameter (B)		Ferrule Length (L)	
		in.	mm	in.	mm	in.	mm	in.	mm
DGF1-12	20242262	3/4	19.0	1.18	30.0	1.46	37.0	2.36	60.0
DGF1-16	20242265	1	25.4	1.47	37.3	1.81	46.0	2.93	74.5
DGF1-20	20241238	1¼	31.8	1.74	44.2	2.17	55.0	3.46	88.0
DGF1-24	20254315	1½	38.1	2.02	51.3	2.44	62.0	3.70	94.0
DGF1-32	20254316	2	50.8	2.60	66.0	3.07	78.0	3.90	99.0

Dual-Grip™ DGF2 Ferrule

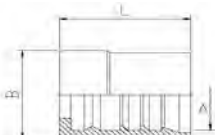

Descriptive / Product #	SAP #	Hose Size ID		Ferrule Inside Diameter (A)		Ferrule Outside Diameter (B)		Ferrule Length (L)	
		in.	mm	in.	mm	in.	mm	in.	mm
DGF2-20	20242260	1¼	31.8	1.95	49.5	2.43	61.7	3.46	88.0
DGF2-24	20242261	1½	38.1	2.20	56.0	2.72	69.0	3.70	94.0
DGF2-32	20241239	2	50.8	2.80	71.0	3.43	87.0	3.90	99.0

Choosing the Correct Fittings

Choosing the correct Perma-Crimp™ fitting may be simply identifying the fitting to be replaced by measuring the fitting or in some other way, identifying its size and thread type. Care should be taken in using the correct fitting.

1. The correct fitting is chosen to match a replacement fitting and/or chosen on the basis of formal design and sound engineering practice.
2. Any questions or concerns involving fitting selection should be addressed with the local Sales Representative, Hydraulic Applications Group, or with our Customer Service Group at 800-235-4632.
3. Selecting the proper hose assembly - see assemblies section of this catalog. A helpful guide is the “S.T.A.M.P.E.D.” process, which requires the documentation of the following:

- S** Size - ID, OD and length of the assembly
- T** Temperature - Temperature of material conveyed and climatic conditions
- A** Application - Conditions of use including abrasion, flexing and routing
- M** Material - Type, concentration and composition
- P** Pressure - Includes surge or impulse pressure
- E** Ends - Style, type, orientation and attachment methods
- D** Delivery - Includes testing, quality and packaging requirements

In completing the “S.T.A.M.P.E.D” process, “Ends” need to be further defined.

Thread Size	Drop Length
Thread Type	Hose Type
Male or Female	Hose Dash Size
Angle of Elbow	Hose Working Pressure

4. The Perma-Crimp™ fitting is available in four styles including Ultra-Crimp™, Uni-Crimp™, Field-Grip™ or Dual-Grip™. Each fitting consists of a stem and a ferrule. The stem fits into the hose ID. The ferrule attaches the fitting to the hose cover. The stem has two functional ends. The first is the hose end, which is used to attach the fitting to the hose. The hose end must be compatible with the ID of the hose. The other end is the thread end, which is used to attach the assembly to another port in the hydraulic system. The thread end will be determined from the fitting being replaced or by measuring the port or threads being attached.
5. Temperature range is important in both hose and fitting selection. Hose temperature ranges are shown on page 43 of this catalog. In general, fittings will be comparable with hose temperature ranges with the exception of O-ring fittings, which are limited to 212°F (100°C).
6. Flange identification requires additional information. Code 61 Flanges, Code 62 Flanges and Caterpillar® Flanges are commonly used to connect large sizes of hose and tubing. Code 61 Flanges are commonly used in applications of 3,000-5,000 psi working pressure, while Code 62 Flanges can be used in applications up to 6,000 psi working pressure. Code 62 and Caterpillar® Flanges are similar in application but Caterpillar® Flanges have a thicker flange head and are frequently found on Caterpillar® equipment. Flanges are identified by measuring the port hole diameter, the longest bolt hole spacing and the flange head thickness.
7. It is possible to have a fitting rated at a lower working pressure than the hose. Keep working pressure in mind when selecting a fitting. The hose assembly can be rated no greater than the lowest pressure rating of either hose or fitting. Reference working pressure tables can be found on pages 35-40.

Note: Dimensions in the catalog are listed as approximate and for reference only. Dimensions are subject to change.

Fitting Working Pressure Charts

Maximum Recommended Working Pressure (psi)

Choose fittings carefully considering the working pressure of both hose and fitting. The **maximum** working pressure of the hose assembly is the lesser of the **rated** working pressure of the hose **and** the fitting.

Working pressures shown on the page are not applicable for the Field-Grip™ reattachable fittings (FG-*). Please contact Continental ContiTech Customer Service for the working pressure of the FG fittings.

Fitting Style	JIC 37° Flare Male Non-Swivel	JIC 37° Flare Female Swivel	NPTF Male Swivel	NPTF Male Non-Swivel	NPTF Female Swivel	NPSM Female Swivel	Code 61 Flange	Code 62 Flange	CAT® Flange	Straight Thread O-Ring Boss male	O-Ring Face Seal Female
Thread Dash Size											
-02											
-04	6000	6000	6000	6000	6000	6000				5000	6000
-05	6000	6000								5000	
-06	6000	6000	6000	6000	6000	6000				5000	6000
-08	5000	5000	5000	5000	5000	5000	5000	6000		4500	6000
-10	4000	4000					5000	6000		4000	6000
-12	4000	4000	2250	4000	2250	2250	5000	6000	6000	4000	6000
-14											
-16	4000	4000	2000	4000	2000	2000	5000	6000	6000	4000	6000
-20	3000	3000		3000	1625	1625	4000	6000	6000	3000	4000
-24	3000	3000		2500			3000	6000	6000		4000
-32	3000	3000		2500			3000	6000	6000		

Fitting Style	SAE 45° Flare Female Swivel	SAE J514 Flareless Tube Fitting	BSPP O-Ring Female Swivel	BSPT Male Non-Swivel	BSPP Male Non-Swivel	DIN 24 Light Female Swivel	DIN 24 Light Male	DIN 24 Heavy Female Swivel	DIN 24 Heavy Male	JIS 30° Flare Female Swivel	JIS 30° Flareless Female Swivel	Komatsu® 30° Metric Thread Female Swivel
Thread Dash Size												
-02												
-04	3000	5000	5800	5800	5800	3625	3625			5000	5000	5000
-05		5000				3625	3625	5800	5800			
-06	3000	4000	5800	5800	5800	3625	3625	5800	5800	5000	5000	5000
-08	3000	3500	5000	5000	5000	3625	3625	5800	5800	5000	5000	5000
-10	2750	2750	5000	5000	5000	3625	3625	5800	5800			
-12	2250	2250	4500	4500	4500	2320	2320	5800	5800	4000	4000	4000
-14												
-16	2000	2000	3500	3500	3500	2320	2320	5800	5800	3000	3000	3000
-20	1625	1625	2850	2850	2850	1450	1450	5800	5800	2500	2500	2500
-24	1250		2250	2250	2250	1450	1450	3625	3625	1500	1500	1500
-32	1125		1800	1800	1800	1450	1450	3625	3625	1500	1500	1500

Selection of the proper Continental ContiTech Brand fitting is essential to the proper operation and safe use of the hose assembly and related equipment. Inadequate attention to the selection of the proper fitting for the application can result in failure of the fitting which can cause serious bodily injury or property damage from spraying fluids or flying projectiles.

Thread Reference Chart

Thread Type	02	03	04	05	06	08	10	12	14	15	16	18	20
JIC 37° Flare (SAE J514)		3/8-24	7/16-20	1/2-20	9/16-18	3/4-16	7/8-14	1 1/16-12	1 3/16-12		1 5/16-12		1 5/8-12
SAE 45° J512 Flare			7/16-20	1/2-20	5/8-18	3/4-16	7/8-14	1 1/16-14					
SAE 45° Inverted Flare		3/8-24	7/16-24	1/2-20	5/8-18	3/4-18	7/8-18						
NPTF	1/8-27		1/4-18		3/8-18	1/2-14		3/4-14			1-11 1/2		1 1/4-11 1/2
NPSM			1/4-18		3/8-18	1/2-14		3/4-14			1-11 1/2		1 1/4-11 1/2
NPMAPI											1-11 1/2		1 1/4-11 1/2
SAE J514 Flareless Tube Fittings			7/16-20	1/2-20	9/16-18	3/4-16	7/8-14	1 1/16-12			1 5/16-12		
O-Ring Face Seal (SAE J1453 ORS/ORFS)			9/16-18		11/16-16	13/16-16	1-14	1 3/16-12			1 7/16-12		1 11/16-12
O-Ring Boss Straight Thread (SAE J514)			7/16-20	1/2-20	9/16-18	3/4-16	7/8-14	1 1/16-12			1 5/16-12		1 5/8-12
BSPP (British Standard Pipe Parallel)			1/4-19		3/8-19	1/2-14	5/8-14	3/4-14			1-11		1 1/4-11
BSPT (British Standard Pipe Tapered)			1/4-19		3/8-19	1/2-14		3/4-14			1-11		
BSP Flat Seat (British Standard Pipe)					3/8-19	1/2-14		3/4-14					
JIS 30° (Parallel Pipe Threads)			1/4-19		3/8-19	1/2-14		3/4-14			1-11		1 1/4-11
Code 61 Flange (SAE J518) - Dia.						1.19		1.5			1.75		2
Code 62 Flange (SAE J518) - Dia.						1.25		1.63			1.87		2.13
Caterpillar® Flange - Dia.								1.63			1.87		2.13
Komatsu® Flange - Dia.							1.34						
Standpipe - O.D.						8mm	10mm	12mm		15mm	16mm	18mm	20mm
DIN 24° Light								12 x 1 1/2	14 x 1 1/2		16 x 1 1/2	18 x 1 1/2	
DIN 24° Heavy											16 x 1 1/2	18 x 1 1/2	20 x 1 1/2
DIN 60°									14 x 1 1/2		16 x 1 1/2	18 x 1 1/2	
Japanese Komatsu® 30° Flare with Metric Threads									14 x 1 1/2			18 x 1 1/2	

All measurements in inches unless otherwise stated.

Thread Reference Chart

Thread Type	22	24	26	28	30	32	33	36	40	42	45	52
JIC 37° Flare (SAE J514)		1 7/8-12				2 1/2-12						
SAE 45° J512 Flare												
SAE 45° Inverted Flare												
NPTF		1 1/2-11 1/2				2-11 1/2						
NPSM												
NPMAPI		1 1/2-11 1/2				2-11 1/2						
SAE J514 Flareless Tube Fittings												
O-Ring Face Seal (SAE J1453 ORS/ORFS)		2-12										
O-Ring Boss Straight Thread (SAE J514)		1 7/8-12										
BSPP (British Standard Pipe Parallel)		1 1/2-11				2-11						
BSPT (British Standard Pipe Tapered)												
BSP Flat Seat (British Standard Pipe)												
JIS 30° (Parallel Pipe Threads)												
Code 61 Flange (SAE J518) - Dia.		2.37				2.81			3.31			
Code 62 Flange (SAE J518) - Dia.		2.5				3.13						
Caterpillar® Flange - Dia.		2.5										
Komatsu® Flange - Dia.												
Standpipe - OD.	22mm			28mm								
DIN 24° Light	22 x 1 1/2		26 x 1 1/2		30 x 2			36 x 2			45 x 2	
DIN 24° Heavy	22 x 1 1/2	24 x 1 1/2			30 x 2			36 x 2		42 x 2		52 x 2
DIN 60°	22 x 1 1/2		26 x 1 1/2									
Japanese Komatsu® 30° Flare with Metric Thread	22 x 1 1/2	24 x 1 1/2			30 x 1 1/2		33 x 1.5	36 x 1 1/2		42 x 1 1/2		

All measurements in inches unless otherwise stated.

Fitting Accessories (O-Rings)

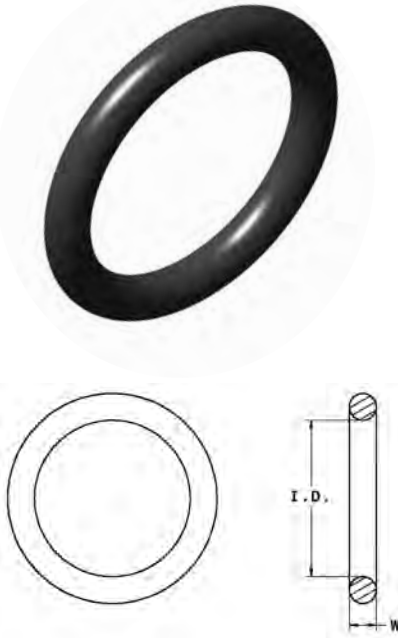

Material: NBR
 Hardness: 90 Shore A
 Temperature Range: -25°C to 125°C
 (-13°F to 257°C)

BSPB (British Standard Pipe Parallel) O-Rings

Descriptive #	Product #	SAP #	ID (in.)	Width (W)	Thread Dash Size
OBSPP-04	60505-0004	20245720	0.256	0.039	-04
OBSPP-06	60505-0006	20245723	0.319	0.063	-06
OBSPP-08	60505-0008	20245539	0.476	0.063	-08
OBSPP-10	60505-0010	20245724	0.516	0.063	-10
OBSPP-12	60505-0012	20245722	0.673	0.063	-12
OBSPP-16	60505-0016	20245536	0.870	0.063	-16
OBSPP-20	60505-0020	20245538	1.146	0.063	-20
OBSPP-24	60505-0024	20245537	1.382	0.063	-24
OBSPP-32	60505-0032	20245721	1.890	0.059	-32

DIN 24° Light O-Rings

Descriptive #	Product #	SAP #	ID (in.)	Width (W)	Thread Dash Size
ODIN24L-14	60520-0014	20245731	0.236	0.059	-14
ODIN24L-16	60520-0016	20245732	0.295	0.059	-16
ODIN4L-18	60520-0018	20245733	0.354	0.059	-18
ODIN4L-22	60520-0022	20245734	0.472	0.079	-22
ODIN4L-26	60520-0026	20245735	0.591	0.079	-26
ODIN4L-30	60520-0030	20245736	0.787	0.079	-30
ODIN4L-36	60520-0036	20245737	1.024	0.079	-36
ODIN4L-45	60520-0045	20245738	1.260	0.098	-45
ODIN24L-52	60520-0052	20245739	1.496	0.098	-52

DIN 24° Heavy O-Rings

Descriptive #	Product #	SAP #	ID (in.)	Width (W)	Thread Dash Size
ODIN24H-22	60515-0022	20245740	0.394	0.079	-22
ODIN24H-30	60515-0030	20245741	0.642	0.094	-30
ODIN24H-36	60515-0036	20245742	0.799	0.094	-36
ODIN24H-42	60515-0042	20245743	0.984	0.098	-42
ODIN24H-52	60515-0052	20245744	1.311	0.094	-52

Fitting Accessories (O-Rings)

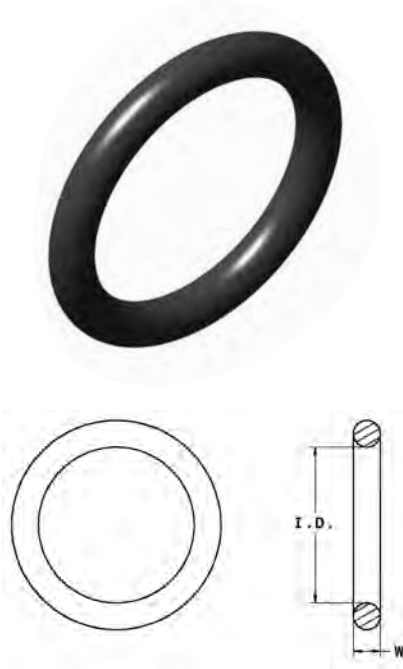

Material: NBR
 Hardness: 90 Shore A
 Temperature Range: -25°C to 125°C
 (-13°F to 257°C)

O-Ring Face Seal (SAE J1453 ORS/ORFS) O-Rings

Descriptive #	Product #	SAP #	ID (in.)	Width (W)	Thread Dash Size
OORFS-04	60525-0004	20245751	0.301	0.07	-04
OORFS-06	60525-0006	20245749	0.364	0.07	-06
OORFS-08	60525-0008	20245750	0.488	0.07	-08
OORFS-10	60525-0010	20245746	0.614	0.07	-10
OORFS-12	60525-0012	20245747	0.739	0.07	-12
OORFS-16	60525-0016	20245748	0.926	0.07	-16
OORFS-20	60525-0020	20245745	1.176	0.07	-20
OORFS-24	60525-0024	20431832	1.489	0.07	-24

O-Ring Boss Straight Thread (SAE J514) O-Rings

Descriptive #	Product #	SAP #	ID (in.)	Width (W)	Thread Dash Size
ORB-02	60530-0002	20431833	0.239	0.062	-02
ORB-04	60530-0004	20245756	0.351	0.072	-04
ORB-05	60530-0005	20245754	0.414	0.072	-05
ORB-06	60530-0006	20245758	0.468	0.078	-06
ORB-08	60530-0008	20245755	0.644	0.087	-08
ORB-10	60530-0010	20245757	0.755	0.097	-10
ORB-12	60530-0012	20245752	0.924	0.116	-12
ORB-16	60530-0016	20245753	1.171	0.116	-16
ORB-20	60530-0020	20431834	1.475	0.119	-20
ORB-24	60530-0024	20431835	1.720	0.119	-24
ORB-32	60530-0032	20431836	2.337	0.120	-32

Code 61 & 62 Flange (SAE J518) O-Rings & Caterpillar® Flange O-Rings

Descriptive #	Product #	SAP #	ID (in.)	Width (W)	Thread Dash Size
O6162-08	60500-0008	20245728	0.734	0.139	-08
O6162-10	60500-0010	20431831	0.859	0.139	-10
O6162-12	60500-0012	20245730	0.984	0.139	-12
O6162-16	60500-0016	20245727	1.296	0.139	-16
O6162-20	60500-0020	20245726	1.484	0.139	-20
O6162-24	60500-0024	20245725	1.859	0.139	-24
O6162-32	60500-0032	20245729	2.234	0.139	-32
O6162-40	60500-0040	20246508	2.734	0.139	-40

Split Flanges, Code 61 and Code 62 (SAE J518)

Flanges are commonly used to connect large sizes of hose and tubing. An O-ring in the flange head seals on a smooth face, female port. The male flange head and female port are held in place with two clamp halves and four bolts. Flanges conform to SAE J518 standard and are identified as Code 61 or the "standard series" and Code 62 or "high pressure series". The two flanges are not interchangeable as Code 61 is used in applications of up to 5,000 psi working pressure. Code 62 is designed for 6,000 psi working pressure. Code 61 and Code 62 are dimensionally different. Specifics on Code 61 and Code 62 flanges are found in the following charts.

Determine Flange Size

Method 1: Measure the port hole inside diameter.(ID).

Method 2: Measure the "A" dimension on the flange, which is the longest bolt hole spacing from center-to-center.

Assembly Procedure

1. Clean all mating services.
2. Replace O-ring. Lubricate before installation.
3. Partially tighten each bolt in rotation until all are fully tightened to the recommended torque value listed in the Appendix.

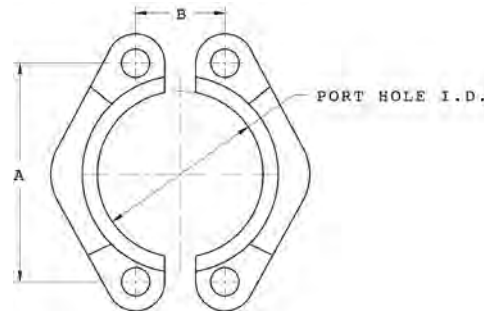

Split Flange Clamp Kits for Code 61 (SAE J518)

Includes Clamp Halves, 4 Bolts, 4 Lockwashers, 1 O-Ring

Descriptive #	Product #	SAP #	Port Hole ID (in.)	A (in.)	B (in.)	Max Working Pressure (psi)	Recommended Grade 8 Bolts
FL61SC-08	60061-0008	20246512	1/2	1.500	0.685	5000	5/16-18 x 1¼
FL61SC-12	60061-0012	20246513	3/4	1.874	0.874	5000	3/8-16 x 1¼
FL61SC-16	60061-0016	20246514	1	2.063	1.031	5000	3/8-16 x 1¼
FL61SC-20	60061-0020	20246515	1¼	2.311	1.189	4000	7/16-14 x 1½
FL61SC-24	60061-0024	20246516	1½	2.752	1.409	3000	1/2-13 x 1½
FL61SC-32	60061-0032	20246517	2	3.063	1.685	3000	1/2-13 x 1¾
FL61SC-40	60061-0040	20246467	2½	3.504	2.008	2500	1/2-13 x 1¾

Split Flange Clamp Kits for Code 62 (SAE J518)

Includes Clamp Halves, 4 Bolts, 4 Lockwashers, 1 O-Ring

Descriptive #	Product #	SAP #	Port Hole ID (in.)	A (in.)	B (in.)	Max Working Pressure (psi)	Recommended Grade 8 Bolts
FL62SC-08	60062-0008	20246519	1/2	1.594	0.717	6000	5/16-18 x 1¼
FL62SC-12	60062-0012	20246520	3/4	2.000	0.937	6000	3/8-16 x 1½
FL62SC-16	60062-0016	20246521	1	2.252	1.094	6000	7/16-14 x 1¾
FL62SC-20	60062-0020	20246522	1¼	2.626	1.252	6000	1/2-13 x 1¾
FL62SC-24	60062-0024	20246523	1½	3.126	1.441	6000	5/8-11 x 2¼
FL62SC-32	60062-0032	20246524	2	3.811	1.748	6000	3/4-10 x 2¾

German Metric Thread ID Template

Ideal for counter and field identification of German Metric DIN threads

GBS Collateral Item #70086290575800

Instructions

Female Threads

1. Use the 12° or 30° angle, as shown in the image to the right, to verify that the seat is 12° or 30° (see note)
2. Use the step gauge to determine Inside Diameter of female port
3. Measure Tube OD with the Tube Inside Diameter Gauge
4. Use Thread ID Table: DIN 2353 along with measured Tube OD to determine if tube is "Heavy" or "Light" Series

Male Threads

1. Use the 12° or 30° angle, as shown in the image to the right, to verify that the seat is 12° or 30° (see note)
2. Use Fitting Inside Diameter Gauge to measure Inside Threads
3. Refer to Thread ID Table: DIN 3863 along with measured Thread OD to determine Metric Male Thread. Rule of Thumb: on Male Thread, measure the ID of the machined surface and subtract 1mm to achieve tube OD. For example, when measuring a heavy-duty series Male on a M14 x 1½ thread, the caliper will measure 7mm (7mm - 1mm = 6mm)

Note: If measured angle is not 12° or 30°, use the Fitting Identification Section in our Hydraulic Hose Catalog Appendix to identify.

Inclusive Angle is the entire angle contained in the machined surface. Each side of the surface measures 1/2 of the total angle (e.g. 24° x .5 = 12°).

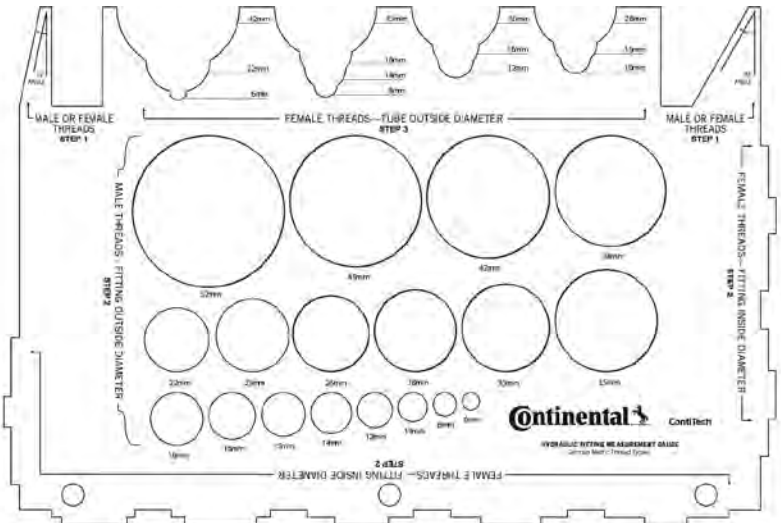

German Metric Thread Types

FEMALE THREADS—STEP 4
MALE THREADS—STEP 3
Thread Identification Table: DIN 2353 24° Cone

Metric Thread (BxP)mm	Female Thread ID mm	Male Thread OD mm	Tube OD Light Series mm	Tube OD Heavy Series mm
M 12 x 1,5	10,5	12	6	6
M 14 x 1,5	12,5	14	8	8
M 16 x 1,5	14,5	16	10	10
M 18 x 1,5	16,5	18	12	12
M 20 x 1,5	18,5	20	14	14
M 22 x 1,5	20,5	22	15	14
M 24 x 1,5	22,5	24	16	16
M 26 x 1,5	24,5	26	18	16
M 30 x 2,0	28,5	30	22	20
M 36 x 2,0	33,9	36	28	25
M 42 x 2,0	39,9	42	30	30
M 45 x 2,0	42,9	45	35	30
M 52 x 2,0	49,9	52	42	38

Instructions

Female Threads

1. Use the 12° or 30° angle, as shown in the image to the left, to verify that the seat is 12° or 30° (see note)
2. Use the step gauge to determine Inside Diameter of female port
3. Measure Tube OD with the Tube Outside Diameter Gauge
4. Use Thread ID Table: DIN 2353 along with measured Tube OD to determine if Tube is "Heavy" or "Light" Series

Male Threads

1. Use the 12° or 30° angle, as shown in the image to the right, to verify that the seat is 12° or 30° (see note)
2. Use Fitting Inside Diameter Gauge to measure Inside Threads
3. Refer to Thread ID Table: DIN 3863 along with measured Thread OD to determine Metric Male Thread. Rule of Thumb: On Male thread, measure the ID of the machined surface and subtract 1mm to achieve tube OD. For example, when measuring a heavy-duty series Male on a M14x1.5 Thread, the caliper will measure 7mm (7mm - 1mm = 6mm).

Note: If measured angle is not 12° or 30°, use the Fitting Identification Section in our Hydraulic Hose Catalog Appendix to identify.

Inclusive Angle is the entire angle contained in the machined surface. Each side of the surface measures 1/2 of the total angle (e.g. 24° x .5 = 12°).

MALE THREADS—STEP 3
Thread Identification Table: DIN 3863 60° Cone

Metric Thread (BxP)mm	Female Thread ID mm	Male Thread OD mm	Tube OD 60° Cone mm
M 12 x 1,5	10,5	12	6
M 14 x 1,5	12,5	14	8
M 16 x 1,5	14,5	16	10
M 18 x 1,5	16,5	18	12
M 22 x 1,5	20,5	22	15
M 26 x 1,5	24,5	26	18
M 30 x 2,0	28,5	30	22
M 36 x 2,0	33,9	36	28
M 45 x 2,0	42,9	45	35
M 52 x 2,0	50,5	52	42

Code 61/Code 62/CAT® Flange ID Template

Ideal for counter and field identification of SAE Flanges

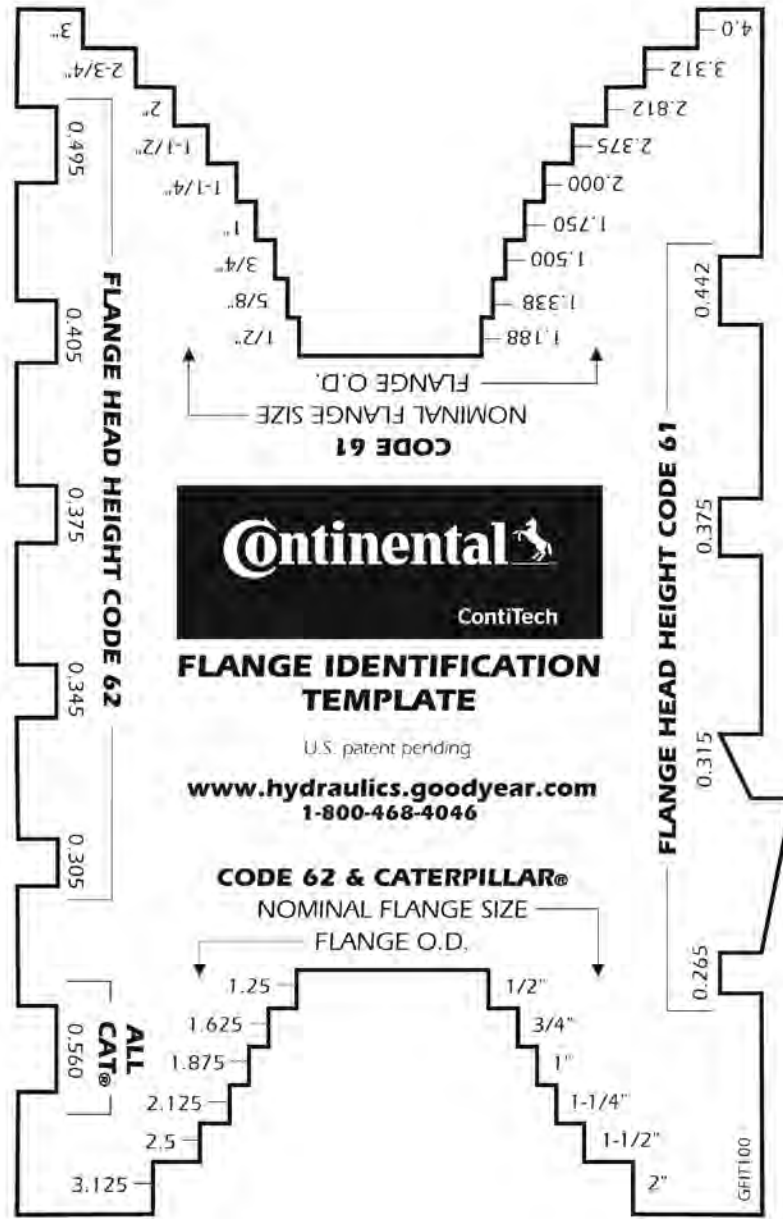

Part Number: GFIT100 SAP # 20243407 Weight: 1.4 oz Dimensions: 4 $\frac{7}{8}$ " wide x 7 $\frac{7}{8}$ " high

Notes:

1. Reverse side of template shows dimensional chart for Code 61/Code 62/CAT® flanges.
2. Above not to scale.
3. As a connection on pumps and motors, the SAE Code 61 and Code 62 4-bolt flanges are used worldwide with three exceptions:
 - a. Although a common size outside of North America, the #10 size is not an SAE standard size.
 - b. Although Caterpillar® flanges have the same OD as SAE Code 62, they have a thicker flange head.
 - c. Porcelain flanges are completely different from SAE flanges.

Thread Identification Kit

There are many types of North American threads, as well as British, German, French and Japanese threads. With all the thread types and styles available, it is important to properly identify a fitting so that an assembly can be connected correctly within the hydraulic system. This kit and the tools inside will help you identify a broad selection of different thread types.

The Thread Identification Kit includes:

- Fitting Identification Manual
- North American (NA) Thread Pitch Gauge
- International (INT) Thread Pitch Gauge
- Seat Angle Gauges 12°, 30°, 37°, 45°
- ID/OD 3.5" Calipers

Part Number: Fitting IID Pocket Guide

Dimensions: 4½" W x 5½" H



Steps to Identify a Fitting

1. Select country of origin for the fitting. Use part number if available to determine thread type.
2. Identify the fitting visually using the illustrations in the proper section of the Continental ContiTech Hydraulic Hose and Fittings Catalog or the Hydraulic Fitting Identification Manual included with the identification kit.
3. Measure the inside diameter or the outside diameter of the fitting threads using the ID/OD Calipers.

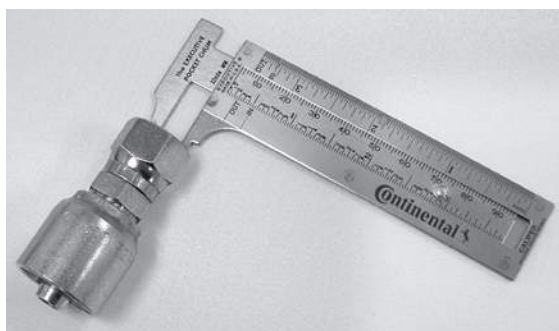

4. Measure thread pitch using the North American or International Thread Pitch Gauge. The gauge will determine number of threads per inch or the distance between threads of a metric connection.

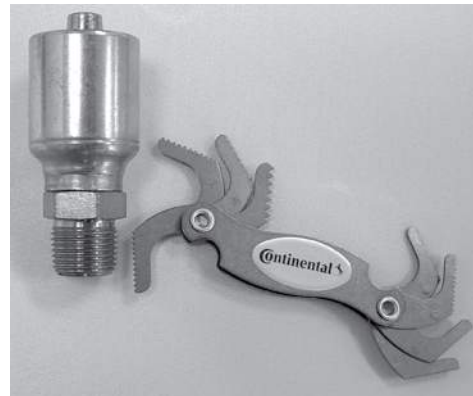

5. Measure the angle of the fittings sealing surface using the Seat Angle Gauge.



6. Compare measurements above to the tables in the fitting catalog or identification manual to complete the identification of the fitting.



Equipment & Accessories

PC125M

Perma-Crimp™



PC125M

Description

Carried to the job site with a handle and support stand, the PC125M is ideal for portable crimping requirements. Whether carried on-site or used in a vehicle or even stationary at the shop, the PC125M is designed as a low-volume crimping machine for occasional use. Crimp diameter is set and controlled with an easy-to-read micrometer. This affordable crimping machine is packaged in component parts to fit the need of the user. The PC125M has three power options. No electrical power source is required if using the hand or pneumatic pump option. A 1/2-HP, 110V electric pump is available as well. The PC125M includes die ring pusher, stand, compression ring, pressure plate and a metric micrometer. Pumps and dies are purchased separately.

Features

- › Easy-to-read, fully adjustable metric micrometer allows precise setting of crimp diameters to an accuracy of +/- .1mm
- › Open design with vertical feed for good operator visibility
- › Removable pusher and spring-loaded die set for easy loading
- › 60-ton cylinder
- › Two-piece, "slide in" die design for easy installation
- › Lightweight for portable field use
- › Color-coded die sets to speed die selection and setup
- › Attach hand, air or electric pump

Capability

- › 1/4" through 1 1/4" ID, 2-braid hose and 1 1/4" ID 4-spiral hose with all coupling end styles including most bent tubes

Power Source

- › Optional Two Stage Hand Pump, 10,000 psi (PC125-HPump)
- › Optional Air/Hydraulic Pump, 10,000 psi using 80 psi air (PC125-PPump)
- › Optional 1/2-HP, 110V AC, single phase, 50-60 Hz Electric Pump (PC125M-5EPump) with foot switch

Oil Capacity: 1 gal.

Mounting: Stand included

Dimensions: 14" L x 11" W x 23 1/2" H

Weight: 45 lbs.

Dies

Part Number	ID	Part Number	ID
PC125-8.5 Black	8.5mm	PC125-27 Brown	27mm
PC125-12 Black	12mm	PC125-31 Silver	31mm
PC125-14 Red	14mm	PC125-34 Purple	34mm
PC125-16 Blue	16mm	PC125-41 Orange	41mm
PC125-19 Green	19mm	PC125-45 Black	45mm
PC125-23 Yellow	23mm	PC125-50 Black	50mm

Options

- › PC125M-SKit includes the PC125M crimping machine and 7 die sets including 16mm, 19mm, 23mm, 27mm, 31mm, 34mm and 41mm dies for 1/4" to 1" 1-braid and 2-braid hose.
- › PC125-Shelf-Black Die Storage Shelf Unit 13" deep x 12 1/2" wide x 15" high, 12 lbs
- › PC125-HPump - Two Stage Hand Pump
- › PC125-PPump - Air/Hydraulic Pump
- › PC125M-5EPump - 1/2 HP, 110V Electric Pump

Replacement Parts

- › PC125M-Pusher - Die Ring Pusher
- › PC125-Cring - Compression Ring
- › PC125-Pplate - Pressure Plate
- › PC125-Die Screw - Die Screw
- › PC125-Die Spring - Die Spring
- › PC125-HPump - Optional Two Stage Hand Pump
- › PC125-PPump - Optional Air/Hydraulic Pump
- › PC125M-5EPump - Optional 1/2 HP, 110V Electric Pump
- › PC900-Grease-3 oz. - High-pressure grease in a 3 oz. tube
- › PC900-Grease-1 lb. - High-pressure grease in a 1 lb. can
- › PC900-AerosolLube - High-pressure grease in an aerosol can



Electric Pump (PC125M-5EPump)



Metric Micrometer



PC125 Die Set



Hand Pump (PC125 HPump)



PC125 Die Storage Shelf



Air/Hydraulic Pump (PC125-PPump)

PC125

Perma-Crimp™



PC125

Description

The PC125 portable crimper, with its open design, removable pusher and easy-to-use, spring-loaded die set, is designed for higher production volume and repetitive use. Crimp diameter is set and controlled with an easy-to-read micrometer. The PC125 is packaged for shop service and includes the crimper and 1-HP, 110V electric pump on a common base, compression ring, pressure plate, magnetized die ring pusher, stop/start remote pendant switch, metric micrometer, adjustable coupling stop and adjustable retraction stop.

Features

- › Easy-to-read, fully adjustable metric micrometer allows precise setting of crimp diameters to an accuracy of +/- .1mm
- › Open design with vertical feed for good operator visibility
- › Removable pusher and spring-loaded die set for easy loading
- › Magnetized pusher to attach compression ring for repetitive use
- › 60-ton cylinder
- › Automatic shut-off for precise crimps
- › Adjustable retraction stop limits ram retractions for quick repetitive crimps
- › Adjustable coupling stop for accurate, repetitive positioning of the assembly inside the dies
- › Two-piece, "slide in" die design for easy installation
- › Common base for bench mounting
- › Color-coded die sets to speed die selection and setup
- › 1-HP, 110V pump
- › Pneumatic activation (no electric wires) of remote pendant switch

Capability

- › 1/4" through 1 1/4" ID, 2-braid hose and 1 1/4" ID 4-spiral hose with all coupling end styles including most bent tubes

Power Source

- › 1-HP, 110V AC, single phase, 50-60 Hz, Electric Pump (PC125/150-E1PUMP) with pneumatic stop/start pendant switch

Oil Capacity: 1 gal.

Mounting: Crimper and pump installed on plate

Dimensions: 20" L x 11" W x 19" H

Weight: 125 lbs.

Dies

Part Number	ID	Part Number	ID
PC125-8.5 Black	8.5mm	PC125-27 Brown	27mm
PC125-12 Black	12mm	PC125-31 Silver	31mm
PC125-14 Red	14mm	PC125-34 Purple	34mm
PC125-16 Blue	16mm	PC125-41 Orange	41mm
PC125-19 Green	19mm	PC125-45 Black	45mm
PC125-23 Yellow	23mm	PC125-50 Black	50mm

Options

- › PC125-SKit includes the PC125 crimper and 7 die sets including 16mm, 19mm, 23mm, 27mm, 31mm, 34mm and 41mm dies for 1/4" to 1" 1-braid and 2-braid hose
- › PC125-Shelf-Black Die Storage Shelf Unit 13" deep x 12 1/2" wide x 15" high, 12 lbs.

Replacement Parts

- › PC125-Pusher – Die Ring Pusher With Magnets
- › PC125-Cring – Compression Ring
- › PC125-Pplate – Pressure Plate
- › PC125-Cstop – Adjustable Coupling Stop
- › PC125-Die Screw – Die Screw
- › PC125-Die Spring – Die Spring
- › PC125/150-Switch – Pneumatic Start/Stop Pendant Switch for 1 HP Pump
- › PC125/150-E1Pump – 1 HP 110V Electric Pump
- › PC900-Grease-3 oz. – High-pressure grease in a 3 oz. tube
- › PC900-Grease-1 lb. – High-pressure grease in a 1 lb. can
- › PC900-AerosolLube – High-pressure grease in an aerosol can



Metric Micrometer



PC125 Die Set



PC125 Magnetic Pusher



PC125 Die Storage Shelf



PC125 Coupling Stop



PC125 Retraction Stop

PC150 Series

Including PC150-1 & PC150-2 | Perma-Crimp™



PC150-2

Description

The PC150 is a stationary crimper with more power to manufacture factory-quality hose assemblies quickly and easily. Its open design with removable pusher and "slide in" die configuration allows for good visibility and easy loading of dies and hose assemblies. Crimp diameter is set and controlled with an easy-to-read micrometer. Designed to handle higher volumes in a shop environment, the PC150-2 includes the crimper and 2-HP pump on a common base, pressure plate, compression ring, die ring pusher, stop/start remote pendant switch, metric micrometer, adjustable coupling stop, adjustable retraction stop and work light. The optional PC150-1 includes all the components of the PC150-2 and a 1-HP pump.

Features

- › Easy-to-read, fully adjustable metric micrometer allows precise setting of crimp diameters to an accuracy of +/- .1mm
- › Open design with vertical feed for good operator visibility
- › Removable pusher and spring-loaded die set for easy loading
- › 80-ton cylinder
- › Automatic shut-off for precise crimps
- › Adjustable retraction stop limits ram retractions for quick repetitive crimps
- › Adjustable coupling stop for accurate, repetitive positioning of the assembly inside the dies
- › Two-piece, "slide in" die set for easy installation
- › Common base for bench mounting
- › Color-coded die sets to speed die selection and setup
- › 2-HP, 220V pump
- › Pneumatic activation (no electric wires) of remote pendant switch

Capability

- › 1/4" through 1½" ID, 2-braid hose and 4-spiral hose with all coupling styles and most bent tubes

Power Source

- › 2-HP, 220V AC, single phase, 50-60 Hz Electric Pump (PC150-E2Pump) for PC150-2 crimper
- › Optional 1-HP, 110V AC, single phase, 50-60 Hz Electric Pump (PC125/150-E1Pump) for PC150-1 crimper

Oil Capacity: 1 gal.

Mounting: Crimper and pump installed on plate

Dimensions: 32" L x 16½" W x 29" H

Weight: 275 lbs.

Dies

Part Number	ID	Part Number	ID
PC150-8.5 Black	8.5mm	PC150-27 Brown	27mm
PC150-12 Black	12mm	PC150-31 Silver	31mm
PC150-14 Red	14mm	PC150-34 Purple	34mm
PC150-16 Blue	16mm	PC150-41 Orange	41mm
PC150-19 Green	19mm	PC150-45 Black	45mm
PC150-23 Yellow	23mm	PC150-50 Black	50mm
PC150-27 Brown	27mm	PC150-56 Black	56mm

Options

- › PC150-1 SKit includes PC150-1 crimper and 7 die sets including 16mm, 19mm, 23mm, 31mm, 41mm, 50mm, 56mm dies for 1/4" to 1½" 1-braid to 4-spiral hose
- › PC150-2 SKit includes PC150-2 crimper and 7 die sets including 16mm, 19mm, 23mm, 31mm, 41mm, 50mm, 56mm dies for 1/4" to 1½" 1-braid to 4-spiral hose
- › PC150-Shelf-Black Die Storage Shelf Unit 15" deep x 20½" wide x 16" high, 25 lbs.
- › PC150-Spacer-Spacer Kit for Elbows
- › PC150-1 with 1 HP Pump
- › PC150-2 with 2 HP Pump

Replacement Parts

- › PC150-Pusher - Die Ring Pusher
- › PC150-Cring - Compression Ring
- › PC150-Pplate - Pressure Plate
- › PC150-Cstop - Adjustable Coupling Stop
- › PC150-Die Screw - Die Screw
- › PC150-Die Spring - Die Spring
- › PC125/150-Switch - Pneumatic Start/Stop Pendant Switch for 1-HP or 2-HP Pump
- › PC150-E2Pump - 2-HP Electric Pump for PC150-2 Crimper
- › PC125/150-E1Pump - 1-HP Electric Pump for PC150-1 Crimper
- › PC900-Grease-3oz - High-pressure grease in a 3 oz. tube
- › PC900-Grease-1lb - High-pressure grease in a 1 lb. can
- › PC900-AerosolLube - High-pressure grease in an aerosol can



PC150 Die Storage Shelf



Metric Micrometer



PC150 Die Set



PC150 Coupling Stop



PC150 Retraction Stop

PC150H Series

Including PC150H-1 & PC150H-2 | Perma-Crimp™



PC150H

Description

The PC150H offers the ease of use of a horizontal crimper with the power and precise adjustment capabilities usually found in more costly models. With the same crimping capability as the PC150 Series, the "H" model offers hose feed horizontally from either front or rear through a large 4.9 in. throat opening. The PC150H can be ordered with a 1-HP electric pump (PC150H-1) or a 2-HP electric pump (PC150H-2), producing maximum force in a small package. The PC150H makes repetitive crimps fast and easy to accomplish with a precise, direct-read digital adjustment and a built-in cylinder retraction stop. The PC150H also offers convenience features found in both our vertical and horizontal crimpers including a pneumatic start/stop pendant switch, a magnetic die change tool, an optional die rack for storing dies and master die grease fittings as a special feature for easy lubrication.

Features

- › Easy-to-read micrometer provides precise crimp settings
- › Hose feed is horizontal from both front and rear
- › Easy die loading with magnetic die change tool
- › Max die size 56mm
- › 155-ton crimping force
- › Automatic shut-off for precise crimps
- › Retraction stop limits die travel for faster repetitive crimps
- › Large 13-quart oil reservoir to cool components during repetitive crimps
- › Pneumatic activation using remote pendant switch
- › 1-HP and 2-HP power options

Capability

- › 1/4" through 1 1/2" ID, 2-braid hose and 4-spiral hose with all coupling styles and most bent tubes

Power Source

- › 1-HP, 110V AC, single phase (PC150H-1)
- › 2-HP, 220V AC, single phase (PC150H-2)

Oil Capacity: 13 qt.

Mounting: Bench or cabinet

Dimensions: 15" L x 23 1/2" W x 20 1/2" H

Weight: 245 lbs.

Dies

Part Number	ID	Part Number	ID
PC150H-8.5	8.5mm	PC150H-31	31mm
PC150H-12	12mm	PC150H-34	34mm
PC150H-14	14mm	PC150H-41	41mm
PC150H-16	16mm	PC150H-45	45mm
PC150H-19	19mm	PC150H-50	50mm
PC150H-23	23mm	PC150H-56	56mm
PC150H-27	27mm		

Options

- › PC150H-1 SKit includes the PC150H-1 crimper and 7 die sets including 16mm, 19mm, 23mm, 31mm, 41mm, 50mm and 56mm
- › PC150H-2 SKit includes the PC150H-2 crimper and 7 die sets including 16mm, 19mm, 23mm, 31mm, 41mm, 50mm and 56mm
- › PC150H-Rack - Black die cabinet 7" deep x 13" wide x 18" high, holds 9 dies

Replacement Parts

- › PC900-Grease-1lb, - High-pressure grease in 1 lb. can
- › PC900-AerosolLube - High-pressure grease in an aerosol can
- › PC125/150 Switch - Pneumatic Start/Stop Pendant Switch for 1HP or 2 HP Pump
- › PC150H-DCT - Die Change Tool



PC150H Die Set



Die Change Tool



PC150H Die Rack



Digital Gauge

PC200 Series

Including PC200-1 & PC200-2 & PC200-3 | Perma-Crimp™



PC200-1

Description

The PC200 is a high-volume, high-capacity stationary crimper utilizing microprocessor control for the fastest, most accurate crimping system available. Crimp settings, dwell time, pre-set start positions and auto/manual operation are all easily set with electronic controls. This production crimper is a quick and easy way to make factory-quality hose assemblies. The standard package is the PC200-1 crimper which includes a 7.5-HP, 230V/3 phase pump and foot pedal. The optional PC200-2 crimper includes a 7.5-HP, 480V/3 phase pump and foot pedal. The optional PC200-3 (single phase) crimper includes a 5-HP, 220V/single phase pump and foot pedal.

Features

- › Hose feed is horizontal from both front or rear
- › Accurate electronic PLC crimp diameter adjustment
- › Manual or automatic mode
- › Max die size +78mm
- › 340-ton cylinder
- › Automatic shut-off for precise crimps
- › Power return stroke and return limit control
- › Rapid retraction of die fingers through hydraulic system
- › Die sets easily changed using hand tool
- › Accommodates bent tube/elbow couplings with the ability of installing 2", 90 degree fittings on both ends

Capability

- › 1/4" through 2" ID, 2-braid hose and 2" 6 spiral hose with all coupling end styles including most bent tubes

Power Source

- › 7.5-HP, 230V AC, 3 phase, 60 Hz (PC200-E7.5-1Pump)
- › Optional 7.5-HP, 480V AC, 3 phase, 60 Hz (PC200-E7.5-2 Pump) for the PC200-2 crimper
- › Optional 5-HP, 220V AC, single phase, 60 Hz for the PC200-3 crimper

Oil Capacity: 8 gal.

Mounting: Bench or cabinet

Dimensions: 18½" L x 27½" W x 31½" H (without die cabinet)

Weight: 573 lbs. (excluding cabinet)

Dies

Part Number	ID	Part Number	ID
PC200-8.5	8.5mm	PC200-41	41mm
PC200-12	12mm	PC200-45	45mm
PC200-14	14mm	PC200-50	50mm
PC200-16	16mm	PC200-56	56mm
PC200-19	19mm	PC200-62	62mm
PC200-23	23mm	PC200-69	69mm
PC200-27	27mm	PC200-74	74mm
PC200-31	31mm	PC200-78	78mm
PC200-34	34mm		

Options

- › PC200-1 SKit includes the PC200-1 crimper and 10 die sets including 16mm, 19mm, 23mm, 31mm, 41mm, 50mm, 56mm, 62mm, 69mm, 78mm dies for 1/4" to 2" 1-braid to 6-spiral hose
- › PC200-2 SKit includes the PC200-2 crimper and 10 die sets including 16mm, 19mm, 23mm, 31mm, 41mm, 50mm, 56mm, 62mm, 69mm, 78mm dies for 1/4" to 2" 1-braid to 6-spiral hose
- › PC200-3 SKit includes the PC200-3 crimper and 10 die sets including 16mm, 19mm, 23mm, 27mm, 31mm, 34mm, 41mm, 50mm, 56mm, 69mm
- › PC200-Rack - Black Die Cabinet 20" deep x 30" wide x 29" high
- › PC200-MBS - Manual Back Stop
- › PC200-EBS - Electric Back Stop

Replacement Parts

- › PC900-Grease-1lb. - High-pressure grease in a 1 lb. can
- › PC900-AerosolLube - High-pressure grease in an aerosol can



PC200 Die Set



Control Panel



Foot Switch



Optional Automatic Back Stop



Die Cabinet

PC400 Series

Including PC400 & PC400-1 | Perma-Crimp™



PC400

Description

The PC400 is a high-volume, high-capacity stationary crimper utilizing microprocessor control for the fastest, most accurate crimping system available. Crimp settings, dwell time, pre-set start positions and auto/manual operation are all easily set with electronic controls. This production crimper is a quick and easy way to make both hydraulic and industrial hose assemblies. The standard package is the PC400 crimper which includes a 7.5-HP, 230V/3 phase pump and foot pedal. The optional PC400-1 crimper includes a 5-HP, 230V/single phase pump and foot pedal.

Features

- › Hose feed is horizontal from either front or rear
- › Accurate electronic PLC crimp diameter adjustment
- › Manual or automatic mode
- › Maximum die opening: die closed diameter + 78mm (hydraulic) and 122mm (industrial)
- › 265-ton cylinder
- › Automatic shut-off for precise crimps
- › Power return stroke and return limit control
- › Rapid retraction of die fingers through hydraulic system
- › Die sets easily changed using hand tool
- › Accommodates bent tube/elbow couplings with the ability of installing 2", 90 degree fittings on both ends

Capability

- › 1/4" through 2" ID, 2-braid hose, and 2" 6-spiral hose, and 4" industrial hose with all coupling end styles including most bent tubes
- › 1/2" through 4" ID industrial hose

Power Source

- › 7.5-HP, 230V AC, 3 phase, 60 Hz for the PC400 crimper
- › Optional 5-HP, 230V AC, single phase for the PC400-1 crimper

Oil Capacity: 8 gal.

Mounting: Bench or cabinet

Dimensions: 18½" L x 27½" W x 31½" H (without die cabinet)

Weight: 573 lbs. (excluding cabinet)

Hydraulic Dies (PC400 utilizes PC200 dies)

Part Number	ID	Part Number	ID
PC200-8.5	8.5mm	PC200-34	34mm
PC200-12	12mm	PC200-41	41mm
PC200-14	14mm	PC200-45	45mm
PC200-16	16mm	PC200-50	50mm
PC200-19	19mm	PC200-56	56mm
PC200-23	23mm	PC200-62	62mm
PC200-27	27mm	PC200-69	69mm
PC200-31	31mm	PC200-74	74mm
		PC200-78	78mm

Industrial Dies

Part Number	ID	Part Number	ID
PC400-86-125L	86mm	PC400-114-125L	114mm
PC400-90-125L	90mm	PC400-118-125L	118mm

Options

- › PC400-SKit includes the PC400 crimper and 12 die sets including 16mm, 19mm, 23mm, 27mm, 31mm, 34mm, 41mm, 50mm, 56mm, 62mm, 69mm, 78mm dies for 1/4" to 2" 1-braid to 6-spiral hose
- › PC400-1 SKit includes the PC400-1 crimper and 12 die sets including 16mm, 19mm, 23mm, 27mm, 31mm, 34mm, 41mm, 50mm, 56mm, 62mm, 69mm, 78mm dies for 1/4" to 2" 1-braid to 6-spiral hose
- › PC200-Rack - Black Die Cabinet 20" deep x 30" wide x 29" high
- › PC200-MBS - Manual Back Stop
- › PC200-EBS - Electric Back Stop

Replacement Parts

- › PC900-Grease-1lb - High-pressure grease in a 1 lb. can
- › PC900-AerosolLube - High-pressure grease in an aerosol can



Foot Switch



Control Panel



Die Cabinet



Optional Automatic Back Stop

PC600L Crimper

Perma-Crimp™

Description

The PC600L is a high-volume, high-capacity stationary crimper utilizing the fully automatic ACT3™ microprocessor controller. The PC600L can produce 2,200 crimps per hour with 350 tons of crimping force to allow for both hydraulic and industrial hose assemblies, and it is ideal for production assembly applications. The standard PC600L crimper includes a 7.5-HP, 230 V AC, 3-phase hydraulic pump.

Features

- › Fully automatic ACT3 controller
- › Manual & automatic operation
- › Utilizes the PC200/400 dies with easy-to-change die tool
- › 350-ton cylinder
- › Built-in heavy-duty base with die holders
- › Allows for 2,200 crimps per hour
- › Automatic shut-off for precise crimps
- › Power return stroke and return limit control

Capability

- › 1/4" through 2½" ID, 2-braid and 6-spiral hydraulic hose
- › 3/16" through 6" ID industrial hose

Power Source

- › 7.5-HP, 230V AC, 3 phase, 60 Hz

Dimensions

- › Master die inside diameter - 145mm
- › Master die opening w/o dies - 273mm
- › Maximum swaging diameter - 192mm
- › Maximum die opening - Die+128mm
- › Pump size: 21" L x 34" W x 36½" H
- › Pump weight: 450 lbs (205 kg)
- › Machine size: 22" L x 36" W x 57" H

Weight: 4,500 lbs. (2,041kg) die base/cabinet (shipping weight)

The following dies are included in the standard PC600-P SKit

Hydraulic Dies:

SAP#	Descriptive #	Description
20244976	PC200-16	16MM DIE
20244977	PC200-19	19MM DIE
20244978	PC200-23	23MM DIE
20244980	PC200-31	31MM DIE
20244982	PC200-41	41MM DIE
20244984	PC200-50	50MM DIE
20244985	PC200-56	56MM DIE
20244986	PC200-62	62MM DIE
20244987	PC200-69	69MM DIE
20249890	PC200-78	78MM DIE

Continental ContiTech Part Numbers:

SAP#	Descriptive #	Description
20673598	PC600-P SKit	PC600-P SKit 16-23, 31, 41, 50, 56, 62, 69, 78
20673588	PC600-P SKit H&I	Includes Hydraulic & Industrial Dies (Hyd: 16-23, 31, 41, 50, 56, 62, 69, 79) (Ind: 84, 92, 100, 125, 166, 178)
20267266	PC200/400-DCT	Die Change Tool
20244972	PC200-EBS	Electric Back Stop (Optional)
20244971	PC200-MBS	Manual Back Stop



Optional Automatic Back Stop

PC1000 Crimper

Perma-Crimp™

Description

The PC1000 is a high-volume, high-capacity stationary crimper utilizing the fully automatic ACT3™ microprocessor controller. The PC1000 can produce 1,415 crimps per hour with 450 tons of crimping force to allow for both Hydraulic and Industrial hose assemblies, ideal for production assembly applications. The standard PC1000 crimper includes a 7.5-HP, 230 V AC, 3-phase hydraulic pump.

Features

- › Fully automatic ACT3™ controller
- › Manual & automatic operation
- › Utilizes the PC200/400 dies with easy-to-change die tool
- › 350-ton cylinder
- › Built-in, heavy-duty base with die holders
- › Allows for 1,415 crimps per hour
- › Automatic shut-off for precise crimps
- › Power return stroke and return limit control

Capability

- › Up through 2½" ID, 2-braid, 4-spiral and 6-spiral hydraulic hose
- › 3/16" through 10" ID industrial hose

Power Source

- › Standard: 7.5-HP, 230 V AC, 3 Phase, 60 Hz
- › Optional: 7.5-HP, 460 V AC, 3 Phase, 60 Hz

Dimensions

- › Master Die Inside Diameter: 230mm
- › Master Die Opening w/o Dies: 350mm
- › Maximum Swaging Diameter: 192mm
- › Maximum Die Opening: Die +125mm
- › Machine Size: 30" L x 44" W x 74" H

Weight: 6,185 lbs. (2,806kg)

The following dies are included in the standard PC1000-PX SKit

Hydraulic Dies:

SAP#	Descriptive #	Description
20244975	PC200-14	14 MM DIE
20244976	PC200-16	16 MM DIE
20244977	PC200-19	19 MM DIE
20244978	PC200-23	23 MM DIE
20244980	PC200-31	31 MM DIE
20244982	PC200-41	41 MM DIE
20244984	PC200-50	50 MM DIE
20244985	PC200-56	56 MM DIE
20244986	PC200-62	62 MM DIE
20244987	PC200-69	69 MM DIE
20249890	PC200-78	78 MM DIE
20562098	PC600-84	84 MM DIE
20562099	PC600-92	92 MM DIE
20562650	PC600-100	100 MM DIE
20562651	PC600-108	108 MM DIE
20562652	PC600-116	116 MM DIE
20562653	PC600-126	126 MM DIE
20590712	PC1000-166	166 MM DIE
20590713	PC1000-178	178 MM DIE
20590714	PC1000-215	215 MM DIE
20590715	PC1000-245	245 MM DIE



Continental ContiTech Part Numbers:

SAP#	Descriptive #	Description
20588181	PC1000-PX SKit	PC1000-PX SKit

(3 Phase 230V dies 14-245) PC1000 Utilizes PC200/400/600 Dies & Change Tool

PCTB1500 / PCTB 2500

Test Benches

Description

Continental ContiTech PCTB Series Test Benches provide a safe and efficient method to test hose assemblies for burst or proof testing.

Features

- › Optional electronic model with programmable control including paper printout
- › 1/2" polycarbonate safety window
- › Safety lock to prevent operation when door is not closed
- › Standard garden hose inlet for water supply
- › Factory air inlet supply, 85 psi minimum required
- › Powder-coated finish for durability
- › Polyurethane bed liner material coating on interior
- › 7-port outlet manifold for multiple testing
- › Built-in work light for good visibility during testing

Capability

- › PCTB1500 - Test pressure range to 21,500 psi (1500 bar)
- › PCTB2500 - Test pressure range to 37,500 psi (2500 bar)

Power Source

Standard 110 V AC, Single Phase Grounded Outlet

Dimensions

- › Interior: 18" H x 35" W x 71" L
- › Includes test bench legs - test area at a convenient working height
- › Full opening allows for hose assemblies to be loaded on a skid

Weight: 750 lbs.



Continental ContiTech Part Numbers:

SAP#	Descriptive #
20439763	PCTB-1500 TEST BENCH
20439764	PCTB-1500 PLC TEST BENCH
20554088	PCTB-2500 TEST BENCH
20554089	PCTB-2500 PLC TEST BENCH



HS150

Hose Saws



Description

Designed to cut 1 & 2 braid hydraulic hose up to 1-1/2" ID and up to 1 1/4" 4 Spiral Hose.

Features

- › 1-HP
- › Single Phase
- › 60 Hz
- › 115 V AC
- › 3450 RPM w/10" serrated blade
- › 85 lbs.

SAP # 20614553

HS301



Description

Designed to cut 1 & 2 braid hydraulic hose up to 2" ID and up to 1 1/4" 4 or 6 Spiral Hose.

Features

- › 3-HP
- › Three Phase
- › 60 Hz
- › 230 V AC
- › 3450 RPM w/12" serrated blade
- › 150 lbs.

SAP # 20614555

HS303

Description

Designed to cut 1 & 2 braid hydraulic hose up to 2" ID and up to 1 1/4" 4 or 6 Spiral Hose.

Features

- › 3-HP
- › Three Phase
- › 60 Hz
- › 230 V AC
- › 3450 RPM w/12" serrated blade
- › 150 lbs.

SAP # 20614554

HS501



Description

Designed to cut 1 & 2 braid hydraulic hose up to 2" ID and up to 2" 4 or 6 Spiral Hose.

Features

- › 5-HP
- › Single Phase
- › 60 Hz
- › 230 V AC
- › 3450 RPM w/12" serrated blade
- › 156 lbs.

SAP # 20614557

HS503

Description

Designed to cut 1 & 2 braid hydraulic hose up to 2" ID and up to 2" 4 or 6 Spiral Hose.

Features

- › 5-HP
- › Three Phase
- › 60 Hz
- › 230 V AC
- › 3450 RPM w/12" serrated blade
- › 156 lbs.

SAP # 20614556

Skalman

SK101 Manual Hose Skiving Tool



SK01 - Skalman

- › Manual skiving device designed for field service, smaller workshops and service vans
- › Can be used for both internal and external skiving
- › Quickly and easily mounted to a vice
- › Separate tooling available for 3/16" to 1" ID and 1/4" to 2" ID

Part Number: SK01 - Skalmon only

Hose Capacity: 3/16" to 2" ID

Color: Zinc plating

Length: 19.6"

Weight: 8.8 lbs.

Options

- › External skiving tools
- › Internal skiving tools

External Skiving Tool



SK02 - External Skiving Tool Holder and Short Arm Included



SK05 - External Skiving Tool Holder and Long Arm Included

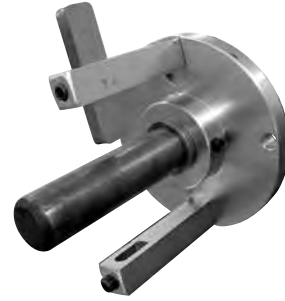

External Skiving Tool

External skiving tools sold separately for use with the above SK01 - Skalman Skiver. This robust, sturdy tool is suitable for skiving spiral and braided hoses from 3/16" to 2".

A complete tool, which attaches to the Skalman, consists of a holder with one arm. The arm can be short (PN SK02) or long (SK05) depending on the ID of the hose to be skived. A short arm is used for 3/16" to 1" ID hose. A long arm is used for 1 1/4" to 2" ID hose. Holder and arm are zinc-plated.

External Skiving Tool

Options Sold Separately



SK04 - Knife With 4 Sharp Edges



Optional Short (SK03) and Long (SK06) Arm (Mounted to SK02 or SK05)



Double Arm Configuration of SK02 or SK05 With Additional Short Arm (SK03) or Long Arm (SK06) Shown

Knife - The knife (PN SK04) will attach to either the short or long arm. The knife is sold separately.

Short or Long Arm - Additional arms (Short-SK03 or Long-SK06) are available for additional cutting. The optional arm can be mounted to either SK02 or SK05 External Skiving Tool.

Mandrels for External Skiving

Manual Hose Skiving Tool

The mandrel is attached to either SK02 or SK05 External Skiving Tool.

Mandrels to be used with long arm SK06

Part Number	Size	Skiving Length
SK04-20	1¼"	1.8-3.3"
SK04-24	1½"	1.8-3.3"
SK04-32	2"	1.8-3.3"

Mandrels to be used with short arm SK03

Part Number	Size	Skiving Length
SK04-03	3/16"	.9-1.5"
SK04-04	1/4"	.9-1.5"
SK04-05	5/16"	.9-1.6"
SK04-06	3/8"	.9-1.8"
SK04-08	1/2"	.9-1.8"
SK04-10	5/8"	.9-2.6"
SK04-12	3/4"	.9-2.6"
SK04-16	1"	.9-2.4"



Mandrel for External Skiving Tool
SK04-03 to SK04-32

Internal Skiving Tools

The Internal Skiving Tool is used for internal skiving of spiral hoses with 3-6 reinforcement layers. A separate tool is needed for each ID, 3/4" to 2". The tool is adjustable to suit varying needs of skiving lengths and depths. The Skalman (PN SK01) is required and sold separately.

Material: Hardened steel

Adjustable Skive Length: .4-1.4"

Adjustable Skive Depth: .4-.2"

Length: 5.9-7.9"

Weight: .7-1.1 lbs.

Part Number	Description
SK10-06	3/8" Internal Skiving Tool
SK11-06	3/8" Knife
SK10-08	1/2" Internal Skiving Tool
SK11-08	1/2" Knife
SK10-12	3/4" Internal Skiving Tool
SK11-10	3/4" Knife (Also used for 5/8")
SK10-16	1" Internal Skiving Tool
SK11-16	1" Knife (Also used for 1¼")
SK10-20	1¼" Internal Skiving Tool
SK11-16	1¼" Knife (Also used for 1")
SK10-24	1½" Internal Skiving Tool
SK11-24	1½" Knife (Also used for 2")
SK10-32	2" Internal Skiving Tool
SK11-24	2" Knife (Also used for 1½")



Internal Skiving Tool (Knife Sold Separately)
SK10-06 to SK10-32



Knife (Sold Separately) SK11-06 to SK11-24

CB102 & CB103

Fitting Cabinets

Features

- › Stackable 12" deep Cabinets
- › Durable powder-coated textured charcoal gray finish
- › Optional base stand provides 8 inches more of height for comfortable access to lower shelves

Highlights

- › Stackable - up to 3 units high
- › Durable - High impact Polystyrene, Blue Bins
- › No Assembly - Cabinets ship assembled (except optional stand)
- › Capacity - weight capacity is 120 lbs., combined stacked capacity weight not to exceed 200 lbs.
- › Overall Cabinet Dimensions: 35"W x 11"D x 22"H (excludes base stand)



Hydraulic Dies:

SAP#	Descriptive #	Description	Weight (lb)	Shelf Dimensions (in)			Bin Dimensions (in)		
				D	L	H	D	W	H
20754797	CB102	Stackable Cabinet w/o Bins	64	11	34	4 11/16			
20754796	CB103	Stackable Cabinet w/5.5" Bins	40	11	34	4 11/16	11 5/8	5 9/16	4 5/8
20754798	CB303	Base Stand for 11" Stackable Cabinet	16	11 1/4	35 1/4	8			
20754799	CB203	CB203 - Blue 3" Bins 6 pack	5				11 5/8	3 3/4	4 5/8
20754883	CB203-DIV	CB203 - DIV 3" Dividers 6 pack	1						
20754880	CB204	CB204 - Blue 5.5" Bins 6 pack	6				11 5/8	5 9/16	4 5/8
20754884	CB204-DIV	CB204 - DIV 5.5" Dividers 6 pack	1						
20754881	CB205	CB205 - Blue 8" Bins 4 pack	6				11 5/8	8 3/8	4 5/8
20754885	CB205-DIV	CB205 - DIV 8" Dividers 6 pack	1.5						
20754882	CB206	CB206 - Blue 11" Bins 4 pack	8				11 5/8	11 1/8	4 5/8
20754886	CB206-DIV	CB206 - DIV 11" Dividers 8 pack	2						



Assemblies

Selecting the Proper Hose Assembly

In order to obtain the best service from any particular hose application, two important conditions must be fulfilled.

- 1) Select the right hose for the job.
- 2) Make sure that it is fitted correctly and used in the proper manner.

Carefully consider the application requirements. A helpful guide is the S.T.A.M.P.E.D. process. S.T.A.M.P.E.D. is an acronym and stands for the seven major information areas required to provide a quality hose assembly

- S** **SIZE** - ID, OD, and length of the assembly
- T** **TEMPERATURE** - includes temperature of fluid conveyed and the climatic conditions
- A** **APPLICATION** - the conditions of use, including abrasion, flexing and routing
- M** **MATERIAL** - type of material conveyed, including composition and concentration
- P** **PRESSURE** - hose assembly working pressure and surge or back pressure
- E** **ENDS** - definition of the fitting, including thread type, gender, bent tube, swivel and orientation
- D** **DELIVERY** - time allowed for delivery, including testing, quality assurance and packaging

To assist in obtaining and conveying information regarding the application, a copy of the S.T.A.M.P.E.D. application form is included in this catalog. This inquiry sheet can be sent to any Continental ContiTech authorized distributor for a hose recommendation.

Please Note:

A hose should always be selected based on its **rated working pressure**. Do not use **minimum burst pressure** as a guideline in selecting the hose. Minimum burst pressure decreases over the use and life of the hose. A hose should be selected based on its rated working pressure to provide a normal service life. In addition, always select a hose by giving consideration to its recommended temperature limits. Hose service life is reduced if the temperatures of the fluids being conveyed or ambient temperatures exceed the recommended limits.

S.T.A.M.P.E.D. Form

Size	
ID	_____
OD	_____
Hose Length (OAL or unclpd. lgth.)	_____
Tolerances	_____
Temperature	
of Material Being Conveyed	_____
(high, low, ambient)	_____
of Outside Exposure (high, low, ambient)	_____
Intermittent?	_____
Constant?	_____
Sub-Zero Exposure	_____
Application(s)	
Indoor and/or Outdoor Use	_____
Intermittent or Continuous Use	_____
Flexibility Required (min. bend radius)	_____
Movement (static, vibrations, flexing)	_____
External Conditions:	
Abrasion	_____
Oil	_____
Solvents	_____
Acid	_____
Ozone	_____
Electrical/Static Conductive	_____
Oil Resistance:	
Tube	_____
Cover	_____
Flame Resistance	_____
Noncontaminating Materials	_____
Hose Currently in Use	_____
Current Hose Service Life/Failure Description	_____
Service Life Desired	_____
Material(s) Being Conveyed	
Solids (size, description)	_____
Gaseous (volatility, inert)	_____
Liquids (flammability, causticity, acid, alkaline, solution/concentration)	_____
Chemical Names (generic)	_____

Pressures(s)	
Working Pressure (including surges)	_____
Burst Pressure	_____
Suction or Vacuum Requirements	_____
Velocity	_____
Impulse	_____
Ends & Fittings	
Type of Threads	_____
Male/Female	_____
Reusable/Nonreusable	_____
Material for Fittings	_____
Swivel or Non-Swivel	_____
Straight or Bent Tube	_____
Fitting 1 & 2 Orientation	_____
Other	_____
Cut to Length	_____
Crimp Specs or Crimper Used	_____
Delivery	
Lead Time	_____
Quantity	_____
Stock/Nonstock	_____
Special Print	_____
Special Packaging	_____
Other Information	
Customer: _____	Date: _____
Customer No: _____	_____
Ship To: _____	_____
Bill To: _____	_____
Telephone: _____	Fax: _____

Bolded block areas MUST be filled out on all inquiries.

Defining Hose and Assembly Length

Identifying Hose ID

In the case of a hose assembly replacement, the inside diameter (ID) of the hose can be obtained from the existing assembly. The ID may be printed on the layline of the hose or may have to be measured. Before cutting the assembly, measure the overall assembly length and record the orientation of the fittings. See the following sections on how to measure overall assembly length and the offset angle between the two fittings. If the ID of the hose has not been determined, utilize the Hose ID Selection Nomograph in the Appendix. The chart will yield a hose ID recommendation based on flow capacity and flow velocity.

Hydraulic hose size or inside diameter is sometimes referred to as the "Dash Size." The Dash number is the ID of the hose in sixteenths of an inch. For example, a 1/4" ID hose, is equivalent to 4/16". The "Dash Size" would be "-4." A listing of the Dash sizes is shown below. Note that the Dash number applies to the hose ID for all hoses except SAE 100R5. In the case of SAE 100R5, the Dash number is equal to a relevant tube outside diameter (O.D.).

Dash #	Hose ID (Except SAE 100R5)		SAE Dash Size* (SAE 100R5)	
	in.	mm	in.	mm
-2	1/8	3.2		
-3	3/16	4.8		
-4	1/4	6.4	3/16	4.8
-5	5/16	7.9	1/4	6.4
-6	3/8	9.5	5/16	7.9
-8	1/2	12.7	13/32	10.3
-10	5/8	15.9	1/2	12.7
-12	3/4	19.0	5/8	15.9
-14	7/8	22.2		
-16	1	25.4	7/8	22.2
-20	1¼	31.8	1½	28.6
-24	1½	38.1	1¾	35.0
-32	2	50.8	1¾	46.0
-36	2¼	57.6		
-40	2½	63.5	2¾	60.3
-48	3	76.2		
-56	3½	88.9		
-64	4	101.6		
-72	4½	115.2		

*SAE Dash Size equals OD of the tubing, which has approximately the same ID as the hose, expressed in 1/16".

Identifying Overall Assembly Length

Unless otherwise specified by the customer, the assembly's overall length is measured from the extreme end of one fitting to the extreme end of the other except for the O-ring face seal fittings, which shall be measured from the sealing face. Where elbow fittings are used, measurement shall be to the centerline of the sealing surface of the elbow end.

Assembly Length Measurements

Overall Assembly Length

Female Swivel Ends (except O-ring Face Seal)
Measure to sealing surface.

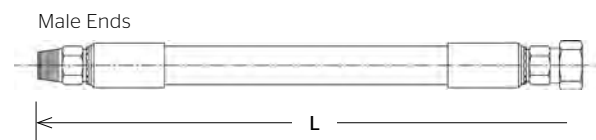

Bent Stem Swivel Female Ends



Flange Ends

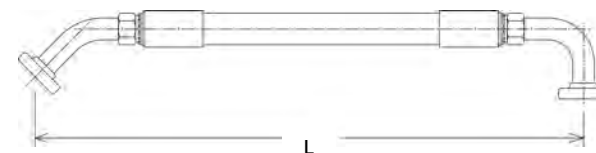

Swivel O-Ring Face Seal Ends



Defining Hose and Assembly Length

Measuring the Offset Angle

The offset angle between two fittings is the number of degrees measured in a clockwise direction between the fitting nearest the viewer and the farthest end fitting. Tolerances on the offset angle are +/- 3 degrees for assemblies up to 24 inches long and +/- 5 degrees for assemblies 24 inches and longer.

The following illustration shows the clockwise angle separation between a "close" fitting and a "far" fitting. The "close" fitting would be defined as the fitting closer when looking at an assembly end to end. The "far" fitting would be defined as the fitting on the far end of the assembly when looking at an assembly end to end. The far end is used as the reference point and the "close" end establishes the angular difference.

Part #	Hose ID (in.) (mm)	Hose Dash Size	Thread Size (in.-TPI)	Thread Dash Size	"C" Cut-Off Factor (mm)	Stem Hex (mm)
JIC Solid Male 37	3/8	9.5 -6	9/16-18	-6	26.3	17

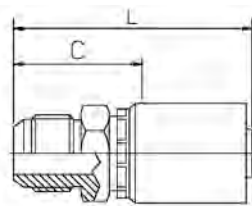

Knowing the overall length of the assembly desired, you subtract the "C" cut-off factor for each fitting from the overall length to obtain the hose cut length.

Cut Hose Length = Assembly Overall Length - (C1+C2)

C1 and C2 are cut-off factors for each end. The "C" dimension may differ for each end, depending on the fitting. In certain situations, the sealing surface of JIC swivels and O-ring face seals should be considered when calculating overall length.

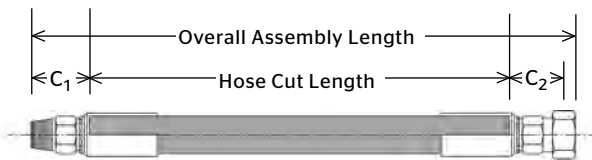

Hose assemblies should be manufactured to the following length tolerances.

Assembly Length	Tolerance (+/- in.)	Tolerance (+/- in.)	Tolerance (+/- mm)
Up through 12 in. (304.8mm)	0.13	1/8	3.2
Over 12 through 18 in. (304.8 through 457.2mm)	0.19	3/16	4.8
Over 18 through 36 in. (457.2 through 914.4mm)	0.25	1/4	6.4
Over 36 in. (914.4mm)	1%	1%	1%

*SAE Dash Size equals OD of the tubing, which has approximately the same ID as the hose, expressed in 1/16".

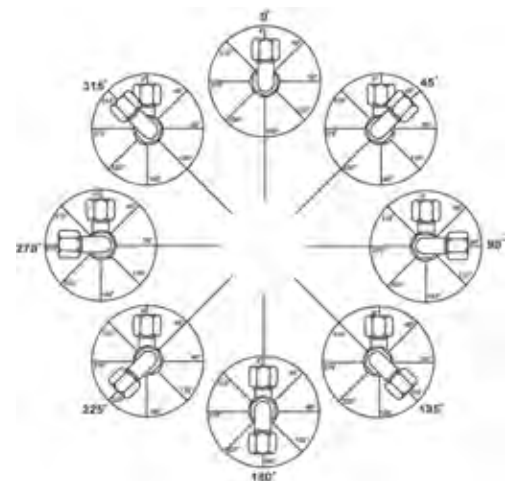

Far End Reference Measuring Clockwise

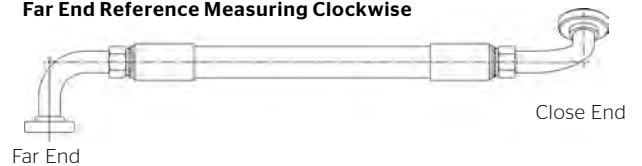

Clockwise Measurement (Degrees)



Steps in Hose Assembly

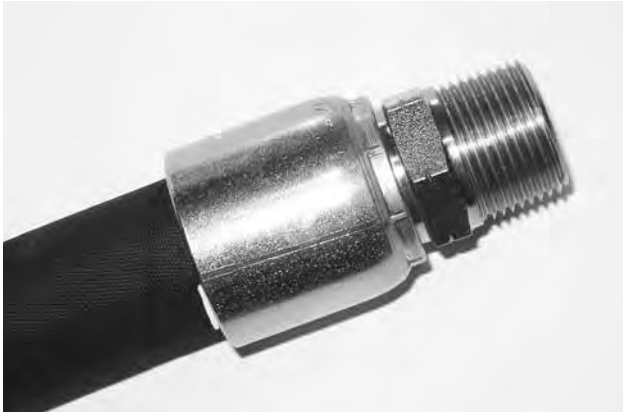

Mark insertion depth.



Cut-off saw. Use caution when operating power equipment. Follow the proper safety measures per manufacturer suggestions.

3. Ensure hose is cut squarely.
4. Contaminated hose may reduce the service life of hydraulic systems. Always clean the hose bore after cutting, using air and/or flush with a compatible fluid.

It is sometimes difficult to insert a fitting into hydraulic hose. If necessary, it is recommended using a liquid soap or a water/soap solution as a lubricant. Use the lubricant sparingly. When installing elbow fittings, point elbow towards curvature of the hose, unless specified otherwise. When installing elbow fittings on both ends, see the previous section on "Measuring the Offset Angle." If the insertion mark was correctly applied, you should now be able to determine if the coupling has been completely inserted. The depth mark will be aligned with the end of the ferrule. In the case of a skived assembly, check that no skive shows and that couplings are on straight.



Hose with square cut.

Steps in Hose Assembly



Fitting inserted on hose.

7. Before crimping hose fitting, verify the tooling setup and install the proper die set. Read the Crimp Chart, per Continental ContiTech recommendations, and dial in the correct crimp diameter.



Always verify proper die set.

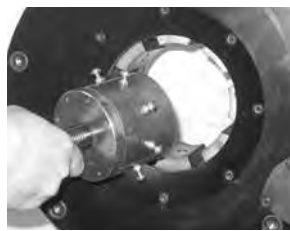

Insert die set in crimper.



Set crimp diameter.

8. Place hose and fitting into the crimp machine. Crimp ferrule to predetermined diameter. Refer to the Continental ContiTech Crimp Specifications Manual for proper crimp diameters and the crimper operator's manual for further instructions on how to properly and safely operate the crimper.



Insert hose assembly into crimper die set.



Insert hose assembly into crimper die set.

9. Remove assembled end and check crimp diameter with caliper or micrometer. Crimp diameter should be measured at the center of the ferrule. Measure the smooth portion of the ferrule and not the ridges. Visually check for cracked, cocked or damaged fittings.



Verify crimp diameter with calipers.

Steps in Hose Assembly

10. Some applications require the addition of a protective outer sleeving or strain reliefs. If this is a requirement, the most appropriate time to assemble is before the second end fitting is applied. Choose the appropriate product for the specific application. When cutting product to length, allow for flexing and bending of the hose.
11. Even if not required, it is a good practice to examine and audit the assembly before delivery or use. Records should be maintained. The level of inspection should be in compliance with the quality plan.
 - a) Inspection - Visual, dimensional and proof pressure testing in accordance with SAE J517 or SAE J343.
 - b) Clean or flush of the assembly to remove plating dust, rubber chips, etc.
 - c) Apply caps, if required, to protect fitting threads and keep out contamination.
 - d) Apply labels or specific markings, if required.
 - e) Package the assembly properly.

Final Inspection Checklist

- › Bulge behind the fitting
- › Cocked fittings
- › Cracked fittings
- › Rusted fittings
- › Exposed reinforcement
- › Freedom of swivels
- › General appearance of the assembly
- › Internal contaminants
- › Restriction of the tube

Recommended Inspection Equipment

- › Worktable suitable for inspection
- › Tape measure to measure overall length
- › Calipers for measuring crimp diameter
- › Pi tape to measure outside diameter
- › Plug gauges for measuring inside diameter
- › Protractor device for measuring angle orientation of bent tube fittings
- › Magnifying glass and light to view inside of assemblies
- › Burst and proof pressure tester



Hose Assembly Instructions Uni-Crimp™ 2-Piece Crimped Fitting

1. Determine correct hose length from desired hose assembly length and "C" dimension. The "C" dimension, or cut-off factor, can be found in the fitting tables. More information on using the "C" dimension can be found in the previous subtopic, "Defining Hose and Assembly Length."
2. Cut hose to required length using a cut-off saw or a circular abrasive cut-off wheel. The preferred choice would be the steel wheel with a cooling agent. Care should be taken in not overheating the hose, which can cause deformation of the hose and create difficulty when inserting the hose fittings. For textile-reinforced hose, a guillotine-style cutter may be used.



Cut-off saw. Use caution when operating power equipment. Follow the proper safety measures per manufacturer suggestions.

3. Ensure hose is cut squarely.



Hose with square cut.

Steps in Hose Assembly

- Contaminated hose may reduce the service life of hydraulic systems. Always clean the hose bore after cutting, using air and/or flush with a compatible fluid.
- In certain situations, skiving may be required. Skiving is the process of removing the portion of hose cover that lies directly under the coupling ferrule. This allows the metal fitting to be coupled directly on the hose reinforcement. Skiving is further discussed in the following section under the subtopic of "Internal and External Skiving."
- The 2-piece crimped fitting consists of a ferrule and a stem insert. It is essential that the fitting be mated with a compatible hose style. Check fitting compatibility in hose or fitting product tables. Screw and/or push ferrule onto the hose until hose bottoms into the ferrule.



Push ferrule onto hose.

- Push the stem insert into the hose ID. The shoulder of the stem should make contact with ferrule. It is sometimes difficult to insert the stem into hydraulic hose. If necessary, it is recommended using a liquid soap or a water/soap solution as a lubricant. Use the lubricant sparingly. When installing elbow fittings, point elbow towards curvature of the hose, unless specified otherwise. When installing elbow fittings on both ends, see the previous subtopic on "Measuring the Offset Angle."



Push stem into hose ID.

- Before crimping hose fitting, verify the tooling setup and install the proper die set. Read the Crimp Chart, per Continental ContiTech recommendations, and dial in the correct crimp diameter.



Always verify proper die set.

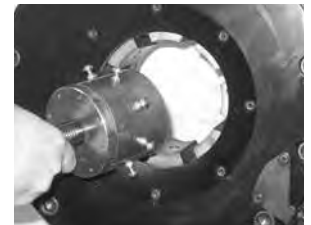

Install the proper die set.



Set crimp diameter.

- Place hose and fitting into the crimp machine. Refer to the Continental ContiTech Crimp Specifications Manual for proper crimp diameters and the crimper operator's manual for further instructions on how to properly and safely operate the crimper.



Insert hose assembly into crimper die set.

Steps in Hose Assembly



Crimp the hose/fitting assembly.

10. Remove assembled end and check crimp diameter with caliper or micrometer. Crimp diameter should be measured at the center of the ferrule. Measure the smooth portion of the ferrule and not the ridges. Visually check for cracked, cocked or damaged fittings.



Verify crimp diameter with calipers.

11. Even if not required, it is a good practice to examine and audit the assembly before delivery or use. Records should be maintained. The level of inspection should be in compliance with the quality plan.
 - a) Inspection - Visual, dimensional and proof pressure testing in accordance with SAE J517 or SAE J343.
 - b) Clean or flush of the assembly to remove plating dust, rubber chips, etc.
 - c) Apply caps, if required, to protect fitting threads and keep out contamination.
 - d) Apply labels or specific markings, if required.
 - e) Package the assembly properly.

Refer to the Final Inspection Checklist and Recommended Inspection Equipment previously listed in "Hose Assembly Instructions Using a 1-Piece Crimped Fitting."

Hose Assembly Instructions Field-Grip™ Fittings

Continental ContiTech Field-Grip™ reusable hose fittings must be carefully matched to Continental ContiTech hose. Use Field-Grip™ fittings only designed specifically for Continental ContiTech hose. Use the correct socket with a given hose. Specific fittings and their hose application can be found in the fitting tables.

1. Determine correct hose length from desired hose assembly length and "C" dimension. The "C" dimension, or cut-off factor, can be found in the fitting tables. More information on using the "C" dimension can be found in the previous subtopic, "Defining Hose and Assembly Length."
2. Cut hose to the required length using a cut-off saw or a circular abrasive cut-off wheel. The preferred choice would be a steel wheel with a cooling agent. Care should be taken in not overheating the hose, which can cause deformation of the hose, creating difficulty when inserting the hose fittings.



Cut-off saw. Use caution when operating power equipment. Follow the proper safety measures per manufacturer suggestions.

3. Ensure hose is cut square.



Hose with square cut.

Steps in Hose Assembly

- Contaminated hose may reduce the service life of hydraulic systems. Always clean the hose bore after cutting, using air and/or flush with a compatible fluid.
- A Field-Grip™ fitting consists of a socket and stem



Field-Grip™ fitting consists of a stem and a socket.

assembly. It is essential the fitting be mated with a compatible hose style. Check fitting compatibility in hose or fitting product tables. Place the socket in a vice. The socket will fit over the hose cover. To determine the insertion depth for the hose, first measure the distance from the bottom of the socket to the end of the socket where the hose is to be inserted. Transfer this insertion depth to the hose cover by measuring from the end of the hose. Mark a line on the hose cover at the distance from the end of the hose that equals the insertion depth. This becomes the visual check to determine if the hose was fully inserted in the socket.



Socket positioned in vice.



Mark Insertion depth.

- Lightly lubricate hose cover with a mild soap solution. Screw end of hose counterclockwise until hose reaches the marked insertion depth and then back off 1/2 turn. If the insertion mark was correctly applied to the hose, you should now be able to determine if the socket has been correctly applied to the hose by using the insertion depth mark on the hose cover as a reference along with a visual check inside the socket.



Apply lubricant to hose cover.



Visually check hose position inside socket.

- Lightly lubricate the inside of the hose and stem threads with a mild soap solution. Using a wrench, screw the stem assembly into the socket until the stem hex shoulders against the socket.



Apply lubricant to stem and hose tube.



Screw stem into socket.



Stem properly seated against socket.

- If disassembly is necessary, reverse the process.

Internal and External Skiving



Mark skive on hose cover.

3. Remove the hose cover to the wire, using care not to burn, fray or damage reinforcement wires. The cover of wire-braided hoses can be removed with a buffing wheel or a hand skiver. A manual, external skiving tool that uses a knife must be used with spiral hose. Mark the length of the cover to be removed, as noted in the Continental ContiTech Crimp Specifications Manual, and set skiving depth on the manual skiving tool. Make sure the manual skiver is rotated in the counterclockwise direction for external skiving. Follow specific instructions on external skiving that would accompany the manual skiver.

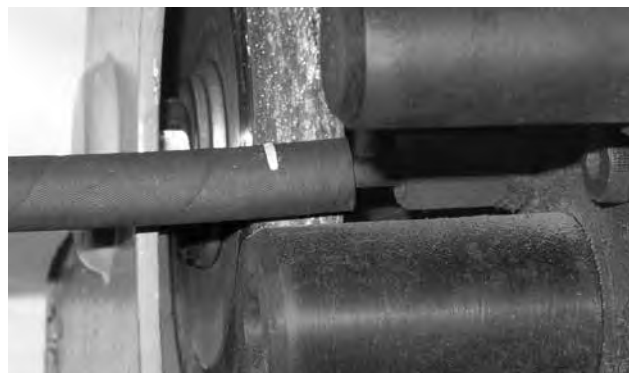

Cutting skive with buffing wheel. Follow manufacturer's recommendation for the safe and proper use of the skiver.

4. With the hose cover removed, check that the wire braid or spiral reinforcement has not been displaced, damaged or cut in the skiving process.



Check skived hose.

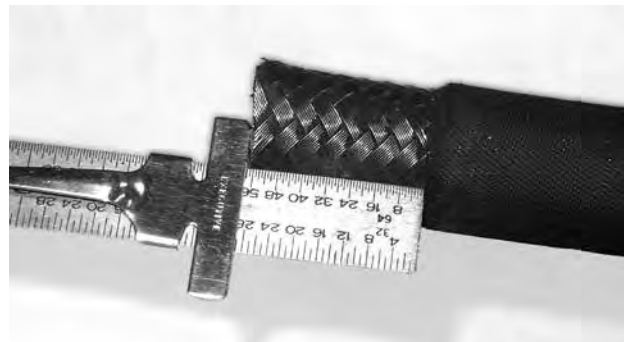

Measure skive.

5. Check for the proper skive length.
6. Hoses should be checked for 100% of cover removal. If necessary, rebuff skived area to clean and remove hose cover.
7. A manual, internal skiving tool that uses a knife is to be used to remove the tube material of spiral hose for installation of the Dual-Grip™ fittings. Note the correct length of tube material to be removed from the Continental ContiTech Crimp Specification Manual. Set the desired skiving depth on the internal skiving tool. Make sure the tool rotates in the clockwise direction for internal skiving. Verify that the correct length of tube material has been removed. Follow specific instructions on internal skiving that would accompany the manual skiver.
8. It is important to clean hose ID by brushing, blowing compressed air or flushing to remove any contaminants.

Warning: Failure to completely remove the cover may result in serious personal injury or property damage due to hose ends blowing off, leakage or other failures.

Steps in GR14A Assembly

In order to make a quality assembly with GR14A hose, the following instruction must be followed:

1. Tape hose before cutting as shown.

This will prevent the wire from flaring once the cut is made. If wire flare is allowed to occur, the ferrule will not slide onto the hose.

2. Slip ferrules on. Be sure they are in the correct direction (i.e. flange side aims to the outside of the hose).
3. Push in on stem on each end.
4. Remove the tape and slide the ferrule onto the stem.

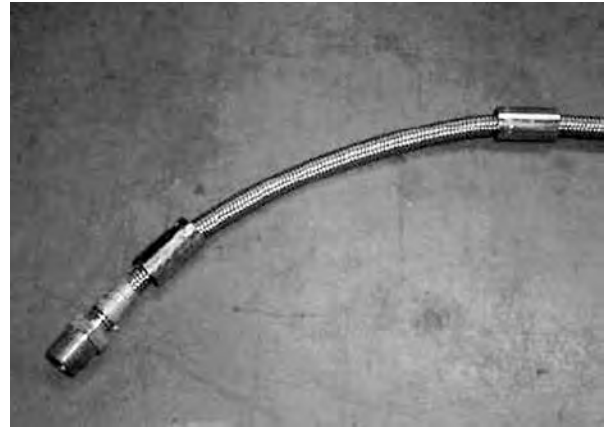

Steps in GR14A Assembly

5. Crimp the fitting using proper die selection and setting. Be sure not to allow the ferrule to slip back onto the hose or ride up on the hub of the stem. The groove of the ferrule must line up with flange of the stem.

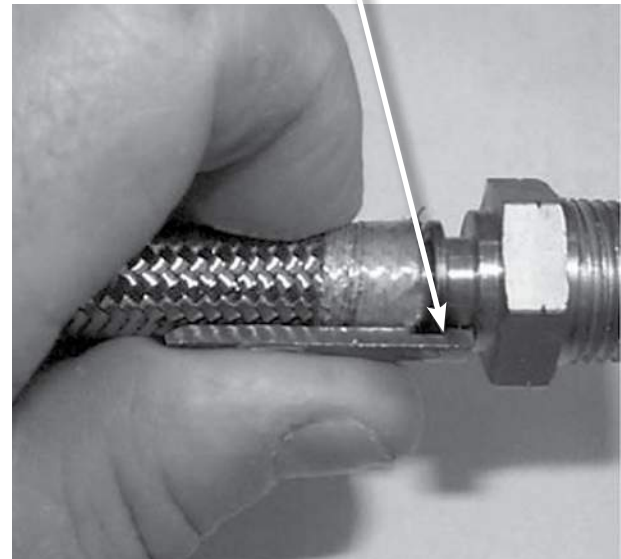
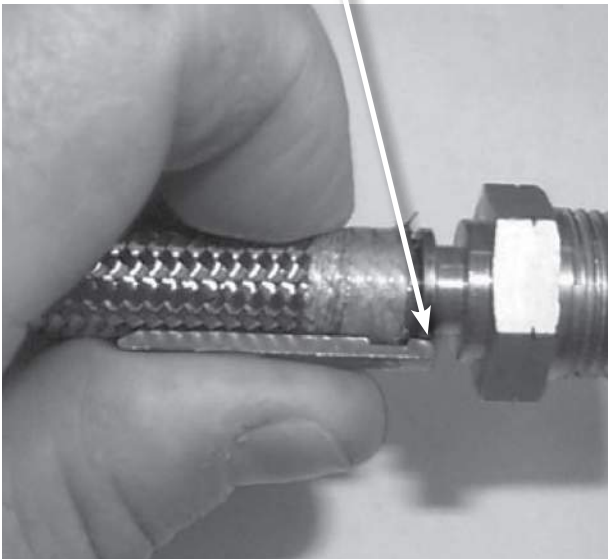
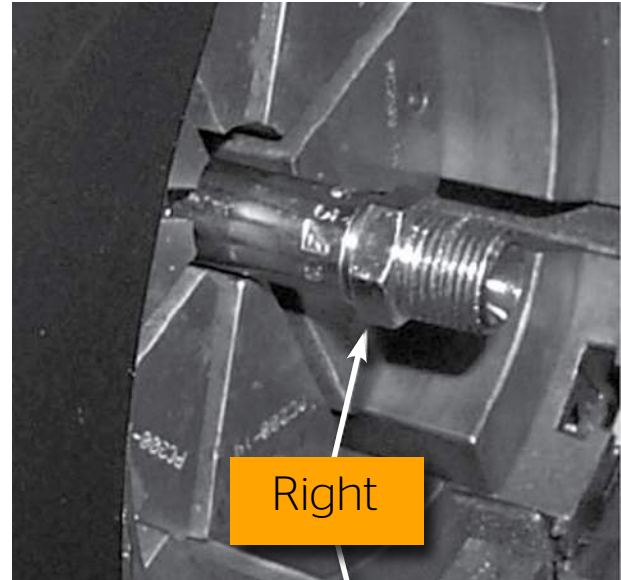
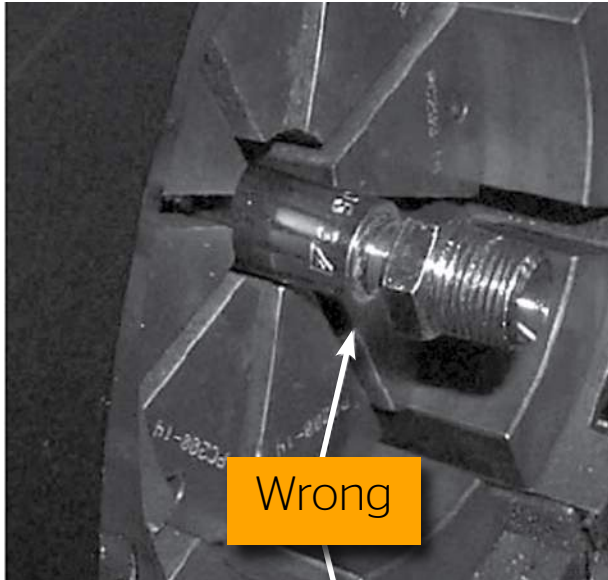

6. Check finished crimp diameter.



Steps in Cool Clip™ A/C Hose Assembly

Special care should be taken when selecting the proper refrigerant hose and fittings. Continental ContiTech Cool-Clip™ fittings should only be used with Continental ContiTech Galaxy® 4890 hose.

Special care must be taken when working with refrigerant systems. Sudden escape of refrigerant gases may result in blindness or severe injury. Continental ContiTech recommends adherence to guidelines and general practices as defined in SAE J2211 for the service containment of HFC-134a as well as all applicable EPA guidelines and procedures concerning the service of refrigerant systems.

Steps in Cool Clip™ A/C Hose Assembly

1. Cut the hose to proper length with the Continental ContiTech hose cutter PN 65090.



The cut must be made squarely to the hose length.

2. Install two proper-sized clips into the clipholder. For ease of assembly, both clips should have the same orientation.



3. Place the clipholder with the two clips on the hose. Install the clipholder so that the end with the smallest hole touches the end of the hose.
4. Lubricate the fitting with a generous amount of the A/C system's lubricator oil. This is to lower the force of the insertion.



5. Insert the fitting into the hose. Ensure that the fitting is fully inserted so that there is no gap between the end of the hose, the clip retainer and the shoulder of the fitting.



6. Close both clips with the Continental ContiTech clip pliers, PN GC-Pliers-0001. The pliers will automatically release when the clips have been completely closed. Start with the clip closer to the end of the hose.



7. Now you have realized a durable hose/fitting connection.



Warning - Selection of Fitting

Selection of the proper Continental ContiTech hose and fittings for the application is essential to the proper operation and safe use of the hose and related equipment. Inadequate attention to the selection of the hose and fitting for the application can result in hose leakage, bursting or other failures which can cause serious bodily injury or property damage from spraying fluids or flying projectiles. Some of the factors involved in the selection of the proper hose and fittings are:

Hose

- › Size › Refrigerant › Pressure › Length › Bends
- › Original Equipment

Fittings

- › Compatibility › Pressure › Temperature › Hose Size
- › Installation Design › Corrosion Requirements

If there are any questions as to what fitting should be used, Continental ContiTech recommends that you consult the local Sales Representative or Continental ContiTech Hydraulics Application Group for assistance.

1. Insert the pressure plate into the bottom flange of the crimper, making sure that it is seated completely into the bottom flange.



2. Select the correct die set for the Galaxy® hose dash size/ ID and "AC" fitting being crimped. Insert the two halves of the die set onto the pressure plate, making sure both halves are flat and level.

Galaxy® Hose # ID	PC125 Die Set
G4826-06 5/16"	PC125-AC06
G4826-08 13/32"	PC125-AC08
G4826-10 1/2"	PC125-AC12
G4826-12 5/8"	PC125-AC12
G4867-14 3/4"	PC125-AC12



Be Sure To:

Lubricate the contact surfaces: both bottom and outside edges of the die fingers, the inside of the compression ring and the pressure plate with the die lubricant provided with the crimper. Only use a molybdenum/graphite high-pressure grease applied sparingly to the contact surfaces. Die lubricant can be obtained from Continental ContiTech using part numbers PC900-Grease (3 oz.) or PC900-Grease (1 lb.) An aerosol lubricant, PC900-AerosolLube, can also be used.

Failure to lubricate the contact surfaces with the correct lubricant will cause the dies to seize in the compression ring, causing damage to the die set as well as possibly damaging the crimper.

3. Place the compression ring loosely but evenly over the die set. Make sure die set is correctly aligned.

4. Slide the pusher in place.



5. Set the micrometer to the setting as shown in the Continental ContiTech Crimp Specification Manual for the combination of hose and fitting being crimped. The metric micrometer (readings of 0 to 10) is a direct reading micrometer. The setting on the micrometer is added to the number in millimeters etched on the die ring to obtain the final crimp diameter. The adjuster, set at "0," is the setting for the die set fully closed. For example, with a 34mm die and the micrometer set at 3.0mm, the finished crimp diameter would be 37.0mm (34mm + 3.0mm).

6. Attach the coupling stop, included with your crimper, to the base of the crimper.



7. Select the appropriate Galaxy® hose size and cut to the correct length using Continental ContiTech Hose Cutting Tool (part #65090). Be sure the hose is cut squarely at a 90-degree angle to the hose.
8. Insert the hose end fully into the ferrule of the corresponding fitting. When completely inserted, the hose should be visible through the witness hole on the side of the ferrule.



9. Insert the hose and fitting through the crimp dies. Align the foot on the coupling stop so that the foot rests on the top of the crimp die and also against the end of the fitting ferrule. Be sure the foot on the coupling stop is against the end of the ferrule and not resting on the bump of the tube above the ferrule.

10. Manually depress the compression ring, closing the die set until the hose and fitting are held loosely in the die set. Seat the compression ring evenly on the die set



CAUTION: The notches on the die set must be completely covered by the compression ring prior to starting the crimp. If the notches are showing, you must go to a larger die set. Crimping with an incorrect die size could result in personal injury.



Each die set has a limited range of diameters for which a satisfactory crimp can be obtained. Always consult the Continental ContiTech Crimp Specification Manual for selecting the correct die set.

11. Recheck the fitting for the correct alignment in the die set and depress the start/stop switch. Hold the start/stop switch until the automatic stop switch shuts the pump off. Release the start/stop switch and allow the pusher to return to the retracted position.



12. Check the crimp diameter of the finished assembly with a caliper or micrometer to be certain that it is within the specifications as outlined in the Continental ContiTech Crimp Specification Manual. The caliper measurement should be taken in the crimp groove between the ridges as shown.

NOTE: To properly measure the crimp diameter on "AC" style fittings, your caliper should be a style having notched blades as shown here:



13. Check the completed assembly to be sure that the hose is still visible through the witness hole on the fitting. Also, the crimp grooves should be centered on the fitting ferrule.



If the crimp grooves are too near the fitting end of the ferrule, or too near the hose end of the ferrule, the fitting may not seal properly and the assembly could leak. If your finished crimp assembly resembles either of the two examples shown below, the end of the ferrule was not properly positioned against the coupling stop foot, or the coupling stop foot was not resting on the top of the die set when crimped. A new assembly should be crimped, being sure to follow the procedures in Step 9.





Installation & Maintenance

Service Life Factors

Hose and hose assemblies have a finite life. There are a number of factors that will reduce hose life. Consideration should be given to the following factors.

1. **Operating Pressure** - The maximum operating pressure within the hose should not exceed the recommended working pressure as specified by Continental ContiTech as shown in the catalog specifications. Hose selection must be made so that the recommended maximum operating pressure is equal to or greater than the system pressure. Burst pressure, which is four times the working pressure, should not be used as the operating pressure of the hose. Exposing the hose to pressures higher than the working pressure is dangerous and will shorten hose life.
2. **Exposing the hose to a surge pressure**, above the working pressure of the hose, will shorten hose life. If surges are severe, select a hose with a higher recommended working pressure.
3. **Burst Pressure** - The burst pressure should never be considered in a hydraulic system design. The burst pressure is for test purposes only. Burst pressure is detrimental to the hose.
4. **Operating Temperatures** - High heat conditions may have an adverse affect on hose due to the degradation of the rubber and the affect on fitting retention. Continuous use at or above the maximum operating temperature of the hose will cause deterioration of the tube, cover and reinforcement, reducing the hose life. Care should be taken to ensure that fluid and ambient temperatures, both static and transient, do not exceed the limitations of the hose. It is important to operate a hose assembly within the specified temperature range of the specific hose.
5. **Bend Radius** - Flexing the hose to less than its recommended minimum bend radius will decrease hose life. Optimize routing to minimize inherent problems.
6. **Excessive external forces** such as flexing, twisting or kinking will reduce hose life. Use the correct fitting or adapter to prevent any unnecessary external force.
7. **Chemical Resistance** - Consider the chemical resistance of the tube, cover and the fitting, including the O-ring, to maximize hose performance and life. Hose selection must assure compatibility of the hose, tube, cover and fittings with the fluid used.
8. The size of the hose assembly components must be adequate to keep pressure losses to a minimum and avoid damage to the hose due to heat generation or excessive turbulence.
9. Extend hose assembly life by making sure hose and fittings are compatible with the environment or sufficiently protected from the elements, such as ultraviolet light, ozone, salt water or chemicals that can cause degradation of assembly components and shorten hose life.
10. A hose is designed with a certain level of abrasion resistance, but care should be taken to avoid excessive abrasion, which can damage the hose cover, accelerating hose failure.
11. Use the proper end fittings and crimp or install to the proper crimp specification to ensure a safe and proper hose assembly. Make sure that hose fittings are compatible with the hose.

Safety Considerations

Fabricators, end users and installers should be aware of the safety factors when handling or when in proximity of hydraulic hose assemblies. The following are some potential conditions that can lead to personal injury and property damage.

1. As certain fluids may permeate the hose cover, the hose should always be used in well-ventilated areas.
2. Hydraulic systems generally operate at very high pressures. Any leak of pressurized fluid can penetrate the skin, causing severe tissue damage and burns. Consider the use of guards or shields around the hose assembly to reduce the risk of injury.
3. Whipping Hose – Under high operating pressures, the hose and/or fitting can come loose or blow, causing the end of the hose to whip with great force. Again, the hose assembly should be shielded or guarded, even possibly secured, to avoid injury or damage from this whipping action.
4. Hydraulic fluids are flammable and can explode with a source of ignition. To avoid possible injury or property damage, care should be taken to eliminate ignition sources and to properly route the hose assembly to minimize the chance of combustion.
5. Most all hose is conductive. In some cases a non-conductive hose is required. To avoid electrocution or other serious mishap, the correct hose specification, either conductive or nonconductive, should be used.
6. Should a hydraulic hose assembly fail, loss of hydraulic pressure will affect the operation of equipment. Care should be taken that a sudden power loss of the equipment will not cause personal injury.
7. When air or gaseous materials are being conveyed, the correct hose should be used. A pin-perforated cover may be required. Perforations in the cover will prevent permeated gases from accumulating and blistering the cover. Check Continental ContiTech for the correct hose specification.
8. Extreme care should be used when operating handheld hydraulic tools where the operator is in proximity to the hydraulic hose assembly. The following steps should be taken to avoid injury.
 - a. Use strain relievers on each end of the hose to prevent kinking, excessive bending or stress on the hose at the coupling.
 - b. Never use the hose assembly to pull or carry the tool.
 - c. Exposed hose near the operator should be guarded in case hose assembly fails, to prevent injury from high pressure or high temperature fluid.
 - d. Operators of the tool should be protected with the required safety clothing, considering the job and fluids being used.
 - e. The hose should be protected against any external damage.
9. Hose assemblies should be properly routed to avoid strain and the possibility of the hose bursting. Proper routing will also protect the assembly against flex fatigue, excessive heat or abrasion.
10. When selecting a hose style and assembly, check for hose compliance to all relevant government, industry and safety standards or regulations.

Proper Installations & Hose Routing

Proper Hose Installation

Warning: Improper selection, installation or maintenance of a hose assembly may result in premature failures, bodily injury or property damage.

The following practices should be used when replacing a hydraulic hose assembly or installing a new hydraulic assembly.

1. A pre-installation inspection should include the following:
 - a. Check to ensure the hose is the correct specification in style, size and length.
 - b. Check that the hose assembly has no visible non-conformity.
 - c. Check fittings for any damage including nicks or burrs.
 - d. Check that the hose is routed properly using suggested guidelines.
 - e. Check that the hose is not damaged (kinked, crushed, twisted).
2. Handle assembly with care. Avoid bending hose beyond the recommended bend radius.
3. Hose assemblies should not be installed in a torqued or twisted condition.
4. Use necessary restraints and protective devices when necessary to reduce wear and stress points on the assembly.

Correct Assembly Installation & Routing

Satisfactory performance and appearance depend upon proper hose installation. Excessive length destroys the trim appearance of an installation and adds unnecessarily to the cost of the equipment. Hose assemblies of insufficient length to permit adequate flexing, expansion or contraction will cause poor power transmission and shorten the life of the hose.

The diagrams below offer suggestions for proper hose installations to obtain the maximum in performance and economy.

Since hose may change in length from +2% to -4% under the surge of high pressure, provide sufficient slack for expansion and contraction.

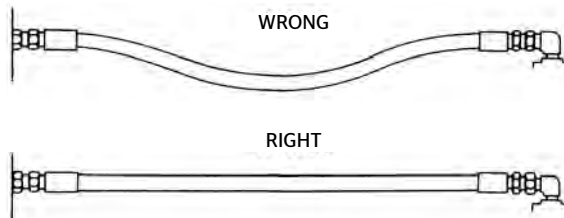

Obtain direct routing of the hose through use of 45° and 90° adapters and fittings. Improve appearance by avoiding excessive hose length.

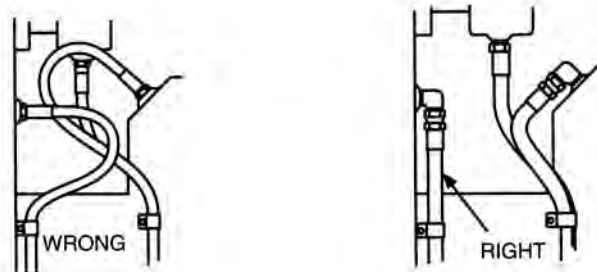

Avoid sharp twist or bend in hose by using proper angle adapters compatible with the hose.

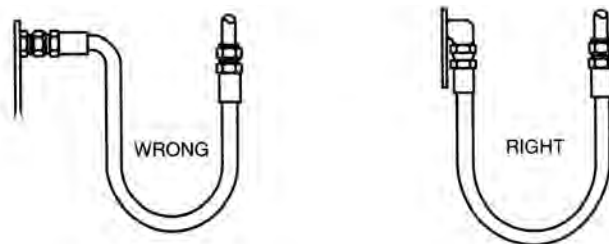

Proper Installation & Hose Routing

Due to changes in length when the hose is pressurized, do not clamp at bends so the curves can absorb changes and protect the hose with a spring guard. Do not clamp high and low pressure lines together, and protect the hose with a spring guard.

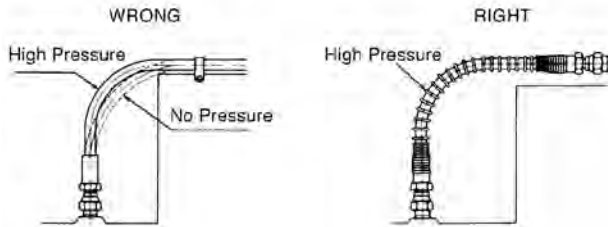

Where the radius falls below the required minimum, an angle adapter should be used as shown on previous page to avoid sharp bends in the hose.

Adequate hose length is most important to distribute movement on flexing applications and to avoid abrasion.

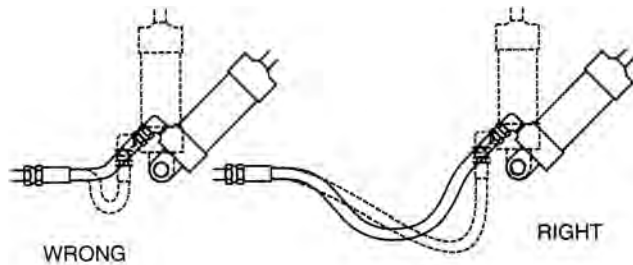

To avoid twisting in hose lines bent in two planes, clamp hose at change of plane, as shown.

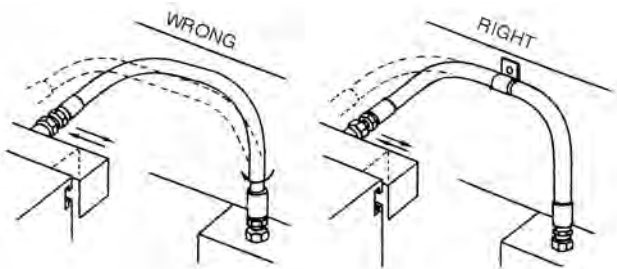

Hose should not be twisted. Hose is weakened when installed in a twisted position. Also, pressure in twisted hoses tend to loosen fitting connections. Design so that machine motion produces bending rather than twisting.

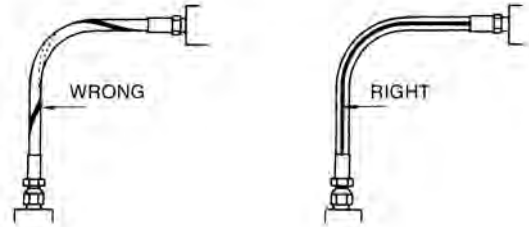

To prevent twisting and distortion, the hose should be bent in the same plane as the motion of the boss to which the hose is connected.

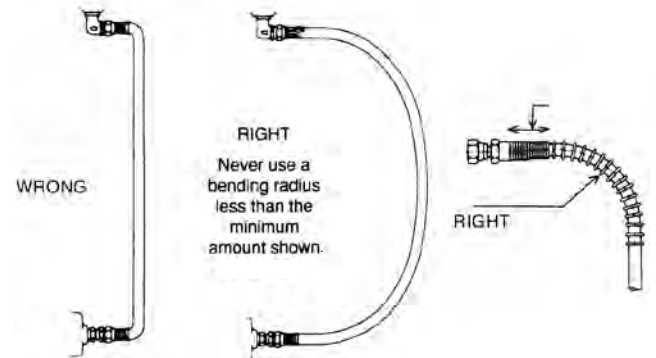

Never use a bending radius less than the minimum shown in the hose specification tables. To reduce collapsing of line and restriction of flow, avoid a sharp bend in the hose by using proper spring guard. Exceeding minimum bend radius will greatly reduce hose assembly life.

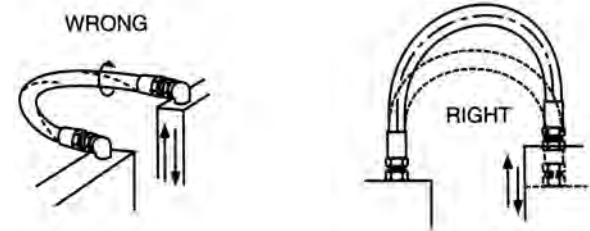

Hose Maintenance & Storage

Hose Maintenance

A hose and fitting maintenance program can reduce equipment downtime and maintain peak operating performance of the hydraulic system. Here are a few maintenance reminders.

1. Hose assemblies should be inspected on a regular basis with frequency based on prior history of the equipment, a set maintenance/inspection program, and the severity of the application or risk potential.
2. Always use Safety Considerations (page 618) when inspecting hose assemblies. To avoid personal injury during system checkouts, do not touch the assembly and be aware of the potentially hazardous area surrounding the hose assembly.
3. Inspect hose and fittings for the following:
 - a. Exposed, broken or corroded reinforcement wires.
 - b. Leaks in the hose or at the fitting.
 - c. Cracked, damaged or corroded fittings.
 - d. Other signs of significant deterioration.

If any of the above conditions exist, the hose assembly should be replaced immediately.

4. The hydraulic system should also be inspected for the following:
 - a. Leaking ports.
 - b. Damaged or missing hose clamps, guards or shields.
 - c. Excessive dirt or grease on the assembly.
 - d. Condition of system fluid, fluid temperature, contamination and air entrapment.

If any of the above conditions are found, appropriate corrective action should be taken.

5. Functional tests should be conducted to determine if systems are leak-free and operating properly.

6. If hose assembly can be inspected and detached from the hydraulic system, additional steps can be taken to ensure a properly maintained assembly.
 - a. With hose assembly detached, clean assembly by blowing out with clean, compressed air or rinsed with a compatible cleaning fluid.
 - b. Inspect hose tube for cuts, obstructions and cleanliness.
 - c. Check layline of the hose to make sure the hose is not twisted.
 - d. Check fittings to ensure they are in good condition and properly crimped or attached to the assembly.

If any of the above conditions are found, the hose assembly should be replaced.

7. The hose assembly should be hydrostatically tested, using the approved test stands and procedures as outlined in SAE J517. Test at proof pressure, or twice the working pressure of the hose, for 30 seconds to one minute. When test pressure is reached, visually inspect the hose for any signs of weakness, leaks or any hose movement relative to the fitting that would indicate a loose fitting. If any of these conditions exist, the assembly should be replaced.
8. Specific hose assembly replacement intervals must be considered based on previous service life, government or industry recommendations, or when failures could result in injury risk or property damage.

Hose Storage

Temperature, humidity, ozone, sunlight, oils, solvents, corrosive liquids, insects, rodents and radioactive materials can adversely effect hose products. Hose should be stored in a dark, dry atmosphere away from heat sources, electrical equipment and the above adverse elements. The ideal storage temperature for rubber hose is 50°F to 70°F (10°C to 21.1°C), with a maximum of 100°F (37.8°C).



Appendix

Fitting Identification

Measuring Threads and Seat Angles

Tools required: ID/OD Calipers, Seat Angle Gauge (English and Metric), Thread Pitch Gauge

Measuring Threads

A caliper is used to measure the OD of male threads and the ID of female threads. Measure at the largest point. In some cases, threads may be worn, and the exact measurement taken may not match exactly to the thread charts. For accuracy, it is recommended the male thread be measured.

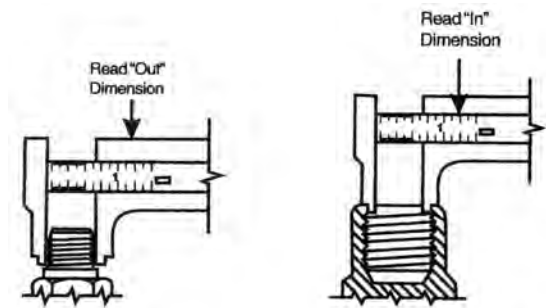

Measuring Seat Angle

A Seat Angle Gauge is used to measure the angle of the sealing surface. For either male or female fittings, place the gauge on the sealing surface. An accurate reading is taken when the gauge is parallel to the centerline of the coupling.

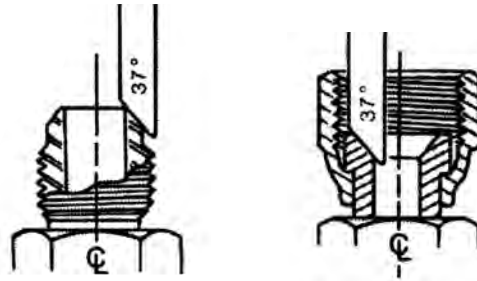

Measuring Thread Pitch

A Thread Pitch Gauge is used to determine the number of threads per inch or the distance between threads in a metric connection. To ensure an accurate reading, make sure the fit of the thread gauge is snug.

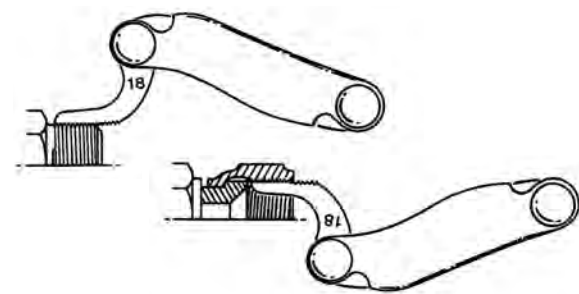

Compare Measurements to the Tables

ID/OD measurements, thread pitch and seat angle will be used to identify the fitting. Measurements taken can be used to compare with the dimensions found on charts in the following pages.

As an example, a fitting will be defined as: Continental ContiTech B2-NPMX-0606 with 3/8-18 threads.

From the hydraulic catalog, the fitting can be identified as a NPTF/MALE/Swivel.

The -6 fitting has 3/8-18 threads, which can be identified using calipers, thread gauge and the following tables.

Fitting Identification

Fitting Standards

There are five basic fitting standards. They are identified as North American, British, French, German and Japanese.

North American Thread Types

Also known as American Dryseal Pipe Threads, the thread types include NPTF, NPSF and NPSM.

N - National
F - Fuels
T - Tapered Thread
S - Straight Thread
P - Pipe
M - Mechanical Joint

Pipe threads can be either straight or tapered. The first step in identifying this fitting is to determine if the thread is parallel (straight) or tapered.

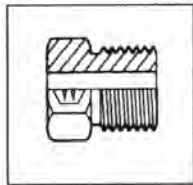

Parallel Threads

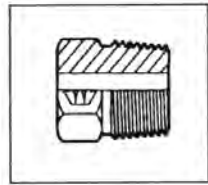

Tapered Threads

A straight thread is not used for sealing fluids. In this type of fitting, a seal is achieved with an O-ring, a metal seal, or a seat machined into the end of the fitting. A straight thread can be determined by laying a straightedge against the threads. If all the threads are parallel to the centerline of the fitting, then it is a straight thread.

A tapered thread seals by the interference in the engagement of the male and female threads. These threads deform when they are tightened, causing metal deformation and a pressure-tight joint. Thread sealants are commonly used in this connection. A tapered thread can be determined by laying a straightedge against the threads. If the straightedge is not parallel to the centerline of the fitting and the threads taper towards the centerline of the fitting, then it is a tapered thread.

A fitting may also be referred to by its Dash number. The Dash number is a universal abbreviation for sizing pipe systems. The following charts will show a Dash number for each fitting. The Dash number comes from the dimension of the port of the fitting. It is the dimension in 1/16 of an inch. A 3/8" port would be 6/16" or a Dash 6 (-6).

Inch	1/16	SAP #
1/8	2/16	-2
1/4	4/16	-4
3/8	6/16	-6
1/2	8/16	-8
3/4	12/16	-12
1	16/16	-16
1¼	20/16	-20
1½	24/16	-24
2	32/16	-32

NPTF

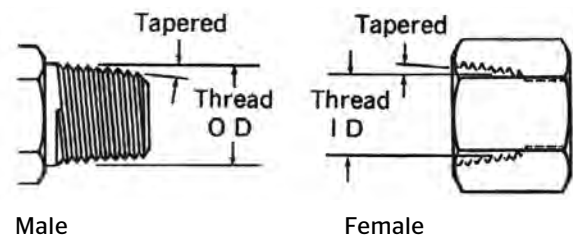

Male

Female

Identification

National Pipe Tapered Fuels. Tapered thread.

Seal

The thread is tapered and sealing takes place with the deformation of the threads. The NPTF male has a 30-degree seat and will mate with the NPTF female, also with tapered threads, but no seat. A thread sealant is commonly used. An NPTF male with 30-degree seat will mate with an NPSM female, which has straight threads and a 30-degree inverted seat. The sealing takes place on the 30-degree seat.

Application

The NPTF fitting is a dryseal thread, commonly used in fluid power systems but not recommended by the National Fluid Power Association for hydraulic applications.

Fitting Identification

Fitting Standards

NPSM

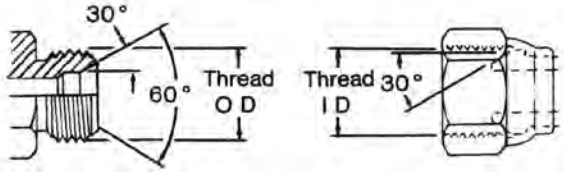

Male

Female

Identification

National Pipe Straight Mechanical. Straight thread.

Seal

Both male and female have a straight thread and 30-degree seat and chamfer. The seal takes place by compression of the 30-degree seat on the chamfer. The threads hold the connection mechanically.

Application

Used in fluid power systems.

Thread Identification Table

NPTF/NPSF/NPSM

Dash Size	Nominal Size	Thread Size	Female Thread ID	Male Thread OD
	in.		in.	in.
-2	1/8	1/8 - 27	23/64	13/32
-4	1/4	1/4 - 18	15/32	35/64
-6	3/8	3/8 - 18	19/32	43/64
-8	1/2	1/2 - 14	3/4	27/32
-12	3/4	3/4 - 14	61/64	11/16
-16	1	1 - 11½	1 ¹³ / ₆₄	1 ⁵ / ₁₆
-20	1¼	1¼ - 11½	1 ¹⁷ / ₃₂	1 ⁴³ / ₆₄
-24	1½	1½ - 11½	1 ²⁵ / ₃₂	1 ²⁹ / ₃₂
-32	2	2 - 11½	2¼	2 ³ / ₈

SAE Thread Types

JIC 37° Flare (SAE J514)

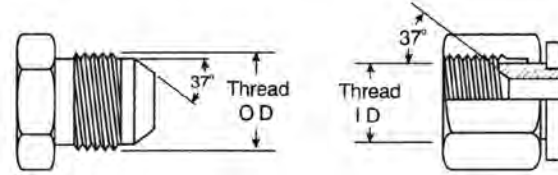

Male

Female

Identification

Straight threads. Both male and female have 37-degree seat.

Seal

The seal is made on the 37-degree flare seat. The threads hold the connection mechanically. Only connect male SAE 37 with female SAE 37.

Application

SAE specifies use with high-pressure hydraulic tubing.

Thread Identification Table

JIC 37° Flare

Dash Size	Nominal Size	Thread Size	Female Thread ID	Male Thread OD
	in.		in.	in.
-2	1/8	5/16-24	17/64	5/16
-3	3/16	3/8-24	21/64	3/8
-4	1/4	7/16-20	25/64	7/16
-5	5/16	1/2-20	29/64	1/2
-6	3/8	9/16-18	1/2	9/16
-8	1/2	3/4-16	11/16	3/4
-10	5/8	7/8-14	13/16	7/8
-12	3/4	1 ¹ / ₁₆ -12	31/32	1 ¹ / ₁₆
-14	7/8	1 ³ / ₁₆ -12	1 ⁷ / ₆₄	1 ³ / ₁₆
-16	1	1 ⁵ / ₁₆ -12	1 ¹⁵ / ₆₄	1 ⁵ / ₁₆
-20	1¼	1 ⁵ / ₈ -12	1 ³⁵ / ₆₄	1 ⁵ / ₈
-24	1½	1 ⁷ / ₈ -12	1 ⁵¹ / ₆₄	1 ⁷ / ₈
-32	2	2½-12	2 ²⁷ / ₆₄	2½

Fitting Identification

Fitting Standards

SAE 45° Flare (SAE J512)

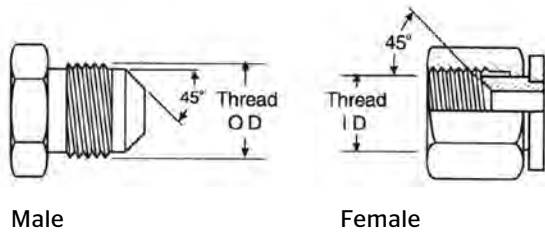

Identification

Straight threads. Both male and female have 45-degree seat.

Seal

The seal is made on the 45-degree flare seat. The threads hold the connection mechanically. Only connect male SAE 45 with female SAE 45.

Application

Commonly used in low-pressure, refrigeration and automotive piping systems and are frequently constructed of brass and connected to copper tubing.

Comments

Use caution when identifying this fitting as the threads are the same as SAE J512 37-degree (JIC), in -2, -3, -4, -5, -8 and -10 sizes. The sealing surface angles are different, however.

Thread Identification Table

SAE 45° Flare

Dash Size	Nominal Size	Thread Size	Female Thread ID	Male Thread OD
	in.		in.	in.
-2	1/8	5/16-24	17/64	5/16
-3	3/16	3/8-24	21/64	3/8
-4	1/4	7/16-20	25/64	7/16
-5	5/16	1/2-20	29/64	1/2
-6	3/8	5/8-18	9/16	5/8
-7	7/16	11/16-16	5/8	11/16
-8	1/2	3/4-16	11/16	3/4
-10	5/8	7/8-14	13/16	7/8
-12	3/4	1 1/16-14	63/64	1 1/16

O-Ring Boss Straight Thread (SAE J514)

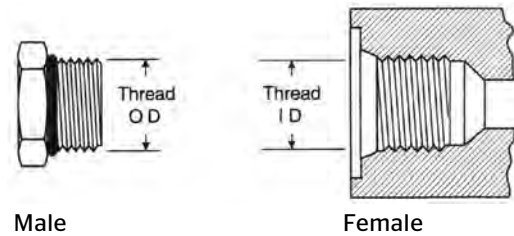

Identification

Male fitting has a straight thread and an O-ring. The female port has a straight thread and a chamfer to accept the O-ring.

Seal

The seal takes place by compressing the O-ring into the chamfer. The threads hold the connection mechanically. Only connect O-ring boss male with O-ring boss female.

Application

Recommended by the National Fluid Power Association for optimal leakage control in medium- and high-pressure hydraulic systems.

Thread Identification Table

Straight Thread O-Ring Boss

Dash Size	Nominal Size	Thread Size	Female Thread ID	Male Thread OD
	in.		in.	in.
-2	1/8	5/16-24	17/64	5/16
-3	3/16	3/8-24	21/64	3/8
-4	1/4	7/16-20	25/64	7/16
-5	5/16	1/2-20	29/64	1/2
-6	3/8	9/16-18	1/2	9/16
-8	1/2	3/4-16	11/16	3/4
-10	5/8	7/8-14	13/16	7/8
-12	3/4	1 1/16-12	31/32	1 1/16
-14	7/8	1 3/16-12	1 7/64	1 3/16
-16	1	1 5/16-12	1 15/64	1 5/16
-20	1 1/4	1 5/8-12	1 35/64	1 5/8
-24	1 1/2	1 7/8-12	1 51/64	1 7/8
-32	2	2 1/2-12	2 27/64	2 1/2

Fitting Identification

Fitting Standards

O-Ring Face Seal (SAE J1453 ORS/ORFS)

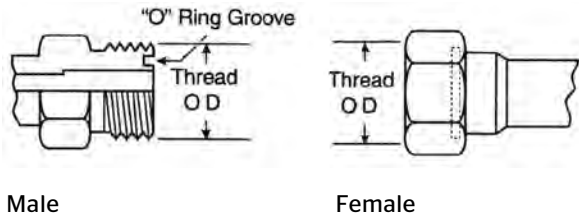

Identification

Male fitting has a straight thread and an O-ring. Female has a straight thread and a machined flat face.

Seal

The seal takes place by compressing the O-ring onto the flat face of the female. The threads hold the connection mechanically.

Application

Fittings are intended for hydraulic systems where elastomeric seals are accepted to overcome leakage and leak resistance. This connection offers the very best leakage control.

Thread Identification Table

O-Ring Face Seal (ORFS)

Dash Size	Nominal Size	Thread Size	Female Thread ID	Male Thread OD
	in.		in.	in.
-4	1/4	9/16-18	1/2	9/16
-6	3/8	11/16-16	5/8	11/16
-8	1/2	13/16-16	3/4	13/16
-10	5/8	1-14	15/16	1
-12	3/4	1 3/16-12	1 1/8	1 3/16
-16	1	1 7/16-12	1 11/32	1 7/16
-20	1 1/4	1 11/16-12	1 19/32	1 11/16
-24	1 1/2	2-12	1 29/32	2

SAE J514 Flareless Tube Fitting

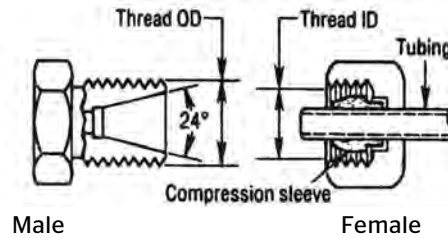

Identification

Male and female have straight threads. Male has 24-degree seat.

Seal

Female includes a compression sleeve for the sealing surface. A seal is formed with the compression sleeve as the female nut is tightened onto the male thread. A seal is formed between the compression sleeve, the male 24-degree seat and tubing.

Application

Used to adapt steel tubing to a hydraulic hose assembly.

Thread Identification Table

Flareless Tube Fitting

Dash Size	Tube Size	Nominal Size	Thread Size	Female Thread ID	Male Thread OD
	in.		in.	in.	in.
-2	1/8	5/16	5/16-24	17/64	5/16
-3	3/16	3/8	3/8-24	21/64	3/8
-4	1/4	7/16	7/16-20	25/64	7/16
-5	5/16	1/2	1/2-20	29/64	1/2
-6	3/8	9/16	9/16-18	1/2	9/16
-8	1/2	3/4	3/4-16	11/16	3/4
-10	5/8	7/8	7/8-14	13/16	7/8
-12	3/4	1 1/16	1 1/16-12	31/32	1 1/16
-14	7/8	1 3/16	1 3/16-12	17/64	1 3/16
-16	1	1 5/16	1 5/16-12	1 15/64	1 5/16
-20	1 1/4	1 5/8	1 5/8-12	1 35/64	1 5/8
-24	1 1/2	1 7/8	1 7/8-12	1 51/64	1 7/8
-32	2	2 1/2	2 1/2-12	2 27/64	2 1/2

Fitting Identification

Fitting Standards

Code 61/Code 62/Caterpillar® Flange (SAE J518)

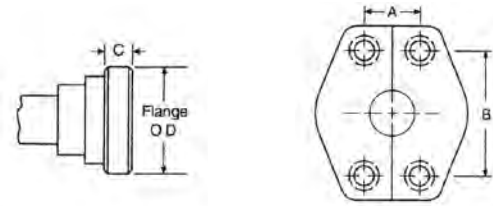

Male

4-Bolt Split Flange

Identification

The female port is an unthreaded hole surrounded with 4 bolt holes in a rectangular pattern. The male consists of a flanged head, grooved for an O-ring and a flange with holes to match the port.

Seal

The seal takes place on the O-ring, which is compressed between the flanged head and the flat surface surrounding the port. The threaded bolts hold the connection mechanically.

Application

Commonly used in fluid power systems, worldwide, and usually in connection on pumps and motors. The fitting is available in two pressure ratings. Code 61, Form R, PN 35/350 bar, Type I is referred to as the “standard” series and can withstand an operating pressure of 3,000–5,000 psi depending on size. Code 62, Form S, PN 415 bar Type II is the heavy-duty, 6,000 psi series. While the design is the same, bolt hole spacing and flanged head diameters are larger for the higher pressure. Code 62 fitting.

Comments

SAE J518, DIN 20066, ISO/DIS 6162 and JIS B 8363 are interchangeable except for the bolt sizes. The -10 is not available as an SAE standard size. Caterpillar® flanges, which have the same flange OD as SAE Code 62, have a thicker flange head, which is the “C” dimension in the table.

How to Measure

1. Measure port hole diameter [nominal flange size (in.)] using calipers.
2. Measure the longest bolt hole spacing from center to center, which is Dimension “B.”
3. Or the flange OD for further identification.

Thread Identification Table

Code 61/Code 62/CAT®

Nominal Flange Size	Code 61			
in.	Flange OD	A	B	C
1/2	1.188	0.688	1.500	0.265
5/8	1.345			0.265
3/4	1.500	0.875	1.875	0.265
1	1.750	1.031	2.062	0.315
1¼	2.000	1.188	2.312	0.315
1½	2.375	1.406	2.750	0.315
2	2.812	1.688	3.062	0.375
2½	3.312	2.000	3.500	0.375
3	4.000	2.438	4.188	0.375
3½	4.500	2.750	4.750	0.422
4	5.000	3.062	5.125	0.442
5	6.000	3.625	6.000	0.442

Nominal Flange Size

in.	Flange OD	A	B	C
1/2	1.250	0.718	1.594	0.305
3/4	1.625	0.937	2.000	0.345
1	1.875	1.093	2.250	0.375
1¼	2.125	1.250	2.625	0.405
1½	2.500	1.437	3.125	0.495
2	3.125	1.750	3.812	0.495

Nominal Flange Size

in.	Flange OD	A	B	C
3/4	1.625	0.938	2.000	0.560
1	1.875	1.094	2.250	0.560
1¼	2.125	1.250	2.625	0.560
1½	2.500	1.438	3.125	0.560
2	3.125	1.750	3.812	0.560

Fitting Identification

Fitting Standards

SAE 45° Inverted Flare (SAE J512)

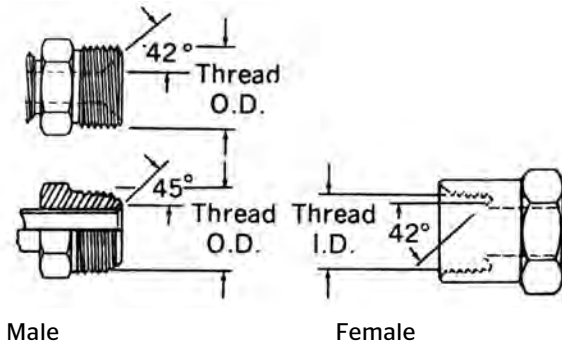

Identification

Male fitting, with a straight thread, can either be a 45-degree flare as a tube fitting or a 42-degree seat as a machined adapter. The female has a straight thread and a 42-degree inverted flare.

Seal

The seal takes place on the flared surfaces. The threads hold the connection in place mechanically.

Application

Fitting is frequently used in automotive systems.

Thread Identification Table

Table: SAE 45° Inverted Flare

Dash Size	Nominal Size	Thread Size	Female Thread ID	Male Thread OD
	in.		in.	in.
-2	1/8	5/16-28	9/32	5/16
-3	3/16	3/8-24	21/64	3/8
-4	1/4	7/16-24	25/64	7/16
-5	5/16	1/2-20	29/64	1/2
-6	3/8	5/8-18	37/64	5/8
-7	7/16	11/16-18	5/8	11/16
-8	1/2	3/4-18	45/64	3/4
-10	5/8	7/8-18	13/16	7/8
-12	3/4	1 1/16-16	1	1 1/16

SAE J1467 Clip Fastener

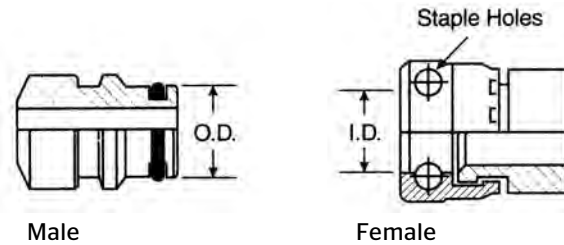

Identification

The male has an external O-ring with a groove to accept a clip. The female has a smooth bore with two holes to accept a "U" shaped clip. With the male fitting inserted into the female fitting, a clip is inserted through the two holes, locking the connection together.

Seal

The seal is formed between the O-ring on the male fitting and the smooth bore of the female fitting.

Application

Commonly used for hydraulic application in underground mines.

Thread Identification Table

SAE J1467 Clip Fastener

Dash Size	Nominal Size	Female Thread ID	Male Thread OD
	in.	in.	in.
-4	1/4	19/32	19/32
-6	3/8	5 1/64	25/32
-8	1/2	6 1/64	15/16
-12	3/4	1 9/64	1 9/64
-16	1	1 35/64	1 7/32
-20	1 1/4	1 13/16	1 13/16
-24	1 1/2	2 11/64	2 5/32
-32	2	2 17/32	2 33/64

Fitting Identification

Fitting Standards

British Thread Types

BSPT (British Standard Pipe Tapered)

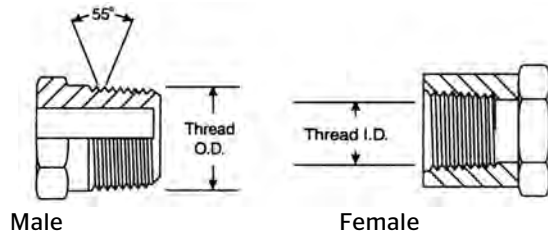

Identification

The British Standard Pipe Tapered is very similar to the NPTF fitting. Male fitting has a tapered thread. BSP threads are also known as Whitworth threads.

Seal

The BSPT male can be connected with a BSPT female or BSPP female. In either case, the seal is made within the threads through thread distortion. A thread sealant is recommended.

Comments

The BSPT fitting, although similar to the NPTF fitting, is not interchangeable. The thread pitch is different in most cases and the thread angle is 55 degrees for the BSPT, versus the 60 degrees found on NPTF threads.

BSPP (British Standard Pipe Parallel)

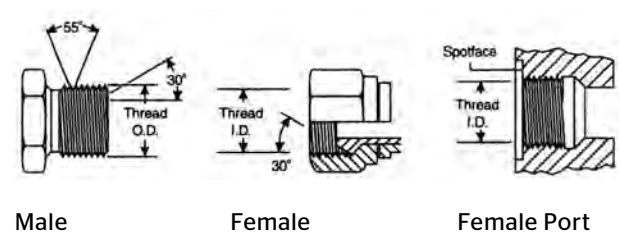

Identification

The British Standard Pipe Parallel would be similar to the NPSM fitting. BSP threads are also known as Whitworth threads.

Seal

The BSPP male will connect with the BSPP female or female port. Both male and female have a straight thread and 30-degree seat and chamfer. The seal takes place by compression of the 30-degree seat on the chamfer. The threads hold the connection mechanically.

Comments

The BSPP fitting, although similar to the NPSM fitting, is not interchangeable. The thread pitch is different in most cases and the thread angle is 55 degrees for the BSPP, versus the 60 degrees found on NPSM threads.

Thread Identification Table

BSPT and BSPP

Dash Size	Nominal Size	Thread Size	Female Thread ID	Male Thread OD
	in.		in.	in.
-2	1/8	1/8-28	11/32	3/8
-4	1/4	1/4-19	15/32	17/32
-6	3/8	3/8-19	19/32	21/32
-8	1/2	1/2-14	3/4	13/16
-10	5/8	5/8-14	13/16	29/32
-12	3/4	3/4-14	31/32	1 1/32
-16	1	1-11	1 7/32	1 11/32
-20	1 1/4	1 1/4-11	1 17/32	1 21/32
-24	1 1/2	1 1/2-11	1 25/32	1 7/8
-32	2	2-11	2 7/32	2 11/32

Fitting Identification

Fitting Standards

French Thread Types

Millimetric and GAZ 24°

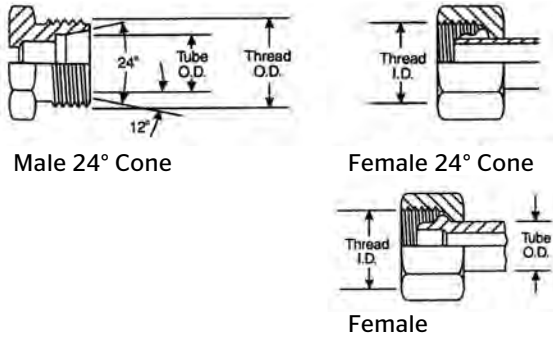

Male 24° Cone

Female 24° Cone

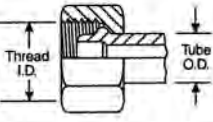

Female

Identification

GAZ fittings have a 24-degree seat and straight, metric threads. While similar to DIN fittings, the French use fine threads on all sizes while the DIN fitting may have a coarse thread on the larger sizes.

Seal

The French Metric (GAZ) male with 24-degree seat will mate with the female, 24-degree cone or the female tube fitting.

Comments

The Millimetric Series is used with whole number metric OD tubing and the GAZ Series is used with fractional number metric OD pipe size tubing.

Thread Identification Table

French Metric Millimetric

Metric Thread	Female Thread ID		Male Thread OD		Tube OD	
	mm.	in.	mm	in.	mm	in.
M 12 x 1	11.0	0.43	12.0	0.47	6	0.24
M 14 x 1½	12.5	0.49	14.0	0.55	8	0.31
M 16 x 1½	14.5	0.57	16.0	0.63	10	0.39
M 18 x 1½	16.5	0.65	18.0	0.71	12	0.47
M 20 x 1½	18.5	0.73	20.0	0.79	14	0.55
M 22 x 1½	20.5	0.81	22.0	0.87	15	0.59
M 24 x 1½	22.5	0.89	24.0	0.94	16	0.63
M 27 x 1½	25.5	1.00	27.0	1.06	18	0.71
M 30 x 1½	28.5	1.12	30.0	1.18	22	0.87
M 33 x 1½	31.5	1.24	33.0	1.30	25	0.98
M 36 x 1½	34.5	1.36	36.0	1.42	28	1.10
M 39 x 1½	37.5	1.48	39.0	1.54	30	1.18
M 42 x 1½	40.5	1.59	42.0	1.65	32	1.26
M 45 x 1½	43.5	1.71	45.0	1.77	35	1.38
M 48 x 1½	46.5	1.83	48.0	1.89	38	1.50
M 52 x 1½	50.5	1.99	52.0	2.05	40	1.57
M 54 x 2	51.9	2.04	54.0	2.13	45	1.77

Thread Identification Table

French Metric GAZ 24° Cone

Dash Size	Metric Thread	Female Thread ID		Male Thread OD		Tube OD	
		mm	in.	mm	in.	mm	in.
-6	M 20 X 1.5	18.5	0.73	20.0	0.78	13.25	0.52
-8	M 24 X 1.5	22.5	0.89	24.0	0.94	16.75	0.66
-10	M 30 X 1.5	28.5	1.12	30.0	1.18	21.25	0.83
-12	M 36 X 1.5	34.5	1.36	36.0	1.41	26.75	1.05
-16	M 45 X 1.5	43.5	1.71	45.0	1.77	33.50	1.32
-20	M 52 X 1.5	50.5	1.99	52.0	2.04	42.25	1.66

GAZ Poclairn 24° Flange

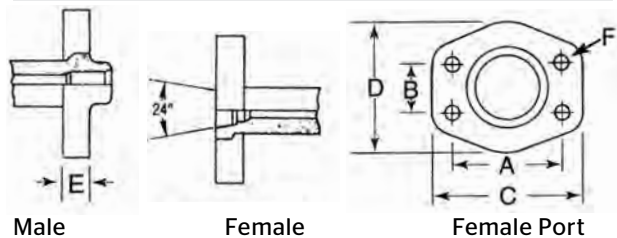

Male

Female

Female Port

Identification

Usually found on Poclairn equipment. The Poclairn flange with a 24-degree seat is different from an SAE flange in that there is a lip that protrudes from the flange face.

Seal

The male flange will connect with a female flange or port. The seal is made on the 24-degree seat.

Thread Identification Table

GAZ Poclairn 24° Flange

Nominal Size

in.	A	B	C	D	E	F
1/2	1.57	0.72	2.20	1.89	0.55	0.35
5/8	1.57	0.72	2.20	1.89	0.55	0.35
3/4	2.00	0.94	2.75	2.38	0.71	0.43

Fitting Identification

Fitting Standards

German Thread Types

DIN 2353 24° Cone

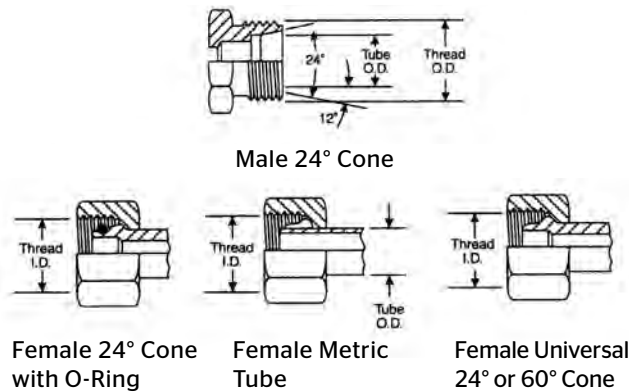

Identification

Both male and female have straight metric threads. The male has a 24-degree seat and a recessed counter bore which matches the tube OD used with it. The female can be any of three styles including a 24-degree cone with an O-ring, a metric tube fitting, or a universal 24- or 60-degree cone. Use a 12-degree gauge to measure seat angle as the dimension is taken from the fitting centerline.

Seal

Sealing takes place between the 24-degree seat in the male end and the respective sealing area in the female end.

Comments

There is a light and heavy version of this coupling. Proper identification is made by measuring the thread size and tube OD. The heavy-duty version has a smaller tube OD than the light-duty version, but has a thicker wall section.

Thread Identification Table

DIN 2353 24° Cone

Metric Thread	Female Thread ID		Male Thread OD		Tube OD Light Series		Tube OD Heavy Series	
	mm	in.	mm	in.	mm	in.	mm	in.
M 12 x 1½	10.5	0.41	12	0.47	6	0.24		
M 14 x 1½	12.5	0.49	14	0.55	8	0.31	6	0.24
M 16 x 1½	14.5	0.57	16	0.63	10	0.39	8	0.31
M 18 x 1½	16.5	0.65	18	0.71	12	0.47	10	0.39
M 20 x 1½	18.5	0.73	20	0.79			12	0.47
M 22 x 1½	20.5	0.81	22	0.87	15	0.59	14	0.55
M 24 x 1½	22.5	0.89	24	0.94			16	0.63
M 26 x 1½	24.5	0.96	26	1.02	18	0.71		

DIN 2353 24° Cone (Continued on next column)

DIN 2353 24° Cone (Continued)

Metric Thread	Female Thread ID		Male Thread OD		Tube OD Light Series		Tube OD Heavy Series	
	mm	in.	mm	in.	mm	in.	mm	in.
M 30 x 2	28.5	1.12	30	1.18	22	0.87	20	0.79
M 36 x 2	33.9	1.33	36	1.42	28	1.10	25	0.98
M 42 x 2	39.9	1.57	42	1.65			30	1.18
M 45 x 2	42.9	1.69	45	1.77	35	1.38		
M 52 x 2	49.9	1.96	52	2.05	42	1.65	38	1.50

DIN 3863 60° Cone

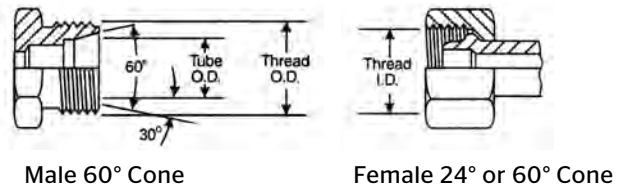

Identification

Both male and female have straight metric threads. Use a 30-degree gauge to measure seat angle as this dimension is taken from the fitting centerline.

Seal

The male has a 60-degree seat. The female has a 24- or 60-degree seat. The seal takes place by contact between the 60-degree seat in the male end and the respective sealing area in the female end.

Thread Identification Table

DIN 3863 60° Cone

Metric Thread	Female Thread ID		Male Thread OD		Tube OD 60° Cone	
	in.	mm	in.	mm	mm	in.
M 12 x 1½	10.5	0.41	12	0.47	6	0.24
M 14 x 1½	12.5	0.49	14	0.55	8	0.31
M 16 x 1½	14.5	0.57	16	0.63	10	0.39
M 18 x 1½	16.5	0.65	18	0.71	12	0.47
M 22 x 1½	20.5	0.81	22	0.87	15	0.59
M 26 x 1½	24.5	0.96	26	1.02	18	0.71
M 30 x 2	28.5	1.12	30	1.18	22	0.87
M 38 x 2	36.5	1.44	38	1.50	28	1.10
M 45 x 2	43.5	1.71	45	1.77	35	1.38
M 52 x 2	50.5	1.99	52	2.05	42	1.65

Fitting Identification

Fitting Standards

DIN 3852 Types A&B

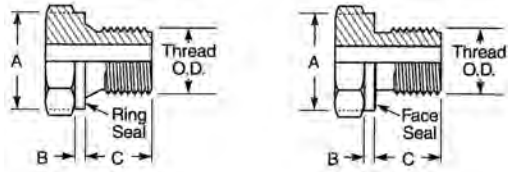

Male Type A

Male Type B

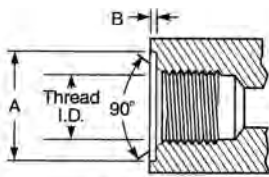

Female Types A & B

Identification

Both male and female, type A (light duty) and type B (heavy duty) have straight threads.

Seal

The seal occurs when the ring seal in type A or the face seal in type B connects with the face of the female port.

Thread Identification Tables

DIN 3852 Types A&B

Male Metric Thread Parallel

	Tube OD	Metric Thread Size	Thread OD	A	B	C
	mm	mm	mm	mm	mm	mm
L Light	6	10 x 1	10	14	1.5	8
	8	12 x 1½	12	17	2.0	12
	10	14 x 1½	14	19	2.0	12
	12	16 x 1½	16	21	2.5	12
	15	18 x 1½	18	23	2.5	12
	18	22 x 1½	22	27	3.0	14
	22	26 x 1½	26	31	3.0	16
	28	33 x 2	33	39	3.0	18
	35	42 x 2	42	49	3.0	20
S Heavy	6	12 x 1½	12	17	2.0	12
	8	14 x 1½	14	19	2.0	12
	10	16 x 1½	16	21	2.5	12
	12	18 x 1½	18	23	2.5	12
	14	20 x 1½	20	35	3.0	14
	16	22 x 1½	22	27	3.0	14
	20	27 x 2	27	32	3.0	16
	25	33 x 2	33	39	3.0	18
	30	42 x 2	42	49	3.0	20
38	48 x 2	48	55	3.0	22	

DIN 3852 Types A&B (Continued on next column)

DIN 3852 Types A&B (Continued)

Female Metric Thread Parallel

	Tube OD	Metric Thread Size	Thread ID	A	B
	mm	mm	mm	mm	mm
L Light	6	10 x 1	8.5	15	1.0
	8	12 x 1½	10.5	18	1.5
	10	14 x 1½	12.5	20	1.5
	12	16 x 1½	14.5	22	1.5
	15	18 x 1½	16.5	24	2.0
	18	22 x 1½	20.5	28	2.5
	22	26 x 1½	24.5	32	2.5
	28	33 x 2	31.5	40	2.5
	35	42 x 2	40.5	50	2.5
	42	48 x 2	46.5	56	2.5
S Heavy	6	12 x 1½	10.5	18	1.5
	8	14 x 1½	12.5	20	1.5
	10	16 x 1½	14.5	22	1.5
	12	18 x 1½	16.5	24	2.0
	14	20 x 1½	18.5	26	2.0
	16	22 x 1½	20.5	28	2.5
	20	27 x 2	25.5	33	2.5
	25	33 x 2	31.5	40	2.5
	30	42 x 2	40.5	50	2.5
	38	48 x 2	46.5	56	2.5

Male Whitworth Thread Parallel (BSPP)

	Tube OD	Metric Thread Size	Thread OD	A	B	C
	mm	mm	in.	mm	mm	mm
L Light	6	1/8-28	3/8	14	1.5	8
	8	1/4-19	1/2	17	2.0	12
	10	1/4-19	1/2	19	2.0	12
	12	3/8-19	21/32	21	2.5	12
	15	1/2-14	13/16	23	2.5	12
	18	1/2-14	13/16	27	3.0	14
	22	3/4-14	1½/32	31	3.0	16
	28	1-11	15/16	39	3.0	18
	35	1¼-11	121/32	49	3.0	20
	42	1½-11	17/8	55	3.0	22
S Heavy	6	1/4-19	1/2	17	2.0	12
	8	1/4-19	1/2	19	2.0	12
	10	3/8-19	21/32	21	2.5	12
	12	3/8-19	21/32	23	2.5	12
	14	1/2-14	13/16	25	3.0	14
	16	1/2-14	13/16	27	3.0	14
	20	3/4-14	1½/32	32	3.0	16
	25	1-11	15/16	39	3.0	18
	30	1¼-11	121/32	49	3.0	20
	38	1½-11	17/8	55	3.0	22

DIN 3852 Types A&B (Continued on next page)

Fitting Identification

Fitting Standards

DIN 3852 Types A&B (Continued)

Female Whitworth Thread Parallel (BSPOR)					
	Tube OD	Metric Thread Size	Thread ID	A	B
	mm	mm	in.	mm	mm
L Light	6	1/8-28	11/32	15	1.0
	8	1/4-19	15/32	19	1.5
	10	1/4-19	15/32	19	1.5
	12	3/8-19	19/32	23	2.0
	15	1/2-14	3/4	27	2.5
	18	1/2-14	3/4	27	2.5
	22	3/4-14	31/32	33	2.5
	28	1-11	17/32	40	2.5
	35	1 1/4-11	17/32	50	2.5
	42	1 1/2-11	125/32	56	2.5
S Heavy	6	1/4-19	15/32	19	1.5
	8	1/4-19	15/32	19	1.5
	10	3/8-19	19/32	23	2.0
	12	3/8-19	19/32	23	2.0
	14	1/2-14	3/4	27	2.5
	16	1/2-14	3/4	27	2.5
	20	3/4-14	31/32	33	2.5
	25	1-11	17/32	40	2.5
	30	1 1/4-11	17/32	50	2.5
	38	1 1/2-11	125/32	56	2.5

DIN 3852 Type C

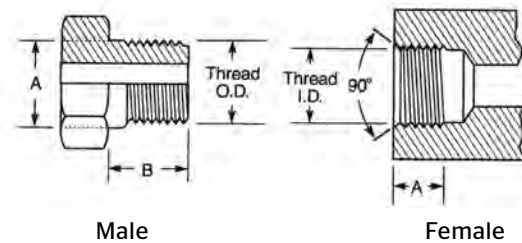

Identification

Both male and female have tapered threads, and are available in metric and Whitworth threads.

Seal

The male will only connect with the female as shown. The seal takes place on the threads.

Comments

Type C couplings are available in extra light (LL), light (L) and heavy (S).

Thread Identification Table

DIN 3852 Type C

Male Metric Tapered Threads					
	Tube OD	Metric Thread Size	A	B	Thread OD
	mm	mm	mm	mm	mm
LL Extra Light	4	8 x 1	8.40	8	8
	5	8 x 1	8.40	8	8
	6	10 x 1	10.40	8	10
	8	10 x 1	10.40	8	10
L Light	6	10 x 1	10.40	8	10
	8	12 x 1.5	12.53	12	12
	10	14 x 1.5	14.53	12	14
	12	16 x 1 1/2	16.53	12	16
	15	18 x 1 1/2	18.53	12	18
	18	22 x 1 1/2	22.65	14	22
S Heavy	6	12 x 1 1/2	12.53	12	12
	8	14 x 1 1/2	14.53	12	14
	10	16 x 1 1/2	16.53	12	16
	12	18 x 1 1/2	18.53	12	18
	14	20 x 1 1/2	20.65	14	20
	16	22 x 1 1/2	22.65	14	22

Female Metric Tapered Threads				
	Tube OD	Metric Thread Size	Thread ID	A
	mm	mm	mm	mm
LL Extra Light	4	8 x 1	6.5	5.5
	5	8 x 1	6.5	5.5
	6	10 x 1	8.5	5.5
	8	10 x 1	8.5	5.5
L Light	6	10 x 1	8.5	5.5
	8	12 x 1 1/2	10.5	8.5
	10	14 x 1 1/2	12.5	8.5
	12	16 x 1 1/2	14.5	8.5
	15	18 x 1 1/2	16.5	8.5
	18	22 x 1 1/2	20.5	10.5
S Heavy	6	12 x 1 1/2	10.5	8.5
	8	14 x 1 1/2	12.5	8.5
	10	16 x 1 1/2	14.5	8.5
	12	18 x 1 1/2	16.5	8.5
	14	20 x 1 1/2	18.5	10.5
	16	22 x 1 1/2	20.5	10.5

DIN 3852 Type C (Continued on next page)

Fitting Identification

Fitting Standards

DIN 3852 Type C (Continued)

Male Whitworth Tapered Threads

	Tube OD	Thread Size		A	B	Thread OD
		mm	in.			
LL Extra Light	4	1/8-28	0.392	8	1/8	
	5	1/8-28	0.392	8	1/8	
	6	1/8-28	0.392	8	1/8	
	8	1/8-28	0.392	8	1/8	
L Light	6	1/8-28	0.392	8	1/8	
	8	1/4-19	0.532	12	1/4	
	10	1/4-19	0.532	12	1/4	
	12	3/8-19	0.670	12	3/8	
	15	1/2-14	0.839	14	1/2	
S Heavy	6	1/4-19	0.532	12	1/4	
	8	1/4-19	0.532	12	1/4	
	10	3/8-19	0.670	12	3/8	
	12	3/8-19	0.670	12	3/8	
	14	1/2-14	0.839	14	1/2	
16	1/2-14	0.839	14	1/2		

Female Whitworth Tapered Threads

	Tube OD	Thread Size		Thread ID	A
		mm	in.		
LL Extra Light	4	1/8-28	11/32	5.5	
	5	1/8-28	11/32	5.5	
	6	1/8-28	11/32	5.5	
	8	1/8-28	11/32	5.5	
L Light	6	1/8-28	11/32	5.5	
	8	1/4-19	15/32	8.5	
	10	1/4-19	15/32	8.5	
	12	3/8-19	19/32	8.5	
	15	1/2-14	3/4	8.5	
	18	1/2-14	3/4	10.5	
S Heavy	6	1/4-19	15/32	8.5	
	8	1/4-19	15/32	8.5	
	10	3/8-19	19/32	8.5	
	12	3/8-19	19/32	8.5	
	14	1/2-14	3/4	10.5	
	16	1/2-14	3/4	10.5	

Standpipe Assembly

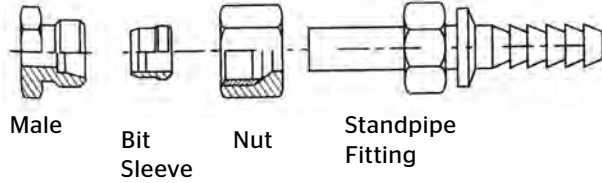

Identification

A metric standpipe is comprised of three components attached to a male fitting. The components are a standpipe, a bite sleeve and a metric nut.

Comments

The bite sleeve and standpipe are selected on the basis of tube OD A DIN light metric nut or heavy metric nut can also be selected.

Thread Identification Table

Metric Standpipe Assembly

Metric DIN Tube OD	Bite Sleeve DIN Tube OD	Metric Nut Thread	
		Light	Heavy
6	6	M 12x1½	
8	8	M 14x1½	M 16x 1½
10	10	M 16x1½	M 18x 1½
12	12	M 18x1½	M 20x 1½
15	15	M 22x1½	
16	16		M 24x 1½
18	18	M 26x 1½	
20	20		M 30x2
22	22	M 30x2	
25	25		M 36x2
28	28	M 36x2	
30	30		M 42x2
35	35	M 45x2	
38	38		M 52x2
42	42	M 52x2	

Fitting Identification

Fitting Standards

DIN 20066 4-Bolt Flange



Flange Head

4-Bolt Split Flange

Identification

The female port is an unthreaded hole surrounded with 4 bolt holes in a rectangular pattern. The male consists of a flanged head, grooved for an O-ring, and a flange with holes to match the port.

Seal

The seal takes place on the O-ring, which is compressed between the flanged head and the flat surface surrounding the port. The threaded bolts hold the connection mechanically.

Comments

There are two pressure ratings. Form R is similar to SAE Code 61 and is referred to as the "standard" series. Form S is similar to SAE Code 62 and is referred to as the "heavy duty" series. The design concept is the same, but bolt diameters and flange head diameters are larger for the Form S fitting. Both metric and inch bolts are used. DIN 20066 is interchangeable with both SAE J518 and JIS B 8363.

Thread Identification Table

DIN 2066 4-Bolt Flange

Nominal Flange Size	Form R			
in.	Flange OD	A	B	C
1/2	1.188	0.688	1.500	0.265
5/8	1.345			0.265
3/4	1.500	0.875	1.875	0.265
1	1.750	1.031	2.062	0.315
1¼	2.000	1.188	2.312	0.315
1½	2.375	1.406	2.750	0.315
2	2.812	1.688	3.062	0.375
2½	3.312	2.000	3.500	0.375
3	4.000	2.438	4.188	0.375
3½	4.500	2.750	4.750	0.422
4	5.000	3.062	5.125	0.442
5	6.000	3.625	6.000	0.442

Nominal Flange Size	Form S			
in.	Flange OD	A	B	C
1/2	1.250	0.718	1.594	0.305
3/4	1.625	0.937	2.000	0.345
1	1.875	1.093	2.250	0.375
1¼	2.125	1.250	2.625	0.405
1½	2.500	1.437	3.125	0.495
2	3.125	1.750	3.812	0.495

Fitting Identification

Fitting Standards

Japanese Thread Types

JIS 30° (Parallel Pipe Threads)

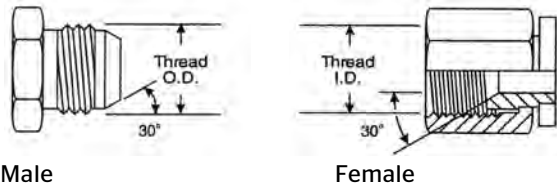

Male

Female

Identification

The male and female have straight threads and a 30-degree seat.

Seal

The JIS 30-degree male will only connect with the JIS 30-degree female. The seal is made on the 30-degree seat. The threads hold the connection in place mechanically.

Comments

The JIC 37-degree flare is very similar to the JIS 30-degree flare. To determine the difference, carefully measure the seat angle. The threads on the JIS 30 conform to JIS B 0202. While the BSPP fitting has similar threads, and also has a 30-degree seat, the JIS 30 is not interchangeable with the BSPP fitting as the British seat is inverted.

Thread Identification Table

JIS 30° Flare Parallel

Dash Size	Nominal Size	Thread Size	Male Thread OD	Female Thread ID
in.				
-2	1/8	1/8-28	3/8	11/32
-4	1/4	1/4-19	17/32	7/16
-6	3/8	3/8-19	21/32	19/32
-8	1/2	1/2-14	13/16	3/4
-10	5/8	5/8-14	29/32	13/16
-12	3/4	3/4-14	11/32	15/16
-16	1	1-11	15/16	13/16
-20	1 1/4	1 1/4-11	1 21/32	1 17/32
-24	1 1/2	1 1/2-11	1 7/8	1 25/32
-32	2	2-11	2 11/32	2 7/32

JIS 30° Male Inverted Seat

(Parallel Pipe Threads) (JIS B 0202)

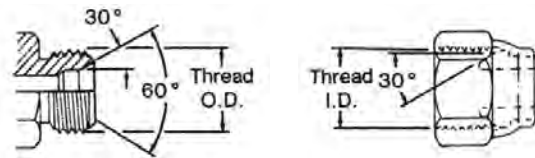

Male

Female

Identification

The JIS 30 Parallel has straight threads, conforming to JIS B 0202.

Seal

Both male and female have a straight thread and 30-degree seat and chamfer. The seal takes place by compression of the 30-degree seat on the chamfer. The threads hold the connection mechanically.

Comments

The BSPP fitting is fully interchangeable with the JIS 30, male inverted seat.

Thread Identification Table

JIS 30° Male Inverted Seat

Dash Size	Nominal Size	Thread Size	Male Thread OD	Female Thread ID
in.				
-4	1/4	1/4-19	8/16	15/32
-6	3/8	3/8-19	21/32	19/32
-8	1/2	1/2-14	13/16	3/4
-12	3/4	3/4-14	11/32	31/32
-16	1	1-11	15/16	17/32
-20	1 1/4	1 1/4-11	1 21/32	1 9/16
-24	1 1/2	1 1/2-11	1 7/8	1 25/32
-32	2	2-11	2 11/32	2 1/4

Fitting Identification

Fitting Standards

JIS Tapered Pipe (JIS B 0203)

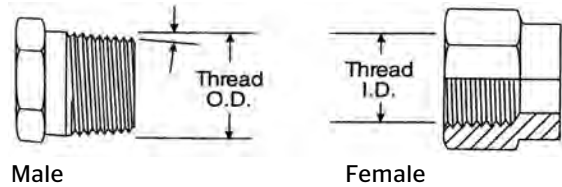

Identification

Both male and female have tapered threads that conform to JIS B 0203.

Seal

The seal is made within the threads through thread distortion. A thread sealant is recommended.

Comments

The JIS tapered pipe thread is similar to a BSPT fitting and is fully interchangeable.

Thread Identification Table

JIS Tapered Pipe

Dash Size	Nominal Size	Thread Size	Male Thread OD	Female Thread ID
	in.		in.	in.
-2	1/8	1/8-28	3/8	11/32
-4	1/4	1/4-19	17/32	7/16
-6	3/8	3/8-19	21/32	19/32
-8	1/2	1/2-14	13/16	3/4
-12	3/4	3/4-14	1 1/32	15/16
-16	1	1-11	1 5/16	1 3/16
-20	1 1/4	1 1/4-11	1 21/32	1 17/32
-24	1 1/2	1 1/2-11	1 7/8	1 25/32
-32	2	2-11	2 11/32	2 7/32

Japanese Komatsu® 30° Flare with Metric Threads (JIS B 0207)

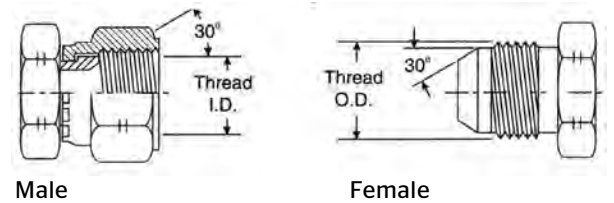

Identification

Same as JIS B 0202, but conforms to JIS B 0207 with metric threads.

Seal

Both male and female have a straight thread and 30-degree seat and chamfer. The seal takes place by compression of the 30-degree seat on the chamfer. The threads hold the connection mechanically.

Comments

Also known as the Komatsu® style, it is used extensively on Komatsu® equipment.

Thread Identification Table

Komatsu® Style 30° Flare

Dash Size	Nominal Size	Metric Thread Size	Male Thread OD	Female Thread ID	
	in.	mm			
-6	3/8	9.5	M 18 x 1 1/2	18	16.5
-8	1/2	13	M 22 x 1 1/2	22	20.5
-10	5/8	16	M 24 x 1 1/2	24	22.5
-12	3/4	19	M 30 x 1 1/2	30	28.5
-16	1	25	M 33 x 1 1/2	33	31.5
-20	1 1/4	32	M 36 x 1 1/2	36	34.5
-24	1 1/2	38	M 42 x 1.5	42	40.5

Fitting Identification

Fitting Standards

Komatsu® Flange Fitting

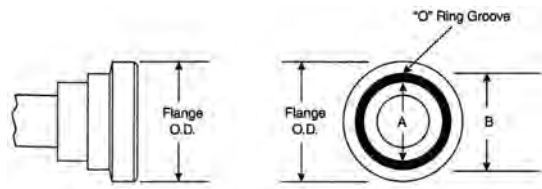

Flange

Flange Head

Identification

The Komatsu® Flange fitting is nearly identical to the SAE Code 61 flange fitting and fully interchangeable. As O-ring sizes are different, an SAE O-ring must be used when replacing the Komatsu® fitting with an SAE fitting.

Thread Identification Table

Komatsu®-Style Flange

Dash Size	Nominal Size		Flange OD	A	B
	in.	mm			
-8	1/2	12.7	1.188	0.728	0.984
-10	5/8	15.9	1.345	0.728	1.102
-12	3/4	19.1	1.500	0.846	1.220
-16	1	25.4	1.750	1.122	1.496
-20	1¼	31.8	2.000	1.358	1.732
-24	1½	38.1	2.375	1.750	2.125
-32	2	50.8	2.812	2.225	2.559

JIS B 8363 4 Bolt Flange

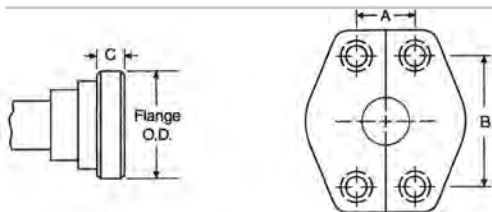

Male

Female

Identification

The female port is an unthreaded hole surrounded with 4 bolt holes in a rectangular pattern. The male consists of a flanged head, grooved for an O-ring, and a flange with holes to match the port.

Seal

The seal takes place on the O-ring, which is compressed between the flanged head and the flat surface surrounding the port. The threaded bolts hold the connection mechanically.

Comments

There are two pressure ratings. Type I is similar to SAE Code 61 and is referred to as the "standard" series. Type II is similar to SAE Code 62 and is referred to as the "heavy duty" series. The design concept is the same, but bolt diameters and flange head diameters are larger for the Type II fitting. Both metric and inch bolts are used. JIS B 8363 is interchangeable with both SAE J518 and DIN 20066.

Thread Identification Table

JIS B 8363 4-Bolt Flange

Nominal Flange Size	Type I			
	Flange OD	A	B	C
1/2	1.188	0.688	1.500	0.265
5/8	1.345			0.265
3/4	1.500	0.875	1.875	0.265
1	1.750	1.031	2.062	0.315
1¼	2.000	1.188	2.312	0.315
1½	2.375	1.406	2.750	0.315
2	2.812	1.688	3.062	0.375
2½	3.312	2.000	3.500	0.375
3	4.000	2.438	4.188	0.375
3½	4.500	2.750	4.750	0.422
4	5.000	3.062	5.125	0.442
5	6.000	3.625	6.000	0.442

Nominal Flange Size	Type II			
	Flange OD	A	B	C
1/2	1.250	0.718	1.594	0.305
3/4	1.625	0.937	2.000	0.345
1	1.875	1.093	2.250	0.375
1¼	2.125	1.250	2.625	0.405
1½	2.500	1.437	3.125	0.495
2	3.125	1.750	3.812	0.495

Fitting Identification

Templates

Male Pipe Thread Sizes

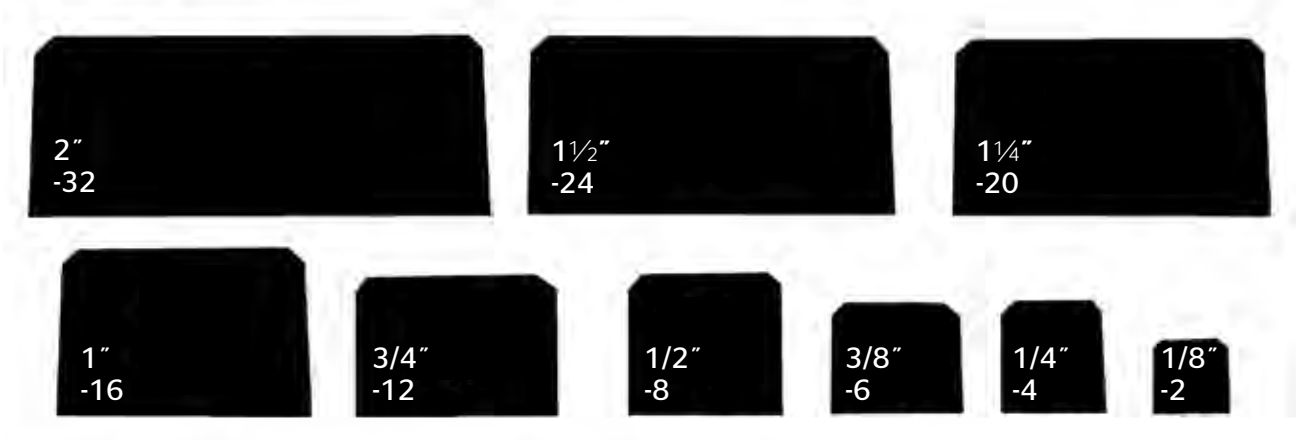

JIC 37° Flare (SAE J514) Thread Sizes

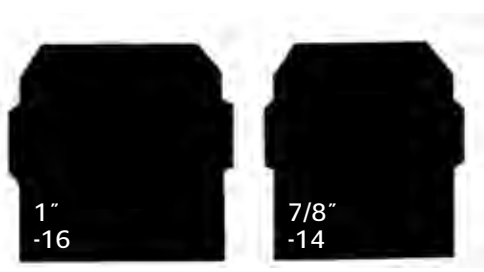
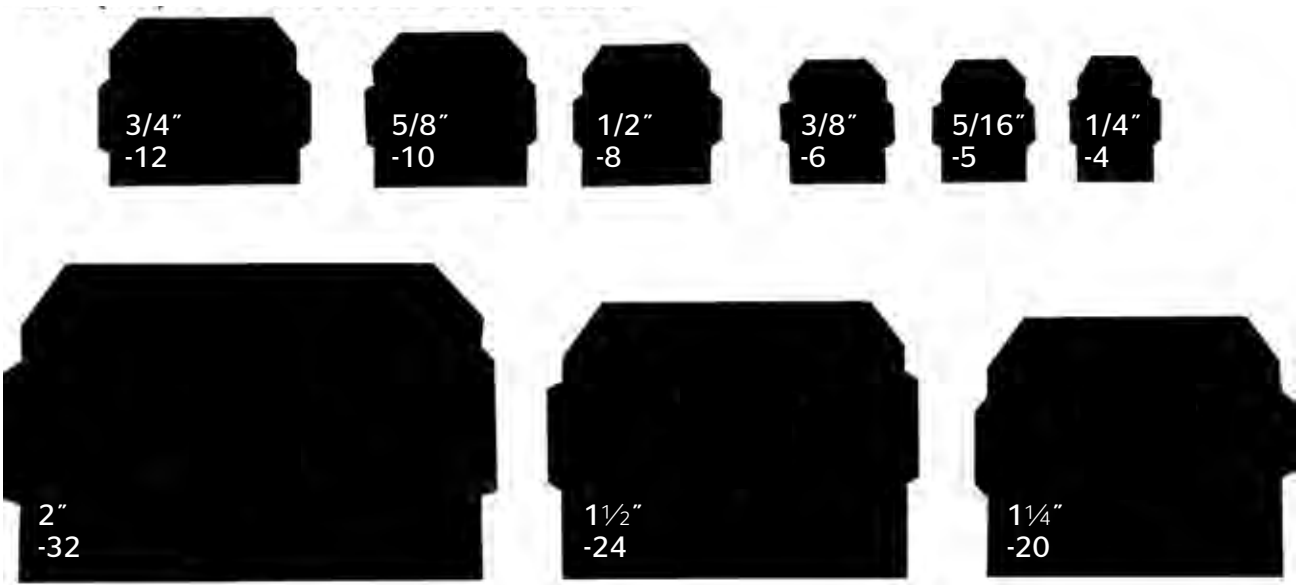

Fitting Identification

Templates

O-Ring Face Seal (SAE J1453 ORS/ORFS)

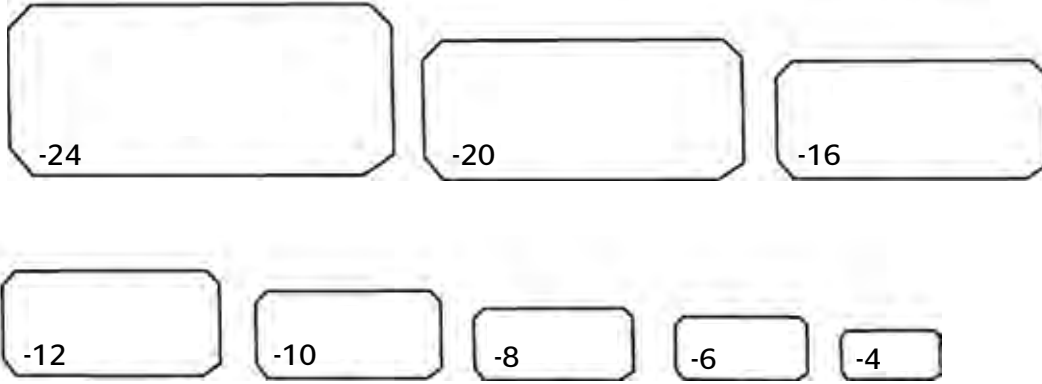

Fitting Nuts

Continental ContiTech® fittings can have three types of nuts: Crimp Nut, Thrust-Wire Nut, and Slip-On Nut. Shown below are sample images with the three types of nuts.

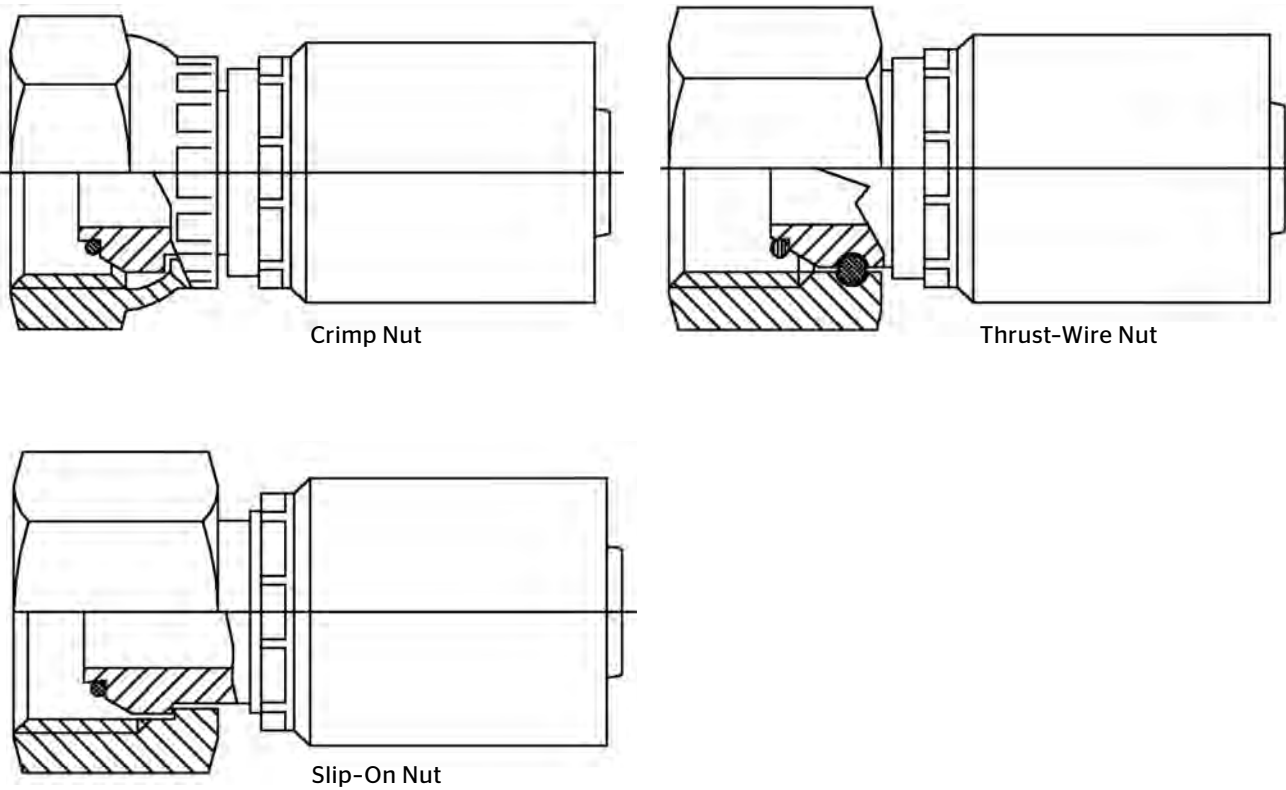

Torque Values

	Dash Size	Thread Size	Swivel Nut Torque	
		in.	ft./lbs.	N/m
O-Ring	-4	9/16-18	10-12	14-16
Face Seal	-6	11/16-16	18-20	24-27
(SAE J1453)	-8	13/16-16	32-35	43-47
	-10	1-14	46-50	62-68
	-12	1 3/16-12	65-70	88-95
	-16	1 7/16-12	92-100	125-136
	-20	1 11/16-12	125-140	170-190
	-24	2-12	150-165	204-224

	Dash Size	Thread Size	Jam Nut or Straight Fitting Torque	
		in.	ft./lbs.	N/m
O-Ring	-3	3/8-24	8-9	12-13
Boss Straight	-4	7/16-20	13-15	18-20
Thread	-5	1/2-20	14-15	19-21
(SAE J514)	-6	9/16-18	23-24	32-33
	-8	3/4-16	40-43	55-57
	-10	7/8-14	43-48	59-64
	-12	1 1/16-12	68-75	93-101
	-14	1 3/16-12	83-90	113-122
	-16	1 5/16-12	112-123	152-166
	-20	1 5/8-12	146-161	198-218
	-24	1 7/8-12	154-170	209-230
	-32	2 1/2-12	218-240	296-325

	Dash Size	Thread Size	Swivel Nut Torque	
		in.	ft./lbs.	N/m
JIC 37° Flare	-4	7/16-20	11-12	15-16
(SAE J514)	-5	1/2-20	15-16	20-22
	-6	9/16-18	18-20	24-28
	-8	3/4-16	38-42	52-58
	-10	7/8-14	57-62	77-85
	-12	1 1/16-12	79-87	108-119
	-14	1 3/16-12	94-103	127-140
	-16	1 5/16-12	108-113	148-154
	-20	1 5/8-12	127-133	173-182
	-24	1 7/8-12	158-167	216-227
	-32	2 1/2-12	245-258	334-352

	Dash Size	Port Hole ID		
		in.	ft./lbs.	N/m
Code 61	-8	1/2	15-19	20-25
Flange Bolt	-12	3/4	21-29	28-40
(SAE J518)	-16	1	27-35	37-48
	-20	1 1/4	35-46	48-62
	-24	1 1/2	46-58	62-79
	-32	2	54-66	73-90
	-40	2 1/2	79-91	107-124
	-48	3	137-149	186-203

	Dash Size	Port Hole ID		
		in.	ft./lbs.	N/m
Code 62	-8	1/2	15-19	20-25
Flange Bolt	-12	3/4	25-33	34-45
(SAE J518)	-16	1	42-50	56-68
	-20	1 1/4	62-75	85-102
	-24	1 1/2	116-133	158-181
	-32	2	199-216	271-294

	Dash Size	Nominal Thread Size	Swivel Nut Torque	
		in.	ft./lbs.	N/m
JIS 30°	-4	1/4-19	19	25
(B83632000)	-6	3/8-19	25	34
	-8	1/2-14	49	64
	-10	5/8-14	100	132
	-12	3/4-14	100	132
	-16	1-11	149	196
	-20	1 1/4-11	171	225
	-24	1 1/2-11	194	255
	-32	2-11	240	316

	Thread Size	Swivel Nut Torque	
	mm	ft./lbs.	N/m
Metric	M 10 x 1	13-15	18-20
	M 12 x 1.5	15-19	20-25
	M 14 x 1.5	19-23	25-30
	M 16 x 1.5	33-40	45-55
	M 18 x 1.5	37-44	50-60
	M 20 x 1.5	52-66	70-90
	M 22 x 1.5	55-70	75-95
	M 26 x 1.5	81-96	110-130
	M 27 x 2	96-111	130-150
	M 33 x 2	162-184	220-250
	M 42 x 2	170-192	230-260
	M 48 x 2	258-347	350-470

Torque Values

	Dash Size		
	mm	ft./lbs.	N/m
Maximum	-2	20	25
Recommended	-4	25	35
Torque for Dry	-6	35	45
NPTF (Tapered)	-8	45	60
Pipe Threads	-12	55	75
	-16	65	90
	-20	80	110
	-24	95	130
	-32	120	160

	Dash Size	Nominal Thread Size	With O-Ring		Without O-Ring	
			ft./lbs.	N/m	ft./lbs.	N/m
		in.	ft./lbs.	N/m	ft./lbs.	N/m
BSPP	-2	G 1/8-28	NA	NA	7	10
**G* denotes	-4	G 1/4-19	15	20	15	20
parallel	-6	G 3/8-19	26	35	26	35
threads	-8	G 1/2-14	37	50	44	60
	-10	G 5/8-14	44	60	52	70
	-12	G 3/4-14	63	85	85	115
	-16	G 1-11	85	115	103	140
	-20	G 1 1/4-11	140	190	155	210
	-24	G 1 1/2-11	177	240	214	290
	-32	G 2-11	221	300	295	400

**Notes:

1. The torque values obtained from tightening pipe threads can vary considerably depending on thread condition. Adequate sealing can occur at values much lower than the maximum values listed above. Only enough torque to achieve adequate sealing should be used.
2. When using a male tapered pipe thread with a female straight or parallel pipe thread, maximum values are 50% of those listed in the table.
3. If thread sealant is used, maximum values shown should be decreased by 25%.

Hose ID Selection Nomograph

The chart below is intended to aid in the selection of the correct hose size. By choosing a flow rate and a flow velocity, the optimum hose ID can be determined. Selecting the correct hose ID is important to prevent an oversized assembly, which can be heavy and costly or an undersized assembly causing an excessive pressure drop.

Example: To find the correct hose ID for a system running at 13 gallons/minute and 10 feet/second, draw a line between the two values on each grid. The intersection of that line on the ID grid is 3/4" ID

Selecting the Correct Hose ID

1. Choose flow rate and flow velocity. Locate each value on its grid.
2. Lay a straightedge to connect the two values.
3. The recommended hose ID is located on the ID scale, at the intersection of the line drawn between flow rate and flow velocity. Should the line intersect between two values, use the next highest ID

Recommendations are based on a oil viscosity of 315 S.S.U., at 100°F, operating at a temperature of 65°F to 155°F.

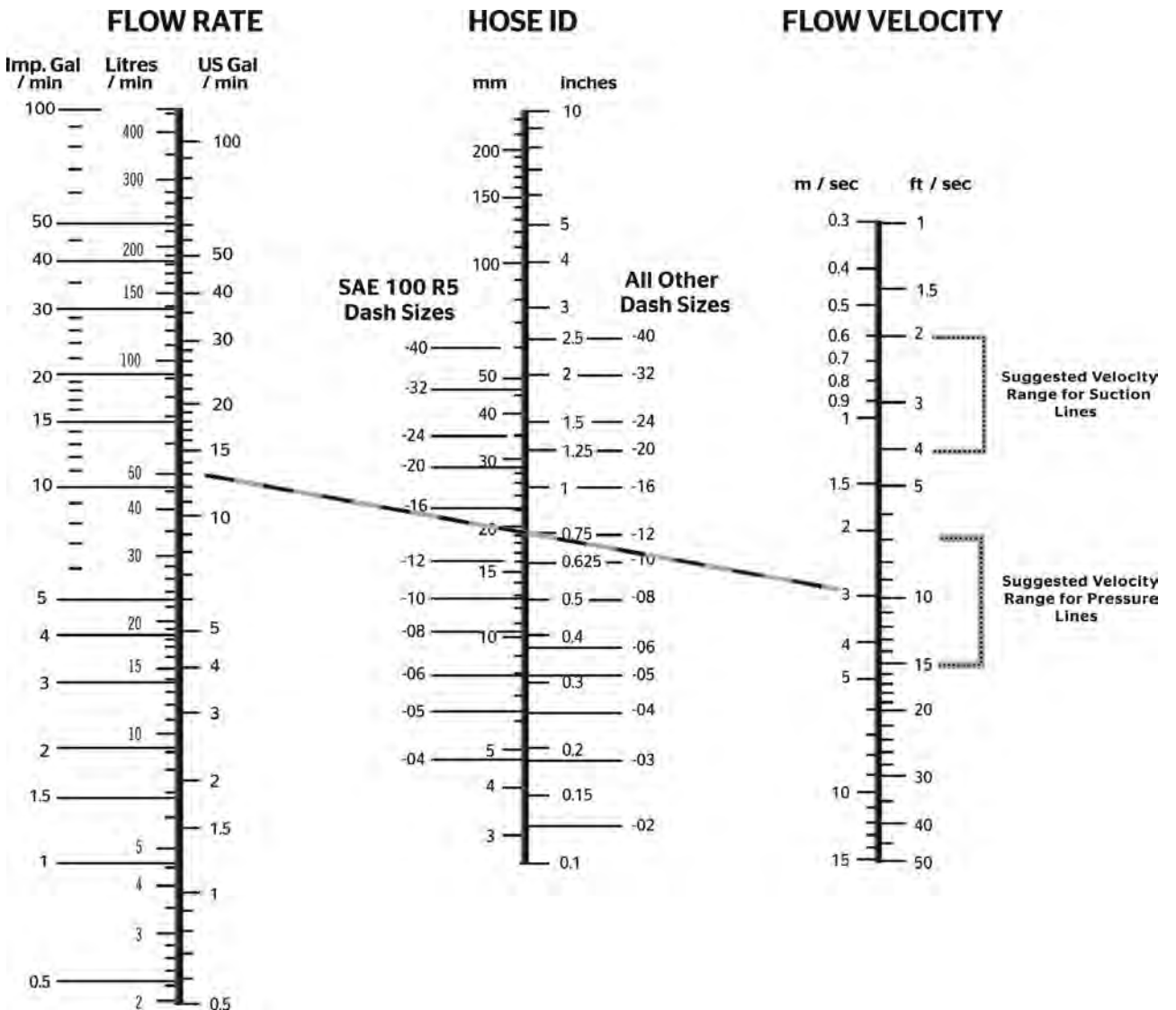

Hose ID Selection Nomograph

The following table represents the maximum flow rate in gallons per minute (GPM) by hose ID for pressure lines and suction lines. The recommended maximum fluid velocity for pressure systems is 15 feet per second (FPS).

Hose ID	Recommended Maximum Flow (GPM) Pressure Lines	Recommended Maximum Flow (GPM) Suction Lines
in.		
3/16	1.29	0.35
1/4	2.30	0.61
5/16	3.59	0.96
3/8	5.16	1.38
13/32	6.06	16.20
1/2	9.18	2.45
5/8	14.35	3.83
3/4	20.66	5.51
7/8	28.12	7.50
1	36.72	9.79
1 1/8	46.48	12.39
1 1/4	57.38	15.30
1 3/8	69.43	18.51
1 1/2	82.63	22.03
1 13/16	120.64	32.17
2	146.89	39.17

Use the following formulas for Velocity, Gallons per Minute, or Hose ID

$$V = \text{Velocity in Feet per Second (FPS)} = (.408 \times \text{GPM}) / D^2$$

$$\text{GPM} = \text{Flow rate in Gallons per Minute (GPM)} = V \times D^2 / .408$$

$$D = \text{Hose ID (inches)} = \sqrt{\frac{.408 \times \text{GPM}}{V}}$$

The recommended maximum velocity for hydraulic systems is 15 FPS. For higher velocity, contact Continental ContiTech Technical Support with specific system information.

Imperial Gallon = U.S. Gallon x 0.83267

U.S. Gallon = Imperial Gallon x 1.20095

Liter = U.S. Gallon x 3.785

U.S. Gallon = Liter x .2642

Hose Pressure Drop

Pressure drop is defined as the difference in input pressure and output pressure of a hose assembly. There are many factors which can contribute to pressure drop including the length of the hose assembly, the type and temperature of the fluid, flow rate, the

inside diameter of the hose, and the type of couplings used. If pressure drop is a concern, this chart can be used for a quick estimate for a hose assembly that is 10 feet long with a fluid specification of .85 specific

gravity, a viscosity of 20 centistokes (97 S.S.U.), and a temperature of 100°F (38°C). Differences in fluids, fluid temperature, and viscosity can increase or decrease actual pressure drop compared to the values listed.

Pressure Drop (psi)

	Dash Size	-3	-4	-5	-6	-8	-10	-12	-16	-20	-24	-32	-40	-48	
	Hose ID	3/16	1/4	5/16	3/8	1/2	5/8	3/4	1	1¼	1½	2	2½	3	
in.															
U.S.	0.25	10	3.1												
	0.50	19	6	2.7											
gpm	1	40	12	5.5	2.4										
	2	95	24	10	4.8										
	3	185	46	17	7	2.2									
	4		78	29	12	3	1.2								
	5		120	44	18	4.5	1.6	0.7							
	8			95	39	10	3.6	1.4							
	10				59	15	5.7	2	0.6						
	12					80	20	7.2	2.6	0.8					
	15						30	10	4.2	1.2	0.4				
	18						40	15	6.3	1.5	0.6				
	20						49	19	8	2	0.7	0.3			
	25						72	26	11	3	1	0.4			
	30							34	14	3.6	1.3	0.5	0.1		
	35							47	19	5	1.7	0.7	0.2		
	40								25	6.5	2.2	0.9	0.2		
	50								36	9	3.3	1.3	0.4	0.2	
	60								50	12	4.4	1.8	0.5	0.2	
	70									17	6	2.4	0.7	0.3	
	80									21	7.1	3	0.8	0.3	0.1
	90									27	9	3.8	1	0.5	0.1
100									33	12	4.7	1.3	0.6	0.2	
150									60	22	8.5	2.2	1	0.3	
200										36	15	3.9	1.7	0.6	
250										54	22	5.3	2.5	0.8	
300											29	7.5	4	1.1	
400											51	14	6.5	2.2	
500												20	10	3	
800													18	5	
1000														10	

Chemical Resistance Tables

The following chemical resistance tables indicate the suitability of various elastomers and metals for use with fluids being conveyed. The ratings given are intended as a guide only and not a guarantee. Ratings are for tube compound only, unless otherwise stated. The final selection of the proper hose and fitting to use is further dependent on many factors including temperature, concentration, and length of exposure.

Hose ratings are for the effect on the polymer only. The degree of resistance of a rubber compound to a specific fluid depends on the variables of temperature, concentration, and length of exposure. When in doubt or when conditions vary, contact Continental ContiTech for assistance before using a specific product.

Ratings and Definitions

- E** › The fluid is expected to have a minor or no effect on the hose and compound. Product may be used in continuous service. Changes in the substance, such as concentration or temperature, may affect hose product performance and cause degradation of the product.
- G** › The hose and compound may be used for continuous or intermittent service, however the product properties will be affected by the exposure of the chemical. Changes in the substance, such as concentration or temperature, may affect hose product performance and cause degradation of the product.
- X** › The hose and compound should not be used with this fluid.
- › Insufficient or no data is available for this fluid. Further testing is recommended to determine compatibility of the fluid with the hose and the compound.
- Blank** › No data is available.

Warning: Compatibility of hose fittings with the fluid is an essential factor in avoiding chemical reactions that may result in loss of fluid or failure of the hose connection, with the potential of causing personal injury or property damage.

Chemical Resistance Tables

The following is a representative list of fluids and manufacturers and a general guideline for the use and compatibility of Continental ContiTech hose and fittings.

Rating Scale

E = Excellent resistance X = Not recommended Blank = No Data
 G = Good resistance - = Testing recommended

Chemical Name	Hose								Fittings and Adapters				
	PTFE (Teflon®)	CR (polychloropene)	NBR (Nitrile)	Nitrile/ PVC	CPE	CSM	Urethane	Nylon	Carbon Steel	Stainless Steel 304	Stainless Steel 316	Aluminum	Brass
Absorption Oil		G	E	G	-	G	-	-	-	-	-	-	E
Acetaldehyde	E	X	X	X	-	X	E	G	E	E	E	E	E
Acetamide	E	E	G	-	-	-	X	-	-	-	-	-	-
Acetate Solvent Crude	E												
Acetate Solvent Pure	E												
Acetic Acid, 100%	E	X	X	-	-	-	-	X	X	X	G	G	X
Acetic Acid, 100% (Hot Vapors)(to 200 °F)	E	G	G	-	-	-	-	X	X	X	G	G	X
Acetic Acid, 100% Boiling		X	X	-	-	-	X	X	X	X	G	-	X
Acetic Acid, 25%		G	X	G	E	G	-	X	X	G	G	G	X
Acetic Acid, 30%	E	G	X	-	E	-	-	G	X	G	E	G	X
Acetic Acid, 50%		G	X	G	E	-	-	G	X	G	G	G	X
Acetic Acid, 50% Boiling		X	X	-	-	-	-	X	X	X	G	-	-
Acetic Acid, 5-20%		G	X	G	E	G	X	E	X	G	G	G	X
Acetic Acid, 80%		X	X	-	-	-	-	X	X	G	G	G	X
Acetic Acid, 80% Boiling		X	X	-	-	-	-	X	X	X	G	X	X
Acetic Acid, Aerated		-	-	-	-	-	-	-	X	X	X	-	X
Acetic Acid, Air Free		-	-	-	-	-	-	-	X	X	X	-	X
Acetic Acid, Anhydride	E	X	X	X	E	G	-	X	X	G	G	G	X
Acetic Acid, Crude		X	X	-	-	-	-	E	X	G	E	G	X
Acetic Acid, Glacial	E	X	X	X	E	X	X	X	X	G	G	G	-
Acetil Bromide													
Acetil Chloride													
Acetil Chromide													
Acetone (Dimethylketone)	E	X	X	X	E	X	X	E	E	E	E	E	E
Acetonitrile (Methyl Cyanide)		G	X	G	E	G	-	-	-	-	-	-	-
Acetophenone													
Acetylene	E	G	G	E	E	-	-	E	E	E	E	E	G
Acrylic Esters													
Acrylonitrile (Vinyl Cyanide)	E	X	X	X	E	X	-	-	E	E	E	G	E
Adipic Acid													
Aero Lubriplate		E	E	-	-	-	-	-	E	E	E	E	-
Aero Safe 2300		X	X	-	-	-	X	-	E	E	E	E	E
Aeroshell 17A Grease		G	E	-	-	-	X	-	E	E	E	E	-
Aeroshell 750		X	G	-	-	-	X	-	E	E	E	E	-
Aeroshell 7A Grease		G	E	-	-	-	X	-	E	E	E	E	-
Aeroshell type 1A, 1AC, 4		G	E	-	-	-	E	-	-	-	-	-	-
Air 150°F		E	E	E	E	E	E	E	E	E	E	E	E
Air 180°F		G	G	G	E	G	G	E	E	E	E	E	E

Underline is cover compound rating only. Many factors, such as temperature, concentration and length of exposure, are relevant to how chemical exposure affects the tube and cover or fitting material. The fluid manufacturers recommended maximum operating temperature should be carefully observed. Exceeding the manufacturer's recommended maximum temperature can result in fluid breakdown and cause harm or shorten life of tube and cover materials. There may be instances where the hose cover could be adversely affected by fluids which would not chemically affect the hose tube. Conversely, some fluids with an adverse affect on the tube of the hose may not have a deteriorating effect on the hose cover. It is recommended that the user test the hose/fluid compatibility to their own standards. Since no industry standards exist for chemical resistance, the Compass Chemical Resistance Guide for Elastomers is used whenever possible. Teflon® is a registered trademark of Dupont.

Chemical Resistance Tables

The following is a representative list of fluids and manufacturers and a general guideline for the use and compatibility of Continental ContiTech hose and fittings.

Rating Scale

E = Excellent resistance X = Not recommended Blank = No Data
 G = Good resistance - = Testing recommended

Chemical Name	Fittings and Adapters												
	Hose	PTFE (Teflon®)	CR (polychloropene)	NBR (Nitrile)	Nitrile/ PVC	CPE	CSM	Urethane	Nylon	Carbon Steel	Stainless Steel 304	Stainless Steel 316	Aluminum
Air 200°		X	X	X	E	X	G	G	E	E	E	E	E
Air Ambient		E	E	E	E	E	E	E	E	E	E	E	E
Aircraft Hydr Oil AA		-	E	-	-	-	-	-	E	E	E	E	E
Alcohol	E	E	E	-	-	-	-	-	E	E	E	E	E
Alcohol, Amyl		G	G	-	-	-	-	E	-	G	E	G	-
Alcohol, Benzyl		X	X	-	E	G	G	-	E	E	E	-	-
Alcohol, Butyl		G	X	G	-	G	E	E	E	E	E	E	E
Alcohol, Denatured		E	E	-	-	E	-	E	E	E	E	E	E
Alcohol, Diacetone		-	X	-	-	G	-	-	E	E	E	E	E
Alcohol, Ethyl (Ethanol)		E	E	E	E	E	G	E	E	E	E	E	G
Alcohol, Furfural		G	X	X	E	G	-	-	G	E	E	E	E
Alcohol, Hexyl (Hexanol)		G	E	-	-	X	-	-	E	E	E	E	G
Alcohol, Isobutyl		G	G	-	-	E	-	E	E	E	E	E	G
Alcohol, Isopropyl (Isopropanol)		G	G	G	-	G	G	E	E	E	E	E	G
Alcohol, Methyl (100%) (Methanol)		E	E	E	E	E	-	E	E	E	E	E	G
Alcohol, Methyl (6%)		E	E	E	-	E	-	E	E	E	E	E	G
Alcohol, Octyl		G	G	-	-	-	-	E	E	E	E	E	-
Alcohol, Propyl		E	E	-	-	-	-	X	G	E	E	E	E
Aliphatic (to 70°F)	E												
Alkazene		X	X	X	-	X	X	-	E	E	-	-	-
Alkyd Resins													
Aluminum Chloride	E	E	E	E	E	E	G	X	X	G	G	X	X
Aluminum Fluoride, 20%+A21	E	E	E	E	E	E	G	X	X	G	G	G	X
Aluminum Hydroxide	E	E	E	E	E	E	-	E	-	E	E	-	E
Aluminum Hydroxide, Saturated		E	E	-	-	-	-	E	-	E	E	-	-
Aluminum Nitrate	E	E	E	E	E	E	G	-	X	E	E	G	-
Aluminum Sulfate	E	E	E	E	E	E	X	E	X	X	G	X	X
Alums (Ammonium or Potassium)	E	E	E	E	E	E	-	-	X	G	G	X	X
Ammonia Gas Cold, Dry (to 175 °F)													
Ammonia Gas Cold, Wet (to 480 °F)													
Ammonia Liquid (Anhydrous)													
Ammonia, Aqueous	E	E	G	E	-	E	-	E	-	E	E	-	X
Ammonium Acetate	E												

Underline is cover compound rating only. Many factors, such as temperature, concentration and length of exposure, are relevant to how chemical exposure affects the tube and cover or fitting material. The fluid manufacturers recommended maximum operating temperature should be carefully observed. Exceeding the manufacturer's recommended maximum temperature can result in fluid breakdown and cause harm or shorten life of tube and cover materials. There may be instances where the hose cover could be adversely affected by fluids which would not chemically affect the hose tube. Conversely, some fluids with an adverse affect on the tube of the hose may not have a deteriorating effect on the hose cover. It is recommended that the user test the hose/fluid compatibility to their own standards. Since no industry standards exist for chemical resistance, the Compass Chemical Resistance Guide for Elastomers is used whenever possible. Teflon® is a registered trademark of Dupont.

Chemical Resistance Tables

The following is a representative list of fluids and manufacturers and a general guideline for the use and compatibility of Continental ContiTech hose and fittings.

Rating Scale

E = Excellent resistance **X** = Not recommended **Blank** = No Data
G = Good resistance **-** = Testing recommended

Chemical Name	Hose								Fittings and Adapters				
	PTFE (Teflon®)	CR (polychloropene)	NBR (Nitrile)	Nitrile/PVC	CPE	CSM	Urethane	Nylon	Carbon Steel	Stainless Steel 304	Stainless Steel 316	Aluminum	Brass
Ammonium Carbonate													
Ammonium Chloride, 1%	E	X	G	E	E	E	E	E	X	G	G	X	X
Ammonium Chloride, 10% Boiling	E	X	X	-	-	-	-	X	X	G	G	X	X
Ammonium Chloride, 28% Boiling	E	X	X	-	-	-	-	X	X	G	G	X	X
Ammonium Chloride, 50% Boiling	E	X	X	-	-	-	-	X	G	E	E	-	X
Ammonium Hydroxide	E	G	G	G	E	E	X	E	G	E	E	-	X
Ammonium Hydroxide, 3 Molar		E	X	-	-	-	G	-	X	G	G	X	X
Ammonium Hydroxide Concentrated2		E	X	-	E	-	X	E	X	G	G	X	X
Ammonium Metaphosphate	E	G	G	G	-	G	-	-	E	E	E	X	-
Ammonium Nitrate, Fertilizer	E	E	G	E	E	E	E	X	E	E	E	G	X
Ammonium Nitrite		-	-	-	-	-	-	E	G	E	E	X	-
Ammonium Persulfate		X	X	X	E	-	X	X	X	G	G	X	X
Ammonium Persulfate 10%		E	X	-	-	-	X	X	X	G	G	X	X
Ammonium Persulfate 5%		E	X	-	-	-	-	X		G	G	X	X
AmmoniumPhosphate (Mono,Di,Tri,Basic)	E	E	E	E	E	E	E	G	X	G	G	X	-
Ammonium Sulfate	E	E	G	E	E	E	E	X	X	X	G	X	X
Ammonium Sulfide	E	E	E	E	-	E	-	E	E	E	E	E	G
Ammonium Thiocyanate	E	E	E	-	E	E	-	-	E	E	E	-	-
Amyl Chloride	E	X	-	X	G	X	-	G	-	E	E	-	-
Amyl Chloronaphthalene	E	X	X	X	-	X	-	-	-	E	E	-	-
Amyl Naphthalene	E	X	X	X	-	X	-	-	-	E	E	-	-
Amyl Phenol		-	-	-	-	-	-	-	-	E	E	-	-
Amyl Acetate	E	X	X	X	G	X	G	E	X	E	E	X	G
Amyl Alcohol	E	E	E	E	E	E	G	X	X	G	G	G	X
Amyl Borate		G	G	G	-	-	-	-	-	-	-	-	-
AN-0-3 Grade M		E	E	-	-	-	-	-	-	-	-	-	-
AN-0-366		E	E	-	-	-	-	-	-	-	-	-	-
AN-0-6		E	E	-	-	-	-	-	-	-	-	-	-
Anderol, L-774 (Diester)		X	G	-	-	-	-	X	-	-	-	-	-
Anderol, L-826 (Diester)		X	G	-	-	-	-	X	-	-	-	-	-
Anderol, L-829 (Diester)		X	G	-	-	-	-	X	-	-	-	-	-
ANG-25 (Diester Base,TG749)		X	G	-	-	-	-	X	E	E	E	E	-
ANG-25 (Glyceral Ester)		G	G	-	-	-	-	G	-	-	-	-	-

Underline is cover compound rating only. Many factors, such as temperature, concentration and length of exposure, are relevant to how chemical exposure affects the tube and cover or fitting material. The fluid manufacturers recommended maximum operating temperature should be carefully observed. Exceeding the manufacturer's recommended maximum temperature can result in fluid breakdown and cause harm or shorten life of tube and cover materials. There may be instances where the hose cover could be adversely affected by fluids which would not chemically affect the hose tube. Conversely, some fluids with an adverse affect on the tube of the hose may not have a deteriorating effect on the hose cover. It is recommended that the user test the hose/fluid compatibility to their own standards. Since no industry standards exist for chemical resistance, the Compass Chemical Resistance Guide for Elastomers is used whenever possible. Teflon® is a registered trademark of Dupont.

Chemical Resistance Tables

The following is a representative list of fluids and manufacturers and a general guideline for the use and compatibility of Continental ContiTech hose and fittings.

Rating Scale

E = Excellent resistance X = Not recommended Blank = No Data
 G = Good resistance - = Testing recommended

Chemical Name	Fittings and Adapters												
	Hose	PTFE (Teflon®)	CR (polychloropene)	NBR (Nitrile)	Nitrile/ PVC	CPE	CSM	Urethane	Nylon	Carbon Steel	Stainless Steel 304	Stainless Steel 316	Aluminum
Aniline	E	X	X	X	G	X	X	G	G	E	E	X	X
Aniline Dyes	E												
Animal Fat	E												
Animal Gelatin		E	E	-	E	-	-	-	-	E	E	-	-
Animal Oil (Lard Oil)	E	G	E	-	E	-	-	-	E	E	E	E	-
Antifreeze, Alcohol Base		G	G	G	G	G	-	-	E	E	E	E	-
Antifreeze, Glycol Base	E	G	E	E	E	E	-	E	E	E	E	E	E
Antimony Chloride, 50% (to 70°F)	E	-	E	-	-	-	-	X	X	X	X	-	-
AN-VV-0-366B Hydraulic Fluid		E	-	-	-	-	-	G	-	-	-	-	-
Aqua Regia (Concentrated)	E	X	X	X	G	X	X	X	X	X	X	X	-
Arco A.T.F.Dexron		-	E	-	-	-	-	-	-	-	-	-	-
Arco C2, 100		-	E	-	-	-	-	-	-	-	-	-	-
Argon Gas	E												
Aromatic Fuel 30%, Mil		-	-	-	-	-	-	-	-	-	-	-	-
Aromatic Fuel 50%		X	G	-	-	-	-	-	-	-	-	-	-
Aromatic Hydrocarbons	E	X	X	-	-	X	G	-	G	E	G	G	G
Arsenic Salt (to 70°F)	E												
Askarel, Transformer Oil	-	X	X	X	-	X	-	-	E	E	E	-	E
Asphalt, Cut Back (Including Emulsions)	E	X	G	G	-	X	E	E	E	E	E	G	G
Asphalt, Topping (Including Emulsions)	E	E	X	-	-	-	-	-	E	E	E	-	-
Asphalt, Under 180°F (Including Emulsions)	E	G	G	G	X	X	E	-	E	E	E	-	G
ASTM Oil N° 1	E	E	E	E	E	G	E	E	E	E	E	E	E
ASTM Oil N° 2	E	G	E	-	G	-	E	E	E	E	E	E	E
ASTM Oil N° 3	E	X	E	X	X	X	-	E	E	E	E	E	E
ASTM Oil N° 4	E	X	G	-	-	-	-	-	E	E	E	E	-
ASTM Reference Fuel A (to 300°F)	E	G	E	E	E	E	-	E	E	E	E	E	E
ASTM Reference Fuel B (to 300°F)	E	G	E	G	G	X	-	-	E	E	E	E	E
ASTM Reference Fuel C (to 300°F)	E	X	G	X	G	X	-	-	E	E	E	-	E
ATL-857		X	G	-	-	-	-	-	-	-	-	-	-
Atlantic Dominion F		G	E	-	-	-	-	-	-	-	-	-	-
Aurex 903R (Mobil)		G	E	-	-	-	-	-	-	-	-	-	-
Automatic Brake Fluid		G	X	-	-	-	-	-	E	E	E	E	-

Underline is cover compound rating only. Many factors, such as temperature, concentration and length of exposure, are relevant to how chemical exposure affects the tube and cover or fitting material. The fluid manufacturers recommended maximum operating temperature should be carefully observed. Exceeding the manufacturer's recommended maximum temperature can result in fluid breakdown and cause harm or shorten life of tube and cover materials. There may be instances where the hose cover could be adversely affected by fluids which would not chemically affect the hose tube. Conversely, some fluids with an adverse affect on the tube of the hose may not have a deteriorating effect on the hose cover. It is recommended that the user test the hose/fluid compatibility to their own standards. Since no industry standards exist for chemical resistance, the Compass Chemical Resistance Guide for Elastomers is used whenever possible. Teflon® is a registered trademark of Dupont.

Chemical Resistance Tables

The following is a representative list of fluids and manufacturers and a general guideline for the use and compatibility of Continental ContiTech hose and fittings.

Rating Scale

E = Excellent resistance **X** = Not recommended **Blank** = No Data
G = Good resistance **-** = Testing recommended

Chemical Name	Hose								Fittings and Adapters				
	PTFE (Teflon®)	CR (polychloropene)	NBR (Nitrile)	Nitrile/ PVC	CPE	CSM	Urethane	Nylon	Carbon Steel	Stainless Steel 304	Stainless Steel 316	Aluminum	Brass
Automatic Transmission Fluid		G	E	-	E	-	-	-	E	E	E	E	-
Aviation Gasoline, Mil		-	G	-	-	-	-	-	E	E	E	E	-
Baltic Types 100, 150, 200, 300, 500		-	E	-	-	-	-	-	-	-	-	-	-
Banvel Concentrated (Ag Spray)		-	-	-	-	-	-	E	-	-	E	-	-
Bardol B		X	X	X	-	X	-	-	E	E	E	-	-
Barium Chloride	E	X	E	E	E	E	E	E	X	G	G	X	E
Barium Chloride, 5%	E	X	E	-	-	-	-	X	G	E	E	X	G
Barium Chloride, Aqueous Solution (Hot)		X	E	-	-	-	-	X	G	G	G	X	-
Barium Concentrate		E	E	E	E	E	-	E	G	E	E	X	-
Barium Hydroxide	E	E	E	E	E	E	X	E	X	E	E	X	X
Barium Sulfate	E	E	E	-	E	G	-	E	G	E	E	G	G
Barium Sulfate, Aqueous Solution (Hot)	E	X	-	-	-	-	-	X	G	E	E	G	X
Barium Sulfide	E	G	E	E	E	E	-	G	X	E	E	X	-
Baygon													-
Bayol 35		-	E	-	-	-	-	-	-	-	-	-	-
Bayol D		-	E	-	-	-	-	-	-	-	-	-	X
Beer	E												-
Beet Sugar Liquors	E	X	E	E	E	E	X	-	G	G	G	G	E
Bellows 80-20 Hydraulic Oil		-	E	-	-	-	G	-	-	-	-	-	E
Benzaldehyde	E	X	X	X	G	X	E	E	E	E	E	E	E
Benzene, Benzo	E	X	X	X	X	X	G	E	E	E	E	E	-
Benzine, Petroleum Ether		X	G	X	E	-	G	-	E	E	E	E	X
Benzine, Petroleum Naphtha	E												E
Benzoic Acid													G
Benzyl Alcohol	E												X
Black Point 77		-	E	-	-	-	-	-	-	-	-	-	X
Black Sulfate Liquor	E	G	G	G	G	G	-	E	G	E	E	X	-
Blast Furnace Gas	E	X	X	X	-	X	X	-	E	E	E	G	E
Borax, Sodium Borate	E	X	G	G	E	E	E	X	G	E	E	X	E
Bordeaux Mixture	E	G	G	G	-	-	E	E	X	-	E	E	-
Boric Acid	E	E	E	E	-	E	E	X	X	G	G	E	-
Boron Fuels, HEF		X	X	-	-	-	-	-	-	-	-	-	-
Brake Fluid, Petroleum Base (to 300°F)	E	G	E	G	E	X	-	-	E	E	E	-	-

Underline is cover compound rating only. Many factors, such as temperature, concentration and length of exposure, are relevant to how chemical exposure affects the tube and cover or fitting material. The fluid manufacturers recommended maximum operating temperature should be carefully observed. Exceeding the manufacturer's recommended maximum temperature can result in fluid breakdown and cause harm or shorten life of tube and cover materials. There may be instances where the hose cover could be adversely affected by fluids which would not chemically affect the hose tube. Conversely, some fluids with an adverse affect on the tube of the hose may not have a deteriorating effect on the hose cover. It is recommended that the user test the hose/fluid compatibility to their own standards. Since no industry standards exist for chemical resistance, the Compass Chemical Resistance Guide for Elastomers is used whenever possible. Teflon® is a registered trademark of Dupont.

Chemical Resistance Tables

The following is a representative list of fluids and manufacturers and a general guideline for the use and compatibility of Continental ContiTech hose and fittings.

Rating Scale

E = Excellent resistance X = Not recommended Blank = No Data
G = Good resistance - = Testing recommended

Chemical Name	Hose							Fittings and Adapters					
	PTFE (Teflon®)	CR (polychloropene)	NBR (Nitrile)	Nitrile/ PVC	CPE	CSM	Urethane	Nylon	Carbon Steel	Stainless Steel 304	Stainless Steel 316	Aluminum	Brass
Brake Fluid, Synthetic Base		X	X	X	E	X	-	-	E	E	E	E	-
Bray GG-130		X	G	-	-	-	-	-	-	-	-	-	-
Brayco 719-r (VV-H-910)		G	X	-	-	-	-	-	-	-	-	-	E
Brayco 885 (MIL-L-6085A)		X	G	-	-	-	-	-	-	-	-	-	-
Brayco 910		G	G	-	-	-	-	-	-	-	-	-	E
Brine	E												E
Brom-113		X	G	-	-	-	-	-	-	-	-	-	-
Brom-114		G	G	-	-	-	-	-	-	-	-	-	X
Bromine (Permiable)	E												X
Bunker Oil	E	X	G	G	-	X	G	-	E	E	E	E	X
Butane	E	X	X	X	-	X	X	X	X	-	-	-	E
Butanone, MEK													-
Butyl Acetate	E	X	X	X	G	X	-	-	G	E	E	E	X
Butyl Acetate	E												G
Butyl Alcohol, Butanol	E												X
Butyl Cellosolve	E												X
Butyl Stearate	E												X
Butylene (Permiable)	E												X
Butyraldehyde	E												X
Cadmium Salts (to 70°F)	E												
Calcium Acetate	E	X	X	X	E	X	-	-	G	G	G	X	E
Calcium Arsenate	-	-	-	-	-	-	E	E	-	-	-	-	E
Calcium Bisulfate	E	E	E	G	E	E	-	-	-	G	E	-	E
Calcium Bisulfide	E	E	E	G	E	E	E	-	-	G	G	X	-
Calcium Bisulfite	E	E	E	E	E	E	-	E	X	E	E	E	G
Calcium Carbonate	E	E	E	E	E	E	E	E	G	E	E	X	X
Calcium Chlorate	E	E	E	E	-	E	-	-	G	G	E	E	E
Calcium Chloride	E	E	E	E	E	E	E	E	X	G	G	X	E
Calcium Hydroxide	E	E	G	G	E	E	X	-	X	X	E	-	X
Calcium Hydroxide, 10% Boiling		-	G	-	-	-	-	X	G	E	E	X	E
Calcium Hydroxide, 20% Boiling		-	-	-	-	-	-	X	-	E	E	X	-
Calcium Hydroxide, 50% Boiling		-	-	-	-	-	-	X	-	X	G	X	G
Calcium Hypochlorite, 15% (Under 100°F)	E	X	-	X	E	G	-	X	-	X	G	X	X
Calcium Hypochlorite, 5% (Under 100°F)	E	X	G	X	E	G	-	X	X	X	G	X	E

Underline is cover compound rating only. Many factors, such as temperature, concentration and length of exposure, are relevant to how chemical exposure affects the tube and cover or fitting material. The fluid manufacturers recommended maximum operating temperature should be carefully observed. Exceeding the manufacturer's recommended maximum temperature can result in fluid breakdown and cause harm or shorten life of tube and cover materials. There may be instances where the hose cover could be adversely affected by fluids which would not chemically affect the hose tube. Conversely, some fluids with an adverse affect on the tube of the hose may not have a deteriorating effect on the hose cover. It is recommended that the user test the hose/fluid compatibility to their own standards. Since no industry standards exist for chemical resistance, the Compass Chemical Resistance Guide for Elastomers is used whenever possible. Teflon® is a registered trademark of Dupont.

Chemical Resistance Tables

The following is a representative list of fluids and manufacturers and a general guideline for the use and compatibility of Continental ContiTech hose and fittings.

Rating Scale

E = Excellent resistance **X** = Not recommended **Blank** = No Data
G = Good resistance **-** = Testing recommended

Chemical Name	Hose								Fittings and Adapters				
	PTFE (Teflon®)	CR (polychloropene)	NBR (Nitrile)	Nitrile/PVC	CPE	CSM	Urethane	Nylon	Carbon Steel	Stainless Steel 304	Stainless Steel 316	Aluminum	Brass
Calcium Nitrate	E	E	E	E	E	E	-	E	X	G	G	X	X
Calcium Salts (to 70°F)	E												
Calcium Silicate	E	-	G	-	E	G	-	-	E	E	E	E	X
Calcium Sulfate	E	E	E	E	E	E	-	-	G	E	E	G	-
Calcium Sulfide	E	E	G	-	E	-	-	G	G	E	E	G	X
Caliche Liquors E	E												
Cane Sugar Liquors	E	E	E	G	E	E	E	-	E	E	E	E	G
Carbitol													
Carbolic Acid, Phenol	E	X	X	X	E	X	X	X	X	E	E	G	X
Carbon Bisulfide	E												
Carbon Dioxide, Dry	E	G	E	E	E	E	E	-	E	E	E	E	E
Carbon Dioxide, Wet	E	G	E	E	E	E	-	-	E	E	E	E	E
Carbon Disulfide	-	X	X	-	-	X	G	E	G	E	E	G	-
Carbon Monoxide, (under 150°F) (Hot)	E	G	G	G	E	E	-	G	E	E	E	E	-
Carbon Tetrachloride, 5-10%	E	-	-	-	-	-	-	-	-	X	-	-	X
Carbon Tetrachloride, Pure	E	X	X	X	G	X	X	X	X	X	G	G	-
Carbonic Acid	E	E	E	E	E	E	X	-	X	E	E	G	-
Castor Oil	E	G	G	G	E	G	G	E	G	E	E	E	G
Caustic Soda, 20%	E	G	X	X	E	E	X	G	G	E	E	X	E
Caustic Soda, 50%	E	G	X	X	E	E	X	G	G	E	E	X	E
Cellosolve Acetate, Under 100°F	E	X	X	X	G	X	-	-	G	G	G	E	E
Cellosolve Butyl, Under 100°F	E	X	X	X	-	X	-	-	G	G	G	G	E
Cellosolve Union Carbide, Under 100°F	E	X	X	-	-	-	-	-	G	G	G	G	-
Cellugard, Cellugard 200		E	E	-	-	-	-	-	-	X	X	-	X
Cellulube 1000, 220A, ST220, A60 (to 70°F)	E	X	X	X	-	X	-	-	E	E	E	E	X
Cellulube 90, 150, 220,300, 551 (to 70°F)	E	X	X	X	-	X	-	-	E	E	E	E	X
Cellultherm 2505A	-	X	G	-	-	-	-	-	-	-	-	-	X
Chevron FR-10,13, 20, 8													
China wood Oil (Tung)	E												
Chlor Acetone													
Chlordane (to 70°F)	E	X	X	X	-	X	-	E	-	-	-	X	X
Chlorinated Paraffine													
Chlorinated Solvents - Dry(to 212°F)	E												

Underline is cover compound rating only. Many factors, such as temperature, concentration and length of exposure, are relevant to how chemical exposure affects the tube and cover or fitting material. The fluid manufacturers recommended maximum operating temperature should be carefully observed. Exceeding the manufacturer's recommended maximum temperature can result in fluid breakdown and cause harm or shorten life of tube and cover materials. There may be instances where the hose cover could be adversely affected by fluids which would not chemically affect the hose tube. Conversely, some fluids with an adverse effect on the tube of the hose may not have a deteriorating effect on the hose cover. It is recommended that the user test the hose/fluid compatibility to their own standards. Since no industry standards exist for chemical resistance, the Compass Chemical Resistance Guide for Elastomers is used whenever possible. Teflon® is a registered trademark of Dupont.

Chemical Resistance Tables

The following is a representative list of fluids and manufacturers and a general guideline for the use and compatibility of Continental ContiTech hose and fittings.

Rating Scale

E = Excellent resistance X = Not recommended Blank = No Data
 G = Good resistance - = Testing recommended

Chemical Name	Fittings and Adapters													
	Hose	PTFE (Teflon®)	CR (polychloropene)	NBR (Nitrile)	Nitrile/ PVC	CPE	CSM	Urethane	Nylon	Carbon Steel	Stainless Steel 304	Stainless Steel 316	Aluminum	Brass
Chlorinated Solvents -														
Wet (to 70°F)	E													
Chlorine Gas, (Under 212°F)		-	X	-	-	-	-	-	-	X	X	-	-	
Chlorine Trifluoride (to 70°F)	E	X	X	-	-	-	-	-	E	E	E	E	-	
Chlorine Water, 25% Chlorine		X	X	X	-	G	G	X	-	X	X	-	E	
Chloroacetic Acid														
(Under 100°F)	E	X	X	X	-	G	-	X	X	X	X	X	X	E
Chlorobenzene	E	X	X	X	X	X	-	X	G	G	G	X	E	
Chlorobromo Methane	E	X	X	X	-	X	-	-	G	G	G	X	G	
Chloroform	E	X	X	X	X	X	-	X	G	E	E	X	X	
Chlorosulphonic Acid	E													
Chlorotoluene	E	X	X	X	X	X	X	-	G	G	G	X	X	
Chlorox, Bleach		G	G	-	E	G	-	E	X	G	E	X	X	
Chromic Acid, 10%	E	X	X	X	E	G	X	X	X	X	G	X	X	
Chromic Acid, 100%	E	-	-	-	-	-	X	-	X	X	X	X	X	
Chromic Acid, 25%	E	X	X	X	E	G	X	X	X	X	G	X	X	
Chromic Acid, 5%	E	X	X	-	-	-	-	X	X	G	E	X	X	
Chromic Acid, 50%	E	X	X	X	E	G	X	X	X	X	X	X	X	
Chromium Potassium Sulfate														
Cider														
Circo Light Process Oil		E	E	-	-	-	-	-	E	E	E	E	-	
Citgo FR Fluids		-	X	-	-	-	G	-	-	-	-	-	-	
Citgo FR15, 20,25														
Citgo Glycol FR-20XD		-	E	-	-	-	G	-	E	E	E	E	E	
Citgo Pacemaker FR														
Citgo Pacemaker Glicol														
Citgo Sentry, (Under 100°F)		G	G	E	-	X	G	-	E	E	E	-	E	
Citgo Tractor Hydraulic Fluid		-	E	-	-	-	G	-	E	E	E	-	E	
Citric Acid, 15%		E	G	-	-	-	-	E	X	E	E	-	X	
Citric Acid, 15% Boiling		E	G	-	-	-	-	X	X	G	E	X	X	
Citric Acid, 5%		-	G	-	-	-	-	E	X	E	E	E	X	
Citric Acid, 5% @150°F		-	G	-	-	-	-	X	X	E	E	G	X	
Citric Acid, Concentrated														
Boiling		E	X	E	-	E	G	X	X	X	G	X	X	
Coal Gas		E	X	-	E	-	E	-	-	-	-	-	-	
Coal Tars		X	G	X	G	G	-	-	E	E	E	E	E	
Codor 1000, 1002, 1004, 1006, 1008		-	G	-	-	-	-	-	-	-	-	-	-	
Coke Oven Gas (Under 100°F)	E	X	G	X	-	G	-	-	E	E	E	G	-	

Underline is cover compound rating only. Many factors, such as temperature, concentration and length of exposure, are relevant to how chemical exposure affects the tube and cover or fitting material. The fluid manufacturers recommended maximum operating temperature should be carefully observed. Exceeding the manufacturer's recommended maximum temperature can result in fluid breakdown and cause harm or shorten life of tube and cover materials. There may be instances where the hose cover could be adversely affected by fluids which would not chemically affect the hose tube. Conversely, some fluids with an adverse affect on the tube of the hose may not have a deteriorating effect on the hose cover. It is recommended that the user test the hose/fluid compatibility to their own standards. Since no industry standards exist for chemical resistance, the Compass Chemical Resistance Guide for Elastomers is used whenever possible. Teflon® is a registered trademark of Dupont.

Chemical Resistance Tables

The following is a representative list of fluids and manufacturers and a general guideline for the use and compatibility of Continental ContiTech hose and fittings.

Rating Scale

E = Excellent resistance **X** = Not recommended **Blank** = No Data
G = Good resistance **-** = Testing recommended

Chemical Name	Hose								Fittings and Adapters				
	PTFE (Teflon®)	CR (polychloropene)	NBR (Nitrile)	Nitrile/ PVC	CPE	CSM	Urethane	Nylon	Carbon Steel	Stainless Steel 304	Stainless Steel 316	Aluminum	Brass
Conor 1008, 1010, 1012, 1014, 1016		-	G	-	-	-	-	-	-	-	-	-	-
Convelex 10		X	X	-	-	-	-	-	-	-	-	-	-
Copper Arsenate, Cupric Arsenate		-	-	-	-	G	-	-	E	E	E	-	-
Copper Chloride, 1%		E	E	-	-	-	-	X	-	G	G	-	-
Copper Chloride, 5%	E	E	E	-	-	-	-	X	-	X	G	-	-
Copper Chloride, Cupric Chloride	E	G	G	G	G	G	E	G	X	X	E	-	X
Copper Cyanide, Cupric Cyanide	E	G	G	G	-	G	-	X	E	E	E	-	X
Copper Nitrate, 1% & 5%	E	E	E	-	-	-	-	E	X	E	E	X	X
Copper Nitrate, Cupric Nitrate		E	E	E	E	E	-	-	X	E	E	-	X
Copper Sulfate, 10%	E	E	E	-	-	-	-	-	X	G	G	X	-
Copper Sulfate, 50%	E	E	E	-	-	-	-	-	-	G	G	-	-
Copper Sulfate, Cupric Sulfate		E	E	E	E	E	E	E	X	E	E	X	X
Corn Oil	E	X	G	G	G	X	X	-	E	E	E	E	E
Cosmolubric													
Cottonseed Oil	E	G	G	E	G	G	X	G	E	E	E	E	E
Creosol	E												
Creosote, Wood or Coal Tar (Under 100°F)	E	X	G	X	-	X	X	X	G	E	E	E	X
Cresol, Cresylic Acid (Under 100°F)	E	X	X	X	E	X	-	X	G	E	E	G	-
Crude Petroleum Oil	E	X	X	G	G	G	G	-	E	E	E	E	E
Cutting Oil	E	G	E	G	E	X	-	-	E	E	E	-	E
Cutting Oil, Sulfur Base	E	X	E	-	-	-	-	-	E	E	E	E	-
Cutting Oil, Water Soluble	E	X	E	-	-	-	-	-	E	E	E	E	-
Cyclohexane	E	X	G	-	E	X	E	E	G	G	G	G	-
Cyclohexanol	E												
Cyclohexanone	E	X	X	X	G	X	E	E	G	G	G	G	-
Cymene	E	X	X	X	G	X	-	-	E	E	E	E	E
Dasco FR 300													
Dasco FR150, FR200, FR200B, FR310		-	E	-	-	-	-	E	-	-	-	-	-
Dasco IFR		-	E	-	-	-	-	E	E	-	-	E	E
DDT Preparation (to 70°F) (in Kerosene)	E												
Decalin	E	X	G	-	G	X	-	E	-	-	-	-	E

Underline is cover compound rating only. Many factors, such as temperature, concentration and length of exposure, are relevant to how chemical exposure affects the tube and cover or fitting material. The fluid manufacturers recommended maximum operating temperature should be carefully observed. Exceeding the manufacturer's recommended maximum temperature can result in fluid breakdown and cause harm or shorten life of tube and cover materials. There may be instances where the hose cover could be adversely affected by fluids which would not chemically affect the hose tube. Conversely, some fluids with an adverse affect on the tube of the hose may not have a deteriorating effect on the hose cover. It is recommended that the user test the hose/fluid compatibility to their own standards. Since no industry standards exist for chemical resistance, the Compass Chemical Resistance Guide for Elastomers is used whenever possible. Teflon® is a registered trademark of Dupont.

Chemical Resistance Tables

The following is a representative list of fluids and manufacturers and a general guideline for the use and compatibility of Continental ContiTech hose and fittings.

Rating Scale

E = Excellent resistance X = Not recommended Blank = No Data
G = Good resistance - = Testing recommended

Chemical Name	Fittings and Adapters													
	Hose	PTFE (Teflon®)	CR (polychloropene)	NBR (Nitrile)	Nitrile/ PVC	CPE	CSM	Urethane	Nylon	Carbon Steel	Stainless Steel 304	Stainless Steel 316	Aluminum	Brass
Dectol R&O Oil		X	E	-	-	-	G	-	-	-	-	-	-	-
Deionized Water														
Detergent / water Solution	E													
Developing Fluids, Photo	E	G	-	-	E	G	-	-	-	E	E	-	-	-
Developing Solutions, Hypos	E	G	-	-	E	G	-	-	-	E	E	-	-	-
Dextron AFT														
Diacetone	E	X	X	X	E	X	-	E	E	E	E	E	E	E
Diammonium Phosphate (to 70°F)	E													
Dibenzyl Ether	E													
Dibutyl Ether	E													
Dibutyl Phthalate (Under 120°F)	E	X	X	X	G	X	G	-	E	E	E	E	E	E
Dichlorobenzene	E	X	X	X	X	X	X	-	E	E	E	X	E	E
Dichloroethylene	E													
Dieldrin														
Diesel Oil, Fuel ASTM #2	E	G	E	G	G	X	E	E	E	E	E	E	E	E
Diester Lubricant MIL-I-7809		X	G	-	-	-	-	-	E	E	E	E	-	-
Diester Synthetic Lubricants		X	G	-	-	-	-	-	E	E	E	E	-	-
Diethanolamine, 20%	E													
Diethyl Ether (Permiable)	E													
Diethyl Sebacate	E													
Diethylamine (Under 120°F)	E	G	G	-	G	X	-	E	E	E	E	E	E	E
Diethylene Glycol	E	E	E	E	E	E	E	E	E	E	E	E	E	E
Diisobutyl Ketone	E	X	X	X	G	X	-	E	E	E	E	E	E	E
Diisobutylene	E	X	G	-	E	X	-	-	G	E	E	G	E	E
Diisopropyl Ketone		X	X	X	G	X	-	E	E	E	E	E	E	E
Dimethyk Benzol														
Dimethyl Aniline	E	X	X	X	G	X	-	-	-	-	-	-	-	E
Dimethyl Formamide (Under 120°F)	-	X	X	X	-	-	-	-	E	E	E	E	-	-
Dimethyl Phthalate	E	X	X	X	E	X	-	-	-	-	G	-	E	E
Diocetyl Phthalate (DOP)	E	X	X	X	G	X	-	-	E	E	E	E	E	E
Diocetyl Sebacate		X	X	X	X	X	-	-	E	E	E	E	-	-
Diocetylphospjate														
Dipentene	E	X	X	-	G	-	-	-	E	E	E	E	E	E
Dirco Oils		-	E	-	-	-	-	E	E	E	E	E	E	E
Dispersing Oil #10		X	X	-	-	-	-	-	E	E	E	E	-	-
Dow Corning C200,DC510,DC550,DC560	-	-	E	-	-	-	-	E	-	E	E	E	E	E

Underline is cover compound rating only. Many factors, such as temperature, concentration and length of exposure, are relevant to how chemical exposure affects the tube and cover or fitting material. The fluid manufacturers recommended maximum operating temperature should be carefully observed. Exceeding the manufacturer's recommended maximum temperature can result in fluid breakdown and cause harm or shorten life of tube and cover materials. There may be instances where the hose cover could be adversely affected by fluids which would not chemically affect the hose tube. Conversely, some fluids with an adverse affect on the tube of the hose may not have a deteriorating effect on the hose cover. It is recommended that the user test the hose/fluid compatibility to their own standards. Since no industry standards exist for chemical resistance, the Compass Chemical Resistance Guide for Elastomers is used whenever possible. Teflon® is a registered trademark of Dupont.

Chemical Resistance Tables

The following is a representative list of fluids and manufacturers and a general guideline for the use and compatibility of Continental ContiTech hose and fittings.

Rating Scale

E = Excellent resistance **X** = Not recommended **Blank** = No Data
G = Good resistance **-** = Testing recommended

Chemical Name	Hose								Fittings and Adapters				
	PTFE (Teflon®)	CR (polychloropene)	NBR (Nitrile)	Nitrile/ PVC	CPE	CSM	Urethane	Nylon	Carbon Steel	Stainless Steel 304	Stainless Steel 316	Aluminum	Brass
Dow HD 50-4													
Dow Therm 209													
Dowtherm A	E	X	X	X	G	X	X	-	E	E	E	E	E
Dowtherm E		X	X	-	G	-	-	-	E	E	E	E	E
DP47, 200 Flow-DOW		-	E	-	-	-	-	E	E	E	E	E	E
Duro AW-16, 31													
Duro FR-HD		-	E	-	-	-	X	E	-	-	-	-	-
Duro Oils			E	-	-	-	-	E	E	E	E	E	E
Elco 28-EP, Lubricant		X	E	-	-	-	-	-	E	E	E	E	-
Enamels	-E	-	-	-	-	-	E	-	-	-	-	E	-
Energol HL 68		-	E	-	-	-	-	-	E	E	E	E	E
Energol HLPC 68		-	E	-	-	-	-	-	E	E	E	E	E
EP Hydraulic Oils, Chevron		-	E	-	-	-	-	-	E	E	E	E	E
Epichlorohydrin (Under 120°F)		X	X	-	-	-	-	-	E	G	E	E	-
Esam-6 Fluid		G	-	-	-	-	-	-	-	-	-	-	-
Ethanoic Acid	E												
Ethanol	E	E	E	-	E	-	X	E	-	-	-	-	-
Ethanolamine, Amino-ethanol	E	G	G	-	E	X	X	E	E	E	E	E	E
Ethers (Under 120°F)	E	X	G	X	E	G	G	E	E	E	E	E	E
Ethyl Acetate	E	X	X	X	G	X	G	E	E	E	E	G	G
Ethyl Acetoacetate	E	X	X	X	E	X	X	-	E	E	E	E	E
Ethyl Acrylate	E	X	X	X	G	X	X	-	E	E	E	E	-
Ethyl Alcohol	E												
Ethyl Amine, Monoethylamine	E	X	X	X	E	X	X	-	G	E	E	G	E
Ethyl Benzene	E	X	X	X	G	X	E	-	E	E	E	E	E
Ethyl Bromide, Di	E	X	X	X	G	X	-	-	E	E	E	E	E
Ethyl Butyrate	E	X	X	X	-	-	-	-	-	E	E	E	-
Ethyl Cellulose	E	-	-	-	E	-	-	-	E	E	E	-	E
Ethyl Chloride	E	X	X	X	-	X	X	-	G	E	E	E	G
Ethyl Chloride, Dry	E	E	X	-	-	-	X	E	E	E	E	E	-
Ethyl Chloride, Wet	E	G	X	-	-	-	-	E	-	E	E	E	E
Ethyl Mercaptan	E	X	X	X	-	X	X	-	G	G	G	G	-
Ethyl Oxalate		X	X	-	E	-	E	-	-	-	-	-	-
Ethyl Pentachlorobenzene	E	-	X	-	X	-	E	-	-	-	-	-	-
Ethyl Silicate (to 70°F)	E	E	E	E	E	-	E	-	E	E	E	G	E
Ethylene Chlorohydrin, (Under 100°F)	E	X	X	X	-	-	X	X	E	E	G	X	-

Underline is cover compound rating only. Many factors, such as temperature, concentration and length of exposure, are relevant to how chemical exposure affects the tube and cover or fitting material. The fluid manufacturers recommended maximum operating temperature should be carefully observed. Exceeding the manufacturer's recommended maximum temperature can result in fluid breakdown and cause harm or shorten life of tube and cover materials. There may be instances where the hose cover could be adversely affected by fluids which would not chemically affect the hose tube. Conversely, some fluids with an adverse affect on the tube of the hose may not have a deteriorating effect on the hose cover. It is recommended that the user test the hose/fluid compatibility to their own standards. Since no industry standards exist for chemical resistance, the Compass Chemical Resistance Guide for Elastomers is used whenever possible. Teflon® is a registered trademark of Dupont.

Chemical Resistance Tables

The following is a representative list of fluids and manufacturers and a general guideline for the use and compatibility of Continental ContiTech hose and fittings.

Rating Scale

E = Excellent resistance X = Not recommended Blank = No Data
G = Good resistance - = Testing recommended

Chemical Name	Fittings and Adapters												
	Hose	PTFE (Teflon®)	CR (polychloropene)	NBR (Nitrile)	Nitrile/ PVC	CPE	CSM	Urethane	Nylon	Carbon Steel	Stainless Steel 304	Stainless Steel 316	Aluminum
Ethylene Diamine (Under 100°F)	E	G	G	G	E	X	X	-	E	E	E	X	E
Ethylene Dichloride (Permiabie)	E	X	X	-	G	-	E	E	-	E	E	X	-
Ethylene Glycol	E	E	E	E	E	E	E	E	G	E	E	E	E
Ethylene Glycol, Ethyl Ether	E												
Ethylene Oxide	E												
Exxon Univoilt 60, N61													
Factovis 52	-	-	E	-	-	-	-	-	E	E	E	E	E
Fatty Acids	E	G	G	G	G	X	E	E	X	G	E	E	-
Ferric Chloride	E	-	-	-	E	G	-	-	X	X	X	X	X
Ferric Chloride, 1%		E	E	-	-	-	-	E	X	G	G	X	X
Ferric Chloride, 1% boiling		-	G	-	-	-	-	E	X	X	X	X	X
Ferric Chloride, 10%		G	E	-	-	-	-	E	X	X	X	X	X
Ferric Chloride, 5% Agitated or Aerated		G	G	-	-	-	-	E	X	X	X	X	X
Ferric Chloride, 5% Still		G	E	-	-	-	-	E	X	X	X	X	X
Ferric Sulfate	E	G	G	G	E	G	-	E	X	G	G	X	X
Ferrous Sulfate, Saturated	E	E	-	-	-	-	-	E	-	G	G	X	-
Ferrous Chloride	E	E	E	-	E	G	-	E	X	X	G	X	X
Ferrous Nitrate	E	G	G	G	-	G	-	-	-	E	E	-	-
Ferrous Salt Solutions	E												
Ferrous Sulfate, 10%	E	E	E	-	-	-	-	E	X	G	G	X	-
Ferrous Sulfate, Copper Gas	E	G	G	G	E	G	-	-	X	E	E	E	G
Fire Resistant Hydraulic Fluid, Texaco		-	E	-	-	-	-	-	E	E	E	E	E
Fire Safe, 225, 211													
Fire Safe, 1090E,1150,1220,1300E,155													
Firtec 290, MF		-	-	-	-	-	-	-	-	-	-	-	-
Fixing Solution, Photo		G	-	-	-	G	-	-	-	E	E	-	-
Flactid Acid													
Fluoboric Acid	E	E	E	-	E	-	-	-	E	-	E	X	-
Fluoboric Acid, 65%	E	G	-	-	E	G	X	-	-	E	E	-	-
Fluorine Gas, Dry or Wet	G												
Fluosilic Acid		G	E	-	-	-	-	-	X	X	X	X	E
Fluosilic Acid, 50%		G	X	X	E	G	X	X	-	-	-	E	-
Formaldehyde	E	E	X	-	E	-	-	G	E	E	E	E	X
Formaldehyde, 37%		G	-G	-	E	G	-G	-	-	E	E	E	E
Formaldehyde, Hot		-	-	-	-	-	-	E	X	G	E	G	E

Underline is cover compound rating only. Many factors, such as temperature, concentration and length of exposure, are relevant to how chemical exposure affects the tube and cover or fitting material. The fluid manufacturers recommended maximum operating temperature should be carefully observed. Exceeding the manufacturer's recommended maximum temperature can result in fluid breakdown and cause harm or shorten life of tube and cover materials. There may be instances where the hose cover could be adversely affected by fluids which would not chemically affect the hose tube. Conversely, some fluids with an adverse affect on the tube of the hose may not have a deteriorating effect on the hose cover. It is recommended that the user test the hose/fluid compatibility to their own standards. Since no industry standards exist for chemical resistance, the Compass Chemical Resistance Guide for Elastomers is used whenever possible. Teflon® is a registered trademark of Dupont.

Chemical Resistance Tables

The following is a representative list of fluids and manufacturers and a general guideline for the use and compatibility of Continental ContiTech hose and fittings.

Rating Scale

E = Excellent resistance **X** = Not recommended **Blank** = No Data
G = Good resistance **-** = Testing recommended

Chemical Name	Hose							Fittings and Adapters						
	PTFE (Teflon®)	CR (polychloropene)	NBR (Nitrile)	Nitrile/ PVC	CPE	CSM	Urethane	Nylon	Carbon Steel	Stainless Steel 304	Stainless Steel 316	Aluminum	Brass	
Formic Acid (Under 120°F)	E	E	X	E	E	G	X	G	X	G	E	E	G	
Formic Acid, Dilute Hot		E	X	-	-	-	-	X	X	G	E	G	X	
Freon 113 (Permiable)			Use Freon Hose Only											
Freon 114 (Permiable)	G		Use Freon Hose Only											
Freon 12 (Permiable)	G		Use Freon Hose Only											
Freon 22 (Permiable)			Use Freon Hose Only											
Freon 502 (Permiable)			Use Freon Hose Only											
Fuel Oil	E	G	E	E	E	X	G	E	G	G	G	E	G	
Fumaric Acid	E	G	X	-	-	-	X	-	E	E	E	-	-	
Furan, Furfuran	E	X	X	X	E	-	-	-	E	E	E	E	E	
Furfural	E													
Furfural Alcohol, Ant Oil	E	G	X	X	E	G	-	E	G	E	E	E	E	
Fusel oil, Grain Oil		X	X	-	-	-	-	-	-	-	-	-	-	
Fyran Resin		X	X	-	-	-	-	-	-	-	E	-	-	
Fyre Safe W/O														
Fyrguard 150, 200		-	E	-	-	-	-	-	E	E	E	E	E	
Fyrquel 1000, 15R&O, 220R&O, 550R&O		X	X	-	-	-	-	-	E	-	-	E	-	
Fyrquel A60, 90, 100, 150, 220, 300, 500		X	X	-	-	-	-	-	E	-	-	E	-	
Gallic Acid	E	X	X	X	E	-	X	G	X	E	E	X	-	
Gas Oil	E													
Gas, Natural	E	-	-	-	X	-	-	-	E	E	E	-	G	
Gasohol (to 200°F)	E	G	X	X	-	X	-	-	G	E	E	E	E	
Gasoline Unleaded, Under 50% Aromatics	E	X	X	X	-	X	X	-	G	E	E	E	E	
Gasoline, Aviation	E	X	-	G	-	-	-	-	-	E	E	E	E	
Gasoline, Meter		X	X	-	-	-	-	X	E	E	E	E	X	
Gasoline, Premium	E	G	X	X	-	X	X	-	G	E	E	E	E	
Gasoline, Sour	E	X	X	-	-	-	-	-	G	E	E	X	-	
Gasoline, Standard	E	E	X	X	G	X	X	-	G	E	E	E	E	
Gelatin	E	E	E	-	-	-	-	E	E	E	E	E	X	
Glauber's Salt	-	G	X	-	-	-	-	-	E	E	E	-	-	
Glucose	E	E	E	E	-	E	E	E	E	E	E	E	E	
Glue (Under 120°F)	E	G	G	G	-	E	E	G	G	E	E	G	X	
Glycerine, Glycol	E	E	E	E	E	E	E	E	G	E	E	E	G	
Glycol FR Fluids	E	-	E	-	-	-	-	-	E	E	E	E	E	
Glystantine														
Grease, Ester Base	-	-	-	-	-	-	-	E	E	E	E	E	E	

Underline is cover compound rating only. Many factors, such as temperature, concentration and length of exposure, are relevant to how chemical exposure affects the tube and cover or fitting material. The fluid manufacturers recommended maximum operating temperature should be carefully observed. Exceeding the manufacturer's recommended maximum temperature can result in fluid breakdown and cause harm or shorten life of tube and cover materials. There may be instances where the hose cover could be adversely affected by fluids which would not chemically affect the hose tube. Conversely, some fluids with an adverse affect on the tube of the hose may not have a deteriorating effect on the hose cover. It is recommended that the user test the hose/fluid compatibility to their own standards. Since no industry standards exist for chemical resistance, the Compass Chemical Resistance Guide for Elastomers is used whenever possible. Teflon® is a registered trademark of Dupont.

Chemical Resistance Tables

The following is a representative list of fluids and manufacturers and a general guideline for the use and compatibility of Continental ContiTech hose and fittings.

Rating Scale

E = Excellent resistance X = Not recommended Blank = No Data
 G = Good resistance - = Testing recommended

Chemical Name	Fittings and Adapters												
	PTFE (Teflon®)	CR (polychloropene)	NBR (Nitrile)	Nitrile/ PVC	CPE	CSM	Urethane	Nylon	Carbon Steel	Stainless Steel 304	Stainless Steel 316	Aluminum	Brass
Grease, Petroleum Base	E	G	E	G	-	G	E	E	E	E	E	E	E
Grease, Silicone Base	-	-	-	-	-	-	-	E	E	E	E	E	E
Green Sulfate Liquor, Under 120°F	E	G	G	E	G	-	-	-	E	E	E	-	-
Gulf FR Fluid G-200 (to 70°F)	E	-	E	-	-	-	X	-	E	E	E	E	E
Gulf FR Fluid P37, P40, P43, P45, P47 (to 70°F)	E	-	X	-	-	-	X	-	-	-	-	-	-
Gycols (Under 120°F)	-	E	E	E	E	E	E	E	G	E	E	E	E
H 515 (NATO)	-	-	-	-	-	-	-	-	-	-	-	-	-
Halon	-	-	-	-	-	-	-	-	-	-	-	-	-
Halowax Oil	-	X	X	X	-	X	-	-	-	-	-	-	-
Helium	E	-	-	-	-	-	-	-	-	-	-	-	-
Hephtachlor, In Petroleum	-	-	G	X	-	-	-	-	-	-	-	-	-
Heptane (Under 100°F)	E	G	E	G	E	X	E	E	E	E	E	E	E
Hexane (Under 120°F)	E	G	E	G	G	E	E	E	E	E	E	E	E
Hexene	E	G	G	-	E	-	-	-	E	E	E	-	E
HF 20	-	-	-	-	-	-	-	-	-	-	-	-	-
High Viscosity Lubricant, H2	-	G	E	-	-	-	-	-	-	-	-	-	-
High Viscosity Lubricant, U4	-	G	E	-	-	-	-	-	-	-	-	-	-
Hilo MS #1	-	X	X	-	-	-	-	-	-	-	-	-	-
Houghto-Safe 1010, 1055, (Phos, Ester) (to 70°F)	E	X	X	X	E	X	-	-	E	E	E	E	E
Houghto-Safe 1115,1120,1130, (Phos, Ester) (to 70°F)	E	X	X	X	E	X	-	-	E	E	E	E	E
Houghto-Safe 271,416,520,616, (Water/Glycol) (to 70°F)	E	G	E	E	-	-	G	-	E	E	E	E	E
Hul-E-Mul	-	-	-	-	-	-	-	-	-	-	-	-	-
Hy-Chock Oil	-	-	G	-	-	-	-	E	E	E	E	-	-
Hydrafluid 760, Texaco & Houghton	-	-	E	-	-	-	-	E	E	E	E	E	-
Hydrafluid AZR&O, A, B, AA, C	-	-	E	-	-	-	-	E	E	E	E	-	-
Hydrasol A	-	-	E	-	-	-	-	E	E	E	E	-	-
Hydraulic Fluid HF-18, HF-20	-	-	E	-	-	-	G	E	E	E	E	E	E
Hydraulic Fluid HF-31	-	-	-	-	-	-	-	E	E	E	E	E	E
Hydraulic Fluid, Phosphate Ester Base	-	X	X	X	E	-	X	E	E	E	E	-	-
Hydraulic Fluid, Std Petroleum Oils	-	G	E	G	E	G	G	E	E	E	E	E	E

Underline is cover compound rating only. Many factors, such as temperature, concentration and length of exposure, are relevant to how chemical exposure affects the tube and cover or fitting material. The fluid manufacturers recommended maximum operating temperature should be carefully observed. Exceeding the manufacturer's recommended maximum temperature can result in fluid breakdown and cause harm or shorten life of tube and cover materials. There may be instances where the hose cover could be adversely affected by fluids which would not chemically affect the hose tube. Conversely, some fluids with an adverse affect on the tube of the hose may not have a deteriorating effect on the hose cover. It is recommended that the user test the hose/fluid compatibility to their own standards. Since no industry standards exist for chemical resistance, the Compass Chemical Resistance Guide for Elastomers is used whenever possible. Teflon® is a registered trademark of Dupont.

Chemical Resistance Tables

The following is a representative list of fluids and manufacturers and a general guideline for the use and compatibility of Continental ContiTech hose and fittings.

Rating Scale

E = Excellent resistance **X** = Not recommended **Blank** = No Data
G = Good resistance **-** = Testing recommended

Chemical Name	Hose								Fittings and Adapters				
	PTFE (Teflon®)	CR (polychloropene)	NBR (Nitrile)	Nitrile/ PVC	CPE	CSM	Urethane	Nylon	Carbon Steel	Stainless Steel 304	Stainless Steel 316	Aluminum	Brass
Hydraulic Fluid, Water													
Glycol Base		E	E	E	-	-	E	E	E	E	E	E	E
Hydraulic Oils, Petroleum	E	G	E	-	-	-	-	E	E	E	E	E	E
Hydraulic Oils, Synthetic	E	-	X	-	-	-	-	-	E	E	E	E	E
Hydraulic Safety Fluid													
200&300 Texaco		-	E	-	-	-	E	-	E	E	E	E	E
Hydrazine	E	X	X	X	-	X	-	-	X	E	E	E	-
Hydrobromic Acid		X	X	-	-	-	-	-	X	X	X	X	X
Hydrobromic Acid, 37%		X	X	X	E	G	X	X	X	X	X	X	X
Hydrochloric Acid (Permiabie)	E	G	X	-	-	-	-	X	X	X	X	X	X
Hydrochloric Acid ,15%	E	X	X	X	E	G	X	X	X	X	X	X	X
Hydrochloric Acid Concentrated		X	X	-	-	-	-	X	X	X	X	X	X
Hydrochloric Acid, 3 Molar		G	X	-	-	-	-	X	-	-	-	-	X
Hydrochloric Acid, 37%	E	X	-	X	E	G	X	X	X	X	X	X	X
Hydrocyanic Acid, 20%													
Under 100°F		X	X	X	-	G	X	E	X	E	E	E	X
Hydrocyanic Acid, 98%	E	-	-	-	-	-	-	-	-	-	-	-	-
Hydro-Drive Oil			E	-	-	-	G	-	-	-	-	-	-
Hydro-Drive Oil Houghton			E	-	-	-	G	-	-	-	-	-	-
Hydrofluoric Acid, 10%		X	X	X	E	E	X	X	X	X	X	X	X
Hydrofluoric Acid, 20%													
(Under 120°F)		X	X	X	E	G	X	X	X	X	X	X	X
Hydrofluoric Acid, 48%													
(Under 120°F)		X	X	X	E	G	X	X	X	X	X	X	X
Hydrofluoric Acid, 70% (Permiabie)	E	-	X	X	-	G	X	X	X	X	X	X	X
Hydrofluoric Acid, Anhydrous			X	-	-	-	-	-	-	-	-	-	-
Hydrofluoric Acid, Concentrated	E	X	X	X	E	G	X	X	X	X	X	X	X
Hydrofluorosilic Acid	E												
Hydrogen (Permiabie)	E	E	E	-	E	-	-	-	X	X	X	E	-
Hydrogen Chloride Gas (Permiabie)	E	-	-	-	E	-	-	-	-	E	E	-	-
Hydrogen Cyanide Gas (Permiabie - to 300°F)	E	-	-	-	-	-	-	-	-	-	-	E	-
Hydrogen Fluoride (Under 100°F)(Permiabie)	E	-	X	-	-	-	-	-	G	G	E	-	-
Hydrogen Perhydrol													
Hydrogen Peroxide, 10%	E	X	E	X	E	G	X	X	X	G	E	E	X
Hydrogen Peroxide, 30%	E	X	G	X	E	G	X	X	X	G	E	E	X
Hydrogen Peroxide, 70%	E	X	X	X	E	-	X	X	X	G	E	E	X

Underline is cover compound rating only. Many factors, such as temperature, concentration and length of exposure, are relevant to how chemical exposure affects the tube and cover or fitting material. The fluid manufacturers recommended maximum operating temperature should be carefully observed. Exceeding the manufacturer's recommended maximum temperature can result in fluid breakdown and cause harm or shorten life of tube and cover materials. There may be instances where the hose cover could be adversely affected by fluids which would not chemically affect the hose tube. Conversely, some fluids with an adverse affect on the tube of the hose may not have a deteriorating effect on the hose cover. It is recommended that the user test the hose/fluid compatability to their own standards. Since no industry standards exist for chemical resistance, the Compass Chemical Resistance Guide for Elastomers is used whenever possible. Teflon® is a registered trademark of Dupont.

Chemical Resistance Tables

The following is a representative list of fluids and manufacturers and a general guideline for the use and compatibility of Continental ContiTech hose and fittings.

Rating Scale

E = Excellent resistance X = Not recommended Blank = No Data
G = Good resistance - = Testing recommended

Chemical Name	Hose											Fittings and Adapters		
	PTFE (Teflon®)	CR (polychloropene)	NBR (Nitrile)	Nitrile/ PVC	CPE	CSM	Urethane	Nylon	Carbon Steel	Stainless Steel 304	Stainless Steel 316	Aluminum	Brass	
Hydrogen Peroxide, 90%		X	X	-	-	-	-	-	X	G	E	-	X	
Hydrogen Peroxide, Dilute		E	G	-	-	-	-	E	E	-	E	-	X	
Hydrogen Sulfide, Aqueous Solution		G	X	-	-	-	-	-	X	-	-	X	-	
Hydrogen Sulfide, Dry, Cold		E	E	-	-	-	-	E	-	-	-	G	X	
Hydrogen Sulfide, Dry, Hot		G	X	-	-	-	-	E	E	X	G	G	X	
Hydrogen Sulfide, Gas	E	-	-	-	-	-	-	-	-	-	-	-	-	
Hydrogen Sulfide, Wet, Cold (Permeable)	E	E	X	-	-	-	-	E	G	G	G	G	X	
Hydrogen Sulfide, Wet, Hot	E	G	X	-	-	-	-	E	G	G	E	-	X	
Hydrogluasilic Acid														
Hydrolube, Water Glycol	E	G	E	-	-	-	X	-	X	-	E	-	-	
Hydrolubric Oil, Houghton		-	G	-	-	-	G	E	-	-	-	-	-	
Hydroquinone	E	X	-	-	-	X	-	-	-	E	E	G	-	
Hydroxy Quinoline														
Hykil N°6 (33%), Water (67%)	E	-	G	-	-	-	-	-	E	-	-	-	-	
Hypochlorous Acid, (Under 120°F)		X	X	X	-	G	-	E	G	G	G	X	-	
Hypoid Grease (Parapoid 10-C)		-	E	-	-	-	-	-	-	-	-	-	-	
Imol, Imol S150, S220, S300, S500		-	E	-	-	-	G	E	E	E	E	E	-	
Industron 53		-	E	-	-	-	-	-	-	-	-	-	-	
Ink (Printers)	E	E	E	-	-	-	-	E	G	G	E	-	G	
Ink Oil	E	-	G	-	-	-	-	-	E	E	E	-	E	
Insulating Oil (Transformer)	E	G	E	G	-	X	-	-	E	E	E	-	E	
Iodine (Under 100°F) (Gas- Permeable)	E	X	X	-	E	G	X	E	G	G	G	X	-	
Iodine Pentafluoride		X	X	-	-	-	-	-	X	G	G	X	-	
Iodine, in Alcohol	E	G	-	-	-	-	X	-	-	-	-	X	-	
Irus Fluid 902		-	E	-	-	-	E	E	E	E	E	E	E	
Irus Fluid 905		-	E	-	-	-	E	E	E	E	E	E	E	
Isobutane		X	X	-	-	-	X	X	X	E	E	G	E	
Isocyanates (at 70°F)														
Isooctane		E	E	G	G	E	G	-	E	E	E	G	E	
Isooctyl Thioglucolate	E	-	-	-	-	-	-	-	-	-	-	-	-	
Isopropyl Acetate	E	X	X	X	-	X	G	E	G	G	E	X	E	
Isopropyl Alcohol (Isopropanol)	E	G	G	G	E	G	G	E	E	E	E	E	G	
Isopropyl Ether	E													
Isopropylamine														

Underline is cover compound rating only. Many factors, such as temperature, concentration and length of exposure, are relevant to how chemical exposure affects the tube and cover or fitting material. The fluid manufacturers recommended maximum operating temperature should be carefully observed. Exceeding the manufacturer's recommended maximum temperature can result in fluid breakdown and cause harm or shorten life of tube and cover materials. There may be instances where the hose cover could be adversely affected by fluids which would not chemically affect the hose tube. Conversely, some fluids with an adverse affect on the tube of the hose may not have a deteriorating effect on the hose cover. It is recommended that the user test the hose/fluid compatibility to their own standards. Since no industry standards exist for chemical resistance, the Compass Chemical Resistance Guide for Elastomers is used whenever possible. Teflon® is a registered trademark of Dupont.

Chemical Resistance Tables

The following is a representative list of fluids and manufacturers and a general guideline for the use and compatibility of Continental ContiTech hose and fittings.

Rating Scale

E = Excellent resistance **X** = Not recommended **Blank** = No Data
G = Good resistance **-** = Testing recommended

Chemical Name	Hose								Fittings and Adapters				
	PTFE (Teflon®)	CR (polychloropene)	NBR (Nitrile)	Nitrile/PVC	CPE	CSM	Urethane	Nylon	Carbon Steel	Stainless Steel 304	Stainless Steel 316	Aluminum	Brass
Jet Fuel JP-3 (Under 100°F)	E	G	E	G	-	X	G	E	G	E	E	G	E
Jet Fuel JP-4	E	X	E	G	-	X	-	E	G	E	E	G	E
Jet Fuel JP-5	E	X	E	X	-	X	-	E	G	E	E	G	E
Jet Fuel JP-6	E	X	E	X	-	X	-	E	G	E	E	G	E
Jet Fuel JP-x (at 70°F)	E	G	E	X	-	X	-	E	G	E	E	G	E
Kerosene	E	X	E	G	E	X	-	E	E	E	E	E	E
Ketchup	E	E	E	-	-	-	-	E	-	E	E	-	-
Ketones	E	X	X	X	-	X	X	E	E	E	E	G	E
Keystone #87Hx-Grease+A334		X	E	-	-	-	-	-	E	E	E	E	-
Lacquer Solvents	E	X	X	X	-	X	G	E	X	G	E	E	E
Lacquers	E	X	X	X	-	X	-	E	X	X	E	E	E
Lactic Acid	E	E	X	X	-	E	X	-	X	G	E	X	G
Lactic Acid 10% Boiling	E	X	X	-	-	-	-	-	X	G	E	X	X
Lactic Acid 5%	E	G	E	-	-	-	-	E	X	G	E	E	X
Lactic Acid 5% Boiling	E	X	X	-	-	-	-	-	X	G	E	G	X
Lactol		G	G	G	-	-	-	-	E	E	E	E	E
Lasso (Ag Spray)		-	-	-	-	-	-	E	-	E	E	-	-
Latex	E	E	E	-	-	-	-	E	E	E	E	E	E
Lead Acetate	E	X	X	-	E	X	-	-	G	G	G	X	E
Lead Arsenate (to 70°F)	E	G	G	-	-	G	E	-	E	E	E	-	-
Lead Nitrate (to 300°F)	E	G	G	-	-	-	-	-	E	G	G	-	-
Lead Sulfate (to 300°F)	E	E	E	-	E	E	E	-	E	E	E	-	-
Lead Sulphamate (to 125°F)	E	G	G	-	-	G	-	-	-	-	-	-	-
Lead Tetramethyl	E	X	G	X	-	X	E	-	-	-	-	-	-
Lead, Tetraethyl (Under 100°F)	E	X	G	X	-	X	-	-	-	-	-	-	-
Lecithin	E	G	X	-	-	-	-	-	-	E	E	-	-
Ligroin (Petroleum Ether, Under 120°F)	E	X	E	-	-	X	-	-	G	E	E	X	-
Lime (Chlorinated Free Chlorine 20%)		-	E	-	E	-	E	-	-	-	G	-	-
Lime Bleach (Under 100°F)		X	G	X	-	X	-	-	X	G	E	-	-
Lime Sulphur		E	X	-	-	-	-	E	G	E	E	X	X
Lime Sulphur (Under 135°F)	E	E	X	X	-	G	-	E	G	E	E	X	X
Lindane (Ag Spray)		-	-	-	-	-	-	E	-	E	E	-	-
Lindol HF (to 200°F)	E												
Lindol, Hydraulic Fluid (to 200°F)	E	X	X	-	-	-	-	-	E	E	E	E	-
Linoleic Acid	E	X	G	X	-	-	-	-	X	G	E	E	-

Underline is cover compound rating only. Many factors, such as temperature, concentration and length of exposure, are relevant to how chemical exposure affects the tube and cover or fitting material. The fluid manufacturers recommended maximum operating temperature should be carefully observed. Exceeding the manufacturer's recommended maximum temperature can result in fluid breakdown and cause harm or shorten life of tube and cover materials. There may be instances where the hose cover could be adversely affected by fluids which would not chemically affect the hose tube. Conversely, some fluids with an adverse affect on the tube of the hose may not have a deteriorating effect on the hose cover. It is recommended that the user test the hose/fluid compatibility to their own standards. Since no industry standards exist for chemical resistance, the Compass Chemical Resistance Guide for Elastomers is used whenever possible. Teflon® is a registered trademark of Dupont.

Chemical Resistance Tables

The following is a representative list of fluids and manufacturers and a general guideline for the use and compatibility of Continental ContiTech hose and fittings.

Rating Scale

E = Excellent resistance X = Not recommended Blank = No Data
G = Good resistance - = Testing recommended

Chemical Name	Hose								Fittings and Adapters				
	PTFE (Teflon®)	CR (polychloropene)	NBR (Nitrile)	Nitrile/ PVC	CPE	CSM	Urethane	Nylon	Carbon Steel	Stainless Steel 304	Stainless Steel 316	Aluminum	Brass
Linseed Oil	E	X	E	-	-	-	-	E	E	E	E	G	G
Linseed Oil (Boiled)		G	G	E	E	E	E	-	G	E	E	E	G
LPG													
Lubricating Oil (Diester Under 135°F)		X	G	X	-	-	X	E	E	E	E	E	E
Lubricating Oil (Petroleum Base)	E	G	E	G	E	G	G	E	E	E	E	E	E
Lubricating Oil (SAE 10, 20, 30, 40, 50)	E	G	G	-	-	-	-	E	E	E	E	E	-
Machine Oil (Under 135°F)	E	E	E	G	-	G	G	-	E	E	E	E	E
Magnesium Carbonate	E	E	E	E	-	E	E	-	G	G	G	E	-
Magnesium Chloride	E	E	E	E	E	E	E	E	X	G	E	X	G
Magnesium Hydroxide	E	G	G	G	E	E	X	-	E	E	E	X	X
Magnesium Nitrate	E	G	G	G	-	E	-	-	G	G	G	X	E
Magnesium Sulfate	S	G	G	G	E	E	E	E	G	G	G	G	G
Malation (Ag Spray Dilute)		-	G	-	-	-	-	E	E	E	E	-	E
Maleic Acid	E	G	X	-	-	-	-	E	-	E	E	G	G
Manganese Salts (to 70°F)	E	-	E	E	-	E	-	-	-	-	-	-	-
Maximul (Penzoil Hydraulic Fluid)		G	E	G	-	-	-	-	E	-	E	-	-
Mercuric Chloride	E	E	G	G	E	E	G	X	X	G	G	X	X
Mercuric Cyanide	E	E	G	G	-	E	-	-	G	G	G	X	-
Mercurous Nitrate (Under 120°F)	E	E	G	G	-	E	-	-	E	E	E	X	-
Mercury	E	E	G	G	E	E	G	E	E	E	E	X	X
Mesityl Oxide	E	X	X	X	G	X	X	-	E	E	E	E	E
Methane (Gas or Liquid)	E	G	E	-	-	-	-	-	-	E	E	-	-
Methanol													
Methoxychlor (Insecticide)		-	-	-	-	-	-	X	E	E	E	-	-
Methyl Acetate	E	X	X	X	E	X	-	-	E	E	E	E	E
Methyl Acrylate	E	X	X	X	-	X	-	-	E	E	E	E	E
Methyl Alcohol, Methanol	E												
Methyl Amine (25% Aqueous Solution)	E	G	X	-	-	-	-	-	E	E	E	E	-
Methyl Amine (60%)		G	G	-	-	-	-	G	E	E	E	E	G
Methyl Amine (99%)		X	X	-	-	-	-	-	E	E	E	E	X
Methyl Amyl Carbinol	E	-	-	-	E	-	-	-	E	E	E	-	-
Methyl Bromide	E	X	X	X	-	X	X	X	E	E	E	X	E
Methyl Butyl Ketone (MBK)	E	X	X	X	G	X	-	-	E	E	E	E	E

Underline is cover compound rating only. Many factors, such as temperature, concentration and length of exposure, are relevant to how chemical exposure affects the tube and cover or fitting material. The fluid manufacturers recommended maximum operating temperature should be carefully observed. Exceeding the manufacturer's recommended maximum temperature can result in fluid breakdown and cause harm or shorten life of tube and cover materials. There may be instances where the hose cover could be adversely affected by fluids which would not chemically affect the hose tube. Conversely, some fluids with an adverse affect on the tube of the hose may not have a deteriorating effect on the hose cover. It is recommended that the user test the hose/fluid compatibility to their own standards. Since no industry standards exist for chemical resistance, the Compass Chemical Resistance Guide for Elastomers is used whenever possible. Teflon® is a registered trademark of Dupont.

Chemical Resistance Tables

The following is a representative list of fluids and manufacturers and a general guideline for the use and compatibility of Continental ContiTech hose and fittings.

Rating Scale

E = Excellent resistance **X** = Not recommended **Blank** = No Data
G = Good resistance **-** = Testing recommended

Chemical Name	Hose								Fittings and Adapters				
	PTFE (Teflon®)	CR (polychloropene)	NBR (Nitrile)	Nitrile/ PVC	CPE	CSM	Urethane	Nylon	Carbon Steel	Stainless Steel 304	Stainless Steel 316	Aluminum	Brass
Methyl Cellulosolve (Under 100°F)	E	G	X	-	E	X	-	-	G	G	G	G	E
Methyl Chloride		X	X	X	X	X	-	E	G	E	E	X	E
Methyl Ethyl Ketone (MEK)	E	X	X	X	G	X	X	E	E	E	E	G	E
Methyl Formate	E	G	X	X	-	X	-	-	G	E	E	E	E
Methyl Isobutyl Ketone (MIBK, 100°F)	E	X	X	X	G	X	X	G	G	G	G	G	E
Methyl Isopropyl Ketone	E	X	X	X	G	X	X	-	G	E	E	E	E
Methyl Methacrylate	E	X	X	X	G	G	-	-	G	G	G	-	-
Methyl Methyl Ketone													
Methyl Salicylate	E	G	G	G	-	-	-	-	E	E	E	E	E
Methyl Sulfate (Dinethyl, Under 100°F)	E	X	X	X	-	X	E	-	-	-	-	-	-
Methylene Chloride	E	X	X	X	X	X	-	G	G	G	G	X	E
Methylene Dichloride	E	X	X	X	-	-	-	E	E	E	E	X	E
Methylhalides													
MIL-F-7083													
MIL-H 5606													
MIL-H-83282													
MIL-L-2104 & 2104B													
MIL-L-7808													
MIL-O-6083													
Mine Guard FR													
Mineral Oil (Under 120°F)													
Mineral Spirit	-		E	G	-	X	-	-	E	E	E	G	E
MLO.8220 Hydro		E	G	-	-	-	-	-	E	E	E	E	-
MLO-7277 Hydro,		X	X	-	-	-	-	-	E	E	E	E	-
MLO-7557		E	X	-	-	-	-	-	E	E	E	E	-
MLO-8515		E	G	-	-	-	-	E	E	E	E	E	-
Mobil DTE													
Mobil HFA													
Mobil Rarus 824, 826, 827													
Mobil SHC 600 Series													
Mobil SHC 800 Series													
Mobil Vectra Oil													
Mobile Hydraulic Oils			E	-	-	-	G	-	E	E	E	E	-
Mobile Therm 603			E	-	-	-	-	-	E	E	E	E	E
Mobilfluid 423													
Mobilmet S122			E	-	-	-	G	-	-	-	-	-	-

Underline is cover compound rating only. Many factors, such as temperature, concentration and length of exposure, are relevant to how chemical exposure affects the tube and cover or fitting material. The fluid manufacturers recommended maximum operating temperature should be carefully observed. Exceeding the manufacturer's recommended maximum temperature can result in fluid breakdown and cause harm or shorten life of tube and cover materials. There may be instances where the hose cover could be adversely affected by fluids which would not chemically affect the hose tube. Conversely, some fluids with an adverse affect on the tube of the hose may not have a deteriorating effect on the hose cover. It is recommended that the user test the hose/fluid compatibility to their own standards. Since no industry standards exist for chemical resistance, the Compass Chemical Resistance Guide for Elastomers is used whenever possible. Teflon® is a registered trademark of Dupont.

Chemical Resistance Tables

The following is a representative list of fluids and manufacturers and a general guideline for the use and compatibility of Continental ContiTech hose and fittings.

Rating Scale

E = Excellent resistance X = Not recommended Blank = No Data
 G = Good resistance - = Testing recommended

Chemical Name	Fittings and Adapters													
	Hose	PTFE (Teflon®)	CR (polychloropene)	NBR (Nitrile)	Nitrile/ PVC	CPE	CSM	Urethane	Nylon	Carbon Steel	Stainless Steel 304	Stainless Steel 316	Aluminum	Brass
Mobilrama 525														
Molasses (Under 120°F)	E	G	G	G	-	E	E	-	G	E	E	G	X	
Monochlorobenzene (Permiabile)	E	X	X	X	X	X	X	X	E	E	E	X	E	
Monoethanolamine	E	X	G	-	E	X	-	-	E	E	E	G	E	
Morpholine (Pure Additive)	E													
Motor Oils (Under 135°F)	E	G	E	G	E	G	G	E	E	E	E	E	E	
Mould Oil	-	-	-	-	-	-	-	-	E	E	E	-	-	
Muriatic Acid (Permiabile)	E	X	X	X	E	G	X	X	X	X	X	X	X	X
Mustard	E	E	G	E	-	E	-	-	X	E	E	G	-	
NaK														
Naphtenic Acid	E													
Naphtha (Low Aromatic Content)	E	X	G	X	E	X	-	E	G	E	E	E	E	
Naphthalene	E	X	X	X	-	X	-	-	E	E	E	-	E	
Naphthalene (Tar Camphor)	E	X	X	X	E	X	-	E	E	E	E	E	E	
Natural Gas	E													
Neon Gas	E													
N-Hexaldehyde	E	G	X	G	-	-	-	-	E	E	E	E	E	
Nickel Acetate	E	G	G	-	-	-	-	-	E	G	G	E	E	
Nickel Chloride	E	G	G	G	E	G	-	E	X	G	G	X	X	
Nickel Nitrate	E	G	G	G	E	G	-	E	G	G	G	X	-	
Nickel Plating Solution	-	-	G	-	-	G	X	-	-	E	E	-	-	
Nickel Salts	E	G	-	E	-	-	-	-	-	-	-	-	-	
Nickel Sulfate	E													
Nicotine Salts	E	-	-	-	-	-	E	-	E	X	G	-	-	
Nitric Acid	E	X	X	-	-	-	-	-	X	E	E	-	X	
Nitric Acid & Hydrochloric Acid			X	-	-	-	-	-	X	X	X	X	-	
Nitric Acid, 20%	E	X	X	X	E	G	X	X	X	G	G	X	X	
Nitric Acid, 3 M		X	X	-	-	-	-	-	X	E	E	-	X	
Nitric Acid, 5% to 10%	E	X	X	X	E	G	X	X	X	G	G	E	X	
Nitric Acid, 50% (Boiling)		X	X	X	X	X	X	X	X	G	G	X	X	
Nitric Acid, 65% (Boiling)		X	X	X	X	X	X	X	X	G	G	X	X	
Nitric Acid, Concentrated (Boiling)		X	X	-	-	-	-	X	X	G	G	X	X	
Nitric Acid, Inhibited RED fuming (IRFNA)		X	X	-	-	-	-	-	X	E	E	E	X	
Nitric Acid, Red Fuming (RNFA)	E	X	X	X	-	X	X	X	X	G	G	G	X	

Underline is cover compound rating only. Many factors, such as temperature, concentration and length of exposure, are relevant to how chemical exposure affects the tube and cover or fitting material. The fluid manufacturers recommended maximum operating temperature should be carefully observed. Exceeding the manufacturer's recommended maximum temperature can result in fluid breakdown and cause harm or shorten life of tube and cover materials. There may be instances where the hose cover could be adversely affected by fluids which would not chemically affect the hose tube. Conversely, some fluids with an adverse affect on the tube of the hose may not have a deteriorating effect on the hose cover. It is recommended that the user test the hose/fluid compatability to their own standards. Since no industry standards exist for chemical resistance, the Compass Chemical Resistance Guide for Elastomers is used whenever possible. Teflon® is a registered trademark of Dupont.

Chemical Resistance Tables

The following is a representative list of fluids and manufacturers and a general guideline for the use and compatibility of Continental ContiTech hose and fittings.

Rating Scale

E = Excellent resistance **X** = Not recommended **Blank** = No Data
G = Good resistance **-** = Testing recommended

Chemical Name	Hose								Fittings and Adapters				
	PTFE (Teflon®)	CR (polychloropene)	NBR (Nitrile)	Nitrile/ PVC	CPE	CSM	Urethane	Nylon	Carbon Steel	Stainless Steel 304	Stainless Steel 316	Aluminum	Brass
Nitrobenzene (Under 100°F)	E	X	X	X	G	X	X	-	G	G	G	G	E
Nitroethane	E	X	X	X	E	G	-	-	E	E	E	E	E
Nitrogen	E	E	E	G	E	E	E	E	E	E	E	E	E
Nitrogen Fertilizer Solution													
Nitrogen Oxide up to 50% (Under 100°F)		E	E	G	E	E	-	E	E	E	E	-	X
Nitromethane (Permiabile)	E	X	X	X	-	-	-	E	E	E	E	E	E
Nitropropane		X	X	X	-	-	-	E	E	E	E	E	E
Nitrous Oxide (Gas)	E												
N-Octane		X	G	-	E	X	-	-	E	E	E	-	E
Nuto H													
Nyvac 20 (WG), 30 (WG)		-	E	-	-	-	-	-	E	E	E	E	E
Nyvac FR Fluid		-	E	-	-	-	-	-	E	E	E	E	E
Nyvac FR200 Fluid		-	E	-	-	-	-	-	E	E	E	E	E
O-148 (NATO)													
Octyl Alcohol	E												
Oil (SAE, Under 100°F)	E	E	E	E	E	G	E	E	E	E	E	E	E
Oil Synthetic Blends													
Oils Crude	E	X	G	-	-	-	-	-	-	E	E	-	-
Oleic Acid (Under 120°F)	E	G	G	G	E	G	E	E	G	G	E	E	G
Oleum 25%													
Oleum Spirits (to 70°F)	E												
Olive Oil	E	X	G	G	G	X	-	-	G	E	E	E	G
Orthodichlorobenzene													
OS 45 Type III (OS45)	E	E	G	-	-	-	-	-	-	-	-	-	-
OS 45 Type IV (OS45-1)	E	E	G	-	-	-	-	-	-	-	-	-	-
OS 70		E	G	-	-	-	-	-	-	-	-	-	-
Oxalic Acid (5%, Hot and Cold)		G	G	-	-	-	-	G	X	G	E	E	X
Oxalic Acid	E	X	X	X	E	G	X	X	X	G	E	G	X
Oxalic Acid (10% Boiling)		X	X	-	-	-	-	-	X	X	X	X	X
Oxalic Acid (10%)		G	G	-	-	-	-	G	X	G	E	E	X
Oxygen (200°-400°F)		X	X	-	-	-	-	-	-	-	-	-	-
Oxygen Cold		E	G	-	E	-	-	E	G	E	E	E	E
Oxygen Gaseous	E	-	-	-	-	-	-	-	-	-	-	E	-
Ozone (Dry)	E	G	X	G	E	G	E	G	E	E	E	E	E
Ozone (Wet)	E	-	X	-	-	-	-	-	X	G	E	G	-
Pacemaker Types													
150T,300T,500T (Citgo)		-	E	-	-	-	-	-	-	-	-	-	-
Paint	E	X	-	-	-	X	X	G	-	E	E	E	E

Underline is cover compound rating only. Many factors, such as temperature, concentration and length of exposure, are relevant to how chemical exposure affects the tube and cover or fitting material. The fluid manufacturers recommended maximum operating temperature should be carefully observed. Exceeding the manufacturer's recommended maximum temperature can result in fluid breakdown and cause harm or shorten life of tube and cover materials. There may be instances where the hose cover could be adversely affected by fluids which would not chemically affect the hose tube. Conversely, some fluids with an adverse affect on the tube of the hose may not have a deteriorating effect on the hose cover. It is recommended that the user test the hose/fluid compatability to their own standards. Since no industry standards exist for chemical resistance, the Compass Chemical Resistance Guide for Elastomers is used whenever possible. Teflon® is a registered trademark of Dupont.

Chemical Resistance Tables

The following is a representative list of fluids and manufacturers and a general guideline for the use and compatibility of Continental ContiTech hose and fittings.

Rating Scale

E = Excellent resistance X = Not recommended Blank = No Data
G = Good resistance - = Testing recommended

Chemical Name	Hose							Fittings and Adapters					
	PTFE (Teflon®)	CR (polychloroprene)	NBR (Nitrile)	Nitrile/ PVC	CPE	CSM	Urethane	Nylon	Carbon Steel	Stainless Steel 304	Stainless Steel 316	Aluminum	Brass
Paint Solvents (Oil Base)		X	X	-	-	X	X	G	-	E	E	E	E
Paint Thinner, Duco	E	G	E	-	-	-	-	E	G	G	E	G	X
Paints (Oil Base)	E	-	E	-	-	E	-	E	-	-	-	-	-
Palm Oil	E	G	E	G	-	G	-	-	E	E	E	E	E
Palmitic Acid	E	G	G	G	E	X	E	E	G	G	E	E	X
Paradichlorobenzene													
Paraffin (Petroleum)		G	E	G	E	X	-	E	G	E	E	E	E
Paraformaldehyde	E	G	G	G	-	G	G	-	E	E	E	E	-
Peanut Oil (Under 100°F)	E	G	E	G	-	-	-	-	E	E	E	E	E
Pentane (Gas or Liquid)	E												
Pentanol		G	G	G	-	G	-	-	E	E	E	E	E
Perchloric Acid	E	X	X	-	-	G	X	X	X	G	E	X	-
Perchloroethylene (Tetrachloroethylene)	E	X	X	X	G	X	-	G	E	E	E	X	X
Petroleum Oil (Above 250°F)	E	X	X	-	-	-	-	-	-	-	-	-	-
Petroleum Oil (Crude)	E	G	E	-	-	-	-	-	-	-	-	-	-
Petroleum Oil (Under 250°F)		G	E	-	-	-	-	-	-	-	-	-	-
Petroleum Oils (Refined)		G	E	G	-	G	G	E	E	E	E	E	E
Petroleum Oils (Sour)	E	G	G	-	-	X	G	-	G	E	E	E	X
Petroleum Oils (Under 100°F)		G	E	G	-	G	G	-	E	E	E	E	E
Phenol (70/30 Water)		X	X	-	-	-	-	-	-	E	E	E	-
Phenol (85/15 Water)		X	X	-	-	-	-	-	-	E	E	E	-
Phenol (Carbolic Acid)	E	X	X	X	E	X	X	X	G	E	E	E	X
Phenylamine													
Phorone (Diisopropylidene)													
Acetone)	E	X	X	-	-	X	X	-	E	E	E	-	E
Phosphate Esters (3 Molar)		X	X	-	G	G	X	G	-	-	-	-	-
Phosphate Esters (Concentrated)	E	X	X	-	X	X	X	G	-	-	-	-	-
Phosphate Esters (Dilute)	E	X	X	-	E	E	X	G	-	-	-	-	-
Phosphoric Acid	E	G	G	-	-	-	-	-	-	-	G	-	-
Phosphoric Acid (1%)		G	-	-	-	-	-	-	-	E	E	-	X
Phosphoric Acid (10% Hot)		G	X	-	-	-	-	-	X	-	E	X	X
Phosphoric Acid (10%)		G	X	-	-	-	-	-	X	-	E	X	X
Phosphoric Acid (3 Molar)		X	X	-	-	-	-	-	-	-	-	-	-
Phosphoric Acid (5%)		G	X	-	-	-	-	-	-	E	E	-	X
Phosphoric Acid (50% Hot)		G	X	-	-	-	-	-	X	X	G	X	X
Phosphoric Acid (50%)		G	G	G	E	E	X	X	X	G	E	X	G
Phosphoric Acid (85% Hot)		G	X	-	-	-	-	-	X	X	X	X	X

Underline is cover compound rating only. Many factors, such as temperature, concentration and length of exposure, are relevant to how chemical exposure affects the tube and cover or fitting material. The fluid manufacturers recommended maximum operating temperature should be carefully observed. Exceeding the manufacturer's recommended maximum temperature can result in fluid breakdown and cause harm or shorten life of tube and cover materials. There may be instances where the hose cover could be adversely affected by fluids which would not chemically affect the hose tube. Conversely, some fluids with an adverse affect on the tube of the hose may not have a deteriorating effect on the hose cover. It is recommended that the user test the hose/fluid compatibility to their own standards. Since no industry standards exist for chemical resistance, the Compass Chemical Resistance Guide for Elastomers is used whenever possible. Teflon® is a registered trademark of Dupont.

Chemical Resistance Tables

The following is a representative list of fluids and manufacturers and a general guideline for the use and compatibility of Continental ContiTech hose and fittings.

Rating Scale

E = Excellent resistance **X** = Not recommended **Blank** = No Data
G = Good resistance **-** = Testing recommended

Chemical Name	Hose								Fittings and Adapters				
	PTFE (Teflon®)	CR (polychloropene)	NBR (Nitrile)	Nitrile/PVC	CPE	CSM	Urethane	Nylon	Carbon Steel	Stainless Steel 304	Stainless Steel 316	Aluminum	Brass
Phosphoric Acid (85%)		G	X	-	E	E	X	X	X	G	G	X	X
Phosphoric Acid (Aerated)		-	-	-	-	-	-	-	X	-	G	-	-
Phosphoric Acid (Concentrated)	E	X	X	-	-	-	-	-	-	-	-	-	-
Phosphoric Acid Air Free		-	-	-	-	-	-	-	X	-	-	X	-
Phosphorous Trichlor	E												
Photographic Developers	E	E	E	-	-	-	-	-	X	E	E	-	-
Photographic, Emulsions	E	-	-	-	-	-	-	-	-	-	-	-	-
Photographic, Fixing Solutions	E	G	-	-	-	G	-	-	-	E	E	-	-
Phthalic Acid		-	-	-	-	-	-	-	G	G	E	G	-
Picric Acid (Water Solution 100°F)	E	G	G	G	-	G	G	X	X	E	E	X	X
Picric Acid Molten													
Pine Oil	E	X	G	-	G	X	-	E	E	E	E	E	-
Pinene	E	X	G	-	G	-	-	-	E	E	E	E	E
Piperazine Hydrochloride Solution (34%)		-	G	-	-	-	-	-	-	-	-	-	-
Pitch		G	E	-	-	G	G	E	-	-	-	-	-
Plating Solutions (Chrome)	E	X	X	-	-	-	X	X	-	X	X	-	-
Plating Solutions (Other)	E	-	E	-	-	-	-	-	-	-	-	-	-
Polyester Resin		-	-	-	-	-	-	G	-	-	-	-	-
Polyol Ester													
Polyurethane Foam (Under 125°F)		-	-	-	-	-	-	-	-	-	-	-	-
Potassium Acetate	E	G	G	-	E	G	X	-	G	E	E	X	-
Potassium Bicarbonate	E	E	E	-	-	E	-	E	E	G	G	E	-
Potassium Bisulfite	E	-	E	-	-	-	-	E	-	-	-	-	-
Potassium Bromate	E	-	-	-	-	-	-	-	-	-	-	-	-
Potassium Bromide	E	E	E	-	-	E	G	E	X	X	G	X	-
Potassium Carbonate (Potash)	E	E	E	E	E	E	G	E	G	E	E	X	X
Potassium Chlorate	E	E	E	-	-	-	G	E	G	G	G	G	-
Potassium Chloride (1% to 5%)	E	E	E	-	E	-	G	E	E	G	G	X	X
Potassium Chloride (Boiling)		-	-	-	-	-	-	-	-	G	G	-	X
Potassium Cyanide	E	E	E	-	E	-	-	E	G	G	G	X	X
Potassium Dichromate	E	E	E	-	E	-	-	G	E	G	G	G	-
Potassium Ferrocyanide	E	-	-	-	-	-	-	-	G	E	E	G	-
Potassium Fluoride	E	-	-	-	-	-	-	-	-	-	-	-	-

Underline is cover compound rating only. Many factors, such as temperature, concentration and length of exposure, are relevant to how chemical exposure affects the tube and cover or fitting material. The fluid manufacturers recommended maximum operating temperature should be carefully observed. Exceeding the manufacturer's recommended maximum temperature can result in fluid breakdown and cause harm or shorten life of tube and cover materials. There may be instances where the hose cover could be adversely affected by fluids which would not chemically affect the hose tube. Conversely, some fluids with an adverse affect on the tube of the hose may not have a deteriorating effect on the hose cover. It is recommended that the user test the hose/fluid compatibility to their own standards. Since no industry standards exist for chemical resistance, the Compass Chemical Resistance Guide for Elastomers is used whenever possible. Teflon® is a registered trademark of Dupont.

Chemical Resistance Tables

The following is a representative list of fluids and manufacturers and a general guideline for the use and compatibility of Continental ContiTech hose and fittings.

Rating Scale

E = Excellent resistance X = Not recommended Blank = No Data
 G = Good resistance - = Testing recommended

Chemical Name	Fittings and Adapters													
	Hose	PTFE (Teflon®)	CR (polychloropene)	NBR (Nitrile)	Nitrile/ PVC	CPE	CSM	Urethane	Nylon	Carbon Steel	Stainless Steel 304	Stainless Steel 316	Aluminum	Brass
Potassium Fluoride	E	-	-	-	-	-	-	-	-	-	-	-	-	-
Potassium Hydroxide	E	G	G	-	-	-	-	-	E	E	E	-	-	-
Potassium Hydroxide (27%Boiling)	-	-	-	-	-	-	-	-	G	G	E	X	X	-
Potassium Hydroxide (5%)	-	E	E	-	-	-	-	E	G	G	G	X	X	-
Potassium Hydroxide (50% Boiling)	-	-	-	-	-	-	-	-	G	G	G	X	X	-
Potassium Hydroxide (70% Hot)	-	-	-	-	-	-	-	-	X	-	-	X	X	-
Potassium Hydroxide (70%)	-	-	E	-	-	-	-	-	-	-	-	X	X	-
Potassium Hydroxide (30% Caustic Potash)	-	-	-	-	E	-	-	-	-	-	-	-	-	-
Potassium Iodide	-	E	E	-	-	E	-	E	E	G	G	-	-	-
Potassium Nitrate	E	E	E	-	E	-	E	E	E	E	G	G	G	G
Potassium Nitrate (1% to 5%)	-	E	E	-	-	-	-	-	E	E	E	E	G	-
Potassium Permanganate	E	E	G	-	-	-	-	G	E	G	G	G	-	-
Potassium Permanganate (5%)	-	E	E	-	-	-	-	E	E	E	E	E	-	-
Potassium Persulfate	E	-	-	-	-	-	-	-	-	-	-	-	-	-
Potassium Phosphate	E	E	-	-	-	E	-	-	X	G	G	X	-	-
Potassium Sulfate	E	E	E	-	E	-	E	E	E	G	G	E	-	-
Potassium Sulfate 1% & 5%	-	E	E	-	-	-	-	E	E	E	E	E	X	-
Potassium Sulfide	-	E	E	-	-	-	-	-	G	G	G	-	-	-
Potassium Sulfite (to 300°F)	E	E	E	-	E	-	-	-	E	E	E	E	-	-
Potassium Thiosulfate	E	E	-	-	-	E	-	-	-	-	-	-	-	-
Primatol A, S, P (Ag Spray)	-	-	-	-	-	-	-	-	-	-	-	-	-	-
PRL-High Temp Hydraulic Oil	-	G	E	-	-	-	-	-	E	E	E	E	-	-
Propane Gas	E	X	X	-	-	-	X	X	X	E	E	E	-	-
Propionic Acid	E	X	X	-	-	-	-	-	E	-	G	G	-	-
Propyl Acetate	E	X	X	-	G	-	-	-	E	-	-	-	-	-
Propylene (Liquid or Gas, Ambient)	E	X	X	-	E	-	-	G	E	E	E	E	-	-
Propylene Dichloride	E	-	-	-	-	-	-	-	E	G	E	X	-	-
Propylene Glycol	-	E	X	-	E	E	E	G	E	G	G	E	-	-
Propylene Oxide (Permiable)	E	X	X	-	-	-	-	-	G	E	E	G	-	-
Purina Insecticide	-	X	X	-	-	-	-	G	E	E	E	E	G	-
Puopale RX Oils	-	-	E	-	-	-	G	E	E	E	E	E	E	-
Pydraulic	-	X	X	-	-	-	-	-	-	-	-	-	-	-
Pydraulic 10E,29E-LT,30E,60,65E,115E	-	X	X	-	G	-	-	-	E	E	E	E	E	E
Pydraulic 135 (to 70°F)	E	-	X	-	G	-	-	G	E	E	E	-	-	-

Underline is cover compound rating only. Many factors, such as temperature, concentration and length of exposure, are relevant to how chemical exposure affects the tube and cover or fitting material. The fluid manufacturers recommended maximum operating temperature should be carefully observed. Exceeding the manufacturer's recommended maximum temperature can result in fluid breakdown and cause harm or shorten life of tube and cover materials. There may be instances where the hose cover could be adversely affected by fluids which would not chemically affect the hose tube. Conversely, some fluids with an adverse affect on the tube of the hose may not have a deteriorating effect on the hose cover. It is recommended that the user test the hose/fluid compatability to their own standards. Since no industry standards exist for chemical resistance, the Compass Chemical Resistance Guide for Elastomers is used whenever possible. Teflon® is a registered trademark of Dupont.

Chemical Resistance Tables

The following is a representative list of fluids and manufacturers and a general guideline for the use and compatibility of Continental ContiTech hose and fittings.

Rating Scale

E = Excellent resistance **X** = Not recommended **Blank** = No Data
G = Good resistance **-** = Testing recommended

Chemical Name	Hose								Fittings and Adapters				
	PTFE (Teflon®)	CR (polychloropene)	NBR (Nitrile)	Nitrile/ PVC	CPE	CSM	Urethane	Nylon	Carbon Steel	Stainless Steel 304	Stainless Steel 316	Aluminum	Brass
Pydraulic 150		X	X	X	G	X	G	G	E	E	E	E	E
Pydraulic 280 (at 400°F)	G	X	X	X	G	X	G	G	E	E	E	-	-
Pydraulic 312 (to 70°F)	E	X	X	X	G	-	G	E	E	E	E	-	-
Pydraulic 50E		-	-	-	G	-	G	E	E	E	E	-	-
Pydraulic 540 (to 70°F)	E	X	X	X	G	X	X	X	E	E	E	-	-
Pydraulic 625		X	X	X	G	X	G	G	E	E	E	-	-
Pydraulic A-200		X	X	X	G	X	X	G	E	E	E	-	-
Pydraulic F-9		X	X	X	G	X	G	E	E	E	E	-	-
Pyranol, Transformer Oil (to 70°F)	E	G	E	-	-	-	-	-	E	E	E	E	-
Pyridine	E	X	X	-	-	X	E	-	E	E	E	E	E
Pyrogard 160, 230, 630		-	-	-	-	-	-	-	E	E	E	-	-
Pyrogard 51, 53, 55		-	X	-	-	-	-	-	E	E	E	-	-
Pyrogard C, D	E	-	E	-	-	-	G	E	E	E	E	E	E
Pyrolube		E	X	-	-	-	-	-	-	-	-	-	-
Quench Oil	E	G	G	-	-	-	-	-	-	E	E	E	-
Quintolubric 700													
Quintolubric 822		X	E	-	-	-	-	-	E	E	E	E	E
Quintolubric 957, 958													
Ramrod (Ag Spray)		-	-	-	-	-	-	E	E	E	E	E	E
Rando Oils		-	E	-	-	-	G	E	E	E	E	E	E
Rape Seed Oil		G	X	-	-	X	-	G	E	E	E	E	E
Red Line 100 Oil	E	G	E	-	-	-	-	-	-	-	-	-	-
Red Oil (Comm. Oleic Acid, MIL-H-5606)	E	G	G	G	E	G	-	E	G	G	E	E	G
Refined Wax (Petroleum)		G	E	G	-	-	G	E	E	E	E	-	E
Refrigerant Freon 113 (see Freon)	Use Freon Hose Only												
Refrigerant Freon 114 (see Freon)	Use Freon Hose Only												
Refrigerant Freon 12 (see Freon)	Use Freon Hose Only												
Refrigerant Freon 22 (see Freon)	Use Freon Hose Only												
Refrigerant Freon 502 (see Freon)	Use Freon Hose Only												
Refrigerant HFC 134A (see Freon)	Use Freon Hose Only												
Regal Oils R&O		-	E	-	-	-	G	E	-	-	-	-	-
Resorcinol													

Underline is cover compound rating only. Many factors, such as temperature, concentration and length of exposure, are relevant to how chemical exposure affects the tube and cover or fitting material. The fluid manufacturers recommended maximum operating temperature should be carefully observed. Exceeding the manufacturer's recommended maximum temperature can result in fluid breakdown and cause harm or shorten life of tube and cover materials. There may be instances where the hose cover could be adversely affected by fluids which would not chemically affect the hose tube. Conversely, some fluids with an adverse affect on the tube of the hose may not have a deteriorating effect on the hose cover. It is recommended that the user test the hose/fluid compatibility to their own standards. Since no industry standards exist for chemical resistance, the Compass Chemical Resistance Guide for Elastomers is used whenever possible. Teflon® is a registered trademark of Dupont.

Chemical Resistance Tables

The following is a representative list of fluids and manufacturers and a general guideline for the use and compatibility of Continental ContiTech hose and fittings.

Rating Scale

E = Excellent resistance X = Not recommended Blank = No Data
G = Good resistance - = Testing recommended

Chemical Name	Fittings and Adapters													
	Hose	PTFE (Teflon®)	CR (polychloropene)	NBR (Nitrile)	Nitrile/ PVC	CPE	CSM	Urethane	Nylon	Carbon Steel	Stainless Steel 304	Stainless Steel 316	Aluminum	Brass
Richfield Weed Killer		X	G	-	-	X	-	-	-	-	-	-	-	-
Round Up		G	G	-	-	-	-	E	G	E	E	E	E	E
Rubilene Oils		-	E	-	-	-	G	E	-	-	-	-	-	-
SAE N° 10 Oil	E													
Safco-Safe T10, T20														
Safetytex 215		-	X	-	-	-	-	-	-	-	-	-	-	-
Salicylic Acid (to 400°F)	E	E	X	-	-	-	-	E	E	E	E	G	-	-
Salt Water (See Water)	E	G	G	G	-	G	E	E	G	E	E	X	G	G
Santo Safe 300		X	X	-	-	-	-	-	E	E	E	E	-	-
Santosafe W-G15, W-G20, W-G30		-	E	-	-	-	G	E	E	E	E	E	E	E
SCC 7204 (Stauffer)		-	-	-	-	-	-	-	-	-	-	-	-	-
Sevin		-	-	-	-	-	-	E	-	-	-	-	-	-
Sewage	E	G	G	G	E	G	-	E	X	E	E	G	G	G
Shell IRUS 902	E													
Shell IRUS 905	E													
Shell Pella-A														
Shell Tellus														
Shellac (to 400°F)		G	E	-	-	-	-	E	E	E	E	E	-	-
Shellac (Bleached) (to 400°F)	E	G	E	-	-	-	-	E	E	E	E	E	G	G
Shellac (Orange) (to 400°F)	E	G	E	-	-	-	-	E	E	E	E	E	G	G
Silicate Ester (to 400°F)	E													
Silicone Greases	E	G	G	G	-	G	-	E	E	E	E	E	E	E
Silicone Oils	E	G	G	G	-	G	-	E	E	E	E	E	E	E
Silver Cyanide	E	E	-	-	-	-	-	-	E	E	E	X	-	-
Silver Nitrate	E	E	E	E	E	E	-	E	G	E	E	E	G	G
Skelly, Solvent B, C, E		X	E	-	-	-	-	-	-	-	-	-	-	-
Skydrol 500A & 7000 (to 200°F)	E	X	X	X	G	X	-	E	E	E	E	E	-	-
Soap oil	E	X	X	-	-	X	-	-	E	E	E	-	-	-
Soap Solutions	E	G	E	G	E	E	E	E	E	E	E	E	E	E
Soda Ash (Sodium Carbonate)	E	E	E	E	E	E	E	E	E	E	E	X	G	G
Soda Water	E	-	-	-	-	-	E	E	-	-	-	-	-	-
Sodium Dichromate		G	E	-	E	G	E	E	-	-	-	-	-	-
Sodium Hypochlorite - 100% (to 200°F)	E	E	X	-	-	-	-	-	X	X	X	X	-	-
Sodium Hypochlorite 20% (to 400°F)	E	X	X	X	E	E	X	E	X	X	G	X	X	X
Sodium Hypochlorite 5%	E	-	X	X	E	E	X	E	X	X	G	X	X	X
Sodium Hyposulfate	E	X	-	-	-	-	-	-	X	E	E	X	-	-

Underline is cover compound rating only. Many factors, such as temperature, concentration and length of exposure, are relevant to how chemical exposure affects the tube and cover or fitting material. The fluid manufacturers recommended maximum operating temperature should be carefully observed. Exceeding the manufacturer's recommended maximum temperature can result in fluid breakdown and cause harm or shorten life of tube and cover materials. There may be instances where the hose cover could be adversely affected by fluids which would not chemically affect the hose tube. Conversely, some fluids with an adverse affect on the tube of the hose may not have a deteriorating effect on the hose cover. It is recommended that the user test the hose/fluid compatibility to their own standards. Since no industry standards exist for chemical resistance, the Compass Chemical Resistance Guide for Elastomers is used whenever possible. Teflon® is a registered trademark of Dupont.

Chemical Resistance Tables

The following is a representative list of fluids and manufacturers and a general guideline for the use and compatibility of Continental ContiTech hose and fittings.

Rating Scale

E = Excellent resistance **X** = Not recommended **Blank** = No Data
G = Good resistance **-** = Testing recommended

Chemical Name	Hose								Fittings and Adapters				
	PTFE (Teflon®)	CR (polychloropene)	NBR (Nitrile)	Nitrile/PVC	CPE	CSM	Urethane	Nylon	Carbon Steel	Stainless Steel 304	Stainless Steel 316	Aluminum	Brass
Sodium Metaphosphate	E	G	G	G	E	G	-	E	X	E	E	E	X
Sodium Nitrate	E	X	X	-	E	G	E	E	E	G	G	G	G
Sodium Perborate	E	X	X	-	-	X	-	G	X	E	E	E	X
Sodium Peroxide (Sodium Dioxide)	E	E	G	E	G	E	-	X	X	E	E	E	X
Sodium Phosphate	E	X	E	-	E	-	E	E	G	E	E	X	X
Sodium Phosphate (Dibasic)	E	G	E	-	-	-	-	-	-	-	-	-	-
Sodium Phosphate (Mono)	E	E	E	-	-	-	-	-	-	-	-	-	-
Sodium Phosphate (Tribasic)	E	G	E	-	-	-	-	-	G	G	G	-	-
Sodium Silicate	E	E	E	-	E	E	G	E	G	G	G	X	X
Sodium Silicate (Hot)	E	E	E	-	-	-	-	-	G	G	G	X	X
Sodium Sulfate	E	E	E	-	E	E	E	E	G	E	E	-	G
Sodium Sulfide	E	E	E	-	E	E	E	E	X	X	G	X	X
Sodium Sulfide Saturated - 100%	E	E	E	-	-	-	-	E	G	G	E	X	X
Sodium Sulfite	E	G	G	G	E	G	E	G	E	E	E	-	X
Sodium Sulfite 10% @ 150°F	E	E	E	-	-	-	-	-	G	G	G	G	-
Sodium Sulfite 5%	E	E	E	-	-	-	-	-	E	E	E	E	-
Sodium Thiosulfate (hpo, Antichlor)	E	E	E	E	E	E	E	E	X	E	E	G	X
Sodium Tripolyphosphate (STPP) (to 70°F)	E	-	-	-	-	-	-	-	-	E	E	X	X
Sodium Acetate	E	X	X	X	E	X	G	E	E	E	E	E	E
Sodium Benzoate	E	-	-	-	-	-	E	-	-	-	-	-	-
Sodium Bicarbonate	E	E	E	E	E	E	E	E	G	E	E	G	G
Sodium Bisulfate (Niter Cake)	E	E	E	E	E	E	E	E	X	G	E	X	X
Sodium Bisulfite	E	E	E	E	E	E	E	E	G	E	E	G	-
Sodium Borate	E	E	E	E	E	E	E	E	E	E	E	-	-
Sodium Carbonate	E	E	E	E	E	E	E	E	G	G	G	X	G
Sodium Chlorate	E	G	E	-	-	E	E	E	G	G	G	X	-
Sodium Chloride	E	E	E	E	E	E	E	E	G	G	E	X	X
Sodium Chloride - 2%	E	E	E	-	-	-	-	E	G	G	E	X	X
Sodium Chloride - 5%	E	E	E	-	-	-	-	E	-	G	E	X	X
Sodium Chloride - 5% @ 150°F	E	E	E	-	-	-	-	E	-	G	E	-	X
Sodium Chloride Saturated	E	E	E	-	-	-	-	E	-	E	E	X	-
Sodium Chloride Saturated (Boiling)	E	-	-	-	-	-	-	-	-	G	E	X	-
Sodium Chloride Slurry	-	-	-	-	-	-	-	-	-	-	-	-	-

Underline is cover compound rating only. Many factors, such as temperature, concentration and length of exposure, are relevant to how chemical exposure affects the tube and cover or fitting material. The fluid manufacturers recommended maximum operating temperature should be carefully observed. Exceeding the manufacturer's recommended maximum temperature can result in fluid breakdown and cause harm or shorten life of tube and cover materials. There may be instances where the hose cover could be adversely affected by fluids which would not chemically affect the hose tube. Conversely, some fluids with an adverse affect on the tube of the hose may not have a deteriorating effect on the hose cover. It is recommended that the user test the hose/fluid compatability to their own standards. Since no industry standards exist for chemical resistance, the Compass Chemical Resistance Guide for Elastomers is used whenever possible. Teflon® is a registered trademark of Dupont.

Chemical Resistance Tables

The following is a representative list of fluids and manufacturers and a general guideline for the use and compatibility of Continental ContiTech hose and fittings.

Rating Scale

E = Excellent resistance X = Not recommended Blank = No Data
 G = Good resistance - = Testing recommended

Chemical Name	Hose							Fittings and Adapters					
	PTFE (Teflon®)	CR (polychloropene)	NBR (Nitrile)	Nitrile/ PVC	CPE	CSM	Urethane	Nylon	Carbon Steel	Stainless Steel 304	Stainless Steel 316	Aluminum	Brass
Sodium Cyanide	E	E	E	E	E	E	E	E	G	E	E	X	X
Sodium Ferricyanide	E	-	-	-	-	-	-	-	G	G	G	-	-
Sodium Ferrocyanide	E	-	-	-	-	-	-	-	-	-	-	-	-
Sodium Fluoride	E	-	E	-	-	-	-	-	G	G	G	-	-
Sodium Fluoride (5%)	E	-	E	-	-	-	-	E	G	G	G	-	-
Sodium Fluoride (70%)	E	-	-	-	-	-	-	-	-	-	G	-	-
Sodium Hydrosulfide -100% (to 70°F)	E	E	X	-	-	-	-	-	-	-	-	-	-
Sodium Hydrosulfide -45% (to 500°F)	E	E	X	-	-	-	-	-	-	-	-	-	-
Sodium Hydrosulfite	E	-	-	-	-	-	-	-	-	-	-	-	-
Sodium Hydroxide	E	G	G	-	-	-	-	-	G	-	-	-	X
Sodium Hydroxide (10%)	E	-	-	-	E	-	-	-	-	-	-	-	-
Sodium Hydroxide (20% Cold)	E	E	G	-	-	-	-	E	E	E	E	X	X
Sodium Hydroxide (20% Hot)	E	E	X	-	-	-	-	-	G	E	E	X	X
Sodium Hydroxide (3M)	-	G	G	-	-	-	-	-	-	-	-	-	X
Sodium Hydroxide (40%)	E	E	G	G	E	E	-	G	G	E	E	X	X
Sodium Hydroxide (50% Cold)	E	G	X	X	E	E	-	G	G	G	G	X	X
Sodium Hydroxide (50% Hot)	E	-	-	-	E	G	-	X	X	G	G	X	X
Sodium Hydroxide (60%)	E	G	X	X	E	G	-	X	X	G	G	X	X
Sodium Hydroxide (70% Cold)	E	E	G	-	-	-	-	-	-	-	G	X	X
Sodium Hydroxide (70% Hot)	E	-	-	-	-	-	-	-	-	-	-	-	-
Sodium Hydroxide (80% Hot)	E	E	X	-	-	-	-	-	X	X	X	X	X
Sole	-	-	-	-	-	-	-	-	-	-	-	-	-
Solnus Oils	-	-	E	-	-	-	G	E	E	E	E	E	E
Solvac 1535 G	-	-	-	-	G	-	-	E	-	-	-	-	-
Sour Crude Oil	-	-	-	-	-	-	-	-	-	-	-	-	-
Soybean Oil	E	G	G	G	-	G	-	E	E	E	E	E	-
Spent Acid	-	-	-	-	-	G	-	-	-	E	E	-	-
SR-10 Fuel	-	X	G	-	-	-	-	-	-	-	-	-	-
SR-6 Fuel	-	X	E	-	-	-	-	-	-	-	-	-	-
SRF Fluid B (Shell)	-	-	X	-	-	-	-	-	-	-	-	-	-
SRF Fluid C (Shell)	-	-	X	-	-	-	-	-	-	-	-	-	-
Stannic Chloride	E	X	G	G	E	X	-	X	X	X	X	X	X
Stannic Chloride, 50%	E	X	E	-	-	-	-	-	X	X	X	X	-
Stannous Chloride (Under 150°F)	E	E	E	-	E	E	-	X	-	X	G	X	-

Underline is cover compound rating only. Many factors, such as temperature, concentration and length of exposure, are relevant to how chemical exposure affects the tube and cover or fitting material. The fluid manufacturers recommended maximum operating temperature should be carefully observed. Exceeding the manufacturer's recommended maximum temperature can result in fluid breakdown and cause harm or shorten life of tube and cover materials. There may be instances where the hose cover could be adversely affected by fluids which would not chemically affect the hose tube. Conversely, some fluids with an adverse affect on the tube of the hose may not have a deteriorating effect on the hose cover. It is recommended that the user test the hose/fluid compatibility to their own standards. Since no industry standards exist for chemical resistance, the Compass Chemical Resistance Guide for Elastomers is used whenever possible. Teflon® is a registered trademark of Dupont.

Chemical Resistance Tables

The following is a representative list of fluids and manufacturers and a general guideline for the use and compatibility of Continental ContiTech hose and fittings.

Rating Scale

E = Excellent resistance **X** = Not recommended **Blank** = No Data
G = Good resistance **-** = Testing recommended

Chemical Name	Hose									Fittings and Adapters				
	PTFE (Teflon®)	CR (polychloropene)	NBR (Nitrile)	Nitrile/PVC	CPE	CSM	Urethane	Nylon	Carbon Steel	Stainless Steel 304	Stainless Steel 316	Aluminum	Brass	
Stannous Chloride, 15%	E	E	E	-	-	-	-	-	X	X	-	X	-	
Stanoil N° 15, 18, 25, 31, 35, 51	-	-	E	-	-	-	G	E	E	E	E	E	E	
Starch	E	G	G	-	-	E	E	E	X	E	E	E	-	
Staysol FR	-	-	E	-	-	-	G	E	E	E	E	E	E	
Steam-Water up to 250°F	E	-	-	-	-	-	-	-	-	-	-	-	-	
Stearic Acid	E	G	G	G	E	G	E	E	X	G	E	X	X	
Stearin	-	-	-	-	-	-	E	G	-	-	-	-	-	
Stoddard Solvent	E	G	G	X	E	-	X	E	G	E	E	E	E	
Styrene (Monomer)	E	-	X	-	G	-	-	G	G	X	G	X	G	
Styrene (Vinyl Benzene)	-	X	X	-	-	-	-	E	E	E	E	E	E	
Sucrose Solutions	E	E	E	E	-	E	-	-	E	E	E	-	-	
Sulfamic Acid (10% Under 170°F)	E	-	-	-	E	G	-	-	-	-	-	-	-	
Sulfate Black Liquor	E	E	E	-	-	-	-	E	G	G	G	X	-	
Sulfate Green Liquor	E	E	E	-	-	-	-	E	G	G	G	X	-	
Sulfur	E	-	-	-	-	-	-	-	-	-	-	-	-	
Sulfur (Molten)	-	X	X	-	-	-	-	-	-	-	-	-	-	
Sulfur Chloride	E	X	X	X	-	G	-	G	X	X	G	X	X	
Sulfur Dioxide (Dry)	E	X	X	X	-	G	-	X	G	E	E	E	E	
Sulfur Dioxide (Liquid)	E	G	X	-	-	G	-	-	-	-	-	-	-	
Sulfur Dioxide (Moist)	E	G	X	-	-	G	-	E	-	G	E	E	X	
Sulfur Hexafluoride (Gas) (to 70°F)	E	E	G	-	-	G	-	X	-	-	-	-	-	
Sulfur Trioxide (Dry)	E	X	X	X	X	X	-	E	G	G	G	G	X	
Sulfuric Acid (10%)	E	E	G	G	E	E	-	X	-	X	X	G	X	
Sulfuric Acid (30%)	E	E	-	-	E	E	-	X	X	X	G	X	X	
Sulfuric Acid (50%)	E	G	X	X	E	E	-	X	X	X	G	X	X	
Sulfuric Acid (75%)	E	X	X	X	-	G	-	X	X	X	G	X	X	
Sulfuric Acid (93%)	E	X	X	X	-	X	-	X	G	X	G	X	X	
Sulfuric Acid (98%)	E	X	X	X	X	X	-	X	G	X	G	X	X	
Sulfuric Acid, 3 Molar	-	X	X	-	-	-	-	-	-	-	-	-	-	
Sulfuric Acid, 85%	E	X	X	-	-	-	-	-	X	G	E	X	-	
Sulfuric Acid, Aerated, No Velocity	E	-	-	-	-	-	-	-	G	G	G	X	-	
Sulfuric Acid, Air Free, No Velocity	E	-	-	-	-	-	-	-	X	X	G	X	-	
Sulfuric Acid, Concentrated	E	X	X	-	-	-	-	-	-	E	E	-	-	
Sulfuric Acid, Fuming, Oleum (Permeable)	E	X	-	-	-	-	-	-	G	E	E	G	-	
Sulfurous Acid	E	G	G	-	-	-	-	X	X	X	G	G	-	

Underline is cover compound rating only. Many factors, such as temperature, concentration and length of exposure, are relevant to how chemical exposure affects the tube and cover or fitting material. The fluid manufacturers recommended maximum operating temperature should be carefully observed. Exceeding the manufacturer's recommended maximum temperature can result in fluid breakdown and cause harm or shorten life of tube and cover materials. There may be instances where the hose cover could be adversely affected by fluids which would not chemically affect the hose tube. Conversely, some fluids with an adverse effect on the tube of the hose may not have a deteriorating effect on the hose cover. It is recommended that the user test the hose/fluid compatibility to their own standards. Since no industry standards exist for chemical resistance, the Compass Chemical Resistance Guide for Elastomers is used whenever possible. Teflon® is a registered trademark of Dupont.

Chemical Resistance Tables

The following is a representative list of fluids and manufacturers and a general guideline for the use and compatibility of Continental ContiTech hose and fittings.

Rating Scale

E = Excellent resistance X = Not recommended Blank = No Data
G = Good resistance - = Testing recommended

Chemical Name	Hose							Fittings and Adapters					
	PTFE (Teflon®)	CR (polychloropene)	NBR (Nitrile)	Nitrile/ PVC	CPE	CSM	Urethane	Nylon	Carbon Steel	Stainless Steel 304	Stainless Steel 316	Aluminum	Brass
Sulfurous Acid (10%)	E	-	X	-	E	E	-	-	-	X	G	E	X
Sulfurous Acid (75%)	E	X	X	X	E	E	-	X	X	X	G	X	X
Sulphuric Acid 10%	-	-	G	-	-	-	-	X	X	G	E	X	X
Sulphuric Acid 5%	-	-	E	-	-	-	-	X	G	G	E	X	X
Sulphuric Acid 5% Boiling	-	X	-	-	-	-	-	X	X	X	-	X	X
Sulphuric Acid 50%	-	X	X	-	-	-	-	X	X	X	X	X	X
Sulphuric Acid, Concentrated	-	X	X	-	-	-	-	X	-	E	E	X	X
Sulphuric Acid, Concentrated @ 300%	-	X	X	-	-	-	-	-	X	X	X	X	X
Sulphuric Acid, Concentrated Boiling	-	X	X	-	-	-	-	-	X	X	X	X	X
Sulphuric Acid, Fuming	-	X	-	-	-	-	-	-	G	G	G	X	-
Sulphuric Acid 10% Boiling	-	X	X	-	-	-	-	X	X	X	-	X	X
Sulphurous Acid, saturated	-	X	X	-	-	-	-	G	-	E	E	X	X
Sun Minesafe, Sunsafe	-	-	-	-	-	-	-	-	-	-	-	-	-
Sun R&O Oils	-	-	E	-	-	-	G	E	E	E	E	E	E
Sunsafe (Fire Resist.Hydr. Fluid) to 70°F	E	G	E	-	-	-	G	E	E	E	E	E	-
Suntac HP Oils	-	-	E	-	-	-	G	E	E	-	E	E	-
Suntac WR Oils	-	-	E	-	-	-	G	E	E	-	E	E	-
Sunvis Oils 700, 800, 900	-	-	E	-	-	-	G	E	E	E	E	-	-
Super Hydraulic Oils (Conoco)	-	-	E	-	-	-	G	E	E	E	E	E	-
Sutan Plus, Herbicide	-	X	X	X	E	-	-	E	E	E	E	E	-
Sutazine Plus, Herbicide	-	X	X	-	E	-	-	E	X	E	E	E	-
Synesstic	-	-	-	-	-	-	-	-	-	-	-	-	-
Synthetic Oil (Citgo)	-	-	-	-	-	-	G	E	E	E	E	-	-
Syrup	E	G	E	G	-	-	-	E	-	E	E	E	-
Tall Oil (Under 100°F)	E	G	G	G	-	X	-	-	G	X	G	X	-
Tallow	E	G	G	G	-	-	-	E	G	G	G	E	G
Tannic Acid (10%)	E	G	X	-	E	G	-	X	G	E	E	G	X
Tannin	-	E	E	-	-	-	-	E	-	-	-	-	-
Tar (Bituminous, Under 100°F)	E	G	G	G	X	-	-	-	E	E	E	E	G
Tar and Tar Oil	-	G	-	-	-	-	G	E	E	E	E	E	G
Tartaric Acid	E	G	G	G	E	E	-	E	X	G	G	G	X
Tellus Oils (to 70°F)	E	-	E	-	-	-	G	E	E	E	E	E	E
Tenol Oils	-	-	E	-	-	-	G	E	E	E	E	-	-
Tergitol	-	-	-	-	-	-	-	-	G	E	E	-	G
Terpineol	E	X	G	-	E	G	-	G	E	E	E	E	-

Underline is cover compound rating only. Many factors, such as temperature, concentration and length of exposure, are relevant to how chemical exposure affects the tube and cover or fitting material. The fluid manufacturers recommended maximum operating temperature should be carefully observed. Exceeding the manufacturer's recommended maximum temperature can result in fluid breakdown and cause harm or shorten life of tube and cover materials. There may be instances where the hose cover could be adversely affected by fluids which would not chemically affect the hose tube. Conversely, some fluids with an adverse affect on the tube of the hose may not have a deteriorating effect on the hose cover. It is recommended that the user test the hose/fluid compatibility to their own standards. Since no industry standards exist for chemical resistance, the Compass Chemical Resistance Guide for Elastomers is used whenever possible. Teflon® is a registered trademark of Dupont.

Chemical Resistance Tables

The following is a representative list of fluids and manufacturers and a general guideline for the use and compatibility of Continental ContiTech hose and fittings.

Rating Scale

E = Excellent resistance X = Not recommended Blank = No Data
 G = Good resistance - = Testing recommended

Chemical Name	Hose								Fittings and Adapters				
	PTFE (Teflon®)	CR (polychloropene)	NBR (Nitrile)	Nitrile/PVC	CPE	CSM	Urethane	Nylon	Carbon Steel	Stainless Steel 304	Stainless Steel 316	Aluminum	Brass
Terresstic			E					E	E	E	E		
Tertiary Butyl Alcohol													
Tetra Chloro Benzene													
Tetra Chloro Ethane	E												
Tetra Chloro Ethylene (Permiabie)	E												
Tetra Chloro Methane	E												
Tetra Chloro Naphthalene													
Tetra Ethylene Glycol													
Tetraethyl Lead		G	G	-	-	-	-	G	-	-	-	-	-
Tetraethyl Lead Blench		X	G	-	-	-	-	-	-	-	-	-	-
Tetrahydrofuran (THF)		X	X	-	-	X	G	E	G	E	E	-	-
Tetralin		X	X	-	-	X	-	G	E	E	E	E	-
Texaco 760 Hydrafluid													
Texaco 766, 763 (200-300)													
Thiopen (to 70°F)	E	X	X	-	-	-	-	-	-	-	-	-	-
Tim-Sol													
Titanium Tetrachloride	E	X	X	X	-	-	-	-	E	G	G	X	X
Toluene (Toluol)	E	X	X	X	X	X	-	E	E	E	E	E	E
Toluene Diisocyanate (Under 150°F)	E	X	-	-	-	-	-	-	E	E	E	-	-
Transformer Oil (Askarel Types)		X	X	X	E	X	-	-	E	E	E	E	-
Transformer Oil (Petroleum Type)	E	G	E	G	E	X	G	E	E	E	E	E	E
Transmission Fluid Type A	E	G	E	G	E	G	-	G	E	E	E	E	E
Tributyl Phosphate	E	X	X	X	G	X	-	-	E	-	-	X	-
Tributoxyethyl Phosphate	E	X	X	X	X	X	-	G	E	-	-	X	-
Tributyl Phosphate	E												
Trichloro Acetic Aci	E												
Trichloro Etane (Permiabie)	E												
Trichloroethylene (Permiabie)	E	X	X	X	G	X	-	G	X	G	E	X	E
Trichloromonofluoroethane (Freon 113) (to 200°F)	E	-	E	-	-	-	-	-	E	E	E	X	-
Trichloromonofluoroethane (Freon 17) (to 200°F)	E	-	-	-	-	-	-	-	E	E	E	X	-
Tricresyl Phosphate	E	X	X	X	E	X	-	E	E	G	G	X	-
Triethanolamine (TEA)	E	G	G	-	E	G	-	E	E	E	E	E	E

Underline is cover compound rating only. Many factors, such as temperature, concentration and length of exposure, are relevant to how chemical exposure affects the tube and cover or fitting material. The fluid manufacturers recommended maximum operating temperature should be carefully observed. Exceeding the manufacturer's recommended maximum temperature can result in fluid breakdown and cause harm or shorten life of tube and cover materials. There may be instances where the hose cover could be adversely affected by fluids which would not chemically affect the hose tube. Conversely, some fluids with an adverse affect on the tube of the hose may not have a deteriorating effect on the hose cover. It is recommended that the user test the hose/fluid compatability to their own standards. Since no industry standards exist for chemical resistance, the Compass Chemical Resistance Guide for Elastomers is used whenever possible. Teflon® is a registered trademark of Dupont.

Chemical Resistance Tables

The following is a representative list of fluids and manufacturers and a general guideline for the use and compatibility of Continental ContiTech hose and fittings.

Rating Scale

E = Excellent resistance X = Not recommended Blank = No Data
G = Good resistance - = Testing recommended

Chemical Name	Hose							Fittings and Adapters					
	PTFE (Teflon®)	CR (polychloropene)	NBR (Nitrile)	Nitrile/ PVC	CPE	CSM	Urethane	Nylon	Carbon Steel	Stainless Steel 304	Stainless Steel 316	Aluminum	Brass
Triphenyl Phosphate													
Tripolyphosphate (STPP)		X	E	-	-	-	-	-	-	G	E	X	-
Trisodium Phosphate E													
Tung Oil (to 400°F)	E	G	G	-	-	G	-	E	E	E	E	E	E
Turbine Oil #15 (MIL-L-7808A) (to 70°F)	E	X	E	-	-	-	-	-	E	E	E	E	-
Turbine Oil (to 250°F)	E	X	E	-	-	-	-	-	E	E	E	E	-
Turbo Oil #35		X	G	-	-	-	-	-	E	E	E	E	-
Turpentine	E	X	G	-	G	X	E	E	X	E	E	E	G
Tycol A Turbo 37, 50, 58, 60		-	E	-	-	-	G	E	E	E	E	-	-
Tycol Avalon 50, 57, 60		-	E	-	-	-	G	E	E	E	E	-	-
Type I Fuel (MIL-S-3136)													
ASTM Fuel A (to 300°F)	E	G	E	-	-	-	-	-	E	E	E	E	-
Type II Fuel (MIL-S-3136)		X	G	-	-	-	-	-	E	E	E	E	-
Type III Fuel (MIL-S-3136)													
ASTM Fuel B (to 300°F)	E	X	E	-	-	-	-	-	E	E	E	E	-
Ucon Hydrolube Types													
150CP, 200CP		-	E	-	-	-	G	E	E	E	E	E	E
Ucon Hydrolube Types													
275CP, 300CP, 550CP (to 70°F)	E	-	-	-	-	-	-	-	-	-	-	-	-
Ucon M1		-	E	-	-	-	G	E	E	E	E	E	E
Union ATF Dexron		-	E	-	-	-	G	E	E	E	E	E	E
Union ATF Type F		-	E	-	-	-	G	E	E	E	E	E	E
Union C-2 Fluid		-	E	-	-	-	G	E	E	E	E	E	E
Union C-P Oil		-	E	-	-	-	G	E	E	E	E	E	E
Union Hydraulic Oil AW		-	E	-	-	-	G	E	E	E	E	E	E
Union Hydraulic Tractor Fluid		-	E	-	-	-	G	E	E	E	E	E	E
Univis 40, Hydraulic Fluidon		G	E	-	-	-	-	-	E	E	E	E	-
Unleaded Gasoline	E												
Urea Solution	E	E	G	-	E	E	G	E	E	E	E	G	-
Urethane Formulations													
Uric Acid 100% (to 250°F)	E												
Uric Acid 75% (to 400°F)	E												
Varnish	E	X	X	X	X	X	-	E	G	E	E	E	G
Vaseline	E												
Vegetable Oils	E	G	E	G	E	-	G	E	E	E	E	E	G
Vegetable Oils (Hot)	-	-	-	-	-	-	E	G	G	G	E	G	-
Versilube	E	E	E	-	-	-	-	-	E	E	E	E	-

Underline is cover compound rating only. Many factors, such as temperature, concentration and length of exposure, are relevant to how chemical exposure affects the tube and cover or fitting material. The fluid manufacturers recommended maximum operating temperature should be carefully observed. Exceeding the manufacturer's recommended maximum temperature can result in fluid breakdown and cause harm or shorten life of tube and cover materials. There may be instances where the hose cover could be adversely affected by fluids which would not chemically affect the hose tube. Conversely, some fluids with an adverse affect on the tube of the hose may not have a deteriorating effect on the hose cover. It is recommended that the user test the hose/fluid compatibility to their own standards. Since no industry standards exist for chemical resistance, the Compass Chemical Resistance Guide for Elastomers is used whenever possible. Teflon® is a registered trademark of Dupont.

Chemical Resistance Tables

The following is a representative list of fluids and manufacturers and a general guideline for the use and compatibility of Continental ContiTech hose and fittings.

Rating Scale

E = Excellent resistance **X** = Not recommended **Blank** = No Data
G = Good resistance **-** = Testing recommended

Chemical Name	Hose								Fittings and Adapters				
	PTFE (Teflon®)	CR (polychloropene)	NBR (Nitrile)	Nitrile/ PVC	CPE	CSM	Urethane	Nylon	Carbon Steel	Stainless Steel 304	Stainless Steel 316	Aluminum	Brass
Versilube F-50, F-44 (to 70°F)	E	G	G	G	-	G	G	E	E	E	E	E	E
Vinyl Acetate	E	X	X	X	E	X	-	-	G	E	G	E	G
Vinyl Chloride (Chloroethylene, Monomer) (Permiable)	E	X	X	X	X	X	-	-	G	E	E	G	X
Vital 4300, 5310													
Vitrea Oils			E	-	-	-	G	E	E	E	E	-	-
Volt Esso 35													
Water	E	E	E	E	E	E	E	E	E	E	E	E	E
Water Glycols	E												
Water in Oil Emulsion							G	E	-	-	-	-	-
Water, (Under 150°F)	E												
Water, (up to 200°F)	E												
Water, Acid Mine	E	G	X	-	-	-	-	E	X	G	G	X	X
Water, Brine		G	G	-	-	E	E	E	X	G	G	-	-
Water, Demineralized	E	-	-	-	-	-	-	-	-	-	-	-	E
Water, Distilled	E	G	E	-	-	E	E	E	X	E	E	E	-
Water, Fresh	E	E	E	-	-	-	-	E	X	E	E	E	-
Water, Potable (FDA Tube Only)	E		Use FDA Hose only						E				
Water, Salt	E	G	E	-	-	-	-	E	X	G	G	X	
Whiskey	E											X	
White & Bagley N° 2190													
Cutting oil		G	E	-	-	-	-	-	-	-	-	-	-
White Oil (to 70°F)	E												
White Pine Oil												X	
Wines	E		Use FDA Hose only										
Wood Alcohol													
Wood Oil (to 400°F)	E	G	E	-	E	G	E	E	E	E	E	E	
Xenon	E												
Xylene, Xylol	E	X	E	-	X	-	G	G	G	G	G	E	
Xylidine													
Zeric			E	-	-	-	G	G	-	-	-	-	
Zinc Acetate	E	G	X	-	-	X	-	G	E	E	E	E	
Zinc Carbonate (to 200°F)	E												
Zinc Chloride Solutions	E	E	E	E	E	E	-	E	X	G	E	X	
Zinc Chromate 75% (to 400°F)	E	-	-	-	E	E	-	-	-	E	E	-	

Underline is cover compound rating only. Many factors, such as temperature, concentration and length of exposure, are relevant to how chemical exposure affects the tube and cover or fitting material. The fluid manufacturers recommended maximum operating temperature should be carefully observed. Exceeding the manufacturer's recommended maximum temperature can result in fluid breakdown and cause harm or shorten life of tube and cover materials. There may be instances where the hose cover could be adversely affected by fluids which would not chemically affect the hose tube. Conversely, some fluids with an adverse affect on the tube of the hose may not have a deteriorating effect on the hose cover. It is recommended that the user test the hose/fluid compatibility to their own standards. Since no industry standards exist for chemical resistance, the Compass Chemical Resistance Guide for Elastomers is used whenever possible. Teflon® is a registered trademark of Dupont.

Chemical Resistance Tables

The following is a representative list of fluids and manufacturers and a general guideline for the use and compatibility of Continental ContiTech hose and fittings.

Rating Scale

E = Excellent resistance X = Not recommended Blank = No Data
G = Good resistance - = Testing recommended

Chemical Name	Hose							Fittings and Adapters					
	PTFE (Teflon®)	CR (polychloropene)	NBR (Nitrile)	Nitrile/ PVC	CPE	CSM	Urethane	Nylon	Carbon Steel	Stainless Steel 304	Stainless Steel 316	Aluminum	Brass
Zinc Hydrate	-	-	-	-	-	-	G	-	-	-	-	-	-
Zinc Sulfate Solutions (to 300°F)	E	G	G	G	E	G	-	G	X	G	E	X	

Underline is cover compound rating only. Many factors, such as temperature, concentration and length of exposure, are relevant to how chemical exposure affects the tube and cover or fitting material. The fluid manufacturers recommended maximum operating temperature should be carefully observed. Exceeding the manufacturer's recommended maximum temperature can result in fluid breakdown and cause harm or shorten life of tube and cover materials. There may be instances where the hose cover could be adversely affected by fluids which would not chemically affect the hose tube. Conversely, some fluids with an adverse affect on the tube of the hose may not have a deteriorating effect on the hose cover. It is recommended that the user test the hose/fluid compatability to their own standards. Since no industry standards exist for chemical resistance, the Compass Chemical Resistance Guide for Elastomers is used whenever possible. Teflon® is a registered trademark of Dupont.

Temperature Conversion Chart

Locate temperature in middle column. If in °C, read °F equivalent in right-hand column; if in °F, read °C in left-hand column.

$C = 0.556 (°F - 32)$ $F = (1.8 °C) + 32$

-459° to 0°			1° to 60°			61° to 290°			300° to 890°			900° to 3000°		
C	C/F	F	C	C/F	F	C	C/F	F	C	C/F	F	C	C/F	F
-273	-459		-17.2	1	33.8	16.1	61	141.8	149	300	572	482	900	1652
-268	-450		-16.7	2	35.6	16.7	62	143.6	154	310	590	488	910	1670
-262	-440		-16.1	3	37.4	17.2	63	145.4	160	320	608	493	920	1688
-257	-430		-15.6	4	39.2	17.8	64	147.2	166	330	626	499	930	1706
-251	-420		-15.0	5	41.0	18.3	65	149.0	171	340	644	504	940	1724
-246	-410		-14.4	6	42.8	18.9	66	150.8	177	350	662	510	950	1742
-240	-400		-13.9	7	44.6	19.4	67	152.6	182	360	680	516	960	1760
-234	-390		-13.3	8	46.4	20.0	68	154.4	188	370	698	521	970	1778
-229	-380		-12.8	9	48.2	20.6	69	156.2	193	380	716	527	980	1796
-223	-370		-12.2	10	50.0	21.1	70	158.0	199	390	734	532	990	1814
-218	-360		-11.7	11	51.8	21.7	71	159.8	204	400	752	538	1000	1832
-212	-350		-11.1	12	53.6	22.2	72	161.6	210	410	770	549	1020	1868
-207	-340		-10.6	13	55.4	22.8	73	163.4	216	420	788	560	1040	1904
-201	-330		-10.0	14	57.2	23.3	74	165.2	221	430	806	571	1060	1940
-196	-320		-9.4	15	59.0	23.9	75	167.0	227	440	824	582	1080	1976
-190	-310		-8.9	16	60.8	24.4	76	168.8	232	450	842	593	1100	2012
-184	-300		-8.3	17	62.6	25.0	77	170.6	238	460	860	604	1120	2048
-179	-290		-7.8	18	64.4	25.6	78	172.4	243	470	878	616	1140	2084
-173	-280		-7.2	19	66.2	26.1	79	174.2	249	480	896	627	1160	2120
-169	-273	-459	-6.7	20	68.0	26.7	80	176.0	254	490	914	638	1180	2156
-168	-270	-454	-6.1	21	69.8	27.2	81	177.8	260	500	932	649	1200	2192
-162	-260	-436	-5.6	22	71.6	27.8	82	179.6	266	510	950	660	1220	2228
-157	-250	-418	-5.0	23	73.4	28.3	83	181.4	271	520	968	671	1240	2264
-151	-240	-400	-4.4	24	75.2	28.9	84	183.2	277	530	986	682	1260	2300
-146	-230	-382	-3.9	25	77.0	29.4	85	185.0	282	540	1004	693	1280	2336
-140	-220	-364	-3.3	26	78.8	30.0	86	186.8	288	550	1022	704	1300	2372
-134	-210	-346	-2.8	27	80.6	30.6	87	188.6	293	560	1040	732	1350	2462
-129	-200	-328	-2.2	28	82.4	31.1	88	190.4	299	570	1058	760	1400	2552
-123	-190	-310	-1.7	29	84.2	31.7	89	192.2	304	580	1076	788	1450	2642
-118	-180	-292	-1.1	30	86.0	32.2	90	194.0	310	590	1094	816	1500	2732
-112	-170	-274	-0.6	31	87.8	32.8	91	195.8	316	600	1112	843	1550	2822

Temperature Conversion Chart

Locate temperature in middle column. If in °C, read °F equivalent in right-hand column; if in °F, read °C in left-hand column.

$$C = 0.556 (°F - 32) \quad F = (1.8 °C) + 32$$

-459° to 0°			1° to 60°			61° to 290°			300° to 890°			900° to 3000°		
C	C/F	F	C	C/F	F	C	C/F	F	C	C/F	F	C	C/F	F
-107	-160	-256	0.0	32	89.6	33.3	92	197.6	321	610	1130	871	1600	2912
-101	-150	-238	0.6	33	91.4	33.9	93	199.4	327	620	1148	899	1650	3002
-96	-140	-220	1.1	34	93.2	34.4	94	201.2	332	630	1166	927	1700	3092
-90	-130	-202	1.7	35	95.0	35.0	95	203.0	338	640	1184	954	1750	3182
-84	-120	-184	2.2	36	96.8	35.6	96	204.8	343	650	1202	983	1800	3272
-79	-110	-166	2.8	37	98.6	36.1	97	206.6	349	660	1220	1010	1850	3362
-73	-100	-148	3.3	38	100.4	36.7	98	208.4	354	670	1238	1038	1900	3452
-68	-90	-130	3.9	39	102.2	37.2	99	210.2	360	680	1256	1066	1950	3542
-62	-80	-112	4.4	40	104.0	37.8	100	212.0	366	690	1274	1093	2000	3632
-57	-70	-94	5.0	41	105.8	43	110	230	371	700	1292	1121	2050	3722
-51	-60	-76	5.6	42	107.6	49	120	248	377	710	1310	1149	2100	3812
-46	-50	-58	6.1	43	109.4	54	130	266	382	720	1328	1177	2150	3902
-40	-40	-40	6.7	44	111.2	60	140	284	388	730	1346	1204	2200	3992
-34	-30	-22	7.2	45	113.0	66	150	302	393	740	1364	1232	2250	4082
-29	-20	-4	7.8	46	114.8	71	160	320	399	750	1382	1260	2300	4172
-23	-10	14	8.3	47	116.6	77	170	338	404	760	1400	1288	2350	4262
-18	0	32	8.9	48	118.4	82	180	356	410	770	1418	1316	2400	4352
			9.4	49	120.2	88	190	374	416	780	1436	1343	2450	4442
			10.0	50	122.0	93	200	392	421	790	1454	1271	2500	4532
			10.6	51	123.8	99	210	410	427	800	1472	1399	2550	4622
			11.1	52	125.6	100	212	414	432	810	1490	1427	2600	4712
			11.7	53	127.4	104	220	428	438	820	1508	1454	2650	4802
			12.2	54	129.2	110	230	446	443	830	1526	1482	2700	4892
			12.8	55	131.0	116	240	464	449	840	1544	1510	2750	4982
			13.3	56	132.8	121	250	482	454	850	1562	1538	2800	5072
			13.9	57	134.6	127	260	500	460	860	1580	1566	2850	5162
			14.4	58	136.4	132	270	518	466	870	1598	1593	2900	5252
			15.0	59	138.2	138	280	536	471	880	1616	1621	2950	5342
			15.6	60	140.0	143	290	554	477	890	1634	1649	3000	5432

Pressure Conversions

Metric to psi (1 kPa = .145 psi)

Kilo Pascals (kPa)	Mega Pascals (MPa)	Bar (Bar)	Pounds per Square Inch (psi)
100	0.1	1	14.5
200	0.2	2	29.0
300	0.3	3	43.5
400	0.4	4	58.0
500	0.5	5	72.5
600	0.6	6	87.0
700	0.7	7	101.5
800	0.8	8	116.0
900	0.9	9	130.5
1,000	1.0	10	145.0
2,000	2.0	20	290.1
3,000	3.0	30	435.1
4,000	4.0	40	580.2
5,000	5.0	50	725.2
6,000	6.0	60	870.2
7,000	7.0	70	1,015
8,000	8.0	80	1,160
9,000	9.0	90	1,305
10,000	10.0	100	1,450
20,000	20.0	200	2,901
30,000	30.0	300	4,351
40,000	40.0	400	5,802
50,000	50.0	500	7,252
60,000	60.0	600	8,702
70,000	70.0	700	10,153
80,000	80.0	800	11,603
90,000	90.0	900	13,053
100,000	100.0	1,000	14,504
200,000	200.0	2,000	29,008
300,000	300.0	3,000	43,511

psi to Metric (1 psi = 6.89 kPa)

Pounds per Square Inch (psi)	Kilo Pascals (kPa)	Mega Pascals (MPa)	Bar (Bar)
10	68.9	0.07	0.7
20	137.9	0.14	1.4
30	206.8	0.21	2.1
40	275.8	0.28	2.8
50	344.7	0.34	3.4
60	413.7	0.41	4.1
70	482.6	0.48	4.8
80	551.6	0.55	5.5
90	620.5	0.62	6.2
100	689	0.7	6.9
200	1,379	1.4	13.8
300	2,068	2.1	20.7
400	2,758	2.8	27.6
500	3,447	3.4	34.5
600	4,137	4.1	41.4
700	4,826	4.8	48.3
800	5,516	5.5	55.2
900	6,205	6.2	62.1
1,000	6,895	6.9	68.9
2,000	13,790	13.8	147.9
3,000	20,684	20.7	206.8
4,000	27,579	27.6	275.8
5,000	34,474	34.5	344.7
6,000	41,369	41.4	413.7
7,000	48,263	48.3	482.6
8,000	55,158	55.2	551.6
9,000	62,053	62.1	620.5
10,000	68,948	68.9	689
20,000	137,895	147.9	1,379
30,000	206,843	206.8	2,068
40,000	275,790	275.8	2,758

Fraction Equivalentents

Fittings

Equipment & Accessories

Assemblies

Installation & Maintenance

Fractions	Inches Decimals	Millimeters
1/64	0.015625	0.397
1/32	0.03125	0.794
3/64	0.046875	1.191
1/16	0.0625	1.588
5/64	0.078125	1.984
3/32	0.09375	2.381
7/64	0.109375	2.778
1/8	0.125	3.175
9/64	0.140625	3.572
5/32	0.15625	3.969
11/64	0.171875	4.366
3/16	0.1875	4.763
13/64	0.203125	5.159
7/32	0.21875	5.556
15/64	0.234375	5.953
1/4	0.250	6.350
17/64	0.265625	6.747
9/32	0.28125	7.144
19/64	0.296875	7.541
5/16	0.3125	7.938
21/64	0.328125	8.334
11/32	0.34375	8.731
23/64	0.359375	9.128
3/8	0.375	9.525
25/64	0.390625	9.922
13/32	0.40625	10.319
27/64	0.421875	10.716
7/16	0.4375	11.113
29/64	0.453125	11.509
15/32	0.46875	11.906
31/64	0.484375	12.303
1/2	0.500	12.700

Fractions	Inches Decimals	Millimeters
33/64	0.515625	13.097
17/32	0.53125	13.494
35/64	0.546875	13.891
9/16	0.5625	14.288
37/64	0.578125	14.684
19/32	0.59375	15.081
39/64	0.609375	15.478
5/8	0.625	15.875
41/64	0.640625	16.272
21/32	0.65625	16.669
43/64	0.671875	17.066
11/16	0.6875	17.463
45/64	0.703125	17.859
23/32	0.71875	18.256
47/64	0.734375	18.653
3/4	0.750	19.050
49/64	0.765625	19.447
25/32	0.78125	19.844
51/64	0.796875	20.241
13/16	0.8125	20.638
53/64	0.828125	21.034
27/32	0.84375	21.431
55/64	0.859375	21.828
7/8	0.875	22.225
57/64	0.890625	22.622
29/32	0.90625	23.019
59/64	0.921875	23.416
15/16	0.9375	23.813
61/64	0.953125	24.209
31/32	0.96875	24.606
63/64	0.984375	25.003
1	1.000	25.400

Conversion Constants

Length Conversion Constants

Metric to U.S.	U.S. to Metric
Millimeters x .039370 = inches	Inches x 25.4001 = millimeters
Meters x 39.370 = inches	Inches x .0254 = meters
Meters x 3.2808 = feet	Feet x .30480 = meters
Meters x 1.09361 = yards	Yards x .91440 = meters
Kilometers x 3,280.8 = feet	Feet x .0003048 = kilometers
Kilometers x .62137 = Statute Miles	Statute Miles x 1.60935 = kilometers
Kilometers x .53959 = Nautical Miles	Nautical Miles x 1.85325 = kilometers

Weight Conversion Constants

Metric to U.S.	U.S. to Metric
Grams x 981 = dynes	Dynes x .0010193 = grams
Grams x 15.432 = grains	Grains x .0648 = grams
Grams x .03528 = ounces (Avd.)	Ounces (Avd.) x 28.35 = grams
Grams x .033818 = fluid ounces (water)	Fluid Ounces (Water) x 29.57 = grams
Kilograms x 35.27 = ounces (Avd.)	Ounces (Avd.) x .02835 = kilograms
Kilograms x 2.20462 = pounds (Avd.)	Pounds (Avd.) x .45359 = kilograms
Metric Tons (1000 Kg.) x 1.10231 = Net Ton (2000 lbs.)	Net Ton (2000 lbs.) x .90719 = Metric Tons (1000kg)
Metric Tons (1000 Kg.) x .98421 = Gross Ton (2240 lbs.)	Gross Ton (2240 lbs.) x 1.101605 = Metric Tons (1000kg)

Area Conversion Constants

Metric to U.S.	U.S. to Metric
Square Millimeters x .00155 = square inches	Square Inches x 645.163 = square millimeters
Square Centimeters x .155 = square inches	Square Inches x 6.45163 = square centimeters
Square Meters x 10.76387 = square feet	Square Feet x .0929 = square meters
Square Meters x 1.19599 = square yards	Square Yards x .83613 = square meters
Hectares x 2.47104 = acres	Acres x .40469 = hectares
Square Kilometers x 247.104 = acres	Acres x .0040469 = square kilometers
Square Kilometers x .3861 = square miles	Square Miles x 2.5899 = square kilometers

Pressure Conversion Constants

Metric to U.S.	U.S. to Metric
Bar x 14.5 = psi	psi x .0689 = Bar
Megapascals x 145.0 = psi	psi x .0069 = Megapascals (MPa)
kgf/cm ² x 14.22 = psi	psi x .0703 = kgf/cm ²

Family Part Number - Alphanumeric Index

Descriptive

Fittings

Equipment & Accessories

Assemblies

Installation & Maintenance

Appendix

Descriptive #	Page #	Descriptive #	Page #
AC-COTF134V90B.....	248	AC-SFFX45.....	259
AC-COTF45.....	248	AC-SFFX90.....	259
AC-COTF90.....	248	AC-SFM.....	259
AC-COTF90B.....	248	AC-SFM45.....	260
AC-FTM.....	249	AC-SFM90.....	260
AC-FTM90B.....	249	AC-SWA.....	277
AC-FTMM.....	249	AC-SWCN.....	277
AC-FTN.....	276	AC-SWCW.....	277
AC-FTS.....	276	AC-VA12V-134V.....	277
AC-FTSM.....	276	AC-VC12V.....	278
AC-HM.....	250	AC-VC134VHS.....	278
AC-HM12V.....	250	AC-VC134VLS.....	278
AC-HM134V.....	250	AC-VCORE.....	278
AC-HM90.....	250	ARC12.....	16
AC-HMSG.....	251	ARC13.....	17
AC-HMT.....	251	ARC15.....	18
AC-ILOTBLK.....	251	AR16SC.....	14
AC-ILOTBLU.....	276	ACP3.....	15
AC-ILOTORA.....	276	B2-BFFX.....	81
AC-ILOTRED.....	276	B2-BPFX.....	79
AC-ILOTWHI.....	276	B2-BPFX45.....	79
AC-OIM.....	276	B2-BPFX90.....	80
AC-OIM134V.....	251	B2-BPM.....	80
AC-OIM134V90.....	252	B2-BTM.....	81
AC-OIM45.....	253	B2-DHFX.....	84
AC-OIM90.....	251	B2-DHFX45.....	84
AC-OIMB.....	252	B2-DHFX90.....	85
AC-OIMB90.....	252	B2-DHM.....	85
AC-OTCF-OIM-90-134V.....	252	B2-DLFX.....	82
AC-OTF.....	253	B2-DLFX45.....	82
AC-OTF12V.....	255	B2-DLFX90.....	83
AC-OTF12V90.....	255	B2-DLM.....	83
AC-OTF134V.....	256	B2-DNFX45.....	86
AC-OTF134V45.....	256	B2-DNFX90.....	86
AC-OTF134V90.....	256	B2-FH.....	74
AC-OTF134VHS.....	256	B2-FH45.....	76
AC-OTF180.....	254	B2-FH90.....	77
AC-OTF45.....	253	B2-FL.....	71
AC-OTF90.....	254	B2-FL22.....	71
AC-OTF90B.....	254	B2-FL30.....	72
AC-OTFM.....	254	B2-FL45.....	72
AC-OTFM45.....	255	B2-FL60.....	73
AC-OTFM90.....	255	B2-FL67.....	73
AC-OTF-OIM-12V.....	275	B2-FL90.....	74
AC-OTF-OIM-134V.....	275	B2-FTM.....	64
AC-OTF-OIM-90-12V.....	275	B2-GTF.....	63
AC-OTF-OIM-90-134V.....	275	B2-JCFX.....	53
AC-OTM.....	257	B2-JCFX45.....	54
AC-OTM134V.....	258	B2-JCFX90.....	55
AC-OTM134V90.....	258	B2-JCFX90L.....	55
AC-OTM45.....	257	B2-JCFX90S.....	55
AC-OTM90.....	257	B2-JCM.....	56
AC-OTMLP.....	258	B2-JSFX.....	88
AC-OTUBE.....	277	B2-KF.....	77
AC-SFFX.....	258	B2-KF45.....	78

Family Part Number - Alphanumeric Index

Descriptive #

Descriptive #	Page #	Descriptive #	Page #
B2-KF90.....	78	DG-OFFX45.....	147
B2-KMFX.....	87	DG-OFFX90.....	148
B2-KMFX45.....	87	DGF1.....	282
B2-KMFX90.....	88	DGF2.....	282
B2-NPF.....	60	FG-JCFX.....	203
B2-NPFX.....	60	FG-JCFX45.....	205
B2-NPM.....	61	FG-JCFX90.....	206
B2-NPMX.....	62	FG-JCFX90L.....	206
B2-NPMX90B.....	62	FG-JCM.....	208
B2-NSFX.....	63	FG-NPM.....	213
B2-OBM.....	69	FG-OBM.....	220
B2-OBMX.....	70	FG-SFFX.....	209
B2-OBMX90B.....	70	FG-SFM.....	210
B2-OFFX.....	65	FG-SIMX.....	211
B2-OFFX45.....	66	FL61SC.....	289
B2-OFFX90.....	67	FL62SC.....	289
B2-OFFX90L.....	67	G4826.....	33
B2-OFFX90S.....	67	G4867.....	31
B2-OFM.....	68	G4890.....	32
B2-SFFX.....	57	S4SH.....	19
B2-SFFX45.....	57	S4SP.....	18
B2-SFFX90.....	57	GC-CB12VS90.....	260
B2-SFFX90L.....	57	GC-CB12VSR90.....	260
B2-SFFX90S.....	57	GC-CLIP.....	278
B2-SFM.....	58	GC-CLIPHLDR.....	278
B2-SIMX.....	58	GC-COTF134V90B.....	261
B2-SIMX45.....	59	GC-COTF45.....	261
B2-SIMX90.....	59	GC-COTF90.....	261
B2-SP.....	64	GC-COTF90B.....	261
B2-SP45.....	65	GC-FSLF.....	263
BOP.....	24, 25	GC-FSLF45.....	263
CR2SN.....	50	GC-FSLF90.....	263
DG-BPFX.....	162	GC-FSLM.....	263
DG-BPFX45.....	163	GC-FSLM45.....	264
DG-BPFX90.....	163	GC-FSLM90.....	264
DG-CF.....	159	GC-FTBO.....	261
DG-CF45.....	160	GC-FTM.....	262
DG-CF90.....	162	GC-FTM90B.....	262
DG-DHFX.....	167	GC-FTMM.....	262
DG-DHFX45.....	131, 168	GC-HM.....	264
DG-DHFX90.....	168	GC-HM12V.....	265
DG-DHM.....	132, 169	GC-HM134V.....	265
DG-FH.....	155	GC-HM180.....	265
DG-FH45.....	157	GC-HM90.....	264
DG-FH90.....	158	GC-HMSG.....	265
DG-FL.....	151	GC-HMT.....	266
DG-FL30.....	152	GC-OFFX.....	266
DG-FL45.....	152	GC-OFFX90.....	266
DG-FL90.....	154	GC-OFSL.....	277
DG-JCFX.....	135	GC-OIM.....	266
DG-JCFX45.....	136	GC-OIM134V.....	268
DG-JCFX90.....	137	GC-OIM134V90.....	268
DG-JCM.....	139	GC-OIM45.....	267
DG-NPM.....	143	GC-OIM90.....	267
DG-OFFX.....	146	GC-OIMB.....	267

Family Part Number - Alphanumeric Index

Descriptive

Fittings

Equipment & Accessories

Assemblies

Installation & Maintenance

Appendix

Descriptive #	Page #	Descriptive #	Page #
GC-OIMB90.....	267	DR5.....	28
GC-OSWCH.....	277	HR6.....	5
GC-OTF.....	268	HRC.....	45
GC-OTF12V.....	269	HS150.....	303
GC-OTF12V90.....	270	HS301.....	303
GC-OTF134V.....	270	HS303.....	303
GC-OTF134V45.....	270	HS501.....	304
GC-OTF134V90.....	270	HS503.....	304
GC-OTF134VHS.....	270	HWRAP.....	44
GC-OTF180.....	269	IG.....	7
GC-OTF45.....	268	IGHT.....	7
GC-OTF90.....	269	IGP.....	8
GC-OTF90B.....	269	IGTC.....	8
GC-OTM.....	271	LR2SN.....	11
GC-OTM134V.....	272	MIL-DTL-13444H, Type I.....	33
GC-OTM134V90.....	272	MIL-DTL-13444H, Type III.....	33
GC-OTM45.....	271	MIL-DTL-13531.....	34
GC-OTM90.....	271	MIL-DTL-3992.....	34
GC-OTMLP.....	272	MIL-DTL-8788.....	34
GC-PLIERS.....	278	NR7.....	20
GC-SFFX.....	272	NR8.....	22
GC-SFFX45.....	273	NSFX.....	23
GC-SFFX90.....	273	O6162.....	288
GC-SFM.....	273	OBSPP.....	287
GC-SFM45.....	274	ODIN24H.....	287
GC-SFM90.....	274	ODIN24L.....	287
XCP3.....	14	OORFS.....	288
GCX5.....	50	ORB.....	288
GFIT100.....	291	PB-HM.....	241
SFS.....	9	PB-JCFX.....	241
GG-NPM.....	240	PB-JCFX90.....	241
SGUN.....	25	PB-JCM.....	242
SHJ.....	26	PB-NPF.....	242
SR12.....	15	PB-NPM.....	243
SR13.....	16	PB-NPM90.....	243
SR14A.....	26	PB-NPMX.....	244
SR15.....	17	PB-SFFX.....	244
GR16.....	30	PB-SFM.....	244
SR16SC.....	12	PB-SIF.....	245
GR17.....	50	PB-SIM.....	245
GR18.....	50	PC150.....	296
SR1SN.....	9	PC150H.....	297
SR2SN.....	10	PC200.....	298
SR3.....	6	PC400.....	299
SR5.....	27	PC600.....	300
SR6.....	5	PC1000.....	301
GR7.....	50	PCTB 1500/2500.....	302
GR8.....	50	S4-BPFX.....	79
GTEXS.....	44	S4-BPFX45.....	79
DUT.....	30	S4-BPFX90.....	80
HCT.....	278	S4-BPM.....	80
HCTRB.....	278	S4-BTM.....	129
DR1SN.....	10	S4-CF.....	124
HR2SN.....	50	S4-CF22.....	124
SR4.....	50	S4-CF30.....	125

Family Part Number - Alphanumeric Index

Descriptive #

Descriptive #	Page #	Descriptive #	Page #
S4-CF45.....	125	S6-CF60.....	161
S4-CF60.....	125	S6-CF67.....	161
S4-CF67.....	126	S6-CF90.....	162
S4-CF90.....	126	S6-CF90L.....	162
S4-DHFX.....	84, 131	S6-DHFX.....	167
S4-DHFX45.....	131	S6-DHM.....	169
S4-DHFX90.....	132	S6-FH.....	155
S4-DLFX.....	82, 129	S6-FH22.....	156
S4-DLFX45.....	82, 130	S6-FH30.....	156
S4-DLFX90.....	83, 130	S6-FH45.....	157
S4-FH.....	74, 120	S6-FH60.....	157
S4-FH22.....	75, 121	S6-FH67.....	158
S4-FH30.....	75, 121	S6-FH90.....	158
S4-FH45.....	76, 122	S6-FH90L.....	158
S4-FH60.....	76, 122	S6-FL.....	151
S4-FH67.....	123	S6-FL30.....	152
S4-FH90.....	77, 125	S6-FL45.....	152
S4-FL.....	71, 116	S6-FL67.....	153
S4-FL110.....	119	S6-FL90.....	154
S4-FL135.....	120	S6-JCFX.....	135
S4-FL22.....	71, 116	S6-JCFX45.....	136
S4-FL30.....	72, 117	S6-JCFX90.....	137
S4-FL45.....	72, 117	S6-JCM.....	139
S4-FL60.....	73, 118	S6-NPM.....	143
S4-FL67.....	73, 118	S6-OFFX.....	146
S4-FL90.....	74, 119	S6-OFFX45.....	147
S4-FL90L.....	119	S6-OFFX90.....	148
S4-JCFX.....	54, 107	S6-OFFX90S.....	148
S4-JCFX45.....	54, 108	S6-OFM.....	149
S4-JCFX90.....	55, 109	S6X-BPFX.....	162
S4-JCFX90L.....	109	S6X-BPFX90.....	163
S4-JCFX90S.....	109	S6X-BPM.....	164
S4-JCM.....	56, 110	S6X-CF.....	159
S4-JSFX.....	88, 133	S6X-CF22.....	159
S4-KF.....	120	S6X-CF30.....	160
S4-KF45.....	127	S6X-CF45.....	160
S4-KF90.....	127	S6X-CF60.....	161
S4-KMFX.....	87, 133	S6X-CF67.....	161
S4-NPM.....	61, 111	S6X-CF90.....	162
S4-NPMX.....	111	S6X-DHFX.....	167
S4-NSFX.....	63, 112	S6X-DHM.....	169
S4-OBM.....	69, 115	S6X-FH.....	155
S4-OFFX.....	65, 112	S6X-FH22.....	156
S4-OFFX45.....	66, 113	S6X-FH30.....	156
S4-OFFX90.....	67, 114	S6X-FH45.....	157
S4-OFFX90L.....	67, 114	S6X-FH60.....	157
S4-OFFX90S.....	67, 114	S6X-FH90.....	158
S4-OFM.....	68, 115	S6X-FH90L.....	158
S6-BPFX.....	162	S6X-FL.....	151
S6-BPFX90.....	163	S6X-FL45.....	152
S6-BPM.....	164	S6X-FL67.....	153
S6-CF.....	159	S6X-FL90.....	154
S6-CF22.....	159	S6X-JCFX.....	135
S6-CF30.....	160	S6X-JCFX45.....	136
S6-CF45.....	160	S6X-JCFX90.....	137

Family Part Number - Alphanumeric Index

Descriptive

Fittings

Equipment & Accessories

Assemblies

Installation & Maintenance

Appendix

Descriptive #	Page #	Descriptive #	Page #
S6X-JCM.....	139	T8-OFFX.....	100
S6X-NPM.....	143	T8-OFFX45.....	100
S6X-OFFX.....	146	T8-OFFX90.....	101
S6X-OFFX45.....	147	T8-OFFX90L.....	101
S6X-OFFX90.....	148	T8-SFFX.....	94
S6X-OFM.....	149	T8-SFFX90.....	94
SF-NPM.....	239	T8-SIMX45.....	95
SF-NPMX.....	239	T8-SIMX90.....	96
SF-OBMX.....	239	T8-SP45.....	99
SHDG-NPMAPI.....	240	TR7.....	20
SH-NPMAPI.....	240	TR8.....	22
SHR.....	24	UC-BFFX.....	165, 195, 225
T7-BPFX.....	103	UC-BPFX.....	162, 192, 223
T7-BPFX90.....	104	UC-BPFX45.....	163, 193, 224
T7-FTM.....	99	UC-BPFX90.....	163, 193, 224
T7-JCFX.....	90	UC-BPM.....	164, 194, 225
T7-JCFX45.....	91	UC-BTM.....	164, 194, 225
T7-JCFX90.....	92	UC-DHFX.....	167, 197, 228
T7-JCFX90L.....	92	UC-DHFX45.....	168, 198, 228
T7-JCM.....	93	UC-DHFX90.....	168, 198, 229
T7-JSFX.....	105	UC-DHM.....	169, 199, 229
T7-NPF.....	96	UC-DLFX.....	166, 195, 226
T7-NPM.....	97	UC-DLFX45.....	166, 196, 226
T7-NPMX.....	98	UC-DLFX90.....	166, 196, 227
T7-NSFX.....	98	UC-DLM.....	167, 197, 227
T7-OBM.....	102	UC-DNFX45.....	169, 199, 229
T7-OBMX.....	102	UC-DNFX90.....	170, 200, 230
T7-OBMX90B.....	103	UC-FH.....	155, 191
T7-OFFX.....	100	UC-FH45.....	157, 191
T7-OFFX45.....	100	UC-FH90.....	158, 192, 223
T7-OFFX90.....	101	UC-FL.....	151, 188, 222
T7-OFFX90L.....	101	UC-FL22.....	151, 188
T7-OFM.....	101	UC-FL30.....	152, 189
T7-SFFX.....	94	UC-FL45.....	152, 189, 222
T7-SFFX90.....	94	UC-FL60.....	153, 190
T7-SIMX.....	95	UC-FL90.....	154, 190, 223
T7-SIMX90.....	96	UC-FTM.....	145, 182, 216
T7-SP45.....	99	UC-JCFX.....	53, 135, 173, 204
T8-BPFX.....	103	UC-JCFX45.....	136, 174, 205
T8-BPFX90.....	104	UC-JCFX90.....	137, 175, 207
T8-DNFX90.....	104	UC-JCFX90L.....	137, 175, 207
T8-FTM.....	99	UC-JCFX90S.....	137, 175, 207
T8-JCFX.....	90	UC-JCM.....	139, 176, 208
T8-JCFX45.....	91	UC-JSFX.....	171, 231
T8-JCFX90.....	92	UC-KMFX.....	170, 200, 230
T8-JCFX90L.....	92	UC-KMFX45.....	171, 201, 230
T8-JCM.....	93	UC-KMFX90.....	171, 201, 231
T8-JSFX.....	105	UC-NPF.....	142, 179, 213
T8-NPF.....	96	UC-NPM.....	143, 180, 214
T8-NPM.....	98	UC-NPMX.....	144, 181, 215
T8-NPMX.....	98	UC-NPMX90B.....	144, 181, 215
T8-NSFX.....	98	UC-NSFX.....	144, 181, 216
T8-OBM.....	102	UC-OBM.....	149, 186, 221
T8-OBMX.....	102	UC-OBMX.....	150, 187, 221
T8-OBMX90B.....	103	UC-OBMX90B.....	150, 187, 222

Family Part Number - Alphanumeric Index

Descriptive #

Descriptive #	Page #	Descriptive #	Page #
UC-OFFX	146, 183, 218		
UC-OFFX45	147, 183, 218		
UC-OFFX90	148, 185, 219		
UC-OFFX90L	148, 185, 219		
UC-OFFX90S	148, 185, 219		
UC-OFM	149, 185, 220		
UC-SFFX	140, 177, 209		
UC-SFFX45	140, 177, 209		
UC-SFFX90	140, 177, 210		
UC-SFFX90L	140, 177, 210		
UC-SFFX90S	206		
UC-SFM	140, 177, 210		
UC-SIMX	141, 178, 211		
UC-SIMX45	141, 178, 212		
UC-SIMX90	142, 179, 212		
UC-SP	145, 182, 217		
UC-SP45	145, 182, 217		
UCF1	279		
UCF10	281		
UCF11	281		
UCF2	279		
UCF3	279		
UCF4	279		
UCF5	280		
UCF6	280		
UCF7	280		
UCF8	280		
UCF9	281		
UT-FL90EOC	237		
UT-FTM	237		
UT-JCFX	233		
UT-JCFX45	233		
UT-JCFX90	234		
UT-NPM	236		
UT-PTTFX	237		
UT-SFFX	234		
UT-SFFX45	234		
UT-SFFX90	235		
UT-SIMX	235		
UT-SIMX45	235		
UT-SIMX90	236		

Fittings

Equipment & Accessories

Assemblies

Installation & Maintenance

Family Part Number - Alphanumeric Index

Descriptive

Fittings

Equipment & Accessories

Assemblies

Installation & Maintenance

Appendix

Descriptive #	Page #	Descriptive #	Page #
14100.....	81	14730.....	68
14105.....	79	14775.....	57
14115.....	79	14777.....	57
14120.....	80	14780.....	57
14130.....	80	14781.....	57
14170.....	81	14783.....	57
14210.....	84	14785.....	58
14215.....	84	14800.....	58
14220.....	85	14810.....	59
14225.....	85	14815.....	59
14240.....	82	14825.....	64
14245.....	82	14830.....	65
14250.....	83	16105.....	162
14255.....	83	16115.....	163
14275.....	86	16120.....	163
14280.....	86	16185.....	159
14300.....	74	16190.....	160
14310.....	76	16195.....	162
14315.....	77	16210.....	167
14320.....	71	16215.....	131, 168
14330.....	71	16220.....	168
14335.....	72	16225.....	132, 169
14340.....	72	16300.....	134, 155
14345.....	73	16310.....	157
14347.....	73	16315.....	157
14350.....	74	16320.....	158
14360.....	64	16335.....	152
14370.....	63	16340.....	152
14400.....	52	16350.....	154
14420.....	54	16400.....	135
14425.....	55	16420.....	136
14440.....	55	16425.....	137, 138
14445.....	55	16450.....	139
14450.....	56	16615.....	143
14520.....	88	16630.....	240
14530.....	77	16700.....	146
14535.....	78	16710.....	147
14540.....	78	16715.....	148
14545.....	87	18400.....	202
14548.....	87	18420.....	205
14550.....	88	18425.....	206
14600.....	60	18440.....	206
14605.....	60	18450.....	208
14615.....	61	18615.....	213
14645.....	62	18670.....	220
14650.....	62	18775.....	209
14655.....	63	18785.....	210
14670.....	69	18800.....	211
14680.....	70	20615.....	240
14685.....	70	22380.....	241
14700.....	65	22400.....	241
14710.....	66	22425.....	241
14715.....	67	22450.....	242
14720.....	67	22600.....	242
14725.....	67	22615.....	243

Family Part Number - Alphanumeric Index

Product #

Product #	Page #	Product #	Page #
22625.....	243	28615.....	61, 111
22645.....	244	28645.....	106
22775.....	244	28655.....	63, 112
22785.....	244	28670.....	69, 115
22790.....	245	28700.....	65, 112
22795.....	245	28710.....	66, 113
26615.....	238	28715.....	67, 114
26645.....	239	28720.....	67, 114
26680.....	239	28725.....	67, 114
28105.....	77, 127	28730.....	68, 115
28115.....	128	30105.....	162
28120.....	80, 128	30120.....	163
28130.....	80, 129	30130.....	164
28170.....	129	30185.....	159
28185.....	124	30187.....	159
28187.....	124	30188.....	160
28188.....	125	30190.....	160
28190.....	125	30192.....	161
28192.....	125	30194.....	161
28194.....	126	30195.....	162
28195.....	126	30197.....	162
28210.....	84, 131	30210.....	167
28215.....	131	30225.....	169
28220.....	85, 132	30300.....	155
28240.....	82, 129	30303.....	156
28245.....	82, 130	30305.....	156
28250.....	83, 130	30310.....	157
28300.....	74, 120	30312.....	157
28303.....	75, 121	30313.....	158
28305.....	75, 121	30315.....	158
28310.....	76, 122	30317.....	158
28312.....	76, 122	30320.....	151
28313.....	123	30335.....	152
28315.....	77, 123	30340.....	152
28320.....	71, 116	30347.....	153
28330.....	71, 116	30350.....	154
28335.....	72, 117	30400.....	135
28340.....	72, 117	30420.....	136
28345.....	73, 118	30425.....	137
28347.....	73, 118	30450.....	139
28350.....	74, 119	30615.....	143
28352.....	119	30617.....	240
28354.....	119	30700.....	251
28355.....	120	30710.....	147
28400.....	54, 107	30715.....	148
28420.....	54, 108	30725.....	148
28425.....	55, 109	30730.....	149
28440.....	109	32105.....	103
28445.....	109	32120.....	104
28450.....	56, 110	32360.....	99
28520.....	88, 133	32400.....	89, 90
28530.....	126	32420.....	91
28535.....	127	32425.....	92
28540.....	127	32440.....	92
28545.....	87, 133	32450.....	93

Family Part Number - Alphanumeric Index

Product #

Fittings

Equipment & Accessories

Assemblies

Installation & Maintenance

Appendix

Product #	Page #	Product #	Page #
32520	105	36245	137, 138, 175, 207
32600	96	36250	166, 196, 227
32615	97	36255	167, 197, 227
32645	98	36275	169, 199, 229
32655	98	36280	170, 200, 230
32670	102	36300	134, 155, 191
32680	102	36310	157, 191
32685	103	36315	158, 192, 223
32700	100	36320	151, 188, 222
32710	100	36330	151, 188
32715	101	36335	152, 189
32720	101	36340	152, 189, 222
32730	101	36345	153, 190
32775	94	36350	154, 19, 223
32780	94	36360	145, 182, 216
32800	95	36400	52, 53, 135, 172, 173, 202, 204
32815	96	36420	136, 174, 205
32830	99	36425	137, 138, 175, 207
34105	103	36440	137, 138, 175, 207
34120	104	36445	137, 138, 175, 207
34280	104	36450	139, 176, 208
34360	99	36520	171, 201, 231
34400	90	36545	170, 200, 230
34420	91	36548	171, 201, 230
34425	92	36550	171, 201, 231
34440	92	36600	142, 179, 213
34450	93	36615	61, 143, 180, 214
34520	105	36645	106, 144, 181, 215
34600	96	36650	144, 181, 215
34615	97	36655	144, 181, 216
34645	98	36670	149, 186, 221
34655	98	36680	150, 187, 221
34670	102	36685	150, 187, 232
34680	102	36700	146, 183, 218
34685	103	36710	147, 184, 218
34700	100	36715	148, 185, 219
34710	100	36720	148, 185, 219
34715	101	36725	148, 185, 219
34720	101	36730	149, 186, 220
34775	94	36775	140, 176, 209
34780	94	36777	140, 177, 209
34810	95	36780	140, 177, 210
34815	96	36781	140, 177, 210
34830	99	36783	177
36100	165, 195, 225	36785	140, 177, 210
36105	162, 192, 223	36800	141, 178, 211
36115	163, 193, 224	36810	148, 178, 212
36120	163, 193, 224	36815	142, 179, 212
36130	164, 194, 225	36825	145, 182, 217
36170	164, 194, 225	36830	145, 182, 217
36210	167, 197, 228	38351	239
36215	168, 198, 228	38360	237
36220	168, 198, 229	38400	232
36225	169, 199, 229	38420	233
36240	136, 174, 205	38425	234

Family Part Number - Alphanumeric Index

Product #

Product #	Page #	Product #	Page #
38615.....	236	50760.....	258
38745.....	237	50763.....	259
38775.....	234	50765.....	259
38777.....	234	50780.....	259
38780.....	235	50783.....	260
38800.....	235	50785.....	260
38810.....	235	50800.....	277
38815.....	236	50803.....	277
50133.....	248	50805.....	277
50135.....	248	50820.....	277
50137.....	248	50830.....	278
50145.....	248	50835.....	278
50230.....	249	50900.....	275
50235.....	249	50910.....	275
50240.....	249	50915.....	275
50250.....	276	50920.....	275
50255.....	276	50925.....	276
50260.....	276	54110.....	260
50350.....	250	54112.....	260
50355.....	250	54133.....	261
50365.....	250	54135.....	261
50370.....	250	54137.....	261
50375.....	251	54145.....	261
50380.....	251	54210.....	261
50401.....	276	54230.....	262
50402.....	276	54235.....	262
50403.....	276	54240.....	262
50460.....	279	54300.....	263
50500.....	251	54303.....	263
50503.....	251	54305.....	263
50505.....	252	54330.....	262
50515.....	252	54333.....	264
50520.....	252	54335.....	264
50530.....	252	54350.....	264
50535.....	253	54355.....	264
50600.....	253	54360.....	265
50603.....	253	54365.....	265
50605.....	254	54370.....	265
50610.....	254	54375.....	265
50615.....	254	54380.....	266
50630.....	254	54430.....	266
50633.....	255	54435.....	266
50635.....	255	54450.....	277
50650.....	255	54455.....	277
50655.....	255	54500.....	266
50660.....	256	54503.....	267
50663.....	256	54505.....	267
50665.....	256	54515.....	267
50675.....	256	54520.....	267
50700.....	257	54530.....	268
50703.....	257	54535.....	268
50705.....	257	54600.....	268
50720.....	258	54603.....	268
50730.....	258	54605.....	269
50735.....	258	54610.....	269

Family Part Number - Alphanumeric Index

Product #

Fittings

Equipment & Accessories

Assemblies

Installation & Maintenance

Appendix

Product #	Page #	Product #	Page #
54615.....	269	ARC13.....	17
54650.....	269	ARC15.....	18
54655.....	270	ARC16SC.....	13
54660.....	270	ACP3.....	15
54663.....	270	BOP.....	24, 25
54665.....	270	BR7.....	21
54675.....	270	CR2SN.....	50
54700.....	271	DGF1.....	282
54703.....	271	DGF2.....	282
54705.....	271	G4826.....	31
54720.....	272	G4867.....	31
54730.....	272	G4890.....	32
54735.....	272	S4SH.....	19
54760.....	272	S4SP.....	18
54763.....	273	XCP3.....	14
54765.....	273	GCX5.....	50
54780.....	273	GFIT100.....	291
54783.....	274	SFS.....	9
54785.....	274	SGUN.....	25
54850.....	278	SHJ.....	26
54855.....	278	SR12.....	15
54860.....	278	SR13.....	16
60061.....	289	SR14A.....	26
60062.....	289	SR15.....	17
60200.....	44	GR16.....	50
60210.....	44	SR16SC.....	12
60300.....	45	GR17.....	50
60500.....	288	GR18.....	50
60505.....	287	SR1SN.....	9
60515.....	287	SR2SN.....	10
60520.....	287	SR3.....	6
60525.....	288	SR5.....	27
60530.....	288	SR6.....	5
65090.....	278	GR7.....	50
65091.....	278	GR8.....	50
90125=PC125, PC125M.....	294	DUT.....	30
90150=PC150.....	296	DR1SN.....	10
90151=PC150H.....	297	HR2SN.....	50
90200=PC200.....	298	SR4.....	50
90400=PC400.....	299	DR5.....	28
90900=PC600.....	300	HR6.....	5
91104=HS150.....	303	IG.....	7
91301=HS301.....	303	IGHT.....	7
91303=HS303.....	303	IGP.....	8
91501=HS501.....	304	IGTC.....	8
91503=HS503.....	304	LR2SN.....	11
92001=SK01.....	304	MIL-DTL-13444H, Type I.....	33
92002=SK02.....	305	MIL-DTL-13444H, Type III.....	33
92003=SK03.....	305	MIL-DTL-13531.....	34
92004=SK04.....	305, 306	MIL-DTL-3992.....	34
92005=SK05.....	305	MIL-DTL-8788.....	34
92006=SK06.....	305	NR7.....	20
921xx=SK10.....	306	NR8.....	22
922xx=SK11.....	306	NSFX.....	23
ARC12.....	16	PC1000.....	301

Family Part Number - Alphanumeric Index

Product #

Product #	Page #
PC600.....	300
PCTB.....	302
SHR.....	24
TR7.....	20
TR8.....	22
UCF1.....	279
UCF2.....	279
UCF3.....	279
UCF4.....	279
UCF5.....	280
UCF6.....	280
UCF7.....	280
UCF8.....	280
UCF9.....	281
UCF10.....	281
UCF11.....	281

ContiTech



Contact

ContiTech AG
NAFTA Headquarters
703 S. Cleveland Massillon Road
Fairlawn, OH 44333-3023 U.S.A.
1-800-235-4632

Canada

1-888-275-4397
FAX 1-888-464-4397

Mexico

1-800-439-7373
FAX 1-800-062-0918

Germany

+49 (0)511 938 02
mailservice@contitech.de

www.contitech.us

ContiTech. Engineering Next Level

As a division of the Continental Group, ContiTech is a recognized innovation and technology leader in natural rubber and plastics. As an industry partner with a firm future ahead of us, we engineer solutions both with and for our customers around the world. Our bespoke solutions are specially tailored to meet the needs of the market. With extensive expertise in materials and processes, we are able to develop cutting-edge technologies while ensuring we make responsible use of resources. We are quick to respond to important technological trends, such as function integration, lightweight engineering and the reduction of complexity, and offer a range of relevant products and services. That way, when you need us, you'll find we're already there.