

Gulf of Mexico Offshore Operations Monitoring Experiment, Final Report

Phase I: Sublethal Responses to Contaminant Exposure

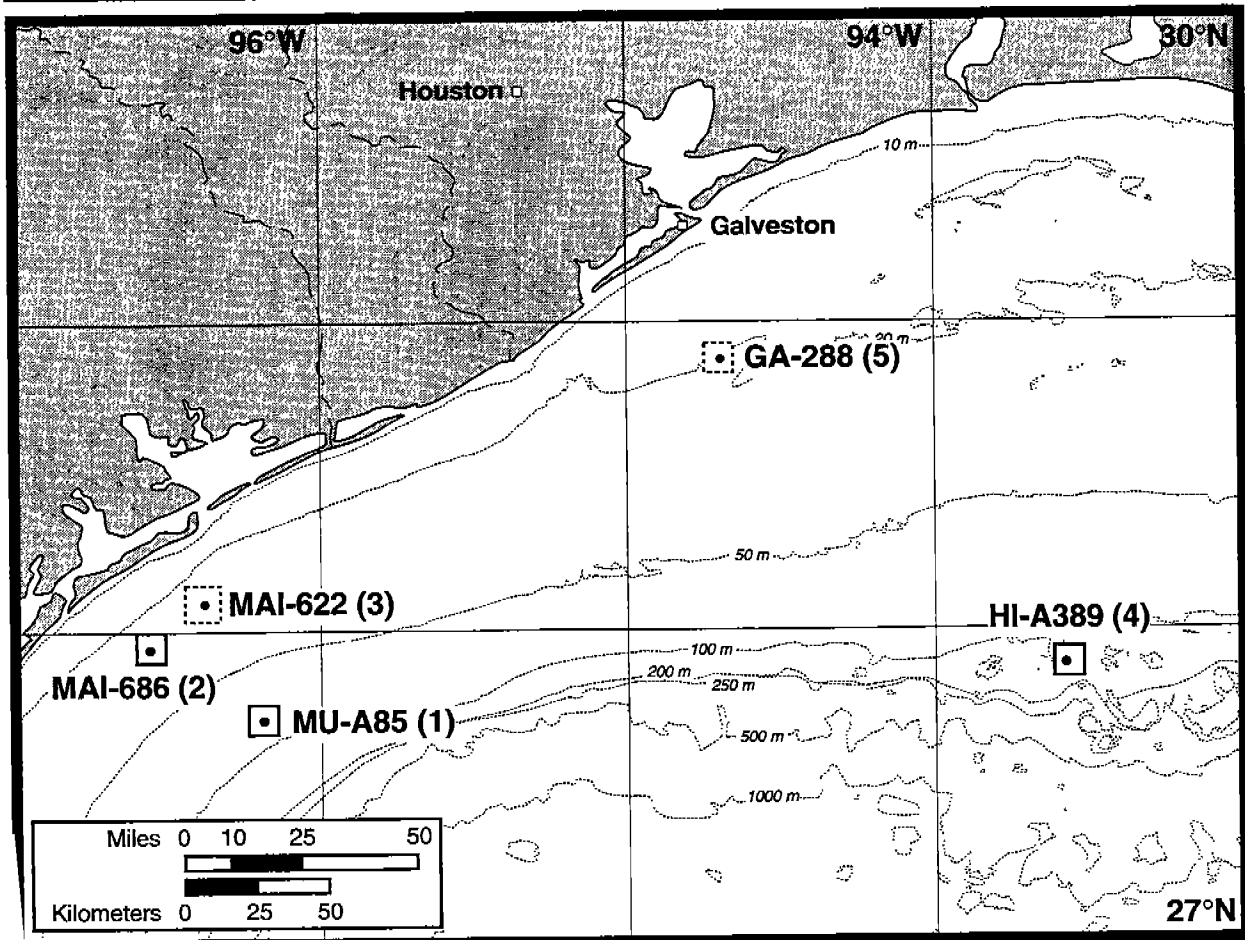
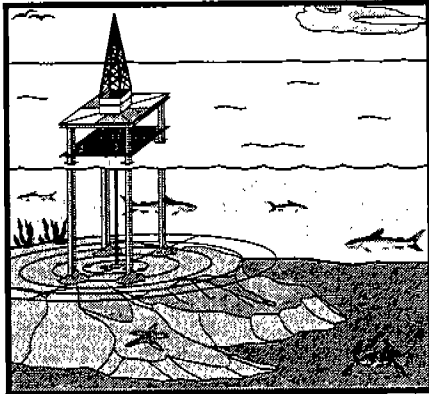

Gulf of Mexico Offshore Operations Monitoring Experiment, Final Report

Phase I: Sublethal Responses to Contaminant Exposure

Editor

Mahlon C. Kennicutt II

Prepared under MMS Contract

14-35-0001-30582

by

Texas A&M University

Texas A&M Research Foundation

College Station, Texas

Published by

**U.S. Department of the Interior
Minerals Management Service
Gulf of Mexico OCS Region**

**New Orleans
September 1995**

DISCLAIMER

This report was prepared under contract between the Minerals Management Service (MMS) and Texas A&M University. This report has been technically reviewed by the MMS and approved for publication. Approval does not signify that the contents necessarily reflect the views and policies of the Service, nor does mention of trade names of commercial products constitute endorsement or recommendation for use. It is, however, exempt from review and compliance with MMS editorial standards.

REPORT AVAILABILITY

Extra copies of the report may be obtained from the Public Information Unit (Mail Stop 5034) at the following address:

U.S. Department of the Interior
Minerals Management Service
Gulf of Mexico OCS Region
Public Information Unit (MS 5034)
1201 Elmwood Park Boulevard
New Orleans, Louisiana 70123-2394

Telephone Number: (504) 736-2519
1-800-200-GULF

CITATION

Suggested Citation:

Kennicutt, M.C., II, ed. 1995. Gulf of Mexico Offshore Operations Monitoring Experiment, Phase I: Sublethal Responses to Contaminant Exposure. Final Report. OCS Study MMS 95-0045. U.S. Department of the Interior, Minerals Management Service, Gulf of Mexico OCS Region, New Orleans, Louisiana. 709 pp.

TABLE OF CONTENTS

	<u>PAGE</u>
List of Figures	xiii
List of Tables.....	xxxix
Acknowledgments	xliii
Executive Summary.....	1
1.0 Introduction.....	1-1
1.1 Study Site Selection.....	1-5
1.2 History of Operations at the Study Sites.....	1-12
1.2.1 Matagorda Island Area Block 686 (MAI-686).....	1-12
1.2.2 Mustang Island Area Block A85 (MU-A85).....	1-12
1.2.3 High Island A389 (HI-A389)-East Flower Garden Bank	1-15
2.0 Study Design and Statistical Model	2-1
2.1 Statistical Model Development - Univariate Analysis	2-2
2.1.1 Total Design Analyses.....	2-4
2.1.2 By Platform Analyses.....	2-5
2.1.3 By Cruise Analyses	2-6
2.1.4 By Cruise*Platform Analyses.....	2-7
2.1.5 Decomposition of Models for Trawl Data.....	2-8
2.2. Multivariate Analyses	2-9
2.3 The Sampling Design	2-10
2.4 Variables and Transformations Used in the Study Design	2-11
2.5 Power Analysis.....	2-18
3.0 Field Methods.....	3-1
3.1 Navigation.....	3-1
3.2 Hydrocasts and CTD Profiler	3-1
3.3 Boxcoreing and Trawling	3-3
3.4 Sedimentology.....	3-7
3.5 Sediment Samples for Contaminant Chemistry.....	3-7
3.6 Biological Tissue Sampling for Chemistry and Toxicology.....	3-8
3.6.1 Megafauna - Invertebrates	3-8
3.6.1.1 Taxonomic Identification and Sorting.....	3-8
3.6.1.2 Chemistry and Toxicology	3-8

3.6.2	Megafauna - Demersal Fish.....	3-11
3.7	Meiofauna	3-14
3.8	Macroinfauna Community Studies.....	3-15
3.9	Megafauna - Invertebrate Reproductive Studies.....	3-16
3.9.1	Immunological Probe Development and Incubation	3-19
3.10	Pore Water for Toxicity Testing.....	3-21
4.0	Laboratory Methods.....	4-1
4.1	Physicochemical Measurements.....	4-1
4.1.1	Nutrients	4-1
4.1.2	Salinity.....	4-1
4.1.3	Dissolved Oxygen.....	4-2
4.1.4	Quality Assurance	4-2
4.2	Sedimentology.....	4-3
4.2.1	Grain Size.....	4-3
4.2.2	Mineralogy	4-5
4.2.3	Total Organic Carbon and Total Carbon	4-6
4.2.4	Redox.....	4-7
4.3	Contaminant Analyses.....	4-7
4.3.1	Hydrocarbons.....	4-7
4.3.1.1	Clean Procedures	4-9
4.3.1.2	Sediment Extraction	4-9
4.3.1.3	Sediment Extract Purification.....	4-9
4.3.1.4	Tissue Extraction.....	4-10
4.3.1.5	Tissue Extract Purification.....	4-10
4.3.1.6	Quantitative Determination of Aliphatic Hydrocarbons and the Unresolved Complex Mixture (UCM) - Sediment Only.....	4-11
4.3.1.7	Quantitative Determination of Polynuclear Aromatic Hydrocarbons (PAH) - Sediments, Pore Waters, and Tissues.....	4-12
4.3.1.8	Quality Control.....	4-16
4.3.2	Trace Metals	4-16

4.3.2.1	Sample Preparation.....	4-16
4.3.2.2	Sample Digestion and Analysis	4-17
4.3.2.3	Quality Control/Assurance Procedures.....	4-18
4.4	Meiofauna	4-20
4.4.1	Nematode Feeding Types	4-20
4.4.2	Nematode Biomass	4-22
4.4.3	Harpacticoid Life History and Reproduction Study	4-22
4.4.4	Harpacticoid Toxicity Testing.....	4-23
4.4.5	Diversity Analysis.....	4-24
4.4.6	Fish Predation on Meiofauna	4-26
4.4.7	Nematode Production Modeling.....	4-26
4.5	Meiofauna Genetic Variability.....	4-28
4.6	Macrofauna.....	4-34
4.7	Megafauna - Invertebrates	4-35
4.7.1	Reproductive Effort.....	4-35
4.7.2	Immunological Probe.....	4-42
4.8	Megafauna - Demersal Fish.....	4-45
4.8.1	Necropsies.....	4-46
4.8.2	Histopathology and Splenic Macrophage Aggregate Analysis Methods	4-46
4.8.3	Analysis of Fish Food.....	4-47
4.9	Detoxification.....	4-47
4.9.1	Crustaceans.....	4-47
4.9.2	Annelids.....	4-48
4.9.3	Molluscs.....	4-48
4.9.4	Fish	4-48
4.9.5	Ethoxyresorufin O-deethylase (EROD) Assay for Fish	4-48
4.9.6	Aryl Hydrocarbon Hydroxylase (AHH) Assay for Fish and Invertebrates	4-49
4.9.7	Rat Hepatoma H-4IIE Assay.....	4-49
4.9.8	mRNA Method.....	4-50
4.9.8.1	Isolation of RNA.....	4-50
4.9.8.2	Northern Blot	4-51
4.9.9	PAH Metabolites in Bile.....	4-52
4.9.10	Dosing Experiments	4-52
4.9.11	Ah Receptor Binding.....	4-52

4.10	Pore Water Toxicity Testing.....	4-53
4.10.1	Sea Urchin Tests.....	4-54
4.10.2	Tests with Meiobenthic Species.....	4-55
5.0	Descriptive Results.....	5-1
5.1	Physicochemical Characteristics of the Study Sites	5-1
5.2	Sedimentology.....	5-15
5.2.1	Grain Size.....	5-22
5.2.2	Mineralogy	5-32
5.2.3	Carbon Content.....	5-35
5.2.4	Redox Conditions (Eh).....	5-45
5.3	Contaminants.....	5-45
5.3.1	Hydrocarbons in Sediments	5-52
5.3.2	Trace Metals in Sediments.....	5-68
5.3.3	Hydrocarbons in Fish Livers, Fish Stomach Contents, and Invertebrate Soft Tissues.....	5-86
5.3.4	Trace Metals in Fish Livers, Fish Stomach Contents, and Invertebrate Soft Tissues.....	5-96
5.3.5	Sediment Interstitial (Pore) Water.....	5-96
5.4	Meiofauna	5-106
5.4.1	Vertical Distribution and Power.....	5-106
5.4.2	Community Abundance and Diversity.....	5-108
5.4.3	Community Structure.....	5-118
5.4.4	Nematode Trophic Dynamics.....	5-126
5.4.4.1	Modeling of Nematode Trophic Dynamics.....	5-134
5.4.5	Predation on Meiofauna.....	5-141
5.4.6	Life History and Reproduction.....	5-144
5.4.6.1	Reproduction.....	5-144
5.4.6.2	Life History Characteristics.....	5-144
5.4.7	Genetic Variability	5-147
5.5	Macroinfauna.....	5-147
5.5.1	Seasonal Trends	5-153
5.5.2	Diversity.....	5-153
5.5.3	Abundance.....	5-158

5.5.4	Comparison of Abundances of Numerically Dominant Taxa	5-162
5.6	Megafauna - Invertebrates	5-173
5.6.1	Catch Per Unit Effort.....	5-178
5.6.2	Individual Size and Size Frequency Distributions.....	5-178
5.6.3	Histopathology.....	5-188
5.6.4	Reproductive Effort.....	5-194
5.6.5	Male-to-Female Ratios and Percent Gravid Females	5-196
5.6.6	Stage of Reproductive Development	5-202
	5.6.6.1 Visual Inspection.....	5-202
	5.6.6.2 Histological Analysis.....	5-202
	5.6.6.3 Immunological Probe.....	5-212
5.7	Megafauna - Demersal Fish.....	5-212
5.7.1	Fish Food Analysis.....	5-213
5.7.2	Histopathology.....	5-223
5.8	Detoxification.....	5-224
5.8.1	AHH Activity in Invertebrates	5-229
5.8.2	EROD and AHH Activity in Fish	5-229
5.8.3	Biliary PAH Metabolites in Fish	5-250
5.8.4	Rat Hepatoma H-4IIE Bioassays	5-250
5.8.5	CYP1A mRNA	5-250
5.9	Sediment Porewater Toxicity Testing.....	5-259
5.9.1	Sea Urchin Tests.....	5-259
5.9.2	Tests with Meiobenthic Species.....	5-264
6.0	Discussion	6-1
6.1	Physicochemical Parameters.....	6-1
6.1.1	Water Temperature.....	6-12
6.1.2	Salinity.....	6-13
6.1.3	Nutrients	6-16
6.1.4	Dissolved Oxygen.....	6-19
6.1.5	Suspended Particulate Matter	6-28
6.2	Sedimentology and Contaminant Chemistry.....	6-30
6.2.1	Principal Component Analysis of Sediment and Contaminant Variables.....	6-33

6.2.2	Hypothesis Testing.....	6-35
6.2.3	Spatial and Temporal Variations in Sediment Contaminants.....	6-47
6.2.4	Comparative Evaluation of Contaminant Levels at the Platform Sites.....	6-51
6.2.4.1	Hydrocarbons.....	6-51
6.2.4.2	Metals	6-52
6.2.4.2.1	Comparisons with Previous Platform Monitoring Studies.....	6-54
6.2.4.2.2	Comparisons with Other Sedimentary Settings.....	6-61
6.2.4.2.3	The Potential for Biological Effects Associated with the Observed Sediment Metal Levels	6-66
6.3	Biological Accumulation of Contaminants in Megafauna.....	6-66
6.3.1	Hypothesis Testing.....	6-69
6.3.2	Historical Comparisons of Trace Metals in Tissues	6-70
6.4	Meiofauna	6-80
6.4.1	Meiofaunal Communities.....	6-82
6.4.1.1	Meiofaunal Abundance and Diversity.....	6-82
6.4.1.2	Meiofaunal Community Structure.....	6-85
6.4.1.3	Nematode Trophic Dynamics.....	6-100
6.4.1.4	Predation Pressure on Meiofauna.....	6-106
6.4.2	Reproduction and Life History.....	6-107
6.4.2.1	Reproduction.....	6-108
6.4.2.2	Life History Characteristics.....	6-109
6.4.2.3	Body Size	6-124
6.4.3	Harpacticoid Genetic Diversity.....	6-124
6.4.4	Relationship to Environmental Variables.....	6-131
6.4.4.1	Meiofauna Community Structure	6-134
6.4.4.2	Harpacticoid Life History.....	6-136
6.4.4.3	Harpacticoid Genetic Variability.....	6-140
6.5	Macroinfauna.....	6-141
6.5.1	Analysis of the Overall Study Design.....	6-145
6.5.2	Analysis by Platform Site.....	6-148

6.5.3	Macroinfauna Community Structure.....	6-154
6.5.4	Relationship to Environmental Parameters	6-167
6.6	Megafauna - Invertebrates	6-169
6.6.1	Catch Per Unit Effort (CPUE)	6-171
6.6.2	Size-Frequency Distributions	6-173
6.6.3	Histopathology.....	6-176
6.6.4	Reproductive Effort.....	6-180
6.6.5	Male-to-Female Ratios and Percent Gravid Females..	6-181
6.6.6	Stage of Reproductive Development.....	6-182
6.6.7	Histopathology and Stage of Reproductive Development.....	6-188
6.7	Megafauna - Demersal Fish.....	6-190
6.8	Detoxification.....	6-193
6.8.1	AHH Activity in Invertebrates	6-195
6.8.2	EROD and AHH Activity in Fish.....	6-197
6.8.3	Biliary PAH Metabolites in Fish	6-200
6.8.4	Rat Hepatoma H4IIE Bioassays.....	6-202
6.8.5	CYP1A mRNA Levels.....	6-203
6.8.6	Dosing Experiments	6-204
6.9	Pore Water Toxicity.....	6-209
7.0	Summary, Conclusions, and Recommendations.....	7-1
7.1	Summary of Major Programmatic Results.....	7-1
7.1.1	Summary of the Abiotic Setting	7-1
7.1.2	Summary of Meiofaunal Studies	7-2
7.1.3	Summary of Macroinfaunal Studies.....	7-4
7.1.4	Summary of Megafauna Studies.....	7-5
7.1.5	Summary of Detoxification Studies.....	7-6
7.1.6	Summary of Porewater Toxicity Studies.....	7-9
7.2	Assessment of Benthic-Based Indicators of Biological Response	7-11
7.2.1	Confounding of Environmental Variables	7-11
7.2.2	Sediment Quality Triad Approach to Integration of Results.....	7-22
7.2.3	Utility of Higher Taxonomic Levels	7-31
7.3	Megafaunal, Epibenthic Organisms as Indicators of Biological Response.....	7-47
7.4	Testing the Generality of the Observed Patterns.....	7-48
7.5	Heterogeneity of Variance as an Impact Response	7-51

7.6	Genetic Variability as a Measure of Impact.....	7-54
7.7	Recommendations for Future Studies	7-54
8.0	Literature Cited.....	8-1

LIST OF FIGURES

Figure	Page
1	Location of the original five study sites sampled on Cruise 14
1.1	Program organizational chart.....1-2
1.2	Location of the original five study sites sampled on Cruise 11-6
1.3	Frequency distribution of total unresolved complex mixture (UCM, ppm), total alkanes (C ₁₀ -C ₃₄ , ppb) and total polycyclic aromatics (PAH, ppb) concentrations in sediments for Cruise 1.....1-9
1.4	Distribution of barium concentrations (ppm) in sediments from Cruise 1 by radii and distance from the platform..... 1-10
1.5	Monthly production of condensate, gas, and water at MAI-686..... 1-14
1.6	Monthly production of condensate, gas, and water at MU-A85..... 1-17
1.7	Monthly production of condensate, gas, and water at HI-A389..... 1-18
2.1	Summary of boxcorer and trawl locations at MAI-686 for Cruises 1 (January 1993), 2 (June 1993), 3 (January 1994), and 4 (June 1994).....2-12
2.2	Summary of boxcorer and trawl locations at MU-A85 for Cruises 1 (January 1993), 2 (June 1993), 3 (January 1994), and 4 (June 1994).....2-14
2.3	Summary of boxcorer and trawl locations at HI-A389 for Cruises 1 (January 1993), 2 (June 1993), 3 (January 1994), and 4 (June 1994).....2-16
3.1	Activities at each quantitative boxcoring station including sampling protocols for water column and boxcore samples3-2
3.2	Boxcore illustrating "vegematic" partitioning.....3-5
3.3	Sample processing protocol for trawl collections.....3-6
3.4	Sample processing protocol for megafaunal invertebrates from trawls3-9

3.5	Sample processing protocol for megafaunal invertebrate and demersal fish tissues for contaminant chemistry and toxicology	3-10
3.6	Sample processing protocol for fish taken from trawls.....	3-12
3.7	Megafaunal invertebrate life history sampling protocol	3-20
4.1	Summary of hydrocarbon analytical protocols.....	4-8
4.2	The model for predicting platform effects on deposit-feeding nematode standing stock	4-27
5.1	Summary of the temperatures (°C) and salinities for surface, mid-, and bottom waters at MAI-686 for Cruises 1 and 4.....	5-8
5.2	Summary of dissolved oxygen concentrations (mL/L) for surface, mid-, and bottom waters at MAI-686 for all cruises	5-10
5.3	Relationship between oxygen and nutrient concentrations at MAI-686 for all cruises	5-11
5.4	Summary of the temperatures (°C) and salinities for surface, mid-, and bottom waters at MU-A85 for Cruises 1 and 2.....	5-12
5.5	Salinity values for surface, mid-, and bottom waters at MU-A85 for Cruise 3.....	5-13
5.6	Summary of dissolved oxygen concentrations (mL/L) for surface, mid-, and bottom waters at MU-A85 for all cruises.....	5-14
5.7	Summary of nitrate (µM) concentrations for surface, mid-, and bottom waters at MU-A85 for all cruises.....	5-16
5.8	Relationship between oxygen and nutrient concentrations at MU-A85 for all cruises	5-17
5.9	Summary of the temperatures (°C) and salinities for surface, mid-, and bottom waters at HI-A389 for Cruises 1 and 2.....	5-18
5.10	Summary of dissolved oxygen concentrations (mL/L) for surface, mid-, and bottom waters at HI-A389 for Cruise 2.....	5-19
5.11	Summary of phosphate and nitrate concentrations (µM) for surface, mid-, and bottom waters at HI-A389 for Cruise 2.....	5-20
5.12	Relationship between oxygen and nutrient concentrations at HI-A389 for all cruises.....	5-21

5.13	Summary of sediment grain size at MAI-686 by distance from the platform	5-23
5.14	Summary of sediment grain size at MU-A85 by distance from the platform	5-24
5.15	Summary of sediment grain size at HI-A389 by distance from the platform	5-25
5.16	Variability in mean sand content (%) with distance from the platform by cruise at MAI-686.....	5-26
5.17	Areal distribution of mean sand content (%) as a composite of all four cruises.....	5-28
5.18	Variability in mean sand content (%) with distance from the platform by cruise at MU-A85.....	5-29
5.19	Variability in mean sand content (%) with distance from the platform by cruise at HI-A389	5-30
5.20	X-ray diffractograms of sediments from the study area.....	5-33
5.21	Variability in mean total organic carbon content (%) in sediments with distance from the platform by cruise at MAI-686.....	5-36
5.22	Areal distribution of mean total organic carbon content (%) as a composite of all four cruises.....	5-37
5.23	Variability in mean total organic carbon content (%) in sediments with distance from the platform by cruise at MU-A85.....	5-38
5.24	Variability in mean total organic carbon content (%) in sediments with distance from the platform by cruise at HI-A389.....	5-39
5.25	Relationship between sand and total organic carbon content (%) in sediments at all sites for all cruises	5-40
5.26	Variability in mean total inorganic carbon content (%) in sediments with distance from the platform by cruise at MAI-686.....	5-41
5.27	Areal distribution of mean total inorganic carbon content (%) as a composite of all four cruises	5-42

5.28	Variability in mean total inorganic carbon content (%) in sediments with distance from the platform by cruise at MU-A85.....	5-43
5.29	Variability in mean total inorganic carbon content (%) in sediments with distance from the platform by cruise at HI-A389.....	5-44
5.30	Relationship between sand and total inorganic carbon content (%) in sediments at all sites for all cruises.....	5-46
5.31	Relationship between organic and inorganic carbon content (%) in sediments at all sites for all cruises.....	5-47
5.32	Variability in mean redox potential (mV) in sediments with distance from the platform by cruise at MAI-686.....	5-48
5.33	Areal distribution of mean redox potential (mV) as a composite of all four cruises.....	5-49
5.34	Variability in mean redox potential (mV) in sediments with distance from the platform by cruise at MU-A85.....	5-50
5.35	Variability in mean redox potential (mV) in sediments with distance from the platform by cruise at HI-A389.....	5-51
5.36	Variability in mean total PAH concentrations (ppb) in sediments with distance from the platform by cruise at MAI-686.....	5-53
5.37	Variability in mean total PAH concentrations (ppb) in sediments with distance from the platform by cruise at MU-A85.....	5-54
5.38	Variability in mean total PAH concentrations (ppb) in sediments with distance from the platform by cruise at HI-A389.....	5-55
5.39	Variability in mean total alkane concentrations (ppb) in sediments with distance from the platform by cruise at MAI-686.....	5-56
5.40	Variability in mean total alkane concentrations (ppb) in sediments with distance from the platform by cruise at MU-A85.....	5-57
5.41	Variability in mean total alkane concentrations (ppb) in sediments with distance from the platform by cruise at HI-A389.....	5-58

5.42	Variability in mean total UCM concentrations (ppm) in sediments with distance from the platform by cruise at MAI-686.....	5-59
5.43	Variability in mean total UCM concentrations (ppm) in sediments with distance from the platform by cruise at MU-A85.....	5-60
5.44	Variability in mean total UCM concentrations (ppm) in sediments with distance from the platform by cruise at HI-A389.....	5-61
5.45	Areal distribution of mean total PAH concentrations (ppb) in sediments as a composite of all four cruises	5-62
5.46	Areal distribution of mean total aliphatic hydrocarbon concentrations (ppb) in sediments as a composite of all four cruises	5-63
5.47	Areal distribution of mean total UCM concentrations (ppm) in sediments as a composite of all four cruises	5-64
5.48	Gas chromatograms (flame ionization detection) of sediment extracts from MAI-686.....	5-65
5.49	Gas chromatograms (flame ionization detection) of sediment extracts from HI-A389.....	5-66
5.50	Gas chromatograms (flame ionization detection) of sediment extracts from MU-A85.....	5-67
5.51	Variability in mean iron concentrations (ppm) in sediments with distance from the platform by cruise at MAI-686.....	5-70
5.52	Variability in mean iron concentrations (ppm) in sediments with distance from the platform by cruise at MU-A85.....	5-71
5.53	Variability in mean iron concentrations (ppm) in sediments with distance from the platform by cruise at HI-A389.....	5-72
5.54	Variability in mean aluminum concentrations (ppm) in sediments with distance from the platform by cruise at MAI-686.....	5-73
5.55	Variability in mean aluminum concentrations (ppm) in sediments with distance from the platform by cruise at MU-A85.....	5-74

5.56	Variability in mean aluminum concentrations (ppm) in sediments with distance from the platform by cruise at HI-A389.....	5-75
5.57	Variability in mean barium concentrations (ppm) in sediments with distance from the platform by cruise at MAI-686.....	5-76
5.58	Variability in mean barium concentrations (ppm) in sediments with distance from the platform by cruise at MU-A85.....	5-77
5.59	Variability in mean barium concentrations (ppm) in sediments with distance from the platform by cruise at HI-A389.....	5-78
5.60	Variability in mean cadmium concentrations (ppm) in sediments with distance from the platform by cruise at MAI-686.....	5-79
5.61	Variability in mean cadmium concentrations (ppm) in sediments with distance from the platform by cruise at MU-A85.....	5-80
5.62	Variability in mean cadmium concentrations (ppm) in sediments with distance from the platform by cruise at HI-A389.....	5-81
5.63	Areal distribution of mean iron concentrations (ppm) in sediments as a composite of all four cruises.....	5-82
5.64	Areal distribution of mean aluminum concentrations (ppm) in sediments as a composite of all four cruises.....	5-83
5.65	Areal distribution of mean barium concentrations (ppm) in sediments as a composite of all four cruises.....	5-84
5.66	Areal distribution of mean cadmium concentrations (ppm) in sediments as a composite for all four cruises.....	5-85
5.67	Correlation between mercury (Hg) and barium (Ba) concentrations in sediments at all sites for all cruises.....	5-88
5.68	Correlation between cadmium (Cd) and barium (Ba) concentrations in sediments at all sites for all cruises.....	5-89
5.69	Correlation between lead (Pb) and barium (Ba) concentrations in sediments at all sites for all cruises.....	5-90

5.70	Correlation between zinc (Zn) and barium (Ba) concentrations in sediments at all sites for all cruises	5-91
5.71	Correlation between copper (Cu) and barium (Ba) concentrations in sediments at all sites for all cruises	5-92
5.72	Variability of mean total PAH concentrations (ppb) in tissues by type, cruise, and distance from the platform at MAI-686.....	5-93
5.73	Variability of mean total PAH concentrations (ppb) in tissues by type, cruise, and distance from the platform at MU-A85.....	5-94
5.74	Variability of mean total PAH concentrations (ppb) in tissues by type, cruise, and distance from the platform at HI-A389.....	5-95
5.75	Summary of mean metal concentrations in fish liver tissues at MAI-686 as a composite of all four cruises.....	5-97
5.76	Summary of mean metal concentrations in fish liver tissues at MU-A85 as a composite of all four cruises.....	5-98
5.77	Summary of mean metal concentrations in fish liver tissues at HI-A389 as a composite of all four cruises	5-99
5.78	Summary of mean metal concentrations in invertebrate soft tissues at MAI-686 as a composite of all four cruises.....	5-100
5.79	Summary of mean metal concentrations in invertebrate soft tissues at MU-A85 as a composite of all four cruises.....	5-101
5.80	Summary of mean metal concentrations in invertebrate soft tissues at HI-A389 as a composite of all four cruises	5-102
5.81	Summary of mean metal concentrations in fish stomach contents at MAI-686 as a composite of all four cruises.....	5-103
5.82	Summary of mean metal concentrations in fish stomach contents at MU-A85 as a composite of all four cruises.....	5-104
5.83	Summary of mean metal concentrations in fish stomach contents at HI-A389 as a composite of all four cruises	5-105
5.84	Areal distribution of mean meiofauna density (ind/10 cm ²) as a composite of all four cruises	5-110
5.85	Areal distribution of mean nematode density (n × 10 cm ⁻²) as a composite of all four cruises.....	5-111

5.86	Areal distribution of mean harpacticoid density ($n \times 10 \text{ cm}^{-2}$) as a composite of all four cruises	5-112
5.87	Areal distribution of mean "other meiofauna" density ($\text{ind}/10 \text{ cm}^2$) as a composite of all four cruises.....	5-113
5.88	Areal distribution of mean nematode biomass ($\text{mg wet weight} \times 10 \text{ cm}^{-2}$) as a composite of all four cruises	5-114
5.89	Areal distribution of mean nematode:copepod ratio (N:C ratio) as a composite of all four cruises.....	5-115
5.90	Areal distribution of mean nematode diversity (H') as a composite of all four cruises.....	5-116
5.91	Areal distribution of mean harpacticoid diversity (H') as a composite of all four cruises.....	5-117
5.92	Composition of feeding groups based on the mean numbers of individuals for the nematode community at MAI-686 by distance from the platform.....	5-128
5.93	Composition of feeding groups based on the mean biomass for the nematode community at MAI-686 by distance from the platform	5-129
5.94	Composition of feeding groups based on the mean numbers of individuals for the nematode community at MU-A85 by distance from the platform.....	5-130
5.95	Composition of feeding groups based on the mean biomass for the nematode community at MU-A85 by distance from the platform	5-131
5.96	Composition of feeding groups based on the mean numbers of individuals for the nematode community at HI-A389 by distance from the platform.....	5-132
5.97	Composition of feeding groups based on the mean biomass for the nematode community at HI-A389 by distance from the platform	5-133
5.98	Average predicted production for the meiofaunal community at MAI-686 over the timeframe of the study sampling efforts.....	5-135
5.99	Average predicted production for the meiofaunal community at MU-A85 over the timeframe of the study sampling efforts	5-136

5.100	Average predicted production for the meiofaunal community at HI-A389 over the timeframe of the study sampling efforts.....	5-137
5.101	Average production efficiency for the meiofaunal community at MAI-686 over the timeframe of the study sampling efforts.....	5-138
5.102	Average production efficiency for the meiofaunal community at MU-A85 over the timeframe of the study sampling efforts.....	5-139
5.103	Average production efficiency for the meiofaunal community at HI-A389 over the timeframe of the study sampling efforts.....	5-140
5.104	Comparison of seasonal trends in mean numbers of individuals of macroinfauna at all sites.....	5-155
5.105	Summary of the mean number of macroinfaunal species by distance from the platforms.....	5-156
5.106	Areal distribution of the number of macroinfaunal species as a composite of all four cruises	5-157
5.107	Summary of the mean index of diversity (H') for macroinfauna by distance from the platforms.....	5-159
5.108	Areal distribution of the mean index of diversity (H') for macroinfauna as a composite of all four cruises.....	5-160
5.109	Summary of the mean number of macroinfauna by distance from the platforms	5-161
5.110	Areal distribution of the mean abundances of macroinfaunal individuals as a composite of all four cruises.....	5-163
5.111	Summary of the mean abundances of polychaetes by distance from the platforms	5-164
5.112	Summary of the mean abundances of amphipods by distance from the platforms	5-165
5.113	Summary of the mean abundances of nemertean by distance from the platforms.....	5-167
5.114	Summary of the mean abundances of bivalves by distance from the platforms	5-168
5.115	Summary of the mean abundances of decapods by distance from the platforms	5-169

5.116	Summary of the mean abundances of isopods by distance from the platforms	5-170
5.117	Summary of the mean abundances of forams by distance from the platforms	5-171
5.118	Summary of the mean abundances of ophiuroids by distance from the platforms	5-172
5.119	Size frequency distributions for the mollusc <i>Amusium papyraceum</i> at MU-A85.....	5-189
5.120	Size frequency distributions for <i>Astropecten duplicatus</i> at MAI-686.....	5-190
5.121	Size frequency distributions for <i>Solenocera atlantidis</i> at MU-A85.....	5-191
5.122	Body wet weight versus egg wet weight of <i>Callinectes similis</i>	5-200
5.123	Results of splenic macrophage aggregate analysis of fishes collected from MAI-686, MU-A85, and HI-A389 for all cruises	5-226
5.124	Mean hepatic EROD activities in various fish species.....	5-230
5.125	Catalytic enzyme activities and biliary metabolite concentrations in <i>Ancyclopsetta dilecta</i>	5-233
5.126	Catalytic enzyme activities and biliary metabolite concentrations in <i>Ancyclopsetta quadrocellata</i>	5-234
5.127	Catalytic enzyme activities and biliary metabolite concentrations in <i>Caulolatilus intermedius</i>	5-235
5.128	Catalytic enzyme activities and biliary metabolite concentrations in <i>Centropristis philadelphica</i>	5-236
5.129	Catalytic enzyme activities and biliary metabolite concentrations in <i>Cynoscion arenarius</i>	5-237
5.130	Catalytic enzyme activities and biliary metabolite concentrations in <i>Cyclopsetta chittendeni</i>	5-238
5.131	Catalytic enzyme activities and biliary metabolite concentrations in <i>Lagodon rhomboides</i>	5-239

5.132	Catalytic enzyme activities and biliary metabolite concentrations in <i>Lutjanus campechanus</i>	5-240
5.133	Catalytic enzyme activities and biliary metabolite concentrations in <i>Ogcocephalus declivirostris</i>	5-241
5.134	Catalytic enzyme activities and biliary metabolite concentrations in <i>Paralichthys lethostigma</i>	5-242
5.135	Catalytic enzyme activities and biliary metabolite concentrations in <i>Portinus longispinis</i>	5-243
5.136	Catalytic enzyme activities and biliary metabolite concentrations in <i>Pristipomoides aquilonaris</i>	5-244
5.137	Catalytic enzyme activities and biliary metabolite concentrations in <i>Syacium gunteri</i>	5-245
5.138	Catalytic enzyme activities and biliary metabolite concentrations in <i>Synodus foetens</i>	5-246
5.139	Catalytic enzyme activities and biliary metabolite concentrations in <i>Trichopsetta ventralis</i>	5-247
5.140	Catalytic enzyme activities and biliary metabolite concentrations in <i>Urophycis</i> spp.	5-248
5.141	Correlation between EROD and AHH activities in fish captured on Cruises 1 and 2 (excluding <i>Lagodon rhomboides</i>).....	5-249
5.142	Species variations in mean biliary metabolite concentrations	5-251
5.143	Species difference in rat hepatoma H-4IIE cell bioassay-derived TEQs.....	5-252
5.144	TEQs derived from rat hepatoma H-4IIE cells dosed with <i>Trachypenaeus similis</i> extracts.....	5-253
5.145	TEQs derived from rat hepatoma H-4IIE cells dosed with <i>Solenocera atlantidis</i> extracts.....	5-254
5.146	TEQs derived from rat hepatoma H-4IIE cells dosed with <i>Squilla empusa</i> extracts.....	5-255
5.147	TEQs derived from rat hepatoma H-4IIE cells dosed with <i>Callinectes similis</i> extracts	5-256

5.148	TEQs derived from rat hepatoma H-4IIE cells dosed with <i>Penaeus aztecus</i> extracts.....	5-257
5.149	Northern blot analysis of CYP1A mRNA in A: marine fish; and B: lizard fish from near and far stations.....	5-258
5.150	Summary of sea urchin embryological development and fertilization porewater toxicity tests for sediments from Cruise 1.....	5-260
5.151	Summary of sea urchin embryological development porewater toxicity tests for sediments from Cruise 2.....	5-262
6.1	Relationship between ChemPC1 and ChemPC2 for sediment contaminant data coded by distance and grouped by site.....	6-36
6.2	Distribution of barium concentrations (ppm) with depth in the sediment column at all three sites.....	6-50
6.3	Comparison of sediment PAH concentrations at GOOMEX sites to the NOAA-National Status & Trends and EPA Environmental Monitoring and Assessment (EMAP) databases for coastal Gulf of Mexico sites.....	6-53
6.4	Relationship between sediment iron concentrations and A: aluminum concentrations; and B: distance from the platform at MAI-686 at two samples 14 years apart.....	6-56
6.5	Relationship between sediment barium and lead concentrations and distance from the platform at MAI-686 at two samplings 14 years apart.....	6-57
6.6	Relationship between barium concentrations in sediment collected immediately (HI-A341, V-321, HI-A384) and 5-10 years after (MU-A85, HI-A389) cessation of drilling activities.....	6-58
6.7	Relationship between lead concentrations in sediment collected immediately (HI-A341, V-321) and 5-10 years after (MU-A85, HI-A389) cessation of drilling activities.....	6-60
6.8	Relationship between nickel and cadmium concentrations and aluminum concentrations in sediments from HI-A389, MU-A85, and EMAP-NC coastal samplings.....	6-62
6.9	Relationship between lead and zinc concentrations and aluminum concentrations in sediments from HI-A389, MU-A85, and EMAP-NC coastal samplings.....	6-63

6.10	Relationship between mercury and aluminum concentrations in sediments from HI-A389 and EMAP-NC coastal samplings	6-64
6.11	Relationship between iron and chromium concentrations and aluminum concentrations in sediments from HI-A389, MU-A85, and EMAP-NC coastal samplings.....	6-65
6.12	Comparison of the ranges of selected trace metal concentrations in sediments from the GOOMEX study sites, EMAP-NC data, and Long and Morgan (1990) 10 % and 50 % biological effects threshold.....	6-67
6.13	Percent of samples from the GOOMEX sites that exceeded the Long and Morgan (1990) A: 50 % and B: 10 % bioeffects criteria.....	6-68
6.14	Comparison of STOCS and GOOMEX organism trace metal data in <i>Lutjanus campechanus</i> (Red Snapper) liver tissue.....	6-74
6.15	Comparison of STOCS and GOOMEX organism trace metal data for <i>Pristipomoides aquilonaris</i> (Wenchman) liver tissue.....	6-75
6.16	Comparison of STOCS and GOOMEX organism trace metal data for <i>Squilla empusa</i> (Mantis Shrimp) soft tissue.....	6-77
6.17	Comparison of STOCS and GOOMEX organism trace metal data for fish liver tissue	6-78
6.18	Comparison of STOCS and GOOMEX organism trace metal data for shrimp soft tissues.....	6-79
6.19	Principal components analysis (PCA) of harpacticoid species for entire sampling design by platform.....	6-92
6.20	Principal components analysis (PCA) of nematode species for entire sampling design by platform.....	6-93
6.21	Principal components analysis (PCA) of harpacticoid species at MAI-686 by distance from the platform.....	6-94
6.22	Principal components analysis (PCA) of harpacticoid species at MU-A85 by distance from the platform.....	6-95
6.23	Principal components analysis (PCA) of harpacticoid species at HI-A389 by distance from the platform.....	6-96
6.24	Principal components analysis (PCA) of nematode species at MAI-686 by distance from the platform.....	6-97

6.25	Principal components analysis (PCA) of nematode species at MU-A85 by distance from the platform.....	6-98
6.26	Principal components analysis (PCA) of nematode species at HI-A389 by distance from the platform.....	6-99
6.27	Mean reproductive effort among all cruises, platforms, and three species	6-110
6.28	Average clutch size among all cruises, platforms, and three species.....	6-111
6.29	Harpacticoid life history stages mean density ($n \times \text{core}^{-1}$) for all platforms, cruises, stations, and species.....	6-113
6.30	Harpacticoid life history stage density ($n \times \text{core}^{-1}$) for all cruises, stations, and species at MAI-686	6-115
6.31	Harpacticoid life history stage density ($n \times \text{core}^{-1}$) for all cruises, stations, and species at MU-A85	6-116
6.32	Harpacticoid life history stage density ($n \times \text{core}^{-1}$) for all cruises, stations, and species at HI-A389.....	6-117
6.33	Harpacticoid life history percent composition for all platforms, stations, and species.....	6-118
6.34	Harpacticoid life history stage percent composition for all cruises, stations, and species at MAI-686	6-119
6.35	Harpacticoid life history stage percent composition for all cruises, stations, and species at MU-A85	6-120
6.36	Harpacticoid life history stage percent composition for all cruises, stations, and species at HI-A389.....	6-121
6.37	Mean density ($n \times \text{core}^{-1}$) of gravid harpacticoid females for all platforms, stations and species.....	6-122
6.38	Mean body lengths (μm) of <i>Longipedia americana</i> , weighted for sexual differences, at all platforms and stations.....	6-125
6.39	Mean body lengths (μm) of <i>Diathrodes</i> sp., weighted for sexual differences, at all platforms and stations.....	6-126

6.40	Mean body lengths (μm) of <i>Cletodes pseudodissimilis</i> , weighted for sexual differences for all platforms and stations.....	6-127
6.41	Genetic variability of harpacticoid copepods by species for all platforms and cruises.....	6-130
6.42	Genetic variability of harpacticoid copepods by platform for all species and cruises.....	6-132
6.43	Genetic variability of harpacticoid copepods by cruise for all species and platforms.....	6-133
6.44	Relationship between haplotype diversity for all species, platforms, and cruises and the environmental variables PC1 (ChemPC1) by distance from the platform.....	6-142
6.45	PCA of total macroinfauna species community structure by platform.....	6-155
6.46	PCA of total macroinfauna species community structure at MAI-686.....	6-156
6.47	PCA of total macroinfauna species community structure at MU-A85.....	6-157
6.48	PCA of total macroinfauna species community structure at HI-A389.....	6-158
6.49	PCA of amphipod species community structure by platform.....	6-159
6.50	PCA of amphipod species community structure at MAI-686.....	6-160
6.51	PCA of amphipod species community structure at MU-A85.....	6-161
6.52	PCA of amphipod species community structure at HI-A389.....	6-162
6.53	PCA of polychaete species community structure by platform.....	6-163
6.54	PCA of polychaete species community structure at MAI-686.....	6-164
6.55	PCA of polychaete species community structure at MU-A85.....	6-165
6.56	PCA of polychaete species community structure at HI-A389.....	6-166
6.57	Average GSI of <i>P. spinicarpus</i> at MU-A85 and HI-A389.....	6-187
6.58	Biomarkers used in GOOMEX.....	6-196

6.59	Molecular mechanism of action of TCDD and related PAHs and HAHS.....	6-205
6.60	Ah receptor profile in <i>Synodus foetens</i> (lizard fish).....	6-206
6.61	Ah receptor profile in <i>Lagodon rhomboides</i> (pin fish).....	6-207
6.62	Whole sediment A: zinc; and B: lead concentrations and pore water toxicity at HI-A389	6-212
6.63	Whole sediment A: cadmium; and B: barium concentrations and pore water toxicity at HI-A389.....	6-213
6.64	Whole sediment total PAH concentrations and pore water toxicity at HI-A389	6-214
7.1	Correlation between total PAH concentrations in sediments and hepatic EROD activities in fish	7-7
7.2	Significance of the relationships between SQT components.....	7-25
7.3	Relationship between the first two principal components of the meiofauna abundance data and the environmental variables PC1	7-27
7.4	Relationship between the first two principal components of the macroinfauna abundance data and the environmental variables PC1	7-28
7.5	Relationship between survivability in the sea urchin embryo pore water assays (MDEVEL) and the environmental variable PC1 (ChemPC1)	7-30
7.6	Comparison of PCA at the species and family levels for harpacticoid families for all platforms.....	7-35
7.7	Comparison of PCA at the species and family levels for nematode families for all platforms.....	7-36
7.8	Comparison of PCA at the species and family levels for harpacticoid families at MAI-686.....	7-37
7.9	Comparison of PCA at the species and family levels for harpacticoid families at MU-A85.....	7-38
7.10	Comparison of PCA at the species and family levels for harpacticoid families at HI-A389.....	7-39

7.11	Comparison of PCA at the species and family levels for nematode families at MAI-686	7-40
7.12	Comparison of PCA at the species and family levels for nematode families at MU-A85	7-41
7.13	Comparison of PCA at the species and family levels for nematode families at HI-A389	7-42
7.14	Comparison of PCA at the species and family levels for macroinfauna families for all platforms	7-43
7.15	Comparison of PCA at the species and family levels for macroinfauna families for MAI-686	7-44
7.16	Comparison of PCA at the species and family levels for macroinfauna families at MU-A85	7-45
7.17	Comparison of PCA at the species and family levels for macroinfauna families at HI-A389	7-46
7.18	Median variance of selected variables between subcores within a boxcore by distance from the platform	7-53

LIST OF TABLES

Table	Page
1 Summary of GOOMEX Phase I Work Elements.....	2
2 Summary of recommendations for further study at platform sites	16
1.1 Summary of GOOMEX Phase I Work Elements.....	1-3
1.2 Summary of significant Spearman correlations in sediment trace element data from Cruise 1.....	1-12
1.3 Summary of the drilling history and associated discharges at the Matagorda Island Block 686 site through 1980.....	1-13
1.4 A summary of drilling discharges form the first six wells at Mustang Island Block A-85	1-16
2.1 Different analysis categories for different subsets to examine the total design and interactions within the design.....	2-3
2.2 ANOVA table for total design analysis	2-5
2.3 ANOVA table for by platform analysis.....	2-6
2.4 ANOVA table for by cruise analyses	2-6
2.5 ANOVA table for by cruise-platform analyses.....	2-8
2.6 Partial list of variables being used in the GOOMEX study.....	2-18
2.7 Variance components analysis for boxcore data.....	2-20
2.8 Power analysis for boxcore data based on two replicate subcores from two boxcores taken at two stations at all five platforms during the first cruise	2-22
3.1 Visual reproductive development for female shrimp.....	3-18
3.2 Visual reproductive development for female crabs.....	3-18
4.1 Analytical conditions for aliphatic hydrocarbon analysis.....	4-13
4.2 Aliphatic hydrocarbons (AH) of interest.....	4-13

4.3	Target polycyclic aromatic hydrocarbon analytes.....	4-14
4.4	Trace element analytical methodologies by matrix.....	4-17
4.5	Major meiofauna taxonomic categories.....	4-21
4.6	Formulas used in the model for predicting platform effects on deposit-feeding nematode standing stock.....	4-29
4.7	The best fit parameters of model for platform HI-A389 after 6,000 calibrating runs.....	4-30
4.8	Parameters of model for platform MAI-686.....	4-31
4.9	Parameters of model for platform MU-A85.....	4-32
4.10	A standard embedding procedure for histological analysis.....	4-37
4.11	Standard hematoxylin-eosin procedure to stain slides.....	4-38
4.12	Histological reproductive development scale for crabs.....	4-39
4.13	Histological reproductive development scale for shrimp.....	4-40
4.14	Histological reproductive development stages for scallops.....	4-41
4.15	Histological reproductive development stages for starfish and stomatopods.....	4-42
4.16	Summary of immunization protocol.....	4-43
5.1	Summary of CTD and discrete bottle data measured at MAI- 686 during Cruise 1.....	5-2
5.2	Summary of CTD and discrete bottle data measured at MAI- 686 during Cruise 2.....	5-2
5.3	Summary of CTD and discrete bottle data measured at MAI- 686 during Cruise 3.....	5-3
5.4	Summary of CTD and discrete bottle data measured at MAI- 686 during Cruise 4.....	5-3
5.5	Summary of CTD and discrete bottle data measured at MU- A85 during Cruise 1.....	5-4
5.6	Summary of CTD and discrete bottle data measured at MU- A85 during Cruise 2.....	5-4

5.7	Summary of CTD and discrete bottle data measured at MU-A85 during Cruise 3.....	5-5
5.8	Summary of CTD and discrete bottle data measured at MU-A85 during Cruise 4.....	5-5
5.9	Summary of CTD and discrete bottle data measured at HI-A389 during Cruise 1	5-6
5.10	Summary of CTD and discrete bottle data measured at HI-A389 during Cruise 2	5-6
5.11	Summary of CTD and discrete bottle data measured at HI-A389 during Cruise 3	5-7
5.12	Summary of CTD and discrete bottle data measured at HI-A389 during Cruise 4	5-7
5.13	Range values of total organic carbon (TOC) and inorganic carbon (TIC) concentrations at the three sites in percent (%) carbon	5-35
5.14	Summary of the ranges in Eh potential (mV) at the three study sites measured by platinum electrode.....	5-45
5.15	The ranges in metal concentrations (ppm) in surficial sediments from GOOMEX study sites.....	5-69
5.16	Matrix of correlation coefficients between individual metal concentrations measured in sediments at all study sites from all cruises	5-87
5.17	Continental shelf meiofauna densities reported in the periodic literature	5-107
5.18	Vertical distribution of meiofauna in the Gulf of Mexico	5-107
5.19	The overall average abundance and diversity for meiofauna variables at all platforms, stations, and cruises.....	5-109
5.20	Mean density ($n \times 10 \text{ cm}^{-2}$) for Copepoda species found at all three platforms for all cruises	5-119
5.21	Mean density ($n \times 10 \text{ cm}^{-2}$) for Nematoda species found at all three platforms for all cruises	5-123
5.22	The overall average abundance of Nematoda feeding group variables at the three platforms	5-127

5.23	The predicted average production ($\mu\text{g WW} \times 10 \text{ cm}^{-2} \times \text{month}^{-1}$) and production efficiency based on the long-term model simulation of deposit feeding nematode.....	5-141
5.24	The number and mean lengths of fish used in stomach contents analyses and mean number of organisms in stomachs for fish caught during the third and fourth cruises for all sites	5-142
5.25	The number and mean length of fish used in stomach content analyses and the mean number of organisms in the stomachs.....	5-143
5.26	Average harpacticoid reproductive effort based on frequency, least square (LS) clutch size and least square (LS) clutch volume for all species of gravid females encountered on all cruises.....	5-145
5.27	Life history stage densities for all harpacticoids.....	5-147
5.28	Population composition for all harpacticoids	5-147
5.29	Meiofauna genetic variability for <i>Normanella</i> sp. at three platforms and two cruises	5-148
5.30	Meiofauna genetic variability for <i>Cletodes</i> sp. at three platforms and two cruises	5-149
5.31	Meiofauna genetic variability for <i>Enhydrosoma pericoense</i> at three platforms and two cruises.....	5-150
5.32	Meiofauna genetic variability for <i>Robertsonia</i> sp. at three platforms and two cruises	5-151
5.33	Meiofauna genetic variability for <i>Tachidiella</i> sp. at three platforms and one cruise	5-152
5.34	Numbers of stations having unique species assemblages in each of the three subcores collected.....	5-154
5.35	The number of individuals collected for each species at the Near and Far stations during Cruise 1.....	5-174
5.36	The number of individuals collected for each species at the Near and Far stations during Cruise 2.....	5-175
5.37	The number of individuals collected for each species at the Near and Far stations during Cruise 3.....	5-176

5.38	The number of individuals collected for each species at the Near and Far stations during Cruise 4.....	5-177
5.39	Catch per unit effort (CPUE, individuals m ⁻²) for each trawl and overlapping species collected during Cruise 3.....	5-179
5.40	Catch per unit effort (CPUE, individuals m ⁻²) for each trawl and overlapping species collected during Cruise 4.....	5-181
5.41	Summary data for overlapping species collected from each platform during Cruise 1.....	5-183
5.42	Summary of the numbers of individuals collected and size range for overlapping species at each platform during Cruise 2.....	5-184
5.43	Summary of the numbers of individuals collected and size range for overlapping species at each platform during Cruise 3.....	5-186
5.44	Summary of the numbers of individuals collected for overlapping species at each platform during Cruise 4.....	5-187
5.45	Prevalence and intensity of each parasite and pathology in the shrimp species collected during all four cruises.....	5-192
5.46	Prevalence and intensity of parasitism and pathologies in the crab species collected on all four cruises.....	5-195
5.47	Prevalence and intensity of parasitism and pathologies of starfish and scallop tissues collected on all four GOOMEX cruises.....	5-196
5.48	Male:Female ratios for species collected at Near and Far stations.....	5-197
5.49	The percent of female crabs collected that were gravid and average wet weight (g) of the egg sacs at each site for each cruise.....	5-199
5.50	Egg protein, percent water and gonadal somatic index (GSI) for egg sacs collected from gravid female crabs.....	5-201
5.51	Results of visual inspection and gross dissection for the determination of stage of reproductive development in females of shrimp and crab species collected during Cruises 2, 3, and 4.....	5-203

5.52	Sex and stage of reproductive development for overlapping species collected at each platform for histological examination during Cruise 2	5-206
5.53	Sex and stage of reproductive development for overlapping species collected at each platform for histological examination during Cruise 3	5-208
5.54	Sex and stage of reproductive development for overlapping species collected at each platform for histological examination during Cruise 4	5-210
5.55	Summary data for immunological probe results for non-gravid female crabs.....	5-213
5.56	Fish species employed (x) in the food analyses during all four cruises and showing the cruise number and collecting sites represented by each species	5-214
5.57	Results of stomach food analyses from Cruise 1 fish	5-216
5.58	Results of stomach food analyses from Cruise 2 fish	5-217
5.59	Results of stomach food analyses for Cruise 3 fish	5-218
5.60	Results of stomach food analyses for Cruise 4 fish	5-219
5.61	Results of Chi-Square comparisons of the food of fishes taken at Near and Far stations for sites on each of the four cruises	5-220
5.62	Pathological abnormalities in liver and spleen.....	5-225
5.63	Fish species captured at both Near and Far stations of at least one platform.....	5-227
5.64	Invertebrate species captured at both Near and Far stations of at least one platform.....	5-228
5.65	AHH activities of invertebrates collected on Cruise 1.....	5-228
5.66	Mean of EROD and AHH activities and mean biliary PAH metabolite concentrations for those species of fish captured at Near and Far stations.....	5-231
5.67	Results of tests for three species exposed to pore water from selected stations at HI-A389, Cruise 1.....	5-265

6.1	Summary of significance of interactions for the overall study design based on physicochemical data.....	6-2
6.2	Tukey's multiple comparison test results by distance for the overall study design based on physicochemical data for surface waters.....	6-3
6.3	Tukey's multiple comparison test results by distance for the overall study design based on physicochemical data for mid-water	6-4
6.4	Tukey's multiple comparison test results by distance for the overall study design based on physicochemical data for bottom waters.....	6-5
6.5	Tukey's multiple comparison test results by site (platform) for the overall study design based on physicochemical data for surface waters.....	6-6
6.6	Tukey's multiple comparison test results by site (platform) for the overall study design based on physicochemical data for mid-waters.....	6-7
6.7	Tukey's multiple comparison test results by site (platform) for the overall study design based on physicochemical data for bottom waters.....	6-8
6.8	Summary of the significance of interactions for physicochemical data at MAI-686.....	6-9
6.9	Summary of the significance of interactions for physicochemical data at MU-A85.....	6-10
6.10	Summary of the significance of interactions for physicochemical data at HI-A389.....	6-11
6.11	Tukey's multiple comparison test results at each site and water depth by distance and by cruise for temperature (°C).....	6-14
6.12	Tukey's multiple comparison test results for each site and water depth by distance and cruise for salinity for the overall study design.....	6-17
6.13	Tukey's multiple comparison test results for each site and water depth by distance and cruise for water column phosphate concentrations (μM).....	6-20
6.14	Tukey's multiple comparison test results for each site and water depth by distance and cruise for nitrate (μM)	6-22

6.15	Tukey's multiple comparison test results for each site and water depth by distance and by cruise for silicate concentrations (μM).....	6-24
6.16	Tukey's multiple comparison test results for each site and water depth by distance and cruise for dissolved O_2 concentrations (mL/L).....	6-26
6.17	Tukey's multiple comparison test results for each site and water depth by distance and by cruise for transmittance (%).....	6-29
6.18	Principal Component Analysis (PCA) factor patterns for reduced and combined sediment and contaminant variables.....	6-35
6.19	Summary of the significance of interactions by distance at all platforms for the overall study design based on sedimentology and contaminant data.....	6-37
6.20	Summary of the significance of interactions by platform for the overall study design based on sedimentology and contaminant data.....	6-38
6.21	Summary of the significance of distance at platforms based on sedimentology and contaminant data.....	6-39
6.22	Tukey's multiple comparison test results by distance for the overall study design based on sedimentology and contaminant data.....	6-41
6.23	Tukey's multiple comparison test results by platform for the overall study design based on sedimentology and contaminant data.....	6-42
6.24	Tukey's multiple comparison test results by distance based on sedimentology and contaminant data at MAI-686.....	6-45
6.25	Tukey's multiple comparison test results by distance based on sedimentology and contaminant data at MU-A85.....	6-46
6.26	Tukey's multiple comparison test results by distance based on sedimentology and contaminant data at HI-A389.....	6-48
6.27	General characteristics of the study sites.....	6-49
6.28	A mass balance of excess barium in sediments at the three study sites.....	6-51

6.29	Summary of the significance of interactions for the overall study design based on contaminants in fish livers	6-71
6.30	Summary of the significance of interactions for the overall study design based on contaminants in fish stomach content.....	6-71
6.31	Summary of the significance of interactions for the overall study design based on contaminants in invertebrate soft tissues.....	6-72
6.32	Summary of the significance of interactions for different tissue types at MAI-686 based on contaminants.....	6-72
6.33	Summary of the significance of interactions for different tissue types at MU-A85 based on contaminants.....	6-73
6.34	Summary of the significance of interactions for different tissue types at HI-A389 based on contaminants.....	6-73
6.35	Summary of the significance of interactions for the overall sample design based on meiofaunal data.....	6-83
6.36	Summary of tests of the main effects for overall sample design based on meiofaunal data.....	6-84
6.37	Summary of the significance of interactions by platform based on meiofaunal data	6-84
6.38	Summary of the interpretations of interactions for analysis of variance by platform based on meiofaunal data.....	6-84
6.39	Tukey's multiple comparison test results by distance at MAI-686 based on meiofaunal data.....	6-86
6.40	Tukey's multiple comparison test results by distance at MU-A85 based on meiofaunal data.....	6-87
6.41	Tukey's multiple comparison test results by distance at HI-A389 based on meiofaunal data	6-88
6.42	Tukey's multiple comparison test results by cruise at MAI-686 based on meiofaunal data.....	6-89
6.43	Tukey's multiple comparison test results by cruise at MU-A85 based on meiofaunal data.....	6-90
6.44	Tukey's multiple comparison test results by cruise at HI-A389 based on meiofaunal data	6-91

6.45	Multiple analysis of variance for nematode feeding groups for the overall study design.....	6-102
6.46	Multiple analysis of variance for nematode density by feeding group by platform.....	6-103
6.47	Multiple analysis of variance for nematode biomass by feeding group by platform	6-104
6.48	Analysis of covariance on fish stomach contents.....	6-107
6.49	Life history stage densities for all harpacticoids.....	6-112
6.50	Life history stages for all harpacticoids by platform	6-112
6.51	Population composition for all harpacticoids	6-114
6.52	Population composition for all harpacticoids by platform.....	6-123
6.53	Summary of harpacticoid haplotype diversity	6-131
6.54	Correlation between meiofaunal variables and environmental factors for all sites	6-135
6.55	Correlation between meiofaunal variables and environmental factors by site.....	6-135
6.56	Correlation between nematode feeding group variables and environmental factors for all sites.....	6-137
6.57	Correlation of between nematode feeding group variables and environmental factors by site	6-138
6.58	Correlation of reproduction variables with axes of the principal component analysis (PCA).....	6-138
6.59	Correlation of life history stage densities for all harpacticoids encountered with axes from the chemistry principal component analysis (PCA).....	6-139
6.60	Correlation of body lengths with axes of principal component analysis.....	6-140
6.61	Summary of the significance of interactions for the overall sample design based on macroinfaunal data	6-146
6.62	Summary of tests of the main effects for overall sample design	6-146

6.63	Tukey's multiple comparison test results by distance for the overall study design based on macroinfaunal variables	6-147
6.64	Tukey's multiple comparison test results by platform for the overall study design based on macroinfaunal variables	6-149
6.65	Summary of the significance of interaction tests by platform based on macroinfaunal data.....	6-150
6.66	Summary of the significance of main effects tests by platform based on macroinfaunal data.....	6-150
6.67	Tukey's multiple comparison test results by distance at MAI-686 based on macroinfaunal data	6-151
6.68	Tukey's multiple comparison test results by distance at MU-A85 based on macroinfaunal data	6-152
6.69	Tukey's multiple comparison test results by distance at HI-A389 based on macroinfaunal data.....	6-153
6.70	Correlation between macroinfauna variables and environmental factors for all sites.....	6-168
6.71	Correlation between macroinfauna variables and environmental factors by site.....	6-169
6.72	Differences in catch per unit effort (CPUE) for species collected from the Near and Far Stations at each platform.....	6-172
6.73	Species collected at each platform that had a significant relationship between individual size and the time of collection.....	6-174
6.74	Results of multiple analysis of covariance determining whether individuals are significantly larger at the Near or Far site at each platform	6-175
6.75	Results of MANCOVA analysis determining whether a relationship exists between individual size and the cruise on which the individual was collected.....	6-177
6.76	Results of histopathological analysis of tissues to determine whether a significant relationship exists between the intensity of parasitism and the distance from the platform.....	6-179
6.77	Results of MANCOVA analysis to determine which species have a significant relationship between sex and distance from the platform	6-182

6.78	Results of stage of reproductive development determined through visual inspection.....	6-184
6.79	Results of stage of reproductive development determined through histological analysis.....	6-185
6.80	Comparisons of results of reproductive effort studies comparing visual inspection, histological analysis and immunological probe.....	6-189
6.81	Results of histopathological analysis of tissues to determine whether a relationship exists between prevalence of parasitism and stage of reproductive development.....	6-190
6.82	Summary of literature values for biliary metabolite concentrations versus sediment PAH concentration.....	6-201
6.83	EROD activity and BaP metabolite concentrations in <i>L. Rhomboides</i> dosed with benzo[a]pyrene.....	6-208
6.84	EROD activity and BaP metabolite levels in <i>Fundulus</i> sp. dosed with BaP.....	6-209
6.85	Summary of the significance of interactions for the overall design and by site based on pore water toxicity tests of percent successful development of sea urchin embryos.....	6-210
6.86	Summary of porewater toxicity testing results.....	6-210
7.1	EROD induction in relationship to environmental contamination.....	7-8
7.2	Summary of suspected constitutive levels of EROD enzyme activities in various species of fish.....	7-10
7.3	Effects of anthropogenic pollution on benthic communities in the marine environment.....	7-15
7.4	Summary of correlation coefficients among SQT biological and toxicological and chemical components.....	7-29
7.5	Summary of heterogeneity of variance.....	7-52
7.6	Summary of recommendations for further study at platform sites.....	7-56

ACKNOWLEDGMENTS

This report is the product of the contribution of many people. The GOOMEX Phase I principal investigators and their associates provided input for their work elements: Dr. Denis Wiesenburg, Mr. Frank Kelly, and Mr. Steve Sweet-Physicochemical Studies; Dr. Richard Rezak-Sedimentology; Drs. James Brooks, Terry Wade, B.J. Presley, and Paul Boothe-Contaminants; Dr. Don Harper-Macroinfauna; Drs. Paul Montagna, Jian Li, Mr. Mark Lanzott and Mr. Greg Street-Meiofauna; Dr. Eric Powell, Mr. Matt Ellis, and Dr. Bess Wilson-Ormond-Macroinvertebrates; Dr. Rezneat Darnell and Ms. Hera Konstantinou-Demersal Fish Food Studies; Dr. John Fournie and Mr. Lee Courtney-Fish Histopathology; Drs. Stephen Safe, Sue McDonald, and Ms. Kristi Willett-Detoxification Response; Dr. Scott Carr and Mr. Duane Chapman-Pore Water Toxicity Testing; Dr. John McEachran-Fish Taxonomy; Dr. Roger Fay-Field Logistics; Dr. Gary Wolff-Data Management; and Dr. Roger Green-Study Design and Data Synthesis. I would also like to recognize the advice and counsel provided by the GOOMEX Scientific Review Board, Dr. Robert Carney, Dr. Robert Spies, Dr. Donald Boesch, and Dr. James Ray. I would also like to acknowledge those who participated in the cruises and made these complex operations work - Mr. Jim Campbell, Mr. Hugh Barnett, Mr. Jim Jobling, Mr. Paul Stine, Mr. Richard Kalke, Mr. Steve Sweet, Dr. Sue McDonald, Mr. Logan Respness, Dr. Bess Wilson-Ormond, Ms. Hera Konstantinou, Dr. Paul Montagna, Mr. Mike Fredericks, Mr. Blake Mackan, Ms. Tamara Davis, Mr. Roy Davis, Ms. Kate Foster-Springer, Mr. Matt Ellis, and Mr. Shawn Powers. The land-based support by Mr. K.J. Morgan and Mr. Billy Bohn in equipment maintenance, fabrication, and staging of cruises was invaluable. I would also like to thank the crew and Captain of the *J.W. Powell* for their support and help at sea. Secretarial, editorial, graphics and data analysis support was provided by Ms. Debbie Paul, Ms. Helen Cyr, Mr. Dave Martin, Mr. Neal Kirk, and Mr. Eric Owen, respectively.

Finally, the MMS personnel, Dr. Pasquale Roscigno (COTR), Dr. James Kendall and Dr. Tom Ahlfeld of the MMS, and Mr. Joseph McHugh (CO) of the NBS, have been very supportive throughout the program.

EXECUTIVE SUMMARY

The Gulf of Mexico Offshore Operations Monitoring Experiment (GOOMEX): Phase I was designed to assess the nature and extent of chronic sublethal effects associated with the exposure of marine organisms to contaminants at three sites of long-term offshore oil and gas exploration and development. The findings of this experiment will be used to design further studies that will ultimately provide a scientific basis for developing monitoring techniques and strategies to assess environmental changes associated with the long-term presence of offshore oil and gas platforms. A chronic impact was defined as the cumulative effects of long duration contaminant exposure on the endemic benthos. Long duration sites were defined as sites where platforms had been continuously present and actively producing for more than ten years. The most common contaminants discharged at platforms are hydrocarbons and trace metals. The underlying sediments were assumed to be the long-term repository for these contaminants. Contaminant surveys described the quantity and spatial and temporal variability of contaminants in sediments, biota, and pore waters. Biological studies measured life history, reproductive success, reproductive effort and assemblage composition for a variety of organisms from meiofauna to megafauna. The induction of detoxification enzymes in megafauna was also evaluated (Table 1).

THE STUDY DESIGN

To address the many goals of the Phase I program two related study designs were adopted. One approach was designed to analyze benthic sediment samples taken in a radial pattern around each platform. This design tested the hypothesis that the benthic environment varied with distance from a platform and whether the observed patterns covaried with the platform-generated contaminant-field. Intensive sampling within the near-field defined the spatial pattern of the contaminant field. The sampling pattern included comparison with control stations by extension of each radius beyond most detectable sedimentary contamination ($\geq 3,000$ meters). Studies included assessment of the abundance, diversity, and community structure of meiofauna and macroinfauna; meiofaunal life history,

Table 1. Summary of GOOMEX Phase I Work Elements

Work Element	Variables
<u>INDEPENDENT VARIABLES - SEDIMENTS/WATER COLUMN</u>	
• Physicochemical	- salinity, oxygen, nutrients, light transmittance
• Sedimentology	- grain size, carbon content (organic and inorganic), mineralogy, redox condition
• Contaminants	- hydrocarbons, metals
<u>INDEPENDENT VARIABLES - BIOTA</u>	
• Contaminants	- hydrocarbons and metals in fish livers, fish stomach contents, and invertebrate soft tissues
• Physiological	- percent moisture, lipid content
<u>INDEPENDENT VARIABLES - PORE WATERS</u>	
• Contaminants	- hydrocarbons and trace metals
<u>DEPENDENT VARIABLES^a</u>	
• Meiofauna ^b	- abundance, diversity, community structure, nematode trophic dynamics, life history and reproduction, genetic diversity
• Macrofauna ^c	- abundance, diversity, and community structure
• Megafauna Invertebrates	- catch per unit effort, size and size frequency, histopathology, reproductive effort, reproductive development, and detoxification response ^d
• Megafauna - Fish	- fish food analysis, histopathology, and detoxification response ^e

^afor the purposes of determining if there were relationships between contaminant dose and biological responses the biological measurement were considered dependent variables.

^balso pore water toxicity testing—bioassays with meiobenthic species.

^calso pore water toxicity testing—sea urchin fertilization and embryological development test,

^ddetoxification response—AHH activity, *in vitro* rat hepatoma H-4IIE cell assays.

^edetoxification response—EROD and AHH activity, biliary PAH metabolites, CYP1A mRNA levels, laboratory dosing experiments.

reproduction, and genetic diversity; contaminant distributions in sediments and pore waters; and testing of pore water toxicity by bioassay (Table 1). The sampling technique of choice for this design was the boxcorer.

A second approach provided for Near- (impacted) and Far- (unimpacted) field, pairwise comparisons of suspected indicators of exposure. These studies included assessment of community health based on megafaunal invertebrate life history and reproduction studies, histopathology of invertebrates and fish, contaminant distributions in invertebrate and fish tissues, the presence and intensity of detoxification responses in fish, and *in vitro* toxicological assessment of contaminants in invertebrates by bioassay (Table 1). The sampling technique of choice for this design was the otter trawl.

SUMMARY OF STUDY RESULTS AND CONCLUSIONS

Study sites were chosen based on a set of criteria that included active oil and/or gas development and production activities for more than ten years, a location outside of the influence of the Mississippi River plume, the availability of appropriate controls, availability of previous data, and confirmed contaminant gradients. The study sites were not chosen to be typical or representative of platforms in general and the number of study sites was not sufficient to allow for conclusions about platform attributes or discharge histories. Two of the sites (HI-A389 and MU-A85) are somewhat unusual in that platform discharges were shunted near to the seabottom due to adjacent topographic features. Therefore, extrapolation of conclusions to platforms other than those studied should be done with caution.

The program consisted of four field activities over a one and one-half year period (January 1993 to June 1994). Initially, five study sites were sampled with a reduction to the three most suitable sites for long-term study after a screening cruise (Figure 1). The final sites were selected primarily on the basis of confirming evidence of a contaminant gradient and were MAI-686, MU-A85, and HI-A389. The three sites are situated in the northwestern Gulf of Mexico in water depths from 29 to 125 m.

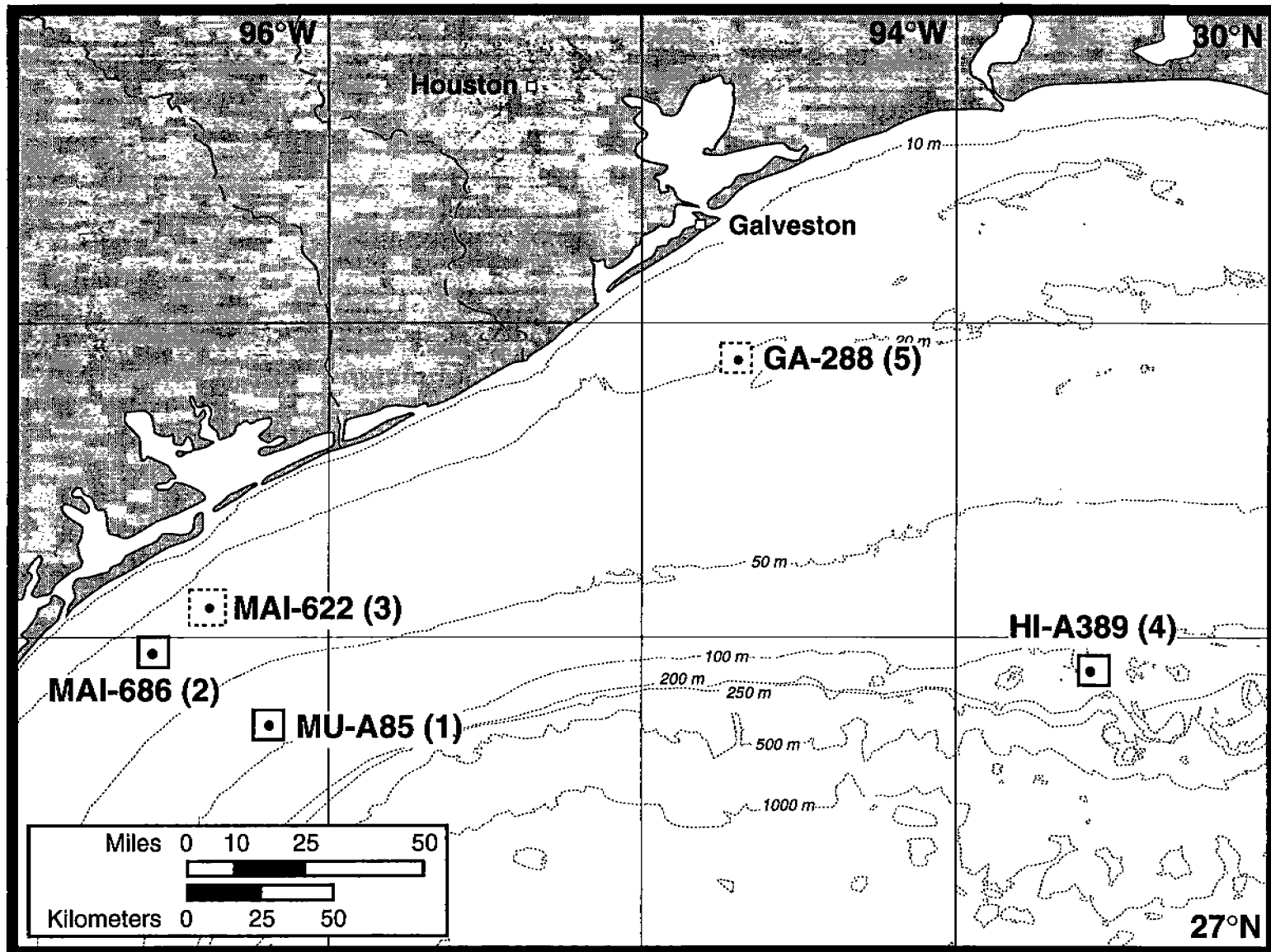

Figure 1. Location of the original five study sites sampled on Cruise 1.

PHYSICOCHEMICAL

In general, the physicochemical properties of the water column were unaffected by the presence of platforms. For example, salinity and temperature were controlled by regional phenomenon unrelated to the platform. An exception was the nutrient and oxygen content of bottom waters close to two of the platforms. Changes in bottom water oxygen and nutrient levels were observed. The development of bottom water hypoxia near a platform occurred when the water column was highly stratified.

In summary,

- **Platforms had little effect on most ambient water properties.**
- **Hypoxia in the summer was observed near the platforms at MAI-686 and MU-A85 and occurred during periods of highly-stratified water columns.**
- **Nutrient regeneration (i.e., NO₃, PO₄, SiO₃) co-occurred with the hypoxic events.**
- **Water depth and time of year exerted the greatest effect on water column physicochemical properties.**

SEDIMENTOLOGY

Sediment texture was strongly correlated with distance from the platform with sediments close to the platform highly enriched in sand. Based on visual examination and chemical analysis, most of the increase in sand content appeared to be related to disposal of cuttings during drilling activities. The increase in sand paralleled a decrease in organic carbon content. Inorganic carbon generally increased near the platform, most likely due to deposition of calcareous debris from platform associated fauna and the disposal of carbonate-containing cuttings.

In summary,

- **All three study sites studied exhibited a significant enhancement of sand close to the platform (from 25 to 60 % enhancement over a few hundred meters). The increase in sand content was often detectable well beyond 500 meters distance.**
- **The sand was primarily deposited by discharge of cuttings during drilling activities.**

- **Organic carbon was decreased near platforms, but not in proportion to the increased sand content.**
- **Inorganic carbon increased close to the platform due to platform related sources such as biogenic debris (calcareous remains) and disposal of carbonate-containing cuttings.**

CONTAMINANTS

Contaminants near platforms include hydrocarbons and metals. As a direct consequence of the disposal of drill muds and cuttings, a close association between these contaminants is a general feature at all three sites. This resulted in an unusual situation in which contaminant concentrations were highest in the coarsest sediments. Hydrocarbons were elevated at HI-A389 and MU-A85 in sediments close to the platforms and rapidly decreased over a distance of 100 to 200-m from the platform. Spatial patterns exhibited a strong directional orientation reflecting a redistribution by currents after the discharge events. Most hydrocarbons were biodegraded with the exception of several stations at MAI-686, which were rich in n-alkanes. Between cruise variations at the deeper water sites were small suggesting that the benthic hydrocarbon contaminant field was stable over a period of years. Polycyclic aromatic hydrocarbons (PAH) levels in sediments were well below levels known to be associated with toxic biological effects (< 4,000 ppb). No significant enhancement of bioaccumulation of hydrocarbons was observed in megafaunal invertebrates (soft tissues) or fish (livers and stomach contents) that resided near platforms.

Sediments at two of the three study sites (HI-A389 and MU-A85) exhibited strong gradients in certain metal concentrations (Ba, Ag, Cd, Hg, Pb, Sb, and Zn). Metals that decreased with distance from the platform were generally correlated with barium concentrations. These metals (Cu, Hg, and Sb) appear to be constituents of the original barite ore used in the drilling muds. Other metals (Cd, Pb, and Zn) had significant non-drilling discharge sources. At HI-A389, metal concentrations (Pb, Cd, and Zn) in sediments close to the platform contained concentrations of metals that are known to elicit biological effects. As with hydrocarbons, no significant

enhancement in bioaccumulation of metals in invertebrates or fish was associated with proximity to the platform.

In summary,

- **A suite of contaminants was associated with the platforms -- trace metals, hydrocarbons and sand.**
- **Contaminants were closely associated with coarse sediments at platforms.**
- **Distance and direction were the most important main effects in defining contaminant distributions.**
- **Petroleum contaminant indicators were high nearest a platform and decreased rapidly with distance away from a platform.**
- **Sediment hydrocarbon contamination was predominantly related to disposal practices during the drilling phase.**
- **Compared to marine settings impacted by spills and coastal areas that experience long-term non-point source chronic contamination, sediment hydrocarbon concentrations were low at the sites studied.**
- **Sediment PAH levels were below documented biological effects thresholds for marine biota.**
- **Sediment trace metal concentrations at several locations exceeded levels known to elicit biological effects.**
- **The extent of a discernable contaminant plume was contaminant dependent (i.e., PAH to 200-m, barium to > 500-m, sand to 200 to 500-m).**
- **No enhanced bioaccumulation of contaminants was observed in megafauna (invertebrates and demersal fish) residing close to platforms.**
- **Sediment properties such as Al content decreased near the platform due to dilution with sand.**
- **Several metals appeared to have sources other than the cutting/drill mud discharged during drilling (i.e., Pb, Zn, and Cd).**
- **An evaluation of the three-dimensional distribution of contaminants demonstrated the presence of subsurface maxima in contaminant concentrations (down to 10 to 20 cm).**

- **A comparison of samplings fourteen (14) years apart at the MAI-686 site confirmed an ongoing loss of fine particulates and contaminants at this site.**
- **At all three sites, lead (Pb) was shown to continue to accumulate in sediments near the platform over a period of years. Contaminant concentrations increased to levels known to elicit biological responses.**
- **At deeper water sites (> 80-m) the contaminant field was stable over time periods of years (an exception was the observed increase in lead).**
- **Chromium and iron concentrations suggested there was a platform related source of these metals.**
- **Comparison of tissue metal concentrations with historical background data suggested that metals in fish livers from animals near platforms were comparable to background levels.**
- **Comparison of contaminant levels in invertebrates from the continental shelf in general with those at the present study sites, suggested that body burdens of some metals (i.e., Cd, Pb) increased in response to increased concentrations of metals in sediments.**

POREWATER TOXICITY

Sea urchin embryological development assays using pore waters exhibited significant toxicity for 12 % of sediment pore waters tested during the first cruise and this toxicity was similar for the second cruise. All of the significant toxicity was observed within 100-m of a platform. Two other bioassays using a polychaete and an indigenous meiofauna species with different endpoints, confirmed the sea urchin results. Correlation of data indicates a covariation in toxicity and sediment trace metal concentrations.

In summary,

- **When observed, toxic sediments were generally within 100-m of a platform.**
- **A consistent toxic response was observed for two samplings over a one year time period.**
- **There was excellent agreement among the toxic responses for three different test species and end-points.**

- **There was a significant correlation between the concentrations of metal contaminants and the observed toxicities.**

MEIOFAUNA

Meiofaunal communities provided sensitive indicators of stress and exposure. Harpacticoids exhibited sublethal responses at the population and genetic levels of biological organization. The abundance of total nematodes was enhanced near platforms by about a factor of two at MU-A85 and HI-A389. Nematode abundance at MAI-686 was lowest near the platform. At all three platforms non-selective deposit feeders were enhanced in biomass close to the platform typically by more than a factor of five; consistent with the effects of modest organic enrichment. Harpacticoid copepod abundance was consistently depressed near platforms. The effect was most intense at the HI-A389 site, where contaminants were highest. This pattern is consistent with previous studies showing the sensitivity of harpacticoid copepods to toxic chemicals. As a consequence of the differential response in meiofaunal species, the ratio of nematodes to copepods was a good discriminator of distance from the platform.

In summary,

- **Harpacticoid diversity was a sensitive measurement of impact. Diversity decreased near platforms.**
- **Meiofauna community responses were consistent with patterns observed in cases of modest organic enrichment and contaminant discharge.**
- **Abundance of total nematodes was enhanced near platforms at MU-A85 and HI-A389. Total abundance was lowest close to MAI-686.**
- **Biomass of nonselective deposit feeding nematodes was enhanced near all three platforms.**
- **Abundance of total harpacticoids was lowest near all three platforms.**
- **The nematode:copepod ratio increased near platforms.**
- **Harpacticoids appeared to have reduced reproductive success near platforms as reflected in greater reproductive effort and less successful recruitment.**
- **Harpacticoids exhibited a toxic response on exposure to some of the porewaters from sediments collected near platforms.**

- **Harpacticoid genetic haplotype diversity decreased with increasing contamination.**

MACROINFAUNA

Macroinfaunal abundance and numbers of macroinfaunal species were generally enhanced near platforms. Polychaetes were enhanced and amphipods were depressed near platforms. Enhancement of biomass was mainly attributed to increased abundances of polychaetes. This pattern was not significant at the shallowest site, MAI-686. Amphipod abundances were depressed around the platforms with effects confined within 100-m at MAI-686 and MU-A85 and extending to at least to 500-m distance at HI-A389. The reduction in amphipod abundance is consistent with a biological response to toxic contaminant exposure.

In summary,

- **The greatest macroinfaunal abundances were found in close proximity to the platform.**
- **Diversity patterns were less uniform than abundance patterns. However, the largest numbers of species were within 100-m of the platform.**
- **Polychaetous annelids were the numerically dominant macroinfauna and therefore, macroinfaunal abundance trends were primarily due to polychaete abundances.**
- **Nemertean, bivalves, decapods, and isopods abundances were highest near platforms.**
- **Amphipoda and foraminifera had low abundances adjacent to platforms and higher abundances in the far-field.**
- **The polychaete/amphipod ratio was correlated with intensity of contamination.**

MEGAFUNA

Few effects on megafaunal invertebrate populations were noted that could be unambiguously attributed to proximity to platforms or contaminant exposure. Each platform appeared to affect megafaunal populations in different and unique ways. The prevalence of parasites and pathologies in

megafauna were significantly related to distance from the platform but no consistent Near/Far patterns were observed. While differences in megafaunal populations residing in close proximity to offshore platforms were observed, the most significant observation was that each platform exhibited unique patterns. Among the various biological variables measured for megafaunal invertebrates, size and histopathology exhibited the most significant differences. Differences in catch per unit effort (CPUE) were rare and differences in reproductive stage were minor in comparison to size and health (histopathology). The presence of a platform did not appear to exert an overriding influence on megafaunal invertebrate population dynamics. Histopathological evaluations of fish found no increase in contaminant related liver lesions near platforms.

In summary,

- **Few effects were noted in megafaunal invertebrates in relation to distance from the platform except as related to size.**
- **Differences in gonadal protein content were noted with proximity to the platforms, however, results were species and platform specific.**
- **The prevalence of parasites and pathologies had a strong effect on reproductive stage at one site (MU-A85).**
- **No contaminant related lesions were observed in demersal fish.**
- **Parasites and parasite related lesions were common in demersal fish but were unrelated to proximity to a platform.**
- **Macrophage aggregate size and percent area in fish occupied were not significantly related to distance from the platform.**

DETOXIFICATION

The detoxification work element concentrated on *in vivo* and *in vitro* indicators of organic contaminant exposure. *In vivo* assays were used to determine CYP1A induction in fish and included ethoxyresorufin O-deethylase (EROD) activity, aryl hydrocarbon hydroxylase (AHH) activity and CYP1A mRNA levels in livers. The production of PAH metabolites in fish bile was also monitored. AHH activity was low or non-detected in invertebrate tissues indicating little or no induction or no exposure. *In vitro* bioassays using rat hepatoma H4IIE cells were conducted to evaluate the toxicities

and potencies of contaminant extracted from invertebrate tissues. No significant activities were induced by invertebrate contaminant extracts. There were no statistically significant differences in catalytic enzyme activities, biliary PAH metabolite levels, and CYP1A mRNA of any species of fish for Near and Far station pairwise comparisons at the three sites. There was an excellent correlation between AHH and EROD activity for most fish species, which confirms that these two assays measure the same effect (i.e., CYP1A induction). Laboratory dosing experiments confirmed the presence of a nuclear Ah receptor in two species of fish captured at GOOMEX sites.

In summary,

- **No significant differences in hepatic AHH and EROD activities and biliary PAH metabolite concentrations of fish were observed that were related to distance from the platform.**
- **Very low to non-detectable enzyme activity was observed in invertebrate microsome samples.**
- **CYP1A-dependent enzyme activities were most likely basal or constitutive levels and levels were species dependent.**
- **AHH and EROD activities were highly correlated in most species.**
- **The nuclear Ah receptor complex necessary for transcription was identified in pinfish and lizard fish.**
- **Northern blot analysis demonstrated that CYP1A mRNA was present in all of the fish species examined.**
- **Gel electrophoresis indicated that CYP1A mRNA transcripts were similar for all of the fish species examined.**
- **The lack of CYP1A induction and differences in biliary PAH metabolite concentrations in fish enzymes are consistent with low levels of sediment PAH and lack of significant bioaccumulation of contaminants in the tissues of fauna near platforms.**

CROSS-WORK ELEMENT SYNTHESIS

One of the strengths of the GOOMEX Phase I program was the adherence to a statistically rigorous study design supported by a coordinated sample collection plan. In order to verify the soundness of the scientific interpretations, concordance across diverse elements was closely examined.

In general, multiple lines of evidence were available to support the conclusions.

In summary,

- **Covariation in environmental variables with distance from platforms could be reduced to four categories of potential importance in driving biological responses near platforms: sand enrichment, hydrocarbon contamination, metal contamination, and organic enrichment.**
- **The observed increase in the abundance of polychaetes, (especially intense among deposit feeders), an increase in nematodes relative to harpacticoids and an absolute increase in the density of non-selective deposit-feeding nematodes is consistent with species-specific effects on benthic communities.**
- **The pattern of increase in deposit-feeding polychaetes and non-selective deposit-feeding nematodes in the near-field around platforms was contrary to the trend expected to accompany an increase in sediment-size.**
- **A decrease in abundance of amphipods and harpacticoid copepods was best explained as a consequence of sediment toxicity near platforms.**
- **The relatively low levels of substantially degraded hydrocarbons suggested that hydrocarbons are not the primary source of toxicity in the benthos.**
- **The lack of an enhanced induction of the CYP1A detoxification systems in the near-field supported the conclusion that hydrocarbon exposure was low.**
- **Increased metal concentrations near one platform were at levels at which toxic effects may be expected. Bioassays using sea urchin development and harpacticoid survival showed that porewater from these stations was toxic.**
- **An evaluation of sediment contaminant levels, benthic community data, and results of porewater toxicity tests demonstrated a high degree of concordance among the three variables.**
- **Hypoxia in bottom waters near shallow platforms was tightly coupled with enhanced nutrient regeneration and interpreted to be a consequence of organic enrichment.**
- **The use of multivariate techniques to evaluate community response of either macroinfauna or meiofauna to environmental gradients has**

been shown to be an especially sensitive tool for detection of significant biological responses.

- **The overall biological impact at these study sites was low compared to impacts near platforms in the North Sea. Compared to other anthropogenic discharges of treated municipal wastewater and industrial discharges, responses at the study sites were low.**
- **Variance in response variables was higher near platforms due to small scale heterogeneity and provided an additional indication of impact.**
- **Comparisons of genetic variability may be a useful technique to identify sublethal chronic impacts that occur as a result of environmental disturbance.**
- **Analysis of benthic fauna at the family level should be undertaken with caution and may not be generally applicable due to loss of information provided at the species level of identification.**

RECOMMENDATIONS

From a close evaluation of the study design, the variables measured, the trends observed, and the information gained in GOOMEX Phase I, a number of recommendations and conclusions are provided. These observations set the stage for developing the follow-on phases of the GOOMEX Program.

In summary,

- **An integrated approach at several levels of biological organization (molecular to community) and organism size (bacteria to fish) is needed to assess the state of a system.**
- **Rigorous statistical design, objective site selection, and high quality data generation are the underpinnings of a successful program.**
- **The major discontinuity at the seawater/sediment requires that very different approaches and interpretations be applied to results based on benthic and epibenthic indicators of exposure and response. Interactions across this discontinuity are also important.**
- **A threshold response in organisms leading to rapid deterioration, may be a more appropriate model than a gradual and continuous dose-response model.**

- **Contaminants are not regularly distributed in sediments and are heterogeneous (small scale variability) in impacted areas. Steep and abrupt gradients are often observed and distance is not always an adequate surrogate for distance.**
- **"Control" type comparisons may not be optimal. Incidence, prevalence, and intensity of indicators of impact over a range of exposures may more accurately predict impact. The spatial and temporal scales of populations are not well-defined, particularly in mobile megafaunal communities.**
- **Strong covariation of multiple environmental variables may make it difficult if not impossible to identify cause and effect from field observations alone. Manipulative field and laboratory studies are needed to more directly address questions of causation.**
- **Comparison of field observations with laboratory and other controlled exposure experiments is necessary to assess the relative importance of the observed responses (i.e., the dynamic range of indicators must be established).**
- **Integrated, multidisciplinary approaches imply that appropriate multivariate statistical analyses be developed to provide optimal utilization of the data produced.**

The results from Phase I lay the groundwork for continuing studies directed at determining the mechanistic explanations for the patterns observed. A series of recommendations are made in Table 2 for the structure and content of follow-on studies. Definitive testing of the patterns associated with platforms and development of a sound scientific basis for identifying the most appropriate and sensitive variables for future monitoring and management of activities associated with offshore oil and gas exploration and development are a primary goal for Phase II. A variety of design approaches will be needed to provide for the multiple goals of Phase II including: tests of generality of trends and patterns, continued development of promising Phase I indicators, introduction and testing of new more appropriate indicators, laboratory verification of causation, measurement of process variables (i.e., fluxes measured by benthic chambers, pore water profiles, and sediment trays), and in-field sampling to verify responses under well-characterized contaminant settings (including manipulative experiments, i.e., transplants, sediment trays, etc.).

Table 2. Summary of recommendations for further study at platform sites.

Work Element	Recommendations
(1) Physicochemical	<ul style="list-style-type: none"> *Provide a synoptic view of each site to more fully delineate platform related effects on water column oxygen and nutrient conditions and thus organic enrichment.
(2) Sedimentology	<ul style="list-style-type: none"> *Provide a mass balance of the sediments based on origins (cuttings, <i>in situ</i> sand, terrigenous materials, etc.), not just particle size or bulk chemistry. *Discontinue x-ray diffraction
(3) Contaminant Chemistry	<ul style="list-style-type: none"> *Chemistry must be closely coupled with biological effects studies (no baselines or surveys). *Provide an integrated concentration/area or volume estimation of the contaminant field to various, appropriate depths (0-2 cm, 0-10 cm). *Define bioavailable contaminants more effectively - pore water chemistry must be carefully and accurately defined especially for metals with particular reference to redox conditions and speciation. *To truly understand the chemistry of contaminants, flux measurements may be needed based on porewater profiles and benthic chamber data.
(4) Meiofauna	<ul style="list-style-type: none"> *Target the most useful and sensitive indicators of impact such as harpacticoid diversity. *Measure the temporal distribution of nematodes (e.g., for one year) to more accurately predict long-term changes in population. *Pursue genetic diversity studies <i>in situ</i> and in the lab by simulating exposure scenarios on appropriate time frames.
(5) Macroinfauna	<ul style="list-style-type: none"> *Target the most useful and sensitive indicator species for enumeration. *Develop and apply reproductive effort, life history, and other studies analogous to the meio and megafaunal work efforts (targeted at specific species). *Investigate the utility of genetic diversity studies.
(6) Megafauna Invertebrates	<ul style="list-style-type: none"> *Concentrate on a few abundant species especially for histopathology *Closely couple with contaminant measurements of more appropriate tissues (i.e., eggs). *Genetic diversity *Institute transplanted animal experiments to constrain their range and thus exposure. *Extend reproduction studies to egg quality.
(7) Megafauna fish	<ul style="list-style-type: none"> *Discontinue food studies. *Discontinue histopathology.

Table 2. (Cont.)

Work Element	Recommendations
(8) Detoxification	<ul style="list-style-type: none"> *Emphasize toxic responses to trace metals (i.e., metallothioneins). *Extend in vitro assays to a more comprehensive testing of invertebrates in coordination with contaminant measurements and pore water toxicity testing. *Focus studies intensively on a few of the more appropriate species. *Pursue invertebrate bioindicators of exposure *Evaluate other potential biomarkers of contamination such as heat shock proteins. *Integrate laboratory studies with in-field exposures (transplanted animal experiments) to define the dynamic range of the indicators.
(9) Pore Water Toxicity Bioassays	<ul style="list-style-type: none"> *Additional standard bioassays for comparison including whole sediment. *Monitor contaminant concentrations during the assays and <i>in situ</i> to more effectively delineate the causative agents. *Coordinate bioassays of animals with in vitro toxicological assays. *Design dosing experiments to develop cause and toxic effects linkages in the laboratory.
(10) Study Design	<ul style="list-style-type: none"> *Test generality of observed trends. *Develop a more comprehensive sediment quality model incorporating more extensive toxicological and bioassay results. *Expand the surveys to oil platforms. *Consider discarding the radial pattern and utilize a evenly spaced grid approach. *Develop a fully integrated model of response which will ultimately provide a plan for actual monitoring programs.

1.0 INTRODUCTION

A mandate to conduct studies to predict, assess, and manage the effect of Outer Continental Shelf (OCS) oil and gas development activities on the marine environment is provided to the MMS under the OCS Lands Act Amendments. In response to this mandate, the MMS Environmental Studies Program has sponsored a series of ecosystem investigations and monitoring studies of drilling discharges and production activities in the Gulf of Mexico, Pacific, and Atlantic OCS Regions. At the present time, the most significant unanswered questions related to the environmental impacts of offshore oil and gas development and production are those involving chronic, low-level stresses on ecosystems. These stresses result from discharges, spills, and leaks associated with the long-term development of energy resources (Boesch et al. 1987; Aurand 1988; Ahlfeld 1990; Kendall 1990). The Gulf of Mexico Offshore Operations Monitoring Experiment (GOOMEX) is a three-phase study to test and evaluate a range of biological, biochemical, and chemical methodologies that may indicate chronic sublethal exposure to contaminants associated with OCS oil and gas development and production. Program results will be used to formulate and recommend an approach to assess the importance of environmental changes associated with the long-term development of energy resources on the US OCS based on sound scientific evidence.

The primary objective of Phase I of GOOMEX was to document responses in resident fauna that were the result of exposure to contaminants at long-term OCS production sites. GOOMEX Phase I combined "state-of-the-art" determinations of chemical contaminant distributions with advanced studies of organismal response to contaminants. Study components included the analysis of contaminants (trace metals and hydrocarbons) in sediments, pore waters, and biological tissues; assemblage analysis of benthic meiofauna, macroinfauna, and megafauna; meiofauna and megafauna invertebrate life history and reproduction studies; and the presence and intensity of inducible detoxification responses in megafaunal biota (Figure 1.1; Table 1.1). All study components were linked by a common, statistically rigorous study design.

A "chronic" impact was defined as the cumulative effects on ecosystems caused by long duration exposure to chemicals in the

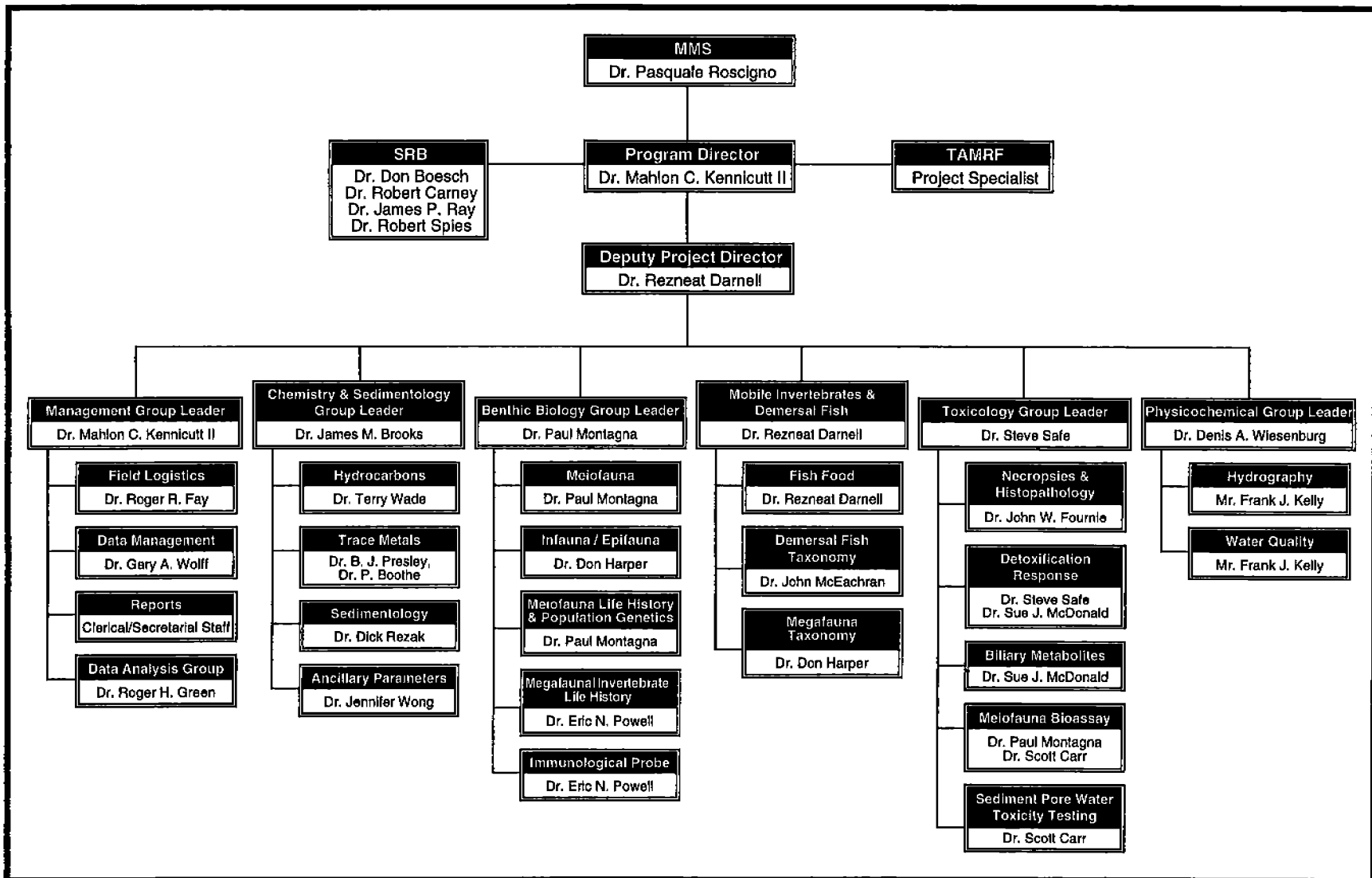

Figure 1.1. Program organizational chart.

Table 1.1 Summary of GOOMEX Phase I Work Elements

Work Element	Variables
<u>INDEPENDENT VARIABLES - SEDIMENTS/WATER COLUMN</u>	
• Physicochemical	- salinity, oxygen, nutrients, light transmittance
• Sedimentology	- grain size, carbon content (organic and inorganic), mineralogy, redox condition
• Contaminants	- hydrocarbons, metals
<u>INDEPENDENT VARIABLES - BIOTA</u>	
• Contaminants	- hydrocarbons and metals in fish livers, fish stomach contents, and invertebrate soft tissues
• Physiological	- percent moisture, lipid content
<u>INDEPENDENT VARIABLES - PORE WATERS</u>	
• Contaminants	- hydrocarbons and trace metals
<u>DEPENDENT VARIABLES^a</u>	
• Meiofauna ^b	- abundance, diversity, community structure, nematode trophic dynamics, life history and reproduction, genetic diversity
• Macroinfauna ^c	- abundance, diversity, and community structure
• Megafauna Invertebrates	- catch per unit effort, size and size frequency, histopathology, reproductive effort, reproductive development, and detoxification response ^d
• Megafauna - Fish	- fish food analysis, histopathology, and detoxification response ^e

^afor the purposes of determining if there were relationships between contaminant dose and biological responses the biological measurement were considered dependent variables.

^balso pore water toxicity testing—bioassays with meiobenthic species.

^calso pore water toxicity testing—sea urchin fertilization and embryological development test,

^ddetoxification response—AHH activity, *in vitro* rat hepatoma H-4IIE cell assays.

^edetoxification response—EROD and AHH activity, biliary PAH metabolites, CYP1A mRNA levels, laboratory dosing experiments.

environment. Long duration was defined as sites where platforms were present and actively producing for more than ten (10) years. Contaminants released from a point-source over a period of years might reach a "steady state" spatial pattern in the adjacent sediments, thereby setting the stage for chronic effects. However, other processes including cessation of discharges, chemical transformation, sedimentation, biological oxidation, and erosion tend to disperse or dilute contaminants with time.

Detection of impacts or biological effects responding to contaminant exposure requires confirmation that the exposure has taken place and that the observed "biological patterns" are beyond those attributable to natural variations (Carney 1987). It is also imperative that dose is measured directly and not inferred from response or estimated from a surrogate (distance). Biological response to exposure can be highly variable in both mechanism and intensity. Biological changes can have a short time-span (i.e., induced detoxification or reduced reproductive effort in an individual) or a long time-span (i.e., compositional shifts in communities). The impact of a particular contaminant event can be expected to manifest itself differently from species to species and from population to population due to differences in the history of exposure and organismal response to exposure.

GOOMEX Phase I was designed to provide an integrated assessment of biological effects covering a range of important marine species including meiofauna, macroinfauna and megafaunal invertebrates and fish. Biological indicators of impact or effect covered a range of potential markers from the molecular to the population and ecosystem level of biological organization (Table 1.1). Assemblage data were collected for meiofauna and macroinfauna. Reproduction and life history studies concentrated on meiofaunal and megafaunal invertebrates including an emphasis on harpacticoid life histories. Megafaunal invertebrate reproductive effort and development studies provided indicators of community health and energy flow. Demersal fish were examined for chronic impacts at several levels of detail including necropsies (gross pathology), histopathology of representative tissues, stomach-content analysis, liver and stomach-content contaminant analysis, and fish biliary hydrocarbon metabolites. Biological analyses were closely coordinated with measurements of contaminant levels in appropriate tissues.

Detoxification responses were monitored by measuring biological indicators that demonstrate that toxicants have entered an organism, have partitioned into their tissues, and are eliciting a chemical response. Indicators of contaminant exposure were mechanistic-based and included assays for the inducible detoxification systems ethoxyresorufin O-deethylase (EROD), aryl hydrocarbon hydroxylase (AHH), and CYP1A mRNA levels in hepatic tissues of demersal fish. The detoxification studies were closely coordinated with measurement of contaminants in the appropriate tissues.

Several new techniques, or techniques not previously applied to a marine setting, were also evaluated including:

- (1) an immunological probe to measure the rate of synthesis of gonadal protein in selected megafaunal invertebrates (reproductive effort);
- (2) genetic variations in meiofauna populations as indicators of stress;
- (3) development of bioassays utilizing indigenous meiofaunal organisms to provide direct evidence of impact or potential for injury; and
- (4) *in vitro* assays of contaminants extracted from a variety of matrices (including invertebrate tissues) with sensitized cell lines to indicate toxicities and potencies.

The GOOMEX program was designed to provide an adequate number of measurements to statistically test a series of fundamental hypotheses. Rigorous statistical design prior to sampling and maintenance of the continuity of the study design throughout the program guaranteed that statistically valid conclusions could be drawn. The GOOMEX Phase I results will be used to formulate a series of focused, process-oriented studies to be pursued during Phases II of the GOOMEX Program.

1.1 Study Site Selection

Initially, five sites were sampled during Cruise 1 (Figure 1.2). After evaluation of Cruise 1 results, three sites were selected for final study. The criteria for site selection included:

- (1) The site must be located in an area with a long history of oil and/or gas development and production must have been active for no less than ten years.

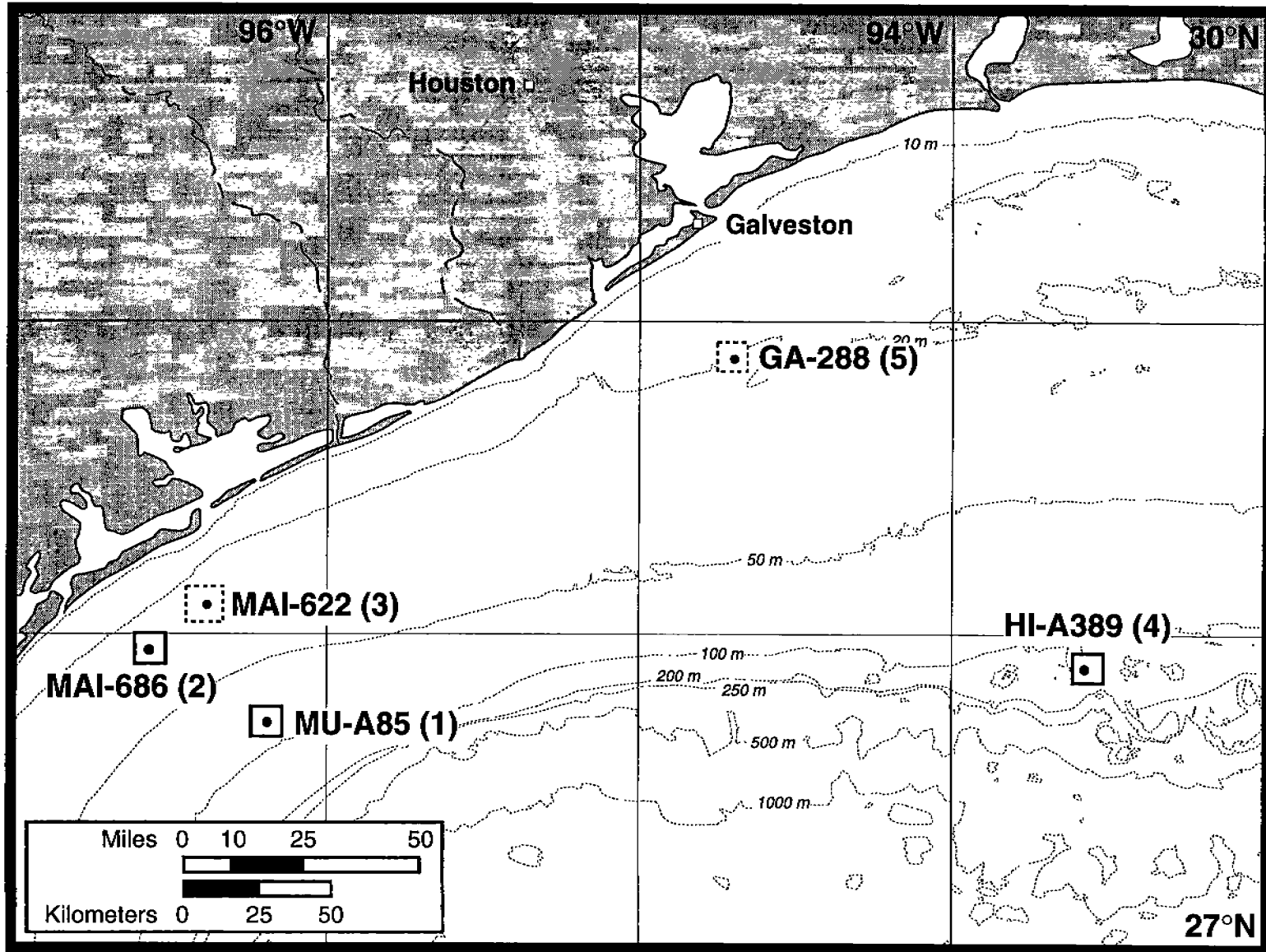

Figure 1.2. Location of the original five study sites sampled on Cruise 1.

- (2) The site must be located in the western and/or central Gulf of Mexico far enough to the west to be outside the perpetual, confounding influence of the Mississippi River plume.
- (3) Comparison stations (controls) must be available that are located away from suspected present or past influences of any platform or pipeline and be similar to the near platform stations in depth, sediment characteristics, physicochemical parameters, ambient current regime, and benthic fauna.

Mississippi River discharge causes fluctuations in physical and sedimentological that lead to significant variability over time and space in the benthic setting. It was deemed important to choose sites outside of the confounding influence of the Mississippi River Plume to enhance one's ability to recognize a perturbation. In this particular study, "river" influence was primarily judged based on homogeneity of benthic substrate. However, it is recognized that the Mississippi River has substantial influence on water masses throughout the Gulf of Mexico. Based on these criteria and the regional occurrence of major petroleum producing reservoirs, site selection was restricted to the western Gulf of Mexico which is primarily a gas/condensate producing region. As such, "oil" platform sites per se were not included in the study. Long-term production activity and water depth were also constraining factors in site selection. Other secondary considerations in site selection included the availability of data from the sites and the confirmed presence of a detectable, chemical contaminant gradient.

The five sites chosen were Mustang Island Block-A85, Matagorda Island Block-686, Matagorda Island Block-622, High Island Block-A389, and Galveston Area Block-288 (Buccaneer Gas and Oil Field; Figure 1.2). Due to the short time between GOOMEX Cruises 1 and 2, only preliminary results were available to select the final three study sites. A primary consideration was the documentation of a gradient in chemical contaminants in sediments surrounding the platform sites. The presence of a detectable spatial contaminant gradient was seen as the most important factor in selecting the final three study sites. The underlying assumption was that the stronger (steeper) the gradient, the greater the likelihood of observing statistically significant biological effects between near- and far-field samples.

A comparison of indicators of hydrocarbon contamination clearly demonstrated the highest contaminant concentrations were at MU-A85 and HI-A389 (Figure 1.3). MAI-686 and MAI-622 were similar and MAI-686 exhibited elevated alkanes due to the leakage of condensate near the platform. GA-288 exhibited little or no gradient in hydrocarbons. Metal distributions, especially barium, exhibited contaminant gradients similar to those observed for hydrocarbons (petroleum; Figure 1.4). Barite (barium sulfate) is a major component of drilling fluids and has been used as a tracer of the settleable fraction of drilling discharges. One criteria for final site selection was the magnitude and areal extent of the barium plume at the platforms and the correlations observed between barium and other metals. The steepest gradients in barium were at MU-A85 and HI-A389. Metal contaminants at both sites were significantly elevated. It should be noted that both of these sites are somewhat atypical for the Gulf of Mexico in that drill muds and cuttings were shunted near to the seafloor due to the proximity of shallow fishing banks and/or coral reefs. GA-288 showed little trend in barium concentrations with the most distant stations being slightly elevated over the near-field stations. GA-288 was dropped from further consideration as a study site. MAI-686 and 622 were similar in sediment contaminant levels; however a more consistent metal contaminant field was present at MAI-686 than MAI-622 and several metals co-varied with barium as well (Table 1.2).

Most biological measurements were preliminary at the time of final site selection and could only be used in a qualitative sense. Cluster analysis of macroinfauna data from the five sites resulted in a dendrogram having two site groups. One site group consisted of the three shallower sites, GA-288, MAI-686, and MAI-622. The two deeper sites, MU-A85 and HI-A389, formed a second site group. Therefore, a range of benthic settings were provided by the choice of MAI-686, MU-A85, and HI-A389. Meiofauna results were similar.

Based primarily on the existence of chemical gradients; as confirmed by Cruise 1 results; MU-A85, MAI-686, and HI-A389 were chosen as the final study sites. The data from all five sites sampled during Cruise 1 are used to test hypotheses when appropriate. The data collected for all parameters at all sites are available through the National Oceanographic Data Center, Washington, DC (NODC).

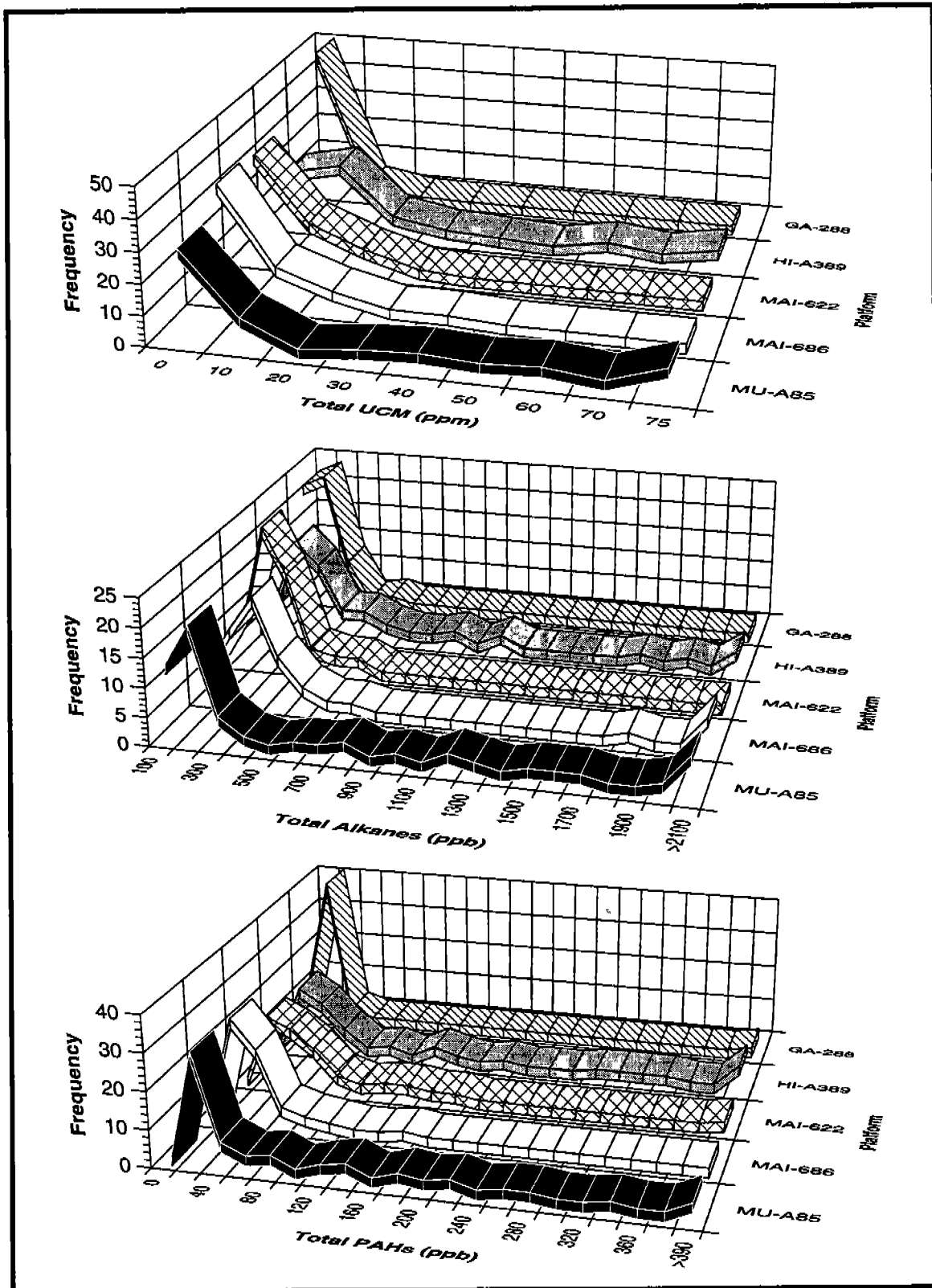

Figure 1.3. Frequency distribution of the total unresolved complex mixture (UCM, ppm), total alkane (C_{10} - C_{34} , ppb), and total polycyclic aromatic (PAH, ppb) concentrations in sediments for Cruise 1.

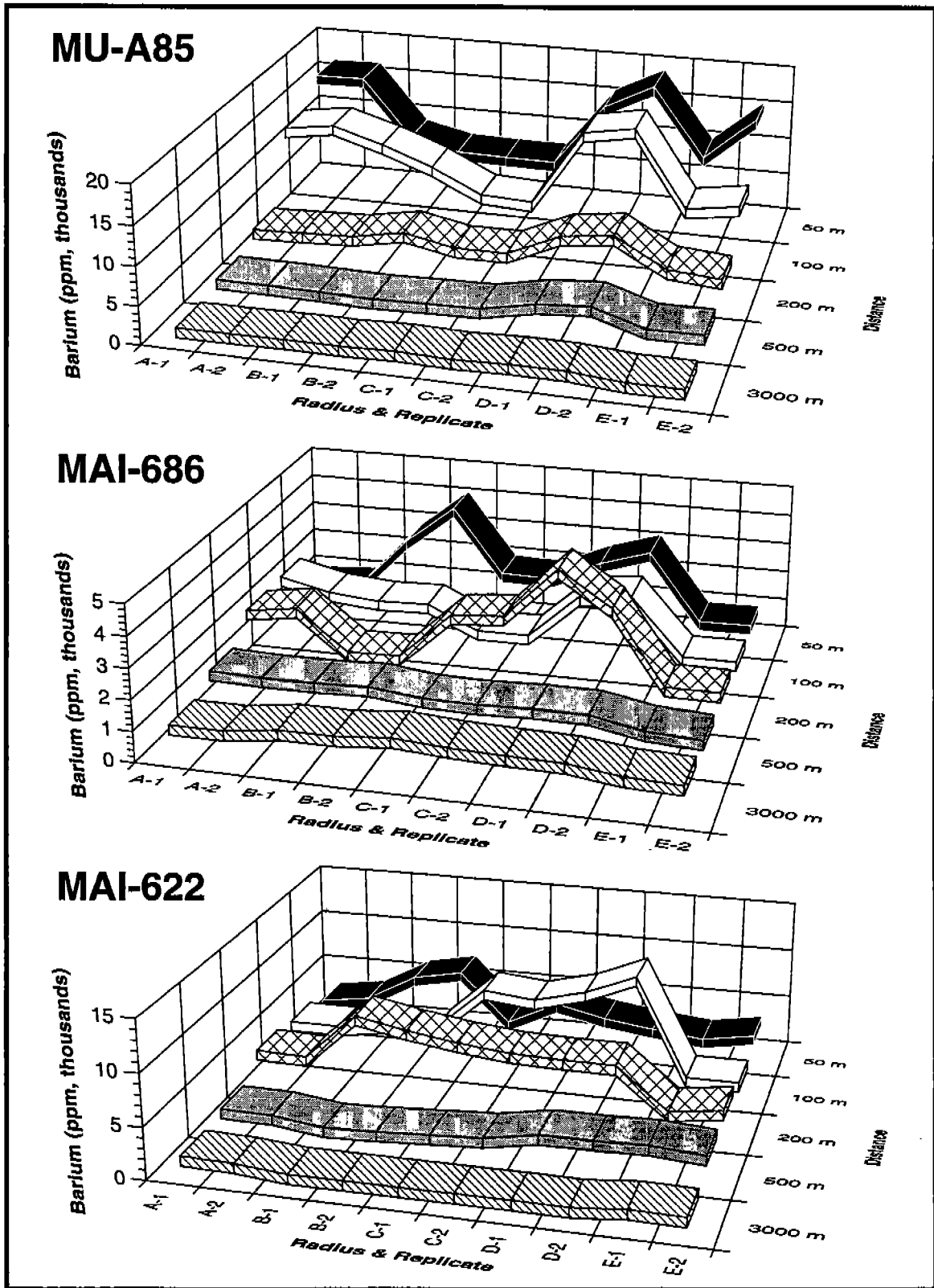

Figure 1.4. Distribution of barium concentrations (ppm) in sediments from Cruise 1 by radii and distance from the platform.

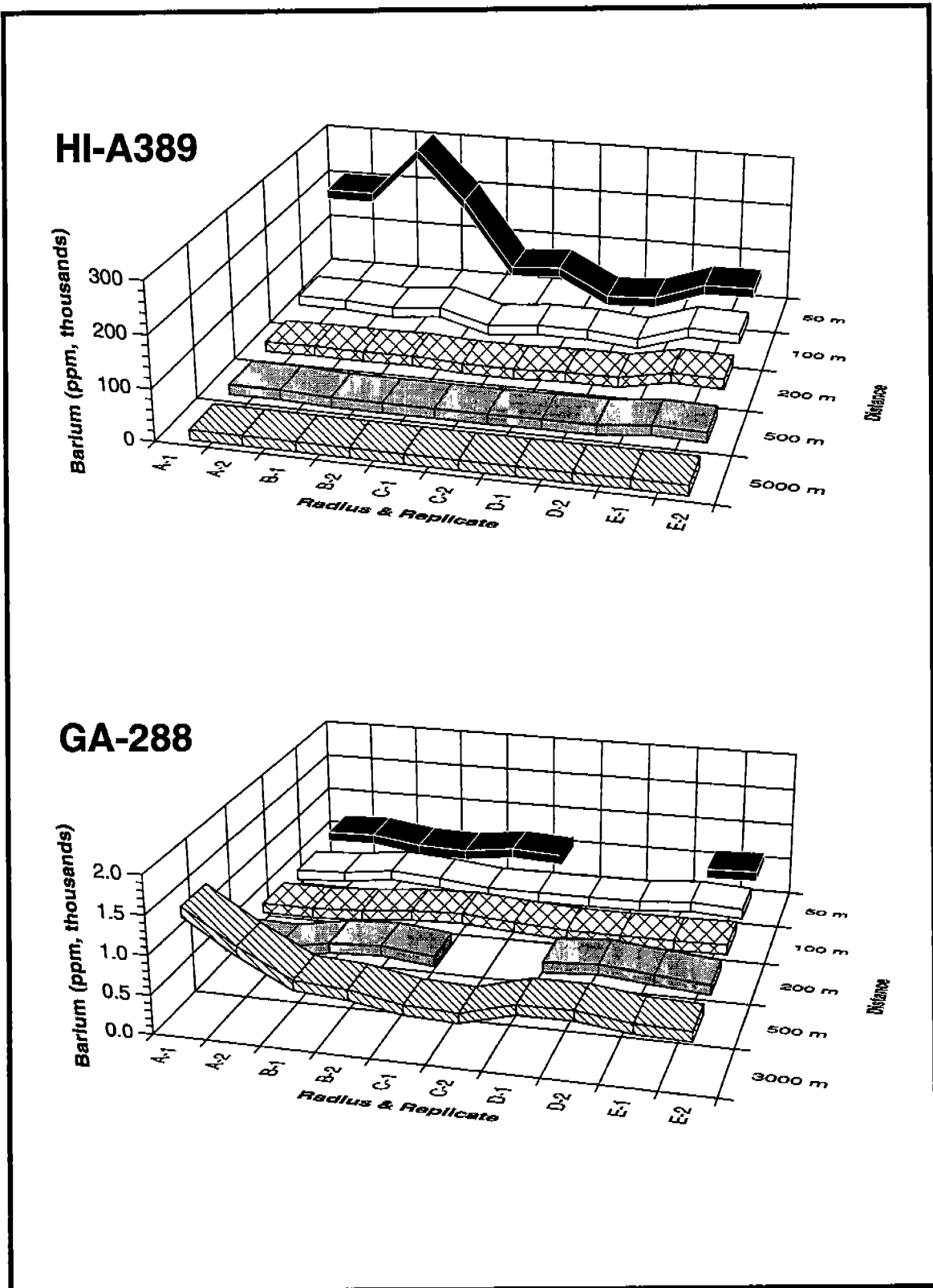

Figure 1.4 (cont.). Distribution of barium concentrations (ppm) in sediments from Cruise 1 by radii and distance from the platform.

Table 1.2. Summary of significant Spearman correlations in sediment trace element data from Cruise 1.

Site	Significant ($p < 0.01$) Negative Correlation with Distance from Site	Significant Positive Correlation with Barium
HI-A389	Ba, Ag, Cd, Cu, Hg, Pb, Sb, Zn	Ag, Cd, Cu, Hg, Pb, Sb, Zn
MU-A85	Ba, Ag, Cd, Hg, Pb, Sb, Zn	Ag, Cd, Hg, Pb, Sb, Zn
MAI-686	---	Cd, Hg, Pb, Zn
MAI-622	Ba	---
GA-288	Ag, As, Cu, Pb	---

1.2 History of Operations at the Study Sites

The final study sites for the GOOMEX Phase I field program were Matagorda Island Block 686 (MAI-686-2), Mustang Island Block A85 (MU-A85-1), and High Island A389-East Flower Garden Bank (HI-A389-4). Presented below are limited descriptions of production histories at these three sites.

1.2.1 Matagorda Island Area Block 686 (MAI-686)

The Matagorda Island Block 686 (MAI-686) platform is operated by Occidental Oil Company. Between 1977 and 1981, a total of 12 wells were drilled. This gas field produces from depths of 9,152 to 12,260 ft. A summary of the drilling history and associated discharges until 1980 is provided in Table 1.3. Monthly production of condensate, gas, and water is summarized in Figure 1.5.

1.2.2 Mustang Island Area Block A85 (MU-A85)

The Mustang Island-A85 (MU-A85) field was first drilled by Conoco, Inc., and is currently operated by Amerada-Hess. Drilling occurred as recently as 1986, and a total of 18 wells have been spudded. Discharges associated with the first six wells are summarized in Table 1.4 (Gettleson

Table 1.3. Summary of the drilling history and associated discharges at the Matagorda Island Block 686 site through 1980 (after Boothe and Presley 1985).

Characteristic	Matagorda 686
Type of drilling activity	Development
Type of wells	Gas
Number of wells	8 (4 additional wells drilled after 1980)
Total well depth (sum of all wells, m)	24,938
Total volume of cuttings discharged ^a (sum of all wells, m ³)	3130
Drill mud components used (total of all wells in kg x 10 ³) ^b	5334
Total barite used (total of all wells in kg x 10 ³ , percent of total components used)	4547 (85)
Total barium used (TBU, total of all wells in kg x 10 ³) ^c	2326
Discharge pipe location bearing in °T from rig (± water surface, m)	022 (-6)
Number of adjacent drilling sites (number of wells drilled within 3000 m radius of study rig)	1 (1)
Nearest adjacent drilling site to study site (m, °T)	1500 (095)

^aEstimated as 1.1 times total volume all wells

^bMud systems used: Seawater/gel (to 900 m), Lignite/lignosulfonate (below 900 m)

^cAssuming the barite used was 87 % BaSO₄ and that the percent composition of Ba in BaSO₄ is 58.8 %.

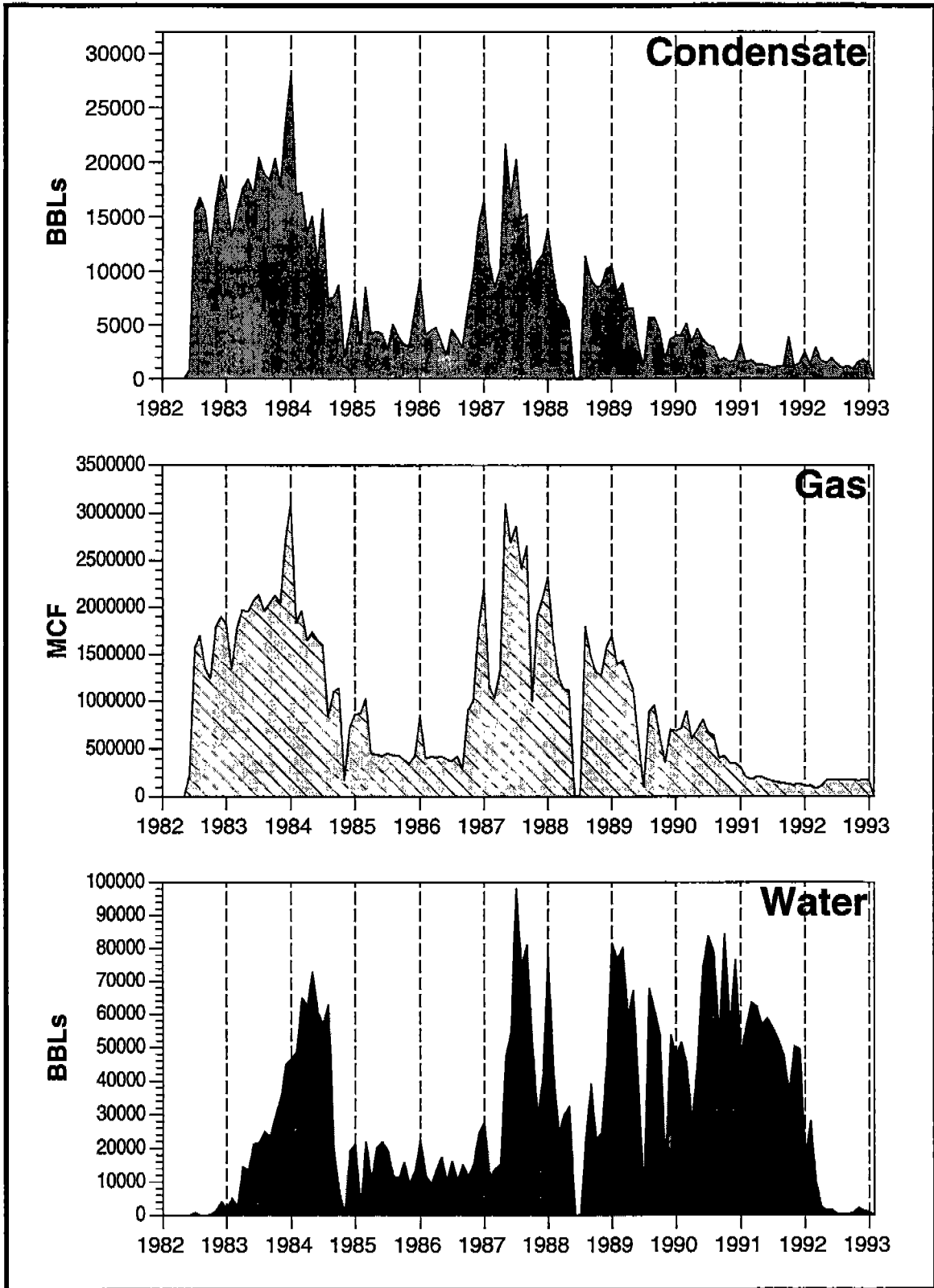

Figure 1.5. Monthly production of condensate, gas, and water at MAI-686.

and Laird 1980). Monthly production of condensate, gas, and water is summarized in Figure 1.6. Exploratory wells No. 1, No. 2, and No. 3 were drilled between 1976 and 1978. In most instances drilling muds and cuttings were discharged near the seafloor due to the proximity of the drill-site to Baker Bank, a topographic high that serves as a fishing bank on the OCS. Pre- and post-drilling sediment barium surveys documented a benthic barium plume extending 1,000 meters from the drill site.

1.2.3 High Island A389 (HI-A389)-East Flower Garden Bank

The High Island A389 (HI-A389) platform is operated by Mobil Oil Exploration and Producing U.S., Inc., and Union is a 50% partner. The platform has six wells, and current production is 22.0 MMCFD of natural gas. A comprehensive history of hydrocarbon development at the site is given by Boland et al. (1983). Preliminary exploratory drilling near the East Flower Garden Bank took place in the spring of 1975. Drilling continued in the fall of 1977 in 129 m of water. A total of 129,000 L of drilling fluid and 1,035,000 kg of drill cuttings were discharged during October and November 1977. Residues from the fluids and cuttings were detected up to 1000 m from the drill site by CSA (1985), but not on the reef monitoring stations 2000 m away. Results of the exploratory phases indicated the presence of commercial quantities of natural gas. The present platform was installed in October 1981, approximately midway between the two exploratory wells.

Additional drilling began on 26 April 1982 and continued into 1983. Drill fluid and cuttings were shunted to within 10 m of the bottom prior to release. This was required because the platform is located within the "shunting and monitoring" zone around the East Flower Garden Bank. Discharges were stopped when operations required oil-based drill fluids. Oil-based fluid drilling requires a closed system. Cuttings, muds, and discharge water were barged for disposal elsewhere. Six production wells were drilled. The last drilling occurred on 19 April 1983. Depth of the six wells ranged from 1827 to 4313 m. Monthly production of condensate, gas, and water is summarized in Figure 1.7

Table 1.4. A summary of drilling discharges from the first six wells at Mustang Island Block A-85 (from Gettleson and Laird 1980).

Well	Amount of Muds Used (lbs.)	Percent Barite by Weight of Mud Used	Weight of Cuttings Discharged ^a (lbs.)	Weight of Mud Discharged (lbs.)	Weight of Barium Discharged (lbs.)
No. 1 Block A-85	4,157,000	---	---	2,536,916 ^a	317,765 ^b
No. 2 Block A-85	1,875,000	---	---	1,144,267 ^a	143,327 ^b
Platform A No. A-3 through A-6 Block A-85	8,798,636	87	7,696,087	4,070,465	509,852 ^b

^aEstimated from mean (mud discharged/mud used) of Platform A Well No.'s A-3, 4 and 5 (A-6 judged atypical).

^bEstimated from barium content of muds discharged from Platform A Well No.'s A-5 and 6.

--- = No Data

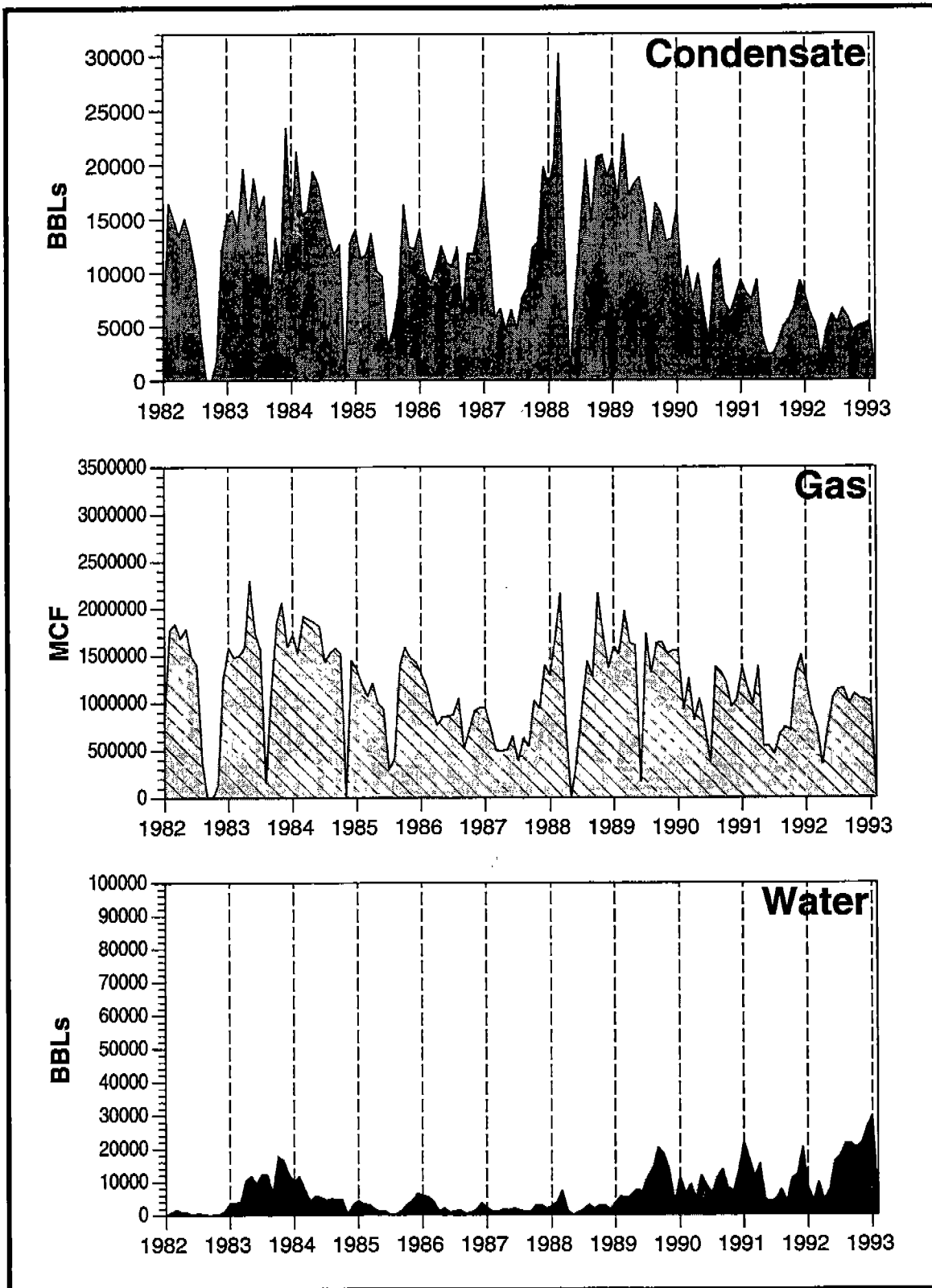

Figure 1.6. Monthly production of condensate, gas, and water at MU-A85.

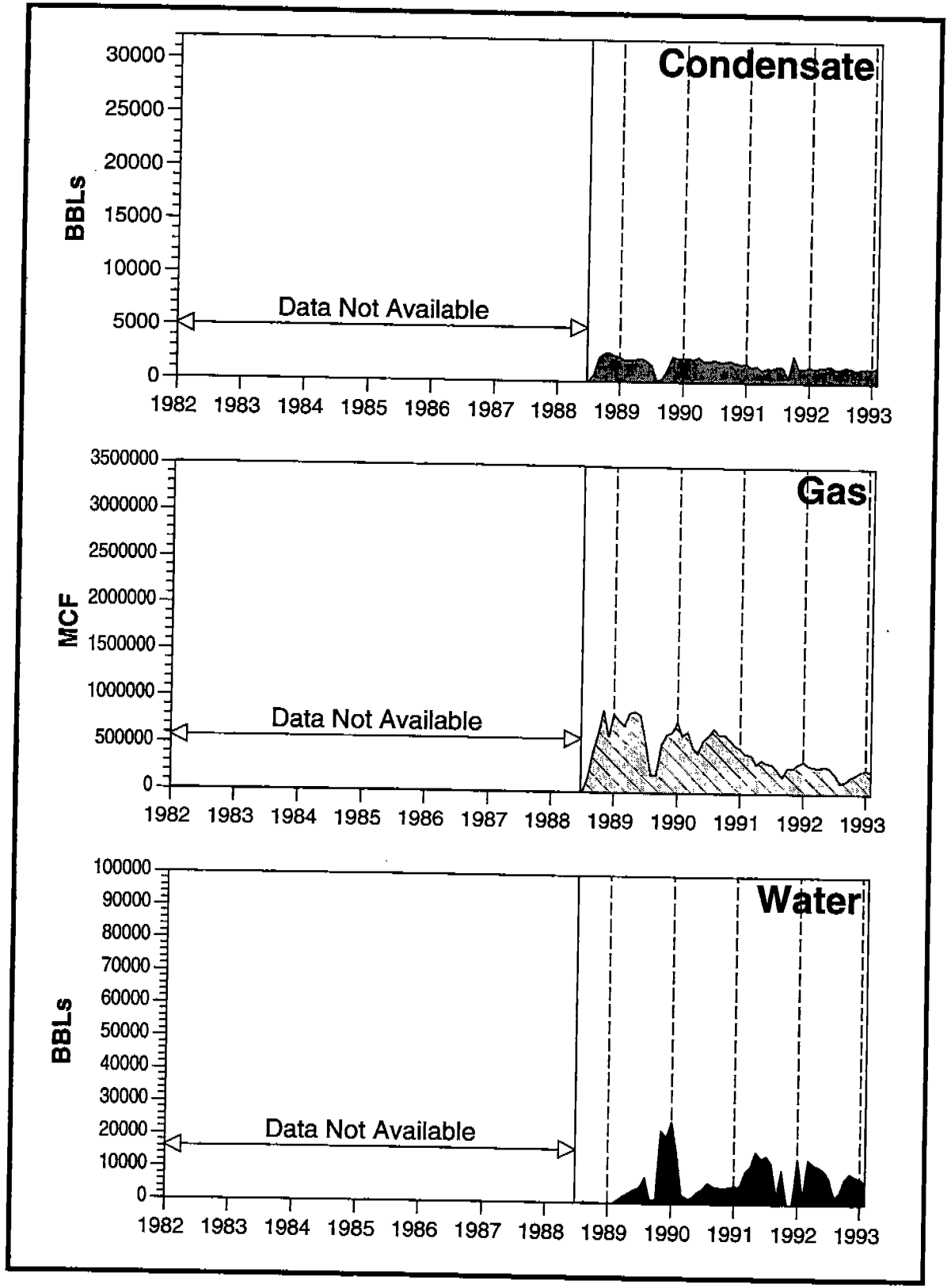

Figure 1.7. Monthly production of condensate, gas, and water at HI-A389.

2.0 STUDY DESIGN AND STATISTICAL MODEL

The primary goal of the GOOMEX Phase I program was to collect a set of data that would rigorously test the major programmatic hypotheses. The null hypotheses to be addressed by GOOMEX Phase I, as originally cast, were:

- H₀: There are no differences in any chemical and/or biological parameters measured between platform stations (at distances less than 2,000 meters from the platform, or platform group) and comparison stations (located a minimum distance of 3,000 meters from any present or historic platform, or platform group).
- H₀: There are no differences in assays for primary detoxification responses of the resident biota between platform stations (at distances less than 2,000 meters from the platform, or platform group) and comparison stations (located a minimum distance of 3,000 meters from any present or historic platform, or platform group).
- H₀: There are no differences in the reproductive indices of the resident biota between platform stations (at distances less than 2000 meters from the platform, or platform group) and comparison stations (located a minimum distance of 3,000 meters from any present or historic platform, or platform group).

The null hypotheses as stated define spatial variability in the design, but lack generality. In these hypotheses, "platform-stations" were defined as those stations that are at distances less than 2,000 m from the platform (or platform group). "Comparison-stations" were defined as stations $\geq 3,000$ m away from the platform (or platform group). As originally stated, the null hypotheses do not allow for an *a priori* test to answer the question: how far away from platforms do effects extend? Also, it is possible that platform effects occur, but do not extend out to a distance of 2,000 m, and may not be detected if the general criteria of the original null hypotheses were used. Two, more general, null hypotheses provided a more powerful test for differences among station at multiple distances from the platform site. The following are the null hypotheses that were used to guide the development of the statistical models for the analysis of the variables measured during GOOMEX Phase I:

H₀: There are no differences in any sedimentological, chemical, community, population, reproductive, toxic or detoxification variables between seasons, among platforms (or platform groups), or with distance or direction away from platforms (or platform groups).

H₀: There are no functional relationships between chemical contaminant gradients and community, population, reproductive, toxic or detoxification measures of biological response.

The approach to test the first hypothesis is univariate analysis of variance (ANOVA) for all variables being measured at all stations in the study design. However, the categorical variables in such a design, particularly distance from the platform, are surrogates for the contaminant gradients that might exist among and within platform-stations. Therefore, the approach to test the second hypothesis is a multivariate approach that includes a direct measure of contaminant exposure or dose. Some data elements required additional analyses that were unique to their particular area of science (e.g., size frequency analysis for the life history analyses).

2.1 Statistical Model Development - Univariate Analysis

The study design is based on a dose-response model. The dose-response model determines the dependent and independent variables. All independent variables are dose or dose-related while all dependent variables are response or response-related. Contaminant concentrations (i.e., dose) were expected to decline exponentially with distance away from a platform. Biological variables should react to the contaminant gradient (i.e., response), thus the magnitude of the biological response is expected to decrease with increasing distance from a platform as well. The basic form of the dose-response model is:

$$Y = e^{-kX}$$

where Y is the response, and X is the dose. This non-linear response can be reformulated, so that a linear model can be used to analyze the data:

$$\ln Y = a + bX$$

Four different views of the study design are useful for interpreting the GOOMEX Phase I results. The primary view is the data set in its entirety.

Subviews, or decomposed views, exist to explore interactions among design elements. These different views of the study design and the relationship among these categories are summarized in Table 2.1.

Table 2.1. Different analysis categories for different subsets to examine the total design and interactions within the design.

Number of Cruises (C)	Number of Platforms (P)	
	3	1
4	Total Design Analyses	By Platform Analyses
1	By Cruise Analyses	By C*P Analyses

The standard SAS notation and conventions are used to simplify the presentation (SAS Institute Inc. 1990). The notation for the independent variables is as follows:

<u>Variable</u>	<u>Variable Notation</u>
<i>Cruise</i>	<i>C</i>
<i>Platform</i>	<i>P</i>
<i>Radial</i>	<i>R</i>
<i>Distance</i>	<i>D</i>

Interaction terms are used to indicate that the variables are crossed and are designated with an asterisk (*):

*C*P = an interaction term for C and P.*

For crossed variables, every level of a variable occurs in every level of the other variable. For example, every platform was sampled on every cruise. Nested terms are used to indicate that the variables are hierarchical and are designated with parentheses.

P(R) = a nested term where R is nested within (or is unique to) P

For hierarchical variables, the nested term occurs only once in each level. For example, each radii is unique to a platform. Radius A at one platform has no relationship to Radius A at another platform. In this sense, radii (R) are a random effect, and represent a form of replication. In contrast, platforms

(P) are fixed variables. The terms random and fixed are important in determining the expected mean squares, and thus the appropriate denominators for F-tests.

Error in data of the type collected in this program can arise from several levels: (1) analytical error, (2) small-scale variation within boxcores, (3) sampling error (i.e., among boxcores), and (4) location error (large-scale spatial variation that is not related to distance or direction). It is essential that the appropriate error be used for testing hypotheses. Parametric statistical tests with more than about 10 error degrees of freedom (df) provide the needed robustness to failures of assumptions (Harris 1975).

Multiple terms in a linear model are summed, but in SAS notation there is just a blank space where a plus or addition sign is intended. In SAS, "I" is a short hand notation to indicate all possible interactions. Therefore, C|P indicates C and P and all possible interactions with C and P. In this simple example, there is only one, C*P, but in complex three- and four-way interactions, this short hand notation is useful. All text in capitol letters signifies that it is written in SAS syntax.

C, P, and R are categorical main effects. However, D could be a continuous variable (i.e., the actual distance from the platform is used in the analysis). Since the use of a logarithm transformation is already used for all data as a surrogate for a dose-response model, all variables, including D are treated as categorical. In the discussions below, Y is used to indicate any dependent variable.

2.1.1 Total Design Analyses

This is the first analysis model, with all P and all C included (Table 2.2). It is used to demonstrate that platforms are heterogeneous, and whether the model should be decomposed to perform "by P" analyses. R is nested within P. Here D and C are crossed with both P and R(P). The appropriate SAS model is:

$$Y = C P C*P R(P) C*R(P) D P*D D*R(P) D*C P*D*C D*C*R(P),$$

$$\text{or } Y = C | P | D | R(P)$$

Table 2.2. ANOVA table for total design analysis. Model: $Y = C P C^*P R(P) C^*R(P) D P^*D D^*R(P) D^*C P^*D^*C D^*C^*R(P)$, where $R(P)$, $C^*R(P)$, $D^*R(P)$ and $D^*C^*R(P)$ are declared random.

Source		df	Test Against	df if D is continuous
1	P	3-1=2	2	2
2	R(P)	(5-1)3=12	(7+8)-11	12
3	D	5-1=4	7	1
4	C	4-1=3	8	4
5	P*D	(3-1)(5-1)=8	7	2
6	P*C	(3-1)(4-1)=6	8	6
7	D*R(P)	(5-1)(5-1)3=48	11	12
8	C*R(P)	(4-1)(5-1)3=36	11	36
9	D&C	(5-1)(4-1)=12	11	3
10	P*D*C	(3-1)(5-1)(4-1)=24	11	24
11	D*C*R(P)	(5-1)(4-1)(5-1)3=144	12	36
12	Rep. error	(3)(4)(5)(5)(2-1)=300		461
Total		(3)(4)(5)(5)(2)-1=599		599

R is a random effect, and C, P and D are fixed effects. P is tested against R(P), and D and P*D against D*R(P). C and P*C are tested against D*C*R(P). R(P), D*R(P), C*R(P) and D*C*R(P) are tested against replicate error.

2.1.2 By Platform Analyses

This is the P-by-P analysis model, with more than one cruise involved (Table 2.3). It is used to test and describe distance and direction effects at each Platform, given that the total design model, which includes P in it, shows significant interactions involving P. This is a fully crossed model, because now levels of R are sampled at all C and D. When the data set is analyzed BY P, the appropriate SAS model is:

$$Y = C R C^*R D C^*D R^*D C^*R^*D,$$

$$\text{or } Y = C \mid R \mid D$$

Although R is now a crossed variable, it is still a random effect. So, C is tested against C*R, R is tested against a composite error term, and D is tested against R*D. The double interaction terms, C*R, C*D, R*D are tested

Table 2.3. ANOVA table for by platform analysis. Model: $Y = C R C^*R D C^*D R^*D C^*R^*D$, where R , C^*R , R^*D , and C^*R^*D are declared random.

	Source	df	Test Against	df if D is continuous
1	C	4-1=3	4	3
2	R	5-1=4	4+6-7	4
3	D	5-1=4	6	1
4	C*R	(4-1)(5-1)=12	7	12
5	C*D	(4-1)(5-1)=12	7	3
6	R*D	(5-1)(5-1)=16	7	4
7	C*R*D	(4-1)(5-1)(5-1)=48	8	24
8	Rep. error	(4)(5)(5)(2-1)=100		197
	Total	(4)(5)(5)(2-1)=100		249

against the triple interaction term C^*R^*D . The triple interaction term is tested against replicate error.

2.1.3 By Cruise Analyses

There are three uses for the by cruise analysis: (1) examine the power of the sampling design where replicate boxcores were taken, (2) where more than three platforms were sampled on a single cruise, and (3) where seasonal or interannual interactions are occurring (Table 2.4). It is necessary to analyze each cruise separately if there are significant seasonal or temporal interactions. For example, if the populations being measured change through time.

Table 2.4. ANOVA table for by cruise analyses. Model: $Y = P R(P) D P^*D D^*R(P)$, where $R(P)$ and $D^*R(P)$ is declared random.

	Source	df	Test Against	df if D is continuous
1	P	5-1=4	2	4
2	R(P)	(5-1)5=20	5	20
3	D	5-1=4	5	1
4	P*D	(5-1)(5-1)=16	5	4
5	D*R(P)	(5-1)(5-1)5=80	6	20
6	Rep. error	(5)(5)(5)(2-1)=125		200
	Total	(5)(5)(5)(2-1)=249		

Power and variance components analysis is a special case applicable only to the first cruise where there are two replicate boxcores for power analysis. D reduces to two levels, Near (N) and Far (F). It is not necessary to designate R. The design is fully hierarchical with D nested within P, the replicate boxcores (B) are nested within D. Among versus within boxcore variation are compared to see how many boxcores are needed to detect differences between particular P, R and D combinations at a given time, or between two times for a particular P, R and D combination. The appropriate SAS model is:

$$Y = P D(P) B(P D)$$

P is tested by D(P), D(P) is tested by B(P D), and B(P D) is tested by the error.

Multiple platform analysis would have to be done on data from a single cruise. However, the importance of this analysis model is questionable, at least in the end, because more can be done with the data by analyzing multiple cruises together. The R are unique to a particular P, so R is nested within P. The D, on the other hand, are crossed with both P and R(P). For BY C analyses, the appropriate SAS model is:

$$Y = P R(P) D P*D D*R(P),$$

or in SAS shorthand:

$$Y = P | D | R(P)$$

P is tested against R(P) which tacitly assumes R are random within a P. D and P*D are tested against D*R(P). R(P) and D*R(P) are tested against replicate error.

2.1.4 By Cruise*Platform Analyses

This is a trivial case with limited usefulness. It is only useful for specific questions about R and D patterns at a specific platform at a specific time (Table 2.5). It implies there is no generality. It is also the simplest case. It is performed BY P C, and described by the model:

$$Y = R D R*D$$

Table 2.5. ANOVA table for by cruise-platform analyses. Model: $Y = R D R^*D$, where R is declared a random effect.

Source	df	Test Against	df if D is continuous
1 R	5-1=4	3	4
2 D	5-1=4	4	1
3 R*D	(5-1)(5-1)=16	4	4
4 Rep. error	(5)(5)(2-1)=25		40
Total	(5)(5)(2)-1=49		49

This model can be used to discover directional (i.e., R) effects at specific platforms that are different during each cruise. All terms are tested against the error term.

2.1.5 Decomposition of Models for Trawl Data

All data from box cores (e.g., contaminant concentrations, grain size, meiofauna, macroinfauna, and pore water toxicity tests) were analyzed using the same statistical procedures. Data from trawls (e.g., metabolic induction or macroinvertebrate reproductive effort) are a subset of the same design.

The preceding sections developed full statistical models where there were 25 stations, i.e., 25 R*D combinations. This was true for all boxcore samples. However, trawling occurred at only 2 R*D combinations, i.e., there was only two stations. There is no need to specify R and D, since there are no replicates and this designation decomposes to just 2 stations (S), which have been designated Near and Far. The following is a modification for each model where R and D have been replaced by stations (S). In these instances, P, C, and S are always crossed variables, and fixed effects. Therefore, the effects are always tested against the mean square error term.

In the total design analyses P, C and S are crossed. The appropriate SAS model is:

$$Y = C P C^*P S C^*S P^*S C^*P^*S,$$

$$\text{or } Y = C \mid P \mid S$$

When the data set is analyzed by platform, the appropriate SAS model is:

$$Y = C S C^*S,$$

When the data set is analyzed by cruise, the appropriate SAS model is:

$$Y = P S P^*S$$

Analyses are performed by platform and cruise, and described by the model:

$$Y = S$$

2.2 Multivariate Analyses

The univariate analyses are adequate for testing the first revised null hypothesis, where distance from the platform is the most interesting main effect. A second issue is how all the variables measured, and there are almost 200, relate to one another. In addition, many of the variables measured came from a specific sample, meaning that a true multivariate sampling design was followed. Also, distance is simply used as a surrogate for the actual environmental gradient or contaminant exposure at each platform. It is expected that the platform effect will cause many of the variables to covary with distance from the platform. Also, the platform effect may not be symmetric around the platform, even though it is easiest to sample that way. A directional effect would cause significant interactions, which makes interpretation of the univariate ANOVA difficult. Concordance of biological responses with increasing measures of contamination would be strong circumstantial evidence that contaminants are causing the changes that might be observed near platforms. Experiment-wise error rates must be controlled, therefore a huge matrix of *t*-tests is not appropriate. The second null hypothesis can be tested using multivariate statistical techniques. Many exist, but Principal Components Analysis (PCA) was chosen. This allowed the large data set of 91 abiotic variables to be reduced to two factors that represent the first and second principal components (PC1 and PC2) that contain most of the variability in the data set. Then regression or correlation analysis was used where PC1 and PC2 were the independent variables representing the covarying variables that make up the contamination gradient and biotic responses were the dependent variables. Within the contaminant gradient other gradients may be present that covary with distance or direction from platforms, e.g., sediment grain size. The

data set was prepared for PCA by merging the means of all the transformed pseudoreplicates according to the boxcore from which the data was derived. This produced a data set with 300 observations (4C X 3P X 5D X 5R), one for each boxcore sample.

2.3 The Sampling Design

The notation used in this description follows the standard practice of using capital letters to denote a variable, and a lowercase letter to denote the level or number of levels within a variable. The sampling plan was designed to detect near-field impacts and contaminant gradients extending out from a platform (P). The sampling design included a radial (R) pattern to $\geq 3,000$ m distance (D) to define the platform's contamination gradient. Oversampling within the near-field was designed to define the spatial scale of the impact. There was an assumption that there was an exponential decline in contaminant concentrations away from a platform. Two sampling designs formed the basis of the GOOMEX Phase I program. Both rely on the dose/response model but differ in details of the sampling design.

The first design provided for an assessment of the benthos and included r radii ($r=5$), d distances per radii ($d=5$) and n pseudoreplicates ($n= 2$, or 3) per each $R \cdot D$ combination, which was defined as a station (S). Since replicate cores come from within boxcores, the samples replicate box cores, so box cores and stations are confounded. Therefore replicates are considered pseudoreplicates (Hurlbert 1971). The number of r and d was as high as possible, as these replicates were needed to test for directional and distance patterns. The number of r and d were chosen based on the relative benefits of high power compared to the cost associated with a large number of replicates. It was determined that five (5) was the best number of radii and distances to minimize costs and maximize samplings, given the constraints of the total cost of the project. The total number of stations per platform was 25 and the total number of measurements was 50 (for meiofauna or chemical analyses) or 75 (for macroinfaunal analyses). The overall sampling strategy provided a total sampling effort of 150 (or 225) field samples per sampling time, or 600 (or 900) provided by four sampling events or cruises (C). The design emphasized description of spatial patterns (especially distance and direction from a platform) and estimation of

patchiness on spatial scales covered by replicate samplings at sites. The sampling locations at the three study sites are summarized in Figures 2.1-2.3.

The second study design employed a Near (or impacted) versus Far (or unimpacted) pairwise comparison of indicators of contaminant exposure. Due to the need for large amounts of biomass for the various work elements, boxcorers were insufficient as a collection technique. Therefore, sample collection primarily relied on otter trawls. Samples were taken as close as possible to the platform (< 100 m) and at a comparison station (\geq 3000 m). The studies utilizing this design employed laboratory techniques that were generally time intensive, and/or relatively untested so that they were only evaluated at the presumed extremes of exposure.

2.4 Variables and Transformations Used in the Study Design

Dependent and independent variables were measured (Table 2.6 and Table 1.1). As mentioned, the underlying dose-response model determines that dose or dose-related variables are independent variables and response or response-related variables are dependent. Biological responses can be considered as related to aspects of the environment that may be causing or inducing the observed change or difference. Therefore, the biological response parameters in this study design are dependent variables. The spatial and temporal aspects of the design were considered independent environmental variables that may be causing or co-varying with the dependent biological responses.

The dose-response model coupled with an exponential decrease with distance from the point-source indicates that contaminant concentration and organism abundance variables should be transformed using the natural logarithm. Percentage data, e.g. percent sand, or toxicity test results should receive a special treatment, the "arcsin square root" transformation. Log transformation of the variables was also appropriate for another independent reason. An important assumption in the analysis of variance (ANOVA) is that sample variances are homogeneous. This means that the variance of each sample should be the same. A common feature of benthic organism

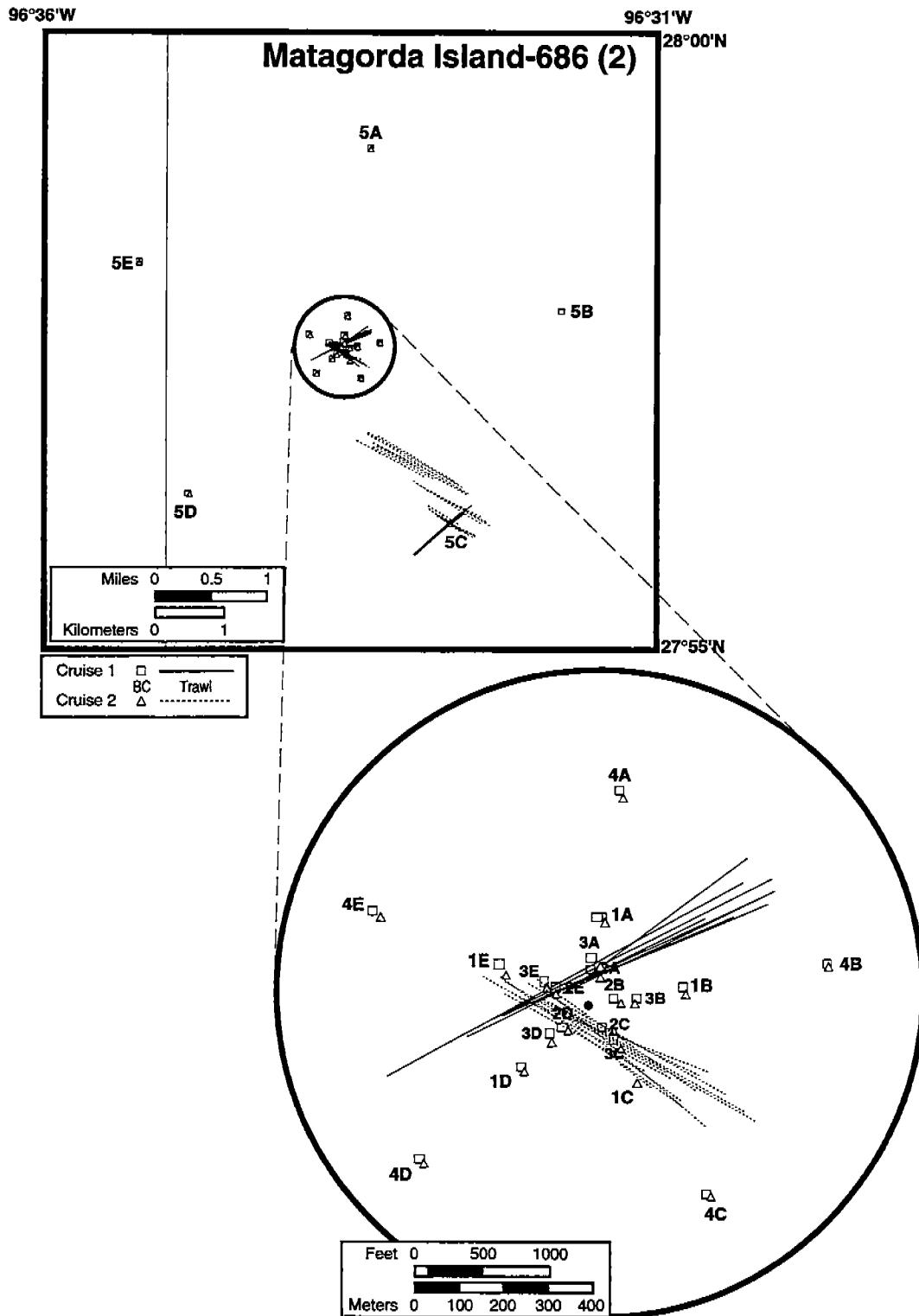

Figure 2.1. Summary of boxcorer and trawl locations at MAI-686 for Cruises 1 (January 1993) and 2 (June 1993).

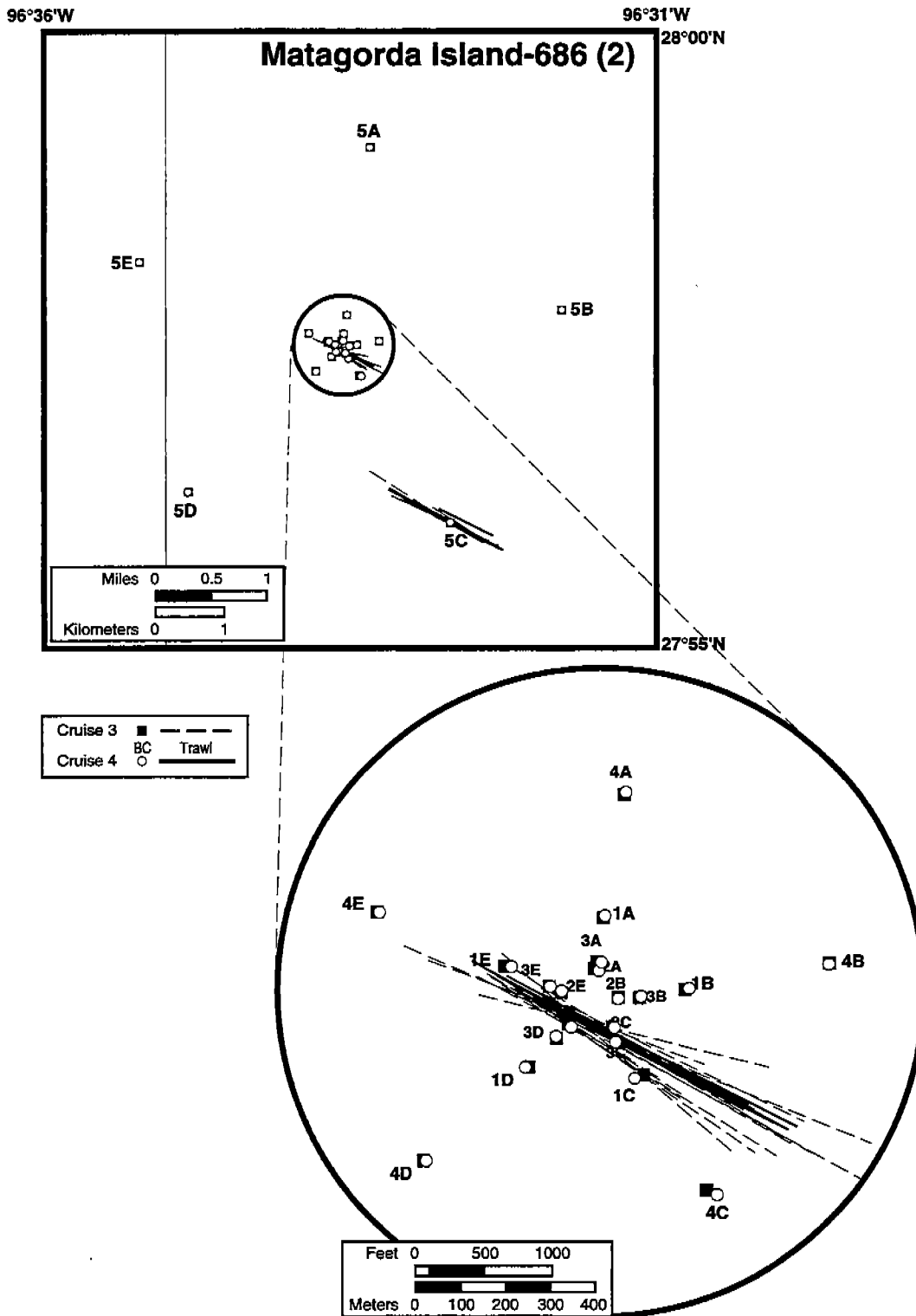

Figure 2.1 (cont.). Summary of boxcorer and trawl locations at MAI-686 for Cruises 3 (January 1994) and 4 (June 1994).

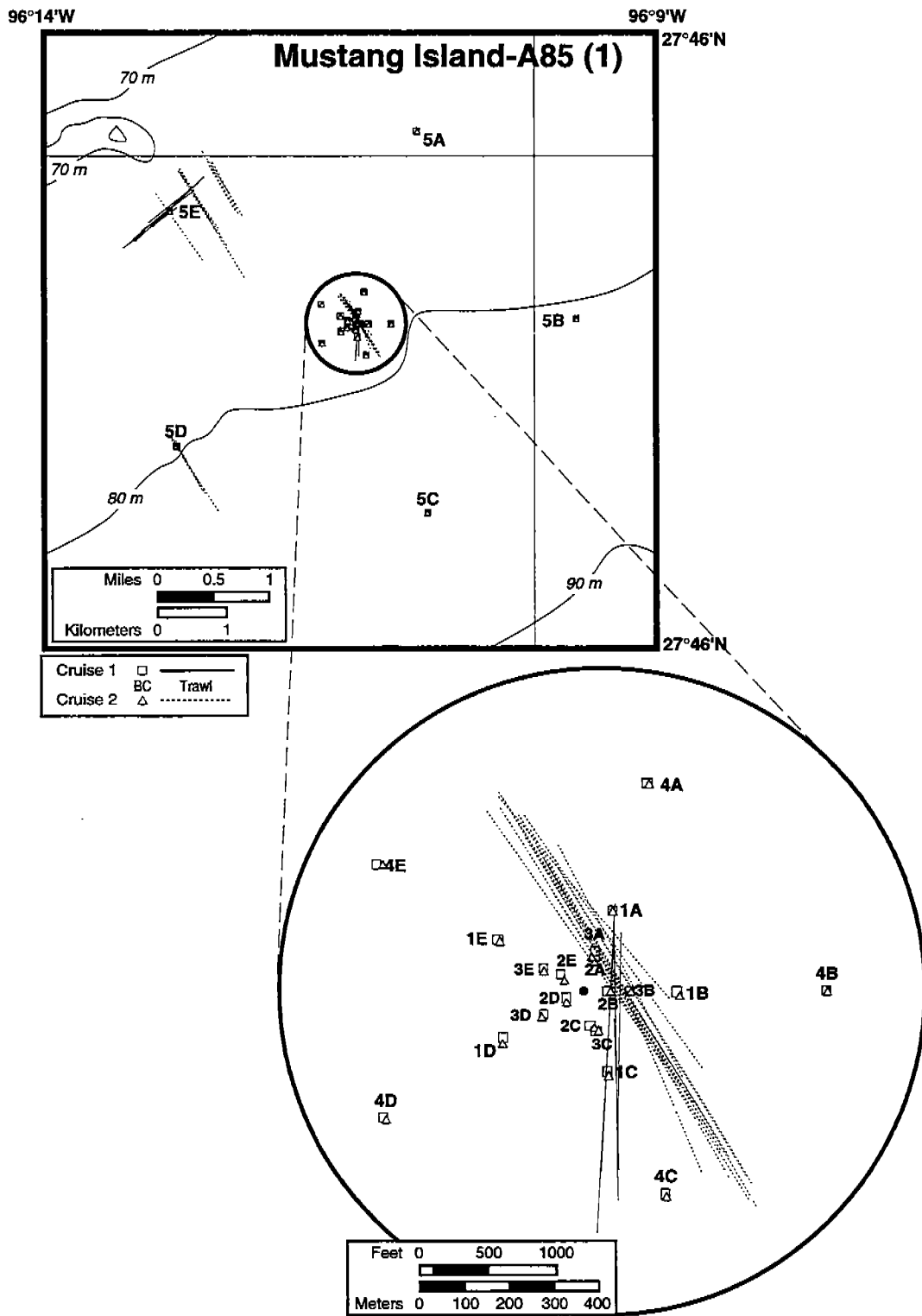

Figure 2.2. Summary of boxcorer and trawl locations at MU-A85 for Cruises 1 (January 1993) and 2 (June 1993).

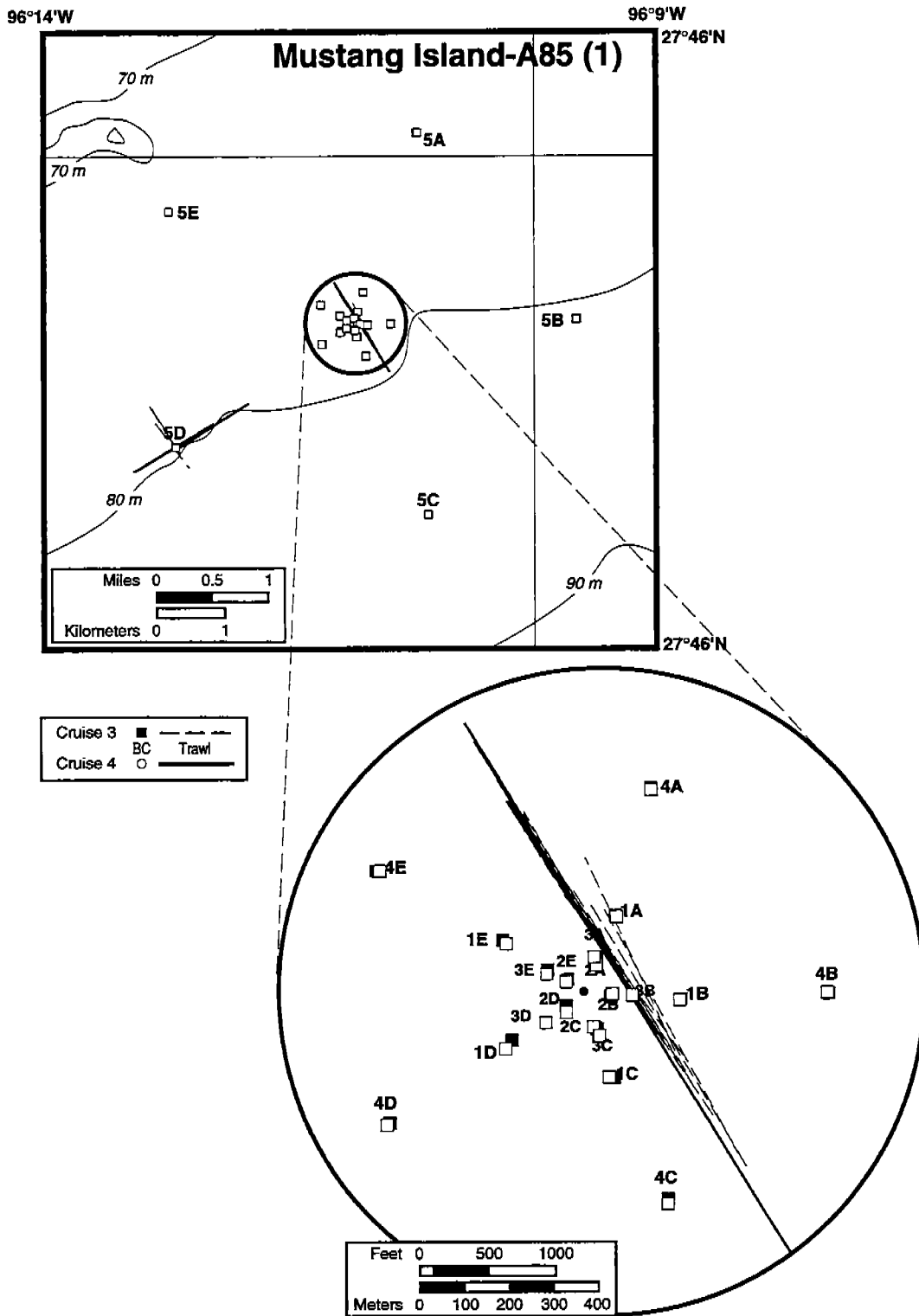

Figure 2.2 (cont.). Summary of boxcorer and trawl locations at MU-A85 for Cruises 3 (January 1994) and 4 (June 1994).

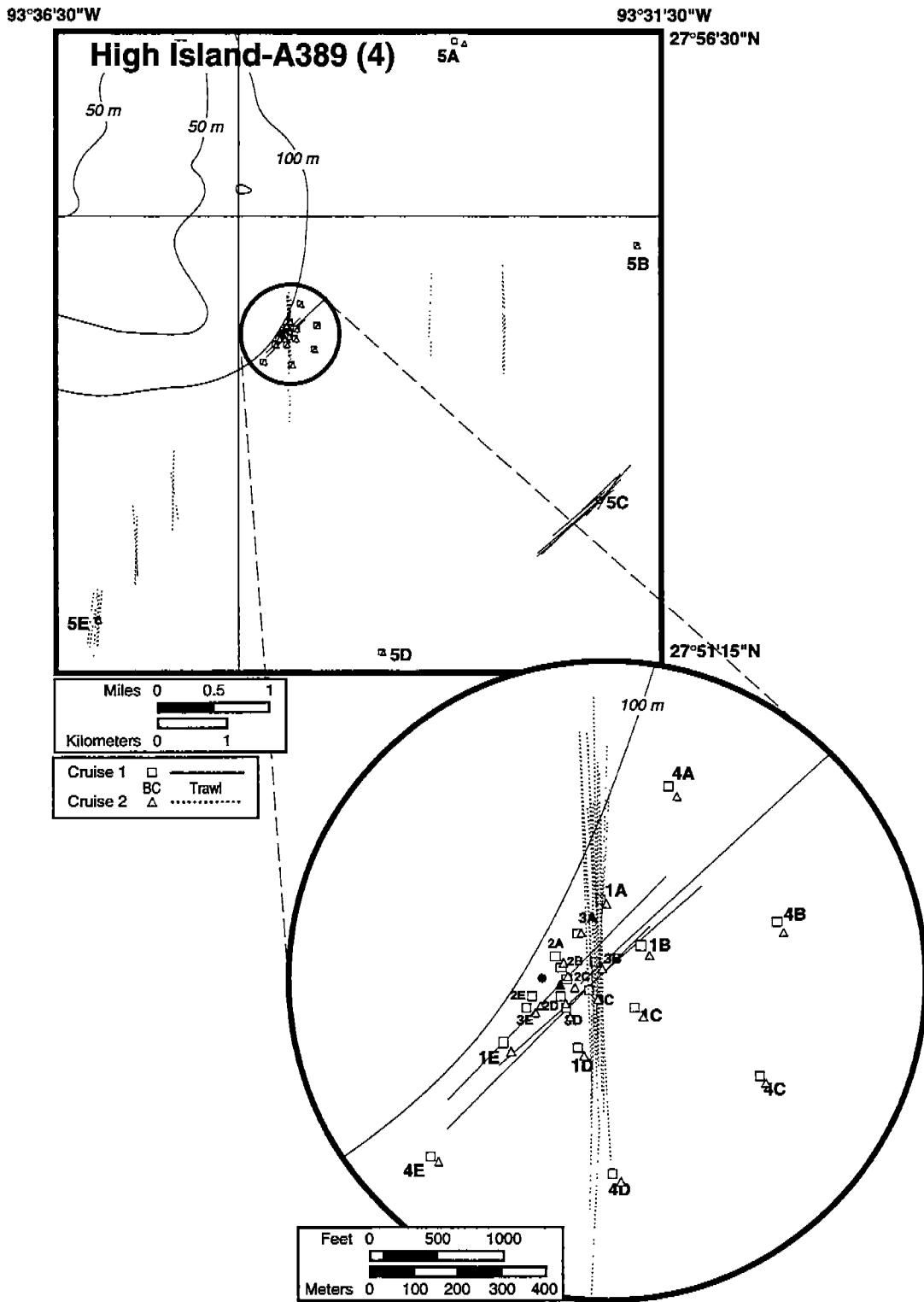

Figure 2.3. Summary of boxcorer and trawl locations at HI-A389 for Cruises 1 (January 1993) and 2 (June 1993).

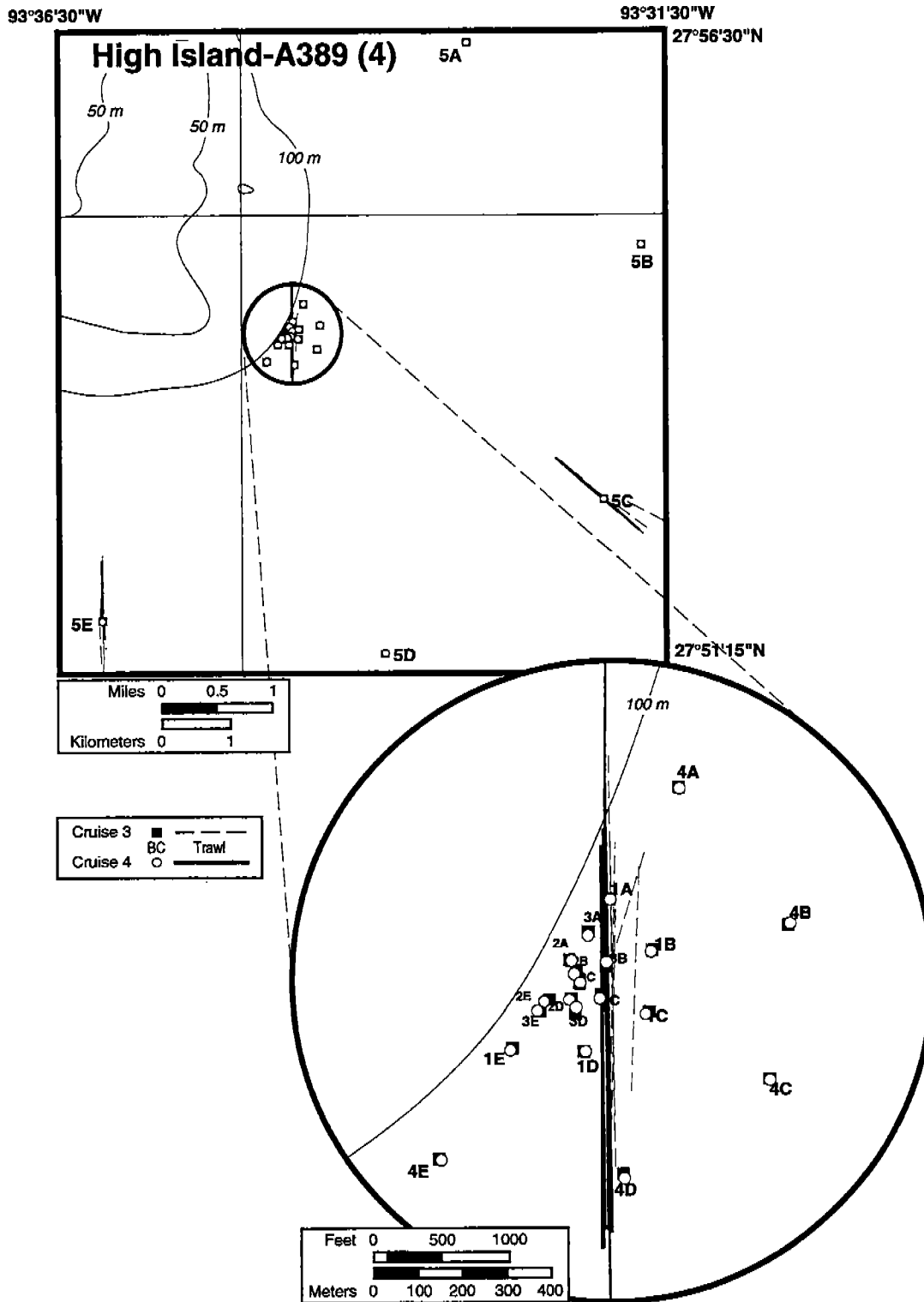

Figure 2.3 (cont.). Summary of boxcorer and trawl locations at HI-A389 for Cruises 3 (January 1994) and 4 (June 1994).

Table 2.6. Partial list of variables being measured in the GOOMEX study (for details see Table 1.1).

Dependent Variables	Independent Covariates
Tissue Trace Metal Content	Pore Water/Sediment Trace Metals
Tissue Hydrocarbon Content	Pore Water/Sediment Hydrocarbons
Pathology	Mineralogy
Bile Metabolites	Sediment Grain Size
MFO/P450 Induction	TOC/Carbonates
Pore Water Toxicity Tests	Sediment Redox
Macrofaunal Abundance/Structure	Water Dissolved Oxygen
Meiofaunal Abundance/Structure	Water Nutrients
Harpacticoid Life History Characteristics	Water Salinity
Harpacticoid Genetic Diversity	Distance From Platforms
Macrofauna Reproduction Effort	Seasonal Variability

abundance and chemical concentration data is that the mean and variance are correlated, which violates the assumption of homogeneity of variances. It is common in these cases to use a logarithmic transformation. The data from the first two cruises was tested and it was found that the variances of contaminant and organism abundance variables were stabilized by log transformation.

2.5 Power Analysis

Power of the sampling design can be calculated where there is true error replication. This is only true where multiple boxcores were taken, such as at the Near and Far stations during the first cruise. The design of this analysis is already described. The most direct approach that is compatible with the study design is to determine the detectable change in the population at a given power (1-β) and sample size (n) calculated by:

$$\Delta = \frac{(t_{\alpha} + t_{\beta}) \times SD \times \sqrt{\frac{2}{n}}}{\bar{X}}$$

where Δ is the percent change in the population, SD is the pooled standard deviation, t_{α} and t_{β} are tabled values for a two-tailed test assuming a pooled estimate of variance from a large sample size, and \bar{X} is the sample mean. Values of $\alpha = 0.05$, and powers of 0.95, 0.80, 0.50 are used in the analysis.

During the first cruise, two stations at each platform were sampled twice to test our ability to detect change with the sampling design being adopted for the program. One station was in the inner ring, and one station was at the outer ring. These stations were labeled Near and Far. A second boxcore (BOX) was taken at each station. Therefore, there were 40 samples (5 platforms X 2 distances X 2 boxcores X 2 subcores). This design is a fully hierarchical sampling design described by the following SAS notation:

$$Y = P D(P) BOX(P D).$$

Platforms are unique, stations are unique to platforms, and each box is unique to a station. As in all design, replicate (i.e., subcore) error is fully nested. Y represents any variable measured from the boxcore. In each boxcore, abiotic (e.g., sediment grain size, trace metal concentration, and hydrocarbon concentration) and biotic variables (e.g., meiofauna and macrofauna populations) were measured. Using the above statistical model, the variance components of each source of variation were calculated and converted to a percent of the variance due to that component. All variables, except for sediment grain size were transformed using the natural logarithm.

The results of these calculations are found in Table 2.7. Station differences, i.e., Near vs. Far differences, accounted for most of the variability. In most cases, except for sediment grain size, replication error (i.e., error associated with subcores taken within boxes) accounted for more error variance than between boxcore variance. All abiotic measures had similar responses, i.e., most of the variation was among stations. However, the fauna had a different response, with most of the variation at the platform level of variance. The low composition of variance due to taking multiple boxcores demonstrates that little precision is lost by taking two pseudoreplicates from one boxcore.

The change in the variables response that can be detected with the current sampling design can also be calculated. This is a power analysis. The percent detectable decrease (Δ) is calculated by:

$$\Delta = (t_{\alpha} + t_{\beta}) s \sqrt{2/n},$$

Table 2.7. Variance components analysis for boxcore data. Results based on two boxcores taken at 2 stations at all five platforms during the first cruise.

Variable	Variance Source ^a			
	Platform	Station	Boxcore	Error
Sand	0	98	1	1
Silt	5	81	13	2
Clay	0	86	12	2
<i>Sed Avg.</i>	<i>1.7</i>	<i>88.3</i>	<i>8.7</i>	<i>1.7</i>
Total ALK	0	89	4	7
UCM	0	83	2	15
Total PAH	7	75	0	18
<i>HC Avg.</i>	<i>2.3</i>	<i>82.3</i>	<i>2.0</i>	<i>13.3</i>
Al	0	96	2	2
Ag	0	86	5	9
As	0	92	4	4
Ba	0	98	2	0
Cd	25	73	1	1
Cr	29	59	3	9
Cu	3	90	4	3
Fe	44	46	5	5
Hg	22	73	1	4
Mn	0	90	2	8
Ni	0	94	4	2
Pb	3	51	9	37
Sb	23	3	2	72
Se	48	24	8	20
Sn	14	78	0	8
V	0	95	2	3
Zn	24	71	2	3
<i>TM Avg.</i>	<i>13.8</i>	<i>71.7</i>	<i>3.3</i>	<i>11.2</i>
Tot Meiofauna	61	29	2	8
Nematodes	60	31	1	8
Harpacticoids	63	12	7	18
Other Meiofauna	70	12	0	18
Macrofauna	46	19	5	30

^aPercent of variance due to each source. Calculated using a fully hierarchical model. All variables, except sediment grain size, were transformed using natural logarithm.

Where t_α is the students t value at $\alpha = 0.05$ (approximately 1.96), t_β is the t value for the power of the test (1-0.8) at $\beta = 0.2$, s is the root of the sample variance, and n is the sample size. The s value came from the variance components analysis. Power analysis was calculated for two cases, where two boxcores were taken (between box variation), or where two subcores from within a box are taken. To calculate the percent detectable increase (Δ_i) the following formula is used:

$$\Delta_i = 100[100/(100-\Delta)-1].$$

Two replicates from within one boxcore are able to detect from 18 % to 96 % change in the variables measured (Table 2.8). The sediment grain size variables have the greatest discrimination at 18 %. Most other variables are higher. As was found in the variance components analysis, little precision was lost by using two pseudoreplicates rather than two replicate boxcores. For example, an 88% decrease could be detected for PAH with two boxcores, and a 90% decrease could be detected with two subcores.

The use of pseudoreplicates does not compromise hypothesis testing because interaction terms are used as the error terms for almost all tests (Tables 2.2 to 2.5). The time level of replication is among radii and cruises. The pseudoreplicates are used to improve estimates of values within boxcores for multivariate analyses.

Table 2.8. Power analysis for boxcore data based on two replicate subcores from two boxcores taken at two stations at all five platforms during the first cruise.

Variable	% Decrease Detectable ^a	
	Between Box	Within Box
Sand	28	18
Total ALK	87	74
UCM	98	97
Total PAH	88	90
Al	38	26
Ag	81	68
As	59	40
Ba	86	30
Cd	80	58
Cr	49	42
Cu	58	35
Fe	55	36
Hg	63	58
Mn	56	49
Ni	54	32
Pb	98	95
Sb	93	93
Se	98	96
Sn	54	58
V	49	39
Zn	69	54
Total Meiofauna	90	85
Nematodes	89	86
Harpacticoids	99	96
Other Meiofauna	93	93
Macrofauna	98	96

^aThe % decrease detectable for each source of variance, i.e., between or within boxcores. Mean square error term was calculated using a fully hierarchical model. All variables, except sediment grain size was transformed using natural logarithm.

3.0 FIELD METHODS

This section provides a detailed description of how stations were located and samples were taken and processed during the field collection activities of GOOMEX Phase I.

3.1 Navigation

The Global Positioning System (GPS) was used for general navigation. Selective Availability (SA) reduces the accuracy of GPS to approximately 100 m. To increase the accuracy of GPS, the Skyfix Precision Positioning Service was used. Skyfix provided Differential GPS (DGPS) pseudo-range corrections via INMARSAT-A satellite links to increase positioning accuracy to ± 3 m. The DGPS system was coupled to a computerized navigation system that logged all sample locations as the samples were taken.

3.2 Hydrocasts and CTD Profiler

Continuous profiles of the following parameters were collected at each station: salinity, temperature, and light transmittance (Figure 3.1). Also, at each station, water was sampled from three depths: within the surface mixed layer, below the mixed layer, and near the bottom. Discrete samples were collected using PVC Niskin bottles attached to the CTD cable. Water samples were collected for nutrient, salinity, and oxygen analyses. A complete suite of duplicate samples was drawn from three stations at each site for QA/QC purposes. Salinity samples were stored in air-tight glass bottles and nutrient samples were frozen immediately in 50-mL seasoned Nalgene bottles. The discrete salinity and nutrient samples were returned to shore and analyzed by the Marine Technical Services Group of the Texas A&M University Department of Oceanography. Salinity was measured on an Autosal and concentrations of inorganic nutrients were determined using AutoAnalyzer techniques. The cruise chemist analyzed the oxygen samples at-sea using a modified Winkler technique.

The primary data collection device for water column physicochemical measurements was a Sea-Bird Electronics, Inc. SBE-19 conductivity-temperature-depth (CTD) system, which outputs data to an IBM-compatible

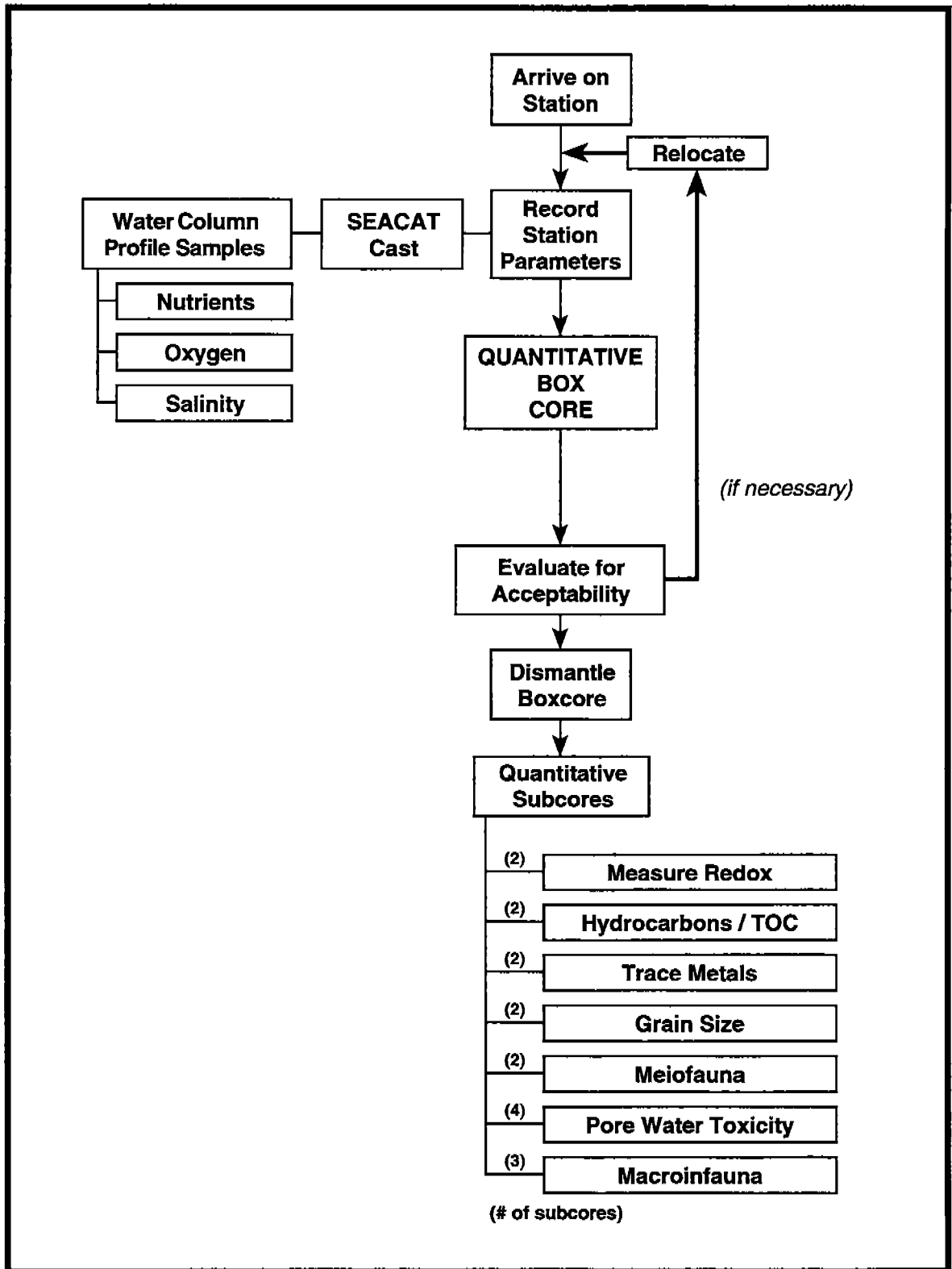

Figure 3.1. Activities at each quantitative boxcoring station including sampling protocols for water column and boxcore samples.

computer for data processing and storage. This system is called a SEACAT profiler. The SEACAT was operated with a variety of externally mounted *in situ* sensors using proven hardware and software. Two SEACATs were provided for each cruise to ensure that a complete backup system was available. The system collected continuous profiles of conductivity, temperature, and pressure from which salinity and density were calculated. The auxiliary analog-to-digital channels on the SBE-19 were used to continuously measure beam attenuation coefficient light transmittance (Sea-Tech, Inc., 25-cm transmissometer).

The SEACAT used temperature and conductivity sensors which have an established record for reliability and long-term dependability. A pump supplied water to the conductivity sensor in order to match the dynamic response of the conductivity sensor to that of the temperature sensor. A strain gauge supplied pressure/depth information. All sensors output frequency signals were individually digitized twice per second. The SEACAT records the digitized data internally in solid state memory. When the SEACAT was brought back onboard, it was connected to a PC computer that downloaded the data to disk. Sea-Bird software combines instrument calibration data and sensor algorithms to compute temperature, conductivity, salinity, and depth. The cruise chemist processed the CTD data at sea and plots of vertical profiles of the raw data and the 1-m averaged data were generated on a Hewlett-Packard 7475A plotter.

3.3 Boxcoring and Trawling

A boxcorer was the technique of choice to quantitatively sample sediments. The boxcorer was an Ocean Instruments BX-600 Deep Ocean Corer outfitted with an extra spade; teflon-coated inner core box head; stainless steel boxes fitted with stainless steel vegematic frame, rods, and bolts; two sets each of 25 aluminum-anodized vegematic core tubes and stainless steel screens with PVC frames to fit the core tubes; jacking dollies; vent doors; and lifting and closing cables. The boxcorer provides an effective penetration of up to 50 cm depending on sediment texture and the water depth of deployment. Two complete boxcorer systems were provided on each cruise. The 0.25-m² boxcore was subdivided into twenty-five 100-cm² compartments and used to sample sediment for each study

element. To avoid bow waves, which can disrupt surficial sediments, the boxcore was deployed by stopping just above the sediment/water interface followed by a free fall to the seabottom. The allocation of subcores to individual work elements is depicted in Figure 3.2.

The subcores around the perimeter of the boxcore were used for pore water toxicity testing. The nine interior subcores were distributed among the chemistry (4), macroinfauna (3), and grain size/mineralogy (2) work elements. Meiofauna samples were extruded from subcores placed in the grain size subcore section. The assignment of cores was determined by a random ordering of the nine interior subcore locations. The random number generation function used for determining the ordering of the subcores is called RAN3. RAN3 is Knuth's (1981) suggestion for a portable random number generation routine and is a subtractive method rather than a linear congruential model.

A boxcorer configuration form was used to record the condition of the boxcore and provide assignment of subcores to work elements. These forms were bound and consecutively assigned to boxcores as they were taken at-sea. The condition of the boxcore was determined on a qualitative scale:

- Good (G) - Undisturbed surface in the core.
- Acceptable (A) - A slight amount of disturbance of the core's surface with little perturbation (mixing) of the vertical structure (integrity) of the sample.
- Poor (P) - Considerable vertical perturbation of the core's vertical structure of the core. Boxcores determined to be poor were resampled.

Invertebrates and demersal fish were collected by otter trawl. The primary purpose of trawling was to collect specimens for chemical contaminant analysis, megafaunal invertebrate biological studies, detoxification, histopathology, and stomach content analyses. Trawl samples were sorted and target species were selected by the onboard taxonomists (Figure 3.3). Otter trawls were of the semi-balloon type. The mesh measured 4.04 cm (1.5") and the mouth opening was 17.58 m (50'). The trawls were deployed with 67.58 m (200') bridles and were spread with 1.830 m X 0.915 m (6' X 3') wood doors. A spare set of smaller doors 1.525 m X 0.915 m (5' X 3'), was carried on-board the ship as backup. Trawls

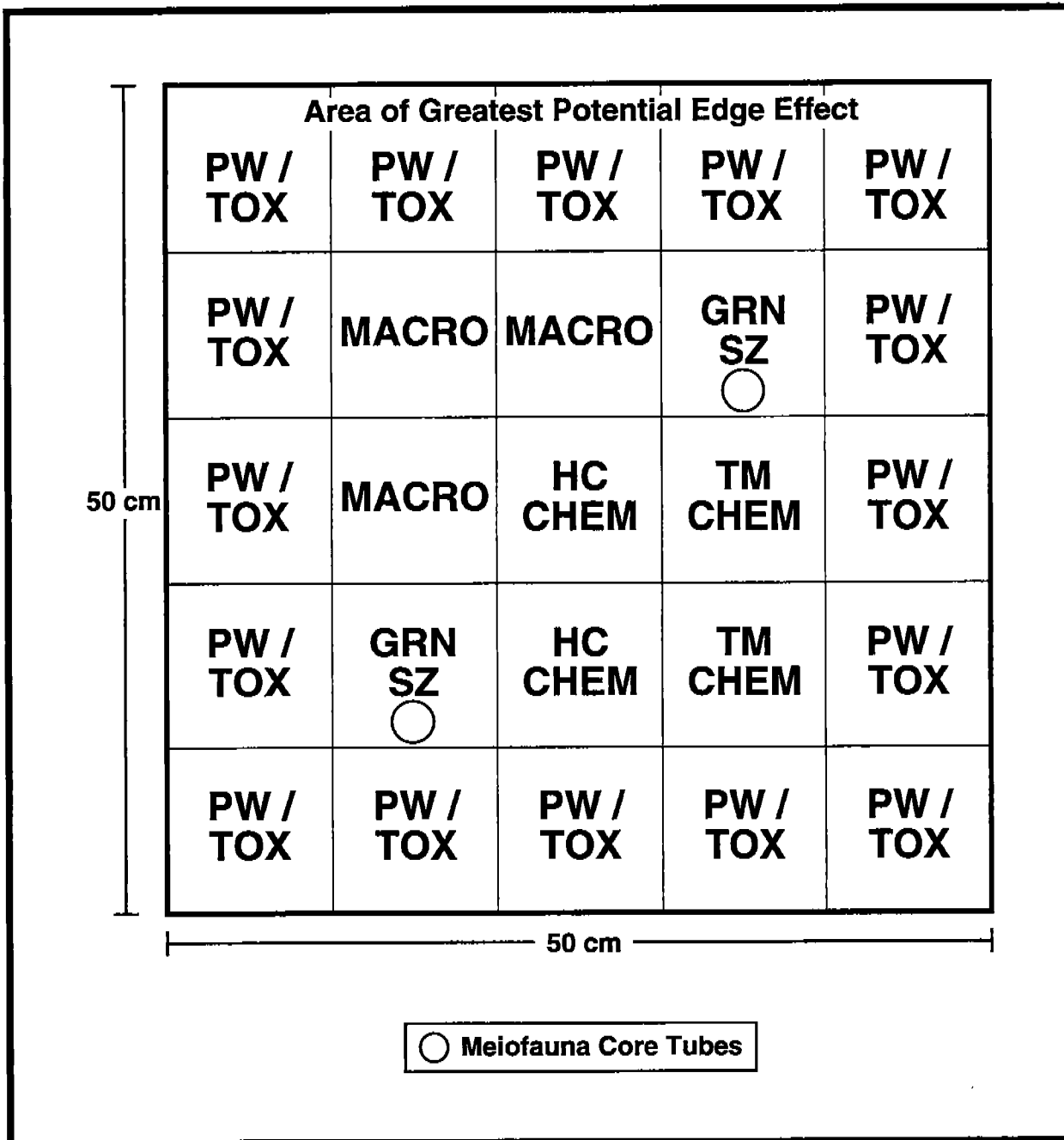

Figure 3.2. Boxcore illustrating “vegematic” partitioning. Subsamples were randomly assigned to the inner boxes. (MACRO=macroinfauna; PW/TOX=pore water toxicity testing; HC CHEM=hydrocarbon chemistry; TM CHEM=trace metal chemistry; GRN SZ=grain size).

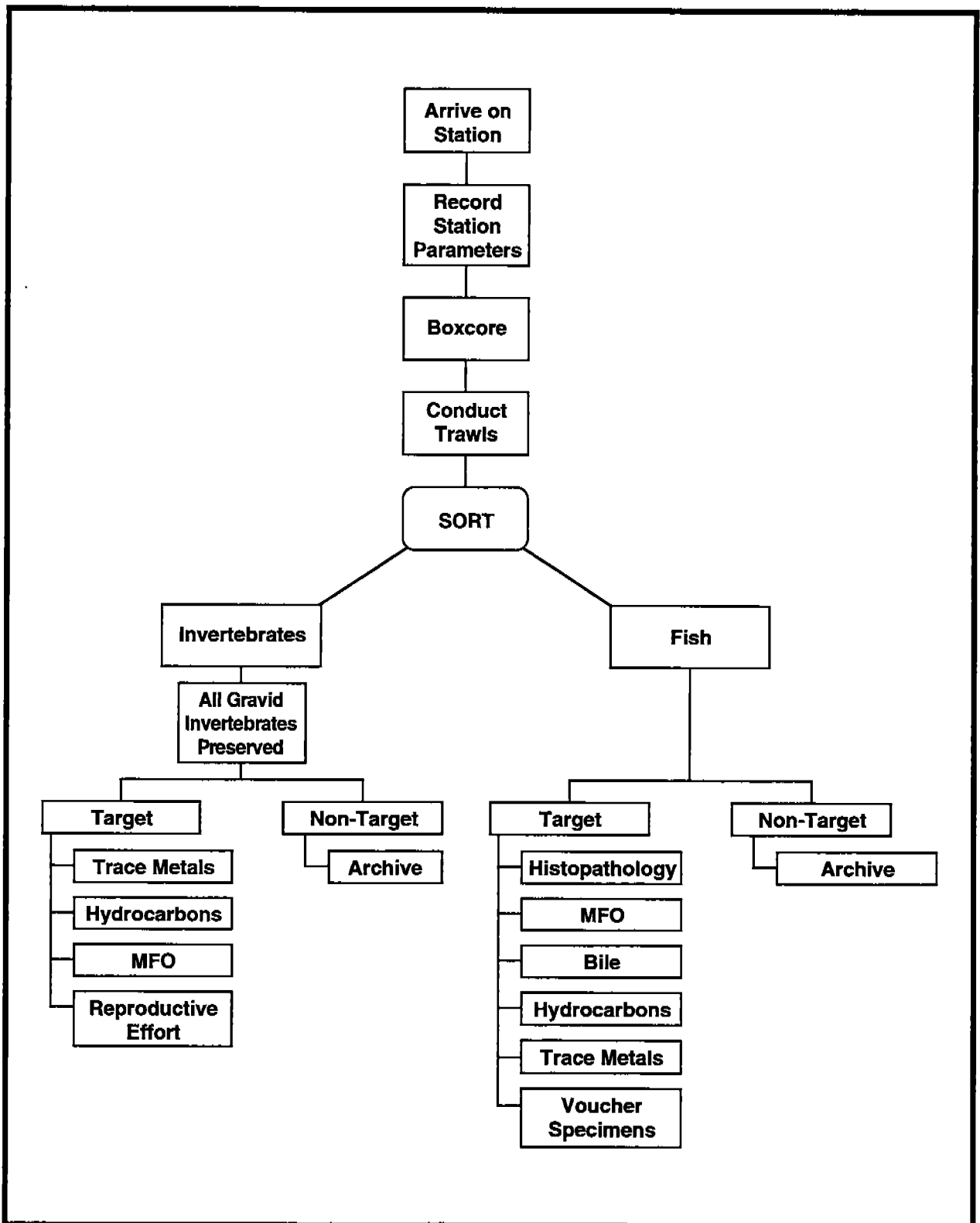

Figure 3.3. Sample processing protocol for trawl collections.

were made perpendicular to the radials around the rig when possible at a distance of 100 m or less from the platform allowing for safety considerations. Trawl times on bottom varied from 10 to 15 min. at 0.5 knots, the object being to recover a sufficient number of live specimens. Shorter durations did not recover sufficient quantities and longer trawls had a high degree of mortality in the catch.

3.4 Sedimentology

Sediment samples for sedimentological analyses were taken from two subcores at each quantitative boxcore station (Figure 3.2). The top 2 cm was sampled using a spatula or scoop. A minimum of 50 g of sample was collected in a plastic bag and stored refrigerated (4 °C), not frozen. This sample was used for mineralogy and grain size analyses.

Redox potential (mV) was measured by direct insertion of a combination platinum electrode into sediment. The electrode was calibrated with a ferrous-ferric solution every six hours and polished to expose a bright surface after each reading. The electrode was inserted to a uniform sediment depth of 2 cm. Two readings were taken per boxcore from the subcores used for sedimentology.

3.5 Sediment Samples for Contaminant Chemistry

Duplicate sediment samples for trace metals and hydrocarbons were taken from each boxcore (Figure 3.2). Between samplings the subcorers for organic contaminants were thoroughly rinsed with water, dried with acetone, cleaned with methylene chloride between samplings, and covered with combusted aluminum foil after cleaning to minimize airborne contamination. Samples were taken from the upper 2 cm of the sediment with a teflon-coated scoop. The scoop was rinsed with distilled water, acetone, and methylene chloride prior to each sampling. Separate samples were taken for hydrocarbons and trace metals. Total organic and inorganic carbon were measured on a subsample of the hydrocarbon sample. Hydrocarbon subsamples were immediately placed into precleaned (combusted at 425 °C) 1/2-pint glass jars with teflon-lined lids (~150 g). Trace metal samples were immediately placed into plastic bags (~150 g).

All sediment samples for contaminant chemistry were stored frozen (-20 °C).

3.6 Biological Tissue Sampling for Chemistry and Toxicology

The goal was to sample enough biomass of common macroinfauna, mobile invertebrates, and fish at both Near and Far stations to supply all study components with the tissues needed. Megafaunal invertebrates and demersal fish were collected by trawling. As far as possible, the organisms processed at the Near and Far stations were the same species. The goal for chemistry/detoxification samples was five species of megafaunal invertebrates and three species of demersal fish.

3.6.1 Megafauna - Invertebrates

3.6.1.1 Taxonomic Identification and Sorting

The procedures followed for processing megafaunal invertebrates are outlined in Figure 3.4. For Cruise 1, invertebrates were collected by trawl and boxcore; however, on subsequent cruises, megafaunal invertebrates were exclusively collected by trawl. The specimens were roughly sorted (crabs, shrimp, etc.), taxonomically identified, and the target species designated. All dissections were performed with solvent-cleaned utensils in a clean environment. Collections were repeated until sufficient biomass of the target species was collected. Within practical limits, specimens of the target species that were collected were of approximately the same size class. Voucher specimens of target and non-target invertebrate species were preserved in 10 % buffered formalin and returned to the laboratory for final identification.

3.6.1.2 Chemistry and Toxicology

Invertebrate species for the chemical and detoxification studies were individually tagged and maintained alive until processing. Some species of invertebrates required different tissues for trace contaminant and detoxification analyses (Figure 3.5). All animals were rinsed with reagent water to remove extraneous materials prior to sampling. For detoxification

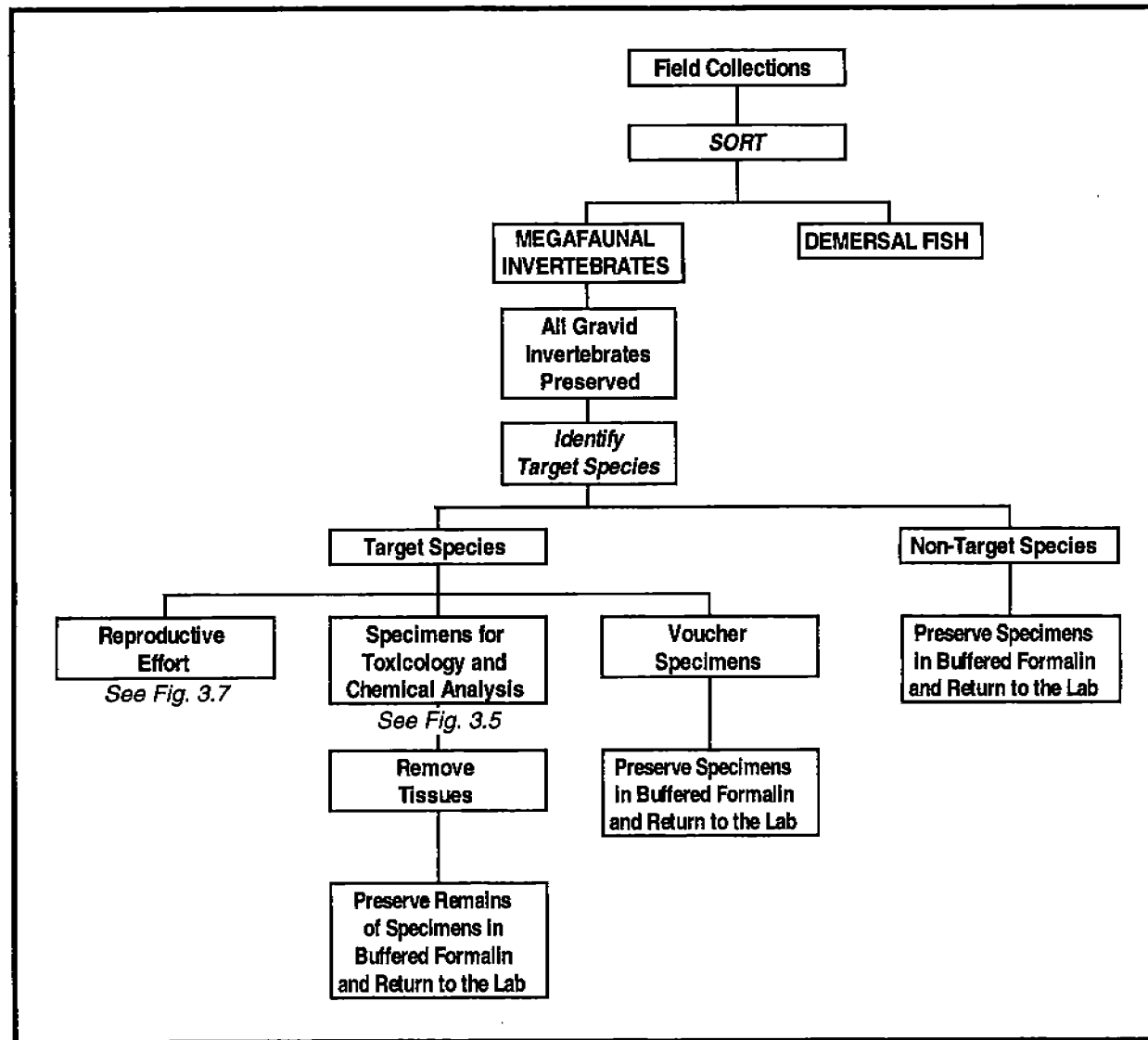
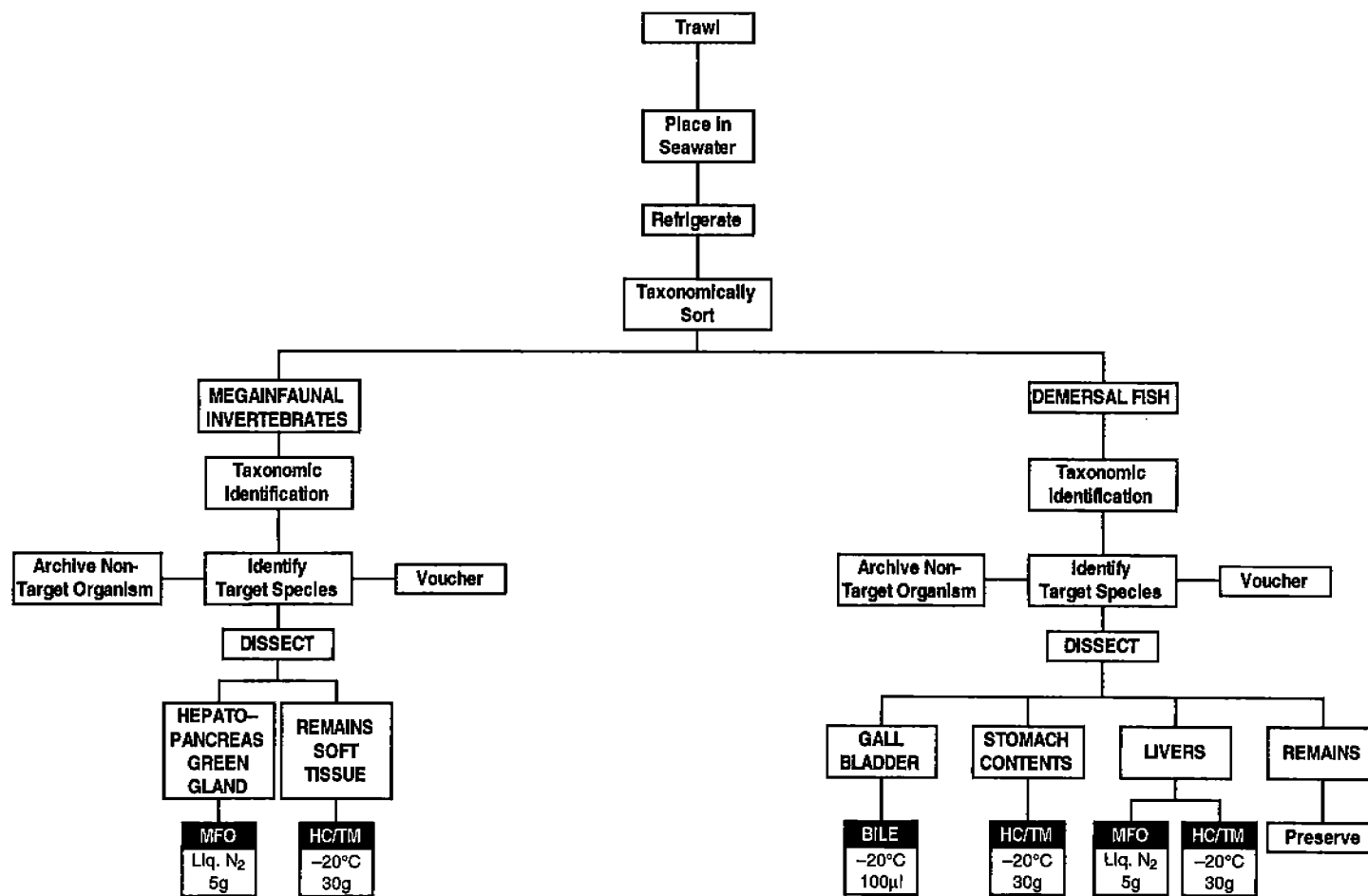

Figure 3.4. Sample processing protocol for megafaunal invertebrates from trawls.

Contaminant Chemistry / Toxicology



Target: Megafauna
 Mobile Invertebrates & Demersal Fish

3 Species x 3 Replicates x 2 Stations / Site
 5 Species x 3 Replicates x 2 Stations / Site

Figure 3.5. Sample processing protocol for megafaunal invertebrate and demersal fish tissues for contaminant chemistry and toxicology.

studies, large animals were dissected and small specimens were sampled whole. Only the hepatopancreas from crabs, scallops, and gastropods and the green gland from shrimp were used in detoxification studies. All dissections were carried out on ice and samples were immediately frozen in liquid nitrogen. For trace contaminant analyses, the residual tissues not used in detoxification studies and/or additional whole samples were placed in clean glass jars with teflon-lined lids (organic) or acid-cleaned plastic containers (trace metals) and stored frozen (-20 °C). Individual species were sampled in triplicate when possible. Voucher specimens were collected and preserved for all target organisms.

3.6.2 Megafauna - Demersal Fish

Procedures for processing demersal fish are outlined in Figure 3.6. All tissue sampling was conducted in a clean environment and all utensils were pre-cleaned by water, acetone, and methylene chloride rinses. Once the trawl was onboard, the fish were separated from the invertebrates and sorted. Live fish were placed in cool, aerated seawater in large coolers. The fish were taxonomically identified and the target species designated. Trawling was repeated until sufficient biomass of the target species was collected. At each site, 20 individuals of the target species were collected for histopathology.

At each station, all fish taken in each trawl were examined to assay for gross pathological abnormalities. All specimens were preserved in Dietrich's fixative. A thorough external inspection of the body surfaces, fins, eyes, branchial chamber, and buccal cavity was performed on preserved samples upon arrival in the laboratory. All observations and measurements were recorded on a data sheet.

The following instructions were followed:

- (A) Body surfaces and fins: Any discolorations of body surfaces (i.e., darkening, hemorrhaging, cloudiness), raised scales, white spots, or parasites visible to the naked eye were noted. Any lumps, bumps, or other growths, ulcerations, fin erosion, skeletal deformities, swelling of the anus, or any other abnormal conditions were noted as well.
- (B) Eyes: The eyes were checked for cloudiness, hemorrhage, exophthalmia (i.e., pop eye), and/or depression in the orbits.

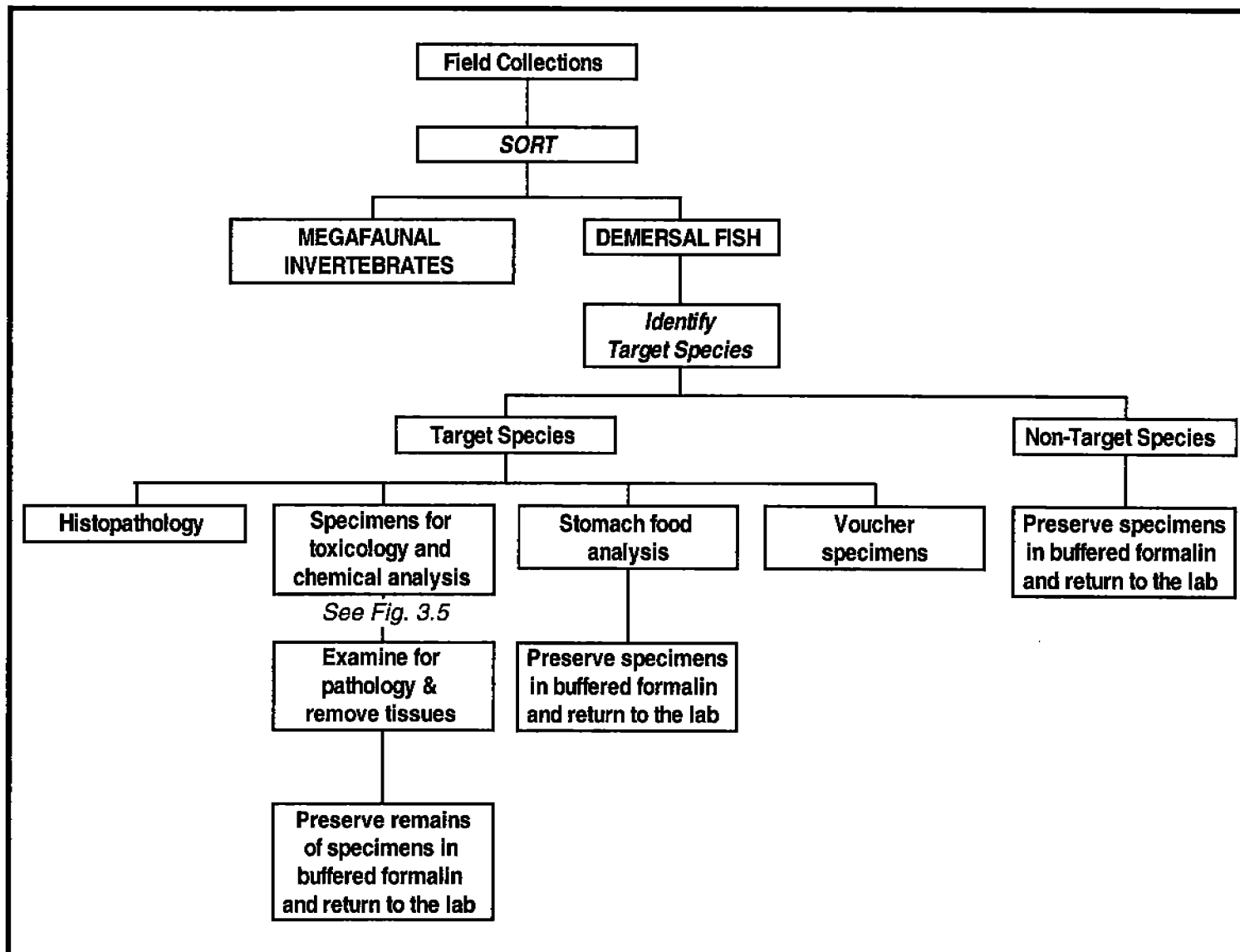

Figure 3.6. Sample processing protocol for fish taken from trawls.

- (C) Branchial chamber: The opercula were lifted and the branchial chambers examined for any perforations or deformities. Color, erosion, deformities, and parasitic infestations in the gills were noted. The chambers internal surfaces were examined for lumps, bumps or other growths, ulcerations, or any other abnormal conditions.
- (D) Buccal cavity: The mouth was examined for any deformities, ulcerations, and/or growths.
- (E) All specimens with gross lesions or other suspect conditions, as identified above, were processed and coded individually.
- (i) The entire length of the abdominal cavity was cut open using scissors or a sharp knife. The scissors were gently inserted into the abdomen near the anus and an incision to the operculum was made. Care was taken not to injure the visceral organs.
 - (ii) For fishes smaller than 15 cm, the entire fish was saved.
 - (iii) Tissue samples (visceral cavity and abnormalities excised) were placed in Zip-lock® bags with sufficient perforations to permit a flow of fixative through the bag. Whole fish and heads were tagged with all pertinent information and placed directly into the fixative. Specimens were fixed in Dietrich's fixative.
 - (iv) The pertinent information relating to each individual sample was carefully recorded on data sheets.
- (F) In addition to those specimens collected with visual abnormalities, a random, representative subset of specimens was collected from those fish without visual abnormalities. From specimens of target fish species that "passed" the gross pathological inspection, a maximum of 20 individual fishes were preserved.

Proper fixation of specimens was critical to the ultimate quality of the data obtained. Fish were examined and fixed while still alive or shortly after death.

Stomach contents were collected for as many species as possible that were also collected for trace contaminant analysis. Stomachs were preserved in 10 % buffered formalin. For toxicology, bile was removed using vacutainers and stored at -20 °C until analysis. Next, livers were removed and placed on ice and either subsampled individually or pooled depending on the size of the livers. Samples for enzyme assays and P4501A mRNA

were frozen in liquid nitrogen (LN₂) until analysis. Both livers and stomach contents were sampled from fish and used for hydrocarbon and trace metal analyses. Hydrocarbon samples were placed in a combusted glass jar with a teflon-lined lid. Trace metal samples were placed in clean plastic containers. All tissue samples for contaminant analysis were stored frozen (-20 °C). When practical, individuals of approximately the same size were collected.

All target and non-target specimens were preserved in 10 % buffered formalin and returned to the laboratory for final identification. In any single collection, if the amount of non-target specimens occupied more than one five gallon sample container, then a representative subsample was taken. Specimens are retained as voucher specimens at the Texas Cooperative Wildlife Collection (TCWC).

3.7 Meiofauna

Two core samples were taken from each boxcore sample and stored for meiofaunal community analysis. Each core sample was from a different randomized subcore (Figure 3.2) to minimize autocorrelation among the replicates (Eckman 1979). Meiofauna were collected by a 1.9-cm i.d. core tube (Montagna 1991). The two core tubes were mounted inside a subcore. A mounted core tube ensures that the meiofauna are collected from an undisturbed surface. Taking the sample from inner subcores reduces edge effects (Eckman and Thistle 1988). Bow waves of sampling devices in deep water can have an enormous impact on surface dwelling meiofauna (Hulings and Gray 1971). The 0 to 2 cm section of sediment was extruded out of the core tube and placed into a 50 cc plastic centrifuge tube. The meiofauna were anesthetized by adding 7 % MgCl₂ and waiting about 5 min. The sample was then preserved with an equal volume of 10 % buffered formalin (yielding a final concentration of 5 % formalin). Recovery of the animals for community analyses was performed at a land-based.

For life history and reproduction analyses, three species of harpacticoids were chosen from the materials obtained in the meiobenthic community structure study. No additional sampling was required. For the meiofauna genetic variation analysis, further aliquots of sediment were collected. Since the meiofauna core tubes are about 4 cm², there was about

90 cm² remaining in each subcore. The 0 to 2 cm of the remaining sediment in each subcore was collected at 50 m and ≥ 3000 m stations. The sediment was preserved with EDTA buffered alcohol and stored at 4°C (Dessauer et al. 1990). Meiofauna were extracted at a shore-based laboratory for DNA analysis.

Sediments were collected during GOOMEX Cruise 2 to provide live meiofauna for toxicity testing. The surface 2 cm of sediment remaining in the boxcorer subcores after the community samples were removed were retained and kept fresh by aeration. Live meiofauna were extracted at a shore-based laboratory to attempt toxicity testing on indigenous species.

3.8 Macroinfauna Community Studies

Three subcores were used for analysis of macroinfauna. To minimize the effects of disturbance, only the nine central compartments were used for macroinfaunal samples. The three subcores, or samples, to be used for analysis were randomly chosen prior to deploying the boxcore. Each of the subcores was carefully extruded to a depth of 10 cm and placed in a shallow pan. The 10-cm depth was chosen because extensive prior experience in the northern Gulf of Mexico, in addition to extensive documentation in the periodical literature, indicates that the majority of small infaunal organisms, which constitute the majority of specimens collected, are found in the upper 1-2 cm of sediment. Very few deep-burrowing organisms are missed by this process. In addition, past experience, especially in deeper water, has shown that sediments below 10 cm tend to be thick clays which require a great deal of processing and yield little additional biological information. The sample was then placed on a 0.5-mm mesh sieve, submersed in a pan of seawater, and the sieve was rotated and agitated until all sediments smaller than 0.5-mm passed through the mesh. The remaining deeper sediments were examined for the presence of large, deep-burrowing organisms. Material retained on the sieve was placed in a prelabeled plastic jar and fixed with 5% buffered seawater-formalin. The outside label (site, station, date, replicate) was written with grease pencil. The inside label (same information) was a plastic Dymo label. These labels were used instead of paper labels because of the probability that paper labels would be abraded by shell hash, sand, or gravel.

3.9 Megafauna - Invertebrate Reproductive Studies

The protocol for field collection for the megafaunal invertebrate reproduction study was greatly revised from the original plan due to difficulties in collecting sufficient numbers of individuals and species during Cruise 1. The original target for this work effort was 10 individuals from 10 different species. Five species were to be taken from boxcore samples and five species from trawls. To fulfill this requirement, one entire boxcore was dedicated to this work element on Cruise 1 and animals were taken from multiple trawls. However, very few animals were obtained from the boxcore and further boxcoring did not significantly increase the number of individuals or biomass collected. Therefore, the sampling of megafauna from the boxcores for the reproductive effort was discontinued after Cruise 1. The number of trawls was increased to provide more individuals and to increase the likelihood of overlap of species between the Near and Far stations.

After retrieving each trawl, the catch was rinsed and roughly sorted into four groups: echinoderms, molluscs, shrimp, and crabs. The animals were stored at 4 °C, if immediate fixation was not possible. The echinoderms, molluscs, and shrimp were kept in seawater and the crabs were placed in isotonic MgCl₂ to relax them. All individuals were placed in fixative within three hours of collection to minimize autolysis from digestive enzymes and the effects of capture. Egg sacs from all gravid crabs were either immediately frozen in liquid nitrogen to be processed for the immunological probe study or were placed in fixative for later microscopic and histological examination.

Size structure was used as a surrogate for age structure because growth curves were not available for most of the invertebrate species. Therefore, all specimens of the target species were counted and measured in the field (to the nearest mm). The dimensions measured were: bivalves, maximum posterior to anterior length; crabs, maximum carapace width; shrimp, tip of rostrum to the rear of the carapace; mantis shrimp (stomatopods), maximum length (during Cruise 1 the measurement was made from the eyes to the rear of the carapace); starfish, central disc width. For Cruise 2, individuals for each species were randomly chosen and length was measured for up to a maximum of 50 individuals. If larger numbers of

shrimps or crabs were collected in a single trawl and a gravid (external eggs visible) female was found, all individuals were measured regardless of the final numerical total. On Cruises 3 and 4, all individuals of the target species were measured from every trawl to determine catch per unit effort. Catch per unit effort was calculated as follows:

$$CPUE = \frac{\text{total number of individuals caught in a trawl}}{\text{distance trawled} \times \text{width of trawl}}$$

During Cruise 2 several additional observations were initiated at the time of collection to determine the sex and to qualitatively describe the stage of reproductive development for individuals of all shrimp and crab species. For each shrimp collected, an external determination of sex was made based on the presence of the thyleca in females or the claspers in males (King 1948). Each female was further examined and a numerical value for the stage of reproductive development was assigned based on the size and color of the ovary visible through the carapace (Chamberlain and Lawrence 1983). The characteristics used to determine the stage of reproductive development based on the appearance of the ovary are summarized in Table 3.1. Crabs were sexed based on the appearance of the ventral carapace (Hill et al. 1989). The dorsal carapace of females, not preserved for histological analysis, was removed and a visual determination of reproductive stage was made based on the development and color of the ovary (Hard 1942). Definitions of the developmental stages used for female crabs are summarized in Table 3.2. Beginning on Cruise 3, stomatopods and hermit crabs were also sexed externally by visual inspection. External determination of sex in stomatopods was made based on the presence of claspers at the base of the sixth set of legs, indicating a male or, in their absence, a female. Hermit crabs were sexed according to the presence of gonopores on the third set of legs, for females, or their absence, for males.

Preparation for fixation depended on the species (Figure 3.7). For crabs, a portion of the dorsal carapace was removed to allow penetration of the fixative into the tissues. For shrimp, during Cruise 1, the tail end was cut off just behind the carapace and discarded; only the head and thorax were preserved. Based on histological analysis, a new procedure was developed for shrimp after Cruise 1. The tail of the shrimp was sliced open

Table 3.1. Visual reproductive development for female shrimp (after Chamberlain and Lawrence 1983).

Numerical Designator	Developmental Stage	Appearance of Ovary
1	Undeveloped	No ovary visible externally, no pigmentation.
2	Beginning Development	Anterior and posterior lobes of ovary faintly visible.
3	Nearly Ripe	Ovaries easily recognizable externally, anterior and posterior lobes enlarged and pigmented.
4	Ripe	Anterior and posterior lobes of ovary appear broad and dark, may even determine recent mating if the spermatophore is still visible in thylecum.
5	Spent	Difficult to distinguish from Stage 2 without dissection, posterior lobe may still be pigmented and slightly enlarged.

Table 3.2. Visual reproductive development for female crabs (after Hard 1942).

Numerical Designator	Developmental Stage	Appearance of Ovary
1	Undeveloped	Ovary small and inconspicuous, white in color, spermathecae large and pink in color.
2	Early Development	Ovaries increased in length and diameter, orange in color, spermathecae decreased in size.
3	Mature	Ovary bright orange and large, no sponge or egg remnants on swimmeretes.
4	Spawned	Ovary bright orange and somewhat smaller than stage 3, sponge or egg remnants found on swimmerets.
5	Spent	Ovary collapsed, grey or brownish in color, sponge or egg remnants found on swimmeretes.

on the ventral surface, a piece of the carapace removed, and the head split open ventrally. This allowed for better penetration of the fixative, ensuring better preservation of the digestive tract and fixation of the complete reproductive system. Hermit crabs were carefully extracted from the shell and a small cut was made along the dorsal carapace. For starfish, one arm was removed flush with the central disc. After Cruise 1, this procedure was changed and a minimum of two arms (depending on the size of the individual) were cut off to ensure proper preservation and decalcification of the individual animals collected. Scallops were placed in cold water until they relaxed and gaped, allowing a blade to be slipped between the valves to cut the adductor muscle. Tissues were removed from the shell for fixation. For stomatopods, the tail was sliced open on the ventral surface.

Individuals were preserved in Bouin's fixative. On Cruise 1, the largest individuals of each species were preserved. On subsequent cruises, an effort was made to preserve equal numbers of males and females (5 each), again retaining the largest individuals of each sex. The samples in fixative were stored in the refrigerator aboard ship for 48 hours, after which the jars were sealed and stored at room temperature.

Any female portunid crabs not used for histological analysis were frozen in liquid nitrogen for gonadal analysis using the immunological probe.

3.9.1 Immunological Probe Development and Incubation

The goals of this portion of the program were two-fold. First, to produce immunological probes that react to egg protein in specific species of invertebrates. Those probes be used to determine the quantitative state of reproductive development in individuals and second, to use the probe to determine instantaneous rates of reproduction in these species by assessing the incorporation of labeled leucine into egg protein over time.

The development of immunological probes sensitive to egg and sperm protein for invertebrate species depends on the collection of sufficient eggs or sperm from the species of interest. During Cruise 1, all egg sacs from crab species were collected for the immunological probe study. Females of other species found to be gravid were also sampled. For example, the ovary and testis of scallops were removed and frozen separately in liquid nitrogen. These samples were returned to the laboratory to be used in the

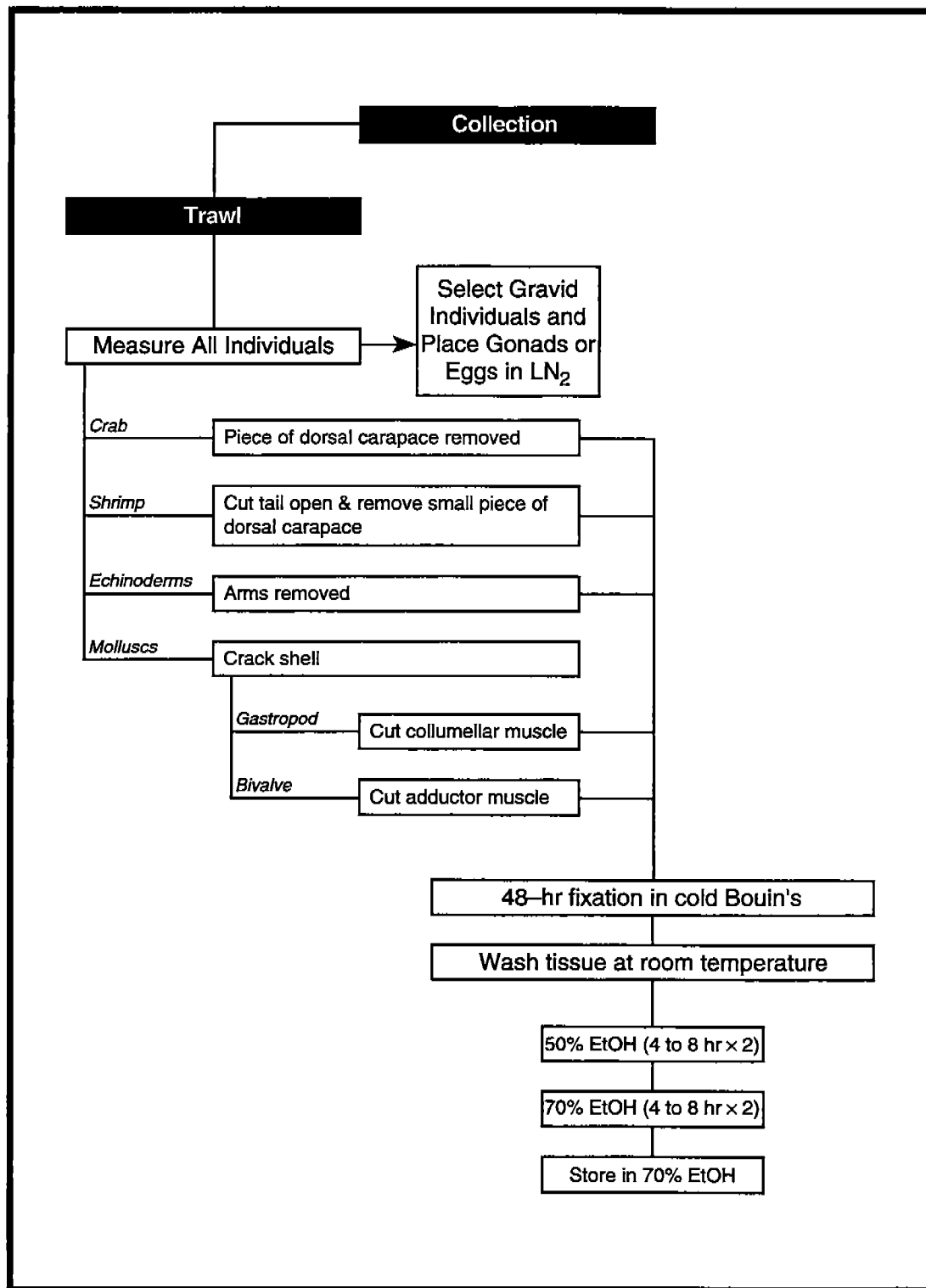

Figure 3.7. Megafaunal invertebrate life history sampling protocol

development of an immunological probe for quantitative reproductive effort studies. The specific details for the laboratory development of the immunological probe are presented in Section 3.7.3.

Once developed, the immunological probe can be used to separate gonadal protein from somatic protein to determine the instantaneous rate of reproductive development. Inoculation experiments were conducted on Cruise 2 at two of the three sites to determine instantaneous reproductive effort. A portunid crab and scallop were chosen. Twenty individuals of two different species were injected with 2 mCi of ^{14}C leucine. Subsets of five individuals of each species were incubated separately for 1, 2, 5 and 10 h in seawater at ambient temperature, after which they were immediately frozen in liquid nitrogen. Use of the immunological probe in the treatment of these samples for determination of instantaneous reproductive rate is described in Section 3.7.3.

3.10 Pore Water for Toxicity Testing

A composite of 16 subcores was used to provide a sample for pore water toxicity testing (Figure 3.2). The top 2 cm of sediment from each subcore was carefully removed with a teflon-coated scoop and placed in a 4-liter precleaned polyethylene container. The containers were stored at 4 °C until transported to the shore-based laboratory.

4.0 LABORATORY METHODS

This section provides a detailed discussion of laboratory protocols and procedures used to produce the analytical results and data for GOOMEX Phase I.

4.1 Physicochemical Measurements

4.1.1 Nutrients

Water samples were analyzed for phosphate, silicate, and nitrate using an Alchem Analyzer or a Technicon AutoAnalyzer. The system was standardized by analyzing calibration standards of all nutrients prior to and after each set of samples. The peak height data were collected with a PC and peak heights from the AutoAnalyzer were converted to nutrient concentrations in μM by linear interpolation from absorbance relative to the calibration standards.

Silicate was determined by the ammonium molybdate, tartaric acid, stannous chloride method; phosphate by ammonium molybdate, hydrazine method; and nitrate by sulfanilamide, NEDA method (after reduction to nitrite with a cadmium reduction column). All of these analyses except phosphate, which was heated in a 70 °C bath, were conducted at room temperature (25 °C). Colorimeter interference filters in the spectrophotometers of the AutoAnalyzer were 660 nm (silicate), 880 nm (phosphate) and 550 nm (nitrate and nitrite).

For each cruise, the precision and accuracy of the analysis of each nutrient analytical technique was evaluated by analyzing at least 20 replicates of the highest calibration standard. The standard deviation in μM was 0.05 for a 6- μM nitrate standard, 0.005 for a 0.50- μM phosphate standard, 0.05 for a 6.5- μM nitrate standard, and 0.005 for a 0.50- μM nitrite standard. The coefficient of variation was 1 % for each group of replicates.

4.1.2 Salinity

Salinity samples were analyzed using a Guildline Model 8400 Autosal Laboratory Salinometer. The specifications of the Autosal are as follows:

Range:	0 to 40
Accuracy:	±0.003
Temperature Compensation:	±0.0007/ °C

The Autosal system uses conductivity to directly determine salinity. Each sample was analyzed three times to ensure an accurate analysis and the mean was reported. The sample was held at a constant temperature in a water bath while the conductivity was measured. The conductivity and temperature were then used to calculate salinity based on the practical salinity scale.

4.1.3 Dissolved Oxygen

Samples were collected and analyzed for dissolved oxygen by the microWinkler technique (Carpenter 1965). Oxygen samples were the first samples drawn from the Niskin bottle. After rinsing with an aliquot of seawater, the oxygen (iodine) flasks were filled using a seasoned piece of tygon tubing from the bottom of the flask. The samples were preserved using a divalent manganese solution, followed by the addition of strong alkali to each sample. Care was taken to avoid introduction of any bubbles into the iodine flasks along with these reagents. The precipitated manganous hydroxide was dispersed evenly throughout the seawater sample, which completely filled the stoppered flask. Any dissolved oxygen rapidly oxidizes an equivalent amount of divalent manganese to basic hydroxides of higher valency states. When the solution is acidified in the presence of iodide, the oxidized manganese again reverts to the divalent state, and iodine, equivalent to the original dissolved oxygen content of the water, is liberated. This iodine is titrated using standardized sodium thiosulfate and the oxygen content in each sample is calculated. The microWinkler method has a precision of 0.01-mL/L oxygen at STP. Oxygen concentrations were measured at sea by the onboard chemist.

4.1.4 Quality Assurance

Quality assurance activities include proper care and maintenance of instrumentation, pre-cruise calibration of instruments, and calibration

checks for parameters during the cruises. Care was taken to ensure that all instruments were in calibration before each cruise. The Sea-Bird SEACAT SBE-19 is calibrated by returning it to Sea-Bird. Sea-Bird has the SEACAT calibrated by the Northwest Regional Calibration Center, which is operated under contract to NOAA.

4.2 Sedimentology

Sediment ancillary data included mineralogy, grain size, total organic carbon content, total inorganic carbon content, and redox potential (Eh). The analytical protocols utilized are compatible with those currently used in the NOAA National Status and Trends Program (NS&T).

4.2.1 Grain Size

Fifteen (15) to 20 g of sample were placed in a large glass jar. This sample size minimizes the interaction of individual grains with each other during settling, avoids flocculation, and maximizes the amount of material to be weighed (i.e., small sample size increases errors in weighing). The sample was treated with between 50 to 100 mL of 30 % hydrogen peroxide for 12 hours prior to analysis in order to oxidize organic matter. The amount of hydrogen peroxide added varies with the amount of organic material present in the sample. In general, hydrogen peroxide solution is slowly added to the sample until effervescence is no longer observed. The sample was washed with distilled water to remove soluble salts. Four hundred (400) mL of sodium hexametaphosphate solution (~5.5 g/L) was added to disperse the sample, followed by shaking for ~24 hours on a shaker table. A 62.5 μ screen was placed over a 1-liter graduated cylinder. The dispersed sediment was poured over the screen and washed with dispersant to rinse any remaining fine-grained sediment into the cylinder. This procedure separates the gravel/sand fraction (on the screen) from the silt/clay fraction (in the cylinder). The coarse fraction was washed into a preweighed beaker with distilled water and placed in an oven (100 to 130 °C) for 24 h. The beaker was removed from the oven and left to cool. The beaker was allowed to equilibrate with moisture in the air. The beaker was weighed to 0.1 mg with an analytical balance. The sand fraction was dry

sieved at 2-mm (1 phi) and 62.5- μ (4 phi) intervals to separate gravel from sand-sized material. The weights of the gravel (> 2 mm) and sand-sized (62.5- μ to 2 mm) material were recorded on data sheets.

The graduated cylinder containing the silt/clay material was filled to exactly one liter of dispersant solution. The cylinder was stirred vigorously and left to stand for one day. If the cylinder showed no sign of flocculation, analysis was continued. If the sample flocculated, the sample was discarded and the procedure was repeated. The fine fraction was analyzed at 4-phi and 8-phi intervals. Two labelled beakers were preweighed to 0.1 mg. The cylinder was stirred vigorously starting at the bottom and working up until all the sediment was uniformly distributed throughout the cylinder. At the end of the vigorous stirring, long smooth strokes of a rod the full length of the cylinder from the bottom until the stirring rod breaks the surface, were used to homogenize the suspension. As soon as the rod emerged for the last time, the timer was started. At the end of 20 seconds a pipette was inserted to a depth of 20 cm. Exactly 20 mL was withdrawn; this is the 4-phi aliquot. The suspension was pipetted into a preweighed beaker, the pipette rinsed with 20-mL of distilled water and the rinse water was added to the same beaker. At the 2:03:00 (two h, 3 min.) time, a 20-mL aliquot was withdrawn at a depth of 10 cm; this was the 8-phi aliquot. The suspension was pipetted into a second preweighed beaker. The pipette was rinsed with 20 mL of distilled water and the rinse water was added to the beaker. The beakers were placed in an oven and evaporated to dryness for at least 24 hours at 100 to 130 °C. After 24 h the samples were removed from the oven and allowed to cool to room temperature. The sample was allowed to come to equilibrium with the moisture content of the ambient air. The beakers were weighed to 0.1 mg with an analytical balance, and the weights recorded on a data sheet.

The 4- and 8-phi dry weights include the weight of the added dispersant. The dispersant weight (g/L) was multiplied by the fraction of the total solution removed (20/1000) and subtracted from the aliquot weight. This total was then multiplied by 50 (1000 mL/20 mL) to yield the sample weight of the silt + clay fraction.

Three weights (wt) are needed to calculate the total dry sample weight.

wt. sand (2 mm to 62.5 μ size range) + wt. gravel (2 mm and greater size range) + wt. of 4-phi residue = total dry sample weight

$$\% \text{ gravel} = \frac{\text{weight gravel fraction}}{\text{total dry sample wt}}$$

$$\% \text{ sand} = \frac{\text{wt sand fraction}}{\text{total dry sample wt}}$$

$$\% \text{ silt} = \frac{[(\text{wt } 8\text{-phi residue} - \text{dispersant}) \times 50]}{\text{total dry sample wt}}$$

$$\% \text{ clay} = \frac{\{[(\text{wt } 4\text{-phi} - 8\text{-phi}) - \text{dispersant}] \times 50\}}{\text{total dry sample wt}}$$

Duplicate samples were run every 20 samples. Results were reported to three (3) significant figures.

4.2.2 Mineralogy

X-ray diffraction analysis was conducted to characterize the bulk mineralogy of the sediments. The preparation procedure consisted of gently crushing the sample, reducing skeletal and other coarse grains to a uniform fine silt particle size, without causing changes in the carbonate or clay phases. The sample powder was packed into a "dry powder type" sample holder using the back-loading method of Moore and Reynolds (1989). This method of sample preparation results in maximum random orientation of mineral crystallites.

Each sample was subjected to Cu Ka radiation and scanned from 2° to 60° 2q on a computer automated Rigaku X-ray diffractometer. After several preliminary analyses, the optimal scan speed, sampling interval, and slit sizes for the sediments were selected. Binary intensity data was stored on 5.25" IBM-type floppy disks. The data were converted to an ASCII format. For each sample analysis a standard plot of intensity (in counts per second) vs. ° 2q was generated. All major mineral phases in each sample were identified and listed in order of decreasing abundance.

4.2.3 Total Organic Carbon and Total Carbon

Carbon concentrations were determined on freeze-dried (or oven-dried at 40 to 50 °C) sediment using a LECO Model 523-300 induction furnace (or equivalent) to burn samples in an oxygen atmosphere. One hundred (100) to 500 mg (to the nearest milligram) of freeze dried (or oven dried), finely ground, homogenized sediment was weighed into a tared, carbon-free combustion crucible. The amount of sample depended upon the expected carbon concentration. Ideally, between 0.5 mg and 8.6 mg of carbon was combusted to fall within the range of the standard curve. One scoop of copper and iron chip accelerator was added to the crucible containing the samples. All crucibles were kept covered with aluminum foil prior to analysis. The crucible was placed on the oven pedestal, the oven closed, and oxygen allowed to flow. The carbon dioxide produced was swept from the furnace's combustion chamber with the oxygen flow. The gases then passed through a dust trap and two reaction tubes. The first reaction tube was a two-stage chamber with the first stage consisting of manganese dioxide. The manganese dioxide absorbed the sulfur oxides that form during combustion. The second stage contained anhydrous, which removed water vapor from the gas stream. The second tube, filled with platinized silica, was maintained at an elevated temperature by an external heating jacket. The contents of this tube acted as a catalyst to convert carbon monoxide to carbon dioxide. Carbon dioxide was detected and quantified with a Horiba PIR-2000 infrared detector. The output signal from the Horiba was recorded by an HP 3396A integrator which calculated the quantity of carbon dioxide based on peak area. Standard LECO pin and ring carbon standards were placed into an empty crucible with one scoop of copper accelerator. Standards were analyzed by the same procedure as a sample to calibrate the detector.

The appropriate amount of freeze dried (or oven dried) sample was acidified with small amounts of 10 % HCl in methanol solution. The treated samples were dried overnight at 50 °C in the drying oven. Carbonate content was determined by subtracting the total organic carbon concentration from the total carbon concentration. To express as percent calcium carbonate, the total carbonate carbon content is multiplied by 8.33.

Quality control samples were processed the same as samples. A method blank was run with every 20 samples, or with every sample set, whichever was more frequent. Blank levels were maintained at less than three times the method detection limit (MDL). Duplicate samples were analyzed every 20 samples, or with every sample set. Duplicates were maintained at ± 20 % for low level (< 1.0 % carbon) samples and ± 10 % for normal/high level (> 1.0 % carbon) samples. Duplicates were less precise for large grain size samples. Reporting units were percent organic carbon (on a dry weight basis) and percent carbonate carbon (on a dry weight basis). The minimum method performance standard for the method is detection of 0.02 % carbon in a sample. Results were reported to two (2) significant figures. All duplicate analyses were reported.

4.2.4 Redox

An estimate of the redox condition of the sediments was obtained by Eh (mV) measurements (Whitfield 1969). Eh measurements were performed by direct insertion of a combination platinum electrode into the top 2 cm of the sediment and reading a pH/mV meter. The Eh probe was inserted directly in the subcore before disassembly of the boxcore. The overlying water was retained in-place to minimize sediment disturbance and mixing with air. Readings were converted to values on the hydrogen scale (Whitfield 1969). The platinum electrode was calibrated prior to each sample with a ferrous-ferric solution (Light 1972) and was polished to expose a bright surface before each reading.

4.3 Contaminant Analyses

The contaminants measured in this study included hydrocarbons and trace metals.

4.3.1 Hydrocarbons

Aliphatic and aromatic hydrocarbons were quantitatively measured in sediments, pore waters, and biological tissues. The protocols and procedures used in this study (Figure 4.1) are identical to those presently

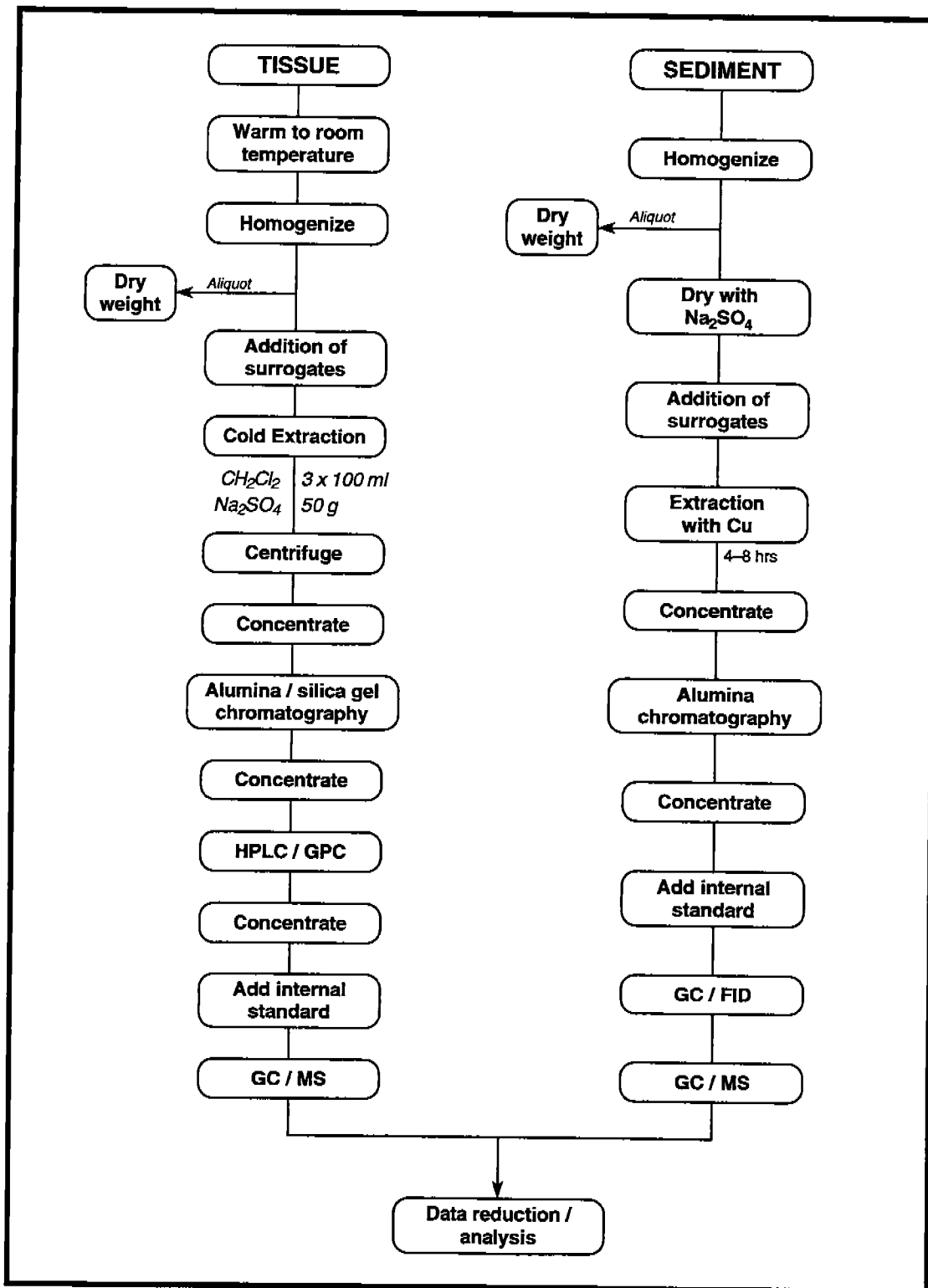

Figure 4.1. Summary of hydrocarbon analytical protocols.

used in the NOAA National Status and Trends Program and EPA's EMAP Program.

4.3.1.1 Clean Procedures

All glassware was cleaned by detergent (micro cleaning solution), washed with water, and rinsed with tap water. The glassware was then combusted in a muffle furnace at 400 °C for at least 4 hours. Solvent rinses with acetone used to remove residual moisture followed by methylene chloride were substituted for the muffle furnace heating when determined to be appropriate by the analyst. After drying and cooling, glassware was sealed with combusted aluminum foil and stored in a clean environment to prevent the accumulation of dust or other contaminants.

4.3.1.2 Sediment Extraction

A one (1) g sediment subsample was weighed, oven-dried, and reweighed to obtain percent moisture. A ten (10) g sediment subsample was chemically dried with thirty (30) g anhydrous sodium sulfate and added to an extraction thimble. A ball of copper wire was successively cleaned with HCl, water, methanol, and methylene chloride and placed in a 250-mL extraction flask with 150 mL of methylene chloride and one to two boiling chips. Fifty (50) mL of methylene chloride was added to the thimble, the appropriate amount of surrogate was added and the sample was Soxhlet-extracted with 150 mL of methylene chloride for four (4) to eight (8) hours, recycling every ten (10) minutes. The extract was concentrated by Kuderna-Danish techniques to two (2) mL hexane.

4.3.1.3 Sediment Extract Purification

A plug of glass wool and 2 cm of combusted sand were placed in a glass chromatographic column and the column was filled with hexane. Ten (10) g of combusted neutral alumina were added and allowed to settle. One (1) g of anhydrous sodium sulfate and ten (10) g of activated copper were added to the top of the column. The hexane was drained to the top of the column and the sample extract was transferred onto the column. The

extract vial was rinsed with two 1-mL rinses of methylene chloride. The rinses were each added to the column and drained to the top of the column. One hundred (100) mL of methylene chloride were added, eluted at one (1) mL/min., and collected in a 250-mL flat bottom flask. The eluent contained the aliphatic and aromatic hydrocarbons. The extract was concentrated by Kuderna-Danish techniques to one (1) mL of methylene chloride.

4.3.1.4 Tissue Extraction

All tissue samples were mechanically macerated prior to extraction. If necessary, organisms were rinsed with reagent water to remove extraneous material. The macerated tissue was weighed into a centrifuge tube (2 to 15 g wet weight). A separate one (1) g aliquot of macerated tissue was removed, placed in a tared weighing pan, and weighed. The tissue was dried at 50 °C to a constant weight, allowed to cool, and then reweighed to obtain percent moisture. One hundred (100) mL CH₂Cl₂, 50-g Na₂SO₄ and the appropriate amount of surrogate was added to each sample. The tissue was macerated for three (3) minutes with a Tissumizer. The CH₂Cl₂ was decanted into a 500 mL flat bottom flask (centrifuged at ~2000 rpm for 5 minutes, if necessary). The extraction was repeated two more times with 100-mL aliquots of CH₂Cl₂. The CH₂Cl₂ aliquots were combined in a 500-mL flat bottom flask. The extract was concentrated as described for sediments above.

4.3.1.5 Tissue Extract Purification

A plug of glass wool and 2 cm of combusted sand were placed in a glass chromatographic column and the column was filled with hexane. Ten (10) g of alumina (deactivated 1 % with water) in CH₂Cl₂ was slurry-packed into the column and allowed to settle. Twenty (20) g of silica gel (deactivated 5 % with water) in CH₂Cl₂ was slurry packed into the column and allowed to settle. One (1) cm of combusted sand was added on top of the packed column and the CH₂Cl₂ was allowed to drain to the top of the sand. Fifty (50) mL of pentane was added to the column and drained to the top of the sand. A 500-mL flat bottom flask was placed under the column. The sample extract was transferred to the column in hexane. The column

was drained to the top of the sand. The concentrator tube was rinsed twice with one (1) mL of 50:50 pentane:CH₂Cl₂ solution that was added to the column. The column was drained to the sand layer. Two hundred (200) mL of 50:50 pentane:CH₂Cl₂ solution was added to the column, eluted at one (1) mL/min., and collected. This fraction contains the hydrocarbons. The extract was concentrated as described previously.

The aromatic fraction was further purified by high performance liquid chromatography (HPLC) using a Spectra-Physics SP8000 ternary pump, two size exclusion columns connected in series (22.5 X 250 mm Phenogel 100 Å columns), and a precolumn (8 X 50 mm Phenogel 100 A). Filtered (0.45-µM) dichloromethane was used as the mobile phase. The sample was injected onto the columns with an autosampler (Gilson Model 321). The HPLC unit was equipped with a UV absorbance detector (Model Water 440-Millipore). The fractions containing the compounds of interest were collected in 50-mL vials using the LKB Bromma 2211 fraction collector. The time interval in which the desired fraction was collected was based on the retention times of (4,4') dibromooctafluoro-biphenyl (DBOBF) and perylene. These retention time markers were analyzed three times. Collection of the sample fraction began 1.5 min. before the elution of DBOBF and ended two (2) min. after the elution of perylene. Assuming a constant isocratic flow of the mobile phase of seven (7) mL/min, the total time needed to collect the fraction was ~7 min. At the end of every batch of ten samples, the marker standard mixture was analyzed again to check retention time. After running a batch of samples (20), the columns were flushed and the precolumn was backflushed to remove sample matrix contamination from the system. On average, time for purification was ~35 min. The extract was then concentrated to one (1) mL.

4.3.1.6 Quantitative Determination of Aliphatic Hydrocarbons and the Unresolved Complex Mixture (UCM) - Sediment Only

This method quantitatively determines compounds from n-C₁₀ to n-C₃₄ and is based on high resolution, capillary gas chromatography using flame ionization detection (GC/FID). A gas chromatograph with a split/splitless injection system, capillary column capability, and a flame ionization detector (FID) was utilized. The output from the detector was

collected and processed by an automated HP-LAS 3357 data acquisition software package. A 30-m X 0.32-mm I.D. fused silica capillary column with DB-5 bonded phase (J&W Scientific or equivalent) was used. The analytical conditions are summarized in Table 4.1.

Calibration solutions were comprised of the n-alkanes and isoprenoids listed in Table 4.2. Calibration standards were prepared in the concentration range from 1.25 to 50 mg/mL (at five concentrations). The surrogate compounds for all sample types was deuterated n-alkanes with 12, 20, 24, and 30 carbons. A surrogate solution is made by weighing an appropriate amount of pure standard into a volumetric flask and diluting to volume with methylene chloride. The internal standard for this analysis was deuterated n-C₁₆. The matrix spiking solution consists of alkanes from with 10 to 34 carbons and pristane (Table 4.1). The matrix spike was added to samples at a concentration of ~10 X the MDL. The calibration mixture was also used as a retention index solution.

4.3.1.7 Quantitative Determination of Polynuclear Aromatic Hydrocarbons (PAH) - Sediments, Pore Waters, and Tissues

The method described determines the concentration of polynuclear aromatic hydrocarbons (PAH) and their alkylated homologues in extracts of water, tissues, and sediments. Quantitation was performed by gas chromatography-mass spectrometry (GC/MS) in the selected ion monitoring mode (SIM). Target analytes and confirmation criteria are listed in Table 4.3. The analytical systems included a temperature programmable gas chromatograph (Hewlett-Packard 5890A, or equivalent) and all accessories including syringes, analytical columns, and gases. Analyses were performed in a splitless mode. A 30-m X 0.32-mm I.D. fused silica capillary column with DB5-MS bonded phase (J&W Scientific) was used. The autosampler was capable of making 1 to 4 µL injections. The mass spectrometer (HP/MSD) operated at 70-eV electron energy in the electron impact ionization mode and was tuned to maximize the sensitivity of the instrument based on manufacturer specifications. The GC capillary column was directly inserted into the ion source of the mass spectrometer. The mass spectrometer computer system allowed for continuous acquisition and storage of all data during the chromatographic analyses. Computer software

Table 4.1. Analytical conditions for aliphatic hydrocarbon analysis.

Instrument:	Hewlett-Packard 5880A or HP 5890 Gas Chromatograph
Features:	Split/splitless capillary inlet system, HP-1000 LAS 3357 data acquisition system
Inlet:	Splitless
Detector:	Flame ionization
Column:	0.32-mm I.D. X 30-m DB-5 fused silica capillary column (J&W Scientific)
Gases:	
Carrier:	Helium 2 mL/min.
Make-Up:	Helium 33 mL/min.
Detector:	Air 360 mL/min. Hydrogen 33 mL/min.
Temperatures:	
Injection port:	300 °C
Detector:	300 °C
Oven Program:	60 °C for 1 min. then 6 °C/min. to 300 °C, hold 5 min.
Daily Calibration:	Mid-level calibration solution; Retention index solution (20 mg/mL)
Quantification:	Internal standard/calibration

Table 4.2. Aliphatic hydrocarbons (AH) of interest.

Compounds of Interest
N-C10
N-C11
N-C12
N-C13
N-C14
N-C15
N-C16
N-C17
Pristane
N-C18
Phytane
N-C19
N-C20
N-C21
N-C22
N-C23
N-C24
N-C25
N-C26
N-C27
N-C28
N-C29
N-C30
N-C32
N-C34

Table 4.3. Target polycyclic aromatic hydrocarbon analytes.

Analyte	Quantification Ion	Confirmation Ion	% Relative Abundance of Confirmation Ion
d8-Naphthalene	136	134	15
Naphthalene	128	127	15
C1-Naphthalenes (including isomers)	142	141	80
C2-Naphthalenes	156	141	ND
C3-Naphthalenes	170	155	ND
C4-Naphthalenes	184	169,141	ND
d10-Acenaphthene	164	162	95
Acenaphthylene	152	153	15
Biphenyl	154	152	30
Acenaphthene	154	153	98
d10-Fluorene	176	174	85
Fluorene	166	165	95
C1-Fluorenes	180	165	100
C2-Fluorenes	194	179	25
C3-Fluorenes	208	193	ND
d10-Phenanthrene	188	184	ND
Phenanthrene	178	176	20
Anthracene	178	176	20
C1-Phenanthrenes/anthracenes	192	191	60
C2-Phenanthrenes/anthracenes	206	191	ND
C3-Phenanthrenes/anthracenes	220	205	ND
C4-Phenanthrenes/anthracenes	234	219,191	ND
Dibenzothiophene	184	152,139	15
C1-Dibenzothiophenes	198	184,197	25
C2-Dibenzothiophenes	212	197	ND
C3-Dibenzothiophenes	226	211	ND
Fluoranthene	202	101	15
d12-Chrysene	240	236	ND
Pyrene	202	101	15
C1-Fluoranthenes/pyrenes	216	215	60
Benzo [a] anthracene	228	226	20
Chrysene	228	226	30
C1-Chrysenes	242	241	ND
C2-Chrysenes	256	241	ND
C3-Chrysenes	270	255	ND
C4-Chrysenes	284	269,241	ND
d12-Benz (a)pyrene	264	260	20
Benzo [b] fluoranthene	252	253,125	30, 10
Benzo [k] fluoranthene	252	253, 125	30, 10
Benzo (e) pyrene	252	253	30, 10
Perylene	264	253	20
d12-Perylene	264	260	ND
Benzo [a] pyrene	252	253, 125	30, 10
Indeno[1,2,3-c,d]pyrene	276	277, 138	25,30
Dibenzo [a,h] anthracene	278	279, 139	25,20
Benzo [g,h,i]perylene	276	277, 138	25,20

ND = Not determined

allowed display of any GC/MS data file for ions of a specific mass and plotting ion abundances versus time or scan number. Extracts were injected onto the capillary column of the gas chromatograph using the following conditions:

Injector Temp:	300 °C
Transfer Line Temp:	280 °C
Initial Oven Temp:	40 °C
Initial Hold Time:	0 min.
Ramp Rate:	10 °C
Final Temperature:	300 °C
Final Time:	4 min.

Qualitative identification of target compounds was based on relative retention time (RRT) criteria. RRT windows for alkyl homologues were based on analysis of National Institute of Standards and Technology (NIST) SRM 1582 or other suitable reference oil. Just prior to analysis, an aliquot of internal standard solution was added to the sample.

The compounds in the surrogate solution were naphthalene-d₈, acenaphthene-d₁₀, phenanthrene-d₁₀, chrysene-d₁₂, and perylene-d₁₂. All sample analyte concentrations were corrected for surrogate recoveries. The internal standards were resolved from all, but elute in close proximity to, the analytes of interest. The internal standards were fluorene-d₁₀ and benzo(a)pyrene-d₁₂. A solution containing 2 to 5-ring PAH compounds was used to fortify matrix spike samples.

A five-point response factor calibration curve was established to demonstrate the linear range of the detector. The standard concentrations were 20, 100, 250, 500, 1000 ng/mL. The percent relative standard deviation for all calibrated analytes did not exceed ±15 % with an R > 0.99 with a first degree fit of the data. After every 6 to 8 samples, the mass spectrometer response for each PAH relative to the internal standard was determined using check standards at concentrations of 250 ng/mL. Daily response factors for each compound were compared to the initial calibration curve. If the average daily response factors for all analytes were within ±15 % of the calibration value, analyses proceeded. If, for any analyte, the daily response factor exceeded ±35 % of calibration value, a five-point calibration was repeated for that compound prior to the analysis of samples.

4.3.1.8 Quality Control

The methods employed were equivalent to NOAA National Status and Trends methodologies and the associated quality assurance is the same as for the NOAA methods. A method blank was run with every 20 samples, or with every sample set, whichever was more frequent. Blank levels were no more than three times the method detection limit (MDL). If blank levels for any component are above three times the MDL, samples analyzed in that sample set were re-extracted and reanalyzed. If insufficient sample was available for re-extraction, the data were reported and appropriately qualified. Matrix spike/matrix spike duplicate (MS/MSD) samples were run with every 20 samples, or with every sample set, whichever was more frequent. The appropriate spiking level was ten times the MDL. Surrogate materials were spiked into every sample and QC sample. The appropriate spiking level was ten times the MDL. Surrogate and matrix spike recovery acceptance criteria are described in the instrumental section.

Method interferences may be caused by contaminants in solvents, reagents, glassware, and other sample processing hardware and can lead to false positives during instrumental analysis. All materials used in this method are routinely demonstrated to be free from interferences by processing procedural blanks identical to samples (one blank per 20 samples or each batch, whichever was more frequent). Matrix interferences result from co-extraction of compounds other than the analytes of interest.

4.3.2 Trace Metals

Total trace element concentrations were determined in sediments, biological tissues, and pore waters from each study site. The analytical methods were optimized for the each element/matrix type to ensure high quality data. The analytical methods used are summarized in Table 4.4.

4.3.2.1 Sample Preparation

All samples were received frozen. Sediment samples were thawed, homogenized, and a representative aliquot taken for freeze-drying. After freeze-drying, the samples were homogenized by grinding to a powder prior

Table 4.4. Trace element analytical methodologies by matrix^a.

Element	Sediment	Tissue	Pore Water
Al	FAAS	--	--
Ag	GFAAS	GFAAS	---
As	GFAAS	GFAAS	---
Ba	INAA	DCP-AES	DCP-AES
Cd	GFAAS	GFAAS	GFAAS
Cr	INAA	GFAAS	---
Cu	GFAAS	GFAAS	GFAAS
Fe	INAA	FAAS	---
Hg	CVAAS	CVAAS	CVAAS
Ni	GFAAS	GFAAS	---
Pb	GFAAS	GFAAS	GFAAS
Sb	INAA	--	---
Se	GFAAS	GFAAS	---
Sn	GFAAS	GFAAS	---
V	DCP-AES	DCP-AES	GFAAS
Zn	FAAS	FAAS	GFAAS

^aAnalytical methods are flame atomic absorption spectrophotometry (FAAS), graphite furnace or flameless AAS (GFAAS), instrumental neutron activation analysis (INAA), direct current plasma atomic emission spectroscopy (DCP-AES), and cold vapor AAS (CVAAS), --- not analyzed.

to digestion. Fish liver and stomach content tissue samples were sub-sampled in the field and were received ready for freeze-drying. For whole organism samples (e.g., shrimp, crabs, gastropods), the soft tissues were separated prior to freeze-drying. After freeze-drying, all tissue samples were homogenized by grinding to a powder prior to digestion. Pore water samples were prepared for analysis by acidification to pH < 2 with ultrapure nitric acid.

4.3.2.2 Sample Digestion and Analysis

For most elements in sediments and tissues, NOAA National Status and Trends Mussel Watch methodologies, which incorporate a closed teflon bomb acid digestion, were used (Lauenstein et al. 1993). These are sensitive (low detection limit), total digestion methods (i.e., MDL's for most elements in the 0.01 to 1.0 ppb dry wt. range) developed for use in baseline monitoring programs. These methods are capable of accurately measuring trace element levels in uncontaminated, pristine areas. Mercury was determined according to EPA method 245.1 (U.S. EPA 1991), which

involves a separate sulfuric/nitric acid and permanganate/persulfate digestion followed by cold vapor atomic absorption spectrophotometry (CVAAS).

For certain elements of special interest to this study (e.g., Ba, V), specialized analytical techniques were used. For example, sediment barium is the most important elemental tracer of drilling mud discharges and was a critical parameter for interpreting the chemical gradients observed in the vicinity of the platform sites. To maximize data quality, sediment barium concentrations were determined by instrumental neutron activation analysis (INAA). INAA is the analytical method of choice for sediment barium determination because barium is difficult to dissolve by normal acid digestion procedures. INAA is a nuclear technique that is free of chemical interferences, and has an essentially unlimited linear dynamic range. This characteristic was especially important for this study because sediment barium concentrations which ranged over four (4) orders of magnitude (i.e., 200 to 200,000 ppm dry wt). The INAA determinations were made using the method of Boothe and James (1985), which is optimized for marine sediments. Other elements (Cr, Fe, Sb) were determined simultaneously by this multi-element technique. In tissue and pore water samples, with very low barium and vanadium concentrations, atomic emission spectroscopy, which is especially sensitive for these elements, was used.

4.3.2.3 Quality Control/Assurance Procedures

Trace element analyses were conducted under a comprehensive Quality Assurance project plan designed to consistently produce high quality, verifiable data. All sample processing and analysis procedures were performed to minimize contamination and maximize data quality (accuracy and precision). All procedures were conducted by properly trained personnel according to approved laboratory standard operating procedures (SOPs). Good laboratory practices (e.g., daily refrigerator/freezer temperature checks, balance calibrations, etc.) were consistently followed.

All sample handling was done using new or acid-cleaned, metal-free containers and implements. Cleaning procedures and sample processing were performed in a clean room to avoid sample contamination. Also, all containers were kept closed or covered except when material was being

added or removed. Distilled-deionized high purity water was used to prepare all detergent and acid cleaning solutions and for all rinses during cleaning procedures. Double-distilled, ultra-pure water was used for all dilutions and to prepare all sample digestion/processing reagents. Ultra-pure reagents were used whenever necessary to ensure that the procedural blank for a given analytical procedure was below the method detection limit for that procedure.

A detailed log was prepared for each digestion, specifying all aspects of the procedure (e.g., SOP to be used, matrix spike levels, QA samples, etc.). As the digestion was performed, all information was recorded in a bound, pre-printed logbook for the specific digestion procedure being used. A full suite of laboratory quality assurance (QA) samples was run with each set of 30 to 45 samples digested. These include certified reference materials ($\geq 5\%$), laboratory control samples (blank spikes, $\geq 5\%$), matrix spikes ($\geq 5\%$), laboratory duplicates ($\geq 5\%$) and procedural blanks ($\geq 5\%$). For the entire GOOMEX study over 35 % of all samples analyzed were QA samples.

All standards used were traceable to National Institute of Standards and Technology standards and within expiration dates. The preparation of all standard solutions (including lot numbers, measuring devices, and amounts used, etc.) was recorded in a single log book and all solutions were clearly labeled and traceable to a logbook entry.

During each analytical procedure, the instrument was calibrated at the beginning of the run and the calibration was checked (or re-calibrated) frequently during the run. Full re-calibrations were performed as necessary if the calibration changed more than 5 % between any two checks. All data entered were verified independently by a second person.

Each analytical batch was also evaluated based on the results of the QA samples and stringent QA acceptance criteria consistent with those recommended by the EPA (U.S. EPA 1989). The acceptance criterion for percent recovery (i.e., QA parameter for CRM, matrix spikes, blank spikes) was 80 to 120 %. The acceptance criterion for relative percent difference for duplicates at ten times the MDL was $\leq 20\%$. The acceptance criterion for procedural blanks was less than twice the MDL. Finally, 95 % of all QA analyses performed for each batch of samples had to meet these acceptance criteria. When one or more QA parameters fell outside the acceptance

criteria for a given digestion set and element, the samples were re-analyzed. If re-analysis did not bring the QA parameter(s) within acceptable ranges, the samples were re-digested and re-analyzed. All final metal data for the GOOMEX Study met these QA requirements.

4.4 Meiofauna

Extraction of meiofauna from sediment was performed using the decantation technique (Pfannkuche and Thiel 1988). The sediment was dispersed and allowed to settle for a few seconds before meiofauna were rinsed onto a sieve. This process was repeated several times until all animals were removed. Meiofauna were those animals retained on a 0.063-mm sieve.

Samples were counted to major metazoan taxonomic category and all harpacticoid copepods were sorted using the subsampling techniques described in Sherman et al. (1984). All harpacticoid copepods were identified to the species level. A subset of nematodes was identified to the species level. The first 50 nematodes encountered were mounted in a drop of glycerin on a slide for taxonomic analyses. The formalin-ethanol-glycerol transfer technique was used to protect specimens from collapse (Seinhorst 1959). On rare occasions, less than 50 nematodes were encountered in a sample. In these cases, all nematodes were identified to the species level. After nematodes and harpacticoids, the remaining taxa (usually 1 to 5 % of the total fauna) were identified to the major taxonomic level. The major meiofauna taxonomic categories are listed in Table 4.5.

4.4.1 Nematode Feeding Types

Marine nematodes can be classified into four feeding types based on mouth part morphology (Wieser 1953). These are the selective and non-selective deposit feeders (collectively referred to as the deposit feeders) and the epigrowth feeders and omnivore-predators (collectively referred to as toothed nematodes). Deposit feeders are defined as nematodes without teeth. Deposit feeders take in food actively by engulfing particles, or passively by pumping the pharynx (Romeyn and Bouwman 1983). Selective-deposit feeders (hereafter referred to as the "1A" group) have a greatly

Table 4.5. Major meiofauna taxonomic categories.

Phylum	Class	Order
Kinorhyncha		
Gastrotricha		
Rhyncocoela		
Nematoda		
Arthropoda	Crustacea	Copepoda (Harpacticoida) Ostracoda Amphipoda Isopoda Tanaida Cumacea
Annelida	Polychaeta	
Mollusca		

diminished or total lack of a buccal cavity. Selective deposit feeders can utilize only small, bacteria-sized particles. Non-selective deposit feeders (1B) have a wide buccal cavity and can feed on particles up to diatom size (Romeyn and Bouwman 1983). Nematodes with teeth are classified as either epigrowth feeders (2A) or omnivore-predators (2B). Epigrowth feeders have a small buccal cavity that is armed with one or more simple teeth. Epigrowth feeders use these teeth to puncture the frustule of diatoms and suck out the cell contents (Romeyn and Bouwman 1983; Jensen 1987). Omnivore-predators have a wide buccal cavity armed with claws, mandibles, or gland-equipped teeth. Prey items are captured by these armaments or simply engulfed (Wieser 1953). Excretions from esophageal salivary glands can accelerate digestion (Jensen 1987).

Jensen (1986) suggested updating Wieser's (1953) classification system. Under Jensen's classification system, deposit feeders are not subdivided into two groups. In addition, a new group, the scavengers, are formed from two families, the *Oncholaimidae* and the *Enchelidiidae*, formerly classified as omnivore-predators. The justification for the creation of the scavenger feeding type is that these two families can feed on dissolved organic matter. However, older juveniles and adults of these families can continue to feed on animals (Jensen 1987). The nematodes identified for the GOOMEX Phase I study contained only a few members of the *Oncholaimidae* (e.g., *Viscosia* spp.). For this reason, Wieser's (1953) classification system is suitable for the present study.

The four different nematode feeding types are thought to have different respiration rates and production efficiencies (Li et al. 1995a,b). Differences utilize different food sources, or digest the same food source using different mechanisms. Thus, Wieser's (1953) classification system, which is based on morphology, does have ecological relevance to determining the trophic structure of nematode communities and the relationship between these communities and their environment.

4.4.2 Nematode Biomass

The biomass of nematodes (B) was calculated from the measurement of nematode body sizes as follows:

$$B = \frac{(a^2) X (b)}{1600000}$$

Where a is the body width (μm) at the widest point, b is the body length (mm), and 1600000 is a conversion factor (Andrassy 1956). B is the expected wet weight in milligrams (mg).

4.4.3 Harpacticoid Life History and Reproduction Study

Three species of harpacticoida were chosen for the meiofauna life history and reproduction studies. The harpacticoids come from the material obtained in the meiobenthic community structure studies. The three species chosen are different in terms of their suspected food requirements or in potential niche and habitat choices based on body morphology (Coull 1977; Montagna 1981). The body shape nomenclature, as recently revised by Warwick and Gee (1984), was used for these purposes. *Cletodes pseudodissimilis* is a semi-cylindrical depressed form from the family Cletodidae. It is a typical burrower. The second organism is *Longipedia americana*. It exhibits a pyriform body, which suggests a more epibenthic lifestyle. This species is being used for the meiofauna toxicity tests. The third organism is a species of *Diathrodes*, family Thalestridae, which is another epibenthic form. All three of the species used in the life history study are semi-cylindrical in shape. For every individual of the three

species, the copepodite stage class was used to determine the structure of the population and the number of sexually mature males and females was determined. For all mature males and females, individual body size and the number of gravid females were determined. For each gravid female, the number of eggs per gravid female and the size of eggs in clutches was determined to calculate clutch volume.

All life history and reproductive measurements were made by placing individuals in drops of lactic acid and examining them using a Zeiss phase-contrast microscope. Body size was determined using a calibrated ocular micrometer with resolution of 5- μ at 100 X. Egg number (clutch size), diameter, and volume were measured with a resolution of 1- μ at 400 X. Total clutch volume was determined by assuming the eggs were spherical. This assumption allowed egg radius (r) measures to be converted to volume (V) estimates using the formula:

$$V = \pi r^3$$

Individual egg volume values (V_i) from each clutch were then summed to generate a measure of total reproductive effort (RE) for each gravid female.

$$RE = V_i$$

Life history stages were determined by enumerating the number of body segments in the abdomen of harpacticoid copepodites. Harpacticoid copepodites add abdominal segments with each molt up to the adult stage, which has six abdominal segments. Thus, the first stage is called "C1" with one abdominal segment, the second stage is called "C2" with 2 abdominal segments, etc., until the sixth and last segment is added which is the adult stage. Only adults, i.e., C6 copepodites, are sexually dimorphic. Meiofauna were preserved in 70 % alcohol and 10 % glycerin. Voucher specimens were retained.

4.4.4 Harpacticoid Toxicity Testing

Pore water was extracted from Cruise 1 samples, using the pressurized squeeze-extraction method described elsewhere. Pore water was then centrifuged and at least 4 aliquots of each water sample were

frozen separately. One aliquot was used for chemical analysis, and another was used in the copepod toxicity test. Water samples used in the toxicity test were kept in the freezer for two days before the test, and then they were placed in the refrigerator to thaw slowly. The day before the test, pore water samples were mixed and water quality measurements were taken. Samples were then refrigerated overnight before the test was conducted.

The copepods used in the test was *Longipedia americana*, were collected from the Port Aransas ship channel and maintained in the laboratory until the females became gravid. Gravid females were collected and isolated into a separate culture container, less than 48 hours before a test, until the eggs hatched. Therefore, all nauplii were less than 48 hours old at the start of a test. The nauplii, which are phototactic, were concentrated in the culture dish by using a point source of light. A pipette was used to transfer the nauplii to a small counting dish. Five nauplii were transferred from the counting dish into each testing chamber, and three replicates of each treatment were performed. The number of samples tested from each platform was 18, 3, 6, 9, and 2 from HI-A389, MU-A85, GA-288, MAI-686, and MAI-622, respectively. The Far sites at each platform were used as a control. Test chambers were standard petri dishes containing 10 mL of pore water. Nauplii were fed a mixture of three types of algae (*Dunaliella*, *Thalassioira*, and *Isochrysis*, approximately 20,000, 30,000, and 120,000 cells per replicate, respectively). Test chambers were incubated at 22 °C for 96 hours; then the test was terminated and the number of surviving nauplii was determined for each chamber.

4.4.5 Diversity Analysis

Species composition and diversity was analyzed by computing techniques given in Ludwig and Reynolds (1988). Two diversity indices were calculated for each boxcore at each station. Replicates within boxcores were pooled to avoid artificially high diversity values due to low sample numbers. One method is Hill's diversity number one, N_1 (Hill 1973). N_1 is a measure of the effective number of species in a sample, and indicates the number of abundant species. It is calculated as the exponentiated form of the Shannon diversity index:

$$N1 = e^{H'}$$

As diversity decreases, $N1$ will tend toward 1. The Shannon index is the average uncertainty per species in an infinite community made up of species with known proportional abundances (Shannon and Weaver 1949). The Shannon index is calculated by:

$$H' = - \sum_{i=1}^S \left[\left(\frac{n_i}{n} \right) \ln \left(\frac{n_i}{n} \right) \right]$$

where n_i is the number of individuals belonging to the i th of S species in the sample and n is the total number of individuals in the sample. This index is based on information theory and is a measure of the average degree of uncertainty in predicting what species and individual will belong. Therefore, it is biased toward common species, whereas the $N1$ indicates the degree of species dominance.

How equally component species are represented is expressed as an index of evenness. Evenness is a component of diversity. Two evenness indices, $E1$ and $E5$, have been calculated. $E1$ is probably the most common; it is the familiar J' of Pielou (1975). It expresses H' relative to the maximum value of H' :

$$E1 = \frac{H'}{\ln(S)} = \frac{\ln(N1)}{\ln(NO)}$$

$E1$ is sensitive to species richness. $E5$ is an index that is not sensitive to species richness. $E5$ is a modified Hill's ratio (Alatalo 1981):

$$E5 = \frac{(1/\lambda) - 1}{N1 - 1}$$

$$\text{where, } \lambda = \sum_{i=1}^S \frac{n_i(n_i - 1)}{n(n - 1)}$$

λ is the Simpson (1949) diversity index. $E5$ approaches zero as a single species becomes more and more dominant.

4.4.6 Fish Predation on Meiofauna

During the third and fourth cruises, 570 small fish (< 10 cm) were collected from trawls to study the predation pressure of small fish on meiofauna. The specimens were preserved on-board ship and analyzed in the laboratory. Fish standard body lengths were measured from the tip of the nose to the flute of the tail. The stomachs were removed from the fish and cut open, and their contents examined under a dissecting microscope. Organisms found inside the guts were placed in the following taxonomic categories: nematodes, harpacticoids, calanoids, shrimp, amphipods, isopods, mysid, crabs, ostracods, polychaetes, fish, gastropods, bivalves, and squid. These categories were then grouped into habitat categories as follows: meiofauna, macroinfauna, epifauna, or pelagic. Meiofauna are the sum of nematodes, harpacticoids, and ostracods. Macroinfauna are the amphipods, isopods, polychaetes, gastropods, and bivalves. Shrimp, crabs, and mysids make up the epifauna group. The pelagic group is the sum of calanoids, fish and squid. A nematode specialist checked all the nematodes and made sure that parasitic types were not counted as food.

4.4.7 Nematode Production Modeling

Deposit feeding nematodes are the dominant feeding group at all three platforms, composing 53-70 % of total nematode biomass, and 51-67 % of total nematode abundance. Deposit feeding nematodes feed predominantly on particulate organic matter by non-selectively engulfing whole particles. Therefore, it is relatively easy to model the trophic dynamics and productivity of the deposit feeders. Unlike other nematode feeding groups, information about resident meiofauna are not needed in order to construct models for deposit feeders. A time dynamic model was used to predict energy flow through the biomass of nematode deposit feeders. Four processes were considered for this model: input, assimilation, predatory death, and other losses (including respiration, excretion, and non-predatory death; Figure 4.2). Based on this model, the change in nematode biomass (D) over one month (t=time) is calculated by following formula:

$$\frac{d(D)}{d(t)} = (IXP_{12}) - L - P$$

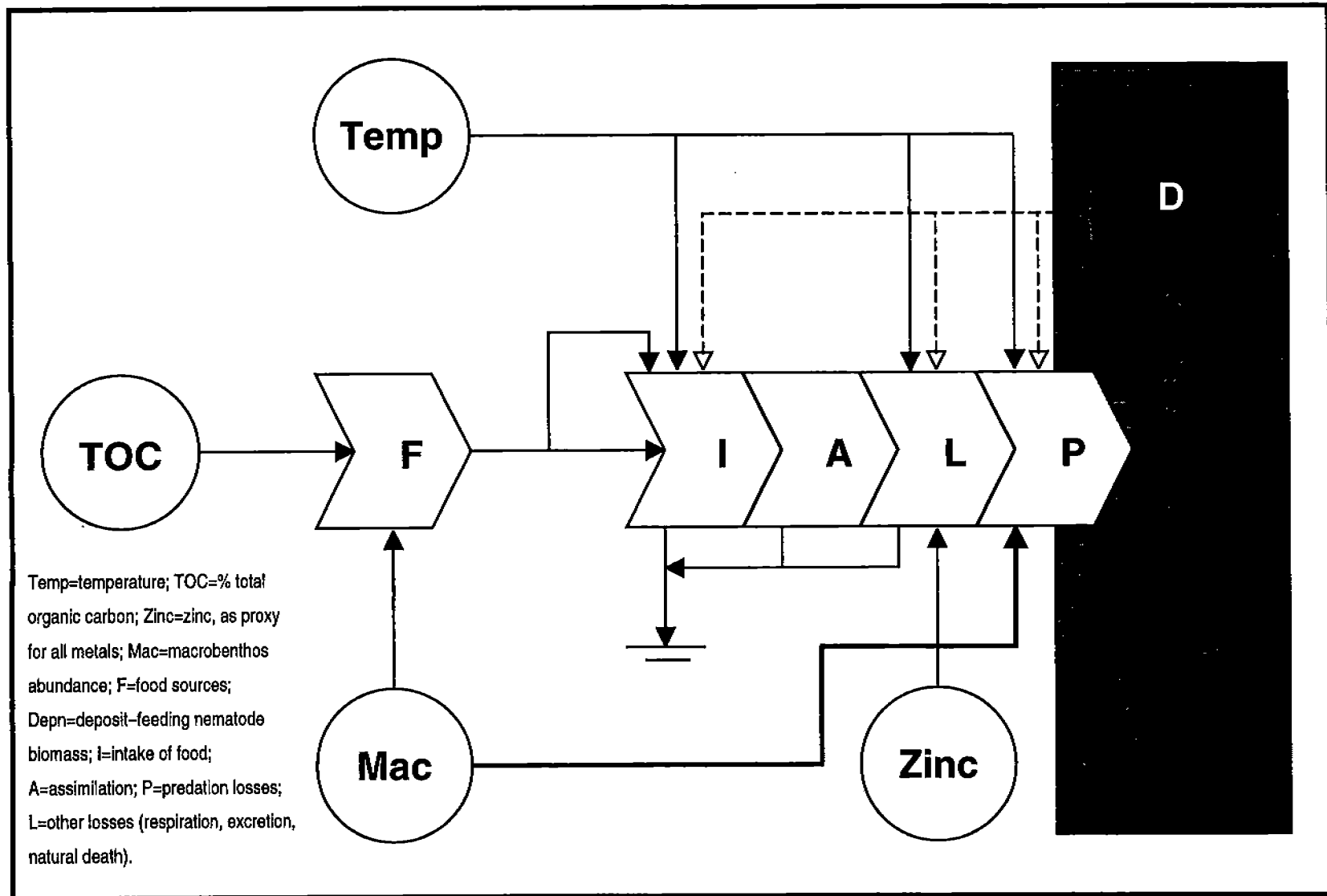

Figure 4.2. The model for predicting platform effects on deposit-feeding nematode standing stock.

where I = monthly intake of food by deposit feeding nematodes, P_{12} = assimilation efficiency, L = monthly loss due to respiration, excretion, and natural death, and P = monthly losses of nematodes due to predation by macrobenthos. Detailed formulas for each of these processes can be found in Table 4.6.

The model was created in FORTRAN 77 language, and facilitated by the PC software package, SENECA, a Simulation ENvironmental ECological Application (de Hoop et al. 1989). SENECA simplifies the model setup and allows for easy calibration by estimating the best fit parameter values according to a goodness-of-fit test. The model included 75 stations (3 platforms, 5 distances, and 5 radii) over 16 months (January 1993 to June 1994). Simulated variables included the biomass, monthly production, and production efficiency of deposit-feeding nematodes (Table 4.6). Inputs to the model were temperature, TOC, macrobenthos abundance, and zinc concentrations (as a proxy for total trace metal contaminants).

The calibrations for the model were based on the biomass data of deposit-feeding nematodes for all four cruises. The initial range of parameters were large to account for all possibilities reported in the literature. Data sets from each platform were used independently to calibrate the model three times. The calibration provides three groups of new parameter ranges that best fit the model. In this study, the best fit parameters and new parameter ranges were based on over 6000 calibrations analyses for each platform (Tables 4.7 to 4.9). The simulation of total nematodes are based on the best fit parameters at each station [(INIP(I), where $I=1$ to 25)] from each of the three platforms. Therefore, the different simulations on deposit-feeding nematodes alone (e.g., production and production efficiencies) among platforms and among distances are based on nematode data, environmental data, and energy conservation, and are used to predict platform effects on nematode trophic dynamics.

4.5 Meiofauna Genetic Variability

Five species of harpacticoida were chosen for the genetic diversity study: *Normanella* sp., *Enhydrosoma pericoense*, *Cletodes* sp., *Robertsonia* sp. and *Tachidiella* sp. Of the five species, only *E. pericoense* has been previously described, and therefore assigned a species name. Species were

Table 4.6 Formulas used in the model for predicting platform effects on deposit-feeding nematode standing stock.

Formulas^a

$$F = (TOC \times P_2) - (MAC \times P_1)$$

$$TEMAC = P_6 \left(\frac{T - 20}{20} \right)$$

$$TENEM = P_{10} \left(\frac{T - 20}{10} \right)$$

$$I = \text{MIN} \left(\frac{F}{D^{P_{11}}} D \times \left[\left(\frac{F \times P_4 \times TENEM}{F + P_3} \right) \right] \right)$$

$$L = D \times P_5 \times TENM \times Zn^{(0.5^{P_9})}$$

$$P = MAC \times P_1 \times P_8 \times D \times e \left(\frac{-P_7}{D} \right) \times TEMAC$$

$$PROD = I \times P_{12} - L$$

$$PROD / L = \frac{P}{I}$$

^aVariables: F = food source for deposit-feeding nematodes, TOC = composition of total organic matter in the sediment, MAC = abundance of macrobenthos, TEMAC = temperature effects on macrobenthos, T = temperature, TENEM = temperature effects on nematodes, I = monthly food intake by deposit feeding nematodes, D = biomass of deposit-feeding nematodes, L = other losses (respiration, excretion, and natural death), Zn = concentration of zinc (as a proxy for all trace metals), P = losses due to predation, PROD = productivity. Parameters: P₁ = transformation of macroinfauna abundance to biomass, P₂ = mg wet weight * cm³ sediment, P₃ = half intake rate of food concentration, P₄ = maximum daily intake rate, P₅ = maximum daily loss rate, P₆ = Q10 of macrobenthos, P₇ = parameter related to regression effect on nematodes, P₈ = macrobenthos grazing rate, P₉ = trace metal effect on increasing loss rate, P₁₀ = Q10 for nematodes, P₁₁ = parameter related to food limitations, P₁₂ = assimilation efficiency of nematodes.

Table 4.7. The best fit parameters of model for platform HI-A389 after 6,000 calibrating runs, where the new parameter has goodness of fit ranging from 0.1313238 to 0.1327957.

Parameter ^a	Best	Reduction	New Range		Initial Range	
INIP(1)	0.9361043	0.676	0.5424589	1.028764	0.5	2.0
INIP(2)	1.2548680	0.810	1.225867	1.510679	0.5	2.0
INIP(3)	0.5074684	0.450	0.507185	1.332499	0.5	2.0
INIP(4)	1.5847950	0.948	1.506373	1.584795	0.5	2.0
INIP(5)	1.4786050	0.722	1.441152	1.857598	0.5	2.0
INIP(6)	1.0676830	0.832	0.9090889	1.160968	0.5	2.0
INIP(7)	0.6141453	0.908	0.5849091	0.7222145	0.5	2.0
INIP(8)	1.1500900	0.793	0.9149311	1.225619	0.5	2.0
INIP(9)	0.9571383	0.787	0.9275897	1.247702	0.5	2.0
INIP(10)	1.0810150	0.863	1.066609	1.271845	0.5	2.0
INIP(11)	1.5271690	0.937	1.527169	1.622284	0.5	2.0
INIP(12)	1.5485610	0.412	0.7544864	1.636125	0.5	2.0
INIP(13)	1.3199690	0.746	1.155985	1.536358	0.5	2.0
INIP(14)	1.8346610	0.854	1.66701	1.886112	0.5	2.0
INIP(15)	1.4899490	0.929	1.450695	1.556915	0.5	2.0
INIP(16)	1.1772290	0.874	1.177229	1.365997	0.5	2.0
INIP(17)	0.7429799	0.817	0.5444198	0.8193204	0.5	2.0
INIP(18)	0.7475748	0.414	0.6660943	1.544794	0.5	2.0
INIP(19)	1.3526970	0.545	0.7899158	1.472353	0.5	2.0
INIP(20)	1.0927740	0.666	0.9609983	1.461972	0.5	2.0
INIP(21)	1.1441420	0.736	0.9688078	1.364944	0.5	2.0
INIP(22)	1.4230840	0.640	0.978984	1.518411	0.5	2.0
INIP(23)	1.2528330	0.819	1.233783	1.50482	0.5	2.0
INIP(24)	0.5241628	0.389	0.5072048	1.423935	0.5	2.0
INIP(25)	0.8827865	0.550	0.7503395	1.425961	0.5	2.0
P1	0.0010400	0.964	1.04E-03	1.37E-03	0.0	0.0
P2	13.7638000	0.886	10.19716	14.74051	10.0	50.0
P3	9.65e+07	0.931	9.20E+07	9.89E+07	1.0E+05	1.0E+08
P4	1.2099420	0.649	1.109215	1.459813	1.0	2.0
P5	0.0143797	0.927	0.01043488	0.014815	0.0	0.1
P6	2.9950710	0.829	2.824108	2.995275	2.0	3.0
P7	204.0115000	0.940	184.6213	208.6834	0.0	400.0
P8	9.7479710	0.749	7.44383	9.951478	0.0	10.0
P9	8.2228670	0.813	8.188109	8.934392	8.0	12.0
P10	2.8902760	0.745	2.676807	2.932302	2.0	3.0
P11	0.1782269	0.773	4.93E-03	0.2320168	0.0	1.0
P12	0.2698020	0.878	0.2649387	0.2698069	0.2	0.3

^a(INIP(I) = a parameter to calibrate the initial observed nematode biomass at 25 stations. Parameters P1-12 are defined in Table 4.6.

Table 4.8. Parameters of model for platform MAI-686. Best fit after 6,000 calibrating runs, where the new parameter range has a goodness of fit ranging from 0.1737823 to 0.1782664.

Parameter ^a	Best	Reduction	New Range		Initial Range	
INIP(26)	0.787178	0.195	0.568246	1.775283	0.5	2.0
INIP(27)	0.734622	0.541	0.507121	1.195570	0.5	2.0
INIP(28)	1.000626	0.763	0.804389	1.159595	0.5	2.0
INIP(29)	1.017869	0.506	0.976372	1.717177	0.5	2.0
INIP(30)	0.618092	0.338	0.507255	1.500551	0.5	2.0
INIP(31)	1.641609	0.270	0.626015	1.720911	0.5	2.0
INIP(32)	1.150913	0.304	0.609408	1.654071	0.5	2.0
INIP(33)	0.781886	0.696	0.507339	0.963048	0.5	2.0
INIP(34)	1.659900	0.727	1.566071	1.974927	0.5	2.0
INIP(35)	1.532813	0.393	0.721394	1.631522	0.5	2.0
INIP(36)	1.283881	0.743	1.181829	1.566752	0.5	2.0
INIP(37)	1.500102	0.788	1.389735	1.707566	0.5	2.0
INIP(38)	1.356195	0.231	0.507428	1.661371	0.5	2.0
INIP(39)	1.324965	0.482	0.597160	1.373497	0.5	2.0
INIP(40)	1.480931	0.884	1.456288	1.629766	0.5	2.0
INIP(41)	1.212993	0.373	0.933311	1.873757	0.5	2.0
INIP(42)	1.379516	0.484	0.860670	1.635332	0.5	2.0
INIP(43)	0.507490	0.188	0.506695	1.725278	0.5	2.0
INIP(44)	1.421562	0.590	0.927627	1.543347	0.5	2.0
INIP(45)	1.479420	0.485	1.011199	1.782992	0.5	2.0
INIP(46)	1.288508	0.195	0.507207	1.714884	0.5	2.0
INIP(47)	1.509393	0.785	1.386894	1.710140	0.5	2.0
INIP(48)	1.532623	0.242	0.856077	1.992650	0.5	2.0
INIP(49)	0.805555	0.376	0.684776	1.620163	0.5	2.0
INIP(50)	1.528447	0.690	1.175900	1.641003	0.5	2.0
P1	0.008070	0.215	0.002770	0.009830	0.0	0.0
P2	36.785340	0.639	35.169520	49.594200	10.0	50.0
P3	9.34e+07	0.892	8.87e+07	9.95e+07	1.0E+05	1.0E+08
P4	1.534280	0.607	1.449959	1.842921	1.0	2.0
P5	0.010697	0.970	0.010298	0.012098	0.0	0.1
P6	2.984037	0.528	2.523217	2.995256	2.0	3.0
P7	386.804200	0.958	381.350200	398.003100	0.0	400.0
P8	0.483498	0.769	0.411571	2.719052	0.0	10.0
P9	11.682260	0.378	9.334862	11.822620	8.0	12.0
P10	2.528471	0.379	2.261208	2.882230	2.0	3.0
P11	0.524114	0.205	0.004960	0.799774	0.0	1.0
P12	0.231563	0.769	0.230888	0.240137	0.2	0.3

^aSee Tables 4.6 and 4.7 for definition of parameters.

Table 4.9. Parameters of model for platform MU-A85. Best fit after 6,000 calibrating runs, where the new parameter range has a goodness of fit ranging from 0.1266568 to 0.129108.

Parameter ^a	Best	Reduction	New Range		Initial Range	
INIP(51)	1.365014	0.781	1.132753	1.461522	0.5	2.0
INIP(52)	1.472296	0.913	1.441750	1.571882	0.5	2.0
INIP(53)	0.702359	0.571	0.516049	1.159231	0.5	2.0
INIP(54)	0.953722	0.677	0.709280	1.194510	0.5	2.0
INIP(55)	1.424662	0.807	1.248380	1.537863	0.5	2.0
INIP(56)	0.861547	0.596	0.671945	1.278293	0.5	2.0
INIP(57)	1.026084	0.796	0.954036	1.260379	0.5	2.0
INIP(58)	1.368381	0.823	1.317784	1.582814	0.5	2.0
INIP(59)	0.679144	0.89	0.654537	0.819603	0.5	2.0
INIP(60)	0.618613	0.904	0.564922	0.708398	0.5	2.0
INIP(61)	0.967431	0.855	0.928181	1.145470	0.5	2.0
INIP(62)	1.414623	0.803	1.306570	1.602253	0.5	2.0
INIP(63)	0.511540	0.821	0.507648	0.775528	0.5	2.0
INIP(64)	0.585186	0.781	0.510507	0.839273	0.5	2.0
INIP(65)	1.519279	0.832	1.292134	1.543693	0.5	2.0
INIP(66)	1.537281	0.893	1.468087	1.629288	0.5	2.0
INIP(67)	1.362997	0.895	1.319530	1.477052	0.5	2.0
INIP(68)	1.259910	0.536	0.698133	1.394772	0.5	2.0
INIP(69)	1.230649	0.748	1.173548	1.552061	0.5	2.0
INIP(70)	0.656314	0.711	0.591527	1.024937	0.5	2.0
INIP(71)	0.615935	0.899	0.507486	0.658928	0.5	2.0
INIP(72)	0.507499	0.89	0.507357	0.672533	0.5	2.0
INIP(73)	1.106946	0.479	0.507302	1.288762	0.5	2.0
INIP(74)	0.604189	0.776	0.526370	0.861635	0.5	2.0
INIP(75)	1.248599	0.819	1.058088	1.330311	0.5	2.0
P1	0.003420	0.348	0.001780	0.007650	0.0	0.0
P2	18.333480	0.929	17.775540	20.624800	10.0	50.0
P3	9.86e+07	0.927	9.22e+07	9.95e+07	1.0E+05	1.0E+08
P4	1.153606	0.895	1.084593	1.189447	1.0	2.0
P5	0.010980	0.99	0.010661	0.011263	0.0	0.1
P6	2.840917	0.395	2.374043	2.978718	2.0	3.0
P7	283.671600	0.817	268.804400	341.858800	0.0	400.0
P8	0.922790	0.897	0.646343	1.678361	0.0	10.0
P9	9.749174	0.614	9.416418	10.960470	8.0	12.0
P10	2.481387	0.578	2.380938	2.803078	2.0	3.0
P11	0.084598	0.666	0.004780	0.339168	0.0	1.0
P12	0.251372	0.614	0.239325	0.254782	0.2	0.3

^aSee Tables 4.6 and 4.7 for definition of parameters.

selected based on abundance at all three platforms and ease of identification, thereby limiting confounding population effects due to differences between cryptic species.

Genetic diversity was estimated for populations of harpacticoida at the 50-m and ≥ 3000 -m stations at the three platforms during Cruises 2 and 3. Genetic diversity was estimated by performing restriction fragment length polymorphisms (RFLP) on 16S rRNA mitochondrial DNA (mtDNA) generated by the polymerase chain reaction (PCR) from individual harpacticoids (Karl and Avise 1993). PCR was necessary in order to generate enough genetic material from a single copepod to use for analysis. Originally, three mitochondrial loci were examined for optimization purposes, 16S rRNA, cytochrome b, and the control region. The most consistent amplification was obtained for the 16S rRNA locus, which was used for all samples. Following PCR, RFLPs were used to estimate an index of genetic variability for each station.

Specific reaction conditions are as follows. Harpacticoids were preserved in ethanol buffered with disodium ethylenediamine tetraacetate (EDTA) and refrigerated (Dessauer et al. 1990). Individuals were rinsed, ground under a dissecting scope, and placed in a microfuge tube with 33.8- μ L dH₂O, 5- μ L of 2-mM dNTPs, 3- μ L of 25-mM Mg²⁺, and 5- μ L of 10 X PCR buffer. One μ L each of 2-mM upstream and downstream primers (Bucklin et al. 1992), and one unit (0.2- μ L) of Taq polymerase was added last, for a total volume of 50- μ L. Thirty-six rounds of PCR were performed in a MJ Researcher, model PTC-150-16, thermal cycler. Products were visualized on a 2 % Tris-acetate-EDTA agarose gel stained with ethidium bromide. Bands of the appropriate size range (500 bp) were cored and subjected to a second round of PCR. Four restriction enzymes, Rsa I, Hae III, Msp I, and Taq I were used to digest the second round PCR products for RFLP, following manufacturer's instructions (Sigma Chemical and GIBCO - BRL).

Haplotypes were scored by analyzing restriction fragments on ethidium bromide stained, 2 % Tris-acetate-EDTA agarose electrophoresis gels.

The index of genetic variability used was haplotype diversity,

$$h = 1 - \sum x_i^2$$

where h = haplotype diversity, x_i = the frequency of the i th haplotype, and i = the number of haplotypes (Nei 1987).

Although there are molecular techniques that can provide finer resolution (e.g., direct sequencing, end-labeling; Avise 1994), the rationale in this study was to develop an approach for detecting sublethal effects in populations. In keeping with this strategy, it was necessary to process a large number of samples (> 1000), at a low cost, in a short amount of time.

A chronological summary of the steps in the genetic analysis procedure is outlined below:

- (1) DNA extraction from individuals
- (2) PCR amplification of mtDNA 16S rRNA locus
- (3) Agarose gel electrophoresis to determine success of amplification
- (4) Second PCR amplification to purify the target DNA sample
- (5) Restriction digest
- (6) Agarose gel electrophoresis to generate RFLPs
- (7) Estimation of haplotype diversity by station

4.6 Macroinfauna

Macroinfaunal samples remained in buffered formalin until they were returned to the laboratory. Samples were washed with fresh water on a 0.5-mm mesh sieve to remove formalin and any remaining sediments, and then placed in rose bengal stained 70 % ethanol. The samples remained in the stain-alcohol mixture for at least 24 hours to permit the stain to penetrate the more dense exoskeletons of benthic arthropods. Samples were then examined using dissecting microscopes. All organisms were removed from the shell hash or debris in the sample and were placed in clean 70 % ethanol, a process that allowed some destaining prior to identification. The sorter initialed and noted the date on the tracking sheet, and then returned all materials to the sample jar. The sample was subsequently re-examined by another sorter who removed any organisms missed by the first sorter. When the tracking sheet indicated that a sample had been examined twice, the organisms were sorted to polychaete and non-polychaete categories and placed these organisms in separate vials. The specimens were then identified and counted. All specimens of each species were placed in a vial with a label bearing species name, station number, and date. Notes were

made regarding the presence of ovigerous females, sex, and numbers of young specimens (based on general knowledge of sizes of adult organisms) in the population. The data were recorded on printed data sheets. Macroinfauna diversity calculations were calculated the same as for meiofauna data (Section 4.4.6).

4.7 Megafauna - Invertebrates

At least five individuals (10 when possible) of the most abundant species of macroinvertebrates common to the platform and comparison sites were targeted for analysis. Most of the megainvertebrates collected were fairly large, easily identifiable species. Therefore, most specimens were identifiable on shipboard with existing taxonomic keys.

4.7.1 Reproductive Effort

Upon return to the laboratory, all preserved animals were rinsed in fresh water at room temperature for 6 to 12 hrs to remove the Bouin's fixative. The samples were then dehydrated by rinsing twice each in 50 % and 70 % ethyl alcohol for 4 to 8 hrs and were then stored in 70 % alcohol until further processing.

The methods used and the tissues selected and prepared for histological embedding were specific to species. For shrimp, the tail was cut off behind the carapace. The exoskeleton and all exterior appendages were removed. The heads were then longitudinally cut in half. After dehydration and paraffin infusion (see below), shrimp were placed with the sagittal cut facing the bottom of the mold to be cast. Crabs were longitudinally cut in half. The exoskeleton and all exterior appendages were removed from one side of the skeleton. Crabs were oriented upside-down in the paraffin mold so that the gonad/digestive tissue was next to the bottom of the mold. Starfish were cut so that all arms were removed from the central body disc. Starfish were further decalcified at this point if the skeleton had not been completely dissolved by the Bouin's fixative. Starfish legs were positioned in the paraffin mold so that the oral ends were next to the bottom of the mold. For scallops; the stomach, gonad, gills, and a portion of the mantle tissue were excised from the adductor muscle and

other viscera. Scallops were placed so that the entire section was oriented horizontally in the mold. For stomatopods the ventral exoskeleton, head, and appendages were removed. After dehydration and paraffin infusion, the dorsal exoskeleton was removed. Each stomatopod specimen was then cut into four serial segments and embedded with the distal end of each section facing downward in the paraffin mold. Hermit crabs were dissected so that their tail section was separated from the body. The exterior integument covering the tail was cut in several places to allow adequate dehydration and diffusion of paraffin into the tissue. Hermit crabs were cut serially into as many sections as required, usually three or four. The distal end of each section was placed facing down in the paraffin mold.

All animal tissues were dehydrated before being embedded in paraffin for histological analysis. Samples were processed using an MX-200 TissueTek automated histological preparation machine. A standard embedding procedure is summarized in Table 4.10. Once the samples were processed by the TissueTek, they were placed in paraffin in a vacuum oven overnight. The next day, individual tissues were placed into a mold and cast in fresh paraffin, as previously discussed. The paraffin blocks were sliced at 10- μ M on an AO microtome. The sections were affixed to microscope slides using albumin adhesive by standard methods, and placed on a warming tray for 6 hrs to smooth the sections. Two or three sections, depending on size, were placed on each slide and triplicate slides were made of each sample. The slides were then exposed to formalin fumes overnight to harden the albumin adhesive. The slides were stained using a standard hematoxylin-eosin (H&E) procedure following Preece (1972; Table 4.11)

After staining, tissue sections were analyzed for sex and stage of reproduction. No scales for stages of reproductive development were available for most crab and shrimp species. Scales were developed based on literature information and observations. The stages of reproduction were based on the size and development of eggs and the overall density of gametes. The reproductive scale for crabs was based on Johnson (1980) and is summarized in Table 4.12.

The scale for reproductive development was similar for shrimp species and is based on Bell and Lightner (1988). More information was available for the stages of reproductive development in penaeid shrimp, especially for females, so the scale for shrimp (Table 4.13) was more

Table 4.10. A standard embedding procedure for histological analysis.

Procedure	Treatment	Time
Dehydration	80 % EtOH	1 h
	95 % EtOH	2 h
	95 % EtOH	2 h
	100 % EtOH	2 h
	100 % EtOH	2 h
	100 % EtOH	2 h
	100 % EtOH	1 h
Clearing	xylene	1 h
	xylene	2 h
	xylene	2 h
Infiltration	50:50, xylene and paraffin	2 h
	paraffin	2 h

Table 4.11. Standard hematoxylin-eosin procedure to stain slides (after Preece 1972).

Procedure	Treatment	Time
Deparaffinization	Xylene	5 min.
	Xylene	5 min.
	100 % EtOH	5 min.
	100 % EtOH	5 min.
Colloidionization	Celloidin solution	quick dip
Hydration	80 % EtOH	2 min.
	50 % EtOH	2 min.
	30 % EtOH	2 min.
	Water wash	5 min.
Staining	Harris' hematoxylin	8 min.
Rinsing	Water wash	5 min.
Decolorizing	Acid alcohol	3 quick dips
Rinsing	Water wash	1 min.
Bluing	Lithium carbonate	.5 min.
Washing	Water wash	2 min.
Counterstaining	Picro-eosin/Navy eosin	1 min.
Dehydration	95 % EtOH	2 dips
	95 % EtOH	3 dips
	100 % EtOH	1 min.
	100 % EtOH	1 min.
	100 % EtOH	1 min.
Clearing	Xylene	5 min
	Xylene	5 min
Mounting	Permount	24 h to dry

Table 4.12. Histological reproductive development scale for crabs (after Johnson 1980).

Numerical Designator	Reproductive Stage	Characteristics of Stage
FEMALE		
1	Early	Few eggs or sperm present, but few and very small
2	Mid	Ova do not fill cyst, loosely arranged
3	Mature	Ova fill space, closely packed, nucleated
4	Fertilized	Spermatophore present
MALE		
1	Early	Small loosely packed spermatids
2	Mid	Mixed ages of sperm
3	Mature	Closely packed sperm, sperm in ducts
4	Spawning	Spermatophores in anterior vas deferens

detailed than that for crabs. The scale used for scallops (Table 4.14) analyzed was the same scale used for oysters as more fully described in Craig et al. (1989) and used by Wilson et al. (1992). Little information is available on the reproductive cycles of starfish and stomatopods so the sex was determined and an approximate stage of reproductive maturity assigned (Table 4.15) based on the size of eggs and the overall density of gametes (Freeman and Bracegirdle 1971).

Histopathological analyses of tissue samples were conducted on ten (10) individuals of each target species. After Cruise 1, an effort was made to preserve the five (5) largest female and five largest male individuals for histopathological analyses. Analysis of parasitism and disease was hampered by a lack of scales to describe the severity of parasitism or pathologies found in these species. Each tissue section was scanned and the total number of occurrences of each specific parasite and pathology was counted.

Table 4.13. Histological reproductive development scale for shrimp (after Bell and Lightner 1988).

Numerical Designator	Reproductive Stage	Characteristics of Stage
FEMALE		
1	Undeveloped	Ovary barely noticeable
2	Early	Ova do not fill cyst, loosely arranged
3	Late	Ova fill space, closely packed, no rod-shaped peripheral bodies visible
4	Ripe	Peripheral bodies visible in ova
5	Spawning	peripheral bodies visible in remaining ova, spaces left by spawned ova visible
6	Spent	Few ripe ova left, remnants of follicles
7	Resorbing	Disorganized zone of resorption present in core of cyst, some ripe ova visible
MALE		
1	Undeveloped	Vas deferens visible but no sperm found
2	Early	Few sperm, loose packed
3	Late	Dense sperm
4	Mature	Very dense sperm, sperm in ducts

Table 4.14. Histological reproductive development stages for scallops.

Numerical Designator	Reproductive Stage	Characteristics of Stage
1	Undifferentiated	Little or no gonadal tissue visible
2	Early	Follicles beginning to expand
3	Mid	Follicles expanded and beginning coalesce; no mature gametes present
4	Late	Follicles greatly expanded, coalesced, but considerable connective tissue remaining; some mature gametes present
5	Fully developed	Most gametes mature; little connective tissue remaining
6	Spawning	Gametes visible in gonoducts
7	Spawned	Reduced number of gametes; some mature gametes still remaining; evidence of renewed reproductive activity
8	Spawned	Few or no gametes visible, gonadal tissue atrophying

Table 4.15. Histological reproductive development stages for starfish and stomatopods.

Numerical Designator	Reproductive Stage	Characteristics of Stage
1	Early	Eggs very small; and few eggs or sperm present
2	Mid	Eggs larger and more mature; gametes more dense
3	Late	Eggs larger and mature; gametes very dense
4	Spawning	Number of eggs present are reduced; some mature gametes still remaining; evidence of renewed reproductive activity

Two common descriptors of parasitism and disease, prevalence and infection intensity, were calculated to describe the frequency and severity of parasitism and disease in these populations. Prevalence (P) describes the proportion of individuals in the population that were infected by a specific parasite or pathology and was calculated as:

$$P = \left(\frac{\text{number of individuals with the parasite or pathology}}{\text{number of individuals analyzed}} \right) \times 100$$

Intensity (I) of parasitism was calculated for each of the major categories of parasites and pathologies and is a measure of the relative severity of infection within the population. Tabulated values of intensity (I) represent the mean condition in the infected individuals and was calculated for each species at each site as:

$$I = \frac{\text{total number of occurrences of a parasite or pathology}}{\text{number of individuals that have the parasite}}$$

For statistical analysis of intensity, uninfected individuals were also included.

4.7.2 Immunological Probe

The protocol for developing the antibody to egg protein is described. New Zealand white rabbits were used as the host animal to raise antibodies

against egg protein for each species selected. Three portunid crab species were chosen (*Portunus gibbesii*, *Callinectes similis*, and *Callinectes spinicarpus*). Eggs were obtained from gravid females and prepared for injection as described by Choi et al. (1994). Freund's adjuvant complete, which contains a water-in-oil emulsion and a mycobacteria cell suspension as an antibody production stimulant, was used for the initial injection. Subsequent injections used Freund's adjuvant incomplete, which lacks mycobacteria. For injection, the antigen (i.e., egg protein) was well-mixed with Freund's adjuvant and injected into the rabbit subcutaneously at the hind legs. The total volume of injected material was adjusted to 1 mL. This 1 mL was injected in 200- μ L aliquots at several different sites around the hind legs. The injection schedule and protocol used in the production of antiserum is summarized in Table 4.16.

Table 4.16. Summary of immunization protocol.

Time	Activity	Treatment
1st Week	Initial injection	1-mg Antigen in 500 μ L + 500- μ L FAC
2nd Week	Booster	500 - μ g Antigen in 500- μ L + 500- μ L FAI
3rd Week	None	None
4th Week	Booster and test bleeding	500 - μ g Antigen in 500- μ L + 500- μ L FAI
5th Week	Booster	500- μ g Antigen in 500- μ L + 500- μ L FAI
6th Week	Booster	500- μ g Antigen in 500- μ L + 500- μ L FAI
7th Week	None	None
8th Week	Test bleeding	None

FAC: Freund's adjuvant complete. FAI: Freund's adjuvant incomplete.

At the 4th and 8th week after injection, 10-mL of test blood was withdrawn from the rabbit and the antiserum isolated from the red blood cells. To do this, the blood was collected in a clotting vial, which was then stored at 4 °C overnight or at room temperature for 10 h. After clotting, the blood was centrifuged at 700 μ g for 15 min., the antiserum pipetted into a centrifuge tube, and stored at 4 °C.

To determine percent water, and to store egg masses, each egg mass was weighed, frozen, lyophilized and reweighed for 24 h. Percent water was calculated as lyophilized wt/wet wt.

Egg protein content was determined by adding a known quantity of lyophilized eggs to a 50-mL polystyrene centrifuge tube and mixing with a known quantity of PBS solution (0.15 M NaCl, 0.003 M KCl, 0.01 M

NaH₂PO₄, 0.01 M KH₂PO₄, pH 7.4). Eggs in PBS were sonicated using a Branson Sonifier 250 equipped with a microtip set at level 6 for 2 min. To prevent excessive warming during sonication, the tube was placed in an ice-filled beaker. After sonication, the egg homogenate was centrifuged at 7000 X g for 20 min to precipitate the insoluble material. The quantity of soluble protein contained in the egg homogenate was determined using the BCA Protein Assay.

The immune response of the rabbit to the egg protein was followed using a passive hemagglutination technique as described by Choi et al. (1993). Polyclonal antibodies often exhibit cross-reactions with non-target tissues. Cross-reactions were assessed using Ouchterlony's double diffusion method using gill, muscle, and stomach tissues. The method is described in detail in Choi et al. (1993). Cross-reactions were not observed. Tests of cross-reactivity between species showed that all three egg antibody preparations from the three species strongly cross-reacted. Very likely, antibodies made against egg protein from any one species can be used in assays for all three. Nevertheless, species specificity was retained in all assays by only using antibodies raised against egg protein from one species for assays on that species.

The assay used to determine the quantity of egg protein present was the single ring immunodiffusion method described by Choi et al. (1993). Crabs to be analyzed were weighed and the gonad/digestive gland complex removed and weighed. Tissues were first homogenized using a glass syringe-piston tissue grinder and further homogenized using an ultrasonicator. The crab homogenate was placed in an ice-filled beaker during sonication. After 3-min. sonication, the homogenate was centrifuged at 900-μg for 15 min and the volume of supernatant was recorded. Then, one (1) mL of supernatant was concentrated by lyophilization to permit detection of lower concentrations of gonadal protein. After lyophilization, a known amount of PBS was added for resuspension.

Twenty (20) mL of agarose gel in barbital buffer was liquefied by placing the gel in boiling water. The tube containing gel was then placed in a water bath adjusted to 50 °C. Above 56 °C, antiserum can be denatured and can lose its specificity. Two (2) mL of antiserum was added to the gel tube and agitated until the serum was completely mixed with the gel. A 10-cm X 10-cm glass plate was placed on a horizontal table and the plate was leveled.

The gel containing antiserum was poured on the plate and allowed to solidify for 10 min. The plate coated with gel was then placed at 4 °C for 15 min. to further solidify the gel. Four (4) mm diameter wells were made in the gel plate using a gel puncher connected to an aspirator. Each well was 1.8-mm in depth and 4-mm in diameter, and held up to 25 µL antigen.

Twenty µL of antigen were added to each well. The plate was placed in a humid chamber, and incubated at 4 °C for 3 to 6 days. Each plate contained standards and the samples to be analyzed. Standards were prepared using egg protein in a range of 10 to 100-µg/mL by making serial two-fold dilutions.

After incubation, the plate was washed with distilled water to remove any residual antigen in each well and a 10.2-cm X 10.2-cm wet filter paper was placed on the plate. The plate was then placed on a 0.5 cm thick layer of paper towels and covered with a layer of paper towels 2.5 cm thick. The plate was pressed with several volumes of books for 1 h. The plate was dried at 45 °C until the filter paper could be pulled off. The plate was stained with 0.5 % Coomassie brilliant blue staining solution for 2 to 3 h and destained with destaining solution for 1 to 2 h.

The diameter of the precipitation ring was measured to 0.1 mm using a vernier caliper. A standard curve was constructed using the ring diameter squared (mm²) versus the standard concentration (mg/mL). The concentration of gonadal protein was interpolated from the standard curve and expressed as milligram of gonadal protein per milliliter of crab homogenate.

The total amount of gonadal protein was estimated by multiplying the SRID value (mg gonadal protein per mL crab homogenate) by the total homogenate volume (mL). The total dry weight of eggs was estimated by dividing the total amount of gonadal egg protein measured from SRID by the average percent weight of egg protein.

4.8 Megafauna - Demersal Fish

Most of the demersal fish collected were easily identifiable species. Most specimens of interest in the present study were identified on shipboard with existing taxonomic keys immediately after they had been captured. Following appropriate necropsies and removal of stomachs, bile,

and tissue samples, these specimens were immediately preserved in 10 % buffered formalin and returned to the laboratory for taxonomic confirmation. Each specimen identified on shipboard was individually tagged, numbered, and re-identified on-shore. Since each tissue sample and stomach removed bears the same number as the fish from which it was removed, subsequent taxonomic changes could be made without ambiguity.

4.8.1 Necropsies

All individuals of each target species were examined externally for gross pathological disorders including skin ulcers, fin erosion, gill abnormalities, visible tumors, cataracts, or vertebral abnormalities. Fish found to have pathological defects were preserved for detailed histopathological examination.

4.8.2 Histopathology and Splenic Macrophage Aggregate Analysis Methods

Samples of the liver and spleen were taken from all specimens and processed for histopathological analysis. Tissue samples were dehydrated in an ethanol gradient, cleared in xylene, and infiltrated and embedded in paraffin. Sections were cut at 6- μ M on a rotary microtome and slides were stained with Harris' hematoxylin and eosin. Stained slides were examined microscopically by fish pathologists. Results were tabulated to identify any pathological abnormalities and to create a baseline of histopathological data.

Splenic macrophage aggregate (MA) analysis was performed on tissue sections of spleen prepared for histological evaluation as described above. Data are generated using a true color (HSI imaging) Particle Analysis package (Microcomp Image Analysis System with Sony 3CCD color video camera input). The system was calibrated and data collected at 10 X magnification. Three fields of view (screens) were randomly selected, and analyzed from each spleen sample. After a screen was randomly selected minor adjustments of the microscope stage position were made so that no MAs are lying on the edge of the counting field. Then, the full color image was captured as a digital image. Analysis was performed on images generated by computer-produced masks of the MAs in each screen with the number of MAs per screen and the area in μ M² of each MA recorded and

stored under an appropriate file name for future statistical analysis. A size discriminator was used to eliminate objects $< 50\text{-}\mu\text{M}^2$ (~size of three aggregated macrophages). Total screen area counted was also determined for calculation of percent area occupied by MAs.

4.8.3 Analysis of Fish Food

Fish food analysis was conducted for fish species whose food was also analyzed for chemical contaminants. On shipboard, specimens for food analysis were identified, labeled, and preserved in 10 % buffered formalin. In the laboratory, these specimens were re-identified, the stomachs were removed, rinsed in water overnight, and transferred to 70 % ethanol for storage. Food analysis procedures followed those of Darnell (1958) and Rogers (1977). Food volumes were determined by volume displacement. Stomach contents were then transferred to a petri dish containing a bottom grid so that the percentage composition of each food group could be visually estimated. Identification of food items was made to the lowest reasonable taxonomic level. Results were reported in terms of pooled data (i.e., all individuals examined from the Near station at a site or Far were pooled).

4.9 Detoxification

CYP1A-catalyzed enzyme assays (ethoxyresorufin o-deethylase, EROD and aryl hydrocarbon hydroxylase AHH) were optimized with respect to pH, temperature, protein content, substrate concentration, and length of time for linearity for fish. Microsomal preparations were made from all samples as noted in Section 4.9.1. Microsomal protein content was analyzed by the method of Bradford (1976). After removal from liquid nitrogen, samples were kept on ice during all processing steps. The samples were homogenized using a Polytron in an appropriate buffer.

4.9.1 Crustaceans

The green gland, or hepatopancreas, was homogenized in a buffer containing 0.1 M potassium phosphate, pH 7.4, 0.1-M KCl, 1-mM EDTA, 0.1-mM phenanthroline, 1.0 mM dithiothreitol and 1.0 mg/mL trypsin inhibitor. The samples were then centrifuged at 600 X g for 20 min, 10,000 X g for 20 min and finally 100,000 X g for 60 min. The microsomal pellets were resuspended in a buffer containing 0.1-mM potassium phosphate, pH

7.4, 1.0 mM EDTA, 1.0-mM dithiothreitol, 0.1 mM phenanthroline, 1.0 mg/mL trypsin inhibitor and 15 % glycerol. Microsomes were immediately frozen in liquid nitrogen until enzyme assays were conducted.

4.9.2 Annelids

Whole annelids were homogenized in a buffer containing 50-mM Tris at pH 7.5, 0.15-M KCl, 0.25-M sucrose. Following homogenization, samples were centrifuged at 700 X g for 10 min.; 8000 X g for 10 min.; and 100,000 X g for 60-min. Microsomal pellets were resuspended in a buffer containing 50-mM Tris at pH 7.5, and 1-mM EDTA in 20 % glycerol and immediately frozen in liquid nitrogen until analysis.

4.9.3 Molluscs

The hepatopancreas was homogenized in a buffer containing 20-mM Tris at pH=7.6, 0.5-M sucrose, 0.15-M KCl, and 1-mM EDTA. Samples were centrifuged at 500 X g for 1 h; 10,000 X g for 45 min.; and 100,000 X g for 90-min. The microsomal pellets were resuspended in a buffer containing 20 mM Tris at pH=7.6, 1-mM EDTA, and 20 % glycerol. Samples were immediately frozen and stored in liquid nitrogen until analyses.

4.9.4 Fish

Livers were homogenized in a buffer containing a 0.1-M Tris at pH=7.4 containing 0.25-M sucrose and centrifuged at 600 X g for 10 min.; 5000 X g, for 10 min.; 13,000 X g for 10 min.; and 100,000 X g for 60 min. The microsomal pellet was resuspended in a 50-mM Tris at pH=7.5 containing 1-mM EDTA in 20 % glycerol. Samples were immediately frozen in liquid nitrogen until enzyme assays were conducted.

4.9.5 Ethoxyresorufin O-deethylase (EROD) Assay for Fish

EROD activity was measured in fish hepatic samples fluorometrically as described by Pohl and Fouts (1980) with modifications. The assays were conducted in 1.15-mL incubation mixtures consisting of 0.1-M HEPES at pH=8.0, 0.1-mg NADPH, 0.1-mg NADH, 0.7-mg BSA, 0.7-mg of MgSO₄, and 50- μ L of microsomes (200 to 250- μ g microsomal protein). The samples were preincubated for 2-min. at 30 °C. The reactions were initiated by the

addition of 50- μ L of 100-mM ethoxyresorufin. The samples were allowed to incubate for 10 or 15-min. and stopped with the addition of 2.5-mL of methanol. The samples were allowed to sit in the incubator for 5-min., after which they were centrifuged for 15-min to pellet the flocculated protein. Samples were read on a spectrofluorometer at 550-nm excitation and 585-nm emission wavelength settings.

4.9.6 Aryl Hydrocarbon Hydroxylase (AHH) Assay for Fish and Invertebrates

AHH activity was assayed in both fish and invertebrates as described by Nebert and Gelboin (1968) with modifications. For fish the assays were conducted in 1.0 mL of reaction mixture containing 0.1-M HEPES at pH=8.0, 0.4-mM NADPH, and 500- μ g of microsomal protein. The samples were preincubated at 30 °C. The reaction was initiated with the addition of 80- μ M benzo[a]pyrene (BaP) in 40- μ L of methanol. The samples were incubated for 10 or 15 min and stopped with the addition of 1-mL cold acetone, after which 3.25 mL of hexane was added. The samples were shaken and then two (2) mL of the organic layer was withdrawn and extracted with five (5) mL of NaOH. The samples were shaken again and a NaOH aliquot was read on a spectrofluorometer at 396 excitation and 522 emission wavelength settings. The spectrofluorometer was calibrated using an authentic 3-hydroxy BaP standard. This assay was slightly modified for the invertebrate assays. The reaction mixture consisted of 50 mM Tris at pH=7.6, 0.1-mM NADPH and 5000- μ g protein. The reaction was initiated by the addition of 60- μ M BaP in methanol. The samples were incubated for 15 min at 30 °C and stopped with the addition of 1-mL of cold acetone. The extraction procedure and instrument analysis were as described for fish.

4.9.7 Rat Hepatoma H-4IIE Assay

Invertebrate tissues were extracted using a Tissumizer with 50-g of NaSO₄ and 100-mL of CH₂Cl₂ in 200-mL centrifuge tubes and described in the contaminant section. The extraction was repeated two more times with 100 mL of CH₂Cl₂. The extracts were combined and concentrated. The concentrates were purified using silica gel/alumina columns and HPLC to remove matrix interferences. The purified extracts were then evaporated to near dryness and redissolved in a known volume of DMSO.

Rat hepatoma H-4IIE cells were grown as a continuous cell line in α -minimum essential media supplemented with 2.2-g/L sodium bicarbonate, 10 % fetal bovine serum, and 10-mL/L antibiotic/antimycotic solution (Sigma Chemical Co.). Stock culture cells were grown in 150-cm² plates at 37 °C in a humidified air/carbon dioxide (95 %/5 %) atmosphere. After confluency, cells from one plate were trypsinized and seeded in six 6-well plates of two (2) mL medium per well. After 24 h, cells were dosed with the 5-mL test extracts so that the final concentration of DMSO was 0.25 %. Each sample was dosed in triplicate wells. For maximum induction measurements, cells were treated with 1-nM 2,3,7,8-TCDD. After 24 h incubation, media was removed from the cells (approximately 10⁶ cells/well). Cultures were washed with 2-mL Hanks' solution (Hanks' balanced salts, 0.35-g/L sodium bicarbonate at pH=7.4). Cells were harvested by scraping in 4-mL of Tris and sucrose solution (Tris base 6.05 g/L, sucrose 59.45 g/L, pH 8.0). The cellular pellet was isolated after centrifuging for 5 min at 1000 rpm at 4 °C. Cells were resuspended in 200- μ L Tris and sucrose solution of which 50- μ L was used for protein determination and 50- μ L for EROD analysis.

4.9.8 mRNA Method

4.9.8.1 Isolation of RNA

Total RNA was isolated from homogenized liver samples in one (1)-mL of solution D (4-M guanidinium thiocyanate, 100-mM NaOAc, 0.5 % sarcosyl at pH=5.5 and 0.1-M 2-mercaptoethanol) by the method of Chomczynski and Sacchi (1987) with modifications. RNA was extracted by adding 50 μ L of 2 M sodium acetate to 125 to 500- μ L of sample to which 500- μ L of water-saturated phenol, 200- μ L water, and 200- μ L of Sevag (24:1 chloroform:isoamyl alcohol) was added. The samples were vortexed and centrifuged for 15 min. at 12,000 X g. This extraction was repeated three times. The final aqueous layer was added to one volume of isopropyl alcohol and precipitated overnight at -20 °C. The resulting precipitate was centrifuged at 12,000 X g for 15 min, supernatant decanted, and the pellet washed with two 70 % washes and one 100 % ethyl alcohol wash. The dried pellet was resuspended in 15 to 50- μ L formamide by heating at 55 °C. The RNA was quantitated by UV absorption at the 260 nm wavelength.

4.9.8.2 Northern Blot

A sample containing 20- μ g RNA in 2 X sample loading buffer (35 % formaldehyde, 10 % 10 X SPC, 25 % TE, and 30 % 6 X tracking dye; the TE solution was 10-mM TRIS and 1 mM EDTA at pH=8 and the dye was 0.25 %-xylene cyanol, 0.25 %-bromophenol blue, 25 %-ficoll, and 0.1-M EDTA) was loaded onto a 1.2 % agarose gel (0.66-M formaldehyde) and analyzed at 50-75 V for 3-4 h in 1 X SPC buffer (10 X SPC contained 200-mM Na_2HPO_4 and 20-mM EDTA at pH=6.8). The gel was stained with ethidium bromide, washed, and transferred to a HybondTM-N+nucleic acid transfer membrane for a minimum of 12 h. The membrane was washed in 0.1 X SPC, cross-linked by UV exposure and baked for 1 to 2 h at 80 °C. The membrane was prehybridized in Denhardt's (20 % 5 X SSPE, 1 % SDS, 10 % dextran sulfate, and 0.1 % of each polyvinylpyrrolidone, bovine serum albumin, and ficoll; the 20 X SSPE contained 3.0-M NaCl, 0.2-M NaPO_4 , and 0.02 Na_2EDTA) for 12 h at 42 °C. Membranes were hybridized for approximately 24 hr in the prehybridizing solution with the addition of 10^6 cpm/mL ^{32}P randomly labeled freshwater rainbow trout probe for P4501A. The trout CYP1A1 cDNA plasmid (pfP14503) was a gift from Dr. John Lech (Medical College of Wisconsin, Milwaukee). The plasmid was transfected into DH5 α competent cells (amp R) and the plasmids were amplified. A 1.4 kb size cDNA fragment was obtained by excising with Eco RI and PST I. The levels of CYP1A were standardized against β -Tubulin using human fetal brain β -Tubulin plasmid HFBA18 (ATCC). a 1.5 kb cDNA fragment was obtained by excising from transfected Ecoli EL1-Blue with EcoRI. After hybridization, membranes were washed twice at ambient temperature in 2 X SSC for 10 min. Two additional washes were carried out at 50 °C for 45-min each in 2 X SSC and 0.1 % SDS. Membranes were washed twice more for 30 min at room temperature in 0.1 X SSC. The membranes were quantitated on a Betagen Betascope 603 Blot Analyzer imaging system. Finally, the membranes were exposed to X-OMAT imaging film (Kodak) and photographed. Membranes were stripped by washing twice in stripping buffer (0.1 X SSPE and 1 % SDS) at 100 °C.

4.9.9 PAH Metabolites in Bile

Biliary PAH metabolites were analyzed by HPLC/fluorescence detection, which has been described in detail elsewhere (Krahn et al. 1984; 1986a,b). Bile was injected into an HPLC. Metabolites were resolved using a C-18 reverse-phase column and fluorometrically quantified. Aromatic compounds fluorescing at naphthalene (290/335), phenanthrene (260/380), and BaP (380/430) excitation/emission wavelengths were analyzed. Metabolites eluting from the column within specific retention times were summed to yield total fluorescence based on equivalents of known amounts of naphthalene, phenanthrene, and benzo[a]pyrene standards.

4.9.10 Dosing Experiments

Fish used in dosing experiments were captured by trawling. Fish were maintained in flow-through tanks on the deck of the ship. Fish were acclimated for 2 days prior to dosing with ^3H]TCDD.

4.9.11 Ah Receptor Binding

^3H]TCDD synthesized in this laboratory to 95 % purity (30 Ci/nmol) in corn oil was administered to *Lagodon rhomboides* and *Synodus foetens* in a single i.p. injection (1 $\mu\text{L/g}$ fish to equal 2.5 $\mu\text{g/kg}$). Nuclear extract baselines were obtained by cotreatment with 100-fold excess unlabeled TCDD. Four fish of each species were used for both completed and uncompleted trials. Fish were maintained in tanks for 4 h prior to sacrifice. Livers were isolated, resuspended in HEGD (25 mM HEPES, 1.5 mM EDTA, 1.0 mM dithiothreitol, 10 % glycerol (v/v), pH 7.6 buffer), homogenized using a teflon pestle/drill apparatus and centrifuged at 4000 x g for 10 min at 4 °C. The resulting nuclear pellet was washed twice with 10 mL HEGD and was resuspended in HEGD buffer, containing 0.5 M potassium chloride and incubated at 4 °C for 1 hr. Samples were frozen in liquid nitrogen and returned to the laboratory for further processing. Upon receipt in the laboratory, samples were thawed and after a 30 min, 105,000 x g spin at 4 °C, unbound and loosely bound ^3H]TCDD was removed by incubating with

dextran coated charcoal (0.5 mL of 0.01:0.001 % charcoal:dextran per mL of nuclear extract) for 10 min at 4 °C. Protein concentrations were determined by the method of Bradford (1976).

Aliquots (400 µg of protein) of sample were layered onto linear sucrose density gradients (5 to 25 %) prepared in HEDG buffer containing 0.5 M potassium chloride and centrifuged at 4 °C for 2.5 h at 404,000 x g. After centrifugation, 30 fractions were collected from each gradient, 0.5 mL of tissue solubilizer (DuPont) was added and samples were then incubated at 50 °C for 4 h before counting the radioactivity in each fraction. [¹⁴C]labeled bovine serum albumin (4.4 S) and catalase (11.3 S) were used as external standards.

4.10 Pore Water Toxicity Testing

As soon as possible after the sediment samples arrived in the lab, pore waters were pressure extracted, centrifuged to remove fines, particulates, and frozen. Recent studies have demonstrated that if the suspended particulate material is removed prior to freezing, there is no difference in toxicity between fresh and frozen/thawed samples (Carr 1993; Carr and Chapman 1995). A separate aliquot of each pore water sample was frozen for later chemical analysis. Pore water was stored frozen until two days before the start of the toxicity test, at which time samples were removed from the freezer and placed in a refrigerator to thaw slowly overnight. Samples that remained partially frozen in the morning were allowed to thaw at room temperature or in a tepid water bath. Water quality measurements (dissolved oxygen, pH, temperature, hydrogen sulfide, and ammonia) were then made, and the salinity of the samples adjusted to 35 ±1 ‰, if necessary. Hypersaline brine (~100 ‰) and bottled purified water (Baker water for HPLC) were used to adjust sample salinity. If the dissolved oxygen concentration was below 80 % saturation, samples were gently aerated until this concentration was achieved. Samples were then stored refrigerated overnight and returned to 20 °C before the start of the tests.

4.10.1 Sea Urchin Tests

The toxicity of the sediment pore waters was determined using two different tests with the sea urchin *Arbacia punctulata*; the fertilization test and the embryological development test (Oshida et al. 1981; Carr and Chapman 1992). The fertilization test consisted of exposing a known quantity of sea urchin sperm in a 5-mL pore water sample in a scintillation vial for 30 min., followed by the addition of a predetermined number of eggs and an additional 30 min. incubation. After the incubation, the test was terminated with the addition of 10 % buffered formalin and the percentage of fertilized eggs was determined. Five replicates of each treatment were performed. Treatments that produced statistically significant reduced fertilization, compared to a control, are considered toxic. The embryological development test is similar, except that the eggs were added first, followed immediately by the sperm. The embryos were allowed to develop for 48 hours before the test was fixed with formalin. Treatments that significantly reduced development to the pluteus stage, compared to a control, were considered toxic. Both tests were performed on samples from the first cruise. Only the embryological development test was performed on samples from the second cruise. A reference pore water collected in Redfish Bay near Port Aransas, Texas, was included with each toxicity test. This site is far removed from any known sources of contamination and has been used previously as a reference site (Carr 1993; Carr and Chapman 1992; U.S. FWS 1992).

In addition, a dilution series test with sodium dodecyl sulphate (SDS) was also conducted with each test as a positive control and the EC_{50} determined in order to maintain a record of gamete viability and test acceptability. Filtered (0.45- μ M) seawater and seawater reconstituted from brine and bottled water were also included as controls with each test. These methods have been used in several sediment quality assessment surveys (i.e., Tampa Bay, Florida 1991 and 1992; Galveston Bay, Texas, 1991; Pensacola and St. Andrew Bay, Florida, 1993).

Dunnett's one tailed t-test, $\alpha=0.01$, was used to determine significant difference in fertilization (fertilization test) and development to the pluteus stage (embryological development test) between samples and the reference pore water. The Spearman-Kärber method, with Abbott's correction,

(Hamilton et al. 1977) was used to determine the EC₅₀ in the SDS dilution series.

4.10.2 Tests with Meiobenthic Species

Longipedia americana adults were collected from the Port Aransas ship channel and maintained in the laboratory until females became gravid. No earlier than 48 hours before a test, gravid females were isolated in a separate culture container until the eggs hatched. In this manner, it was ensured that all nauplii were less than 48 hours old at the start of a test. The nauplii, which are phototactic, were concentrated in the culture dish by means of a point source of light. A pipette was used to transfer the nauplii to a small counting dish. Five nauplii were transferred from the counting dish into each test chamber. Test chambers were stender dishes containing 10 mL of pore water. Nauplii were fed a mixture of three types of algae (*Dunaliella*, *Thalassiosira*, and *Isochrysis*, approximately 20,000, 3000, and 120,000 cells per replicate, respectively). Test chambers were incubated at 20 °C for 96 h, then the test was terminated and the number of surviving nauplii was determined for each chamber. At the end of the test, water from all replicates was pooled and dissolved oxygen and salinity of the pooled sample were measured.

Three replicates of each treatment were performed. A larger number of replicates or animals per replicate was not possible because of the difficulty in obtaining a sufficient number of test animals. On the first test occasion, five pore water samples from the High Island A-389 platform were tested. On the second occasion, nine samples were tested. The number of samples tested was dictated by the number of nauplii available.

Dinophilus gyrociliatus used in the test were obtained from laboratory cultures that have been maintained by the National Biological Survey at the Marine Science Institute in Port Aransas, Texas for over two years. The test was performed using the methods of Carr et al. (1989). The test was begun with four newly hatched juvenile female polychaetes per replicate. Five replicates per treatment were performed. The endpoint measured was the number of eggs produced per female after 7 days of exposure at 20 °C. The test was performed in conjunction with the first copepod test. All samples (15) from High Island A-389 transects A, C, and E were tested.

5.0 DESCRIPTIVE RESULTS

The following section provides a detailed and descriptive review of the data produced during Phase I of GOOMEX. As appropriate, data are presented in tabular and graphic formats. Graphical presentations include crossplots of variables, histograms, ternary diagrams, and plan-view contour plots. The data are described in detail to set the foundation for later statistical analysis and integrated synthesis of project results in Sections 6.0 and 7.0.

5.1 Physicochemical Characteristics of the Study Sites

The physicochemical variables documented at each site are summarized in Tables 5.1 to 5.12. Data derived from Niskin bottle sampling were integrated into the dataset by matching laboratory measured salinities with CTD-derived salinities to determine a more accurate depth of sampling than length of "wire-out." Salinity values are reported using the practical salinity scale which is a unitless variable. The physicochemical work element included the collection and analysis of 350 CTD/transmissometry profiles, 1171 salinity samples, 1163 nutrient samples, and 1173 oxygen samples.

MAI-686 was the shallowest of the three sites studied (water depth = 29 m). Cruises 1 and 3 and Cruises 2 and 4 exhibited well-mixed and stratified water columns, respectively (Figure 5.1). Salinities ranged from 31.9 to 34.9 and 28.3 to 35.5 for Cruises 1 and 3 and Cruises 2 and 4, respectively. Water temperatures were lower during Cruises 1 and 3: (Cruise 1: 15.8 °C to 17.8 °C; Cruise 3: 15.0 °C to 16.3 °C) than Cruises 2 and 4 (Cruise 2: 22.4 °C to 26.9 °C; Cruise 4: 21.8 °C to 28.2 °C). Bottom water temperatures and salinities were most variable during Cruises 2 and 4. This variability was due to a thin layer of low temperature, high salinity bottom water. An extended period of calm had produced a well stratified water column during Cruise 4. While hypoxic conditions clearly existed in bottom waters during Cruise 4, the areal extent of hypoxia could not be completely discerned as the pycnocline/oxycline deteriorated with time, thus preventing a systematic sampling of the bottom water layer. Patterns in the data can result from bottle placement relative to the bottom water layer.

Table 5.1. Summary of CTD and discrete bottle data measured at MAI-686 during Cruise 1.

Variable*	N	Mean	StdDev	Minimum	Maximum
Temp (°C)	563	16.92	0.48	15.78	17.82
Salinity	563	33.61	0.81	31.93	34.90
Sigma-t	563	24.47	0.52	23.37	25.24
XMISS (%)	563	69.87	11.40	7.00	88.00
SOUNDV (m/s)	563	1511.2	2.46	1505.8	1515.5
PO ₄ (µM)	74	0.07	0.04	0.00	0.21
NO ₃ (µM)	74	0.42	0.43	0.00	2.18
NO ₂ (µM)	74	0.09	0.04	0.03	0.20
SIO ₃ (µM)	74	1.98	0.65	1.21	4.31
O ₂ (mL/L)	74	5.54	0.09	5.37	5.82
Salinity (from Niskin bottle)	74	33.49	0.89	31.56	34.78

*Temp = Temperature, Sigma-t = (Density-1) X 1000; XMISS = Transmissivity; SOUNDV = Sound Velocity

Table 5.2. Summary of CTD and discrete bottle data measured at MAI-686 during Cruise 2.

Variable*	N	Mean	StdDev	Minimum	Maximum
Temp (°C)	652	25.62	1.31	22.44	26.89
Salinity	652	30.97	2.20	28.33	35.50
Sigma-t	654	20.11	1.99	17.93	24.48
XMISS (%)	654	71.59	21.92	1.80	88.40
SOUNDV (m/s)	654	1531.7	1.73	1528.5	1535.0
PO ₄ (µM)	74	0.09	0.13	0.01	0.63
NO ₃ (µM)	74	0.65	1.32	0.00	6.03
NO ₂ (µM)	74	0.15	0.20	0.00	0.89
SIO ₃ (µM)	74	5.70	3.93	2.99	21.86
O ₂ (mL/L)	74	4.69	0.60	2.47	5.27
Salinity (from Niskin bottle)	73	30.61	1.86	28.33	34.98

*Temp = Temperature, Sigma-t = (Density-1) X 1000; XMISS = Transmissivity; SOUNDV = Sound Velocity

Table 5.3. Summary of CTD and discrete bottle data measured at MAI-686 during Cruise 3.

Variable*	N	Mean	StdDev	Minimum	Maximum
Temp (°C)	668	15.58	0.19	15.02	16.29
Salinity	668	34.12	0.37	30.39	34.75
Sigma-t	668	25.16	0.29	22.30	25.58
XMISS (%)	668	54.95	13.18	1.09	73.66
SOUNDV (m/s)	668	1507.7	0.77	1503.1	1509.5
PO ₄ (µM)	73	0.16	0.04	0.01	0.29
NO ₃ (µM)	73	0.32	0.10	0.05	0.55
NO ₂ (µM)	73	0.49	0.17	0.03	1.07
SIO ₃ (µM)	73	3.66	0.98	2.02	8.16
O ₂ (mL/L)	70	5.89	0.20	5.56	6.43
Salinity (from Niskin bottle)	72	34.03	0.53	31.56	34.67

*Temp = Temperature, Sigma-t = (Density-1) X 1000; XMISS = Transmissivity; SOUNDV = Sound Velocity

Table 5.4. Summary of CTD and discrete bottle data measured at MAI-686 during Cruise 4.

Variable*	N	Mean	StdDev	Minimum	Maximum
Temp (°C)	659	25.96	2.01	21.77	28.38
Salinity	659	31.03	2.27	27.67	35.01
Sigma-t	659	20.05	2.31	16.91	24.26
XMISS (%)	659	78.70	13.89	18.73	88.02
SOUNDV (m/s)	659	1532.6	2.50	1526.6	1535.9
PO ₄ (µM)	75	0.19	0.21	0.01	0.88
NO ₃ (µM)	75	1.28	2.41	0.01	10.19
NO ₂ (µM)	75	0.63	1.00	0.00	3.81
SIO ₃ (µM)	75	7.66	12.76	0.47	51.23
O ₂ (mL/L)	75	4.12	1.28	0.45	5.34
Salinity (from Niskin bottle)	75	30.61	2.18	28.32	34.64

*Temp = Temperature, Sigma-t = (Density-1) X 1000; XMISS = Transmissivity; SOUNDV = Sound Velocity

Table 5.5. Summary of CTD and discrete bottle data measured at MU-A85 during Cruise 1.

Variable*	N	Mean	Std	Minimum	Maximum
Temp (°C)	1801	20.57	0.27	19.36	21.07
Salinity	1801	35.85	0.05	35.75	36.00
Sigma-t	1801	25.26	0.10	25.10	25.62
XMISS (%)	1801	86.13	2.68	47.00	89.00
SOUNDV (m/s)	1801	1524.6	0.49	1521.8	1525.8
PO ₄ (µM)	74	0.04	0.03	0.00	0.11
NO ₃ (µM)	74	0.23	0.32	0.00	1.91
NO ₂ (µM)	74	0.08	0.08	0.00	0.25
SIO ₃ (µM)	74	2.49	0.62	1.35	4.80
O ₂ (mL/L)	69	5.07	0.07	4.76	5.20
Salinity (from Niskin bottle)	74	35.87	0.05	35.79	35.96

*Temp = Temperature, Sigma-t = (Density-1) X 1000; XMISS = Transmissivity; SOUNDV = Sound Velocity

Table 5.6. Summary of CTD and discrete bottle data measured at MU-A85 during Cruise 2.

Variable*	N	Mean	StdDev	Minimum	Maximum
Temp (°C)	1849	24.25	1.90	20.44	27.13
Salinity	1849	34.73	2.06	30.22	36.54
Sigma-t	1849	23.36	2.04	19.16	25.67
XMISS (%)	1849	77.37	3.82	55.77	82.55
SOUNDV (m/s)	1849	1532.8	2.90	1525.2	1537.3
PO ₄ (µM)	74	0.11	0.11	0.00	0.55
NO ₃ (µM)	74	1.11	1.46	0.02	3.93
NO ₂ (µM)	74	0.19	0.25	0.00	1.14
SIO ₃ (µM)	74	3.88	2.58	2.06	9.96
O ₂ (mL/L)	74	4.51	0.44	3.82	5.26
Salinity (from Niskin bottle)	74	34.17	2.42	30.35	36.20

*Temp = Temperature, Sigma-t = (Density-1) X 1000; XMISS = Transmissivity; SOUNDV = Sound Velocity

Table 5.7. Summary of CTD and discrete bottle data measured at MU-A85 during Cruise 3.

Variable*	N	Mean	StdDev	Minimum	Maximum
Temp (°C)	1921	17.41	0.80	15.87	18.81
Salinity	1921	35.44	0.37	34.23	35.91
Sigma-t	1921	25.75	0.17	24.90	26.06
XMISS (%)	1921	81.51	4.86	27.85	87.56
SOUNDV (m/s)	1921	1515.2	2.81	1508.7	1519.5
PO ₄ (µM)	74	0.12	0.05	0.05	0.27
NO ₃ (µM)	74	0.16	0.11	0.01	0.48
NO ₂ (µM)	74	0.43	0.18	0.12	0.73
SIO ₃ (µM)	73	2.11	0.40	1.35	3.92
O ₂ (mL/L)	73	5.37	0.17	5.10	5.79
Salinity (from Niskin bottle)	74	35.45	0.38	34.57	35.91

*Temp = Temperature, Sigma-t = (Density-1) X 1000; XMISS = Transmissivity; SOUNDV = Sound Velocity

Table 5.8. Summary of CTD and discrete bottle data measured at MU-A85 during Cruise 4.

Variable*	N	Mean	StdDev	Minimum	Maximum
Temp (°C)	1876	22.09	3.07	19.14	28.84
Salinity	1876	34.57	2.71	27.75	36.40
Sigma-t	1876	23.84	2.93	16.69	25.98
XMISS (%)	1876	83.46	6.23	19.60	91.22
SOUNDV (m/s)	1876	1527.0	4.59	1514.5	1536.8
PO ₄ (µM)	74	0.13	0.13	0.00	0.56
NO ₃ (µM)	74	1.83	2.07	0.02	6.40
NO ₂ (µM)	74	0.13	0.17	0.00	0.52
SIO ₃ (µM)	74	1.85	1.65	0.15	5.77
O ₂ (mL/L)	74	4.48	0.45	3.55	5.56
Salinity (from Niskin bottle)	74	33.46	3.63	28.04	36.25

*Temp = Temperature, Sigma-t = (Density-1) X 1000; XMISS = Transmissivity; SOUNDV = Sound Velocity

Table 5.9. Summary of CTD and discrete bottle data measured at HI-A389 during Cruise 1.

Variable*	N	Mean	StdDev	Minimum	Maximum
Temp (°C)	2921	20.59	1.01	15.36	21.35
Salinity	2921	36.08	0.10	35.10	36.42
Sigma-t	2921	25.43	0.32	24.88	26.63
XMISS (%)	2921	77.30	7.55	3.00	89.00
SOUNDV (m/s)	2921	1525.3	2.43	1510.5	1527.5
PO ₄ (µM)	74	0.23	0.29	0.00	0.88
NO ₃ (µM)	74	3.84	5.36	0.01	14.24
NO ₂ (µM)	74	0.03	0.02	0.00	0.06
SIO ₃ (µM)	74	2.97	1.53	1.06	6.03
O ₂ (mL/L)	74	4.37	1.01	2.70	5.56
Salinity (from Niskin bottle)	74	36.15	0.14	36.02	36.47

*Temp = Temperature, Sigma-t = (Density-1) X 1000; XMISS = Transmissivity; SOUNDV = Sound Velocity

Table 5.10. Summary of CTD and discrete bottle data measured at HI-A389 during Cruise 2.

Variable*	N	Mean	StdDev	Minimum	Maximum
Temp (°C)	3158	21.08	3.14	15.84	27.11
Salinity	3158	35.61	0.99	33.04	36.41
Sigma-t	3158	24.90	1.59	21.29	26.62
XMISS (%)	3158	77.13	4.07	51.70	83.30
SOUNDV (m/s)	3158	1525.8	6.73	1513.1	1537.5
PO ₄ (µM)	75	0.29	0.38	0.00	0.93
NO ₃ (µM)	75	4.50	6.23	0.01	14.12
NO ₂ (µM)	75	0.02	0.02	0.00	0.07
SIO ₃ (µM)	75	3.50	2.46	1.22	9.64
O ₂ (mL/L)	75	4.27	0.96	2.87	5.15
Salinity (from Niskin bottle)	75	35.16	1.25	33.16	36.32

*Temp = Temperature, Sigma-t = (Density-1) x 1000; XMISS = Transmissivity; SOUNDV = Sound Velocity

Table 5.11. Summary of CTD and discrete bottle data measured at HI-A389 during Cruise 3.

Variable*	N	Mean	StdDev	Minimum	Maximum
Temp (°C)	3119	19.39	1.03	15.61	21.01
Salinity	3119	36.14	0.07	35.39	36.50
Sigma-t	3119	25.79	0.26	25.27	26.65
XMISS (%)	3119	85.85	2.98	60.65	89.19
SOUNDV (m/s)	3119	1522.1	2.42	1512.4	1525.7
PO ₄ (µM)	74	0.27	0.29	0.05	0.92
NO ₃ (µM)	74	4.20	5.53	0.10	16.07
NO ₂ (µM)	74	0.19	0.16	0.00	0.61
SIO ₃ (µM)	74	3.69	1.98	1.84	8.40
O ₂ (mL/L)	74	4.55	0.089	2.82	5.49
Salinity (from Niskin bottle)	74	36.17	0.06	36.10	36.46

*Temp = Temperature, Sigma-t = (Density-1) X 1000; XMISS = Transmissivity; SOUNDV = Sound Velocity

Table 5.12. Summary of CTD and discrete bottle data measured at HI-A389 during Cruise 4.

Variable*	N	Mean	StdDev	Minimum	Maximum
Temp (°C)	3166	21.24	3.18	15.52	28.77
Salinity	3166	35.71	1.27	30.78	36.52
Sigma-t	3166	24.94	1.81	19.00	26.75
XMISS (%)	2295	87.35	4.19	12.08	93.01
SOUNDV (m/s)	3166	1526.4	6.48	1512.2	1539.8
PO ₄ (µM)	72	0.26	0.30	0.00	0.85
NO ₃ (µM)	72	3.53	5.29	0.02	14.65
NO ₂ (µM)	72	0.05	0.07	0.00	0.45
SIO ₃ (µM)	72	2.42	2.17	0.29	11.20
O ₂ (mL/L)	72	4.40	0.88	2.95	5.25
Salinity (from Niskin bottle)	72	34.68	2.15	30.86	36.33

*Temp = Temperature, Sigma-t = (Density-1) X 1000; XMISS = Transmissivity; SOUNDV = Sound velocity

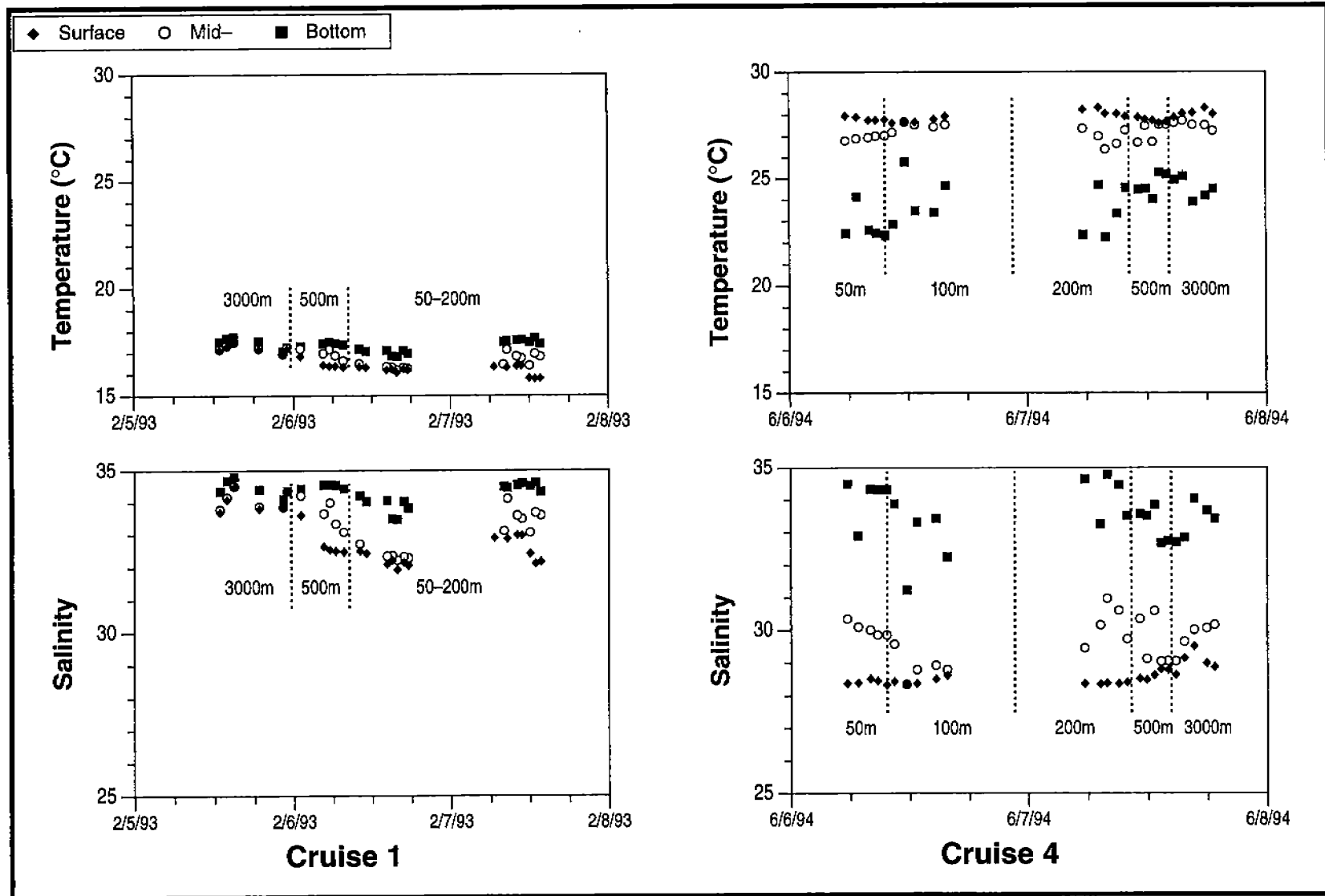

Figure 5.1. Summary of the temperatures (°C) and salinities for surface, mid-, and bottom waters at MAI-686 for Cruises 1 and 4.

However, the patterns observed during Cruises 2 and 4 strongly suggest that near platform hypoxia (Figure 5.2) in bottom waters develops in response to stratified water column conditions (Figure 5.1).

Inorganic nutrients at MAI-686 during Cruises 1 and 3 were elevated in surface waters with low salinity. Conversely, nutrients from Cruises 2 and 4 were elevated in bottom waters with low oxygen concentrations. Silicate concentrations ranged from 1.2 to 8.2 μM during Cruises 1 and 3 and from 0.5 to 51.2 μM during Cruises 2 and 4. Elevated silicate concentrations in surface and mid-waters during Cruises 1 and 3 were associated with low salinity water. The highest silicate concentrations encountered during all samplings were associated with low oxygen bottom waters sampled during Cruises 2 and 4. Nitrate concentrations ranged from 0.0 to 2.2 μM for Cruises 1 and 3 and from 0.0 to 10.2 μM for Cruises 2 and 4. The highest nitrate concentrations were associated with low oxygen bottom waters during the Cruises 2 and 4. Regeneration of nutrients in bottom waters was apparent during Cruises 2 and 4 at MAI-686 (Figure 5.3).

MU-A85 is located in 80 m of water. Physicochemical characteristics at MU-A85 were similar to those at MAI-686 (Figure 5.4). The water column during Cruises 1 and 3 was well mixed or weakly stratified while during Cruises 2 and 4 the water column was strongly stratified. The salinity range (34.2 to 36.0) was smaller for Cruises 1 and 3 as compared to Cruises 2 and 4 (27.8 to 36.5). The dynamic nature of water masses was illustrated by the increased salinities during the latter half of sampling during Cruise 3 (Figure 5.5). During a sampling hiatus, the water mass at MU-A85 changed due to the passage of a front. The effects of vertical mixing on the salinity structure in the upper 40 m of the water column are clearly evident in Figure 5.5. Initially, salinities from surface and mid waters (approximately 39 m at MU-A85) differed by 0.77 while at the end of the first sampling period the difference was reduced to 0.14. During this time, the sea state worsened and the depth of the mixed layer increased (from 22 m to 40 m). The temperature and the temperatures range was greatest during the Cruises 1 and 3. Dissolved oxygen concentrations varied between 4.8 to 5.8 mL/L for all depths for Cruises 1 and 3. Near bottom oxygen concentrations were generally 1 mL/L lower than mid- and surface water during summer samplings (Figure 5.6). As at MAI-686, though not as dramatic, reduced oxygen levels were observed in bottom waters during the

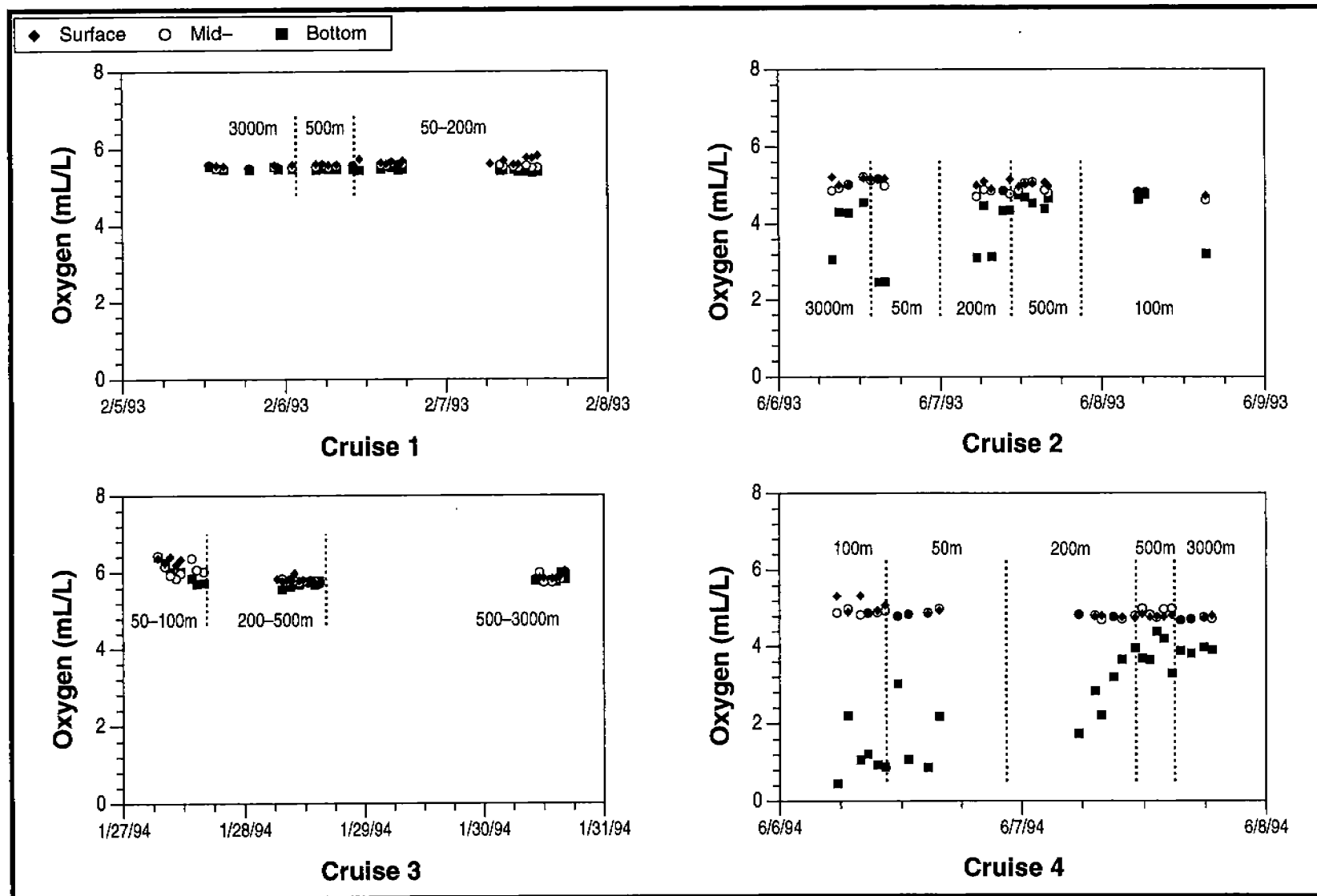

Figure 5.2. Summary of dissolved oxygen concentrations (mL/L) for surface, mid-, and bottom waters at MAI-686 for all cruises.

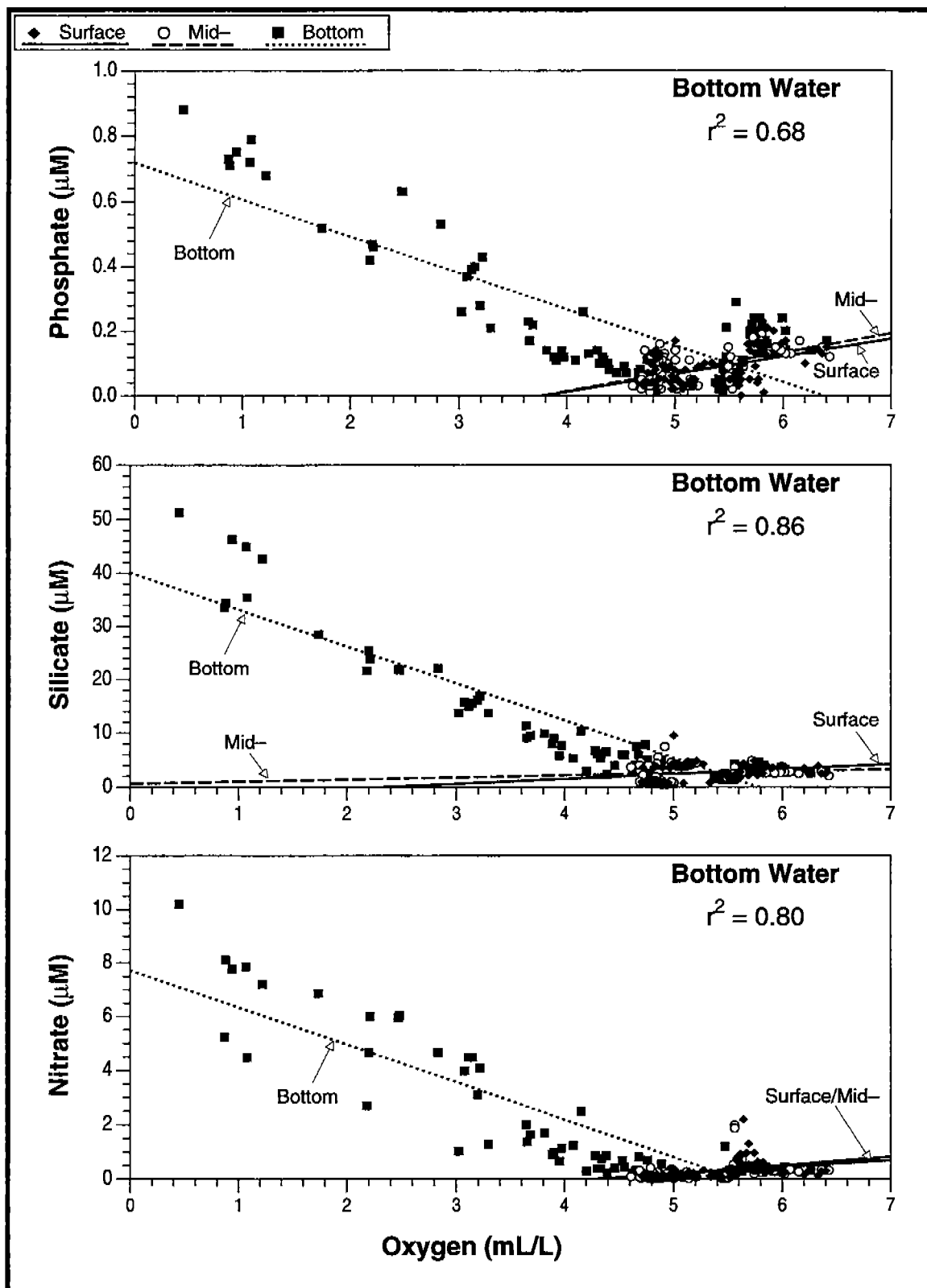

Figure 5.3. Relationship between oxygen and nutrient concentrations at MAI-686 for all cruises.

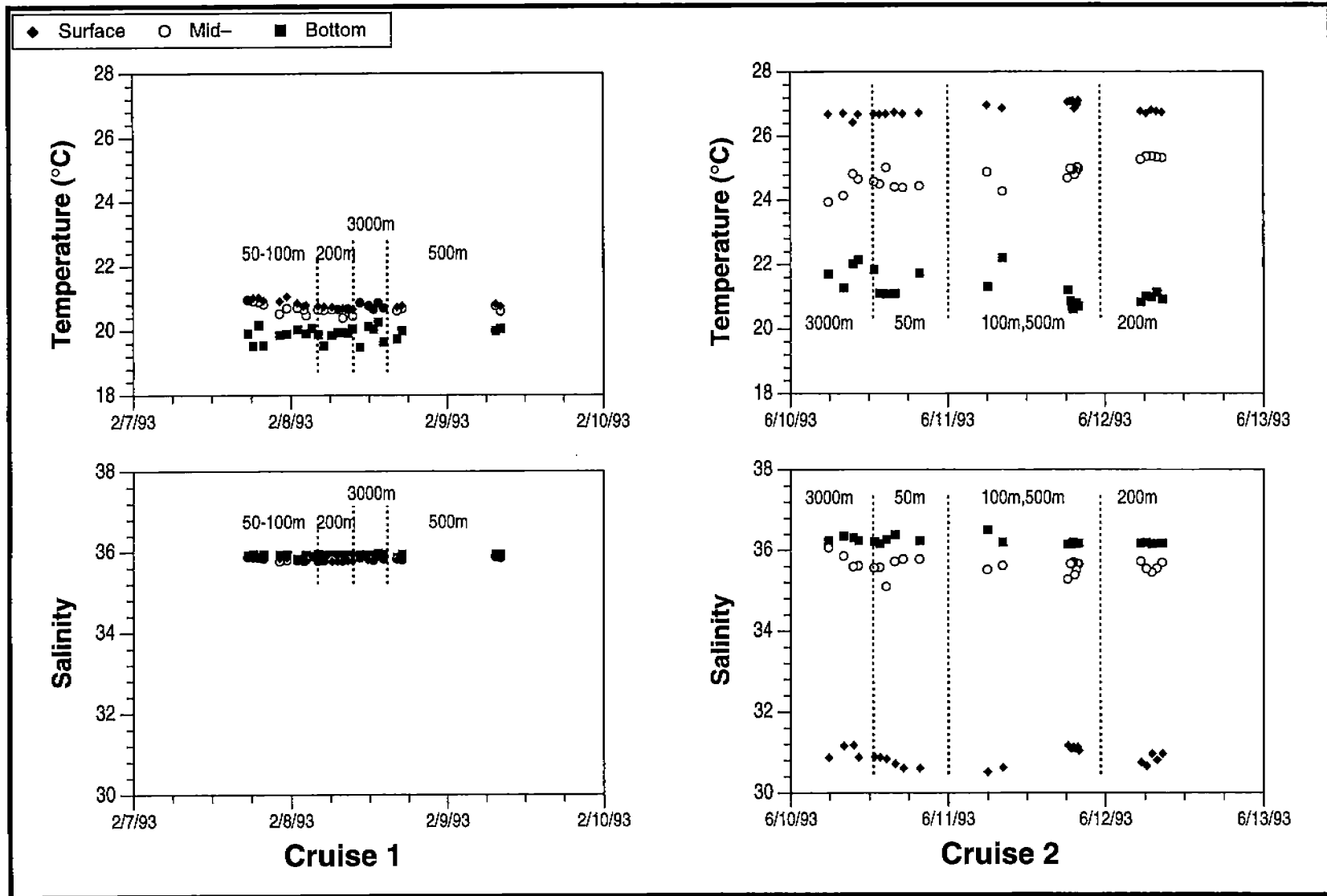

Figure 5.4. Summary of the temperatures (°C) and salinities for surface, mid-, and bottom waters at MU-A85 for Cruises 1 and 2.

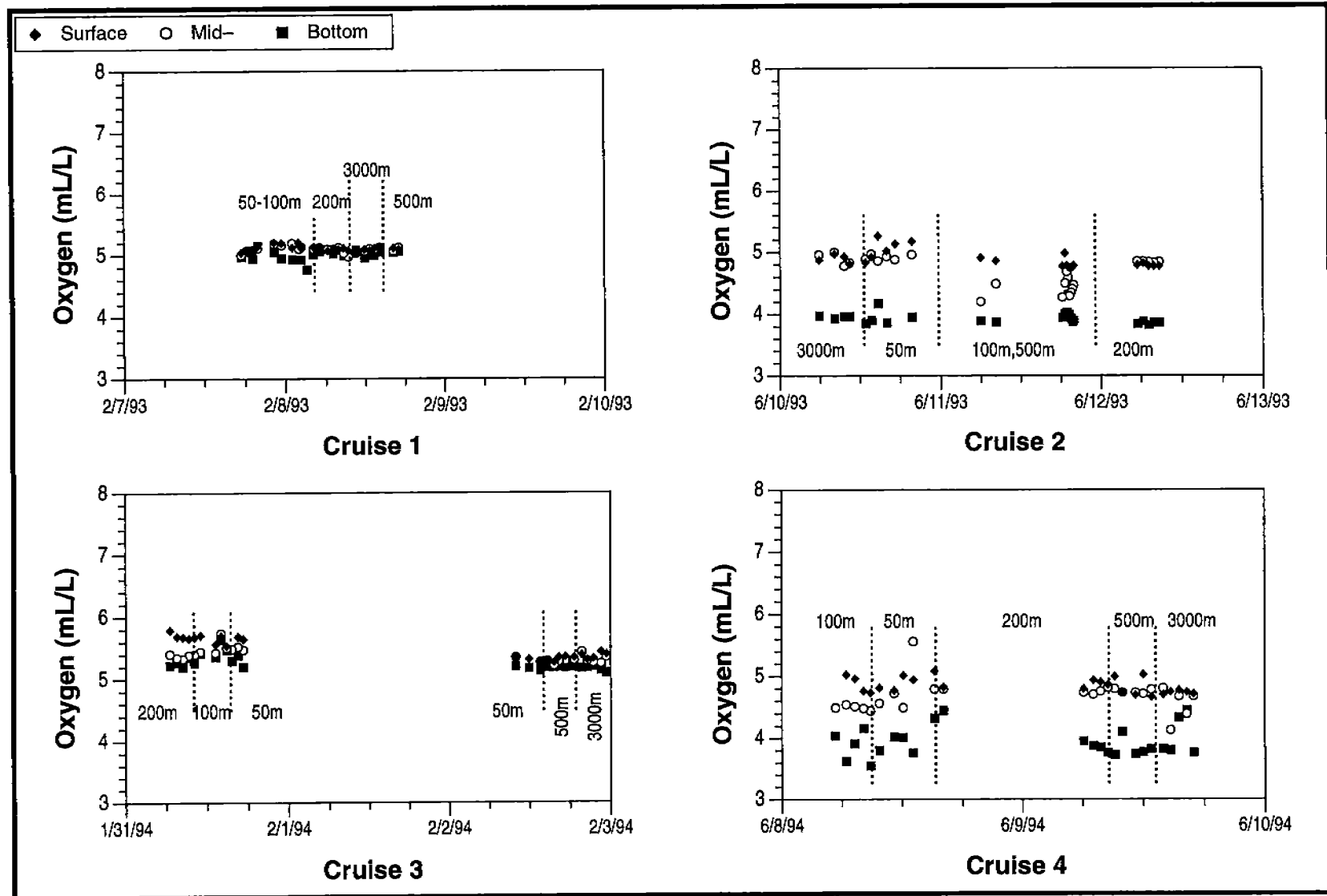

Figure 5.6. Summary of dissolved oxygen concentrations (mL/L) for surface, mid-, and bottom waters at MU-A85 for all cruises.

summer samplings. Nitrate concentrations during Cruises 2 and 4 were much higher in the bottom waters compared to surface and mid-waters. Nitrate concentrations were much lower in bottom waters during the Cruises 1 and 3 as compared to Cruises 2 and 4 (Figure 5.7). Silicate concentrations during Cruise 1 were fairly uniform throughout the water column; while during Cruise 3, the silicate concentrations were about 1- μ M higher in bottom water as compared to surface and mid-waters. During Cruises 2 and 4, silicate concentrations in bottom waters were 1.5 to 3 times higher than in the surface or mid-water. The relationship between dissolved oxygen, bottom water silicate, and phosphate was similar to that observed at MAI-686 (Figure 5.8).

The deepest site sampled was HI-A389 with bottom depths ranging from 110 to 157 m. Physicochemical variables at HI-A389 are summarized in Tables 5.9 to 5.12. During Cruises 1 and 3, the water column was well mixed down to approximately 100 m. During Cruises 2 and 4, the water column was strongly stratified (Figure 5.9). The temperature was lower for near-surface and mid-waters during the winter (20 °C to 21.4 °C, 19.2 °C to 21.4 °C; top, mid-water) as compared to the summer (26.2 °C to 28.8 °C, 19.9 °C to 24.0 °C) while the bottom water was similar for all cruises (15.4 °C to 18.9 °C). For all depths during Cruises 1 and 3, salinities ranged between 36.0 and 36.4. The stations at 5000-m distance on Cruise 3 were influenced by a tongue of high salinity water at a depth of 60 to 100 m. Surface salinities were significantly lower for Cruises 2 and 4 as compared to Cruises 1 and 3, probably due to local precipitation. Bottom salinities were similar for all four cruises. Dissolved oxygen profiles for all cruises were similar; surface and mid-water concentrations were ~5-mL/L and bottom water concentrations were ~3-mL/L (Figure 5.10). Nitrate, silicate, and phosphate concentrations were generally low in surface and mid-water samples and enriched in bottom waters (Figures 5.11 and 5.12).

5.2 Sedimentology

Substantial heterogeneity in sediment texture; as expressed in grain size, mineralogy, and carbon content; was apparent at all of the sites studied. Redox potential, as measured by platinum Eh electrode, was also highly variable. The sedimentologic setting at each site is described in detail in

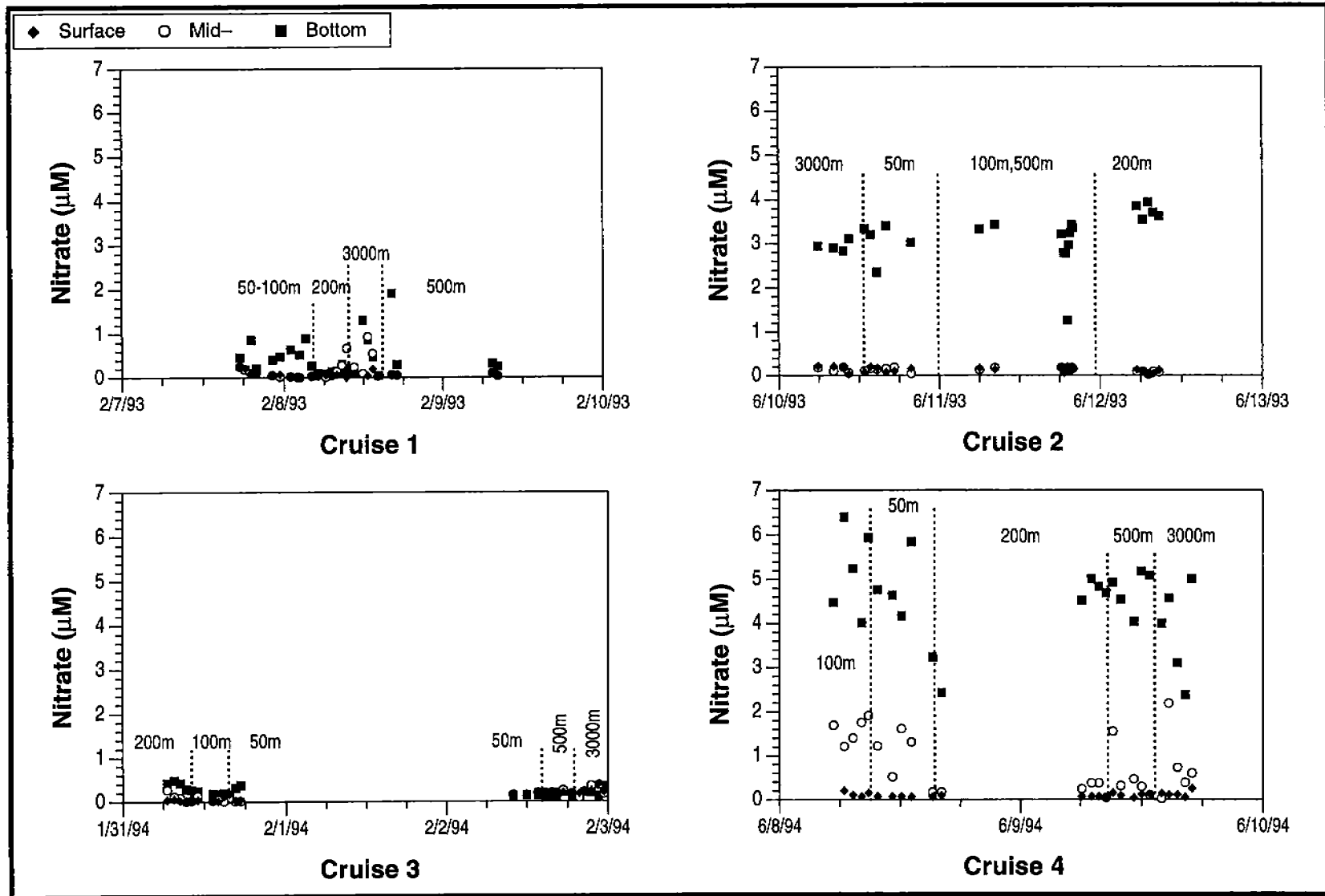

Figure 5.7. Summary of nitrate (μM) concentrations for surface, mid-, and bottom waters at MU-A85 for all cruises.

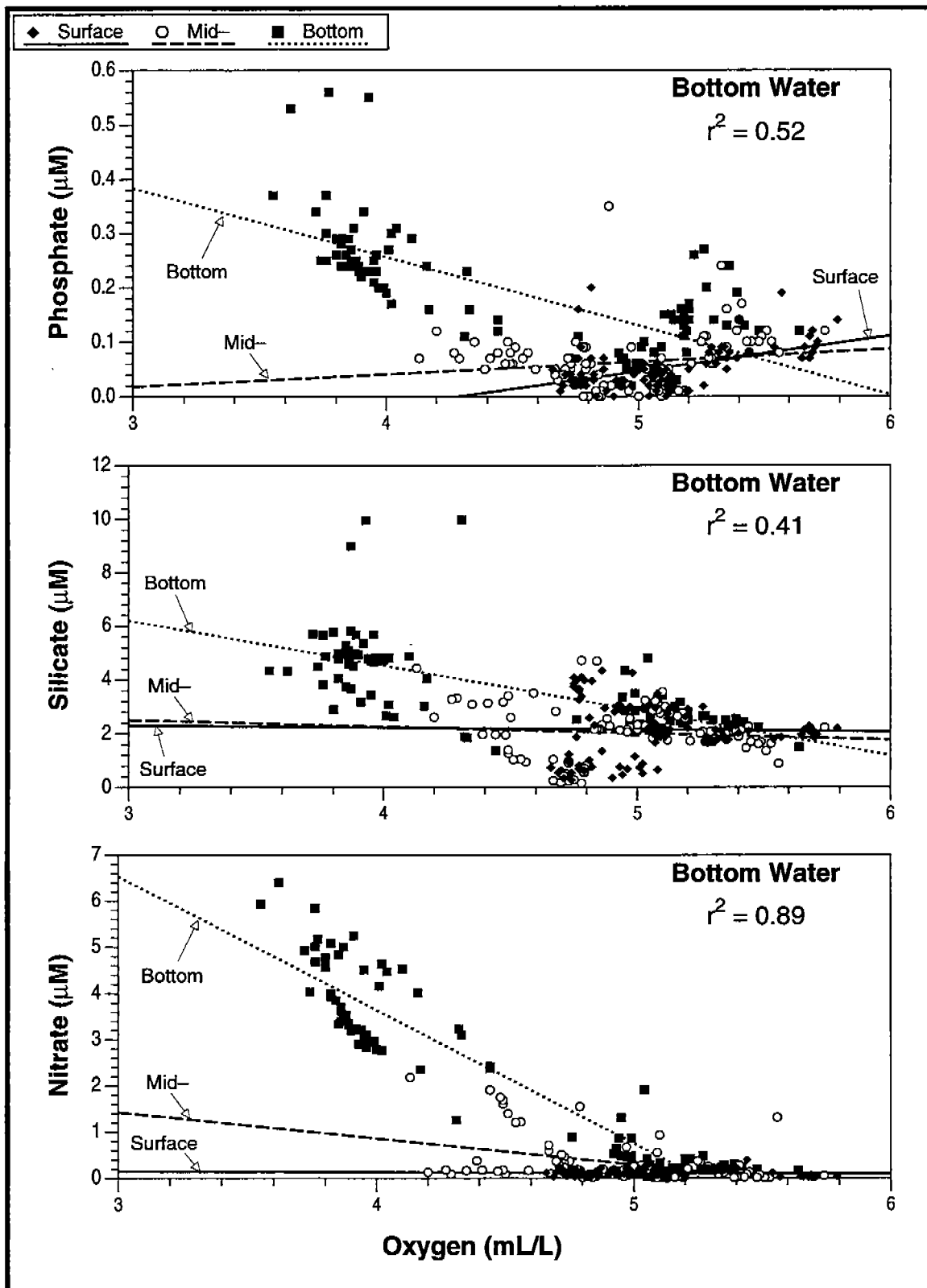

Figure 5.8. Relationship between oxygen and nutrient concentrations at MU-A85 for all cruises.

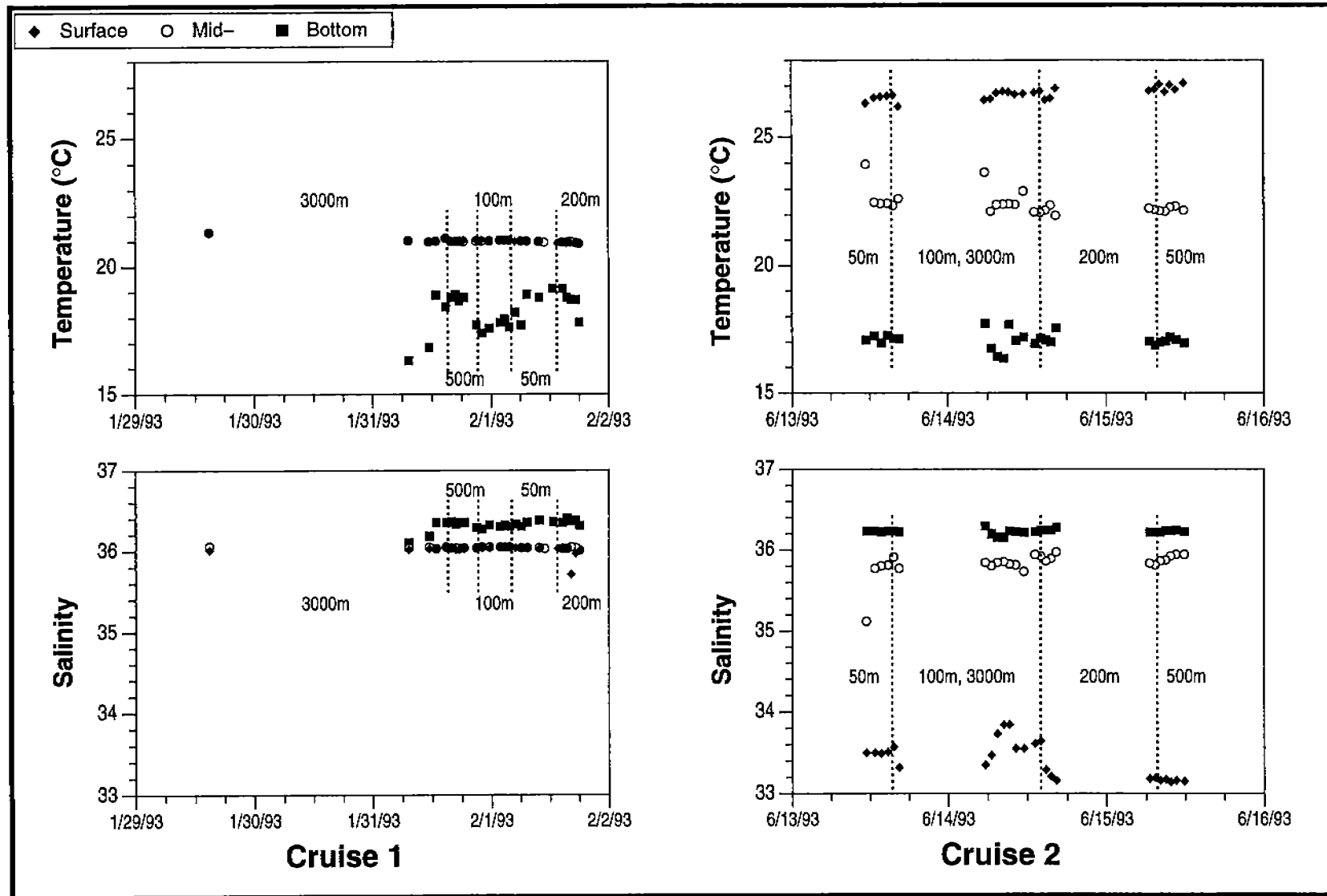

Figure 5.9. Summary of the temperatures (°C) and salinities for surface, mid-, and bottom waters at HI-A389 for Cruises 1 and 2.

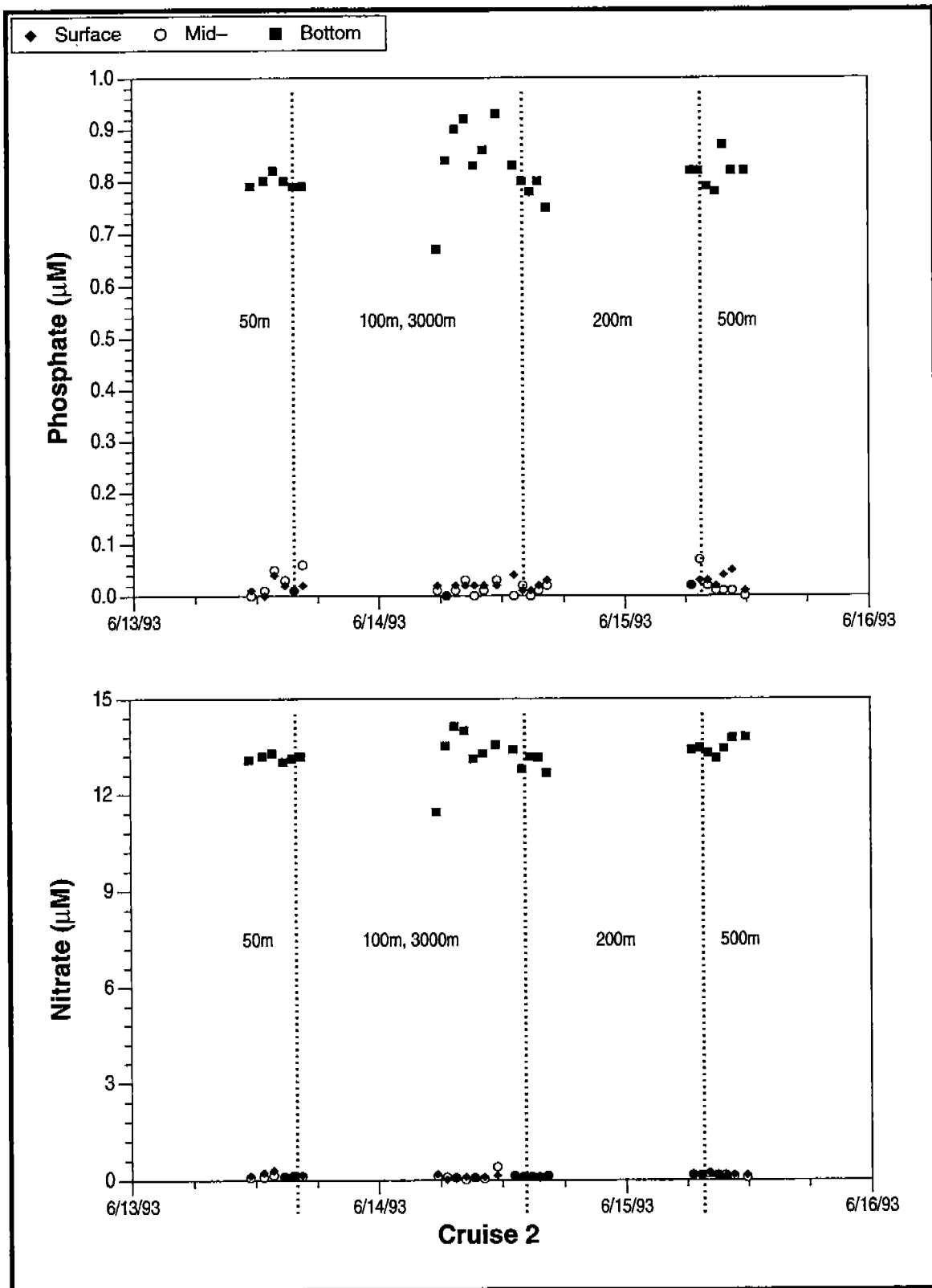

Figure 5.11. Summary of phosphate and nitrate concentrations (μM) for surface, mid-, and bottom waters at HI-A389 for Cruise 2.

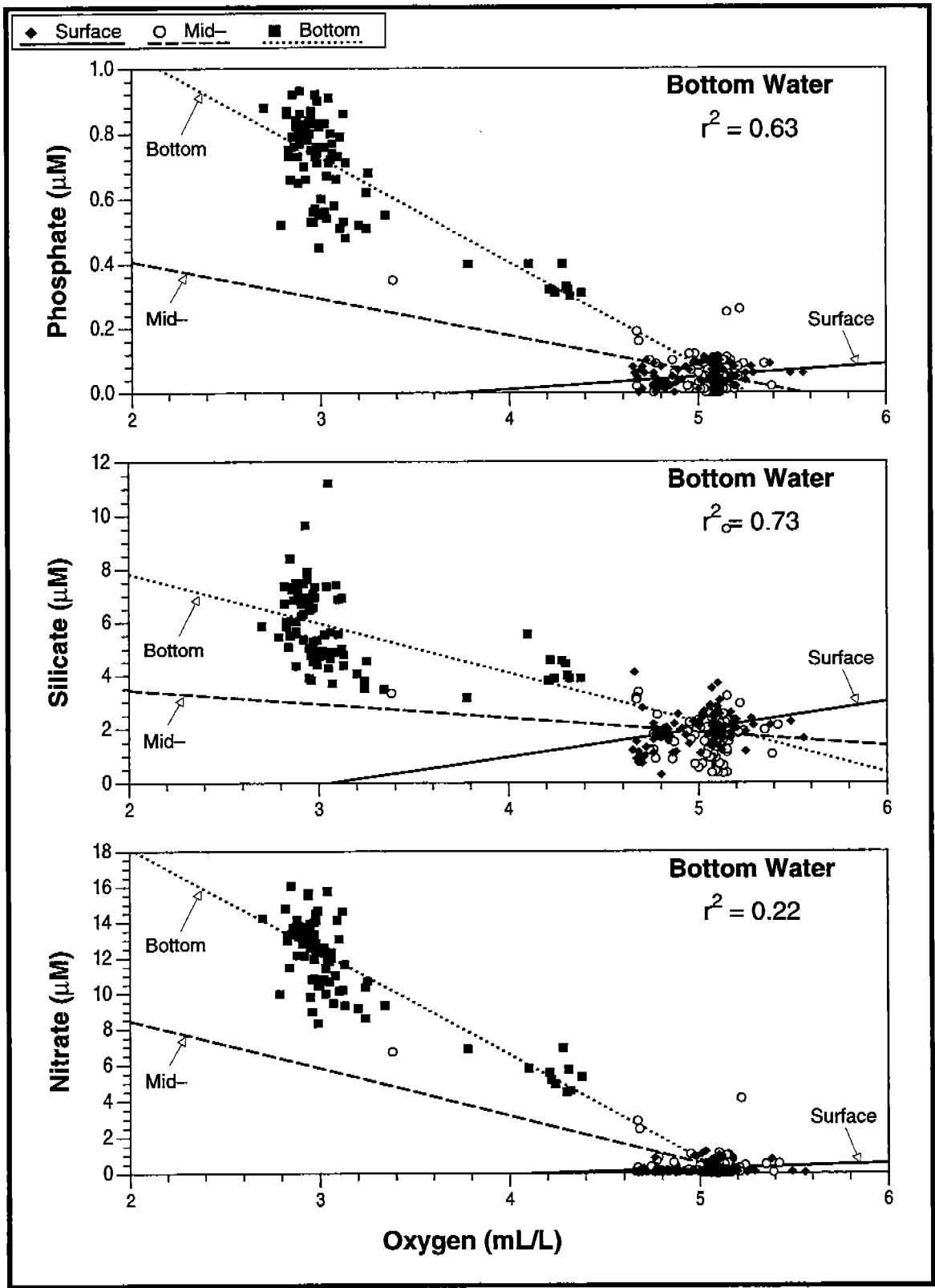

Figure 5.12. Relationship between oxygen and nutrient concentrations at HI-A389 for all cruises.

the following sections. The sedimentology work element included the collection and analysis of 718 grain size, 125 mineralogy, 760 carbon, and 720 Eh samples.

5.2.1 Grain Size

Grain size data by study site is summarized in Figures 5.13 to 5.15. The most dramatic feature was the relationship between sand content (%) and distance from the platform. Stations out to a distance of 100 m were clearly enhanced in sand content. Stations between 200 and 500 m were impacted to varying degrees, apparently depending on water depth, discharge location (i.e., near-bottom shunting), and the volume of the discharge. The sand content of sediments at the near-field stations was increased above background sediment by 35 to 60 % depending on the site. All indications were that most of this increase in sand size materials was the result of disposal of drill cuttings and muds during the drilling phase of the platform's history. Sand content is also enhanced by winnowing of fine particles by bottom currents from sediments adjacent to a structure, sand disposal during sand blasting activities, and deposition of large carbonate skeletal fragments from platform-associated biota. It should be noted that the shallowest, highest energy site exhibited the greatest enhancement in sand. However, the mechanics of effluent discharge and the magnitude of the discharge are important controls on the sand content observed in sediments adjacent to a platform.

During Cruise 1, all samples from MAI-686 at 500 and 3000 m distance were sandy muds with percent sand ranging from 19 to 50 % for the 3000 m sample, and 25 to 39 % for the 500 m samples (Figure 5.16). All samples from 200-m distance were also sandy muds, with the exception of sample 1D, a muddy sand. Sand percentages ranged from 28 to 34 % except for 1D which was about 70 % sand. All remaining samples from rings \leq 100-m distance were muddy sands and varied from 61 to 84 % sand. On Cruise 2, samples from 500 and 3000 meters distance were all sandy muds, with sand varying from 15 to 39 %. The 200-m stations were also sandy muds except for the station on the D radial which had a sand content of 74 %, slightly higher than the Cruise 1 samples from the same station. The sample from the E radial at 200 m falls on the boundary between sandy mud

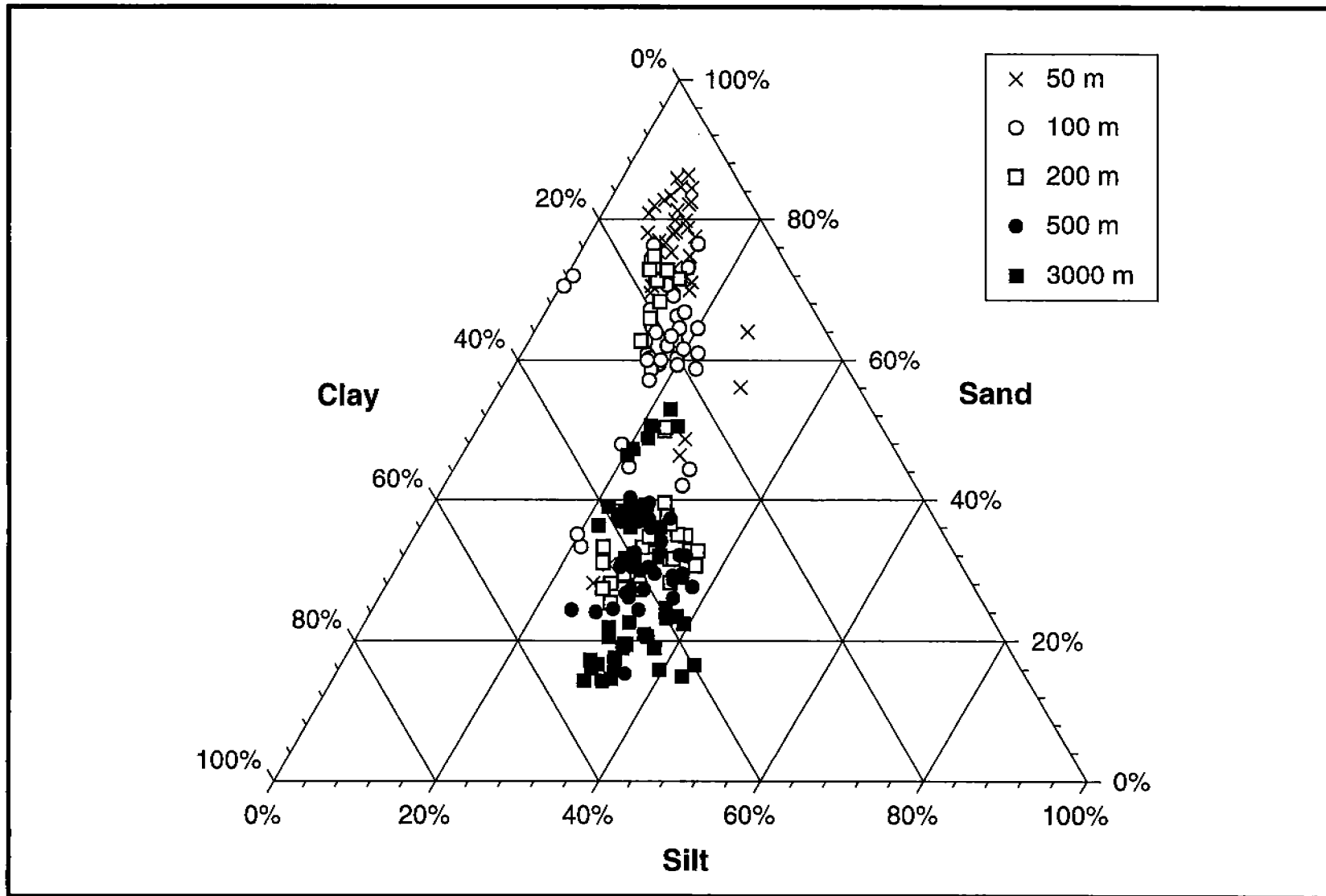

Figure 5.13. Summary of sediment grain size at MAI-686 by distance from the platform.

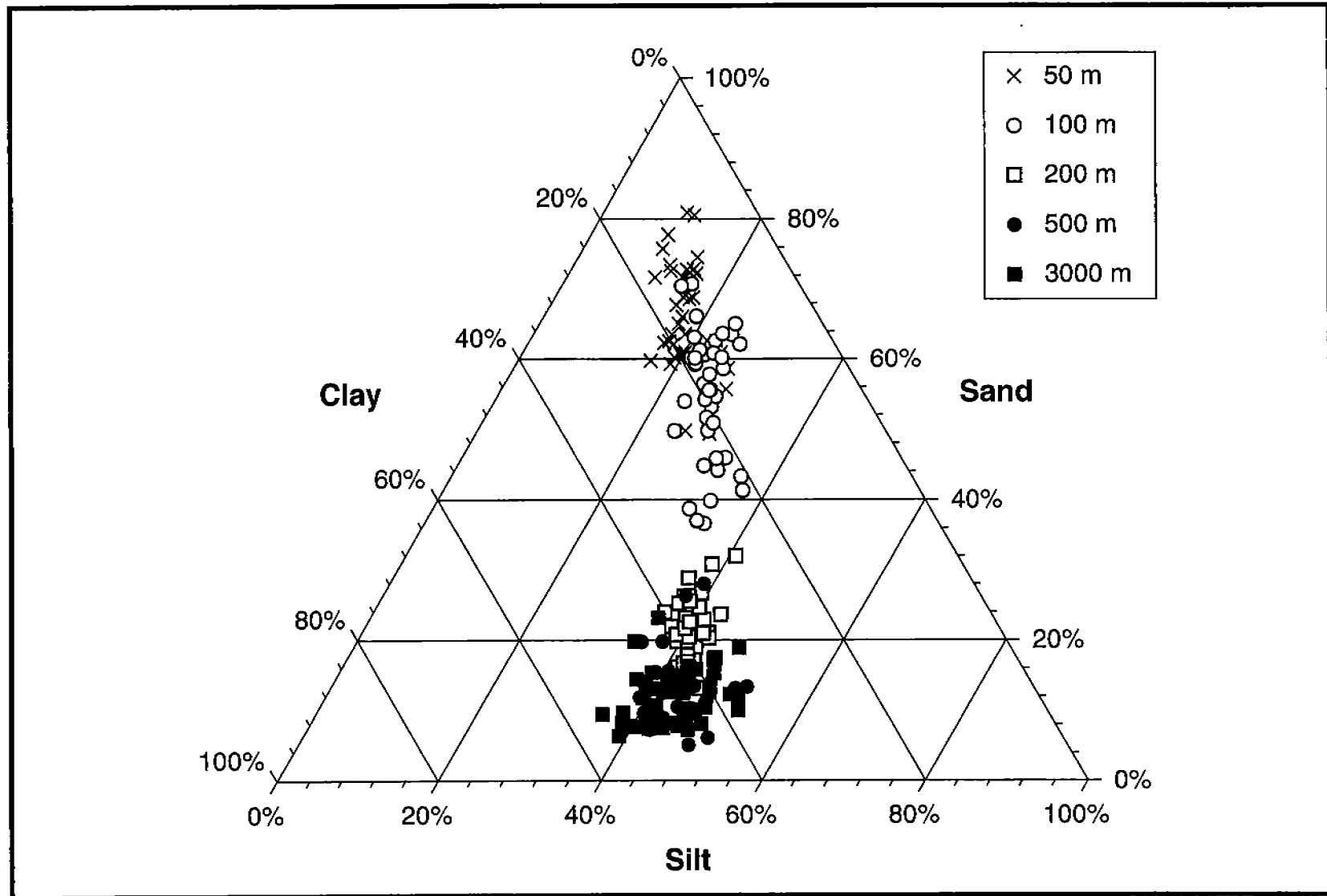

Figure 5.14. Summary of sediment grain size at MU-A85 by distance from the platform.

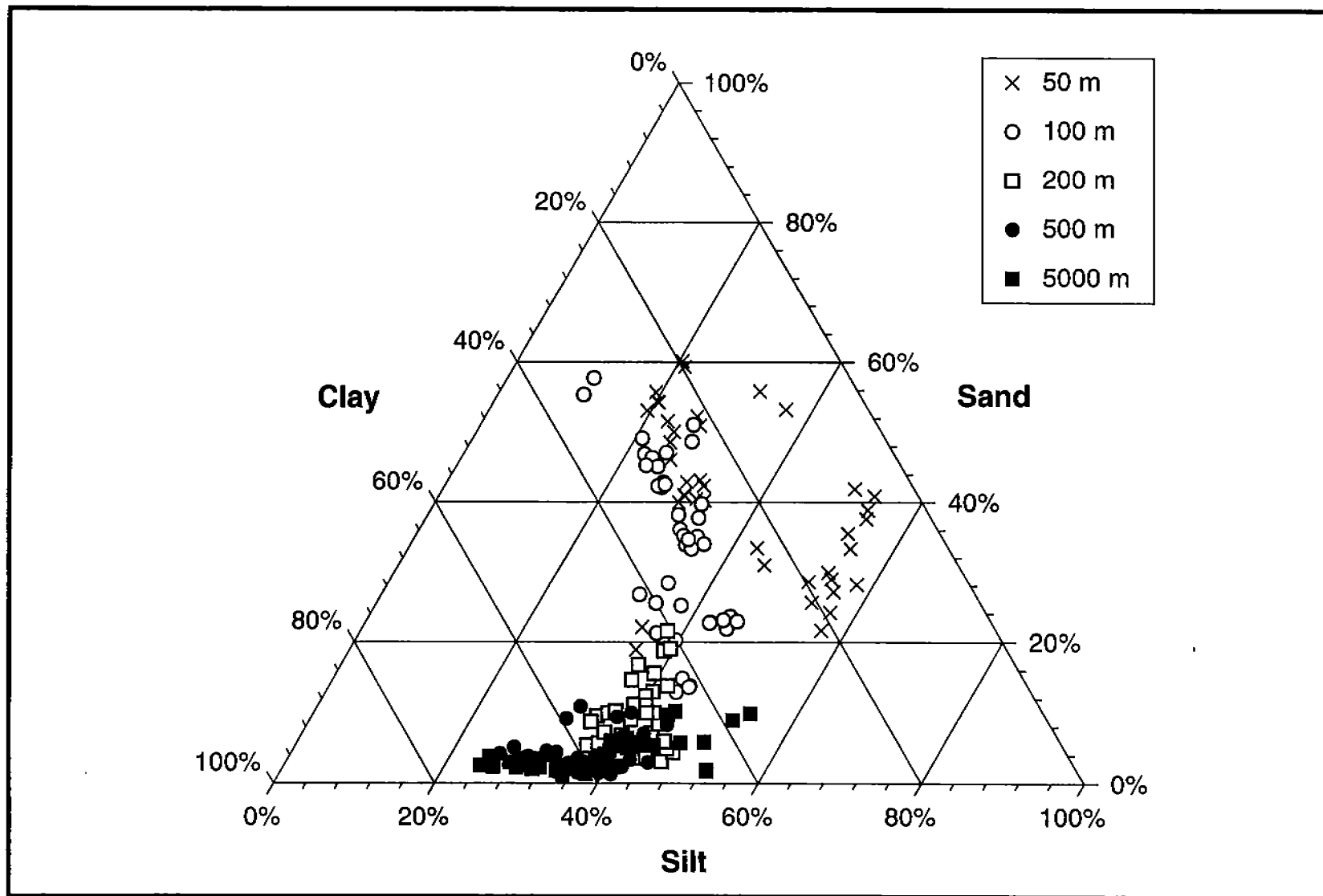

Figure 5.15. Summary of sediment grain size at HI-A389 by distance from the platform.

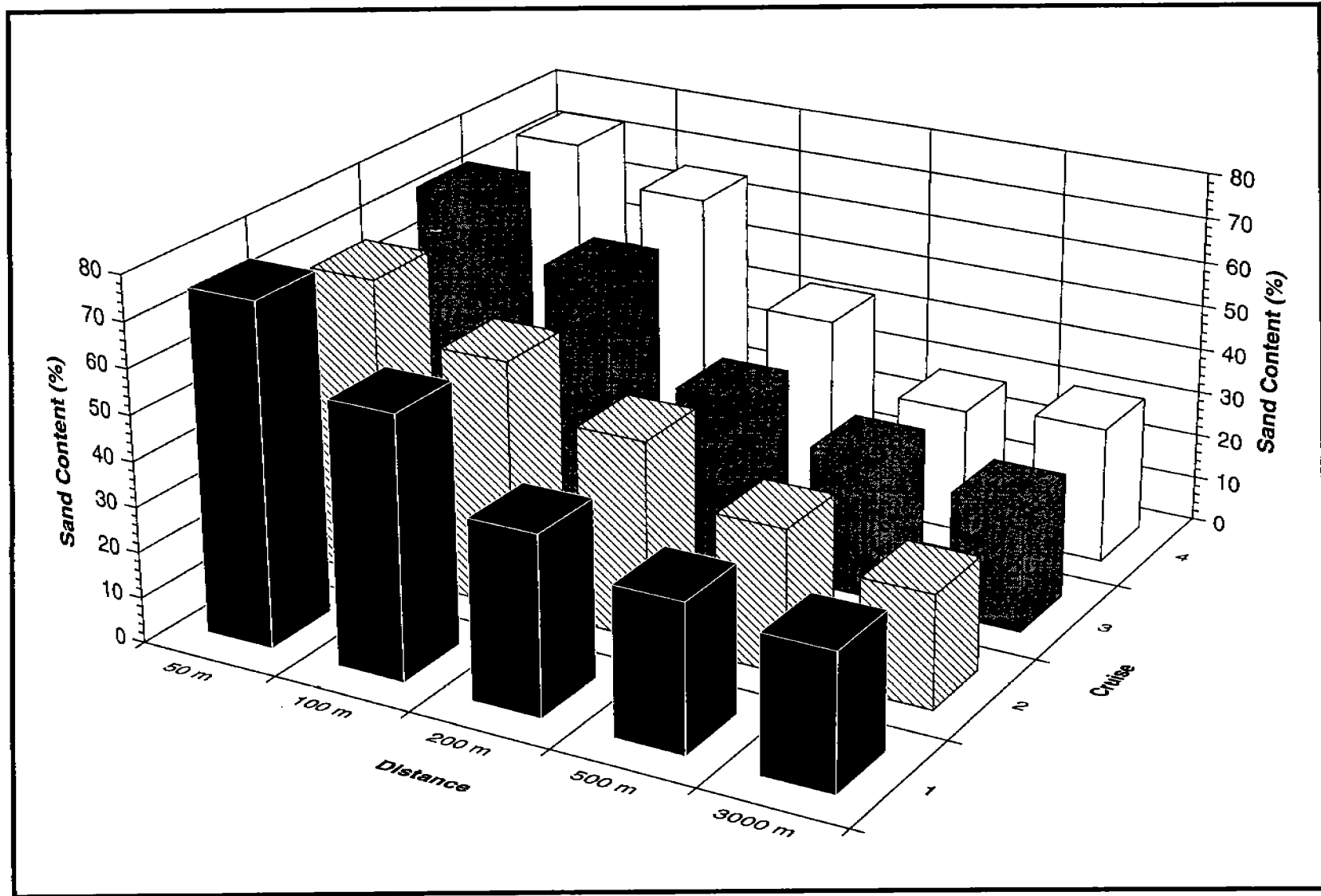

Figure 5.16. Variability in mean sand content (%) with distance from the platform by cruise at MAI-686.

and muddy sand. Sediments \leq 100-m distance from the platform were much the same during the first two cruises except for stations 2A and 3C. At station 3C, the Cruise 1 sample was a muddy sand. On Cruise 2, the same station yielded a sample that was sandy mud. The difference was about 14 % less sand in the Cruise 2 sample, from 60 % to 46 %. The boundary between the two sedimentary classifications is 50 %. However, on Cruises 3 and 4 the same station yielded sandy muds with 45 % and 37 % sand, respectively. Sediments with a high percentage of sand form an irregular elongate shape around the platform oriented in a southwest/northeast direction with the highest amounts of sand close to the platform (Figure 5.17). This pattern reflects the southwesterly flowing currents that transported the sand away from the drill site.

At MU-A85, sediments at 3000-m distance were sandy muds except for station 5D which contained only 8 % sand and was classified as a mud (Figures 5.17 and 5.18). Sediments at 500 m distance were also sandy muds except station 4A which was classified as a mud and contained at least 6.1 % sand (i.e., 3.9 % below the boundary between mud and sandy mud). All samples from the 200 m distance were sandy muds. At 100-m distance, four samples were muddy sands and one station, 3E, was sandy mud containing 45 % sand. Sediments closest to the platform were muddy sands containing between 28 and 40 % mud. Samples collected during Cruises 2, 3, and 4 were generally within a few percent of the grain size compositions observed for Cruise 1. Station 4C (500 m) was an exception; it was a sandy mud during Cruise 1 and a mud during Cruise 2. However, this was not a significant difference as sand content at station 4C of Cruise 1 was 13.5 and 13.9 % and the equivalent sample from Cruise 2 was 9.5 and 8.9 % sand. The boundary between sandy mud and mud is 10 % sand. The two samples from Cruise 2 lie within the mud field by only 0.5 and 1.1 %; respectively. A similar relationship was seen between samples 3D and 3E (100 m distance). Samples from these stations during Cruises 2 and 3 were sandy muds, but during Cruise 4 only 3D was classified as a sandy mud. The sand content isopleths indicated an easterly orientation to the sand halo (Figure 5.17). This could be due to transport by the prevailing currents.

Sediments collected at HI-A389 during Cruise 1 at a distance of 500 and 5000 m were all muds (Figure 5.17 and 5.19) except for station 4E which was borderline between mud and sandy mud. Samples at 200 m

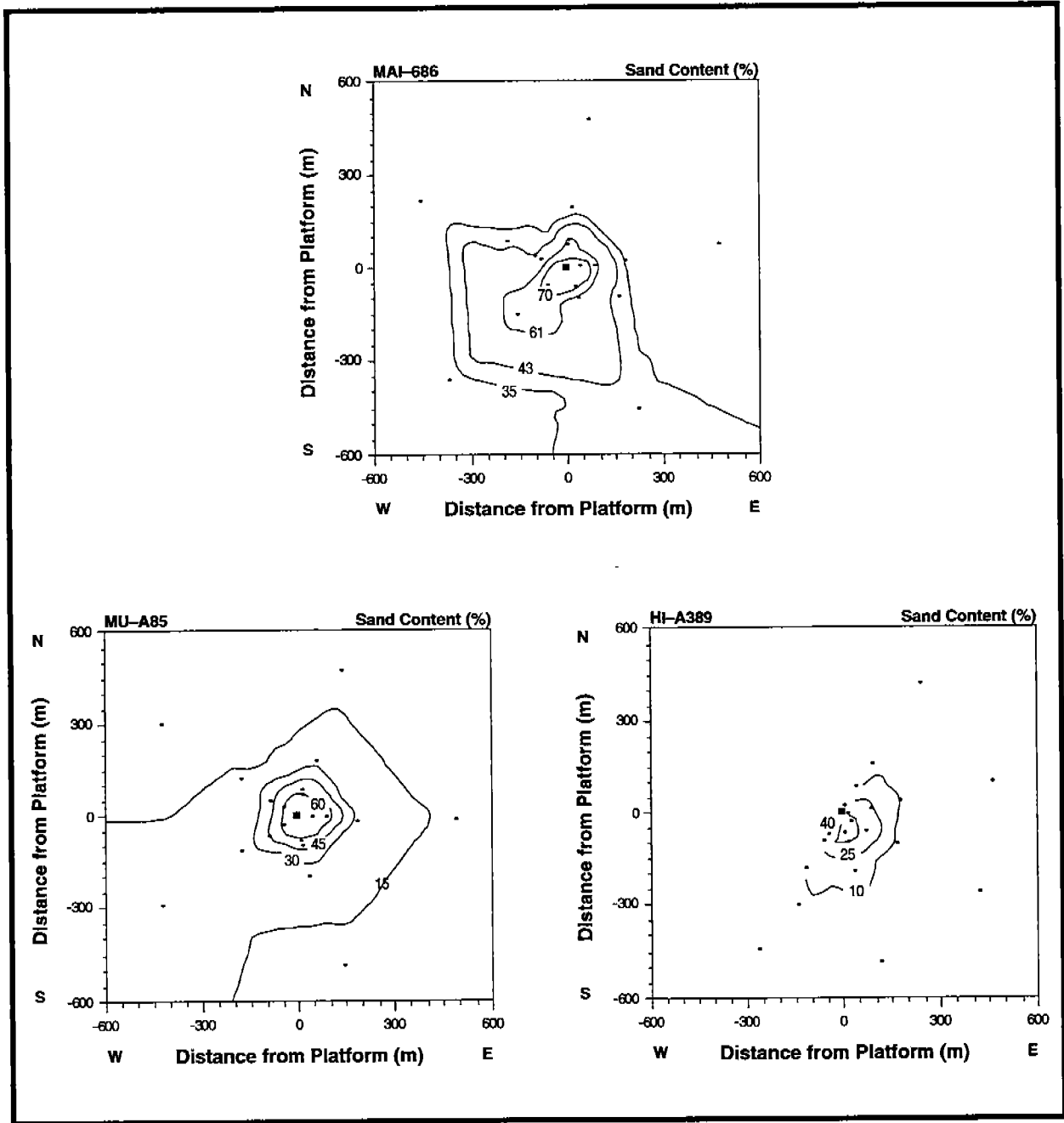

Figure 5.17. Areal distribution of sand content (%) in sediments as a composite of all four cruises.

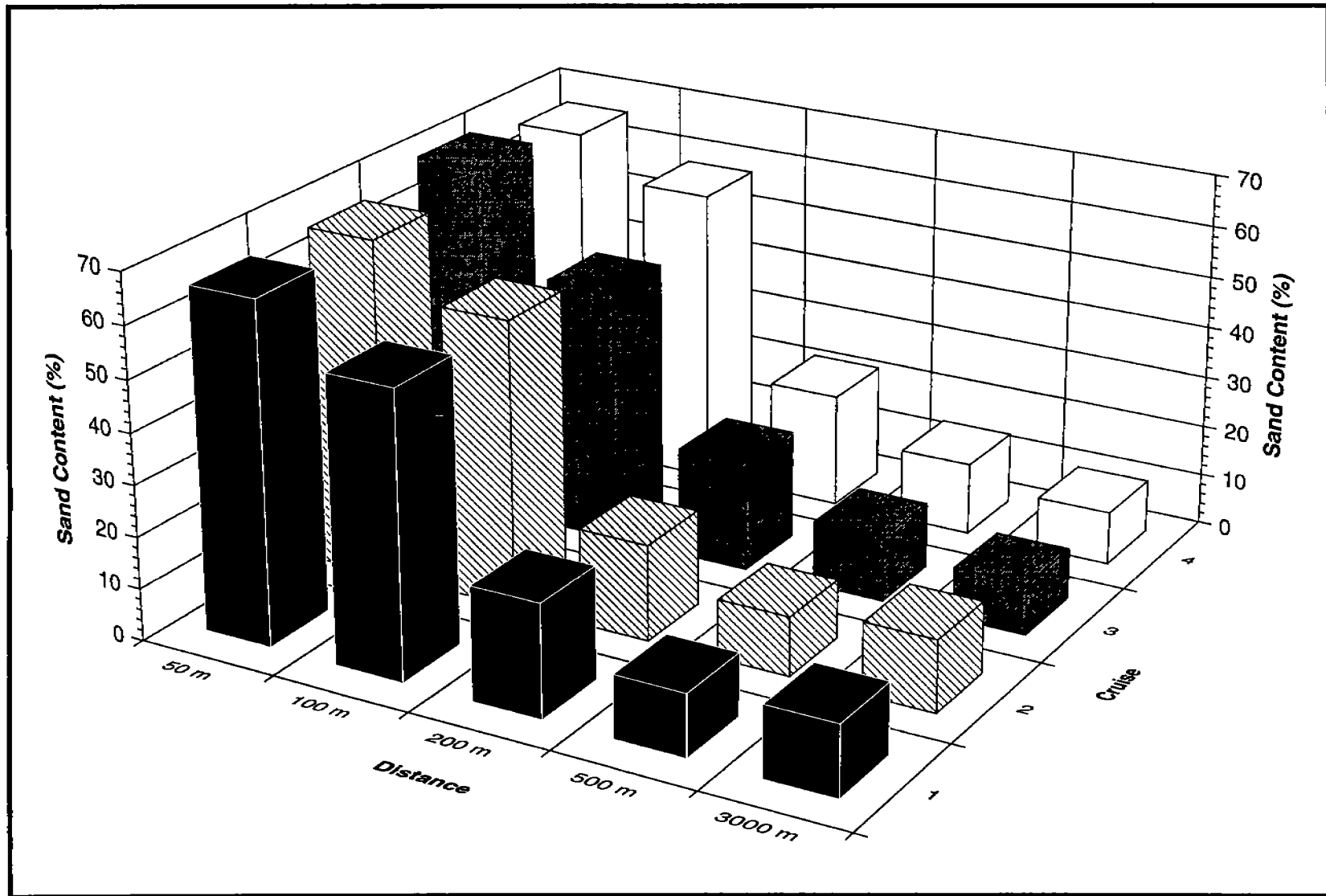

Figure 5.18. Variability in mean sand content (%) with distance from the platform by cruise at MU-A85.

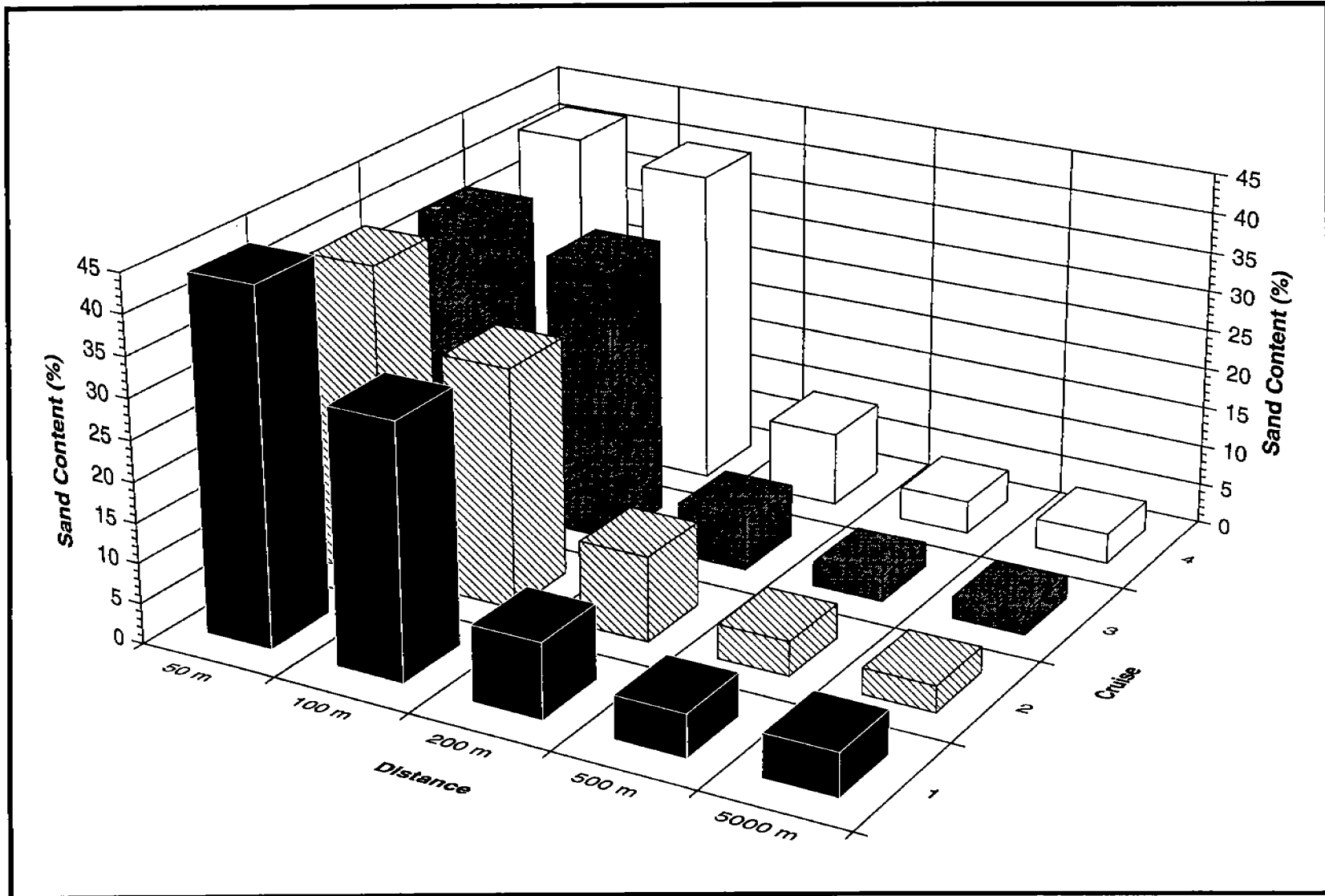

Figure 5.19. Variability in mean sand content (%) with distance from the platform by cruise at HI-A389.

distance from the platform were muds or sandy muds. Samples from all five locations at 100 m distance were sandy muds. The closest samples at stations 2A, 2B, and 2C were sandy muds but stations 2D and 2E were muddy sands. With only one exception, the analyses of samples taken at the same station varied by less than 11 % in sand content and most samples between cruises varied by only a few percent (Figure 5.19). On Cruise 2, samples from 200 to 5000-m distance on radii A, B, and C were all muds. The 50 and 100 m stations were all sandy muds except for the samples from 50-m distance on radial B which were muddy sands. On radial D, samples from 5000 and 500 m were both muds, samples from 200 and 100 m distance were sandy muds, and from 50 m distance were muddy sands. On radial E, the 500 and 5000 m stations were muds and the 50, 100, and 200 m stations were sandy muds. On Cruise 3, all ten samples from the 500-m and 5000-m distance were muds. All ten samples at 500 and 5000 m from Cruise 4 were muds except for station 5A which was a sandy mud. On the last two cruises, the sediments at the 200-m sampling stations were all muds except for Cruise 3, stations 1B and 1E and Cruise 4, station 1D which was sandy mud. All of the samples from the 100 m distance on both cruises were sandy muds except from station 3C which were muddy sands. During both cruises the 50-m samples were sandy muds except for station 2D which was a muddy sand.

An examination of sand fractions from all three sites, using a stereoscopic microscope and reflected light, indicates the presence of drill cuttings in samples from the innermost stations at all three sites. The cuttings were characterized as very large rounded quartz-sand grains (two to three times as large as grains in background sediments from the area) and lithoclasts (fossiliferous limestones, chert and/or fine grained limestone). In addition, there were some angular, very fine, quartz-sand grains that may have been derived from sand blasting of the platform during rust-control programs. Small sand-size metallic spheres were interpreted to be droplets of molten metal from welders or cutting torches that fell into and were quenched by seawater. Also visible were fragmented carbonate skeletal material derived from organisms that encrust the underwater parts of the platform. The most abundant skeletal remains were polychaete worm tubes and barnacles. The enhancement in sand size particles was clear at all three sites and was consistent with previous studies around platforms. The

addition of sand-sized particles to the adjacent sediments as part of drilling disposal practices has been well documented. At HI-A389, an enhanced silt fraction was also evident in a cluster of samples closest to the platform (Figure 5.15). This indicated an addition of silt-size materials as the result of drill mud disposal. Sediments at HI-A389 within 50 m of the platform were more than 40 % barite in some instances.

5.2.2 Mineralogy

Mineralogic analysis was only conducted for Cruise 1 samples and is summarized by site. At MAI-686, quartz, clays, and feldspar were the dominant minerals (Figures 5.20D and E). Quartz, clays, and feldspars were the only minerals identified on the X-ray diffraction patterns of samples taken at MAI-686. At MU-A85, 500-m and 3000-m distance from the platform, the sequence of minerals was generally clays, quartz, feldspar, and calcite, in order of abundance with the exception of samples 5A, 5B, and 5C which had about equal amounts of quartz and clays. Barite was detected in samples 3D, 2D, and 2E (Figure 5.20). The mineralogy of samples at HI-A389 at 500-m and 5000-m distance was typical of sediments on this side of the East Flower Garden Bank (Figures 5.20F and G). Clays dominate the clay size fraction while quartz and calcite were distributed in varying proportions in the sand- and silt-size fractions. The sand-size fraction consisted mostly of planktonic foraminifera and eroded debris from dead coralline algae patchreefs that are scattered over the bottom at these depths. The silt-size fraction is mostly a mixture of quartz and tests of foraminifera. The presence of feldspar and dolomite at this distance from the platform is most probably because of the erosion of seafloor outcrops of Pleistocene and/or older sediments. Such outcrops have been documented in the general area (Rezak et al. 1985). Sediments 200-m distance from the HI-A389 platform began to show the effects of drilling activity with traces of barite at stations 1A, 1B, 1D, and 1E. The aragonite in sample 1D is probably a mollusc fragment derived from the nearby bank. Barite was also detected at 100-m distance at stations 3A, 3B, and 3E in about the same relative amounts. Also, quartz was the most abundant mineral within 100-m of the platform because of the shunting of drill cuttings. The relative amount of barite increased at stations 2A, 2B, and 2C. At station 2E, there was no increase in barite

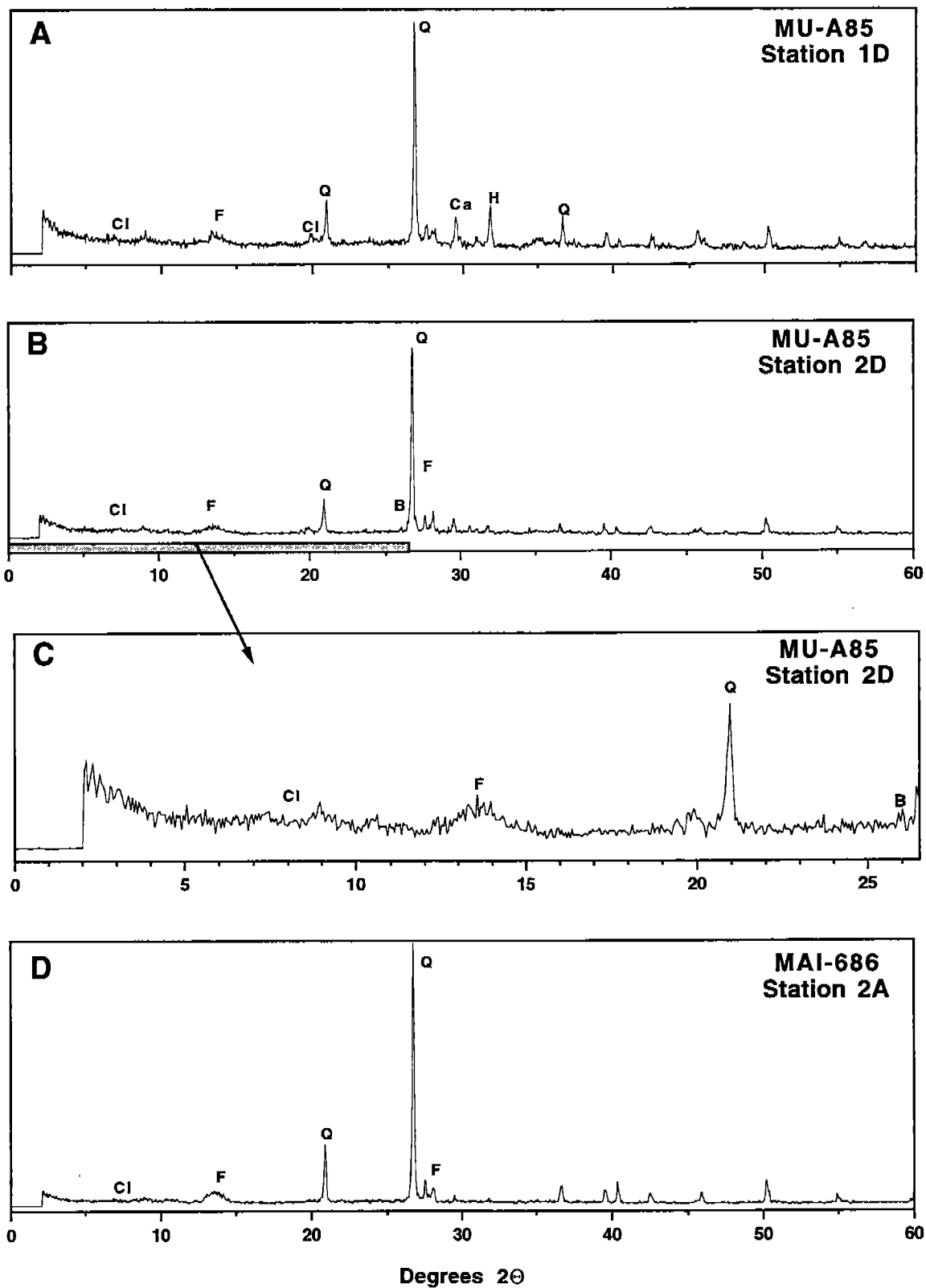

Figure 5.20. X-ray diffractograms of sediments from the study area. (B=barite, Ca=calcite, Cl=clay, F=feldspar, H=halite, I=illite, Q=quartz). **A**: MU-A85, station 1D; **B**: MU-A85, station 2D (note small main barite peak at 25.8°); **C**: Enlargement of **B** showing the barite peak; **D**: MAI-686, station 2A.

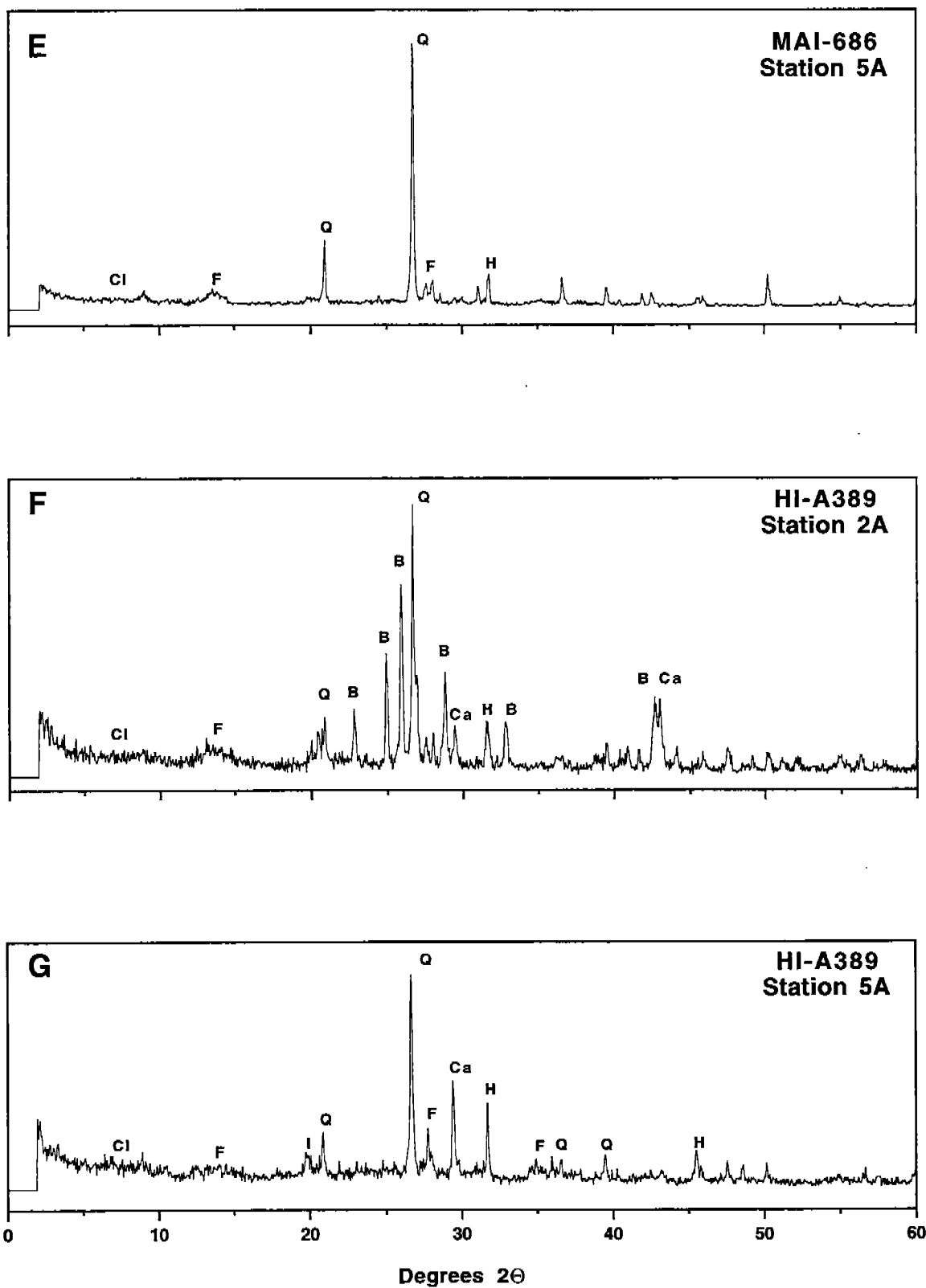

Figure 5.20 (cont.).

E: MAI-686, station 5A; **F:** HI-A389, station 2A (note the main barite peak at 25.8°); **G:** HI-A389, station 5A (the halite is an artifact of the evaporation of interstitial seawater).

content over that present at station 3E. The distribution of barite around this platform supports the conclusion that the predominant bottom current-direction near this site is towards the northeast (Rezak et al. 1985); however transport of materials has occurred in both directions (i.e., southwest).

The mineralogy of the sediments on the Texas OCS has been investigated in considerable detail. The primary role of the X-ray diffraction in this study was to determine if barite could be identified. The limit of sensitivity of the technique was about 5 % barite. X-ray diffraction was able to identify barite at two of the study sites. Neutron activation analysis for barium is a much more sensitive technique than x-ray diffraction and therefore, it is more effective in determining the presence and amount of barite in sediments.

5.2.3 Carbon Content

Organic and inorganic carbon content in sediments varied depending upon a number of factors including sedimentation rates, water depth, water column primary productivity, influx of land-derived detritus, sediment redox conditions (preservation), *in situ* production (bacterial), and anthropogenic inputs (i.e., cuttings). The organic carbon content of sediments at the study sites was generally within the range found on the Texas OCS (Table 5.13).

Table 5.13 Range values of total organic carbon (TOC) and inorganic carbon (TIC) concentrations at the three sites in percent (%) carbon.

Site	TOC (%) Range	TIC (%) Range
MAI-A686	0.1 to 1.5	0.0 to 3.4
MU-A85	0.2 to 1.5	0.3 to 2.2
HI-A389	0.4 to 2.5	0.0 to 5.0

The areal distribution of total organic carbon (TOC) was often quite complex around the platform (Figures 5.21 to 5.24). However, in general, TOC content in sediments decreased near the platform. The addition of sand sized particles reduced TOC content by dilution (Figure 5.25).

Total inorganic carbon (TIC) enrichment near the platform included debris deposited by platform-associated biota (Figures 5.26 to 5.29). There

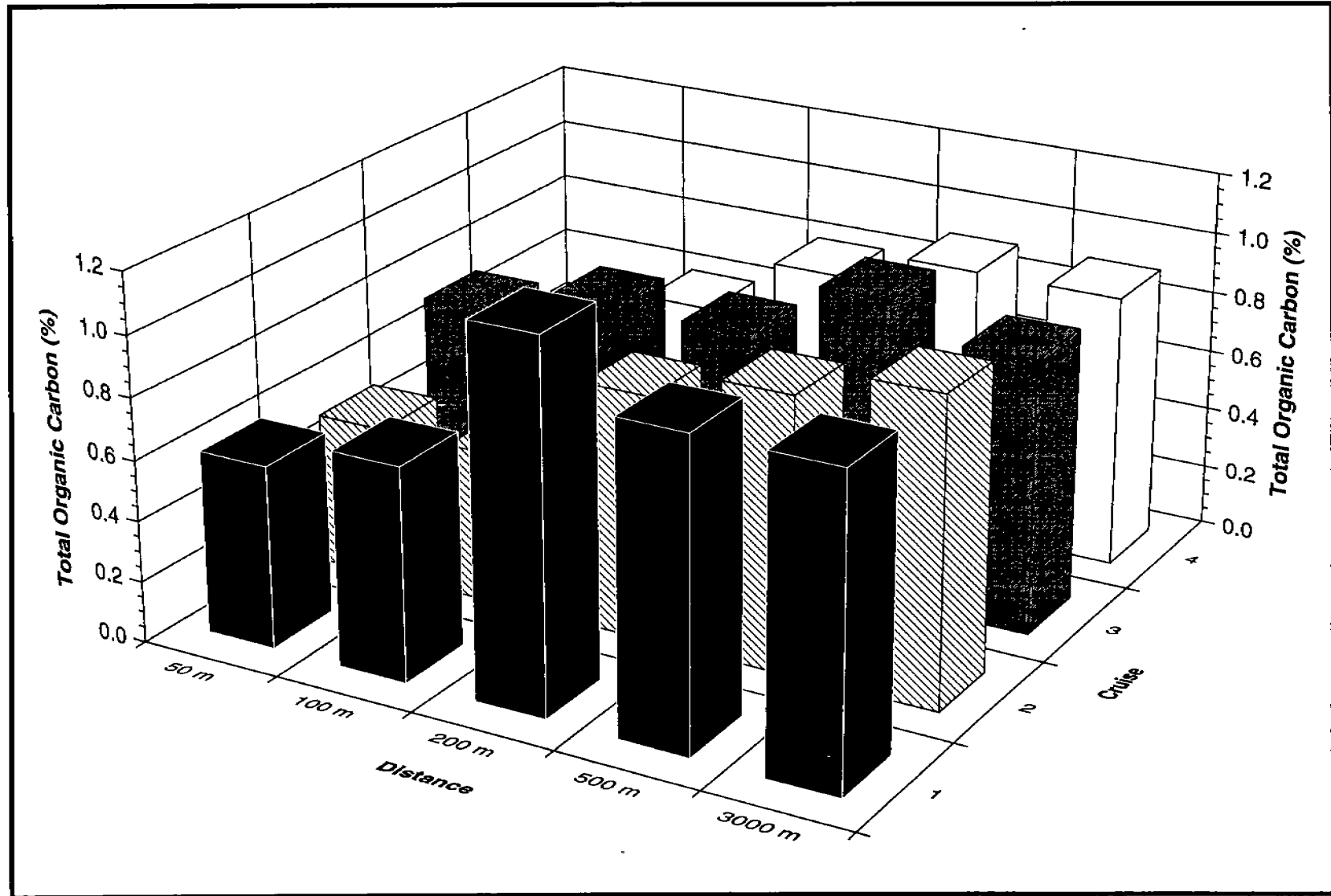

Figure 5.21. Variability in mean total organic carbon content (%) in sediments with distance from the platform by cruise at MAI-686.

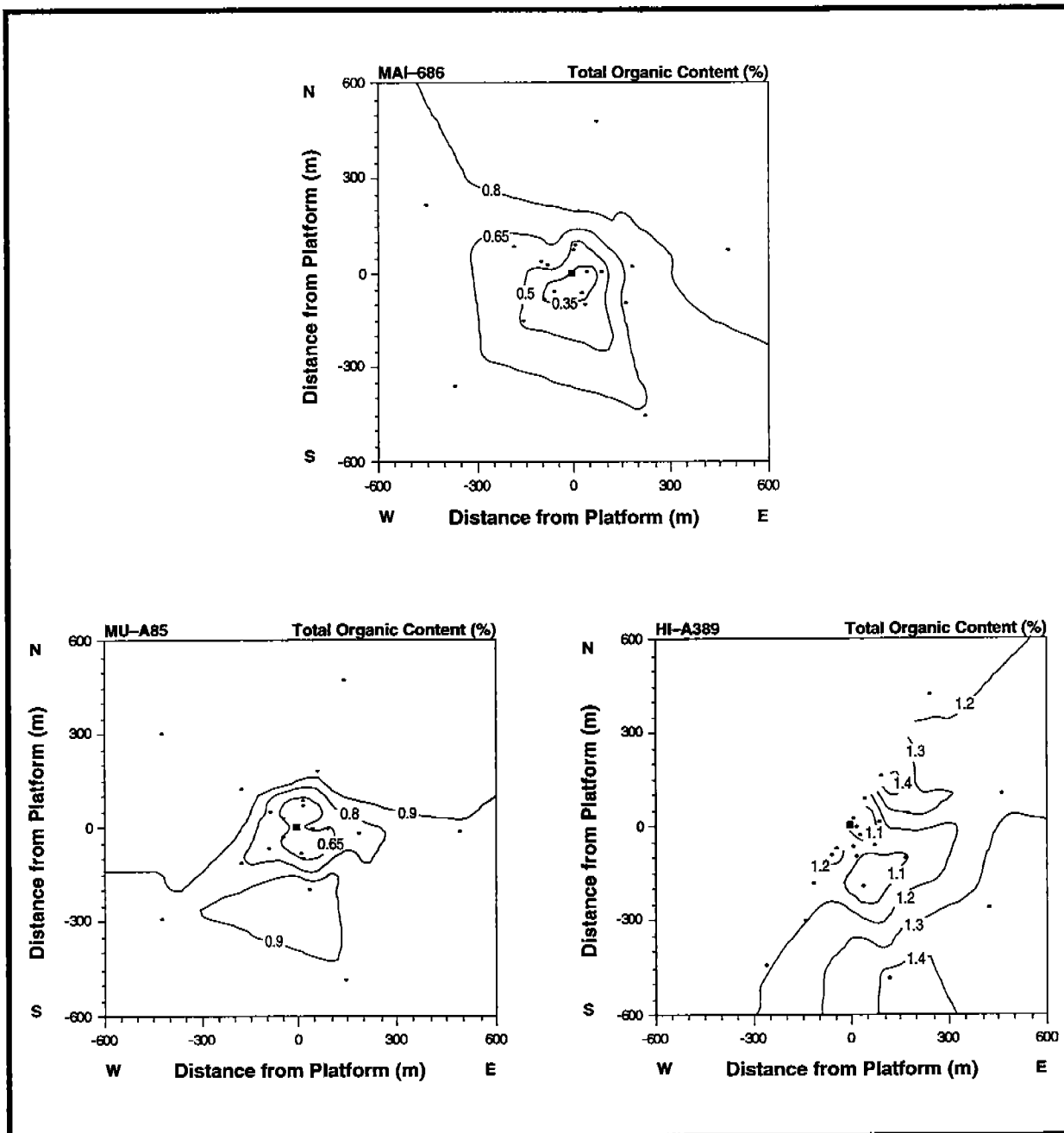

Figure 5.22. Areal distribution of mean total organic carbon content (%) in sediments as a composite of all four cruises.

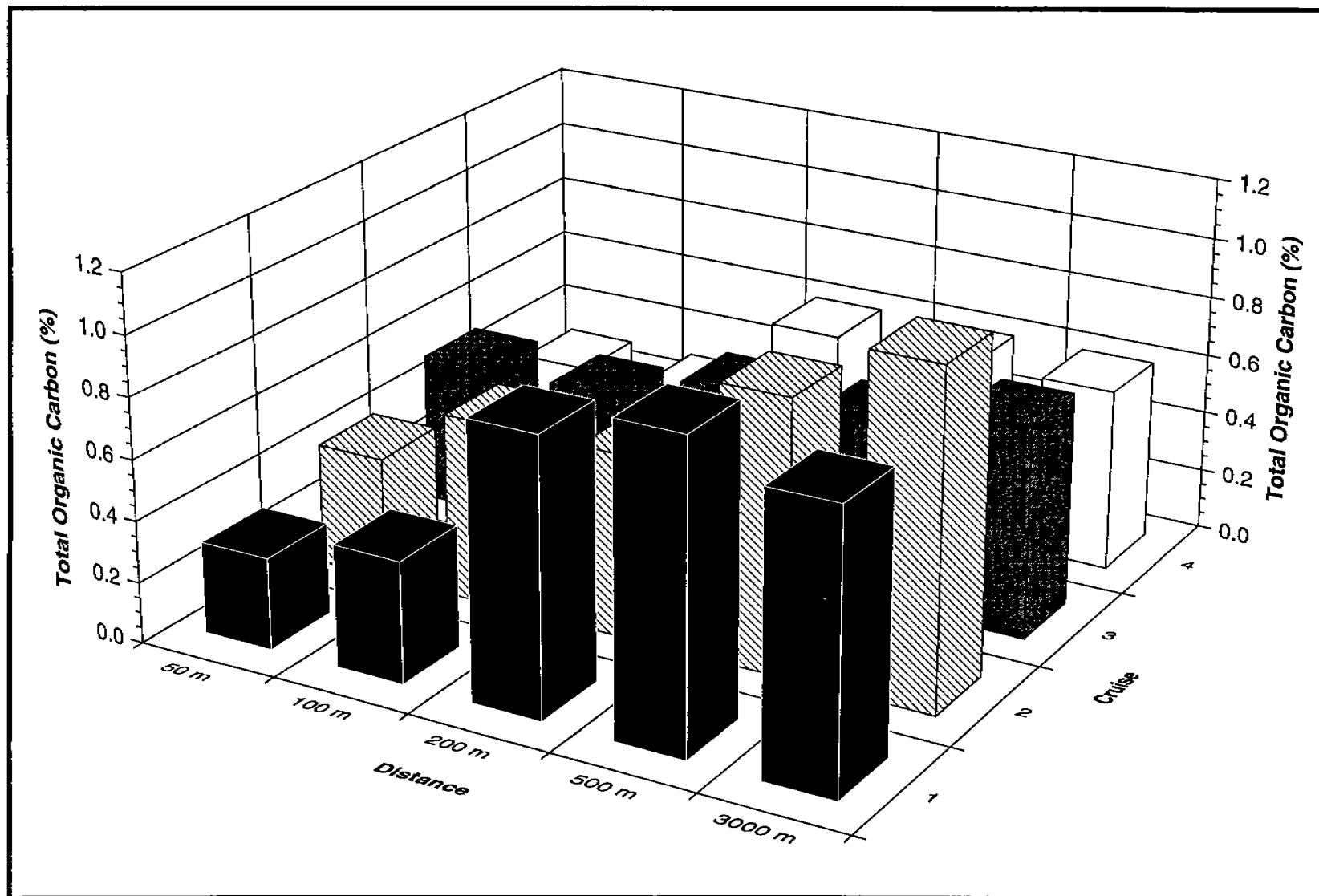

Figure 5.23. Variability in mean total organic carbon content (%) in sediments with distance from the platform by cruise at MU-A85.

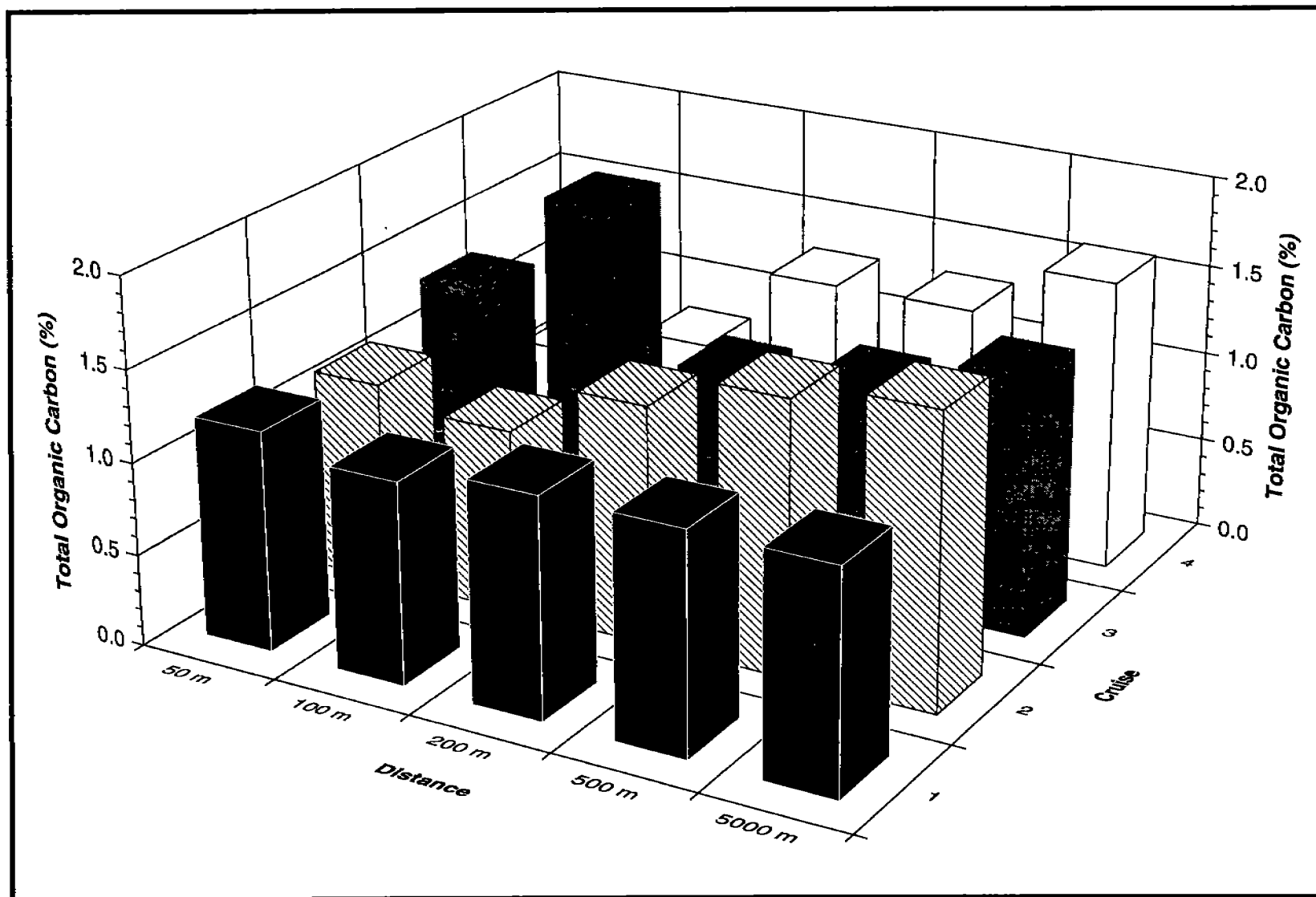

Figure 5.24. Variability in mean total organic carbon content (%) in sediments with distance from the platform by cruise at HI-A389.

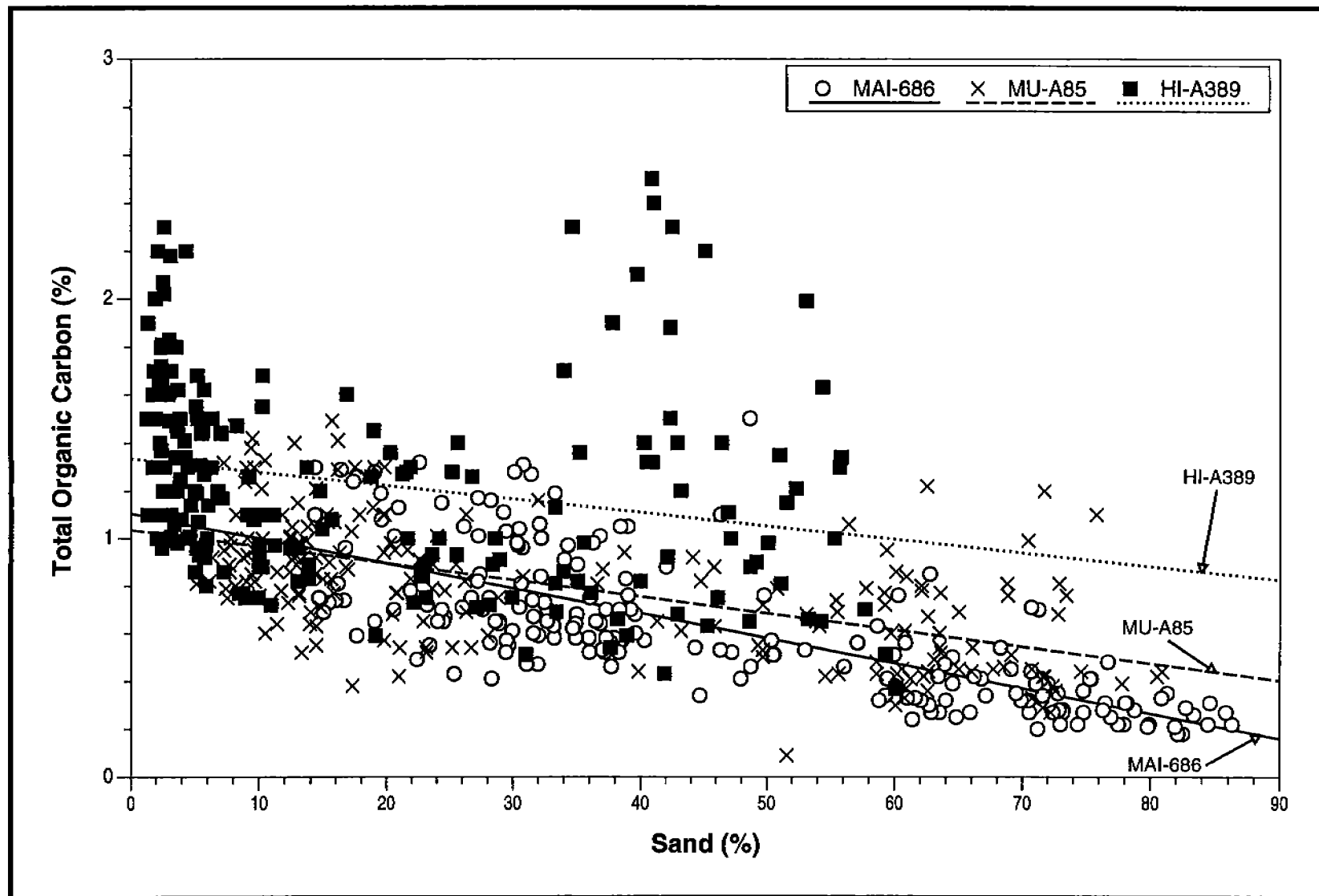

Figure 5.25. Relationship between sand and total organic carbon content (%) in sediments at all sites for all cruises.

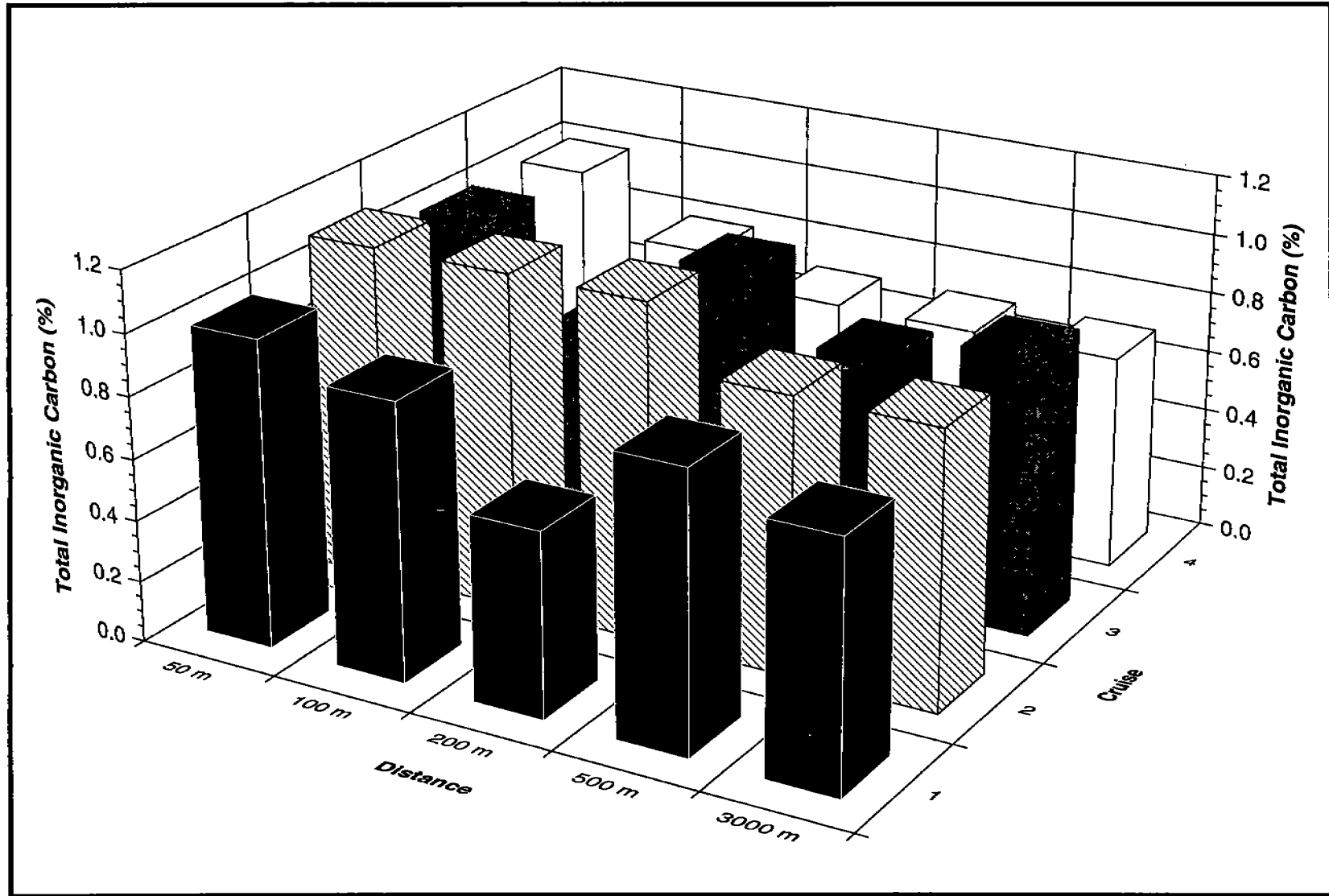

Figure 5.26. Variability in mean total inorganic carbon content (%) in sediments with distance from the platform by cruise at MAI-686.

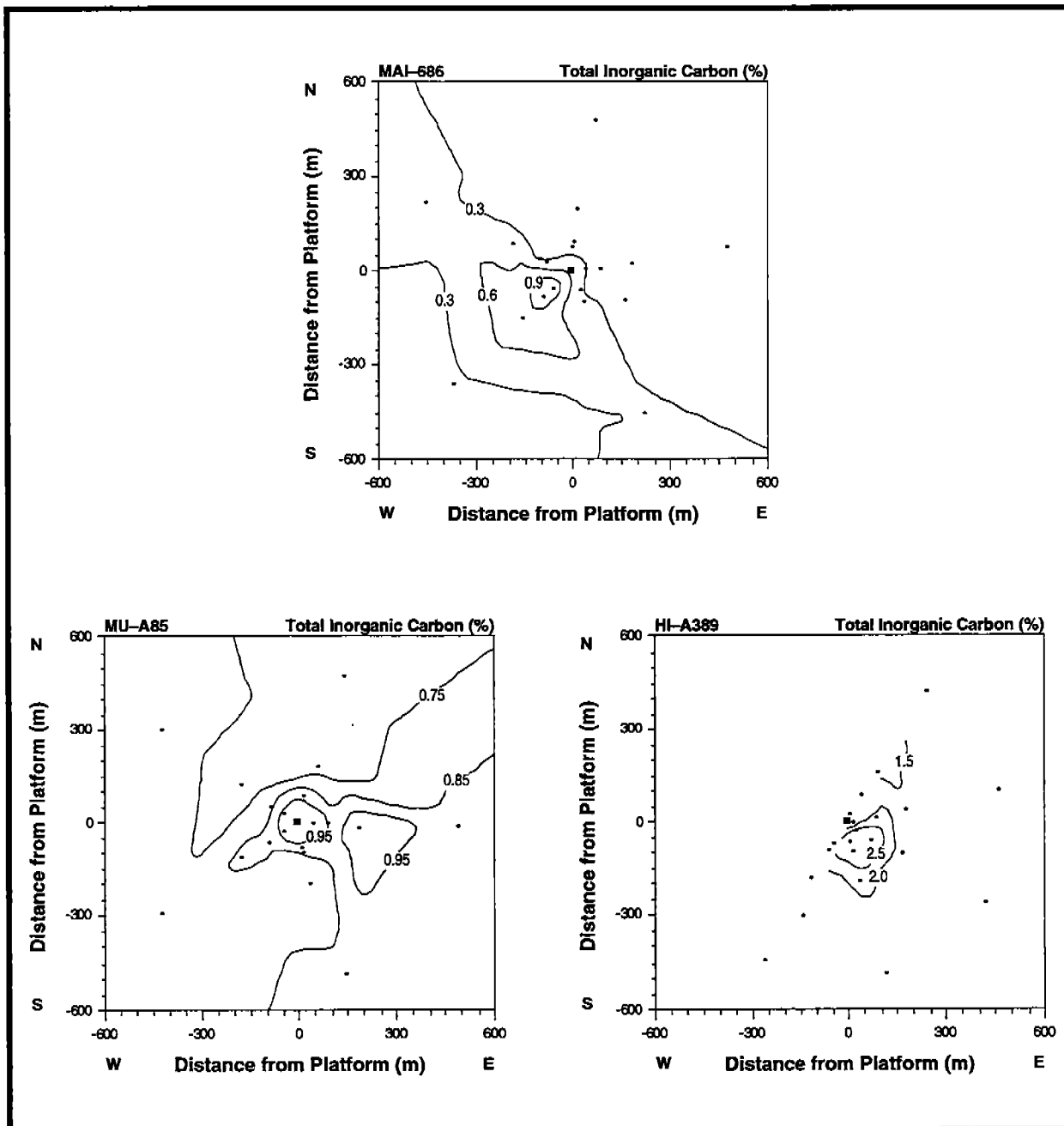

Figure 5.27. Areal distribution of mean total inorganic carbon content (%) in sediments as a composite of all four cruises.

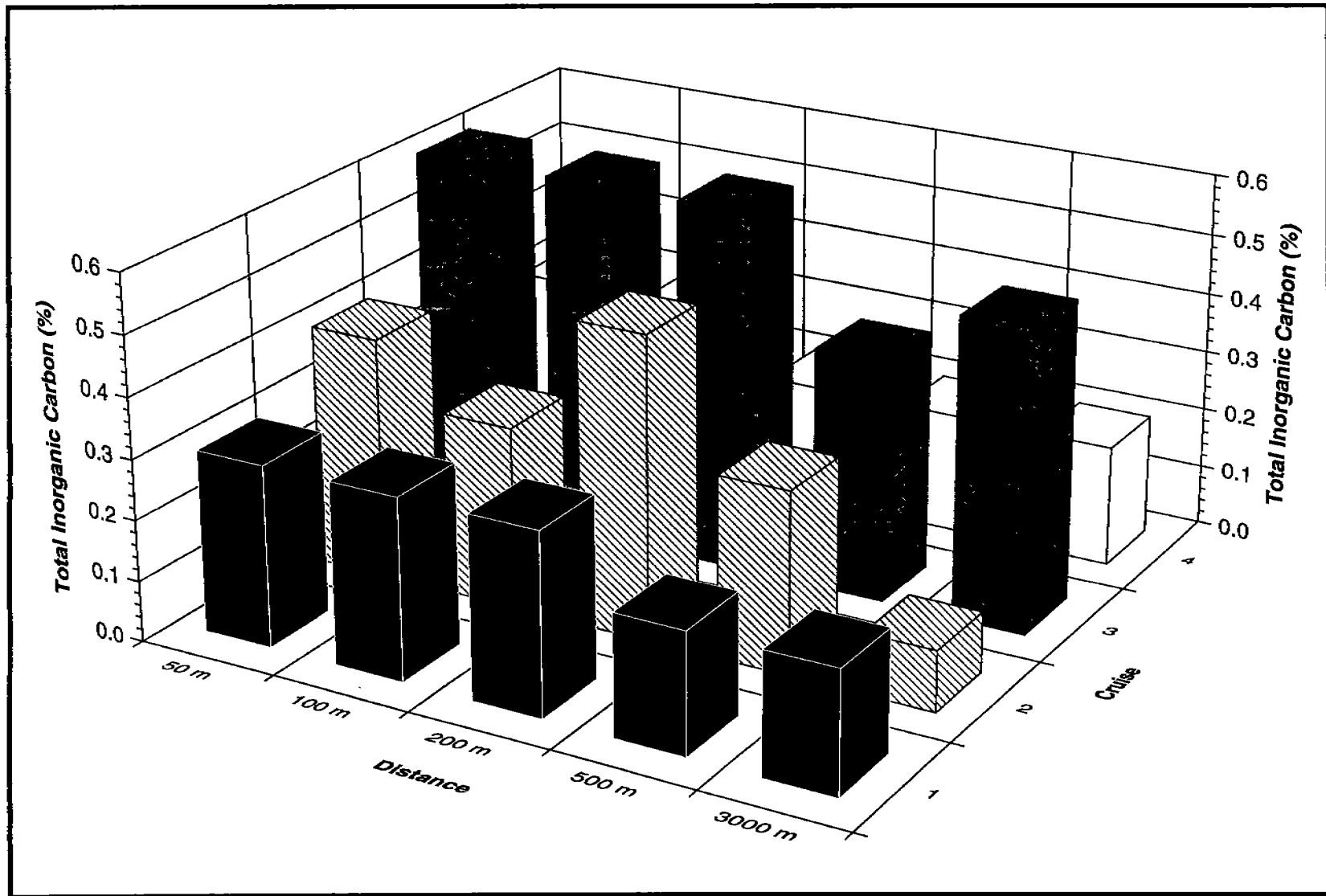

Figure 5.28. Variability in mean total inorganic carbon content (%) in sediments with distance from the platform by cruise at MU-A85.

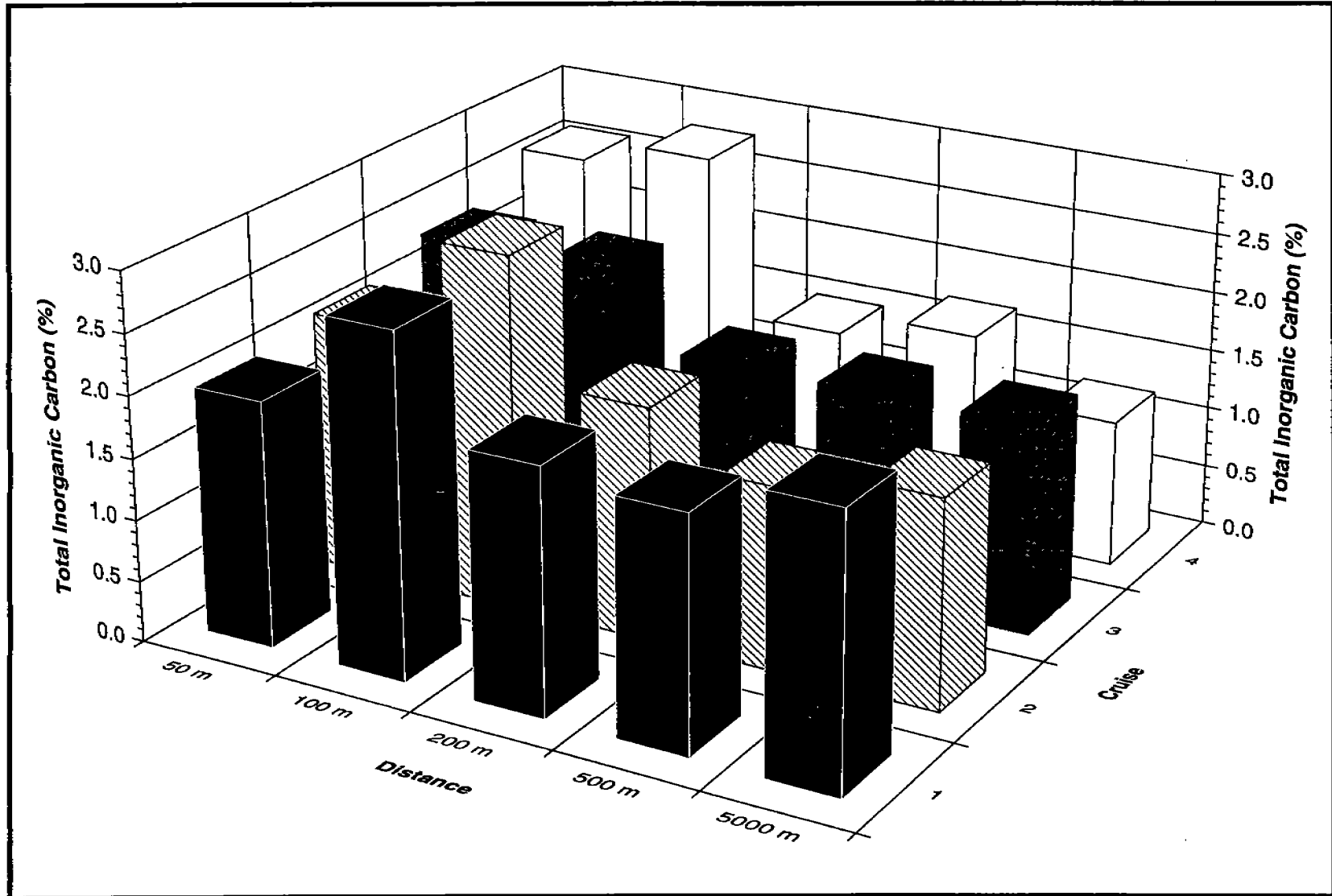

Figure 5.29. Variability in mean total inorganic carbon content (%) in sediments with distance from the platform by cruise at HI-A389.

was also a source of inorganic carbon in the discharged cuttings. TIC content closely correlated with sand and suggested that the sand-sized particles contain carbonate (Figure 5.30). TIC and TOC content were also correlated with TOC. TOC content decreased as TIC increased suggesting a dilution of TOC similar to the trend observed with sand (Figure 5.31).

5.2.4 Redox Conditions (Eh)

The range in redox potential, as measured by a platinum electrode at each site, is summarized in Table 5.14. The areal distribution of redox potentials at each site are summarized in Figures 5.32 to 5.35. Redox potential as measured as Eh (mV) was highly variable at the study sites. Redox conditions showed significant variations among cruises and among sites (Table 5.14). Trends with distance from the platform were also highly variable and difficult to interpret. More detailed and rigorous studies will be needed to fully understand the influence of redox conditions on benthic animals and contaminant disturbances.

Table 5.14. Summary of the ranges in Eh-potential (mV) at the three study sites measured by platinum electrode.

Site	Eh (mV)
MAI-686	-93 to +204.0
MU-A85	-93 to +268.5
HI-A389	-92 to +233.0

5.3 Contaminants

The contaminant portion of this study included the analysis of a suite of organic and inorganic analytes previously detected near platforms. Organic analytes included aliphatic and aromatic hydrocarbons in sediments. Polycyclic aromatic hydrocarbon (PAH) concentrations were also determined in megafaunal tissues (invertebrates and demersal fish) and pore waters. A suite of major and trace metals were analyzed in tissues, sediments, and pore waters. The methods employed are those utilized by the NOAA National Status and Trends Program and the EPA-EMAP program, making the results presented here directly comparable to these large environmental databases. The contaminant work element collected and

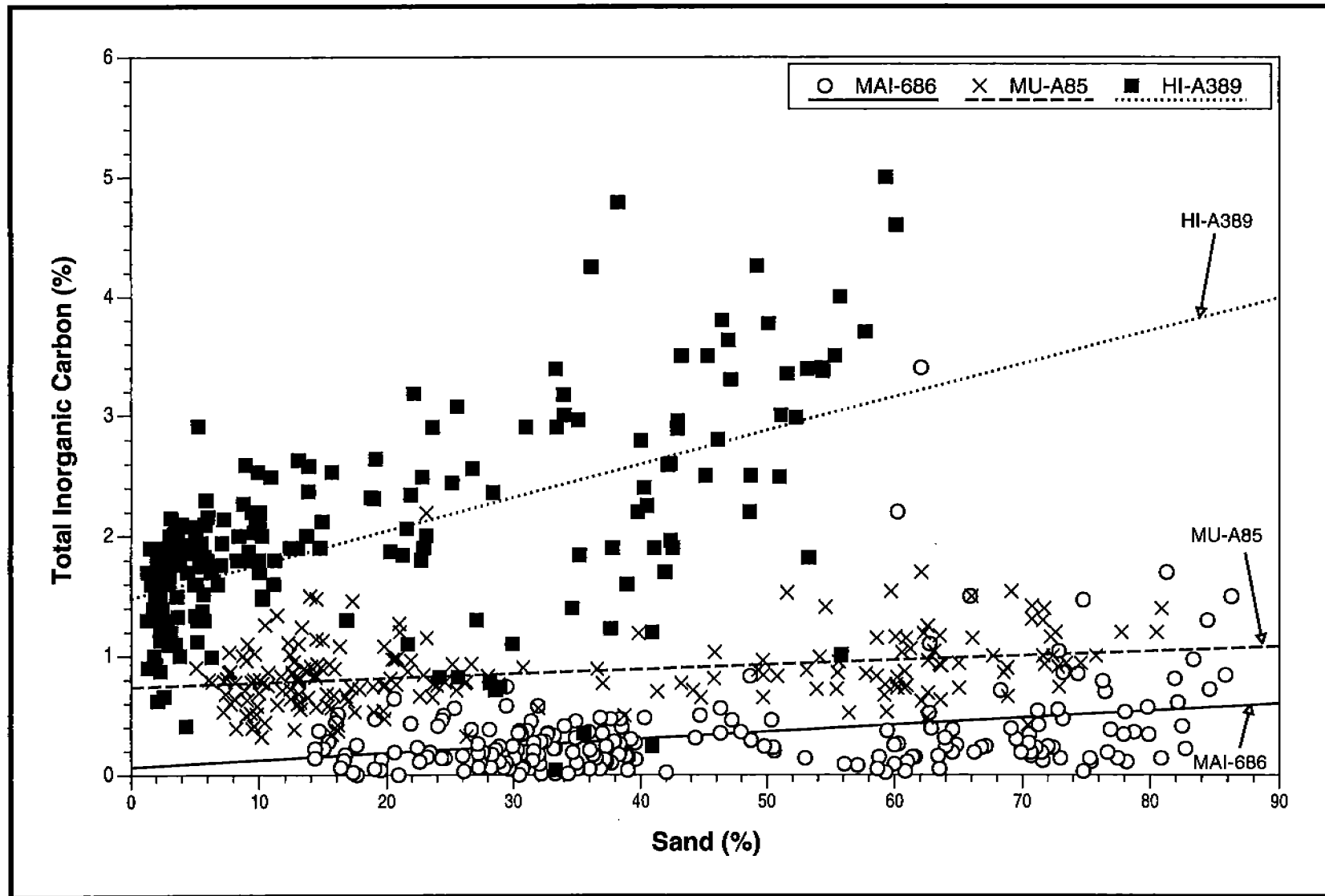

Figure 5.30. Relationship between sand and total inorganic carbon content (%) in sediments at all sites for all cruises.

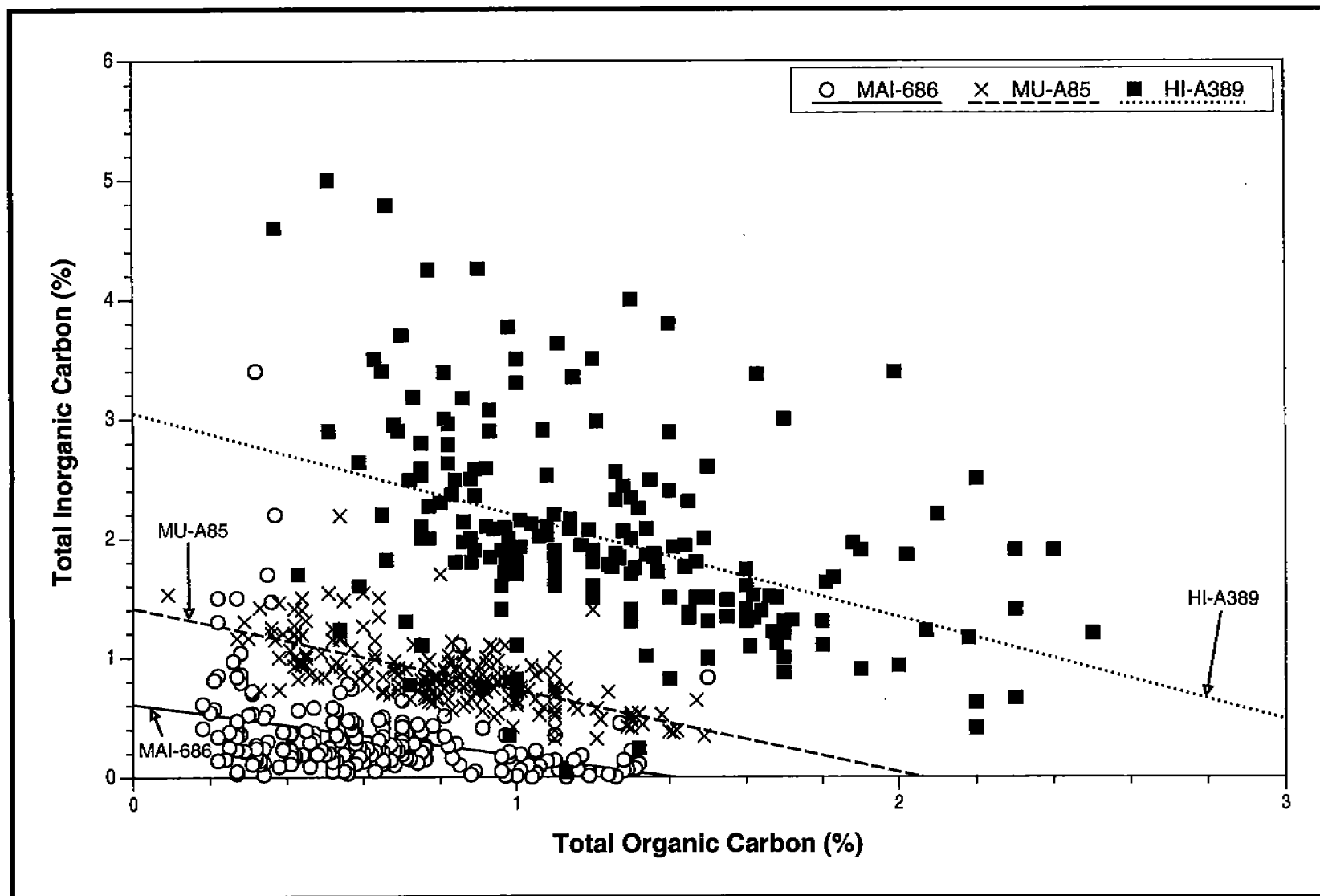

Figure 5.31. Relationship between organic and inorganic carbon content (%) in sediments at all sites for all cruises.

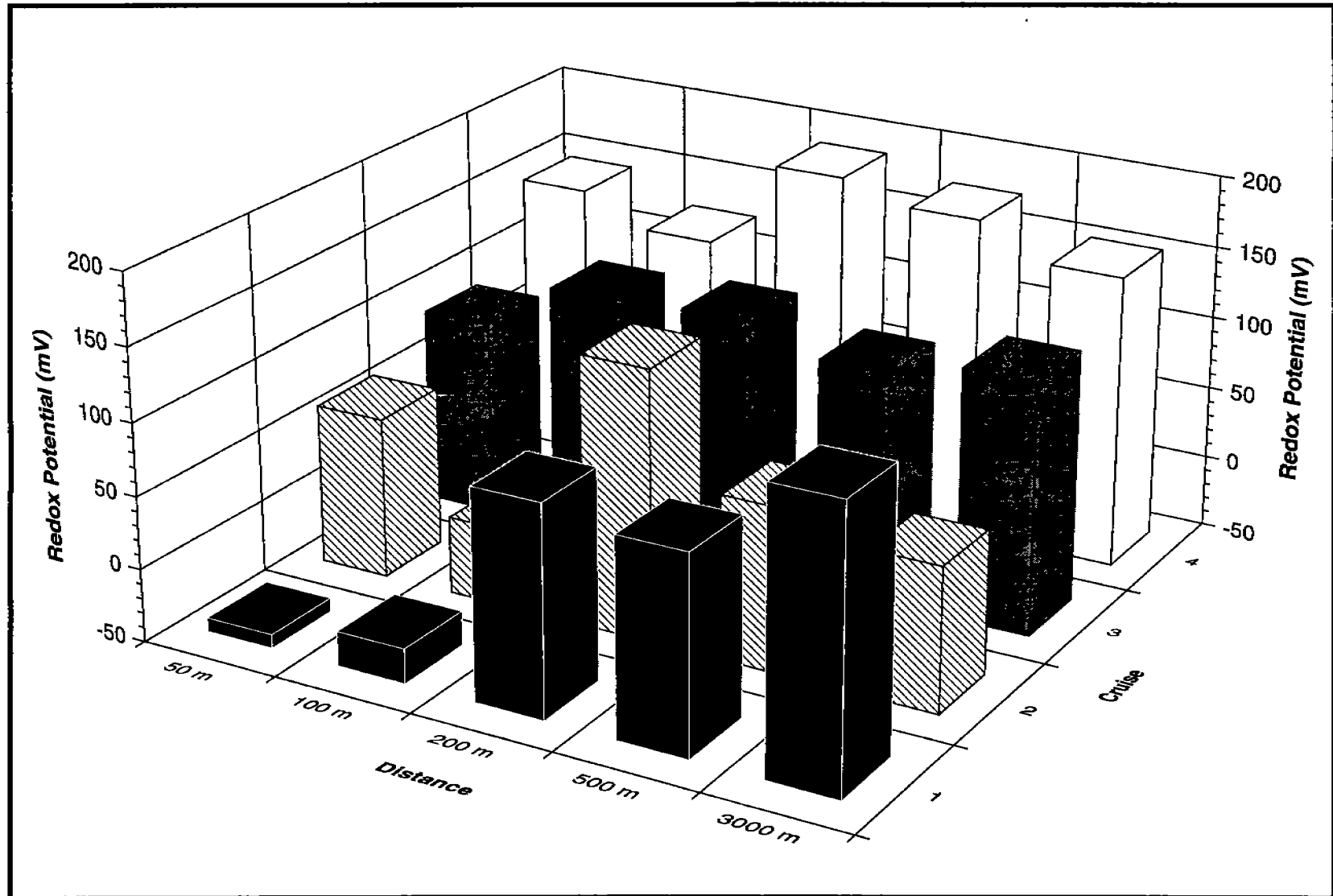

Figure 5.32. Variability in mean redox potential (mV) in sediments with distance from the platform by cruise at MAI-686.

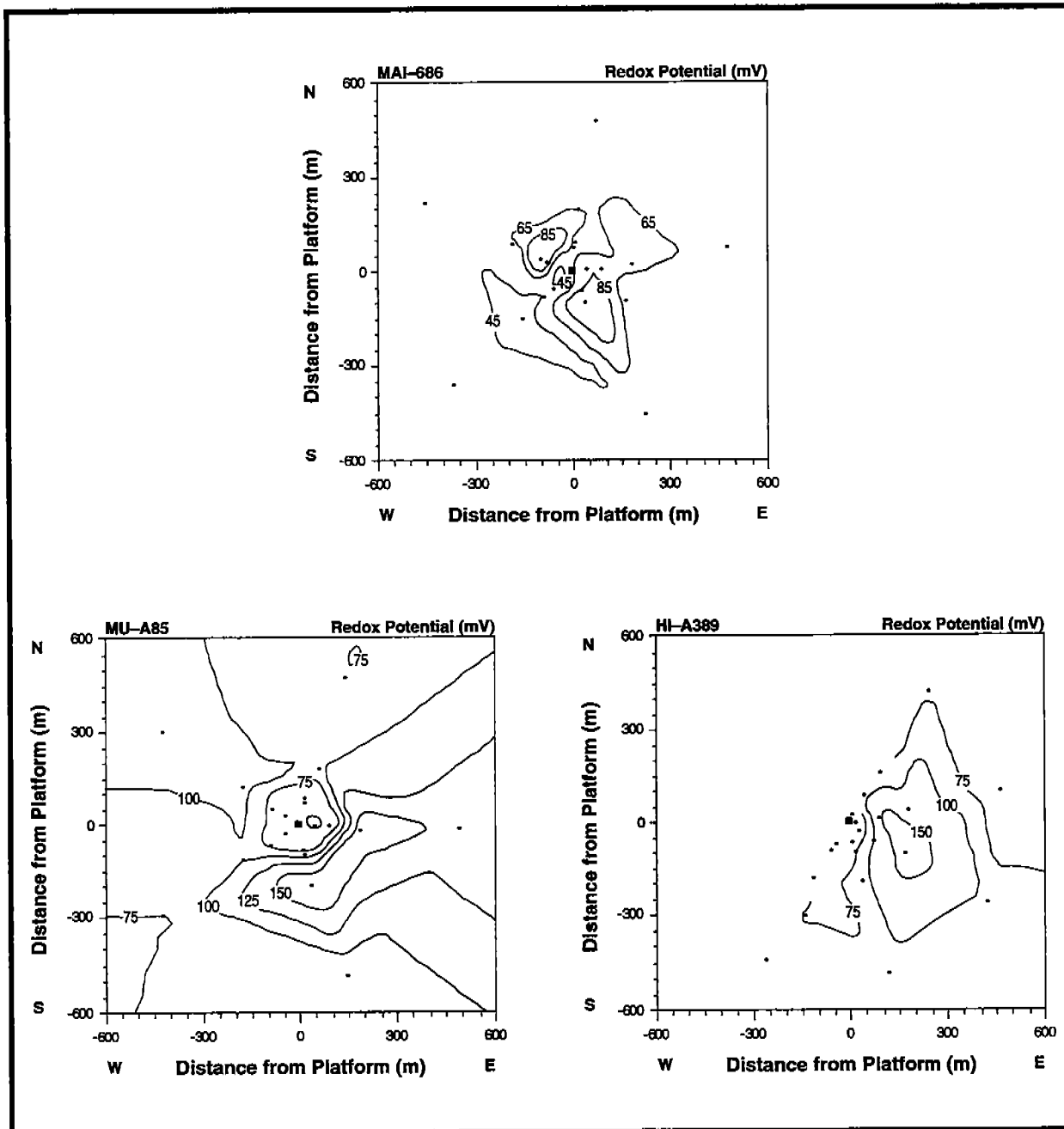

Figure 5.33. Areal distribution of mean redox potential (mV) in sediments as a composite of all four cruises.

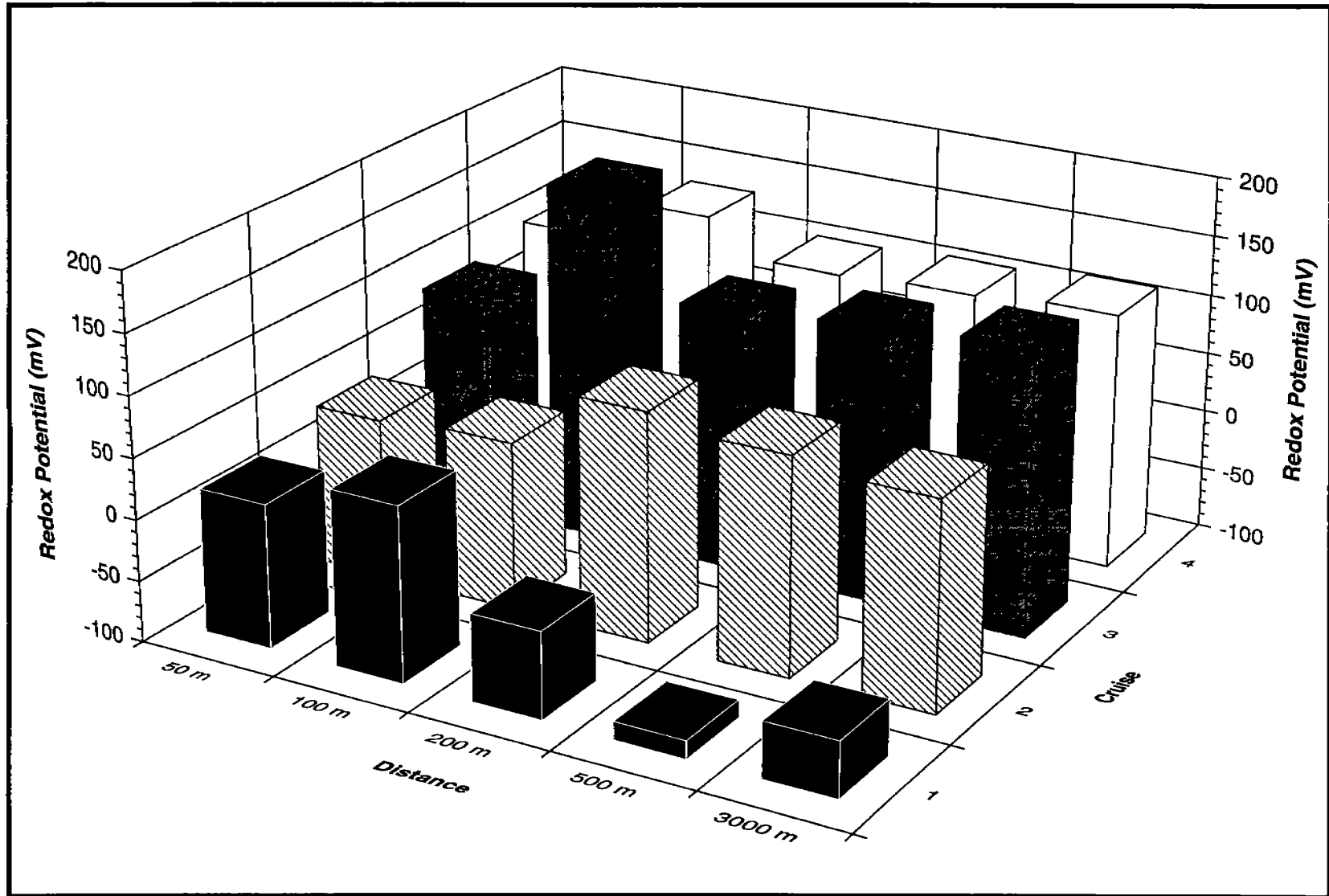

Figure 5.34. Variability in mean redox potential (mV) in sediments with distance from the platform by cruise at MU-A85.

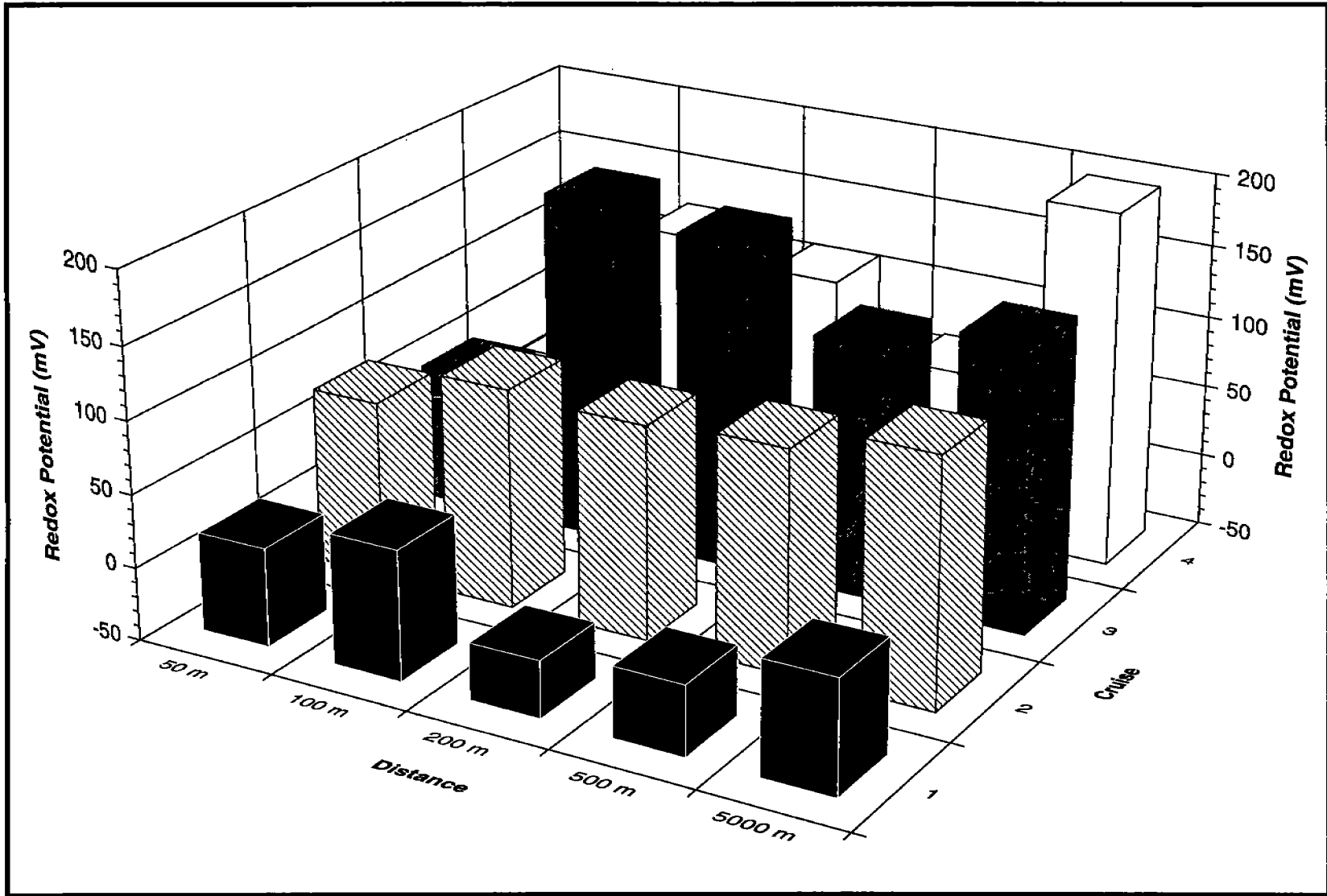

Figure 5.35. Variability in mean redox potential (mV) in sediments with distance from the platform by cruise at HI-A389.

analyzed 760 sediments, 810 tissues, and 60 pore waters for hydrocarbons and metals.

5.3.1 Hydrocarbons in Sediments

Total polycyclic aromatic hydrocarbons (PAH), aliphatic hydrocarbons (AH), and the unresolved complex mixture (UCM) concentrations are summarized by cruise for each site in Figures 5.36 to 5.44. At MAI-686, total alkanes, total PAH, and total UCM concentrations varied from 72 to 9,568 (mean=800) ppb; 7.8 to 588 (mean=53) ppb; and 0.0 to 119.4 (mean=7.5) ppm, respectively. At MU-A85, the same parameters varied from 68 to 13,960 (mean=789) ppb; 12.7 to 6,358.5 (mean=162) ppb; and 0.0 to 381.8 (mean=27.8) ppm, respectively. At HI-A389, the same parameters varied from 63 to 15,927 (mean=571) ppb; 11.4 to 1,238.1 (mean=146.5) ppb; and 0.0 to 406.1 (mean=26.7) ppm, respectively. A weak gradient in petroleum related variables was observed at MAI-686 (Figure 5.36). Steeper gradients with distance from the platform were observed in total alkane, UCM, and PAH concentrations at the MU-A85 and HI-A389 sites (Figures 5.36 and 5.44).

Sediments from most stations contained little or no evidence of petroleum contamination. Concentrations for UCM, total PAH and total alkanes at most stations were less than 10 ppm, 150 ppb, and 500 ppb, respectively. The method detection limit for total PAH in sediment is approximately 100 to 150 ppb. The areal distribution of the hydrocarbon contaminants was not symmetrical around the platforms with concentration gradients varying in steepness among radii (Figures 5.45 to 5.47). Concentrations generally reached constant, background levels at distances of 100 to 200 m from the platform (Figures 5.36 to 5.44). Two exceptions were noted for total alkanes at MAI-686 and PAH at HI-A389 which were enhanced above background to a distance of 200 m (Figure 5.46, respectively). At MAI-686 a few stations exhibited gas chromatograms typical of fresh condensate contamination (predominance of lower molecular weight n-alkanes and no UCM) during all four cruises, suggesting a recent and continuing influx of hydrocarbons (i.e., pipeline leak or an active seep; Figure 5.48). In contrast, the contaminants at most stations at MU-A85 and HI-A389 lacked n-alkanes and exhibited a large UCM (Figures 5.49 and 4.50). Sediment extracts at HI-A389 exhibited a range of compositions

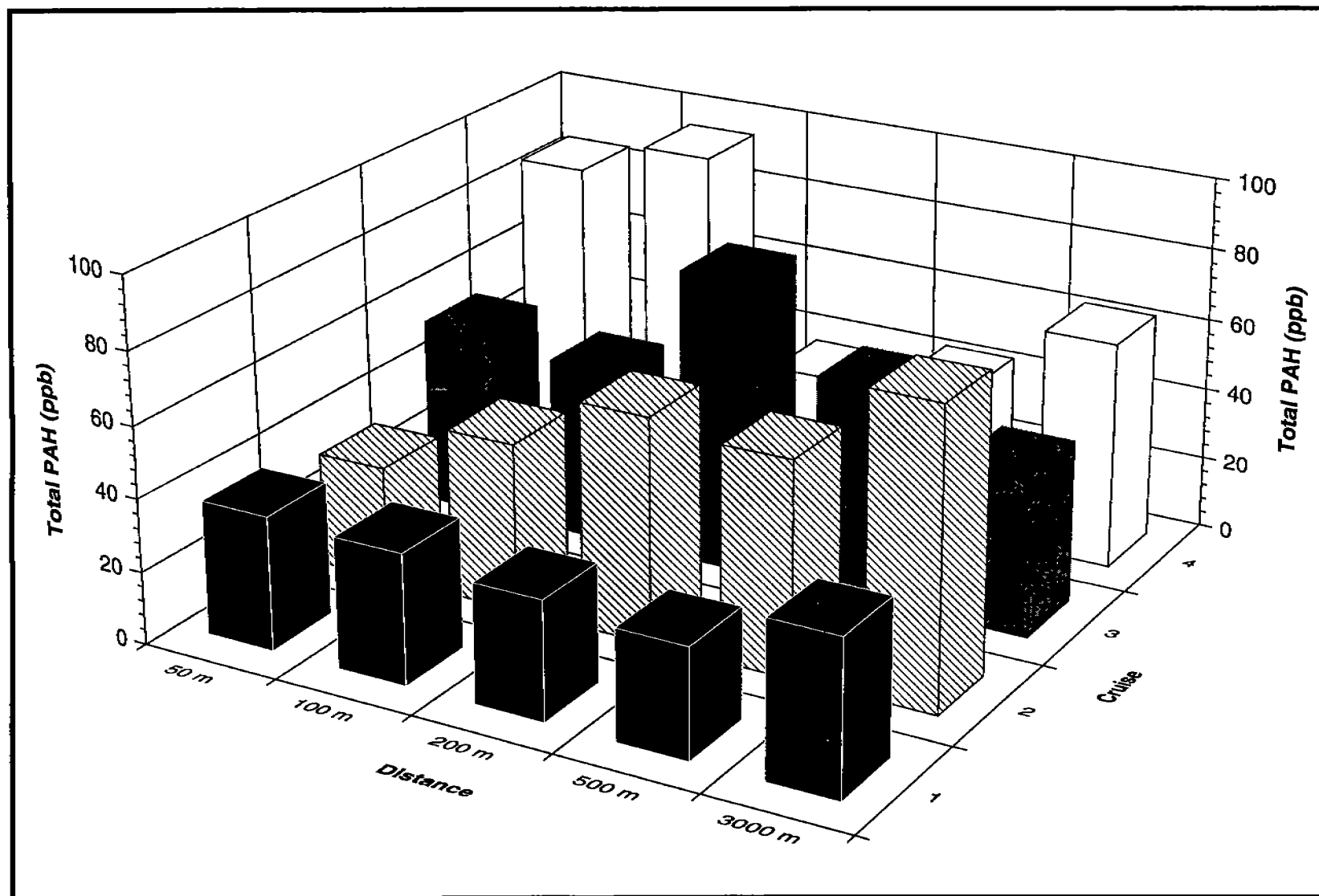

Figure 5.36. Variability in mean total PAH concentrations (ppb) in sediments with distance from the platform by cruise at MAI-686.

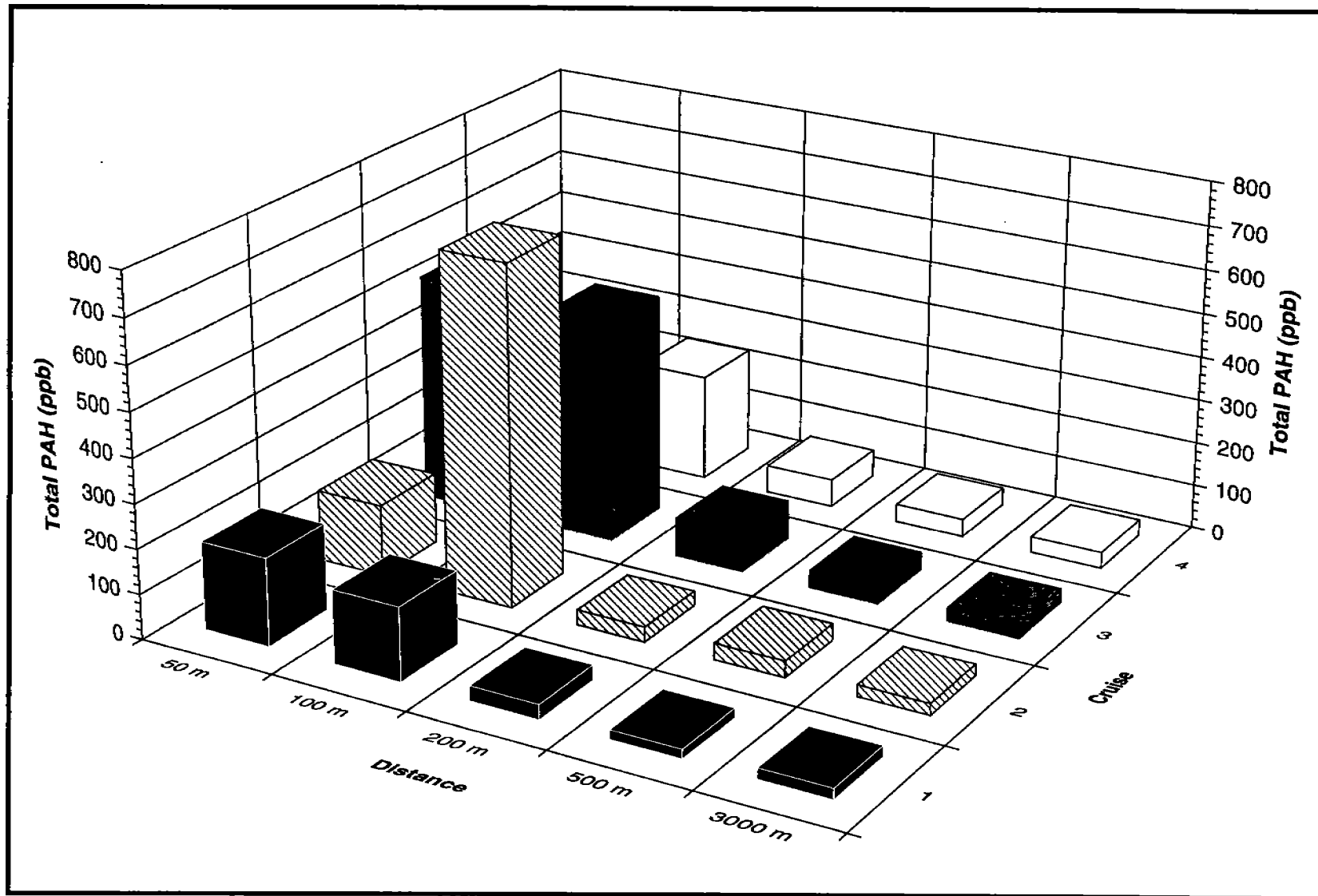

Figure 5.37. Variability in mean total PAH concentrations (ppb) in sediments with distance from the platform by cruise at MU-A85.

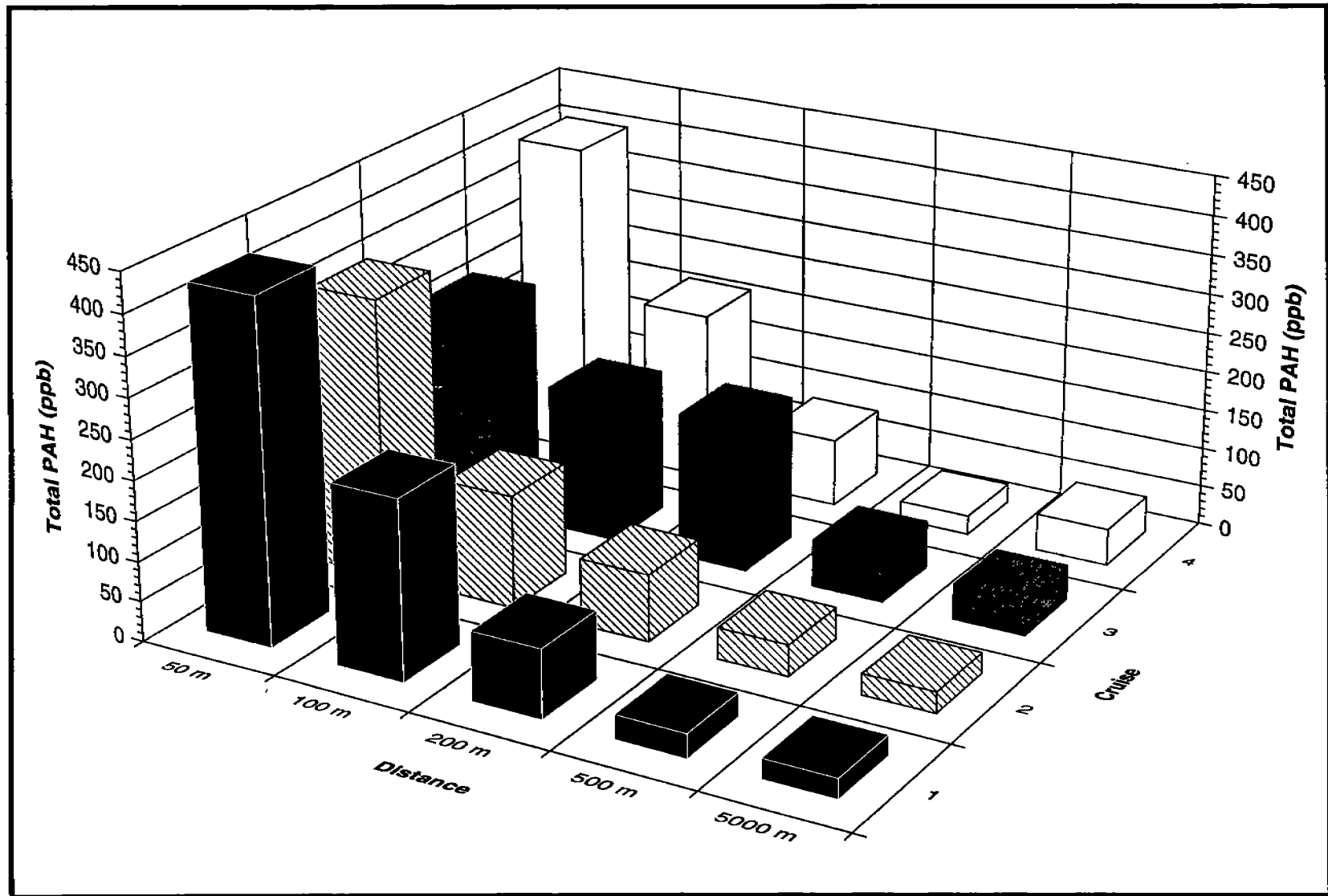

Figure 5.38. Variability in mean total PAH concentrations (ppb) in sediments with distance from the platform by cruise at HI-A389.

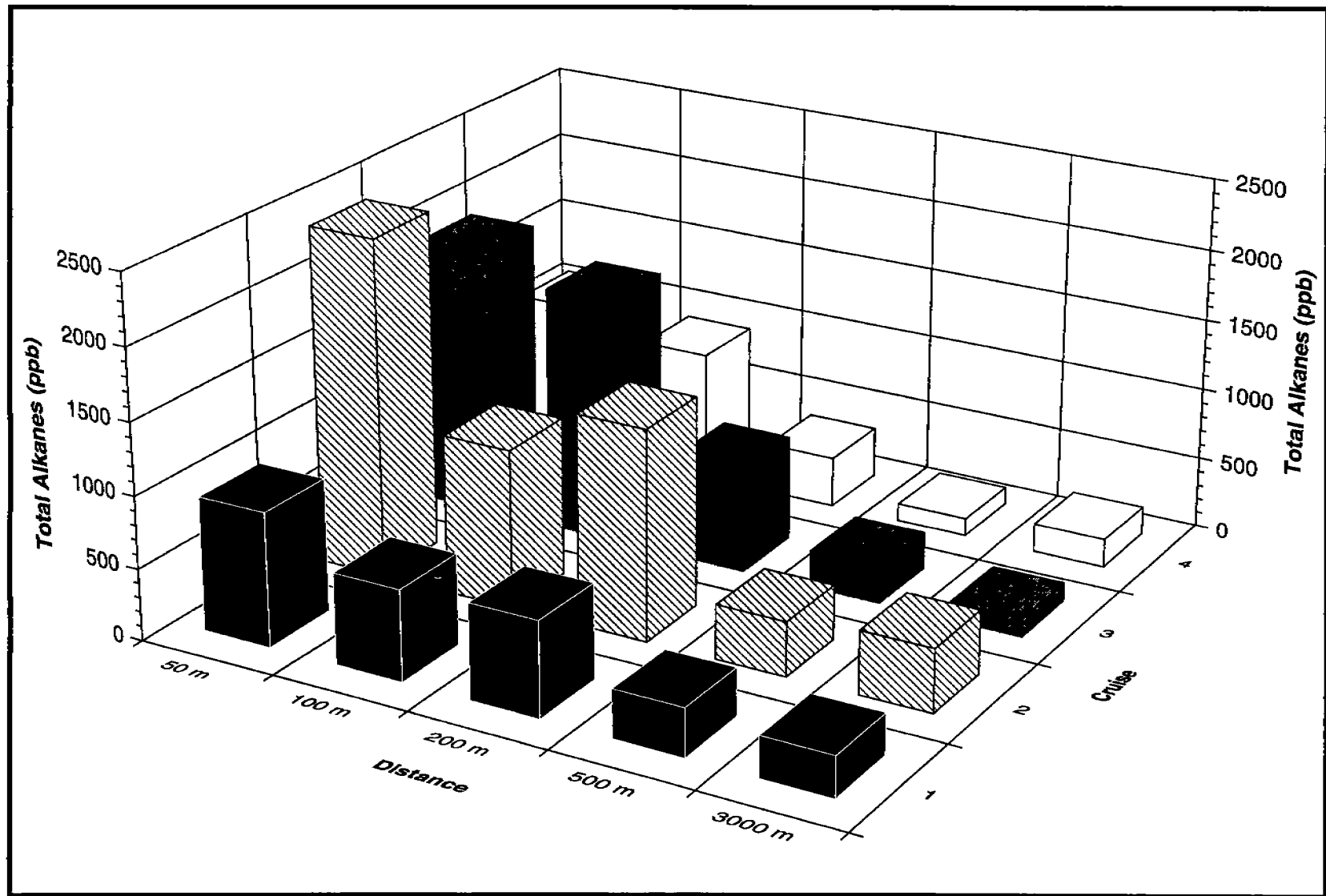

Figure 5.39. Variability in mean total alkane concentrations (ppb) in sediments with distance from the platform by cruise at MAI-686.

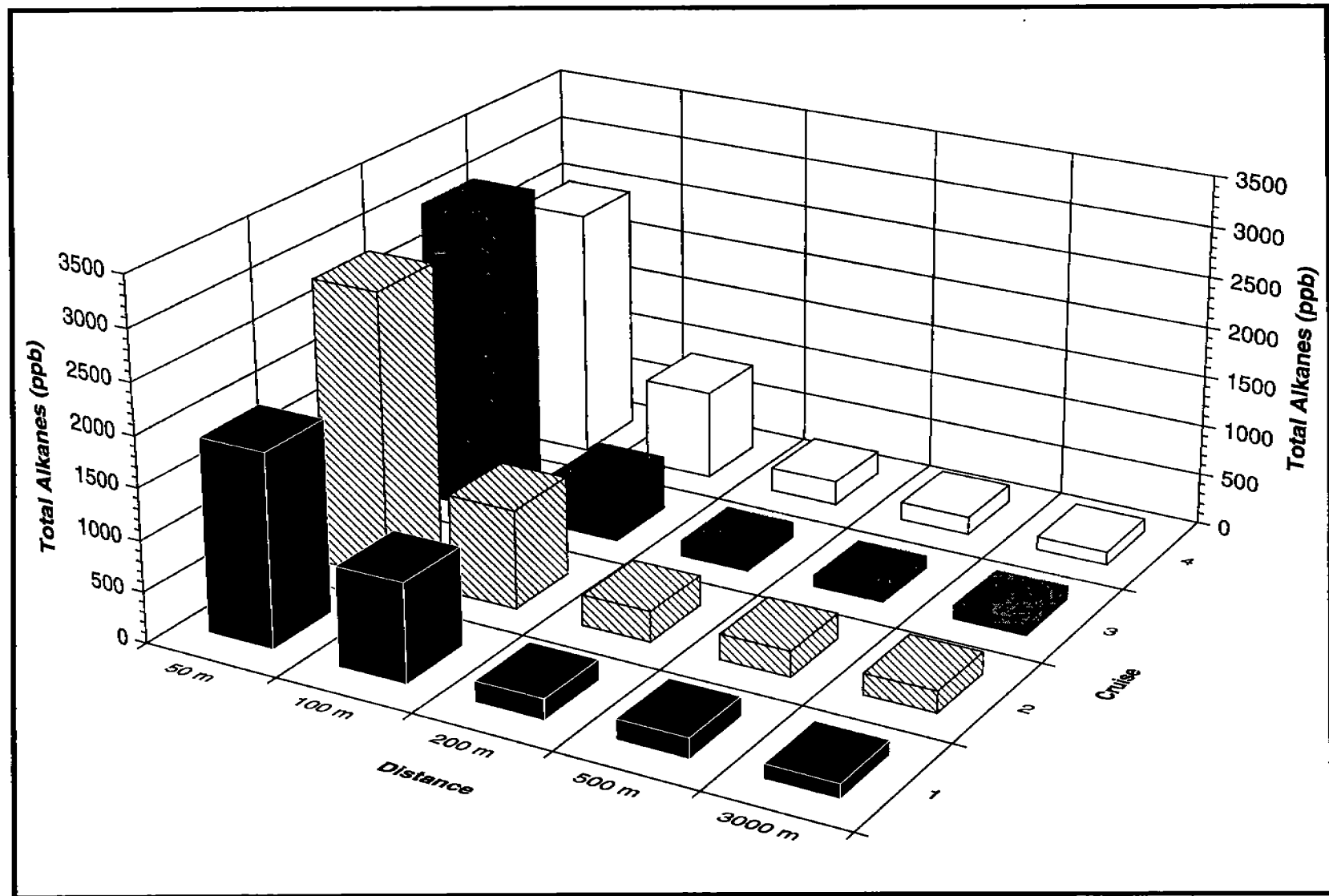

Figure 5.40. Variability in mean total alkane concentrations (ppb) in sediments with distance from the platform by cruise at MU-A85.

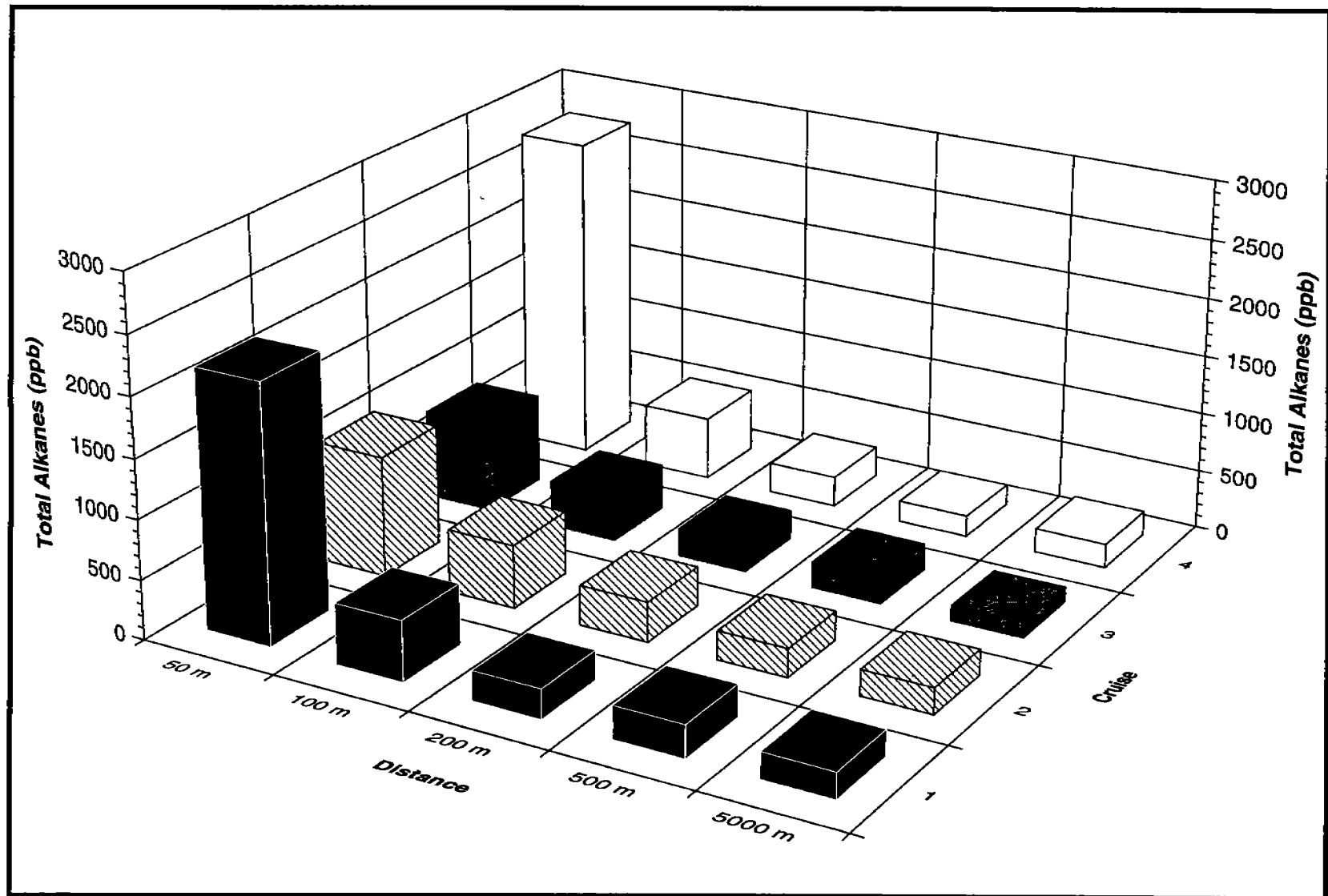

Figure 5.41. Variability in mean total alkane concentrations (ppb) in sediments with distance from the platform by cruise at HI-A839.

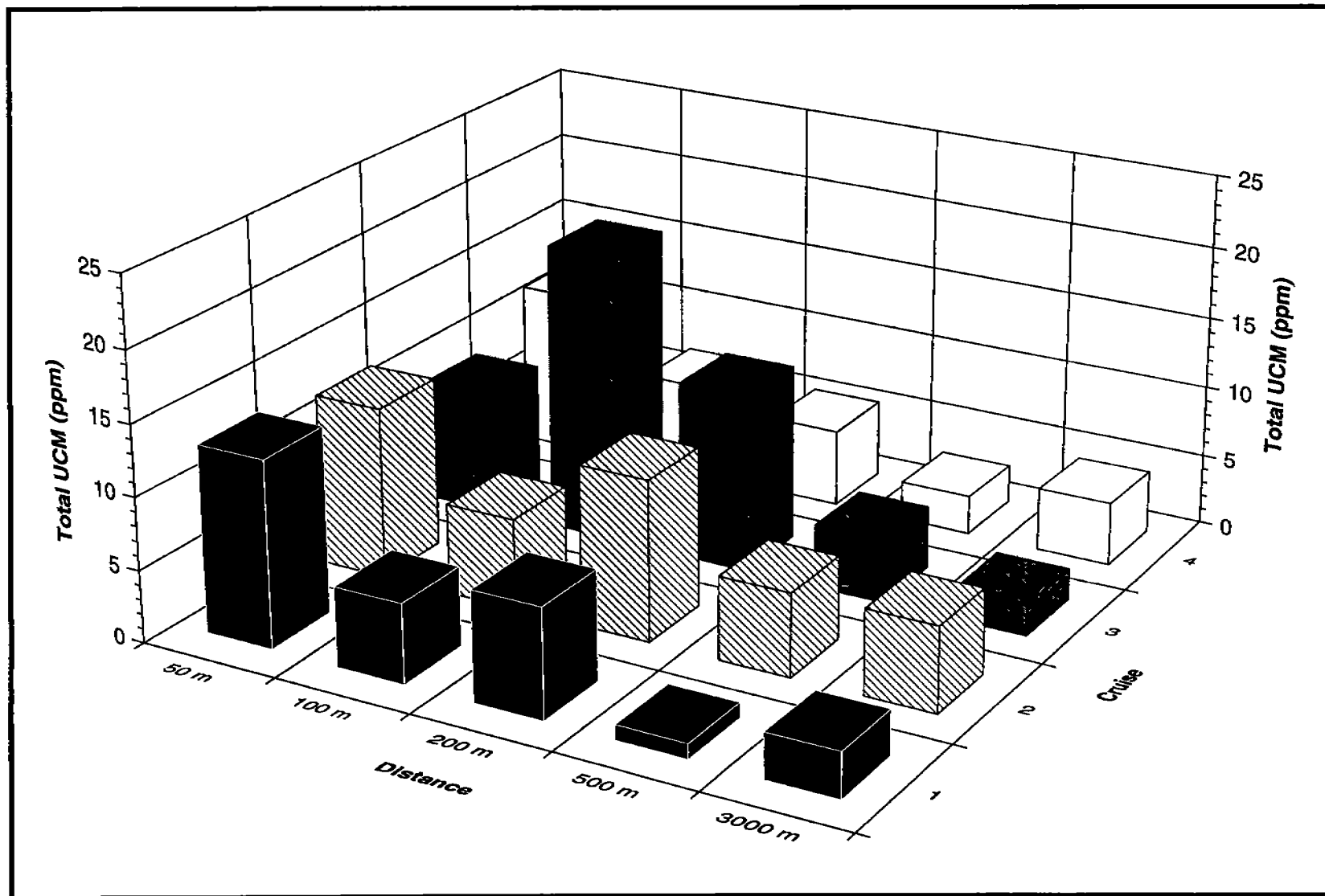

Figure 5.42. Variability in mean total UCM concentrations (ppm) in sediments with distance from the platform by cruise at MAI-686.

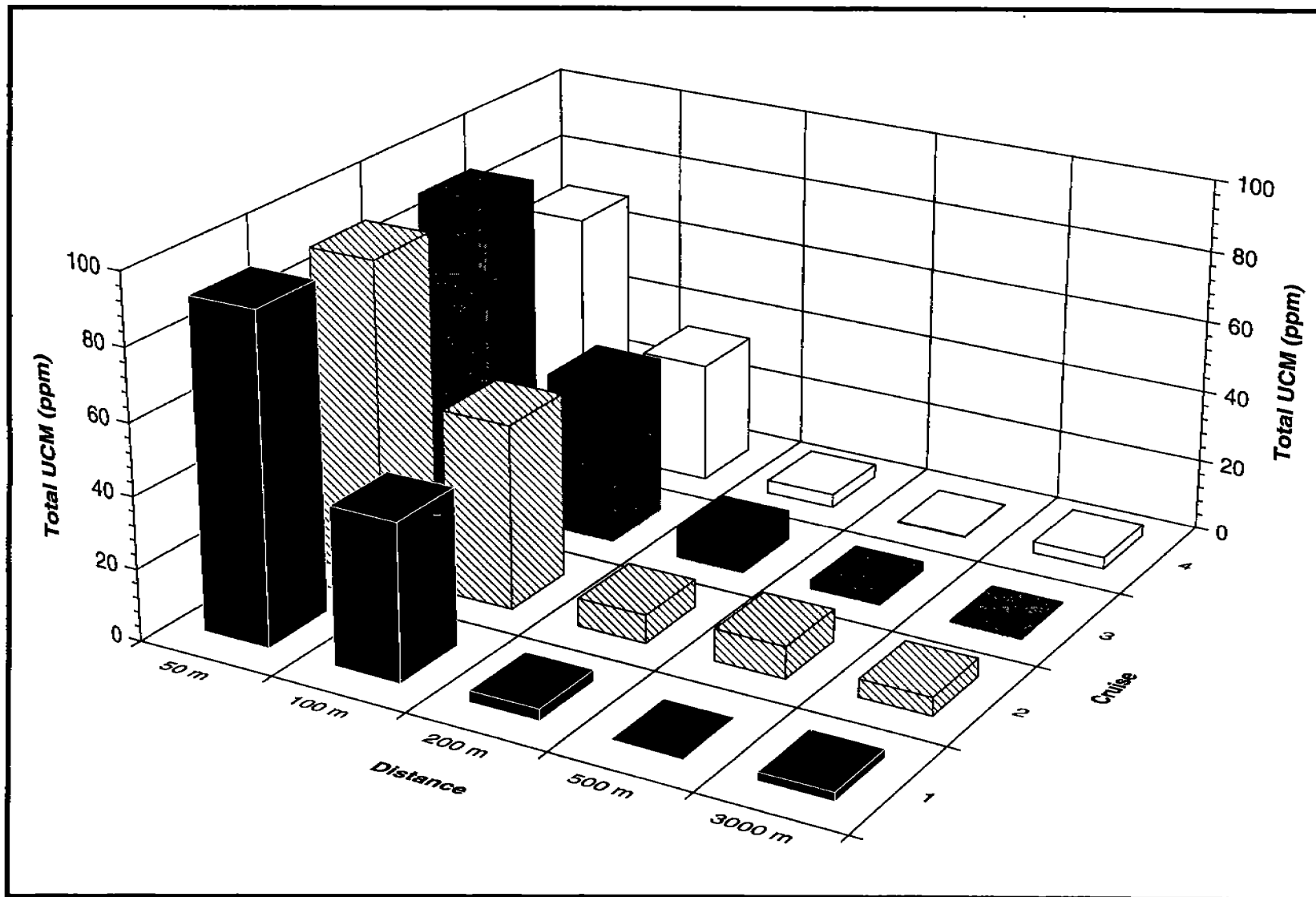

Figure 5.43. Variability in mean total UCM concentrations (ppm) in sediments with distance from the platform by cruise at MU-A85.

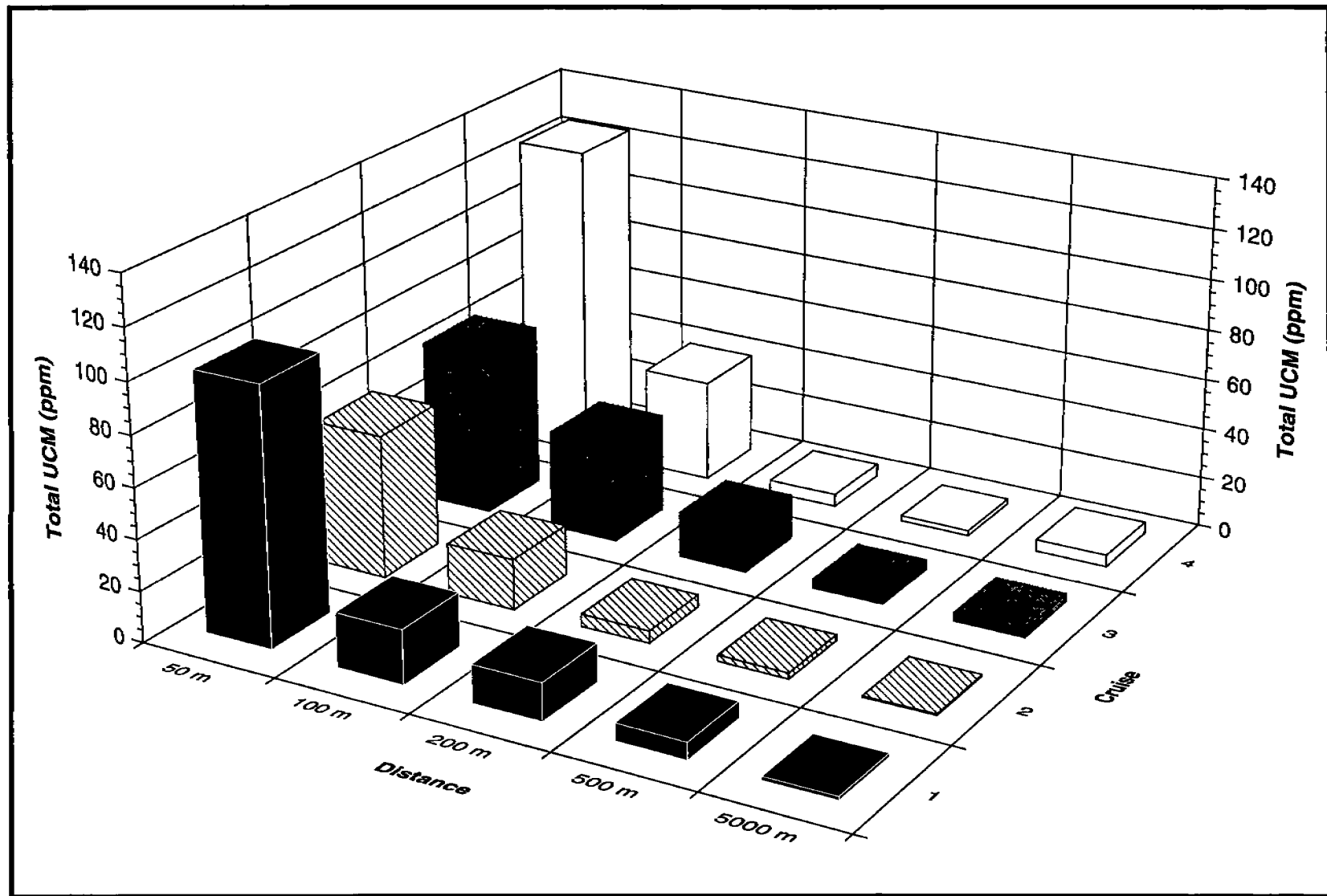

Figure 5.44. Variability in mean total UCM concentrations (ppm) in sediments with distance from the platform by cruise at HI-A389.

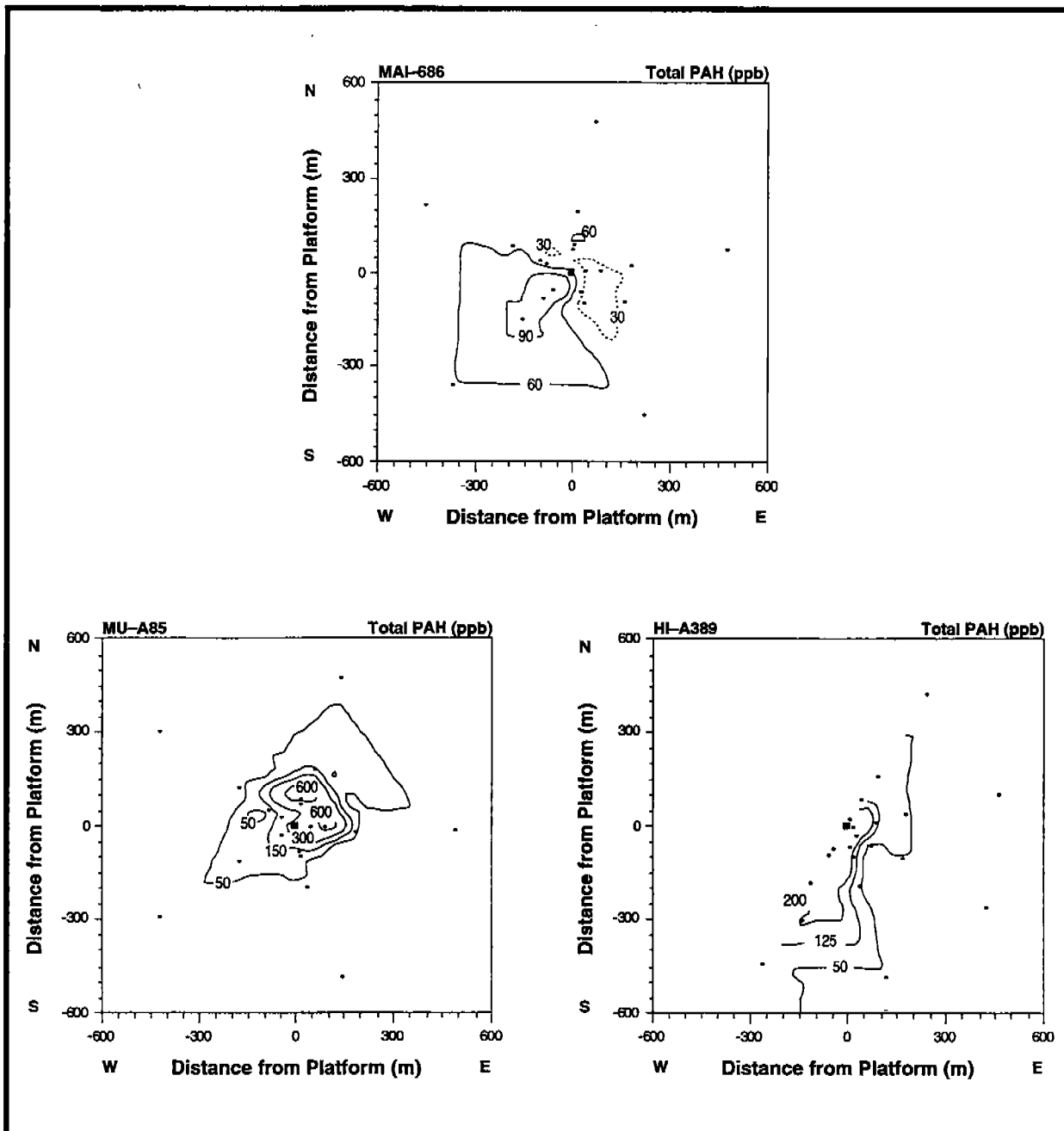

Figure 5.45. Areal distribution of mean total PAH concentrations (ppb) in sediments as a composite of all four cruises.

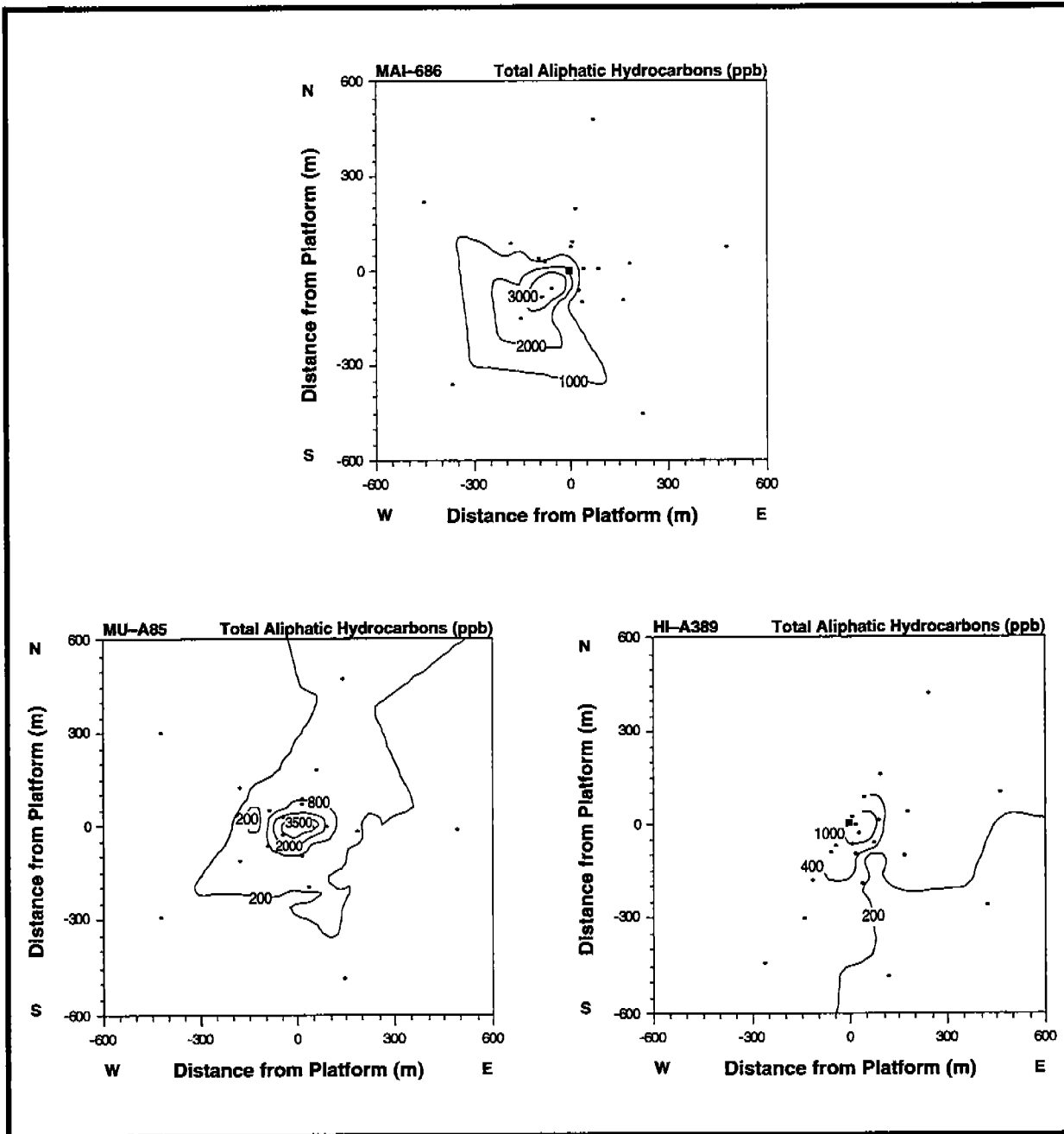

Figure 5.46. Areal distribution of mean total aliphatic hydrocarbon concentrations (ppb) in sediments as a composite of all four cruises.

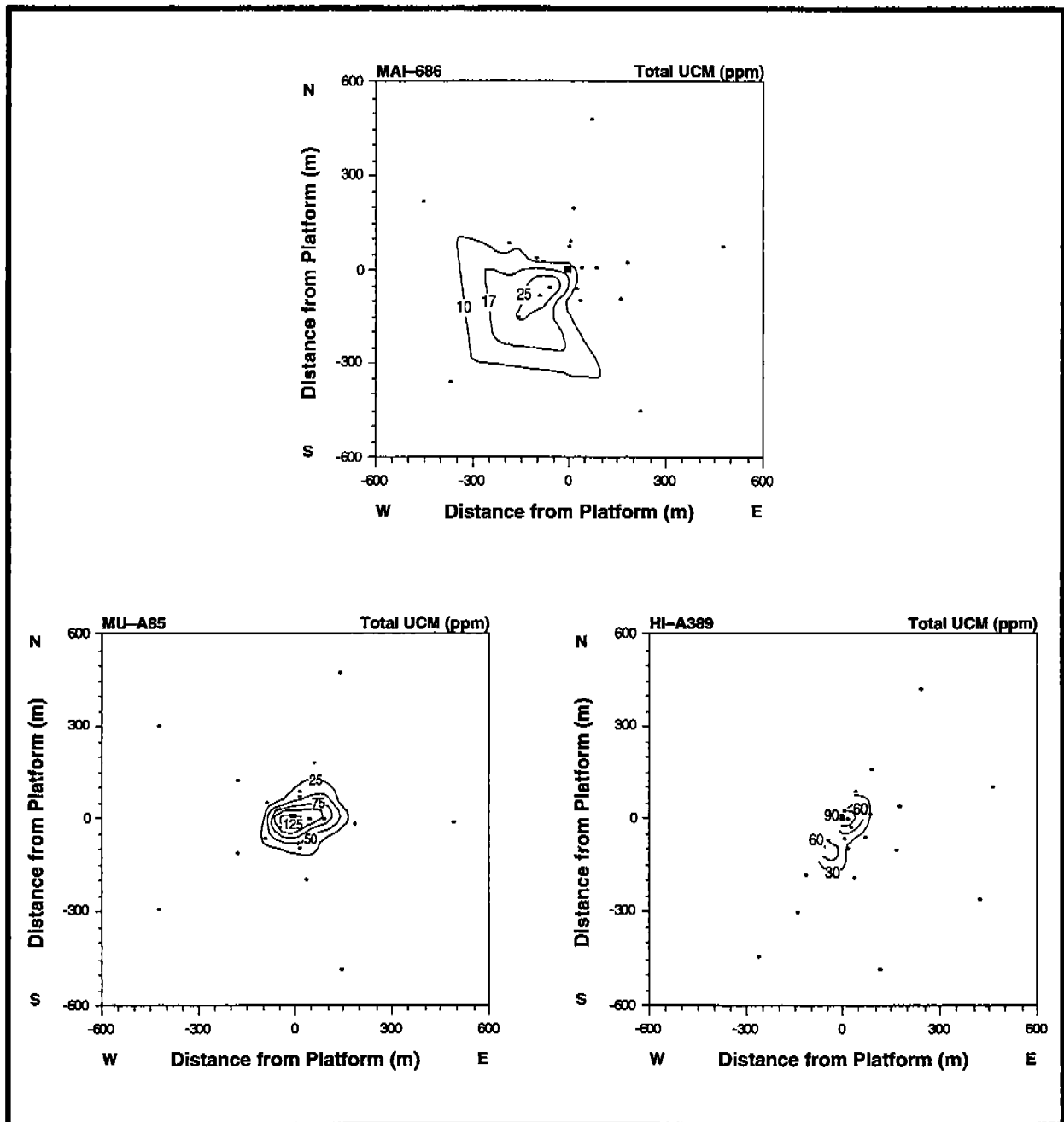

Figure 5.47. Areal distribution of mean total UCM concentrations (ppm) in sediments as a composite of all four cruises.

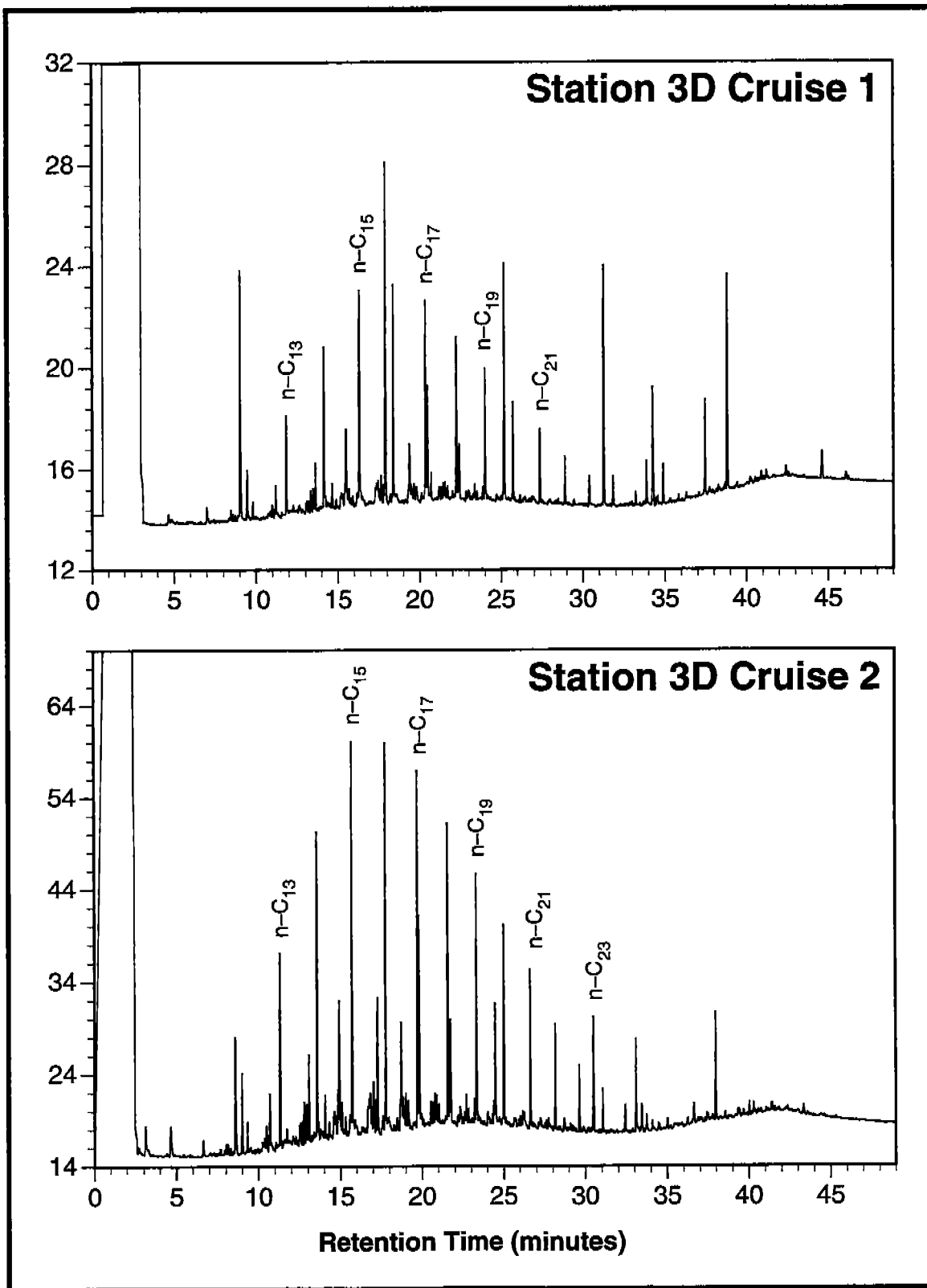

Figure 5.48. Gas chromatograms (flame ionization detection) of sediment extracts from MAI-686.

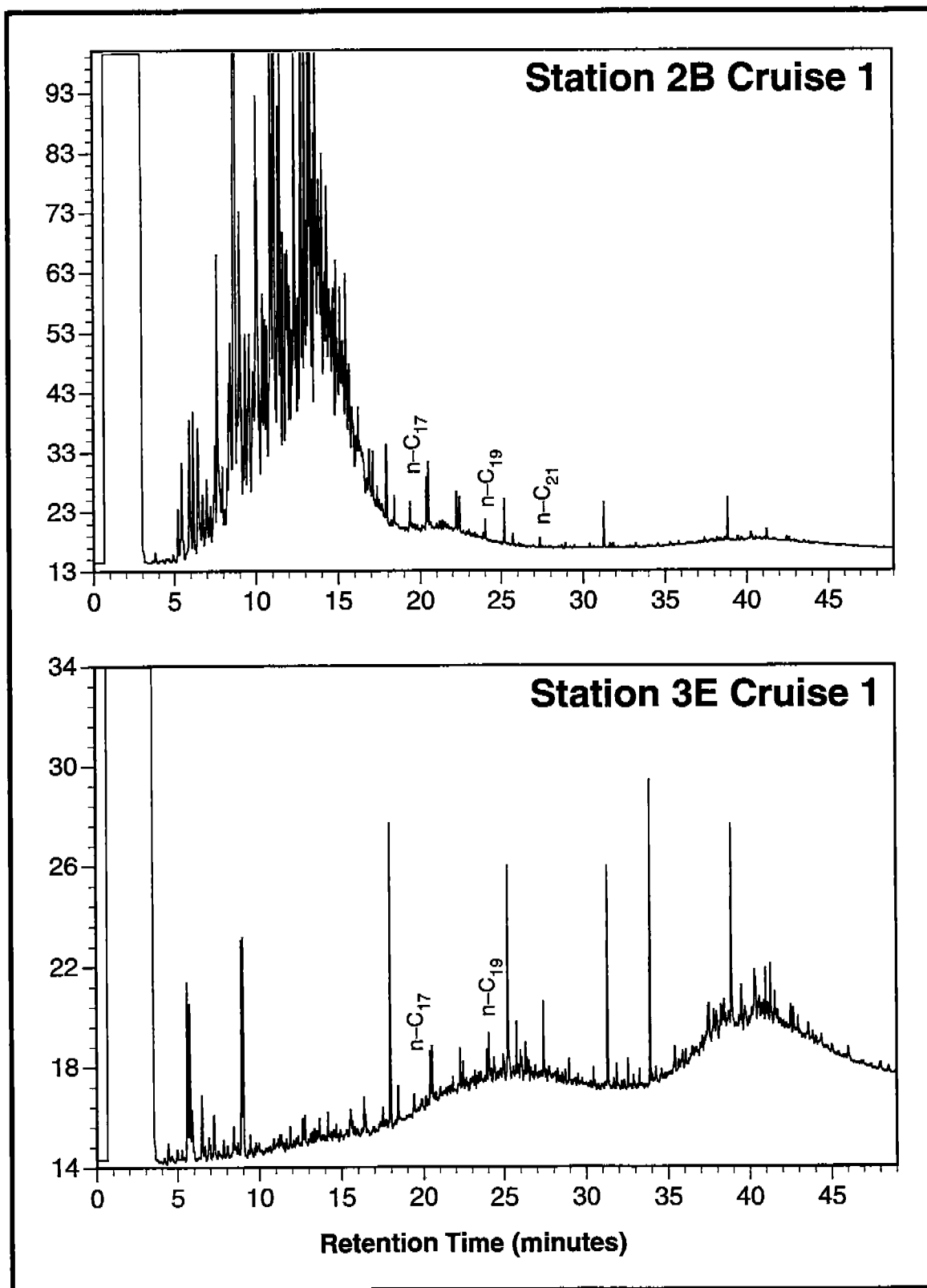

Figure 5.49. Gas chromatograms (flame ionization detection) of sediment extracts from HI-A389.

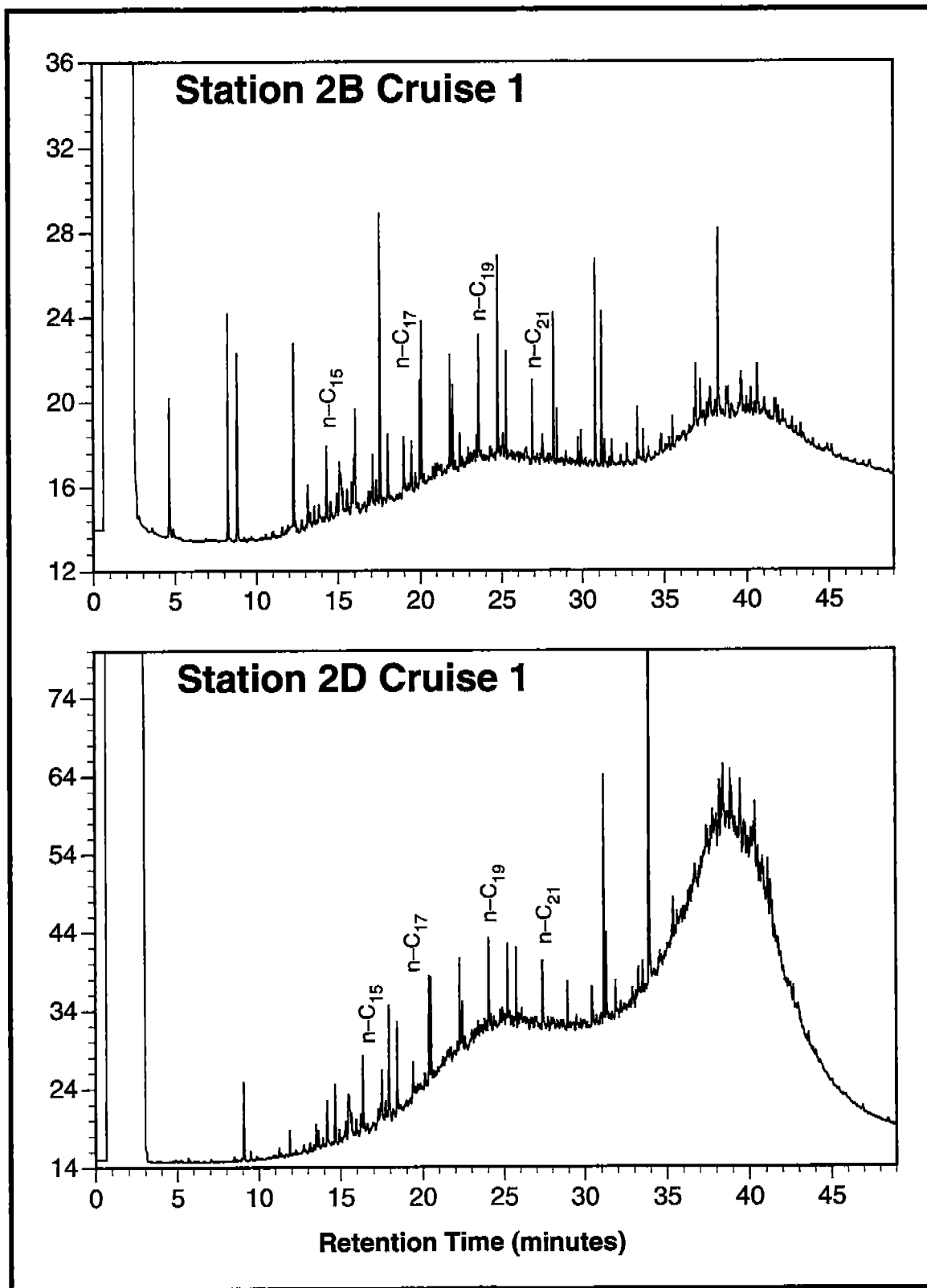

Figure 5.50. Gas chromatograms (flame ionization detection) of sediment extracts from MU-A85.

probably resulting from differential input from multiple sources of hydrocarbon contaminants. One station appeared to be contaminated with a low molecular weight fluid. Other stations exhibited a bimodal UCM suggesting that possibly two or more sources of petroleum were present in the area (Figure 5.50).

Hydrocarbon concentrations were similar between cruises, suggesting that the low level contamination observed was relatively stable over time. The greatest variations between cruises were detected at stations nearest to the platform, reflecting steep, near-platform gradients and the heterogeneous distribution of hydrocarbons in sediments.

5.3.2 Trace Metals in Sediments

Metal concentrations are summarized in Table 5.15. Variations in metal concentrations (on a dry wt basis) among cruises are illustrated for selected metals in Figures 5.51 to 5.62. Contour plots are presented for aluminum and iron, which are major elemental constituents of the aluminosilicate minerals, and cadmium (Cd) and barium (Ba), which are typical metal contaminants (Figures 5.63 to 5.66). In regard to the level of contamination by metals among sites MAI-686 site was lowest, MU-A85 was intermediate and HI-A389 was highest, the same order observed for hydrocarbon contamination. Metals exhibited one of three distributions: (1) metal concentrations that increased near the platform, (2) metal concentrations that decreased near the platform, and (3) metal concentrations that had no detectable change in concentration in relation to the platform. The metals with near uniform distributions include silver, arsenic, copper, mercury, antimony, selenium, and tin. These metals show little change relative to distance from the platform. An exception to this relatively uniform pattern was an increase for a few of the metals (Ag, As, Ca, and Hg) near the platform at HI-A389 where the very highest metal levels were observed. Since a dilution of the sediments with 35 to 60 % of sand has occurred, uniform concentrations suggest that a platform-related source must be present to counteract the documented dilution event. In support of this interpretation, several metals show a decrease near the platform including aluminum, chromium (occasionally), iron, nickel, and vanadium. The remaining metals; barium, cadmium, lead, and zinc; increase in

Table 5.15. The ranges in metal concentrations (ppm) in surficial sediments (0 to 2 cm) from GOOMEX study sites.

Metal	MAI-686 (ppm)	MU-A85 (ppm)	HI-A389 (ppm)
Ag	0.1-1.7	0.0-1.0	0.0-3.8
Al	17,700-71,000	29,100-121,626	11,359-75,037
As	4.2-21.6	3.6-39.1	3.4-32.2
Ba	653-4680	720-26,250	785-280,220
Cd	0.0-1.6	0.0-2.3	0.1-63.7
Cr	25.5-82.0	37.8-131.0	35.0-171.0
Cu	3.8-48.9	5.5-36.2	9.0-106.1
Fe	11,940-30,280	13,680-69,940	15,400-36,590
Hg	0.0-0.1	0.0-0.3	0.0-3.5
Ni	0.5-28.5	7.5-28.5	9.2-35.4
Pb	0.2-555	15.2-436	0.2-694.8
Sb	0.3-2.4	0.3-5.5	0.4-7.5
Se	0.0-0.3	0.1-0.8	0.2-0.8
Sn	0.2-3.0	0.7-79.5	0.5-3.2
V	43.3-119.5	27.8-208.5	3.41-145.5
Zn	43.1-3850	54.6-1440	65.7-11,444

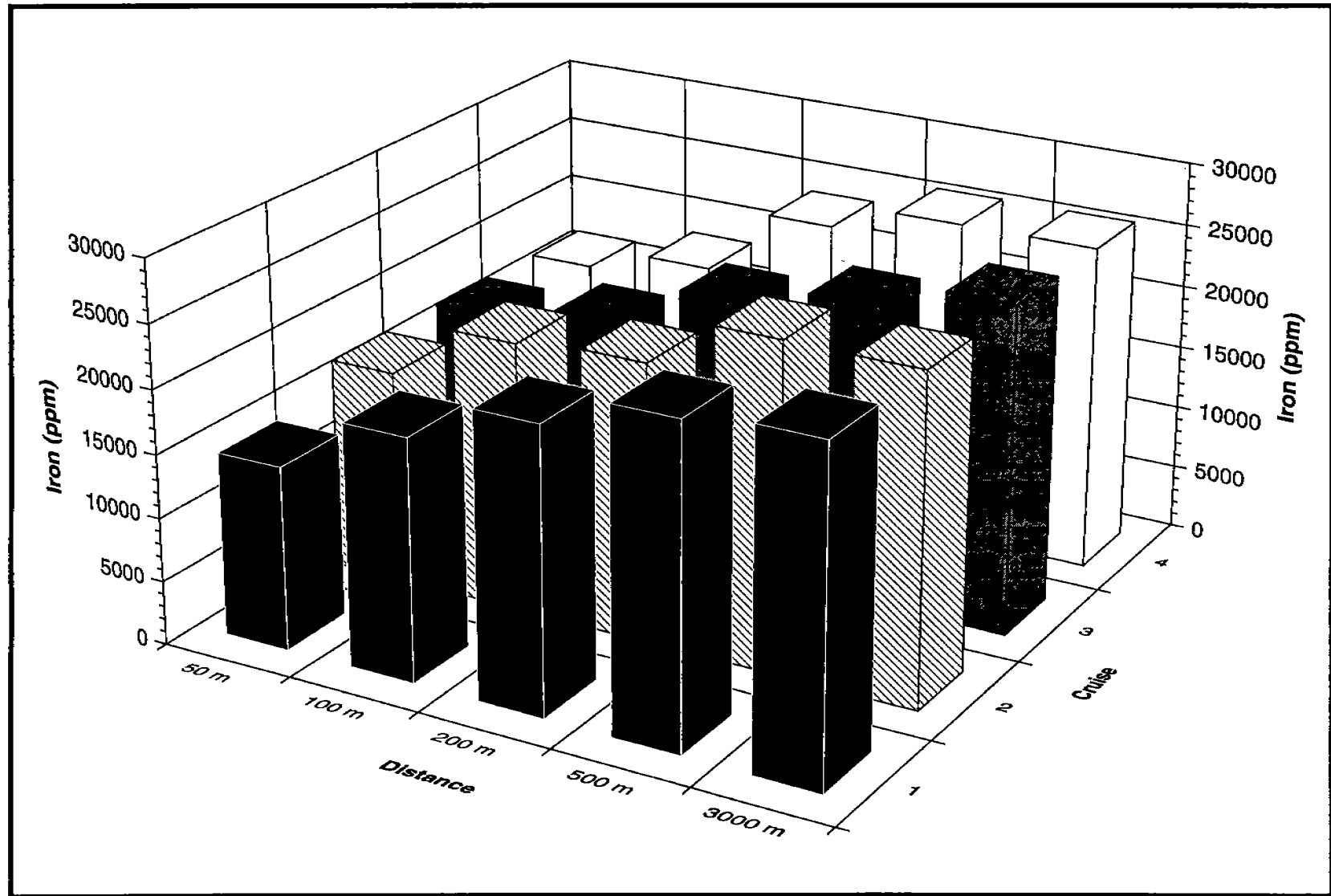

Figure 5.51. Variability in mean iron concentrations (ppm) in sediments with distance from the platform by cruise at MAI-686.

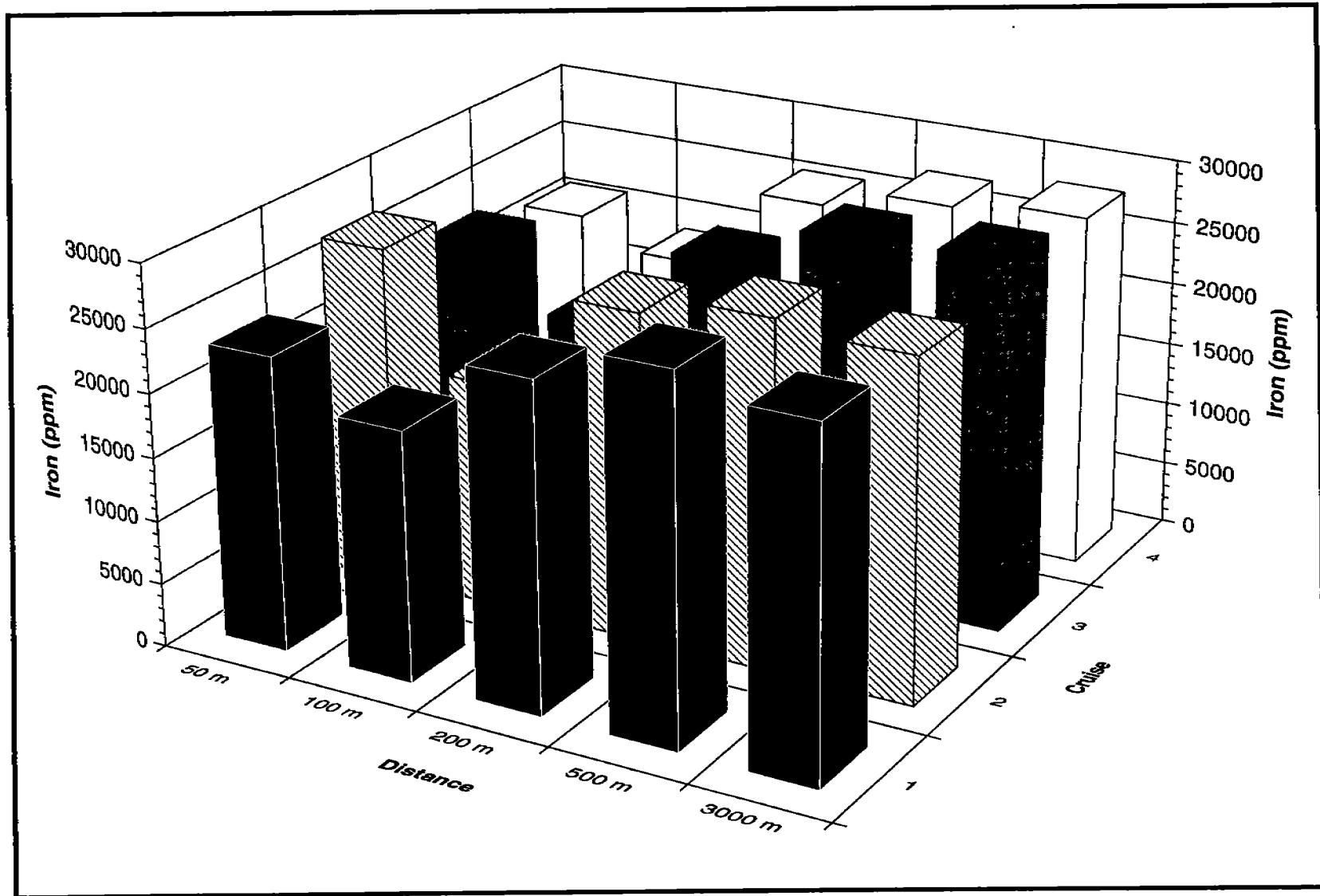

Figure 5.52. Variability in mean iron concentrations (ppm) in sediments with distance from the platform by cruise at MU-A85.

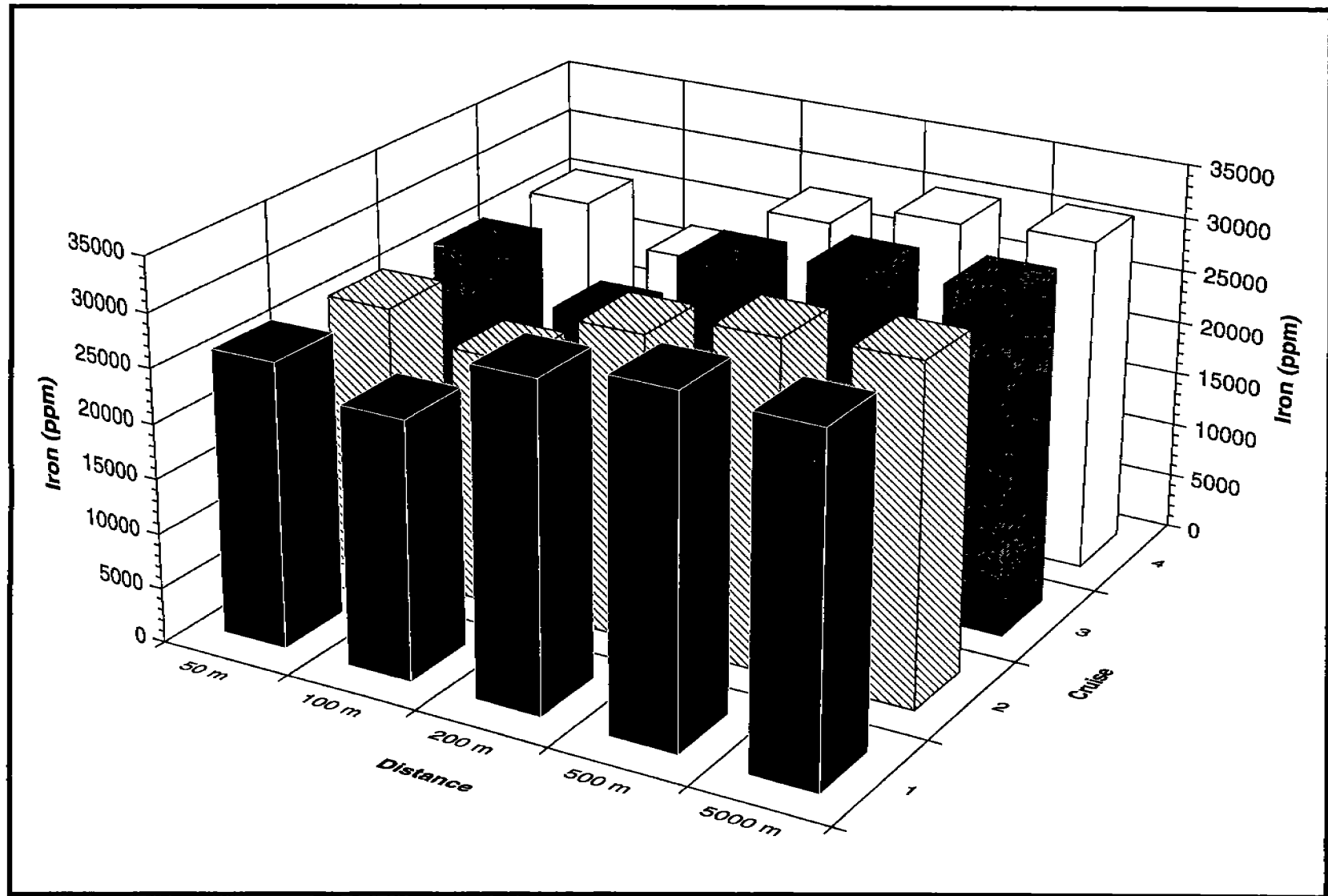

Figure 5.53. Variability in mean iron concentrations (ppm) in sediments with distance from the platform by cruise at HI-A389.

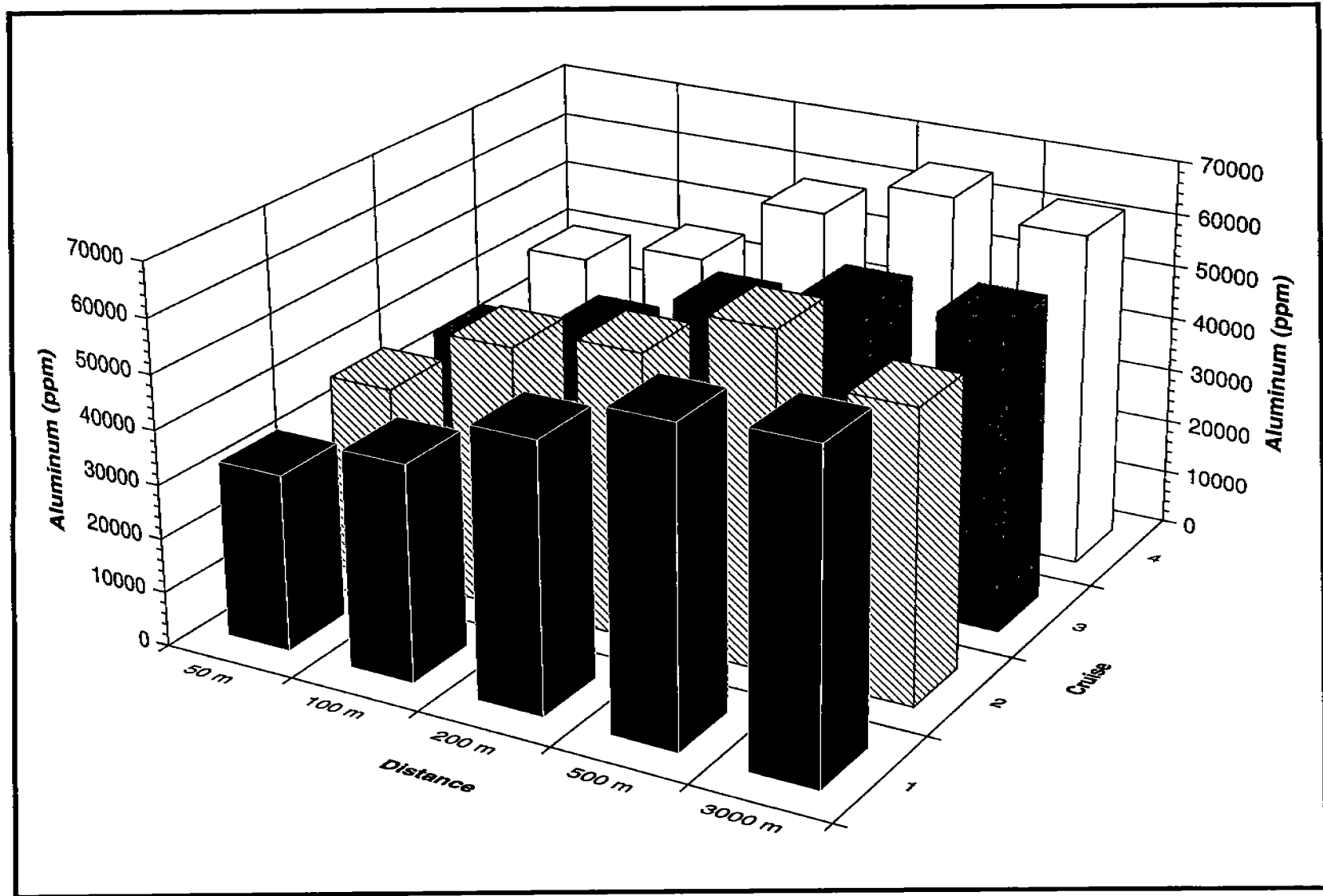

Figure 5.54. Variability in mean aluminum concentrations (ppm) in sediments with distance from the platform by cruise at MAI-686.

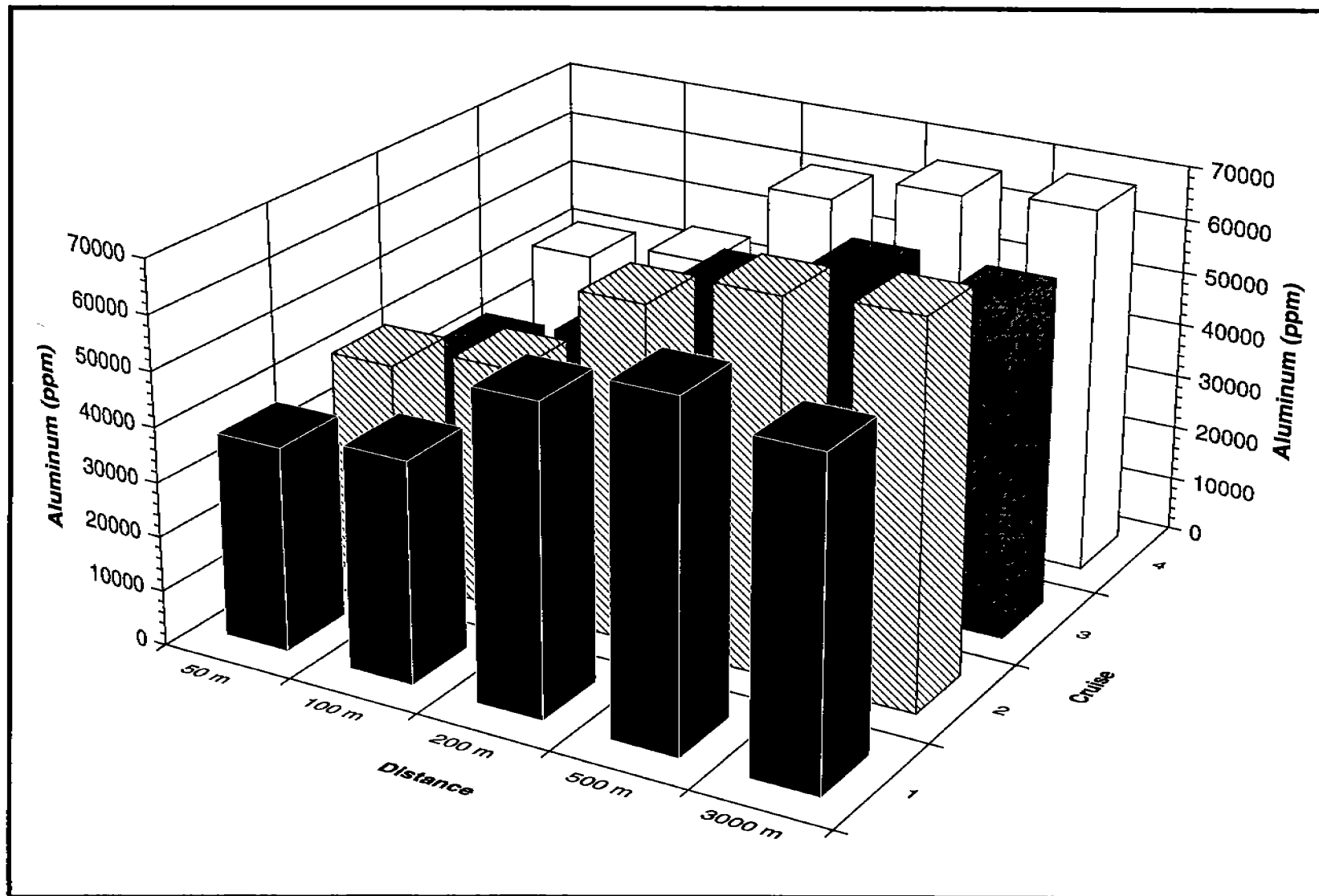

Figure 5.55. Variability in mean aluminum concentrations (ppm) in sediments with distance from the platform by cruise at MU-A85.

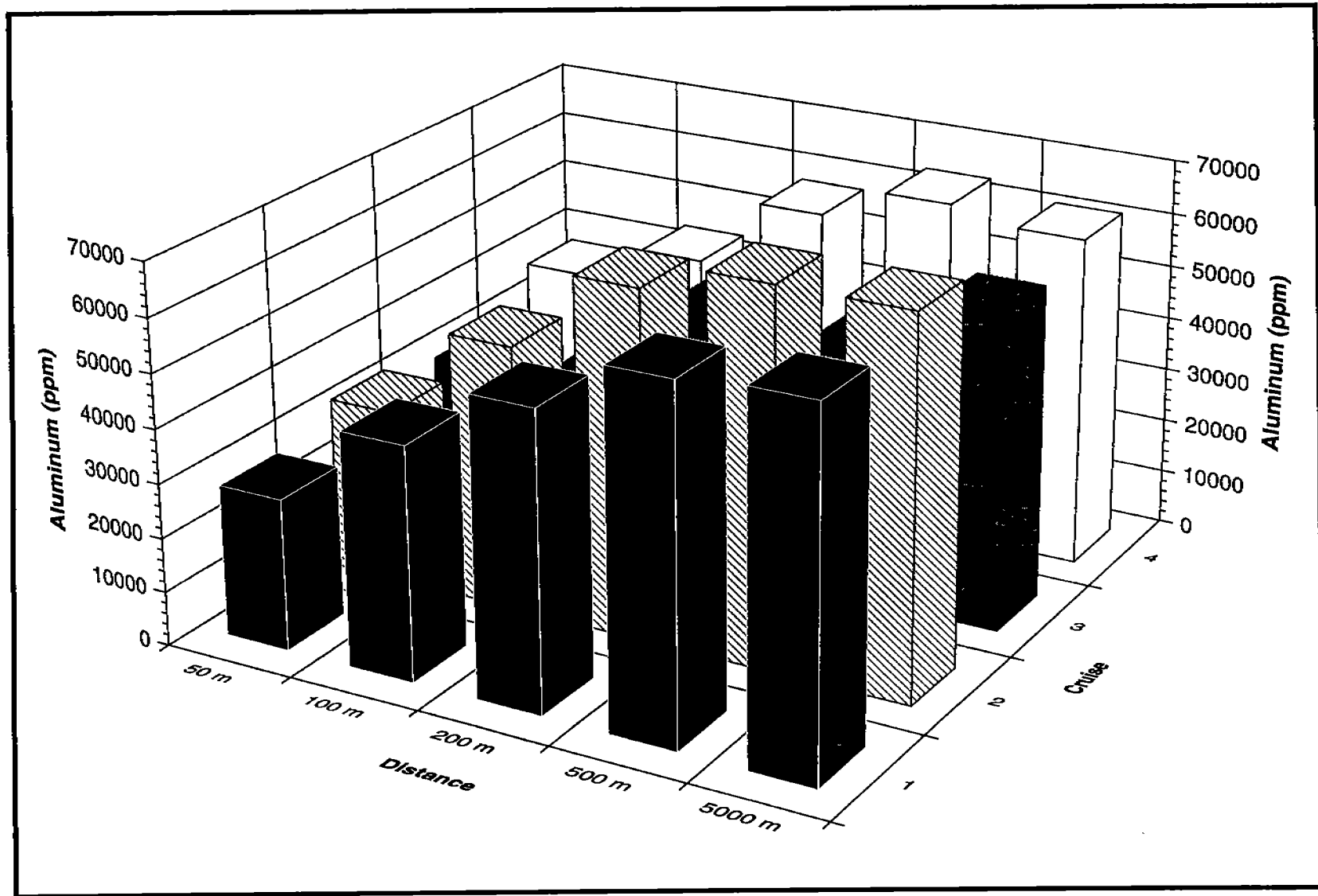

Figure 5.56. Variability in mean aluminum concentrations (ppm) in sediments with distance from the platform by cruise at HI-A839.

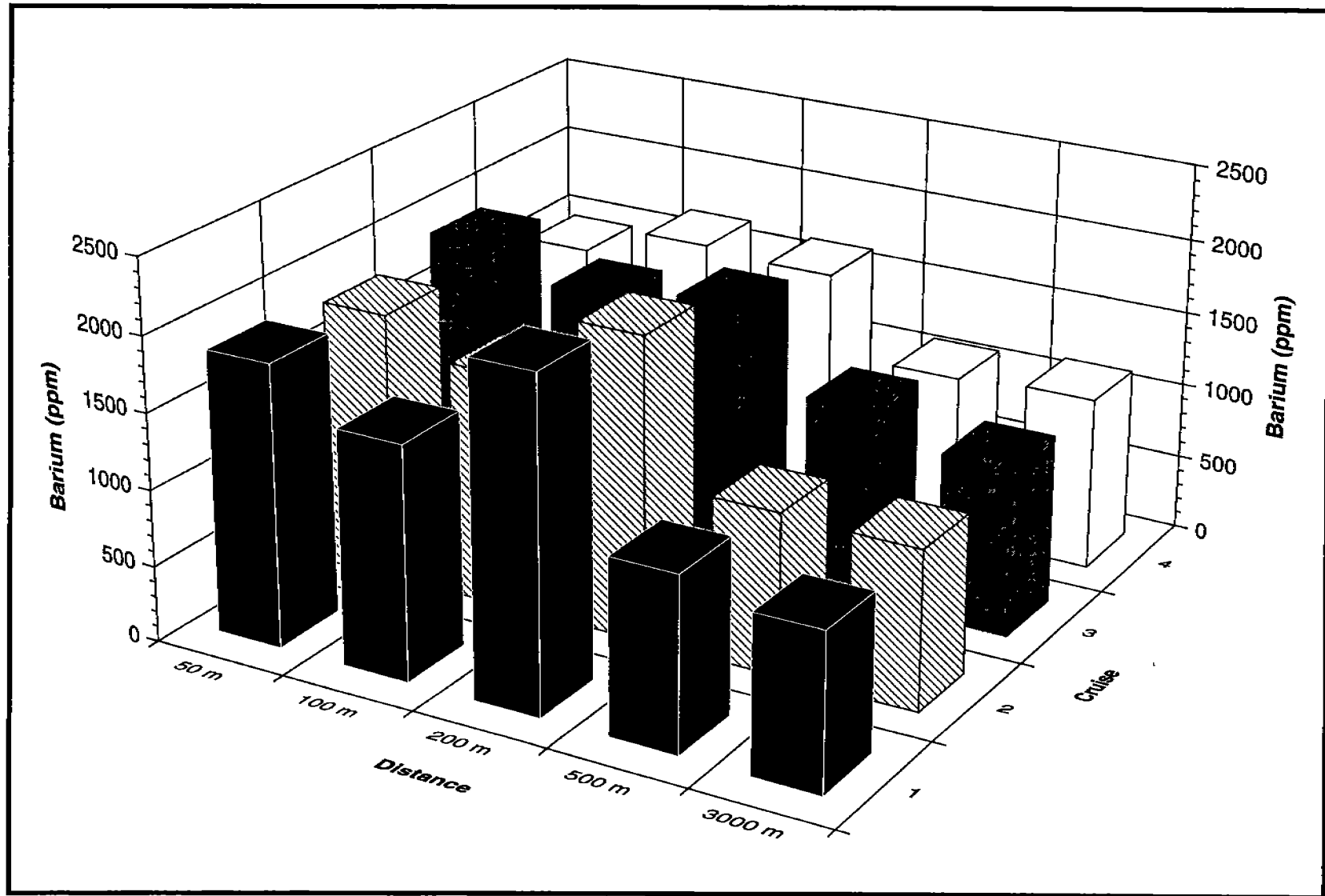

Figure 5.57. Variability in mean barium concentrations (ppm) in sediments with distance from the platform by cruise at MAI-686.

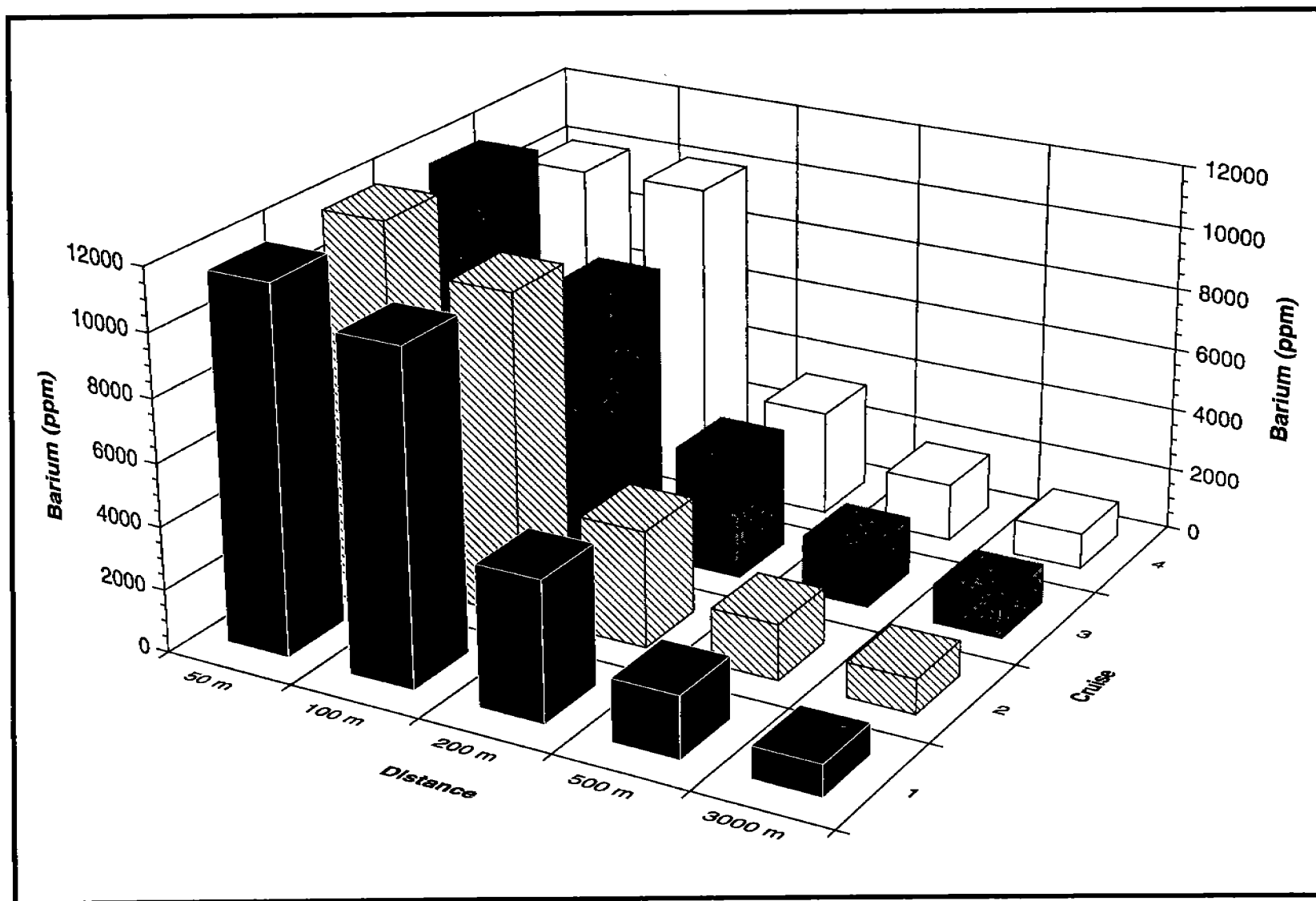

Figure 5.58. Variability in mean barium concentrations (ppm) in sediments with distance from the platform by cruise at MU-A85.

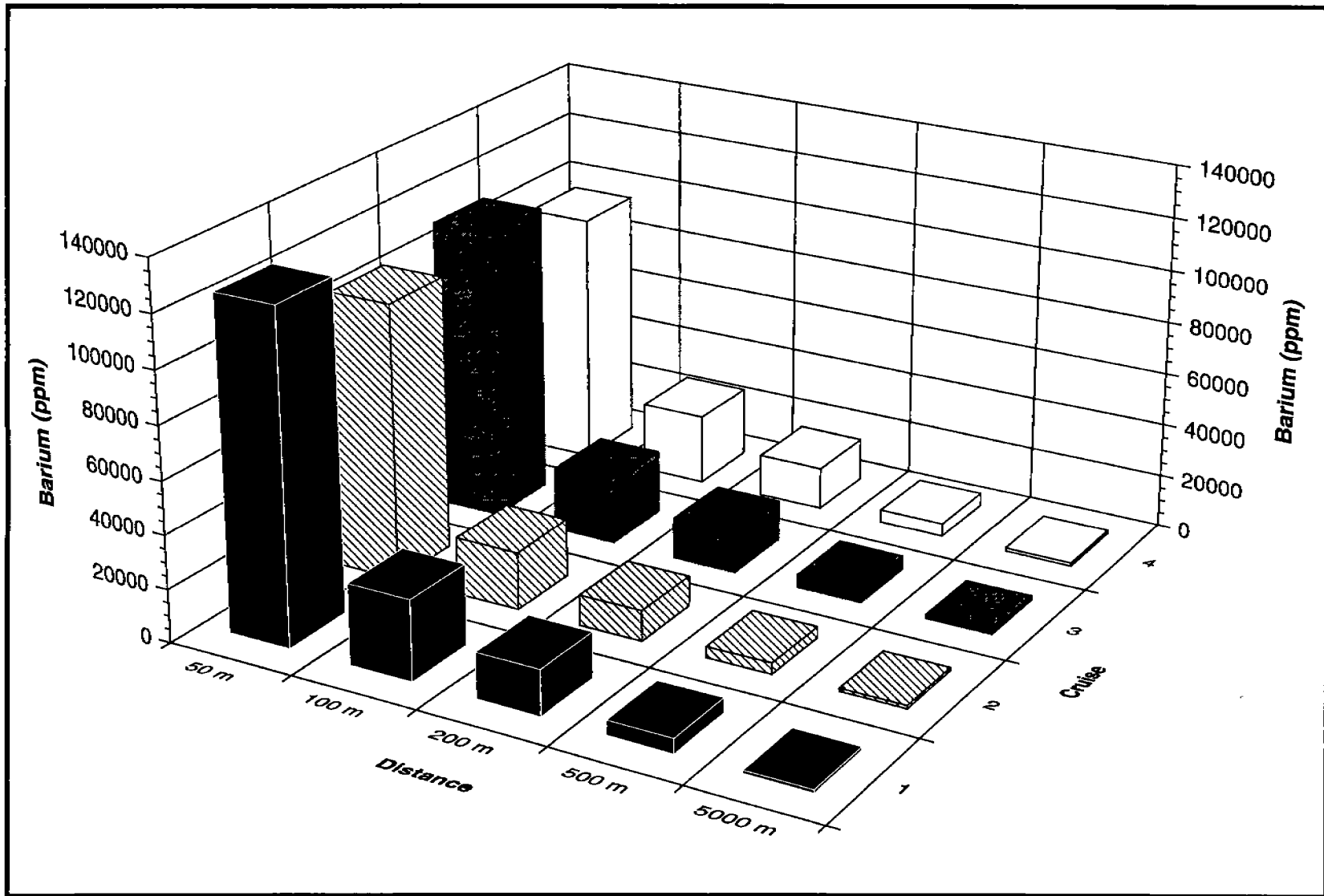

Figure 5.59. Variability in mean barium concentrations (ppm) in sediments with distance from the platform by cruise at HI-A389.

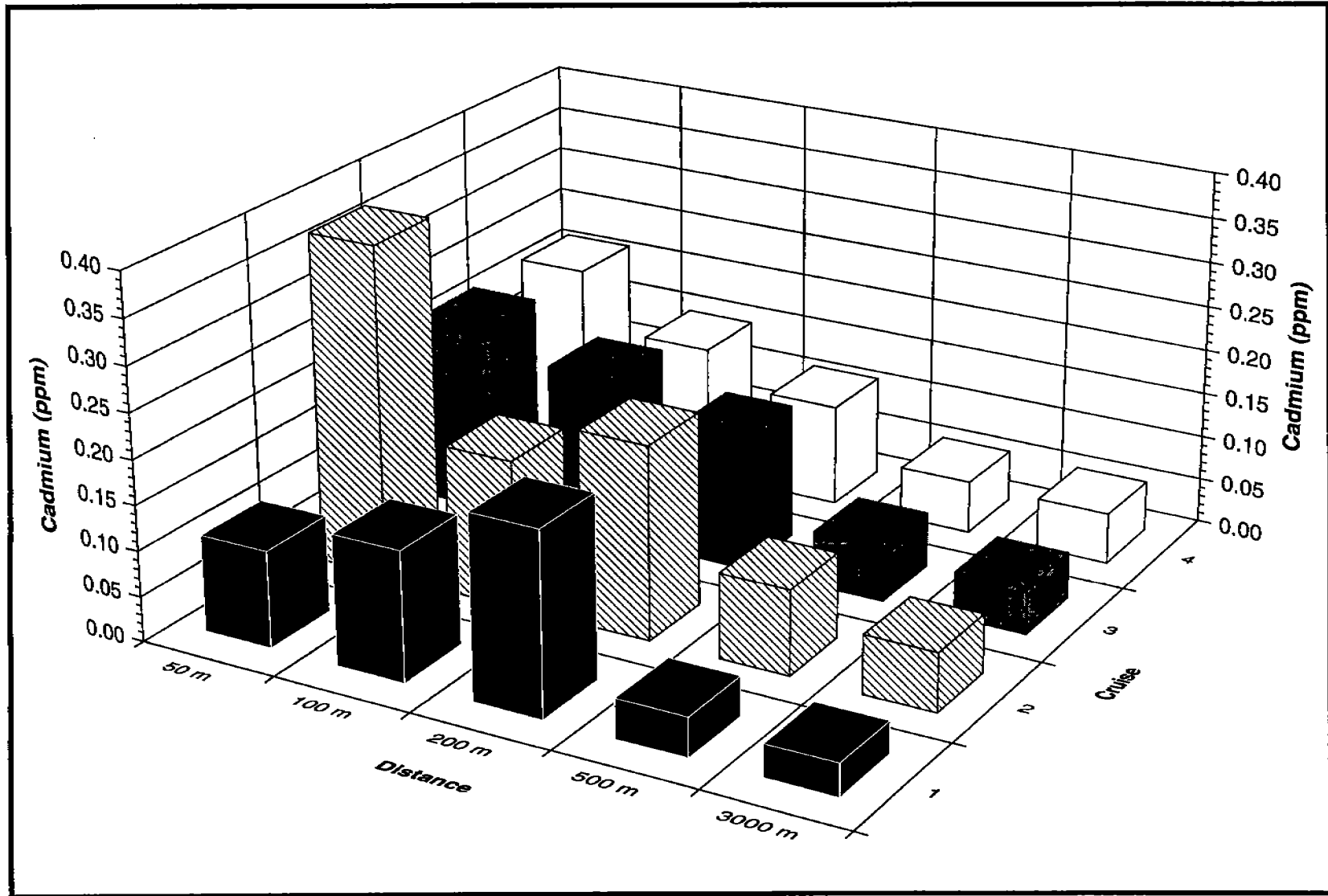

Figure 5.60. Variability in mean cadmium concentrations (ppm) in sediments with distance from the platform by cruise at MAI-686.

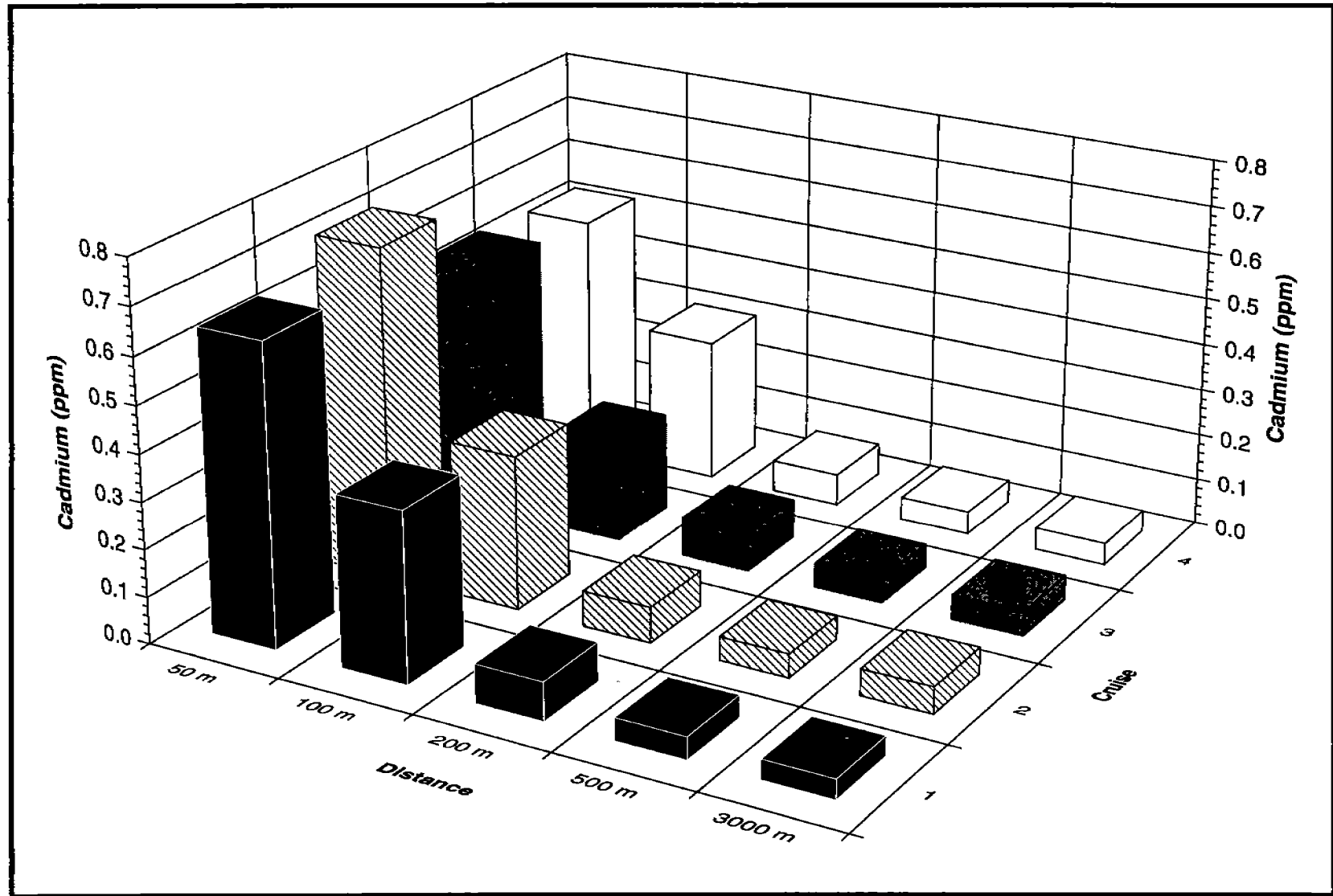

Figure 5.61. Variability in mean cadmium concentrations (ppm) in sediments with distance from the platform by cruise at MU-A85.

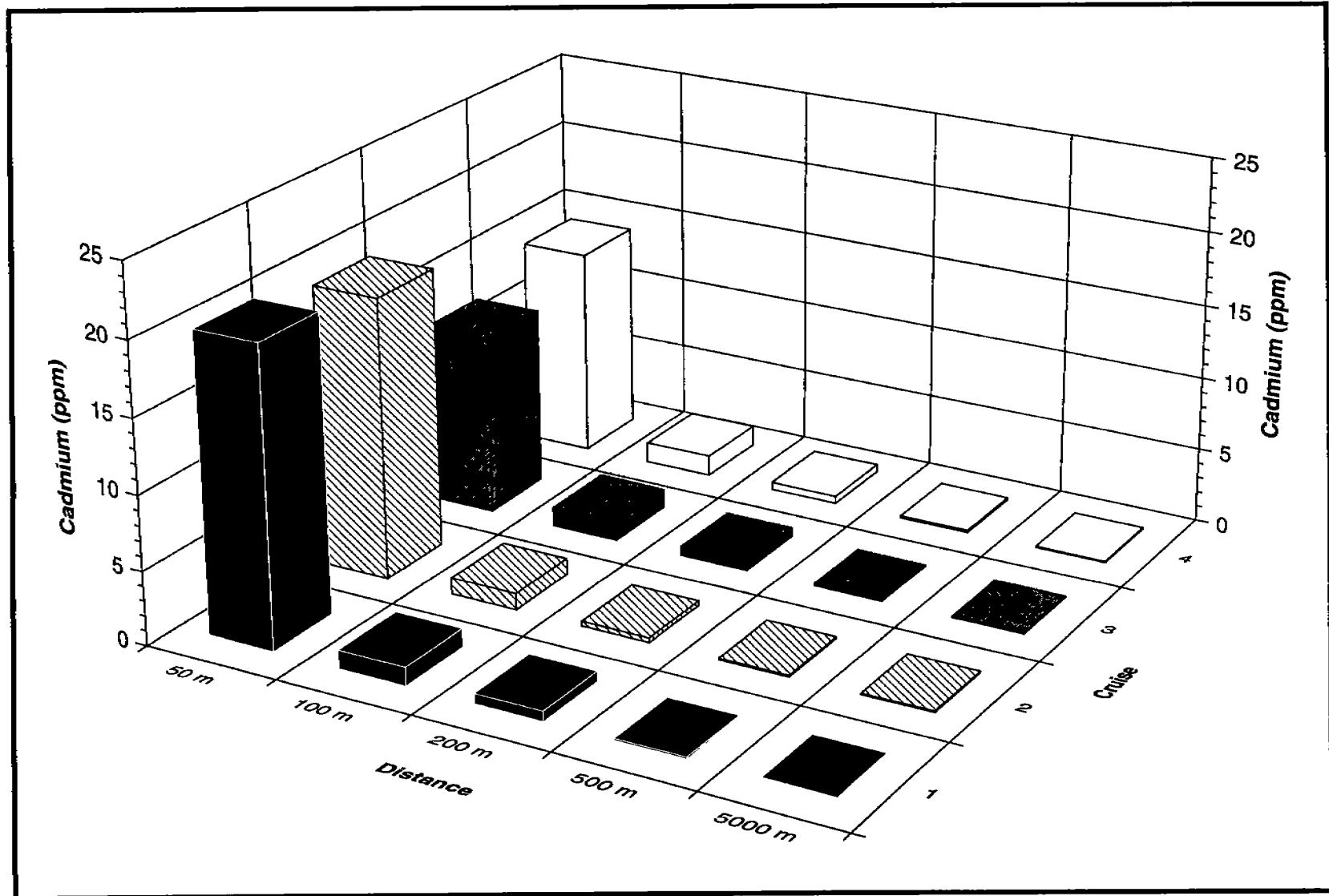

Figure 5.62. Variability in mean cadmium concentrations (ppm) in sediments with distance from the platform by cruise at HI-A389.

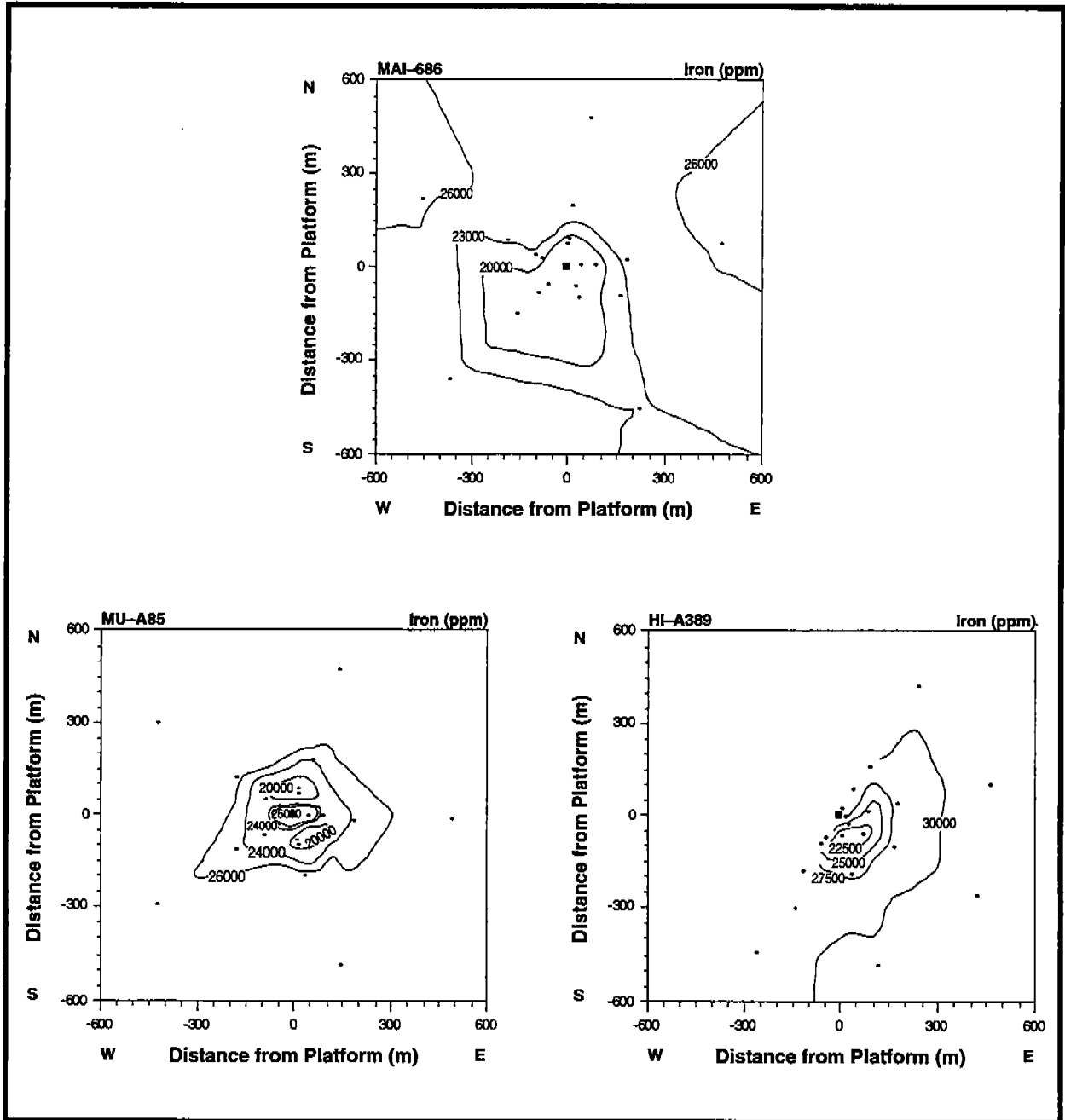

Figure 5.63. Areal distribution of mean iron concentrations (ppm) in sediments as a composite of all four cruises.

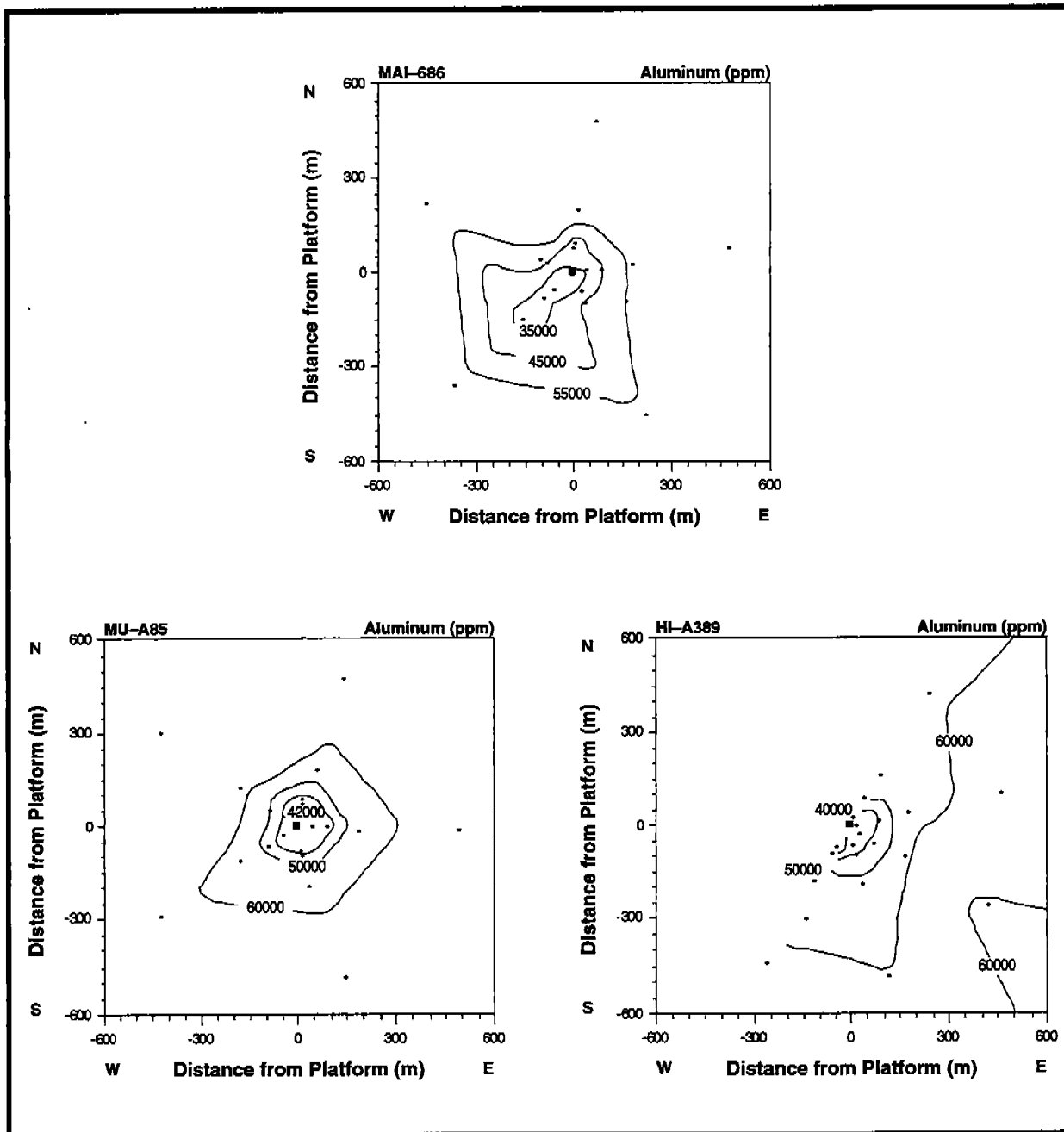

Figure 5.64. Areal distribution of mean aluminum concentrations (ppm) in sediments as a composite of all four cruises.

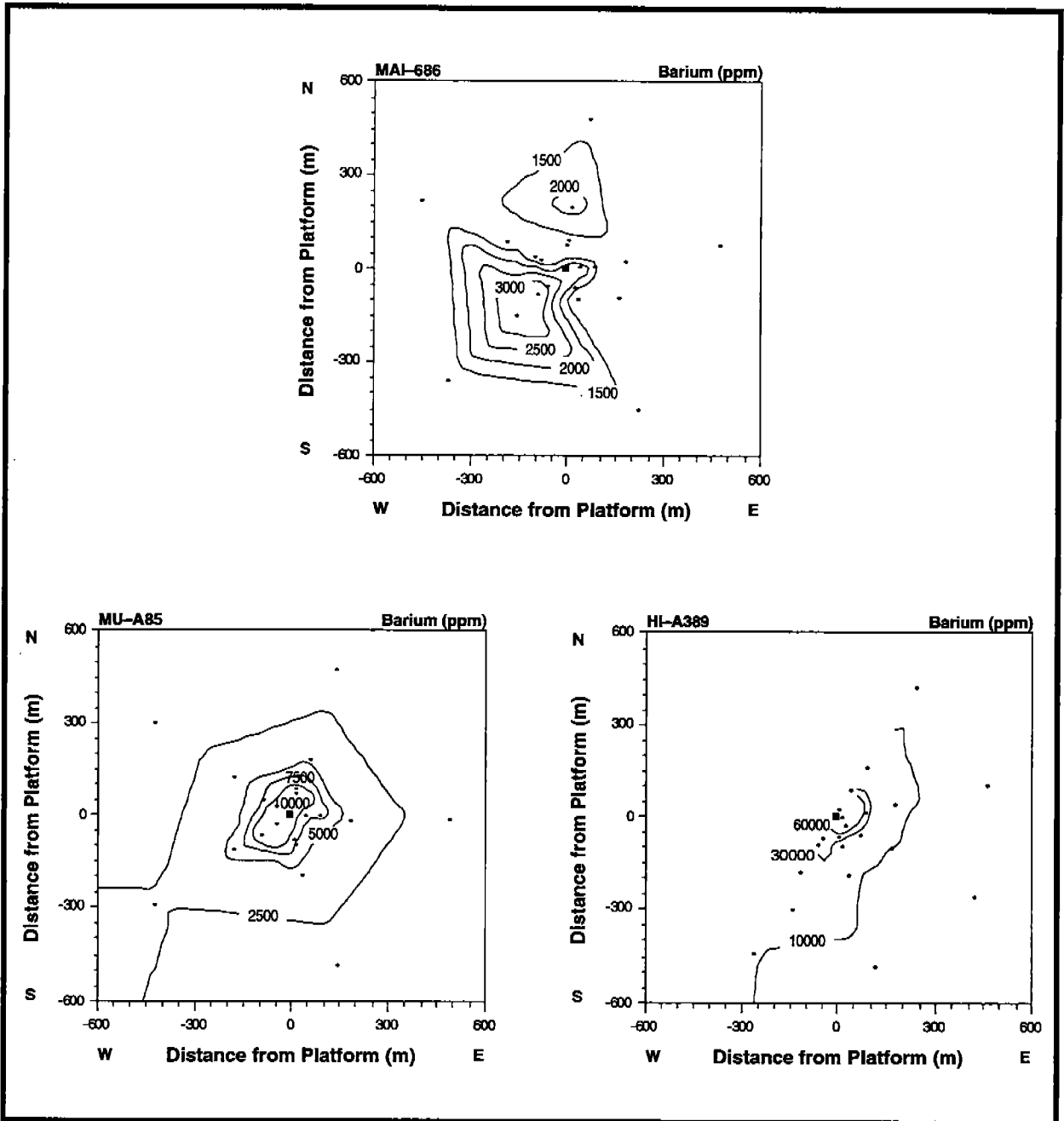

Figure 5.65. Areal distribution of mean barium concentrations (ppm) in sediments as a composite of all four cruises.

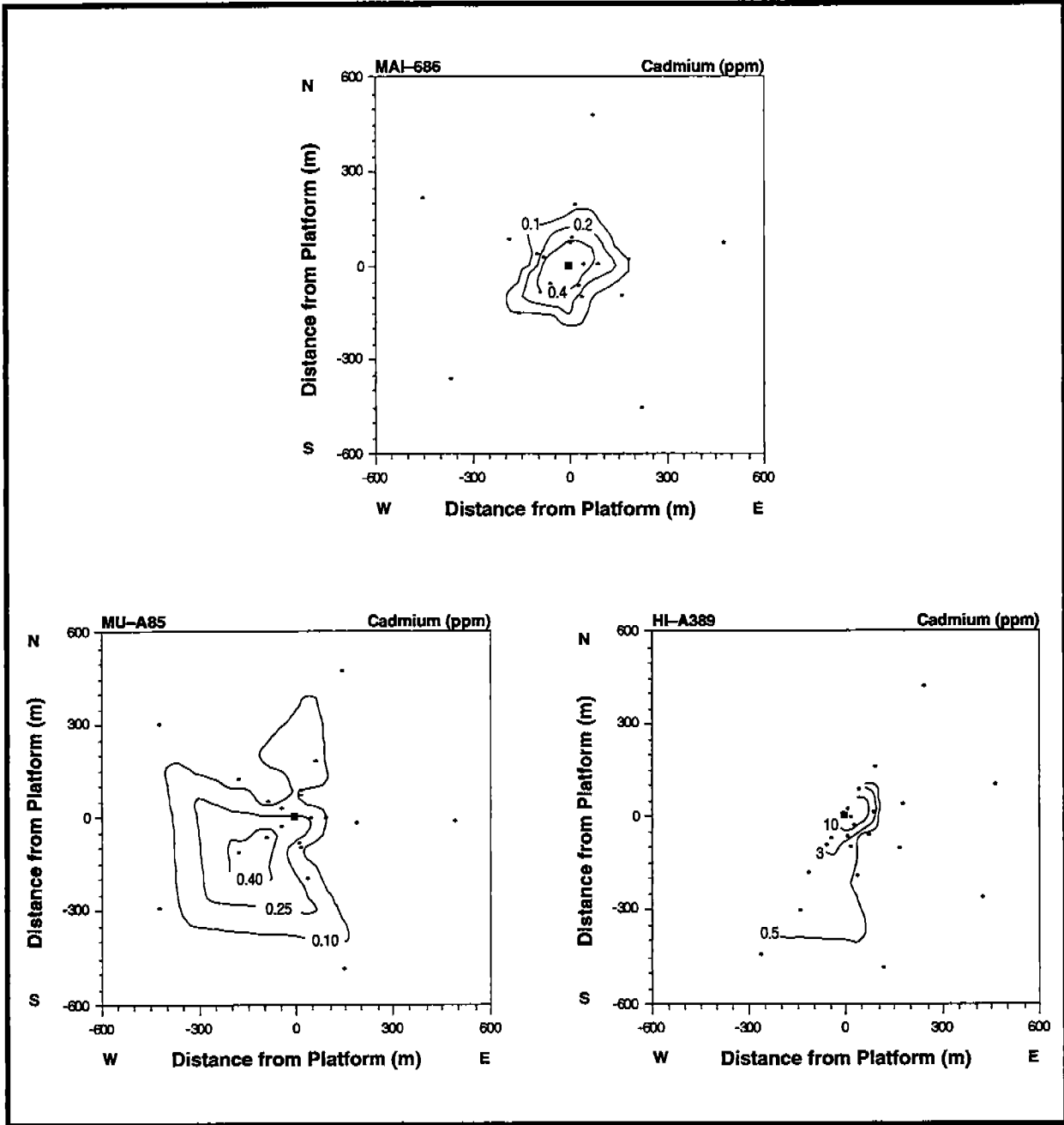

Figure 5.66. Areal distribution of mean cadmium concentrations (ppm) in sediments as a composite of all four cruises.

sediments near platforms. The magnitude of the increase is determined in part by the metal content of the original materials discharged at each site.

A covariate analysis of metal concentrates delineates those metals that strongly covary ($r > 0.4$) with barium; these metals are silver, cadmium, mercury, lead, and zinc (Table 5.16; Figures 5.67 to 5.70). Linear regression best fit lines are provided on each figure based on the data by site. These metals are common constituents of the barite ore used as a drill mud additive. Therefore, these metals acts as a suite of contaminants, reflecting the distribution of discharged drill muds. The concentrations for each metal is determined by the original metal content of the metal ore and the amount of barite discharged at the site. Metals that occur at low concentrations in the ore were only weakly correlated with barium. For lead and zinc, metal concentrations in excess of that attributable to the ore were present at some stations. Lead and zinc have been detected in produced waters and are thought to be derived from corrosion of galvanized structures on the platform. The weak correlation between barium, antimony, and copper suggests additional sources for these metals including background sediments (Figure 5.71). Other metals (i.e., Al, Fe, Cr, Ni, Se, and V), associated with indigenous sediments show weak, if any, correlation with barium. If platform related inputs are low for these metals, they should negatively correlate with sand due to dilution. Arsenic, copper, and tin are of mixed origins based on correlations with barium and background sediment metals. For copper, the correlation with barium was weak except at high barium levels, suggesting low copper concentrations were present in the original ore (Figure 5.71).

5.3.3 Hydrocarbons in Fish Livers, Fish Stomach Contents, and Invertebrate Soft Tissues

The ranges in the mean PAH concentrations by tissue type and distance from the platform and site are summarized in Figures 5.72 to 5.74. The majority of the PAH concentrations were at or below the method detection limit and indicate little or no enhanced accumulation of PAH related to distance from the platform. Further discussions of this data are reserved for the later statistical analyses in Section 6.3.

Table 5.16. Matrix of correlation coefficients between individual metal concentrations measured in sediments at all study sites from all cruises (correlations were based on log₁₀-transformed data, correlation coefficients > 0.4 are highlighted in bold type).

Variable	AG	AL	AS	BA	CD	CR	CU	FE	HG	NI	PB	SB	SE	SN	V	ZN	SANDP	SILTP	CLAYP
CLAYP	0.18	0.54	0.00	0.08	0.18	0.23	0.02	0.49	0.04	0.55	0.19	0.04	0.27	0.13	0.78	0.09	0.66	0.33	
SILTP	0.00	0.22	0.08	0.01	0.00	0.45	0.19	0.47	0.04	0.36	0.00	0.04	0.31	0.06	0.47	0.01	0.66		
SANDP	0.08	0.45	0.04	0.01	0.07	0.40	0.11	0.62	0.00	0.59	0.08	0.00	0.42	0.13	0.80	0.01			
ZN	0.66	0.30	0.29	0.65	0.87	0.14	0.55	0.02	0.73	0.03	0.64	0.55	0.09	0.04	0.07				
V	0.16	0.65	0.02	0.06	0.17	0.33	0.03	0.60	0.02	0.64	0.15	0.02	0.23	0.17					
SN	0.07	0.24	0.00	0.05	0.10	0.13	0.01	0.20	0.05	0.16	0.01	0.02	0.01						
SE	0.00	0.03	0.16	0.09	0.05	0.32	0.34	0.33	0.10	0.26	0.01	0.08							
SB	0.39	0.18	0.25	0.37	0.46	0.15	0.40	0.04	0.51	0.00	0.36								
PB	0.50	0.31	0.12	0.47	0.61	0.06	0.29	0.00	0.46	0.07									
NI	0.13	0.49	0.02	0.03	0.09	0.30	0.06	0.51	0.01										
HG	0.56	0.27	0.31	0.60	0.70	0.14	0.52	0.02											
FE	0.00	0.29	0.23	0.00	0.00	0.65	0.32												
CU	0.31	0.01	0.43	0.31	0.40	0.43													
CR	0.04	0.11	0.19	0.11	0.05														
CD	0.65	0.42	0.19	0.72															
BA	0.46	0.27	0.11																
AS	0.17	0.02																	
AL	0.32																		
AG																			

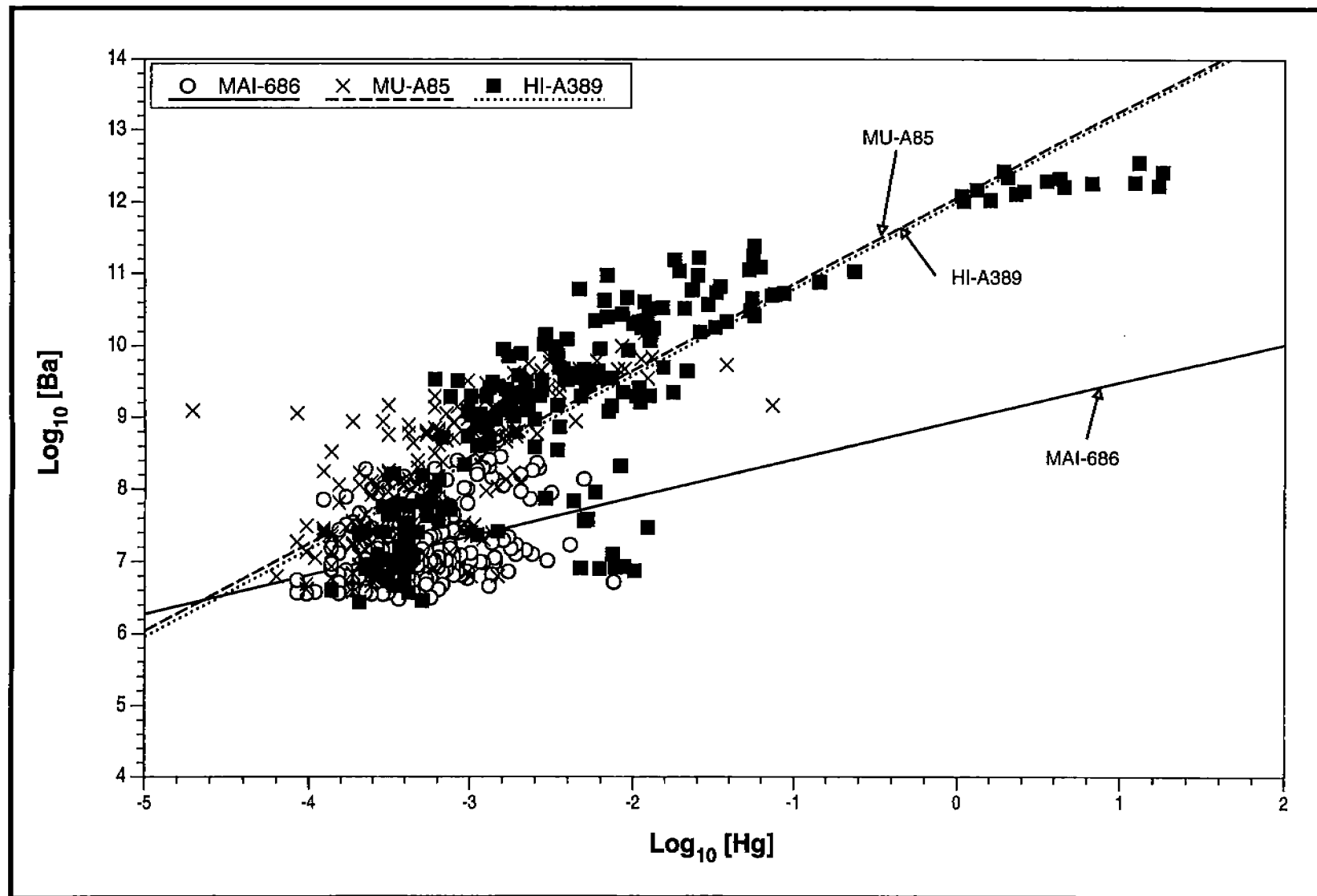

Figure 5.67. Correlation between mercury (Hg) and barium (Ba) concentrations in sediments at all sites for all cruises.

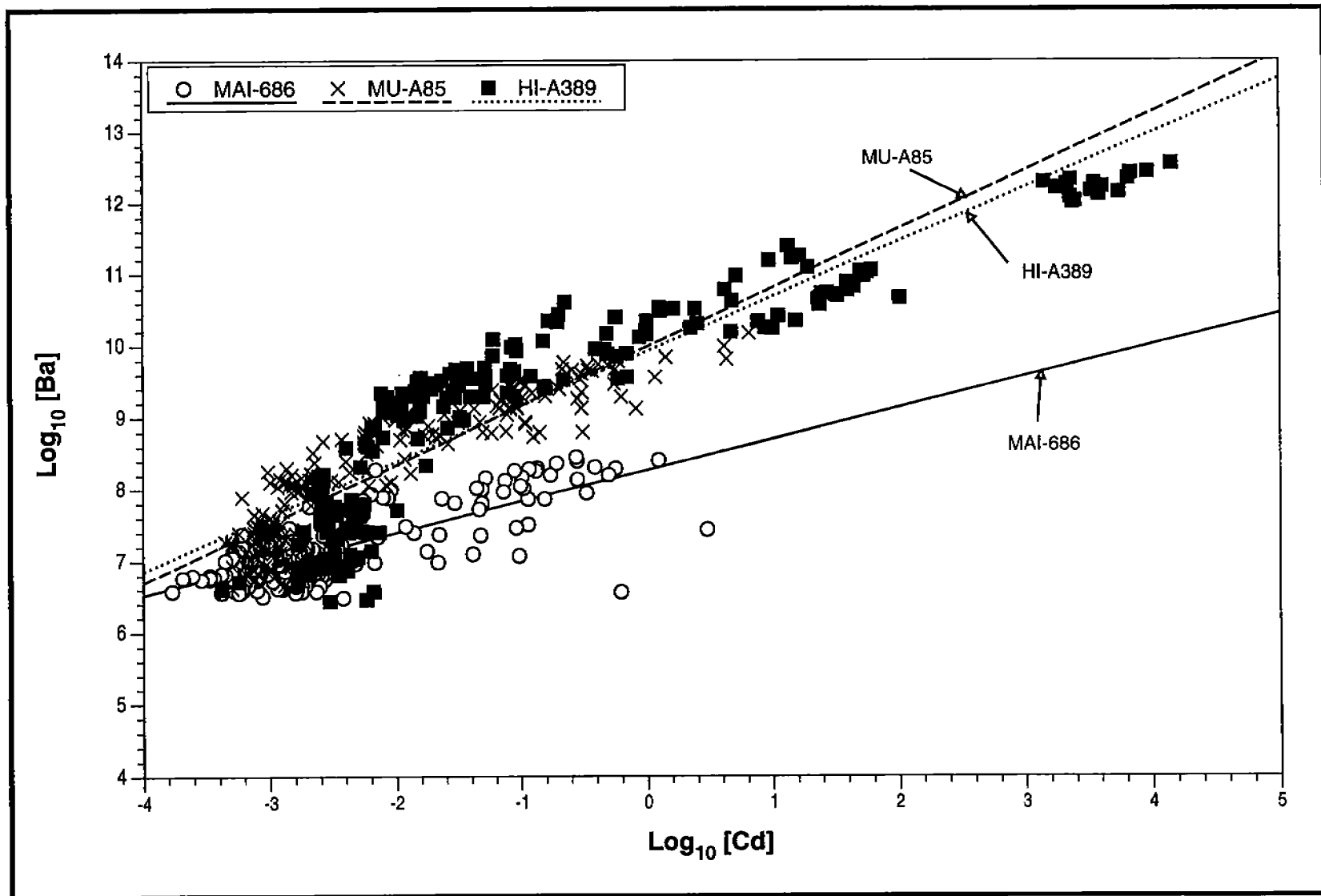

Figure 5.68. Correlation between cadmium (Cd) and barium (Ba) concentrations in sediments at all sties for all cruises.

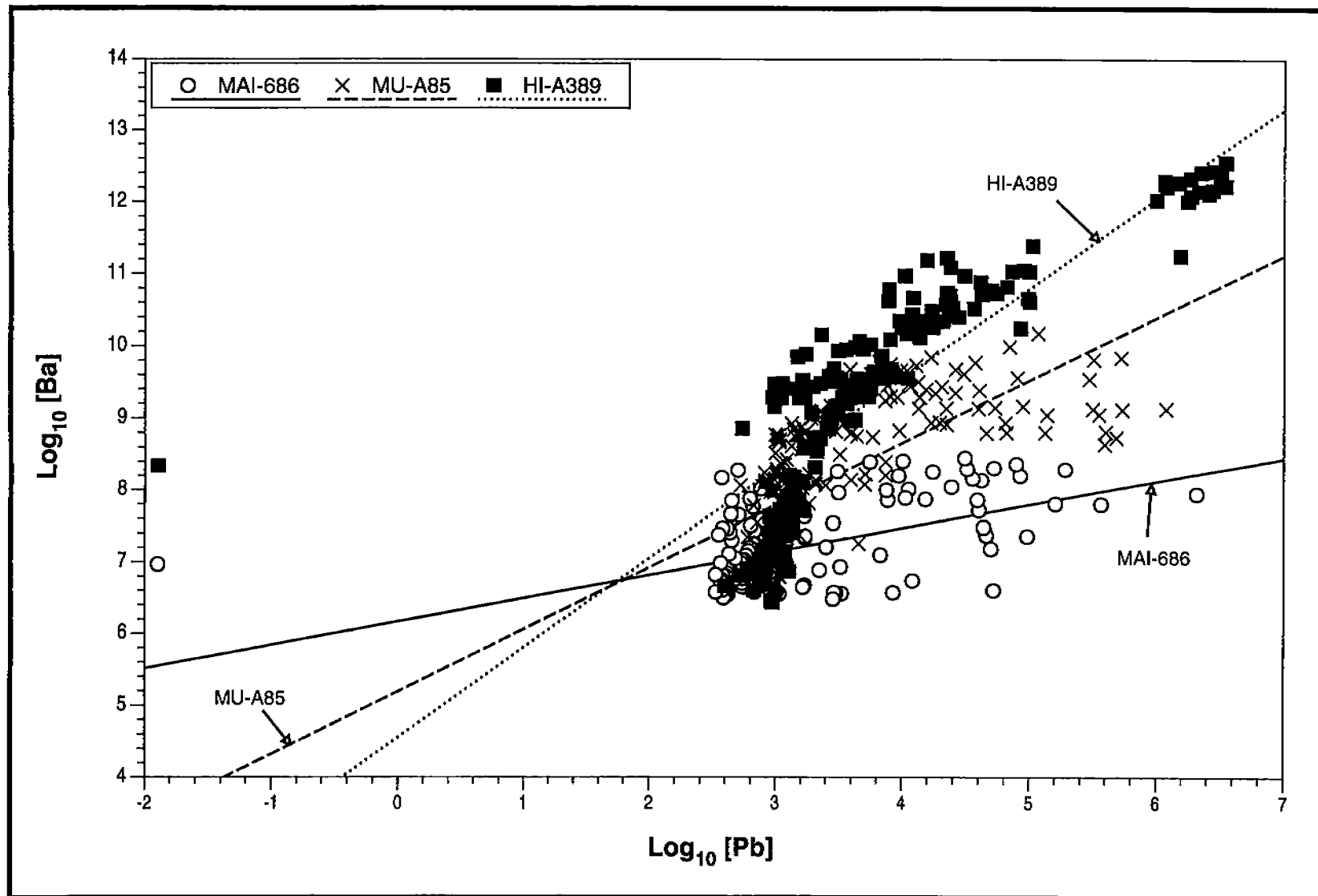

Figure 5.69. Correlation between lead (Pb) and barium (Ba) concentrations in sediments at all sites for all cruises.

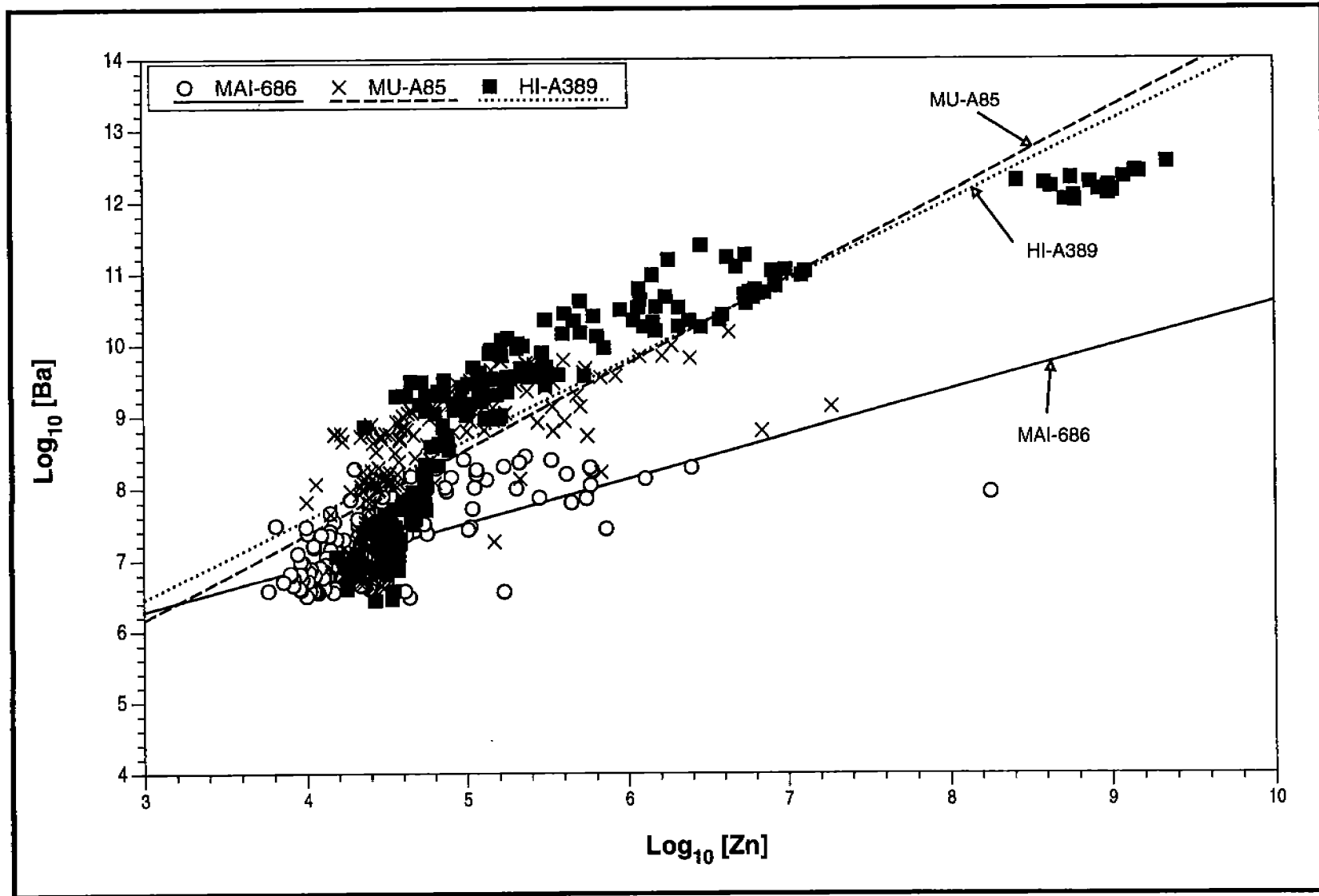

Figure 5.70. Correlation between zinc (Zn) and barium (Ba) concentrations in sediments at all sites for all cruises.

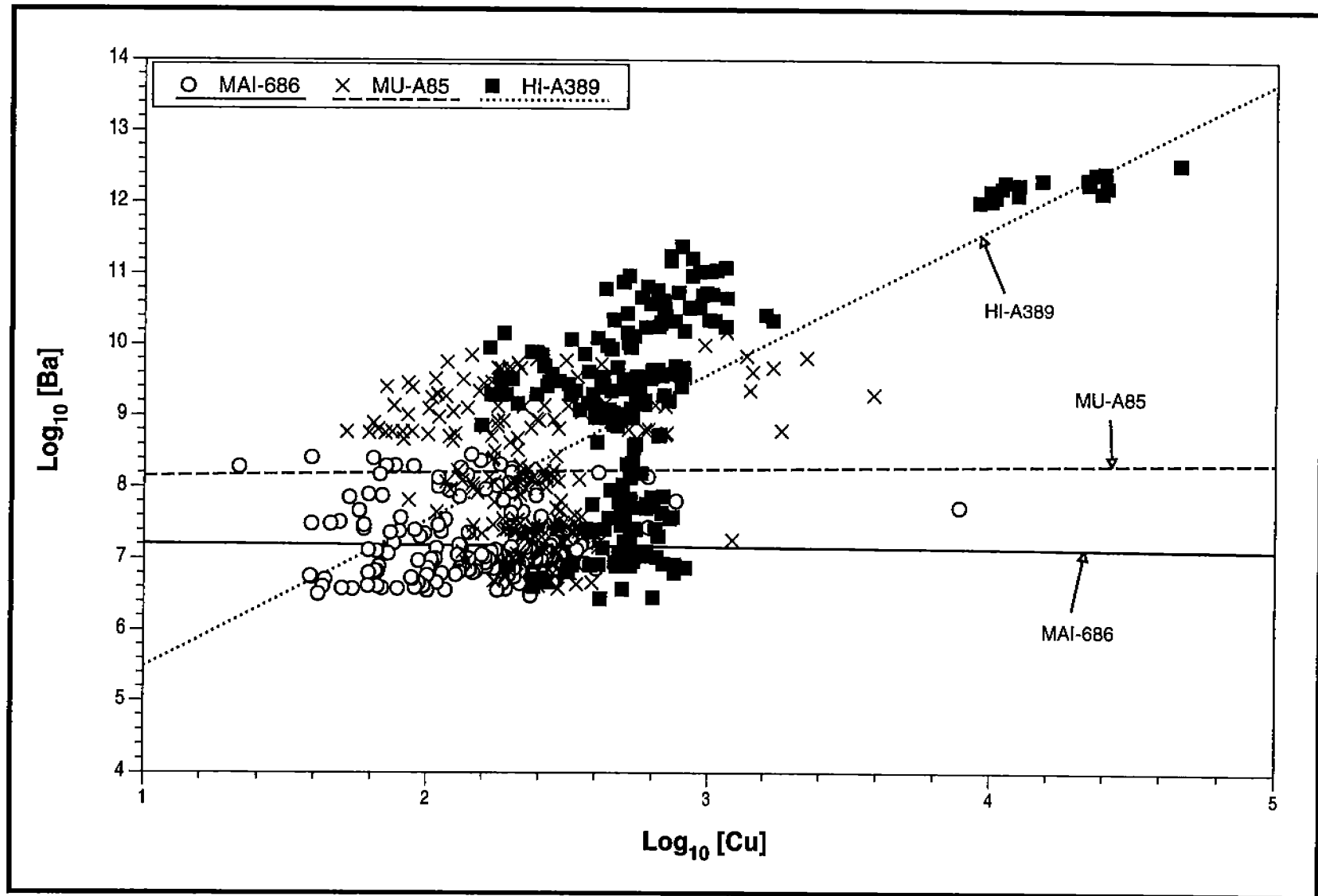

Figure 5.71. Correlation between copper (Cu) and barium (Ba) concentrations in sediments at all sites for all cruises.

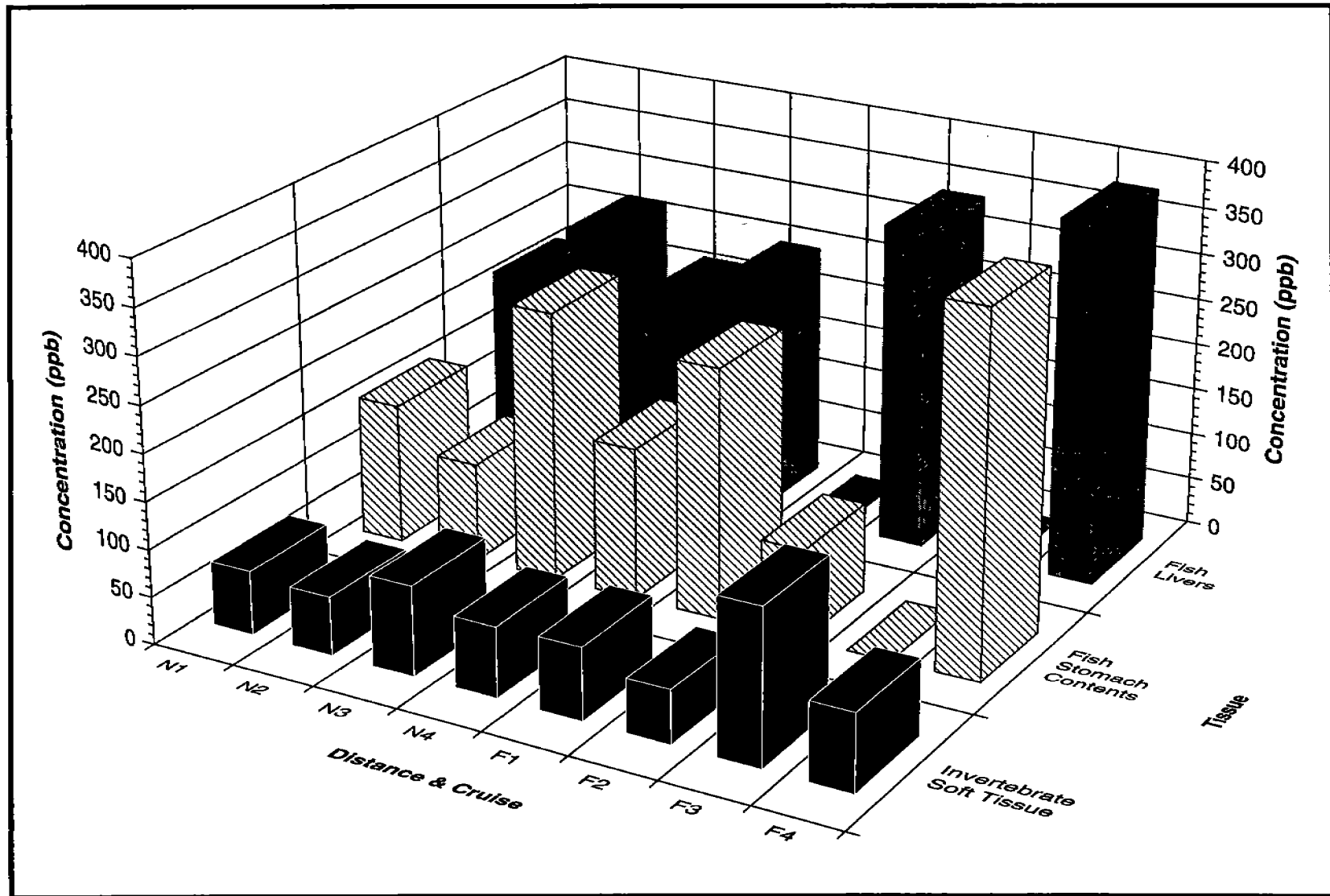

Figure 5.72. Variability of mean total PAH concentrations (ppb) in tissues by type, cruise, and distance from the platform at MAI-686.

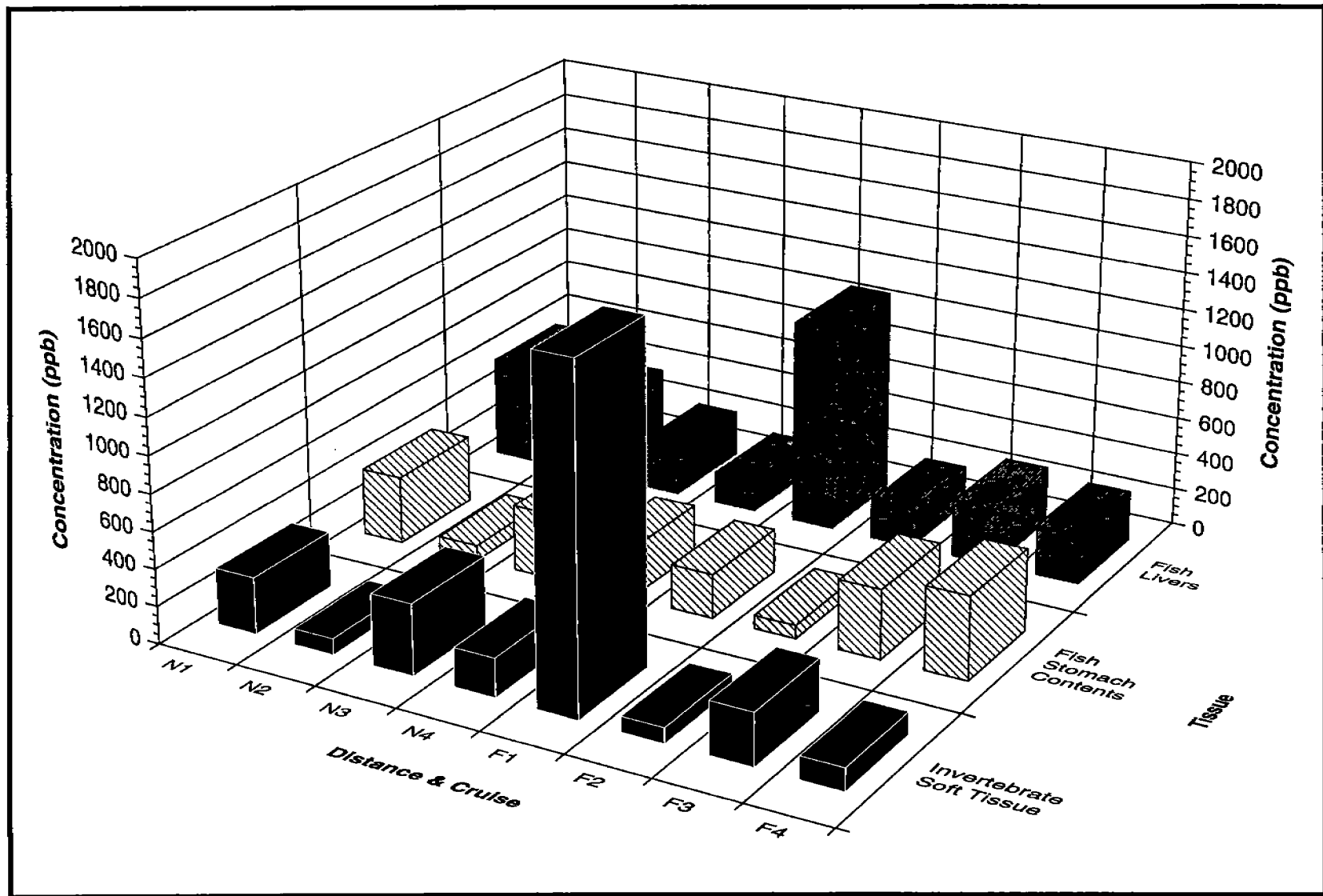

Figure 5.73. Variability of mean total PAH concentrations (ppb) in tissues by type, cruise, and distance from the platform at MU-A85.

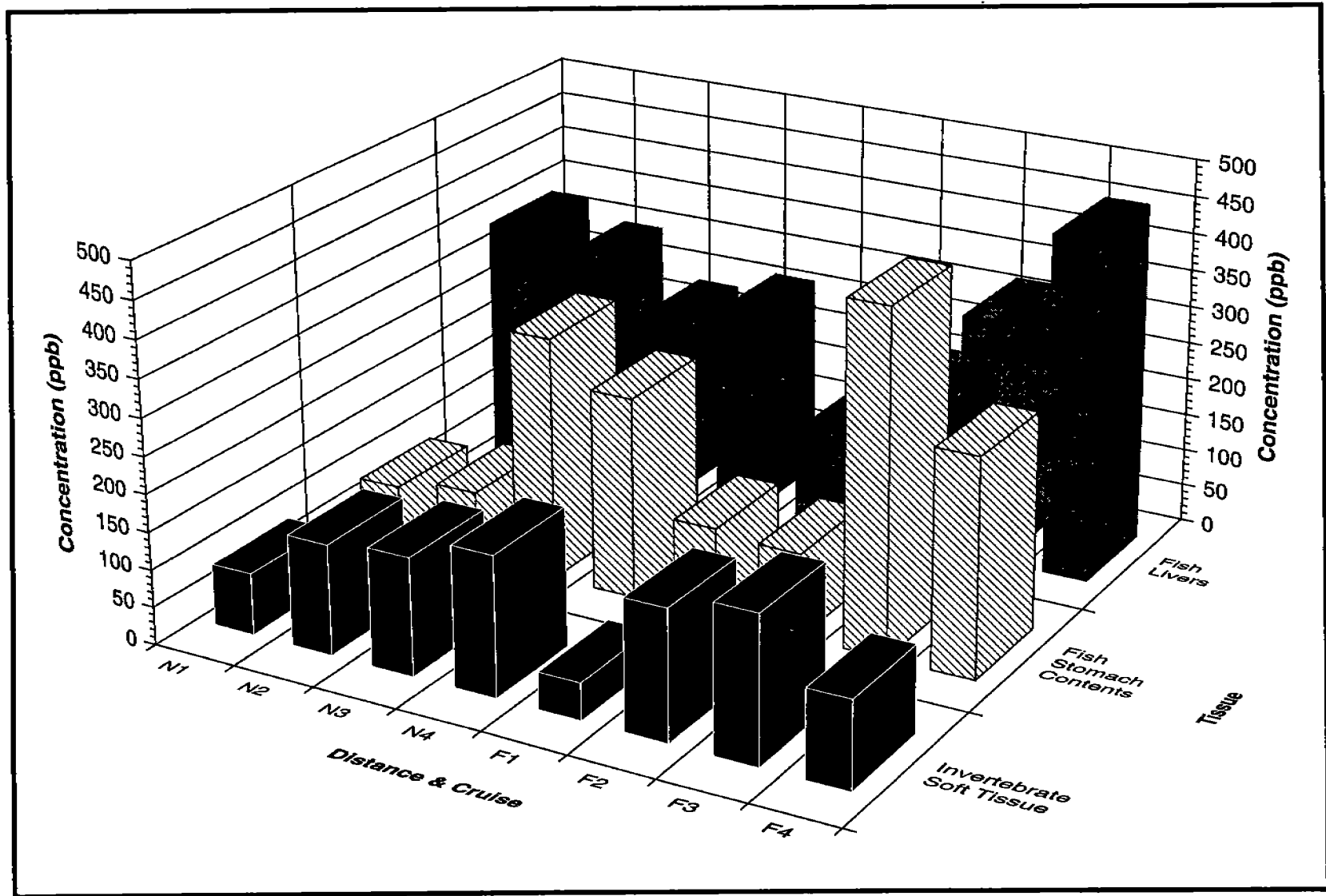

Figure 5.74. Variability of mean total PAH concentrations (ppb) in tissues by type, cruise, and distance from the platform at HI-A389.

5.3.4 Trace Metals in Fish Livers, Fish Stomach Contents, and Invertebrate Soft Tissues

Invertebrate soft tissue (278 samples; shrimp, crabs, bivalves, polychaetes), fish livers (248 samples), and fish stomach contents (321 samples) were analyzed for a suite of metals. The metal data from all cruises for the various tissue types are summarized by site in Figures 5.75 to 5.83. Again, little if any enhanced bioaccumulation of metals could be attributed to proximity to a platform. As with the hydrocarbon tissue data further discussions of the tissue metal data is deferred to the statistical analyses in Section 6.3.

5.3.5 Sediment Interstitial (Pore) Water

Hydrocarbon and metal concentrations were measured in 60 selected pore water samples from each of the first two cruises to provide potential chemical correlates for the pore water toxicity testing work element. The pore water samples were filtered prior to analysis to provide a measure of the dissolved contaminants. The pore water data did not significantly correlate with the pore water toxicity results. Also, the correlation between pore water and solid phase levels was weak. This lack of correlation may be valid but it could be the result of sampling and/or analytical artifacts. It was not possible to collect the pore water samples using "clean chemistry" methodologies. This limitation can result in either an overestimation (i.e., contamination) or under-estimation (adsorptive loss) of the actual dissolved contaminants present. Clean chemistry techniques are required to obtain accurate dissolved contaminant data (especially in seawater) and guidance to implement this approach as a requirement for compliance monitoring is currently being developed (U.S. EPA 1994a,b). If properly sampled, pore water measurements can provide a quantitative estimate of the dissolved contaminant concentrations to which infaunal organisms are exposed. Pore water chemical measurements should be expanded and more rigorously applied in future studies.

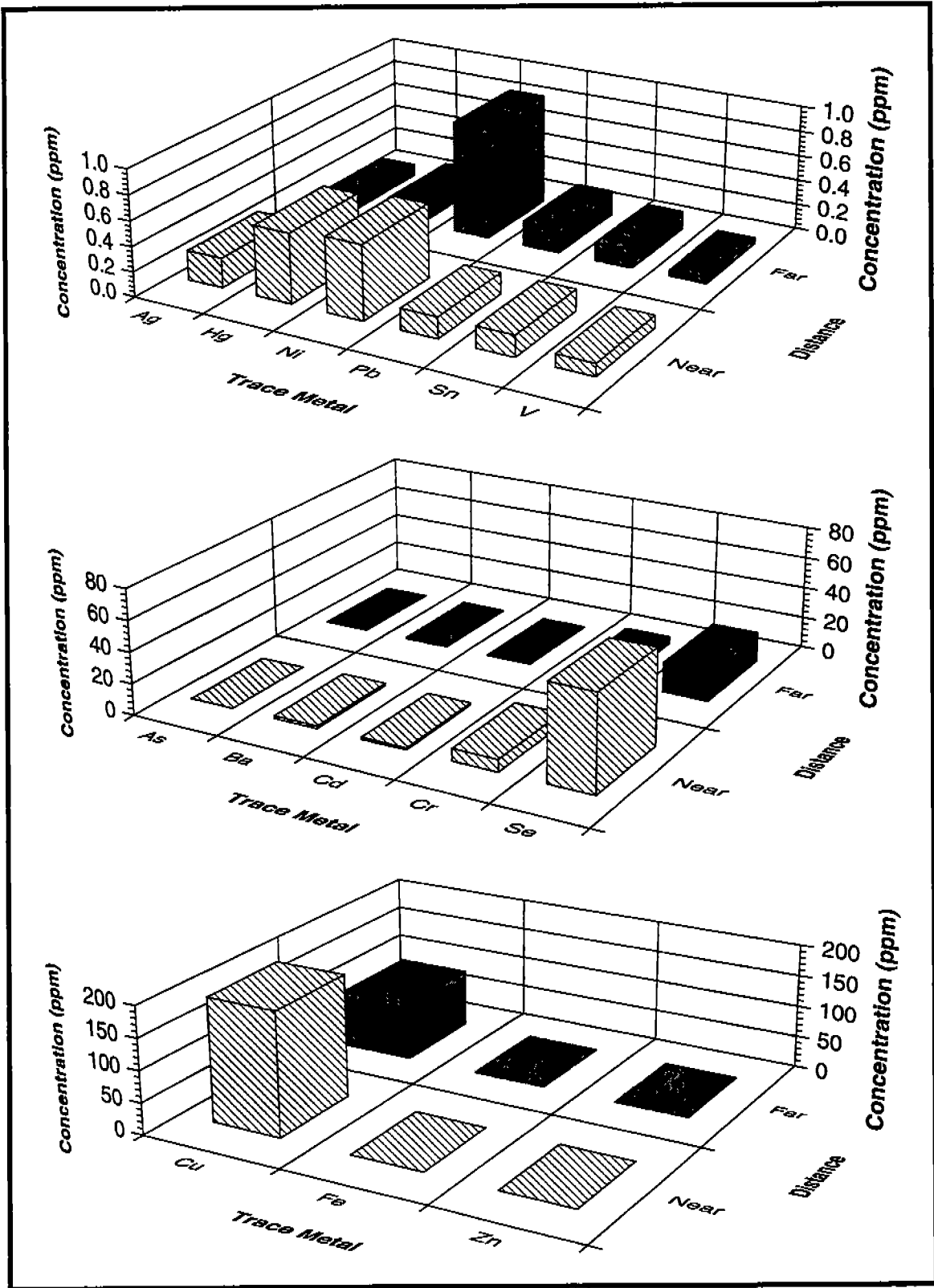

Figure 5.75. Summary of mean metal concentrations in fish liver tissues at MAI-686 as a composite of all four cruises.

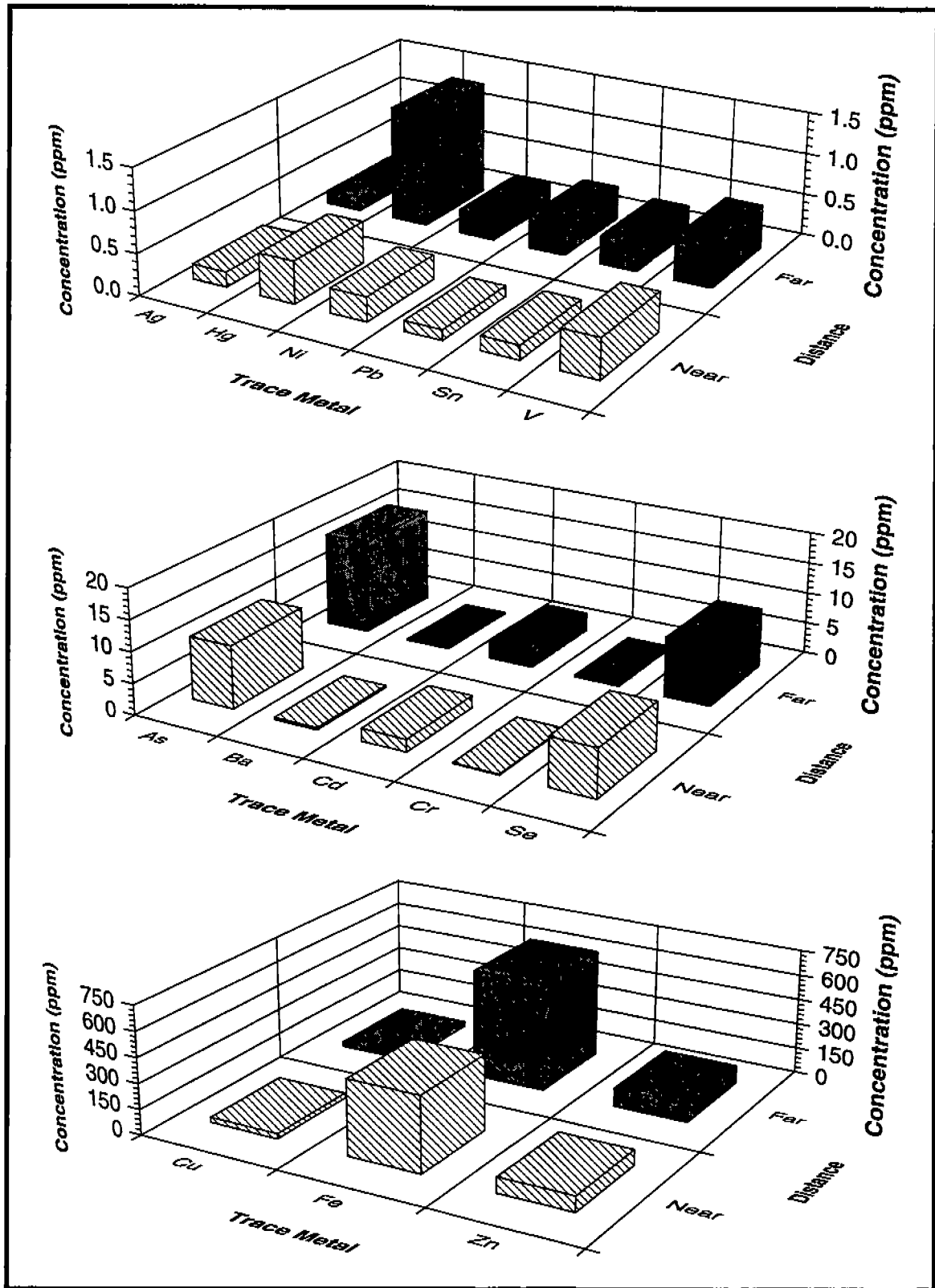

Figure 5.76. Summary of mean metal concentrations in fish liver tissues at MU-A85 as a composite of all four cruises.

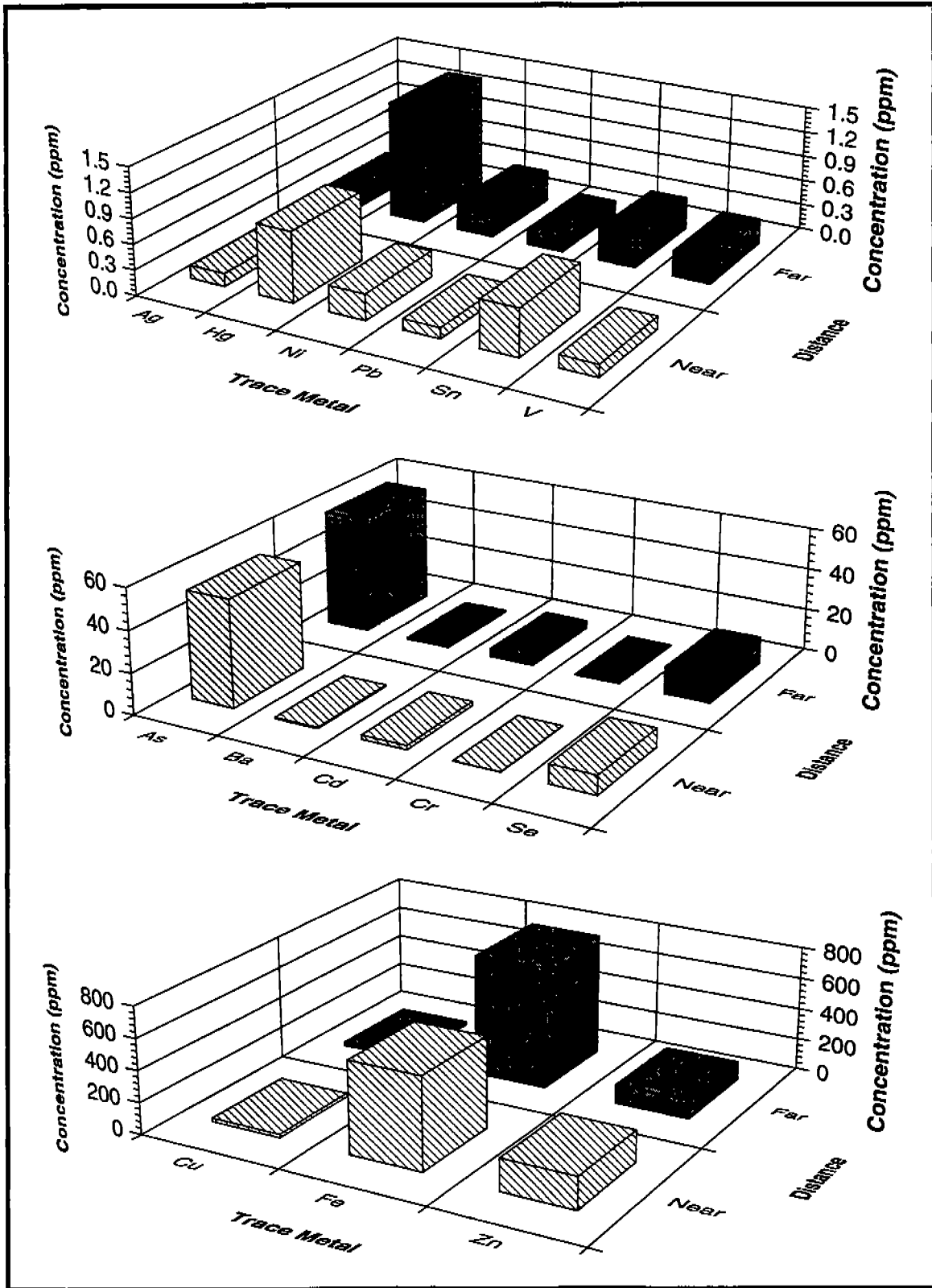

Figure 5.77. Summary of mean metal concentrations in fish liver tissues at HI-A389 as a composite of all four cruises.

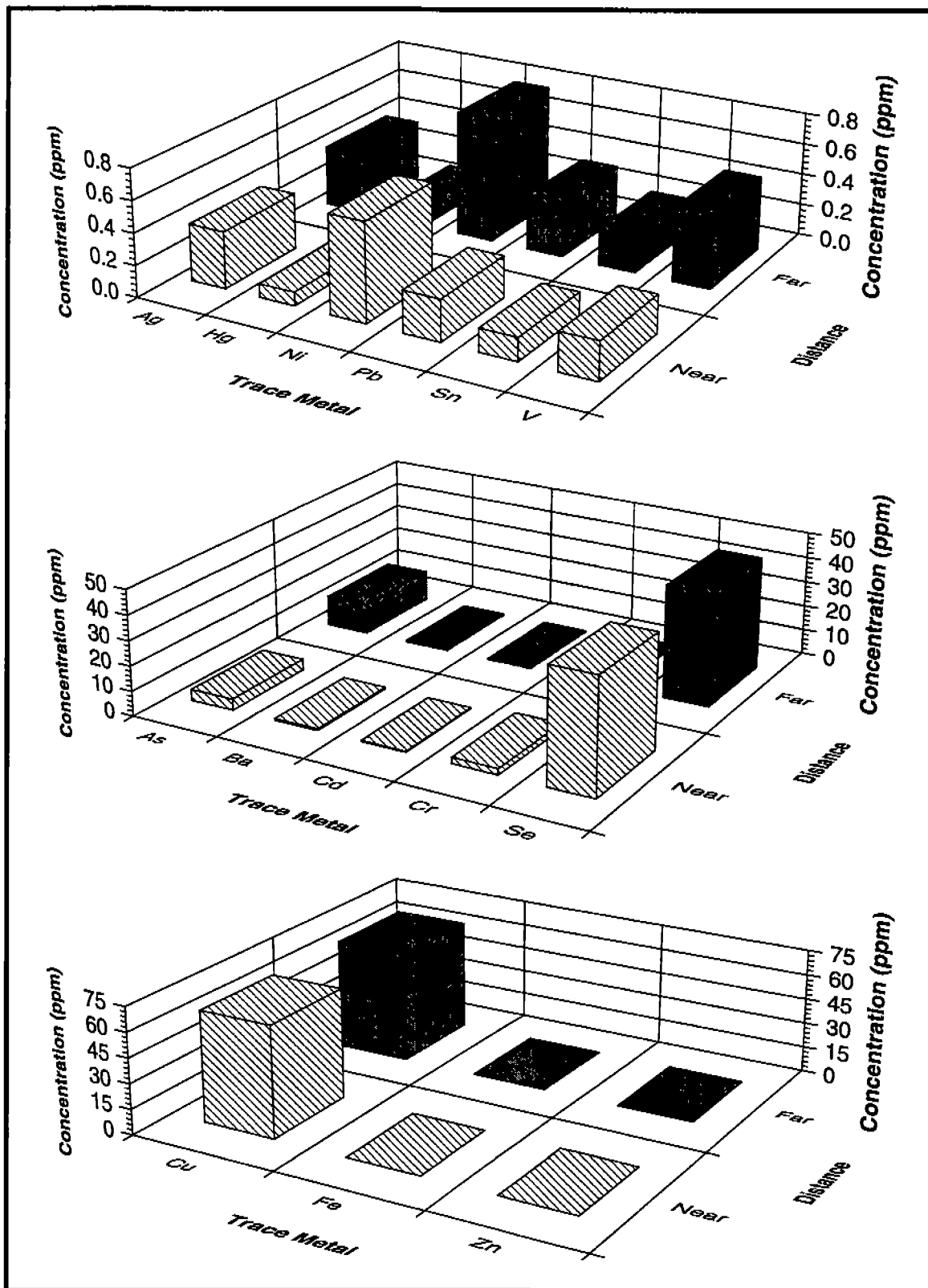

Figure 5.78. Summary of mean metal concentrations in invertebrate soft tissues at MAI-686 as a composite of all four cruises.

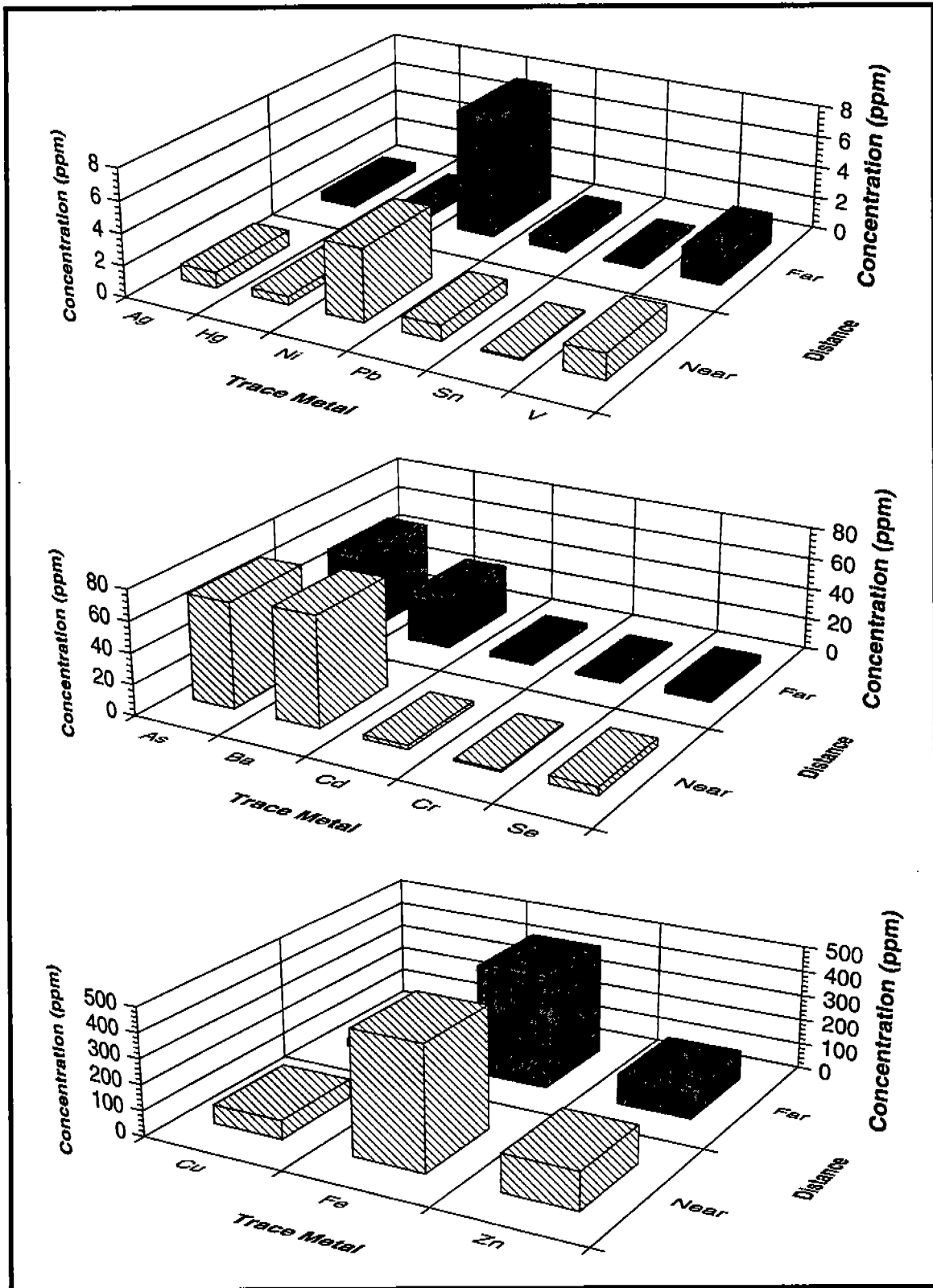

Figure 5.79. Summary of mean metal concentrations in invertebrate soft tissues at MU-A85 as a composite of all four cruises.

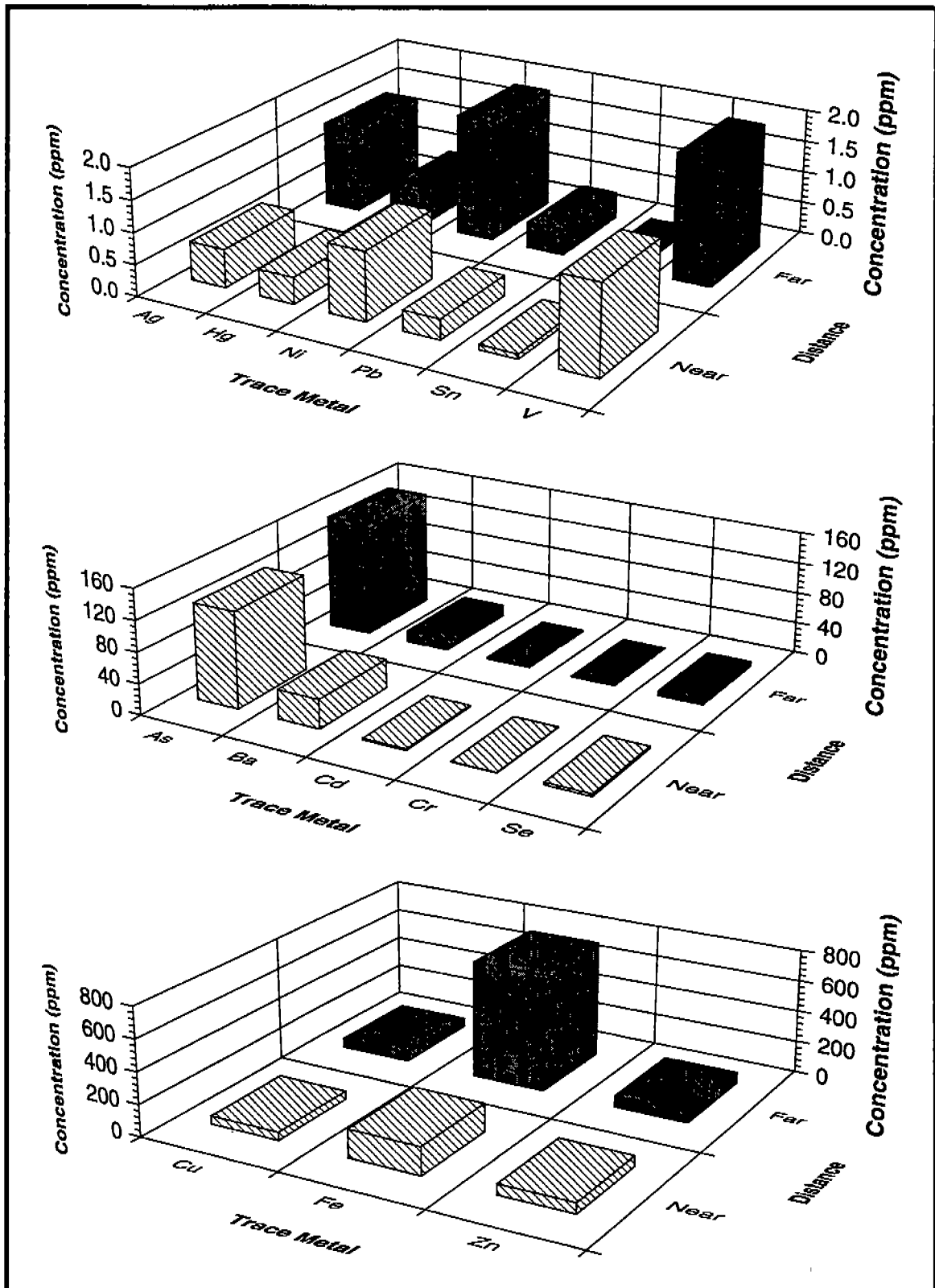

Figure 5.80. Summary of mean metal concentrations in invertebrate soft tissues at HI-A389 as a composite of all four cruises.

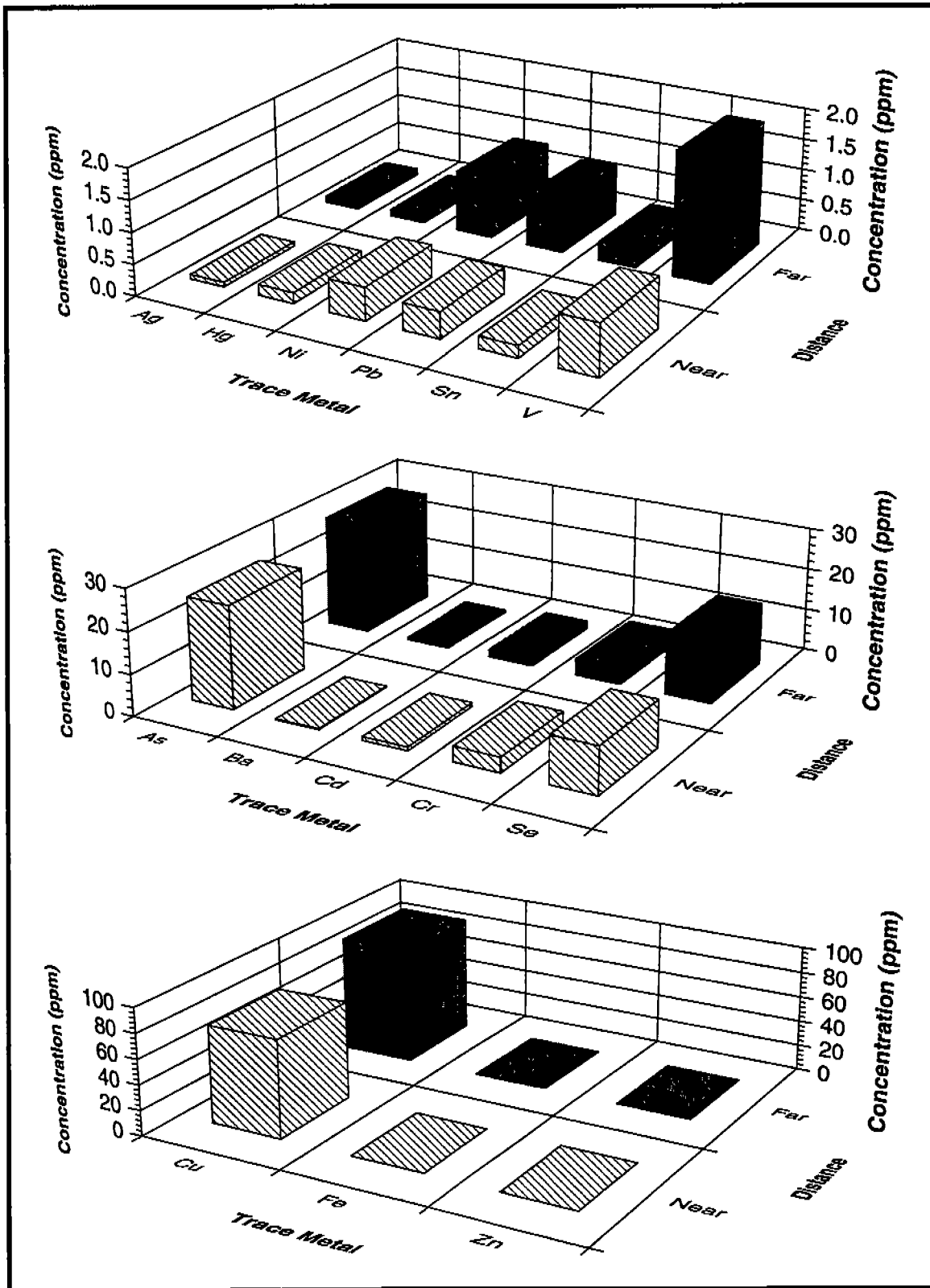

Figure 5.81. Summary of mean metal concentrations in fish stomach contents at MAI-686 as a composite of all four cruises.

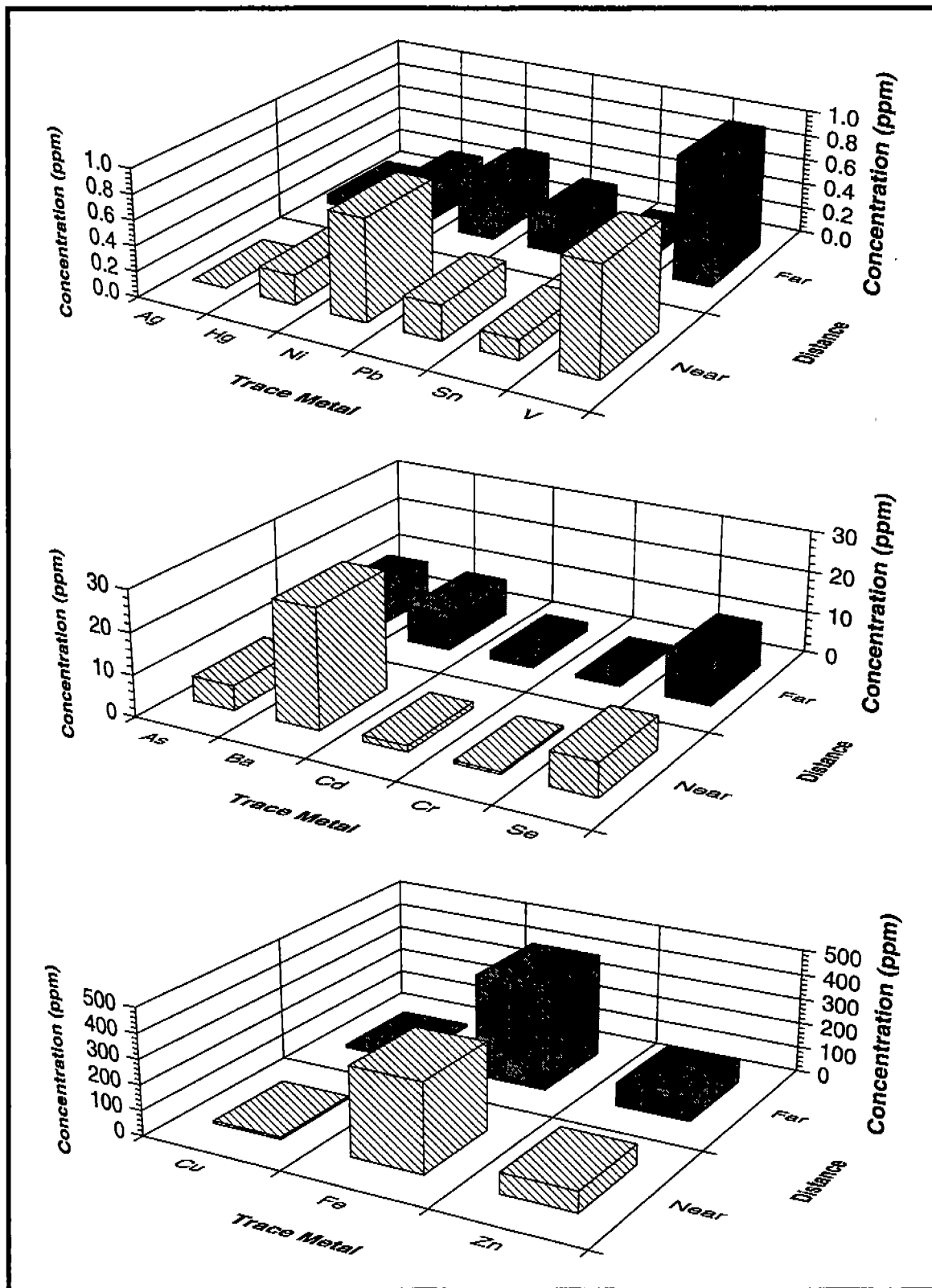

Figure 5.82. Summary of mean metal concentrations in fish stomach contents at MU-A85 as a composite of all four cruises.

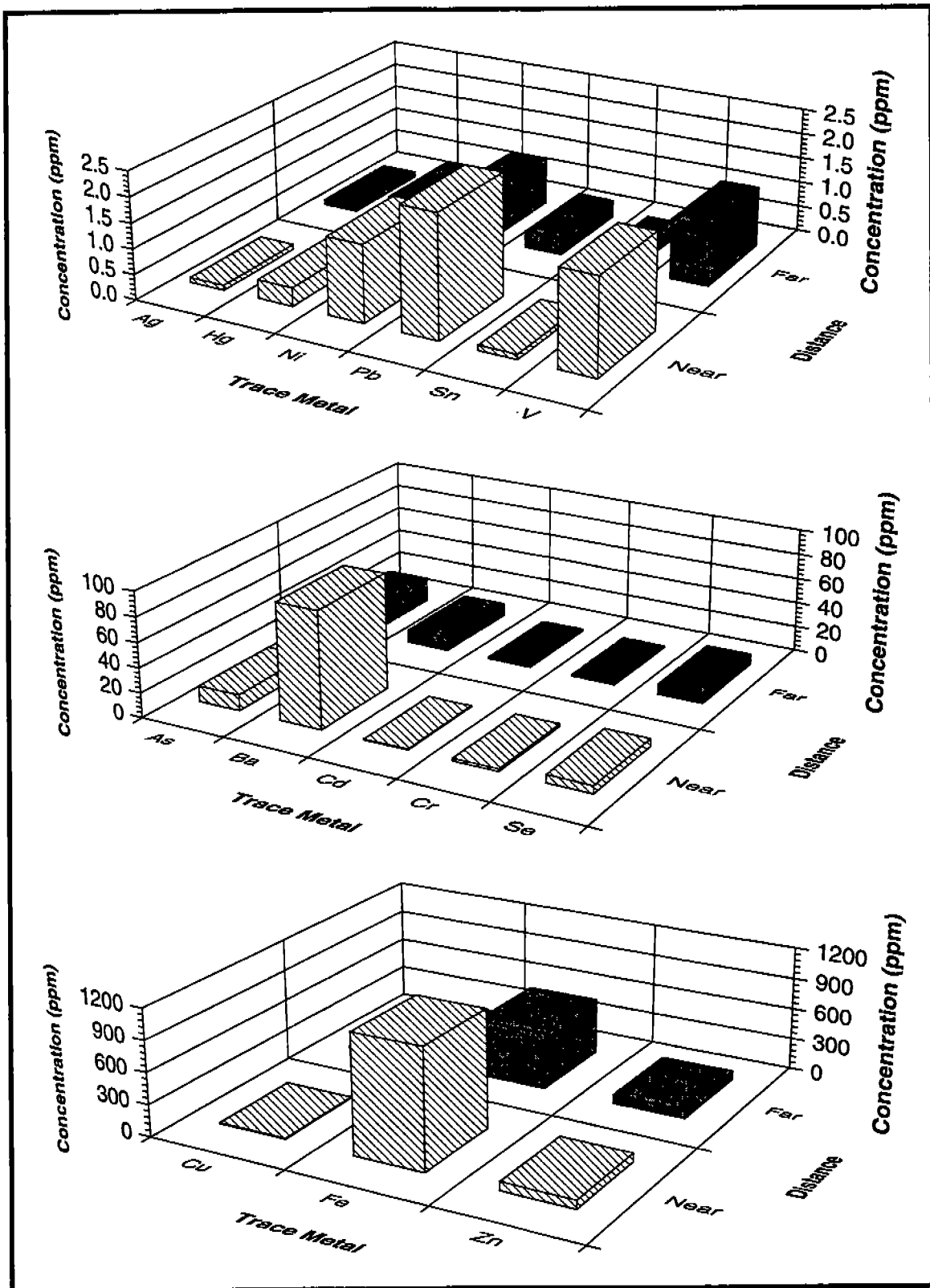

Figure 5.83. Summary of mean metal concentrations in fish stomach contents at HI-A389 as a composite of all four cruises.

5.4 Meiofauna

Most of what is known about meiofauna is from studies of shallow water systems. Many studies have also been done in the deep sea, but there have been few studies of continental shelf or slope meiofaunal communities (Coull et al. 1982). Studies where meiofauna have been sampled seasonally from shelf sediments are rare. Meiofauna abundances decrease with water depth (Thiel 1978; Coull et al. 1982; Montagna 1991) and average about 800 individuals per 10 cm² (Table 5.17). Nematodes are generally the dominant taxa, comprising between 50 and 95 % of the community, followed by harpacticoid copepods, which comprise between 5 and 20 % of the community (Coull et al. 1977; Coull et al. 1982; Montagna 1991).

5.4.1 Vertical Distribution and Power

Little information is available about the vertical distribution of meiofauna on the Gulf of Mexico continental shelf. To determine the appropriate sampling depth, sediments near Port Aransas in Matagorda Island Block 746 in a water depth of 18 m were sampled. Seventy-one (71) percent of the fauna were in the top 2 cm and 93 % were in the top 4 cm (Table 5.18). Almost all (95 %) harpacticoids were in the top one (1) cm of sediment. Since little information is gained by sampling below two (2) cm, all samples were taken from the 0 to 2 cm depth interval. The observed total density to 4 cm (3,743 individuals X 10 cm⁻²) is much higher than values previously reported in the literature (Table 5.17).

A major assumption that formed the basis of the sampling protocol was verified during the first cruise (i.e., two replicate cores per boxcore were sufficient for the study design). Two stations at each platform, one within 50 m of the platform and one at ≥ 3000 m distance, were oversampled to test this assumption. A second boxcore was taken at this subset of stations to determine the power of the sampling design. The second boxcore at the ten paired boxcore stations was used to document between boxcore replication. The overall average density was 722 individuals X core⁻¹ and the mean square error was 62,983. The mean population size was converted to 1.00 so that the percentage change of population size could be calculated. The change of population density increases with decreasing numbers of

Table 5.17. Continental shelf meiofauna densities reported in the periodic literature.

Ocean	Shelf Location	Depth ^a	Density ^a	Author
E Pacific	Santa Maria Basin	90-410	1900	Montagna 1991
E Pacific	Santa Maria Basin	565	97	Montagna 1991
E Pacific	Santa Barbara Channel	18	1750	Montagna et al. 1989
Gulf of Mexico	Louisiana	8-13	1810	Murrell and Fleeger 1989
Gulf of Mexico	Louisiana	355	580	Pequegnat et al. 1990
Gulf of Mexico	E Flower Gardens	72	*98	Powell et al. 1983
Gulf of Mexico	S Texas	10-82	*200	Pequegnat and Sikora 1979
Gulf of Mexico	S Texas	91-134	*50	Pequegnat and Sikora 1979

^aIndicates sediment depth of 10 cm.

^adepth in meters, meiofaunal density in $n \times 10 \text{ cm}^{-2}$ to a sediment depth of 10 cm.

Table 5.18. Vertical distribution of meiofauna in the Gulf of Mexico (18 m water depth).

Depth (cm)	Total ^a ($n \times 10 \text{ cm}^{-2}$)	Total ^a	NEMA ^a	HARPA ^a	NAUP ^a	OTHER ^a
		(n X core ⁻¹)				
0-1	2088	592	216	116	80	180
1-2	778	221	186	3	0	32
2-3	476	135	121	1	0	13
3-4	401	114	101	1	0	12
4-5	150	43	38	0	0	5
5-6	69	20	18	1	0	1
6-7	32	9	4	0	0	5
7-8	6	2	1	0	0	1
8-9	6	2	1	0	0	1
9-10	4	1	0	0	0	1
0-10	4010	1139	686	122	80	251

^aThe average of three replicates, density in $n \times 10 \text{ cm}^{-2}$, and $n \times \text{core}^{-1}$. (NEMA = Nematoda, HARP = Harpacticoida, NAUP = harpacticoid nauplii, and OTHER = other taxa)

samples. At any given number of samples (n), certainty about change increases with increasing differences. There is a break in the curve at about four samples, meaning more than four samples does little to increase resolving power. Most tests will be based on 20 samples (=2 replicates X 5 radii X 2 distances) allowing detection of a 40 % change with 0.80 power ($b=0.20$). With just two samples, i.e. two replicates per boxcore, a 100 % change (which is a doubling) among stations is detectable. An analysis of variance components was performed to determine if using subcores as replicates from one box core was sufficient. Most of the variability in the study is among platforms (54 %) and the platform*station interaction (33 %). Practically, none of the variability was due to replicate boxcores (0.1 %). Therefore, one boxcore per station and two replicate subcores was a sufficient sampling protocol for the meiofaunal studies.

5.4.2 Community Abundance and Diversity

Meiofaunal communities were sampled by a boxcorer. Six hundred (600) samples were analyzed from four cruises, three platforms, twenty-five stations at each platform, and two replicates (area=2.8 cm²) from each boxcore. Eight different variables were examined: total meiofauna density, Nematoda density, Harpacticoida density, other meiofauna taxa density, the nematode:copepod (NC) ratio, nematode biomass, nematode diversity, and harpacticoid diversity. Diversity was computed using the Shannon-Weaver index, H' . The abundances were transformed using the logarithm to the base 10 and all values reported here are detransformed. Because geometric means are computed and round off errors occur, component means will not add up to overall means.

The overall detransformed, average density for the meiofauna community was 1170 individuals X 10 cm⁻² in the top 2 cm of sediment (Table 5.19). This is equivalent to densities recorded for continental shelf sediments in other areas (Table 5.18). Sixty-nine (69) percent of the Gulf of Mexico community was composed of nematodes, which averaged 757 individuals X 10 cm⁻². Fifteen (15) percent of the community was composed of harpacticoids, which averaged 161 individuals X 10 cm⁻². The remaining 16 percent of the community was composed of 11 "other" taxa, which averaged 182 individuals X 10 cm⁻². The "other" taxa were Kinoryncha,

Table 5.19. The overall average abundance and diversity for meiofauna variables at all platforms, stations, and cruises.

Variables ^a	HI-A389	MAI-686	MU-A85	Mean
Meiofaunal density	734	2571	846	1169
Nematode density	481	1864	482	757
Harpacticoid density	85	283	171	161
Other meiofaunal density	100	369	164	182
Nematode biomass	0.674	1.084	1.280	1.000
Nematode:Copepod ratio	5.64	6.60	2.81	5.02
Nematode diversity	2.74	3.12	3.31	3.06
Harpacticoid diversity	2.00	2.56	2.52	2.36

^aNumbers for density (individuals X 10 cm⁻²) and for biomass (mg wet weight X 10 cm⁻²) are detransformed from log₁₀. Diversity values are the Shannon-Weaver index (H'). Averages for 600 samples.

Polychaeta, Ostracoda, Mollusca, Rhyncocoela, Amphipoda, Isopoda, Tanaidacean, Cumacea, Priapulida and unknown or unidentifiable soft body taxa. None of these "other" taxa occur in large numbers. Nematode biomass averaged 1.00 mg wet weight X 10 cm⁻² in the Gulf of Mexico. Nematode communities were more diverse (H' of 3.06) than harpacticoid communities (H' of 2.36). However, H' is sensitive to sample size so the diversity of nematodes was higher than harpacticoids because nematode density was higher than harpacticoids.

Contours of density, biomass, and diversity gradients were produced to illustrate gradients (Figures 5.84 to 5.91). The strongest gradient for total meiofauna density around a platform was found at MAI-686 (Figure 5.84). The gradient was relatively uniform around the platform (i.e., there is no strong directional influence). There was no significant pattern evident around MU-A85 for total meiofauna (Figure 5.84). There was a significant gradient around HI-A389, but its distribution was not symmetrical (Figure 5.84). There was a large increase in density, relative to background levels, southwest of the platform. MAI-686 was also unique in that there was a significant difference between cruises. This was due to lower meiofauna densities near the platform during Cruises 2 and 4 than in Cruises 1 and 3. These low densities occurred coincidentally with an hypoxic event near this platform each summer.

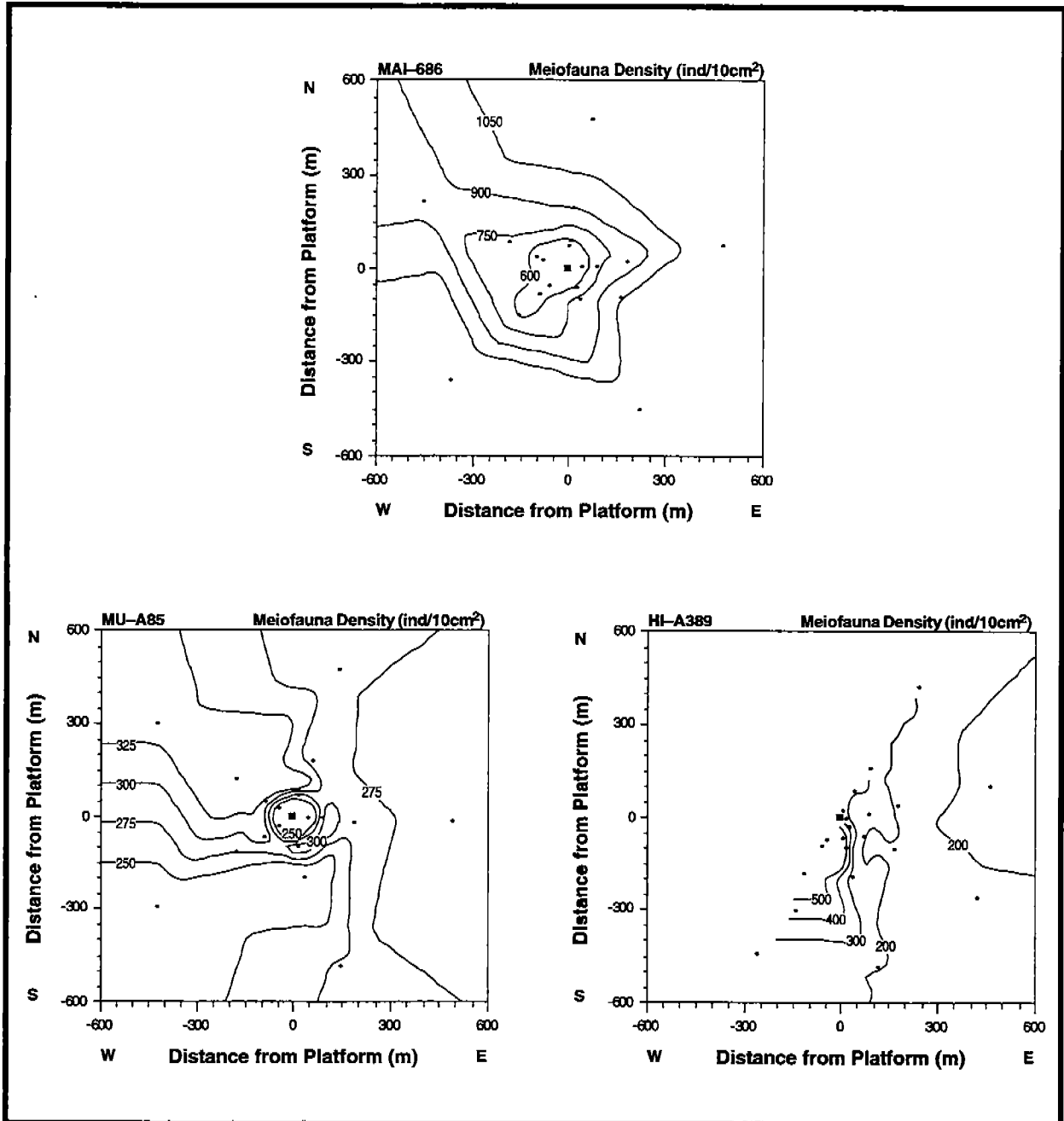

Figure 5.84. Areal distribution of mean meiofauna density (ind/10 cm²) as a composite of all four cruises.

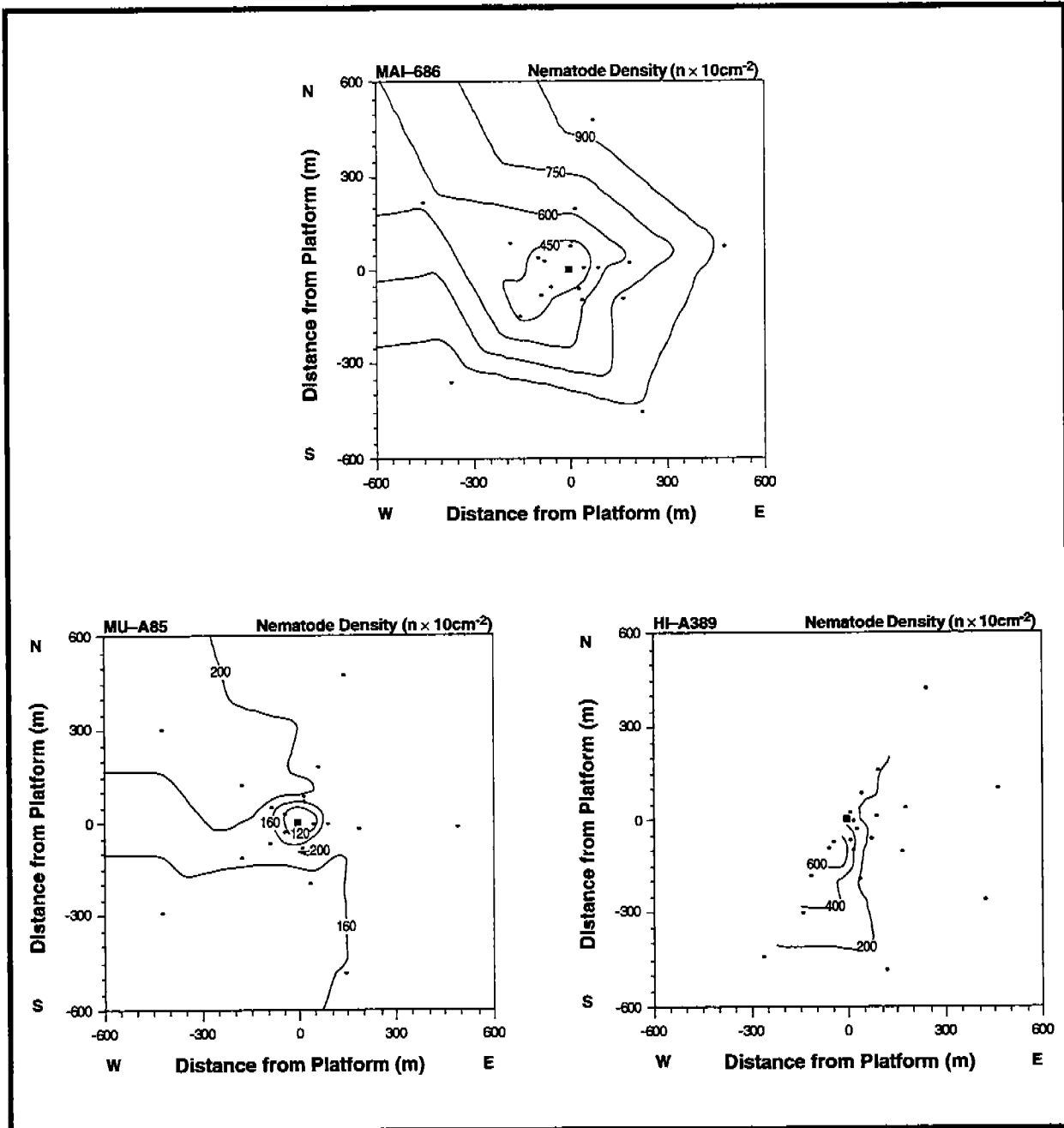

Figure 5.85. Areal distribution of mean nematode density ($n \times 10 \text{ cm}^{-2}$) as a composite of all four cruises.

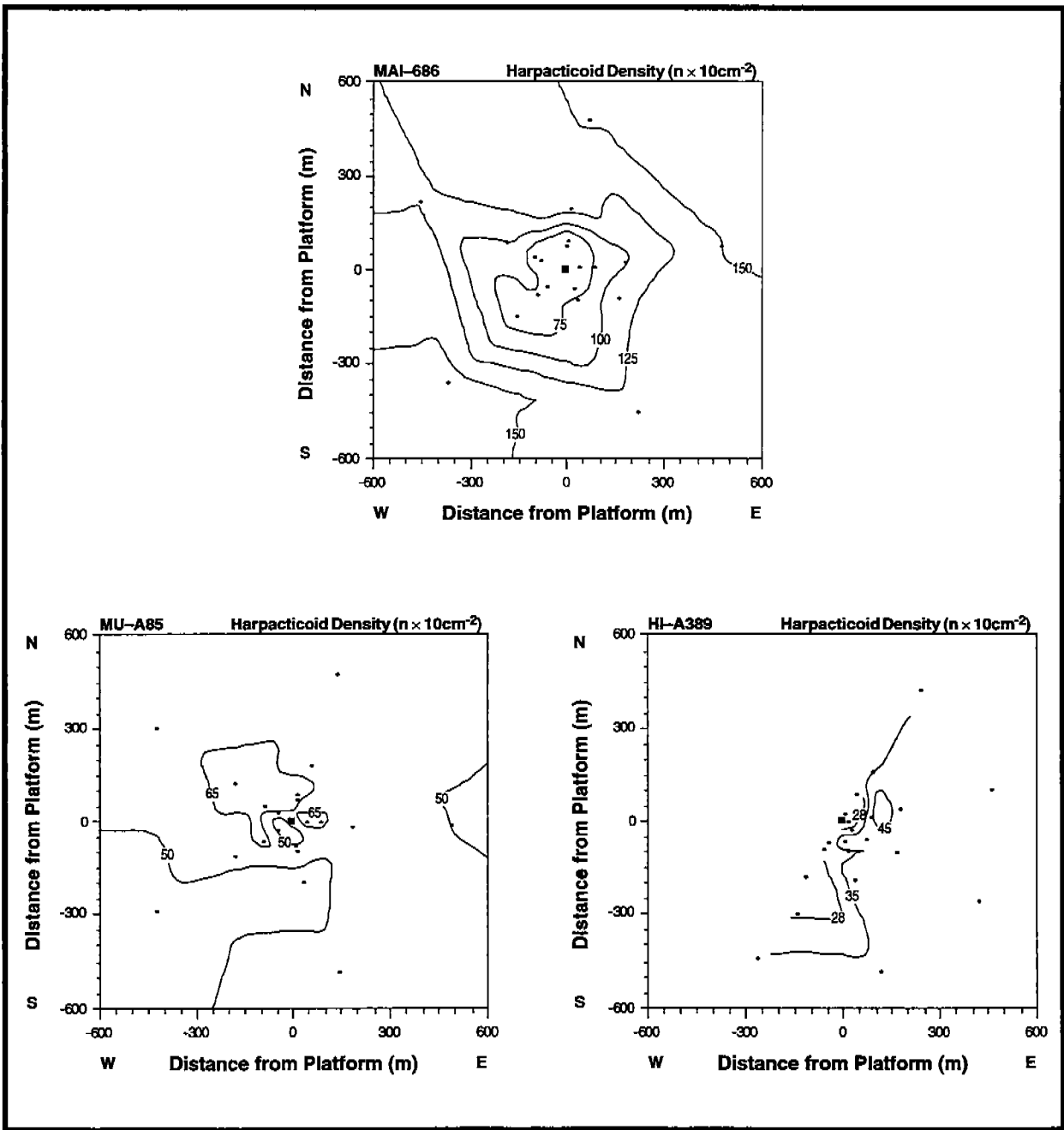

Figure 5.86. Areal distribution of mean harpacticoid density ($n \times 10 \text{ cm}^{-2}$) as a composite of all four cruises.

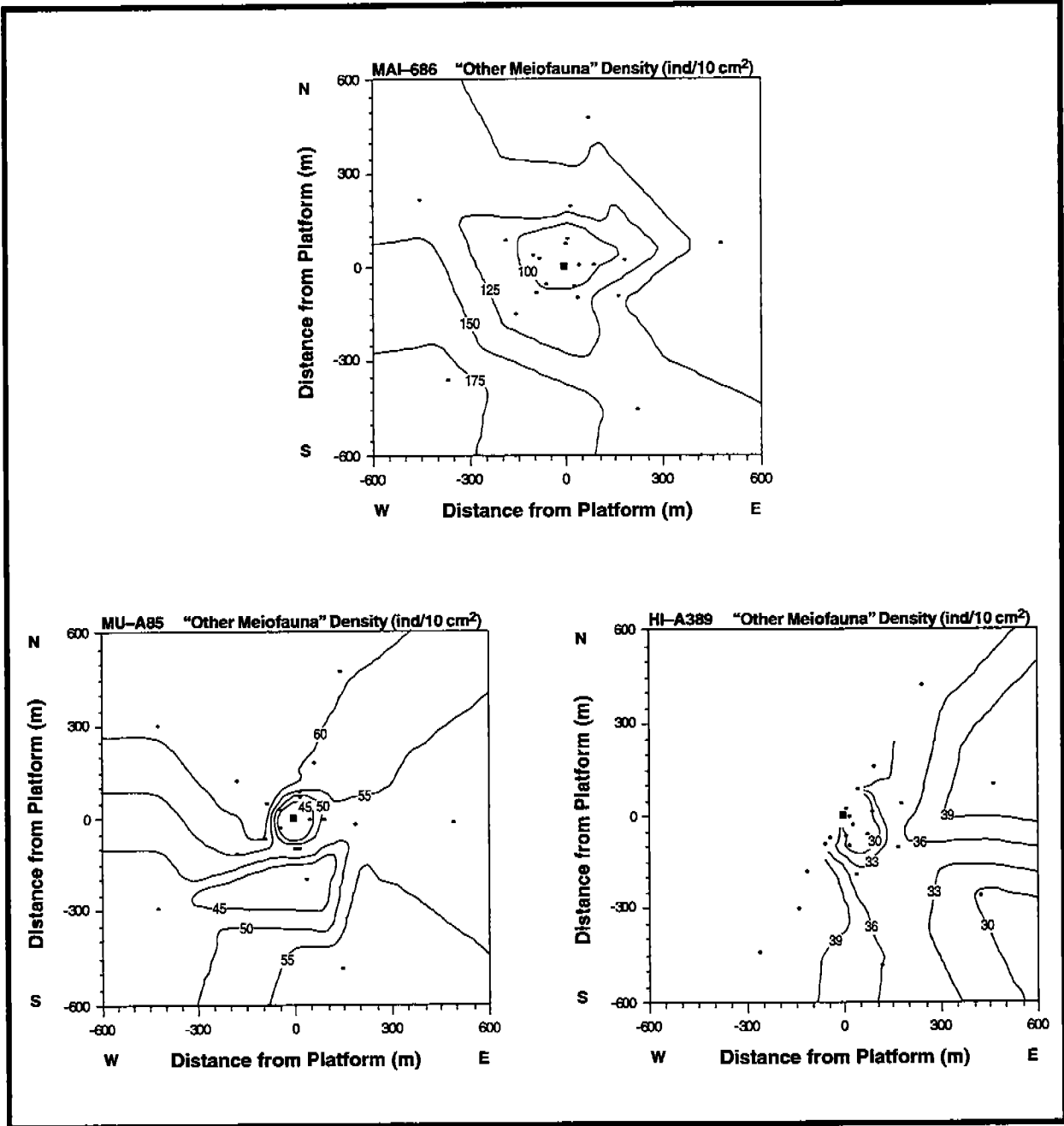

Figure 5.87. Areal distribution of mean "other meiofauna" density (ind/10 cm²) as a composite of all four cruises.

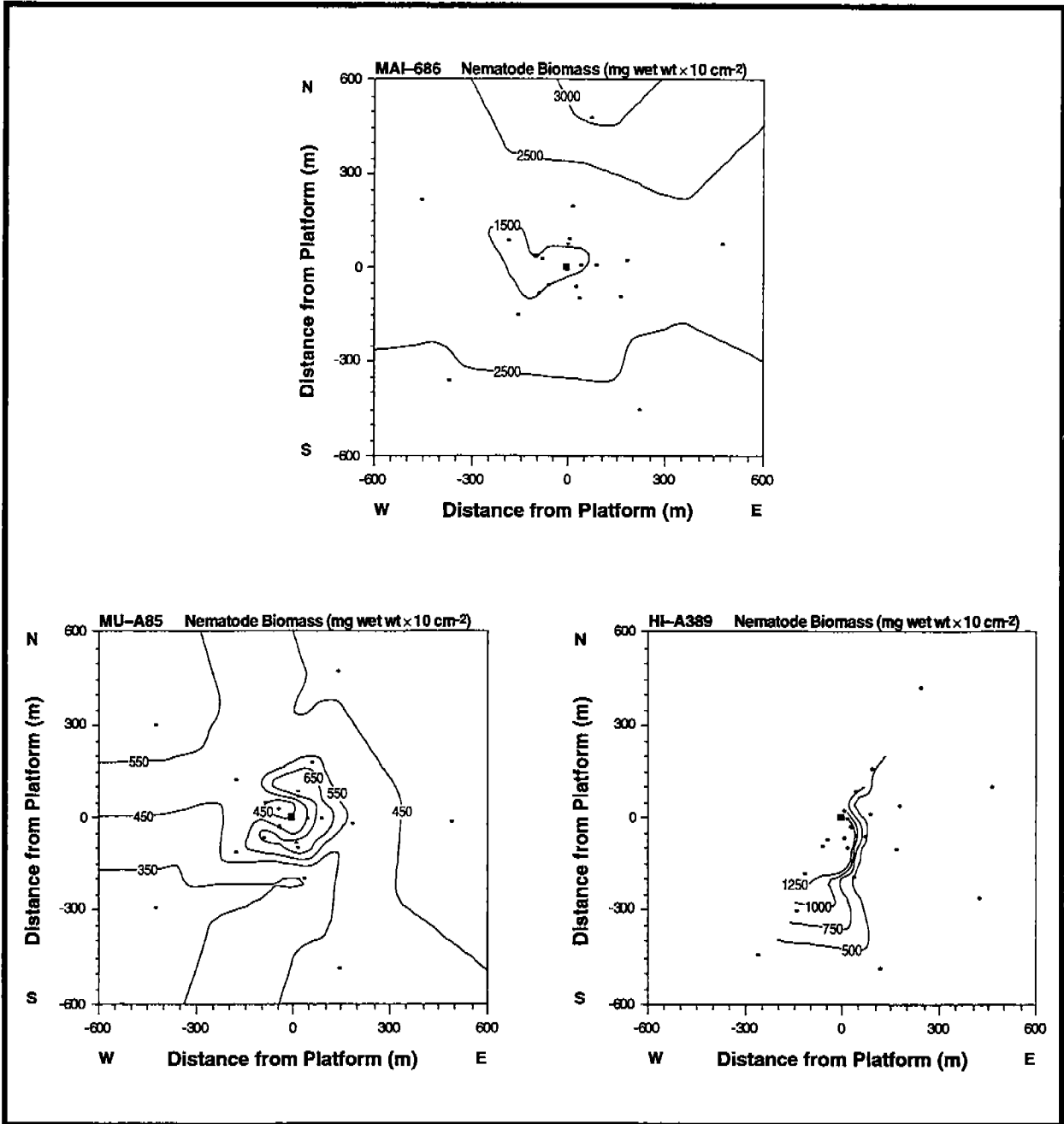

Figure 5.88. Areal distribution of mean nematode biomass (mg wet weight $\times 10 \text{ cm}^{-2}$) as a composite of all four cruises.

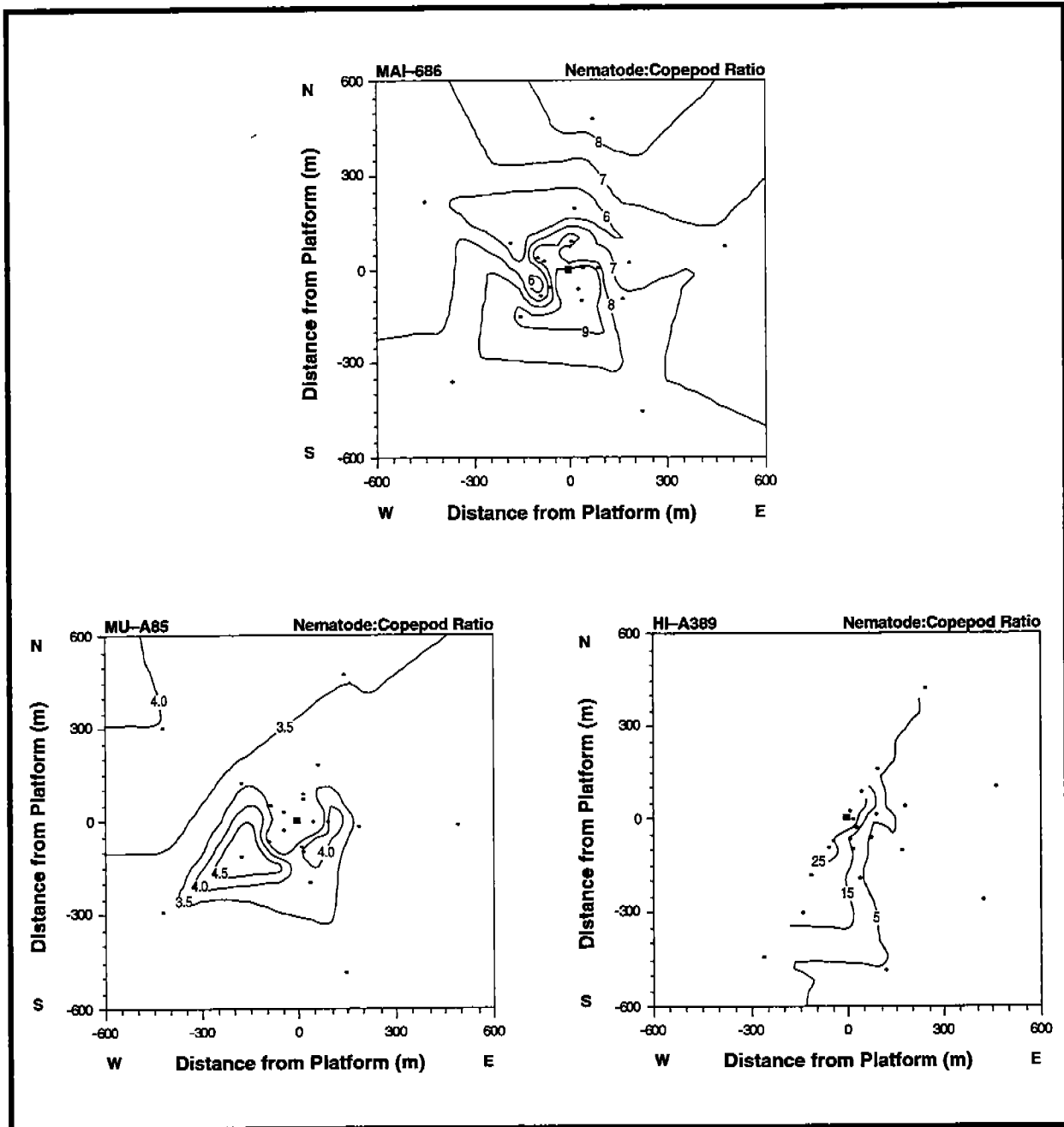

Figure 5.89. Areal distribution of mean nematode:copepod ratio (N:C ratio) as a composite of all four cruises.

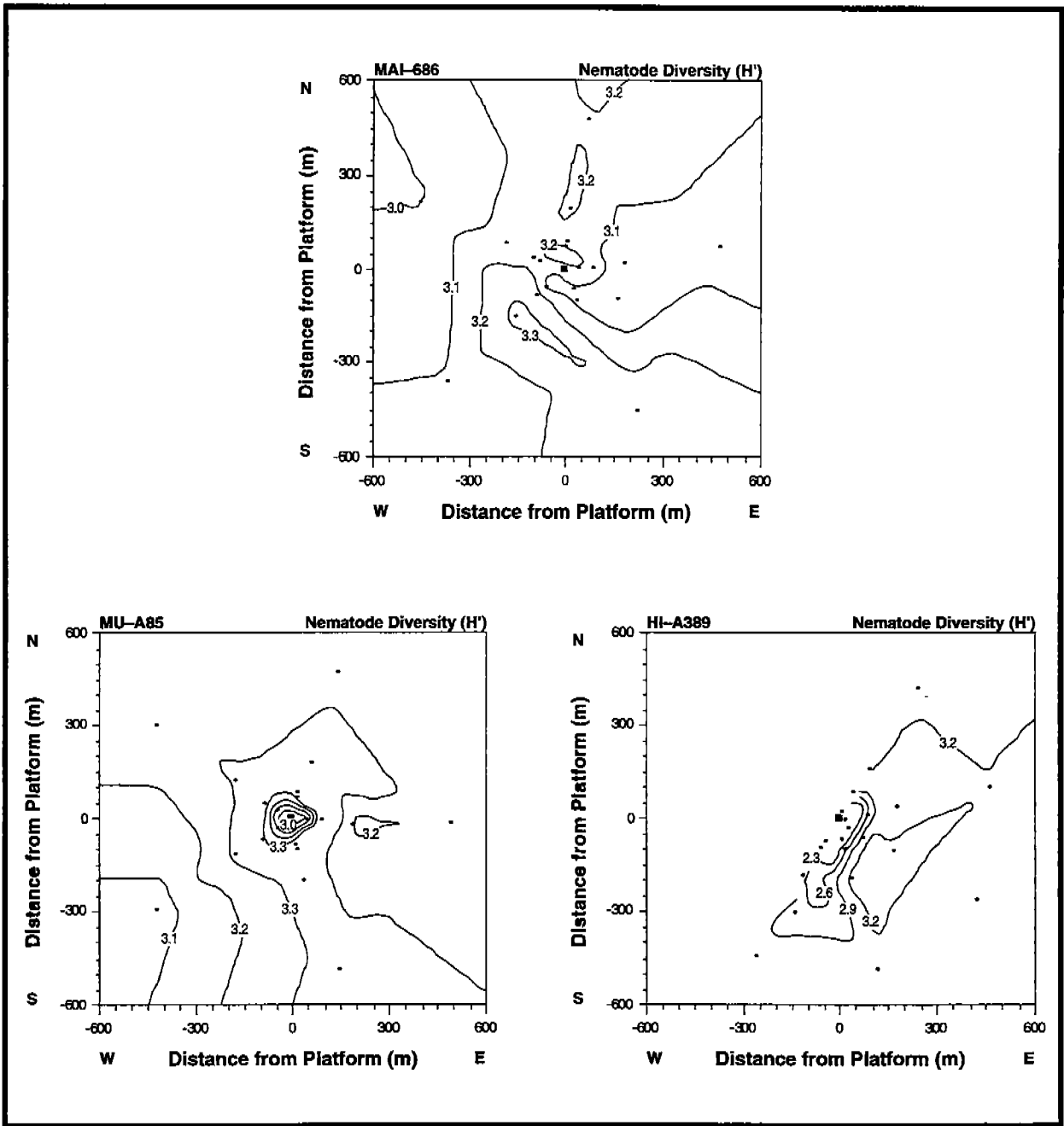

Figure 5.90. Areal distribution of mean nematode diversity (H') as a composite of all four cruises.

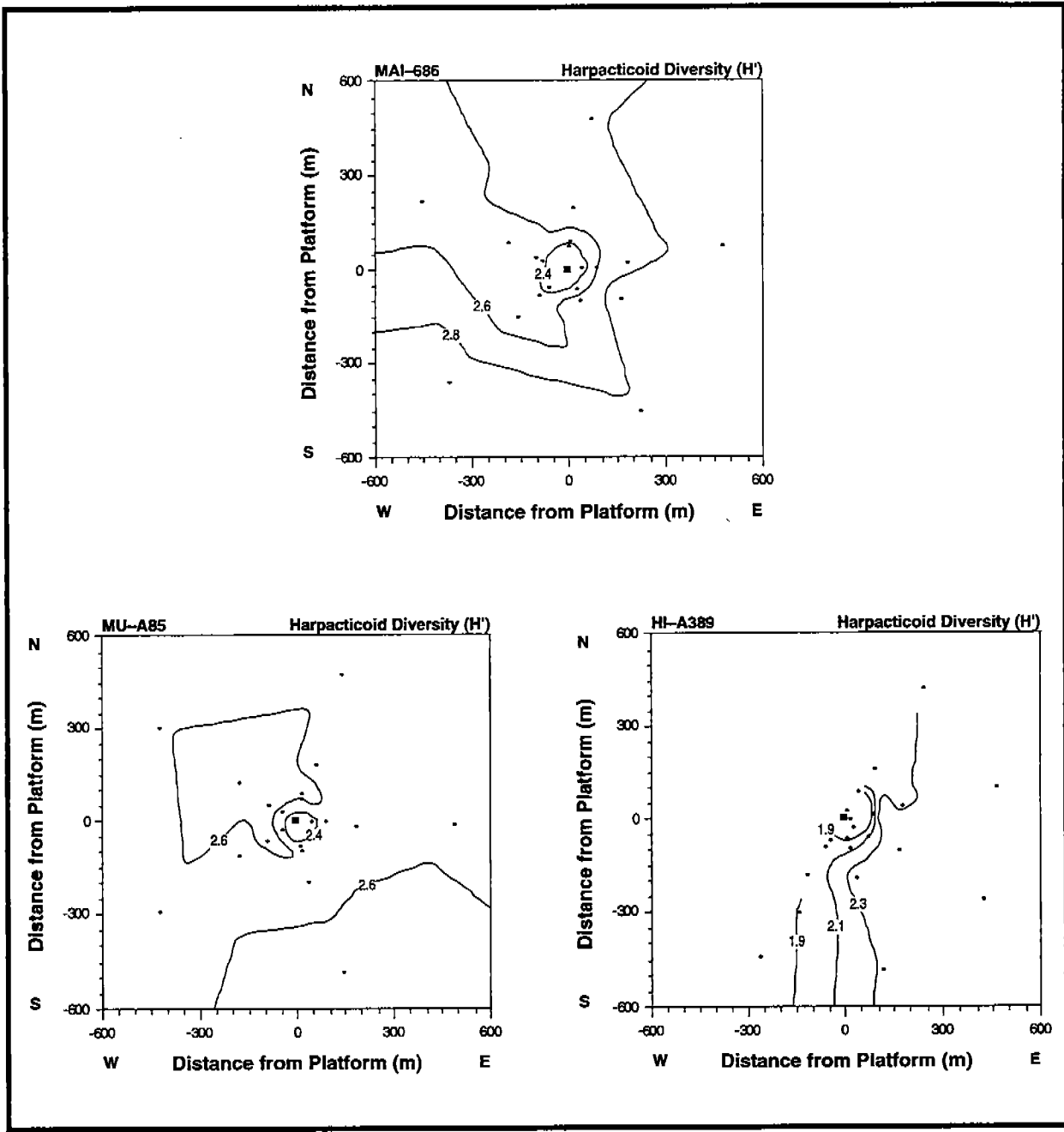

Figure 5.91. Areal distribution of mean harpacticoid diversity (H') as a composite of all four cruises.

Since nematodes were the dominant taxa, the trends observed for total meiofauna were very similar for nematode abundance (Figure 5.85). Nematode density changes with distance at platforms MAI-686 and HI-A389, but not at MU-A85. Harpacticoid abundance also decreased uniformly away from MAI-686 (Figure 5.86). There was no obvious trend with distance from MU-A85 for harpacticoids (Figure 5.86). As with nematodes, harpacticoid density was highest southwest of platform HI-A389 (Figure 5.86). The trend for other meiofauna taxa was strongest at platform MAI-686 (Figures 5.87). Response of nematode biomass was slightly different from the trend observed for nematode density (Figure 5.88). Like abundance, nematode biomass increased uniformly with distance away from platform MAI-686 (Figure 5.88). At MU-A85 and HI-A389, nematode biomass decreased with distance from the platforms (Figures 5.88).

The nematode:copepod (NC) ratio has been suggested as an index of organic enrichment (Figures 5.89). Some studies show that this index also increases along contaminant gradients. There was a weak gradient of decreasing NC ratio away from MAI-686 (Figure 5.89). In contrast, the NC ratio at MU-A85 significantly increased with distance from the platform (Figure 5.89). There was a strong decrease in the NC ratio away from HI-A389 (Figure 5.89).

Nematode diversity appeared to be relatively uniform near platforms at MAI-686 and MU-A85 (Figures 5.90). Nematode diversity (H') decreased near HI-A389 (Figure 5.90). Harpacticoid diversity (H') increases with distance away from platforms MAI-686 and HI-A389 (Figures 5.91). There was no significant directionality to diversity trends at MU-A85 and MAI-686, but there was significant directionality at HI-A389 (Figures 5.91). Harpacticoid diversity at HI-A389 was low near the platform (Figure 5.91).

5.4.3 Community Structure

The harpacticoid community was very diverse. A total of 154 species of harpacticoids was found (Table 5.20). Only nine of the species were easily distinguished as described species. The rest are either new or a Gulf of Mexico variant that is undescribed. Members of the Ectinosomidae dominated the fauna. This family has long, torpedo-like body shapes, and most members are very small. For many of the species, genus designation

Table 5.20. Mean density (n X 10 cm⁻²) for Copepoda species found at all three platforms for all cruises.

Taxa	MAI-686	MU-A85	HI-A389
Copepoda			
Harpacticoida			
Longipediidae			
<i>Longipedia americana</i>	0.63	1.38	0.44
Canuellidae			
<i>Ellucana secunda</i>	0.04	0.00	0.02
Ectinosomidae			
<i>Ectinosomid</i> sp. 6	0.04	0.16	0.04
<i>Ectinosomid</i> sp. 8	2.54	2.70	3.44
<i>Ectinosomid</i> sp. 12	0.00	0.11	0.00
<i>Ectinosomid</i> sp. 32	0.00	0.00	0.05
<i>Ectinosomid</i> sp. 34	2.13	0.16	0.12
<i>Ectinosomid</i> sp. 35	0.14	0.04	0.12
<i>Ectinosomid</i> sp. 51	1.46	0.00	0.00
<i>Ectinosomid</i> sp. 52	1.34	0.02	0.04
<i>Ectinosomid</i> sp. 55-B	0.00	0.04	0.19
<i>Ectinosomid</i> sp. 68-E	0.00	0.07	0.02
<i>Ectinosomid</i> sp. 82	0.00	0.00	0.18
<i>Ectinosomid</i> sp. 83	0.00	0.00	0.09
<i>Ectinosomid</i> sp. 87	1.15	0.55	0.35
<i>Ectinosomid</i> sp. 88-U	0.00	0.00	0.04
<i>Ectinosomid</i> sp. 92-M	0.00	0.00	0.04
<i>Ectinosomid</i> sp. 96-AA	0.02	0.00	0.07
<i>Ectinosomid</i> sp. 97-AB	0.11	0.19	0.05
<i>Ectinosomid</i> sp. 98-AC	0.04	0.00	0.25
<i>Ectinosomid</i> sp. 102-AO	0.00	0.00	0.04
<i>Ectinosomid</i> sp. 104-AL	0.00	0.02	0.02
<i>Ectinosomid</i> sp. 107-AT	0.00	0.02	0.02
<i>Ectinosomid</i> sp. 109-AY	0.00	0.00	0.02
<i>Ectinosomid</i> sp. 110-AZ	0.02	0.00	0.30
<i>Ectinosomid</i> sp. 113-BF	0.00	0.00	0.02
<i>Ectinosomid</i> sp. 115-BH	0.04	0.00	0.02
<i>Ectinosomid</i> sp. 122-BT	0.04	0.00	0.02
<i>Ectinosomid</i> sp. 124-BW	0.05	0.00	0.02
<i>Ectinosomid</i> sp. 126-BZ	0.00	0.00	0.09
<i>Ectinosomid</i> sp. 129-MB	16.01	3.53	2.77
<i>Ectinosomid</i> sp. 130	8.32	0.95	0.11
<i>Ectinosomid</i> sp. 133-MH	1.75	1.02	0.46
<i>Ectinosomid</i> sp. 134-ME	3.69	0.19	0.12
<i>Ectinosomid</i> sp. 135-MT	7.53	0.00	0.00
<i>Ectinosomid</i> sp. 137-ML	0.51	0.11	0.00
<i>Ectinosomid</i> sp. 138-MM	15.18	1.82	1.23
<i>Ectinosomid</i> sp. 139-MO	1.34	0.99	0.28
<i>Ectinosomid</i> sp. 140-MP	0.32	0.04	0.00
<i>Ectinosomid</i> sp. 142-MI	0.05	0.02	0.00
<i>Ectinosomid</i> sp. 143-MQ	0.00	0.02	0.04
<i>Ectinosomid</i> BP	1.45	0.12	0.18
<i>Ectinosomid</i> (unidentified)	8.01	10.55	5.59

Table 5.20. (Cont.)

Taxa	MAI-686	MU-A85	HI-A389
Tachiidae			
<i>Euterpina acutifrans</i>	0.00	0.00	0.04
Tisbidae			
<i>Tisbe</i> sp. 1	0.00	0.04	0.00
<i>Zosime</i> n sp. A	0.00	0.30	0.25
<i>Zosime</i> n sp. B	0.00	0.04	0.11
<i>Zosime</i> n sp. 54-C	0.18	1.45	2.43
<i>Idyella</i> sp.	0.04	0.02	0.04
<i>Tachidiella</i> sp. 86-BL	7.95	1.90	1.66
Genus A	0.00	0.02	0.05
Thalestridae			
<i>Diarthrodes</i> sp.	5.61	1.90	0.04
Diosaccidae			
<i>Stenhelia</i> (<i>Stenhelia</i>) sp. 37	1.08	0.00	0.00
<i>Stenhelia</i> (<i>Delavalia</i>) sp. 2	7.05	0.39	0.00
<i>Stenhelia</i> (<i>Delavalia</i>) sp. 81	0.00	0.04	0.26
<i>Stenhelia</i> (<i>Delavalia</i>) sp. 31	3.14	0.04	0.05
<i>Stenhelia</i> (<i>Delavalia</i>) sp. 44	0.00	0.04	0.00
<i>Stenhelia</i> (<i>Delavalia</i>) sp. 48	0.00	0.07	0.00
<i>Stenhelia</i> (<i>Delavalia</i>) sp. 101-AG	0.00	0.00	0.18
<i>Stenhelia</i> (<i>Delavalia</i>) sp. 118-BU	0.00	0.00	0.12
<i>Stenhelia</i> (<i>Delavalia</i>) sp. 119-BO	0.00	0.32	0.18
<i>Stenhelia</i> (<i>Delavalia</i>) sp. 120-BV	0.00	0.00	0.05
<i>Stenhelia</i> sp.	0.67	1.09	1.23
<i>Robertsonia</i> n sp. A	0.30	0.26	0.00
<i>Amphiascus</i> sp. (minutas group)	0.63	0.21	0.32
<i>Robertgurneya</i> sp. A	3.77	0.46	0.19
<i>Robertgurneya</i> sp. B	0.14	0.09	0.00
<i>Robertgurneya</i> sp. C	0.60	0.18	0.00
<i>Typhlamphiascus</i> sp.	2.70	0.14	0.00
<i>Amphiascoides</i> sp. A	1.06	0.11	0.04
<i>Amphiascoides</i> sp. B	0.14	0.05	0.00
<i>Haloschizopera</i> sp.	2.59	0.74	0.04
<i>Diosaccid</i> sp. 5	0.09	0.00	0.05
<i>Diosaccid</i> sp. 42	0.00	0.02	0.00
<i>Diosaccid</i> sp. 45	1.25	0.35	0.04
<i>Diosaccid</i> sp. 46	0.67	1.15	0.07
<i>Diosaccid</i> sp. 53	0.00	0.04	0.12
<i>Diosaccid</i> sp. 65	0.00	0.39	0.07
<i>Diosaccid</i> sp. 66-F	0.07	0.44	0.51
<i>Diosaccid</i> sp. 67	0.00	0.00	0.05
<i>Diosaccid</i> sp. 89-S	0.00	0.07	0.12
<i>Diosaccid</i> sp. 91-J	0.00	0.00	0.02
<i>Diosaccid</i> sp. 95-X	0.00	0.02	0.05
<i>Diosaccid</i> sp. 99-AD	0.00	0.00	0.05
<i>Diosaccid</i> sp. 100-AE	0.00	0.93	0.05
<i>Diosaccid</i> sp. 103-AP	0.00	0.00	0.05
<i>Diosaccid</i> sp. 105-AV	0.00	0.00	0.07
<i>Diosaccid</i> sp. 106-AW	0.00	0.00	0.05
<i>Diosaccid</i> sp. 108-AX	0.00	0.00	0.05

Table 5.20. (Cont.)

Taxa	MAI-686	MU-A85	HI-A389
<i>Diosaccid</i> sp. 111-BC	0.07	0.00	0.07
<i>Diosaccid</i> sp. 114-BG	0.00	0.02	0.04
<i>Diosaccid</i> sp. 121-BS	0.00	0.02	0.04
<i>Diosaccid</i> sp. 131-MF	0.00	0.00	0.02
<i>Diosaccid</i> sp. 132-MG	0.28	0.00	0.04
<i>Diosaccid</i> (unidentified)	9.03	7.41	1.85
Ameiridae			
<i>Ameiridae</i> sp. 79	9.13	3.60	2.68
<i>Pseudameira</i> sp.	8.34	3.23	1.76
<i>Anoplosoma</i> sp. A	0.00	0.00	0.02
<i>Anoplosoma</i> sp. B	0.00	0.00	0.11
<i>Ameirid</i> sp. 79	0.00	0.37	0.78
Tetragonicipitidae			
Genus A.	0.00	0.00	0.05
Canthocamptidae			
<i>Canthocamptidae</i> (unidentified)	0.12	0.18	0.14
Genus A.	0.00	0.09	0.51
Genus B.	0.00	0.02	0.04
Genus C.	0.00	0.00	0.04
Cletodidae			
<i>Cletodes</i> aff. <i>macrura</i> -61	0.00	0.60	0.71
<i>Cletodes</i> aff. <i>tuberculatas</i>	9.65	0.67	0.00
<i>Cletodes</i> <i>pseudodissimilis</i>	6.75	0.11	0.04
<i>Cletodes</i> sp. A-AJ	0.00	0.00	0.11
<i>Enhydrosoma</i> <i>pericoense</i>	21.16	0.18	0.58
<i>Stylicletodes</i> aff. <i>longicaudata</i>	0.00	0.04	0.44
<i>Cletodid copepodid</i>	0.02	0.00	0.11
<i>Cletodid</i> sp. 128	0.72	0.04	0.00
Genus A. -41	0.05	0.37	1.52
Genus B. -62-AS	0.00	1.46	1.82
<i>Cletodid</i> (unidentified)	0.56	0.37	0.32
Argestidae			
<i>Eurycletodes</i> sp. -75	0.00	0.69	0.26
<i>Leptocletodes</i> sp. T	0.00	0.11	0.11
Laophontidae			
<i>Paralaophonte</i> aff. <i>pacifica</i>	0.11	0.00	0.00
Genus A	0.12	0.04	0.02
<i>Laophontid</i> (unidentified)	0.00	0.00	0.14
Normanellidae			
<i>Normanella</i> sp. A	6.40	0.37	0.11
<i>Normanella</i> sp. B	3.53	0.11	0.07
<i>Normanella</i> sp. C	0.14	0.34	0.21
<i>Cletopsyllas</i> sp. A	0.00	0.16	0.05
Genus A	0.00	0.00	0.09
Families uncertain			
<i>Harpacticoid</i> sp. 50	0.04	0.02	0.00
<i>Harpacticoid</i> sp. 56	0.00	0.04	0.16
<i>Harpacticoid</i> sp. 57	0.00	0.04	1.48
<i>Harpacticoid</i> sp. 58	0.00	0.21	0.65
<i>Harpacticoid</i> sp. 59	0.00	0.02	0.14

Table 5.20. (Cont.)

Taxa	MAI-686	MU-A85	HI-A389
<i>Harpacticoid</i> sp. 60	0.00	0.42	0.51
<i>Harpacticoid</i> sp. 63	0.00	0.07	0.41
<i>Harpacticoid</i> sp. 64	0.00	0.07	0.23
<i>Harpacticoid</i> sp. 73	0.00	0.00	0.09
<i>Harpacticoid</i> sp. 74	0.00	0.00	0.02
<i>Harpacticoid</i> sp. 78	0.00	0.00	0.02
<i>Harpacticoid</i> sp. 80	0.42	1.50	0.23
<i>Harpacticoid</i> sp. 84	0.00	0.00	0.19
<i>Harpacticoid</i> sp. 90	0.04	0.00	0.04
<i>Harpacticoid</i> sp. 93	0.00	0.04	0.09
<i>Harpacticoid</i> sp. 94	0.00	0.02	0.07
<i>Harpacticoid</i> sp. 112	0.00	0.00	0.04
<i>Harpacticoid</i> sp. 116	0.00	0.00	0.04
<i>Harpacticoid</i> sp. 117	0.00	0.00	0.02
<i>Harpacticoid</i> sp. 123	0.00	0.00	0.02
<i>Harpacticoid</i> sp. 125	0.00	0.02	0.00
<i>Harpacticoid</i> sp. 127	0.00	0.00	0.02
<i>Harpacticoid</i> 139-B	0.00	0.00	0.02
<i>Harpacticoid</i> (unidentified)	7.14	8.54	8.94
Cyclopoida			
<i>Cyclopoid</i> sp. 1-69	0.09	0.11	0.53
<i>Cyclopoid</i> sp. 2-77	0.11	0.34	0.72
<i>Cyclopoid</i> (unidentified)	0.72	4.09	2.65

was unsure. At HI-A389, the dominant species (in order of abundance) were *Ameridae* sp. 79, *Ectinosomid* sp. 129-MB, *Pseudameira* sp., and *Ectinosomid* sp. 8. At MAI-686, the dominant species (in order of abundance) were *Enhydrosoma pericoense*, *Ectinosomid* sp. 129-MB, *Ectinosomid* sp. 138-MM, and *Ameridae* sp. 79. Of the dominant species, *Enhydrosoma pericoense* was the only one restricted to shallow water depths. The other species were fairly common throughout the study sites.

The nematode community was also very diverse, containing 130 species (Table 5.21). The community was also more cosmopolitan, 31 species were previously described species. Again, the rest of the species were new or unknown Gulf of Mexico variants. No one family dominated the nematode fauna as in the harpacticoids. However, dominance by a single species was characteristic of HI-A389 and MAI-686. At HI-A389 the dominant species was *Molgolaimus turgofrons* followed by *Sabattieria ornata*, *Linhomoeus gittingsi*, and *Halalaimus meyeri*. At MAI-686, the dominant species was *Desmodora curvispiculum* followed by *Actinonema* sp. 1, *Microlaimus* sp. 1, and *Tricocoma filipjevi*. At MU-A85, dominance was

Table 5.21. Mean density (n X 10 cm⁻²) for Nematoda species found at three platforms for all cruises.

Taxa	MAI-686	MU-A85	HI-A389
Adenophorea			
Enoplida			
Thoracostomopsidae			
<i>Enoploides</i> Sp. 1	1.14	3.55	2.58
Phanodermatidae			
<i>Crenopharynx</i> sp. 1	0.00	0.10	0.00
Anticomidae			
<i>Cephalanticoma</i> sp. 1	0.19	0.08	0.00
<i>Odontanticoma</i> sp. 1	0.20	0.00	0.00
Ironidae			
<i>Trissonchulus</i> sp. 1	8.67	0.13	0.08
<i>Trissonchulus</i> sp. 2	0.88	0.20	0.27
Oxistominidae			
<i>Nemanema</i> sp. 1	0.45	1.70	2.23
<i>Oxystomina</i> sp. 1	1.51	3.89	6.79
<i>Halalaimus thalassinus</i>	97.06	33.50	29.09
<i>Halalaimus meyersi</i>	21.90	12.15	5.55
<i>Halalaimus</i> sp. 1	2.58	1.82	1.22
<i>Halalaimus</i> sp. 2	10.23	3.67	0.93
<i>Halalaimus</i> sp. 3	0.84	6.86	6.32
Oncholaimidae			
<i>Viscosia</i> sp. 1	4.84	2.35	9.04
<i>Viscosia macramphida</i>	14.85	10.18	7.53
<i>Viscosia</i> sp. 3	0.59	0.09	0.00
<i>Metoncholaimus</i> sp. 1	14.96	0.82	8.69
<i>Pontonema</i> sp. 1	0.00	0.62	0.39
<i>Oncholaimellus</i> sp. 1	0.56	0.35	0.35
Enchelidiidae			
<i>Pareurystomina scillonensis</i>	0.36	0.54	0.18
<i>Calyptonema</i> sp. 1	0.99	2.71	0.09
<i>Polygastrophora</i> sp. 1	0.45	2.34	1.65
Tripyloididae			
<i>Bathylaimus</i> sp. 1	0.00	0.33	1.37
<i>Tripyloides</i> sp. 1	2.80	0.42	0.53
Trefusiida			
Trefusiidae			
<i>Trefusia</i> sp. 1	2.86	1.99	26.93
Chromadorida			
Chromadoridae			
<i>Acantholaimus</i> sp. 1	0.28	0.57	12.00
<i>Actinonema</i> sp. 1	165.02	7.65	11.02
<i>Actinonema longicandata</i>	1.73	0.96	1.04
<i>Rhips</i> sp. 1	0.40	0.13	0.08
<i>Chromadorita chitwoodi</i>	42.26	0.58	0.16
<i>Chromadorita</i> sp. 1	5.60	0.51	0.33
<i>Spilophorella paradoxa</i>	9.52	1.97	1.29
<i>Ptycholaimellus</i> sp. 1	16.24	3.37	0.77
<i>Hypedontolaimus</i> sp. 1	4.10	17.08	6.81

Table 5.21. (Cont.)

Taxa	MAI-686	MU-A85	HI-A389
<i>Neochromadora</i> sp. 1	77.55	3.50	1.20
<i>Neochromadora</i> sp. 2	25.55	2.37	1.41
<i>Dichronadora</i> sp. 1	2.29	4.10	2.69
<i>Parapinnanema</i> sp. 1	0.41	2.67	0.65
Comesomatidae			
<i>Setosabatieria hilarula</i>	21.41	10.50	7.10
<i>Sabatieria ornata</i>	30.85	18.39	53.98
<i>Sabatieria punctata</i>	77.84	22.64	26.31
<i>Sabatieria</i> sp. 1	0.51	0.11	0.46
<i>Pierrickia</i> sp. 1	5.09	1.33	1.43
<i>Laimella</i> sp. 1	4.83	0.94	1.75
<i>Cervonema</i> sp. 1	13.45	18.24	15.55
<i>Cervonema</i> sp. 3	21.21	20.81	11.29
<i>Dorylaimopsis punctata</i>	2.21	4.44	2.33
<i>Hopperia</i> sp. 1	18.44	1.36	0.60
<i>Comesoma</i> sp. 1	1.40	0.00	0.64
Ethmolaimidae			
<i>Comesa</i> sp. 1	10.42	5.10	2.48
Cyatholaimidae			
<i>Metacyatholaimus</i> sp. 1	13.88	5.41	2.10
<i>Paracanthonchus platypus</i>	1.85	1.57	0.52
<i>Marylynnia johanseni</i>	42.50	3.98	0.95
<i>Marynnia punctata</i>	1.91	2.27	0.85
<i>Longicyatholaimus</i> sp. 1	1.78	2.20	1.73
<i>Minolaimus</i> sp. 1	0.61	0.37	0.00
Selachinematidae			
<i>Cheironchus</i> sp. 1	0.59	2.00	0.90
<i>Richtersia</i> sp. 1	0.61	1.80	1.27
<i>Richtersia</i> sp. 2	0.88	0.05	0.09
<i>Halichoanolaimus duodecimpapill</i>	0.23	1.98	1.45
<i>Halichoanolaimus</i> sp. 1	0.77	4.86	2.48
<i>Latronema</i> sp. 1	0.12	2.74	0.50
<i>Synonchiella</i> sp. 1	4.00	2.01	0.69
Desmodoridae			
<i>Acanthopharyngoides chitwoodi</i>	0.26	4.39	0.31
<i>Desmodora curvispiculum</i>	309.76	18.51	9.48
<i>Desmodora</i> sp. 1	1.29	0.21	0.23
<i>Desmodora</i> sp. 2	3.51	11.63	5.75
<i>Metachromadora</i> sp. 1	56.29	1.38	0.73
<i>Molgolaimus turgofrons</i>	22.16	3.80	313.95
<i>Onys</i> sp. 1	0.77	0.00	0.11
Microlaimidae			
<i>Draconema</i> sp. 1	0.00	5.45	0.41
Ceramonomatidae			
<i>Microlaimus</i> sp. 1	138.79	18.26	8.87
<i>Microlaimus</i> sp. 2	7.58	0.11	0.18
<i>Bolbolaimus</i> sp. 1	5.15	3.05	1.40
Aegialoalaimidae			
<i>Pterygonema</i> sp. 1	0.00	0.18	0.00
<i>Pselionema</i> sp. 1	22.86	33.47	20.38
<i>Pselionema</i> sp. 2	1.41	7.41	3.85

Table 5.21. (Cont.)

Taxa	MAI-686	MU-A85	HI-A389
Leptolaimidae			
<i>Cyartonema</i> sp. 1	7.31	1.86	1.48
Tubolaimoididae			
<i>Leptonema</i> sp. 1	26.49	11.73	21.09
<i>Leptonema</i> sp. 2	6.24	0.44	2.11
<i>Antomicron</i> sp. 1	3.42	0.92	0.27
<i>Antomicron</i> sp. 2	1.55	0.74	0.24
Desmoscolecidae			
<i>Tubolaimoides</i> sp. 1	0.70	0.14	0.03
Desmoscolecidae			
<i>Greeffia</i> sp. 1	0.00	0.25	0.16
<i>Pareudesmoscolex</i> sp. 1	29.83	7.15	3.79
<i>Desmoscolex nudus</i>	21.71	14.39	8.53
<i>Desmoscolex</i> sp. 1	2.94	1.03	1.39
<i>Tricoma filipjevi</i>	115.15	9.13	4.39
<i>Tricoma</i> sp. <i>inosoides</i>	81.90	7.06	1.80
<i>Tricoma</i> sp. 1	17.08	1.50	1.74
<i>Tricoma</i> sp. 2	3.05	0.49	0.00
<i>Tricoma</i> sp. 4	4.90	0.61	0.66
<i>Desmolorenzenin</i> sp. 1	10.90	1.15	0.72
Monhysterida			
Xyalidae			
<i>Daptonema buetschlioides</i>	11.10	0.20	1.81
<i>Daptonema trabeculostus</i>	35.73	0.76	0.02
<i>Daptonema</i> sp. 3	4.68	1.66	1.96
<i>Theristus copulatus</i>	36.59	5.55	2.86
<i>Theristus rezaki</i>	8.33	1.53	0.80
<i>Theristus</i> sp. 1	4.84	0.48	1.86
<i>Paramonhystera</i> sp. 1	55.19	5.37	3.80
<i>Paramonhystera</i> sp. 2	31.90	5.15	4.27
<i>Retrotheristus</i> sp. 1	2.30	1.14	1.39
<i>Elzalia</i> sp. 1	13.27	21.32	14.18
<i>Gnomoryala</i> sp. 1	2.36	3.45	6.58
<i>Steinera</i> sp. 1	3.53	1.49	5.12
<i>Amphimonthystrella</i> sp. 1	1.07	2.54	3.40
<i>Gonionchus intermedius</i>	0.36	0.39	0.32
Sphaerolaimidae			
<i>Sphaerolaimidae</i> sp. 1	3.36	5.09	2.02
<i>Sphaerolaimidae</i> sp. 2	8.30	5.52	3.70
Siphonolaimidae			
<i>Siphonolaimidae</i> sp. 1	17.89	1.37	2.82
<i>Siphonolaimidae</i> sp. 2	3.40	2.05	0.47
Linhomoeidae			
<i>Linhomoeus gittingsi</i>	15.47	1.19	31.18
<i>Linhomoeus iniquus</i>	5.29	3.35	6.81
<i>Linhomoeus</i> sp. 1	104.38	1.22	8.55
<i>Metalihomoeus</i> sp. 1	17.05	1.26	3.54
<i>Desmolaimoides thiobioticus</i>	1.09	0.09	0.06
<i>Eleutherolaimus</i> sp. 1	36.63	2.36	0.82
<i>Terschellingia longispiculata</i>	18.20	2.26	6.87

Table 5.21. (Cont.)

Taxa	MAI-686	MU-A85	HI-A389
<i>Terschellingia longicaudata</i>	19.24	2.72	11.01
<i>Didelta</i> sp. 1	0.00	0.00	0.43
Axonolaimida			
<i>Axonolaimus</i> sp. 1	1.58	8.47	0.38
<i>Odontophora</i> sp. 1	2.08	2.88	0.08
<i>Paraodontolaimus</i> sp. 1	14.11	0.19	0.00
<i>Ascolaimus</i> sp. 1	0.93	1.55	1.38
Diplopeltidae			
<i>Campylaimus</i> sp. 1	25.71	14.04	4.24
<i>Campylaimus</i> sp. 2	0.67	0.14	0.23
<i>Araeolaimus</i> sp. 1	11.01	3.54	1.83
<i>Diplopeltula</i> sp. 1	0.43	0.08	0.14
<i>Diplopeltula</i> sp. 3	0.58	0.44	0.17
<i>Diplopeltula</i> sp. 4	13.78	6.80	4.72

shared by about 12 species. The most dominant species (in order of Ectinosomid sp. 6, Ectinosomid sp. 129-MB, Ameridae sp. 79, and Zosime sp. 54-C. At MU-A85, the dominant species (in order of abundance) were abundance) *Halalaimus thalassinus*, *Pselionema* sp. 1, *Sabatieria punctata*, *Elzalia* sp. 1, and *Cervonema* sp. 3. There was no overlap of dominant species at the three platforms.

5.4.4 Nematode Trophic Dynamics

In general, harpacticoids are mostly grazers, eating diatoms and bacteria, but some are also omnivorous. So, harpacticoids probably represent only one trophic group. In contrast, nematodes have more varied eating habits and include some deposit feeders. Because biomass was measured for nematodes, trophic group dominance may be based on abundance or biomass. Deposit-feeding nematodes dominated the density and biomass of the community (Table 5.22). Non-selective deposit feeders accounted for 31 % of the density, but 50 % of the biomass, indicating this trophic group was important in Gulf of Mexico shelf sediments.

Predators accounted for only 6 % of the density and 13 % of the biomass (Table 5.22). The distributions of trophic groups are shown in Figures 5.92 to 5.97. The general pattern was that epigrowth feeder density was highest near the platform and deposit feeder biomass was highest near

Table 5.22. The overall average abundance of nematode feeding groups at the three platforms.

Variables	Abundance ^a			
	HI-A389	MAI-686	MU-A 85	Mean
Density (individual X 10 cm ⁻²)				
Selective deposit feeder	121	421	146	196
Non-selective deposit feeder	136	445	138	204
Epigrowth feeder	121	758	108	216
Predator	27	69	32	39
Biomass (mg wet weight 10 X cm ⁻²)				
Selective deposit feeder	0.047	0.129	0.045	0.065
Non-selective deposit feeder	0.156	0.532	0.171	0.243
Epigrowth feeder	0.055	0.420	0.063	0.114
Predator	0.033	0.151	0.046	0.062
Density Composition (%)				
Selective deposit feeder	30	25	34	30
Non-selective deposit feeder	34	26	33	31
Epigrowth feeder	30	45	25	33
Predator	6	4	8	6
Biomass Composition (%)				
Selective deposit feeder	16	10	14	13
Non-selective deposit feeder	54	43	53	50
Epigrowth feeder	19	34	19	24
Predator	11	13	14	13

^aDensity (individual X 10 cm⁻²) and biomass (mg wet weight X 10 cm⁻²) are detransformed from log₁₀, total number of samples = 600.

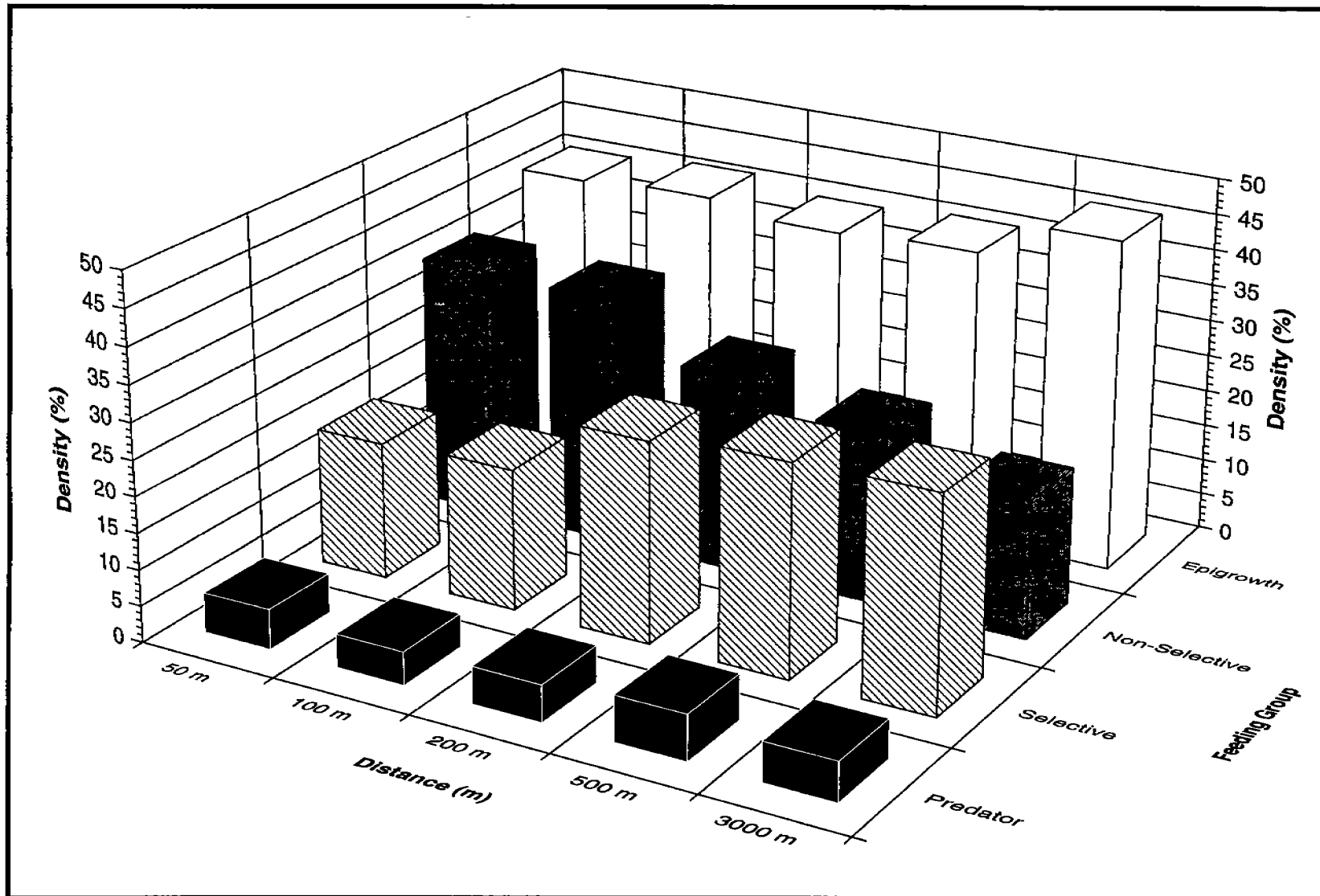

Figure 5.92. Composition of feeding groups based on the mean numbers of individuals for the nematode community at MAI-686 by distance from the platform.

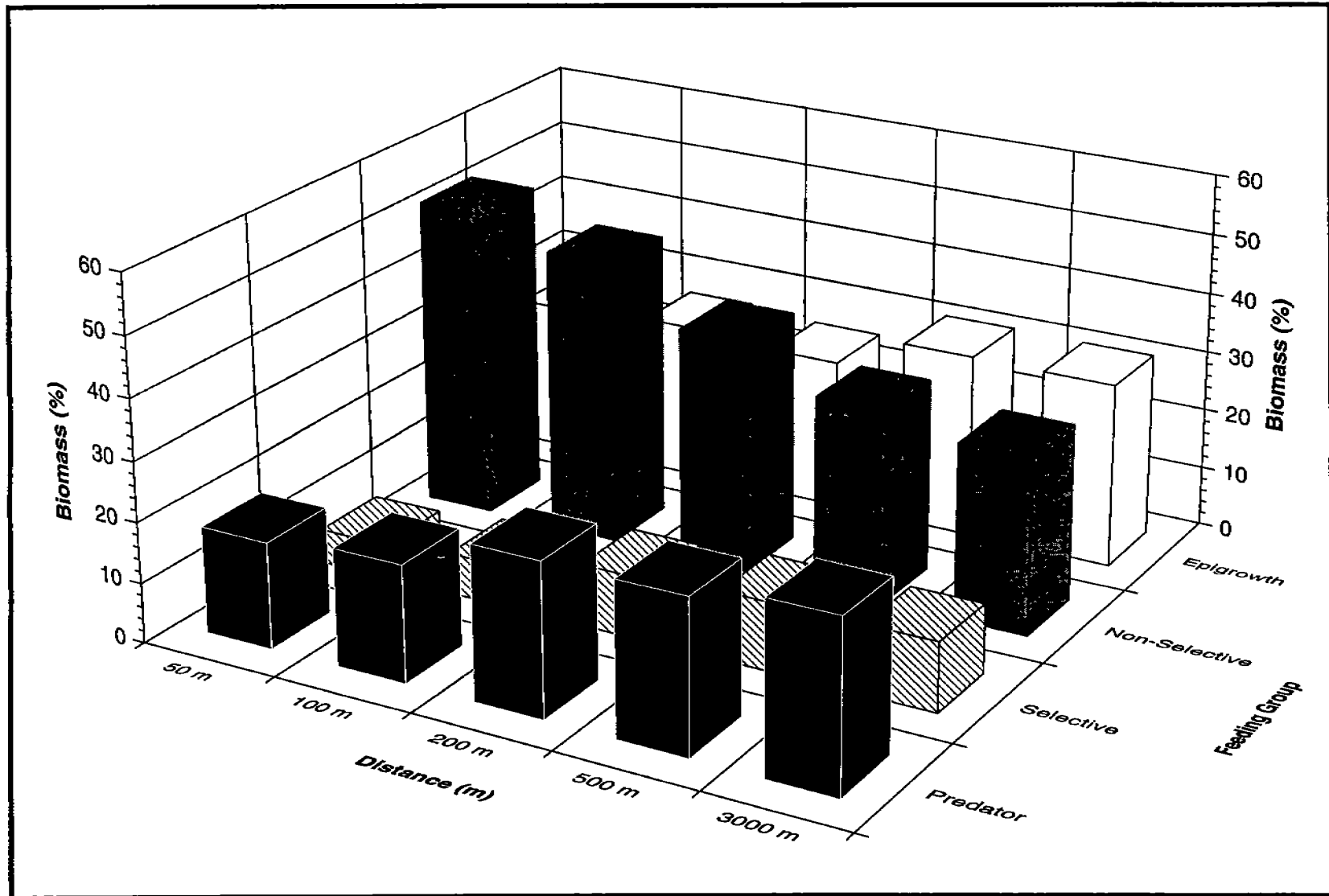

Figure 5.93. Composition of feeding groups based on the mean biomass for the nematode community at MAI-686 by distance from the platform.

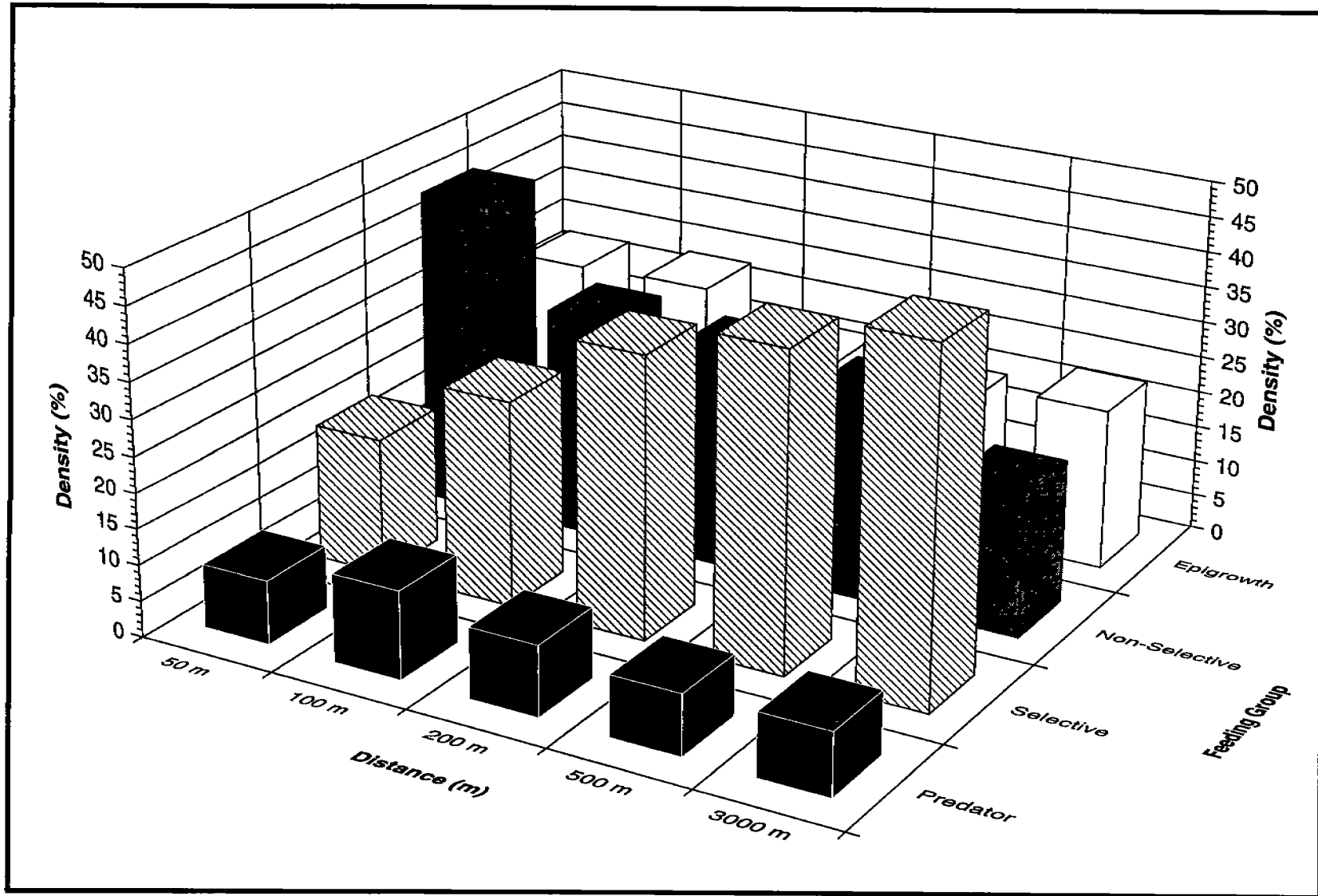

Figure 5.94. Composition of feeding groups based on the mean numbers of individuals for the nematode community at MU-A85 by distance from the platform.

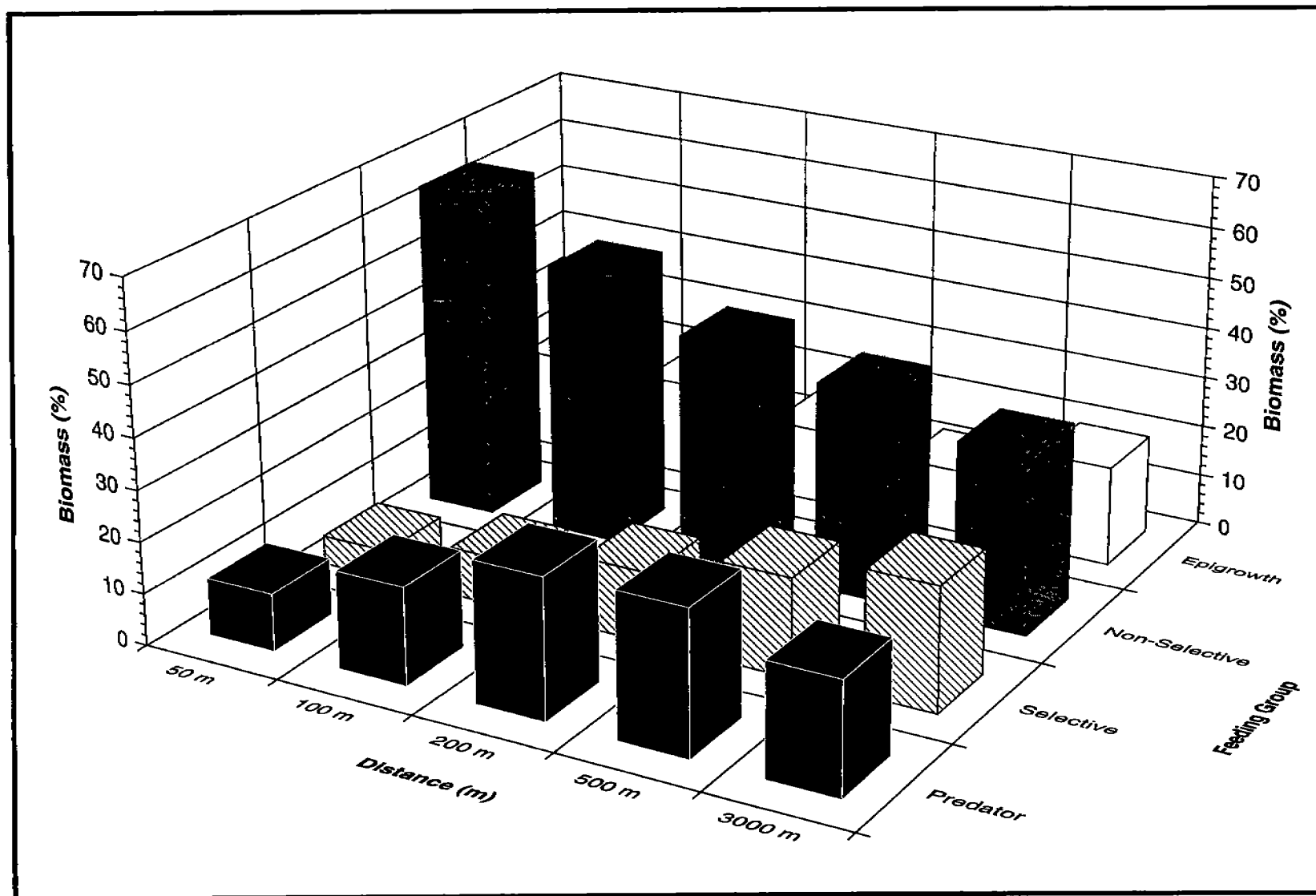

Figure 5.95. Composition of feeding groups based on the mean biomass for the nematode community at MU-A85 by distance from the platform.

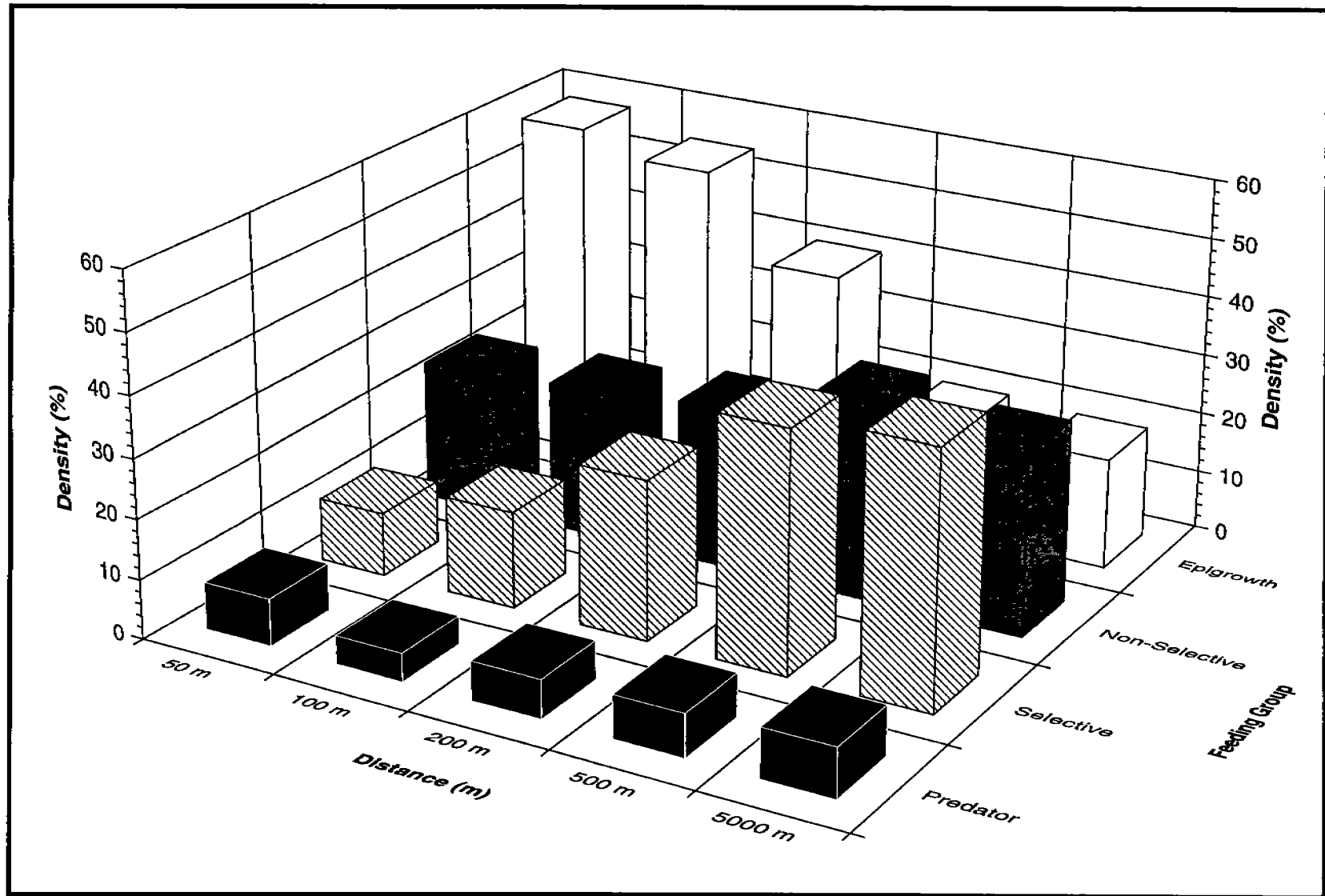

Figure 5.96. Composition of feeding groups based on the mean numbers of individuals for the nematode community at HI-A389 by distance from the platform.

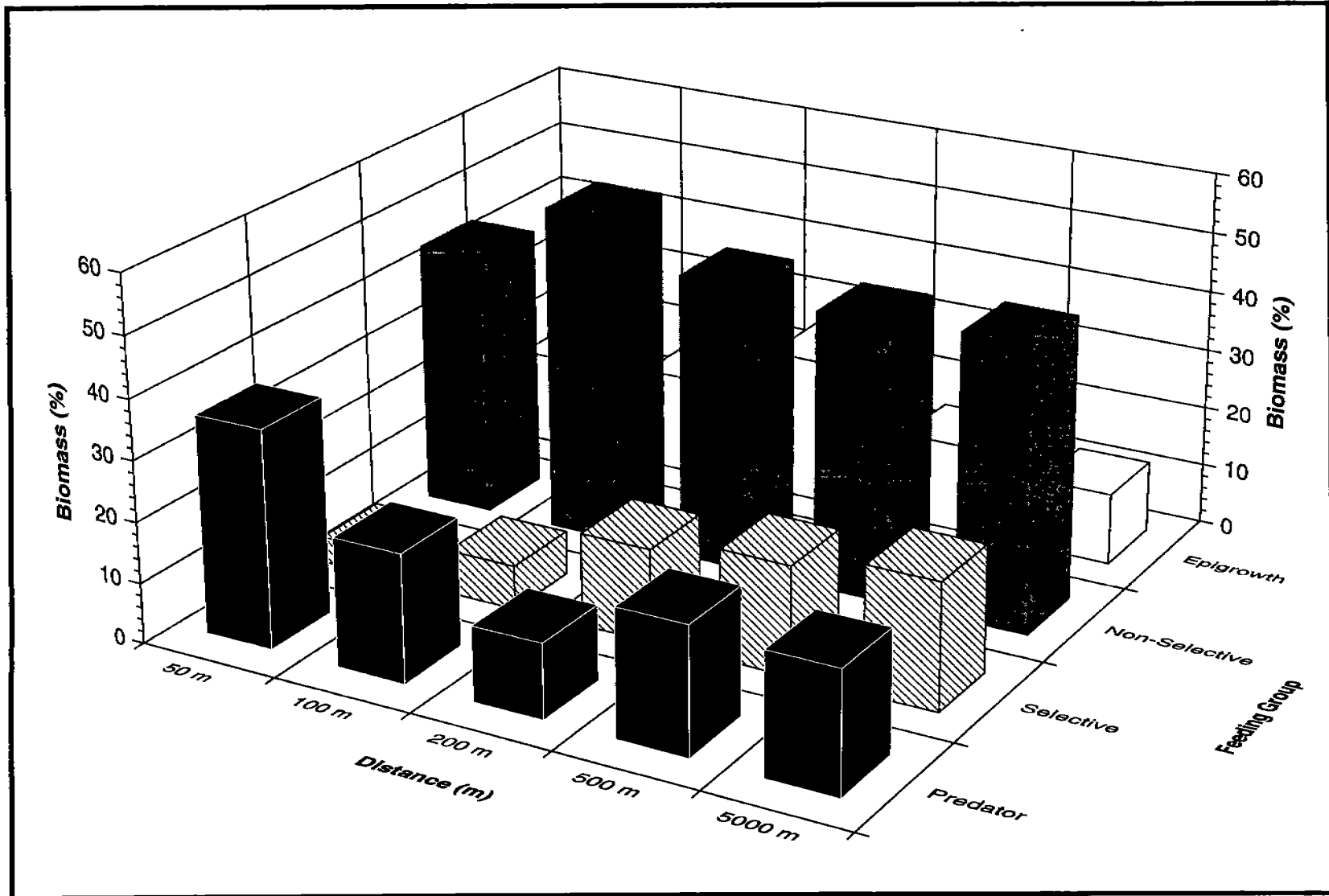

Figure 5.97. Composition of feeding groups based on the mean biomass for the nematode community at HI-A389 by distance from the platform.

the platform. Selective deposit feeders increased in dominance away from the platform in density and biomass while non-selective deposit feeders were increasingly dominant near the platform. Epigrowth feeders and predators were also increasingly dominant away from the platform. In general, the proportion of deposit feeders increased nearer the platform.

At MU-A85, selective deposit feeders were increasingly dominant away from the platform in density (Figure 5.94) and biomass (Figure 5.95), while non-selective deposit feeders were increasingly dominant near the platform. Epigrowth feeders were increasingly dominant nearer the platform. Predator density and biomass were increased near the platform. In general, the proportion of deposit feeders increased near the platform. At HI-A389, deposit-feeders' density was least dominant southwest of the platform and epigrowth feeders' density was most dominant in this area. Non-selective deposit feeders were more dominant in terms of biomass. Predator biomass was prominent south of the platform (Figures 5.96 and 5.97).

5.4.4.1 Modeling of Nematode Trophic Dynamics

These results are based on a simulation of the 16 months during which sampling was performed. A simulation run for 120 months, based on data for the first 16 months, yields stable, average predicted production and production efficiency values (Table 5.23). The long-term simulation suggests that production of deposit-feeding nematodes was lower at near stations than at far stations for HI-A389 and MAI-686. No differences with distance from the platform site were found for MU-A85.

Modeling deposit-feeding nematode trophic dynamics suggests that MAI-686 had a higher monthly production than HI-A389 or MU-A85 (Figures 5.98 to 5.103). MAI-686 had higher production because of a higher production efficiency (Figures 5.98 and 5.101). Among distances, significant differences existed for production only at MAI-686. At MAI-686, production was higher at 500 to 3000 m than it was at 50 to 200 m from the platform (Figure 5.98). This result was due to the higher production efficiency at the far stations (Figure 5.98).

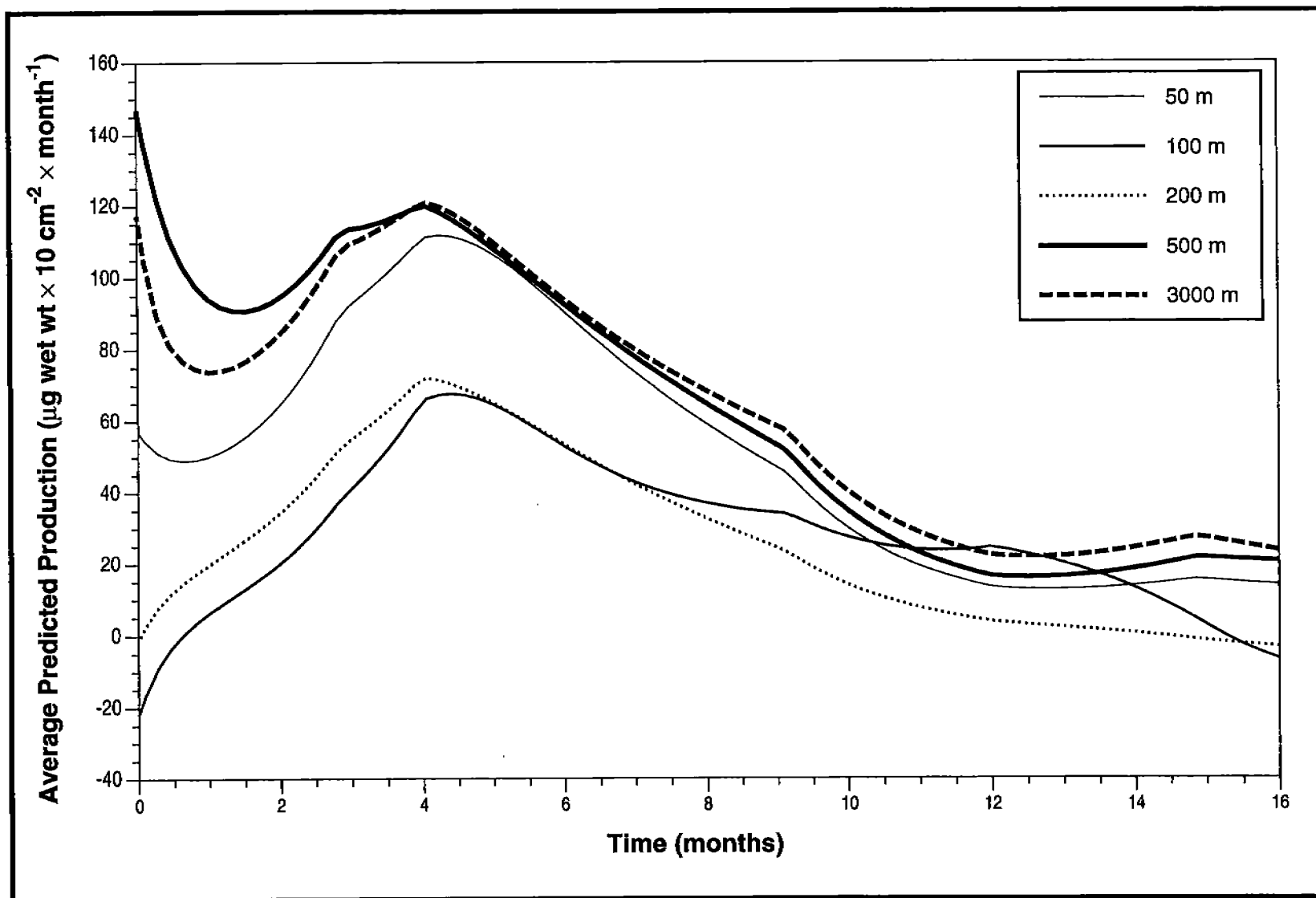

Figure 5.98. Average predicted production for the meiofaunal community at MAI-686 over the timeframe of the study sampling efforts (0=February 1993).

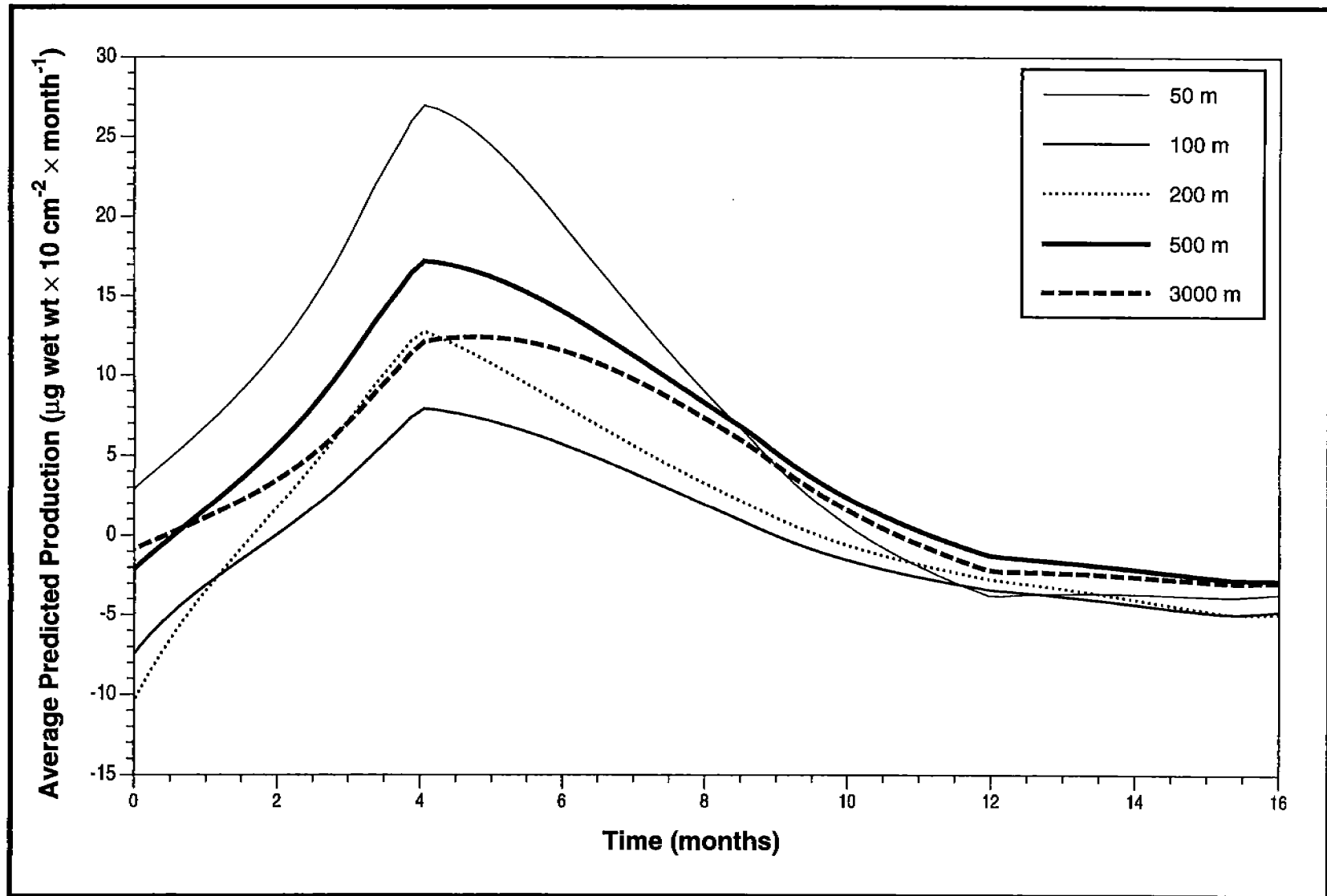

Figure 5.99. Average predicted production for the meiofaunal community at MU-A85 over the timeframe of the study sampling efforts (0=February 1993).

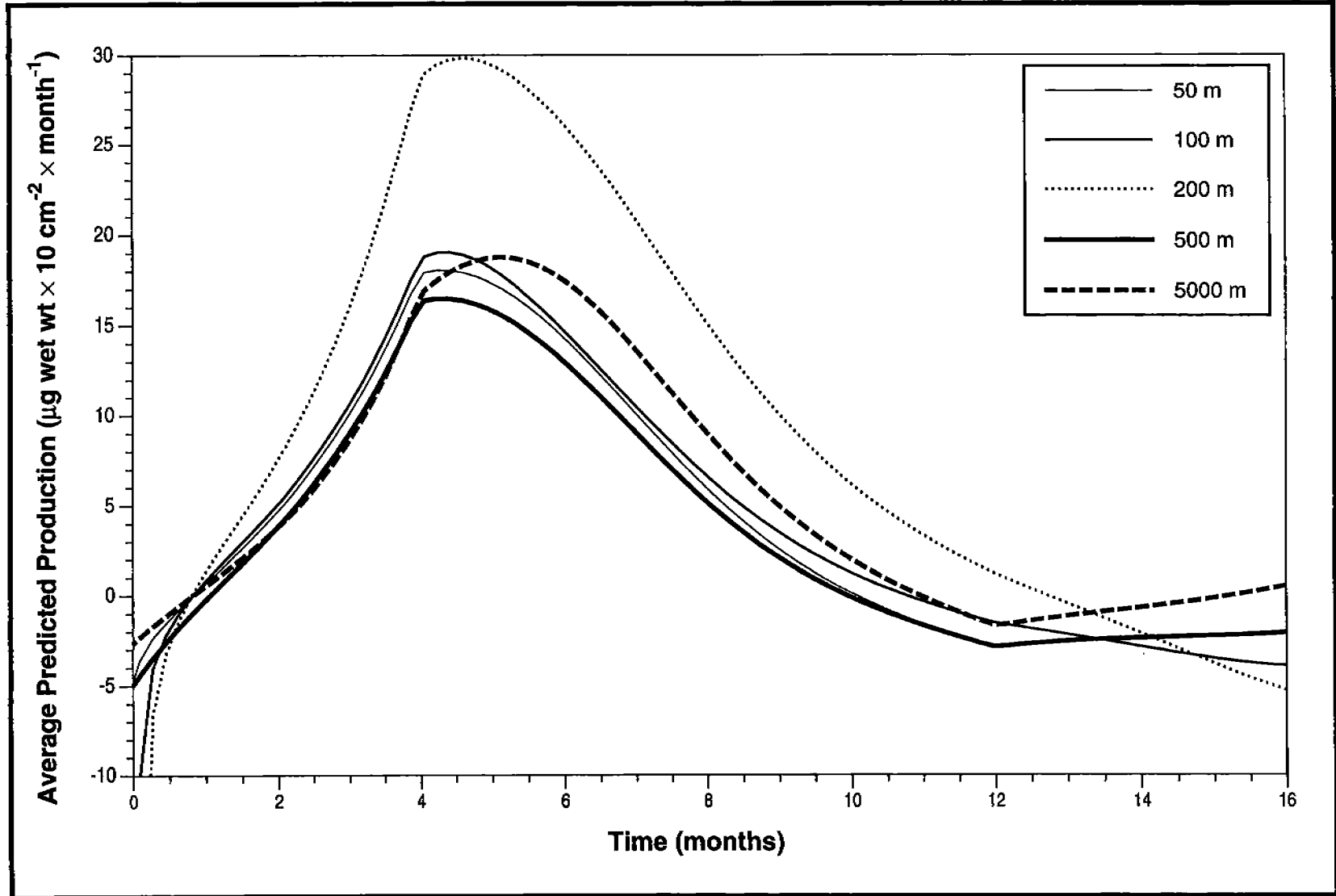

Figure 5.100. Average predicted production for the meiofaunal community at HI-A389 over the timeframe of the study sampling efforts (0=February 1993).

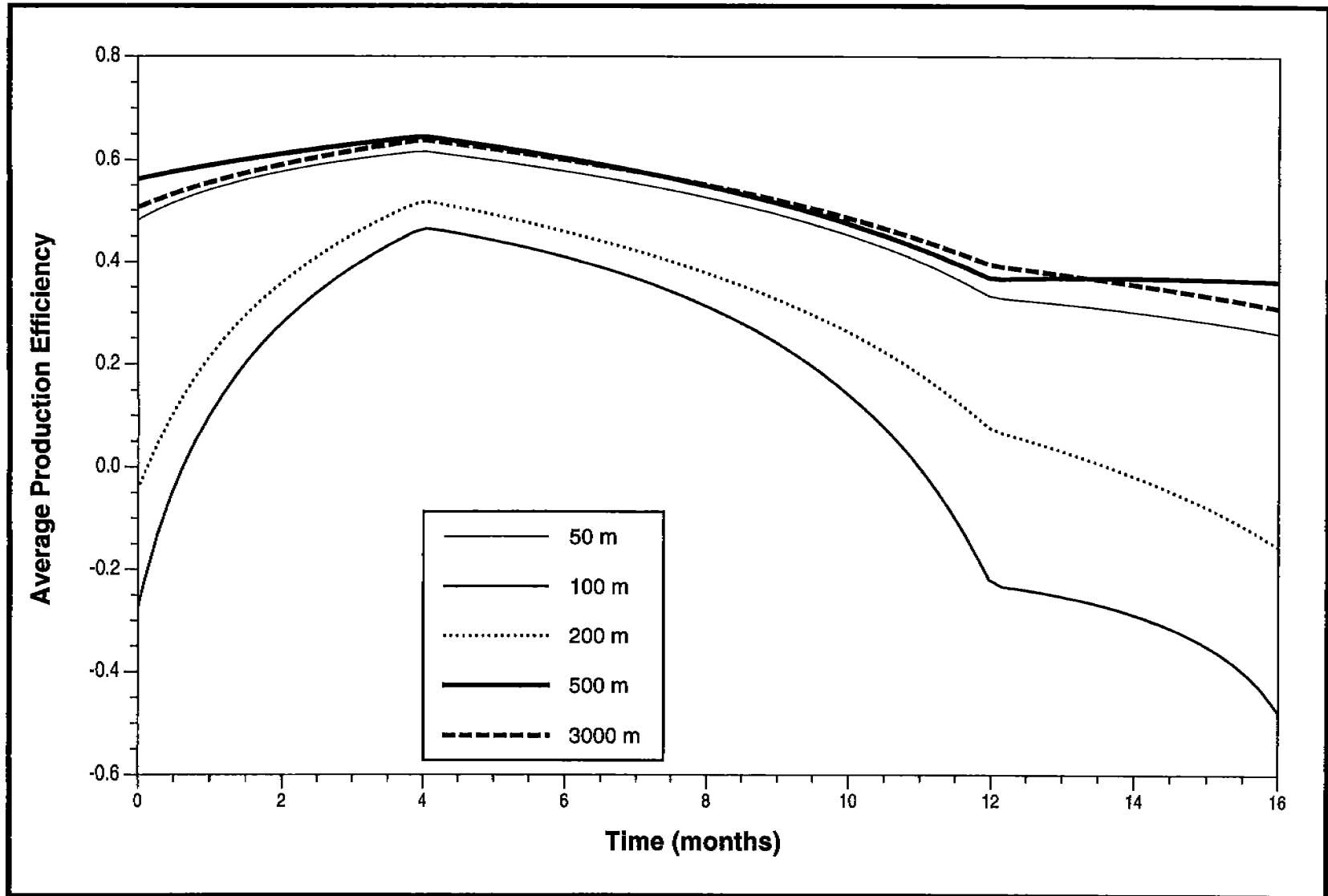

Figure 5.101. Average production efficiency for the meiobenthic community at MAI-686 over the timeframe of the study sampling efforts (0=February 1993).

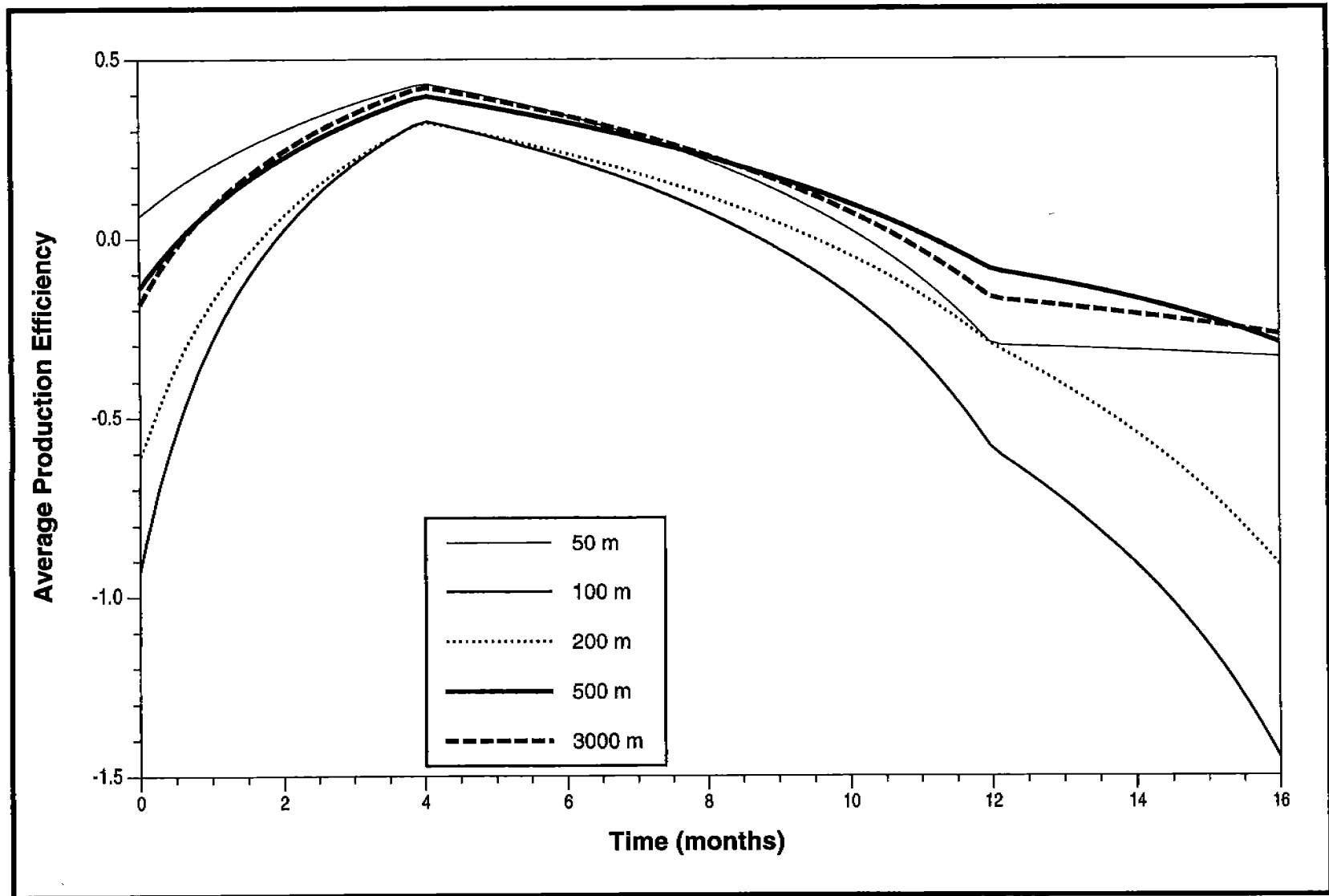

Figure 5.102. Average production efficiency for the melofaunal community at MU-A85 over the timeframe of the study sampling efforts (0=February 1993).

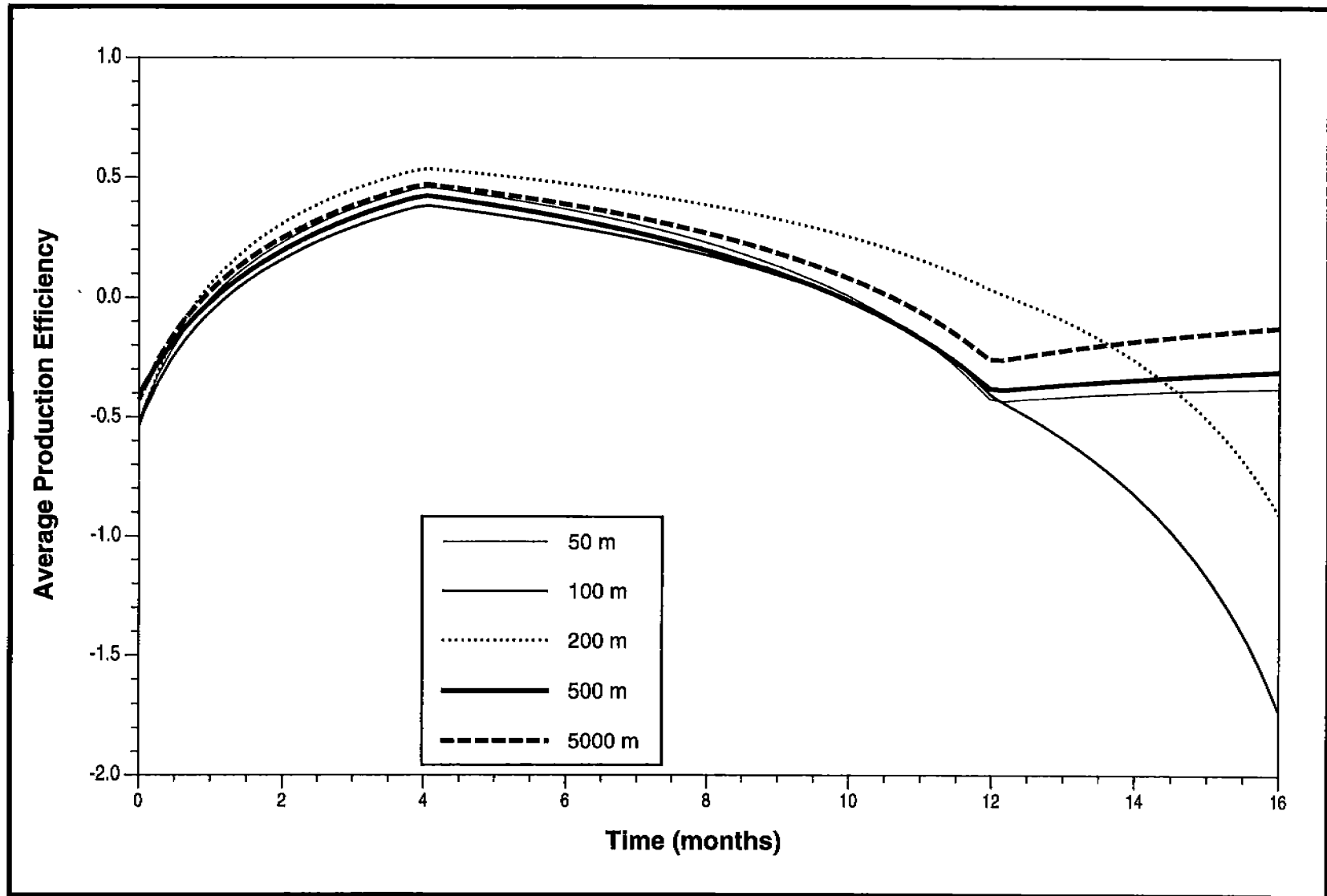

Figure 5.103. Average production efficiency for the meiobenthic community at HI-A389 over the timeframe of the study sampling efforts (0=February 1993).

Table 5.23. The predicted average production ($\mu\text{g WW X } 10 \text{ cm}^{-2} \text{ X month}^{-1}$) and production efficiency based on the long-term model simulation of deposit feeding nematode.

Distances	50 m	100 m	200 m	1000 m	3000 m
HI-A389					
Production	1.05	1.27	3.43	0.83	3.19
Efficiency	-0.12	-0.41	-0.13	-0.10	1.8E-4
MAI-686					
Production	42.1	14.1	13.0	50.9	52.0
Efficiency	0.45	-4.9E-2	0.14	0.50	0.48
MU-A85					
Production	3.1	-0.2	-7.2E-2	2.0	1.9
Efficiency	0.01	-0.55	-0.32	5.1E-3	-5.3E-3

5.4.5 Predation on Meiofauna

The feeding habits of the eight species of small fish were examined in this study (Tables 5.24 and 5.25). Three of the eight species of fish were primarily benthic feeders: *Syacium gunteri*, *Halieutichthys aculeatus*, and *Ogcocephalus radiatus*. The remaining species fed primarily on pelagic fauna.

Only one fish, *Syacium gunteri*, had a feeding preference for meiofauna, and it fed mostly on nematodes. This species also fed on macroinfauna, such as, amphipods, and polychaetes. Epifauna eaten by *Syacium gunteri* included shrimp, mysid, and crabs. A total of 122 specimens were dissected with an average size of 7.8 cm. *Syacium gunteri* also had the highest numbers of meiofauna in their guts of all the fish studied.

Halieutichthys aculeatus fed mostly on macroinfauna, e.g., gastropods and polychaetes, but also ate large numbers of nematodes and ostracods. Crabs, mysids and shrimp were the epifauna eaten by this species. The average size of the 129 specimens of *H. aculeatus* was 5.5 cm. Only three *Ogcocephalus radiatus* were dissected, and had only macroinfauna in their guts.

Table 5.24. The number and mean lengths of fish used in stomach contents analyses and mean number of organisms in stomachs for fish caught during the third and fourth cruises for all sites.

	Predator		Prey	
	Number	Total Length (cm)	MEIO	MACR
<i>Cynoscion arenarius</i>	84	8.3 (2.1)	0.40 (0.95)	0.20 (0.53)
<i>Halieutichthys aculeatus</i>	129	5.5 (0.6)	0.78 (1.16)	1.54 (1.79)
<i>Hoplunnis sp.</i>	11	34.2 (6.2)	0 (0)	0.36 (0.67)
<i>Ogcocephalus radiatus</i>	3	7.1 (0.2)	0 (0)	1.67 (2.08)
<i>Prionotus stearnsi</i>	88	8.1 (0.9)	0.18 (0.56)	0.11 (0.58)
<i>Saunida brasiliensis</i>	101	6.6 (1.9)	0.04 (0.20)	0.07 (0.29)
<i>Syacium gunteri</i>	122	7.8 (2.0)	1.88 (2.85)	1.10 (1.50)
<i>Synodus foetens</i>	32	8.6 (2.0)	0.03 (0.18)	0.06 (0.25)

	Predator		Prey	
	Number	Total Length (cm)	EPIF	PELA
<i>Cynoscion arenarius</i>	84	8.3 (2.1)	6.76 (10.83)	15.25 (22.73)
<i>Halieutichthys aculeatus</i>	129	5.5 (0.6)	0.72 (1.43)	0.02 (0.12)
<i>Hoplunnis sp.</i>	11	34.2 (6.2)	0.73 (1.49)	0.36 (0.67)
<i>Ogcocephalus radiatus</i>	3	7.1 (0.2)	0 (0)	0 (0)
<i>Prionotus stearnsi</i>	88	8.1 (0.9)	0.20 (0.55)	0.69 (0.72)
<i>Saunida brasiliensis</i>	101	6.6 (1.9)	0.07 (0.26)	0.61 (0.66)
<i>Syacium gunteri</i>	122	7.8 (2.0)	1.08 (1.28)	0.05 (0.22)
<i>Synodus foetens</i>	32	8.6 (2.0)	0.19 (0.47)	0.41 (0.50)

^aThe mean is presented with the standard deviation in parentheses, MEIO=Meiofauna, MACR=Macrofauna, EPIF=Epifauna, PELA=Pelagic.

Table 5.25. The number and mean length of fish used in stomach content analyses and the mean number of organisms in the stomachs.

<i>A. Halieutichthys aculeatus</i>						
	MAI-686		MU-A85		HI-A389	
	Near	Far	Near	Far	Near	Far
Sample Size (n)	10	25	51	43	-	-
Total Length (cm)	4.6 (0.7)	5.0 (0.4)	5.5 (0.4)	5.9 (0.4)	-	-
Meiofauna	1.30 (1.25)	1.08 (1.26)	0.45 (1.12)	0.86 (1.06)	-	-
Macroinfauna	0.70 (0.82)	0.16 (0.37)	1.94 (1.79)	2.07 (1.97)	-	-
Epifauna	0.20 (0.42)	0.12 (0.33)	1.38 (2.00)	0.47 (0.76)	-	-
Pelagic	0 (0)	0 (0)	0 (0)	0.05 (0.21)	-	-

<i>B. Saunida brasiliensis</i>						
	MAI-686		MU-A85		HI-A389	
	Near	Far	Near	Far	Near	Far
Sample Size (n)	-	64	20	17	-	-
Total Length (cm)	-	7.3 (2.0)	5.7 (0.6)	5.2 (0.7)	-	-
Meiofauna	-	0.03 (0.18)	0.05 (0.22)	0.06 (0.24)	-	-
Macroinfauna	-	0.08 (0.32)	0.10 (0.31)	0 (0)	-	-
Epifauna	-	0.09 (0.29)	0.05 (0.22)	0 (0)	-	-
Pelagic	-	0.69 (0.73)	0.55 (0.51)	0.41 (0.51)	-	-

<i>C. Syacium gunteri</i>						
	MAI-686		MU-A85		HI-A389	
	Near	Far	Near	Far	Near	Far
Sample Size (n)	53	59	-	-	-	-
Total Length (cm)	7.4 (1.9)	8.3 (1.9)	-	-	-	-
Meiofauna	1.22 (1.49)	2.58 (3.70)	-	-	-	-
Macroinfauna	1.62 (1.80)	0.54 (0.77)	-	-	-	-
Epifauna	1.17 (1.26)	0.48 (1.29)	-	-	-	-
Pelagic	0.05 (0.21)	0.05 (0.22)	-	-	-	-

<i>D. Prionotus stearnsi</i>						
	MAI-686		MU-A85		HI-A389	
	Near	Far	Near	Far	Near	Far
Sample Size (n)	-	-	-	25	45	18
Total Length (cm)	-	-	-	7.5 (0.6)	8.4 (0.9)	8.3 (0.9)
Meiofauna	-	-	-	0.20 (0.65)	0.16 (0.42)	0.22 (0.73)
Macroinfauna	-	-	-	0 (0)	0.20 (0.79)	0.06 (0.24)
Epifauna	-	-	-	0.24 (0.66)	0.22 (0.55)	0.11 (0.32)
Pelagic	-	-	-	0.60 (0.82)	0.71 (0.73)	0.78 (0.55)

Five of the eight species were pelagic feeders and were not feeding primarily on benthos. Four species occasionally ate meiofauna. The meiofauna that *Prionotus stearnsi* fed upon most often were nematodes and ostracods. This species fed primarily on pelagic organisms, mainly small fish. There were 88 specimens collected and they had an average length of 8.1 cm. *Cynoscion arenarius* is a pelagic feeder eating mostly calanoids. The average size of the 84 species dissected was 8.3 cm. *Hoplumnis* sp. surveyed ate mostly pelagic fish and macroinfaunal polychaetes. The average length was 34.2 cm and 11 fish were dissected. *Saunida brasiliensis* fed mostly on fish, calanoids, amphipods, and shrimp. The sample size was 101 individuals and the average length was 6.6 cm.

5.4.6 Life History and Reproduction

5.4.6.1 Reproduction

Measures of reproductive effort (clutch volumes and clutch sizes) were determined at Near and Far stations for all gravid females encountered. Near stations represent those samples which came from the 50 m radii, and Far stations represent the combination of all remaining radii. This pooling of radii was performed to alleviate a shortage of specimens at some individual radii, and to increase overall sample size to increase the power of statistical tests.

No one species dominated the frequency distribution of all gravid females (Table 5.26). A species of *Tachidiella* was the most abundant of all with a frequency of 12, or less than 10 % of all gravid females encountered. This frequency distribution of animals demonstrates the diversity of species measured for analysis of reproductive effort and negates the possibility that a single or even groups of species can be utilized for this analysis. For this reason, all species were pooled and average clutch size and clutch volume were adjusted for body length for statistical analysis

5.4.6.2 Life History Characteristics

Analysis of life history characteristics were performed on all harpacticoids encountered in the study. Harpacticoids were identified and assigned accordingly into females, gravid females, males, and copepodites. The copepodite category included all nauplii and copepodite stages (Tables 5.27 and 5.28).

Table 5.26. Average harpacticoid reproductive effort based on frequency, least square (LS) clutch size and least square (LS) clutch volume for all species of gravid females encountered on all cruises. Groupings are done by Near and Far stations (n=170).

Platform Station	Species Names	Frequency	LS Mean Clutch Size	LS Mean Clutch Volume (mm ³)
<u>HI-A389</u> Far	<i>Diosaccid</i> sp. 67	2	6	1.77e-03
	<i>Ectinosomid</i> BP	1	2	1.23e-04
	<i>Ectinosomid</i> sp. 8	1	2	1.80e-05
	<i>Enhydrosoma pericoense</i>	1	15	3.05e-04
	<i>Stenhelia</i> (Delavalia) sp. 31	1	15	3.05e-04
	<i>Zosime n</i> sp. 54-C	1	6	1.74e-04
	Unknown	2	8	1.38e-04
Near	<i>Diosaccid</i> sp. 111-BC	2	1	3.10e-05
	<i>Ectinosomid</i> sp. 110-AZ	2	5	6.40e-05
	<i>Ectinosomid</i> sp. 87	2	8	5.93e-04
	Genus A. -41	1	8	5.80e-04
	<i>Tachidiella</i> sp. 86-BL	4	12	3.79e-04
<u>MAI-686</u> Far	<i>Ameiridae</i> sp. 79	1	4	1.79e-04
	<i>Amphiascoides</i> sp. A	1	1	1.44e-04
	<i>Amphiascus</i> sp. (minutas)	1	2	8.82e-04
	<i>Bopyridae</i> (unidentified)	1	1	4.94e-02
	<i>Cletodes aff. tuberculatas</i>	2	4	2.37e-04
	<i>Cletodes pseudodissimilis</i>	1	5	2.35e-04
	<i>Diosaccid</i> sp. 45	2	2	1.73e-04
	<i>Diosaccid</i> sp. 46	1	7	3.52e-04
	<i>Ectinosomid</i> BP	1	3	1.30e-04
	<i>Ectinosomid</i> sp. 129-MB	9	4	1.56e-04
	<i>Ectinosomid</i> sp. 130	7	4	1.96e-04
	<i>Ectinosomid</i> sp. 133-MH	1	7	8.30e-04
	<i>Ectinosomid</i> sp. 134-ME	2	2	1.58e-04
	<i>Ectinosomid</i> sp. 139-MO	1	3	9.90e-05
	<i>Ectinosomid</i> sp. 34	5	6	1.60e-03
	<i>Ectinosomid</i> sp. 52	1	3	3.62e-04
	<i>Ectinosomid</i> sp. 8	1	3	6.70e-05
	<i>Enhydrosoma pericoense</i>	3	5	1.06e-04
	<i>Haloschizopera</i> sp.	2	2	1.25e-04
	<i>Harpacticoid</i> sp. 56	1	2	2.01e-04
	<i>Normanella</i> sp. A	2	5	2.12e-04
	<i>Normanella</i> sp. B	2	4	1.47e-04
	<i>Normanella</i> sp. C	1	3	1.17e-04
	<i>Pseudameira</i> sp.	3	7	2.65e-04
	<i>Pyramidella</i> sp.	1	15	3.23e-04
	<i>Robertgurneya</i> sp. A	6	3	1.89e-04
	<i>Robertgurneya</i> sp. C	1	5	1.43e-04
	<i>Stenhelia</i> (Delavalia) sp. 2	4	7	2.70e-04
	<i>Stenhelia</i> (Stenhelia) sp. 37	1	4	6.90e-04
	<i>Tachidiella</i> sp. 86-BL	12	9	1.85e-04
	<i>Typhlamphiascus</i> sp.	3	3	2.81e-04
	Unknown	5	4	1.32e-04

Table 5.26. (Cont.)

Platform Station	Species Names	Frequency	LS Mean Clutch Size	LS Mean Clutch Volume (mm ³)
Near	<i>Ameiridae</i> sp. 79	2	6	2.38e-04
	<i>Ectinosomid</i> (unidentified)	1	4	2.74e-04
	<i>Ectinosomid</i> sp. 124-BW	1	4	1.61e-04
	<i>Ectinosomid</i> sp. 129-MB	1	4	1.79e-04
	<i>Ectinosomid</i> sp. 130	2	3	1.39e-04
	<i>Ectinosomid</i> sp. 133-MH	1	8	3.45e-04
	<i>Ectinosomid</i> sp. 134-ME	3	3	1.31e-04
	<i>Ectinosomid</i> sp. 135-MT	2	5	2.91e-04
	<i>Ectinosomid</i> sp. 34	1	7	8.95e-04
	<i>Ectinosomid</i> sp. 52	1	7	2.94e-04
	<i>Microarthridion</i> sp.	1	4	1.11e-04
	<i>Normanella</i> sp. B	2	5	2.32e-04
	<i>Robertgurneya</i> sp. A	5	4	1.83e-04
	<i>Stenhelia</i> (Delavalia) sp. 2	1	10	3.01e-04
	<i>Tachidiella</i> sp. 86-BL	2	7	1.70e-04
Unknown	2	5	1.38e-04	
<u>MU-A85</u>	<i>Ameiridae</i> sp. 79	1	2	3.36e-04
Far	<i>Diarthrodes</i> sp.	1	7	7.35e-04
	<i>Ectinosomid</i> sp. 129-MB	4	5	1.70e-04
	<i>Robertgurneya</i> sp. C	1	19	9.39e-04
	Unknown	3	8	4.09e-04
Near	<i>Ectinosomid</i> sp. 129-MB	4	5	1.01e-04
	<i>Ectinosomid</i> sp. 133-MH	2	11	4.03e-04
	<i>Ectinosomid</i> sp. 134-ME	1	7	2.05e-04
	<i>Ectinosomid</i> sp. 139-MO	2	7	3.97e-04
	<i>Ectinosomid</i> sp. 143-MQ	1	20	9.67e-04
	<i>Ectinosomid</i> sp. 34	1	11	8.84e-04
	<i>Stenhelia</i> (Delavalia) sp. 2	1	4	8.95e-05
	<i>Tachidiella</i> sp. 86-BL	4	10	3.18e-04
Unknown	5	7	8.48e-04	

Table 5.27. Life history stage densities for all harpacticoids.

Stage	Station Mean Density		
	P	Near	Far
Female	0.0001	8.47	13.27
Gravid Females	0.0001	0.85	0.41
Males	0.0001	5.83	8.66
Copepodites	0.0001	10.57	15.15

Table 5.28. Population composition for all harpacticoids.

Stage	Mean % Composition	
	Near	Far
Female	0.35	0.35
Gravid Females	0.03	0.01
Males	0.23	0.21
Copepodites	0.39	0.43

5.4.7 Genetic Variability

Each of the five species of harpacticoid copepod used in the genetic variability study displayed the same haplotype pattern (Tables 5.29 to 5.33). Populations were composed of a single, ubiquitous haplotype, and numerous unique haplotypes. Haplotype is defined as a region of DNA with a particular sequence and roughly corresponds to the "allele" of classic genetics (Nei 1987). The dominant haplotype occurred in more than half of the individuals in the study, and occurred at all platforms and cruises. A heavily skewed genotype frequency is consistent with observations from other populations of marine crustacea, such as calanoid copepods (A. Bucklin, pers. comm.), harpacticoid copepods (Burton and Feldman 1981), and decapods (Silberman et al. 1994).

5.5 Macroinfauna

Many subsamples for the macroinfaunal work element yielded small numbers of individuals and species, especially during Cruises 1 and 4. At 33 of 300 stations (11 %) the faunal composition of each of the three subcores

Table 5.29. Meiofauna genetic variability for *Normanella* sp. at three platforms and two cruises. The number of individuals with the dominant haplotype, the number of individuals with a unique haplotype, and haplotype diversity (*h*) are presented.

Platform	Cruise	Variable	Obs	Station ^a									
				Near					Far				
				1	2	3	4	5	1	2	3	4	5
MU-A85	2	#dominant	4	.	7	10	8		1	6	10	.	6
		#unique	1	.	2	0	2		1	2	6	.	3
		<i>h</i>	0.32	.	0.37	0.00	0.34		0.50	0.41	0.59	.	0.52
	3	#dominant	.	11	1	4	3		5	.	2	1	7
		#unique	.	3	0	1	1		1	.	1	1	1
		<i>h</i>	.	0.37	0.00	0.32	0.38		0.28	.	0.44	0.50	0.22
MAI-686	2	#dominant	10	10	6	4	3		12	9	6	.	7
		#unique	5	1	1	0	1		3	4	3	.	2
		<i>h</i>	0.53	0.17	0.24	0.00	0.38		0.35	0.50	0.52	.	0.37
	3	#dominant	1	5	5	7	3		1	6	8	5	1
		#unique	0	1	1	1	0		0	1	3	3	1
		<i>h</i>	0	0.28	0.28	0.22	0.00		0.00	0.25	0.45	0.56	0.50
HI-A389	2	#dominant	.	8	14	2	.		8	.	9	10	10
		#unique	.	1	3	0	.		2	.	2	4	3
		<i>h</i>	.	0.20	0.31	0.00	.		0.34	.	0.31	0.47	0.39
	3	#dominant	6	4	2	10	.		10	10	4	10	5
		#unique	0	0	0	2	.		3	3	1	4	1
		<i>h</i>	0.00	0.00	0.00	0.29	.		0.39	0.39	0.32	0.47	0.28

^aSamples in which no individuals of the appropriate species were collected are indicated by a period.

Table 5.30. Meiofauna genetic variability for *Cletodes* sp. at three platforms and two cruises. The number of individuals with the dominant haplotype, the number of individuals with a unique haplotype, and haplotype diversity (h) are presented.

Platform	Cruise	Variable	Obs	Station ^a									
				Near					Far				
				1	2	3	4	5	1	2	3	4	5
MU-A85	2	#dominant	5	8	6	.	7	10	4	9	5	.	
		#unique	0	3	0	.	1	3	1	3	0	.	
		h	0.00	0.45	0.00	.	0.22	0.39	0.32	0.42	0.00	.	
	3	#dominant	3	7	5	8	.	10	3	.	.	10	
		#unique	1	3	0	1	.	3	0	.	.	4	
		h	0.38	0.48	0.00	0.20	.	0.39	0.00	.	.	0.47	
MAI-686	2	#dominant	7	2	.	10	9	10	8	9	2	10	
		#unique	3	0	.	2	2	0	2	1	1	3	
		h	0.48	0.00	.	0.29	0.31	0.00	0.34	0.18	0.44	0.39	
	3	#dominant	3	1	6	10	4	10	9	.	13	3	
		#unique	1	0	0	0	1	1	4	.	4	1	
		h	0.38	0.00	0.00	0.00	0.32	0.17	0.50	.	0.40	0.38	
HI-A389	2	#dominant	.	7	8	8	10	.	.	10	4	.	
		#unique	.	0	0	1	2	.	.	2	2	.	
		h	.	0.00	0.00	0.20	0.29	.	.	0.29	0.50	.	
	3	#dominant	10	2	1	10	8	4	4	.	6	.	
		#unique	2	1	0	1	0	1	1	.	2	.	
		h	0.29	0.44	0.00	0.17	0.00	0.32	0.32	.	0.41	.	

^aPeriod indicates no data. Samples in which no individuals of the appropriate species were collected are indicated by a period.

Table 5.31. Meiofauna genetic variability for *Enhydrosoma pericoense* at three platforms and two cruises. The number of individuals with the dominant haplotype, the number of individuals with a unique haplotype, and haplotype diversity (h) are presented.

Platform	Cruise	Variable	Obs	Station ^a										
				Near					Far					
				1	2	3	4	5	1	2	3	4	5	
MU-A85	2	#dominant
		#unique
		h
	3	#dominant	.	.	4	10	.	10	26	6	.	8		
		#unique	.	.	1	2	.	4	14	1	.	1		
		h	.	.	0.32	0.29	.	0.47	0.57	0.24	.	0.20		
MAI-686	2	#dominant	10	5	1	7	10	5	11	6	8	10		
		#unique	2	0	0	1	0	1	0	3	1	3		
		h	0.29	0.00	0.00	0.22	0.00	0.28	0.00	0.52	0.20	0.39		
	3	#dominant	3	2	70	14	14	24	12	4	39	41		
		#unique	2	0	11	0	2	3	1	2	10	11		
		h	0.56	0.00	0.25	0.00	0.23	0.21	0.14	0.50	0.36	0.37		
HI-A389	2	#dominant	
		#unique		
		h		
	3	#dominant	.	.	.	3	7	.	12	8	.	2		
		#unique	.	.	.	0	1	.	5	3	.	1		
		h	.	.	.	0.00	0.22	.	0.48	0.45	.	0.22		

^aSamples in which no individuals of the appropriate species were collected are indicated by a period.

Table 5.32. Meiofauna genetic variability for *Robertsonia* sp. at three platforms and two cruises. The number of individuals with the dominant haplotype, the number of individuals with a unique haplotype, and haplotype diversity (h) are presented.

Platform	Cruise	Variable	Ops	Station ^a										
				Near					Far					
				1	2	3	4	5	1	2	3	4	5	
MU-A85	2	#dominant		5	10	4	5	8		9	10	10	10	10
		#unique		1	2	3	0	0		2	3	0	4	1
		h		0.28	0.29	0.61	0.00	0.00		0.31	0.39	0.00	0.47	0.17
	3	#dominant		1	3	.	10	.		.	.	4	2	2
		#unique		0	1	.	3	.		.	.	1	0	1
		h		0.00	0.38	.	0.39	.		.	.	0.32	0.00	0.44
MAI-686	2	#dominant	
		#unique	
		h	
	3	#dominant		2		.	6	6	.	.
		#unique		0		.	1	2	.	.
		h		0.00		.	0.24	0.41	.	.
HI-A389	2	#dominant		.	.	13	10	4		12	10	10	6	.
		#unique		.	.	3	1	1		2	3	4	2	.
		h		.	.	0.33	0.17	0.32		0.26	0.39	0.47	0.41	.
	3	#dominant		.	3	.	3	.		.	.	4	7	7
		#unique		.	0	.	1	.		.	.	1	1	1
		h		.	0.00	.	0.38	.		.	.	0.32	0.22	0.22

^aSamples in which no individuals of the appropriate species were collected are indicated by a period.

Table 5.33. Meiobenthic genetic variability for *Tachidiella* sp. at three platforms and one cruise. The number of individuals with the dominant haplotype, the number of individuals with a unique haplotype, and haplotype diversity (h) are presented.

Platform	Cruise	Variable	Obs	Station ^a										
				Near					Far					
				1	2	3	4	5	1	2	3	4	5	
MU-A85	3	#dominant		1	2	2	6	11		6	.	3	4	.
		#unique		0	0	0	2	3		0	.	1	3	.
		h		0.00	0.00	0.00	0.41	0.37		0.00	.	0.38	0.61	.
MAI-686	3	#dominant		3	.	1	22	3		1	.	.	10	2
		#unique		0	.	0	5	0		0	.	.	3	2
		h		0.00	.	0.00	0.33	0.00		0.00	.	.	0.39	0.63
HI-A389	3	#dominant		4	.	1	1	.		3	9	8	.	.
		#unique		1	.	0	0	.		0	4	2	.	.
		h		0.32	.	0.00	0.00	.		0.00	0.50	0.34	.	.

^aSamples in which no individuals of the appropriate species were collected are indicated by a period.

was unique; no species was common to two or more subcores (Table 5.34). This occurred most frequently at MU-A85 and HI-A389 during Cruise 1 and at MAI-686 during Cruise 4. These results suggest that a larger sample size may have been needed; however, pooling results from the three replicates minimized the effects of small sample sizes.

5.5.1 Seasonal Trends

Seasonal trends in abundance at MAI-686 and MU-A89 were similar (Figure 5.104). Between 700 and 900 total individuals were collected in winter 1993 and summer 1993 (Cruises 1 and 2). Both sites experienced a marked increase (1500 to 1800 individuals) in the winter of 1994 (Cruise 3) and then declined again to about 600 to 700 individuals in June of 1994 (Cruise 4). Abundances at HI-A389 underwent a more gradual increase and decrease, beginning with about 900 individuals, increasing to 1200 individuals, and then decreasing to about 600 individuals. These trends in abundance were unusual because highest abundances occur in the winter-spring period and are lowest during the summer and fall. The numbers of individuals collected during the winter of 1993 (Cruise 1) were much lower than expected and, at two of the three platforms were lower than abundances the following summer. The data suggests that this was a widespread phenomenon because a relatively low number of animals was collected at all three study sites. The cause of this low abundance is not known.

5.5.2 Diversity

When the total numbers of species were considered in relation to distance from the platform, there was a general trend of the highest numbers of species occurring close to the platform (Figure 5.105). The largest mean number of species occurred at the 50-m stations. In all cases, the largest mean number of species occurred close to the platform. The total numbers of species per station are presented as contour plots in Figure 5.106. At MAI-686, most stations had between 40 and 60 species of macroinfauna and the numbers varied with distance from the platform (Figure 5.106). The only deviation from this pattern occurred to the northwest where there was a pronounced decrease in the number of species

Table 5.34. Numbers of stations having unique species assemblages in each of the three subcores collected. Each distance had five stations.

Distance	Cruise 1	Cruise 2	Cruise 3	Cruise 4
<u>MAI-686</u>				
50 m	0	0	0	0
100 m	0	0	1	1
200 m	1	1	0	1
500 m	0	0	0	2
3000 m	0	0	1	2
Total =	1	1	2	6
<u>MU-A85</u>				
50 m	1	1	0	0
100 m	1	0	0	0
200 m	2	0	0	1
500 m	3	0	0	0
3000 m	1	0	0	0
Total =	8	1	0	1
<u>HI-A389</u>				
50 m	3	1	0	0
100 m	0	0	0	1
200 m	1	0	0	0
500 m	3	2	0	2
5000 m	0	0	0	1
Total =	7	3	0	4

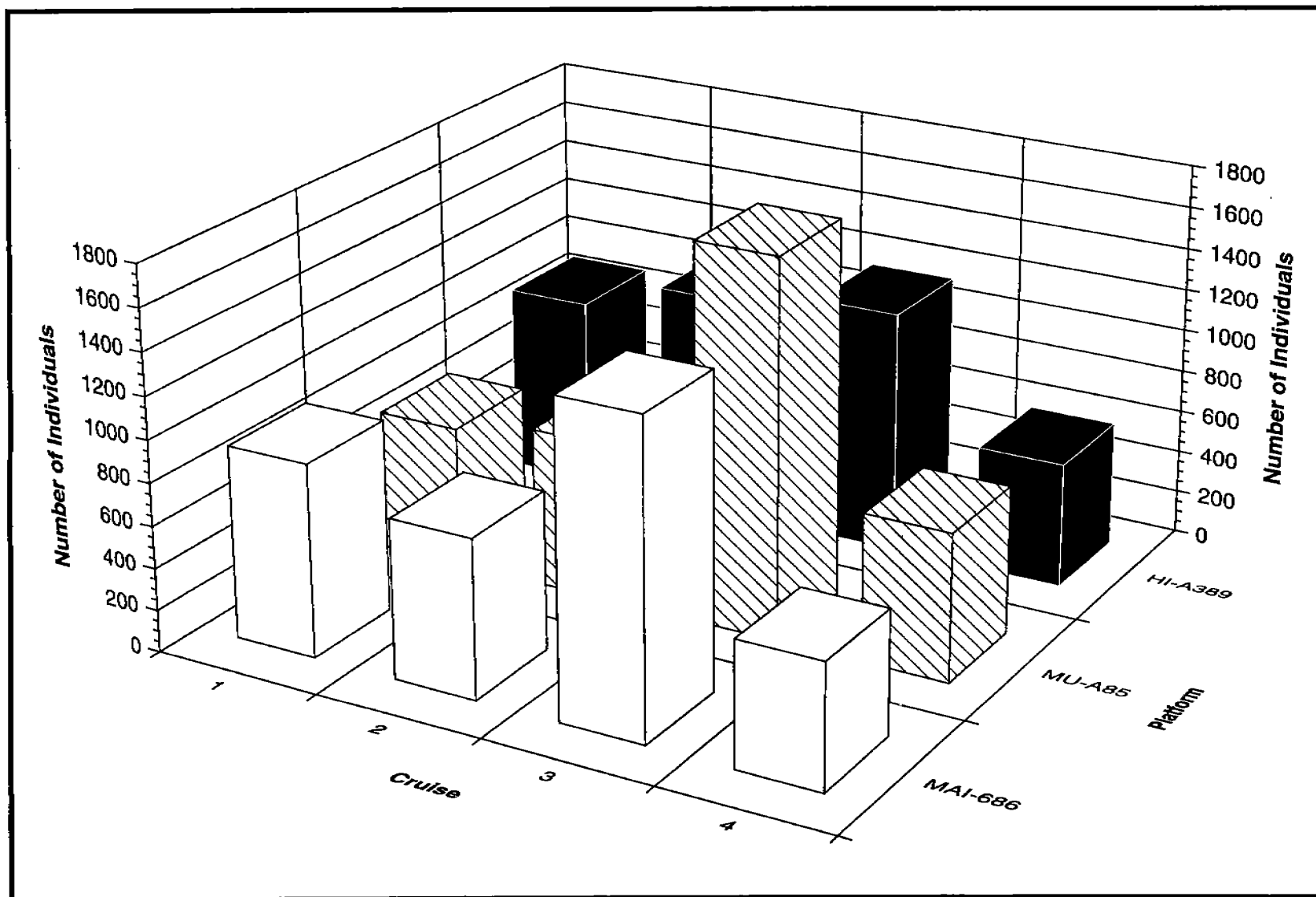

Figure 5.104. Comparison of seasonal trends in mean numbers of individuals of macroinfauna at all sites.

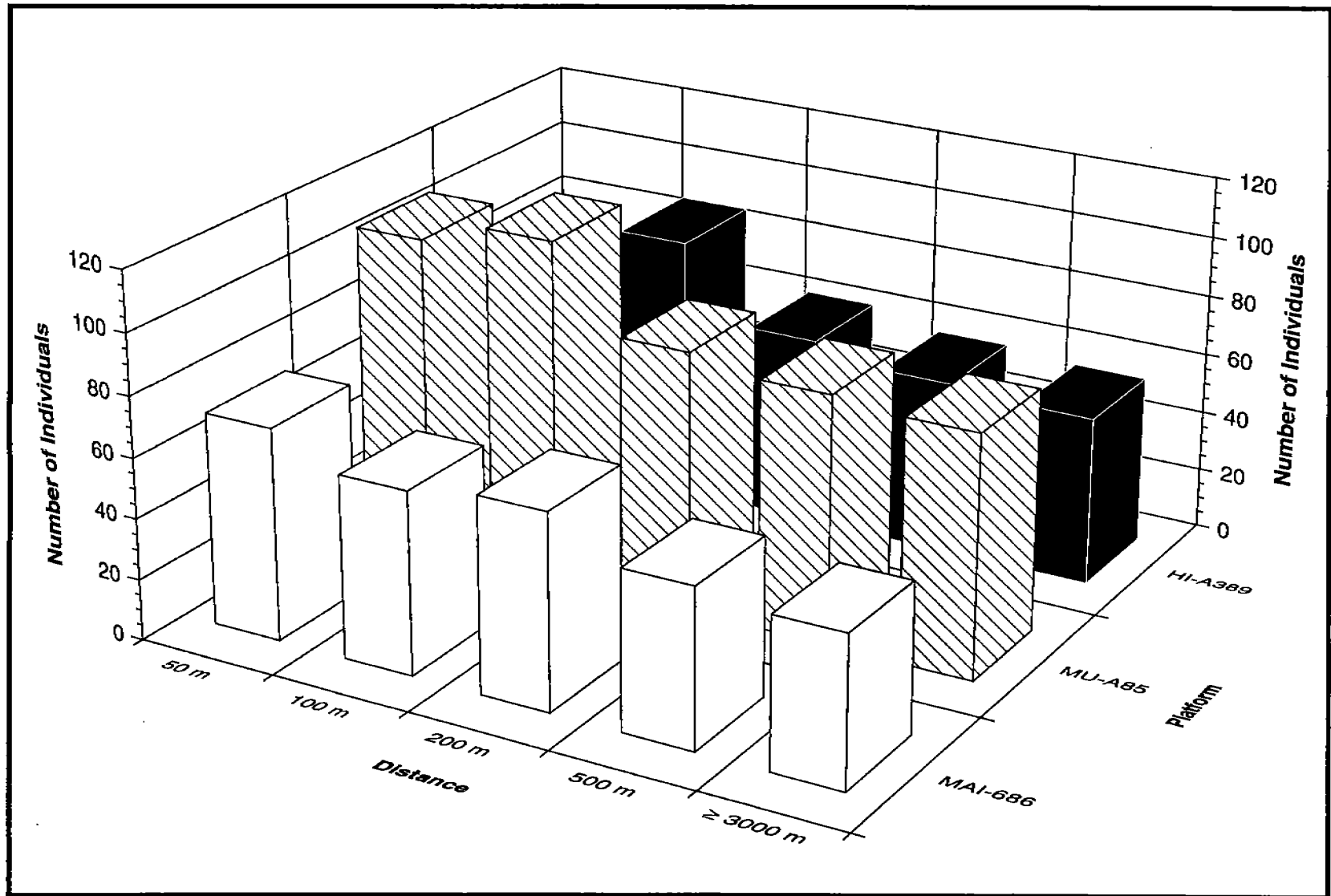

Figure 5.105. Summary of the mean number of macroinfaunal species by distance from the platforms.

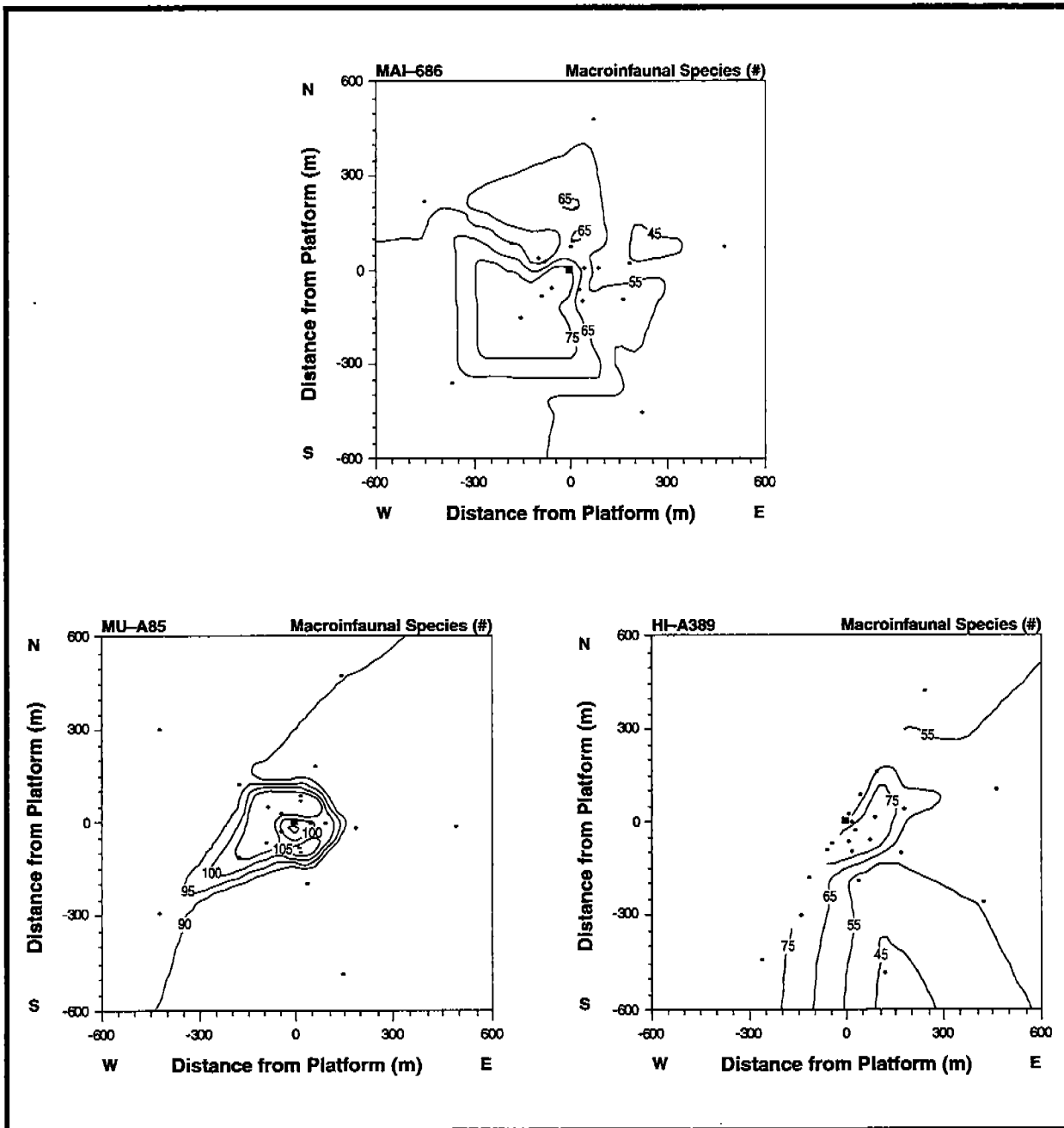

Figure 5.106. Areal distribution of the number of macrofaunal species as a composite of all four cruises.

with increased distance from the platform (Figure 5.106). Distinct regional trends in the number of species were also observed at MU-A85 (Figure 5.106). The 95-species isopleth included most of the 50- and 100-m stations. Highest numbers of species were observed toward the west. At HI-A389, the numbers of species were higher at the 50-m stations (Figure 5.106). Three stations to the northeast and east had reduced numbers of species compared to the surrounding stations.

The Shannon-Weaver Index of Diversity (H') was calculated for each station based on pooled data (Figure 5.107). H' along transects at MAI-686 changed little with distance (Figure 5.108). The areal distribution of H' values at MAI-686 suggests a region of slightly higher values to the southwest at 200-m distance. The only exception was a slightly higher H' at one station 500-m distance from the platform. At MU-A85, H' was generally highest at the 100-m stations (Figure 5.108). On three transects there was a trend of decreasing H' beyond the 100-m stations. On two transects the 200- and 500-m stations had a lower H' than the other stations. H' values at MU-A85 were fairly uniform with no particular trend except one area of lower values. At HI-A389, H' is low at the 50-m stations at two stations (Figure 5.108). The other stations at this site had similar H' values. The large abundances of infauna close to the platform (50 m), relative to the rest of the stations, contributed to a region of low H' values which trends northeast to southwest at HI-A389. Outside of the 50-m distance, the area had fairly uniform H' values. There was little difference between distances or sites in regard to mean H' values.

5.5.3 Abundance

Trends in macroinfaunal abundance with distance from the platform were different at MAI-686 than at the two deeper sites. At MAI-686, the number of individuals increased away from the platform on four of the five radii. Large numbers of individuals were collected at one station (50 m) as compared with the other four stations near the platform (Figure 5.109). At the two deeper sites, macroinfaunal abundances were higher close to the platform and decreased rapidly with increasing distance from the platform. Abundances decreased rapidly and were generally very low far from the platform. Mean abundances at MAI-686 were greatest at the 50-m station, but only because of the large number of individuals collected at one station.

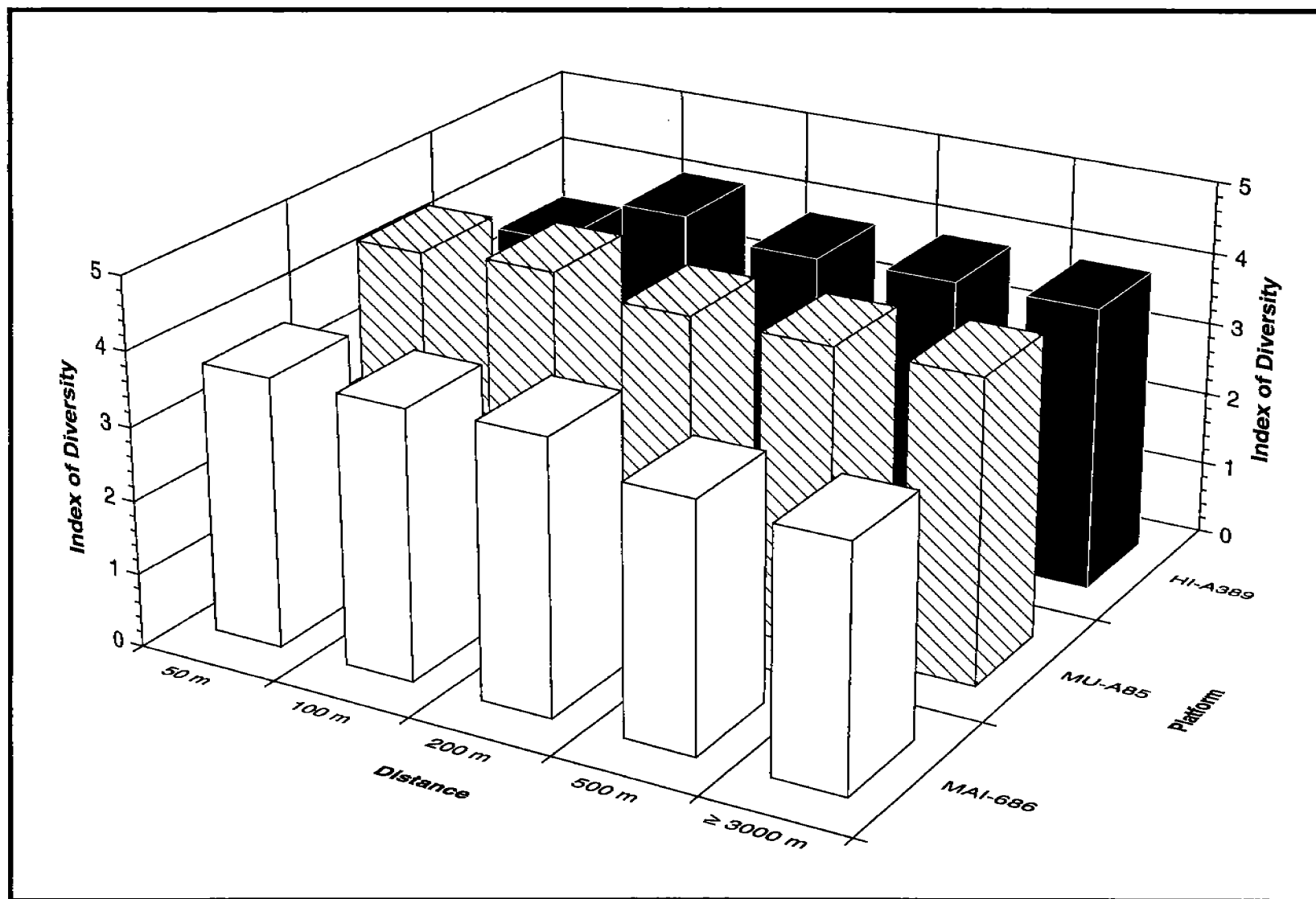

Figure 5.107. Summary of the mean index of diversity (H') for macroinfauna by distance from the platforms.

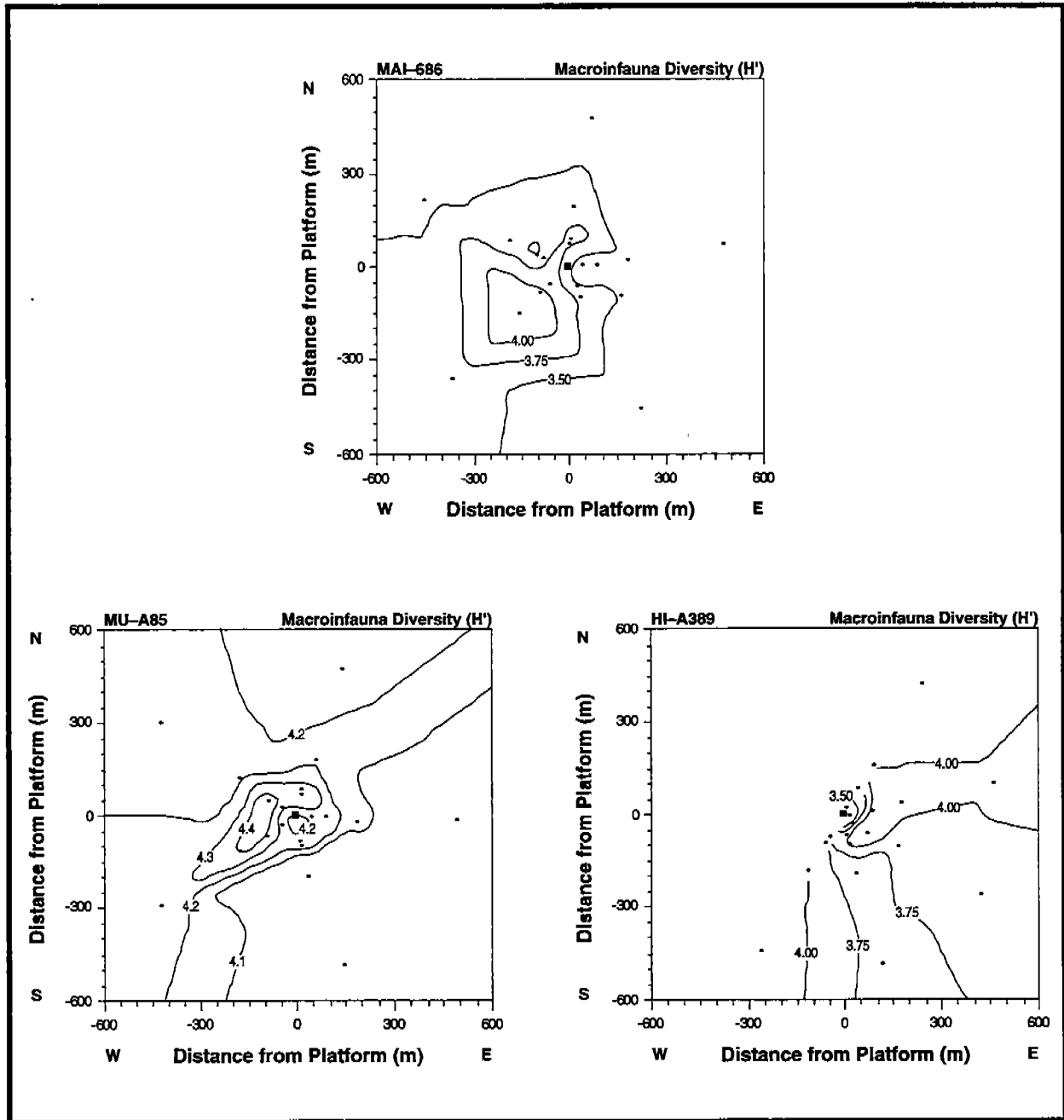

Figure 5.108. Areal distribution of the mean index of diversity (H') for macrofauna as a composite of all four cruises.

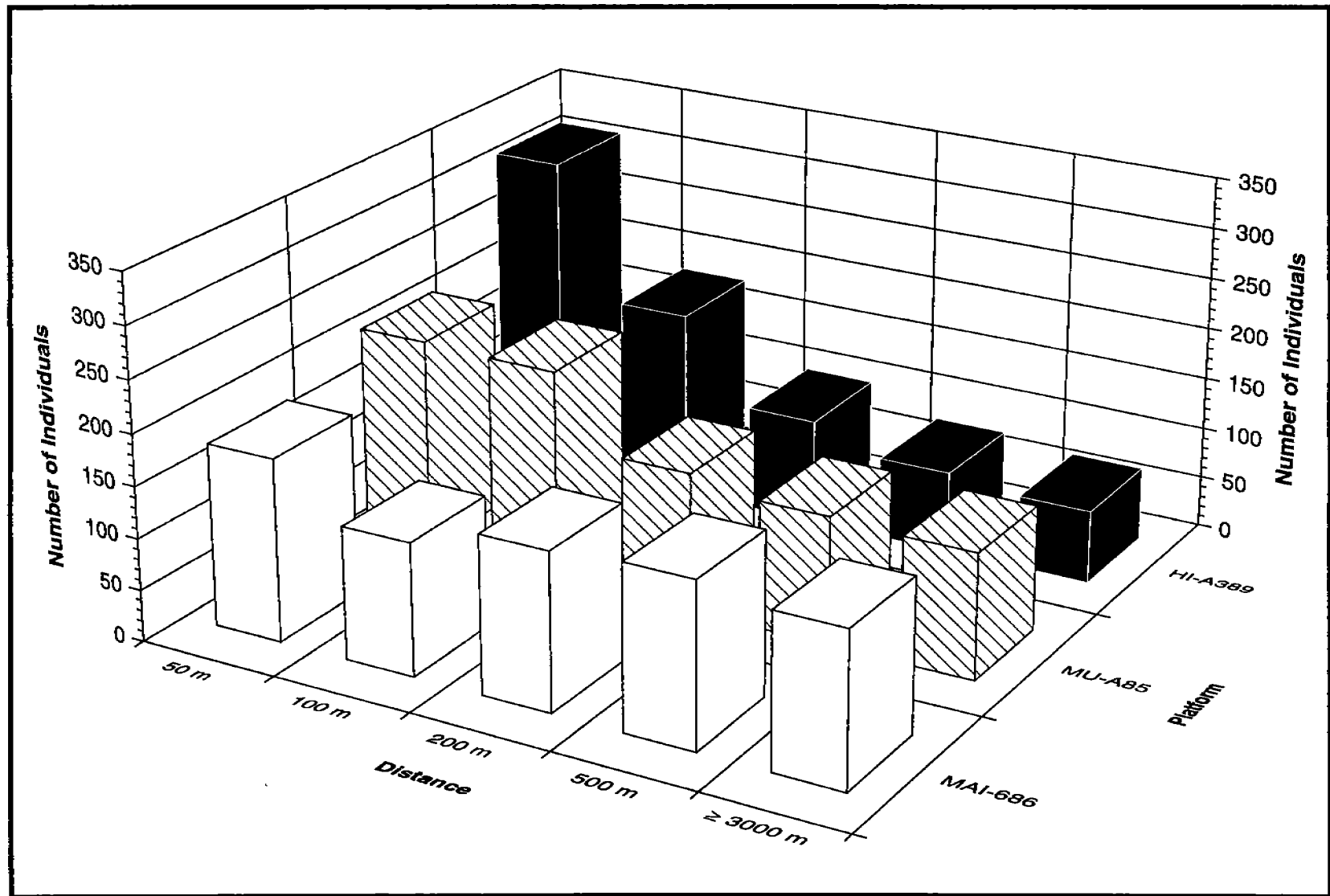

Figure 5.109. Summary of the mean number of macroinfauna by distance from the platforms.

Mean abundances at the 200-, 500-, and 3000-m stations were nearly the same as those at the 100-m stations. In contrast, mean abundances were considerably higher at the 50-m station as compared to the 3000-m stations. At MU-A85, mean abundances at the 50- and 100-m stations were nearly identical, about 200 individuals, while the 200 to 3000-m stations had a nearly uniform number of individuals (n=135 to 140). Mean abundances at HI-A389 decreased logarithmically with distance from the platform.

Abundance data are also presented as contour maps for each study site in Figure 5.110. A regional high in macroinfauna was apparent to the southwest of platform MAI-686 (n > 300; Figure 5.110). To the northwest, there was a three-station area of reduced numbers of individuals (< 100) relative to the other stations. At MU-A85, the 190 individual isodeme and the 130 individual isodeme included all 50- and 100-m stations, and extended out to the 200-m stations at two stations (Figure 5.110). There was an area of increased abundances that was nearly symmetrical around the platform. The mean number of individuals at HI-A389 was quite high at the 50-m stations. The contour map illustrates a region of high abundance (n > 200) that paralleled the 100-m isobath (Figure 5.110). Note that to the southwest, the 100-individual isodeme extended to the 500-m station.

5.5.4 Comparison of Abundances of Numerically Dominant Taxa

The two most abundant macroinfaunal taxa were polychaetous annelids and amphipoda. Polychaetous annelids were the overall numerically dominant taxonomic group at all sites. Their dominance is shown by comparing the mean numbers of individuals by distance from the platform (Figure 5.111). The largest number of polychaetes occurred either at the 50-m (MAI-686, HI-A389) or the 100-m (MU-A85) stations. Note that the mean number of polychaetes was similar at all distances at MAI-686, whereas there is a decrease in numbers with increased distance at MU-A85 and HI-A389. The trend of mean abundances of amphipods (Crustacea: Peracarida), the second most abundant overall group, was the inverse of the polychaetous annelid distribution. Abundances were lowest at the 50-m or 100-m stations and increased with increased distance from the platform (Figure 5.112). Amphipods were much more abundant at the shallowest site (MAI-686). Amphipods, particularly in the Family Ampeliscidae, appear to

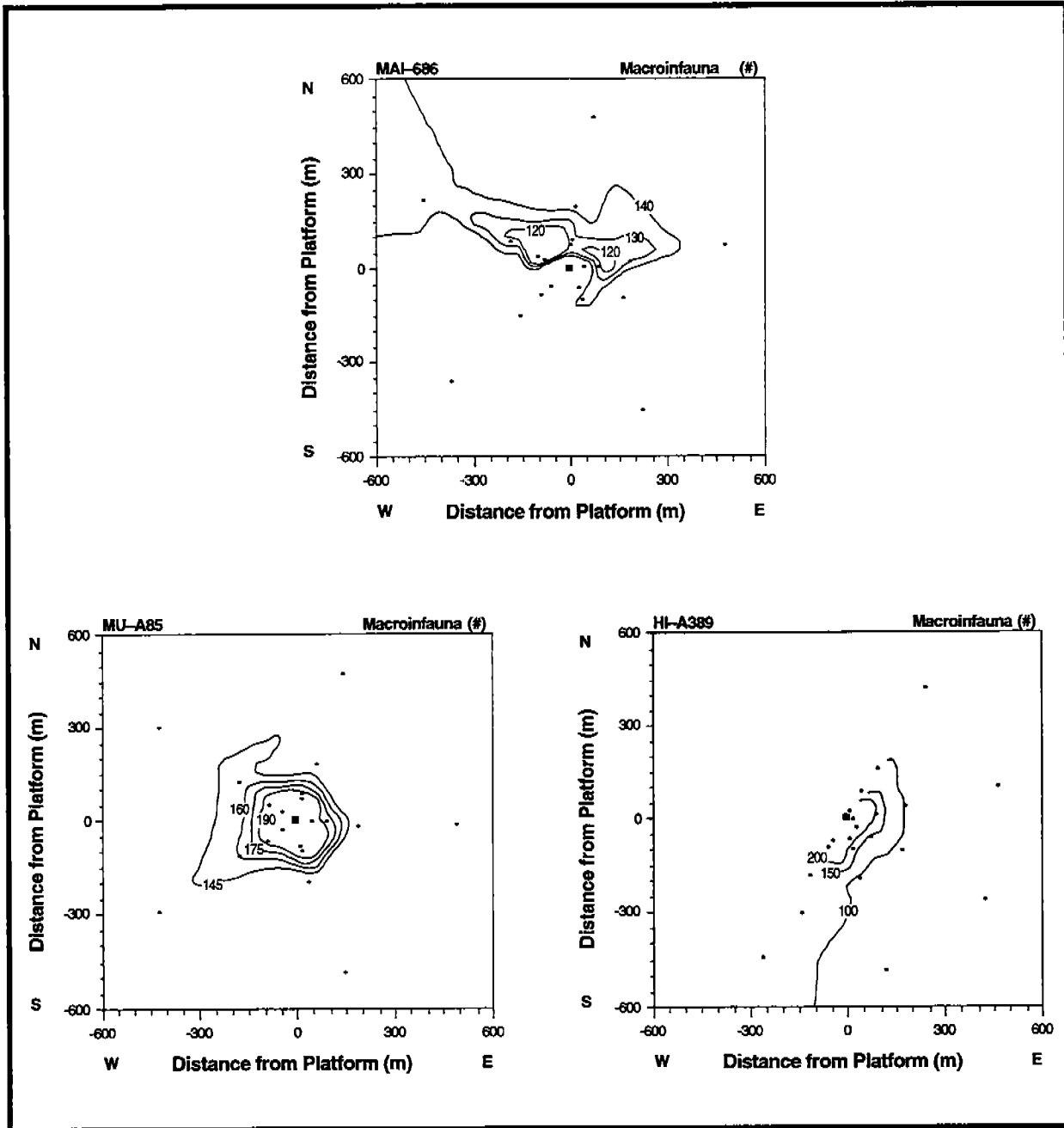

Figure 5.110. Areal distribution of the mean abundances of macroinfaunal individuals as a composite of all four cruises.

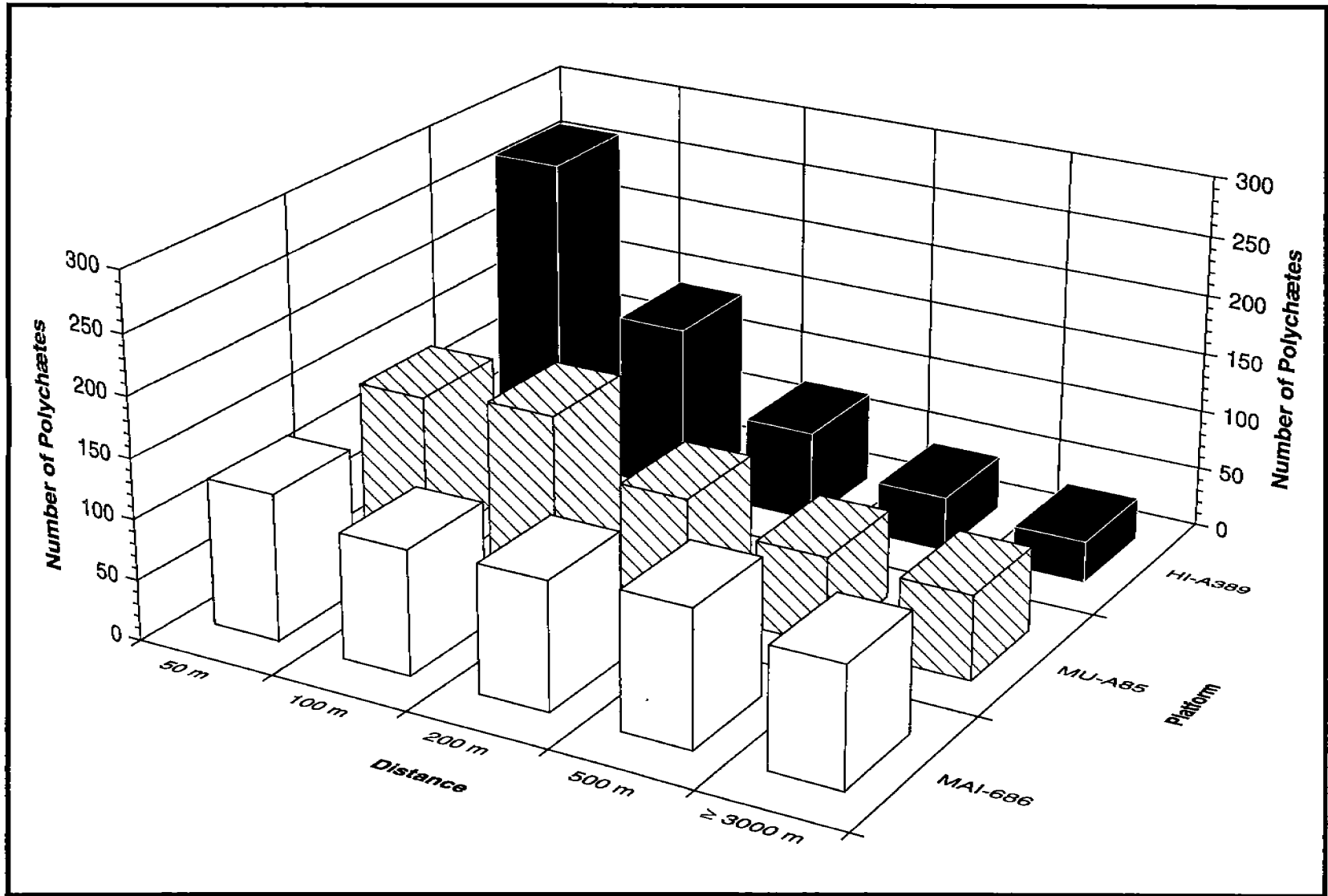

Figure 5.111. Summary of the mean abundances of polychaetes by distance from the platforms.

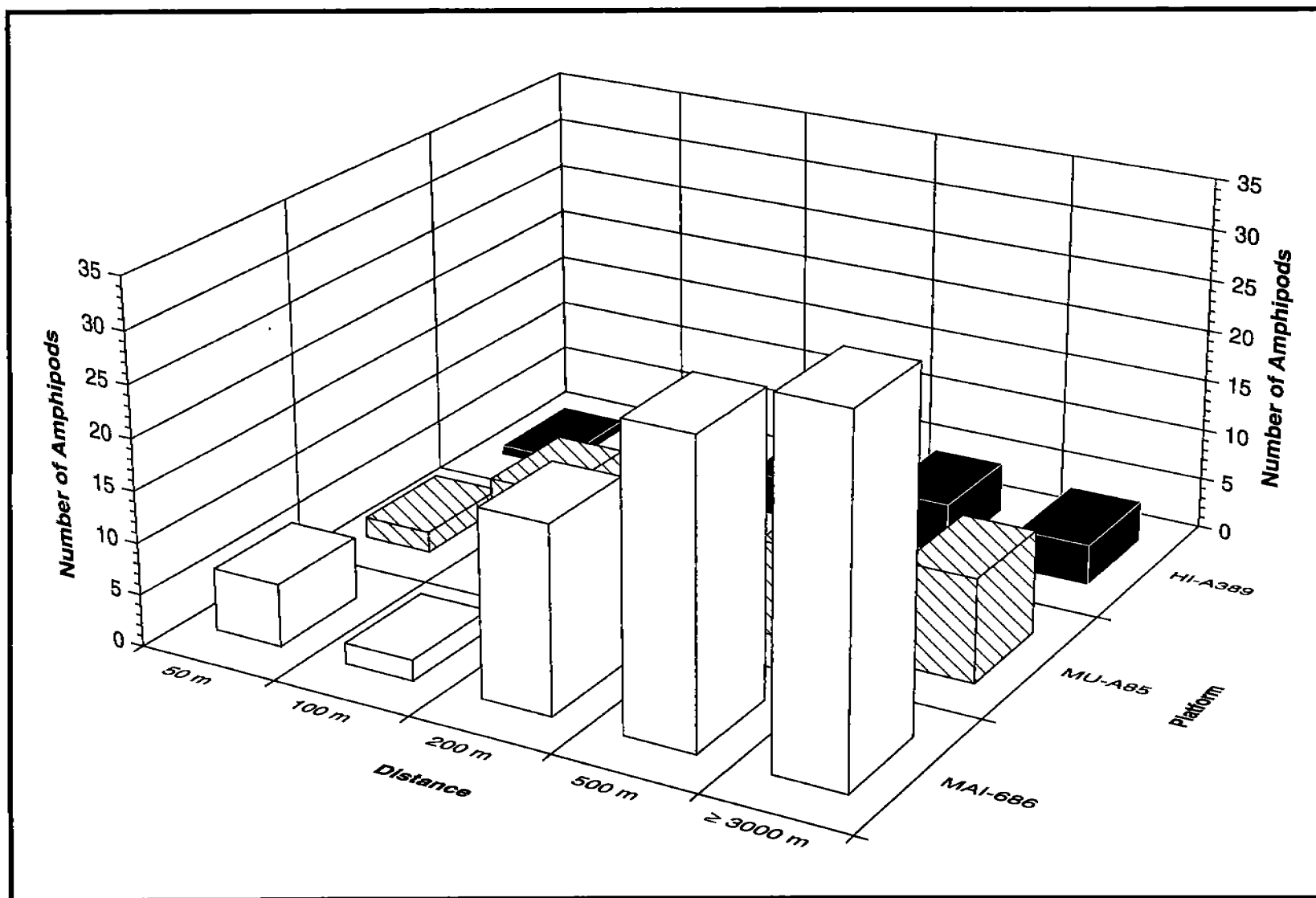

Figure 5.112. Summary of the mean abundances of amphipods by distance from the platforms.

be sensitive to environmental perturbations. Amphipods were completely eliminated following a major hypoxic event on the upper Texas coast (Harper et al. 1981a, 1991) and remained absent for four years from a Galveston beach following an oil spill (unpublished data). Amphipods lack planktonic larvae, and thus must rely on migration of adult or young members to repopulate an area.

Other taxa of lesser abundance included Nemertea, Bivalvia, Decapoda, Isopoda, Foraminera, and Ophiuroidea. Nemerteans were most abundant at the MU-A85 site (Figure 5.113). Mean abundances were highest at the 50- or 100-m stations. There was an especially strong gradient at MU-A85 with increasing distance from the platform. There was a pronounced decrease in mean abundances of bivalves (Mollusca) with increasing distance from platform HI-A389 (Figure 5.114). At the other two sites there was no clear trend. Mean abundances at some far stations were equal to, or similar to, abundances at the near stations. Decapod crustacean mean abundances varied depending on water depth (Figure 5.115). At MAI-686, there was virtually no difference in abundance with distance from the platform and the overall numbers of decapods collected was low. At the deeper MU-A85 and HI-A389 sites, the greatest mean abundances occurred at the 50-m stations and there were large step-wise reductions in abundance with increased distance from the platforms. Isopods (Crustacea:Peracarida) were absent at the shallowest site (MAI-686; Figure 5.116). There was a pronounced abundance gradient at MU-A85 with fewer individuals collected at greater distances from the platform. Isopods were infrequently collected at HI-A389, and were most abundant at the 100- and 200-m stations. Foraminiferans were absent at the MAI-686 site (Figure 5.117). At the deeper sites, the foraminifera displayed abundance trends similar to the amphipods; the mean numbers of individuals increased with increased distance from the platforms. Mean abundances were highest at the 500-m stations at the MU-A85 site and at the 5000-m stations at the HI-A389 site. Ophiuroids (Echinodermata: Stellerioidea) were not among the numerically dominant groups, but are included because they are the only echinoderm group represented in the infaunal assemblages, and serve as the echinoderm surrogate for comparison with the pore water toxicity tests. Mean abundances of brittlestars were lowest at the 200-m stations at MU-A85 and HI-A389 sites (Figure 5.118). At MAI-686 there was a general decrease in

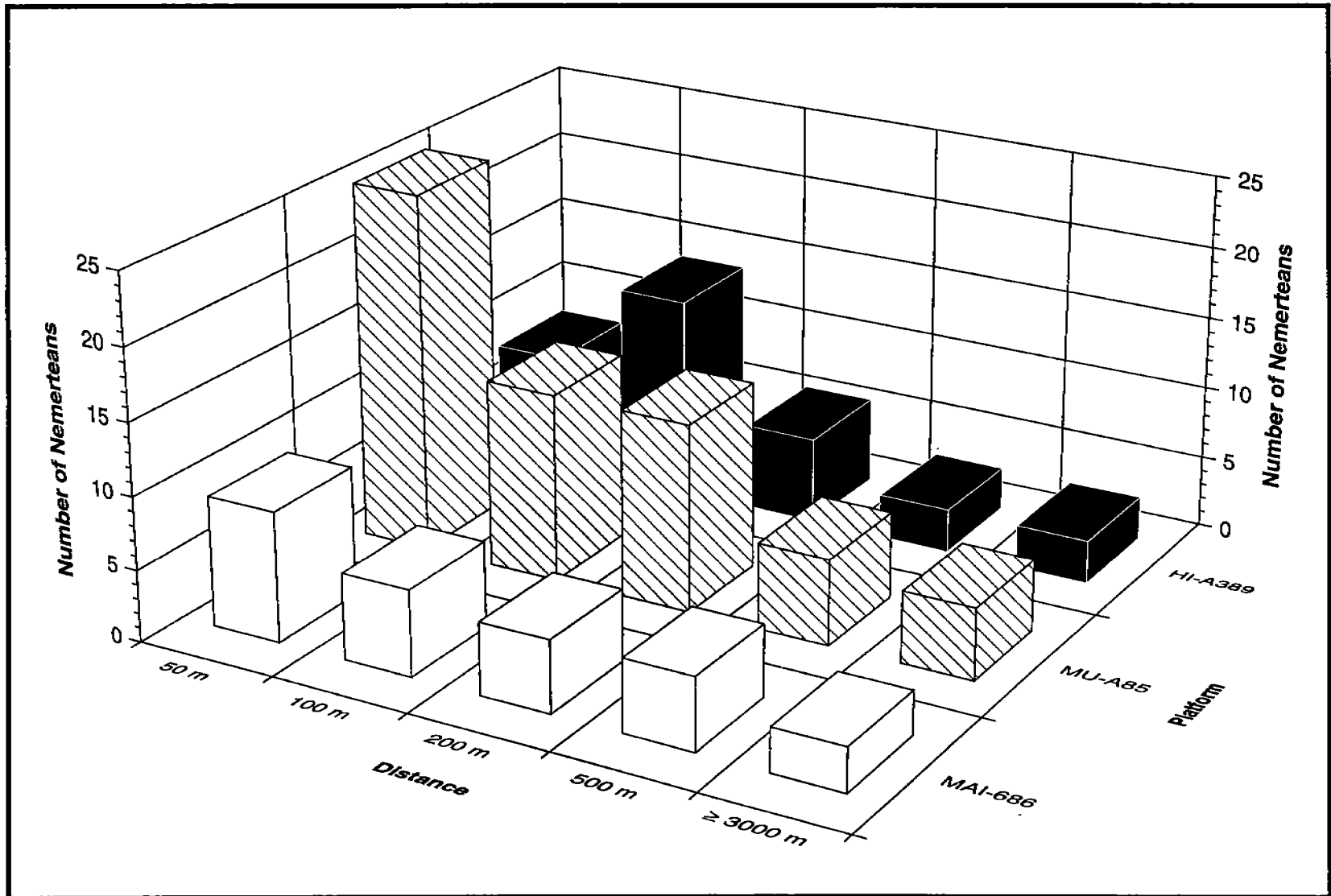

Figure 5.113. Summary of the mean abundances of nemerteans by distance from the platforms.

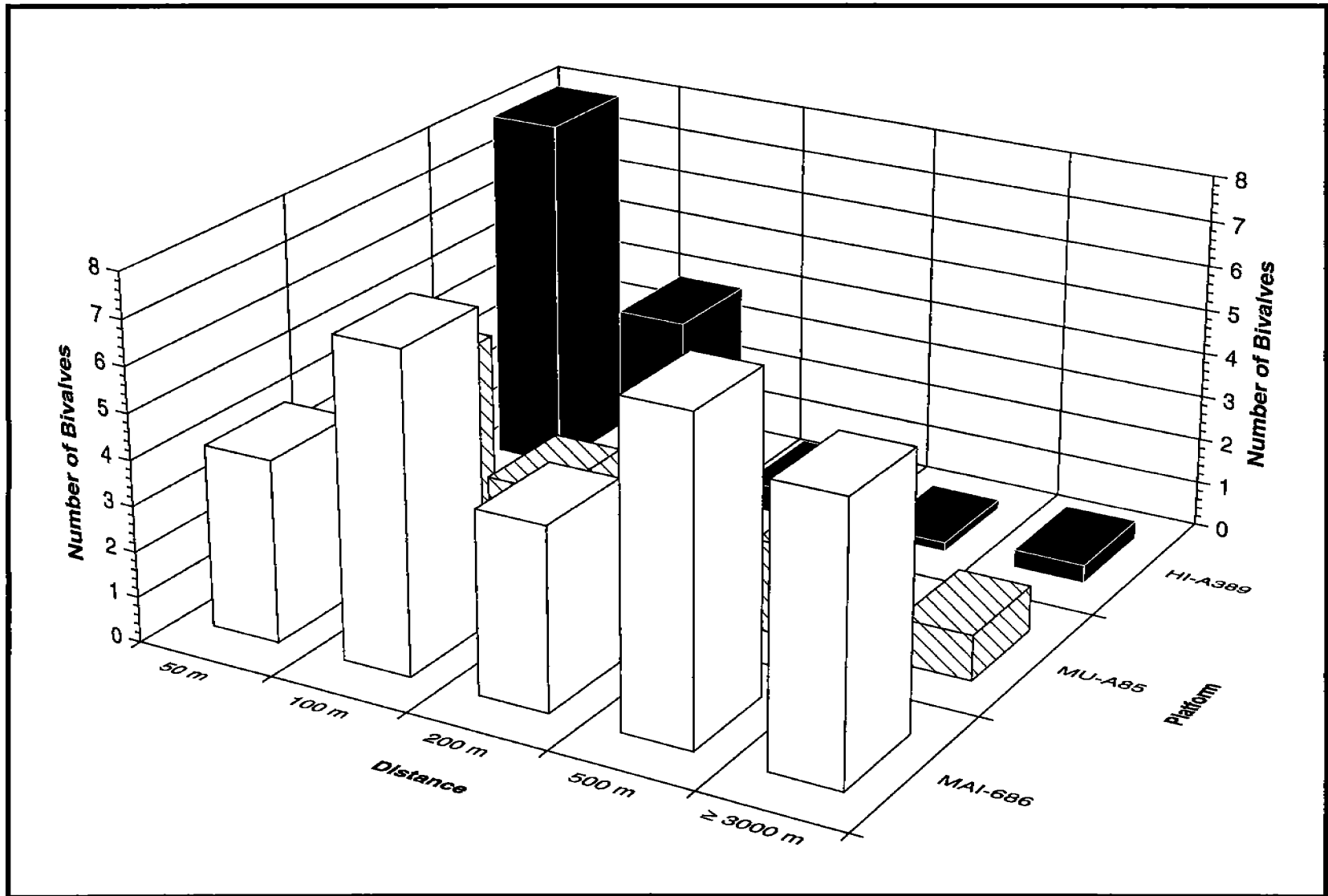

Figure 5.114. Summary of the mean abundances of bivalves by distance from the platforms.

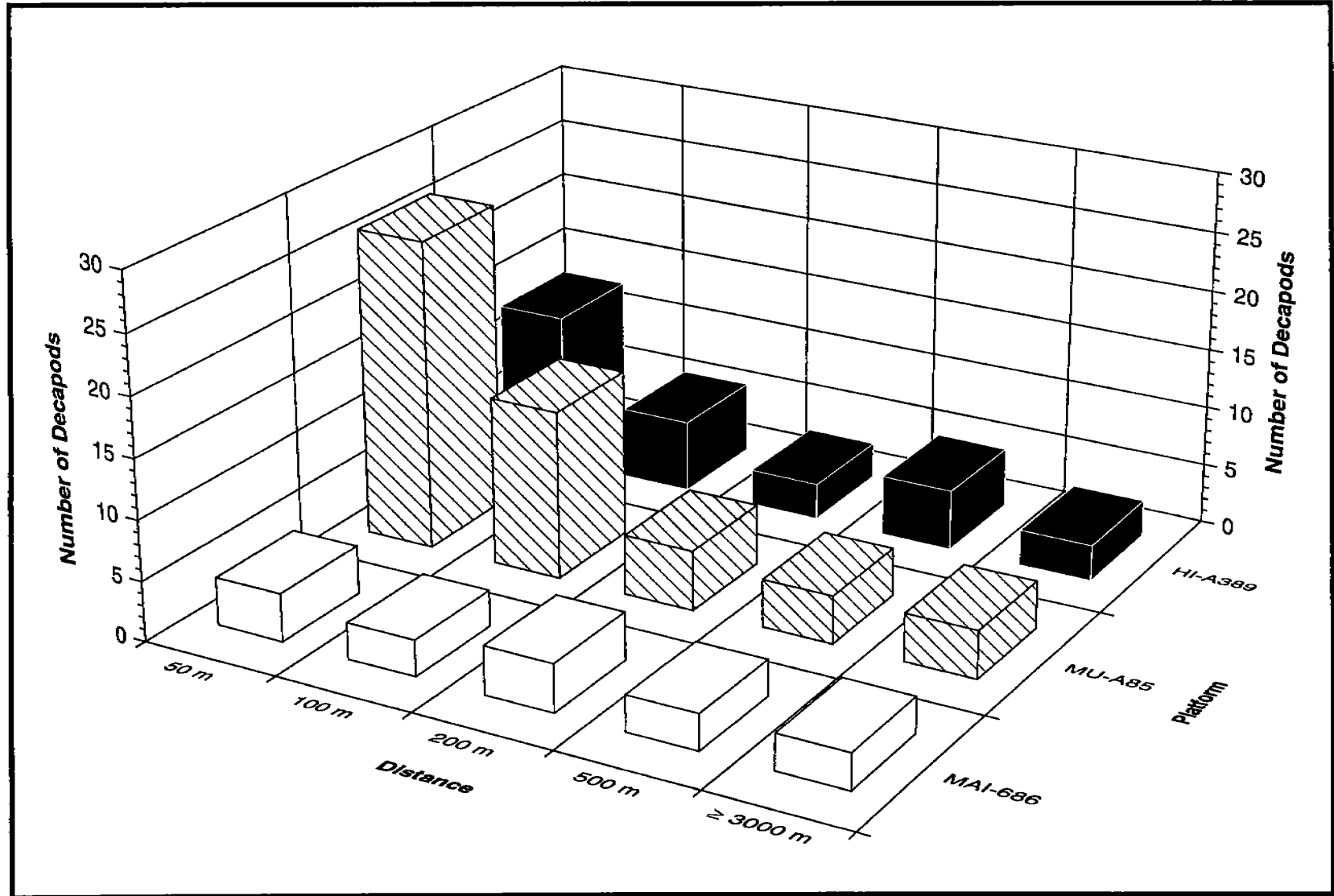

Figure 5.115. Summary of the mean abundances of decapods by distance from the platforms.

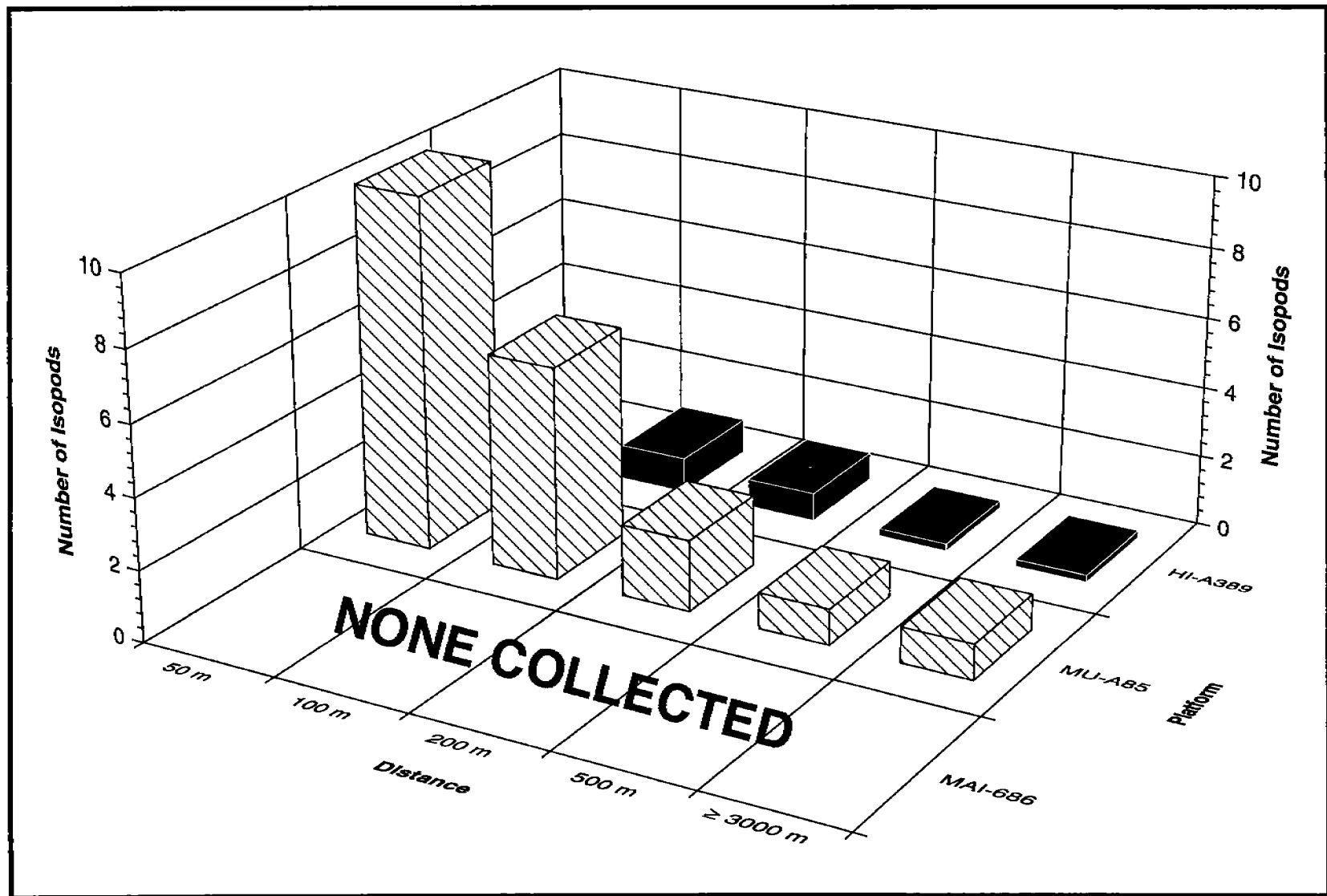

Figure 5.116. Summary of the mean abundances of isopods by distance from the platforms.

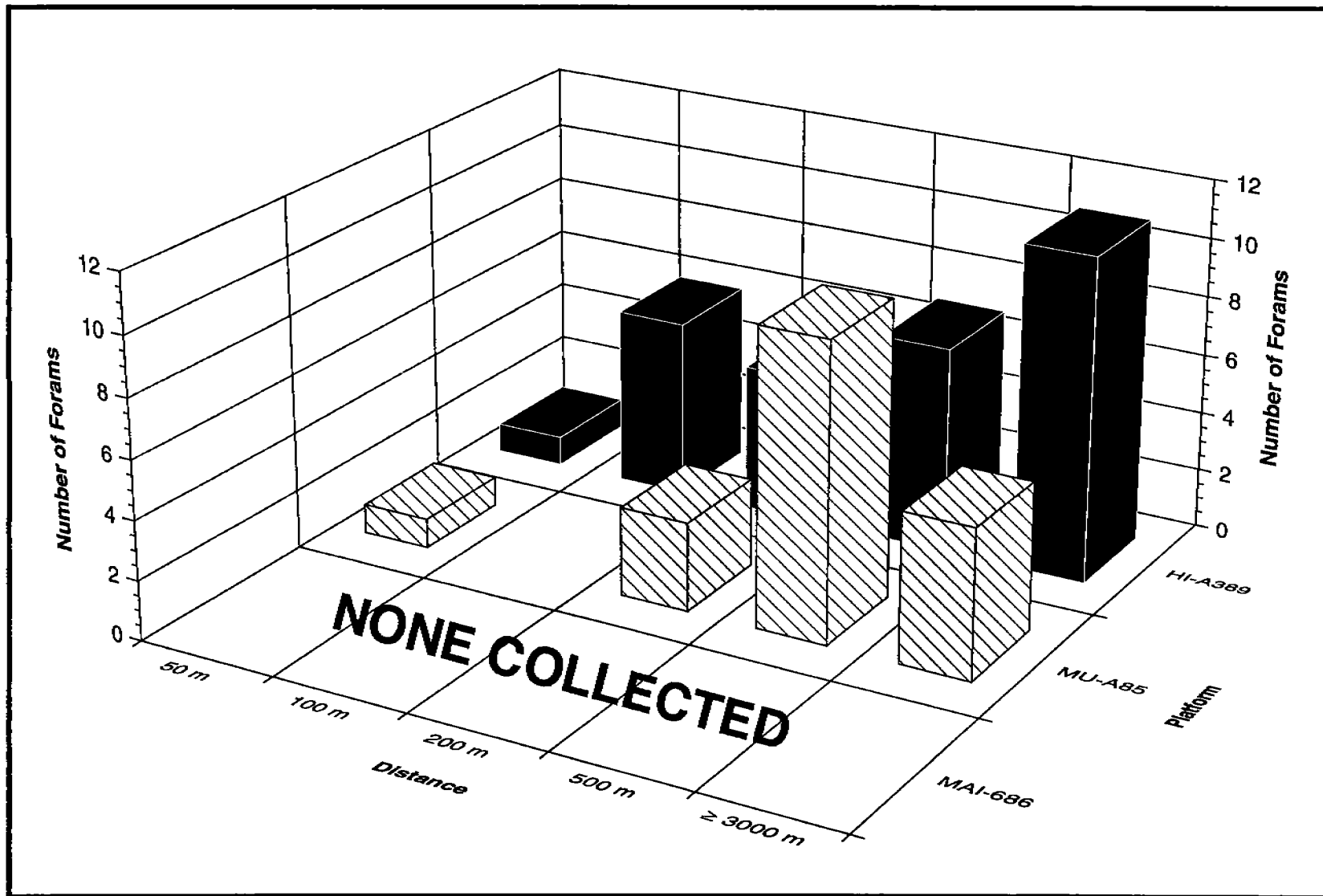

Figure 5.117. Summary of the mean abundances of forams by distance from the platforms.

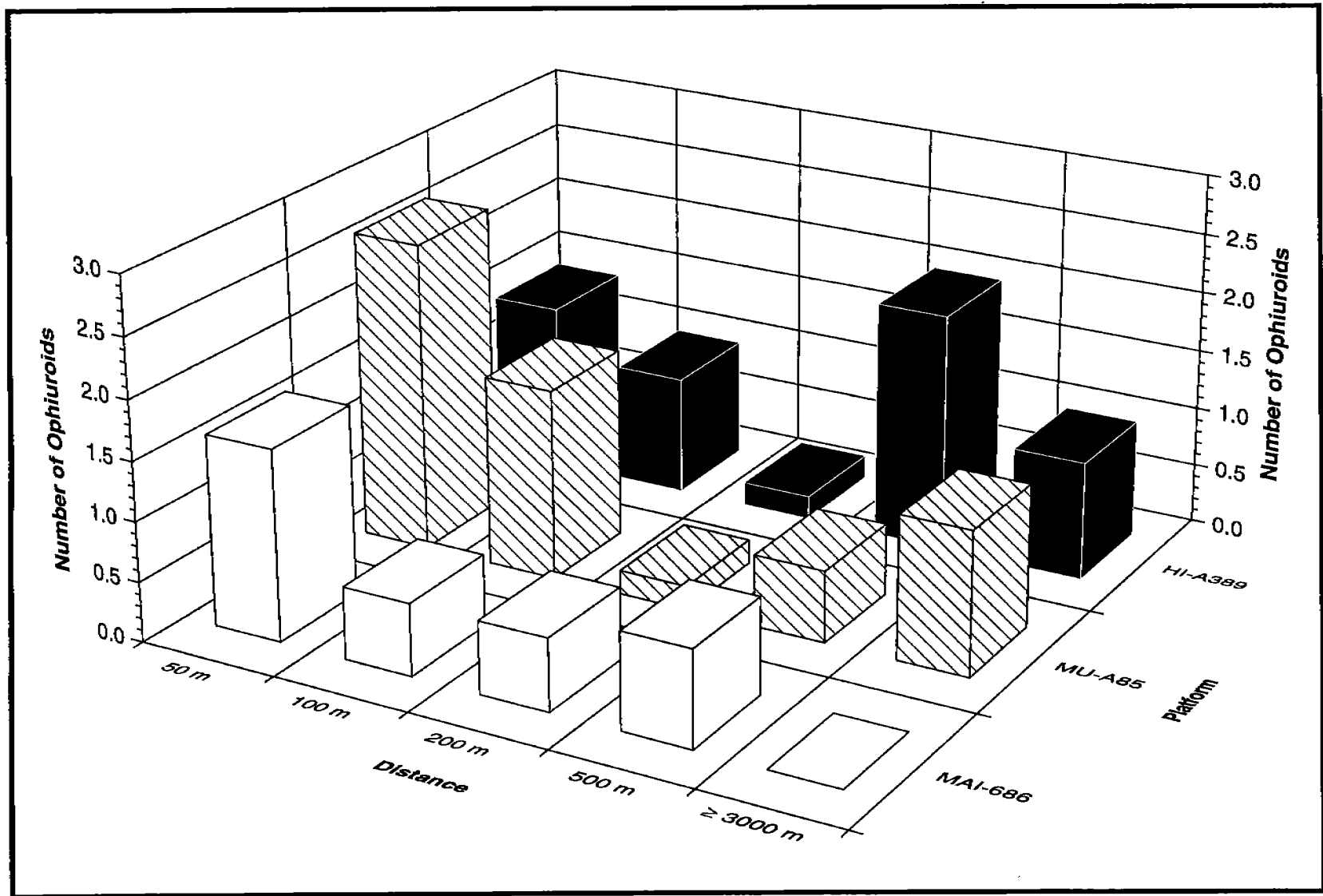

Figure 5.118. Summary of the mean abundances of ophiuroids by distance from the platforms.

mean abundance with increasing distance from the platform. Echinoderms were absent at the 3000-m stations.

5.6 Megafauna - Invertebrates

Physiological and environmental parameters including: salinity, temperature, food availability, disease, parasitism and exposure to environmental contaminants can affect the health and productivity of marine invertebrates (Peterson and Black 1988; Sindermann 1983). In this section abundance, catch per unit effort, size and sex distributions, stage of reproductive development, and the health of the populations based on the presence or absence of parasites and disease are presented for megafaunal invertebrates.

Target species were chosen based on the most abundant invertebrates collected in trawls to provide pair-wise comparisons between the Near and Far stations and also to represent a variety of taxa. The goal was to target between 5 and 10 species at each platform for analysis. A second consideration was to include species that represented the major taxa collected, including decapods, molluscs, and echinoderms. Therefore, not only was overlap between the Near and Far stations important, but the distribution of species among important taxa was also considered in selecting target species. Species overlap between the Near and Far sites was poor for Cruise 1, particularly at HI-A389. Increased and improved trawling activities during subsequent cruises improved the number of individuals caught as well as the species overlap between the Near and Far stations.

The species collected at each platform and the extent of overlap between the Near and Far stations achieved during the four cruises are summarized in Tables 5.35 to 5.38. Similar species were collected at each platform during each cruise, but some differences in species composition existed among platforms. In general, species collected at MAI-686 and MU-A85 were similar, whereas species collected at HI-A389 were different from those at the other platforms. This between-platform difference resulted primarily from differences in water depths at the sites. MAI-686 and MU-A85 are located in relatively shallow water, 29 and 75 m respectively, whereas HI-A389 is located in much deeper water (~125 m). This difference in water depth results in a different assemblage of animals being

Table 5.35. The number of individuals collected for each species at the Near and Far stations during Cruise 1.

Species	Number of Individuals ^a										
	Site	GA-288		HI-A389		MAI-686		MAI-622		MU-A85	
	Station	Near	Far	Near	Far	Near	Far	Near	Far	Near	Far
Shrimp											
<i>Penaeus aztecus</i>		-	10	-	-	10	10	10	10	10	10
<i>Trachypenaeus similis</i>		10	10	9	-	10	10	10	10	-	-
<i>Sicyonia dorsalis</i>		10	10	-	-	-	10	10	10	-	-
<i>Sicyonia brevistriata</i>		-	10	-	-	-	-	-	-	-	-
Crabs											
<i>Callinectes similis</i>		8	10	-	-	5	10	10	10	-	7
<i>Portunus gibbesii</i>		6	4	-	-	10	10	10	10	-	-
<i>Portunus spinicarpus</i>		-	10	10	-	-	-	-	-	9	10
<i>Acanthocarpus alexandria</i>		-	-	10	10	-	-	-	-	-	-
<i>Myropsis quinquespinosa</i>		-	-	10	10	-	-	-	-	-	-
<i>Dromida antillensis</i>		-	-	-	9	-	-	-	-	-	-
<i>Raninotides louisianensis</i>		-	-	-	-	-	-	-	-	-	9
<i>Munida irrasa</i>		-	-	10	-	-	-	-	-	-	-
Hermit crab (spp.)		-	-	8	-	-	-	-	-	10	-
Molluscs											
<i>Amusium papyraceum</i>		-	-	-	-	-	-	-	-	10	10
<i>Anadara transversa</i>		-	-	-	-	-	-	-	-	-	10
<i>Pitar cordatus</i>		-	-	-	-	-	-	-	-	-	10
<i>Murex fulvescens</i>		-	-	10	-	-	-	-	-	-	-
<i>Polystira albida</i>		-	-	-	-	-	-	-	-	-	10
Echinoderms											
<i>Astropecten cingulatus</i>		-	-	6	-	-	-	-	-	10	10
<i>Astropecten duplicatus</i>		-	-	-	-	10	10	-	-	-	10
<i>Echnocardium flavescens</i>		-	-	-	9	-	-	-	-	-	-
Brittle star (spp.)		10	4	-	-	-	-	-	-	-	-
Stomatopods											
<i>Squilla empusa</i>		6	10	-	-	-	10	10	9	-	-

^a"-" indicates no data.

Table 5.36. The number of individuals collected for each species at the Near and Far stations during Cruise 2.

Species	Number of Individuals ^a						
	Site	MU-A85		MAI-686		HI-A389	
	Station	Near	Far	Near	Far	Near	Far
Shrimp							
<i>Penaeus aztecus</i>		10	10	10	10	-	-
<i>Trachypenaeus similis</i>		3	10	10	10	-	-
<i>Solenocera atlantidis</i>		10	10	-	-	10	6
Crabs							
<i>Callinectes similis</i>		3	9	10	10	-	-
<i>Portunus gibbesii</i>		-	-	10	-	-	-
<i>Portunus spinicarpus</i>		10	10	-	-	10	2
<i>Portunus spinimanus</i>		-	-	10	-	-	-
<i>Acanthocarpus alexandria</i>		-	-	-	-	5	10
<i>Myropsis quinquespinosa</i>		-	-	-	-	3	10
Hermit crab (spp.)		-	-	-	-	10	10
Molluscs							
<i>Amusium papyraceum</i>		10	10	-	-	-	-
<i>Polystira albida</i>		10	10	-	-	-	-
Echinoderms							
<i>Astropecten cingulatus</i>		7	9	-	-	5	5
Stomatopods							
<i>Squilla empusa</i>		-	-	10	10	-	-
<i>Squilla chydrea</i>		10	10	-	-	-	-
<i>Squilla edentata</i>		-	-	-	-	7	10

^a"-" indicates no data.

Table 5.37. The number of individuals collected for each species at the Near and Far stations during Cruise 3.

Species	Number of Individuals ^a						
	Site	MU-A85		MAI-686		HI-A389	
	Station	Near	Far	Near	Far	Near	Far
Shrimp							
<i>Penaeus aztecus</i>		10	10	9	10	-	-
<i>Trachypenaeus similis</i>		7	10	10	10	-	-
<i>Solenocera atlantidis</i>		10	10	-	-	10	10
<i>Styonia dorsalis</i>		-	10	-	10	-	-
<i>Parapenaeus similis</i>		-	-	-	-	10	10
Crabs							
<i>Callinectes similis</i>		-	-	7	10	-	-
<i>Portunus gibbesii</i>		-	-	8	10	-	-
<i>Portunus spinicarpus</i>		10	10	-	-	10	-
<i>Acanthocarpus alexandria</i>		-	-	-	-	1	4
<i>Myropsis quinquespinosa</i>		-	-	-	-	-	3
Hermit crab (spp.)		-	-	-	-	6	10
Molluscs							
<i>Amusium papyraceum</i>		10	10	-	-	-	-
Echinoderms							
<i>Astropecten cingulatus</i>		-	10	-	-	-	3
<i>Astropecten duplicatus</i>		-	2	10	10	-	-
Stomatopods							
<i>Squilla empusa</i>		-	-	10	10	-	-
<i>Squilla chydrea</i>		10	1	7	10	2	-
<i>Squilla edentata</i>		-	-	-	-	2	4

^a "-" indicates no data.

Table 5.38. The number of individuals collected for each species at the Near and Far stations during Cruise 4.

Species	Number of Individuals ^a						
	Site	MU-A85		MAI-686		HI-A389	
	Station	Near	Far	Near	Far	Near	Far
Shrimp							
<i>Penaeus aztecus</i>		9	10	10	10	-	-
<i>Trachypenaeus similis</i>		-	-	10	10	-	-
<i>Solenocera atlantidis</i>		10	10	-	-	10	10
Crabs							
<i>Callinectes similis</i>		-	-	10	10	-	-
<i>Portunus gibbesii</i>		-	-	10	10	-	-
<i>Portunus spinicarpus</i>		10	10	-	-	4	-
<i>Acanthocarpus alexandria</i>		-	-	-	-	9	9
<i>Myropsis quinquespinosa</i>		-	-	-	-	9	9
Hermit crab (<i>spp.</i>)		-	-	-	-	3	2
Molluscs							
<i>Amusium papyraceum</i>		10	10	-	-	-	-
Echinoderms							
<i>Astropecten cingulatus</i>		8	10	-	-	5	10
<i>Astropecten duplicatus</i>		-	-	10	10	-	-
Stomatopods							
<i>Squilla empusa</i>		-	-	10	10	-	-
<i>Squilla chydarea</i>		10	4	10	10	-	-

^a"-" indicates no data.

found at HI-A389. The target species collected during the majority of the cruises included three species of shrimp (*Penaeus aztecus*, *Trachypenaeus similis* and *Solenocera atlantidis*), three portunid crabs (*Callinectes similis*, *Portunus spinicarpus* and *Portunus gibbesii*), two starfish (*Astropecten cingulatus* and *Astropecten duplicatus*), a scallop (*Amusium papyraceum*), and three species of stomatopods (*Squilla empusa*, *Squilla chydrea* and *Squilla edentata*). These species were typically collected with sufficient site overlap to provide pair-wise comparisons between Near and Far stations and represented each of the major taxa present.

5.6.1 Catch Per Unit Effort

Catch per unit effort (CPUE) is one measure of species abundance. High values indicate that more individuals were collected per trawled area and that the species is more abundant than organisms caught in lower numbers. It should be noted that this assumes equal collection success for all of the species inventoried and that other processes (such as schooling) do not create sampling artifacts. These assumptions may be more or less important depending on the species.

CPUE was calculated for the target species on Cruises 3 and 4 by dividing the number of individuals of a specific species collected in a trawl by the distance on bottom for the trawl as determined by shipboard navigation. Values of CPUE for each of the overlapping species collected at each platform and on each trawl are given in Tables 5.39 and 5.40. Shrimp were typically the most abundant species collected, regardless of platform, cruise, or station. *T. similis* was collected in extremely high numbers with CPUE values as high as 5.1 m⁻² at the Near station and 10.5 m⁻² at the Far station. Brusher et al. (1972) also recorded large catches of *T. similis* from the northwest Gulf of Mexico. *Callinectes similis* was the most abundant crab species with CPUE as high as 4.0 m⁻² at MAI-686 on Cruise 4. Species at HI-A389 were usually less abundant than species collected at the other sites.

5.6.2 Individual Size and Size Frequency Distributions

The differences between the size frequency distributions of individuals collected at the Near and Far stations for overlapping species on each cruise are summarized in Tables 5.41 to 5.44. Those individuals collected and

Table 5.39. Catch per unit effort (CPUE, individuals m⁻²) for each trawl and overlapping species collected during Cruise 3.

MAI-686 ^a												
Trawl	<i>Penaeus aztecus</i>		<i>Trachypenaeus similis</i>		<i>Callinectes similis</i>		<i>Squilla empusa</i>		<i>Squilla chydrea</i>		<i>Astropecten duplicatus</i>	
	Near	Far	Near	Far	Near	Far	Near	Far	Near	Far	Near	Far
1	0	--	0.011	--	0	--	0	--	0	--	0	--
2	0	0.034	0.053	5.888	0	0.023	0.011	0.023	0	0.034	0	0.057
3	0	0.006	0	0.324	0	0	0.009	0.006	0	0.019	0	0.031
4	0.011	0.091	0.021	8.634	0	0	0.011	0.082	0	0.055	0.011	0.073
5	0	0.052	0	2.199	0	0.017	0	0.172	0	0.129	0	0.043
6	0	0.132	0.010	10.461	0	0.011	0.010	0.449	0.010	0.153	0.019	1.063
7	0.009	0.131	0.118	2.231	0	0.113	0.018	0.105	0	0.113	0	0.322
8	0.015	0.010	0.095	4.758	0	0.019	0.058	0.268	0	0.099	0.007	0.169
9	0.021	0	0.563	*	0	0	0.031	0	0.021	0.008	0.010	0.129
10	0.034	0	2.941	*	0.034	0	0.147	0	0	0	0.023	0.176
11	0.046	0.017	5.059	*	0.015	0	0.169	0	0	0	0	0.118
12	0	0	3.398	*	0	0	0.135	0	0	0.007	0	0.193
13	0.015	0	2.536	*	0.015	0.069	0.077	0	0	0	0	0
14	0.031	0	2.381	*	0.031	0	0.122	0	0.031	0	0.015	0.597
15	--	--	--	--	--	--	--	--	--	--	--	--
16	0.039		1.573		0		0.146		0.010		0	
17	0.013		1.216		0		0.254		0.040		0.054	
18	0.025		1.957		0		0.226		0		0.050	
Mean	0.015	0.036	1.290	4.928	0.007	0.019	0.084	0.085	0.007	0.047	0.011	0.228
S. D.	0.015	0.048	1.489	3.406	0.012	0.033	0.081	0.132	0.012	0.054	0.017	0.284

^aDashes (--) indicate trawls during which no invertebrates were collected; zeroes indicate that no individuals of that species were collected during that trawl. Asterisks indicate that the species may have been collected during that trawl but individuals were not counted or measured. Solid lines under sites indicate that no more trawls were done at that site. Mean is the average CPUE for all trawls; S.D. is the standard deviation.

Table 5.39. (Cont.)

MU-A85 ^a										
	<i>Penaeus aztecus</i>		<i>Solenocera atlantidis</i>		<i>Portunus spinicarpus</i>		<i>Squilla chydrea</i>		<i>Amusium papyraceum</i>	
Trawl	Near	Far	Near	Far	Near	Far	Near	Far	Near	Far
1	--	0.024	--	0.032	--	0.024	--	0	--	0.039
2	--	0.049	--	0.059	--	0	--	0	--	0.089
3	--	0.025	--	0.049	--	0.008	--	0.008	--	0.123
4	0	0.018	0	0.071	0	0.018	0	0	0.010	0.089
5	0.009	0	0	0	0	0	0	0	0.018	0.017
6	0.039	0.020	0.039	0	0	0	0.026	0	0.039	0.040
7	0.038	0.011	0.086	0	0	0.011	0.076	0	0.009	0.074
8	0.029	0.011	0.252	0	0.281	0	0.029	0	0.029	0.192
9	0	0.025	0.026	0	0.197	0.012	0.105	0	0.026	0.172
10	0.042	0.054	0.266	0.161	0.337	0	0.224	0	0.084	0.174
11	0.084	0.065	0.336	0.285	0.322	0.013	0.126	0	0.028	0.169
12	0.160	0.055	0.027	0.088	0.147	0.055	0	0	0.027	0.164
13	0.114	0.106	0.149	0.071	0	0.018	0.069	0	0.046	0.071
14		0.124		0.172		0.019		0		0.162
Mean	0.052	0.042	0.118	0.071	0.128	0.013	0.066	0.001	0.032	0.113
S.D.	0.049	0.035	0.118	0.081	0.138	0.014	0.068	0.002	0.021	0.057

HI-A389 ^a														
	<i>Solenocera atlantidis</i>		<i>Parapenaeus similis</i>		<i>Portunus spinicarpus</i>		<i>Acanthocarpus alexandria</i>		Hermit crab		<i>Squilla chydrea</i>		<i>Squilla edentata</i>	
Trawl	Near	Far	Near	Far	Near	Far	Near	Far	Near	Far	Near	Far	Near	Far
1	--	--	--	--	--	--	--	--	--	--	--	--	--	0.013
2	0	0.049	0.123	0.017	0	0.017	0	0	0.012	0	0	0	0	0
3	0	0.058	0.041	0.047	0	0	0	0.070	0	0.058	0	0	0	0
4	0	0.015	0.111	0	0	0	0.009	0	0.009	0	0	0	0	0
5	0	0.047	0.008	0.066	0.105	0	0	0	0	0	0.015	0	0.008	0
6	0.084	0.042	0.274	0.084	0.008	0	0	0.014	0.030	0.014	0.023	0	0	0.014
7	0.032	0	0.333	0	0.011	0	0	0	0	0	0	0	0.017	0
8		0		0		0		0.016		0.008		0		0
9		0		0		0		0.007		0.007		0		0
10		0		0		0		0		0		0		0.008
11		0.089		0.032		0		0		0		0		0.008
12		0.125		0.055		0		0		0.008		0		0
13		0.168		0.232		0		0		0		0		0
14		0.051		0.110		0		0		0.007		0.015		0
Mean	0.019	0.049	0.148	0.049	0.021	0.001	0.002	0.008	0.009	0.008	0.006	0.001	0.004	0.003
S.D.	0.031	0.050	0.118	0.063	0.038	0.005	0.003	0.019	0.011	0.015	0.009	0.004	0.006	0.005

^aDashes (--) indicate trawls during which no invertebrates were collected; zeroes indicate that no individuals of that species were collected during that trawl. Asterisks indicate that the species may have been collected during that trawl but individuals were not counted or measured. Solid lines under sites indicate that no more trawls were done at that site. Mean is the average CPUE for all trawls; S.D. is the standard deviation.

Table 5.40. Catch per unit effort (CPUE, individuals m⁻²) for each trawl and overlapping species collected during Cruise 4.

MAI-686 ^a														
Trawl	<i>Penaeus aztecus</i>		<i>Trachypenaeus similis</i>		<i>Callinectes similis</i>		<i>Portunus gibbesii</i>		<i>Squilla empusa</i>		<i>Squilla chydrea</i>		<i>Astropecten duplicatus</i>	
	Near	Far	Near	Far	Near	Far	Near	Far	Near	Far	Near	Far	Near	Far
1	0.011	0.064	0.023	0.231	1.592	0.208	0.068	0.008	0.046	0	0.011	0.008	0.159	0.335
2	0	0.121	0.101	0.336	1.234	0.316	0.038	0.040	0.063	0	0	0	0.151	0.578
3	0	0.126	0.081	0.498	1.881	0.442	0.041	0.049	0.081	0.007	0	0.014	0.257	0.688
4	0.011	0.121	0.011	1.211	0.554	1.173	0.064	0.006	0.011	0	0.011	0	0.277	2.009
5	0	0.084	0.139	0.318	1.960	0.684	0.043	0.018	0.075	0	0	0	0.032	0.870
6	0	0.116	0.389	0.569	4.218	0.436	0.139	0.018	0.129	0	0.030	0	0.549	3.814
7	0.012	0.043	0.257	0.219	2.218	0.336	0.105	0.024	0.164	0.024	0	0	0.199	0.629
8		0.110		0.774		0.606		0.045		0.026		0.006		1.727
9		0.092		0.763		0.513		0.033		0.026		0		1.558
10		0.185		3.749		0.678		0.022		0.316		0.016		1.046
11		*		*		0.229		*		0		0		*
Mean	0.005	0.106	0.143	0.867	1.951	0.511	0.071	0.026	0.081	0.036	0.007	0.004	0.232	1.325
S.D.	0.006	0.037	0.126	1.004	1.056	0.262	0.035	0.014	0.047	0.089	0.010	0.006	0.149	0.979

MU-A85 ^a													
Trawl	<i>Penaeus aztecus</i>		<i>Solenocera atlantidis</i>		<i>Portunus spinicarpus</i>		<i>Squilla chydrea</i>		<i>Amusium papyraceum</i>		<i>Astropecten cingulatus</i>		
	Near	Far	Near	Far	Near	Far	Near	Far	Near	Far	Near	Far	
1	--	0.011	--	0	--	0	--	0	--	0.039	--	0.011	
2	--	0.006	--	0	--	0.017	--	0	--	0.296	--	0.041	
3	--	0.033	--	0.017	--	0.050	--	0.011	--	0.326	--	0.028	
4	0	0.019	0.028	0.240	0	0.221	0.028	0.013	0.041	0.366	0.014	0.069	
5	0	0.025	0	0.225	0	0.119	0	0	0.080	0.244	0.046	0.081	
6	0	0.056	0	0.365	0.011	0.167	0	0	0.044	0.303	0	0.006	
7	0		0		0		0		0.019		0		
8	0		0.365		0		0.037		0.182		0.055		
9	0.029		1.381		0.045		0.089		0.223		0		
10	0.019		0.516		0.029		0.038		0.029		0		
11	0.031		0.677		0.041		0.062		0.051		0		
12	0.019		0.548		0.049		0.039		0.039		0		
Mean	0.011	0.025	0.391	0.141	0.019	0.096	0.033	0.004	0.079	0.262	0.013	0.039	
S.D.	0.013	0.016	0.434	0.143	0.020	0.080	0.029	0.006	0.069	0.106	0.021	0.028	

^aDashes (--) indicate trawls during which no invertebrates were collected; zeroes indicate that no individuals of that species were collected during that trawl. Asterisks (*) indicate that the species may have been collected during that trawl but individuals were not counted or measured. Solid lines under sites indicate that no more trawls were done at that site. Mean is the average CPUE for all trawls; S.D. is the standard deviation.

Table 5.40. (Cont.)

HI-A399 ^a											
Trawl	<i>Solenocera atlantidis</i>		<i>Myropsts quinquespinosa</i>		<i>Acanthocarpus alexandria</i>		Hermit crab		<i>Astropecten cingulatus</i>		
	Near	Far	Near	Far	Near	Far	Near	Far	Near	Far	
1	--	--	--	--	--	--	--	--	--	--	--
2	0	0	0	0.006	0	0	0	0	0.008	0	0
3	0	0	0	0	0	0	0	0	0.007	0.006	0
4	0	0.022	0.011	0.007	0.011	0	0.011	0	0.011	0	0
5	0	0.027	0	0	0	0	0	0	0	0	0
6	0	0.091	0.009	0	0	0.008	0.009	0.015	0	0	0
7	0.014	0.026	0.007	0.026	0.007	0.059	0	0.009	0	0.051	0
8	0.049	0	0.028	0.021	0	0.021	0	0	0	0.014	0.014
9	0.057	0	0.014	0.007	0.014	0.019	0.007	0	0.014	0.019	0.019
10	0.183	0	0.007	0	0.007	0	0	0	0.007	0.006	0.006
11	0.153	0	0	0	0.009	0.012	0.009	0	0	0.006	0.006
12	0.031	0	0.008	0.006	0.023	0.012	0	0	0	0	0
Mean	0.044	0.015	0.008	0.007	0.006	0.012	0.003	0.002	0.004	0.009	0.009
S.D.	0.062	0.026	0.008	0.009	0.007	0.017	0.004	0.005	0.005	0.015	0.015

^aDashes (--) indicate trawls during which no invertebrates were collected; zeroes indicate that no individuals of that species were collected during that trawl. Asterisks (*) indicate that the species may have been collected during that trawl but individuals were not counted or measured. Solid lines under sites indicate that no more trawls were done at that site. Mean is the average CPUE for all trawls; S.D. is the standard deviation.

Table 5.41. Summary data for overlapping species collected from each platform during Cruise 1.

Platform	Species	Station ^a	Total Collected	Mean Size ^b	Size Range ^c		Standard Deviation
					Largest	Smallest	
GA-288	<i>T. similis</i>	N	50	27.8	35	18	5.6
		F	50	28.2	36	11	6.7
GA-288	<i>S. dorsalis</i>	N	50	17.0	20	15	1.3
		F	53	17.1	21	11	1.7
GA-288	<i>C. similis</i>	N	8	42.6	46	38	3.2
		F	12	45.5	58	35	6.8
GA-288	<i>P. gibbesii</i>	N	8	44.5	54	30	6.9
		F	4	41.0	42	40	1.0
GA-288	<i>S. empusa</i>	N	6	30.8	35	26	3.4
		F	16	25.3	33	18	3.8
GA-288	Brittle star	N	10	12.5	17	9	2.7
		F	4	11.8	14	9	1.8
HI-A389	<i>M. quinquespinosa</i>	N	10	16.7	23	14	2.8
		F	11	27.0	38	17	7.3
MAI-622	<i>P. aztecus</i>	N	16	41.2	45	35	3.5
		F	13	40.5	48	28	4.9
MAI-622	<i>T. similis</i>	N	50	28.9	36	15	5.3
		F	50	30.1	36	18	4.2
MAI-622	<i>S. dorsalis</i>	N	18	13.4	16	8	2.1
		F	50	15.1	18	13	2.3
MAI-622	<i>C. similis</i>	N	11	48.6	55	42	3.9
		F	18	52.1	73	41	8.9
MAI-622	<i>P. gibbesii</i>	N	10	40.8	45	30	4.4
		F	11	39.5	47	28	4.8
MAI-622	<i>S. empusa</i>	N	14	20.9	26	16	3.7
		F	9	20.9	23	19	1.5
MAI-686	<i>P. aztecus</i>	N	10	41.8	52	33	6.2
		F	10	43.5	48	37	3.6
MAI-686	<i>T. similis</i>	N	50	29.4	36	17	4.8
		F	52	28.9	35	17	4.5
MAI-686	<i>C. similis</i>	N	5	55.0	61	51	3.4
		F	27	56.9	81	40	9.6
MAI-686	<i>P. gibbesii</i>	N	10	43.0	53	27	7.2
		F	10	44.4	53	36	5.4
MAI-686	<i>A. duplicatus</i>	N	17	13.0	15	12	0.8
		F	15	12.1	15	9	1.7
MU-A85	<i>P. aztecus</i>	N	14	54.1	63	40	5.9
		F	12	57.4	66	50	5.8
MU-A85	<i>P. spinicarpus</i>	N	38	40.9	56	31	6.1
		F	26	47.0	56	33	6.0
MU-A85	<i>A. papyraceum</i>	N	16	50.9	61	38	6.4
		F	50	50.4	62	35	5.8
MU-A85	<i>A. duplicatus</i>	N	15	15.5	27	10	5.5
		F	12	8.3	10	7	1.0

^aN=near-field station; F=far-field station.

^bAll measurements are in mm.

^cRange presents the largest and smallest individual collected.

Table 5.42. Summary of the numbers of individuals collected and size range for overlapping species at each platform during Cruise 2.

Platform	Species	Station ^a	Number Collected		Mean Size ^b		Size Range				Standard Deviation	
			Male	Female	Male	Female	Male		Female		Male	Female
							High	Low	High	Low		
MAI-686	<i>P. aztecus</i>	N	6	15	32.8	33.1	35	31	50	21	1.3	7.2
		F	21	29	38.0	43.2	48	25	55	31	6.6	7.6
MAI-686	<i>T. similis</i>	N	2	31	18.5	28.7	20	17	36	20	2.1	3.5
		F	4	83	21.8	29.9	26	18	37	23	3.5	3.3
MAI-686	<i>C. similis</i>	N	127	22	40.6	51.3	79	27	75	27	9.7	16.1
		F	119	15	40.9	63.2	100	27	72	50	14.5	6.3
MU-A85	<i>P. aztecus</i>	N	23	27	48.8	58.6	57	40	78	44	5.5	8.4
		F	16	34	50.5	58.9	65	41	71	43	6.1	7.3
MU-A85	<i>T. similis</i>	N	0	3	-	33.7	-	-	36	32	-	2.1
		F	2	41	22.0	33.8	23	21	38	25	1.4	2.9
MU-A85	<i>S. atlantidis</i>	N	19	29	14.5	20.9	20	12	31	10	2.0	5.6
		F	14	39	14.1	21.7	20	11	32	12	2.5	4.7
MU-A85	<i>C. similis</i>	N	10	0	42.6	-	75	29	-	-	13.1	-
		F	9	0	40.6	-	48	36	-	-	4.5	-
MU-A85	<i>P. spinicarpus</i>	N	8	42	47.0	41.0	51	37	55	28	4.4	-
		F	1	73	41.0	36.7	41	41	56	18	-	7.2
HI-A389	<i>S. atlantidis</i>	N	21	10	14.6	21.0	17	13	30	13	1.1	4.9
		F	3	3	15.3	25.0	16	15	30	15	0.6	8.7
HI-A389	<i>P. spinicarpus</i>	N	15	17	52.4	51.9	60	42	60	41	5.6	5.4
		F	0	2	-	46.5	-	-	47	46	5.6	0.7
HI-A389	<i>M. quinquespinosa</i>	N	1	2	17.0	24.0	17	17	26	22	-	2.8
		F	7	7	23.0	21.7	28	17	33	13	4.1	6.5
HI-A389	<i>A. alexandria</i>	N	2	3	27.5	24.7	33	22	27	23	7.8	2.1
		F	13	8	31.3	27.6	41	13	34	21	8.1	3.9

^aN=near-field station; F=far-field station.

^bAll measurements in mm, "-" indicates no data.

Table 5.42. (Cont.)

Platform	Species	Station ^a	Number Collected	Mean Size ^b	Size Range		Standard Deviation
					High	Low	
MAI-686	<i>S. empusa</i>	N	50	113.8	142	82	11.7
		F	50	115.0	135	55	14.0
MU-A85	<i>S. empusa</i>	N	13	109.8	133	48	22.4
		F	11	111.3	128	85	15.7
MU-A85	<i>A. cingulatus</i>	N	7	15.7	25	10	15.7
		F	9	15.3	21	9	15.3
MU-A85	<i>A. papyraceum</i>	N	50	46.3	66	22	11.5
		F	50	35.6	57	25	7.7
MU-A85	<i>P. albida</i>	N	18	52.9	64	41	7.1
		F	50	52.2	69	40	6.8
HI-A389	Hermit crabs	N	22	11.5	23	7	11.5
		F	24	12.9	23	7	4.6
HI-A389	<i>S. empusa</i>	N	25	111.5	167	75	24.6
		F	7	143.0	164	100	20.6
HI-A389	<i>A. cingulatus</i>	N	5	12.2	22	3	7.4
		F	5	15.6	18	13	2.3

^aN=near-field station; F=far-field station.

^bAll measurements in mm, "-" indicates no data.

Table 5.43. Summary of the numbers of individuals collected and size range for overlapping species at each platform during Cruise 3.

Platform	Species	Station ^a	Number Collected		Mean Size ^b		Size Range				Standard Deviation	
			Male	Female	Male	Female	Male		Female		Male	Female
MAI-686	<i>P. aztecus</i>	N	13	9	41.1	39.6	56	33	48	31	6.0	4.9
		F	24	28	42.5	44.7	57	35	61	35	5.9	6.2
MAI-686	<i>T. similis</i>	N	71	1210	18.2	29.1	24	11	39	12	2.8	3.9
		F	318	1228	16.2	26.8	31	10	39	9	3.4	6.4
MAI-686	<i>C. similis</i>	N	3	4	44.7	46.5	50	38	52	38	6.1	6.2
		F	19	9	59.2	47.3	83	41	67	38	13.2	8.9
MAI-686	<i>P. gibbesii</i>	N	0	9	-	46.2	-	-	59	30	8.3	4.7
		F	0	57	-	42.5	-	-	84	30	10.4	8.4
MAI-686	<i>S. empusa</i>	N	67	50	101.7	101.4	125	60	135	64	12.1	16.1
		F	56	55	93.5	95.8	113	57	126	56	12.6	19.2
MAI-686	<i>S. chydrea</i>	N	4	5	67.8	73.6	78	63	78	71	6.9	2.7
		F	19	47	66.9	70.4	78	56	93	50	5.9	9.9
MU-A85	<i>P. aztecus</i>	N	10	31	52.2	61.0	57	46	73	54	2.9	5.7
		F	22	36	54.0	61.9	63	46	80	54	3.8	6.0
MU-A85	<i>T. similis</i>	N	2	7	17.5	25.1	18	17	28	20	0.7	2.9
		F	3	19	16.0	23.0	16	16	31	18	0.0	3.8
MU-A85	<i>S. atlantidis</i>	N	33	56	14.1	20.2	20	8	30	6	2.3	5.6
		F	35	57	14.6	20.7	25	10	30	10	2.5	4.4
MU-A85	<i>P. spinicarpus</i>	N	0	91	-	33.9	-	-	46	20	-	4.7
		F	0	18	-	40.7	-	-	61	44	-	8.4
MU-A85	<i>S. chydrea</i>	N	22	29	84.1	90.4	112	13	118	52	24.5	18.8
		F	0	1	-	127.0	-	-	127	127	-	-
HI-A389	<i>S. atlantidis</i>	N	6	8	15.3	23.1	17	14	33	18	1.5	4.5
		F	33	39	16.2	22.8	19	13	32	12	1.6	5.5
HI-A389	<i>P. similis</i>	N	7	89	13.0	21.0	14	11	31	9	1.2	4.3
		F	8	65	13.3	21.3	18	9	30	8	3.1	4.9
HI-A389	<i>P. spinicarpus</i>	N	0	16	-	50.8	-	-	61	45	-	4.6
		F	0	1	-	31.0	-	-	31	31	-	-
HI-A389	<i>A. alexandria</i>	N	1	0	24.0	-	24	24	-	-	-	-
		F	7	3	30.0	26.0	40	18	30	20	8.2	5.3
HI-A389	Hermit crabs	N	2	4	10.0	6.3	11	9	8	5	1.4	1.5
		F	6	4	11.8	9.8	16	9	13	6	2.9	2.9
HI-A389	<i>S. chydrea</i>	N	1	4	118.0	107.3	118	118	110	102	-	3.6
		F	1	1	105.0	83.0	105	105	83	83	-	-
HI-A389	<i>S. edentata</i>	N	2	0	98.5	-	121	76	-	-	31.8	-
		F	3	1	119.3	137.0	130	108	137	137	11.0	-

Platform	Species ^c	Station	Number Collected	Mean Size	Size Range		Standard Deviation
					High	Low	
MAI-686	<i>A. duplicatus</i>	N	16	8.4	12	5	2.4
		F	351	6.6	17	3	1.8
MU-A85	<i>A. papyraceum</i>	N	27	45.6	65	29	8.5
		F	149	50.6	65	26	7.1

^aN=near-field station; F=far-field station.

^bAll measurements in mm, "-" indicates no data.

^cSpecies listed at bottom of table were not sexed based on external characteristics in the field so the results include both males and females.

Table 5.44. Summary of the number of individuals collected for overlapping species at each platform during Cruise 4.

Platform	Species	Station ^b	Number Collected ^a			Mean Size			Size Range ^c						Standard Deviation			
			M	F	Int.	M	F	Int.	Male		Female		Int.		M	F	Int	
									High	Low	High	Low	High	Low				
MAI-686	<i>P. aztecus</i>	N	5	4	-	35.8	36.0	-	40	30	40	32	-	-	3.6	3.4	-	
		F	51	63	-	33.9	36.3	-	41	25	46	23	-	-	3.4	4.1	-	
MAI-686	<i>T. similis</i>	N	20	72	-	20.1	28.3	-	22	18	34	20	-	-	0.9	2.6	-	
		F	28	301	-	20.4	28.4	-	22	16	38	16	-	-	1.4	3.0	-	
MAI-686	<i>C. similis</i>	N	200	12	165	44.9	62.6	40.1	93	29	75	52	67	22	9.4	7.2	6.4	
		F	77	28	30	59.2	66.3	41.6	107	30	78	53	64	31	21.9	5.7	9.4	
MAI-686	<i>P. gibbesii</i>	N	0	35	10	-	40.6	35.2	-	-	-	57	30	45	27	-	5.2	7.2
		F	6	23	10	48.5	43.6	42.6	57	41	52	30	52	28	5.7	5.5	8.4	
MAI-686	<i>S. empusa</i>	N	17	33	-	91.8	92.8	-	100	78	127	79	-	-	6.9	9.9	-	
		F	41	30	-	95.4	99.3	-	122	100	192	72	-	-	16.6	20.5	-	
MAI-686	<i>S. chydrea</i>	N	0	5	-	-	79.6	-	-	-	89	73	-	-	-	6.1	-	
		F	0	7	-	-	82.4	-	-	-	90	72	-	-	-	7.5	-	
MU-A85	<i>P. aztecus</i>	N	0	9	-	-	70.6	-	-	-	79	65	-	-	-	4.1	-	
		F	8	17	-	57.0	71.1	-	60	52	80	64	-	-	2.7	4.1	-	
MU-A85	<i>S. atlantidis</i>	N	63	52	-	15.7	24.4	-	19	11	31	14	-	-	1.7	4.7	-	
		F	44	92	-	17.0	26.1	-	20	14	35	15	-	-	1.5	4.5	-	
MU-A85	<i>P. spinipectus</i>	N	0	4	12	-	45.8	41.0	-	-	50	40	53	32	-	4.3	7.8	
		F	0	40	53	-	48.0	48.5	-	-	56	40	60	25	-	4.4	8.2	
MU-A85	<i>S. chydrea</i>	N	13	11	-	94.8	87.7	-	131	54	132	50	-	-	25.6	29.3	-	
		F	1	3	-	90.0	111.7	-	90	90	133	89	-	-	-	22.0	-	
HI-A389	<i>S. atlantidis</i>	N	24	41	-	15.1	23.9	-	19	10	35	15	-	-	1.9	3.9	-	
		F	7	15	-	16.9	25.5	-	20	14	35	18	-	-	2.0	4.9	-	
HI-A389	<i>M. quinquespinosa</i>	N	8	3	-	19.0	20.7	-	25	16	26	18	-	-	2.9	4.6	-	
		F	6	4	-	23.0	25.0	-	28	16	36	15	-	-	4.3	8.6	-	
HI-A389	<i>A. alexandria</i>	N	7	2	-	29.3	34.0	-	38	22	36	32	-	-	6.7	2.8	-	
		F	11	6	-	21.3	29.7	-	44	12	36	13	-	-	9.9	2.8	-	
HI-A389	Hermit crabs	N	4	0	-	12.8	-	-	18	10	-	-	-	-	3.6	-	-	
		F	2	1	-	18.5	14.0	-	22	15	14	14	-	-	4.9	-	-	

Platform	Species ^d	Station	Number Collected	Mean Size	Size Range		Standard Deviation
					High	Low	
MAI-686	<i>A. duplicatus</i>	N	129	9.8	15	6	9.8
		F	128	9.3	16	7	1.9
MU-A85	<i>A. cingulatus</i>	N	8	12.0	26	6	7.6
		F	44	13.9	23	7	3.5
MU-A85	<i>A. papyraceum</i>	N	53	30.2	66	21	8.5
		F	117	45.7	67	20	13.7
HI-A389	<i>A. cingulatus</i>	N	6	16.5	22	10	4.6
		F	14	12.0	17	9	2.5

^aM=male; F=Female; Int.=intermediate, immature stage for crab species.

^bN=near-field station; F=far-field station.

^cAll measurements are in mm, "-" indicates no data.

^dSpecies listed at end of table were not sexed through external observation and therefore contain both males and females.

measured on Cruise 1 were not separated by sex, so the results include both males and females. Three generalities were apparent from these data. First, for several species, a difference in mean size of individuals existed between the Near and Far stations. Second, for several species, individuals of one sex had a different mean size than individuals of the other sex. Third, for several species, more individuals of one sex were collected as compared to the other sex.

Size frequency histograms were constructed for each species from the field measurements of individuals collected at both the Near and Far stations at each platform. Three examples of size-frequency distributions are presented as histograms in Figures 5.119 to 5.121. Examples show that *A. duplicatus* at MAI-686 were larger at the Near station, whereas individual *S. atlantidis* at HI-A389 and *A. papyraceum* at MU-A85 were larger at the Far station. A more detailed statistical analysis is provided in Section 6.4.

5.6.3 Histopathology

Little information exists in the periodical literature on the normal histology or histopathology of many of the offshore species collected. *P. aztecus* is an important exception in that information on common parasites and pathologies was available, due mostly to its commercial value (Murchelano and MacLean 1990). Common parasites observed in shrimp tissues were nematodes, cestodes, and a virus cf. *Baculovirus* and common pathologies included gut inflammations and cysts in muscle or connective tissue (see also Overstreet 1978). Crabs were also parasitized by nematodes and had maladies of the gills such as malformed gill filaments and gill filaments with inclusive bodies. Starfish were often highly parasitized by nematodes. Scallops were also parasitized by nematodes, and a few individuals had unidentified encysted masses in the mantle tissue. Parasites and pathologies were not recognized in the species of mantis shrimp collected.

Prevalence and intensity of infection were calculated for each of the main categories of parasites and pathologies for each species at both the Near and Far stations for each platform. *P. aztecus* was consistently the most highly parasitized species at any of the platforms (Table 5.45). Nearly every individual of *P. aztecus* analyzed had at least one of the major parasites or pathologies present. Prevalence of nematodes in *P. aztecus* ranged from

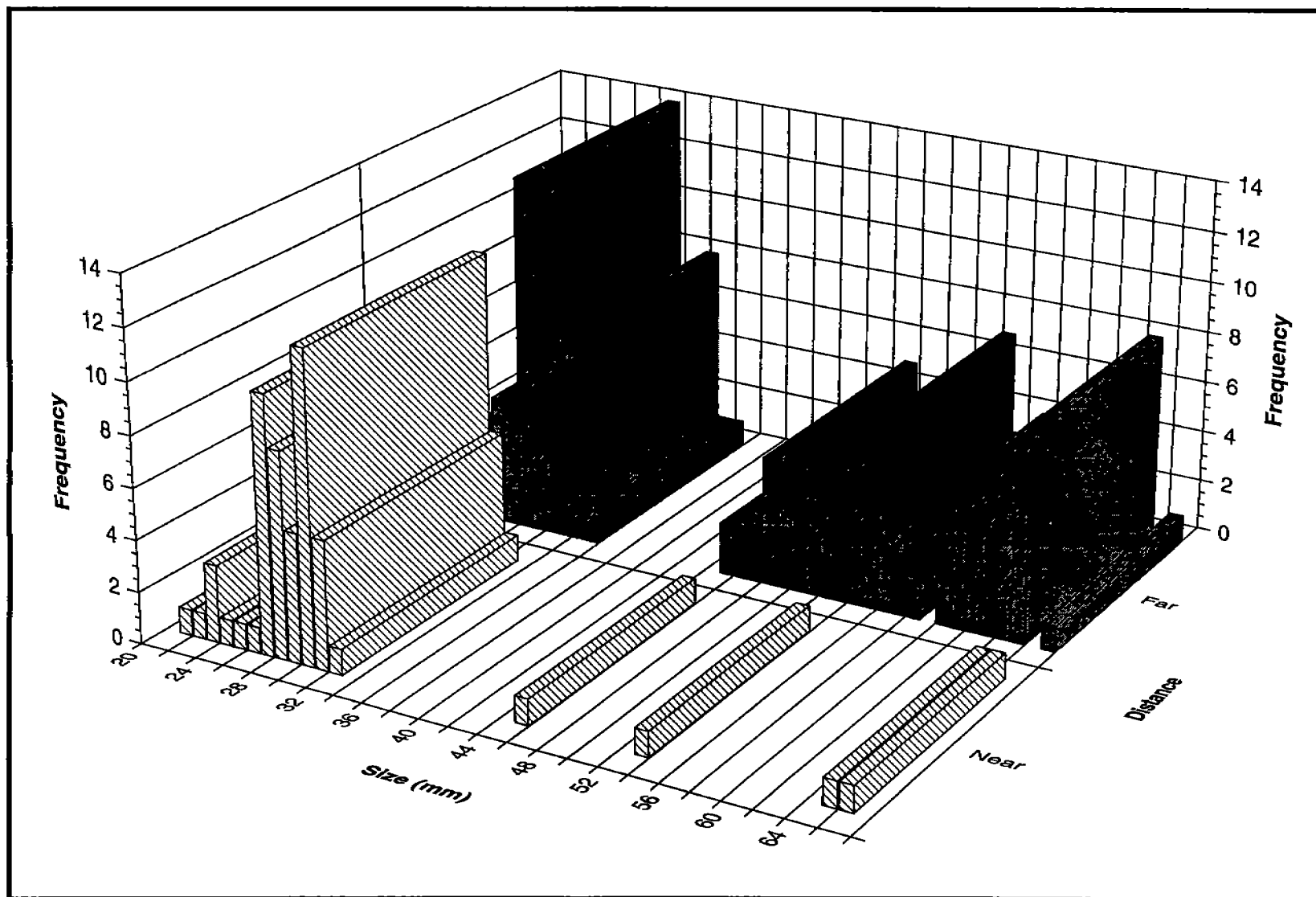

Figure 5.119. Size frequency distributions for the mollusc *Amusium papyraceum* at MU-A85.

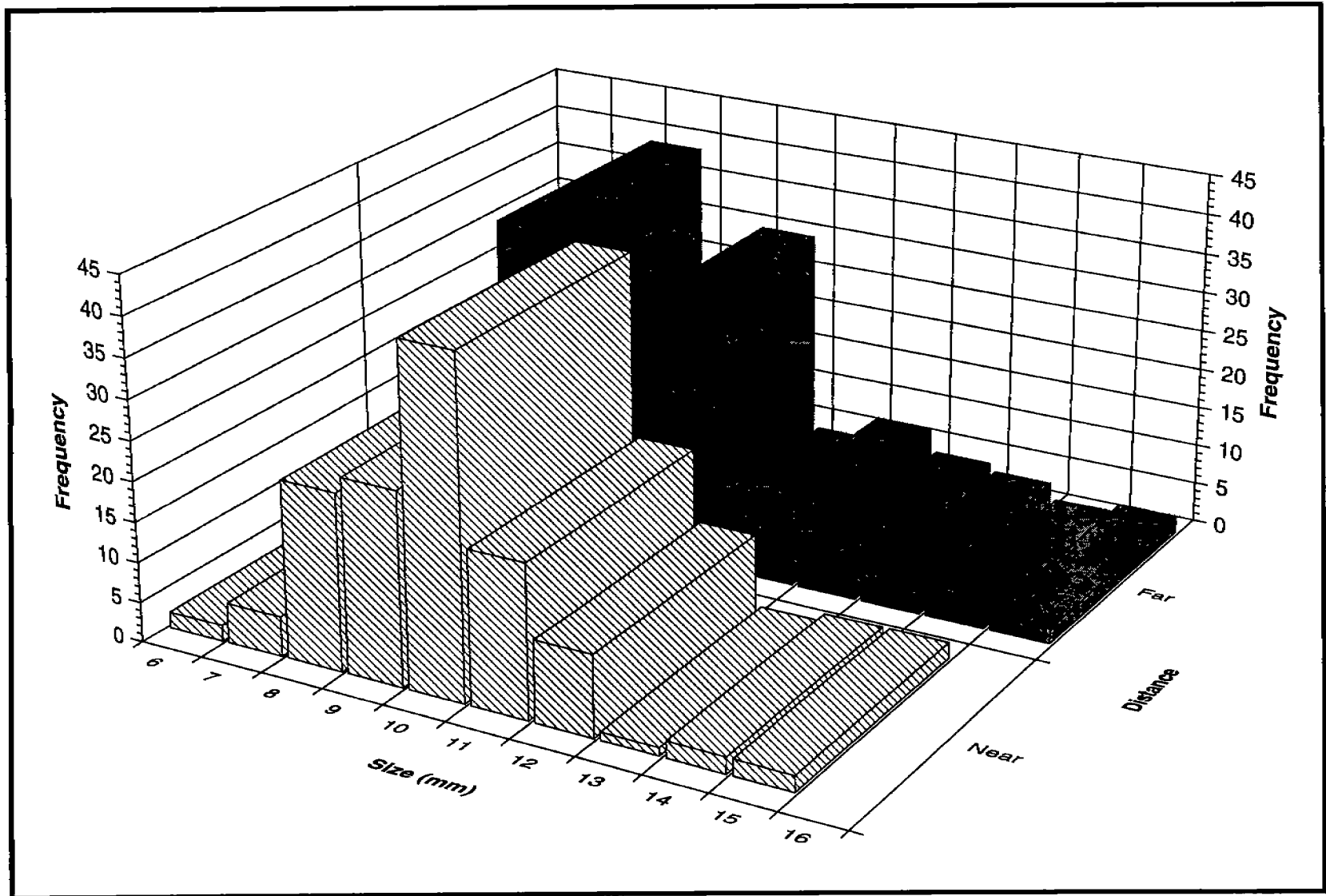

Figure 5.120. Size frequency distributions for *Astropecten duplicatus* at MAI-686.

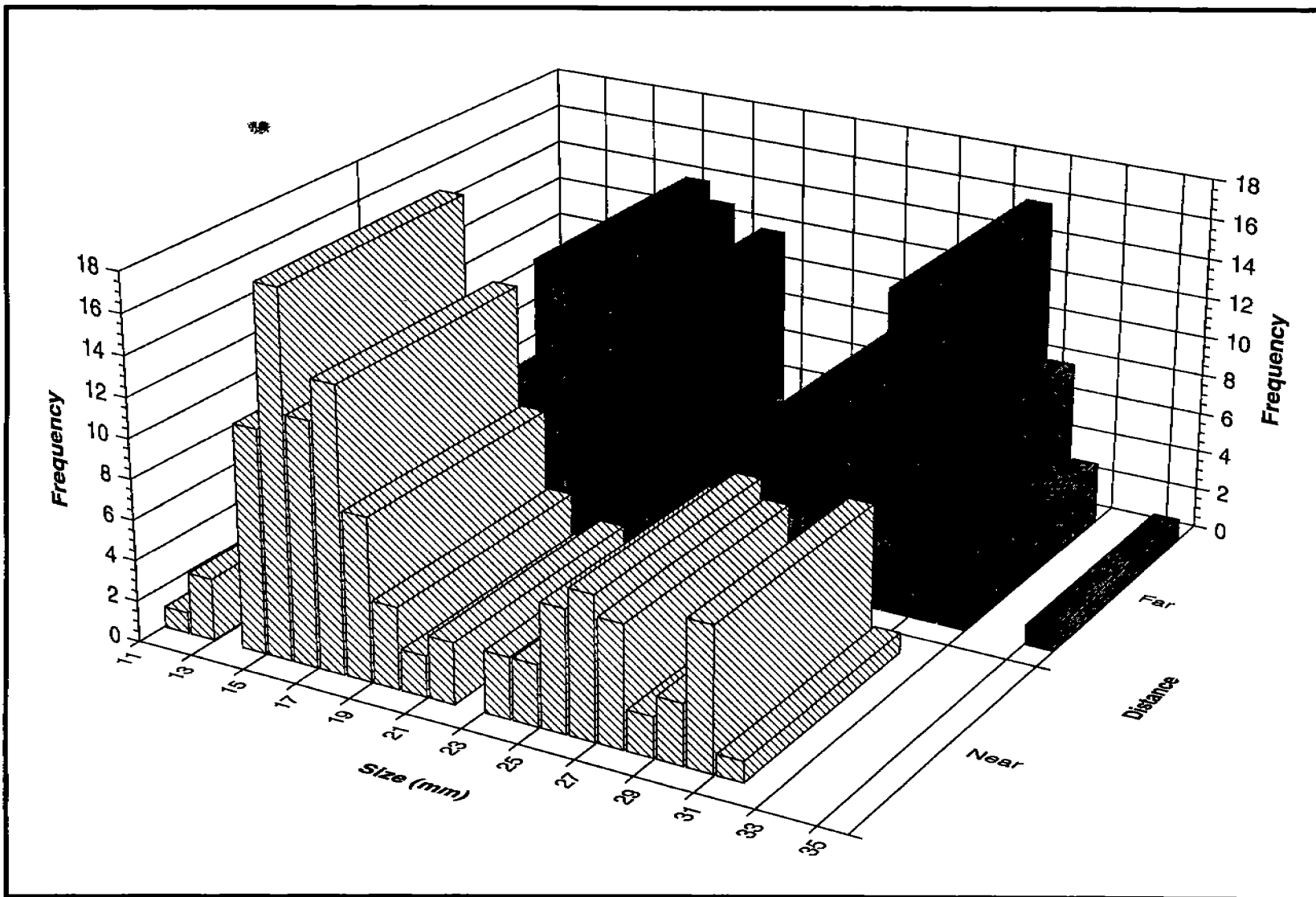

Figure 5.121. Size frequency distributions for *Solenocera atlantidis* at MU-A85.

Table 5.45. Prevalence and intensity of each parasite and pathology in the shrimp species collected during all four cruises.

Cruise	Site/Station	Pathology/Parasite ^a									
		Nematode		Cestode		Inflamed Gut		Baculo-virus		Cyst	
		P	I	P	I	P	I	P	I	P	I
<i>Penaeus aztecus</i>											
1	MAI-686 Near	40	6.0	40	1.0	40	1.0	-	-	0	0
	Far	80	6.8	0	0	0	0	-	-	40	2.5
1	MU-A85 Near	80	3.3	0	0	20	2.0	20	45	20	1.0
	Far	80	2.3	20	2.0	80	1.3	0	0	40	1.0
1	MAI-622 Near	100	2.2	19	1.0	60	2.0	-	-	-	-
	Far	60	1.7	40	1.0	0	0	-	-	-	-
2	MAI-686 Near	70	3.3	30	2.0	20	1.0	-	-	30	1.0
	Far	80	8.4	40	1.3	40	1.5	-	-	20	1.0
2	MU-A85 Near	100	5.7	10	1.0	20	1.0	50	24	30	1.3
	Far	70	6.1	10	1.0	10	3.0	60	121	60	2.2
3	MAI-686 Near	50	3.4	20	1.0	30	1.0	-	-	0	0
	Far	60	6.2	30	1.0	11	3.0	-	-	11	2.0
3	MU-A85 Near	80	28	10	1.0	-	-	-	-	20	1.0
	Far	100	26	11	3.0	-	-	-	-	11	2.0
4	MAI-686 Near	60	6.2	40	1.3	20	1.5	-	-	-	-
	Far	80	1.8	20	1.0	30	2.3	-	-	-	-
4	MU-A85 Near	100	19	0	0	11	1.0	-	-	11	1.0
	Far	80	13	10	1.0	10	1.0	-	-	0	0
<i>Trachypenaeus similis</i>											
1	MAI-686 Near	40	1.0	-	-	0	0	0	0	-	-
	Far	20	1.0	-	-	20	1.0	20	38	-	-
1	MAI-622 Near	20	1.0	20	1.0	0	0	-	-	-	-
	Far	25	1.0	0	0	25	1.0	-	-	-	-
2	MAI-686 Near	50	2.2	30	1.0	0	0	0	0	20	1.0
	Far	60	3.2	10	1.0	30	1.3	10	4.0	20	1.0
2	MU-A85 Near	100	4.0	0	0	-	-	-	-	-	-
	Far	40	1.8	10	1.0	-	-	-	-	-	-
3	MAI-686 Near	20	1.0	20	1.0	10	1.0	-	-	-	-
	Far	10	3.0	0	0	10	1.0	-	-	-	-
3	MU-A85 Near	-	-	0	0	0	0	-	-	-	-
	Far	-	-	10	2.0	10	2.0	-	-	-	-
4	MAI-686 Near	20	1.0	60	1.3	20	1.0	-	-	-	-
	Far	10	1.0	20	1.0	0	0	-	-	-	-

^aP = Prevalence (% of individuals with the parasite or pathology); I = Intensity (average number of occurrences of parasite or pathology in those individuals that exhibit the parasite or pathology; "-" indicates no data).

Table 5.45. (Cont.)

Cruise	Site/Station	Pathology/Parasite ^a									
		Nematode		Cestode		Inflamed Gut		Baculo-virus		Cyst	
		P	I	P	I	P	I	P	I	P	I
<i>Solenocera atlantidis</i>											
2	MU-A85 Near	20	2.0	-	-	-	-	-	-	-	-
	Far	30	1.0	-	-	-	-	-	-	-	-
2	HI-A389 Near	20	1.0	10	1.0	-	-	-	-	-	-
	Far	0	0	0	0	-	-	-	-	-	-
3	MU-A85 Near	30	2.3	-	-	20	1.0	-	-	-	-
	Far	0	0	-	-	0	0	-	-	-	-
3	HI-A389 Near	10	1.0	0	0	-	-	-	-	-	-
	Far	10	1.0	10	1.0	-	-	-	-	-	-
4	MU-A85 Near	30	1.7	-	-	-	-	-	-	-	-
	Far	50	3.2	-	-	-	-	-	-	-	-
4	HI-A389 Near	30	1.3	10	1.0	0	0	-	-	-	-
	Far	0	0	20	1.0	10	1.0	-	-	-	-
<i>Parapenaeus similis</i>											
3	HI-A389 Near	0	0	0	0	-	-	-	-	-	-
	Far	0	0	10	1.0	-	-	-	-	-	-

^aP = Prevalence (% of individuals with the parasite or pathology); I = Intensity (average number of occurrences of parasite or pathology in those individuals that exhibit the parasite or pathology; "-" indicates no data).

40 % to 100 %. The highest mean intensities were 26 (Far) and 28 (Near) nematodes per individual at MU-A85 on Cruise 3. Specific individuals collected from MU-A85 on Cruise 3 were parasitized at the rate of 131 and 146 nematodes, respectively. The other common parasites and pathologies were present but in much lower prevalences and intensities. At least one epizootic of cf. *Baculovirus* was sampled in *P. aztecus* at MU-A85 (Cruise 2). This epizootic occurred at both the Near and Far stations, suggesting a widespread viral outbreak in the population. Viruses such as cf. *Baculovirus* (Murchelano and MacLean 1990) can cause mass mortalities in populations contained in mariculture conditions. Cysts and gut inflammations were present in the population in low to medium prevalences. Intensities were also typically low, usually averaging only 1 to 3 occurrences per individual. *T. similis* and *S. atlantidis* were also frequently parasitized by nematodes, however, intensities were typically low. High prevalences of cf. *Baculovirus* were also observed in *T. similis* at MAI-686 during both Cruises 1 and 2.

Unlike the epizootic noted in *P. aztecus*, cf. *Baculovirus* was only found at the Far stations, suggesting that the Near and Far stations were separate populations.

In general, parasites and pathologies occurred infrequently in crabs (Table 5.46). For example, the prevalence of nematode infection was never greater than 40 % and many stations had no individuals parasitized by nematodes. In all species of crabs gill maladies were more common than parasitism by nematodes. Prevalence of malformed gill filaments reached highs of 67 % at Near stations and 60 % at Far stations, and the prevalence of gill filaments with inclusive bodies ranged from 60 % at Near stations to 30 % at Far stations.

Nematodes were the only parasite or pathology recognized in species of starfish (Table 5.47). *A. cingulatus* had prevalences as high as 60 % with intensities as high as 5 per individual. *A. duplicatus* collected from MAI-686 were more highly parasitized. Prevalence was never less than 90 % on either Cruise 3 or 4. In both cases, prevalence was 100 % at the Far station. Intensities were also high, with means as high as 13.6 nematodes per individual, at the Far station. Scallops were also parasitized by nematodes but prevalence and intensity were typically low at both the Near and Far stations.

5.6.4 Reproductive Effort

Little is known about the reproductive effort of most continental shelf invertebrates. Shrimp species such as *P. aztecus* and *P. setiferus* and the blue crab, *Callinectes sapidus*, have been well studied because of their commercial value (Chamberlain and Lawrence 1983; King 1948; Hard 1942). Several methods were utilized to assess differences in the reproductive effort of invertebrate species living near and far from platforms. Differences in male-to-female ratios; percent gravid females (crab species); and stage of reproductive development determined by visual inspection, histological analysis, and immunological probe were used as indicators of possible sublethal effects of exposure to chemical contaminants or other platform related factors.

Table 5.46. Prevalence and intensity of parasitism and pathologies in the crab species collected on all four cruises.

Cruise	Site/Station	Species	Parasite/Pathology ^a					
			Nematode		Malformed gill filaments		Gill filament with body	
			P	I	P	I	P	I
1	MAI-686 Near	<i>Callinectes similis</i>	-	-	0	0	0	0
	Far		-	-	40	3.0	20	2.0
1	GA-288 Near	<i>Callinectes similis</i>	0	0	-	-	-	-
	Far		33	1.0	-	-	-	-
2	MAI-686 Near	<i>Callinectes similis</i>	10	1.0	40	3.0	-	-
	Far		0	0	20	2.5	-	-
2	MU-A85 Near	<i>Callinectes similis</i>	-	-	67	1.0	-	-
	Far		-	-	20	2.5	-	-
3	MAI-686 Near	<i>Callinectes similis</i>	-	-	14	1.0	14	1.0
	Far		-	-	10	3.0	10	1.0
4	MAI-686 Near	<i>Callinectes similis</i>	-	-	40	3.3	20	2.0
	Far		-	-	40	2.0	30	1.0
1	MU-A85 Near	<i>Portunus spinicarpus</i>	40	1.0	20	2.0	60	2.0
	Far		0	0	0	0	0	0
2	MU-A85 Near	<i>Portunus spinicarpus</i>	40	2.3	0	0	10	1.0
	Far		40	3.3	10	1.0	0	0
3	MU-A85 Near	<i>Portunus spinicarpus</i>	-	-	10	1.0	10	1.0
	Far		-	-	0	0	0	0
4	MU-A85 Near	<i>Portunus spinicarpus</i>	20	2.5	0	0	30	1.7
	Far		20	1.5	0	0	0	0
1	MAI-686 Near	<i>Portunus gibbesii</i>	20	1.0	0	0	-	-
	Far		0	0	20	3.0	-	-
1	MAI-622 Near	<i>Portunus gibbesii</i>	-	-	20	1.0	20	1.0
	Far		-	-	0	0	20	2.0
3	MAI-686 Near	<i>Portunus gibbesii</i>	-	-	25	3.0	13	1.0
	Far		-	-	60	1.5	20	2.0
4	MAI-686 Near	<i>Portunus gibbesii</i>	10	1.0	30	2.3	0	0
	Far		0	0	10	3.0	10	1.0
2	HI-A389 Near	Hermit crabs	9	1.0	-	-	-	-
	Far		23	3.0	-	-	-	-
3	HI-A389 Near	Hermit crabs	33	1.5	-	-	-	-
	Far		40	2.0	-	-	-	-
2	HI-A389 Near	<i>M. quinquespinosa</i>	0	0	-	-	0	0
	Far		10	8.0	-	-	10	1.0
4	HI-A389 Near	<i>M. quinquespinosa</i>	11	2.0	-	-	-	-
	Far		11	2.0	-	-	-	-

^aP=prevalence (% of individuals with the parasite or pathology); I=intensity (average number of occurrences of parasite or pathology in those individuals that exhibit the parasite or pathology); "-" indicates no data.

Table 5.47. Prevalence and intensity of parasitism and pathologies of starfish and scallop tissues collected on all four GOOMEX cruises.

Cruise	Site	Station	Species	Nematodes	
				Prevalence ^a	Intensity ^b
2	MU-A85	Near	<i>Astropecten cingulatus</i>	0	0
		Far		11	5.0
4	MU-A85	Near	<i>Astropecten cingulatus</i>	60	1
		Far		30	4
4	HI-A389	Near	<i>Astropecten cingulatus</i>	0	0
		Far		10	2
3	MAI-686	Near	<i>Astropecten duplicatus</i>	90	3
		Far		100	8
4	MAI-686	Near	<i>Astropecten duplicatus</i>	90	7
		Far		100	14
2	MU-A85	Near	<i>Amusium papyraceum</i>	10	3
		Far		30	3
4	MU-A85	Near	<i>Amusium papyraceum</i>	10	3
		Far		20	3

^aPrevalence is the percent of individuals infected with a particular parasite or pathology.

^bIntensity is the average number of occurrences of the parasite or pathology in those individuals exhibiting the parasite or pathology.

5.6.5 Male-to-Female Ratios and Percent Gravid Females

Immediately after collection, individuals of target species were sexed by visual inspection. Only species with obvious external sexual characteristics, such as shrimp (presence of thyleca or claspers), crabs (shape of ventral carapace), and stomatopods (presence of claspers) were sexed in this way. For species of shrimp, individuals collected at both the Near and Far stations were overwhelmingly female, with male:female ratios as low as 1:17 (*T. similis*, MAI-686, far-field, Table 5.48). More male than female crabs and stomatopods were typically collected, particularly at HI-A389, but the number of males was not overwhelming compared to the number of females. The fact that the majority of shrimp collected were female may result from the females being larger, and therefore females may be retained more efficiently by the trawl nets. Brusher et al. (1972) collected female *T. similis* in numbers as high as 50 times that of males and also suggested that males were not easily retained in the net because of their small size. Alternatively, females may simply outnumber males in the natural populations.

Table 5.48. Male:Female ratios for species collected at Near and Far stations. Only species with obvious external sexual characteristics were included in this analysis.

Platform	Species	Male:Female ^a	
		Near	Far
Cruise 1			
Not measured			
Cruise 2			
MAI-686	<i>T. similis</i>	2:31	4:84
	<i>P. aztecus</i>	6:15	21:29
	<i>C. similis</i>	127:22	1:73
MU-A85	<i>T. similis</i>	0:3	2:41
	<i>P. aztecus</i>	23:27	16:34
	<i>S. atlantidis</i>	18:29	14:39
	<i>C. similis</i>	10:0	9:0
HI-A389	<i>P. spinicarpus</i>	8:42	1:73
	<i>S. atlantidis</i>	22:10	3:3
	<i>M. quinquespinosa</i>	1:2	7:7
	<i>A. alexandria</i>	2:3	13:8
	<i>P. spinicarpus</i>	15:17	0:2
Cruise 3			
MAI-686	<i>T. similis</i>	35:586	339:1342
	<i>P. aztecus</i>	4:3	23:25
	<i>C. similis</i>	3:4	3:2
	<i>P. gibbesii</i>	0:9	0:53
	<i>S. empusa</i>	67:50	1:1
	<i>S. chydæa</i>	4:5	9:23
MU-A85	<i>T. similis</i>	2:7	1:3
	<i>P. aztecus</i>	10:31	11:18
	<i>S. atlantidis</i>	33:56	33:57
	<i>P. spinicarpus</i>	0:91	0:18
HI-A389	<i>S. atlantidis</i>	3:4	11:13
	<i>P. similis</i>	7:89	8:65
	Hermit crabs	1:2	3:2
Cruise 4			
MAI-686	<i>T. similis</i>	5:18	14:151
	<i>P. aztecus</i>	5:4	51:63
	<i>P. gibbesii</i>	13:32	16:25
	<i>S. chydæa</i>	13:16	1:11
	<i>S. empusa</i>	17:33	41:30
MU-A85	<i>P. aztecus</i>	0:9	8:17
	<i>S. atlantidis</i>	31:26	11:23
	<i>P. spinicarpus</i>	3:1	57:39
	<i>S. chydæa</i>	13:11	1:3
HI-A389	<i>S. atlantidis</i>	23:41	7:15
	<i>P. spinicarpus</i>	1:4	-
	<i>M. quinquespinosa</i>	8:3	3:2
	<i>A. alexandria</i>	7:2	11:6
	Hermit crabs	4:0	2:1

^a "-" indicates no data

Differences in the percentage of gravid female crabs were determined for each species collected at both the Near and Far stations (Table 5.49). A gravid female crab was one collected 'in sponge', that is, with a visible egg sac. When a difference in the percent gravid females existed between the Near and Far station, more gravid females were collected more frequently at the Far station, however this difference was not statistically significant. Each egg mass collected from gravid females was immediately frozen in liquid nitrogen. In the laboratory, the egg masses were weighed, lyophilized and reweighed. The average wet weight (g) of the egg sacs for each species is presented in Table 5.49. Where differences in egg sac weights exist between the Near and Far stations, the egg sacs were heaviest at the Far station regardless of species or platform.

Differences in weight could result from differences in fecundity, egg size, or time since spawning. Generally, larger individuals should have larger egg sacs (Somers 1991; Wenner et al. 1991). A good relationship exists between the wet weight of egg sacs and the body size of individuals. An example of the relationship between the wet weight of the egg sac and body length for *C. similis* collected from MAI-686 is shown in Figure 5.122. Because of this relationship, a gonadal-somatic index (GSI) was calculated using the relationship between egg sac dry weight and body dry weight and then, body weight-specific changes in egg sac weight were examined. GSI was calculated for individuals collected during the last two cruises (Table 5.50).

Changes in egg composition have been related to egg quality and, ultimately, juvenile survivorship. As eggs mature, the chemical composition also changes. Older eggs may have less protein because the yolk protein is being metabolized, for instance. Time-dependent changes in egg composition are unknown for these portunid crabs, so the two alternatives cannot be distinguished. Nevertheless, egg sacs collected from gravid females were analyzed for percent protein and percent water. In the three cases where overlap between the Near and Far station existed for a species, the site with the highest GSI also had the lowest percent protein in the egg sacs. Higher GSI indicates that the egg mass was heavier in comparison to the body weight of the individual. Decreased protein could indicate differences in maturity, but then, a consistent relationship with GSI might not be expected.

Table 5.49. The percent of female crabs collected that were gravid and average wet weight (g) of the egg sacs at each site for each cruise.

Species	Site ^a					
	MAI-686		MU-A85		HI-A389	
	Near	Far	Near	Far	Near	Far
Cruise 1						
<i>C. similis</i>	0.0	4.0	NC	22.0	-	-
		2.05	-	4.48		
<i>P. gibbesii</i>	60.0	38.0	-	-	-	-
	0.88	0.60	-	-	-	-
<i>P. spinicarpus</i>			0.0	13.0		
				0.78		
Cruise 2						
<i>C. similis</i>	13.0	13.0	0.0	0.0	-	-
	1.66	3.58	-	-	-	-
<i>P. gibbesii</i>	12.0	NC	-	-	-	-
	0.93	-	-	-	-	-
<i>P. spinicarpus</i>	-	-	7.0	1.0	0.0	0.0
	-	-	0.62	0.69	-	-
Cruise 3						
<i>C. similis</i>	0.0	0.0	-	-	-	-
	-	-	-	-	-	-
<i>P. gibbesii</i>	11.0	2.0	-	-	-	-
	1.20	0.45	-	-	-	-
<i>P. spinicarpus</i>	-	-	1.0	6.0	44.0	0.0
	-	-	0.40	1.14	1.43	
<i>A. alexandria</i>	-	-	-	-	0.0	0.0
	-	-	-	-	-	-
hermit crabs	-	-	-	-	0.0	20.0
	-	-	-	-	-	--
Cruise 4						
<i>C. similis</i>	1.0	8.0	-	-	-	-
	3.63	4.45	-	-	-	-
<i>P. gibbesii</i>	11.0	25.0	-	-	-	-
	0.94	0.97	-	-	-	-
<i>P. spinicarpus</i>	-	-	0.0	1.0	20.0	NC
	-	-	-	0.75	2.40	-
<i>A. alexandria</i>	-	-	-	-	0.0	6.0
	-	-	-	-	-	--
hermit crabs	-	-	-	-	0.0	0.0
	-	-	-	-	-	-

^aNC = no females of that species were collected. Zeroes indicate that females were collected at that station but none were gravid; "-" indicates no data)

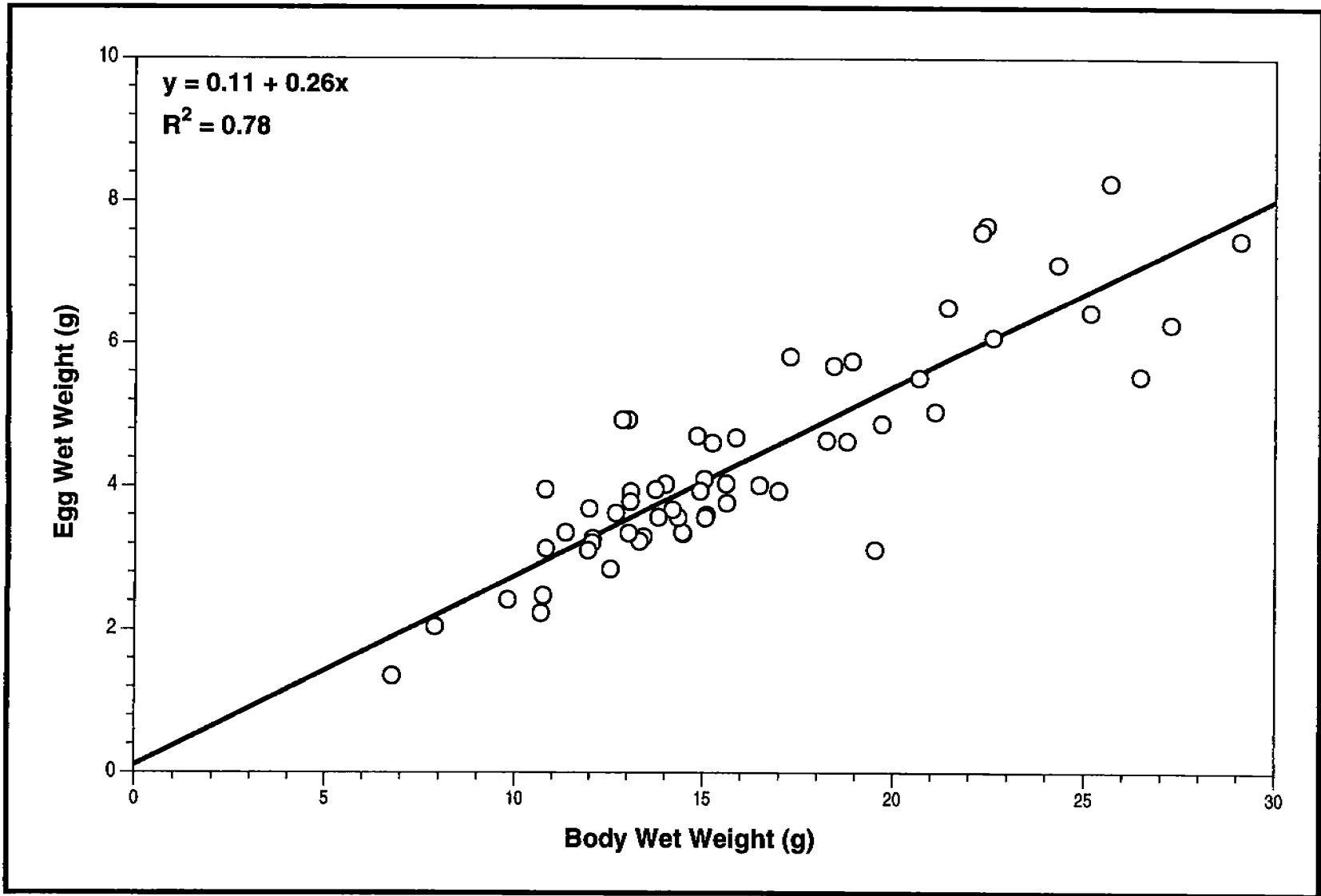

Figure 5.122. Body wet weight versus egg wet weight of *Callinectes similis*.

Table 5.50. Egg protein, percent water and gonadal somatic index (GSI) for egg sacs collected from gravid female crabs.

Cruise	Platform	Site	Species	Average carapace width (mm) ^a	% Protein in Eggs ^a	% Water in Eggs ^a	GSI ^a egg dry wt (g) body dry wt (g)
1	MAI-686	Near	<i>P. gibbesii</i>	-	36.6	30.9	-
	HI-A389	Near	<i>P. spinicarpus</i>	-	30.4	25.7	-
3	MAI-686	Far	<i>P. gibbesii</i>	43.7	28.9	32.9	0.081
	MU-A85	Near	<i>P. spinicarpus</i>	37.9*	38.9*	34.9*	0.144
	MU-A85	Far	<i>P. spinicarpus</i>	44.4*	19.0*	22.2*	0.173*
	HI-A389	Near	<i>P. spinicarpus</i>	48.9	29.7	24.0	0.137
4	MAI-686	Near	<i>C. similis</i>	60.7	23.0	25.7	0.226
	MAI-686	Far	<i>C. similis</i>	64.1	27.1	23.0	0.202
	MAI-686	Near	<i>P. gibbesii</i>	41.7	25.5	25.4	0.139
	MAI-686	Far	<i>P. gibbesii</i>	42.8	34.2	25.8	0.128
	MU-A85	Far	<i>P. spinicarpus</i>	41.4*	36.9*	18.0*	0.142*
	HI-A389	Near	<i>P. spinicarpus</i>	56.8*	21.0*	30.9*	0.174*

^adata from single individuals, "-" indicates no data.

5.6.6 Stage of Reproductive Development

For most species collected, stage of reproductive development was evaluated by two methods; visual inspection and histological analysis. In portunid crabs, an immunological probe was also used. The three methods employed all have unique benefits and complement one another. Visual inspection can be done shipboard, is rapid, provides immediate results, and allows a large number of individuals to be analyzed. However, stage identification is less precise because fewer stages can be discriminated. Histological examination provides more detail because more stages can be discriminated and also allows a relationship with parasitism and pathology to be determined. However, quantification is difficult and only a few individuals can be assayed. The immunological probe provides quantification and a larger number of individuals can be analyzed using a subsample of the homogenate prepared for chemical analyses, but histopathology cannot be assessed. Hence, all three approaches provide useful, albeit different, views of reproductive status.

5.6.6.1 Visual Inspection

The reproductive development stage was determined through visual inspection and gross dissection for all females of the shrimp and crab species. The results of determination of the stage of reproductive development for Cruises 2 through 4 is summarized in Table 5.51. For most of the species at most of the platforms, females were early in their reproductive development. *T. similis* on Cruises 2 and 4 at MAI-686 had individuals that were ripe and nearly ready to spawn. These results agree with the increased frequency of ripe *T. similis* collected during June, July, and September by Brusher et al. (1972), suggesting a mid-summer to early fall spawning season for *T. similis* in the northwest Gulf of Mexico. *C. similis* and *P. gibbesii*, also collected at MAI-686 (Cruise 4), were also mature and preparing to spawn. These results agree with the relatively high percentage of gravid females at this site (Table 5.49).

5.6.6.2 Histological Analysis

The reproductive development stage was determined through histological examination for both males and females of target species and the

Table 5.51. Results of visual inspection and gross dissection for the determination of stage of reproductive development in females of shrimp and crab species collected during Cruises 2, 3, and 4.

Species	Stage ^a	MAI-686		MU-A85		HI-A389	
		Frequency		Frequency		Frequency	
		Near	Far	Near	Far	Near	Far
Cruise 2							
<i>P. aztecus</i>	1	4	16	9	18	-	-
	2	3	7	11	8	-	-
	3	0	0	1	1	-	-
	4	0	0	1	0	-	-
	5	0	0	0	0	-	-
<i>T. similis</i>	1	15	47	8	1	-	-
	2	1	11	14	2	-	-
	3	3	12	11	0	-	-
	4	2	3	0	0	-	-
	5	0	0	0	0	-	-
<i>S. atlantidis</i>	1	-	-	3	26	7	1
	2	-	-	2	8	3	2
	3	-	-	0	2	0	0
	4	-	-	0	0	0	0
	5	-	-	0	0	0	0
<i>C. similis</i>	1	1	2	-	-	-	-
	2	3	1	-	-	-	-
	3	0	1	-	-	-	-
	4	0	0	-	-	-	-
	5	0	2	-	-	-	-
<i>P. spinicarpus</i>	1	-	-	27	18	-	-
	2	-	-	7	3	-	-
	3	-	-	0	0	-	-
	4	-	-	0	0	-	-
	5	-	-	0	0	-	-
Cruise 3							
<i>P. aztecus</i>	1	7	15	23	25	-	-
	2	2	11	8	10	-	-
	3	0	0	0	0	-	-
	4	0	0	0	0	-	-
	5	0	0	0	0	-	-
<i>T. similis</i>	1	94	19	4	18	-	-
	2	26	31	1	1	-	-
	3	0	0	2	0	-	-
	4	0	0	0	0	-	-
	5	0	0	0	0	-	-

^aNumerical rankings of the reproductive stage are described in the text; "-" indicates no data).

Table 5.51. (Cont.)

Species	Stage ^a	MAI-686		MU-A85		HI-A389	
		Frequency		Frequency		Frequency	
		Near	Far	Near	Far	Near	Far
<i>S. atlantidis</i>	1	-	-	30	35	8	25
	2	-	-	22	16	0	10
	3	-	-	3	2	0	4
	4	-	-	0	3	0	0
	5	-	-	0	0	0	0
<i>P. similis</i>	1	-	-	-	-	43	23
	2	-	-	-	-	32	25
	3	-	-	-	-	12	12
	4	-	-	-	-	1	4
	5	-	-	-	-	0	0
<i>C. similis</i>	1	0	0	-	-	-	-
	2	3	6	-	-	-	-
	3	1	3	-	-	-	-
	4	0	0	-	-	-	-
	5	0	0	-	-	-	-
<i>P. gibbesii</i>	1	0	0	-	-	-	-
	2	4	28	-	-	-	-
	3	4	27	-	-	-	-
	4	0	0	-	-	-	-
	5	0	0	-	-	-	-
Cruise 4							
<i>P. aztecus</i>	1	3	38	1	3	-	-
	2	1	25	2	10	-	-
	3	0	0	6	4	-	-
	4	0	0	0	0	-	-
	5	0	0	0	0	-	-
<i>T. similis</i>	1	32	157	-	-	-	-
	2	25	105	-	-	-	-
	3	9	29	-	-	-	-
	4	6	9	-	-	-	-
	5	0	0	-	-	-	-
<i>S. atlantidis</i>	1	-	-	23	36	29	8
	2	-	-	18	39	9	3
	3	-	-	10	17	3	4
	4	-	-	1	0	0	0
	5	-	-	0	0	0	0
<i>C. similis</i>	1	1	1	-	-	-	-
	2	4	5	-	-	-	-
	3	2	4	-	-	-	-
	4	0	0	-	-	-	-
	5	7	18	-	-	-	-

^aNumerical rankings of the reproductive stage are described in the text; "-" indicates no data).

Table 5.51. (Cont.)

Species	Stage ¹	MAI-686		MU-A85		HI-A389	
		Frequency		Frequency		Frequency	
		Near	Far	Near	Far	Near	Far
<i>P. gibbesii</i>	1	5	2	-	-	-	-
	2	10	7	-	-	-	-
	3	6	5	-	-	-	-
	4	0	0	-	-	-	-
	5	11	10	-	-	-	-
<i>P. spinicarpus</i>	1	-	-	2	13	-	-
	2	-	-	1	19	-	-
	3	-	-	1	7	-	-
	4	-	-	0	0	-	-
	5	-	-	0	0	-	-

^aNumerical rankings of the reproductive stage are described in the text; "-" indicates no data).

results are summarized in Tables 5.52 to 5.54. On Cruise 1, only 5 individuals were histologically analyzed. On subsequent cruises, 10 individuals were analyzed however an effort was made to examine 5 females and 5 males. Therefore, the number of individuals analyzed histologically was much smaller than that analyzed by visual inspection. The results of histological analysis indicated that most individuals were in the middle stages of their reproductive development. These results typically assigned a higher stage to reproductive development than the results of visual inspection of individuals obtained at the same platform and station. Visual inspection is a three-dimensional determination of gonad size and stage, based on color (Chamberlain and Lawrence 1983), whereas histological examination examines the size and maturity of individual eggs in a microscopic field but does not address the volumetric size of the gonad. Since most of these species had eggs and sperm of different maturities present in the gonad at the same time, and since the volumetric size of the gonad and the developmental stage of the gametes were not necessarily correlated if the same gonadal sections are examined visually and histologically as was done in this study, the results of the two analyses provided different views of the stage of reproductive development.

Table 5.52. Sex and stage of reproductive development for overlapping species collected at each platform for histological examination during Cruise 2.

Species	Stage ^a	MAI-686				MU-A85				HI-A389			
		Near		Far		Near		Far		Near		Far	
		F	M	F	M	F	M	F	M	F	M	F	M
<i>P. aztecus</i>	1	0	0	0	1	0	0	0	0	-	-	-	-
	2	8	2	4	2	1	0	0	0	-	-	-	-
	3	0	0	2	1	1	2	2	2	-	-	-	-
	4	0	0	0	0	3	3	2	2	-	-	-	-
	5	0	0	0	0	0	0	2	0	-	-	-	-
<i>T. similis</i>	1	0	0	0	0	0	0	0	0	-	-	-	-
	2	4	0	5	0	0	0	1	0	-	-	-	-
	3	2	0	4	0	0	0	0	0	-	-	-	-
	4	4	0	1	0	3	0	7	2	-	-	-	-
	5	0	0	0	0	0	0	0	0	-	-	-	-
<i>S. atlantidis</i>	1	-	-	-	-	0	0	0	0	0	0	0	0
	2	-	-	-	-	0	2	0	0	5	5	0	0
	3	-	-	-	-	3	3	5	4	0	0	0	3
	4	-	-	-	-	2	0	1	0	0	0	1	0
	5	-	-	-	-	0	0	0	0	0	0	2	0
<i>C. similis</i>	1	1	0	0	0	0	0	0	9	-	-	-	-
	2	1	2	1	1	0	1	0	0	-	-	-	-
	3	3	3	2	6	0	2	0	0	-	-	-	-
	4	0	0	0	0	0	0	0	0	-	-	-	-
	5	0	0	0	0	0	0	0	0	-	-	-	-
<i>P. spinicarpus</i>	1	-	-	-	-	0	0	0	0	-	-	-	-
	2	-	-	-	-	1	3	3	4	-	-	-	-
	3	-	-	-	-	1	5	3	0	-	-	-	-
	4	-	-	-	-	0	0	0	0	-	-	-	-
	5	-	-	-	-	0	0	0	0	-	-	-	-
<i>M. quinquispinosa</i>	1	-	-	-	-	-	-	-	-	1	0	0	0
	2	-	-	-	-	-	-	-	-	1	1	3	4
	3	-	-	-	-	-	-	-	-	0	0	2	1
	4	-	-	-	-	-	-	-	-	0	0	0	0
	5	-	-	-	-	-	-	-	-	0	0	0	0
<i>A. alexandria</i>	1	-	-	-	-	-	-	-	-	0	0	1	0
	2	-	-	-	-	-	-	-	-	2	2	0	1
	3	-	-	-	-	-	-	-	-	0	0	3	5
	4	-	-	-	-	-	-	-	-	0	0	0	0
	5	-	-	-	-	-	-	-	-	0	0	0	0
Hermit crab	1	-	-	-	-	-	-	-	-	0	2	0	4
	2	-	-	-	-	-	-	-	-	1	1	2	3
	3	-	-	-	-	-	-	-	-	1	4	3	0
	4	-	-	-	-	-	-	-	-	0	2	0	1
	5	-	-	-	-	-	-	-	-	0	0	0	0

^aM=male; F=female; stages of reproductive development are defined in the laboratory methods section; "-" indicates no data.

Table 5.52. (Cont.)

Species	Stage ^a	MAI-686				MU-A85				HI-A389			
		Near		Far		Near		Far		Near		Far	
		F	M	F	M	F	M	F	M	F	M	F	M
<i>A. cingulatus</i>	1	-	-	-	-	0	4	2	6	2	3	2	3
	2	-	-	-	-	1	2	0	1	0	0	0	0
	3	-	-	-	-	0	0	0	0	0	0	0	0
	4	-	-	-	-	0	0	0	0	0	0	0	0
<i>S. empusa</i>	1	0	0	0	0	-	-	-	-	-	-	-	-
	2	4	5	2	5	-	-	-	-	-	-	-	-
	3	0	1	2	1	-	-	-	-	-	-	-	-
	4	0	0	0	0	-	-	-	-	-	-	-	-
<i>S. chydaea</i>	1	-	-	-	-	0	0	0	0	-	-	-	-
	2	-	-	-	-	2	6	5	1	-	-	-	-
	3	-	-	-	-	1	1	1	2	-	-	-	-
	4	-	-	-	-	0	0	1	0	-	-	-	-
<i>S. edentata</i>	1	-	-	-	-	-	-	-	-	0	0	0	0
	2	-	-	-	-	-	-	-	-	2	0	1	3
	3	-	-	-	-	-	-	-	-	4	1	4	1
	4	-	-	-	-	-	-	-	-	0	0	1	0
<i>A. papyraceum</i>						<u>m/f</u>	<u>m/f</u>						
	1	-	-	-	-	0	0	-	-	-	-	-	-
	2	-	-	-	-	0	0	-	-	-	-	-	-
	3	-	-	-	-	3	6	-	-	-	-	-	-
	4	-	-	-	-	4	0	-	-	-	-	-	-
	5	-	-	-	-	3	2	-	-	-	-	-	-
	6	-	-	-	-	1	2	-	-	-	-	-	-
	7	-	-	-	-	0	0	-	-	-	-	-	-
8	-	-	-	-	0	0	-	-	-	-	-	-	

^aM=male; F=female; stages of reproductive development are defined in the laboratory methods section; "-" indicates no data.

Table 5.53. Sex and stage of reproductive development for overlapping species collected at each platform for histological examination during Cruise 3.

Species	Stage ^a	MAI-686				MU-A85				HI-A389			
		Near		Far		Near		Far		Near		Far	
		F	M	F	M	F	M	F	M	F	M	F	M
<i>P. aztecus</i>	1	0	0	0	0	0	0	0	0	-	-	-	-
	2	2	5	1	4	0	0	1	3	-	-	-	-
	3	2	0	3	1	2	4	3	2	-	-	-	-
	4	0	0	1	0	3	1	1	0	-	-	-	-
	5	0	0	0	0	0	0	0	0	-	-	-	-
<i>T. similis</i>	1	0	0	0	0	0	0	0	0	-	-	-	-
	2	0	4	2	3	4	1	2	2	-	-	-	-
	3	2	1	3	2	0	1	4	1	-	-	-	-
	4	3	0	0	0	1	0	1	0	-	-	-	-
	5	0	0	0	0	0	0	0	0	-	-	-	-
<i>S. atlantidis</i>	1	-	-	-	-	0	0	0	0	0	0	0	0
	2	-	-	-	-	1	2	1	5	3	4	0	3
	3	-	-	-	-	4	3	4	0	2	1	5	2
	4	-	-	-	-	0	0	0	0	0	0	0	0
	5	-	-	-	-	0	0	0	0	0	0	0	0
<i>P. similis</i>	1	-	-	-	-	-	-	-	-	0	0	0	0
	2	-	-	-	-	-	-	-	-	1	4	1	1
	3	-	-	-	-	-	-	-	-	4	1	3	2
	4	-	-	-	-	-	-	-	-	0	0	3	0
	5	-	-	-	-	-	-	-	-	0	0	0	0
<i>C. similis</i>	1	3	0	1	1	-	-	-	-	-	-	-	-
	2	1	3	3	2	-	-	-	-	-	-	-	-
	3	0	0	1	2	-	-	-	-	-	-	-	-
	4	0	0	0	0	-	-	-	-	-	-	-	-
	5	0	0	0	0	-	-	-	-	-	-	-	-
<i>P. spinicarpus</i>	1	-	-	-	-	2	0	0	0	-	-	-	-
	2	-	-	-	-	3	4	1	3	-	-	-	-
	3	-	-	-	-	0	1	0	6	-	-	-	-
	4	-	-	-	-	0	0	0	0	-	-	-	-
	5	-	-	-	-	0	0	0	0	-	-	-	-
<i>P. gibbesii</i>	1	0	0	0	0	-	-	-	-	-	-	-	-
	2	4	3	1	6	-	-	-	-	-	-	-	-
	3	1	0	0	3	-	-	-	-	-	-	-	-
	4	0	0	0	0	-	-	-	-	-	-	-	-
	5	0	0	0	0	-	-	-	-	-	-	-	-
Hermit crab	1	-	-	-	-	-	-	-	-	1	0	0	2
	2	-	-	-	-	-	-	-	-	2	2	2	3
	3	-	-	-	-	-	-	-	-	1	0	3	1
	4	-	-	-	-	-	-	-	-	0	0	0	0
	5	-	-	-	-	-	-	-	-	0	0	0	0

^aM=male; F=female; stages of reproductive development are defined in laboratory methods section; "-" indicates no data.

Table 5.53. (Cont.)

Species	Stage ^a	MAI-686				MU-A85				HI-A389			
		Near		Far		Near		Far		Near		Far	
		F	M	F	M	F	M	F	M	F	M	F	M
<i>A. duplicatus</i>	1	0	1	0	0	-	-	-	-	-	-	-	-
	2	3	2	3	0	-	-	-	-	-	-	-	-
	3	3	1	4	3	-	-	-	-	-	-	-	-
	4	0	0	0	0	-	-	-	-	-	-	-	-
<i>S. empusa</i>	1	0	0	0	0	-	-	-	-	-	-	-	-
	2	0	5	0	4	-	-	-	-	-	-	-	-
	3	0	0	1	1	-	-	-	-	-	-	-	-
	4	5	0	4	0	-	-	-	-	-	-	-	-
<i>S. chydaea</i>	1	-	-	-	-	0	0	0	0	-	-	-	-
	2	-	-	-	-	1	4	0	5	-	-	-	-
	3	-	-	-	-	2	0	1	0	-	-	-	-
	4	-	-	-	-	0	0	4	0	-	-	-	-
<i>A. papyraceum</i>	1	-	-	-	-	<u>m/f</u> 2	<u>m/f</u> 0	-	-	-	-	-	-
	2	-	-	-	-	6	5	-	-	-	-	-	-
	3	-	-	-	-	1	4	-	-	-	-	-	-
	4	-	-	-	-	1	1	-	-	-	-	-	-
	5	-	-	-	-	0	0	-	-	-	-	-	-
	6	-	-	-	-	0	0	-	-	-	-	-	-
	7	-	-	-	-	0	0	-	-	-	-	-	-
	8	-	-	-	-	0	0	-	-	-	-	-	-

^aM=male; F=female; stages of reproductive development are defined in laboratory methods section; "-" indicates no data.

Table 5.54. Sex and stage of reproductive development for overlapping species collected at each platform for histological examination during Cruise 4.

Species	Stage ^a	MAI-686				MU-A85				HI-A389			
		Near		Far		Near		Far		Near		Far	
		F	M	F	M	F	M	F	M	F	M	F	M
<i>P. aztecus</i>	1	0	0	0	0	0	0	0	0	-	-	-	-
	2	2	5	1	4	0	0	1	3	-	-	-	-
	3	2	0	3	1	2	4	3	2	-	-	-	-
	4	0	0	1	0	3	1	1	0	-	-	-	-
	5	0	0	0	0	0	0	0	0	-	-	-	-
<i>T. similis</i>	1	0	0	0	0	0	0	0	0	-	-	-	-
	2	0	4	2	3	4	1	2	2	-	-	-	-
	3	2	1	3	2	0	1	4	1	-	-	-	-
	4	3	0	0	0	1	0	1	0	-	-	-	-
	5	0	0	0	0	0	0	0	0	-	-	-	-
<i>S. atlantidis</i>	1	-	-	-	-	0	0	0	0	0	0	0	0
	2	-	-	-	-	1	2	1	5	3	4	0	3
	3	-	-	-	-	4	3	4	0	2	1	5	2
	4	-	-	-	-	0	0	0	0	0	0	0	0
	5	-	-	-	-	0	0	0	0	0	0	0	0
<i>P. similis</i>	1	-	-	-	-	-	-	-	-	0	0	0	0
	2	-	-	-	-	-	-	-	-	1	4	1	1
	3	-	-	-	-	-	-	-	-	4	1	3	2
	4	-	-	-	-	-	-	-	-	0	0	3	0
	5	-	-	-	-	-	-	-	-	0	0	0	0
<i>C. similis</i>	1	3	0	1	1	-	-	-	-	-	-	-	-
	2	1	3	3	2	-	-	-	-	-	-	-	-
	3	0	0	1	2	-	-	-	-	-	-	-	-
	4	0	0	0	0	-	-	-	-	-	-	-	-
	5	0	0	0	0	-	-	-	-	-	-	-	-
<i>P. spinicarpus</i>	1	-	-	-	-	2	0	0	0	-	-	-	-
	2	-	-	-	-	3	4	1	3	-	-	-	-
	3	-	-	-	-	0	1	0	6	-	-	-	-
	4	-	-	-	-	0	0	0	0	-	-	-	-
	5	-	-	-	-	0	0	0	0	-	-	-	-
<i>P. gibbesii</i>	1	0	0	0	0	-	-	-	-	-	-	-	-
	2	4	3	1	6	-	-	-	-	-	-	-	-
	3	1	0	0	3	-	-	-	-	-	-	-	-
	4	0	0	0	0	-	-	-	-	-	-	-	-
	5	0	0	0	0	-	-	-	-	-	-	-	-
Hermit crab	1	-	-	-	-	-	-	-	-	1	0	0	2
	2	-	-	-	-	-	-	-	-	2	2	2	3
	3	-	-	-	-	-	-	-	-	1	0	3	1
	4	-	-	-	-	-	-	-	-	0	0	0	0
	5	-	-	-	-	-	-	-	-	0	0	0	0

^aM=male; F=female; stages of reproductive development are defined in laboratory methods section; "-" indicates no data.

Table 5.54. (Cont.)

Species	Stage ^a	MAI-686				MU-A85				HI-A389			
		Near		Far		Near		Far		Near		Far	
		F	M	F	M	F	M	F	M	F	M	F	M
<i>A. duplicatus</i>	1	0	1	0	0	-	-	-	-	-	-	-	-
	2	3	2	3	0	-	-	-	-	-	-	-	-
	3	3	1	4	3	-	-	-	-	-	-	-	-
	4	0	0	0	0	-	-	-	-	-	-	-	-
<i>S. empusa</i>	1	0	0	0	0	-	-	-	-	-	-	-	-
	2	0	5	0	4	-	-	-	-	-	-	-	-
	3	0	0	1	1	-	-	-	-	-	-	-	-
	4	5	0	4	0	-	-	-	-	-	-	-	-
<i>S. chydaea</i>	1	0	0	0	0	-	-	-	-	-	-	-	-
	2	1	4	1	5	-	-	-	-	-	-	-	-
	3	2	0	4	0	-	-	-	-	-	-	-	-
	4	0	0	0	0	-	-	-	-	-	-	-	-
<i>S. chydaea</i>	1	-	-	-	-	0	0	0	0	-	-	-	-
	2	-	-	-	-	2	6	5	1	-	-	-	-
	3	-	-	-	-	1	1	1	2	-	-	-	-
	4	-	-	-	-	0	0	1	0	-	-	-	-
<i>S. edentata</i>	1	-	-	-	-	-	-	-	-	0	0	0	0
	2	-	-	-	-	-	-	-	-	2	0	1	3
	3	-	-	-	-	-	-	-	-	4	1	4	1
	4	-	-	-	-	-	-	-	-	0	0	1	0
<i>A. papyraceum</i>						<u>m/f</u>	<u>m/f</u>						
	1	-	-	-	-	0	0	-	-	-	-	-	-
	2	-	-	-	-	0	0	-	-	-	-	-	-
	3	-	-	-	-	3	6	-	-	-	-	-	-
	4	-	-	-	-	4	0	-	-	-	-	-	-
	5	-	-	-	-	3	2	-	-	-	-	-	-
	6	-	-	-	-	1	2	-	-	-	-	-	-
	7	-	-	-	-	0	0	-	-	-	-	-	-
8	-	-	-	-	0	0	-	-	-	-	-	-	

^aM=male; F=female; stages of reproductive development are defined in laboratory methods section; "-" indicates no data.

5.6.6.3 Immunological Probe

Immunological probes active against egg protein were developed for the three species of portunid crabs collected during this study; *C. similis*, *P. spinicarpus*, and *P. gibbesii*. With these probes, the quantity of gonadal protein can be determined for females that are in the midst of their reproductive cycle; that is, they are not yet in sponge. The probe provides a measure of total gametic protein present. Comparison of gonadal weight in animals ready to spawn, as measured by the probe, to the weight of protein in egg masses collected from gravid females, yielded equivalent results, indicating that the probe satisfactorily measured total egg protein concentration in gonadal tissues.

Results of the gonadal protein assays are summarized in Table 5.55. As these analyses were done on individuals left after histopathological needs had been met, the number of assays was limited to the larger collections, most of which took place on Cruises 2 and 4. GSI, gonadal somatic index, is another measure of the relationship between the amount of egg present (dry weight) and the weight of the individual. High values of GSI would suggest an individual with a high gonadal weight compared to its own body weight.

5.7 Megafauna - Demersal Fish

For the various tasks and analyses performed, large numbers of fish were required. During each cruise, trawl collections were made at Near and Far sites for each platform site until sufficient biomass was obtained. For all four cruises a total of 42,884 fish specimens was obtained, representing 52 families and 125 species. The catches by individual cruise were as follows: Cruise 1-3,500 fish, 38 families and 89 species; Cruise 2-15,411 fish, 45 families and 95 species; Cruise 3-13,607 fish, 29 families and 59 species; Cruise 4-10,366 fish, 41 families and 90 species. After shipboard identification, specimens were provided for the various test procedures and representative specimens were preserved and returned to the laboratory. Final taxonomic identifications were made, specimens were provided for stomach food analysis, and voucher specimens were labeled and stored in the Texas Cooperative Wildlife Museum.

The most abundant species captured during each cruise were as follows: Cruise 1-*Halieutichthys aculeatus*, *Pontinus longispinis*, *Serranus*

Table 5.55. Summary data for immunological probe results for non-gravid female crabs.

Cruise	Platform	Site	Species	Gonadal protein ^a (mg/animal)	GSI ^a egg dry wt (g) body dry wt (g)
2	MU-A85	Near	<i>P. spinicarpus</i>	2.498	0.00457
	MU-A85	Far	<i>P. spinicarpus</i>	0.863	0.00191
	HI-A389	Near	<i>P. spinicarpus</i>	20.139	0.02092
3	MAI-686	Far	<i>P. gibbesii</i>	9.136	0.02323
4	MAI-686	Near	<i>C. similis</i>	86.621	0.06874
	MAI-686	Far	<i>C. similis</i>	163.432	0.11112
	MAI-686	Near	<i>P. gibbesii</i>	29.306	0.06229
	MAI-686	Far	<i>P. gibbesii</i>	23.397	0.02800
	MU-A85	Far	<i>P. spinicarpus</i>	1.826*	0.00274*

^a*data from single individual

atrobranchus, *Pristipomoides aquilonaris*, and *Syacium gunteri*; Cruise 2-*Saurida brasiliensis*, *Orthopristis chrysoptera*, *Upeneus parvus*, *Peprilus burti*, and *Syacium gunteri*; Cruise 3-*Serranus atrobranchus*, *Pristipomoides aquilonaris*, *Cynoscion arenarius*, and *Syacium gunteri*; Cruise 4-*Pristipomoides aquilonaris*, *Lagodon rhomboides*, *Peprilus burti*, and *Syacium gunteri*.

One species of squirrel fish captured during the first cruise at the MU-A85 (far) site appears to be a new record for the Gulf of Mexico. This species, *Corniger spinosus*, has previously been reported to range along the Atlantic coast from South Carolina to Brazil as well as the Canary Islands and off Benin from the west coast of Africa. One problematic species of seabass was sent to Dr. Carol Baldwin of the Smithsonian Institution and was identified as *Hemanthias leptus*.

5.7.1 Fish Food Analysis

The food of twenty-three (23) species of fish was analyzed and quantified on a volumetric basis. A complete listing of these species giving the cruises and stations, is presented in Table 5.56. For the four cruises, 943 stomach contents were analyzed. The number of species and total number of stomachs (given in parentheses) was as follows: Cruise 1, 19 spp. (218); Cruise 2, 9 spp. (269); Cruise 3, 10 spp. (230); and Cruise 4, 17 spp.

Table 5.56. Fish species employed (x) in the food analyses during all four cruises and showing the cruise number and collecting sites represented by each species.

Fish Species	Cruise				Site		
	1	2	3	4	MAI-686	MU-A85	HI-A389
Synodontidae							
<i>Synodus foetens</i>	x	x	x	x	x	x	x
Gadidae							
<i>Urophycis cirrata</i>	x		x	x		x	x
<i>Urophycis floridana</i>			x	x			x
Ogcocephalidae							
<i>Ogcocephalus declivirostris</i>	x		x				x
Scarpaenidae							
<i>Pontinus longispinis</i>	x	x	x	x			x
Serranidae							
<i>Centropristis philadelphia</i>	x		x	x		x	
Malacanthidae							
<i>Caulolatilus intermedus</i>	x						x
Lutjanidae							
<i>Anthias</i> sp.	x						x
<i>Lutjanus campechanus</i>	x		x	x	x	x	
<i>Pristipomoides aquilonaris</i>	x	x	x	x		x	x
Haemulidae							
<i>Haemulon aurolineatum</i>	x						
<i>Orthopristis chrysoptera</i>	x						
Sparidae							
<i>Archosargus probatocephalus</i>	x				x		
<i>Lagodon rhomboides</i>				x		x	
Sciaenidae							
<i>Cynoscion arenarius</i>	x	x	x	x	x	x	
<i>Equetus umbrosus</i>	x					x	
<i>Pogonias chromis</i>	x					x	
Bothidae							
<i>Ancylosetta dilecta</i>		x		x		x	x
<i>Cyclosetta chittendeni</i>	x	x				x	
<i>Paralichthys albigutta</i>	x				x		
<i>Paralichthys lethostigma</i>		x					x
<i>Syacium gunteri</i>	x	x		x	x		
<i>Trichopsetta ventralis</i>	x					x	x

(226). Results of the stomach food analyses by cruise are provided in Tables 5.57 to 5.60. Shrimp, fish, crabs, and squids made up the bulk of the food observed, and identification to lower taxonomic levels is available. Miscellaneous food items of low abundance include algae, bryozoans, polychaetes, snails, copepods, amphipods, mantis shrimp, and undetermined organic matter.

The food analyses were primarily performed to provide information for interpretation of the stomach content contaminant study. However, it is of interest to determine whether the food of a given species differs significantly in Near/Far comparisons for a given site on each cruise. For those species with sufficient numbers for comparison, the significance of the Near/Far differences is summarized in Table 5.61. The data show that at the shallower station (MAI-686, 29-m depth) differences were not significant; but for all the species compared at the two deeper stations (MU-A85 and HI-A389 m) all of the Near/Far differences were significant. For a given species it is assumed that the food intake is related to food availability within the range of food items consumed by the species.

As an aid in the interpretation of the food contaminant studies, a brief sketch of pertinent life history information is provided for each species analyzed.

Synodus foetens (inshore lizardfish) - As shown in Table 5.56, specimens of this species were analyzed for food content for all four cruises at all sites. Its distribution includes the entire continental shelf, but the species is most abundant in the 60 to 80 m depth range. This fish regularly buries itself in the sediments. It is a predator. During the present study, it was found that squids comprise about a third of the food, fish about two-thirds, and shrimp were only a trace. The species is regularly cannibalistic, consuming other synodontids as well as its own young.

Urophycis cirrata (gulf hake) - The gulf hake was analyzed from all but the second cruise, and it was studied at MU-A85 and HI-A389. This is a deep-water member of the codfish family and is largely limited to the outer continental shelf beyond a depth of 80 m, although during winter it occasionally appears in shallower water. The species remains close to the bottom where it feeds on benthic invertebrates and fish. In the present study, the food was about half penaeid shrimp and half fish with a small percentage of mantis shrimp. This is one of the top carnivores of the

Table 5.57. Results of stomach food analyses from Cruise 1 fish. Numbers represent the percent composition by volume for each food category. The letter "e" indicates that all stomachs were empty.

Station Number	Fish Species	Number of Individuals	Silt, Sand	Tubes (Polych., amphip.)	Polychaete Worms	Squids	Crustaceans				Fishes	Flesh (undet.)
							Copepods	Amphipods	Shrimp	Crabs		
MU-A85 Near	<i>Centropristis philadelphica</i>	2						90	10			
	<i>Equetus umbrosus</i>	28						100				
	<i>Pogonias cromis</i>	3		50					10	40		
	<i>Cyclosetta chittendent</i>	2-e										
MU-A85 Far	<i>Synodus foetens</i>	2-e										
	<i>Urophycis cirrata</i>	3	t	95						5		
	<i>Centropristis philadelphica</i>	7						90			10	
	<i>Trichopsetta ventralis</i>	5						20	20			50
MAI-686 Near	<i>Lutjanus campechanus</i>	10						100				
	<i>Archosargus probatocephalus</i>	9		10				t	86	4	t	
	<i>Cynoscion arenarius</i>	3							100			
	<i>Paralichthys albigutta</i>	2							99			1
	<i>Syactum gunteri</i>	11				27		6	67			
MAI-686 Far	<i>Syactum gunteri</i>	6	t			t		2	98			
4-N HI-A389 Near	<i>Ogcocephalus declivirostris</i>	10				80						20
	<i>Urophycis cirrata</i>	10-e										
	<i>Pontinus longispinis</i>	4-e										
	<i>Caulolatilus intermedius</i>	3				95		1	4			
	<i>Hemanthias leptus</i>	7							100			
	<i>Pristipomoides aquilonaris</i>	10							70			30
HI-A389 Far	<i>Urophycis cirrata</i>	7-e										
	<i>Pontinus longispinis</i>	10				1			9			90
	<i>Pristipomoides aquilonaris</i>	10-e										

5-216

Table 5.58. Results of stomach food analyses from Cruise 2 fish. Numbers represent the percent composition by volume for each food category. Trace amounts are denoted as "t".

Site and Species	Stomachs Examined	With Food	Food Volume (mL)	Sargassum Leaf	Polychaetes	Squids	Amphipods	Shrimp	Crabs	Mantis Shrimp	Fish
MAI-686-Near											
<i>C. arenarius</i>	20	13	90		t			2			98
<i>S. gunter</i>	20	13	1.3		t		t	100			
MAI-686-Far											
<i>C. arenarius</i>	20	14	5.5						t		100
<i>S. gunter</i>	20	19	3.0		t		t	100			
MU-A85-Near											
<i>A. dilecta</i>	5	4	2.4					t	1		99
<i>S. foetens</i>	16	6	16.0			100				t	
<i>P. aquilonaris</i>	20	6	<0.5	18				t	2		80
MU-A85-Far											
<i>A. dilecta</i>	2	2	1.3					40			60
<i>S. foetens</i>	17	7	23.5			5					95
<i>C. chittendent</i>	1	0	--								
<i>L. campechanus</i>	12	6	2.5			2		50			48
HI-A389-Near											
<i>A. dilecta</i>	20	13	2.5					13	2		85
<i>P. longispinis</i>	14	10	2.0						40		60
<i>P. aquilonaris</i>	20	9	1.5					60	t		40
<i>P. lethostigma</i>	2	1	52.0								100
HI-A389-Far											
<i>A. dilecta</i>	20	15	4.5	t	t			70	10		20
<i>P. longispinis</i>	20	11	4.0						95		5
<i>P. aquilonaris</i>	20	6	0.5					5	50		45

5-217

Table 5.59. Results of stomach analyses for Cruise 3 fish. The values represent percent composition by volume for each food category. Trace amounts are denoted as "t".

Station number and fish species	Stomachs examined with food	Food volume (mL)	Polychaetes	Snails	Squids	Copepods	Amphipods	Shrimp	Crabs	Mantis shrimp	Fishes	Flesh undet
MAI-686-Near												
<i>Lutjanus campechanus</i>	20/7	0.5			25	t	t	75				
<i>Cynoscion arenarius</i>	20/13	7.5			45			10			45	
MU-A85-Near												
<i>Synodus foetens</i>	17/4	5.0			99			1				
<i>Lutjanus campechanus</i>	20/7	16.4						21		15	64	
<i>Cynoscion arenarius</i>	16/5	7.6			2			60		8	30	
MU-A85-Far												
<i>Synodus foetens</i>	8/6	16.8									100	
<i>Centropristis philadelphica</i>	14/7	2.0		5				47	48			
<i>Pristipomoides aquilonaris</i>	1/0	---										
HI-A389-Near												
<i>Urophycis cirrata</i>	2/1	<0.5										100
<i>Urophycis floridana</i>	1/0	---										
<i>Ogcocephalus declivirostris</i>	17/7	1.6	40	13				1	1		45	
<i>Pontinus longispinis</i>	20/15	3.6						2	2		95	1
<i>Pristipomoides aquilonaris</i>	20/3	1.3			55			30			15	
<i>Ancylopsetta dilecta</i>	3/2	0.7			15			85				
HI-A389-Far												
<i>Synodus foetens</i>	1/1	4.0									100	
<i>Urophycis cirrata</i>	2/1	1.1							55		45	
<i>Urophycis floridana</i>	1/1	1.0							60		40	
<i>Pontinus longispinis</i>	20/9	1.1			80			5		10	5	
<i>Pristipomoides aquilonaris</i>	20/5	0.5					5		50		45	
<i>Ancylopsetta dilecta</i>	7/6	3.6							85	5	10	

Table 5.60. Results of stomach food analyses for Cruise 4 fish. The values represent percent composition by volume for each food category. Trace amounts are denoted as "t".

Station Number and Fish Species	Stomachs Examined With Food	Food Volume (mL)	Bryozoa	Polychaetes	Squids	Amphipods	Shrimp	Crabs	Mantis Shrimp	Fish
MAI-686-Near										
<i>Lutjanus campechanus</i>	12/5	.5			16		4			80
MAI-686-Far										
<i>Synodus foetens</i>	20/10	5.5					1			99
<i>Syactum gunteri</i>	20/3	1.4					1	1		98
MU-A85-Near										
<i>Lagodon rhomboides</i>	20/7	3.3	t	t			85			15
<i>Cynoscion arenartus</i>	5/5	6.7			5		60	t		35
MU-A85-Far										
<i>Synodus foetens</i>	9/0	---								
<i>Urophycis ctrrata</i>	20/19	6.9				t	50	t	10	40
<i>Centropristis philadelphica</i>	19/5	8.5					20			80
HI-A389-Near										
<i>Urophycis ctrrata</i>	2/0	---								
<i>Urophycis floridana</i>	3/2	3.5					60	50		t
<i>Pontinus longispinis</i>	20/12	5.0					t			100
<i>Pristipomoides aquilonaris</i>	20/11	6.6			25					75
<i>Ancylosetta dillecta</i>	2/2	2.0								100
HI-A389-Far										
<i>Urophycis ctrrata</i>	1/1	1.0					100			
<i>Urophycis floridana</i>	7/5	14.5			38		4	14	10	34
<i>Pontinus longispinis</i>	20/9	1.8					t	70	t	30
<i>Pristipomoides aquilonaris</i>	20/2	0.5					3	95		2

Table 5.61. Results of Chi-Square comparisons of the food of fishes taken at Near and Far stations for sites on each of the four cruises. Only those species for which at least fourteen specimens were analyzed at both near and far stations are included.

Cruise	Site	Species	Number Analyzed (near/far)	PC2	Differences are Significant
2	MAI-686	<i>Cynoscion arenarius</i>	20/20	0.157	No
2	MAI-686	<i>Syacium gunteri</i>	20/20	1.00*	No
2	MU-A85	<i>Synodus foetens</i>	16/17	< 0.001	Yes
2	HI-A389	<i>Pontinus longispinis</i>	14/20	< 0.001	Yes
2	HI-A389	<i>Pristipomoides aquilonaris</i>	20/20	< 0.001	Yes
2	HI-A389	<i>Ancylosetta dilecta</i>	20/20	< 0.001	Yes
3	HI-A389	<i>Pontinus longispinis</i>	20/20	< 0.001	Yes
3	HI-A389	<i>Pristipomoides aquilonaris</i>	20/20	< 0.001	Yes
4	HI-A389	<i>Pontinus longispinis</i>	20/20	< 0.001	Yes
4	HI-A389	<i>Pristipomoides aquilonaris</i>	20/20	< 0.001	Yes

*Food composition was identical at both near and far stations

bottom community of the outer shelf.

Urophycis floridana (southern hake) - This cod was analyzed for the last two cruises and only at HI-A389. As in the previous species, the southern hake is normally limited to the outer shelf, but in cooler weather it occurs across the shelf. This is a bottom living species which takes in benthic invertebrates and fish. In the present study, the southern hake showed a varied diet including penaeid shrimp and fish with lesser amounts of squids, crabs, and mantis shrimp. This is one of the top predators of the bottom community of the outer shelf.

Ogcocephalus declivirostris (slantbrow batfish) - This batfish was analyzed on the first and third cruises and only at HI-A389. It appears to be limited to the outer continental shelf where it lives on the bottom and feeds upon small benthic invertebrates and fishes. In the present study, polychaetes and fish each made up somewhat less than half the food, snails made up 13 %, and shrimp and crabs made up about 1 % each. Since this batfish ingests polychaetes and other benthic invertebrates, it frequently takes in quantities of bottom sediments with its food.

Pontinus longispinis (longspine scorpionfish) - This species was studied on all four cruises at HI-A389. It is limited to deep water beyond the 80-m depth contour. In the present study it was found to consume

fishes 55 %, crabs 31 %, squids 12 %, and very small amounts of polychaetes and penaeid shrimp. This outer shelf carnivore is one of the few species in which crabs made up about a third of the diet.

Centropristis philadelphica (rock sea bass) - The rock sea bass was analyzed for all but the second cruise at MU-A85. This species occurs at all depths but is most abundant in the 40 to 80-m depth range. In the present study, the food was found to be largely penaeid shrimp with modest amounts of fish and crabs and traces of snails. This small, active predator of the lower water column seldom ingests bottom sediments

Caulolatilus intermedius (anchor tilefish) - This tilefish was studied on the first cruise at HI-A389. This is an outer shelf species that seldom occurs at depths shallower than 100 m. It was found to feed largely on polychaete worms (95 %) with small percentages of amphipods and shrimp. The anchor tilefish lives in burrows in the bottom sediments and consumes largely polychaete worms.

Anthias sp. (seabass) - This fish was examined on the first cruise at HI-A389. Apparently it is an outer shelf species. Shrimp made up 100 % of the food encountered. Since the species was not completely identified, nothing can be said about its habits.

Lutjanus campechanus (red snapper) - The red snapper was analyzed on all but the second cruise at MAI-686 and MU-A85. This is essentially a mid-shelf species that rarely occurs inshore or beyond a depth of 100 m. Penaeid shrimp made up 50 % of the food, fish made up 38 %, and squids and mantis shrimp made up less than 10 % each. This lower water column predator mostly consumes shrimp and small fish. It is known to reside around platform bases.

Pristipomoides aquilonaris (wenchman) - Food from this small snapper was examined during all four cruises at MU-A85 and HI-A389. This is the most abundant fish species in trawl catches on the OCS, and it is rarely taken at depths shallower than 80 m. Shrimp and fish each made up about a third of the food, crabs about 20 %, and squids 10 %. This is a small, active predator of the outer shelf.

Archosargus probatocephalus (sheepshead) - The sheepshead was analyzed from MAI-686 on the first cruise. Young sheepshead frequent bays and estuaries, but adults range widely across the continental shelf. In the present study, shrimp made up 85 % of the food with polychaetes,

amphipods, and crabs each contributing small amounts. This species often occurs around jetties, platforms, and other structures where it consumes invertebrates attached to hard substrates. However, it also roams freely and consumes infauna such as polychaetes and epifauna and demersal forms such as shrimp and crabs.

Lagodon rhomboides (pinfish) - The pinfish was examined on Cruise 4 at MU-A85. Young of pinfish inhabit beds of submerged and emergent vegetation in the bays and estuaries but the adults range across the shelf into deep water. In the present study, the food was found to be shrimp (85 %) and fish (15 %), with trace amounts of bryozoans and polychaetes. Food habits of the pinfish are much like those of the previous species.

Cynoscion arenarius (sand seatrout) - This species was examined on all four cruises at MAI-686 and MU-A85. This is one of the most abundant and widespread fish species of the northwestern Gulf shelf. Young are generally found in the bays and estuaries but adults roam throughout the continental shelf at all seasons. They are particularly abundant off passes. In the present study fish made up 44 % of the food, penaeid shrimp made up 33 %, and squids made up 22 %, with trace amounts of polychaetes and mantis shrimp.

Equetus umbrosus (cubbyu) - This drumfish was studied at MU-A85 on the first cruise. The species, which is rarely taken in the northwestern Gulf, tends to occur on the middle to outer shelf. In the present study, penaeid shrimp made up 100 % of the food.

Pogonias cromis (black drum) - The black drum was analyzed on the first cruise at MU-A85. The young are found primarily in the bays, estuaries, and the shallow Gulf shelf. Adults range widely in the bays and across the shelf. This species feeds largely on clams and oysters, but it will take crustaceans and other invertebrates. In the present study, only three specimens were analyzed, and these contained crabs (40 %), tubes of polychaetes or amphipods (25 %), shrimp 15 %, and undetermined matter (20 %).

Ancylopsetta dilecta (three-eye flounder) - This flounder was examined on the second and fourth cruises at MU-A85 and HI-A389. It is an outer continental shelf species that rarely strays onto the middle shelf. In the present study fish made up 73 %, shrimp (25 %), and crabs made up less than 3 % of the food observed. This small carnivore feeds near the

bottom.

Cyclopsetta chittendeni (Mexican flounder) - The Mexican flounder was analyzed for the first and second cruises at MU-A85. The species occurs across the middle and outer shelf and is most abundant in the 40 to 80 m depth range. All stomachs examined were empty. The species is a carnivore that feeds on small benthic invertebrates and fish.

Paralichthys albigutta (gulf flounder) - This species was analyzed on the first cruise at MAI-686. This is a rare species but it occurs at all depths on the continental shelf. Food consisted of shrimp (99 %) and fish (1 %).

Paralichthys lethostigma (southern flounder) - This flounder was studied on the second cruise at HI-A389. Young are found in bays and estuaries but adults are found across the continental shelf. In the present study, fish made up 100 % of the food.

Syacium gunteri (shoal flounder) - This flounder was analyzed on the first, second, and fourth cruises at MAI-686. Although the species occurs in bays and estuaries and across the shelf, it is most abundant in the 10 to 40 m depth range. Food consisted of shrimp (64 %), polychaetes (16 %), fish (12 %), crabs (7 %), and amphipods (1 %). Stomachs often contained quantities of silt and sand apparently ingested while digging for polychaetes.

Trichopsetta ventralis (sash flounder) - This species was examined on the first cruise at MU-A85. It is an outer shelf species that occasionally occurs as shallow as 40-m. In the present study, fish made up 50 % of the food, shrimp and crabs made up 20 % each, and amphipods made up 10 %.

5.7.2 Histopathology

Histopathological evaluations were performed on liver and spleen samples taken from 543 fish specimens. This reflected 189, 126, 122, and 106 fishes from Cruise 1, 2, 3, and 4; respectively. Species collected for histopathological examination were *Syacium gunteri* (site MAI-686, all cruises), *Trichopsetta ventralis* (site HI-A389, Cruises 2 to 4 and site MU-A85, all cruises) and *Pontinus longispinis* (site HI-A389, Cruise 1). Liver and spleen samples were taken from all specimens and processed for histopathological analysis. Tissue samples were processed for routine paraffin histology. Sections were cut at 6 μ m, stained with Harris' hematoxylin and eosin, and examined microscopically by fish pathologists. No contaminant-related liver lesions (e.g., hydropic vacuolation, hepatic

megalocytosis, and hepatocellular neoplasms) were observed in any of the tissues examined. However, a number of other pathological findings were noted (Table 5.62). Parasitic infections were the most common abnormalities, with microsporidians being the most prevalent. Two other prevalent lesions included inflammatory foci and granulomatous inflammation. These lesions were usually associated with parasitic infections (e.g., nematodes) and were not related to the study sites.

Splenic MA analyses are performed on 416 flatfishes collected from sites MAI-686, HI-A389, and MU-A85 during Phase 1 sampling. The number of MAs per mm², average size of MAs in μm², and percent area occupied by MAs for each site/station and cruise are summarized in Figure 5.123.

5.8 Detoxification

The detoxification work element evaluated 31 species of fish and 14 invertebrate species for evidence of PAH exposure. Of this group, only 16 species of fish and 5 invertebrate species were collected at both Near and Far stations for at least one of the three study sites (Tables 5.63 and 5.64). Only two species of fish, *Synodus foetens* (lizard fish) and *Paralichthys lethostigma* (southern flounder), were captured at all stations. No invertebrate species were collected at all study sites. The best overlap in species between Near and Far stations was collected at MU-A85 and HI-A389. The following fish species were collected at both Near and Far stations at these two sites: *Ancyclopsetta dilecta* (three-eyed flounder), *Caulolatilus intermedius* (tile fish), *Cynoscion arenarius* (sand sea trout), *Paralichthys lethostigma* (southern flounder), *Pristipomoides aquilonaris* (wenchman), *Synodus foetens* (lizard fish), *Trichopsetta ventralis* (sash flounder), and *Urophycis* spp. (hake)

Over 1500 detoxification analyses/assays were conducted as part of the detoxification effort, including 266 and 543 assays for AHH and EROD activity, respectively and 178 assays for CYP1A mRNA levels derived from fish liver preparations. In addition, 81 AHH assays of invertebrates and 384 bile metabolite analyses were conducted. Nearly 100 invertebrate tissue extracts were used to dose rat Hepatoma H4IIE cells to derive toxic equivalent values (TEQs). AHH activity was measured in both fish liver and invertebrate digestive tissue for Cruise 1 samples. AHH activity was also

Table 5.62. Pathological abnormalities in liver and spleen.

Site	Station ^a	Species	Lesion	% Prevalence for Cruise			
				1	2	3	4
MAI-686	N	<i>Syacium gunteri</i>	Granulomas	5.0	0.0	0.0	0.0
			Inflammatory foci	35.0	0.0	0.0	0.0
			Microsporidians	35.0	64.7	21.1	40.0
			Nematodes	5.0	17.6	10.5	6.7
			Sporozoan (?)	10.0	0.0	5.3	6.7
	F	<i>Syacium gunteri</i>	Granulomas	0.0	0.0	10.5	0.0
			Inflammatory foci	15.0	0.0	10.5	0.0
			Microsporidians	0.0	54.2	52.6	25.0
			Nematodes	0.0	4.2	5.3	10.0
			Sporozoan (?)	0.0	12.5	10.5	10.0
HI-A389	N	<i>Trichopsetta ventralis</i>	Granulomas	--	15.0	25.0	10.0
			Inflammatory foci	--	10.0	15.0	40.0
			Microsporidians	--	10.0	0.0	0.0
			Nematodes	--	0.0	5.0	5.0
			Sporozoan (?)	--	0.0	10.0	0.0
	F	<i>Trichopsetta ventralis</i>	Granulomas	--	5.0	27.3	10.0
			Inflammatory foci	--	5.0	18.2	0.0
			Microsporidians	--	25.0	13.6	0.0
			Nematodes	--	15.0	9.1	5.0
MU-A85	N	<i>Trichopsetta ventralis</i>	Granulomas	30.0	31.8	30.0	10.0
			Inflammatory foci	0.0	13.6	5.0	20.0
			Microsporidians	20.0	27.3	60.0	0.0
			Nematodes	25.0	5.5	10.0	0.0
			Sporozoan (?)	10.5	10.0	20.0	0.0
	F	<i>Trichopsetta ventralis</i>	Granulomas	31.6	21.7	34.8	38.1
			Inflammatory foci	47.4	34.8	26.1	19.0
			Microsporidians	10.5	26.1	26.1	19.0
			Nematodes	5.3	8.7	4.3	0.0
			Sporozoan (?)	0.0	4.3	13.0	0.0

^aN = near station; F = far station

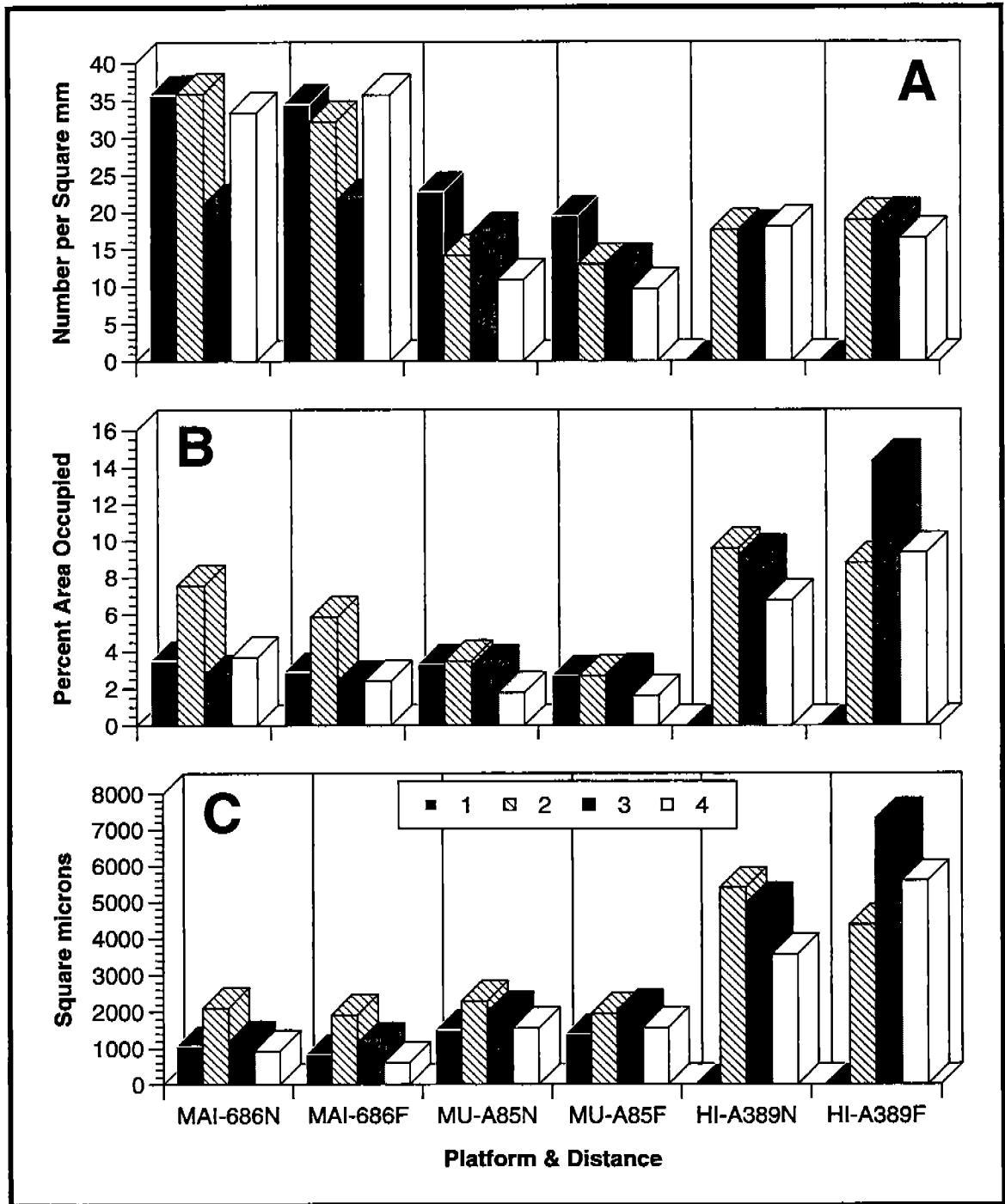

Figure 5.123. Results of splenic macrophage aggregate analysis of fishes collected from MAI-686, MU-A85, and HI-A389 for all cruises. The species examined at MAI-686 was *Syacium gunteri*; at MU-A85 and HI-A389 was *Trichopsetta ventralis*. A: Number of macrophage aggregates per mm² of splenic tissue sections; B: Percent area of splenic tissue sections occupied by macrophage aggregates; C: Average size of macrophage aggregates (μm²).

Table 5.63. Fish species captured at both Near and Far stations of at least one platform.

Scientific Name	Common Name	Stations Captured	N
<i>Ancyclopsetta dilecta</i>	3-eyed flounder	MU-A85	9
		HI-A389	18
<i>Caulolatilus intermedius</i>	Tile fish	MU-A85	10
		HI-A389	15
<i>Centropristis philadelphica</i>	Rock sea bass	MU-A85	14
<i>Cynoscion arenarius</i>	Sand sea trout	MAI-686	21
		MU-A85	11
<i>Cyclopsetta chittendeni</i>	Mexican flounder	MU-A85	15
<i>Lagodon rhomboides</i>	Pinfish	MU-A85	14
<i>Ogcocephalus declivirostris</i>	Batfish	HI-A389	10
<i>Paralichthys lethostigma</i>	Southern Flounder	HI-A389	14
		MAI-686	5
		MU-A85	7
<i>Pontinus longispinis</i>	Scorpion fish	HI-A389	36
<i>Pristipomoides aquilonaris</i>	Wenchman	MU-A85	22
		HI-A389	39
<i>Syacium gunteri</i>	Shoal flounder	MAI-686	34
<i>Synodus foetens</i>	Lizard fish	MU-A85	28
		HI-A389	16
		MAI-686	12
<i>Trichopsetta ventralis</i>	Sash flounder	MU-A85	14
		HI-A389	18
<i>Urophycis</i> spp.	Hake	MU-A85	12
		HI-A389	25
<i>Ancyclopsetta quadrocellata</i>	Ocellated flounder	MAI-686	3
<i>Lutjanus campechanus</i>	Red snapper	MU-A85	16
		MAI-686	19

Table 5.64. Invertebrate species captured at both Near and Far stations of at least one platform.

Scientific Name	Common Name	Stations Captured	N
<i>Trachypenaeus similis</i>	Shrimp	MAI-686	17
<i>Squilla empusa</i>	Mantis shrimp	MAI-686	15
<i>Peneaus aztecus</i>	Brown shrimp	MAI-686	10
		MU-A85	16
<i>Callinectes similis</i>	Crab	MAI-686	13
<i>Solenocera atlanticus</i>	Shrimp	MU-A85	12

Table 5.65. AHH activities of invertebrates collected on Cruise 1.

Site	Station	Species	AHH (pmol/min/mg)
HI-A389	Near	<i>Trachypenaeus similis</i>	1.9±3.2
HI-A389	Far	Spider crab	0
		Mixed fauna	0
MAI-686	Near	<i>Trachypenaeus similis</i>	3.0±4.2
		Welk	0
		Mixed infauna	0.1±0.1
MAI-686	Far	<i>Trachypenaeus similis</i>	0
		<i>Callinectes similis</i>	0
		Welk	
MU-A85	Near	Bristle worm	0
		Brown shrimp	1.2
MU-A85		<i>Amusium papyraceum</i>	0
		<i>Penaeus aztecus</i>	1.1±0.9
		Mixed infauna	0

measured in hepatic fish samples collected on Cruise 2. EROD activity and biliary PAH metabolite concentrations were measured in fish collected on all four cruises. CYP1A mRNA levels were determined on selected fish samples from Cruises 2, 3, and 4.

5.8.1 AHH Activity in Invertebrates

AHH activity was measured in selected invertebrate tissues collected during Cruise 1. Activities were low to non-detectable for several species of infauna and epifauna (Table 5.65). *In vivo* invertebrate assays were discontinued for subsequent cruises due to the very low activities observed for Cruise 1 samples.

5.8.2 EROD and AHH Activity in Fish

Although approximately 600 fish were analyzed, statistical evaluations were conducted on a more limited data set. Included in this data is information collected only for those species captured at both Near and Far station for at least one of the three study sites. No consistent differences were detected in EROD and AHH activities between the four cruises, therefore, the cruises were considered replicates.

EROD activities in various fish species were highly variable and species-dependent (Figure 5.124; Table 5.66). Activities ranges from non-detectable to 345 pmol/min/mg. The highest EROD activities were consistently measured in *Lagodon rhomboides* (pinfish; 7 to 348 pmol/min/mg) and *Caulolatilus intermedius* (tilefish; 15.1 to 182 pmol/min/mg). Consistently lower EROD activities were measured for *Centropristis philadelphica* (rock seabass) and *Ancyclopsetta dilecta* (three-eyed flounder; Figure 5.124). However, no difference was observed between Near/Far stations for any of the species evaluated (Figures 5.125 to 5.140).

AHH activity was measured in all fish collected on Cruises 1 and 2. The assay for this activity was discontinued for subsequent cruises because a highly significant correlation between the two assays (EROD vs. AHH) was established for most species (Figure 5.141). Other studies have shown a similar relationship between the two assays for several fish species (Collier et al. 1992). The two assays measure the activity of the same enzyme (i.e., CYP1A); however, the EROD assay is typically more sensitive and uses a less toxic substrate than the AHH assay. AHH and EROD activities were not

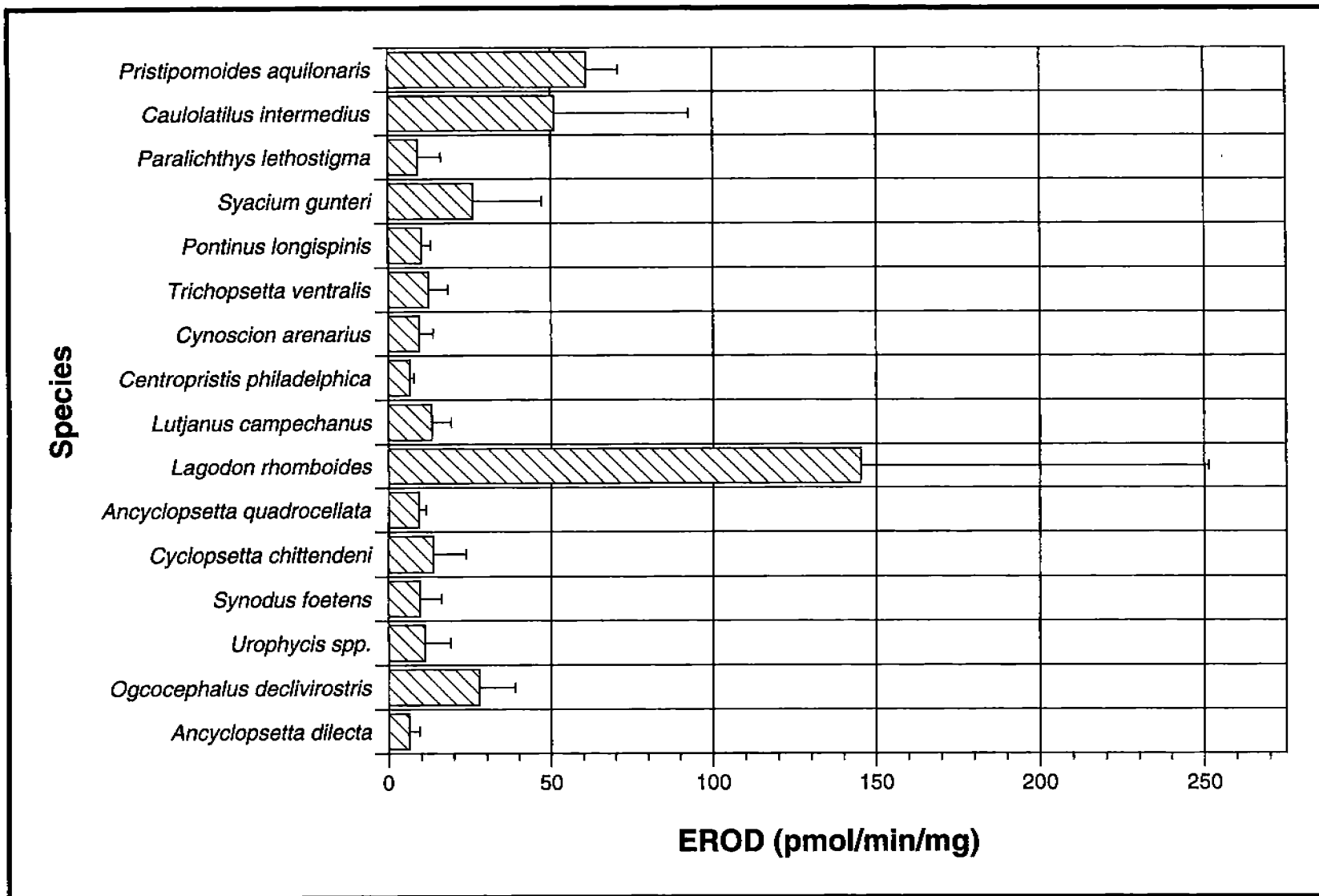

Figure 5.124. Mean hepatic EROD activities in various fish species.

Table 5.66. Mean (\pm SD) of EROD and AHH activities and mean biliary PAH metabolite concentrations for those species of fish captured at Near (N) and Far (F) stations.

Species	Site	CYP1A-Catalyzed Enzymes		Bile PAH Metabolites		
		EROD (pmol/min/mg)	AHH (pmol/min/mg)	Naphthalene (ng/g)	Phenanthrene (ng/g)	Benzo[a]pyrene (ng/g)
<i>Ancyclopsetta dilecta</i>	MU-A85N	6.8 \pm 0.8	0			
	MU-A85F	4.3 \pm 3.4	0			
	HI-A389N	6.6 \pm 2.6	0			
	HI-A389F	7.1 \pm 4	0			
<i>Caulolatilus intermedtus</i>	MU-A85N	69.6 \pm 37.9		20000	4000	0
	MU-A85F	66 \pm 38.5		130000 \pm 67000	17000 \pm 6500	140 \pm 200
	HI-A389N	56.7 \pm 59.1		150000 \pm 33000	37000 \pm 14000	0
	HI-A389F	26.1 \pm 10.5		68000 \pm 22000	11000 \pm 3000	280 \pm 250
<i>Centropristis philadelphica</i>	MU-A85N	6.8 \pm 1	4 \pm 3.9	140000 \pm 49000	27000 \pm 10000	360 \pm 190
	MU-A85F	6.2 \pm 1.4	1.2 \pm 1.6	70000 \pm 35000	9900 \pm 3500	180 \pm 120
<i>Cynoscion arenarius</i>	MU-A85N	8.4 \pm 2.3		88000 \pm 33000	18000 \pm 8400	100 \pm 0
	MU-A85F	6.4 \pm 2.4		130000 \pm 74000	21000 \pm 9200	110
	MAI-686N	10.7 \pm 5.2		100000 \pm 35000	19000 \pm 8800	250 \pm 180
	MAI-686F	9.8 \pm 1.7		110000 \pm 60000	19000 \pm 7400	120 \pm 10
<i>Cyclopsetta chittident</i>	MU-A85N	12.7 \pm 11.3	0.7 \pm 1.1	54000 \pm 11000	12000 \pm 4700	110 \pm 150
	MU-A85F	15.6 \pm 8.1	6.8 \pm 9.2	68000 \pm 30000	15000 \pm 9400	210 \pm 200
<i>Lagodon rhomboides</i>	MU-A85N	140.5 \pm 101.4	11.3 \pm 14	190000 \pm 71000	49000 \pm 25000	120 \pm 80
	MU-A85F	156.9 \pm 132.9	51 \pm 21.4	190000 \pm 95000	35000 \pm 20000	180 \pm 190
<i>Ogocephalus declivirostris</i>	HI-A389N	26.2 \pm 4.9		33000 \pm 18000	7900 \pm 4300	0
	HI-A389F	34.8 \pm 29.6		73000	15000	420
<i>Paralichthys lethostigma</i>	HI-A389N	9.7 \pm 10.7				
	HI-A389F	6.9 \pm 3.3				
	MAI-686N	10.8 \pm 4.8				
	MAI-686F	6.5 \pm 0				
	MU-A85N	7.5 \pm 2.6				
	MU-A85F	7.2 \pm 0.7				
<i>Pontinus longispinis</i>	HI-A389N	9.8 \pm 1.5	0	120000 \pm 56000	29000 \pm 22000	0
	HI-A389F	10.4 \pm 3.6	0.2 \pm 0.4	120000 \pm 60000	33000 \pm 31000	270 \pm 180
<i>Pristipomoides aquilonaris</i>	MU-A85N	10.7 \pm 5.3		82000 \pm 10000	16000 \pm 1400	110 \pm 70
	MU-A85F	8.3 \pm 1.6		90000 \pm 33000	16000 \pm 4800	160 \pm 50
	HI-A389N	10.8 \pm 3.5		79000 \pm 42000	18000 \pm 12000	160 \pm 40
	HI-A389F	9.9 \pm 2.5		10000 \pm 5000	20000 \pm 12000	170 \pm 100

Table 5.66. (Cont.)

Species	Site	CYP1A-Catalyzed Enzymes		Bile PAH Metabolites		
		EROD (pmol/min/mg)	AHH (pmol/min/mg)	Naphthalene (ng/g)	Phenanthrene (ng/g)	Benzo[a]pyrene (ng/g)
<i>Syactum gunter</i>	MAI-686N	21.6±15.6	15.4±15.4			
	MAI-686F	28.2±23.4	21.3±26.6			
<i>Synodus foetens</i>	HI-A389N	12.3±14	0	57000±25000	11000±4500	0
	HI-A389F	8.9±3.5	0	88000±45000	16000±9400	190±160
	MU-A85N	8±1.7	0	110000±53000	19000±9700	280±140
	NU-A85F	6.4±1.6	0	83000±35000	17000±7200	210±160
	MAI-686N	22.4±8.8	0	180000	42000	460
	MAI-686F	12.6±6.6	0	140000	23000	150
<i>Tricopsetta ventralis</i>	MU-A85N	10.5±5	0			
	MU-A85F	9.3±3.7	0			
	HI-A389N	13±4.9	0			
	HI-A389F	15.5±7.8	0			
<i>Urophycis spp.</i>	MU-A85N	10.6±3.8	0			
	MU-A85F	10.9±6.4	0			
	HI-A389N	10.5±7.1	1.2±2			
	HI-A389F	11.7±10.5	2±2.8			
<i>Ancyclopsetta quadrocellata</i>	MAI-686N	11.3±0				
	MAI-686F	8.4±1.6				
<i>Lutjanus campechanus</i>	MU-A85N	14.1±4.3				
	MU-A85F	14.1±5.6				
	MAI-686N	13.2±7.3				
	MAI-686F	8±0.8				

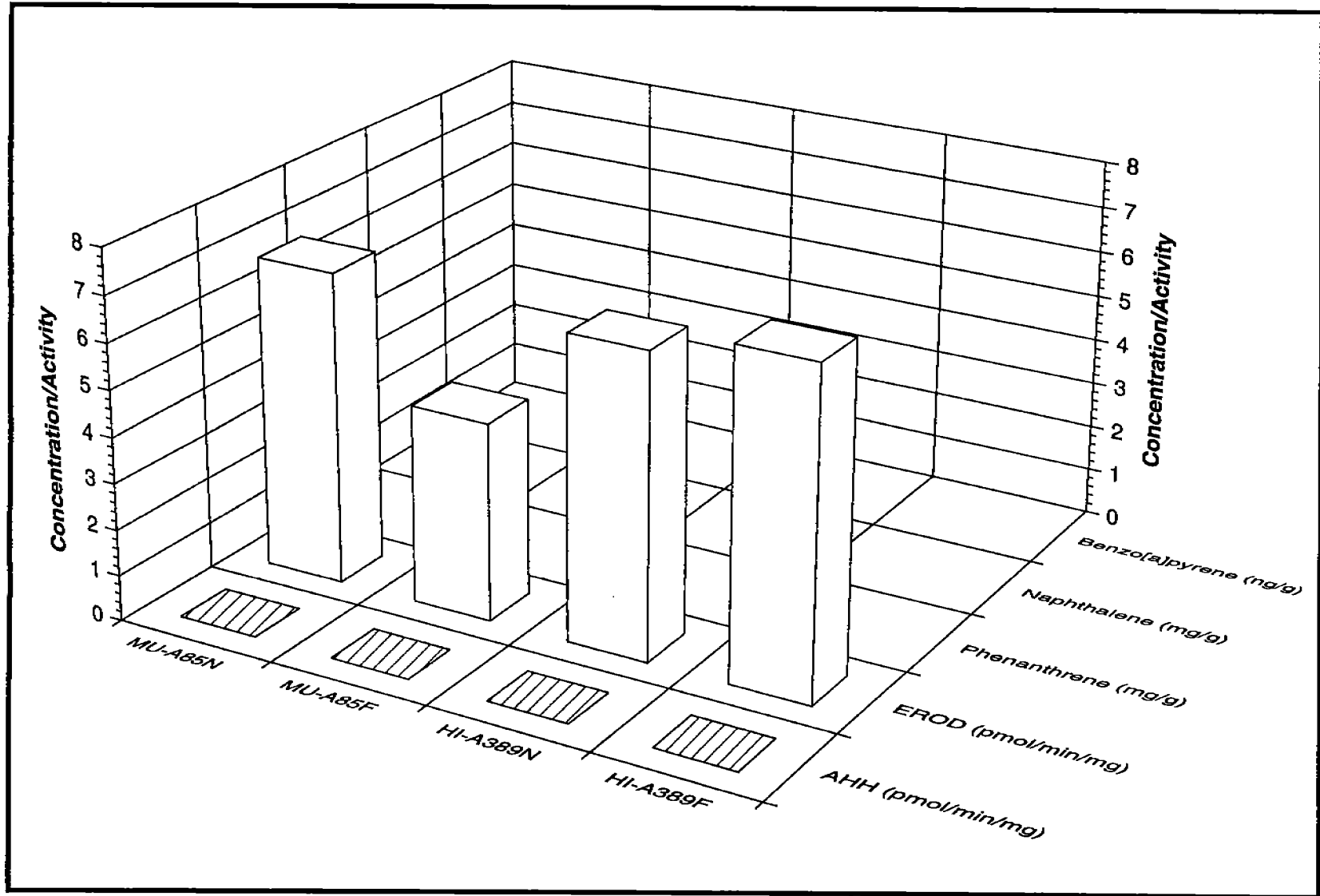

Figure 5.125. Catalytic enzyme activities and biliary metabolite concentrations in *Ancylopussetta dilecta*.

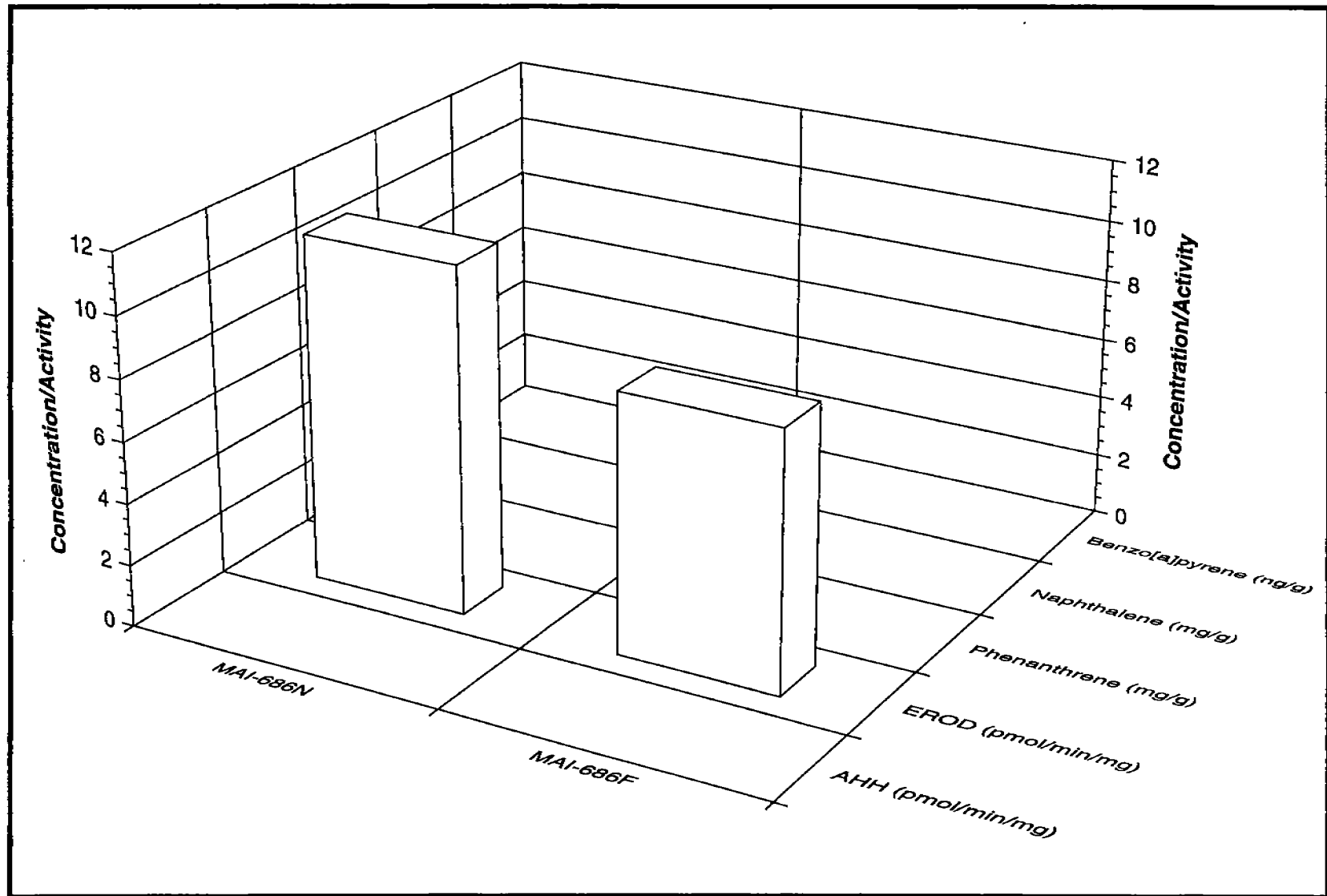

Figure 5.126. Catalytic enzyme activities and biliary metabolite concentrations in *Ancyloperetta quadrocellata*.

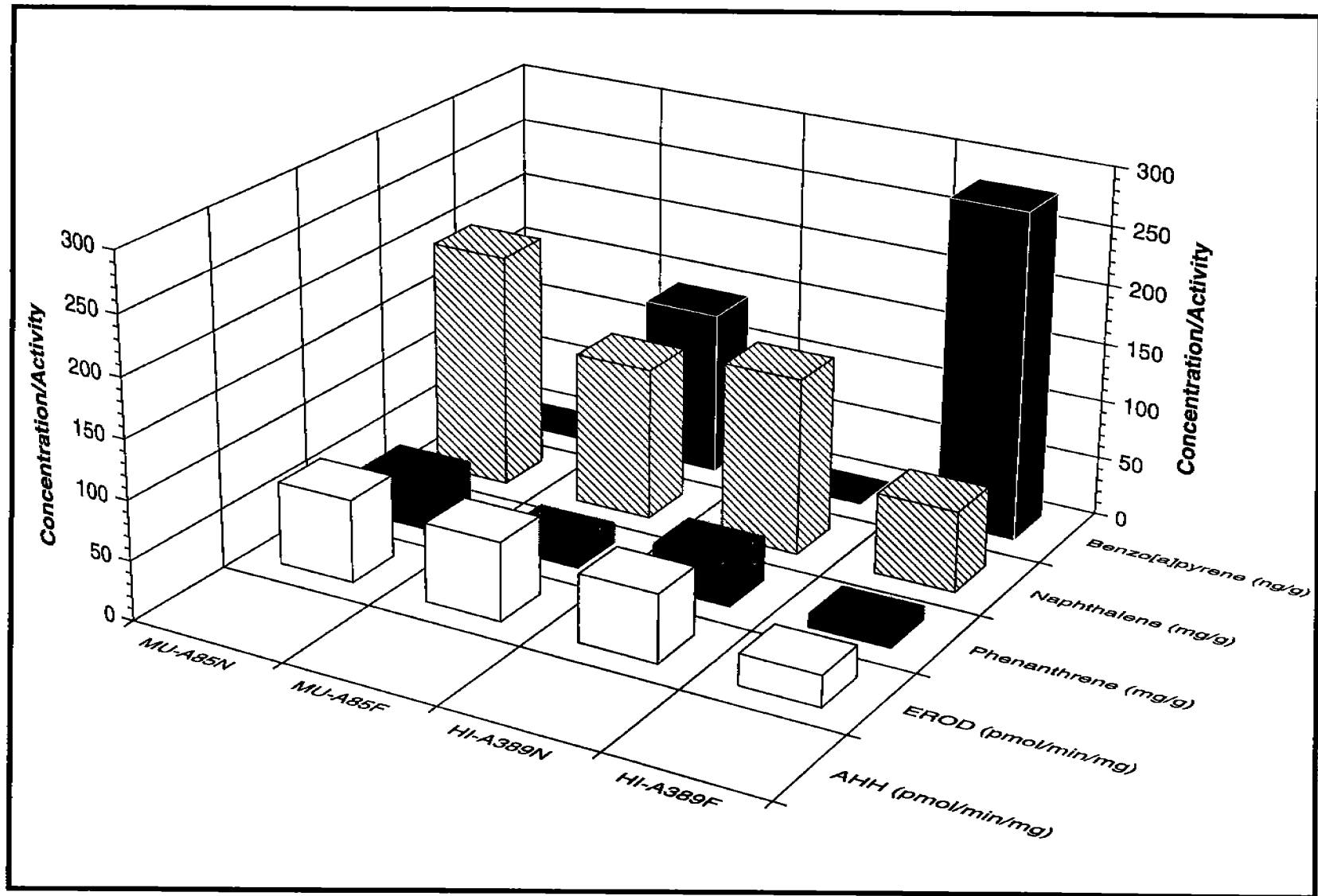

Figure 5.127. Catalytic enzyme activities and biliary metabolite concentrations in *Caulolatilus intermedius*.

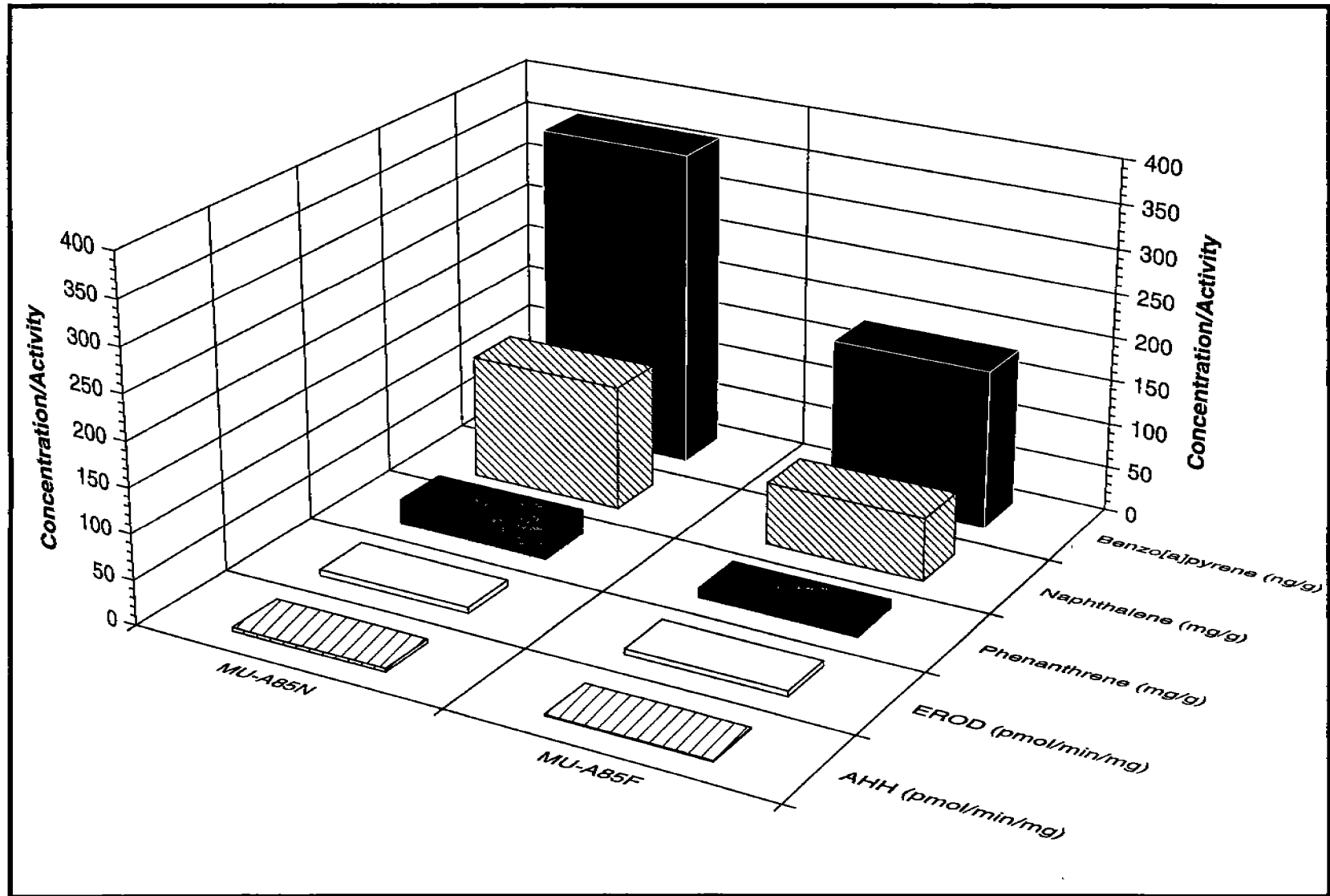

Figure 5.128. Catalytic enzyme activities and biliary metabolite concentrations in *Centropomus philadelphicus*.

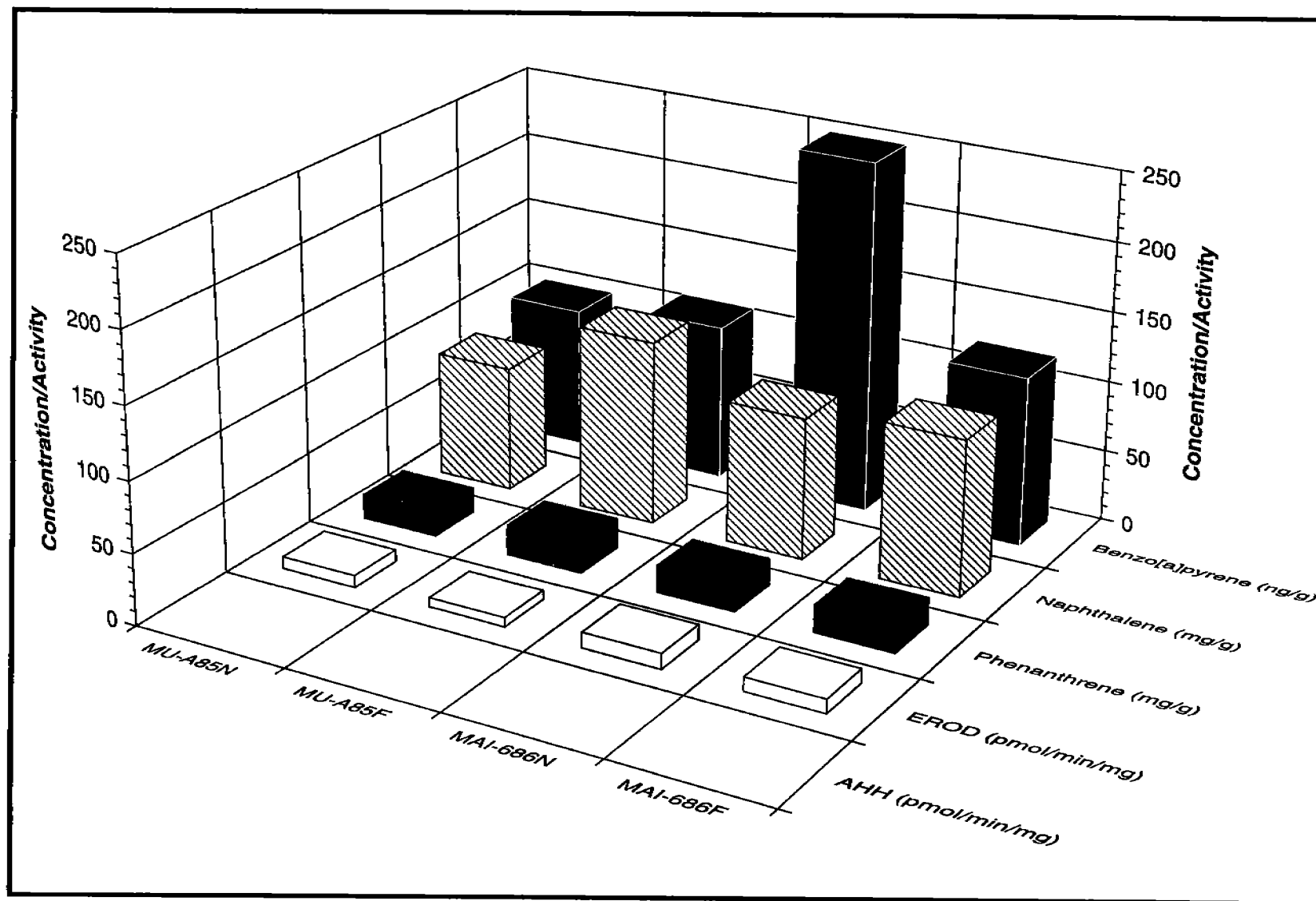

Figure 5.129. Catalytic enzyme activities and biliary metabolite concentrations in *Cynoscion arenarius*.

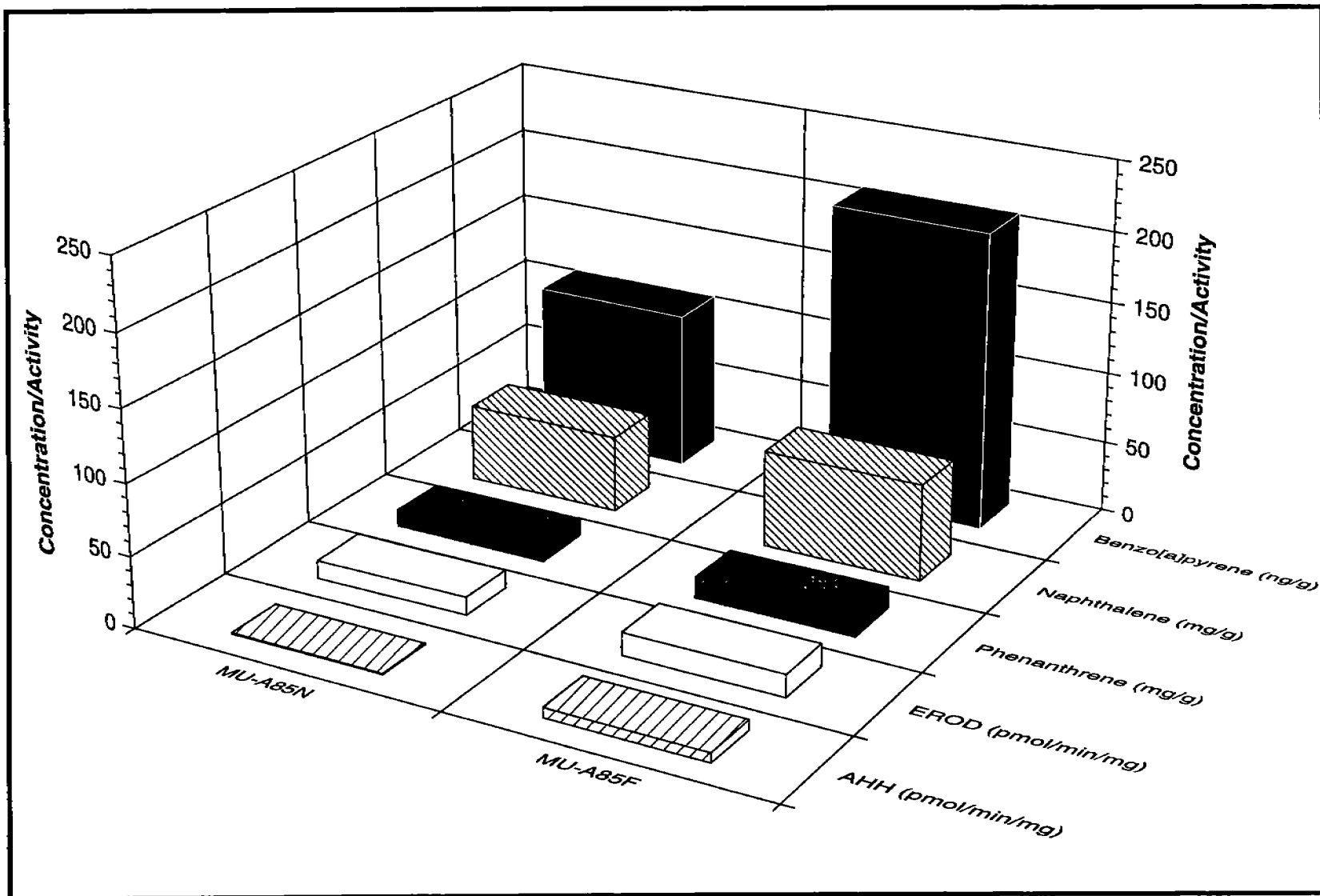

Figure 5.130. Catalytic enzyme activities and biliary metabolite concentrations in *Cyclopsetta chittendeni*.

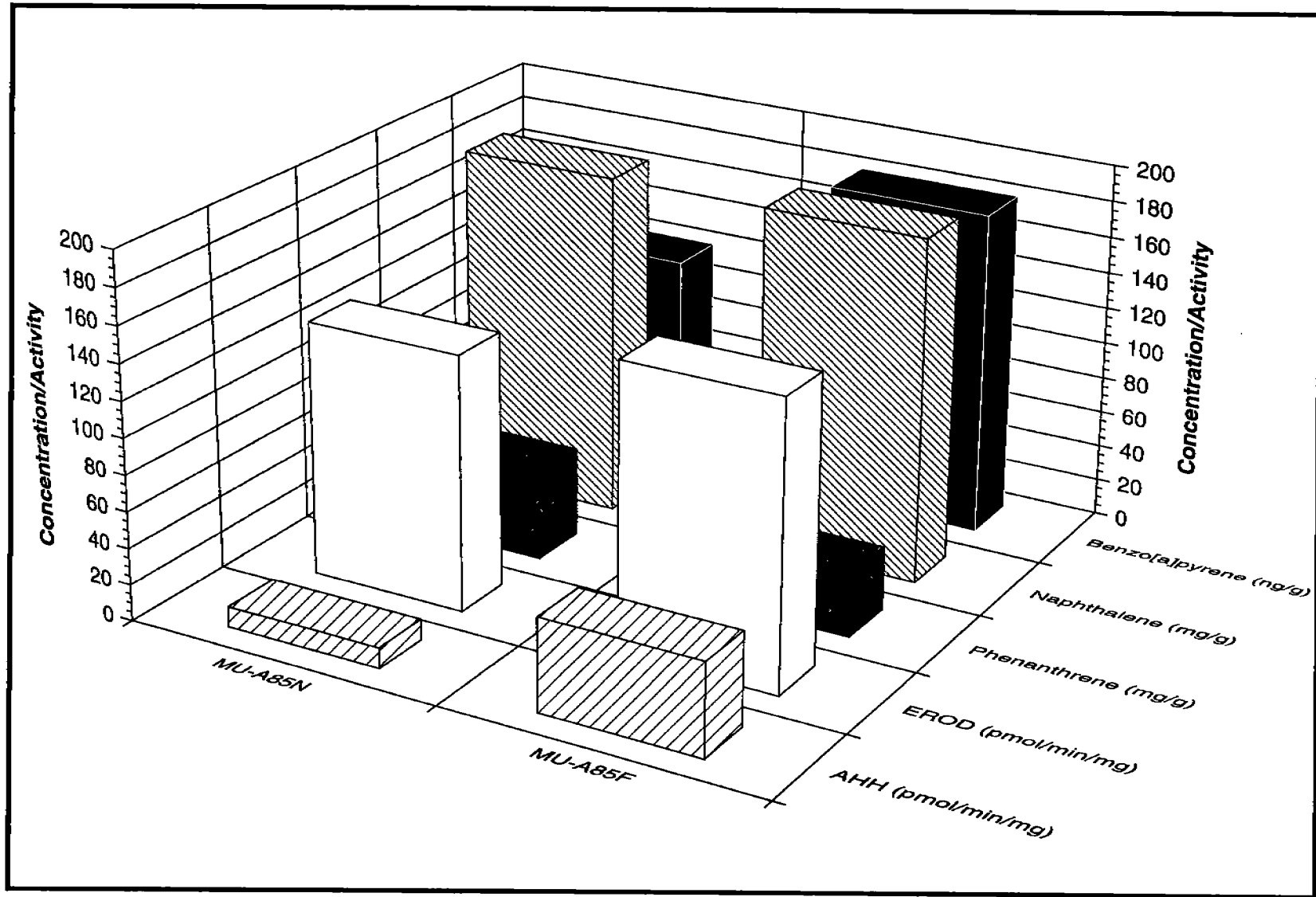

Figure 5.131. Catalytic enzyme activities and biliary metabolite concentrations in *Lagodon rhomboides*.

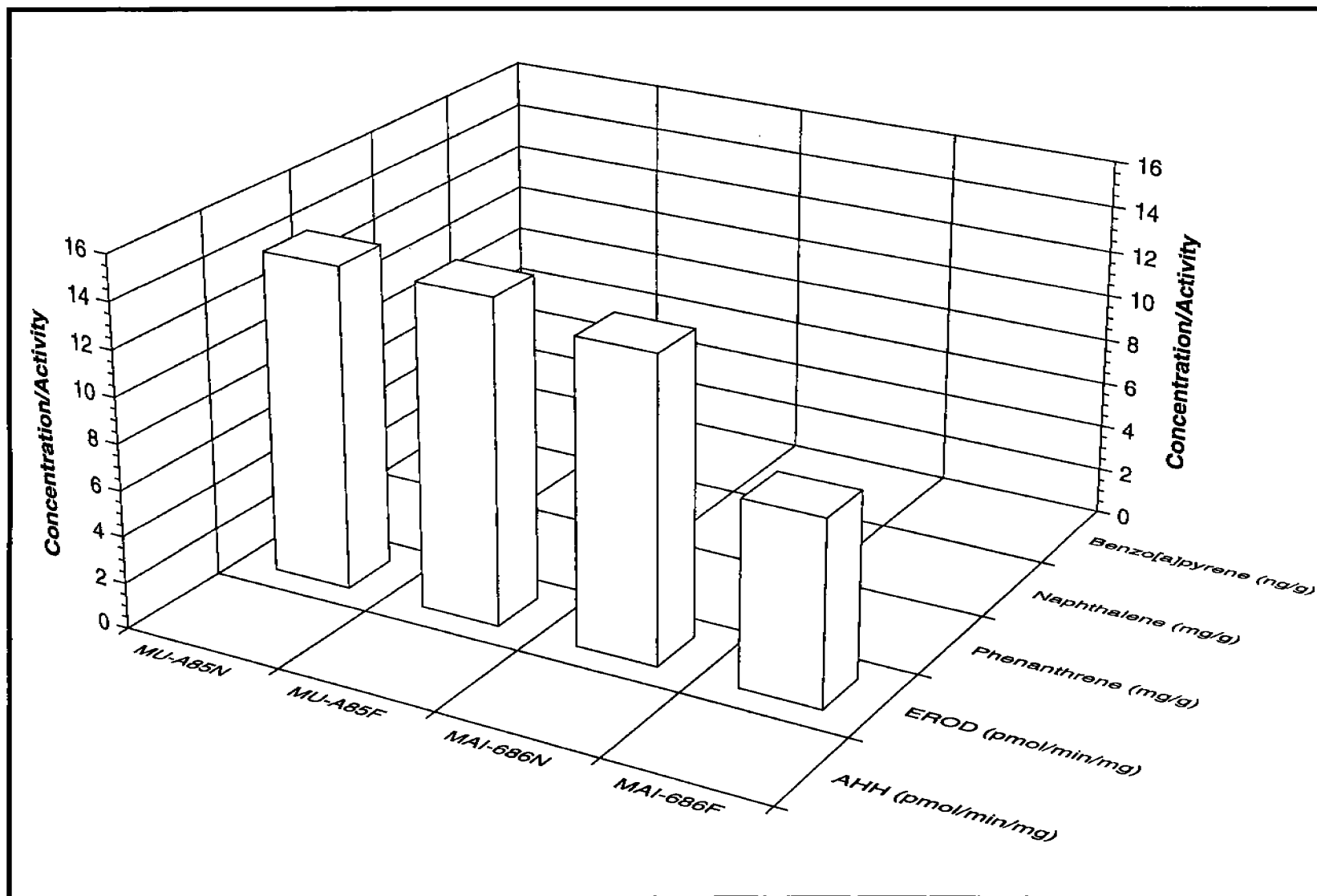

Figure 5.132. Catalytic enzyme activities and biliary metabolite concentrations in *Lutjanus campechanus*.

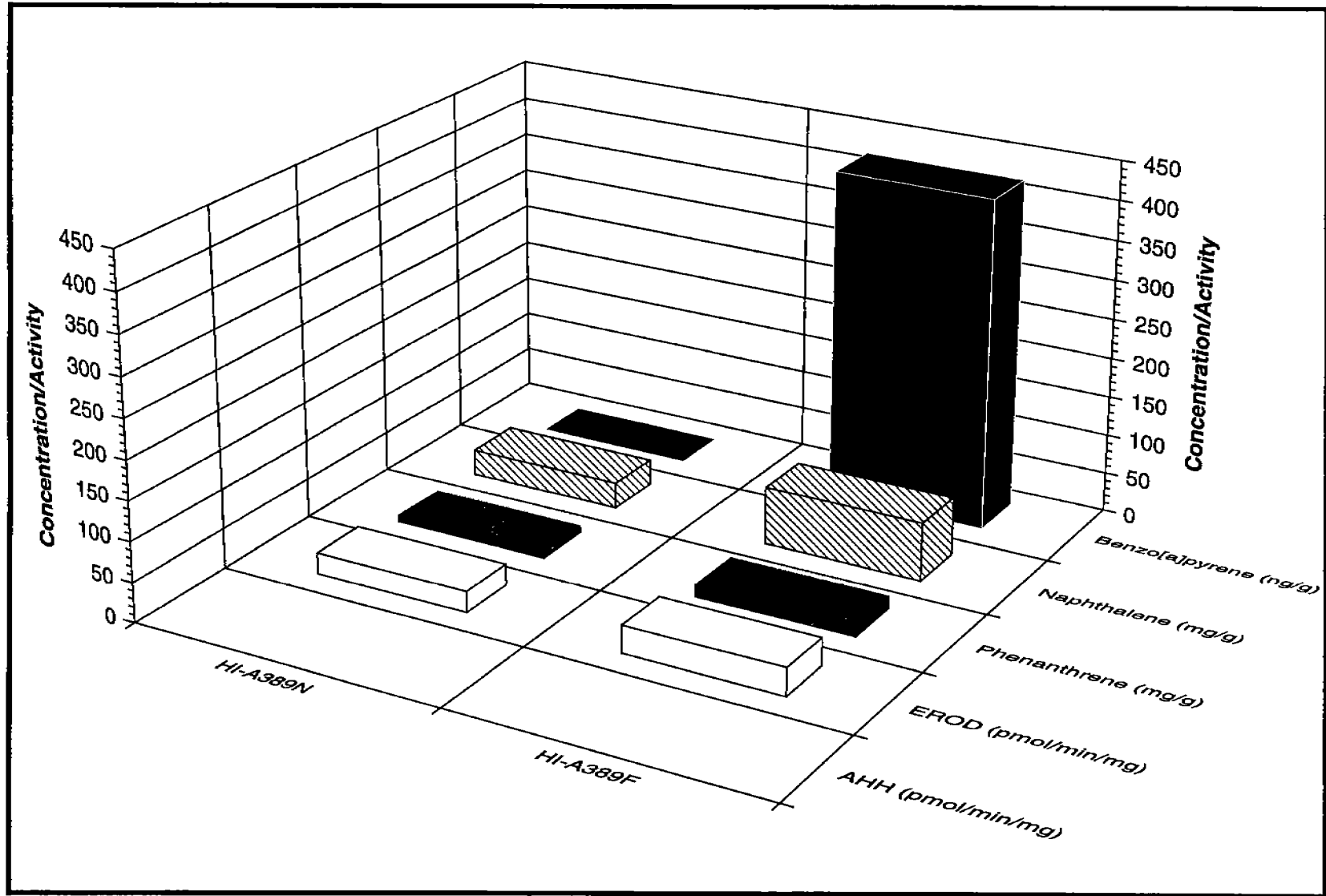

Figure 5.133. Catalytic enzyme activities and biliary metabolite concentrations in *Ogcocephalus declivirostris*.

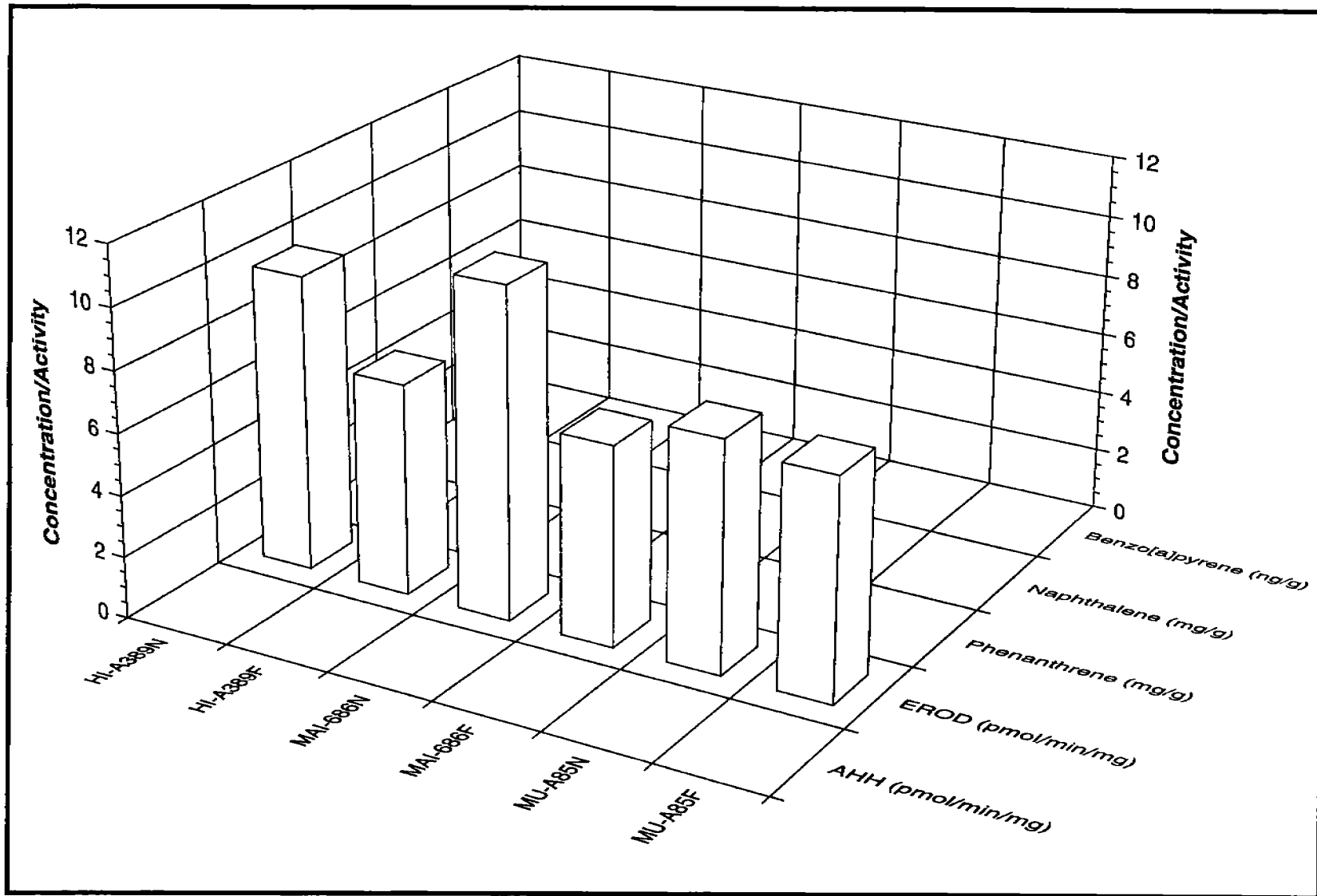

Figure 5.134. Catalytic enzyme activities and biliary metabolite concentrations in *Paralichthys lethostigma*.

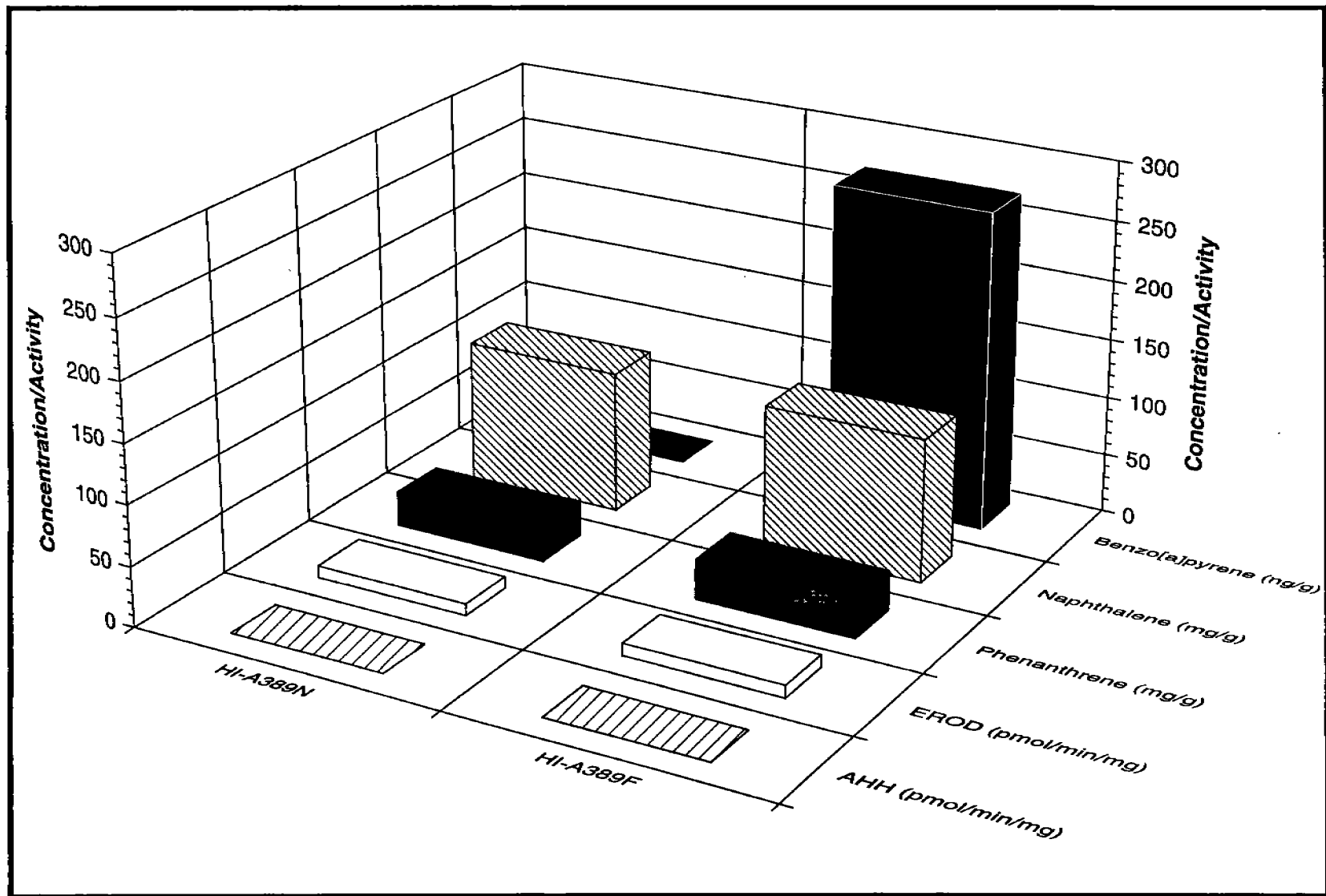

Figure 5.135. Catalytic enzyme activities and biliary metabolite concentrations in *Pontinus longispinis*.

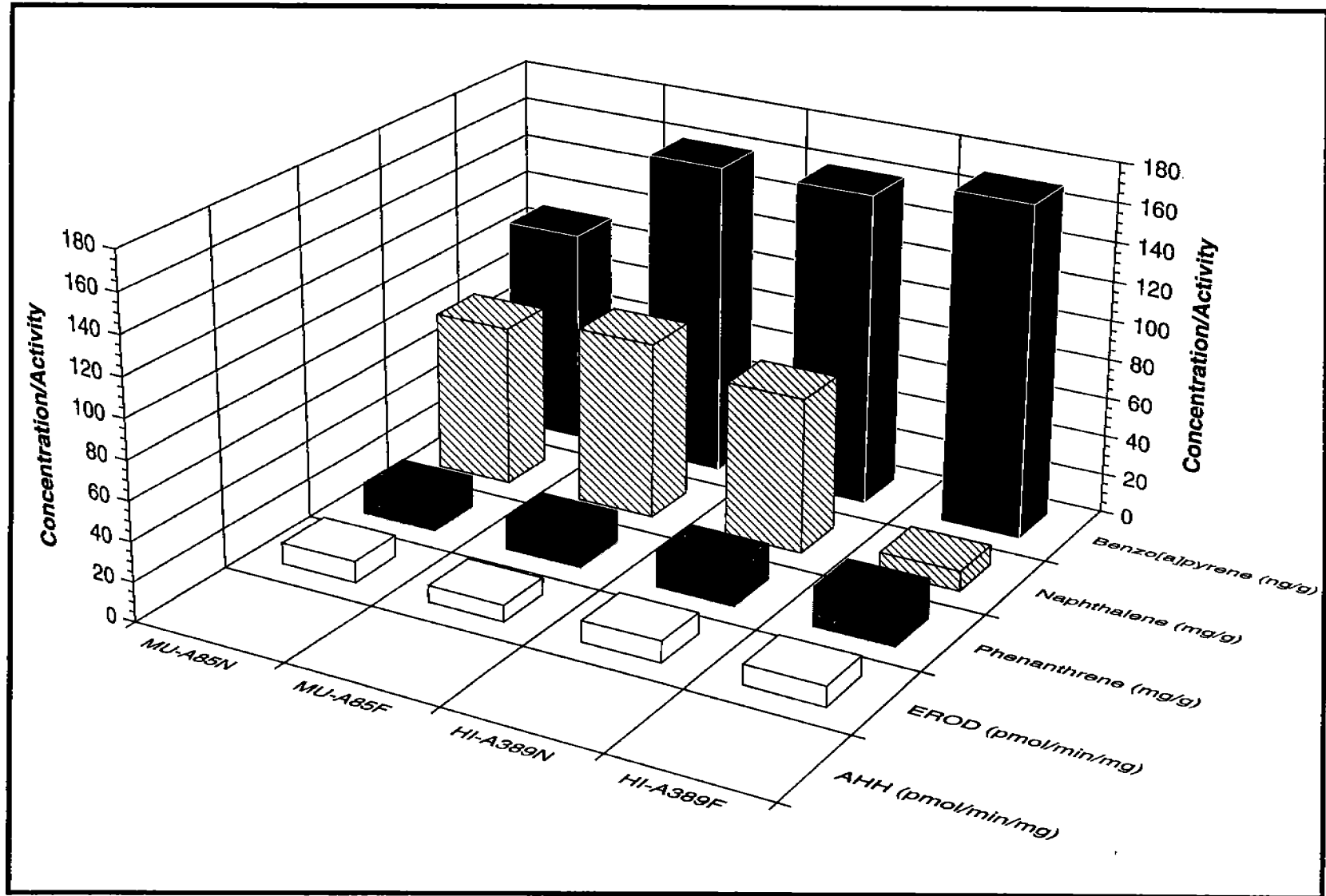

Figure 5.136. Catalytic enzyme activities and biliary metabolite concentrations in *Pristipomoides aquilonaris*.

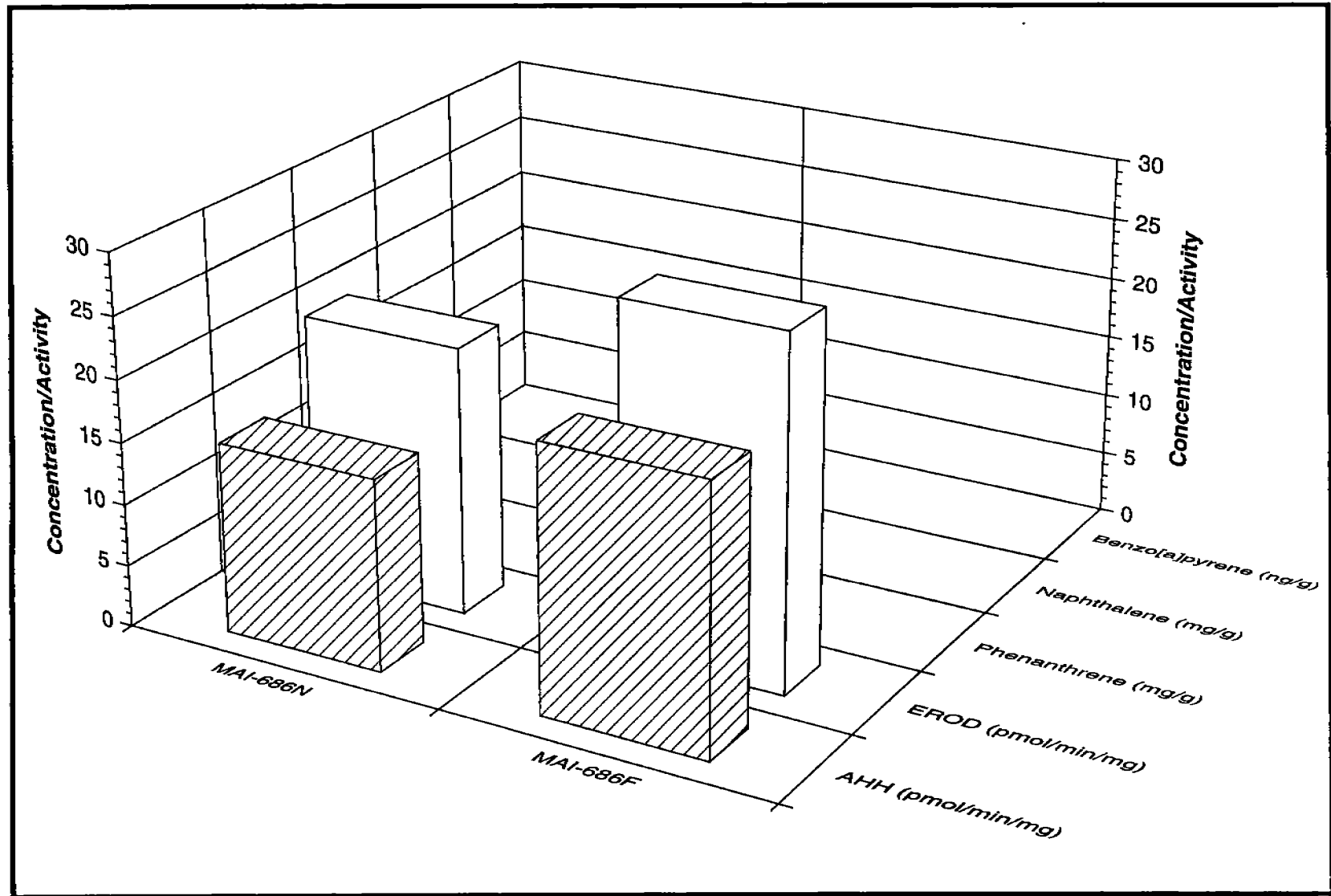

Figure 5.137. Catalytic enzyme activities and biliary metabolite concentrations in *Syacium gunteri*.

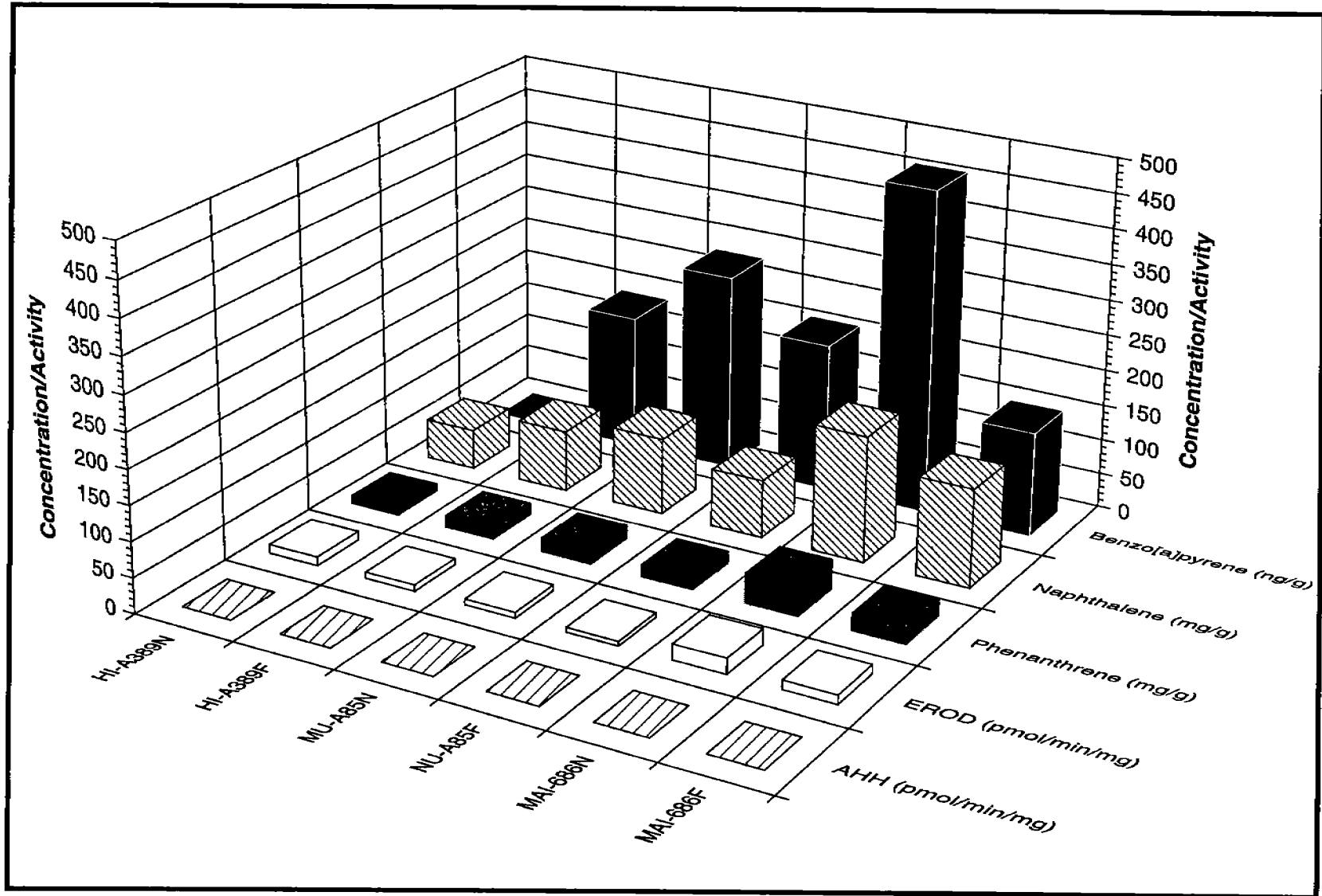

Figure 5.138. Catalytic enzyme activities and biliary metabolite concentrations in *Synodus foetens*.

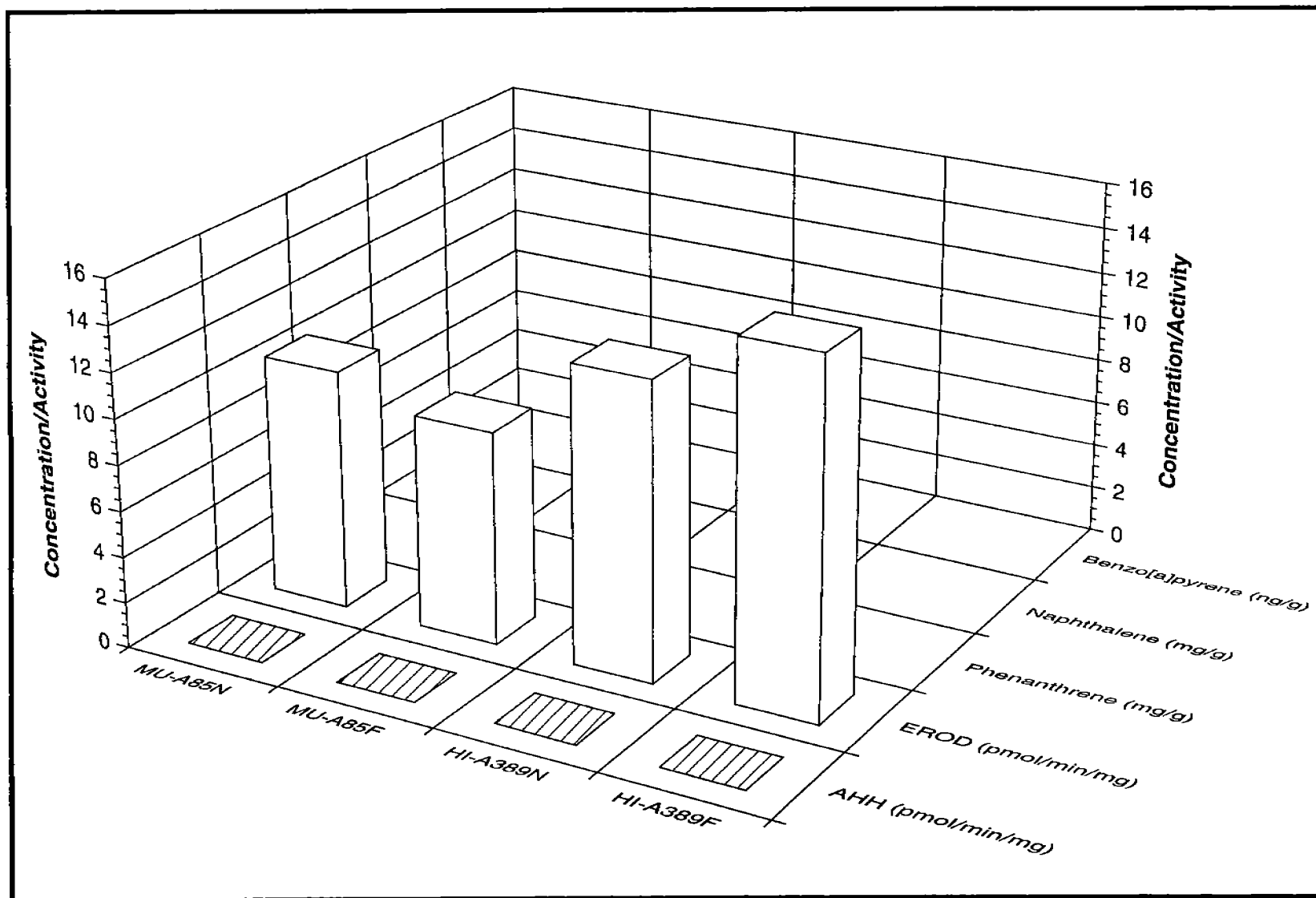

Figure 5.139. Catalytic enzyme activities and biliary metabolite concentrations in *Trichopsetta ventralis*.

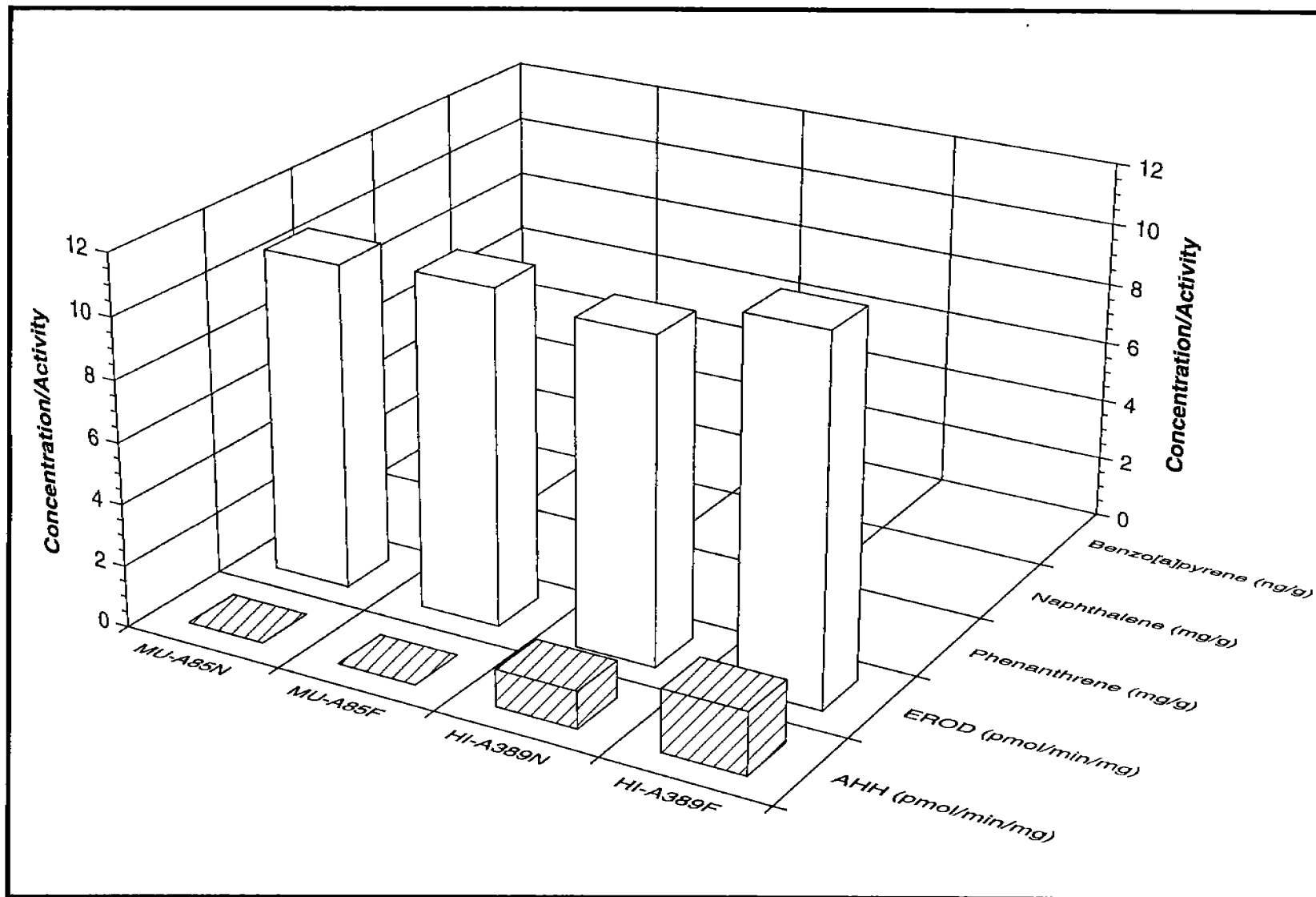

Figure 5.140. Catalytic enzyme activities and biliary metabolite concentrations in *Urophycis* spp.

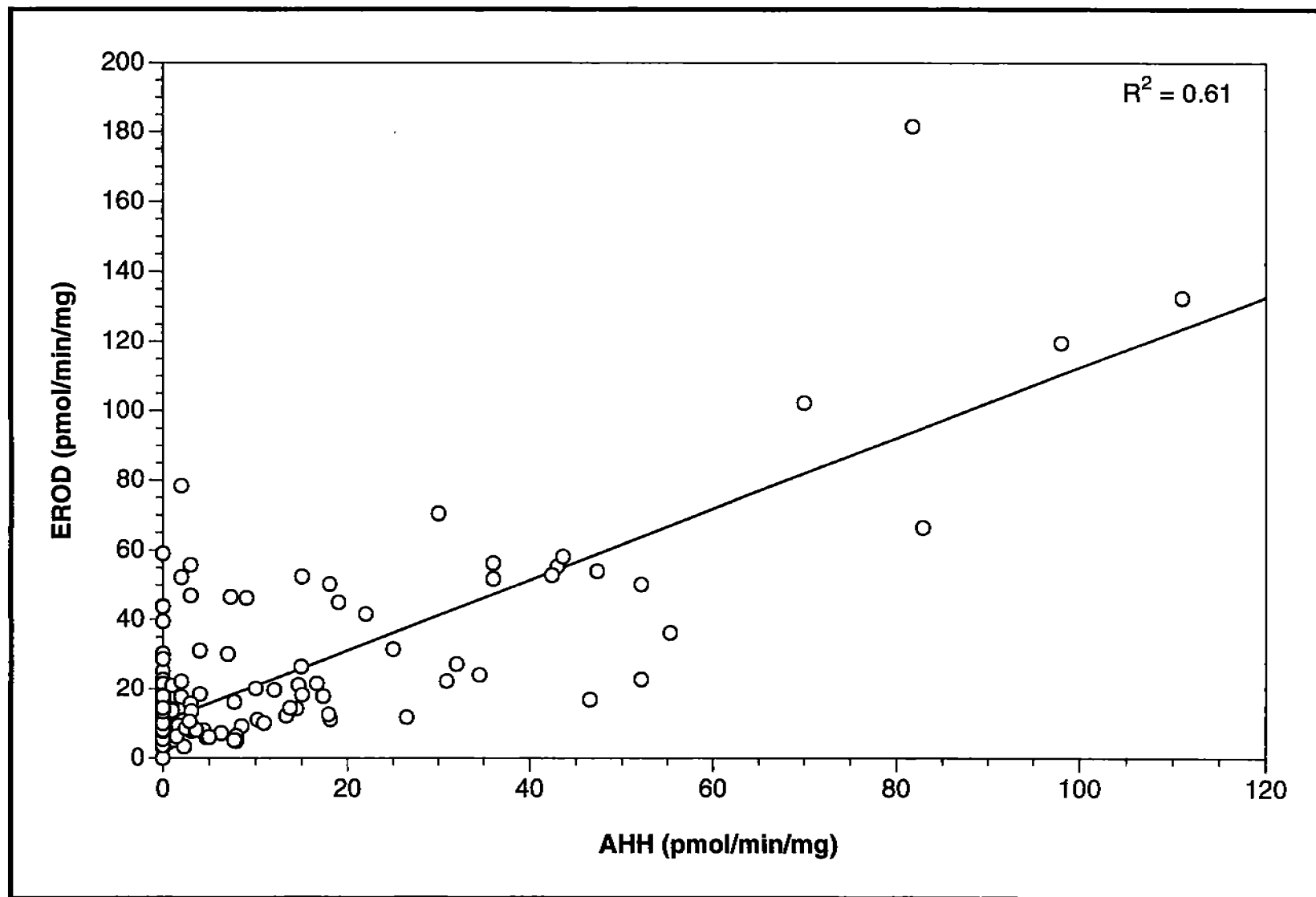

Figure 5.141. Correlation between EROD and AHH activities in fish captured on Cruises 1 and 2 (excluding *Lagodon rhomboides*).

closely correlated for two species: *Lagodon rhomboides* (pinfish) and *Arius felis* (hardhead catfish), for which EROD activity was significantly higher than the AHH activities for these two species. The fish that do not exhibit a coordinated induction of AHH and EROD activity (i.e., EROD >> AHH) may express an altered CYP1A protein compared to other fish species studied.

5.8.3 Biliary PAH Metabolites in Fish

Significant species differences were observed in biliary PAH metabolite concentrations (Figure 5.142; Table 5.66). The concentrations of naphthalene and phenanthrene-equivalent metabolites were higher in *Lagodon rhomboides* (pinfish). Benzo(a)pyrene-equivalent metabolite concentrations were higher in *Urophycis* spp. (hake). No significant Near/Far differences in biliary PAH metabolites concentrations were detected for any species.

5.8.4 Rat Hepatoma H-4IIE Bioassays

The highest TEQ values were derived from rat hepatoma cells treated with *Amusium papyraceum* (scallop) extracts (Figure 5.143). The TEQs for these extracts were nearly ten times higher than observed for extracts from other species, which is consistent with the expected higher levels of contaminant accumulation in bivalves. However, a Near/Far station comparison was not possible because scallops were unavailable from the Near station for this assay. The only significant station difference observed was at MAI-686 for extracts of *Penaeus aztecus* (brown shrimp) collected at the Near station. These shrimp exhibited higher TEQ values (Figures 5.144 to 5.148).

5.8.5 CYP1A mRNA

Regardless of species, the CYP1A mRNA gel electrophoretic transcripts were similar for the fish sampled as shown in Figure 5.149. The Figure shows CYP1A1 transcripts for eight representative species caught on the fourth cruise. Hepatic CYP1A1 levels were determined in 48, 85, and 45 fish samples for Cruises 2, 3, and 4, respectively. Thirteen different fish species were sampled.

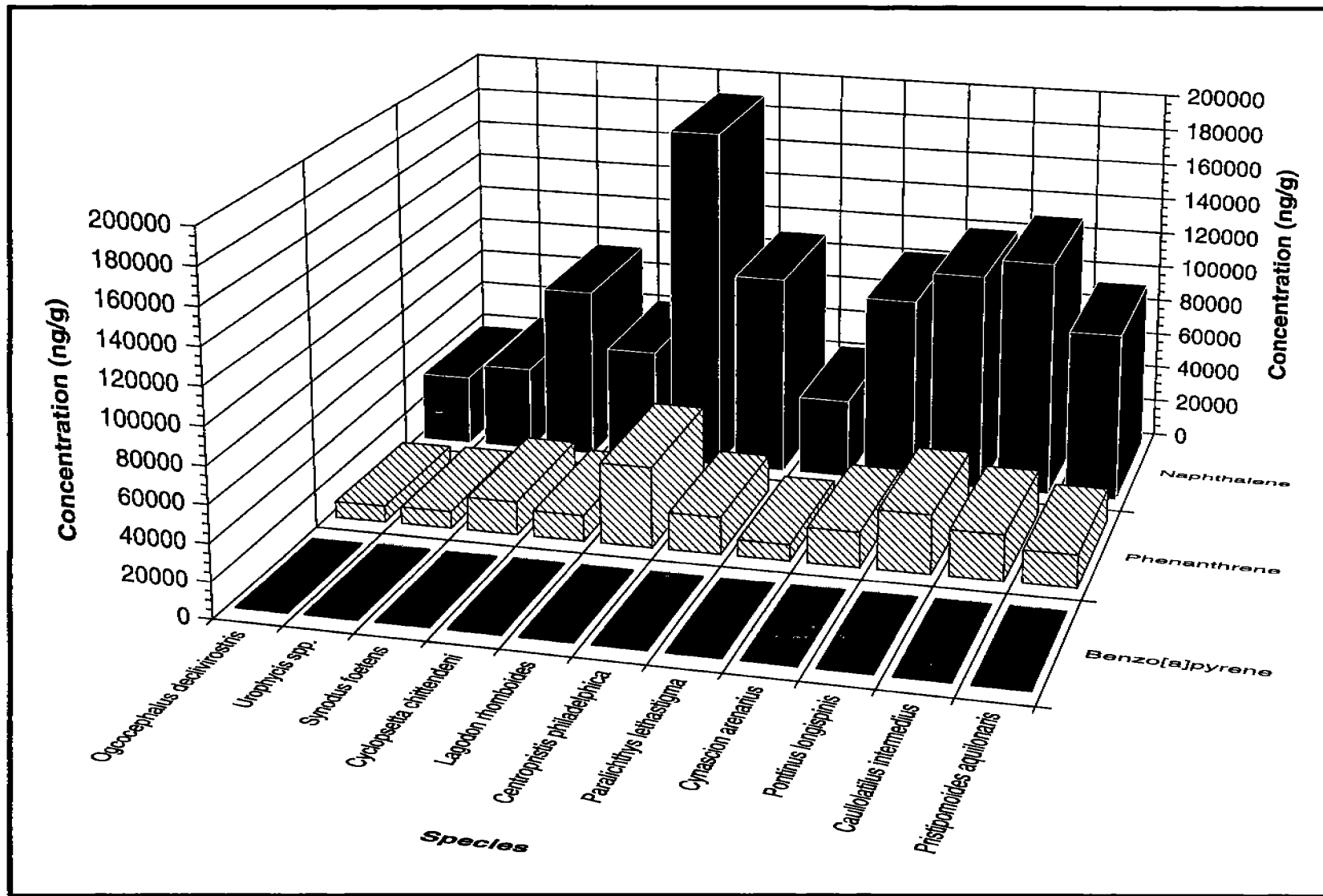

Figure 5.142. Species variations in mean biliary metabolite concentrations.

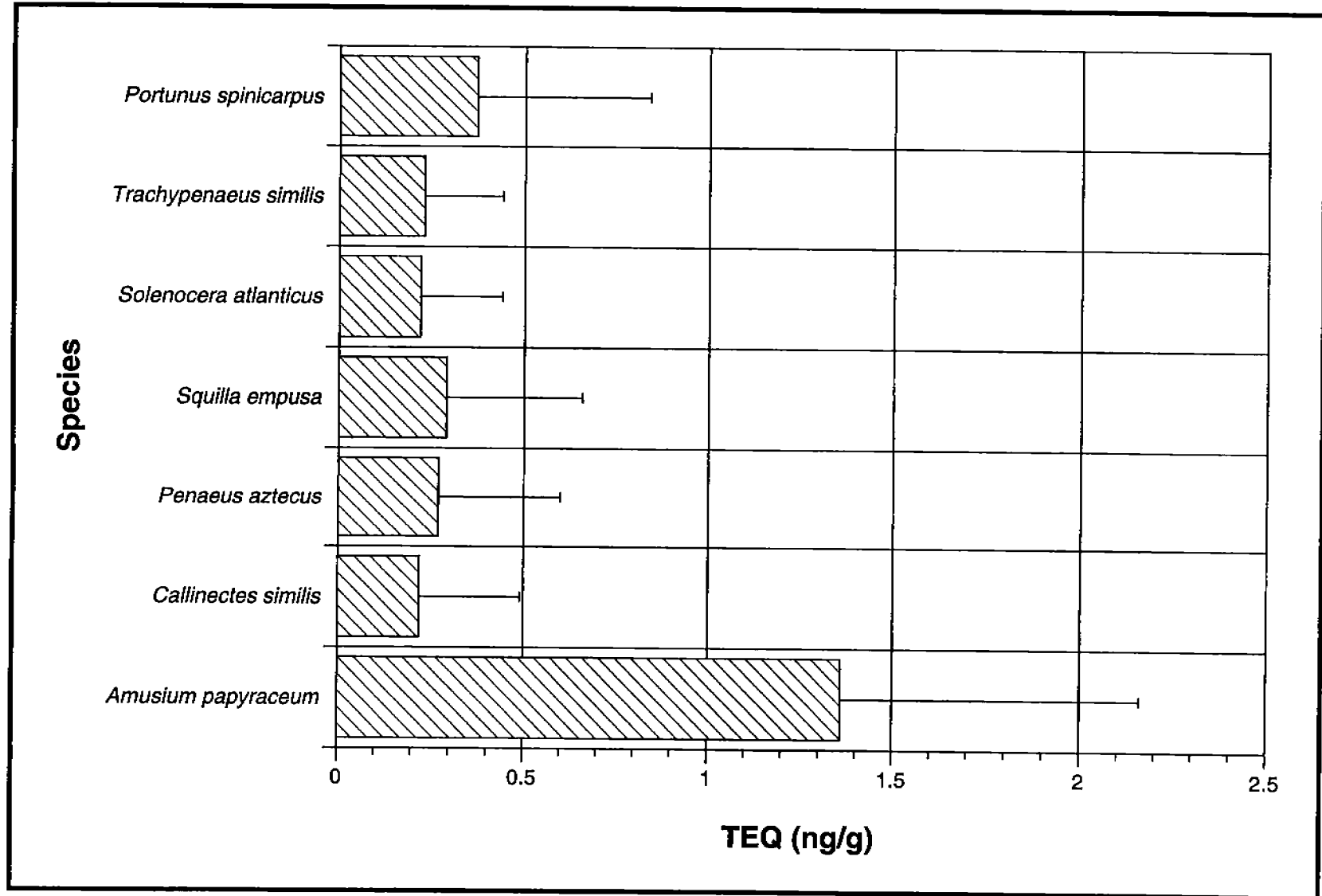

Figure 5.143. Species difference in rat hepatoma H-411E cell bioassay-derived TEQs.

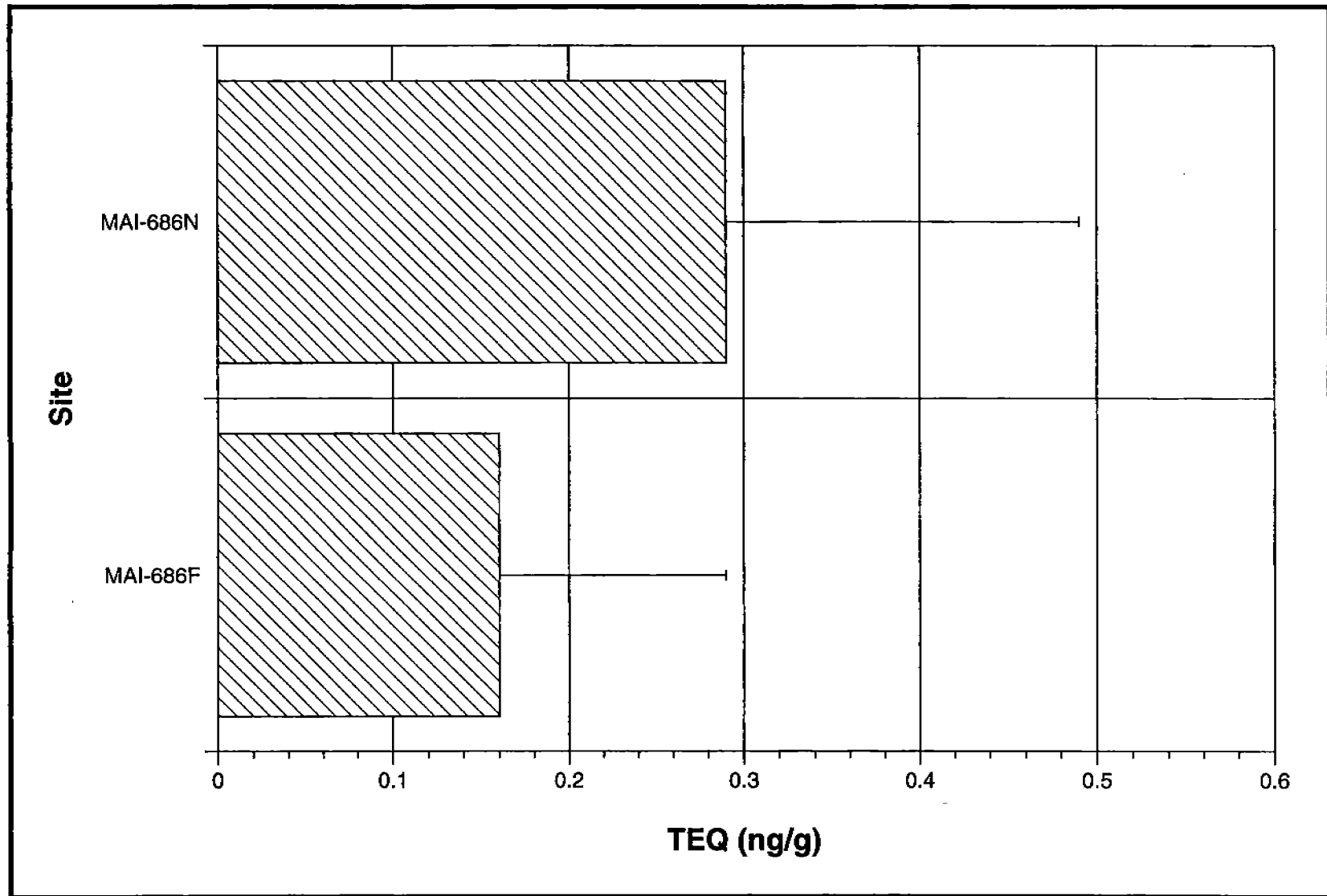

Figure 5.144. TEQs derived from rat hepatoma H-4IIE cells dosed with *Trachypenaes similis* extracts.

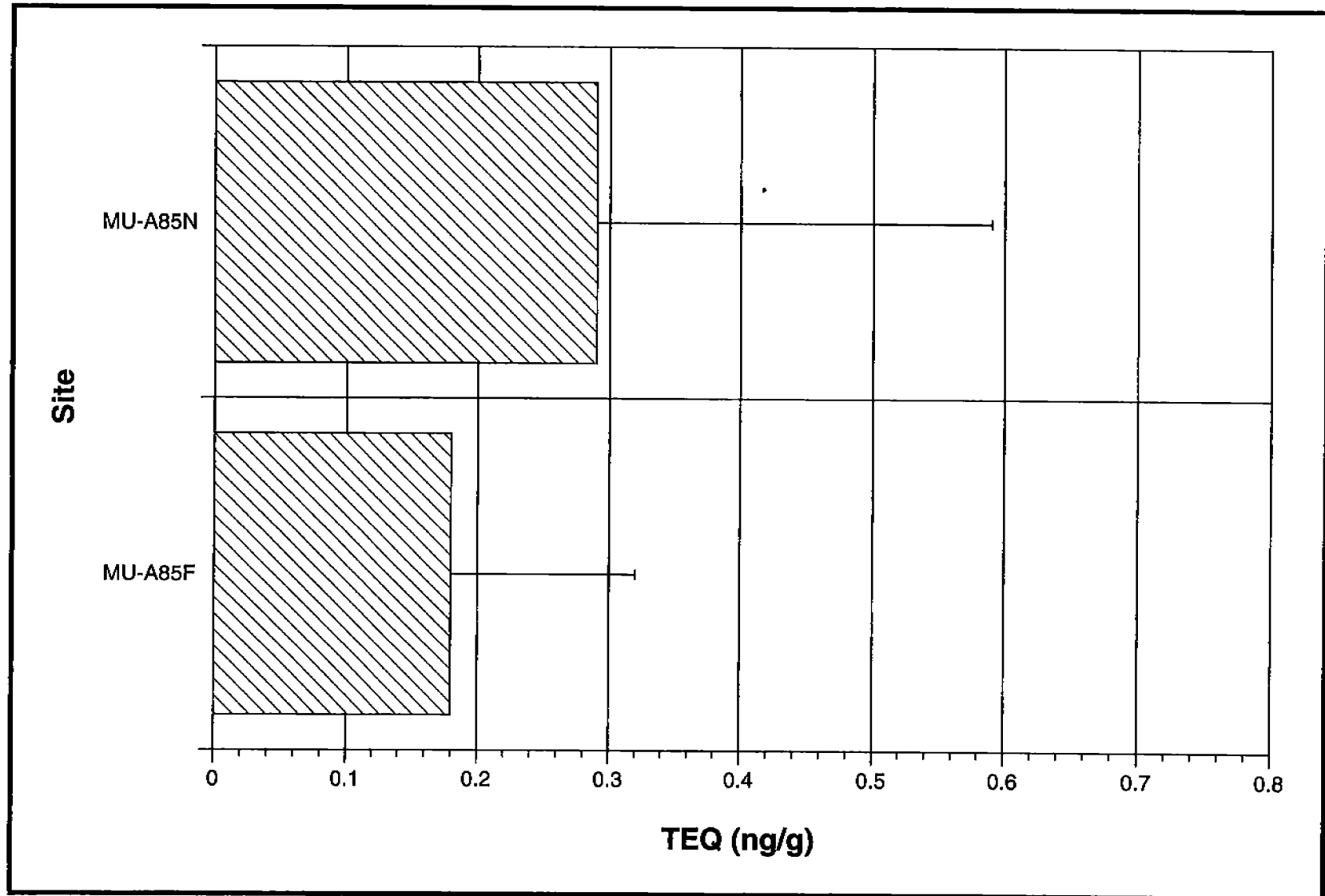

Figure 5.145. TEQs derived from rat hepatoma H-4IIE cells dosed with *Solenocera atlantidis* extracts.

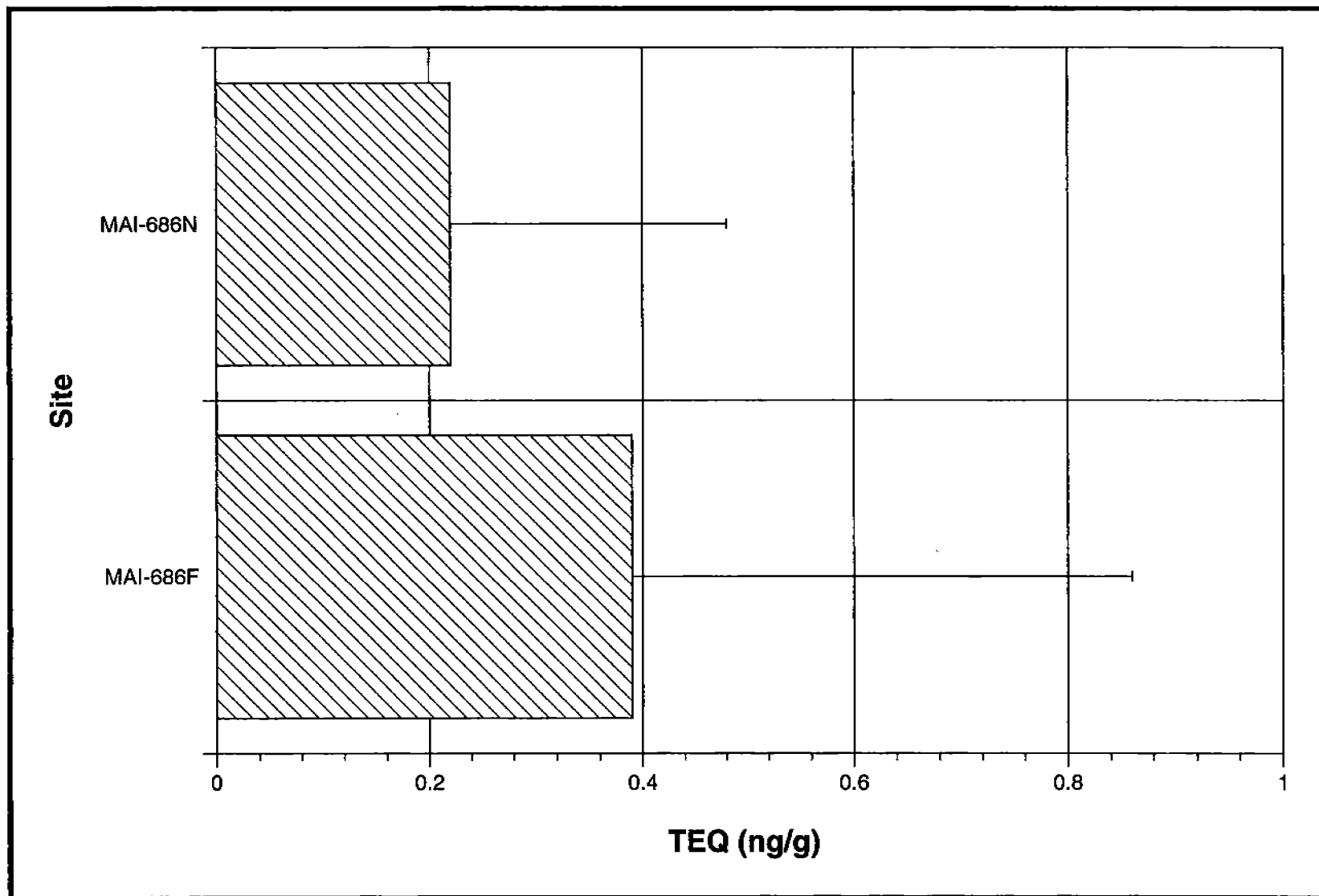

Figure 5.146. TEQs derived from rat hepatoma H-4IIE cells dosed with *Squilla empusa* extracts.

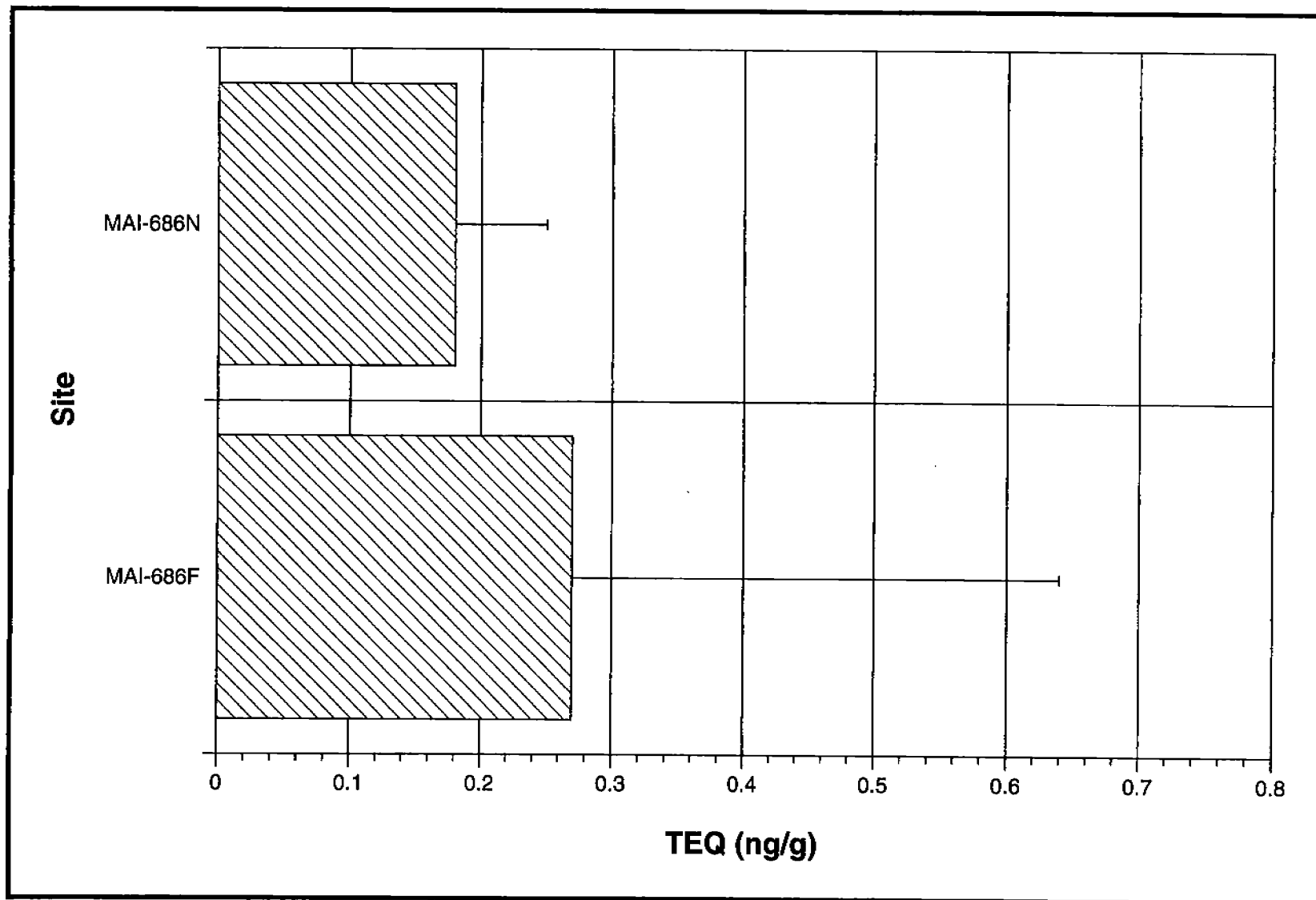

Figure 5.147. TEQs derived from rat hepatoma H-4IIE cells dosed with *Callinectes similis* extracts.

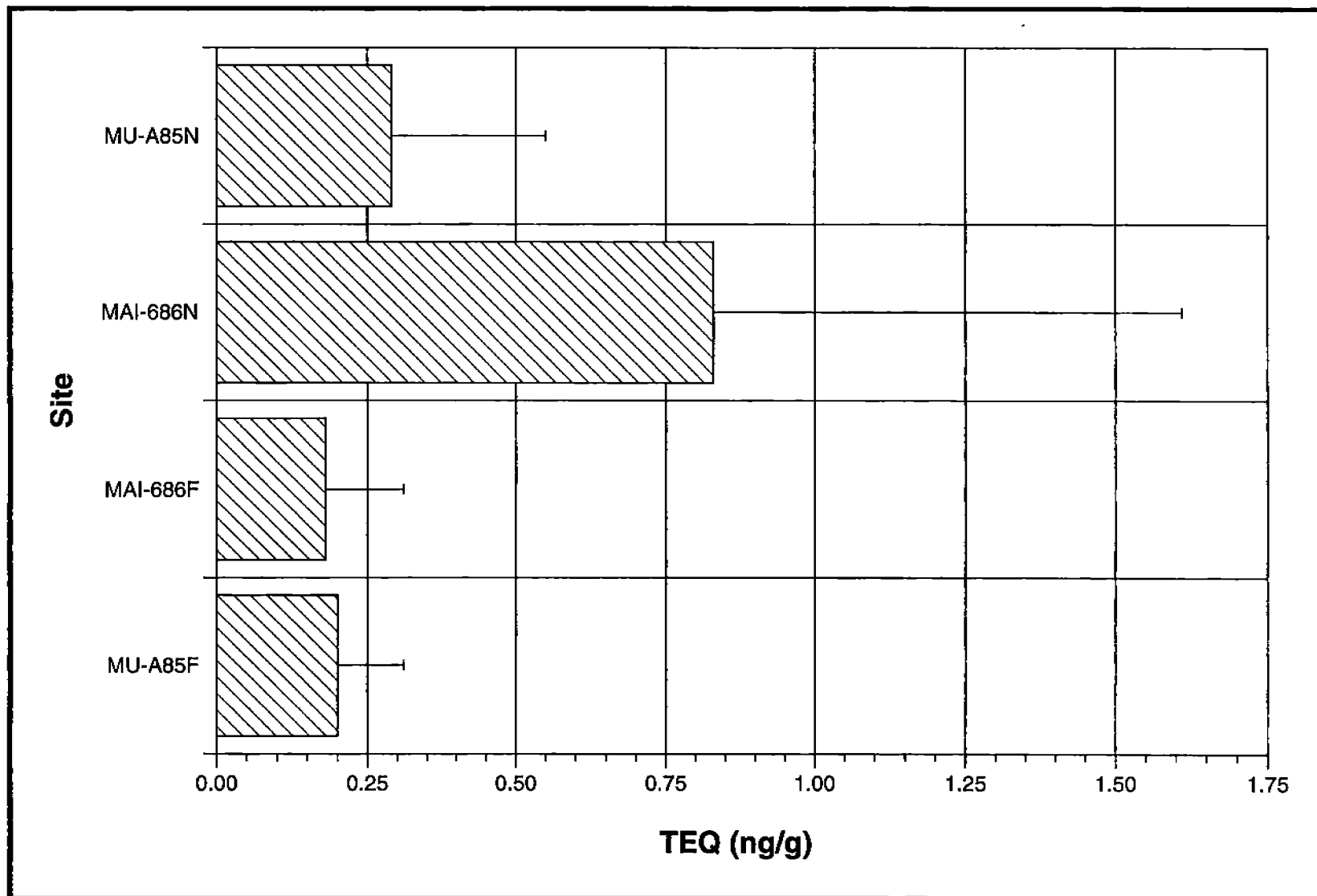

Figure 5.148. TEQs derived from rat hepatoma H-4IIE cells dosed with *Penaeus aztecus* extracts.

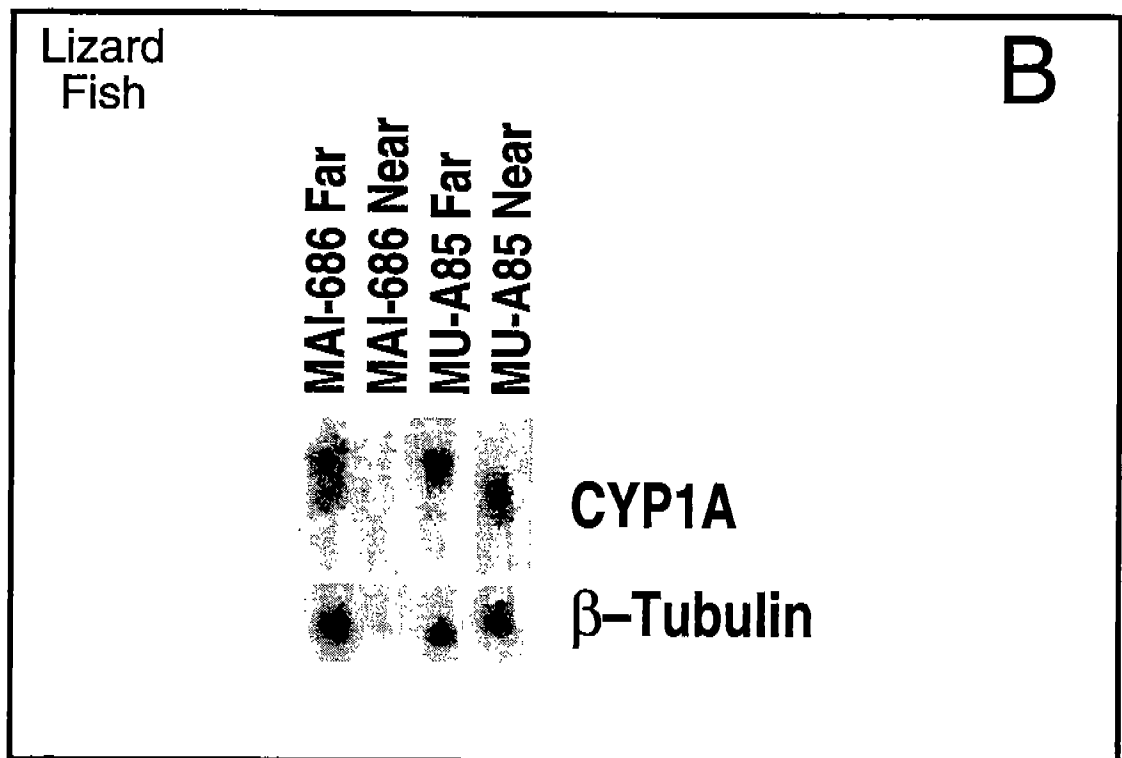
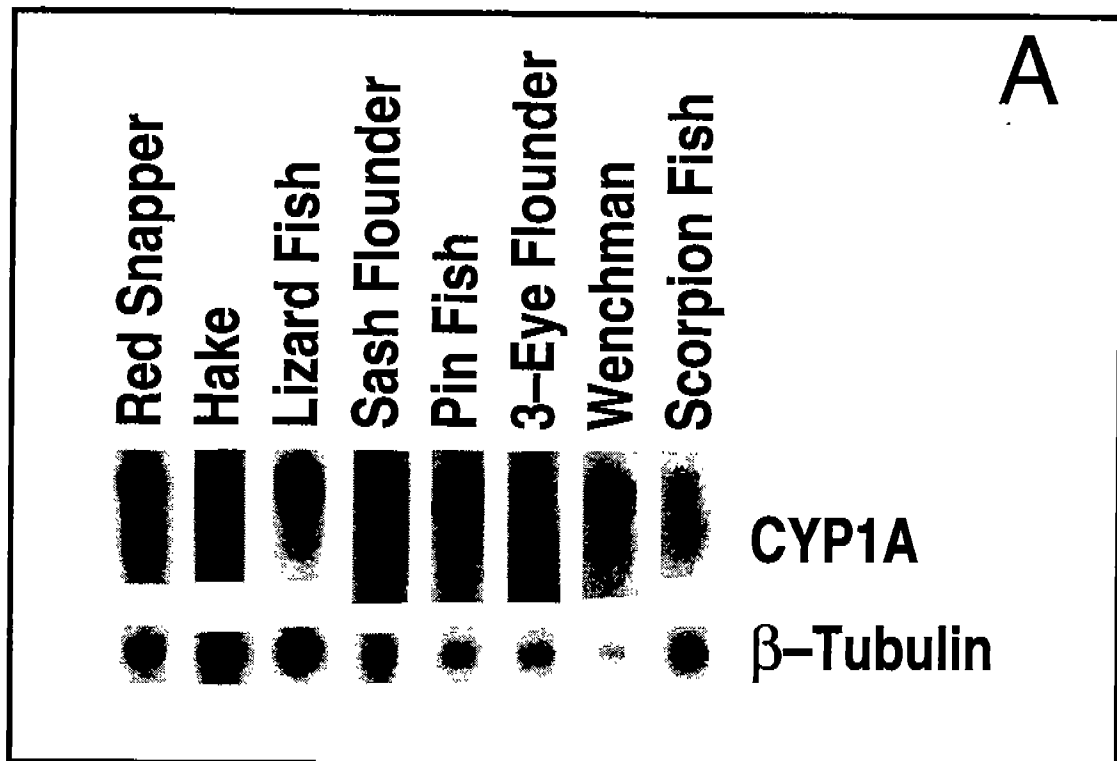

Figure 5.149. Northern blot analysis of CYP1A mRNA in A: marine fish; and B: lizard fish from near and far stations.

5.9 Sediment Porewater Toxicity Testing

Sediment samples were received for processing in two groups from each of the first two cruises and extracted within 10 days of the time of collection. The water quality parameters for the pore waters were very similar among all stations from both cruises. All Cruise 1 porewater salinities were between 34 and 37 ‰, therefore very few samples required dilution to reach the target salinity (35 ± 1 ‰) for the tests. No dilution of samples was required for Cruise 2 samples, since the salinities of all samples were between 34 and 36 ‰. Hydrogen sulfide concentrations were below the detection limit (0.01 µg/L) in all pore water assayed.

5.9.1 Sea Urchin Tests

Porewater toxicity was observed at 14 of 150 stations as detected by the sea urchin embryological development assay and at three of 75 stations by the sea urchin fertilization test (Figure 5.150). All stations showing reduced fertilization also exhibited impaired development in the embryological development assay. All but three of the toxic stations were within 100 meters of a platform. Significant toxicity was observed in the vicinity of two of the three platforms sampled during the second cruise (Figure 5.151). As in the first cruise, no toxicity was observed near the MU-A85 platform, but toxicity was observed at one of the distant stations (5C). Three of the five stations closest to the platform were toxic at MAI-686. Four stations near the platform exhibited significant toxicity at HI-A389 and corresponded with four of the six stations observed to be toxic during the first cruise. Of the 75 samples collected during Cruise 2, significant toxicity was observed at eight (8) stations based on the sea urchin embryological development assay. Stations that were toxic in the bioassays (except the one reference station at MU-A85) were within ~100-m of a platform.

The EC_{50} s for sodium dodecyl sulfate (SDS) in the fertilization (6.29 mg/L-Cruise 1) and embryological development tests (Cruise 1-3.91 mg/L and Cruise 2-4.65 mg/L) indicate normal gamete viability. Filtered seawater and reconstituted seawater controls were not statistically different from reference pore water in any test.

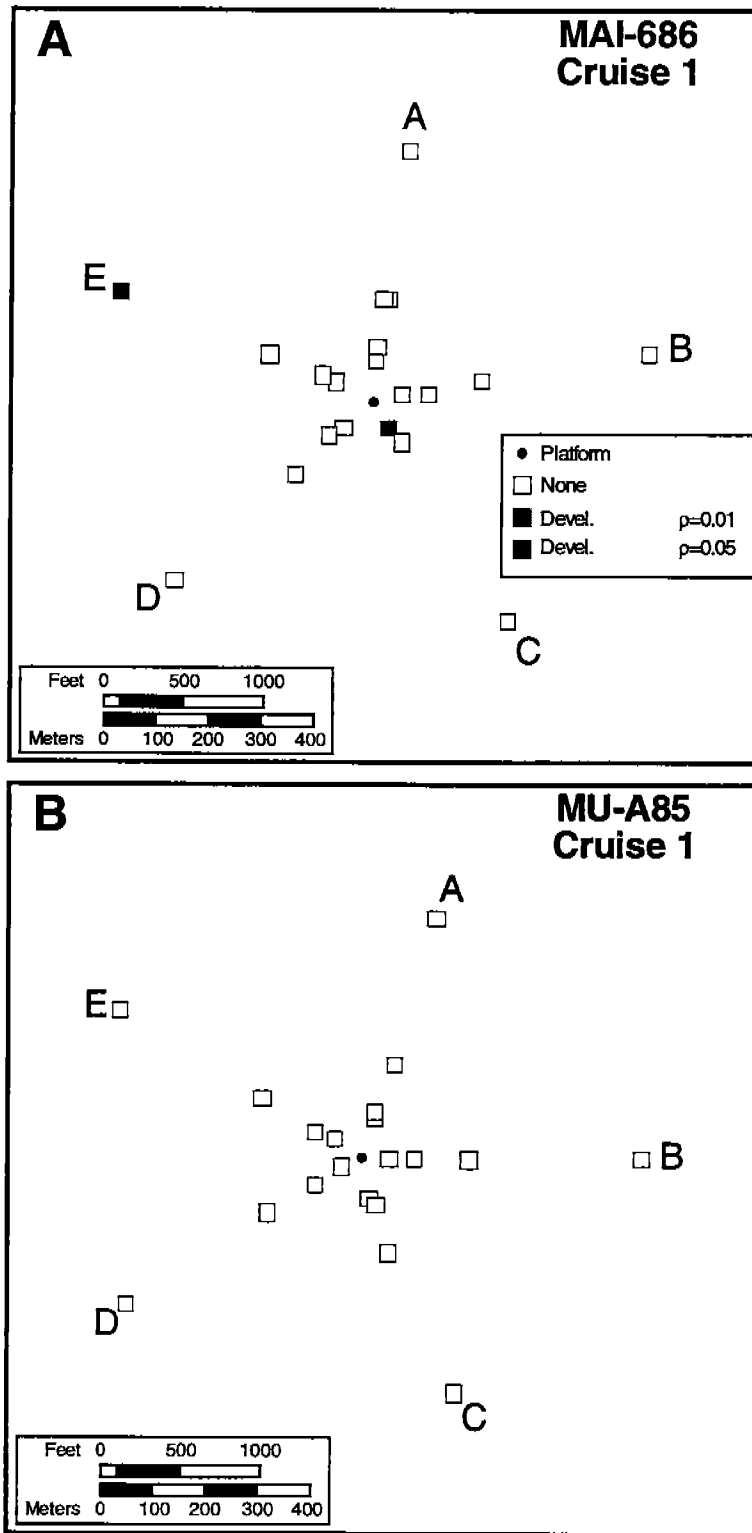

Figure 5.150. Summary of sea urchin embryological development and fertilization porewater toxicity tests for sediments from Cruise 1 at A: MAI-686; and B: MU-A85.

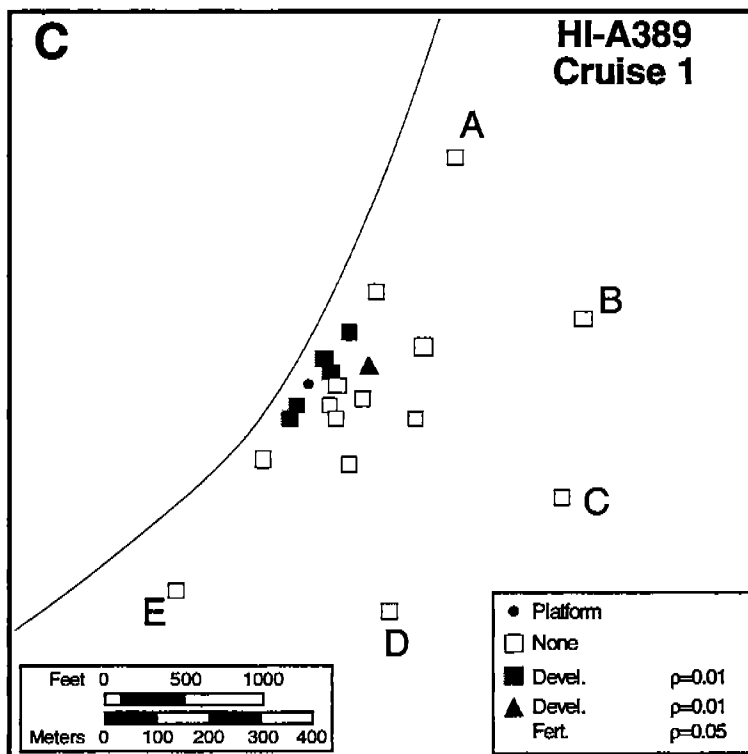

Figure 5.150 (cont.). Summary of sea urchin embryological development and fertilization porewater toxicity tests for sediments from Cruise 1 at C: HI-A389.

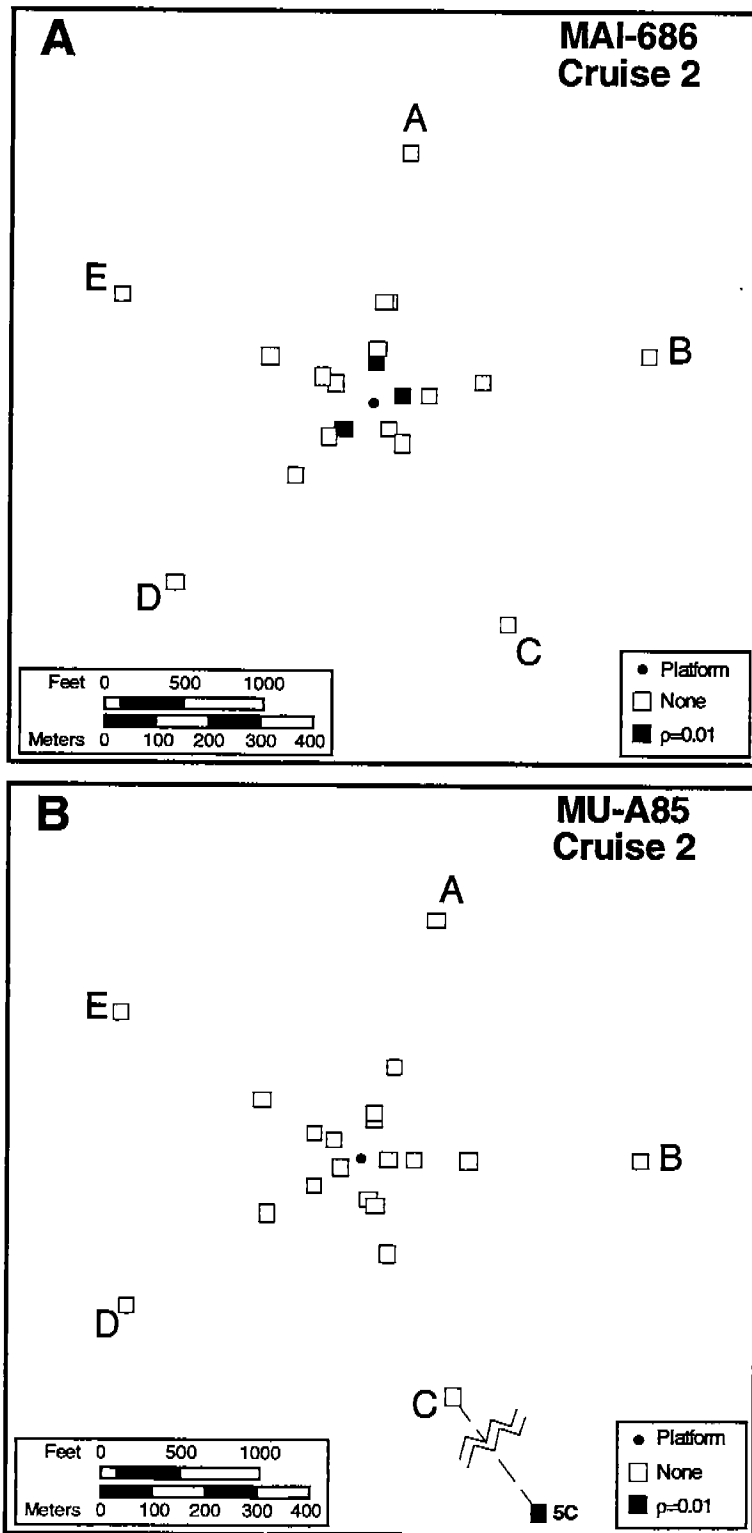

Figure 5.151. Summary of sea urchin embryological development porewater toxicity tests for sediments from Cruise 2 at A: MAI-686; and B: MU-A85.

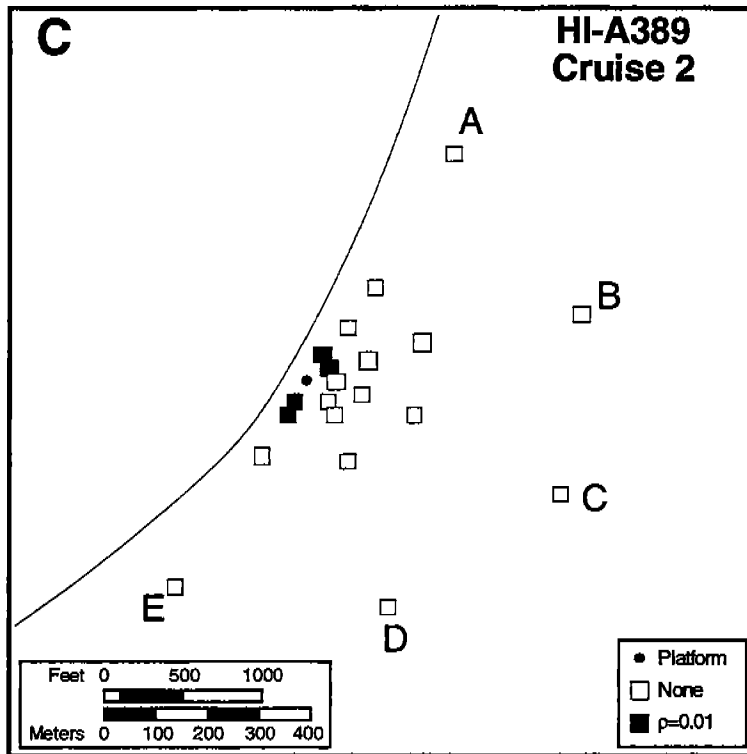

Figure 5.151 (cont.). Summary of sea urchin embryological development porewater toxicity tests for sediments from Cruise 2 at C: HI-A389.

5.9.2 Tests with Meiobenthic Species

The response of two meiobenthic invertebrates to selected pore waters from High Island A-389 was evaluated and compared to the results of the sea urchin tests. One species, *Dinophilus gyrociliatus* - a small polychaete, has been previously used in toxicity testing. The techniques for the culture and testing of this organism are well established and the sensitivity of the reproductive endpoint has been demonstrated. The other species, *Longipedia americana*, a benthic harpacticoid copepod, has not been previously cultured or used in toxicity testing.

Dissolved oxygen was above 90 % saturation in all samples both before and after the tests. Salinity, 35 to 36‰ at test start, increased by up to 1‰ by test end in the 96 hour test and by up to 2‰ in the seven day test. Sample pH was between 8.0 and 8.2 both at the beginning and end of the tests. Total ammonia-nitrogen was measured at the beginning and end of the *Dinophilus* test and these values were well below the concentrations known to produce an adverse effect for this species. Results of copepod and polychaete tests are shown in Table 5.67. Results of the sea urchin embryological development test are shown for comparison. With the exception of site 3A, which was toxic only in the sea urchin embryological development test, there was close agreement between the three tests. That is, sites which were toxic in one test were toxic for the other tests performed. Toxicity was observed at stations close to the platform. All sites which were toxic in the meiobenthic animal tests were also toxic in the sea urchin embryological development test. The copepod nauplii were quite sensitive test organisms, but a high rate of control mortality and the few numbers of nauplii available for the test reduced its statistical power. In an attempt to increase control survivability (and also the potential duration of the test), a variety of conditions were tested, including different feeds, test containers, stocking densities, salinities and the use of an antibiotic. None of these variations in the technique produced appreciably greater control survival. One problem which must be overcome if tests of greater duration are to be performed is that nauplii easily become attached to the surface film after molting. The first molt usually occurs at about 96 hours. Nauplii which are attached to the surface film cannot forage effectively and apparently starve.

Table 5.67. Results of tests for three species exposed to pore water from selected stations at HI-A389, Cruise 1.

Station	Approx. distance from platform center (m)	Sea urchin development to pluteus larvae (% ± SD) ^a	Polychaete number eggs/female (mean ± SD) ^a	Copepod survival (% ± SD) ^a
5A	3000	64.6 ± 6.9	2.6 ± 0.6	53.3 ± 23.1
5C		73.0 ± 6.2	2.4 ± 0.6	60 ± 0
5E		74.6 ± 3.8	2.4 ± 0.6	46.7 ± 11.5
4A	500	67.2 ± 5.3	2.1 ± 0.6	-
4C		75.0 ± 3.2	1.5 ± 0.7	-
4E		74.8 ± 4.8	2.2 ± 0.7	-
1A	200	62.0 ± 4.6	1.5 ± 1.2	40.0 ± 20.0
1C		65.2 ± 6.0	1.1 ± 0.1	-
1E		61.2 ± 2.4	1.7 ± 1.3	40 ± 0
3A	100	43.2 ± 8.2**	1.1 ± 1.2	60.0 ± 20.0
3B		44.6 ± 5.1**	-	13.3 ± 11.5*
3C		67.6 ± 1.5	1.5 ± 0.6	33.3 ± 11.5
3E	50	20.6 ± 8.5**	0 ± 0**	0 ± 0**
2A		3.4 ± 3.2**	0 ± 0**	0 ± 0**
2B		9.8 ± 5.5**	-	0 ± 0**
2C	50	73.8 ± 4.6	1.6 ± 0.5	20.0 ± 20.0
2D		73.6 ± 6.2	-	26.7 ± 23.1
2E		0 ± 0**	0 ± 0**	0 ± 0**

^aSignificant differences between 3000 m sites (5A, 5C, 5E) and other sites as determined by Ryan's Q test indicated by asterisks.; (a ≤ 0.05); ** (a ≤ 0.01) on that sample.

There was a high degree of agreement between the two meiobenthic tests and the sea urchin embryological development test performed previously. The sea urchin embryological development test appears to be similar in sensitivity, or slightly more sensitive, than the two meiobenthic tests and is more reliable, cost efficient, and simpler to conduct. The urchin assay can be used as a surrogate for assessment of the potential impacts of contaminated pore waters.

6.0 DISCUSSION

This section provides a work element-by-work element test of the program's guiding hypotheses. Extended discussions of the ramifications of the patterns observed are included. Each variable is also described in the broader context of the "natural" processes that control or contribute to the observed variations. Selected passages in the text are in **bold-face type** to draw the reader's attention to significant programmatic conclusions.

6.1 Physicochemical Parameters

Physicochemical parameters were measured to address three objectives:

- (1) describe the GOOMEX sites within the broader context of northern Gulf of Mexico continental shelf oceanography;
- (2) document variations in water column characteristics that could be related to the presence of a platform; and
- (3) characterize variations in water column parameters that are associated with potentially confounding influences on patterns observed in the underlying benthos (i.e., hypoxia, nutrient regeneration, etc.).

Based on ANOVA analysis of the physicochemical data, no significant ($p \leq 0.01$) variations with distance (D) from the platform were detected when testing the overall study design (Table 6.1). In contrast, many significant interactions among platforms (P) and cruises (C) were apparent. The trends were similar for all water depths (Table 6.1). Where main effects were testable, no distance effects were significant. Based on a Tukey's test of the overall study design, water properties are relatively uniform with regard to distance from the platform (Table 6.2 to 6.4). In contrast, **the sites were unique from each other based on many of the hydrographic variables measured** (Tables 6.5 to 6.7). Based on differences in hydrographic properties platform sites were ordered by water depth by Tukey's tests.

Analysis of individual platform sites provides insight into variations in water column characteristics at each site (Tables 6.8 to 6.10). As in the test of the overall design, many significant interactions among cruises and distances were observed (i.e., season). Distance effects could be tested

Table 6.1. Summary of the significance of interactions for the overall study design based on physicochemical data.

Variable ^a	Interaction ^b				
	C*D	D*R	P*D	P*C*D	D
<u>surface water</u>					
T	Yes	No	Yes	Yes	---
Sal	Yes	No	Yes	Yes	---
Sigma-t	Yes	No	No	Yes	---
PO ₄	No	No	No	No	No
NO ₃	Yes	No	Yes	Yes	---
NO ₂	Yes	No	Yes	Yes	---
SiO ₃	Yes	No	Yes	Yes	---
TXMISS	Yes	No	Yes	Yes	---
O ₂	Yes	No	Yes	Yes	---
<u>mid-water</u>					
T	Yes	No	Yes	Yes	---
Sal	Yes	No	Yes	Yes	---
Sigma-t	Yes	No	Yes	Yes	---
PO ₄	No	No	No	Yes	---
NO ₃	Yes	No	Yes	Yes	---
NO ₂	Yes	No	Yes	Yes	---
SiO ₃	No	No	Yes	Yes	---
TXMISS	Yes	No	No	Yes	---
O ₂	No	No	No	No	No
<u>bottom water</u>					
T	Yes	Yes	Yes	Yes	---
Sal	Yes	No	Yes	Yes	---
Sigma-t	Yes	No	Yes	Yes	---
PO ₄	Yes	No	Yes	Yes	---
NO ₃	Yes	No	Yes	Yes	---
NO ₂	Yes	No	Yes	Yes	---
SiO ₃	Yes	No	Yes	Yes	---
TXMISS	No	No	No	No	No
O ₂	Yes	No	Yes	Yes	---

^aT=temperature (°C), sal=salinity, PO₄=phosphate (μM), NO₃=nitrate (μM), NO₂=nitrite (μM), SO₃=silicate (μM), TXMISS=% light transmittance (%), O₂=dissolved oxygen (mL/L).

^bP=platform, C=Cruise, D=Distance, R=radius; Yes=significant, p≤0.01; No=not significant, p≥0.01; ---=not testable due to higher interactions.

Table 6.2. Tukey's multiple comparison test results by distance for the overall study design based on physicochemical data for surface waters.

Variable ^a	Distance ^b				
T (°C)	<u>≥ 3000 m</u> (22.7)	<u>500 m</u> (22.7)	50 m (22.5)	<u>200 m</u> (22.4)	<u>100 m</u> (22.3)
Sal	500 m (32.97)	<u>≥ 3000 m</u> (32.76)	<u>200 m</u> (32.47)	<u>100 m</u> (32.53)	50 m (32.38)
Sigma-t	No difference (22.2)				
PO ₄ (μM)	No difference (0.06)				
NO ₃ (μM)	<u>50 m</u> (0.21)	<u>200 m</u> (0.20)	500 m (0.20)	100 m (0.20)	≥ 3000 m (0.15)
NO ₂ (μM)	<u>500 m</u> (0.09)	<u>200 m</u> (0.08)	100 m (0.08)	50 m (0.07)	≥ 3000 m (0.07)
SiO ₃ (μM)	<u>200 m</u> (2.23)	<u>50 m</u> (2.19)	<u>100 m</u> (2.16)	500 m (2.01)	≥ 3000 m (1.92)
TXMISS (%)	No difference (78.3)				
O ₂ (mL/L)	<u>100 m</u> (5.19)	<u>50 m</u> (5.15)	<u>200 m</u> (5.14)	≥ 3000 m (5.10)	500 m (5.08)

^aSee Table 6.1 for definition of variables.

^bDetransformed means are presented (x) and means that are underlined are not different at the 0.05 level.

Table 6.3. Tukey's multiple comparison test results by distance for the overall study design based on physicochemical data for mid-water.

Variable ^a	Distance ^b				
T (°C)	<u>≥ 3000 m</u> (21.1)	<u>500 m</u> (21.0)	<u>50 m</u> (20.9)	<u>200 m</u> (20.9)	<u>100 m</u> (20.7)
Sal	<u>500 m</u> (34.69)	<u>200 m</u> (34.42)	<u>≥ 3000 m</u> (34.40)	<u>100 m</u> (34.31)	<u>50 m</u> (34.20)
Sigma-t	<u>500 m</u> (24.1)	<u>200 m</u> (23.9)	<u>100 m</u> (23.9)	<u>≥ 3000 m</u> (23.8)	<u>50 m</u> (23.7)
PO ₄ (μM)	No difference (0.08)				
NO ₃ (μM)	No difference (0.30)				
NO ₂ (μM)	<u>100 m</u> (0.19)	<u>500 m</u> (0.19)	<u>200 m</u> (0.17)	<u>50 m</u> (0.13)	<u>≥ 3000 m</u> (0.13)
SiO ₃ (μM)	No difference (2.00)				
TXMISS (%)	No difference (80.0)				
O ₂ (mL/L)	No difference (5.1)				

^aSee Table 6.1 for definition of variables.

^bDetransformed means are presented (x) and means that are underlined are not different at the 0.05 level.

Table 6.4. Tukey's multiple comparison test results by distance for the overall study design based on physicochemical data for bottom waters.

Variable ^a	Distance ^b				
T (°C)	<u>50 m</u> (19.1)	<u>100 m</u> (19.1)	<u>500 m</u> (19.0)	<u>200 m</u> (18.9)	<u>≥ 3000 m</u> (18.9)
Sal	<u>50 m</u> (35.38)	<u>500 m</u> (35.38)	<u>≥ 3000 m</u> (35.24)	<u>200 m</u> (35.20)	<u>100 m</u> (35.10)
Sigma-t	No difference (25.1)				
PO ₄ (μM)	No difference (0.33)				
NO ₃ (μM)	<u>50 m</u> (3.06)	<u>200 m</u> (3.03)	<u>100 m</u> (2.66)	<u>≥ 3000 m</u> (2.57)	<u>500 m</u> (2.52)
NO ₂ (μM)	<u>100 m</u> (0.33)	<u>50 m</u> (0.32)	<u>≥ 3000 m</u> (0.26)	<u>200 m</u> (0.26)	<u>500 m</u> (0.24)
SiO ₃ (μM)	No difference (4.70)				
TXMISS (%)	No difference (71.0)				
O ₂ (mL/L)	<u>≥ 3000 m</u> (4.25)	<u>500 m</u> (4.13)	<u>100 m</u> (4.10)	<u>200 m</u> (4.02)	<u>50 m</u> (3.9)

^aSee Table 6.1 for definition of variables.

^bDetransformed means are presented (x) and means that are underlined are not different at the 0.05 level.

Table 6.5. Tukey's multiple comparison test results by site (platform) for the overall study design based on physicochemical data for surface waters.

Variable ^a	Platform ^b		
T (°C)	HI-A389 (23.9)	MU-A85 (22.9)	MAI-686 (20.9)
Sal	HI-A389 (34.29)	MU-A85 (32.40)	MAI-686 (31.19)
Sigma-t	HI-A389 (23.1)	MU-A85 (22.0)	MAI-686 (21.6)
PO ₄ (μM)	MAI-686 (0.09)	MU-A85 (0.05)	HI-A389 (0.05)
NO ₃ (μM)	MAI-686 (0.25)	HI-A389 (0.23)	MU-A85 (0.14)
NO ₂ (μM)	MAI-686 (0.13)	MU-A85 (0.08)	HI-A389 (0.04)
SiO ₃ (μM)	MAI-686 (2.50)	MU-A85 (2.14)	HI-A389 (1.89)
TXMISS (%)	MU-A85 (79.4)	HI-A389 (79.4)	MAI-686 (73.2)
O ₂ (mL/L)	MAI-686 (5.39)	MU-A85 (5.07)	HI-A389 (4.96)

^aSee Table 6.1 for definition of variables.

^bDetransformed means are presented (x) and means that are underlined are not different at the 0.05 level.

Table 6.6. Tukey's multiple comparison test results by site (platform) for the overall study design based on physicochemical data for mid-waters.

Variable ^a	Platform ^b		
T (°C)	no difference (20.9)		
Sal	HI-A389 (36.05)	MU-A85 (35.64)	MAI-686 (31.70)
Sigma-t	HI-A389 (25.3)	MU-A85 (24.9)	MAI-686 (21.6)
PO ₄ (μM)	MAI-686 (0.09)	MU-A85 (0.08)	HI-A389 (0.06)
NO ₃ (μM)	HI-A389 (0.34)	MU-A85 (0.30)	MAI-686 (0.23)
NO ₂ (μM)	MU-A85 (0.23)	MAI-686 (0.15)	HI-A389 (0.11)
SiO ₃ (μM)	MAI-686 (2.36)	MU-A85 (1.85)	HI-A389 (1.76)
TXMISS (%)	MU-A85 (83.9)	HI-A389 (82.3)	MAI-686 (74.3)
O ₂ (mL/L)	MAI-686 (5.29)	HI-A389 (5.02)	MU-A85 (4.99)

^aSee Table 6.1 for definition of variables.

^bDetransformed means are presented (x) and means that are underlined are not different at the 0.05 level.

Table 6.7. Tukey's multiple comparison test results by site (platform) for the overall study design based on physicochemical data for bottom waters.

Variable ^a	Platform ^b		
T (°C)	MAI-686 (20.0)	MU-A85 (19.4)	HI-A389 (17.6)
Sal	HI-A389 (36.26)	MU-A85 (36.01)	MAI-686 (33.58)
Sigma-t	HI-A389 (26.3)	MU-A85 (25.7)	MAI-686 (23.5)
PO ₄ (μM)	HI-A389 (0.65)	<u>MAI-686 (0.20)</u>	<u>MU-A85 (0.18)</u>
NO ₃ (μM)	HI-A389 (10.34)	MU-A85 (1.49)	MAI-686 (0.91)
NO ₂ (μM)	MAI-686 (0.58)	MU-A85 (0.26)	HI-A389 (0.06)
SiO ₃ (μM)	HI-A389 (5.48)	<u>MAI-686 (5.29)</u>	MU-A85 (3.34)
TXMISS (%)	<u>MU-A85 (76.5)</u>	<u>HI-A389 (76.6)</u>	MAI-686 (62.4)
O ₂ (mL/L)	MU-A85 (4.53)	MAI-686 (4.50)	HI-A389 (3.29)

^aSee Table 6.1 for definition of variables.

^bDetransformed means are presented (x) and means that are underlined are not different at the 0.05 level.

Table 6.8. Summary of the significance of interactions for physicochemical data at MAI-686.

Variable ^a	Interactions ^b			
	C*D	D*R	D	C
<u>surface water</u>				
T	Yes	No	---	---
Sal	Yes	No	---	---
Sigma-t	Yes	No	---	---
PO ₄	No	No	No	Yes
NO ₃	Yes	No	---	---
NO ₂	Yes	No	---	---
SiO ₃	Yes	No	---	---
TXMISS	No	No	No	Yes
O ₂	Yes	No	---	---
<u>mid-water</u>				
T	Yes	No	---	---
Sal	Yes	No	---	---
Sigma-t	Yes	No	---	---
PO ₄	Yes	No	---	---
NO ₃	Yes	No	---	---
NO ₂	Yes	No	---	---
SiO ₃	Yes	No	---	---
TXMISS	No	No	No	Yes
O ₂	No	No	No	Yes
<u>bottom water</u>				
T	Yes	No	---	---
Sal	Yes	No	---	---
Sigma-t	Yes	No	---	---
PO ₄	Yes	No	---	---
NO ₃	Yes	No	---	---
NO ₂	Yes	No	---	---
SiO ₃	Yes	No	---	---
TXMISS	No	No	No	Yes
O ₂	Yes	No	---	---

^aSee Table 6.1 for definition of variables.

^bSee Table 6.1 for definition of variables and symbols.

Table 6.9. Summary of the significance of interactions for physicochemical data at MU-A85.

Variable ^a	Interactions ^b			
	C*D	D*R	D	C
<u>surface water</u>				
T	Yes	No	---	---
Sal	Yes	No	---	---
Sigma-t	No	No	No	Yes
PO ₄	No	No	No	Yes
NO ₃	Yes	No	---	---
NO ₂	Yes	No	---	---
SiO ₃	Yes	No	---	---
TXMISS	Yes	No	---	---
O ₂	Yes	No	---	---
<u>mid-water</u>				
T	Yes	No	---	---
Sal	Yes	No	---	---
Sigma-t	Yes	No	---	---
PO ₄	Yes	No	---	---
NO ₃	Yes	No	---	---
NO ₂	Yes	No	---	---
SiO ₃	No	No	Yes	Yes
TXMISS	Yes	No	---	---
O ₂	Yes	No	---	---
<u>bottom water</u>				
T	Yes	No	---	---
Sal	Yes	No	---	---
Sigma-t	Yes	No	---	---
PO ₄	Yes	No	---	---
NO ₃	No	No	No	Yes
NO ₂	Yes	No	---	---
SiO ₃	No	No	No	Yes
TXMISS	No	No	No	Yes
O ₂	No	No	No	Yes

^aSee Table 6.1 for definition of variables.

^bSee Table 6.1 for definition of variables and symbols.

Table 6.10. Summary of the significance of interactions for physicochemical data at HI-A389.

Variable ^a	Interactions ^b			
	C*D	D*R	D	C
<u>surface water</u>				
T	Yes	No	---	---
Sal	Yes	No	---	---
Sigma-t	No	No	No	No
PO4	Yes	No	---	---
NO3	Yes	No	---	---
NO2	Yes	No	---	---
SiO3	Yes	No	---	---
TXMISS	Yes	No	---	---
O2	Yes	No	---	---
<u>mid-water</u>				
T	Yes	No	---	---
Sal	No	No	No	Yes
Sigma-t	Yes	No	---	---
PO4	No	No	Yes	Yes
NO3	No	No	No	Yes
NO2	Yes	No	---	---
SiO3	Yes	No	---	---
TXMISS	Yes	No	---	---
O2	No	No	No	No
<u>bottom water</u>				
T	Yes	Yes	---	---
Sal	No	No	No	Yes
Sigma-t	Yes	No	---	---
PO4	Yes	No	---	---
NO3	Yes	No	---	---
NO2	Yes	No	---	---
SiO3	Yes	No	---	---
TXMISS	No	No	No	No
O2	Yes	No	---	---

^aSee Table 6.1 for definition of variables.

^bSee Table 6.1 for definition of variables and symbols.

directly in 19 of 81 cases and were significant in only two cases. Silicate values for mid-water samples at MU-A85 and phosphate values at HI-A389 exhibited a significant distance effect. These variations may be related to the juxtaposition of topographic features to the west of these platforms that rise to mid-water depths. Significant cruise differences were noted in 16 of 19 cases where it could be directly tested. Oxygen depletion previously noted at MAI-686 is most significant as a cruise effect rather than a distance effect, possibly due to its location along only one radial and its relationship to stratified water column conditions.

6.1.1 Water Temperature

The spatial and temporal variability of water temperature on the Texas-Louisiana shelf is caused by advection, turbulent and convective mixing, and air-sea exchange processes. Temperature is the most frequently measured hydrographic variable. Variability in water temperature on the Texas-Louisiana shelf is well documented. Temple et al. (1977) reported monthly data from the Gus III cruises; Robinson (1973) and Etter and Cochran (1975) produced mean temperature maps from largely independent data sets; Ulm (1983) prepared a volumetric T-S census for the waters of the shelf; subsurface temperature time series were reported from multi-year studies at the various DOE/SPR brine disposal sites along the inner shelf and the MMS environmental studies at the Flower Gardens on the outer shelf; and analyses of thermal imagery from satellites described synoptic-scale spatial variability of sea surface temperatures (Rezak et al. 1985).

Monthly mean sea surface temperatures for the northwestern Gulf of Mexico (Robinson 1973) illustrate the seasonal cycle of temperature. Shelf waters cool from summer highs near 29-30 °C to inshore lows of about 14 °C in January and offshore lows of about 20 °C in February. Warming occurs from March through July. The eastern half of the shelf warms more rapidly and reaches higher temperatures than the western half because of upwelling that begins along the lower Texas coast in May, reaching the west Louisiana coast by July. Over the eastern shelf a warm region extends offshore in July and August. Huh et al. (1981) described the seasonal cycle of sea surface

temperature in the northeastern Gulf, including the Mississippi Bight, for 1976 to 1977 using a time series of NOAA satellite data.

Bottom temperatures over the inner half of the shelf vary with sea-surface temperatures to the extent that the mixed-layer depth reaches the bottom. However, seaward of about the 75-m isobath, bottom water temperatures reflect the annual variations in the off-shelf Gulf. Seaward of about the 120-m isobath, bottom water temperatures vary only slightly (Etter and Cochran 1975). Mean summer temperatures near the bottom are higher nearshore than offshore, with isotherms closely paralleling isobaths. During fall and winter, nearshore and offshore mean bottom temperatures are low with somewhat higher temperatures in-between.

The physicochemical parameters were analyzed statistically to determine if variability can be attributed to proximity to a platform. Each water depth (near surface, above the thermocline, and near bottom) was analyzed as a discrete set of data. Temperature data is summarized and described in detail in Section 5.1. **For temperature, no significant variations related to distance from the platform were detected** (Table 6.11) Most temperature variations could be related to the time of year of the sampling. The winter cruises (Cruises 2 and 4) were lowest in temperature compared to the summer cruises (Cruises 1 and 3). The significance of this difference decreased with water depth with near bottom water at the two deeper sites, exhibiting little or no discernable seasonality.

6.1.2 Salinity

Wind-driven currents and freshwater influx from the Mississippi-Atchafalaya River system determine much of the spatial distribution and temporal variability of salinity on the shelf. A band of low-salinity water lies along the coast from September through June, carried by the inshore limb of the gyre of cyclonic circulation that prevails on the shelf during this time. Minimum salinities occur all along the coast in May after the spring flood of the Mississippi in April. The May distribution also shows less saline water, extending northwest, and covering the shelf from the south Texas coast to the outer edge. This pattern is attributed to convergence in the wind stress and current fields near the coast and to the offshore limb of the cyclonic gyre. The band recedes upcoast in June and disappears by August, although

Table 6.11. Tukey's multiple comparison test results at each site and water depth by distance and by cruise for temperature (°C).

Site/Water Depth	Distance ^a				
<u>MAI-686</u>					
surface water	3000 m (21.1)	100 m (20.9)	<u>50 m (20.9)</u>	500 m (20.9)	200 m (20.8)
mid-water	50 m (21.1)	200 m (21.0)	<u>3000 m (20.9)</u>	500 m (20.9)	100 m (20.7)
bottom water	No difference (20.0)				
<u>MU-A85</u>					
surface water	500 m (23.3)	3000 m (23.1)	50 m (22.9)	200 m (22.5)	100 m (22.4)
mid-water	3000 m (21.2)	500 m (21.2)	<u>50 m (20.9)</u>	100 m (20.5)	200 m (20.5)
bottom water	3000 m (19.7)	500 m (19.5)	50 m (19.4)	100 m (19.3)	200 m (19.3)
<u>HI-A389</u>					
surface water	500 m (24.0)	<u>5000 m (24.0)</u>	200 m (23.9)	50 m (23.9)	100 m (23.8)
mid-water	5000 m (21.2)	<u>200 m (20.9)</u>	100 m (20.9)	500 m (20.9)	50 m (20.8)
bottom water	100 m (18.0)	<u>50 m (18.0)</u>	200 m (17.5)	500 m (17.5)	5000 m (17.0)

^aDetransformed means are presented (x) and means that are underlined are not different at the 0.05 level.

Table 6.11. (Cont.)

Site/Water Depth	Cruise ^a			
<u>MAI-686</u>				
surface water	4 (27.8)	2 (26.5)	1 (16.5)	3 (15.6)
mid-water	4 (27.2)	2 (26.3)	1 (16.8)	3 (15.5)
bottom water	2 (24.8)	4 (23.9)	1 (17.3)	3 (15.6)
<u>MU-A85</u>				
surface water	4 (27.9)	2 (26.5)	1 (20.8)	3 (17.2)
mid-water	2 (24.8)	4 (21.1)	1 (20.7)	3 (17.5)
bottom	2 (21.2)	1 (19.9)	4 (19.6)	3 (17.4)
<u>HI-A389</u>				
surface water	4 (28.3)	2 (26.7)	1 (21.0)	3 (20.6)
mid-water	2 (22.4)	4 (21.0)	1 (21.0)	3 (19.4)
bottom water	1 (18.2)	3 (17.6)	4 (17.5)	2 (17.1)

^aDetransformed means are presented (x) and means that are underlined are not different at the 0.05 level.

brackish water remains along the coast from the Mississippi delta to about 92°W and in a region extending seaward over the shelf. The absence of low-salinity water west of about 92.5°W in July is caused by upcoast currents and upwelling driven by the upcoast wind stress. In September, currents all along the coast rapidly return to prevailing downcoast flow, bringing with them a coastal band of low-salinity water.

At most sites during the first cruise, the 25 CTD casts oversampled the 28 to 78 km² of area around each platform. For example, salinity values at MU-A85 ranged between 35.75 and 36.00, with a mean of 35.85. This small range reflects a uniform water mass. However, at MAI-686 the salinity range was considerably greater: 31.56 to 34.90. The larger salinity range at

MAI-686 was caused by a combination of vertical stratification and spatial variability. The site was influenced by the brackish coastal jet that hugs the Texas coast during September through May (Cochrane and Kelly 1986).

No salinity differences could be attributed to the presence of a platform (Table 6.12). The few associations with distance as determined by Tukey's test can be attributed to a time aliasing effect. Stations were not occupied in random order, with all stations at a given distance often sampled together. Sampling generally extended over a 2 to 3 day period; therefore, variables that vary in this timeframe may be similar due to time of sampling not other design variables (i.e., distance). **As with temperature the most significant effect was the time of year during which the sampling event occurred.** Salinity data is summarized and described in detail in Section 5.1. The relationship to time of year becomes less significant with increasing water depth.

6.1.3 Nutrients

Concentrations of nutrients, such as nitrate, nitrite, phosphate, and silicate on the Texas-Louisiana shelf are controlled by both biological and physical processes. The interaction of these processes results in low-nutrient concentrations in the surface water of the open Gulf (Barnard and Froelich 1981) and higher concentrations nearshore, especially near river mouths (Ho and Barrett 1977). Processes affecting nutrient concentrations on the shelf include river discharge, coastal currents and winds, intrusions of open Gulf waters, upwelling, biological activity, rainfall, and proximity to coastal marshes (Ho and Barrett 1977; Barrett et al. 1978; Brooks 1980; Flint and Rabalais 1980; Dagg 1988). Nutrient concentrations in coastal waters generally decrease in a westward direction from high values found near the Mississippi River (Riley 1937).

There is a general seasonal pattern in the shelf nutrient concentrations. On the Texas shelf, concentrations reach peaks in the spring and then are consumed by phytoplankton blooms, resulting in low concentrations for the remainder of the spring and summer. Nutrient replenishment occurs in the fall and winter (Flint and Rabalais 1980). A similar seasonal variation occurs on the Louisiana shelf where the spring peak is due to high river flow (Sklar and Turner 1981) that brings the high

Table 6.12. Tukey's multiple comparison test results for each site and water depth by distance and cruise for salinity for the overall study design.

Site/Water Depth	Distance ^a				
<u>MAI-686</u>					
surface water	500 m (31.99)	3000 m (31.36)	<u>200 m (31.06)</u>	<u>100 m (30.93)</u>	50 m (30.62)
mid-water	500 m (32.47)	<u>200 m (31.65)</u>	<u>3000 m (31.60)</u>	<u>100 m (31.58)</u>	50 m (31.07)
bottom water	500 m (33.93)	50 m (33.89)	<u>3000 m (33.53)</u>	<u>200 m (33.45)</u>	100 m (33.16)
<u>MU-A85</u>					
surface water	100 m (32.60)	500 m (32.57)	<u>3000 m (32.47)</u>	<u>50 m (32.37)</u>	200 m (32.27)
mid-water	3000 m (35.72)	500 m (35.72)	<u>50 m (35.64)</u>	<u>200 m (35.60)</u>	100 m (35.58)
bottom water	3000 m (36.06)	500 m (36.03)	<u>50 m (36.02)</u>	<u>100 m (36.97)</u>	200 m (36.95)
<u>HI-A389</u>					
surface water	3000 m (34.53)	500 m (34.39)	<u>50 m (34.25)</u>	<u>200 m (34.17)</u>	100 m (34.14)
mid-water	No difference (36.0)				
bottom water	200 m (36.28)	50 m (36.27)	100 m (36.26)	500 m (36.26)	5000 m (36.22)

^aDetransformed means are presented (x) and means that are underlined are not different at the 0.05 level.

Table 6.12. (Cont.)

Site/Water Depth	Cruise ^a			
<u>MAI-686</u>				
surface water	3 (33.81)	1 (32.87)	2 (29.78)	4 (28.59)
mid-water	3 (34.09)	1 (33.40)	2 (29.92)	4 (29.70)
bottom water	1 (34.32)	3 (34.28)	4 (33.51)	2 (32.25)
<u>MU-A85</u>				
surface water	1 (35.83)	3 (35.21)	2 (30.91)	4 (28.28)
mid-water	1 (35.82)	4 (35.73)	2 (35.61)	3 (35.43)
bottom water	2 (36.21)	4 (36.20)	1 (35.92)	3 (35.70)
<u>HI-A389</u>				
surface water	3 (37.14)	1 (37.01)	2 (34.41)	4 (32.80)
mid-water	4 (36.19)	3 (36.14)	1 (36.04)	2 (35.82)
bottom water	1 (36.32)	4 (36.30)	2 (36.22)	3 (36.21)

^aDetransformed means are presented (x) and means that are underlined are not different at the 0.05 level.

nitrate and silicate concentrations that are strongly associated with low-salinity nearshore waters (Wiseman et al. 1986).

Coastal wind-induced upwelling has been identified as a mechanism by which surface water nutrients in the coastal boundary layer are transported to the middle shelf (Dagg 1988). In slope and deep Gulf waters, nutrient maxima occur at about 400 to 600 m (Paskausky and Nowlin 1968; Morrison et al. 1983). At the shelf-edge, bottom Ekman upwelling can raise water with high nutrient concentrations (from near the depth of the maximum) to the shelf. This is an idea developed by Cochrane (1969) for the Campeche Bank, which has analogous currents along the shelf-edge.

Phosphate concentrations showed little or no relationship to distance from the platform (Table 6.13). One location of increased phosphate was in near bottom water adjacent to the platform at MAI-686 during Cruise 4. Increases in bottom water phosphate during summer cruises were observed at MU-A85. **Nitrate concentrations also exhibited little relationship to distance from the platform** other than at MAI-686 where bottom waters were enhanced in nitrate during the summer cruises (Table 6.14). **An increase in bottom water silicate near the platform at MAI-686 and MU-A85 was observed during summer cruises** (Table 6.15). A similar though less dramatic increase in silicate concentrations in bottom waters during the summer was also observed at MU-A85. Nutrient data is summarized and described in detail in Section 5.1.

6.1.4 Dissolved Oxygen

Dissolved oxygen concentrations on the shelf vary from well-oxygenated to hypoxic (less than 2-mg L⁻¹ dissolved oxygen). Hypoxic bottom waters occur almost annually in the summer in the Mississippi Bight (Turner and Allen 1982) and frequently extend into west Louisiana (SAIC 1989) and Texas waters (Harper et al. 1981a; Rabalais 1988). Hypoxia develops as early as April and continues to as late as October, covering areas of up to 10,000 km² (Boesch and Rabalais 1988).

Near-bottom oxygen concentrations on the inner shelf drop when strong vertical stratification develops. Such stratification may be caused by less dense coastal water overriding denser shelf water. Boesch and Rabalais (1988) suggest that the increasing nitrate enrichment by Mississippi River discharge contributes to observed increases in frequency and intensity of shelf hypoxia since the 1960s. Nitrate increase is attributable to increased use of agricultural fertilizers, waste discharge, and atmospheric precipitation.

Low values of dissolved oxygen (less than 3 mL/L) were observed in bottom waters at HI-A389 during all cruises (Table 6.16). **The low oxygen concentrations at the HI-A389 were caused by impingement of the oxygen minimum layer on the outer shelf. In contrast, the low oxygen concentrations observed at MAI-686 and MU-A85 were related to summer vertical stratification.** Time aliasing could account for some of the observed

Table 6.13. Tukey's multiple comparison test results for each site and water depth by distance and cruise for water column phosphate concentrations (μM).

Site/Water Depth		Distance ^a				
<u>MAI-686</u>						
surface water		No difference (0.08)				
mid-water		No difference (0.09)				
bottom water	<u>50 m</u> (0.30)	<u>100 m</u> (0.23)	200 m (0.18)	500 m (0.15)	3000 m (0.14)	
<u>MU-A85</u>						
surface water		No difference (0.05)				
mid-water		No difference (0.05)				
bottom water		No difference (0.17)				
<u>HI-A389</u>						
surface water	100 m (0.06)	200 m (0.06)	50 m (0.05)	500 m (0.04)	5000 m (0.04)	
mid-water	5000 m (0.07)	200 m (0.07)	100 m (0.06)	50 m (0.05)	500 m (0.04)	
bottom water	5000 m (0.78)	200 m (0.73)	500 m (0.71)	50 m (0.67)	100 m (0.57)	

^aDetransformed means are presented (x) and means that are underlined are not different at the 0.05 level.

Table 6.13. (Cont.)

Site/Water Depth	Cruise ^a			
<u>MAI-686</u>				
surface water	3 (0.15)	4 (0.08)	1 (0.06)	2 (0.05)
mid-water	3 (0.16)	4 (0.09)	1 (0.07)	2 (0.04)
bottom water	4 (0.37)	3 (0.19)	2 (0.18)	1 (0.07)
<u>MU-A85</u>				
surface water	3 (0.09)	2 (0.04)	4 (0.04)	1 (0.03)
mid-water	3 (0.11)	4 (0.06)	2 (0.05)	1 (0.03)
bottom water	4 (0.29)	2 (0.24)	3 (0.1)	1 (0.0)
<u>HI-A389</u>				
near surface	3 (0.08)	4 (0.06)	1 (0.03)	2 (0.02)
mid-water	3 (0.11)	4 (0.07)	1 (0.03)	2 (0.02)
bottom water	2 (0.82)	4 (0.65)	1 (0.63)	3 (0.61)

^aDetransformed means are presented (x) and means that are underlined are not different at the 0.05 level.

Table 6.14. Tukey's multiple comparison test results for each site and water depth by distance and cruise for nitrate (μM).

Site/Water Depth	Distance ^a				
<u>MAI-686</u>					
surface water	500 m (0.29)	200 m (0.28)	100 m (0.26)	50 m (0.26)	3000 m (0.17)
mid-water	100 m (0.31)	50 m (0.26)	200 m (0.23)	500 m (0.21)	3000 m (0.16)
bottom water	50 m (1.53)	100 m (1.19)	200 m (0.94)	3000 m (0.58)	500 m (0.49)
<u>MU-A85</u>					
surface water	3000 m (0.15)	500 m (0.11)	100 m (0.10)	50 m (0.10)	200 m (0.06)
mid-water	100 m (0.36)	3000 m (0.32)	50 m (0.27)	500 m (0.23)	200 m (0.12)
bottom water	No difference (2.50)				
<u>HI-A389</u>					
surface water	50 m (0.29)	200 m (0.28)	100 m (0.23)	500 m (0.21)	5000 m (0.13)
mid-water	5000 m (0.50)	200 m (0.44)	50 m (0.26)	100 m (0.21)	500 m (0.21)
bottom water	5000 m (12.91)	200 m (12.54)	500 m (12.51)	50 m (10.26)	100 m (8.21)

^aDetransformed means are presented (x) and means that are underlined are not different at the 0.05 level.

Table 6.14. (Cont.)

Site/Water Depth	Cruise ^a			
<u>MAI-686</u>				
near surface	1 (0.56)	3 (0.28)	<u>2</u> (0.14)	<u>4</u> (0.08)
mid-water	1 (0.43)	3 (0.31)	<u>2</u> (0.15)	<u>4</u> (0.07)
near bottom	4 (2.78)	2 (1.18)	<u>3</u> (0.36)	<u>1</u> (0.17)
<u>MU-A85</u>				
near surface	3 (0.13)	2 (0.13)	<u>4</u> (0.10)	1 (0.07)
mid-water	4 (0.71)	<u>1</u> (0.14)	<u>3</u> (0.14)	<u>2</u> (0.12)
near bottom	4 (4.42)	2 (3.10)	1 (0.41)	3 (0.22)
<u>HI-A389</u>				
near surface	3 (0.57)	<u>1</u> (0.18)	<u>2</u> (0.14)	4 (0.07)
mid-water	3 (0.91)	<u>1</u> (0.22)	<u>2</u> (0.12)	4 (0.15)
near bottom	<u>2</u> (13.24)	<u>1</u> (11.27)	3 (10.09)	4 (9.95)

^aDetransformed means are presented (x) and means that are underlined are not different at the 0.05 level.

Table 6.15. Tukey's multiple comparison test results for each site and water depth by distance and by cruise for silicate concentrations (μM).

Site/Water Depth	Distance ^a				
<u>MAI-686</u>					
surface water	50 m (2.87)	200 m (2.54)	3000 m (2.45)	500 m (2.33)	100 m (2.31)
mid-water	No difference (3.30)				
bottom water	50 m (7.78)	100 m (6.48)	200 m (5.38)	3000 m (4.63)	500 m (3.90)
<u>MU-A85</u>					
surface water	100 m (2.28)	200 m (1.98)	50 m (1.90)	500 m (1.86)	3000 m (1.74)
mid-water	3000 m (2.45)	100 m (2.14)	50 m (1.75)	500 m (1.65)	200 m (1.62)
bottom water	No difference (3.4)				
<u>HI-A389</u>					
surface water	200 m (2.19)	50 m (1.91)	100 m (1.90)	500 m (1.86)	5000 m (1.62)
mid-water	200 m (2.14)	100 m (1.75)	50 m (1.60)	500 m (1.59)	5000 m (1.57)
bottom water	200 m (6.27)	500 m (6.01)	5000 m (5.78)	50 m (5.04)	100 m (4.74)

^aDetransformed means are presented (x) and means that are underlined are not different at the 0.05 level.

Table 6.15. (Cont.)

Site/Water Depth	Cruise ^a			
<u>MAI-686</u>				
surface water	2 (4.14)	3 (3.92)	1 (2.18)	4 (0.86)
mid-water	2 (4.21)	3 (3.29)	1 (1.94)	4 (0.96)
bottom water	4 (16.19)	2 (7.49)	3 (3.53)	1 (1.66)
<u>MU-A85</u>				
surface water	2 (3.39)	1 (2.28)	3 (1.96)	4 (0.74)
mid-water	2 (2.69)	1 (2.38)	3 (1.83)	4 (0.88)
bottom water	2 (5.37)	4 (4.53)	1 (2.66)	3 (2.37)
<u>HI-A389</u>				
surface water	3 (2.52)	1 (1.92)	2 (1.86)	4 (1.38)
mid-water	3 (2.43)	1 (1.96)	2 (1.72)	4 (0.95)
bottom water	2 (6.89)	3 (5.99)	1 (5.01)	4 (4.44)

^aDetransformed means are presented (x) and means that are underlined are not different at the 0.05 level.

Table 6.16. Tukey's multiple comparison test results for each site and water depth by distance and cruise for dissolved O₂ concentrations (mL/L).

Site/Water Depth	Distance ^a				
<u>MAI-686</u>					
surface water	100 m (5.51)	<u>50 m (5.28)</u>	<u>3000 m (5.33)</u>	<u>500 m (5.31)</u>	<u>200 m (5.30)</u>
mid-water	100 m (5.36)	<u>50 m (5.32)</u>	<u>500 m (5.29)</u>	<u>3000 m (5.29)</u>	<u>200 m (5.20)</u>
bottom water	500 m (4.93)	<u>3000 m (4.82)</u>	<u>200 m (4.55)</u>	<u>100 m (4.32)</u>	<u>50 m (3.88)</u>
<u>MU-A85</u>					
surface water	50 m (5.15)	<u>200 m (5.11)</u>	<u>100 m (5.09)</u>	<u>3000 m (5.02)</u>	<u>500 m (5.00)</u>
mid-water	50 m (5.05)	<u>200 m (5.02)</u>	<u>3000 m (4.96)</u>	<u>100 m (4.88)</u>	<u>500 m (4.87)</u>
bottom water	No difference (4.5)				
<u>HI-A389</u>					
surface water	No difference (5.0)				
mid-water	No difference (5.0)				
bottom water	100 m (3.43)	<u>5000 m (3.34)</u>	<u>50 m (3.26)</u>	<u>200 m (2.97)</u>	<u>500 m (2.96)</u>

^aDetransformed means are presented (x) and means that are underlined are not different at the 0.05 level.

Table 6.16. (Cont.)

Site/Water Depth	Cruise ^a			
<u>MAI-686</u>				
surface water	3 (5.94)	1 (5.63)	2 (5.03)	4 (4.87)
mid-water	3 (5.90)	1 (5.54)	2 (4.92)	4 (4.85)
bottom water	3 (5.83)	1 (5.46)	2 (4.11)	4 (2.65)
<u>MU-A85</u>				
surface water	3 (5.49)	1 (5.11)	2 (4.88)	4 (4.84)
mid-water	3 (5.37)	1 (5.09)	2 (4.70)	4 (4.67)
bottom water	3 (5.25)	1 (5.01)	2 (3.94)	4 (3.93)
<u>HI-A389</u>				
surface water	3 (5.12)	1 (5.07)	4 (4.88)	2 (4.84)
mid-water	No difference (5.05)			
near bottom	3 (3.71)	4 (3.20)	1 (2.94)	2 (2.93)

^aDetransformed means are presented (x) and means that are underlined are not different at the 0.05 level.

distance effects because the stations were sampled in order by distance as previously mentioned. However, such aliasing would require rapid, massive movement of bottom waters during the sampling period and there is no evidence for such transport at MAI-686. CTD profiles documented a pronounced pycnocline at 7 to 8 m above the bottom close to the platform and 3 to 5 m above the bottom more distant (> 100 m) from the platform. **There was a strong ($p \leq 0.01$) correlation between high silicate, nitrate, and phosphate concentrations and the low oxygen** (see Section 5.1). The hypoxic events detected at MAI-686 were masked in the statistical analyses by strong seasonal and directional (radial) interactions. A lowering of oxygen

concentrations during the summer samplings was also apparent at MU-A85 suggesting that platform-related hypoxia may be a common feature associated with organic enrichment driven by the "reef effect" of the platform structure. The oxygen data is summarized and described in Section 5.1.

6.1.5 Suspended Particulate Matter

Much of the suspended sediment observed in shelf waters enters the Gulf via the Mississippi and Atchafalaya Rivers, with smaller amounts contributed by other rivers, bay discharges, and coastal erosion. Most of these sediments are initially deposited close to the point where they entered the Gulf. Shelf currents resuspend the sediments, resulting in westward transport of the fine-grained fraction by the mean flow (Adams et al. 1982). Suspended sediments can be examined using light scattering data (Plank et al. 1972). Light transmission is another technique (Pak and Zaneveld 1977) that has been used on the Texas-Louisiana shelf. Continuous measurements of light transmission (beam attenuation coefficient) show that suspended sediment is often concentrated in layers within the water column. Called nepheloid layers, these have relatively high light scattering and low light transmission. On the Texas shelf, suspended sediment is often concentrated into surface nepheloid layers associated with Texas river and bay discharges, in bottom nepheloid layers across the shelf due to sediment resuspension and advection by shelf currents, and in intermediate nepheloid layers over the slope, resulting from off-shelf transport of the bottom nepheloid layer (Shideler 1981; McGrail and Carnes 1983; Sahl and Merrell 1987; Halper et al. 1988). On the Texas-Louisiana shelf several processes have been identified as important in nepheloid layer transport, which are: (1) lateral shelf water exchange processes (Shideler 1979); (2) diffusion and ebb-tide discharge from coastal inlets (Shideler 1978); (3) coastal currents associated with the passage of meteorological fronts (Holmes 1982); and (4) bottom Ekman upwelling at the shelf edge.

Few differences in percent light transmittance were apparent in relation to distance from the platform or cruise (Table 6.17). At MU-A85 transmittance was lower in close proximity to the platform and higher close to the platform at HI-A389 in mid and surface waters. Little cruise effect

Table 6.17. Tukey's multiple comparison test results for each site and water depth by distance and by cruise for transmittance (%).

Site/Water Depth	Distance ^a				
<u>MAI-686</u>					
near surface	No difference (73)				
mid-water	No difference (74)				
near bottom	No difference (64)				
<u>MU-A85</u>					
near surface	<u>500 m</u> (84.3)	<u>200 m</u> (83.9)	<u>3000 m</u> (83.7)	<u>50 m</u> (81.0)	<u>100 m</u> (79.8)
mid-water	<u>500 m</u> (85.6)	<u>200 m</u> (84.9)	<u>3000 m</u> (84.8)	<u>50 m</u> (83.3)	<u>100 m</u> (81.1)
near bottom	No difference (77.0)				
<u>HI-A389</u>					
near surface	<u>100 m</u> (84.1)	<u>50 m</u> (81.6)	<u>3000 m</u> (77.7)	<u>200 m</u> (78.0)	<u>500 m</u> (73.9)
mid-water	<u>100 m</u> (84.7)	<u>50 m</u> (82.1)	<u>200 m</u> (82.1)	<u>500 m</u> (81.4)	<u>5000 m</u> (81.1)
near bottom	No difference (78.0)				

^aDetransformed means are presented (x) and means that are underlined are not different at the 0.05 level.

Table 6.17. (Cont.)

Site/Water Depth	Cruise ^a			
<u>MAI-686</u>				
near surface	4 (85.3)	2 (80.7)	1 (70.3)	3 (59.4)
mid-water	4 (85.7)	2 (81.4)	1 (72.1)	3 (60.0)
near bottom	4 (72.6)	1 (65.7)	2 (63.3)	3 (49.8)
<u>MU-A85</u>				
near surface	1 (87.1)	4 (84.4)	3 (83.6)	2 (75.7)
mid-water	1 (88.1)	4 (85.8)	3 (83.7)	2 (78.3)
near bottom	4 (81.3)	1 (78.3)	2 (73.5)	3 (73.4)
<u>HI-A389</u>				
near surface	3 (86.4)	4 (81.4)	2 (77.1)	1 (73.8)
mid-water	4 (88.8)	3 (87.4)	2 (77.8)	1 (77.6)
near bottom	No difference (77.0)			

^aDetransformed means are presented (x) and means that are underlined are not different at the 0.05 level.

was apparent in transmittance in the summer samplings at MAI-686. **Transmittance decreased in bottom waters compared to surface waters at all sites, reflecting the presence of a near bottom nepheloid layers.** Transmittance data is summarized and described in detail in Section 5.1.

6.2 Sedimentology and Contaminant Chemistry

A series of independent, abiotic variables were measured in sediments to aid in defining perturbations related to the presence of a platform and to provide a framework for the interpretation of concurrent biological studies.

Abiotic variables measured in sediments included grain size, mineralogy, organic and inorganic carbon content, redox potential, and contaminant concentrations. Data for these variables are summarized and described in detail in Sections 5.2 and 5.3.

Sediment texture (i.e., grain size) is an important variable in the evaluation of biological assemblage data and contaminant distributions in benthic systems. Numerous studies have shown a strong correlation between biology, chemistry, and sediment texture and quality. In benthic ecosystem studies, cross-correlations between study sites are often dependent on substrate characteristics. Correlation of biological response variables with contaminant exposure can be confounded by the effects of variations in substrate. The distribution of sands, muds, and hard bottoms on the OCS off Texas has been known in general for many years. The sediments on the continental shelf offshore of Texas were deposited by marine processes of transport and deposition and are largely fluvial in origin. Sediments consist primarily of quartz sands, silts, and clays with an additional input of skeletal and fragmentary remains of organisms living on and in the sediments. Organic and inorganic carbon content of sediments is another important measure of sediment quality. The carbon content of sediments near platforms may be influenced by organic enrichment (i.e., reef effect), disposal of drill mud and cuttings, and discharges from the platform. The oxygen content of sediment pore water as measured by redox potential is also an important factor in determining the quality of the benthic substrate. Redox conditions also play an important role in the mobility and bioavailability of metals in the marine environment.

The release of petroleum to the surrounding environment can occur during drilling as well as in the production phase of a platform's lifetime. Petroleum hydrocarbons are potentially present in a variety of discharges including drilling fluids, drill cuttings, produced water, spills, deck drainage, and other releases. Hydrocarbons are a major constituent of produced petroleum and as such might be expected to be a contaminant at platform sites. Hydrocarbons are ubiquitous in the marine environment. However, petroleum-derived hydrocarbons can be differentiated from naturally occurring biogenic hydrocarbons (Brassell et al. 1978; Philp 1985; Boehm and Requejo 1986; Kennicutt and Comet 1992). Aliphatic hydrocarbons synthesized by organisms (both planktonic and terrestrial)

include a suite of normal alkanes with odd numbers of carbons from fifteen (15) to thirty-three (33). Petroleum contains a homologous series of n-alkanes with one (1) to more than thirty (30) carbons with odd and even n-alkanes present in nearly equal amounts. Petroleum also contains a complex mixture of branched and cycloalkanes generally not found in organisms. This complex mixture is detected as an unresolved complex mixture (UCM) in gas chromatograms. The presence and amount of the UCM is a diagnostic indicator of petroleum contamination but can also be derived in part from indigenous biological lipids. Petroleum also contains an extensive suite of polycyclic aromatic hydrocarbons (PAH) that are known to be toxic to organisms. PAH are synthesized by organisms; however, petroleum PAH can be easily differentiated by the structural complexity of the mixture. The amount and composition of PAH can indicate the amount and type of petroleum contamination. PAH, as the toxic component of oil, also indicate the potential for biological effects in resident organisms. Based on considerations of petroleum chemistry, biological occurrences of hydrocarbons, and toxicological effects; aliphatic and aromatic hydrocarbons were chosen as indicators of petroleum contamination near platforms.

Trace metals are also released to the environment in discharges from offshore petroleum drilling activities. Metals represent a source of enhanced, chronic contaminant exposure that can potentially impact both infauna and epifauna in the vicinity of drilling platforms. Many of the trace metals selected for analysis are priority pollutants (Ag, As, Cd, Cr, Cu, Hg, Ni, Pb, Sb, Se, and Zn) that are known to be toxic to organisms and discharged in drill muds. Tin (Sn) was included because of its potential toxicity and its presence in antifouling paints. Barium (Ba) was selected as a tracer of the particulate, settleable fraction of drilling discharges. Barium (as barite, barium sulfate) is the dominant component of drill mud (up to 90 % on a dry weight basis). Barium is an ideal tracer of the particulate (settleable) fraction of discharged drilling fluids and cuttings because it occurs in high concentrations in drill muds and has a low, natural background in ambient sediments (200 to 500 ppm dry weight). Aluminum (Al) and iron (Fe) as representative of alumino-silicate minerals were monitored to document changes in sediment type. Vanadium (V) was included because it can occur in high concentrations in crude oil. Sixteen (16) elements were measured in sediments, fourteen (14) in biota tissues

(except Al and Sb), and seven (7) in pore waters (Ba, Cd, Cu, Hg, Pb, V and Zn).

6.2.1 Principal Component Analysis of Sediment and Contaminant Variables

In order to provide the most effective variables to test covariation of biological effects with benthic environmental variables, Principal Components Analysis (PCA; SAS Institute Inc. 1990) was performed on sedimentologic and contaminant variables together. PCA is effective in defining interrelationships between sediment texture and contaminant content and providing effective representation of variance in the data. Sediment texture and contaminant content are closely coupled at platform sites. Excess barium in sediments is directly attributable to discharges during drilling activities. A suite of several metals characteristic of the barite ore strongly covary with barium (see Section 5.3). There was strong evidence based on visual examination and chemical analysis that a major portion of the hydrocarbons deposited in the sediments were intrinsic components of the drill cuttings discharged during drilling activities. The bulk of the sand size particles were visually identifiable as cuttings; thus the anomaly in sediment sand content was closely coupled to discharges during drilling (see Section 5.2). Sand may also be deposited with produced waters or during sand blasting of the platform structure. Additionally, currents may enhance sand content by preferential winnowing and transport of fines away from the platform site. Based on these conceptual linkages, principal components analysis was used to provide a reduced set of variables that describe the spatial pattern of the platform-associated suite of contaminants.

The contaminant and sedimentologic data used for final PCA analysis and score calculations were generated by a two-step data reduction procedure. As previously discussed, many contaminant variables (individual PAH and metals) strongly covary (see Section 5.3). The sediment trace element data set was characterized by a strong covariance (both positive and negative) with barium. At both HI-A389 and MU-A85, several metals (Cd, Hg, Pb, and Zn) showed highly significant, positive correlations with sediment barium. For metals such as cadmium and mercury, the correlation with barium suggested a common source in the barite ore. In contrast, the

lesser correlation of lead and zinc with barium suggested that a source (e.g., produced water discharges, lubricants, welding operations, etc.) other than drilling discharges was important. Lead and zinc have been detected in produced waters and are thought to be derived from the corrosion of galvanized structures on the platform or the oil-water separator system (Neff et al. 1981). Zinc is also a major metal in sacrificial anodes. Other metals (i.e. Al, Fe, Cr, Ni, Se, and V) associated with indigenous sediments showed weak, if any, correlations with barium. Finally, arsenic, copper, and tin were of mixed origins based on correlations with both barium and sediment metals (e.g., Fe). For copper, the correlation with barium was weak except at high barium concentrations suggesting that the concentration of copper in the original barite ore was low.

Initial statistical analysis suggested that inclusion of all measured contaminant parameters might skew the resulting principal components due to the high degree of variable covariation. To more accurately reflect the consortium of materials present, strongly covarying parameters were reduced in number by either summing (TOTPAH) or selecting representatives of classes of contaminants as defined by statistical correlations (i.e., barium as a marker of drill muds). This reduced data set was then analyzed by PCA to provide a set of representative covariates that could be correlated with results from other study elements (Table 6.18). However, PCA conducted at all levels of complexity (all variables, reduced variables, extended sets of variable) produced similar classifications of the data and thus led to equivalent interpretations. The consistency in the conclusions drawn from a variety of statistical treatments illustrates the robustness of the conclusions to changes in analytical design.

An important observation was that sand content positively correlated with contaminant content. This contrasts with most environmental studies where contaminants are associated with fine-grained particles. **This was a consequence of the origins of the contaminants, the composition of the materials discharged, the rapidity of the initial discharge, and the energetics of sediment transport at the site of deposition. A gradient in sand content was present at all three sites studied;** however, the contaminant gradient was quite different between sites with little or no contaminant gradient apparent at MAI-686. This resulted from differential redistribution of discharged materials based on grain size association,

Table 6.18. Principal Component Analysis (PCA) factor patterns for reduced and combined sediment and contaminant variables (all variables were transformed as summarized in Section 2.0).

Variable	ChemPC1	ChemPC2
Total PAH	0.60	0.54
Total UCM	0.79	0.38
Total Alkanes	0.79	0.20
% Sand	0.85	-0.48
% Silt	-0.61	0.58
% Clay	-0.88	0.30
TOC	-0.50	0.63
TIC	0.08	0.64
Redox Potential	-0.26	0.03
Iron (Fe)	-0.61	0.58
Cadmium (Cd)	0.69	0.64
Aluminum (Al)	-0.86	-0.05
Barium (Ba)	0.54	0.71
% of Variance	43.6 %	24.7 %

discharge history, and discharge technique. At MAI-686 the barium anomaly was weak, suggesting loss of silt-sized materials due to winnowing. Timing of discharges, mode of discharge, and the amount of materials discharged are also important influences on sediment characteristics and cannot be fully resolved by the present study.

A crossplot of ChemPC1 versus ChemPC2 clearly differentiates the stations by distance from platform and by site (Figure 6.1). Translated into the variables measured, contamination increases as ChemPC1 increases (i.e., near stations are more contaminated with hydrocarbons, metals, and sand than far stations). **Grain size decreases with distance from the platform.** As ChemPC2 increases, fines increase and **the sites were classified based on water depth and depositional setting.**

6.2.2 Hypothesis Testing

As demonstrated by statistical analysis, many sediment contaminant variables covary. Thus, representative contaminant and sedimentologic parameters and PC scores were used to test the chemistry component of the programmatic hypotheses (Tables 6.19 to 6.21). The overall study design was tested to detect interactions among cruises, platforms, and distances from platforms (Table 6.19). Higher order interactions prohibited a direct interpretation of the main study design elements such as distance. The

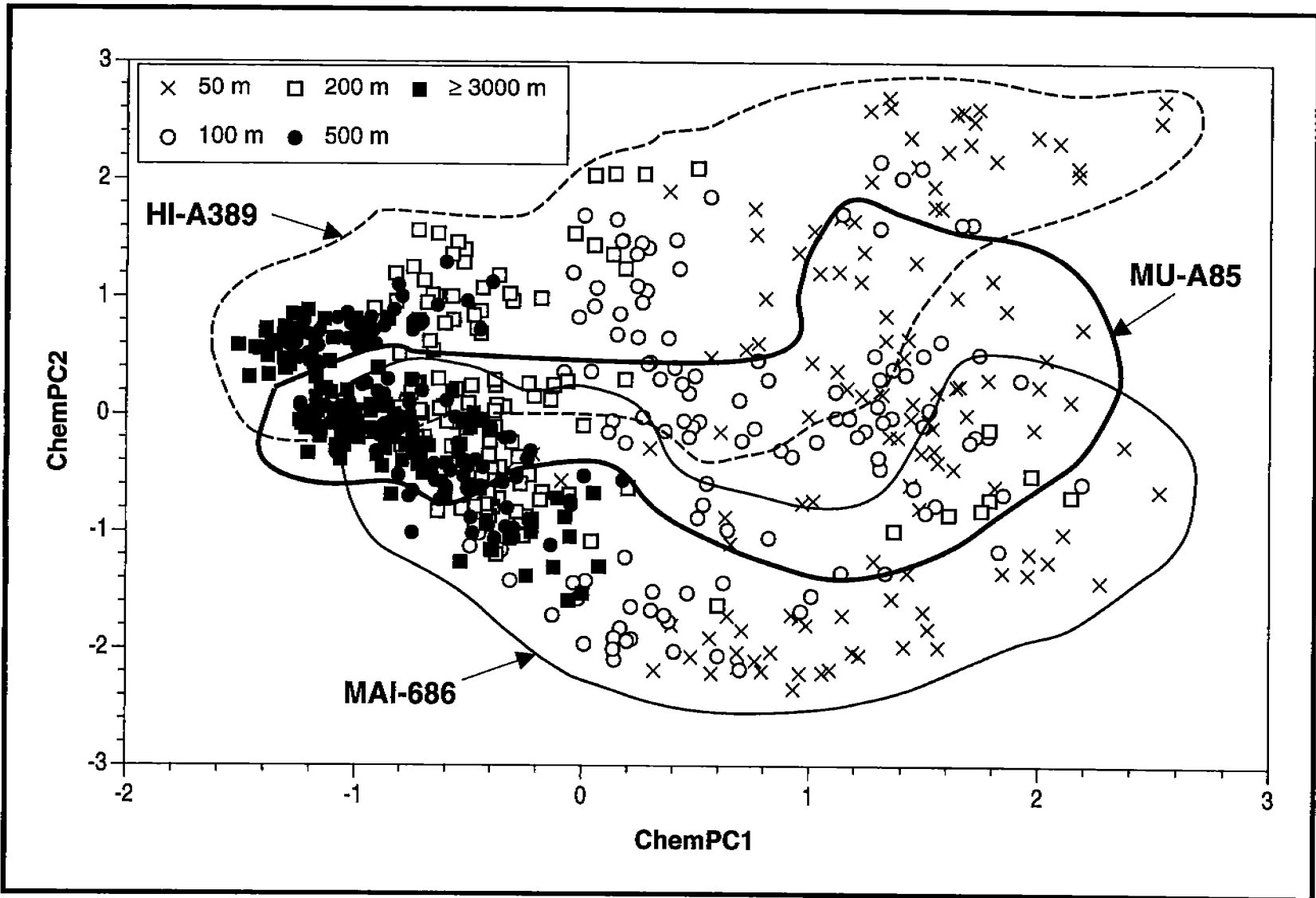

Figure 6.1. Relationship between ChemPC1 and ChemPC2 for sediment contaminant data coded by distance and grouped by site.

Table 6.19. Summary of the significance of interactions by distance at all platforms for the overall study design based on sedimentology and contaminant data.

Variable ^a	Interactions ^b			
	C*D	P*D	P*C*D	D*R(P)
ChemPC1	Yes	Yes	No	Yes
ChemPC2	No	Yes	No	Yes
TOTPAH	No	Yes	No	Yes
TOTUCM	Yes	Yes	Yes	Yes
TOTALK	No	Yes	No	Yes
Ba	No	Yes	No	Yes
Fe	No	No	No	Yes
Cd	No	Yes	No	Yes
Al	Yes	No	Yes	Yes
% Sand	No	No	No	Yes
% Silt	No	Yes	Yes	Yes
% Clay	No	No	Yes	Yes
TOC	Yes	No	Yes	No
TIC	Yes	No	No	No
Redox	No	Yes	Yes	No

^aChemPC1-first principal component, ChemPC2-second principal component, TOTPAH-sum of all measured PAH, TOTUCM-unresolved complex mixture, TOTALK-sum of all resolved alkanes measured, Ba-barium, Fe-iron, Cd-cadmium, Al-aluminum, % sand-sand content, % silt-silt content, % clay-clay content, TOC-total organic carbon, TIC-total inorganic carbon, Redox-Eh measured by platinum electrode.

^bP=platform, C=Cruise, D=Distance, R=radius; Yes=significant, $p \leq 0.01$; No=not significant, $p \geq 0.01$.

Table 6.20. Summary of the significance of interactions by platform for the overall study design based on sedimentology and contaminant data.

Site Variable ^a	Interactions ^b								
	MAI-686			MU-A85			HI-A389		
	C*D	D*R	C*D*R	C*D	D*R	C*D*R	C*D	D*R	C*D*R
ChemPC1	No	Yes	Yes	No	Yes	Yes	No	Yes	Yes
ChemPC2	No	Yes	Yes	No	Yes	Yes	No	Yes	Yes
TOTPAH	No	No	Yes	No	Yes	No	No	Yes	No
TOTUCM	No	Yes	Yes	Yes	Yes	No	Yes	Yes	Yes
TOTALK	No	Yes	Yes	No	Yes	No	No	Yes	No
Ba	No	Yes	Yes	No	Yes	Yes	No	Yes	No
Fe	No	Yes	Yes	No	Yes	Yes	No	Yes	Yes
Cd	No	Yes	No	No	Yes	Yes	No	Yes	Yes
Al	No	Yes	Yes	No	Yes	Yes	No	Yes	Yes
% Sand	No	Yes	Yes	No	Yes	Yes	No	Yes	Yes
% Silt	No	Yes	Yes	Yes	Yes	Yes	No	Yes	Yes
% Clay	No	Yes	Yes	Yes	Yes	Yes	No	Yes	Yes
TOC	No	Yes	Yes	Yes	No	No	Yes	No	Yes
TIC	No	Yes	No	No	No	No	Yes	Yes	No
Redox	Yes	No	Yes	No	No	Yes	No	No	Yes

^aSee Table 6.19 for variable definition.

^bSee Table 6.19 for definition of variables and symbols.

Table 6.21. Summary of the significance of distance at platforms based on sedimentology and contaminant data.

Variable ^a	Site ^b		
	MAI-686	MU-A85	HI-A389
ChemPC1	---	---	---
ChemPC2	---	---	---
TOTPAH	---	---	---
TOTUCM	---	---	---
TOTALK	---	---	---
Ba	---	---	---
Fe	---	---	---
Cd	---	---	---
Al	---	---	---
%Sand	---	---	---
%Silt	---	---	---
%Clay	---	---	---
TOC	---	---	---
TIC	---	Yes	---
Redox	---	---	---

^aSee Table 6.1 for variable definition

^bSee Table 6.29 for definition of variables and symbols, "---" not testable due to higher interactions

analysis of hydrocarbons, trace metals, grain size, carbon content, redox conditions, and PC scores based on contaminants and sedimentology revealed many two- and three-way interactions (Table 6.19). Significant interactions due to platform uniqueness were common. Distance and radius interactions were present for all variables except TOC, TIC, and redox in a test of the overall study design. This suggested that many parameters vary not only in relationship to distance from the platform, but also among radii within a site. Due to extensive higher order interactions, more detailed can be provided if the data is tested on a site-by-site basis.

On a site-by-site basis, significant distance effects were clearly evident at all sites (Table 6.20). In general, significant effects related to distance were independent of the site in that the analysis of data individually at all three sites gives similar and concordant results. The only variable exhibiting no higher order interactions was TIC at MU-A85 and distance (D) was significant (Table 6.21). Few interactions between cruise and distance were apparent but distance interactions with radius were significant at all sites for almost all contaminant and sedimentologic variables. This signifies that **most "platform-perturbed" variables had a strong directional orientation since distances were not equivalent along different radii. While distance was a significant determinant in variable variances, more direct indicators of contaminant and sedimentologic properties must be used to investigate biological associations (i.e., distance is insufficient as a surrogate for contamination or exposure).**

Another approach for identifying differences among sample means is a multiple comparison test. The technique of choice was Tukey's multiple comparisons (see Section 2.0). These comparisons are effective in summarizing and highlighting among distances and among site differences. The Tukey's test results succinctly illustrate the attributes of each study site. An evaluation of the overall study design is presented first in order to assess the generality of the observed trends. ChemPC1 clearly ordered the stations by increasing distance from the platform (Table 6.22). ChemPC2 ordered the data most effectively by site and reflected the effects of water depth and the increasing clay and silt content of sediments in deeper waters (Table 6.23). ChemPC2 was confounded in that the distribution of sand was also related to distance from the platform. **Hydrocarbon based variables differentiated stations out to 500-m.** Stations at greater than 500-m

Table 6.22 Tukey's multiple comparison test results by distance for the overall study design based on sedimentology and contaminant data.

Variable ^a	Distance from the Platform ^b				
ChemPC1	50 m (1.32)	100 m (0.66)	200 m (-0.30)	500 m (-0.77)	<u>≥ 3000 m (-0.90)</u>
ChemPC2	200 m (0.17)	500 m (0.04)	50 m (0.00)	≥ 3000 m (-0.05)	100 m (0.16)
TOTPAH (ppb)	50 m (114)	100 m (73)	200 m (48)	500 m (35)	<u>≥ 3000 m (35)</u>
TOTUCM (ppm)	50 m (29)	100 m (14)	200 m (6)	500 m (3)	<u>≥ 3000 m (3)</u>
TOTALK (ppb)	50 m (925)	100 m (433)	200 m (265)	500 m (199)	<u>≥ 3000 m (179)</u>
Ba (ppm)	50 m (10,217)	100 m (6065)	200 m (4359)	500 m (2019)	<u>≥ 3000 m (1149)</u>
Fe (ppm)	<u>≥ 3000 m (27,900)</u>	500 m (27,686)	200 m (25,232)	50 m (20,436)	100 m (19,825)
Cd (ppm)	50 m (0.73)	100 m (0.25)	200 m (0.13)	500 m (0.07)	<u>≥ 3000 m (0.06)</u>
Al (ppm)	<u>≥ 3000 m (61,248)</u>	500 m (61,175)	200 m (54,776)	100 m (41,680)	50 m (33,982)
Sand (%)	50 m (60.5)	100 m (49.2)	200 m (21.9)	500 m (13.8)	<u>≥ 3000 m (12.6)</u>
Silt (%)	<u>≥ 3000 m (36.7)</u>	500 m (36.6)	200 m (35.4)	100 m (24.7)	50 m (21.5)
Clay (%)	<u>≥ 3000 m (48.5)</u>	500 m (47.4)	200 m (40.4)	100 m (24.7)	50 m (16.8)
TOC (%)	<u>≥ 3000 m (1.02)</u>	500 m (0.98)	200 m (0.89)	100 m (0.69)	50 m (0.61)
TIC (%)	<u>100 m (1.07)</u>	50 m (1.00)	200 m (0.83)	500 m (0.79)	<u>≥ 3000 m (0.75)</u>
Redox (mv)	<u>≥ 3000 m (100.0)</u>	200 m (98.4)	100 m (82.2)	500 m (75.4)	50 m (55.1)

^aSee Table 6.19 for definition of variables

^bDetransformed means are presented (x) and means that are underlined are not different at the 0.05 level.

Table 6.23. Tukey's multiple comparison test results by platform for the overall study design based on sedimentology and contaminant data.

Variable ^a	Platform ^b		
ChemPC1	MAI-686 (0.11)	MU-A85 (-0.01)	HI-A389 (-0.10)
ChemPC2	HI-A389 (+1.04)	MU-A85 (-0.02)	MAI-686 (-1.02)
TOTPAH (ppb)	HI-A389 (70.7)	MU-A85 (60.8)	MAI-686 (38.5)
TOTUCM (ppm)	HI-A389 (8.7)	MU-A85 (8.2)	MAI-686 (5.2)
TOTALK (ppb)	MAI-686 (339)	MU-A85 (337)	HI-A389 (307)
Ba (ppm)	HI-A389 (9874)	MU-A85 (3693)	MAI-686 (1307)
Fe (ppm)	HI-A389 (27,244)	MU-A85 (23,947)	MAI-686 (21,082)
Cd (ppm)	HI-A389 (0.40)	MU-A85 (0.12)	MAI-686 (0.08)
Al (ppm)	MU-A85 (51,694)	HI-A389 (48,218)	MAI-686 (48,016)
Sand (%)	MAI-686 (46.2)	MU-A85 (31.3)	HI-A389 (14.9)
Silt (%)	HI-A389 (36.9)	MU-A85 (33.4)	MAI-686 (22.6)
Clay (%)	HI-A389 (44.1)	MU-A85 (31.7)	MAI-686 (29.3)
TOC (%)	HI-A389 (1.2)	MU-A85 (0.8)	MAI-686 (0.6)
TIC (%)	HI-A389 (1.9)	MU-A85 (0.8)	MAI-686 (0.3)
Redox (mv)	MU-A85 (91.5)	HI-A389 (91.4)	MAI-686 (63.6)

^aSee Table 6.19 for variable definition

^bDetransformed means are presented (x) and means that are underlined are not different at the 0.05 level.

distance from the platform were indistinguishable from each other (i.e., background). **Barium content differentiated all distances, suggesting a much wider dispersion of barium. Iron and aluminum, as background sediment constituents, reflected a near-field dilution caused by the addition of sand.** However iron, in general, was only diluted 30 % compared to a 45 % dilution in aluminum, suggesting a secondary source of iron near the platform. Cadmium distributions were similar to those of barium and differentiated sediments at all distances. **The distribution of Cd and Ba was similar to that observed for sand content.** However, note that Ba and Cd increased by a factor of 10 or more over controls and sand increased by a factor of 5. Sediment silt and clay content reflected the dilution with sand; but also exhibited independent behaviors. **Sand content differentiated sediments to ≥ 3000 m, whereas silt only differentiated sediments to a distance of 500-m.** The distance of recognizable differences based on various size fractions suggested a differential influence of transport processes related to the hydraulic properties of the materials. Various size fractions were also influenced to varying degrees by contaminant additions, both as enhancements and dilutions. To more fully understand the origin of sediments at the sites, the distributions of selected variables within grain sizes is needed.

Carbon content distributions also reflected multiple processes. **In the most general case, organic carbon decreased and inorganic carbon increased toward the platform.** Organic carbon may be decreased due to dilution from sand and/or remineralization. Note that TOC decreased by only 30 % and yet sand and metals were increased by factors of 5 to 10 or more, suggesting a possible additional source of TOC at the platforms. Organic carbon increases in response to the deposition of the remnants of primary production, enhanced biological productivity associated with the platform, and perhaps microbial production with the structure acting as a "reef." An additional source of TOC in cuttings was possible but the importance of this source is unknown. Total inorganic carbon content (TIC) was subject to the sand dilution events; however, TIC had an additional source in debris from platform-associated biota such as barnacles and serpulids. Carbonate contributions from cuttings were also a source of inorganic carbon as illustrated by the close correlation between the sand and TIC content in sediments. TIC was enhanced by 30 % on average for all sites; however, the

input may be substantially higher since the increase was counteracted by the sand dilution events.

Redox potential is difficult to interpret but the two deeper sites appeared to be more oxygenated in general than the shallow water sites. This is consistent with observed hypoxic events at MAI-686.

A site-by-site analysis of Tukey's test results provides insight into the attributes of individual sites and are useful in interpreting biological patterns. **The variation in contaminant patterns at MAI-686 confirmed previous interpretations, PAH were low and not significantly associated with distance from the platform** (Table 6.24). Other hydrocarbon parameters were somewhat correlated with distance but the association was weak and most likely primarily related to a pipeline leak or seep previously identified along radius D that was not a site-wide contaminant event. **Metals believed associated with drill muds (Ba and Cd) were only weakly correlated with distance;** stations within 200-m were differentiated from stations that were further away. However, a coherent ordering of stations was not apparent. Sediment associated metals (Fe and Al) reflected dilution with sand, and the **sand content differentiated sediments out to as far as 3000-m**. As in the overall design tests, **TOC decreased and TIC increased with decreasing distance from the platform but only weakly at MAI-686**. Redox conditions showed little trend. In general, lower redox potentials were measured at stations closest to the platform. At this site the increases and decreases in variables were relatively concordant, suggesting a common depositional event (i.e., Fe and Al concentrations decreased by 40 %; sand content increased by a factor of 2.6).

MU-A85 clearly had enhanced contaminants concentrations near the platform (Table 6.25). **Hydrocarbon concentrations were significantly higher near the platform than away. The effect was most significant to 100-m. The 200-m stations were not significantly different from the 500-m stations for all hydrocarbon variables other than UCM which differentiated sediments to a distance of 500-m. Barium and cadmium concentrations differentiated sites to 500-m and in the case of barium, out to 3000-m distance.** This distribution was similar to changes in sand content. Iron and aluminum were diluted in response to the increase in sand content close to the platform. TOC was lower near the platform (≤ 100 m) and TIC was increased. Sediment redox potential showed little trend but redox potential

Table 6.24. Tukey's multiple comparison test results by distance based sedimentology and contaminant data at MAI-686.

Variable ^a	Distance ^b				
ChemPC1	50 m (1.00)	100 m (0.4)	200 m (0.04)	500 m (-0.44)	3000 m (0.49)
ChemPC2	3000 m (0.64)	500 m (-0.66)	200 m (-0.73)	100 m (-1.40)	50 m (-1.65)
TOTPAH (ppb)	3000 m (49)	500 m (43)	200 m (40)	50 m (32)	100 m (30)
TOTUCM (ppm)	50 m (8.4)	200 m (6.3)	100 m (5.2)	3000 m (3.8)	500 m (3.8)
TOTALK (ppb)	50 m (596)	100 m (382)	200 m (362)	500 m (236)	3000 m (231)
Ba (ppm)	200 m (1625)	50 m (1459)	100 m (1323)	500 m (1134)	3000 m (1072)
Fe (ppm)	3000 m (25,563)	500 m (24,929)	200 m (22,050)	100 m (18,882)	50 m (15,700)
Cd (ppm)	50 m (0.13)	200 m (0.11)	100 m (0.09)	500 m (0.06)	≥ 3000 m (0.05)
Al (ppm)	500 m (59,742)	3000 m (57,457)	200 m (50,599)	100 m (42,078)	50 m (34,922)
Sand (%)	50 m (72.8)	100 m (59.8)	200 m (40.8)	500 m (30.6)	≥ 3000 m (27.4)
Silt (%)	3000 m (30.3)	500 m (30.1)	200 m (25.5)	100 m (16.5)	50 m (12.8)
Clay (%)	3000 m (41.3)	500 m (39.1)	200 m (32.7)	100 m (22.7)	50 m (13.9)
TOC (%)	3000 m (0.79)	500 m (0.78)	200 m (0.65)	100 m (0.42)	50 m (0.35)
TIC (%)	50 m (0.36)	100 m (0.31)	200 m (0.30)	500 m (0.23)	3000 m (0.19)
Redox (mv)	100 m (85.1)	50 m (61.8)	3000 m (59.9)	200 m (58.7)	500 m (52.4)

^aSee Table 6.19 for variable definition

^bDetransformed means are presented (x) and means that are underlined are not different at the 0.05 level.

Table 6.25. Tukey's multiple comparison test results by distances based on sedimentology and contaminant data at MU-A85.

Variable ^a	Distance ^b				
ChemPC1	50 m (1.47)	100 m (1.00)	200 m (-0.53)	500 m (-0.95)	3000 m (-1.03)
ChemPC2	200 m (0.09)	500 m (0.02)	50 m (-0.01)	3000 m (-0.08)	100 m (-0.13)
TOTPAH (ppb)	50 m (180.9)	100 m (126.4)	200 m (42.3)	500 m (31.7)	3000 m (27.1)
TOTUCM (ppm)	50 m (56.4)	100 m (30.9)	200 m (4.1)	3000 m (2.2)	500 m (2.4)
TOTALK (ppm)	50 m (1473)	100 m (601)	200 m (205)	500 m (171)	3000 m (142)
Ba (ppm)	50 m (10,064)	100 m (9263)	200 m (3706)	500 m (1817)	3000 m (1094)
Fe (ppm)	500 m (27,867)	3000 m (27,587)	200 m (25,473)	50 m (21,822)	100 m (18,429)
Cd (ppm)	50 m (0.46)	100 m (0.25)	200 m (0.07)	500 m (0.05)	3000 m (0.05)
Al (ppm)	500 m (64,119)	3000 m (63,386)	200 m (57,971)	100 m (41,956)	50 m (37,339)
Sand (%)	50 m (67.0)	100 m (54.8)	200 m (20.80)	500 m (12.2)	3000 m (11.6)
Silt (%)	500 m (43.1)	3000 m (42.9)	200 m (40.7)	100 m (26.0)	50 m (16.7)
Clay (%)	3000 m (45.1)	500 m (44.4)	200 m (38.2)	100 m (19.0)	50 m (15.8)
TOC (%)	3000 m (0.93)	500 m (0.92)	200 m (0.90)	100 m (0.62)	50 m (0.55)
TIC (%)	50 m (1.02)	100 m (0.86)	500 m (0.79)	200 m (0.78)	3000 m (0.77)
Redox (mv)	200 m 132.0	3000 m (111.8)	500 m (97.9)	50 m (60.7)	100 m (55.3)

^aSee Table 6.19 for variable definition

^bDetransformed means are presented (x) and means that are underlined are not different at the 0.05 level.

was generally lower near the platform. At this site sand and barium concentrations increased by 5 and 10 fold; however Al, Fe, and TOC decreased are only 25 to 50 %.

HI-A389 sediment characteristics reflected the intensity of the contaminant discharges, near bottom shunting, and the low energy environment of deeper water (Table 6.26). **Total PAH concentrations differentiated sediments to 500-m, and UCM concentrations were significantly different to 5000-m.** Barium and cadmium concentrations differentiated sediments to a distance of at least 5000-m. As at the other sites, iron and aluminum contents reflected dilution by sand. TOC, TIC, sand, and redox showed little trend at this site; however, the overall pattern was consistent with that observed at the other sites, although not statistically significant.

Based on these statistical comparisons, the characteristics of each site are summarized in Table 6.27.

6.2.3 Spatial and Temporal Variations in Sediment Contaminants

Changes in sediment chemistry are long-lasting perturbations that are associated with the drilling phase of a field's development and production. The discharges input both coarse (cuttings) and fine-grain (drilling muds) sediments to areas of the Gulf of Mexico continental shelf that have low natural sedimentation rates ($\ll 1$ cm per year). No drilling mud discharges have occurred at these sites for 12 (MAI-686), 7 (MU-A85), or 6 (HI-A389) years, respectively. These observations are consistent with the permanence of the sand lens observed at exploratory sites where no further production occurred and the platform was removed after drilling (Shinn et al. 1993). At these sites, enhancement of sand and barium was evident more than ten years after removal of the platform (see additional historical comparisons below).

Contamination, and other perturbations at a site, are expected to exhibit significant three dimensional variability. Subsurface pockets of contaminants not adequately represented by a 0 to 2 cm sampling interval could be influencing biotic patterns in the overlying sediments. To define the three-dimensional distribution of contaminants at each study sites, subsurface samples were taken to a depth of 20 cm in 2 cm intervals along

Table 6.26. Tukey's multiple comparison test results by distance based on sedimentology and contaminant data at HI-A389.

Variable ^a	Distance from the Platform ^b				
	50 m	100 m	200 m	500 m	5000 m
ChemPC1	50 m (1.46)	100 m (0.53)	200 m (-0.41)	500 m (-0.92)	5000 m (-1.18)
ChemPC2	50 m (1.65)	200 m (1.17)	100 m (1.05)	500 m (0.77)	5000 m (0.57)
TOTPAH (ppb)	50 m (256)	100 m (103)	200 m (65)	500 m (33)	5000 m (32)
TOTUCM (ppm)	50 m (51.7)	100 m (15.6)	200 m (7.8)	500 m (3.6)	5000 m (2.1)
TOTALK (ppm)	50 m	100 m	200 m	500 m	5000 m
Ba (ppm)	50 m (72,605)	100 m (18,196)	200 m (13,756)	500 m (3993)	5000 m (1293)
Fe (ppm)	5000 m (39,794)	500 m (30,552)	200 m (28,601)	50 m (24,911)	100 m (22,388)
Cd (ppm)	50 m (6.4)	100 m (0.65)	200 m (0.29)	500 m (0.11)	5000 m (0.08)
Al (ppm)	5000 m (63,082)	500 m (59,776)	200 m (56,027)	100 m (41,011)	50 m (30,091)
Sand (%)	50 m (40.3)	100 m (33.4)	200 m (8.5)	500 m (3.9)	5000 m (3.5)
Silt (%)	200 m (40.6)	50 m (37.2)	5000 m (37.1)	500 m (37.0)	100 m (32.4)
Clay (%)	5000 m (59.1)	500 m (58.9)	200 m (50.4)	100 m (33.1)	50 m (21.0)
TOC (%)	5000 m (1.40)	500 m (1.27)	200 m (1.19)	100 m (1.13)	50 m (1.02)
TIC (%)	100 m (2.66)	50 m (1.96)	200 m (1.71)	500 m (1.66)	5000 m (1.62)
Redox (mv)	5000 m (128.2)	100 m (106.0)	200 m (104.5)	500 m (75.80)	50 m (42.7)

^aSee Table 6.19 for variable definition

^bDetransformed means are presented (x) and means that are underlined are not different at the 0.05 level.

Table 6.27. General characteristics of the study sites.

	MAI-686	MU-A85	HI-A389
<u>Physical Attributes</u>			
-water depth	29-m	80-m	125-m
-offshore	nearshore	intermediate	offshore
-energy setting	high	med-low	low
-seasonal effects	high	medium	low
-shunting depth	near surface	near bottom	near bottom
-time since last drilling	12 y	7 y	6 y
<u>Physicochemical</u>			
-oxygen levels in bottom waters	seasonal hypoxia	seasonal hypoxia	oxycline impingement
-organic carbon decrease	Yes	Yes	maybe
-inorganic carbon enrichment	Yes	Yes	maybe
<u>Contaminants (within 100 m of the platform)</u>			
-hydrocarbons	low	low	medium
-trace metals	low	medium	very high
-sand gradient	high	high	high

radius "C" during Cruise 3. The distribution of barium with depth in the sediment column is illustrated in Figure 6.2. **The discharged drilling muds and cuttings (enriched in barium) formed a thin veneer of material 10 to 15 cm thick near the platforms which thinned with distance from the platform.** This was also true for the hydrocarbons with most of the hydrocarbons residing in the top two centimeters of the sediment column. **Two sites (MAI-686 and MU-A85) exhibited sub-surface barium maxima illustrating the heterogeneous nature of contaminant distributions.** The three-dimensional nature of the contaminant distributions suggest that assessments of exposure might be more accurately expressed as amount per square meter of surface area or cubic meters of sediment volume integrated over a defined near-field area (i.e., out to a distance of 100 m). **The sediment column, especially at the deeper water sites (MU-A85, HI-A389), was not well mixed with respect to barium despite the long time since cessation of drilling activities.** This observation confirms that the sedimentary contaminant field is quite stable over periods of years. Previous research (Boothe and Presley 1985) has shown fine, undisturbed barite

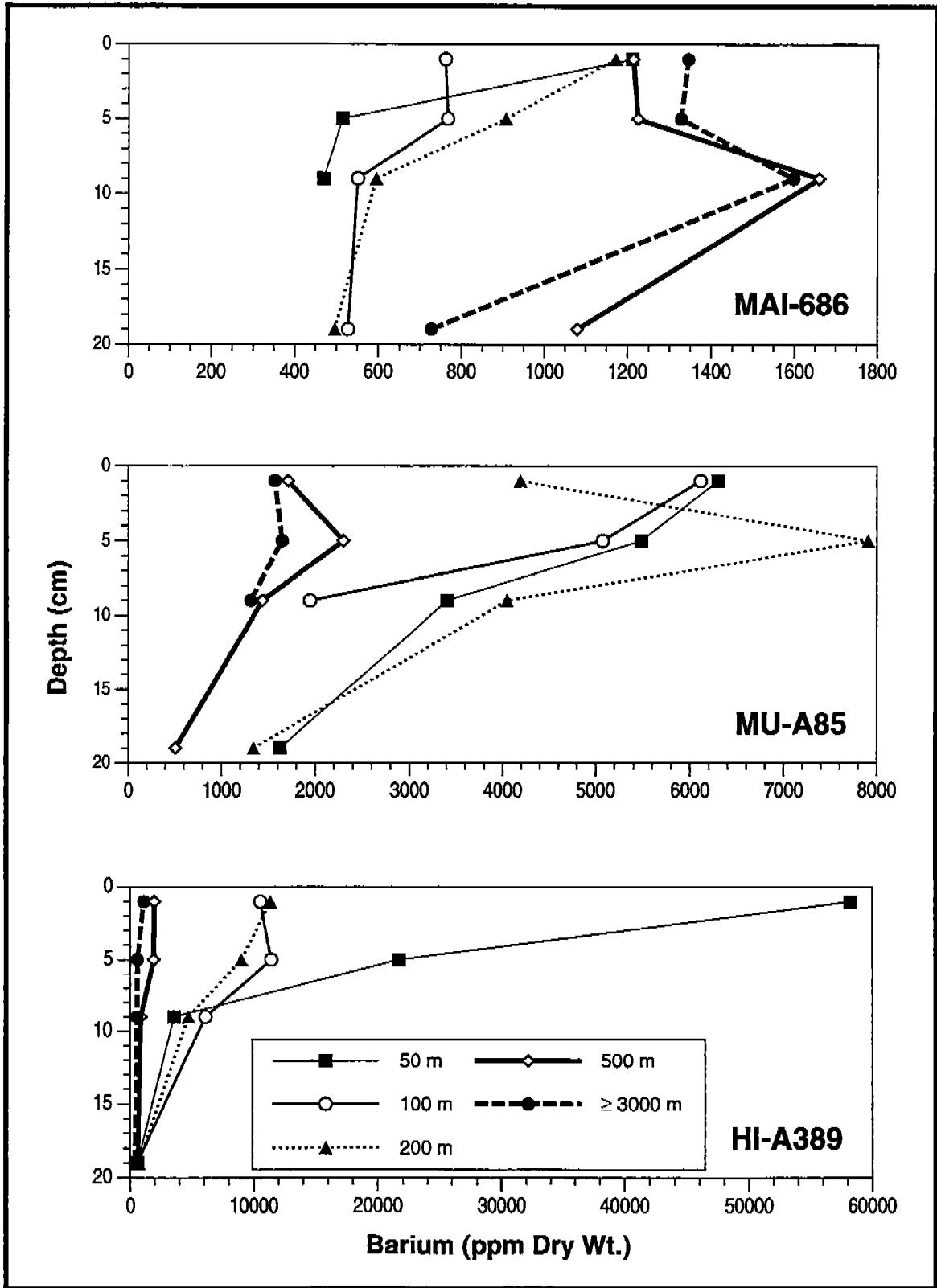

Figure 6.2. Distribution of barium concentrations (ppm) with depth in the sediment column at all three sites.

laminations in the sediment column up to a decade after the cessation of drilling discharges.

Based on samples taken in 1980 prior to the cessation of drilling, Table 6.28 shows that even though more barite was used at the shallow water sites (MAI-686 and MU-A85), the greatest accumulation of barium occurred at the deep water HI-A389 site. **Also only a small fraction of the total barium discharged at any site was retained within the near-field (< 500 m distance) sediments.** Additional drilling at the sites (i.e. a total of 18, 6 and 12 wells at MU-A85, HI-A389 and MAI-686 respectively) did not change the relative intensity of the contaminant fields observed at the three sites in 1980.

Table 6.28. A mass balance of excess barium in sediments at the three study sites (after Boothe and Presley 1985).

Site	Water Depth	Wells ^a	TBU ^b	%TBU @500 m	%TBU @ 1000 m
MU-A85	75	1	820	1.3	3.8
HI-A389	124	2	618	5.5	13.0
MAI-686	29	8	2,334	0.93	----

^aDrilled by 1980

^bTotal Barium Used (TBU) in Drilling Activities 1,000 kg

6.2.4 Comparative Evaluation of Contaminant Levels at Platform Sites

A further evaluation of the contaminant levels observed in this study is provided by a comparison with other, similar studies and with sediment levels known to elicit biological effects. While biological effects were directly measured, comparison with literature values provides an assessment of potential for effect or impact.

6.2.4.1 Hydrocarbons

The concentration of total PAH at the study sites is presented as a frequency distribution along with sediment PAH concentrations from the NOAA National Status and Trends (NS&T) Program and the Environmental Protection Agency's (EPA) Environmental Monitoring and Assessment

Program-Near Coastal (EMAP-NC) programs (Figure 6.3). Sediment total PAH concentrations at the platform sites were generally less than 1,000 ppb with only a few exceptions close to the platform at HI-A389 and MU-A85. The EMAP-NC data represents 183 sites along the Gulf Coast collected on a probability based sampling design. As expected **the median PAH concentrations in shelf sediments were nearly an order of magnitude lower than in coastal areas of the Gulf of Mexico.** However, at a few locations, PAH concentrations at the platform sites approached the highest values observed in coastal bays.

The PAH values observed at the platform sites were significantly below the Long and Morgan (1990) 10 % biological effects criteria of 4000 ppb (Figure 6.3). These effects criteria are based on a compilation of chemical concentrations observed, or predicted, to be associated with biological effects (broadly defined). Note that the definition of total PAH is highly variable and that these values only serve as a semi-quantitative guide. The 10 % criteria is defined as the level at which biological effects were observed 10 % of the time. Long and Morgan (1990) also note that compounds such as PAH, which may be mutagenic or teratogenic, may not be toxic in acute tests of mortality.

6.2.4.2 Metals

For sediment metal data two types of comparisons were made. First, the data were compared with sediment data from previous Gulf of Mexico platform monitoring studies conducted at sites with similar drilling histories. This approach aids in determining if the perturbations observed at the three study sites were similar to perturbations observed elsewhere. Also, since some of the previous studies were conducted at sites that were chosen for this study, changes in sediments over time can be evaluated. Second, the data were compared to nearshore Gulf of Mexico sediment metal data generated by the U.S. EPA-EMAP-NC program. This comparison provides an evaluation of the degree to which drilling operations have altered sediment metal concentrations compared to those found in coastal sediments.

As previously discussed, trace element concentrations showed strong correlations with sediment grain size. For example, trace element

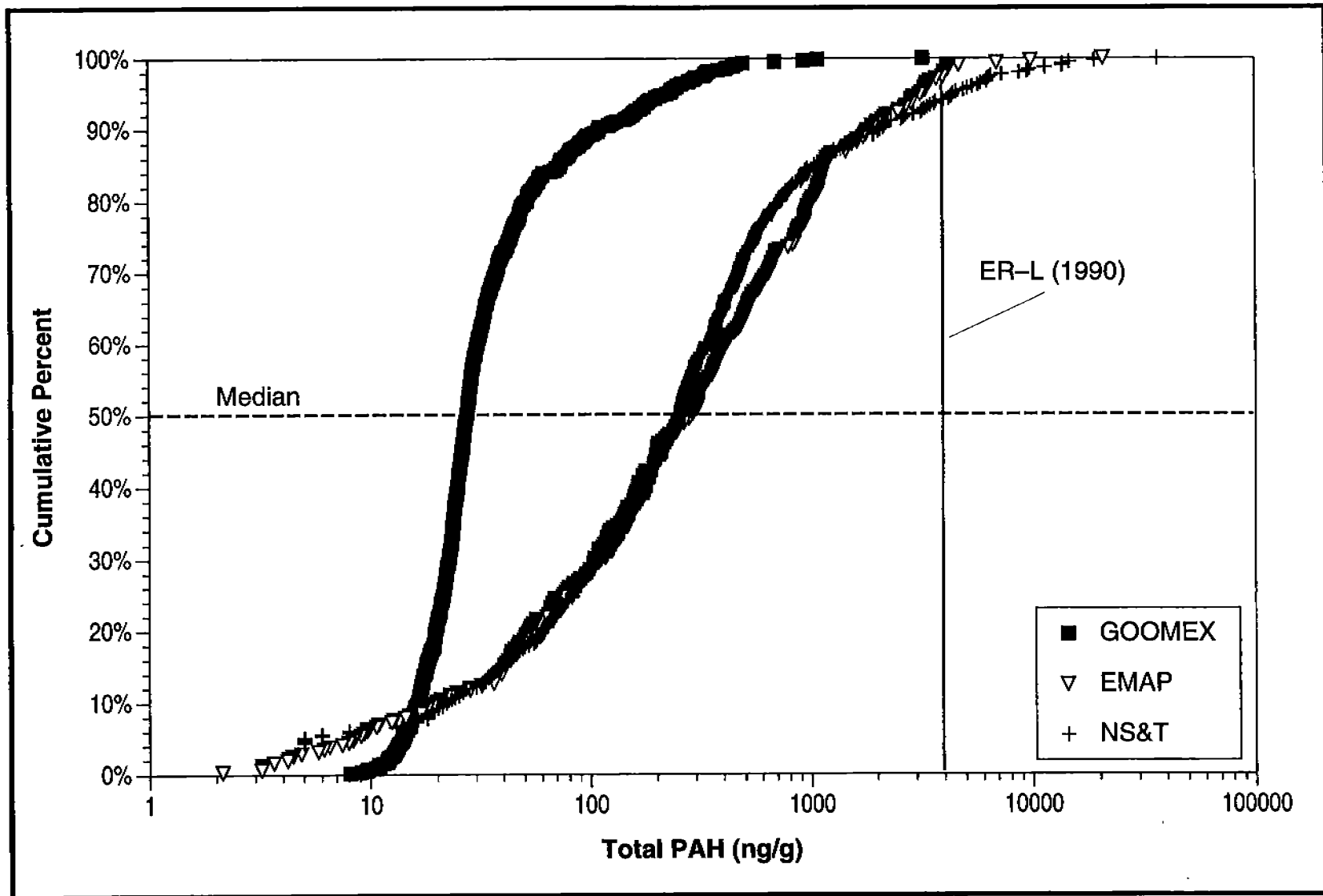

Figure 6.3. Comparison of sediment PAH concentrations at GOOMEX sites to the NOAA-National Status & Trends and EPA Environmental Monitoring and Assessment (EMAP) databases for coastal Gulf of Mexico sites.

concentrations were much higher in fine-grained, clay-rich sediments than in coarse, sandy ones. This relationship was the result of both physical (i.e., surface area) and chemical (alumino-silicate versus quartz minerals) differences among the grain-size fractions in typical marine sediments. Even in pristine, unperturbed sediments, metal concentrations will vary considerably solely on the basis of differences in sediment texture. Therefore, sediment contaminant levels must be compared after normalizing the data to take into account differences in sediment texture. One accepted normalization approach is to relate metal concentrations to aluminum content. Aluminum is a major component of the minerals that comprise most marine sediments (i.e., alumino-silicate clay minerals) and occurs at concentrations at the percent level. It is unlikely that anthropogenic inputs of aluminum would be sufficient to significantly alter the indigenous concentrations of aluminum in sediments. Iron (Fe) is also a percent level component of sediments and can be used as a normalization factor for trace metal comparisons. However, a suspected source of iron related to the platform makes these comparisons less useful. The relationships between metal concentrations and aluminum content were used to evaluate the sediment trace metal perturbations observed in the present study. In the following graphical presentations stations within 100-m of a platform are distinguished from those further away.

6.2.4.2.1 Comparisons with Previous Platform Monitoring Studies

Two previous studies, with sufficiently reliable data, were available for comparison. One study sponsored by the American Petroleum Institute sampled sediments (40 stations in a radial pattern) surrounding six (6) drilling sites in 1980 (Boothe and Presley 1985). Barium, chromium, and iron were determined at all stations and aluminum, cadmium, copper, mercury, lead, and zinc at a reduced number of stations. A second study, conducted by Continental Shelf Associates investigated a drilling site at HI-A384 near the West Flower Gardens in 1982 (CSA 1983). Barium and iron were measured at 44 stations arranged in a similar radial pattern. Chromium was determined at 17 stations.

The MAI-686 site was sampled in 1980 as part of the API study and resampled as part of this study (1993 to 1994). Eight wells had been drilled

prior to the 1980 sampling. **The characteristics of the ambient sediments changed significantly during the 14 year period between samplings. Much of the finer-grained sediment (Al and Fe rich) has been removed** (Figure 6.4). Evaluation of aluminum and iron content clearly showed a significant change in sediment composition with essentially no overlap in compositions for the two sampling events. The relationship between iron and distance from the platform for the two studies confirmed this conclusion (Figure 6.4). **Essentially all of the elevated barium levels observed in 1980 within ≤ 125 m of the platform were no longer present** (Figure 6.5). Barium levels beyond 125-m were essentially unchanged over the 14 year period. **The concentration of mercury showed the same decline as barium.** The concentrations of cadmium, copper, and zinc also appeared to have decreased between the two sampling events but the decrease was less dramatic. **Lead was the only element which increased over the 14 year period suggesting a continuing, non-drilling discharge source for lead** (Figure 6.5). The change in sediment texture between 1980 and 1993 to 1994 was the result of a continuing process of sediment resuspension and transport at this shallow water, high energy site.

Deeper water development and production sites from the 1980 API study (High Island A341 and Vermilion 321) were selected for comparison with the two remaining GOOMEX study sites (MU-A85 and HI-A389). The API sites had similar drilling histories (HI-A341: 8 wells, V-321: 25 wells) and sediment types (based on Al and Fe concentrations). These data sets provided a comparison of metal distributions measured soon after the cessation of drilling (API sites) and again 5 to 10 years later (GOOMEX sites). The magnitude of the sediment barium enrichments within each pair of sites was similar (Figure 6.6). The only significant difference in barium enrichment was the anomalous 18-28 % barium enrichment at the HI-A389 site caused by shunting of the drilling discharges within 10 m of the seafloor (Figure 6.6). **The similarity in barium concentrations suggested that, for sites with similar drilling histories and in deep water depositional environments (i.e., ≥ 50 -70 m and lower energy), there has been little change in the ambient sediments over time.** The temporal stability of barium at the deeper water sites was also apparent for other elements. Enrichments in chromium, cadmium copper, mercury, and zinc at the HI-A341 and MU-A85 sites were similar. **Again, as observed for the MAI-686**

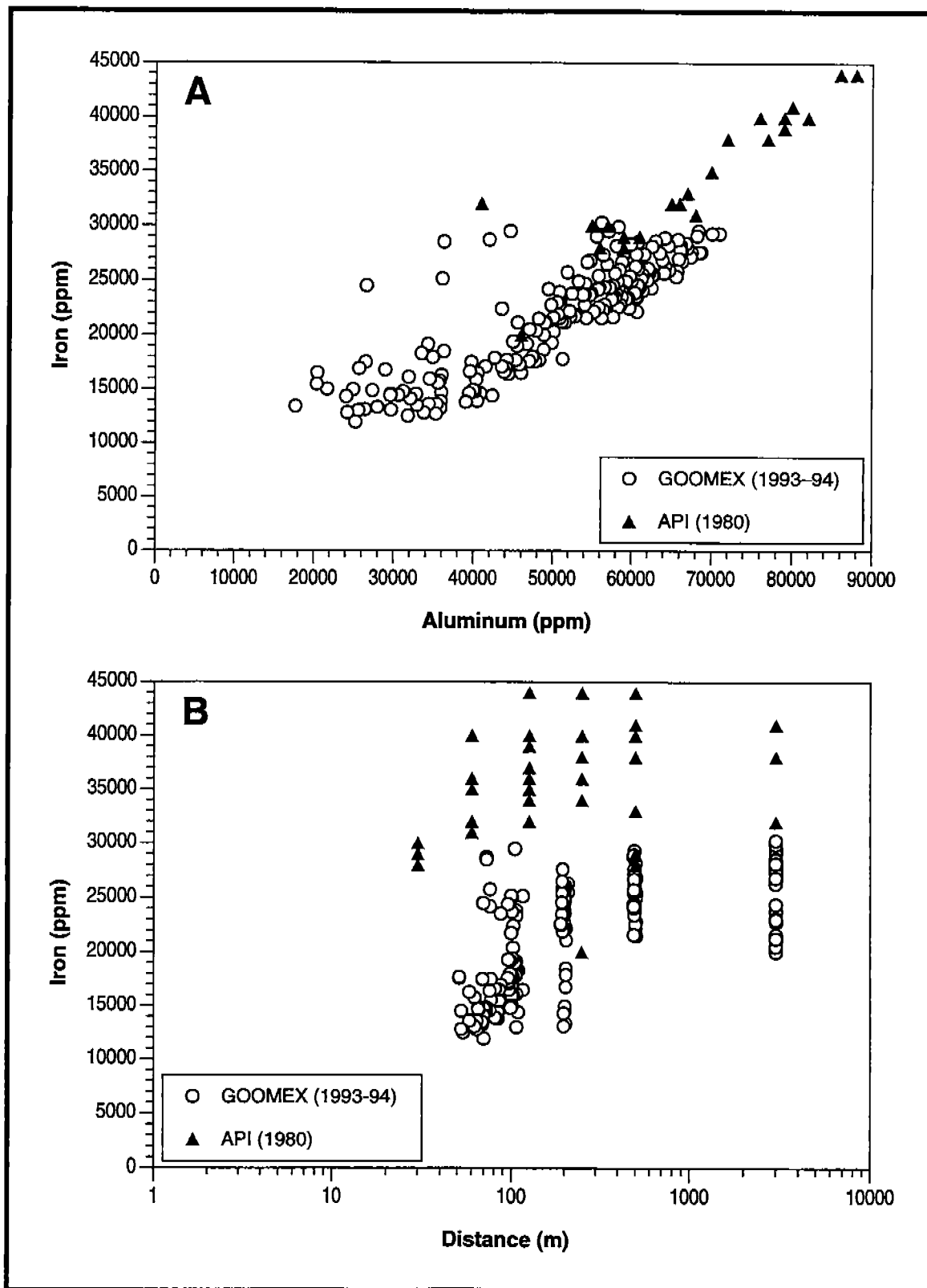

Figure 6.4. Relationship between sediment iron concentrations and A: aluminum concentrations; and B: distance from the platform at MAI-686 at two samplings 14 years apart.

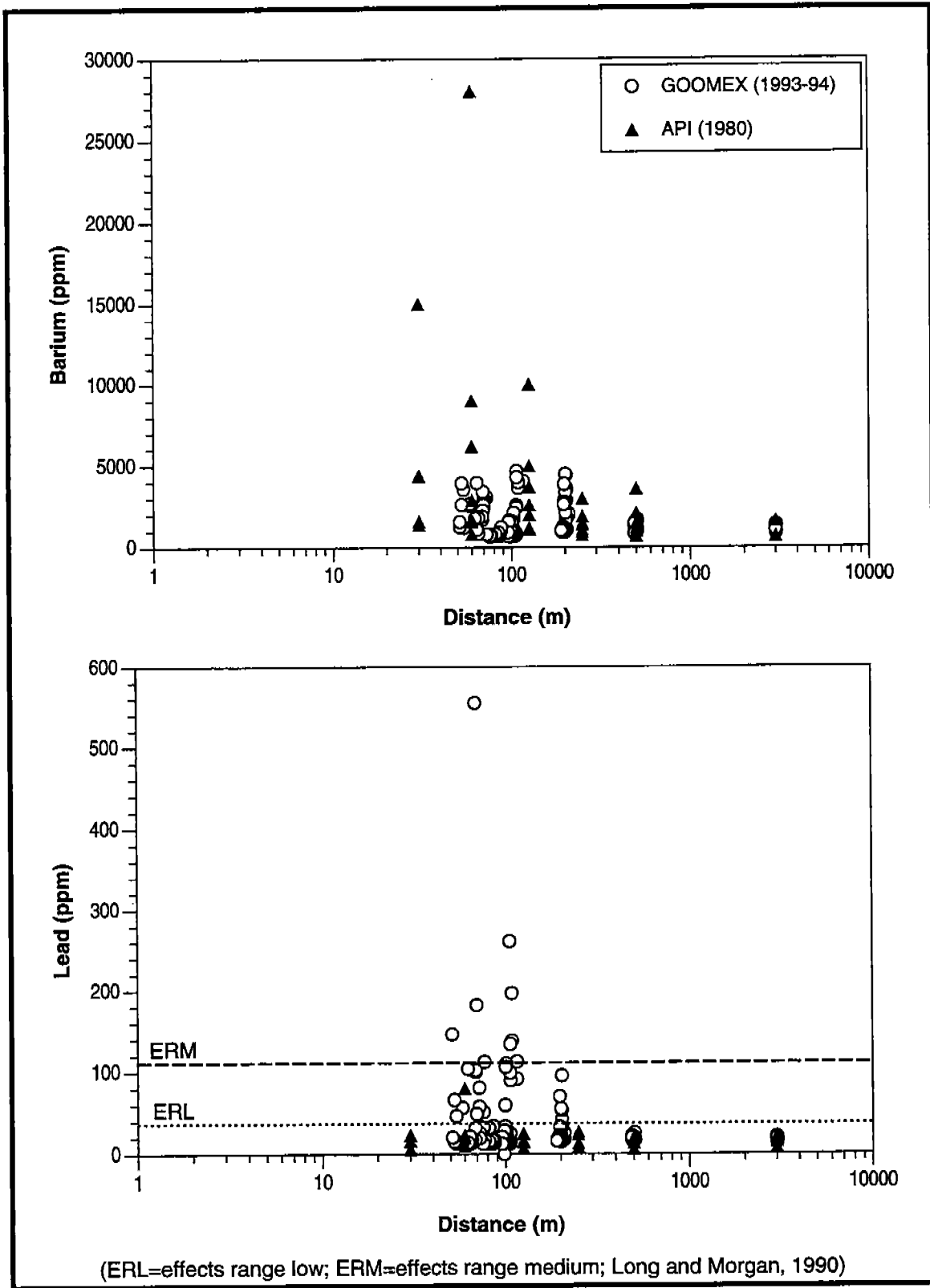

Figure 6.5. Relationship between sediment barium and lead concentrations and distance from the platform at MAI-686 at two samplings 14 years apart.

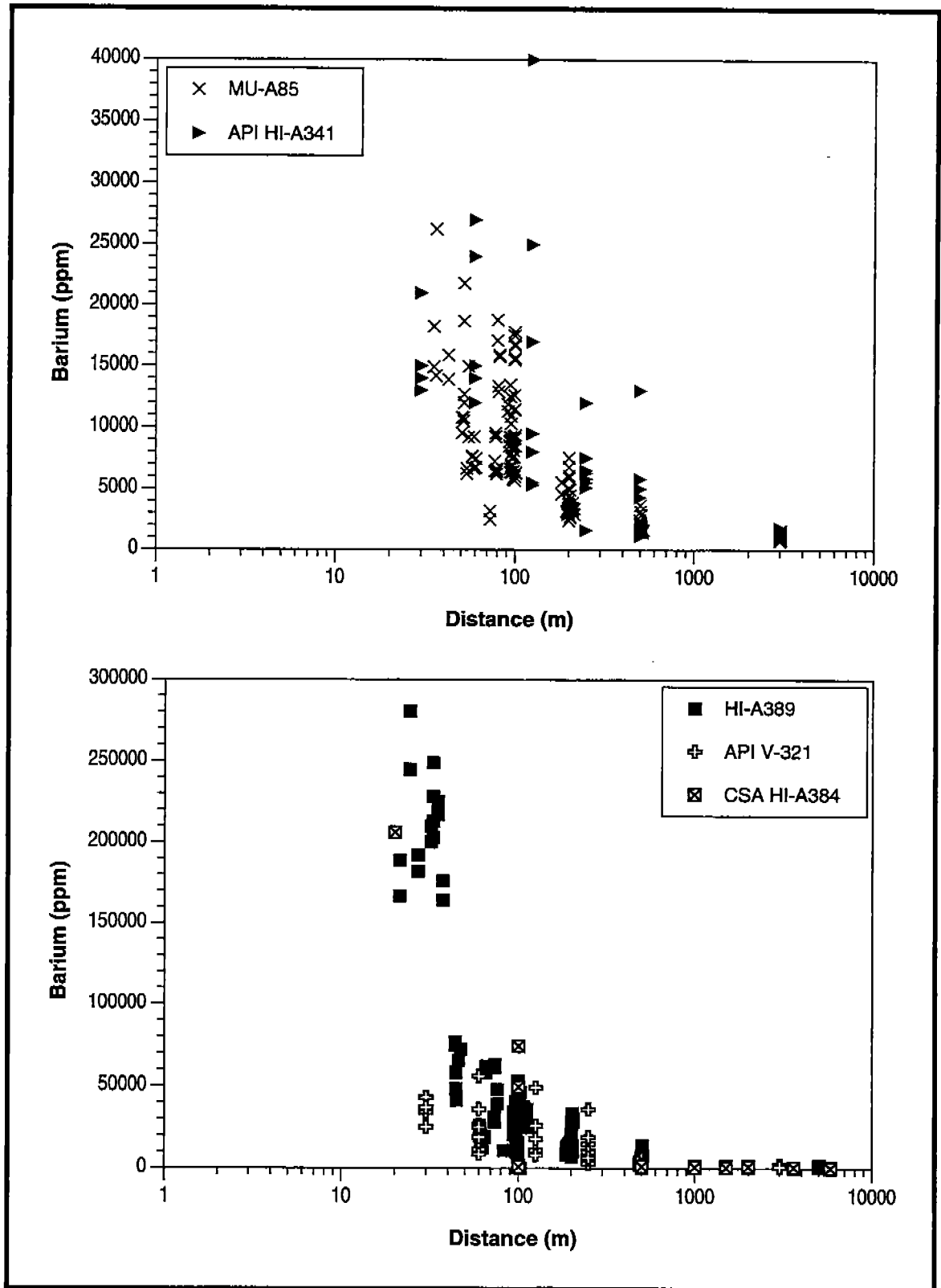

Figure 6.6. Relationship between barium concentrations in sediment collected immediately (HI-A341, V-321, HI-A384) and 5-10 years after (MU-A85, HI-A389) cessation of drilling activities.

site, the only exception is lead which was significantly higher at the MU-A85 site suggesting a continuing input of this element after the cessation of drilling discharges (Figure 6.7). The relationship was similar at the more highly enriched V-321 and HI-A389 sites. Even excluding the high barium samples, lead levels were several fold higher at the HI-A389 site (Figure 6.7). **In addition, cadmium and zinc levels were significantly higher at the HI-A389 site suggesting a continuing input of these metals after cessation of drilling operations.**

The CSA study in 1982 (CSA 1983) suggested that **the magnitude of surface enrichments from drilling discharges among sites within similar depositional environments (i.e., judged by water depth) were similar regardless of the number of wells drilled. Differences in the amount of drilling resulted in a thicker veneer of metal enriched sediments overlying the native sediment, but no clear difference in the magnitude of surface enrichment was apparent.** This may indicate that the contaminant to inert material ratio for the discharges was similar at the sites and that this original concentration was the highest value possible at a site. The veneer of materials on top of the indigenous sediments was primarily drilling discharges. The CSA study sampled around a single exploratory well in lease block HI-A384 while six wells were drilled at the GOOMEX HI-A389 site. The two sites are in essentially identical depositional environments and separated by only about 20-km distance. Both sites are in approximately 100 to 120 m of water and both are located in close proximity to a topographic feature (West and East Flower Gardens, respectively). Finally, the drilling discharges were shunted to within 10 m of the seafloor at both sites. The surficial sediment barium distribution, an indicator of the distribution of the drilling discharge contaminant field, was essentially identical at both sites (Figure 6.6). Even the more than 20 % barium enrichment caused by shunting was present at both sites. This comparison is another indication of the stability of the contaminant fields at deeper water sites. The CSA study was conducted immediately after drilling while the sampling of HI-A389 reported here occurred almost 10 years after the last drilling event. Although based on only two samples, the levels of cadmium and lead also appeared to be quite similar and elevated above suspected drilling discharge levels at the two sites.

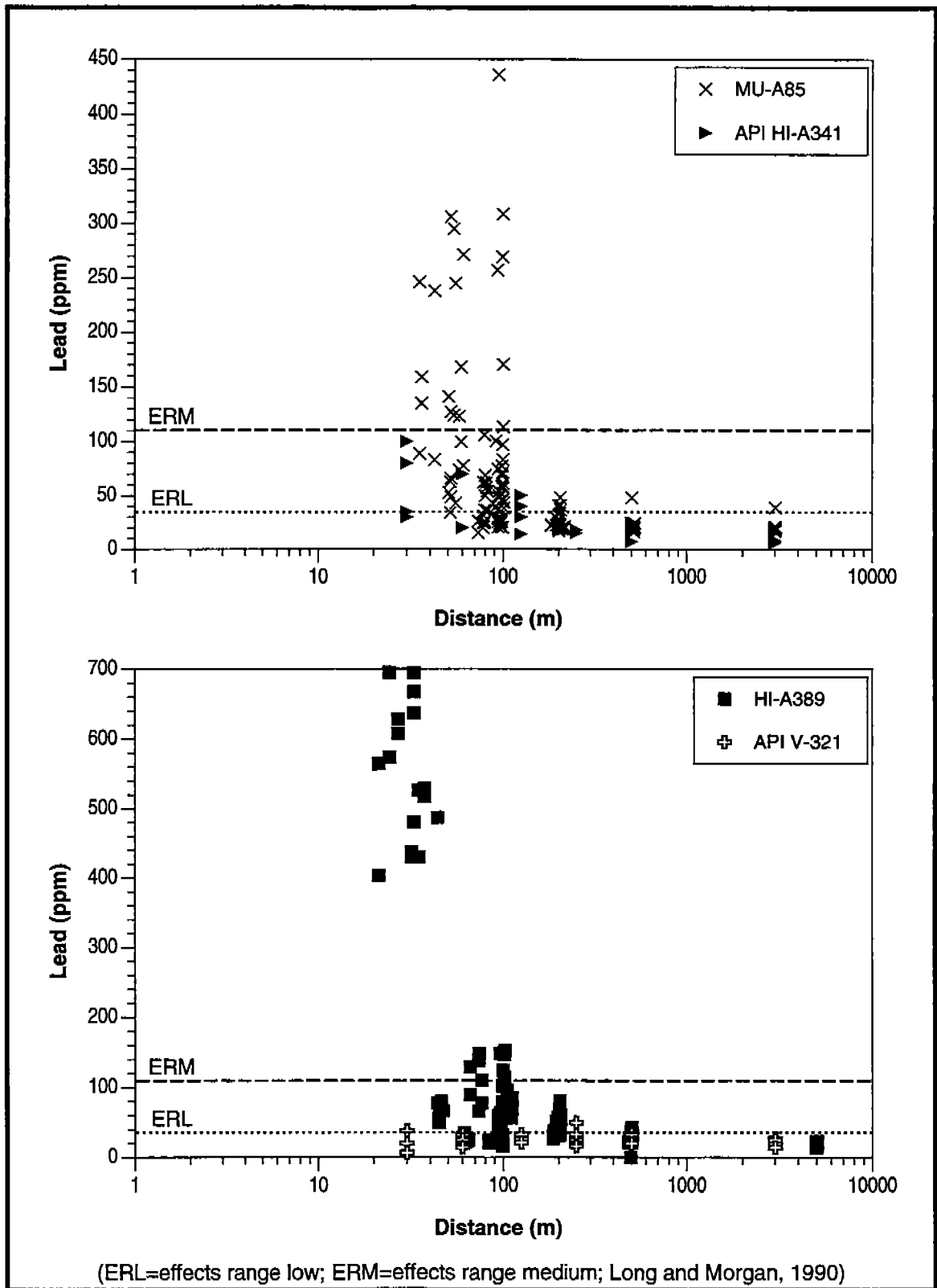

Figure 6.7. Relationship between lead concentrations in sediment collected immediately (HI-A341, V-321) and 5–10 years after (MU-A85, HI-A389) cessation of drilling activities.

6.2.4.2.2 Comparisons With Other Sedimentary Settings

Sediment samples were systematically collected from bays and estuaries from the southern tip of Texas to western Florida as part of the EPA EMAP-NC Program. An average of 168 samples were collected annually from 1991-1993 (total of 504 samples) and analyzed for a suite of metals similar to those measured in the present study, except barium and vanadium. The EMAP-NC data set provides a baseline of coastal Gulf of Mexico sediment metal concentrations against which to compare data from the present study.

Comparison of the this study and EMAP-NC sediment data sets, normalizing to aluminum concentrations, revealed several conclusions concerning sediment metal perturbations at the study sites. **Significant elevations in sediment concentrations were restricted to the near field (≤ 200 m) and did not involve all metals.** Sediments ≥ 200 m from the platforms are generally indistinguishable from background Gulf of Mexico sediments for all elements which could be compared (i.e., Ba and V not determined in EMAP-NC). **Several elements (Mn, Ni, Se, Sn) showed no anomalous enrichments at any distance or platform site.** The typical relationship observed for this group of elements is illustrated for nickel in Figure 6.8. **Barium, lead, zinc, and to a lesser extent, cadmium showed significant near field enrichments at all three platforms.** Examples typical of this distribution among the three sites are shown in Figures 6.8 and 6.9. The enrichments are especially striking since they occurred in the coarser sediments (sand) near the platforms. In undisturbed sandy sediments (typically $< 20,000$ ppm Al), background metal concentrations are low. **The HI-A389 site showed significant enrichments for a larger suite of elements including Ag, As, Cu, Hg, and Sb.** A typical pattern for this group of elements is shown in Figure 6.10. At MAI-686 and MU-A85, these elements showed patterns very similar to those of the EMAP-NC sediments. At HI-A389 and MU-A85, both chromium and iron concentrations were higher in near-field sandy sediments relative to aluminum than is typical for background Gulf of Mexico sediments (Figure 6.11). The additional chromium and iron could be a characteristic of the formation solids discharged as cuttings. A more likely explanation is that the **chromium and**

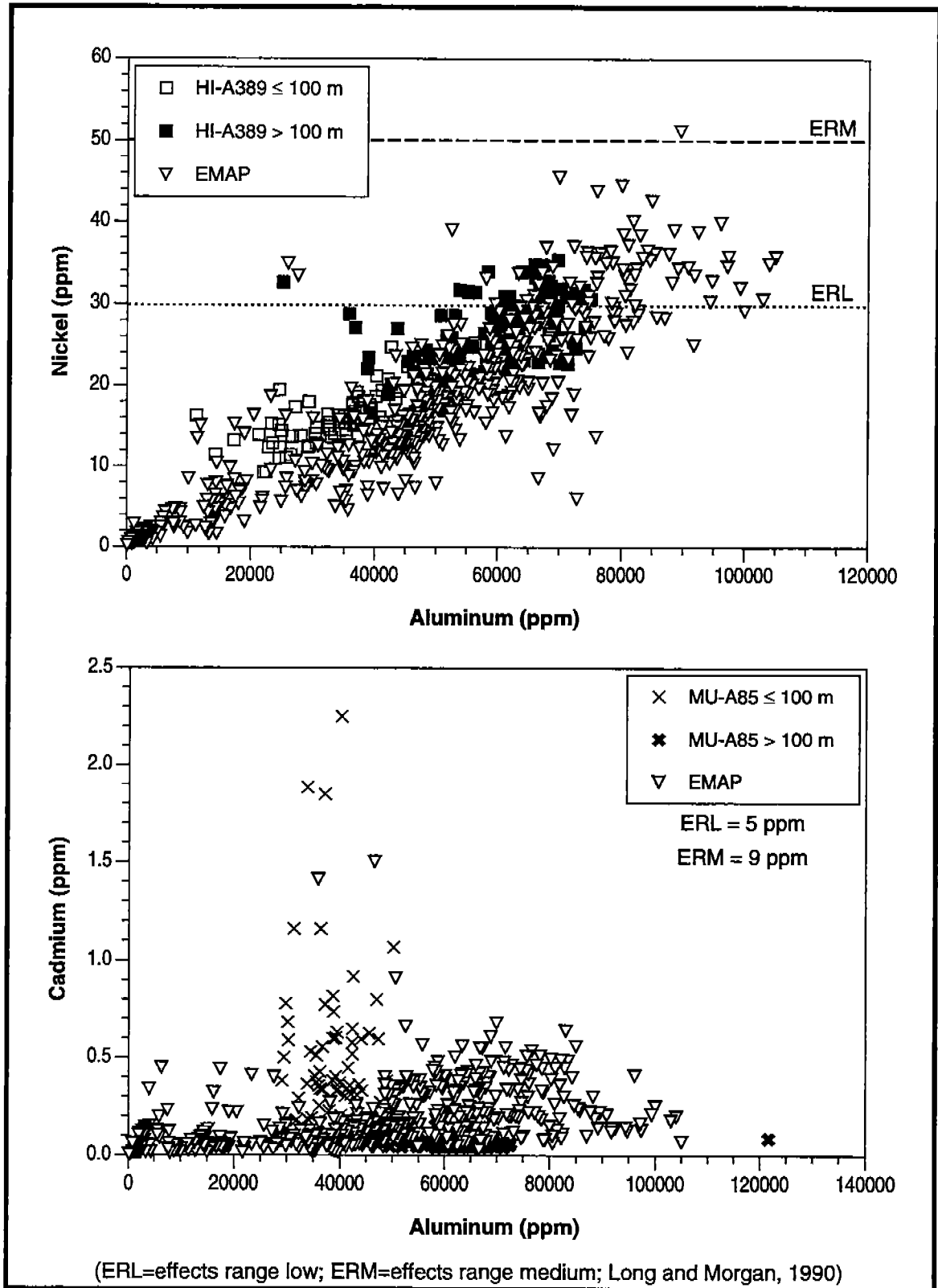

Figure 6.8. Relationship between nickel and cadmium concentrations and aluminum concentrations in sediments from HI-A389, MU-A85, and EMAP-NC coastal samplings.

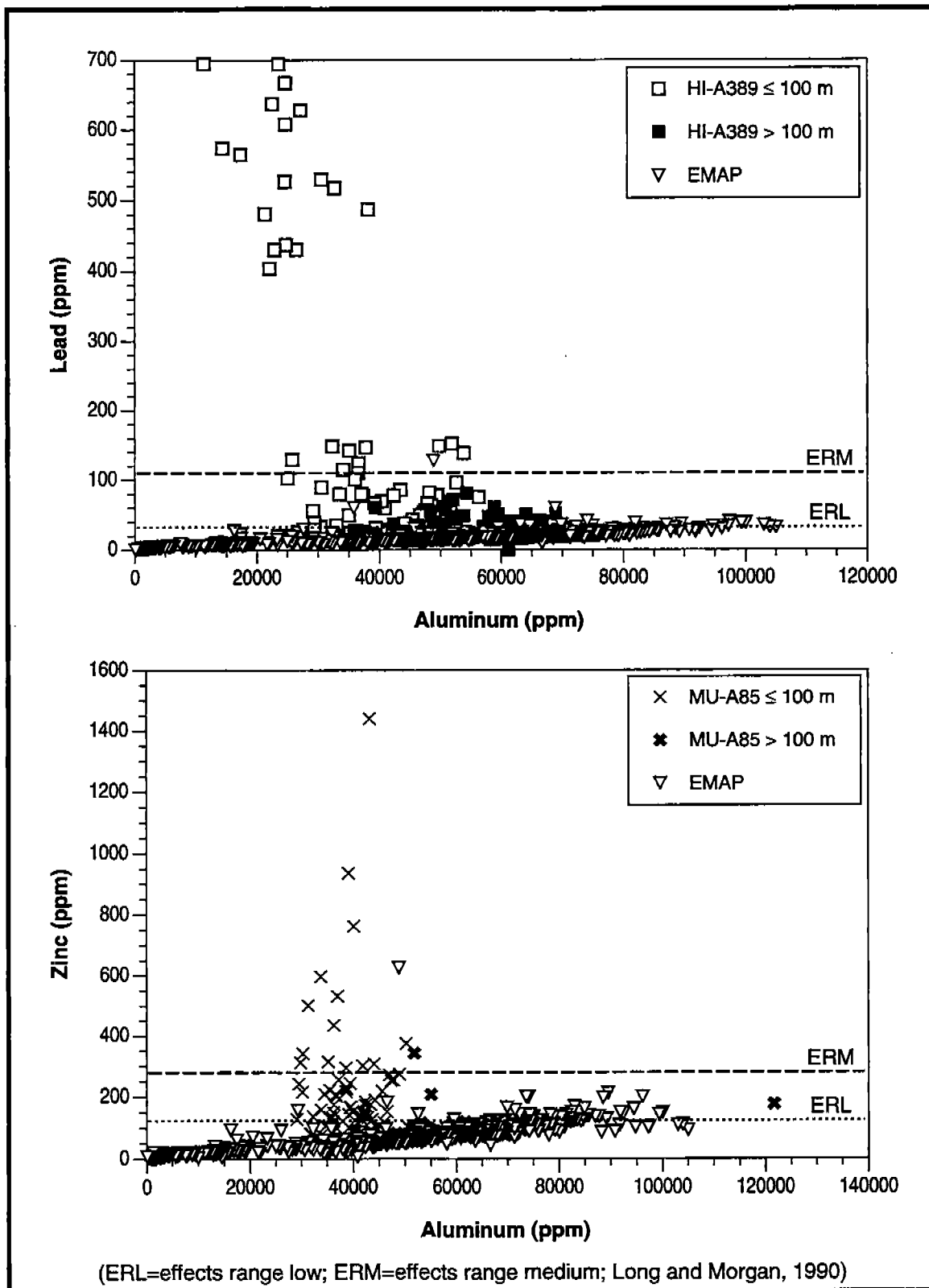

Figure 6.9. Relationship between lead and zinc concentrations and aluminum concentrations in sediments from HI-A389, MU-A85, and EMAP-NC coastal samplings.

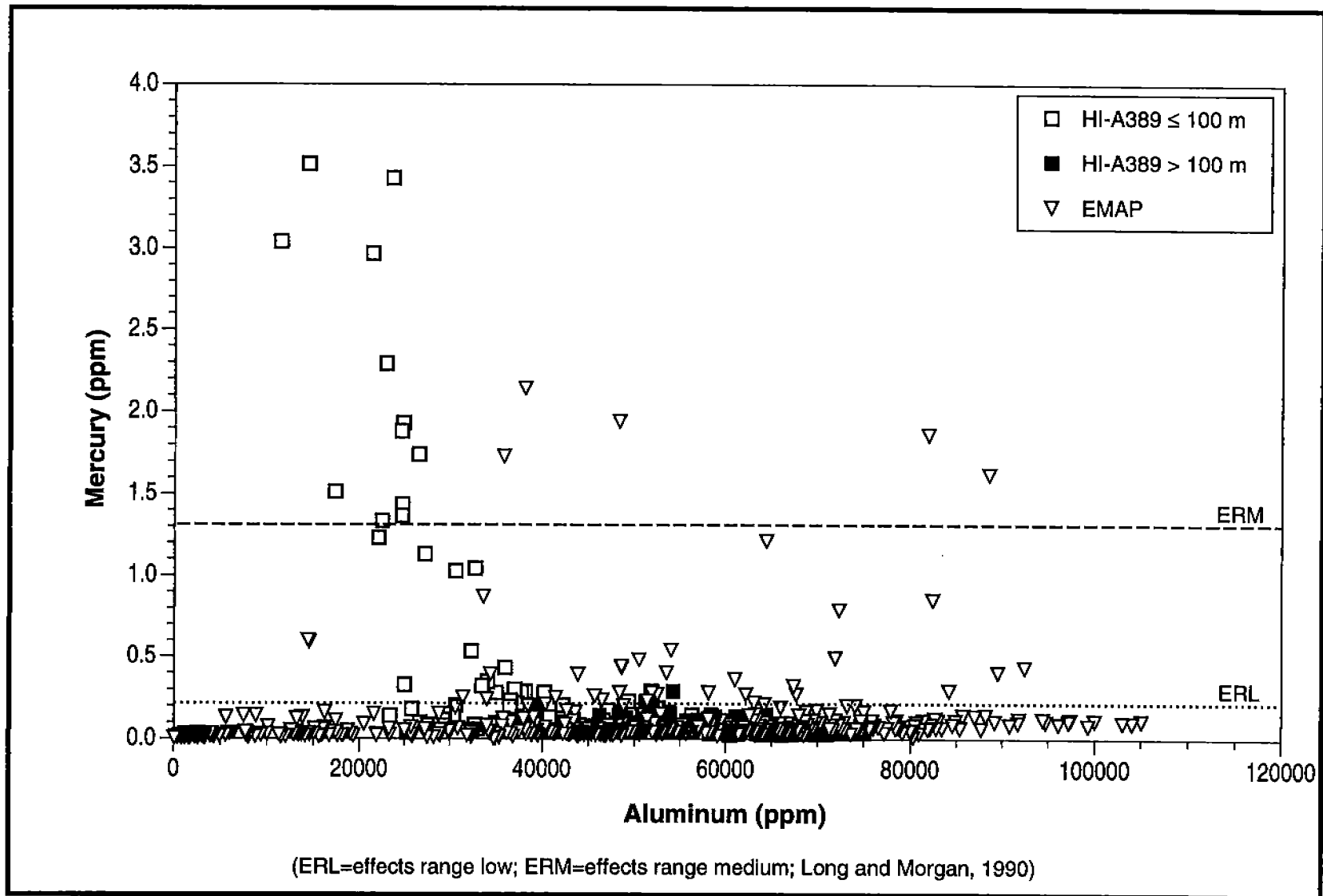

Figure 6.10. Relationship between mercury and aluminum concentrations in sediments from HI-A389 and EMAP-NC coastal samplings.

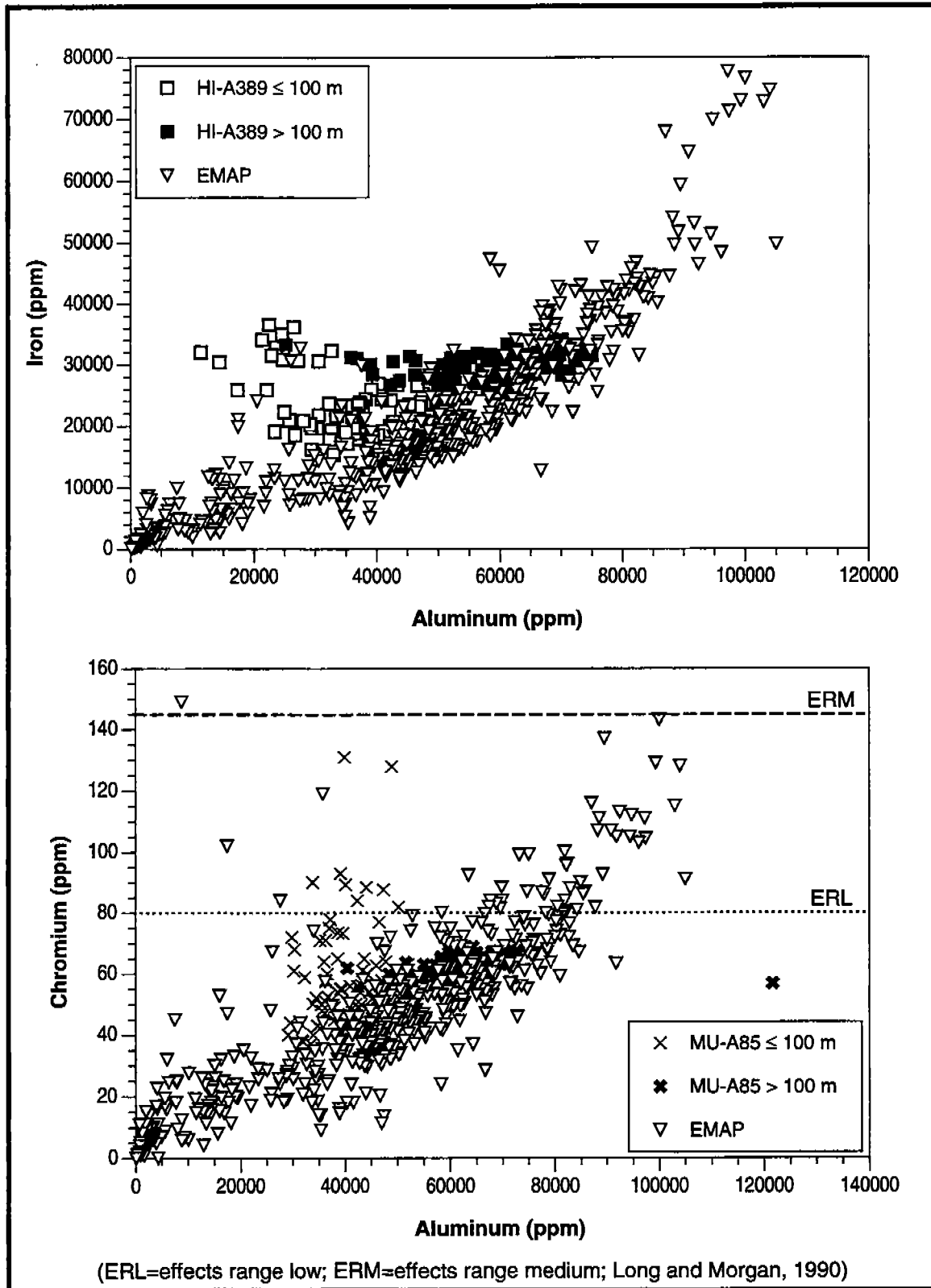

Figure 6.11. Relationship between iron and chromium concentrations and aluminum concentrations in sediments from HI-A389, MU-A85, and EMAP-NC coastal samplings.

iron are being added to the coarse sediment during the drilling process probably from drilling fluids.

6.2.4.2.3 The Potential for Biological Effects Associated with the Observed Sediment Metal Levels

To assess the potential for biological effects from the observed near-field sediment metal enrichments observed the data were compared to the effects threshold data of Long and Morgan (1990). The ranges in metal concentrations at the three sites were compared to the Long and Morgan effects criteria and the EMAP-NC data in Figure 6.12. The percentage of sediment samples that exceeded the Long and Morgan low (ER-L, 10 %) and median (ER-M, 50 %) effects ratios were compared to the EPA EMAP-NC sediment data (Figure 6.13). As expected from the comparisons discussed above, **several metals exceeded the effects levels in many of the near-field sediment samples.** Of these metals, **lead and zinc exceeded the EMAP-NC data at all three sites.** The ranges of lead and zinc concentrations at the sites were compared with those observed for the EMAP-NC data set in Figures 6.12 to 6.13. **These comparisons suggested that a significant percentage of sediments at the study sites might elicit biological responses.** While these comparisons are informative they are not definitive for predicting biological effects. **Sediment metals may or may not be bioavailable and a detailed evaluation of redox potential and metal speciation is needed to determine a causal link between sediment metals and observed biological effects.**

6.3 Biological Accumulation of Contaminants in Megafauna

A second facet of the contaminant studies was documentation of the contaminant levels in fish livers, fish stomach contents, and invertebrate soft tissues at the study sites. The sampling scheme was reduced from the more detailed boxcore design and animals were collected from trawls taken Near (≈ 100 m or less) and Far from the platform (≥ 3000 m). Tissue contaminant data are summarized and described in Sections 5.3.3 and 5.3.4.

Contaminant concentrations in tissues have been widely used to assess the bioavailability of contaminants. Tissue contaminant concentrations are

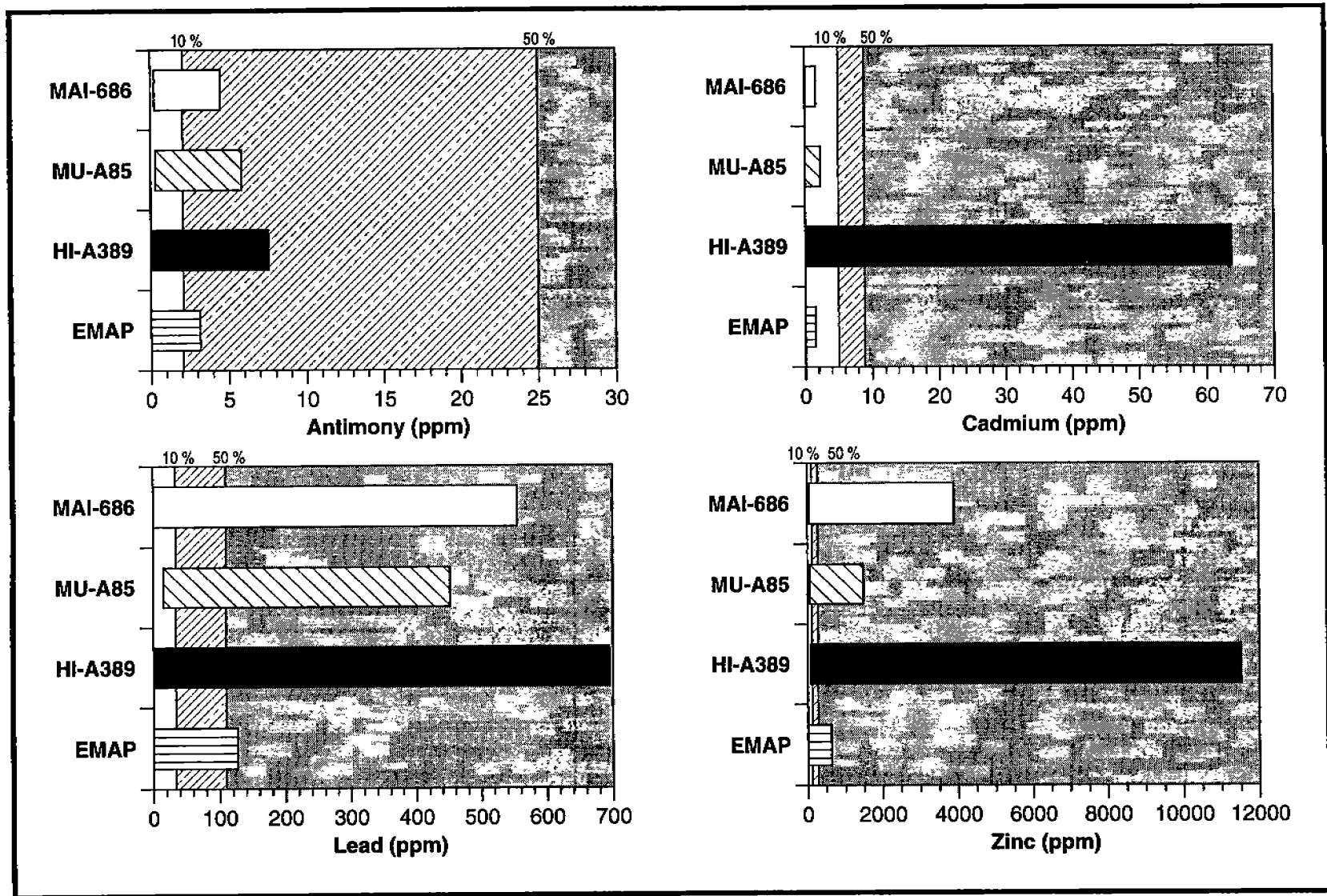

Figure 6.12. Comparison of the ranges of selected trace metal concentrations in sediments from the GOOMEX study sites, EMAP-NC data, and Long and Morgan (1990) 10 % and 50 % biological effects threshold.

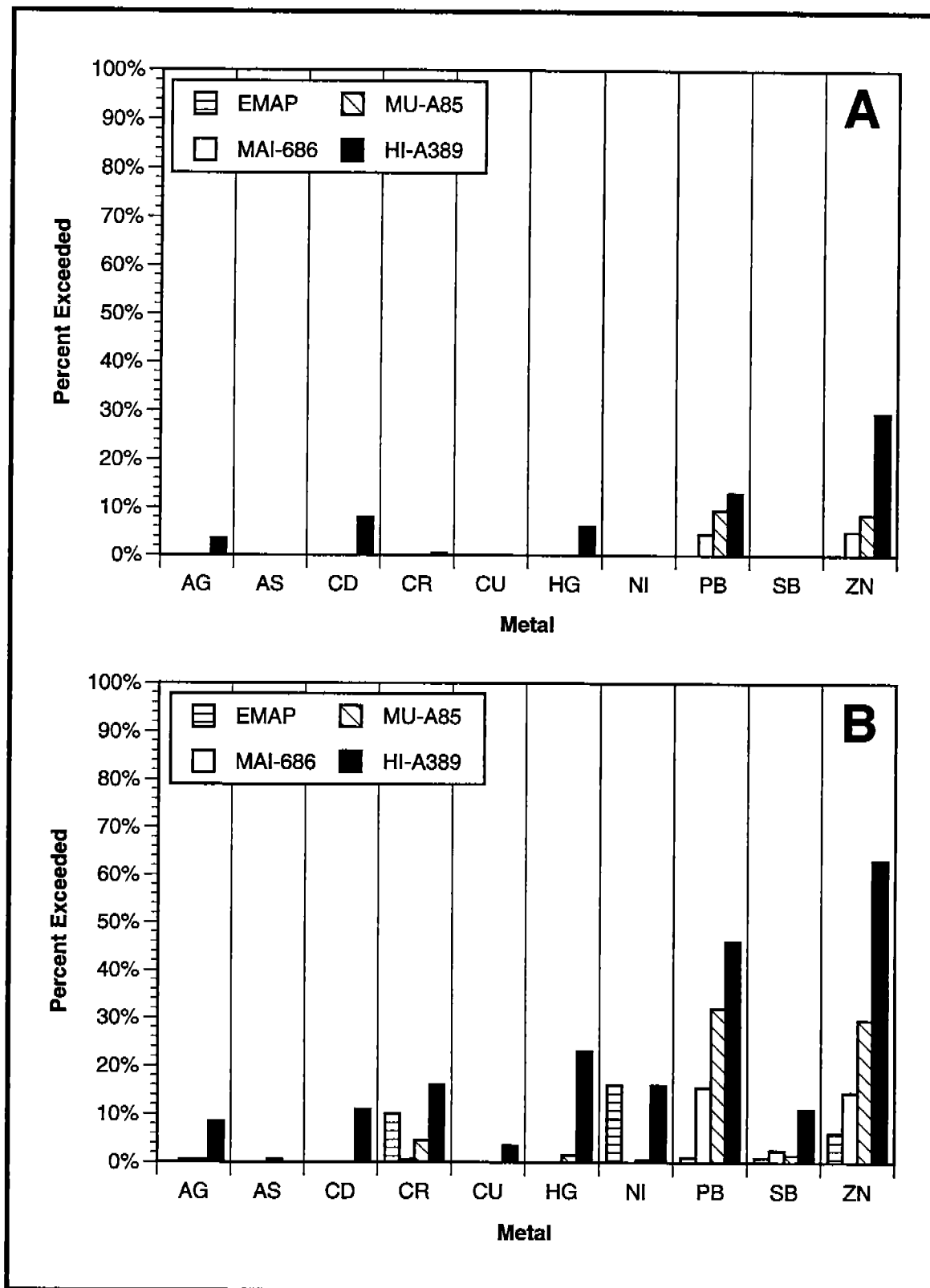

Figure 6.13. Percent of samples from the GOOMEX sites that exceeded the Long and Morgan (1990) A: 50 % and B: 10 % bioeffects criteria.

determined by the interplay of several factors including uptake, metabolism, and depuration. These confounding factors can obscure the relationship between body burden and actual exposure. The rates of uptake, metabolism and depuration of contaminants are often species, life stage, and sex dependent. The presence of detoxification enzyme systems in fish provides an ability to metabolize (transform) and eliminate contaminants, such as PAH, from their tissues. However, the presence of contaminants in tissues does confirm recent exposure. The materials analyzed in this study; the soft tissues of invertebrates, liver tissues from fish, and fish stomach contents; were chosen for various reasons. Invertebrates may accumulate contaminants due to their often intimate relationship with sediments. Fish livers are a primary site of PAH metabolism/storage and thus would be the most likely tissue to exhibit PAH contamination in contrast to muscle tissue. The liver is also lipid-rich, compared to muscle tissue, and PAH tend to preferentially accumulate in lipid-rich organs. Stomach contents were analyzed to determine if contaminant exposure in fish was due to dietary sources or ingestion of contaminated sediments. Other routes of potential exposure include uptake across exposed external organs such as gills.

6.3.1 Hypothesis Testing

To proceed with hypothesis testing a suite of parameters was chosen based on the consortium of contaminants detected in the adjacent sediments, the assumed primary source of chronic exposure for organisms. Total PAH, Cd, Fe, and Ba were chosen as indicators of hydrocarbons, contaminant metals, sediment, and drilling muds, respectively. Principal components derived from PCA analysis of the PAH data were of little use due to the data being close to or below the method detection limits (MDL). Most of the variance in the data was due to the procedures followed for data censoring. Data are reported for a subset of target PAH analytes when values are below the MDL. Thus, patterns in the data related to data censorship are created. A majority of the variance in the data was attributable to data processing methods illustrating the near uniformity of the results obtained.

For hypothesis testing, statistical analysis of variance no longer considers R (direction), and D was treated as a category. As with the boxcorer data, the most general case was first tested and then the data set

was decomposed by other study design classifications (see Section 6.0). In the test of the overall design, no two-way or higher interactions were significant (Table 6.29 to 6.31). Consideration of the data by tissue type across all sites showed significant differences related to cruise for PAH and barium in stomach contents and barium for invertebrate soft tissues. Significant differences related to platform site were observed for PAH and barium in invertebrate soft tissues. Further analysis of the data by site confirmed the presence of significant differences due to cruise. However, no significant differences due to distance from the platform were evident (Tables 6.32 to 6.34).

In conclusion, **no enhanced bioaccumulation of hydrocarbons or trace metals in fish livers, fish stomach contents, or invertebrate soft tissues could be related directly to distance from a platform.** Differences related to cruise and site are most likely due to difference in the species analyzed at each site and during each cruise. It was difficult to collect the same species at both the Near and Far stations and was particularly difficult to collect the same species consistently across all three sites due to differences in water depths. In general, **most of the contaminant levels observed were close to method detection limits. Random occurrences of bioaccumulation of contaminants were noted but they were apparently unrelated to distance from the platform.**

6.3.2 Historical Comparisons of Trace Metals in Tissues

The MMS-sponsored South Texas Outer Continental Shelf Baseline Study (STOCs, 1975-77) provided a survey of background concentrations in organisms for comparison with the present study (Boothe and Presley 1979). Analyses of the same species provide the most meaningful comparisons. Three such comparisons were possible utilizing the STOCs dataset. These species-specific comparisons included two fish and a burrowing crustacean. Comparisons of metal concentrations in livers from the commercially important red snapper (*Lutjanus campechanus*) showed that the STOCs baseline concentrations were consistently higher (except Cr; Figure 6.14) than the data from this study. For livers from wenchman (*Pristipomoides aquilonaris*), an epibenthic shelf species (Figure 6.15), the concentrations were similar. **These comparisons suggest that for mobile**

Table 6.29. Summary of the significance of interactions for the overall study design based on contaminants in fish livers.

Variable ^a	Interactions ^b	
	C*D	P*D
TOTPAH	No	No
Cd	No	No
Fe	No	No
Ba	No	No

Variable ^a	Interactions ^b		
	P	C	D
TOTPAH	No	No	No
Cd	No	No	No
Fe	No	No	No
Ba	No	No	No

^aSee Table 6.19 for definition of variables.

^bSee Table 6.19 for definition of variables and symbols.

Table 6.30. Summary of the significance of interactions for the overall study design based on contaminants in fish stomach content.

Variable ^a	Interactions ^b	
	C*D	P*D
TOTPAH	No	No
Cd	No	No
Fe	No	No
Ba	No	No

Variable ^a	Interactions ^b		
	P	C	D
TOTPAH	No	Yes	No
Cd	No	No	No
Fe	No	No	No
Ba	No	Yes	No

^aSee Table 6.19 for definition of variables.

^bSee Table 6.19 for definition of variables and symbols.

Table 6.31. Summary of the significance of interactions for the overall study design based on contaminants in invertebrate soft tissues.

Variable ^a	Interactions ^b	
	C*D	P*D
TOTPAH	No	No
Cd	No	No
Fe	No	No
Ba	No	No

Variable ^a	Interactions ^b		
	P	C	D
TOTPAH	Yes	No	No
Cd	No	No	No
Fe	No	No	No
Ba	Yes	Yes	No

^aSee Table 6.19 for definition of variables.

^bSee Table 6.19 for definition of variables and symbols.

Table 6.32. Summary of the significance of interactions for different tissue types at MAI-686 based on contaminants.

Tissue Type Variable ^a	Interactions ^b	
	C*D	D
<u>Liver</u>		
TOTPAH	No	No
Cd	No	No
Fe	No	No
Ba	No	No
<u>Stomach Contents</u>		
TOTPAH	No	No
Cd	No	No
Fe	No	No
Ba	No	No
<u>Invertebrate Soft Tissues</u>		
TOTPAH	No	No
Cd	No	No
Fe	No	No
Ba	No	No

^aSee Table 6.19 for definition of variables.

^bSee Table 6.19 for definition of variables and symbols.

Table 6.33. Summary of the significance of interactions for different tissue types at MU-A85 based on contaminants.

Tissue Type	Interactions ^b	
Variable ^a	C*D	D
<u>Liver</u>		
TOTPAH	No	No
Cd	No	No
Fe	No	No
Ba	No	No
<u>Stomach Contents</u>		
TOTPAH	No	No
Cd	No	No
Fe	No	No
Ba	No	No
<u>Invertebrate Soft Tissues</u>		
TOTPAH	No	No
Cd	No	No
Fe	No	No
Ba	No	No

^aSee Table 6.19 for definition of variables.

^bSee Table 6.19 for definition of variables and symbols.

Table 6.34. Summary of the significance of interactions for different tissue types at HI-A389 based on contaminants.

Tissue Type	Interactions ^b	
Variable ^a	C*D	D
<u>Liver</u>		
TOTPAH	No	No
Cd	No	No
Fe	No	No
Ba	No	No
<u>Stomach Contents</u>		
TOTPAH	No	No
Cd	No	No
Fe	No	No
Ba	No	No
<u>Invertebrate Soft Tissues</u>		
TOTPAH	No	No
Cd	No	No
Fe	No	No
Ba	No	No

^aSee Table 6.19 for definition of variables.

^bSee Table 6.19 for definition of variables and symbols.

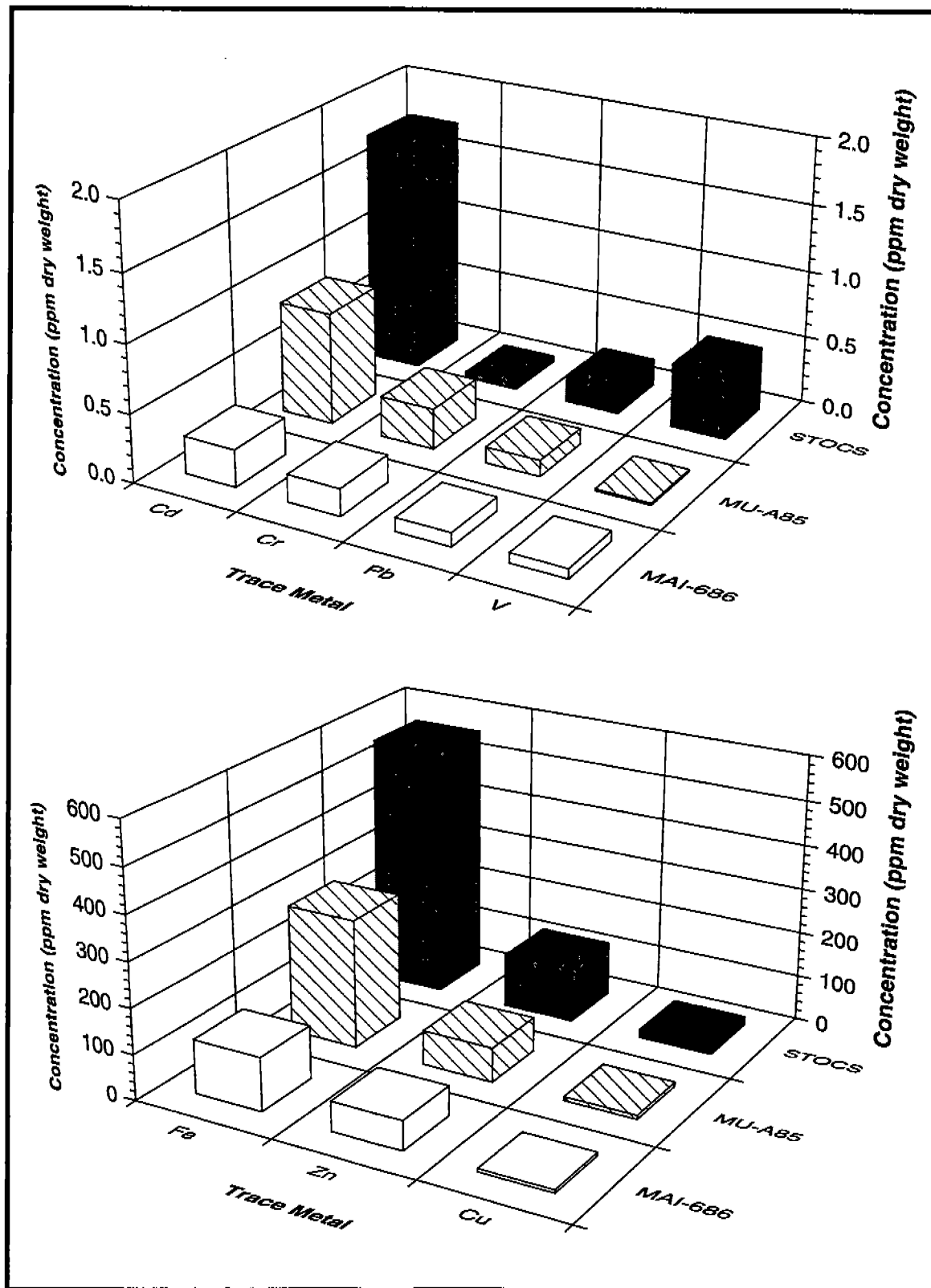

Figure 6.14. Comparison of STOCS and GOOMEX organism trace metal data in *Lutjanus campechanus* (Red Snapper) liver tissue.

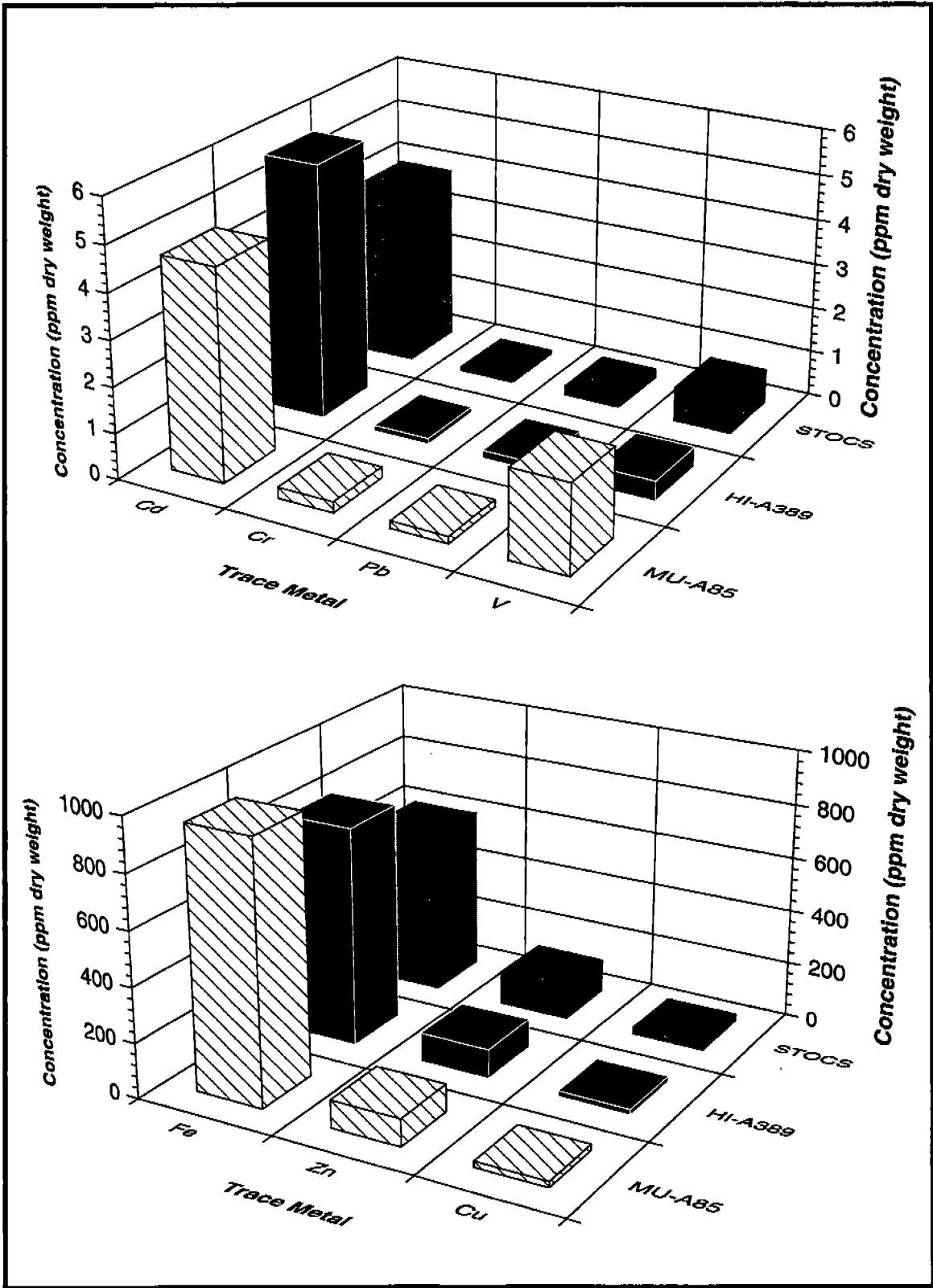

Figure 6.15. Comparison of STOCS and GOOMEX organism trace metal data for *Pristipomoides aquilonaris* (Wenchman) liver tissue.

species, metal concentrations in tissues near platforms are not elevated over background values, confirming little or no enhanced bioaccumulation of metals near platforms. For the less mobile, burrowing mantis shrimp (*Squilla empusa*) there was an indication of bioaccumulation related to the level of sediment contamination (Figure 6.16; Boothe and Presley 1987). Cadmium levels were significantly higher in *Squilla empusa* from the two sites (HI-A389 and MU-A85) with the highest levels of sediment contamination. Iron levels were also higher in mantis shrimp from all three study sites in this study. The cause of this consistent difference in iron was uncertain but a similar elevation was observed in the STOCS study (Boothe and Presley 1987).

Broader comparisons involving the pooling of data from many different species of the same organism type, were also possible with the available data. Because of inter-species differences, these comparisons have higher variability but they give a more comprehensive picture because of the larger sample sizes involved (e.g., GOOMEX 340 fish and 120 shrimp samples, STOCS 150 fish and 65 shrimp samples). The concentrations of seven trace metals in fish liver tissue from the two studies in are compared in Figure 6.17. As observed with the species-specific comparisons above, the data were similar from the two studies with the STOCS data generally being higher than the present data. **Again, there was no indication of enhanced bioaccumulation of metals in near-platform demersal fish populations.**

Shrimp soft tissue data is compared in Figure 6.18. Several commercially important penaeid shrimp species were included in both pooled data sets. The situation for the shrimp soft tissue data was the same as that observed for the closely related mantis shrimp. Cadmium body burdens were significantly higher at the most contaminated sites (HI-A389 and MU-A85). Lead levels were also higher at the sites but the differences were smaller and not significant. Also the Pb levels did not correlate well with sediment enrichment at a site. Shrimp from the much less contaminated MAI-686 site had Pb levels similar to shrimp from the more contaminated MU-A85 platform. Again, Fe levels are significantly higher at all three sites compared to the STOCS baseline data.

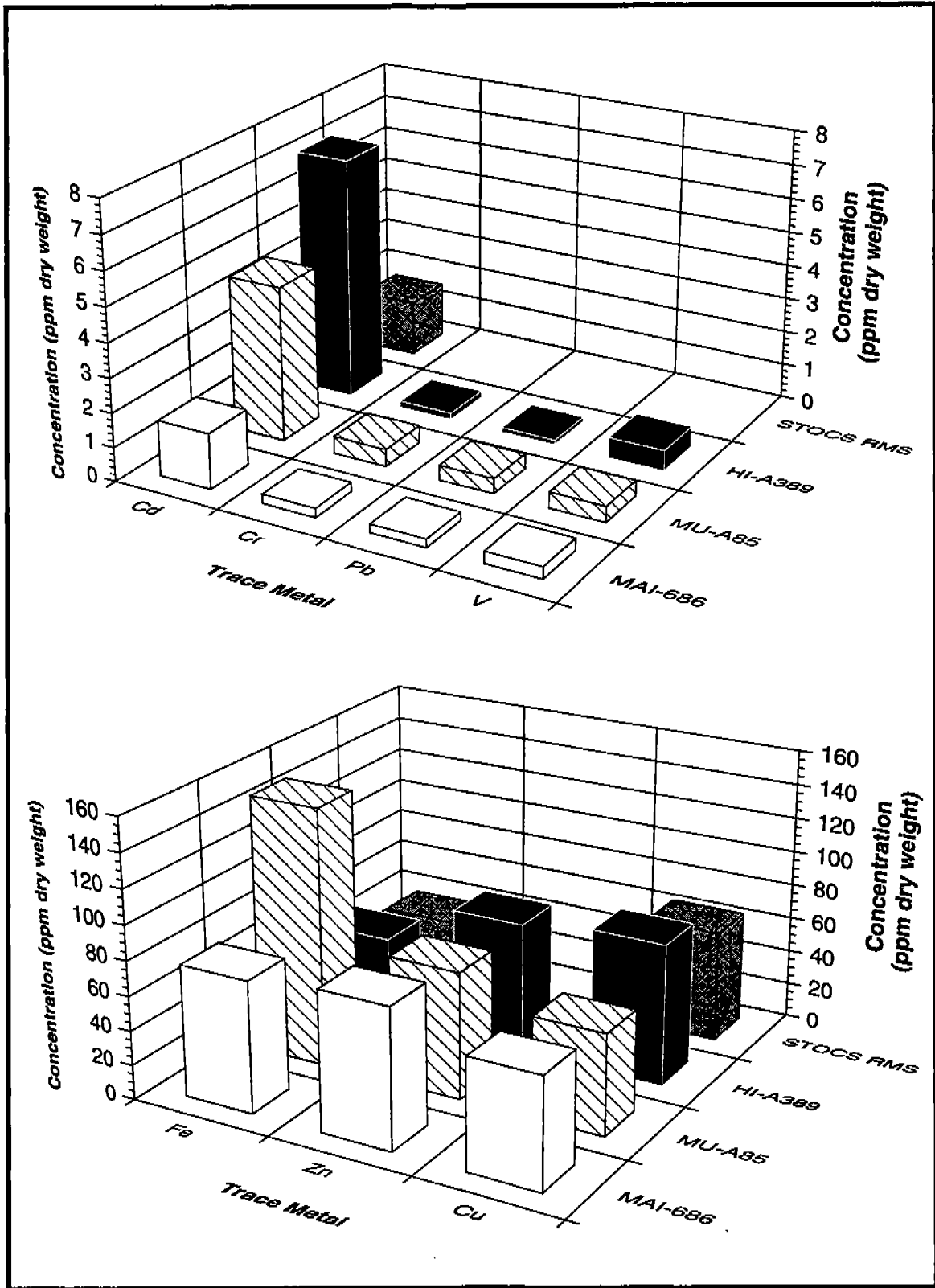

Figure 6.16. Comparison of STOCS and GOOMEX organism trace metal data for *Squilla empusa* (Mantis Shrimp) soft tissue.

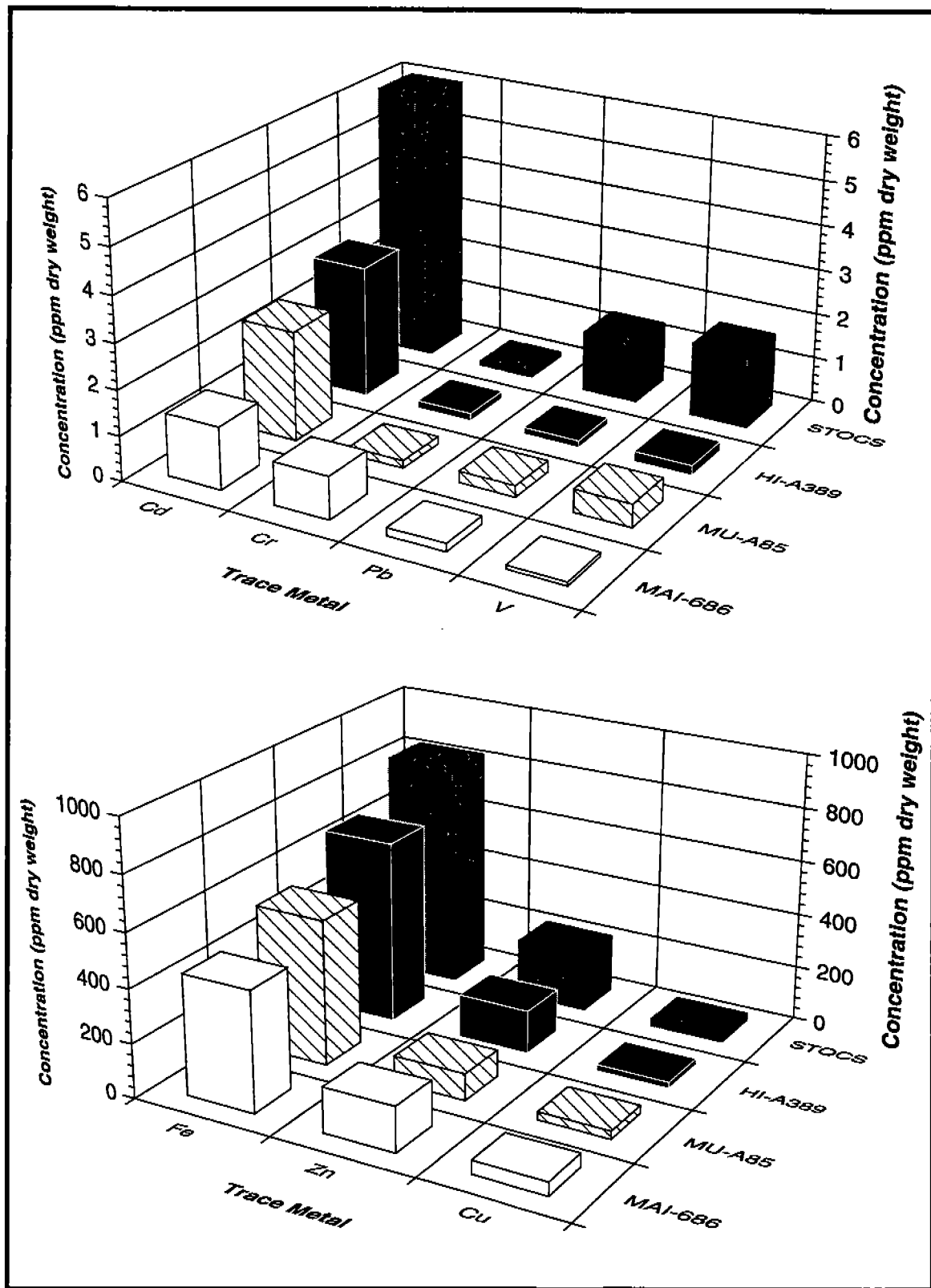

Figure 6.17. Comparison of STOCs and GOOMEX organism trace metal data for fish liver tissue.

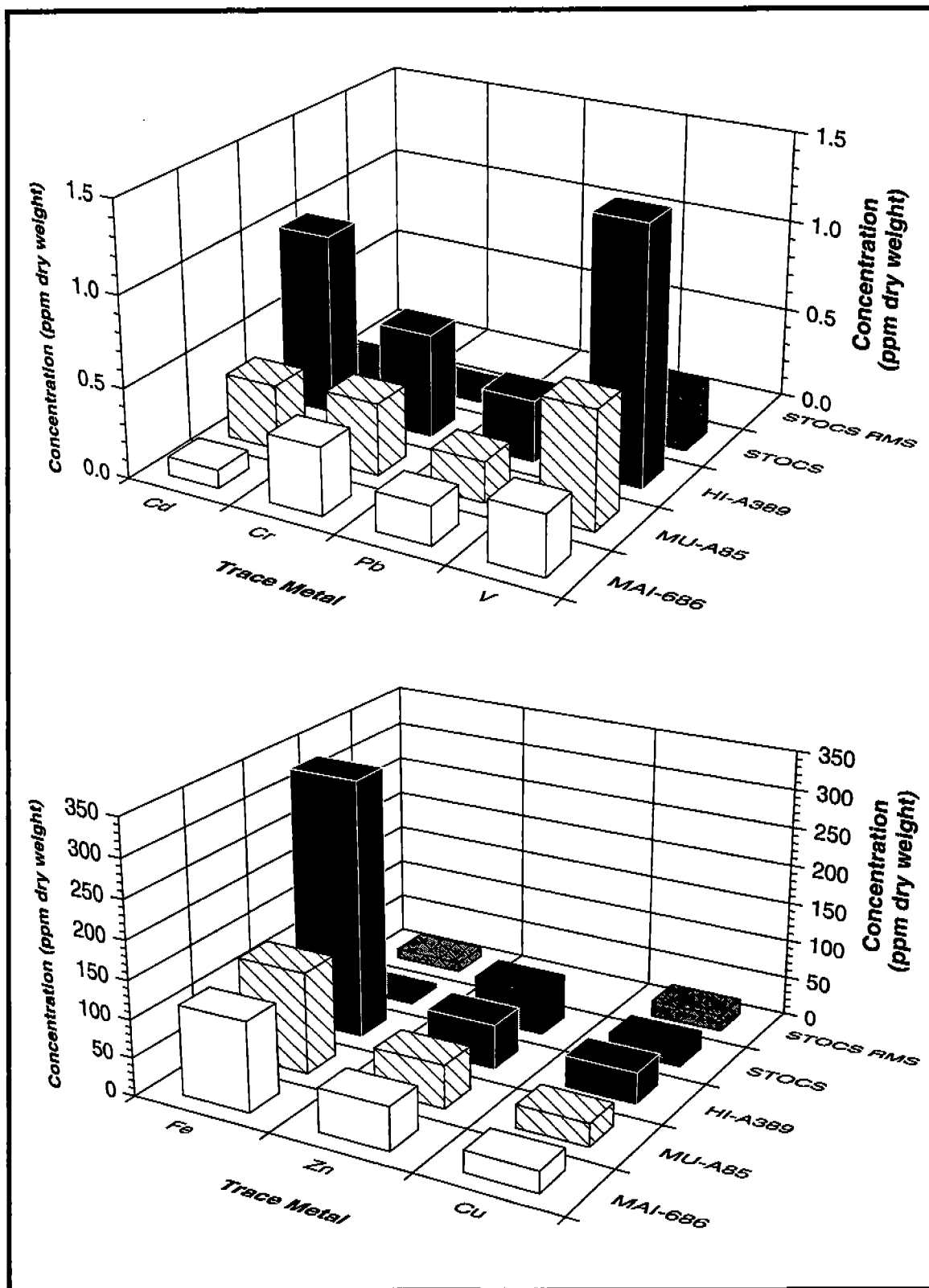

Figure 6.18. Comparison of STOCs and GOOMEX organism trace metal data for shrimp soft tissues.

6.4 Meiofauna

The term "meiobenthos" was first coined by Mare (1942) to describe those benthic organisms that are of intermediate size. These are metazoans that are smaller than macrofauna but larger than the single-celled microbenthos (e.g., bacteria, microalgae, and protozoans). By convention, the definition of meiofauna is those animals that pass through a 0.5-mm sieve but are retained on a 0.063-mm sieve (Coull and Bell 1979). Meiofaunal communities can be further subdivided into two groups. Temporary meiofauna are those juveniles of the macrofauna that will eventually grow into organisms larger than 0.5 mm in body width (e.g., polychaetes). Permanent meiofauna are those groups where adults are less than 0.5 mm in width (e.g., Nematoda, Copepoda, Gastrotricha, Turbellaria, Acarina, Gnathostomulida, Kinoryncha, Tardigrada, Ostracoda, and some Rhyncocoela, Oligochaeta and Polychaeta). In 1971, Thiel suggested that the grouping of benthic organisms according to size differences had little taxonomic or ecological justification, except convenience of sample processing (quoted from Thiel 1975). However, extensive ecological literature since 1971 has shown that meiofauna are different from macrofauna, and have different roles in marine ecosystems (for reviews see: Coull and Bell 1979; Coull and Palmer 1984). Even where meiofauna share ecological properties with macrofauna, the processes operate on much smaller spatial and temporal scales for meiofauna (Bell 1980). Meiofauna are good candidates for indicating contaminant exposure for several reasons. Meiofauna have short generation times thus providing the potential for exhibiting a rapid response. Meiofauna also live and grow in the benthos with no planktonic larvae, thus assuring life long exposure to sediment contaminants and sampling is less labor intensive than for macroinfauna (Warwick 1988a,b).

Although nematodes are the dominant meiofaunal taxa, harpacticoid copepods are most suitable for meiobenthic reproductive studies. Harpacticoids have reproductive characteristics that are easy to measure. Harpacticoids brood their eggs externally, have five copepodite (or juvenile) stages that are easily identifiable, and have an adult stage that is sexually dimorphic. The likelihood of detecting changes in community structure is very high because this group of organisms is so diverse (Coull 1972).

Harpacticoids are usually more sensitive to hydrocarbon exposure than nematodes (Fricke et al. 1981; Bodin and Boucher 1983; Hennig et al. 1983). It has been suggested that nematode:copepod ratios (i.e., decreasing numbers of harpacticoids) are a good indicator of exposure to hydrocarbons (Hennig et al. 1983) and organic waste (Raffaelli and Mason 1981; Raffaelli 1982; Amjad and Gray 1983; Shiells and Anderson 1985). However, one must be careful when applying such an index (e.g., the nematode:copepod ratio) for comparing exposure at different habitats or different times, because meiofauna abundances and community structure are dependent on granulometry and seasonal fluctuations (Coull et al. 1981). All of the needed ancillary variables have been measured (i.e., chemical, geological, spatial, and temporal parameters) to evaluate the usefulness of the nematode:copepod ratio. Harpacticoids are more sensitive than nematodes to the addition of barite and sand (Cantelmo et al. 1979). This phenomenon may be difficult to separate from contaminant exposure. However, granulometry data should be useful in separating out effects due to toxicity and effects due to changes in sediment composition. Because harpacticoids disperse at faster rates than nematodes they are the first colonizers of drilling muds and cuttings. After an intertidal mud flat was disturbed by turning it over, meiofauna recovered to predisturbance levels within one tidal cycle (Sherman and Coull 1980). Meiofauna act like passive particles of sediment, and are resuspended in proportion to the erosion velocities of surface sediments (Palmer and Gust 1985). Behavior also plays an important role in dispersion. Since harpacticoids are more often found in surface sediments, they are much more common in the drifting meiofauna than nematodes (Bell and Sherman 1980; Palmer 1984). This is consistent with the observation that harpacticoid populations recovered within one week during a colonization experiment of oiled sediments, but nematodes took up to 90 days to fully recover (Alongi et al. 1983). Harpacticoids also recolonized azoic trays faster than nematodes in natural hydrocarbon seep sediments of OCS areas of California (Palmer et al. 1988).

The meiofauna component included sampling at the community, population, and genetic level. Eight different variables were examined at the community level: total meiofauna density, Nematoda density, Harpacticoida density, "other" meiofauna taxa density, the nematode:copepod (NC) ratio, Nematoda biomass, Nematoda diversity, and Harpacticoida diversity.

Additionally, nematode trophic dynamics and predation pressure on meiofauna were also examined. At the population level, the variables measured included harpacticoid egg clutch volume, clutch size, and life history stages. The meiofauna porewater toxicity study also falls in this category. At the genetic level, halotype diversity was estimated for harpacticoid populations.

6.4.1 Meiofaunal Communities

There was a gradient in meiofauna abundance and diversity among the platforms. **Density of all taxa and harpacticoid diversity decreased from MAI-686 to MU-A85, to HI-A389.** There were three gradients present, which are confounded. Water depth increases along this gradient, contamination concentrations increase along this gradient, and sand content decreases. Therefore, depth, contamination, and sediment texture are confounded, precluding the simple conclusion that differences among platforms represent differences in contaminant levels. The nematode data provided insight into this issue. Both the NC ratio and nematode diversity did not follow the depth-contaminant-sand trend. Nematode diversity and biomass was not highest at MAI-686, nor was the NC ratio the lowest. These data indicated that environmental differences were interacting at platforms HI-A389 and MAI-686 to produce the observed trends.

6.4.1.1 Meiofaunal Abundance and Diversity

The first statistical analysis of meiofaunal data was performed to test the overall sample design to detect interactions among cruises, platforms, and distances from platforms (Table 6.35). Meiofaunal community abundance and diversity data is summarized and described in detail in Section 5.4.2. Interactions among cruises, platforms and distances mean that overall analyses cannot be directly interpreted (i.e., the overall test for a distance effect is invalid). Harpacticoid diversity was the only variable where interactions with cruise or platform were not present. Cruise interactions were significant for all density measures, but not significant for diversity measures. Significant interactions related to platform uniqueness was common. Distance interactions were present for all variables. This means

Table 6.35. Summary of the significance of interactions for the overall sample design based on meiofaunal data.

Variable	Interactions ^a			
	C*D	P*D	P*C*D	D*R(P)
Meiofauna density	Yes	Yes	Yes	Yes
Nematode density	Yes	Yes	Yes	Yes
Harpacticoid density	Yes	No	Yes	Yes
Other meiofauna density	Yes	Yes	Yes	Yes
Nematode biomass	Yes	No	No	Yes
Nematode:Harpacticoid ratio	No	Yes	No	Yes
Nematode diversity	No	Yes	No	Yes
Harpacticoid diversity	No	No	No	Yes

^aP=platform, C=Cruise, D=Distance, R=radius; Yes=significant, $p < 0.01$; no=not significant, $p \geq 0.01$;

that there were different responses with respect to distance from the platforms at all platforms and radii within platforms, and that in general, platforms should be independently analyzed.

When higher order interactions were not present, then the test for the main effect (e.g., cruise, distance, or platform) was easily interpreted. This is summarized in Table 6.36. Harpacticoid diversity exhibited statistically significant cruise, platform, and distance differences. A Tukey's test revealed that the 50-m stations had the lowest diversity of all stations. The highest diversity was found at distances of ≥ 3000 -m from a platform. There was a significant linear increase in harpacticoid diversity with respect to distance from a platform (linear contrast). These results indicated that harpacticoids were the only response variable for which a general statement about all platforms could be made.

Each platform was also individually analyzed (Tables 6.37 and 6.38). Significant interaction effects were still present for many variables. Distance effects were clearly evident at HI-A389. **Every variable, except the density of "other meiofauna taxa", exhibited a statistically significant response with respect to distance from the platform.** MAI-686 had significant differences for all abundance measures, harpacticoid diversity, and nematode biomass (Table 6.37). The platform MU-A85 had only one significant difference with distance, nematode biomass (Table 6.37). Many significant interactions with cruise and distance still existed for abundance measures, but not for harpacticoid diversity (Table 6.37). The effect of distance could be tested for

Table 6.36. Summary of tests of the main effects for the overall sample design based on meiofaunal data.

Variable ^a	Platform	Cruise	Distance
Meiofauna density	---	---	---
Nematode density	---	---	---
Harpacticoid density	---	---	---
Other meiofauna density	---	---	---
Nematode biomass	---	---	---
Nematode:Harpacticoid ratio	---	---	---
Nematode diversity	---	---	---
Harpacticoid diversity	Yes	Yes	Yes

^aResult of significance tests for the three main effects are reported where higher order interactions were not significant ("---" = unable to test due to the significant higher interactions)

Table 6.37. Summary of the significance of interactions by platform based on meiofaunal data.

Site Variable	Interactions ^a								
	MAI-686			MU-A85			HI-A389		
	C*D	D*R	C*D*R	C*D	D*R	C*D*R	C*D	D*R	C*D*R
Meiofauna density	Yes	Yes	Yes	Yes	No	Yes	Yes	Yes	Yes
Nematode density	Yes	Yes	Yes	Yes	No	Yes	Yes	Yes	Yes
Harpacticoid density	Yes	Yes	Yes	No	No	Yes	Yes	Yes	No
Other meiofauna density	Yes	Yes	Yes	Yes	No	Yes	No	No	No
Nematode biomass	Yes	No	No	No	No	No	Yes	No	No
Nematode:Harpacticoid ratio	No	No	No	No	No	No	No	Yes	Yes
Nematode diversity	No	No	---	Yes	Yes	---	No	Yes	---
Harpacticoid diversity	No	No	---	No	No	---	No	Yes	---

^aFor definition of variables and symbols see Tables 6.35 and 6.36.

Table 6.38. Summary of the interpretations of interactions for analysis of variance by platform based on meiofauna data.

Variable	Platform ^a		
	MAI-686	MU-A85	HI-A389
Meiofauna density	---	---	---
Nematode density	---	---	---
Harpacticoid density	---	---	---
Other meiofauna density	---	---	Yes
Nematode biomass	Yes	Yes	---
Nematode:Harpacticoid ratio	No	no	---
Nematode diversity	No	---	---
Harpacticoid diversity	Yes	No	---

^aFor definition of variables and symbols see Tables 6.35 and 6.36.

in only 7 of 32 instances. Significant distance effects were apparent for harpacticoid diversity and nematode biomass at MAI-686. Tukey multiple comparisons were performed by platform (Tables 6.39 to 6.44). At MAI-686, there was a linear gradient in all density, biomass, and harpacticoid diversity values, which increased away from the platform (Table 6.39). Nematode diversity declined at MAI-686 along this gradient. At MU-A85, 50-m stations were different and had the lowest values for all variables measured (Table 6.40). It appeared that "natural" or background levels occur at 100 to 200 m away from the platform. At HI-A389, densities of harpacticoids were generally higher away from the platform, but nematode density and biomass was greater near the platform (Table 6.39). **Harpacticoid densities declined in a near linear fashion with distance from the platform. Since nematodes increased and harpacticoids decreased with distance, the NC ratio also declined with distance from a platform** (Table 6.40).

Tukey's multiple comparisons were also performed to evaluate between cruise differences (Tables 6.42 to 6.44). Platforms MU-A85 and HI-A389 had similar responses with generally higher abundance and diversity values during Cruises 3 and 4 (Tables 6.43 and 6.44). MAI-686 had an opposite trend with generally higher values during Cruises 1 and 2 (Table 6.42).

6.4.1.2 Meiofaunal Community Structure

A principal components analysis (PCA) was performed on the nematodes and harpacticoids species composition data to determine which environmental factors were correlated with changes in community structure (Figures 6.19 to 6.26). **For harpacticoids (Figure 6.19) and nematodes (Figure 6.20) differences were mainly due to platforms.** Platform MU-A85 had species in common with HI-A389 and MAI-686, which were very different from one another. Nematode patterns at the two deeper platforms (MU-A85 and HI-A389) shared some species, but the shallowest water platform (MAI-686) was very different from the two deeper water platforms. There were also differences due to station proximity to the platform.

Since so few species were common between platforms, it was more effective to analyze on a platform-by-platform basis (Figures 6.21 and 6.26).

Table 6.39. Tukey's multiple comparison test results by distance at MAI-686 based on meiofaunal data.

Variable	Distance from the Platform ^a				
	3000	1000	200	100	50
Total meiofauna density (n X 10 cm ⁻²)	3000 (3868)	1000 (3534)	200 (2477)	100 (1976)	50 (1681)
Nematode density (n X 10 cm ⁻²)	3000 (2818)	1000 (2589)	200 (2589)	100 (1786)	50 (1451)
Harpacticoid density (n X 10 cm ⁻²)	3000 (449)	1000 (402)	200 (297)	100 (205)	50 (164)
Other meiofauna density (n X 10 cm ⁻²)	3000 (534)	1000 (490)	200 (353)	100 (278)	50 (267)
NC ratio (n X 10 cm ⁻²)	50 (15.2)	3000 (13.1)	100 (12.6)	1000 (11.3)	200 (10.2)
Nematode diversity (n X 10 cm ⁻²)	50 (3.16)	100 (3.13)	200 (3.12)	1000 (3.11)	3000 (3.10)
Harpacticoid diversity (n X 10 cm ⁻²)	3000 (2.75)	1000 (2.73)	200 (2.62)	100 (2.44)	50 (2.24)
Nematode biomass (n X 10 cm ⁻²)	3000 (2.48)	1000 (1.17)	200 (0.98)	100 (0.85)	50 (0.42)

^aDetransformed means are presented (x) and means that are underlined are not different at the 0.05 level.

Table 6.40. Tukey's multiple comparison test results by distance at MU-A85 based on meiofaunal data.

Variable	Distance from the Platform ^a				
	100	1000	200	3000	50
Total meiofauna density (n X 10 cm ⁻²)	100 (1098)	1000 (892)	200 (874)	3000 (782)	50 (647)
Nematode density (n X 10 cm ⁻²)	100 (660)	1000 (533)	200 (525)	3000 (434)	50 (326)
Harpacticoid density (n X 10 cm ⁻²)	100 (212)	50 (167)	1000 (166)	200 (162)	3000 (156)
Other meiofauna density (n X 10 cm ⁻²)	100 (191)	1000 (180)	3000 (173)	200 (162)	50 (125)
NC ratio (n X 10 cm ⁻²)	200 (7.1)	1000 (6.4)	100 (6.2)	3000 (5.7)	50 (4.3)
Nematode diversity (n X 10 cm ⁻²)	100 (3.45)	200 (3.37)	3000 (3.31)	1000 (3.27)	50 (3.18)
Harpacticoid diversity (n X 10 cm ⁻²)	100 (2.69)	1000 (2.54)	3000 (2.51)	200 (2.48)	50 (2.38)
Nematode biomass (n X 10 cm ⁻²)	3000 (2.16)	200 (1.75)	1000 (1.63)	100 (1.18)	50 (0.23)

^aDetransformed means are presented (x) and means that are underlined are not different at the 0.05 level.

Table 6.41. Tukey's multiple comparison test results by distance at HI-A389 based on meiofaunal data.

Variable	Distance from the Platform ^a				
Total meiofauna density (n X 10 cm ⁻²)	100 (929)	200 (805)	50 (751)	500 (636)	3000 (597)
Nematode density (n X 10 cm ⁻²)	100 (649)	50 (546)	200 (534)	500 (397)	3000 (346)
Harpacticoid density (n X 10 cm ⁻²)	3000 (119)	1000 (118)	200 (104)	100 (97)	50 (34)
Other meiofauna density (n X 10 cm ⁻²)	200 (119)	1000 (115)	3000 (112)	100 (93)	50 (70)
NC ratio (n X 10 cm ⁻²)	50 (30.3)	100 (23.6)	200 (16.3)	1000 (6.3)	3000 (6.0)
Nematode diversity (n X 10 cm ⁻²)	1000 (3.21)	3000 (3.10)	200 (3.04)	100 (2.58)	50 (1.76)
Harpacticoid diversity (n X 10 cm ⁻²)	200 (2.26)	3000 (2.26)	1000 (2.22)	100 (2.01)	50 (1.25)
Nematode biomass (n X 10 cm ⁻²)	3000 (2.48)	1000 (0.85)	200 (0.77)	100 (0.13)	50 (0.016)

^aDetransformed means are presented (x) and means that are underlined are not different at the 0.05 level.

Table 6.42. Tukey's multiple comparison test results by cruise at MAI-686 based on meiofaunal data.

Variance	Cruise ^a			
	1	2	3	4
Meiofauna density (n X 10 cm ⁻²)	1 (3363)	<u>2</u> (2613)	<u>3</u> (2343)	<u>4</u> (2125)
Nematode density (n X 10 cm ⁻²)	<u>1</u> (2372)	<u>2</u> (2001)	<u>3</u> (1654)	<u>4</u> (1541)
Harpacticoid density (n X 10 cm ⁻²)	1 (472)	<u>3</u> (306)	<u>2</u> (268)	<u>4</u> (166)
Other meiofauna density (n X 10 cm ⁻²)	1 (482)	<u>4</u> (388)	<u>3</u> (331)	<u>2</u> (302)
NC ratio (n X 10 cm ⁻²)	<u>4</u> (16.8)	<u>2</u> (13.4)	<u>3</u> (10.1)	<u>1</u> (9.6)
Nematode diversity (n X 10 cm ⁻²)	<u>1</u> (3.19)	<u>2</u> (3.17)	<u>3</u> (3.11)	<u>4</u> (3.01)
Harpacticoid diversity (n X 10 cm ⁻²)	1 (3.00)	<u>2</u> (2.58)	<u>3</u> (2.40)	<u>4</u> (2.25)
Nematode biomass (n X 10 cm ⁻²)	1 (2.34)	<u>2</u> (1.93)	<u>3</u> (0.95)	<u>4</u> (0.94)

^aDetransformed means are presented (x) and means that are underlined are not different at the 0.05 level.

Table 6.43. Tukey's multiple comparison test results by cruise at MU-A85 based on meiofaunal data.

Variable	Cruise ^a			
	3	4	2	1
Meiofauna density (n X 10 cm ⁻²)	3 (950)	4 (937)	2 (850)	1 (677)
Nematode density (n X 10 cm ⁻²)	3 (572)	2 (521)	4 (492)	1 (369)
Harpacticoid density (n X 10 cm ⁻²)	4 (199)	3 (186)	2 (154)	1 (152)
Other meiofauna density (n X 10 cm ⁻²)	4 (232)	3 (162)	2 (143)	1 (136)
NC ratio (n X 10 cm ⁻²)	3 (7.4)	2 (7.0)	1 (4.9)	4 (4.4)
Nematode diversity (n X 10 cm ⁻²)	4 (3.45)	3 (3.44)	2 (3.34)	1 (3.02)
Harpacticoid diversity (n X 10 cm ⁻²)	1 (2.81)	4 (2.48)	3 (2.46)	2 (2.33)
Nematode biomass (n X 10 cm ⁻²)	2 (0.46)	3 (0.41)	1 (0.33)	4 (0.33)

^aDetransformed means are presented (x) and means that are underlined are not different at the 0.05 level.

Table 6.44. Tukey's multiple comparison test results by cruise at HI-A389 based on meiofaunal data.

Variable	Cruise ^a			
Meiofauna density (n X 10 cm ⁻²)	3 (1003)	<u>4</u> (745)	<u>2</u> (714)	1 (545)
Nematode density (n X 10 cm ⁻²)	3 (717)	<u>4</u> (495)	<u>2</u> (488)	1 (310)
Harpacticoid density (n X 10 cm ⁻²)	3 (112)	<u>4</u> (91)	<u>2</u> (83)	1 (63)
Other meiofauna density (n X 10 cm ⁻²)	1 (105)	4 (105)	2 (96)	3 (94)
NC ratio (n X 10 cm ⁻²)	3 (19.4)	1 (16.9)	4 (16.8)	2 (13.0)
Nematode diversity (n X 10 cm ⁻²)	4 (2.97)	3 (2.93)	2 (2.78)	1 (2.27)
Harpacticoid diversity (n X 10 cm ⁻²)	1 (2.13)	3 (2.03)	2 (1.96)	4 (1.89)
Nematode biomass (n X 10 cm ⁻²)	3 (0.46)	4 (0.41)	2 (0.35)	1 (0.22)

^aDetransformed means are presented (x) and means that are underlined are not different at the 0.05 level.

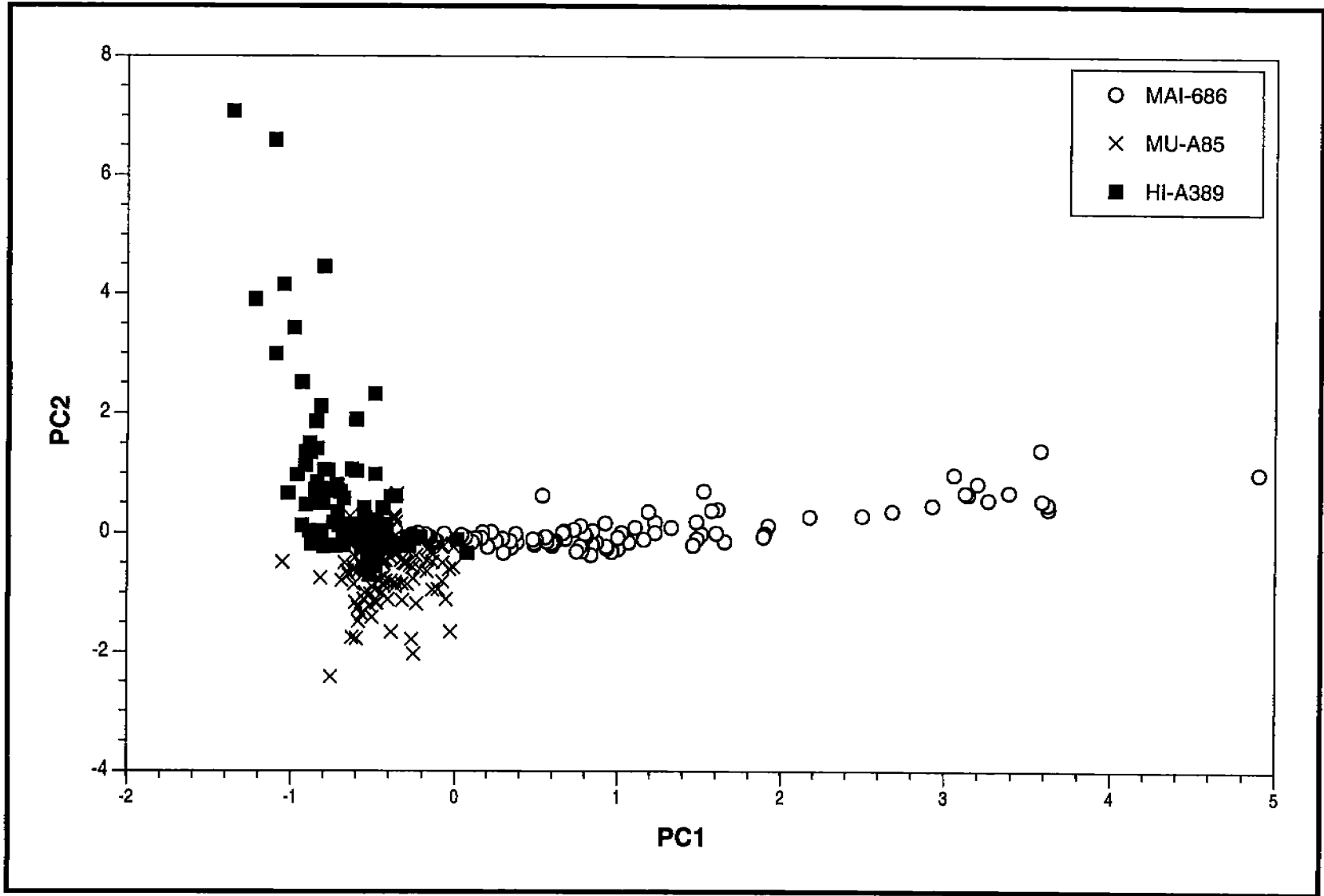

Figure 6.19. Principal components analysis (PCA) of harpacticoid species for entire sampling design by platform.

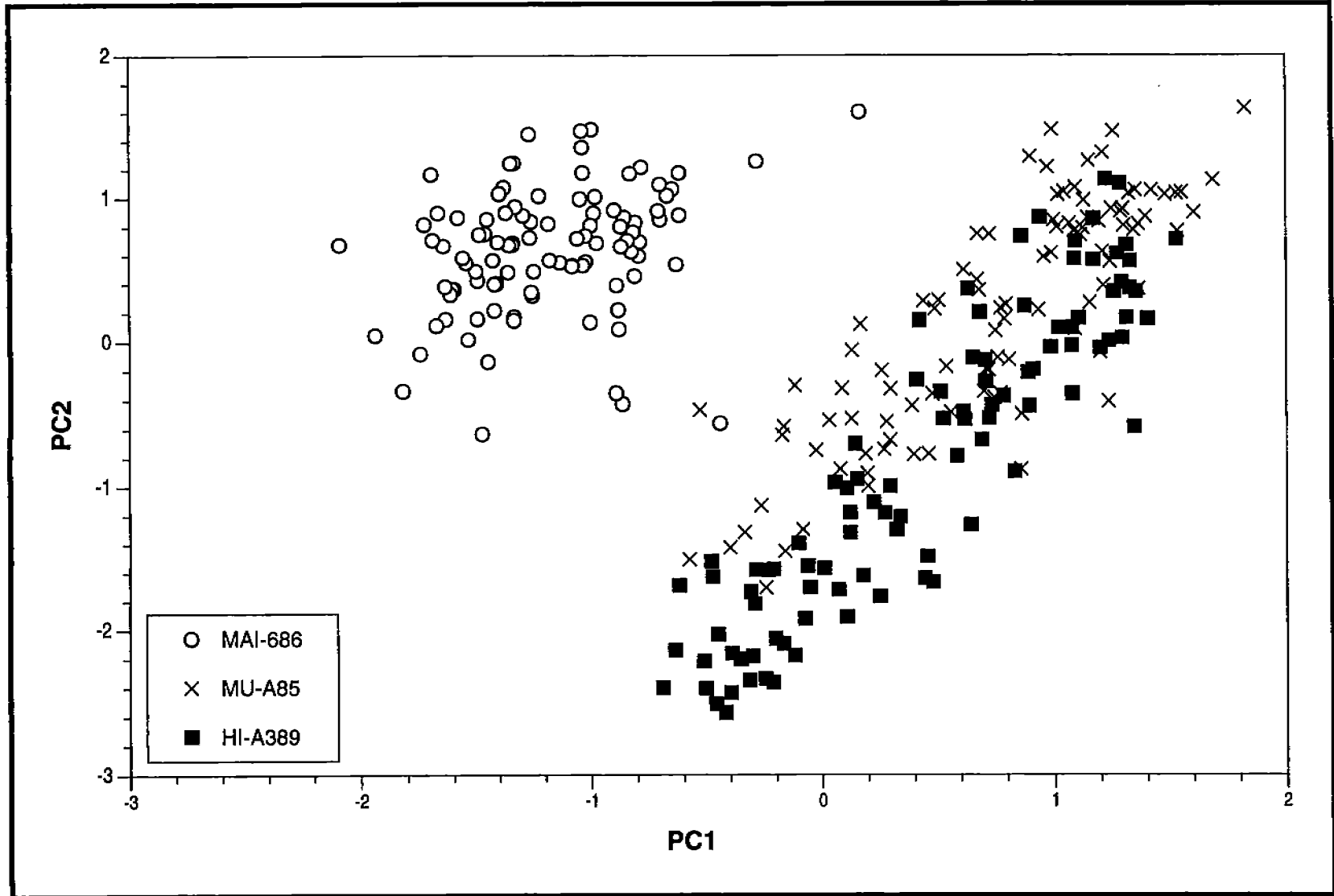

Figure 6.20. Principal components analysis (PCA) of nematode species for entire sampling design by platform.

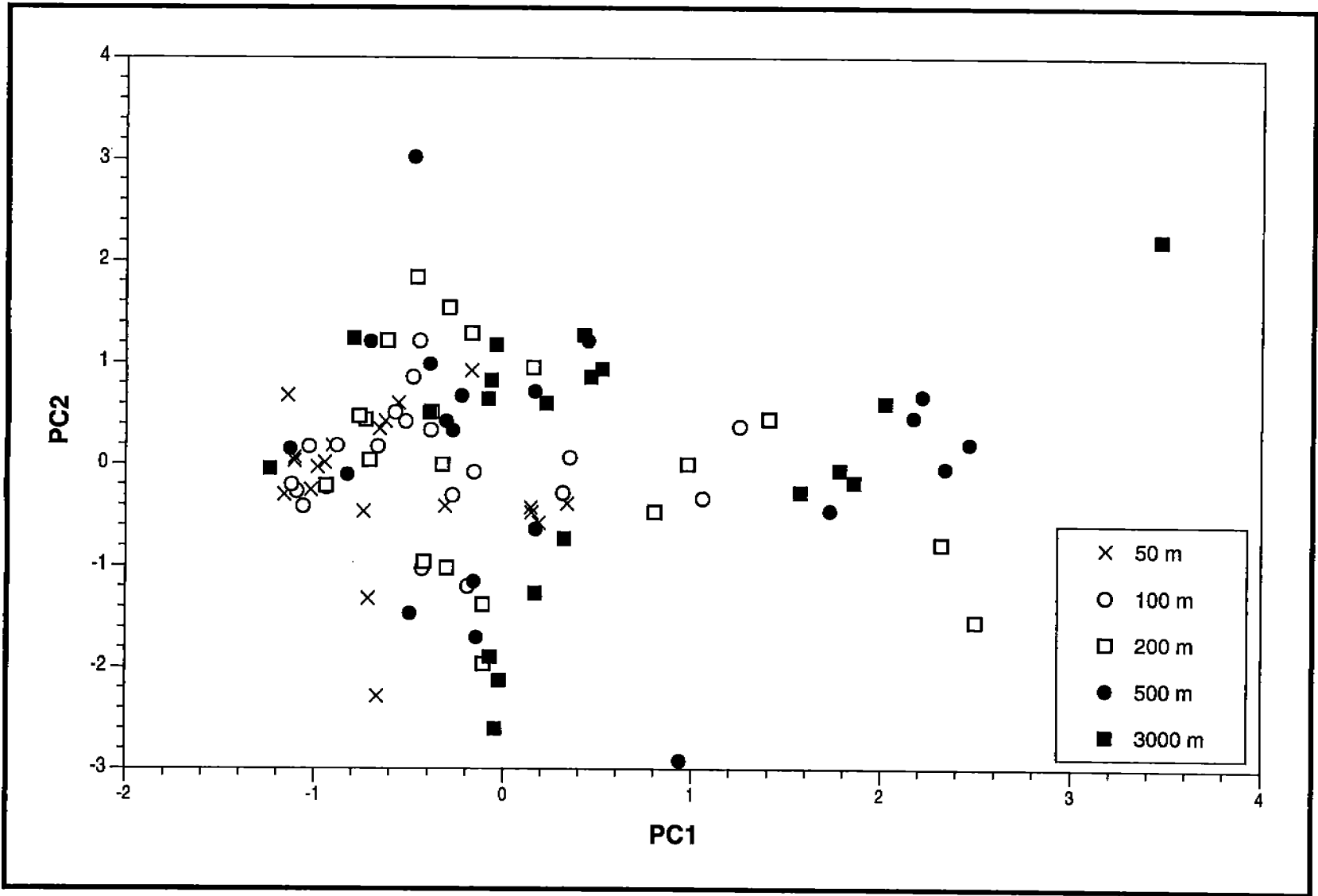

Figure 6.21. Principal components analysis (PCA) of harpacticoid species at MAI-686 by distance from the platform.

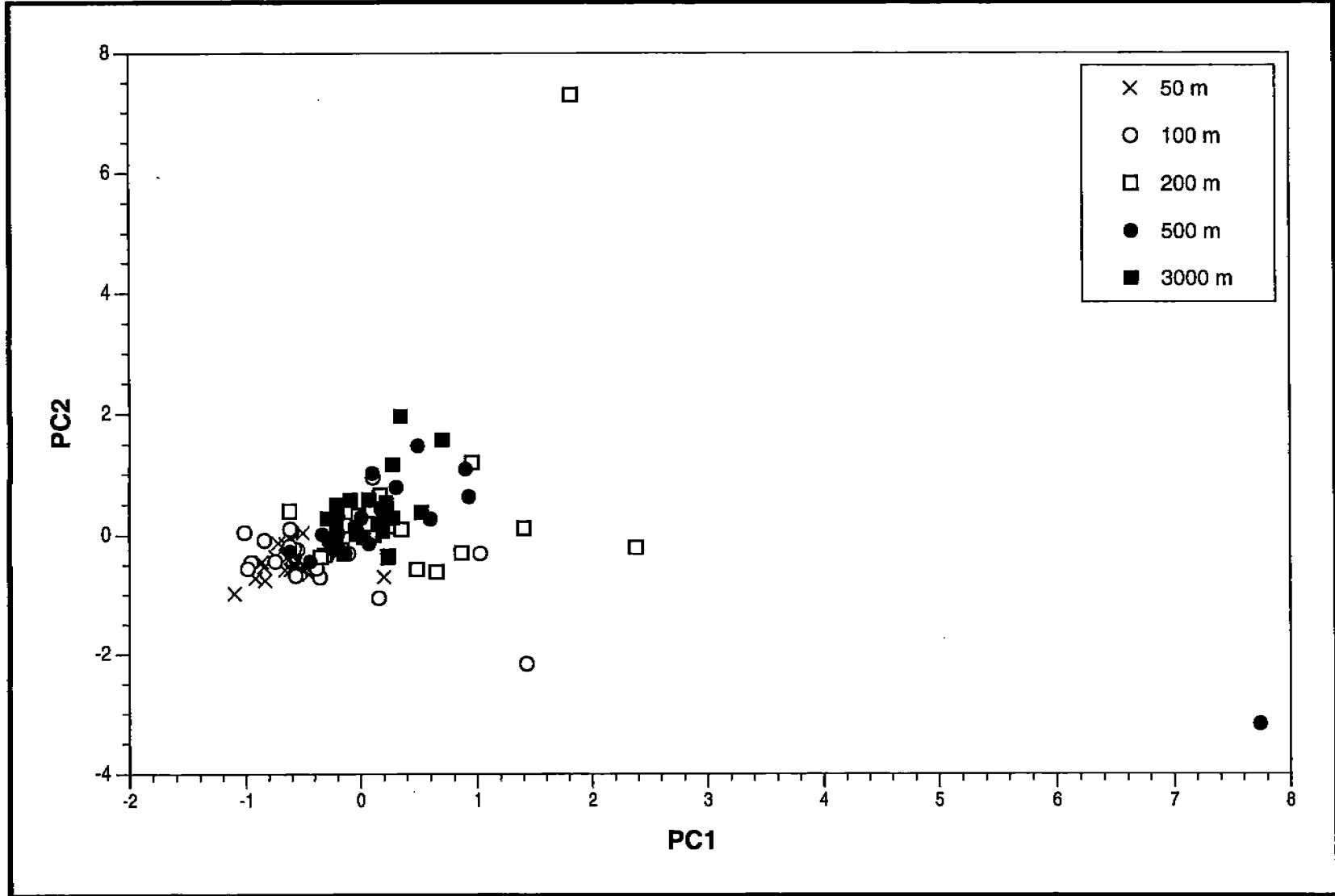

Figure 6.22. Principal components analysis (PCA) of harpacticoid species at MU-A85 by distance from the platform.

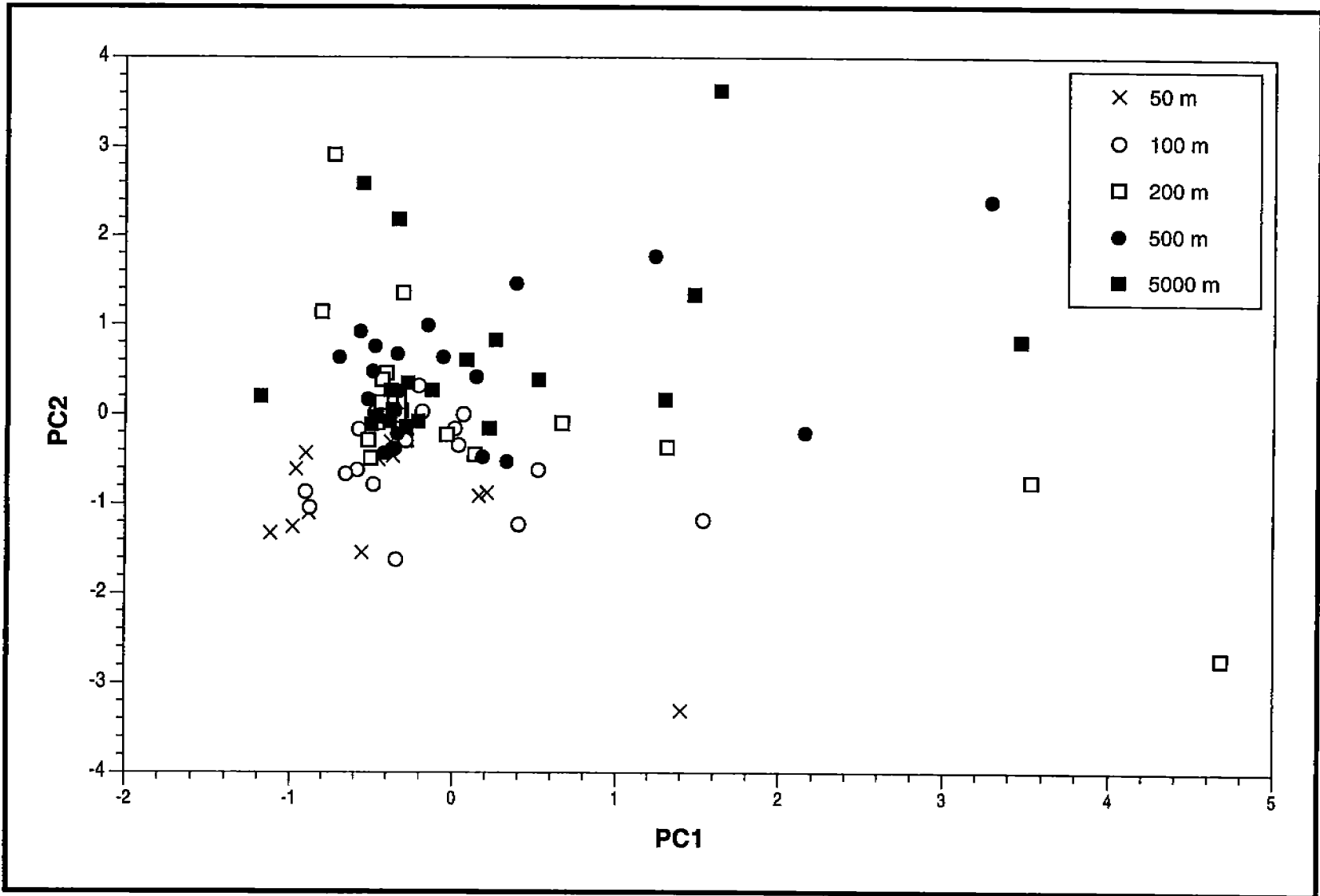
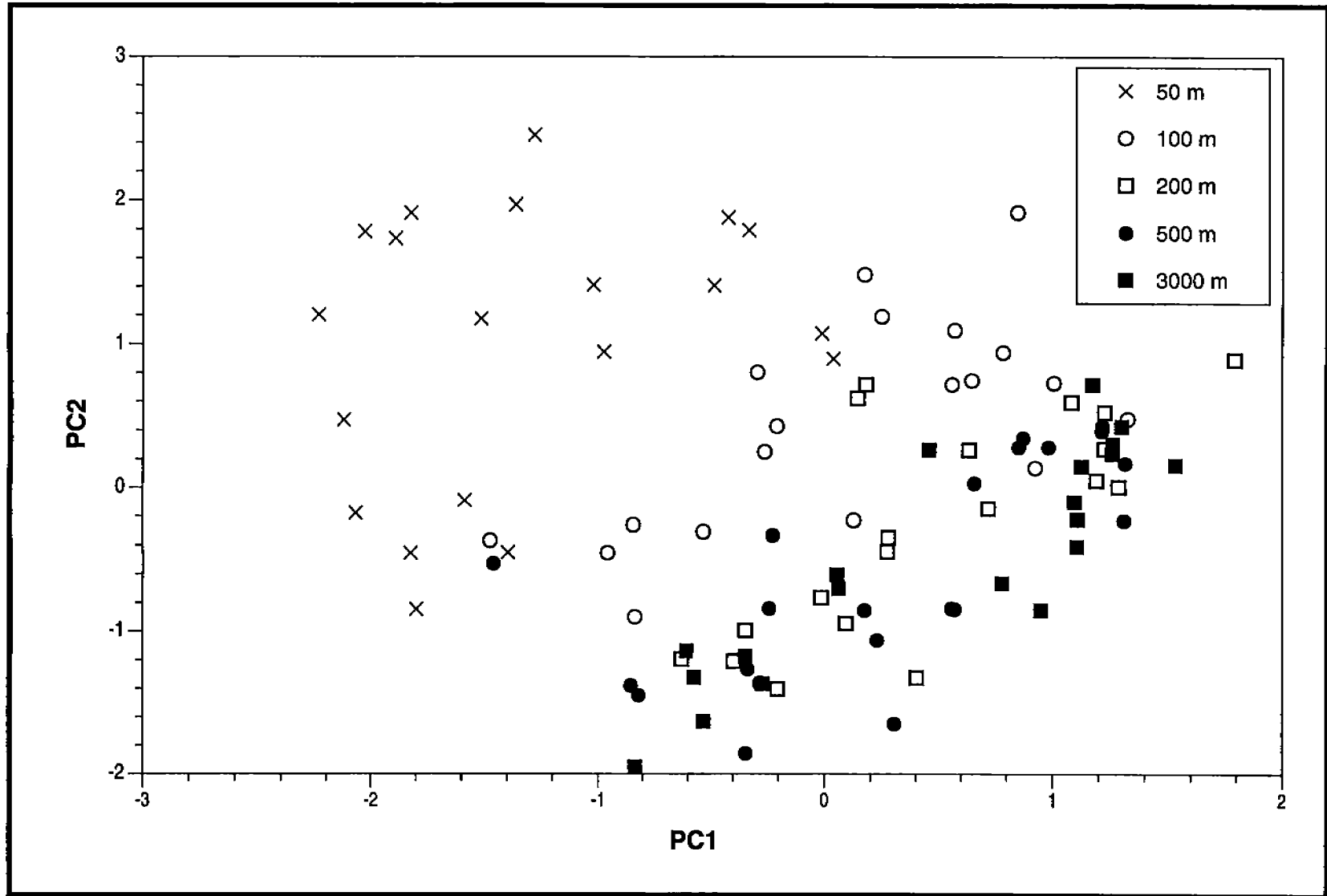

Figure 6.23. Principal components analysis (PCA) of harpacticoid species at HI-A389 by distance from the platform.



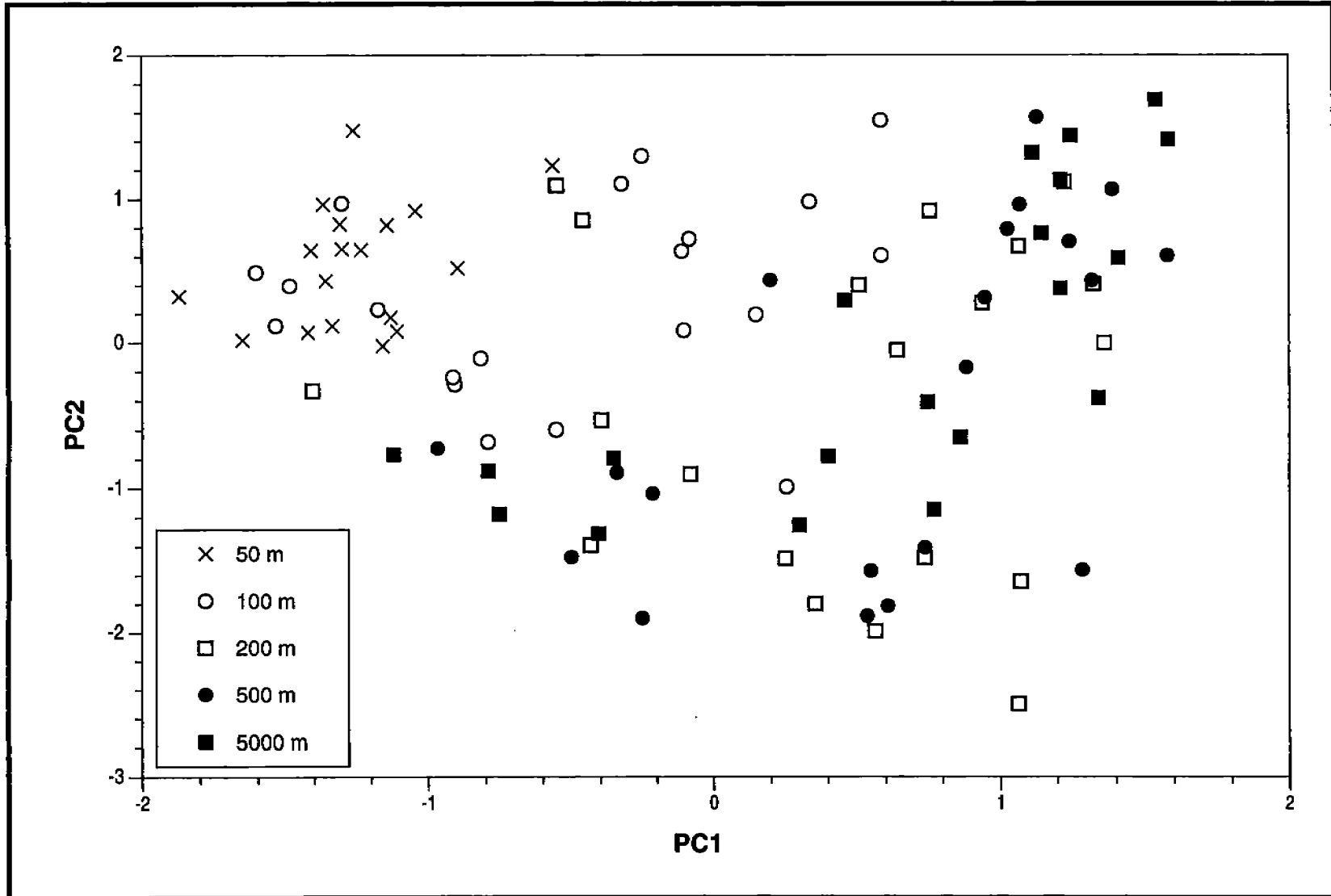

Figure 6.26. Principal components analysis (PCA) of nematode species at HI-A389 by distance from the platform.

There was a uniform distribution of harpacticoid species at the shallowest platform, MAI-686. However, there were differences in community structure at the 50 and 100-m stations at the two deeper platforms (MU-A85 and HI-A389; Figures 6.22, 6.23, 6.25, and 6.26). A similar trend was also true for nematode species. The distribution at MAI-686 was partly uniform, but 50-m stations clustered together (Figures 6.21 and 6.23). The 50 and 100-m stations clustered together for the deeper water platforms, MU-A85 and HI-A389 (Figures 6.22, 6.23, 6.25, and 6.26). Meiofaunal community structure data is summarized and described in detail in Section 5.4.3.

6.4.1.3 Nematode Trophic Dynamics

Nematodes are sensitive to contaminants such as PCBs, PAHs, and metals (Tietjen and Lee 1984). Nematodes are used in bioassays, because their population size decreases in the presence of contaminated sediments (Tietjen and Lee 1984). Natural populations of nematodes are also thought to be controlled by predation from macroinfaunal deposit feeders and a variety of macroepifauna (Li et al. 1995a,b). Macroinfaunal deposit feeders may engulf nematodes as they process sediment. Therefore, a decrease in macroinfauna abundance in a contaminated environment may relax predation pressures on nematodes. Thus, the abundance of nematodes may actually increase, although nematode diversity may decrease in a contaminated environment (Bouwman et al. 1984). Predation pressure may be a stronger force in structuring nematode populations than environmental parameters such as food availability and temperature (Li et al. 1995a,b). In estuarine habitats, nematode abundance is thought to increase with a gradient of increasing sediment grain size (van Damme et al. 1980; Li and Vincx 1993). The reason for this trend may be that deposit-feeding macroinfauna abundance increases in muddy sediments. Because nematode abundance follows an inverse relationship with these deposit feeders, due to predation, nematodes are often more abundant in sediment with large particle sizes. Nematode trophic relationships based on biomass calculations are summarized and described in detail in Section 5.4.4.

Multiple analysis of variance (MANOVA) was performed to determine if the trophic structure of the nematode community changed over the entire

study design (Table 6.45). Every term in the model was significant, so by-platform analyses were performed in a multivariate mode. The results for density (Table 6.46) and biomass (Table 6.47) of feeding groups were the same. All the interaction terms at every platform were significant (Tables 6.46 and 6.47). The significant interactions make the MANOVA difficult to interpret. At HI-A389, there were D*R interactions for both density and biomass. The patterns at MAI-686 were easier to interpret, because the D*R interactions were not significant for density and biomass.

Sediment grain size decreased with distance away from a platform. Sand content was higher in the near-field, while silt and clay content was higher at the far-field. **Nematode biomass and density also decrease with distance from a platform. The trend in nematode abundance and biomass may be related to predation by macroinfaunal deposit feeders.** Near the platforms, the dominant macroinfauna were *Cirratulus cirratus*, *Tharyx* cf. *annulosus*, *Paraprionospio pinnata*, and *Mediomastus californiensis*. These species were predominantly surface deposit feeders (Fauchald and Jumars 1979). Surface deposit-feeders should not exert as intense predation pressures as deposit-feeders that live deeper in the sediment. Nematodes are generally affected by surface deposit feeders to sediment depths of less than 1 cm (Warwick and Gee 1984). Densities and biomass were measured to a depth of 2 cm in this study. Therefore, even though macroinfauna abundance increased with proximity to a platform, predation on nematodes did not correspondingly increase.

Additional evidence to support this theory comes from analyzing individual platform. MAI-686 had the highest sand content and the lowest silt and clay contents. Nematode abundance was higher at MAI-686 than at the other two platforms. Therefore, the abundance and distribution patterns of nematodes around platforms were not due to platform-mediated contamination by PAHs or trace metals. Instead, the sediment grain-size gradient may have resulted in decreased predation pressures on nematodes by deposit-feeding macroinfauna (Li et al. 1995a,b). Therefore, nematode abundance and biomass may not be as good an indicator of platform contamination effects as nematode diversity.

The proportion of different nematode feeding types in a community is influenced by environmental factors, particularly sediment grain size (Wieser 1953). The importance of grain size in structuring nematode communities

Table 6.45. Multiple analysis of variance for nematode feeding groups for the overall study design.

A. Dependent Variables^a: $\log_{10}(1A \text{ density} + 1) \log_{10}(1B \text{ density} + 1) \log_{10}(2A \text{ density} + 1) \log_{10}(2B \text{ density} + 1)$

Source	Error	Pillai's Trace	F	Numerator DF	Denominator DF	Pr > F
C	C*R(P)	1.1000	5.0627	12	105	0.0001
P	R(P)	1.3726	5.4691	8	20	0.0010
P*C	C*R(P)	1.1649	2.4655	24	144	0.0005
D	D*R(P)	1.0851	4.4668	16	192	0.0001
C*D	MSE	0.2638	2.5541	48	1736	0.0001
P*D	D*R(P)	1.0914	2.2515	32	192	0.0004
P*C*D	MSE	0.4142	2.0775	96	1736	0.0001
R(P)	MSE	0.4781	4.9093	48	1736	0.0001
C*R(P)	MSE	0.3624	1.2011	144	1736	0.0586
D*R(P)	MSE	0.8491	2.4367	192	1736	0.0001

B. Dependent Variables = $\log_{10}(1A \text{ biomass} + 1) \log_{10}(1B \text{ biomass} + 1) \log_{10}(2A \text{ biomass} + 1) \log_{10}(2B \text{ biomass} + 1)$

Source	Error	Pillai's Trace	F	Numerator DF	Denominator DF	Pr > F
C	C*R(P)	1.1846	5.7099	12	105	0.0001
P	R(P)	1.1775	3.5791	8	20	0.0098
P*C	C*R(P)	1.2002	2.5720	24	144	0.0003
D	D*R(P)	0.9410	3.6917	16	192	0.0001
C*D	MSE	0.2119	2.0234	48	1736	0.0001
P*D	D*R(P)	1.0744	2.2033	32	192	0.0006
P*C*D	MSE	0.3650	1.8157	96	1736	0.0001
R(P)	MSE	0.3995	4.0132	48	1736	0.0001
C*R(P)	MSE	0.3763	1.2519	144	1736	0.0271
D*R(P)	MSE	0.8080	2.2886	192	1736	0.0001

^aThe four feeding groups are: selective deposit feeders (1A), non-selective deposit feeders (1B), epigrowth feeders (2A), and predators (2B). The model is: $1A \ 1B \ 2A \ 2B = C \ P \ C*P \ D \ C*D \ P*D \ C*P*D \ R(P) \ C*R(P) \ D*R(P)$ where P, D, and C are fixed, and R is random. Table finds P value for the Pillai's Trace statistic for the null hypothesis that there are no differences in feeding group structure for the source of variation. A. Log density+1. B. Log biomass+1.

Table 6.46. Multiple analysis of variance for nematode density by feeding group by platform.

A. Platform: MAI-686, Dependent Variables^a: $\log_{10}(1A \text{ density} + 1)$ $\log_{10}(1B \text{ density} + 1)$
 $\log_{10}(2A \text{ density} + 1)$ $\log_{10}(2B \text{ density} + 1)$

Source	Error	Pillai's Trace	F	Numerator DF	Denominator DF	Pr > F
C	C*R	1.6372	3.3038	12	33	0.0032
R	MSE	0.3195	2.1268	16	392	0.0069
C*R	MSE	0.7070	1.7533	48	392	0.0022
D	D*R	1.1643	1.6424	16	64	0.0830
C*D	MSE	0.8746	2.2853	48	392	0.0001
D*R	MSE	1.0313	2.1278	64	392	0.0001
C*D*R	MSE	1.7037	1.5148	192	392	0.0001

B. Platform: MU-A85, Dependent Variables: $\log_{10}(1A \text{ density} + 1)$ $\log_{10}(1B \text{ density} + 1)$
 $\log_{10}(2A \text{ density} + 1)$ $\log_{10}(2B \text{ density} + 1)$

Source	Error	Pillai's Trace	F	Numerator DF	Denominator DF	Pr > F
C	C*R	1.6372	3.1176	12	33	0.0048
R	MSE	0.1519	0.9674	16	392	0.4920
C*R	MSE	0.3802	0.8579	48	392	0.7380
D	D*R	2.0907	4.3800	16	64	0.0001
C*D	MSE	1.0746	2.9998	48	392	0.0001
D*R	MSE	0.8997	1.7775	64	392	0.0005
C*D*R	MSE	1.6475	1.4298	192	392	0.0017

C. Platform: HI-A389, Dependent Variables: $\log_{10}(1A \text{ density} + 1)$ $\log_{10}(1B \text{ density} + 1)$
 $\log_{10}(2A \text{ density} + 1)$ $\log_{10}(2B \text{ density} + 1)$

Source	Error	Pillai's Trace	F	Numerator DF	Denominator DF	Pr > F
C	C*R	1.2069	1.8508	12	33	0.0801
R	MSE	0.8633	6.6057	16	384	0.0001
C*R	MSE	0.7095	1.7249	48	384	0.0030
D	D*R	1.2680	1.8565	16	64	0.0423
C*D	MSE	0.8709	2.2267	48	384	0.0001
D*R	MSE	1.4530	3.4227	64	384	0.0001
C*D*R	MSE	1.7088	1.5565	184	384	0.0002

^aFor definitions see Table 6.45.

Table 6.47. Multiple analysis of variance for nematode biomass by feeding group by platform.

A. Platform: MAI-686, Dependent Variables^a: $\log_{10}(1A \text{ biomass} + 1)$ $\log_{10}(1B \text{ biomass} + 1)$
 $\log_{10}(2A \text{ biomass} + 1)$ $\log_{10}(2B \text{ biomass} + 1)$

Source	Error	Pillai's Trace	F	Numerator DF	Denominator DF	Pr > F
C	C*R	1.7459	3.8283	12	33	0.0011
R	MSE	0.3154	2.0971	16	392	0.0079
C*R	MSE	0.7187	1.7887	48	392	0.0016
D	D*R	1.1597	1.6332	16	64	0.0854
C*D	MSE	0.8495	2.2021	48	392	0.0001
D*R	MSE	0.8928	1.7599	64	392	0.0007
C*D*R	MSE	1.6110	1.3768	192	392	0.0044

B. Platform: MU-A85, Dependent Variables: $\log_{10}(1A \text{ biomass} + 1)$ $\log_{10}(1B \text{ biomass} + 1)$
 $\log_{10}(2A \text{ biomass} + 1)$ $\log_{10}(2B \text{ biomass} + 1)$

Source	Error	Pillai's Trace	F	Numerator DF	Denominator DF	Pr > F
C	C*R	1.6447	3.3374	12	33	0.0030
R	MSE	0.1883	1.2101	16	392	0.2568
C*R	MSE	0.3671	0.8252	48	392	0.7906
D	D*R	2.2990	5.4063	16	64	0.0001
C*D	MSE	0.8569	2.2264	48	392	0.0001
D*R	MSE	0.8220	1.5843	64	392	0.0048
C*D*R	MSE	1.5781	1.3303	192	392	0.0097

C. Platform: HI-A389, Dependent Variables: $\log_{10}(1A \text{ biomass} + 1)$ $\log_{10}(1B \text{ biomass} + 1)$
 $\log_{10}(2A \text{ biomass} + 1)$ $\log_{10}(2B \text{ biomass} + 1)$

Source	Error	Pillai's Trace	F	Numerator DF	Denominator DF	Pr > F
C	C*R	1.4381	2.5322	12	33	0.0172
R	MSE	0.7895	5.9022	16	384	0.0001
C*R	MSE	0.6877	1.6611	48	384	0.0053
D	D*R	1.1266	1.5684	16	64	0.1041
C*D	MSE	0.7710	1.9102	48	384	0.0005
D*R	MSE	1.3876	3.1871	64	384	0.0001
C*D*R	MSE	1.6900	1.5268	184	384	0.0003

^aFor definitions see Table 6.45.

seems to increase with depth, because the trend is very strong in the deep sea (Carman et al. 1987). In general, deposit feeders dominate at muddy habitats, composing up to 62 % of total nematode abundance, relative to only 11 % in sandy habitats (Wieser 1953). Epigrowth feeders and omnivore-predators dominate in sandy habitats and are rare in muddy habitats. Deposit-feeding nematodes utilize the same habitat as deposit-feeding macroinfauna, while epigrowth feeders utilize the same habitat as harpacticoids.

The proportion of deposit-feeding nematodes was lower and the proportion of epigrowth-feeding nematodes was higher at the nearer stations where there was more sand. Among platforms, deposit feeders were present in lower abundance and epigrowth feeders were present in higher abundance at the relatively sandy MAI-686 compared to the other platforms in the study. At MAI-686, epigrowth feeders composed 34 to 45 % of total nematode abundance and biomass relative to 19 to 30 % for the other platforms. Deposit-feeding nematodes composed 51 to 53 % of total nematode abundance and biomass compared to 64 to 70 % at the other platforms. These results support the idea that sediment grain size was important in determining nematode community structure.

At HI-A389 and MU-A85, the same trend was not apparent. HI-A389 had lower sand content than MU-A85, yet the proportion of deposit feeders and epigrowth feeders was not significantly different at the two stations. A possible explanation for this observation was that HI-A389 had higher levels of sediment contaminants than MU-A85. The relatively smaller percent of epigrowth feeders at HI-A389 may have been related to a contaminant effect on nematode-feeding type composition.

The relationship between total nematode density, biomass, and sediment type may be correlated with a contaminant effect or a water depth effect. MAI-686 had the highest total nematode abundance, the highest abundance of epigrowth feeders, and the lowest abundance of deposit feeders. MAI-686 was also the shallowest and had the lowest trace metal concentrations of the platforms in this study. Nematode abundance and feeding type composition at MAI-686 could have been due to the combined effects of low trace metal concentrations, high sand composition, and shallow water depth. The trend of nematode feeding types indicated a platform and a sediment grain-size effect.

The distribution of harpacticoids around platforms did not follow the same trends as the nematodes. Harpacticoids were predominantly epigrowth feeders, and would be expected to be more common in sandy sediments. However, at all three platforms, sand composition was higher in the near-field, while harpacticoid abundance was higher in the far-field. Proximity to a platform seemed to decrease the abundance of harpacticoids. Most diversity indices are sensitive to samples size, so the significance of the harpacticoid diversity trends are less than for nematode diversity. The best bio-indicators of platform contaminant effects, at the meiofauna level, are harpacticoid abundance and nematode species diversity.

6.4.1.4 Predation Pressure on Meiofauna

To provide insight into the possible effects of grazing on meiofauna abundance and biomass, stomach contents of selected small fish were examined. Fish predator data is summarized in Section 5.4.2.1. Five of the eight species examined were pelagic feeders, and were not feeding primarily on the benthos. Four species occasionally ate meiofauna. *Prionotus stearnsi* fed upon some nematodes and ostracods, but this species fed primarily on pelagic organisms, mainly small fish. Eighty-eight (88) specimens of *P. stearnsi* were collected, averaging 8.1 cm in length. *Cynoscion arenarius* was a pelagic feeder that ate mostly calanoids. The average size of the 84 specimens dissected was 8.3 cm. *Hoplunnis* sp. ate mostly pelagic fish and macrofaunal polychaetes. The average length was 34.2 cm and 11 fish were dissected. *Saunida brasiliensis* fed mostly on fish, calanoids, amphipods, and shrimp. The sample size was 101 individuals and the average length was 6.6 cm.

The total amount of food collected in stomachs was generally not a function of fish size. An analysis of covariance was performed by fish species, where the stations were all considered different. Only two fish, *Saunida brasiliensis* and *Syacium gunteri*, had significant covariate coefficients (Table 6.48). This means that for these two fish, larger fish ate more prey. In some cases, fish were only found at one station (df=0 in Table 6.48), so the model decomposes to a linear regression.

Four species of fish were found in sufficient abundances to perform Near versus Far comparisons to determine if **more prey items were taken**

Table 6.48. Analysis of covariance on fish stomach contents. All stomach contents were pooled. Each platform*station combination was treated as a separate station, thus the design reduces to a one-way ANCOVA,

Fish Species	Source	df	F	P
<i>Cynoscion arenarius</i>	Station	0	-	-
	Length	1	0.12	0.7315
<i>Halieutichthys aculeatus</i>	Station	3	5.21	0.0020
	Length	1	0.61	0.4353
<i>Hoplunnis sp.</i>	Station	0	-	-
	Length	1	0.52	0.4883
<i>Ogcocephalus radiatus</i>	Station	0	-	-
	Length	1	0.50	0.6088
<i>Prionotus stearnsi</i>	Station	2	0.18	0.8315
	Length	1	0.01	0.9069
<i>Saunida brasiliensis</i>	Station	2	0.31	0.7328
	Length	1	5.32	0.0232
<i>Syacium gunteri</i>	Station	1	0.35	0.5569
	Length	1	11.91	0.0008
<i>Synodus foetens</i>	Station	1	0.11	0.7433
	Length	1	0.24	0.6289

near platforms. In all cases, the stomach contents of fish from the Near and Far stations were similar. Only one fish, *Halieutichthys aculeatus*, had different stomach contents among stations (ANCOVA, Table 6.45). The difference was due to more prey items at MU-A85 (average total of 3.60 prey/fish) than at MAI-686 (average total 1.60 prey/fish).

6.4.2 Reproduction and Life History

Harpacticoid life history is complex, but reproductive parameters are easy to measure (Webb and Montagna 1993). Harpacticoids undergo five naupliar stages and six copepodite stages before they reach maturity, cohorts are easy to identify. The sixth copepodite stage is the mature adult, and the adults are sexually dimorphic. Whereas sex ratios of mature adults are sometimes 1:1, more often females predominate. Copepods brood their

eggs and have multiple broods, thus embryos can be easily counted and measured for size differences at the platform and comparison sites, and through time. Harpacticoids generally have between four to twenty broods per individual, with four to thirty eggs in each clutch (Hicks and Coull 1983). Egg diameters are in the range of 20 to 150 μM . Adult harpacticoid body lengths are between 0.3 to 1.5 mm, the smaller sizes being interstitial, the larger sizes being epibenthic.

Two breeding patterns exist: (1) continuous breeders, where eggs are produced throughout the year and (2) discontinuous, where breeding is restricted to seasonal events. Subpopulations of one species have been shown to have different reproductive patterns, although separated by only 8 m (Palmer and Coull 1980). It is not known why harpacticoids exhibit such variable life history patterns. One hypothesis suggests food availability and differential capability of various species to exploit these resources are important (Hicks 1979).

Development rates are influenced by temperature, food supply and salinity. Development times will increase with lower temperatures (Feller 1980; Palmer and Coull 1980). A complete life cycle (Hatch to Hatch) can take from 11 days at 20 °C to 36 days at 8 °C (Muus 1967). Hicks and Coull (1983) reviewed 31 studies and found all development times less than 42 days except one study that took 167 days (Feller 1980). Development times and rates of estuarine harpacticoids are modified by changes in salinity (Hicks and Coull 1983). All of the studies were performed in the laboratory with estuarine species. Development rates are unknown for Gulf of Mexico shelf species. However, salinity is constant, temperatures vary within a narrow range, and the food supply decreases along a gradient away from Mississippi River influence. Gravid females and juveniles were found continuously throughout the year (Webb and Montagna 1993). Data related to meiofauna reproduction is summarized and described in detail in Section 5.4.5.

6.4.2.1 Reproduction

Measures of reproductive effort (total egg volume in a clutch) were compared for Near and Far stations for the three study sites for all gravid females encountered. Clutch volumes were significantly ($P = .014$) larger for

Far stations than at Near stations for MAI-686 (Figure 6.27). Mean clutch volume was also greater at the Far than Near stations at MU-A85, however, the lower sample size ($n = 39$) was probably responsible for the lack of significance. At HI-A389, Near and Far stations did not follow the same trends as MAI-686 and MU-A85. HI-A389 Near stations had greater clutch volume than Far stations, although sample size was low ($n = 16$ individuals; Figure 6.27). **The reduced clutch volumes at near stations may be a function of diverted energies from growth and maintenance to detoxification of contaminants.** This diversion of energies results in lower availability of resources for reproductive efforts and subsequently reduces clutch volumes. Reduced brood sizes and total reproductive production have been demonstrated in mesocosm studies using the water soluble fraction of Louisiana crude oil on harpacticoida copepod, *Nitocra affinis*. In all oil-contaminated tanks, reproductive efforts were diminished relative to control values (Ustach 1979). This same relationship may be occurring at MAI-686 and MU-A85 Near stations.

MU-A85 and HI-A389 Near stations did have slightly reduced clutch size differences relative to Far stations, they were not statistically significant (Figure 6.28). A significant relationship between clutch size and water depth may be explained by changes among the benthic habitats found at the three different water depths. **Therefore the variation in clutch size may actually be a function of varying species structure within each community, since slightly different mean clutch sizes were found for all platforms.**

6.4.2.2 Life History Characteristics

Analysis of life history characteristics was performed on all harpacticoids encountered in the study. Harpacticoids were identified as females, gravid females, males, and copepodites. All nauplii and copepodite stages (C1 to C5) were assigned in a single category, copepodites. With all three platforms combined (HI-A389, MU-A85, and MAI-686), Far station densities were significantly greater for harpacticoid females ($P = 0.0001$), males ($P = 0.0001$), and copepodites ($P = 0.0001$; Table 6.49; Figure 6.29). Using the same analysis, gravid female densities were significantly larger at Near stations relative to Far stations ($P = 0.0001$; Table 6.50).

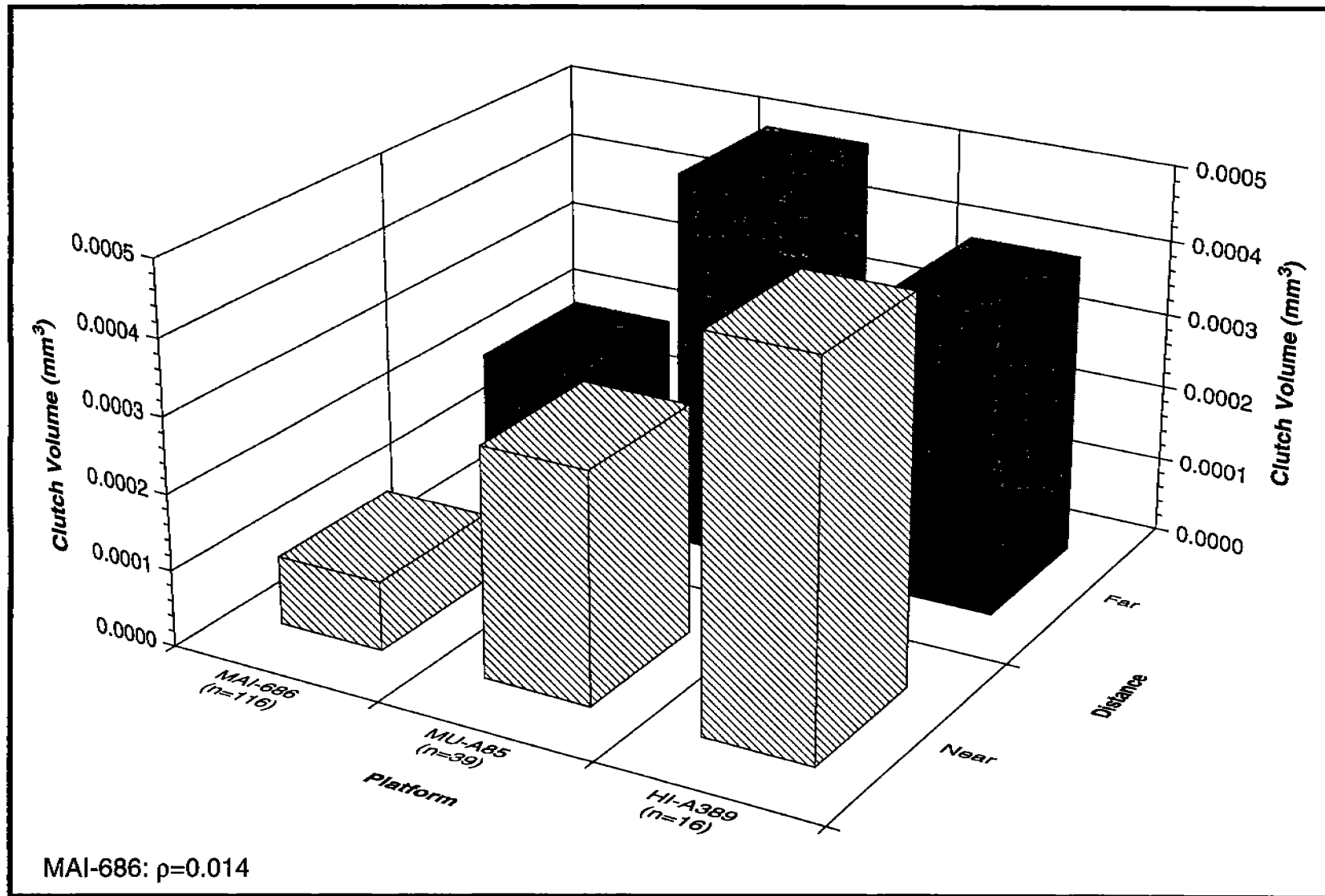

Figure 6.27. Mean reproductive effort among all cruises, platforms, and three species. Reproductive effort is the total clutch volume (mm³).

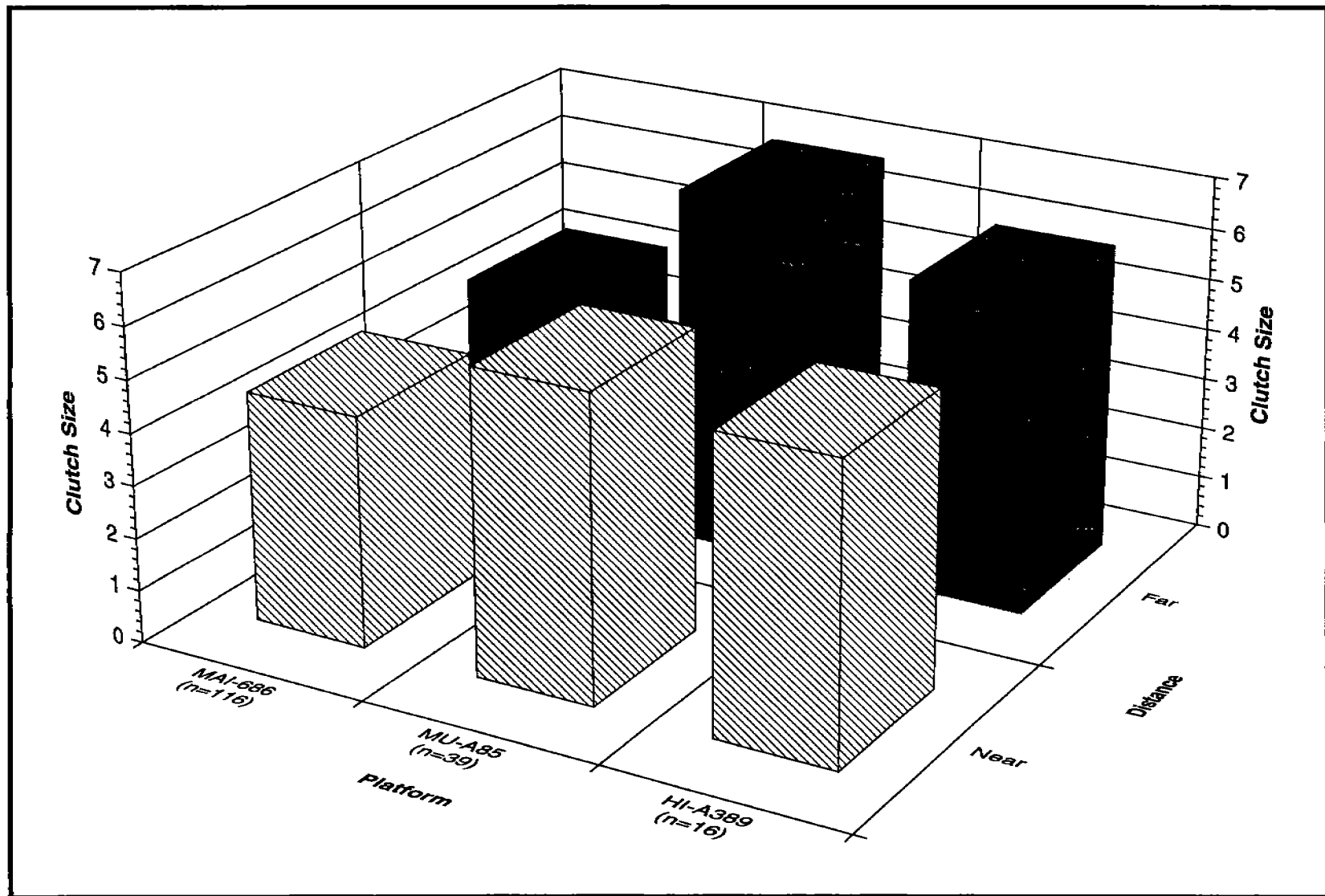

Figure 6.28. Average clutch size among all cruises, platforms, and three species. Clutch size is the number of eggs per female.

Table 6.49. Life history stage densities for all harpacticoids.

Stage	pa	Station Mean Density	
		Near	Far
Females	0.0001	8.47	13.27
Gravid Females	0.0001	0.85	0.41
Males	0.0001	5.83	8.66
Cop.	0.0001	10.57	15.15

^aTwo-way ANOVA was performed and P values for station differences is given, with mean density (n/core) and platforms were pooled.

Table 6.50. Life history stages for all harpacticoids by platform.

Stage	MAI-686 ^a		MU-A85 ^a		HI-A389 ^a	
	P	Station	P	Station	P	Station
Female	0.0001	Far	0.9513	Near	0.960	Far
Gravid Females	0.881	Near	0.0002	Near	0.006	Near
Males	0.0001	Far	0.348	Near	0.045	Near
Cop.	0.0003	Far	0.918	Near	0.390	Far

^aOne-way ANOVA was performed to determine station (Near and Far) differences. P value for station differences is given and the station with larger mean density is reported.

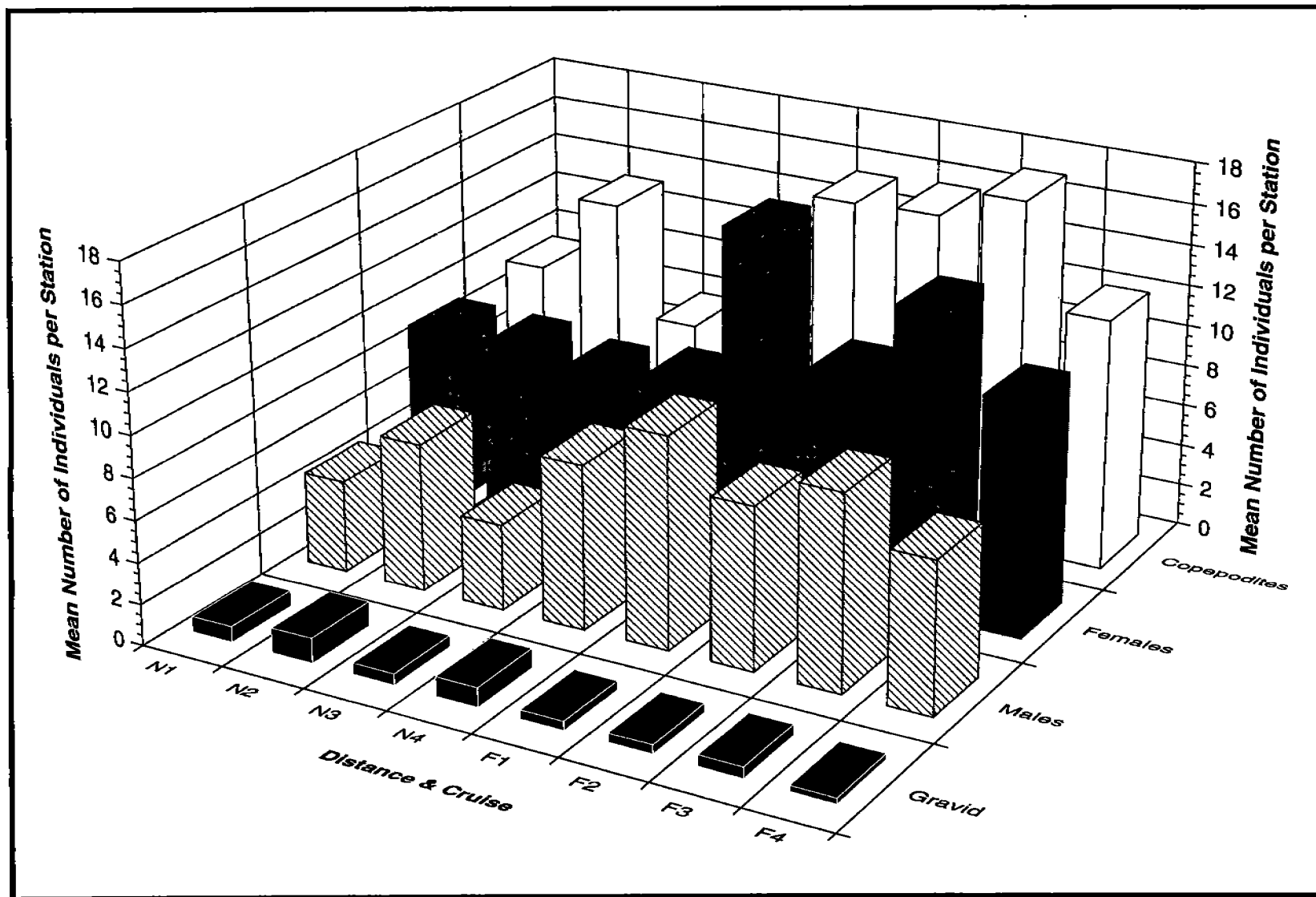

Figure 6.29. Harpacticoid life history stages mean density ($n \times \text{core}^{-1}$) for all platforms, cruises, stations, and species.

Between station (Near and Far) differences were further analyzed by site (Figures 6.30 to 32). The density of gravid females was significantly more abundant at Near than at Far stations at HI-A389 ($P=0.006$) and MU-A85 ($P=0.0002$). Also, significantly higher densities at Near stations were found for males ($P=0.045$) at HI-A389 and males and females at MAI-686 ($P=0.0001$). Densities of copepodites were significantly larger at the Far stations of MAI-686 (Table 6.50).

Analysis was then performed on the proportion that each life history stage represents of the total population. Population composition was examined to reduce the possibility that larger sample sizes would skew mean values. With data from all three study sites combined, significant ($P=0.0001$) station differences were found for all life history proportions (Table 6.51; Figures 6.33). In this analysis, gravid females and males constituted larger proportions of the populations at Near relative to Far stations. Copepodites' and females' life history stage proportions were significantly larger at Far relative to Near station.

Table 6.51. Population composition for all harpacticoids.

Stage	pa	Mean % Composition	
		Near	Far
Female	0.0001	0.35	0.35
Gravid Females	0.0001	0.03	0.01
Males	0.0001	0.23	0.21
Copepodite	0.0001	0.39	0.43

^aPlatforms were pooled and a two-way ANOVA was performed on life history stage proportions. P values are reported for Station differences and mean values.

Individual platforms were analyzed for between station (Near and Far) differences in population composition (Figures 6.34 to 6.36). Gravid females were significantly more abundant at Near stations than at Far stations at MAI-686 ($P = 0.001$), and MU-A85 ($P = 0.0001$; Figure 6.37). Significant proportion differences were also found for harpacticoid males at MAI-686 ($P=0.05$) and for both males ($P=0.011$) and copepodites ($P=0.034$) at HI-A389. Far stations had larger proportions of copepodites at HI-A389 and males at MAI-686. Composition of males at Near stations were larger at HI-A389 (Table 6.52).

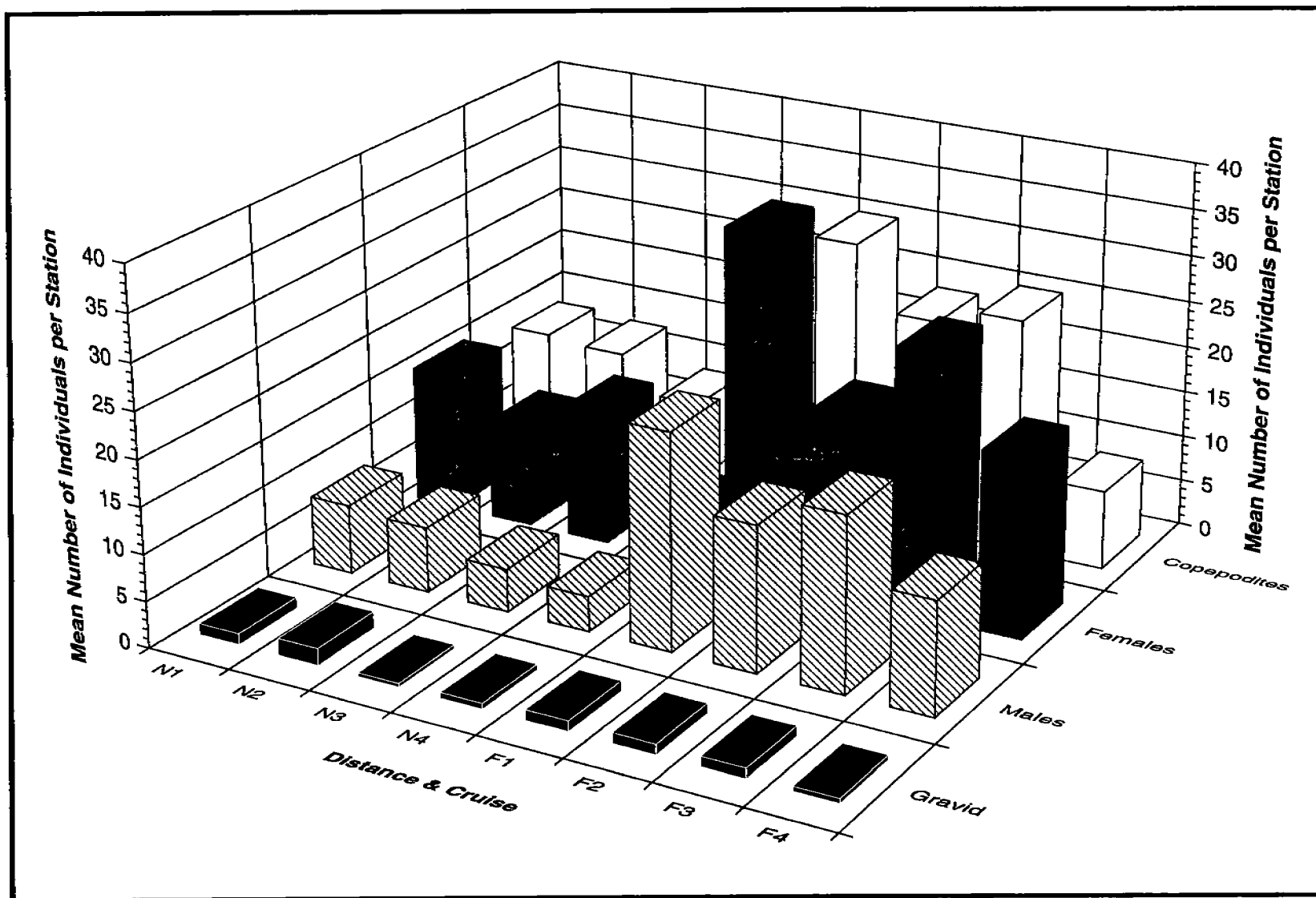

Figure 6.30. Harpacticoid life history stage density ($n \times \text{core}^{-1}$) for all cruises, stations, and species at MAI-686.

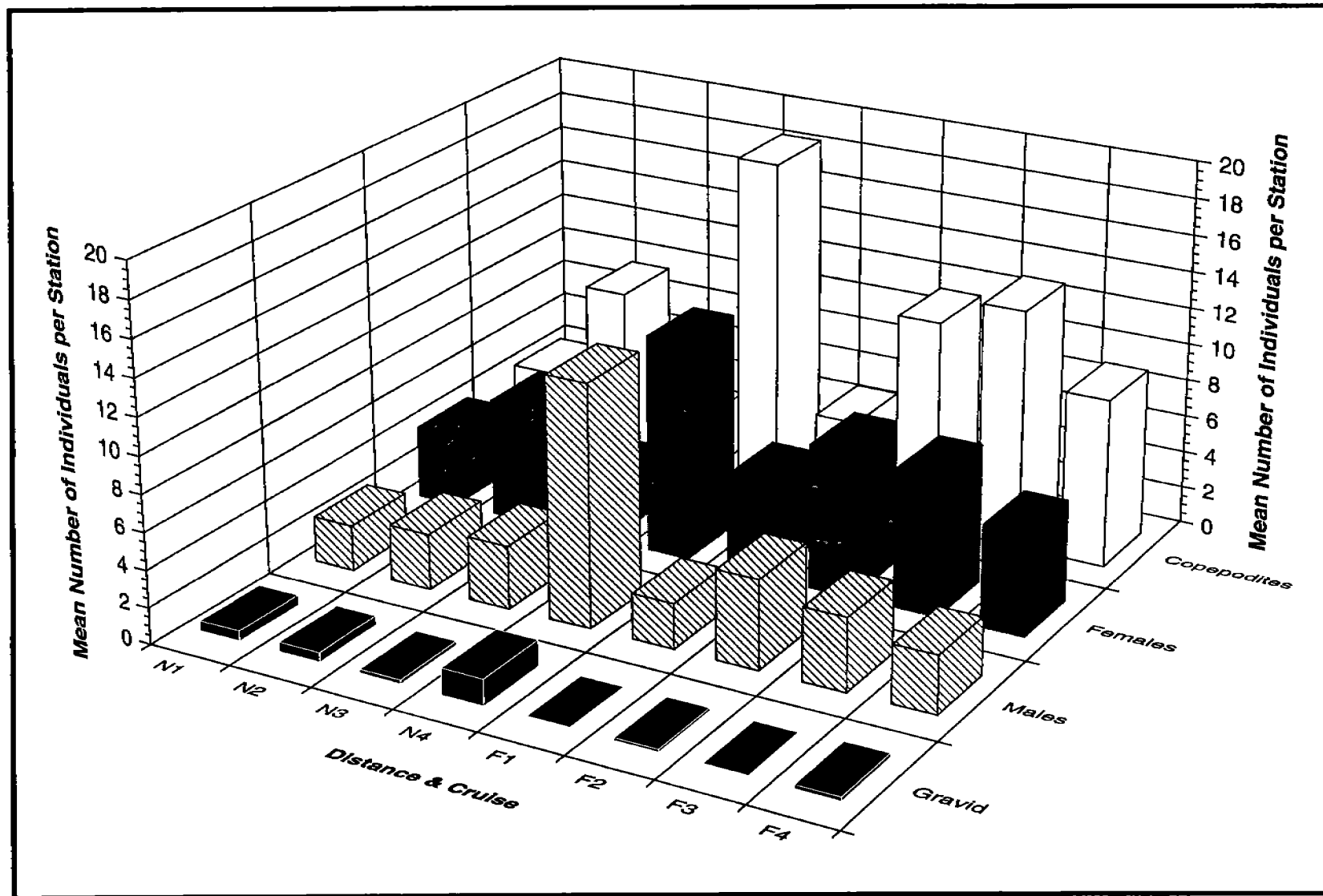

Figure 6.32. Harpacticoid life history stage density ($n \times \text{core}^{-1}$) for all cruises, stations, and species at HI-A389.

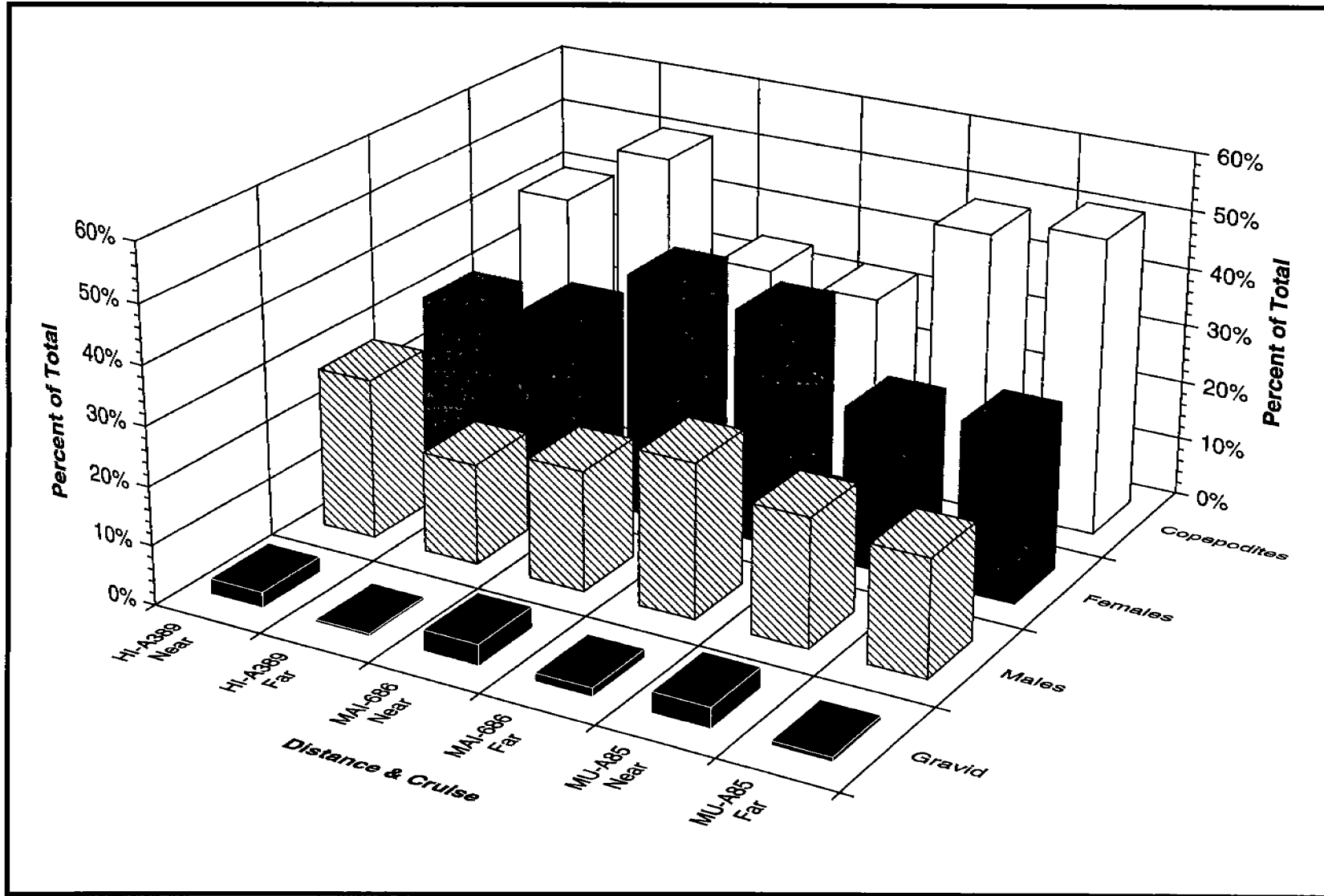

Figure 6.33. Harpacticoid life history percent composition for all platforms, stations, and species.

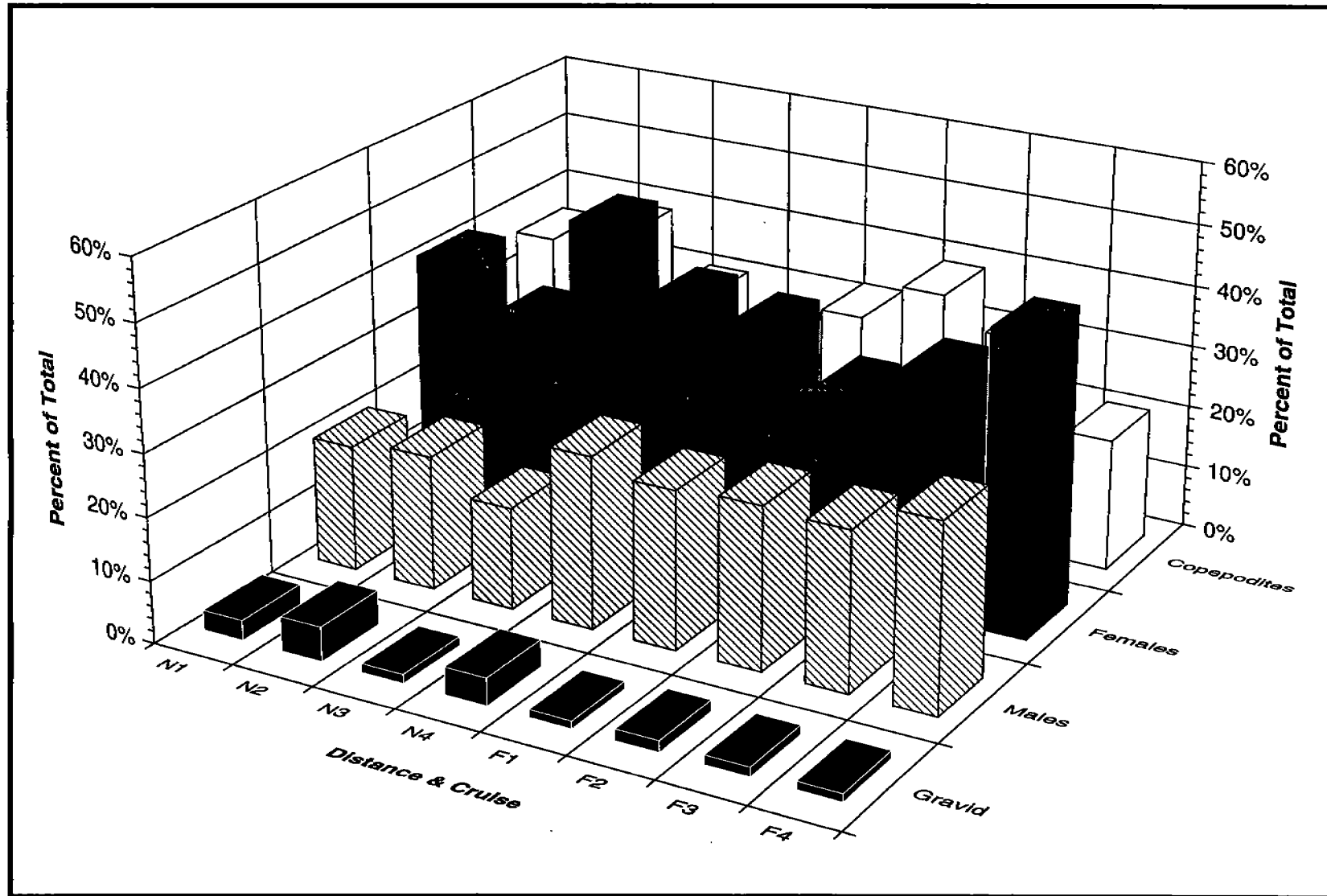

Figure 6.34. Harpacticoid life history stage percent composition for all cruises, stations, and species at MAI-686.

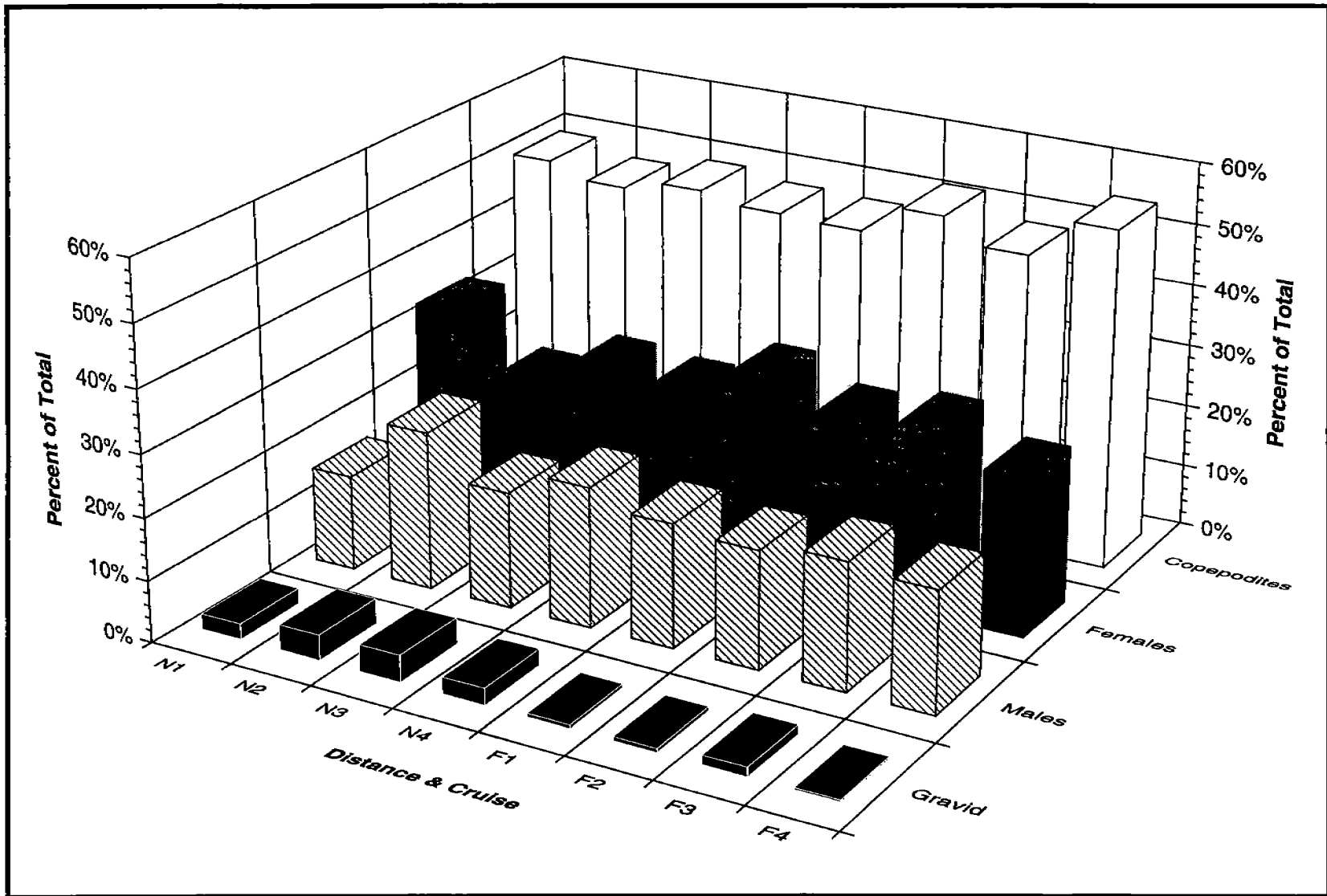

Figure 6.35. Harpacticoid life history stage percent composition for all cruises, stations, and species at MU-A85.

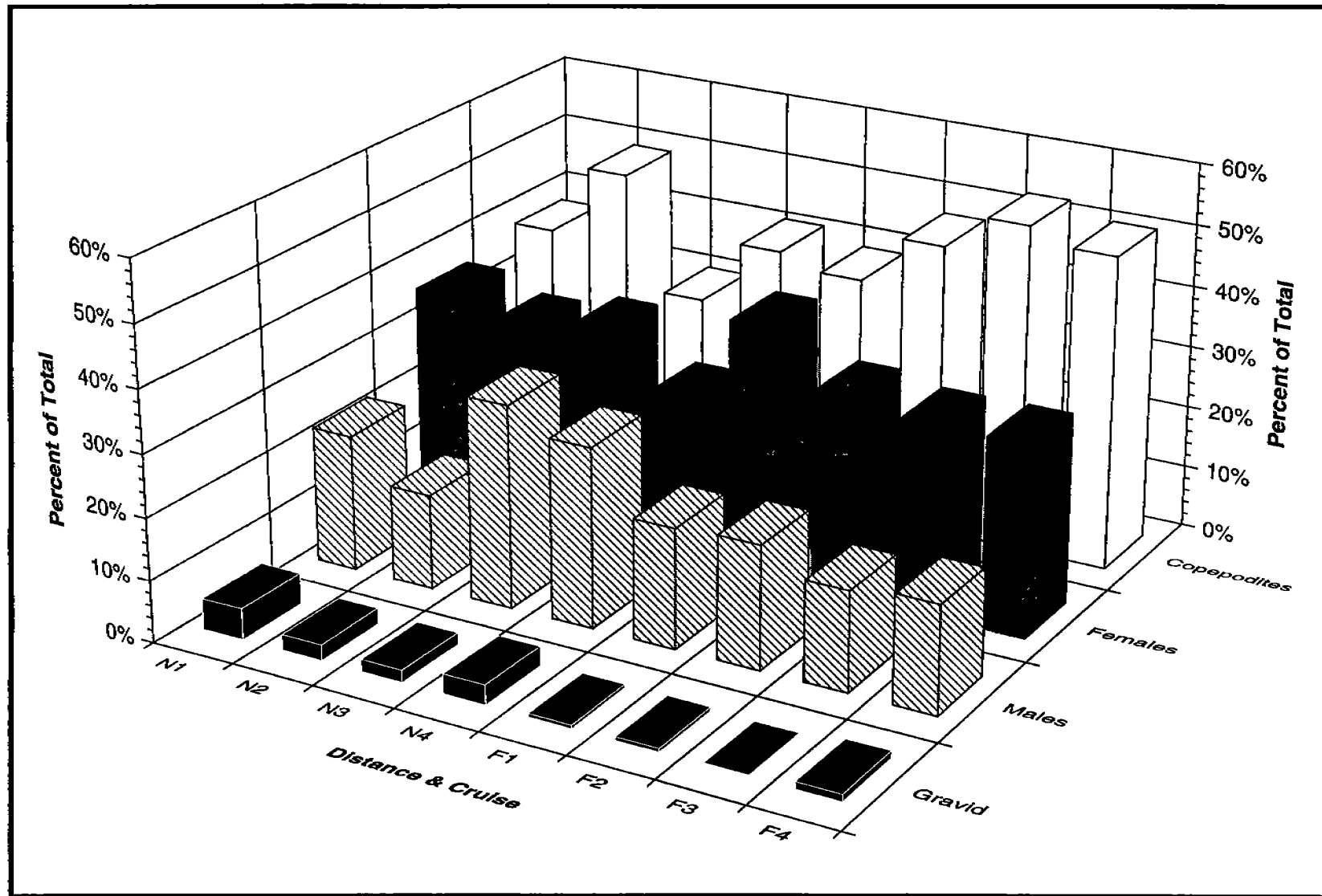

Figure 6.36. Harpacticoid life history stage percent composition for all cruises, stations, and species at HI-A389.

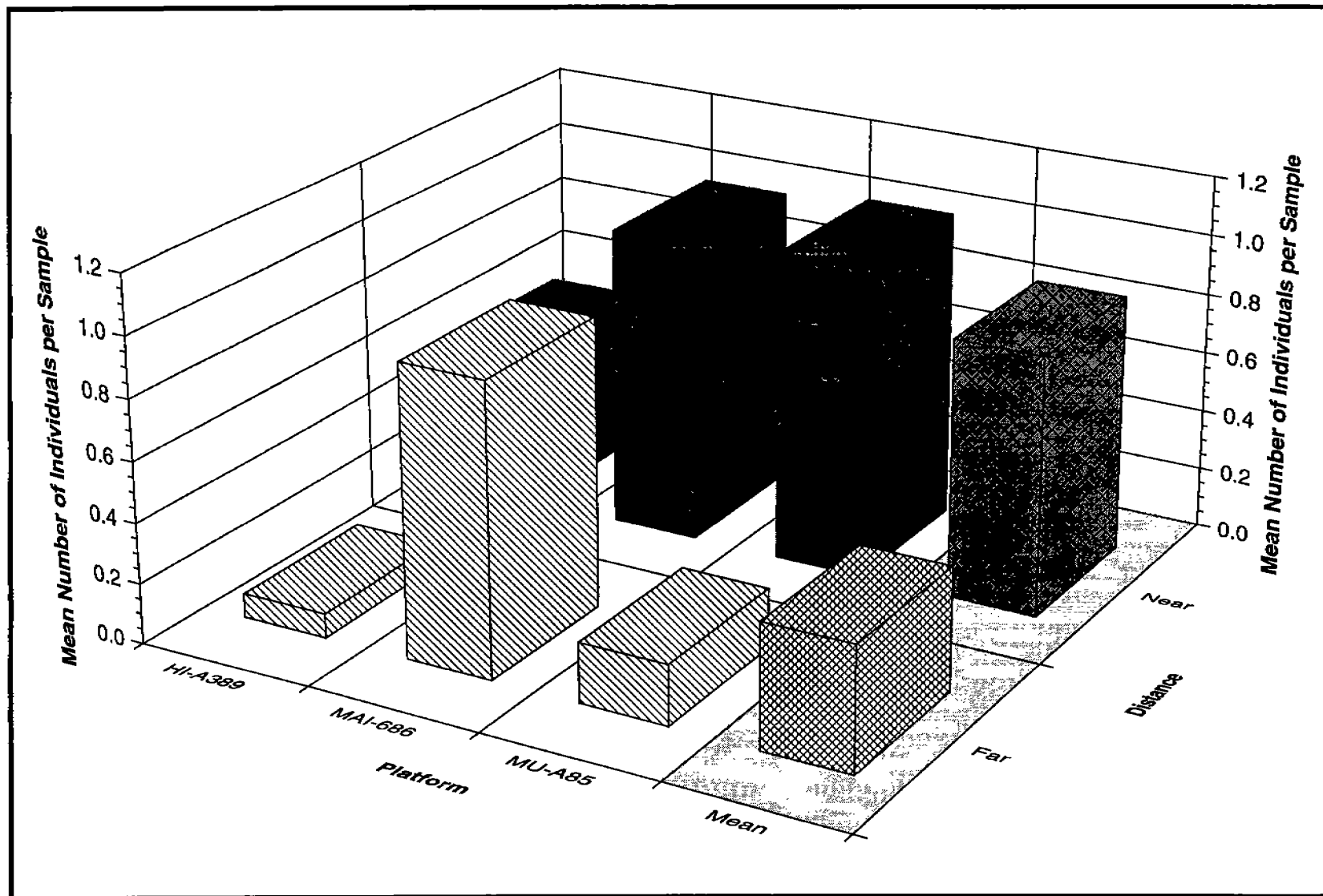

Figure 6.37. Mean density ($n \times \text{core}^{-1}$) of gravid harpacticoid females for all platforms, stations, and species.

Table 6.52. Population composition for all harpacticoids by platform.

Stage	HI-A389 ^a		MAI-686 ^a		MU-A85 ^a	
	P	Station	P	Station	P	Station
Female	0.861	Far	0.725	Near	0.856	Near
Gravid Females	0.0821	Near	0.001	Near	0.0001	Near
Males	0.011	Near	0.050	Far	0.523	Near
Copepodite	0.034	Far	0.520	Near	0.150	Far

^aOne-way ANOVA was performed by platform on life history stage composition to determine station (Near and Far) differences. P values for Station differences and the Station with larger mean are reported.

The mean density trend indicated that platforms were affecting harpacticoid abundance. However, life history stage composition was constant among platforms and between Near and Far stations. So, whatever is causing population reduction appeared to equally affect all life history stages. The significantly increased abundances of gravid females for Near stations could be attributed to organic enrichment from the platforms. Harpacticoids have been known to breed continuously in situations where exploitation of abundant food supplies is possible (Hicks 1979). Organic carbon levels are decreased near the platforms; however, this decrease is not in proportion to the dilution from the increased sand contents. Also, organic carbon loading from the platform could be in a labile form and its assimilation and regeneration by scavenger organisms would be rapid. This scenario suggests possible enhanced TOC (total organic carbon) production resulting from a concentration of organisms associated with the platforms. Likewise, TIC (total inorganic carbon) from biogenic debris, and possibly drill cuttings, increases near the platform. An overall increase in the amount of available carbon is consistent with abundant food resources that are highly labile. Labile organic carbon enrichment could be sufficient to drive a continuous breeding pattern for harpacticoids near platforms. Although this scenario seems plausible, increasing the availability of food resources has also been linked to overall increases in clutch size (Webb 1984). No significant difference in clutch size was found between Near and Far stations suggesting that enrichment is not driving continuous breeding strategies near the platforms. **Therefore, the increased density and proportion of gravid females found at Near stations for all three platforms was not a function of enrichment based on continuous breeding.**

Some studies suggest increased gravid female abundances may be latitudinally attributed to a continuous breeding pattern. A few meiofaunal species have been shown to reproduce throughout the year in tropical latitudes (Coull 1975). In contrast, Hicks (1977) cites studies that suggest a seasonal pattern in temperate latitudes, with most harpacticoid copepods exhibiting a breeding maximum in spring, summer, fall, or winter depending upon the species. The location of the study site on the "border" between temperate and tropical regions in the northern hemisphere may account for mixed breeding strategies. However, **increases in gravid female life history stage percentages found at Near stations cannot be explained by varying reproductive strategies between near and far stations on the basis of latitudinal differences.**

6.4.2.3 Body Size

Harpacticoid body sizes were compared between Near and Far stations for three selected species (*Diathrodes* sp., *Longipedia americana*, and *Cletodes pseudodissimilis*). Weighted body length means were used, because size differences between males and females exist. *Diathrodes* sp. showed no statistically significant differences in body size between stations at platforms MU-A85 ($P = 0.65$) and MAI-686 ($P = 0.14$). Weighted mean body size was 30 μM greater for *Diathrodes* sp. at MU-A85 than at MAI-686. Only one individual of *Diathrodes* sp. was found at HI-A389. *Longipedia americana* exhibited no statistically significant differences in body sizes between Near and Far stations for MU-A85 ($P = 0.55$), MAI-686 ($P = 0.46$), or HI-A389 ($P = 0.52$, Figure 6.38). *Longipedia americana* body sizes were relatively constant over all three platforms and between stations (Figure 6.39). Analysis of *Cletodes pseudodissimilis* was inhibited because no individuals were found at near stations for all platforms. *Cletodes pseudodissimilis* was found only at the MAI-686 Far station ($n = 40$) and at the HI-A389 Far station ($n = 1$; Figure 6.40).

6.4.3 Harpacticoid Genetic Diversity

The objective of this component was to determine if genetic differences in invertebrate populations can be used to detect and monitor chronic, sublethal effects of offshore platforms. **Generally, this approach is**

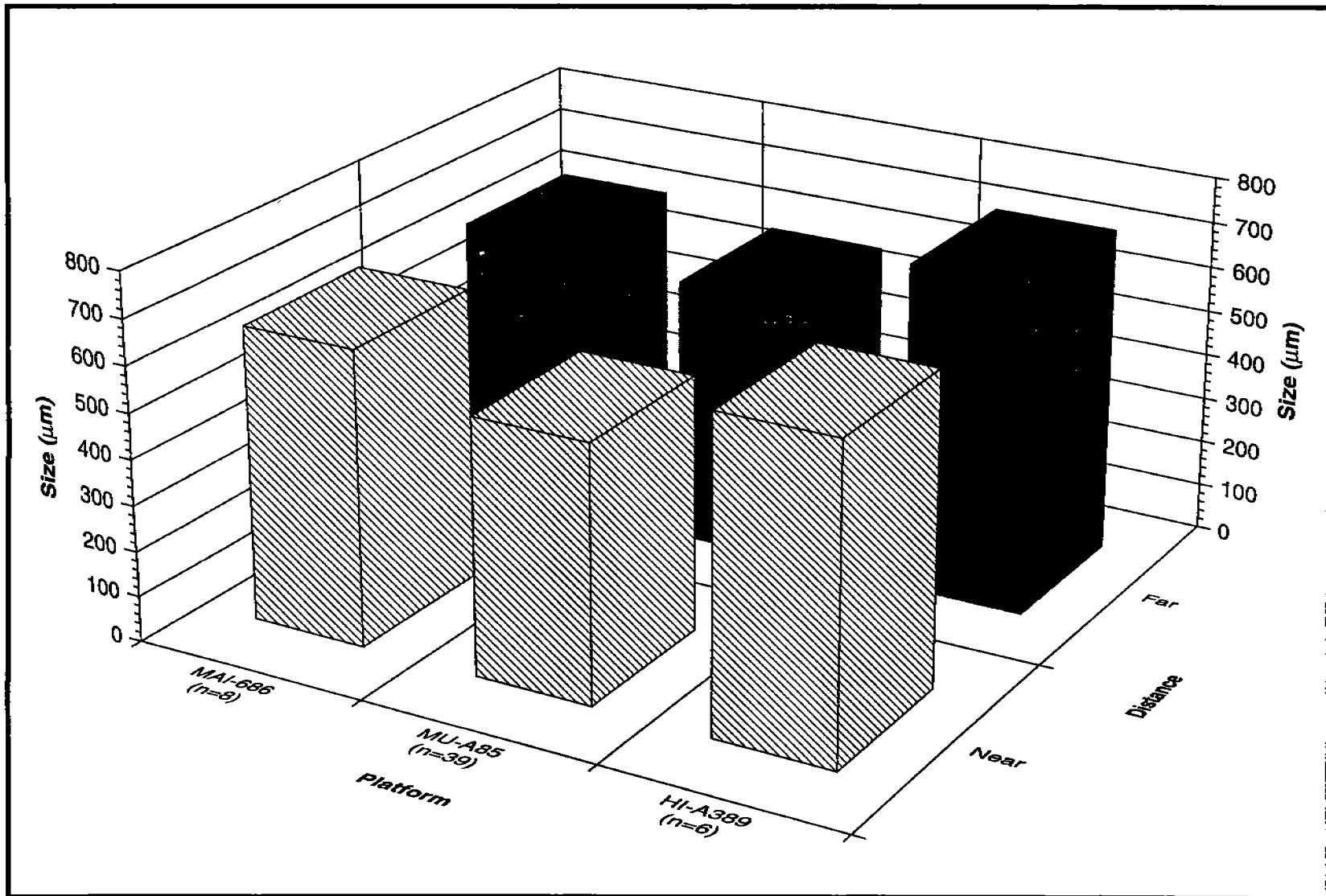

Figure 6.38. Mean body lengths (μm) of *Longipedia americana*, weighted for sexual differences, at all platforms and stations.

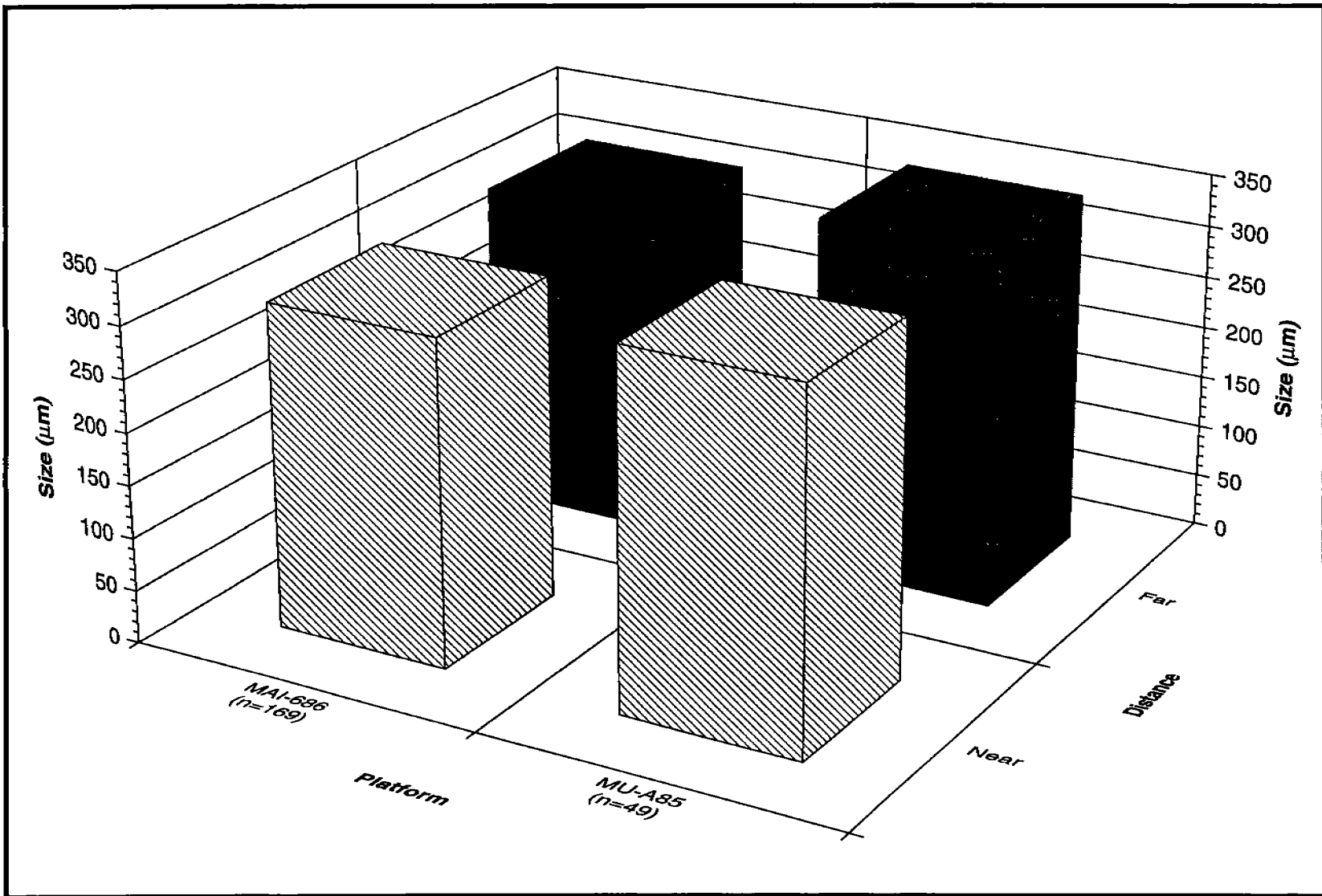

Figure 6.39. Mean body lengths (μm) of *Diathrodes* sp., weighted for sexual differences, at all platforms and stations.

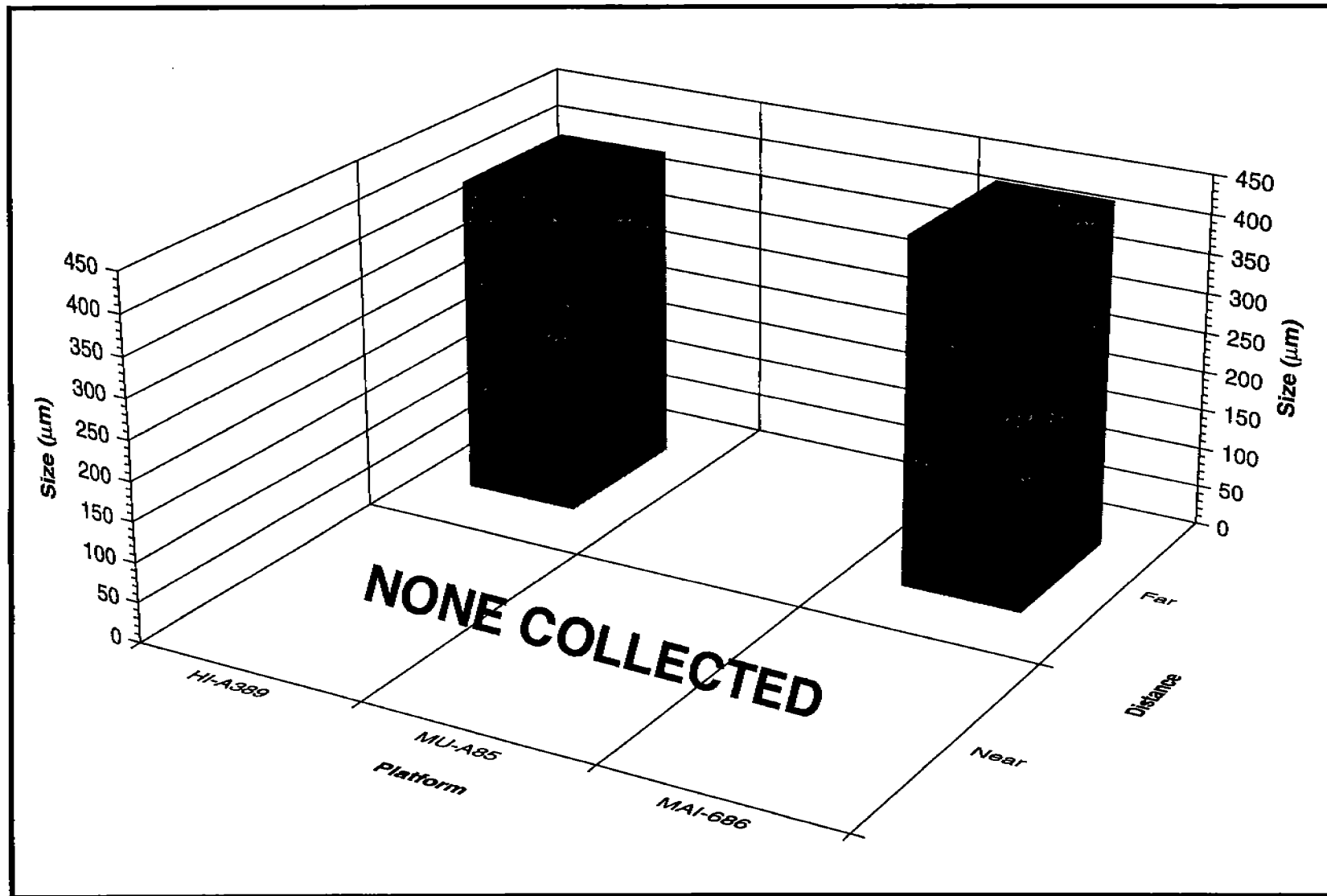

Figure 6.40. Mean body lengths (μm) of *Cletodes pseudodissimilis*, weighted for sexual differences, for all platforms and stations.

used to determine if selective pressures have increased due to a sublethal stress. Strong selective pressures may act to lower genetic variability by eliminating less fit phenotypes and the associated genotypes from a population (Awise 1994, Burton 1983). Human activities might potentially create selective pressures of this kind (Alberte et al. 1994; Levinton 1980; Murdoch and Hebert 1994). Long term stresses associated with offshore oil and gas platforms might act to reduce the levels of genetic variability in populations living close to the platforms. The primary hypothesis of this component was that populations at Near stations will have less genetic diversity than populations at the Far stations. Although it cannot be directly tested, it was assumed that increased natural selection at the Near stations would be responsible for this difference. A secondary hypothesis was that contaminants associated with offshore drilling and production can be correlated with this loss of diversity. Support for this hypothesis might suggest that contaminants can account for increased selection at Near stations.

The genetic diversity method is a novel approach to measure sublethal effects. Generally, sublethal effects are of two types. The first approach demonstrates a sublethal impact by quantifying a detoxification response. Examples of this approach are measuring cytochrome P450 or bile metabolite concentrations. An alternative approach is to look for changes in abundance, diversity, or size of supposedly impacted organisms. Examples of this approach are the macroinfauna and meiofauna components. The genetic approach does not target possible responses to a sublethal impact. However, if a population is responding to a sublethal stress, then natural selection may cause an impacted population to look different from non-impacted populations. The disadvantage of this approach is that virtually nothing is learned about the nature of the sublethal response (e.g., a detoxification response occurs or reproductive output decreases). However, the genetic approach is sensitive to a wide variety of sublethal impacts that might be overlooked by targeting selected responses.

The specific locus that was the focus of this study was the 16S (or large subunit) of ribosomal RNA (rRNA) of the mitochondrial genome. Mitochondrial DNA (mtDNA) is a useful marker for population studies. It evolves rapidly, relative to nuclear DNA, and is maternally inherited, thereby avoiding the confounding effects of recombination (Awise et al. 1987). It is

not suggested that the mtDNA genes are under rigorous selection because of platform effects. Rather, mtDNA diversity is serving as an indicator for population subdivisions that might occur because of selection operating on specific, but unidentified, alleles that are the products of nuclear genomes (Hedrick 1986). Frequency differences at the 16S mtRNA should be regarded as indicators of associated genome-wide differences. The usefulness of a genetic marker as an indicator of environmental quality is dependent primarily on a predictable frequency of change in a stressed population (Changon and Guttman 1989).

Results of the genetic variability study supported the primary hypothesis of this component. Genetic variability data is summarized and described in detail in Section 5.4.6. **In each of the 30 stations, populations of all five species were dominated by a single, nearly ubiquitous haplotype, and a series of unique haplotypes.** Halotype is defined as a region of DNA with a particular sequence and roughly corresponds to the "allele" of classic genetics (Nei 1987). A heavily skewed genotype frequency is consistent with observations from other populations of marine crustacea, including calanoid copepods (Bucklin, per. comm.), harpacticoid copepods (Burton and Feldman 1981), and decapods (Silberman et al. 1994). Despite the contribution of the dominant haplotype, values of halotype diversity (h) still varied from station to station. A multiple analysis of variance was performed on h for each species, using distance (Near vs. Far), platform (HI-A389, MAI-686 and MU-A85), and cruise (2 vs. 3) as main effects.

The h values for three species (*Normanella* sp., *Cletodes* sp., and *E. pericoense*) near a platform were approximately half the value of populations away from a platform (Figure 6.41). For *Normanella* sp., the h value of 0.199 at the Near stations was less than the value of 0.396 at the Far stations ($P = 0.0001$). *Cletodes* sp. showed a similar trend with h at Near stations of 0.188 and h at Far stations of 0.315 ($P=0.025$). The h value for *E. pericoense* was 0.170 Near and 0.343 Far from a platform ($P=0.014$). The other two species (*Robertsonia* sp. and *Tachidiella* sp.) had the same trend, but were not significantly different between Near and Far. The lack of significance was likely a function of the sample size, which was greater than 300 individuals for the three species that were significant, and less than 300 for the two species that were not significant.

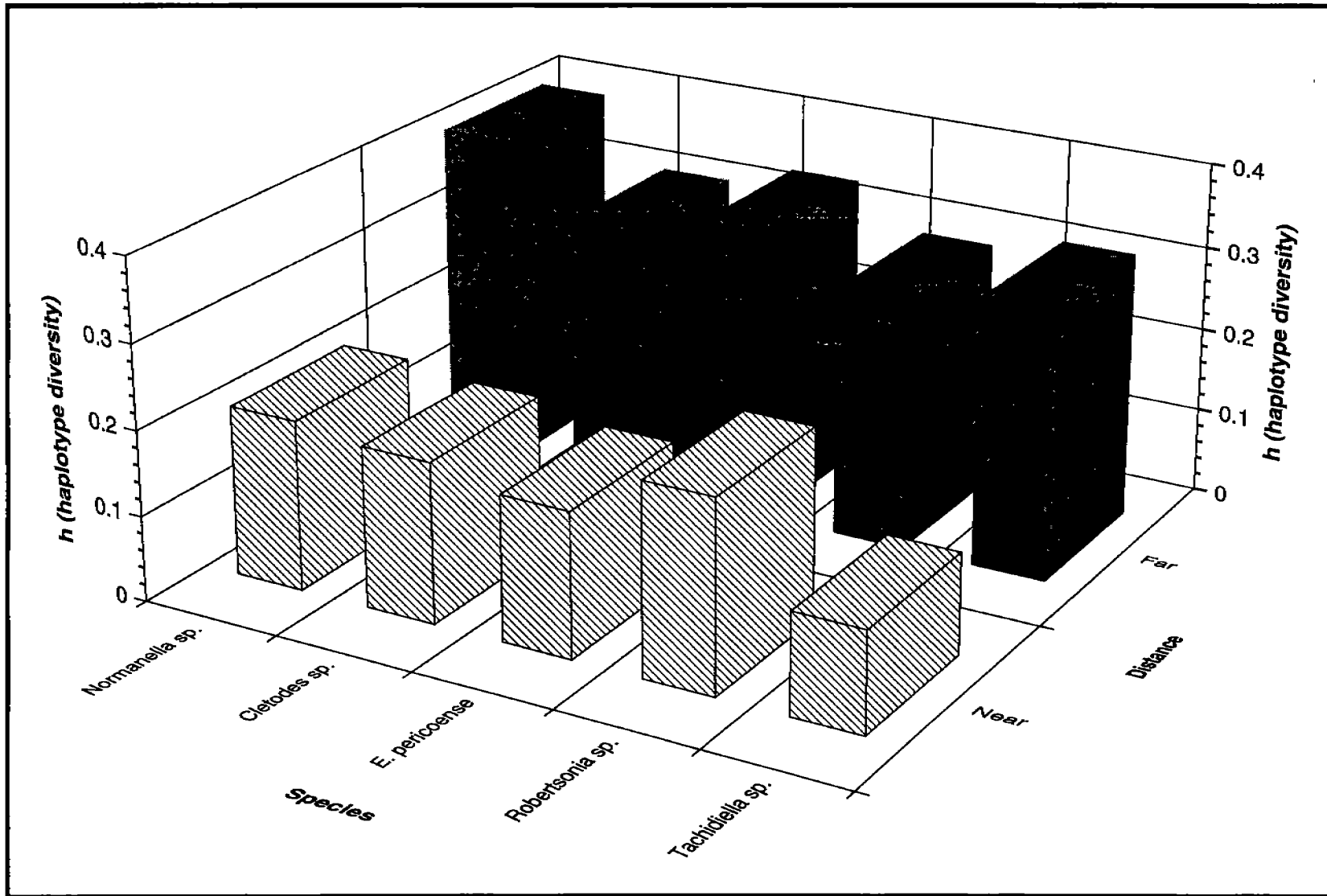

Figure 6.41. Genetic variability of harpacticoid copepods by species for all platforms and cruises.

There were no significant differences in h values among species or between distances by cruise (Figure 6.42). Similarity between cruises taken at different times of the year suggested that there was no seasonal effect for any of the five species. Values of h Near were different from values Far from a platform for all three platforms (Figure 6.43). However, there were no differences among the Near stations at any platforms, nor among the Far stations at any platforms. **Similarity at all the far stations suggests that the platforms are having an effect.** If populations were merely subdivided over large geographic scales (relative to the size of a copepod), then the Far stations at one platform might have a different level of haplotype diversity from those at another platform. **Differences in genetic diversity** (Table 6.53) suggested that offshore oil and gas platforms may have a chronic, sub-lethal impact on harpacticoid copepod populations. **A loss of genetic variability may reduce fitness by compromising a population's ability to respond to intense selection.**

Table 6.53. Summary of harpacticoid haplotype diversity.

Test	Difference ^a	p^a
Distance: near vs. far	Yes	0.001
Platform: all near stations	No	0.536
Platform: all far stations	No	0.444
Species	No	0.464
Cruise: 2 vs. 3	No	0.380

^aResults of tests for a significant difference.

6.4.4 Relationship to Environmental Variables

The observed patterns in meiofaunal distributions can be correlated to changes in the environment due to the presence of platforms. As described earlier, principal components analysis was performed on all sediment environmental variables to extract two principal components axes (PCA) to describe variability in the environmental data. ChemPC1 is related to distance, which represents the contaminant and sand gradients associated with platforms. ChemPC2 is related to differences between platforms including hydrographic setting. This setting is mostly controlled by the

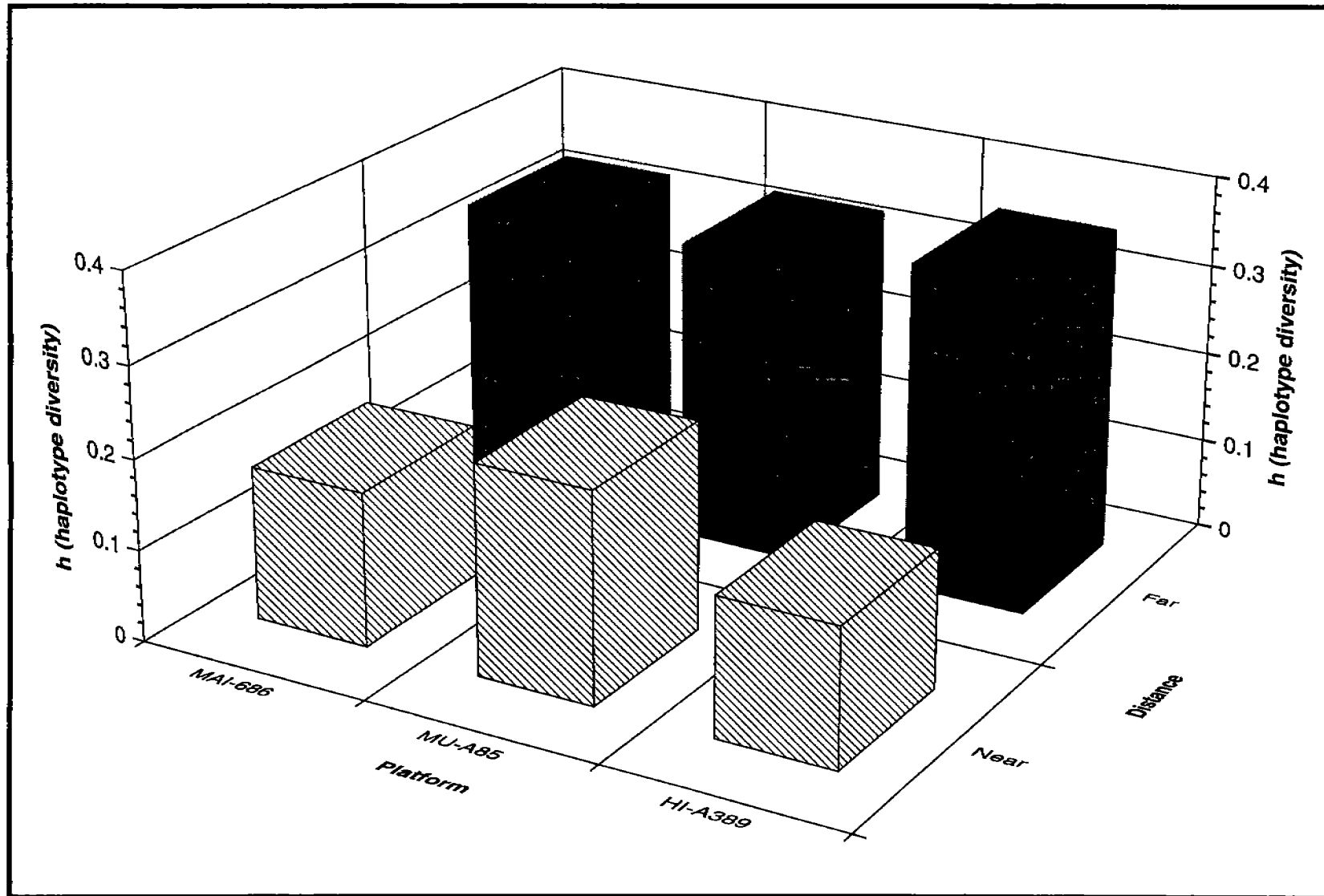

Figure 6.42. Genetic variability of harpacticoid copepods by platform for all species and cruises.

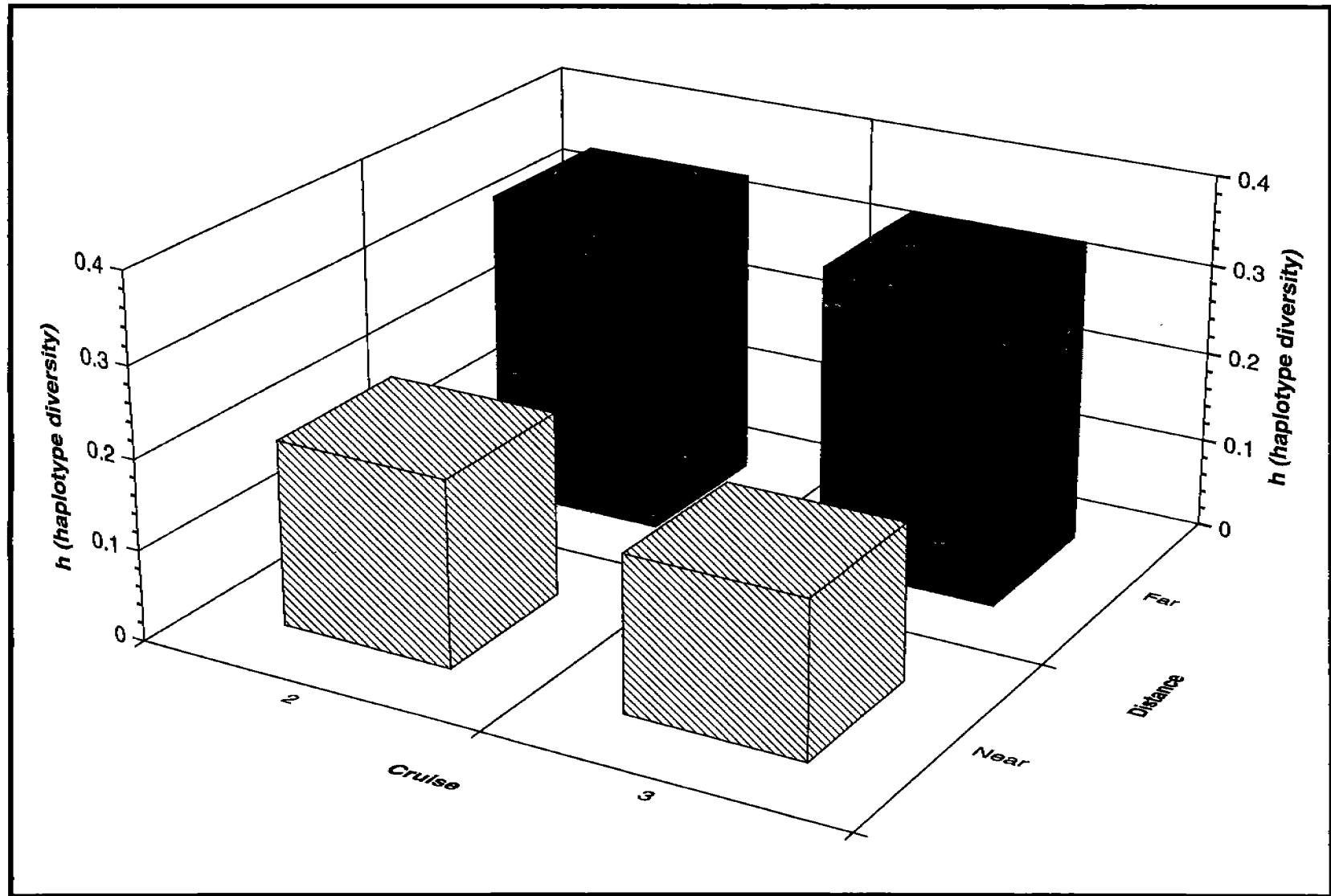

Figure 6.43. Genetic variability of harpacticoid copepods by cruise for all species and platforms.

water depth that platform is located in, which is also confounded with the contaminant gradient among platforms.

6.4.4.1 Meiofauna Community Structure

Except for two cases, all eight meiofauna variables were correlated with the two sedimentology/contaminant PCA factors (Table 6.54). Many factors had a significant negative relationship with all meiofauna variables. This means that in general, as depth and contamination increase, declines in meiofauna population abundance and diversity will also occur. The only exceptions were nematode density and biomass which were positively correlated with ChemPC1, and increase near a platform. The NC ratio had a positive relationship with all PCA factors, because harpacticoid abundances decreased relative to nematode abundance with increasing water depth and proximity to the platforms. For harpacticoid abundance and diversity, the strongest relationships occurred with ChemPC2, which represents the platform differences and gradient across the continental shelf. For nematode diversity, the strongest negative relationship was with ChemPC1, which represents distance from the platform.

The general pattern in nematode trophic dynamics, at all three platforms was an increase in non-selective deposit feeders and epigrowth feeders near the platforms, and a decrease in selective deposit feeders and predators near the platforms. A correlation analysis with the PC axes was performed to determine which environmental factors were correlated with changes in trophic community structure (Table 6.55). All biomass and density values were highly and negatively correlated with ChemPC2, which indicates a general decline in abundance and diversity with respect to water depth. There were significant and non-significant correlations with ChemPC1 and ChemPC2. Selective deposit feeder density and biomass was negatively correlated with ChemPC1, indicating a decline near platforms related to the contaminant gradient. Non-selective deposit feeder density and biomass was positively correlated with ChemPC1, indicating a declining density and biomass away from the platform. The results of the correlation analysis are consistent with results from the MANCOVA.

Table 6.54. Correlation between meiofaunal variables and environmental factors for all sites.

Variables	ChemPC1 ^a	ChemPC2 ^a
Meiofauna density	-0.007 (0.9077)	-0.472 (0.0001)
Nematode density	0.012 (0.8337)	-0.431 (0.0001)
Harpacticoid density	-0.216 (0.0002)	-0.507 (0.0001)
Others meiofauna density	-0.141 (0.0145)	-0.630 (0.0001)
NC Ratio	0.276 (0.0001)	0.221 (0.0001)
Nematode biomass	0.255 (0.0001)	-0.417 (0.0001)
Nematode diversity	-0.339 (0.0001)	-0.380 (0.0001)
Harpacticoid diversity	-0.282 (0.0001)	-0.420 (0.0001)

^aThe variables are the axes from the Principal Component Analysis (PCA) of the sediment/contaminant data (see Section 6.2)

Table 6.55. Correlation between meiofaunal variables and environmental factors by site.

Variables	MAI-686 ^a		MU-A85 ^a		HI-A389 ^a	
	ChemPC1	ChemPC2	ChemPC1	ChemPC2	ChemPC1	ChemPC2
Meiofauna density	-0.496 (0.0001)	-0.167 (0.0966)	-0.081 (0.4241)	-0.067 (0.5079)	0.164 (0.1037)	-0.219 (0.0287)
Nematode density	-0.492 (0.0001)	-0.140 (0.1653)	-0.119 (0.2400)	-0.083 (0.4094)	0.208 (0.0378)	-0.205 (0.0411)
Harpacticoid density	-0.489 (0.0001)	-0.400 (0.0001)	0.092 (0.3645)	-0.107 (0.2873)	-0.456 (0.0001)	-0.452 (0.0001)
Others meiofauna density	-0.401 (0.0001)	-0.080 (0.4266)	-0.215 (0.0319)	0.0658 (0.5156)	-0.297 (0.0027)	0.030 (0.7654)
NC Ratio	0.165 (0.1000)	0.467 (0.0001)	-0.150 (0.1363)	0.0740 (0.4645)	0.497 (0.0001)	0.242 (0.0152)
Nematode biomass	-0.269 (0.0069)	-0.220 (0.0276)	0.373 (0.0001)	0.062 (0.5432)	0.480 (0.0001)	-0.194 (0.0558)
Nematode diversity	0.139 (0.1665)	-0.318 (0.0012)	-0.067 (0.5096)	0.004 (0.9712)	-0.725 (0.0001)	-0.079 (0.4358)
Harpacticoid diversity	-0.382 (0.0001)	-0.390 (0.0001)	-0.030 (0.7701)	-0.185 (0.0653)	-0.556 (0.0001)	-0.386 (0.0001)

^aThe variables are the axes from the Principal Component Analysis (PCA) of the sediment/contaminant data (see Section 6.2).

6.4.4.2 Harpacticoid Life History

Clutch volume was not significantly correlated to either of the environmental principal component axes. No statistically significant difference in clutch size occurred between Near and Far stations at any of the three study sites. Platforms HI-A389 and MU-A85 exhibited slightly greater clutch sizes for Far stations than at Near, 0.4 and 1.1 eggs/clutch, respectively. For MAI-686, there was virtually no difference in the mean clutch size between Near and Far stations. However, clutch size was significantly correlated with ChemPC1 ($P = 0.038$) and ChemPC2 ($P = 0.003$; Table 6.56). The smaller clutch volumes found at Near stations for MAI-686 could be attributed to physiological factors. Gravid female body length was not significantly correlated to ChemPC1 (Table 6.57). The insignificant correlation between gravid female body lengths and ChemPC2 diminishes the likelihood that there is a positive relationship between body lengths and clutch volumes as found in other harpacticoid copepods (Webb and Montagna 1993). Density-dependent effects did not seem to affect clutch volumes, since gravid female abundance at MAI-686 was nearly equal ($\pm 2\%$) at MAI-686 Near and Far stations. The lack of influence of body length and clutch size on clutch volume for MAI-686 and suggested that a possible platform effect may be driving reproductive output independently of physiological parameters.

Clutch size was significantly correlated to ChemPC1 (Table 6.58). Significant positive correlation of PC1 with clutch size was related to distance from the platform. This finding is inconsistent with the result that no significant clutch size differences were found between Near and Far stations for all platforms. MU-A85 and HI-A389 Near stations had slightly reduced, but non-significant, clutch sizes relative to Far stations. In contrast, the Pearson coefficient (0.22) was positive for ChemPC1. The relationship between clutch size and contamination gradient suggested a positive correlation between contamination and clutch size. Mean clutch size was also significantly correlated to ChemPC2, which represents platform effects. Of all of the components, ChemPC2 was primarily driven by water depth. **A significant relationship between clutch size and water depth may be explained by changes among benthic habitats found in the three different depths or platform sites.** Therefore, the variation in clutch

Table 6.56. Correlation between nematode feeding group variables and environmental factors for all sites.

Variables	ChemPC1 ^a	ChemPC2 ^a
Density (individual X 10 cm ⁻²)		
Selective deposit feeder	-0.291 (0.0001)	-0.362 (0.0001)
Non-selective deposit feeder	0.200 (0.0005)	-0.387 (0.0001)
Epigrowth feeder	0.161 (0.0053)	-0.420 (0.0001)
Predator	-0.040 (0.4876)	-0.343 (0.0001)
Biomass (mg wet weight X 10 cm ⁻²)		
Selective deposit feeder	-0.225 (0.0001)	-0.295 (0.0001)
Non-selective deposit feeder	0.348 (0.0001)	-0.365 (0.0001)
Epigrowth feeder	0.212 (0.0002)	-0.485 (0.0001)
Predator	0.029 (0.6141)	-0.417 (0.0001)

^aThe variables are axes from the Principal Component Analysis (PCA) of the sediment/contaminant data (see Section 6.2).

Table 6.57. Correlation between nematode feeding group variables and environmental factors by site.

Variables	HI-A389 ^a		MAI-686 ^a		MU-A85 ^a	
	ChemPC1	ChemPC2	ChemPC1	ChemPC2	ChemPC1	ChemPC2
Density (individual X 10 cm ⁻²)						
Selective deposit feeder	-0.102 (0.3197)	0.011 (0.9122)	-0.565 (0.0001)	0.092 (0.3601)	-0.512 (0.0001)	-0.116 (0.2493)
Non-selective deposit feeder	0.328 (0.0010)	0.127 (0.2124)	-0.158 (0.1173)	-0.380 (0.0001)	0.315 (0.0014)	-0.090 (0.3755)
Epigrowth feeder	0.460 (0.0001)	-0.158 (0.1201)	-0.514 (0.0001)	-0.078 (0.4379)	0.091 (0.3671)	0.045 (0.6602)
Predator	0.010 (0.9248)	-0.345 (0.0005)	-0.376 (0.0001)	-0.334 (0.0007)	-0.036 (0.7238)	-0.010 (0.9214)
Biomass (mg wet weight X 10 cm ⁻²)						
Selective deposit feeder	0.088 (0.3900)	-0.059 (0.5664)	-0.539 (0.0001)	0.056 (0.5831)	-0.490 (0.0001)	-0.111 (0.2698)
Non-selective deposit feeder	0.389 (0.0001)	-0.037 (0.7174)	0.011 (0.9104)	-0.370 (0.0002)	0.567 (0.0001)	0.015 (0.8862)
Epigrowth feeder	0.403 (0.0001)	-0.190 (0.0612)	-0.428 (0.0001)	0.015 (0.8789)	0.425 (0.0001)	0.096 (0.3439)
Predator	0.055 (0.5919)	-0.326 (0.0010)	-0.195 (0.0522)	-0.251 (0.0116)	-0.036 (0.7191)	0.118 (0.2430)

^aThe variables are axes from the Principal Component Analysis (PCA) of the sediment/contaminant data (see Section 6.2).

Table 6.58. Correlation of reproduction variables with axes of the principal component analysis (PCA).

Axis ^a	Clutch Volume ^b	Clutch Size ^b
ChemPC1	-0.126 (0.238)	0.220 (0.038)
ChemPC2	0.046 (0.668)	0.305 (0.003)

^aThe variables are axes from the Principal Component Analysis (PCA) of the sediment/contaminant data (see Section 6.2).

^bSamples size is all gravid females encountered on all cruises (n=170 observations). Table gives Pearson correlation coefficients and the probability the coefficient is equal to zero in parentheses.

size may actually be a function of varying species structure within each community, since slightly different mean clutch sizes were found for all platforms.

Gravid females were more common at near stations at all platforms and for all cruises. Gravid female abundance was significantly positively correlated ($P = .0007$) with ChemPC2 of the environmental variables principal component analysis (Table 6.57). This correlation with distance may suggest a possible sediment relationship with gravid female density. **Abundance of all life history stages was significantly negatively correlated ($P = .0001$) with ChemPC2** (Table 6.59). This correlation indicates that a change in community structure is driven by water depth differences among platforms, since the three experimental platforms are in three different depth regimes on the continental slope of the Gulf of Mexico. Deeper stations may be lacking in food, therefore lower reproduction would be common if predation is food limited.

Table 6.59. Correlation of life history stage densities for all harpacticoids encountered with axes from the chemistry principal component analysis (PCA).

Axis ^a	Females ^b	Gravid ^b	Males ^b	Copepodites ^b
ChemPC1	-0.098 (0.092)	0.194 (0.0007)	-0.031 (0.589)	-0.133 (0.022)
ChemPC2	-0.443 (0.0001)	-0.242 (0.0001)	-0.382 (0.0001)	-0.242 (0.0001)

^aThe variables are axes from the Principal Component Analysis (PCA) of the sediment/contaminant data (see Section 6.2).

^bCopepodite life history stage includes all C1 to C5 copepodites. Total samples used: $n = 300$, 4 Cruises, 3 Platforms, 25 stations. Pearson correlation coefficients and the probability the coefficient is equal to zero in (parentheses) is provided.

There were significant correlations between body lengths and ChemPC2 for both *Diathrodes* sp. ($P=0.001$) and *Cletodes pseudosimilis* ($P = 0.011$). Pearson correlation coefficients were positive for both species, indicating increased body length with increased grain size or contamination. The fact that highest sand concentrations were found closest to the platform suggests that male body size may increase with increased proximity to the platform, suggesting a possible platform effect. No significant PCA

correlation was found for *Longipedia americana* males or females (Table 6.60). Only females of *Cletodes pseudodissimilis* had a negative correlation with ChemPC1, indicating smaller females near the platforms. There was little compelling evidence that there are obvious effects on body size related to distance from a platform or exposure to contaminants.

Table 6.60. Correlation of body lengths with axes of principal component analysis.

Axis ^a	<i>Cletodes pseudodissimilis</i> ^b		<i>Diathrodes sp.</i> ^b		<i>Longipedia americana</i> ^b	
	Males	Females	Males	Females	Males	Females
ChemPC1	-0.654 (0.021)	-0.127 (0.710)	-0.041 (0.811)	-0.266 (0.047)	0.213 (0.465)	-0.153 (0.520)
ChemPC2	0.609 (0.035)	0.371 (0.262)	0.539 (0.001)	0.106 (0.435)	-0.341 (0.233)	0.370 (0.109)

^aThe variables are axes from the Principal Component Analysis (PCA) of the sediment/contaminant data (see Section 6.2).

^bSample size is n = 312 between the three species. Table gives Pearson correlation coefficients and the probability the coefficient is equal to zero (in parentheses) is provided.

6.4.4.3 Harpacticoid Genetic Variability

Despite a clear trend of increasing haplotype diversity away from a platform, it was impossible with the present design to determine what factors cause this trend. It was possible to correlate changes in genetic diversity with changes in the physicochemical environment around each platform. A logistic, linear regression was used to search for a statistical associations between genetic variability and environmental characteristics described by the principal components axes (Carson and Templeton 1984). The logistic regression was useful for this purpose because it can be used to describe binomial, categorical data (SAS Institute Inc. 1990). The dependent variable in the logistic model was the number of individuals not in the dominant haplotype divided by the total number of individuals surveyed per station. All five species were used in this analysis, since there were no significant differences between species, and increasing sample size increases the power to detect change. The independent variables used in the equation were ChemPC1 and ChemPC2. Using a forward selection procedure, ChemPC1 was included in the model: $y = -0.2431 X PC1 - 1.485$

($\chi^2 = 18.16$, $P = 0.0001$). The second principal components axis was not significant. **Frequency of unique genotypes decreases as PC1, which is primarily driven by contaminant and sand content increases. Frequency of unique genotypes diversity did not change with ChemPC2, which represents between-platform variations.**

In addition to the logistic, linear regression performed on frequency of unique genotypes data, a linear regression was used on values of h for all species, platforms and cruises. ChemPC1 was included in the model: $y = -0.063 X PC1 + 0.319$ ($R^2 = 0.376$; Figure 6.44). The trend was very similar to that of the logistic, linear regression, and both regression results were consistent with the ANOVA results.

There was a clear difference between the Near and Far stations (Figure 6.44). Variance at the Near stations was greater than variance at the Far stations due, in this case, to the directional nature of benthic patterns (Hartley's test for homogeneity of the variance). If variance at the Far stations was greater than variance at the Near stations, then the difference between Near and Far might be an artifact of sampling areas of two different sizes. Because variance was higher near a platform, the total area sampled does not seem to present a problem.

6.5 Macroinfauna

Benthic macroinfaunal organisms are useful for studying both the general ecology of a region or area, and the acute and chronic effects associated with human perturbations such as discharges of toxic substances. Some portions of contaminants eventually settle to the bottom due to their density relative to sea water or by adsorption onto sediment particles which then settle. These substances then affect the organisms associated with the bottom - the infauna and epifauna. The benthic infauna are primarily non-mobile or slow moving, small organisms and tend to be associated with specific sediment types. This is caused, in many cases, by the larval stages being induced to metamorphose by specific sediment types or by adults that are already established. Once established, the organisms tend to remain in that locality until removed by death or predation.

Environmental stresses in the form of natural events (low concentrations of dissolved oxygen, changes in salinity and temperature)

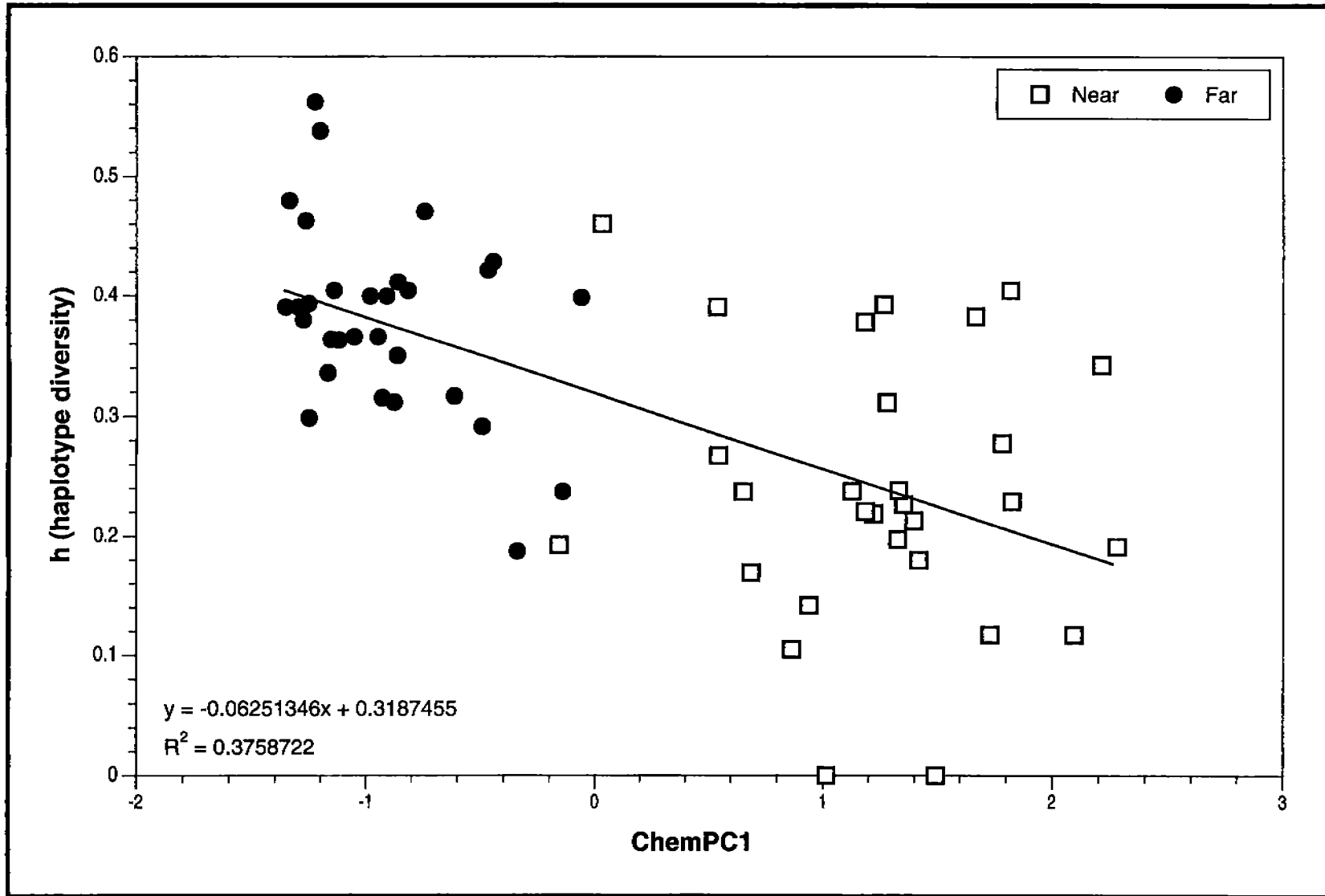

Figure 6.44. Relationship between haplotype diversity for all species, platforms, and cruises and the environmental variables PC1 (ChemPC1) by distance from the platform.

and human induced stresses (discharges, dredging operations, trawling activities) have some influence on the structure of benthic assemblages, usually by removing part of the assemblage or causing those organisms that can migrate to move away from the stress. Infaunal organisms that cannot tolerate an environmental stress and cannot escape, perish.

Environmental stresses are of two types, acute (short-term, relatively intense) and chronic (low level exposure over a long period of time). The acute stress may kill large numbers of organisms, but once the stress is removed, the bottom is recolonized. If the stress is chronic, larvae of the "normal" inhabitants may be unable to settle and metamorphose, and the stressed area thus remains devoid of intolerant species. Changes in benthic species composition and abundance as one approaches a discharge site is one indication of stress. Studies in shallow water have demonstrated that the bottoms around produced water discharges are very depauperate (Mackin 1971; Armstrong et al. 1979, Nance 1984, 1991). At some distance beyond the depauperate zone there may be a zone of enhanced benthic abundances. There has been no evidence of such a zone of enhancement in offshore marine settings presumably because the greater water depth and water movement causes discharges to be diluted to levels that are not as toxic as in shallower, quieter waters.

Studies of benthic organism assemblages inhabiting soft bottoms have been conducted in the northern and northwestern Gulf of Mexico since the 1950s. These studies have tended to cover wide areas with infrequent sampling, or limited areas with frequent sampling. The earliest studies were conducted by Hildebrand (1954) and Parker (1960), who reported on macroepifauna and infauna, respectively, over broad areas of the shelf. More regional studies involving infauna have been done on the Louisiana shelf (Southwest Research Institute 1981; Fitzhugh 1984; McKinney et al. 1984; Gaston 1985, Rabalais et al. 1991). Macroinfaunal studies on the Texas continental shelf include studies along the upper Texas coast (Harper and Case 1975), at the Buccaneer Oil/Gas Field (Harper et al. 1981b), off Freeport, Texas (Harper et al. 1981a; 1991) and in the vicinity of Matagorda Island Area Block 622 field (CSA 1989). The South Texas Outer Continental Shelf Study (Berryhill 1977; Flint and Rabalais 1980) was a shelf-wide study in the western Gulf of Mexico which had a macroinfaunal component.

These studies indicate several trends. The principal abiotic factors governing the distribution of macroinfauna appear to be sediment type and water depth. Water depth manifests itself as increasingly stable abiotic factors including temperature, salinity, dissolved oxygen, etc. with increasing water depth. Shallower water abiotic factors, in contrast, are much less stable as a result of seasonal variations. Although some species are ubiquitous, the general trend is for certain infaunal assemblages to be associated with specific depths. Abundances of infaunal organisms generally decrease with increasing depth across the continental shelf. Seasonal variability in species composition and abundance also decreases with increasing water depth. Although the same species tend to be found throughout the northern and western Gulf of Mexico, abundances of infaunal organisms tend to decrease toward the southwest on the Gulf of Mexico continental shelf. Infaunal assemblages are usually dominated by polychaetous annelids in soft muddy bottoms whereas mollusks or crustaceans may dominate in sandy or shelly bottoms.

Studies near oil field discharges in estuaries have indicated that polychaetous annelids may be better able to tolerate hydrocarbons in the sediments because they occur in larger numbers close to platforms than other groups (Mackin 1971, Armstrong et al. 1979). Crustaceans, as a group, may be least able to tolerate environmental stress. In particular, ampeliscid amphipod populations were depressed in the vicinity of both platforms in the Buccaneer Field Study (Harper et al. 1981a,b). Ampeliscid amphipods were considered one of the most affected organisms during the West Falmouth spill (Sanders et al. 1980). Also, ampeliscid amphipod populations were reduced to virtually zero in the northwestern Gulf of Mexico, coinciding with the onset of hypoxia (Harper et al. 1991). These data suggest that crustaceans in general and ampeliscid amphipods in particular may be useful as indicators of environmental stress.

The only major systematic offshore study of petroleum production platforms in the western Gulf of Mexico occurred at the Buccaneer Field south of Galveston, Texas. During a preliminary study, sediments adjacent to the platform were found to be heavily oiled (208 ppm hydrocarbons) and infaunal abundances were depressed at that location. Further studies showed that both major platforms had a halo of depressed infaunal abundances. The depression, however, may have been due to scour which

removed most of the soft sediments and exposed hard clay substrate rather than toxic effects due to contaminants.

6.5.1 Analysis of the Overall Study Design

The macroinfauna variables measured were total density ($n \times \text{core}^{-1}$), density of 8 taxonomic groups ($n \times \text{core}^{-1}$), species diversity (H'), total number of species and an amphipod:polychaete (AP) ratio. The AP ratio was designed to be analogous to the nematode:copepod (NC) ratio, since polychaetes seem to increase with proximity to a platform, possibly due to enrichment near platforms.

The test of the overall sample design; using all cruises, platforms and distances; revealed significant interactions between variables (Table 6.61). These interactions mean that the overall analysis cannot be interpreted for most of these variables. Because there were different responses with respect to cruise, platform, radii and distances; platforms should, in general, be analyzed separately. The three variables that did not have significant interactions were bivalve density, nemertean density and ophiuroid density (Table 6.62). The tests for main effects of cruise, platform and distance on these three macroinfauna variables were easily interpreted. Ophiuroids exhibited no differences with respect to platform, cruise or distance from platform. Nemertean density was just the opposite, exhibiting differences among platforms, cruises and distances. Bivalve density was different among platforms and cruises, but did not vary with distance from the platform (Table 6.62). The significant cruise interactions were attributed to the large number of animals collected during Cruise 3 (winter 1994).

Total macroinfauna density was lower at the farthest stations than at the 50 m and 100 m stations (Table 6.63). Diversity, measured by H' and richness (number of species) was higher near platforms. Amphipods and foraminiferans increased away from the platform. Decapods, isopods, nemerteans and polychaetes increased towards the platform. Bivalves and ophiuroids did not change with distance from the platform (Table 6.63). Because amphipods decreased towards the platforms, and polychaetes increased towards the platforms, the AP ratio decreased towards the platform (Table 6.63).

Table 6.61. Summary of the significance of interactions for the overall sample design based on macroinfaunal data.

Variable	Interactions ^a			
	C*D	P*D	P*C*D	D*R(P)
Total density (n X core ⁻¹)	No	Yes	No	No
Diversity (H')	Yes	No	No	Yes
Number of species (n X core ⁻¹)	Yes	No	No	Yes
Amphipod density (n X core ⁻¹)	Yes	Yes	No	No
Bivalve density (n X core ⁻¹)	No	No	No	No
Decapod density (n X core ⁻¹)	No	Yes	No	No
Foram density (n X core ⁻¹)	Yes	Yes	Yes	No
Isopod density (n X core ⁻¹)	No	Yes	No	No
Nemertean density (n X core ⁻¹)	No	No	No	No
Ophiurid density (n X core ⁻¹)	No	No	No	No
Polychaete density (n X core ⁻¹)	No	Yes	No	No
Amphipod:Polychaete ratio	Yes	No	No	No

^aP=platform, C=Cruise, D=Distance, R=radius; Yes=significant, p≤0.01; No=Not significant, p≥0.01.

Table 6.62. Summary of tests of the main effects for overall sample design.

Variable	Main Effects ^a		
	Platform	Cruise	Distance
Total density (n X core ⁻¹)	---	---	---
Diversity (H')	---	---	---
Number of species (n X core ⁻¹)	---	---	---
Amphipod density (n X core ⁻¹)	---	---	---
Bivalve density (n X core ⁻¹)	Yes	Yes	No
Decapod density (n X core ⁻¹)	---	---	---
Foram density (n X core ⁻¹)	---	---	---
Isopod density (n X core ⁻¹)	---	---	---
Nemertean density (n X core ⁻¹)	Yes	Yes	Yes
Ophiurid density (n X core ⁻¹)	No	No	No
Polychaete density (n X core ⁻¹)	---	---	---
Amphipod:Polychaete ratio	---	---	---

^aResult of significance tests for the three main effects are reported where higher order interactions were Not significant ("---"=Not testable due to higher interactions).

Table 6.63. Tukey's multiple comparison test results by distance for the overall study design based on macroinfaunal variables.

Variable	Distance from the Platform ^a				
	50	100	200	1000	3000
Total density (n X core ⁻¹)	50 (46)	100 (35)	200 (26)	1000 (25)	3000 (22)
Diversity (H')	100 (2.70)	200 (2.53)	50 (2.50)	1000 (2.41)	3000 (2.34)
Number of species (n X core ⁻¹)	100 (21.7)	50 (21.1)	200 (17.8)	1000 (16.0)	3000 (15.4)
Amphipod density (n X core ⁻¹)	1000 (3.2)	3000 (2.9)	200 (2.4)	100 (1.5)	50 (1.5)
Bivalve density (n X core ⁻¹)	50 (1.8)	100 (1.6)	1000 (1.5)	200 (1.4)	3000 (1.4)
Decapod density (n X core ⁻¹)	50 (3.3)	100 (2.2)	1000 (1.7)	200 (1.6)	3000 (1.6)
Foram density (n X core ⁻¹)	3000 (1.7)	1000 (1.7)	200 (1.4)	100 (1.2)	50 (1.1)
Isopod density (n X core ⁻¹)	50 (1.3)	100 (1.3)	200 (1.2)	1000 (1.1)	3000 (1.1)
Nemertean density (n X core ⁻¹)	100 (3.1)	50 (3.0)	200 (2.1)	1000 (1.9)	3000 (1.7)
Ophiurid density (n X core ⁻¹)	50 (1.3)	1000 (1.2)	100 (1.2)	3000 (1.1)	200 (1.1)
Polychaete density (n X core ⁻¹)	50 (32.8)	100 (26.0)	200 (18.5)	1000 (14.9)	3000 (13.1)
Amphipod:Polychaete ratio	3000 (0.29)	1000 (0.28)	200 (0.20)	100 (0.03)	50 (0.03)

^aDetransformed means are presented (x) and means that are underlined are not different at the 0.05 level.

There was no difference in species diversity among the three platforms (Table 6.64). Although several of the respective taxonomic groups were different at different platforms, total abundance of all macroinfauna was not different at different platforms (Table 6.64). Polychaete and ophiuroid densities were not different at any of the platforms.

6.5.2 Analysis by Platform Site

Each platform was individually analyzed (Tables 6.65 and 6.66). Significant interactions were still present for all variables except bivalve, decapod, isopod, nemertean and ophiuroid densities (Table 6.65). Note that no isopods were found at MAI-686. MAI-686 had distance effects only for diversity and nemertean density (Table 6.66). MAI-686 had cruise effects for total density, species richness, and polychaete density. MU-A85 had distance effects for species richness and amphipod, decapod, foraminiferan, isopod and nemertean density. There were cruise effects for diversity, richness, and amphipod, bivalve, nemertean and isopod densities. At HI-A389, there were cruise effects for total density, and foraminiferan and polychaete densities. Although several variables could not be tested due to significant interactions, distance effects at HI-A389 were evident for all variables except for amphipod and ophiuroid densities. Only ophiuroids and the AP ratio had no changes with respect to cruise or distance from a platform.

Differences between the five distances were tested at each platform (Table 6.67 to 6.69). At MAI-686 (Table 6.67), there were few significant differences among distances from the platform. Total abundance was higher at the 50 m and 100 m stations than at all other stations. There were no obvious patterns in specific taxa that would account for the increase. Only amphipods and nemerteans showed any significant differences. Amphipods increased away from MAI-686 and nemerteans increased towards MAI-686.

At MU-A85, the more distance effects were apparent (Table 6.68). Again, total abundance was higher at 50-m and 100-m stations than at all other distances. The number of species increased towards the platform, although H' did not. Foraminiferans were significantly lower at the three farthest distances. Decapods, isopods, nemerteans, and polychaetes were higher in abundance near the platform.

Table 6.64. Tukey's multiple comparison test results by platform for the overall study design based on macroinfaunal variables.

Variance ^a	Platform ^a		
Total density (n X core ⁻¹)	MU-A85 (32)	MAI-686 (30)	HI-A389 (28)
Diversity (H')	MU-A85 (2.82)	MAI-686 (2.20)	HI-A389 (2.47)
Number of species (n X core ⁻¹)	MU-A85 (23.3)	MAI-686 (14.8)	HI-A389 (17.1)
Amphipod density (n X core ⁻¹)	MAI-686 (3.0)	MU-A85 (2.3)	HI-A389 (1.5)
Bivalve density (n X core ⁻¹)	MU-A85 (2.0)	MAI-686 (1.4)	HI-A389 (1.3)
Decapod density (n X core ⁻¹)	MU-A85 (2.5)	HI-A389 (2.0)	MAI-686 (1.6)
Foram density (n X core ⁻¹)	HI-A389 (1.8)	MU-A85 (1.5)	MAI-686 (1.0)
Isopod density (n X core ⁻¹)	MU-A85 (1.6)	HI-A389 (1.1)	MAI-686 (0.0)
Nemertean density (n X core ⁻¹)	MAI-686 (1.7)	HI-A389 (2.2)	MU-A85 (2.1)
Ophiurid density (n X core ⁻¹)	MU-A85 (1.2)	HI-A389 (1.2)	MAI-686 (1.1)
Polychaete density (n X core ⁻¹)	MAI-686 (21.7)	MU-A85 (19.5)	HI-A389 (18.5)
Amphipod:Polychaete ratio	MAI-686 (0.30)	MU-A85 (0.13)	HI-A389 (0.07)

^aDetransformed means are presented (x) and means that are underlined are not different at the 0.05 level.

Table 6.65. Summary of the significance of interaction tests by platform based on macroinfaunal data.

Site Variable	Interactions ^a					
	MAI-686		MU-A85		HI-A389	
	C*D	D*R	C*D	D*R	C*D	D*R
Total density (n X core ⁻¹)	No	No	Yes	No	No	No
Diversity (H')	No	No	No	No	Yes	No
Number of species (n X core ⁻¹)	No	No	No	No	Yes	No
Amphipod density (n X core ⁻¹)	Yes	No	No	No	No	No
Bivalve density (n X core ⁻¹)	No	No	No	No	No	No
Decapod density (n X core ⁻¹)	No	No	No	No	No	No
Foram density (n X core ⁻¹)	No	No	No	No	Yes	No
Isopod density (n X core ⁻¹)	---	---	No	No	No	No
Nemertean density (n X core ⁻¹)	No	No	No	No	No	No
Ophiurid density (n X core ⁻¹)	No	No	No	No	No	No
Polychaete density (n X core ⁻¹)	No	No	Yes	No	No	Yes
Amphipod:Polychaete ratio	No	No	No	No	Yes	No

^aFor definition of variables and symbols see Tables 6.61 and 6.62.

Table 6.66. Summary of the significance of main effects tests by platform based on macroinfaunal data.

Site ^a Variable	MAI-686		MU-A85		HI-A389	
	C	D	C	D	C	D
Total density (n X core ⁻¹)	Yes	No	---	---	Yes	Yes
Diversity (H')	No	Yes	Yes	No	---	---
Number of species (n X core ⁻¹)	Yes	No	Yes	Yes	---	---
Amphipod density (n X core ⁻¹)	---	---	Yes	Yes	No	No
Bivalve density (n X core ⁻¹)	No	No	Yes	No	No	Yes
Decapod density (n X core ⁻¹)	No	No	No	Yes	No	Yes
Foram density (n X core ⁻¹)	No	No	No	Yes	Yes	Yes
Isopod density (n X core ⁻¹)	---	---	Yes	Yes	---	---
Nemertean density (n X core ⁻¹)	No	Yes	Yes	No	No	Yes
Ophiurid density (n X core ⁻¹)	No	No	No	No	No	No
Polychaete density (n X core ⁻¹)	Yes	No	---	---	Yes	---
Amphipod:Polychaete ratio	No	No	No	No	---	---

^aFor definition of variables and symbols see Tables 6.61 and 6.62.

Table 6.67. Tukey's multiple comparison test results by distance at MAI-686 based on macroinfaunal data.

Variable	Distance from the Platform ^a				
	1000	50	200	3000	100
Total density (n X core ⁻¹)	1000 (36)	50 (33)	200 (31)	3000 (26)	100 (26)
Diversity (H')	50 (2.44)	100 (2.39)	200 (2.33)	1000 (2.02)	3000 (1.83)
Number of species (n X core ⁻¹)	50 (17.6)	200 (16.1)	100 (15.1)	1000 (13.0)	3000 (12.2)
Amphipod density (n X core ⁻¹)	1000 (5.9)	3000 (4.9)	200 (3.2)	50 (2.1)	100 (1.3)
Bivalve density (n X core ⁻¹)	50 (1.6)	200 (1.5)	1000 (1.3)	100 (1.3)	3000 (1.2)
Decapod density (n X core ⁻¹)	50 (1.9)	200 (1.7)	100 (1.6)	1000 (1.5)	3000 (1.4)
Foram density (n X core ⁻¹)	200 (1.0)	100 (0.0)	50 (0.0)	1000 (0.0)	3000 (0.0)
Isopod density (n X core ⁻¹)	-	-	-	-	-
Nemertean density (n X core ⁻¹)	50 (4.5)	100 (3.1)	200 (2.5)	100 (2.0)	3000 (2.0)
Ophiurid density (n X core ⁻¹)	50 (1.2)	1000 (1.1)	200 (1.1)	100 (1.1)	3000 (0.0)
Polychaete density (n X core ⁻¹)	1000 (23.8)	50 (23.6)	100 (21.5)	200 (21.3)	3000 (18.5)
Amphipod:Polychaete ratio	3000 (0.56)	1000 (0.49)	200 (0.33)	50 (0.38)	100 (0.33)

^aDetransformed means are presented (x) and means that are underlined are not different at the 0.05 level.

Table 6.68. Tukey's multiple comparison test results by distance at MU-A85 based on macroinfaunal data.

Variable	Distance from the Platform ^a				
	50	100	200	3000	1000
Total density (n X core ⁻¹)	50 (45)	100 (41)	200 (27)	3000 (26)	1000 (25)
Diversity (H')	100 (2.94)	50 (2.92)	200 (2.76)	3000 (2.73)	1000 (2.72)
Number of species (n X core ⁻¹)	100 (28.2)	50 (26.2)	200 (21.6)	1000 (20.6)	3000 (19.9)
Amphipod density (n X core ⁻¹)	3000 (3.0)	200 (2.7)	1000 (2.7)	100 (2.2)	50 (1.3)
Bivalve density (n X core ⁻¹)	1000 (2.2)	100 (2.1)	3000 (2.1)	200 (1.8)	50 (1.8)
Decapod density (n X core ⁻¹)	50 (5.7)	100 (3.2)	1000 (1.8)	200 (1.8)	3000 (1.7)
Foram density (n X core ⁻¹)	1000 (2.2)	3000 (1.8)	200 (1.5)	50 (1.1)	100 (1.1)
Isopod density (n X core ⁻¹)	50 (2.3)	100 (2.0)	200 (1.3)	1000 (1.3)	3000 (1.2)
Nemertean density (n X core ⁻¹)	50 (2.8)	100 (2.4)	1000 (2.0)	200 (1.8)	3000 (1.5)
Ophiuroid density (n X core ⁻¹)	50 (1.4)	100 (1.3)	3000 (1.2)	1000 (1.1)	200 (1.1)
Polychaete density (n X core ⁻¹)	50 (27.1)	100 (27.1)	200 (18.5)	1000 (14.7)	3000 (14.4)
Polychaete:Amphipod ratio	1000 (0.23)	3000 (0.18)	200 (0.18)	100 (0.05)	50 (0.02)

^aDetransformed means are presented (x) and means that are underlined are not different at the 0.05 level.

Table 6.69 Tukey's multiple comparison test results by distance at HI-A389 based on macroinfaunal data.

Variable	Distance from the Platform ^a				
	50	100	200	1000	3000
Total density (n X core ⁻¹)	50 (2165)	100 (1327)	<u>200</u> (696)	<u>1000</u> (547)	<u>3000</u> (805)
Diversity (H')	100 (2.77)	<u>200</u> (2.50)	<u>1000</u> (2.49)	<u>3000</u> (2.45)	50 (2.14)
Number of species (n X core ⁻¹)	100 (22.9)	<u>50</u> (19.4)	<u>200</u> (15.7)	<u>1000</u> (14.5)	<u>3000</u> (14.1)
Amphipod density (n X core ⁻¹)	1000 (34)	3000 (22)	<u>200</u> (21)	50 (6)	100 (6)
Bivalve density (n X core ⁻¹)	50 (37)	<u>100</u> (15)	<u>200</u> (4)	3000 (2)	1000 (1)
Decapod density (n X core ⁻¹)	50 (98)	<u>100</u> (34)	<u>1000</u> (24)	<u>3000</u> (17)	200 (14)
Foram density (n X core ⁻¹)	3000 (60)	<u>1000</u> (37)	<u>200</u> (26)	100 (21)	50 (6)
Isopod density (n X core ⁻¹)	100 (6)	200 (4)	50 (2)	<u>1000</u> (1)	<u>3000</u> (1)
Nemertean density (n X core ⁻¹)	100 (105)	<u>50</u> (39)	<u>200</u> (36)	<u>1000</u> (21)	<u>3000</u> (20)
Ophiuroid density (n X core ⁻¹)	1000 (11)	50 (8)	100 (5)	3000 (4)	200 (1)
Polychaete density (n X core ⁻¹)	50 (1807)	100 (1015)	200 (504)	<u>1000</u> (281)	<u>3000</u> (243)
Polychaete:Amphipod ratio	50 (3.83)	100 (3.29)	200 (2.29)	<u>3000</u> (1.61)	<u>1000</u> (1.55)

^aDetransformed means are presented (x) and means that are underlined are not different at the 0.05 level.

At HI-A389 (Table 6.69), there was a significantly greater total density of macroinfauna at the 50-m station than at the 100-m station. Species richness was also higher near the platform. Among specific taxa groups, amphipods and foraminifera had significantly higher densities at far stations

(\geq 500-m). Bivalves, decapods and polychaetes densities were higher at near stations (50-m and 100-m). Isopods, nemerteans, and ophiuroids abundances were not significantly different among platforms. The AP ratio did not change with respect to distance. This suggested that the AP ratio may not be a sensitive indicator of macroinfauna response at platforms.

In summary, **the variables that had the highest values near platforms were total species abundance and species richness (number of species) for nemerteans, decapods, and polychaetes. Densities of ophiuroids and isopods were low at all sites and did not significantly change with distance.**

6.5.3 Macroinfauna Community Structure

A principal components analysis (PCA) was performed on total macroinfauna density (Figures 6.45 to 6.48), amphipod density (Figures 6.49 to 6.52) and polychaete density (Figures 6.53 to 6.56) to look for species trends associated with platform or distances. There were 649 total species used for the total macroinfauna species density PCA. However, of these, 22 species were responsible for 25 % of the variation in the data set analyzed. Fifty-seven (57) species accounted for 50 % of the variation and 112 species were responsible for 75 % of the variation in the data. **The fact that less than a quarter of the macroinfauna species accounted for three quarters of the variation in the data suggests that trends in macroinfauna density were driven by a small number of species, and that approximately 500 of the species collected and identified did not appreciably change the trend in the data.** There were 42 species of amphipods. Of these, 6 accounted for 25 % of the variance, 14 accounted for 50 % of the variance, and 24 accounted for 75 % of the variance. There were 310 species of polychaetes identified in the study. Fifteen (15) of these species accounted for 25 % of the variance in the data set. Thirty nine (39) species accounted for 50 % of the variance, and 75 % of the variance can be explained by only 79 species. **The vast majority of total macroinfauna, amphipods and polychaetes were not distributed in any consistent patterns.**

There were platform effects evident for total macroinfauna and polychaete abundance. **For total macroinfauna (Figure 6.45), the clustering of points on crossplots of the macroinfauna PC1 vs. PC2 suggest that both axes accounted for variations among platforms.** MU-A85 had the highest

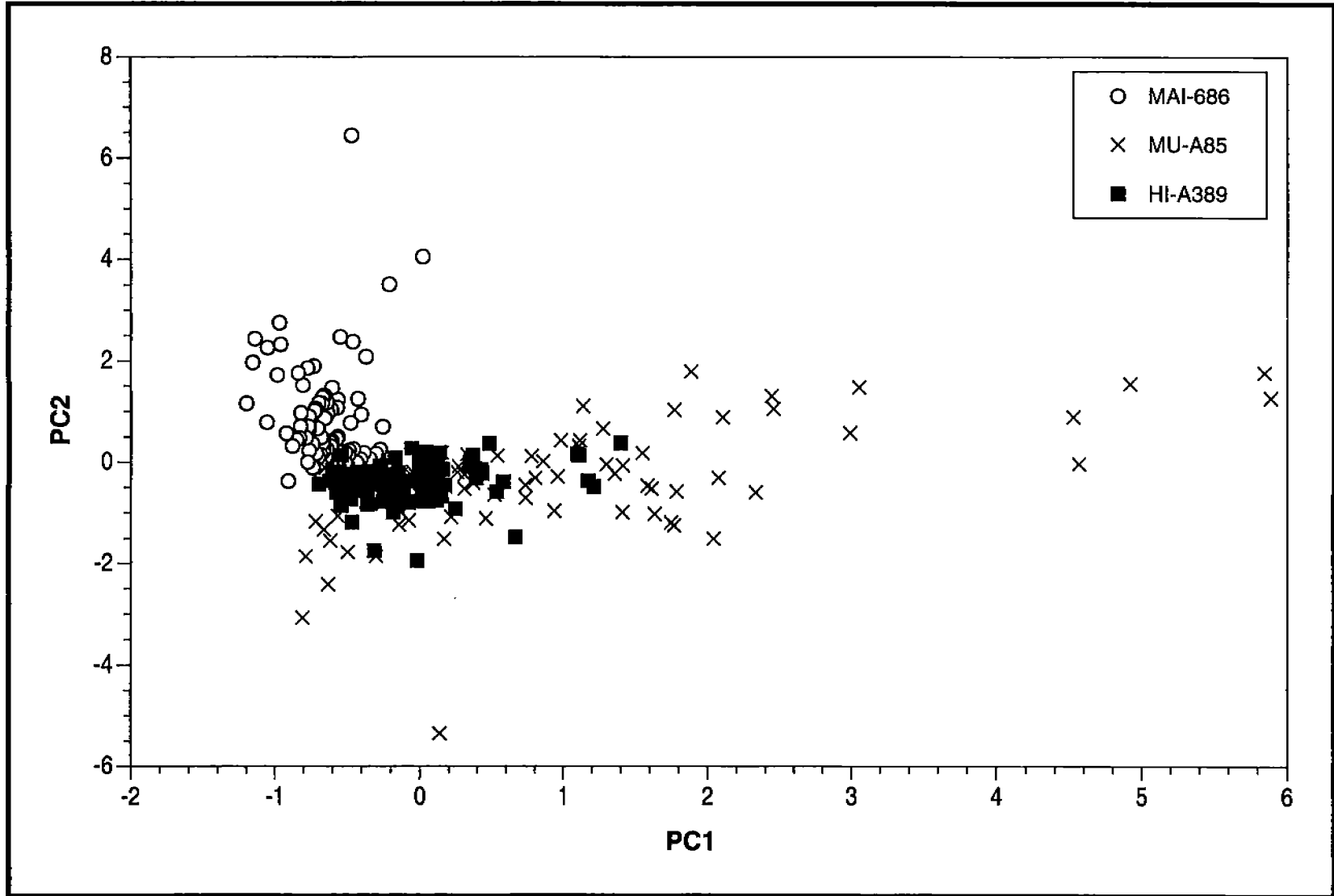
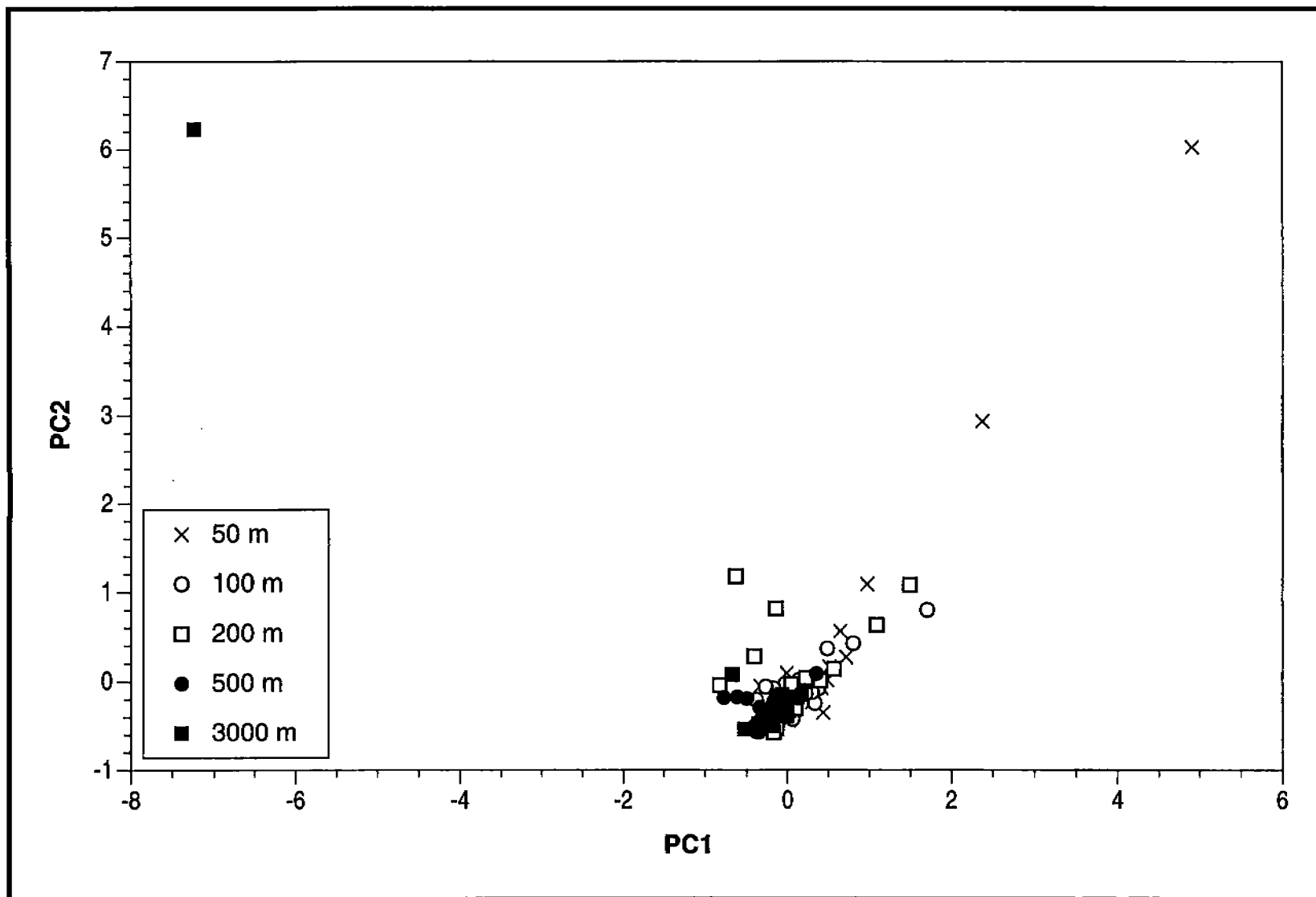

Figure 6.45. PCA of total macroinfauna species community structure by platform.



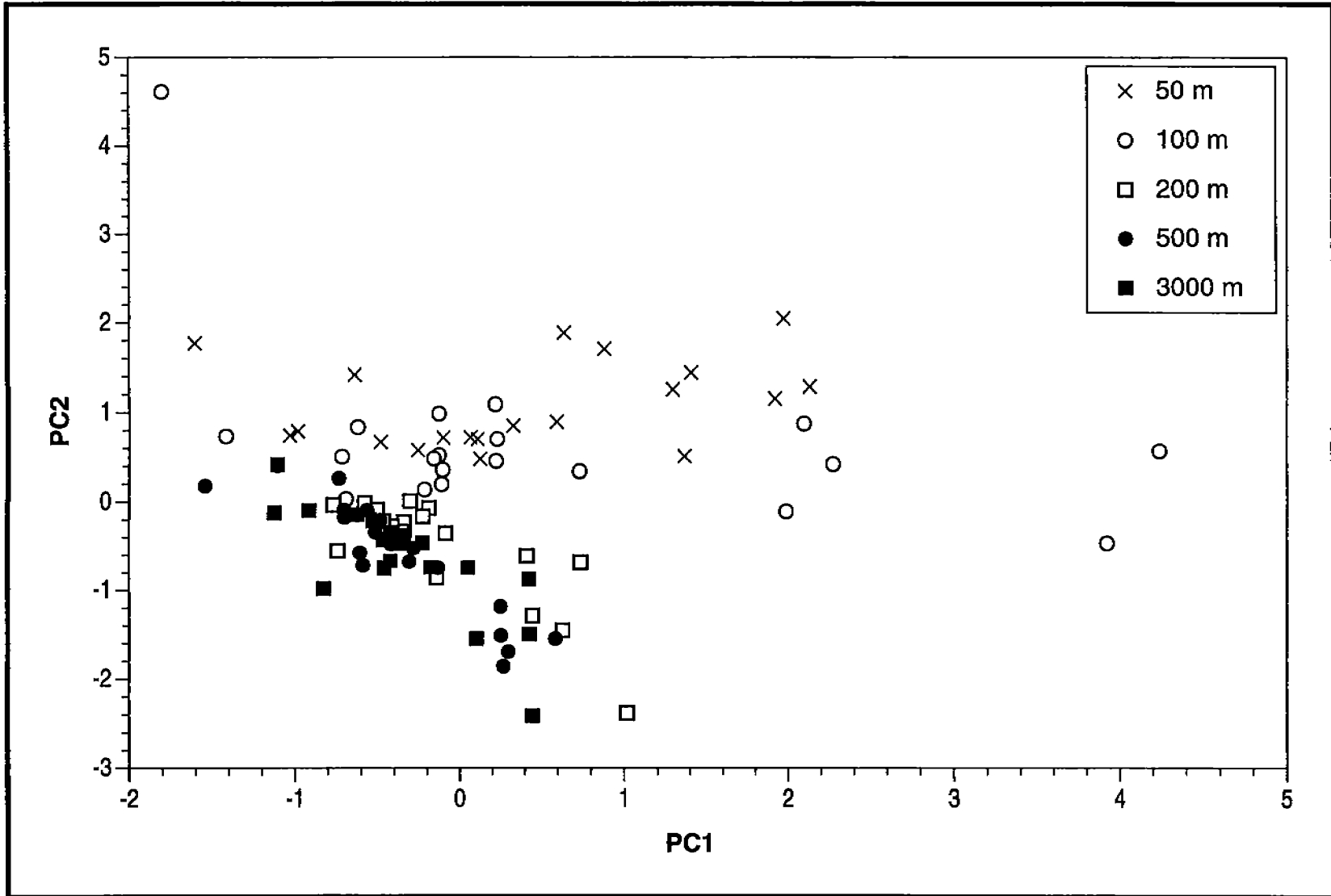
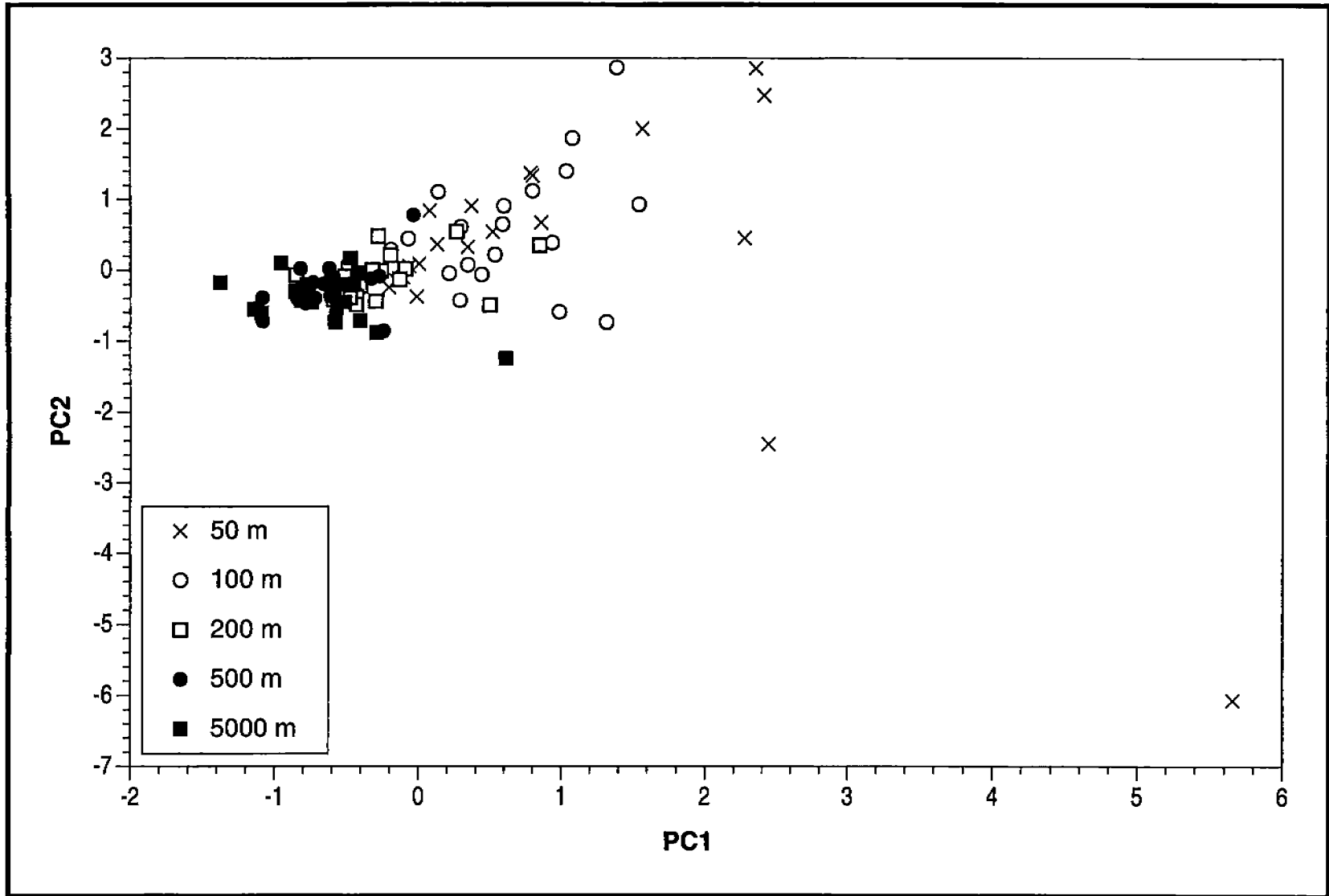

Figure 6.47. PCA of total macroinfauna species community structure at MU-A85.



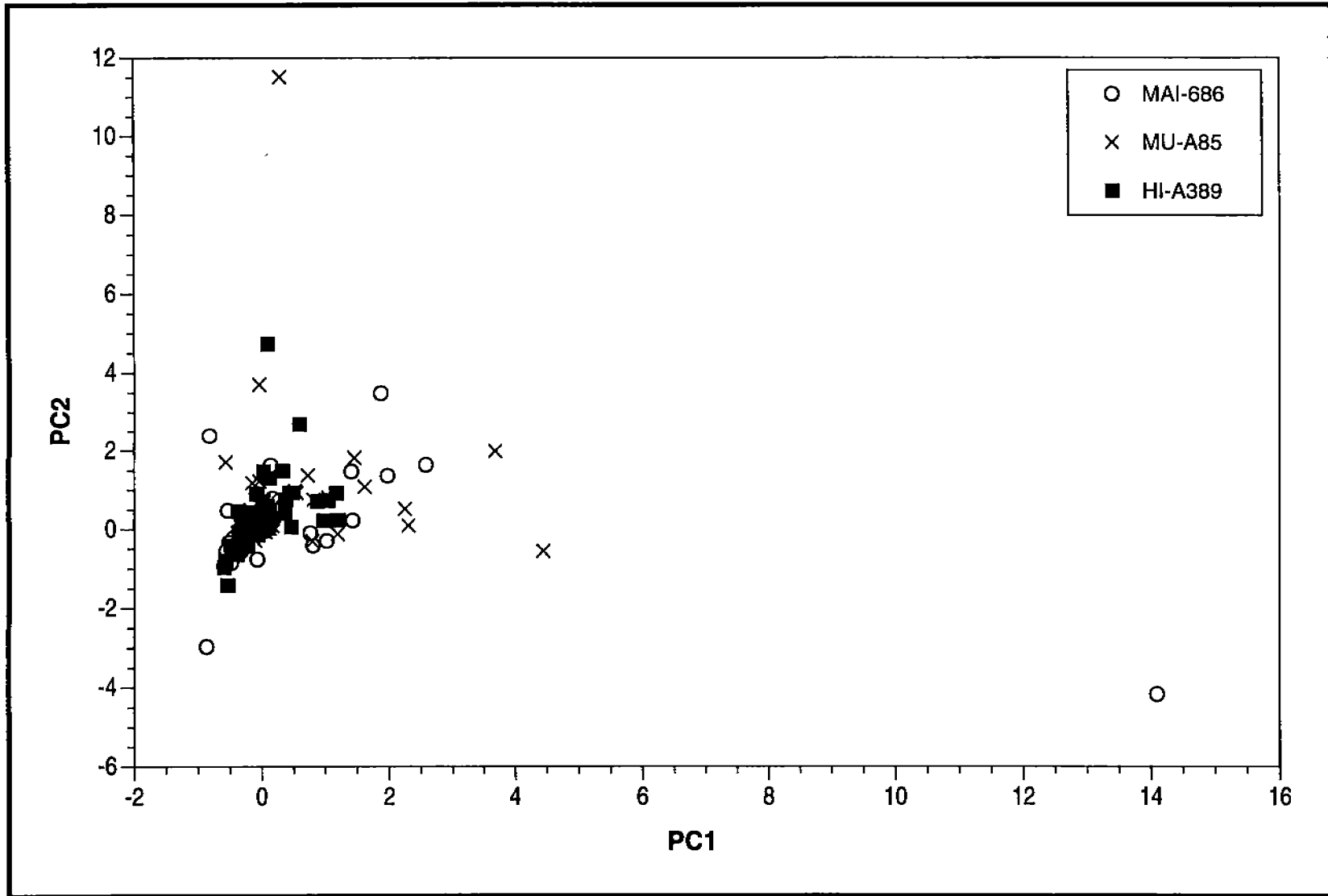

Figure 6.49. PCA of amphipod species community structure by platform.

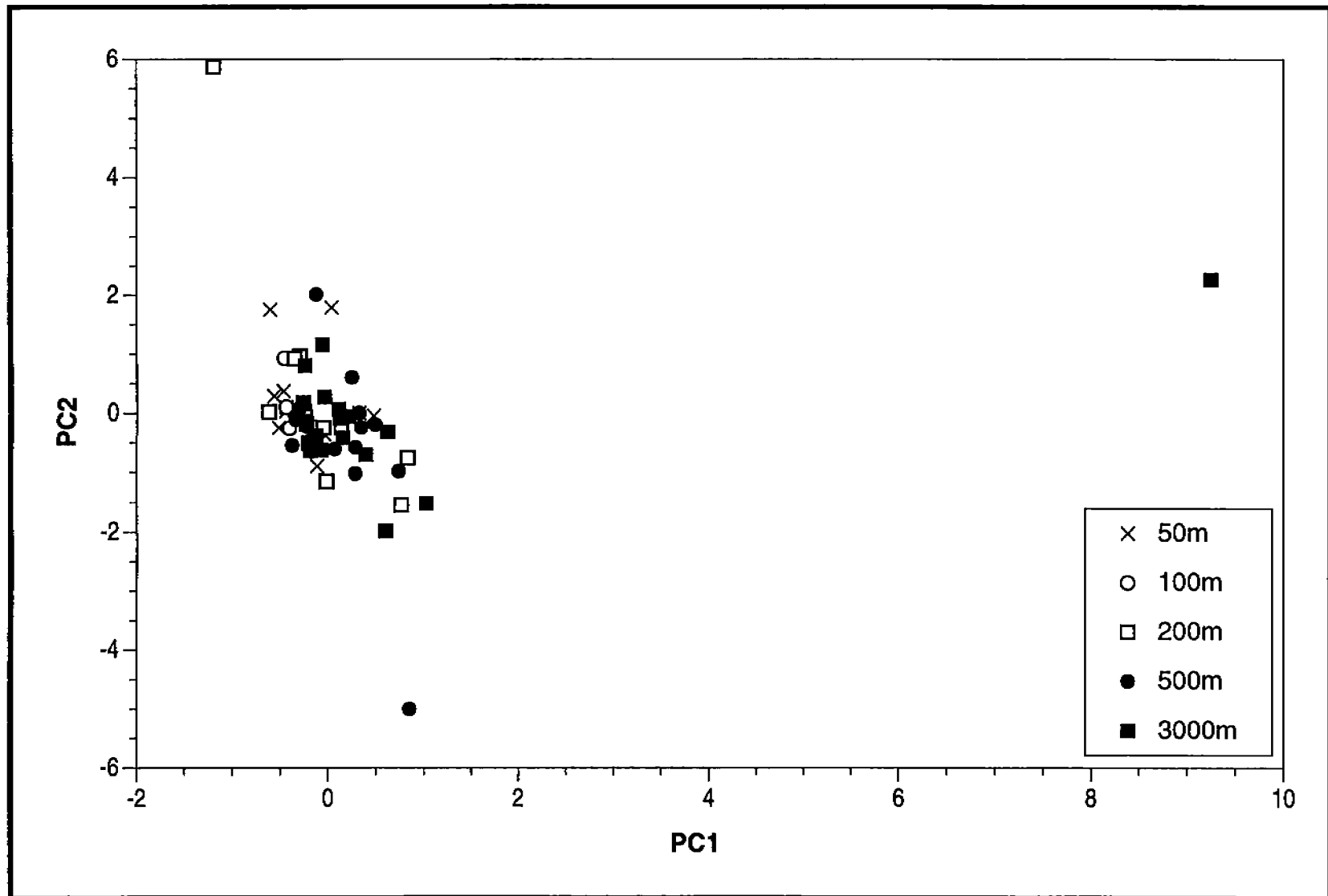

Figure 6.50. PCA of amphipod species community structure at MAI-686.

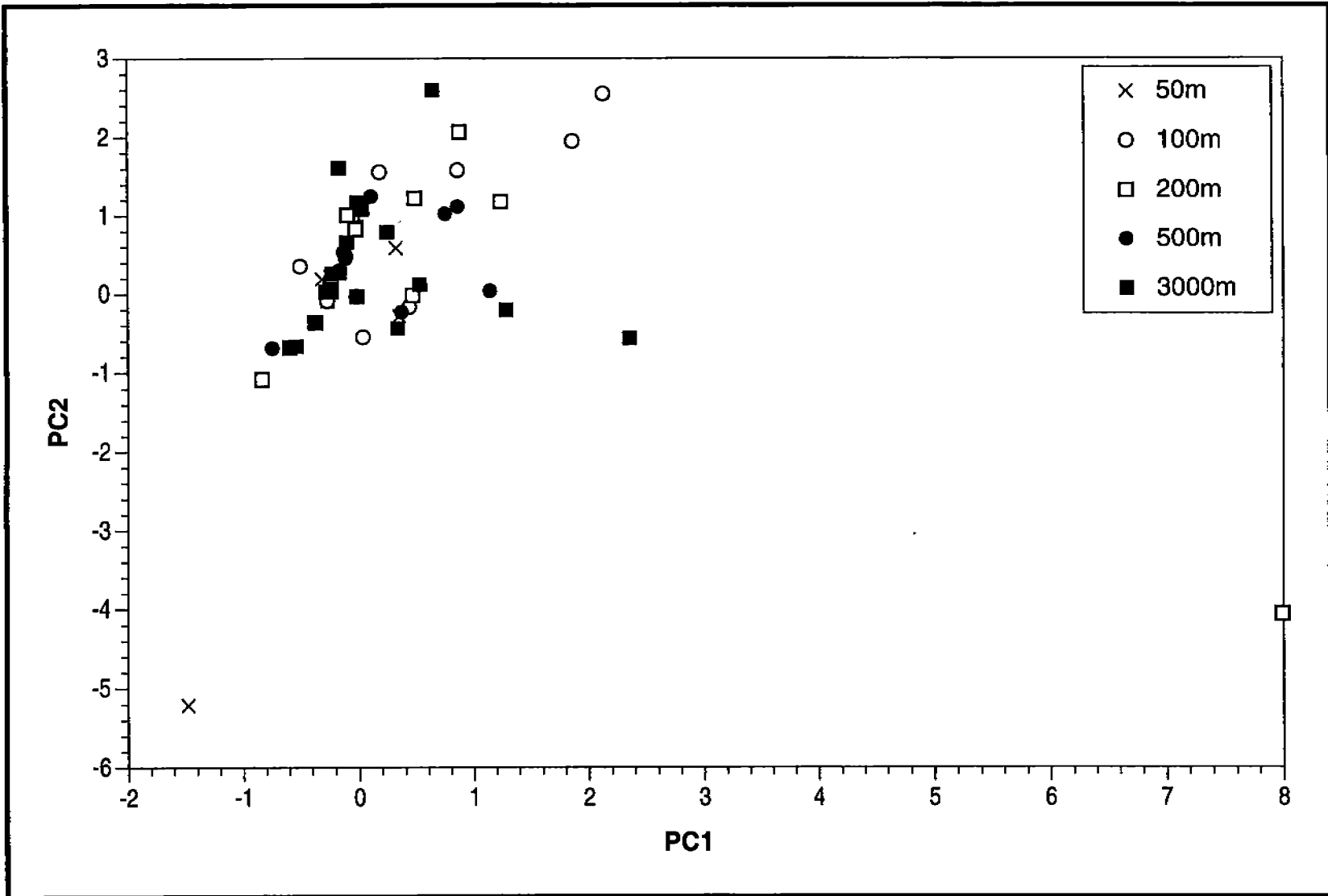

Figure 6.51. PCA of amphipod species community structure at MU-A85.

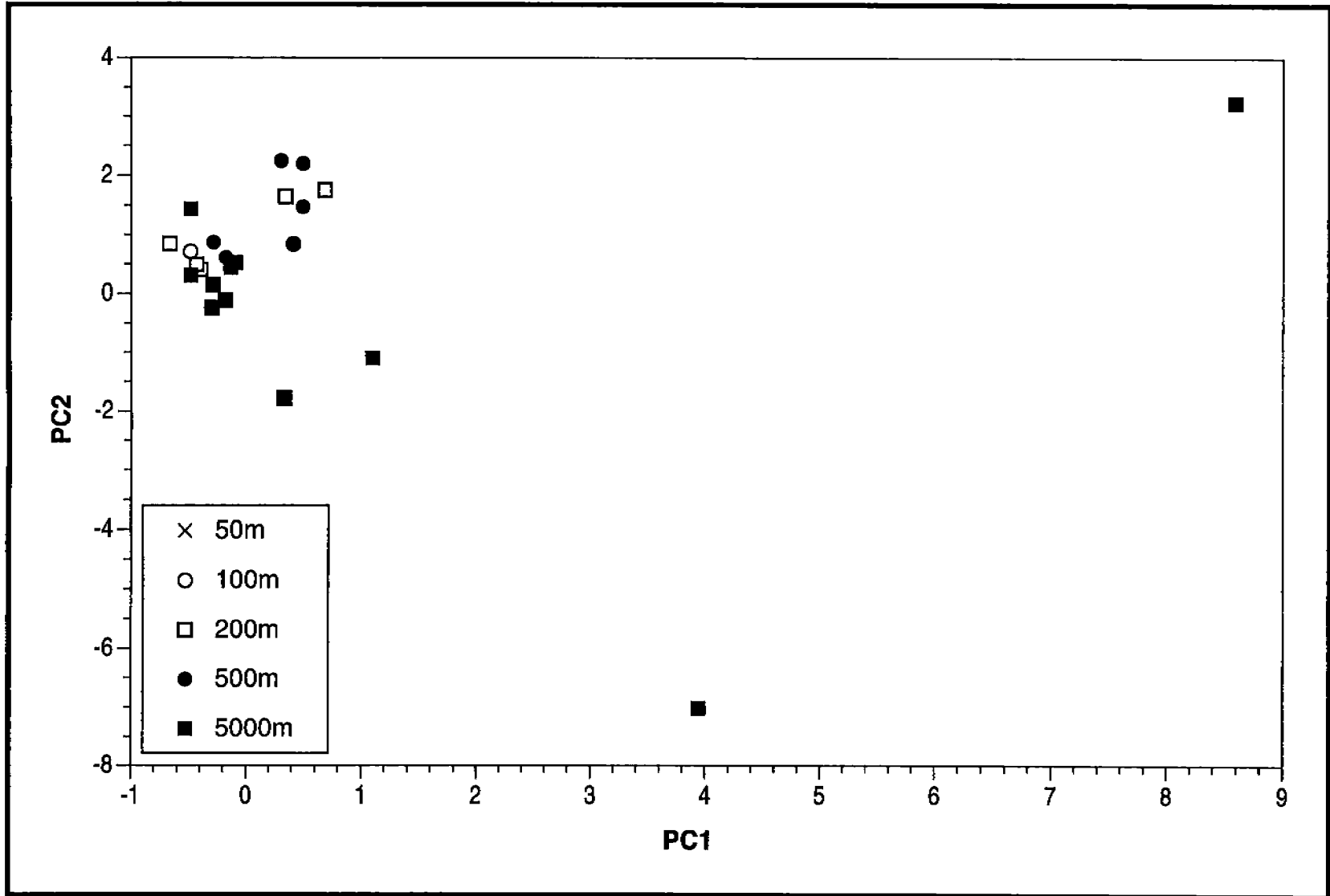

Figure 6.52. PCA of amphipod species community structure at HI-A389.

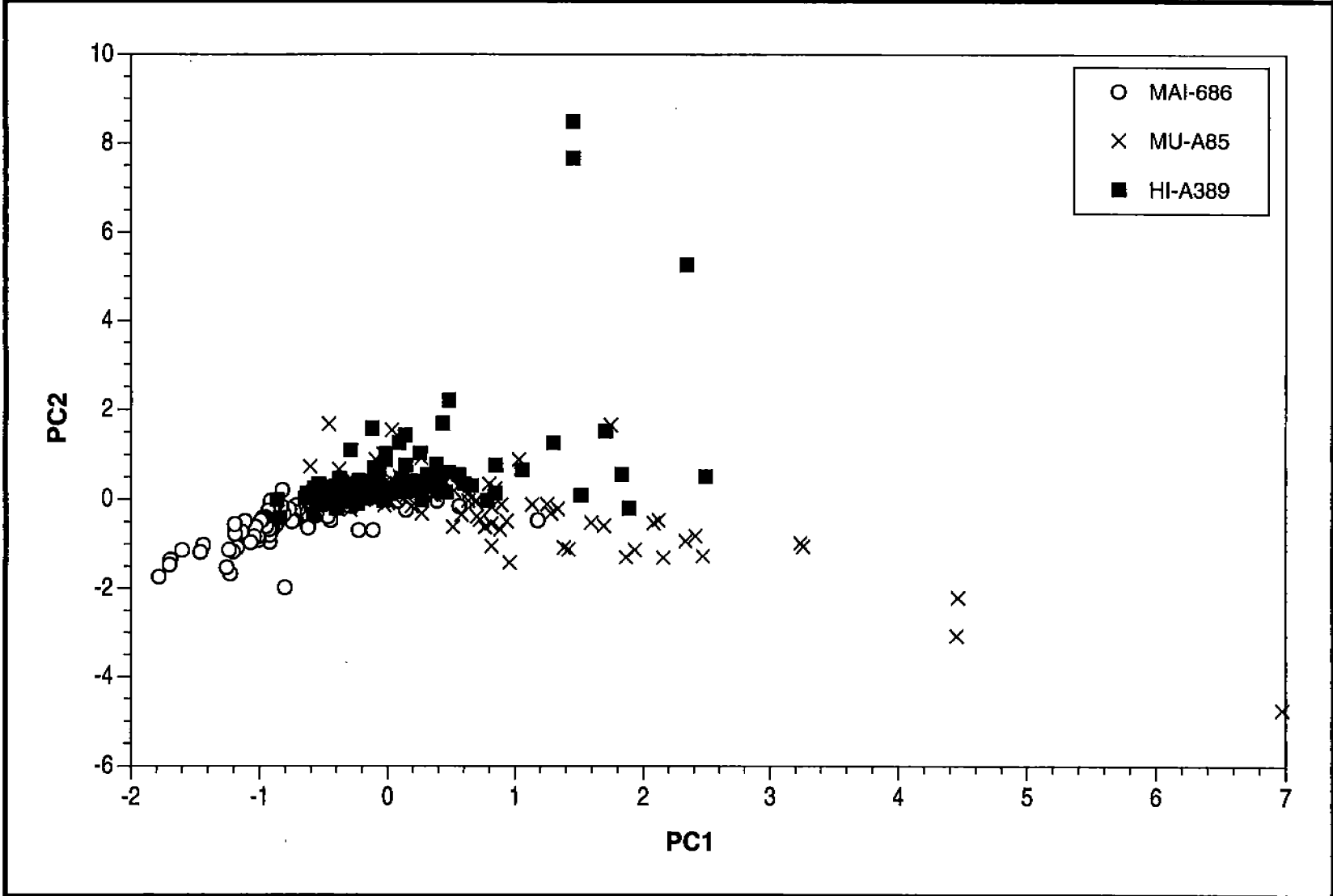

Figure 6.53. PCA of polychaete species community structure by platform.

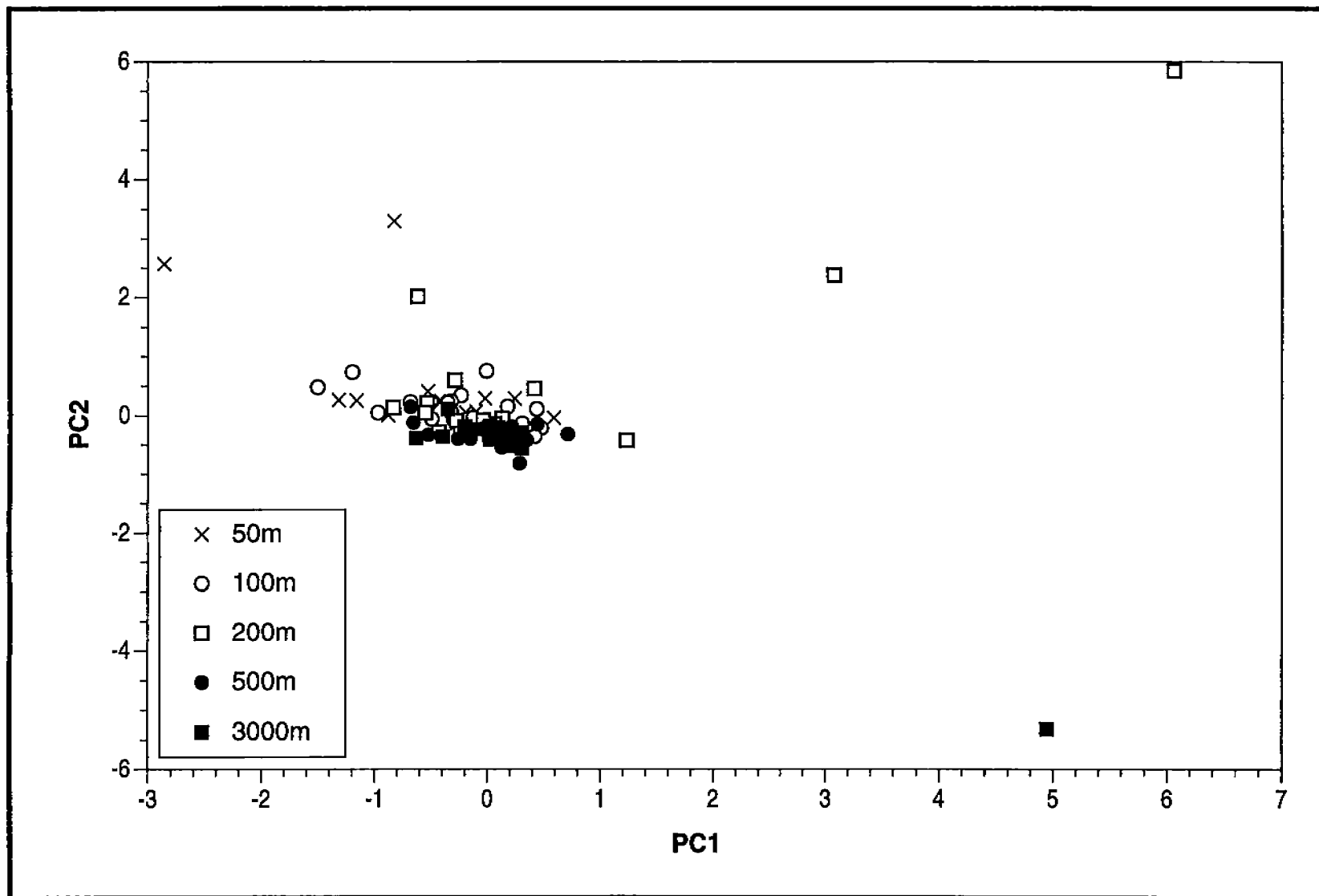

Figure 6.54. PCA of polychaete species community structure at MAI-686.

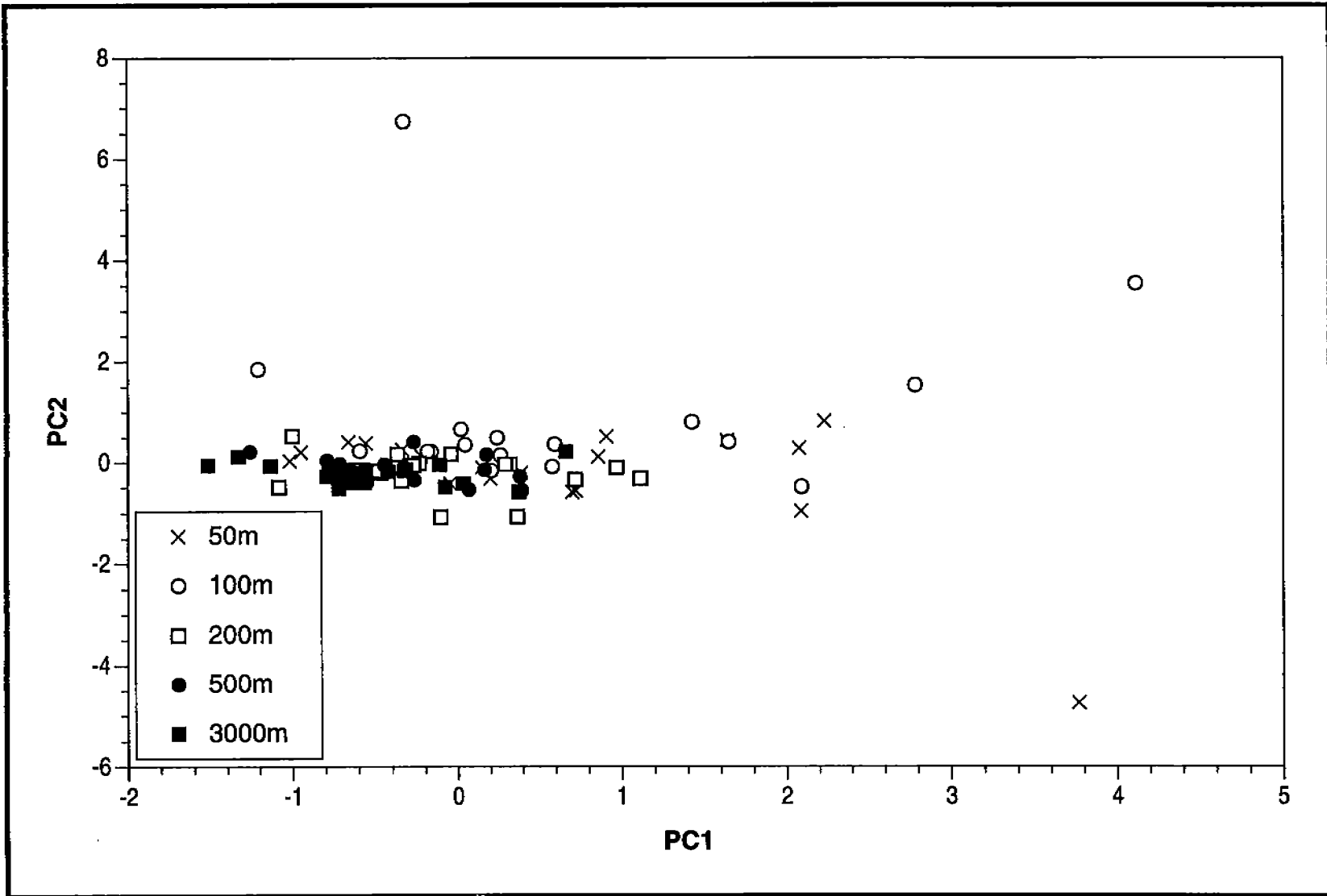

Figure 6.55. PCA of polychaete species community structure at MU-A85.

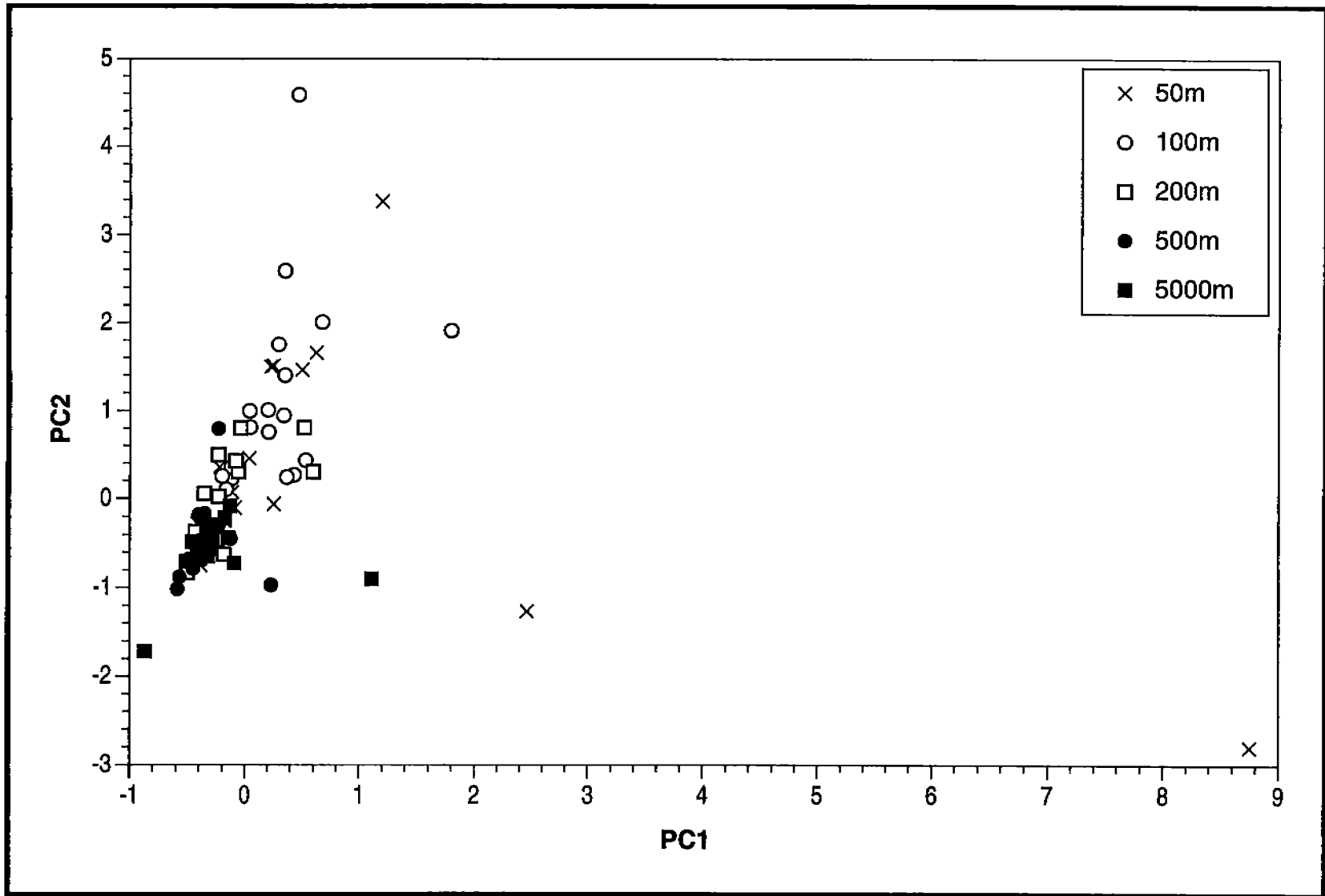

Figure 6.56. PCA of polychaete species community structure at HI-A389.

values for PC1, with HI-A389 intermediate, and MAI-686 with the lowest values for both PC1 and PC2. The species that accounted for this trend were the spionid polychaetes (*Polydora* sp., *Prionospio* sp., *Spiophanes* cf. *missionensis*) and an isopod (*Xenanthura brevitelson*). All of these species were associated with the MU-A85 platform. For polychaete species (Figure 6.53) the stations were distributed along PC1 suggesting a platform effect. The MU-A85 platform had higher values for this axis, while MAI-686 was lowest and HI-A389 was intermediate. PC2 also seemed to show some platform effect but the separation was not as clear as with PC1. In addition to the species mentioned above, the association of *Eurythoe* sp., *Levesenia reducta*, and species of the family Onuphidae with MU-A85 were the dominant determinant at differences among platforms. For amphipods (Figure 6.49) there were no strong platform effects. However, amphipod species and abundance were lower than polychaetes, and the small sample size could account for the lack of significant trends.

It was necessary to do the analysis by platform to test for species differences at the five distances from the platforms using a principal components analysis. There was no consistent separation of species by distance for amphipods at MAI-686 (Figure 6.46), MU-A85 (Figure 6.47), or HI-A389 (Figure 4.49 to 4.52). For polychaetes, there was no difference between species for any distances at MAI-686 and MU-A85, and only a weak separation of species by distance along PC1 at HI-A389 (Figures 6.54 to 6.56). However, at all three platforms, there was more variance at the inner three distances than at the outer two distances. **In summary, there were species differences among platforms for total macroinfauna and polychaetes. There were no species differences along distances from platforms for any taxa.**

6.5.4 Relationship to Environmental Parameters

The demonstrated trends in macroinfauna variables can be correlated to the principal components axes generated from the environmental data. When data from all platforms were considered, there was a positive relationship between ChemPC1 and total macroinfauna density and species richness that was highly significant ($P < 0.0001$; Table 6.70). **As ChemPC1 increased species abundance and richness increased.** This trend was most

Table 6.70. Correlation between macroinfauna variables and environmental factors for all sites.

Variable	ChemPC1 ^a	ChemPC2 ^a
Total density (n X core ⁻¹)	0.427 (0.0001)	-0.074 (0.2027)
Diversity (H')	0.023 (0.6947)	-0.130 (0.0242)
Number of species (n X core ⁻¹)	0.253 (0.0001)	-0.092 (0.1137)

^aThe variables are axes from the Principal Component Analysis (PCA) of the sediment/contaminant data (see Section 6.2).

likely due to organic enrichment effects near platforms and not contaminant effects related to ChemPC1. ChemPC2 was not correlated with species abundance or richness, and only a slight negative correlation ($P = 0.0242$) with species diversity (H').

When platforms were considered independently, a similar trend was revealed (Table 6.71). ChemPC1 was strongly correlated with species abundance at HI-A389 and MU-A85 at the $P < 0.001$ level, and MAI-686 at the $P < 0.05$ level. ChemPC2 was negatively correlated with species abundance at MAI-686, and MU-A85 only. The interpretation was that there were more animals in shallow waters than deeper waters. Species diversity (H') was correlated negatively with ChemPC1 at HI-A389. In this case, macroinfauna could be responding to a contaminant toxic effect and not the organic enrichment effects. Species diversity was positively correlated to ChemPC1 at the other two platforms. Because these platforms were less contaminated, organic enrichment was probably responsible for the observed trend. Diversity showed a significant negative correlation with ChemPC2 at all platforms. This observation is consistent with diversity patterns in the continental shelf. In general, diversity increases with depth. Species richness followed a pattern similar to the diversity index. **There were positive correlations between species richness and ChemPC1, and negative correlations between richness and ChemPC2. Diversity increased towards a platform and towards deeper water.**

Table 6.71. Correlation between macroinfauna variables and environmental factors by site.

Variable	MAI-686 ^a		MU-A85 ^a		HI-A389 ^a	
	ChemPC1	ChemPC2	ChemPC1	ChemPC2	ChemPC1	ChemPC2
Abundance (n X core ⁻¹)	0.236 (0.0180)	-0.399 (0.0001)	0.347 (0.0004)	-0.493 (0.0001)	0.702 (0.0001)	0.148 (0.1404)
Diversity (H')	0.504 (0.0001)	-0.220 (0.0277)	0.215 (0.0321)	-0.346 (0.0004)	-0.235 (0.0186)	-0.376 (0.0001)
Number of species (n X core ⁻¹)	0.521 (0.0001)	-0.410 (0.001)	0.287 (0.0037)	-0.581 (0.0001)	0.285 (0.0040)	-0.234 (0.0191)

^aThe variables are axes from the Principal Component Analysis (PCA) of the sediment/contaminant data (see Section 6.2).

6.6 Megafauna - Invertebrates

Physiological and environmental parameters such as temperature, salinity, food availability, and exposure to chemical contaminants can affect the health and productivity of marine invertebrates (Koehn and Bayne 1989; Peterson and Black 1988; Sindermann 1983). These factors may act alone or in concert to alter an organism's energy balance, affecting growth rate, reproductive capacity, and susceptibility to disease and parasitism. Ultimately, these factors can affect community composition and structure, the ability to reproduce, and population health (Sindermann 1983). Measures of community structure, reproductive development, and the prevalence and intensity of parasites and disease were used to assess the impact of platforms on the productivity and health of megafaunal invertebrate species living at the study sites. Megafaunal invertebrate data is summarized and described in detail in Section 5.7.

Statistical analysis was performed according to the overall data analysis plan as outlined in Section 2.0. The sampling regime for the megafaunal invertebrate reproduction work element included samples from Near and Far stations. Radii were not included in the sampling scheme. Without radii in the analyses, the statistical approach becomes a multivariate analysis of covariance (MANCOVA). Each dependent variable was analyzed by MANCOVA to determine the effect of cruise, distance, platform, and covariates of reproductive effort and health. All analyses were first performed using MANCOVA models that included all interaction terms.

More detailed analyses were performed by platform and by sex to eliminate those interactions what were significant. Dependent variables include size, sex, stage of reproductive development, prevalence of parasitism and disease, intensity of parasitism and disease, and catch per unit effort. Dependent variables were transformed by ranking when appropriate. Cruise, distance, platform, sex, stage of reproductive development, and time of collection were treated as class variables. In some models, size was also used as a covariate. Three MANCOVA models were used for each analysis. The first analysis was at the level of species. This model included all information about individuals of each species regardless of platform, distance, or sex. The second model was sorted by species and platform, thereby comparing all individuals of each species at each separate platform. The third level sorted individuals by sex. Particular attention was focused on differences between Near and Far stations at each platform. Accordingly, these differences were investigated for each species and, where possible, for each sex.

Histological analysis limited the number of individuals of each species at each platform and each distance to ten (10). In some instances, a greater examined number of individuals was obtained by collectively analyzing species of the same higher taxon. Four groupings of species were used; portunid crabs, mantis shrimp, starfish, and penaeid shrimp. The assumption underlying these groupings is that these species have similar lifestyles and, thus, should react similarly to environmental gradients. In combining species into higher groupings, differences in species size were minimized by normalization to the largest individual. For example, individual species of shrimp were very different in size (i.e., *P. aztecus* is much larger than *T. similis*). The maximum size for each species collected during all four cruises was determined by univariate analysis. The size of each individual was then normalized to the maximum individual size. Thus, in this analysis, size was used as a dependent variable, or a covariate, and was defined as a proportion of the maximum size collected for that species. By this means, species with different size ranges could be grouped together and analyzed. Analyses on groups of species followed the same approach as for individual species.

6.6.1 Catch Per Unit Effort (CPUE)

Differences in CPUE were compared for each species between the Near and Far stations using multiple analysis of covariance (Table 6.72). CPUE is summarized and described in detail in Section 5.6.1. Significant differences in CPUE between the Near and Far stations were few; however, more species had significantly different CPUE values at MAI-686. Several species at MAI-686 were more abundant at the Far station, including three species of shrimp and a starfish. Species of crabs and mantis shrimp were more abundant at the Near station. At MU-A85, the scallop and one species of shrimp were more abundant at the Far station and a species of mantis shrimp was more abundant at the Near station. One species of crab and one shrimp at HI-A389 were significantly more common at the Near station. Of the seven species that were collected at more than one platform, (*T. similis*, *P. aztecus*, *A. duplicatus*, *S. chydrea*, *P. spinicarpus*, *S. atlantidis*, and *A. cingulatus*), only *T. similis* had significantly different CPUE values at both platforms. In both cases, *T. similis* were more common at the Far site. The absence of additional examples like *T. similis* suggested that **characteristics specific to individual platforms exert a primary control on species distributions and abundances.**

Many marine invertebrates are more active from dusk to dawn. Trawling was conducted from noon to midnight to bracket dusk and include trawling time after dark. CPUE can be biased by the time of day when the collections were made (Brusher et al. 1972). To determine whether collections and, therefore, CPUE were biased by time of day, the trawls were assigned to one of three equal time periods: 1200 to 1559; 1600 to 1959, and 2000 to 2400. Except during the longer spring days, time period 2 bracketed dusk and time period 3 was after sunset. Several species at each platform had significant relationships between time of collection and CPUE; those species are designated in Table 6.72. In each of the significant cases, time period 3 (after dusk) had higher CPUE than the other time periods. In fact, in every case except *A. cingulatus* (HI-A389), time period 3 had a higher CPUE, whether significant or not, suggesting that **time of day had a significant relationship to the numbers of individuals collected and, therefore, that measures of abundance increased after dark due to increased activity in megafaunal species.** Thus, overall means include this bias.

Table 6.72. Differences in catch per unit effort (CPUE) for species collected from the Near and Far Stations at each platform.

CPUE is Higher at the Far Station ^a	No Difference in CPUE Between Near and Far Station ^a	CPUE is Higher at the Near Station ^a
<u>MAI-686</u>		
<i>T. similis</i> ** (***) <i>S. dorsalis</i> *** (**) <i>P. aztecus</i> *** <i>A. duplicatus</i> ***	<i>C. similis</i> <i>S. chydrea</i>	<i>P. gibbesii</i> *** <i>S. empusa</i> * (***)
<u>MU-A85</u>		
<i>T. similis</i> * <i>A. papyraceum</i> *** (*)	<i>A. duplicatus</i> <i>P. aztecus</i> (*) <i>S. atlantidis</i> (***) <i>P. spinicarpus</i> (**) <i>A. cingulatus</i>	<i>S. chydrea</i> ***
<u>HI-A389</u>		
	<i>S. atlantidis</i> (***) <i>M. quinquespinosa</i> <i>A. alexandria</i> Hermit crabs <i>A. cingulatus</i> <i>S. chydrea</i> <i>S. edentata</i>	<i>P. spinicarpus</i> ** <i>P. similis</i> * (*)

^aAsterisks (*) designate the level of significance for species that have different CPUE between the Near and Far stations (MANCOVA, * P = 0.05 - 0.01; ** P = 0.01 - 0.001; *** P = 0.001 - 0.0001). Dark circles in parentheses indicate species that have a significant relationship between CPUE and the time of day of collection (MANCOVA, • P = 0.05 - 0.01; •• P = 0.01 - 0.001; ••• P = 0.001 - 0.0001).

To determine whether small animals or small species were discriminated against during collection, the size of the organisms in each trawl was compared to the time of day they were collected. Species, by sex, at each platform that had a significant relationship between the time of collection and the size of individuals collected are listed in Table 6.72. Although some species at each platform showed a significant relationship between time of collection and size collected, during no particular time period were either larger or smaller individuals consistently collected across all taxa. For example, larger individuals were not always collected later in the day than smaller individuals for any species or grouped taxon.

Species that had a significant relationship with size are summarized in Table 6.73. These results suggest that **size classes were collected equivalently at all times and that differences in size were probably related to differences in species' activity patterns, making certain sizes more active and available for collection at different times.**

6.6.2 Size-Frequency Distributions

Exposure to environmental stresses, including chemical contaminants, can reduce growth rates in invertebrate species (Sindermann 1983). Inspection of the size-frequency distributions, described in Section 5.7.3, indicated that larger animals were often found farther from the platform (Table 6.73). This difference was specifically tested using a MANCOVA as reported in Table 6.74. At MAI-686, almost as many species were significantly larger near the platform as far from the platform. Female *P. aztecus* and most crabs were larger at the Far station whereas *T. similis* and starfish were larger near the platform. Some of these differences were sex specific. A different pattern occurred at MU-A85. At this platform, no species had larger individuals at the Near station. In all significant cases, larger individuals were collected at the Far station. This was true for both sexes of *S. atlantidis*, scallops, some crabs and female stomatopods. The opposite pattern occurred at HI-A389. At this platform, when significant, larger animals were collected at the Near station. Species larger near the platform included female (but not male) crabs and female stomatopods. These results suggest that, although differences in size exist in some species between sexes (see also Table 6.74), **the differences in sizes observed are more often related to differences in the size of the individual per se and not just the preferential distribution of sexes between Near and Far stations.**

Changes in size-frequency distributions may be related to season because spawning and recruitment of younger, smaller individuals into the population occurs only during certain periods of the year. Sex frequency data for megafaunal invertebrates is summarized and described in detail in Section 5.6.2. The difference in individual size between the summer (2 and 4) and winter (1 and 3) cruises was tested for significance using MANCOVA. Individual size differed between cruises; some species were consistently larger during the winter cruises as opposed to the summer cruises,

Table 6.73. Species collected at each platform that had a significant relationship between individual size and the time of collection.

Significant Relationship Between Size and Time of Collection ^a	No Significant Relationship Between Size and Time of Collection ^a
<u>MAI-686</u>	
<i>T. similis</i> , M*** (1), F*** (2) <i>C. similis</i> , F* (1) <i>P. gibbesii</i> , F* (2) <i>A. duplicatus</i> *** (1) Portunid crabs, F*** All starfish*** All shrimp, M***, F***	<i>S. dorsalis</i> , M (2), F (3) <i>P. aztecus</i> , M (3), F (3) <i>C. similis</i> , M (2), Int (2) <i>P. gibbesii</i> , M (3), Int (3) <i>S. empusa</i> , M (1), F (1) <i>S. chydarea</i> , M (2), F (1) Portunid crabs, M, Int All stomatopods, M, F
<u>MU-A85</u>	
<i>S. chydarea</i> , F* (2) <i>A. papyraceum</i> ** (1) All stomatopods, F* All shrimp, M*	<i>T. similis</i> , M (2), F (3) <i>S. atlantidis</i> , M (3), F (3) <i>P. aztecus</i> , M (2), F (3) <i>P. spinicarpus</i> , F (2), Int (3) <i>S. chydarea</i> , M (3) <i>A. cingulatus</i> (2) Portunid crabs, M, F All stomatopods, M All starfish All shrimp, F
<u>HI-A389</u>	
<i>P. similis</i> , M* (2) <i>S. edentata</i> , M* (2)	<i>S. atlantidis</i> , M (2), F (1) <i>P. similis</i> , F (1) <i>P. spinicarpus</i> , F (3) <i>M. quinquespinosa</i> , M (1), F (1) <i>A. alexandria</i> , M (3), F (3) Hermit crabs, M (1), F (2) <i>S. chydarea</i> , F (2) <i>A. cingulatus</i> (2) Portunid crabs, F All stomatopods, M, F All starfish All shrimp, M, F

^aResults are for individuals collected on Cruise 3 and Cruise 4 only. M= male; F=female; Int=intermediate stage. Asterisks designate the level of significance, (MANCOVA, * P = 0.05 - 0.01; ** P = 0.01 - 0.001; *** P = 0.001 - 0.0001). Numbers in parentheses indicate the time period during which the largest individuals were collected (1 = 1200 - 1559; 2 = 1600 - 1959; 3 = 2000 - 2400).

Table 6.74. Results of multiple analysis of covariance determining whether individuals are significantly larger at the Near or Far site at each platform.

Individuals are Larger at the Far Station ^a	No Difference in Size Between Near and Far Station ^a	Individuals are Larger at the Near Station ^a
<u>MAI-686</u>		
<i>P. aztecus</i> , F*** <i>C. similis</i> , F** Portunid crabs, M*, F**, Int***	<i>P. aztecus</i> , M All shrimp, M, F <i>C. similis</i> , M, Int <i>P. gibbesii</i> , F, Int <i>S. empusa</i> , M, F <i>S. chydæa</i> , M, F All stomatopods, M, F	<i>T. similis</i> , M***, F*** <i>A. duplicatus</i> *** All starfish***
<u>MU-A85</u>		
<i>S. atlantidis</i> , M**, F* <i>P. spinicarpus</i> , Int* Portunid crabs, Int** <i>S. chydæa</i> , F* <i>A. papyraceum</i> ***	<i>T. similis</i> , M, F <i>P. aztecus</i> , M, F All shrimp, M, F <i>C. similis</i> , M <i>P. spinicarpus</i> , M, F Portunid crabs, M, F <i>S. chydæa</i> , M All stomatopods, M, F <i>A. cingulatus</i> All starfish	
<u>HI-A389</u>		
	<i>S. atlantidis</i> , M, F <i>P. similis</i> , M, F All shrimp, M, F <i>M. quinquespinosa</i> , M, F <i>A. alexandria</i> , M, F Hermit crabs, M, F <i>S. edentata</i> , M All stomatopods, M, F <i>A. cingulatus</i> All starfish	<i>P. spinicarpus</i> , F*** Portunid crabs, F*** <i>S. chydæa</i> , F**

^aM=male; F=female; Int=intermediate stage. Asterisks (*) describe the level of significance:
 * P = 0.05 - 0.01; ** P = 0.01-0.001; *** P = 0.001 - 0.0001.

regardless of distance or platform (Table 6.75). For example, *P. aztecus* at MAI-686 and *A. papyraceum* at MU-A85 were larger during the winter cruises at both the Near and Far stations than during the summer cruises, suggesting a late winter or early spring spawning season in these species at these platforms. *T. similis* and starfish at both MAI-686 and MU-A85 were larger during the summer cruises, indicating that younger, smaller

individuals were collected during the winter cruises. This suggested a fall spawning season for these species. These differences in size based on cruises may indicate when spawning occurs in these populations. However, more frequent sampling is required to rigorously assess the timing of spawning in these populations.

The results of size-frequency distribution and CPUE can be combined to compare the size and abundance of species at both the Near and Far stations. Combined results show that **not only are some species larger farther from the platform, but they are also present in higher abundance.** For other species, abundances do not change whereas size distributions do (Tables 6.73 and 6.75). For example, *P. aztecus* were more abundant at the Far station of MAI-686 and the females were also larger. The same is true for scallops (*A. papyraceum*) at MU-A85. In the case of *T. similis* and *A. duplicatus* at MAI-686, the individuals were larger near the platform, but were more abundant far from the platform. *S. empusa* at MAI-686 and *P. similis* at HI-A389 were more abundant at the Near station, however size-class distributions were unaffected. **These distinctly different patterns in size-class distributions and abundances are thus platform specific and are probably related to unique environmental and chemical conditions locally present at each platform, rather than the presence of the structure in the habitat.**

6.6.3 Histopathology

Pathologies may be used as indicators of environmental degradation (Sindermann 1983). Environmental stresses resulting from exposure to chemical contaminants can affect individual health by altering the physiological, biochemical, and behavioral processes of an organism, causing cell and tissue damage, and lowering resistance to disease and parasitism (Sindermann 1983). Therefore, the increased prevalence or intensity of parasitism or disease with proximity to platforms could indicate chronic exposure to chemical contaminants. Megafaunal invertebrate histopathology data is summarized and described in detail in Section 5.6.3.

Prevalence of parasitism was compared for each species at both the Near and Far stations of each platform using multiple analysis of covariance. Only one species showed significant differences in prevalence of parasitism

Table 6.75. Results of MANCOVA analysis determining whether a relationship exists between individual size and the cruise on which the individual was collected.

Significant Relationship Between Individual Size and Cruise ^a	No Significant Relationship Between Individual Size and Cruise ^a
<u>MAI-686</u>	
<i>P. aztecus</i> *** (3) <i>C. similis</i> *** (2) All shrimp*** (3) Portunid crabs*** (2) <i>S. empusa</i> * (3) <i>S. chydrea</i> * (4) All stomatopods* (3) <i>A. duplicatus</i> *** (4) All starfish*** (4)	<i>T. similis</i> <i>P. gibbesii</i>
<u>MU-A85</u>	
<i>T. similis</i> *** (2) <i>P. aztecus</i> *** (4) <i>S. atlantidis</i> *** (4) All shrimp*** (4) <i>A. cingulatus</i> ** (4) <i>A. papyraceum</i> *** (3) <i>P. spinicarpus</i> *** (4) Portunid crabs*** (4) All starfish*** (4)	<i>C. similis</i> <i>S. chydrea</i> All stomatopods <i>A. duplicatus</i>
<u>HI-A389</u>	
All shrimp* (4) <i>P. spinicarpus</i> *** (4) Portunid crabs*** (2) <i>M. quinquespinosa</i> ** (3) Hermit crabs** (4)	<i>S. atlantidis</i> <i>P. similis</i> <i>A. alexandria</i> <i>S. chydrea</i> <i>S. edentata</i> All stomatopods <i>A. cingulatus</i> All starfish

^aAsterisks (*) represent levels of significance * P = 0.05 - 0.01; ** P = 0.01 - 0.001; *** P = 0.001 - 0.0001. Number in parentheses indicates the cruise on which the largest individuals were collected. Cruises 2 and 4 are summer cruises, Cruise 3 is a winter cruise.

between Near and Far stations. *A. duplicatus* had a significantly higher prevalence of parasitism at the Far station than at the Near station at MAI-686 (MANCOVA, $P = 0.0001$). **None of the shrimp or crab species analyzed had significant differences in prevalence of parasitism based on proximity to the platforms.**

Intensity of each individual parasite and pathology was compared for individual species at both sites and each platform using MANCOVA. The model compared differences in the intensity of each parasite and pathology among platforms, distances and cruises. In this model, only two intensities of parasitism were significantly different between Near and Far stations; nematodes in *T. similis* and gill filaments with inclusive bodies in *P. spinicarpus*. In both cases, the intensity was higher at the Near station at MU-A85 ($P = 0.036$ and 0.025 , respectively).

However, size, and therefore age, are normally important in determining infection intensity. By virtue of their longer life, older individuals have a higher possibility of being parasitized or diseased because of increased exposure to infective agents. Thus, significant differences in infection might be obscured or enhanced by the substantial size differences between individuals at Near and Far stations. Accordingly, individual size was added to the model as a covariate, so that individuals of the same size were compared to determine whether intensities of parasitism were different between Near and Far stations. Like differences in size distributions, the pattern produced by differences in intensity of individual parasites and pathologies was platform specific (Table 6.76). At MAI-686 and HI-A389, a similar number of parasites or pathologies was found at higher intensities at Near and Far stations. Many more significant differences were observed at MAI-686, but the data set was larger. At MU-A85, many more parasites and pathologies were found in higher intensity close to the platform. Thus, only at MU-A85 was the distribution of parasites and pathologies consistent across megafaunal taxa and across malady type. Once again, **platform-specific effects produced by the local physical or chemical environment seem to be most important in determining the health of invertebrate populations.**

Most individuals analyzed histologically had occurrences of more than one parasite or pathology in their tissues. Little information exists in the literature concerning the relative effect of any of the parasites observed on

Table 6.76. Results of histopathological analysis of tissues to determine whether a significant relationship exists between the intensity of parasitism and the distance from the platform.

Intensity of Parasitism is Higher at the Far Station ^a	Intensity of Parasitism is Higher at the Near Station ^a
<u>MAI-686</u>	
<i>T. similis</i> , F* - Bac <i>P. aztecus</i> , M* - Gut All starfish, M** - Nem <i>A. duplicatus</i> , M** - Nem <i>P. aztecus</i> , M* - Ces <i>T. similis</i> , F*** - Cyst	<i>T. similis</i> , F** - Gut <i>C. similis</i> , M***, F* - Nem <i>P. aztecus</i> , F* - Ces <i>C. similis</i> , M* - GFB
<u>MU-A85</u>	
<i>P. aztecus</i> , F* - Bac	<i>A. cingulatus</i> , F*** - Nem All starfish, F*** - Nem <i>P. aztecus</i> , F* - Ces <i>P. spinicarpus</i> , M** - GFB Portunid crabs, M*** - GFB <i>C. similis</i> , M* - MGF Portunid crabs, M** - MGF
<u>HI-A389</u>	
<i>P. similis</i> , M*, F* - Ces	<i>M. quinquespinosa</i> , M*** - MGF

^aM=males; F=females. Abbreviations are used for the parasite or pathology category: Nem, nematodes; Ces, cestodes; Bac, Baculovirus; Gut, gut inflammations; Cyst, cyst in muscle or connective tissue; GFB, gill filament with inclusive body; MGF, malformed gill filament. Asterisks (*) indicate the level of significance determined by MANCOVA: * P = 0.05 - 0.01; ** P = 0.01 - 0.001; *** P = 0.001 - 0.0001.

an organism. Deciding which parasite or pathology has the most detrimental impact on host health or reproductive effort is difficult. For example, cestode parasites were much larger than nematode parasites, but nematodes were typically more abundant in an individual than cestodes. Therefore, determining whether the larger parasite or the more numerous parasite had a more detrimental effect is difficult. Consequently, to determine the cumulative effect of total parasitism and disease on an individual's health and reproductive effort, the number of occurrences of each separate parasite were weighed based on the maximum number of occurrences recorded in that species. In this way, none of the parasites or pathologies were given more importance than the others. The maximum number of occurrences of each parasite in each species was divided into

quartiles; the 25th, 50th, 75th, and 100th; using univariate analysis. Each individual was given a score from 0 to 4. Thus, true zeroes were maintained. The number of occurrences of parasites in each individual was then allocated to the appropriate quartile and the score assigned. For example, for nematodes in *P. aztecus*, the 25th quartile had two occurrences, the 50th three occurrences, the 75th 10 occurrences and the 100th 146 occurrences. An individual of *P. aztecus* with 26 occurrences of nematodes received a score of 4 for nematodes. The scores for each parasite and pathology were then summed and a single score representing the total amount of parasitism was obtained. That final score representing the cumulative effect of all parasitism was considered a measure of overall health and used in the MANCOVA.

No species had significantly different levels of total parasitism and disease associated with distance from the platforms. The results of this model suggest that **populations at both Near and Far stations are parasitized and that the differences observed are parasite specific.** Some maladies may respond to the environmental gradients present while others do not.

Generally, older individuals are more highly parasitized than younger, smaller individuals. When size was added to the model using cumulative parasitism (size was assumed to imply age), only female *P. aztecus* at both MAI-686 and MU-A85 had a significant relationship between size and parasitism ($P=0.0197$ and 0.0038 , respectively). Larger individuals were more heavily parasitized. *P. aztecus* is one species in which females are larger than males. Thus, the result may also suggest a sex difference in intensity of parasitism, in that females were more highly parasitized than males.

6.6.4 Reproductive Effort

Little is known about the reproductive effort of most continental shelf invertebrates. Accordingly, whether reproductive effort is affected in these species by the presence of a platform is largely unknown. Widdows (1985) suggested that stress caused by exposure to pollutants reduces fecundity, egg size, egg lipid content, and larval survivability and growth. Reproductive responses can therefore serve as an ecologically important measure of contamination impacts because it influences production and maintenance of

populations (Widdows 1985). Therefore, several methods were utilized to assess differences in the reproductive effort of megafaunal invertebrate species living near and far from platforms. Differences in male-to-female ratios, percent gravid females (crab species), and stage of reproductive development determined by visual inspection, histological analysis and by immunological probe were used to indicate sublethal effects of exposure to chemical contaminants or other platform related perturbations of reproductive effort. The relationship between health (as defined by prevalence and intensity of parasitism and pathologies) and stage of reproductive development was also examined. Data related to reproductive effort for megafaunal invertebrates is summarized and described in detail in Section 5.6.4.

6.6.5 Male-to-Female Ratios and Percent Gravid Females

Differences in the distribution of males and females between Near and Far stations was determined for all individuals collected using MANCOVA (Table 6.77). Sex ratios and percent gravid female data are summarized and described in detail in Section 5.6.5. Although sex was determined for a number of stomatopod and crab species, significant effects were only observed for two species of shrimp and one species of crabs. Of the four significant results, females were more common at the Near station for three of them; *T. similis* (MAI-686) and *C. similis* (MAI-686 and MU-A85). *S. atlantidis* (MU-A85) populations had significantly more females at the Far station. Size was added to the model to determine whether a difference existed unrelated to size. In this case, more species had significantly different results, and significant results were found in shrimp, crabs, and stomatopods (Table 6.77). The Near and Far stations at MAI-686 and MU-A85 had similar numbers of species with significantly larger females. Females were only significantly larger for species collected at the Near station at HI-A389.

The percentage of gravid female crabs was determined for each species collected at both the Near and Far stations. A gravid female crab was one collected "in sponge"; that is with a visible egg sac. **MANCOVA analysis indicated that no significant difference existed in the number of gravid females collected related to distance from the platform.**

Table 6.77. Results of MANCOVA analysis to determine which species have a significant relationship between sex and distance from the platform.

Females more common Far Station ^a	No difference between Near and Far Station ^a	Females more common Near Station ^a
<u>MAI-686</u>		
P. aztecus (••) P. gibbesii (••)	S. empusa S. chydrea	T. similis*** (•••) C. similis*** (•••)
<u>MU-A85</u>		
S. atlantidis*** (•••) T. similis (•••)	P. spinicarpus S. chydrea	S. atlantidis (•••) P. aztecus, F (•••) C. similis *** (•••)
<u>HI-A389</u>		
	S. atlantidis P. spinicarpus M. quinquespinosa A. alexandria S. edentata Hermit crabs	P. similis, F (•••) S. chydrea F (••)

^aAsterisks (*) indicate the level of significance, * P = 0.05 - 0.01; ** P = 0.01 - 0.001; *** P = 0.001 - 0.0001. Dark circles indicate significant differences when size was included in the model (• P = 0.05 - 0.01; •• P = 0.01 - 0.001; ••• P = 0.001 - 0.0001).

A gonadal-somatic index (GSI) was calculated using the relationship between egg sac dry weight and body dry weight to determine body weight-specific changes in egg sac weight. Larger individuals should have larger egg sacs. GSI was calculated for individuals collected on the last two cruises. Only two comparisons could be analyzed statistically, both at MAI-686. At this site, GSI for *C. similis* was significantly higher at the Near as compared to the Far station (MANCOVA, P = 0.0318). *P. gibbesii* also had a higher GSI at the Near station, however, it was not significant.

6.6.6 Stage of Reproductive Development

The cost of reproduction to an individual can be measured in terms of energy taken away from basic metabolism and growth for the production of gametes (Calow 1979). Environmental stresses may alter an organism's energy budget and thereby, the partitioning of energy between growth and

reproduction, often resulting in delayed reproductive development (Koehn and Bayne 1989). However, some species may accelerate their reproductive effort in the presence of stress to assure the production of the next generation (Calow 1979). Therefore, differences in the stage of reproductive effort between individuals collected from Near and Far stations could represent different responses to environmental stresses. Reproductive effort may also be related to the age and size of the organism which can also be adversely affected by environmental stresses. All data collected on the stage of reproductive development in megafaunal invertebrates is summarized in Section 5.6.6.

Stage of reproductive development was determined through visual inspection of all females of shrimp and crab species. Reproductive development may be delayed by exposure to contaminants and may also be related to the size (age) of the individual. **Few significant differences in the stage of reproductive development with proximity to the platforms were found** (Table 6.78). However, two species of shrimp showed a relationship between distance from the platform and stage of reproductive development. *S. atlantidis* and *P. similis* at HI-A389 both were significantly further along in reproductive development at the Far station, where the largest females were also collected. Thus, variations in size between populations could obscure site-to-site differences in reproductive development. Accordingly, size was added to the model as a covariate. In this analysis, stage of reproductive development varied significantly with distance from the platform for nearly all species at MAI-686 and for *S. atlantidis*, at MU-A85. *S. atlantidis* for example, had a higher stage of reproductive development at the Far station at MU-A85 and *T. similis* had a higher stage of reproductive development at the Far station at MAI-686, even though larger individuals were collected at the Near station. These results indicated that **the largest individuals were not always the farthest along in reproductive development.**

The stage of reproductive development was also determined through histological examination of both males and females of target species. Again, few differences in stage of reproductive development were related to distance from the platform (Table 6.79). Regardless of distance from the platforms, in each of these species, the larger individuals were farther along in their reproductive development. If size was included in the analysis, fewer significant differences occur. These results suggested that **size, and**

Table 6.78. Results of stage of reproductive development determined through visual inspection.

Stage of Reproductive Development is Higher at the Far Station ^a		Stage of Reproductive Development is Higher at the Near Station ^a
	<u>MAI-686</u>	
<i>T. similis</i> (••) All shrimp (•••) <i>C. similis</i> (•) Portunid crabs (•)	<i>P. aztecus</i>	<i>P. gibbesii</i> (•)
	<u>MU-A85</u>	
	<i>T. similis</i> <i>P. aztecus</i> All shrimp <i>P. spinicarpus</i> Portunid crabs	<i>S. atlantidis</i> (•••)
	<u>HI-A389</u>	
<i>S. atlantidis</i> *** (•••) <i>P. similis</i> ** (••) All shrimp **	<i>P. spinicarpus</i> Portunid crabs <i>M. quinquespinosa</i> Hermit crabs <i>A. alexandria</i>	

^aResults are for females only. Significant differences between stage and proximity to the platform are indicated by asterisks (*), (MANCOVA* P = 0.05 - 0.01; ** P = 0.01 - 0.001; *** P = 0.001 - 0.0001. Species marked by dark circles have a significant relationship between stage of reproductive development and proximity to the platform when size was added to the model as a covariate. Level of significance is the same as asterisks.

Table 6.79. Results of stage of reproductive development determined through histological analysis.

Reproductive Stage is Higher at the Far Station ^a	No Difference Between the Near and Far Stations ^a	Reproductive Stage is Higher at the Near Station ^a
<u>MAI-686</u>		
<i>A. duplicatus</i> , M*	<i>C. similis</i> , M	<i>T. similis</i> , F*
<i>P. aztecus</i> , F**	<i>P. gibbesii</i> , M, F	<i>T. similis</i> , M(•)
<i>C. similis</i> , F**	Portunid crabs, M, F	All shrimp, M(••)
All starfish, M*	<i>S. empusa</i> , M, F	
<i>P. aztecus</i> , M(•)	<i>S. chydarea</i> , M, F	
	<i>A. duplicatus</i> , F	
	<i>A. cingulatus</i> , M, F	
	All stomatopods, M, F	
	All starfish, F	
	All shrimp, M, F	
<u>MU-A85</u>		
<i>P. aztecus</i> , M*	<i>T. similis</i> , M, F	<i>C. similis</i> , M***
All stomatopods, F(•)	<i>P. aztecus</i> , F	<i>A. cingulatus</i> , M(••)
	<i>S. atlantidis</i> , M, F	
	<i>C. similis</i> , F	
	<i>P. spiricarpus</i> , M, F	
	<i>S. chydarea</i> , M, F	
	<i>A. cingulatus</i> , M, F	
	<i>A. papyraceum</i>	
	Portunid crabs, M, F	
	All shrimp, M, F	
	All stomatopods, M, F	
	All starfish, M, F	
<u>HI-A389</u>		
<i>S. atlantidis</i> , M***, F*** (•)	<i>A. alexandria</i> , M, F	<i>M. quinquespinosa</i> , M(•)
All shrimp, M***, F***	<i>M. quinquespinosa</i> , M(•)	
	<i>S. edentata</i> , M, F	
	<i>P. similis</i> , M, F	
	All stomatopods, M, F	
	All starfish, M, F	

^aSignificant differences between stage and proximity to the platform are determined by MANCOVA (* P = 0.05 - 0.01; ** P = 0.01 - 0.001; *** P = 0.001 - 0.0001). Species marked with dark circles have a significant relationship between stage of reproductive development and proximity to the platform when size was added as a covariate. Levels of significance are the same as asterisks.

not proximity to platforms, was most important in determining the stage of reproductive development in these species. However, the data were obtained by selection of the largest individuals, so that statistical tests with size may be biased.

Immunological probes active against egg protein were developed for three species of portunid crabs, *C. similis*, *P. gibbesii*, and *P. spinicarpus*. The quantity of egg protein was determined with these probes for females that were in the midst of their reproductive cycle; that is, they were not yet in sponge. The probe provided a measure of total gamete protein present. Comparison of gamete weight in animals ready to spawn, as measured by the probe, to the weight of protein in egg masses collected from gravid females yielded equivalent results, indicated that the probe satisfactorily measured total egg protein concentrations in gonadal tissues.

Statistical analyses were possible in three cases. On Cruise 2, *P. spinicarpus* from MU-A85 and *P. gibbesii* at MAI-686 had a higher quantity of gamete protein measured in individuals collected near the platform. *C. similis* from MAI-686 (Cruise 4) showed the opposite pattern with higher quantity of gonadal protein measured at the Far station. Only for *P. gibbesii* was the difference statistically significant.

GSI, or gonadal somatic index, is another measure of the relationship between the amount of egg present (dry weight) and the weight of the individual. High values of GSI would suggest an individual with a high gonadal weight compared to its own body weight. For the three cases, both *P. spinicarpus* at MU-A85 and *P. gibbesii* at MAI-686 had higher GSI at the Near stations, but neither trend was significant. In one case, *P. gibbesii*, these results agreed with the results obtained from analysis of gravid females. Egg sacs were also heavier at the Near station. The opposite was true for *C. similis* at MAI-686 where the higher GSI was recorded at the Far station, but the GSI for gravid females was higher at Near stations.

Besides distance effects on GSI, some platform-specific effects also occurred. The results of GSI analysis for *P. spinicarpus* from the Near stations at both MU-A85 and HI-A389 collected on Cruise 2 are summarized in Figure 6.57. HI-A389 had a much higher GSI as compared to MU-A85. These results agree with the results obtained from visual inspection and suggest once again that platform-specific characteristics in the physical or

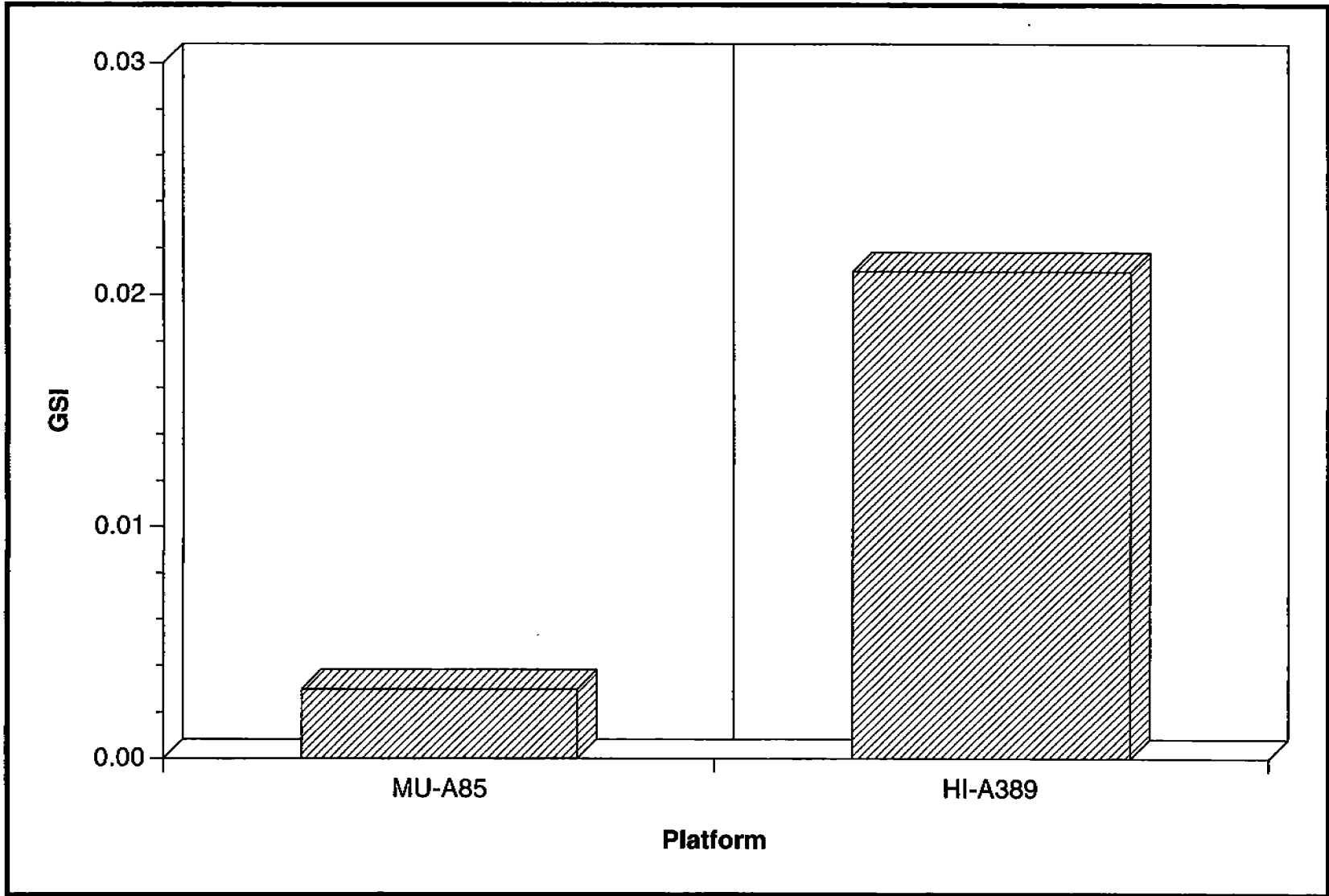

Figure 6.57. Average GSI of *P. spincarpus* at MU-A85 and HI-A389.

chemical environment effect the reproductive development of resident organisms.

The results obtained from the three types of reproductive analyses; visual, histological, and quantitative using the immunological probe; are compared in Table 6.80. No case occurred where the three analyses provided opposing conclusions. Numerous cases occurred where one analysis provided a significant result and another did not. Thus, visual and histological stage and gamete quantity were different variables. Stage measures advancement in the reproductive cycle, whereas gamete quantity measures true fecundity. The strength of the immunological analysis was that it provides a quantitative measure of fecundity which histological analysis and visual inspection fail to provide. In all three cases however, where sampling was adequate, few significant differences were observed.

6.6.7 Histopathology and Stage of Reproductive Development

One of the advantages of determining the stage of reproductive development by histological analysis is that it allows for comparisons to be made between the stage of reproductive development and levels of parasitism and disease in the same individuals (see Section 5.7 for histological results and Section 5.6.6 for reproductive development data). Prevalence of parasitism and disease was used in statistical models to determine whether the presence of parasites had an effect on reproductive development. **Prevalence had a significant relationship with stage of reproductive development only at MU-A85 (Table 6.81). At this platform, scallops, male and female starfish, and all shrimp had lower stages of reproductive development with higher prevalences of infection.** Reproductive stage in crabs was unaffected by parasitism or disease. Although prevalence was related in a few cases to stage of reproductive development, intensity of the individual parasites or pathologies was never significantly related to the stage of reproductive development in any of the species at any platform. The measure of total parasitism was used in models to determine whether overall health was related to the stage of reproductive development. In only two cases, female *P. aztecus* at MAI-686 ($P = 0.0329$) and female *A. cingulatus* at MU-A85 ($P = 0.0057$), was total parasitism

Table 6.80. Comparisons of results of reproductive effort studies comparing visual inspection, histological analysis and immunological probe.

Species	Platform	Stage of Reproductive Development	
		Visual Inspection	Histological Analysis
<i>C. similis</i>	MAI-686	Higher Far Station	No Difference between Near and Far Station
<i>P. gibbesii</i>	MAI-686	Higher Near Station	No Difference between Near and Far Station
<i>P. spincarpus</i>	MU-A85	No Difference between Near and Far Station	No Difference between Near and Far Station

Species	Platform	Immunological Probe	
		Gonadal Protein	Gonadal Somatic Index (GSI)
<i>C. similis</i>	MAI-686	No Difference between Near and Far Station	No Difference between Near and Far Station
<i>P. gibbesii</i>	MAI-686	Higher Near Station	No Difference between Near and Far Station
<i>P. spincarpus</i>	MU-A85	Higher Near Station	No Difference between Near and Far Station

Table 6.81. Results of histopathological analysis of tissues to determine whether a relationship exists between prevalence of parasitism and stage of reproductive development.

Prevalence of Parasitism is Significantly Related to Stage of Reproductive Development ^a	Prevalence of Parasitism is Not Significantly Related to Stage of Reproductive Development ^a
<u>MAI-686</u>	
	<i>T. similis</i> , M, F <i>P. aztecus</i> , M, F <i>A. duplicatus</i> , M, F <i>C. similis</i> , M, F <i>P. gibbesii</i> , M, F Portunid crabs, M, F All starfish, M, F All shrimp, M, F
<u>MU-A85</u>	
<i>A. cingulatus</i> , M**, F* <i>A. papyraceum</i> ** All starfish, M* All shrimp, M*, F**	<i>T. similis</i> , M, F <i>P. aztecus</i> , M, F <i>S. atlantidis</i> , M, F <i>C. similis</i> , M, F <i>P. spinicarpus</i> , M, F Portunid crabs, M, F All starfish, F
<u>HI-A389</u>	
	<i>A. alexandria</i> , M, F Hermit crabs, M, F <i>A. cingulatus</i> , M, F <i>S. atlantidis</i> , M, F <i>P. similis</i> , M, F <i>M. quinquespinosa</i> , M, F All starfish, M, F All shrimp, M, F

^aAsterisks indicate the level of significance (MANCOVA, * P = 0.05 - 0.01; ** P = 0.01 - 0.001; *** P = 0.001 - 0.0001). M = males; F = females.

related to stage of reproductive development. In each of these cases, more heavily infected individuals had lower stages of reproductive development.

6.7 Megafauna - Demersal Fish

While gross fish pathology is a potential response indicator of environmental status that is easy and economical to measure, it will not allow the identification of important contaminant-associated pathological

abnormalities. Histopathological examination of select tissues is widely recognized as a reliable method for assessing the adverse effects of exposure to anthropogenic contaminants in marine fishes. For example, certain pathological conditions in the liver of wild fishes morphologically resemble lesions induced in fishes by experimental exposure to a variety of toxicants, including carcinogens. Furthermore, some of these lesions have also been shown to be positively associated with exposure to xenobiotic chemical contaminants in field studies. Summary of histopathological observations for demersal fish is provided in Section 5.7.2.

Macrophage aggregates (MAs), particularly those in the spleen, also appear to be a good histopathological indicator of contaminant exposure. MAs are focal accumulations of macrophages found in the spleen, liver and kidney of fishes that contain the pigments hemosiderin, ceroid/lipofuscin, and melanin (Wolke 1992). Occurrence of MAs may vary depending on the size, nutritional status, or health of a particular fish species (Agius 1980; Wolke et al. 1985). In addition, the number and size of MAs increase with age in some species (Brown and George 1985; Blazer et al. 1987). Suggested functions for these aggregates include the centralization of foreign material and cellular debris for destruction, detoxification or reuse.

Changes in splenic MA parameters (e.g., number, size) in relation to environmental contamination have been noted by several investigators (Kranz and Peters 1984; Wolke et al. 1985; Spazier et al. 1992). Hence, it has been suggested that these structures may be sensitive, non-specific indicators of stress. Preliminary studies from the Environmental Monitoring and Assessment Program in the Gulf of Mexico demonstrated an increase in splenic MA number and percent of tissue replaced in most species from contaminated sites. Some species were good indicators of elevated tissue contaminants while others were good indicators of sediment contaminants (Blazer et al. 1994).

Analysis of the demersal fish histopathology data indicates four main points: (1) fish from site MAI-686 had a statistically greater number of MAs per mm² during all cruises except the third cruise, (2) MAs from fish at site MAI-686 were generally smaller than those from the other two sites (3) when analyzed for Near/Far station comparisons, no significant difference was noted among samples, and (4) the MA size and percent area occupied by

MAs at site HI-A389 were significantly greater than the MAs at either site MAI-686 or MU-A85.

Histopathological evaluation of tissues samples from study site fish revealed no lesions attributable to contaminant exposure. Parasitic infections, predominantly microsporidians and nematodes, were commonly found in fishes at all sites and stations. All pathological findings from these fishes (i.e., granulomas and inflammatory foci) were associated with parasitic infections.

The reason fish from MAI-686 had a greater number of MAs per mm² during three of the four cruises and that MAs in those fish were generally smaller was probably due to species differences. *Syacium gunteri* was the only species collected at site MAI-686, whereas *T. ventralis* was the only species collected at the other two sites. Since no other data on MAs from *S. gunteri* are available for comparison, no difference between Near and Far stations at site MAI-686 was seen. No apparent correlations were noted with contaminant data and the MA parameters at site MAI-686. Little can be said regarding these findings. **The lack of Near/Far station differences may be related to the relative proximity of these sites.** The Far station is only 3000-m from the platform (near site); while this may be sufficient separation when looking at sediment contaminants, the **fish may range over an area greater than the station separation**, thus a single population is sampled.

Point four above should be viewed as two separate observations, a statistical difference in MA size and percent area occupied by MAs between sites HI-A389 and MAI-686 and between sites HI-A389 and MU-A85. Examination of the data suggests that the HI-A389 and MAI-686 site differences reflect the cross-species comparison discussed earlier and therefore cannot be compared. However, the differences between the samplings at sites HI-A389 and MU-A85 are statistically significant site differences within a single species (*T. ventralis*). These differences were also consistent with observations from three cruises. No comparisons were possible between these two sites during Cruise 1 because no flatfish were collected from HI-A389. These observations did not correlate with hydrocarbon or metal sediment contaminant data. Therefore, the macrophage aggregate data did not indicate any obvious contaminant effects relative to the study sites and are presently unexplained.

6.8 Detoxification

Historically, the bioavailability of contaminants has been assessed by measuring contaminant levels sequestered in biological tissues utilizing standardized analytical procedures. However, it is difficult to correlate tissue levels of complex chemical mixtures with biological responses. Consequently, a number of *in vitro* and *in vivo* assays have been developed as biomarkers of exposure of marine fish and invertebrates to polycyclic and halogenated aromatic hydrocarbons (PAHs and HAHs; Ankley et al. 1991; Collier and Varanasi 1991; Collier et al. 1992, 1995; Krahn et al. 1987; Payne et al. 1987; Stegeman et al. 1981; 1987; Tillitt et al. 1991a; Van Veld et al. 1990). *In vitro* and *in vivo* bioassays for PAH mixtures are highly sensitive to these compounds and observed responses are due to the combined or integrated effects of all the individual compounds in these mixtures. Hydrocarbon exposure in fish has been correlated with numerous physiological responses including reproductive impairment (Thomas 1990; Hose et al. 1989); histologically identifiable diseases, including liver neoplasms (Malins et al. 1984; Murchelano and Wolke 1985; Baumann et al. 1982; Collier et al. 1992); and immune dysfunction (Weeks et al. 1992). Studies have shown that certain PAHs, such as benzo[a]pyrene (BaP), are carcinogenic in some fish species (Hendricks et al. 1985; Schultz and Schultz 1982; Metcalfe et al. 1988).

Cytochrome P450 enzymes play a major role in the oxidative metabolism of xenobiotics and pollutants. P450 enzymes catalyze the oxidative metabolism of numerous hazardous substances including BaP and other PAH as well as halogenated aromatic hydrocarbons. The cytochrome P450 system also metabolizes numerous endogenous substances including steroids, fat-soluble vitamins, fatty acids, and other natural products. Cytochrome P450 enzymes are found in every biological kingdom and virtually all cell types. Cytochrome P450s are a gene super family consisting of over 200 genes in more than 30 gene families (Nelson et al. 1993). The ancestral P450 gene is probably more than two billion years old (Nebert and Gonzalez, 1987; Nebert et al. 1989). The earliest functions of P450 were probably related to the assimilation of energy-rich organic substrates and metabolism of steroids and fatty acids. A proliferation of P450 genes occurred during the past 800 million years that most likely resulted from

the divergence of plants and animals (Nebert and Gonzalez 1987; Nebert et al. 1989). Additionally, ancient combustion events (i.e., forest fires) and diagenesis are linked to the development of P450s capable of metabolizing combustion products (i.e., PAH). Induction of mammalian CYP1A1 (P4501A1) genes is dependent on initial binding of the chemical contaminants to a cytosolic protein known as the Ah receptor. These compounds induce formation of the transformer receptor complex which translocates into the nucleus and binds to specific regions of genomic DNA thus transactivating genes. Induction of CYP1A1 gene expression results in increased CYP1A1 mRNA levels followed by increased CYP1A1 protein and dependent enzyme activities.

Studies have shown that fish P450 proteins induced by PAH and related compounds can be classified in the CYP1A subfamily and have properties similar to the mammalian CYP1A1 subfamily. The presence of cytosolic and nuclear Ah receptors has been documented in several fish species suggesting that CYP1A induction in teleost fish is also controlled by the Ah receptor and consequently the induction of CYP1A proteins is preceded by an increase in CYP1A mRNA (Hahn et al. 1994; Willett et al. 1995). Induction can be assessed by measuring CYP-associated enzyme activities (i.e., AHH and EROD), CYP1A protein levels, or CYP1A mRNA levels (Figure 6.58). CYP1A induction can be used to indicate environmental contamination by pollutants. In many studies it has been shown that there is a strong correlation between levels of contamination and the enhancement of CYP1A-dependent activities in various fish species. Although P4501A induction in fish can be affected by species-specific differences, reproductive condition, season, and temperature; CYP1A-mediated responses are largely related to exposures to organic xenobiotics. The specificity and sensitivity of CYP1A to potential inducers make this response attractive as a biomarker of environmental contamination.

Invertebrates, particularly sessile mollusks, are routinely utilized as indicators of environmental contamination by PAHs because these organisms readily bioconcentrate these compounds from their immediate surroundings (Geyer et al. 1982; Goldberg et al. 1978). Invertebrate CYP1A induction responses have been used with only limited success as indicators of contamination. Although P450 systems have been characterized in some marine invertebrates, their P450-dependent activities are usually low to

non-detectable (Lee 1982; Livingstone 1990; James 1989; Livingstone 1991). Moreover, since CYP1A-dependent activities are not routinely detected or induced in marine invertebrates relatively low metabolism and increased retention of PAH is observed. Although proliferative diseases have been noted in mollusks from contaminated sites, the involvement of procarcinogen activation in invertebrate diseases has not been demonstrated. Several studies have reported that in some invertebrate groups the rate of metabolism of BaP to mutagenic and carcinogenic oxidized metabolites is minimal (Stegeman 1985; Livingstone et al. 1989). In mammals and fish the induction of cytochrome CYP1A1(A) is regulated by the Ah receptor. However, studies using photoaffinity labeling techniques failed to detect the cytosolic Ah receptor in several invertebrate species (Hahn et al. 1992; 1994). This suggests that unlike most vertebrates, invertebrates lack a functional Ah receptor. This is consistent with the failure to observe significant PAH-induced CYP1A-dependent monooxygenase activity.

CYP1A induction responses were evaluated in both fish and invertebrate species in this study using several *in vitro* and *in vivo* assays (Figure 6.58). Detoxification data are summarized and described in detail in Section 4.8. AHH activity was measured for invertebrates collected on Cruise 1 and fish collected on Cruises 1 and 2. EROD activity and biliary PAH metabolite concentrations (i.e., naphthalene, phenanthrene, and BaP) were measured for all fish species collected on Cruises 1, 2, 3, and 4. CYP1A mRNA levels were determined for selected fish species collected on Cruises 2, 3, and 4. The activity of invertebrate extracts as inducers of CYP1A1 was determined utilizing rat hepatoma H4IIE cells.

6.8.1 AHH Activity in Invertebrates

AHH activity was measured in a number of invertebrate species collected by trawling and boxcoring on Cruise 1. AHH activity was low to non-detectable in the following invertebrates; *Trachypenaeus similis*, *Callinectes similis*, *Penaeus aztecus*, *Amusium papyraceum*, a species of spider crab, an unidentified welk, and mixed infauna from boxcorers. **No significant differences in invertebrate AHH activity for near/far station comparisons were observed.**

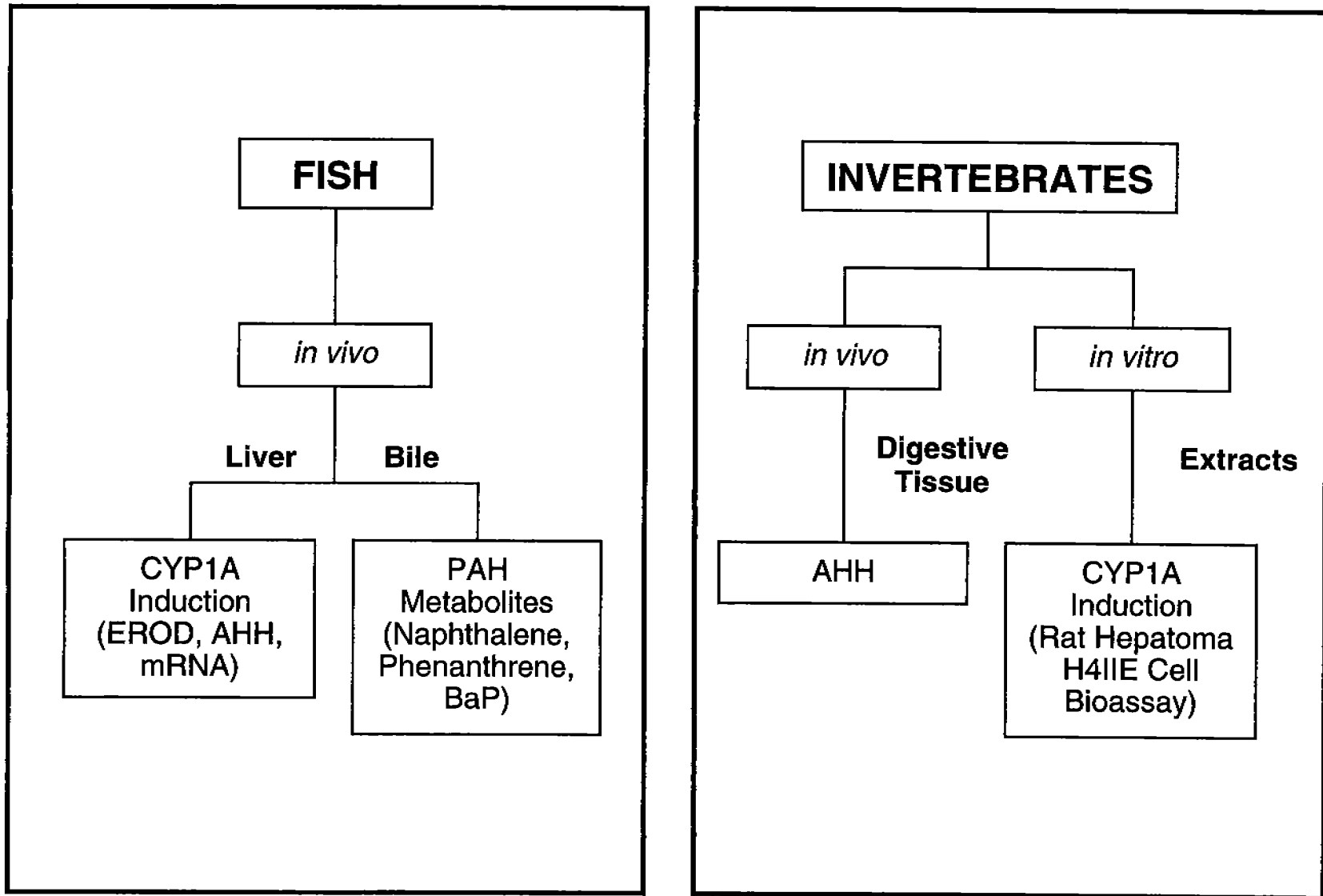

Figure 6.58. Biomarkers used in GOOMEX.

Although the presence of monooxygenase enzymes has been confirmed in a number of invertebrate species (Lee 1982; James 1989; Livingstone 1991), numerous studies were unable to demonstrate CYP1A induction after exposure to hydrocarbons (Lee et al. 1972; Payne 1977; James and Little 1984; Kurelec et al. 1986). Other studies reported minimal induction of AHH activity in invertebrates exposed to hydrocarbons (Anderson 1978; Livingstone et al. 1985; Schlenk and Buhler 1988; den Besten et al. 1990; 1993; Livingstone 1990; 1991). Some forms of P450 have been partially purified from crustaceans (James and Shiverick 1984), and an immunoreactive protein has been detected in chiton and mussel tissue by CYP1A fish antibody (Schlenk and Buhler 1989a,b; Parte et al. 1995); however, their relationship to vertebrate P4501A(1) is unclear. Although, at present there is limited potential for using P4501A induction responses in invertebrates to assess hydrocarbon exposure, continuing studies may reveal some diagnostic inducible responses that could be useful in future monitoring programs. However, based on the minimal induction of CYP1A-dependent responses in Cruise 1 samples, AHH measurements in invertebrates were discontinued for subsequent cruises.

6.8.2 EROD and AHH Activity in Fish

Of the 25 species of fish collected during the GOOMEX project, 16 were collected at both Near and Far stations for at least one platform. No consistent difference between the winter and summer cruises were observed and consequently, the data from all four cruises were pooled. Two factors that can impact hydrocarbon metabolism in fish are temperature and reproductive condition. Studies have reported that PAH induction of CYP1A is suppressed in cold acclimated animals (Spies et al. 1982; Blanck et al. 1989; Kloepper-Sams and Stegeman 1992a,b). A strong sex-dependent difference in P450 and CYP1A content in the livers of spawning fish has also been observed (Stegeman et al. 1982; Gray et al. 1991). CYP1A mRNA and protein levels are suppressed in maturing fish and in those treated with estradiol (Gray et al. 1991). For this study, fish were collected by bottom trawling and bottom water temperatures were fairly consistent between summer and winter months. Mean bottom water temperatures varied approximately 1 °C, 2 °C, and 6 °C between summer and winter cruises for

HI-A389, MU-A85, and MAI-686 respectively. Due to sampling limitations, fish were not separated by sex; however, virtually all specimens were reproductively immature. Consequently, it is unlikely that temperature and reproductive condition significantly contributed to data variability.

A range of EROD activities were determined in fish. The highest EROD activities were measured in *Lagodon rhomboides* (pin fish) and *Caulolatilus intermedius* (tile fish). Lower activities were measured in *Centropristis philadelphica* (rock sea bass) and *Ancyclopsetta dilecta* (3-eyed flounder). Species-dependent differences in catalytic enzyme activities have been observed in other studies (Collier et al. 1995; Davies et al. 1984). Both hepatic AHH and EROD activities were measured in all fish species collected on Cruises 1 and 2. The assay for AHH activity was discontinued for fish captured on subsequent cruises because a good correlation between the two assays was established for most species. The assay for EROD activity uses a less toxic substrate than BaP which is used for determining AHH activity. However, EROD and AHH activities were not closely correlated for *Lagodon rhomboides* and *Arius felis* (captured only at GA-288 and not presented). This has been observed in other studies (Foureman et al. 1983; James and Bend 1980; Stegeman et al. 1981). In both species, EROD activity was significantly higher than the corresponding AHH activity. Other studies have shown a good concordance between hepatic AHH and EROD activity in fish (Collier et al. 1992; 1995). The two assays measure the activity of the same enzyme (i.e., CYP1A) and fish that do not exhibit a for the coordinated induction of AHH and EROD activities may express an altered CYP1A protein compared to other fish species.

A significant PAH contaminant gradient was detected at HI-A389 and MU-A85; however, no significant differences in catalytic enzyme activities were observed for fish species captured at these sites. Moreover, EROD and AHH activities were generally low and these activities may represent basal or constitutive expression. Several potential factors may have contributed to the lack of induction of EROD and AHH activities observed in fish. Although a sediment PAH gradient was detected for two platforms, mean sediment ΣPAH concentrations were relatively low (for details see Section 5.3). The mean sediment ΣPAH concentration for the Near and Far stations at MU-A85 was 280 ng/g (maximum = 2304 ng/g) and 29 (maximum = 58 ng/g), respectively and for HI-A389 was 361 ng/g (maximum = 1103 ng/g) and 35

(maximum = 84 n/g) for Near and Far stations, respectively. Additionally, sediment PAH were highly degraded and contained low to non-detectable levels of ≥ 4 -ring PAH, which are strong inducers of P4501A. Another potential contributing factor to the lack of induction response may have been patterns of fish movement which do not correspond to the highly localized nature of the contaminant field. The populations of fish species examined may be highly mobile and do not permanently reside at the platform. Although captured near the platforms, the fish may have fed elsewhere thereby lacking exposure to the potentially toxic environments.

Other studies have used CYP1A induction responses to evaluate hydrocarbon contamination associated with offshore oil and gas drilling in the North Sea and in a region known to have natural hydrocarbon seepage off the coast of California (Spies et al. 1982; Davies et al. 1984; Renton and Addison 1992; Goksoyr et al. 1992). Two of three fish species collected from near stations exhibited significantly higher hepatic AHH activities than those captured up to 16 km from platforms (Beryl Field) in the northern area of the North Sea (Davies et al. 1984). The significant differences in AHH activity correlated with a dramatic PAH gradient at the North Sea sites where total sediment PAH concentrations ranged from 997 ppb at 16 km to $> 429,000$ ppb at 400 m from the platform (Davies et al. 1984). In another North Sea study, the Bremerhaven Workshop, no significant differences in EROD activity, CYP1A protein levels, and CYP1A mRNA levels were observed in *Limanda limanda* captured at reference and abandoned drilling sites off the Netherlands (Renton and Addison 1992; Goksoyr et al. 1992). However, no significant sediment PAH gradient was observed at this site either. Mean sediment PAH concentrations (PAH= Σ naphthalene, C1 to C3 naphthalenes, anthracene, phenanthrene, C1 phenanthrene, fluoranthene, pyrene, benz[a]anthracene, chrysenes, triphenylene, benzofluoranthenes, benzo[e]pyrene, benzo[a]pyrene, and perylene) at a site collected at the center of an abandoned exploratory platform and ~5000 m away were 305-ppb and 338-ppb dry weight, respectively (Stebbing et al. 1992). Additionally, AHH activity was significantly higher in two sand dab species (*Citharichthys sordidus* and *C. stigmaeus*) collected near natural petroleum seeps near Santa Barbara, California than in fish collected from a relatively uncontaminated site in Monterey Bay, California (Spies et al. 1982). These data suggest that significant exposure to ≥ 4 -ring PAHs results in induction

of EROD or AHH activity in fish, and the results obtained in the present study are consistent with the low levels of hydrocarbon contaminants at the study sites.

6.8.3. Biliary PAH Metabolites in Fish

PAH exposure in fish was also been assessed by measuring biliary PAH metabolite levels. Hepatic PAH metabolites are concentrated in bile for subsequent elimination (Varanasi et al. 1989), and levels of fluorescent aromatic metabolites have been correlated with PAH exposure in fish in both laboratory and field studies (Collier and Varanasi 1991; Krahn et al. 1992; McDonald et al. 1991; 1992). **Although no significant near/far station differences were observed in fish captured at the study sites, significant differences among species were observed** (see Section 5.9.2 for details). The concentrations of naphthalene and phenanthrene equivalent metabolites were consistently higher in the bile of *Lagodon rhomboides*. Levels of BaP equivalent metabolites were typically low for all species and this correlates with the low to non-detectable levels of ≥ 4 -ring PAHs measured in sediments and tissues.

Estimating PAH exposure in fish by measuring the production of biliary PAH metabolites is not a routine assay; however, several studies have shown that the technique is sensitive (Willett et al. 1995; McDonald et al. 1992; 1995; Krahn et al. 1992, 1986a,b; Table 6.82). In laboratory dose- and time-course experiments with BaP, *Fundulus* sp. were used as a model to evaluate the relative sensitivities of several biomarkers of exposure. Biliary metabolite levels were one of the more sensitive indicators (Willett et al. 1995). Additionally, this technique can be used to estimate exposure to lower molecular weight PAHs such as di- and tricyclic (i.e., naphthalenes and phenanthrenes) compounds which are not potent CYP1A1(I) inducers. Field studies have also shown that the formation of biliary PAH metabolites can be used to estimate PAH exposure in fish from both combustion and petroleum hydrocarbon sources (Krahn et al. 1986a,b; 1992; McDonald et al. 1991; 1992; 1995).

During the course of this study evidence of sample degradation was observed in approximately 40 % of the bile samples. The bile of fish collected at the deeper sites, HI-A389 and MU-A85, was particularly prone

Table 6.82. Summary of literature values for biliary metabolite concentrations versus sediment PAH concentration.

Site	Species	Sediment TotPAH (ng/g)	Sediment BaP (ng/g)	Bile naphthalene	Bile phenanthrene	Bile BaP	Ref	
Puget Sound	Eagle Harbor	<i>Parophrys vetulus</i>	310000	2300	n/a	n/a	2100±1500 ng/g	(1)
	Duwamish Waterway	<i>Parophrys vetulus</i>	2600	73	n/a	n/a	1400±2200 ng/g	
	Clinton	<i>Parophrys vetulus</i>	120	13	n/a	n/a	1300±1700 ng/g	
	Inner Everett Harbor	<i>Parophrys vetulus</i>	5600	<14	n/a	n/a	520±410 ng/g	
	Outer Everett Harbor	<i>Parophrys vetulus</i>	2000	<5	n/a	n/a	270±220 ng/g	
	Richmond Beach	<i>Parophrys vetulus</i>	290	290	n/a	n/a	270±700 ng/g	
	West Point	<i>Parophrys vetulus</i>	34000	2200	n/a	n/a	240±160 ng/g	
	Carkeek	<i>Parophrys vetulus</i>	220	22	n/a	n/a	110±120 ng/g	
	President Point	<i>Parophrys vetulus</i>	1100	41	n/a	n/a	100±89 ng/g	
	Edmonds	<i>Parophrys vetulus</i>	650	34	n/a	n/a	91±82 ng/g	
	Useless Bay	<i>Parophrys vetulus</i>	130	5	n/a	n/a	67±45 ng/g	
Lake Erie	Black River	brown bullheads	180000	800	n/a	n/a	37.1 ng/ul	(2)
		carp	180000	800	n/a	n/a	196.5 ng/ul	
	Old Woman Creek	brown bullheads	1170	271	n/a	n/a	21.9 ng/ul	
		carp	1170	271	n/a	n/a	4.7 ng/ul	
Antarctica Palmer Station	Bahla Paraiso wreck	<i>Notothenia coriiceps neglecta</i>	297-668	<5	69000±56000 ng/g	9400±9900 ng/g	<100 ng/g	(3)
	Palmer Station remote		427-14491	<5	77000±46000 ng/g	11000±8300 ng/g	<100 ng/g	
			n/a	n/a	33000±14000 ng/g	5100±2000 ng/g	<100 ng/g	
McMurdo Station	Winter Quarters Bay	<i>Trematomus bernacchii</i>	2848	358	140000±51000	25000±13000	940±730	
	Cape Armitage		255	24	92000±36000	13000±5100	930±440	
	remote		167	12	51000±27000	7200±3700	780±430	
GOOMEX	MAI-686							
	MU-A85							
	HI-A389							

na -not analyzed; (1) Krahn et al. 1987; (2) Johnston and Baumann 1989; (3) McDonald et al. 1995

to degradation. The results indicate that bile degrades in fish that are dead or moribund, and consequently is not useful for determining PAH metabolite levels. Trawl recovery time and depth cause stress in fish and these factors may contribute to bile degradation. All fish were alive at the time of dissection. Results obtained from degraded bile samples were not included in data analyses.

6.8.4. Rat Hepatoma H4IIE Bioassays

The *in vitro* rat hepatoma H4IIE cell bioassay was developed to determine the biological potency of extracts from a variety of environmental and industrial samples that contain PAH and related chemicals, which induce CYP1A-dependent activity (Bradlaw and Casterline 1979; Tillitt et al. 1991a,b; 1993; Trotter et al. 1982; Zacharewski et al. 1989). Since these compounds elicit similar toxic and biochemical responses via the Ah receptor signal transduction pathway, (Safe 1990) various Ah receptor-mediated responses, including CYP1A induction, have been used to determine bioassay-derived toxic equivalents (TEQs) for mixtures of chemicals (Ankley et al. 1991; 1992; Bradlaw and Casterline 1979; Krishnan and Safe 1993; Tillitt et al. 1991a,b; Trotter et al. 1982). This approach detects all bioactive components in a mixture and gives an integrated response for these compounds. Bioassays are also particularly useful for invertebrates. There is no conclusive evidence showing that the invertebrate CYP1A system is inducible with exposure to PAH, and thus, it is difficult to determine any direct induction responses (Lee et al. 1972; Payne 1977; James and Little 1984; Kurelec et al. 1986). However, the activity of PAH contained in extracts from invertebrates can be readily assessed by determining their activities in *in vitro* bioassays.

For Cruises 2, 3, and 4, rat hepatoma H4IIE cells were treated with invertebrate extracts to determine the induction potential of these extracts. Seven species of invertebrates were extracted for use in these assays. **The highest induction responses of TEQs were derived from scallop extracts, and this is consistent with the ready bioaccumulation of contaminants in filter-feeding mollusks. The only significant station differences were observed for *Penaeus aztecus* from MAI-686. Although *P. aztecus* extracts from the near station at MAI-686 had significantly higher TEQs than**

extracts from the far station, a parallel sediment or tissue contamination gradient was not observed. A combination of factors may be contributing to the lack of significant near/far station differences in bioassay-derived TEQs. Often invertebrate specimens were at a premium and thus replication was low. Also, no significant differences were measured in tissue PAH burdens for any of the invertebrate species collected, thus indicating that there was not a site-dependent difference in hydrocarbon exposure.

Although no significant site-dependent differences were measured for invertebrates that correlated with sediment contaminant concentrations, recent studies have correlated the induction of EROD activity and TEQs in rat hepatoma H4IIE cells with exposure to known levels of PAHs in marine fish and invertebrate tissues (McDonald et al. 1994; 1995). The activity of clam (*Laternula elliptica*) extracts as inducers of CYP1A-dependent EROD activities in rat hepatoma H4IIE cells was highly correlated with sediment contaminant levels in McMurdo Sound, Antarctica (McDonald et al. 1994). Additionally, in laboratory experiments a good correlation was established between hepatic PAH (i.e., BaP, 3-ring PAH, and > 3-ring PAH) levels and TEQ values of H4IIE cells treated with hepatic extracts of fish dosed with BaP and diesel fuel (McDonald et al. 1995)

6.8.5 CYP1A mRNA Levels

Exposure to PAHs and related compounds results in increased CYP1A(1) gene expression. The increased enzyme activities are also accompanied by increased levels of CYP1A mRNA in target tissues (Whitlock 1986; Safe 1990). Accordingly, increased levels of this transcript can also be used as a sensitive and specific assay for exposure of marine organisms to this class of toxicants (Haasch et al. 1989; Hahn and Stegeman 1994; Courtenay et al. 1993). Haasch and coworkers (1992) detected a three-fold induction of CYP1A mRNA in killifish sampled at a contaminated site compared to those taken from a clean site. The cytochrome P450 cDNA probe used in these studies was isolated and sequenced from the liver of 3-methylcholanthrene-treated rainbow trout (*Salmo gairdneri*; Heilmann et al. 1988). Likewise, in this study, total RNA was isolated from homogenized liver samples by subcellular fractionation and extraction by a modification of the method of Chomczynski and Sacchi (1987). CYP1A mRNA levels were

determined by Northern blot analysis using a cDNA pfP_{1450-3'} probe (courtesy of Dr. John Lech). CYP1A mRNA levels were standardized relative to β -tubulin mRNA in the same sample. **No significant differences were observed in CYP1A mRNA gel electrophoretic transcripts for any of the fish species sampled.** This data is consistent with the other biomarkers measured for GOOMEX and indicates that there was no significant differences in hydrocarbon exposure for fish captured at MAI-686, MU-A85, and HI-A389.

6.8.6 Dosing Experiments

High molecular weight PAHs can act as Ah receptor agonists and PAHs bind to the intracellular Ah receptor and form a ligand-induced nuclear transcription factor which binds to specific regions of genomic DNA, thereby initiating transcription (Figure 6.59). The Ah receptor is a soluble protein which is necessary for the proper development of the liver and immune system. The Ah receptor has been previously identified in the cytosolic fraction of three fish hepatoma cell lines (Lorenzin and Okey 1990; Swanson and Pewdew 1991; Hahn et al. 1993). The photoaffinity-labeled Ah receptor was also identified in the hepatic cytosol of seven species of teleost and elasmobranch fish (Hahn et. al. 1994). To date, there is no reported evidence in fish of the nuclear Ah receptor which is necessary for P4501A mRNA transcriptional activation. ***Lagodon rhomboides* (pin fish) and *Synodus foetens* (lizard fish) were dosed with [³H] TCDD to characterize their nuclear Ah receptor. The Ah receptor profiles for both *L. rhomboides* and *S. foetens* showed a specifically bound Ah receptor complex which sedimented at 5.4S (Figures 6.60 and 6.61).** Similar Ah receptor profiles were also found in laboratory experiments using killifish (Willett et al. 1995). Although cartilaginous fish diverged evolutionarily 450 to 550 million years ago (Carroll 1988), the sedimentation characteristics of the nuclear Ah receptor in these fish were similar to the mammalian Ah receptor from several different species, including humans.

L. rhomboides consistently expressed higher constitutive EROD activities and higher biliary metabolite concentrations than other fish species captured during this study, therefore dosing experiments were conducted to investigate potential maximum induction of EROD activity in

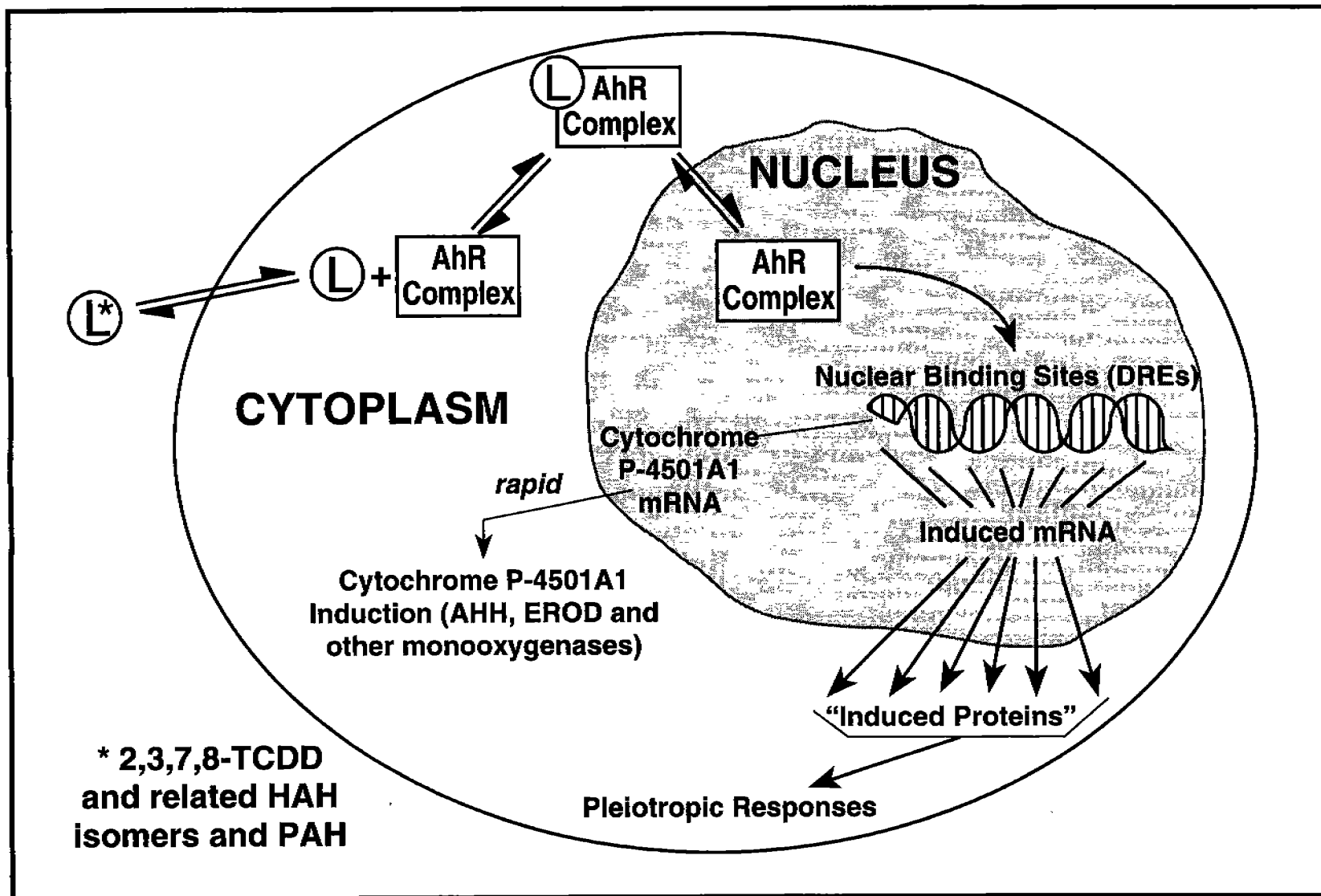

Figure 6.59. Molecular mechanism of action of TCDD and related PAHs and HAHs.

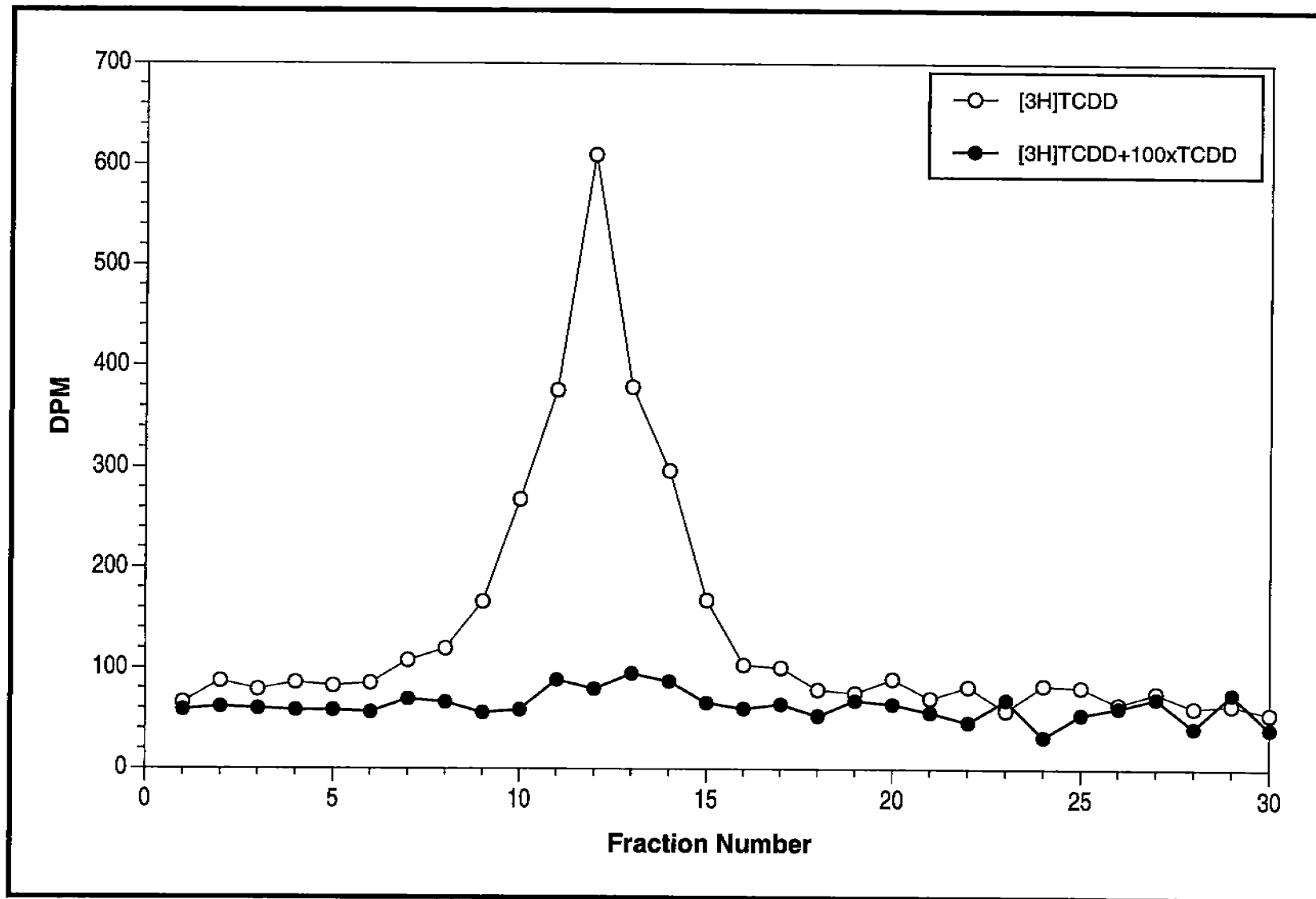

Figure 6.60. Ah receptor profile in *Synodus foetens* (lizard fish).

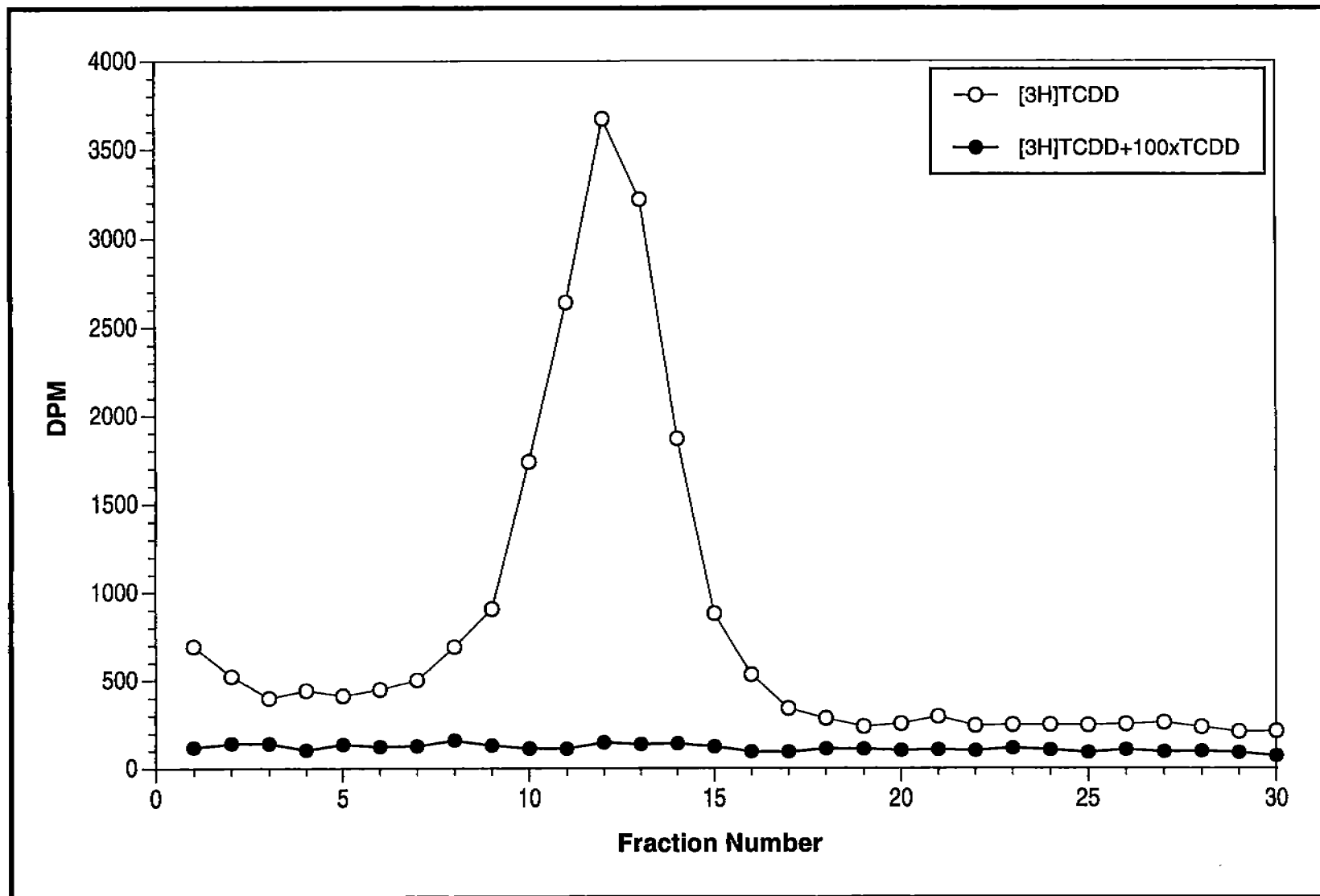

Figure 6.61. Ah receptor profile in *Lagodon rhomboides* (pin fish).

this species. *L. rhomboides* were collected from MAI-686 near; three individuals were dosed i.p. with 200 μ L of corn oil, and seven were injected with approximately 5-mg/kg body weight of BaP in corn oil (2.5-mg/mL). Fish were maintained for approximately 65 h in on-board flow-through sea water tanks. Fish were dissected and the livers and bile were pooled to determine EROD activity, CYP1A mRNA, and BaP metabolite levels. **The dosing experiments indicate that there were significant inter-individual differences in response to a similar BaP dose** (Table 6.83).

Table 6.83. EROD activity and BaP metabolite concentrations in *L. Rhomboides* dosed with benzo[a]pyrene (5 mg/kg for 65 h).

Treatment	EROD (pmol/min/mg)	BaP ng/g
control	29	14000
5 mg/kg-A	314	94000
5 mg/kg-B	207	380000
5 mg/kg-C	1010	1500000

The significant variability in catalytic enzyme activity and the production of biliary metabolites observed for individual dosed fish is unusual but has been observed for other species such as whiting and hardhead catfish (Davies et al. 1984; Van der Weiden 1993; Kreamer et al. 1991; Hahn and Stegeman 1994; and unpublished data). Davies et al. (1984) exposed cod, saithe, and whiting to BaP and found that unlike the other two species, whiting exhibited variable and relatively low AHH activity. In contrast, other species of fish (i.e., *Fundulus grandis*, *F. similis*, and *Coriiceps neglecta*) dosed with BaP exhibited a more consistent pattern of induction (Willett et al. 1995; McDonald et al. 1995). For example, treatment of *F. grandis* and *F. similis*, a small estuarine fish, with BaP gave a dose-response and time-dependent induction of EROD activity, biliary metabolites levels, and CYP1A mRNA levels and exhibited minimal intra-individual differences in the responses (Table 6.84). Two Gulf of Mexico fish species that exhibited an inconsistent induction response to BaP are the same species that do not exhibit coordinated AHH and EROD activities. These results suggest that some fish species may not respond uniformly to contaminant exposure.

Table 6.84. EROD activity and BaP metabolite levels in *Fundulus* sp. dosed with BaP (Willett et al. 1995).

Time (day)	EROD (pmol/min/mg)	BaP (ng/g)
0	136±4	830±140
2	1049±130	78,000±2300
4	1174±197	110,000±5800
8	1812±50	94,000±21,000
14	505±68	48,999 ±25,000

Dose (mg/kg, after 4 day)	EROD (pmol/min/mg)	relative mRNA levels	BaP (ng/g)
0	189±28	.009±.001	707±26
1	465±31	.008±.002	29,000±5300
5	1174±114	.02±.005	110,000±5800
15	1529±208	.03±.01	140,000±5800
50	1510±95	.04±.01	530,000±180,000

6.9 Pore Water Toxicity

ANOVA analysis of the "percent successful development" test based on sea urchin embryological development results are summarized in Tables 6.85 and 6.86. Pore water toxicity data are summarized in Section 5.9. The results confirm other variable distributions related to contamination in that distance effects are unique to a platform and distance effects within platforms differ among radii (i.e., directional). The trends observed in the tests of overall study design are mostly a result of the samples collected at HI-A389, the site of highest contamination. "Percent successful development" is depressed at stations within 50 m of the platform and is not significant at 100 m distance or greater. In the "site-by-site" analysis, the only significant results were obtained for the HI-A389 sediments.

Highly significant statistical associations were observed between pore water toxicity and the bulk sediment concentrations of several metals (e.g., Zn, Pb, Hg, and Ag) at the High Island site. MacDonald (1993) determined a "probable effects level" (PEL) for zinc in whole sediments to be 300 mg/Kg. All of the toxic High Island sites were near or exceeded this concentration

Table 6.85 Summary of the significance of interactions for the overall design and by site based on pore water toxicity tests of percent successful development of sea urchin embryos.

	Interactions ^a			
	C*D	D*R	P*D	D
Overall	no	Yes	Yes	---
MAI-686	no	no	NA	no
MU-A85	no	no	NA	no
HI-A389	no	Yes	NA	---

^aP=platform, C=Cruise, D=Distance, R=radius; Yes=significant, $p \leq 0.01$; no=not significant, $p \geq 0.01$; ---=not testable due to higher interactions.

Table 6.86 Summary of porewater toxicity testing results.^a

D	% Devel*	.95 CL % Devel
50 m	76.1	62.6-87.3
100 m	85.8	77.9-92.2
200 m	88.4	82.5-83.3
500 m	88.3	82.4-93.1
≥ 3000 m	87.5	82.0-92.1

D	% Devel*	.95 CL % Devel
HI-A389	79.2	70.2-86.9
MAI-686	86.7	82.4-90.5
MU-A85	89.7	85.8-93.1

*%Develop - percent development based on sea urchin embryo bioassays, CL- confidence level

^aP=platform, C=Cruise, D=Distance, R=radius; Yes=significant, $p \leq 0.01$; no=not significant, $p \geq 0.01$; ---=not testable due to higher interactions.

(Figure 6.62). Other metals which appear to be elevated at sites exhibiting toxicity were lead (Figure 6.62), cadmium and barium (Figure 6.63). The PELs for lead (160 mg/Kg) and for cadmium (7.5 mg/Kg) are also exceeded at some sites, and the PEL of silver (2.5 mg/Kg) was exceeded at one site (2B). **However, since the PEL of zinc is far exceeded at all of the sites where the PEL of other elements are exceeded, it is possible that the toxicity of the High Island sediments is largely controlled by zinc alone or in combination with other metals. Hydrocarbon concentrations in whole**

sediment do not appear to be the major source of toxicity. Concentrations of total PAH, low molecular weight PAH, and high molecular weight PAH in whole sediments do not approach their respective PELs (Figure 6.64; MacDonald 1993).

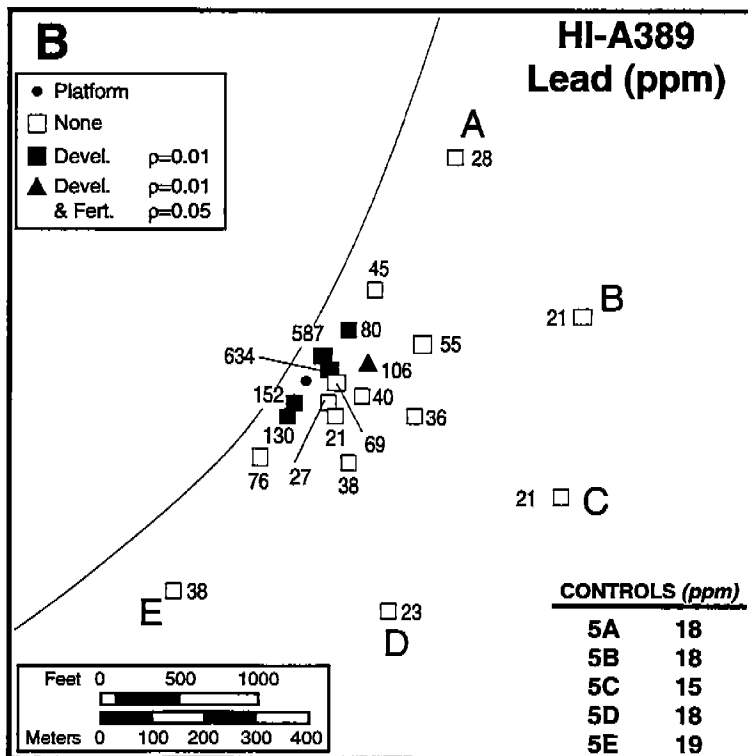
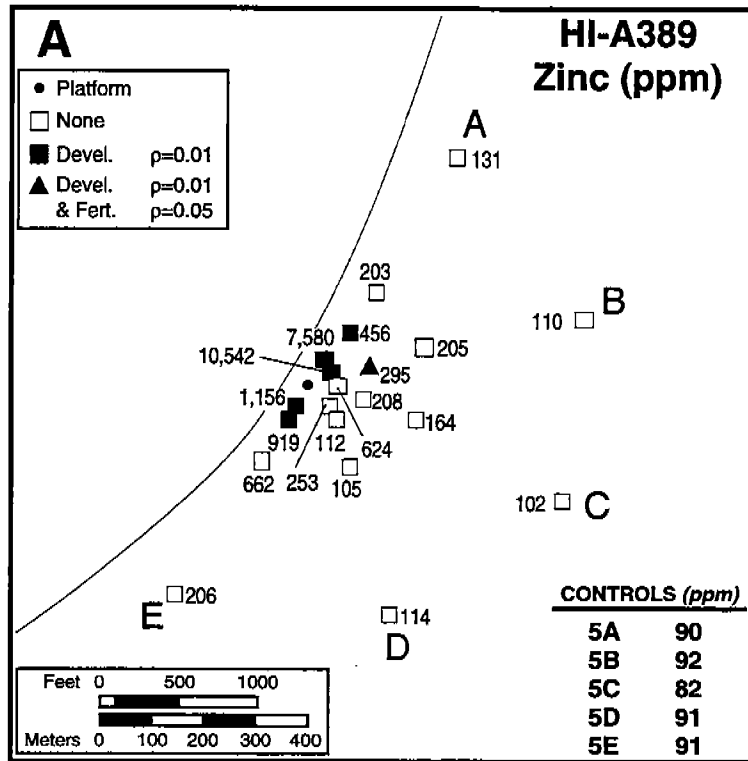

Figure 6.62. Whole sediment A: zinc; and B: lead concentrations and pore water toxicity at HI-A389. (Devel.=standard sea urchin developmental assay; Fert.=standard sea urchin embryo fertilization assay).

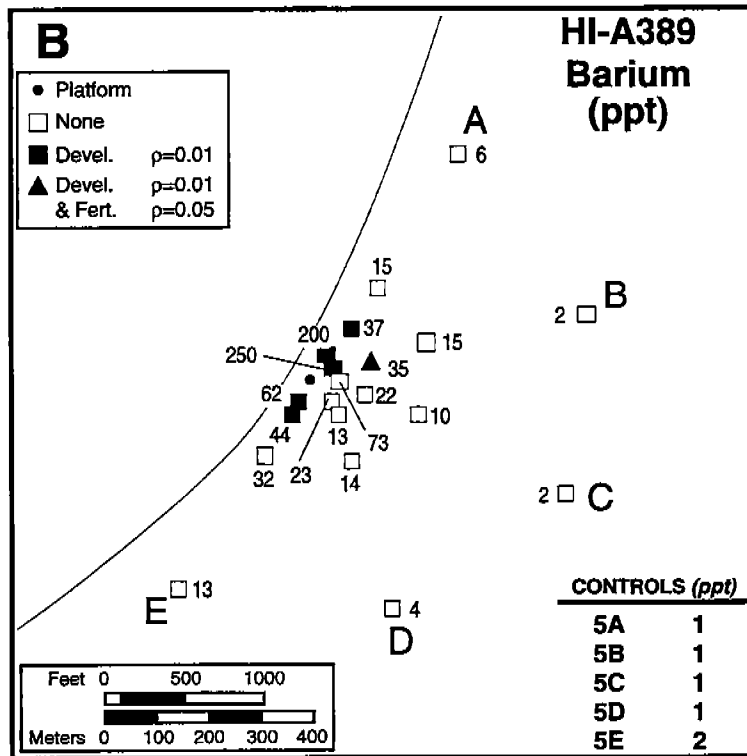
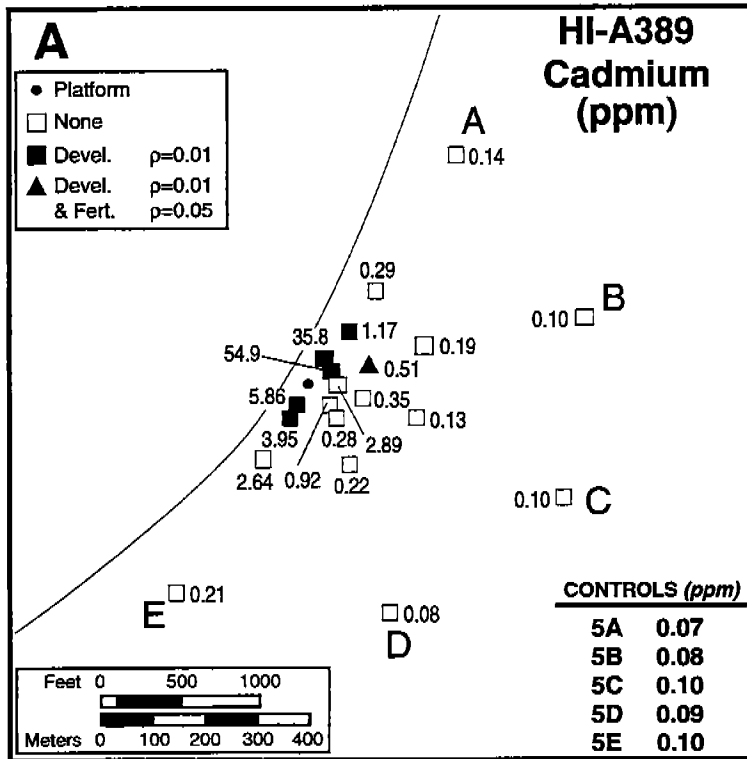

Figure 6.63. Whole sediment A: cadmium; and B: barium concentrations and pore water toxicity at HI-A389. (Devel.=standard sea urchin developmental assay; Fert.=standard sea urchin embryo fertilization assay).

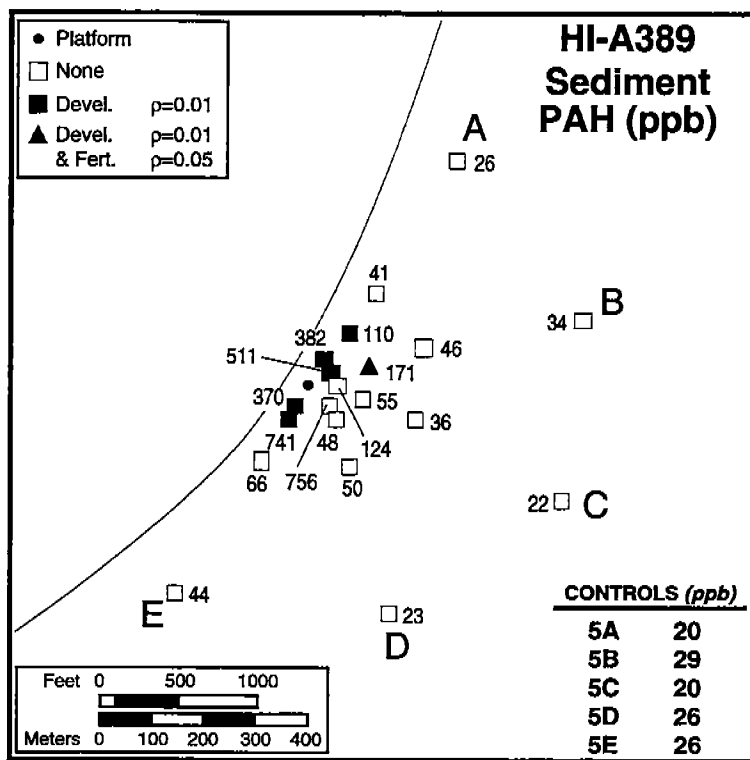

Figure 6.64. Whole sediment total PAH concentrations and pore water toxicity at HI-A389. (Devel.=standard sea urchin developmental assay; Fert.=standard sea urchin embryo fertilization assay).

7.0 SUMMARY, CONCLUSIONS, AND RECOMMENDATIONS

A number of variables have been evaluated and judged more or less useful as indicators of perturbations associated with the presence of offshore platforms on the OCS. While many significant trends were observed, those related to chronic contaminant exposure are of primary interest. This section summarizes some of the more important conclusions from the many work elements, provides an integrated cross-work element interpretation of study results, and outlines a series of recommendations for the structure and content of future studies.

7.1 Summary of Major Programmatic Results

The following section provides a brief synopsis of the most significant findings of the GOOMEX Phase I program on a work element-by-work element basis. The reader is also referred to items in **bold-faced type** in "Section 6.0 Discussion" that highlight programmatic findings. The "Executive Summary" also provides a synopsis of the program's major conclusions.

7.1.1 Summary of the Abiotic Setting

At the three sites studied, the presence of a platform or platform group had little effect on ambient water properties. However, summer hypoxic events and regeneration of nutrients in bottom waters were observed close to the platform at two of the sites. Water depth and time of year exerted the greatest effects on water column physicochemical properties.

Alteration of the benthic environment adjacent to offshore platforms was the result of the presence of the structure, materials discharged from the platform, and the oceanographic setting. Sediments close to platforms were highly enriched in sand-sized materials derived primarily from discharged cuttings. Hydrocarbon and trace metal (silver, barium, cadmium, mercury, lead, and zinc) contaminants were associated with these coarse grain sediments. Compared to coastal sediments, hydrocarbon concentrations at platforms were low. The observed PAH concentrations were below levels known to induce biological responses. At a few locations close to one platform, a few trace metals occurred at concentrations in

excess of levels known to induce biological effects. It should be noted that these metals concentrations are bulk values and it is presently unclear what fraction of the metals are actually bioavailable. In deep water (> 80 m), sediment trace metal contaminants were stable for periods of years. A few metals (lead, cadmium) exhibited evidence of long-term accumulation in sediments from sources other than discharges during drilling. Significant perturbations of the benthos adjacent to platforms were generally restricted to within 100's of meters of the platform. No enhanced bioaccumulation of contaminants in fish or invertebrates was detected near platforms.

To adequately support an informed interpretation of the observed biological patterns the abiotic characteristics of the benthic setting must be adequately described. As noted, contaminants near platforms acted as a suite of materials and included hydrocarbons, metals, and sand. As a consequence of the disposal of drill muds and cuttings, a close association between contaminants and sand-size particles was a general feature at the three sites studied. The common origins of these materials caused the unusual covariance of contaminants and coarse grain-sized material. In most other environmental settings, contaminants are associated with fine grain-sized particles. This unusual association provided a framework for disentangling the multiple effects of toxin exposure, organic enrichment, and grain size variations. The association amongst the suite of contaminants was modified over time by redistribution, transportation, dilution, remineralization, and remobilization processes.

The areal extent of contamination is dependent on many factors including discharge history (i.e., timing), amount and composition of the discharge, disposal technique, and oceanographic setting. The processes could not be resolved by the present study design. The contaminant field is heterogeneous, directionally oriented, and often exhibits abrupt and steep gradients that are not adequately described by a logarithmically decreasing model. Distance was not an adequate surrogate for exposure and closely coordinated measurement of variables was needed for an effective interpretation of programmatic results.

7.1.2 Summary of Meiofaunal Studies

The responses of the meiofaunal community to the presence of platforms were generally consistent with patterns observed in cases of

modest organic enrichment and toxic contamination of the marine environment. The abundance of total nematodes was enhanced at the 50- and 100-m stations by about a factor of two at the two deeper water platforms, MU-A85 and HI-A389. At the shallow site nematode abundance was depressed close to the platform. MAI-686 was the highest energy site. The processes of transport and dispersion that act to remove finer materials from near the platform, including organic detritus, were strongest at the MAI-686 site. At all three platforms nonselective deposit-feeders were enhanced in biomass close to the platform by more than a factor of five, on average. This enhancement is consistent with the effects of modest organic enrichment. The response of the nematodes, and especially nonselective deposit-feeding nematodes, was opposite to that predicted on the basis of the sediment texture gradient. Non-selective depositing feeding nematodes typically increase as sediments become finer in size. Consequently, the enhancement in nematodes near platforms was a particularly noteworthy pattern. In contrast to the nematodes, total harpacticoid copepods were depressed near platforms. Total harpacticoid abundance close to the platform was only 40 % of that at distant stations. The effect was most intense at the HI-A389 site, where the contaminant gradient was steepest. This pattern is also consistent with the results of previous studies that document the sensitivity of harpacticoid copepods to toxic chemicals. As a consequence, the ratio of nematodes to copepods provided a particularly effective discriminator of distance from the platform. This pattern in the nematode to copepod ratio is consistent with the previous suggestions that the nematode to copepod ratio should respond to pollutant exposure.

Harpacticoids exhibited responses that indicate sublethal effects were occurring at the population level at the platform sites. Harpacticoid genetic haplotype diversity decreased with increased contamination, but there were no differences among platforms or among five different species. This indicated that there was population subdivision at the genetic level, but nothing that was morphologically distinct. There appeared to be reduced reproductive success associated with the contaminant gradient. This is indicated as increased reproductive effort (in terms of more gravid females and greater clutch sizes) and decreased recruitment near platforms (indicated by fewer copepodites and adults). Harpacticoids also exhibited a toxic response to porewater exposure.

7.1.3 Summary of Macroinfauna Studies

Abundances of macroinfauna were unexpectedly low during the first cruise. Subsequent data indicated that the normal winter-spring maximum and summer-fall minimum in abundances occurred. The largest number of species and individuals were generally found within 100-m of a platform. Both diversity and abundances decreased with increased distance from the platforms. These patterns were generally dictated by abundances of the numerically dominant group, the polychaetous annelids. The pattern was most pronounced at the deepest site (HI-A389) and least evident at the shallowest site (MAI-686). The largest overall abundances, in excess of 3000 individuals per m², were found adjacent to HI-A389. No patterns were obvious in the indices of diversity (i.e., H'). Of the numerically dominant taxa, polychaetes, bivalves, nemertean, decapods and isopods all displayed a trend of decreased abundance with increased distance from a platform. Amphipod and foraminiferan abundance were low close to a platform and increased with increased distance from a platform.

Statistical testing of the overall sample design using macroinfauna data revealed significant interactions between cruises, platforms, and distances. Due to the interactions among variables, analysis by platform was most effective. Significant variations in abundances with distance were found at HI-A389, less at MU-A85 and few at MAI-686. Principal component analysis indicated that because of the numerical dominance of some species of macroinfauna, less than 25% of the 649 species accounted for 75% of the variation. Crossplots of the first two principal components indicated that both axes based on macroinfauna numerical data accounted for variations among platforms and that water depth was an important determinant of species composition. PCA for individual platforms indicated that there were species differences among platforms for total abundance and polychaete abundance, but no species differences among distances for any of the taxon enumerated. Organic enrichment near the platforms was considered the most likely cause of increased overall abundances of macroinfauna near platforms. The ratio of the abundances of relatively toxin resistant polychaetes to the toxin sensitive amphipods may be a sensitive indicator of toxic response. Furthermore, diversity increased toward a given platform and toward deeper water.

7.1.4 Summary of Megafauna Studies

The single most significant generality from the megafaunal invertebrate studies was the platform-specificity of the observed trends. Forcing factors producing megafaunal patterns at platforms might be water column chemical anomalies, contaminant gradients, or other naturally-occurring environmental gradients. Many of the environmental variables are platform specific and opposing gradients are common. The megafaunal taxa in this study vary considerably in their physiology and behavior and thus could be expected to respond differently to the varying signals presented by the platform-specific gradients involved. Even within a species, consistent trends were rarely observed. *Penaeus aztecus*, for example, was larger in the far-field at MAI-686 but not at MU-A85. *Squilla chydrea* was more common in the near-field at MU-A85 but not at MAI-686. Thus, even within a species, platforms failed to produce similar trends. Combined, the taxon and environmental complexity reduces the likelihood of the existence of general trends among all species and platforms, and few, if any, were observed. Each platform produced a distinctive effect on the shelf biota. The single trend among platforms was the clear decrease in frequency of near-field/far-field effects with increased water depth and a concomitant decreased importance of seasonal influence on population structure.

Thus, the single most significant generality from the megafaunal population studies was that platform-specificity was observed in nearly all variables. Among the various biological variables measured for megafaunal invertebrates, size and histopathology exhibited the most significant differences in pairwise comparison of Near and Far stations. Differences in CPUE were rare and differences in reproductive stage were minor in comparison to size and health (histopathology) differences. The presence of a platform did not exert an overriding influence on megafaunal invertebrate population dynamics. Although some generalities can be made about the characteristics of megafaunal invertebrate populations with respect to proximity to platforms, each platform associated community responded quite differently. Thus, no generalities among platforms were observed that could be clearly extrapolated to all platforms, nor were generalities among subsets of platforms observed that might be attributed to shallow versus deep-water platforms. The overwhelming trend was towards specificity of

site. The forcing factors that produce these site-specific biological patterns are unclear. Sampling of a larger number of sites is needed to better define the relationships, if any, between megafauna invertebrate size and health and specific platform attributes.

7.1.5 Summary of Detoxification Studies

The detoxification study results speak clearly to the question of whether hydrocarbon contamination had detectable sublethal impacts on fish at the three study sites. No differences in CYP1A activities in fish livers existed between Near and Far stations. Measurement of PAH metabolites in fish bile similarly failed to reveal evidence of any differential exposure to PAHs between Near and Far stations. Measurements of CYP1A mRNA levels also failed to demonstrate a differential exposure to hydrocarbons as a function of distance from the platform. The absence of evidence for hydrocarbon exposure and physiological responses in fish may be due to the low levels of hydrocarbon contaminants and/or the intrinsic mobility of fish. Fish may move rapidly across the short distances represented by the contaminant gradients at the study sites thus minimizing exposure. Avoidance and other behavioral characteristics may make fish ill-suited as indicator organisms in open ocean settings.

Comparison of hydrocarbon and CYP1A induction levels between this study and other similar studies showed that the present study sites were most similar to uncontaminated sites (Figure 7.1 and Table 7.1). CYP1A induction has been demonstrated around natural petroleum seeps (Spies et al. 1982) and around oil production platforms in the North Sea (Davies et al. 1984). The sediment PAH concentrations at these sites greatly exceeded those documented in the present study. Based on data from these and other studies, sediment concentrations ranging from 3,000-10,000 ng/g appear to be required before a significant induction in hepatic EROD activity in fish can be detected. The relationship between total PAH levels in sediments and hepatic EROD activities for this compilation of data is significant ($P = 0.004$, $r^2 = 0.73$). As a comparison, mean sediment Σ PAH concentrations at the study sites ranged from 20.8 to 428 ng/g. Natural variations in hepatic EROD activities are caused by differences in sex, water temperature, fish movement, reproductive stage, timing of feeding, and the analytical techniques utilized. Consequently, detectable induction of CYP1A-

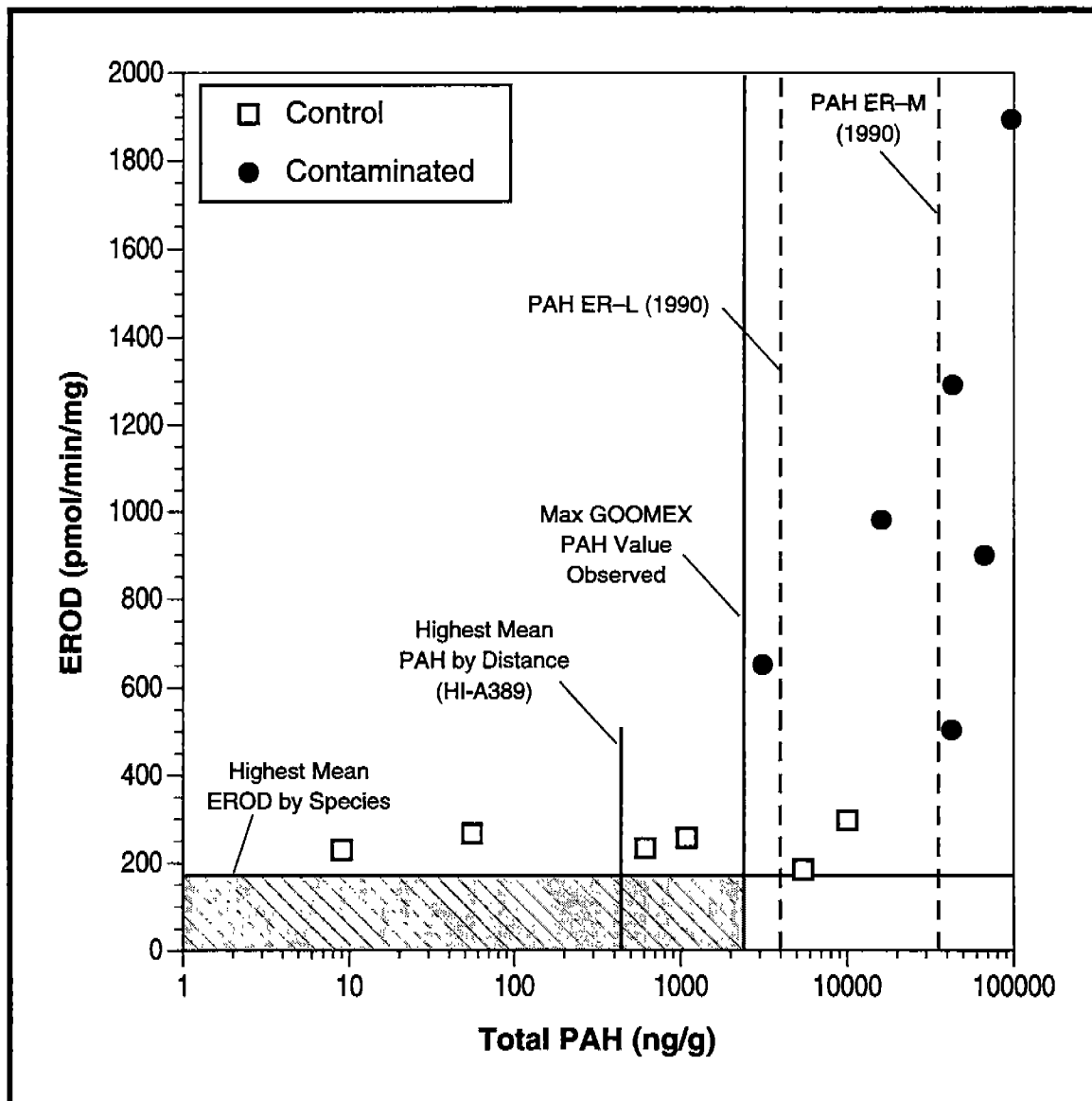

Figure 7.1. Correlation between total PAH concentrations in sediments and hepatic EROD activities in fish. (ER-L: effects level-low (10%); ER-M: effects level-medium (50%); see Long and Morgan, 1990; see Table 7.3 for references).

Table 7.1. EROD induction in relationship to environmental contamination.

Species	Region	Site	Sediment total PAH (ng/g dry wt.)	Contamination total PCBs (ng/g dry wt.)	EROD (pmol/min/mg)	Reference
<i>Fundulus heteroclitus</i>	Rhode Island	Seekonk River Succotash Salt Marsh	66,403	2371±1550	900±70*	Elskus and Stegeman, 1989
			1082	2.3±0.9	257±23	
<i>Pseudopleuronectes americanus</i>	Sydney Harbor Nova Scotia	Georges Bay	na	na	233±107	Addison et al., 1994
		Outer Harbor	610±340	na	234±68.3	
		Northwest Arm	5450±2210	na	185±89.7	
		Southeast Bar	10000	na	297±114	
		South Arm	42500±9300	na	504±130*	
<i>Leiostromus xanthurus</i>	Elizabeth River Virginia	1	9	na	230±100	Van Veld et al., 1990
		2	55	na	267±52	
		3	3100	na	652±207*	
		4	16000	na	981±678*	
		5	96000	na	1894±813*	
		6	43000	na	1292±682*	
<i>Pleuronectes vetulus</i>	Puget Sound Washington	Duwamish Waterway	3600a	570a	<300->800	Collier et al., 1995
		Polnell Point	21a	30a	<100	

* - significantly different from reference site

na - data not available

a - data based on wet weight

dependent activities above background, constitutive levels in fish require at least moderate levels of exposure to PAH.

The induction of CYP1A catalytic activities and mRNA levels are also directly correlated with the chemical structure of the contaminant. Structure determines the binding affinity of the contaminant for the Ah receptor. Laboratory studies have shown that 2- and 3-ring PAHs (such as naphthalenes and phenanthrenes) and many 4-ring PAHs, do not bind to the Ah receptor (Piskorska-Pliszczynska et al. 1986). Therefore, P450-related biomarkers do not detect the presence of these PAH contaminants. At the three study sites, not only were PAH contaminant concentrations low, but when present the PAH were predominantly 2 and 3-ring aromatics which are only weak inducers of CYP1A related enzyme activities. Bile metabolites provided an indicator of exposure that was inducible by a much broader range of PAH structures than CYP1A mediated enzymes. However, metabolite production in fish bile was not sensitive enough to detect significant PAH exposure at the sites studies.

Based on the low levels of PAH contamination observed, it was concluded that most variations observed in EROD activities represent variations in constitutive or basal levels. Constitutive levels of EROD activities are species-dependent (Table 7.2). Significant interspecies differences in basal EROD activities were also observed in the present study. *Lagodon rhomboides* (pinfish) and *Caulolatilus intermedius* (tile fish) expressed significantly higher EROD activities compared to other species but these differences were not attributed to increased exposure to PAH. There were also no significant differences in fish EROD activities in the same species collected at Near and Far stations. The reason for differential enzyme activities is presently unclear; but may be related to differences in the structure of P4501A genes and gene products in these species.

7.1.6 Summary of Porewater Toxicity Studies

Based on data from the sea urchin fertilization and embryological development assays, toxicity was observed at some stations located within 150 m of a platform. There was excellent agreement among the results of porewater tests that utilized three difference species (sea urchins embryological development, polychaete reproduction, and copepod nauplii

Table 7.2. Summary of suspected constitutive levels of EROD enzyme activities in various species of fish.

Species	EROD (pmol/min/mg)	Site	Study
Bluegill sunfish <i>Lepomis macrochirus</i>	6-10	Stream, Oak Ridge, TN	Jimenez et al. 1988
Sergeant major <i>Abudefduf saxatilis</i>	150	Ferry Reach, Bermuda	Stegeman et al. 1990
French grunt <i>Haemulon flavolineatum</i>	20	Ferry Reach, Bermuda	Stegeman et al. 1990
English sole <i>Pleuronectes vetulus</i>	< 100	Polnell Point	Collier et al. 1995
Rock sole <i>Lepidopsetta bilineata</i>	< 200	Polnell Point	Collier et al. 1995
Starry flounder <i>Platichthys stellatus</i>	< 100	Polnell Point	Collier et al. 1995
Spot <i>Leiostomus xanthurus</i>	30	Chesapeake Bay	Van Veld et al. 1990
Gizzard Shad <i>Dorosoma cepedianum</i>	≤ 30	Acton Lake, Ohio	Levine et al. 1995
Killifish <i>Fundulus heteroclitus</i>	257 - 269	Succotash Salt Marsh	Elskus and Stegeman 1989
Winder flounder <i>Pseudopleuronectes americanus</i>	233 ± 107 in 1989 33.4 ± 21 in 1990	Sydney Harbour, NS Sydney Harbour, NS	Addison et al. 1994
	160	Georges Bank, RI	Monosson and Stegeman 1991
White sucker <i>Catostomus commersoni</i>	23.1	Mountain Bay, Lake Superior	Munkittrick et al. 1993

survival). The sediment concentration of several metals were well in excess of sediment quality assessment guidelines for a number of stations and there was good agreement between the predicted toxicity and toxicity observed with the porewater toxicity tests. It appears that the porewater concentrations for several metals were high enough to account for the observed toxicity. At these platform sites it appears that the primary contaminants of concern were the metals. Highly sensitive toxicity test results suggested that the area for potential contaminant-induced impacts was limited to the immediate vicinity of a platform.

7.2 Assessment of Benthic-Based Indicators of Biological Response

Operationally two independent, though related approaches were used to provide an overall assessment of community response and health at platform sites. The study design, field collections, and ultimate data interpretations are most effectively considered in two steps. First, those indicators or responses based on benthic sediment samplings are considered. Next those indicators or responses based on epibenthic or trawl samplings are considered. The following section assesses, integrates, and interprets the results based on benthic samples.

7.2.1 Confounding of Environmental Variables

When several environmental variables strongly covary, it is difficult to identify which factor, factors, or interaction of factors is responsible for the observed biological responses, thus the concept of "confounded variables." This "confounding" of multiple environmental variables is typical of most anthropogenic discharges into marine environments (Pearson and Rosenberg 1978). In the present study, sand content, concentrations of several metals, barium, inorganic carbon, and petroleum hydrocarbons were all elevated in close proximity to platforms. In an analogous study of the impacts of North Sea oil production platforms, Gray et al. (1990) encountered significant covariation in environmental variables, with barium, mud content, and total hydrocarbon concentrations elevated around platforms. If the suite of environmental variables associated with a particular anthropogenic activity always behave in the same way and to the same

degree, then there is little practical motivation to unravel the effects. In this situation, causation may be more of an academic interest, however managers would have what they need to know to regulate. On the other hand, if various management alternatives can independently control individual deleterious effects, then an understanding of causation is in the interest of effective management. The possibility of independently controlling deleterious effects exists for the management of the complex operations associated with offshore production platforms. Therefore, it is of interest to propose supportable hypotheses to unravel the independent effects of the processes that are extant at platform sites.

The present understanding of benthic community response to pollution incorporates an implicit recognition that anthropogenic contaminants can have a range of effects. This range of effects is often species-specific. Evidence to support an emerging paradigm of differential benthic biological response to pollution in the marine environment comes from a review of an extensive suite of studies of marine pollution. It is difficult to find studies of benthic community response to pollution where toxicity is the only effect influencing biological patterns. For example, discharges of treated sewage typically enhance metal concentrations in sediments. However, organic matter is also enhanced (i.e., the discharge of sewage to the Palos Verdes Peninsula; Swartz et al. 1986; the Firth of Clyde in Scotland, Pearson 1987). In the North Sea platform study, sediments near the platforms that were enriched in hydrocarbons also had elevated organic carbon concentrations (Gray et al. 1990). A supply of organic matter external to the pollutant is not the only source of labile carbon. In virtually every study of environmental effects of petroleum spills and seeps, hydrocarbons act as a source of labile carbon as well as toxins (e.g., Spies and DesMarais 1983, Braddock et al. 1995). Organic enrichment can exceed the degradation capacity of the indigenous microbes and cause the production of toxic chemicals (i.e., H_2S). Determining the relative effects of organic enrichment and toxicity is important in evaluating biological responses to releases of pollutants (e.g., Spies et al. 1988, Agard et al. 1993).

Cases in which only one of these processes is operative allows for an independent resolution and assessment of impact. One example of a well-studied and unconfounded gradient related to a marine discharge is a study of the effects of cooling water discharge from the San Onofre Nuclear

Generating Station on the shelf of the Southern California Bight (MRC 1989). As seawater is used for cooling and discharged onto the shelf, natural organic detritus is created and discharged in the form of dead phytoplankton, zooplankton, larval fish, and macerated macrophytes. There are no detectable toxic chemical contaminants in the discharge or in the benthos. Also, the organic enrichment from the discharged detritus does not exceed the capacity of the microbial community. Only slight increases in sediment organic carbon content and phaeopigment concentrations are present in the vicinity of the diffusers. However, an increased flux of seston is clearly evident. In response to this discharge of detritus and modest organic enrichment of the sediments, increased abundances were detected in virtually all major taxa of macroinfauna. These enhancements extended to 3.5 and in some cases to 6.7 kilometers downcoast. As is typical, even of discharges that include both organic enrichment and toxic chemicals, polychaetes and nematodes were enhanced in abundance. But unlike perturbations that include contaminants the crustaceans; including amphipods, ostracods, tanaids, and mysids; were also enhanced in abundance. There was also no evidence of a decrease in the abundance of echinoderms and little observable effect on benthic biomass. The lack of an effect was most likely a consequence of increased near-field predation due to the enhanced abundances of most demersal fish species.

The San Onofre example contrasts sharply with the case of Los Angeles County sewage treatment plants which discharge onto the Palos Verdes shelf (Swartz et al. 1986; LACSD 1990). The LA County discharge differs from the San Onofre discharge in that not only is there an organic enrichment but also an introduction of toxic contaminants. Toxins in this case include DDT, PCB, H₂S, and metals. Polychaetes, as a class, are enhanced in abundance near the discharge source. The enhancement response is driven by several opportunistic rather than non-selective deposit feeders, *Tharyx* spp., *Capitella capitata*, *Mediomastus* spp., and *Schistomeringos longicornis*. At very high organic loadings *Ophyrotrocha* sp. is enhanced as well. A bivalve mollusc, *Parvilucina tenuisculpta*, is also enhanced. In this case, which involves toxicity, echinoderms as a group are grossly depressed around the outfall. The decrease is largely due to decreases in the abundances of the ophiuroid *Amphiodia urtica* and the sea cucumber *Parastycopus parvimensus*. Other declines include the urchin

Lytechinus anamensis and the seastar *Luidia foliolata* (Tetra Tech 1981; Swartz et al. 1986). Amphipods also decline in abundance near the outfall, as reflected in decreases in the abundance of the dominant species (*Heterophoxus oculatus*). Meiofaunal community responses were not assessed in this study. The toxic chemicals in the discharge do little to affect the enhancement of polychaetes in response to organic enrichment, as seen at San Onofre. Chemical contamination affected the physiologically sensitive macroinfaunal taxa causing a reduction in echinoderms and amphipods. These differing biological responses to these two discharges demonstrates the effects of organic enrichment and toxicity on benthic communities. These observations set the stage for response the development of a series of indicators based on the ratio of "the tolerant species to the sensitive species."

Other examples of the effects of anthropogenic discharges into the marine environment on benthic community biology involve both organic enrichment and toxic chemical enhancement. A review of these reports is useful in determining whether the patterns of polychaete and nematode enhancement and echinoderm and amphipod depression are general responses. Even though separate causation cannot be unequivocally ascribed in these cases, a preponderance of typical patterns should be apparent if the emerging paradigm is supportable. A review of studies on soft-sediment benthic community response to gradients in organic enrichment and toxic chemicals is presented in Table 7.3. This includes the effects of oil spills, natural petroleum seeps, sewage discharges, industrial discharges, experimental mesocosms, and other field studies. For the macroinfauna, the pattern of enhancement in polychaetes, especially certain non-selective deposit feeders, and depression in echinoderms and amphipods is compellingly consistent and common. For the meiofauna, there appears to be more need to separately analyze different families or trophic groups of nematodes and harpacticoids. However, there is evidence for a general enhancement of non-selective feeders among nematodes and declines in some harpacticoids. One limitation in the application of this paradigm is the difficulty in objectively defining the feeding status of bulk macroinfauna and meiofauna feeders. An objective definition of trophic group and what constitutes an opportunistic life history is an important but challenging goal. Nevertheless, defining an effective taxonomic criteria for evaluating

Table 7.3. Effects of anthropogenic pollution on benthic communities in the marine environment.

Pollution Case Study	Organic Enrichment	Toxic Chemicals	Benthos Enhanced	Benthos Suppressed	Sources
A. Macroinfauna					
Exxon Valdez oil spill	Yes, with evident stimulation of oil-degrading bacteria	Yes, with elevated PAH's, etc.	Total polychaetes enhanced as well as <i>Nereis</i> , <i>Nephtys</i> , <i>Polydora</i> , and <i>Lucina</i> in eelgrass beds	Total crustaceans and total echinoderms occasionally show reductions (never increases), while total amphipods declined as well as a crab (<i>Telmessus</i>) and a seastar (<i>Dermasterias</i>)	Jewett et al. (1994), Braddock et al. (1995)
Amoco Cadiz oil spill	Yes	Yes	Total polychaetes enhanced	Total echinoderms and total crustaceans declined, as well as amphipods	Dauvin (1984), Dauvin (1987), Warwick and Clarke (1993)
Florida oil spill	Yes	Yes	Opportunistic, surface deposit-feeding polychaetes increased, especially <i>Capitella capitata</i> , <i>Mediomastus ambiseta</i>	Several amphipod amphipods declined	Sanders et al (1972, 1980), Sanders (1978)
Irini oil spill	Yes	Yes	Unclear from data available	Amphipods (<i>Gammarus</i> spp.) and isopods (<i>Idotea</i> spp.) declined	Notini (1978)
Arrow oil spill	Yes	Yes	Unclear from data available	An amphipod (<i>Gammarus oceanicus</i>) was selectively reduced	Thomas (1978)
Esso Essen oil spill	Yes	Yes	Unclear from data available	Amphipods in intertidal and subtidal declined greatly	Stander and Venter (1968)
General M.C. Meigs oil spill	Yes	Yes	Unclear from data available	The sea urchin <i>Strongylocentrotus purpuratus</i> suffered evident lethal and sublethal impacts	Clarke et al. (1978)
Palos Verdes sewage wastewater discharge	Yes, with detectable organic C, N enhancement	Yes, with DDT, PCB, heavy metals, and H ₂ S elevated	Total polychaetes enhanced, as well as <i>Tharyx</i> spp., <i>Capitella capitata</i> , <i>Mediomastus</i> spp., <i>Schistomeringos longicornis</i> , and <i>Ophryotrocha</i> spp.	Total echinoderms reduced, as well as ophiuroid <i>Amphiodia urtica</i> , sea cucumber <i>Parastichopus parvimensus</i> , sea urchin <i>Lytechinus anamensis</i> , and seastar <i>Luidia foliolata</i> , amphipod <i>Heterophoxus oculatus</i> also reduced	Tetra Tech (1981), Swartz et al. (1986), LACSD (1990)

Table 7.3. (Cont.)

Pollution Case Study	Organic Enrichment	Toxic Chemicals	Benthos Enhanced	Benthos Suppressed	Sources
San Onofre Nuclear Generating Station cooling water discharge	Yes, with evident organic C and phaeopigment enhancement	No	Total polychaetes, total crustaceans, total amphipods, total molluscs all enhanced	None	MRC (1989)
Firth of Clyde sewage sludge disposal	Yes, with organic C and N elevated	Yes, with Cd elevated along with other metals	Total polychaetes enhanced	Total echinoderms, total crustaceans both depressed	Pearson (1987), Clarke and Atkinson (1993)
Swedish pulp mill discharge	Yes	Unclear	Total polychaetes enhanced, especially <i>Capitella capitata</i> and other opportunistic deposit feeders	Total echinoderms depressed	Rosenberg (1972)
Antarctic sediment contamination around Winter Quarters Bay	Presumably, in that hydrocarbon levels are elevated	Yes, with PCB, hydrocarbons, and heavy metals elevated	In most contaminated areas, <i>Capitella</i> and <i>Ophryotrocha</i> enhanced, while in modest contamination <i>Tharyx</i> and <i>Haploscoloplos</i> enhanced	Total crustaceans depressed, especially amphipods, isopods, tanaids	Lenihan and Oliver (1995)
Industrial pollution gradient in fjord near Oslo	Presumably	Yes, heavy metal concentrations elevated	Deposit-feeding polychaetes may be elevated	Total echinoderm biomass is clearly depressed, especially an echinoid	Gray et al. (1988)
Experimental crude oil addition in mesocosm	Probably not because of short-term nature of experiment	Yes	None (time frame too short to test)	Total echinoderms, especially the ophiuroid <i>Ophiura affinis</i> depressed	Gray et al. (1988)
Natural oil seep and refinery discharges in Trinidad	Yes, with organic C elevated	Yes, with PAH elevation at seep and refinery and metals elevated at refinery	Total polychaetes enhanced especially in biomass at the seep	Unclear from data available	Agard et al. (1993)
Natural oil seep	Yes, with enhanced microbial production	Yes, with PAH elevation	Oligochaetes and many deposit-feeding polychaetes enhanced	The only abundance echinoderm <i>Lytechinus pictus</i> and the only abundant amphipod <i>Paraphoxus abronius</i> depressed	Spies et al. (1980)
Experimental fuel oil addition in mesocosm	Possibly, given 25 wk exposure to oil	Yes	Time frame probably too short to test	Total amphipod abundance declined by 98%	Grassle et al. (1981)
Field experiment of crude oil addition to tide pools	Probably not because of short-term nature of experiment	Yes	Time frame too short to test	Negative effects on amphipods, isopods, tanaids	Bonsdorff and Nelson (1981)
Meta-analysis of all benthic community data for NE Atlantic	Yes	Yes	total polychaetes are enhanced	Total echinoderms and total crustaceans are depressed	Warwick and Clarke (1993)

Table 7.3. (Cont.)

Pollution Case Study	Organic Enrichment	Toxic Chemicals	Benthos Enhanced	Benthos Suppressed	Sources
B. Meiofauna					
Review of marine pollution events	Yes	Yes	Nematodes are enhanced	Harpacticoid copepods are depressed	Raffaelli and Mason (1981)
Raw domestic sewage discharge	Yes	Probable	The copepod/nematode ratio is enhanced by pollution		Vidakovic (1983)
Organic enrichment	Yes	No	The copepod/nematode ratio is enhanced with organic enrichment		Gee et al. (1985)
Organic enrichment	Yes	Probable	The copepod/nematode ratio is enhanced with organic enrichment		Moore and Pearson (1986)
Natural oil seep	Yes, with enhanced microbial production	Yes, with PAH elevation		The nematode/harpacticoid ratio is enhanced with oil addition	Montagna et al. (1987)
Review of organic pollution in marine sediments	Yes	Usually Yes	Non-selective deposit-feeding nematodes generally enhanced	Some other nematode groups may be depressed	Heip et al. (1985)
Industrial pollution gradient in fjord near Oslo	Presumably	Yes, heavy metal concentrations elevated	Total nematodes are enhanced as well as some harpacticoid copepod groups	Unclear from data available	Heip et al. (1988)
Meta-analysis of all benthic community data for NE Atlantic	Yes	Yes	Total nematodes are generally enhanced	Harpacticoids, etc. not analyzed	Warwick and Clarke (1993)

macroinfaunal community response may not require trophic characterization.

A review of past benthic community responses to marine pollution and the emerging paradigm of multiple causation, including impacts of both organic enrichment and toxin exposure, provide a means of interpreting the broad suite of environmental and biological responses in the present study. These interpretations are suggested hypotheses that will require explicit testing through further study. It is clear that in the present data set, as in virtually all other data sets on the effects of anthropogenic discharges into the marine environment, there is tremendous covariance in variable patterns. Four major types of environmental variables can be delineated as the important independent forcing variables that control biological patterns at these sites (e.g., Pearson and Rosenberg 1978).

First, there was an enhancement of barite-enriched sands at all three platforms. This enhancement varies from background values of about 30 % to 70 % at MAI-686, from about 10 % to 65 % at MU-A85, and from about 5 % to 40 % at HI-A389. The proportion of fine sediments decreases along this gradient of increased sands and enhancement of silt-sized particles was apparent close to the HI-A389 platform.

Second, there is evidence of modest hydrocarbon contamination (PAHs, AHs, and UCM) around the platforms. These contaminants extend, although not symmetrically, in every direction to 100 or 200-m depending on the site. The shallow water platform, MAI-686, did not exhibit significant evidence of a hydrocarbon gradient. In contrast, the gradients were clear at MU-A85 and HI-A389. In general, there was little change in the distribution of hydrocarbons among cruises. The composition of the hydrocarbons reflected older, degraded sources except in isolated instances.

Third, there was a strong signal of contamination in certain toxic metals (Ag, Cd, Hg, Pb, and Zn) in sediments near the platforms. Metal concentrations were lowest at MAI-686, intermediate at MU-A85, and highest at HI-A389. Again elevated concentrations were restricted to distances of 100 to 200-m from the platforms depending on the site. Concentrations of metals in pore waters, although not well correlated with solid phase concentrations, probably because of pore-water sampling constraints, were also elevated at certain sampling sites to a distance of 100-m from the platform.

Fourth, there was evidence of organic enrichment near the platforms. This enrichment was not apparent in organic carbon content because of dilution with sand. Evidence of organic enrichment around the platforms primarily comes from the summer cruises at the shallow water platform at MAI-686. Density stratification of the water column is strong during the summer. Under these conditions, hypoxia was evident near the platform, implying that low oxygen may be an occasional stress at that site. Enhanced production and benthic deposition of organic matter near the platforms is probably occurring. Organic enrichment was detectable at this site and time because conditions allowed for the development of low-oxygen bottom waters. In the bottom waters near platforms, low oxygen was linearly associated with increased concentrations of inorganic nutrients. This covariation implies that benthic microbial degradation of organic matter produced the low oxygen conditions and the concurrent nutrient enhancements.

The major patterns in biological responses to these environmental gradients can be interpreted largely as the consequence of two of these four environmental forcings, organic enrichment and metal toxicity. The hydrocarbons occur in concentrations that seem too low to be important contributors to the observed toxicological effects. The pattern of increased sand content doubtless affects benthic invertebrates but the observed trends are often opposite to the usual biotic response to sediment texture. The emergence of patterns in benthic meiofaunal and macroinfaunal communities that are broadly consistent with other documented responses to organic enrichment and sediment toxicity, despite the sediment grain-size gradient, leads to the conclusion that sediment grain-size patterns are not a primary driver of the observed biological responses.

As previously mentioned, meiofaunal community responses to the presence of platforms are consistent with patterns observed during modest organic and contaminant discharges. The abundance of total nematodes was enhanced near platforms by about a factor of two at the two deeper water platforms. At the shallowest site nematode abundance was depressed close to the platform. At all three platforms non-selective deposit-feeders were enhanced in biomass close to a platform. This enhancement is consistent with the effects of modest organic enrichment. The response of the nematodes is opposite to that predicted on the basis of the sediment texture

gradient. Non-selective depositing feeding nematodes typically increase as sediments become finer in size. In contrast to the nematodes, total harpacticoid copepods are depressed near the platforms. This pattern again is consistent with the previous studies of the sensitivity of harpacticoid copepods to toxic chemicals. This pattern in the nematode to copepod ratio is consistent with the previous suggestions that the nematode to copepod ratio responds to pollutant exposure (Raffaelli and Mason 1981). The macroinfaunal community revealed a pattern of change with distance from the platforms that was also consistent with earlier studies of low-level organic and chemical discharges to the marine environment. Total macroinfaunal densities were enhanced at near platforms as a consequence of enhanced abundances of polychaetes. This pattern was weakest at MAI-686. Enhancement of polychaete abundances is typical in cases of modest organic enrichment in marine environments. It is noteworthy, that the increase in polychaete abundance occurs despite a gradient in sediment sand content. Polychaetes are normally more abundant in finer sediments. In contrast to the polychaetes, amphipod abundances are depressed near platforms. This effect on amphipods is consistent with modest chemical contamination. Echinoderms were not sufficiently common at the study sites to conclusively determine how they responded to the platforms, but the patterns observed suggested an absence of any toxicological or density responses in this group.

Attributing the pattern of amphipods and harpacticoids abundances to a toxicological cause is supported by the results of porewater toxicity testing. Toxicity tests on percent normal development and percent fertilization of sea urchins (*Arbacia punctulata*), an echinoderm, revealed a pattern of toxic responses similar to the pattern of chemical contamination. The embryological development test proved more sensitive than the fertilization test, with all cases of significant toxicity in the fertilization test corresponding to significant toxicities in the development test. The toxicity results revealed that, with one exception, all cases of significant sediment toxicity were within 100-m of a platform. The most compelling pattern of toxicity comes from the most contaminated site (HI-A389). Several stations within 50 m of the HI-A389 platform showed significant toxicity in the sea urchin development test during two independent samplings. Concentrations of contaminants in these samples suggested that the

observed toxicity was most likely a consequence of certain metals (Zn, Cd, Pb). Concentrations of several metals in sediments at these stations approached or exceeded probable biological effects levels (Long and Morgan 1990). Results of a novel set of toxicity tests using naupliar survival of the harpacticoid copepod, *Longipedia americana*, and egg production for the meiofaunal polychaete, *Dinophilus gyrociliatus*, provided further evidence of toxicity close to the platform. Both of these species proved less sensitive than the sea urchin to sediment toxicity, but stations that proved toxic to either of these meiofauna were also toxic in the sea urchin development tests. These tests confirm the toxicity of some sediments close to the platforms, especially at HI-A389. These results support the inference that toxicity is driven by metal contamination. Furthermore, toxicity was demonstrated using not only standard test species but also species indigenous to the study region. The demonstrated toxicological effects on a harpacticoid provides support for the inference that the pattern of depressed abundances of harpacticoids near the platforms is indeed a response to the toxicity of the sediments.

Various physiological and genetic results provide further evidence that the crustaceans around the platforms exhibited sublethal responses to contaminant exposure. In the pooled data set for all harpacticoid copepods, the percentage of gravid females was greater and the percentage of juveniles was reduced at the 50-m stations around platforms. In addition, reproductive effort (egg numbers times egg sizes) for those female harpacticoids carrying eggs was reduced in sediments within 50-m of the platforms. These responses could be explained as sublethal physiological responses to modest levels of stress due to exposure to toxicants. The observation that genetic diversity in several species of harpacticoid copepods was significantly reduced near the platforms also suggests that this approach is detecting sublethal response.

Although the trawling component of GOOMEX was not designed to measure how fish and mega-invertebrates varied in abundance with distance from the platform, the trawl data can still provide some indication of large abundance differences, if there were any. This question has importance for interpretation of the benthic community response results. Benthic abundance patterns can be driven by top-down differences in predation pressure as well as by bottom-up differences in food supply and toxicity.

There is little evidence of substantial differences between Near and Far stations in the abundance of large invertebrates. There may be enhancement of some fish near platforms (as indicated by the trawl results). Enhancement of species that utilize the hard substrate "reef" habitat would be expected. Bottom trawling is not an effective method of quantifying pelagic species, because they are too large and can avoid the net (pelagic predators such as king mackerel) and/or they are too closely associated with the reef structure to be accurately sampled (sheepshead, snappers, pinfish). A more accurate and complete census of fish species that utilize the platform structure as habitat would almost certainly have revealed enhanced abundances. Analysis of gut contents in small fish showed no differences in dietary composition or in gut fullness between Near and Far stations. Nevertheless, increased abundance in fish in the near-field may indicate somewhat greater predation pressure on macroinfauna near platforms. Based upon the analogy with other studies of ecosystem response to organic enrichment, especially the San Onofre power plant study (MRC 1989) and the Los Angeles County sewage outfall study (Tetra Tech 1981, 1984), it seems more likely that enhanced demersal fish abundance occurs in response to food abundance rather than serving as a driver of benthic abundance patterns. If this were true for platform sites, then increased polychaete abundances in the near-field may be contributing to some increase in demersal fish.

7.2.2 Sediment Quality Triad Approach to Integration of Results

As a follow-on to the interpretations provided in Section 7.2.1, a statistical test of the concordance of programmatic results was considered an important concept to pursue. The Sediment Quality Triad (SQT) is one such approach that attempts to integrate concurrently obtained (synoptic) toxicological, sediment chemistry, and benthic infauna data to describe degradation of the environment (Chapman and Long 1983; Long and Chapman 1985; Chapman et al. 1986; Chapman et al. 1987a,b, Chapman 1989; Chapman 1990). In evaluating effects associated with an oil platform, Chapman et al. (1991) suggested that the SQT "incorporates three essential components; measures to determine the presence and degree of anthropogenic contamination (i.e., bulk sediment chemistry); measures that

demonstrate that substances are present that can interfere with the normal functioning of at least some biological organisms tested in the laboratory (i.e., sediment toxicity tests); and, assessments of *in situ* alteration of resident biological communities (i.e., measures of benthic infaunal community structure)." One of the weaknesses of the SQT approach is a "lack of statistical criteria for the combined Triad components." Green et al. (1993) pointed out that appropriate statistical methods had not been used in previous applications of the SQT concept to evaluate environmental impact. Appropriate statistical methods are those that can relate conceptually different sets of variables in multivariate data.

Chapman et al. (1991) applied the SQT approach to data obtained from sampling along three radii centered on Platform "C" of the MAI-622 field, 22 km offshore in water depths ranging from 24 to 26 m. Benthic infaunal community data obtained from cores provided the biological component. Limited sediment chemistry data provided the contamination component, and the toxicological component consisted of an amphipod bioassay, an assessment of abnormalities in oyster larvae, and Microtox test results. As in the Chapman et al. (1989) and earlier applications of the SQT, the statistical analyses were mostly descriptive in nature and applied independently to each component rather than as an integrated approach that relates several components. Comparisons in previous studies were often based on a "ratio-to-reference" criterion (the ratio of values at possibly impacted stations to values at an *a priori* defined reference station).

An integration of results demonstrating coherence between diverse work elements provides strong circumstantial evidence of effect or impact. Therefore, the SQT concept described in Green (1993a,b) was applied to the data collected in the present study. This additional integration of results provides a statistically rigorous cross-work element interpretation based on pollutant exposure and biological response.

For the SQT components the following variables were used:

- Biological: abundances of four major meiofaunal and macroinfaunal taxa.
- Chemical: the variables TOTPAH, UCM, TOTALK, SAND, SILT, CLAY, TOC, TIC, REDOX, Fe, Cd, Al, and Ba.

- Toxicological: the test of porewater toxicity using a percentage successful development of sea urchin embryos as a criterion.

The sea urchin embryo development assay was done for samples from all stations on Cruises 1 and 2. Therefore the data analyzed by the SQT approach were from samples taken on the first two cruises at all stations ($n = 2 \text{ cruises} \times 3 \text{ platforms} \times 5 \text{ radii} \times 5 \text{ distances} = 50$). There is only one toxicological variable, and the environmental variables have already been reduced to a PC score (see Section 6.2). Two analyses were carried out, one based on meiofauna community response and one based on macroinfaunal community response. For the meiofauna analysis total harpacticoid abundance and total nematode abundance were used as variables, reflecting the long standing use of the taxa and their relative abundances as indicators of environmental impact as previously discussed. Abundances were log-transformed, so a difference between nematode and harpacticoid abundance represents this ratio. Analogously, the macroinfauna component used total amphipod abundance and total polychaete abundance. Again abundances were log-transformed. The SQT analysis was also carried out on all four of these taxa combined. These combined results were statistically significant and consistent with the results from the analyses of the meiofauna and macroinfauna separately, but the results of the separate analyses were easier to interpret. Therefore the combined analysis results were not pursued further. The SQT analyses were also carried out platform-by-platform.

The statistical analysis procedure was the same for the meiofauna-based analysis as for the macroinfauna-based analysis. First the correlations among components were calculated. The two correlations involving the biological component (the correlation between the biological and chemical components and the correlation between the biological and toxicological components) were determined by the multiple correlation of the non-biological component with the two taxa abundances defining the biological component. The correlation between the chemical and toxicological components is the simple bivariate correlation coefficient r . Thus the significance and strength of each of the three between-component relationships was evaluated, and were placed on the sides of a triangle representing the SQT (Figure 7.2). Second, the entire among-component correlation matrix was tested against the null hypothesis H_0 : "no real relationships exist among the three SQT components," using Bartlett's

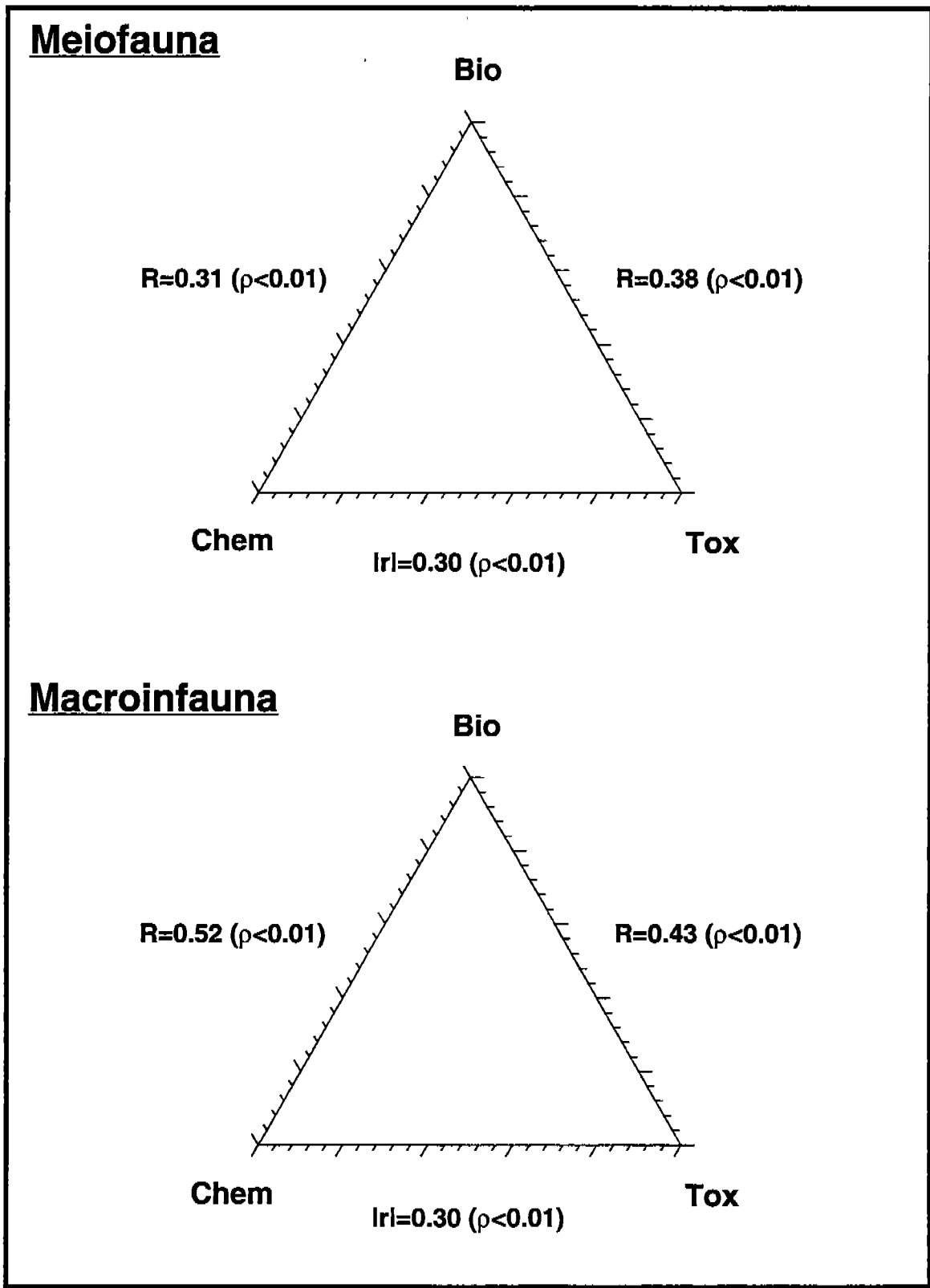

Figure 7.2. Significance of the relationships between SQT components.

sphericity test. Third, a principal component analysis (PCA) was done on the correlation matrix to evaluate the structural relationship(s) among the three SQT components. This was done by a two-step procedure. First a PCA was done on the two log-transformed taxa abundance variables to derive size- and shape-PCs. That is, in a PCA on such data one of the PCs (the size-PC) is invariably related (same strength of relationship and same sign) to the original variables and represents a tendency for two variables to go up and down together. Here it would represent increases or decreases in abundance of both taxa, and presumably of the entire meiofaunal or macroinfaunal community. The other PC will have opposite-signed relationships to the original variables and in these log-transformed data will represent changes in the ratio of the abundances of the two taxa. Then the PC scores for these two PCs (hereafter referred to as BioPCs), which are expected to have clear interpretations, are used in the final PCA along with the chemical and toxicological measures.

The results for the meiofauna-based analysis and for the macroinfauna-based analysis are similar. The strength and significance of between-component SQT relationships in the two analyses is shown in Figure 7.2. All three relationships in both analyses are highly significant ($p < 0.01$). Between-component relationships are illustrated in Figures 7.2 to 7.4. For both analyses Bartlett's sphericity test is highly significant, with χ^2 (6 df) = 43.9 ($p < 0.01$) for the meiofauna-based analysis and χ^2 (6 df) = 78.6 ($p < 0.01$) for the macroinfauna-based analysis. The PCA results are shown in Table 7.4. In the meiofauna-based analysis, BioPC1 was a size-PC and BioPC2 was a shape-PC indicating that fluctuations in the abundance of both taxa together dominate the abundance variation, with relative abundance changes (changes in the nematode to harpacticoid ratio) being smaller in magnitude (Figure 7.3). However in the macroinfauna-based analysis the BioPC1 was the shape-PC and the BioPC2 was the size-PC, indicating that the relative abundance changes (the polychaete-to amphipod ratio) dominate the fluctuations in abundance of both taxa together (Figure 7.4). In the final PCA, for both SQT analyses there is a dominant PC1 (41.5 % of the structure in the meiofauna-based analysis and 45.6% of the structure in the macroinfauna-based analysis) which can be interpreted as follows (Table 7.4). As chemical contamination increases (positive relationship with ChemPC1) the percentage of successful development of sea urchin embryos decreases

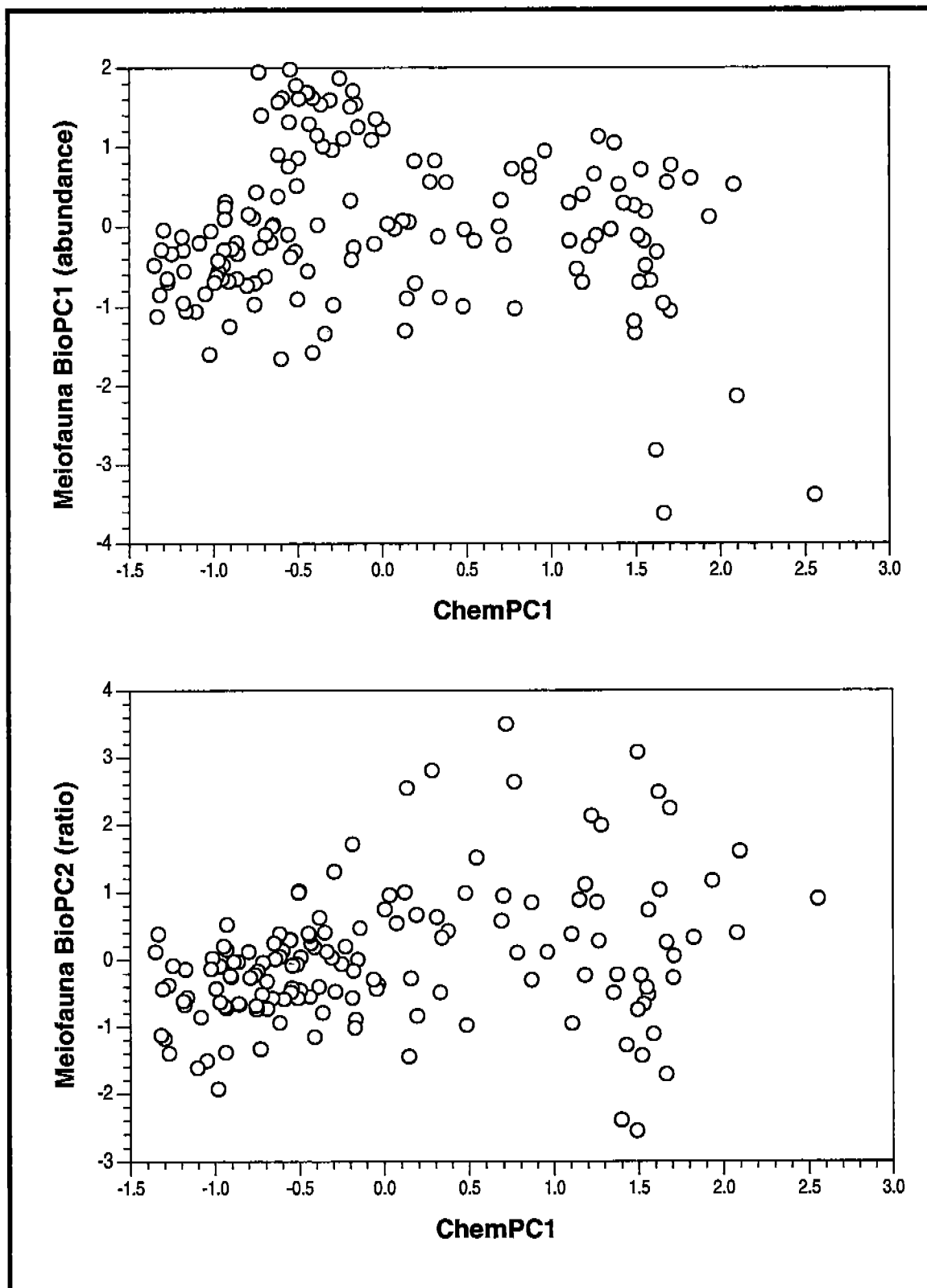

Figure 7.3. Relationship between the first two principal components of the meiofauna abundance data and the environmental variables PC1.

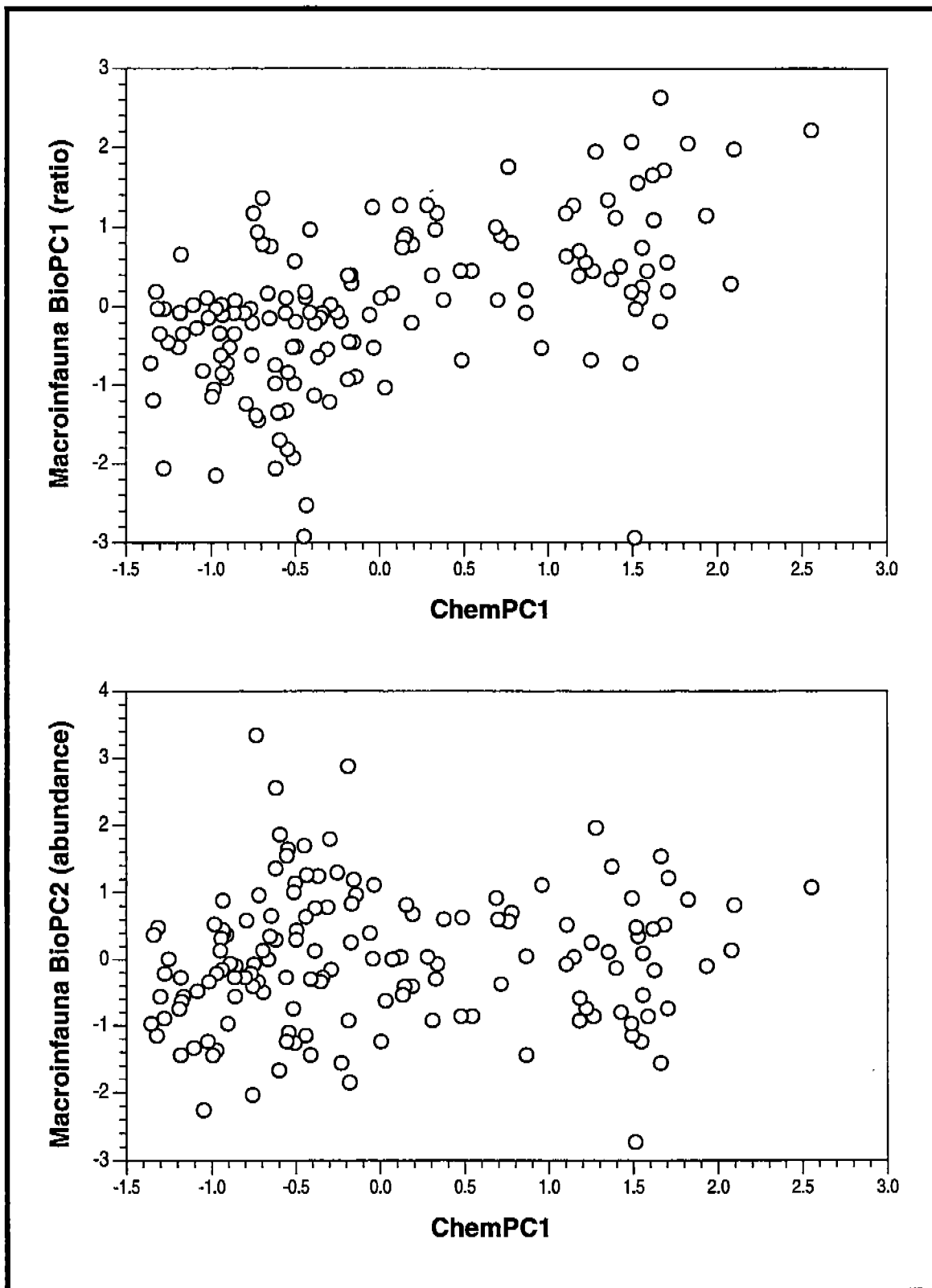

Figure 7.4. Relationship between the first two principal components of the macroinfauna abundance data and the environmental variables PC1.

Table 7.4. Summary of correlation coefficients among SQT biological and toxicological and chemical components

<u>Meiofauna</u>		PC1 (41.5%)
Chemical Component		0.703
Toxicological Component		-0.758
Bio Component (total abundance)		-0.267
Bio Component (NEMA/HARP)		0.721
<u>Macroinfauna</u>		PC1 (45.6%)
Chemical Component		0.782
Toxicological Component		-0.706
Bio Component (total abundance)		0.255
Bio Component (NEMA/HARP)		0.805

(negative relationship with the toxicological measure; Figure 7.5). The biological community responds in the direction of increasing the ratio of the abundance of the "more tolerant taxon" to the "more sensitive taxon." Thus, the same relationships among the SQT components are seen in both the meiofauna-based and the macroinfauna-based SQT analyses, which strengthens the interpretations and conclusions.

Variation in meiofaunal abundances was dominated by change in total abundance (nematodes and harpacticoids going up and down together) whereas variation in macroinfaunal abundances was dominated by relative abundance changes (changes in the "polychaete to amphipod ratio").

Although neither community shows a strong relationship between ChemPC1 and total abundance (it is mostly between ChemPC1 and the relative abundances of the taxa), such relationship as there is, is a negative one for the meiofauna and a positive one for the macroinfauna. As previously discussed, organic enrichment of the macroinfaunal community near the platform may cause increased total macroinfaunal abundance. If such enrichment does not affect the meiofaunal community, then most variation in total meiofaunal abundance would be a contaminant-driven response near platforms. This is in fact what is seen. In other words, both communities show impact effects in their ratios of "tolerant to sensitive taxa abundances." The meiofaunal community also shows some negative response in total abundance, but in the macroinfaunal community any such response is overwhelmed by enhancement of total abundance, probably by organic enrichment near platforms.

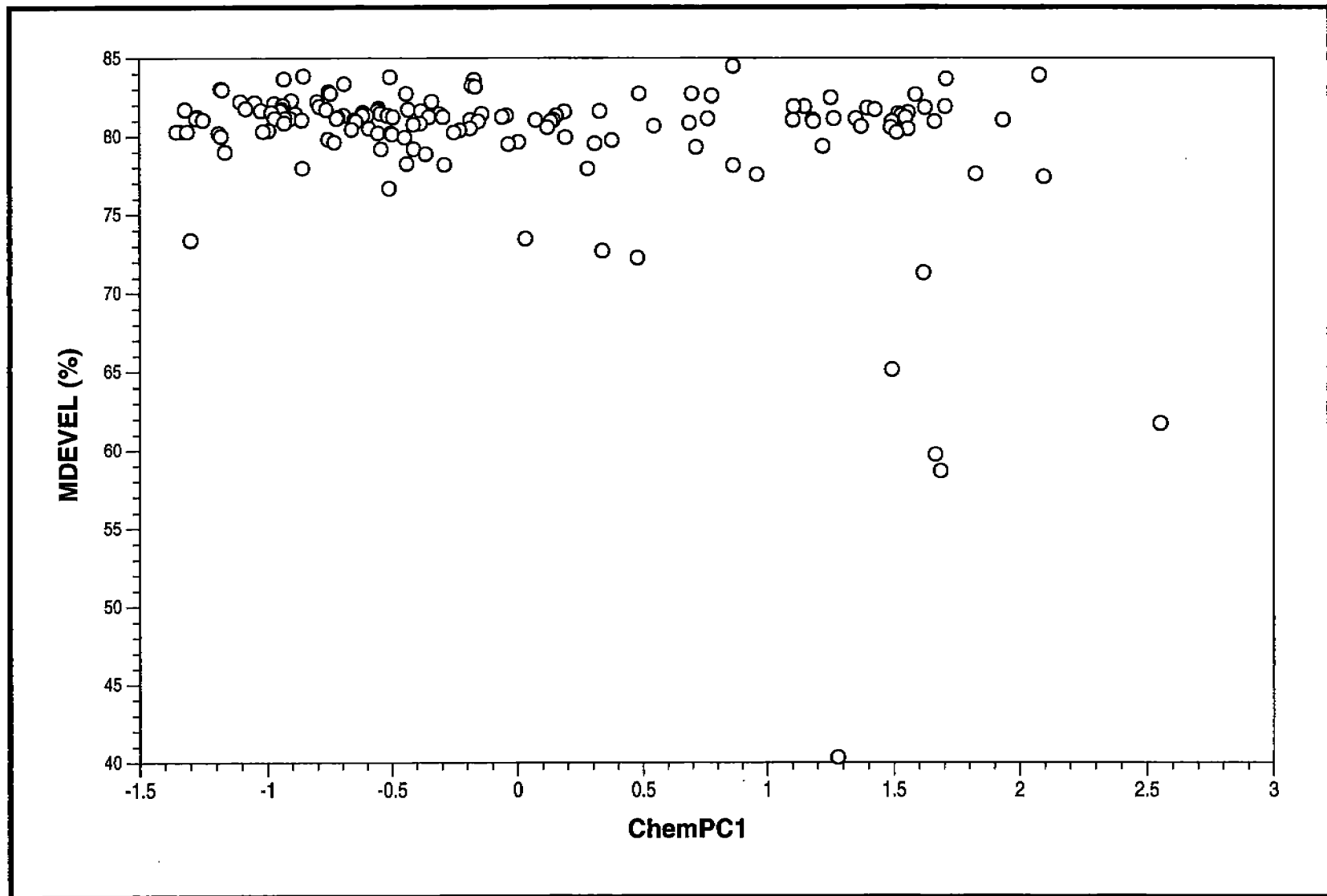

Figure 7.5. Relationship between survivability in the sea urchin embryo pore water assays (MDEVEL) and the environmental variable PC1 (ChemPC1).

The platform-by-platform analyses indicate that most of the patterns in tests of the overall study design are due to the intensity of the patterns at the HI-A389 site. The patterns at the other two platforms are not obviously different, but they are certainly weaker. At HI-A389, Bartlett's sphericity test is highly significant and all three SQT relationships are highly significant for both meiofauna and macroinfauna. At MU-A85, there is no TOX-CHEM relationship, and no BIO-TOX relationship for either meiofauna or macroinfauna. There is a significant ($p < 0.01$) BIO-CHEM relationship for macroinfauna and a marginally non-significant one ($p = 0.11$) for meiofauna. However, the overall test of whether there are any significant SQT relationships, Bartlett's sphericity test, is not significant for either meiofauna or macroinfauna at MU-A85. At MAI-686 Bartlett's sphericity test is highly significant for both meiofauna and macroinfauna, but only the BIO-CHEM relationship is significant ($p < 0.01$, for both meiofauna and macroinfauna). The BIO-TOX and the TOX-CHEM relationships are non-significant for both meiofauna and macroinfauna at MAI-686.

Finally, it should be remembered that the environmental variable score (ChemPC1), used as a measure of the chemical contaminant SQT component, is a measure of chemical and substrate grain-size gradient related to distance from the platform. All interpretations are made with this reality in mind. However, the same is true for all spatial pattern data in this study, as well as all environmental impact studies based on observational data. However, as previously noted, many of the biological patterns are opposite that expected for grain-size driven ecological trends. The most common and consistent pattern at all three sites is the enhancement of sand near the platform. However, despite strong covariance in many of the independent variables, underlying trends related to toxic response are discernable.

7.2.3 Utility of Higher Taxonomic Levels

Many different techniques have been utilized to detect changes in community structure. In the present study, ANOVA of diversity indices and PCA on species data was used. Thus, both an *a priori* univariate technique (ANOVA), and a *post hoc* multivariate technique (PCA) was used. Using these two techniques, it has been demonstrated that both meiofaunal and

macroinfaunal assemblages change among platforms and with distance from platforms. The use of these techniques based on data collected at the species level was powerful. However, significant costs and time was associated with identification of all organisms to the species level. It is becoming evident that biological responses to pollution may be detectable at higher taxonomic levels than species.

For macroinfauna, detection of impacts is possible at the level of the phylum (Warwick 1988a,b), and at least in some cases phyletic analysis provides superior discrimination (Warwick and Clarke 1993, Agard et al. 1993). The biological basis for a differential response to pollution, rests upon intrinsic physiological and ecological differences among higher taxa. As summarized above, echinoderms and crustaceans, especially amphipods and some harpacticoid copepods, are relatively more sensitive to toxic chemicals in their environment than other organisms. It is by design that standard EPA biotoxicity tests for benthic invertebrates involve an echinoderm (sea urchin reproductive stages) and an amphipod (*Rhepoxinius*) so that testing uses the most sensitive indicators of pollution toxicity. In analyses of community response to marine pollution that involves toxicity, echinoderms and crustaceans, at least amphipods and some groups of harpacticoids, typically show large declines. In contrast, polychaetes and nematodes are not especially sensitive to toxic chemicals yet include species with both opportunistic life histories and other feeding types (especially non-selective deposit feeders) that would allow them to utilize carbon from organic pollution. Consequently, polychaetes and nematodes (at least non-selective deposit-feeding nematodes) typically show substantial increases during organic pollution events. It is this unequal effect of organic pollution upon different groups of benthic meiofauna and macroinfauna that makes ordination techniques of benthic community analysis so effective in discriminating the effects of pollution at higher levels of taxonomic classification, including the phylum level for macroinfauna (Warwick and Clarke 1993). If higher taxon approaches are to be adopted, information on effects at the species-level must be preserved (Kingston and Riddle, 1989).

For both meiofauna and macroinfauna, identification to only the Suborder or Family level is one possible alternative approach. The GEEP (Group of Experts on Effects of Pollution) workshop performed an

intercalibration study and evaluated techniques for the assessment of pollution in the sea (Bayne et al. 1988). All levels of biological organization were studied from the molecular to the community, and all biological components from bacteria to macroinfauna were included. Both mesocosm and field experiments were performed. In the GEEP mesocosm experiment Warwick et al. (1988) found meiofauna to be very sensitive to the treatments. Harpacticoids exhibited a graded response of decreasing diversity with increasing exposure to pollutants, but diversity profiles for nematodes were virtually unaffected. Diversity was not useful in detecting the pollution gradient in the field study, but community differences were distinct and species-level data gave no more information for discrimination than did nematode Suborder or harpacticoid Family groupings (Heip et al. 1988). Macroinfauna family groupings were just as adequate for distinguishing the pollution gradient as was species level data (Warwick 1988a). The most remarkable result from these studies was that identifications at higher taxonomic levels were as good as species identifications. This indicated that it may be possible to obtain up to 80% of the information at a cost of less than 25% of the resources. The results also indicated that meiofauna and macroinfauna can indicate impacts at different levels in an ecosystem. Finally, harpacticoid copepod species were the most sensitive indicators of stress in both field and mesocosm GEEP studies. Higher level identifications were found to be just as good as species identifications for detecting pollution gradients in one other study. Macroinfauna family level identifications were adequate to assess pollutant contaminant impacts on the Southern California Bight (Ferraro and Cole 1990).

As previously described the nematode:copepod ratio should not require species identifications to detect anthropogenic disturbances (Raffaelli and Mason 1981; Raffaelli 1982; Warwick 1988b). The nematode:copepod ratio was originally conceived to detect gradients of organic enrichment, e.g., exposure to sewage disposal (Raffaelli and Mason 1981). This was successfully used in Scotland (Raffaelli and Mason 1981) and Norway (Amjad and Gray 1983). However, the ratio was not effective in South Africa (Hennig et al. 1983), or Yugoslavia (Vidakovic 1983). The ratio has been criticized as being too simplistic. Coull et al. (1981) suggested that seasonal variation or non-pollution events can cause the observed variations. Hennig et al. 1983 showed that nematodes and harpacticoids can have

different responses to different kinds of disturbances. Further analyses have shown that these criticisms were correct for the Scottish coast. Resampling by Lambshead (1984), Moore and Pearson (1984), and Shiells and Anderson (1985) found that seasonal variation and sediment grain-size caused the ratio to inconsistently vary, leading to the conclusion that the ratio could not be used to specifically indicate organic pollution. In oil pollution studies the ratio was effective, because the presence of the oil decreased the number of harpacticoids while nematode numbers remained constant or increased slightly (Montagna et al. 1987; 1989). However, other studies of oil contamination have produced inconsistent results. The ratio declined, rather than increased, near a platform in the North Sea and in experimental mesocosms when drilling muds were added (Moore et al. 1987; Leaver et al. 1987). In the present study, the nematode:copepod ratio successfully detected near-field effects. The response of the ratio was due to nematode populations generally increasing or staying the same, while harpacticoid populations decreased.

To test the generality of responses at the family level for meiofauna and macroinfauna, species data from the present study was combined at the family level and reanalyzed. In the meiofauna, the harpacticoids and nematodes, were reanalyzed separately (Figures 7.6 to 7.13). In the macroinfauna, the total dataset, amphipods and polychaetes were separately reanalyzed (Figures 7.14 to 7.17).

For harpacticoids at the family level, platform differences were obvious (Figure 7.6), but not as obvious as at the species level. For nematodes at the family level differences were not obvious, but they were obvious at the species level (Figure 7.7). To determine differences attributable to distance from the platform, PCA was redetermined at each platform. For harpacticoids analyzed by-platform, distance effects were not noticeable at MAI-686 at either the family or species level (Figure 7.8). For harpacticoids analyzed by-platform at MU-A85 distance effects were noticeable at the family level with high loadings for PC1 at stations at 50 and 100 m, but not at the species level (Figure 7.10). For harpacticoids at HI-A389, differences were found at the species level, but not as clearly at the family level (Figure 7.10). For nematodes analyzed by platform, distance effects were not noticeable at the family level for platforms MAI-686 (Figure 7.11) but were quite evident at MU-A85 (Figure 7.12) and HI-A389 (Figure 7.14). Distance

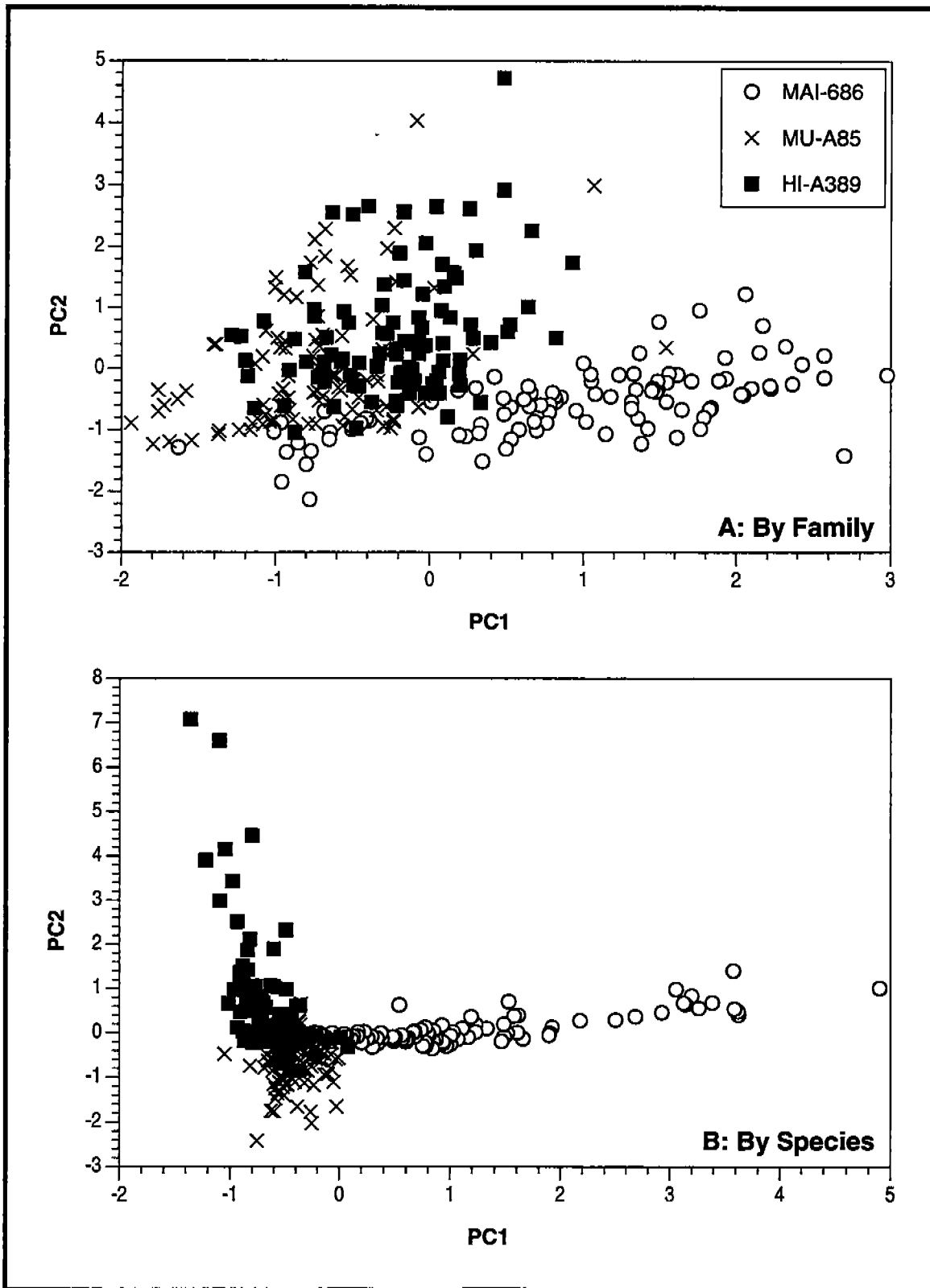

Figure 7.6. Comparison of PCA at the species and family levels for harpacticoid families for all platforms.

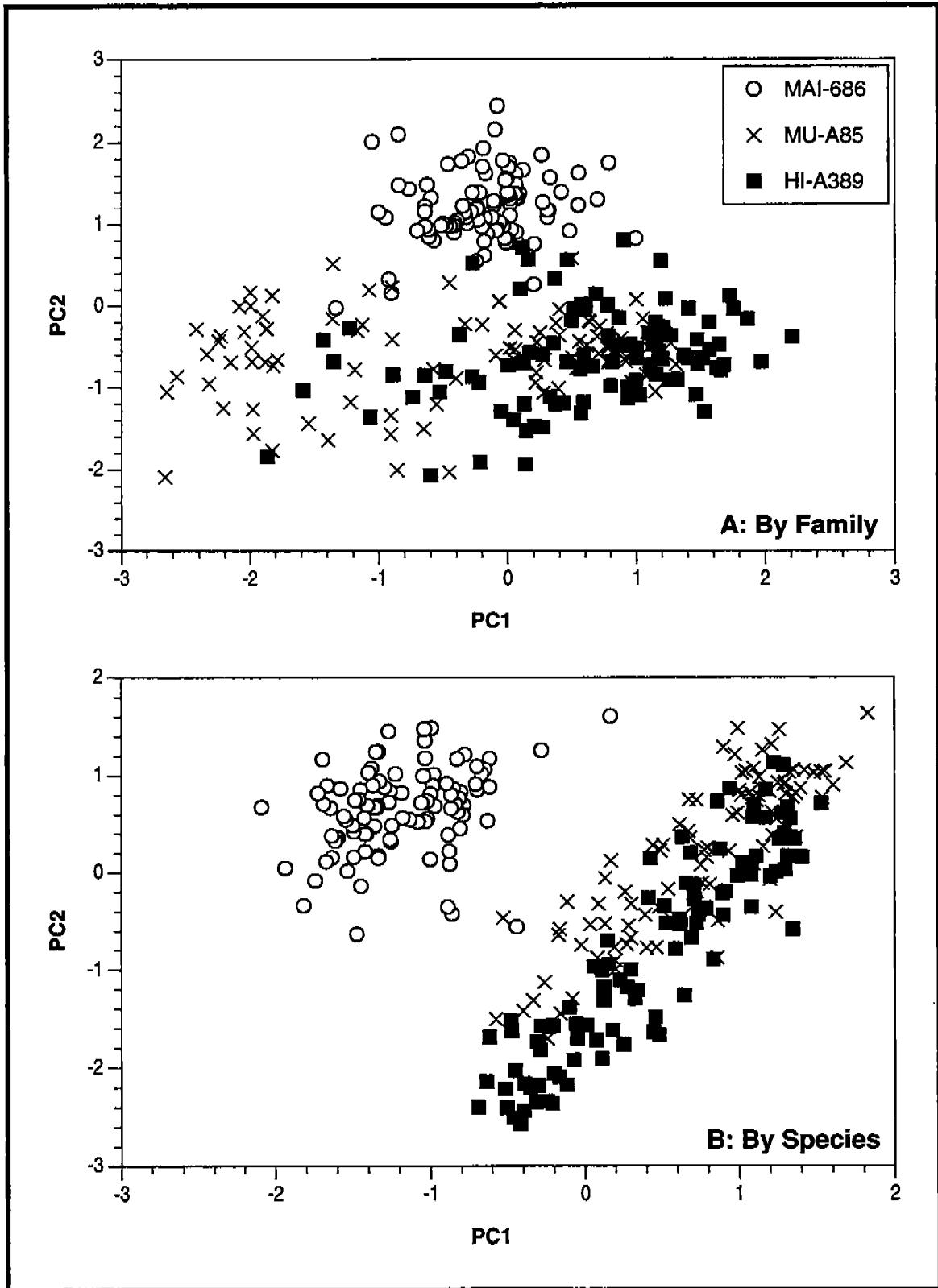

Figure 7.7. Comparison of PCA at the species and family levels for nematode families for all platforms.

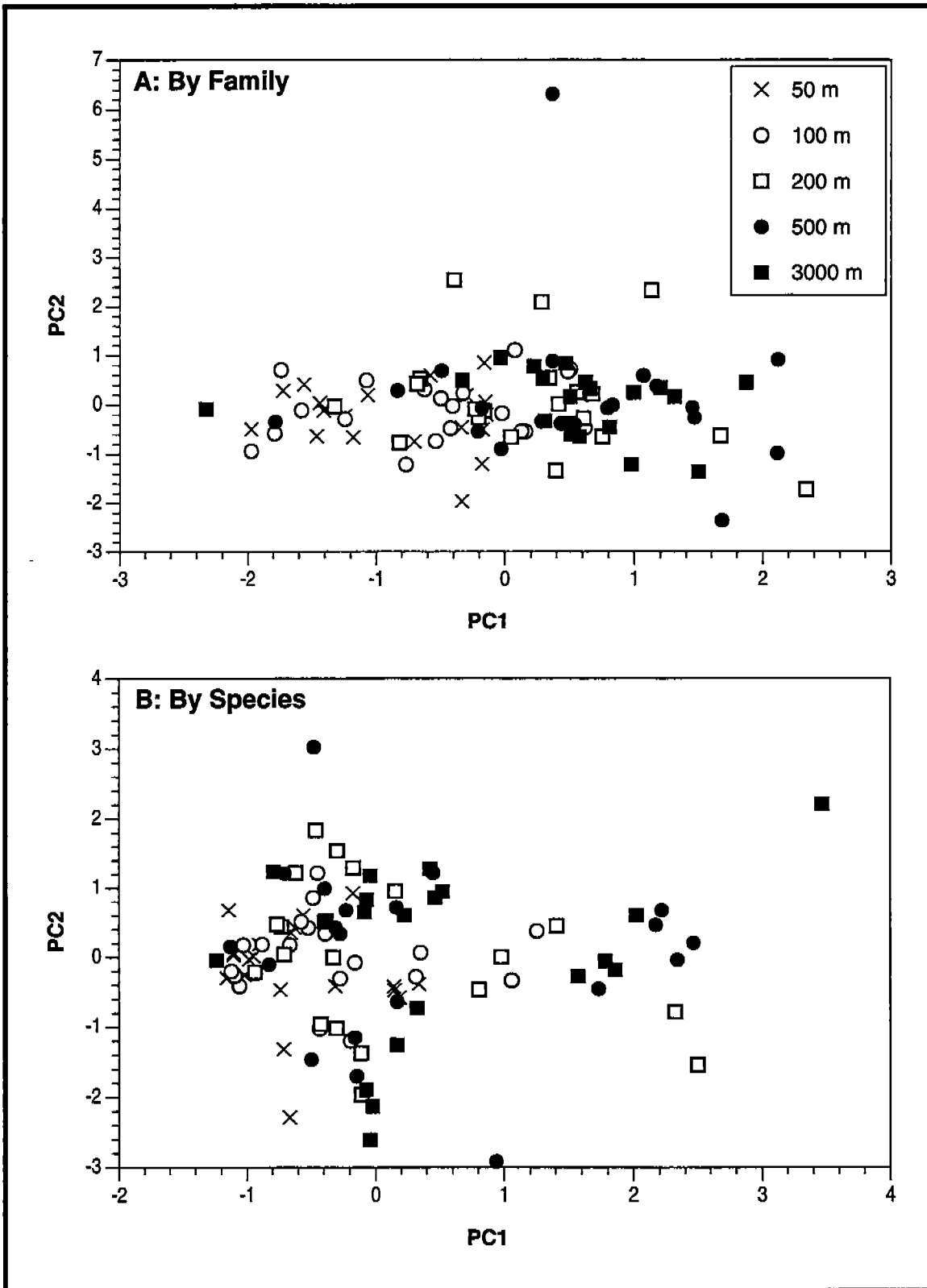

Figure 7.8. Comparison of PCA at the species and family levels for harpacticoid families at MAI-686.

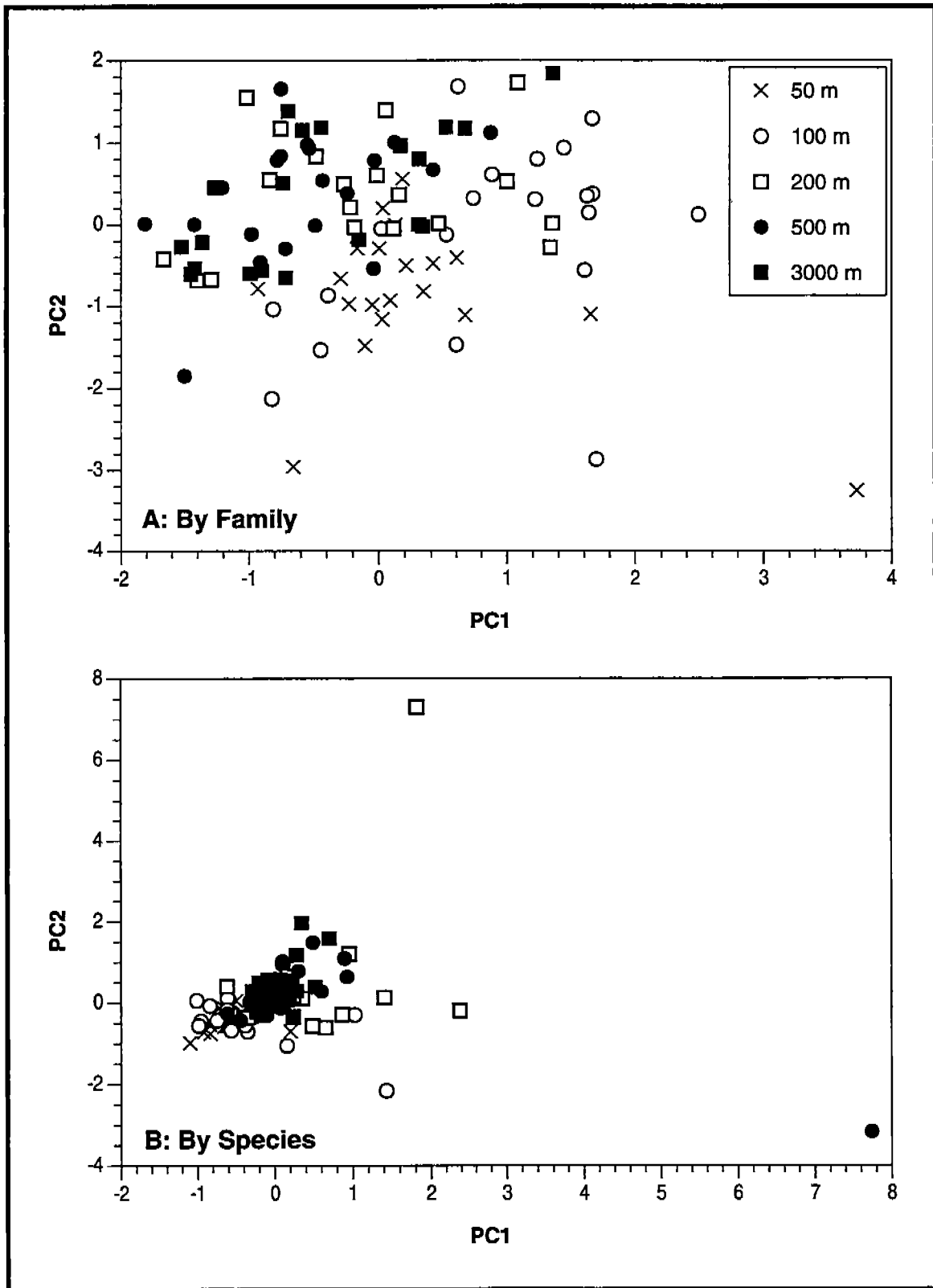

Figure 7.9. Comparison of PCA at the species and family levels for harpacticoid families at MU-A85.

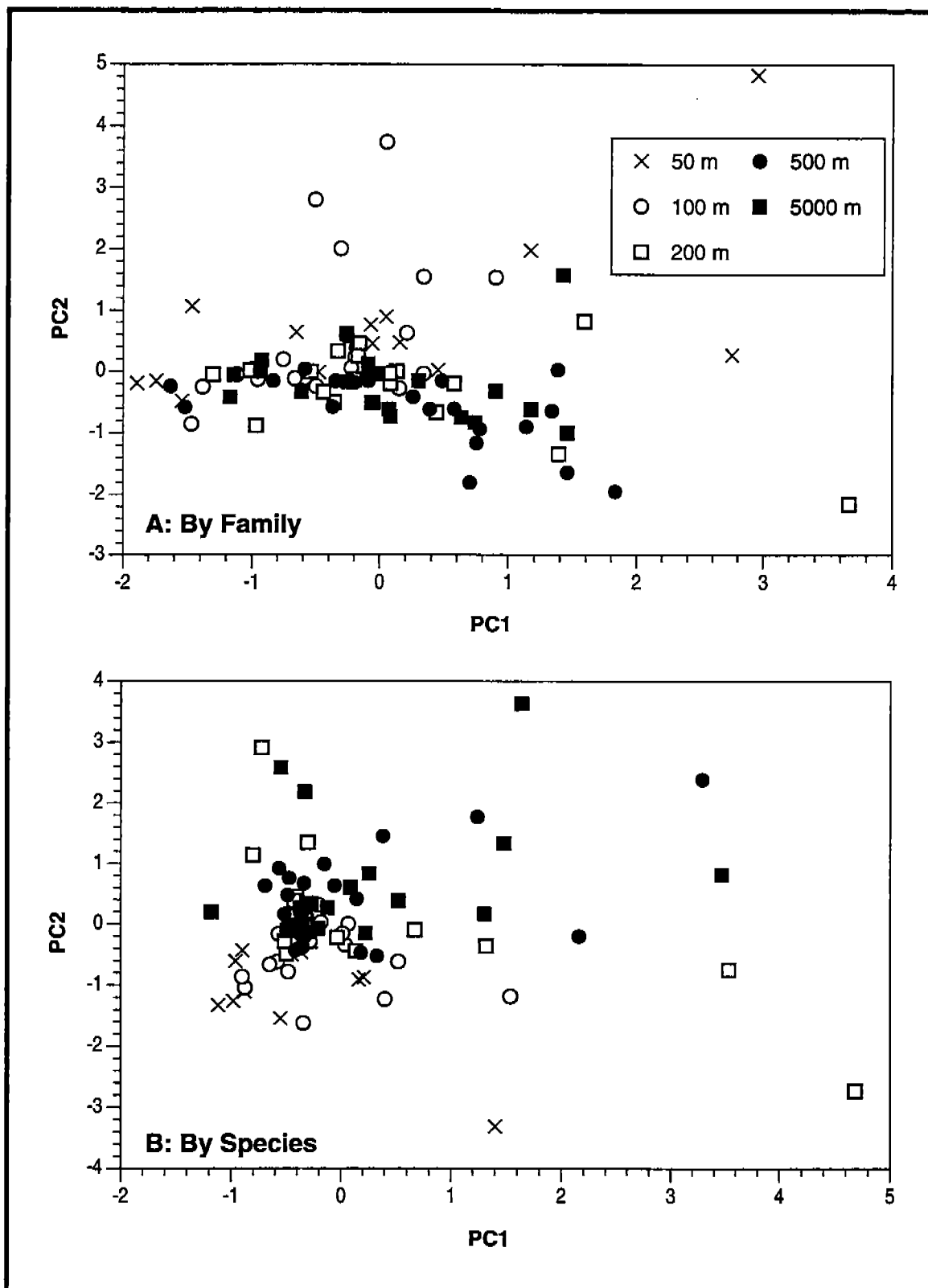

Figure 7.10. Comparison of PCA at the species and family levels for harpacticoid families at HI-A389.

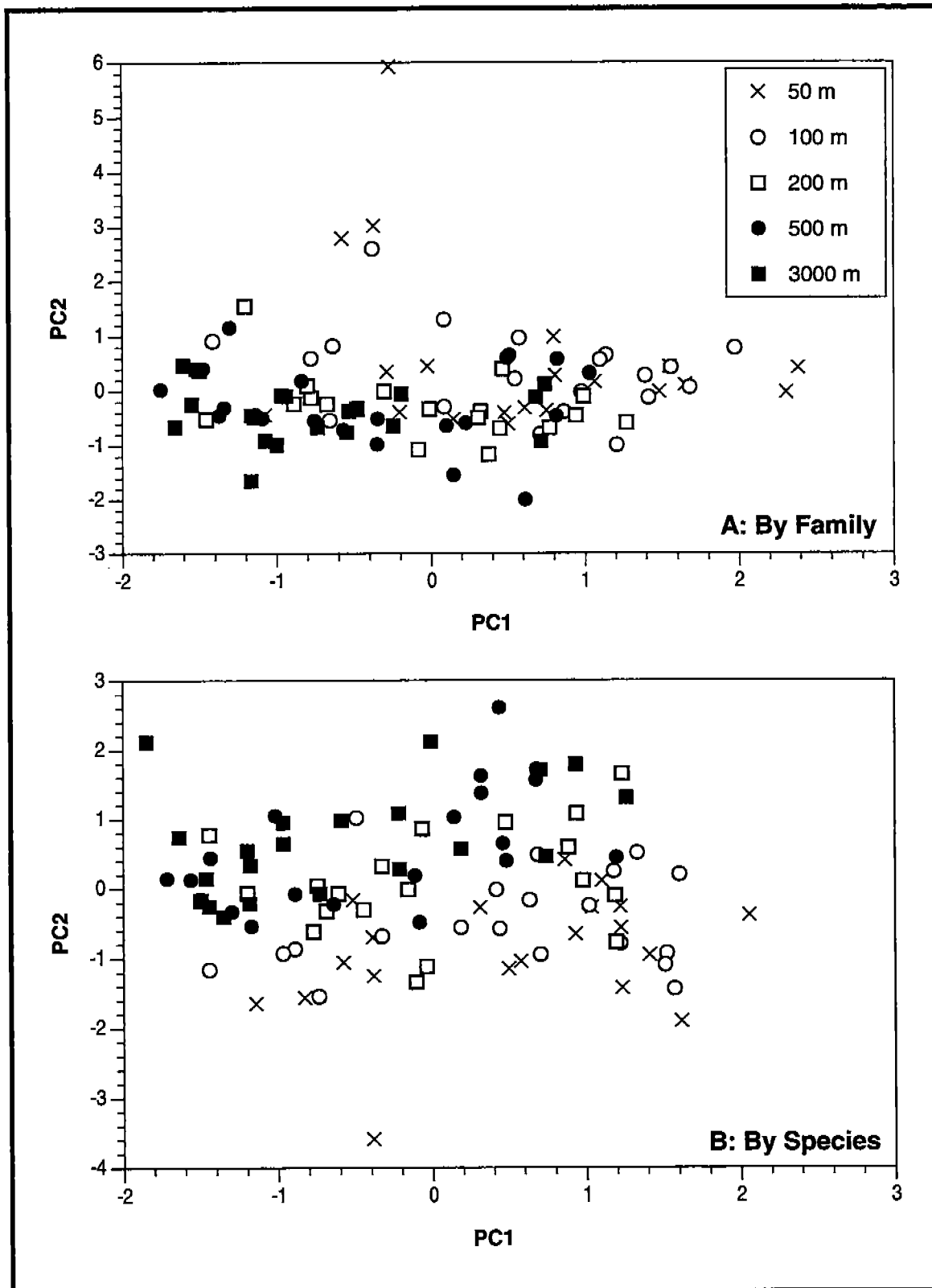

Figure 7.11. Comparison of PCA at the species and family levels for nematode families at MAI-686.

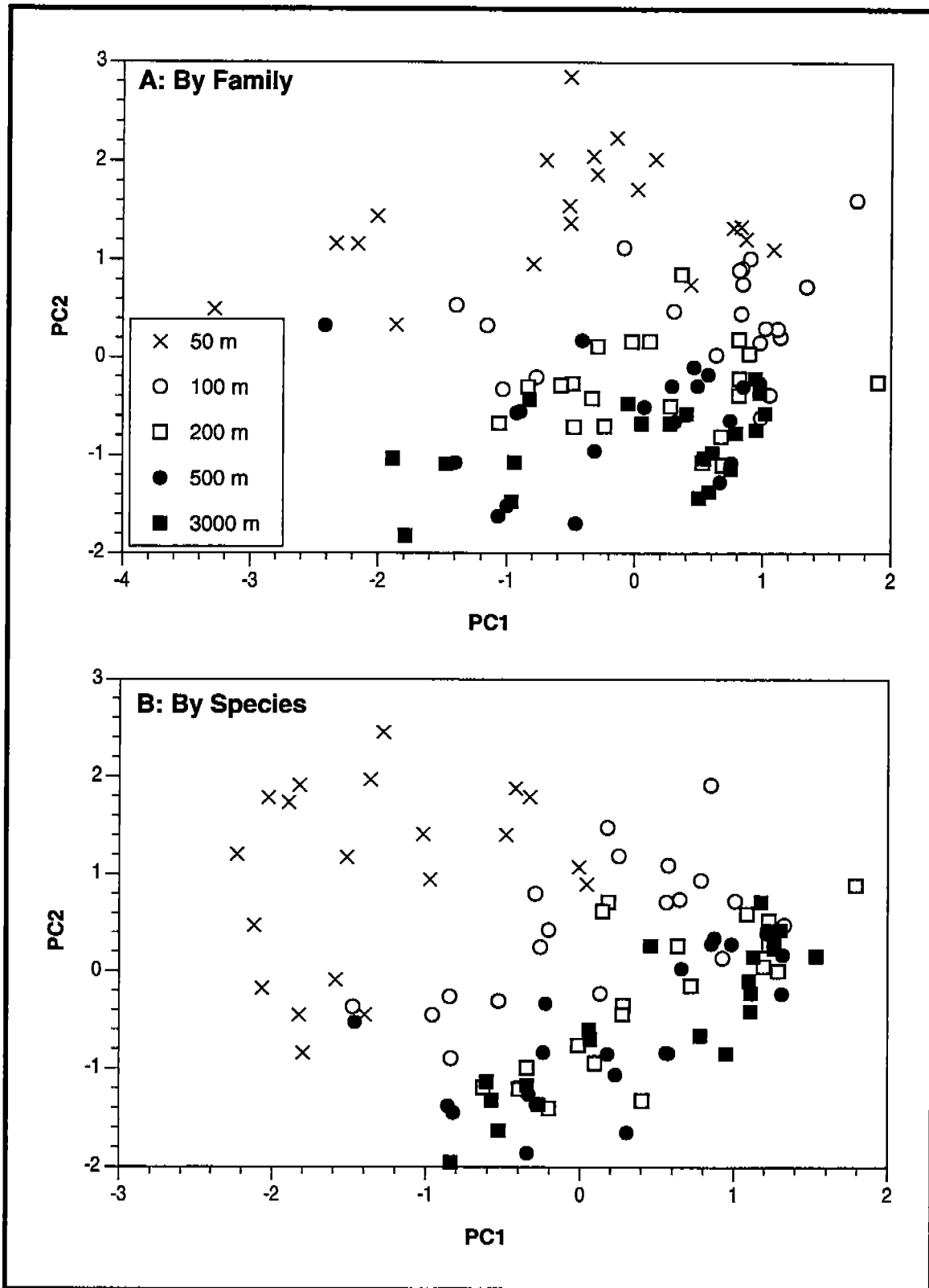

Figure 7.12. Comparison of PCA at the species and family levels for nematode families at MU-A85.

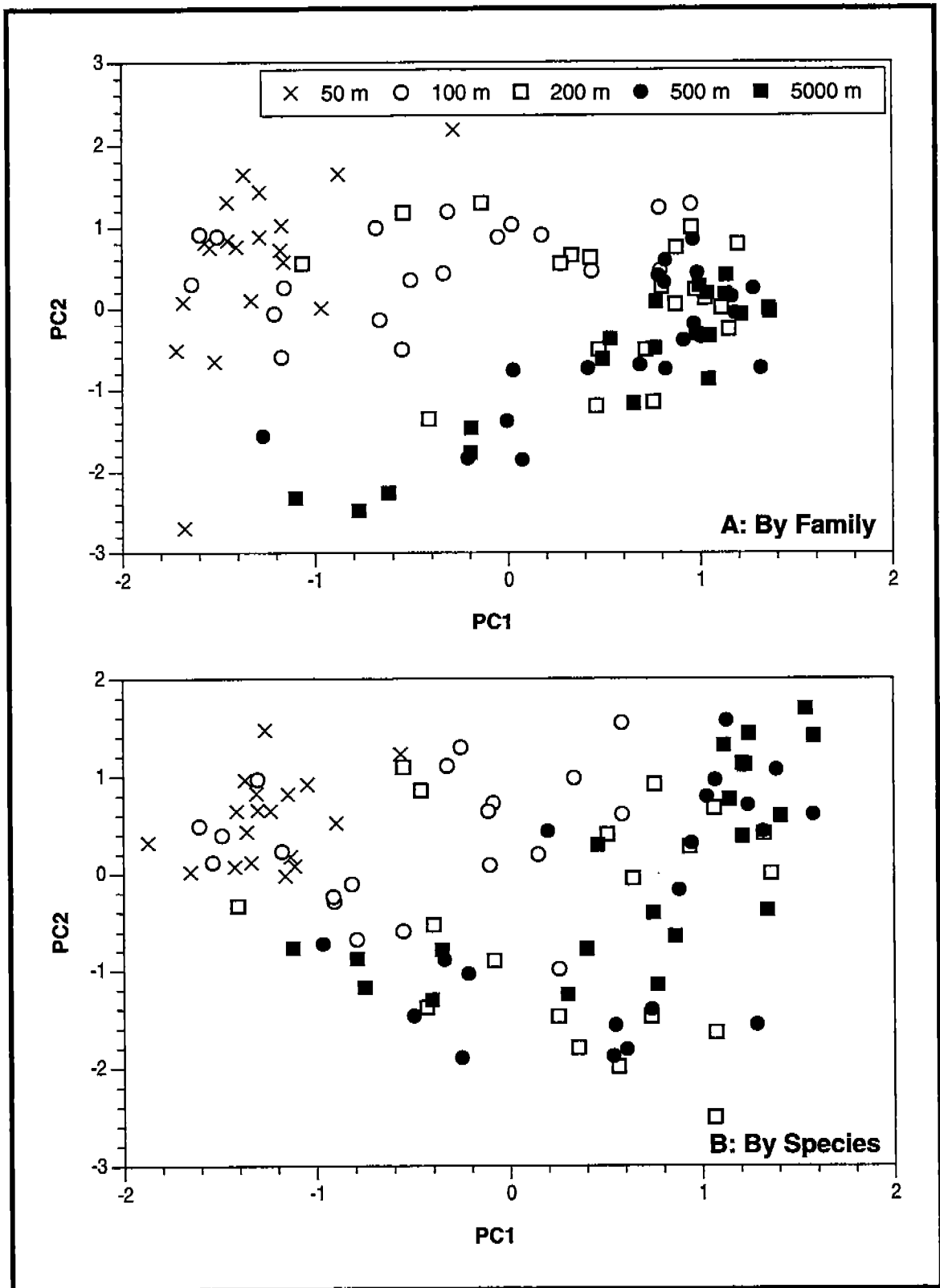

Figure 7.13. Comparison of PCA at the species and family levels for nematode families at HI-A389.

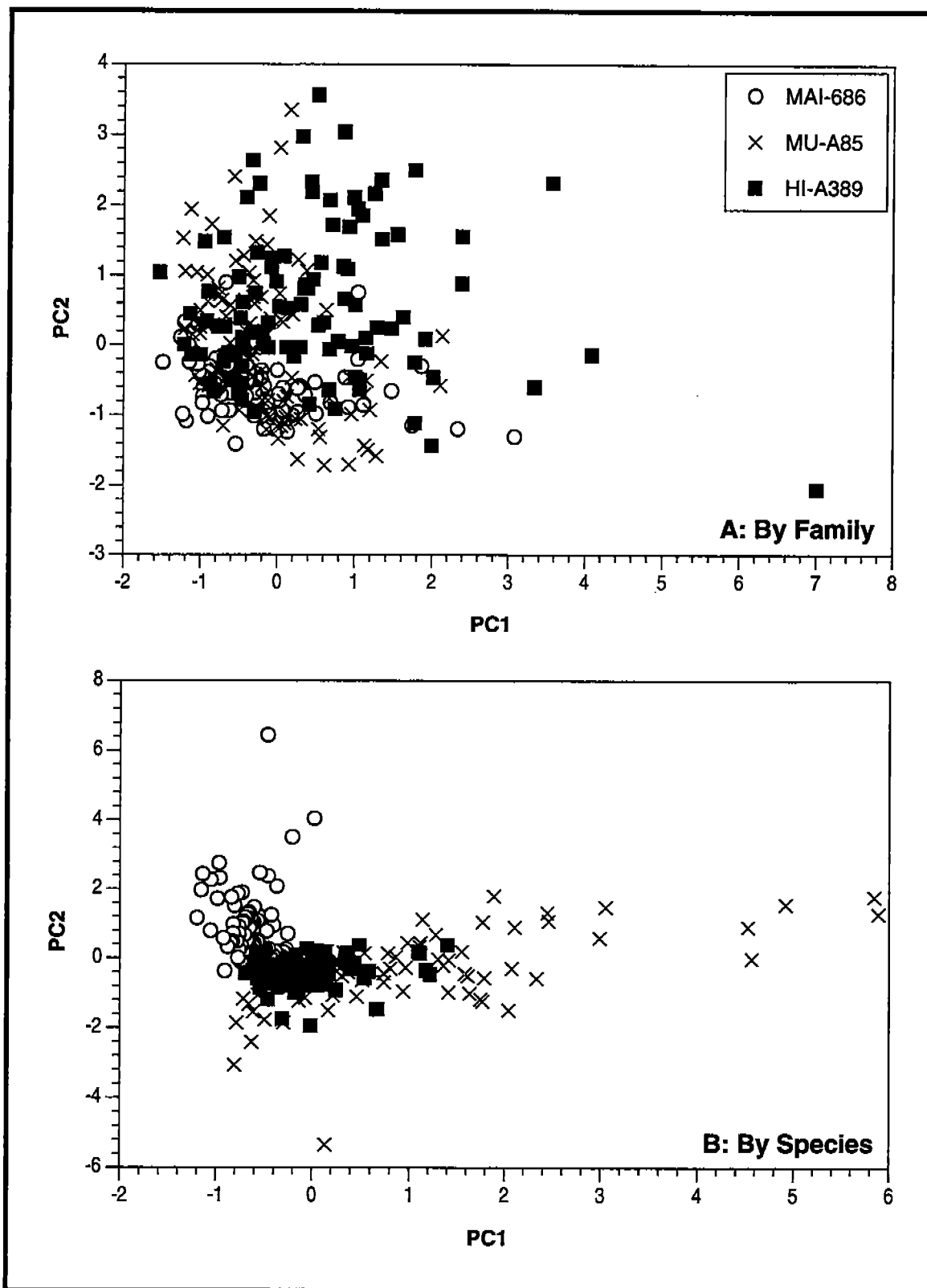

Figure 7.14. Comparison of PCA at the species and family levels for macroinfauna families for all platforms.

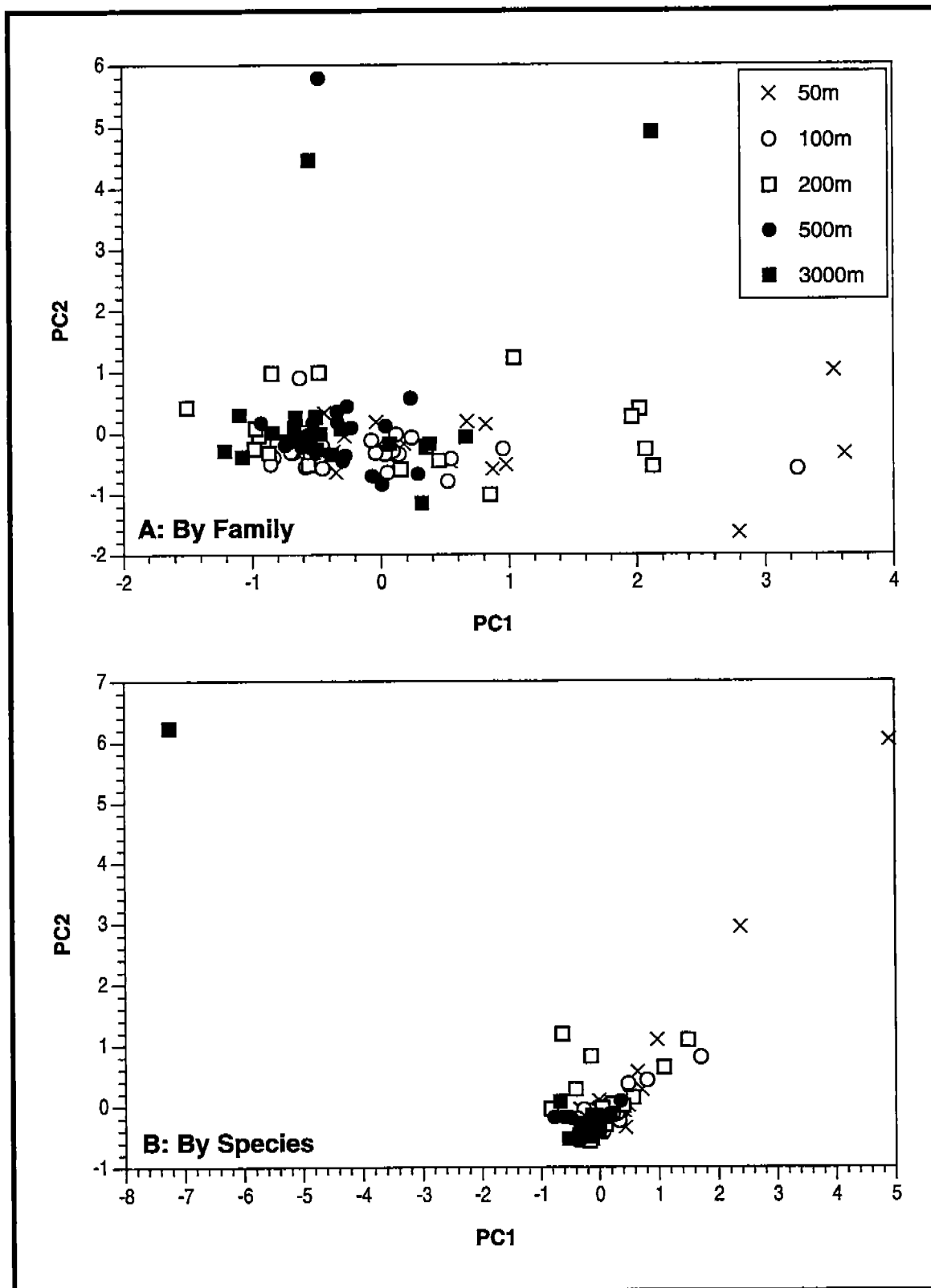

Figure 7.15. Comparison of PCA at the species and family levels for macroinfauna families for MAI-686.

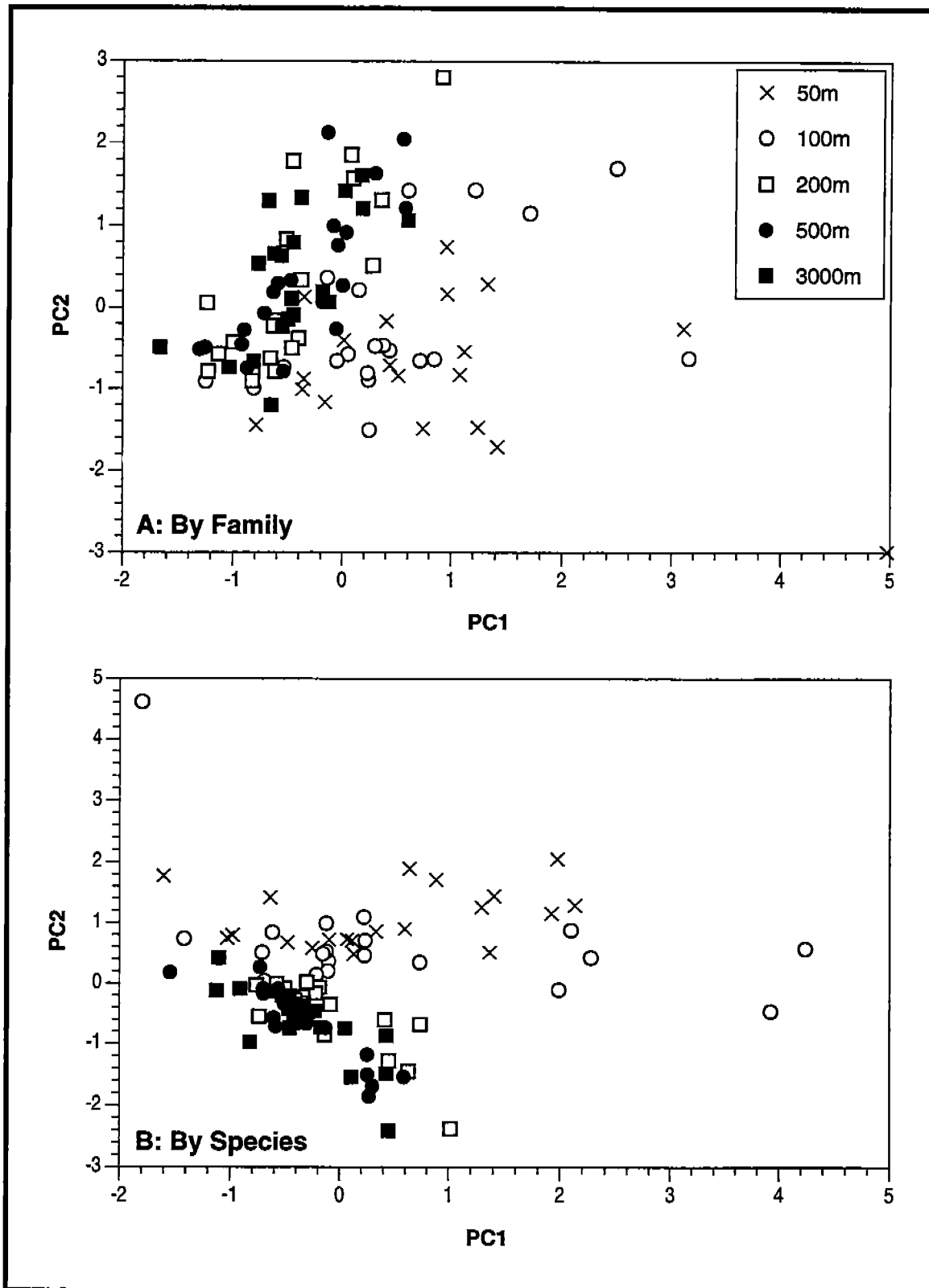

Figure 7.16. Comparison of PCA at the species and family levels for macroinfauna families at MU-A85.

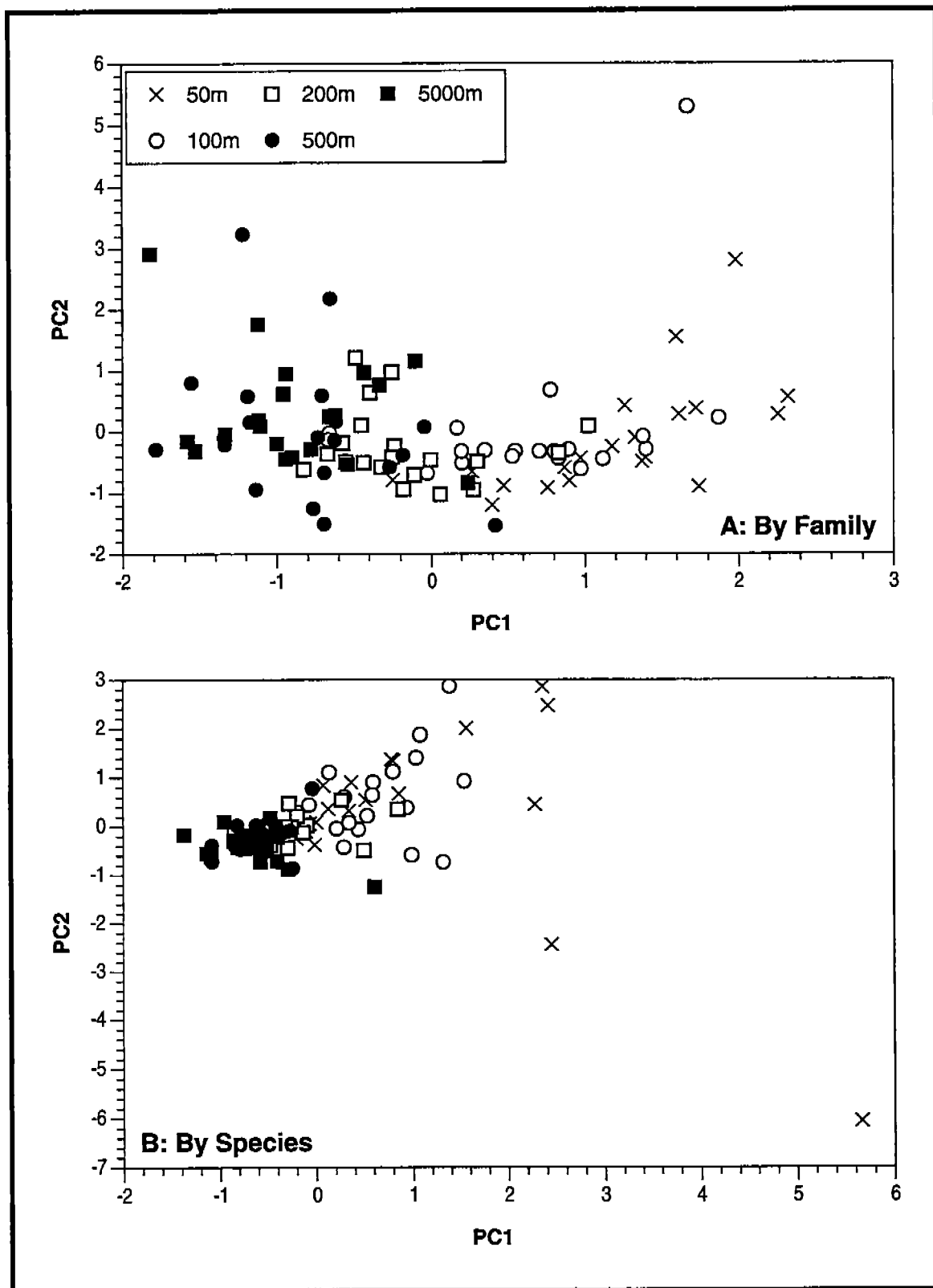

Figure 7.17. Comparison of PCA at the species and family levels for macroinfauna families at HI-A389.

effects were noticeable at all platforms at the species level for nematodes (Figures 7.11 to 7.13). The macroinfauna species data exhibited the same trends as the meiofauna species data. Platform differences were obvious at the species level, but not as clear at the family level (Figure 7.14). Distance differences could not be easily discerned at the family level at any of the sites (Figure 7.15 to 7.17). The conclusion from this exercise is that analyses of benthic data at the family level should be done with caution and may not be generally applicable. Information is lost and may not be adequate to describe among platform differences and differences among distances from platforms. The most promising groups for higher taxa analysis are nematode and macroinfauna Families. However, it should be kept in mind that, in general, the contaminant exposure at the three sites studied is considered to be low and therefore the dynamic range of the indicators may not be fully realized at these sites.

7.3 Megafaunal, Epibenthic Organisms as Indicators of Biological Response

Megafaunal community studies offer a range of indications of impact based on reproductive effort, community structure, and life history. While infauna were an obvious choice for contaminant, toxicological, and histopathological techniques, an inability to harvest sufficient biomass to satisfy methodological needs limited the use of macroinfauna as target organisms. The use of megafauna as primary target organisms for these work elements resulted in large part from the realities of field sampling. Boxcoring as a technique for biomass harvesting was abandoned early in the program because of the small amounts of biomass recovered. Low recoveries were due to low biomass densities and difficult identifications. Collection of megafauna by trawls thus became the focus of many of the Near/Far work elements as organisms that could be collected in sufficient quantity for biomass intensive techniques.

The selection of mobile megafauna (epifauna) as target organisms for study, entails consideration of a variety of influences on biological patterns that are not as important for benthic-based responses. Site loyalty, avoidance, range, ability to detoxify and depurate, and other issues tend to complicate an interpretation of megafaunal pattern as indicators of exposure. A near/far comparison design may not be appropriate for studies of fish in

that the same population may be sampled on the spatial scale of the present study design (1000's of meters). However, other evidence suggests that megafaunal invertebrate populations may maintain their integrity over appropriate time spans and spatial scales to reflect exposure to sediment contaminants. The degree to which sedimentary contaminants and epibenthic animals are coupled is still unclear and undoubtedly varies among megafaunal species depending on feeding habits and ecological niche. Field observations also need to be carefully evaluated in the context of responses established in controlled laboratory and/or field exposure experiments.

7.4 Testing the Generality of the Observed Patterns

It is important to realize that the results reported here are only valid for the three sites studied. Two of the sites are somewhat anomalous in that drilling discharges were shunted near the seabottom to protect nearby topographic features. Also, due to other prescribed site requirements, the study sites are limited to gas production facilities. Therefore, extrapolation of findings to other platforms and settings must be carefully considered as the sites chosen for this study were not intended to be typical or representative of platforms in general. The sampling design described in Section 2.0 was used throughout this report for hypothesis testing and interpretation. The sampling design contained the following key components: three (3) Platforms (if more than one Cruise is included), four (4) Cruises (times, at half-year intervals), five (5) Distances from platform within Platforms [in some cases two (2) Distances, Near and Far], and five (5) Radii (directions) within each Platform leading to 300 observations (600 if pseudoreplicates are included). This sampling design is typical for point-source pollution studies and incorporates intensive sampling around the "point-source" (i.e., a platform) to describe the direction and distance (spatial scale) of impacts in relation to the suspected origin of the contaminants. This design assumes highest contamination, and thus, impact would occur close to the source and diminish with distance away from the source in a regular fashion. Inevitably, in allocating resources, there is a trade-off between including more point-sources or increasing the intensity of "oversampling" around each point-source.

Elucidating the pattern of impact (direction and distance) around a point-source calls for a different approach than one designed to provide generalizations about impacts from other similar point-sources. Requiring that a study accomplish both objectives inevitably leads to compromises and to sub-optimal designs. The present study design adequately describes impact patterns around each of the three platforms studied. However, with only three platforms, each of which is environmentally unique, it is not possible to generalize about among-platform differences. Any attempt to relate impact differences among platforms to production or environmental differences among platforms, leads to a regression or correlation based on only three data points (i.e., three sites). Even if a perfect rank correlation between impact effect and contaminant intensity at a platform is apparent, that perfect rank correlation would have a probability of 1-in-6 (0.17) of occurring by chance. Typically 0.05 is required for a judgment of statistical significance. Increasing the number of platforms to four provides a 1-in-24 probability of a chance correlation, or 0.04 and with five platforms a 1-in-120 probability of a chance correlation, or 0.008. Therefore, the addition of a few platforms greatly improves the power of the experiment to differentiate differences and minimizes chance correlations. In the present study, it also happens that the rank order of sites by contaminant levels is also a perfect rank order by water depth and distance from shore as well as all environmental variables that are related to these characteristics.

In other words, the present study design describes and tests the spatial pattern of impact around these three platforms (i.e., platforms treated as fixed-effect blocks, or strata, in the design), but there is little ability to generalize to impacts caused by "platforms" as a generic class, or to describe differences in platform effects caused by "kinds-of-platforms". Three is simply too few platforms. If the platforms are thought of as a sample of "platforms-of-a-kind" in the region, then three is too few and these platforms are too different for any meaningful conclusion to be reached about "platforms". If each of these three platforms is considered a representative of a "platform-type" (i.e., contamination levels, water depth, and distance from shore), then there is no replication within "platform-type" and nothing about impact differences among "platform-types" can be tested.

To generalize, rather than describe distributions around a platform, the number of platforms must be increased. Correspondingly the effort allocated around each platform must necessarily decrease, given fixed resources. For example, one could propose twelve (12) or more platforms with sampling at Near and Far distances (50 m and 3000 m in the GOOMEX Phase I study) along one radius in one direction (preferably the direction of the maximum contaminant gradient). This provides a paired design, in which the "Near vs. Far" difference would be tested based on a sample of $n \geq 12$ platforms. The frequency of sampling and selection of the response variables to be monitored would be optimized based on previous experience. GOOMEX Phase I provides the data to support an informed choice of study design elements for implementation in Phase II studies. The procedure for selecting platforms is critical. A region must be defined *a priori* and objective criteria for a type of platform (or two or three types of platforms) must be stated. Then all platforms of that type in the region to be studied must be enumerated, and the ones to be included in the study must be selected randomly from those enumerated.

Various concerns influence the number of platforms chosen. Twelve (12) or more platforms are suggested for two reasons. First, robustness of statistical tests can be assured by having at least 10 error degrees of freedom (df) for the tests. The error for most tests in this design is the among-platform variation in the Near vs. Far difference, and the error degrees of freedom (df) will be the number of platforms less one (or if there is more than one type of platform it will be the number of "platform types" times one less than the number of platforms of each type). Second, power in tests (ability to detect significant differences) increases with sample size (number of platforms). Simulations with specified mean Near vs. Far differences and standard deviations for those differences indicate that power initially increases rapidly with the number of platforms but then begins to be less sensitive to increasing numbers of platforms at an n of 10 to 12.

If continuing studies are to have a dual purpose, requiring a compromise design capable of (a) elucidating patterns of impact around platforms (such as developing and evaluating new response variables) and (b) generalizing about impacts to platforms in a region, then the most effective design will be paired platforms with $n \geq 12$ for the generality tests, with one

or more of the platforms (or a platform pair) dedicated to intensive spatial pattern sampling and method development.

7.5 Heterogeneity of Variance as an Impact Response

It is usual to formulate response variables for impact studies in terms of mean values of contaminant concentrations, taxa abundances, etc. However, variances as well as means respond to impacts. The response is usually "patchy" since the small-scale spatial distribution of the impact (e.g., the contaminants) is rarely uniform. This is visually obvious in intertidal areas after an oil spill. An increased variance among small-scale spatial replicate samples (cores, quadrants) is the result. This is most often observed in the data when the data are examined to see whether the assumptions for Analysis of Variance (ANOVA) are satisfied since one of the ANOVA assumptions is "homogeneity of error variance." Many environmental scientists focus on a concern about this ANOVA assumption for testing whether means differ, without realizing that such variance heterogeneity can itself be evidence of impact. Green (1993a,b) discusses this question, and Underwood (1993) describes an ANOVA design that incorporates a test of impact-driven variation.

Small-spatial-scale variance in the present study is the "between subcores within boxcores" variance. Because there is only one boxcore per station, the variance among boxcores cannot be used. That variance would include variation attributable to predictors in the model, e.g., among radii. The transformed scale (e.g., logarithmic for most response variables) is the appropriate scale for measuring the response, i.e., if percent variation is appropriate for the evaluation of response mean values then it will also be appropriate for evaluation of the magnitude of variance. If it is concluded that variance of contaminant concentrations is higher near a platform (where contaminant mean concentration is higher), it must be clear that the relationship between the error variance and the mean, which always exists in (untransformed) data reflecting percent variation, is not the cause of the trends observed. Response variable data is typically log-transformed. The PC scores used to represent the contaminant gradient are calculated from a linear additive function of appropriately transformed variables, so ChemPC1 as a synthetic variable is also being measured on the appropriate scale.

Between-subcore within-boxcore variance was estimated for each distance, pooled over Platforms and Cruises, on the appropriate response scale, for barium, cadmium, ChemPC1, nematode abundance (NEMA), harpacticoid abundance (HARP), and nematode/harpacticoid copepod (N/C) ratio. Macroinfauna data was not used because it is likely that the within-boxcore spatial scale is too small for assessment of macroinfauna patchiness. Using these variance estimates as the response variables in among-distances ANOVAs, significant (< 0.01) heterogeneity of variance was found for barium (Ba), cadmium (Cd), and ChemPC1, but not for nematode (NEMA) and harpacticoid (HARP) abundances ($p > 0.05$). For the N/C ratio heterogeneity of variance was significant at $p < 0.05$. Because of concern about the distributional properties of the estimated variances used as ANOVA response variables, ANOVA were repeated as nonparametric ANOVA (Kruskal-Wallis tests of medians). The significances and non-significances were unchanged. The estimated median variance for each distance, for these six variables, is summarized in Table 7.5. For the four variables, with significant heterogeneity of variance, the pattern is one of increased variance near the platform. The variances vs. distance relationship for the variables is illustrated in Figure 7.18.

Table 7.5. Summary of heterogeneity of variance.

D	Median between-subcore variance					
	Cd	PC1	Ba	Nema	Harp	N/C
50 m	.0491	.0119	.0039	.0770	.0822	.0870
100 m	.0245	.0115	.0021	.0566	.0793	.1184
200 m	.0167	.0057	.0029	.0940	.0931	.0628
500 m	.0043	.0044	.0010	.0293	.0770	.0463
≥ 3000 m	.0046	.0033	.0009	.0406	.0543	.0442

These results provide additional evidence for platform-derived impacts. The pattern for barium (Ba), cadmium (Cd), ChemPC1 and N/C suggests that the impact reaches to 200-m distance from the platform. The absence of heterogeneity of variance for the two meiofaunal taxa taken by themselves contrasts with the heterogeneity of variance for the N/C ratio. This provides additional support for the use of a "ratio of a tolerant-to-a-sensitive taxa" as an indicator of biological impact.

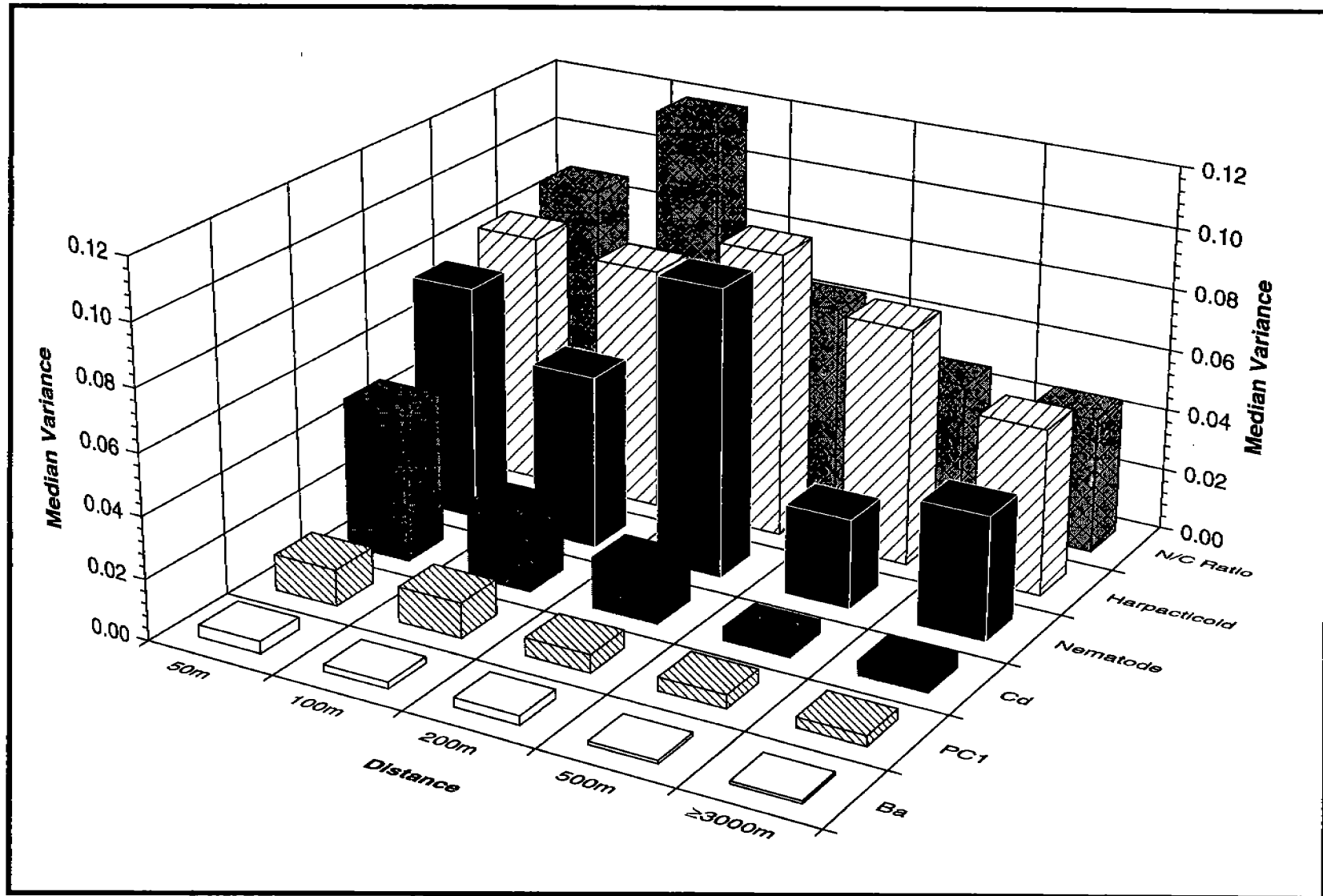

Figure 7.18. Median variance of selected variables between subcores within a boxcore by distance from the platform.

7.6 Genetic Variability as a Measure of Impact

Comparing population genetic variability may be a useful approach to identifying sublethal, chronic impacts that occur as a result of environmental disturbance. This approach has several advantages over traditional means of assessing sublethal impacts. The genetic diversity approach produces interpretable results that are not dependent upon the species selected or the location and time of sampling. Unlike approaches which measure the induction of protein products, a phenotypic response, the genetic variability approach depends upon changes in DNA sequence, a genotypic response. Unlike macroinfaunal abundance and diversity studies, estimating genetic diversity does not require an extensive knowledge of taxonomy or tedious visual sorting. Molecular techniques, in general, are experiencing an enormous growth at the present time. Molecular-based methods should continue to become increasingly automated, inexpensive, and do-able without extensive training in molecular biology. The genetic variability approach is especially well suited for use with meiofauna, because meiofauna are easy to sample and show sensitivity to a variety of environmental changes. However, this approach may also be applicable to a wide variety of target organisms. Estimation of genetic variability for environmental monitoring purposes still requires extensive development, including an appropriate interpretation of results. However, the ability to link environmental disturbance to changes at the DNA level should eventually become a powerful tool for detection and monitoring sublethal effects and merit further investigation.

7.7 Recommendations for Future Studies

The results obtained during Phase I of the GOOMEX Program set the stage for advancement toward the longer term goal which is to develop and implement effective monitoring and management strategies for offshore oil/gas platforms. Phase I was designed as a broad-ranging program of measurements of a suite of independent environmental variables coupled with a diverse suite of suspected dependent indicators of biological response or impact. As such, Phase I results have lead to a series of revised hypotheses requiring further study during Phase II. Mechanistic

explanations for the patterns that have emerged during Phase I are needed to support informed management decisions. A combination of study designs will be required to effectively address the multiple goals that will be important in the next phase of the GOOMEX program. Tests of the generality of the patterns observed, continued development of promising Phase I indicators, introduction and testing of new potential indicators, laboratory verification of cause and effect relationships, and in-field testing and verification of laboratory results (including manipulative experiments) should be pursued during the next phase of study (Table 7.6)

The proof of generality of the observed trends is important to the implementation of comprehensive and effective monitoring programs. As discussed, a test of the observed patterns at a series of "typical" and/or "representative" platform sites is necessary to assess generality. The features that effectively describe and determine the character of a platform and its site must be carefully delineated. Study sites must then be chosen based on these characteristics and a sampling design of appropriate power devised. The importance of a variety of platform attributes will need to be tested (i.e., discharge history, including produced waters; water depth; duration of drilling; volume and composition of muds and cuttings discharged; oil vs. gas production; etc.). *One critical generality issue is whether differences related to the type of production, oil or gas, exist and do monitoring programs need to be tailored to production characteristics.* The sites studied here included only platforms producing gas and very little liquid hydrocarbons. Production of liquid hydrocarbons (oil and condensate) may imply differing intensities or types of discharges, and thus chronic exposures, if increased contamination is associated with oil platforms. To evaluate the consequences of the type of production, further studies should include oil-producing platforms.

Another important question to be answered is what role does the simple presence of the platform structure itself play as opposed to chronic effects associated with contaminant release and accumulation? This test could be accomplished through a comparison of decommissioned sites with and without platforms. This question has important practical implications for management since there is an option of retaining or removing platforms at the termination of a production site. *Another effective test would be to*

Table 7.6 Summary of recommendations for further study at platform sites.

Work Element	Recommendations
(1) Physicochemical	<ul style="list-style-type: none"> *Provide a synoptic view of each site to more fully delineate platform related effects on water column oxygen and nutrient conditions and thus organic enrichment.
(2) Sedimentology	<ul style="list-style-type: none"> *Provide a mass balance of the sediments based on origins (cuttings, <i>in situ</i> sand, terrigenous materials, etc.), not just particle size or bulk chemistry. *Discontinue x-ray diffraction
(3) Contaminant Chemistry	<ul style="list-style-type: none"> *Chemistry must be closely coupled with biological effects studies (no baselines or surveys). *Provide an integrated concentration/area or volume estimation of the contaminant field to various, appropriate depths (0-2 cm, 0-10 cm). *Define bioavailable contaminants more effectively - pore water chemistry must be carefully and accurately defined especially for metals with particular reference to redox conditions and speciation. *To truly understand the chemistry of contaminants, flux measurements may be needed based on porewater profiles and benthic chamber data.
(4) Meiofauna	<ul style="list-style-type: none"> *Target the most useful and sensitive indicators of impact such as harpacticoid diversity. *Measure the temporal distribution of nematodes (e.g., for one year) to more accurately predict long-term changes in population. *Pursue genetic diversity studies <i>in situ</i> and in the lab by simulating exposure scenarios on appropriate time frames.
(5) Macroinfauna	<ul style="list-style-type: none"> *Target the most useful and sensitive indicator species for enumeration. *Develop and apply reproductive effort, life history, and other studies analogous to the meio and megafaunal work efforts (targeted at specific species). *Investigate the utility of genetic diversity studies.
(6) Megafauna Invertebrates	<ul style="list-style-type: none"> *Concentrate on a few abundant species especially for histopathology *Closely couple with contaminant measurements of more appropriate tissues (i.e., eggs). *Genetic diversity *Institute transplanted animal experiments to constrain their range and thus exposure. *Extend reproduction studies to egg quality.
(7) Megafauna fish	<ul style="list-style-type: none"> *Discontinue food studies. *Discontinue histopathology.

Table 7.6 (Cont.)

Work Element	Recommendations
(8) Detoxification	<ul style="list-style-type: none"> *Emphasize toxic responses to trace metals (i.e., metallothioneins). *Extend in vitro assays to a more comprehensive testing of invertebrates in coordination with contaminant measurements and pore water toxicity testing. *Focus studies intensively on a few of the more appropriate species. *Pursue invertebrate bioindicators of exposure *Evaluate other potential biomarkers of contamination such as heat shock proteins. *Integrate laboratory studies with in-field exposures (transplanted animal experiments) to define the dynamic range of the indicators.
(9) Pore Water Toxicity Bioassays	<ul style="list-style-type: none"> *Additional standard bioassays for comparison including whole sediment. *Monitor contaminant concentrations during the assays and <i>in situ</i> to more effectively delineate the causative agents. *Coordinate bioassays of animals with in vitro toxicological assays. *Design dosing experiments to develop cause and toxic effects linkages in the laboratory.
(10) Study Design	<ul style="list-style-type: none"> *Test generality of observed trends. *Develop a more comprehensive sediment quality model incorporating more extensive toxicological and bioassay results. *Expand the surveys to oil platforms. *Consider discarding the radial pattern and utilize a evenly spaced grid approach. *Develop a fully integrated model of response which will ultimately provide a plan for actual monitoring programs.

study structures that have had no drilling activities or associated discharges. This might be include gathering facilities or other large offshore structures.

The covariance of important environmental variables prevents definitive testing of causation by field observations alone. **One means of decoupling these variables to assess their independent and joint effects would be to perform various *in situ* manipulative experiments including sediment settlement trays and caged animals.** Biological responses can be assessed by evaluating differences in the community structure of macroinfauna and meiofauna that colonize settlement trays. This is especially useful in decoupling toxic contaminant effects from variations in sand content. Settlement trays have been successfully used in benthic

ecology and could be effectively adapted for use in marine setting. Caged animal experiments would assure that animals remain in a known contaminant exposure regime by limiting spatial movements. Uptake of contaminants and the resultant biological effects on indicators of exposure would be more directly assessed than with field collections alone. Other observed responses could be simulated in time-frames compatible with controlled laboratory exposures (i.e., genetic variability in meiofauna).

The speciation and biological availability of metals is an other important issue. Much of the bulk metals detected may be present in relatively inert forms. *Redox conditions, metal speciation, and bioavailability need to be more adequately assessed.* Dissolved contaminant levels in pore water provide a more direct indicator of the toxic components. There is a growing consensus that dissolved metal more closely approximate the bioavailable fraction of a particular metal than does total recoverable metal (Prothro 1993). Measurements of water-borne contaminants must be done using clean chemistry methodologies (U.S. EPA 1994a,b). Careful sampling and sample storage is a necessity to provide reliable data. The low concentrations and the possibility of contamination during sampling, storage, and analysis require stringent sampling and analytical procedures to obtain consistent and accurate data. *It is also clear that further bioassays, such as pore water toxicity testing, need to be closely coupled with high quality chemical measurements to delineate the exact agents responsible for organismal response. Proper sampling and monitoring of contaminant chemistries during assays is essential to relate laboratory observations to field conditions and to assure that the observed toxicities are not an artifact of sample handling and/or treatment.*

The inclusion of sublethal biological indicators sensitive to trace metals in Phase II is important since metals have been identified as a likely cause of toxic response. The most commonly used biological indicator of metal exposure is a family of low-molecular weight cysteine-rich metal binding proteins and oligopeptides known as metallothioneins (MT). The cysteinyl residues function as ligands for the chelation of metals by MT. Additionally, MT are inducible and their synthesis can be activated by exposure to metals such as Cd, Cu, Zn, Hg, Co, Ni, Ba, and Ag (Engel and Brouwer 1989; Bracken and Klaassen 1987). MT are thought to serve a protective function by binding and thereby limiting the intracellular

concentration of reactive heavy metals and reducing their potential for toxicity. In addition to metal exposure, levels of MT are sensitive to a variety of natural factors including temperature, activity, reproductive cycle, season, growth, molt cycle, tissue regeneration, food type and habitat (Oh et al. 1978; Engel 1988). Cu and Zn bound to MT are particularly prone to endogenous factors; whereas, non-essential metals such as Hg, Ag, and Cd are less likely to be confounded by natural sources of variation. Numerous studies have correlated the levels of metals bound to MT with elevated metal concentrations (Roesijadi 1981; Hamilton and Mehrle 1986; Roch and McCarter 1984; Talbot and Magee 1978; Langston and Zhou 1986; Hylland et al. 1992). Although MT induction can be confounded by numerous factors other than metals, data has indicated that MT can be useful indicators of environmental levels of metals.

The importance of hypoxic events in response to organic enrichment associated with the "reef effect" of a platform can only be evaluated through process-oriented studies. These studies would need to establish the flux of materials to the sediments and the concomitant remineralization and release of nutrients from the sediments to the overlying water. The flux of materials (both organic debris and contaminants) as a function of distance from the platform must be known in order to evaluate the importance of organic enrichment (reef effect) as well as providing further evidence that some contaminants are accumulating with time. *A combination of benthic chambers, sediment traps, and pore water profiles should be used to determine the operative processes that control redox conditions and metal speciation in sediments and ultimately organismal exposure and response.*

Another important set of processes related to material fluxes need to be more fully elucidated, that is the role and function of bacteria in the sediments near platforms. Sedimentary microbial ecology is directly linked to organic enrichment and mediates oxygen depletion, nutrient remineralization, and contaminant degradation. *Microbial activity needs to be evaluated by substrate type so that hydrocarbon-degrading and sulfate reduction rates can be measured to assess the degradation of a variety of organic substrates.* Hydrocarbons role as a source of labile organic carbon needs to be evaluated further. Hydrocarbon inputs may be rendered relatively innocuous by rapid rates of microbial degradation. *The ability and*

capacity of the system to respond to continued chronic inputs of contaminants is an important characteristic to evaluate.

Several continuing areas of investigation utilizing megafaunal invertebrates including many commercially important species, may prove fruitful. **Basic principals suggest that megafaunal invertebrates fecundity, egg viability, growth and survival should decline if a population is impacted.** On the other hand, prevalence and intensity of parasitism and disease should increase in impacted areas. A more comprehensive test of these potential responses in megafauna can only be properly tested at a series of platforms with differing contaminant exposure regimes. Phase I results have demonstrated a high degree of natural variability resulting in site specific megafaunal community characteristics. While no generalities were apparent from the Phase I studies, significant variations in megafaunal population structure and dynamics were documented. The mobility of higher-level consumers megafauna makes the use of physiological effects as indicators of exposure difficult to interpret if field collections alone are used. *Therefore as an adjunct to the in situ field observations, exposures of test organisms in cages at platform sites are needed to test whether contaminants at a site are inducing physiological responses.* Experimental exposure of indigenous suspension-feeding bivalves (scallops perhaps) would provide additional information on the physiological responses to long-term exposure.

In summary, refinement of our understanding of the patterns observed in the Phase I study, including establishment of cause and effect relationships, can only be accomplished through coordinated, process-oriented studies. As a first critical step, revised hypotheses must be clearly defined and stated. Secondly, appropriate statistical designs for sampling must be devised that provide for meaningful interpretations of programmatic results. Thirdly, as mentioned above, the selection of appropriate sites for each study design is critical, recognizing that any one site may (and probably will) not satisfy all work element goals and that a series of sites targeted for specific studies may be the optimal design given the potentially conflicting goals within a comprehensive follow-on study. If a series of sites are chosen, that are not common across all work elements, a core of key measurements must be collected in order to provide for the broadest interpretation of the resultant data. The next phase of studies will greatly enhance the scientific basis for promulgation and implementation of

meaningful, and cost-effective monitoring and management guidelines for the long-term emplacement and operation of offshore platform facilities.

8.0 LITERATURE CITED

- Adams, C.E., Jr., J.T. Wells, and J.M. Coleman. 1982. Sediment transport on the central Louisiana continental shelf: implications for the developing Atchafalaya River delta. *Contrib. Mar. Sci.* 25:133-148.
- Addison, F.R., D.E. Willis, and M.E. Zinck. 1994. Liver microsomal mono-oxygenase induction in winter flounder (*Pseudopleuronectes americanus*) from a gradient of sediment PAH concentrations at Sydney Harbour, Nova Scotia. *Mar. Environ. Res.* 37:283-296.
- Agard, J.B.R., J. Gobin, and R.M. Warwick. 1993. Analysis of marine macrobenthic community structure in relation to pollution, natural oil seepage and seasonal disturbance in a tropical environment (Trinidad, West Indies). *Mar. Ecol. Progr. Ser.* 92:233-243.
- Agius, C. 1980. Phylogenetic development of melano-macrophage centers in fish. *J. Zool. London* 191:111-132.
- Ahlfeld, T.E. 1990. Changing emphases in OCS studies, pp. 11-13. In: R.S. Carney, ed. Northern Gulf of Mexico Environmental Studies Planning Workshop. Proceeding of a Workshop held in New Orleans, Louisiana, 15-17 August 1989. Prepared by Geo-Marine, Inc. OCS Study MMS 90-0018. U.S. Dept. of the Interior, Minerals Management Service, New Orleans, LA, 156 pp.
- Alatalo, R.V. 1981. Problems in the measurement of evenness in ecology. *Oikos* 37:199-204.
- Alberte, R.S., G.K. Suba, G. Procaccini, R.C. Zimmerman, and S.R. Fain. 1994. Assessment of genetic diversity of seagrass populations using DNA fingerprinting: Implication for population stability and management. *Proc. Natl. Acad. Sci. USA* 91:1049-1053.
- Alongi, D.M., D.F. Boesch, and R.J. Diaz. 1983. Colonization of meiobenthos in oil-contaminated subtidal sands in the lower Chesapeake Bay. *Mar. Biol.* 72:325-335.
- Amjad, S. and J.S. Gray. 1983. Use of the nematode-copepod ratio as an index of organic pollution. *Mar. Pollut. Bull.* 14:178-181.
- Anderson, R.S. 1978. Benzo[a]pyrene metabolism in the American oyster *Crassostrea virginica*. EPA Ecol. Ser. Monogr. EPA-600/3-78-009:1-178.
- Andrassy, I. 1956. The determination of volume and weight of nematodes. *Acta Zool.* 2:1-15.
- Ankley, G.T., K.B. Lodge, D.J. Call, M.D. Balcer, L.T. Brooke, P.M. Cook, R.G. Kreis, A.R. Carlson, R.D. Johnson, G.J. Niemi, R.A. Hoke, C.W. West, J.P.

- Giesy, P.D. Jones, and Z.C. Fuying. 1992. Integrated assessment of contaminated sediments in the lower Fox River and Green Bay, Wisconsin. *Exotoxicol. Environ. Safety* 23:46-63.
- Ankley, G.T., D.E. Tillitt, J.P. Giesy, P.S. Jones, and D.A. Verbrugge. 1991. Bioassay-derived 2,3,7,8-tetrachlorodibenzo-p-dioxin equivalents (TCDD-EQ) in PCB-containing extracts from flesh and eggs of Lake Michigan chinook salmon (*Oncorhynchus tshawytscha*) and possible implications for reproduction. *Can. J. Fish. Aquat. Sci.* 48:1685-1690.
- Armstrong, H.W., K. Fucik, J.W. Anderson, and J.M. Neff. 1979. Effects of oil field brine effluents on sediments in benthic organisms in Trinity Bay, Texas. *Mar. Env. Res.* 2:55-69.
- Aurand, D.V. 1988. The future of the Department of the Interior OCS studies program. *Oceans '88. Proceedings of a conference sponsored by the Marine Technology Society and IEEE. Vol. I. IEE catalog number 88-CH2585-8, Baltimore, MD.*
- Avise, J.C. 1994. *Molecular markers, natural history and evolution.* Chapman and Hall, New York. 511 pp.
- Avise, J.C., J. Arnold, R.M. Bell, E. Bermingham, T. Lamb, J.E. Neigel, C.A. Reeb, and N.C. Saunders. 1987. Intraspecific phylogeny: the mitochondrial DNA bridge between populations genetics and systematics. *Annu. Rev. Ecol. Syst.* 15:133-164.
- Barnard, W.R. and P.N. Froelich, Jr. 1981. Nutrient geochemistry of the Gulf of Mexico. *Environmental research needs in the Gulf of Mexico; 30 September-5 October 1979; Key Biscayne, Florida. Miami, FL: NOAA/AOML. IIA: pp. 127-146.*
- Barrett, B.B., J.L. Merrel, T.P. Morrison, M.C. Gillespie, E.J. Ralph, and J.F. Burdon. 1978. A study of Louisiana's major estuaries and adjacent offshore waters. Baton Rouge, LA, Louisiana Dept. Wildlife and Fisheries. Tech. Bull. No. 27. 197 pp.
- Baumann, P., W. Smith, and M. Ribick. 1982. Hepatic tumor rates and polycyclic aromatic hydrocarbon levels in two populations of brown bullhead (*Ictalurus nebulosus*), pp. 93-102. In: M. Cook, A.J. Denis, and G.L. Fisher, eds. *Polycyclic Aromatic Hydrocarbons: Physical and Biological Chemistry.* Springer-Verlag, New York.
- Bayne, B.L., K.R. Clarke, and J.S. Gray. 1988. Background and rationale to a practical workshop on biological effects of pollutants. *Mar. Ecol. Progr. Ser.* 46:1-5.
- Bell, S.S. 1980. Meiofauna-macrofauna interactions in a high salt marsh habitat. *Ecol. Monogr.* 50:487-505.

- Bell, S.S. and K.M. Sherman. 1980. A field investigation of meiofaunal dispersal: tidal resuspension and implications. *Mar. Ecol. Progr. Ser.* 3:245-249.
- Bell, T.A. and D.V. Lightner. 1988. A handbook of normal penaeid shrimp histology. World Aquaculture Society, Baton Rouge, LA. 114 pp.
- Berryhill, H.L. (ed). 1977. Environmental Studies, South Texas Outer Continental Shelf, 1975: An atlas and integrated study. Final report to Bureau of Land Management. 303 pp.
- Blanck, J., P. Lindstrom-Seppa, J.J. Agren, O. Hanninen, H. Rein, and K. Ruckpaul. 1989. Temperature compensation of hepatic microsomal cytochrome P-450 activity in rainbow trout. I. Thermodynamic regulation during water cooling in autumn. *Comp. Biochem. Physiol.* 93:55-60.
- Blazer, V.S., D.E. Facey, J.W. Fournie, L.A. Courtney, and J.K. Summers. 1994. Macrophage aggregates as indicators of environmental stress, pp. 169-185. In: J.S. Stolen and T.C. Fletcher, eds. *Modulators of Fish Immune Responses: Volume 1, Models for Environmental Toxicology, Biomarkers, Immunostimulators.* SOS Publications, Fair Haven, NJ.
- Blazer, V.S., R.E. Wolke, J. Brown, and C.A. Powell. 1987. Piscine macrophage aggregate parameters as health monitors: Effect of age, sex, relative weight, season and site quality in largemouth bass (*Micropterus salmoides*). *Aquat. Toxicol.* 10:199-215.
- Bodin, P. and D. Boucher. 1983. Evolution a moyen terme du meiobenthos et des pigments chlorophylliens sur quelques plages polluees par la Maree Noire de l'Amoco Cadiz. *Oceanologica. Acta* 6:321-332.
- Boehm, P.D. and A.G. Requejo. 1986. Overview of the recent sediment hydrocarbon geochemistry of Atlantic and Gulf Coast over continental shelf environments. *Est. Coast. Shelf. Sci.* 23:29-58.
- Boesch, D.F. and N.N. Rabalais. 1988. Possible large scale consequences in the Gulf of Mexico of nutrient enrichment of the Mississippi River. Joint Oceanographic Assembly. (Abstract No 387.54(R)).
- Boesch, D.F., J.N. Bulter, D.A. Cacchione, J.R. Geraci, J.M. Neff, J.P. Ray, and J.M. Teal. 1987. An assessment of the long-term effects of U.S. offshore oil and gas development activities: future research needs, pp. 1-53. In: D.F. Boesch and N.N. Rabalais, eds. *Long-term Environmental Effects of Offshore Oil and Gas Development.* Elsevier Applied Science, New York, NY.
- Boland, G.S., B.J. Gallaway, J.S. Baker, and G.S. Lewbel. 1983. Ecological effects of energy development on reef fish of the Flower Garden Banks.

- Final report to National Marine Fisheries Service, Southeast Fisheries Center, Galveston, TX. Contract number NA80-GA-C-00057. 466 pp.
- Bonsdorff, E. and W.G. Nelson. 1981. Fate and effects of Ekofisk crude oil in the littoral of a Norwegian fjord. *Sarsia* 66:231-240.
- Boothe, P.N. and W.D. James. 1985. Neutron activation analysis of barium in marine sediments from the north central Gulf of Mexico. *J. Trace and Microprobe Techniques* 3:377-399.
- Boothe, P.N. and B.J. Presley. 1979. Trace metals in epifauna, zooplankton and macronekton, pp. 6-1 to 6-47. In: *Environmental studies, south Texas outer continental shelf, biology, and chemistry. Volume 1. Chapter 6.* University of Texas, Marine Science Institute, Port Aransas, TX.
- Boothe, P.N. and B.J. Presley. 1985. Distribution and behavior of drilling fluids and cuttings around Gulf of Mexico drilling sites. American Petroleum Institute, Washington, DC, 140 pp.
- Boothe, P.N. and B.J. Presley. 1987. The effects of exploratory petroleum drilling in the northwest Gulf of Mexico on trace metal concentrations in near rig sediments and organisms. *Environ. Geol. Water Sci.* 9:173-182.
- Bouwman, L.A., K. Romeijn, and W. Admiraal. 1984. On the ecology of meiofauna in an organically polluted estuarine mudflat. *Estuar. Coastal, and Shelf Sci.* 19:633-653.
- Bracken, W.M. and C.D. Klaassen. 1987. Induction of metallothionein in rat primary hepatocytes culture: evidence for direct and indirect induction. *J. Toxicol. Environ. Health* 22:163-174.
- Braddock, J.F., J.E. Lindstrom, and E.J. Brown. 1995. Distribution of hydrocarbon-degrading microorganisms in sediments from Prince William Sound, Alaska following the *Exxon Valdez* oil spill. *Mar. Pollut. Bull.*
- Bradford, M.M. 1976. A rapid and sensitive method for quantitation of microgram quantities of protein using the principle of protein-dye binding. *Anal. Biochem.* 72:248-254.
- Bradlaw, J.A. and J.L. Casterline, Jr. 1979. Induction of enzyme activity in cell culture: a rapid screen for detection of planar polychlorinated organic compounds. *J. Assoc. Office. Anal. Chem.* 62:904-916.
- Brassell, S.C., G. Eglinton, J.R. Maxwell, and R.P. Philip. 1978. Natural background of alkanes in the aquatic environment, pp. 69-86. In: O. Huntzinger, L.H. van Lelyveld, and B.C.J. Zoetman, eds. *Aquatic*

Pollutants, Transformations and Biological Effects, Oxford, Pergamon Press.

- Brooks, J.M. 1980. Determine seasonal variations in inorganic nutrient composition and concentration of the water column. In: W.B. Jackson and G.M. Faw, eds. Biological/chemical survey of Texoma and Capline sector salt dome brine disposal sites off Louisiana, 1978-79. NOAA Tech. Mem. No. NMFS-SEFC-32. 31 pp.
- Brown, C.L. and C.T. George. 1985. Age-dependent accumulation of macrophage aggregates in the yellow perch *Perca flavescens* (Mitchell). J. Fish Dis. 8:135-138.
- Brusher, H.A, W.C. Renfro, and R.A. Neal. 1972. Notes on distribution, size, and ovarian development of some penaeid shrimps in the northwestern Gulf of Mexico, 1961-62. Contri. Mar. Sci. 16:75-87.
- Bucklin, A., B.W. Frost, and T.D. Kocher. 1992. DNA sequence variation of the mitochondrial 16S rRNA in *Calanus* (Copepoda; Calanoida): intraspecific and interspecific patterns. Mar. Mol. Bio. Biotech. 1:397-407.
- Burton, R.S. 1983. Protein polymorphisms and genetic differentiation of marine invertebrate populations. Mar. Biol. Lett. 4:193-206.
- Burton, R.S. and M.W. Feldman. 1981. Population genetics of *Tigriopus californicus*. II. Differentiation among neighboring populations. Evolution 35:1192-1205.
- Calow, P. 1979. The cost of reproduction - a physiological approach. Biol. Rev. 54:23-40.
- Cantelmo, F.R., M.E. Tagatz, and K.R. Ranga Rao. 1979. Effect of barite on meiofauna in a flow-through experimental system. Mar. Environ. Res. 4:301-309.
- Carman, K.R., K.M. Sherman, and D. Thistle. 1987. Evidence that sediment type influences the horizontal and vertical distribution of nematodes at deep-sea site. Deep-Sea Res. 34:45-53.
- Carney, R.S. 1987. A review of study designs for the detection of long term environmental effects of offshore petroleum activities, pp. 651-696. In: D.F. Boesch and N.N. Rabalais, eds. Long term environmental effects of offshore oil and development. Elsevier Applied Science.
- Carpenter, J. 1965. The accuracy of the Winkler Method for dissolved oxygen analysis. Limnol. Oceanogr. 14:135-140.

- Carr, R.S. 1993. Survey of Galveston Bay bottom sediments and benthic communities. Galveston Bay National Estuary Program report, GBNEP-30. 101 pp.
- Carr, R.S. and D.C. Chapman. 1992. Comparison of solid-phase and pore-water approaches for assessing the quality of marine and estuarine sediments. *Chem. Ecol.* 7:19-30.
- Carr, R.S. and D.C. Chapman. 1995. Comparison of methods for conducting marine and estuarine sediment porewater toxicity tests. I. Extraction, storage and handling techniques. *Arch. Environ. Contam. Toxicol.* 28:69-77.
- Carr, R.S., J.W. Williams, and C.T.B. Fragata. 1989. Development and evaluation of a novel marine sediment pore water toxicity test with the polychaete *Dinophilus gyrociliatus*. *Environ. Toxicol. Chem.* 8:533-543.
- Carroll, R.L. 1988. *Vertebrate Paleontology and Evolution*. W.H. Freeman and Company, New York, NY, 698 pp.
- Carson, H.L. and A.R. Templeton. 1984. Genetic revolutions in relation to speciation phenomena: the founding of new populations. *Ann. Rev. Ecol. Syst.* 15:97-131.
- Chamberlain, G.W. and A.L. Lawrence. 1983. Reproductive activity and biochemical composition of *Penaeus setiferus* and *Penaeus aztecus* in the Gulf of Mexico. Texas A&M Sea Grant College Program, TAMU-SG-84-203. 35 pp.
- Changon, N.L. and S.I. Guttman. 1989. Differential survivorship of allozyme genotypes in mosquitofish populations exposed to copper and cadmium. *Environ. Toxicol. Chem.* 8:319-326.
- Chapman, P.M. 1989. Current approaches to developing sediment quality criteria. *Environ. Toxicol. Chem.* 8:589-599.
- Chapman, P.M. 1990. The sediment quality triad approach to determining pollution-induced degradation. *Sci. Total Environ.* 97/98:815-825.
- Chapman, P.M., R.N. Dexter, S.F. Cross, and D.G. Mitchell. 1986. A field trial of the Sediment Quality Triad in San Francisco Bay. NOAA Technical Memorandum NOS OMA 25. U.S. Department of Commerce, Rockville, MD.
- Chapman, P.M., R.N. Dexter, and E.R. Long. 1987a. Synoptic measures of sediment contamination, toxicity, and infaunal community composition (the sediment quality triad) in San Francisco Bay. *Mar. Ecol. Progr. Ser.* 37:75-96.

- Chapman, P.M., R.C. Barrick, J.M. Neff, and R.C. Swartz. 1987b. Hazard assessment, short communication - four independent approaches to developing sediment quality criteria yield similar values for model contaminants. *Environ. Toxicol. Chem.* 6:723-725.
- Chapman, P.M. and E.R. Long. 1983. The use of bioassays as part of a comprehensive approach to marine pollution assessment. *Mar. Pollut. Bull.* 14:81-84.
- Chapman, P.M., C.A. McPherson, and K.R. Munkittrick. 1989. An assessment of the ocean dumping tiered testing of ocean using the Sediment Quality Triad. Prepared for Institute of Ocean Sciences, Fisheries and Oceans. Canada, Sidney, BC, Canada. DSS Project No. 06SB.FP941-8-9060.
- Chapman, P.M., E.A. Power, R.N. Dexter, and H.B. Andersen. 1991. Evaluation of effects associated with an oil platform, using the sediment quality triad. *Environ. Toxicol. Chem.* 10:407-424.
- Choi, K.-S., D.H. Lewis, E.N. Powell, and S.M. Ray. 1993. Quantitative measurement of reproductive output in the American oyster, *Crassostrea virginica* (Gmelin), using an enzyme-linked immunosorbent assay (ELISA). *Aqua. Fish. Manag.* 24:299-322.
- Choi, K.-S., E.N. Powell, D.H. Lewis, and S.M. Ray. 1994. Instantaneous reproductive effort in female American oysters, *Crassostrea virginica*, measured by a new immunoprecipitation assay. *Biol. Bull.* 186:41-61.
- Chomczynski, P. and N. Sacchi. 1987. Single step method of RNA isolation by acid guanidium thiocyanate-phenol-chloroform extraction. *Anal. Biochem.* 162:156-159.
- Clarke, K.R. and M. Ainsworth. 1993. A method of linking multivariate community structure to environmental variables. *Mar. Ecol. Progr. Ser.* 92:205-219.
- Clarke, R.C., Jr., B.G. Patten, and E.E. DeNike. 1978. Observations of a cold-water intertidal community after five years of a low-level, persistent oil spill from the *General M.C. Meigs*. *J. Fish. Res. Board Can.* 35:754-765.
- Cochrane, J.D. 1969. Water and circulation on Campeche Bank in May, pp. 123-128. In: Papers in dedication to Professor Michitaka Uda. Bulletin of Japanese Society of Fisheries Oceanography. Special Number (Professor Uda's Commemorative Papers).
- Cochrane, J.D. and F.J. Kelly. 1986. Low-frequency circulation on the Texas-Louisiana continental shelf. *J. Geophys. Res.* 91:10,645-10,659.

- Collier, T.K. and U. Varanasi. 1991. Hepatic activities of xenobiotic metabolizing enzymes and biliary levels of xenobiotics in English sole (*Parophrys vetulus*) exposed to environmental contaminants. *Arch. Environ. Contam. Toxicol.* 20:462-473.
- Collier, T.K., B.F. Anulacion, J.E. Stein, A. Goksoyr, and U. Varanasi. 1995. A field evaluation of cytochrome P450IA as a biomarker of contaminant exposure in three species of flatfish. *Environ. Toxicol. Chem.* 14:143-152.
- Collier, T.K., S.D. Connor, B.-T.L. Eberhart, B.F. Anulacion, A. Goksøyr, and A. Varanasi. 1992. Using cytochrome P450 to monitor the aquatic environment: Initial results from regional and national surveys. *Mar. Environ. Res.* 34:195-199.
- Continental Shelf Associates, Inc. 1983. Environmental Monitoring Program for Exploratory Well No. 3, Lease OCS-G 3316, Block A-384, High Island Area, South Extension near the West Flower Garden Bank. Draft Final Report to Union Oil Company. Tequesta, FL. 2 Vol.
- Continental Shelf Associates, Inc. 1985. Environmental monitoring program for Platform "A", lease OCS-G 2759, High Island Area, South Extension, East Addition, Block A-389 near the East Flower Garden Bank. Final Report to Mobil Producing Texas and New Mexico, Inc., Houston, TX. 3 Vol.
- Continental Shelf Associates, Inc. 1989. Fate and effects of drilling fluid and cutting discharges in shallow nearshore waters. Prepared for the American Petroleum Institute, September 14, 1989. 129 pp.
- Coull, B.C. 1972. Species diversity and faunal affinities of meiobenthic Copepoda in the deep sea. *Mar. Biol.* 14:48-51.
- Coull, B.C. 1975. Reproductive periodicity of meiobenthic copepods: seasonal or continuous? *Mar. Biol.* 13:289-293.
- Coull, B.C. 1977. Marine flora and fauna of the northeastern United States. Copepoda: Harpacticoida. NOAA Technical Report NMFS Circular 399. Washington, DC, U.S. Government Printing Office. 48 pp.
- Coull, B.C. and S.S. Bell. 1979. Perspectives of marine meiofauna ecology, pp. 189-216. In: R.J. Livingston ed. *Ecological Processes in Coastal and Marine Systems*, Plenum Publishing Corp., New York.
- Coull, B.C., R.L. Ellison, J.W. Fleeger, R.P. Higgins, W.D. Hope, W.D. Hummon, R.M. Rieger, W.E. Sterrer, H. Thiel, and J.H. Tietjen. 1977. Quantitative estimates of the meiofauna from the deep sea off North Carolina, USA. *Mar. Biol.* 39:233-240.

- Coull, B.C., G.R.F. Hicks, and J.B.J. Wells. 1981. Nematode/copepod ratios for monitoring pollution: a rebuttal. *Mar. Pollut. Bull.* 12:378-381.
- Coull, B.C. and M.A. Palmer. 1984. Field experimentation in meiofaunal ecology. *Hydrobiologia* 118:1-19.
- Coull, B.C., Z. Zo, J.H. Tietjen, and B.S. Williams. 1982. Meiofauna of the southeastern United States continental shelf. *Bull. Mar. Sci.* 32:139-150.
- Courtenay, S., C. Grunwald, G.-L. Kreamer, R. Alexander, and I. Wirgin. 1993. Induction and clearance of cytochrome P450IA mRNA in Atlantic tomcod caged in bleached kraft mill effluent in the Miramichi River. *Aquat. Toxicol.* 27:225-244.
- Craig, M.A., E.N. Powell, R.R. Fay, and J.M. Brooks. 1989. Distribution of *Perkinsus marinus* in Gulf coast oyster populations. *Estuaries* 12:82-91.
- Dagg, M.J. 1988. Physical and biological responses to the passage of a winter storm in the coastal and inner shelf waters of the northern Gulf of Mexico. *Cont. Shelf Res.* 8:167-178.
- Darnell, R.M. 1958. Food habits of fishes and larger invertebrates of Lake Pontchartrain, Louisiana, an estuarine community. *Publ. Inst. Mar. Sci., Univ. Texas*, 5:353-416.
- Dauvin, J.-C. 1984. Dynamique d'écosystèmes macrobenthiques des fonds sédimentaires de la Baie de Morlaix et leur perturbation par les hydrocarbures de l'Amoco-Cadiz. PhD Thesis, Univ. Pierre et Marie Curie, Paris.
- Dauvin, J.C. 1987. Evolution of long terme (1978-1986) des populations d'amphipodes des sables fins de la Pierre Noire (Baie de Morlaix, Manche occidentale) après la catastrophe de l'Amoco Cadiz. *Mar. Environ. Res.* 21:247-273.
- Davies, J.M., J.S. Bell, and C. Houghton. 1984. A comparison of the levels of hepatic aryl hydrocarbon hydroxylase in fish caught close and distant from North Sea Oil Fields. *Mar. Environ. Res.* 14:23-45.
- de Hoop, B.J., P.M.J. Herman, H. Scholten, and K. Soetaert. 1989. SENECA 1.5: a simulation environment for ecological application. Netherlands Inst. Ecol. Center for Estuarine and Coastal Ecology. 180 pp.
- den Besten, P.J., H.J. Herwig, E.G. van Donselaar, and D.R. Livingstone. 1990. Cytochrome P-450 monooxygenase system and benzo(a)pyrene metabolism in echinoderms. *Mar. Biol.* 107:171-177.
- den Besten, P.J., P. Lemaire, D.R. Livingstone, B. Woodin, J.J. Stegeman, H.J. Herwig, and W. Seinen. 1993. Time-course and dose-response of the apparent induction of the cytochrome P450 monooxygenase system of pyloric caeca microsomes of the female sea star *Asterias rubens* L. by

- benzo[a]pyrene and polychlorinated biphenyls. *Aquat. Toxicol.* 26:23-40.
- Dessauer, H.C., C.J. Dole, and M.S. Mafner. 1990. Collection and storage of tissues, pp. 25-39. In: D.M. Hillis, and C. Mortiz, eds. *Molecular Systematics*. Sinauer Associates, Inc. Sunderland, MA. 588 pp.
- Eckman, J.E. 1979. Small-scale patterns and processes in a soft-substratum intertidal community. *J. Mar. Res.* 37:437-457.
- Eckman J.E. and D. Thistle. 1988. Small-scale spatial pattern in meiobenthos in the San Diego Trough. *Deep-Sea Res.* 35:1565-1578.
- Elskus, A.A. and J.J. Stegeman. 1989. Induced cytochrome P-450 in *Fundulus heteroclitus* associated with environmental contamination by polychlorinated biphenyls and polynuclear aromatic hydrocarbons. *Mar. Environ. Res.* 27:31-50.
- Engel, D.W. 1988. The effect of biological variability on monitoring strategies: metallothioneins as an example. *Water Resour. Bull.* 24:981-987.
- Engel, D.W. and M. Brouwer. 1989. Metallothionein and metallothionein-like proteins: physiological importance. *Adv. Comp. Environ. Physiol.* 4:53-75.
- Etter, P.C. and J.D. Cochrane. 1975. Water temperature on the Texas-Louisiana shelf. Texas A&M University: Sea Grant Program. *Mar. Adv. Bull.* SG75-604. 24 pp.
- Fauchald, K. and P.A. Jumars. 1979. The diet of worms: a study of polychaete feeding guilds. *Oceanogr. Mar. Biol. Ann. Rev.* 17:193-284.
- Feller, R.J. 1980. Development of the sand-dwelling meiobenthic harpacticoid copepod *Huntemannia jadensis* Poppe in the laboratory. *J. Experim. Mar. Biol. and Ecol.* 46:1-15.
- Ferraro, S.P. and F.A. Cole. 1990. Taxonomic level and sample size sufficient for assessing pollution impacts on the Southern California Bight macrobenthos. *Mar. Ecol. Progr. Ser.* 67:251-262.
- Fitzhugh, K. 1984. Temporal and spatial patterns of the polychaete fauna on the central Northern Gulf of Mexico continental shelf, pp. 211-226. In: P.A. Hutchings, ed. *Proceedings of the First International Polychaete Conference*. Linnean Society of New South Wales.
- Flint, R.W. and N.N. Rabalais (eds.). 1980. Environmental studies, South Texas outer continental shelf, 1975-1977. Vol. III, Study area final reports. Univ. Texas Mar. Sci. Inst.: Bureau of Land Management, Washington, DC. NTIS No. PB80-181522. 650 pp.

- Foureman, F.L., N.B. White, Jr., and J.R. Bend. 1983. Biochemical evidence that winter flounder (*Pseudopleuronectes americanus*) have induced hepatic cytochrome P450-dependent monooxygenase activities. *Can. J. Fish. Aquat. Sci.* 40:854-865.
- Freeman, W.H. and B. Bracegirdle. 1971. An atlas of invertebrate structure. Heinemann Educational Books Ltd, London. 129 pp.
- Fricke, A.H., H.F.-K. Hennig, and M.J. Orren. 1981. Relationship between oil pollution and psammolittoral meiofauna density of two South African beaches. *Mar. Environ. Res.* 5:59-77.
- Gaston, G. 1985. Effects of hypoxia on macrobenthos of the inner shelf off Cameron, Louisiana. *Estuar. Coastal and Shelf Sci.* 29:603-613.
- Gee, J.M., R.M. Warwick, M. Schanning, J.A. Berge, and W.G. Ambros, Jr. 1985. Effects of organic enrichment on meiofauna abundance and community structure in sublittoral soft sediments. *J. Exp. Mar. Biol. Ecol.* 91:247-262.
- Gettleson, D.A. and C.E. Laird. 1980. Benthic barium levels in the vicinity of six drill sites in the Gulf of Mexico, pp. 739-788. In: Symposium Research on Environmental Fate and Effects of Drilling Fluids and Cuttings. Proceedings Vol. II.
- Geyer, H., P. Sheenan, K. Kotzias, D. Freitag, and F. Korte. 1982. Prediction of ecotoxicological behavior of chemicals: relationship between physicochemical properties and bioaccumulation of organic chemicals in the mussel *Mytilus edulis*. *Chemosphere* 11:1121-1134.
- Goksoyr, A., H.E. Larsen, S. Blom, and L. Forlin. 1992. Detection of cytochrome P450IA1 in North Sea dab liver and kidney. *Mar. Ecol. Progr. Ser.* 91:83-88.
- Goldberg, E.D., V.T. Bowen, J.W. Farrington, G. Harvey, J.H. Martin, P.L. Parker, R.W. Risebrough, E. Scheider, and E. Gamble. 1978. The mussel watch. *Environ. Conser.* 5:101-125.
- Grassle, J.F., R. Elmgren, and J.P. Grassle. 1981. Response of benthic communities in MERL experimental ecosystems to low level, chronic additions of No. 2 fuel oil. *Mar. Environ. Res.* 4:279-297.
- Gray, J.S., M. Aschan, M.R. Carr, K.R. Clarke, R.H. Green, T.H. Pearson, R. Rosenberg, and R.M. Warwick. 1988. Analysis of community attributes of the benthic macrofauna of Frierfjord/Langesundfjord and in a mesocosm experiment. *Mar. Ecol. Progr. Ser.* 46:151-165.
- Gray, J.S., K.R. Clarke, R.M. Warwick, and G. Hobbs. 1990. Detection of initial effects of pollution of marine benthos: an example from the

- Ekofisk and Eldfisk oilfields, North Sea. *Mar. Ecol. Progr. Ser.* 66:285-299.
- Gray, E.S., B.R. Woodin, and J.J. Stegeman. 1991. Sex differences in hepatic monooxygenases in winter flounder (*Pseudopleuronectes americanus*) and scup (*Stenotomus chrysops*) and regulation of P450 forms by estradiol. *J. Exp. Zool.* 259:330-342.
- Green, R.H. 1993a. Relating two sets of variables in environmental studies, pp. 151-165. In: C.R. Rao, ed. *Multivariate Analysis: Future Directions*. Elsevier. Amsterdam.
- Green, R.H. 1993b. Application of repeated measures designs in environmental impact and monitoring studies. *Austr. J. Ecol.* 18:81-98.
- Green, R.H., J.M. Boyd, and J.S. Macdonald. 1993. Relating sets of variables in environmental studies: the Sediment Quality Traid as a paradigm. *Environmetrics* 4:439-457.
- Haasch, M.L., E. Guardokus, L.A. Sutherland, M.S. Goodrich, R. Price, K. Cooper, and J.J. Lech. 1992. CYP1A1 protein and mRNA in teleosts as an environmental bioindicator: laboratory and environmental studies. *Mar. Environ. Res.* 34:139-145.
- Haasch, M.L., P.J. Wejksnora, J.J. Stegeman, and J.J. Lech. 1989. Cloned rainbow trout liver P-450 complementary DNA as a potential environmental marker. *Toxicol. Appl. Pharmacol.* 98:362-368.
- Hahn, M.E., T.M. Lamb, M.E. Schultz, R.M. Smolowitz, and J.J. Stegeman. 1993. Cytochrome P450IA induction and inhibition by 3,3,4,4'-tetrachlorobiphenyl in an Ah receptor-containing fish hepatoma cell line (PLHC-1). *Aquat. Toxicol.* 26:185-208.
- Hahn, M.E., A. Poland, E. Glover, and J.J. Stegeman. 1992. The Ah receptor in marine animals: Phylogenetic distribution and relationship to cytochrome P450IA inducibility. *Mar. Environ. Res.* 34:87-92.
- Hahn, M.E., A. Poland, E. Glover, and J.J. Stegeman. 1994. Photoaffinity labeling of the Ah receptor: Phylogenetic survey of diverse vertebrate and invertebrate species. *Arch. Biochem. Biophys.* 310:218-228.
- Hahn, M.E. and J.J. Stegeman. 1994. Regulation of cytochrome P450IAI in teleosts: sustained induction of CYP1A1 mRNA, protein, and catalytic activity by 2,3,7,8-tetrachlorodibenzofuran in the marine fish *Stenotomus chrysops*. *Toxicol. Appl. Pharmacol.* 127:187-198.
- Halper, F.B., D.W. McGrail, and W.J. Merrell, Jr. 1988. Seasonal variability in the currents on the outer Texas-Louisiana Shelf. *Estuar. Coastal and Shelf Sci.* 26:33-50.

- Hamilton, S.J. and P.M. Mehrle. 1986. Importance in assessing stress from metal contaminants. *Trans. Am. Fish. Soc.* 115:596-609.
- Hamilton, M.A., R.C. Russo, and R.V. Thurston. 1977. Trimmed Spearman-Kärber method for estimating median lethal concentrations in toxicity bioassays. *Environ. Sci. Technol.* 11:714-719; Correction 12:417 1978.
- Hard, W.L. 1942. Ovarian growth and ovulation in the mature blue crab *Callinectes sapidus* Rathbun. Contribution #46, Bulletin Chesapeake Biological Laboratory. 17 pp.
- Harper, D.E., Jr. and R.J. Case. 1975. Numerical analysis of benthic data. In: SEADOCK, Inc., Environmental Report: Texas Offshore Crude Oil Unloading Facility. Vol. 2, Chapt. 10, Sect. 10.4, pp. 531-537. Texas A&M Research Foundation project 945 final report to SEADOCK, Inc.
- Harper, D.E., Jr., L.D. McKinney, R.R. Salzer, and R.J. Case. 1981a. The occurrence of hypoxic bottom water off the upper Texas coast and its effects on the benthic biota. *Contrib. Mar. Sci.* 24:53-79.
- Harper, D.E., Jr., D.L. Potts, R.R. Salzer, R.J. Case, R.L. Jaschek, and C.M. Walker. 1981b. Distribution and abundance of macrobenthic and meiobenthic organisms, pp. 133-177. In: B.S. Middleditch, ed. Environmental effects of offshore oil production. The Buccaneer Gas and Oil Field Study. Plenum Press, New York. 446 pp.
- Harper, D.E., Jr., L.D. McKinney, J.M. Nance and R.R. Salzer. 1991. Recovery responses of two benthic assemblages following an acute hypoxic event on the Texas Continental shelf, northwestern Gulf of Mexico, pp. 49-64. In: R.V. Tyson and T.H. Pearson, eds. Modern and Ancient Continental Shelf Anoxia. *Geol. Soc. Special Pub. No. 58.*
- Harris, R.J. 1975. A primer of multivariate statistics. Academic, New York.
- Hedrick, P.W. 1986. Genetic polymorphisms in heterogeneous environments: a decade later. *Ann. Rev. Ecol. Syst.* 17:535-566.
- Heilmann, L.J., Y.-Y. Shee, S.W. Bigelow, and D.N. Nebert. 1988. Trout P4501A:cDNA and deduced protein sequence, expression in liver, and evolutionary significance. *DNA* 7:379-387.
- Heip, C., M. Vincx, and G. Vranken. 1985. The ecology of marine nematodes. *Oceanogr. Mar. Biol. Ann. Rev.* 23:399-489.
- Heip, C., R.M. Warwick, M.R. Carr, P.M.J. Herman, R. Huys, N. Smol, and K. van Holsbeke. 1988. Analysis of the community attributes of the benthic meiofauna of Frierfjord/Langesundfjord. *Mar. Ecol. Progr. Ser.* 46:171-180.

- Hendricks, J.D., T.R. Meyeres, D.W. Shelton, J.L. Casteel, and G.S. Bailey. 1985. Hepatocarcinogenicity of benzo(a)pyrene to rainbow trout by dietary exposure and intraperitoneal injection. *J. Natl. Cancer Inst.* 74:839-851.
- Hennig, H.F.-K., G.A. Eagle, L. Fielder, A.H. Fricke, W.J. Gledhill, P.J. Greenwood, and M.J. Orren. 1983. Ratio and population density of psammolittoral meiofauna as a perturbation indicator of sandy beaches in South Africa. *Environ. Monit. and Assessment* 3:45-60.
- Hicks, G.R.F. 1977. Breeding activity of marine phytoplankton harpacticoid copepods from Cook Strait. *New Zealand J. Mar. Freshwater Res.* 11:645-66.
- Hicks, G.R.F. 1979. Pattern and strategy in the reproductive cycles of benthic harpacticoid copepods, pp. 139-147. In: E. Naylor and R.G. Hartnoll, eds. *Cyclic Phenomena in Marine Plants and Animals*, Pergamon Press, Oxford.
- Hicks, G.R.F. and B.C. Coull. 1983. The ecology of marine meiobenthic harpacticoid copepods. *Oceanogr. Mar. Biol. Ann. Rev.* 21:67-175.
- Hildebrand, H.H. 1954. A study of the brown shrimp (*Penaeus aztecus Ives*) grounds in the western Gulf of Mexico. *Publications of the Institute of Marine Science, Univ. of Texas* 3:233-366.
- Hill, J., D.L. Fowler, and M.J. VanDen Avyle. 1989. Species profiles: life histories and environmental requirements of coastal fishes and invertebrates (Mid-Atlantic)--Blue Crab. U.S. Fish Wildl. Serv., Biol. Rep. 82(11.100). U.S. Army Corps of Engineers, TR EL-82-4. 18 pp.
- Hill, M.O. 1973. Diversity and evenness: a unifying notation and its consequences. *Ecol.* 54:427-432.
- Ho, C.L. and B.B. Barrett. 1977. Distribution of nutrients in Louisiana's coastal waters influenced by the Mississippi River. *Estuar. Coast. Mar. Sci.* 5:173-195.
- Holmes, C.W. 1982. Geochemical indices of fine sediment transport, northwest Gulf of Mexico. *J. Sed. Petrol.* 52:307-321.
- Hose, J.E., J.N. Cross, S.G. Smith, and D. Diehl. 1989. Reproductive impairment in a fish inhabiting a contaminated coastal environment off Southern California. *Environ. Pollut.* 57:139-148.
- Huh, O.K., W.J. Wiseman, Jr., and L.J. Rouse, Jr. 1981. Intrusion of loop current waters onto the West Florida continental shelf. *J. Geophys. Res.* 86:4186-4192.

- Hulings, N.C. and J.S. Gray. 1971. A manual for the study of meiofauna. *Smithsonian Contrib. Zool.* 78:1-84.
- Hurlbert S.H. 1971. The nonconcept of species diversity: a critique and alternative parameters. *Ecol.* 52:577-586.
- Hylland, K., C. Haus, and C. Hogstrand. 1992. Hepatic metallothionein and heavy metals in dab *Limanda limanda* from the German Bight. *Mar. Ecol. Progr. Ser.* 91:89-96.
- James, M.O. 1989. Cytochrome P450 monooxygenase in Crustaceans. *Xenobiotica* 19:1063-1076.
- James, M.O. and J.R. Bend. 1980. Polycyclic aromatic induction of cytochrome P450-dependent mixed-function oxidases in marine fish. *Toxicol. Appl. Pharmacol.* 54:117-133.
- James, M.O. and P.J. Little. 1984. 3-methylcholanthrene does not induct *in vitro* xenobiotic metabolism in spiny lobster hepatopancreas, or affect *in vivo* disposition of benzo(a)pyrene. *Comp. Biochem. Physiol.* 78:241-245.
- James, M.O. and K.T. Schiverick. 1984. Cytochrome P450-dependent oxidation of progesterone, testosterone, and ecdysone in the spiny lobster, *Panulirus argus*. *Arch. Biochem. Biophys.* 233:1-9.
- Jensen, P. 1986. Nematode fauna in the sulphide-rich brine seep and adjacent bottoms of the East Flower Garden, NW Gulf of Mexico. *Mar. Biol.* 92:489-503.
- Jensen, P. 1987. Feeding ecology of free-living aquatic nematodes. *Mar. Ecol. Progr. Ser.* 35:187-196.
- Jewett, S.C., T.A. Dean, R.O. Smith, M. Steckoll, L.J. Halderson, D.A. Laur, and L. McDonald. 1994. The effects of the *Exxon Valdez* oil spill on shallow subtidal communities in Prince William Sound, Alaska 1989-93. Draft Final Report of EVOS Study No. 93047, Exxon Valdez Trustee Council, Anchorage, AK. 231 pp. plus appendices.
- Jimenez, B.D., L. Burtis, G.H. Ezell, B.Z. Egan, N.E. Lee, J. Beauchamp, and F. McCarthy. 1988. The mixed function oxidase system of bluegill sunfish *Lepomis macrochirus*, correlation of activities in experimental and wild fish. *Environm. Toxicol.* 7:623-634.
- Johnson, P.T. 1980. Histology of the blue crab *Callinectes sapidus*. A model for the Decapoda. Praeger Publishers, New York, NY. 440 pp.
- Johnston, E.P. and P.C. Baumann. 1989. Analysis of fish bile with HPLC-fluorescence to determine environmental exposure to benzo[a]pyrene. *Hydrobiologia* 188/189:561-566.

- Karl, S.A. and J.C. Avise. 1993. PCR-based assays of Mendelian polymorphisms from anonymous single-copy nuclear DNA: Techniques and applications or population genetics. *Mol. Biol. Evol.* 10:342-361.
- Kendall, J.J. 1990. Detection of effects at long-term production sites, pp. 23-28. In: R.S. Carney, ed. Northern Gulf of Mexico Environmental Studies Planning Workshop. Proceeding of a Workshop held in New Orleans, Louisiana, 15-17 August 1989. Prepared by Geo-Marine, Inc. OCS Study MMS 90-0018. U.S. Dept. of the Interior, Minerals Management Service, New Orleans, LA, 156 pp.
- Kennicutt, M.C. II and P. Comet. 1992. Resolution of sediment hydrocarbon sources: Multiparameter approaches. In: J.K. Whelan and J.W. Farrington, eds. Organic productivity, accumulation, and preservation in recent and ancient sediments. Columbia University Press. pp. 308-337.
- King, J.E. 1948. A study of the reproductive organs of the common marine shrimp, *Penaeus setiferus* (Linnaeus). *Biol. Bull.* 94:244-262.
- Kingston, P.F. and M.J. Riddle. 1989. Cost effectiveness of benthic faunal monitoring. *Mar. Pollut. Bull.* 20:490-496.
- Klopper-Sams, P.J. and J.J. Stegeman. 1992a. The temporal relationships between P450E protein content, catalytic activity, and mRNA levels in the teleost *Fundulus heteroclitus* following treatment with β -naphthoflavone. *Arch. Biochem. Biophys.* 268:525-535.
- Klopper-Sams, P.J. and J.J. Stegeman. 1992b. Effects of temperature acclimation on the expression of hepatic cytochrome P450IA mRNA and protein in the fish *Fundulus heteroclitus*. *Arch. Biochem. Biophys.* 15:38-46.
- Knuth, D.E. 1981. Seminumerical algorithm. 2nd ed., vol. 2 of the Art of Computer Programming. Reading, MA, Addison-Wesley, §§ 3.2-3.3.
- Koehn, R.K. and B.L. Bayne. 1989. Towards a physiological and genetical understanding of the energetics of the stress response. *Biol. J. Linn. Soc.* 37:157-171.
- Krahn, M.M., D.G. Burrows, W.D. MacLeod, Jr., and D.C. Malins. 1987. Determination of individual metabolites of aromatic compounds in hydrolyzed bile of English sole (*Parophrys vetulus*) from polluted sites in Puget Sound, Washington. *Arch. Environ. Contam. Toxicol.* 16:511-522.
- Krahn, M.M., D.G. Burrows, G. Ylitalo, D.W. Brown, C.A. Wigren, T.K. Collier, S.-L. Chan, and U. Varanasi. 1992. Mass spectrometric analysis for aromatic compounds in bile of fish sampled after the Exxon Valdez oil spill. *Environ. Sci. Technol.* 26:116-126.

- Krahn, M.M., L.J. Kittle, Jr., and W.W. MacLeod, Jr. 1986a. Evidence of exposure of fish to oil spilled in the Columbia River. *Mar. Environ. Res.* 20:291-298.
- Krahn, M.M., L.D. Rhodes, M.S. Meyer, L.K. Moore, W.D. MacLeod, Jr., and D.C. Malins. 1986b. Associations between metabolites of aromatic compounds in bile and the occurrence of hepatic lesions in English sole (*Parophrys vetulus*) from Puget Sound, Washington. *Arch. Environ. Contamin. Toxicol.* 15:61-67.
- Krahn, M.M., M.S. Meyers, D.G. Burrows, and D.C. Malins. 1984. Determination of metabolites and xenobiotics in the bile of fish from polluted waterways. *Xenobiotica* 14:633-646.
- Kranz, H. and G. Peters. 1984. Melano-macrophage centers in liver and spleen of ruffe (*Gymnocephalus cernua*) from the Elbe estuary. *Helgol. Meeresunters.* 37:415-424.
- Kreamer, G.-L., K. Squibb, D. Gioelil, S.J. Garte, and I. Wirgin. 1991. Cytochrome P450IA mRNA expression in feral Hudson River tomcod. *Environ. Res.* 55:64-78.
- Krishnan, V. and S. Safe. 1993. Polychlorinated biphenyls (PCBs), dibenzo-p-dioxins (PCDDs) and dibenzofurans (PCDFs) as antiestrogens in MCF-7 human breast cancer cells: quantitative structure-activity relationships. *Toxicol. Appl. Pharmacol.* 120:55-61.
- Kurelec, B., S. Britivic, S. Krc'ic, and R.K. Kahn. 1986. Metabolic fate of aromatic amines in the mussel *Mytilus galloprovincialis*. *Mar. Biol.* 91:523-527.
- LACSD (Los Angeles County Sanitation Districts). 1990. Palos Verdes Ocean Monitoring. Annual Report 1990. Los Angeles County Sanitation Districts, Whittier, CA.
- Lamshead, P.J.D. 1984. The nematode/copepod ratio some anomalous results from the Firth of Clyde. *Mar. Pollut. Bull.* 15:256-259.
- Langston, W.J. and M. Zhou. 1986. Evaluation of the significance of metal-binding proteins in the gastropod *Littorina Littorea*. *Mar. Biol.* 92:505-515.
- Lauenstein, G.G., A.Y. Cantillo and S.S. Dolvin. 1993. Benthic surveillance and mussel watch projects analytical protocols 1984-1992. NOAA Technical Memorandum NPS OCRA. NOAA, Silver Spring, MD. pp. III-151 to III-185.
- Leaver, M.J., D. Murison, J.M. Davis, and D. Raffaelli. 1987. Experiment studies of the effects of drilling discharges. *Phil. Trans. R. Soc. Lond. B.* 315:625-640.

- Lee, R.F. 1982. Mixed function oxygenase (MFO) in marine invertebrates. *Mar. Biol. Lett.* 2:87-105.
- Lee, R.F., R. Sauerhebel, and A.A. Benson. 1972. Petroleum hydrocarbons: uptake and discharge by the marine mussel *Mytilus edulis*. *Science* 177:344-346.
- Lenihan, H.S. and J.S. Oliver. 1995. Anthropogenic and natural disturbances to marine benthic communities in Antarctica. *Ecol. Applic.* In press.
- Levine, S.L., J.T. Oris, and T.E. Wissing. 1995. Influence of environmental factors on the physiological condition and hepatic ethoxyresorufin O-deethylase (EROD) activity of gizzard shad (*Dorosoma cepedianum*). *Environ. Toxicol. Chem.* 14:123-128.
- Levinton, J. 1980. Genetic divergence in estuaries. In: V.S. Kennedy, ed. *Estuarine perspectives*. Academic Press, New York. 520 pp.
- Li, J. and M. Vincx. 1993. The temporal variation of intertidal nematodes in the Westerschelde I. The importance of an estuarine gradient. *Netherland J. Aquat. Ecol.* 27:319-326.
- Li, J., M. Vincx, and P.M.J. Herman. 1995a. Carbon flow through nematode standing stock. *Ophelia*.
- Li, J., M. Vincx, and P.M.J. Herman. 1995b. A model of nematode dynamics in the Westerschelde Estuary. *Model. Ecol.*
- Light, T.S. 1972. Standard solution for Redox potential measurements. *Anal. Chem.* 44:1038-1039.
- Livingstone, D.R. 1990. Cytochrome P-450 and oxidative metabolism in molluscs. *Biochem. Soc. Trans.* 18:15-19.
- Livingstone, D.R. 1991. Organic xenobiotic metabolism in marine invertebrates. pp. 45-185. In: R. Gilles, ed. *Advance in Comparative and Environmental Physiology*. Springer-Verlag.
- Livingstone, D.R., M.A. Kirchin, and A. Wiseman. 1989. Cytochrome P-450 and oxidative metabolism in molluscs. *Xenobiotica* 19:1041-1062.
- Livingstone, D.R., M.N. Moore, D.M. Lowe, C. Nasci, and S.V. Farrar. 1985. Responses of the cytochrome P450 monooxygenase system to diesel oil in the common mussel *Mytilus edulis* L. and the periwinkle *Littoria littorea* L. *Aquat. Toxicol.* 7:79-91.
- Long, E.R. and P.M. Chapman. 1985. A sediment quality triad: measures of sediment contamination, toxicity, and infaunal community composition in Puget Sound. *Mar. Pollut. Bull.* 16:405-415.

- Long, E.R. and L.G. Morgan. 1990. The potential for biological effects of sediment-sorbed contaminants tested in the National Status and Trends Program. NOAA Technical Memorandum NOS OMA 52. U.S. Dept. of Commerce, National Oceanographic and Atmospheric Administration, Seattle, WA. 215 pp.
- Lorenzen, A. and A.B. Okey. 1990. Detection and characterization of [³H]2,3,7,8-tetrachlorodibenzo-r-dioxin binding to Ah receptor in a rainbow trout hepatoma cell line. *Toxicol. Appl. Pharmacol.* 106:53-62.
- Ludwig J.A. and J.F. Reynolds. 1988. *Statistical ecology: A primer on methods and computing.* John Wiley & Sons, New York. 337 pp.
- MacDonald, D.D. 1993. Development of an approach to the assessment of sediment quality in Florida coastal waters. Report to Florida Department of Environmental Regulation. 133 pp.
- Mackin, J.G. 1971. A study of the effect of oil field brine effluents in biotic communities in Texas estuaries. Texas A&M Research Foundation Project 735 Final Report to Humble Oil and Refinery Company. 72 pp.
- Malins, D.C. B.B. McCain, D.W. Brown, S.L. Chan, M.S. Myers, J.T. Landahl, P.G. Phrohaska, A.J. Friedman, L.D. Rhodes, D.G. Burrows, W.D. Gronlund and H.O. Hodgins. 1984. Chemical pollutants in sediments and diseases in bottom-dwelling fish in Puget Sound, Washington. *Environ. Sci. Technol.* 18:705-713.
- Mare, M.F. 1942. A study of marine benthic community with special reference to the micro-organisms. *J. Mar. Biol. Assoc. United Kingdom* 25:517-554.
- McDonald, S.J., M.C. Kennicutt II, and J.M. Brooks. 1992. Evidence of polycyclic aromatic hydrocarbon (PAH) exposure in fish from the Antarctic Peninsula. *Mar. Pollut. Bull.* 25:3313-3317.
- McDonald, S.J., T.L. Wade, J.M. Brooks, and T.J. McDonald. 1991. Assessing the exposure of fish to a petroleum spill in Galveston Bay, Texas. pp. 707-718. In: L.C. Wroebel and C.A. Brebbia, eds. *Water Pollution: Modelling, Measuring and Prediction.* Southampton: Computational Mechanics Publications.
- McDonald, S.J., M.C. Kennicutt II, H. Liu, and S.H. Safe. 1995. Assessing aromatic hydrocarbon exposure in Antarctic fish captured near Palmer and McMurdo Stations, Antarctica. *Arch. Environ. Contam. Toxicol.* 29:232-240.
- McDonald, S.J., M.C. Kennicutt II, J. Sericano, T.L. Wade, H. Liu, and S.H. Safe. 1994. Correlation between bioassay-derived P4501A1 induction

- activity and chemical analysis of clam (*Laternula elliptica*) extracts from McMurdo Sound, Antarctica. *Chemosphere* 28:2237-2248.
- McGrail, D.W. and M. Carnes. 1983. Shelf edge dynamics and the nepheloid layer in the northwestern Gulf of Mexico. In: D.J. Stanley and G.T. Moore, eds. *The shelfbreak: Critical interface on continental margins*. Soc. Econ. Paleontol. Mineral., Spec. Publ. 33:251-264.
- McKinney, L.D., D.E. Harper, Jr. and J.M. Nance. 1984. Benthos. In: R.W. Harn, C.P. Giammona, and R.E. Randal, eds. *Offshore oceanographic and environmental monitoring services for the Strategic Petroleum Reserve. Annual report for the West Hackberry site from September 1983 through August 1984*. Texas A&M Research Foundation project 4900 report to Department of Energy on contract DOE-P010850-5.
- Mearns, A.J., M.J. Allen, L.S. Word, J.Q. Word, C.S. Greene, M.J. Sherwood, and B. Meyers. 1976. Quantitative responses of demersal fish and benthic invertebrate communities to coastal municipal waste discharges. Final Report to EPA, Grant R801152. Southern California Coastal Water Research Project, Long Beach, CA. Vol. 1, 67 pp., Vol. 2, 179 pp.
- Metcalfe, C.D., V.W. Cairns, and J.D. Fitzsimons. 1988. Experimental induction of liver tumors in rainbow trout (*Salmo gairdneri*) by contaminated sediment from Hamilton Harbour, Ontario. *J. Fish. Aquat. Sci.* 45:2161-2167.
- Monosson, E. and J.J. Stegeman. 1991. Cytochrome P450E (P4501A) induction and inhibition in winter flounder by 3,3',4,4'-tetrachlorobiphenyl: comparison of response in fish from Georges Bank and Narragansett Bay. *Environ. Toxicol. Chem.* 10:765-774.
- Montagna, P.A. 1981. Morphological adaptation in the deep sea benthic harpacticoid copepod family Cerviniidae. *Crustaceana* 42:37-43.
- Montagna, P.A. 1991. Meiobenthic communities of the Santa Maria Basin on the California continental shelf. *Cont. Shelf Res.* 11:1355-1378
- Montagna P.A., J.E. Bauer, D. Hardin, and R.B. Spies. 1987. Temporal variability and the relationship between benthic meiofaunal and microbial populations of a natural coastal petroleum seep. *J. Mar. Res.* 45:761-789.
- Montagna P.A., J.E. Bauer, D. Hardin, and R.B. Spies. 1989. Vertical distribution of microbial and meiofaunal populations in sediments of a natural coastal hydrocarbon seep. *J. Mar. Res.* 47:657-680.
- Moore, C.G. and T.H. Pearson. 1984. Response of a marine benthic copepod assemblage to organic enrichment. pp. 369-373. In: G. Schriever, H.K. Schminke, and C.-T. Shih, eds. *Proceedings of the Second*

International Conference on Copepoda, National Museums of Canada, Ottawa.

- Moore, D.M. and R.C. Reynolds. 1989. X-ray diffraction and the identification and analysis of clay minerals. Oxford University Press, Oxford, New York, 332 pp.
- Moore, C.G., D.J. Murison, S. Mohdlong, and D.J.L. Mills. 1987. The impact of oily discharges on the meiobenthos of the northern Sea. Phil. Trans. R. Soc. Lond. B. 316:525-544.
- Morrison, J.M., W.J. Merrell, Jr., R.M. Key, and T.C. Key. 1983. Property distributions and deep chemical measurements within the western Gulf of Mexico. J. Geophys. Res. 88:2601-2608.
- MRC (Marine Review Committee). 1989. Final technical report to the California Coastal Commission. I. Soft bottom benthos. Marine Review Committee, Dept. of Biol. Sic., Univ. Calif., Santa Barbara, CA.
- Munkittrick, K.R., M.R. van den Heuvel, D.A. Metner, W.L. Lockhart, and J.J. Stegeman. 1993. Interlaboratory comparison and optimization of hepatic microsomal ethoxyresorufin O-deethylase activity in white sucker (*Catostomus commersoni*) exposed to bleached kraft pulp mill effluent. Environ. Toxicol. Chem. 12:1273-1282.
- Murchelano, R.A. and S.A. MacLean. 1990. Histopathology atlas of the registry of marine pathology. U.S. Department of Commerce, National Oceanic and Atmospheric Administration. 77 pp.
- Murchelano, R. and R. Wolke. 1985. Epizootic carcinoma in the winter flounder *Pseudopleuronectes americanus*. Science 728:587-589.
- Murdoch, M.H. and P.D.N. Hebert. 1994. Mitochondrial DNA diversity of brown bullhead from contaminated and relatively pristine sites in the Great Lakes. Environ. Toxicol. and Chem. 13:1-9.
- Murrell, M.C. and J.W. Fleeger. 1989. Meiofauna abundance on the Gulf of Mexico continental shelf affected by hypoxia. Cont. Shelf Res. 9:1049-1062.
- Muus, B.J. 1967. The fauna of Danish estuaries and lagoons: distribution and ecology of dominating species in the shallow reaches of the mesohaline zone. Meddr. Danm. Fisk.-og Havunders (N.S.). 5:3-316.
- Nance, J.M. 1984. The seasonal distribution of macrobenthos and sediments chronically impacted by oil and gas field produced water. Ph.D. Dissertation, Texas A&M University, College Station, Texas.
- Nance, J.M. 1991. Effects of oil/gas field produced water on the macrobenthic community in a small gradient estuary. Hydrobiologica 220:189-204.

- Nebert, D.W. and H.V. Gelboin. 1968. Substrate-inducible microsomal aryl hydroxylase in mammalian cell culture. I. Assay and properties of induced enzyme. *J. Biol. Chem.* 243:6242-6249.
- Nebert, D.W. and F.J. Gonzales. 1987. P450 genes. Structure, evolution and regulation. *Ann. Rev. Biochem.* 56:945-993.
- Nebert, D.W., D.R. Nelson, M. Adesnik, M.J. Coon, R.W. Estabrook, F.J. Gonzales, F.P. Guengerich, I.C. Gunsalus, E.F. Johnson, B. Kemper, W. Levin, I.R. Phillips, R. Sato, and M.R. Waterman. 1989. The P450 superfamily: updated listing of all genes and recommended nomenclature for the chromosomal loci. *DNA Cell Biology* 8:1-13.
- Neff, J.M., N.N. Rabalais, and D.F. Boesch. 1981. Offshore oil and gas development activities potentially causing long-term environmental effects. In: D.F. Boesch and N.N. Rabalais, eds. *Long-term environmental effects of offshore oil and gas development.* Elsevier Appl. Sci. pp. 149-173.
- Nei, M. 1987. *Molecular evolutionary genetics.* Columbia University Press, New York. 512 pp.
- Nelson, P.R., T. Kamataki, D.J. Waxman, F.P. Guengerich, R.W. Estabrook, R. Feyereisen, F.J. Gonzales, M.J. Coon, I.C. Gunsalus, O. Gotoh, K. Okuda, and D.W. Nebert. 1993. The P450 superfamily - update on new sequences, gene mapping, accession numbers, early trivial names of enzymes, and nomenclature. *DNA Cell Biol.* 12:1.
- Notini, M. 1978. Long-term effects of an oil spill on *Fucus* macrofauna in a small Baltic bay. *J. Fish. Res. Board Can.* 35:745-753.
- Oh, S.H., J.T. Deagan, P.D. Whanger, and P.H. Weswig. 1978. Biological function of metallothionein V. Its induction in rats by various stresses. *Am. J. Physiol.* 3:E282-E285.
- Oshida, P.S., T.K. Goochey, and A.J. Mearns. 1981. Effects of municipal wastewater on fertilization, survival and development of the sea urchin, *Strongylocentrotus purpuratus*, pp. 389-402. In: F.J. Vernberg, A. Calabrese, F.P. Thurberg, and W.B. Vernberg, eds. *Biological Monitoring of Marine Pollutants*, Academic Press, New York.
- Overstreet, R.M. 1978. Marine maladies? Worms, germs, and other symbionts from the northern Gulf of Mexico. Mississippi-Alabama Sea Grant Consortium, MASGP-78-021. 140 pp.
- Pak, H. and J.R.V. Zaneveld. 1977. Bottom nepheloid layers and bottom mixed layers observed on the continental shelf off Oregon. *J. Geophys. Res.* 82:3921-3931.

- Palmer, M.A. 1984. Invertebrate drift: behavioral experiments with intertidal meiobenthos. *Mar. Behav. Phys.* 10:235-253.
- Palmer, M.A. and B.C. Coull. 1980. The prediction of development rate and the effects of temperature for the meiobenthic copepod, *Microarthridion littorale* (Poppe). *J. Exper. Mar. Biol. Ecol.* 48:73-83.
- Palmer, M.A. and G. Gust. 1985. Dispersal of meiofauna in a turbulent tidal creek. *J. Mar. Res.* 43:179-210.
- Palmer, M.A., P.A. Montagna, R.B. Spies, and D. Hardin. 1988. Meiofauna dispersal near natural petroleum seeps in the Santa Barbara Channel: a recolonization experiment. *Oil Chem. Pollut.* 4:179-189.
- Parker, R.H. 1960. Ecology and distributional patterns of marine macroinvertebrates, northern Gulf of Mexico, pp. 203-337. In: F.P. Shepard, F.B. Phleger, and T.H. van Andel, eds. *American Association of Petroleum Geologists*, Tulsa, Oklahoma.
- Payne, J.F. 1977. Mixed function oxidase in marine organisms in relation to petroleum hydrocarbon metabolism and detection. *Mar. Pollut. Bull.* 8:112-116.
- Payne, J.F. L.L. Fancey, A.D. Rahimtula, and E.L. Porter. 1987. Review and perspective on the use of mixed-function oxygenase enzymes in biological monitoring. *Comp. Biochem. Physiol.* 86:233-245.
- Paskausky, D.F. and W.D. Nowlin, Jr. 1968. Measured and preformed phosphate in the Gulf of Mexico region. *ONR Technical Report 68-12T*. 18 pp.
- Pearson, T.H. 1987. The benthic biology of an accumulating sludge disposal ground, pp. 195-200. In: J. Capuzzo and D. Kester, eds. *Biological processes and wastes in the sea. Oceanic processes: marine pollution*, Vol. 1. Krieger, Melbourne, FL.
- Pearson, T.H. and R. Rosenberg. 1978. Macrobenthic succession in relation to organic enrichment and pollution in the marine environment. *Oceanogr. Mar. Biol. Ann. Rev.* 16:229-311.
- Pequegnat, W.E. and W.B. Sikora. 1979. Meiofauna Project, pp. 16-1, 16-34. In: Rice University, Texas A&M University, and University of Texas, eds. *Environmental studies, south Texas outer continental shelf, biology and chemistry*. Port Aransas: Univ. of Texas Marine Science Institute.
- Pequegnat, W.E., B.J. Gallaway, and L.H. Pequegnat. 1990. Aspects of the ecology of the deep-water fauna of the Gulf of Mexico. *Amer. Zool.* 30:45-64.

- Peterson, C.H. and R. Black. 1988. Density-dependent mortality caused by physical stress interacting with biotic history. *Amer. Nat.* 131:257-270.
- Pfannkuche, O. and H. Thiel. 1988. Sample processing, pp. 134-135. In: R.P. Higgins and H. Thiel, eds. *Introduction to the study of meiofauna*. Smithsonian Institution Press, Washington, DC.
- Philp, R.P. 1985. Fossil fuel biomarkers: application and spectra. *Methods in geochemistry and geophysics*, vol. 23. Elsevier, New York.
- Pielou, E.C. 1975. *Ecological diversity*. Wiley, New York.
- Piskorska-Pliszczynska, J., B. Keys, S. Safe, and M.S. Newman. 1986. The cytosolic receptor binding affinities and AHH induction potencies of 29 polynuclear aromatic hydrocarbons. *Toxicol. Lett.* 34:67-74.
- Plank, W.S., H. Pak, and R.V. Zaneveld. 1972. Light scattering and suspended matter in nepheloid layers. *J. Geophys. Res.* 77:1689-1694.
- Pohl, R.J. and J.R. Fouts. 1980. A rapid method for assaying the metabolism of 7-ethoxyresorufin by microsomal subcellular fractions. *Anal. Biochem.* 107:150-155.
- Porte, C., P. Lemaire, L.D. Peters, and D.R. Livingstone. 1995. Partial Purification and Properties of Cytochrome P450 from Digestive Gland Microsomes of the Common Mussel, *Mytilus edulis* L. *Mar. Environ. Res.* 39:27-31.
- Powell, E.N., T.J. Bright, A. Woods, and S. Gittings. 1983. Meiofauna and the thiebios in the East Flower Garden brine seep. *Mar. Biol.* 73:269-283.
- Preece, A. 1972. *A manual for histologic technicians*. Little, Brown and Company, Boston. 428 pp.
- Prothro, M.G. 1993. Office of Water Policy and Technical Guidance on Interpretation and Implementation of Aquatic Life Metals Criteria. Memorandum dated 1 October 1993. U.S. Environmental Protection Agency. Washington, DC. 48 pp.
- Rabalais, N.N. 1988. Hypoxia on the continental shelf of the northwestern Gulf of Mexico, pp. 81-87. In: T. Mitchell, ed. *Physical Oceanography of the Louisiana-Texas Continental Shelf*. OCS Study MMS 88-0065 U.S. Dept. of the Interior, Minerals Management Service, Gulf of Mexico OCS Regional Office, New Orleans, LA, 197 pp.
- Rabalais, N.N., B.A. McKee, D.J. Reed, and J.C. Means. 1991. Fate and effects of nearshore discharges of OCS produced waters, Vols. I-III OCS Study MMS 91-0004 to 91-0006. U.S. Dept. of the Interior,

Minerals Management Service, Gulf of Mexico OCS Region, New Orleans, LA, Vol. I-48 pp., Vol. II-337 pp. and Vol. III-225 pp.

- Raffaelli, D. 1982. An assessment of the potential of major meiofauna groups for monitoring organic pollution. *Mar. Environ. Res.* 7:151-164.
- Raffaelli, D.G. and C.F. Mason. 1981. Pollution monitoring with meiofauna using the ratio of nematodes to copepods. *Mar. Pollut. Bull.* 12:158-163.
- Renton, K.W. and R.F. Addison. 1994. Hepatic microsomal mono-oxygenase activity and P451A mRNA in North Sea dab *Limanda limanda* from contaminated sites. *Mar. Ecol. Progr. Ser.* 91:65-69.
- Rezak, R., T.J. Bright, and D.W. McGrail. 1985. Reefs and banks of the northwestern Gulf of Mexico: Their geological, biological, and physical dynamics. John Wiley & Sons, New York. 259 pp.
- Riley, G.A. 1937. The significance of Mississippi River discharge of biological conditions in the northern Gulf of Mexico. *J. Mar. Res.* 1:60-74.
- Robinson, M.K. 1973. Atlas of monthly mean sea surface and subsurface temperature and depth of the top of the thermocline, Gulf of Mexico and Caribbean Sea. University of California at San Diego, Scripps Institution of Oceanography, SIO Ref. 73-8, 105 pp.
- Roch, M. and J.A. McCarter. 1984. Hepatic metallothionein production and resistance to heavy metals by rainbow trout (*Salmo gairdneri*) - II held in a series of contaminated lakes. *Comp. Biochem. Physiol.* 77:77-82.
- Roesijadi, G. 1981. The significance of low molecular weight, metallothionein-like proteins in marine invertebrates: current status. *Mar. Environ. Res.* 4:167-179.
- Rogers, R.M., Jr. 1977. Trophic interrelationships of selected fishes on the continental shelf of the northern Gulf of Mexico. Ph.D. dissertation, Texas A&M University, College Station, TX, 244 pp.
- Romeyn, K. and L.A. Bouwman. 1983. Food selection and consumption by estuarine nematodes. *Hydrobiol. Bull.* 17:103-109.
- Rosenberg, R. 1972. Benthic faunal recovery in a Swedish fjord following the closure of a sulphite pulp mill. *Oikos* 23:92-108.
- Safe, S.H. 1990. Polychlorinated biphenyls (PCBs), dibenzo-p-dioxins (PCDDs), dibenzofurans (PCDFs) and related compounds: environmental and mechanistic considerations which support the

- development of toxic equivalency factors (TEFs). *Crit. Rev. Toxicol.* 21:51-88.
- Sahl, L.E. and W.J. Merrell, Jr. 1987. Salinity, temperature and mixing on the Texas continental shelf. *Contrib. Mar. Sci.* 30:1-16.
- SAIC (Science Applications International Corporation). 1989. Gulf of Mexico Physical Oceanography Program; final report: year 5. Volume II: Technical Report. OCS Report MMS 89-0068. U.S. Dept. of the Interior, Minerals Management Service, Gulf of Mexico OCS Region, New Orleans, LA. 333 pp.
- Sanders, H.L. 1978. *Florida* oil spill impact on the Buzzards Bay benthic fauna: West Falmouth. *J. Fish. Res. Board Can.* 35:717-730.
- Sanders, H.L., J.F. Grassle, and G.R. Hampson. 1972. The West Falmouth oil spill. I. Biology. Woods Hole Oceanographic Inst., Tech. Rept. WHOI-72-20. 23 pp.
- Sanders, H.L., J.F. Grassle, G.R. Hampson, L.S. Morse, S. Garner-Price, and C.C. Jones. 1980. Anatomy of an oil spill: long-term effects from the grounding of the barge *Florida* off West Falmouth, Massachusetts. *J. Mar. Res.* 38:263-280.
- SAS Institute Inc. 1990. SAS/STAT User's Guide, Version 6, fourth edition, Volume 2. Cary, NC. SAS Institute Inc. 846 pp.
- Schlenk, D. and D.R. Buhler. 1988. Cytochrome P-450 and phase II activities in the gumboat chiton *Cryptochiton stelleri*. *Aquat. Toxicol.* 13:167-187.
- Schlenk, D. and D.R. Buhler. 1989a. Xenobiotic biotransformation in the Pacific oyster (*Crassostrea gigas*). *Comp. Biochem. Physiol.* 94:469-475.
- Schlenk, D. and D.R. Buhler. 1989b. Determination of multiple forms of cytochrome P-450 in microsomes from the digestive gland of *Cryptochiton stelleri*. *Biochem. Biophys. Res.* 163:476-480.
- Schultz, M. and J. Schultz. 1982. Induction of hepatic tumors with 7,12-dimethylbenzanthracene in two species of viviparous fishes (genus *Poeciliopsis*). *Environ. Res.* 27:337-351.
- Seinhorst, J.W. 1959. A rapid method for the transfer of nematodes from a fixative to anhydrous glycerin. *Nematologica* 4:67-69.
- Shannon, C.E. and W. Weaver. 1949. The mathematical theory of communication. University of Illinois Press, Urbana, IL.

- Sherman, K.M. and B.C. Coull. 1980. The response of meiofauna to sediment disturbance. *J. Experim. Mar. Biol. Ecol.* 46:59-71.
- Sherman K.M., D.A. Meeter, and J.A. Reidenauer. 1984. A technique for subsampling an abundant taxon while completely sorting other taxa. *Limnol. Oceanogr.* 29:433-439.
- Shideler, G.L. 1978. A sediment dispersal model for the south Texas continental shelf, northwestern Gulf of Mexico. *Mar. Geol.* 26:289-313.
- Shideler, G.L. 1979. Regional surface turbidity and hydrographic variability on the south Texas continental shelf. *J. Sediment. Petrol.* 49:1195-1208.
- Shideler, G.L. 1981. Development of the benthic nepheloid layer on the south Texas continental shelf, western Gulf of Mexico. *Mar. Geol.* 41:37-61.
- Shiells, G.M. and K.J. Anderson. 1985. Pollution monitoring using the nematode/copepod ratio - a practical application. *Mar. Pollut. Bull.* 16:62-68.
- Shinn, E.A., B.H. Lidz and C.D. Reich. 1993. Habitat impacts of offshore drilling: Eastern Gulf of Mexico. Minerals Management Service, New Orleans, LA. 73 pp.
- Silberman, J.D., S.K. Sarver, and P.J. Walsh. 1994. Mitochondrial DNA variation in seasonal cohorts of spiny lobster (*Panulirus argus*) postlarvae. *Mol. Mar. Biol. Biotech.* 3:165-170.
- Simpson, E.H. 1949. Measurement of diversity. *Nature* 163:688.
- Sindermann, C.J. 1979. Pollution-associated diseases and abnormalities of fish and shellfish: A review. *Fish. Bull.* 76:717-741.
- Sindermann, C.J. 1983. An examination of some relationships between pollution and disease. *Rapp. P.-V. Reun. Cons. Int. Explor. Mer.* 182:37-43.
- Sklar, F.H. and R.E. Turner. 1981. Characteristics of phytoplankton production off Barataria Bay in an area influenced by the Mississippi River. *Contribut. Mar. Sci.* 24:93-106.
- Somers, K.M. 1991. Characterizing size-specific fecundity in crustaceans. In: A. Wenner, and A. Kuris, eds. *Crustacean egg production*. Balkema, Netherlands. 401 pp.
- Southwest Research Institute. 1981. Ecological investigations of petroleum production platforms in the Central Gulf of Mexico. In: C.A. Bedinger,

- ed. Final report to the Bureau of Land Management on contract AA551-CT8-17.
- Spazier, E., V. Storch, and T. Braunbeck. 1992. Cytopathology of spleen in eel *Anguilla anguilla* exposed to a chemical spill in the Rhine River. *Dis. Aquat. Org.* 14:1-22.
- Spies, R.B. and D.J. DesMarais. 1983. Natural isotope study of trophic enrichment of marine benthic communities by petroleum seepage. *Mar. Biol.* 73:67-71.
- Spies, R.B., P.H. Davis, and D. Stuermer. 1980. Ecology of a petroleum seep off the California coast, pp. 229-263. In R. Geyer. *Marine Environmental Pollution*. Elsevier, Amsterdam.
- Spies, R.B., J.S. Felton, and L. Dillard. 1982. Hepatic mixed-function oxidases in California flatfishes are increased in contaminated environments and by oil and PCB ingestion. *Mar. Biol.* 70:117-127.
- Spies, R.B., D.D. Hardin, and J.P. Teal. 1988. Organic enrichment or toxicology? A comparison of the effects of kep and crude oil in sediments on the colonization and growth of benthic infauna. *J. Exp. Mar. Ecol.* 124:261-282.
- Stander, G.H. and J.A.V. Venter. 1968. Oil pollution in South Africa, pp. 231-259. In: International conference on oil pollution of the sea. 7-9 October 1968 at Rome, Report of Proceedings.
- Stebbing, A.R.D., V. Dethlefsen, and M. Carr. 1992. Biological effects of contaminants in the North Sea: Appendix I. Chemistry: Organic and trace metal data. *Mar. Ecol. Progr. Ser.* 91:331-348.
- Stegeman, J.J. 1985. Benzo[a]pyrene oxidation and microsomal enzyme activity in the mussel (*Mytilus edulis*) and other bivalve mollusc species from the western North Atlantic. *Mar. Biol.* 89:21-30.
- Stegeman, J.J., A.V. Klotz, B.R. Woodin, and A.M. Pajor. 1981. Induction of hepatic cytochrome P-450 in fish and the indication of environmental induction in scup (*Stenotomus chrysops*). *Aquat. Toxicol.* 1:197-221.
- Stegeman, J.J., A.M. Pajo, and P. Thomas. 1982. Influence of estradiol and testosterone on cytochrome P450 and monooxygenase activity in immature brook trout *Salvelinus fontinalis*. *Biochem. Pharmacol.* 31:3979-3989.
- Stegeman, J.J., K.W. Renton, B.R. Woodin, Y. -S. Zhang, and R.F. Addison. 1990. Experimental and environmental induction of cytochrome P450E in fish from Bermuda waters. *J. Exp. Mar. Biol. Ecol.* 138:49-67.

- Stegeman, J.J., F.Y. Tend, and E.A. Snowberger. 1987. Induced cytochrome P450 in Winter Flounder (*Pseudopleuronectes americanus*) from coastal Massachusetts evaluated by catalytic assay and monoclonal antibody probes. *Can. J. Fish. Aquat. Sci.* 44:1270-1277.
- Swanson, H.I. and G.H. Pewdew. 1991. Detection of the Ah receptor in rainbow trout. Use of 2-azido-3-[¹²⁵I]iodo-7,8-dibromodibenzo-p-dioxin in cell culture. *Toxicol. Lett.* 58:85-95.
- Swartz, R.C., F.A. Cole, D.W. Schults, and W.A. Debea. 1986. Ecological changes in the Southern California Bight near a large sewage outfall: benthic conditions in 1980 and 1983. *Mar. Ecol. Progr. Ser.* 31:1-13.
- Talbot, V. and R.J. Magee. 1978. Naturally occurring heavy metal binding proteins in invertebrates. *Arch. Environ. Contam. Toxicol.* 7:73-81.
- Temple, R.F., D.L. Harrington, and J.A. Martin. 1977. Monthly temperature and salinity measurements of continental shelf waters in the Western Gulf of Mexico 1963-1965. NOAA Tech. Rep., SSRF-707, 29 pp.
- Tetra Tech. 1981. Technical evaluation of County Sanitation Districts of Los Angeles County Joint Water Pollution Control Plant Section 301(h) application for modification of secondary treatment requirements for discharge into marine waters. Prepared for U.S. EPA, Washington, DC. Tetra Tech, Inc. Bellevue, WA. 639 pp.
- Tetra Tech. 1984. Technical review of the Los Angeles Sanitation District's Section 301(h) application for modification of secondary treatment requirements for discharge into marine waters. Prepared for U.S. EPA, Washington, DC. Tetra Tech, Inc. Bellevue, WA. 259 pp.
- Thiel, H. 1975. The size structure of the deep-sea benthos. *Internationale Revue gestamen der Hydrobiologia* 60:575-606.
- Thiel, H. 1978. Benthos in upwelling regions, pp. 124-138. In: R. Boje and M. Tomczak, eds. *Upwelling ecosystems*. Springer-Verlag, Berlin.
- Thomas, M.L.H. 1978. Comparison of oiled and unoiled intertidal communities in Cheabucto Bay, Nova Scotia. *J. Fish. Res. Board Can.* 35:707-711.
- Thomas, P. 1990. Teleost model for studying the effects of chemicals on female reproductive endocrine function. *J. Exper. Zool.* 4:126-128.
- Tietjen, J.H. and J.J. Lee. 1984. The use of free-living nematodes as a bioassay for estuarine sediments. *Mar. Environ. Res.* 11:233-251.
- Tillitt, D.E., G.T. Ankley, D.A. Verbrugge, J.P. Giesy, J.P. Ludwig, and T.J. Kubiak. 1991a. H4IIE cell bioassay derived 2,3,7,8-tetrachlorodibenzo-p-dioxin equivalents in colonial fish-eating

- waterbird eggs from the Great Lakes. *Arch. Environ. Contam. Toxicol.* 21:91-101.
- Tillitt, D.E., J.P. Giesy, and G.T. Ankley. 1991b. Characterization of the H4IIE rat hepatoma cell bioassay as a tool for assessing toxic potency of planar halogenated hydrocarbons in environmental samples. *Environ. Sci. Technol.* 25:87-92.
- Tillitt, D.E., T.J. Kubiak, G.T. Ankley, and J.P. Giesy. 1993. Dioxin-like toxic potency on Forster's tern eggs from Green Bay, Lake Michigan, North America. *Chemosphere* 26:2079-2084.
- Trotter, W.J., S.J.V. Young, J.L. Casterline Jr., J.A. Bradlaw, and L.R. Kamps. 1982. Induction of aryl hydrocarbon hydroxylase activity in cell cultures by Aroclors, residues from Yusho oil samples, and polychlorinated biphenyl residues from fish samples. *J. Assoc. Off. Anal. Chem.* 65:838-844.
- Turner, R.E. and R.L. Allen. 1982. Bottom water oxygen concentration in the Mississippi River Delta Bight. *Mar. Sci.* 25:161-172.
- Ulm, W.F. 1983. A volumetric temperature-salinity census for the continental shelf of the northwestern Gulf of Mexico, 1963-1965. M.S. Thesis. Texas A&M University, College Station, TX, 56 pp.
- Underwood, A.J. 1993. The mechanics of spatially replicated sampling programmes to detect environmental impact in a variable world. *Austr. J. Ecol.* 18:99-116.
- U.S. EPA. 1989. Preparing perfect project plans. EPA/600/9-89/087. Risk Reduction Engineering Laboratory. Cincinnati, OH. 61 pp.
- U.S. EPA. 1991. Methods for the determination of metals in environmental samples. EPA/600/4-91/010. Office of Research and Development. Washington, DC. pp. 227-239.
- U.S. EPA. 1994a. Trace metals briefing book. Measurement of Contaminants in the Environment Conference. 3-5 May 1994. Norfolk, VA.
- U.S. EPA. 1994b. Use of the water-effect ratio in water quality standards. Office of Science and Technology Memorandum. 22 February 1994. Washington, DC. Appendix C.
- U.S. Fish and Wildlife Service. 1992. Amphipod solid-phase and sea urchin porewater toxicity tests of Tampa Bay, Florida sediments. Report submitted by the U.S. Fish and Wildlife Service to National Oceanic and Atmospheric Administration, Ocean Assessment Division, Seattle, WA, 9 pp. + 19 appendices.

- Ustach, J.F. 1979. Effects of sublethal oil concentrations on the copepod, *Nitocra affinis*. *Estuaries* 2:273-276.
- van Damme, D., R. Herman, Y. Sharma, M. Holvoet, and P. Martens. 1980. Benthic studies of the Southern Bight of the North Sea and its adjacent continental estuaries. Progress Report II: fluctuations of the meiobenthic communities in the Westerschelde estuary. ICES, CM/L 23:131-170.
- van der Weiden, M.E.J., H.J.H. Tibosch, R. Bleumink, T.L. Sinnige, C. Van de Guchte, W. Seinen, and M. Van den Berg. 1993. Cytochrome P4501A induction in the common carp (*Cyprinus carpio*) following exposure to contaminated sediments halogenated polyaromatics. *Chemosphere* 27:1297-1309.
- Van Veld, P.A., D.J. Westbrook, B.R. Woodin, R.C. Hale, C.L. Smith, F.J. Huggett, and J.J. Stegeman. 1990. Induced cytochrome P450 in intestine and liver of spot (*Leiostomus xanthurus*) from a polycyclic aromatic hydrocarbon contaminated environment. *Aquat. Toxicol.* 17:119-132.
- Varanasi, U., J.E. Stein, and M. Nishimoto. 1989. Biotransformation and deposition of polycyclic aromatic hydrocarbons (PAH) in fish, pp. 93-150. In: U. Varanasi, ed. *Metabolism of polycyclic aromatic Hydrocarbon in the aquatic environment*. CRC Uniscience Series, CRC Press Inc., Boca Raton, FL.
- Vidakovic, J. 1983. The influence of raw domestic sewage on density and distribution of meiofauna. *Mar. Pollut. Bull.* 14:84-88.
- Warwick, R.M. 1988a. Analysis of community attributes of the macrobenthos of Frierfjord/Langesundfjord at taxonomic levels higher than species. *Mar. Ecol. Progr. Ser.* 46:167-170.
- Warwick, R.M. 1988b. Effects on community structure of a pollutant gradient summary. *Mar. Ecol. Progr. Ser.* 46:207-211.
- Warwick, R.M., M.R. Carr, K.R. Clarke, J.M. Gee, and R.H. Green. 1988. A mesocosm experiment on the effects of hydrocarbon and copper pollution on a sublittoral soft-sediment meiobenthic community. *Mar. Ecol. Progr. Ser.* 46:181-191.
- Warwick, R.M. and K.R. Clarke. 1993. Comparing the severity of disturbance: a meta-analysis of marine macrobenthic community data. *Mar. Ecol. Progr. Ser.* 92:221-231.
- Warwick, R.M. and J.M. Gee. 1984. Community structure of estuarine meiobenthos. *Mar. Ecol. Progr. Ser.* 18:97-111.

- Webb, D.G. 1984. Resource predictability and reproductive strategy in *Tisbe cucumariae* Humes (Copepoda: Harpacticoida). *J. Experiment. Mar. Biol. Ecol.* 77:1-10.
- Webb, D.G. and P.A. Montagna. 1993. Reproductive patterns in meiobenthic Harpacticoida (Crustacea, Copepoda) of the California continental shelf. *Cont. Shelf Res.* 13:723-739.
- Weeks, B.A., D.P. Anderson, A.P. DuFour, A. Fairbrother, A.J. Goven, G.P. Lahuis, and G. Peters. 1992. Immunological biomarkers to assess environmental stress, pp. 211-234. In: R.J. Huggett, R.A. Kimerle, P.M. Mehrle, Jr. and H.L. Bergman, eds. *Biomarkers: biochemical, physiological, and histological markers of anthropogenic stress.* Lewis Publishers, Ann Arbor, MI.
- Wenner, A.M., J. Dugan, and H. Wells. 1991. Estimating egg production in multi-brooding populations. In: A. Wenner and A. Kuris, eds. *Crustacean egg production.* Balkema, Netherlands. 401 pp.
- Whitfield, M. 1969. Eh as an operational parameter in estuarine studies. *Limnol. Oceanogr.* 14:547-558.
- Whitlock, J.P., Jr. 1986. The regulation of cytochrome P450 gene expression. *Annu. Rev. Pharmacol. Toxicol.* 26:333-369.
- Widdows, J. 1985. Physiological responses to pollution. *Mar. Pollut. Bull.* 16:129-134.
- Wieser, W. 1953. Die beziehung zwischen mundhohlengestalt, ernahrungsweise und vorkommen bei freilebenden marinen nematoden. *Archives fur Zoologie*, 4: 439-484.
- Willett, K., M. Steinberg, J. Thomsen, T.R. Narasimham, S. Safe, S. McDonald, K. Beatty, and M.C. Kennicutt II. 1995. Exposure of killifish to benzo[a]pyrene: comparative metabolism, DNA adduct formation and aryl hydrocarbon (Ah) receptor agonist activities. *Comp. Biochem. Physiol.*
- Wilson, E.A., E.N. Powell, T.L. Wade, R.J. Taylor, B.J. Presley, and J.M. Brooks. 1992. Spatial and temporal distributions of contaminant body burden and disease in Gulf of Mexico oyster populations: The role of local and large-scale climatic controls. *Helgol. Meeresunt.* 46:201-235.
- Wiseman, W.J., Jr., R.E. Turner, F.J. Kelly, L.J. Rouse, Jr., and R.F. Shaw. 1986. Analysis of biological and chemical associations near a turbid coastal front during winter 1982. *Contribut. Mar. Sci.* 29:141-151.
- Wolke, R.E. 1992. Piscine macrophage aggregates: A review. *Ann. Rev. Fish Dis.* 2:91-108.

- Wolke, R.E., C.J. George, and V.S. Blazer. 1985. Pigmented macrophage accumulations (MMC; PMB): Possible monitors of fish health, pp. 93-97. In: W.J. Hargis, Jr., ed. Parasitology and pathology of the world oceans. NOAA Tech. Rep. NMFS 25, Washington, DC.
- Zacharewski, T., L. Safe, S. Safe, B. Chittim, D. DeVault, K. Wibers, P.A. Bergqvist, and C. Rappe. 1989. Comparative analysis of polychlorinated dibenzo-p-dioxin and dibenzofuran congeners in Great Lakes fish by gas chromatography-mass spectrometry and in vitro enzyme induction activities. Environ. Sci. Technol. 23:730-735.



The Department of the Interior Mission

As the Nation's principal conservation agency, the Department of the Interior has responsibility for most of our nationally owned public lands and natural resources. This includes fostering sound use of our land and water resources; protecting our fish, wildlife, and biological diversity; preserving the environmental and cultural values of our national parks and historical places; and providing for the enjoyment of life through outdoor recreation. The Department assesses our energy and mineral resources and works to ensure that their development is in the best interests of all our people by encouraging stewardship and citizen participation in their care. The Department also has a major responsibility for American Indian reservation communities and for people who live in island territories under U.S. administration.



The Minerals Management Service Mission

As a bureau of the Department of the Interior, the Minerals Management Service's (MMS) primary responsibilities are to manage the mineral resources located on the Nation's Outer Continental Shelf (OCS), collect revenue from the Federal OCS and onshore Federal and Indian lands, and distribute those revenues.

Moreover, in working to meet its responsibilities, the **Offshore Minerals Management Program** administers the OCS competitive leasing program and oversees the safe and environmentally sound exploration and production of our Nation's offshore natural gas, oil and other mineral resources. The **MMS Royalty Management Program** meets its responsibilities by ensuring the efficient, timely and accurate collection and disbursement of revenue from mineral leasing and production due to Indian tribes and allottees, States and the U.S. Treasury.

The MMS strives to fulfill its responsibilities through the general guiding principles of: (1) being responsive to the public's concerns and interests by maintaining a dialogue with all potentially affected parties and (2) carrying out its programs with an emphasis on working to enhance the quality of life for all Americans by lending MMS assistance and expertise to economic development and environmental protection.