



GROWER SUPPLIES

2024 CATALOG

ALTOGETHER. BETTER.

Plants & Seed | Grower Supplies | Retail | CEA | Construction



ABOUT GRIFFIN

Griffin is a partner to horticulture professionals. Family owned and operated since 1947, we apply our knowledge, experience and resources to enhance customer success from production to retail.

End-to-end solutions are our specialty. We represent the industry's leading breeders and producers, spanning seed and vegetative, bedding and potted crops, ornamentals and edibles. Our grower supplies offer includes reliable inputs and equipment to help your crops thrive through all production stages. Finally, our quality retail products drive add-on sales for you, while enhancing consumer success and enjoyment.

To learn more about our company, we invite you to visit us online at www.griffins.com, follow us on LinkedIn, Instagram and Facebook.

A LEGACY OF QUALITY AND SERVICE

Charlie Griffin founded his namesake company in 1947 with a simple vision: To maximize products and service for his customers. Originally headquartered in Reading, Mass., his was a one-man operation with a limited offering, delivering supplies to growers in the local community.

Ken Hyslip, Sr. first became an employee of Griffin Greenhouse Supplies in 1952, as a truck driver at the age of 17. At the time, Griffin operated from a single location with no more than five employees. He went on to buy the business from the Griffin family in 1968. Under his leadership, Griffin grew steadily across the East Coast.

Today, Griffin thrives among horticulture's premier distributors, serving growers and retailers nationwide. Under the leadership of the Hyslip family, the business has earned a reputation for operational excellence, quality products, and first-class customer service.

We know you have many choices among supplier partners, and we sincerely thank you for your business. We look forward to serving you in the season ahead.

GRIFFIN IS COMMITTED TO EXCEPTIONAL CUSTOMER SERVICE

Our goal is simple: To meet your needs and exceed your expectations. From the time you place your order until it's delivered to your location, our team works to treat you with the utmost care every step of the way.

We strive to deliver every order on time and in full. We'll contact you 24 hours before your delivery date to ensure you're ready for the product. If we're unable to honor a delivery date, we'll notify you in advance and make every effort to reschedule at a time that's convenient for you. In the event of any issue, we're dedicated to working with you and our suppliers as needed to find a swift resolution.

Your opinion matters to us! Customer feedback is key to helping our team deliver on our service pledge. Please don't hesitate to contact me directly – by phone or e-mail – with any questions or input that may help us serve you better.

Dan Lowery | Corporate Customer Service Manager | 800.888.0054 x81404 | dlowery@griffinmail.com

GRIFFIN LOCATIONS

Fourteen Distribution Centers Throughout the United States



TO PLACE AN ORDER

Phone: 1.800.888.0054
Grower / Retail Fax: 1.877.636.3623
E-mail: orders@griffinmail.com

GENERAL QUESTIONS

1.800.888.0054

ONLINE ORDERING

www.griffins.com

OFFICE HOURS

Our office is open for normal business and telephone service from 8:00 AM to 5:00 PM, Monday through Friday.

WAREHOUSES

Hours for pick-up orders and counter sales are 8:00AM to 5:00PM, local time, Monday through Friday.

BRANCH LOCATIONS

5303 Havana St, Suite 120
Denver, CO 80239

20 Grandview Ct
Cheshire, CT 06410

10 Middle River Drive
Stafford Springs, CT 06076

5350 Ball Ground Hwy
Ball Ground, GA 30107

2143 Internationale Parkway
Suite 400, Woodridge, IL 60517

1619 Main St
Tewksbury, MA 01876

50 W Gray Rd
Gray, ME 04039

1240 B Hwy 77
Bridgeton, NJ 08302

1 Ellis Dr
Auburn, NY 13021

2165 Montauk Hwy
Brookhaven, NY 11719

126 Van Guysling Ave
Schenectady, NY 12305

58 S.E. 223rd Ave.,
Gresham, OR 97030

200 Mountain View Rd
Morgantown, PA 19543

5612 Pride Rd
Richmond, VA 23224







PRODUCTION SUPPLIES

Griffin's roots are in production supplies, and they remain the backbone of our company today. We're proud to offer reliable inputs and equipment to help your crops thrive through all growing stages. Look to us for containers, growing media, chemistry and more from the manufacturers you know and trust. With the increasing demand for more efficient and environmentally friendly methods of growing food crops, we now specialize in Controlled Environment Agriculture for food and cannabis. Our 14 branch locations service customers nationwide with convenience and efficiency. Shop all of our grower products and place your order with your Griffin sales representative or on www.griffins.com.

RETAIL SOLUTIONS

Griffin is the independent retailer's best source for lawn & garden products. We make it easy for IGCs to do business, with complete vendor offerings, low order minimums and efficient shipping solutions. Raise your retail game with help from our experts! Count on us for seasonal promotion ideas, merchandising best practices and space-planning tips to maximize your display areas and drive sales. Shop all of our retail products and place your order with your Griffin sales representative or on www.griffins.com.

GREEN GOODS

Griffin is a full-service broker of live goods to professional growers. Our assortment includes seed and vegetative material, bedding and potted crops, ornamentals and edibles from the industry's most respected breeders and producers. We're uniquely committed to the seed business, stocking more than 3,300 variety/product-form combinations in our state-of-the-art seed operations facility. Count on us for annuals, perennials, grasses, herbs and vegetables. We're serious about seed quality: Inventory monitoring and regular performance testing ensure every variety meets its full potential, from the greenhouse to the garden center. Browse our complete portfolio and book your product selections through your Griffin sales representative or on www.griffins.com.

TECHNICAL SUPPORT

GGSPRO is our in-house technical services team. With more than a century of combined experience, GGSPRO delivers prompt, practical and accurate support to Griffin customers nationwide. The team's areas of expertise include: Crop culture, sanitation protocols, plant physiology and pathology, chemical controls, biological control agents (BCAs), and plant nutrition. GGSPRO endorses a holistic approach to plant protection, utilizing a mix of cultural practices alongside chemical and biological controls to manage pests and diseases. Visit www.griffins.com/ggspro or contact GGSPRO at **1.800.888.0054**.

CONSTRUCTION SERVICES

Our construction team assists with all aspects of greenhouse planning, construction and maintenance. Whether it's a new operation or expansion, upgrades or replacements, we can help with options to meet your needs and fit your budget. We offer a full range of equipment to help you grow efficiently and profitably. Look to us for greenhouse structures, films and coverings, lighting, climate control, irrigation, carts and more. Visit us at www.griffins.com/construction to learn more about our product portfolio, see our project showcase, and submit a request for a free quotation.

Table of **CONTENTS**



GREENHOUSES

11



COVERINGS

29



RETAIL

105



CONTAINERS

121



FERTILIZERS

247



IRRIGATION

285



CLIMATE CONTROL

55



SHADING

79



BENCHING

83



EQUIPMENT

93



GROUND COVER

195



GENERAL SUPPLIES

199



SOILLESS MIXES AND
SPECIALTY MEDIA

215



CROP PROTECTION

323



PROTECTIVE EQUIPMENT
AND SPRAYERS

377



INDEX

390

CONNECT *with us*

SOCIAL MEDIA

Add us to your social network! For news on products, events and more, follow us on LinkedIn and like us on Facebook. Simply log on and search "Griffin Greenhouse Supplies." Also follow us on Instagram. Log on and search "Griffin Greenhouse".



GRIFFIN GAZETTE

Published especially for top customers, the Griffin Gazette is loaded with news you can really use. Our team serves up timely production advice, retail inspiration, and product and variety information to help you bring your best crop to market.

Check out the digital Gazette for exclusive bonus content not available in print! Visit www.griffins.com/publications to browse the Gazette archives.



E-MAIL PROGRAMS

We offer several topical e-mail programs for growers and retailers. Tailor your subscriptions to meet your unique needs and interests, from technical tips to product specials and much more. Visit www.griffins.com to subscribe or update your preferences.

GRIFFIN CATALOGS

From production to point-of-sale, we've got you covered! Our Grower Supplies, Seed & Plant, CEA and Retail catalogs feature must-have inputs from quality manufacturers, breeders and producers.

Contact your Griffin sales representative to request our catalogs, or check out our convenient and portable digital editions at www.griffins.com/publications.



SOURCING HAS NEVER BEEN THIS SIMPLE

One login connects you to the industry's broadest selection of products for growers and independent retailers:

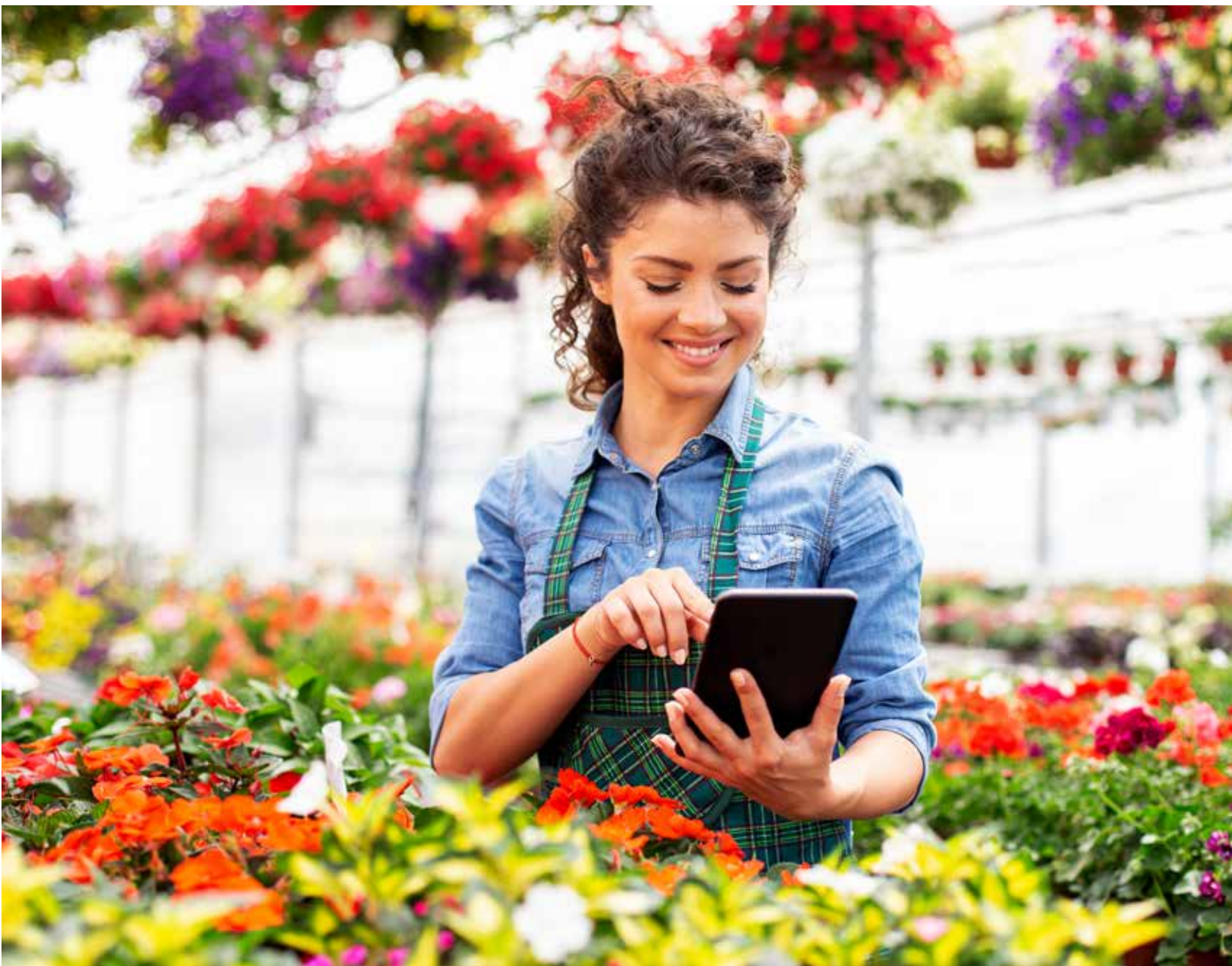

- Green goods including seed, cuttings and young plants
- Production supplies including containers, growing media and plant protection products
- Greenhouse structures and equipment
- Retail supplies including lawn & garden products, accessories and gift items



CHECK OUT OUR
CLEARANCE ITEMS!

Place your order today: www.griffins.com



GriffinExpo

SAVE THE DATES!

Virtual Expo

August 19 - October 31, 2024

In-Person Expos

August 28-29, 2024

*Silver State Pavilion at Grand Sierra
Reno, NV (**New Location**)*

September 25-26, 2024

*New Jersey Convention and Expo Center
Edison, NJ*

GREENHOUSES





Are you considering expanding
or updating your infrastructure?

Griffin's Construction Division guides our customers through technical sales.

Our Specificities Include:

Greenhouses & Structures, Coverings, Air Circulation, Heating & Cooling Systems, Environmental Controls, Vents and Curtains, Shade Systems, Production Lines, Lighting, Irrigation, Benching & Carts.

Our consultations focus on matching your facility upgrades to your organization's short term and long term goals. Partner with us on your next project.





PLANNING A NEW GREENHOUSE?

Here is a helpful step by step checklist

- STEP 1**
Do you need stamped engineered drawing for wind and snow loads?
Stamped engineered drawing are required when applying for building / occupancy permits. Check with your municipal or county government to ask if this applies to your project.
- STEP 2**
Decide on the Builder for Your Greenhouse
- STEP 3**
Choose the Greenhouse Style/Frame (pg. 13-28)
- STEP 4**
Types of Coverings (pg. 29-53)
- STEP 5**
Doors and Hardware (pg. 53)
- STEP 6**
Cooling & Ventilation Systems (pg. 56-61, 65)
- STEP 7**
Heating Systems (pg. 62-63, 65-66)
- STEP 8**
Environmental Controls (pg. 64, 67-72)
- STEP 9**
Benching (pg. 83-92)
- STEP 10**
Call Griffin's Construction Department for a written proposal.
- STEP 11**
Order your greenhouse!



Why choose a Gothic Style Greenhouse over a Quonset Hoop House?

Better Light Transmission:

The steep roof angle allows for more light waves to enter the greenhouse and results in a more uniform crop.

Ideal for Natural Ventilation:

The ridge angle is better for connecting mid roof vents than a Quonset hoop house.

More Head Room:

Gothic style greenhouses offer more head room at the side wall compared to a Quonset hoop house.

In Case of Heavy Snow:

Gothic style greenhouses were originally designed to prevent snow from accumulating on top of the structure.

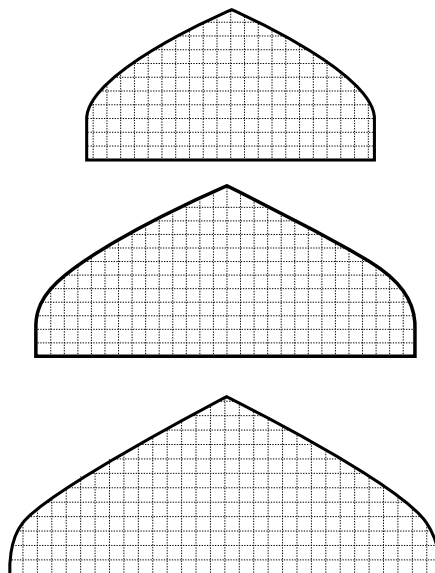

Griffin Construction Department

Partner with us on your next project.
Call for consultation and quote:
1.800.888.0054 then press 3.





Ovaltech: Ground-to-Ground

The popularity of the Ovaltech testifies to its versatility and durability. It has become the standard in terms of wind and snow resistance. Its efficient design lets abundant light in, which promotes uniform crop growth across the greenhouse. Furthermore, it is engineered to enhance natural ventilation, creating a favorable environment for healthy crops while saving energy. **Stamped engineered drawings are available upon request.**

Griffin's #1 Selling Greenhouse

Ovaltech IV

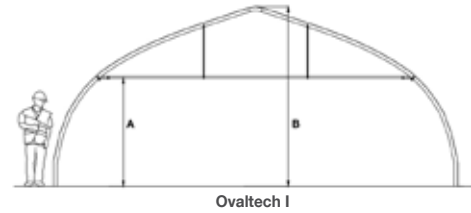

Ovaltech I

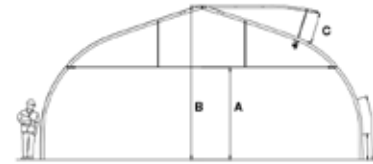

Ovaltech III

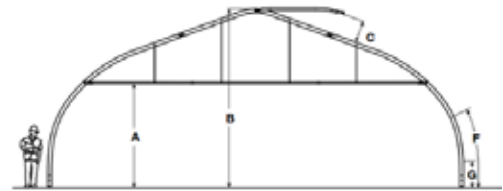

Ovaltech IV

	Ovaltech I			Ovaltech III				Ovaltech IV					
Width	20'	25'	27'	25'	30'	32'	35'	25'	30'	32'	35'	42'	
Arch spacing	5'		6'	3' - 5' - 6'		3' - 5' - 6'		6'	6'	6'	3', 4', 5', 6'		
Inside clearance A	6'9"			9'-1"				9'-1"			10"		
Total height B	11'-2"	11'- 6-3/8"		14'-1"	14'-11"	15'-2"	15'-9"	14'-1-3/16"	14'-10-5/16"	15'-2"	16'-7"	17'6"	
Tubing Dimensions	1- 5/8" x 2-3/4"			2" x 3-9/16"				2 3/4" x 4 5/16"					
Mid roof vent C	-			-	37"			-	29"	33"	27"	42"	33"
Roll up Vent F	-			72" - 84"				72" - 84"			84" - 120"		
Skirt G	-			24" - 30"				24" - 30"					





Luminosa: Gutter Connected

Available in different widths. Models 21'-4", 26'-3", 30', 31'-6" and 36' are optimized for vine crops, laid out according to European (metric) best practices, with rows spaced every 5 or 6 ft. These models are the best choice for tomatoes, cucumbers or peppers as they optimize the greenhouse space and enhance the profitability of the operation. Stamped engineered drawing are available upon request.

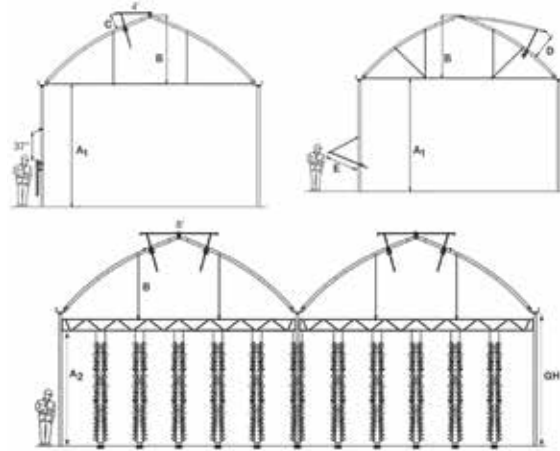

2024

Models	Series 8				Series 9			Series 11
Width	21'-4"	24'	25'	26'-3"	28'	30'	31'-6"	36'
Height under gutter GH	12' 14' 16' 18' 6m							
Inside clearance (with tube) A1	arch $1\text{-}\frac{5}{8}\text{'}$ x $2\text{-}\frac{3}{4}\text{'}$ = GH + 3"							
	arch 2' x $3\text{-}\frac{9}{16}\text{'}$ = GH + $1\text{-}\frac{5}{8}\text{'}$							arch 2' x $3\text{-}\frac{9}{16}\text{'}$ = GH + $1\text{-}\frac{5}{8}\text{'}$
	arch $2\text{-}\frac{3}{4}\text{'}$ x $4\text{-}\frac{5}{16}\text{'}$ = GH + $1\text{-}\frac{3}{8}\text{'}$							arch $2\text{-}\frac{3}{4}\text{'}$ x $4\text{-}\frac{5}{16}\text{'}$ = GH + $1\text{-}\frac{3}{8}\text{'}$
Inside clearance (with truss) A2	GH - 23" (15" truss)							GH - 29- $\frac{3}{4}$ " (22" truss)
	GH - 27- $\frac{7}{16}$ " (20" truss)							GH - 38- $\frac{3}{4}$ " (31" truss)
Height of gable B	7'-8- $\frac{1}{2}$ "	8'-3- $\frac{1}{2}$ "	8'-6- $\frac{1}{4}$ "	8'-9"	9'-3- $\frac{1}{2}$ "	9'-8- $\frac{1}{2}$ "	10'	10'-3- $\frac{5}{8}$ "
Dimension of arch tubing	1- $\frac{5}{8}$ " x 2- $\frac{3}{4}$ " or 2" x 3- $\frac{9}{16}$ " or 2- $\frac{3}{4}$ " x 4- $\frac{5}{16}$ "							2- $\frac{3}{4}$ " x 4- $\frac{5}{16}$ "
Dimension of Vents								
Roof vent (opening) C	36"	35"					34- $\frac{1}{2}$ "	
Simple 4', double 8'								
Mid-roof vent D	38- $\frac{1}{2}$ "	37- $\frac{5}{8}$ "	37- $\frac{3}{8}$ "	50- $\frac{5}{8}$ "	49- $\frac{1}{4}$ "	48- $\frac{3}{4}$ "	48- $\frac{1}{2}$ "	60- $\frac{3}{8}$ "
Side panel (opening) E								39- $\frac{1}{2}$ "
Gullottinie panel (opening) F								37"





Cold Frame & TunnelPro™

Tunnels Greenhouses

Three-season greenhouses that offer several economic advantages for producers.

This range includes two models:

Cold frame

- Designed for three-season use;
- Offers an ideal environment for the hardening of perennials and shrubs
- De-clutter main production greenhouses, especially when plants are awaiting shipment
- Provide a protected area to allow the plants to reach the optimal size

TunnelPro™

- Structure is manufactured using pregalvanized, oval tubing made of structural steel for years of corrosion protection
- Fast and easy assembly
- Built-in stop mechanism hand cranks for work crew safety
- Screw-type anchors installed below frost to ensure stability and provide superior uplift resistance
- Covering is secured with durable 1" wide, UV stabilized nylon straps that are stronger than rope and will not cut through the poly



TunnelPro™

Widths	28'		30'		31'	
Arch spacing	10'	12**	10'	12**	10'	12'
Side vent height (A)	84"	60"	84"	60"	84"	60"
Leg height (B)	63"	39"	63"	39"	63"	39"
Clearance (inside) (C)	114"	90"	126"	102"	130"	108"

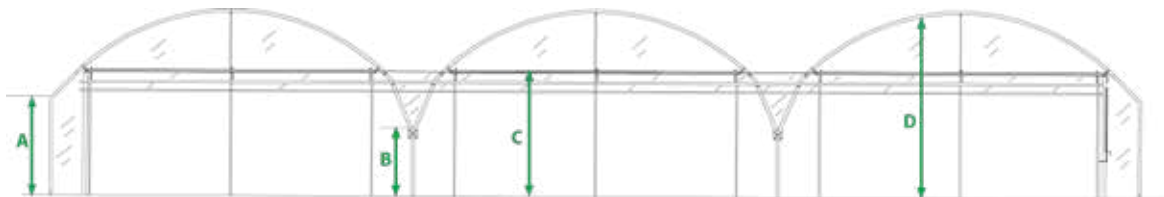



EzKit

Elevate your production site with the EZkit by Harnois, an economical yet quality storage that's easy to assemble. Upgrade your temporary storage with the customizable end walls and sunlight-permeable membrane. It is delivered as a complete kit, with a reliable 10-5 year warranty.

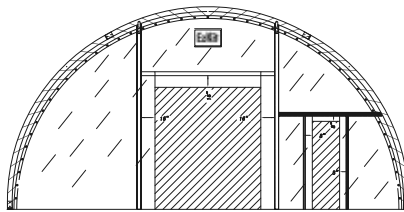

End wall easy to customize

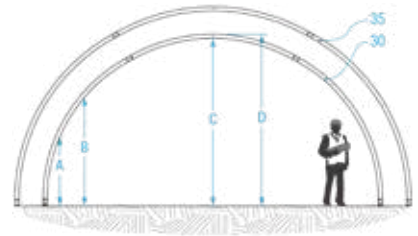

Interior clearance : Maximize storage space

	30'	35'
Available lengths	40' or 64'	40' or 64'
Spacing of arches	Every 4'	Every 4'
A (2')	7' 7"	7' 6"
B (4')	10' 3"	10' 5"
C	14' 11"	16' 8"
D	15' 2"	16' 11"

Steel structure: 2" x 3-9/16" oval tubing

- Galvanized for corrosion resistance
- Spacing of arches: every 4'
- The sill plate helps to ensure a better quality of installation
- The EXKit shelter can be installed on the ground, on a concrete foundation, or on concrete blocks (anchoring included).



Roof membrane

- Translucent membrane
- PowerShield membrane 12 oz/sq. yd., 23 mil thickness



Warranty

- 10-year limited warranty against manufacturing defects of the steel structure
- 5-year limited warranty against manufacturing defects in the tarp covering

End walls customized according to your needs

- Open ends, closed ends, closed ends with door opening
- Necessary hardware included
- Two ventilation windows included

	30'	35'
Opening width	10'	12'
Opening height	10' or 12'	12' or 14'
Door height on 2' foundation	14'	16'



Northern-Star Series | Gothic Style Greenhouses

Size	Pipe O.D.	Wall Thickness	Height 1' from side	Height 2' from side	Height 3' from side	Height 4' from side	Ridge Height	Poly Width
17'	1.660"	.083"	4'8"	5'9"	6'5"	6'11"	10'3"	28'
21'	1.660"	.083"	4'10"	5'11"	6'7"	7'2"	10'11"	36'
25'	1.660"	.083"	5'0"	6'0"	6'9"	7'4"	12'3"	40'
25'	1.900"	.095"	5'0"	6'0"	6'9"	7'4"	12'3"	40'
28'	1.900"	.095"	4'9"	5'8"	6'4"	6'11"	12'1"	44'
30'	1.900"	.095"	4'6"	5'6"	6'3"	6'9"	12'3"	44'
34'	1.900"	.095"	4'4"	5'5"	6'2"	6'7"	12'10"	48'

All measurements are with standard posts 1' out of the ground.

- 1.660" O.D. 14 gauge Galvanized Pipe, .083 wall thickness, both rafters and posts, on the 25' model only
- 1.900" O.D. 13 gauge Galvanized Pipe, .095" wall thickness, on both rafters and posts on 28', 30' & 34' models
- 4' Rafter spacing (standard)
- Hardware for assembly and bolts for baseboards
- Gable frame brackets are standard on all models
- Gable end wind bracing included on all models
- 1 Ridge, pre-drilled 4' on center, included on all models
- 2 Purlins included on 21', 25', 28' & 30' models
- Cross-ties and four purlins included on the 34' model
- Can accept polyethylene or polycarbonate covering with the purchase of additional parts

Solar-Star Series | Quonset Style Greenhouses

Size	Pipe O.D.	Wall Thickness	Height 1' from side	Height 2' from side	Height 3' from side	Height 4' from side	Ridge Height	Poly Width
17'	1.660"	.083"	4'4"	5'4"	5'11"	6'5"	7'3"	28'
20'	1.660"	.083"	5'1"	6'4"	7'1"	7'9"	10'1"	36'
22'	1.660"	.083"	4'4"	5'3"	6'1"	6'8"	9'4"	36'
26'	1.660"	.083"	4'10"	5'11"	6'9"	7'6"	11'2"	40'

All measurements are with standard posts 1' out of the ground.

- 1.660" O.D. 14 gauge Galvanized Pipe, .083" wall thickness, on both rafters and posts
- 4' Rafter spacing (standard)
- Hardware for assembly and bolts for baseboards are included
- Gable frame brackets are standard on all models
- 1 Ridge, pre-drilled 4' on center, included on all models
- 2 Purlins included on the 20', 22' & 26' models
- Gable end wind bracing included on the 20', 22' & 26' models

Solar-Mate Series | Quonset Style Greenhouses

Size	Pipe O.D.	Wall Thickness	Height 1' from side	Height 2' from side	Height 3' from side	Height 4' from side	Ridge Height	Poly Width
12'	1.315"	.058"	4'7"	5'11"	6'10"	7'8"	8'5"	24'
14'	1.315"	.058"	4'3"	5'3"	5'11"	6'5"	7'2"	24'
17'	1.315"	.058"	3'6"	4'10"	5'10"	6'6"	7'2"	28'

All measurements are with standard posts 1' out of the ground.

- 12', 14' & 17' models feature 1.315" O.D x .058" Wall, 17 gauge galvanized pipe rafters and 1.660" O.D. x .083" Wall, 14 gauge galvanized pipe posts
- Standard 4' rafter spacing on all models
- Includes ridge, pre-drilled 4' on center
- All models include gable frame brackets





Free-Standing Greenhouses

Features:

- Quality American-made parts
- Prefabricated parts and simple design for easy installation
- All load bearing pipe has a minimum yield strength of 50,000 PSI
- 4' bow spacing eliminates pocketing
- Maximum light transmission
- Designed for any covering: Poly or Polycarbonate Structured Sheet

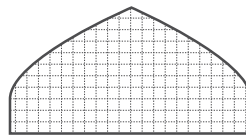

21' wide

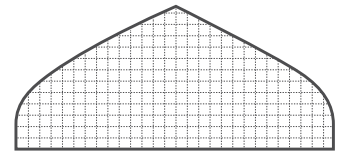

26' wide

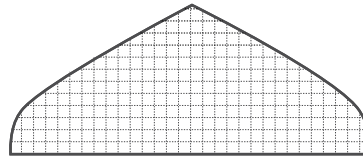

30' wide*

Free-standing gothic greenhouse with a steeply pitched roof designed to invite in the sunlight. Constructed of heavy duty tubing, the gothic shape is ideal for incorporating roof vents for passive ventilation. It is an economical greenhouse for the grower in a lighter snow area.

These greenhouses are in keeping with new gothic styles without losing the high quality you have come to expect.

This design incorporates appropriately sized rafter bows that allow more light to reach plants, providing a better growing environment. These houses are the choice if you are producing seasonal plants or overwintering perennial or nursery material.

The result is a freestanding greenhouse that can withstand the elements; a time-tested greenhouse you can rely on.

**Shipped direct from factory.
Freight to be added. Call for pricing.**

Metal Ends & Doors

Our metal endwalls are custom designed to meet your specifications. Packages include studs, purlins, glazing bars and all hardware required for your choice of covering. A complete line of welded, steel and aluminum constructed greenhouse doors are available, which can be mounted on hinges or sliding tracks.



Griffin Construction Department

Partner with us on your next project.
Call for consultation and quote:
1.800.888.0054 then press 3.





Conley's Superstar Series 3600

Outstanding Features

- Economy, Value & Strength
- Superior strength: rollformed arches, purlins and gutters ensure unmatched structural integrity
- Large easy to walk in gutters are lapped one into the other and cantilevered for increased strength
- 6' arch spacing virtually eliminates structural damage caused by rain and snow
- Components are shipped pre-punched and cut to length simplifying the installation
- Rollformed components nest one into the other during shipment, substantially reducing freight rates
- Certified to meet international building codes

Accessory Equipment:

- Conley's Rack & Pinion roof vents- roof vents can be placed at gutter or ridge
- Conley's Rack & Pinion side vents or end vents
- Internal retractable shading systems
- Conley's roll up side or end wall curtains
- Conley's swing, sliding or roll up door assemblies
- Conley's stationary, rolling or palletized bench assemblies
- Conley's space saver sidewall extension

Gutter Height: 8'-10'-12'-14' Width: 21'-24'-30'



Arch to gutter adapters connect to the bottom of the gutter for optimum weight distribution.

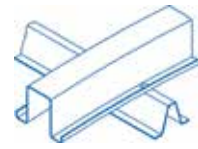

Arch and purlin design offers "I" beam technology for superior strength.



Super strength arch to gutter adapter



Rack & Pinion Gutter Vent





Arch Series & Gable Series

Outstanding Features

- Superior rollformed trusses or arches and rollformed purlins ensure unmatched structural integrity
- Each truss or arch assembly is produced from one rollformed component, no splices required, from peak to gutter connection
- Condensate control features built into rollformed arches and purlins
- Can be covered with polyethylene or rigid covering
- Certified to meet international building codes
- Stamped engineered drawings are available upon request

Standard Widths

Arch Series: 21', 24', 30', 35.5', 41.5'

Gable Series: 18', 21', 24', 30', 35.5', 41.5', 50'

Heavy duty column-to-arch connectors are manufactured by Conley's to meet stringent industry safety standards.

Aluminum gutter trim provides an effective means of "Sealing Off" structural coverings.

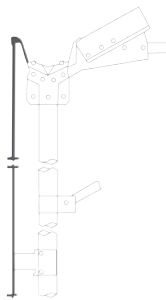

Griffin Construction Department

Partner with us on you next project.
Call for consultation and quote:
1.800.888.0054 then press 3.



Arch Series 6500



Gable Series 7500

Griffin's #1 selling greenhouse structure for Garden Centers

Conley's Gable Series 7500



The Conley's Advantage



Cantilevered Gutters

Conley gutters are cantilevered a full 2 feet over greenhouse columns, transferring the normal loads created by gutter connections away from the column. This increases the strength and stability of the structure. Gutters also lap one onto the other, virtually eliminating connection leaks.

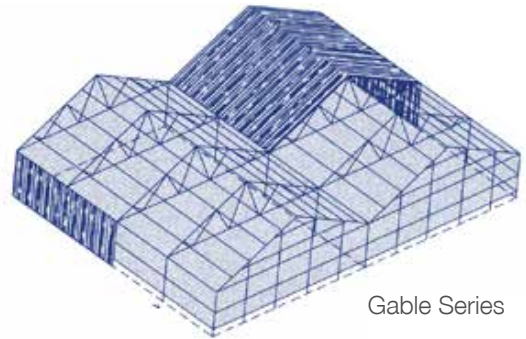

Gable Series

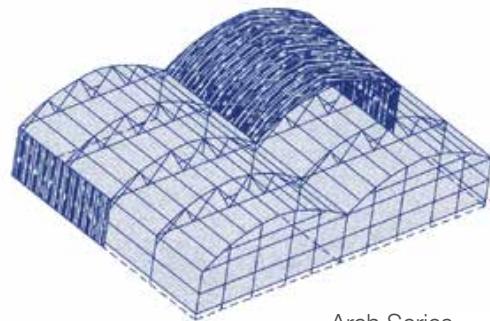

Arch Series

Superior Strength Rollformed Technology

Rollformed components incorporate the same design principle applied to industrial "I" beams. Engineered to be longer than wide, Conley's rollformed members offer substantially greater resistance to the deflection causing forces of rain, snow and wind when compared to conventional components.

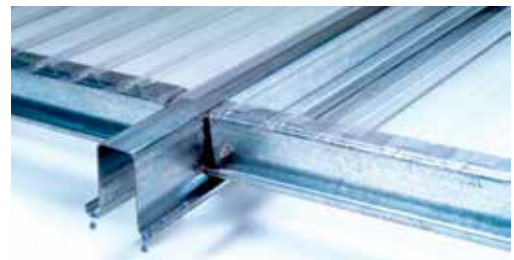

PROSPIANT

Windjammer Series 6000 Gutter Connected Cold Frames

- Gutter connected performance-cold frame pricing
- Ideal as a production house or retail structure
- Easy to walk in gutters
- 2" Square tube bows - 2 1/4" square ground stakes
- Gothic Arch profile
- Simple Construction



Accessories Available

Roll-up Side Walls, Rack & Pinion Roof Vents, Poly or Rigid Roof Coverings, Exhaust Fans, H.A.F. Circulation Fans, Evaporative Cooling Pads, Doors – Sliding, Roll Up or Swing, Watering Booms, Complete Heating Systems, Benches, Heavy-Duty Webbed Truss Assemblies, Electric Drive Motors, Steel Side & End Frame Kits

Specifications

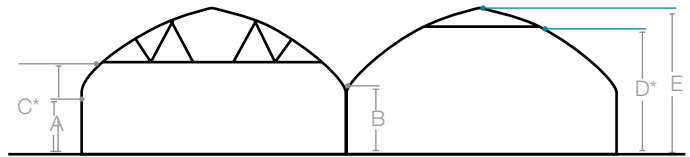

7' 4" sidewall (A) 8' 8" under gutter (b)

width	C	D	E
16'	n/a	n/a	11'10"
20'	n/a	11' 4"	12'10"
24'	9'9"	12'4"	14' 4"
30'	11'5"	15'4"	17'4"
35'	11'3"	16'4"	19'4"

8' 4" sidewall (A) 9' 8" under gutter (b)

width	C	D	E
16'	n/a	n/a	12'10"
20'	n/a	12' 4"	13'10"
24'	10'9"	13'4"	15' 4"
30'	12'5"	16'4"	18'4"
35'	12'3"	17'4"	20'4"

9' 4" sidewall (A) 10' 8" under gutter (b)

width	C	D	E
16'	n/a	n/a	13'10"
20'	n/a	13' 4"	14'10"
24'	11'9"	14'4"	16' 4"
30'	13'5"	17'4"	19'4"
35'	13'3"	18'4"	21'4"

C* Optional cross bar and "W" style truss

D* Standard cross bar

Custom sidewall height available



Windjammer Series 5000 High Tunnel Performance

- 2" Square tube bows - 2 1/4" ground stakes
- Structures include a straight 4', or optional 6' tall, side wall
- A 30' wide structure, with 6' side walls, provides 16' at the peak
- Additional height improves growing environments
- Taller structures increase ventilation efficiency

Call for pricing.



Specifications

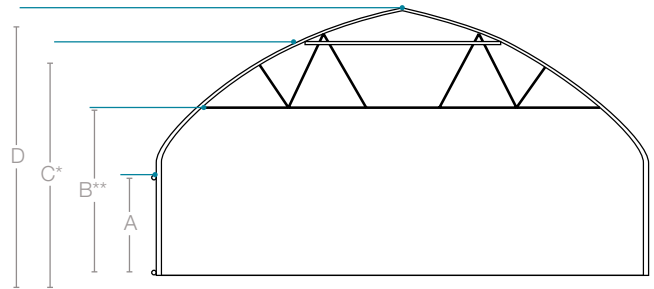

4' tall sidewall height

width	purlins	A	B**	C*	D
16'	3	4'	—	—	8'6"
20'	3	4'	—	8'	9'6"
24'	3	4'	6'6"	9'	11'
30'	3	4'	8'	12'	14'
35'	5	4'	8'	13'	16'

6' tall sidewall height

width	purlins	A	B**	C*	D
16'	3	6'	—	—	10'6"
20'	3	6'	—	10'	11'6"
24'	3	6'	8'6"	11'	13'
30'	3	6'	10'	14'	16'
35'	5	6'	10'	15'	18'

B** Optional cross bar and "W" style truss

C* Standard cross bar

Custom sidewall height available





W-Truss Shade Structure

Shade structures like the W-Truss are one of the most economical ways to keep customers and products out of the blazing sun. Mix and match flat roof sides with a peaked canopy entryway for maximum customer comfort and visual appeal to the front or side entrance to your brick and mortar store. Freestanding 20' wide canopy sections can be connected for multiple peaks or linked together in a row to cover larger spaces. Call a customer representative today to find a configuration that matches your needs!

Specifications

Width/Lengths: 20' x 20' blocks standard

Anchors: concrete anchor bolts

Footing: Base Plate/ Anchor Bolts in Concrete

Vertical posts: 3" x 3" x 13' galvanized steel with base plate

Truss: 2" x 2" square top and bottom chords, galvanized webbing

Cover: 30%, 50%, 60%, & 90% black shade cloth, 50% red shade cloth, 60% available both blue & green colors.

W-Truss complete packages include:

3" x 3" x 13' x 12 ga. vertical posts with 7" x 7" base plates in 20' x 20' blocks, expansion anchor bolts, 20' galvanized truss members, 60% black knitted shade cloth with hemmed edges and grommets, 10" canopy ball bungee every 18", fittings, hardware, and assembly instructions.

Available with peaked roof option!

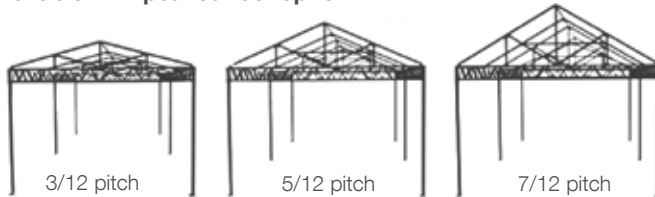

14', 16', 18' & 20' standard widths

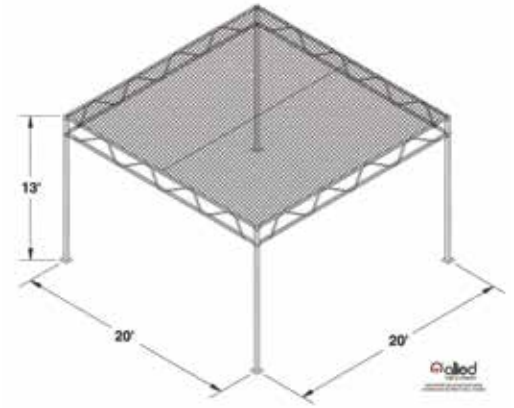

Sturdy horizontal trusses allow for spans of up to 28' to provide larger growing and display areas between supports.



10" canopy ball bungee attachment system makes quick work of seasonal shade cloth installation and removal.





Sunstopper

The Sunstopper is Griffin's #1 selling shade structure. This cost effective option is both strong and easy to assemble.

Specifications

Width/Lengths: 20' x 20' blocks (custom sizes available)

Anchors: ground stands or optional base plates with concrete anchor bolts

Vertical posts: 2.5" O.D. 12 ga. x 10' galvanized steel posts

Horizontal supports: 2 1/2" O.D. 12 ga. x 20' galvanized steel supports

Cover Options: 30%, 50%, 60%, & 90% black shade cloth, 50% red shade cloth, 60% available both blue & green colors

Sunstopper Standard Packages Include:

2.5" O.D. 12 ga. x 10' vertical posts with base plates in 20' x 20' blocks, 2.5" O.D. 12 ga. x 20' galvanized horizontal members, 60% black knitted shade cloth with taped edges and grommets, 10" canopy ball bungee every 18", diagonal cable shade panel support (1) per 20' x 20' block, fittings, hardware, and assembly instructions.

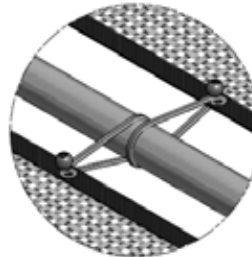
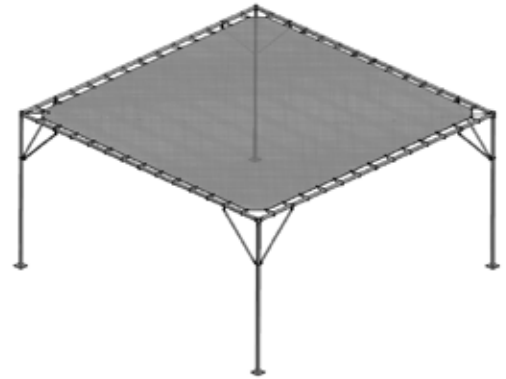

51% LARGER TUBING!

The Sunstopper is built to last with tough 2 1/2" O.D. 12 gauge galvanized steel tubing. That's 51% LARGER than what most manufacturers use. Get a better product for your investment with the Sunstopper.

SUNSTOPPER
2 1/2"

Others
1.66"

Sunstopper uses larger diameter tubing.

Others use smaller diameter tubing.



Vermax by Harnois

Introducing venlo style glasshouses designed and manufactured in North America that meet international building standards. Optimally designed with high tech cultivation systems according to your needs. Turnkey option available.

Contact us for more information.



2024

Griffin Construction Department

Partner with us on your next project.
Call for consultation and quote:
1.800.888.0054 then press 3.



COVERINGS

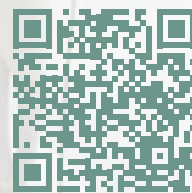

What Size Cover for my House?

Quonset Greenhouse							
House Width	14'	17'	20'	22'	25'	28'	30'
Poly Size Use	24' wide	28' wide	32' wide	32' wide	40' wide	42' wide	48' wide

Gothic Greenhouse							
House Width	17'	20'	21'	26'	27'	29'	30'
Poly Size Use	32' wide	36' wide	36' wide	40' wide	42' wide	42' wide	48' wide

Use this information as a guide to find the poly width for a standard ground to ground greenhouse frame. High tunnels, roll up sides, or raised greenhouses are not accounted in the chart above. Griffin recommends using a soft measuring tape to make a ground to ground measurement before ordering.

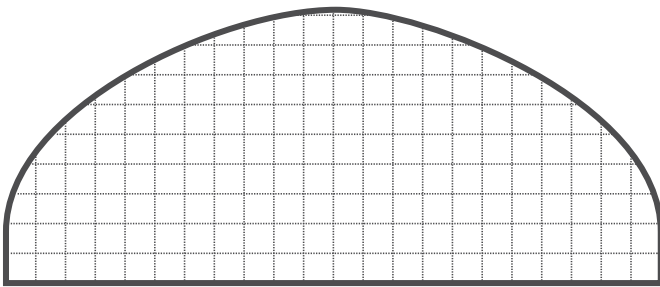

Quonset Greenhouse

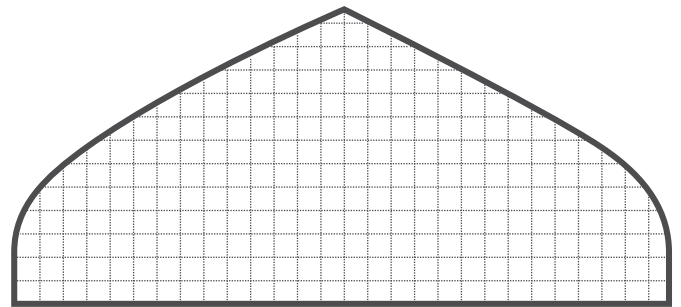

Gothic Greenhouse





EVO AC[®]

8-layer greenhouse films

Brighter greenhouse
Healthier plants
Higher profits

EVO AC[®] sets the new standard for condensation and mist control. Trusted by the top growers around the world.



Longest lasting anti-drip



No mist



Superior strength



More & better light



Less phytosanitary treatments



Improved crop yield



www.sunmasterfilm.com

 **sunmaster**



2024

Sunmaster® EVO AC® IR

The benefits of EVO AC® IR:

- Permanent AC - cost savings on film & labor
- Mist elimination - less spraying & less diseases
- Highest light transmission - more and better production
- Outstanding mechanical properties - better crop protection

The properties:

- 8-layer co-extruded technology
- >90% PAR light transmission, UV-Open
- Permanent anti-condensate (AC) reduces costs and increases production
- Thermal film with superior Infrared (IR) retention promoting plant growth and energy savings
- High-diffusion (75%) which scatters sunlight uniformly, reducing shadow zones and preventing sunburns.
- Super-Strong for maximum resistance against strong winds, hail & snow loads.
- Superior mechanical properties (folds, tear & puncture) for maximum crop protection
- UV-stabilized for four years

Item	Width	Mil	Length	Fold	Weight/ lbs.
SMTHM624110EAC	24	6	110	4B	70
SMTHM628110EAC	28	6	110	4B	81
SMTHM628150EAC	28	6	150	4B	121
SMTHM632110EAC	32	6	110	4B	102
SMTHM636110EAC	36	6	110	4B	114
SMTHM636150EAC	36	6	150	4B	156
SMTHM642110EAC	42	6	110'	4B	134

Sunmaster® is the leading brand of greenhouse covers in North America, offering growers a wide product range from high-performance four-year films to one-year overwintering. With decades of experience in the industry, our covers are designed to meet the unique needs of your greenhouses, ensuring maximum quality and yields.

Sunmaster® films can be produced in different versions depending on the application and needs of the grower. Stock products and sizing are based on most requested items, but Sunmaster® can produce films with various other properties for drop-ship orders.

In double-inflated greenhouses with two sheets, Sunmaster® recommends:

- EVO AC® IR as the inside layer for maximum condensation control, light distribution, and temperature regulation.
- Sunmaster® IV as the outside layer to maximize light transmission.



Classic AC film after 2 years

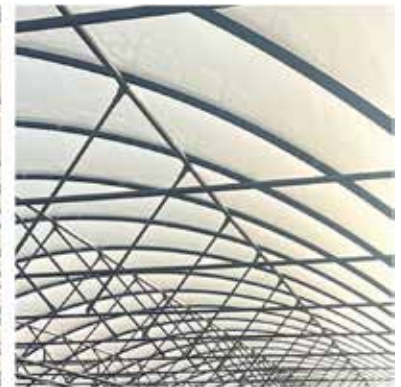

EVO AC® after 4 years



Mist under classic AC film



EVO AC® anti-mist effect

Sunmaster® IR/AC Max

- 7-layer co-extruded
- >89% PAR light transmission, UV-Open
- Provides superior condensation control
- High-diffusion (75%) for uniform lighting when direct sunlight is not preferred
- Thermal film with superior Infrared (IR) retention promoting plant growth and energy savings
- Superior mechanical properties (folds, tear & puncture) for maximum crop protection
- UV-stabilized for four years

Savings

PURCHASE	SAVE
\$750.00	8%
\$1,500.00	13%
\$2,500.00	18%

Savings applies to Polyethylene Film

Sunmaster® IR/AC Max Films

Item	Width	Mil	Length	Fold	Weight/lbs.
SMTHM628100	28'	6	100'	4B	84
SMTHM628150	28'	6	150'	4B	126
SMTHM636150	36'	6	150'	6	162
SMTHM642100	42'	6	100'	6	126
SMTHM642150	42'	6	150'	6	190
SMTHM648110	48'	6	110'	6	158
SMTHM648150	48'	6	150'	6	218

Sunmaster® IR/AC Max Tubes

Item	Width	Mil	Length	Fold	Weight/lbs.
SMTHM620100T	20'	6	100'	6	120
SMTHM624100T	24'	6	100'	6	144

Fold Code: 4A = C Fold 4B = U-Fold 4C = Gusseted fold 6 = Double U-Fold 8 = Multi U-Fold

2024





Sunmaster® IV

- 3-layer co-extruded
- Crystal Clear film maximizing direct sunlight penetration is desired for specific plant growth.
- >90% PAR light transmission
- UV-stabilized for four years
- Provides superior strength (folds, tear & puncture) and high light transmission

Item	Width	Mil	Length	Fold	Weight/lbs.
SMIV620150	20'	6	150'	4B	90
SMIV624110	24'	6	110'	4B	79
SMIV624150	24'	6	150'	4B	79
SMIV628100	28'	6	100'	4B	84
SMIV628110	28'	6	110'	4B	92
SMIV628150	28'	6	150'	4B	126
SMIV628200	28'	6	200'	4B	168
SMIV632100	32'	6	100'	6	96
SMIV632110	32'	6	110'	6	106
SMIV632150	32'	6	150'	6	144
SMIV636100	36'	6	100'	6	108
SMIV636110	36'	6	110'	6	118
SMIV636150	36'	6	150'	6	162
SMIV640150	40'	6	150'	6	180
SMIV642100	42'	6	100'	6	126
SMIV642110	42'	6	110'	6	138
SMIV642150	42'	6	150'	6	190
SMIV648110	48'	6	110'	6	158
SMIV648150	48'	6	150'	8	216
SMIV650150	50'	6	150'	8	225
WHITE					
SMIV632100W	32'	6	100'	6	96
SMIV640100W	40'	6	100'	6	120
SMIV648100W	48'	6	100'	8	144

Fold Code: 4A = C Fold 4B = U-Fold 6 = Double U-Fold 8 = Multi U-Fold

Sunmaster® IV Greenhouse Tubes

Item	Width	Mil	Length	Fold	Weight/lbs.
SMIV624100T	24'	6	100'	4B	144
SMIV624110T	24'	6	110'	4B	158
SMIV624150T	24'	6	150'	4B	216

Fold Code: 4A = C Fold 4B = U-Fold 6 = Double U-Fold 8 = Multi U-Fold



Horticulture films that help your business grow

SUPER4™ Greenhouse Film

The Durability and Toughness You Need

Super 4™ is a super clear, super tough, longlife product that provides the best value in a 6-mil, 4-year greenhouse film. Super 4™ is also available with 55% white opacity in selected sizes.

- Outstanding light transmission, haze, and clarity ratings help optimize yield in greenhouse applications.
- A unique manufacturing process and advanced resin technology provide superior tear strength.
- Advanced UV stabilizers maximize physical properties and help protect film from chemical damage.
- Bee compatibility feature allows more of the UV spectrum to pass through, making it easier for bees to navigate and achieve more efficient pollination.

THERMAX™ Anti-condensate Film

Durability, Energy Savings, Plus Condensation Control

Thermax™ combines outstanding thermal qualities and exceptional condensation control properties in one revolutionary, diffused greenhouse film.

- Outstanding thermal properties keep the heat in by reducing radiant heat loss. Heaters consume less energy to maintain a set temperature leading to potential energy savings of 15–20%.
- Directional condensation control ensures the additive migrates to the surface facing the crop. This feature controls drips, maintains light transmission and enhances thermal benefit.
- Diffused light reaches plants from many angles while par light transmission remains the same, optimizing light distribution in the greenhouse.

LUMINANCE® Tunnel Film

The Results You Want

LUMINANCE® has been specially engineered to give you the results you need from a highly diffused greenhouse and high tunnel film.

- Lowers greenhouse temperature by as much as 9°F when compared to standard film.
- Produces higher-yielding plants with stronger than normal root systems.
- Less demand for watering.
- Inhibits fungus spore development for healthier plants.
- Inhibits insect propagation.
- Prolongs the growing season.
- Allows for an earlier harvest—up to three weeks earlier harvests have been recorded.

Smarter Flexible Solutions for Horticulture



Bee
Friendly

Premium Greenhouse and
High Quality Tunnel Solutions

www.bpihorticulture.com

Toll-Free 1-800-661-3606
Email: edmonton@rpc-bpi.com



Tufflite IV™

Tufflite IV™ is a high quality PAR (photosynthetic active radiation) film offering high clarity, outstanding durability and easy installation. Retains Clarity— Tufflite IV™ stays clear without discoloration or cracking. Outstanding Durability— proprietary manufacturing yields tough sheeting that resists tears, punctures and UV degradation. Easy Installation— heavy duty packing protects every roll and improved folding makes installation fast and easy.

Fold Code: CF= Center Fold CFF= Center Fold Folded CFDF= Center Fold Double Folded CSTF= Center-slit Tubing Folded STDF= Slit Tubing Double Folded TDF= Tubing Double Folded

See page 30 for proper poly sizing for your greenhouse.

Tufflite IV™ Greenhouse Film

Item	Width	Mil	Length	Fold	Weight/lbs.
061-6161101	16'	6	110'	CFDF	50
061-6201101	20'	6	110'	CSTF	63
061-6241101	24'	6	110'	CSTF	75
061-6241501	24'	6	150'	CSTF	103
061-6281101	28'	6	110'	CSTF	88
061-6281501	28'	6	150'	CSTF	120
061-6321101	32'	6	110'	STDF	100
061-6361101	36'	6	110'	STDF	113
061-6401101	40'	6	110'	STDF	126
061-6401501	40'	6	150'	STDF	171
061-6421101	42'	6	110'	STDF	132
061-6421501	42'	6	150'	STDF	180
061-6481101	48'	6	110'	STDF	151
061-6481501	48'	6	150'	STDF	205
061-6501101	50'	6	110'	STDF	157
061-6501501	50'	6	150'	STDF	214
061-6561101	56'	6	110'	STDF	176

Tufflite IV™ Greenhouse Film Tubes

Item	Width	Mil	Length	Fold	Weight/lbs.
061-6201101T	20'	6	110'	TDF	126
061-6201501T	20'	6	150'	TDF	171
061-6241101T	24'	6	110'	TDF	151
061-6241501T	24'	6	150'	TDF	205





Tufflite Infrared™

Designed to last up to four years, Tufflite Infrared contains both the Drip-Less feature and an additive that will delay the exit of infrared waves from the greenhouse— maintaining heat factors and thus saving energy.

Reduced Energy Costs— improved nighttime heat retention allows for lower fuel bills.

Improved Light Diffusion— reduces shadows.

Getting the Best of Both Worlds

Combine the extraordinary clarity of Tufflite™ with Tufflite Infrared™ and reap the rewards. When using sheeting (vs. Tubing), your combination of Tufflite IV™ on the outside and Tufflite Infrared™ on the inside gives you:

- The Highest Light Transmission
- Anti-Condensation Protection
- Optimum Energy Savings

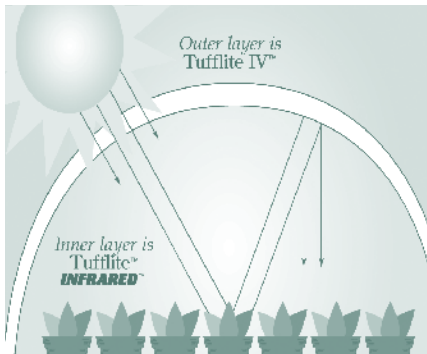

Tufflite Infrared™ Greenhouse Films

Item	Width	Mil	Length	Fold	Weight/lbs
062-6201101	20'	6	110'	CSTF	63
062-6241101	24'	6	110'	CSTF	75
062-6281101	28'	6	110'	CSTF	88
062-6321101	32'	6	110'	STDF	100
062-6321501	32'	6	150'	STDF	137
062-6361101	36'	6	110'	STDF	113
062-6401101	40'	6	110'	STDF	126
062-6401501	40'	6	150'	STDF	171
062-6421101	42'	6	110'	STDF	132
062-6421501	42'	6	150'	STDF	180
062-6481101	48'	6	110'	STDF	151
062-6481501	48'	6	150'	STDF	205
062-6501101	50'	6	110'	STDF	157
062-6501501	50'	6	150'	STDF	214

Tufflite Infrared™ Film Tubes

Item	Width	Mil	Length	Fold	Weight/lbs.
062-6241101T	24'	6	110'	TDF	151
062-6241501T	24'	6	150'	TDF	205

Fold Code: CSTF= Center-slit Tubing Folded
STDF= Slit Tubing Double Folded TDF= Tubing Double Folded





K50 Clear 6mil (50 Month)

- Features clear HALS ultra violet light stabilizer
- Contains "Anti-Dust" additive that repels dirt and dust
- Strong EVA co-polymer resin for excellent durability

The innovative technologies that Klerk's introduced have now proven themselves throughout the U.S. particularly in the Eastern U.S. market. Klerk's use of co-extrusion techniques demonstrates that "no-drip" features will perform for years.

The Bottom Line

A greenhouse business day begins when the sun comes up and shines through the film you put between the sun and the money a greenhouse is trying to produce.

Greenhouse film is the least expensive but most important decision a grower can make for his greenhouse.

The sun is the only free energy resource available to the greenhouse.

Klerks innovative products help to manipulate this free energy to benefit your plants' growth, which financially affects the grower in the long run.

**Klerks film is available to order by drop ship only.
Call for pricing and sizes.**

IMPORTANT NOTE: If 1 layer of IR film is used in a double layer installation, it should be applied as the inside layer.

K50-IR/AC 6mil (50 Month)

Has the same properties as K50 with added advantages:

- Lower heating costs
- Infrared retention and light diffusing system to reduce energy costs
- Holds in re-radiation at night
- Diffuses the sun's rays during the day to average leaf temperatures and reduces stress
- Earlier, faster growth due to higher usable light levels
- Lowers nighttime heating cost by capturing and re-radiating infrared heat that normally passes right through traditional greenhouse film

Klerk's 2-in-1 Film

- Offers the advantages of two sheets of greenhouse film in a single installation
- A value-added alternative to 20' and 24' tubes
- Available in: K50-IR/AC, and Koolite Plus
- Bottom layer can be pulled tightly to allow water to sheet off
- Saves money by not putting additive film on top
- Not a stocked item. Please call your sales representative for more information

Research Supports the Principle

Diffused light has the advantage of getting more light down into plant foliage canopies.

This advantage applies to plants which grow upright, where the newly emerging leaves end up shadowing older, more productive leaves.

Since 1982 when IR films were first introduced to North America there has been significant research on the effects of light diffusion on plant productivity, concluding that diffusion averages leaf temperatures by evenly distributing light from the top of the canopy to the bottom leaves.

This evenly distributed energy results in more photosynthesis, causing earlier and fuller development of healthier, disease resistant crops.



Overwintering Greenhouse Films



White Overwintering Film - 55% Opacity

Tri-layer extrusion and resin technologies result in a film that meets or exceeds the physicals of .003 and .004 mil film. Made with Metallocene.

Item	ml	Width	Length	Fold	lbs.
824-241103	2.4	24'	110'	4A	31
824-242203	2.4	24'	220'	4A	61
824-281400	2.4	28'	110'	4A	36
824-281402	2.4	28'	220'	4A	68
824-322800	2.4	32'	110'	6	41
824-322802	2.4	32'	220'	6	78
824-362203	2.4	36'	220'	6	92
824-420500	2.4	40'	110'	6	51

Clear Overwintering Film

Made with Metallocene.

Item	ml	Width	Length	Fold	lbs.
824-241105	2.4	24'	110'	4A	31
824-242201	2.4	24'	220'	4A	61
824-281401	2.4	28'	110'	4A	36
824-281403	2.4	28'	220'	4A	68
824-322801	2.4	32'	110'	6	41
824-322803	2.4	32'	220'	6	78
824-362201	2.4	36'	220'	6	92
824-420501	2.4	40'	110'	6	51

Savings

PURCHASE	SAVE
\$750.00	8%
\$1,500.00	13%
\$2,500.00	18%

Savings applies to Polyethylene Film



Nursery White Overwintering Film 70% Opacity

Extrusion techniques now allow for a bonded, tri-layer, 3mil thickness (1 mil per layer). Extensive field trials throughout the country over the last few years have provided excellent results. The performance of these films shows a stronger, more puncture-proof and dependable overwinter protection covering with improved tear resistance.

Item	ml	Width	Length	Fold	lbs.
782-3241102	3	24'	110'	CSTF	38
782-3242202	3	24'	220'	CSTF	75
782-3281102	3	28'	110'	CSTF	44
782-3282202	3	28'	220'	CSTF	88
782-3321102	3	32'	110'	STDF	50
782-3322202	3	32'	220'	STDF	100
782-3401102	3	40'	110'	STDF	63
782-3402202	3	40'	220'	STDF	126

33% and 55% opacity available as special order.

Nursery Clear Film

- Designed to withstand sub-zero temperatures
- White opaque films help maintain a more uniform temperature
- Co-extruded for puncture and tear resistance as compared to single extruded films
- Higher performing alternative to standard films
- As strong as 4mil co-poly film

Item	ml	Width	Length	Fold	lbs.
782-3241101	3	24'	110'	CSTF	38
782-3242201	3	24'	220'	CSTF	75
782-3281101	3	28'	110'	CSTF	44
782-3282201	3	28'	220'	CSTF	88
782-3321101	3	32'	110'	STDF	50
782-3322201	3	32'	220'	STDF	100
782-3401101	3	40'	110'	STDF	63
782-3402201	3	40'	220'	STDF	126

Other sizes available as special order.
Please check with our office for necessary lead times.

Woven Batten Tape

1 3/4" x 300'

Item: 05-2100



Fold Code: 4B = U-Fold. 6 = Double U-Fold. 8 = Multi U-Fold, CSTF = Center-slit Tubing Folded, STDF = Slit Tubing Double Folded



2024



Mulch Films

Berry mulch films offer easy application and removal. Designed to help growers reduce their overall labor cost and improve yields, our offering includes an extensive range of film types to meet your requirements. Designed to control weeds and conserve water.

Affects of Color on Growth

The color of mulch film influences soil temperature, the surface temperature of the film, the light reflected to plants, and impacts plant and weed growth.

Black: ideal for weed control, opacity, and UV blocking

White: brighter, reflective, typically 12°F cooler than conventional black films, and 4-8°F cooler than white over black film. Ideal for Hemp Production.

Black Embossed Mulch 1.25 mil

Item	Size	Sq. Ft./Roll
78-1025	3' x 2000'	6,000
78-1030	4' x 2000'	8,000
78-1031	4' X 4000'	16,000

White Embossed Mulch

Item	Size	Sq. Ft./Roll
78-1032	4' X 4000'	16,000





Plastic Sheeting & Film

Construction Grade Plastic Sheeting

Uses include an all purpose cover, vapor barrier, dust barrier, landscaping and concrete curing cover. Available in a number of mil thickness and sizes.

2 mil Construction Grade Translucent Sheeting

Item	Size	Sq. Ft./Roll
06-2908200	8' 4" x 200'	1667
06-2912200	12' x 200'	2400
06-2920200	20' x 200'	4000

4 mil Construction Grade Translucent Sheeting

Item	Size	Sq. Ft./Roll
06-49041	4' x 100'	400
06-4908	8' x 100'	800
06-4910	10' x 100'	1000
06-4912	12' x 100'	1200
06-4916	16' x 100'	1600
06-4920	20' x 100'	2000
06-4932	32' x 100'	3200
06-4940	40' x 100'	4000

6 mil Construction Grade Translucent Sheeting

Item	Size	Sq. Ft./Roll
06-6906	6' x 100'	600
06-6908	8' x 100'	800
06-6910	10' x 100'	1000
06-6912	12' x 100'	1200
06-6916	16' x 100'	1600
06-6920	20' x 100'	2000
06-6924	24' x 100'	2400
06-6928	28' x 100'	2800
06-6932	32' x 100'	3200
06-6940	40' x 100'	4000

IMPORTANT NOTE: Construction Grade Plastic Sheeting is not manufactured or recommended for use as a greenhouse covering.



Agricultural Black Film

A black "No-Light" sheeting used as a liner under pots or as a blackout covering over those crops that at some point in their growth need complete darkness. Available in 4 and 6 mil. Opaque, resists root penetration and prevents weed growth.

4 mil Construction Grade Black Film

Item	Size	Sq. Ft./Roll
06-4808	8' x 100'	800
06-4810	10' x 100'	1000
06-4812	12' x 100'	1200
06-4816	16' x 100'	1600
06-4820	20' x 100'	2000

6 mil Construction Grade Black Film

Item	Size	Sq. Ft./Roll
06-6808	8' x 100'	800
06-6810	10' x 100'	1000
06-6812	12' x 100'	1200
06-6816	16' x 100'	1600
06-6820	20' x 100'	2000
06-6824	24' x 100'	2400
06-6828	28' x 100'	2800
06-6832	32' x 100'	3200
06-6840	40' x 100'	4000

SOLARIG LINE

WOVEN PLASTIC SHEETING FOR HIGH TECH AGRICULTURE

- Most Technologically Advanced
- The Strongest
- Longest Lasting
- Up to 6 yr Warranty

Crops grow strong and people work better under ideal environment conditions -such as those provided by the SOLARIG family of woven polyethylene sheeting from PIC PLAST.

PIC PLASTIC (PUYOUNG Group) offers the most technologically advanced, strongest, long-lasting, storm-resistant and efficient plastic sheeting, that is being use all over the world.

PUYOUNG's advantage lies in its special manufacturing processes, the use of sophisticated coatings, its strict quality control (ISO 9001) and its total dedication to customer satisfaction.

Solaroof 182

Item	Description
062-1000	24' X 105'
062-1005	24' X 155'
062-1002	28' X 105'
062-1007	28' X 155'
062-1010	32' X 105'
062-1015	32' X 155'
062-1030	42' X 105'
062-1035	42' X 155'
062-1040	48' X 105'
062-1045	48' X 155'

Solarig 156 IR & AF

Item	Description
062-2000	24' X 105'
062-2005	24' X 155'
062-2002	28' X 105'
062-2007	28' X 155'
062-2010	32' X 105'
062-2015	32' X 155'
062-2030	42' X 105'
062-2035	42' X 155'
062-2040	48' X 105'
062-2045	48' X 155'

Larger lengths available upon request in increments of 5'.

SOLAROOF 182

- The SOLAROOF premier greenhouse covering is for all types of cultivation
- Made from high quality coated woven polyethylene cloth to the highest standards consistent with PUYOUNG'S ISO 9001 accreditation
- Contains special new additives to give extra performance
- SOLAROOF'S extra strength makes it hail and tear resistant and long lasting
- SOLAROOF unique package of additives assures that it blocks out the harmful UV light
- The absence of UV light greatly reduces the spread of fungal diseases such as *Botrytis*
- The lack of UV light deters insects such as aphids from entering the greenhouse
- Contains Antidrip to help prevent droplets of moisture falling onto the plants and improving light transmission
- Contains IR additives to keep the foliar temperature high in the greenhouse during the cold night
- 6 yr warranty for double layer application

Solarig 156 IR & AF

- 2nd layer/bottom layer in a double layer system
- Tear resistant and long lasting coated woven polyethylene cloth
- Contains Antidrip to help prevent droplets of moisture falling onto the plants and improving light transmission
- Can be sewn to create any size or shape, with ropes, eyelets, etc.
- Lightweight, low cost option
- Can be sewn to insect net
- 6 yr warranty for double layer application



Wire-Lock Poly Attachment



Single Wire-Lock (09-16501 wire not included)

Single wire-lock is the most versatile of our wire-lock options. Griffin recommends use for baseboard applications. It can be used anywhere you need to secure covering materials.



Double Wire-Lock (09-16501 wire not included)

Double wire-lock is designed to secure roll up sides separate from the covering. This increases flexibility during maintenance and replacement projects.



Gable Rafter Trim

With a curved based for easy installation to the end bow, our gable rafter trim features a drip edge that extends over end wall polycarbonate glazing.



Griffin's Wire-Lock system features an aluminum base and preformed stainless steel wire insert holds coverings securely in place. We recommend using carriage bolts to secure our wire-lock to your framing.

When to Use Griffin's Wire-Lock System

- Single layer of polyethylene 4 mil or thicker
- Double layer of polyethylene 4 mil or thicker
- Roll up sidewalls
- Secure shade cloths

Item	Description
81-500150	Wire-Lock (12' Sections) Alum. Base
09-16251	Wire-Lock (6' Sections) Alum. Base
81-500160	Gable Rafter Trim 12' Alum.
81-500170	Double Wire-Lock 12' Alum.
09-16501	6' Zig Zag Wire (2 per 12' base)

Poly Grip

The Poly Grip Lock is a cam-type locking system. This lock was designed for installation with 2 layers of 6 mil poly that is air inflated. It is a simple and secure lock with a track record of dependability. The lock consists of an aluminum base channel and aluminum locking ring. The ring is easily inserted into the base for quick application. This system is not flexible (bendable) and cannot be used on gable ends of quonset houses.

Item	Description	Length
09-1525	Alum. Base Channel	12'
09-1535	Alum. Locking Ring	5' 11 3/4"

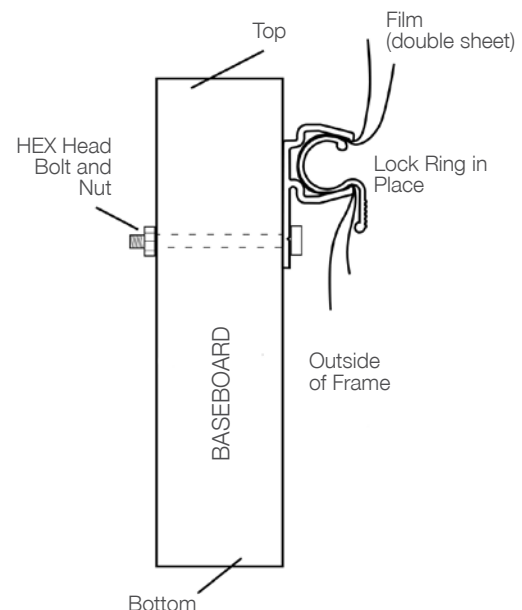

Get the Most from Your Poly with Inflation Best Practices

Improper maintenance of the air pressure between the layers of double poly covered greenhouses can prematurely wear film and shorten life expectancy. Here are some tips for keeping your poly inflated properly:

1. Control the pressure by connecting a rheostat (variable speed control) to you inflation blower. Slowing down the speed of the fan inflates to a lower pressure. While speeding up the fan inflates to a higher pressure. Use a manometer to monitor your pressure.
2. Change inflation pressure according to the weather. Optimal inflation pressure is 0.2" of water column pressure during hot weather and 0.45" of water column pressure during cold and/or windy weather.
3. Avoid stressing your poly. The "perfect" dead air space is 4". However, since the space from the locking device to the top of the house cannot be the same distance, 4" - 8" is the recommended space. If overinflated, the poly stretches and becomes thinner, making it weaker. If under-inflated, the poly flaps and wears prematurely.
4. Maintain the installation as air tight as possible. Check poly locks occasionally to find and repair air leaks that lead to under-inflation.
5. Although many growers us inside air, outside air is still considered best practice. Outside air is usually drier and does not contain pesticides or other volatile chemicals that can interact with the poly.

Questions about Inflation Blowers?

Griffin's sales team will be happy to find you answers. Call 1.800.888.0054 then press 3



Outside Air Inflation System

This kit has all you need to air inflate your greenhouse

Features:

- Outside air intake regulator with deflector/bushing
- Blower Bracket for mounting unit on bow
- Pre-assembled hose for outside air
- 60 cfm

Item: 81-510105

Weatherproof Line Voltage Fan Control

- Great for control of 120v fans/ventilators
- On/Off control with minimum speed adjustment for motor types - shaded pole, PSC and universal
- Weather & corrosion proof all polycarbonate thermoplastic construction
- Standard 7/8 opening
- Rating: 5 amps at 120 volts



Before installing you should check to make sure your inflation blower is recommended for use with any type of speed control device.

Item: 24-6020



KenbarAir Inflation Unit Double with Blower Motor

This kit has all you need to air inflate your greenhouse

Features: 148 CFM

Item	Description
38-023305	Air Inflation Unit Double with Blower Motor
81-520400	Jaderloon 36" Jumper Hose

Blower Motors & Brackets

Shaded Pole Blower 4C440

Open drip-proof motors rated for continuous duty

Features:

- Forward curved wheels driven by dependable energy-efficient motors
- Sleeve bearings suitable for all position mounting
- Adjustable air inlet damper (Only on model #B60)
- Baked enamel finish
- 60 CFM
- 3-Bolt



(Motor Only, used on smaller greenhouse)

Item: 81-510200

Shaded Pole & Permanent Split Capacitor (PSC ITDP7) Blower

Replaces 4C446 blower

Features:

- Forward curved wheels driven by dependable energy efficient motors
- Sleeve bearings suitable for all position mounting
- Baked enamel finish
- 146 CFM
- 4-Bolt

(Motor Only)
(Replacement motor for Tee & Single Stack units also)



Item: 09-1220

Adjustable Blower Deflector & Bracket

3-Bolt
(round flange)

Item: 81-510400

4-Bolt
(square)

Item: 81-510410



Protect the Life of Your Poly



White Felt Adhesive Tape

Protects greenhouse hoops from wearing and tearing greenhouse film.

Item: 09-1404

Size: 1.5" X 48' 1/8

Sun Clear

A concentrated water dispersible liquid formula which, when diluted, increases light transmission, eliminates fogging and improves visibility on glass and polyethylene greenhouses.

- Stops Condensate Drip
- Increases Solar Light
- Reduces Heating Costs

Item: 75-2982

Item: 75-2983

Size: 1 qt.

Size: 1 gal.





All Purpose Poly Repair Tape

Super adhesion! Made with a tough polyethylene backing and aggressive adhesive, this highly conformable all-purpose tape exhibits superior adhesion to film and plastic sheeting.

- All purpose tape for repairing polyethylene and other types of plastic film
- Once applied, it holds fast
- Handles easily, is waterproof
- Won't shrink, crack, dry out or become brittle

Item: 09-14302 **Size/Color:** 2" x 108' Clear
Item: 09-14352 **Size/Color:** 4" x 100' Clear
Item: 09-1425 **Size/Color:** 2" x 108' White



Poly Repair Tape

Clear poly repair tape with white paper backing for easy handling and application to your greenhouse film. A complete first aid kit for greenhouses, the rugged patching tape bonds aggressively to polyethylene film.

Item: 09-1406 **Size:** 2" x 48'
Item: 09-1411 **Size:** 4" x 48'
Item: 09-1416 **Size:** 6" x 48'
Item: 09-14202 **Size:** 10" x 48'

2024

The Most Inexpensive Method to Secure Poly



Batten Tape - Vinyl

Batten tape is a tough, white vinyl plastic strip $\frac{3}{4}$ " wide x $\frac{1}{32}$ " thick for securing plastic film to wood frames, greenhouses, cold frames, windows, etc.

Item: 09-1450 **Size:** 500'
Item: 09-1455 **Size:** 1,000'

Batten Tape - Woven

Woven Batten Material. 2.75" x 1500'.

Item: 05-2100 **Size:** 1.75" x 300'
Item: 05-21011 **Size:** 2.75" x 1500'



Stapler and Staples

PC4000 Bostitch Power Tacker T6-8

Item: 83-2080

STCR5019 9/16 Staple

Item: 83-2128

Qty: 4,000/Box

Add Hanging Basket Space

Use swedge purlins to give you more hanging pot space.



Hanging Basket Line

Item	Description
81-510441	1 3/8" x 1 3/8" Cross Connector
81-510440	2" x 1 3/8" Cross Connector Set
81J15838	1 5/8" x 1 3/8" Cross Connector Set
02-3150	16' 2.5" x 1.315 OD x 17 GA swedge purlin pipe



2024

Roll Up Side Components

Roll Bar Options

Below are two roll bar options.

- 1) Use the Alum Roll Tube with wiggle wire to secure your curtain fabric
- 2) Secure curtain fabric to purlin pipe with poly clip

Item	Description
09-5237	Alum Roll Tube 1.5"OD X 146"L W/Wirelock Slot Splice
09-16501	6' Zig Zag Wire (2 per 12' base)
02-3150	16' 2.5" x 1.315 OD x 17 GA swedge purlin pipe
02-3101	Poly clip for tube 1.25" used for roll-up sidewall



09-5237
Alum Roll Tube

Alum Roll Tube joins end-to-end with inserted square splice piece hardware included.

02-3101
Poly clip for tube



Base Board Bracket

- (1) #10 x 1" Pan Head
- (1) #12 x 1" wood Pan Head

Item: RUBBB

This bracket holds the roll bar in place in the closed position.



EZ SNAP Rope Hook

Item: 87-EZSNAP

Use the EZ SNAP to secure wind rope in place.

Learn more about Roll Up and Roll Up Kits.



Griffin Construction Department | Partner with us on your next project. Call for consultation and quote: 1.800.888.0054 then press 3.



Multi-Wall Structured Polycarbonate Sheets

Griffin has both stocked panels and custom offerings to cover your polycarbonate glazing needs.

Griffin Stock Panels

8mm Twin-Wall Clear Polycarbonate Panels are the industry standard for glazing greenhouses. Griffin stock panels are right sized for end wall glazing projects. Other popular applications for our stock panels include small timber framed greenhouses, awnings, and other architectural applications.

Custom Orders

Need a Nonstock Piece of Polycarbonate?

Griffin has you covered. We offer a variety of widths, lengths, colors and thicknesses of multi-wall polycarbonate. All custom orders are direct shipped from Polygal FOB Freight Origin.

Custom Possibilities

- Lengths up to 36' in 8mm twin-wall clear
- Widths in 47.25", 48", 71.25", 72"
- Twin-wall in 6mm, 8mm & 10 mm thickness
- Triple-wall in 16 mm thickness
- Available in clear, bronze, ice/white in all thicknesses
- Options in 8mm only 100% diffused, temperature reduction and blackout





Griffin Construction Department
Partner with us on your next project.
Call for consultation and quote:
1.800.888.0054 then press 3.





Item	Description
08-4027	48" X 12' 8MM Twin Wall Clear POLYGAL Panel w/ Anti-Fog
08-4037	48" X 16' 8MM Twin Wall Clear POLYGAL Panel w/ Anti-Fog
08-4047	72" X 12' 8MM Twin Wall Clear POLYGAL Panel w/ Anti-Fog
08-4057	72" X 16' 8MM Twin Wall Clear POLYGAL Panel w/ Anti-Fog

Thickness, Weight & Insulation Values

Product Profile	Thickness		Weight		U-Value	R-Value
	in	mm	lb/psf	g/m2	(Btu/h/ft2/F)	(Btu/h/ft2/F)
	1/4	6	0.27	1300	0.63	1.59
	1/3	8	0.31	1500	0.60	1.67
	3/8	10	0.35	1700	0.53	1.89
	5/8	16	0.55	2700	0.41	2.44

Light Transmission

Product Profile	Thickness	Color or Tint		
		Clear	Bronze	Ice
	6 mm	80%	42%	32%
	8 mm	79%	42%	32%
	10 mm	78%	42%	32%
	16 mm	74%	42%	32%

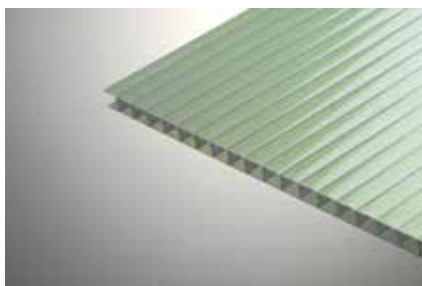

100% Diffused 8mm Twin-wall Polycarbonate

Accessories for Multi-Wall Polycarbonate Projects

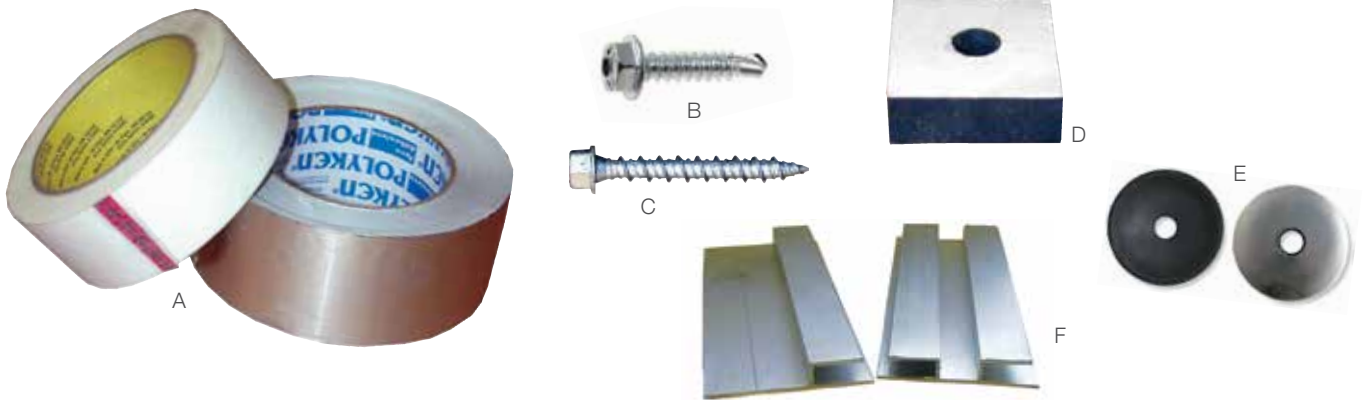

Aluminum & Vent Tape (A)

- Vent Tape is used at bottom of PCSS*
- Aluminum Tape is used at top of PCSS*

#394 Vent Tape
Item: 09-6025

Size: 1½" X 36 yds

Aluminum Foil Duct Tape
Item: 09-6030

Size: 2" X 50 yds

Self Drilling Plated Screws #12 (B)

- Designed to drill, tap, and fasten in one operation
- Use in metal application
- Hex head self tapping - No Washer
- 1½" #12 HWH

Please Note: #12 Hex Head Self-Tapping Screws are available in bulk on request. Not stocked. Ask for sizing and pricing.

Item: 09-2255

Qty: 100/box

Self Drilling Plated Screws #10 (C)

- Designed to drill, tap, and fasten in one operation
- Use in Wood application
- #10 Woodtite Screw - No Washer
- Self drilling piercing point hex head

Item: 09-2251

Size/Qty: 1½" - 100/box

Foam Spacer (D)

- 1" x 1" x 3/8"
- One side sticky
- Used on purlins for spacer with PCSS*

Item: 09-6035

Qty: 100/bag

Washers (E)

Perma-Seal Sealing Washer

Item	Description	Qty
09-5020	#10 x 1½" Neo/Bonded Washer	100/bag
09-6020	#10 x 5/8" Neo/Bonded Washer	100/bag
09-6023	#12 x 5/8" Neo/Bonded Washer	100/bag
09-5026	#12 x 1½" Neo/Bonded Washer	100/bag

Single & Double "H" Alum Extrusions for 8 mm Polycarbonate (F)

For use with 8 mm polycarbonate structured sheets on end walls and side walls.

12' Single

Item: 09-5235

12' Double

Item: 09-5236

Gable Framing Bracket

- (2) #14 x ¾" Tec screws
- (2) #14 x ½" wood screws

Item: 83-201000





Hi-Core® XL Glazing Construction Panels

Hi-Core® XL is a rigid, multi-wall, translucent sheet, made from a tough polyolefin alloy that is protected from UV and weather by an Environmental Protection System that is exclusive to Matra Plast. Light passing through Hi-Core® XL is highly diffused, (over 95%). Diffused light is bent to many different angles. Compared to non-diffusing materials, Hi-Core® XL allows the light to make a service building brighter or to penetrate deeper into the leaf canopy to impact with more crop. For more information, contact Griffin.



Sheet widths

48" (1220 mm), 72" (1830 mm), 80" (2030 mm) (Available Direct from Factory)

Sheet lengths

8' (2440 mm) to 50' (15,240 mm) (Subject to available transportation restrictions)

8MM Light Transmission (ASTM E 424-71): 73%

Insulation: R factor = 1.64 U factor = 0.61

Item: 08-4030

Size: 8mm panel 4' x 8'

Single and Double "H" Extrusions for 8 mm Hi-Core®

For use with 8 mm Hi-Core® structured sheets on end walls and side walls.

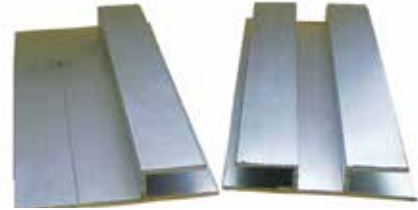

12' Single

Item: 09-5235

12' Double

Item: 09-5236

Crystalite Standard Flat Fiberglass

Economical greenhouse panel, ideal in moderate climates for use on side walls and gable ends, when initial cost is a prime factor.



Item: 07-3255

Size: 5 oz. Crystalite 4' x 50'

Drop Ship Only



Eskay-Lite Vinyl Covering

- 16 mil clear vinyl covering
- Unusually clear, very small light loss
- 4 year life under most conditions
- A good compromise between poly and fiberglass as cover material. Use on ends and sides for see-thru clarity

Item: 05-1025

Size: 16 mil 54" x 50'

Item: 05-1030

Size: 16 mil 54" x 225'

IMPORTANT NOTE: Eskay Lite and poly should never be applied so both products come in direct contact with one another. A chemical reaction will occur and product deterioration can result.

ACRYLITE® ACRYLITE® Acrylic Glazing for Greenhouses



Creating optimal growing conditions with ACRYLITE®

ACRYLITE® multi-skin acrylic's state-of-the-art product features provide significant performance benefits in growing environments of all types. From the far north to the deep south. From tender seedlings and finicky exotics to hardy bedding plants and hydroponic vegetables. No matter where your operation is located or what you are cultivating, controlling the growing environment is critical to your bottom line. ACRYLITE® glazing puts the grower in control and provides solid return on investment over decades of use making it the best value in greenhouse covering available today. Let ACRYLITE® help you create the ideal environment for growth.

Reasons to choose ACRYLITE®

1. High light transmission for growth results
2. Never yellows
3. Protection from hail
4. Energy savings of over 40%* per year
5. Anti-condensate technology, with anti-algae technology
6. Strength and durability
7. Life expectancy of 30+ years
8. Environmental protection
9. The best warranties in the industry

2024



Griffin Construction Department

Partner with us on your next project.
Call for consultation and quote:
1.800.888.0054 then press 3.





Corrugated Single-Ply Polycarbonate

Griffin has both stocked panels and custom offerings to cover your polycarbonate glazing needs.

Griffin Stock Panels

Clear Greca Corrugated Polycarbonate Panels are commonly used to glazed greenhouse in cases where polycarbonate is desired, and multi-wall is not needed. Installation costs of corrugated polycarbonate do not require extrusions and so are less expensive than multi-wall installations.

Custom Orders

Need a Nonstock Piece of Polycarbonate?

Griffin has you covered. We offer a variety of widths, lengths, and colors of corrugated polycarbonate. All custom orders are direct shipped from Polygal FOB Freight Origin.

Custom Possibilities

- Lengths up to 36'
- Width: 49.6"
- Available in clear, ice/white & 100% diffused

Item	Description
08-4059	49.6" X 12' Clear Greca Corrugated Polycarbonate Panel 0.8 mm
08-4060	49.6" X 16' Clear Greca Corrugated Polycarbonate Panel 0.8 mm
08-4040	Grecca Horizontal Foam Closure 3' length
09-3525	No Drip Spacer
193921	1" X 1" X 40" Vertical Foam Closure
09-2255	#12- Self Drilling Metal Screw 1 1/2" 100/Bag
09-6023	#12 X 5/8" Neo/Bonded Washer 100/Bag
09-2251	#10 Woodtite Screw 1 1/2" 100/bag
09-6020	#10 X 5/8" Neo/Bonded Washer 100/Bag

Greca Corrugated Polycarbonate Panel

Color	Light Transmission
Clear	89%
ICE/WHITE	50%
DIFFUSED	85%

Installation Guides

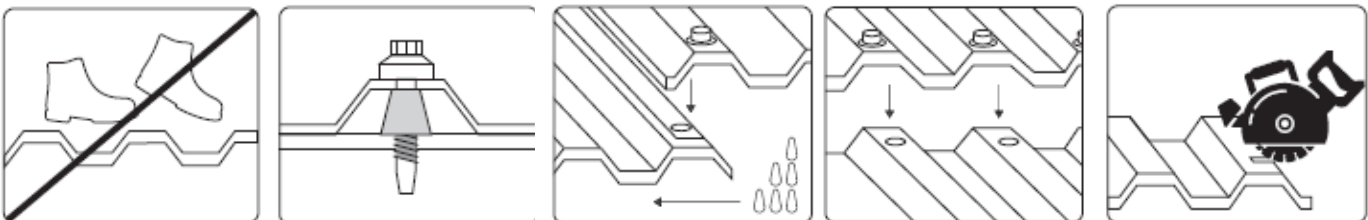

HC Quality Doors

Aluminum Greenhouse Doors



Sliding Door Polycarbonate



Double Hung Aluminum Door



Single Hung Aluminum Door



Double Sliding Aluminum Doors



Single Sliding Aluminum Doors

Custom greenhouse doors made to fit any size opening. Below are Griffin's most popular options.

- Single Hung Swinging Door
- Single Sliding Door
- Double Hung Swinging Doors*
- Double Sliding Doors*

HC Quality doors are made with aluminum tubing with stainless steel hinges / hardware and standard polycarbonate glazing. 3'x8' and 4'x8' sized doors are popular sizes.

*Double Doors package includes two doors.



Griffin Construction Department

Partner with us on your next project.
Call for consultation and quote:
1.800.888.0054 then press 3.



Roll-Up Door

Strong, Smooth, Quiet - Rolled Into One Great Door



Features

- Withstands higher wind loads
- Strong, durable materials
- Smooth, quiet operation
- Easy installation
- Custom sizes
- Multiple applications
- Low maintenance
- Minimal back room requirements
- Rust resistant
- 30/25 Year paint and 3-year material warranties



TuffliteIV™

TuffliteIV is a high-quality greenhouse covering that is available in a wide variety of options that allow for maximum protection and ease of installation.



1.877.662.3779

berryglobal.com

CLIMATE CONTROL



Windmaster Exhaust Fans

- Slant arrangement protects motor and drives from weather
- High air flow capacity- shutter directs air to fan
- Select fan at 0.5" sp. instead of .10"
- Constructed of heavy gauge galvanized or aluminum
- Includes guard on outlet side
- Wiring knockout allows wiring connections inside building

Exhaust Fan with Slant Wall Housing - Stocked in 115 Volt

Item	Size	Speed	HP
23-1121	24"	1	1/3 HP
23-1126	24"	2	1/3 HP
23-1131	30"	1	1/2 HP
23-1136	30"	2	1/2 HP
23-1141	36"	1	1/2 HP
23-1146	36"	2	1/2 HP
23-1150	42"	1	1/2 HP
23-1155	42"	2	1/2 HP
23-1165*	48"	2	1/2 HP

All Guards for wall housings have 1" x 1/2" welded galvanized wire in aluminum frame for inlet side of wall housing. Outlet guards are included on WS wall housings as standard equipment. Inlet guards are mounted with quick release clips.

*Nonstock item: order will ship direct FOB Freight Origin.



Automatic Aluminum Shutter

Item	Fan Size	Wall Housing Model	Shutter Model
23-1240	24"	WS24DC	WAA2727
23-1245	30"	WS30DC	WAA3333
23-1250	36"	WS36DC	WAA3939
23-1255	42"	WS42DC	WAA4545
23-1260	48"	WS48DC	WAA5454
23-1265*	54"	WS54DC	WAA6060



Griffin Construction Department

Partner with us on your next project.

Call for consultation and quote:
1.800.888.0054 then press 3.

Master-Ex®

Housing

Heavy gauge plastic and fiberglass provides strength and corrosion resistance while being easy to clean and mount. 14" thru 24" fans have plastic housing and diffuser. 36" thru 54" fans have fiberglass housing and plastic diffuser. The slant design on the DDPS improves performance and assists run-off condensation.

Propeller

Direct drive DDPS fan sizes 14" thru 36" feature stainless steel cambered twist blades riveted through the center, eliminating stress. Belt drive DDPS 36" fans are available with either stainless steel or galvanized propellers.

Motor

High efficiency motors are totally enclosed with shielded ball bearings for protection from the environment.

Frame

Stainless steel provides a strong vertical support that aligns the propeller centered in the orifice for maximum performance.

Front Guard

Heavy gauge and coated to prevent corrosion.

Inlet Guard

Heavy gauge welded galvanized wire in aluminum frame.

Shutter

Unique design lowers resistance with preventing back drafts. Available in aluminum or plastic.

Flomaster Motorized Shutters

- Precision counterbalanced aluminum blades open easier, wider to permit higher fan capacity
- Corrosion-proof nylon bearings throughout to help prevent sticking
- Suitable for dusty or humid applications
- Stainless hinge pins will not rust, ensure easy positive blade action
- All shutter blades are reinforced with polished galvanized steel rods, and equipped with double tie-rods
- Automatic: Used with exhaust fans; opens automatically when fan is on, closes automatically when fan is off
- Corrosion resistant heavy gauge aluminum frame
- Keeps out wind, rain, and back drafts when fan is not in operation (See fan selection for shutter sizes)



Shutter

Item	Shutter Model	Overall	Opening	Sq. Ft. Opening	Wt.
23-1325	WAAC1818MT	18" x 18"	15" x 15"	1.56	10
23-1330	WAAC2626MT	26" x 26"	23" x 23"	3.67	14
23-1335	WAAC3333MT	33" x 33"	30" x 30"	6.25	18
23-1340	WAAC4040MT	40" x 40"	37" x 37"	9.50	22
23-1345	WAAC6318MT	63" x 18"	60" x 15"	6.25	19
23-1350	WAAC6340MT	63" x 40"	60" x 37"	15.42	35
23-1355	WAAC6362MT	63" x 62"	60" x 59"	24.58	52

Motorized Inlet Shutters

- Cam pulley operator provides long life to motor and is corrosion resistant
- Motor draws only 17 watts
- WAAC models are center pivoted to open easier against house static pressures
- Motors available in 24v, 115v, 230v, 460v (specify voltage required (Stock 115v))
- Replacement: Motors, motor and cam linkage or cam linkage only can be purchased separately.

Replacement Motor

Item	Description
23-1362	Damper Motor with Spring (Motor Only) 115v
23-1375	Motor and Linkage 115v

DC/DCA Belt Tightener

- Designed to fit your Acme equipment
- Easy to install
- Payback starts immediately
- One unit fits both sizes

When you go into a greenhouse and hear the high pitched squeal of fan belts, you are listening to the sound of dollars being sucked out of the house. Manually keeping belts tight is a never ending job-an automatic belt tightener is absolutely necessary.

The bottom line? Saving on your electric bill and reduced maintenance (no more belts to tighten) for a very small capital outlay.

Stop Belt Slippage & Cut Electrical Usage



DC/DCA 24, 30 & 54

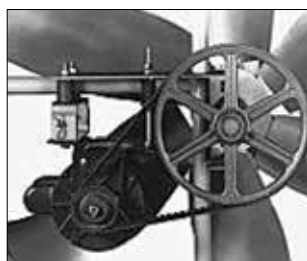

DC/DCA 36 through 48

Item: 23-1860



Adjustable Belt Makes Any Length You Need!

Stock One Belt Size to Suit all Your V-Belt Needs

For permanent replacement of V-belts. Eliminates the need to stock extensive line of replacement belts.

- Unaffected by common horticultural chemicals
- Assembles to any length required, by hand, in seconds, without tools
- Easy to install without having to move motor to tension belt
- Increased fan and heater efficiency
- Longer belt life
- Higher heat resistance

Item	Width	Length
23-60251	1/2"	6 1/2 ft
23-60601	5/8"	32 ft

Horizontal Air Flow System

The Horizontal Air Flow (HAF) system has been proven to be the most efficient method for good greenhouse air circulation. The benefits of more uniform temperature, better growth and less disease help you produce higher-quality plants. Fan Capacity to keep the air mass moving at the 50–100 ft. / min. velocity, it takes a certain amount of energy to overcome turbulence and friction losses. A rule of thumb based on greenhouse trials and smoke bomb tests is 2 cu. ft. / min fan capacity for each square foot of floor area. For example, in the 30' by 144' greenhouse the total CFM fan capacity needed is $30 \times 144 \times 2 = 8640$ CFM. This can be reduced slightly in houses with plants grown only on the floor. It may need to be increased slightly in houses with crops such as tomatoes, roses or hanging baskets. Using 2475 CFM output fans, 4 fans would be needed.

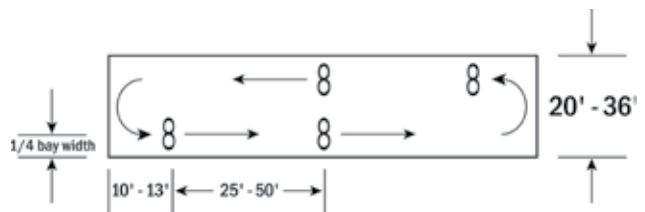

Typical HAF fan placement in a narrow individual greenhouse.

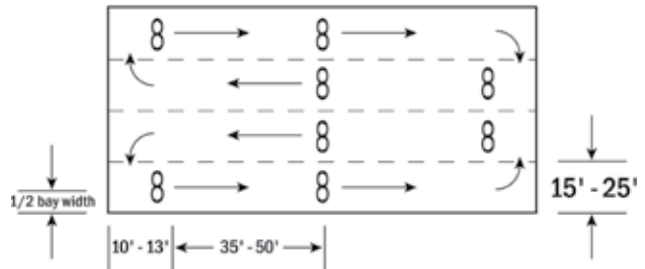

Typical HAF fan placement for even number of bays.

2024

DRAMM

Dramm AME fans

- Shrouded design
- Sealed motor with quiet, cool operation and long life
- Variable speed control
- Engineered installation plans

350 mm HAF fan, 208-240V Single Phase, 1850 cfm
Item: 41-350MM

400 mm HAF fan, 208-240V Single Phase, 2860 cfm
Item: 41-400MM

These fans drop-ship to the site from the manufacturer.

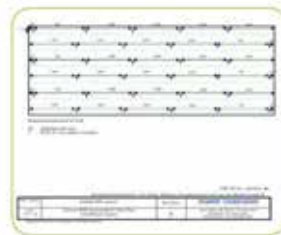

SCHAEFER

12" Patented Plant Air® H.A.F. Fans

- Significantly more efficient air-to-energy usage than other fans
- Wider guards with less restrictive wire spacing allow for twice the air flow
- Variable speed capability (with optional control) allows for air flow control to accommodate temperature and crop changes
- No-maintenance, completely enclosed motor never needs oiling
- Model VT12PA: 1/10 HP, 115/230 volts, 1.3/.65 amps, 1725 RPM, 1649 CFM
- Includes unattached 120V cord with standard plug

Item: 23-5025





Horizontal Air Flow System

- Propeller - Aluminum blades held securely in place by a steel spider and hub provide quiet operation
- Motor - Heavy duty PSC, totally enclosed motor with automatic thermal overload protection and ball bearings is energy efficient. Motor can be used with variable speed control for more precise air movement
- Guards - Two piece wire guard for easy access has a gray plastic coating to resist corrosion
- Installation - Two piece rotational bracket provides a locking tilt adjustment for proper angle of air flow. "S" bracket provides two different dimensional mountings
- Wiring - Motor comes factory-wired on the "A4" with a 6'3" conductor cord with grounding type molded plug for easy installation



	HAF12A4	HAF20A4
Size	12"	20"
RPM	1566	1626
Motor HP	1/15	1/15
Voltage	115/1	115/1
Watts	124.5	105.0
Air Flow	1145	3005

Item: 23-4020 Size: 12"
 Item: 23-4025 Size: 20"

2024

18" Multifan Horizontal Circulation Fan

- Powerful and quiet
- Energy efficient
- Easy installation and maintenance
- Variable speed with controller
- Versatile use - HAF and with poly tubes
- 120V, 240 V, and 3-phase options
- 3 year warranty on motor



Multifan V-FloFan

- Constant air movement and vertical turnover of air
- Blows warm air down along the perimeter of the space
- Pulls cool air up in the center of the space
- Easy installation and maintenance
- 120V, 240V and three-phase
- 3 year warranty

Item: 23-10300
 Description: 28.0 Multifan V-Flo with 9' power cord 120 V





Economical, Practical, Effective

American Coolair's Type NBF/AL fan provides the solution to fresh air ventilation in most types of farm buildings. Type **NBF fans** are built to give you years of heavy-duty trouble-free service. The rugged, belt driven construction operates in any position, has permanently lubricated ball bearings, and is available with single or two speed totally enclosed motors. Coolair has developed a complete ventilation system for farm use combining the Type NBF fan with all aluminum shutter (Type LRW) and heavy gauge galvanized steel wall housing (square box or slope) for exterior mounting, allowing a maximum of unobstructed interior space. American Coolair's **AL all-aluminum fans** are the answer to concerns about rust and corrosion in today's damp greenhouse environment. Combined with an aluminum wall housing, an aluminum shutter, and a vinyl coated wire guard, the AL fan will provide years of trouble-free and corrosion-free service.

Exclusive Drive Assembly

Our engineering department has developed an innovative drive assembly for the Type NBF fan. Our use of quality materials and precise engineering techniques in constructing wheel assemblies assure you of years of quiet, trouble-free service. Power is applied through V-belts directly to the propeller with blade load concentrated directly over the bearings to eliminate overhang bearing load. The exclusive, time tested design has been widely acclaimed by engineers.

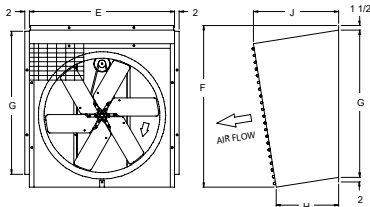

Type GSWH (Slope) Wall Housing

The SLOPE wall housing allows the shutter to be placed on the intake side of the fan and eliminates air turbulence that occurs with the shutter on the down-wind side of the fan. It prevents the warm air from being lost through the metal wall housing to the outside cold air in cold climate conditions. The GSWH housing is constructed of galvanized steel for long, durable wear and low maintenance.

Fan Model	E	F	G	H	J	Ship wt
GSWH24/SWHA24	32 ³ / ₈	37 ¹¹ / ₁₆	32 ¹¹ / ₁₆	23 ⁷ / ₈	29 ⁹ / ₁₆	52
GSWH30/SWHA30	38 ³ / ₈	44 ¹ / ₂	38 ³ / ₄	23	29 ⁹ / ₁₆	67
GSWH36/SWHA36	44 ³ / ₈	50 ⁵ / ₁₆	44 ¹⁹ / ₁₆	22 ¹ / ₂	29 ⁹ / ₁₆	82
GSWH48/SWHA48	50 ³ / ₈	56 ⁵ / ₁₆	50 ¹⁵ / ₁₆	21 ³ / ₄	29 ¹ / ₁₆	104
GSWH48/SWHA48	56 ³ / ₈	62 ³ / ₈	57	21 ⁵ / ₈	30 ¹ / ₂	122
GSWH54/SWHA54	62 ³ / ₈	68 ¹¹ / ₁₆	63 ¹ / ₁₆	22 ³ / ₄	32 ⁹ / ₁₆	132
GSWH60	68 ³ / ₈	74 ¹ / ₄	69 ³ / ₈	22 ¹ / ₄	33	152

Rough Opening for GSWH Housings:

Add ¹/₂" to 'E' for Width
 For 4" Wall: Add ¹/₄" to 'G' for Height
 For 2" Wall: Add ³/₄" to 'G' for Height
 For 6" Wall: Add ¹/₂" to 'G' for Height



Type NBF Fan

Performance and Efficiency

When economy is measured in terms of cubic feet of air per minute per dollar invested, the Type NBF wall fan exhaust unit is unsurpassed. American Coolair's Type NBF fan is today's best investment, Coolair uses only the most efficient ball bearing motors available. They are totally enclosed resilient base motor.

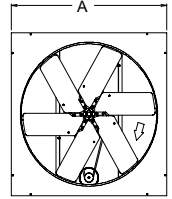

Fan Model	A	B	C	D
NBF24/AL24	32	5 ¹ / ₈	12 ¹ / ₂	5
NBF30/AL30	38	5 ¹ / ₈	12 ¹ / ₂	5 ¹ / ₈
NBF36/AL36	44	5 ¹ / ₈	13 ³ / ₄	5 ¹ / ₄
NBF42/AL42	50	5 ¹ / ₈	13 ³ / ₄	5 ⁵ / ₈
NBF48/AL48	56	5 ¹ / ₈	13 ³ / ₄	6 ¹ / ₄
NBFA54/AL54	62	5 ¹ / ₈	13 ³ / ₄	6 ¹ / ₂
NBF60	68	6 ¹ / ₈	18	6

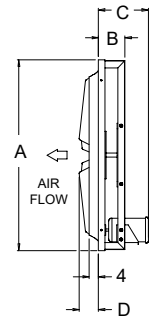

Coolair® Motorized LRW Air Inlet Shutter

The LRW Air Inlet Shutter is designed to be opposite side or end of buildings. It features a sturdy aluminum frame, aluminum blades, aluminum reinforcing brackets and nylon bearings on all movable linkage. The LRW Air Inlet Shutter is fully automatic and comes standard with a motor to automatically open and close shutters.

Air Inlet Shutter Model	Air Flow Capacity CFM	Required Opening Dim.	Overall Dim. Including Flange
LRW16E	1,000	17 x 17	19 ¹ / ₄ x 19 ¹ / ₄
LRW21E	1,800	22 x 22	24 ¹ / ₄ x 24 ¹ / ₄
LRW27E	3,000	28 x 28	30 ¹ / ₄ x 30 ¹ / ₄
LRW33E	4,500	34 x 34	36 ¹ / ₄ x 36 ¹ / ₄
LRW39E	6,300	40 x 40	42 ¹ / ₄ x 42 ¹ / ₄
LRW45E	8,400	46 x 46	48 ¹ / ₄ x 48 ¹ / ₄
LRW51E	10,700	52 x 52	54 ¹ / ₄ x 54 ¹ / ₄

Air Inlet Shutter Model	Air Flow Capacity CFM	Required Opening Dim.	Overall Dim. Including Flange
LRW57E	13,400	58 x 58	60 ¹ / ₄ x 60 ¹ / ₄
LRW66E	18,000	67 x 67	69 ¹ / ₄ x 69 ¹ / ₄
LRW4527E	5,000	46 x 28	48 ¹ / ₄ x 30 ¹ / ₄
LRW4515E	2,800	46 x 16	48 ¹ / ₄ x 18 ¹ / ₄
LRW6024E	6,000	61 x 25	67 ¹ / ₄ x 27 ¹ / ₄
LRW6036E	8,900	61 x 37	64 ¹ / ₄ x 39 ¹ / ₄

Evaporative Cooling Systems

Evaporative Cooling in Concept: To counter periods of extreme temperature that affect in-house environments and therefore production, Coolair Evaporative Cooling Pad Systems are used with outstanding success. When large quantities of air are pulled through Evaporative Cooling Pads that are saturated with water, a substantial cooling effect is realized due to the evaporation of that water. Used in conjunction with Coolair fans, a temperature reduction of 10-25 degrees is commonplace. Suited for virtually all geographic locations, the Coolair Evaporative Cooling System delivers the greatest economic benefits to areas where higher temperatures during longer periods of time are normal. Coolair has created a brown out housing accessory for their current evaporative cooling systems and is an easy retrofit if needed. The brown out housing attached to their evaporative cooling system in conjunction with light traps is the perfect system for all of your light deprivation needs.



Weatherproof Line Voltage Fan Control

- Great for control of 120v fans/ventilators
- On/Off control with minimum speed adjustment for motor types - shaded pole, PSC and universal
- Weather & corrosion proof all polycarbonate thermoplastic construction
- Standard 7/8" opening
- Rating: 5 amps at 120 volts

Item: 24-6020



2024

Ultra Violet Ventilation Tubing

Engineered to your specifications

For greenhouse use, Ultra Violet Tubing is used where the sun is most intense, or wherever a longer lasting tube is desired. If handled properly, it should last for two seasons of service, thus requiring less frequent replacement.

Custom length ordering notes:

- All tubing is custom cut and punched
- All orders under 50' in length are subject to an up-charge
- Shipped direct from factory; allow shipping time (FOB factory)

Punch Positions

Numbers in circle are as positions on a clock.

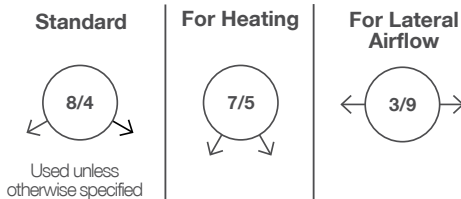

Item	Diameter	Lay Flat Measurement
23-3030	UV 12"	19"
23-3035	UV 18"	28½"
23-3045	UV 24"	38"
23-3050	UV 30"	47½"

Tube Hanger Set

Unique hanger clamps onto tubing for easy attachment to overhead support wire with snap ring.

Item: 23-1825



Tube Support Wire Package

Wire support kits, available in 50', 100' and 150' lengths, include six strand 10 gauge wire, turnbuckle and 2 securing clips.

- Item: 23-1875 Size: 50'
- Item: 23-1880 Size: 100'
- Item: 23-1885 Size: 150'

Recommended Spacing
 12" tubing every 10 ft.
 18" tubing every 10 ft.
 24" tubing every 8 ft.
 30" tubing every 6 ft.



**Your Extended Forecast:
Up to 97% Efficiency with 100% Chance of Savings.**

High-Efficiency Condensing Gas-Fired Separated Combustion Unit Heaters

IN COMPARISON, THERE'S NO COMPARISON.

Modine's Effinity (model PTC) condensing unit heater line is the most efficient gas-fired, condensing unit heater in North America.

With six models available — from 135,000 to 310,000 BTU/hr — all operating at up to 97% efficiency, the Effinity will dramatically lower energy costs through decreased fuel consumption.

Effinity Propeller Unit Heater Model PTC General Performance Data

Model PTC Sizes										
	55	65	85	110	135	156	180	215	260	310
BTU/Hr Input	55,000	65,000	85,000	110,000	135,000	155,000	180,000	215,000	260,000	310,000
BTU/Hr Output	51,150	60,450	79,050	102,300	125,500	144,150	167,400	199,950	241,800	288,300
Condensate Production (Gal./Hr.)	0.3	0.4	0.5	0.7	1.0	1.1	1.3	1.6	1.9	2.3
Entering Airflow (CFM) @ 70°F	1097	1141	1650	1750	2160	2600	3020	3865	4585	5400
Outlet Velocity (FPM)	618	650	619	668	719	862	676	699	831	765
Air Temp Rise (°F)	43	49	44	54	54	51	51	48	49	49
Max Mounting Height (ft.)	12	12	13	13	14	18	15	17	20	19
Heat Throw (ft.) @ Max Mtg Ht	43	43	48	46	51	62	53	60	70	67
Motor Type	PSC	PSC	PSC	PSC	PSC	PSC	PSC	PSC	PSC	PSC
Motor HP	1/8	1/8	1/8	1/3	1/3	1/3	1/3	1/2	3/4	3/4
Motor RPM	1440	1440	1550	1075	1075	1075	1075	1075	1125	1125

Hot Dawg Heater

Gas-fired, Power-exhausted, Low Profile (Also available in Separated-Combustion)

Propeller	Model Number					
	HD 30	HD 45	HD 60	HD 75	HD 100	HD 125
BTU/Hr Input	30,000	45,000	60,000	75,000	100,000	125,000
BTU/Hr Output	24,000	36,000	48,000	60,000	80,000	100,000
Vent Dia. (in.)*	3 or 5	3 or 5	3 or 5	3 or 5	4 or 6	4 or 6
CFM @ 70°F	505	720	990	1,160	1,490	1,980
Air Temp Rise (°F)	44	46	45	48	50	47
Max Mounting Height (ft.)**	10	10	12	14	12	16
Heat Throw (ft.)**	25	27	36	38	42	56
Motor HP	1/25	1/15	1/12	1/12	1/12	1/8



- 80% Thermal Efficiency
- Horizontal or vertical venting
- Field convertible to propane
- Low profile casing
- Direct spark ignition
- 100% Shut-off with continuous retry
- Mounting brackets supplied
- Commercial or residential applications

*Vent size varies depending upon application.

**At 65°F ambient temperature and unit fired at full-rated input. Mounting height is measured from floor to bottom of unit.



Gas-Fired, Power-Exhausted High-Efficiency Unit Heaters

(Also available in Separated-Combustion)

- 80% Thermal efficiency
- Rotating power exhaust
- Horizontal or vertical venting
- Field-convertible to propane
- Field-adjustable level hanging
- Intermittent pilot ignition, 100% shut-off with continuous retry



Propeller		Model Number						
		PDP 150	PDP 175	PDP 200	PDP 250	PDP 300	PDP 350	PDP 400
BTU/Hr Input	For power exhausted models rated 30,000 to 125,000 BTU/hr, Please see the previous page.	150,000	175,000	200,000	250,000	300,000	350,000	400,000
BTU/Hr Output		120,000	140,000	160,000	200,000	240,000	280,000	320,000
Vent Dia (In.)		5	5	5	6	6	6	6
CFM @ 70°F		2180	2550	2870	3700	4460	4870	5440
Air Temp Rise (°F)		51	51	52	50	50	53	54
Max Mounting Height (ft)		16	17	15	19	21	20	19
Heat Throw (ft)*		55	59	51	67	74	70	69
Motor HP		1/8	1/6	1/6	1/3	1/2	3/4	3/4

Many sizes in stock. Call for more information.

* At 65° ambient temperature and unit fired at full-rated input. Mounting height is measured from floor to bottom of unit.

Horizontal Power Vented Unit Heater

Horizontal power vented, PTP unit heater line. The PTP delivers 80% thermal efficiency in a small business-friendly package. This unit features a stainless steel tubular heat exchanger as standard on all units with a 10-year heat exchanger warranty that provides customers with a peace of mind. The PTP is available in 7 models sizes - 150,000 to 400,000 BTU/hr.



Steam and Hot Water Unit Heaters

Proven for greenhouse, industrial and commercial application. Has adjustable horizontal air deflector blades. Vertical deflector blades are optionally available for complete directional control. Horizontal units available with top/bottom inlet/outlet piping connections.

Verticals are designed for overhead and out-of-the-way mounting. Four deflector types are available for various air distribution patterns, from high, jet-like beam to low, broad, gentle cone. V models have copper tubes, VN models have cupro nickel tubes.



IMPORTANT NOTE: Installation instructions must be strictly followed for all Modine units to avoid damage.



Griffin Construction Department | Partner with us on you next project.
Call for consultation and quote: 1.800.888.0054 then press 3.

Greenhouse Thermostats

- Weather-proof Line Voltage
- 16 Full load amp rating at 120 Volt
- 30° to 110°F

Item	Vendor	Description
24-6001	KJ16110	Single Stage Thermostat
24-6002	KT16110	Double Stage Thermostat
24-6010	KP16110	Portable Prewired Single Stage Thermostat - comes with 8' cord



DRAMM

Mechanical Thermostats

Dramm / Microfan mechanical thermostats are designed with rough environments in mind. These high quality thermostats are perfect for any situation where harsh conditions may damage less durable equipment. Protected in durable PVC housing, these thermostats offer stainless steel coil sensors and accuracy to 1° C.

Item	Description
24-2300	T41-SV Single Stage Thermostat
24-2305	T42-SV Double Stage Thermostat

Features:

- Durable PVC housing
- Unlimited accuracy
- Non-corrosive construction
- Sealed wiring strain relief
- Single-stage or two-stage



Green-tek

Anti-Insect Nets Insect Screening

Excluding pests from growing areas is the most effective control method. Some growers have reduced their pesticide use by 90% using Green-Tek Insect Screen in combination with insect-free stock, good sanitation, and ventilation allowances. In addition to being the most effective, it is also the least expensive form of Prevention.



50 Mesh is the top seller, as it maximizes the trade off between exclusion and airflow. Stops whiteflies and some thrips.

75 Mesh is a very tight weave, designed exclusively to stop thrips. Ventilation allowances are a must with 75 Mesh.

OPTINET 50 | Dynamic insect screen cleverly doubles effectiveness by combining the weave of 50 Mesh with an exclusive colorant formula that disrupts the UV light that insects use to navigate, feed, and reproduce. Result: They are visibly repelled before they even try to get in. Excellent choice vs. thrips where more airflow is needed.

Common Name	Insects	Width
17 Mesh	Large	12.13'
25 Mesh	Sharpshooter	13.12, 14.75'
40 Mesh	Aphids	9.84, 14.75, 16.4'
50 Mesh	Aphids, Whiteflies, Leafminer, some Thrips	6.5, 9.84, 11.48, 13.12, 14.75, 16.4'
OPTINET 50	Aphids, Whiteflies, Leafminer, many Thrips	6.5, 9.84, 11.48, 13.12, 16.4'
75 Mesh	Thrips and Larger	11.75'

Please contact our office for proper sizing and requirements.



Griffin Construction Department

Partner with us on your next project. Call for consultation and quote: 1.800.888.0054 then press 3.

BioTherm's Cultivation Climate Technologies are tailored to specific climate and growing conditions. Their systems are durable and efficient, which results in high-success rates and peak crops. They now offer some of their climate systems in pre-packaged configurations, providing climate technology systems to growers of all sizes—no engineering needed!

BioTherm has invested over four decades into developing rugged climate solutions that are robust and designed to go the distance to help plants thrive.

Upstart® Professional Rootzone Heating Kit

Start your own plants with a professional hot water rootzone heating system!

- Heats up to 500 sq. ft. of growing space
- Uses a locally acquired hot water heater
- System comes complete with a remote media sensor for control

How it works:

Upstart head unit is attached to your water heater. Hot water is pumped through BioTherm's Roll'N Grow Mat. Plants are placed directly on the mat. The media temperature sensor tells the head unit when to cycle on & off to maintain optimum media temperature.

Product includes:

- 1 – Upstart Heat Unit
- 1 – 4'x25' Roll'N Grow Heating Mat
- 1 – Piping & fitting pack (up to 25' distance)

Ship weight: 91lbs. *Custom configurations are available for \$250 fee



BT-530 Overhead Dehumidifier

The BT-530 Dehumidifier has been meticulously designed with today's indoor grow environmental challenges squarely as its foundation.

Independent laboratory testing has proved the BT-530 airflow rate is superior to its closest rivals in tests performed at the industry standard conditions of 80°F/ 60%RH. This industry leading performance results in potentially requiring less units to cover a grow area than comparable units.



Roll'n Grow™

Roll'n Grow™ is the perfect way to apply Root Zone Heating (RZH) to growing beds or benches! Like a carpet, your growing surfaces can now be covered with growth-enhancing gentle heat in a fraction of the time it used to take.



For larger, engineered climate technology systems, please contact Griffin's construction department.



Griffin Construction Department

Partner with us on you next project. Call for consultation and quote: 1.800.888.0054 then press 3.



Oil & Gas Heating Systems



Heatmaster Oil Models

200, 300 or 400,000 BTU



Quantum Models

180,000 BTU (Gas) or 210,000 BTU (Oil)



Heat Reclaimer

Gain 5% efficiency



Royal Models

240,000 BTU (Oil or Gas), 320,000 BTU (Oil), or 360,000 BTU (Gas)



Heatwave Waste Oil Heater

150, 250, or 350,000 BTU



Drop Ship Only

All of the Siebring heaters listed on this page are drop ship only.



Griffin Construction Department | Partner with us on your next project. Call for consultation and quote: 1.800.888.0054 then press 3.

Link4 CORPORATION



Link4 – Commercial environmental, irrigation and fertigation controllers.

A controller solution for any grower's needs.

Link4 offers a full line of commercial controllers that will solve any size or complex environmental or irrigation application. Cloud based controls allow you to monitor and control your situation from a remote device and develop reports from the stored data.



L4 RO SYSTEM | Produces high purity water by reducing contaminants such as dissolved minerals, particulates, and organic impurities using a reverse osmosis membrane system. Complete, skid mounted, pre-plumbed, pre-wired reverse osmosis (RO) system for quick installation and start-up.

Indoor Controllers

iPonic 614/624

For warehouse facilities for CO₂, lights, temperature, humidity, recycle timers, vent fans, high temperature shut-off, irrigation, central air conditioning, heating and more. 8 120v outlets to control Fuzzy Logic. Digital integrated sensor included (2 with the 624). Alarm capabilities. Single zone with 614, dual zone with 624 (8 outputs each).

iPonic 614/624 Commercial

Like the iPonic 614 and 624 but includes a pre-wired integrated, UL listed contactor or lighting panel. Suitable for 120v, 240v, 277v, 480v; up to 18 amps per circuit.

Advanced Controllers

iGrow 800

For mid-size warehouse or greenhouse facilities. Controls fans, heaters, vents, pad systems, irrigation, shade curtains (blackout curtains), and more with Cloud and alarm access. 8 outputs expandable to 32.

iGrow 1800

For advanced warehouse or greenhouse facilities. Controls fans, heaters, vents, pad systems, smart irrigation, shade curtains (blackout curtains), smart (DLI) lighting, VPD, alarming and more. The auxiliary controls are flexible, and user defined to control conditions to fit your unique growing requirements. The LinkConn software allows you to control, monitor and report from one location. Up to 144 outputs.

Irrigation/Fertigation

Sapphire

Commercial irrigation controller that is ideal for applications requiring misting, flood, drip or standard irrigation. Integrated with the Cloud to monitor or change settings along with the new Grower Journal. 8 independent outlets with irrigation, mist, pulse or drip control for each output.

iDoser

A complete plug-and-play fertigation system for your growing operation. Automatic recipe switching and delivery scheduling with EC and pH monitoring for accurate plant nutrition. Additional control options – add functionality to enhance control or send alerts.

Additional Control Options

iDrive

Communicates and controls vents, curtains, and wall vent AC or DC motors with 5 position manual override switch, motor reverse delay and high quality components.

iOptimizer

Regulate the output of fans and pumps for energy savings and optimization of air flow patterns.

iAlert

Provides primary or backup alarming via Cloud based monitoring and alarm system. Receive email or texts to your phone.

Contactors Panels

Operates the on/off signal between the controller and equipment. Saves electrical installation costs. UL Listed.





Seed®



A sophisticated touchscreen climate control so intuitive it makes managing multiple zones a snap. Our most capable control to date.

- Highly intuitive operation – the easiest control you'll ever operate!
- Design accommodates both beginners and highly knowledgeable growers
- Apple and Android phone app
- Highly responsive touchscreen technology
- Customize your home screen to make it your own
- Configure alarms and notification communications
- Define equipment responses address your specific environment
- Extensive information at a glance
 - Equipment Status lists current conditions
 - Why Code displays explanation for equipment status
 - Graph data tracks all or selected equipment and sensors
 - View equipment settings, overrides, lockout and setpoints from a single screen
 - Tracks Vapor Pressure Deficit and Daily Light Integral in a variety of units
- Cloud connection
- Compatible with HE Anderson fertigation (J+ Advanced Hybrid)
- Sphere companion software increases accessibility, capability and storage. Compatible with both PC & Macs.
- Predictive Weather provides forecasting that allows Seed to anticipate needed equipment responses to keep your structure and crop safe
- Soil Analyzer reads soil temperature, moisture, and electrical conductivity (EC) to allow for specific alarms, watering schedules, and data analysis
- Create calculated sensor values using Sensor Pools

EnviroSTEP



Item: M-4840

There's no better combination of performance and value than the EnviroSTEP. This integrated control delivers solutions in the most demanding environments. The EnviroSTEP controls all aspects of your climate: temperature, humidity, light level, CO₂ and watering based on VPD.

- Single zone control
- 3 set point temperature periods — day, night and DIF
- 12 relay outputs with manual override switches
- 2 analog outputs (0 to 10VDC) to control variable-speed equipment
- Records the status of all inputs and outputs
- Alarm notification: temperature, RH and power failure
- Largest display in the industry; has menu-driven choices & graphic functions
- Keypad for easy operation
- This is an approved energy saving device
- Solar-guarded aspirated temperature and humidity sensor and 100' of cable
- Requires - Solar-shielded outdoor temperature sensor and cable

Items not stocked. Prices FOB factory.

STEP Up Control™



Aspirated Temperature Sensor
Item: M-4040

Step Up Control System
Item: M-5000

STEP Up to improved control and increased profits. This control is an approved energy saving device.

- 6 stages: 2 stages of heating and 4 stages of cooling
- 3 setpoint temperature periods — day, night and DIF; auto adjusts based on sunrise and sunset
- 2 modulating outputs control up to 2 vents or 1 vent and 1 curtain.
- Alarm output
- Large menu-driven screen displays current temperature, time, date, grow weeks, equipment status
- Logs and graphs data
- Timed override switches in addition to the manual override toggle switches
- Includes: Solar-guarded aspirated temperature sensor and 100' of cable

STEP UP Control System requires a contactor panel.

Power Pull Energy Curtain

Save on your heating bill



Save 30-40% on energy costs. It's an efficient way to cool, control light and heat loss. This truss-to-truss system does not stress the greenhouse and has minimal maintenance.

- Positive drive rack and pinion system — no cable to re-tension
- Fabric glides between monofilament or stainless steel lines
- Each project custom engineered with drawings
- Slow-moving system optimizes management of cold air spill
- Built-in safety limits protect your system
- Durable fabric resists UV, heat and chemicals
- Small bundle size ensures minimal shade
- Positive seal when closed
- Flexible design, easy installation for new projects or retrofitting
- Cools 10°-15° F during warm months
- Reduces plant stress

Vent Automation

Our drive units set the standard for smooth operation and reliability.

- Thermal overload protection – automatic reset – continuous duty
- Quick reversing
- Worm gear with tapered roller bearings on dual output shafts immersed in synthetic oil
- Dual output shaft
- Sealed for life; limited or no maintenance required
- Superior heat dissipation through fin & casting design

VC-2000

- Gear motor: 1/5 HP - 115V; 60Hz; 2.5amps - TEFC
- Ball bearing motor with copper windings - Class B insulation
- Gear reducer: total reduction 1350:1; 1.2 and 3 RPM final output
- Output torque 1500 inch lb / 169 Nm
- Lifts up to 325' of 4' polycarbonate roof ridge vent or 400' of 4' polycarbonate side vent

Item	Description
M-1190	VC 2000/ILS 1-3/8" O.D. Shaft (No Control)

All items on this page are not stocked. Prices are FOB Factory.

Rack and Pinion Systems

Connecting the vent to the shaft, the rack pushes the vent open or pulls it closed

- Aluminum rack and pinion
- Corrosion-proof pinion gear
- Easy alignment, the rack works even when it's not perfectly square with vent
- Available in straight or curved, to accommodate tight spaces



Versatile Vent Control

If you don't have an environmental control, the Versatile Vent is available with an aspirated temperature sensor and cable. It will open your vent or roll-up sidewall in four increments: closed, 1/4 open, 1/2 open and fully open.

Versatile Vent Complete Package

- Control indicates power, open, close and alarm
- Adjustable idle delay to reduce wear
- Adjustable run time to insure continued accuracy
- Independent vent management controller
- Manual override toggle switches
- Includes transformer and relays
- The unit displays temperature, vent position
- Easy to program – the instructions on the faceplate
- Temperature Alarm output
- Acts as lead control for up to six 2R Follower Controls
- Works with our Weather Guard control
- Includes aspirated temperature sensor and 100' of cable, wiring diagrams
- NEMA 4 rated cabinet (7.1" x 11.8" x 7.8") / UL Listed

Item: M-1460

Versatile Vent

- Manual override toggle switches
- Includes transformer and relays
- When paired with an integrated control (EnviroSTEP, STEP Up and VersiSTEP), vent opens and closes proportionally
- When paired with a staged control (MiniSTEP and 4-Stage), vent opens and closes incrementally, closed, 1/4 open, 1/2 open and fully open
- Acts as lead control for up to six 2R Follower Controls
- No display in this mode
- Cabinet size 7.1" x 11.8" x 7.8"
- NEMA 4 rated cabinet and UL Listed

Item: M-1465

SENSAPHONE™
REMOTE MONITORING SOLUTIONS

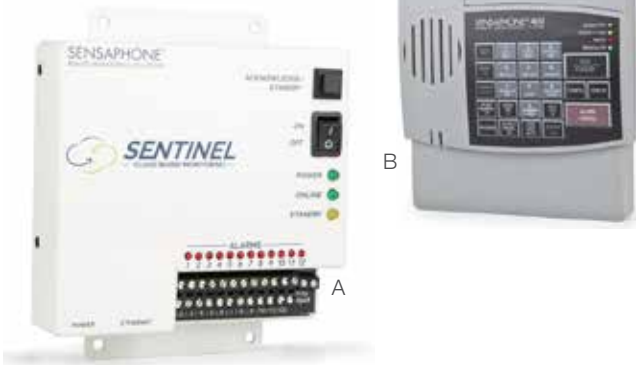

MONITOR YOUR ENVIRONMENT FROM ANYWHERE!

Environmental Monitoring for the mobile age with the Sentinel cloud-based monitor. Sentinel can call, text or email alarms to an unlimited number of contacts. Connect up to 12 sensors to monitor environment.



Sentinel (A)

Cloud-Based Environmental Monitoring

The Sentinel remotely monitors greenhouses to prevent loss of valuable plant assets. The system is ideal for greenhouse operators, commercial growers and retailers. The Sentinel system monitors up to 12 different environmental and equipment status conditions including temperature, humidity, power failure and water detection.

When the system identifies issues, it instantly sends alerts via phone, text or email over a standard internet connection. Users can access information and make system changes from any web-enabled device or mobile app. The system stores all readings in the cloud, which protects against data loss, provides unlimited information storage and allows multiple devices to be managed from one account. No software is required, so installation, integration and management are easy. A cellular option is available for locations where there is no internet connectivity.

- Notifies an unlimited number of people by e-mail, text message or voice phone calls in the event of an alarm
- Up to twelve external sensors monitor temperature, humidity, water and more
- Temperature sensing range of -109° to 168°F | -85° to 76°C
- Manage multiple units, make programming changes and access status conditions using a simple, powerful web-based interface

Item: 24-3135

Sensaphone™ 400 Monitoring System (B)

Security Monitoring System

- Phone line needed for operation
- Continually monitors major environmental conditions
- Provides instant, verbal communication
- Lets you listen in to "live" sounds in your house
- Keeps working, even if there's a power failure
- Automatically dials up to 4 numbers, 32 digits
- A snap to install

The Sensaphone system allows you to establish two-way communication and direct security monitoring of your property, even when there's no one there.

It calls to tell you there's a problem and reports on:

- Power failure
- Temperature changes

Detection Options Available:

- Fire and smoke
- Leaks or flooding
- Intruders and more

Item	Vendor #	Description
24-3145	FGD 400	Sensaphone Model #400
24-3130	FGD 0100	Remote Temperature Sensor
60FGD0101	FGD 0101	Weatherproof Temperature Sensor



Temp° Alert® (C)

The Temp Alert Temperature Switch can be used with all Sensaphone models to monitor air temperature from -30° to 130°F (-34° to 54°C). Simply determine the acceptable temperature limits for your application by adjusting the temperature limit arms. When the temperature exceeds the setting, the sensor triggers an alarm. The temp alert can be mounted to any wall or vertical surface. Multiple temp alerts may be wired in parallel to a single input. It requires no power for operation and mounts easily on any flat surface.

Item: 24-4125

Thermalarm III (D)

Thermalarm III is a temperature sensitive instrument containing an ambient temperature-indicating hand and two adjustable side hands for limiting the temperature range. When properly installed it will trigger a 6 to 12-volt alarm system when the temperature reaches a predetermined high or low setting.

- Hermetically sealed contacts
- Easily adjusted set hands
- Improved corrosion resistance
- Quicker response to temperature changes

Item: 24-2125



Growmaster Growcom

Single Zone Advanced Computer Control

Enjoy the same precision control of our Growmaster Procom, a single zone environment with our Growcom system. We have packed the most common environmental control equipment in use in a single zone control system. The Growcom can also be used with our Growlink Windows-based software. A Zone Temperature Sensor, as well as a Solar Sensor, come with the Growcom. The Growcom features four separate daily operation modes including DIF. Low voltage 24 VAC operation.

- Use as a stand alone system, or with your PC with our Growlink system
- Cooling, air circulation, ventilation, and shading equipment
- All heating equipment including hot water valves and boilers
- Optional fogging and dehumidify with humidity sensor available
- Full alarm functions and sensor history record and display for 30 seconds

Item: 24-5000



Growmate

For Smaller Installations

The Growmate offers many of the very same features as the Growmate Plus. It is designed for smaller greenhouses, but offers exacting computer-based control of cooling, heating, and air circulation equipment. DIF settings, separate day and night temperature control, and manual override switches are standard features. Low voltage 24 VAC operation.

- Accurate microprocessor control
- Large digital display and convenient program switches
- Three cooling stages, two heating stages
- Air circulation output for HAF fans
- DIF operations are standard

Item: 24-5024

All Items on this page are not stocked. Prices are FOB Factory.



Ventmate Plus

The Ventmate Plus has the same enhanced features of the Growmate Plus system, yet it is designed for use with ventilation cooled structures. Two separate ventilation outputs can control roof vents, side vents, roll ups walls, or retractable roof ranges. Vents may be operated in up to eight separate stages of operation. Add on a Weatherstat or Weathermaster for wind and rain roof vent safety overrides. Separate day and night temperature settings, as well as DIF come standard. As on all of our control systems, manual override switches are a standard feature. Low voltage 24 VAC operation.

- Accurate microprocessor control
- Cost effective solution for heating, venting and air circulation
- Day, night and DIF settings
- Optional humidity sensor available
- Large digital display

Item: 24-5026

Growmate Plus

Affordable, Accurate, Control

An affordable choice for many growing operations, the Growmate Plus puts the power of a microprocessor based control system in your hands at a price that anyone can afford. All temperature settings can be adjusted independently for day and night heating and cooling, as well as DIF settings. A large and informative display assists in programming, while providing a constant readout of all sensors. Manual override switches for all outputs are conveniently located on the front panel. Includes a temperature sensor and photocell. An optional humidity sensor is available for accurate and true dehumidify functions. Low voltage 24 VAC operations.

- Accurate microprocessor control
- Large digital display and convenient program switches
- Five cooling stages, two heating stages
- Air circulation output for HAF fans
- DIF operations are standard
- Optional humidity sensor available

Item: 24-5025





Environmental Controls

- LED display or touchscreen interface
- Multiple dry contacts
- Holds programming in power outage
- Variable vent motor run time (incremental opening)
- Variable pause interval between vent opening
- DIF growing and light deprivation ready (model dependant)
- Optional sensors override
- Quick & easy programming
- Manual override feature
- 2-year limited warranty
- 100' temperature sensor included
- Optional remote control (AEGISTECP)



Vendor #	Screen	Supply Power	Motors	Output Power	Watt	
41-VCU2-24	LED	110AC	220AC	2	24V DC	300
41-AEGISTEC	Touch	110AC	220AC	3	24V DC	300
41-AEGISTECP	Touch	110AC	220AC	3	24V DC	600

2024

Curtain Drive & Rack & Pinion Motors

- 24 Volt DC
- 4-year limited warranty*
**When used with an Advancing Alternative controller*
- High torque output in a compact design
- Easy access limit switches (directional limits)
- Guide wheel assembly for left or right output
- Multiple roll bar diameter adapters available
- Single and dual output shafts available



Vendor #	Amps	Watt	Output Torque/Speed	Mounting	Output	Shaft
61-LVM60-GW	3	72	60Nm 2.7 RPM	Guidewheel	Single	20 mm
61-LVM100-GW	4.2	100	100Nm 3 RPM	Guidewheel	Single	20 mm
61-LVM1002D-GW	4.2	100	100Nm 3 RPM	Guidewheel	Dual	20 mm



Rack & Pinion Motors

Vendor #	Amps	Watt	Output Torque/Speed	Mounting	Output	Shaft
61-LVM100-SRP	4.2	100	100Nm 3 RPM	Stationary	Dual	20 mm
61-LVM180-SRP	10.2	250	200Nm 4.45 RPM	Stationary	Dual	22 mm

Roll Bar Adapters for Motors

Item #	Roll Bar Style	Motor Shaft
65-RBA20M-1.3	1.315" OD Roll Bar	20 mm
65-RBA20M-1.5	1.5" OD Aluminum Bar	20 mm
65-RBA20M-SC	2" Aluminum Side Clasp Roll Bar	20 mm
65-RBA22M-1.3	1.315" OD Roll Bar	22 mm
65-RBA22M-1.5	1.5" OD Aluminum Bar	22 mm
65-RBA22M-SC	2" Aluminum Side Clasp Roll Bar	22 mm

Curtain Packages

- Inflatable High Tunnel Curtains
- Internal Curtain Walls
- Inflatable Gutter Connect Curtains
- External Curtain Walls
- Retrofit Rack & Pinion Systems
- Roll to Peak Light Deprivation



2024

Manual Gear Crank Packages

GCP5:1B Gear Cranks

Recommended for curtain lengths up to 120'. Includes guide pipe hardware and adapter for Side Clasp Roll Bar or 1.315" roll pipe.



Description

Using Side Clasp

Using 1.315" OD

Minimum of a 10" baseboard is required to use this operator.

GCP7:1 Gear Crank

For curtain lengths up to 72' ONLY. Package includes one adapter, guide pipe hardware, and choice of short or 24" crank handle.



Description

Using Side Clasp

Using 1.315" OD

All items on this page are not stocked.

GCP13:1 Gear Crank

Gear Crank can be used on curtains up to 240'. Package includes one adapter, guide pipe hardware, and choice of short or 24" crank handle.



Description

Using Side Clasp

Using 1.315" OD

GCP15:1 Gear Crank

Gear Crank can be used on curtains up to 300'. Package includes one adapter, guide pipe hardware, and choice of short or 24" crank handle.



Description

Using Side Clasp

Using 1.315" OD



Griffin Construction Department

Partner with us on your next project. Call for consultation and quote: 1.800.888.0054 then press 3.



P.L. LIGHT SYSTEMS
THE LIGHTING KNOWLEDGE COMPANY

High Pressure Sodium Lamps

Lighting options to increase intensity for increased growth and day length extension for photoperiod control. Higher percentage of red light than from metal halide fixtures.

HSE NXT2 | Electronic ballast for quiet operation and extended lifetime. Cooling ribs for more efficient heat dispersal. Double ended lamps. Use with Alpha or Beta reflectors. **600W:** 277V or 347V. 1450 $\mu\text{mol/s}$. **1000W:** 277V, 347V or 400V. 2100 $\mu\text{mol/s}$.

HSE NXT-LP | Designed especially for low profile mounting for low ceiling height applications. Double ended lamps. Dimmable, electronic ballasts. Use with Alpha or Beta reflectors. **600W:** 277V or 347V. 1450 $\mu\text{mol/s}$. **1000W:** 208V, 240V, 277V or 347V. 2100 $\mu\text{mol/s}$.



CHOOSING REFLECTORS

Superior reflector technology from PL Light Systems can reduce fixture count by up to 15%, saving on cap ex and operating costs.

Choose **Alpha** for strongest uniformity; good choice when vertical space is limited.

Choose **Beta** for deeper light penetration; good choice for high mounting heights in very tall greenhouses, such as over tomatoes.



Alpha



Beta

PL LIGHT IQ

Achieve multi-zone lighting control of up to 512 ballasts in up to 4 zones. Works with control-enabled NXT-LP fixtures.



TriPlane



TriPlane Linear



ParFX Ultra

PL Light Systems develops and manufactures advanced reflectors, LED and HID (HPS & CMH) fixtures for the horticultural market.

Talk to Griffin's Construction Department about customized light plans from PL Light for your next project.

LED Fixtures

Options for sole source lighting, supplemental lighting for increased intensity and photoperiod control or tiered production. Customizable to crop specific spectra (fixed spectrum). Passively cooled.

VertiMax | High-output, full spectrum LED lighting solution for multi-tier applications. PAR output of 1800 $\mu\text{mol/s}$ and system efficacy of 2.8 $\mu\text{mol/J}$. Integrated driver for reduced installation time and expense. Dimmable. Daisy-chainable.

TriPlane | High output, true 1:1 HPS replacement for greenhouse and warehouse. Plug and play: integrated drivers, standard power connectors, easy mounting. Daylight spectrum for sole source applications or / RWMB_FR spectrum for supplemental lighting. Field-adjustable for site-specific optimization of distribution pattern. Up to 2203 $\mu\text{mol/s}$, 3.3 $\mu\text{mol/J}$. IP-66. Daisy-chain capable, dimmable, and DLC listed.

TriPlane Linear | Engineered to cast minimal shadowing on the crop canopy—while delivering a performance on par with standard TriPlane model, the TriPlane Linear offers the ideal combination of form and function in greenhouse applications.

The unique mounting brackets on the TriPlane Linear's LED modules allow for the mounting angle to be adjusted in either direction, for a highly customized light distribution—depending on the application.

ParFX Ultra | Engineered to deliver a light output of up to 3745 $\mu\text{mol/s}$ and a system efficacy of 3.6 $\mu\text{mol/J}$, the ParFX Ultra delivers ultra-high performance in both full LED and/or hybrid applications. The luminaire features a unique optical lens that produces a symmetrical batwing distribution. This optimized distribution delivers industry-leading uniformity to allow for wider row spacing—enabling growers to achieve their target light levels and consistent crop growth, with fewer luminaires. Available in multiple spectrums, including custom.

Complete Lighting Solutions for Professional Greenhouse Growers

PARsource has developed some of the best available horticultural lighting products and has some of the most efficient light fixtures in the industry.



Hydrofarm Brand

Phantom PHOTOBIO LED Fixtures

Phantom PHOTOBIO fixtures offer high efficiency LEDs designed for horticultural professionals looking to increase performance and yields while maximizing ROI. Robust commercial designs combine with high efficiency S4 spectrum to provide more red, far-red, and blue wavelengths that deliver vigorous vegetative growth and optimal flower development.

Phantom PHOTOBIO*T and TX | The PHOTOBIO T Series offers 2.6 umol/joule efficacy, controlled dimming, and advanced heat dissipation technology in a tight form factor to reduce shading in your greenhouse. Both the T and the TX operate in a range of 100-277V. The T system uses 330W and has a PPF output of 858 umol/s. The TX system uses 680W and has a PPF output of 1768 umol/s.

Phantom PHOTOBIO*MX | The PHOTOBIO MX offers 2.6 umol/joule efficacy, controlled dimming, and advanced heat dissipation technology in a slim form factor. The remote driver option is perfect for limited clearance in indoor cultivation situations. The MX operates in a range of 100-277V. It uses 680W and has a PPF output of 1768 umol/s.

Phantom PHOTOBIO CX 2125 | The PHOTOBIO CX offers 2.5 umol/s and dimming capabilities. This toplighting fixture is a direct 1:1 replacement for a 1000W HPS fixtures. Slim design supports low ceiling mounts. Passive cooling for operational efficiency. S4 spectrum supports flower development. 120-277V. 850W. 2125umol/s output at 277V. IP66 with 5 year warranty.

Phantom 1000W HPS Fixtures

Next gen technology, dimmable, for HPS or MH bulbs (do not dim with MH bulbs – run at 100% power only). 277-400V

Phantom 60 Series – PHRE 1000277 | 1150W HPS, enclosed reflector.

Phantom 60 Series – PHRO1000277 | 1000W HPS, open reflector.

Replacement Lamps

HPS and MH lamps have a lifespan of 10,000 hours. The reduction in output after 10,000 hours will impact production and yield. Lamps in use 16 hours a day should be replaced after 1.75 years. Lamps used 12 hours/day should be replaced after 2.25 years.

Item: 93-2500

Description: PARsoure AgroSun DE HPS 1000W bulb





Evaporative Cooling Pad System



2024

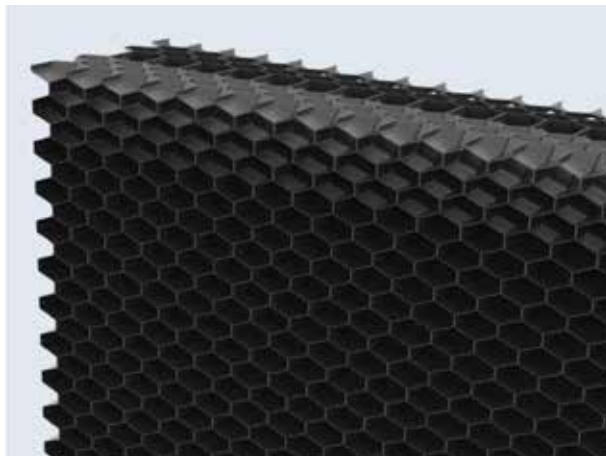

The Benefits of Lubing's Plastic Pads

- **Excellent cooling capacity – patented design:** The special layout of solid surfaces and mesh structures ensures ideal water distribution through the Pad. This allows for proper wetting and less splashing, resulting in highly efficient cooling capacity
- **Easy to clean:** The use of welded, highly resistant polymer sheets allows the plastic pad to be easily cleaned without damaging the Pads
- **Long service life:** The use of polymer sheets in combination with thermal welding guarantees best stability and a long service life
- **Lowest pressure loss:** At an air velocity of 300 ft/min (1.5m/s) the plastic pad's pressure drop is only at 0.40 inches of water (10 Pa.) substantially lowering energy consumption
- **High UV resistance:** The use of UV-stabilizing additives ensures outstanding resistance to UV light for years
- **Impermeable to light:** The plastic pad's geometry blocks out light from the outside
- **Chemical resistance:** The plastic pad is made of Polypropylene, which is highly resistant to most chemicals.
- **Pad width:** Pads are offered in 2' wide sections



Griffin Construction Department

Partner with us on your next project. Call for consultation and quote: 1.800.888.0054 then press 3.

Pure Flowering 200 Lamp

The Science of Photoperiodic Lighting

- Use for night interruption lighting to achieve long-day conditions to promote or prevent flowering in ornamental and medicinal crops.
- Effective - Ideal spectrum for photoperiodic flowering control
- Efficient - Save over 90% compared to incandescent bulb use
- Easy - Simple installation, screw-in LED replacements (E26 socket) with excellent coverage and uniformity (200 sq ft/bulb)
- Safe - No toxic heavy metals or thin glass breakage risk
- Durable - Waterproof, dust-proof, long-lived (50,000 hrs, IP65)
- 100-240V, 34 umol/s, 2.0 umol/J

Item #	Description
93-2950	TotalGrow Pure Flowering 200 Lamp

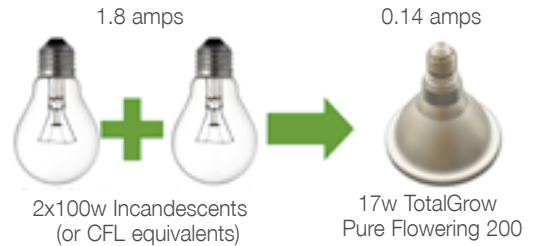
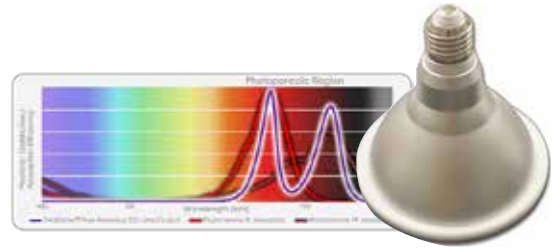

Light Deprivation Systems

- Flower short day crops any time of the year
- Required for year-round product of cannabis and hemp
- Prevent light pollution from your greenhouse to your neighbors
- Fully automated systems for interior (Wadsworth) or exterior installation (Advancing Alternatives)
- Custom designed solutions for all types of structures





Beneficial Insectary

PROVIDING A NATURAL BALANCE IN PEST MANAGEMENT



BIOLOGICAL SOLUTIONS FOR:

- ✓ Mites (Spider, Broad, Russet)
- ✓ Thrips (Western Flower, Others)
- ✓ Aphids
- ✓ Whiteflies
- ✓ MORE!

ABOUT US

Based in Redding, CA
U.S. Production for 35 years
Expert Technical Support
Next-Day Shipping*
Top-Rated Customer Support

*On organisms produced by
Beneficial Insectary in Redding, CA

Follow
-US- 
@beneficialinsectary

CONTACT US
(530) 226 6300 | 1-800-477-3715
www.insectary.com

SHADING

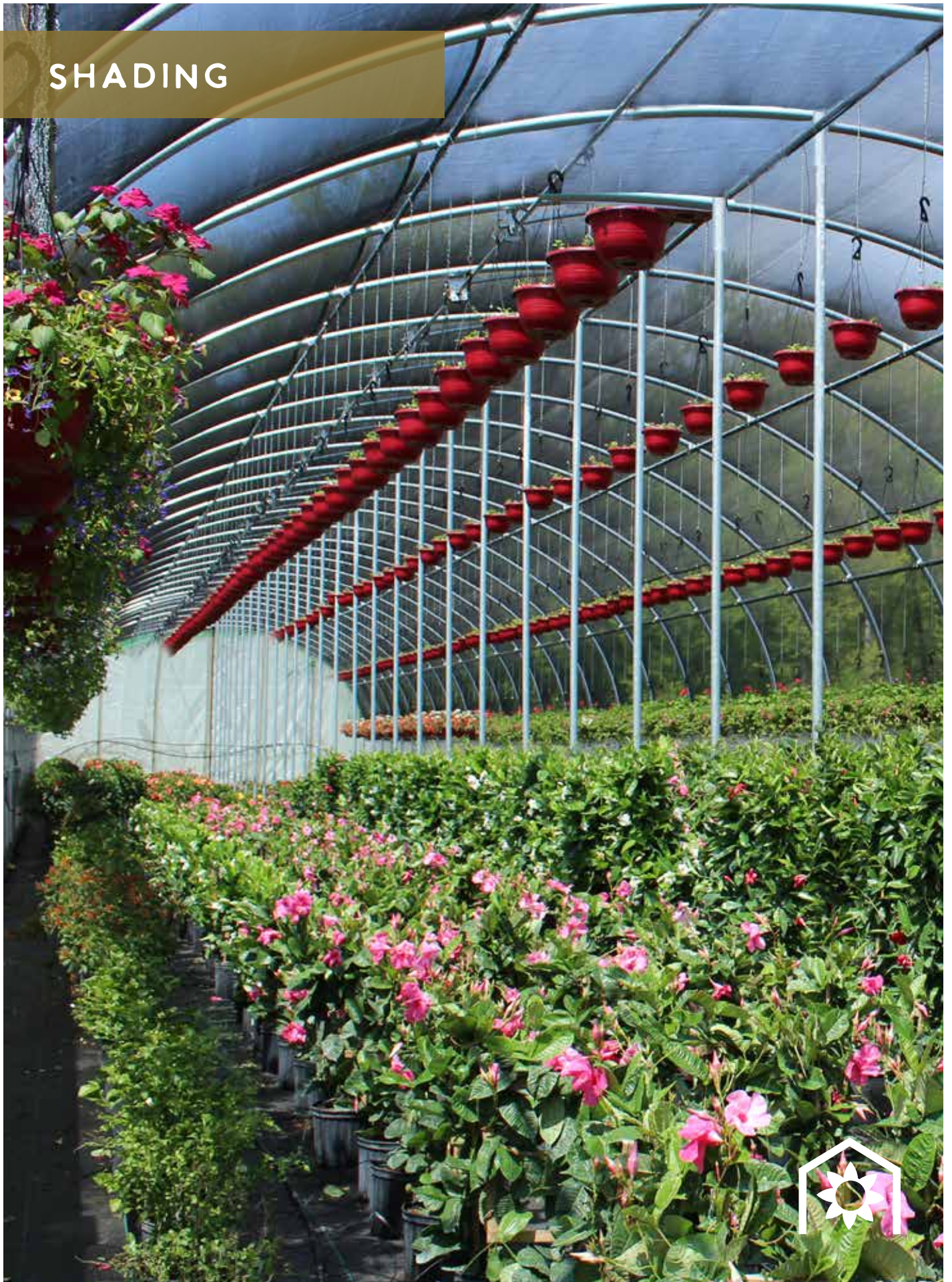

Shade Cloth and Netting

Woven & Knitted Shade, Aluminet and Insect Netting options for your Greenhouse shading needs!

Woven 30%



Woven 40%



Woven 55%



Woven 63%



Woven 73%



Woven 80%



Knitted Red 30%



Knitted Red 50%



Knitted White 50%



Knitted Black 30%



Knitted Black 40%



Knitted Black 50%



Knitted Black 60%



Knitted Black 70%



Knitted Black 80%



Knitted Green 60%

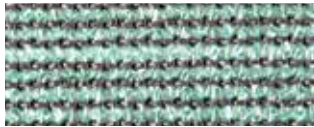

Knitted Ultra Tan 60%



Knitted Alumi-Shade 50%



Knitted Steel Grey 50%



Knitted Mocha 80%



Knitted Alumi-Shade 70%



Insect Netting

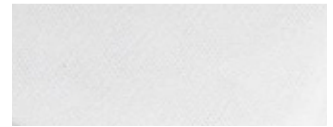

Custom Shade

- GROMMET
- BATTEN TAPE
- CUT DOWN
- HEM • SEAM



ChromatiNet Light Spectrum Management

ChromatiNet® is a series of colored shade nets with special optical properties which improve the utilization of solar radiation by agricultural crops. The technology promotes differential stimulation of desirable physiological responses, which determine the commercial value of each crop. Using ChromatiNet is an economical and environmentally friendly alternative to current labor-consuming methods (such as pruning and thinning) and intensive use of growth regulators and other chemicals.

Lumite

Shade Cloth

Custom Made Shade Cloth. Wide range of shade percentages available. Made to your specifications with or without grommets. Non-refundable. Allow 4 weeks for delivery. FOB Factory for all orders.



KOOL-RAY Classic Liquid Shading

KOOL RAY CLASSIC is specifically designed to lower inside greenhouse temperatures during the warmer spring and summer growing seasons. During the course of the year, CLASSIC's environmentally friendly ingredients will slowly wear off (weather permitting) allowing for increased light levels as the daylight decreases. CLASSIC works best when spray applied. **A 1:8 dilution will cover 1575 sq. ft. with a 30% reduction of light.**

5 gal. Kool-Ray liquid shading cannot be sent UPS or FedEx.

Classic White

Item: 16-3160

Size: 1 gal.

Item: 16-3162

Size: 5 gal.

X-tra Stick Binder

Item: 16-3150

Size: 1 qt.

Item: 16-3155

Size: 1 gal.

Shark-Bite



The ultimate gripper-fastener for almost any netting, fabric or film! Use it and re-use it over and over.

Item: 30-3035

Double S hook



For use with Shark-Bite Fastener. The ultimate gripper-fastener for almost any netting, fabric or film! Use it and re-use it over and over.

Item: 30-3034

Nylon Cable Ties



11" non-releasable nylon cable ties. UV treated.

Item: 30-2825

Clip-Its™ Shade Cloth Fasteners



Use these durable clips for securing shade cloths, plastics, and fabrics.

Item: 30-3025

ReduSystems® enables growers to make optimal use of sunlight in their greenhouses throughout the year. Products influence natural light and heat transmission from the sun in every season to optimize the greenhouse climate for the crop – from a cooler climate in summer and more light in winter to diffusing light and influencing the light spectrum.



- Choose your own shading percentage
- Select products based on need – affect light and/or heat
- Wear and frost-resistant
- Potentially higher yield and better quality
- Use with glass and plastic greenhouse coverings
- Easily removed with ReduClean



ReduSol

ReduSol is a shading agent that reflects high levels of solar energy to protect crops against heat and light. Wear-resistant shade across the whole spectrum.

ReduHeat

ReduHeat is a shading agent that blocks infrared energy to reduce heat load while allowing high light transmission of photosynthetically active radiation (PAR) that drives plant growth. Great for high-light crops.

ReduFuse

ReduFuse is a light and heat diffusing agent. Light and heat are spread through the greenhouse more evenly for more uniform crops and stronger light penetration into the crop. Beneficial for vegetables, cannabis, cut flowers, and other high light dependent crops.

ReduFuse IR

ReduFuse IR diffuses light through the greenhouse while reflecting heat. Light penetrates deeper into the crop for a general net increase in photosynthesis. Good for heat sensitive crops that also demand high light.

ReduClean

Formulated to easily remove ReduSystems coatings. Dissolved coatings will rinse off the greenhouse with rain. Safe for glass and plastic greenhouse coverings.

Item	Description	Size
16-3230	ReduSol	14.5 L
16-3240	ReduHeat	13.5 L
16-3290	ReduFuse	14.85 L
16-3295	ReduFuse IR	13.5 L
16-3287	ReduClean	20 L

How Many Buckets Per Acre?

	Average buckets per acre (in North America)	Net shading (excl. roof/structure)		Average buckets per acre (in North America)	Net shading (excl. roof/structure)
ReduSol	4 - 5	22% - 25%	ReduFuse	5 - 6	5% - 6%
ReduHeat	5 - 7	6% - 9%	ReduFuseIR	7 - 9	11% - 15%

Note: products have to be mixed with water. For machine application 120-150 gallon spray liquid (water + coating) is used per acre. For manual application 180-200 gallon spray liquid per acre is used.

BENCHING

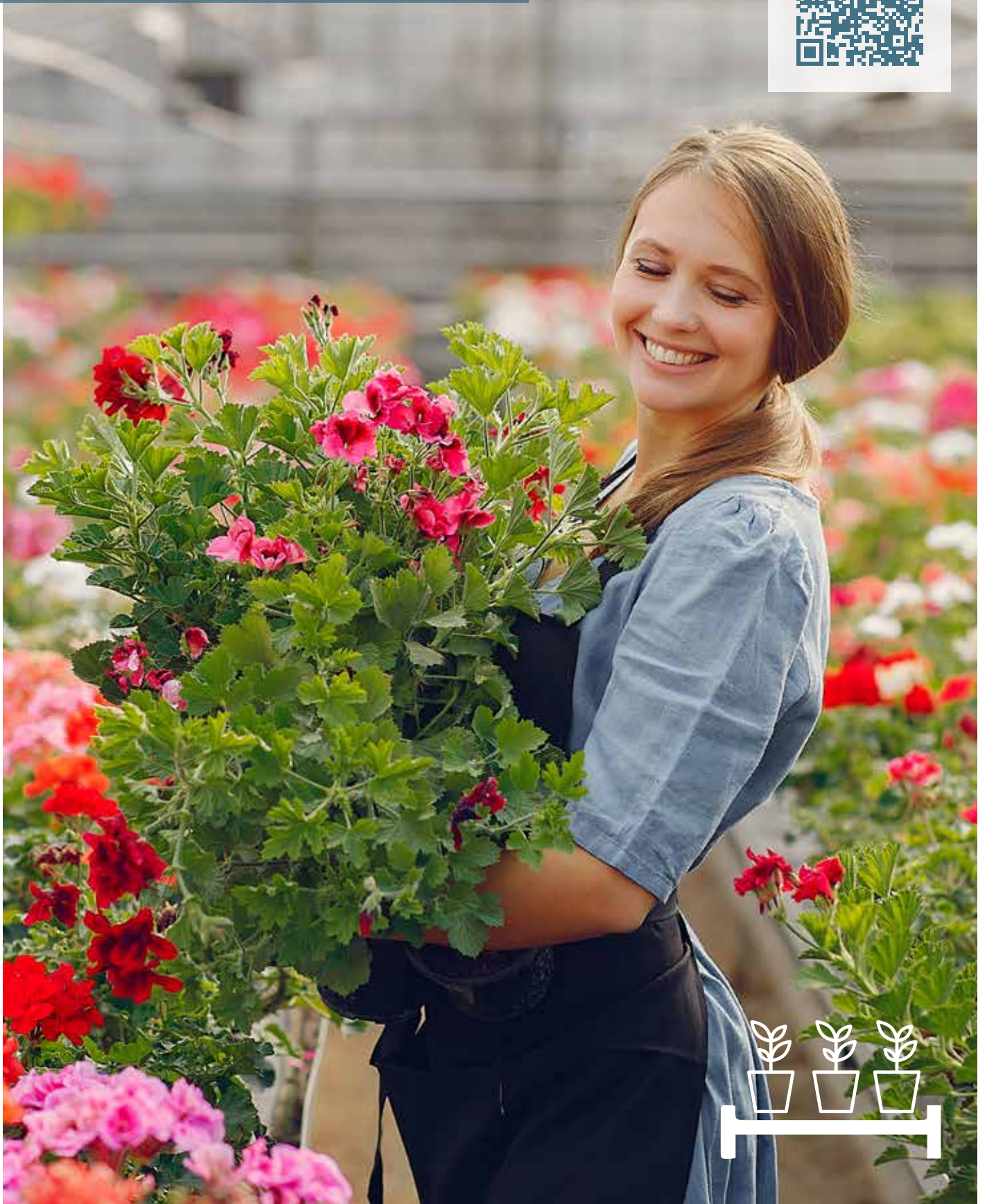



2024

Custom Production Systems

I GE is the premier benching supplier to commercial growers throughout North America. Helping clients succeed by customizing innovative solutions for demanding markets.

- Custom-made to order to match needs
- Great benching options for production and retail displays
- Fixed, Max Roll, and Track installation options
- Single-level, multi-level, and archive rack systems
- Heavy-duty galvanized steel legs, headers and framework
- Extruded marine-grade aluminum side rails with rounded, snag-free corners
- Euro-style NFT systems - simple to automated



Ebb & Flow Trays

US-made, vacuum-formed, UV-resistant, polystyrene trays with molded drain channels. Long pieces minimize frequency of glue joints. Available as replacement trays, retrofits or as a component of a complete ebb & flow benching system.

Expanded Metal Benches

All benches can be outfitted with expanded metal tops. Expanded metal benching is hot dip galvanized after expanded for superior durability and long service life.

Max Roll Benches

Extended cantilever reach for maximum use of floor space. Extend the roll distance by 2-4 feet, depending on bench size. Install over concrete for proper anchoring. No floor drill installation.

Ebb & Flow Benches

Reduce your water and fertilizer use by up to 90%! Galvanized steel and vacuum formed plastics for long life. Available in stationary or rolling models. Standard widths: 4', 5', 6'. Additional custom sizes available. Pre-drilled for easy assembly.

Track Benches

Benches roll on floor-mounted tracks for fully adjustable aisle widths. Most often used with Archive Racking or Ebb & Flow benching.

Plant Support Systems

Plant supports designed to fit Innovative benches for use with trellis netting to support tall crops.





Grow Racks

Warehouse production calls for efficient use of every square foot of production space. Grow Racks from IGE are designed and manufactured in the US and built to order.

Stationary Racking

Stationary, vertical benching for warehouse production. Custom height in 2' increments from 8 to 24 feet. Custom lengths in increments of 8, 10 or 12 feet. White powder coated with adjustable bench placement. Stationary Racks utilize IGE's Ebb and Flow tray inserts for clean production space that is easily sanitized.

Archive Racking

Space-saving, rolling, tiered racking for warehouse crop production. Lengths up to 60' in 8, 10 and 12 foot increments. Height up to 24' tall in 2' increments. Direct, chain-driven, aluminum carriages on corrosion-resistant channels. Stainless steel drive rods, wheels and fasteners for long life in horticultural production spaces. Channels mount to level, concrete floors with anti-tip protection at every track. System supports 1500 pounds per linear foot. Custom designed.

Catwalk Systems

Gain safe, easy access to tiered crops with this easy-to-install, on-demand catwalk system. Designed to integrate with IGE's archive racks: Rails secure to racks, lightweight, EZ-Roll platforms slide into place when racks are rolled apart. 2' wide catwalks available in 2' or 4' lengths.

Air Flow Systems

Production on tiered Grow Racks presents unique air flow needs. IGE's Airflow Systems are designed to integrate with their rack systems and utilize duct socks to ensure airflow across all tiers.





Show More, Sell More!

Make it easier for your customers to buy more. Tier benching provides a clean and attractive display and allows you to double your display area.

Saves Work, Time and Money

Enhance Indoor and Outdoor Merchandise

- Benchmaster holds up to 50% more plant material than conventional wood displays
- Creates a clean and professional look

Strong, Durable and Long Lasting

- Molded from tough, high-density, UV stabilized, post consumer recycled plastic
- Will not rot, rust or corrode
- Stains and liquids will not absorb like wood
- Non-porous surface cleans up by hosing it off

Easy Setup and Teardown

- Snap-together design will save time and money
- No tools required
- Change an entire floor plan in minutes

People Friendly

- No splinters, no sharp edges
- Stable and safe to shop and work

Item	Description
36-2035	2' x 8' BenchMaster Bench
36-2040	3' x 8' BenchMaster Bench
36-2030	16" x 8' BenchMaster Bench
36-2140	½ of 36" Round Bench
36-2150	½ of 48" Round Bench
36-2160	½ of 60" Round Bench

Item	Description
36-2045	12" Plastic Leg
36-2046	18" Plastic Leg
36-2050	24" Plastic Leg
36-2060	30" Plastic Leg
36-2065	36" Plastic Leg
36-2058	Plastic Collar*

Unlimited configuration & sizes

- Make it any size or shape and move it anywhere
- Season to season, department to department
- Call for specialized configurations



Caster Bars



*Use plastic collars for stability for multi-tier displays.

Call for more information on mobile benching.



5' Round Display

Consists Of	Item
2- ½ of 60" Round Bench	36-2160
15- Legs, Any Size	



5' Round 2 Tier Display

Consists Of	Item
2- ½ of 60" Round	36-2160
2- ½ of 36" Round	36-2140
15- 12" Plastic Legs	36-2045
6- 24" Plastic Legs	36-2050



3 Tier Round System

Consists Of	Item
2- ½ of 60" Round	36-2160
2- ½ of 48" Round	36-2150
2- ½ of 36" Round	36-2140
6- 24" Plastic Legs	36-2050
6- 36" Plastic Legs	36-2065



3 Tier ½ Round Display

Consists Of	Item
1- ½ of 36" Round	36-2140
1- ½ of 48" Round	36-2150
1- ½ of 60" Round	36-2160
3- 24" Plastic Legs	36-2050
3- 36" Plastic Legs	36-2065



Focal Point Display

Many styles to choose from. Call for information.
Drop Ship.



***3 Tier 8' Wall Display**

Consists Of	Item
2- 16" x 8' Drilled Base	36-2025
3- 16" x 8' Top	36-2030
8- 36" Plastic Legs	36-2065
8- 24" Plastic Legs	36-2050
12- 12" Plastic Legs	36-2045

*For 3 tier 8' Island Display use 2 Wall Displays back-to-back. *Also available in 5.5' model and 3' model.



3' x 8' Bench Display

Consists Of	Item
1- 3'x8' Top	36-2040
11- Legs, Any Size	



3 Tier 8' Display

Consists Of	Item
3- 2' x 8' Tops	36-2035
16 - 24" Plastic Legs	36-2050
8 - 12" Plastic legs	36-2045
16 - Plastic Collars	36-2058



2 Tier 8' Island Display

Consists Of	Item
1 - 3' x 8' Top	36-2040
2 - 16" x 8' Tops	36-2030
2 - 16" x 8' Drilled Bases	36-2025
16 - 12" Plastic Legs	36-2045
8 - 24" Plastic Legs	36-2050



Maine Attractions

Premium Display Tables

This isn't just a bench, it's a work of art, handmade from the finest materials by craftsmen who take pride in their work.

Specifications:

Assembly: Mostly assembled, legs attached by customer with bolts (supplied).

Legs: 4" square finished White Cedar legs available in 24" & 30" heights.

Frame: 1¼" and 1" (before planing) by 4" cedar board, attached to the legs with thru bolts.

Top: Premium vinyl coated and galvanized hi-tensile steel mesh, 1" x 1½" - for maximum strength, durability, and support.



Stack Maine Attractions tables back-to-back and side-by-side to create a unique, attractive sales island. Then add end cap tables for the ultimate merchandising fixture!

2024

Multi-tiered

Classic Retail Display Tables

Use "wall of color" two or three tier presentation to WOW your customers. The art of retail display reaches attractive new heights with these classic-look multi-tier retail display units that included basket rods.



Multi-tiered



Benchmates

Benchmates

Stackable Display Tables

Benchmates unique design puts attractive Cedar where it counts - as trim to show off your product to its greatest advantage.

Benchrunner Movable Trays

Bartlett's Benchrunner system move trays on a pair of tubular rails and can be transported to and from the rails by cart or flanged wheel tracks. They are similar in function and utility to "dutch" trays, typically made of aluminum frames, with expanded metal or other bench surface.

Benchrunner Benefits

- **Custom sizing:** There is little or no limit to the size of tray that can be done.
- **Job size:** The system can accommodate 2,000 sq. ft. and up.
- **Cost:** This tough, durable, and versatile bench tray system will fit the most sophisticated 21st century growing operation, without the 21st century price you would expect to pay.



Please contact our Construction Department to design the Benchrunner System that fits your growing needs.

Griffin's Stocked Bench Top Options



Bench Top Rolls

Fully hot dip galvanized after welded for long life. Extra strong 12½ gauge, 1½" x 1½" squares.

Item	Description
36-4025	3' x 100' roll
36-4030	4' x 100' roll
36-4035	5' x 100' roll
36-4040	6' x 100' roll

10 ½ gauge mesh available on special order.

2024



Galvanized Expanded Metals for Greenhouse Benches

- Open mesh design prevents accumulation of excess moisture or sediment. Keeps benches clean and dry.
- Allows free passage of air. Improves air circulation.
- Designed to be structurally strong but lightweight for ease of handling. Ideal for rolling benches.
- Insects discouraged by metal surface.
- Manufactured from galvanized steel, aluminum or carbon steel, hot dip galvanized. Provides years of maintenance-free use.
- Available in stock panels or custom sizes manufactured for individual requirements.
- 13 gauge

- Item:** 36-1225 **Size:** 3' x 6'
- Item:** 36-1230 **Size:** 4' x 6'
- Item:** 36-1235 **Size:** 5' x 6'
- Item:** 36-1240 **Size:** 6' x 6'

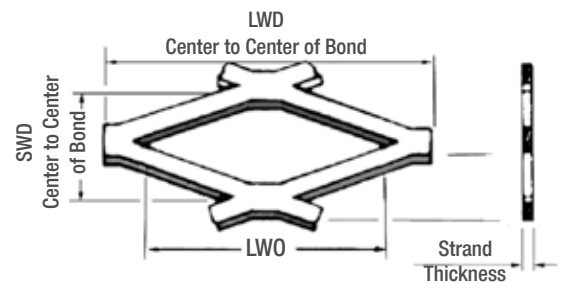

HC Quality Doors

Greenhouse Benches

HC Quality's custom benches come standard with aluminum welded frames and expanded metal tops. These benches are available in both stationary and rolling options.

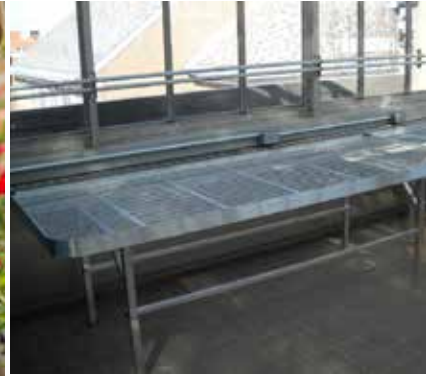

Two Tiered Bench

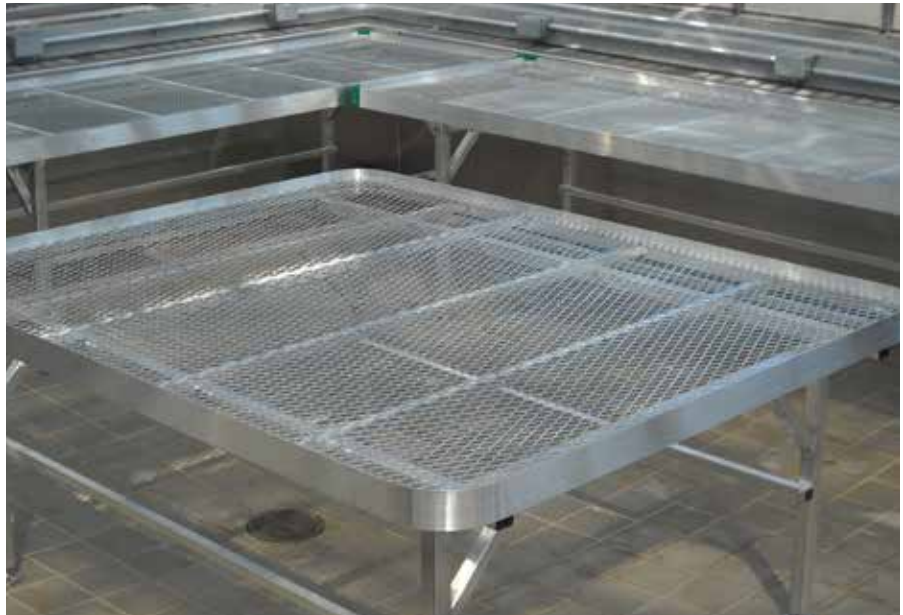

Stationary Above Ground Benches



Griffin Construction Department
Partner with us on you next project.
Call for consultation and quote:
1.800.888.0054 then press 3.

2024

Floating Aisle Benches

Indoor or Outdoor Complete Benching for Growing or Display

The "Floating Aisle" concept, where one aisle is shared by several benches through lateral moving bench tops, turns unprofitable aisle areas into profit producing growing areas. In most cases, when converting from fixed benches to floating benches, you could expect a 20-30% increase in bench area. Floating benches should be considered for growing areas only, and are not recommended for retail sales areas. Floating Aisle benches can be converted to stationary benches simply by moving the limit clip. Anti-Tip options are also available.

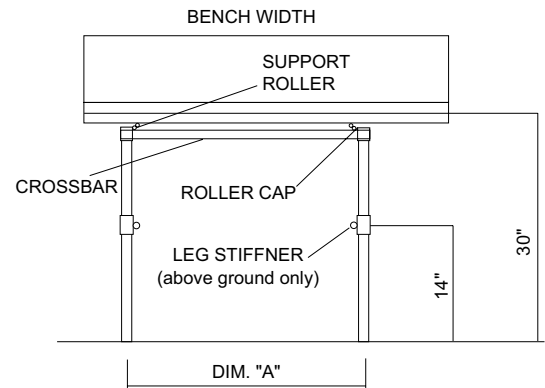

- Strong
- Neat
- Clean
- Sanitary
- Maintenance Free
- Versatile



Display Benching

When you're looking for improved visual impact and streamlined merchandising efforts, let Poly-Tex help. They have more than just plant displays and benches—they have solutions. These displays are highly configurable and all beautifully display your flats and pots.



A



B



C



D

Optional wreath attachment.



PX7001 Fence-on-a-Step Bench (A)

The PX7001 display offers lots of space in a semi-tiered design. With several configurations, you'll find just the one to suit your needs. Use as a freestanding display, back-to-back as a center aisle, or connected in a run of any length.

Item: 13-PX7001CP

Basket Tower (B)

This display is a fun way to showcase your hanging baskets and other hanging merchandise, such as wind chimes and bird houses/feeders. Think vertical merchandising that can be shopped from any side. Imagine a tower of hanging baskets or a spiral of wind chimes!

Item: 13-BT3000

PX7024 Double Bench Display (C)

Hold it all with this high-capacity display unit. With 72 square feet of bench area, this display gives you room to grow—and profit.

Item: 13-PX7024P

BH3000 Basket Hanger (D)

A versatile year-round fixture. Display hanging baskets or use the optional wreath kit to convert it to a high-capacity wreath display. Available with optional casters and powder coating.

Basket Hanger

Item: 13-BH3000

Wreath Attachment

Item: 13-WREATH

All products Drop Ship FOB Factory

Many other benching options available. Call for information and pricing.



Plastic Bench Tops

- Polypropylene, UV protected
- No rust, rot or decay
- Strong, durable and lightweight
- Flats, trays, and pots slide easily
- No protruding wires or jagged metal edges
- Easy, positive interlocking feature, no clips required
- Installs on any type frame
- Easy to clean and disinfect

Item	Size
36-6045	18" x 36" - Fits 18", 36", 54" and 72" wide benches
36-6050	24" x 48" - Fits 24", 48", 72" and 96" wide benches

Fiberglass bench framing available as a direct ship option.

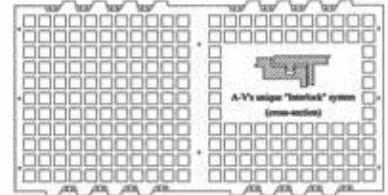

Item: 36-6045 **Size:** 18"x36" - Top

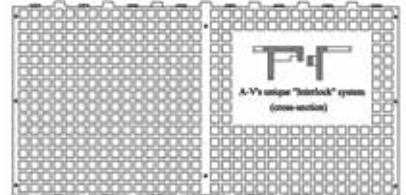

Item: 36-6050 **Size:** 24"x48" - Top



Griffin Construction Department | Partner with us on you next project.
Call for consultation and quote: 1.800.888.0054 then press 3.

FAST-TRACK YOUR PLANT SALES

Cut crop time in your greenhouse with quick finish and pre-finished plants from Griffin. Our vendor network serves all major regions of the country with quality material and reliable fill rates. Contact your Griffin sales representative or browse current availability on Griffins.com.



EQUIPMENT



Automated Equipment

FOR GREENHOUSES



WHY AUTOMATE?

Save on labor costs and minimize the impact of labor shortages by reallocating your staff's time to be more efficient.

HOW CAN AUTOMATION HELP YOU?

Soil handling, container filling, irrigation, product transportation, spacing, transplanting.

WHAT TYPES OF AUTOMATION MACHINES ARE AVAILABLE?

Mixers	Bale Shavers
Potters	Baggers
Flat Fillers	Watering Solutions
Conveyers	Custom Equipment



Griffin Construction Department | Partner with us on your next project.
Call for consultation and quote: 1.800.888.0054 then press 3.

As labor costs continue to rise, sometimes adopting costly technology and automation is an option that growers have to take into serious consideration.

Read below to see how Griffin's customer Zino Nursery has approached this challenge through innovation and automation.

Hardscrabble Farms, a tree farm headquartered in Croton Falls, New York, purchased greenhouse space four years ago in Dover Plains, New York. The location had been abandoned for 12 years and was in desperate need of renovation. With only 10 employees they needed to find a way to grow quickly without having to deal with labor shortages and absorbing high labor costs.

After acquiring the space, a year was spent renovating the greenhouses. They knew automation would be necessary. The purpose of the new location — which currently operates 12 acres of production under the name Zino Nursery — was to produce perennials, grasses, shrubs, evergreens, ferns and other similar products for its wholesale customers.

Because of the nature of the work, they knew finding labor would be a problem. Part of what Zino Nursery does is 1-, 2- and 3-gallon-sized pot production. It is a lot of lifting all day long.

ACTION PLAN AND TIPS:

- Zino Nursery depends on Griffin for their high level of service and industry expertise
- Have an industry partner that is always there to help guide you through new upgrades and expansion ideas
- Potting line was key so that they could expand quickly with the same amount of people
- Zino Nursery implemented potting lines from Pack Manufacturing, along with upgrades along the way. The company has since expanded and still employs the same 10 people.
- Purchased a whole system from Pack Manufacturing that includes a soil mixer, an incline conveyor and a potting machine
- Zino Nursery's ultimate goal is to get to 16,000 to 18,000 pots per day

Customer TESTIMONIAL

“On a good day, we are able to do upwards of 10,000 to 12,000 pots in a day, a task that if done manually would only be able to have an output of 1,000 pots per day.”

- Brady Cullen, General Manager, Zino Nursery

COST JUSTIFICATION CALCULATOR

See the tables below to see how this can be affordable for you and how it will pay off!

WITHOUT EQUIPMENT

ANNUAL UNITS	200,000
NUMBER OF EMPLOYEES	4
8 HR WORK DAYS	60
HOURLY PAY RATE	\$18.00
LABOR RATE PER UNIT	\$0.17

WITH PM20 MIXER AND FLAT FILLER

ANNUAL UNITS	200,000
NUMBER OF EMPLOYEES	2
8 HR WORK DAYS*	25
HOURLY PAY RATE	\$18.00
LABOR RATE PER UNIT	\$0.0360

* Based on 1000 Units Per Hour

SAVINGS

SAVINGS PER UNIT	\$0.14
ANNUAL SAVINGS	\$27,360.00
EQUIPMENT COST	\$20,125.00

DAYS TO PAY OFF EQUIPMENT	295.33
YEARS TO PAY OFF	0.81



Batch Mixer

Pack Manufacturing offers standard Batch Mixers in sizes designed to accommodate everyone from beginning grow operations to the largest nursery. The Pack Mfg. 1/2 Cu. Yd. and 1 Cu. Yd. are perfect for lower volume operations. The Pack Mfg. 2 Cu. Yd. and 3 Cu. Yd. Batch Mixers offer the capability to mix grow media for medium and high-volume growers, while our 4 Cu. Yd., 6 Cu. Yd. and above Batch Mixers offer extreme amounts of volume. All Pack Mfg. Batch Mixers are dependable, low maintenance, and made to last-constructed from solid steel and equipped with sealed gearboxes. Numerous options are available to customize your mixer to fit your needs.



Griffin Construction Department

Partner with us on you next project.

Call for consultation and quote:

1.800.888.0054 then press 3.

CUSTOM Equipment

If you don't see what you
are looking for, ask!

Pack can build it!



PM20 Mixer & Flat Filler

Deciding which jobs to automate and which jobs to do manually can be a challenge for new growers. Pack Manufacturing is making that decision easier with the PM20 Combination Mixer and Flat Filler. This innovative new design combines the functionality of a 1 Cubic Yard Batch Mixer with a high volume mobile flat filler. The PM20 features a clear polycarbonate mixer door with safety cutoff switch, adjustable rotary brush and sweep, roller take-offs, soil return to eliminate wasted media, and 15" wide filling conveyor- all on a mobile frame. The PM20 is capable of mixing 1 cubic yard of media every 3- 5 minutes and filling 770 trays or 1,800 1 gallon pots every hour.

The Pack Manufacturing Equipment Line provides a full selection of custom made agricultural material handling solutions. They create solutions from small scale batch mixing of potting soil and grow media to fully automated potting and filling lines. If you don't see what you are looking for, ask! Pack can build it!

Mixers
Potters
Flat Fillers
Conveyers

Bale Shavers
Baggers
Watering Solutions
Custom Equipment

Pack Manufacturing Inline Mixing Systems

Pack Manufacturing Inline Mixing Systems are the ultimate solution for any high-volume operation. With the capability to deliver from 30 to 200 Cubic Yards of Media every hour, even the largest media needs can be met. Each Custom Inline Mixing System is built to the customer's needs, incorporating any number of bulk ingredients and low-volume additives. Pack Inline Mixing Systems can be managed from the Touchscreen control or over a network. Recipes can be saved and recalled with the press of a button to deliver mountains of custom media. Custom Inline Mixing System outputs can feed multiple production lines.



PM1100 Pack Filler

The PM1100 Pack Filler® is the elite solution for high volume production lines. With clearances of 20" wide and 16" tall, the Pack Filler® has the versatility to fill everything from flats to production pots. The included tooling ensures every container comes out packed and uniformly perfect every time. Excess soil is delivered right back into the hopper for no mess and efficient operation. With the PM1100AUTO, the entire setup process is automated and adjusted with the press of a button. Save settings for potting speed, soil speed, and tooling height for instant recall the next time these containers are used. This and much more is included in every Pack Filler®, and custom options are available.



PM1002 Double Potter

Made with the largest operations in mind, the PM1002 comes complete with a 4 cubic yard hopper, variable speed control, adjustable hopper gate, independent feed control, excess soil recycling, media vibrator, powered take-off, all sealed bearings, direct drive gearboxes, and 10' filling conveyor. Perfect for transplanting or potting bare roots. The PM1002 adds a layer of media to the bottom of the container and allows for a plant to be inserted before filling the remainder of the container with media- all accomplished in a single efficient production line capable of filling 750 15-gallon pots an hour. Additional options include extended conveyor and custom hopper sizes.



Pack Manufacturing High Speed Potters

Pack Manufacturing three separate styles of Single Hopper Potters for potted trees and large plant production. Each High-Speed Potter is built with solid steel construction, sealed bearings, tracking guide belts, direct drive transmissions, variable speed controls, a powered pot transfer, and soil return systems to deliver excess media back to the hopper. The PM1000 includes a 2-Yard Hopper and 18" wide conveyor belts. The PM1500 includes a 4-Yard Hopper, vibrating UHMW bed, and a 22" wide conveyor belt. The PM2500 includes a 6-Yard Hopper, vibrating UHMW bed, and a 26" wide conveyor belt, capable of filling up to 35-gallon pots!



PM10C Flat Filler

The Pack Manufacturing PM10C series is an introductory level automated Flat Filler. Capable of filling flats and trays under 6" in height, the PM10C makes an excellent first choice for customers looking to reduce expensive labor costs. The PM10C comes equipped with a 16.2 Cubic Foot Soil Hopper, variable speed conveyor, fully adjustable compacting sweeps, a rotary brush, heavy drag chain soil delivery, and the side chute soil return system to deliver any excess soil media right back to the hopper. The PM10C is available with 12" or 15" belt widths and operates on a standard 120VAC plug. Custom options are available.



Pioneer Filler

The economy Pioneer™ Filler from Pack manufacturing is the perfect entry level machine for any pioneering new grower. The Pioneer™ Filler from Pack Manufacturing provides a grower with the same high-volume capability as the competition for a fraction of the cost. Standard with all essential elements- 1 cubic yard hopper, pot sweep, drag chain, filling conveyor, rotary brush and roller transfers. The Pioneer™ Filler allows for up to 1,400 flats or 950 5-gallon pots an hour. Add-ons to make your Pioneer™ Filler the custom machine for any operation. The Pack Mfg. Pioneer™ Filler also offers the advanced features seen on the most expensive fillers, but you only add the features you need, and skip the features you don't need.



Trailblazer Filler

The Trailblazer Filler™ is the premiere solution for established growers with multiple filling needs. The Trailblazer Filler™ includes all the options of the Pioneer Filler®, along with the fully loaded options package to include low-profile casters, vibrator on belt for soil compaction and elimination of air pockets, powered roller take-off to eliminate tipping, an enhanced auger driven soil return to recycle excess media, and reverse options for easy cleanout and large container filling. All these features and more come standard with the Trailblazer Filler™ to provide growers the ability to fill over 1,500 containers an hour with absolute minimal labor! AUTO options are also available.



Pack Mfg. Water Tunnels

Many grower production lines include watering plants in as a process in seeding, propagation, and shipping lines. Pack Manufacturing provides multiple solutions to these applications, including the Deluxe Water Tunnel with controlled water delivery that conserves water by only running water when a container is present. Pack Manufacturing Sub-Irrigators take this concept further by submerging roots on each container as it dips into a specially designed conveyor system that can water both the top and bottom of the plant simultaneously. All Water Tunnels have variable speed controls and are constructed of stainless steel and aluminum bodies.



Pack Power Washer

The Pack Power Washer is a High Pressure Horizontal Power Washer for any grower wishing to reuse flats and growing trays, reducing material costs and environmental impacts. The Horizontal Power Washer uses two extremely heavy duty motor-powered pumps to clean flats with a series of interchangeable high pressure water nozzles. The Power Washer is constructed of high-quality stainless steel, with a stainless-steel feed chain, stainless flights, and adjustable guiderails to feed trays through the washing system. Optional chemical injectors can be added, as well as a third motor driven pump to remove stickers and labels from the sides of trays.



Pack Manufacturing Spike Dibbler

The Pack Manufacturing Spike Dibbler is a standalone solution for quickly inserting accurately placed divots in flats, cell packs, or shuttle trays, allowing for easily inserting the plant material. Pack Manufacturing Dibblers can be placed inline for sticking lines, production lines, or for automated transplanters. The magnetic dibble pins are quickly interchangeable for different hole calibers or dibble patterns for different flats or pots. The pins are held in place with stout neodymium magnets that hold in place until moved by the user. Drill Dibbler options are also available for larger pots or plant material.



Pack Manufacturing Field Potters

For large container field or tree production, nothing combines efficiency and mobility like Pack Manufacturing Field Potters. Available in a 4 Cubic Yard Field Potter and a 10 Cubic Yard Field Potter size, these units are towable machines powered from hydraulic PTO or optional gas or diesel drives, bringing the production line to the field. Each size is equipped with an extended output conveyor capable of pivoting 180° to fill containers on either side of the row. The heavy duty drag chain delivers media via the conveyor, quickly filling the largest containers with the easy-to-use variable speed output control.



Pack Manufacturing Tracking Wagons

For field operations, Tracking Wagons are the most cost-effective solution to field mobility. Whether moving products, materials, or labor over distance, Pack Manufacturing Tracking Wagons provide a perfect solution. Constructed from heavy duty angle iron and expanded metal bottoms, these Tracking Wagons have a long life in harsh environments. Able to be customized to many different applications, the Wagons are fully tracking, allowing multiple wagons to attach together and turn independently. Standard sizes are 4'x8', 4'x10', 5'x10', and 6'x12'. Custom sizes, custom rigging, custom shelving, hitches, and No-Flat tires are all options available with Pack Manufacturing Tracking Wagons.



Pack Manufacturing Volumetric Bagger

For customers wishing to bag their custom grow mixes for either internal use or to market as bagged grow media for consumers, the Pack Manufacturing Volumetric Bagger can provide everything to streamline this process. The Touchscreen controls allow the user to store bag volume information, and interchangeable bagging chutes allow for quickly changing between multiple size bags. The user simply places the bag in the chute and presses the foot pedal. The bag is instantly clamped, filled, and released onto the bagging conveyor. Options include hot air sealers, bag kickers, palletizing conveyors, and pallet carousels to create a full assembly line.



NS1100 Pack Power Seeder™

The Pack Manufacturing NS1100 Pack Power Seeder™ is a fully automated Needle Seeder that delivers full control to the operator with the Touchscreen controller. The Pack Power Seeder™ includes an auto-indexing powered Conveyor Belt, Seed Hopper, Dibbler, Topcoat Hopper, Belt Vibrator, Seed Vacuum to retrieve excess seeds, air clean-off tools, and operates from a 120VAC outlet. The Power Seeder indexes trays to each station, and the operator has full control over the unit and number of seeds delivered per cell. Custom seed manifolds and needle sizes are available for different tray and seed sizes. Fully Pneumatic NS1000 option also available.



Bale Shaver

Compressed peat bales offer plenty of advantages for shipping and storage, but compressed peat or coir can inhibit root growth and prohibit water retention. Pack Mfg. Bale Shavers allow you to enjoy the benefits of compressed media without hindering your plants. Pack Mfg. has three models of Bale Shaver to meet any situation. Each Bale Shaver will finely shave your compressed or frozen bales into light, fluffy material perfect for root growth. The PM1220 Vertical and PM1210 Horizontal Bale Shavers accommodate bales up to 113" tall, and our 3.8 Peat Fluffer is designed just for 3.8 Cubic Feet bales.



Conveyors

Pack Manufacturing provides a full range of conveyor solutions for any application. Production potting lines, incline soil delivery systems, over-head soil delivery systems, planting conveyors, and V-Roller systems are just a few of the options Pack Manufacturing has available. Our economical line of Aluminum Conveyors provides a cost-effective solution to material handling, adding buffers to planting lines, and delivering plants and materials multiple locations. Many options can be added to provide customized solutions to any workflow process. Water Tunnels, Vermiculite Toppers, low-level sensors to activate soil delivery, and limit switches to halt containers are just a few of the custom options available.



Planting Conveyors

Pack Manufacturing Custom Planting Conveyors have multiple applications. From simple fold down tables for sticking lines, propagation trays, and inserting liners to full double stacked Click-Clack lines, Pack Manufacturing offers solutions custom tailored to the customer's needs. Double stacked Click-Clack lines provide a two-tiered conveyor system- the top conveyor feeding trays filled with media to sticking lines as they are needing, holding the line until another tray is pulled from the top layer to the bottom layer, where the plant material is added. Once the tray is filled, it is delivered to the next station, keeping a line running as fast as the trays can be populated.



RP1002 Fabric Pot Filler

Growers using more environmentally friendly fabric pots can now keep pace with the rest of the industry with the new Patent Pending Fabric Pot Filler from Pack Manufacturing! The Fabric Pot Filling System takes the fabric pot at the start, travels the pot along the potting conveyor where it is held open, filled by the potter, and deposits the filled pot to the powered takeoff. All excess grow media is delivered back into the hopper with the open conveyor extended heavy duty soil return. The open conveyor soil return system supports nearly any media type.



Pack Manufacturing Scoreboard with Reporting

Setting and communicating a production schedule across a diverse and multilingual workforce can be challenging. The Pack Manufacturing Production Scoreboard with Reporting helps resolve both scheduling and inventory production tracking, while at the same time providing a motivational tool for the workforce. The Pack Manufacturing Scoreboard includes a large screen TV to display production numbers on the line in real time. The reporting function emails daily reports for the quantity of each product produced, as well as all downtime and reasons for stoppages on the line. The Pack Manufacturing Scoreboard is an excellent tool for tracking production performance, inventory, and gaining insight into your workflow.

PRODUCT NAME		ROSECHANG	NEXT PRODUCT
KNOCKOUT		ROSECHANG OVER TIME	HYDRANGEA
		00:00	
BATCH SIZE	AVERAGE PER MIN	PRODUCED	
3000	49	155	
TARGET TIME	TARGET PER MIN	+/-	
180 MIN	16.6	-2845	
ON TIME	TOTAL TIME	INACTIVE TIME	
100%	00:03:09	00:00:00	
← SETUP	PAUSE	RESET	REPORTS



The POPagation Station™ Plug Popper

The POPagation Station™ Plug Popper custom made by T.O. Plastics dislodges fully rooted plugs from plug trays to minimize damage when transplanting. This two-piece system contains a base board and a spring-actuated stabilizer frame. The base board is custom built with hardened steel pegs to fit any plug tray and can function as a dibble board for seeding. Materials can easily be sterilized.

- Cost effective, high quality equipment
- Easier to use with less force required than other on market
- Portable and easy to move and store
- Customize your POPagation Station to any manufacturer's plug tray with a standard 10x20 perimeter trim

Item	Vendor	Description
59-9100	790500C	TOP Popagation Station Std Frame Plug Popper
59-9101	790528C	TOP Popagation Base Board 128 Plug Popper
59-9102	790535C	TOP Popagation Base Board 200 Plug Popper
59-9103	790540C	TOP Popagation Base Board 288 Plug Popper
59-9104	790542C	TOP Popagation Base Board 392 Plug Popper
59-9110	790501C	TOP Popagation Sta SureRoot-50 Frame Plug Popper
59-9111	790515C	TOP Popagation Base Board SR50-3 Plug Popper

2024



Sow the SEEDS OF SUCCESS with Griffin

Griffin stocks 3,300+ seed variety/product-form combinations—annuals, perennials, grasses, herbs and vegetables. We've carefully curated our packet sizes and product forms to meet your production needs. Browse the full assortment in our Seed & Plant catalog or on Griffins.com.



Germination Chamber

Phytotronics Germination Chamber: Designed by horticulturists with all the features needed to successfully germinate your valuable seeds. Available in both 6 shelf or 12 shelf options.

Features:

- Stainless steel and aluminum construction
- Doors swing fully open on piano hinges
- Clear polycarbonate doors
- The circular vents can be rotated from closed to open
- Thermostatically controlled heating element is submerged in water provide moist heat
- Aluminum heat baffle for more even heating
- Digital display shows temperature within the chamber
- Easy-set thermostat controls both heat and ventilation fans
- Shelf Brackets are spaced at 5"
- Metal edged plastic shelves are removable for easy cleaning
- 8" Casters roll smoothly over doorjamb and bumps, 2 locking
- Ships fully assembled and ready to use

Drop ship only



Griffin Construction Department

Partner with us on your next project.

Call for consultation and quote:

1.800.888.0054 then press 3.



The Plug Popper

Dislodge plugs from their tray in a matter of seconds. No more broken stems or damaged roots. This indispensable horticultural tool works with a simple foot-pedal operation.

No cords, hoses, or motors to maintain. The Plug Popper is easy to use and handles any tray with the swap of an insert. This heavy-duty workhorse pays for itself in a single season.

Item	Description
40-1013	Antal Cayson Plug Popper includes (1) Insert Tray
40-1017	Plug Popper Tray Insert

Drop ship only. Customer to send sample trays to vendor before product ships. Contact your sales rep for details.



Garden Center Wagons

- Plastic and Metal Decks
- Pneumatic tires, powder coated frames
- All wagons come with Auto-Steering which keeps weight centered over steering axle and keeps cart from tipping

Made in Canada.



A



B



C



D



E

Item	Description
39-5000	20" x 38" Plastic Green Wagon (A)
39-5020	20" x 38" Green Nursery Wagon, Metal Deck, Metal Frame (B)
39-5040	2WGC 24" x 48" Green Garden Cart 2-Wheel Garden Cart 4" x 16" Pneumatic Tires (C)
39-5035	4WGC 24" x 48" Green 4-Wheel Nursery Cart, 2 - 4" x 10" Swivel Casters and 2 - 4" x 16" Pneumatic Tires (D)
39-5030	EFRW-G 24" x 48" Green Wagon, Metal Deck, Metal Frame (E)



Transportation & Merchandising Carts (A)

- 1 base, 3 shelves, 4 posts, 1 drawbar, and 4 tires (2 swivel, 2 rigid)
- Shelves are adjustable in 2" intervals
- Shelves are galvanized wire mesh
- Overall height is 81"
- Standard post length of 77"
- Carts constructed with drawbar and pin for train make-up with one cart following another around corners when in tow
- Shelves can be tilted for easy display of products
- All units are hot dip galvanized to resist rusting
- All units can be collapsed to 20% of original size for easy storage and allowing economic return to greenhouse supplier

Item: 39-7025 **Desc:** 22" x 59" Wellmaster Rectan. Trans. Cart

Item: 39-7030 **Desc:** 22" x 59" Wellmaster Wire Mesh Shelf

360° Cart (E)

Wellmaster's 360° Cart features a dynamic design to meet all horticultural needs. What makes this cart unique is its zero turn radius for close tight turns. Too many times are growers, nurseries or garden centers restricted by their own environment to efficiently move about. The 360° Cart can help you get you and your products where you want to go. Handles on each end of the cart provide ease when maneuvering sharp turns over various terrains whether you are pushing or pulling the unit. 10" swivel tires are placed at each end for load stability while 15" tires are placed at the center to act as a pivot point. This unit is completely compatible with the industry standard 22" x 59" shelves. Your adjustable 59" shelves that you use on other carts can be used on this unit to suit your specific needs. Two fork guides occupy the underside of the unit for transport via lift truck. This unit also features a hot-dip galvanized finish. *Some assembly required.*

Item: 39-053304 **Size:** 22"x 59"

Grizzly Cart (B)

The Wellmaster Grizzly is a "bear" of a cart and is essential for all Garden Center or Nursery settings. Its easy-to-assemble design and versatility make it ideal for moving products throughout your environment. 15" flat-free tires at the back and 10" flat-free tires at the front will glide over rough terrains with great ease while the push handle offers both comfort and leverage. Offers a hot dip galvanized finish with the deck being 18" from the ground. This product is a boxed shipment which saves on freight. Ideally suited for garden centers or nurseries to carry a wide variety of products including bedding plants, perennials, hanging baskets, pots or landscaping products.

Item: 39-7090 **Size:** 24" Wide x 48" Long x 37" Height

The BIG Red Wagon (C)

- 30"W x 46½"L x 23"H
- Galvanized frame
- Durable plastic deck
- 7½" H inside dimension of box
- Combination pull handle / tractor hitch
- 12" tires

Some assembly required.

Item: 39-7080 **Size:** 30"W x 46½"L x 23"H

Nesting Retail Shopping Carts (D)

- Holds 5-10" by 20" flats
- Short wheel base for easy maneuverability
- 8" HD casters for all types of terrain 2 x 5 and 2 x 8 cushion ride casters
- Flip top allows for tall plants or large loads on bottom shelf
- Carts nest at 15" to conserve storage space
- 300 lb. capacity
- 24"W x 37"L - 44"H assembled

Some assembly required.

Item: 39-7075 **Size:** 24" x 37"



Commercial PRO Seedling Heat Mats

SUNPAD™ PRO Commercial Seedling Heat Mats for professional growers, reliably warm the root zone 10°F-20°F above ambient air temperature, creating excellent rooting conditions for seedlings and cuttings. Used with the required SUNPACK® Temperature Controller and tray domes, growers can dial in the ideal temperature and humidity for germination. These rugged and waterproof mats have a patented double-layer construction that makes it the right choice for greenhouses, nurseries, and commercial operations. Increases propagation success rate. Warms root zone to optimal temperature. Waterproof and easy to clean. Can be daisy chained with the SUNPAD™ Add-on mats for a total of five mats. For indoor use only.

Item	Description
SP10150	Commercial Seedling Heat Mat, 60" x 21", 150W
SP10160	Commercial Seedling Heat Mat, 60" x 21", 150W ADD-ON



Heat Mat Temperature Controller

This digital thermostatic device allows growers to select and maintain optimal temperatures when germinating seeds or rooting cuttings for the fastest growth. It is compatible with all DSM&T heat mats, and most other 120V heat mats on the market as well.



Item	Description
SPTMP	SUNPACK Heat Mat Temperature Controller



Propagating Mats & Thermostats

You can use any open space for a propagation area. The mat is light enough to put on counters and tough enough to use on any concrete or dirt floor or growing area. It is so rugged it will last for years, and its sturdy, molded construction makes it completely waterproof and impervious to soil, chemicals and fertilizers. Just roll out your mat and plug it in. There are no wires to tangle, no concrete to pour. It's ready to go at once.

Item	Description
38-1225	PM-9A Mat 22" x 60" 200 watts per mat
38-1235	GC-1 Thermostat accommodates 2 mats- range 40 to 100
38-1240	GC-4 Thermostat accommodates 4 mats- range 40 to 100



Propagation Kits

AGRITAPE is the best source of bottom heat available due to its design, flexibility, durability, performance and relative low cost. AGRITAPE, custom designed to each customers' needs, can be used for a few square feet or for several thousand. (Available in 11" continuous width.) 20 Amp control units in 2 convenient sizes: the AT-1 for up to 120' of 11" tape or the AT-Jr for up to 60' of 11" tape.



Aluminum mesh screen protects against abrasion while safely grounding Agritape.

11" AGRITAPE provides uniform heat distribution due to its unique heat pattern.

*Styrofoam insulation beneath Agritape increases efficiency and reduces operational cost.

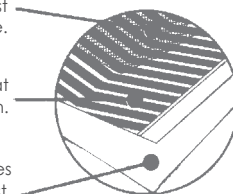

Item	Description
38-1040	10' x 11" Mat & Grounding Screen
38-1045	AT-1 Jr. will handle up to 6 Agritape mats - 60'
38-1050	AT-1 will handle up to 12 Agritape mats - 120'

Seed E-Z Seeder, Inc.



E-Z Seeder

Each E-Z Seeder fits a particular flat size and will accommodate all plugs and cells that fit that size. Plates are available for your seed variety, from large seed to small. The Plates are all aluminum, durable, static free, lightweight, and interchangeable in seconds. The Seed E-Z Seeder can achieve 55,000 to 75,000 seeds per hour depending on the seed size and flat used. You visually see the tray with the seeds on it. Seed drops directly in the center of the plugs, ensuring maximum growing capacity. Templates sold separately. **Drop ship only.**

Item	Description
40-4025	E-Z Seeder



Vibro Motor™ Hand Seeder



Battery powered, this hand held unit offers a two speed operation. Recommended for the seed group of 50,000 to 250,000 seeds per ounce (medium to small seed).

Options Available: Power converter plug, Magnifier attaches to tip to aid when small seeds are sown.

Item	Description
40-4525	Vibro Motor™ Hand Seeder
40-4535	Power Converter for Vibro Motor™ Hand Seeder
40-4545	Magnifier for Vibro Motor™ Hand Seeder

RETAIL READY

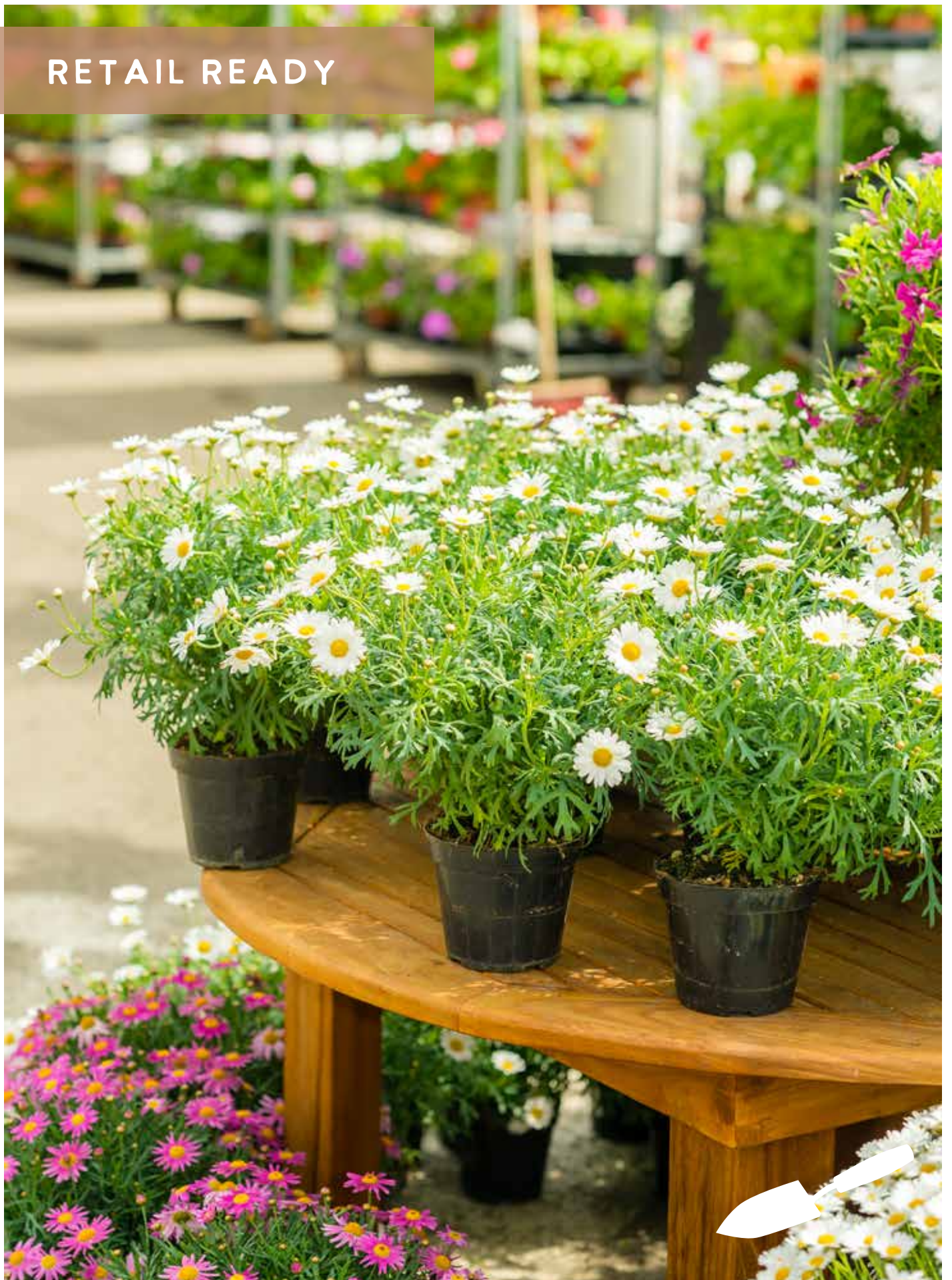



Perennials

POINT OF PURCHASE SIGNAGE
from Griffin

High-quality signage, at affordable prices, with NO minimums! Available in pre-designed and custom options!

FREE DESIGN WORK ON ALL CUSTOM ORDERS!



Perennials



Sunny Annuals



Shade Annuals



Herb Garden



Vegetables



Poinsettias

Custom Coroplast Posters

- Printed in UV cured ink/long-lasting durability
- Full color bleeds
- Durable high-quality outdoor 4mm coroplast
- Shipped within 5 days of proof approval
- Custom sizes available

Options

- Grommets in top corners - Free
- Double Sided - Additional cost, same as front or new image

Step stakes available Item # PP-SS

Custom Vinyl Banners

- Printed in true digital color
- Full color bleeds
- Durable high-quality outdoor 13oz scrim vinyl
- Reinforced on all 4 sides with banner welding
- Drop-shipped within 5 days of proof approval

Options

- **Grommets** (2-3') - Free
- **Rope** - Additional cost
 - 500 pound nylon cord welded with 2' of slack
 - Location: top, bottom, top & bottom
- **Pole Pockets** - Additional cost
 - Size: 1, 2, 3, or 4" (Dimensions unchanged)
 - Location: top, bottom, top & bottom, left, right, left & right

Pre-designed Poster Options

- 2 sided printing on Coroplast
- Full color print
- UV coated
- Grommets for easy hanging (24x36)

Item	Description
PP-1623PE	Perennials
PP-1623PO	Poinsettias
PP-1623SH	Shade Annuals
PP-1623SU	Sunny Annuals
PP-1623VG	Vegetables
PP-1623HG	Herb Garden

16" x 24"

Item	Description
PP-2436PE	Perennials
PP-2436PO	Poinsettias
PP-2436SH	Shade Annuals
PP-2436SU	Sunny Annuals
PP-2436VG	Vegetables
PP-2436HG	Herb Garden

24" x 36"

TOOLS

2024



We carry many gardening tools:

Hand Tools, Long Handled Tools, Wheelbarrows, Garden Cleanup, Sprayers

This page shows a sampling. For the complete listing see the Retail Catalog.



POTS AND PLANTERS

2024



We carry a great selection of retail planters:

Decorative Plastic, Metal, Moss Planters
Ceramic and Clay, Hanging Baskets, Macrame
Self Watering, Urns, Window Box and Railing
Succulent and Small Planters.

*These pages show a sampling.
For the complete listing
see the Retail Catalog.*





GARDEN ACCESSORIES & DÉCOR

2024

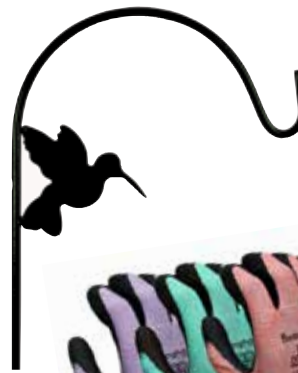

We carry many garden accessories:

Gloves and Kneelers, Plastic/Cork Saucers, Shepherd Hooks/Trellis/Obelisk/Plant Stand, Flags, Garden Décor, Fountains, Citronella & Torches.

This page shows a sampling. For the complete listing see the Retail Catalog.



WATERING

2024



We carry many watering products:

Sprinkler, Hoses & Wands, Watering Cans, Watering Accessories

This page shows a sampling. For the complete listing see the Retail Catalog.



BIRDING

2024



We carry many birding items:

Bird Baths, Bird houses/feeders, Bird Seed & Suet, Hooks & Hangers, Hummingbird Supplies

This page shows a sampling. For the complete listing see the Retail Catalog.



SEED STARTING

2024



We carry indoor gardening supplies:

Misters/Sprayers, Indoor Plant Care, Lighting, Domes & Kits, Peat Pots & Trays, Plant labels, Grow Bags

*This page shows a sampling.
For the complete listing
see the Retail Catalog.*



SYNDICATE



LAWN CARE

2024

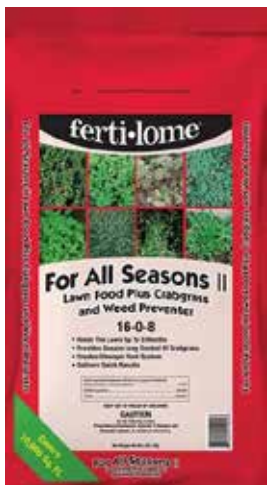
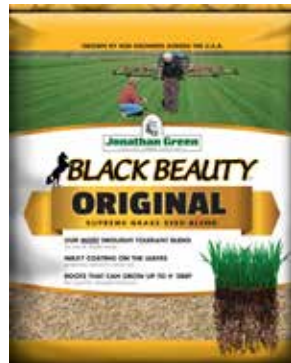
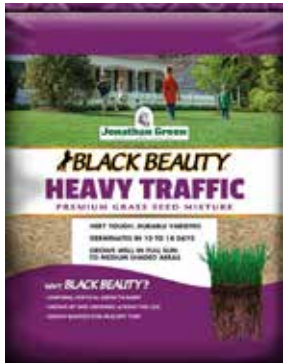

We carry many lawn care items:

Grass Seed, Lawn Fertilizer, Spreaders, Weed & Pest Control, Straw

This page shows a sampling. For the complete listing see the Retail Catalog.



CROP SUPPORT

2024



We carry crop support:

Netting & Burlap, Stakes, Tomato Support and Weed Barriers

This page shows a sampling. For the complete listing see the Retail Catalog.



SOILS & AMENDMENTS



2024



We carry many great soil brands:

Soil, Soil Cover and Moss Soils, and Soil Conditioners

*This page shows a sampling.
For the complete listing
see the Retail Catalog.*



PLANT CARE & FOOD



2024



We carry plant care & food:

Liquid & Granular Fertilizers, Water Soluble & Time Release Fertilizers, Meters & Soil Testers

This page shows a sampling. For the complete listing see the Retail Catalog.



LAWN AND GARDEN SOLUTIONS

2024



We carry lawn and garden solutions:

Animal Repellents, Disease & Weed Control and Pest Solutions

These pages shows a sampling. For the complete listing see the Retail Catalog.





2024





BRINGING YOU THE BEST
SOLUTIONS
IN TAGS, ADHESIVE LABELS,
PACKAGING & MERCHANDISING

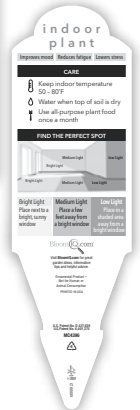
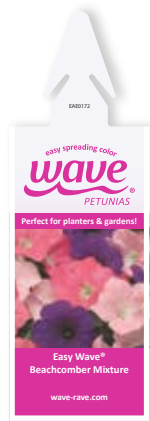

CONTACT GRIFFIN TO ORDER TODAY

CONTAINERS & PLANTERS





greenhouse



Greenhouse



Nursery



Sustainable



Retail



Cannabis



Contact your HC representative for more information



Leaders in
Innovation



Leaders in
Sustainability



Leaders in
Accessibility



Leaders in
Service

HC produces growing containers to meet the unique needs
of every grower, in every market



Leader in
Horticultural
Containers

(800) 225-7712 |    



Leader in
Horticultural
Containers



**Quilted
Planter**
Black



**Shell
Hanging
Basket**
Black



**Quilted
Hanging
Basket**
White

Shell & Quilted Series

Item	Description	Color	Outside Diameter	Height	Liquid Volume US	Qty
49-8849	10.00 Shell Hanging Planter	White	10.00	6.56"	1.50 gal	50 / cs
49-8850	10.00 Shell Hanging Planter	Black	10.00	6.56"	1.50 gal	50 / cs
51-3283	10.00 Shell Hanging Planter	White	10.00	6.56"	1.50 gal	3,200/pallet
51-3282	10.00 Shell Hanging Planter	Black	10.00	6.56"	1.50 gal	3,200/pallet
49-8847	10.00 Quilted Hanging Planter	White	10.00	6.56"	1.50 gal	50 / cs
49-8848	10.00 Quilted Hanging Planter	Black	10.00	6.56"	1.50 gal	50 / cs
51-3285	10.00 Quilted Hanging Planter	White	10.00	6.56"	1.50 gal	3,200/pallet
51-3284	10.00 Quilted Hanging Planter	Black	10.00	6.56"	1.50 gal	3,200/pallet

Cap dish is included. Hangers are sold separately. Other color available.



Leader in Horticultural Containers



Hanging Basket
Platinum Gray

Planter
Walnut

Hammered Metal Series

Item	Description	Color	Outside Diameter	Height	Liquid Volume US	Qty/cs
51-8830	10.0 Hanging Basket	Platinum Gray	10"	6.5"	1.5 gal.	50
51-8831	10.0 Hanging Basket	Black	10"	6.5"	1.5 gal.	50
51-8832	10.0 Hanging Basket	Walnut	10"	6.5"	1.5 gal.	50
51-8833	10.0 Hanging Basket	Valley Blue	10"	6.5"	1.5 gal.	50
49-8830	10.0 Planter	Platinum Gray	10"	7.25"	1.7 gal.	50
49-8831	10.0 Planter	Black	10"	7.25"	1.7 gal.	50
49-8832	10.0 Planter	Walnut	10"	7.25"	1.7 gal.	50
49-8833	10.0 Planter	Valley Blue	10"	7.25"	1.7 gal.	50
51-8443*	10.0 Hanging Basket*	Platinum Gray	10"	6.5"	1.5 gal.	3,200
51-8444*	10.0 Hanging Basket*	Black	10"	6.5"	1.5 gal.	3,200
51-8445*	10.0 Hanging Basket*	Walnut	10"	6.5"	1.5 gal.	3,200
51-8447*	10.0 Hanging Basket*	Valley Blue	10"	6.5"	1.5 gal.	3,200
53-8830*	10.0 Planter*	Platinum Gray	10"	7.25"	1.7 gal.	3,125
53-8831*	10.0 Planter*	Black	10"	7.25"	1.7 gal.	3,125
53-8832*	10.0 Planter*	Walnut	10"	7.25"	1.7 gal.	3,125
53-8833*	10.0 Planter*	Valley Blue	10"	7.25"	1.7 gal.	3,125

Note: Hangers are sold separately. | *Non-Stock Item

Savings

PURCHASE	SAVE
\$750.00	10%
\$1,500.00	15%
\$2,500.00	20%

Savings apply to all HC Companies products.



Valley Blue Black



Leader in
Horticultural
Containers



Progression Series

Item	Description	Color	Outside Diameter	Height	Liquid Volume US	Qty
51-3164	10.00 Progression Hanging Basket	Dark Gray	10"	6.50"	1.50 gal.	50
51-3165	10.00 Progression Hanging Basket	Chocolate	10"	6.50"	1.50 gal.	50
51-3166	10.00 Progression Hanging Basket	Black	10"	6.50"	1.50 gal.	50
51-3167	10.00 Progression Planter	Dark Gray	10"	8"	1.70 gal.	50
51-3168	10.00 Progression Planter	Chocolate	10"	8"	1.70 gal.	50
51-3169	10.00 Progression Planter	Black	10"	8"	1.70 gal.	50
51-70310	10.00 Progression Hanging Basket - ½ pallet (includes cap dish and hanger)	Dark Gray	10"	6.50"	1.50 gal.	1,250
51-70320	10.00 Progression Hanging Basket - ½ pallet (includes cap dish and hanger)	Chocolate	10"	6.50"	1.50 gal.	1,250
51-70330	10.00 Progression Hanging Basket - ½ pallet (includes cap dish and hanger)	Black	10"	6.50"	1.50 gal.	1,250
51-3174	10.00 Progression Hanging Basket - pallet	Dark Gray	10"	6.50"	1.50 gal.	3,200
51-3175	10.00 Progression Hanging Basket - pallet	Chocolate	10"	6.50"	1.50 gal.	3,200
51-3176	10.00 Progression Hanging Basket - pallet	Black	10"	6.50"	1.50 gal.	3,200
51-3177	10.00 Progression Planter - pallet	Dark Gray	10"	8"	1.70 gal.	3,200
51-3178	10.00 Progression Planter - pallet	Chocolate	10"	8"	1.70 gal.	3,200
51-3179	10.00 Progression Planter - pallet	Black	10"	8"	1.70 gal.	3,200

Wrapt HP
Sandstone



Old Fashioned
Matte Black



Wrapt HP
Timeless Black



Leader in
Horticultural
Containers

Wrapt and Old Fashioned Series

Item	Description	Color	Outside Diameter	Height	Liquid Volume US	Qty/cs
51-70210	11.00 Hanging Planter	Chocolate	11"	6 $\frac{5}{8}$ "	1.7 gal.	25
51-70220	11.00 Hanging Planter	Sandstone	11"	6 $\frac{5}{8}$ "	1.7 gal.	25
51-70230	11.00 Hanging Planter	Timeless Black	11"	6 $\frac{5}{8}$ "	1.7 gal.	25
51-70240	13.00 Hanging Planter	Chocolate	13"	7 $\frac{3}{4}$ "	2.73 gal.	25
51-70250	13.00 Hanging Planter	Sandstone	13"	7 $\frac{3}{4}$ "	2.73 gal.	25
51-70260	13.00 Hanging Planter	Timeless Black	13"	7 $\frac{3}{4}$ "	2.73 gal.	25
48-0491	9 $\frac{1}{4}$ " Basket	Matte Black	9 $\frac{1}{4}$ "	7.85"	1.5 gal.	50/Cs
48-0492	9 $\frac{1}{4}$ " Basket	Matte Black	9 $\frac{1}{4}$ "	7.85"	1.5 gal.	3,660/Pt

Savings

PURCHASE	SAVE
\$750.00	10%
\$1,500.00	15%
\$2,500.00	20%

Savings apply to all HC Companies products.

Wrapt: Cap dish is included with the Wrapt Hanging Baskets. *Hangers are sold separately.



Leader in Horticultural Containers

Decorative Planters

Clay Item	Black Item	Mocha Item	Chocolate Item#	Description	Outside Diameter	Height	Liquid Volume	Qty/cs	Hgr or pot Compatibility	
Decorative Bowls										
49-3460	-	49-3660	-	10.00 Color Bowl	9 ⁵ / ₁₆ "	4 ³ / ₄ "	1.02 gal.	82	Hanger E-10 or E-10L	
49-3470	-	49-3670	-	12.00 Color Bowl	12 ¹ / ₁₆ "	5 ³ / ₁₆ "	1.85 gal.	42	Hanger E-12	
48-3475	-	48-3675	-	14.00 Color Bowl	14 ³ / ₄ "	5 ⁵ / ₈ "	2.57 gal.	45		
39PAD0800C	-	-	-	08.00 Panterra Bowl	8"	3 ³ / ₈ "	2.17 qt.	250		
39PAD1000C	-	-	-	10.00 Panterra Bowl -TagGrip	10"	4 ¹ / ₈ "	1.01 gal.	100		
39PAD1200C	-	-	-	12.00 Panterra Bowl -TagGrip	12"	5 ¹ / ₈ "	1.67 gal.	50		
39PAD1400C	-	-	-	14.00 Panterra Bowl -TagGrip	14"	5 ³ / ₄ "	2.44 gal.	50		
Decorative Pots										
49-3630	-	49-3830	49-3930	08.00 Color Pot TL	8 ¹ / ₁₆ "	6 ¹ / ₁₆ "	1.00 gal.	58	Hanger E-10 or E-10L	
49-3638	-	49-3838	49-3938	10.00 Color Pot 1	10 ⁷ / ₁₆ "	7 ³ / ₄ "	2.00 gal.	58	Hanger E-12	
49-3637	-	49-3837	-	10.00 Color Pot 3 TL	9 ⁷ / ₈ "	7 ⁷ / ₈ "	1.57 gal.	50		
49-3646	-	49-3546	49-3446	12.00 Color Pot 1	13 ³ / ₁₆ "	9 ¹ / ₂ "	3.62 gal.	28		
49-3645	-	49-3545	49-3945	12.00 Color Pot 2 TL	11 ¹³ / ₁₆ "	9 ¹ / ₂ "	2.87 gal.	40		
49-3654	-	49-3854	49-3954	14.00 Color Pot	15 ¹ / ₃₂ "	11 ⁵ / ₁₆ "	5.66 gal.	20		
39PAD06C	-	-	-	06.00 Panterra Pot	6.62"	5.12"	1.78 qt.	350		
39PAD08PC	49-2464*	-	-	08.00 Panterra Pot	8 ⁷ / ₈ "	6"	2.83 qt.	250		
39PAD10PC	49-2483*	-	-	10.00 Panterra Pot	11 ¹ / ₈ "	7 ³ / ₄ "	1.92 gal.	100		
39PAD12PC2	49-2561*	-	-	12.00 Panterra Pot	13 ¹ / ₄ "	9 ¹ / ₂ "	3.35 gal.	58		
39PAD14PC	49-2587*	-	-	14.00 Panterra Pot	15 ⁵ / ₈ "	11 ³ / ₈ "	5.54 gal.	25		
55-3846	55-3847	-	-	12.00 Cordova Pot	13"	8 ¹ / ₂ "	3.14 gal.	25		
55-3854	-	-	-	14.00 Cordova Pot	15"	10"	5.20 gal.	22		

* Black Panterra Pots are Non-Stock Items.

Support Cage	Qty /cs
51-3202 Climbing Plant Support Cage**	48

**Container sold separately. Fits the 12" Color Pot and the 12" Panterra Pot. Items: 49-3646, 49-3546, 53-3648, 53-3848, 39PAD12PC. Welded, Green coated wire, hook under lip.



Square Planter
Clay

Decostone Planters
Clay, Black & Sandstone



Centabella
Black



Panterra Oval
Clay



Leader in Horticultural Containers

Decorative Planters

Item	Description	Color	Outside Diameter	Height	Liquid Volume	Qty/cs	Hanger Compatibility
Centabella Planters							
39CBU1250C	12.50 Centabella with TagGrip	Clay	12 1/2"	9 1/2"	3.25 gal.	24	
39CBU1250S	12.50 Centabella with TagGrip	Sandstone	12 1/2"	9 1/2"	3.25 gal.	24	
49-2263	12.50 Centabella with TagGrip	Black	12 1/2"	9 1/2"	3.25 gal.	24	
39CBU1550C	15.50 Centabella	Clay	15 1/2"	12 1/2"	6.19 gal.	12	
39CBU1550SS	15.50 Centabella	Sandstone	15 1/2"	12 1/2"	6.19 gal.	12	
49-2290	15.50 Centabella	Black	15 1/2"	12 1/2"	6.19 gal.	12	
39CBU1900C	19.00 Centabella	Clay	19"	15"	11.40 gal.	12	
39CBU1900SS	19.00 Centabella	Sandstone	19"	15"	11.40 gal.	12	
49-2320	19.00 Centabella	Black	19"	15"	11.40 gal.	12	
Decostone Planters							
51-3140	11.50 Decostone Planter	Clay	11"	8 1/2"	2.00 gal.	50	
51-3142	11.50 Decostone Planter	Sandstone	11"	8 1/2"	2.00 gal.	50	
49-2845	11.50 Decostone Planter	Black	11"	8 1/2"	2.00 gal.	50	
51-3150	13.50 Decostone Planter	Clay	13 3/8"	10"	3.38 gal.	25	
51-3152	13.50 Decostone Planter	Sandstone	13 3/8"	10"	3.38 gal.	25	
49-2872	13.50 Decostone Planter	Black	13 3/8"	10"	3.38 gal.	25	
51-3154	16.00 Decostone Planter	Clay	15 3/4"	12"	5.28 gal.	20	
51-3156	16.00 Decostone Planter	Sandstone	15 3/4"	12"	5.28 gal.	20	
49-2893	16.00 Decostone Planter	Black	15 3/4"	12"	5.28 gal.	20	
Oval Planters							
49-3870	12.00 Oval Color Planter	Clay	12 31/32"	5"	1.06 gal.	88	Hanger E-12
49-3880	16.00 Oval Color Planter	Clay	16 19/16"	5 7/8"	2.06 gal.	43	Hanger E-12
49-3890	20.00 Oval Color Planter	Clay	20 7/8"	6"	2.72 gal.	28	
49-3770	12.00 Oval Color Planter	Mocha	12 31/32"	5"	1.06 gal.	88	Hanger E-12
49-3780	16.00 Oval Color Planter	Mocha	16 19/16"	5 7/8"	2.06 gal.	43	Hanger E-12
49-3790	20.00 Oval Color Planter	Mocha	20.87"	6"	2.72 gal.	28	
39PAP1200C	Panterra Oval	Clay	13.62"	5"	3.86 qt.	50	
39PAD16PC	Panterra Oval	Clay	16.75"	6"	1.97 gal.	50	
Square Planters							
49-3840	08.00 Square Color Planter	Clay	8"	7 1/16"	1.30 gal.	56	
49-3846	12.00 Square Color Planter	Clay	11 3/8"	10"	3.08 gal.	32	
53-3858	15.00 Square Color Planter	Clay	14 3/8"	12 3/8"	6.50 gal.	10	



Leader in Horticultural Containers

Hanging Baskets

Green Item	White Item	Description	Outside Diameter	Height	Liquid Volume	Qty/cs
Euro Style— Swirl Sidewall (Without saucer. Includes capdish.)						
51-7422	51-7522	06.00 Euro SL HB	6.50"	4¼"	1.59 qt	100
51-7430	51-7530	08.00 Euro SL HB 2	8"	5⅞"	3.23 qt.	50
51-7438	51-7538	10.00 Euro SL HB 2	10"	6⅞"	1.39 gal.	50
51-7446	51-7546	12.00 Euro SL HB	11¾"	7¼"	2.39 gal.	50
Traditional Style— Smooth Sidewall (Without saucer. Includes capdish.)						
51-2332	-	8.00 Traditional SL HB (HTS0800)	8.75"	5.06"	2.86 qt	50
51-2334	51-2333	10.00 Traditional SL HB (HTS1000)	10¾"	5.87"	1.47 gal.	50
51-8438	51-8538	10.00 Traditional SL HB 1	10¾"	6⅞"	1.64 gal.	50
51-2326	51-2325	11.00 Traditional SL HB (HTS1100)	10¾"	6.50"	1.73 gal.	50
51-8446	51-8546	12.00 Traditional SL HB	12"	7⅞"	2.21 gal.	50
51-2340	51-2335	12.00 HTS HB	13"	7½"	2.77 gal.	50
51-2039	51-2139	10.00 Kord SL HB (HNI1000)	10¾"	6¾"	1.66 gal.	100
Traditional Style (With External Saucers)						
51-8030	-	08.00 Traditional WS HB	8¾"	5⅞"	2.86 qt.	50
51-8038	51-8138	10.00 Traditional WS HB	10¾"	5⅞"	1.61 gal.	50
51-8040*	51-8140	Super Traditional WS HB	11⅞"	5⅞"	1.77 gal.	50
Cascade Style						
51-74382	51-75382	10.0 Cascade SL HB	10"	6.12"	1.34 gal.	100
Tuscan Style						
51-76382	51-77382	10.0 Tuscan SL HB	10"	5.75"	1.27 gal.	100
Half Pallet Hanging Basket Program (Without saucer) **						
51-74395*	51-75395*	10.00 Euro 2 SL HB ½ Pallet 1600/bulk w/capdish	10"	6⅞"	1.39 gal.	1,600
51-84395**	51-85395*	10.00 Trad SL HB ½ Pallet 1200/bulk w/capdish	10¾"	6⅞"	1.64 gal.	1,200
51-8439	-	10.00 Trad SL HB Pallet 2400 bulk (capdish and hanger not included)	10¾"	6⅞"	1.64 gal.	2,400

** Must have equipment to unload Half Pallet and Pallet. Available while supplies last.

*Seasonal production item, please call for availability.

HB = Hanging Basket SL = Saucerless WS = With Saucer



Decorative Hanging Baskets

Item	Size / Description	Color	Outside Diameter	Height	Liquid Volume	Qty/cs
Color Basket						
51-32461	12.00 SL Basket	Clay	12 ³ / ₁₆ "	7 ¹ / ₄ "	2.29 gal.	25
51-34461	12.00 SL Basket	Mocha	12 ³ / ₁₆ "	7 ¹ / ₄ "	2.29 gal.	25
Decostone Basket						
51-3160	12.00 Basket	Clay	12 ⁷ / ₈ "	7"	2.17 gal.	50
51-3162	12.00 Basket	Sandstone	12 ⁷ / ₈ "	7"	2.17 gal.	50
Ultra Basket						
39U11HPC	11.00 Basket	Clay	11"	6 ¹ / ₂ "	1.65 gal.	100
39U11HPSS	11.00 Basket	Sandstone	11"	6 ¹ / ₂ "	1.65 gal.	100
49-3006	12.00 Basket	Sandstone	12"	7"	2.15 gal.	50
Centabella Basket						
51-10036	12.0 Basket	Sandstone	12.37"	7"	2.30 gal.	50

For more decorative hanging baskets: See the collections on pages 123-126

HIGH-END & HASSLE-FREE COMBOS

Vegetative mix programs like Kwik Kombos™ and Confetti Gardens® take the guesswork out of producing premium combos. Start with our Seed & Plant catalog or contact your Griffin sales representative!



Syngenta Flowers Cabrio
Speed Limit Mix Kwik Kombos

Hanger / Basket Compatibility



Leader in Horticultural Containers

Plastic Hangers & Basket Compatibility

Hanging Baskets	Hanger
All 06.00 HB, 08.00 HB, 10.00 HB, 08.00 Color Pot, 10.00 Color Bowl	E-10 3-Strand Plastic
All 08.00 HB, 10.00 HB, 11.00 Wrapt HB	18.0 Long Snap Hanger 3-strand
All 08.00 HB, 10.00 HB, 08.00 SL Hanging Point. Pot, SL Hanging Point. Pot, 10.00 Color Bowl, 08.00 Color Pot, 11.00 Shimmer HB	E-10 L (Long) 3-Strand Plastic
All 12.00 HB, Super TRAD HB, 12.00 Color Bowl, 10.00 Color Pot 1, 12.00 Oval Planter, 16.00 Oval Planter	E-12 4-Strand Plastic
12.00 HTS 1200, 12.00 Kord SL, 13.00 Wrapt HB	22.00 Long Snap Hanger 4 Strand



Wire Hangers & Basket Compatibility

Hanging Baskets	Hanger
All 06.00 HB, 08.00 HB, 10.00 HB	17" 3-Strand Metal
All 08.00 HB, 10.00 HB	21" 3-Strand Metal
12.00 TRAD SL HB, 12.00 Euro SL WS, SUPER TRAD WS HB	24" 4-Strand Metal
12.00 TRAD SL HB, 12.00 Euro SL WS, SUPER TRAD WS HB	24" 4-Strand Metal

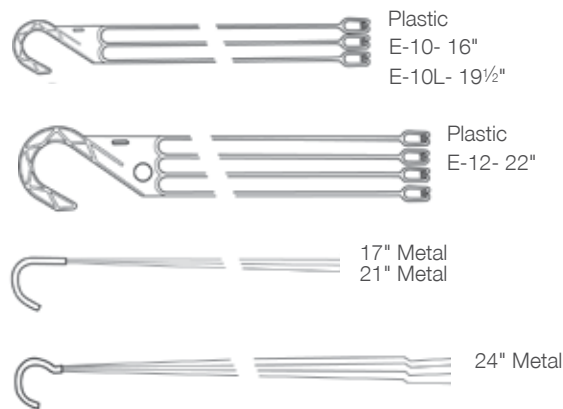

Hangers

Plastic Hangers

Hanger	Green Item	White Item	Clay Item	Mocha Item	Chocolate Item	Black Item	Sandstone Item	Length	Qty /cs
E-10 3-Strand Plastic Hanger	51-5582	51-5583	51-5578	51-5679	—	51-5510BK	51-55SS	16"	50
18.00 Medium Snap Hanger 4-strand	—	—	—	—	—	—	39P4SMHSS	18"	25
18.00 Long Snap Hanger 3-strand	39P3SLHG	39P3SLHW	39P3SLHC	—	39P3SLHCEBN	39P3SLHB	39P3SLHSS	18"	25
E-10 L (Long) 3-Strand Plastic Hanger	51-5592	51-5593	51-5596	51-5697	51-55937	51-55BLK	—	19 1/2"	50
E-12 4-Strand Plastic Hanger	51-5587	51-5588	51-5598	51-5699	—	—	—	22"	25

Wire Hangers

Hanger	Item	Length (Tip to Tip)	Qty /cs
14" Hoop & Hanger Assembly for Cordova	51-5574	25 1/2"	22
17" 3-Strand Metal	51-5575	17"	50
21" 3-Strand Metal	51-5576	21"	50
21" 4-Strand Metal	51-2477	21"	50
24" 4-Strand Metal	51-5577	24"	50

Co-Ex Pots & Trays

- Co-extruded with a barrier layer for maximum opacity
- Lightweight design for greater cost efficiency
- Sized to fit existing Carry Trays for quick compatibility in your system
- North American sizes to fit existing benches, carts, and handling systems for added convenience
- Customize with offset printing to create unique packaging solutions
- Quart size has tag locator for captivating graphic displays
- Color outer layer ideal for offset printing for maximum retail impact
- Strong rims for efficient use in automated systems
- Polypropylene construction is lightweight, yet durable



Leader in Horticultural Containers



Item	Description	Color	Tray Count	Outside Diameter	Height	Liquid Volume	Qty/cs
4.00 STD TL Pots and Trays							
45-7012	P 4.00 STD TL Coex Pot	BK	-	4"	3½"	1.00 pt.	1,260
45-7014	P 4.00 STD TL Coex Pot	GN	-	4"	4"	1.00 pt.	1,260
45-7013	P 4.00 STD TL Coex Pot	TC	-	4"	4"	1.00 pt.	1,260
53-XTR104004	CTXR410 CX PP Tray	-	10	20 ¹ / ₁₆ " x 8 ¹ / ₄ "	4"	-	50
53-XTA154004	CTXR415 CX PP Tray	-	15	20 ³ / ₄ " x 12 ¹ / ₂ "	4"	-	50
4.25 GER Pots and Trays							
45-7812	P 04.25 GER TL Coex Pot	BK	-	4 ¹ / ₄ "	4 ¹ / ₄ "	1.26 pt.	520
45-7814	P 04.25 GER TL Coex Pot	GN	-	4 ¹ / ₄ "	4 ¹ / ₄ "	1.26 pt.	520
45-7813	P 04.25 GER TL Coex Pot	TC	-	4 ¹ / ₄ "	4 ¹ / ₄ "	1.26 pt.	520
53-TG1043304	CTXG42510 CX PP Tray	-	10	21" x 8 ¹ / ₂ "	5 ¹ / ₂ "	-	50
4.50 GER Pots and Trays							
45-7818	P 04.50 GER TL Coex Pot	BK	-	4 ¹ / ₂ "	3 ³ / ₄ "	1.26 pt.	720
45-7816	P 04.50 GER TL Coex Pot	GN	-	4 ¹ / ₂ "	3 ³ / ₄ "	1.26 pt.	720
45-7817	P 04.50 GER TL Coex Pot	TC	-	4 ¹ / ₂ "	3 ³ / ₄ "	1.26 pt.	720
45-7815	P 04.50 GER TL Coex Pot	WH	-	4 ¹ / ₂ "	3 ³ / ₄ "	1.26 pt.	720
53-XTG104504	CTXG4510 CX PP Tray	-	10	23" x 9 ¹ / ₂ "	3 ³ / ₄ "	-	50
53-XTG124504	CTXG4512CX PP Tray	-	12	18 ¹ / ₂ " x 14"	3 ³ / ₄ "	-	50
53-XTG154504	CTXG4515 CX PP Tray	-	15	23" x 14"	3 ³ / ₄ "	-	50
4.00 Square - 01.00 Quart Pots and Trays							
45-4184	04.00 1 Q Square Pot	BK/BK	-	4"	5.75"	1.0 qt.	400
45-4186	04.00 1 Q Square Pot	GN/BK	-	4"	5.75"	1.0 qt.	400
53-XTS15402	CTS415QT CX TRAY	BK/BK	15	20.50" x 12.50"	2"	-	50
01.00 Quart Pots and Trays							
45-4246	P 01.00 Q PER TL CX Pot	GN/BK	-	4 ⁵ / ₈ "	5 ¹ / ₄ "	1.0 qt.	432
45-42233	P 01.00 Q PER TL CX Pot	CL/BK	-	4 ⁵ / ₈ "	5 ¹ / ₄ "	1.0 qt.	432
45-4223	P 01.00 Q PER TL CX Pot	BK/BK	-	4 ⁵ / ₈ "	5 ¹ / ₄ "	1.0 qt.	432
53-41082	CTQ8R CX Tray	-	8	19 ¹ / ₂ " x 10"	4 ³ / ₄ "	-	50
53-41182	TRS10QD Tray	-	10	23" x 9 ⁷ / ₁₆ "	4 ¹ / ₈ "	-	50
5.00 AZ Short Pots							
45-7718	05.00 AZ Short CX Pot	BK/BK	-	5"	3.75"	1.76 pt.	675
45-77182	05.00 AZ Short CX Pot	GN/BK	-	5"	3.75"	1.76 pt.	675
48-1180	CTA58 CX TRAY	BK/BK	8	19.87" x 9.87"	3.75"	-	50

Bk = Black Cl = Clay TC = Terracotta GN = Green COEX = Co-Extruded CX = Co-Extruded Per = Perennial TL = Tag Locator Q = Quart SQ = Square

*Season production item, please reach out to Customer Service for availability.

P = Offset Printing Available



Leader in
Horticultural
Containers

Co-Ex Pots & Trays

Item	Description	Color	Tray Count	Outside Diameter	Height	Liquid Volume	Qty/cs
5.50 AZ Pots							
45-7520	05.50 AZ CX Pot	BK/BK	-	5.25"	4.50"	1.25 qt.	496
45-7620	05.50 AZ CX Pot	CL/BK	-	5.25"	4.50"	1.25 qt.	496
45-7720	05.50 AZ CX Pot	GN/BK	-	5.25"	4.50"	1.25 qt.	496
53-31222	CTA558CX TRAY	BK/BK	8	22.00" x 11.00"	4.62"	-	50
6.00 Standard Coex Pots and Trays							
45-7016BB	06.00 Standard CX Pot	BK	-	6"	5.710"	1.82 qt.	480
53-3270	CTR66 Tray	BK	6	18½" X 12¾"	5"	-	50
15CM Short Euro Pots and Trays							
45-8531	15CM Short Euro CX Pot	BK/BK	-	6"	4¼"	1.37 qt.	680
45-8533	15CM Short Euro CX Pot	GN/BK	-	6"	4¼"	1.37 qt.	680
48-2680	6 Pocket Tray - 15CM Short	-	6	17½" x 11½"	4¾"	-	50
15CM Tall Euro Pots and Trays							
45-8539	P 15CM Tall Euro CX Pot	BK/BK	-	6"	5½"	1.65 qt.	488
45-8540	P 15CM Tall Euro CX Pot	GN/BK	-	6"	5½"	1.65 qt.	488
45-8541	P 15CM Tall Euro CX Pot	TC/BK	-	6"	5½"	1.65 qt.	488
48-2682*	6 Pocket Tray - 15 CM Tall	-	6	17½" x 11½"	5½"	-	50
16CM Euro Pots and Trays							
45-8503 *	16CM Euro CX Pot	CL/BK	-	6.29"	6.69"	2.50 qt.	200
45-8501	16CM Euro CX Pot	BK/BK	-	6.29"	6.69"	2.50 qt.	200
17CM Short Euro Pots and Trays							
45-75240	17CM Short Euro CX Pot	BK/BK	-	6¾"	5"	2.00 qt.	300
45-75250	17CM Short Euro CX Pot	GN/BK	-	6¾"	5"	2.00 qt.	300
45-76240	17CM Short Euro CX Pot	CL/BK	-	6¾"	5"	2.00 qt.	300
3906171	6 Pocket Tray - 17 CM Short	-	6	20¼" x 13¼"	5"	-	50
17CM Tall Euro Pots and Trays							
45-7524T	17CM Tall Euro CX Pot	BK/BK	-	6¾"	6"	2.58 qt.	294
45-7624T	17CM Tall Euro CX Pot	CL/BK	-	6¾"	6"	2.58 qt.	294
48-2684	6 Pocket Tray- 17 CM Tall	-	6	20¼" x 13¼"	6¼"	-	50
19CM, 21CM and Mum Pan Pots and Trays							
45-8519	P 19CM Short Euro CX Pot	BK/BK	-	7½"	5¾"	3.00 qt.	220
45-8619T2	P 19CM Tall Euro CX Pot	GN/BK	-	7½"	7¾"	1.00 gal.	132
45-8619T	19CM Tall Euro CX Pot	BK/BK	-	7½"	7¾"	1.00 gal.	132
45-8521	21CM Short Euro CX Pot	BK/BK	-	8"	5"	3.22 qt.	230
45-85213	21CM Short Euro CX Pot	CL/BK	-	8"	5"	3.22 qt.	230
45-85217	21CM Medium Euro CX Pot	GN/BK	-	8"	6"	3.61 qt.	210
45-85215	21CM Medium Euro CX Pot	BK/BK	-	8"	6"	3.61 qt.	210
45-8524T	21CM Tall Euro CX Pot	GN/BK	-	8"	7¼"	1.11 gal.	190
45-8521T	21CM Tall Euro CX Pot	BK/BK	-	8"	7¼"	1.11 gal.	190
45-3145	P 08.00 X 05.00 Mum pan CX Pot	CL/BK	-	8"	5"	2.78 qt.	170
45-3045	P 08.00 X 05.00 Mum pan CX Pot	BK/BK	-	8"	5"	2.78 qt.	170
45-3146	P 08.00 X 05.00 Mum pan CX Pot	GN/BK	-	8"	5"	2.78 qt.	170
45-3055	09.00 X 06.25 Mum pan CX Pot	BK/BK	-	8¾"	6¼"	1.20 gal.	90
45-3155	09.00 X 06.25 Mum pan CX Pot	CL/BK	-	8¾"	6¼"	1.20 gal.	90
45-3156*	09.00 X 06.25 Mum pan CX Pot	GN/BK	-	8¾"	6¼"	1.20 gal.	90

*Seasonal production item, please call for availability.

P = Offset Printing Available

Az = Azalea Bk = Black Cl = Clay COEX = Co-Extruded CX = Co-Extruded
TRAD = Traditional Per = Perennial TL = Tag Locator Q = Quart GER = Geranium



Leader in Horticultural Containers



Co-Ex Pots & Trays

Item	Description	Color	Tray Count	Outside Diameter	Height	Liquid Volume	Qty/cs
1.00 T1G Squat Pots and Trays							
45-4620*	P 01.00 T1G SQUAT CX Pot	CL/BK	-	6½"	6½"	2.5 qt.	140
45-4120	P 01.00 T1G SQUAT CX Pot	BK/BK	-	6½"	6½"	2.5 qt.	140
45-4320	P 01.00 T1G SQUAT CX Pot	GN/BK	-	6½"	6½"	2.5 qt.	140
53-41018	CTGAS16 CX Tray	-	6	20⅞" X 13⅞"	6¼"	-	50
M6 SQ Pots and Trays							
45-4122*	M6 SQ CX Pot	BK/BK	-	5"	5⅞"	1.5 qt.	468
45-4122S	M6 SQ Short CX Pot	BK/BK	-	5"	4½"	1.25 qt.	585
53-3025	CTS68 Tray	-	8	19¾" x 9⅞"	3¾"	-	50
Mum Pans - Half Pallet							
45-30552	09.00 X 06.25 Mum pan CX Pot	BK/BK	-	8¾"	6¼"	1.20 gal	2,700
45-31552	09.00 X 06.25 Mum pan CX Pot	CL/BK	-	8¾"	6¼"	1.20 gal	2,700
45-31562	09.00 X 06.25 Mum pan CX Pot	GN/BK	-	8¾"	6¼"	1.20 gal	2,700

*Seasonal production item, please call for availability.
P = Offset Printing Available

Az = Azalea Bk = Black Cl = Clay COEX = Co-Extruded CX = Co-Extruded
TRAD = Traditional Per = Perennial TL = Tag Locator Q = Quart GER = Geranium

Injection Molded Thinwall Round Pots & Trays

- HC Companies offers more than 25 sizes of Round Thinwall Pots in popular styles including Azalea, Standard Round, Geranium, Jumbos, and Mum Pans
- Offset printing- High quality offset printing is available for many sizes of round containers. (Indicated by the symbol below)
- Custom colors available (Minimum orders apply)
- High-gloss finish for ease of cleaning and label adhesion



Item	Description	Color	Tray Count	Outside Diameter	Height	Liquid Volume	Qty/cs
48-7012	P 03.50 STD TL TW Pot	GN	-	3½"	3¼"	11 fl oz.	1,225
53-3108	CTR3512 Tray	BK	12	21¼" x 7⅞"	3½"	-	50
48-7014	P 04.00 STD TW Pot	GN	-	4"	3½"	1.01 pt.	1,550
48-7015	P 04.00 STD TW Pot	CL	-	4"	3½"	1.01 pt.	1,550
53-3008	CTR410 Tray	Bk	10	20" x 8"	3⅞"	-	50
48-2724	TRS15400 Tray	BK	-	22" x 12¼"	3½"	-	50
48-7414	P 04.00 AZ TW Pot	GN	-	4"	2⅞"	14.2 fl oz.	1,980
48-2724	TRS15400 Tray	BK	-	22" x 12¼"	3½"	-	50
48-7815	P 04.25 GER TL TW Pot	GN	-	4¼"	3⅜"	1.25 pt.	680
53-3140	CTG42510 Tray	Bk	10	21½" x 8¾"	4¼"	-	50
53-3143	CTG458 Tray	BK	-	19⅞" x 10"	4"	-	50
48-7817	04.50 GER TW Pot	WH	-	4½"	3⅜"	1.26 pt.	850
48-7816	P 04.50 GER TW Pot	GN	-	4½"	3⅜"	1.26 pt.	850
53-3145	CTG4515 Tray	Bk	15	22¾" x 13¾"	4"	-	50
53-3146	CTG4512 Tray	Bk	12	18¼" x 14"	3¾"	-	50
53-3143	CTG458 Tray	BK	-	19⅞" x 10"	4"	-	50
39E045AG	4.5 Elite Ultra Aza	GN	-	4½"	3.25"	1.28 pt	1000

P = Offset Printing Available

CTG = Carry Tray Geranium CTR = Carry Tray Round DP= Deep GER= Geranium GN = Green WH = White BK = Black
IST = Injection Shuttle Tray JUM = Jumbo M = Matte Finish STD = Standard TL = Tag Locator TW = Thinwall TRAD = Traditional



Leader in Horticultural Containers



Injection Molded Thinwall Round Pots & Trays

Item	Description	Color	Tray Count	Outside Diameter	Height	Liquid Volume	Qty/cs
39E05AG	P 05.00 Elite Ultra AZ TW Pot	GN	-	5"	3 ³ / ₈ "	1.68 pt.	750
53-3123	CTA58 Tray	BK	8	19 ⁷ / ₈ " x 9 ⁷ / ₈ "	3 ³ / ₄ "	-	50
48-7420	P 05.50 AZ TRAD TW (TX600) Pot	GN	-	5 ¹ / ₂ "	4 ⁹ / ₁₆ "	1.36 qt.	544
53-3122	CTA558 Tray	BK	8	22" x 11"	4 ⁵ / ₈ "	-	50
48-7022	P 06.00 STD TW Pot	GN	-	6"	5 ³ / ₄ "	1.87 qt.	440
53-3270	CTR66 Tray	BK	6	18 ¹ / ₂ " x 12 ⁵ / ₈ "	5"	-	50
48-7523	06.00 AZ Pot	BK	-	6"	4.25"	1.39 qt.	352
48-7423	06.00 AZ Pot	GN	-	6"	4.25"	1.39 qt.	352
53-3160	CTA66 Tray	BK	6	18.5" x 12.37"	5"	-	50
48-2694	6 Elite Pocket Tray	BK	6	18" x 12"	4.25"	-	50
53-3162	CTA66L Tray	BK	6	20" x 11.25"	4.25"	-	50
48-8421	06.00 AZ JUM TW Pot	GN	-	6 ¹ / ₈ "	4 ⁵ / ₁₆ "	1.70 qt.	528
48-7425	06.50 Round AZ Pot	GN	-	6 1/2"	4 ⁵ / ₈ "	1.81 qt.	438
48-7435	06.50 Round AZ Pot	BK	-	6 1/2"	4 ⁵ / ₈ "	1.81 qt.	438
48-7445	06.50 Round AZ Pot	TC	-	6 1/2"	4 ⁵ / ₈ "	1.81 qt.	438
39665R	TRS0665 Tray	BK	6	19 ⁷ / ₈ " x 13 ¹ / ₈ "	5 ⁵ / ₁₆ "	-	50
48-8424	P 06.50 AZ TRAD TW Pot	GN	-	6 ¹ / ₂ "	4 ¹⁵ / ₁₆ "	2.01 qt.	240
53-3185	CTAJ656 Tray	BK	6	19 ³ / ₁₆ " x 13 ¹ / ₄ "	5"	-	50
39E07AG	7.0 Elite Ultra Aza Grn	GN	-	7"	5"	2.20 qt.	250
39E075AG	7.5 Elite Ultra Aza Grn	GN	-	7.5"	5.5"	2.73 qt.	200
39E08AG	08.00 Elite Ultra AZ Pot	GN	-	8"	5 ⁵ / ₈ "	3.27 qt.	270
51-6035	08.00 Standard Pot	GN	-	8.43"	7.12"	1.01 gal.	100
48-74321	P 08.50 AZ TW Pot	GN	-	8 ¹ / ₂ "	5 ¹⁵ / ₁₆ "	3.85 qt.	130
48-1651	10.00 AZ TW Pot	GN	-	10"	7 ¹ / ₂ "	1.73 gal.	100
52-4119	1.0 T1G2 Wide TW TL Gallon Pot	GN	-	6.5"	7"	2.88 qt.	128

Bulb Pans

50-1696	08.00 TRAD Bulb Pan	Gn	-	8"	4"	2.56 qt.	96
48-4638	10.00 Bulb Pan 2 TW	Gn	-	10 ¹ / ₁₆ "	5 ¹ / ₁₆ "	1.32 gal.	96
48-4646	12.00 Bulb Pan	Gn	-	11 ¹⁵ / ₁₆ "	6 ³ / ₁₆ "	2.30 gal.	58
52-3045	P 08.00 x 05.00 Mum Pan TW	BK	-	8"	5 ¹ / ₁₆ "	3.04 qt.	150
52-3145	P 08.00 x 05.00 Mum Pan TW	Cl	-	8"	5 ¹ / ₁₆ "	3.04 qt.	150
52-3146	P 08.00 x 05.00 Mum Pan TW	GN	-	8"	5 ¹ / ₁₆ "	3.04 qt.	150
52-3055	P 09.00 x 06.50 Mum Pan TW	Bk	-	9"	6 ³ / ₁₆ "	1.25 gal.	54
52-3155	P 09.00 x 06.50 Mum Pan TW	Cl	-	9"	6 ³ / ₁₆ "	1.25 gal.	54

P = Offset Printing Available

AZ = Azalea CTA = Carry Tray Azalea CTG = Carry Tray Geranium CTR = Carry Tray Round DP= Deep GER= Geranium GN = Green WH = White BK = Black IST = Injection Shuttle Tray JUM = Jumbo M = Matte Finish STD = Standard TL = Tag Locator TW = Thinwall TRAD = Traditional

Injection Molded Thinwall Square Pots

- Available in 12 sizes (glossy and matte finishes)
- Six sizes feature Tag Locator slots (TL) for easy plant identification
- Five sizes are designed with a deeper bottom for crops such as perennials
- High quality molding - no flashed drain holes or sharp edges
- Custom colors available (Minimum orders apply)
- **Ultra Square Pot:** Injection formed design is ideal for automated machines. Easy tag installation and locking capabilities. Multi-level drainage with four drainage levels!



Ultra Square
Pot and Tray
Four Levels of Drainage!



2024

Item	Description	Color	Pots per Tray	Outside Dimensions	Height	Liquid Volume US	Qty/cs
50-1208	2.5 SQ TRAD Pot	GN	-	2.5"	2.25"	4.8 fl oz	992
50-1210	03.00 SQ TRAD Pot	GN	-	3"	2½"	7.68 fl oz.	504
53-10301	TRK2830 Tray	GN	28	20¾" x 12"	2¼"	-	50
52-3012	03.50 SQ DP PER TL TW Pot	BK	-	3¾"	3⅞"	1.010 pt.	832
53-3012	CTS32512 Tray	BK	12	19½" x 6⅝"	1⅞"	-	100
53-2008	CTS32518PF Tray	BK	18	19⅞" x 9⅞"	1⅞"	-	50
50-1212	03.50 SQ Pot	GN	-	3½"	3"	12.2 fl oz.	504
53-1012	TKP18350 Tray	BK	18	20½" x 10½"	2¼"	-	50
46-4184	4.00 Ultra Square Quart Wave Lock Pot	BK	-	3.92"	5.78"	1.0 qt.	500
53-3032	CTS410QTCX0 Tray	BK	10	19.87" x 7.88"	2.65"	-	50
48-7214	04.00 SQ TL TW Pot	GN	-	3⅜"	3⅞"	1.35 pt.	846
48-7314	04.00 SQ TL TW Pot	BK	-	3⅜"	3⅞"	1.35 pt.	846
53-3040	CTS1540 Tray	BK	15	20¼" x 12¼"	2"	-	50
50-8214	04.00 SQ TRAD TW M Pot	GN	-	3⅞"	3⅞"	1.16 pt.	900
53-3440	CTS415 Tray	BK	15	19½" x 11¾"	3⅞"	-	50
50-023502	4.0 SQ Presto Sheet Pot	BK	15	20.00" x 12.00"	4"	0.7160014 qt	50
53-1014	ST1540 Sutton Tray	BK	15	20.25" x 12.25"	2"	-	50
50-24141	4.0 SQ Pot	GN	-	3.5"	4.00"	1.36 pt.	960
9010094	TLC 4.0 SQ Form Pot	BK	-	4"	3.25"	1.22 pt.	1000
48-0928	4.5 SQ DP PER TL Pot	GN	-	4.21"	4.93"	1.03 qt.	441
52-3215	4.5 SQ DP PER TL TW Pot	CL	-	4.21"	4.93"	1.03 qt.	441
48-7417	04.50 SQ Quick Lock Wave Lock Pot	TC	-	4.25"	3.84"	1.59 pt.	660
48-7228	04.50 SQ Quick Lock Wave Lock Pot	GN	-	4.25"	3.84"	1.59 pt.	660
48-7229	04.50 SQ Quick Lock Wave Lock Pot	BK	-	4.25"	3.84"	1.59 pt.	660
53-1016	ST1545 Sutton Tray	BK	15	21.25" x 12.75"	2"	-	50
41ST1245	ST1245 Sutton Tray	BK	12	16.87" x 12.25"	2"	-	50
41ST1045	ST1045 Sutton Tray	BK	10	21.00" x 8.50"	2"	-	50
53-1146	KT1545 QL Tray	BK	15	21.25" x 12.75"	2"	-	50
48-8216	04.50 SQ TRAD TW M Pot	GN	-	4⅞"	3½"	1.35 pt.	765
53-3445	CTS4515 Tray	BK	-	20⅞" x 12½"	3½"	-	50
52-3216	04.50 SQ DP PER TL TW Pot	BK	-	4⅞"	4⅞"	1.03 qt.	441
53-3015	CTS4510SR Tray	BK	10	21" x 8½"	3"	-	50
53-3045	CTS1545 Tray	BK	15	21¼" x 13"	2"	-	50
52-4118	05.50 SQ JUM TL TW Pot	BK	-	5⅜"	5⅞"	1.89 qt.	288
53-3025	CTS68 Tray	BK	8	19¾" x 9⅞"	3¾"	-	50
52-3218	05.50 SQ DP PER TL TW Pot	BK	-	5¼"	5⅞"	2.04 qt.	256
53-3020	CTS558 Tray	BK	8	21¼" x 10⅞"	3⅞"	-	50

BK = Black CL = Clay CTS = Carry Tray Square DP = Deep GN = Green HWWT = Heavyweight JUM = Jumbo LTWT = Lightweight
M = Matte Finish MDWT = Medium weight PER = Perennial SQ = Square STD = Standard TL = Tag Locator TW = Thinwall TRAD = Traditional
P = Offset Printing Available



Leader in Horticultural Containers

Vacuum Pots and Trays

- Vacuum Square Pots come in five sizes and seven packaging configurations
- Most Square Pots press-fit into matching trays
- Custom colors or co-extruded versions are available; call for details
- Smooth finish ideal for easy label adhesion



Item	Description	Color	Outside Diameter	Height	Liquid Volume US	Qty/cs
53-2010	DSQVP3PF/D - Pot	BK	2 5/8"	3 1/2"	9.47 fl oz.	800
53-2013	CTS332PF (Press Fit) - (32 pots per tray) - Tray	BK	21 1/8" x 10 5/8"	1 7/8"	-	50
53-2012	DSQVP325/D - Pot	BK	3 1/4"	3 5/8"	1.00 pt.	1,200
53-2009	DSQVP325PF/D - Pot	BK	3 1/4"	3 5/8"	15.5 fl oz.	450
53-2008	CTS32518PF (Press Fit) - (18 pots per tray) - Tray	BK	19 7/8" x 9 7/8"	1 7/8"	-	50
53-2014	DSQVP4PF/D - Pot	BK	3 1/2"	3 1/2"	1.08 pt.	450
53-2017	CTS418PF (Press Fit) - (18 pots per tray) - Tray	BK	21 1/4" x 10 5/8"	2 3/8"	-	50
53-2016	DSQVP45PF - Pot	BK	4 1/8"	3 5/8"	1.65 pt.	375
53-2018	DSQVP45PF/D - Pot	BK	4 1/8"	5"	1.20 qt.	375
53-3019	CTS4510PF (Press Fit) - (10 pots per tray) - Tray	BK	21 1/4" x 8 5/8"	2"	-	50
53-2021	CTS4512PF (Press Fit) - (12 pots per tray) - Tray	BK	16 3/4" x 12 1/2"	2 3/8"	-	50
53-2019	CTS4515PF (Press Fit) - (15 pots per tray) - Tray	BK	21" x 12 5/8"	2 3/8"	-	50

BK = Black CTS = Carry Tray Square DSQVP = Square Vacuum Pot D = Deep PF = Press Fit

Sheet of Pots

- Economic alternatives to single pots
- Available in a 10 cell Annual Sheet and 10 or 18 cell Perennial Sheets
- Perforated for easy pot separation at retail or uncut for landscape applications
- Match with Carrying Trays for easy handling

Item	Description	Color	Outside Dimensions LxW	Height	Liquid Volume US	Qty/cs	Tray Compatibility
53-4805	TPS1801 Cut	BK	20" x 10"	3 1/2"	13.0 fl oz.	100	TV1020P18, T Series Open Flats
53-6850	DPS1801 Cut	BK	21" x 10 1/2"	3 1/2"	14.0 fl oz.	100	CTS418PF, D Series Open Flats
9021541	3.5 SQ Presto Sheet Pot	BK	20 1/2" x 10 1/4"	3 1/2"	15.5 fl oz.	100	18-Pocket Tray TKP1835
53-4820	PS1501 Deep	BK	20 3/4" x 12 1/2"	4 3/4"	1.75 pt.	50	CTS4515

BK = Black CTS = Carry Tray Square D = Standard DP = Deep DSQVP = Square Vacuum Pot DPS = Standard Perennial Sheet
 PF = Press Fit PS = Perennial Sheet STD = Standard SQ = Square T = True TL = Tag Locator TW = Thinwall

Landscaper Flat

Item	Description	Color	Length	Width	Height	Qty/cs
51-24010	24 Pocket Flat	BK	15"	10"	3 1/4"	85

***Seasonal production item, please contact Customer Service for availability.**





Leader in Horticultural Containers



Vacuum Inserts

- Designed to optimize performance in automated handling systems-ideal for filling, growing, and shipping
- Match with Injection or Vacuum Flats to create an efficient growing system
- Standard, True, Slim Jim (long and short), Super Thin, and Space Saver sizes
- Exact sheet thickness for strong corner and cell bottom construction
- Precision burned holes and die-cut trims deliver consistent performance
- Variety of configurations to fit automated equipment
- Consistent sheet thickness for strong corners and cell bottoms
- Precision die-cut for easy part separation

Savings

PURCHASE	SAVE
\$750.00	10%
\$1,500.00	15%
\$2,500.00	20%

Savings apply to all HC Companies products.

2024

Item	Description	Color	Outside Dimensions L x W	Height	Liquid Volume US	Qty/cs	Configuration
Standard Inserts							
39601	D601	BK	21" x 10½"	2¼"	1.12 qt.	100	
53-6435	D606	BK	21" x 10½"	2¼"	1.90 pt.	100	
53-6440	D801	BK	21" x 10½"	2¼"	1.75 pt.	100	Standard Inserts fit most Standard Injection & Vacuum Flats
53-6545	D804	GN	21" x 10½"	2¼"	1.25 pt.	100	
53-6445	D804	BK	21" x 10½"	2¼"	1.25 pt.	100	
53-6452	D806	BK	21" x 10½"	2¼"	1.50 pt.	100	
53-6450	D806R	BK	21" x 10½"	2¼"	1.50 pt.	100	
53-6550	D806R	GN	21" x 10½"	2¼"	1.50 pt.	100	
53-6490	D1203	BK	21" x 10.50"	2¼"	13.80 fl. oz.	100	
53-6495	D1204	BK	21" x 10½"	2¼"	11.83 fl. oz.	100	
53-6400	D1206	BK	21" x 10½"	2¼"	11.8 fl. oz.	100	
53-6500	D1801	BK	21" x 10½"	2¼"	9.81 fl. oz.	100	
53-6555	DJ606	BK	21" x 10½"	¾"	1.33 qt.	100	
391004	1004	BK	21" x 10½"	2¼"	1.1 pt.	100	
True Inserts							
53-4745	T804	BK	20" x 10"	2½"	1.50 pt.	100	True Inserts fit most True Injection & Vacuum Flats
53-4750	T806	BK	20" x 10"	2½"	1.12 pt.	100	
53-4752	T806R	BK	20" x 10"	2½"	15.0 fl. oz.	100	
53-4780	T1201	BK	20" x 10"	2½"	15.0 fl. oz.	100	
53-4790	T1203	BK	20" x 10"	2½"	13.5 fl. oz.	100	
53-4795	T1204	BK	20" x 10"	2½"	1.00 pt.	100	
53-4800	T1206	BK	20" x 10"	2½"	12.0 fl. oz.	100	
53-4930	TJ606 (Jumbo)	BK	20" x 10"	¾"	1.12 qt.	100	T1020R6I (Item #53-4315), TVF1020R6
53-8825	T306BP(H) (True 6 Cell Single Basket Pack)	WH	10" x 6¾"	¾"	2.25 qt.	300	Accepts DPC Handle 2, TV1020R3, Basket Clip Handle
53-3239	DPC Utility Handle 2	WH	16¼"	-	-	1,000	For T306BP(H), SJ224HP(H), HPSJ120(H)
Slim Jim Inserts							
53-4945	SJ606S (Jumbo)	BK	20" x 8½"	¾"	1.87 pt.	100	SJ8520R6I, SJV Vacuum Flats
53-4940	SJ606L	BK	21" x 8½"	3.125"	1.99 pt.	100	



Leader in Horticultural Containers

Vacuum Flats

- Available in Standard, True (shallow and full depth), Slim Jim (short) and Skinny Minnie styles
- Flats are constructed from sturdy gauge material for durability
- Choose from a variety of rib configurations to fit any growing need



Item	Description	Color	Outside Dimensions L x W	Height	Qty/cs	Compatibility
Vacuum Standard Flats						
53-4325*	DVF1020R	BK	21" x 10½"	2¾"	100	D Series Inserts
True Flats						
53-8820	TV1020R3	BK	20" x 10"	2"	100	T306BP(H) x 3 (V)

*Seasonal production item, please contact Customer Service for availability.

2024

Injection Flats

- Flats provide outstanding strength and effective insert holding for automation efficiency
- Standard and True web flat models range from lightweight to extra heavy versions to support any requirement
- All injection Flats deliver increased flexibility and economy-constructed using quality, blended, recycled raw material with additives
- All products are stretch wrapped on a pallet for secure shipping

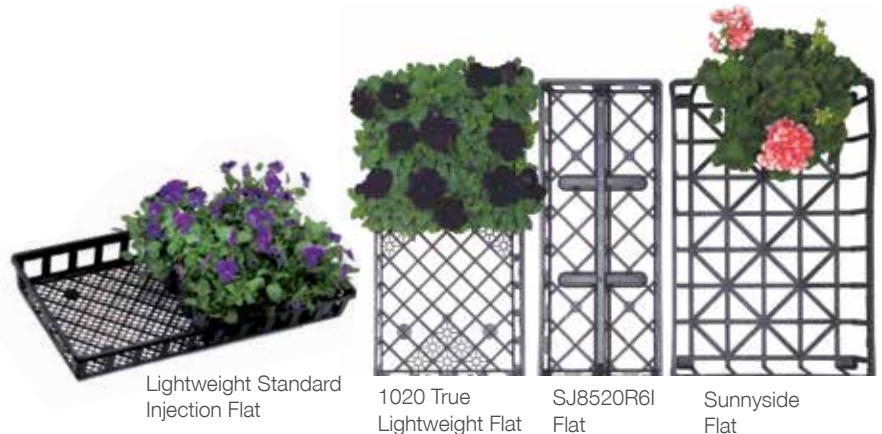

Item	Description	Color	Outside Dimensions L x W	Height	Qty/cs	Compatibility
Standard Flats						
53-3325	1020 STD LTWT Flat	BK	21½" x 10½"	2½"	50	D Series Inserts, 03.50 SQ TRAD, DPS1801
53-33251	1020 STD LTWT Flat (Pallet)	BK	21½" x 10½"	2½"	2700	D Series Inserts, 03.50 SQ TRAD, DPS1801
73S1020ID	Daisy 1020 Web Flat	BK	21" x 10¾"	2.38"	50	Standard 1020 Inserts
53-3330	1020 STD MDWT Flat	BK	21½" x 10½"	2½"	50	D Series Inserts, 03.50 SQ TRAD, DPS1801
53-3335	1020 STD HWWT Flat	BK	21½" x 10½"	2½"	50	D Series Inserts, 03.50 SQ TRAD, DPS1801
53-1310	1020 Trad No Hole Flat	BK	21.5" x 11"	2½"	100	
True Flats						
53-4305	1020 True LTWT Flat	BK	20" x 10"	2½"	50	T Series Inserts, 05.50 SQ JUM TL TW, M-6 SQ TW, TPS1801
53-4310	1020 True MDWT Flat	BK	20" x 10"	2½"	50	T Series Inserts, 05.50 SQ JUM TL TW, M-6 SQ TW, TPS1801
Slim Jim Flats						
53-4730	SJ8520R6I SJ SH Flat	BK	20" x 8¾"	2"	50	SJ606S, SJ1204JS, SJ224HP(H), SJ412QP, SJ412
Utility Flats						
53-3240	Sunnyside Flat	BK	19¾" x 12"	2¾"	25	06.00 STD TW, 06.00 COLOR POT TL, 06.00 AZ JUM TW, 06.00 AZ TW

AZ = Azalea BK = Black GER = Geranium HWWT = Heavyweight IST = Injection Shuttle Tray JUM = Jumbo L = Staggered LG = Long LTWT = Lightweight MDWT = Medium weight PER = Perennial SH = Short SJ = Slim Jim SQ = Square STD = Standard T = True TRAD = Traditional TW = Thinwall WH = White



Leader in Horticultural Containers

Injection Trays

Injection Spacer Trays (IST)

- Locks pots safely inside the tray
- Ideal for multiple transport, growing, and shipping applications
- Open design provides optimal air circulation which prevents algae bloom and stimulates plant growth
- Perfect for capillary mats, ebb and flood, or flooded floor watering systems
- Designed for superior durability and strength
- Made from high quality recycled material



Pocket Style Injection Spacer Tray

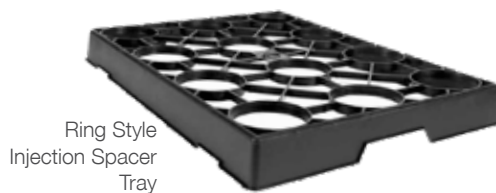

Ring Style Injection Spacer Tray



Universal Injection Spacer Tray
Tray shown with four sizes of pots, 16cm – 17cm

Universal Injection Spacer Trays

- Self adjusting pot cavities allow for multiple sized containers to fit in the same tray
- Sturdy injection tray can be reused until ready to be recycled
- Features tag slots for easy identification at retail

Carryall Trays

- Flexible, durable, and open-perfect for all plant sizes
- 6.50 Carryall Tray features handles for ease of carrying in the greenhouse



4.50 Carryall Injection Tray



6.50 Carryall Injection Tray

Item	Description	Color	Outside Dimensions L x W	Height	Qty/cs	Compatibility
Injection Trays						
53-3286	S-6CT Trade Gal	BK	19" x 12.60"	2.60"	25	XNS0T1G2, XRD16000, EU170S50, EU170T50
53-3265	4/12/8 IST Ring	BK	15½" x 12½"	2"	25	04.00 AZ TW, 04.00 STD TW, 04.00 GER TRAD TW
53-3210	4.5/12/8 IST Ring	BK	21½" x 16"	2"	25	04.50 GER TRAD TW, 04.50 GER TW, 04.50 GER TL TW
Carryall Trays						
53-3255*	04.50 Carryall Tray	BK	17¼" x 13"	3"	25	04.50 SQ TW, 04.50 SQ TRAD TW, 04.50 SQ TL TW
53-3277*	06.50 Carryall Tray	BK	19½" x 12½"	3"	25	06.50 AZ TW, 06.50 AZ TRAD TW

AZ = Azalea BK = Black GER = Geranium HWWT = Heavyweight IST = Injection Shuttle Tray JUM = Jumbo L = Staggered LG = Long LTWT = Lightweight MDWT = Medium weight PER = Perennial SH = Short SJ = Slim Jim SQ = Square STD = Standard T = True TRAD = Traditional TW = Thinwall WH = White

*Seasonal production item, please contact Customer Service for availability.



Leader in Horticultural Containers

Vacuum Propagation Sheets

- Available in the most popular sizes to meet your growing needs
- Round and square cell configurations offer a premium rooting system for soft annuals, foliage, or woody ornamentals
- Strips can be separated to provide further space for growing
- Compatible sectioned Carry Tray is available for the DPS60 and DPS72 models



Item	Description	Color	Outside Dimensions L x W	Height	Liquid US	Cell Diameter	Qty/cs	Configuration
53-6810	DPS24 (Round Cell)	BK	20 ³ / ₄ " x 10 ⁵ / ₁₆ "	2 ³ / ₈ "	3.66 qt.	2 ³ / ₈ "	100	3 x 8
53-6815	DPS38 (Round Cell)	BK	20 ³ / ₄ " x 10 ⁵ / ₁₆ "	2 ³ / ₈ "	1.25 gal.	2 ³ / ₁₆ "	100	
53-6825	DPS50 (Round Cell)	BK	20 ³ / ₄ " x 10 ⁵ / ₁₆ "	2 ³ / ₈ "	1.13 gal.	1 ⁷ / ₈ "	100	5 x 10
53-6840	DPS72 (Round Cell)	BK	20 ³ / ₄ " x 10 ⁵ / ₁₆ "	2 ³ / ₈ "	3.53 qt.	1 ¹ / ₁₆ "	100	6 x 12
53-6835*	DPS98 (Round Cell)	BK	20 ³ / ₄ " x 10 ⁵ / ₁₆ "	1 ⁹ / ₁₆ "	2.96 qt.	1 ¹ / ₁₆ "	100	7 x 14

BK = Black DPS = Propagation Sheet

Vacuum Formed Plug Trays

- Choose round, square or hex cells; Common Element, True, or Standard dimensions
- Ideal for seed germination or vegetative propagation
- Precision punched holes guarantee optimal drainage and air pruning performance



Item	Description	Color	Outside Dimensions L x W	Height	Qty/cs	Configuration
53-6628	DVPT102HX VT	BK	21" x 10 ¹ / ₂ "	1 ¹ / ₁₆ "	50	6 x 17
53-6630	DVPT105HX E VT	BK	20 ³ / ₄ " x 10 ¹ / ₄ "	1 ³ / ₄ "	50	7 x 15
53-6640	DVPT288CE	BK	20 ¹ / ₂ " x 10 ¹ / ₄ "	1 ¹ / ₁₆ "	50	12 x 24
53-6655	DVPT512CE	BK	20 ¹ / ₂ " x 10 ¹ / ₄ "	7 ⁸ / ₁₆ "	50	16 x 32

BK= Black CE = Common Element DVPT = Standard Vacuum Plug Tray
 E = Endless HX = Hexagon RD = Round Cell SQ = Square Cell
 TVPT = True Vacuum Plug Tray VT = Ventilated

20 Row Seedling Flat

The ideal method of sowing seed. The separate rows of soil prevent the translocation of soil born disease organisms. The rows also conserve soil while helping to prevent overwatering. Twenty 10" x 7⁸/₁₆" x 1¹/₄" deep rows across flat for easy seeding.



Item	Description	Qty/cs
54-2051	20 Row Seed tray	50



Leader in Horticultural Containers

Low Profile Tray

- Innovative design: Polypropylene tray with 30% less resin use and weight
- Labor saving: Pots pre-filled in trays eliminates manual pot placement
- Soil saving: Open frame design maximizes soil reclaim in pot filling
- Automation friendly: Clear sight line for tagging equipment with pre-oriented tag slots
- Brand optimized: Maximizes space and visibility to your brand message
- Labor friendly: Ergonomic handling and multiple grip points
- Warehouse stocked in black, co-extruded pots
- Customized branding and special order colors include black/black, terra cotta/black, white/black, and green/black



Item	Description	Packed as	Availability
53-LPT104004S	Dillen CX Low Profile 10CT Tray w/4" Pots Short	48/Case (480 Pots)	Whse Stocked, Drop Ship
53-LPT104004SB	Dillen XST04002 CX Low Profile 10CT Tray w/4" Pots Short	2,200/Pallet (22,000 Pots)	Special Order, Drop Ship
53-LPT104004L	Dillen XST04002 CX Low Profile 10CT Tray w/4" Pots Long	48/Case (480 Pots)	Special Order, Drop Ship
53-LPT104004LB	Dillen XST04002 CX Low Profile 10CT Tray w/4" Pots Long	2,200/Pallet (22,000 Pots)	Special Order, Drop Ship

Options listed above ship with 4" standard, round pots preloaded in the trays (XST04002; 4" diameter, 4" height, 1 pt vol). Low-Profile Trays are also available with 4" azalea pots (XAZ04000; 4" dia, 3" height, 12.88 fl oz vol).

2024



Leader in Horticultural Containers

Nursery Pots and Trays

- Tag Locator slots are molded into the rim of the T1G size to display marketing tags
- Six color offset printing available
- High-gloss finish on all pots allows easy cleaning and label application
- Large drain holes prevent waterlogging; side or bottom drainage option for many sizes



Item	Description	Color	Outside Dimensions	Height	Liquid Volume US	Qty/cs	Compatibility
52-4224	P 01.00 Q Perennial Pot TL TW	GN	4¾"	4¾"	1.94 pt.	475	CTQ12, CTQ8R
52-4223	P 01.00 Q Perennial Pot TL TW	BK	4¾"	4¾"	1.94 pt.	475	CTQ12, CTQ8R
53-4110	CTQ12 12/QT Carry Tray	BK	14.75" x 19.5"	4.75"	-	50	01.00 Q Perennial Pot TL TW
52-4115	P 01.00 T1 G TL TW Pot	BK	6½"	7"	2.72 qt.	128	FPGA16, DWT1GA3, 1G/6/10 IST, CTGA16, trellis
53-4115	FPGA16 TRAY	BK	13.00" x 20.00"	2.5"	-	50	01.00 T1 G TL TW
53-3245	12.0 X 16.0 Nursery Flat - Open Tray	BK	16.31" x 12.38"	3"	-	50	

Plant Support & Cages

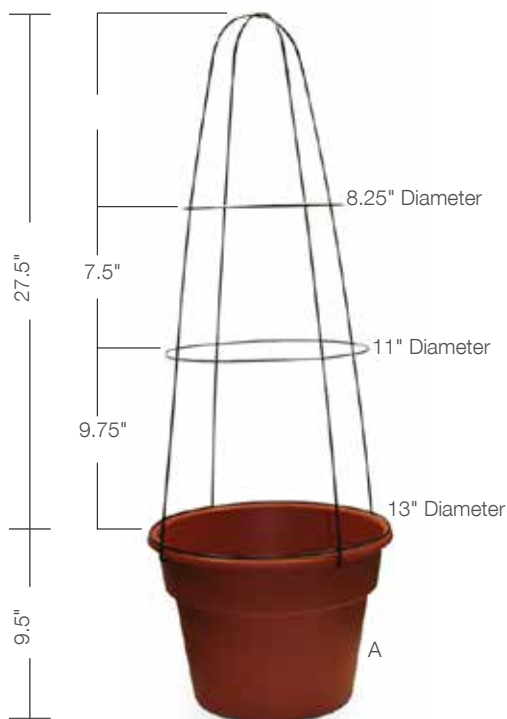

Climbing Plant Support Cage (A)



Container sold separately. Fits the HC Companies 12" Color Pot and the 12" Panterra Pot. Items: 49-3646, 49-3546, 53-3648, 53-3848, 39PAD12PC. Welded, Green coated wire, hook under lip.

Item	Height	Qty
51-3202	27.5"	48

1 Gallon Trellis (B)



Item	Dimensions	Height	Qty	Compatible Pots
51-41151	5 1/8"	17"	128	01.00 T1G TL TW

Support Rings (C)



- The HC Companies rings give support for top heavy foliage plants
- Support Rings snap onto the rim of the pot providing a secure hold
- Long inside leg for fast assembly
- Standard Color: Green

Item	Outside Dia.	Height	Qty/cs	Compatible Pots
51-2606*	6"	3 3/4"	720	5, 5.5 and 6
51-2607*	7"	4 9/8"	720	5.5, 6, 6.5 and 7
51-2608	8"	5"	840	6, 6.5, 7, 7.5 and 8
51-2610	10"	5 1/16"	320	7, 7.5, 8, 8.5, 9 and 10
51-2611*	11 1/2"	6 3/4"	400	11, 11.5, 12 and PA1000



Bamboo Fan Trellis (D)

Bamboo U Trellis (E)

Item	Dimensions	Qty
133-0089	18"	50
133-0012	24"	50
133-0090	30"	50
133-0091	36"	50
133-0092	48"	50

Item	Dimensions	Qty
133-0085	18"	100
133-0086	24"	100
133-0087	30"	100
133-0088	36"	100
133-0152	48"	100

Tomato Cages (F)



Top quality tomato cages made from galvanized steel. Rust-proof with long-lasting welds.

Item	Description	Diameter	Qty/cs
51-3210	32" Tomato Cage	13"	25
51-4210	42" Tomato Cage	14"	25
51-3212	32" Balcony Tomato Cage for 1200 pot	14"	25
51-3216	32" Balcony Tomato Cage for 1600 pot	16"	25

Point Cage (G)



Item	Description	Height	Qty
51-4537	08.00 Point Cage 2 - Green	5.00	100
51-45381	10.00 Point Cage - Green	6.00	60

*Seasonal production item, contact Customer Service for availability.

Custom Container Printing

In four steps, our professional graphic design team will help transform your ideas into unique containers, labels, or printing to package your plants, help grow your sales, and build customer loyalty.

1. Consultation: Our graphic design team works with you to learn about your plants and merchandising needs.

2. Design: We match your needs with our creative expertise to craft logos, copy, illustrations and photography into colorful designs that reflect the “uniqueness” of your brand and plants.

3. Design Reviews: Provide quick feedback and choose your design via electronic e-proof reviews.

4. Digital Production: After your artwork is assembled, you will receive an e-proof and/or hard copy for final approval prior to production.



Adhesive Labeling -

Colorful, cost-effective, and durable

- From simple 1" x 1" black on white labels to larger sizes in multiple colors
- Feature photos, bar codes, care instructions, and more on smudge, chemical, and water-resistant labels
- Perfect solution for "Weights and Measures" compliance

Offset Printing -

Unique designs and vibrant printing

- Up to 8 bright colors can be wrapped around many sizes of round pots for high impact at retail.
- COMING SOON!!! Up to 4 bright colors can be printed on all four sides of square pots.
- Perfect for custom illustrations, bar codes, text, logos and planting and care instructions.
- Available for many round Thinwall Pots and Nursery Containers.
- Oriented Printing Available

Call Griffin for more information on HC Companies branding products

Process	Container Sizes	Colors	Min Order*	Lead Time**
Adhesive Labels	Most Containers	1-6 Colors	5,000	4 weeks
Offset Printing	Specific Rounds: 03.50 Standard to 9 x 6.25	1-8 Colors	50,000 [†]	6-8 weeks
Offset Printing	Square Pots	1-4 Colors	COMING SOON!!	

* **Minimum order based on stocked color** ** Lead time starts from your final approval of digital artwork. Lead time may be longer during peak season: November through March. [†] Speak to your Griffin Sales Representative for lower minimum in non-peak season.



Branded Containers

The perfect way to complete your blooms for Sunfinity, Senetti, and SunPatiens with branded containers and tags from Summit Plastic.



Item	Description	Qty/cs
Sunfinity		
50-5750	Summit Sunfinity Printed 16 cm T-2.5 QT Pots	385
50-5751	Summit Sunfinity Printed 22 cm T-1.5 Gal. Pots	150
97-350751	Mastertag Sunfinity Sunflower Tag MT#2245272	25
Senetti		
50-5749	Senetti printed 19 cm T-1 Gal pots	270
Sun Patiens		
50-5741	SunPatiens 12cmT (4.5") Printed Pot	1,425
50-5748	SunPatiens Pot 15cm (6") 5"L Printed Pot	600

K&C Plastics, Inc.

**Pen Paks
& Carriers**



142 Pen paks | 300 per package; 6¹/₂" x 5" x 2³/₄"
142 Pen Paks fit the 142 Carrier listed below.

142 Carrier | 25 per bundle; 15" x 16" x 2⁵/₈". This tray holds the 142 Pen Pak listed here as well as the NC142 Fiber Pak found on page 183.

144 Carrier | 25 per bundle; 17¹/₂" x 16" x 2⁵/₈". This tray holds the 144 Fiber Pak and the S-144 Fiber Pak listed on page 183.

Item	Description	Qty/cs
53-3027	142 Pen Pak	300
53-3231	140 Plastic Carrier	25
53-3225	142 Plastic Carrier	25
53-3230	144 Plastic Carrier	25

Hanging Pots



Item	Description	Qty/cs
53-3038	10" Hanging Pot Green - Wire Hanger	50
53-3039	10" Hanging Pot White - Wire Hanger	50

Curtis Wagner Plastics Corp.



Clear Propagation Dome

The clear acrylic dome helps maintain an incubator-like atmosphere at soil level. Seeds germinate and emerge into the perfect warm, moist environment. The dome can be reused continuously.

Item	Description	Qty/cs
54-2305	Propagation Dome	50

SUNBLASTER
HORTICULTURAL LIGHTING



7" NanoDome

A lot of thought went into our 7" NanoDome. This is a high humidity vented dome that incorporates our ingenious light tracks. These tracks receive our T5HO Combo or LED strip lights. By placing your lighting in these tracks your plants receive the light they need. Fits 10" x 20" trays. Light & Tray not included.

Item #	Desc	UPC	Vendor	CS/UOS
81740063	Vents	628836142321	1400232	25/25

2024



Al's Flower POUCH
the original

Flower Pouch Growing Bag

- Creates colorful hanging flower display
- Designed to hang against a flat surface such as wall or deck
- Provides an excellent source of additional revenue and margins
- Can be grown on normally unused wall space in greenhouses
- Made of heavy gauge polyethylene film
- Use double hook to grow 2 flower bags back to back
- 20" bag + 7" handle - 10 T-slits

Item	Description
50-8605	Pouch Style Growing Bag SSH 720 HG 8 ¹ / ₂ " .05 (50/bundle)
51-45026	4" Double Hook For Flower Bags (Galvanized) (100/bundle)



2024

3D System - Forward Facing Pot



- Six sizes with matching trays
- Retail Marketing Appeal— Your message up front and center every time
- Designed for Automation
- Correct Pot Orientation every time
- Footprint reduction vs traditional round pots
- More pots per square foot grower sites
- Maximizes cart utilization
- Increased usage of shipping space reduces freight costs
- More shelf facings at retail

Sizes available: 1 pint, 1.25 pint, 1 quart, and 1.25 quart.
Contact your sales rep. for more information.

Nu-Pots & Nu-Pot Trays

Once seen Nu-Pots & Nu-Trays are not forgotten easily- blooms abound. Abundant soil volumes complement decorative, fluted side-slopes giving excellent gradient rates for strong root development for all plant types- annuals, perennials, foliage.

Item	Description	Dimensions	Qty/cs
49-6210	Nu-Pot 4	3¼" sq x 3⅞" deep	1600
49-6216	Nu-Pot 5	4⅜" sq x 4¾" deep	450
49-6135	Nu-Tray 4-18	19½" x 10" x 2"	90
49-6147	Nu-Tray 5-10	22" x 8¾" x 2½"	90
49-6145	Summit Nu-Tray 5-12 Holds 12 Nu-Pot5 Blk	17 ½" X 13" X 3 ¼"	75



Root Tutor™

Distinguishing Root Tutors from regular plugs trays is easy- Root Tutors feature internal channels for root directioning and depth for increased gradient ratings. And, the individual plug sizes are larger (Tray Size: 10½"x 21").

- Channels guide roots down, reducing root circling
- Large bottom holes stimulate air pruning
- Star pattern encourages root branching

Item	Description	Depth	Qty/cs
49-6152	Root Tutor 32	4"	50
49-6150	Root Tutor 72	3½"	50

Filling Trays for JanorPots®

The expanded and redesigned Filling Tray line fits JanorPot containers creating reliable, complete systems with flush top fit, snug interiors and opened-up sides for better container graphics viewing.

- New, stronger resin blend
- Flush fit at the top
- New trays have slots and/or slits for FlatTalker locking tags
- Bottom and sidewall drainage
- Soil deflecting design
- Easy denesting

Item	Description	Dimensions W x L	Qty
49-053211	2 QT Square 8 Count Tray	21" x 30 ⅝"	100
49-053201	10 cm H-10 CT Filling Tray - Black	19 ¾" X 8" X 3" ¾" H	100
49-6172	10.5 cm Filling Tray - 15" x 4" Round Pots	12 ¼" x 20 ⅝"	100
49-6271	11 cm H-10 Filling Tray (4.25" Round) Pot Black	21" X 7 ¼" X 3" ½" H	100
49-6174	12 cm Filling Tray - 15" x 4.5" Round Pots	14 ⅞" x 23 ⅞"	50
49-8620	12 cm H-8 **SPACE** Tray - Black	20" X 10" X 4" 1/8" H	100
49-6220	12 cm H-8 Filling Tray - Black	18 ½" X 9" X 4" 1/8" H	100
49-61961	13 cm H-8 Filling Tray - 5" Round Pots Black		50
49-6178	15 cm Filling Tray - 6" x 6" Round Pots	10 ⅝" x 21 ⅝"	50
49-6182	17 cm H-6 Filling Tray - 6 Trade Gallon Pots	20" X 16 ¼" x 6 ¼"	50

Flats, Trays and Inserts

Item	Description	Dimensions	Qty/cs
49-8623	Root Stepper Landscaper Tray (18)	20" X 10" X 3 ⅝" H	100
49-6100	Marketmate 6 Basket	20" X 10" X 3 ½" H	100
49-61003	Deep 804 Black Insert	21" X 10 ½" X 3 ⅞" H	100



Round JanorPots®

JanorPot containers are designed with a dual-level drainage system for optimum water and aeration exchange that maximizes the plants' growth potential. To complete the system, these pots fit Summit Plastic Trays.

Quality is designed into JanorPot containers because automation requires consistency! The smooth, rolled lip, ease in denesting and no sharp edges or projections make these pots the right choice for automation.

All pots are Duo, two layers of material. By using 100% light-proof materials, the plants root zone develops unhindered. This results in an ideal rooting environment allowing plants to grow better, faster and healthier.

Item	Description	Width	Height	Color	Qty/cs
49-5200	Janor 3.5 Std / 9cm-H Pot	3 9/16"	3 1/2"	TRC	2340
49-5300	Janor 4.0 Std / 10cm-H Pot	3 15/16"	3 9/16"	Black	1680
49-5402	Janor 4.25 Std / 11cm-H Pot	4 3/8"	3 9/16"	Green	2000
49-5600	Janor 4.5 Ger / 12cm-H Pot	4 3/4"	3 15/16"	Black	1425
49-5210	Janor 4.5 Ger / 12cm-H Pot	4 3/4"	3 15/16"	TRC	1425
49-6101	Janor 6.0 Aza / 15cm-T Pot	5 7/8"	4 1/4"	Black	600
49-6102	Janor 6.0 Aza / 15cm-T Pot	5 7/8"	4 1/4"	Green	600
49-5311	Janor 2 Quart Square Pot	5 3/8"	6 1/2"	Black	480
49-5430	Janor 17cm-H / Trade Gal Pot	6 11/16"	6 1/8"	White	360
49-5330	Janor 17cm-H / Trade Gal Pot	6 11/16"	6 1/8"	Green	360
49-5130	Janor 17cm-H / Trade Gal Pot	6 11/16"	6 1/8"	Black	360
49-6302	Janor 6.5 Aza / 17cm-L Pot	6 11/16"	4 15/16"	White	414
49-5230	Janor Trade gal. / 17cm-H Pot	6 3/4"	6 1/8"	TRC	360
49-6503	Janor Full gal. / 19cm-T Pot	7 1/2"	7 1/4"	TRC	270
49-6806	Janor 1.5 gal. / 22cm-T Pot	8 5/8"	7 7/8"	TRC	150
49-6805	Janor 1.5 gal. 22cm-T Pot	8 5/8"	7 7/8"	Black	150

Color Imprinting on the Pots

If marketing creativity is not your forté, the marketing/graphics group of JanorPot is ready to assist in container graphics design. From simple identification or part of a coordinated marketing program, JanorPot facilitates graphics and copy requirements through an entire project. Put your message right up front- the front of JanorPot's. Please contact our office for lead times and minimums.



Talk to your Griffin representative about Summit/Janor custom printing and labeling programs.

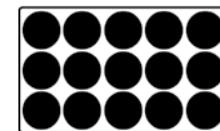

4"-15, 100/carton
Carries 15, 4" round pots
12 1/16" x 20 5/16" x 3 3/4"

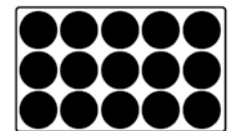

4 1/2" -15, 50/carton
Carries 15, 4 1/2" round pots
12 1/16" x 20 5/16" x 3 3/4"

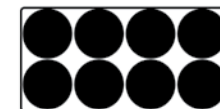

5 1/2" T6 Tray, 50 carton
Carries 8, 5 1/2" pots

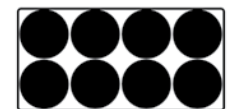

5" Std-8 High, 50/carton
Carries 8, 5" round pots
10" x 20" x 4 1/2"

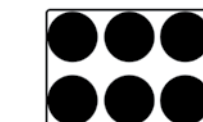

6"-6 Az Low, 50/ carton
Carries 6, 6" round pots
18" x 11 1/2" pots

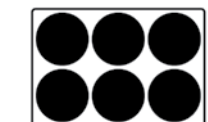

Trade Gallon 6, 50/carton
Carries 6, 6" round pots
13 1/4" x 20" x 6 1/4"



Propagation Sheets

Prop Sheets are ideal for agricultural and horticultural production and are available in a wide variety of sizes and configurations. The Prop Sheets listed below have burned drainage holes and de-nest with ease. Recommended to be paired with standard 1020 flats, excluding 24-Prop.

Item	Vendor	Description	Depth	Qty/cs
59-5140	725600C	24 Square Seedling Sheets	4.50"	50
59-5000	725601C	38 Round Prop-Sheets	2.31"	100
59-5005	725602C	50 Round Prop-Sheets	2.31"	100
59-5010	725607C	72 Round Prop-Sheets	2.31"	100
59-5011	725611C	72 Square Prop-Sheets	2.35"	100
59-5015	725610C	98 Round Prop-Sheets	1.50"	100

#24- Prop-Sheet

24 Pots - Top: 2.37" x 3.25". Depth: 4.5"

#38- Prop-Sheet

38 Pots - Top: 2.25" . Depth: 2.31"

#50- Prop-Sheet

Top: Depth:

#72- Prop-Sheet

72 Round Pots - Top: 1.46" . Depth: 2.31"

72 Square Pots - Top: 1.64" . Depth: 2.35"

#98- Prop-Sheet

Top: Depth:



Open Bottom Propagation Sheets

Item	Vendor	Description	Depth	Qty/cs
59-5012	725622C	78 SQ Prop Sheet	1.74"	50
59-5013	725623C	78 (3x26) Strip Square Prop Sheet	1.74"	50
59-5014	725624C	78 (6x13) Strip Square Prop Sheet	1.74"	50



Round Pot Carry Trays

- The best and most versatile trays in the industry
- Fits the majority of size-appropriate pots from a variety of manufacturers
- Rounded corners reduce end wall and corner splitting
- Streamlined design allows for pot-to-pot set up wasting no bench or rack space
- Sloping sides to shed excess soil
- Stocked in a variety of sizes

			Qty/cs
59-9000	755810C	15-count Carry Tray for 400 Germanium Pot	50
59-9020	755838C	15-count Carry Tray for 450 Germanium Pot	50
59-9050	755835C	12-count Carry Tray for 450 Germanium Pot	50
59-9010	755830C	10-count Carry Tray for 450 Germanium Pot	75
59-9030	755850C	6-count Carry Tray for 600 Azalea Pot	50
59-7046	755875C	6-count Carry Tray for Nursery Pot	25

755810C Pot Compatibility

HC Companies 04.00 Ger TW • EJ SP-400 • LM4RMGT • Poppelmann VCC10 • HC Companies 4" STD Injected Pot HC Companies 4" STD Thermo Pot

755830C, 755835C, 755838C Pot Compatibility

HC Companies 04.50 TW • HC Companies PW HC Companies STT0450 • EJ SP 450

755850C Pot Compatibility

HC Companies 06.00 JUMBO • HC Companies 06.00 TW EJ SP-600 • LM X-6RMGT • Poppelmann VCB 15 HC Companies 6" Elite AZE 0600 HC Companies Euro EU 150 S70

755875C Pot Compatibility

HC Companies Injection NC.0100 • HC Companies Euro E170165 Janor Pot C17CM H • HC Companies 2.5 Qt/2.4L HC Companies XRD 16000 (16 CM RD Coex Pot) Nursery Supplies PF310S • Nursery Supplies Classic 300s Landmark X-65NTGT • Summit-Janor Pot 16CM T

Plug Trays

Feature die-cut holes, square corners and formed edges.

- Maximum cell sizes for optimum soil capacity
- Cell wall "root ribs" to promote downward root growth
- Precisely centered, punched drain holes
- Larger label ramps to meet grower requirements



Plug Trays for Automatic Seeders | Compatible with all automatic seeders. Measure 11"x 21.25" outside diameter.

Item	Vendor	Description	Footprint	Depth	Vent Hole	Qty/CS
59-5025	720463C	50 Plug Tray	5 x 10	2.37"	0.25"	100
59-5030	720469C	72 Plug Tray	6 x 12	2.25"	0.25"	100
59-5035	720477C	98 Plug Tray	7 x 14	2.00"	0.25"	100
59-50401	720494C	128 Plug Tray	8 x 16	2.00"	0.18"	50
59-5045	720497C	162 Plug Tray	9 x 18	1.75"	N/A	100
59-50501	720507C	200 Plug Tray	10 x 20	1.50"	N/A	50
59-5065	720512C	200 Plug Tray - Deep	10 x 20	1.75"	N/A	50
59-50701	720520C	200 Plug Tray Extra Deep	10 x 20	2.12"	N/A	50
59-50551	720528C	288 Plug Tray	12 x 24	1.25"	N/A	50
59-50751	720532C	288 Plug Tray - Deep	12 x 24	1.50"	N/A	50
59-50601	720536C	392 Plug Tray	14 x 28	1.15"	0.15"	50
59-5063	720539C	406 Plug Tray	14 x 29	1.15"	N/A	50
59-5081	720544C	512 CE Plug Tray	16 x 32	0.94"	0.16"	50

Star and Hexagon Plug Trays

Plug Trays feature die-cut holes, square corners, deeper cells and formed edges. Regular weights are stocked at all our locations.

Item	Vendor	Description	Footprint	Plug Dim.	Depth	Qty/CS
59-5143	720549C	21 Star Deep Plug Tray	3 x 7	2.72"	4.00"	50
59-5232	720556C	32 Star Deep Plug Tray	4 x 8	2.22"	4.00"	50
59-5150	720557C	36 Star Plug Tray	4 x 9	2.12"	3.00"	50
59-51451	720562C	38 Star Deep Plug Tray	3 x 8, 2 x 7	2.13"	5.00"	25
59-720566	720566C	50 Star Plug Tray	5 x 10	1.77"	2.35"	50
59-5086	720568C	50 Star Deep Plug Tray	5 x 10	1.94"	4.50"	50
59-5085	720573C	58 Star Plug Tray	3 x 12, 2 x 11	1.53"	2.38"	100
59-5087	720575C	72 Star Plug Tray	6 x 12	1.56"	2.25"	100
59-5091	720582C	72 Star Deep Plug Tray	6 x 12	1.56"	3.00"	50
59-5090	720589C	105 Hex Plug Tray	7 x 15	1.24"	1.50"	100
59-5092	720594C	144 Hex Plug Tray	8 x 18	1.47"	1.06"	50

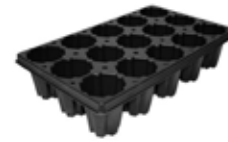
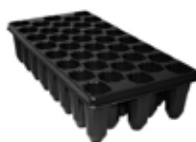

SureRoots® Plug Trays

Item	Vendor	Description	Footprint	Plug Dim.	Depth	Qty/CS
59-720700	720700C	SureRoots 50 Deep Plug Tray	5 x 10	2.00"	5.00"	25
59-720720	720720C	SureRoots 15 Plug Tray	3 x 5	3.55"	4.59"	25
59-720715	720715C	SureRoots 15 HW Plug Tray	3 x 5	3.55"	4.59"	25
59-720716	720723C	SureRoots 15 Pop Bottom Plug Tray	3 x 5	3.55"	4.38"	25
SureRoots® Elite						
59-720750	720750C	SureRoots Elite 50 Plug Tray - 40mm	5 x 10	1.94"	1.75"	50
59-720753	720753C	SureRoots Elite 50 Plug Tray - 50mm	5 x 10	1.74"	1.75"	50
59-720765	720765C	SureRoots Elite 72 Plug Tray	6 x 12	1.64"	1.58"	50
59-720770	720770C	SureRoots Elite 102 Plug Tray - Cut	6 x 17	1.19"	1.62"	50
59-720778	720778C	SureRoots Elite 102 Plug Tray - Uncut	6 x 17	1.19"	1.62"	50



- Serrated between packs for easy separation
- Clean edges for easy handling
- Silicone coated for easy removal and flat filling
- Water flow dispersed evenly between cells
- All standard cell packs are 2.25" deep

Standard 1020 Flats & Inserts

Item	Vendor	Description	Qty/cs
Standard 1020 Flats - 10.94" x 21.44"			
59-3170	710245C	1020 Open Flat	100
59-3175	710251C	1020 Open Flat - No Holes	100
59-3195	710254C	1020 Open 3X HW Flat - No Holes	50
59-3179	790900C	1020 Open LW Web Flat	50
Standard 1020 Inserts - 10.50" x 21.00"			
59-3005	715347C	601 Insert	100
59-3010	715348C	606 Insert	100
59-3020	715352C	801 Insert	100
59-3025	715353C	804 Insert	100
59-3030	715357C	806 Insert	100
59-3035	715362C	809 Insert	100
59-3040	715364C	812 Insert	100
59-3045	715366C	1001 Insert	100
59-3048	715367C	1004 Insert	100
59-3050	715369C	1006 Insert	100
59-3055	715371C	1201 Insert	100
59-3060	715373C	1202 Insert	100
59-3065	715374C	1203 Insert	100
59-3070	715377C	1204 Insert	100
59-3075	715382C	1206 Insert	100
59-3080	715385C	1801 Insert	100
59-3085	715387C	1802 Insert	100
59-3090	715389C	1803 Tri-Pack Insert	100
59-3105	715399C	2401 Insert	100
59-3110	715401C	3601 Insert	100
59-3130	715405C	606 Deep Insert (Jumbo 606)	100
59-3132	715408C	806 Deep Insert	100

Connecticut Flats & Inserts



11.25"W x 15.00"H x 2.75"D

Item	Vendor	Description	Qty/cs
59-8010	771601C	CT803 Insert	100
59-8020	771611C	CT804 Insert	100
59-8030	771621C	CT806 Insert - Low Center	100
59-8031	771623C	CT806 Insert	100

11.25"W x 15.00"H x 3.00"D

Item	Vendor	Description	Qty/cs
59-8001	771501C	CT R8 Flat	100

New Jersey Flats & Inserts

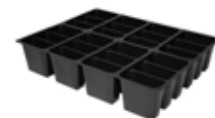

10.5"W x 13.5"H x 2.95"D

Item	Vendor	Description	Qty/cs
59-8040	771520C	NJ Flat	100
59-771522	771522C	NJ R8 Flat	100
59-8050	771638C	NJ803 Insert	100
59-8060	771640C	NJ804 Insert	100

1020 Clear Domes



Item	Vendor	Description	Dimensions L x W x D	Qty/cs
59-5135	760549C	1020 Dome	21.50" x 11.00" x 2.10"	50
59-5136	760525C	1020 Tall Dome	21.52" x 11.02" x 7.04"	25

Germination Tray

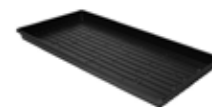

Item	Vendor	Description /	Dimensions	Qty/cs
59-3330	745730C	Germination Tray	21.25" x 10.81" x 1.29"	100
59-3331	745731C	Germination Tray - No Holes	21.25" x 10.81" x 1.29"	100



Savings

PURCHASE	SAVE
\$750.00	10%
\$1,500.00	15%
\$2,500.00	20%

Savings apply to all T.O. Plastics products.

Square Pots

Item	Vendor	Description	Depth	Top Outside Dimensions	Max Dry Volume	Max Liquid Volume	Qty/cs
59-2011	700003C	2.5 Sq. Deep Pot	3.44"	2.60"	14.46 cu. in.	7.84 fl. oz.	800
59-20201	700014C	3.25 Sq. Deep Pot	3.50"	3.31"	28.56 cu. in.	1.00 pt.	450
59-2031	700026C	3.5 Sq. Deep Pot	3.50"	3.52"	31.43 cu. in.	1.08 pt.	450
59-2022	700112C	3.25 Sq. Deep Pot - Tag Slot	4.00"	3.31"	28.09 cu. in.	0.97 pt.	600
59-2050	700035C	3.5 Sq. Nursery Pot	5.00"	3.52"	42.45 cu. in.	1.50 pt.	450
59-2165	700070C	4.0 Sq. Pot	3.11"	3.66"	32.83 cu. in.	1.13 pt.	500
59-21801	700087C	4.5 Sq. Pot	3.62"	4.20"	49.73 cu. in.	1.72 pt.	375
59-9075	700042C	4.5 Sq. Deep Pot	4.91"	4.20"	65.42 cu. in.	1.13 qt.	300
59-21301	700051C	4.5 Sq. Deep Pot - Heat Treated Pallet	4.91"	4.20"	65.42 cu. in.	1.13 qt.	375
59-20203	700162C	4.5 Sq. Deep Pot - Tag Slot	5.19"	4.20"	58.27 cu. in.	1.00 qt.	500
59-20401	700099C	5.5 Sq. Deep Pot	6.0"	5.36"	116.56 cu. in.	2.06 qt.	200

Square Pot Carry Trays

Item	Vendor	Description	Width	Length	Depth	Qty/cs
59-4100	705104C	32-count Carry Tray for 2.5 Pot	10.75"	21.19"	2.50"	50
59-40251	705119C	18-count Carry Tray for 3.25 Pot	10.00"	20.00"	1.88"	50
59-4110	705215C	12-count Carry Tray for 3.25 Pot - Tag Slot	6.75"	20.00"	3.63"	25
59-4140	705129C	18-count Carry Tray for 3.5 Pot	10.81"	21.25"	1.93"	50
59-4036	705137C	18-count Carry Tray for 3.5 Nursery Pot	10.81"	21.25"	3.50"	50
59-4055	705142C	15-count Carry Tray for 4.0 Pot	11.25"	18.75"	1.94"	50
59-4160	705151C	10-count Carry Tray for 4.5 Pot	8.75"	21.19"	2.13"	50
59-4070	705155C	12-count Carry Tray for 4.5 Pot	12.88"	17.00"	2.13"	50
59-4075	705165C	15-count Carry Tray for 4.5 Pot	12.88"	21.19"	2.13"	50
59-4076	705200C	10-count for 4.5 Pot - Tag Slot	8.40"	21.00"	4.66"	50
59-4090	705193C	8-count Carry Tray for 5.5 Pot	10.94"	21.44"	3.03"	25
59-4080	705190C	15-count Irrigation Tray for 4.5 Pot <i>(non-stock)</i>	12.88"	21.19"	2.13"	50



PLUG INTO QUALITY

Griffin delivers premium plugs from reputable producers nationwide. Our assortment includes market-leading varieties in the most popular product forms to meet your needs and preferences. Call your Griffin sales representative today to build your best program!



Sheet Pots

Item	Vendor	Description	Tray Dimensions		Cell Dimensions		Max Dry Volume	Max Liquid Volume	Trays/cs
			Width	Length	Height/Depth	Top			
59-3145	730645C	18 pots per sheet	10.56"	21.06"	3.14"	3.25"	26.06 cu. in.	427.04 ml.	100
59-3150	730640C	15 pots per sheet	12.53"	20.88"	3.88"	3.89"	51.08 cu. in.	837.00 ml.	50
Deep Sheet Pots									
59-3135	730649C	18 pots per sheet	10.56"	21.06"	3.55"	3.38"	27.83 cu. in.	456.32 ml.	50
59-3152	730643C	15 pots per sheet	12.53"	20.88"	4.85"	3.89"	63.73 cu. in.	1.04 l.	50
59-3140	730654C	32 pots per sheet	10.56"	21.06"	3.00"	2.59"	11.59 cu. in.	190.00 ml.	100
Landscaper Tray									
59-6020	740702C	SPT-R-18-LNDSCP	10.82"	21.25"	3.50"		28.45 cu. in.	467.68 ml.	50

Liner Trays

Item	Vendor	Description	Qty/cs
59-3160	735676C	18 Liner Tray - Deep	50
59-3158	735680C	24 Liner Tray	100
59-3155	735683C	32 Liner Tray	100

18 Liner Tray

Solid sheet of 18 pots 3.38" Sq. x 3.55" deep.

24 Liner Tray

Solid sheet of 24 pots Top: 3.10" x 2.25" - Depth: 3"

32 Liner Tray

Solid sheet of 32 pots 2.59" Sq. x 3" deep.

306 Carry Pack

White only. Fits in standard 1020 tray. Pack of six 3.5" pots, three packs per sheet. Carry handles sold separately.

Item	Vendor	Description	Qty/Ctn
59-5110	760746C	Standard 306 Market Pack (A)	50
59-5123	795979C	Slim Handles - 0.75"x17.875" (B)	100



Plant Pie Containers

- More profitable than flats and are easy to grow - the shallow dish is ideal for a thorough / healthy root system
- The dish makes for easier handling, transporting and shipping
- Plant Pies have multiple uses as they can be used in containers, hanging baskets and bedding
- They have excellent shelf life and can be sold at different stages
- They save on soil and space
- Great for succulent gardens, combo planters, fairy gardens, and decorative container drop in!



Savings

PURCHASE	SAVE
\$750.00	10%
\$1,500.00	15%
\$2,500.00	20%

Savings apply to all T.O. Plastics products.

Item	Vendor	Description	Qty/cs
59-90605	790967C	8" Plant Pie - 3" depth	50
59-90705	790968C	11" Plant Pie - 3" depth	50
59-9065	790980C	Muffin Tray 8" x 4" - 3" depth	50





12" & 14" Saucerless Hanging Baskets (A)

Includes: Wire hanger and inside Saucer.

Item	Desc.	Color	Dimensions	Vol.	Qty/cs
50-012403	12" Saucerless Basket Wire Hanger	Green	11.75" x 7"	2.28 gal.	25
51-9240	12" Saucerless Basket Flex Wire Hanger	Green	11.75" x 7"	2.28 gal.	25
51-9239	14" Saucerless Basket Flex Wire Hanger	Green	14" x 8.25"	3.96 gal.	25
51-9339	14" Saucerless Basket Flex Wire Hanger	White	14" x 8.25"	3.96 gal.	25
51-9349	14" Saucerless Basket Flex Wire Hanger	Black	14" x 8.25"	3.96 gal.	25
41B14H-BTSL	14" Saucerless Basket Wire Hanger	Terra-cotta	14" x 8.25"	3.96 gal.	25

16" Saucerless Hanging Baskets (B)

Includes: Wire hanger and inside Saucer. With a Weekend - Water Management Reservoir. 1 Gallon Water Reservoir.

Item	Description	Color	Dimensions	Vol.	Qty/cs
50-012405	16" Saucerless Basket Flex Wire Hanger	Green	16" x 9.75"	5 gal.	15
50-012406	16" Saucerless Basket Flex Wire Hanger	White	16" x 9.75"	5 gal.	15
50-012407	16" Saucerless Basket Flex Wire Hanger	Black	16" x 9.75"	5 gal.	15
50-012408	MTO 16" Saucerless Basket Flex Wire Hanger	Terra-cotta	16" x 9.75"	5 gal.	15

Pop Basket (C)

Item	Desc.	Color	Dimensions	Vol.	Qty/cs
51-9424	10" POP Basket - Plastic Hanger	Green	10" x 16.5"	1.53 gal.	50
51-9324	10" POP Basket - Metal Hanger	Green	10" x 16.5"	1.53 gal.	50

Contemporary Hanging Basket w/Saucer

Item	Desc.	Color	Dimensions	Vol.	Qty/cs
50-6905180	10" Contemporary Basket with Saucer / Wire Hanger	Green	10"x5.75"	1.4 gal.	50

Hanging Garden™ (D)

Separates into three parts: the bottom, with side holes into which the full-grown plants can be laid; the lid, which completes the side hole and gives added height for planting the top layer; and the saucer, which can be removed for drainage, then snapped on when the Hanging Garden is ready for sale only minutes after it's filled with flowers!

Item	Description	Qty/cs
51-9230	8" Green Basket with Wire Hanger	50
51-9238	10" Green Basket with Wire Hanger	25

Round Growing Container (E)

Item	Desc.	Color	Dimensions	Vol.	Qty/cs
41B12AG	12" Azalea	Green	12" x 9"	3.03 gal.	25
41B12SB	12" Standard	Black	12" x 10 3/4"	3.52 gal.	25

Squares (F)

All fit standard 1020 trays

Mini Squares | 18 square pots sized in-between a standard 3 1/2" square and a 4" square. Pot Size: 3 1/2" x 2 7/8".

Maxi Squares | 18 square 4" pots. Save space in greenhouse. Ideal for use with flat fillers. Pot Size: 3 1/2" x 3 1/2".

Jumbo Squares | 8 square pots with the same soil content as a 6 1/2" Azalea, but only 5 1/4" diameter. Space saving of nearly 20% in the greenhouse or on a truck.

Magnum Squares | Pot Size: 6" x 6.5".

Item	Description	Qty/cs
50-9622	Magnum Square Black	150
50-9612	Jumbo Square Black	200
50-9505	Maxi Square Black	540
50-9502	Mini Square Black	540



2024

Blow Molded

- Available in various weights
- Label compatible
- Strong and flexible
- One year quality guarantee

Custom - Black - Our economy line of blow-molded containers. This container is designed to get your plants to market efficiently. It is available in sizes from 1/2 to 10 gallon.



Item	Description	Color	Size d x h	CCY*	Qty/Stk	Qty/Plt
52-1530	#200C Custom	Blk	6"x6"	438	125	14,750
41PT275C	#275C squat 1/2 gal	Blk	6 ⁵ / ₈ " x 5 ¹ / ₂ "	369	100	9,200
41PT300SCN2	#300SC trade gal squat	Blk	6 ¹ / ₂ " x 6 ¹ / ₂ "	324	106	10,388
41PT300C	#300C trade gal	Blk	6 ³ / ₈ " x 7 ¹ / ₄ "	275	100	9,200
41PT350C	#350C 1 gal mum pan	Blk	8" x 5 ⁵ / ₈ "	264	130	8,320
41PT400CN2	#400C 1 gal	Blk	7 ³ / ₄ " x 7"	202	92	6,440
41PT550CTCN2	#550C 1 1/4 gal mum pan	TC	9" x 6 ⁵ / ₈ "	167	97	4,850
41PT550CN2	#550C 1 1/4 gal mum pan	Blk	9" x 6 ⁵ / ₈ "	167	97	4,850
41600CN2	#600C trade 2 gal	Blk	9" x 8 ¹ / ₂ "	135	105	5,250
41PT900CN2	#900C 2 gal	Blk	9 ¹ / ₂ " x 9 ⁵ / ₈ "	104	83	3,818
52-1577	#1000SC squat	Blk	10 ¹ / ₈ " x 7 ¹ / ₂ "	104	75	2,700
41PT1000CN2	#1000C 2 1/2 gal	Blk	10 ¹ / ₈ " x 9 ⁵ / ₈ "	90	70	2,520
41PT1200SCN2	#1200SC squat	Blk	11" x 7 ¹ / ₂ "	87	60	1,920
41PT1200CN3	#1200C 3 gal	Blk	11" x 9 ¹ / ₂ "	67	56	1,792
411600C	#1600C 4 gal	Blk	11 ⁷ / ₈ " x 10 ⁵ / ₈ "	57	47	1,316
411600SC	#1600SC	Blk	11 ⁷ / ₈ " x 7 ⁷ / ₈ "	70	47	1,316
412000C	#2000C 5 gal	Blk	11 ⁷ / ₈ " x 11"	53	44	1,232
41PT2100CN	#2100C 5 gal squat	Blk	14" x 9 ⁵ / ₈ "	39	31	837
41PT2800CN	#2800C 7 gal	Blk	14" x 11 ¹ / ₂ "	34	31	837
Olympian						
41PT4000BXL	#4000C (BXL) Olympian	Blk	15 ³ / ₈ " x 15"	23	27	432
525-113	#6900BXL Olympian Smooth	Blk	18 ³ / ₈ " x 15 ¹ / ₈ "	15	18	270
19000	#6900SBXL Olympian Squat	Blk	18 ³ / ₈ " x 12 ¹ / ₈ "	19	19	285

*CCY= Number of containers necessary to hold a cubic yard of soil.

**Vendor requires minimums. Call for details.



Pressure-Formed

- Economical
- Automation friendly
- Strong and resilient
- Label and printing compatible



Item	Description	Color	Volume	Dia. x Ht	CCY	Qty/Stk	Qty/Plt
52-35351	PF310S #1 trade gal	Black	.66 gal	6 1/8" x 6 1/2"	306	80	7,360
52-2114T	PF 310 #1 trade gal	Black	.68 gal	6 1/8" x 7"	298 CCY	-	7,360
52-35501	PF400 True #1	Black	1.0 gal	7 1/2" x 7 1/8"	202	85	5,440
52-3565	PF600 #2 trade gal	Black	1.5 gal	8 1/2" x 8 1/2"	135	90	4,140
52-3570	PF800 True #2	Black	2.00 gal	8 7/8" x 9 3/8"	101	87	4,002
52-35751	PF1000 #10 Foliage	Black	2.25 gal	9 5/8" x 9 1/8"	90	89	3,204
52-35801	PF1200 True #3	Black	3.0 gal	10 1/2" x 9 3/8"	68	71	2,272
41PF550CN	PF 550 large mum pan	Black	1.55 gal	9 1/2" x 6"	131	91	3,276

*CCY= Number of containers necessary to hold a cubic yard of soil.

Other sizes available. Call for details.

2024

Grip-Lip®

- Available in two weights
- Pot-in-pot
- Label, hot stamp and printing compatible
- Automation friendly
- One year quality guarantee
- Strong lip (rim)

Available in stocked sizes from 3 gallon to 65 gallon



Item	Description	Size d x h	CCY*	Qty/Stk	Qty/Plt
Econogrip Containers					
41PT1200EG	#EG 1200 3 gal	9 5/8" x 9 1/2"	75	44	1,584
41PT2000EG	#EG 2000 5 gal	10 7/8" x 11" 1/8"	51	35	980
41PT4000EG	#EG 4000 10 gal	14 1/4" x 14 1/4"	23	19	342
41PT6900SEGN2	#EG 6900-S 10 gal squat	17 1/4" x 12 1/8"	19	17	170
41PT6900EGN2	#EG 6900 15 gal	17 1/4" x 15 5/8"	16	17	170
41PT8000SEG	#EG 8000-S 15 gal squat	19 1/2" x 12"	15	18	144
41PT8000EG	#EG 8000 GL 20 gal	19 1/2" x 17"	11	16	128
4110000EG	#EG 10000 25 gal	22 3/4" x 18 1/8"	8	10	150
4110000SEG	#EG 10000-S 20 gal squat	22 3/4" x 13 1/8"	10	14	168
Large Classic Containers					
52-1295	Classic 18000 45 gal	30" x 20"	4.5	5	N/A

Griffin now stocks the economy weight (Econo-Grip) containers in the Grip-Lip line. The Econo-Grips are used for general plant growing and as the growing pot (liner) in a Pot-in-Pot system. Heavy weight Grip-Lips are mostly used as the in-ground container in a Pot-in-Pot system.

*CCY= Number of containers necessary to hold a cubic yard of soil.

Savings

PURCHASE	SAVE
\$500.00	5%
\$1,250.00	10%
\$2,000.00	15%

Savings applies to all Nursery Supplies Products.



Lerio® Large Vacuum Form

- Exceptional strength
- Durable
- Available in a wide range of sizes



Item	Description	Gallon	Size d x h	CCY*	Qty/Stk
41SW45	SW45 Gal Vacuum Form	42.812	28" x 19"	5	1
41LER95	LER95 Gal Vacuum Form	93.281	36" x 24 ³ / ₈ "	2	1
41SW200	SW200 Gal Vacuum Form	186.078	48" x 26 ¹ / ₂ "	1	1

PRINTING CAPABILITIES

Branding moves products and NSI is your branding expert. We offer our blow molded, thermoformed and injection molded containers in many standard colors or select a custom color to meet your marketing requirements. Ensure your customers knows you year-after-year by developing that recognized brand. When your company requires that branded appearance, let NSI work with you to make it happen.

Contact your Griffin Sales Representative for more information.

2024

Injection Molded

- Strong and rigid
- Tier stacking
- Label, hot stamp and printing compatible
- Tag slots available on some sizes



GO GREEN

Green: More than the color of the Nursery Supplies logo: Recycling has been always been a vital part of Nursery Supplies and now they are looking to “go greener”. They are increasing the percentage of post-consumer and post-industrial regrind and reprocessed material in their containers. They have increased their recycled content up to 100% in all three manufacturing processes, blow-molding, injection-molding and thermo-forming of the pot material (excluding color and additives). “Green” is truly more than the color of their logo; it is the driving force to their commitment to the environment in which we live.

Item	Description	Color	Dia. x Ht.	CCY*	Qty/Stk	Qty/Pit
52-11353	1 Gal NS300 Polytainer		6" x 6 ⁷ / ₈ "	311	55	6,490
52-11402	2 Gal NS600 Polytainer	Blk	8 ¹ / ₂ " x 8 ¹ / ₂ "	117	48	2,880
52-35809	5 Gal NS1400 Polytainer	Blk	10 ¹ / ₄ " x 12 ¹ / ₄ "	57	37	1,332
52-11403	5 gal squat Polytainer	Blk	11" x 10"	55	41	900
52-11801	7 gal squat Polytainer	Blk	14" x 11"	33	15	300

*CCY= Number of containers necessary to hold a cubic yard of soil.

Dec-Grow®

**Tough enough to grow in.
Beautiful enough to show in.**

- Choice of side or bottom holes
- Grow and show
- Growing container or cover sleeve
- One year quality guarantee
- Four designs in one package



Item	Description (Trade Size)	Dia. x Ht	Qty/STK	Qty/Pit
52-10381	#10 Dec-Grow Florida Terra Cotta	9 ⁷ / ₈ " x 8 ³ / ₄ "	45	1,440
52-10463	#12 Dec-Grow Florida Terra Cotta	11 ⁷ / ₈ " x 10 ³ / ₄ "	36	720



Knockout Rose and Drift

Item	Description	Volume	Qty/Stk	Qty/Plt
41PT400KO	Knock Out Rose Pot PF400	1 gal.	85	5,440
41PT800KO	Knock Out Rose Pot PF800	2 gal.	87	4,002
52-028402	Knock Out Rose Pot PF1200	3 gal.	71	2,272
52-35802	Drift Rose Pot PF1200	3 gal.	71	2,272
52-028400	PF600 Meet Petite Knock Out #2	1.5 gal.	90	4,140

In stock for your convenience. Please see your Griffin rep for drop ship program pricing.

Brindabella Roses

Item	Description	Volume	Qty/Stk
52-35820	NSI PF1200 Brindabella Rose Printed Pot	3 Gal	71



Pot-In-Pot Systems

Pot-In-Pot by Nursery Supplies has proven itself to be a very remarkable way to combine the natural advantages of field growing with the control and convenience of above-ground growing.



AGS® Above Ground System

The AGS Above Ground System is the easiest to install Pot-In-Pot system available. Simply place the AGS on the ground, surround the base with mulch, and it's ready to go - no need to dig holes or trenches! Also used to keep containers from falling over in retail situations. Available in 7 gal. and 15 gal. sizes.

All of the EG/GL sizes can be used in Pot-In-Pot growing. Call for details.

Item	Description	Color	Dia. x Ht.	Qty/Stk	Qty/Plt
52-1010	AGS2800 Above Ground System	Blk	15 ¼" x 12 ½"	9	108



Pot-In-Pot - Above Ground System



Pot-In-Pot System - In Ground System

MICROFAB | High-performance anti-root barrier

For pot in pot container nursery production. Microfab, inserted between socket pot and plant pot, controls the rooting out from pot's drain holes. It will ease pot harvest, save labor and ensure good water permeability with its high density micro-perforated structure. For increased root control, Microfab can be placed inside of plant pot. Microfab lets water go through while keeping roots in. Widths: 23" (6 rolls), 27 5/8" (5 rolls), 34 1/2" (4 rolls), 46" (3 rolls), 69" (2 rolls) or 1 roll of 11' 6" x 300'. Drop Ship Only. Contact Griffin for more Information.





Plug Sheets, Plug Trays, Seedling Trays

Item	Description	Cell Depth	Cell Top Dia.	Cell Config.	Compatible Trays	Qty/cs
Plug Sheets <i>Lighter gauge best supported with use of an under tray. Inquire about additional cell counts</i>						
132-2159	72 Square Plug Sheet with Root Channels	2.375"	1.625"	6x12	I-L1020SS, L-1020NCR	100
Plug Trays <i>Can be self-supportive without use of an under tray for many applications. Ask about additional cell counts including hexagonal & octagonal shapes</i>						
132-2201	72 Square Plug Tray	1.75"	1.25"	6x12	I-L1020SS, L-1020NCR	100
132-2319	512 Square Plug Tray CE Compliant	1.00"	.563"	16x32	I-L1020SS, L-1020NCR	100
Seedling Trays <i>Rugged plug trays with additional cell depth</i>						
132-2169	72 Seedling Tray	3.25"	1.625"	6x12	I-L1020SS, L-1020NCR	50

Round Thermoform Standard Pots

Item	Description	Outside Top Diameter	Height	US Liquid Volume	Compatible Trays	Qty/cs
132-2286	3.50 Standard TF Pot	3.50"	3.25"	12.27 fl oz	X-35TPP10B, X-35TP12B, X-3.5TPB	450
132-2288	4.33 Deep Standard Maxi-Grow Pot with tag slot	4.33"	5.00"	1.58 pt	X-43DTHS8B, X-43DTH10B	540
132-2399	6.50 Nursery Trade Gallon Pot	6.50"	6.50"	2.50 qt.	X-6.5WM	200

Transport and Carry Trays for Round Thermoform Pots

Item	Description	Tray Depth	Overall Tray Length	Overall Tray Width	Compatible Pots	Qty/cs
132-2433	4.00 Transport Tray (15)	3.50"	20.25"	12.13"	X-4RMGT	85
132-2207	4.33 (11 cm) Transport Tray (10)	4.06"	21.63"	8.63"	X-43RMGT	100
132-2217	4.33 (11 cm) Transport Tray (12)	4.12"	17.22"	13.00"	X-43RMGT	100
132-2016	4.50 Transport Tray (8)	4.25"	19.50"	10.00"	X-45RMGT	50
132-2157	4.50 Transport Tray (10)	4.19"	22.40"	8.90"	X-45RMGT	75
132-2325	4.50 Transport Tray (15)	3.94"	23.06"	14.06"	X-45RMGT	90
132-2204	6.00 Azalea Transport Tray (6)	4.25"	21.56"	10.76"	X-6AMGT	100
132-2215	6.50 Azalea Transport Tray (6)	5.25"	19.63"	13.00"	X-65AMGT	100
132-2215	6.50 Transport Tray	5.25"	19.63"	13.00"	X-65NTGT	100

Round Azalea Thermoform Pots

(Black is standard color for pots. Add 15% for any other color.)

Item	Description	Color	Outside Top Diameter	Height	Liquid Volume	Compatible Trays	Qty/cs
132-2290	5.00 Azalea Maxi-Grow TF Pot	Black	5.00"	3.61"	1.67 pt	X-T5TPPPB	440
132-2086	5.00 Azalea Maxi-Grow TF Pot	Green	5.00"	3.61"	1.67 pt	X-T5TPPPB	440
132-2235	6.00 Azalea Maxi-Grow TF Pot	Black	6.00"	4.38"	1.40 qt	X-6TPPPB	220
132-2064	6.00 Azalea Maxi-Grow TF Pot	Green	6.00"	4.38"	1.40 qt	X-6TPPPB	220
132-2396	6.50 Azalea Maxi-Grow TF Pot	Black	6.50"	5.00"	2.08 qt	X-3QTTWL3, X-6.5TPPPB	240
132-2087	6.50 Azalea Maxi-Grow TF Pot	Green	6.50"	5.00"	2.08 qt	X-3QTTWL3, X-6.5TPPPB	240



Square Thermoform Pots

Item	Description	Outside Top Diameter	Height	Liquid Volume	Compatible Trays	Qty/cs
Square TF Pots / Press-Fit Pots						
132-2092	3.00 Sq Press-Fit Pot	2.63"	2.25"	6.00 fl oz	L-PF32TRAY	800
132-2081	3.00 Sq Pot Deep with Root Channels	2.63"	3.50"	9.50 fl oz	L-PF32TRAY	800
132-2246	4.00 Sq Press-Fit Pot	3.50"	3.50"	1.05 pt	L-PF12TRAY, L-PF18TRAY	450
132-2093	4.50 Sq Press-Fit Pot	4.19"	3.63"	1.69 pt	X-4.5SPT12, L-4.5PF12, L-PF15TRAY	375
132-2114	4.50 Sq Pot Deep	4.19"	4.88"	1.15 qt	X-4.5SPT12, L-4.5PF12, L-PF15TRAY	375
Sheet of Pots						
132-2036	4.50 Sq Sheet of Pots (15)	3.65"	4.09"	1.55 pt	L-PF15TRAY	100

2024

Trays for Square Thermoform Pots

Item	Description	Tray Depth	Overall Tray Length	Overall Tray Width	Compatible Pots	Qty/cs
132-2196	3.00 Sq Press-Fit Tray (32)	1.50"	21.23"	10.79"	X-3P800, X-3PD	100
132-2198	4.00 Sq Press-Fit Tray (18)	2.31"	21.23"	10.79"	X-4P450	100
132-2151	4.50 Sq Press-Fit Tray (15)	2.31"	21.10"	12.71"	X-4.5P, X-4.5PD, X-4.5PXD	50

Vacuum Inserts and Trays

Item	Description	Cell Depth	Cell Length	Cell Width	Qty/cs
Standard L Series Inserts					
132-2109	L 606 Pack	2.33"	6.44"	4.85"	100
132-2129	L 606 Super Jumbo Pack	3.13"	2.35"	2.15"	100
132-2119	L 806 Super Jumbo Pack	3.12"	2.35"	1.60"	100
Standard L Series Tray <i>Compatible with L Series Inserts shown above</i>					
132-2067	L 1020 Injection Molded Web Tray Solid Side	2.39"	21.13"	10.67"	50
True T Series Tray <i>Compatible with T Series Inserts shown above</i>					
132-2256	T Injection Molded Tray	2.63"	20.00"	10.00"	100
P Series Tray <i>Compatible with P Series Inserts shown above</i>					
132-2255	P Tray	2.94"	11.38"	14.88"	75

Hemp Propagation Supplies

Item	Description	Cell Depth	Cell Top Dia.	Cell Config.	Qty/cs
132-2807	T50R: T50 Round Plug Tray	1.75"	1.75"	5x10	50
132-2808	72FPT: 72 Round with vent holes & feet	2.25"	1.49"	6x12	100





Location Availability

For Classic Home and Garden Products, look for the location availability in the tables to see if the products are available National, East or West.



2024

Bear Planter w/ Drainage Plug



Item #	Desc	Vendor	CS/UOS	Location
81792431	Bear Planter	260082P-028	8/8	National

Rooster Planter

Cement rooster planter with removable drainage plug. Open diameter 5" Overall height 7" Volume 0.3 gal



Item #	Desc	Vendor	CS/UOS	Location
81792123	Rooster planter	260027-C148	8/8	National



Cement Car Pots

Cement trucks or cars come with removable drainage plug. 5.7" x 3.15" x 2.4"

Item #	Desc	Vendor	CS/UOS	Location
81792173	Truck Antique Red	260000P-006	48/48	East
81792174	Truck Antique Blue	260000P-007	48/48	East
81792176	Car Antique Red	260001P-006	48/48	East

Classic Coral Fish

Overall 6.5" long



Item #	Desc	Vendor	CS/UOS	Location
81792196	3.5"	260032-579	16/16	National

Large Mouth Fish Planter

Cement planters opening diameter 3 1/2" - overall height 4 1/4" - Volume 0.34 gal Removable drainage plug



Item #	Desc	Vendor	CS/UOS	Location
81792119	Weathered Bronze	260023-C154	16/16	National

Cow Planter



NATURAL BROWN



LIGHT EARTH

Item #	Desc	Vendor	CS/UOS	Location
81792433	Small - Natural Brow	260074P-700	12/12	National
81792434	Small - Light Earth	260074P-147	12/12	National
81792435	Large - Natural Brow	260073P-700	6/6	National
81792436	Large - Light Earth	260073P-147	6/6	National

Yellow Duck Planter w/ Drainage Plug



Item #	Desc	Vendor	CS/UOS	Location
81792432	Yellow Duck	260083P-005	8/8	National

Moose Planter w/ Drainage Plug



Item #	Desc	Vendor	CS/UOS	Location
81792430	Moose - Light Brown	260081P-455	8/8	National

Cam the Sloth Planter

No drainage, great for drop ins!



Item #	Desc	Vendor	CS/UOS	Location
81792364	Sloth Planter	260031	6/6	National

Cement Buddies

Forest animal planters | *Adorable addition to any home or garden.*



PLANTERS & CONTAINERS

2024



Item #	Desc	Vendor	UOS/CS	Location	Item #	Desc	Vendor	UOS/CS	Location	Item #	Desc	Vendor	UOS/CS	Location
Bird - S: 6.25" x 4" x 4.75" / L: 8.75" x 5.25" x 5.5"					Owl: 4.5" x 4.25" x 4.75" / L: 5.5" x 5" x 6"					Sleeping Cat - S: 7" x 4.75" x 4" / L: 8" x 5.75" x 4.5"				
81791016	Rust - S	9/3411R/1	12/12	National	81791573	Rust - S	260006P-433	12/12	National	81791575	Rust - S	260010P-433	12/12	National
81791017	Nat - S	9/3411/1	12/12	National	81791565	Nat - S	260006P-396	12/12	National	81791567	Nat - S	260010P-396	12/12	National
81791018	Rust - L	9/3412R/1	6/6	National	81791572	Rust - L	260005P-433	8/8	National	81791574	Rust - L	260009P-433	6/6	National
81790079	Nat - L	9/3412/1	6/6	National	81791564	Nat - L	260005P-396	8/8	National	81791566	Nat - L	260009P-396	6/6	National
Elephant - 7" x 5" x 6"					Piglet - S: 6" x 3.75" x 3.5" / L: 7.5" x 4.75" x 4"					Sleeping Dog: 7" x 6.25" x 3.25"				
81791571	Rust	260004P-433	8/8	National	81791578	Rust - S	260014P-433	12/12	National	81791576	Rust - S	260011P-433	6/6	National
81791563	Natural	260004P-396	8/8	National	81791570	Nat - S	260014P-396	12/12	National	81791568	Nat - S	260011P-396	6/6	National
Frog - S: 5.75" x 4.75" x 4" / L: 7.5" x 6" x 5.5"					Rabbit - S: 6" x 4.75" x 3.75" / L: 8" x 6" x 4.5"					Snail - S: 5.75" x 4.5" x 4.25" / L: 8" x 6" x 5.5"				
81791027	Rust - S	9/3431R/1	18/18	National	81791577	Rust - L	260013P-433	8/8	National	81791031	Rust - S	9/3471R/1	12/12	National
81791028	Nat - S	9/3431/1	18/18	National	81791569	Nat - L	260013P-396	8/8	National	81791032	Nat - S	9/3471/1	12/12	National
81791029	Rust - L	9/3432R/1	8/8	National	Turtle - S: 6" x 4.75" x 3.5" / L: 7.75" x 6" x 4.5"					81791033	Rust - L	9/3472R/1	4/4	National
81791030	Nat - L	9/3432/1	8/8	National	81790089	Nat - S	9/3441/1	12/12	National	81790076	Nat - L	9/3472/1	4/4	National
Hedgehog - S: 5" x 4.25" x 3" / L: 7.75" x 6" x 4.25"					81791020	Rust - L	9/3442R/1	6/6	National					
81791021	Rust - S	9/3431R/1	18/18	National	81790088	Nat - L	9/3442/1	6/6	National					
81791022	Nat - S	9/3431/1	18/18	National										
81791023	Rust - L	9/3432R/1	8/8	National										
81790078	Nat - L	9/3432/1	8/8	National										

All animals have removable drainage plugs!

EASILY MOVE LARGE PLANTS

WITH DEVAULT DOLLIES

Easily move hefty plants to and from your garden! Weather-resistant, durable tool will last you many seasons. Choose from our large selection of dolly's to fit your needs, today!



2024



Cement Square Planter



Jagger Shell Planter

Cement planter with removable drainage plug. Opening diameter 4 1/2" Overall height 3 1/2" -Volume 0.12 gal



Item #	Desc	Vendor	CS/UOS	Location
81792124	Small Natural	3/0935/1	4/4	East

Item #	Desc	Vendor	CS/UOS	Location
81792120	Beige	260024-C149	18/18	National

Cement Shell Planter



Sea Shell planters made of cement feature a removable drainage plug. Opening diameter 5" - Overall height 2.5" Volume 0.15 gal

Item #	Desc	Vendor	CS/UOS	Location
81792121	Light Earth	260025-C147	24/24	East
81792122	Shell Grey	260025-C151	24/24	East
81792222	Harbor Blue	260025-580	24/24	East

Maxwell Planters

Maxwell cement planters with removable drainage plug. Perfect for succulents, foliage or flowers!
Round: 4" x 4"
Urn: 6.5" x 5.75"



Item #	Desc	Vendor	CS/UOS	Location
81792190	Round Straw Weave	210055-587	12/12	East
81792191	Round Country Blue Weave	210055-580	12/12	East
81792192	Urn Straw Weave	270003-587	8/8	East
81792193	Urn Country Blue Weave	270003-580	8/8	East



Zinc and Black Cement Pot Assortments

Small: 5.3x5.3x4.7
 Large: 7.5x7.5x6.1
 *Comes with a removable drainage plug



Item #	Desc	Vendor	CS/UOS	Location
81791818	Large Zinc & Black Assorted	31005	8/8	East
81791819	Small MOD Zinc & Black Assorted	31006	12/12	East
81791820	Large MOD Zinc & Black Assorted	31007	8/8	East



Dotted Ceramix Planters

Item #	Desc	Vendor	CS/UOS	Location
81792400	2.5" Mix Blue, Green, White & Pink	K90072-000	1/1	National
81792405	4" - Black	K90108-001	1/1	National
81792404	4" - White	K90108-089	1/1	National
81792403	4" Mix Pink, Green, Blue & Purple	K90075-000	1/1	National
81792349	5.7" x 4.2" White	50002-WH	16/16	East
81792350	5.7" x 4.2" Black	50002-EB	16/16	East
81792414	6.5" - White	K90106-089	1/1	National
81792415	6.5" - Dark Blue	K90106-448	1/1	National
81792351	8.27" x 5.35" White	50003-WH	6/6	East
81792352	8.27" x 5.35" Black	50003-EB	6/6	East

Artichoke Cement Planter

Gorgeous, heavy cement planters with removable drainage plugs



Item #	Desc	Vendor	CS/UOS	Location
81792353	Small 5.75" x 5.75" x 5"	50011	6/6	East
81792354	Large 8.25" x 8.25" x 6.75"	50012	6/6	East

Kiawah Ceramic Planters



Item #	Desc	Vendor	CS/UOS	Location
81792406	4" Sage & Denim	K90080-000	24/1	National
81792410	6" Sage & Denim	K90078-000	12/1	National



Geometric Ceramix Planters

Item #	Desc	Vendor	CS/UOS	Location
81792401	4" Mix Pink, Green, Blue, Purple	K90073-000	1/1	National
81792402	4" Mix White & Black	K90074-000	1/1	National
81792345	5.7" x 4.2" White	50000-WH	16/16	East
81792346	5.7" x 4.2" Black	50000-EB	16/16	East
81792412	6.5" White	K90105-089	1/1	National
81792413	6.5" Dark Blue	K90105-448	1/1	National
81792416	8" White	K90107-089	1/1	National
81792417	8" Dark Blue	K90107-448	1/1	National
81792347	8.27" x 5.35" White	50001-WH	6/6	East
81792348	8.27" x 5.35" Black	50001-EB	6/6	East

Colchester Ceramic Planter



Item #	Desc	Vendor	CS/UOS	Location
81792407	4" - Grey	K90103-781	1/1	National
81792418	8" - Grey	K90104-781	1/1	National

Artie Ceramic Planter



Item #	Desc
81792411	6" Quarry



Falmouth Planter



Item #	Desc	Vendor	CS/UOS	Location
81792427	11" square white	1071CP18B-340V	18/18	East
81792428	24" Deck Rail Window Box	1074CP10B-340V	10/10	East
81792429	24" Window Box	1075CP16B-340V	16/16	East



Self-Watering Raised Garden Bed

Item #	Desc	Vendor	CS/UOS	Location
81792439	30"	740000P-101	4/4	National



Bella Planter

At a height of 9.5" and a top outside diameter of 9.9", the Bella planters are fantastic for all your plantings requiring a deeper rooting solution

Item #	Desc	Vendor	CS/UOS	Location
81791041	7" Metallic Frosted Pearl	1258-027M	25/25	East
81791043	10" Metallic Pearl	1255-147M	20/20	National
81791897	10" Metallic Frosted Pearl	1255-027M	1/20	East



Cement Coffee Cup

7" x 5.5" x 5" - fits 4.5" pot.

Item #	Desc	Vendor	CS/UOS	Location
81791533	Rust	3/12819R/1	12/12	East



Cement Heart Pots

Made of cement and featuring a removable drainage plug these containers are perfect for succulents or foliage plants.

Item #	Desc	Vendor	CS/UOS	Location
81791694	Red Heart 4.7X4.7x6.5	210027P-396	12/12	East
81791695	Red Heart 5.5X5.5x5.1	210028P-396	12/12	East
81791696	Red Heart 4.3X4.3x4	210029P-396	18/18	East
81791697	Red Heart Low Bowl 6.5X6.5x3.1	280000P-396	12/12	East
81791709	Red Wash White Heart 5.2X5.2x4.9	210019-131	12/12	East
81791710	Red Wash White Heart	210019P-328	12/12	East

Yellow Sun Cement Pot

Cement planter with removable drainage plug. Open diameter 4 1/3" Overall height 4". Volume 0.55 gal



Item #	Desc	Vendor	CS/UOS	Location
81792198	4.3" x 4"	210054P-396	16/16	East

Wood Grain Ceramic Planter

White ceramic band complements wood grain, has removable drainage plug.



Item #	Desc	Vendor	CS/UOS	Location
81792355	White with Wood Grain 5.25"x5"	50022	12/12	East



Flora Trio

Cement planters with assorted white and green interiors. Perfect for any houseplant. Comes with a removable drainage plug.

Item #	Desc	Vendor	CS/UOS	Location
81791813	5.3x5.3x4.7	31000	12/12	East
81791814	7.5x7.5x6.1	31001	6/6	East



Lavastone Luzon Urn



Item #	Desc	Vendor	CS/UOS	Location
81792184	14.25 X 13.25	LS7415	1/1	East

Ancient Cement Planters

Aged cement planters
Large 8 x 8 x 7
Mini 3x3x2.8



Item #	Desc	Vendor	CS/UOS	Location
81792150	8"X8"X7"	45000	6/6	East

Tin Planters

7.1" x 7.1" x 5.9" & 5.1" x 5.1" x 4.92"



Item #	Desc	Vendor	CS/UOS	Location
81791404	Set of 2	13055	2/2	East

Ancient Cement Handled Planter



Item #	Desc	Vendor	CS/UOS	Location
81792152	6.5X5X4.3	45002	12/12	East

Dakota Trough

Cement planter with removable drainage plug.



Item #	Desc	Vendor	CS/UOS	Location
81791532	Earth Moss	240001P-432	16/16	National
81791531	Rust	240001P-433	16/16	National

Tin Planter w/ Faux Hose



Item #	Desc	Vendor	CS/UOS	Location
81791418	12"x7"x11"	13069	4/4	East

Weathered Copper Tommy Pot

Copper finish resin planter w/ drainage
8" x 6" Volume .71 gal



Item #	Desc	Vendor	CS/UOS	Location
81792097	8" Tommy Pot	108D-377R	12/12	National

License Plate Metal Planters

Rectangle Sizes: L: 11.6"x6.3"x5.9" S: 8.7"x4.7"x5.5"
Round Sizes: L: 8.9"x8.9"x6.9" S: 8.1"x8.1"x6.7"
Square Sizes: L: 6"x6"x6" S: 5"x5"x5.5"



Item #	Desc	Vendor	CS/UOS	Location
81791372	Rectangle	13013	2/2	East
81791373	Round	13014	2/2	East
81791398	Square	13048	2/2	East

Jake Planter

14" Resin planter straw finish with drainage. Feels and looks real! Overall height 10" - Holds 4 gallon volume



Item #	Desc	Vendor	CS/UOS	Location
81792085	14" Jake planter	2014D-587R	12/12	National



Galvanized Insert

Item #	Desc	Vendor	CS/UOS	Location
81791010	Galvanized	2/934/1	12/12	National



Holiday Star Window Box

Fits two 6" pots

Item #	Desc	Vendor	CS/UOS	Location
81791001	Gold	155244-G	24/24	East



Galvanized Brushed Wood Grain Tin White

Item #	Desc	Vendor	CS/UOS	Location
81791035	6"	510001-089	40/40	National
81791037	8"	510000-089	36/36	East



Santa With Reindeer

Great for drop ins! No drainage

Item #	Desc	Vendor	CS/UOS	Location
81792013	5.3"x4.8"x4.8"	260030P-031	24/24	East



Polar Bear With Igloo

Great for drop ins! No drainage

Item #	Desc	Vendor	CS/UOS	Location
81792011	6.6"x4.3"x5"	260028P-089	18/18	East

Handled - Buffalo Brown



Item #	Desc	Vendor	CS/UOS	Location
81791012	16"x6"x5"	2/60442/1	12/12	National

Birch Oval Planter

Beautiful Birch oval resin planter, with no drainage. Choose from two sizes. 12" L x 6" W x 6.5" H (1.22gal) 16" L x 6.1" W x 6.5" H (1.8gal)



Item #	Desc	Vendor	CS/UOS	Location
81792374	12"	512D-516	24/24	East
81792382	16"	516D-516	20/20	East

Christmas Ornament Planters

Great for drop ins! No drainage



Item #	Desc	Vendor	CS/UOS	Location
81792057	5.75"-Green	159213GR	12/12	East
81792056	5.75"-White	159213S	12/12	East



North Star Pot

Item #	Desc	Vendor	CS/UOS	Location
81792408	White, Gold, Red & Silver	K90076-000	24/1	National



Penguin & Frosty MixPlanter

Item #	Desc	Vendor	CS/UOS	Location
81792409	4" Penguin & Frosty Mix	K90077-396	18/1	National



Tilden Self Watering Pots

6" self watering features a total of five pots (2 white 2 gray 1 teal). Pricing per set

Item #	Desc	Vendor	CS/UOS	Location
81792344	6" - 5 colors	10106CP5D-000V	1/1	National
81792342	8",10", & 12"- White	10111D-622V	1/1	National
81792343	8",10", & 12"- Grey	10111D-621V	1/1	National
81792388	6" - Grey set of 5	10106CP5D-621V	1/1	National



Elle Planter w/ Plug

Resin planter with drainage plug, upgrade any houseplant!

Item #	Desc	Vendor	CS/UOS	Location
81792368	4.7" Gray	404CP24D-352	24/24	National
81792370	4.7" Sand	404CP24D-586	24/24	National
81792366	4.7" Cast	404CP24D-060	24/24	National

Capello Planter

6" Capello resin hanging basket with saucer and hanger. Perfect for dropping in succulents or houseplants. Hanging basket opening diameter 6.69" x 4.53" high. Comes with 18" braided hanger and snap on saucer. Holds .48gal soil volume. Choose from Sandstone, Star White, Black or Antique Copper



Item #	Desc	Vendor	CS/UOS	Location
81792239	6" Sandstone	2001MS6D-045PHNG	50/50	National
81792240	6" Star White	2001MS6D-340PHNG	50/50	National
81792262	6"-Antique Copper w/ black hanger	2001MS6D-174PHNG	50/50	National



Corinthian Collection

Trough: 10"x3.5"x3.25"
Round: 10"x3.5"x3.25"

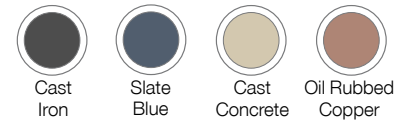

Item #	Desc	Vendor	CS/UOS	Location
81792017	8" Round Cast Concrete	9408CP28D-060	28/28	National
81792018	8" Round Desert	9408CP28D-514	28/28	National
81792199	8" Round Slate Blue	9408CP28D-597	28/28	National
81792019	8" Round Storm	9408CP28D-515	28/28	National
81792071	8" Round Oil Rubbed Copper	9408CP28D-238	28/28	National
81791735	10" Trough Storm	9410-515 CP	36/36	National
81791732	10" Trough Cast Concrete	9410-060 CP	36/36	National
81791733	10" Trough Desert	9410CP36D-514	36/36	National
81791725	10" Round Desert	9411CP28D-514	28/28	National
81791727	10" Round Storm	9411D-515	28/28	National
81791724	10" Round Cast Concrete	9411CP28D-060	28/28	National
81792210	10" Round Slate Blue	9411CP28D-597	28/28	National
81792072	10" Round Oil Rubbed Copper	9411CP28D-238	28/28	National
81791047	12" Bowl Cast Iron	9478D-059	12/12	National
81791046	12" Bowl Cast Concrete	9478D-060	12/12	National
81791165	12" Bowl Oil Rubbed Copper	2/9478/1-097	12/12	National
81791731	13" Round Storm	9413-515 CP	20/20	National
81791728	13" Round Cast Concrete	9413CP20D-060	20/20	National
81791729	13" Round Desert	9413CP20D-514	20/20	National
81792073	13" Round Oil Rubbed Copper	9413CP20D-238	20/20	National
81792212	10" Trough Slate Blue	9410CP36D-597	36/36	National
81792074	18" Trough Cast Concrete	9418CP36D-060	36/36	National
81792075	18" Trough Desert	9418CP36D-514	36/36	National
81792076	18" Trough Storm	9418CP36D-515	36/36	National
81792077	18" Trough Oil Rubbed Copper	9418CP36D-238	36/36	National
81792223	18" Trough Slate Blue	9418CP36D-597	36/36	National



Allaire Tall Planter

Resin planter with drainage hole 12"
Open diameter x 13.5" Height Holds
3.77gal soil volume

Item #	Desc	Vendor	CS/UOS	Location
81791523	12" Round	3/804CG/1	12/12	East



Greenwich Urn

Resin Urns - bottoms screw on or
off for easy storage 16"x16"x18"

Item #	Desc	Vendor	CS/UOS	Location
81791759	Striated Granite	39451D-518R CP	6/6	East
81791758	Striated Fossil	394851D-039R CP	6/6	East

2024



Bellina Planter

Item #	Desc	Vendor	CS/UOS	Location
81791900	7" Metallic Pearl	1258-147M	25/25	National
81792109-137	7" Magenta	1258D-411V	25/25	National
81791075-300	8" Fossil	50D-039T	50/50	East
81791078-404	10" Fossil	51D-039T	25/25	East



Larissa Urn

Resin urn 16" opening diameter, 19" height
Volume 9.4 gal

Item #	Desc	Vendor	CS/UOS	Location
81792136	16" Sand	416P-190	4/4	East



Honeysuckle Planters

Resin planters with drainage.
13" Opening diameter - 10 1/2" height Volume 3.6 gal
15" Opening diameter - 12 1/4" height 5.6 gal

Item #	Desc	UPC	Vendor	CS/UOS	Location
81791099	13" Fossil	858957008286	554D-039T	48/48	National
81791101	13" Stone	858957008293	554D-120T	48/48	National
81791104	13" Blue Jean	858957008309	554D-252R	48/48	National
81792114	13" Tequila Sunrise		554D-245R	48/48	National
81792116	13" Distressed Copper		554D-183R	48/48	National
81791093	15" Stone	858957008262	553D-120T	24/24	National
81791096	15" Blue Jean	858957008279	553D-252R	24/24	National
81792115	15" Tequila Sunrise		553D-245R	24/24	National
81792117	15" Distressed Copper		553D-245R	24/24	National
81791630	15" Vanilla		553D-290S	24/24	National
81791605	15" Fossil		553D-039T	20/20	East

16" Legacy Urn

Durable resin urns, hold 4.1gal. Opening
diameter 15.9", overall height 20.1"
Choose from cast concrete or oil rubbed
bronze finish to elevate plantings



Item #	Desc	Vendor	CS/UOS	Location
81792134	Cast Concrete	569D-060	4/4	National
81792135	Oil Rubbed Bronze	569D-238	4/4	National



Distressed Barrel Planters

Item #	Desc	UPC	Vendor	CS/UOS	Location
81791351	6" - Chestnut		34906D-407R	120/120	National
81791888	8" - Chestnut		34908D-407R	80/80	National
81790010	9" - Oak	858957006511	S74D-265R	30/30	National
81790011	15" - Oak	858957006512	S72D-265R	18/18	National
81791892	15" - Kentucky Walnut		S72D-037R	18/18	National
81790012	20.5" - Oak	858957006513	S1027D-265R	10/10	National



Moroccan Bowl

Resin planter with drainage plug.
7" x 2 3/4"
10" x 4"

Item #	Desc	Vendor	CS/UOS	Location
81792078	7" Cast Concrete	577D-060	50/50	National
81792079	7" Oil Rubbed Bronze	577D-097	50/50	National
81792080	7" Desert	577D-514	50/50	National
81792081	7" Storm	577D-515	50/50	National
81792082-145	7" Slate Blue	577D-597	50/50	East
81791740-351	10" Cast Concrete	572D-060 CP	20/20	National
81791741-351	10" Oil Bronze	572D-097 CP	20/20	National
81791742-351	10" Desert	572D-514 CP	20/20	National
81791743-351	10" Storm	572D-515 CP	20/20	National



Umbria Eco Cast Planter

Item #	Desc	Vendor	CS/UOS	Location
81791130	12"	3/9475/1-060	12/12	National



Jameson Deck Rail Planters

Item #	Desc	Vendor	CS/UOS	Location
81791361	15" - Round	1072D-265R	18/18	National
81791362	24"-Window Box	1073D-265R	12/12	National

Doherty 12" Pots

12" resin planters with drainage.
Opening diameter 11.62" Overall height 9.12" Volume 2.75gal - Great for drop ins or to grow in!



Item #	Desc	Vendor	CS/UOS	Location
81792106	Grained Sky Blue	112D-555R	16/16	National
81792107	Grained Aurora Red	112D-556R	16/16	National
81792108	Grained White	112D-561R	16/16	National

14" Super Bowl Planters

14" resin planters with drainage.
8" height, holds 2.75 gal soil volume.



Item #	Desc	Vendor	CS/UOS	Location
81792185	Distressed Galvanized	9415D-531R	10/10	East
81792186	Vintage Ivory Enamel	9415D-532R	10/10	East

Alena Collection Weathered design

9": 8.9"x8.9"x6.25"
12": 12"x12"x8.5"



Item #	Desc	Vendor	CS/UOS	Location
81791761	9" Enamel	10509D-532 CP	26/26	East
81791760	9" Galvanized	10509D-531 CP	26/26	East
81791861	9" Copper	10509D-377R CP	26/26	East
81791763	12" Enamel	10512D-532 CP	20/20	East
81791762	12" Galvanized	10512D-531 CP	20/20	East
81791862	12" Copper	10512D-377R CP	20/20	East
81792187	12" Teal Gloss	10512CP20D-558R	20/20	East
81792188	12" Ruby Red Gloss	10512CP20D-560R	20/20	East

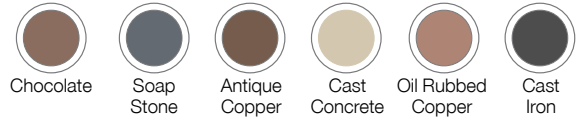

Haverhill (A)

Item #	Desc	Vendor	CS/UOS	Location
PLANTER				
81791143	12" Soap Stone	FM1403D-017PB	30/30	National
81791145	12" Antique Copper	FM1403D-174PB	30/30	National
81792293	12" w/18" Hanger-Antique Copper	FM1412CP42D-174PB	42/42	National

BOWL

81791141	12" Antique Copper	FM1402D-174PB	30/30	National
81791139	12" Soap Stone	FM1402CP30D	30/30	National

Spartan Eco Cast Urn (B)

Item #	Desc	Vendor	CS/UOS	Location
81791049	12" Chocolate	568D-059	10/10	East
81791048	12" Cast Concrete	568D-060	10/10	East
81791050	12"-Oil Rubbed Copper	568D-238	10/10	East

Greco (C)

Item #	Desc	Vendor	CS/UOS	Location
81791108	15" Cast Concrete	563D-060	12/12	National

Nantucket Planter (D)

Item #	Desc	Vendor	CS/UOS	Location
81791352	8" Russet	34208D-408R	20/20	National
81791353	8" Harbor Gray	34208D-409R	20/20	National
81791354	10" Russet	34210D-408R	20/20	National
81791355	10" Harbor Gray	34210D-409R	20/20	National
81791356	12" Russet	34212D-408R	12/12	National
81791357	12" Harbor Gray	34212D-409R	12/12	National



Shaina Planter 15"

Great for drop ins! No drainage

Item #	Desc	Vendor	CS/UOS	Location
81791447	Earth	8005D-188T	12/12	East
81791445	Patina Copper	8005D-378R	12/12	East
81791446	Northern Lights	8005D-379R	12/12	East
81791443	Weathered Copper	8005D-377R	12/12	East
81791444	Indigo	8005D-375R	12/12	East



Rosie Bowl with Saucer 10"

Item #	Desc	Vendor	CS/UOS	Location
81791437	Northern Lights	9010D-379R	12/12	National
81791439	Weathered Copper	9010D-377R	12/12	National
81791438	Indigo	9010D-375R	12/12	National
81791435	White	9010D-4055	12/12	National
81791436	Earth	9010D-188T	12/12	East



ROUND All 12" round planters come with cage

Item #	Desc	Vendor	CS/UOS	Location
WINDOW BOX				
81791316	15" Oil Rubbed Copper	6004D-164PB	44/44	National
81791315	15" Slate	6004D-287PB	44/44	National
SQUARE				
81791296	7" Oil Rubbed Copper	7010D-164PB	34/34	National
81791295	7" Slate	7010D-287PB	34/34	National
81791300	10" Oil Rubbed Copper	3006D-164PB	28/28	National
81791299	10" Slate	3006D-287PB	28/28	National
BOWL				
81791312	11" Oil Rubbed Copper	6002D-164PB	64/64	National
81791311	11" Slate	6002D-287PB	64/64	National
HANGING BASKET -come with a water saving disc and hanger				
81791288	11" Oil Rubbed Copper	6003D-164PB	38/38	National
81791287	11" Slate	6003D-287PB	38/38	National
81792361	13" Oil Rubbed Copper	6005CP54D-164PB	54/54	National
81792363	13" Slate	6005CP54D-287PB	54/54	National

Item #	Desc	Vendor	CS/UOS	Location
81791292	7" Oil Rubbed Copper	90008D-164PB	34/34	National
81791291	7" Slate	90008D-287PB	34/34	National
81791324	8.5" Oil Rubbed Copper	90004D-164PB	40/40	National
81791323	8.5" Slate	90004D-287PB	40/40	National
81791303	11" Slate	3004D-287PB	38/38	National
81791304	11" Oil Rubbed Copper	3004CP38D-164PB	38/38	National
81791537	12" Verde Stone	90005D-036PB	270/270	National
81791162	12" Antique Copper	3009D-174PB	270/270	National
81791330	12" Chocolate	90005D-002P	38/38	National
81791332	12" Oil Rubbed Copper	90005D-164PB	38/38	National
81791538	12" Verde Stone	90005D-036PB	1080/1080	National
81791536	12" Verde Stone	90005CP38D-036PB	38/38	National
81791307	13" Slate	1403D-287PB	30/30	National
81791308	13" Oil Rubbed Copper	1403CP30D-164PB	30/30	National
81792363	13" Slate	6005CP54D-287PB	54/54	National
81792361	13" Oil Rubbed Copper	6005CP54D-164PB	54/54	National

2024

Nassau Round with Cage

Item #	Desc	Vendor	CS/UOS	Location
81791162	12" Antique Copper	3009D-174PB	270/270	National
81791072	12" Antique Copper	3009D-174PB	1080/1080	National



Ashton Manor Collection

12" Hanging Basket: Comes with 18" hanger and disc. 1.8 gal

14" Tall Round: 13.25"x13.25"x14"



Item #	Desc	Vendor	CS/UOS	Location
81791764	Hanging Basket -Oil Rubbed Copper	1502D-164PB CP	48/48	National
81791765	Hanging Basket -Quartz	1502D-053PB CP	48/48	National
81791766	Tall Round-Oil Rubbed Copper	1508D-164PB CP	25/25	National
81791767	Tall Round-Tuscan Stone	1508D-035PB CP	25/25	National



Acacia Wood Collection



2024

Item #	Desc	Vendor	CS/UOS	Location
81791711	Trellis Planter 13.8"x13.8"x15.3"x45.7"	160014	1/1	National
81791712	1/2 Barrel Planter 19.7"x13.8"x7.5" 15"x11.8"x6.7"	160015	1/1	National
81791713	Oval Planter 18.1"x10.2"x9.5" 15.4"x8.3"x8.3"	140011	1/1	National
81791009	Barrel Trio Sold As Set Of 3; SM: 11.38"x7"H; MED: 12.88"x8.38"H; L: 15.63"x9.63H	5/800/3	1/1	National
81791714	21" Barrel Planter 20.9"x20.9"x12.6"	110024	4/4	National
81791715	16" Barrel Planter 15.7"x15.7"x9.5"	110025	6/6	National



Wood Plant Stand

Item #	Desc	Vendor	CS/UOS	Location
81790081	27"x18"x45"	9/801/1	1/1	National

Wood Obelisk

Item #	Desc	Vendor	CS/UOS	Location
81790082	15"x15"x61"	9/802/1	1/1	East

4-Arm Black Plant Stand

Item #	Desc	Vendor	CS/UOS	Location
81792138	64.5"	H18003	1/1	East



Terranova Cylinder



Item #	Desc	Vendor	CS/UOS	Location
81791918	8" Black	TN8D-001P CP	250/250	National
81791920	8" Terra Cotta	TN8D-020P CP	250/250	National
81791922	8" Charcoal	TN8D-101P CP	250/250	National
81791923	8" Antique Copper	TN8D-174PB CP	250/250	National
81791919	8" Chocolate	TN8D-002P CP	250/250	National
81791933	10" Sand Stone	TN10D-045P CP	250/250	National
81791947	12" Antique Copper	TN12D-174PB CP	250/250	National
81791946	12" Charcoal	TN12D-101P	250/250	National
81791942	12" Black	TN12D-001P CP	250/250	National
81791943	12" Charcoal	TN12D-002P CP	250/250	National
81791945	12" Sand Stone	TN12D-045P CP	250/250	National
81791954	14" Black	TN14D-001P CP	250/250	National
81791955	14" Charcoal	TN14D-002P CP	250/250	National
81791959	14" Antique Copper	TN14D-174PB CP	250/250	National
81791957	14" Sand Stone	TN14D-045P CP	250/250	National



Devoncourt Planters

Resin planters with drainage 11" hanging basket comes with hanger and water disc - holds 1.8 gal volume.
11" round holds 2.2 gal, 10" square holds 2.4 gal

Item #	Desc	Vendor	CS/UOS	Location
81792128	11" HB Antique Copper	1400D-173PB	30/30	East
81792130	10" Sq Antique Pewter	1402D-173PB	20/20	East
81792242	20" Window Box Antique Copper	1405D-174PB	24/24	East
81791060	11" Round Antique Pewter	1404D-173PB	24/24	East

Verona Planters

Step up your plantings with these beautiful resin containers. 11" Hanging Basket comes with hanger and water disk, holds 1.8gal 11" Round with drainage holds 2.2gal 10" Square with drainage holds 2.4gal



Item #	Desc	Vendor	CS/UOS	Location
81792125	11" Hanging Basket Soapstone	1420D-017PB	30/30	East
81792126	11" Round Soapstone	1424D-017PB	20/20	East
81792127	10" Square Soapstone	1422D-017PB	20/20	East



Chandler Round Pot

14" resin planter with drainage 14" opening diameter 12" height - Holds 4.97gal volume

Item #	Desc	Vendor	CS/UOS	Location
81792202	14"-Black	4015CP-12D-001P	12/12	East



Arc Bowl Planter

With Drainage plug 12.5"x8.5"x5.25"

Item #	Desc	Vendor	CS/UOS	Location
81791748	Stone	573D-120 CP	20/20	National
81791749	Desert	573D-514 CP	20/20	National
81792084	Concrete	573D-102	20/20	National
81792083	Georgia Clay	573D-093	20/20	National



Coco Hanging Baskets

Item	Description	Weight Limits - LBS	Qty/cs
58-3002*	Coco 14.0 Green Hanging Basket, flat bottom, with latex liner and wire hanger	33 lbs.	24
58-3014*	Coco 14.0 Black Wire Frame Hanger Fiber Pot, flat bottom	33 lbs.	12
58-3007*	Coco 20.0 Black Hanging Basket, flat bottom, with latex liner and chain	44 lbs.	12
58-3008*	Coco 20.0 Green Hanging Basket, flat bottom, with latex liner and chain	44 lbs.	12
58-3012*	Coco 20" Black 3 Strand Hanger for 12+14" coco hanging basket		24
58-3009*	Coco Replacement Liner for 16.0 Basket		18



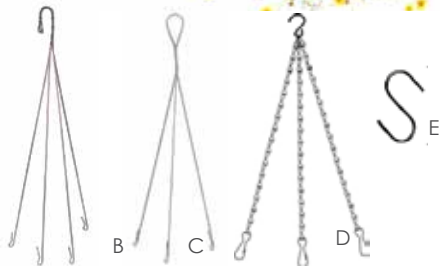

Wire Hanging Basket (A)

Item	Model	Liner	Qty/cs
51-90127	10" #400-J10	401-K	12
51-90107	12" #400-J12	401-A	12
51-90104	14" #400-J14	401-G	12
51-90108	16" #400-J16	401-B	12
51-15066	18" #400-J18	401-C	12
51-15074	22" #400-J22	401-J	12

Each item includes hanging baskets and green plastic liners. Hangers sold separately.

Sturdy Hooks For Hanging Baskets (B-E)

Item	Description	Qty/cs
Open Hook Wire Hangers (B)		
51-90102	18" 3-Strand for 10-12" basket	12
51-90109	22" 3-Strand (#400-HK22) for 14-16" basket	12
51-25026	26" for 18" basket	12
Closed Hook Wire Hangers (C)		
51-15005	Closed Hook Hanger for 18" & 26"	12
51-90103	Closed Hook Hanger for 10,12,14,16"	12
Chain (D)		
51-24126	Galvanized Hanger 25" Chain 4-strands #400-CH25	12
51-24026	Black Hanger 26" 4-Strand #400-HK26PN	12
Extension S Hooks (E)		
51-15014	4" Extension S-Hooks - 7 Gauge	100
51-4612	12" Extension S-Hooks - 9 Gauge	50
51-4618	18" Extension S-Hooks - 9 Gauge	50
51-4624	24" Extension S-Hooks - 9 Gauge	50
51-4630	30" Extension S-Hooks - 9 Gauge	50
51-4636	36" Extension S-Hooks - 9 Gauge	50
51-4648	48" Extension S-Hooks - 9 Gauge	50



MULTI-FORMES

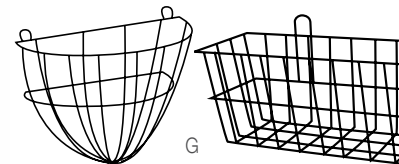

Half Cone (F)

Item	Model	Qty/cs
51-90174	14" Half Basket #750-60	12

Half Basket and Flower Box

Item	Model	Liner	Qty/cs
Half Basket			
51-35046	12" #405-D12	401-K	12
51-35154	14" #405-D14	401-A	12
51-35162	16" #405-D16	401-B	12
51-340621	16" #403-DC16	w/Heart	6
Flower Box			
51-25112	12" #404-B12	401-A	6
51-25124	24" #404-B24	401-D	6
51-25130	30" #404-B30	401-F	6
51-25136	36" #404-B36	401-E	6

Each item includes baskets and green plastic liners

Cocomoss Liners

Item	Description	Qty/cs
51-14012	12.0 Cocomoss Liner	12
51-90106	16.0 Cocomoss Liner	12
51-90101	18.0 Cocomoss Liner	12
51-14023	22.0 Cocomoss Liner	12
51-90126	24.0 Cocomoss Liner	12

Wire Hanging Basket Replacement Liners

Item	Model	Qty/cs
51-00012	#401-A Green Plastic Liner	24
51-00014	#401-G Green Plastic Liner	24
51-00016	#401-B Green Plastic Liner	24
51-00018	#401-C Green Plastic Liner	24
51-00020	#401-D Green Plastic Liner	24
51-00022	#401-E Green Plastic Liner	24
51-00024	#401-F Green Plastic Liner	24
51-00028	#401-H Green Plastic Liner	24
51-00026	#401-J Green Plastic Liner	24
51-00027	#401-K Green Plastic Liner	24



Plastic Banana Leaf & Rattan
Round Hanging Cone



Plastic Banana Leaf & Rattan
Star Hanging Cone



Banana Leaf & Maize Rope

Item	Size / Description	Qty/cs
Plastic Banana Leaf & Rattan		
84-PL2904SH	11" Round Floor Planter with Handle	15
84-PL220414	14" Round Hanging Cone	15
84-PL230414	14" Square Hanging Cone	15
84-PL210414	14" Round Hanging Basket	20
84-PL210414	16" Star Hanging Cone	10
Plastic Banana Leaf Rope & Maize Rope		
84-PL250314	14" Hive Hanging Cone	15
84-PL2703	16" Wall Planter	12
84-PL220312	12" Round Hanging Cone	15
84-PL220314	14" Round Hanging Cone	15
84-PL220314	14" Plastic Hanging Cone	15
84-PL2603	16" Hanging Star Cone	10
Banana Leaf Rope & Maize Rope		
84-2703	16" Wall Planter	12
84-21003H	14" Oval Planter with Handle	15

*Hanging Baskets and Cones come with wire hanger. Hanging Orders must be booked by September 30th to guarantee availability.



Plastic Rattan



84-PL20514-14



84-PL120214



84-PL110314

Random Woven



84-120814



84-1108F12
84-1108F14



84-S1708

Item	Size / Description	Qty/cs
Random Woven		
84-1108F12	12" Square Hanging Basket	20
84-1108F14	14" Square Hanging Basket	20
84-130814	14" Square Cone	15
84-120814	14" Round Cone	15
84-S1708	14" Wall Planter Wire Decor	10
84-11208	24" Floor Trough	12
84-1808H	13" Square Floor Planter with Handle	10
84-1908A	14" Round Floor Planter	10
Plastic Rattan		
84-PL20316-12	12.0 Round Hanging Cone - Bicolor	15
84-PL20514-14	14.0 Round Hanging Cone - Beehive	15
84-PL20214-14	14.0 Round Hanging Cone - Bicolor	15
84-PL120214	14.0 Round Hanging Cone - Black/Brown/Grey	15
84-PL121014	14.0 Round Hanging Cone - White/Grey	15
84-PL1020614	14.0 Round Hanging Cone - Tri-color	15
84-PL110514	14.0 Round Hanging Basket - Black/Brown	20
84-PL110914	14.0 Round Hanging Basket - Black/Grey	20
84-PL110314	14.0 Round Hanging Basket - Black/White/Brown	20
84-PL110414	14.0 Round Hanging Basket - Black/Grey/White	20



Hanging Baskets include wire hanger.
Orders must be booked by September 30th to guarantee availability.



Plastic Brushwood
and Maize Rope
Round Hanging Cone



Plastic Brushwood
and Maize Rope
Square Hanging Cone
and Round Hanging
Basket



Brushwood & Green Moss
Square Hanging Cone



Brushwood & Fern
Wall Planter



Plastic
Brushwood
and Palm Leaf
Wall Planter

Item	Size	Qty/cs
Plastic Brushwood & Maize Rope		
84-PL220514	14" Round Hanging Cone	15
84-PL210514	14" Round Hanging Basket	20
84-PL2305141	14" Square Hanging Cone	15
84-PL250512	12" Hive Hanging Cone	15
Brushwood & Green Moss		
84-2308A14	14" Square Hanging Cone	15
84-2208A14	14" Round Hanging Cone	15
Brushwood & Fern		
84-230912	12" Square Hanging Cone	15
84-2709	14" Wall Planter	15
84-21009H	14" Oval Planter with Handle	15
Plastic Brushwood & Palm Leaf		
84-PL22101	12" Round Hanging Cone	15
84-PL261010	16" Star Hanging Cone	10
84-PLS2710	14" Wall Planter with Wire Decor	10

*Hanging Baskets and Cones come with wire hanger.
Orders must be booked by September 30th to guarantee availability.

Black Rattan
Round Hanging Basket



Sphagnum
Moss



Black Rattan
Round Hanging Cone



Item	Size	Qty/cs
Black Rattan		
84-120114	14" Round Hanging Cone	20
84-110112	12" Round Hanging Basket	24
84-120112	12" Black Rattan Round Hanging Cone w/ wire stand and hanger	20
84-1901W	12" Black Rattan Welcome Floor Planter	10
84-110114	14" Black Rattan Round Hanging Basket w/Wire Hanger	24
84-1701	16" Black Rattan Wall Planter	15
84-110116	16" Round Hanging Basket	24
84-120116	16" Round Hanging Cone	20
Sphagnum Moss		
84-110514	14" Round Hanging Basket	15
84-1705	14" Wall Planter	10
84-110516	16" Round Hanging Basket	12

*Hanging Baskets and Cones come with wire hanger.
Orders must be booked by September 30th to guarantee availability.

2024



Plastic Palm Leaf Rope and Maize Rope Square Hanging Cone

Plastic Palm Leaf Rope and Fern Round Hanging Cone



Item	Size / Description	Qty/cs
Plastic Palm Leaf Rope & Maize Rope		
84-PL220114	14" Round Hanging Cone	15
84-PL230112	12" Square Hanging Cone	15
84-PL250114	14 Hive Hanging Cone	15
Plastic Palm Leaf Rope & Fern		
84-PL220212	12" Hanging Cone	15
84-S2502E	13" Beehive Cone	10
84-PL2102F14	14" Square Hanging Basket	20
Palm Leaf Rope & Fern		
84-21002H	14" Oval Planter with Handle	15
Plastic Palm Leaf & Twig		
84-PL21013H	14" Oval Planter with Handle	15
Plastic Maize Rope & Fern		
84-PL250212	12" Hive Hanging Cone	15

Moss Hanging Baskets

Item	Description	Qty/cs
54-5400	Grower Direct 12" Moss Hanging Basket MHB12	20/CS
54-5401	Grower Direct 14"x7" Moss Hanging Basket MHB14	20/CS
54-5402	Grower Direct 16" Moss Hanging Basket MHB16	20/CS
54-5403	Grower Direct 18" Moss Hanging Basket MHB18	20/CS

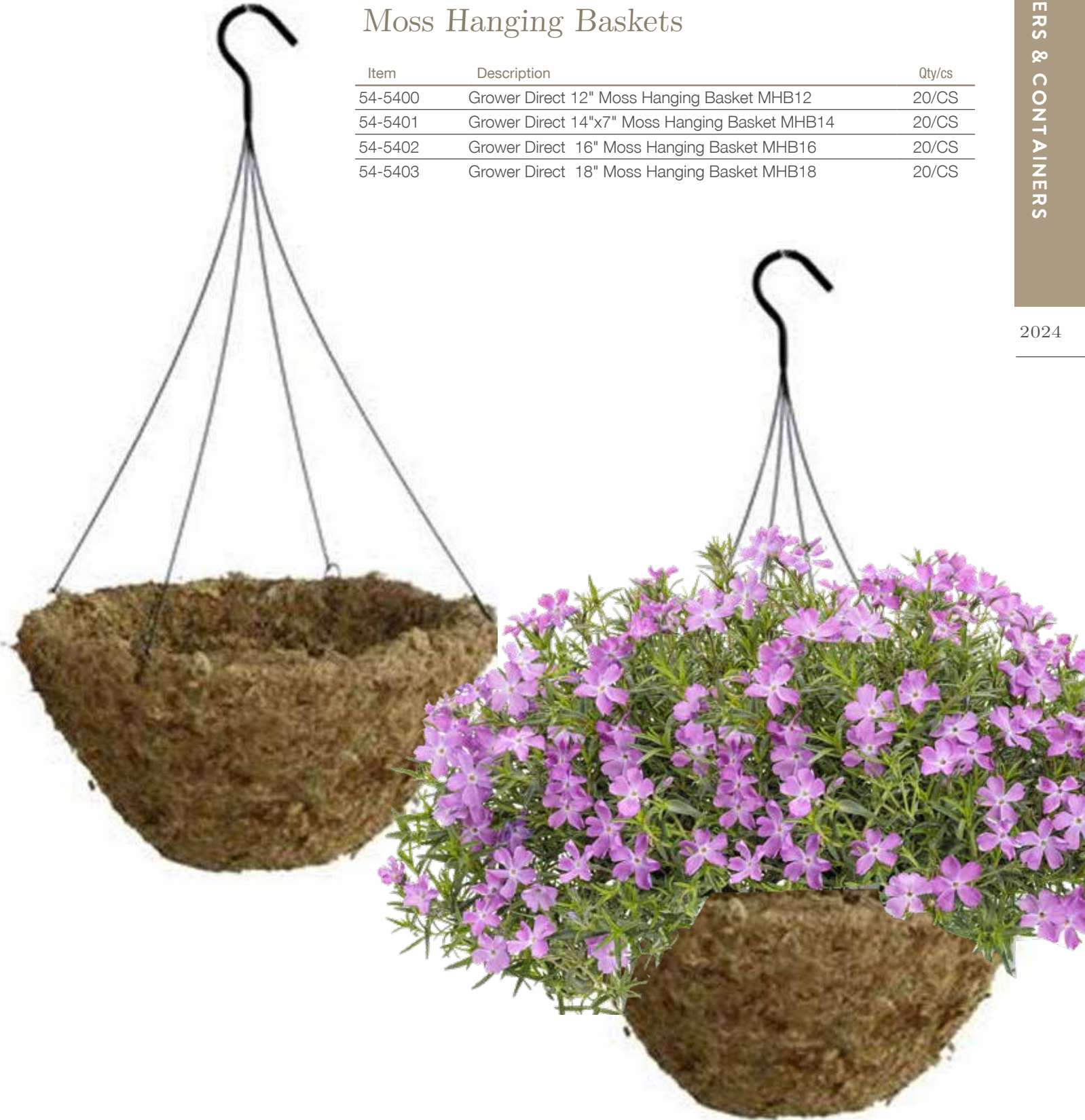



Leader in Horticultural Containers

EcoGrow[®]

EcoGrow[™]

100% Biodegradable & Compostable Container

EcoGrow fiber planting containers breathe like clay pots, provide an optimal environment for root systems, break down quickly when planted or worked into the soil, and are suitable for organic farming. In addition, they are certified by the USDA Biopreferred[®] program as being manufactured of 100% Biobased Content. EcoGrow fiber planting containers are produced in Canada's closed-loop water recycling facility using recycled newsprint and corrugated fibers.



Item	Description	Outside Diameter	Height	Liquid Volume	Tray Type	Compatible Tray	Qty/cs
Pots							
58-10350	3.50 Standard	3.50"	3.25"	10 oz	Plastic	TCR12350	720
58-10377	3.75 Standard	3.88"	3.38"	12.4 oz	Fiber	FCT10400	625
58-10401	4.00 Standard	4.00"	3.50"	14.4 oz	Plastic	TCR10400	625
58-10450	4.5 Geranium	4.50"	3.75"	1.27 pt	Plastic	TRS10450	322
58-10500	5.00 Azalea	5.00"	3.62"	1.48 pt	Plastic	TCA08500	336
58-10510	5.0 Standard	5.00"	4.75"	1.00 qt	Plastic	TRS08510	272
58-10600	6.00 Azalea	6.00"	4.25"	1.32 qt.	Plastic		156
58-10427	4.25 Standard Organic Round	4.25"	3.62"	1.13 pt	Plastic	TCG10430	500
					Volume		
Item	Description	Length	Width	Height	Liters	Qty/cs	
Trays							
58-10460	EcoGrow [™] 1020 True Micro Tray	20.0"	10.0"	1.5"	5.67 L	440	
58-10461	EcoGrow [™] 1020 True Micro Tray	20.0"	10.0"	1.5"	5.67 L	25	



FiberGrow® Paks

North America's No. 1 fiber pak!

- De-nest quickly
- Breathe like clay
- Forgive overwatering
- No sharp edges
- Insulate roots

Item	Description	Qty/cs
57-1030	128 RCP 5½" x 5" x 2¼"	500
57-1045	135 RCP 6½" x 5½" x 2¼"	500
57-1050	136D 6¼" x 5½" x 3"	300
57-1070	144 RCP 7½" x 5½" x 2¼"	250
57-1075	148 RCP 8" x 6¼" x 3"	250
57-1080	157 RCP 8½" x 6¼" x 2¼"	200
57-1085	160 RCP 10¼" x 6¼" x 3"	200
57-1095	1120 Flat RCP 12" x 10" x 3"	100



FiberGrow® Pak Strips

FiberGrow® is Better

Automatic: These rugged strips come out of the carton easily and run through a flat filler perfectly. They separate quickly with no sharp corners. The KF Series fits 11" x 2" standard flat.

Specialty Strips: The S144 strip fits the 144 plastic carrier and the NC 142 fits the NC 142 Carrier, listed on page 145.

Item	Description	Qty/cs
57-1135	KF601 Strip 10½" x 21" x 2½"	50
57-1137	KF601D Strip 10½" x 21" x 3"	50
57-1140	KF801 Strip 10½" x 21" x 2½"	50
57-1145	KF1001 10½" x 21" x 2½"	50
57-1160	KF 3½" Sq. Pot 18-3¼" Pots	50
57-1165	KF 4½" Sq. Pot 8-4½" Pots	50
57-1245	S144 Strip 17½" x 15½" x 2¼"	50
57-1255	NC142 Strip 15½" x 13½" x 3"	50



FiberGrow® Pots

Better Quality

FiberGrow® breathes much like clay so plants are able to develop much healthier root systems because of the improved aeration. This is especially important in the winter when soil in plastic pots often remains too moist for good root development. Larger sizes available.

Item	Description	Dia. x Ht.	Qty/cs
58-1035	2S44 Square	4" x 3¾"	400
58-1055	2R44 Round	4" x 3¾"	400
58-1060	2R44H Round	4" x 3¾"	500
58-1065	2R55 Round	5" x 4¾"	250
58-1075	2R65 Round	5¾" x 5½"	100





Leader in Horticultural Containers

FIBER GROW



FiberGrow® Patio Planters

FiberGrow® planters are constructed with recycled paper and are durable and crush proof. These planters have an appealing natural appearance.

Item	Vendor	Description	Qty/cs
58-1325	SP66	6" Square Patio Planter	60
58-1330	SP99	10" Square Patio Planter	40
58-1355	HX1210	12" Diameter Hexagonal Patio Pot	20
58-1370	DX1508	15" x 8" Decagon Patio Planter	20
58-1375	PP1506	15" x 6" Round Patio Planter	25
58-1380	PP1808	18" x 8" Round Patio Planter	20
58-1390	PP1606	16" Rectangular Patio Planter 16" x 7½" x 5"	24
58-1365	GP2406	24" x 6" Deep Balcony Planter	12
58-1360	RL1209	12" Diameter Liner for Urns	20

FiberGrow® Hanging Pots

FiberGrow® enhances customer appeal and increases profit potential. It is strongly suggested that short-term annual crops planted in soilless mix use the Grommeted Hanging Baskets. Clip-on Swivel Wire assembly and hanger should be used for longer-term/heavier soil crops.

Item	Vendor	Description	Qty/cs
58-133512	HB1207	12" Hanging Basket	12
58-15541	HB1409	14" Hanging Basket Water Saver - No Grommets	6
58-13456	HB1610	16" Hanging Basket Water Saver	6



WaxTough FiberGrow® Hanging Pots

- Waxed Pots are for use in areas with high humidity and long growing seasons
- Wax fortified FiberGrow® Pots are a rich dark earth tone shade
- Full soil volume design maximizes available water capacity
- Fiber breathes like clay improving soil aeration promoting a healthy root environment
- Fiber Containers insulate roots from variations in soil temperature
- Easy to assemble and plant, they are more cost effective than moss or coco
- All grommeted for hangers (hangers sold separately)



Item	Vendor	Description	Qty/cs
58-145212	FHB1000WAX	10" WaxTough HB WG	12
58-144812	FHF1200WAX	12" Floral WaxTough HB WG	12
58-144912	FHS1200WAX	12" Sq. WaxTough HB WG	12
58-145012	FHR1200WAX	12" Rnd. WaxTough HB WG	12
58-14546	FHR1400WAX	14" Rnd. WaxTough HB WG	6
58-1548	FHE12000	12" WaxTough Beehive LX HB WG	12
58-1552	FHE14000	14" WaxTough Beehive HB WG	6
58-14656	FHB1800WAX	18" WaxTough HB	6



Hangers for FiberGrow® Hanging Pots

Item	Vendor	Description	Qty/cs
58-1341	FHZSA12	12" Wire Assembly and Hanger for HB1207	36
58-1555	HB1409A	14" Wire Assembly and Hanger for FHR14000WAX	12
58-1350	HB1610A	16" Wire Assembly and Hanger for HB1610	12
58-145525	HZP24LFG6	4-Strand Plastic Hanger	24
58-1250	HZSSL19	19.0 4-Strand Swivel Wire Hanger	12
58-1255	HZSSL22	22.0 4-Strand Heavy Duty Swivel Wire Hanger	12
58-1437	FHZSL4HD	22.5" 4D Short Wire Hanger	36
58-1343	HB1810A	18.0" HB1810A Assembly Hoop & Wire	12

FiberGrow® Nursery Pots

Available in a wide variety of sizes suitable for container grown stock. FiberGrow® insulates roots from temperature fluctuations, breathes like clay, improves aeration and promotes a healthier root system. These natural looking pots are made with recycled paper.



Leader in Horticultural Containers



- Built to take the abuse of field potting, transport, several handlings and a whole season in the retail center.
- Stackable and crushproof, the root ball remains protected during the complete cycle.
- Easy to handle and naturally attractive.

Item	Description	Dia. x Ht. (ID.)	Qty/cs
58-1125	3R66 .8 gal.	6½" x 6"	80
58-1135	3R67T Thinwall	6" x 7"	70
58-1145	3R77 1.1 gal.	7½" x 7"	70
58-1155	3R88 1.5 gal.	8½" x 8½"	35
58-1160	3R89 Rose Pot	8" x 8½"	35
58-1165	3R89-T Rose Pot	8½" x 8½"	40
58-1175	3R910 2.3 gal.	9½" x 9½"	25
58-1185	3R1011 2.9 gal.	10½" x 10½"	25
58-1200	3R1112 3.8 gal.	11½" x 11½"	20
58-1215	3R1312 4.9 gal.	13" x 11½"	20
58-1230	3R1514 7.6 gal.	15" x 13½"	15
58-1235	3R1815 11.8 gal.	18½" x 14"	10
58-1240	3R2014 14.9 gal.	20" x 14"	10
Fiber Pans			
58-1140	3R76 7" Pan	7½" x 6"	70
58-1090	2R86 8.5" Mum Pan	8½" x 5½"	50
58-1170	3R96 9" Pan	9½" x 6½"	25
58-1180	3R1005 10.5" Pot	9½" x 5½"	30
58-1190	3R1106 10.75" Pot	10½" x 6"	30
Bulk FiberGrow			
58-10901	2R86 8.5" Mum Pan Bulk	8½" x 5½"	1,200



Greenhouse Accessories

Wire Extension Hangers

Item	Description	Qty/cs
51-9660	6" Long Extension Hanger	100
51-9670	12" Long Extension Hanger	100
51-9680	17" Long Extension Hanger	100
51-9690	24" Long Extension Hanger	100
51-4636	36" Long Extension Hanger	50

Extra Purlin Pipe

Add extra purlin pipe to give you more hanging pot space.

Item	Description
02-3150	16' 2½" x 1.315" OD x 17 GA Swedge Purlin Pipe



16" Living Wreath Form

Item#	Description	Qty
51-9600	Living Wreath Form	5/cs



Refer to the Retail Catalog for AquaSav Replacement Liners



2024

AquaSav™ Grower Coco Baskets, Planters and Accessories

How it's Built

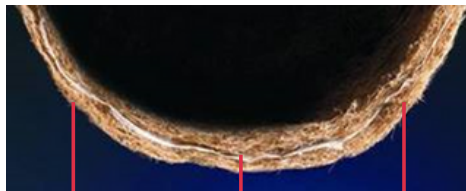

BUILT-IN WATER TRAY
2 LAYERS OF COCO FIBER
BOUND BY NATURAL LATEX

How it Works

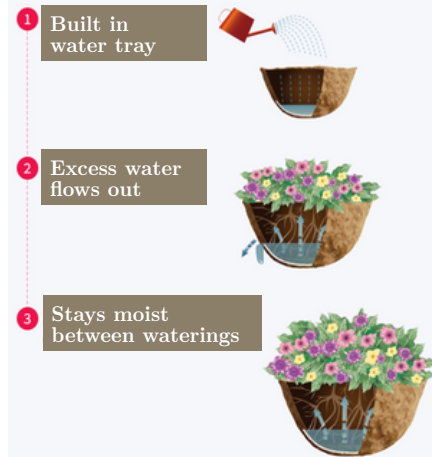

How it Helps

- Retains Water
- Prevents Fertilizer Run Off
- Holds Nutrients for Faster Plant Growth
- Cuts Down Consumer Watering Cycle by 50%

AquaSav™ Grower Hanging Baskets

Item	Description	Vendor	Color	Hanger	Top Diameter x Height	US Liquid Volume	Qty
P5108PB	8.00 HB	5108PB	BLK	3S wire	8" x 5"	0.65 GAL	25
P5108BC	8.00 HB	5108PBC	BLK	3S wire	8" x 5"	0.65 GAL	2500
P5108PB	8.00 Cone HB	5108CP	BLK	3S wire & Stand	8" x 10"	0.85 GAL	25
P5108CPC	8.00 Cone HB	5108CPC	BLK	3S wire & Stand	8" x 10"	0.85 GAL	960
P5108PB	12.00 HB	5112PB	BLK	3S wire	12" x 6"	2 GAL	25
P5108PB	12.00 HB	5112PBC	BLK	3S wire	12" x 6"	2 GAL	1200
P5108PB	12.00 Cone HB	5102HB	BLK	4S wire & Stand	12" x 18"	3 GAL	12
P19450C	12.00 Lattice HB	19450C	BLK	3S wire	12" x 6"	2 GAL	1200
P99256C	12.00 Parisian HB	99256	BLK	3S Plastic	12" x 6"	2 GAL	1200
P99247C	12.00 Suva HB	99247	BLK	3S Plastic	12" x 6"	2 GAL	1200
P19451C	14.00 Lattice HB	19451C	BLK	3S wire	14" x 7"	3 GAL	800
P11421C	14.00 Parisian HB	11421C	BLK	4S Plastic	14" x 7"	3 GAL	720
P5103HBC	14.00 Cone HB	5103HBC	BLK	4S wire	14" x 20"	4 GAL	180



AquaSav™ Grower Hanging Baskets with AquaSav™ Smart Coco Liners

Item	Description	Vendor	Color	Hanger	Top Diameter x Height	US Liquid Volume	Qty
P5114PB	14.00 HB	5114PB	BLK	3S wire	14" x 7"	3 GAL	25
P5114PBC	14.00 HB	5114PBC	BLK	3S wire	14" x 7"	3 GAL	800
P5116PB	16.00 HB	5116PB	BLK	4S wire	16" x 7"	4 GAL	25
P5116PBC	16.00 HB	5116PBC	BLK	4S wire	16" x 7"	4 GAL	720
P19455C	16.00 Lattice HB	19455C	BLK	4S wire	16" x 7"	4 GAL	720
P5118PB	18.00 HB	5118PB	BLK	4S wire	18" x 8"	5 GAL	25
P5118PBC	18.00 HB	5118PBC	BLK	4S wire	18" x 8"	5 GAL	320
P5120XB	20.00 HB Deep	5120XB	BLK	4S chain	20" x 10"	7 GAL	12
P5120XBC	20.00 HB Deep	5120XBC	BLK	4S chain	20" x 10"	7 GAL	250
P5124XB12	24.00 HB Deep	5124XB	BLK	4S chain	24" x 14"	9 GAL	12
P5124XBC	24.00 HB Deep	5124XBC	BLK	4S chain	24" x 14"	9 GAL	140



AquaSav™ Artisan Hanging Baskets

Item	Description	Vendor	Color	Hanger	Top Diameter x Height	US Liquid Volume	Qty
P4100C	12.00 Savona HB	41000	BLK	3S Plastic	12" x 6"	2 GAL	1000
P1008C	14.00 Savona HB	41008C	BLK	3S Plastic	14" x 7"	3 GAL	800
P41029C	14.00 Savona Urn	41029C	BLK	No Hanger	14" x 10"	3 GAL	600
P41031C	12.00 Bali HB	41031C	GOLD	3S Plastic	12" x 7"	2 GAL	1000
P41040C	12.00 Rio HB	41040C	SILVER	3S Plastic	12" x 7"	2 GAL	800
P41412C	14.00 Marrakesh HB	41412C	GARDENIA	4S Plastic	14" x 9"	3 GAL	600
P41408C	14.00 Plaid HB	41408C	BLK	4S Plastic	14" x 9"	3 GAL	600
P44910C	14.00 Dalian HB	44910C	BLK	4S Plastic	14" x 8"	3 GAL	600



AquaSav™ Window/Deck, Patio & Wall Planters

Item	Description	Vendor	Color	Dimensions	US Liquid Volume	Qty
P99261	13.00 Parisian Wall Planter	99261	BLK	13" x 8" x 20"	1.5 GAL	540
P99167C	13.00 Suva Wall Planter	99167	BLK	13" x 8" x 20"	1.5 GAL	540
P51316	14.00 4 x 4 Post Planter	51316	BLK	16" x 16" x 8"	4 GAL	12
P51316C	14.00 4 x 4 Post Planter	51316C	BLK	16" x 16" x 8"	4 GAL	400
P99212C	14.00 Suva Welcome Stand	99212	BLK	14" x 10.5" (24" TH)	3.5 GAL	315
P36106C	14.00 Kensington Welcome Stand	36106	BLK	14" x 10.5" (24" TH)	3.5 GAL	315
P36105	24.00 Kensington Window/Deck Planter	36105	BLK	24" x 7" x 7"	5 GAL	6
P19453	24.00 Lattice Window/Deck Planter	19453	BLK	24" x 8" x 8"	5 GAL	6



AquaSav™ Coco Critters

Item	Description	Vendor	Color	Top Diameter x Height	US Liquid Volume	Qty
See Below	4.00 Drop In Coco Critter	See Below	BROWN	Varies	1 QT	12

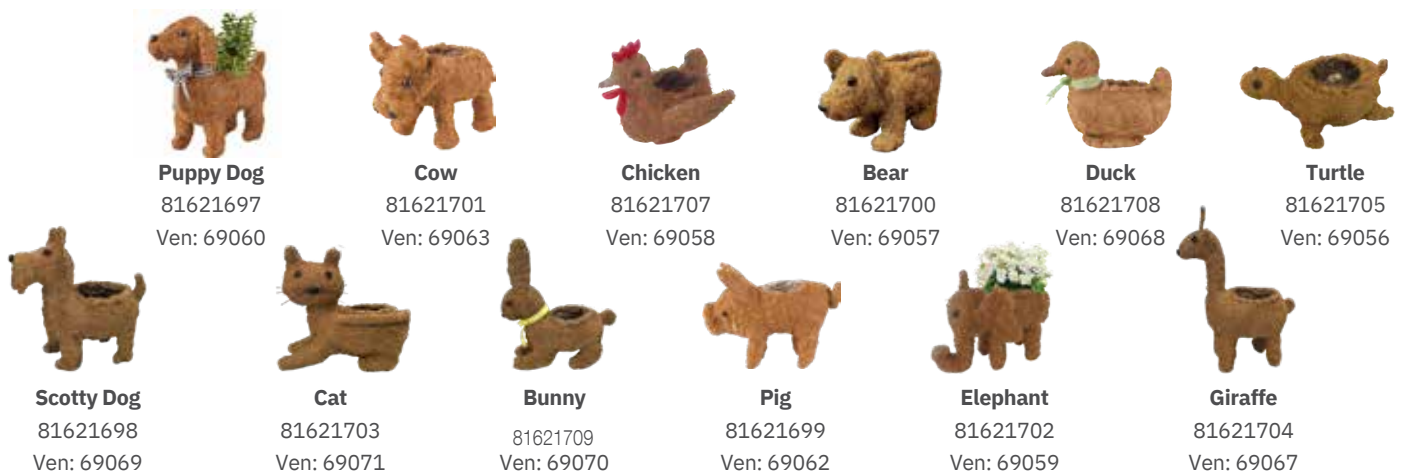

Puppy Dog
81621697
Ven: 69060

Cow
81621701
Ven: 69063

Chicken
81621707
Ven: 69058

Bear
81621700
Ven: 69057

Duck
81621708
Ven: 69068

Turtle
81621705
Ven: 69056

Scotty Dog
81621698
Ven: 69069

Cat
81621703
Ven: 69071

Bunny
81621709
Ven: 69070

Pig
81621699
Ven: 69062

Elephant
81621702
Ven: 69059

Giraffe
81621704
Ven: 69067



Western Pulp Product Company

Premium Quality Molded Fiber Containers

- Heavy duty design, breathable, insulating
- Best in quality since 1958
- Made in the USA from 100% recycled paper

2024

Nursery Containers

Microporous, wax permeated fiber breaths for great root growth. Designed to be planted Pot 'n All to reduce transplant shock. Ask about bulk and case pallets.

Item	Vendor #	Description	Qty/cs
100112	1001-012	6X6 RD, 2.48 qt	44
100312	1003-012	7x7 RD, 1.03 gal	44
100512	1005-012	7x9 RD, 1.28 gal	40
100912	1009-012	8x6 RD, 1.04 gal	68
101114	1011-014	8x8 RD, 1.62 gal	40
101212	1012-012	9x9 RD, 1.80 gal	40
101612	1016-012	10x10 RD, 2.55 gal	36
101912	1019-012	11x11 SQ, 3.77 gal	36
102112	1021-012	12x8 RD, 2.74 gal	40
102312	1023-012	12x11 RD, 3.40 gal	32
102912	1029-012	13x12 RD, 5.52 gal	28
103112	1031-012	15x10 RD, 4.28 gal	20
103312	1033-012	15x13 RD, 6.55 gal	16
103512	1035-012	15x16 RD, 7.97 gal	14
103712	1037-012	18x12 RD, 9.90 gal	12
103912	1039-012	18x16 RD, 12.15 gal	10
104012	1040-012	21x12 RD, 12.15 gal	10
104112	1041-012	21x16 RD, 16.11 gal	8
104302	1043-002*	24x18 RD, 23.38 gal	10

*non-stocking at Griffin



8x8 RD



10x10 RD



15x16 RD



21x12 RD

Hanging Baskets

No-rust brass eyelets for use with wire or barbed hangers.
Use easy to install Clip-on nylon hangers on baskets without eyelets.

Item	Vendor #	Description	Eyelet	Qty/cs
105112	1051-012	10RD Basket, 1.34 gal	yes	22
105512	1055-012	12RD Basket, 2.09 gal	yes	22
104522*	1045-022	10SQ Basket, 1.84 gal	yes	22
105912	1059-012	12SQ Basket, 2.80 gal	yes	22
106612	1066-012	12 Cascade basket, 2.34 gal	yes	22
107712	1077-012	10XLRD basket, 1.59 gal	yes	22
107882	1078-082	12XLRD-II Basket, 2.69 gal	no	22
107112*	1071-012	14XLRD Basket, 3.96 gal	yes	20
106912	1069-012	16X8 Garden Bskt, 4.43 gal	no	20
103812	1038-012	18X10 Garden Bskt, 5.99 gal	no	20
888514	8885-014	Nylon barbed hanger for 10" & 12" eyelet baskets	n/a	22/bag (20 bags/cs)
888534	8885-034	Clip on nylon hanger for 10" & 12" baskets	n/a	22/bag (14 bags/cs)
888802	8888-002	HD Metal Hanger for all 10", 12", and 14" baskets	n/a	100/bag
888612	8886-012	26" Swivel hanger, fits all 10", 12", and 14" baskets	n/a	20/bag
888111	8881-011	Metal hanger for 16" garden baskets	n/a	20
888211	8882-011	Metal hanger for 18" garden baskets	n/a	20

*non-stocking at Griffin



12 RD



12 SQ



14 XL



16 Garden

Patio Planters

Waxed and unwaxed options are consumer favorites.

Item	Vendor #	Description	Waxed	Qty/cs
102212	1022-012	12x5 RD, 1.56 gal	no	50
105412	1054-012	15x6 RD, 2.98 gal	no	40
103612	1036-012	18x8 RD, 5.65 gal	no	20
106012	1060-012	21X8 RD, 7.21 gal	no	16
107312	1073-012	10 Traditional, 2.13 gal	yes	16
103212*	1032-012	12 Traditional, 3.30 gal	yes	16
103412	1034-012	14 Traditional, 5.20 gal	yes	16
109612	1096-012	10 Bell, 1.90 gal	yes	16
109712	1097-012	12 Bell, 3.35 gal	yes	16
109812	1098-012	14 Bell, 5.28 gal	yes	16

*non-stocking at Griffin



18x8 RD



15x6 RD



12 Bell GP



14 Trad GP



Plant Best Coco Coir Pots

Item	Description	Qty	Tray
81910021	Plant Best 3.25" Biodegradable Coco Coir Pot Bulk (A)	1540	HC Companies - MPB06355
81910022	Plant Best 4.25" Biodegradable Coco Coir Pot Bulk (B)	1032	HC Companies - TRS10400, TCR10400, TCR15400, TRS14400, TCR06400, TRS06400, TRS08400, TRS15400, TRS15409, FCT12000
81910023	Plant Best 4.00" Tall Biodegradable CocoCoir Pot Blk	1344	HC Companies - TRS101P, TIS40101, TRS101P
81910026	Plant Best 5.00" Biodegradable Coco Coir Pot Bulk	320	HC Companies - TRS08500, TCA08502
81910031	Plant Best 4.25" Sq. Biodegradable Coc Coir Pot Blk	600	HC Companies - TRK10450, TRK12450
81910133	Plant Best 1 Gallon Fiber Grow Coir Round Pot (D)	264	HC Companies - TRS06170, TRPTGAL0, TCW03SG0
81910047	Plant Best 6" Vented High Dome (10x20) (E)	18	Most 10x20 Trays from any manufacturer



Jiffy Pots



The Compostable Classic

You can use Jiffy Pots anywhere: from very traditional greenhouses, to the most advanced high-tech vertical hydroponic farms. Jiffy Pots Original are also home-compostable and approved for organic production. They are also well-suited to mechanical handling thanks to newly-added de-stacking features. No chemicals are used during the manufacture of Jiffy Pots, which makes them the number-one choice for food crops.

Item	Vendor	Description	Pots/ cs	Pots/Std1020 Flat
60-2021	119	2" rd. x 2" dp. pot with slits	3564	45
60-2026	122	2 1/4" rd. x 2 1/4" dp.	2816	32
60-2028	127	2.75 rd. 3.5 dp. pot	1372	
60-2036	130	3" rd. x 3" dp.	1404	18
60-2262	144	4" rd. x 3 3/4" dp. pot with slits	1100	13
60-2038	132	3" rd. x 4 1/2" dp.	1080	
60-2041	150	5" rd. x 4" dp.	600	
60-2040	340	4 1/2" rd. x 4" dp.	960	14
60-2042	160	6" rd. x 5" dp.	198	
60-2066	230	3" sq. x 3" dp.	1260	18
60-2071	240	3 1/2" sq. x 4" dp. pot with slits	800	
60-2023	245	4.1"x 5.1" Sq with hole	640	
60-2022	119 (1649)	2.17"x 5" Round with slits	3807	
60-2027	122 (1636)	2.4"x 2.2" no hole	3136	
60-2024	170	6.7" x 6" Rd with holes	180	
60-2043	340	4.3 rd. x 3.9" dp	765	
60-2025	117	1.8 x 1.8" pot with slits	3120	



HOME COMPOSTABLE



TIME SAVING



ORGANIC



SUSTAINABLE



ZERO PLASTIC

Strips

Item	Vendor	Description	Pots/ cs	Pots/Std1020 Flat
60-2226	515	12 sq pots/strip 1 1/4" x 2" dp.	7488	98
60-2231	516	10 sq pots/strip 1 3/4" x 2" dp.	5100	50
60-2241	522	12 sq pots/strip 2 1/4" x 2 1/4" dp.	2520	36
60-2247	525	8 sq pots/strip 2 1/2" x 2 1/4" dp.	2304	32
60-2256	527	8 sq pots/strip 2 1/2" x 3" dp.	2560	32
60-2251	530	6 sq pots/strip 3" x 3" dp.	1260	18



Poly-Paks

Item	Vendor	Description	Pots /cs	Sheets /cs
60-2126	218	2" sq. x 2" dp. Jiffy Pots preloaded into a 10" x 20" handling sheet 50/sheet	2300	46
60-2131	220	2" sq. x 3" dp. Jiffy Pots preloaded into a 10" x 20" handling sheet 50/sheet	2000	40
60-2146	529	2 1/2" sq. x 3" dp. Jiffy Pots preloaded into a 10" x 20" handling sheet 32/sheet	1344	42



Jiffy Preforma

Propagation plug solution for every grower

Propagation is easier with Jiffy Preforma plugs, whether you're using seed, cuttings, or tissue culture. Jiffy Preforma plant plug = a mix of a substrate + binder + tray, which gives a high porosity plant plug. With excellent aeration, water-holding, and drainage, every time. Jiffy Preforma provides excellent yields of healthy, usable plants.



CowPots™

Made from composted cow manure, CowPots™ give seedlings a better start. Tender, young roots easily penetrate the sides and bottoms, allowing for unrestricted growth. Plant the whole pot without disturbing roots and eliminate transplant shock. 100% Biodegradable.



Item	Description	Qty/cs	Fits Tray
60-4002	3" Square	1,176	Any 1020 Tray
60-40021	3" Square	400	Any 1020 Tray
60-4004	3" Round	840	ModiForm/EuroDan 3670
60-40041	3" Round	400	ModiForm/EuroDan 3670
60-4006	4" Square	450	Dillen CTS 415
60-40061	4" Square	180	Dillen CTS 415
60-4014	4" Square Tall	330	Dillen CTS 1545 / ITML TRK1045
60-4007	5" Square	192	Dillen CTS 68
60-40081	5" Round	160	Dillen VTA 558
60-4009	6" Square	108	N/A

Item	Description	Qty/cs	Fits Tray
60-40101	6" Round	108	Dillen CTA 66
60-4011	7" Square	90	N/A
60-4012	12" Square	40	N/A
60-4016	17" Round	5	N/A
60-4013	3" Sixcell Tray	50	Any 1020 Tray
60-4017	4" Round Tall	144	Dillen CTS415 / ITML 1045 Carry Tray
60-4018	4" Round Tall	300	Dillen CTS415 / ITML 1045 Carry Tray
60-4019	10 Row Tray	18	Any 1020 Tray

Products are shipped FOB EAST CANAAN, CT

2024

Long Fiber Sphagnum Moss Bale

For use in wire hanging baskets

Item	Description
20-204500*	3.5 Cubic Ft Bale



Refer to page 236 for milled Sphagnum Moss used for seed propagation.



Southern Patio Bushel Basket

Item	Description	Qty/cs
81250755	8" Bushel Basket W/ Drainage Mini Pallet Tan w/ Brown Brush	1,000
81250757	13" Bushel Basket W/ Drainage Mini Pallet Tan w/ Brown Brush	500
81250758	13" Bushel Basket W/ Drainage Mini Pallet Tan w/ Brown Brush	500

Wooden Bushel Baskets

Treated and Untreated

The baskets come in four sizes: bushel, half bushel, peck, and half peck. The bushel and half bushel baskets come with handles.

These baskets are an inexpensive way to add profits to your plant sales. They have traditionally been used for fall mums, but they also lend to very attractive combination planters and patio planters.

Please remember that untreated baskets need to be grown off the ground to ensure that the bottoms do not rot out under long crop conditions like mums. We find most growers transfer the field mums to the baskets before shipping.

2024



Bushel Basket with Handles



Peck Basket



1/2 Peck Basket



1/2 Bushel Basket with Handles

Item	Description
59-2200	Bushel Basket W/Handles (32 Qt) -
59-2202	1/2 Bushel Basket W/Handles (16 Qt) -
59-2205	Peck Basket (8 Qt) -
59-2208	1/2 Peck Basket (4 Qt) -
95-RB04016T	1/2 Bushel Basket W/Handles -
95-RB04032T	Bushel Basket W/Handles -

As with all wood products, to extend the life of wood avoid constant contact with water. Proper air circulation, elevated surfaces and drainage will help extend life. Do not set baskets on bare ground - set on stone or ground cover.



GriffinExpo

SAVE THE DATES!

Virtual Expo

August 19 - October 31, 2024

In-Person Expos

August 28-29, 2024

*Silver State Pavilion at Grand Sierra
Reno, NV (**New Location**)*

September 25-26, 2024

*New Jersey Convention and Expo Center
Edison, NJ*

GROUND COVER



Lumite Blueline Fabricated Ground Cover



2024

The Grower's Choice - The Best Ground Cover You Can Buy

This tightly woven fabric, constructed of tough UV stabilized polypropylene yarn, is designed to inhibit weed growth and improve the aesthetic appearance of professional nurseries.

Lumite's ground cover is:

- UV Stabilized for extended outdoor life
- Low maintenance
- A non-chemical solution for weed infested growing areas
- A cost effective superior alternative to other methods
- Weight is 3.2 oz / sq. yd.

Used for:

- Landscaping
- Shades structures
- Greenhouses
- Under containers or benches

Easy To Install

Available in convenient wide widths, this product can be quickly installed to provide years of service. Simply roll the product out and tack it down.

- Stocked widths up to 15' 6"
- Has blue stripes every 12" for easy pot alignment
- Is built tough to resist tears and punctures

The Woven Fabric - Permeable to Air and Water

1094's tightly woven design allows water and nutrients to pass through, in addition to allowing the ground to breathe.

- Reduces puddling
- Is resistant to most chemicals
- Will not rot, mildew, or become brittle in cold weather
- Helps eliminate odors



Ground Cover Sizes

Item	Description
78-2423	10' x 100' Black
78-2420	3' x 300' Black
78-2422	4' x 300' Black
78-2424	6' x 300' Black
78-2425	10' x 300' Black
78-2430	12' x 300' Black
78-2440	15'6" x 300' Black
78-2445	20' x 300' Black
78-2450	24' x 300' Black

Ground Staples



Item	Description
78-2510	6"-8 gauge 100/bag
78-2515	6"-11 gauge 1,000/cs



Crop Cover

AgroFabric works by establishing a stable, favorable micro-climate by capturing extra heat during the day - and then slowing the loss of stored heat at night from the soil. AgroFabric floats directly over crops without suffocating, crushing or breaking delicate plants. It's porous to air, water and nutrients and UV stable to protect your crops even more.



Lightweight Fabric (Pro 17 - Pro 19 - Pro 25)

- Provides up to 4° frost protection for high-value, frost-sensitive vegetables
- Establish spring transplants, protect from late frosts, extend the growing season and increase yields
- Excellent windbreak, offers effective insect control
- Easy to apply and remove

Medium Weight Fabric (Pro 34)

- Provides up to 4° - 6° frost protection for sensitive ornamentals
- Offers overwintering protection for foliage and woody ornamentals in moderate climates
- Excellent for spring use on nursery stock, foliage and vegetables
- Multi-use potential

Heavy Weight Fabric (Pro 50 - Pro 200)

- Provides up to 6° - 8° frost protection for sensitive ornamentals
- Ideal for overwintering containerized ornamentals
- Gives emergency freeze protection to strawberries, citrus, foliage and nursery stock
- Durable enough for multi-season use

Item	Description
Stocked Sizes	
78-2026	Pro 19 - 6' x 250' - Transmits 95% light
78-2031	Pro 19 - 6' x 2550' - Transmits 95% light
78-2036	Pro 19 - 13' x 300' - Transmits 95% light
Other Sizes Available	
-	Pro 19 - .55 oz sq yd. - Transmits 95% light
-	Pro 25 - 0.75 oz sq yd. - Transmits 85% light
-	Pro 34 - 1.0 oz sq yd. - Transmits 70% light
-	Pro 42 - 1.25 oz sq yd. - Transmits 60% light
-	Pro 50 - 1.5 oz sq yd. - Transmits 50% light
-	Pro 70 - 2.0 oz sq yd. - Transmits 35% light
-	Pro 80 - 2.3 oz sq. yd.- Transmits 35% light
-	Pro 90 - 2.7 oz sq. yd.- Transmits 35% light
-	Pro 100 - 3.0 oz sq. yd.- Transmits 30% light
-	Pro 140 - 4.0 oz sq. yd.- Transmits 25% light
-	Pro 200 - 6.0 oz sq. yd.- Transmits 25% light

Call for quote for custom sizes



MAKE OUTDOOR PRODUCTION MUM-UMENTAL

From garden mums to bare-root perennials, count on Griffin for your green inputs for outdoor production! Your Griffin sales representative can help you develop a winning program – give us a call to get started!

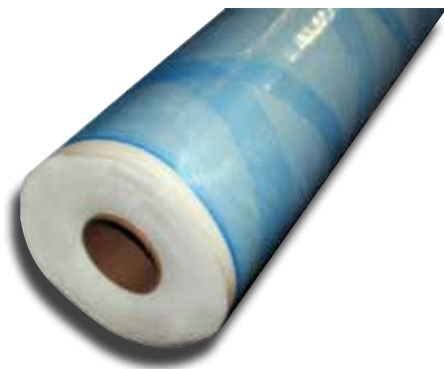

Winter Protection Fabric

Flexible, blanket material used for winter protection of plants. Great resistance to tearing. Applied directly on shrubs or containers. Offers protection: ice, cold, snow, winds, and temperature variations.

- 5-7 year life expectancy
- 6 oz. per square yard

Item: 81-730400 **Size:** 15' x 150' Roll

Other width and lengths are available. Call for more information.

2024



Landscape Fabric 6 year Weed Barrier

Ideal for short-term weed control for annual plantings. This polypropylene product consists of layers that are laminated and spun-bonded for added strength and extra light blockage.

Item #	Description	QTY
80010008	3'x100' Roll	1
80010014	6'x300' Roll	1



Heavy Frost & Cold Protection Crop Cover

Spunbonded Polypropylene

DuPont fabric has a similar crop response to AgroFabric by creating a similar micro-environment. Used as a floating cover, it will last 2-3 seasons or more. DuPont fabric can be used for frost protection up to 6°F, insect protection or for over-wintering, and will last for many seasons.

Specifications: Approx. 10mil, 1.25 oz/yd² white spunbonded polypropylene, 70% transparent.

Stock size available from our warehouse

Item	Description
78-2045	15' x 300' DuPont 1.25oz

* See Overwintering Materials on Page 39

Custom Size / Direct Shipment Only

The four widths shown below can be ordered in lengths from 50 ft. to 500 ft. in 50 ft. increments. Sold as direct shipment only, FOB North Carolina.

Item	Description
78-2005	DuPont in 15' widths
78-2010	DuPont in 30' widths
78-2015	DuPont in 45' widths
78-2020	DuPont in 60' widths



Slitted Row Tunnels

Pre-cut crosswise slits provide a method of ventilating hot air in periods of extreme heat. At night the slits remain closed, reducing the rate of convective heat loss and help to maintain warmer temperatures inside the tunnel. Pre-slitted row covers usually provide from 1°-4°F. frost protection, but more importantly, they elevate daytime air temperatures from 10°-30°F, depending on the sunlight levels.



Uses: Slitted row covers are best suited for northern-most climates where light levels are poor, and the spring warming trend is very slow.

Specifications: .5 mil linear low density clear polyethylene, 95% transparent.

Item	Description	Qty
78-2296	76" Row Cover Hoops 10" Galv. Wire	100
78-21361	Row Covers Clear, Slitted, 6' x 1000'	

GENERAL SUPPLIES

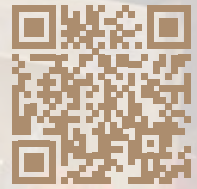

Garden Center Labeling & Tagging Printers



Printer Features

- **Longer Ribbon (984' vs. 244')**
Save money with fewer ribbons & less changeovers
- **More Efficient Calibration**
No labels or tags wasted
- **Integrated Unwinder**
Supports both 1" & 3" cores
- **Faster Printer Speed**
More Labels & Tags in Less Time
- **Adjustable Media Sensor**
Supports Gap, Black Mark, & Side & Center Notches
- **Practically Indestructible Keyboard**
Full size, waterproof keyboard
- **Reduced Cost of Ownership**
3 Year Warranty! Print head – 6 months

NEW AND IMPROVED GC-Select Garden Center Printer *Redesigned in 2023*

**Prints Outdoor Vinyl Tags & Labels...
Waterproof and Sun Resistant!**

Three Label or Tag Formats many more available!



Wrap Around Tag



5" Pot Stake

2" x 1" White
Waterproof Stick-On Label



Printer Models

GC-Select STA

- GC-Select Printer & Keypad
- 3 Formats

GC-Select DLX

- GC-Select Printer & USB Cable
- Label Design Software – Basic

GC-Select Pro

- GC-Select Printer & USB Cable
- Label Design Software – Professional

GC-Select DLX TOTAL

- GC-Select Printer & Keypad
- Label Design Software - Basic
- 3 Formats

GC-SELECT PRO TOTAL

- GC-SELECT Printer and Keyboard
- Label Design Software - Professional
- 3 Formats

Total Select

- Standalone plus PC Software
- Easily upgrade to Total Select from Standalone or PC Software.
 - Quickly & conveniently print waterproof & UV Resistant labels & tags.

Many colors are available for most labels and tags.

Item	Description
42-3000	GC Select-Sta - Stand Alone Printer
42-3005	GC Select-DLX - Printer with PC Basic Software
42-3010	GC Select-PRO - Printer with PC Pro Software
42-3015	GC Select-DLX - Stand Alone Printer with Basic Software
42-3020	GC Select-PRO - Stand Alone Printer with Pro Software
42-3025	GC PRO-Sta Standalone Printer
42-3030	GC PRO-DLX - Printer with PC Basic Software
42-3035	GC PRO-MAX - Printer with PC Pro Software

Item	Description
Labels	
42-2025	3" x 2 ³ / ₈ " White Waterproof Stick on Label 7,200/cs
42-1055	3/4" x 5" White 4 Across Pot Stakes 6,000/cs
42-1094	3/4" x 5" Yellow 4 Across Pot Stakes 6,000/cs
42-1010	1" x 7" White Wrap Around Tags 8,400/cs
42-1090	1" x 7" Yellow Wrap Around Tags 8,400/cs
42-1060	1" x 10" White Wrap Around Tags 6,000/cs
42-1092	1" x 10" Yellow Wrap Around Tags 6,000/cs
42-1015	2" x 1" White Waterproof Stick-On Label 16,560/cs
42-2030	4" x 2" White Waterproof Stick-On Labels 9,000/cs
42-1084	4" x 6" White Waterproof Stick-On Label 900/cs
42-1030	1/2" x 3" White Waterproof Stick-On Plug Tray Label 5,000/cs
42-1005	0.625" x 7" Wrap Around Tree Tag 4,200/cs
Ribbons	
42-1020	3.3" x 244' Black Transfer Ribbon 12 Rolls/cs *For GC-1
42-2020	GC-FLEX Printer Ribbon (6 rolls / cs)
Pricing Gun	
42-1065	Monarch Pricing Gun
42-1070	.75" x .5" Labels Outdoor for Monarch Price Gun 12,000/cs
42-1080	Monarch Large Pricing Gun
42-1082	Outdoor Waterproof Labels for Large Pricing Gun



Treated Burlap Squares (A)

Item	Size	Qty
65SQ28HNR	28" x 28" SQ	100
65SQ30HNR	30" x 30" SQ	100
65SQ32HNR	32" x 32" SQ	100
65SQ36HNR	36" x 36" SQ	100
65SQ40HNR	40" x 40" SQ	100
65SQ45HNR	45" x 45" SQ	50
65SQ48HNR	48" x 48" SQ	50
65SQ54HNR	54" x 54" SQ	50
65SQ60HNR	60" x 60" SQ	50
65SQ72HNR	72" x 72" SQ	25

Non-Treated Burlap Squares (A)

Item	Size	Qty
65SQ32HP	32" x 32" SQ	100
65SQ36HP	36" x 36" SQ	100
65SQ40HP	40" x 40" SQ	100
65SQ48HP	48" x 48" SQ	50
65SQ54HP	54" x 54" SQ	50
65SQ72HP	72" x 72" SQ	25

Burlap Roll (B)

Non-Treated Burlap Roll

Item	Size
65P32100	32" x 100 yd
65P36100	36" x 100 yd
65P48100	48" x 100 yd
65P60100	60" x 100 yd
65P72100	72" x 100 yd

Flagging Tape (C)

Item	Description
65FTB	Blue - 1" x 300'
65FTO	Orange - 1" x 300'
65FTP	Pink - 1" x 300'
65FTR	Red - 1" x 300'
65FTW	White - 1" x 300'
65FTY	Yellow - 1" x 300'

Hardwood Stakes (D)

Hyacinth Stakes- Round pointed & stained green

Item	Size	Qty / Bundle
74-100120	12"	1000
74-100150	15"	1000
74-100180	18"	1000
74-100240	24"	500

Twist-Ems Industrial

Twist Ties (E)

Flat paper tape reinforced with steel wire 1/4" wide and green in color. Quick and easy way of tying plants to a stake.

Item	Size	Qty
88-3025	4"	1000
88-3030	8"	1000
88-3035	16"	1000

Rubber Bands (F)

Constructed with high quality materials to ensure durability and long-life. Packed in 1 lb. bags.

Item	Vendor	Size - L x W
76-300140	79056	14 - 2" x 1/16"
76-300160	79062	16 - 2 1/2" x 1/16"
76-300320	79073	32 - 3" x 1/8"

Polypropylene Twine (G)

Winmore split film polypropylene twine is an industrial strength product used for tying applications. It is manufactured for maximum knot strength retention and hand softness during application.

Item	Description
76-400100	2 lb. Cone Green Twine
76-400400	10 lb. box Tomato Twine Ply 1100 ft

Max Tapener HT-B2 (H)

- 1 machine can tie as much as 4 workers
- Easy to use-makes plant & tree tying faster
- One squeeze of the handle stretches the tape between the jaws, it is ready to wrap around the bamboo stake. A second squeeze automatically staples the tape and cuts it off neatly.

Item	Description	Qty
633705	Max Tapener HT-R2 (Tape Tying Machine)	1
633720	Green Max Tape (.25mm - 100')	10
633708	Staples for Max Tapener HT-B2	4,800
633711	Blades	3

Bamboo - up to 12' lengths!

Natural Tonkin, Green Cane Stakes and Green Split Bamboo Stakes



Bamboo crop supports blend in well with the look of growing things, and enhance the beauty of plants in any situation. The products you see listed here are all fashioned from high quality super strength Chinese bamboo. Bamboo has a very thick wall with a very small hollow core, resulting in a much stronger stake at the same diameter as competing stakes.

2024

Green Cane Stakes

Item	Dimensions	Bale Count
133-0076	1.5' x 3/16"	1000
133-0023	2' x 3/16"	1000
133-0077	2.5' x 1/4"	1000
133-0044	3' x 5/16"	1000
133-0035	4' x 3/8"	500

Green Split

Item	Dimensions	Bale Count
133-0081	12" x 3/16"	5000
133-0082	15" x 3/16"	5000
133-0083	18" x 3/16"	5000
133-0084	24" x 7/32"	2500

Natural Tonkin

Item	Dimensions	Bale Count
133-0057	2' x 5/16"	1000
133-0058	2 1/2' x 3/8"	500
133-0059	3' x 3/8"	500
133-0062	4' x 1/2"	250
133-0038	5' x 1/2"	250
133-0063	6' x 1/2"	200
133-0041	6' x 3/4"	100
133-0066	7' x 5/8"	100
133-0069	8' x 7/8"	50

Larger Diameter

Item	Dimensions	Bale Count
133-0072	10' x 1 1/8"	25
133-0073	12' x 1 1/4"	25

Hoop Trellis

Item	Dimensions	Qty
133-0085	18"	100
133-0086	24"	100
133-0087	30"	100
133-0088	36"	100
133-0152	48"	100

Fan Trellis

Item	Dimensions	Qty
133-0089	18"	50/Bundle
133-0012	24"	50/Bundle
133-0090	30"	50/Bundle
133-0091	36"	50/Bundle
133-0092	48"	50/Bundle



Hoop Trellis

Fan Trellis

Snap-On Stake Fastener

Just push the Snap-On Stake Fastener and it holds the stake to the plant.



Snap-on Stake Fasteners

Item: 0223ROSNAP

Qty: 5,000/box



Identification Card Stand

Light-weight and inexpensive. Put weight support on base.

Item	Model	Qty
51-65118	(A) 18" #414-AF18	50
51-5503	(B) 18" #411-CO18	50
51-5504	30" #411-CO30	50
51-5505	(C) 40" #410-PA40	25

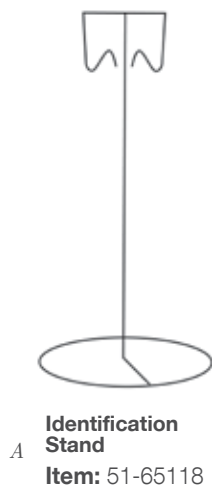

Card Stand for Hanging Basket

7"x 5" blank white sign included in the price. Hang over pipe or into hanging plant.

Item	Model	Qty
51-55018	(D) 18" #412-JCO	50



Coroplast Cards

Item	Description	Qty
51-6675	7" x 5"	50
51-6680	8" x 9"	50

Sign Holders

Galvanized Steel- Heavy Duty

Blank white signs sold separately. Sign base fits all sign holders and is sold separately.

Item	Description	Vendor
86-2125	5"x7" Galvanized Sign Holder with 18" stake	5003B
86-2130	5"x7" Galvanized Sign Holder with 30" stake	5002A
86-2140	11"x7" Galvanized Sign Holder with 30" stake	5001
86-2150	Galvanized Sign Holder Base	5000B
86-2175	7"x5" Blank White Sign	S5014
86-2180	11"x7" Blank White Sign	S5018





Paper Plant Sleeves

Sleeves are manufactured with 50# brown Kraft, water resistant, wet-strength paper. (Holiday Wreath 50# White Kraft Paper not water resistant)

Nested

- Sleeves sit inside one another
- Packed 10 per nest

Benefits:

- Organized and efficient
- Ideal when sleeving on a pole

Pot Sleeves

Item	Vendor	Dimensions B x T x H	Pot size use*	Qty/ctn
87-2526	524B R/D	6" x 22" x 24"	6" - 6½" Azalea	500
87-2546	530A R/D	6½" x 19" x 30"	6" - 6½" Azalea and STD	500
87-2556	730A R/D	9" x 20" x 30"	7" - 7½" Azalea	500
87-2561	948B R/D	12½" x 24" x 48"	9½" - 10" Azalea	250
87-2581	836 B R/D	10½" x 27" x 36"	8" - 9" Azalea, 8" H.B.	300

Hanging Basket Sleeves

Item	Vendor	Dimensions B x T x H	Pot size use*	Qty/ctn
87-2576	824A R/D	10 ½" x 22" x 24"	8" - 9" Hanging basket	500
87-2586	1030A R/D	13 ½" x 24" x 30"	10" Hanging basket	400

*Pot sizes vary from manufacturer to manufacturer. Use chart as a guide only. Actual pot may sit slightly higher or lower in the sleeve.

Satin Plant Sleeves with Holes

- Sleeves are unnested and attached to a wooden header
- Packed 50 per header
- 1000 sleeves per box

Item	Vendor	Dimensions B x T x H	Qty/ctn
87-2588	624Point	8" x 20" x 24"	1000
87-2589	730	9" x 24" x 30"	1000
87-2591	824HB	10 ½" x 22" x 24"	1000
87-2593	830HB	10 ½" x 30" x 30"	1000
87-2594	1030HB	12 ½" x 30" x 30"	500
87-2595	1230HB	16" x 30" x 30"	500
37RD132424	10X24HB	13 ½" x 24" x 24"	1000

Picking the Right Sleeve Size

About special sizes- We're happy to comply!

We stock what we have listed above; however, we receive requests for many other sizes which we supply on a special order basis. Lead time is 4-6 weeks and minimum run amount may apply. Contact your salesperson for details.



Thank You Trunk Liners

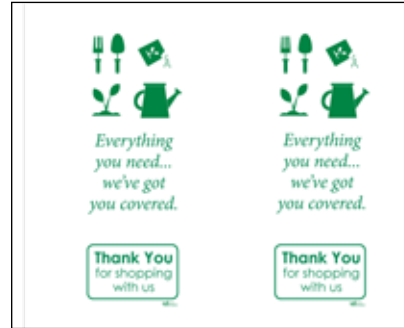

Item: 81550002 Qty: 1,000 Liners/Box

2024



Bagging Machine Bags

Item	Description
87-2130	GV21 Bags (250/roll) Bag size: 13" x 8" x 36"
87-3130*	Continuous Roll Bag. Bag size: 26" x 900' (1 Mil)

*Non-stock Item.

All bags are transparent polyethylene and vented

NOTE: The continuous bag allows you to bag any product regardless of height. Just cut and tie top and bottom to secure.



Polyethylene Utility Bags

- Strong enough for soil!
- Hundreds of uses around the greenhouse!

Item	Description
S15171	11" x 20" Gusseted Bottom 100/bundle
S1738	18" x 30" Gusseted Bottom 100/bundle



Metallic Kwik Covers

Item	Description	Qty
87-20057	(A) 4.0 Std Moss Green	250
87-20166	(C) 4.5 Std Gold	250
87-20165	(B) 4.5 Std Red	250
87-20167	(A) 4.5 Std Moss Green	250
87-24216	(C) 6.0 Az Gold	100
87-24215	(B) 6.0 Az Red	100
87-24217	(A) 6.0 Az Moss Green	100
87-20226	(C) 6.0 Std Gold	100
87-20225	(B) 6.0 Std Red	100
87-20227	(A) 6.0 Std Moss Green	100
87-20007	(C) 6.5 Az Gold	100
87-20006	(B) 6.5 Az Red	100
87-24306	(C) 8.0 Az Gold	100
87-24305	(B) 8.0 Az Red	100
87-24307	(A) 8.0 Az Moss Green	100
87-24386	(C) 10.0 Az Gold	100
87-24385	(B) 10.0 Std Red	100
87-24388	(A) 10.0 Std Moss Green	100

Pearlized Kwik Covers

Item	Description	Qty
87-20268	(D) 4.5 Std Moss Green	250
87-20162	(G) 4.5 Std Lavender	250
87-20163	(E) 4.5 Std Sky Blue	250
87-24211	(F) 6.0 Az Rose Pink	100
87-20222	(G) 6.0 Std Lavender	100
87-20221	(F) 6.0 Std Rose Pink	100
87-20330	(D) 6.0 Std Moss Green	100

Some colors vary by season and subject to seasonal shortages. Other colors are available. Contact your sales rep for a complete listing of available Kwik-Covers.



Embossed Plant Foil Wrap

Used for trimming flower pots & lining or wrapping boxes.

- All colors are silver on one side
- Rolls 20" wide x 50' long
- Colors may be combined for quantity price
- 25 rolls per case

Item	Color
87-1125	Gold
87-1126	Purple
87-1127	Yellow
87-1128	Azalea
87-1129	Pink
87-1130	Nile Green
87-1145	Sky Blue
87-1132	Moss Green
87-1134	Cardinal Red
87-1135	Lavender
87-1136	Hunter Green

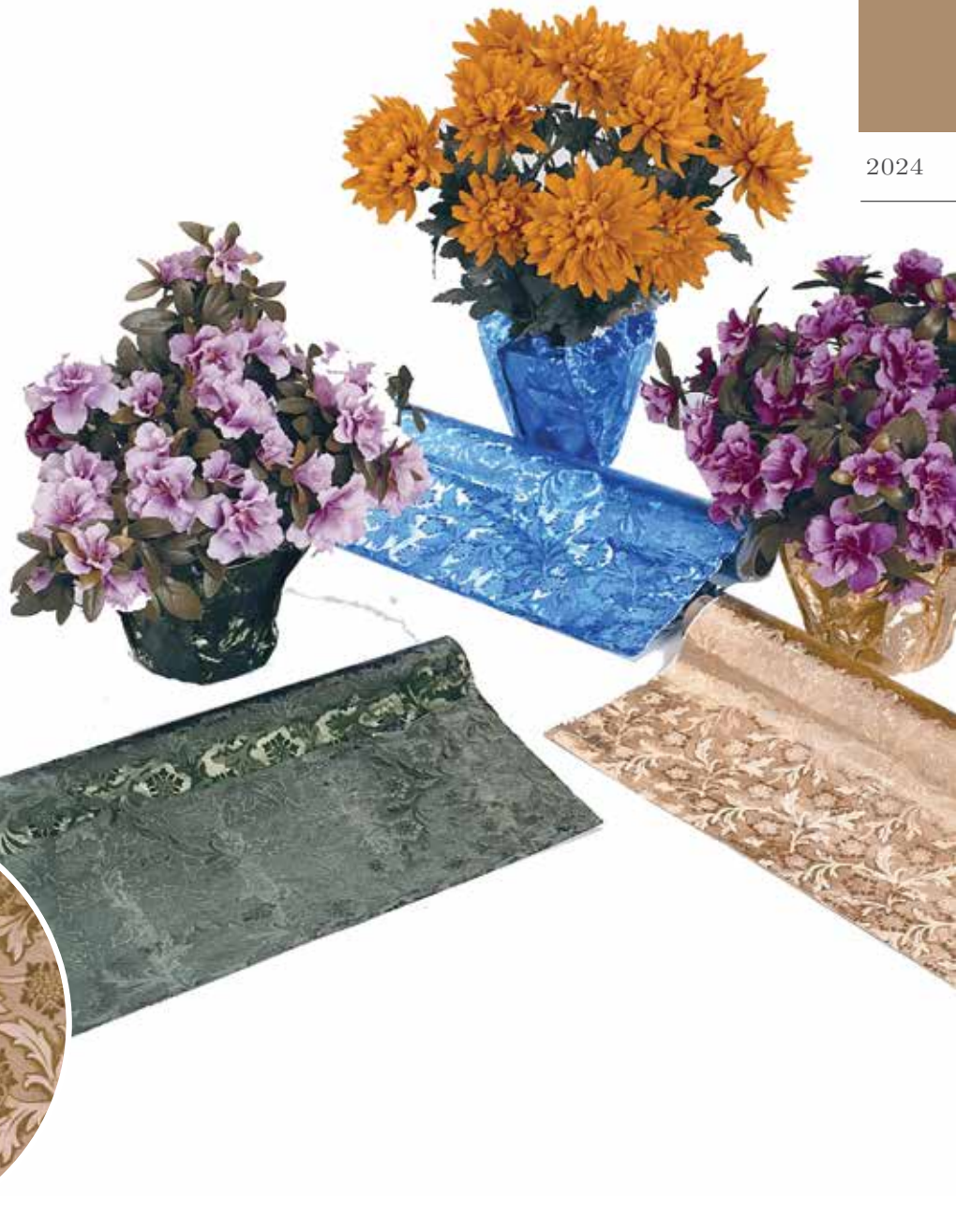

Trellis Netting



2024



Trellis netting is used to support vegetable, cutflower and medicinal crops. Choose from different mesh sizes and product widths to prevent breakage and increase airflow for reduced disease in the crop.

- UV-treated polypropylene stays flexible
- Good visibility with white material
- Three mesh size options for different crop needs
- Very durable - Hortonova tensile ratings up to 70-78 lbs/ft
- Cost-effective, bulk rolls for heavy use rates

Item	Description	Qty
81900065	Tenax Hortonova Trellis Net Sm 36" X 3280' White 5.9"X5.9" Mesh	1
81900104	Tenax Hortonova Trellis Net Sm 48" X 1500' White 5.9"X5.9" Mesh	1
81900076	Tenax Hortonova Trellis Net Sm 48" X 3280' White 5.9"X5.9" Mesh	1
81900079	Tenax Hortonova Trellis Net Lm 59" X 3280' White 5.9"X6.7" Mesh	1
81900081	Tenax Hortonova Trellis Net Lm 67" X 3280' White 5.9"X6.7" Mesh	1
81900089	Tenax Hortonova Trellis Net Lm 79" X 1000' White 5.9"X6.7" Mesh	1
81900090	Tenax Hortonova Trellis Net Lm 79" X 3280' White 5.9"X6.7" Mesh	1
81900112	Tenax Hortonova Trellis Net Lm 120" X 1500' White 5.9"X6.7" Mesh	1
81900113	Tenax Hortonova Trellis Net Lm 120" X 3280' White 5.9"X6.7" Mesh	1
81900298	Tenax Hortonova Trellis Net Sm 79"x 3280' White 4x4 Mesh	1

Live Oak Mum Netting

17" Mum Netting

- For 8" and 10" pots
- Roll size 17" x 3280'
- Net opening 3½" x 3½"

23" Mum Netting

- For 12" and larger pots
- Roll size 23" x 3,280'
- Net opening 3½" x 1½"

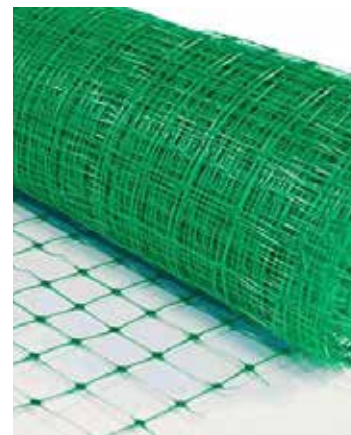

Item	Description	Qty
22-173280	17" Mum Netting 3,280'	1
22-233280	23" Mum Netting 3,280'	1
22-173281	17" x 17" Green Pre-Cut Square	2,200/box
22-233281	23" x 23" Green Pre-Cut Square	2,200/box

MultiLoc Slip-On® Labels

Tie onto nursery stock, hanging baskets, etc.

Item	Description
86-1425	1000 Yellow ¼" x 7" label



Treated Wooden Pot Labels

These labels will biodegrade more rapidly than coated. Labels are not coated.

Item	Size	Qty/Box
86-1025	4" x ⅝"	1000
86-1030	5" x ⅝"	1000
86-1035	6" x ⅝"	1000
86-1040	8" x ⅝"	500
86-1051	12" x 1 ⅛"	250



Bulk Plastic Pot Labels

Item	Size	Qty/Box
86-1125	4"	1000
86-1130	5"	1000
86-1135	6"	1000
86-1140	8"	500





USI BigMouth 12" Thermal Mounting Pouch Laminator

The USI BigMouth (Item #8152) is a mounting pouch laminator. Originally developed by USI in 1985, the BigMouth meets the growing popularity of laminating and mounting items in one step and with only one machine.

- 2 machines in 1: a pouch laminator, and a mounting laminator for more rigid signs
- Ideal for larger items such as documents and displays, and smaller items such as IDs, badges and tags
- Laminates pouch films up to 12" wide and 7 mil thick
- Laminates and mounts pouch boards up to 3/16" thick
- Adjustable temperature
- Very quiet
- Industry-best 2-year warranty
- Free lifetime technical support

Item: 86-4031



Laminator Pouches

A variety of seal pre-cut laminating pouches are available for most laminating needs. Pouches include a non-stick laminating carrier. 9" x 11 1/2"

Item: 86-4045 **Qty:** 100

These items are only a partial list of available laminators and pouches. For more information, please contact your salesperson.



Permanent Markers

- The original pen style permanent marker
- The industry standard
- Permanent on most surfaces
- Fade and water resistant

Item	Color
86-3025	Black*

*For markings constantly exposed to the elements.

Weatherproof Pens for Chalkboard Sign

These colored marking pens are used to put down a colorful, waterproof statement for a plant or display billboard. Colors include: blue, light blue, green, yellow, pink, red, black and white.

Item: 86-1440 **Qty:** 8/Pack





Black Obelisk

Made to look like wrought iron. These obelisks have hook type grips on the bottom of their legs to achieve a secure hold in soil. Steps up the legs allow climbers to attach easily. Two pieces snap easily together.

Item #	Desc	Vendor	CS/UOS
82060090	32"	OB2	25/25

Sign Holder

Tyne classic black sign holders are made of a sturdy UV resistant, black plastic. Securely holds 11" x 7" or 5" x 7" signs in place.

Item #	Desc	Vendor	CS/UOS
82060071	7"x5"	SL904	50/50
82060073	11"x7"	SL911	25/25
82060076	11"x7"	SL605	25/25

Green Tripod

Economically designed with flexible legs to easily insert into soil to form a growing pyramid for vining plants. As the plant grows, it naturally secures itself to small, fine protrusions on the three legs. Top of the tripod features a lug to clip on a label and is soft enough to prevent eye injury.



Item #	Desc	Vendor	CS/UOS
82060092	18"	TR18	50/50
82060093	24"	TR24	50/50
82060094	32"	TR32	50/50

Tan Bamboo-Look

This plastic trellis accents plants with it's natural bamboo look. Designed to insert into potted soil. As the plant grows, roots grip onto the trellis base making it secure enough to be lifted by the top of the trellis for easy transport.



Item #	Desc	Vendor	CS/UOS
82060088	28-3/4"	PS16	50/50
82060089	21-1/2"	PS17	50/50

TY White Heavy Duty Plastic Labels

TY Labels are made from heavy-duty plastic with an ample writing area. They are available in many sizes. They can be used as a stick-in pot label or to attach to a pot with a label gun through pre-punched holes.

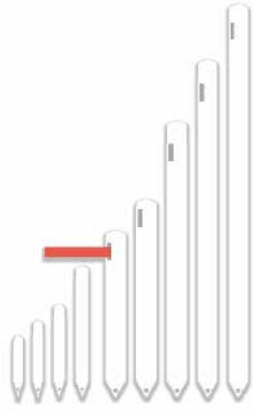

Item #	Desc	Vendor	CS/UOS
82060028	4"	TY4W	1000/1000
82060031	5"	TY5W	1000/1000
82060039	6"	TY6W	1000/1000
82060040	8"	TY8W	500/500

Vinyl Loop Lock Labels

Loop Lock Labels are used to label hanging baskets, vines, bushes, trees, and more! Measures 1/2" wide by 6-1/2" long and has 1000 perforated labels per roll.



Item #	Desc	Vendor	CS/UOS
82060046	White	LL625W	1000/1000
82060047	Yellow	LL625Y	1000/1000

Gro Triangle

Designed to hold three or four canes upright, creating a column. Sized for split or standard canes.



Item #	Vendor	CS/UOS
82060081	GRO-T2	100/100

In-Pot Cane Support

An economical way to reduce the mess and create more saleable items. Cane Supports are designed to grip and hold canes upright and steady in pots, helping to prevent damage to plants. Once the plant is rooted, the pot may be lifted by cane for transport.



Item #	Vendor	CS/UOS
82060084	CBS1	100/100

Angled Marker

The Angled T-label is great for placing near or on the ground for easier viewing. Optional black base is also available and fits all T-label stems.



Item #	Desc	Vendor	CS/UOS
82060018	2-1/2"	SL400W	50/50
82060023	3-7/8"	SL500W	25/25
82060027	Base	BASE	25/25

Blackboard Label

These unique labels are ideal for marking sale items. Also a very economical style - use ordinary chalk or liquid chalk and simply wipe clean to re-use!



Item #	Vendor	CS/UOS
82060057	SL500BB	25/25

Plastic Marker

Straight T-Labels are designed for use where a larger label is needed.



Item #	Vendor	CS/UOS
82060004	SL200W	100/100
82060011	SL445W	50/50

Shipping Trays/Boxes and Staplers

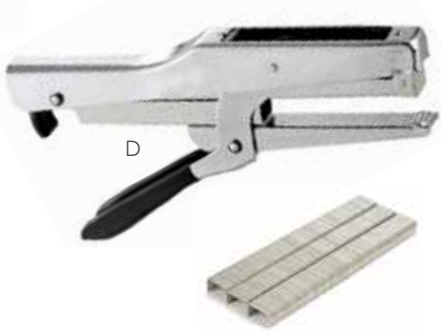

For the shop (D)

P3 - Industrial Plier

This stapling plier is ideal for sealing all kinds of light shipping containers.

Item	Description	Qty/Box
83-2040	P3 - Industrial Plier - Heavy Duty	1
83-2150	SP-19¼" Staples	5,000

Heavy Duty (E)

P6C- 8 Plier

This stapling plier is ideal for sealing all kinds of light shipping containers.

Item	Description	Qty/Box
83-2075	P6 C-8 Plier	1
83-2126	STCR 5019¾" Staples	5,000

Heavy Duty (F)

PC 4000 Tacker

Use it for fastening polyethylene, or wherever a tacking stapler is needed.

Item	Description	Qty/Box
83-2080	PC 4000 Tacker	1
83-2125	STCR 5019¼" Staples	6,000
83-2126	STCR 5019¾" Staples	5,000
83-2129	STCR 5019½" Staples	4,000
83-2128	STCR 5019⅞" Staples	4,000

Beer Boxes (A)

10 ¾" W x 16" L x 2½" D

Item: 87-3030 Qty: 100/Bundle

Self-Locking Plant Trays (B)

No Stapling Required!

17" L x 13" W x 3" D

Item: 87-3065 Qty: 50/Bundle

39 Gauge Eco Stretch Wrap Film (C)

- Extra Strong, 39 Gauge Film
- Holds Up Against Puncturing
- 18" x 1476'

Item: 87-3022 Qty: 4

Thermometers

Wireless Electronic Indoor/ Outdoor Thermometer with Clock (A)

- Wireless Indoor Outdoor Electronic Thermometer
- Outdoor Weather Resistant Temperature Sensor Transmits Data Up To 100 Feet
- Indoor Hygrometer Measures Relative Humidity
- Indoor/ Outdoor Temperature Range From 32°F To 104°F
- Quartz Clock with PM indicator
- Size - 2 13/16" x 4 3/4" x 7/8"
- Size of Remote Sensor - 2 3/4" x 4"

Item: 60-1005



Digital Pocket Thermometer (B)

- Fits in your pocket
- Pocket clip on the back
- Detachable
- Designed with space saving cover that doubles as a handle
- Rubberized handle
- Quick read temperature
- Measures both °F and °C.
- LR44 button battery included
- Materials: plastic and stainless steel

Item: 60-1030

12 1/4" Durable Rain Gauge with Magnified Dial (C)

- Tough all weather molded cases
- Molded in transparent plastic
- Bold numerals for easy viewing at a distance
- UV protected dial ink resists fading

Item: 60-1025





CLS Series Light Duty Grade Radios

- UHF Business Band Operation with 56 selectable UHF frequencies
- 38 analog and 83 digital interference eliminator codes, keypad lock, 3 audible tones
- Compatible with CLP Series and UHF RM & RDX model radios on same frequency and code

Item	Model	Transmit Power	Channels	Weight	Range Indoors (up to)	Range in Warehouse (up to)
83-6070	CLS1110	1 Watt	1	4.5 oz	15 floors	200,000 sq ft
83-6072	CLS1410	1 Watt	4	4.5 oz	15 floors	200,000 sq ft

CP100d Series On-Site Business Two-Way Radios

- Repeater capable
- Exceptionally clear audio: Digital voice pressing with enhanced call signaling ensures faster and more reliable calls.
- Durable and water resistant: Meets Military 810 C,D,E,F and IP54/55 specifications
- Hands-free operation (VOX) with optional accessories

VHF Jobsite Radios -

For Use Outdoors

Item	Model	Transmit Power	Channels	Weight	Range Indoors (up to)	Range in Warehouse (up to)
83-6118	CP100D-VA	5 Watt	16	10.3 oz.	18 floors	300,000 sq. ft

UHF Jobsite Radios -

Best Signal / Range for Use Indoors and Outdoors

Item	Model	Transmit Power	Channels	Weight	Range Indoors (up to)	Range in Warehouse (up to)
83-6120	CP100D-UA	4 Watt	16	10.3 oz.	30 floors	350,000 sq. ft
83-6122	CP100D-UAD	4 Watt	160	10.3 oz.	30 floors	350,000 sq. ft

RM Series Radios

- Durable and water resistant: Meets Military 810 C,D,E,F,G and IP54/55 specifications
- Channel announcement with voice alias
- Easy cloning with single unit charger cloning cable or multi-unit charger
- Hands-free operation (VOX) with optional accessories

RMV2080, RMU2080 and RMU2080d Feature:

NOAA weather radio with alerts on 8 channel models

Item	Model	Transmit Power	Channels	Weight	Range Indoors (up to)	Range in Warehouse (up to)
83-6210	RMU2040	UHF, 2 Watt	4	8.6 oz.	20 floors	250,000 sq ft.
83-6212	RMU2080	UHF, 2 Watt	8	8.6 oz.	20 floors	250,000 sq ft.
83-6216	RMU2080d	UHF, 2 Watt	8	8.6 oz.	20 floors	250,000 sq ft.
83-6214	RMV2080	2 Watt	8	8.9 oz.	20 floors	250,000 sq ft.

Digital Radios

Digital One-to-One Calling - allows you to call and talk privately with a specific user's radio.

Item	Model	Transmit Power	Channels	Weight	Range Indoors (up to)	Range in Warehouse (up to)
83-6124	DTR700	1 Watt	50 Channel	7.87 oz.	30 floors	Up to 350,000 square feet

2024



SOILLESS MIXES & SPECIALTY MEDIA





PRO-MIX

PROFESSIONAL GROWING MIXES



2024

BX Mixes - General Purpose

Features and Benefits

- Traditional peat-based growing medium with perlite
- Contains starter nutrients and pH adjuster
- Multi-purpose, general-purpose mix for transplanting a wide variety of plants species
- Ideal for the production of vegetable transplants in large cell trays
- This product answers the needs of most growing applications
- Light-weight, low bulk-density
- High water-holding capacity
- Vermiculite improves nutrient retention

BX

PRO-MIX® BX is the solution for growers seeking to benefit from perlite's drainage and aeration properties. Combined with high-quality fibrous peat moss, this formulation is ideal for growers looking for a general purpose medium which creates a well-balanced growing environment.

Item: 710B3 **Size:** 2.8 cu. ft. Comp. **Qty/plt:** 57
Item: 65-2005 **Size:** 3.8 cu. ft. Comp. **Qty/plt:** 70

BX MYCORRHIZAE™

The added benefit of Mycorrhizae allows plants better access to nutrients and water for overall improved plant growth. Mycorrhizae expand root system growth, enhance nutrient & water uptake and increase tolerance to abiotic stresses.

Item: 94-1152 **Size:** 2.8 cu. ft. Loose **Qty/plt:** 57
Item: 65-2015 **Size:** 3.8 cu. ft. Comp. **Qty/plt:** 30

BX BIOFUNGICIDE™ + MYCORRHIZAE™

Combining BIOFUNGICIDE™ and Mycorrhizae provides the benefits of reducing incidence of certain plant root diseases (Fusarium, Pythium and Rhizoctonia) and the risk of pathogens developing resistance to chemical fungicides. It also suppresses certain insects, including fungus gnats and thrips that pupate into the growing media, by suppressing their food sources and plant susceptibility.

Item: 94-1140 **Size:** 2.8 cu. ft. Loose **Qty/plt:** 57
Item: 65-2017 **Size:** 3.8 cu. ft. Comp. **Qty/plt:** 30

Product availability varies by location.

Contact our office for direct ship truckloads. Most mixes are available in Mini-bulk & Mega-bale deliveries. Contact our office for details.



HP Mixes - High Porosity

Features and Benefits

- High perlite content, peat-perlite based growing medium
- Low water retention
- Designed for water sensitive crops
- Ideal for cultural conditions with low-light and excess moisture/humidity
- Dries out more frequently than general purpose, peat-based mixes
- Well suited for low-light growing conditions and high humidity
- Difficult to overwater crops
- Reduces incidence of water related problems (root diseases, algae and fungus gnats)
- Holds less water for improved leaching of fertilizer salts during crop cycle

LP15 Mixes - Multipurpose

Features and Benefits

- Multipurpose peat-based growing medium with perlite
- Contains starter nutrients and pH adjusted
- Ideal for short-term transplanting application, such as annuals in bedding trays and pots
- Basic mix for transplanting a wide variety of plant species
- This product answers the needs for short-term crops
- Light-weight, low bulk-density
- High water-holding capacity
- Economic alternative for basic use

HP MYCORRHIZAE™

With a high percent of quality perlite, PRO-MIX® HP® provides a porous environment for growers wanting a growing medium with high air porosity, low water retention and good drainage.

The added benefit of Mycorrhizae allows plants better access to nutrients and water for overall improved plant growth. Mycorrhizae expand root system growth, enhance nutrient & water uptake and increase tolerance to abiotic stresses.

Item: 94-1154 **Size:** 2.8 cu. ft. Loose **Qty/plt:** 57
Item: 65-2040 **Size:** 3.8 cu. ft. Comp. **Qty/plt:** 30

HP BIOFUNGICIDE™ + MYCORRHIZAE™

Combining BIOFUNGICIDE™ and Mycorrhizae provides plants the benefits of reducing incidence of certain plant root diseases (Fusarium, Pythium and Rhizoctonia) and risk of pathogens developing resistance to chemical fungicides. It also suppresses certain insects, including fungus gnats and thrips that pupate into the growing media, by suppressing their food sources and plant susceptibility.

Item: 94-1170 **Size:** 2.8 cu. ft. Loose **Qty/plt:** 57
Item: 65-2044 **Size:** 3.8 cu.ft Comp. **Qty/plt:** 30

HP + MYCORRHIZAE OPEN TOP GROW BAG

The PRO-MIX HP Mycorrhizae Open Top Grow Bag offers the quality performance of Premier's high porosity peat-based mix, but in a new delivery system for growers. The Open Top Grow Bag is deployed easily into production by tearing off the opening and then transplanting directly into the media. This system streamlines production for a cleaner and faster crop turnaround. Ideal for water-sensitive crops, low-light conditions, high humidity, and scenarios where increased drainage and porosity are needed. Equivalent pot sizes 0.5 cu. ft. bag = 3.5-gallon pot, 1.0 cu. ft. bag = 7-gallon pot.

Item: 94-1301 **Size:** 0.5 cu. ft. **Qty/plt:** 294
Item: 94-1300 **Size:** 1.0 cu.ft. **Qty/plt:** 135

LP15

PRO-MIX® LP15 offers growers the needed flexibility for multiple purposes. LP15 is a complete growing mix with 80-90% peat, perlite, ph adjusted with wetting agent and nutrient starter charge.

Item: 65-2045 **Size:** 3.8 cu. ft. Comp. **Qty/plt:** 30

Contact our office for direct ship truckloads. Most mixes are available in Mini-bulk & Mega-bale deliveries. Contact our office for details.



HPCC Mixes - High Porosity & Chunk Coir

Features and Benefits

- Small to medium particle range consisting of short-fibered peat and horticultural grade perlite
- High moisture retention
- For plug trays (512 and larger cells) and open-seeded trays
- Easy filling of plug trays
- Require less frequent watering than peat/perlite plug mixes
- Contains slightly higher fertilizer than FPX for growers wanting high fertilizer content
- Seedling rootball holds together better at transplanting than peat/perlite germination mixes
- Greater frequency of dry-down periods (compared to general purpose peat-based mixes)
- Grower can more easily leach fertilizer salts during crop cycle
- Difficult to over-water
- Well suited for undesirable, year-round weather conditions

HPCC MYCORRHIZAE™

Lightweight, high-porosity peat-based growing medium that contains chunk coir. It ensures optimum growth, especially when high air capacity and extra drainage are required. It is ideal for water-sensitive crops, rooting cuttings and/or low-light growing conditions that contains a beneficial mycorrhizal inoculum (*Glomus intradices* – *PTB297 technology*). These microscopic fungi attach to and colonize the root systems working in symbiosis with plants. It benefits the plant by increasing water and nutrients acquisition (especially Phosphorus, Copper and Zinc). This symbiotic relationship between fungi and plant, results in an overall improved plant growth. PRO-MIX HPCC MYCORRHIZAE™ is suitable for a wide variety of horticultural plants.

Item: 94-1160 **Size:** 2.8 cu. ft. Loose **Qty/plt:** 57
Item: 65-2050 **Size:** 3.8 cu. ft. Comp. **Qty/plt:** 30

HPCC BIOFUNGICIDE™ + MYCORRHIZAE™

Combining BIOFUNGICIDE™ and Mycorrhizae provides plants the benefits of reducing incidence of plant root diseases (Fusarium, Pythium and Rhizoctonia) and risk of pathogens that developing resistance to chemical fungicides. It also suppresses certain insects, including fungus gnats and thrips that pupate into the growing media, by suppressing their food sources and plant susceptibility.

Item: 94-1165 **Size:** 2.8 cu. ft. Loose **Qty/plt:** 57
Item: 65-2080 **Size:** 3.8 cu. ft. Comp. **Qty/plt:** 30

Contact our office for direct ship truckloads. Most mixes are available in Mini-bulk & Mega-bale deliveries. Contact our office for details.



BK MIXES

BK25

PRO-MIX BK25 peat/bark based, medium-weight growing medium designed for the cultivation of greenhouse horticultural crops in 4" pots or larger. The combination of processed southern pine bark, Sphagnum peat moss and perlite makes for a general purpose product that provides good drainage and medium water retention capacity.

Item: 94-1110 **Size:** 2.8 cu. ft. **Qty/plt:** 48

BK55

PRO-MIX BK55 is a peat/bark based, medium-weight growing medium designed for the cultivation of long-term greenhouse crops and perennials grown outdoors. The combination of processed southern pine bark, Sphagnum peat moss and perlite makes for a good air/water balance. The high percentage of bark adds weight, which is perfect for growers looking for container stability.

Item: 94-1111 **Size:** 2.8 cu. ft. **Qty/plt:** 42

BK55 MYCORRHIZAE

PRO-MIX BK55 is a peat/bark based, medium weight growing medium for the cultivation of long-term greenhouse crops and perennials grown outdoors. The added benefit of Mycorrhizae allows plants better access to nutrients and water for overall improved plant growth. Mycorrhizae expand root system growth, enhance nutrient & water uptake and increase tolerance to abiotic stresses.

Item: 94-1177 **Size:** 2.8 cu. ft. **Qty/plt:** 42

BK25 MYCORRHIZAE

PRO-MIX BK25 is a peat/bark based, medium weight growing medium for the cultivation of greenhouse crops in 4" pots and or larger. The added benefit of Mycorrhizae allows plants better access to nutrients and water for overall improved plant growth. Mycorrhizae expand root system growth, enhance nutrient & water uptake and increase tolerance to abiotic stresses.

Item: 94-1176 **Size:** 2.8 cu. ft. **Qty/plt:** 48

MP MYCORRHIZAE™ ORGANIK™ Mix - Organic Growing



PRO-MIX® MP MYCORRHIZAE™ ORGANIK™ provides the perfect solution for growers in need of an organic-certified growing medium that delivers well balanced air/water qualities. OMRI-Listed, this formulation is ideal for a variety of growing uses and is designed to meet crop requirements for certified organic growers. Enriched with Mycorrhizae, this growing medium will not only improve the overall growth and increase yields of your crops, it will also increase plants resistance to environmental stresses.

Item: 94-1185 **Size:** 2.8 cu. ft. Loose **Qty/plt:** 57
Item: 65-2060 **Size:** 3.8 cu. ft. Comp. **Qty/plt:** 30





2024

BRK MIXES

BRK

Formulated with a base of Sphagnum peat moss, processed pine bark and coarse perlite, PRO MIX® BRK is well suited for growers who require low water retention and frequent dry down periods for their crops. Ideal for outdoor growing conditions subject to variable weather conditions and challenging growing environments. PRO MIX® BRK is carefully designed for high container stability and consistent, predictable results.

Item: 94-1182 **Size:** 2.8 cu ft. **Qty/plt:** 48

BRK MYCORRHIZAE™

The added benefit of Mycorrhizae allows plants better access to nutrients and water for overall improved plant growth. Mycorrhizae expand root system growth, enhance nutrient & water uptake and increase tolerance to abiotic stresses.

Item: 330462P **Size:** 2.8 cu ft. **Qty/plt:** 48

BRK BIOFUNGICIDE™ + MYCORRHIZAE™

Combining BIOFUNGICIDE™ and Mycorrhizae provides the benefits of reducing incidence of certain plant root diseases (Fusarium, Pythium and Rhizoctonia) and the risk of pathogens developing resistance to chemical fungicides. It also suppresses certain insects, including fungus gnats and thrips that pupate into the growing media, by suppressing their food sources and plant susceptibility.

Item: 94-1172 **Size:** 2.8 cu ft. **Qty/plt:** 48

BRK20 MIXES

BRK20

PRO MIX® BRK20 is a medium weight growing medium that offers flexibility for growers. Combining the qualities of processed pine bark, professional-grade Sphagnum peat moss and perlite, PRO MIX® BRK20 creates a favorable root zone environment that is suitable for greenhouse and perennial crops grown in medium-size containers.

Item: 94-1167 **Size:** 2.8 cu ft. **Qty/plt:** 48

BRK20 MYCORRHIZAE™:

The added benefit of Mycorrhizae allows plants better access to nutrients and water for overall improved plant growth. Mycorrhizae expand root system growth, enhance nutrient & water uptake and increase tolerance to abiotic stresses.

Item: 94-1164 **Size:** 2.8 cu ft. **Qty/plt:** 48

BRK20 BIOFUNGICIDE™ + MYCORRHIZAE™:

Combining BIOFUNGICIDE™ and Mycorrhizae provides the benefits of reducing incidence of certain plant root diseases (Fusarium, Pythium and Rhizoctonia) and the risk of pathogens developing resistance to chemical fungicides. It also suppresses certain insects, including fungus gnats and thrips that pupate into the growing media, by suppressing their food sources and plant susceptibility.

Item: 94-1172 **Size:** 2.8 cu ft. **Qty/plt:** 48

PROMIX[®]

BIOFUNGICIDE[™] MYCORRHIZAE[™]

THE VALUE-ADDED COMBINATION

ENHANCE

The use of fertilizer and water. Increase resistance to stresses. Improve plant strength and productivity. Optimize plant growth rate and uniformity.

PROTECT

By reducing incidence of plant root diseases (*Fusarium*, *Pythium* and *Rhizoctonia*) and risk of pathogens that develop resistance to chemical fungicides.

SUPPRESS

Certain insects, including fungus gnats and thrips that pupate into the growing media, by suppressing their food sources and plant susceptibility.



DISCOVER OUR
PRODUCT RANGE

 PREMIER
TECH



1 800 667-5366

VISIT PTHORTICULTURE.COM

PRO-MIX[®] is a registered trademark of Premier Horticulture Ltd. BIOFUNGICIDE[™] and MYCORRHIZAE[™] are trademarks of Premier Tech Ltd. and are used under license by Premier Horticulture Ltd.



PROMIX[®]

**BIOFUNGICIDE[™]
MYCORRHIZAE[™]**

THE VALUE-ADDED COMBINATION

ENHANCE

Plant growth rate and uniformity as well as its resistance to stresses.

PROTECT

By reducing incidence of plant root diseases (*Fusarium*, *Pythium* and *Rhizoctonia*) and risk of certain pathogens.

SUPPRESS

Food sources of certain insects, including fungus gnats and thrips.



VIEW OUR COMPLETE OFFER

P PREMIER
TECH



1800 667-5366

VISIT PTHORTICULTURE.COM

PRO-MIX[®] is a registered trademark of Premier Horticulture Ltd. BIOFUNGICIDE[™] and MYCORRHIZAE[™] are trademarks of Premier Tech Ltd. and are used under license by Premier Horticulture Ltd.





PRO-MIX® ORNAMENTAL CONTAINER FILLING GUIDE

DESCRIPTION	DIMENSIONS (INCH)			VOLUME (CU. IN.)	NUMBER OF POTS FILLED							
	SIZE	TOP	HEIGHT		1 CU. FT.	2.8 CU. FT. LOOSE	3.8 CU. FT. COMP.	55 CU. FT. COMP.	60 CU. FT. LOOSE	80 CU. FT. LOOSE	110 CU. FT. COMP.	135 CU. FT. COMP.
BEDDING TRAYS - CELL PACKS (TRUE SERIES INSERT)	606	10 x 20	3 ¼	323	5	15	37	535	321	428	1,089	1,337
	804	10 x 20	2 ¾	316	5	15	38	547	328	437	1,114	1,367
	806	10 x 20	2 ¾	281	6	17	43	615	369	492	1,252	1,537
	1004	10 x 20	2 ½	292	6	17	41	592	355	473	1,205	1,479
	1201	10 x 20	2 ¾	359	5	13	34	481	289	385	980	1,203
	1203	10 x 20	2 ½	320	5	15	38	540	324	432	1,100	1,350
	1204	10 x 20	2 ¼	264	7	18	46	655	393	524	1,333	1,636
	1206	10 x 20	2 ¾	238	7	20	51	726	436	581	1,479	1,815
	1801	10 x 20	3 ½	398	4	12	30	434	261	347	884	1,085
	1803	10 x 20	2 ¾	217	8	22	56	796	478	637	1,622	1,991
STANDARD POTS	3"	3	2 ¾	14	123	346	864	12,343	7,406	9,874	25,143	30,857
	3.5"	3 ½	3	20	86	242	605	8,640	5,184	6,912	17,600	21,600
	4"	4	3 ½	28	62	173	432	6,171	3,703	4,937	12,572	15,429
	4.5"	4 ½	3 ¾	40	43	121	302	4,320	2,592	3,456	8,800	10,800
	5"	5	5	66	26	73	183	2,618	1,571	2,095	5,333	6,545
	6"	6	5 ¾	112	15	43	108	1,543	926	1,234	3,143	3,857
	8"	8	6 ¾	231	7	21	52	748	449	598	1,524	1,870
HANGING BASKETS	8"	8 ¾	5 ½	178	10	27	68	971	582	777	1,978	2,427
	10"	10 ¾	6 ¾	329	5	15	37	525	315	420	1,070	1,313
	11"	10 ¾	6 ½	400	4	12	30	432	259	346	880	1,080
	12"	12 ¾	7 ½	550	3	9	22	314	189	251	640	785
PERENNIAL & NURSERY CONTAINERS	3.5"sq	3 ½	4	34	51	142	356	5,082	3,049	4,066	10,353	12,706
	4.5"sq	4 ½	5	58	30	83	209	2,979	1,788	2,383	6,069	7,448
	5.5"sq	5 ¾	6 ½	124	14	39	98	1,394	836	1,115	2,839	3,484
	Trade #1	6 ½	5 ¾	166	10	29	73	1,041	625	833	2,120	2,602
	Trade #3	10 ¼	9 ¾	597	3	8	20	289	174	232	590	724
	Trade #5	11	12 ¼	868	2	6	14	199	119	159	406	498
	1 quart	4 ½	4 ½	55	31	88	220	3,142	1,885	2,513	6,400	7,855
	1 gal	6 ¼	6 ¾	146	12	33	83	1,184	710	947	2,411	2,959
	300	6 ½	7	173	10	28	70	997	598	798	2,032	2,494
	600	8 ½	8 ½	462	4	10	26	374	224	299	762	935
1200	11	9 ¾	692	2	7	17	250	150	200	508	624	

TOOL AT YOUR DISPOSAL

on PTHORTICULTURE.COM/en/toolbox



BIOFUNGICIDE™ / BIOSTIMULANT Calculator



BIO. + MYCO Calculator



Make Your Own Mix Cost Calculator



Potting Guides



PRO-MIX RETAIL MIXES

Looking for retail PRO-MIX mixes? Consider combining the retail and grower mixes in one order to allow you to get drop ship pricing. Browse the retail catalog for the full lineup.



PRO-MIX Premium Organic Vegetable & Herb Mix

OMRI-Listed and Ready-to-use, this compost-free, peat-based mix is perfect for all your vegetable, fruit, and herb garden needs, whether in-ground or in containers. It is specially formulated with an organic fertilizer that provides gradual feeding to your plants. The gypsum for amazing tomato growth, and MycoActive™ Organic Growth Enhancer helps produce greater yields and vigorous growth.

Item #	Desc	UPC	Vendor	CS/UOS
80310013	1 cu. ft.	025849111519	1010051RG	120/10
80310014	2 cu. ft.	025849107512	1020051RG	54/6

PRO-MIX Premium Potting Mix Organic

- With MYCOACTIVE® technology
- Formulated with natural ingredients
- Suitable for all container planting needs
- Contains compost-free organic material and mycorrhizae for plant health

Item #	Desc	UPC	Vendor	CS/UOS
80310071	1 cu. ft.	025849111113	1010011RG	120/120

PRO-MIX Premium Garden Mix Organic

- With MYCOACTIVE® technology
- Formulated with natural ingredients
- Ideal for raised beds and all outdoor planting needs
- Contains compost-free organic material and mycorrhizae for plant health

Item #	Desc	UPC	Vendor	CS/UOS
80310072	1 cu. ft.	025849111212	1010021RG	120/120

Premier Sphagnum Peat Moss

Sphagnum peat moss is well suited for both indoor and outdoor applications. It conditions all soils by improving aeration and it is used as a soil amendment for gardens as well as preparation and restoration of lawns.

Item #	Desc	UPC	Vendor	CS/UOS
80310007	1 cu. ft.	025849002626	0262P	100/10
80310001	2 cu. ft.	025849001285	0128P	50/50
80310010	3.8 cu. ft.	025849000820	0082P	30/30

Due to harvest and supply challenges straight peat moss availability at our branches may vary.

PRO-MIX Premium Garden Mix

Perfect for planting in-ground outdoor plants as well as improving the quality of existing garden bed soil. It is specially formulated with a high percentage of peat humus and compost, making it the mix to use for plants that require more stability such as perennials and flowering shrubs. It also contains MycoActive™ Organic Growth Enhancer to produce vigorous growth and healthy plants.

Item #	Desc	UPC	Vendor	CS/UOS
80310027	1 cu. ft.	025849111205	1010020RG	120/10
80310028	2 cu. ft.	025849107208	1010020RG	54/54

PRO-MIX Premium All Purpose Mix

Ready-to-use, this peat-based mix is perfect for indoor and outdoor planting. Specially formulated for a wide range of plant species this mix offers ideal water holding, nutrient retention, and aeration properties. Plus the added benefit of MycoActive™ Organic Growth Enhancer, for guaranteed results!

Item #	Desc	UPC	Vendor	CS/UOS
80310019	2 cu. ft.	025849113308	1020030RG	50/5

PRO-MIX Premium Potting Mix

Ready-to-use, this peat-based mix is perfect for all indoor and outdoor container planting. Specially blended for a wide range of plant species, this formulation provides optimum aeration, drainage and nutrients and features MycoActive™ Organic Growth Enhancer to produce vigorous growth and healthy plants.

Item #	Desc	UPC	Vendor	CS/UOS
80310015	8 qt.	025849109103	1008010RGCE	6/6
80310025	16 qt.	025849110109	1016010RGCE	6/6
80310017	1 cu. ft.	025849111106	1010010RG	120/10
80310053	2 cu. ft.	025849003050	0305RG	35/35
80310018	2 cu. ft.	025849107109	1020010RG	54/54

PRO-MIX

GROWING MEDIA SUGGESTIONS CHART

	Peat	Perlite	Southern Pine Bark	Water Retention	Drainage	Comments
GERMINATION						
FPX BIO-FUNGICIDE	80-90% Fine	Fine	-	Medium	High	
PACKS						
LP15	80-90%	Regular	-	Medium	Medium	
BX	75-85%	Regular	-	Medium	Medium	
HP	65-75%	Regular	-	Low	High	
POTS: 4" - 8"						
LP15	80-90%	Regular	-	Medium	Medium	
BX	75-85%	Regular	-	Medium	Medium	
HP	65-75%	Regular	-	Low	High	
BK25	50-60%	Regular	<1/2 In	Low	Medium	
HANGING BASKETS						
HPCC	65-75%	Regular	-	High	Medium	With Chunk Coir
BX	75-85%	Regular	-	Medium	Medium	
LP15	80-90%	Regular	-	Medium	Medium	
BK25	50-60%	Regular	<1/2 In	Low	Medium	
SPECIALITY CROPS						
MUMS						
BK25	50-60%	Regular	<1/2 In	Low	Medium	
PERENNIALS						
HPCC	65-75%	Regular	-	High	Medium	With Chunk Coir
BK25	50-60%	Regular	<1/2 In	Low	Medium	
BK55	25-35%	Regular	<1/2 In	Low	Med-High	
POINSETTIAS						
LP15	80-90%	Regular	-	Medium	Medium	
HP	65-75%	Regular	-	Low	High	
BX	75-85%	Regular	-	Medium	Medium	

*EC = Electrical conductivity

Recent changes in world markets in the availability of the production of vermiculite have caused shortages of supply. This has resulted in certain PRO-MIX products being discontinued. The following chart suggests alternative PRO-MIX formulations that can be used for similar applications. Note that the alternative formulations include perlite, therefore the water holding capacity is lower and the growing medium may dry out faster than the peat/vermiculite formulations. Growers should try the suggested alternative product prior to converting crops to become accustomed to the water holding capacity and adjust irrigation practices accordingly. For specific product information, refer to PRO-MIX Technical Data Sheets.

PRO-MIX Discontinued Product	PRO-MIX Alternative Product	Product Application/Description	Product Base	Standard	BIOFUNGICIDE	MYCORRHIZAE	BIO + MYCO
PRO-MIX PGX		Germination Medium	peat(F)/vermiculite(F)	X			
suggested product >>	PRO-MIX FPX BIO-FUNGICIDE	Germination Medium	peat(F)/perlite(F)		X		
PRO-MIX BK25-V		General Purpose Peat/Bark Based Medium	peat/25% bark/vermiculite	X		X	
suggested product >>	PRO-MIX BRK20	General Purpose Peat/Bark Based Medium	peat/20% bark/perlite	X		X	X
suggested product >>	PRO-MIX BK25	General Purpose Peat/Bark Based Medium	peat/25% bark/perlite	X		X	
PRO-MIX BK45-V		Peat/Bark Based Medium	peat/45% bark/vermiculite	X		X	
suggested product >>	PRO-MIX BRK	Peat/Bark Based Medium	peat/40% bark/perlite	X		X	X
suggested product >>	PRO-MIX BK55	Peat/Bark Based Medium	peat/55% bark/perlite	X		X	



LAMBERT

PROFESSIONAL GROWING MIXES

History

Lambert Peat Moss Company, founded in 1928, is one of the true pioneers in developing the peat moss industry in North America. With the fourth generation of Lambert still operating from the original location in Rivière-Ouelle, Québec, along the south shore of the St-Lawrence River, we have expanded to several bogs along the north shore and near Lac St-Jean. Starting with the original product line of screened and bagged peat moss, we now offer numerous lines of professional growing mixes and retail potting mixes as well as select types of premium peat moss.

Today, Lambert supplies both the amateur horticulturists and professional growers alike. A nationally based distribution network and strong individual product representation is always bringing new products to the trade. Lambert is able to supply the market at competitive prices to distributors and commercial users throughout Canada, United States and Mexico via ground transportation. In order to offer our clients the most efficient means of transportation, Lambert ships directly from their production plants and from their distribution center in Beloeil, near Montréal, Québec.

Quality First...

A Priority At Lambert

Laboratory Lambert

Quality has always been a priority at Lambert, that's why the company owns a complete quality control laboratory. The laboratory staff developed standards and procedures to make sure that every cubic foot of product that leaves our yard complies with our standards. Quality control procedures are also developed regularly to increase the quality of our products. Procedures can be divided into three areas: chemical, physical and packaging. To comply with chemical standards, our products are sampled and analyzed for pH, EC and S.M.E. levels. To assure that physical standards are respected, we analyze particle size distribution, porosity and moisture content. Also, we regularly measure the yield and the firmness of our bags. Finally we run random greenhouse tests in order to evaluate our products' performances. What is not good for us, is not good for you. Therefore, a product that does not conform completely to one or the other of our tested parameters stay in our yard.

Technical Assistance

Their technical staff made up of experienced agronomists and soil technicians is always ready to help their customers with any questions they may have, whether it is about peat moss or on how to use their different products.

Most Favored EPM Mixes:

Grower Friendly! Very Forgiving Mixes!

EcoPeatPlus+® is a natural wood fiber from the peat bog added to our peat moss to produce superior professional substrates with exceptional ratio of air porosity and water holding capacity.

EPM-40 High Porosity Mix

The great amount of EcoPeatPlus+® enhances drainage and porosity. This media is recommended for use in large container, perennials and nursery crops.

EPM-20 All Purpose Mix

The well balanced amount of EcoPeatPlus+® and perlite provides the ideal general purpose mix in greenhouse production in 4 inch pots and larger.

Lambert... At the root of your success since 1928.





LM & EPM - All Purpose Mixes

LM-111 - All Purpose Mix

Blend of coarse Canadian sphagnum peat moss, chunks and perlite. This media is formulated by combining the major components of both LM-3 and LM-6. A Lambert best seller!

Particle size: Coarse **Drainage:** Medium **Water retention:** Medium

Components:

Canadian sphagnum peat moss (80 - 90%)	Dolomitic limestone
Horticultural perlite	Wetting agent
Calcitic limestone	Starter charge

Item: 149-0036 **Size:** 3.0 cu. ft. Loose **Qty/plt:** 48
Item: 149-0038 **Size:** 3.8 cu. ft. Comp. **Qty/plt:** 30

LM-111 - Organic All Purpose Mix



Blend of coarse premium Canadian sphagnum peat moss, chunks and perlite with an organic wetting agent and an extended-release organic fertilizer. Ideal for plants that require good aeration and drainage. Lambert's best seller in organic available!

Particle size: Coarse **Drainage:** Medium **Water retention:** Medium

Components:

Canadian sphagnum peat moss (80 - 90%)	Dolomitic limestone
Horticultural perlite	Organic Wetting agent
Calcitic limestone	Organic slow release fertilizer

Item: 149-0104 **Size:** 3.0 cu. ft. Loose **Qty/plt:** 48
Item: 149-0106 **Size:** 3.8 cu. ft. Comp. **Qty/plt:** 30

LM-3 - All Purpose Mix

Formulated from a blend of coarse Canadian sphagnum peat moss, coarse perlite and medium vermiculite. This substrate is an excellent general or all purpose media. A Lambert Classic Mix!

Particle size: Coarse **Drainage:** Medium

Water retention: Medium

Components:

Canadian sphagnum peat moss (80 - 90%)	Calcitic limestone
Horticultural perlite	Dolomitic limestone
Horticultural vermiculite	Wetting agent
	Starter charge

Item: 149-0031 **Size:** 3.0 cu. ft. Loose **Qty/plt:** 48
Item: 149-0033 **Size:** 3.8 cu. ft. Comp. **Qty/plt:** 30

LM-191 - All Purpose Mix

LM-191 All Purpose Mix is a less coarse version of our best selling all purpose mix, the LM-111. An additional step in the screening process of the peat was done to allow this all-purpose mix to be more widely adaptable, including the utilization in six pack, 50 and 72 cavities trays.

Particle size: Medium **Drainage:** Medium **Water retention:** Medium

Components:

Canadian sphagnum peat moss (80 - 90%)	Dolomitic limestone
Coarse Horticultural perlite	Wetting agent
Calcitic limestone	Starter charge

Item: 149-0535 **Size:** 3.0 cu. ft. Loose **Qty/plt:** 48
Item: 149-0537 **Size:** 3.8 cu. ft. Comp. **Qty/plt:** 30

EPM-20 - All Purpose Mix

Blend of coarse Canadian sphagnum peat moss, EcoPeatPlus+® and perlite. The well balanced amount of EcoPeatPlus+® and perlite provide the ideal general purpose mix.

Particle size: Coarse **Drainage:** Medium **Water retention:** Medium

Components:

Canadian sphagnum peat moss (70 - 80%)	Calcitic limestone
EcoPeatPlus+®	Dolomitic limestone
Horticultural perlite	Wetting agent
	Starter charge

Item: 149-0046 **Size:** 3.0 cu. ft. Loose **Qty/plt:** 48
Item: 149-0048 **Size:** 3.8 cu. ft. Comp. **Qty/plt:** 30



2024

GFM - Green Formula Mixes

GFM – PC-7 All Purpose Peat-Coir Mix

Lambert The Green Formula PC-7 All Purpose Peat & Coir Mix is ideal for plants that require higher water retention. Perfectly suitable for outdoor crops grown in containers.

Particle size: Coarse **Drainage:** Medium **Water retention:** Medium

Components:	Calcitic limestone
Canadian sphagnum peat moss (70 - 80%)	Dolomitic limestone
Coconut Coir	Wetting agent
Horticultural perlite	Starter charge

Item: 149-0113 **Size:** 2.8 cu. ft. Loose **Qty/plt:** 48

GFM – PC-15 All Purpose Peat-Coir Mix

Lambert The Green Formula PC-15 All Purpose Peat & Coir Mix is the perfect all purpose mix combining the physical properties of our best seller LM-111 and the advantage of coir.

Particle size: Coarse **Drainage:** Medium **Water retention:** Medium

Components:	Calcitic limestone
Canadian sphagnum peat moss (60 - 70%)	Dolomitic limestone
Coconut Coir	Wetting agent
Horticultural perlite	Starter charge

Item: 149-0118 **Size:** 2.8 cu. ft. Loose **Qty/plt:** 48

Professional Peats

White Premium High Yield (0 – 20 mm)

This coarse grade particle size peat moss is the perfect choice for growers who formulate their media. The physical properties of this peat allows optimum water-holding capacity and drainage. Blended with aggregates, this peat has a very wide range of uses. This peat has a high compression ratio resulting in higher yields per bale than most standard peat grades.

Components:

Premium coarse Canadian sphagnum peat moss 100% - (0-20 mm)

Item: 149-0512 **Size:** 3.8 cu. ft. **Qty/plt:** 30

LM - Peat Bark Substrates

Formulated from selected Canadian sphagnum peat moss blended with aged bark and perlite. Great for growers that use large containers and for outdoor productions areas. Ideal for perennials, hardy mums and nursery stocks. Mixes that provides weight for container grown crops.

LM -8

Particle size: Mix **Drainage:** Coarse **Water retention:** Medium

Components:	Calcitic limestone
Canadian sphagnum peat moss (60-70%)	Dolomitic limestone
Aged bark	Wetting agent
Coarse Horticultural perlite	Starter charge

Item: 149-0109 **Size:** 2.8 cu. ft. Loose **Qty/plt:** 42

LM -16

Particle size: Coarse **Drainage:** Coarse **Water retention:** High

Components:	Calcitic limestone
Canadian sphagnum peat moss (45-55%)	Dolomitic limestone
Aged bark	Wetting agent
Coarse Horticultural perlite	Starter charge

Item: 149-0111 **Size:** 2.8 cu. ft. Loose **Qty/plt:** 42



LM - Germination, Plugs & Seedlings Mixes

LM-1 Germination Mix

LM-1 Germination Mix is a blend of fine-fibered Canadian sphagnum peat moss along with fine vermiculite and perlite to help promote aeration and ideal water holding capacity.

Particle size: Fine **Drainage:** Low **Water retention:** High

Components:

Canadian sphagnum peat moss (80 - 90%)	Calcitic limestone
Horticultural perlite	Dolomitic limestone
Horticultural vermiculite	Wetting agent
	Starter charge

Item: 149-0006 **Size:** 3.0 cu. ft. **Qty/plt:** 48

LM-2 - Germination Mix

Made of fine Canadian sphagnum peat moss mixed with fine vermiculite to increase water retention. LM-2 is formulated for plugs and transplants.

Particle size: Fine **Drainage:** Low **Water retention:** High

Components:

Canadian sphagnum peat moss (80 - 90%)	Calcitic limestone
Horticultural vermiculite	Dolomitic limestone
	Wetting agent
	Starter charge

Item: 149-0011 **Size:** 3.0 cu. ft. **Qty/plt:** 48

LM-18 - Germination Mix

Composition of fine Canadian sphagnum peat moss and fine perlite. LM-18 is a media formulated to promote effective and uniform seed germination. The added amount of perlite contributes to the germination by increasing air space and drainage.

Particle size: Fine **Drainage:** Low **Water retention:** Medium

Components:

Canadian sphagnum peat moss (80 - 90%)	Dolomitic limestone
Horticultural perlite	Wetting agent
Calcitic limestone	Starter charge

Item: 149-0016 **Size:** 3.0 cu. ft. Loose **Qty/plt:** 48

Item: 149-0018 **Size:** 3.8 cu. ft. Comp. **Qty/plt:** 30

LM-19 Germination Mix

Lambert LM-19 Germination Mix is a composition of fine Canadian sphagnum peat moss and coarse perlite. LM-19 is a media formulated to promote effective and uniform seed germination like the LM-18, but for a grower used to working with coarse grade perlite. That specific amount of perlite contributes to the germination by increasing air space and drainage.

Particle size: Fine **Drainage:** Low **Water retention:** Medium

Components:

Canadian sphagnum peat moss (75-80%)	Calcitic limestone
Horticultural coarse perlite	Dolomitic limestone
	Wetting agent
	Starter charge

Item: 149-0021 **Size:** 3.0 cu. ft. Loose **Qty/plt:** 48



High Porosity Mixes

LM-6 - High Porosity Mix

High porosity growing media with long-fibered Canadian sphagnum peat moss including the addition of large peat chunks and coarse perlite. LM-6 is designed for crops that require higher air capacity and drainage.

Particle size: Extra Coarse **Drainage:** High **Water retention:** Low

Components:

Canadian sphagnum peat moss (75 - 85%)	Dolomitic limestone
Horticultural perlite	Wetting agent
Calcitic limestone	Starter charge

Item: 149-0056	Size: 3.0 cu. ft. Loose	Qty/plt: 48
Item: 149-0058	Size: 3.8 cu. ft. Comp.	Qty/plt: 30

LM-6 - Organic High Porosity Mix



Combination of premium long-fibered Canadian sphagnum peat moss, chunks and coarse perlite with an organic wetting agent and an extended-release organic fertilizer. Ideal for plants that require higher aeration and drainage.

Particle size: Extra Coarse **Drainage:** High **Water retention:** Low

Components:

Canadian sphagnum peat moss (75 - 85%)	Dolomitic limestone
Horticultural perlite	Organic wetting agent
Calcitic limestone	Organic slow release fertilizer

Item: 149-0091	Size: 3.8 cu. ft. Comp.	Qty/plt: 30
-----------------------	--------------------------------	--------------------

LM-40 - High Porosity Mix

High porosity growing media designed with long-fibered Canadian sphagnum peat moss including the addition of large peat chunks and coarse perlite. It is perfectly suitable for hydroponic production.

Particle size: Coarse **Drainage:** High **Water retention:** Low

Components:

Canadian sphagnum peat moss (55 - 65%)	Dolomitic limestone
Horticultural perlite	Wetting agent
Calcitic limestone	Starter charge

Item: 149-0063	Size: 3.8 cu. ft. Comp.	Qty/plt: 30
-----------------------	--------------------------------	--------------------

EPM-40 - High Porosity Mix

Blend of coarse Canadian sphagnum peat moss and EcoPeatPlus+®. The great amount of EcoPeatPlus+® enhances drainage and porosity. This media is recommended for use in large container, perennials and nursery crops.

Particle size: Extra Coarse **Drainage:** High **Water retention:** Medium

Components:

Canadian sphagnum peat moss (55 - 65%)	Dolomitic limestone
EcoPeatPlus+®	Wetting agent
Calcitic limestone	Starter charge

Item: 149-0064	Size: 3.0 cu. ft. Loose	Qty/plt: 48
Item: 149-0066	Size: 3.8 cu. ft. Comp.	Qty/plt: 30

GFM- High Porosity Mix

High porosity growing media with long-fibered Canadian sphagnum peat moss including the addition of large peat chunks and coarse perlite. **Specially designed for crops that require higher air capacity and drainage.**

Particle size: Extra Coarse **Drainage:** High **Water retention:** Low

Components:

Long-fibered Canadian sphagnum peat moss and large peat chunks (75 - 85%)	Calcitic limestone
Horticultural perlite	Dolomitic limestone
	Wetting agent
	Starter charge

Item: 149-0128	Size: 2.8 cu. ft. Loose	Qty/plt: 48
Item: 149-0130	Size: 3.8 cu. ft. Comp.	Qty/plt: 30

GFM- PC-25 High Porosity Peat-Coir Mix

Lambert The Green Formula PC-25 High Porosity Peat & Coir Mix is designed to procure excellent ratio of drainage, air porosity and water retention.

Particle size: Extra Coarse **Drainage:** High **Water retention:** Medium

Components:

Long-fibered Canadian sphagnum peat moss and large peat chunks (50-60%)	Horticultural perlite
Coconut Coir	Calcitic limestone
	Dolomitic limestone
	Wetting agent
	Starter charge

Item: 149-0123	Size: 2.8 cu. ft.	Qty/plt: 48
-----------------------	--------------------------	--------------------

LAMBERT RETAIL MIXES

Looking for retail Lambert mixes? Consider combining the retail and grower mixes in one order to allow you to get drop ship pricing. Browse the retail catalog for the full lineup.



Professional Organic All Purpose Mix

This ready to use, environmentally friendly peat-based substrate promotes healthy and rapid plant growth for all your favorite flowers, vegetables, herbs, trees and shrubs. Uses: all purpose, bedding plants, flowering plants, hanging baskets, foliage, cuttings, seed germination, interiorscapes, whiskey barrels and window boxes.

Item #	Desc	UPC	Vendor	CS/UOS
81940015	1.0 cu. ft.	0664980 64610	6649806461	91/10
81940016	2.0 cu. ft.	0664980 64641	6649806464	65/10

Complete Potting Mix w/Moisture Crystals

Complete Potting Mix with Moisture Crystals is specially formulated to optimize the water retention of the mix and to maintain good aeration for good plant growth.

Item #	Desc	UPC	Vendor	CS/UOS
81940038	1.0 cu. ft.	066498097588	6649809758	91/10
81940039	2.0 cu. ft.	066498097595	6649809759	65/10

Gardening Soil - for Flowers and Vegetables

Ideal for adding organic matter to your vegetable and flower beds. The organic material in this soil helps improve aeration of clay soils and increases water retention in sandy soils. The peat moss can reduce the loss of fertilizer through leaching in addition to helping to protect the soil against drying and curing.

Item #	Desc	UPC	Vendor	CS/UOS
81940009	1.5 cu. ft.	066498064306	6649806430	75/10

Trees & Shrubs Planting Mix

The texture of this soil will promote its soil incorporation. With its pH adjusted, it will loosen the soil and peat contained therein will promote adequate ventilation to promote root growth.

Item #	Desc	UPC	Vendor	CS/UOS
81940011	1.5 cu. ft.	066498064405	6649806440	75/10

All Purpose Organic Potting Mix

All Purpose Organic Potting Mix is a general purpose media with numerous applications for indoor and outdoor use such as hanging baskets and containers. It is a favorite amongst plant lovers. Adjusted pH combined with coarse perlite promotes aeration, drainage and assimilation of nutrients that are essential for optimum plant growth. This all purpose media is easy to use as it has been pre-moistened.

Item #	Desc	UPC	Vendor	CS/UOS
81940002	1.5 cu. ft.	06649807630	6649806461	75/10

Peat Moss

An excellent soil amendment because of its capacity to retain water, aerate the soil and it is completely natural. It is certified by OMRI for organic production. Lambert Peat Moss helps retain moisture, aerate soil, and provide organic matter for gardens and flower beds.

Item #	Desc	UPC	Vendor	CS/UOS
81940032	3.8 cu. ft.	066498021156	6649802115	30/30
81940030	2.2 cu. ft.	066498041154	6649804115	50/50
81940029	1.0 cu. ft.	066498051153	6649805115	100/100

Potting Mix

This Potting Mix is a general purpose media with numerous applications for indoor and outdoor use such as hanging baskets and containers. It is a favorite amongst plant lovers. The adjusted pH combined with perlite promotes aeration, drainage and assimilation of nutrients that are essential for optimum plant growth. This media is easy to use as it has been pre-moistened.

Item #	Desc	UPC	Vendor	CS/UOS
81940008	1.5 cu. ft.	066498064504	6649806450	75/10

LAMBERT

GROWING MEDIA SUGGESTIONS CHART

	Peat	Perlite	Vermiculite	Water Retention	Drainage
GERMINATION					
LM-18	80-90% Fine	Fine		High	Low
LM-1	80-90% Fine	Fine	Fine	Med	Low
LM-19	75-85% Fine	Coarse		Med	Low
LM-2	80-90% Fine		Fine	High	Low
PACKS					
LM-191	80-90% Medium	Coarse		Med	Med
LM-111	80-90% Coarse+Chunks	Coarse		Med	Med
LM-19	75-85% Fine	Coarse		Med	Low
LM-3	80-90% Coarse	Coarse	Coarse	Med	Med
POTS: 4" - 8"					
LM-111	80-90% Coarse+Chunks	Coarse		Med	Med
EPM-20	70-80% Coarse w/20% EcoPeatPlus+®	Coarse		Med	Med
EPM-40	55-65% Extra Coarse w/40% EcoPeatPlus+®			Med	High
HANGING BASKETS					
EPM-20	70-80% Coarse w/20% EcoPeatPlus+®	Coarse		Med	Med
LM-111	80-90% Coarse+Chunks	Coarse		Med	Med
MUMS					
EPM 40	55-65% Extra Coarse w/40% EcoPeatPlus+®			Med	High
LM-6	75-85% Extra Coarse+Chunks	Coarse		Low	High
PERENNIALS					
EPM 40	55-65% Extra Coarse w/40% EcoPeatPlus+®			Med	High
EPM 20	70-80% Coarse w/20% EcoPeatPlus+®	Coarse		Med	Med
LM-111	80-90% Coarse+Chunks	Coarse		Med	Med
POINSETTIAS					
LM-111	80-90% Coarse+Chunks	Coarse		Med	Med
LM-6	75-85% Extra Coarse+Chunks	Extra Coarse		Low	High
EPM 50	45-55% Extra Coarse w/40% EcoPeatPlus+®	Extra Coarse		Low	High



PBH Parboiled Rice Hulls

PBH Parboiled Rice Hulls are a uniquely processed rice hull product from Riceland Foods, Inc. with multiple uses in greenhouses and nurseries. Highly compressed packaging in your choice of a 30-cubic-foot bulk bale or 50-pound bag generates less waste, lowers freight costs and minimizes storage and handling. OMRI Listed® and WSDA registered.

Use PBH Parboiled Rice Hulls as a media amendment for the perfect replacement for perlite in the growing media or as a container topdress to significantly improve weed control for just pennies per container.

Media Amendment Guidelines

- Recommended PBH use rate is 20 to 30% of total growing media
- Media with 20% PBH has approximately 10% air-filled pore space
- Media with 30% PBH has approximately 20% air-filled pore space
- Add PBH last when mixing media
- When replacing another component with PBH, conduct comparisons to determine desired growing media characteristics and meet individual cultural conditions and growth requirements
- PBH has a 6.2 to 6.6 pH range
- PBH has very little nutritional value, fertilize accordingly

Topdressing Guidelines

- Allow space at top of container at transplant
- Apply 1 to 2 inches of PBH on top of media
- Cover entire container surface
- Continue to use granular herbicide where appropriate

OMRI Listed® and WSDA registered.

PBH Yield Information 30 cu. ft. bales have a 3:1 compression to yield in excess of 90 cubic feet of material.

Item: 64-3000 **Size/Qty:** Skid of 16 - 7 cu. ft. bales
Item: 64-3030 **Size/Qty:** Skid of 3 - 30 cu. ft. bales



Rice Hull Blower

- Save time and labor with mechanizing your Rice Hull application process
- Application rate of 185 cf/hour of hulls (26 bales/hour)
- Hopper size of 3 to 4 bales (50 lb bales)
- Honda GX200 engine allow hulls to be delivered through 100 ft of hose. Integrated manual hose reel for ease of use.
- 3 Year Warranty
- Go to www.Stilt.Pro for other labor saving innovation and more information

Coco Coir



Evocoir

High quality, washed and buffered coir in key forms. Open top bags are especially popular for cannabis cultivation.

- Low EC (<0.05 mmos/cm), fully washed and buffered
- Sustainable, responsibly sourced, highly managed from Sri Lanka factory
- Bagged material predrilled for drip stakes and plant placement
- Professional Open Top bags (POTs) ship with pre-cut drain holes



Item #	Description	Volume or Case Count	Dimensions	Per Pallet
POTs – all with compressed 30/70 blocks (30% chip, 70% 16 mm pith) in biodegradable, nonwoven fabric				
150-0001	Evocoir EC Platinum Open Top 1 Gal Biodegradable Coir	1 gal	7"x6"x8"	950
150-0002	Evocoir EC Platinum Open Top 2 Gal Biodegradable Coir	2 gal	7.5"x7.5"x9.5"	650
150-0003	Evocoir EC Platinum Open Top 3 Gal Biodegradable Coir	3 gal	9.8"x7.8"x8.8"	450
Grow Cubes – Non-woven, closed top, biodegradable fabric with precut drain and planting holes, pre-drilled planting hole in the compressed coir				
150-0021	Evocoir EC Platinum Grow Cube 4x4	210/box	10cm x 10cm x 7cm	5040
150-0020	Evocoir EC Platinum Grow Cube 6x6	68/box	15cm x 15cm x 10 cm	1632
Loose fill bags – Fluffed and ready for planting. 70/30 Coco: perlite blend				
150-0010	Evocoir EC Platinum 50 L 70/30 Coco Perlite	1.75 cu ft	–	90
150-0011	Evocoir EC Platinum 80 L 70/30 Coco Perlite	2.8 cu ft	–	60



Pro-Mix CX

Carefully formulated and produced coir products from an industry leader in potting soils. 100% super washed blend of pith and chunks. Ships as compressed blocks in plastic bags with Eco-One organic additive for enhanced biodegradability when placed in a biologically active landfill. Bags have pre-cut drain holes. Blocks are pre-drilled for drip stakes and plant placement.



Item #	Description	Volume	Compressed Size	Expanded Size	Per Pallet
94-1310	Pro-Mix 1 Gal Open Top Bag CX Growing Media	1 gal.	CM: 14.3 x 14.3 x 2.8 Inches: 5.6 x 5.6 x 1.1	CM: 15 x 15 x 15 Inches: 5.9 x 5.9 x 5.9	2721
94-1311	Pro-Mix 2 Gal Open Top Bag CX Growing Media	2 gal.	CM: 19.5 x 19.5 x 4 Inches: 7.7 x 7.7 x 1.6	CM: 21 x 21 x 17 Inches: 8.3 x 8.3 x 6.7	1240
94-1312	Pro-Mix 3 Gal Open Top Bag CX Growing Media	3 gal.	CM: 23.5 x 23.5 x 4.5 Inches: 9.3 x 9.3 x 1.8	CM: 25 x 25 x 18 Inches: 9.8 x 9.8 x 7.1	800
94-1313	Pro-Mix 5 Gal Open Top Bag CX Growing Media	5 gal.	CM: 27.5 x 27.5 x 5.5 Inches: 10.8 x 10.8 x 2.2	CM: 30 x 30 x 21 Inches: 11.8 x 11.8 x 8.3	524



Professional Growing Mixes

Quality Mixes Begin with Quality Ingredients



Oldcastle APG's commitment to quality professional growing mixes begins with raw materials. Pine bark is aged, screened to size, and processed to ensure a consistent mix. High quality Canadian sphagnum peat moss is also a staple ingredient in most of their formulations. Their automated manufacturing lines are fully programmable to blend to your specifications. Computer controlled feed bins regulate the correct amount of each mix component, ensuring consistency in every bag or truckload.

Most mixes available in supersack and bulk. Compressed Bale and Towers available by way of Drop-Ship program. See Sales Representative for details.

HF C/B Growing Mix

Components:	Suggested Uses:
HydraFiber 28%	Flowering Plants
Canadian Peat Moss 28%	Foliage Plants
Aged Pine Bark	Hanging Baskets
Perlite	Seeds & Cuttings
Vermiculite	

Item: 148-0065 Size: 2.8 cu. ft. Qty/plt: 45

C/GV Growing Mix

Components:	Suggested Uses:
Canadian Peat Moss 70%	Plugs
Vermiculite	Seeds
	Cuttings

Item: 148-0061 Size: 2.8 cu. ft. Qty/plt: 45

HF C/25 Growing Mix

Components:	Suggested Uses:
HydraFiber 20%	Perennials
Canadian Peat Moss 20%	Roses
Aged Pine Bark	Garden Mums
Perlite	Nursery Containers
Vermiculite	Interiorscapes

Item: 148-0067 Size: 2.8 cu. ft. Qty/plt: 42

HF C/L Growing Mix

Components:	Suggested Uses:
HydraFiber 28%	Flowering Plants
Canadian Peat Moss 28%	Foliage Plants
Aged Pine Bark	Hanging Baskets
Perlite	Seeds & Cuttings
Vermiculite	

Item: 148-0078 Size: 2.8 cu. ft. Qty/plt: 45

C/GP Growing Mix

Components:	Suggested Uses:
Canadian Peat Moss 70%	Plugs
Medium Perlite	Seeds
Vermiculite	Cuttings

Item: 148-0060 Size: 2.8 cu. ft. Qty/plt: 45

HF 22/G Growing Mix

Components:	Suggested Uses:
HydraFiber 25%	Bedding Plants
Canadian Peat Moss 25%	Hanging Baskets
Aged Pine Bark	Mums
Perlite	Poinsettias

Item: 148-0075 Size: 2.8 cu. ft. Qty/plt: 45

HF C/G Growing Mix

Components:	Suggested Uses:
HydraFiber 40%	Flowering Plants
Canadian Peat Moss 40%	Foliage Plants
Perlite	Hanging Baskets
Vermiculite	Seeds & Cuttings

Item: 148-0074 Size: 2.8 cu. ft. Qty/plt: 45

HF C/6 Growing Mix

Components:
HydraFiber 30%
Canadian Peat Moss 30%
Aged Pine Bark

Item: 148-0076 Size: 2.8 cu. ft. Qty/plt: 45

HF C/20 Growing Mix

Components:	Suggested Uses:
HydraFiber 25%	Flowering Plants
Canadian Peat Moss 60%	Foliage Plants
Perlite	Hanging baskets

Item: 148-0066 Size: 2.8 cu. ft. Qty/plt: 45



Sphagnum Moss

- Ground Milled Sphagnum Moss is excellent for use in seed sowing
- Long Fiber Sphagnum Moss recommended for basket lining.

Item	Description
20-204500	Long fiber Sphagnum Moss 3.5 cu. ft.
65-1025	Ground Milled 2 cu. Bag Sphagnum Moss

2024



HydraFiber EZ Blend

Material that can be used without specialized processing equipment – is now giving many more growers great relief from rising material, manpower and shipping costs while producing superior plants.

Leading growers are using HydraFiber as an amendment or alternative to coir, perlite, peat and other growing mix substrates in their production and seeing positive effects on their plants and their business.

Item: 10-103932 **Size:** 40 lb Bale Comp. **Qty/plt:** 40

Jolly Gardener makes HydroFiber available in custom blended mixes.



Root Riot Plant Starter Cubes

Porous, stabilized, 100% sphagnum peat rooting cubes for seed and cutting propagation. Highly aerated, sponge-like consistency and texture for good water/air ratio. Formulated to support strong root development. 1 5/16" square, tapering to 1" square. 1 7/8" tall. Best used within six months of purchase.

Item	Description	Per Case/Sold By
81860089	Bag of 100	12/12
81860090	Bag of 50	20/20
81860092	Bulk Box of 1500	1/1

Vermiculite and Perlite



Whittemore is our primary partner for vermiculite and perlite for the central and eastern parts of the country. A family-owned company based in Lawrence, MA, Whittemore pops the product with their own furnaces for strong quality control of their horticultural products.

Vermiculite has a high water-holding capacity, good buffering characteristics and adequate cation-exchange capacity. It has an absorptive capacity for fertilizer. The mineral itself contains potassium, magnesium, and calcium available as a slow-release supply. Super Coarse Perlite is screened to remove finer particles. The perlite provides aeration and drainage, in addition to moisture retention for superior plant growth.



Location Availability
Central and Eastern States

Item	Description
65-3110	23 lb. Whittemore Vermiculite A2 Fine (African)
65-3215	15 lb. Whittemore Vermiculite A3 Medium (African)
65-3115	23 lb. Whittemore Vermiculite A3 Medium (African)
65-3216	15 lb. Whittemore Vermiculite A4 Coarse (African)
65-3116	23 lb. Whittemore Vermiculite A4 Coarse (African)
65-3220	15 lb. Whittemore Vermiculite D3 Fine (Domestic)
65-3120	23 lb. Whittemore Vermiculite D3 Fine (Domestic)
65-2225	23 lb. Whittemore Perlite Super Coarse
65-2125	15 lb. Whittemore Perlite Super Coarse

2024



Griffin is pleased to add NorCal Perlite to our assortment as our primary partner for our customers in the mountain, desert southwest, and west coast states. Privately held, NorCal is vertically integrated, from mine to bag. NorCal ships from plants in Richmond, CA and Bakersfield, CA.

NorCal grades range from fine to extra coarse and descriptions may differ from other manufacturers. See descriptions or ask your Griffin sales rep for more information.

Location Availability
Mountain and Western States

Item	Description	Bags/pallet
65-1600	NorCal Perlite Standard #2 4 cf bag	33
65-1601	NorCal Perlite Standard #2 62 cf sack	2
65-1602	NorCal Perlite Premium #3 2 cf bag	70
65-1603	NorCal Perlite Premium #3 4 cf bag	33
65-1604	NorCal Perlite Premium #3 62 cf sack	2
65-1605	NorCal Perlite Hydro 4+ Plus 4 cf bag	33
65-1606	NorCal Perlite Hydro 4+ Plus 62 cf sack	2
65-1607	NorCal Vermiculite Med 2 cf bag	70
65-1608	NorCal Vermiculite Med 4 cf bag	36
65-1609	NorCal Vermiculite Med 62 cf sack	2
65-1610	NorCal Vermiculite Coarse 4 cf bag	36
65-1611	NorCal Vermiculite Coarse 62 cf sack	2

*62cf totes via drop ship only

NorCal Perlite Grades

US mesh size and sieve retain rates

Grade	4	6	8	16	20	Granular Size
#2 (medium)	17%	40%	65%	88%	95%	1/16" - 5/8"
#3 (medium)	23%	45%	68%	92%	97%	1/8" - 5/8"
#4+ (chunky)	50%	90%	98%	99%	100%	1/8" - 5/8"

NorCal Vermiculite Grades

Grade	Particle size	Typical loose bulk density	Lbs/cu ft
Fine	0.7-3 mm	75-85	6-7
Medium	1-8 mm	70-85	5-6
Coarse/Extra Coarse	3-15 mm	60-75	4-6



ASB Greenworld operates peat bogs around the world and formulates their blends with high quality, blonde peat for optimum structure and water holding properties in their mixes. Available in bags, bales, big bales (towers), and retail package sizes. Single plant production in Canada means grower and retail products can ship together for drop ships. With ongoing equipment investment, ASB Greenworld serves growers throughout North America and the world.



ASB Peat Moss with 15% Wood Fiber (Blend) #315640

A simple blend of 85% Canadian Sphagnum peat moss and 15% HydraFiber wood fiber. Note that this is intended for use as a raw input and requires the addition of lime, wetting agent, and starter charge for most production situations.

Item: 122-0002 **Size:** 3.8 cu. ft. Comp. **Qty/plt:** 30



ASB Grower Mix with 15% Perlite #310830/313667

A solid choice for an all-purpose potting mix, this blend of 85% Canadian sphagnum peat moss and 15% coarse perlite provides the structure and drainage your crops need to perform in flats and pots. pH balanced to 5.0-5.9 with wetting agent and a starter charge.

Item: 122-0008 **Size:** 2.8 cu. ft. Loose **Qty/plt:** 45
Item: 122-0005 **Size:** 3.8 cu. ft. Comp. **Qty/plt:** 30



ASB Grower Mix with 15% Wood Fiber #314970/314972

Growers mix of 85% Canadian sphagnum peat moss and 15% HydraFiber wood fiber. Well suited to production in pots. pH balanced with wetting agent and starter charge.

Item: 122-0007 **Size:** 2.8 cu. ft. Loose **Qty/plt:** 45
Item: 122-0004 **Size:** 3.8 cu. ft. Comp. **Qty/plt:** 30



ASB Seed and Plug Mix #313847/313845

Finer grade inputs to support germination and young root development with higher water holding capacity. 85% screened Canadian sphagnum peat moss, 15% fine perlite. pH adjusted to 4.7-5.7. Formulated with wetting agent and mild starter charge.

Item: 122-0009 **Size:** 2.8 cu. ft. Loose **Qty/plt:** 45
Item: 122-0006 **Size:** 3.8 cu. ft. Comp. **Qty/plt:** 30



ASB Grower Grade Peat Moss #310841

100% Canadian sphagnum peat moss.

Item: 122-0010 **Size:** 3.8 cu. ft. Comp. **Qty/plt:** 30



- BETTER, FASTER GERMINATION
- LABORSAVING
- STRONGER ROOTS
- FOOD SAFE
- SUSTAINABLE
- ORGANIC

Jiffy Pellets



Great germination, higher profits

Jiffy Pellets are an open-wall, net container and medium all in one. They are easy to work with, economical to ship (being supplied as lightweight, highly compressed, dry discs) and they transplant well, either into larger containers, or directly into the ground.

Jiffy-7 Pellets

The Jiffy-7 Pellets is a unique concept packing amazing cost saving advantages for the grower on the lookout to minimize input costs. Jiffy-7 Pellets, media and container in one, comes compressed, saving on freight and logistics. Jiffy-7 Pellets is available in many sizes and tray configurations and suited to be used in fully automated sticking lines.

Item	Vendor	Description	Pellets/cs
60-2512	70001324	J7 Hort Peat Pel 25x35 PLA Net Stacked	3,312
60-2236	70001413	J7 Hort Peat Pel 30x40 PLA Net Stacked	1,700
	70001435	J7 Organic Peat Pel 36x41 PLA Net Stacked	2,000
60-2330	70001476	J7 Organic Peat Pel 42x43 PLA Net Stacked	1,000
60-2519	70001478	J7 Hort Peat Pel 42x63-1 PLA Net Stacked	520
60-2338	70000107	J7 Hort Peat Pel 50x95-PLA Net, 50x95mm	486
60-2537	70001509	J7 Organic Peat Pellet 70x70 PLA Net Stacked	180
60-2538	70001507	J7 Hort Peat Pel 70x100 18l PLA Net Stacked	120
Options for CEA			
60-2539	70001566	J7 Organic Peat Pel 18x42-300 CN With Hole H PLA Net	7500
60-2540	70001372	J7 Organic Peat Pel 21x35WH-162 11 mm Cone indent PLA Net	2592
60-2541	70001203	J7 Organic Peat Pel 23x45WH-162 11 Ind PLA Net	2592
60-2542	70001674	J7 Organic Peat Pel 30x40-105 11i WH PLA Net	1995
60-2543	70001432	J7 Organic Peat Pel 30x65-105 PLA Net	1470
60-2544	70001532	J7 Organic Peat Pel 36x41-72WH 11mm Ind. No Precut & No aera	2088
60-2545	70001572	J7 Organic Peat Pel 42x55-50 no net on top PLA Net	1200



What is PLA netting?

PLA netting is a lightweight fine-fiber web made of polylactic acid (PLA). This natural plant based material is 100% fossil plastic free, renewable and sustainable. PLA has a 65% lower production carbon footprint compared to polypropylene plastic.



Innovative Growing Media Solutions

Grodan stone wool media products enable precision growing. Made from natural rock - basalt and limestone - Grodan products are favorites for propagation and production for many CEA and other long-term crops, including lettuce, herbs, tomatoes, peppers, cucumbers, cannabis, hemp, roses, gerbera and other cut flowers. Grodan products are fully inert and truly hydroponic in nature.



2024

Starters

Starters are used for propagation, both seed starting and vegetative propagation. A-OKs ship as a full sheet (sized for a 10x20 tray); individual cubes are separated from the sheet and are suitable for sowing or sticking. The 1" A-OKs are particularly popular for use in NFT systems for lettuce and herb production. 1.5" A-OKs are popular for propagation of many crops, including cannabis. Starters come wrapped (W) or unwrapped (UW) with cellophane. UW are more economical, while W are suitable for retail and/or provide an extra layer of protection against contamination in dusty storage areas.

Item	Description	Qty/case
51-9022	Grodan Starters 1" AOK UW, 1.0x1.57 (25/40)	6000
51-9101	Starters 1.5" AOK UW, 1.4x1.57 (36/40)	2940
51-9002	Starters 1.5" AOK W, 1.4x1.57 (36/40)	2940
51-9106	Grodan Starters 1.5 AOK , Pre-cut	2310 plugs loose in box
51-9105	Grodan Starters 1.5 AOK, Pre-cut, pre-filled trays	50 cubes/tray, 30 trays/box
51-9023	Starters 2" AOK W, 2x1.57 (50/40)	1500
51-9035	Starters 2" AOK UW, 2x1.57 (50/40)	1500
51-9024	Macroplugs, V-cut, 1.5x1.57 (36/40), 50 per bag	35/bags
51-9025	Macroplugs, loose, V-cut, 1.5x1.57 (36/40)	2000
51-9052	Gro-Block Imp Mini Block UW 1.5" (40/40)	2250/cs



Gro-Smart Tray

Heavy-duty, double-sided, reusable tray holds starters during propagation. Perfectly fits in any standard 10x20 flat. Elevates starters from bottom of tray for better moisture management.

Item	Description	Qty/case
51-9017	Gro-Smart Tray - 9.25" x 20" x 2"	5



Gro-Blocks Improved

Optimized for cannabis and hemp, Improved Gro-Blocks bring optimal density and new hydrophilic technology for superior moisture management to support these fast-growing crops. Improved water distribution in the blocks results in more even root distribution with more branched roots and better water/nutrient uptake.

Item	Description	Qty
51-9165	Gro-Block Imp GR4 UW Sm 3x3x2.6 w/Hole, 8/strip	384/cs
51-9166	Gro-Block Imp GR4 W Sm 3x3x2.6 w/Hole, 8/strip	384/cs
51-9167	Gro-Block Imp GR5.6 UW Lg 3x3x4 w/Hole, 8/Strip	256/cs
51-9168	Gro-Block Imp GR6.5 UW Sm 4x4x2.6, 6/Strip	216/cs
51-9169	Gro-Block Imp GR6.5 W Sm 4x4x2.6, 6/Strip	216/cs
51-9170	Gro-Block Imp GR7.5 W Med 4x4x3, 6/Strip	216/cs
51-9160	Gro-Block Imp GR 10 UW Large, Loose, 4x4x4	1584/plt
51-9171	Gro-Block Imp GR10 UW Lg 4x4x4, 6/Strip	144/cs
51-9172	Gro-Block Imp GR10 W Lg 4x4x4, 6/Strip	144/cs
51-9161	Gro-Block Imp Jumbo, GR 22, 6x6x4	64/cs
51-9162	Gro-Block Imp Hugo, GR 32, 6x6x6	64/cs
51-9163	Gro-Block Imp Hugo Loose, GR 32, 6x6x6	512/plt
51-9173	Gro-Block Imp Uni-Block 8x8x4	36/cs

Loose

Loose rockwool products are used with pots. Get the same great water holding capacity and air porosity as in blocks, but for use with any size container.

Item	Description	Qty/case
51-9031	Grow Cubes L, 1x1, 3 bags/box	2.0 cf
51-9032	Grow Cubes M, 1x1, 6 bags/box	1.0 cf
51-9033	Grow Cubes, 1x1, loose pack	5.0 cf
51-9034	Grow Chunks, 2x2, 3 bags/box	2.0 cf
51-9030	Gro-Wool bag	45 lb bag

Improved Gro-Slabs

Slabs are the final step in a slab production system. The new Improved Gro-Slabs are optimized for production of cannabis and hemp with Advanced Wetting Agent for more even water distribution and better wettability. Start with A-OK cubes, then set rooted cubes into Gro-Blocks. When plants are fully rooted in the Gro-Blocks, simply set on top of the slabs for the remainder of production. Utilize drip irrigation (inserted into the Gro-Block.)

Item	Description	Qty/case
51-9015	Grodan Uni-SLAB 9.5" x 8" x 4"	16
51-9176	Gro-Slab Imp 6" wide, 36x6x4	12
51-9177	Gro-Slab Imp 6", 36x6x3	12
51-9178	Gro-Slab Imp 8", 36x8x3	12
51-9179	Gro-Slab Imp 12", 36x12x3	8

New for 2024! Pre-Cut AOKs!

Get your AOKs pre-cut, loose in a box or prefilled in a tray.

Grodan® Stonewool A-OK Starter Plugs™ in Prefilled tray

The Grodan tray comes prefilled with Grodan A-OK Starter Plugs™ for fast and easy propagation from seeds or cuttings prior to transplanting to Grodan Gro-Blocks. The tray fits perfectly in all standard propagation dome kits. These trays are designed with a unique and convenient thumb slot to make tray removal easy and comfortable. 50 plugs per tray, 30 trays per carton.

Item	Description	Qty/case
51-9106	Grodan Starters 1.5 AOK , Pre-cut	2310 plugs loose in box

Grodan® Stonewool A-OK Starter Plugs™ Loose in Carton

A-OK Starter Plugs™ for starting seeds and rooting of cuttings prior to plugging into the larger Grodan Gro-Blocks. A-OK Starter Plugs™ come loose in a carton for those who prefer to saturate as individual plugs. Easy to use with propagation trays such as the Grow Smart Tray. Note: the AOK plugs are shipped as 2,310 individual loose plugs, bulk in the carton. There is no shrink-wrap.

Item	Description	Qty/case
51-9105	Grodan Starters 1.5 AOK, Pre-cut, pre-filled trays	50 cubes/tray, 30 trays/box

2024



Pargro

The Pargro line of stone wool media products from Grodan brings excellent value to cannabis growers using basic irrigation strategies. With a moderate water holding capacity, Pargro blocks are more forgiving of heavier irrigation events. Growers using more technical crop steering methods will appreciate the additional water holding capacity offered by the Grodan Improved line.

Item	Description	Qty/case
51-9183	Pargro PAR6.5 Block Sm	216
51-9185	Pargro PAR10 Block Lg	144
51-9187	Pargro PAR22.5 Jumbo	64
51-9189	Pargro PAR32 Biggie	64
51-9190	Pargro Single Slab	16
51-9191	Pargro Slab 6" w/holes	12
51-9194	Pargro Slab 6"	12
51-9192	Pargro Slab 6" Tall w/holes	12
51-9195	Pargro Slab 6" Tall	12
51-9193	Pargro Slab 8" w/holes	12
51-9196	Pargro Slab 8"	12

2024



Experienced industry supplier of coco coir from India and Sri Lanka.



Grow Bags

Compressed media ships as bagged slabs in upright, open topped grow bags for production without pots. Wet to fluff to perfect level for planting.

Item	Description	Qty
58-19016	Upright Grow Bag, 3 gal size, 8" x 7"x 10", white poly (OMRI listed)	1
58-19030	Upright Grow Bags, 3 gal size, 8"x7"x10", Root Kandy, Buffered Coir, white poly	1

Grow Slabs

Compressed coir in lay flat bags, Commonly used with tomatoes, cucumbers, peppers, strawberries and long lived cut flowers. Wet to fluff. White poly.

Item	Description	Qty
58-19014	1 meter Grow Slab, True Blend (green), 70/30 blend (pith/fiber), 3'x 5"x 6" (OMRI listed)	1
58-19044*	1 meter Grow Slab, Berry Blend (red), 80/20 blend (pith/fiber) optimized for berry production. 3' x 5" x 6" (OMRI listed)	1

*Allow 2-3 weeks lead time for delivery.

Super Sack, Standard, Fluffed Coco Coir

Pre-fluffed coco coir, 2 cubic yards per bag. Custom mixes available.

Item	Description	Qty
58-19019*	Super Sack, Standard Bag, 100% Fluffed Coco Coir (OMRI listed)	1
58-19027	Super Sack, Standard Bag, 50/50 Coir/Perlite (OMRI listed)	1
58-19028	Super Sack, Standard Bag, 70/30 Coir/Perlite (OMRI listed)	1

*Allow 2-3 weeks lead time for delivery.

AmeriCoco Bagged, Fluffed Coco Coir

Pre-fluffed coco coir, 1.5 cubic feet per bag. Custom mixes available.

Item	Description	Qty
81460005	AmeriCoco Colombo Jumbo 100% Coir (OMRI listed)	70
81460007	AmeriCoco Brown Pearl 70/30 Coir/Perlite (OMRI listed)	70
81460009	AmeriCoco Root Kandy, 100% Buffered Coir	70



2024

About Oasis® Grower Solutions

The Oasis® Grower Solutions brand offers a wide variety of rooting systems that are adaptable to nearly every type of plant. These offerings serve a wide variety of growers, from propagators of URCs who rely on superior survival rates, to mass market retail growers who require an excellent product at a competitive price. Hydroponic growers appreciate the technical precision of foam products for superior germination and production rates while growers of hemp realize the increased transplant survivability. Rootcubes®, Rootcubes® Wedge®, Horticultures®, Fertiss®, and Terra Plug are products that growers trust.

Oasis® Foam Medias Make it Easy to Grow

Oasis® Growing Mediums are rigid, open-celled, water-absorbing foams specifically designed for optimal germination, callus development and rapid root formation. Outstanding performance is due, in part, to the unique cell structure which closely resembles the cellular structure of the plant itself. The composition of the foam anchors the plant and provides capillary action to ensure even moisture throughout.

Features and Benefits

- Engineered foam provides ideal air to water ratio in rootzone
- Low cation exchange capacity allows complete nutrient availability without salt accumulation
- Ready to use right out of the box
- Available as solid sheets or cubes
- Inert and sterile when received – free of pathogens
- With or without dibble holes
- Faster rooting than competitor products
- Easy to separate cubes
- Roots undisturbed during transplant, eliminating transplant shock
- Very economical propagation media solution



#5643



#87-50010



Rootcubes®

Advanced formula eliminates the necessity of leaching before use. Since its pH is in the proper range, thorough watering-in is all that is required for propagation. Uniform cell structure assures proper drainage and water-holding capacity for optimum air/water balance. **Rootcubes® Plus** includes a small amount of slowly available nutrition which gives rooted cuttings and seedlings a gentle boost. **Recommended for:** Unrooted cuttings such as poinsettias, foliage, hibiscus, baby's breath, azaleas, geraniums, chrysanthemums, impatiens, roses, hemp and others.

Item	Vendor	Description	Configuration	Units/cs
16-200250	5005	Rootcube 1"	162 units per sheet - 20 sheets per cs	3240
54-1125	5010	Rootcube 1" x 1¼" x 1½"	104 units per sheet - 20 sheets per cs	2080
54-1130	5015	Rootcube 1½" x 1½" x 1½"	50 units per sheet - 20 sheets per cs	1000
54-1150	5020	Rootcube Strip 1" x 20" x 1½"	10 units per strip - 190 strips per cs	1900

2024

Rootcubes® Wedge®

OASIS® Rootcubes® Wedge® is an engineered foam medium with a distinctive design that tapers in shape from top to bottom, for cutting propagation. Along with optimal air to water ratios for fast, uniform rooting, this unique shape aids in directing roots downward for a more rapid development, resulting in greater crop turnover and overall productivity. Each cell is singulated, therefore, there is no tangling of the fibrous root systems. **Recommended for:** Unrooted cuttings such as poinsettias, geraniums, mandevilla, hibiscus, roses, and other woody ornamentals.

These units are ideal for fast layout-ready to go since the system is designed for 10" x 20" flats. The new Oasis Wedges with Universal Size Hole fit most stem diameters. Once plants are rooted, the trays are easily packed into shipping boxes.

- Pre-filled standard 10" x 20" tray size with 102 units
- Pre-filled double strip tray made up of two rows of 17 units. Three double strips to a standard 10" x 20" tray
- Pre-filled single strip trays made of 10 units. Six strips to a standard 10" x 20" tray
- Wedge medium only in a double row of 17 units. Three strips to a standard 10" x 20" tray

Item	Vendor	Description	Configuration	Units/ctn
54-1162	87-50010	Rootcube Wedge Strip 10 CT	10 units per strip - 224 strips per cs	2240
54-1196	5615	Wedge Medium Only Double Strip	17 units/strip 120 strips/ctn	2040
54-1194	5625	Double Strip Wedge Tray - Pre-filled	34 units/tray 72 trays/ctn	2448
54-1193	5643	Wedge Tray & Medium - Pre-filled	102 units/tray 10 trays/ctn	1020
54-1157	87-50013	Wedge Strip (no clip)	224 strip 13 wedges / strip	2912
87-53023	47-5600C	Wedge Carry Tray, Tray Only	3 double strip channels (holds 6 wedge strips)	100





Horticubes®

Here is a versatile medium which has multiple applications in those areas that require high usage of water. Foliage plant propagation of cuttings, NFT and/or hydroponic seed germination are examples of these uses. Horticulture medium is designed to drain off excess water from the base of the cutting or seed, yet provide the proper balance of water and oxygen needed for good root development. Enhanced drainage also keeps the top of the media drier helping to minimize algae growth. Germination rates are increased significantly compared to other medias. Horticulture XL have a higher water holding capacity, designed specifically for production of lettuce and leafy greens. Horticulture eS is biodegradable, has a lower density and higher drainage for strong germination of hydroponic crops. Horticulture AeroMax brings even higher drainage ultra-low density for maximum air-filled pore space and a lower carbon footprint. **Recommended for:** Seed Germination of lettuce, leafy greens, tomatoes, herbs, cucumber, peppers, and other vegetables.

Item	Vendor	Description	Configuration	Units/cs
16-210200	5240	Horticulture 1.25"	104 units per sheet - 20 sheets per cs	2080
54-1141	5231	Horticulture 0.75"	276 units per sheet - 20 sheets per cs	5520
54-1142	5225	Horticulture 1"	162 units per sheet - 20 sheets per cs	3240
54-1202	87-22762	Horticulture XL Multi Seed 3/4"	276 units per sheet - 20 sheets per cs	5520
54-1145	87-31041	Horticulture eS, Single seed, 1.25"	104 units per sheet - 20 sheets per cs	2080
54-1220	87-12762	Horticulture	276 units per sheet - 20 sheets per cs	5520
54-1221	87-20502	Horticulture XL Multi Seed	50 units per sheet - 20 sheets per case	1000
54-1222	87-21621	Horticulture XL Single Seed, 1"	162 units per sheet - 20 sheets per case	3240
54-1223	87-21622	Horticulture XL Multi Seed, 1"	162 units per sheet - 20 sheets per case	3240
54-1224	87-30501	Horticulture eS Single Seed, 1.5",	50 units per sheet - 20 sheets per case	3240
54-1225	87-32762	Horticulture eS Multi Seed	276 units per sheet - 20 sheets per case	5520
54-1226	87-70501	Horticulture 2.0 AeroMax Single Seed, 1.5"	50 units per sheet - 20 sheets per case	1000
54-1227	87-70502	Horticulture 2.0 AeroMax Multi Seed, 1.5"	50 units per sheet - 20 sheets per case	1000
54-1228	87-71041	Horticulture 2.0 AeroMax Single Seed, 1.25"	104 units per sheet - 20 sheets per case	2080
54-1229	87-71042	Horticulture 2.0 AeroMax Multi Seed, 1.25"	104 units per sheet - 20 sheets per case	2080
54-1230	87-71621	Horticulture 2.0 AeroMax Single Seed, 1"	162 units per sheet - 20 sheets per case	3240
54-1231	87-71622	Horticulture 2.0 AeroMax Multi Seed, 1"	162 units per sheet - 20 sheets per case	3240
54-1232	87-72761	Horticulture 2.0 AeroMax Single Seed	276 units per sheet - 20 sheets per case	5520
54-1233	87-72762	Horticulture 2.0 AeroMax Multi Seed	276 units per sheet - 20 sheets per case	5520



> PROPAGATING MORE.

Fertiss®

The proprietary process used to manufacture Fertiss® produces a plug with loose density media for easier sticking of cuttings. Fertiss® cells are delivered in trays with many configurations and are ready to use when delivered. The media is wrapped in an ultra-thin non-woven cellulose sleeve that allows air pruning with greatly reduced root spiraling. Can be packed on pallets for minimal waste compared to products delivered in cases. A cost-effective option for growing liners that are ready for easy transplant. Suitable for both manual and automatic transplanters. **Best for (crops):** vegetative annuals and perennials, woody ornamentals, silviculture, tissue culture, and germination of seeds.



Item	Vendor	Description	Configuration	Units/cs
S5305C2	5305C2	105Ct Fertiss Sq Cell	(30X40mm)	14/CS (1470)
S5326C	5326C	26Ct Fertiss Strip Rd Cell	(30X40mm)	60/CS
S5350C	5350C	50Ct Fertiss Rd Cell Cell	(40X50mm)	10/CS
S5372C2	5372C2	72Ct Fertiss Sq Cell	(32X35mm)	16/CS
87-53022	87-53022	51/102Ct Hex Cell Split	25X40mm	384/pallet
87-53032	87-5300C	Fertiss Carry Tray Only	8 Channel Trays	50/cs

SOILLESS MEDIA FOR RETAIL

YOUR RETAIL CUSTOMERS DESERVE THE BEST TOO

Did you know Griffin also stocks retail soils from Premier and Lambert? Give your customers the same quality brands the pros know and trust. Browse our full lineup of consumer soils in our Retail catalog.



FERTILIZERS

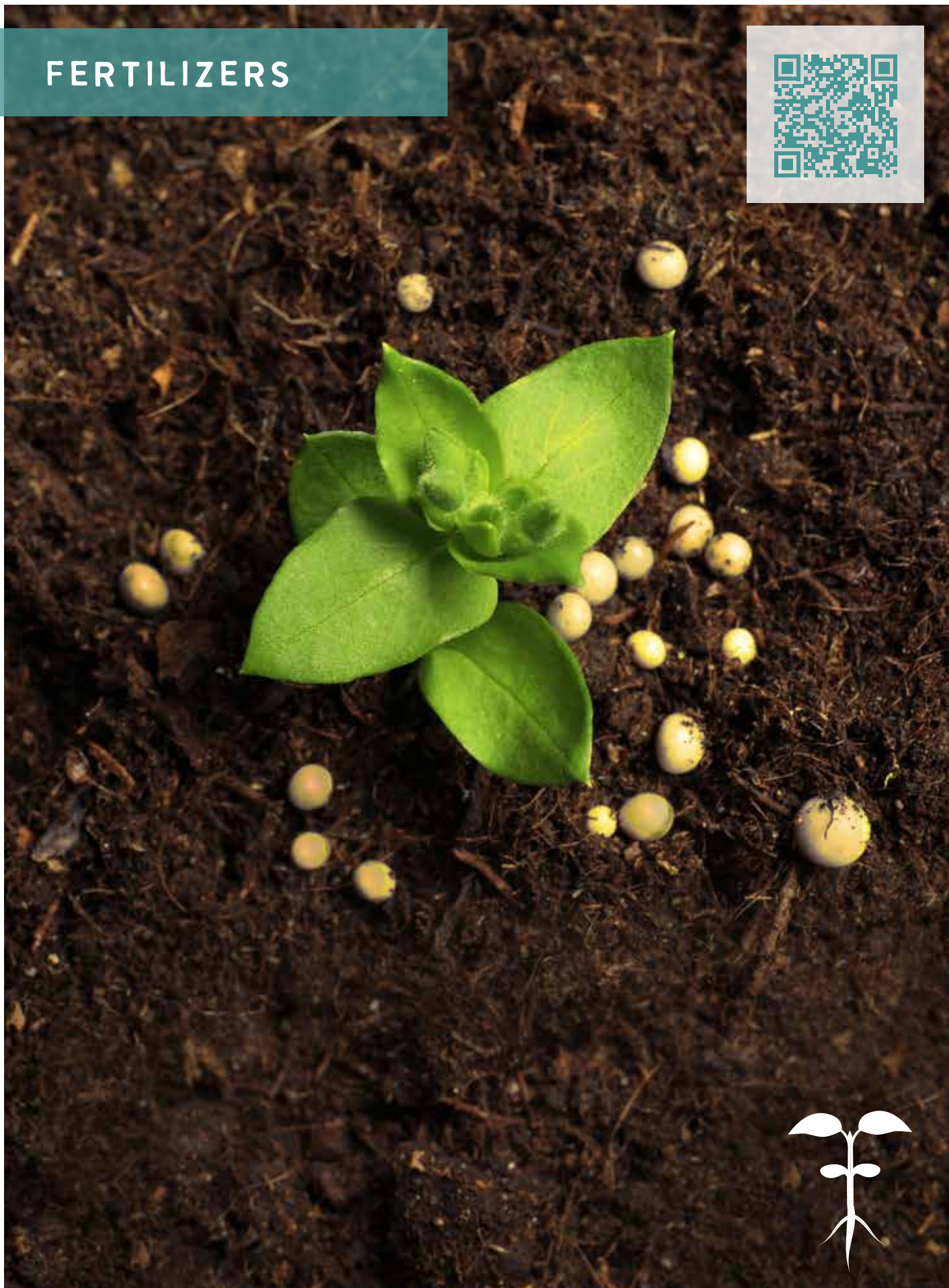
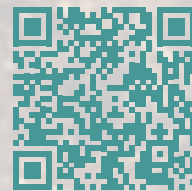



Jack's Professional Water Soluble Fertilizer Formulations



2024

Any product that has the Peat-Lite tag in the name designates that the micronutrient package is elevated to provide a boost of micros when growing in a soilless or "peat-lite" mix.

General Purpose 20-20-20

The general-purpose industry standard, 20-20-20 is great for maintaining plants in garden center and growing facilities. It provides fast green-up and great foliar expansion due to the high percentage of ammonium and urea nitrogen plus balanced phosphorus and potassium for excellent root and shoot growth.

Item: 33612 **Size:** 25 lb.

High Performance 25-5-15

High efficiency formula designed to maximize your NPK delivery while keeping a balance of macro, secondary and micronutrients for optimum plant growth. Best as a continuous feed for heavy feeding plants in moderate to warm temperatures. Micronutrient levels are comparable to peat-lite formulas. Can be used as a nutrient booster for great green-up for almost all varieties.

Item: 33620 **Size:** 25 lb.

Blossom Booster 10-30-20

Use this high phosphorus formulation during periods of bud set to increase number and size of blossoms. Resume use of traditional production fertilizers for the remainder of growing cycle to avoid internode stretch. Great for vegetable production.

Item: 33628 **Size:** 25 lb.

Dark Weather Peat-Lite 15-0-15

Jack's Dark Weather Peat-Lite is an ideal product for growers who want a non-phosphorus, high nitrate product with calcium. The macro nutrient and secondary nutrient levels are very similar to the standard Dark Weather formula, however, the biggest benefit you will get when using this formula is the elevated micronutrient levels.

Alternate with 20-10-20 Peat-Lite or use as a "finisher" for flowering plants like poinsettias. This formula has the Peat-lite micronutrient levels needed for commercially made peat-lite potting media.

Item: 33627 **Size:** 25 lb.

Geranium 15-15-15

An ideal fertilizer for geraniums and other neutral pH loving plants. The high phosphorus content promotes strong root growth and bud set in the plant (also great for pink hydrangeas). The high nitrate nitrogen content (56%) and the general-purpose level of micronutrients help minimize nutritional toxicities on geraniums. Does not contain calcium.

Item: 33622 **Size:** 25 lb.

Peat-Lite 20-10-20

One of the most popular formulations containing additional levels of micronutrients. High nitrate nitrogen levels (60% of the total) provide for green foliage and more compact growth.

Item: 33615 **Size:** 25 lb.

Acid 21-7-7

An ideal fertilizer for acid-loving plants in the nursery and landscape. Provides a rapid correction to a high pH situation. This formulation offered by Jack's, contains NO harmful chlorides.

Item: 33611 **Size:** 25 lb.

Foliar FeED 27-15-12

It is true! Plants can feed through the leaves. This fertilizer is specially formulated to use for foliar feeding of ornamentals, vegetables and fruits. The high urea content and micronutrients promote green-up and foliar expansion. Can be used in conjunction with normal media fertilization or alone. Addition of a surfactant enhances activity.

Item: 33609 **Size:** 25 lb.

Plant Starter 9-45-15

Initial use of this formula when transplanting, supplies the high phosphorus ratio designed to boost root growth prior to shoot development.

Item: 33629 **Size:** 25 lb.

Oasis Hydroponic 16-4-17

Research has shown that using this fertilizer from day one, will dramatically increase root production and branching. Time to transplant into hydroponic solution will be twice as fast compared to the typical method of a clear water start. Give your plants just the right amount of nutrients from the beginning and you will see dramatic results.

Item: J71750 **Size:** 25 lb.

Jack's Professional 15-16-17 Peat Lite

Jack's 15-16-17 is a nice variation of Geranium Special 15-15-15 with slightly elevated micronutrients. With a ratio similar to 20-20-20 but with over 60% nitrate nitrogen, boosted micronutrient levels, and much less acidic reaction in the root media. The balanced N-P-K ratio is excellent for producing fast-growing plants or for maintaining plants in a sales environment.

Item: JP151617 **Size:** 25 lb.

Jack's Professional 21-8-18 Mag Mum

This formula is specifically formulated for the heavy feeding mum crop. It is a high nitrate, high potential acidity formulation that mums require. Extra magnesium is added for improved greening. Contains Peat-Lite trace element level. It also provides a 5% increased efficiency compared to 20-10-20 formula which stretches your fertilizer dollar without compromising performance.

Item: 33-21818 **Size:** 25 lb.

Jack's Professional 15-10-30 Pot Mum Finisher

A smart formulation choice to finish many different crops. The nitrogen to potassium ratio (1:2) is excellent for pot mum production and for other crops with high potassium requirements. This fertilizer has the traditional micronutrient levels found in general purpose formulations.

Item: 33624 **Size:** 25 lb.

Jack's FeED Water Soluble Fertilizer Formulations

Petunia FeED 20-3-19

This product is specially formulated for those chronically iron-hungry crops such as petunia, calibrachoa, bacopa and others. The original Jack's FeED product designed with all three iron chelates, EDTA, DTPA and EDDHA. This innovative formula keeps phosphorus at its lowest level to help prevent excessive elongation but maintain strong and prolific blooms. It is not recommended for use on geraniums or other iron sensitive crops.

Item: 33-20319 **Size:** 25 lb.

Mum FeED 22-5-16

Mums are heavy feeders that respond well to additional magnesium, sulfur and iron. Many times though, the iron becomes unavailable as the pH rises. The elevated iron levels found in the exclusive FeED iron chelate system keeps the iron available to the plant even if the pH rises during the crop cycle. The additional 2% nitrogen in the formula reduces your fertilizer usage by approximately 10%, making this product not only nutritionally effective, but cost effective as well.

Item: 33605 **Size:** 25 lb.

Fall Pansy FeED 17-3-19

Designed specifically for late summer and early fall pansy production. A nitrate ammonium nitrogen system is more efficient in warmer weather than the traditional high nitrate pansy fertilizer. The result is a potentially acidic product that will lower media pH over time.

Item: JP17319 **Size:** 25 lb.





Jack's FeED Water Soluble Fertilizer Formulations

Spring Pansy FeED 15-2-20

Designed specifically for spring pansy production. High nitrate and low phosphorus control plant stretch in low light growing. This formula contains a good amount of soluble calcium and magnesium as well as the extra boron that pansies often need on a constant basis. This balance along with our Iron FeED package will keep pansies compact and green with a strong flower for a beautiful early spring crop.

Item: 33604 **Size:** 25 lb.



2024

Poinsettia FeED Plus Mg 17-5-19

This formula is designed to fit the needs of the newer poinsettia cultivars that require micronutrients, but a lesser amount of macronutrients, containing 50% more iron, manganese, copper and zinc than found in typical poinsettia peat-lite formulations. Low boron levels help prevent toxicity problems.

Item: 3317519 **Size:** 25 lb.

Poinsettia FeED Ca-Mg 15-4-15

This formula is designed to fit the needs of the newer poinsettia cultivars that require micronutrients, but a lesser amount of macronutrients, containing 50% more iron, manganese, copper and zinc than found in typical poinsettia peat-lite formulations. Low boron levels help prevent toxicity problems. The Ca-Mg formula contains extra calcium for water types that are low in this essential nutrient.

Item: 3315415 **Size:** 25 lb.

Jack's LX Water Soluble Fertilizer Formulations

All Purpose LX 21-5-20

This is the ideal fertilizer for moderate to high alkalinity water. This complete formula keeps calcium, magnesium and phosphorus soluble in concentration, giving the grower ultimate flexibility when adjusting their nutrient program. It can be tank mixed with 15-5-15, other Jack's LX formulas as well as calcium nitrate and/or magnesium nitrate.

Item: 33602 **Size:** 25 lb.

Calcium + Magnesium LX 15-5-15

Jack's 15-5-15 is a staple in many grower's fertilizer tool box. It contains 4% calcium and 2% magnesium (making it an ideal choice for water low in those nutrients), 80% nitrate nitrogen, and micronutrients. Potentially basic, this formula will cause the pH in the root zone to rise over time, making this formula ideal for water types that are very pure or low in water alkalinity levels.

Item: 33601 **Size:** 25 lb.

Pure Water LX 17-4-17

Designed specifically for pure water sources like RO filtered or rain water. Formula designers at JR Peters ensured this blend will deliver the desired 4:1:4 macronutrient ratio along with 3% calcium, 1.5% soluble magnesium and a boosted micronutrient package. A potentially NEUTRAL formula- this comes in handy for growers looking to minimize pH swing in the root zone.

Item: 33174 **Size:** 25 lb.

Dark Weather Plus Mag LX 15-0-14

This formula is a great asset to the Jack's LX line. An ideal product for growers who want a non-phosphorus, high nitrate product with calcium and magnesium. Similar to the 15-0-15 Dark Weather, however, it can be mixed into any LX tank mixing fertility program. An extra boost of Ca as well as Mg is essential in times of cooler weather and lower light conditions.

Item: 33-150014 **Size:** 25 lb.

Plug LX 13-2-13

An ideal fertilizer for plug and young plant production. A complete product with 6% soluble calcium and 3% soluble magnesium making this formula very BASIC. It is formulated with 94% nitrate nitrogen to provide an easy to uptake nitrogen form for new roots and also low light, cooler conditions. Low phosphorus and a balanced micronutrient package helps promote compact, sturdy plugs.

Item: 33607 **Size:** 25 lb.

Jack's Aqua Gold High Tunnel Water Soluble Formulations



Grow & Bloom 15-20-28

The ideal fertilizer for encouraging overall healthy plant growth, a strong root system, and rapid development of all plants. Its high phosphorus content encourages rapid root generation which eliminates transplant shock when used as a transplanting solution.

Item: J77004 **Size:** 25 lb.

Finisher 7-15-30

This 1-2-4 finisher has been formulated especially for high tunnel tomato production. 30% potassium helps ripen tomatoes and fend off yellow shoulder.

Item: J71110 **Size:** 25 lb.

Jack's Professional Dry Nutrient Charge

Media Mix Plus III 10-5-10

This product is designed to get plants off to a good start and is most effective when a liquid feed program is initiated immediately after planting.

Item: 33172 **Size:** 50 lb.

Jack's Nutrients Line



The Jack's FeED line is comprised of complete nutrient formulations. Everything your plants need for each stage, from start to finish.



Part A 5-12-26

An improvement on the classic "Part A" formula for general vegetative growing. This redesigned blend is built with purely soluble and available nutrients to allow the grower maximum flexibility. Specific balance of macro, secondary and micronutrients delivers an efficient combination of nutrients suitable for many different growing environments and crop types.

Item: 33-51226 **Size:** 25 lb.
Item: 80060046 **Size/Qty:** 2.2 lb. - 6 per case

Low Phos Part A 6-6-26

A unique formula designed to deliver lower phosphorus levels into any growing program. Jack's Part A 6-6-26 will replace and/or complement any two part growing system paired with typical calcium content from our Jack's Part B by ensuring consistent N, K and micronutrient levels as you expect in our typical Part A 5-12-26.

Item: 33-79220 **Size:** 25 lb.

12-4-16

For the Purest in you. This one part nutrient blend is designed for crops grown in very low alkalinity waters such as reverse osmosis (RO) water, rainwater, and distilled water. Formulated utilizing innovative raw materials to reduce pH crash while delivering all the nutrients essential for vigorous plant growth.

Item: 33-12416 **Size:** 25 lb.
Item: 80060047 **Size/Qty:** 2.2 lb. - 6 per case



15-5-20

Allow your plants to drink up this formula designed to provide all the macro, secondary and micro nutrients in a one-part system. Specifically formulated for tap, city or well water types with slightly higher alkalinity & pH. This combination of nutrients will lower pH over time while including the extra soluble calcium, magnesium and the right balance of micronutrients.

Item: 33-15520 **Size:** 25 lb.
Item: 80060048 **Size/Qty:** 2.2 lb. - 6 per case

Bloom 10-30-20

Need a Boost of Flower Power? The 1:3:2 major nutrient ratio has been trusted by Jack's Professional growers for over 70 years. This soluble and available nutrient combination stimulates blooming, resulting in heavy bud and fruit set.

Item: 33-103020 **Size:** 25 lb.
Item: 80060049 **Size/Qty:** 2.2 lb. - 6 per case

18-8-23

Yep that's right, a nutrient blend specifically tailored for outdoor production. The research team at Jack's has a real knack for making things easy, efficient and cost effective in any growing environment and this product definitely wears its name well. This nutrient blend is potentially acidic and designed to keep your pH in the desired range for optimum nutrient uptake. Plus, perfecting the N:K₂O ratio as well as adding a kick on Mg and S to hit the right balance so that your plants can thrive in the sunlight rich environment. Get ready to see fields of happy plants!

Item: 33-18823 **Size:** 25 lb.

Clone 15-6-17

Like hitting the accelerator for your new plants - this formula will help promote strong and fast root growth and expansion. Best used for fertilizing young seedlings, transplants, clones and newly set rooted cuttings.

Item: 33-15617 **Size:** 25 lb.
Item: 80060050 **Size/Qty:** 2.2 lb. - 6 per case



Jack's Nutrients Line

UltraViolet 5-50-18

Get ready for a serious boost of available phosphorus. The primary goal of this formula is to assist in shutting down the strong vegetative growth stage of the plant and stimulate a switch to the reproductive or flowering phase of plant and flower development.

Item: 33-55018 **Size:** 25 lb.
Item: 80060051 **Size/Qty:** 2.2 lb. - 6 per case

Finish 7-15-30

You've always been told to finish strong. This formula is ideally formulated for this purpose to provide your plants with a very low nitrogen, high phosphorus and very high potassium content to keep the whole plant happy to the end of its crop cycle.

Item: 33-71530 **Size:** 25 lb.
Item: 80060053 **Size/Qty:** 2.2 lb. - 6 per case

Strawberry Part A 8-10-26

Designed to deliver targeted nutrition specific for Strawberry production. This unique formula combines specific macro, secondary and micro nutrients at a low constant feed rate in complement with our Jack's Part B for the calcium source to achieve a complete two part system!

Item: 33-79210 **Size:** 25 lb.



Jack's Nutrients Line



All the little extras your plants may need. Do you need calcium, extra micros, or extra iron? Boost has these supplements and more.



GGSPRO TIP

JACK'S NUTRIENTS 0-12-26 PART A FERTILIZER

This zero-nitrogen formula delivers a proven ratio of P and K along with a micronutrient package to achieve harvest goals in the late flowering stages of cannabis crops. This unique fertilizer also complements programs where nitrogen is solely sourced from calcium nitrate such as Jack's 15-0-0 Cal Nit Part B.

Part A 0-12-26

Zero nitrogen formula delivers a proven ratio of P and K to achieve harvest goals. Designed to follow the Part A system of nutrient delivery. This purely soluble and available formula keeps secondary and micronutrients consistent at each feeding. As with all Jack's fertilizers, we use only the highest-grade technical materials in our formulation. Manufacturing is done under laboratory control with the finest available mixing and blending equipment using an exclusive JR PETERS process. And don't forget 15-0-0 Cal Nit Part B of this two part system!

Item: 33-79230 **Size:** 25 lb.

Cal Nit Part B 15-0-0

An essential "Part B" provides a very soluble and available source of calcium in a two-part nutrient system. Contains very pure and completely available calcium and nitrate nitrogen nutrient sources.

Item: 33-79080 **Size:** 25 lb.
Item: 80060052 **Size/Qty:** 2.2 lb. - 6 per case

Cal-Trate 15-0-0

Jack's 15-0-0 Cal-Trate addresses specific crop and water needs by supplying calcium and nitrogen as well as a balanced micronutrient package. This formula will provide a boost of calcium while maintaining micronutrient targets.

Item: 33-79170 **Size:** 25 lb.

K-Trate 14-5-38

A great formula for providing a boost of potassium and nitrogen along with a balanced micronutrient package. Can be used on all crops and is especially good for finishing crops off by providing elevated levels of potassium while keeping micronutrients on target at the end of a crop cycle.

Item: JP14538 **Size:** 25 lb.

Jack's FERTILIZERS

FORMULATION CHART

Jack's FeED®

		Nitrogen Breakdown														
		NO ₃	NH ₄	%Fe	A/B	To deliver 100 ppm N	Urea Free	Extra Mg	Low P	Extra Fe	with Ca	Plugs	Hard Water	Root & Bloom	Foliar Feeding	Boosted Micro
Mum FeED®	22-5-16	12.54	9.46	0.2000	Acidity	6.1 oz/100 gallons	✓	✓	✓	✓			✓			✓
Petunia FeED Plus Mg	20-3-19	11.96	8.04	0.2000	Acidity	6.8 oz/100 gallons	✓	✓	✓	✓			✓			✓
Boosted Base FeED	18-2-18	6.55	11.5	0.2529	Acidity	7.5 oz/100 gallons	✓	✓	✓	✓						✓
Poinsettia FeED Plus Mg	17-5-19	10.79	6.21	0.1275	Acidity	7.9 oz/100 gallons	✓	✓	✓	✓			✓			✓
Poinsettia FeED Ca-Mg	15-4-15	12.12	2.88	0.1125	Basicity	9.0 oz/100 gallons	✓	✓	✓	✓	✓					✓
Fall Pansy FeED	17-3-19	11.10	5.90	0.1700	Acidity	7.9 oz/100 gallons	✓	✓	✓	✓			✓			✓
Spring Pansy FeED	15-2-20	12.64	2.36	0.0750	Basicity	9.0 oz/100 gallons	✓	✓	✓	✓	✓					✓

Jack's LX™

		Nitrogen Breakdown														
		NO ₃	NH ₄	%Ca	A/B	To deliver 100 ppm N	Urea Free	Extra Mg	Low P	Extra Fe	with Ca	Plugs	Hard Water	Root & Bloom	Foliar Feeding	Boosted Micro
All Purpose	21-5-20	13.08	7.92	0.00	Acidity	6.4 oz/100 gallons	✓		✓				✓			✓
Poinsettia	20-5-19	12.56	7.44	0.00	Acidity	6.8 oz/100 gallons	✓		✓				✓			✓
Pure Water	17-4-17	13.27	3.73	3.00	Neutral	7.9 oz/100 gallons	✓	✓	✓		✓					✓
Hi Alkalinity Water Plug	16-2-15	12.00	4.00	3.00	Acidity	8.4 oz/100 gallons	✓	✓	✓		✓	✓	✓			✓
CA - MG	15-5-15	12.00	3.00	4.00	Basicity	9.0 oz/100 gallons	✓	✓	✓		✓	✓				✓
Dark Weather Plus Mag	15-0-14	12.40	2.60	5.00	Basicity	9.0 oz/100 gallons	✓	✓	✓		✓					✓
Plug	13-2-13	12.22	0.78	6.00	Basicity	10.4 oz/100 gallons	✓	✓	✓		✓	✓				✓

Jack's Professional®

		Nitrogen Breakdown														
		NO ₃	NH ₄	%Ca	A/B	To deliver 100 ppm N	Urea Free	Extra Mg	Low P	Extra Fe	with Ca	Plugs	Hard Water	Root & Bloom	Foliar Feeding	Boosted Micro
High Performance	25-5-15	14.25	10.75	0.00	Acidity	5.4 oz/100 gallons	✓		✓	✓			✓			
MagMum	21-8-18	12.40	8.60	0.00	Acidity	6.4 oz/100 gallons	✓	✓		✓			✓			✓
Acid	21-7-7	0.00	11.47	0.00	Acidity	6.4 oz/100 gallons				✓			✓			
GP	20-20-20	6.07	3.83	0.00	Acidity	6.8 oz/100 gallons							✓		✓	
GP	20-10-20	12.00	8.00	0.00	Acidity	6.8 oz/100 gallons	✓						✓			
Peat-Lite	20-10-20	12.00	8.00	0.00	Acidity	6.8 oz/100 gallons	✓			✓			✓			
Peat-Lite	15-16-17	9.25	3.15	0.00	Acidity	9.0 oz/100 gallons							✓			
Geranium	15-15-15	8.40	2.88	0.00	Acidity	9.0 oz/100 gallons										
Dark Weather	15-0-15	12.12	0.58	11.00	Basicity	9.0 oz/100 gallons			✓		✓					
Dark Weather Peat-Lite	15-0-15	13.50	1.50	10.69	Basicity	9.0 oz/100 gallons	✓		✓		✓					
Blossom Booster	10-30-20	5.00	5.00	0.00	Acidity	13.5 oz/100 gallons	✓	✓						✓	✓	
Plant Starter	9-45-15	0.00	9.00	0.00	Acidity	15 oz/100 gallons	✓							✓		
Orchid- Well Water	16-4-20	12.20	3.80	3.00	Neutral	8.44 oz/100 gallons	✓	✓	✓	✓		✓				✓
Orchid- R.O. Water	12-3-15	11.60	0.40	7.00	Basicity	11.25 oz/100 gallons	✓	✓	✓	✓		✓				✓
Media Mix Plus III	10-5-10					13.5 oz/100 gallons										
Mix of Soluble Traces (MOST)							✓									
Oasis Hydroponic	16-4-17	12.80	3.60	0.1000	Neutral	8.4 oz/100 gallons	✓	✓	✓	✓	✓					✓

Jack's Nutrients

		Nitrogen Breakdown														
		NO ₃	NH ₄	%Ca	A/B	To deliver 100 ppm N	Urea Free	Extra Mg	Low P	Extra Fe	with Ca	Prop	Hard Water	Pure Water	Root & Bloom	Boosted Micro
Part A	5-12-26	5.00	0.00	0.00	Basicity	26 oz/100 gallons	✓	✓		✓				✓		✓
Part B	Cal Nit	14	1	18	Basicity	9oz/100 gallons	✓		✓		✓			✓		✓
12-4-16	12-4-16	11.80	0.20	7.00	Basicity	11.3oz/100 gallons	✓	✓	✓	✓	✓	✓		✓		✓
15-5-20	15-5-20	12.00	3.00	3.00	Basicity	9oz/100 gallons	✓	✓	✓	✓	✓	✓	✓			✓
Bloom	10-30-20	5.00	5.00	0.00	Acidic	13.5oz/100 gallons	✓						✓		✓	
Clone	15-6-17	12.00	3.00	4.00	Basicity	9oz/100 gallons	✓	✓	✓	✓	✓	✓	✓	✓		✓
UltraViolet	5-50-18	0.00	5.00	0.00	Acidic	27oz/100 gallons	✓	✓					✓		✓	
Finish	7-15-30	4.00	3.00	0.00	Acidic	19oz/100 gallons	✓	✓					✓			
Outdoor	18-8-23	11.50	6.50	0.00	Acidic	7.5oz/100 gallons	✓		✓				✓			
Cal-Trate	15-0-0	13.95	1.05	18.00	Basicity	9.0 oz/100 gallons	✓		✓		✓					✓
K-Trate	14-5-38	10.46	0.00	0.00	Basicity	9.64 oz/100 gallons			✓							✓
Mag-Trate	10-0-0	10.00	0.00	0.00	Basicity	13.50 oz/100 gallons	✓	✓	✓							✓
Part A Strawberry	8-10-26	7.00	1.00	0.00	Basicity	17oz/100 gallons	✓	✓		✓				✓		✓
Part A Low Phos	6-6-26	6.00	0.00	0.00	Basicity	22oz/100 gallons	✓	✓		✓				✓		✓



2024

**YOU DON'T NEED JUST ANY FERTILIZER,
*You need Plantex Solutions!***

Fresh Solutions for your Plant's Nutrition. Plantex has Micro Plus Enrichment in most of the Plantex Solutions products, which means enhanced iron, manganese, copper, boron, molybdenum and zinc levels with additional chelating agents, making them available over a broader pH range.

No-Stretch® 15-0-20

No-Stretch works to harden plant structure and prevent leggy growth. Use toward the end of the crop cycle for compact sturdy growth and to keep internodes short.

Item: 31-140105 **Size:** 25 lb.

Complete 17-5-17

Complete is an all-in-one advanced nutritional program containing all 5 macros and high levels of nitrate with no urea. It is effective over a wide pH range. **Comes in a duo bag for easy usage.**

Item: 31-140145 **Size:** 25 lb.

pH Reducer 18-9-18

This balanced growth formulation, decreases pH levels while supplying the growing media with enhanced micronutrients, including three chelating agents.

Item: 31-140155 **Size:** 25 lb.

Fertility Plus 19-2-19

This high nitrate, urea-free fertilizer is balanced with enhanced micronutrient availability and performance, ideal for heavy feeding.

Item: 31-11078 **Size:** 25 lb.

Complete Plus 19-8-13

Complete Plus is a modification of the Complete formulation with more acidic potential. Growers with higher alkaline water can reduce or eliminate the use of acid. **Comes in a duo bag for easy usage.**

Item: 31-140165 **Size:** 25 lb.

Plantex Solutions Specifications

Plantex Formulation	No-Stretch® 15-0-20	Complete 17-5-17	pH Reducer 18-9-18	Fertility Plus 19-2-19	Complete Plus 19-8-13
Total Nitrogen (N)	15%	17%	18%	19%	19%
Nitrate Nitrogen	12.2%	12.1%	8.5%	12.2%	12.1%
Ammoniacal Nitrogen	2.8%	4.9%	9.5%	6.8%	6.9%
Urea Nitrogen	-	-	-	-	-
Available Phosphate (P ₂ O ₅)	-	5%	9%	2%	8%
Soluble Phosphorus (P)	-	2.1%	3.9%	0.8%	3.4%
Soluble Potash (K ₂ O)	20%	17%	18%	19%	13%
Soluble Potassium (K)	16.6%	14.1%	14.9%	15.7%	10.7%
Calcium (Ca)	3%	3%	-	-	2.5%
Magnesium (Mg)	1.5%	1%	0.2%	1.5%	1%
Sulphur (S)	-	-	5.5%	1.8%	-
Iron (Fe)	0.25%	0.10%	0.25%	0.25%	0.25%
Manganese (Mn)	0.075%	0.05%	0.075%	0.075%	0.075%
Zinc (Zn)	0.075%	0.05%	0.075%	0.075%	0.075%
Copper (Cu)	0.05%	0.05%	0.05%	0.05%	0.05%
Boron (B)	0.02%	0.02%	0.02%	0.02%	0.02%
Molybdenum (Mo)	0.015%	0.015%	0.015%	0.015%	0.015%
Chelating agent -	1.48% EDTA 0.95% DTPA 0.1% EDDHA	1.24% EDTA	1.49% EDTA 0.95% DTPA 0.09% EDDHA	1.48% EDTA 0.95% DTPA 0.1% EDDHA	1.48% EDTA 0.95% DTPA 0.1% EDDHA
Potential Acidity (A) / Basicity (B) (lbs CaCO₃ per ton of fertilizer)	154 (B)	105(A)	716 (A)	309 (A)	300 (A)
Solubility (lb per gallon)					
50°F	2 1/6	3 1/4	2 1/2	1	2
60°F	3 1/2	4 1/2	2 3/4	1 2/3	3 1/3
75°F	4 7/8	6 2/3	4	3 2/5	4 2/3
Electrical Conductivity (EC): ppm of Nitrogen					
100	0.91	0.69	0.88	0.78	0.56
200	1.82	1.35	1.72	1.54	1.12
300	2.72	2.00	2.55	2.29	1.67

Reference: EDTA - Ethylene Diamine Tetraacetate • DTPA - Diethylene Triamine Pentaacetate • EDDHA - Ethylene Diamine Dihydroxyphenylacetic Acid

For detailed information please visit www.plantprod.com



Custom mixes are available for any water soluble fertilizer, premix or micronutrient mix.

6-11-31 Hydroponic Water Soluble Fertilizer

Plant-Prod 6-11-31 water soluble fertilizer provides an excellent fertility program for greenhouse vegetable crops grown in Nutrient Film Technique (NFT), rockwool culture and other forms of hydroponic or soilless cultures. It must be used with calcium nitrate for a complete nutritional program.

Item: 31-12703 **Size:** 25 lb.

10-52-10 High P

High P supplies the necessary high phosphorus levels that young plants require with maximum solubility.

Item: 31-10368 **Size:** 25 lb.

12-2-14 Cal Mag + P

Cal Mag + P is designed for plug production with 6% calcium and 3% magnesium as well as a complete micronutrient package.

Item: 31-140075 **Size:** 25 lb.

15-0-15 Cal-Plus

Cal-Plus is a completely water soluble prilled mixture of calcium nitrate, potassium nitrate and micronutrients.

Item: 31-140100 **Size:** 25 lb.

15-15-30 High K

High K has a higher level of potash, particularly well suited for finishing container grown plants.

Item: 31-140125 **Size:** 25 lb.

17-4-19 Pansy

This formula is designed for use by pansy growers wanting an acidic soil reaction and the increased iron, magnesium and boron levels required by pansies. The iron is partially in DTPA form.

Item: 31-140111 **Size:** 25 lb.

18-6-20 Poinsettia Plus

Poinsettia Plus is designed specifically for poinsettias. This formulation may also be used on other crops requiring lower level of boron. This formulation contains over 60% of the nitrogen in nitrate form, a high level of magnesium and chelated micronutrients.

Item: 31-140151 **Size:** 25 lb.

20-10-20 All Purpose High Nitrate

All Purpose High Nitrate is an all season fertilizer with a high potential acidity.

Item: 31-140200 **Size:** 25 lb.

20-20-20 Classic

Classic is a balanced fertilizer that may be used for general feeding. It is ideal for when a more specific formula is not required.

Item: 31-140300 **Size:** 25 lb.

21-5-20 High Nitrate Low P

Effective in soilless media, High Nitrate Low P is a general feed formulation and is the base for many fertilizer programs.

Item: 31-140306 **Size:** 25 lb.

21-7-7 Acid

This highly acidic formulation should be used for crops requiring higher acid soil conditions and when irrigation water has a high pH level.

Item: 31-140310 **Size:** 25 lb.

Media Starter 10-5-10

This premix is designed to be incorporated into the media prior to planting and provides nutrition early in the crop cycle. It serves as a starter charge and has a wetting agent added to ensure uniform penetration. Do not heat/steam sterilize this mix after incorporation.

Item: 31-11104 **Size:** 50 lb.

Plantex Specifications

Plantex Formulation	High P 10-52-10	Cal Mag +P 12-2-14	Cal-Plus 15-0-15	High K 15-15-30	Pansy 17-4-19	Poinsettia Plus 18-6-20	All Purpose High Nitrate 20-10-20	Classic 20-20-20	High Nitrate Low P 21-5-20	Acid 21-7-7	Nutritrace	Media Starter 10-5-10
Total Nitrogen (N)	10%	12%	15%	15%	17%	18%	20%	20%	21%	21%	-	10%
Nitrate Nitrogen	-	11.7%	13.3%	8.9%	11%	11.4%	12%	5.9%	12.8%	2.1%	-	8.4%
Ammoniacal Nitrogen	7.1%	0.3%	1.7%	2.9%	6%	6.6%	8%	3.9%	8.2%	13.2%	-	1.2%
Urea Nitrogen	2.9%	-	-	3.2%	-	-	-	10.2%	-	5.7%	-	0.4%
Available Phosphate (P ₂ O ₅)	52%	2%	-	15%	4%	6%	10%	20%	5%	7%	-	5%
Soluble Phosphorus (P)	22.6%	0.8%	-	6.5%	1.7%	2.62%	4.3%	8.7%	2.1%	3%	-	2.1%
Soluble Potash (K ₂ O)	10%	14%	15%	30%	19%	20%	20%	20%	20%	7%	-	10%
Soluble Potassium (K)	8.3%	11.6%	12.4%	24.9%	15.7%	16.6%	16.6%	16.6%	16.6%	5.8%	-	8.3%
Calcium (Ca)	-	6%	11%	-	-	-	-	-	-	-	-	6%
Magnesium (Mg)	-	3%	-	-	3.25%	2%	0.24%	-	0.20%	-	1.5%	3%
Sulphur (S)	-	-	-	-	4%	2.5%	0.20%	-	0.20%	13%	1%	4%
Iron (Fe)	0.10%	0.10%	0.10%	0.10%	0.18%	0.10%	0.10%	0.10%	0.125%	0.10%	7%	0.75%
Manganese (Mn)	0.05%	0.05%	0.05%	0.05%	0.05%	0.05%	0.05%	0.05%	0.05%	0.05%	2%	0.15%
Zinc (Zn)	0.05%	0.05%	0.05%	0.05%	0.05%	0.05%	0.05%	0.05%	0.05%	0.05%	0.4%	0.15%
Copper (Cu)	0.05%	0.05%	0.05%	0.05%	0.05%	0.05%	0.05%	0.05%	0.05%	0.05%	0.1%	0.05%
Boron (B)	0.02%	0.02%	0.02%	0.02%	0.035%	0.01%	0.02%	0.02%	0.02%	0.02%	-	0.02%
Molybdenum (Mo)	0.0005%	0.015%	0.015%	0.0005%	0.015%	0.06%	0.015%	0.0005%	0.015%	0.0005%	0.06%	0.004%
Chelating agent -	1.24% EDTA	1.24% EDTA	1.24% EDTA	1.24% EDTA	1.24% EDTA 0.56% DTPA	0.71% EDTA 0.70% DTPA	1.24% EDTA	1.24% EDTA	1.24% EDTA 0.17% DTPA	1.24% EDTA	65.4% EDTA	-
Potential Acidity (A) / Basicity (B) (lbs CaCO₃ per ton of fertilizer)	900 (A)	383 (B)	314 (B)	100 (A)	265(A)	304 (A)	437 (A)	570 (A)	440 (A)	1580(A)	-	-
Solubility (lb per gallon)												
50°F	3	4	1¼	2½	2½	2½	3	3	3	4		
60°F	3½	5½	2½	3	3½	4	4½	3½	4½	4½		
75°F	4	6½	3½	3¾	4½	4½	5	4	5	4¾		
Electrical Conductivity (EC): ppm of Nitrogen												
100	0.81	0.89	0.84	0.8	0.91	0.86	0.73	0.45	0.72	0.78		
200	1.61	1.68	1.60	1.4	1.79	1.69	1.45	0.94	1.42	1.52		

Formulation	Potential Acidity (A)/ Basicity (B)	EC (mmhos) at 200 ppm N
Cal Mag +P 12-2-14	383 (B)	1.68
Cal-Plus 15-0-15	314 (B)	1.60
High K 15-15-30	100 (A)	1.40
Pansy 17-4-19	265 (A)	1.79
Poinsettia Plus 18-6-20	304 (A)	1.69
All Purpose High Nitrate 20-10-20	437 (A)	1.45
High Nitrate Low P 21-5-20	440 (A)	1.42
Classic 20-20-20	570 (A)	0.94
High P 10-52-10	900 (A)	1.61
Acid 21-7-7	1580 (A)	1.52
No-Stretch® 15-0-20	154 (B)	1.82
Complete 17-5-17	105 (A)	1.35
Complete Plus 19-8-13	300 (A)	1.12
Fertility Plus 19-2-19	309 (A)	1.54
pH Reducer 18-9-18	716 (A)	1.72

Reference:

- EDTA - Ethylene Diamine Tetraacetate
- DTPA - Diethylene Triamine Pentaacetate
- EDDHA - Ethylene Diamine
Dihydroxyphenylacetic Acid

Potential Acidity/Basicity for Plantex and Plantex Solutions Fertilizers

Acidity potential is the amount in lb. of calcium carbonate needed to neutralize the acidity caused by one ton of the fertilizer. Potential basicity is the amount in lb. of calcium carbonate that has the same alkalizing effect as one ton of the fertilizer.

For detailed information please visit
www.plantprod.com



Simple yet scientific.

The Plant-Prod MJ™ line of fertilizers was designed to bring 77 years of experience to the cannabis growers of today. Plant-Prod® by Plantex is excited to provide licensed growers of medical marijuana products that are scientifically optimized, consistent and completely soluble.

Plant-Prod MJ™ Spike (CaMg)

Spike (CaMg) is a fully chelated supplemental formulation that provides calcium and magnesium in a desirable 2:1 ratio. This has been specifically formulated to meet the high demands of cannabis plants throughout the entire production cycle with no additional nitrogen, phosphorus or potassium. Ideal for use with reverse osmosis (RO) or city water where calcium and magnesium levels are usually low. Application should be limited to two times per week.

Item: 31-M12310 **Size:** 25 lb.
Item: 81970004 **Size/Qty:** 12.3 oz. (12 case)

Plant-Prod MJ™ Bloom 10-30-20

Bloom is an essential formulation to cannabis production. This high phosphorous, moderate potassium formulation encourages full bud set and improves bud filling.

Item: 31-M12206 **Size:** 25 lb.
Item: 81970002 **Size:** 4.4 lb.

Plant-Prod MJ™ Boost 15-30-15

Boost is a high phosphorus formulation that supplies the necessary phosphorus for cannabis transplants and bud sizing.

Item: 31-M12278 **Size:** 25 lb.
Item: 81970003 **Size:** 4.4 lb.



Plant-Prod MJ™ Cal Kick 15-0-14

Cal Kick is a high calcium formulation that should be used as the main calcium source throughout the production cycle when levels in water source are not adequate. Calcium is vital to plant rigidity and bud formation.

Item: 31-M12305 **Size:** 25 lb.

Plant-Prod MJ™ Finisher 4-31-37

Finisher is a cannabis specific finishing formulation with elevated phosphorus and potassium to encourage fullness and density of buds.

Item: 31-M12280 **Size:** 25 lb.
Item: 81970005 **Size:** 4.4 lb.

Plant-Prod MJ™ Grow 12-8-26

Grow is specifically formulated for the vegetative growth stage of cannabis plants. Ideal for use in a mother plant feeding program with Cal Kick.

Item: 31-M12279 **Size:** 25 lb.
Item: 81970001 **Size:** 4.4 lb.

Plant-Prod MJ™ Program Schedule by Week

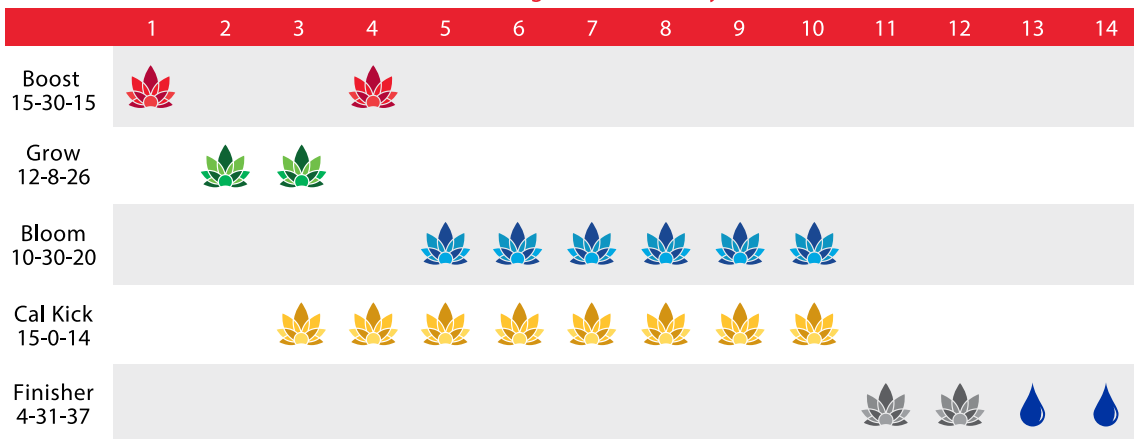

Visit the Plant-Prod website at plantprod.com for full program details and suggested rates.



Peters Excel® Peters Professional®

Peters Water-Soluble Fertilizer is the clear choice

The world standard in water-soluble fertilizer, Peter's superior nutrient uptake brings robust growth, consistent quality and breathtaking color. Using the finest ingredients results in clean formulations and almost total solubility. This purity of product eliminates precipitates and clogged emitters. Specialized product options allow growers to customize nutritional programs to their needs.

PETERS EXCEL

Peters Excel utilizes patented technology and pure ingredients to **counter high alkalinity** and keep stock tank formulations in-solution. Excel's high solubility eliminates precipitate build-up and keeps irrigation lines flowing.

Peters Excel pHLow

With twice the active acidity of regular Peters Excel, pHLow utilizes **bicarbonate-neutralizing** technology to improve water quality in high-alkalinity conditions. Single-tank compatibility saves time, labor, and material costs.

Peters Professional

The exclusive M-77 **chelating** formula results in the highest levels of nutrient uptake efficiency. Suitable for all water types, the Professional line is comprised of 13 products, each formulated for a specific nutritional program.

Peters Professional Peat-Lite

Peat-Lite formulations contain **elevated levels of micronutrients** needed in today's media mixes. Highly specialized formulations let growers dial in their fertilization programs to exacting levels.



Peters Excel®



A total nutrient package in a single tank, with a single injector.

The unique chemistry of Peters Excel makes it possible to combine NPK, calcium, magnesium and sulfated trace elements, without precipitation so all the nutrients are readily available to your plants. Peters Excel means simple one-tank mixing and no need for two-head injectors. It keeps drip lines clean. There's less cost and risk, too, because you can reduce or even eliminate your use of acids. The Excel pHLow line utilizes bicarbonate-neutralizing technology to improve water quality in high-alkalinity conditions.



Peters Excel 15-5-15 Cal-Mag Special with black iron

Peters Excel Cal-Mag Special is an excellent all-purpose, complete formulation that features high nitrate nitrogen and low phosphate with extra calcium and magnesium. Growing with Peters Excel Cal-Mag Special produces healthy, compact plants over a wide variety of species and cultivars. With the addition of M-77 with black iron (containing three iron chelates), iron is available over the broadest possible pH range.

Item: 67-2305 **Size:** 25 lb.

Peters Excel 21-5-20 Multi-purpose

A **one bag** solution with a patented technology to counter high alkalinity in irrigation water. This is a moderately acidic formulation serves as an excellent all-purpose fertilizer for Types 2, 3, and 4 irrigation water (Alkalinity 60-240+).

Item: 67-2308 **Size:** 25 lb.

Peters Excel 13-2-13 Plug & Bedding Plant Special

A **one bag** solution with a patented technology to counter high alkalinity in irrigation water. Ideal for plugs, liners, bedding plants and vegetable transplants with high nitrate and low phosphate levels to encourage healthy, compact growth. Most effective with Water Types 1 and 2 (Alkalinity up to 150).

Item: 67-2304 **Size:** 25 lb.

Peters Excel 15-2-20 Pansy Special

A **one bag** solution with a patented technology to counter high alkalinity in irrigation water. Formulated for compact growth and bright blossoms on pansy, salvia, vinca, etc. with high nitrate, low phosphate and extra boron. Most effective with Water Types 1 and 2 (Alkalinity up to 150). Contains calcium, magnesium and other minor elements.

Item: 67-2302 **Size:** 25 lb.

Peters Professional®

The Peters Professional line is the industry's most widely recognized and trusted brand made with the highest quality ingredients available. The proprietary M-77 chelated formula facilitates stock tank mixing while providing easy "no clog" delivery of your plants' nutrition. Specialized Peat-Lite formulations contain elevated levels of micronutrients needed in today's media mixes.

Peters Professional 5-11-26 Hydroponic Special

Designed exclusively for hydroponic culture, this classic formula is ideal for tomatoes, cucumbers and lettuce.

Item: 67-2320 **Size:** 25 lb.

Peters Professional 20-10-20 General Purpose

Crops that are sensitive to excess micronutrients thrive with this classic formula with its acidifying action that helps suppress the pH of growing media from raising.

Item: 67-2316 **Size:** 25 lb.

Peters Professional 20-20-20 General Purpose

Acidifying action combats excessive pH in mineral soil growing media. Contains low levels of micronutrients.

Item: 67-2318 **Size:** 25 lb.

Peters Professional 20-3-19 Petunia Special with Black Iron

Peters Professional Petunia Special with black iron is a formulation of three chelated Irons, including black iron. This M-77® chelated system is specifically designed for petunias and other high Iron demanding plants. This product is a high Nitrate N and low Phosphate feed that encourages dense, compact, healthy growth in petunias and other flowering plants.

Item: 67-2364 **Size:** 25 lb.



Peters Professional 15-0-15 Peat-Lite Dark Weather Feed

Classic high-nitrate formula for bulbs or any crop that needs extra calcium and magnesium, lower phosphate and slightly higher growing media pH. Provides a full range of essential micronutrients.

Item: 67-2340 **Size:** 25 lb.

15-16-17 Peat-Lite Special

The perfect 1:1:1 N-P-K formulation for geraniums raised in soilless growing media. Contains a full range of essential micronutrients.

Item: 67-2333 **Size:** 25 lb.

18-8-17 High Mg

Highly effective stand-alone fertilizer with extra magnesium to maintain deep green foliage. Substitute for 20-10-20 for magnesium loving crops. Contains a full range of essential micronutrients.

Item: 67-2336 **Size:** 25 lb.

15-3-25 Peat-Lite Flower Crop w/Iron

A low phosphorus containing fertilizer that provides a high amount of chelated iron and other micronutrients readily available to plants grown over a wide soil pH range. Ideal for preventing excessive stretching while also meeting the needs of iron demanding crops such as petunias and calibrachoa.

Item: 67-2348 **Size:** 25 lb.

Peters Professional 22-5-16 Mum Special with Black Iron

An effective formulation of 3 chelated irons specifically designed for mums and other high iron demanding plants. Black iron is the most effective iron chelate used for growing ornamentals, effective over the widest range of media pH levels.

Item: 67-2368 **Size:** 25 lb.

Peter Professional Peat-Lite 17-3-17 Neutral Cal-Mag

Premium all-purpose formulation produces a nearly neutral reaction to help maintain steady pH in growing media.

Item: 67-2346 **Size:** 25 lb.

Peters Professional Peat-Lite 20-10-20

Versatile formula can be used in year-around operations; acidifying action corrects high pH in growing media.

Item: 67-2332 **Size:** 25 lb.



Pure.
Power.

Peters[®]
Professional

The choice is clear.

Peters Professional is the industry's cleanest, most effective water-soluble nutrient source, known for fast starts, robust growth, and stunning color. Pure ingredients keep emitters flowing free, and the patented M-77 chelating formula ensures superior nutrient uptake. Specialized product options allow custom nutrition applications that produce the strongest growth and healthiest bottom line.



growwithpeters.com

ICL Water-soluble Fertilizer Summary Chart

Brand	Product Name	New Stock #	Icon	Ideally Suited for Water Type(s)	Potential Acidity(A)/ Basicity(B) (CCE/iron)	Maximum Solubility (lb/gal)	EC per 100 ppm N (mS/cm)	Oz/100 gal to obtain 100 ppm N	1 level tsp/gal = approx. ppm N	Elemental ppm contained in a 100 ppm N solution													
										NH ₄ -N	Urea-N	NO ₃ -N	P	K	Ca	Mg	S	B	Cu	Fe	Mn	Mo	Zn
Peters Excel®	19-11-21 Multi-Purpose	E99001	B	2 to 4*	290 A	4.50	0.75	7.1	283	36.8	0.0	63.2	25.2	92.1	0.0	0.8	1.1	0.105	0.105	0.500	0.237	0.050	0.237
	18-18-18 Multi-Purpose	E99000	B	2 to 4*	578 A	5.50	0.79	7.5	276	41.7	0.0	58.3	43.5	83.3	0.0	0.0	0.0	0.122	0.122	0.500	0.250	0.050	0.250
	21-7-7 Acid Hammer	G99002	C	3 to 4*	1218 A	3.50	0.85	6.4	276	66.7	0.0	33.3	14.5	27.8	0.0	1.9	48.1	0.128	0.128	0.767	0.243	0.050	0.262
Peters Excel®	21-5-20 Multi Purpose	E99150	B	2 to 4	390 A	4.00	0.63	6.4	320	34.8	5.2	60.0	10.4	79.4	0.0	0.0	0.0	0.125	0.125	0.500	0.250	0.0500	0.250
	21-5-20 Multi Purpose No Boron	E99152	B	2 to 4	377 A	4.00	0.63	6.4	320	34.3	5.2	60.5	10.4	79.4	0.0	0.0	0.0	0.000	0.125	0.500	0.250	0.0500	0.250
	15-5-15 Cal-Mag Special	E99140	A	2	131 B	3.00	0.69	9.0	194	7.3	14.0	78.7	14.5	83.3	33.3	13.3	0.0	0.125	0.125	0.500	0.250	0.0500	0.250
Peters Excel®	15-2-20 Pansy, Salvia & Vinca	E99130	A	1 to 2	234 B	3.50	0.83	9.0	169	10.7	5.3	84.0	5.8	111.1	25.0	13.3	0.0	0.200	0.125	0.667	0.333	0.0500	0.250
	13-2-13 Plug & Bedding Plant Special	E99120	A	1 to 2	335 B	5.00	0.75	10.4	168	0.0	6.9	93.1	6.7	83.3	46.2	23.1	0.0	0.125	0.125	0.500	0.250	0.0500	0.250
	25-5-15 High Efficiency	E99087	B	1 to 4	593 A	5.50	0.57	5.3	355	43.2	0.0	56.8	8.7	50.0	0.0	0.0	0.0	0.156	0.140	0.600	0.300	0.060	0.300
Peters Professional®	24-8-16 Foliage Special	E99720	B	1 to 4	726 A	3.00	0.45	5.6	250	29.6	34.2	36.3	14.5	55.6	0.0	1.5	8.3	0.063	0.063	0.250	0.125	0.0250	0.125
	21-7-7 Acid Special	E99330	C	3 to 4	1518 A	4.00	0.52	6.4	245	49.5	50.5	0.0	14.5	27.8	0.0	2.9	61.9	0.125	0.125	0.714	0.238	0.0476	0.238
	20-20-20 GP	E99290	B	2 to 4	576 A	3.50	0.41	6.8	238	20.5	52.0	27.5	43.5	83.3	0.0	0.3	0.0	0.063	0.063	0.250	0.125	0.0250	0.125
Peters Professional®	20-20-20 GP No Dye	E99291	B	2 to 4	576 A	3.50	0.41	6.8	238	20.5	52.0	27.5	43.5	83.3	0.0	0.3	0.0	0.063	0.063	0.250	0.125	0.0250	0.125
	20-10-20 GP	E99300	B	1 to 4	404 A	3.50	0.62	6.8	305	40.0	0.0	60.0	21.7	83.3	0.0	0.8	0.0	0.063	0.063	0.250	0.125	0.0250	0.125
	20-3-19 Petunia Special with black iron	E99091	B	1 to 4	378 A	4.00	0.77	6.8	305	39.0	0.0	61.0	6.5	79.2	0.0	6.8	12.5	0.100	0.050	1.000	0.250	0.0500	0.250
Peters Professional®	13-2-13 Plug & Bedding Plant Special No Minors, No Dye	E99340	B	1 to 2	356 B	3.00	0.74	10.4	160	3.1	0.0	96.9	6.7	83.3	46.2	23.1	0.0	0.000	0.000	0.000	0.000	0.0000	0.000
	5-11-26 Hydroponic Special	E99310	B	1 to 4	215 B	3.00	1.45	27.0	·	0.0	0.0	100.0	95.7	433.3	0.0	120.0	160.0	1.000	0.300	6.000	1.000	0.2000	0.300
	20-10-20 Peat-Lite Special	E99250	B	1 to 4	415 A	3.00	0.59	6.8	284	40.5	0.0	59.5	21.7	83.3	0.0	0.8	0.0	0.125	0.125	0.500	0.250	0.0500	0.250
Peters Professional® Peat-Lite	20-10-20 Peat-Lite Special No Boron	E99252	B	1 to 4	402 A	3.00	0.57	6.8	284	40.0	0.0	60.0	21.7	83.3	0.0	0.8	0.0	0.000	0.125	0.500	0.250	0.0500	0.250
	20-2-20 Peat-Lite Low Phos Special	E99270	B	1 to 4	290 A	3.00	0.60	6.8	305	36.0	0.0	64.0	4.3	83.3	0.0	5.5	0.0	0.125	0.125	0.500	0.250	0.0500	0.250
	18-8-17 Peat-Lite High Mag Special	E99240	B	1 to 4	381 A	3.00	0.65	7.5	267	40.6	0.0	59.4	19.3	78.7	0.0	13.9	5.6	0.125	0.125	0.500	0.250	0.0500	0.250
Peters Professional®	17-3-17 Peat-Lite Neutral Cal-Mag	E99230	A	1 to 2	27 B	5.00	0.65	7.9	216	23.5	0.0	76.5	7.7	83.3	23.5	7.4	0.0	0.125	0.125	0.500	0.250	0.0500	0.250
	15-16-17 Peat-Lite Special	E99210	B	2 to 4	202 A	4.25	0.62	9.0	197	20.7	26.7	52.7	46.4	94.4	0.0	0.7	0.0	0.125	0.125	0.500	0.250	0.0500	0.250
	15-5-25 Peat-Lite Flowering Crop Special	E99220	B	1 to 4	48 A	2.50	0.77	9.0	225	28.7	0.0	71.3	14.5	138.9	0.0	16.7	6.7	0.045	0.125	0.500	0.250	0.5000	0.250
Peters Professional®	15-3-25 Peat-Lite Flowering Crop Special with black iron	E99321	B	1 to 4	34 A	3.00	0.98	9.0	232	26.7	0.0	73.3	8.7	138.9	0.0	16.7	6.7	0.125	0.125	1.000	0.250	0.0500	0.250
	15-0-15 Peat-Lite Dark Weather Feed	E99260	C	1 to 2	221 B	5.00	0.71	9.0	188	13.3	0.0	86.7	0.0	83.3	33.3	13.3	0.0	0.125	0.125	0.500	0.250	0.0500	0.250
	10-30-20 Peat-Lite Plant Starter	E99350	B	2 to 4	365 A	3.25	0.86	13.5	129	50.0	0.0	50.0	130.4	166.7	0.0	13.0	0.0	0.125	0.125	0.500	0.250	0.0500	0.250
Peters Specialty®	30-10-10 Hi Nitro Foliar Feed	E99710	·	·	1043 A	4.25	0.18	4.5	300	7.0	82.7	10.3	14.5	27.8	0.0	0.0	0.0	0.067	0.167	0.333	0.167	0.0017	0.167
	20-20-20 Ag & Landscape Special	E99700	·	572 A	570 A	3.50	0.51	6.8	242	24.0	49.0	27.0	43.5	83.3	0.0	0.0	0.0	0.100	0.250	0.500	0.250	0.0025	0.250

*Not recommended for use with water sources containing 100 ppm or less total alkalinity.

For more information on Peters Professional® S.T.E.M.™ and Peters Professional® Uni-Mix® 11-5-11, see the Peters® Specialty Products section of <https://calculators.icl-sf.com/productselector/>.

Optimum Plus Water Soluble Fertilizer

20-18-20

General purpose fertilizer for when extra phosphorus is required. Used for starting crops such as garden mums. Acidic formulation.
40 bag minimum.

Item: 31-201820
Size: 25 lb.

18-5-17

Complete, all-in-one Cal-Mag fertilizer. Slightly acidic formulation.
40 bag minimum.

Item: 31-18517
Size: 25 lb.

16-0-15

Dark weather feed. Great source of calcium that is moderately basic.
40 bag minimum.

Item: 31-16015
Size: 25 lb.

21-8-20

Lower phosphorus alternative to 20-18-20. General purpose fertilizer that is acidic.
40 bag minimum.

Item: 31-21820
Size: 25 lb.

Organic and Natural Fertilizers

2024



Plant Probiotic

Bring your soil to life. Nature's Source Plant Probiotic contains a beneficial microbial complex to feed your soil.

Item: 67-0070* **Size:** 5 lb. (1 gal.)

*These items are non-stock.

Professional Plant Food 10-4-3

Nature's Source Professional Plant Food 10-4-3 brings out the best in everything you grow. Imagine better-toned plants, earlier flowering and darker foliage with just one single liquid formula. In addition to N-P-K, Nature's Source contains "Boost Molecules" (amino acids) as well as calcium and magnesium, to improve your plants' performance.

Item: 67-0050 **Size:** 4.7 gal.
Item: 67-0055 **Size:** 55 gal.

Nursery & Landscape Special Plant Food 10-4-5

Simple and sustainable for stand-out woodies and ornamentals. Specially formulated for professional growers and equally effective on professional landscapes. Feeds the plants and feeds the soil with beneficial microbial growth.

Item: 67-0085* **Size:** 2.5 gal. (2 pack)
Item: 67-0086* **Size:** 4.7 gal.
Item: 67-0087* **Size:** 55 gal.

*These items are non-stock.

Organic Plant Food 3-1-1



The plant food your organic crop needs for quick response and healthy growth. Derived from oilseed extract, a renewable source of plant nutrition. Allowed for use in certified organic production in accordance with the USDA National Organic Program. Low salt formulation can be applied to foliage without burning or stretch. Liquid formulation mixes easily with cold water and can be injected into irrigation systems straight from the container. Pathogen-free, heavy metal free, GMO free, food safety certified.

Item: 67-0065 **Size:** 4.7 gal.

Foliar Essentials BioNutrition Spray 2-1-1

Easy, efficient and effective...naturally. New foliar spray to boost your crops' nutrient efficiency.

Item: 67-0082* **Size:** 275 gal.

*These items are non-stock.



Natural Base Fertilizers



Sustane Bolster MycoBio

Bolster MycoBio microbial inoculum is a blend of endo mycorrhizae species and beneficial bacteria, with humic acid and compost to support soil microorganisms. Improves nutrient cycling, seedling success and plant establishment. Mix in potting soil for propagation or transplant stage, in-furrow at seeding, per hole or row in the garden, or in fill dirt for landscape/turf installations. Rates: 1-3 lb per yard of potting media, 1 cup per 2.8 cu ft., 1.5 lb per 1,000 sq ft.

Sustane 4-6-4 All-Purpose Slow Release Fertilizer



4-6-4: Organic non-coated fertilizer in a fast-start granule provides extra phosphorus for plant establishment, along with 4% calcium. 4-6-4 is an all-purpose formulation derived from composted turkey litter, feather meal, bone meal and sulfate of potash also contains 5% humics for soil health.

Sustane 8-2-4 All Natural Slow Release Nitrogen Fertilizer



8-2-4: non-coated, slow release organic fertilizer provides high nitrogen over 6-12 weeks to promote vegetative establishment, specialty crop production. Derived from composted turkey litter, feather meal and sulfate of potash; contains 6% humic acid to build rich soil.

Sustane 8-4-4 All Natural



All natural non-coated slow release granular fertilizer Sustane 8-4-4 is ideal for the production of bedding and foliage crops, hanging baskets, herbs and vegetables. When used in containers the nutrient release profile is 45 days. Sustane 8-4-4 is composed of aerobically composted turkey litter, hydrolyzed feather meal, and sulfate of potash with 5% humates to benefit the soil and soil microbes.

Sustane 12-0-1 Hi N WDF



High nitrogen content in an organic, water dispersible formulation. Suitable for use in hydroponic systems and greenhouse fertigation. Additional uses as in furrow starter fertilizer, foliar feed, and turf fertilizer. May require pre-filtering to prevent clogging of small-bore emitters. Rates: 1-3 lb per 100 gal.

Sustane 12-12-12 CRF Blend

Balanced formulation is a combination of slow release organics and coated controlled release nutrients. Recommended for landscape beds and containers. Supplies primary, secondary, and micronutrients. Provides 12 weeks of release in containers.

Sustane 16-4-8 CRF Blend

This blend is a combination of slow release organics and coated controlled release to provide nursery stock with a time released package. 50% Sustane humus-rich base and provides the benefits of the organics with a pumped-up nutrient analysis. A combination of slow release and controlled release fertilizer to provide nursery stock with a time released 4-1-2 nutrient package blended with a 50% Sustane humus rich, premium organic base. Sustane 16-4-8 is perfect for production of perennials and woody ornamentals. Derived from aerobically composted turkey litter, polymer coated urea, polymer coated MAP, and polymer coated potassium nitrate. 120 day release.

Sustane All-Organic 21-gram Feeder Paks & Compost Tea Bags



Dual use product. Use to brew compost tea for foliar application or place the tea bag directly in the container at potting for extended feeding. Water permeable and fully biodegradable bag supply organic nutrition for hanging baskets, potted plants, or landscape and garden use. Sustane 4-6-4 in water permeable sachets for all hanging baskets, potted plants & landscape maintenance.

Item	Description	CSUOS
80950013	Bolster MycoBio 1 lb. jar	-
80950018	Bolster MycoBio 6 lb. jar	-
67-60604	Bolster MycoBio 40 lb. bag	-
67-30201	4-6-4 All-Purpose 50 lb. Granular Medium Grade OMRI	-
67-30565	8-2-4 All-Natural Organic 50 lb. Granular Medium Grade OMRI	-
67-30569	8-4-4, 45 Day 50 lb. Container Grade, Med/Fine OMRI	-
67-552001	12-0-1 1 lb. jar OMRI	-
67-552003	12-0-1 6 lb. jar OMRI	-
67-552011	12-0-1 20 lb. pail OMRI	-
67-50451	12-12-12, 90 Day, 50 lb. CRF + Organic fertilizer	-
67-50551	16-4-8, 120 Day, 50 lb. Granular Organic Fertilizer & CRF	-
80950005	Compost Tea Bag 4-6-4 (12 bags/unit) OMRI	10/10

Secondary Nutrients Ca & Mg

For organic Ca and Mg,

see the Biostimulants section on pgs 269 - 272



Calcium Chloride Dihydrate

Applied as a foliar spray to safely add calcium to plant tissue.

Item: 35315 **Size:** 1 lb.
Item: 35317 **Size:** 25 lb.



Cal Prime Calcium Nitrate 17-0-0

Calcium nitrate with a higher percentage of calcium and nitrogen than standard calcium nitrate fertilizers.

Item: 67-8125 **Size:** 25 Kg (50 lb.)



Calcium Nitrate 15.5-0-0

Item: 67-8130 **Size:** 50 lb.
Item: 67-8130W **Size:** 50 lb. (WEST COAST)



CalOx FT

CalOx FT patented technology stimulates selective ion channels in plant cell membranes, allowing calcium to flow through plant cells and deliver calcium through the plant even during periods of low transpiration. The 'FT' stands for the calcium Flow Through. CalOx FT increases cellular calcium throughout the plant resulting in stronger stems and optimum growth. Formulation 8-0-0, 10% Ca is stable in storage and does not settle out in container.

Guidelines: Apply CalOx[®] FT as a coarse foliar spray every 7-14 day at 18 fl oz per 100 gal or 1 1/8 tsp per gal with CapSil.

Item: 75-0532 **Size:** 2.5 gal.



Calcium Chelate Sequestar Ca-EDTA 9%

Item: 67-04005 **Size:** 5 lb.
Item: 67-0400 **Size:** 25 lb.



Magnesium Chelate Sequestar EDTA 5.5%

Item: 67-04255 **Size:** 5 lb.
Item: 67-0425 **Size:** 25 lb.



Magnisal Magnesium Nitrate 11-0-0

Item: 67-4106 **Size:** 50 lb.



Epsom Salt, Magnesium Sulfate Heptahydrate

Item: 33-79160 **Size:** 25 lb.



Magriculture Mag Sulfate Hepta Hydrate

Item: 67-7500GW **Size:** 50 lb. (WEST COAST)



Epsom Salts, Magnesium Sulphate Heptahydrate

Item: 14MGSUL **Size:** 50 lb.

Specialty Fertilizer Salts



Potassium Sulfate

Non-Stock. Assorted Sizes Available.



Mono-ammonium phosphate (MAP) 12-61-00

Fully water soluble source of phosphorus and potassium that can be safely used through injectors.

Item: 67-6602 **Size:** 50 lb.



Muriate of Potash 0-0-60

Soluble potassium as the chloride salt suitable for field use or fertilizer mixing.

Item: MP50 **Size:** 50 lb.



Muriate of Potash

Fine grade potassium chloride salt suitable for injection.

Item: 31-10405 **Size:** 25 Kg -50 lb.





Multi-K GG Potassium Nitrate 13.5-0-46.2

Greenhouse grade, fully soluble for chemigation, foliar spray, or side-dressing

Item: 67-8505 **Size:** 50 lb.



Potassium Bicarbonate

Potassium Bicarbonate is used to quickly and safely raise soil pH. It is easily applied through fertilizer injector and leaves no visible residue.

Item: 91-2190 **Size:** 1 lb. (Powder)
Item: 91-21950 **Size:** 50 lb. (Powder)



Ultrazol K Plus Potassium Nitrate 13.7-0-46

Fully water soluble source of potassium and nitrogen suitable for use through injectors and all types of irrigation systems.



Item: 67-9000 **Size:** 25 Kg - 50 lb.



Potassium Bicarbonate

Potassium Bicarbonate is used to raise the pH of potting mix during the production cycle. It is also used to add bicarbonate alkalinity for hydroponic production with reverse osmosis-purified water or other water sources with very low alkalinity.

Item: 31-10404 **Size:** 25 kg



Nitrate of Soda 15-0-2



Chilean nitrate with potassium sulfate from mined sources supplies organic nitrogen for field production. Pallet quantities only.

Item: 67-3845 **Size:** 50 lb.

Soil pH Modification

Aluminum Sulfate

Applied as a soil drench to drop soil pH and in the case of hydrangeas also provides the aluminum required for blue flower color.

Item: 14AS50 **Size:** 50 lb.

pH Adjustment for Potting Mix'

1:100 Injector Rates

- 2 lb. per gallon at a 1:100 ratio
High change = ~ 1 point change
- 1 lb. per gallon at a 1:100 ratio
Low change = ~ .5 point change

Hozon Rates

- 24 oz. per 5 gallon
High change = ~ 1 point change
- 12 oz. per 5 gallon
Low change = ~ .5 point change



CalOx pH

CalOx pH is an easy and effective alternative to bagged lime for use on all types of agricultural field crops, greenhouse ornamentals and vegetable crops, as well as outside nursery and hay fields. It features finely micronized calcium in a liquid suspension that can be absorbed by leaves and roots.



Guidelines: Moderate pH increase: 1:100 injection undiluted. Large pH increase 1:50 injection undiluted. Needs to be used up within a month after receipt.

Direct Ship only, plus freight.

Item: 75-0525 **Size:** 2.5 gal.



pH Reducer

Liquid, based product for use as an organic option for adjusting solution pH and managing media pH. Contains 50% citric acid and a yucca-based, natural wetting agent. Washington State Department of Agriculture (WSDA) approved for use in organic production. Review label for recommended rates.



Item: 1652025GR **Size:** 2.5 gal.

Sulfuric Acid 93% Tech Grade

Added to irrigation water to neutralize excess alkalinity and/or reduce soil pH. Contact GGSPRO for rates and precautions.

Item: 75-5030 1 gal/ 1 cs. min. - 4 per cs.

Micronutrients

Assorted Sizes Available. Non-Stock unless otherwise noted.

Boron: Solu-Bor

Item: BORON1 Size: 1 lb.
Item: J745612 Size: 20 lb.

Copper Chelate EDTA (14%)

Item: 67-04055 Size: 5 lb.
Item: 67-0405 Size: 25 lb.

Copper Sulfate (25%)

Item: 31-11259 Size: 22.68 kg

Iron Sulfate

Item: 14FESUL Size: 50 lb.

Iron Chelate- Fe EDTA (13%)

Item: 67-04205 Size: 5 lb.
Item: 67-0420 Size: 22 lb.

Iron Chelate - Fe DTPA (11%)

Iron Chelate - Fe EDDHA (6%)

Item: 67-04105 Size: 5 lb.
Item: 67-0410 Size: 25 lb.

Manganese Chelate EDTA (13%)

Item: 67-04305 Size: 5 lb.
Item: 67-0430 Size: 25 lb.

Manganese Sulfate

Item: 31-10271 Size: 50 lb.

Ammonium Heptamolybdate

Item: J74744 Size: 1 lb.

Sodium Molybdate 39.6% Mo

Item: 31-12485 Size: 1 Kg 2.2 lb

Zinc Chelate EDTA (14%)

Item: 67-04355 Size: 5 lb.
Item: 67-0435 Size: 25 lb.



Sprint 330 & Sprint 138

High Performance Iron Chelates for Soil Applications

Sprint 330 and Sprint 138 are strong chelated forms of iron that maintain and protect iron availability. Sprint 138 is more effective when soil pH is higher than 6.5. Apply as soil drench at 3-5 oz per 100 gal. (rinse excess off leaves & flowers immediately following drench.)

Item	Description	Size
67-70371	Sprint 138- 6% Fully Chelated EDDHA Iron plus 4-0-0	5 lb/Pkg
67-70361	Sprint 330- Iron Chelated 10% DTPA Iron plus 8-0-0	5 lb/Pkg
67-70365	Sprint 330- Iron Chelated 10% DTPA Iron	50 lb/Pkg

Micronutrient Mixes



M.O.S.T (Mix of Soluble Traces)

A water soluble supplement containing the full package of essential micronutrients: sulfur, boron, copper, iron, manganese, molybdenum, zinc. M.O.S.T is mixable with fertilizers not containing calcium.



Item: J74394 Size: 1 lb.
Item: 33633 Size: 25 lb.



Mix of Soluble Trace Elements With No Boron (MOSTNB)

A NO Boron mix of soluble trace elements for locations naturally high in boron.



Item: JPMOSTNB Size: 25 lb.



S.T.E.M Trace Element Liquid

SOLUBLE TRACE ELEMENT MIX -

Micronutrient liquid supplement containing the ideal balance of essential micronutrients: sulfur, boron, copper, iron, manganese, molybdenum, zinc. Liquid S.T.E.M. in a convenient, ready-to-mix liquid formulation. Goes from the jug to the tank in one easy step with no solubility issues.

Item: 67-2366 Size: 2.64 gal.



NUTRITRACE

Chelated Secondary Micronutrient Mix is a water soluble mix of secondary nutrients which can be used as a general preventative supplement or as a corrective where known deficiencies exist.

No Boron.

Item: 31-11172 Size: 25 lb.



AgSil 16H

Soluble form of potassium silicate provides the plant with an available source of silicon by soil drench or foliar spray. Silicon provides tolerance to salt and mineral toxicity, increased resistance to drought, heat and other abiotic stresses. Disease and pest issues may be reduced by deposition of the silicon in plant tissue as well as inducing the inherent resistance mechanisms of the plant. Monitor pH in stock tank to be maintained above 7.0 at all times or solution will gel. Do not apply with fertilizers other than chelated minerals.

Item: 67-1000 **Size** 50 lb.



Evofactor Nutrient Adjuvant

Fertilizer enhancer improves uptake efficiency, allowing a reduction of fertilizer and improved growth with the OpusMAX delivery system and humic acid. Suitable for ornamental and CEA crops.

Item: 67-9610 **Size:** 2.5 gal.
Item: 67-9615* **Size:** 55 gal.

*This item is non-stock.

GGSPRO TIP

EVOFACTOR

Evofactor is an innovative product labeled as a nutrient adjuvant. Added directly into your concentrated nutrient stock tank, Evofactor will increase nutrient uptake into the plant. It can be used to improve yield or crop quality as well as reduce production costs in the form of decreased water-soluble fertilizer inputs.



2024



ON-Gard 5-0-0



An organic biological plant nutrient formulated from plant-derived proteins applied as a foliar spray or as drench. Acts as a vegetative biostimulant with multiple plant health benefits.

Item: 67-9185* **Size:** 2.5 gal.

*These items are non-stock.

ON-Gard Calcium 1-0-0-5 Ca



Contains 5% calcium derived from calcium chloride and soy protein. Designed to be applied as a foliar spray to quickly treat calcium deficiencies. Ideal for organic production. Contains a protein hydrolysate component which promotes very quick absorption of the calcium. Do not mix with other fertilizers.

Item: 67-9187* **Size:** 2.5 gal.

*These items are non-stock.



Companion Maxx 2-0-1

Companion Maxx Liquid combines the power of *Bacillus subtilis* to convert the complex form of essential nutrients to a simple form used by plant roots. This product's bacterium enhances nutrient uptake and the kelp provides a source of potash and food for beneficial microbes. For use on ornamentals only in greenhouse, landscape and nursery applications.

Item: 166072 **Size:** 2.5 gal.

Item: 166080* **Size:** 30 gal.

*This item is non-stock.



Essential Plus T&O 1-0-1

Essential Plus T&O 1-0-1 is a soil amendment derived from potassium humate, proteins, sugars and a natural wetting agent containing *Yucca schidigera* for use on use on turf and ornamental crops in greenhouses and nurseries. Essential is a rich source of building blocks not found in typical (NPK) fertilizers. A high concentration of humic acid replenishes soils that have been depleted of organic matter, helps alleviate soil compaction, and provides a food source for beneficial soil microorganisms. **No food crop uses.**

Item: 1660105GR **Size:** 1 qt.

Item: 1660110GR **Size:** 1 gal.

Item: 1660120GR **Size:** 2.5 gal.



NOVA Green Essential 1-0-1 Cannabaceae

Nova Green Essential Organic 1-0-1 is a soil amendment supplying carbon rich organic materials in a readily usable form. This powerful carbon solution functions as a plant bio-stimulator and food source for microbial activity. Sugars, enzymes, amino acids, carbohydrates, a natural wetting agent, humus molecules and natural plant saponins and cytokinins to improve germination, rooting, photosynthesis and overall plant growth. It can be used on all potting soil media such as coco, rockwool, peat moss and perlite.

Item: 1690253NG **Size:** 1 qt.

Item: 1690254NG **Size:** 1 gal.

Item: 1690255NG **Size:** 2.5 gal.

Item: 1690256NG **Size:** 30 gal.



TerraGrow

Microbial inoculant is a combination of five *Bacillus* species with humic acid, soy protein extract and kelp extract to support proliferation in the root zone.

Item: 67-2999* **Size:** 5 lb.

Item: 67-3000* **Size:** 10 lb.

Item: 67-3002* **Size:** 25 lb.

*These items are non-stock.





UNTREATED CONTROL

MycoApply® TREATED

MycoApply Mycorrhizae

MycoApply mycorrhizae are mixes of beneficial fungi which colonize the roots of plants and become a functional part of the roots. This enhanced root mass provides for more efficient water and nutrient uptake, increasing the ability of the plant to withstand stresses and establish more quickly. Ninety-five percent of plants form these symbiotic relationships with soil mycorrhizae in nature. The majority utilize the Endo-(interior) mycorrhizae, but many types of trees utilize the Ecto-(exterior) forms. The colonization and benefits last the lifetime of the plant. MycoApply is supplied as a granular formulation for field and soil incorporation, a suspendable powder for soil incorporation or drench application, as injectable powder formulations for drench or boom spray application, or in new next-generation liquid formulations.

Product	Item #	Quantity	OMRI	Application Method				
				# of Mycorrhizae Species	Soil Incorporation	Plug/Liner Dip	Media Drench Applications	Compatible with Drippers, Sprayers, and Injectors
MycoApply Endo - I (Granular)	67-95101	40 lb	•	4 Endo	•			
MycoApply Endo/Ecto - I (Granular)	67-95151	40 lb	•	4 Endo 7 Ecto	•			
*MycoApply Ultrafine Endo	67-9523 67-9525	1 lb 20 lb	•	4 Endo	•	•	•	
*MycoApply Ultrafine Endo/Ecto	67-9518 67-9519	1 lb 20 lb	•	4 Endo 7 Ecto	•	•	•	
*MycoApply Soluble Maxx	67-9530	1 lb	•	9 Endo 10 Ecto	•	•	•	
MycoApply Injector Endo	67-9521	100 grams	•	4 Endo	•	•	•	•
MycoApply Injector Ecto	67-9524	100 grams		5 Ect		•	•	•
MycoApply EndoThrive	67-9526	1 pt		4 Endo		•	•	•
MycoApply EndoThrive	67-9528	1 gal.		4 Endo		•	•	•

*Product can pass through screens up to 300microns (US sieve #50).

** Highlighted boxes indicate most common methods of application

Bio-Stimulants and Inoculants



Bioimin Booster 126



Bioimin® Booster 126 is a micro-nutrient mix, Amino acid-complexed B, Cu, Fe, Mg, Mn, and Zn are bioavailable and non-phytotoxic.

Item: 16-03082 **Size:** 2.5 gal.

Bioimin Calcium 5%



Bioimin® Calcium contains calcium complexed with amino acids for soil and foliar uptake. It is completely bioavailable and non-phytotoxic to plants when applied in accordance to directions. Designed to prevent and correct deficiencies and to boost crops during critical or fast growing periods. May be applied with nitrogen fertilizer.

Item: 16-03012 **Size:** 2.5 gal.

Bioimin Magnesium 3%



Bioimin® Magnesium contains amino acid-chelated magnesium for soil and/or foliar application. Completely bioavailable and non-phytotoxic to plants when applied in accordance to directions. Designed to prevent and correct magnesium deficiencies and to boost crops during critical or fast growing periods. May be applied with nitrogen fertilizers.

Item: 16-03042 **Size:** 2.5 gal.

Bioimin Nitrogen 5-0-0

Bioimin® Nitrogen 5-0-0 is a natural, organic fertilizer derived from hydrolyzed vegetable proteins to supply nitrogen to plants. Nitrogen is important because it is a vital component of living cells, enzymes, proteins, and photosynthesis in plants. It also aids plant growth, improves leaf quality, and increases seed and fruit production.

Item: 16-03422 **Size:** 2.5 gal.

Bioimin Potassium 2-0-25

Bioimin® Potassium 2-0-25 is a liquid plant food designed for soil and/or foliar applications. Bioimin® Potassium is compatible with most fertilizer solutions and pesticides.

Item: 16-03482 **Size:** 2.5 gal.

Bioimin Iron 1-0-0



Bioimin® Iron contains 5% amino acid chelated iron for soil and foliar applications. Completely bioavailable and non-phytotoxic to plants when applied in accordance to directions. May be applied with nitrogen fertilizers.

Item: 16-03032 **Size:** 2.5 gal.

Humax



Humax contains 12% humic acid extracted from leonardite. Humax can be used as a soil or foliar application. It may enhance micronutrient uptake by plants. It is compatible with most fertilizer solutions and biological and enzymatic formulations.

Item: 16-01112 **Size:** 2.5 gal

Fulmax

Fulmax contains 3% fulvic acid extracted from leonardite. It can be applied as a soil or a foliar application to improve nutrient availability, stimulate plant growth, and increase the cation exchange capacity of soil.

Item: 16-01182 **Size:** 2.5 gal

ADDITIONAL BIOSTIMULANT PRODUCTS

Refer to the Fungicides section for these additional products which have both biostimulant activity and fungicidal properties.

Actinovate, Cease, Companion, EcoSwing, Fosphite, Obtego, Phostrol, Regalia, RootShield, RootShield Plus, Stargus, Triathlon BA

GGSPro is available to answer your questions about biostimulants.

Controlled Release Fertilizer

Nutricote Qualities

Nutricote controlled release fertilizers utilize a unique polymer resin which coats the fertilizer granule to provide a continuous slow release of nutrients throughout the crop cycle. The coating is resilient and resists cracking when used in mixing equipment. Nutricote is available in various longevities ranging from 40 days to 360 days of release based on an average soil temperature of 77°F. The products can be either incorporated or topdressed, and are available in both NPK (Nutricote) and NPK + minors (Nutricote Total) formulations.

Important Note: The Nutricote items on this page from Sojitz are available for shipment from Maine through Virginia.

Important Note: Nutricote cannot be steam sterilized.



NPK Controlled Release Fertilizer- No Minor Nutrients

Nutricote Controlled Release Fertilizer contains NPK in a controlled release prill. Resin coating provides safe and predictable nutrient release over a wide range of conditions. Day lengths are calculated on an average soil temperature of 77°F.

Item	Description	Pkg.	Nursery and Uncovered Range release	Greenhouse Release Time at 77°F
32-200199	14-13-13 (100 Day)	50 lb.	4-5 Months	100 Days
32-200229	14-13-13 (140 Day)	50 lb.	7-8 Months	140 Days

2024

NPK + Minor Nutrient Controlled Release Fertilizer

Nutricote Total Controlled Release Fertilizer contains NPK, magnesium and micronutrients in a controlled release prill. Resin coating provides safe and predictable nutrient release over a wide range of conditions. Day lengths are calculated on an average soil temperature of 77°F.



Item	Description	Pkg.	Nursery and Uncovered Range release	Greenhouse Release Time at 77°F
32-200119	13-11-11 w/minors (70 Day)	50 lb.	2-3 Months	70 Days
33-1311100	13-11-11 w/minors (100 Day)	50 lb.	4-5 Months	100 Days
33-11140	13-11-11 w/minors (140 Day)	50 lb.	7-9 Months	140 Days
32-200139	13-11-11 w/minors (180 Day)	50 lb.	9-12 Months	180 Days
32-200320	18-6-8 w/minors (70 Day)	50 lb.	2-3 Months	70 Days
32-200330	18-6-8 w/minors (100 Day)	50 lb.	4-5 Months	100 Days
32-200300	18-6-8 w/minors (140 Day)	50 lb.	7-9 Months	140 Days
32-200340	18-6-8 w/minors (180 Day)	50 lb.	9-12 Months	180 Days

Blend For Quick Start

NPK & Minor Nutrient Controlled Release Fertilizer for extra nutrient release early in the crop cycle

Item	Description	Pkg.	Nursery and Uncovered Range release	Greenhouse Release Time at 77°F
32-200460	17-6-8 w/minors (180 Day)	50 lb.	9-12 Months	180 Days



Max hydration.
Less irrigation.

H₂Pro[®]

You work hard. Your water should, too.

H₂Pro Greenhouse and Nursery Surfactant optimizes the effectiveness of Osmocote[®] water soluble fertilizer by enhancing moisture penetration in growing media. The wetting effects can last up to a year and the moisture distributing action reduces wilting and dry spots. Maximum hydration from reduced irrigation—that's the power of H₂Pro.



icl-growingsolutions.com



Osmocote® Plus

Osmocote® Plus 15-9-12

The Only Patterned Release Fertilizer

- ICL Specialty Fertilizers Patterned Nutrient Release Technology™ delivers: Pre-defined release patterns - Pre-defined longevity
- Coated N-P-K + magnesium and micronutrients; homogeneous
- Full season N-P-K, magnesium and micronutrients
- Designed for general nursery and greenhouse production, special circumstances such as sensitive or high value crops, and dibbling equipment. It can be incorporated or surface applied. Get the best return on your fertilizer investment, safely, by matching the nutrient release patterns with plant needs for optimal quality.
- Recommended for use when growing a wide variety of crops or in combination with water soluble fertilizer for a steady source of nutrition throughout the season
- Available in longevities ranging from 3 to 14 months

Osmocote® Bloom

Osmocote® Bloom 12-7-18

Specially formulated for small container greenhouse plants with a production time of 6-12 weeks. 100% resin-coated homogenous cores contain NPK plus essential micronutrients. The small prill size ensures even distribution of nutrition in the root zone.

Consistent delivery

Osmocote® Bloom features controlled release technology. The same reliable technology more growers have trusted for decades. Simply incorporate the 100% coated prills into your growing media prior to planting. The pre-defined longevity of N-P-K and micronutrients assures your plants will consistently receive the nutrition they need for health growth all the way through to market.

Balanced nutrition

This is a complete package of N-P-K, blended with magnesium and essential trace elements. The formulation ratios encourage faster and stronger root development and facilitates the growth of more compact, consistently sized plants, with excellent color and flowering.

- Specially formulated for plants grown in smaller containers with a production time of 6-12 weeks
- 100% coated, containing N-P-K, magnesium and essential micronutrients
- Small prill size promotes even distribution of nutrition in the root zone

Osmocote® Plus Application Rates for 15-9-12 (Excluding Florida)

Topdressing (established plants) Rates in grams	3-4			5-6			8-9		
	Low	Med	High	Low	Med	High	Low	Med	High
Standard Containers									
6" Aza /HB (1.5 qt.)	3	7	10	5	8	12	7	11	15
8" Mum Pan (1 gal.)	5	14	21	10	17	25	15	23	31
10" HB (1.5 gal.)	9	24	36	17	30	44	26	39	54
Trade 1 gallon	5	12	18	8	15	22	13	20	27
3 gallon	19	52	78	36	65	94	55	84	117



Item: 67-1525

Size: 50 lb.



Item: 67-1530

Size: 50 lb.



Item: 67-1540

Size: 50 lb.

Osmocote® Bloom Application Rates for 12-7-18

Topdressing (established plants) Rates in grams			
	Low	Med	High
Standard Containers			
4" Square (1.25 pt.)	0.9-1.2	1.2-2	2-3
6" Azalea (1.5 qt.)	2-3	3-5	5-6
8" HB (3 qt.)	4-6	6-9	9-13
10" HB (1.5 gal.)	8-10	10-17	17-23
12" Color Bowl (2 gal.)	10-13	13-22	22-31



Item: 67-1010

Size: 50 lb.



Item: 67-1012

Size: 50 lb.



Osmocote® Blend

Reliable performance at an economical price.

ICL Specialty Fertilizers Osmocote® Blends are proven to reliably deliver the nutrition your plants need to thrive. The variety of mixes available provides you with options to choose the right formulation to meet the nutritional needs for a wide range of nursery crops. And as an added bonus, all of these mixes are economically priced, making them a good value for your fertilizer dollar.



Osmocote® Blend 18-5-12

With Micronutrients Featuring Quickstart

- For use on nursery stock, foliage and landscapes
- Contains Osmocote® coated N-P-K blended with micronutrients and other fertilizer technologies, to deliver nutrition consistently within specified longevities
- This product features uncoated, Quickstart® nutrients for an immediately available starter charge which is especially useful for green-up applications or to offset the nitrogen draw of green bark
- Can be incorporated or surface applied

5-6 Item: 67-1578 Size: 50 lb.

8-9 Item: 67-1580 Size: 50 lb.

Osmocote® Blend 21-4-8

With Micronutrients General Purpose Formulations

- For general purpose outdoor production of nursery stock, foliage and in landscapes
- General Purpose formulation of Osmocote® coated N-P-K blended with micronutrients and other fertilizer technologies, to deliver nutrition consistently within specified longevities
- This product contains sulfur-coated urea nitrogen and uncoated granular micronutrients
- Can be incorporated or surface applied

8-9 Item: 67-1564 Size: 50 lb.

12-14 Item: 67-1565 Size: 50 lb.

2024

Osmocote® Blend with Iron 18-5-8

Blended formulation that combines our Osmocote® 100% resin coated prills with our newest E-max polymer coated technologies. Micronutrients are derived from multiple sources to provide a starter charge and two different controlled release coated forms for sustained delivery throughout the predefined product release period.

- Higher Nitrogen reduces rates and the fertilizer cost per container.
- Safe & predictable nutrient release.
- Helps maintain green foliage on iron inefficient plants. Excellent for areas with highly alkaline irrigation water. Contains a starter charge plus two coated forms of extra iron to provide 3 separate presentations of iron to the plants.

3-4 Item: 67-1130 Size: 50 lb.

5-6 Item: 67-1135 Size: 50 lb.

8-9 Item: 67-1140 Size: 50 lb.

12-14 Item: 67-1145 Size: 50 lb.

Osmocote® Blend with Fusion - No-Spill Prill

New Osmocote® Blend with Fusion has been specially developed for surface applications in container nursery stock. When applied as directed, the unique Fusion Technology works to bind the



prills to the growing media. Should containers get knocked over, more of the fertilizer stays in place, minimizing the need for reapplication. This reduces labor and additional fertilizer costs. Efficient and effective, ICL Specialty Fertilizers Fusion Technology™ is proven to help maximize the nursery grower's fertilizer investment.

19-6-9

5-6 Item: 67-1042 Size: 50 lb.

20-4-7

8-9 Item: 67-1043 Size: 50 lb.



Controlled Release

- Coated N-P-K; homogeneous
- Pre-defined longevity of N-P-K with no minor nutrients
- For optimal results use with Micromax[®] Micronutrients

Designed for incorporation in general nursery and greenhouse production. Use in combination with Micromax[®] Micronutrients for optimal results. Osmocote[®] products provide proven, reliable performance.

3-4 14-14-14

- For use in nursery, foliage and greenhouse production, container gardens, interiorscapes and landscapes.
- No minors

Item: 67-1025 **Size:** 50 lb.

8-9 18-6-12

- For use in nursery, foliage and greenhouse production, container gardens, interiorscapes and landscapes.
- No minors

Item: 67-1040 **Size:** 50 lb.

Surface application rates per container (grams)	14-14-14 3-4			18-6-12 8-9		
	Low	Med	High	Low	Med	High
Container Size Topdressing (established plants)						
6" std. round pot	3	8	13	7	11	15
Trade 1 gallon	5	13	20	11	17	23
Trade 2 gallon	13	31	47	25	40	54
3 gallon	23	55	84	45	71	97
10" Hanging Basket	11	26	39	21	33	45
12" Hanging Basket	16	39	59	32	50	68

Low = Sensitive Plants Med = Nursery Stock and Foliage
High = Nursery Stock



Perfect-A-Feed Fertilizer Dispensers

- Large Capacity
 - Holds 5 quarts of granular material
- Precise Application
 - Each drum (1 tsp - 6 grams)
 - (1 tbsp - 18 grams) 100% accurate

Plastic crank feeder with changeable measuring drums. Includes a 1 tsp. (6 grams) measuring drum and a 3' extension. Unit comes with tablespoon and teaspoon measuring drums.

Item: 83-1730



Osmocote Blend with E-Max Release Technology

A new coating chemistry offering greater flexibility to customize fertilizers to meet your exact growing needs. This technology is for use on a wide variety of nutrient components that are incorporated into ICL Specialty Fertilizers controlled release fertilizers. The overall value is the flexibility to customize nutrition solutions to match the specific needs of your crops, which helps to optimize your fertilizer investment.

Features/Advantages

E-Max is a reacted polymer coating that is applied to essential macro and micronutrients. Components coated with this new chemistry are produced to the same high Osmocote® performance standards to ensure reliable, consistent and safe release.

1. The coating's thin weight allows for higher nutrient ratios
2. The coating is strong and durable to assure dependable results
3. Release mechanism is based on moisture and temperature offering predictable longevities even under extremely warm conditions

Grower Benefits

- Offers flexible nutrition solutions while still maintaining a sustainable growing program
- Safe, predictable results
- Enhanced blending and application
- No sulfur; less chance of driving down media pH

Osmocote Blend Topdress Special

These fertilizers are for container nursery stock, foliage and landscapes and are designed to provide a consistent release of high-quality nutrition. Enhanced with E-Max Release Technology™. These formulations are available with important secondary and micronutrients, along with phosphorous, potassium and coated nitrogen. Ideally suited for quick green up applications, these topdress products may be used in conjunction with liquid or dry fertilizer programs.

12-6-6



Item: 67-1571

Size: 50 lb.

12-6-8



Item: 67-1572

Size: 50 lb.

Osmocote Blend 23-4-8

These nursery mixes are specially designed for general purpose outdoor production of nursery stock, foliage and in landscapes. They contain Osmocote® coated N-P-K blended with coated urea Nitrogen featuring E-Max Release Technology™.



Item: 67-1566

Size: 50 lb.



Item: 67-1567

Size: 50 lb.



Item: 67-1568

Size: 50 lb.

Osmocote Blue-Max

Specially formulated for use in the production of blue variety Hydrangeas.

Osmocote Blue-Max™ features polymer-coated E-Max Release Technology™ that conveniently delivers controlled release aluminum sulfate (Al) to create and maintain the desired blue color of hydrangea flowers. With this coated approach, growers can deliver a steady supply of Al to the plant in a safe and reliable manner. And unlike with drenches, the consistent release within specified longevities eliminates the need for repeated applications, saving time, labor and ultimately dollars. **Limited Availability.**



Item: 67-1605

Size: 50 lb.



Micromax

Micromax® Micronutrients

Micromax® is the only homogeneous granular micronutrient fertilizer available. Its homogeneous formula maximizes sulfated elements for optimum plant utilization and prevents micronutrient segregation. This is a good prescriptive product for general nursery and greenhouse production. Each homogeneous prill contains the secondary and micronutrient elements lacking in today's growing media.



- Its granular formulation is designed to increase the efficiency of the major nutrient program and to maximize plant growth by boosting the availability of micronutrients in the root zone
- Topdressing and incorporating Micromax® Micronutrients and Osmocote® provides growers with the opportunity to create an effective and complete nutritional platform to optimize plant growth
- Homogenous granular formulation
- Easy to use

Item: 67-1625 **Size:** 50 lb.

Agriform

Fertilizer Planting Tablets 20-10-5



Safe Fertilization for use at Planting Time

Agriform® planting tablets contain micronutrients derived from sulfates, which results in more nutrition being utilized by the plant. The simplicity of these pre-measured tablets ensures uniform and adequate root zone feeding of trees, shrubs and ground covers for up to two years. 21 gm tablets.

Landscape Established plantings:

Trees: use 2 tablets per 1" of trunk diameter
Shrubs: use 1 tablet per 8" of height or spread

Nursery / Greenhouse	Container Size	Tablets Per Container
	1 Quart Pot	1
	6" Pots	1
	8" Hanging Basket	2 - 3
	10" Hanging Basket	3 - 4
	12" Hanging Basket	6
1 gallon Container	2 - 3	

- Rates should be reduced by one-half for salt sensitive plants or low light interiors
- Irrigate after application
- Keep remaining tablets in a tightly sealed container

Item: 67-1825 **Qty:** 500

Peters Professional

UNI-MIX®
GROWING MEDIA NUTRIENT CHARGE

Peter's Professional® Uni-Mix 11-5-11



Grower Media Nutrient Charge is easy to use. Contains major, secondary and trace elements. Incorporated at 2 lb. per cubic yard of medium. Add Uni-Mix, limestone and wetting agent to growing media blend for professional results.

Item: 67-2352 **Size:** 50 lb.

Osmocote Plus 8-9

Osmocote Plus 15-8-11

7.5 gm Tablets plus Micronutrients

- Convenient, ready-to-use 7.5 gram tablet
- Recommended for use when growing a wide variety of crops or in combination with water soluble fertilizer for a steady source of nutrition throughout the season
- Two sources of iron make it ideal for foliage plants and other woody ornamentals
- Consistently available nutrition through out the entire crop cycle
- The benefit of minors with the convenience of providing all the nutrition plants need in a single application
- Excellent for baskets and patio pots

Item: 67-1905 **Qty:** 1,000

PROFESSIONAL-GRADE PLANT FOODS FOR RETAIL

Quality plant foods are key to a healthy home garden. Give your retail customers the best with professional-grade plant foods. We offer many options for ornamentals, vegetables and houseplants. See our Retail catalog for details.





GAL-XeONE™ Coating Technology

GAL-XeONE™ is a controlled-release fertilizer with a new, advanced polymer coating technology. It delivers optimal nutrients to the plant at a pace that matches a plant's uptake requirements. GAL-XeONE™ fertilizer provides gradual release of plant nutrients to match a plant's growth cycle as needed. It improves efficiency, limits plant damage and reduces nutrient loss.

- Controlled nutrient release from 2 up to 18+ months
- Sustained nutrient delivery to improve plant health
- Reduced losses from volatilization and leaching, and minimized risk of scorching
- Reduced number of applications therefore reducing labor and logistics costs
- Applying the right source of nutrients at the right rate at the right time and in the right place



Item	Description	Pkg.	Release Time at 77°F
33-330110	12-6-6 Florikan CRF NPK PRO w/GAL-XeONE 60 Day	50 lb.	60 day
33-126890FS	12-6-8 Fast Start 90 Day	50 lb.	90 day
33-445140	17-5-11 Florikan CRF NPK MAX w/GAL-XeONE 140 Day	50 lb.	140 day
33-17511180	17-5-11 Florikan CRF NPK MAX w/GAL-XeONE 180 Day	50 lb.	180 day
33-12411100	12-4-11 Florikan CRF NPK PLUS w/GAL-XeONE 100 Day w/ Calcium Nitrate	50 lb.	100 day
33-12411140	12-4-11 Florikan CRF NPK PLUS w/GAL-XeONE 140 Day w/ Calcium Nitrate	50 lb.	140 day
33-12411CFR	12-4-11 Florikan CRF NPK PLUS w/GAL-XeONE 180 Day w/ Calcium Nitrate	50 lb.	180 day
33-1868180	18-6-8 Florikan CRF TOTAL w/Nutricote 180 Day	50 lb.	180 day
33-556270	18-6-8 Florikan CRF TOTAL w/Nutricote 3-Stage 270 Day	50 lb.	270 day
33-453140	18-4-6 Florikan CRF TOTAL w/Nutricote 140 Day	50 lb.	140 day
33-1649270	16-4-9 Florikan CRF TOTAL w/Nutricote 270 Day	50 lb.	270 day
32-200460	Nutricote 17-6-8 (40/180 day) total blend with minors	50 lb.	40/180 day

Important Note: The Nutricote items on this page from Florikan are available for shipment from North Carolina through Florida.

Florikan Nano 14-4-14

- Eliminating the risk of damage from excess salt
- Increases the uniformity of the crops
- Provides ten times more fertilizer than traditional fertilizers
- Provides consistent availability regardless of water requirements

Features

- 100% Polymer Coated Fertilizer
- 1:1 N to K Ratio
- NPK + Micronutrients
- Small Particle Size - SGN 100-150

Item	Description	Pkg.	Release Time at 77°F
33-14414T90N	14-4-14 Florikan CRF NPK MAX w/GAL-XeONE - Nano Mini Prill - 90 Day	50 lb.	90 day
33-16511T180N	16-5-11 Florikan CRF NPK MAX w/GAL-XeONE - Nano Mini Prill - 180 Day	50 lb.	180 day

Florikan™ Sapphire

Florikan Sapphire is a controlled release aluminum sulfate which assists in obtaining blue flowers on various hydrangeas. Florikan Sapphire slowly releases the aluminum element giving more safety to the grower than other conventional sprays and granular versions. This product reduces root damage and multiple applications. Florikan Sapphire is available in both 3-4 month release and 6-7 month release to fit the blooming cycle for most nursery locations.

Item	Description
33-ALS040180	50 lb. - 180 day
33-ALS04090	50 lb. - 90 day





Apogee Light Meter

Apogee's new Daily Light Integral and Photoperiod meters are an elegant and accurate solution for measuring Daily Light Integral (DLI) and Photoperiod for up to 99 days with scientific accuracy and 0.1 hour resolution of DLI. View data onscreen or download. Easily mounts to camera tripod, provides 180° view, and is contained in a rugged and splash-proof housing for durability.

- Item:** 83-2800 **Description:** DLI-400
- Item:** 83-2801 **Description:** DLI-500
- Item:** 83-2802 **Description:** DLI-600



	DLI-400	DLI-500	DLI-600
Spectral Measurement Range (± 5 nm)	370 to 650 nm (sunlight only)	389 to 692 nm	383 to 757 nm
Proton Flux Display Range	0-4000 $\mu\text{mol m}^{-2} \text{s}^{-1}$	0-4000 $\mu\text{mol m}^{-2} \text{s}^{-1}$	0-4000 $\mu\text{mol m}^{-2} \text{s}^{-1}$
Measurement Frequency	3 minutes	3 minutes	3 minutes
Data Log Capacity	99 days (DLI & Photoperiod), 10 days (30 min PPFD/ePPFD averages)	99 days (DLI & Photoperiod), 10 days (30 min PPFD/ePPFD averages)	99 days (DLI & Photoperiod), 10 days (30 min PPFD/ePPFD averages)
Connectivity	CSV file via USB-C data transfer	CSV file via USB-C data transfer	CSV file via USB-C data transfer
Operation	2 AAA batteries, life 6 mo.	2 AAA batteries, life 6 mo.	2 AAA batteries, life 6 mo.
Operating Environment	-10 to 60 C; 0 to 100% relative humidity	-40 to 70 C; 0 to 100% relative humidity	-40 to 70 C; 0 to 100% relative humidity
Ingress Protection	IP65	IP65	IP65
Mounting Compatibility	Brass 1/4-20 threaded mount	Brass 1/4-20 threaded mount	Brass 1/4-20 threaded mount
Warranty	Warranty 4 years against defects in materials and workmanship	Warranty 4 years against defects in materials and workmanship	Warranty 4 years against defects in materials and workmanship



HI98130 Combo (A)

Waterproof pH/EC/TDS/Temperature Tester - 12880 Solution

The HI98130 Combo waterproof tester offers high accuracy pH, EC/TDS and temperature measurements all in a single tester! pH and EC/TDS readings are automatically compensated for the effects of temperature (ATC). These technologically advanced testers have a replaceable pH electrode cartridge with an extendable cloth junction as well as an EC/TDS graphite electrode that resists contamination by salts and other substances.

Use solutions: 74-2535, 74-2540, 74-2536, 74-2525, 74-2530.

Range

pH 0.00 to 14.00 pH EC 0.00 to 20.00 mS/cm
TDS 0.00 to 10.00 ppt Temp 0.0 to 60.0°C or 32.0 to 140.0°F

Item	Vendor	Description
83-1779	HI98130	Combo Waterproof pH/EC/TDS meter
83-1729	HI73127	Replacement pH electrode

HI98312 DiST® 6 (B)

Waterproof EC/TDS/Temperature Tester - 12880 Solution

Hanna Instruments continues the tradition of innovation with the DiST®6. For this series, we have included all the features you have asked for such as a replaceable graphite electrode, adjustable TDS ratio, temperature in C° or F°, automatic temperature compensation with adjustable β, battery level indicator, stability indicator, automatic, and automatic calibration using 12.88 mS/cm solution all in a floating, waterproof casing. These 3-in-1 testers are unmatched in EC/TDS/Temperature measurement! **Use solution:** 74-2536.

Range

EC 0.00 to 20.00 mS/cm TDS 0.00 to 10.00 ppt
Temp 0.0 to 60.0°C or 32.0 to 140.0°F

Item	Vendor	Description
83-1778	HI98312	DiST@6 Waterproof EC/TDS Meter
83-1749	HI73311	Replacement pH electrode

HI98127 pHep®4 pH/Temperature Tester (C)

Waterproof pH/Temperature Tester

The pHep®4 includes features such as a dual-level LCD, battery level indicator, replaceable pH electrode cartridge, stability indicator, automatic shut-off and automatic calibration using pH4 + pH7 solution all in a floating, waterproof casing.

Calibration solutions: 74-2525, 74-2530, 74-2535, 74-2540.

Range

pH 0.0 to 14.0
Temp 0.0 to 60.0°C or 32.0 to 140.0°F

Item	Vendor	Description
83-1724	HI98127	pHep@4 Waterproof pH/temp. Meter
83-1729	HI73127	Replacement pH electrode

Checktemp®1

High accuracy Thermometer with remote probe

- 3 ft. probe cable
- Calibration Check Feature (Cal-Check)
- Long Battery Life

This highly accurate thermometer is equipped with Hanna's unique calibration device (Cal-Check) which allows users to check if the calibration is accurate. This pocket sized thermometer incorporates a remote probe with a 3 foot cable and has an accuracy of ±0.5°F.



Range -50.0 to 150.0°C or -58.0 to 302.0°F

Item	Vendor	Description
83-1743	HI98509	HI98509 Checktemp® 1 Digital Thermometer

Lux Meter (HI97500) Portable Lux Meter

for Rapid Light Measurements

- Three measurement ranges
- Light sensor attached to 1.5 meter coaxial cable
- Rugged, waterproof case
- Low-battery indicator

Hanna's light measuring sensor is a photo diode that converts incident light into an electronic signal that is read and displayed on the meter's LCD as Klx which is 1,000 lx. For Sunlight, 1Klx is about 19 photons or 4 Watts/m2 of light.



Item	Vendor	Description
83-1744	HI97500	Luxmeter



pH Pen (A)

The Bluelab hand held pH pen provides a compact, quick and handy way to manage the success of your crop to ensure maximum uptake of nutrients.

Item: 83-2701

Conductivity (EC/PPM) Pen (B)

The Bluelab Conductivity Pen can read EC, PPM and temperature of water solutions.

Item: 83-2702

Multimedia pH Meter (C)

Accurately measure and monitor pH levels in solution or in a wide range of media. Combine the Multimedia pH Meter and Leap™ pH Probe to take fast accurate measurements.

Item	Description
83-2774	Multimedia pH Meter
83-2776	Leap™ Replacement Probe

Combo Meter Plus (D)

Measures pH, conductivity and temperature in one portable handheld meter. This all-in-one, convenient portable solution for accurate measurement of pH in soil or nutrient solutions. Conductivity (EC) and temperature of solutions. This battery-powered, lightweight unit can be used anywhere, anytime to measure critical parameters related to healthy plant growth. The new Bluelab Leap pH probe included, also allows fast and accurate pH measurements direct from the root zone in a wide range of growing media including soil, coco coir, potting mixes and nutrient solution- no more pH slurries or extraction mixes.

Item	Description
83-2777	Combo Plus Meter
83-2739	Carry Case
83-2776	Leap Spear-Tip Probe

Guardian Monitor (E)

Provides 24 hour continuous reading for pH, conductivity (EC/PPM) and temperature within a nutrient solution in hydroponics and other systems. Connect monitors has alarm notification and wireless data logging.

Item	Description
83-2711	Guardian Connect Monitor
83-2770	Guardian Monitor Inline Connect
83-2772	Guardian Inline pH Probe
83-2737	Connect Stick
83-2738	Connect Range Extender

Combo Meter EC (F)

Measures pH, conductivity (EC) and temperature on the go. Brilliantly simple design that's easy to use, clean and calibrate for solution measurements. Backlit display to capture every measurement with ease. Includes a pH Probe and Conductivity Probe to cover all your nutrient uptake fundamentals. 2-meter cable for measuring in hard-to-reach locations. Customise scales to your preference - conductivity in EC, CF, PPM 500 (TDS) or PPM 700; temperature in °C or °F.

Item: 83-2709

Commercial Truncheon Meter (G)

An EC meter built to last a lifetime – now on a bigger scale. Robust and reliable construction for long-lasting value. Fully waterproof; splash, submerge or sink - we've got you covered. Automatically detects liquids and bright LEDs indicate measurement for brilliantly simple functionality. Long-format design for mixing and measuring nutrient reservoirs simultaneously. No calibration required and easy to clean and disinfect. All conductivity scales included – EC, CF, PPM 500 (TDS), PPM 700. Industry-leading five-year warranty for peace of mind. Ideal for hydroponics.

Item: 83-2706



Guardian Monitor Inline Connect (A)

24/7 monitoring of pH, EC and temperature directly in your irrigation and nutrient feed line. View nutrient feed parameters on your mobile phone no matter where you are. Large, backlit display for at-a-glance viewing. High and low alarms to alert you when your parameters are out of range

Item: 83-2770

Pro Controller (B)

Monitor and automate nutrient and pH dosing in reservoirs when paired with Bluelab PeriPod dosers. In-built safety lockouts prevent excessive dosing. View your reservoir parameters on your mobile phone no matter where you are. Multi-part nutrient dosing possible with multiple PeriPods and Connect software. Controls pH in the up (alkali) or down (acid) direction. High and low alarms to alert you when parameters are out of range.

Item: 83-2779

Calibration Solutions and Probe Care Kits pH & Conductivity



All the tools you need to care for Bluelab probes. The probe surface is where the instrument takes the reading of the solution or soil/media. If the probe face is dirty or contaminated, then the reading will be inaccurate. Accurate readings simplify crop management and provide improved growth.

Item #	BlueLab Calibration Solutions	Amt.
83-2751	pH 7.0 Calibration Solution	500 ml /16.9 fl oz.
83-2754	pH 7.0 Calibration Solution	250 ml /8.45 fl oz.
83-2752	pH 4.0 Calibration Solution	500 ml /16.9 fl oz.
83-2755	pH 4.0 Calibration Solution	250 ml /8.45 fl oz.
83-2753	EC 2.77 Conductivity Solution	500 ml /16.9 fl oz.
83-2756	EC 2.77 Conductivity Solution	250 ml /8.45 fl oz.
83-2758	KCL Storage Solution	120 ml = 4.05 fl oz.
83-2734	Probe Care Kit – Conductivity 2 sachet – EC 2.77, 1 plastic cups, conductivity probe cleaner, chamois	Each single use sachet – 20 ml /0.67 fl oz.
83-2736	Probe Care Kit – pH & Conductivity 2 sachet – pH 7.0, pH 4.0, KCL, EC 2.77 3 plastic cups, pH probe cleaner, conductivity probe cleaner, pH probe brush, chamois	Each single use sachet – 20 ml /0.67 fl oz.
83-2735	Probe Care Kit – pH 2 sachet – pH 7.0, pH 4.0, KCL, 3 plastic cups, pH probe clean-er, pH probe brush	Each single use sachet – 20 ml /0.67 fl oz.

pH Controllers and Dosers (C)

Controllers provide selectable, single-direction correction (either up or down), with the ability to control across the full pH range with an accuracy of +/- 0.1 point. Dosing up to 10 ml per minute to support reservoirs up to 200 gallons. Easy calibration protocols and visual alarm states. pH Controller Connect includes wireless data logging capabilities. Use with Bluelab pH Down (35% phosphoric acid) or pH Up (35% potassium hydroxide) solutions.

Item	Description
83-2712	pH Controller
83-2713	pH Controller Connect

Pulse 3-1 Multimedia Meter (D)

Allows growers to get fast, accurate measurements directly from the root zone sent direct-to-mobile. Quickly and accurately spot-check moisture, conductivity and temperature. Wireless smartphone syncing meter.

Item: 83-2778



Calibration Solutions



The importance of buffer and maintenance solutions could not be understated. These solutions should be used to initially calibrate all Hanna hand held meters and keep them working accurately for years.

Item	Vendor	Description
74-2510	HI500021P	Cal Check Solution 25/pcs
74-2520	HI7031M	¼ liter 1.413 mS/cm
74-2536	HI7030M	12.88 mS/cm Conductivity Solution
74-2525	HI7007M	¼ liter pH 7.01 buffer solution
74-2530	HI7004M	¼ liter pH 4.01 buffer solution
74-2535	HI70300M	¼ liter storage solution
74-2540	HI7061M	¼ liter cleaning solution

IRRIGATION



Professional Hoses

DRAMM

ColorStorm Professional Rubber Hose

ColorStorm-Professional Rubber Hose is made from EPDM rubber for a “crackless” hose cover that is resistant to abrasion, weathering and kinking.



Item	Description
33-2150	50' - 5/8" hose
33-2250	50' - 3/4" hose
33-2175	75' - 5/8" hose
33-2275	75' - 3/4" hose
33-2100	100' - 5/8" hose
33-22100	100' - 3/4" hose



Element® Contractor FARM® Hose

Heavy-duty contractor-grade water hose. 400+ PSI burst strength, powerful enough to handle the high water pressure necessary for extreme work conditions. Heavyweight reinforcement at key areas for maximum durability. The hose is available as both a 5/8-inch garden hose and as a 3/4-inch garden hose, with the extra-large 3/4-inch water hose moving 20 percent more water.

Item	Description
82160041	ELEMENT Contractor/FARM HOSE 3/4" X 50'
82160042	ELEMENT Contractor/FARM HOSE 3/4" X 75'
82160043	ELEMENT Contractor/FARM HOSE 3/4" X 100'
82160044	ELEMENT Contractor/FARM HOSE 5/8" X 50'
82160045	ELEMENT Contractor/FARM HOSE 5/8" X 75'
82160046	ELEMENT Contractor/FARM HOSE 5/8" X 100'



Custom Hose Starter Kit



Make your own hose lengths easily and quickly with our Custom Hose Starter Kit.

Dramm ColorStorm Professional Hose has become the durable and flexible choice of growers around the world. This kit makes it easy to get started cutting your own length of hose.

The kit includes the Dramm Press, our easy to use hose crimper, with one set of jaws, two spools of 330' ColorStorm Hose and 12 male and 12 female fittings with ferrules - enough to make 12 hoses. It is available in either 5/8" or 3/4" kits. Part numbers and components are listed below.

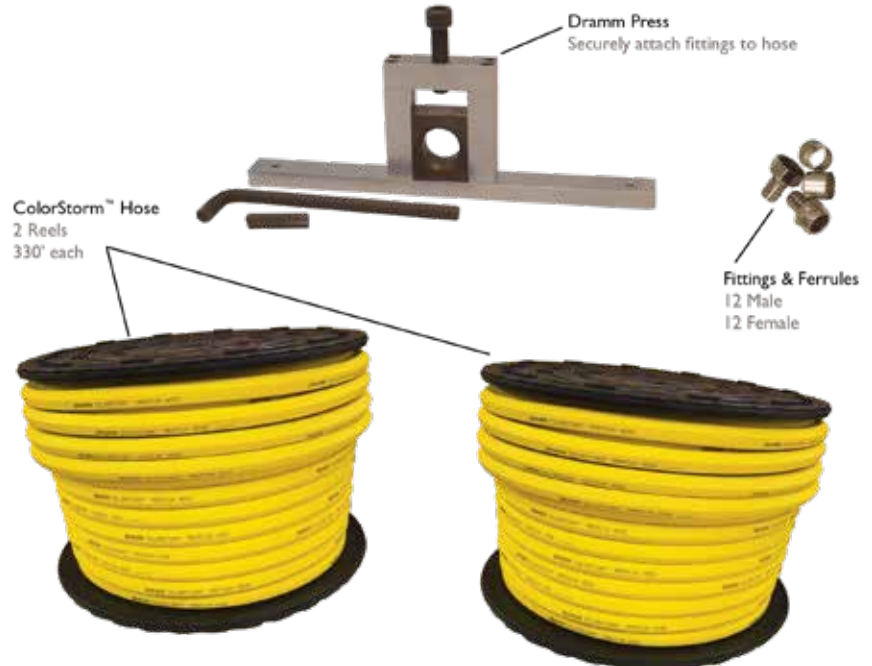

5/8" Custom Hose Kit

- 5/8" Hose
- 2- 330' Spools 5/8" ColorStorm™ hose
- 1- DP Frame – Free of Charge
- 1- DP-J625 5/8" Jaws
- 12- 5/8" Male Fittings/Ferrules
- 12- 5/8" Female Fittings/Ferrules

Item: 33-2266

3/4" Custom Hose Kit

- 3/4" Hose
- 2- 330' Spools 3/4" ColorStorm™ hose
- 1- DP Frame – Free of Charge
- 1- DP-J750 3/4" Jaws
- 12- 3/4" Male Fittings/Ferrules
- 12- 3/4" Female Fittings/Ferrules

Item: 33-2267



Replenishment Parts for Kit

Item	Description	Qty
33-20343	3/4" X 330' Master Roll ColorStorm Hose (No Fitting)	-
33-20583	5/8" X 330' Master Roll ColorStorm Hose (No Fitting)	-
33-22101	5/8" Male Fitting & Ferrule for ColorStorm Hose	12/cs
33-22102	5/8" Female Fitting & Ferrule for ColorStorm Hose	12/cs
33-22301	3/4" Male Fitting & Ferrule for ColorStorm Hose	12/cs
33-22302	3/4" Female Fitting & Ferrule for ColorStorm Hose	12/cs
33-22304	5/8" Splice & Ferrule Set for ColorStorm Hose	12/cs
33-22305	3/4" Splice & Ferrule Set for ColorStorm Hose	12/cs
33-2263	Dp-J750 Press Jaws 3/4" (Only)	-
33-2264	Dp-J625 Press Jaws 5/8" (Only)	-
33-2265	Dp-Frame Press Hose Crimper (Frame Only)	-

ColorStorm™ Custom Size (Min. 10')

Item	Description
33-22000	3/4" ColorStorm Hose ft Yellow Wp 125 psi 17989

Machined Brass Couplers with Worm Gear Clamp

Item	Description
33-67351	3/4" Male
33-67352	3/4" Female
33-67301	5/8" Male
33-67302	5/8" Female



F-series Band Clamps

Preformed clamps are double wrapped and formed to a given diameter. Used primarily where one end of the hose or article is free to allow the clamps to be slid over the hose end before the fitting is inserted.



Item	Description
42-800100	F-38 Locking tool
42-800200	F-3 3/8" x 1 1/8" Galvanized steel preform clamp
42-800300	F-311 3/8" x 1 1/8" Galvanized steel preform clamp
42-800400	F-4 3/8" x 1" Galvanized steel preform clamp
42-800500	F-5 3/8" x 1 1/4" Galvanized steel preform clamp
42-800600	F-6 3/8" x 1 1/2" Galvanized steel preform clamp

Brass Connectors

Item	Vendor	Description
33-6240	7FPS7FH	DFS 3/4" NPT x 3/4" NH
80150557	7MP7FH	3/4" NPT (M) x 3/4" NH (F)



Brass Quick Connectors

- Heavy-duty solid brass construction
- Allows most water flow of any quick connector systems
- Easily attaches to nozzle or sprinkler for quick connection to hose

Item	Description
80150515	Quick Connector Set
80150514	Male Quick Connector
80150152	Female Quick Connector

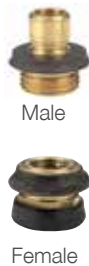

Hose Repair Metal Clinch Couplers

Item	Description
81780172	3/4" Female
81780174	5/8" Male
81780177	5/8" Mender



HiFlo™ 4-Way Hose Valve

Large size allows greater water flow and large knobs ensure easy operation. Durable ABS construction.

Item	Description
81780242	4 Way



QAV Shut-Off Valve

The QAV uses a unique, patent-pending valve design includes a single-piece ball, stem and handle assembly to reduce the time to assemble while strengthening the structure.

Item: 50-72318



Dramm 300 Professional Brass Shut-Off

The Dramm 300 Brass Shut Off offers unmatched durability and flow. Built to last, be repairable, and offer full flow, the 300 Brass Shut Off is the gold standard for hand watering. Flow rate: 17 GPM.

Item	Description
41-400300	Brass Shut-Off
41-400400	Brass Shut-Off Repair Kit



OneTouch High Flow Valve

OneTouch HF will offer twice the flow rate with less than an ounce additional weight. Larger openings to accommodate more flow, light enough for all-day use. Flow rate: 16 GPM.

Item: 33-5365



Heavy Duty Plastic Shut-Off Valve

Made from glass filled polypropylene to be very durable, corrosion resistant and lightweight while offering a full flow. Flow rate: 18 GPM.

Item: 33-51051



Plastic Ball Valves

Impact resistant plastic for long-term service.

Item	Description
30-2425	Blue Ball Valve Hose to Hose
30-2430	Black Ball Valve Pipe to Pipe



1/4 Turn Brass Shut-Off Valves & Repair Kit

Item	Description
33-3275	1/4 Turn Shutoff SO-75 Hose to Hose (A)
33-3276	1/4 Turn Shutoff V-58 Pipe to Hose (B)
33-3277	1/4 Turn Shutoff V-75 Pipe to Pipe (C)
33-3278	1/4 Turn Repair Kit - Replaces all but main body of valve



Gilmour Hose Accessories



593 Comfort Grip Nozzle (A)

- Die-cast zinc body with stylized soft vinyl grip for more comfort
- Grip is molded directly on nozzle body

Item: 80150043

594 Cushion Grip Select-A-Spray® (B)

Select-A-Spray® combines quality construction and convenience for the ultimate water nozzle: choose the precise water coverage you need from the four pattern spray selection.

- Soft vinyl grip for extra cushion
- Heavy-duty, die-cast metal body
- All brass valve stem and adjusting nut

Item: 80150044



2024

01F Replacement Hose Coupling - Female

Fits all 5/8" to 3/4" rubber or plastic hoses

Item: 80150001



01M Replacement Hose Coupling - Male

Fits all 5/8" to 3/4" rubber or plastic hoses

Item: 80150005



01HM Hose Mender

Fits all 5/8" to 3/4" rubber or plastic hoses

Item: 80150003



AY2FF Full Flow Double Hose Shutoff "Y" Connector

- Non-corroding, high impact polymer construction
- Full ball valve prevents leakage

Item: 80150571



01RW Rubber Hose Washers

- 10 washers per package

Item: 80150007



AS1FF Full Flow Water Shut-off Valve

- Swiveling nut prevents hose kinks
- Non-corroding, impact resistant polymer construction

Item: 97-63252



02FW Hose 3/4" Coupling Filter Washers

- Molded-in metal screen, fits all hose couplings
- 3 per package

Item: 80150184





1000PL Water Breaker

Water your plugs or seedlings with the softest full-flow watering nozzle available. The 1000PL Red Head Water Breaker has over 1000 micro holes that create an ultra-soft flower shower which will not disturb delicate soil or harm tender plants. Made in the USA from ABS plastic and stainless steel. Weight 1.6 oz. GPM = 7 @ 40 PSI



Item	Description
33-5233	Regular soft flow - Red
33-5236	Narrow soft flow - Green
33-5237	Wide soft flow - Orange

750 Lemonhead Water Breaker

The 750 Lemonhead Water Breaker is designed to offer a lower, softer flow. Just as soft as the 1000 PL red head, The 750PL allows for more precise watering and gives growers yet another choice for more flexibility in watering. It has 25% less hole surface area which offers a lower flow that can be regulated by a shut-off valve for minimal water and still retain a pattern. Weight 1.6 oz. GPM = 7 @ 40 PSI



Item: 33-5234

Seedling Nozzle

The Seedling Nozzle allows you to water fragile plants, delicate seedlings or plant cuttings. This high-quality nozzle produces an extra fine hollow cone mist pattern and sprays a 1/2 gallon of water per minute. Made in the US from solid brass with 3/4" hose threads. Weight 2.7 oz. GPM = 1/2 @ 40 PSI



Item: 33-5235

170 Aluminum Water Breaker

The 170AL Water Breaker is excellent for watering in areas with low water pressure or with systems which restrict total water volume. It is designed for small containers (hanging baskets), and when using fertilizer siphons. Adjust water flow to 50% of its volume. Cast aluminum with 3/4" hose threads. Weight 1.6 oz. GPM = 7 @ 40 PSI



Item: 33-5225

400 Aluminum Water Breaker

The original full-flow shower head nozzle. The aluminum 400 Water Breaker provides fast, full-flow watering without damage to your plants. Used by professional growers worldwide. Cast aluminum with 3/4" brass hose threads. Manufactured in the USA. Weight 5.1 oz. GPM = 11.1 @ 40PSI



Item: 33-5230

400PL Water Breaker

The 400PL Water Breaker provides fast, full-flow watering without damage to your plants. Patterned after the original 400 Aluminum Water Breaker with 3/4" hose threads, the 400PL is made from high-impact ABS plastic and aluminum to provide a lightweight alternative. Weight 1.3 oz. GPM = 11.1 @ 40PSI



Item: 33-5231

Professional Watering Tools

DRAMM

400PL Water Breaker with Protective Ring

Adds more protection to the plastic 400 PL.

Item: 33-6101



350 PL Water Breaker

High-Flow, Aerated Stream. The plastic 350PL Screen-Aire is a light weight, full flow nozzle for quick watering. Made from durable, lightweight POM plastic and stainless steel screens, the 350PL offers high flow with an ultra-soft, aerated pattern. Perfect for quickly watering containers and nursery stock while not washing the media or fertilizer out of the pot.

Item: 33-350PLC



Handi-Reach Handle Aluminum Extension Rods

Item	Description
33-5120	16" Aluminum Extension Rod
33-5122	24" Aluminum Extension Rod
33-5123	30" Aluminum Extension Rod
33-5124	36" Aluminum Extension Rod
33-5125	36" Extra Curve Aluminum Extension Rod
33-5126	48" Aluminum Extension Rod
33-5128	48" Extra Curve Aluminum

DRAMM

FOGG-IT Nozzle | (4 sizes)

Item	Description
33-5325	2 GPM Regular (Orange)
33-5326	1 GPM Fine (Purple)
33-5327	½ GPM Super Fine (Green)
41-300500	4 GPM Heavy (Blue)
33-6610F4	1/4 GPM Super Superfine (Black)



Wonder Waterer

A must for plug growers

Our most popular seedling waterer. Highest quality nozzle, extension, shutoff and strainer for watering seedlings. The face plate is removable for easy cleaning. Very uniform, soft water pattern.

Item	Description
33-5625	Wonder Waterer w/in-line filter
33-5626	Replacement Face Plate w/gasket
33-5627	Replacement Strainer



Replacement Face Plate



Replacement Strainer



The Netafim Solution

The Netafim solution avoids the problems of the traditional sprinkler layout. Computer modeling was used to produce a design which thousands of installations have proven to be accurate. Netafim sprinklers achieve a very high level of uniformity within a closely spaced 'strip of sprinklers'. By designing with these 'strips' laid out side by side, large areas can be covered uniformly. All Netafim sprinkler systems are designed with 3' spacing between the sprinklers.

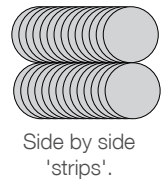

2024

Step 1. Visualize the Greenhouse

Recall that the Netafim system is laid out as individual 'strips' to be watered. Visualize where those strips should be. A strip might be an individual bench, half of bay or other larger or smaller growing area. Evaluate the location of obstacles such as curtains or hanging baskets. Consider aisles and whether they can be wetted. Review cultural practices which might impact the height at which the sprinklers should be placed.

Step 2a. Select a Sprinkler Head for Watering Applications

(go to step 2b for misting or cooling)

Sprinkler

Sprinkler heads should be placed 2' - 6' above crops and spaced 3' on center.

Important | Sprinklers & Misters: Use a 35 PSI regulator and a 120 mesh filter.

Foggers: Use a 65 PSI pressure regulator and a 140 mesh filter.



Single Bench with VibroNet Sprinklers

Bench/ Width (ft)	Spacing Between Sprinklers (ft)	Height Above Crop 2 - 3 ft or 3 - 5 ft
4	3	VN-BL or VN-GN
5	3	VN-BL or VN-GN
6	3	VN-BL or VN-GN

VN-GN = VibroNet Green Nozzle 11.7 GPH • VN-BL = VibroNet Blue Nozzle 9.2 GPH

Item	Vendor	Description
VN-GN	50170151	VibroNet Sprinkler Green (11.7 GPH)
VN-BL	50170152	VibroNet Sprinkler Blue (9.2 GPH)

One Line for Single Bay or Free Standing with SpinNet Sprinklers

Bay Width (ft)	Spacing Between Sprinklers (ft)	Height Above Crops		
		2' - 3'	4' - 5'	6' - 7'
10	3	SN-RRBL	—	—
12	3	SN-RRBL	SN-RRBL	—
14	3	SN-BRBRBL	SN-BRBRBL	SN-RRBL
15	3	SN-RRGY	SN-BRBRBL	SN-RRBL
16	3	SN-RRGY	SN-YBGY	SN-RRBL
18	3	SN-RRGN	SN-YBGY	SN-YBGY
20	3	—	SN-RRGN	SN-BBGN
22	3	—	SN-RRGN	SN-BBGN
24	3	—	—	SN-BBGN

Step 2a. Continued

(go to step 2b for misting or cooling)

Two Line for Single Bay or Free Standing with SpinNet Sprinklers

Bay Width (ft)	Spacing Between Sprinklers (ft)	Spacing Between Sprinkler Lines (ft)	Height Above Crops		
			3'	4' - 5'	6' - 7'
20	3	11	SN-RRBL	—	—
22	3	12	SN-RRBL	SN-RRBL	—
24	3	12	SN-RRBL	SN-RRBL	SN-RRBL
26	3	14	SN-BRBRBL	SN-RRBL	SN-RRBL
28	3	15	SN-BRBRBL	SN-RRBL	SN-RRBL
30	3	16	SN-RRGY	SN-RRGY	SN-BRBRBL
32	3	17	SN-RRGN	SN-RRGY	SN-BRBRBL
34	3	18	SN-RRGN	SN-RRGY	SN-BRBRBL
36	3	19	SN-RRGN	SN-RRGY	SN-RRGN
38	3	20	SN-BBGN	SN-RRGN	SN-RRGN

SN-RRGY - Item 5016150 - (18.4 GPH)
SpinNet Red Body, Red Mist Control, Grey Spinner

SN-RRGN - Item 5016160 - (18.4 GPH)
SpinNet Red Body, Red Mist Control, Green Spinner

SN-YBGY - Item 5016180 - (23.4 GPH)
SpinNet Yellow Body, Brown Mist Control, Grey Spinner

SN-BBGN - Item 5016170 - (23.4 GPH)
SpinNet Brown Body, Brown Mist Control, Green Spinner

SN-RRBL - Item 5016130 - (18.4 GPH)
SpinNet Red Body, Red Mist Control, Blue Spinner

SN-BRBRBL - Item 5016140 - (23.4 GPH)
SpinNet Brown Body, Brown Mist Control, Blue Spinner

Step 2b. Select a Sprinkler Head for Watering Applications

(go to step 2b for misting or cooling)

Misting

For single bench spray watering use VibroNet green or blue VN-GN or VN-BL (see chart).

Order a Leak Prevention Device (LPD), item# 5017065 on **page 294** for each misting or sprinkling head.



CoolNet Pro Fogger & Components

Item	Description
5017077	CoolNet Pro Fogger Assembly
5016013	CoolNet Pro LPD Ivory w/ Orange Pin

Sprinkler System for Bench Crops

Step 3.

Select a Hanging Sprinkler Assembly

Select a hanging sprinkler assembly appropriate for the type of pipe used to supply water to the sprinklers. Polyethylene pipe is recommended.

Hanging Sprinkler Assembly

Item	Tube length
5017067	24"
5017069	36"
5017070	48"
641780	48" Extension

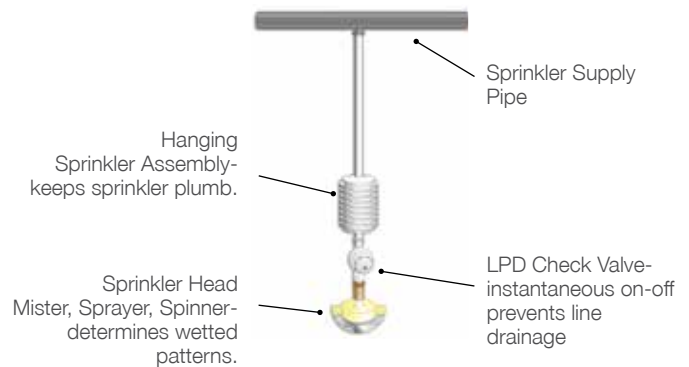

	Item#	Nozzle Color	Avg Flow (GPH)	Length of Sprinkler Supply Pipe					
				25'	50'	75'	100'	125'	150'
CoolNet Pro Fogger	5017077	-	8.1	3/4"	3/4"	3/4"	3/4"	3/4"	3/4"
VibroNet Mister	50170152	Blue	9.2	3/4"	3/4"	3/4"	3/4"	3/4"	3/4"
SpinNet Sprinkler (Body/Mist Cntrl)	5016130	R/R	18.4	3/4"	3/4"	3/4"	1"	1"	1"
	5016170	Br/Br	23.4	3/4"	3/4"	3/4"	1"	1"	-
	5016180	Y/Br	23.4	3/4"	3/4"	3/4"	1"	1"	-

Step 4.

Size the Sprinkler Supply Pipe

Use the chart at right to select the correct sprinkler supply pipe size. Low density polyethylene is strongly recommended. PVC can be used with precautions taken to prevent light penetration into the pipe, which can cause algae growth, leading to nozzle plugging. Use either a gray PVC pipe, or use a dark paint to coat any exposed white PVC piping.



Griffin Irrigation Department

Save Water • Save Labor • Grow More

Call 1.800.888.0054 and ask for an Irrigation Specialist.

Step 5.

Water Control Components | Control Head Components (valve, filter & pressure regulator)

Select and install the correct valves, filters and pressure regulators, based on your system water flow requirements.

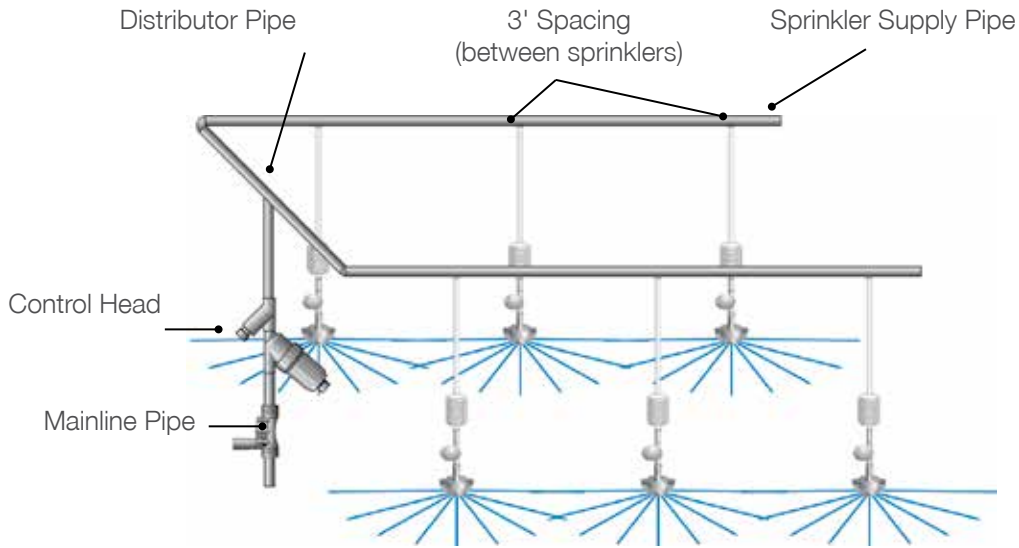

Sprinkler Assembly Components



Item	Description
5017065	Leak Prevention Device (LPD) w/Purple Pin (A)
5017066	SpinNet Base to Dan Sprinkler (B)
5017061	Dan Base to SpinNet Sprinkler (C)

Vibro Spray HF Sprinkler

10' wide coverage with 8' spacing between sprinklers

Item	Description
5017055	Normal flow: 1 GPM at 30 psi



Item	Description
5016025	Grommet for 3/8" Adapter (A)
5017059	3/8" Tapered Thread Adapter (B)
5017057	1/2" Adapter (for Pipe Thread) (C)
5017054	SpinNet Tubing Barb x Male (D)
5013105	4/7 mm Punch (E)



Griffin Irrigation Department

Save Water • Save Labor • Grow More

Call 1.800.888.0054 and ask for an Irrigation Specialist.

Dripper Assemblies

Plastic Weighted, Barbed Stake and Independent Shut-off Assemblies

Delivers precise amounts of water to individual pots. The WPCJ pressure compensated no-leak dripper is ideal for longer runs, when irrigating on slope, or when absolute precision of water volume to each pot is required. The WPCJ's "no-leak" feature stops dripping when the pressure on the main water line drops. All of the drippers on the line start and stop at the same time, leaving the line full of water for the next irrigation. The Woodpecker dripper is used more for non-pressure compensated dripper for shorter level runs.

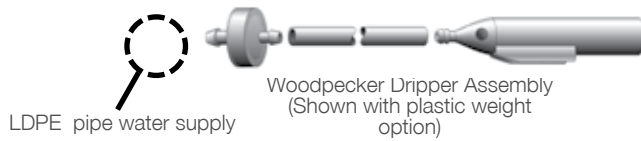

Item	Description
5013718	18" P/C .5 GPH Dripper Assembly w/ slimline weight
5013724	24" P/C .5 GPH Dripper Assembly w/ slimline weight
5013736	36" P/C .5 GPH Dripper Assembly w/ slimline weight



Item	Description
44-800024	24" P/C .5 GPH Dripper Assembly w/ barbed stake
44-800036	36" P/C .5 GPH Dripper Assembly w/ barbed stake
44-800048	48" P/C .5 GPH Dripper Assembly w/ barbed stake

Flow rates:

- Woodpecker: 0.5 GPH
- WPCJ: 0.5 GPH

Recommended uses:

- Hanging baskets
- Potted crops
- Nursery crops
- Landscapes



Hanging Basket Assemblies

Item	Description
5013624	24" WPCJ Pressure Compensating Dripper Assembly - 35 PSI regulator required for proper operation
5013636	36" WPCJ Pressure Compensating Dripper Assembly - 35 PSI regulator required for proper operation
5013424	24" WP Dripper Assembly with Barbed Base Woodpecker - 20 PSI regulator required for proper operation
5013436	36" WP Dripper Assembly with Barbed Base Woodpecker - 20 PSI regulator required for proper operation

Weights are not included with assemblies. Regulators can be found on pg. 310.

Components used with Dripper Assemblies



Item	Description	Vendor
5016090	Plastic Weight for Drippers	1107008C
50160901	Slimline White Weight	1107008SC
50161051	Black Angled 6" Barbed Stake	1101001W
5016100	4" Stabilizer Peg	1107950

PCNL Spray Stakes

Improved Control of Water and Fertilizer

- Pressure Compensation (PC) assures the last container in the row gets the same amount of water as the first
- Prevents over watering. The check valve prevents water in the supply pipes from draining into the lowest plants after the valve shuts off

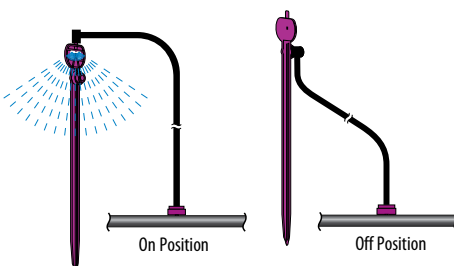

Item	Description	Pot Size	Max flow	Vendor
5010081	Plum Stake	3-5 gal	3.2 GPH	01PSDS-PL1-B
5010091	Grey Stake	5-10 gal	6.6 GPH	01PSDS-GY1-B
5010008	Plum/Black Dripper		3.2 GPH	01WPCJL12
5010009	Orange/Grey Dripper		6.6 GPH	01WPCJL25
5014230	5mm Elbow			11002520
44-800380	Pre-Cut P/E Tubing 24" (100 qty)			40001-002900
44-800391	Pre-Cut P/E Tubing 36" (100 qty)			40001-003200
509-112	36" Plum Stake Assembly (Stake Sold Separately)		3.2 GPH	01PSD032-36B
509-113	48" Plum Stake Assembly (Stake Sold Separately)		3.2 GPH	01PSD032-48B
509-107	36" Grey/Orange Stake Assembly (Stake Sold Separately)		6.6 GPH	01PSD066-36B
509-108	48" Grey Stake Assembly (Stake Sold Separately)		6.6 GPH	01PSD066-48B

Efficient Operation | Netafim solutions for nursery containers are designed to wet the soil surface evenly to maximize water retention by the soil mix and evenly release liquid or timed-release fertilizers.

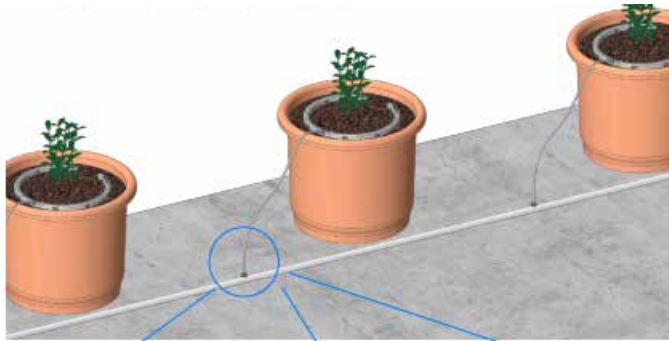

CONNECTION TO PCJ ON-LINE DRIPPER



CONNECTION TO PC ON-LINE DRIPPER



CONNECTION TO UNIRAM™

NetBow

Save Labor! NetBow's evenly spaced emitters distribute water uniformly contributing to optimum root zone development. Compatible with 2 to 15 gallon containers.



Item	Vendor	Description
5010094	77470-000142	NetBow 5" Irrigation Ring
5010093	77470-000106	Netbow 10" Irrigation Ring
44-800380	15FPEW53-24	24" Long Pre-cut 5/3 Tubing (100/Bundle)
44-800391	15FPEW53-36	36" Long Pre-cut 5/3 Tubing (100/Bundle)

Complete NetBow assemblies and several connection options available for direct shipment. Contact Griffin Irrigation Specialist for more details.

Spaghetti Tubing

Item	Qty	Description	Vendor
44-800380	100/Bundle	24" Long Pre-cut 5/3 Tubing	15FPEW53-24
44-800391	100/Bundle	36" Long Pre-cut 5/3 Tubing	15FPEW53-36
5010046	3,000' Roll	.125-197 PE 5/3 Flex Black	15FPE53
5010047	1,000' Roll	.125-197 Super flex UV 5/3 White	15FPEW53



To be used with all dripper assemblies

FlexNet™

Leak proof flexible submain and manifold piping solution. Integral welded connectors ensure leak proof connections to lateral lines.

Item	Description
5010042	Netafim 2" FLEXNET PIPE 60" SPACING 328'
5010043	Netafim 2" FLEXNET PIPE 72" SPACING 328'
5011006	Netafim 1/2"MPT Elbow X.636TWD FLEXNET 100/bg
NPFM20042250G	NETAFIM 2" FLEXNET BLANK MANIFOLD 36PSI 250'



Starting Up a System for the First Time

Always flush the main lines when starting up a new system. Debris from construction can otherwise be washed into the sprinklers or emitters, causing a plug and/or reduced flow. To properly flush the system, first connect all the pipes and assemblies, except the drip assemblies or sprinklers with LPDs. Next, open the ends of the lateral lines. Slowly turn on the water source and then close off the lateral lines, one by one, starting with the opening closest to the water source, and proceeding to the most distant opening. Only after complete flushing should the drip assemblies or sprinklers with LPDs be attached to the lateral lines. The system then can be brought to operating pressure.

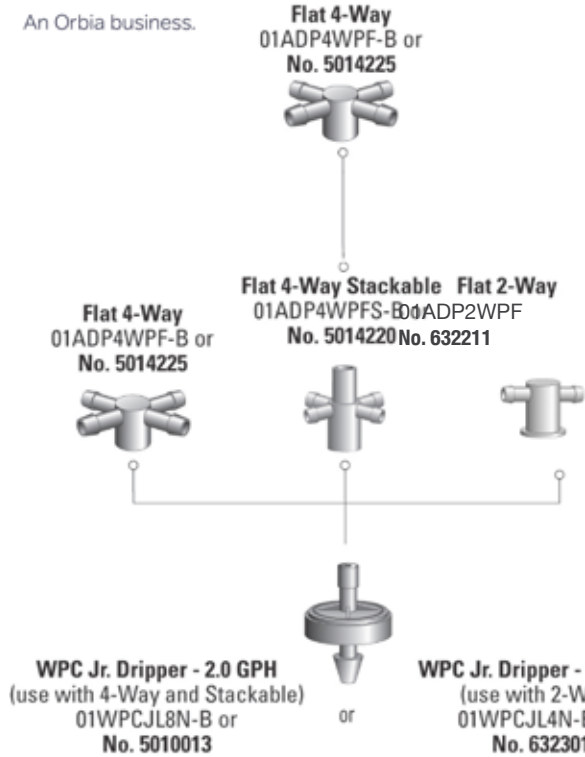

For complete assembly, order one **A** Manifold Assembly and one **B** Woodpecker Pressure Compensating Junior Dripper.

NOTE: The flow per arrow dripper is equal to the dripper flow divided by the number of arrow drippers on that assembly. To ensure plants will receive equal water flow, use the same assemblies on each zone.

Item	Description	Vendor
5014225	Flat 4-way Manifold Fitting	01ADP4WPF
5014220	Flat Stackable Manifold Fitting	01ADP4WPF-S
632211	Flat 2-Way Manifold Fitting	01ADP2WPF
5013231	63/8" Angle Arrow Dripper	01MODS-A-ANG
5013232	33/4" Short Angled Arrow Dripper	01MODS-A-ANGS

Flat 4-Way MOD Assemblies

Item	Vendor	Arrow Dripper	Tube Lengths
5013206	014DM-1818F	Standard	(4) at 18"
-	014DM-1818FS	Short	(4) at 18"
5013210	014DM-1830F	Standard	(2) at 18" & (2) at 30"
-	014DM-1830FS	Short	(2) at 18" & (2) at 30"
A 5014214	014DM-2424F	Standard	(4) at 24"
-	014DM-2424FS	Short	(4) at 24"
5014212	014DM-2436F	Standard	(2) at 24" & (2) at 36"
5014215	014DM-3030F	Standard	(4) at 30"
B 5010013	01WPCJL8N-B	WPC Jr. Dripper 2.0 GPH	

Flat Stackable MOD Assemblies

Item	Vendor	Arrow Dripper	Tube Lengths
5013207	014DMS-1818F	Standard	(4) at 18"
-	014DMS-2424F	Standard	(4) at 24"
A 5015212	014DMS-2436F	Standard	(2) at 24" & (2) at 36"
5015215	014DMS-3030F	Standard	(4) at 30"
B 5010013	01WPCJL8N-B	WPC Jr. Dripper 2.0 GPH	



1.0 & 2.0 GPH WPC Jr. Compensating Dripper - nipple



WPCJ .5 GPH Compensating Dripper - nipple



T-Handle Punch



3.0 mm Punch

2024

WPCJ Pressure Compensating No-Leak Drippers

All the features of the Woodpecker pressure compensating dripper with the added benefit of a "no-leak" device which turns the flow off when the line pressure drops. All the drippers come on and turn off at the same time, leaving the main water line full and ensuring extremely accurate watering from pot to pot.

- WPCJ Nominal flow rate available: .5 GPH for hanging basket assembly
- WPCJL8N Nominal flow rate 2.0 GPH for 4-way / 8-way assembly

Item	Description	Vendor
5010007	WPCJ with CNL Check Valve .5 GPH	01WPCJL2
632301	1GPH WPC Jr. Woodpecker	01WPCJL4N
5010013	2 GPH WPC Jr. Woodpecker	01WPCJL8N
5013100	3mm T-Handle Hole Punch For All Netafim Drippers	HPT125
30-12910	Jain 3.0 mm punch .128 tube WT	12071033

35 PSI Regulator Required for Proper Operation (see page 310)

Woodpecker Non-Pressure Compensating drippers

These are high quality, economical drippers for use on short, level runs. With non-pressure compensating drippers, it is necessary to install a pressure regulator to reduce the pressure to 20 PSI on the line.

- Nominal flow rate available: 0.5 GPH



Woodpecker w/ Barbed Base

Item	Description	Vendor
5010001	Woodpecker Dripper with Barbed Base (COR) .5 GPH	01WPCJL2

20 PSI Regulator Required For Proper Operation (see page 310)

Fittings For Spaghetti Tubing .125 - .197mm

Item	Description	Vendor
5011030	Dual Goof Plugs For 3 - 7mm Holes	1107737
5011036	Nipple Barb x Thread #2 For .125 - .197mm Tubing	1109006
5011035	Nipple Barb x Barb #1 For .125 - .197mm Tubing	1109005
5016110	3 mm Flex Tube Adapter (for nipple outlet drippers)	11WPCON-B
5014230	5mm elbow	11002520



Dual Goof Plug 3mm & 7mm Holes



Nipple Barb x Thread



Nipple Barb x Barb



3mm Flex Tube Adapter



Griffin Irrigation Department

Save Water • Save Labor • Grow More

Call 1.800.888.0054 and ask for an Irrigation Specialist.



Polyethylene Tubing (LDPE)

16mm Polyethylene (.520" x .620") Tubing

Item	Roll Size	Description	Vendor
5010031	100'	16mm .520 - .620 Tubing	14052062-01
5010032	500'	16mm .520 - .620 Tubing	14052062-05
5010030	1000'	16mm .520 - .620 Tubing	14052062

Other Sizes of LLDPE Tubing Available

Item	Roll Size	Description	Vendor
5010035	100'	20mm .820 - .940 Tubing	14082094-01
5010036	500'	20mm .820 - .940 Tubing	14082094
5010040	100'	25mm 1.06 - 1.20 Tubing	14106120-01
5010041	500'	25mm 1.06 - 1.20 Tubing	14106120

IMPORTANT NOTE: Linear low density polyethylene tubing should always be used with Netafim Systems.

20mm Tubing accepts std 3/4" P/E fittings on page 301

25mm Tubing accepts std 1" P/E fittings on page 301

Prepunched UV White™ PE Tubing (.520" x .620")

Fully UV resistant and completely opaque to prevent algae growth. This tubing is not coated or layered white, it is solid white for long-term durability. Netafim's UV White™ PE Tubing produces cooler water temperatures and enhances plant growth.

Item	Roll Size	Description
5013012	500'	16mm Prepunched 12" o/c with 0.125" holes
5013018	500'	16mm Prepunched 18" o/c with 0.125" holes
5013024	500'	16mm Prepunched 24" o/c with 0.125" holes

White Blank Tubing

65402	100'	16mm UV White Blank tube .520 - .620
5011032	500'	16mm UV White Blank tube .520 - .620
65401	100'	20mm UV White Blank tube .820 - .940
653811	500'	20mm UV White Blank tube .820 - .940
1061201W	100'	25mm UV White Blank tube 1.06-1.20
1061205W	500'	25mm UV White Blank tube 1.06-1.20



IRRIGATION

2024



Griffin Irrigation Department
 Save Water • Save Labor • Grow More
 Call 1.800.888.0054 and ask for an Irrigation Specialist.

Easy to Use Spin-Loc Irrigation Fittings - For Netafim .520/.620 & .820/.940 Systems



PSI 1/2" Easy-Loc™ Coupling for .520 ID #31-HC500
Item: 06D31HC500



Compression w/FHT Cap for 16mm tubing .520 ID
Item: 30-2545



PSI 16mm Power-Loc™ x Barb Adapter .400 barb ID #PL-50-400B
Item: 44-800618



PSI 1/2" Power-Loc™ Tee for .520 ID #31-HT555
Item: 06D31HT555

Compression w/FHT Cap for 20 mm tubing .820 ID
Item: 102-225



PSI 3/4" Easy-Loc™ Tee for .820 ID #31-HT888
Item: 06D31HT888



PSI 1/2" Power-Loc™ 90° Elbow for .520 ID #PL-50-PELL
Item: 06D31HE55



PSI 3/4" Easy-Loc™ Elbow for .820 ID #31-HE88
Item: 06D31HE88



PSI 16mm Easy-Loc™ x .400 Barb With Ball Valve ID #31-HV5B400
Item: 06D31HV5B400



Vari-Flow Valve Barb x Barb # 42155
Item: 5013076

2024

Irrigation Fittings - For In-Line Dripline & .520-.620 Tubing



Compression x 3/4" Compression Swivel Tee w/ Screen (3/4" x FH x Comp x Comp)
Item: 30-2530



Compression w/ Threaded Cap (Comp x 3/4" End Cap)
Item: 30-2545



3/4" Female Hose Compression x Swivel Adapter (3/4" FH x Comp)
Item: 30-2525



Series .600 Compression x 3/4" MPT
Item: 30-2570



Figure 8 Line End for 16mm Tubing (.520-.620")
Item: 5011001



Barbed Shut Off for P.E. 16mm Tubing (.520" ID)
Item: 5013078



Insert Male Adapter 1/2" MPT x 16mm Barb
Item: 5011010



16mm Insert Tee
Item: 5011007

Figure 8 Line End for 20mm Tubing (.820-.940")
Item: 5011020

Barbed Shut Off for P.E. 20mm Tubing (.820" ID)
Item: 5013079

Insert Male Adapter 3/4 inch MPT x 16mm Barb
Item: 5011015



16mm Insert Elbow
Item: 5011005

Figure 8 Line End for 25mm Tubing (1.06-1.20")
Item: 5011025

Barbed Shut Off for P.E. 25mm Tubing (1.06" ID)
Item: 5013080



16mm Insert Coupling
Item: 5011003

NOTE: For more detailed design information, please call your sales representative or our office.



Polyethelene Utility Pipe - HDPE



Item	Vendor	Description
31-1335	IRR1001510	100' X 1-1/2" Polypipe {100 Psi}
31-1340	IRR1001525	250' X 1-1/2" Polypipe {100 Psi}

Used for headers only not for drip emitters.

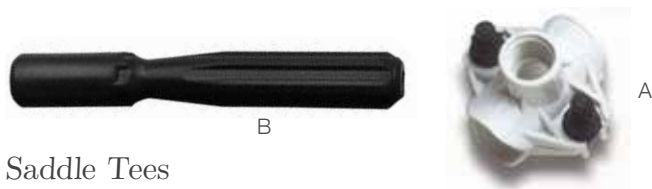

Saddle Tees

Item	Description
31-3040	3/4" x 3/4" Plastic Saddle Tee 75D (A)
31-3045	1" x 3/4" Plastic Saddle Tee 100D (A)
31-3050	3/16" Nut Driver #375 (B)
31-3055	Coring Tool for 3/4" FIPT tees HC55 (C)



Griffin Irrigation Department
 Save Water • Save Labor • Grow More
 Call 1.800.888.0054 and ask for an Irrigation Specialist.

Polyethylene Insert Fittings



	Tee (INSERT)	Elbow (INSERT x INSERT)	Coupling (INSERT x INSERT)
Pipe Size 1/2"	31-2025	31-2030	31-2035
3/4"	31-2125	31-2130	31-2135
1"	31-2225	31-2230	31-2235



	Male Adapter (MPT x INSERT)	Female Adapter (FIPT x INSERT)	Plug (INSERT)
Pipe Size 1/2"	31-2040	31-2045	31-2050
3/4"	31-2140	31-2145	31-2150
1"	31-2240	31-2245	31-2250



	Cross (INSERT)	Combo Tee (INS x INS x FIPT)	Combo Tee (INS x INS x MIPT)	Threaded Coupling (FIPT x FIPT)
Pipe Size 3/4"	31-2155	31-2161	31-2160	-
1"	-	-	31-2260	31-3275



	Reducing Male Adapter	Reducing Tee	Elbow Fitting
31-2075 - 1/2" INSERT x 3/4" MIPT		1" INS x 1" INS x 3/4" FIPT	3/4" Ins X 3/4" FIPT
31-2175 - 3/4" INSERT x 1" MIPT		31-2261	Poly Elbow 31-2166

3/4" & 1" insert fittings to be used for 20mm & 25mm low density tubing listed on page 299.

Special Fittings



Threaded Reducer Bushing	N-1 Pipe-to-Hose Transition Nipple	N-3 Pipe-to-Pipe Transition Nipple
1" MIPT x 3/4" FIPT 31-4690	3/4" MIPT x 3/4" MHT 30-2580	3/4" MIPT x 3/4" MIPT 30-2581

Irrigation Tools and Accessories



Plastic Pipe & Hose Cutter

- PTFE coated hardened steel blade for fast, clean, straight cuts without burrs or sawdust
- Cuts up to 1½" polyethylene and up to 1¼" class PVC Pipe

Nylon Cable Ties

- 11" non-releasable nylon cable ties
- UV treated
- Use with drip irrigation

Item: 30-2825 **Qty:** 100



2024

Item	Description
31-3025	T135 KwikCut Cutter
31-3030	T135 Replacement Blade



3/4 Teflon Tape

Item: 131-2012



Pressure Gauge

Item: 31-3026



Pinch-N-Seal Clamps

100% Stainless steel welded Keystone clamps are quick and easy to install, and provide a uniform, tamper proof seal. For use on both soft hose and rigid plastic pipe at connection points.

Item#	Description
33-6705	Keystone Pinch Clamp for ¾" Pipe
33-6711	Keystone Pinch Clamp for 1" Pipe
33-6700	Crimp Tool for all Pinch-N-Seal Clamps



FPT PVC Ball Valves

Item	Size
06D32401006T	½"
06D32401007T	¾"
06D32401010T	1"
06D32401012T	1¼"

Worm Drive Clamps

With screwdriver slot



Item	Size	Fits
33-6825	¾"	½" thru ¾" Pipe
33-6827	1¼"	¾" thru 1¼" Pipe

Manifolds



Item	Description
33-57965	2 Port Manifold w/ Unions 1" Npt Threads
33-57966	3 Port Manifold w/ Unions 1" Npt Threads
33-57967	4 Port Manifold w/ Unions 1" Npt Threads





Mini-Wobbler™

- Designed specifically for upright installation
- Operation pressures: 20 PSI
- Multi-level throw, approximately 10°
- Standard inlet: ½" NPT male



i-Mini-Wobbler™

- Designed specifically for overhead inverted installation
- Operation pressures: 20 PSI
- Multi-level throw, approximately 0°
- Standard inlet: ½" NPT male



Xcel Wobbler™

Constructed entirely of engineering grade thermoplastics for excellent corrosion resistance

- High angle, approximately 29°
- Mid angle, approximately 18°
- Flow rate: 0.78 to 6.97 GPM
- Standard inlet: ½" or ¾" M NPT

2024

Item	Sprinkler Base Pressure	Flow	Dia. @ 1.5 ft. H
33-5380	Mini - #4 Nozzle Lt Blue	0.50 GPM@20 PSI	28.0
06SMW5	Mini - #5 Nozzle Beige	0.75 GPM@20 PSI	33.5
06SMW6	Mini - #6 Nozzle Gold	1.10 GPM@20 PSI	36.0
33-5381	Mini - #7 Nozzle Lime	1.51 GPM@20 PSI	37.5
06SMW8	Mini - #8 Nozzle Lavender	1.95 GPM@20 PSI	38.5
33-5495	Xcel - #9 Nozzle Gray	1.80 GPM@20PSI	44.0

Item	Sprinkler Base Pressure	Flow	Dia. @ 3 ft. H
06SIMW5	i-Mini - #5 Nozzle Beige	0.75 GPM@20 PSI	30.0
06SIMW6	i-Mini - #6 Nozzle Gold	1.10 GPM@20 PSI	31.0
33-5400	i-Mini - #7 Nozzle Lavender	1.95 GPM@20 PSI	31.0

Irrigating Mini-Wobbler

Recommended spacings based on maximum uniformities



Determine Spacing Square Spacing

Head Spacing: 20 ft
Row Spacing: 20 ft
Offset from sides: 5 ft
Offset from ends: 5 ft

Determine Spacing Single Row Spacing

Head Spacing: 10 ft
Offset from sides: 7.5 ft
Offset from ends: 5 ft

Item	Sprinkler Base Pressure	Flow	Dia. @ 6 ft. H
06SIMW5	iMini - #5 Nozzle Beige - Inverted	0.75 GPM@20PSI	32.0
06SIMW6	iMini - #6 Nozzle Gold - Inverted	1.10 GPM@20PSI	34.0
33-5400	iMini - #8 Nozzle Lavender - Inverted	1.95 GPM@20PSI	35.5

Quick Connect Riser Adapter - .345" Tubing

- Quick-connect with press-fit connection for 0.345" and 0.270" PE tubing (Other connection fittings available)
- Allows sprinklers and spray nozzles with 1/2" M NPT base connection to be mounted securely onto 1/2" PVC, 3/4" PVC, or 5/16" steel rod stakes, connected to low pressure polyethylene laterals
- No gluing or fusing required
- Outlet 1/2" F NPT
- Plug for bushing also available

Item	Description
33-5456	Fitting - FTA1B2T
33-5455	RASM24C3QCTA3T Assembly includes riser adapter, 2 insert adapters, 3' of .345" tubing, and one hose bushing barbed.



2024

PVC Riser with Senninger sprinkler and saddle for poly pipe

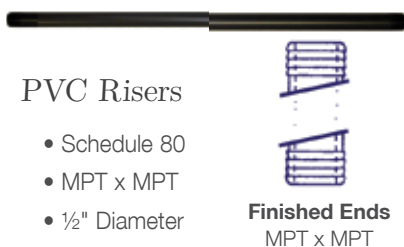
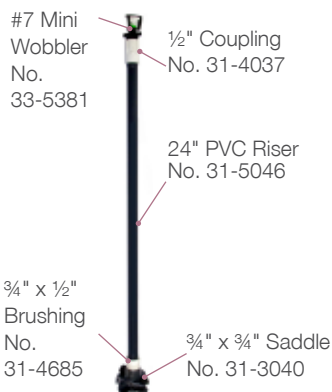

Item#	Description
31-5046	1/2" x 24"
31-5048	1/2" x 36"
31-5050	1/2" x 48"



Ag Impact Sprinkler

Heavy Duty Brass Impact Sprinkler, 1/2" Male NPT, Full and Part Circle operation with quick adjust arc setting. Hammer design keeps water within wetted pattern. Easy distance of throw adjustment using included deflector plate and diffuser screw. Brass bearing and triple washer assembly for trouble free operation in harsh water conditions.

Item: 33-5440





1/2" Plastic Impact Sprinkler

1/2" (13mm) Full or Part Circle, Plastic Impact Sprinkler is designed for a variety of uses where full circle sprinklers should not overthrow water into restricted areas.

- Bearing: 1/2" Male NPT, Plastic
- Trajectory Angle: Standard 23 degrees
- Operating Range: 25-60 psi (1.7-4.1 bar)
- Flow Rate: 1.5-8.4 gpm (0.34-1.91 m3/h)
- Radius: 22-45 ft.(6.7-13.7 m)
- Nozzle: QuickFit Nozzle Port

Item: 32-8620



Nelson S10 Spinner Sprinkler

Improves uniformity and saves water. The S10 Spinner from Nelson features a fine spray - ideal for small plants & propagation.

These items are direct ship.

Item	Description
506-131	Nelson S10 Orange Nozzle #11
506-132	Nelson S10 Purple Nozzle #12
506-133	Nelson S10 Yellow Nozzle #13
506-136	Nelson S10 Red Nozzle #16
506-137	Nelson S10 Turquoise Nozzle #17
506-138	Nelson S10 Gold Nozzle #18
506-139	Nelson S10 Brown Nozzle #20



Irritec P1 Thinwall Dripline Short Reels

Manageable sized rolls - perfect for small jobs. Irritec's P1 short reels feature a premium light wall dripline used for both potted plants and row crop irrigation.

Item	Description
33-3038	Irritec Drip Tape P1 5/8 8MIL .25 GPH 8" w/Flap 1,000'
33-3040	Irritec Drip Tape P1 5/8 8MIL .25GPH 12" w/Flap 1,000'



Griffin Irrigation Department
Save Water • Save Labor • Grow More
Call 1.800.888.0054 and ask for an Irrigation Specialist.

Space-It™ Dripline

A labor-saving drip system for watering potted plants. Space-It is thinwall dripline with pre-spaced drippers designed to be placed directly over the top of pots with the location of each dripper visibly marked on the tubing. Positioning of pots (plants) is quick and easy- just place the pot under the mark on the dripline - saving up to 20% in installation labor costs.

Injection molded drippers welded into a wall of seamless tubing means the flow path is not subject to distortion during installation and the clear outlet hole allows water to exit right at the outlet.

With flexible dripper spacings, Space-It allows you to choose the spacing that matches your pot spacing to fit your needs.

Specifications:

- Wall thickness: 8 mm
- Inside diameter: .636"
- Nominal flow rates: .24 GPH and .36 GPH @ 10 PSI
- Common spacings: 12", 18" and 24"
- Other special spacing available by special order
- Recommended filtration: 120 mesh

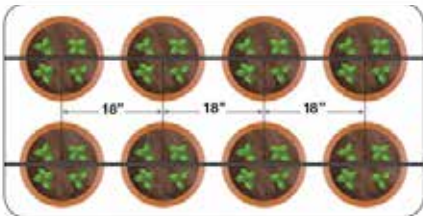
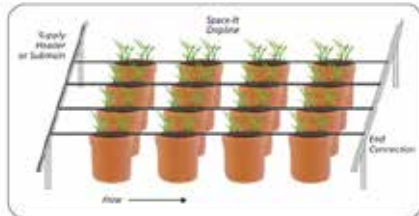

Netafim's Flexible Drinker Spacing

Choose the dripper spacing according to your needs and maximize your growing area.

Item	Description	Coil Length	Qty
5018318	18" spacing, .636", 8 mil, 0.4 GPH	3,000'	1
5018324	24" spacing, .636", 8 mil, 0.4 GPH	3,000'	1
50183129	12" spacing, .636", 8 mil, 0.4 GPH	9,000'	1
50183169	16" spacing, .636", 8 mil, 0.4 GPH	9,000'	1
50183189	18" spacing, .636", 8 mil, 0.4 GPH	9,000'	1
50183249	24" spacing, .636", 8 mil, 0.4 GPH	9,000'	1

Other spacing available in both Space-It and Streamline at 9,000' minimum order.



Space-It™
Dripline

Streamline™ X Dripline

Streamline X Thinwall Dripline is the perfect choice for row crop growers planting short to medium sized runs. Available with variable dripper spacings, allowing growers to customize systems based on their application rates and wetting patterns and numerous wall thicknesses that can weather various environmental conditions. For surface or subsurface installations in practically any soil type.

Product Advantages

- Seamless construction is stronger and more durable than comparable drip tape
- Fortifies against splitting or bursting under high pressures required for proper flushing
- Ribs outside the pipe minimize the dripline abrasion during installation
- Ribs inside the pipe protect the dripper from damage even in very harsh installations
- Flap outlet protection impedes soil ingestion and root intrusion
- Low filtration requirement - 120 mesh.
- Driplines packaged with more feet per reel, the industry's longest, requiring fewer fittings and less time changing reels during installation

Item	Description	Coil Length	Qty
5018612	12" spacing, 8mil, 0.24 GPH	9,000'	1
5018418	18" spacing, 8 mil, 0.36 GPH	9,000'	1
5018424	24" spacing, 8 mil, 0.36 GPH	9,000'	1

Drip Tape Components

For Netafim 630 Series



Jain Tape-Loc® x .420 Barb with Locking Nut & Large Handle Valve
Item: 102-380



TapeLoc x .400 Barb W/ Shut off Valve #101008189
Item: 102-383



PSI 5/8" Tape-Loc® x .400 Series Barb #31-T5B400
Item: 44-800608



API Tape-Loc® x .250 Series Barb #250B-06-LS
Item: 102-400



PSI 3/4" Tape-Loc® x MPT Adapter #12030017
Item: 102-339



PSI 7MM Hole Punch Tool for .400 Series Barb #31-AP070
Item: 5013115



Netafim 1 1/2" 12 PSI Pressure Regulator 11-35 GPM
Item: 5012048



Senninger 12 PSI 3/4" Low Flow Reg. #PRL-12LF .1-8 GPM
Item: 06PRL12LF



Senninger 12 PSI 3/4" FPT Medium Flow Reg. #PMR-12MF 2 -20 GPM
Item: 06PMR12MF



Senninger 12 PSI 1" FPT Medium Flow Reg. #PMR-12MF 2 -20 GPM
Item: 06PMR12MF1



Jain Tape-Loc® Coupling PS 5/8" #12030022
Item: 651381



API Tape-Loc® x Threaded Auto Flush Valve, Low Flow #12030058
Item: 102-390



PSI 3/4" 10 PSI Pressure Regulator .5-15 GPM #131946
Item: 30-1594



Fast coupling connector .630 w/blue rings #32500-016770
Item: 44-800610



.630 blue rings #32500-017430
Item: 44-800616



.630 line end w/blue ring #32500-016490
Item: 44-800617



Fast 16 w/blue ring threaded male 3/4" #32500-015270
Item: 44-800611



Start screw nut connector for PE, fast body w/o ring #32500-018510
Item: 44-800615



Start screw nut connector for PVP, fast body w/o ring #32500-018315
Item: 44-800614

Unique Subirrigation System

- Saves time and labor
- Accelerates plant growth
- Reduces evaporation and runoff
- Uses less water and fertilizer

Contact your Griffin Sales Person for a custom quote. Special order, shipped direct from factory. FOB Factory.

How It Works | The AQUAMAT patented system

Aquamats are the result of 10 years of laboratory research, field tests and ongoing optimization. Its patented assembly consists of internal drip tapes plus four layers of high performance textiles. Each layer plays a specific role and together, they form the most efficient irrigation system currently available.

Aquamats allow even distribution of water from pot to pot, prevent surface evaporation and require considerably less water than conventional overhead irrigation systems. As a result, you get faster and uniform plant growth. Better yet, it is highly affordable and easy to install.



Root & Algae Resistant Cover

Layer 1 | Protects the bottom ones from contamination, roots, UV rays and wear.

Evaporation Block Layer

Layer 2 | Special fluffy textile sheet, which prevents surface evaporation while drawing water into the pot through capillary uptake.

Super Absorbent Felt

Layer 3 | Spreads, evenly and constantly, water throughout the entire area. It can absorb 2.1 gal./sq.yd.

Total Containment Barrier

Layer 4 | Polyethylene sheet to prevent any run-off.

Micro-Perforated Tubes

Drip tapes are placed underneath the third layer at every 2 feet (61 cm).

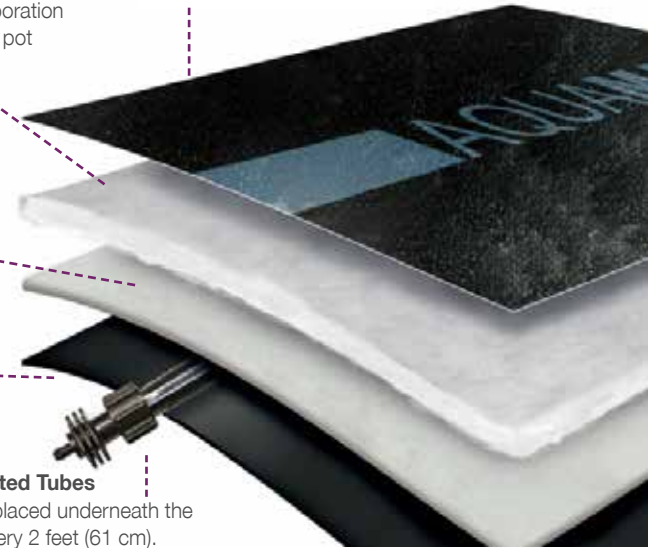

Bench Matting

Bench Matting and Bench Matting Plus capillary mats can reduce up to twenty-fold the time needed for manual watering. Thanks to its water absorption and dispersion properties, Bench Matting irrigates plants consistently over the entire growing surface. This translates into substantial savings in time, water and fertilizers, and thus results in higher productivity for your horticultural operations.

Item	Description
78-52831	3' x 328'
78-5284	4' x 100'
78-5285	5' x 100'
78-5286	6' x 100'





Irrigation Booms

Maximize your greenhouse. Increase available production space by eliminating unnecessary aisles. Get more out of less, lower your labor costs, and regulate your crops with Cherry Creek's proven, reliable, high-quality watering boom for greenhouses.

Automated booms offer flexibility and versatility allowing you to irrigate, mist or spray. Boom mounted controllers and fertigation are also available.



Echo® Hanging Basket System

The Original... and Still the Best

The ECHO® enables growers to accurately water or fertilize each basket. It brings the plants to you for easy setting, inspection and harvesting. Single, double and triple layers are available for ultimate flexibility.



Griffin Irrigation Department

Save Water • Save Labor • Grow More
Call 1.800.888.0054 and ask for an
Irrigation Specialist.

Senninger Pressure Regulators

- Maintains a constant preset outlet pressure while handling varying inlet pressures
- Maximum flow path resists plugging
- 100% water-tested for accuracy
- Can be installed above or below ground
- Very low hysteresis and friction losses



Item/Description	Preset (PSI)	Flow Range (GPM)	Inlet/Outlet Sizes
06PRL12LF	12	0.5 – 8 GPM	¾" FIPT
06PMR12MF	12	2 – 20 GPM	¾" FIPT
30-2230	35	0.5 – 8 GPM	¾" FIPT
30-2202	35	2 – 20 GPM	¾" FIPT



2-Way Solenoid Valves

Netafim valves provide superior hydraulic performance for greenhouse or nursery systems. These valves are available in several sizes and flow ranges. Netafim valves are manufactured with the highest quality materials for dependable operation day after day.



Electric Throttling 2-Way Valves (24VAC)

These valves are ideal for ultra high flow or low flow capacity irrigation systems. A built-in 2-way solenoid offers ease of operation and reliability. Standard with a flow control (throttling) handle, large internal water passages for clog resistance and no moving parts in the flow path. The valves can be installed vertically or horizontally and require no maintenance.

Item	Description	Voltage	Max flow
61ET75GH2	¾" Solenoid Valve	24V	26 GPM
5014247	1" Solenoid valve	24V	50 GPM
5014248	1.5" Solenoid valve	24V	90 GPM
5014249	2" Solenoid valve	24V	175 GPM
44-4147	1" Latching solenoid valve - DC	12V	

Netafim Pressure Regulators

Pressure regulators are devices that reduce the pressure of the watering system to a specific PSI in order to optimize the performance of the sprinklers or drippers in use. Pressures for typical applications are listed.

- Drip tape: 9-12 PSI
- Non pressure compensated drippers: 20 PSI
- Pressure compensated drippers: 35 PSI
- Micro sprinklers: 35 PSI



¾" Pressure Regulator



¾" Medium Flow



1 1/2" Pressure Regulator

Item	Vendor	Description
5012012	32PRV.75LF-15V2	¾" 15 PSI Low Flow Pressure Reg. (.25 -4.4 GPM)
5012035	32PRV.75-35V2K	¾" 35 PSI Medium Flow Pressure Reg. (4.5 - 17.6 GPM)
5012025	32PRV.75-35V2K	¾" 35 PSI Low Flow Pressure Reg. (.25 -4.4 GPM)
5012050	32PRV.75-65V2K	¾" 65 PSI Medium Flow Pressure Reg. (4.5-17.6 GPM)
5012056	32PRV1.5-35V2K	1-1/2" 35Psi Pressure Reg (11-35Gpm)





Disc Filters

Discs are flat, grooved plastic rings with a hole in the center. Rings are stacked together to form a cylindrical filter element. The grooves in the rings criss-cross, forming a network that traps both organic and inorganic contaminants, and allows filtered water to pass through. For easy cleaning remove the cover exposing the discs. They automatically separate allowing access to the accumulation of dirt particles. Wash off the discs with a stream of water, reassemble and the cleaning process is complete. A filter should be used with all Netafim watering systems.

Filters - 120 Mesh

Item	Vendor	Description	Flow Range
5012120	25A45-120	¾" Disc Filter 120 Mesh	1-12 GPM
5012130	25A47-120	1" Disc Filter 120 Mesh	5-26 GPM
5012145	25A17-120	1½" Super Filter 120 Mesh	10-52 GPM
5012146	25A2DL-120	2" Dual Lite	40-110 GPM



Replacement Elements Only

Item	Vendor	Description
5012220	25AP46-120	Replacement ¾" 120 Mesh Red Filter Only (Discs only)
5012230	25AP47-120	Replacement 1" 120 Mesh Red Filter Only (Spine & Discs)
5012245	25AP21121-120	Replacement 1½" 120 Mesh Red Filter Only (Spine & Discs)

Filters - 140 Mesh

Item	Vendor	Description	Flow Range
66110	25A45-140	¾" Disc Filter 140 Mesh	1-12 GPM

Filters - 200 Mesh

Item	Vendor	Description	Flow Range
30-2145	1-0701-1151-1008	Amiad ¾" Filter 200 Mesh	0-13 GPM
5012132	25A47-200	1" Disc Filter 200 Mesh	5-26 GPM
5012147	25A17-200	1½" Super Filter 200 Mesh	10-52 GPM



Replacement Elements Only

Item	Vendor	Description
30-2612	11-0703-1008	Replacement ¾" Amiad 200 Mesh Stainless Steel
5012232	25AP47-200	Replacement 1" 200 Mesh Filter Only (Spine & Discs)
5012247	25AP21121-200	Replacement 1½" 200 Mesh Filter Only (Spine & Discs)

Automated Filtration Systems are Available

Netafim ScreenGuard Vertical Filter

Automatic screen filters provide perfect protection for irrigation systems thanks to extra-large filtration area. ScreenGuard™ also incorporates the most effective self-cleaning mechanism, saving labor, water, and energy.

- Available in 80, 120, 150 screen mesh sizes
- Minimum operating pressure 29 psi . maximum operation pressure 145 psi
- Filter body is made from high quality carbon steel with two-layer coating for corrosion resistance

Drop Ship Only



Griffin Irrigation Department
 Save Water • Save Labor • Grow More
 Call 1.800.888.0054 and ask for an Irrigation Specialist.

Irrigation Controllers



Battery Powered Digital 3/4" FHT Hose End Timer

- 3/4" FHT inlet and MHT outlet
- Use for drip or sprinkler systems
- Easy to read AM/PM clock and program
- Watering durations from 1 min to 11 hrs and 59 mins in 1 min increments
- 7-day calendar schedule w/ four start times/day
- Manual irrigation cycle via the controller
- Irrigation suspension override (rain mode)
- Six buttons with large integrated liquid crystal display
- Weather resistant
- Powered by one 9-volt alkaline battery (lasts up to 1 year)



BlueTooth ii ri Smart Controller with Coil

The ii ri Smart Controller is a battery operated, Bluetooth Connected, irrigation/misting controller that can operate one solenoid valve without wiring. Create different programs on your smartphone and upload them to your ii ri easily to change scenarios. Great for quick installations, single propagation benches, outdoor mum fields and more.

Item: 44-5609

Item: 231-090



ESP4ME3 - Indoor/Outdoor 120V Irrigation Controller

- 4 station base capability, expandable up to 22 stations using 3- or 6-station expansion modules (sold separately)
- Comes with power plug and outdoor cabinet for indoor or outdoor installation
- WiFi Connectivity -- compatible with the new Rain Bird LNK WiFi module (sold separately).
- 4 individual programs with 6 independent start times per program

Item	Description
32-8617	4 Sta Base Wifi Controller In/Out ESP4ME3
32-8619	Link Wifi Module



I-Core Controller

- Number of stations: 6 to 42 (48 stations with DUAL decoders)
- Type: Modular
- Enclosure: Outdoor, plastic or metal
- Independent programs: 4
- Start times per program: 8 (A, B, C); 16 (D)
- Max. station run time: 12 hrs

Item	Description
32-8606	6 Station Controller
32-0006	6 Zone Plug In Add-On



Link4
CORPORATION

Sapphire Controller

Commercial irrigation controller that is ideal for applications requiring misting, flood, drip or standard irrigation. Integrated with the Cloud to monitor or change settings along with the new Grower Journal. 8 independent outlets with irrigation, mist, pulse or drip control for each output.

Contact Griffin for more information.

Phytotronics, inc.

Electronic Leaf™



- Very efficient way to mist cuttings
- Works on the principle of evaporation and weight of mist on the metal screen controls solenoid operation
- 24 volt output, 40 VA, 120 volt in
- 24 volt plug-in transformer with 10' of cord included
- 20' of 18/2 wire for solenoid valve connection also included
- Housing made with durable stainless steel
- Solid state internal components with no hazardous materials
- Green LED light indicates power is provided to the electric leaf
- Blue LED light indicates power is supplied to the solenoid valve

Item: 33-1400

Phytotronics, inc.



Trident Single Zone Controller Model T3A

With a 24-hour clock and up to 8 programmable events, the Trident allows almost endless ON and OFF options. If you want loads of features at a low cost, this is the controller for you.

- Sturdy non-metallic enclosure, UV protected, resists moisture and chemicals
- Toggle switch to select ON/OFF time mode, second/minute, minute/minute, and minute/hour
- 2-to 60-second or minute ON time, and 2- to 180-minute or hour OFF time
- Extra bright LEDs show ON/OFF times when programming and when controller is in use
- 24 hour digital clock, with 8 programmable events to turn controller off
- Includes 24 VAC plug-in Transformer and 20' cord

Item: 32-1020

Mini Mist 2 zone controller also available



Nova 1626ET - 6 Zone Controller

- Sturdy non-metallic enclosure, UV protected, resists moisture & chemicals
- Seconds on, minutes off settings
- 1x, 2x, 3x time extender toggle switch
- One connection for the common wire
- 24 hour digital clock, with 9 programmable events to turn controller off
- Includes 24VAC plug-in transformer

Item: 32-1026

12B Super Nova 12 zone controller also available



Griffin Irrigation Department
Save Water • Save Labor • Grow More
Call 1.800.888.0054 and ask for an Irrigation Specialist.



Why Use an Injection System?

- Improve Water Quality
- Sanitize
- Fertilize

JA160D Pre-assembled Injection System

Anderson's JA160D ships pre-configured for common horticultural applications like dosing fertilizer, acid and sanitizers. All package units ship complete in a crate and arrive ready to install.

JA160D Technical Specifications

Water flow range	1.9 to 160 Gallons per minute
Solutions Injected	3
Solution 1 Injection Range	1:200 (.5%) to 1:2000 (.05%)
Solution 2 Injection Range	1:1600 (.0626%) to 1:16000 (.00626%)
Solution 3 Injection Range	1:5320 (.0188%) to 1:53200 (.00188%)
Pressure Range	30 to 100 psi
Temperature Range	33° to 140° F
Inlet and Outlet Connections	2" PVC Unthreaded Socket
Power Requirements	120VAC @ 2AMP
Dimensions	Width: 64.5in. Height: 52 in. Depth: 27 in.
Weight	350 Lbs.



J+ Advanced Controller

J+ Advanced Ratio: Feeder® injectors control the manifold and pumps to maintain the proper chemical ratio over a wide flow range. Up to 8 chemicals can be injected simultaneously at different rates.

Griffin Irrigation Department

Save Water • Save Labor • Grow More
Call 1.800.888.0054 and ask for an Irrigation Specialist.





Ratio:Guard® Advanced EC & pH Monitor (A)

H.E. Anderson's Ratio: Guard monitor uses inline probes to measure the EC and pH of the water by using industrial grade sensors. The monitor can display EC, pH and temperature simultaneously. Sensors are sold separately.



The DB Series Ratio:Feeder® (B)

The DB Series offers a cost effective way to inject almost any liquid into a water line at an adjustable ratio. Perfect for retail hold or single bay production scenarios.

Features & Benefits

- Positive displacement and volume proportioning
- No sliding seals
- Adjustable feed rate without recalibration
- Fine filter not required
- ¼ to 20 GPM water flow capacity
- Very accurate feed, does not degrade with age
- Virtually no maintenance needed
- Easy installation and operation
- May be powered by 120 VAC, 12 VDC battery or solar power system
- Optional water flow totalizer available
- Maximum Operating Pressure: 125psi - Minimum Operating Pressure: 30psi

Anderson DB Wall-Mount Series chemical injectors come complete with mounting plate, blend tank, and are pre-plumbed for easy installation.

Item	Model	Description
20 GPM, 1" Connections		
33-1034	DB100W	1 Pumper, 1:100 Ratio System
33-1035	DB1000W	1 Pumper, 1:1000 Ratio System (Acid)
33-1036	DB1200W	1 Pumper, 1:1200 Ratio Hypochlorinator
Accessories		
33-1040	20710	DB Plastic Blending Tank (1.9 gal)
33-1038	19076	Totalizer Add-On



Griffin Irrigation Department

Save Water • Save Labor • Grow More

Call 1.800.888.0054 and ask for an Irrigation Specialist.



11 GPM Injector

14 GPM Injector

20 GPM Injector

40 GPM Injector

100 GPM Injector

Ideal for fertilizers, fungicides, acids and more.

Features

- Water-powered, non-electric
- Consistent fertilizer injection
- Proportional: compensates for changes in water flow and pressure

Benefits

- Simple installation
- Easy maintenance
- Over 35 years of product reliability

Accurately Injects

- Fertilizers
- Organics
- Beneficials
- Herbicides

- PGRs for Drenching
- Chlorine
- Insecticides
- Fungicides
- Acids
- Sanitizers

D40MZ series: Precision water-powered chemical injectors that are direct replacements for the D8RE series.

Features: Metal-free piston, 63% less parts, simpler and easier to maintain.

Item	Description / Model	Flow Range	Pressure	Ratios	Unit Size	Pipe Size
33-2414	D25F1	.05 - 11 GPM	4.3 - 85 PSI	1:100 Fixed	14" x 6¼"	¾" NPT Thread
33-2415	D14MZ2	.05 - 14 GPM	4.3 - 85 PSI	1:500 to 1:50	19⅞" x 6⅝"	¾" NPT Thread
33-2420	D45RE15	0.4 - 20 GPM	7 - 70 PSI	1:500 to 1:66	24" x 7½"	1" NPT Thread
33-2430	D40MZ2 (Injector Only)	2.2 - 40 GPM	4.3 to 116 PSI	1:500 to 1:50	25 ¼" x 8 ½"	1½" NPT Thread
33-2432	D40MZ2 (with Bypass)	2.2 - 40 GPM	4.3 to 116 PSI	1:500 to 1:50	25 ¼" x 8 ½"	1½" NPT Thread
33-2525	D20S	5 - 100 GPM	2 - 120 PSI	1:500 to 1:50	55" x 15" (w/legs)	2" NPT Thread

Mega-Flo Acid Dosing System

For Higher Flow Systems With A Max Of 100 - 400 Gpm

The Hi-Flo Acid-Doser Kit gives you the capability to inject:

- Water Treatment products
- Plant Health Additives
- Acids
- Bases

The system proportionally injects directly into the water line using an Ultrasonic Flow Meter.

Item	Description	Pipe Size	Flow
218-1823	MDE0710MF2KITUS	2"	100 GPM
218-1824	MDE1012MF2.5KITUS	2.5"	150 GPM
218-1825	MDE2007MF3KITUS	3"	200 GPM
218-1826	MDE3005MF4KITUS	4"	400 GPM

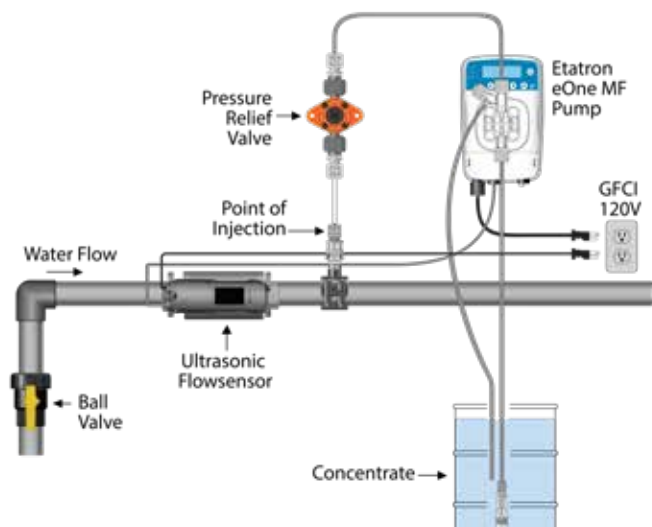

Nutrient Delivery Systems

The Nutrient Delivery System is a simplistic system made up of four main panel sections which can be arranged to accommodate a wide variety of fertigation programs. With total control in mind, customizing the entire panel is easy based on your personal nutrient program! The Nutrient Delivery System thrives anywhere, from greenhouse environments to outdoors, allowing it to be installed in any application. By automating the nutrient delivery process it accurately dispenses the desired solution. This makes the time-draining practice of "measure and pour" a thing of the past, saving you time and money!

Contact your Griffin Sales Representative for more information.

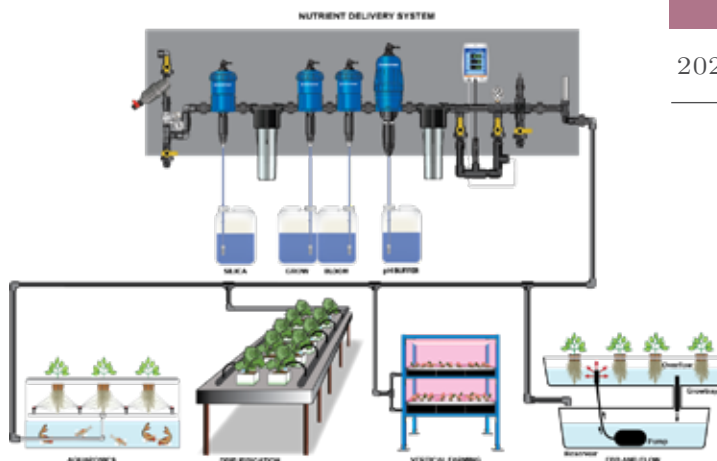

Li'l Bud-D

Perfect for Spot Treatments

- Polyethylene construction
- 10" no flat tires for maximum mobility
- Versatile 5-gallon capability
- Narrow base - fits easily through aisles
- Designed for maximum stability
- Dimensions: 44½"h x 19"w (wheel to wheel) x 22"d
- Includes: cart, 5-gallon bucket and lid



Dosatron unit & Quick Hook-Up kit sold separately.

Li'l Bud-D
Item: 33-2624

Quick Hook-Up Kit
Item: 33-2623

Eco-Cart

Portable Fertilization System

- 5-gallon bucket
- Quick-and-easy on-demand dispensing
- Fits 11 and 14 GPM Dosatron fertilizer injectors
- Dimensions: 40"h x 13½"w x 15"d
- Includes cart, 5-gallon bucket with lid, Dosatron D14MZ2 14GPM, and plumbing

* Filter and check valve not included







Item: 33-2634



Dosatron Mini Maintenance Kits

Do it yourself yearly maintenance kits.
 Keep your Dosatrons injecting accurately!

Kit Contents:

- | | | |
|--|--|---|
| (1) J009:
Plunger seal
 | (1) PD1739:
Top Guide
 | D25F1 - 11 GPM
Item: 219-006 |
| (1) PD1729:
Check Valve
Cone
 | (1) MDI358: Check
Valve Spring
 | D14MZ2 - 14 GPM
Item 219-000 |
| (1) JDH105:
Check Valve
Cone O-ring
 | (1) DOSA-LUBE:
Silicone

<i>Use Dosa-Lube on
specified parts only.</i> | D45RE15 - 20 GPM
Item: 219-001 |
| | | D8RE2 / D40MZ2 40 GPM
Item: 219-005 |
| | | D20S - 100 GPM
Item: 219-004 |

200 Mesh Filters to Protect Your Dosatron Injector



Item	Description
218-731	3/4" 200 Mesh T Filter (AKF5AP11T) for 14 GPM Injector
218-733	1" 200 Mesh Filter (AKF5AP20T) for 20 GPM Injector
218-737	1 1/2" 200 Mesh Filter (AKF5AP40-A) for 40 GPM Injector

200 Mesh Filters Hook-Up Kits to Protect Your Dosatron Injector



Item	Description
218-730	3/4" Y Filter Hook-Up Kit (AKF5AP11KIT-A)
218-735	1" Y Filter Hook-Up Kit (AKF5AP20KIT-A)

EC and pH Meters

Easy to use, high-quality meters at an affordable price. Testing and monitoring digital meters that easily measure conductivity, pH, TDS, and temperature of water.

HM Digital EC Meter

HM Digital pH Meter



Pro Model
Part #: COM-100

Pro Model
Part #: PH-200

Item	Description
33-2705	Pro Model EC/TDS/Temp Meter COM-100
33-2715	Pro Model pH/Temp Meter PH-200

Ask for a copy of "How to Calibrate Your Meters", a quick calibration sheet that eliminates using the manual to calibrate your meters.

Calibration and Storage Solutions

EC and PH solutions work with both ECO and PRO Models.

Individual liquid calibration packets, ready-to-use box of 20. Part #: CP-1000

Individual liquid calibration packets, ready-to-use box of 20. Part #: PH-P7

Storage Solution. Must be used to keep pH meter's bulb moist. Part #: PH-STORE

Item	Description
33-2736	Calibration Packets #CP-1000 - Box of 20 - 1000 ppm
33-2740	Storage Solution #PH-STORE - pH Electrode
33-2746	Calibration Packets #PH-P7 - Box of 20 - pH Buffer Solution



Irrigation Automation Systems



2024

Automation by Design: Configurable Logic Controllers

Designed for monitoring and remote control of multi-bank valves, fans, etc.

- Allows users to remotely start/stop their systems via phone, laptop or computer
- Saves time and money by alleviating dedicated personnel overseeing manual valve control
- Improve crop yield with consistent irrigation scheduling
- An economical way to oversee your irrigation network from anywhere at any time
- On demand or scheduled irrigation control. Gang zones with similar watering times
- Cascade scheduled start time to maintain pump efficiency
- Package includes: 20W solar panel or 24v AC power source, 1 or 2 RCB's
- Available as AC or DC operation. No 110V AC Power? No problem
- Scalable

Hand Held Soil Meter

A portable and inexpensive way to monitor moisture levels in your fields or greenhouses

- Easy to use, no maintenance sensors
- Produces accurate and repeatable soil moisture measurements
- For use in all types of soil – loam, potting, sand, etc.
- Bury sensors for soil cross section and root zone analysis
- Prevent over or under watering
- Perfect for Garden Centers etc.

Item: 83-4091



Griffin Irrigation Department
 Save Water • Save Labor • Grow More
 Call 1.800.888.0054 and ask for an Irrigation Specialist.

Tanks & Pumps

Fertilizer Containers

Tank

Straight sided with cuff flange self supporting and graduated for level determination.

Cover

Secure fit to keep contents safe from unwanted debris.

Tank Fitting

Fitting is supplied "loose". Installed by cutting hole in tank wall, insert fitting (should fit loosely) and thread on and tighten nut.



Item	Description
41-2575	55 gal Polyethylene Storage Tank w/ cover
41-2578	Tank Fitting w/ Viton Gasket



Submersible Pump

Fast and easy way to keep your fertilizer or chemicals in solution.

Item	Description
33-4525	2PO16 submersible

Holding Tank Best Practices

- Size tanks so they will drain completely in 3-5 days
- Use opaque tanks and shield from direct sunlight and heat sources
- Choose tanks with large openings for easier cleaning and sanitizing
- Minimize errors in stock tank prep by clearly labeling tanks and indicating the fill line

Tank size for concentrated stock can vary.

Additional tank sizes are available direct ship. Call for more information.



Griffin Irrigation Department

Save Water • Save Labor • Grow More

Call 1.800.888.0054 and ask for an Irrigation Specialist.

Proven Horticulture Benefits

Moleaer nanobubbles efficiently enhance water in multiple stages of the growth cycle. Nanobubble enriched water has been proven to improve water quality, soil, root, and plant health while lowering treatment and oxygen costs. Many growers have also experienced increased in yield.



Interested? Ask your Griffin rep or Griffin construction rep for more information. Call 1.800.888.0054 and ask for an Irrigation Specialist.

Nanobubble generators sized to your needs:

- Kingfisher**
Perfect for small irrigation reservoirs and ponds for reduced of algae.
- Clear**
Sized for larger irrigation reservoirs and ponds. Great for algae reduction.
- Lotus**
Irrigation water treatment for small-scale production. Prevents disease and improves plant health.
- XTB**
Inline treatment of high-flow irrigation systems. Improves infiltration and soil and plant health.
- Neo**
For irrigation water and production water storage tanks. Reduce disease and biofilm and improve plant health and yields.



Kingfisher



Neo



XTB

Irrigation Water Cycle in Greenhouses

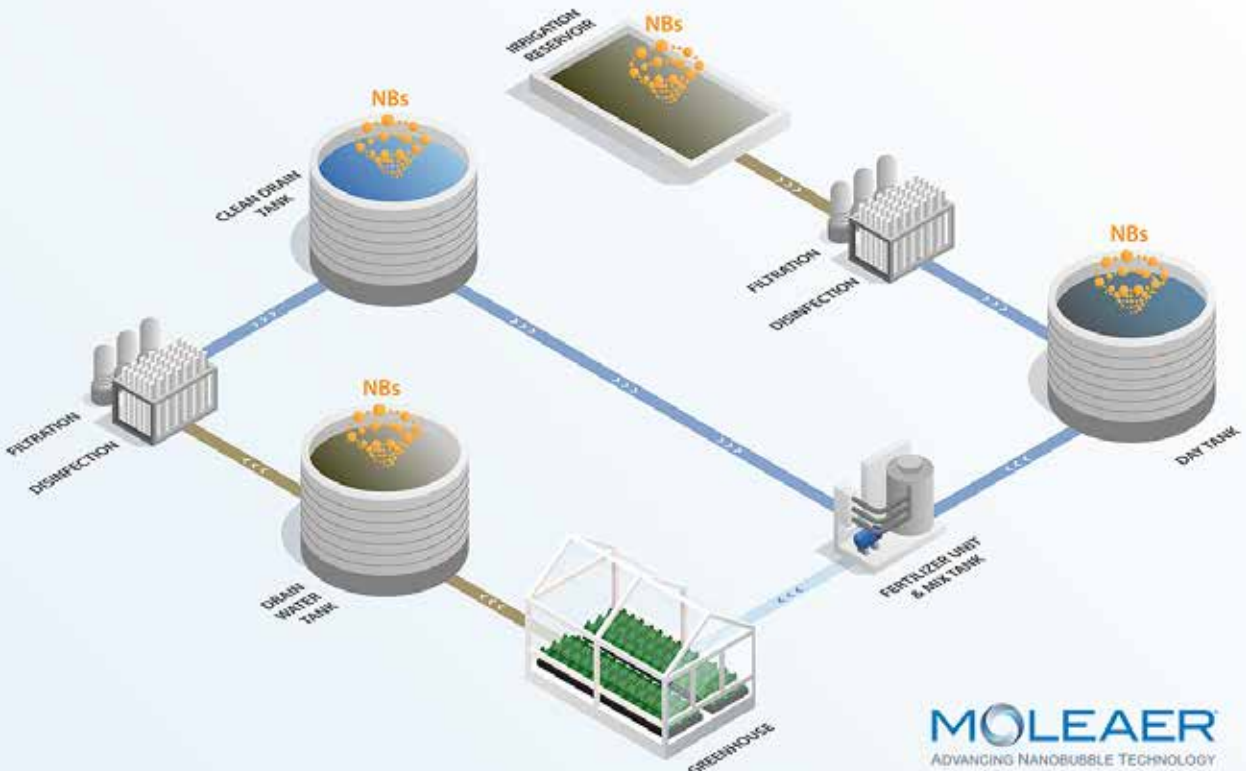

Seido[™]
Fungicide

“*Powdery mildew free, and looking great thanks to a new class of chemistry!*”

- glowing_gerbera_755



Seido is a trademark of OHP, Inc.

- ✓ New mode of action
- ✓ Vapor activity
- ✓ Preventative / early-curative
- ✓ 4 hour REI



Seido's[™] new mode of action provides stopping power you can count on—even when faced with resistant powdery mildew strains. The unique vapor activity enhances distribution on the leaf surface, while also providing excellent rainfastness. Powdery mildew has met its match with Seido fungicide from OHP.

ohp | Partners
with solutions
An American Vanguard Company

CROP PROTECTION



GGSPRO

TECHNICAL REFERENCE GUIDE - 5th Edition



Now Available
in a Spanish
Version!

The GGSPRO Reference Guide is packed full of color pictures, detailed product information as well as easy to use charts and tables. These charts provide Mode of Action, Active Ingredient, REI, Application Rates and Measurement Conversion Tables.

The 5th edition of the Reference Guide includes:

- New! Lighting chapter- overview of supplemental and photoperiodic plant lighting strategies
- New! Scouting chapter- detailed information on how to identify and track insects, mites and diseases
- The latest GGSPRO product recommendations with updated rates and other important information are included throughout the guide.
- Updated chapters with the information you need for effective biological control, use of plant growth regulators, optimizing your crop nutrition and general problem solving strategies.

The GGSPRO Reference Guide has heavy-duty water-resistant pages allowing growers to keep it where it is needed the most. Use it inside the greenhouse or outside in the field. It is a great resource for all employees from IPM scouts to those responsible for fertilizer and pest control decisions.

Item: 98-405 - Reference Guide, 190 pages

Item: 98-408 - Reference Guide - Spanish Version

Visit www.griffins.com/ggspro for more information.



GGSPRO POCKET GUIDES

The Pocket Guides were created as an extension of the GGSPRO Technical Guide. They provide information and images of abiotic plant disorders, nutritional disorders and insect problems. The Pocket Guide titled Insects, assists growers to identify insect and mites pests. The Pocket Guides are full of sharp images and the back of each page contains valuable information. They serve as a reference tool for IPM scouts, growers and educators. Identifying problems quickly and accurately is the first step towards the remedy.

Abiotic: Not all plant symptoms are caused by pests and diseases. Abiotic factors include physiological disorders, phytotoxicities and other non-living causes. Identifying these types of disorders can help to optimize the growing environment and improve plant quality.

Nutrition: Nutritional problems often leave many clues. Soil and tissue testing are great tools, but in between tests the identification of nutritional disorders based on the symptoms, and the location on the plant where they occur allows for early detection and correction.

Insects: The Insect Pocket Guide is a valuable tool for growers to use in scouting their crops and educating less experienced workers on insect and mite identification. The greenhouse environment favors the rapid development of insect and mite pests, making early and accurate identification an important tool in controlling these pests.

Diseases: A grower's reference tool for IPM scouts, growers, educators, and sales representatives in our industry. The earlier you recognize signs and symptoms of foliar plant diseases, the less plant damage and loss will incur. This pocket guide provides a resource for growers to take into the field, recognize the symptoms or signs of foliar pathogens, and put into context the diagnosis and correction. As noted in this guide along with helpful photos and disease descriptions, monitoring crops regularly for environmental conditions such as leaf wetness and humidity can also provide helpful clues to when to take preventative actions for preventing pathogen development.

Item: 98-406

Description: Abiotic Nutrition, 70 pages

Item: 98-407

Description: Insect, 68 pages

Item: 98-409

Description: Diseases, 68 pages

GGSPRO VIDEOS

GGSPRO has begun creating a database of short educational videos to address a wide variety of issues growers face, promote innovate technologies, and discuss ways you can enhance your cultivation practices. These free videos can be accessed online through the Griffin website. www.griffins.com/custom-site/ggspro-videos



2024

IMPORTANT CHEMICAL USAGE INFORMATION

Labels & Registration

Pesticide information in this catalog is believed to be correct but it is the responsibility of the applicator to read and follow all label directions. Labels do change without notice, including state registrations and restricted use status. Final responsibility for compliance rests with the applicator.

Storage

Your storage areas should be clean, well-ventilated and maintained at temperatures between 45° - 90°F. The floor should be covered with a non-absorbent material. All pesticides should be stored in their original containers. Pesticides have shelf lives and should be marked with the date of purchase. Unsafe pesticide storage can lead to serious accidents. Be sure the storage area can be locked and is clearly marked with appropriate pesticide storage signage.

Griffin's Pesticide Permit Policy

Chemicals that have been designated by law as restricted use pesticides require Griffin to only sell to growers that have a current/valid Pesticide Applicators Permit. We are required to record your license to use these products and report that information on demand. No restricted products can or will be allowed out of our warehouse until that copy is on file.

Chemical Shipping

- No chemicals will be left without a customer's signature.** If there isn't anybody there at time of delivery, the chemical materials will NOT be delivered.
- Transportation during extremely cold weather is not possible for many of our liquid chemicals.
- There are certain chemicals that cannot be shipped via commercial carrier, (or there is an upcharge for handling) due to hazardous chemical shipping laws. Please plan ahead for our truck delivery.
- MSDS/SDS - Material Safety Data Sheets for all the different pesticides we carry may often be obtained directly from the manufacturer's website or from our Customer Service Dept.

Restricted-Entry Interval (REI)

All EPA registered pesticides have a REI assigned to them. This is expressed in either hours or days and is included in the descriptions of all pesticides in the Griffin catalog except those labeled for retail purposes. Growers must abide by all re-entry restrictions and personal protection equipment (PPE) requirements as listed on the label for the duration of the REI.

Mode of Action Groups (MOA's)

The mechanism by which a pesticide controls a pest is known as its mode of action. In order to rotate pesticides to reduce the chance of resistance it is necessary to use pesticides that utilize different modes of action. Descriptions of insecticides, fungicides and herbicides in the Griffin catalog include the industry accepted mode of action group. Griffin's GGSPRO technical team is available to help create responsible pesticide rotation programs.

2024

LOOK FOR THIS SYMBOL FOR: EDIBLE CROP FRIENDLY CHEMICALS

Pesticides with this icon have at least some edible crops on the label. Consult the label for an exact list.



LOOK FOR THIS SYMBOL FOR: TOTAL RELEASE

Chemicals with this icon are aerosol cans.



Nationwide Poison Control Center
800-222-1222

CHEMICAL CONVERSION TABLE

Equivalent quantities of liquid materials (Emulsifiable concentrates, etc.) for various quantities of water based on volume per 100 gal

American Fluid Measure

80 drops = 1 teaspoon (tsp)
3 teaspoons = 1 tablespoon (Tbbs)
2 tablespoons = 1 fluid ounce (fl oz)
8 fluid ounces = 1 cup
2 cups = 1 pint (pt)
2 pints = 1 quart (qt)
4 quarts = 1 gallon (gal)

American Dry Measure

3 tsp = 1 Tbls
16 Tbls = 1 cup
28 gm = 1 oz
454 gm = 1 lb

Water	Liquid Chemicals, Smaller Volume Conversions					
100 gal	2 Tbs	4 oz	8 fl oz	16 fl oz	1 qt	2 qt
25 gal	1 Tbls	1 oz	2 fl oz	4 fl oz	8 fl oz	1 pt
5 gal	0.6 tsp	1.25 tsp	2.5 tsp	5 tsp	1.66 fl oz	3.33 fl oz
1 gal	0.12 tsp	0.25 tsp	0.5 tsp	1 tsp	2 tsp	4 tsp

Understanding the GGSPro Bee Safety Codes



Responsible applicators consider bee safety when making their product choices. GGSPro is well versed in managing chemical use for minimizing impacts to biological control agents (BCAs) and now extends this knowledge to bees that can come in contact with pesticides both in greenhouses and outdoors. Our Bee Safety Codes will help you quickly determine which pesticide choices are most appropriate for your specific situation. From there, the GGSPro team can further help you narrow the options and develop strategies that will help you control your pests while minimizing risks to area bee populations.

The GGSPro Bee Safety Codes summarize existing EPA bee caution label content into a simple icon system in which a color and a number provide information on both toxicity and exposure routes. Please note that some application methods (ex. granular) and some product classes (ex. fungicides, surfactants) are not currently subject to bee hazard evaluation by the EPA. Therefore, the lack of a Bee Safety Code should not be considered an indication of complete lack of risk. The GGSPro team is available to discuss your specific concerns. Bee Safety Codes indicate the need to plan pesticide applications carefully to minimize the risk to bees. Products toxic to bees might still be part of a pest control program if the proper precautions are taken. It's all about wise and effective use of pesticides, and GGSPro is here to help you, every step of the way.

All Bee Safety information presented by Griffin Greenhouse Supplies is intended to serve as a reference for growers. It does not replace the need to read and follow the directions on entire pesticide labels or supersede any applicable law, rule, regulation or standard. While every effort has been made to ensure its accuracy, human error is possible and labels do change without notice. Pesticides other than those listed may be safe, legal and effective.

EXPOSURE KEY

1 Toxicity risk through direct exposure only:

avoid treatment when bees are actively visiting or actively foraging in the treatment area. Actively visiting the treatment area refers to bees you see on the plants and pertains to products that do not show residual effect. Bees are protected when bees are absent during treatment.



Highly Toxic
EPA describes as very highly toxic, highly toxic or very toxic to bees

2 Toxicity risk through residual exposure only:

avoid treatment when bees are visiting the treatment area. Visiting the treatment area refers to bees that may visit the plants after treatment. Bees are protected when bees are absent from the area following treatment. Avoid use of these products when crops and/or weeds are in bloom.



Toxic
EPA describes as toxic to bees

3 Toxicity risk through both direct exposure and residual exposure:

avoid treatment when bees are visiting the treatment area. Visiting the treatment area refers to bees that may visit the plants after treatment. Bees are protected when bees are absent from the treatment area both during and following treatment. Avoid use of these products when crops and/or weeds are in bloom.



Low Toxicity
EPA describes as a potential pathogen or with low toxicity to bees



Special case
Special use notes per label; contact GGSPro for more information.

THE NEW EPA BEE ADVISORY BOX

On EPA's new and strengthened pesticide label to protect pollinators

PROTECTION OF POLLINATORS

APPLICATION RESTRICTIONS EXIST FOR THIS PRODUCT BECAUSE OF RISK TO BEES AND OTHER INSECT POLLINATORS. FOLLOW APPLICATION RESTRICTIONS FOUND IN THE DIRECTIONS FOR USE TO PROTECT POLLINATORS.

Look for the bee hazard icon in the Directions for Use for each application site for specific use restrictions and instructions to protect bees and other insect pollinators.

This product can kill bees and other insect pollinators. Bees and other insect pollinators will forage on plants when they flower, shed pollen, or produce nectar. Bees and other insect pollinators can be exposed to this pesticide from:

- Direct contact during foliar applications, or contact with residues on plant surfaces after foliar applications
- Ingestion of residues in nectar and pollen when the pesticide is applied as a seed treatment, soil, tree injection, as well as foliar applications.

When Using This Product Take Steps To:

- Minimize exposure of this product to bees and other insect pollinators when they are foraging on pollinator attractive plants around the application site.
- Minimize drift of this product on to bees and other insect pollinator attractive habitat. Drift of this product onto bees and other insect pollinators may be found at the Pesticide Information on preparing bees and other insect pollinators may be found at the Pesticide Environmental Stewardship website at: <http://www.epa.gov/pesticide-information>

Pesticide incidents (for example, see K15) should immediately be reported to the state/local lead agency. For contact information for your state/tribe, go to: www.epa.gov/pesticide-information. Pesticide incidents can also be reported to the National Pesticide Information Center at: www.1-800-858-0888 or directly to EPA at: bee@epa.gov

Alerts users to separate restrictions on the label. These prohibit certain pesticide use when bees are present.

The new bee icon helps signal the pesticide's potential hazard to bees.

Makes clear that pesticide products can kill bees and pollinators.

Bees are often present and foraging when plants and trees flower. EPA's new label makes it clear that pesticides cannot be applied until all petals have fallen.

Warns users that direct contact and ingestion could harm pollinators. EPA is working with beekeepers, growers, pesticide companies, and others to advance pesticide management practices.

Highlights the importance of avoiding drift. Sometimes, wind can cause pesticides to drift to new areas and can cause bee kills.

The science says that there are many causes for a decline in pollinator health, including pesticide exposure. EPA's new label will help protect pollinators.

Read EPA's new and strengthened label requirements: <http://go.usa.gov/JH4>

FUNGICIDES

Actinovate SP



MOA | REI
BM02 | 1

Active Ingredient: *Streptomyces lydicus* WYEC 108

Bacteria based fungicide. As a soil drench it protects plants from diseases such as: *Pythium*, *Phytophthora*, *Rhizoctonia*, and *Fusarium*. As a foliar spray it suppresses diseases such as *Alternaria*, *Botrytis* and powdery mildew. Labeled for ornamental crops in greenhouses, interiorscapes, outdoor nurseries and turf. **Foliar spray rates:** 1/2-1 tsp per gal or 6-12 oz per 100 gal. **Drench rate:** 4-6 oz per 100 gal. **OMRI listed.**

Item: 71-1117 **Size:** 18 oz.

Adorn



MOA | REI
43 | 12

Active Ingredient: Fluopicolide

Foliar spray or drench to control downy mildew (spray only), *Pythium* and *Phytophthora* on ornamentals in greenhouses and nurseries. **Foliar spray rates:** 1/8-1/4 tsp per gal or 2-4 fl oz per 100 gal. **Drench rates:** 1/8-1/2 tsp per 2 gal or 1-4 fl oz per 100 gal. The label requires that another fungicide labeled for the same disease be tank mixed with Adorn for all applications. *Do not apply to poinsettias.* May damage open blooms. **Restricted use pesticide in NY.**

Item: 71-1130 **Size:** 1 qt.

Affirm WDG



MOA | REI
19 | 4

Active Ingredient: Polyoxin D zinc salt

Broad-spectrum fungicide for use on ornamentals and many edible crops in greenhouses, nurseries, interiorscapes and other labeled sites. Foliar spray controls *Alternaria*, *Botrytis*, *Colletotrichum*, powdery mildew and others. Drench treatments control *Rhizoctonia* and *Thielaviopsis*. Chemigation instructions have been added to the label. **Foliar spray and drench rates:** 1/2-1 tsp per gal or 4-8 oz per 100 gal.

Item: 71-1131 **Size:** 2.4 lb.

Agri-Mycin 50



MOA | REI
25 | 12

Active Ingredient: Streptomycin Sulfate

Bactericide used preventively against bacterial leaf spots, blights and wilts. Labeled for ornamental and certain edible crops. **Foliar spray rates:** 1-2 tsp per gal or 2.66-5.33 oz per 100 gal.

Item: 71-1133 **Size:** 3 lb.

Aliette WDG



MOA | REI
P07 | 12

Active Ingredient: Aluminum Tris (Fosetyl-Al)

Fungicide used as a soil drench and a foliar spray. Controls *Pythium*, *Phytophthora*, and downy mildew. Can be used on certain ornamentals in greenhouses, nurseries, and landscapes. **Foliar spray rates:** 1 1/4-5 tsp per gal or 1 1/4-5 lb per 100 gal. **Drench rates:** 6.4-12.8 oz per 100 gal. Do not apply within 14 days of a copper application.

Item: 71-11352 **Size:** 5 lb.

Areca



MOA | REI
P07 | 12

Active Ingredient: Aluminum tris

Water dispersable granular (WDG) formulation fungicide that can be used as a foliar spray or drench. Controls: *Pythium*, *Phytophthora* and downy mildew on ornamentals in greenhouses, nurseries and landscapes. **Foliar spray rates:** 1.25-5 tsp per gal or 1.25-5 lb per 100 gal. **Drench rates:** 6.4-12.8 lb per 100 gal. Do not apply within 14 days of a copper application. **Restricted use pesticide in NY.**

Item: 71-1180 **Size:** 5 lb.

Astun



MOA | REI
7 | 12

Active Ingredient: Isofetamid

Astun is a SC (Soluble Concentrate) fungicide for the control of *Botrytis* on ornamentals in commercial greenhouses and nurseries. Systemic action provides curative and preventative control when applied as a foliar spray. **Rates:** 2/3-1 tsp per gal or 10-17 fl oz per 100 gal. **Restricted use pesticide in NY.**

Item: 71-1190 **Size:** 1 qt.

GGSPRO TIP CAPSIL SURFACTANT

CapSil is a versatile organo-silicone surfactant that increases spray droplet coverage. Greater coverage ultimately leads to better pesticide efficacy against pests and diseases. Surfactants also help reduce visible residue left behind from foliar-applied pesticides and nutrients such as calcium chloride dihydrate. CapSil can be a valuable tool in all stages of production including propagation. It helps manage water stress of unrooted cuttings by preventing overheard mist from running off waxy foliage.



Avelyo



MOA 3 | REI 12

Active Ingredient: Mefentrifluconazole

Avelyo is a SC (soluble concentrate) translaminar systemic fungicide for use in greenhouse, shadehouses, lathhouses, container and field grown ornamentals and interiorscapes. Foliar sprays control diseases including *Alternaria*, *Colletotrichum*, *Cercospora*, *Phyllosticta*, *Septoria*, *Phomopsis*, powdery mildew, rust, and others. Drench treatments control *Cylindrocladium* and *Thielaviopsis*. No Chemigation. **Foliar spray rates:** ¼-½ tsp per gal or 5-8 fl oz per 100 gal (8-10 fl oz for rust). **Drench rates:** ⅓ tsp per gal or 3 fl oz per 100 gal. **Not registered in ME.**

Restricted use pesticide in NY.

Item: 71-1195 **Size:** 60 fl oz.

Badge SC



MOA M01 | REI 24-48

Active Ingredient: Copper Oxychloride & Copper Hydroxide

Dual copper-based active ingredients used to control a wide variety of bacterial and fungal pathogens. Approved for use on ornamentals, fruiting crops, vegetables, and herbs. Foliar applications on plants grown in greenhouses, shadehouses, outdoor nurseries, landscapes, and field production settings. Rates vary widely by crop, check the label for rates. For greenhouse grown ornamentals: **Foliar spray rates:** 1.5-2 tsp per gal or 24-32 fl oz per 100 gal. Restricted Entry Interval is 24 hours for greenhouse uses and 48 hours for all field applications.

Item: 71-1205 **Size:** 2.5 gal.

Banner Maxx II



MOA 3 | REI 12

Active Ingredient: Propiconazole

Broad-spectrum, translaminar systemic for use on ornamentals in outdoor landscapes and nursery plantings. Not for use in greenhouses. Ornamental diseases controlled include: *Alternaria*, anthracnose, black spot, *Cercospora*, *Entomosporium*, powdery mildew, *Rhizoctonia*, rust, scab and *Septoria*. **Foliar spray rates:** ⅓-1 ½ tsp per gal or 2-24 fl oz per 100 gal.

Item: 71-2972 **Size:** 1 gal.

Item: 71-29712 **Size:** 10 gal.

Banrot 40 WP



MOA 1+14 | REI 12

Active Ingredient: Thiophanate-methyl & Etridiazole

Broad spectrum fungicide for control of damping off, root and stem diseases caused by *Pythium*, *Phytophthora*, *Rhizoctonia*, *Fusarium* and *Thielaviopsis* in ornamental and nursery crops. **Drench rates:** Bedding plants ½-1 tsp per gal or 4-8 oz per 100 gal apply to 800 sq ft. Container and bed grown ¾-1 ½ tsp per gal or 6-12 oz per 100 gal apply to 400 sq ft. Irrigate immediately with additional water equal to at least half the volume of fungicide drench. **Restricted use pesticide in CT & NY.**

Item: 71-1210 **Size:** 2 lb.

Banrot 8 G



MOA 1+14 | REI 12

Active Ingredient: Thiophanate-methyl & Etridiazole

Control of damping off, root and stem rot diseases caused by *Pythium*, *Phytophthora*, *Rhizoctonia*, *Fusarium* and *Thielaviopsis* in ornamental and nursery crops. Labeled for use in greenhouse and nursery. **Rate:** Bedding Plants 8 oz per cu yd. Container and bed grown plants 16 oz per cu yd. Not for top-dress applications.

Restricted use pesticide in NY.

Item: 71-1215 **Size:** 40 lb.

BotryStop WP



MOA NC | REI 4

Active Ingredient: *Ulocladium oudemansii* (U3 Strain)

BotryStop is a WDG formulation fungicide based on a saprophytic fungus for the control of *Botrytis* and *Sclerotinia* spp. Foliar sprays can be applied on ornamentals in greenhouses and nurseries and many edible crops including certain vegetables, berries and tree fruits in field, high tunnel or greenhouse sites. Excellent plant safety but leaves some visible residue. **Foliar spray rates:** 3 Tbls per gal or 3 lb per 100 gal. Requires constant agitation during application. Check Bioworks website for fungicide compatibility information.

OMRI listed.

Item: 71-12601 **Size:** 12 lb.

Item: 71-12603 **Size:** 30 lb.

Broadform



MOA 7+11 | REI 12

Active Ingredient: Fluopyram & Trifloxystrobin

Broad spectrum soluble concentrate (SC) fungicide for use on ornamentals in greenhouses, interiorscapes, landscapes, field and container nurseries. It can also be applied to field grown grapes (except Concord), certain tree fruits and nut trees. Foliar sprays control: *Alternaria*, anthracnose, black spot, *Botrytis*, rust, *Septoria*, scab, *Myrothecium*, aerial *Phytophthora*, powdery mildew, *Rhizoctonia* and others.

Foliar spray rates: 1/4-1/2 tsp per gal or 4-8 fl oz per 100 gal. **Restricted use pesticide in NY. Prohibited in Nassau and Suffolk County, NY.**

Item: 71-1290 **Size:** 12 fl oz.

Camelot O



MOA M01 | REI 4

Active Ingredient: Copper Octanoate

Copper based fungicide/bactericide. Controls anthracnose, *Alternaria*, *Cylindrocladium*, powdery mildew, certain bacterial leaf spots and more. Labeled for use under field conditions, greenhouses, nurseries, interiorscapes and landscapes. Many edible crops on the label. **Foliar spray rates:** 4 tsp-2 fl oz per gal or 0.5-2 gal per 100 gal. **OMRI listed.**

Item: 70-21202 **Size:** 1 gal.

Cease

MOA
BM02 | REI
4**Active Ingredient:** *Bacillus subtilis* QST 713 strain

Mycofungicide that provides preventative control of certain fungal and bacterial diseases such as *Alternaria*, *Botrytis*, downy mildew, powdery mildew and bacterial diseases including *Erwinia*, *Pseudomonas* and *Xanthomonas*. Cease is labeled for use on ornamentals and several vegetable crops in greenhouses, interiorscapes, fields and nurseries. **Foliar spray rates:** range from 1.25-2.5 fl oz per gal or 1-2 gal per 100 gal. Cease can be used as a soil drench to suppress root rots such as *Fusarium*, *Pythium*, *Phytophthora* and *Rhizoctonia*. **Drench rates:** 32-128 fl oz per 100 gal. **OMRI listed.**

Item: 71-13301 **Size:** 1 gal.**Item:** 71-1335 **Size:** 2.5 gal.

Chipco 26019 FLO

MOA
2 | REI
12**Active Ingredient:** Iprodione

Flowable form of iprodione. Labeled for ornamentals in greenhouses and outdoors as well as turf. Effective against *Alternaria*, *Botrytis*, *Rhizoctonia* and others. **Foliar spray rates:** 2-5 tsp per gal or 32-80 fl oz per 100 gal. **Drench rate for Rhizoctonia:** 13 fl oz per 100 gal. **Restricted use pesticide in NY.**

Item: 71-1350 **Size:** 2.5 gal.

Chipco 26019 50%

MOA
2 | REI
12**Active Ingredient:** Iprodione

Wettable powder form of Iprodione. Labeled for greenhouse and outdoor ornamentals. Effective against *Alternaria*, *Botrytis*, *Rhizoctonia* and others. **Foliar spray rates:** 1 $\frac{1}{3}$ - 2 $\frac{2}{3}$ tsp per gal or 1-2 lb per 100 gal. **Drench rate for Rhizoctonia:** 6.5 oz per 100 gal. **Restricted use pesticide in NY.**

Item: 71-13502 **Size:** 2 lb.

3336 EG

MOA
1 | REI
12**Active Ingredient:** Thiophanate-Methyl

Extruded granule (EG) formulation of locally systemic fungicide for use on ornamentals and certain vegetable transplants in greenhouses, landscapes, interiorscapes, and outdoor nurseries. Labeled for foliar sprays, dips, and drench applications. Controls anthracnose, *Cylindrocladium*, *Rhizoctonia*, *Sclerotinia*, *Thielaviopsis*, and others. **Foliar spray rates:** $\frac{2}{3}$ -2 tsp per gal or 8-24 oz per 100 gal. **Drench rates:** 8-16 oz per 100 gal. **Restricted use pesticide in NY.**

Item: 71-2550 **Size:** 5 lb.

3336-F

MOA
1 | REI
12**Active Ingredient:** Thiophanate-Methyl

Locally systemic fungicide for use on ornamentals in greenhouses, landscapes, interiorscapes and outdoor nurseries. Foliar spray, dip and drench applications can be made. Controls anthracnose, *Cylindrocladium*, *Rhizoctonia*, *Sclerotinia*, *Thielaviopsis* and others. A 0 hr REI can be obtained for drench applications that meet label requirements. **Foliar spray rates:** $\frac{1}{2}$ -1 $\frac{1}{2}$ tsp per gal or 8-24 fl oz per 100 gal. **Dip rates:** 1-1 $\frac{1}{2}$ tsp per gal or 16-24 fl oz per 100 gal. **Drench rates:** $\frac{1}{2}$ -1 tsp per gal or 8-16 fl oz per 100 gal. **Restricted use pesticide in CT & NY.**

Item: 71-2575 **Size:** 1 qt.**Item:** 71-2585 **Size:** 2.5 gal.

Companion WP

MOA
BM02 | REI
4**Active Ingredient:** *Bacillus amyloliquefaciens* strain ENV503

Preventative fungicide that can be applied as a foliar spray or a soil drench. Diseases prevented include but are not limited to: *Alternaria*, *Botrytis*, *Colletotrichum*, *Erwinia*, *Fusarium*, *Phytophthora*, powdery mildew, *Pseudomonas*, *Pythium*, *Rhizoctonia* and *Xanthomonas*. Labeled for use on edible crops and ornamentals in field, greenhouse, nursery and shadehouse applications. **Foliar spray and drench rates:** 1-1.5 tsp per gal or 0.5-1.5 lb per 100 gal. **OMRI listed**

Item: 71-1372A2**Size:** 5 lb.**Item:** 71-1375A2**Size:** 20 lb.

Compass

MOA
11 | REI
12**Active Ingredient:** Trifloxystrobin

Broad spectrum translaminar strobilurin foliar disease control for nursery, greenhouse, and interiorscape use. Compass provides long residual control of many foliar diseases including downy mildew, powdery mildew, *Botrytis*, rust, black spot and many other leaf spot and blight diseases. **Foliar spray rates:** $\frac{1}{5}$ tsp- $\frac{2}{3}$ tsp per 2 gal or 1-4 oz per 100 gal. Do not use with an organo-silicone surfactant such as CapSil.

Item: 71-1355 **Size:** 1 lb.**GGSPRO Technical Services**

Our in-house technical services team delivers prompt, practical and accurate support to Griffin customers everywhere. Visit griffins.com for more information.

Concert II



MOA | REI
3+M05 | 12

Active Ingredient: Propiconazole & Chlorothalonil

Combination of systemic and contact fungicides that provide broad-spectrum control of many important plant diseases on ornamentals and conifers. Foliar sprays control *Ascochyta*, *Alternaria*, anthracnose, *Botrytis*, *Cercospora*, *Diplodia*, powdery mildew, *Septoria*, rust and many more. Labeled for use in field and container grown ornamentals in nurseries, lath and shade houses, landscape plantings and specific turf sites. *Do not use in greenhouses.* Damage may occur when used on plants in bud, bloom or with tender new growth. WPS requirements in effect for the next 6 ½ days. Consult label for details. **Foliar spray rates:** ½-4 ⅛ tsp per gal or 9-69 fl oz per 100 gal. **Restricted use pesticide in MA.**

Item: 71-1365 **Size:** 2.5 gal.

CuPRO 5000



MOA | REI
M01 | 48

Active Ingredient: Copper Hydroxide

Broad spectrum fungicide/bactericide in a dry flowable formulation approved for use on ornamentals in greenhouses, shadehouses, outdoor nurseries, landscapes, and Christmas tree farms. Foliar applications control many fungal diseases such as *Alternaria*, anthracnose, *Botrytis*, *Cercospora*, downy mildew, powdery mildew, along with bacterial disease caused *Pseudomonas* and *Xanthomonas*. Also approved for control of Spanish moss and lichens. **Foliar spray rates:** 3 1/3 tsp-3 3/4 Tbls per gal or 1.5-5 lb per 100 gal. **OMRI listed.**

Item: 71-13802 **Size:** 3 lb.

Daconil Ultrex



MOA | REI
M05 | 12

Active Ingredient: Chlorothalonil

A broad spectrum fungicide containing water dispersible granules for easy mixing. Controls leaf spot, *Botrytis*, rust, black spot, powdery mildew, Boxwood blight and others on ornamental and flowering plants. Caution on open blooms. **Foliar spray rates:** 1 Tbls per gal or 1.4 lb per 100 gal. 12 hr REI with additional WPS requirements in effect for the next 6½ days. Consult label for details. **Restricted use pesticide in MA & RI.**

Item: 71-1419 **Size:** 5 lb.

Daconil Weather-stik



MOA | REI
M05 | 12

Active Ingredient: Chlorothalonil

A broad spectrum flowable fungicide for the control of foliar diseases such as *Alternaria*, anthracnose, *Botrytis*, *Cercospora*, powdery mildew, rusts, scabs, Boxwood blight and others. Caution on open blooms. 12 hr REI with additional WPS requirements in effect for the next 6 ½ days. Consult label for details. **Foliar spray rates:** 1⅓ tsp per gal or 22 fl oz per 100 gal. **Restricted use pesticide in MA.**

Item: 71-1417 **Size:** 2.5 gal.

Decree 50 WDG



MOA | REI
17 | 12

Active Ingredient: Fenhexamid

Decree provides long residual control of *Botrytis* with minimal visible residue and excellent plant and bloom safety. Several edible crops are on the label. Labeled for grown to harvest greenhouse tomato, pepper, cucumbers and leafy greens. **Foliar spray rates:** 1-2 tsp per gal or 0.75-1.5 lb per 100 gal.

Item: 71-1439 **Size:** 2.5 lb.

Eagle 20 EW



MOA | REI
3 | 24

Active Ingredient: Myclobutanil

Foliar fungicide for the control of powdery mildew, rust, scab and other diseases. Can be used on ornamentals outdoors, in greenhouses, and on some fruit trees and vine crops. Eagle is locally systemic, with curative and protectant activity. **Foliar spray rates:** ½-¾ tsp per gal or 6-12 fl oz per 100 gal. **Restricted use pesticide in NY. Prohibited in Nassau and Suffolk County, NY.**

Item: 71-1435 **Size:** 1 pt.

Item: 71-1437 **Size:** 1 gal.

EcoSwing



MOA | REI
BM01 | 4

Active Ingredient: Extract of *Swinglea glutinosa*

EcoSwing is a foliar fungicide based on a botanical extract from *Swinglea glutinosa*. EcoSwing is primarily a preventative fungicide with some curative activity for the control of *Alternaria*, basil downy mildew, *Botrytis*, powdery mildew and others. It can be used on ornamental and food crops in greenhouses, nurseries and landscapes. Best results are achieved by using it as part of a regular program at 7-14 day intervals. **Foliar spray rates:** 1.5-2 tsp per gal, or 24-32 fl oz per 100 gal. **OMRI listed.**

Item: 71-1455 **Size:** 1 qt.

Empress Intrinsic



MOA | REI
11 | 12

Active Ingredient: Pyraclostrobin

Broad-spectrum fungicide labeled for use on rooted cuttings, plugs, liners and containers in greenhouse ornamentals, interiorscape, nursery, container or field production. Labeled as a preventative drench against root pathogens including *Pythium*, *Phytophthora*, *Rhizoctonia*, and *Fusarium*. Benefits include improved plant health, including faster rooting. **Drench rates:** ⅛-¾ tsp per 2 gal or 1-6 fl oz per 100 gal. **Not registered in ME.**

Item: 70-1510 **Size:** 24 fl oz.

GGSPRO TIP FENSTOP FUNGICIDE

Rotating MOAs has become more important than ever to slow pesticide resistance. Fenstop is the only MOA 11 that provides excellent *Pythium* control. Consider implementing this product into your arsenal to alleviate reliance on other commonly used *Pythium* products.

Fenstop



Active Ingredient: Fenamidone

A liquid formulation for use on greenhouse and nursery ornamentals as a drench or spray. Foliar sprays control downy mildew and aerial *Phytophthora*. Apply as a soil drench for *Pythium* or *Phytophthora* root rots. **Foliar spray and drench rates:** 1/2-1 tsp per gal or 7-14 fl oz per 100 gal and it can be re-applied at 28 day intervals if needed. **Not Registered in NY.**

Item: 71-14800 **Size:** 1 qt.

Fosphite EC



Active Ingredient: Mono & Di-Potassium Salts of Phosphorous Acid

Broad spectrum, systemic fungicide for control of downy mildew, *Pythium*, *Phytophthora* and many other diseases in greenhouse and nursery outdoor crops. Many edible crops are on the label. Stimulates natural plant defenses. Do not apply within 20 days of a copper application. **Foliar spray rates:** 2-4 tsp per gal or 32-64 fl oz per 100 gal. **Drench rates:** 1/2-3/4 tsp per gal or 6-12 fl oz per 100 gal.

Item: 71-1522 **Size:** 2.5 gal.

Grotto



Active Ingredient: Copper Octanoate

Copper soap based fungicide/bactericide. Controls: anthracnose, *Alternaria*, *Cylindrocladium*, powdery mildew, certain bacterial leaf spots and more. Labeled for ornamentals grown in greenhouses, nurseries and interiorscapes, as well as herbs and vegetable crops in greenhouses and shadehouses. **Foliar spray rates:** 4 tsp-2 fl oz per gal or 0.5-2 gal per 100 gal. **OMRI listed.**

Item: 71-2030 **Size:** 1 gal.

Guarda



Active Ingredient: Thyme Oil

Guarda is an emulsifiable concentrate of a botanical extract of Thyme oil that has been stabilized with the HOLDIt® Technology that allows it to remain active for up to 14 days. Labeled as a spray, drench or dip on ornamentals, turf and edible crops including herbs. Use preventatively against foliar pathogens bacterial blight/canker, *Botrytis*, *Colletotrichum*, downy mildew, fungal leaf spots, powdery mildew, and rust, and for *Fusarium*, *Pythium* and *Rhizoctonia* when applied as a drench. **Foliar spray rates:** 0.8-4.2 fl oz per gal or 80-422 fl oz per 100 gal. **Drench rates:** 5 fl oz per gal or 4 gal per 100 gal. **Pre-Plant Dip rates:** 0.32-0.64 fl oz per gal or 32-64 fl oz per 10 gal.

Item: 71-1610 **Size:** 2.5 gal.

GGSPRO TIP GUARDA FUNGICIDE

Guarda is a botanical extract of thyme oil that has been stabilized, allowing it to provide activity for up to 14 days after application. Labeled as a spray, drench, or dip on ornamentals, turf, and edible crops including herbs. Use this unique oil-based fungicide to combat many foliar pathogens.

Heritage



Active Ingredient: Azoxystrobin

A broad-spectrum, contact and xylem-mobile systemic strobiluron fungicide, labeled for use as a foliar spray or drench on ornamentals as well as many vegetable and herb transplants in greenhouses, container or field-grown crops and other locations. It controls many diseases including *Alternaria*, *Botrytis*, Boxwood Blight, *Cercospora*, downy mildew, powdery mildew, *Rhizoctonia*, and scab. Heritage is available as a WP and an SC formulation. The rates are different as shown below. **Foliar spray rates for WG:** 1 tsp per 2.5-5 gal or 1-4 oz per gal 100 gal. **Drench rates for WG:** 1 oz per 100 gal. **Foliar spray rates for SC:** 1/8 -1 tsp per gal or 2-15.3 fl oz per 100 gal. **Drench rates for SC:** 1/4 tsp per gal or 3.8 fl oz per 100 gal. **Restricted use pesticide in VT.**

Item: 71-1408 **Size:** 4 fl oz., SC formulation

Item: 71-1400 **Size:** 1 lb., WG formulation

Item: 71-1405 **Size:** 6 lb., WG formulation



Active Ingredient: Copper Hydroxide

Broad spectrum fungicide/bactericide in a dry flowable formulation for use on ornamentals and many vegetable and fruit crops. Foliar sprays control many fungal diseases including: *Alternaria*, Anthracnose, *Botrytis*, *Cercospora*, downy mildew, powdery mildew, and others along with bacterial leaf spots caused by *Pseudomonas* and *Xanthomonas*. **Foliar spray rates:** 1/2-2 tsp per gal or 0.5-2 lb per 100 gal. **OMRI listed.**

Item: 71-2050 **Size:** 2.5 lb.

Medallion WDG



Active Ingredient: Fludioxonil

For control of certain root, crown, stem and foliar diseases, Medallion is a residual contact fungicide labeled for use on ornamentals in greenhouse, nursery, interiorscape, and commercial landscapes. Also labeled as a soil drench for *Rhizoctonia*, *Cylindrocladium*, *Sclerotium*, *Thielaviopsis* and *Fusarium*. Foliar diseases controlled include: *Alternaria*, *Botrytis*, Boxwood Blight, *Cercospora*, and *Myrothecium*. **Foliar sprays rates:** 1 tsp per 9.5 - 2.3 gal or 1-4 oz per 100 gal. **Drench rates:** 1-2 oz per 100 gal. **Restricted Use Pesticide NY.**

Item: 71-16502 **Size:** 8 oz.

KleenGrow



Active Ingredient: Didecyldimethylammonium Chloride

Kleengrow is a 4th generation DDAC fungicide, algaecide, and virucide for use on greenhouse ornamentals and cut flowers from propagation to finish. Use as a foliar spray, drip or drench to control diseases such as: *Botrytis*, powdery and downy mildew and bacterial leaf spots. Use as a soil drench or injected into irrigation systems to control water borne pathogens and root rots such as: *Pythium*, *Phytophthora*, *Fusarium*, *Rhizoctonia* and *Thielaviopsis*.

REI	Rate fl oz/gal	Rate fl oz/100 gal	Application
48 HR	0.06 - 0.38	6-38	Spray or drench application over crops
12 HR	0.03 - 0.20	3-20	Intermittent chemigation
0 HR	0.003 - 0.014	0.3-1.4	Continuous chemigation
0 HR	0.06 - 0.50	6-50	Propagation Dips

Item: 74-21125 **Size:** 2.5 gal.
Item: 74-21151-CA **Size:** 5 gal.
Item: 74-21301 **Size:** 30 gal.
Item: 74-21302 **Size:** 55 gal.

Micora



Active Ingredient: Mandipropamid

Contact and translaminar systemic fungicide for use in greenhouses, shade structures, lath houses and nurseries. Foliar sprays control downy mildew and aerial *Phytophthora*. Drench applications control *Phytophthora* on roots and crowns. Also labeled for use on many vegetable transplants, and control of late blight of tomato and downy mildew in basil. **Foliar spray and drench rates:** 1/4-1/2 tsp per gal or 4-8 fl oz per 100 gal. Drench volumes per the label.

Item: 71-1655 **Size:** 1 qt.

Mildew Cure



Active Ingredient: Cottonseed Oil, Clove Oil, Garlic Oil

Foliar spray for the control of powdery mildew on ornamentals and many edible crops. Active ingredients are essential oils and this product is a 25b product (no EPA registration required). **Foliar spray rates:** 1.25 fl oz per gal or 1 gal per 100 gal. **OMRI listed.**

Item: 16-11005 **Size:** 2.5 gal.

LalStop K61 WP



Active Ingredient: *Streptomyces* sp. strain K61

Developed from a naturally occurring bacteria, LalStop K61 WP is a preventative foliar spray or drench product that thrives in the rhizosphere for several weeks and provides effective control on a wide range of pathogens including damping-off caused by various fungi, such as *Alternaria* and *Rhizoctonia*; and wilt and root diseases caused by *Fusarium*, *Phytophthora* and *Pythium*. Also used in hydroponics and plant dipping. Refer to label for application rates. **OMRI listed.**

Item: 71-2061 **Size:** 0.88 oz
Item: 71-2063 **Size:** 3.5 oz
Item: 71-2065 **Size:** 2 lb.

MilStop SP



Active Ingredient: Potassium Bicarbonate

Fast acting broad-spectrum foliar fungicide. Especially effective as a quick knockdown of powdery mildew. Controls *Alternaria*, anthracnose, black spot, *Botrytis*, powdery mildew and others on ornamentals and certain edible crops. **Foliar spray rates:** 1-2 Tbls per gal or 2.5-5 lb per 100 gal. **OMRI listed.**

Item: 71-2878 **Size:** 5 lb.
Item - CA Only: 71-2879B-CA **Size:** 5 lb.
Item: 71-2881 **Size:** 25 lb.

Mural WG

syngenta

MOA
7+11 | REI
12**Active Ingredient: Azoxystrobin & Solatenol**

Combining two active ingredients, this broad-spectrum, translaminar systemic fungicide is labeled for use on many ornamentals and edible crop transplants in greenhouses, shade and lath houses, outdoor nurseries and field grown ornamentals. Labeled for both protective and curative treatments for foliar including *Alternaria*, *Botrytis*, boxwood blight, *Cercospora*, *Colletotrichum*, downy mildew, *Entomosporium*, powdery mildew, rust and many more. Root diseases include *Fusarium*, *Phytophthora*, *Rhizoctonia*, *Sclerotium*, *Sclerotinia* and *Thielaviopsis*. **Foliar spray rates:** 1/4-1/2 tsp per gal or 4-7 oz per 100 gal. **Drench rates:** 2-3 oz per 100 gal. **Restricted use pesticide in NY & VT.**

Item: 71-1690 **Size:** 1 lb.**Multipacks:****Item:** 70-MMM **Description:** Mural/Mainspring GNL Multipak (3) - 1 lb. bottles of Mural Fungicide & (2) - 1 pt. Mainspring GNL insecticide**Item:** 71-PMM **Description:** Postiva/Mural Multipak (4) - 28 fl. Oz bottles of Postiva fungicide & (2) - 1 lb. bottles of Mural Fungicide

2024

Nordox 75 WG

BRANDT

MOA
M01 | REI
12**Active Ingredient: Cuprous Oxide**

Broad-spectrum copper fungicide/bactericide labeled for use on field grown ornamentals, tree fruits, grapes, small fruits and vegetables. Nursery and greenhouse crops include ornamentals and certain vegetables. Labeled for foliar diseases such as *Alternaria*, anthracnose, *Cercospora*, black spot, downy mildew, powdery mildew, and many bacterial leaf spots. **Foliar spray rates:** 1/3 tsp per gal or 10.66 oz per 100 gal. **OMRI listed.**

Item: 71-1700 **Size:** 12.5 lb.

Obtego

MOA
BM02 | REI
4**Active Ingredient: *Trichoderma asperellum* & *Trichoderma gamsii***

Biofungicide used to protect plants against soil-borne diseases. Obtego has shown to be active against *Pythium*, *Rhizoctonia*, *Phytophthora*, *Fusarium*, *Verticillium* and several other soil pathogens. Labeled for all ornamental plants including edible crops, flowering plants, foliage, cut flowers, bulbs, shrubs and trees. Used in greenhouses, nurseries and landscape settings. No refrigeration required. **Rates:** Drench 2.5-7.5 oz per 100 gal; consult label for rates for dip, media incorporation or field broadcast applications. **OMRI listed.**

Item: 71-2105 **Size:** 5 lb.

OHP 6672 4.5 L

MOA
1 | REI
12**Active Ingredient: Thiophanate-Methyl**

Locally systemic fungicide for use on ornamentals in greenhouse or field applications. May be applied as a foliar spray, drench or pre-plant dip for certain crops. Controls anthracnose, *Cylindrocladium*, *Rhizoctonia*, *Sclerotinia*, *Thielaviopsis*, and others. **Foliar sprays and drench rates:** 1/2-1 1/4 tsp per gal or 7.25-20 fl oz per 100 gal. **Restricted use pesticide in CT & NY.**

Item: 71-2670 **Size:** 2.5 gal.

OHP 6672 50 WP

MOA
1 | REI
12**Active Ingredient: Thiophanate-Methyl**

Locally systemic fungicide for use on ornamentals in greenhouse or field applications. May be applied as a foliar spray, drench or pre-plant dip for certain crops. Controls anthracnose, *Cylindrocladium*, *Rhizoctonia*, *Sclerotinia*, *Thielaviopsis* and others. **Foliar sprays and drench rates:** 1 2/3 tsp-4 1/2 tsp per gal or 8-16 oz per 100 gal. **Restricted use pesticide in CT & NY.**

Item: 71-2672 **Size:** 2 lb.

Orkestra Intrinsic

MOA
7+11 | REI
12**Active Ingredient: Fluxapyroxad & Pyraclostrobin**

Liquid suspension concentrate. Foliar spray controls *Botrytis*, Boxwood Blight, downy mildew, powdery mildew and many leaf spot diseases, crown rots, and stem blights. Soil drenches provide preventative control of *Fusarium*, *Rhizoctonia*, and *Sclerotinia*; suppression of *Phytophthora*, *Pythium* and *Thielaviopsis*. For use on ornamental plants in greenhouses, shadehouses, lathhouses, outdoor nurseries, retail nurseries and landscapes. **Foliar spray rates:** 1/4-2/3 tsp for most diseases or 4-10 fl oz per 100 gal. **Drench rate:** 1/2-2/3 tsp per gal or 8-10 fl oz per 100 gal. **Restricted use pesticide in NY. Prohibited in Nassau and Suffolk County, NY. Not registered in ME.**

Item: 71-2200 **Size:** 16 fl oz.**Item:** 71-2205 **Size:** 80 fl oz.

Orvego

MOA
45+40 | REI
12**Active Ingredient: Ametoctradin & Dimethomorph**

Preventative fungicide with contact, translaminar and locally systemic activity, labeled for ornamentals grown in greenhouses, container and field-grown nurseries and interiorscapes. Controls downy mildew (foliar spray) and aerial *Phytophthora* (spray, sprench or drench). **Foliar spray and drench rates:** 3/4-1 tsp per gal or 11-14 fl oz per 100 gal. **Restricted use pesticide in NY. Prohibited in Nassau and Suffolk County, NY.**

Item: 71-2300 **Size:** 28 fl oz.

OxiPhos

MOA
P07+NC | REI
4

Active Ingredient: Mono and Di-Potassium Salts of Phosphorus Acid & Hydrogen Peroxide

Broad spectrum fungicide/bactericide in a liquid formulation that can be applied by foliar spray, drench, trunk spray, root dip or trunk injection depending on the crop. Ornamentals and many edible crops can be treated. Labeled diseases include: bacterial canker, leaf spot and soft rot, downy mildew, powdery mildew, *Phytophthora* and more. 0 hr REI for drench applications if label conditions are met.

Foliar spray rates: 2.5 tsp-1.25 fl oz per gal or 41.6-128 fl oz per 100 gal. **Drench rates:** 3/4-1.5 tsp per gal or 12.8-25.6 fl oz per 100 gal.

Item: 71-2350

Size: 2.5 gal.

Item - CA only: 71-2350-CA

Size: 2.5 gal.

Item: 71-2355

Size: 55 gal.

Pageant Intrinsic TR

MOA
7+11 | REI
12

Active Ingredient: Boscalid & Pyraclostrobin

Total Release aerosol for greenhouse ornamentals providing control of foliar diseases such as *Alternaria*, *Botrytis*, *Cercospora*, powdery mildew and rust. **Rates:** 1 can per 3,000 sq ft except for *Cercospora*, 1 can per 1,500 sq ft. **Restricted use pesticide in NY.**

Item: 71-2683

Qty: 12/3 oz cans

Pageant Intrinsic WG

MOA
7+11 | REI
12

Active Ingredient: Boscalid & Pyraclostrobin

Broad spectrum fungicide combining two active ingredients for foliar and root diseases on ornamentals in greenhouses, interiorscapes, landscapes, nurseries and greenhouse grown tomatoes. Supplemental labels allow for the treatment of many vegetable crops as transplants and grown on to harvest. Foliar diseases include *Alternaria*, *Botrytis*, Boxwood Blight, *Cercospora*, *Colletotrichum*, downy mildew, aerial *Phytophthora*, powdery mildew, rust and scab. Root and crown rots include *Cylindrocladium*, *Fusarium*, *Pythium*, *Rhizoctonia*, and *Sclerotinia*. Plant health benefits include increased cold, heat and drought tolerance. **Foliar spray rates:** 1/2-1 1/2 tsp per gal or 6-18 oz per 100 gal. **Drench rates:** 1-1 1/2 tsp per gal or 12-18 oz per 100 gal. **Restricted use Pesticide in NY.**

Item: 71-26801

Size: 1 lb.

Item: 71-26821

Size: 12 lb.

Palladium WDG

syngenta

MOA
9+12 | REI
12

Active Ingredient: Cyprodinil & Fludioxonil

Broad spectrum foliar spray with contact and translaminar systemic activity controls many foliar and stem diseases, including *Botrytis*, *Alternaria*, Boxwood blight, *Cercospora*, *Myrothecium*, aerial *Rhizoctonia*, *Septoria*, and 10 other diseases. Labeled for use on ornamentals in the greenhouse, some edibles and herb transplants, landscapes, and nurseries. **Foliar spray rates:** 1/4-3/4 tsp per gal or 2-6 oz per 100 gal. **Restricted use pesticide in NY. Nassau and Suffolk County, NY restrictions apply.**

Item: 71-2685

Size: 2 lb.

PerCarb

MOA
NC | REI
1

Active Ingredient: Sodium Carbonate Peroxyhydrate

PerCarb is a contact foliar fungicide and bactericide labeled for field-grown crops, tree crops, berries, small fruits, vine crop, and ornamentals. Provides prevention and control of downy mildew, powdery mildew, *Botrytis*, and bacterial leaf spots. **Rates:** 1-3 lb per 100 gal. **Do not apply to crops in bloom. OMRI listed.**

Item: 71-8687

Size: 50 lb.

Phostrol

Nufarm

MOA
P07 | REI
4

Active Ingredient: Mono & Dibasic Sodium, Potassium & Ammonium Phosphites

Phostrol is a true systemic fungicide labeled for the prevention of *Pythium*, *Phytophthora* and downy mildew and others. Labeled for ornamentals and many edible crops in greenhouses, field production, commercial landscapes, nurseries, and turf. Methods of application vary by crop including foliar sprays, soil drenches, soil incorporation and dipping. Phostrol works by stimulating the natural defenses of plants. Do not apply within 20 days of a copper application. **Foliar spray rates:** 1 2/3-4 tsp per gal or 26-64 fl oz per 100 gal. **Drench rates:** 1/3-2/3 tsp per gal or 5-10 fl oz per 100 gal.

Item: 71-2725

Size: 2.5 gal.

Phyton 35

MOA
M01 | REI
48**Active Ingredient: Copper Sulfate Pentahydrate**

Translaminar systemic copper bactericide and fungicide. Preventative and curative activity against major diseases such as *Alternaria*, *Botrytis*, powdery mildew, *Phytophthora*, *Erwinia*, *Pseudomonas* and *Xanthomonas*. Labeled for use on ornamentals and many edible crops in greenhouses and nurseries. Apply as a spray or drench. See label cautions about interactions with B-Nine and phosphonate fungicides. **Foliar spray rates:** ¼-3 tsp per gal or 13-50 fl oz per 100 gal. **Drench rates:** 13-35 fl oz per 100 gal.

Item: 71-2732 **Size:** 1 ltr.
Item: 71-2737 **Size:** 1 gal.

Postiva

MOA
3+7 | REI
12**Active Ingredient: Pydiflumetofen & Difenoconazole**

Broad spectrum, translaminar systemic with long residual fungicide activity that also suppresses certain bacterial leaf spots. It can be applied as a foliar spray and a drench. Postiva can be used on ornamentals and certain vegetable transplants. Foliar diseases controlled include: *Alternaria*, *Botrytis*, Boxwood blight, *Colletotrichum*, *Cercospora*, powdery mildew, and as well as suppression of the bacterial diseases *Pseudomonas* and *Xanthomonas* spp. Drench treatments provide control of the soilborne pathogens *Fusarium*, *Rhizoctonia* and *Sclerotinia*. Excellent plant and bloom safety. **Foliar spray and Drench rates:** 2/3-1 ¼ tsp per gal or 10-28 fl oz per 100 gal. **Restricted use pesticide in NY.** Not registered in AK, CA.

Item: 71-2400 **Size:** 28 fl. oz.

Multipacks:

Item: 71-PMM **Description:** Postiva/Mural Multipak
(4) - 28 fl. Oz bottles of Postiva fungicide & (2) - 1 lb. bottles of Mural Fungicide

Protect DF

MOA
M03 | REI
24**Active Ingredient: Mancozeb**

Turf and ornamental fungicide. Controls petal blight, leaf spot, *Botrytis*, anthracnose, rust, and black spot on roses, azaleas, mums and many other ornamentals. *Do not use on marigolds.* Tank mix with copper products for even greater control of bacterial diseases. Labeled for certain vegetable transplants. **Foliar spray rates:** 1 Tbls per gal or 1.5 lb per 100 gal.

Item: 71-2748 **Size:** 6 lb.

Regalia CG

MOA
P05 | REI
4**Active Ingredient: Extract of *Reynoutria sachalinensis***

A botanical fungicide labeled for use on ornamentals in greenhouses, shade-houses, outdoor nurseries and landscape plantings. Utilizing Induced Systemic Resistance, Regalia CG primes the plants for self defense. Protects against foliar diseases, like *Alternaria*, *Colletotrichum*, *Botrytis*, *Cercospora*, downy mildew, *Myrothecium*, powdery mildew, rust and *Septoria*. Bacterial disease protection against *Erwinia*, *Pseudomonas* and *Xanthomonas*. Root and crown diseases include *Fusarium*, *Phytophthora*, *Pythium* and *Rhizoctonia*. **Foliar spray and drench rates:** 0.64-1.28 fl oz per gal or 64-128 fl oz per 100 gal. **OMRI listed.**

Item: 70-2841 **Size:** 1 qt.
Item: 70-2844 **Size:** 1 gal.
Item: 70-2845 **Size:** 2.5 gal.

RootShield
GranulesMOA
BM02 | REI
0**Active Ingredient: *Trichoderma harzianum* Rifai strain T-22**

Biological fungicide. Protects plants from root diseases caused by *Pythium*, *Fusarium* and *Rhizoctonia*. Apply as preventive granular incorporation into soil mix before potting or seeding. **Incorporation rates:** 1-1.5 lb per cu yd of soil. **OMRI listed.**

Item: 71-2781 **Size:** 40 lb.
Item: 71-2783 **Size:** 500 lb.
Item: 71-2785 **Size:** 1,000 lb.

RootShield Plus
GranulesMOA
BM02 | REI
0**Active Ingredient: *Trichoderma harzianum* Rifai strain T-22 & *Trichoderma virens* strain G-41**

Naturally occurring fungus that grows along with the roots to protect plants from root and crown diseases such as *Cylindrocladium*, *Fusarium*, *Phytophthora*, *Pythium* and *Rhizoctonia*. Labeled for ornamentals and many edible crops in greenhouses and nurseries. **Incorporation rates:** 1-3 lb per cu yd of soil mix. **OMRI listed.**

Item: 71-27921 **Size:** 40 lb.
Item: 71-27931 **Size:** 500 lb.
Item: 71-27941 **Size:** 1,000 lb.

RootShield WP



Active Ingredient: *Trichoderma harzianum* Rifai strain T-22

Fully compatible with injectors and drip irrigation systems. Biological fungicide for use as a soil drench on ornamentals and many edible crops. Proliferates in the root zone to protect plants from pathogens such as: *Pythium*, *Rhizoctonia* and *Fusarium*. Must be used prior to disease onset. **Drench rates:** Soil drench at 1/2-3/4 tsp per gal or 3-5 oz per 100 gal. **OMRI listed.**

- Item: 71-2789 Size: 1 lb.
- Item: 71-27901 Size: 3 lb.
- Item: 71-27903 Size: 30 lb.

RootShield Plus WP



Active Ingredient: *Trichoderma harzianum* Rifai strain T-22 & *Trichoderma virens* strain G-41

Naturally occurring fungus that grows along with the roots to protect plants from root and crown diseases such as *Cylindrocladium*, *Fusarium*, *Phytophthora*, *Pythium* and *Rhizoctonia*. Improved formulation is fully compatible with injectors and drip irrigation systems. Labeled for ornamentals and many edible crops in greenhouses and nurseries. Approved for hydroponic applications. **Drench rates:** 1/2-1 tsp per gal or 3-8 oz per 100 gal. **OMRI listed.**

- Item: 71-27951 Size: 1 lb.
- Item: 71-27961 Size: 3 lb.
- Item: 71-27971 Size: 30 lb.

Segovis



Active Ingredient: Oxathiapiprolin

Liquid formulation controls downy mildew and *Phytophthora* by spray or drench. For use on ornamental plants in greenhouses, shade houses, lathhouses, outdoor nurseries, commercial landscapes, basil transplants. Longer residual activity at higher rates. **Foliar spray rates:** 1/8 to 1/2 tsp per 3.5 gal or 0.6 to 2.4 fl oz per 100 gal. **Drench rates:** 1/8 to 1 tsp per 5 gal or 0.65 to 3.2 fl oz per 100 gal.

- Item: 71-3100 Size: 1 pt.

Segway O



Active Ingredient: Cyazofamid

Foliar spray or drench to control downy mildew (spray only), *Pythium* and *Phytophthora* on ornamentals in greenhouses, nurseries, and landscapes. Herbs, tomatoes and peppers added to the label, see label for details. **Foliar spray rates:** 3/8-5/8 tsp per 3 gal or 2.1-3.5 fl oz per 100 gal. **Drench rates:** 1/4-1 tsp per 3 gal or 1.5-6 fl oz per 100 gal depending on the disease. **Restricted use pesticide in NY & VT.**

- Item: 71-31102 Size: 16 fl oz.
- Item: 71-3113 Size: 64 fl oz.

Seido



Active Ingredient: Pyriofenone

Seido is a locally translaminar fungicide with vapor activity in a flowable suspension formulation labeled for powdery mildew. Seido will offer a unique rotational option against powdery mildew due to a new MOA for horticulture. Best used as a preventative fungicide and offers up to a 14 day residual. Excellent plant safety, for use in greenhouses, shade houses, outdoor nurseries and field grown plants. **Foliar spray rates:** 1/4-1/3 tsp per gal or 4-5 fl oz per 100 gal.

- Item: 71-1320 Size: 1 qt.

Sil-Matrix LC



Active Ingredient: Potassium Silicate

Sil-Matrix LC is an aqueous liquid concentrate. This versatile product applied as a spray for control of foliar diseases and certain insects and mites. For use on ornamentals and many edible crops including certain vegetables, berries, vines and fruit trees. Foliar diseases controlled: *Botrytis*, powdery mildew and certain turf diseases. Flower caution on label. **Foliar spray rates:** 2 tsp-1.25 fl oz per gal or 32-128 oz per 100 gal. **OMRI listed.**

- Item: 71-2939 Size: 2.5 gal.

Spirato GHN



Active Ingredient: Fludioxonil

For control of foliar, stem and root diseases in ornamentals and certain greenhouse vegetables grown as transplants or grown on to harvest. Labeled for use in interiorscapes, greenhouses, lath, shade and hoop houses, enclosed structures, nurseries and residential landscapes. Foliar diseases include *Alternaria*, *Botrytis*, Boxwood Blight, *Cercospora*, *Myrothecium* and *Rhizoctonia* web blight. Labeled as a soil drench for *Cylindrocladium*, *Fusarium*, *Rhizoctonia*, *Sclerotium* and *Thielaviopsis*. **Foliar spray rates:** 1/4-1/2 tsp per 4 gal or 1-2 fl oz per 100 gal. **Drench rates:** 1/4-1/2 tsp per 4 gal or 1-2 fl oz per 100 gal. **Restricted use pesticide in NY. Nassau and Suffolk County, NY restrictions apply. Not registered in ME.**

- Item: 71-2948 Size: 1 pt.

Stargus

MOA | REI
BM02 | 4**Active Ingredient:** *Bacillus amyloliquefaciens* strain F727

Broad-spectrum biofungicide/bactericide for control or suppression of fungal and bacterial plant diseases. Applications can be made by spray, dip or drench in ornamentals and many edible crops in greenhouses, shadehouses, field, outdoor and retail nurseries, and the landscape. Diseases controlled include: *Alternaria*, *Botrytis*, *Cercospora*, *Colletotrichum*, downy mildew, *Pythium*, *Phytophthora*, powdery mildew, *Rhizoctonia*, *Sclerotinia*, *Xanthomonas* and more. **Foliar spray rates:** 2 tsp-1.25 fl oz or 32-128 fl oz per 100 gal. **Drench rates:** 2 tsp-1.25 fl oz per gal or 32-128 fl oz per 100 gal. **OMRI listed**

Item: 71-2950 **Size:** 2.5 gal.

Stature SC

MOA | REI
40 | 12**Active Ingredient:** Dimethomorph

Locally systemic fungicide for the control of downy mildew and *Phytophthora* diseases on greenhouse and outdoor grown ornamentals. Foliar sprays control downy mildew and aerial *Phytophthora*. Some damage to blooms may occur from sprays. Drenches control *Phytophthora* root and crown rots. **Foliar spray rates:** 1/3-3/4 tsp per gal or 6.12-12.25 fl oz per 100 gal. **Drench rates:** 1/4-3/4 tsp per gal or 3.06-12.25 fl oz per 100 gal. **Not registered in ME.**

Item: 71-14652 **Size:** 25 fl oz.

Subdue Maxx

MOA | REI
4 | 48**Active Ingredient:** Mefenoxam

Systemic residual control of root and stem rot diseases caused by *Pythium* and *Phytophthora*. Applications for downy mildew must be tank mixed with a product for downy mildew from another MOA class. **Drench rate:** Soil drench at time of seeding at 0.13-0.25 fl oz per 100 gal; at time of transplanting 1/2-1 fl oz per 100 gal. A 0 hour REI can be obtained for drench applications that meet label criteria. **Foliar spray rates:** 0.15-0.3 ml per gal or 0.5-1 fl oz per 100 gal. Many vegetable and herb transplants can be treated. **CA and NY require a supplemental label.** Some states have 24C labels that allow for use on basil.

Item: 71-2979 **Size:** 1 qt.
Item: 71-2978 **Size:** 1 gal.
Item: 71-29781 **Size:** 10 gal.

SuffOil-X

Active Ingredient: Horticultural oil

Listed under Insecticides page 359

MOA | REI
UN | 4

Terraguard SC

MOA | REI
3 | 12**Active Ingredient:** Triflumizole

Foliar sprays control *Alternaria*, *Botrytis*, *Rhizoctonia* (aerial), rust and scab. Drench applications control *Cylindrocladium*, *Fusarium* and *Thielaviopsis*. Labeled for use on transplants and grown to harvest on cucumbers and tomatoes only for powdery mildew. *Do not use on impatiens plugs.* **Foliar spray and drench rates:** 1/8-1 tsp per gal or 2-16 fl oz per 100 gal. **Restricted use pesticide in NY. Nassau and Suffolk County, NY restrictions apply.**

Item: 71-30180 **Size:** 1 qt.

Terrazole L

MOA | REI
14 | 12**Active Ingredient:** Etridiazole

Controls *Pythium* and *Phytophthora* in greenhouse and nursery ornamental crops. **Drench rates** for container grown crops: 1/8-3/8 tsp per gal or 2.5-7 fl oz per 100 gal. Label contains drench volumes based on pot size and instructions for bed grown plants. **Restricted use pesticide in NY.**

Item: 71-3023 **Size:** 1 qt.

Triact 70

MOA | REI
UNE | 4**Active Ingredient:** Clarified hydrophobic extract of neem oil

Horticultural oil labeled for the control of foliar fungal diseases of ornamentals and edible crops in greenhouses, interiorscapes, landscapes and nurseries. Diseases controlled include: *Alternaria*, Anthracnose, black spot, *Botrytis*, powdery mildew, rust and scab. Triact 70 is also labeled for insect and mites (see pg. 360). **Foliar spray rates:** 4 tsp-1.28 fl oz per gal or 0.5-1 gal per 100 gal. **OMRI listed.**

Item: 70-3226 **Size:** 2.5 gal.

Triathlon BA 



MOA
BM02 | REI
4

Truban 30 WP



MOA
14 | REI
12

Active Ingredient: *Bacillus amyloliquefaciens* strain D747

Biofungicide/bactericide for use on ornamentals, vegetables and herbs, berries, stone fruits and turf for prevention of many foliar and root diseases. Foliar sprays for anthracnose, *Alternaria*, bacterial leaf spots (*Erwinia*, *Pseudomonas*, *Xanthomonas*), *Botrytis*, black spot on roses, *Cercospora*, downy mildew, *Entomosporium*, *Myrothecium*, powdery mildew, rust, and scab. Soil drench application prevents *Fusarium*, *Pythium*, *Phytophthora*, and *Rhizoctonia*. Labeled for cutting and root dip. **Foliar spray rates:** 1 tsp-2 Tbls per gal or 16-96 fl oz per 100 gal. **Drench rates:** 1 tsp-4½ tsp per gal or 16-72 fl oz per 100 gal. **OMRI listed.**

Item: 71-3040 **Size:** 1 gal.

Active Ingredient: Etridiazole

Controls *Pythium* and *Phytophthora* in ornamental and nursery crops. **Drench rates:** Bedding plants (soil 2-3" deep) ¾-1 tsp per gal or 3-6 oz per 100 gal—apply to 800 sq ft; container and bedgrown plants 3-10 oz per 100 gal—apply to 400 sq ft. Irrigate immediately with additional water to at least half the volume of the fungicidal drench. **Restricted use pesticide in NY.**

Item: 71-3065 **Size:** 2 lb.

Trinity TR



MOA
3 | REI
12

Active Ingredient: Triticonazole

Total release aerosol for greenhouse ornamentals providing broad spectrum prevention and control of diseases including *Alternaria*, *Cylindrocladium*, *Cercospora*, downy mildew, *Fusarium*, *Myrothecium*, powdery mildew and rust. Treatments can be repeated at 7-day intervals, up to 3 consecutive applications. *Do not use with open blooms.* **Rate:** 1 can per 3,000 sq ft except for *Cercospora* and *Fusarium*, 2 cans per 3,000 sq ft. **Not registered in NY.**

Item: 71-3050 **Qty:** 12/3 oz cs.

ZeroTol 2.0



MOA
NC | REI
1

Active Ingredient: Hydrogen Dioxide & Peracetic Acid

For use in greenhouses, garden centers, landscapes, nurseries, hydroponics and turf. Kills algae, bacteria, fungi and their spores on contact. Can be used to treat irrigation water for pathogen control. Labeled for use on ornamentals, herbs, vegetables, small fruits, and hard surface applications. Safe on foliage and most open blooms. Can be applied as a spray, fog or drench. Leaves no residue and has 0 REI for drench treatments if label conditions are met. **Foliar spray rates:** 0.5-1.25 fl oz per gal or 50-128 fl oz per 100 gal. **Drench rates:** 0.25-1.25 fl oz per gal or 25-128 fl oz per 100 gal. **OMRI listed.**

Item: 71-35501

Item - CA only: 71-35501-CA

Item: 71-35511

Item - CA only: 71-35511-CA

Item: 71-35521

Item - CA only: 71-35521-CA

Size: 2.5 gal.

Size: 2.5 gal.

Size: 30 gal.

Size: 30 gal.

Size: 55 gal.

Size: 55 gal.

Truban 25 EC 

MOA
14 | REI
12

Active Ingredient: Etridiazole

Controls *Pythium* and *Phytophthora* in ornamental and nursery crops. **Drench rates:** Bedding plants (soil 2-3" deep) ¼ tsp per gal or 4 fl oz per 100 gal—apply to 800 sq ft; container and bedgrown plants 4-8 fl oz per 100 gal—apply to 400 sq ft. Irrigate immediately with additional water to at least half the volume of the fungicidal drench. Do not tank mix with other products. **Restricted use pesticide in CT & NY.**

Item: 71-3070 **Size:** 1 qt.

GGSPRO TIP ZEROTOL FUNGICIDE

The active ingredients in ZeroTol 2.0; hydrogen dioxide and peracetic acid, kill algae, bacteria, and fungi on contact using their oxidation properties. This multi-use fungicide and disinfecting sanitizer is labeled for use on ornamentals, herbs, vegetables, small fruits, irrigation systems, hard surface applications, and more!



ZeroTol HC



Active Ingredient: Hydrogen Dioxide & Peracetic Acid

ZeroTol HC is a fungicide/bactericide to prevent or control plant diseases on ornamentals, vegetable, berry and fruit crops, turf and lawns. It is also labeled for many hard surfaces to control odor causing bacteria, algae, fungi, moss, mold and mildew. Packaging designed for smaller growers and hobby greenhouses. **Foliar spray rates:** 0.64-0.85 fl oz per gal. **OMRI listed.**

Item: 71-3545 **Size:** 1 gal.

BioSafe Test Strips



Test Strips for ZeroTol 2.0, SaniDate 5.0, and SaniDate 12.0. Measuring the concentration of peracetic acid or peroxyacetic acid (PAA) and hydrogen peroxide (H2O2) is the most useful way of monitoring the strength of oxidizers by BioSafe.

2024 For testing the PAA and H2O2 concentration of the final dilution for applications such as hydroponic production, the low-range test strips are most appropriate. The low range PAA test strips measure concentration ranging from 0-50ppm PAA and the H2O2 test strips measure concentrations ranging from 0-100ppm H2O2.

Item: 31ZTTL Low Range PAA Test Strips 50/vial
Item: 31ZTTK Low Range H2O2 Test Strips 100/vial

For testing higher concentrations of PAA and H2O2 such as for stock solutions, the high-range test strip options are the better choice, measuring PAA from 50-500ppm and H2O2 from 0-1000ppm.

Item: 31ZTTH High Range PAA Test Strips 100/vial
Item: 31ZTTM High Range H2O2 Test Strip 100/vial

GROWTH REGULATORS

Abide



REI 12

Active Ingredient: Ancymidol

Versatile plant growth regulator used to enhance compactness of container-grown ornamentals. Approved for use as a foliar spray or soil drench. Reference label for specific use rates by crop species.

Item: 73-1155 **Size:** 2.5 gal.

Altercel



REI 12

Active Ingredient: Chlormequat

Plant growth regulator for use on poinsettias, azaleas, geraniums, hibiscus, and other crops. Apply as foliar spray or a soil drench. Outdoor use on containerized plants only. Specific rates vary with plant species, timing and type of treatment. Read the label for specific rate information. Not labeled for edibles.

Item: 73-1165 **Size:** 1 gal.

A-Rest



REI 12

Active Ingredient: Ancymidol

Height control of container grown lilies, poinsettias, chrysanthemums, dahlias, tulips, foliage and bedding plants. Predictable response makes it a good choice for use in plug production.

Item: 73-1150 **Size:** 1 qt.
Item: 73-1151 **Size:** 2.5 gal.
Item: 73-1152 **Size:** 30 gal.

B-Nine WSG



REI 12

Active Ingredient: Daminozide

Height control of chrysanthemums, gardenias, azaleas, hydrangea, poinsettias and many bedding plants. Outdoor use on containerized plants only. **Restricted use pesticide in ME, NH, NJ, NY & VT.**

Item: 73-12512 **Size:** 1 lb.
Item: 73-12532 **Size:** 5 lb.

Bonzi



REI 12

Active Ingredient: Paclobutrazol

A powerful gibberellin inhibiting growth regulator producing predictable, consistent response for height control to produce compact growth when used at proper rates and application volumes. Labeled for certain annuals and perennial crops. Bonzi enhances plant quality and flowering. Absorbed quickly into root and stem tissue. Rainfast in 30 minutes. Conduct small-scale trials when treating new varieties or using new rates. Excellent plant safety. **Restricted use pesticide in VT. No outdoor use in NY.**

Item: 70-1260 **Size:** 1 qt.
Item: 70-1270 **Size:** 2.5 gal.

Citadel 

REI 12

Active Ingredient: Chloromequat

Plant height regulator approved for containerized annuals, bedding plants, and woody crop species. Perform small-scale trials to find optimal rates for foliar spray and substrate drench applications. Reference label for recommendations on specific species such as poinsettia, geranium, hibiscus, and azalea.

Item: 73-1280 **Size:** 1 gal.

CytoFlor



REI 12

Active Ingredient: 6-benzyladenine (6-BA)

CytoFlor promotes flowering in certain ornamental crops and increases lateral or basal branching. Additionally, applications of CytoFlor are known to reduce the overall height of specific plants resulting in more compact and marketable plants.

Item: 73-1387 **Size:** 1 qt.Collate 

REI 48

Active Ingredient: Ethephon

Collate can be used for various different purposes such as enhanced branching, bloom delay, flower induction on some specific ornamental bromeliads, reduced internode elongation, and mistletoe removal on ornamental trees and shrubs. Reference label for rates and instructions for specific uses.

Item: 73-1285 **Size:** 1 gal.

Dazide 85 WSG



REI 12

Active Ingredient: Daminozide

Height control of chrysanthemums, gardenias, azaleas, hydrangea, poinsettias and many bedding plants. Labeled for containerized grown ornamentals in commercial or research greenhouses.

Restricted use pesticide in ME, NH, NJ, NY & VT.**Item:** 73-1390 **Size:** 5 lb.Concise 

REI 12

Active Ingredient: Uniconazole

Powerful and long-lasting plant growth regulator used for controlling excessive plant stretching and promoting compactness. Rates can vary widely between ornamental species. Reference label and perform small-scale trials to find optimal foliar spray and substrate drench rates. Approved applications also include pre-plant bulb and liner soaks. **Not labeled for edible crops. No outdoor use.**

Item: 73-1300 **Size:** 1 gal.**Item:** 73-1302 **Size:** 15 gal.

Fascination



REI 4

**Active Ingredient: Benzyladenine
aka N-(phenylmethyl)-1H-purine-6-amine & GA 4 & 7**

Fascination is a combination of two types of plant growth regulators that produce unique and dramatic effects in plants. In several types of lilies lower leaf yellowing can be prevented. It will also greatly prolong the life of lily blooms. Fascination can be used in an attempt to overcome excessive applications of PGR's. It can also be used to safely add height to a number of crops including poinsettias and mums.

Item: 73-1910 **Size:** 0.5 gal.Configure 

REI 12

Active Ingredient: 6-Benzyladenine

Applied as a foliar spray to certain ornamentals in greenhouses. Effects vary by plant species and include increased branching, bud set and production of offsets. Rates vary considerably, please consult the label.

Item: 73-1306 **Size:** 0.5 gal.

Florel



REI 48

Active Ingredient: Ethephon

Florel is used to increase lateral branching and reduce internode elongation. Allow 6 weeks or more from the last treatment to the desired bloom date to allow for the delay in flower initiation that occurs. Crops responsive to treatment to increase lateral branching include garden mums, fuchsia, geraniums, verbena, vinca vine and many more. Several bulb crops are treated with Florel to reduce elongation. See the label for the various rates and application strategies.

Item: 73-16551 **Size:** 1 qt.**Item:** 73-16601 **Size:** 1 gal.**Item:** 73-16611 **Size:** 2.5 gal.**Item:** 73-1660* **Size:** 1 gal. Pistill *CA,NY,WA ONLY**Item:** 73-1661* **Size:** 2.5 gal. Pistill *CA,NY,WA ONLYCrest 

REI 4

Active Ingredient: Cytokinin, Indole-3-butyric acid & GA 3

Multi-ingredient growth promoter with various uses including enhanced seed germination and root production. Approved for use on nursery and greenhouse ornamentals.

Item: 73-1370 **Size:** 1 gal.

Fresco

fine

REI 4

Active Ingredient: 6-Benzyladenine & GA 4 & 7

Dual active ingredient plant growth regulator with several uses such as increased branching and plant height. Reference label for foliar spray rates. The label allows for drench applications.

Item: 73-1700 **Size:** 1 qt.

Paolo Pro

syngenta

REI 12

Active Ingredient: Paclobutrazol

A powerful growth regulator that provides predictable reduction in internode elongation when used at proper rates and application volumes. Labeled for certain annual and perennial crops. Absorbed quickly into root and stem tissue. Rainfast in 30 minutes. Conduct small-scale trials when making treatments to new varieties or when using new rates. **Restricted use pesticide in VT. No outdoor use in NY.**

Item: 73-1830 **Size:** 1 gal.

Pac O

ohp

REI 12

Active Ingredient: Paclobutrazol

A powerful growth regulator that provides predictable reduction in internode elongation when used at proper rates and application volumes. Labeled for certain annual and perennial crops. Absorbed quickly into root and stem tissue. Rainfast in 30 minutes. Conduct small-scale trials when making treatments to new varieties or when using new rates. **No outdoor use in NY.**

Item: 73-1845 **Size:** 1 gal.

Piccolo

fine

REI 12

Active Ingredient: Paclobutrazol

Gibberellin inhibiting growth regulator for controlling plant height. Approved for foliar spray and substrate drench applications. Conduct small-scale trials when treating new varieties or using new rates. **No outdoor use in NY. Restricted use pesticide in VT.**

Item: 73-1915 **Size:** 1 gal.

Piccolo 10XC

fine

REI 12

Active Ingredient: Paclobutrazol

Highly concentrated gibberellin inhibiting growth regulator for controlling plant height. Approved for foliar sprays and substrate drench applications. Conduct small-scale trials when treating new varieties or using new rates. **Restricted use pesticide in VT. No outdoor use in NY.**

Item: 73-1920 **Size:** 1 qt.**Item:** 73-1922 **Size:** 1 gal.

ProGibb LV Plus T & O

VALENT
Nufarm

REI 4

Active Ingredient: Gibberellic Acid GA3

Plant growth regulator used to promote stem elongation, substitution for cold treatment in certain seeds and to hasten flowering in certain plants. Use on azaleas, cala lily, chrysanthemums, cyclamen, fuchsia, geranium, hydrangea and others. Rates vary widely depending on the application. **OMRI listed.**

Item: 73-1929 **Size:** 1 qt.

Sumagic

VALENT
Nufarm

REI 12

Active Ingredient: Uniconazole

Used for height control of azaleas, bedding plants, chrysanthemums, Easter lilies, perennials and more. Plants vary in their response to powerful growth regulators, such as Sumagic. Trial according to label rates on new varieties or when using new rates. Dosage and application rates are important to achieve desired plant response. Labeled for tomato, pepper, and eggplant vegetable transplants.

No outdoor use.**Item:** 73-1951 **Size:** 1 gal.**Item:** 73-1952 **Size:** 15 gal.

Topflor

SePRO

REI 12

Active Ingredient: Flurprimidol

Topflor is a plant growth regulator that reduces internode elongation on a wide variety of annual and perennial plants. Similar in strength to Bonzi and Sumagic but it has shorter residual activity in the plants. Used as directed, Topflor does not delay flowering. Topflor tones and strengthens plants, reducing environmental and shipping stresses. Topflor can be applied as a foliar spray or drench. **Restricted use in NY.**

Item: 73-2005 **Size:** 2 ltr.**Item:** 73-2010 **Size:** 5 gal. Propak

ROOTING HORMONES AND FERTILIZER SOLUTIONS FROM CLONEX

Clonex Gel



REI 0

Active Ingredient: Indole-3-Butyric Acid

Rooting hormone in a gel form. Ready to use product is formulated for all types of cuttings, including herbaceous and woody species, ornamentals and edibles. Water-based, alcohol-free, 0.31% indole-3-butyric acid (IBA). Assorted package sizes available. **Rate:** ready to use from package. Sold in case qty. only.

Item: 81860068 **Size:** Gel 15 ml. Packet (108 per cs.)
Item: 81860067 **Size:** Gel 100 ml. (12 per cs.)
Item: 81860069 **Size:** Gel 250 ml. (12 per cs.)
Item: 81860074 **Size:** Gel Pint (6 per cs.)
Item: 81860075 **Size:** Gel Quart (1 per cs.)

CLONEX®

Clonex® Clone Fertilizer Solution

- Nutrition for plants in propagation – macros, chelated micronutrients and vitamins
- Use when roots are present to enhance growth (avoid use prior to root development)

Rates: 5-10 ml per qt (1-2 tsp per qt)

Item: 81860076 **Size/Qty:** 20 ml packet / 108 qty

REI 0

ROOTING HORMONES

Advocate

fine

REI 12

Active Ingredient: Indole-3-Butyric Acid

Rooting hormone for use during cutting propagation. Approved for use on annual, perennial, and woody plant material. Application methods include foliar sprays and basal cutting dips. Rates vary widely based on plant species.

Item: 73-1157 **Size:** 1 qt.

Dip 'N Grow

REI 24

Active Ingredient: Indole-3-Butyric Acid & 1-Naphthaleneacetic Acid

Liquid rooting agent. A liquid concentrate that is diluted with water to any desired strength. Dip 'N Grow's liquid form allows it to be absorbed more easily by cuttings and ensures that a precise amount of chemical comes in contact with the stem. Contains indole-3-butyric acid and naphthaleneacetic acid. Users should test on soft wood cuttings for compatibility. **Rate:** Use a 1/20 ratio with a 5 second dip for most herbaceous cuttings. The label contains information to aid in choosing the correct dilution.

Item: 73-1410 **Size:** 2 oz.
Item: 73-1430 **Size:** 16 oz.
Item: 73-1440 **Size:** 1 gal.

GGSPRO

HORTUS IBA WATER SOLUBLE SALTS ROOTING HORMONE

Hortus IBA Water Soluble Salts contain the rooting hormone active ingredient Indole-3-Butyric Acid more commonly referred to as "IBA". Hortus IBA can be used to help reduce rooting time on the simplest to most difficult to propagate species. One of the unique benefits of this product is its ability to be applied in a variety of ways such as a dry dip, basal quick dip, spray drip, or total cutting emersion method.

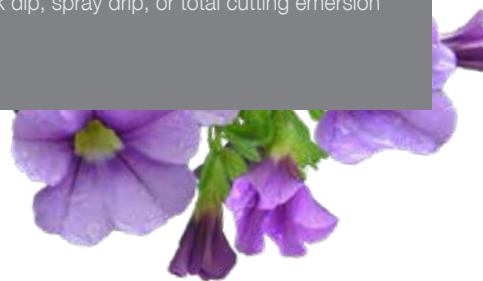

Hortus IBA Water Soluble Salts 20%

REI 0

Active Ingredient: Indole-3-Butyric Acid

Dissolve IBA salts in water to make solution for foliar or basal applications to enhance rooting. May be applied to herbaceous or woody cuttings. Rates vary and are determined by use pattern, please consult the label.

Item: 73-1903 **Size:** 100 gm.
Item: 73-1904 **Size:** ¼ kg.
Item: 73-1905 **Size:** 1 kg.

Item: 10-1000 **Description:** AW US Balance Digital Table Top Scale (0.01 X 500gram)

Item: 10-1001 **Description:** AW US-Scoop (4pcs) Measuring Cup Set

Hormodin Powder

ohp

REI 0

Active Ingredient: Indole-3-Butyric Acid

Hormone powder for rooting cuttings available in three strengths for basal application. Active ingredient is indole-3-butyric acid



- #1 (0.1% IBA) for herbaceous crops.
- #2 (0.3% IBA) for semi-woody ornamentals.
- #3 (0.8% IBA) for evergreen trees and shrubs.

Item: 73-18601 **Desc:** 1 lb Hormodin #1
Item: 73-18611 **Desc:** 1 lb Hormodin #2
Item: 73-18621 **Desc:** 0.5 lb Hormodin #3

ROOT CONTROL COATING

Spin Out 260



REI 0

For Container-Grown Plants

Active Ingredient: Copper Hydroxide

Plant growth regulator that is applied to the inner surface of a nursery container. Spin Out inhibits the root tips when they reach the container sides. As the plant continues to produce new lateral roots, Spin Out serves as a growth regulator to the new roots, thus producing a fibrous root system. Used in growing, propagation containers and trays.

Item: 73-1940 Size: 1 gal.

HERBICIDES

Herbicides come in **pre-emergent** (preventors, applied before weed seeds germinate) or **post-emergent** (eradicators, applied after weeds germinate and are actively growing). Most herbicides are not labeled for use in the greenhouse. Consult the product label for specifics. There are many different products to choose from depending on type of crops being treated, time of treatment, application method, etc. Contact your salesperson, our office, or your state extension station for recommendations.

AXXE

MOA | REI
NC | 24

Active Ingredient: Ammonium Nonanoate

Quick burn-down non-selective **post-emergence** contact herbicide labeled for use on many sites including interiorscapes, greenhouses, and landscapes. **Foliar spray rate:** 6–19 fl oz per gal. Control grasses and broadleaf weeds, mosses, liverworts, nostac algae and lichens. Does not translocate to roots. Do not apply to plants wet with dew. No surfactant needed. Label allows use around specific edible crops. **OMRI listed with restrictions** - Prior to use OMRI certification needs to be verified if applying inside the greenhouse.

Item: 72-1050 Size: 2.5 gal.

Barricade

MOA | REI
3 | 12

Active Ingredient: Prodiamine

A long lasting selective **pre-emergent** herbicide available as a 4L and a 65 WG formulation. Barricade controls grass and certain broadleaf weeds in container and field grown ornamentals, perennials and wild flower production, Christmas tree farms, conifer and hardwood seedling nurseries. One application can give season long control. Apply spring or fall. Barricade has a yellow color so you can see where you spray it, but it does not stain. **Rates** vary by length of control desired. **The 65 WG is a restricted use pesticide in NY.**

Barricade 4L

Item: 72-1574 Size: 4 fl oz.

Item: 72-1575 Size: 1 gal.

Item: 72-15751 Size: 10 gal.

Barricade 65 WG

Item: 72-1571 Size: 5 lb.

Biathlon

MOA | REI
14+3 | 24

Active Ingredient: Oxyfluorfen & Prodiamine

Granular combination **pre-emergent** herbicide for control of broadleaf weeds and certain grassy weeds in field and container ornamentals, grounds maintenance and specified non-crop areas. Use on evergreens (broadleaf and needle) is limited to Christmas tree farms and conifer farms. Provides up to 3 months control. Refer to label for a list of tolerant ornamentals. **Rates:** See label for rates by container size. **Restricted use pesticide in VT.**

Item: 72-1590 Size: 50 lb.

BroadStar

MOA | REI
14 | 12

Active Ingredient: Flumioxazin

Granular **pre-emergent** herbicide for use in certain field and container grown shrubs, trees and ground covers. Same active ingredient as SureGuard. Provides at least 8-12 weeks of control for many broadleaf weeds, grasses and liverworts. Does not inhibit crop root growth when used as directed. A supplemental label for applying Broadstar to landscapes is available except in CA and NY. **Rate:** 2.3-4.6 lb per 1,000 sq ft, 150 lb per acre. **Restricted use pesticide in NY.**

Item: 72-1088 Size: 50 lb.

Casoron 4G

MOA | REI
20 | 12

Active Ingredient: Dichlobenil

Selective **pre-emergent** herbicide for the control of certain broadleaf and grassy weeds in established woody ornamentals, nut and fruit trees, non-crop areas, and other sites. 8-16 mesh. **Rates:** 2.3-4.6 lb per 1,000 sq ft, 100-200 lb per acre.

Item: 7013150 Size: 50 lb.

Cheetah Pro

MOA | REI
10 | 12

Active Ingredient: Glufosinate Ammonium

Broad spectrum, non-selective **post-emergent** herbicide. Useful for glyphosate resistant weeds. Repeat applications may be needed for plants with underground parts or seed. Necrosis of leaves and young shoots generally begins 2-4 days after treatment. Can be used in greenhouses when no desirable vegetation is present. Can also be used for site preparation and non-crop areas. The 12 hr REI expires when the foliage is dry. Foliar spray rates vary by age and maturity of weed to be treated. **Foliar spray rates:** 0.5-2 fl oz per gal or 50 fl oz -1.5 gal per 100 gal. **Restricted use pesticide in NY. Prohibited in Nassau and Suffolk County, NY.**

Item: 72-1595 Size: 1 gal.
Item: 72-1596 Size: 2.5 gal.

Clean Slate

MOA | REI
4 | 12

Active Ingredient: Clopyralid

Selective **post-emergent** broadleaf herbicide for forest sites, forestry nurseries, non-cropland areas, certain ornamental plantings such as conifers, non-leguminous woody species, and ornamental grasses in landscapes and nurseries. **Foliar spray rates:** 0.1-0.25 fl oz per gal per 1,000 sq ft or 4-11 fl oz per 100 gal per acre.

Item: 72-1598 Size: 64 fl oz.

Envoy Plus

MOA | REI
1 | 24

Active Ingredient: Clethodim

Post-emergent herbicide for the control of annual and perennial grasses in greenhouses, nurseries and landscape plantings. Use on many broadleaf crops, including certain groundcovers, flowers, shrubs, trees and non-crop areas. Improved formulation gives better control without requiring spray additives. **Rates:** annual grasses 9-16 fl oz per acre, perennial grasses 12-32 fl oz per acre. Spot spraying 1-1½ Tbls per gal. **Restricted use pesticide in NY & VT.**

Item: 72-14451 Size: 1 gal.

Finale XL T&O

MOA | REI
10 | 12

Active Ingredient: Glufosinate Ammonium

Finale is a non-selective, **post-emergent** herbicide that is labeled for use in greenhouses while plants (except edible crops) are present. It is translocated to the root system for good control of perennial and annual weeds. Best results are obtained when weeds are actively growing. Useful for glyphosate resistant weeds. For greenhouse applications, turn off all fans, use a coarse spray and avoid all contact with desirable vegetation. Label indicates may be applied around immature and/or inedible fruit not intended for harvest outdoors. **Rates:** 1.5-4 fl oz per gal. **Restricted use pesticide in NY. Prohibited in Nassau and Suffolk County, NY. Not registered in ME.**

Item: 72-1605 Size: 2.5 gal.

FireWorxx

MOA | REI
UN | 12

Active Ingredient: Caprylic Acid & Capric Acid

Fast acting, non-selective, **post-emergent** broadleaf weed, grass, algae and moss killer. Results seen in hours to a few days. It can be used in and around edible crops, avoiding contact with desirable foliage. Can be used in greenhouses. FireWorxx can also be added at a 1% rate to improve the performance of other herbicides such as glyphosate and glufosinate. **Rates** are based on the size and woodiness of the weeds: 4-12 fl oz per gal or 3-9 gal per 100 gal. **OMRI listed.**

Item: 72-1608 Size: 1 gal.

Fortress

MOA | REI
3/21 | 12

Active Ingredient: Dithiopyr & Isoxaben

Pre-emergent granular herbicide with Verge® technology, dust free and easy to spread. Labeled for ornamentals in container and field nurseries. Broad spectrum control of broadleaf and grassy weeds including hard to control weeds such as: crabgrass, bittercress and spurge. Control lasts for 3 months or longer. **Rates:** 3.44 lb per 1,000 sq ft or 150 lb per acre. **Not registered in NY**

Item: 72-1610 Size: 50 lb.

FreeHand 1.75 G

MOA | REI
3+15 | 24

Active Ingredient: Pendimethalin & Dimethenamid-P

Pre-emergent broad-spectrum herbicide that combines a new active ingredient (dimethamid-P) with pendimethalin. Provides up to 8 weeks of preemergence control of many difficult grassy and broadleaved weeds, including yellow nutsedge. Labeled sites include commercial ornamental production nurseries (field grown, container, liners), landscapes and non-crop areas as specified on the label. FreeHand is labeled for directed or over the top applications to certain ornamental trees, shrubs, ground covers, perennials, bedding plants (outdoors only), conifer and hardwood seedling liners and Christmas tree plantings. **Rates:** 100-300 lb per acre. **Restricted use pesticide in CT & MA. Not registered in NY.**

Item: 72-16201 Size: 50 lb.

Fuerte

MOA | REI
3+14 | 12**Active Ingredient:** Flumioxazin & Prodiamine

Preemergence control of broadleaf and grassy weeds in field, container and landscape ornamentals, grounds maintenance, Christmas tree and conifer farms and non-cropland areas. Granular herbicide on the low dust Verge® particle. Do not re-apply at less than 3-month intervals. **Rate:** 100 lb per acre.

Item: 72-1625 **Size:** 50 lb.

Fusilade II

MOA | REI
1 | 4**Active Ingredient:** Fluazifop-P-butyl

Broad spectrum, selective **post-emergent** herbicide labeled for over the top use for numerous herbaceous and woody ornamentals. Fast-acting, systemic activity on annual and perennial grassy weed species. Labeled for ornamentals grown in greenhouses, nurseries, and interiorscapes. Also labeled for roadsides, parks, sports fields, golf courses, commercial and residential areas. **Rates:** 0.4-0.6 fl oz per gal or 16-24 fl oz per 100 gal.

Item: 72-1630 **Size:** 1 qt.

Gallery SC

MOA | REI
21 | 12**Active Ingredient:** Isoxaben

Pre-emergent herbicide for the control of certain broadleaf weeds in established turf, landscape ornamentals, container-grown ornamentals, nursery stock, ground covers and other sites. **Rates:** ¼-½ tsp per gal or 16-31 fl oz per acre.

Item: 72-1645 **Size:** 1 qt.

Gemini 3.7 SC

MOA | REI
3+21 | 12**Active Ingredient:** Prodiamine & Isoxaben

Selective **pre-emergent** herbicide with two active ingredients for the control of grasses and broadleaf weeds for certain established ornamentals in nurseries (container and field grown), non-crop areas, Christmas tree farms and other sites. **Spray rates:** 1¾-4 Tbls per 1,000 sq ft or 38-87 fl oz per acre.

Item: 72-1682 **Size:** 2.5 gal.

Gemini Granular

MOA | REI
3+21 | 12**Active Ingredient:** Prodiamine & Isoxaben

Granular **pre-emergent** herbicide for the control of many grassy and broadleaf weeds on selected ornamentals in container, field grown and landscape ornamentals, and Christmas trees. **Rates:** 100-200 lb per acre.

Item: 72-1685 **Size:** 50 lb.

Lontrel

MOA | REI
4 | 12**Active Ingredient:** Clopyralid

Selective **post-emergent** herbicide for the control of broadleaf weeds in turf, certain ornamental plantings in landscapes and nurseries. Rates: 0.1-0.5 fl oz per 1,000 sq ft or 4.5 to 21 fl oz per acre. **Restricted use pesticide in NY. Prohibited in Nassau and Suffolk County, NY.**

Item: 3153212 **Size:** 1 qt.

Marengo

MOA | REI
29 | 12**Active Ingredient:** Indaziflam

Pre-emergent herbicide available as a soluble concentrate for use in field-grown ornamentals, conifers' production areas, and hardscapes for control of grassy and broadleaf weeds. Labeled for shade, hoop, and gutter-connected houses for use on floors or weed mats under benches with no plant contact. Residual control for 6-8 months. Binds tightly to the soil, no odor, and does not volatilize. See the label for rates. **Rate:** 2 tsp per gal or 7.5-14.5 fl oz per acre. **Restricted Use Pesticide in NY & VT. Prohibited in Nassau and Suffolk County, NY.**

Item: 72-2809 **Size:** 18 fl oz.**Item:** 72-28130 **Size:** 64 fl oz.

Marengo G

MOA | REI
29 | 12**Active Ingredient:** Indaziflam

Pre-emergent herbicide available as a granular for use in field-grown ornamentals, containers and hardscapes for control of grassy and broadleaf weeds. Labeled for hoop houses, gutter connected greenhouses and shade houses on floors or weed mat under benches and in containers 6" or larger. Residual control for 6-8 months. Binds tightly to the soil, no odor, and does not volatilize. See the label for rates. **Rate:** 2.3 lb per 1,000 sq ft or 100 lb per acre. **Restricted use pesticide in NY. Prohibited in Nassau and Suffolk County, NY.**

Item: 72-28181 **Size:** 50 lb.

GGSPRO TIP

MARENGO HERBICIDE

This pre-emergent herbicide is available as a soluble concentrate (Marengo) or a broadcast-friendly granular (Marengo G) formulation for use around field-grown ornamentals, conifers' production areas, and hardscapes for control of grassy and broadleaf weeds. Labeled for hoop houses, gutter-connected greenhouses, and shade houses on floors or under benches. Marengo is one of the only pre-emergent herbicides approved for treating empty greenhouses along with providing up to 8 months of control.



OH2

MOA
3+14 | REI
24**Active Ingredient: Pendimethalin & Oxyfluorfen**

Ornamental Herbicide II is a **pre-emergent** granular herbicide for container and field ornamentals. Combines oxyfluorfen and pendimethalin. Broad spectrum control of both broadleaf and grassy weeds. **Rates:** 2.3 lb per 1,000 sq ft; 100 lb per acre. **Restricted use pesticide in VT.**

Item: 67-81451 **Size:** 50 lb.

Pendulum Aquacap

MOA
3 | REI
24**Active Ingredient: Pendimethalin**

Pre-emergent herbicide for control of most grasses and certain broadleaf weeds. Labeled for turf, field and certain container grown ornamentals that appear on the label. **Rates:** for Non-turf uses 1.6-3.2 fl oz per gal; 70 to 139 fl oz per acre. Consult the label for specific details. **Restricted use pesticide in VT.**

Item: 72-2825 **Size:** 2.5 gal.

Pennant Magnum
LiquidMOA
15 | REI
24**Active Ingredient: Metolachlor**

Selective **pre-emergent** control of yellow nutsedge, many annual grasses and broadleaf weeds in nursery and landscape plantings including container and field grown ornamentals, annuals, perennials, woody ornamentals and Christmas trees. Colorless application. **Rates:** 1.5 fl oz per 1,000 sq ft; 0.5 gal per acre.

Restricted use pesticide in MA, NH, NY & VT. Prohibited in Nassau and Suffolk County, NY.

Item: 72-1565 **Size:** 1 gal.

Princep Liquid

MOA
5 | REI
12**Active Ingredient: Simazine**

Pre-emergent for the control of many broadleaf and grass weeds in certain agricultural crops as well as specified non-crop areas. Princep Liquid enters weeds primarily through the roots so moisture is needed to move it into the root zone. **Rates:** 32-153.6 fl oz per acre. Consult the label for specific rates. **Restricted use pesticide in MA, NH & NY. Prohibited in Nassau and Suffolk County, NY.**

Item: 70719025 **Size:** 2.5 gal.

Prosedge 2

MOA
2 | REI
12**Active Ingredient: Halosulfuron-Methyl**

Prosedge contains 75% halosulfuron-methyl in a fast acting, selective **post-emergent**, herbicide for control of nutsedge in various turf sites and landscape woody ornamental plantings. Prosedge also suppresses *Kyllinga spp.* Absorbed into leaf tissue within 24 to 48 hours, and translocated through the vascular system. **Rates:** measuring scoop provided equivalent to 0.03 oz (0.9 gm) per 1-2 gal per 1,000 sq ft; 2/3 - 1 1/2 oz per acre.

Item: 72-28643 **Size:** 10/1.33 oz. cs.

Ranger PRO

MOA
9 | REI
4**Active Ingredient: Glyphosate**

Liquid formulation containing 41% glyphosate salts. Broad spectrum **post-emergent**, systemic herbicide that controls most emerged weeds, including tough to kill perennials. Best results are achieved with applications to actively growing weeds. **Rates:** 0.6-13 fl oz per gal or 16-160 fl oz per acre.

Item: 72-2885 **Size:** 2.5 gal.

Item: 72-2890 **Size:** 30 gal.

Reward

MOA | REI
22 | 24**Active Ingredient: Diquat**

Landscape and aquatic herbicide for fast non-selective **post-emergent** control of broadleaf and grassy weeds in industrial, recreational, commercial, and public areas. Rates vary widely, consult label for details. Can be used in greenhouses when no desirable vegetation is present. **Not labeled in NY except for aquatic use. Restricted use pesticide in CT, NH, NJ & VT.**

Item: 70741004 **Size:** 1 gal.
Item: 72-2866 **Size:** 2.5 gal.

Roundup Quik Pro Dry

MOA | REI
9+22 | 4**Active Ingredient: Glyphosate & Diquat**

Roundup herbicide in water-soluble, dust free, dry formulation. A non-selective **post-emergent** herbicide formulated with diquat for a 24-hour knockdown of weeds. Rainfast in one hour. Turns to solution in minutes and won't settle out. Easy to handle, 1/2 the weight of liquids. No surfactant needed. **Rates:** 0.8-1.5 oz per gal or 5-10 lb per 100 gal. **Restricted use pesticide in NH.**

Item: 72-2879 **Size:** 5-1.5 oz Roundup Quik Pro Dry Paks
Item: 72-2876 **Size:** 6.8 lb Roundup Quik Pro Dry

Roundup Pro Concentrate

MOA | REI
9 | 4**Active Ingredient: Glyphosate**

A non-selective **post-emergent herbicide**, more concentrated version of Roundup Pro. The higher concentration of active ingredient makes this formulation more economical to use. Can be used in greenhouses when no desirable vegetation is present. **Rates:** 0.5-10.5 fl oz per gal or 38.4-128 fl oz per acre.

Item: 72-2869 **Size:** 2.5 gal.

Scythe

MOA | REI
27 | 12**Active Ingredient: Pelargonic Acid**

A naturally occurring fatty acid for use as a non-selective **post-emergent**, burn-down, top-killing herbicide. Scythe has no soil activity, and its non-systemic action making it the ideal choice for trimming and edging, spot weeding, and renovations. **Rate:** 4-13 fl oz per gal or 3-10 gal per 100 gal.

Item: 75-10512 **Size:** 2.5 gal.

Snapshot 2.5 TG

MOA | REI
3+21 | 12**Active Ingredient: Trifluralin & Isoxaben**

Selective **pre-emergent** herbicide for the control of certain broadleaf weeds and annual grasses in landscape and container grown ornamentals, ground covers, Christmas tree plantations and other sites. **Rates:** 2.3-4.6 lb per 1,000 sq ft; 100-200 lb per acre. **Not Registered in NY.**

Item: 72-2972 **Size:** 50 lb.

SureGuard SC

MOA | REI
14 | 12**Active Ingredient: Flumioxazin**

Pre and early post-emergent herbicide for use in certain field and container grown ornamentals, conifers and deciduous trees. Read label carefully before using on containers. Can be used in empty greenhouses with specific instructions per label. Same active ingredient as BroadStar, but in a sprayable formulation. Provides excellent, long term control of many broadleaf weeds and grasses as well as liverworts. **Rate:** 1 3/4-3 tsp per gal; 8-12 fl oz per acre. **Restricted use pesticide in NY.**

Item: 72-8218 **Size:** 1 pt.
Item: 72-8220 **Size:** 64 fl oz.

GGSPRO TIP

SUREGUARD XTRA HERBICIDE

SureGuard® Xtra is a new pre-emergent and early post-emergent herbicide option for various field-and container-grown nursery crops, landscape beds, and non-crop areas. SureGuard Xtra offers long-lasting residual control of up to 8 months for many grassy and broadleaf weeds. This dual mode of action herbicide (MOA 14/15) aids in resistance management, provides growers with the simplicity of a single label rate, and the flexibility to apply during the spring, summer, and fall to combat a wide variety of problematic weeds.



SureGuard Xtra



MOA 14+15 | REI 12

Active Ingredient: Flumioxazin & Pyroxasulfone

A dual mode of action pre and early post-emergent herbicide ideal for outdoor production nurseries, landscape beds, residential and commercial properties, golf courses, schools, and more.

Provides long residual up to 8 months control of numerous grass and broadleaf weeds. **Rate:** 1.4 tsp per gal or 20 fl oz per acre.

Restricted use pesticide in NY.

Item: 72-8222 **Size:** 1 gal.

Tenacity



MOA 27 | REI 12

Active Ingredient: Mesotrione

Systemic **pre-emergent** and **post-emergent** herbicide with contact and residual control of weeds in turf grass. Site use includes residential lawns, commercial sites, non-crop areas, golf courses and other locations. Do not plant any crop other than turfgrass for 18 months after last application. Rates vary, consult label.

Item: 72-3048 **Size:** 8 oz.

Treflan 5G HDG



MOA 3 | REI 12

Active Ingredient: Trifluralin

Pre-emergent herbicide for control of certain annual grasses and broadleaf weeds in container grown ornamentals, landscape ornamentals, nursery stock, ground covers and other sites. **Rate:** 1.8 lb per 1,000 sq ft or 80 lb per acre.

Item: 72-3095 **Size:** 40 lb.

INSECTICIDES

Acelepryn



MOA 28 | REI 4

Active Ingredient: Chlorantraniliprole

Long residual insecticide for use on ornamentals in greenhouses, interior landscapes and nurseries, (field grown and container), by foliar spray, bark treatment or soil drench depending on the crop. Foliar sprays control beetles and caterpillars. Drench applications control: aphids, birch leafminer, lacebugs, woolly adelgid and more.

Foliar spray rates: 1/8-1 tsp per gal or 2-16 fl oz per 100 gal.

Drench rates based on stem diameter (trees) or height (shrubs). 0 hr REI for drenches if label requirements are met. **Prohibited in Kings, Queens, Nassau & Suffolk County, NY. Restricted use pesticide in VT.**

Item: 70-1074 **Size:** 4 fl oz.

Item: 70-1080 **Size:** 0.5 gal.

Acephate 97UP



MOA 1B | REI 24

Active Ingredient: Acephate

Broad-spectrum, translaminar systemic insecticide/miticide for use on certain tree, shrub, floral and foliage crops. Labeled sites include greenhouses, nurseries and landscapes. **Foliar spray rates:** 1/3-1 1/3 tsp per gal or 0.25-1 lb per 100 gal. **Restricted use pesticide in NY.**

Item: 70-1105 **Size:** 1 lb.

Adept



MOA 15 | REI 12

Active Ingredient: Diflubenzuron

Insect growth regulator. Effective control for greenhouse fungus gnat and shorefly larvae. Applied as a soil drench or as a coarse spray to the soil surface. Provides control for up to 30 days. 1 lb pouch contains 16 1-oz water soluble bags. **Drench rate:** 1 oz per 200 gal water. Drench volume determined by pot size, chart is included on the label. *Not for use on poinsettias, hibiscus or reiger begonias.*

Not registered in ME and VT.

Item: 70-1150 **Size:** 1 lb. (16 - 1 oz)

Advion Fire Ant Bait



MOA 22A | REI 4

Active Ingredient: Indoxacarb

Bait for the control of imported fire ants, bigheaded ants, pavement ants, and turfgrass ants. Approved treatment sites include: commercial nursery production of field grown and container ornamentals, non-bearing fruit and nut trees and turf grass sod on sod farms. **Application rates:** 1.5 lb per acre or individual mound treatments of 4 level Tbls per mound. Individual Mound Treatment require uniform distribution of the product 3-4 feet around the mound. Do not disturb the mound and do not apply to tops of mound. Up to 4 applications of Advion Fire Ant Bait may be applied per year, generally at 12-16 week intervals.

Item: 70-1151 **Size:** 25 lb.

Altus



MOA 4D | REI 4

Active Ingredient: Flupyradifurone

Altus is a soluble concentrate (SC) formulation of a broad spectrum insecticide. It is labeled as a translaminar foliar spray or drench for use in greenhouses, field and container nurseries, shadehouses, interiorscapes and landscapes. Labeled pests include: aphids, leafhoppers, mealybugs, plant bugs and whiteflies. Suppression of soft scale and western flower thrips can also be expected. Altus can be applied to ornamentals and many vegetable transplants. In addition, cucumbers, lettuce, peppers and tomatoes can be treated when grown to harvest. **Foliar spray rates:** 1/2-3/4 tsp per gal or 7-14 fl oz per 100 gal. **Drench rates:** 1/6-1/4 tsp per gal or 2.8-3.7 fl oz per 100 gal. 12 REI in CA. **Restricted use pesticide in MA & NY. Prohibited in Nassau and Suffolk County, NY.**

Item: 70-1161 **Size:** 64 fl oz.

Akari 5SC



Active Ingredient: Fenpyroximate

Miticide with 21 to 28 days of residual contact control. The label allows for use on greenhouse ornamentals as well as interiorscapes. Labeled for broad mites, cyclamen mites, spider mites, psyllids and whitefly. Mite feeding stops within a day and control can be evaluated 4 to 7 days after treatment. No visible residue. **Foliar spray rates:** 1-1½ tsp per gal or 16-24 fl oz per 100 gal. Greenhouse grown tomatoes, peppers and cucumbers: 1-2 tsp per gal or 16-32 fl oz per 100 gal.

Item: 70-1160 **Size:** 1 qt.

Aria WDG



Active Ingredient: Flonicamid

Translaminar systemic insecticide that controls pests by contact and ingestion. Controls aphids and mealybugs and suppresses thrips and whiteflies in greenhouses and interiorscapes. Feeding stops quickly, death follows in days. Re-apply in 7-28, days as needed. Rates vary, see label. **Restricted use pesticide in CO, NJ, NV & NY.**

Item: 70-3399 **Size:** 160 gm.

Attain TR



Active Ingredient: Bifenthrin

Micro Total Release. ULV greenhouse aerosol formulation containing bifenthrin (Talstar). The label includes aphids, whiteflies, fungus gnats and mites. Safe on blooms and bracts. **Rate:** 1 can per 3,000 sq ft. **Restricted use pesticide in CT & VT.**

Item: 70-2753 **Qty:** 12-2 oz.

Avalon Golf & Nursery Insecticide



Active Ingredient: Bifenthrin

Quick acting broad-spectrum insecticide and miticide. Labeled for greenhouses, shade houses, nursery and golf courses. Excellent plant safety with very little visible residue. **Foliar spray rates:** ¼ -1 ½ tsp per gal or 5-20 fl oz per 100 gal. **Drench rates:** varies by pest, consult label. **Restricted use pesticide. Nassau and Suffolk County, NY restrictions apply.**

Item: 70-1210 **Size:** 1 gal.

Avid 0.15 EC



Active Ingredient: Abamectin

Miticide/insecticide for the control of spider mites, broad mites, cyclamen mites, thrips and leafminers in shadehouses, greenhouses, field grown ornamentals, including Christmas trees and woody ornamentals. **Foliar spray rates:** 1/2 tsp per gal or 8 fl oz per 100 gal.

Item: 70-1180 **Size:** 8 fl oz.

Item: 70-1185 **Size:** 1 qt.

Item: 70-11851 **Size:** 1 gal.

Multipacks:

Item: 70-AMM **Description:** Avid/Mainspring GNL Multipak (1)-1 gal. of Avid 0.15 EC miticide/insecticide & (4) – 1 pt. Mainspring GNL insecticide

Aza-Direct



Active Ingredient: Azadirachtin

A botanical (neem) insect growth regulator. Tank mix with other insecticides to increase control of a wide range of pests because of its ability to keep larval, pupal, and nymph stages from developing further. Labeled for ornamentals, vegetables, fruit trees, and herbs. Approved for use in greenhouses, nurseries, or outdoor field production. **Foliar spray rates:** 1 1/8-1 1/3 tsp per gal or 18-21 fl oz per 100 gal. **OMRI listed.**

Item: 70-1222 **Size:** 2.5 gal.

AzaGuard EC



Active Ingredient: Azadirachtin

A botanical (neem) insect growth regulator and nematicide. Targets larval, pupal and nymph stages of many insects such as leafhoppers, mealybugs, soft scale, thrips, and whitefly. Labeled for use on ornamentals and many edible crops in greenhouse, hydroponics, interiorscapes and field crops. May damage certain open blooms. **Foliar spray rates:** ¾ -1 tsp per gal or 10-16 fl oz per 100 gal; maximum of 21 fl oz per 100 gal. **Drench rates:** 1¼ - 2 ¼ tsp or 8-16 oz per 100 gal. **OMRI listed.**

Item: 70-1224 **Size:** 1 qt.

Item: 70-1225 **Size:** 1 gal.

Item: 70-1226 **Size:** 2.5 gal.

Azatin O



Active Ingredient: Azadirachtin

Botanical (neem) insect growth regulator with 4.5% active ingredient. Halts the growth process of instar and pupal stages of labeled insects. Controls whiteflies, thrips, mealybugs, leafminer, fungus gnats, soft scale, and more. Herbs and vegetables on the label. **Foliar spray rates:** 2/3 tsp per gal or 10.66 fl oz per 100 gal. **Drench rate:** ½-1 tsp per gal or 8-16 fl oz per 100 gal. **OMRI listed.**

Item: 70-12301 **Size:** 1 qt.

Azera Pro



Active Ingredient: Azadirachtin, Pyrethrins

Azera Pro is a combination of an IGR with natural pyrethrins that provides a quick knockdown through contact and ingestion of many insect and mite pests. It is labeled for ornamentals and a wide range of edible crops in commercial greenhouse use only.

Foliar spray rates: 0.5-1.0 fl oz per gal or 53-107 fl oz per 100 gal. Minimum re-application interval is 5 days. **OMRI listed.**

No outdoor use.

Item: 70-1233 **Qty:** 1 gal.

Beethoven TR



Active Ingredient: Etoxazole

A total release aerosol formulation for ornamentals to control the egg and nymphal stages of mites, including two-spotted spider mites, and suppression of whiteflies. Bloom safety has been good, but not all varieties have been tested. Treatments can be repeated at 7-10 day intervals, if needed. **Rate:** 1 can per 1,500-3,000 sq ft.

Item: 70-1234 **Qty:** 12-2 oz.

Benefit 60 WP



Active Ingredient: Imidacloprid

Insect control on ornamental and certain vegetable transplants in nurseries, greenhouses and interiorscapes. Applications can be made by foliar spray or soil drenches. Controls: aphids, caterpillars, mealybugs, leafminers and other insects. **Foliar spray rates:** One 20-gram packet per 100 gal. See label for soil treatments.

Restricted use pesticide in CO, CT, MA, MD, ME, NJ, NV, NY & VT.

Item: 70-1186 **Size:** 5 x 20 gram packets

BioCeres WP



Active Ingredient: *Beauveria bassiana* strain ANT-03

Naturally occurring bioinsecticide as a wettable powder. Foliar sprays control or suppress: aphids, thrips, whiteflies, plant bugs, beetles and weevils. Labeled for use on ornamental flowers, trees, shrubs and certain herbs, vegetables, berries and fruits in greenhouses and fields. Spray thoroughly but not to runoff, repeat at 5-7 day intervals. Do not apply fungicides within 4 days of applying Bioceres. **Foliar spray rates:** 1 tsp-1 Tbls per gal or 1-3 lb per 100 gal. **OMRI listed.**

Item: 70-1245 **Size:** 1 lb.

Item: 70-1245-CA **Size:** 1 lb.

(Minimum order is case of 12; 6 month shelf life; 18 month if refrigerated)



GGSPRO TIP
BOTANIGARD
INSECTICIDE

BotaniGard utilizes the natural fungus *Beauveria bassiana* to combat a wide range of insects including aphids, thrips, and whiteflies when used as a foliar spray. BotaniGard comes as a wettable powder (WP) or emulsifiable suspension (ES) formulation as well as a combination product containing pyrethrins (Maxx). Pairing BotaniGard with an azadirachtin-based insect growth regulator (IGR) such as Azatin O, Aza-Direct, AzaGuard, or Molt-X will aid in product efficacy.

BotaniGard
22WP



Active Ingredient: *Beauveria bassiana* strain GHA

Wettable powder insecticide. Naturally occurring fungus for use in controlling aphids, thrips and whiteflies on ornamentals, herbs and vegetable crops in greenhouses and outdoor production. Greater compatibility with biological control agents than the ES formulation. No injector use. **Foliar spray rates:** 1-4 tsp per gal; 0.5-2 lb per 100 gal. **Drench rate for soil-dwelling pests:** 1-4 oz per 1000 sq ft. Safe for tomatoes.

Item: 70-12521 **Size:** 1 lb.

BotaniGard
ES



Active Ingredient: *Beauveria bassiana* strain GHA

Emulsifiable suspension mycoinsecticide. A naturally occurring fungus for use in controlling whitefly, aphids and thrips on greenhouse crops, ornamentals, herbs and vegetables. For indoor/outdoor nursery, greenhouse and landscape use. **Foliar spray rates:** 2-4 tsp per gal or 32-64 fl oz per 100 gal. May damage tomatoes.

Item: 70-12501 **Size:** 1 qt.

Item: 70-12511 **Size:** 1 gal.

BotaniGard
Maxx



MOA | REI
3A+UNF | 12

Active Ingredient: Pyrethrins & *Beauveria bassiana* Strain GHA

Natural pyrethrum combined with a naturally occurring fungus. Foliar sprays control: aphids, thrips, whitefly, mealybugs, leafhoppers, plants bugs and many more. Labeled for ornamentals, herbs, vegetables, fruits and nuts in greenhouses, shade houses, nursery, field, landscape, turf and interiorscapes. Use caution on open blooms and *do not apply to poinsettias after bract formulation*. Check compatibility with fungicides prior to tank mix.

Foliar spray rates: ½-2 tsp per gal water; 8-32 fl oz per 100 gal (higher rates on vegetables outside).

Item: 70-1253 **Size:** 1 qt.
Item: 70-1254 **Size:** 1 gal.
Item: 70-1255 **Size:** 2.5 gal.

BT NOW



MOA | REI
11A | 4

Active Ingredient: *Bacillus thuringiensis* ssp. *kurstaki* strain EVB-113-19

BT NOW is toxic to many species of Lepidopteran larvae when applied as a foliar spray. It is labeled for use on ornamentals and edible crops in greenhouses, nurseries and agricultural sites. BT NOW must be ingested by susceptible larvae to be effective. Thorough coverage of target foliage where larvae are feeding is essential. **Foliar spray rates:** ½-3 ½ tsp per gal or 8-56 fl oz per 100 gal. **OMRI listed.**

Item: 70-1290 **Size:** 1 gal.
Item: 70-1290-CA **Size:** 1 gal.

Bug-N-Sluggo



MOA | REI
UN+5 | 4

Active Ingredient: Iron Phosphate & Spinosad

Small bait pellets for the control of ants, earwigs, crickets, cutworms, slugs, snails, sowbugs and pillbugs. Scatter pellets around the perimeter of the field or greenhouse vegetable plantings. Fruit trees, small fruits and ornamentals can also be treated. **Rates:** 0.5-1 lb per 1,000 sq ft for most applications. **OMRI listed.**

Item: 70-1295 **Size:** 50 lb.

Captiva Prime



MOA | REI
UN | 4

Active Ingredient: Capsicum Oleoresin Extract, Garlic Oil, & Canola Oil

Natural plant-based bioinsecticide, miticide, and insect repellent in an emulsifiable concentrate formulation. Tank mix with other insecticides and miticides to increase control of a wide range of pests because of its irritant effect. It is recommended to perform small-scale trials before applying to entire crop areas to identify any phytotoxicity issues. Labeled for a wide range of ornamentals and edibles grown in greenhouses, nurseries, or outdoors. **Foliar spray rates:** ½-1 tsp per gal or 8-16 fl oz per 100 gal. **OMRI listed.**

Item: 70-1307 **Size:** 1 qt.

Citation WSP



MOA | REI
17 | 12

Active Ingredient: Cyromazine

Insect growth regulator for the control of fungus gnat larvae, and dipterous leafminers in interiorscapes, landscape ornamentals, container-grown ornamentals, lath and shade house grown ornamental bedding plants. Also labeled for shoreflies in greenhouse and interiorscapes. Labeled for certain vegetable transplants. **Drench rate:** 1/2 tsp per gal or one 2.66 oz pouch per 100 gal.

Item: 70-13501 **Qty:** 6 - 2.66 oz.

Conserve SC



MOA | REI
5 | 4

Active Ingredient: Spinosad

Conserve insecticide is labeled for control of cutworms, eastern tent caterpillar, gypsy moth larvae as well as thrips, leafminers, leaf rollers and others. **Foliar spray rates:** ⅓-1¼ tsp per gal or 6-22 fl oz per 100 gal water. Many outdoor edible crops on the label.

Item: 70-1365 **Size:** 1 qt.

CoreTect



MOA | REI
4A | 12

Active Ingredient: Imidacloprid & 12-9-4

CoreTect Tree and Shrub tablet insecticide will control insects in containerized, newly-planted, and established trees and shrubs. Approved sites are landscapes, forested areas and interiorscapes. Control can last 1-2 years. Pests controlled include: Aphids, adelgids (such as hemlock woolly adelgid), leaf feeding bugs and beetles, leafhoppers, leafminers, mealybugs, psyllids and certain scale insects. Rates are based on container size and can be found on the label. **Restricted use pesticide in CO, CT, MA, MD, ME, NJ, NV, NY & VT.**

Item: 70-1380 **Qty:** 250 tablets/bottle

Deadline Mini-Pellets



MOA | REI
1A | 12

Active Ingredient: Metaldehyde

Snail and slug bait mini pellets. Use around ornamentals in field, or greenhouses, or orchards, and outdoor vegetables. Resistant to rain and irrigation. **Rates:** 3.6-7.2 oz per 1,000 sq ft; 10-25 lb per acre. **Restricted use pesticide in NY.**

Item: 70-14301 **Size:** 10 lb.

Decathlon 20 WP

MOA
3A | REI
12**Active Ingredient:** Cyfluthrin

Fast acting broad spectrum insecticide for the control of beetles, caterpillars and more on ornamentals. Excellent plant safety. **Foliar spray rates:** ¼ tsp per gal or 7 Tbls per 100 gal. **Restricted use pesticide in CT, NY & VT.**

Item: 70-14202 **Size:** 8 oz.

DiPel Pro DF



Nufarm

MOA
11A | REI
4**Active Ingredient:** *Bacillus thuringiensis kurstaki* ABTS-351

Bacillus thuringiensis for the control of many caterpillars. DiPel works by ingestion, so thorough coverage of foliage is important. **Foliar spray rates:** ½-4 tsp per gal or 0.25-2 lb per 100 gal. Repeat application in 3-14 days to maintain control. **OMRI listed.**

Item: 70-1450 **Size:** 1 lb.

Discus L

MOA
3A+4A | REI
12**Active Ingredient:** Cyfluthrin & Imidacloprid

Nursery insecticide that contains the active ingredients from Marathon and Decathlon. May be applied as a foliar spray or a drench. Translaminar activity with a 2-4 week residual when applied as a foliar spray. Many pests are on the label including aphids, caterpillars, grasshoppers, Japanese beetles, lace bugs, leafminers, mealybugs, scale (crawlers), spittlebugs, whiteflies and others. Labeled for use in greenhouses and outdoor nurseries. Labeled for aphids on vegetable transplants when applied as a drench only. **Foliar spray rates:** 0.25 fl oz per gal or 25 fl oz per 100 gal. **Drench rates** per label. **Restricted use pesticide in CO, CT, MA, MD, NJ, NV, NY & VT.**

Item: 70-14091 **Size:** 1 gal.

Distance IGR



Nufarm

MOA
7C | REI
12**Active Ingredient:** Pyriproxyfen

Insect growth regulator for use in greenhouse, outdoor ornamentals and interiorscapes. Controls whitefly, fungus gnat and shorefly larvae (soil surface spray or drench), scale, and others. **Foliar spray rates:** ⅓-⅔ tsp per gal or 6-12 fl oz per 100 gal. *Do not use on salvia, fern, schefflera, heuchera or gardenia.* **Drench rates** and special instructions for poinsettias are on the label.

Item: 70-1465 **Size:** 1 qt.

Ecotec Plus

BRANDT

MOA
NC | REI
0**Active Ingredient:** Rosemary Oil, Geranio & Peppermint Oil

Broad spectrum 25b contact insecticide/miticide provides quick kill and control of all life stages of certain pests. Foliar sprays control: aphids, thrips, whiteflies, mites, cabbage loopers, armyworms and other pests. Labeled for use on indoor/outdoor ornamentals and edibles in greenhouses, nurseries, interiorscapes and residential use. **Foliar spray rates:** 1-4 tsp per gal or 16-64 fl oz per 100 gal. **OMRI listed.**

Item: 70-1507 **Size:** 2.5 gal.

Endeavor WP

syngenta

MOA
9B | REI
12**Active Ingredient:** Pymetrozine

A unique mode of action controls aphids and whiteflies by interfering with their ability to feed. Applied as a foliar spray, insect death occurs in 2-4 days through translaminar systemic activity. Foliar sprays can be used on ornamentals or vegetable transplants for re-sale. Soil drenches can be used on ornamentals only to provide 5 weeks or more of control. **Foliar spray rates:** 1 Tbls per 5 gal or 5.0 oz per 100 gal. **Drench rates:** 5 oz per 100 gal. **In CA- for ornamentals only.**

Item: 70-1655 **Size:** 15 oz.

Engulf GHN

Nufarm

MOA
20D | REI
12**Active Ingredient:** Bifenazate

Flowable suspension miticide that controls 18 species of spider mite adults including eggs. Not systemic, thorough application necessary. Labeled for ornamentals, interiorscapes, landscapes, nurseries and more. High pH water may reduce effectiveness. Do not use more than two times per year. Labeled for greenhouse grown tomatoes. **Foliar spray rates:** 1/8-1/4 tsp per gal or 2-4 fl oz per 100 gal.

Item: 70-1515 **Size:** 1 pt.

Enstar AQ

Wellmark
diba Central Life SciencesMOA
7A | REI
4**Active Ingredient:** Kinoprene

Insect growth regulator for control of root mealybugs, soft and armored scale, whitefly, aphid, thrips and fungus gnat larvae. Root mealybugs are controlled by submersing the pot, fungus gnat larvae are controlled by a soil surface spray that is followed by a drench, all others pests are controlled by foliar sprays. Recommended for use on ornamentals in greenhouses, shade houses and interiorscapes. **Foliar spray rates:** 1-2 tsp per gal or 16-32 fl oz per 100 gal.

Item: 70-1520 **Size:** 1 qt.

Entrust
SCMOA
5 | REI
4**Active Ingredient:** Spinosad

Labeled for control of foliage feeding Lepidopterous larvae (worms or caterpillars), Colorado potato beetles, leafminers, thrips (suppression only) on ornamentals in greenhouses and nurseries as well as many edible crops in fields and greenhouses. Labeled for certain pests in aquatic production. **Foliar spray rates:** 1/8-1¼ tsp per gal or 3-22 fl oz per 100 gal. **OMRI listed.**

Item: 70-1538 **Size:** 1 qt.

EpiShield



BioWorks

MOA
NC | REI
4**Active Ingredient:** Peppermint Oil, Clove Oil, & Sodium Lauryl Sulfate

Essential oil-based 25b insecticide and miticide approved for ornamentals, edibles, herbs, and hemp. Applied as a foliar spray and plant cutting dip. Provides contact paralysis, suffocation, and desiccation to control aphids and mites. Exempt from REI and PHI restrictions. **Foliar spray rates:** 1/2-3/4 tsp per gal or 9-12 fl oz per 100 gal.

Item: 70-1545 **Size:** 36 oz.

Flagship 25WG

MOA
4A | REI
12**Active Ingredient:** Thiamethoxam

Flagship offers contact, translaminar systemic and systemic control of many greenhouse and nursery pests, including aphids, leafhoppers, mealybugs, whiteflies and others. Flagship sprays are rapidly absorbed into the leaf tissue yielding 2 to 4 weeks residual control. Drench applications can provide systemic control for 6-8 weeks. Certain vegetable transplants are on the label. Consult label for spray rates that vary by pest and crop. **Foliar spray rates and drench rates:** ½-1 tsp per gal or 4-8.5 oz per 100 gal. Drench volumes found on the label. **Restricted use pesticide in CO, CT, MA, MD, ME, NJ, NV, NY & VT. Prohibited in Nassau and Suffolk County, NY. NY use limited to Christmas trees and greenhouses.**

Item: 70-17002 **Size:** 2 lb.

Floramite SC

MOA
20D | REI
12**Active Ingredient:** Bifenazate

Soluble concentrate miticide that controls 8 species of mites, including all life stages of spider mites. Labeled for greenhouses, interiorscapes, landscapes, nurseries and more. High pH water reduces effectiveness. Excellent plant safety. Labeled for tomatoes that are 1" or larger at maturity. **Foliar spray rates:** ¼-½ tsp per gal or 4-8 fl oz per 100 gal.

Item: 70-16531 **Size:** 1 qt.

Fulcrum

MOA
7C | REI
12**Active Ingredient:** Pyriproxyfen

Insect growth regulator for use in greenhouses, outdoor ornamentals, and interiorscapes. Controls whitefly pupae, fungus gnat and shore fly larvae (soil surface spray or drench), scale, and others. *Do not use on salvia, fern, schefflera, heuchera, or gardenias.* See label for special instructions on poinsettias. **Foliar spray rates:** ⅓-⅔ tsp per gal or 6-12 fl oz per 100 gal. **Drench rate:** 2 fl oz per 100 gal, drench volumes per the label.

Item: 70-1710 **Size:** 1 qt.

Gnatrol WDG



Nufarm

MOA
11A | REI
4**Active Ingredient:** *Bacillus thuringiensis israelensis*

Gnatrol WDG is a biological larvacide, applied as a drench for fungus gnat larvae in greenhouses, interiorscapes and nurseries. It is labeled for ornamental and vegetable crops as well as breeding areas on greenhouse floors. **Drench rates:** preventative to moderate infestations, apply 3.2-6.4 oz per 100 gal. For heavier infestations apply 13-26 oz per 100 gal. Apply 3 times at weekly intervals. **OMRI listed.**

Item: 70-1716 **Size:** 16 lb.

Grandevo CG

MOA
UNB | REI
4**Active Ingredient:** *Chromobacterium subtsugae* Strain PRAA4-1T

Biological insecticide/miticide for use on ornamental plants and turf against caterpillars, aphids, mealybugs, thrips, whiteflies and mites on ornamentals and edibles in greenhouses and nurseries. Product needs to be ingested to be effective. **Rates:** 2.5 tsp-2.5 Tbls per gal or 1-3 lb per 100 gal. **OMRI listed.**

Item: 70-1751 **Size:** 1 lb.**Item:** 70-1754 **Size:** 4 lb.**Item:** 70-1756 **Size:** 10 lb.

GGSPRO TIP

KONTOS INSECTICIDE
& MITICIDE

Being a MOA 23, Kontos provides broad-spectrum control over insect and mite species. In fact, it is the only miticide available on the market that can be applied as a substrate drench with several weeks of residual activity. Be sure to check the Kontos label for specific plant tolerance considerations before integrating this valuable product across your entire crop protection program.



Hachi-Hachi SC



MOA 21A | REI 12

Active Ingredient: Tolfenpyrad

Improved formulation of this contact, broad spectrum insecticide controls thrips, aphids, flea beetles, mealybugs, scale, leafhoppers and early instar caterpillars. Suppresses whiteflies and powdery mildew. Labeled for indoor and outdoor ornamental crops, including cut flowers. See label for cut flower rates. Labeled for greenhouse grown cucumber and tomato. *Label cautions against use on salvia, impatiens, gypsophila, N.G. impatiens and poinsettia bracts. Consult label for more information.* **Foliar spray rates:** 1½-2 tsp per gal or 21-32 fl oz. per 100 gal. **Not registered in NY.**

Item: 70-1795 **Size:** 0.5 gal.

LalGuard M52 OD



MOA UNF | REI 4

Active Ingredient: Metarhizium brunneum Strain F52

An effective and versatile bioinsecticide for foliar and soil pest management in edible and ornamental crops. Composed of fungal spores, this microbial based pesticide provides pest control efficacy with minimum impact to applicators, non-targets, and the surrounding environment. Foliar applications controls whiteflies, thrips, mites and aphids. Drench applications targets thrips pupae and weevils. **Foliar spray rates:** 8-64 fl oz per 100 gal. **Drench rates:** 40-80 fl oz per 100 gal.

Item: 70-2291 **Size:** 1L

Hexygon IQ



MOA 10A | REI 12

Active Ingredient: Hexythiazox

Long residual mite growth regulator that controls egg and immature stages of spider mites and several other Tetranychid mites for up to 60 days. Hexygon IQ is labeled for use on ornamentals in greenhouses, landscapes and nurseries. Certain fruiting vegetables in greenhouses can also be treated. Use only one application per crop per year. **Foliar spray rates:** 1/4-1/2 tsp per gal or 4-8 fl oz per 100 gal. **Restricted use pesticide in NY.**

Item: 70-1868 **Size:** 1 qt.

Magus



MOA 21 | REI 12

Active Ingredient: Fenazaquin

Foliar applied insecticide/miticide for the rapid knockdown of all stages of spider mites and whiteflies on ornamental crops and non-bearing fruit and nut trees. Certain states support a supplemental label that allows for use to control powdery mildew. Labeled sites include greenhouses, landscapes, nurseries, shadehouses and field grown plants. **Foliar spray rates:** 3/4-1½ tsp per gal or 12-24 fl oz per 100 gal. **Restricted use pesticide in VT.**

Item: 70-2329 **Size:** 1 qt.

Kontos



MOA 23 | REI 24

Active Ingredient: Spirotetramat

Kontos is a broad spectrum miticide/insecticide that has true systemic activity. It can be applied as a spray or a drench and includes many vegetable transplants on the label. From a foliar spray it controls: aphids, mealybugs, scale, whiteflies and others. Drench applications add spider mite and thrips control. *Kontos damages dracaena, geraniums, verbena and other crops.* See label for list of phyto concerns. **Foliar spray rates:** ½-1 tsp per 5 gal or 1.7-3.4 fl oz per 100 gal. **Drench rates** and volumes per the label. 0 hr REI for drenches if conditions are met.

Item: 70-19601 **Size:** 250 ml (8.45 fl oz).

Mainspring GNL



MOA 28 | REI 4

Active Ingredient: Cyantraniliprole

Foliar and systemic insecticide for use on ornamental plants, shrubs and trees grown in greenhouses and nurseries, shade houses, lath houses, commercial landscapes, and interiorscapes. Controls aphids, caterpillars, lacebugs, leafminers, thrips, whiteflies and others. Can be used as spray or drench (containers only). **Foliar spray rates:** ¼-¾ tsp per gal or 4-12 fl oz per 100 gal. **Drench rates:** ½-¾ tsp per gal or 8-12 fl oz per 100 gal. Drench to wet ½-¾ of soil volume. **Restricted use pesticide in NY & VT, no outdoor use in Nassau and Suffolk County, NY.**

Item: 70-2331 **Size:** 1 pt.

Item: 70-2332 **Size:** 1 gal.

Multipacks:

Item: 70-AMM **Description:** Avid/Mainspring GNL Multipak (1)-1 gal. of Avid 0.15 EC miticide/insecticide & (4) – 1 pt. Mainspring GNL insecticide

Item: 70-MMM **Description:** Mural/Mainspring GNL Multipak (3) - 1 lb. bottles of Mural Fungicide & (2) – 1 pt. Mainspring GNL insecticide

Kopa



MOA UN | REI 12

Active Ingredient: Potassium Salts of Fatty Acids

Kopa is an insecticidal soap applied as a foliar spray for the control of many insects, mites and powdery mildew. Kopa can be applied to many field and greenhouse grown vegetable, herb and ornamental crops. There are some plant and bloom safety concerns. Refer to the label for strategies to reduce the risk of phytotoxicity. **Rates:** 1.25-2.5 fl oz per gal or 1-2 gal per 100 gal. **OMRI listed.**

Item: 70-1970 **Size:** 2.5 gal.

Mallet 0.5 G MOA | REI
4A | 12**Active Ingredient: Imidacloprid**

Systemic insect control on landscape, nursery, and greenhouse ornamentals and turfgrass. Application can be made as a soil broadcast, soil incorporation, and container top dressing. Controls aphids, beetles, mealybugs, leafminers, soil grubs and other insects. See label for specific application rates. **Restricted use pesticide in CO, CT, MA, MD, ME, NJ, NV, NY & VT. Prohibited in Kings, Queens, Nassau & Suffolk County, NY.**

Item: 70-2345 Size: 30 lb.

Mallet 2F   MOA | REI
4A | 12**Active Ingredient: Imidacloprid**

Insect control on ornamentals and certain vegetable transplants in nurseries, greenhouses, and interiorscapes. Application can be made by soil broadcast, sprays and drenches (including ebb and flood treatments). Controls aphids, beetles, mealybugs, leafminers, soil grubs and other insects. **Foliar spray rates:** ½ tsp per 5 gal or 1.7 fl oz per 100 gal. See label for soil treatment rates. **Not registered in DE. Restricted use pesticide in CO, CT, MA, MD, NJ, NV, NY & VT. No soil injection in Nassau and Suffolk Country, NY.**

Item: 70-2340 Size: 1 gal.

Marathon 1% G   MOA | REI
4A | 12**Active Ingredient: Imidacloprid**

Granular systemic insecticide. Controls aphids, mealybugs, caterpillars and others. Long-lasting residual control; 4-6 weeks with a single application. Some edible bedding plant crops can be treated. **Rates:** See label for rate chart. Higher rates are on the label for three or more plants per pot. **Restricted use pesticide in CO, CT, MA, MD, NJ, NV, NY & VT.**

Item: 70-23752 Size: 5 lb.
Item: 70-23812 Size: 50 lb.Marathon II   MOA | REI
4A | 12**Active Ingredient: Imidacloprid**

Insect control on ornamental and certain vegetable transplants in nurseries, greenhouses and interiorscapes. Application can be made by foliar application, soil broadcast sprays and drenches (including ebb and flood treatments). Controls aphids, caterpillars, mealybugs, leafminers and other insects. **Foliar spray rates:** ½ tsp per 5 gal or 1.7 fl oz (50 ml) per 100. See label for soil treatment rates. **Restricted use pesticide in CO, CT, MA, MD, NJ, NV, NY & VT. No soil injection in Nassau and Suffolk County, NY.**

Item: 70-23712 Size: 250 ml.

Minx 2

MOA | REI
6 | 12**Active Ingredient: Abamectin**

Miticicide/insecticide for the control of spider mites, broad mites, cyclamen mites, thrips and leafminers in shadehouses, greenhouses, field grown ornamentals, Christmas trees and woody ornamentals. New low volatile organic compound (VOC), water-based formula. **Foliar spray rates:** 1/2 tsp per gal or 8 fl oz per 100 gal. **Restricted use pesticide in VT.**

Item: 70-2398 Size: 1 qt.
Item: 70-2399 Size: 1 gal.

Molt-X

 BioWorksMOA | REI
UN | 4**Active Ingredient: Azadirachtin**

Botanical (neem) insect growth regulator and nematicide. Targets larval, pupal and nymph stages of many insects such as cutworms, caterpillars, leafhoppers, thrips, and whitefly. Labeled for use on ornamentals and many edible crops in greenhouses, nurseries, and interiorscapes. Excellent plant safety. For heavy infestations or dense foliage use the maximum rates. For tank mixing use the lowest rates. **Foliar spray rates:** ½-1 tsp per gal or 8-16 fl oz per 100 gal. **Drench rates:** ½ tsp per gal or 8 fl oz per 100 gal. **OMRI listed.**

Item: 70-2405 Size: 1 qt.
Item: 70-2410 Size: 1 gal.

M-Pede

MOA | REI
UN | 12**Active Ingredient: Potassium salts of fatty acids**

Concentrated insecticidal soap is a contact insecticide containing naturally occurring fatty acids for control of adult and immature pests on vegetables, greenhouse crops and ornamentals. Controls whitefly, aphids, mealybugs, thrips, spider mites and more. There are some plant and bloom safety concerns. A supplemental 2ee label allows for plant dips. No NY. Refer to the label for strategies to reduce the risk of phytotoxicity. **Foliar spray rates:** 1.25-2.5 fl oz per gal or 1-2 gal per 100 gal. **OMRI listed.**

Item: 75-10262 Size: 2.5 gal.

Marathon II   MOA | REI
4A | 12**Active Ingredient: Imidacloprid**

Insect control on ornamental and certain vegetable transplants in nurseries, greenhouses and interiorscapes. Application can be made by foliar application, soil broadcast sprays and drenches (including ebb and flood treatments). Controls aphids, caterpillars, mealybugs, leafminers and other insects. **Foliar spray rates:** ½ tsp per 5 gal or 1.7 fl oz (50 ml) per 100. See label for soil treatment rates. **Restricted use pesticide in CO, CT, MA, MD, NJ, NV, NY & VT. No soil injection in Nassau and Suffolk County, NY.**

Item: 70-23712 Size: 250 ml.

Mycotrol ESO MOA | REI
UNF | 4**Active Ingredient: *Beauveria bassiana* strain GHA spores**

Emulsifiable suspension mycoinsecticide used in controlling aphids, borers, leaf-feeding insects, thrips, mealybugs, spider mites and whiteflies. Soil drenches add grub and weevil control. Labeled for ornamentals and many edible crops in greenhouses, field production, interiorscapes, and commercial landscapes. Additional surfactant is not recommended for the ESO formulation. **Foliar spray rates:** 1-4 tsp per gal; 16-64 fl oz per 100 gal. **Drench rates:** 2-8 fl oz per 1,000 sq ft. **Dip rates:** 1/2 to 1 fl oz per gallon. **OMRI listed.**

Item: 70-2416 Size: 1 qt.
Item: 70-2417 Size: 1 gal.

Mycotrol WPO

CERTIS USA



MOA | REI
UNF | 4

Active Ingredient: *Beauveria bassiana* strain GHA spores

Wettable powder mycoinsecticide used in controlling aphids, borers, leaf-feeding insects, thrips, mealybugs, spider mites and whiteflies by spray or cuttings/liner dip. Soil drenches add grub and weevil control. Labeled for ornamentals and many edible crops in greenhouses, field production, interiorscapes, and commercial landscapes. No injector use. **Foliar spray rates:** 1-4 tsp per gal or 1/2-2 lb per 100 gal. **Drench rates:** 1-4 oz per 1,000 sq ft.

Dip rates: 1/4 to 1/2 fl oz per gallon.

Item: 70-2420 **Size:** 1 lb.

NoFly WP



MOA | REI
UNF | 12

Active Ingredient: *Isaria fumosorosea* strain FE 9901.

NoFly is a wettable powder insecticide based on a naturally occurring fungus. From a foliar spray it is labeled to control: aphids, leaf hoppers, mealybugs, plant bugs, spider mites, thrips, whiteflies and others. Soil applications can be made by drenching or blending in the soil prior to planting for: aphids (root), mealybugs (root), caterpillars and the pupal stage of thrips. NoFly is labeled for ornamentals as well as many herbs, fruits and vegetables grown in containers in greenhouses, hydroponic systems, nurseries, and field-grown nursery stock. Acceptable storage temperatures are 34-72°F, refrigeration is recommended. **Foliar spray and drench rates:** 1-2 tsp gal or 14-28 oz per 100 gal. **OMRI listed.**

Item: 70-2509 **Size:** 2 lb.

Notavo



MOA | REI
10A | 12

Active Ingredient: Clofentezine

Suspension concentrate (SC) foliar applied contact miticide that is effective against egg and early immature stages of mites for up to 45 days. Two-spotted spider mites and 4 other mites are controlled in commercial greenhouses, saran and shade houses, outdoor container and field grown ornamentals. May leave a magenta stain on white blooms. **Rates:** 1/8 tsp per gal or 2 fl oz per 100 gal.

Item: 70-2520 **Size:** 1 pt.

Overture 35 WSP



MOA | REI
UN | 12

Active Ingredient: Pyridalyl

Overture is an insecticide for thrips and caterpillars on ornamentals produced in commercial greenhouses only. Good translaminar movement in plant tissue. **Rate:** Mix one 2 oz packet in 25 gal. Apply at 14-28 day intervals. Allow 3-6 days to evaluate thrips control.

Item: 70-2590 **Size:** 1 lb. (8 x 2 oz.)

GGSPRO TIP MAINSRING GNL

Mainspring GNL continues to be an important, plant/bloom safe, broad-spectrum foliar spray and drench product for ornamental producers. Its MOA 28 is a valuable tool providing a long residual of 6-8 weeks of control for thrips and aphids as a drench. Use Mainspring as a protectant insecticide to ensure a clean crop stays clean throughout the season.

Pedestal SC



MOA | REI
15 | 12

Active Ingredient: Novaluron

Insect growth regulator for the control of thrips, leafminers, loppers, armyworm, stink bugs and whitefly on ornamentals in greenhouses or nurseries. Tomato transplants grown in greenhouses can also be treated. *Not for use on poinsettias.* **Foliar spray rates:** 1/8-1/2 tsp per gal or 6-8 fl oz per 100 gal. **Limited to indoor greenhouse use in NY.**

Item: 70-29501 **Size:** 1 qt.

Pest Out



MOA | REI
UNE | 0

Active Ingredient: Cottonseed Oil, Clove Oil & Garlic Oil

Foliar spray for the control of aphids, mites and thrips on ornamentals and many edible crops. Active ingredients are essential oils and this product is a 25b product (no EPA registration required). **Foliar spray rates:** 1.25 fl oz per gal or 1 gal per 100 gal. **OMRI listed.**

Item: 16-11010 **Size:** 1 gal.

Item: 16-11011 **Size:** 2.5 gal.

Pradia



MOA | REI
28+29 | 12

Active Ingredient: Cyclaniliprole & Flonicamid

Broad spectrum insecticide in a soluble concentrate formulation. Pradia is labeled for use as a foliar spray on ornamentals including conifers and Christmas trees grown in commercial greenhouses, shadehouses and nurseries. Labeled pests include: adelgids, aphids, caterpillars, flea beetles, Japanese beetles, lace bugs, leafminers, mealybugs, midges, plant bugs, psyllids, soft scales, thrips, and whiteflies. Up to 2 weeks of control from one application. *Do not use on pansy.* **Foliar spray rates:** 2/3-1 tsp per gal or 10-17 fl oz per 100 gal. **Restricted use pesticide in CO, NJ, NV & NY. Prohibited in Nassau and Suffolk County, NY.**

Item: 70-2630 **Size:** 1 qt.

PyGanic 5.0 Specialty



MOA
3A | REI
12

Active Ingredient: Pyrethrins

Insecticide with natural pyrethrins labeled for a wide range of ornamental and edible crops in greenhouses and outdoor crops. Labeled pests include: aphids, beetles, caterpillars, leafhoppers and many others. **Foliar spray rates:** 1-2 tsp per gal or 16-32 fl oz per 100 gal. **OMRI listed.**

Item: 70-2687 **Size:** 1 qt.
Item: 70-2688 **Size:** 1 gal.

Pylon



MOA
13 | REI
12

Active Ingredient: Chlorfenapyr

Miticide/Insecticide/Foliar Nematicide with translaminar activity for use on ornamentals and certain fruiting vegetables in greenhouses only. Pests controlled include: spider mites, broad mites, cyclamen mites, thrips, fungus gnat larvae (soil surfaces spray) and foliar nematodes (consult label for special instructions). *Do not use on poinsettia, salvia, zinnia, roses, kalanchoe and dianthus.* **Foliar spray rates:** mites and thrips 1/3 tsp per gal or 5.2 fl oz per 100 gal. Do not use with a organo-silicone surfactant such as CapSil. **Soil surface spray rates:** for fungus gnat larvae: 1/3-2/3 tsp per gal or 5.2-10 fl oz per 100 gal. **Restricted use pesticide in NY. Not registered in ME.**

Item: 70-2675 **Size:** 1 pt.
Item: 70-26750 **Size:** 1 qt.

Pylon TR



MOA
13 | REI
12

Active Ingredient: Chlorfenapyr

A total release translaminar and contact insecticide for ornamentals and certain fruiting vegetables in greenhouses to control mites, thrips and adult fungus gnats. *Do not use on poinsettia, salvia, zinnia, roses, kalanchoe and dianthus.* **Rate:** 1 can per 1,500-3,000 sq ft. **Restricted use pesticide in NY.**

Item: 70-2660 **Qty:** 12-2 oz.

Pyrethrum TR



MOA
3A | REI
12

Active Ingredient: Pyrethrins & PBO

A ULV greenhouse aerosol formulation containing natural pyrethrins. Broadly labeled for many greenhouse pests on ornamentals and a wide variety of crops including vegetables and herbs. **Rate:** 1 can per 3,000 sq ft.

Item: 70-2693 **Qty:** 12-2 oz.

Rycar



MOA
9B | REI
12

Active Ingredient: Pyrifluquinazon

Quickly stops insect pests from feeding. Used as a foliar spray to control aphids, chilli thrips, leafhoppers, mealybugs, and whitefly. Has contact and translaminar activity with good flower and bract safety. Labeled for use on indoor greenhouse ornamentals and cucumbers, lettuce, peppers and tomatoes grown on to harvest. **Foliar spray rates:** 1/2-1 tsp per 5 gal or 1.6-3.2 fl oz per 100 gal. **Not Registered in NY.**

Item: 70-2900 **Size:** 8 fl oz.

Safari 20 SG



MOA
4A | REI
12

Active Ingredient: Dinotefuran

Safari is labeled as a foliar spray or a drench. Highly systemic drench is taken up into even older woody foliage. Insects controlled include aphids (drench only), fungus gnat larvae, leafminers, mealybugs, scale, thrips (suppression only) and whiteflies. Drench applications remain effective for up to 6 weeks. Labeled sites include ornamentals grown in greenhouses, and outdoor nurseries. Certain vegetable transplants can be treated by foliar spray only. **Foliar spray rates:** at 1/2-1 tsp per gal or 4-8 oz per 100 gal. **Drench rates:** 1.5 -2.5 tsp per gal or 12-24 oz per 100 gal with 4 oz per 6" pot being applied. **Restricted use pesticide in CO, CT, MA, MD, ME, NJ, NV, NY & VT. Special use instructions for NY on 24C label.**

Item: 70-29951 **Size:** 3 lb.

Sanmite SC



MOA
21A | REI
12

Active Ingredient: Pyridaben

Solution concentrate formulation adds additional pests and certain vegetable transplants. Labeled pests include: aphids (certain species), leafhoppers, mites (broad, spider and others) pear psylla, and whiteflies. Sanmite SC is labeled for ornamentals and greenhouse grown tomatoes and cucumbers. **Foliar spray rates:** 1 tsp per 2.5-1.66 gal or 6.4-9.6 fl oz per 100 gal. The REI includes ventilation requirements per the label. **Prohibited in Nassau and Suffolk County, NY. Restricted use pesticide in VT.**

Item: 70-2915 **Size:** 1 qt.



Active Ingredient: Cyclanilprole

Broad spectrum contact and ingestion insecticide in a soluble concentrate formulation. Sarisa is labeled for use as a foliar spray on ornamentals including conifers and Christmas trees grown in commercial greenhouses, shadehouses and nurseries. Labeled pests include: adelgids, armyworms, borers (beetle and caterpillar) flea beetles, plant bugs, Japanese beetles, lace bugs, leafminers, leafrollers, loopers, mealybugs, psyllids, root weevil complex (adults), and webworms. Sarisa also provides suppression of thrips and mealybugs. Up to 2 weeks of control from one application.

Foliar spray rates: 3/4-1 2/3 tsp per gal or 11-27 fl oz per 100 gal. **Restricted use pesticide in NY. Prohibited in Nassau and Suffolk County, NY.**

Item: 70-2975 **Size:** 64 fl oz.



Active Ingredient: Spiromesifen

Flowable concentrate miticide/insecticide that controls: All stages of whitefly and knockdown with residual control of mites (many mite species including: broad, boxwood, cyclamen, lewis). Labeled for ornamental flowers, foliage, shrubs and trees in greenhouses, shade houses and field or container nurseries. *Warnings: Do not use on geraniums (Pelargonium sp.), Dracaena, and New Guinea impatiens.* See label for additional plant safety concerns. **Foliar spray rates:** 1/8-1/4 tsp per gal or 2-4 fl oz per 100 gal. **Restricted use pesticide in VT. Not labeled in NY.**

Item: 70-2980 **Size:** 8 fl oz.



Active Ingredient: Acequinocyl

Miticide for spider mites and spruce mites that combines a quick knockdown and long residual control. Shows activity against all life stages of susceptible mites. Labeled for ornamentals and certain fruiting vegetables in greenhouses and nurseries. Use only the lowest rates on impatiens and roses. *Do not use on miniature roses.* **Foliar spray rates:** 1/2-3/4 tsp per gal or 6.4-12.8 fl oz per 100 gal.

Item: 70-30152 **Size:** 1 pt.



Active Ingredient: Potassium silicate

Sil-Matrix LC is an aqueous liquid concentrate. This versatile product applied as a foliar spray for control of certain insects, mites and foliar diseases. For use on ornamentals and many edible crops including certain vegetables, berries, vines and fruit trees. Insects and mites controlled: aphids, spider mites and whiteflies. Foliar diseases controlled: *Botrytis*, powdery mildew and certain turf diseases. Keep pH >7.0 to prevent gelling of product that occurs at pH 6. **Foliar spray rates:** 2 tsp-1.25 fl oz per gal or 32-128 fl oz per 100 gal. **OMRI listed.**

Item: 71-2940 **Size:** 2.5 gal.



Active Ingredient: Abamectin & Bifenazate

Dual active ingredient insecticide/miticide for the control of spider mites, broad & cyclamen mites, thrips and suppression of whiteflies. **Foliar spray rates:** 1/5-1/4 tsp per gal or 3-4 fl oz per 100 gal.

Item: 70-30171 **Size:** 8 fl oz.

Item: 70-30170 **Size:** 1 qt.



Active Ingredient: Horticultural Oil

Labeled for mite, insect and disease control on ornamentals as well as many vegetables. Labeled insect pests include aphids, mealybugs, mites, scale, whiteflies and many others. Labeled diseases include powdery mildew and rust. **Foliar spray rates:** 1.25-2.5 fl oz per gal or 1-2 gal per 100 gal. **OMRI listed.**

Item: 70-4040 **Size:** 2.5 gal.

Item: 70-4043 **Size:** 30 gal.

GGSPRO TIP SUFFOIL-X INSECTICIDE & MITICIDE

SuffOil-X has proven to be a "go-to" resource for both ornamental and edible growers when managing low pest populations or coming from behind in a mite infestation. Unlike conventional insecticide and miticide options, this high-quality horticultural oil uses suffocation as its primary mode of action, causing death to occur very quickly. If you are new to using oils, reach out to GGSPRO for additional tips and tricks for maximizing efficacy and minimizing phytotoxicity concerns.

Sultan

MOA
25 | REI
12**Active Ingredient:** Cyflumetofen

Miticide with newest mode of action available. Contact activity and rapid knockdown of all life stages of spider mites. Label cautions against certain tank mixes. Labeled for use in greenhouses, nurseries, landscapes, and interiorscapes. Labeled for certain edible transplants and crops grown to harvest. Good plant safety with up to 28 days of control. **Foliar spray rates:** ¾ tsp per gal or 13.7 fl oz per 100 gal. **Not registered in ME as of 3/1/23.**

Item: 70-3045 **Size:** 16 fl oz.

Talstar Nursery Granular

MOA
3A | REI
12**Active Ingredient:** Bifenthrin

For use as a quarantine treatment to control Imported Fire Ants in balled and containerized nursery stock. It can also be pre-incorporated into the media of container grown ornamentals for the control of the following soil borne insects: black vine weevil larvae, fungus gnat larvae, root mealybugs and white grubs.

Application rates are based on the bulk density of the potting media and are included in tables on the label. **Restricted use pesticide in CT & VT.**

Item: 70-3414 **Size:** 50 lb.

Talus 70 DF

MOA
16 | REI
12**Active Ingredient:** Buprofezin

IGR for the control of whiteflies, leafhoppers, scale and mealybugs. Up to 28 days of control from one foliar spray. Greenhouse and outdoor ornamentals and greenhouse tomatoes are on the label. Excellent plant safety including poinsettia bracts. **Foliar spray rates** vary by pest: ⅔ - 1⅓ tsp per gal or 6-14 oz per 100 gal. **Restricted use pesticide in NY. Prohibited in Nassau and Suffolk County, NY.**

Item: 70-1172 **Size:** 3 lb.

TetraSan 5 WDG

MOA
10B | REI
12**Active Ingredient:** Etoxazole

Long residual miticide/ovicide. Foliar spray for the control of egg and nymphal stages of several types of mites, including spider mites. Excellent translaminar activity and residual control for 4-6 weeks. Can be used on greenhouse tomatoes. **Foliar spray rate:** One 2 oz water soluble packet per 12.5-25 gal. Labeled for greenhouses, outdoor and interiorscape uses. **Restricted use pesticide in NY.**

Item: 70-3130 **Size:** 1 lb.

Triact 70

MOA
UNM | REI
4**Active Ingredient:** Clarified hydrophobic extract of neem oil

Horticultural oil labeled for the control of insects and mite pests of ornamentals and edible crops in greenhouses, interiorscapes, landscapes and nurseries. Labeled pests include: aphids, leafhoppers, mealybugs, mites and scale insects. Triact 70 is also labeled for foliar diseases (see Fungicide section). **Foliar spray rates:** 4 tsp-1.28 fl oz per gal or 0.5-1 gal per 100 gal. **OMRI listed.**

Item: 70-3226 **Size:** 2.5 gal.

TriStar 8.5 SL

MOA
4A | REI
12**Active Ingredient:** Acetamiprid

Translaminar systemic insecticide for use on ornamentals and certain vegetable transplants in greenhouses, shadehouses, lath houses and outdoor nurseries. Applied as a foliar spray for aphids, caterpillars, leafhoppers, mealybugs, scale, thrips, whiteflies and other insect pests. Excellent plant safety including poinsettia bracts. *Do not use on verbena.* Allows a one-time drench to greenhouse grown tomatoes. See label for rates.

Foliar spray rates: Rates vary by pest: ¼-1½ tsp per gal or 4-25 fl oz per 100 gal. **Restricted use pesticide in CO, MA, MD, NJ, NV, NY & VT.**

Item: 70-85221 **Size:** 1 qt.**Item:** 70-85241 **Size:** 1 gal.

GGSPRO

TECHNICAL SERVICES

Our in-house technical services team delivers prompt, practical and accurate support to Griffin customers everywhere. Visit griffins.com for more information.

Ultra-Pure Oil



MOA
UNE | REI
4

Active Ingredient: Horticultural Oil

Ultra-Pure oil is highly refined petroleum oil for control of eggs, immature and adult stages of mites and soft bodied insects including adelgids, aphids, mealybugs, plant bugs, thrips and whiteflies. Labeled for ornamental crops and certain vegetables grown in greenhouses and nurseries. Avoid application to plants under moisture or heat stress. See label for further precautions regarding specific greenhouse and nursery crops. **Foliar spray rates:** 1.25-2.5 fl oz per gal or 1-2 gal per 100 gal. **OMRI listed.**

Item: 70-21401 **Size:** 2.5 gal.

Item: 70-21451 **Size:** 30 gal.

Ventigra



MOA | REI
9D | 12

Active Ingredient: Afidopyropen

Insecticide with translaminar systemic activity in a water based Dispersible Concentrate (DC) formulation. Labeled for foliar applications to ornamentals, landscape plants and many vegetable transplants (for resale to home consumer market). Sites include: greenhouses, lath houses, shade houses, interiorscapes, landscapes and outdoor nurseries. Ventigra controls or suppresses certain aphids, mealybugs, scale and whiteflies. *Ventigra should not be used on Coleus, Ficus, and Poinsettia bracts.* **Foliar spray rates:** Aphids only, ¼ tsp per 3 gal or 1.4 fl oz per 100 gal; Other labeled pests, 1/4-1/2 tsp per gal or 4.8-7.0 fl oz per 100 gal. **Prohibited in Nassau and Suffolk County, NY. Restricted use pesticide in NY.**

Item: 70-9550 **Size:** 20 fl oz.

Velifer



MOA | REI
UNF | 12

Active Ingredient: *Beauveria bassiana* strain PPRI 5339

Microbial insecticide/miticide delivered in an oil dispersion formulation for commercial greenhouse use only. Labeled pests include: aphids, mealybugs, mites, thrips and whiteflies. Velifer can be used on ornamentals, fruits, vegetables, herbs and spices. Refer to label about needing time to hydrate. No CapSil or adjuvant required. **Foliar spray rates:** ¼-¾ tsp per gal or 3-13 fl oz per 100 gal. Can be used in non-thermal foggers. New label additions have added drenching and dipping applications. Refer to label for rates. **Not registered in ME.**

Item: 70-9540 **Size:** 1 qt.

XXpire



MOA | REI
4C+5 | 12

Active Ingredient: Sulfoxaflor & Spinetoram

Dual mode of action translaminar systemic insecticide with excellent plant bloom safety. Controls: aphids, beetles, caterpillars, mealybugs, thrips, whiteflies and more. Labeled for ornamentals grown in greenhouses and nurseries. **Foliar spray rates:** ¼-⅓ tsp per gal or 2-2.75 oz per 100 gal. **Not registered in NY, CA & AK.**

Item: 70-9700 **Size:** 1 lb.

Venerate CG



MOA | REI
UNB | 4

Active Ingredient: Heat-killed *Burkholderia* spp. strain A396

Biological insecticide applied as a foliar spray provides control of wide variety of caterpillars and control or suppression of many soft bodied insects, such as aphids, caterpillars, fruit curculios, leafhoppers, mites, psyllids, stink bugs, thrips, true bugs, certain weevils, and whiteflies. Use as a foliar spray on ornamentals and edible crops outdoors or in a greenhouse. Labeled for many food crops, including herbs and fruit-bearing trees. Labeled for certain soil dwelling insects. Refer to label for use directions. **Foliar spray rates:** 4 tsp-2.66 Tbs per gallon or 64-128 fl oz per 100 gal. **OMRI listed.**

Item: 70-9461 **Size:** 1qt.

Item: 70-9464 **Size:** 1 gal.

Item: 70-9465 **Size:** 2.5 gal.

QUALITY RETAIL PROBLEM SOLVERS

Help your retail customers protect their investments with lawn & garden problem solvers from Griffin. We offer a broad selection of products to keep pests, weeds and disease in check for home gardeners. Drop-ship programs are available from VPG and Monterey. Contact your Griffin sales representative to learn more.





Take an Integrated Approach to Greenhouse Pests

Velifer[®] bioinsecticide/miticide works with **Ventigra**[®] insecticide to suppress and maintain low pest populations.

To learn more about adding these two new powerful tools to your program, visit betterplants.basf.us

 @BASFFPlants_us

 Facebook.com/BASF.Plants.us

Velifer[®]
Bioinsecticide/Miticide

Ventigra[®]
Insecticide

Always read and follow label directions.
Products may not be registered for sale or use in all states.
Check with your state or local Extension Service.
Velifer and Ventigra are registered trademarks of BASF.
© 2023 BASF Corporation. All rights reserved.

Biological Control Agents (BCAs)

Griffin supports growers currently using biological control agents (BCAs) and those growers considering BCA use. The GGSPro team serves as a coach and technical resource to these growers. In addition to creating individualized BCA plans, the GGSPro team maintains a collection of Quick Sheets, a BCA compatibility database, and an assortment of useful bulletins to guide grower success. The GGSPro Quick Sheets contain information growers need to be successful with BCAs for control of common insect and mite pests. In addition to rates, the Quick Sheets contain release and placement instructions, viability assessment criteria, temperature and humidity requirements and more. The GGSPro compatibility database compiles information from multiple sources for a well-rounded perspective on pesticide compatibility.

Griffin is also committed to providing high quality BCAs with state-of-the-art packaging, including a variety of sachets (breeding colonies), blister packs and traditional bulk packaging. Both Bioline Agrosociences, Beneficial Insectary and BioBee are prime suppliers to ensure uninterrupted availability and a wide selection of available products to meet individual grower needs.

Ordering deadlines vary by product. Several ship M-TH if order is in by noon (EST). Other ship the next week or may take 2 weeks when in by Tues or Wed 5 pm (EST). To assure delivery, order at least 2 weeks in advance with orders in by end of Tuesday/Wednesday (5 pm EST). Contact GGSPro for assistance.



Photo Credit: Zachary Brubaker

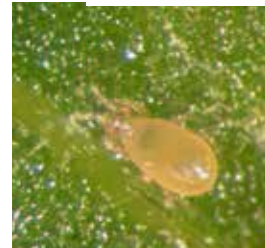

Amblyseius



Aphidoletes



Aphelinus



Chrysoperla



Diglyphus



Encarsia



Eretmocerus



Hypoaspis/
Stratiolaelaps



Orius



Phytoseiulus



Atheta/Dalotia



Amblyseius

Biological Control Agents (BCAs) - Info Chart



BCA Color Key

Green	Aphid Control
Orange	Multiple Pest / Other Pest Control
Gold	Leafminers Control
Teal	Mealybugs Control
Red	Spider Mite Control
Lilac	Thrips Control
Blue	Whitefly Control
Yellow	Pollination
Grey	Supplementary Products

Target Pest	Control Agent
Aphids	<i>Aphelinus abdominalis</i>
Aphids	<i>Aphidius colemani</i>
Aphids	<i>Aphidius ervi</i>
Aphids	<i>Aphidius matricariae</i>
Aphids	<i>Aphidius colemani</i> 50%, <i>ervi</i> 50%
Aphids	<i>Aphelinus abdominalis</i> 50%, <i>Aphidius colemani</i> 25% and <i>A. ervi</i> 25%
Aphids	<i>Aphelinus abdominalis</i> 25%, <i>Aphidius colemani</i> 25%, <i>A. ervi</i> 25%, and <i>A. matricariae</i> 25%
Aphids	<i>Aphidoletes aphidimyza</i>
Aphids	<i>Adalia bipunctata</i>
Aphids	<i>Hippodamia convergens</i>
Aphids	<i>Rhopalosiphum padi</i> (prey aphids for <i>A. colemani</i>)
Aphids	<i>Acyrtosiphon pisum</i> (prey aphid for <i>A. ervi</i>)
Aphids	<i>Chrysoperla carnea</i>
Aphids	<i>Chrysoperla rufilabris</i>
Caterpillar/Moth Eggs	<i>Trichogramma sp</i>
Fungus gnats, shoreflies, thrips pupae	<i>Atheta coriaria</i> (<i>Dalotia coriaria</i>)
Fungus gnats, shoreflies, thrips pupae	<i>Hypoaspis miles</i> (<i>Stratiolaelaps scimitus</i>)
Fungus gnats, shoreflies, thrips pupae	See Nematodes pages
Leafminers	<i>Diglyphus isaea</i>
Leafminers	<i>Dacnusa sibirica</i>
Mealybugs	<i>Anagyrus vladimiri</i> (Available only in CA)
Mealybugs	<i>Cryptolaemus montrouzieri</i>
Mealybugs	<i>Chrysoperla carnea</i>
Mealybugs	<i>Chrysoperla rufilabris</i>
Spider mites	<i>Amblyseius andersoni</i>
Spider mites	<i>Amblyseius californicus</i>
Spider mites	<i>Amblyseius fallacis</i>
Spider mites	<i>Feltiella acarisuga</i>
Spider mites	<i>P. persimilis</i> + <i>A. californicus</i>
Spider mites	<i>Phytoseiulus persimilis</i>
Thrips	<i>Amblyseius cucumeris</i>
Thrips	<i>Orius insidiosus</i>
Thrips	<i>Amblyseius swirskii</i>
Thrips	<i>Atheta coriaria</i> (<i>Dalotia coriaria</i>)
Thrips	<i>Hypoaspis miles</i> (<i>Stratiolaelaps scimitus</i>)
Thrips	See Nematodes pages
Whiteflies	<i>Dicyphus hesperus</i>
Whiteflies	<i>Encarsia formosa</i>
Whiteflies	<i>Encarsia formosa</i> & <i>Eretmocerus eremicus</i>
Whiteflies	<i>Eretmocerus eremicus</i>
Pollination	<i>Bombus impatiens</i>
Food Source <i>Orius</i> , <i>Dicyphus</i> & Lacewing (<i>Chrysoperla</i>)	<i>Epehestia kuehniella</i>
Food source for <i>A. cucumeris</i> , <i>swirskii</i> & <i>Orius</i>	<i>Artemia</i>
Food Source for <i>Chrysoperla</i> (Lacewing larvae)	
Food Source for predatory mites	Typha pollen or <i>Carpoglyphus lactic</i>
European Pepper Moth Lure	
Western Flower Thrips Lure	



Nature's Control

IPM Labs

Aphelinus System		Apheline		
APHIDIUSforce™ C	BioAphidius	Aphiline		
APHIDIUSforce™ E	BioErvi	Erville		
APHIDIUSforce™ M	BioMatricariae			
APHIDIUSforce™ CE		Aphiline Mix		
		Aphiline Veg		
APHIDIUSforce™ Mix				
APHIDOLETESforce™	BioAphidoletes	Aphidoline		
Adalia		Adaline		
			Ladybugs	
Aphid Banker Plants	Aphid Banker Plants			Banker Plants
				Banker Plants
	BioLacewing	Chrysoline		
CHRYSOforce™ R		Chrysoline	Green Lacewing	
TRICHOforce™ B, M, PL and Mix	BioTricho	Tricholine TB & TP		
DALOTIAforce™	BioAtheta	Staphylene		
STRATIOforce™	BioStratiolaelaps	Hypoline		
Diglyphus System	BioDiglyphus	Digline		
Dacnusa System				
Anagryus	BioAnagryus			
CRYPTOforce™	BioCryptolaemus	Cryptoline		
	BioLacewing	Chrysoline		
CHRYSOforce™ R			Green Lacewing	
AMBLYforce™ A	BioAndersoni	Anderline		
CALforce™	BioCalifornicus	Californiline		
	BioFallacis			
FELTIELLAforce™		Feltiline		
		PERCAL Mix		
PERSIMILISforce™	BioPersimilis/BioPersi+	Phytoline		
AMBLYforce™ C	BioCucumeris	Amblyline		
ORIOUSforce™	BioOrius	Oriline		
AMBLYforce™ S	BioSwirskii	STARSKII		
DALOTIAforce™	BioAtheta	Staphylene		
STRATIOforce™	BioStratiolaelaps	Hypoline		
	BioDicyphus			
ENCARSIAforce™	BioEncarsia	Encarline		
ENCAR/ERETforce™	BioEncarsia/BioEretmocerus	Encarline Mix		
ERETforce™	BioEretmocerus	Eretline		
Bombus impatiens				
Ephestia Kuehniella/ NUTRIforce™		Bugfood E		
	BioArtFeed BioArtLine			
Wheast®				
Nutrimite™	BioCLFeed			
		Dupoline PRO		
		Thripline Lure		

NEMATODES

Beneficial or Entomopathogenic nematodes are microscopic roundworms that are parasites of certain insects and can be used effectively as biological control agents (BCAs) in IPM programs. *Steinernematidae* and *Heterohabditidae* are frequently used families of nematodes since they target common greenhouse and nursery pests (fungus gnats and grubs). They are also a safe alternative to traditional pesticides with no personal protective equipment, or REI (restricted-entry interval), required.

Benefits of using nematodes include:

- Fast, effective, residual control.
- No re-entry requirements.
- No pest resistance problems.
- Compatible with other biological and IPM programs.
- Non-toxic. No need for protective clothing.

For a successful nematode application remember to:

- Ensure adequate soil moisture.
- Avoid high light (UV). Cloudy days are best.
- Use cool water, gentle agitation and aeration in stock tank.
- Remove any screens that are finer than 50 mesh.
- Do not tank mix in stock solution.

Agitation/Aeration Bucket

Dramm's Agitation/Aeration Bucket provides a thorough mixing of any solution. Perfect for use with an injector, the Agitation/Aeration Bucket can keep water soluble fertilizers, fungicides, insecticides and PGRs in suspension. With a flip of a switch, agitation turns to aeration. Air is introduced into the passing stream, keeping dissolved oxygen at saturation levels. Use this feature when agitating nematodes or other organisms requiring oxygen. 5 gallon capacity.

DRAMM



Item: 74-2686 100-120V AC #AAB120V
Item: 74-2687 12V/DC #AAB12V

*Steinernema feltiae*Active Ingredient: *Steinernema feltiae*

Beneficial nematode for the control of fungus gnat larvae when applied as a drench. *S. feltiae* when used as the second part of a two part control plan helps kill Western flower thrips pupae and pre-pupae from a soil drench treatment. **Rate for fungus gnat larvae and thrips pupae:** 50 million nematodes treat 1,100 sq ft; 250 million nematodes treat 5,500 sq ft.

BASF
Nemasys

Item: 70-2460 Qty: 5 Trays 50 mil / tray
Item: 70-2489 Qty: 250 mil / tray

BENEFICIAL INSECTARY



NEMAFORCE™ SF

Item: 30F50 Qty: 1 tray 50 mil / tray
Item: 30F250 Qty: 1 tray 250 mil / tray
Item: 30F5T Qty: 5 trays 250 mil / tray
Item: 30F600 Qty: 600 mil 12 x 50 mil trays

BIOBEE



BioSF

Item: BB-0038 Qty: 50 million nematodes / bag
Item: BB-0035 Qty: 250 million nematodes / bag
Item: BB-0032 Qty: 500 million nematodes / bag

NemaPlus Depot

NemaPlus capsules need to be covered into top 0.25" media, not top dressed. The capsules will slowly release nematodes to target soil pests such as fungus gnat larvae and thrips pupae. The capsule is spherical, 0.4mm and is a liquid oil-water emulsion core and a spongy hydrogel outer shell.

Not OMRI

Depot P

Item: BB-0071 Qty: 50 mil / 25k capsules / tray

Depot 200

Item: BB-0056 Qty: 320K / 200 capsules / bag

BIOLINE

Exhibitline SF



Item: SB1011-01 Qty: 1 tray 50 mil / tray
Item: SB1011-02 Qty: 5 trays 50 mil / tray
Item: SB1011-04 Qty: 1 tray 250 mil / tray
Item: SB1011-03 Qty: 5 trays 250 mil / tray

BIOWORKS

NemaShield



Item: 70-6033 Qty: 100 million nematodes / cup
Item: 70-6030 Qty: 250 million nematodes / cup

NIC

Sentry



Item: 70-7010 Qty: 10 mil / sponge*
Item: 70-7025 Qty: 25 mil / sponge**
Item: 70-7035 Qty: 35 mil / sponge**
Item: 70-7050 Qty: 50 mil / sponge**

*10 mil/sponge- 20 sponge minimum order
**25, 30 & 50 mil/sponge- 10 sponge minimum order
10-14 day lead time for delivery

Steinernema carpocapsae

Active Ingredient: *Steinernema carpocapsae*

Beneficial nematode for the control of shorefly larvae, soil dwelling insects and borer larvae. Labeled for use on ornamental and edible crops in greenhouses, interiorscapes, nursery, landscapes and turfgrass. **Rate for shorefly larvae:** 50 million nematodes treat 540-1,080 sq ft; 250 million treats 2,700-5,400 sq ft.

BASF
Millenium



Item: 70-2455 Qty: 5 trays 250 mil / tray

BENEFICIAL INSECTARY
NEMAforce™ SC



Item: 30C50 Qty: 1 tray 50 mil / tray
Item: 30C250 Qty: 1 tray 250 mil / tray
Item: 30C125B Qty: 1 tray 1.25 bil / tray

BIOBEE
BioSC



Item: BB-0039 Qty: 50 million nematodes / bag
Item: BB-0036 Qty: 250 million nematodes / bag
Item: BB-0033 Qty: 500 million nematodes / bag

BIOLINE
Exhibitline SC



Item: SB1012-02 Qty: 1 tray 50 mil / tray
Item: SB1012-01 Qty: 1 tray 250 mil / tray

Heterorhabditis bacteriophora

Active Ingredient: *Heterorhabditis bacteriophora*

Beneficial nematode for controlling the larvae of black vine weevil. It is also reported to control cutworms and white grubs. **Rate for Black Vine Weevil Larvae:** 50 million nematodes treat 1,000-2,000 sq ft depending on pest pressure. 250 million treat 5,000-10,000 sq ft depending on pest and pressure. **Rate for grubs:** 50 mil treats 500 sq ft; 250 mil treats 2,500 sq ft. 10-14 day lead time for delivery.

BASF
Nemasys G



Item: 70-2495 Qty: 2 trays 250 mil / tray
10-14 day lead time for delivery.

BENEFICIAL INSECTARY



NEMAforce™ HB

Item: 30H50 Qty: 1 tray 50 mil / tray
Item: 30H250 Qty: 1 tray 250 mil / tray

BIOBEE
BioHB



Item: BB-0040 Qty: 50 million nematodes / bag
Item: BB-0037 Qty: 250 million nematodes / bag
Item: BB-0034 Qty: 500 million nematodes / bag

BIOLINE

Exhibitline HB



Item: SB1021-01 Qty: 50 million / tray
Item: SB1021-02 Qty: 250 million / tray

BIOWORKS

NemaShield HB



Item: 70-6035 Qty: 50 million nematodes / tray
Item: 70-6036 Qty: 500 million nematodes / tray

Steinernema kraussei

Active Ingredient: *Steinernema kraussei*

Beneficial nematode for controlling the larval and pupal stages of the black vine weevil. Available in trays of 50 million or 250 million. **Rate for Black Vine Weevil Larvae:** 50 million treats 1,000 sq ft; 250 million treat 5,500 sq ft. Available in July-September. 2-3 wk lead time.

BASF

Nemasys L



Item: 70-2475 Qty: 5 trays 250 mil / tray
10-14 day lead time for delivery.

BIOLINE

Nemasys L



Item: SB1014-02 Qty: 50 mil / tray
Item: SB1014-03 Qty: 250 mil / tray

BENEFICIAL INSECTARY

NEMAforce™ SK



Item: 30K250 Qty: 250 / tray

BCA Applicator Tools and Equipment

Release boxes Release Box

**Item:** SB8042-01 **Qty:** 50/bag

Release boxes Release Box

**Item:** 30URB **Qty:** 50/bag

Release boxes Release Box

**Item:** BB-0028 **Qty:** 25/bagNutri-App Powder
Duster Attachment

Applicator tool to dispense Nutrimite. To be attached to a Makita blower (DUB1822)not included. For use with BCAs, do not exceed speed #2

Item: 30NA300890 **Qty:** 1

BugFlow Unit



Applicator tool includes battery housing, strap, and manual. Blower and Makita battery, not included.

Item: BB-BF **Qty:** 1

Sachet Bag

Biobee Sachet Bag for carrying sachets and tubes -call in for more information.

BioFeedLine Artemia
Feed Tape**Item:** BB-0031 **Qty:** 328 ft. (100 meter) roll

CROP PROTECTION-SPECIALTY

Alesco®



REI 4

Active Ingredient: Silver Nitrate

Alesco® is a unique post-harvest product to protect ethylene sensitive crops during shipping and retail display. Ethylene damage can be caused by transportation stress, dark storage, temperature fluctuations and external sources such as forklifts. This product is applied as a foliar spray to blooming plants that cover most of the growing area, ideally 1-2 days before shipping. Alesco remains effective for up to 3 weeks after treatment depending on the variety and environmental conditions. Benefits include: reducing flower petal shatter, bud abortion, leaf yellowing while extending flower longevity. A partial list of ethylene sensitive crops that benefit from an application of Alesco include: campanula, dahlia, dianthus, hibiscus, impatiens, lobelia, pansy, Pelargonium (geranium), petunia, rose, schlumbergera, and viola. **Foliar spray rates:** 3/4 tsp per gal or 12.8 fl oz per 100 gal. (1 container in 50 gal of water treats approximately 1 acre).

Item: 73-1160 **Size:** 200 ml.Brandt Pesticide
Equipment Cleaner**Active Ingredient: Activated Carbon**

Brandt Pesticide Equipment Cleaner will remove and deactivate residual pesticide contamination from storage tanks and spray equipment. Use before changing from one pesticide to another or before storing equipment. **Rates** range from 0.5-1.5 fl oz per gal. See label for specific instructions.

Item: 75-2510 **Size:** 1qt.

FloraLife Finishing Touch



Maximize the natural freshness of fresh cut flower bouquets, floral designs, evergreens, foliage and potted plants. Finishing Touch is a ready to use product for hydration and protection spray refreshes, hydrates, and protects with a simple and fast last step measure of insurance before any plant leaves the door. Provides ingredients vital to keeping flowers fresh and the color of petals and leaves vibrant. Prevents premature petal drop, dehydration, wilting and browning. Extends flower life an additional 1 to 5 days.

Item: 74-1605 **Size:** 1 gal.

LeafShine & Seal



Reduces dehydration of potted plants such as azalea, chrysanthemum, and rose during transport and display in store. It gives leaves their natural gloss and keeps them dust-free which add to the visual appearance of plants. Rates: 1:20 (50 ml/L) - 1:40 (25 ml/L)

Item: 75-5010**Size:** 1 liter**Item:** 75-5015**Size:** 200 liter

ANTI-TRANSPIRANTS

LeafShield



Active Ingredient: Paraffin, Oxidized Polyethylene, Ethoxylated Nonylphenol, Potassium Hydroxide

Locks moisture in the leaves and increases plant survival during transplanting and transporting, and protects against winter/summer desiccation. A wax emulsion that reduces moisture loss. **Rates:** Winter protection-1 part Leafshield to 15 parts water; transplant/transport protection-1 part Leafshield to 30 parts water.

Item: 75-4025 **Size:** 2.5 gal.

Wilt-Pruf



Active Ingredient: Pinolene

WILT-PRUF is an anti-transparent that protects against excessive moisture loss on a wide range of ornamentals including: evergreens, azaleas, boxwoods, laurels, hollies and many others. Key times that this protection are needed include transplanting during spring, summer and fall seasons. Winter protection is a key feature of WILT-PRUF as it protects plants from the desiccation caused by the cold and dry winds of the winter season. **Foliar Spray Rates:** Winter protection dilute at a rate of 1 gal per 5 gal of spray. For other uses the dilution 1 gal per 10 gal.

Item: 80380002 **Size:** 1 pt.
Item: 80380003 **Size:** 1 qt.
Item: 80380004 **Size:** 1 gal.
Item: 80380005* **Size:** 5 gal.
Item: 80380006* **Size:** 55 gal.

*These items are non-stock.

AQUATIC ALGAECIDE & HERBICIDE

Captain XTR



REI 0

Active Ingredient: Copper Ethanolamine Complex

Captain XTR is a chelated copper formulation of an aquatic algaecide/herbicide that controls a broad range of green and blue-green algae. It also works as an herbicide on submerged weed species with susceptibility to copper. Slow moving or quiescent water application sites include but are not limited to: freshwater lakes and ponds used for ornamental purposes, golf courses, irrigation and potable water reservoirs. The ethanolamines reduce the precipitation of copper in water that is high in carbonates and bicarbonates. **Rates** range from 0.6-3.0 gal per acre foot of water depending on variables such as time of year, water quality and target species. The label contains special instructions for use in moving water applications. **No Irrigation Restrictions.**

Item: 74-1555 **Size:** 2.5 gal.

SeClear



REI 0

Active Ingredient: Copper Sulfate Pentahydrate

SeClear is an algaecide and water quality enhancer. Listed aquatic sites include: ponds, lakes, reservoirs, irrigation and drainage canals and potable water sources. This product is effective in including: green, yellow/green and blue-green algae. Treated algae typically begin to show discoloration within a day and degrade over time. **Rates** range from 1-6.5 gal per acre foot based on species concentration of algae and other factors as detailed on the label. Water quality is improved by decreasing phosphorus concentrations through binding and precipitation of excess phosphorus, binding and precipitated suspended solids. **No Irrigation Restrictions.**

Item: 74-5500 **Size:** 2.5 gal.

CLEANERS

Eco-Clean For Maintenance of Irrigation Systems

Eco-Clean is a biocatalyst whose advanced technology maintains drip and sprinkler irrigation systems free of deposits. Systems that are already fouled should be cleaned with an appropriate shock treatment before the constant injection of Eco-Clean begins.

- Great for cleaning drip irrigation and lines
- Vegetable based liquid concentrate
- Non-toxic and non-hazardous
- Environmentally safe

1 gal of Eco-Clean treats 50,000 gal of water at the final dilution

Gal of Stock Solution	1:100 Ratio	1:500 Ratio	1:1000 Ratio
1	0.25 fl oz	1.25 fl oz	2.5 fl oz
30	7.6 fl oz	38 fl oz	76 fl oz
50	12.8 fl oz	64 fl oz	1 gal
100	25.6 fl oz	1 gal	2 gal

Item: 74-1705 **Size:** 5 gal.
Item: 74-1730 **Size:** 30 gal.
Item: 74-1755 **Size:** 55 gal.

FloraLife Strip-It Cleaner



Strip-It Cleaner is an all-around cleaner for greenhouse structures and irrigation systems, water storage tanks and sunblock wash. This product is recommended for between crop cleaning of structures and irrigation systems to prepare them for treatment with an appropriate sanitizing agent. Florallife Strip-It is a specifically formulated combination of sulfuric acid and wetting agents that effectively removes whitewash coatings, organic sludge, heat-set, oil, dirt, calcium and other hard water deposits. **Rates:** Irrigation lines 1-3 fl oz per gal, Interior hard surfaces 4-5 fl oz per gal.

Item: 53-1109 **Size:** 1 gal.

GreenClean Acid Cleaner



Blend of mineral acids and wetting agents that quickly removes greenhouse whitewash, organic deposits, calcium and other hard mineral deposits. Areas of use include: structures and equipment, walkways, coverings, floors and piping. GreenClean acid cleaner can be applied by spray, mop or brush at a **rate** of 3-8 fl oz per gal. Irrigation piping- Inject undiluted at 1:50 to fill the lines, let sit for 8 hours, flush with plenty of water.

Item: 74-2040 **Size:** 5 gal.

GreenClean Alkaline Cleaner



2024 Removes organic and greasy deposits with non-corrosive self-foaming cleaner. Use for structures, tools, and surfaces including soft metals and food handling areas. Rates range from 4-8 oz per gal.

Item: 74-2045 **Size:** 5 gal.

AgH Pro



AgH PRO is a high foaming, multi-purpose, non corrosive alkaline cleaner. Safe to use for indoor and outdoor areas such as around growing spaces, storage facilities, and packing houses. Dissolves dust, debris, algae, and organic material on production tools and equipment. AgH PRO is designed to meet the highest food plant and greenhouse grower sanitation standards and is environmentally friendly. **Rates:** Use 5-7.5 fl oz per gal for hard surface cleaning.

Item: 74-1200 **Size:** 2.5 gal

GGSPRO Technical Services

Our in-house technical services team delivers prompt, practical and accurate support to Griffin customers everywhere. Visit griffins.com for more information.



GGSPRO TIP AGH PRO CLEANER

Coming in as a replacement for Horti-Klor, this new alkaline-based cleaner is environmentally and equipment-friendly. This cleaner is designed to dislodge organic material including algae from hard surfaces within storage facilities, greenhouses, nurseries, and food processing areas. This is a great cleaning product for reducing cross-contamination and prolonging the operational function of tools used in both ornamental and edible operations.

Strip-It PRO



A powerful combination of cleaning and wetting agents that effectively remove whitewash coatings, algae, dirt, calcium and other hard water deposits. Strip-It PRO's intensified scrubbing action will dislodge compacted organic debris and mineral deposits for easy removal with a high pressure hose. Do not allow Strip-It PRO to dry or surface etching may result. Strip-It PRO can be safely used on aluminium, copper, galvanized steel, glass, plastics, fiberglass and concrete and will not harm the greenhouse structure or horticultural equipment. Strip-It PRO can safely be used to clean under benches with no harmful fumes. **Rates:** Direct inject at 1:50, no plants present or treat at 2.5 fl oz per gal for irrigation line cleaning, use 5 fl oz per gal for hard surface cleaning.

Item: 74-2123 **Size:** 2.5 gal.

Item: 74-21230 **Size:** 30 gal.

Item: 74-21255 **Size:** 55 gal.

DISINFECTANTS

GreenClean PRO



REI 1

Active Ingredient: Sodium Carbonate Peroxyhydrate

A broad spectrum granular algaecide/fungicide. Kills algae on contact with its powerful oxidation reaction and is labeled for use in lakes, ponds, and large bodies of water, as well as on non-painted surfaces like benches and walkways. Irrigation water can be used without interruption after treatment. NSF/ANSI Standard 60 certified for drinking water. **Rates:** 1-2 lb per 1,000 sq ft or 0.5 lb per gal. **OMRI listed. Restricted use in CT & NY.**

Item: 74-20521 **Size:** 50 lb.

Active ingredient: Didecylmethylammonium Chloride

Kleengrow is a 4th generation DDAC sanitizing agent for the control of algae, bacteria and viruses on hard surfaces. The EPA has approved the use of Kleengrow as a disinfectant for the human coronavirus. Kleengrow is non-corrosive and has up to 30 days of residual control. To ensure optimum results use after cleaning surfaces with Strip-It Pro or HORTI-Klor. **Rate:** Refer to label for dilution rates for specific applications. Kleengrow is also labeled as a fungicide/bactericide for many ornamental crops where it carries a *48 hr REI. Please see pg. 333 in the Fungicide Section for more information. Product can safely be used to disinfect greenhouse structures, floors, benches, cool pads, irrigation lines, plastic pots/ trays, tools, coolers, and footbaths.

- Item: 74-21125 Size: 2.5 gal.
- Item: 74-21301 Size: 30 gal.
- Item: 74-21302 Size: 55 gal.

SaniDate 5.0



Active Ingredient: Hydrogen Dioxide & Peracetic Acid

This powerful sanitizing agent controls algae and many water-borne pathogens in irrigation water and on many hard surfaces. Not for use over the crop. The EPA has approved the use of SaniDate 5.0 as a disinfectant for the human coronavirus. Labeled for use in all types of irrigation systems, industrial, and commercial water systems, and evaporative coolers. Helps add dissolved oxygen to the water and does not off-gas. Effective at any pH level. Label includes instructions for fruit and vegetable wash. **OMRI listed.**

- Item: 71-35001 Size: 2.5 gal.
- Item - CA Only: 71-35001-CA Size: 2.5 gal.
- Item: 71-35101 Size: 5 gal.
- Item: 71-35151 Size: 30 gal.
- Item - CA Only: 71-35151-CA Size: 30 gal.

SaniDate 12.0



REI 1

Active Ingredient: Hydrogen Dioxide & Peracetic Acid

This powerful sanitizing agent controls algae and many waterborne pathogens in irrigation water and on many hard surfaces. Labeled for use in all types of irrigation systems, industrial and commercial water systems, and evaporative coolers and may be used over the crop. Helps add dissolved oxygen to the water and does not off-gas. Effective at any pH level. **OMRI listed.** Larger sizes available.

- Item: 71-3530-CA Size: 5 gal.
- Item: 71-35351 Size: 30 gal.

SaniDate Sanitizing Wipes

Active Ingredient: Hydrogen Peroxide

Hard surface sanitizer- Activated peroxide sanitizer in a premoistened wipe.

- Item: 80670009 Size: 125 count

ZeroTol 2.0

REI 1

Listed under Fungicides page 339

BioFoamer



Foaming agent that can be used in a wide variety of foaming equipment. Creates a thick foam that can be regulated by changing the rates. For most equipment add 1-4 fl oz of BioFoamer for every gal of solution to be foamed.

- Item: 74-1360 Size: 5 gal.

HydroFoamer #481



For use with Pace 49 products.

The HydroFoamer's unique injection concept mixes the proper amount of concentrate with both air and water to produce a thick, rich foam for longer soak time. Capacity: 96 oz (2.8 liters).



- Item: 74-2103

Compression Foamer
Hand Pressurized, 8L Tank



Disinfecting your greenhouse is the first step in healthy production. Foam improves disinfection by increasing contact time for the disinfectant on the surface. A rich foam can even stick to vertical surfaces. Dramm has developed the FOAM8L to improve foaming at a low cost. Like a compression sprayer, the FOAM8L is pumped full of air to pressurize the solution tank. The unique feature of the FOAM8L is that this compressed air is also mixed with the solution at the nozzle to produce an air-rich foam that lasts.



See the FM20 Foamer on pg. 382.

- Item: 74-2688

WATER & MEDIA SURFACTANTS

Aqua-Gro L with
PsiMatric Technology

AquaGro L with PsiMatric Technology was developed specifically to overcome water repellency in soilless mixes so they perform at full capacity from the start of production until the plants are shipped out the door. University research has proven and grower experience has verified that plants thrive when AquaGro L is consistently applied throughout production.

Benefits include: Overcoming the mix's inability to wet uniformly, more efficient and profitable crop production, improving plant vigor, saving water and money and better plant survival at retail.

Rates during production:

Inject 10 ppm (1/8 fl oz per 100 gal. of water) in every irrigation or Inject 100 ppm (1 1/4 fl oz per 100 gal. of water) weekly or Inject 600 ppm (7 2/3 fl oz per 100 gal. of water) every 4 weeks.

Item: 74-1348 **Size:** 2.5 gal.

Item: 3104955M **Size:** 55 gal.

Aqua-Gro 2000G 

AquaGro 2000 G media surfactant helps you overcome water repellency and control the moisture in your mix. It blends easily in all types of mixes and allows water to flow uniformly. Ensure the wettability of your mix with AquaGro 2000 G.

Benefits include: Fast initial wetting, faster, more uniform water distribution, optimizes air to water ratios and gets plants established quickly.

Rates: Preparation of plug or propagation media: Apply 1/2 pound per cubic yard of mix. Preparation of flats, pots, hanging baskets, and nursery container mixes: Apply 1 pound per cubic yard of mix.

Item: 74-1249 **Size:** 120 lb.

CapSil

**Active Ingredient: Polyether Modified Polysiloxane**

CapSil is a unique organo-silicone surfactant that increases spray droplet coverage by breaking surface tension. Most pesticides perform better, and visible residue from wettable powders is noticeably reduced. Do not use with pesticides that already contain a surfactant. Research has shown that CapSil can be used to decrease water stress and hasten rooting in many unrooted cuttings. **Rate:** 1/4-1/2 tsp per gal or 4-8 fl oz per 100 gal. **OMRI listed.**

Item: 74-1541 **Size:** 1 gal.



H2Pro

H2Pro™ Greenhouse & Nursery surfactant optimizes soilless media water-holding capacity, decreases irrigation frequency, reduces or eliminates dry spots, and helps prevent wilting both in production and post-production.

It comes in both liquid and granular formulations allowing the user to choose the one that best fits their operation.

It can be applied during soil blending, or any time during production, right up through shipping. At high rates, H2Pro Greenhouse and Nursery's rewetting ability can continue for as long as a year - long enough for the entire production cycle - and right through the retail environment for many crops.

Item: 74-1418 **Size:** 50 lb. granular

Item: 74-1424 **Size:** 2.5 gal. liquid

Nu-Film P Spreader

Active Ingredient: Poly-1-p-Menthene

Nu-Film P is a non-ionic spreader-sticker agent designed for use with most pesticides. It forms a sticky, elastic film holding pesticides on crop foliage. **Rate:** 1/4-1/3 tsp per gal or 4-6 fl oz per 100 gal. **OMRI listed.**

Item: 74-2960 **Size:** 1 gal.

Organics Ag Aide

**Active Ingredient: Yucca schidigera**

Non-ionic, organic wetting agent for use with media. Organics Ag Aide composed of 100% extract will improve wetting in both soil-based and soilless media. **Drench rates:** Initial, one-time application at 16 fl oz per 100 gal. Weekly pulse at 1-1.5 fl oz per 100 gal. May also be used as a foliar spreader with most pesticides. **Surfactant spray rates:** 1/4-1 tsp per gal or 4-16 fl oz per 100 gal. **OMRI listed.**

Item: 74-1379 **Size:** 1 gal.

Soil Moist Granular



A synthetic acrylic copolymer developed to reduce the amount of water needed to maintain vigorous plants. When mixed in the soil the crystals will soften and swell as water is added and absorbed. When the potting system dries, the polymer will release its water to the plant. Soil moist acts as a water reservoir, even during periods of drought the stored water is released to the plant. The expansion and retraction of the polymer during the watering cycle helps soil aeration.

- Reduces plant watering by 50%
- Reduces soil compaction
- Lasts for several seasons

Item: 74-2336 **Size:** 8 lb.
Item: 74-2346 **Size:** 50 lb.

UpTake PRO



Active Ingredient: Didecyldimethylammonium Chloride

UpTake is a biodegradable, soil adjuvant/wetting agent/surfactant, designed to improve the performance of fertilizer programs and pesticide activity when added through drip-irrigation systems. UpTake should not be tank mixed in concentrated stock tank solutions with fertilizer but can be tank mixed with most pesticides in either stock tank or spray solutions. This versatile formulation acts as a penetrant, spreader sticker, and wetting agent that will help increase the performance of a companion product, as well as penetration of water through growing media, resulting in improved root growth and plant quality. **Foliar Spray Rates:** 1/8-1/2 tsp per gal or 6-25 fl oz per 100 gal as a spray adjuvant. **Drench Rates:** 1-2 tsp per gal or 0.4-1.2 fl oz per 100 gal as a soil adjuvant/wetting agent.

Item: 74-21261 **Size:** 2.5 gal.
Item: 74-21281 **Size:** 5 gal.
Item: CA Only 74-2128-CA **Size:** 5 gal.
Item: 74-21271 **Size:** 30 gal.
Item: 74-21291 **Size:** 55 gal.

RODENTICIDE

Eaton's Bait Blocks

Active Ingredient: Diphacinone

For use in wet and dry areas. Specially formulated with a blend of favorite foods and grains of rats and mice. Mold and moisture resistant and stays palatable to rodents.

Item: E779A **Desc:** 9 lb Apple Flavor (144- 1 oz)
Item: E779PBM **Desc:** 9 lb Peanut Butter Flavor (144- 1 oz)

SPRAY AIDS

Indicate 5 **BRANDT**

Easy to read color change makes it easy to adjust spray water to the optimum pH for maximum pesticide performance. Prevents alkaline hydrolysis, neutralizes dissolved salts, and adds a surfactant to improve spreading of the spray material while reducing visible residue. Optimum spray water pH varies by product. Request a copy of the GGSPRO bulletin "Optimum Spray Water pH"

Item: 31705 **Size:** 1 gal.

Tripleline Foam-Away **BRANDT**

Active Ingredient: Polydimethylsiloxane

Tripleline is formulated to prevent excessive foaming that can occur in spray tanks with certain pesticides. It can also be used as a defoaming agent if foaming has already occurred. **Rates** range from 1/2-2 fl oz per 100 gal depending on the foaming characteristics of the pesticides being used. In rare cases, higher rates may be required, but rates should never exceed 5% of the spray volume. Always test for compatibility when making new combinations.

Item: 75-2500 **Size:** 1 qt.
Item: 75-2502 **Size:** 1 gal.

CROP PROTECTION ACCESSORIES

Chemical Measuring Kit

The AXIOM® Measuring Kit for oz and ml includes all three containers consisting of 4 oz, 8 oz, 32 oz.

Item: 40-4180



BioSafe Equipment

Item: 41-9007
Description: Self-venting Spigot for 2.5 and 5 gal containers

Item: 41-9016
Description: EZI Pump Drum with measuring cup for 30 and 55 gallon containers

CROP PROTECTION ACCESSORIES

Sensor Monitor Card



The Chemical Company

New Sensor Monitoring Cards the cards you have depended on for years have drastically improved. The new Sensor glue will not stick to your hands. The trap is as dependable as ever with 1" grid printed on each card to help you determine the magnitude of your infestation.



- Item:** 74-36705 Yellow 3 x 5" Cards - Moisture Resistant (Qty 50)
Item: 74-36707 Blue 3 x 5" Cards - Moisture Resistant (Qty 50)
Item: 74-3650 Card Wire Stakes (Qty 100)

Bug-Scan Rolls and Cards



A yellow sticky plate made of durable, recyclable plastic with glue on both sides. Commonly used tool for the timely detection of a new infestation and for monitoring the population size of pests already present. Attracts the most harmful flying insects, such as whitefly, fungus gnats, aphids and leafminers.

- Item:** 30BSY5X4 **Description:** 12.5cm x 10cm card, 100 pack
Item: 30BSRY30X100 **Description:** 30cm X 100m yellow roll
Item: 30BSRY30X125 **Description:** 15cm X 125m yellow roll, 2 pack

Insect Monitoring Sticky Cards



Yellow sticky cards are widely used in scouting/monitoring programs to attract and capture the adult life stage of greenhouse insect pests including fungus gnats, leafminers, shore flies, western flower thrips and whiteflies.

- Item:** SB8051-01 **Description:** Yellow 10 pack
Item: SB8051-03 **Description:** Yellow 20 pack
Item: SB8052-11 **Description:** Blue 10 Pack
Item: SB8052-03 **Description:** Blue 20 pack
Item: SB8052-02 **Description:** Blue 36 pack
Item: SB8061-01 **Description:** Blue 10 pack with pheromone lure for Western Flower Thrips

Insect Monitoring Sticky Cards



These cards will trap the adult stages of flying insects. BioWorks' unique 2-sided (yellow / blue) design allows you to trap a wider variety of the most common plant-damaging insects (yellow for aphids, whitefly, fungus gnats, etc. and blue for thrips).



- Item:** 74-3668

Sticky-Trap Roll



- Item:** 74-12300 12" x 300'
Item: 74-61500 Yellow 6" x 1500'
Item: 74-61500B Blue 6" x 1500'
Item: SB8051-05 Yellow 5.9" x 328'
Item: SB8052-05 Blue 5.9" x 328'
Item: SB8052-15 Blue 5.9" x 328' w/ Pheromone - 2 per cs

EPA APPROVED WARNING SIGNS



14" x 16" Signs

This EPA-approved reusable sign has correct legend and size.

- Item:** 41-1124



Small Signs

Approved for individual potted plants, greenhouse benches and certain nursery situations. These reusable 5" x 5" signs come with 16" PVC stake. Place no more than 25' apart.

- Item:** 41-1123



14" Pesticide Storage Sign

Mount this sign where pesticides are being stored

- UV resistant ink
- 0.030 gauge polyethylene

- Item:** 41-5026

Central Posting Kit

Handy for fulfilling WPS central posting requirements. Kit contains one of each of the following:

- Emergency Medical Facility Sign 10"x12" 0.050 Plastic
- Pesticide Safety Poster 23"x35" Full Color
- Pesticide Application Posting Tablet - 50 Sheets, 8½" x 11"
- EPA How to Comply booklet



- Item:** 41-5025



PERFECT YOUR PROGRAM WITH POSTIVA

Complete your disease management strategy with the unique formulation in Postiva™ fungicide.



Powered by two active ingredients (FRAC groups 3+7), making it an excellent addition to disease management programs.





Rapidly absorbed into plant tissue creating a rainfast barrier of protection to prevent infection and disease progression.



Provides long-lasting control of Fusarium, powdery mildew, Botrytis, leaf spots, black spot and rust, as well as suppression of certain bacterial diseases.

Learn more at [GreenCastOnline.com/Postiva](https://www.GreenCastOnline.com/Postiva)

 @SyngentaOrnamentalsUS  @SyngentaOrnamentals



Postiva™
Fungicide

syngenta®

All photos are either the property of Syngenta or are used with permission.

© 2022 Syngenta. **Important: Always read and follow label instructions. Some products may not be registered for sale or use in all states or counties and/or may have state-specific use requirements. Please check with your local extension service to ensure registration and proper use.** GreenCast®, Postiva™, the Purpose Icon, the Alliance Frame and the Syngenta logo are trademarks of a Syngenta Group Company.

®

Pradia[®]
Insecticide

Pradia solves your
insect puzzle.



Pradia is a trademark of OHP, Inc.



Pradia[®] is a combination product developed to control a wide variety of sucking and chewing pests on ornamental and nursery crops. Pradia delivers a quick knockdown and excellent long-term control on aphids, thrips, whitefly and scale.

ohp | Partners
with
solutions
An American Vanguard Company

PROTECTIVE EQUIPMENT & SPRAYERS



Respiratory Protection

Honeywell

Half Mask Paint & Insecticide Respirator

- OV/R95 paint spray & pesticide respirator with organic vapor cartridges & R95 pre-filters
- Soft & comfortable, non-allergenic, elastomeric blend facepiece provides excellent fit
- Contoured sealing flange eliminates pressure point on face - fits wide range of facial types
- Provides protection against most paints and pesticides



Item: 80-1150

North[®] RU6500 Silicone Full Facepiece

- Polycarbonate lens with 200° field of vision that meets ANSI requirements for high impact
- Silicone nose cup offers a soft, comfortable fit ideal for all day use
- Deeper threaded cartridge connector virtually eliminates accidental disconnections and worker exposure to contaminants
- Wide viewing area for distortion-free visibility and optical clarity



Item: 80-1125

Honeywell

Multi-Purpose Cartridge P100 Filter

Organic vapor, acid gas (chlorine, hydrogen chloride, sulfur dioxide, hydrogen sulfide, hydrogen fluoride, chlorine dioxide), ammonia, methylamine, formaldehyde and P100 cartridge/filter combination (Pair)



Item: 80-1152 Qty: 2



Protective Helmet

Kasco has the right system to protect you against pesticides, dust or any other hazardous chemicals that you might encounter. Kasco helmets can also be utilized to increase worker contentment in atmospheres that are particularly odorous or irritating.

All helmets are triple inspected at the factory, sealed and are covered by a 12 month limited warranty.

WARNING: Do not use KASCO helmets with fumigants. Do not use them in manure pits, silos, or any atmosphere where oxygen may be less than 19.5%.

Item	Description
80-1535*	Professional 88 Kasco Protective Helmet (Battery charger sold separately)
80-1533	ZA1P3 Kasco Filter for Professional 88 Protective Helmet
80-1538*	NC9-2 Battery Charger for Kasco Professional 88 Helmet
80-1540*	#K80S-T8N(G) Kasco Protective Helmet
80-1531	Kasco ZA2P3 Filter for Protective Helmet #K80S-T8N
80-1525*	T5T8 Kasco 6v/6a Battery (2 prong)
58-103320*	Kasco Blue Collar/Band #309038 w/drawstring for K80S Helmet

*These products are drop ship only.

Honeywell

Protection

Nuisance Dust Masks

Provides relief from nuisance level dust



Item	Vendor	Qty
80-1225	RWS-54001	Boxed (50/box)



A20 Breathable Particle Protection Coveralls

Made from strong, breathable, three-layer SMS fabric designed to reduce heat stress and enhance worker comfort and productivity. Offers protection against many fine dusts, fibers, and low surface tension liquid splashes. California's Department of Pesticide Regulation, a division of the state EPA, has approved KLEENGUARD® coveralls for pesticide application. Meets basic coverall requirements.

- Breathable
- Allows sweat and moisture vapor to escape
- Resistant to dry particles
- Repels liquid splashes and sprays
- Anti-static
- Denim Blue
- Zipper front, elastic back, wrists, ankles, hood

Typical Uses:

Laboratories; Decontamination modesty garment; Remediation; Pesticides; Heavy dust environments

Item	Vendor	Size
80-2171	58512	Medium (36-40)
80-2172	58513	Large (37-43)
80-2173	58514	X-Large (44-45)
80-2174	58515	XX-Large (46-54)



2024

A70 Chemical Spray Protection Coveralls

Made from a polyethylene-coated fabric that's lightweight and resistant to many water-based liquids, liquid chemical splashes and sprays. REPEL® coveralls pass ASTM F903 penetration testing for the wide range of liquid chemicals represented by ASTM F1001. California's Department of Pesticide Regulation, a division of the state EPA, has approved REPEL® coveralls as chemical protection in pesticide applications. Meets chemical resistant category.

- Resistant to dry particles
- Repels liquid splashes and sprays
- Resistant to many liquid and dry particulate chemicals
- Anti-static
- Zipper front, storm flap

Typical Uses:

General protection and splash exposure chemical applications such as agricultural mixing and spraying, acid/caustic splash.

Item	Vendor	Size
80-2372	45422	Medium (36-40)
80-2373	45423	Large (37-43)
80-2374	45424	X-Large (44-45)
80-2375	45425	XX-Large (46-54)



Kleenguard Protection
 Only Kleenguard offers protection plus cloth-like comfort.



Vinyl Gloves (A)

Powder Free. 100 per dispenser box.

Item	Size
Powder Free - 100 per box	
80-5380	Small
80-5382	Medium
80-5384	Large

Rubber Palm Ribbed Knit Work Gloves (B)

Double latex coating for extra protection. Ergonomic pre-curved design. Flexible knit wrist. Sanitized[®] Treated.

Item	Vendor	Size
80-5245	8422S	Small
80-5246	8422M	Medium
80-5247	8422L	Large
80-5248	8422J	X-Large

Monogoggle[®] (C)

Polycarbonate Lens, Direct Ventilation

- Ventilated safety goggles
- Fits over most prescription eyewear

Item: 80-1327

Honeywell

Vapor[®] Protective Eyewear (D)

Eclipse Protection Eyewear is designed to meet the demands for durable, high tech eyewear at an unbelievably low price. Inspired by popular sport sunglasses, Eclipse is very lightweight. Its stylish indestructible nylon frame provides an ergonomic fit for all-day comfort and protection.

Item: 80-1328

HOZELOCK

Hozelock P2 2.5 Pint Pump-up Pressure Sprayer w/Viton seals (E)

Heavy duty industrial sprayer for the application of aggressive chemicals. A stainless steel pump rod – with a thicker bottle for durability. Equipped with Viton fluoroelastomer seals that are 4x stronger than general seals

- Simple to operate - simply pump, lock and spray
- Adjustable nozzle from jet to mist
- Anti-theft nozzle
- Sprayer Type: Pressure
- Capacity: 1.25L

Item: 942P2

solo®



425 4-Gallon Professional Piston Backpack Sprayer (A)

- Easily / effectively handles liquid disinfectants, fertilizers, herbicides, pesticides and formulations for tree, shrub and plant protection
- High-performance piston pump for increased pressure capabilities of up to 90 psi
- Extra-large tank openings for easier filling and cleaning
- 28" unbreakable wand and shut-off valve for excellent reach
- Commercial shut-off valve with lock-on/lock-off feature to minimize user fatigue
- Viton® seals in key locations ensure long service and durability
- Interchangeable pump handle for left or right-hand operation
- 48" nylon-reinforced high-pressure hose for extended reach
- Double filtration system: filter basket and nozzle filter
- Four-nozzle assortment: adjustable, fan spray, hollow cone, and jet stream nozzles. TeeJet® compatible

Item: 81140025

456 2.25-Gallon Professional Handheld Sprayer (C)

- Chemical resistant Viton® seals in key locations withstand harsh chemicals for long service and durability
- Rugged piston pump for quick pressurization
- Pressure relief valve vents excess pressure
- Commercial quality shut-off valve with lock-on/lock-off feature reduces operator fatigue
- Large 4.5" tank opening for effortless filling and cleaning
- Four-nozzle assortment: adjustable, flat fan, jet stream and hollow cone. TeeJet® compatible
- Now with large base for added stability. 458 model can accommodate the wheel set and pull handle (accessory kit, part # 49211)

Item: 41-3120

441 Battery-Operated Backpack Sprayer (D)

- Speed Tip Nozzle: multi-spray pattern. Sprays with 3 different settings with a turn of the dial: jet stream, flat spray and full cone mist
- 4 gallon, UV-resistant HDPE tank with large 4.75" opening. The large filter basket is easily removed
- 11V diaphragm pump, 37.5 PSI
- 11V Lithium-ion Battery. 2.5 hour running time. 2-hour charging time
- Integrated carry handle for easy transport and maneuvering
- Adjustable padded straps
- 20" unbreakable wand provides excellent reach. The wand can be stored neatly in a wand holder to protect it from damage
- Commercial shut-off valve with lock-on / lock-off feature reduces operator fatigue
- Stable tank base ensures that the sprayer will not tip when filling

Item: 81140038

430-2G Handheld Sprayer 2-Gallon (E)

- Designed for medium-to-large jobs at home, on the farm, or for professional applications
- Chemical resistant Viton® seals in key locations withstand harsh chemicals for long service and durability
- Commercial quality shut-off valve with lock-on/lock-off feature
- Funnel top for easy fill and large secondary opening for easy clean-up
- Four-nozzle assortment for multiple spraying tasks: plastic adjustable, fan spray, hollow cone, and jet stream nozzles. TeeJet® compatible
- Unique storage compartment for extra nozzles

Item: 81140005

DRAMM



2024

Compression Foamer Hand Pressurized, 8L tank (A)

Disinfecting your greenhouse is the first step in healthy production. Foam improves disinfection by increasing contact time for the disinfectant on the surface. A rich foam can even stick to vertical surfaces. Dramm has developed the FOAM8L to improve foaming at a low cost. Like a compression sprayer, the FOAM8L is pumped full of air to pressurize the solution tank. The unique feature of the FOAM8L is that this compressed air is also mixed with the solution at the nozzle to produce an air-rich foam that lasts.

Item: 74-2688

PulsFOG (B)

The Dramm PulsFOG is perfect for both large and small greenhouses. It can be used at the doorway to treat quonset houses in minutes or gutter connected greenhouses from the aisle. The ultra fine cloud of droplets penetrates deep into the canopy covering all surfaces, ensuring excellent control of greenhouse pests and disease. Bio PulsFOG available for applications of heat sensitive products and biological formulations.

Contact Griffin for sizing options.

Pulsfog Solutions

Item	Description
74-2685	PFC-1G PulsFOG Cleaning Solution - 1 Gallon

Dramm Sprayer Accessories

Hydra Trigger Gun

Adjustable Output for Hydra Sprayers.

Item: 41-1246



Trigger Style Spray Gun

For MSO Sprayers.

Item: 41-1245



L-5 Lance

28 inch spray lance expands to 41 inches with a 5 jet spray ring. Includes valve and handle. Works with Hydra, MSO, and BP-4. Purchase a male stainless quick connect for use with a Hydra.

L-5QC L-5 Lance

L-5 lance with a male stainless quick connect. Works with Hydra and MSO sprayers.

BP4 L-5E L-5 Lance

5 jet ring spray lance for MSO, Hydra, or BP4. Extends to 30 inches. Does not include shut off valve, handle, or quick connect.

Item	Description
41-1240	L-5 Lance, no quick connect
41-1262	L-5QC L-5 Lance with Quick Connect
41-1261	BP4 L-5 Lance without Valve for BP4 Use

Drench Adapter for Hydra Sprayer

Turn your Hydra into a drenching tool with this Handi-Reach combo. 24" Aluminum Handi-Reach Handle, 170AL Water Breaker Nozzle, Brass Shut-Off Valve, and a stainless quick connect.

Item: 41-1276



DRAMM



Heavy Duty Sprayer Model MSO (B)

- Multi-purpose hydraulic sprayer
- Applies most chemical formulations
- Corrosion-resistant pump
- 120 Volts 60 HZ
- 20 gallon solution tank
- Powder coated cart
- 20½" wide with rubber wheels (Big foot option available for variable terrain)
- Hose Reel (Hose lengths 33', 100', 150')
- Trigger Gun

Specs

- **Chemical Output Rate:** Up to 0.5 gpm
- **Maximum Pressure:** Up to 500 psi
- **Compressor HP:** ¼ hp electric
- **Drive system:** Direct drive
- **Cord Length:** 8 ft.
- **Spray Distance:** Stream: 20'; mist 10'
- **Shipping Weight:** 28 lb.

Drop Ship Only

- Item:** 41-1210 **Desc:** MSO Spray 33' Hose
- Item:** 41-12101 **Desc:** MSO Spray 100' Hose

Hydra Sprayer (C)

- High volume hydraulic sprayer
- Applies most chemical formulations
- Variety of droplet sizes and spray distances
- 115 volts or 220 volts 60 HZ
- Bigfoot Option available for variable terrain
- Dedicated agitation

Specs

- **Chemical Tank Volume:** 50 Gallons
- **Chemical Output Rate:** Up to 3.8 gpm
- **Maximum Pressure:** Up to 500 psi
- **Pump HP:** 1.5 hp electric
- **Hose Length:** 150', 200', 250'
- **Dimensions:** 26" wide
- **Shipping Weight:** 315 lb.

CRF (corrosive resistant fittings) package available

Drop Ship Only. Contact Griffin for Hydra sprayer options and packages.

The FM20 Foamer (A)

Uses compressed air (not included) to propel and create a rich, aerated foam for the application of disinfectants. When connected to a compressor, the FM20 can throw a foam up to 15 feet, providing excellent coverage and a persistent foam. Unlike siphon-based foamers and hose-end equipment that create suds, a foam created with compressed air is much richer and will last on surfaces longer. Compressed air foams adhere to vertical surfaces well, allowing for better disinfection. The FM20 is available with our standard, solid rubber wheel package or the BigFoot Upgrade. Larger sizes and hose lengths available.

Drop Ship Only

Item: 74-2689

Spray Trax Sprayer (D)

The Dramm Hydra SprayTrax™ is a high volume hydraulic sprayer capable of performing a variety of tasks. The Hydra™ is perfect for the application of insecticides, fungicides, growth regulators, fertilizers, disinfectants and other chemicals. With a maximum pump output of 7 gallons per minute, the Hydra SprayTrax offers enough volume to utilize a choice of guns, drench, and agitate the tank simultaneously. The pump has a maximum operating pressure of 550 psi with a fully adjustable regulator, allowing for flexibility in choice of spray pattern, droplets and distances. CRF (corrosion resistant fittings) package available.

50 gallon, 100 gallon and 200 gallon sprayers available.

Drop Ship Only

MLVH Mini AutoFog™ (A)

- Automatic chemical application
- Drastically reduce labor costs
- Low volume spraying
- Treats up to 3,000 sq. ft.
- Treats 5,000 sq. ft. with additional fans
- 120 Volts 60 HZ

Specs

- **Chemical Tank Volume:** 8 liters
- **Chemical Output Rate:** 45cc/min
- **System Rated Load:** 12.3 amp
- **Compressor HP:** ¾ hp
- **Compressor Output:** 2.43 CFM @ 21 PSI
- **Cord Length:** 4 ft.
- **Dimensions:** 10" wide
- **Shipping Weight:** 83 lb.

Optional Stainless Steel Nozzle for use with Oxidizers.

Drop Ship Only

Item: 41-1200



AutoFog™ SLVH & LVH Models (B)

- Automatic chemical application
- Low volume spraying
- Separates for portable use

Specs

Category	SLVH20A	LVH20A
Standard Coverage Area:	Up to 12,000 sqft	Up to 30,000 sqft
Coverage with HAF Fans:	Up to 28,000 sqft	Up to 70,000 sqft
Power:	120 Volt, 60 hz single phase	240 Volt, 60hz single phase
Chemical Tank Volume:	7 liters	14 liters
Chemical Output Rate:	45cc/min	55cc/min
System Rated Load:	11.1 amp	8 amp
Compressor Horsepower:	¾ hp	1 hp
Compressor Output Rate:	2.43 CFM@ 21 PSI	4.06 CFM@ 28.5 PSI
Hose & Cord Length:	33 ft	100 ft
Dimensions:	18.25" wide	18.25" wide
Shipping Weight:	156 lbs.	187 lbs.

Item	Description	Optional Stainless Steel Nozzle for use with Oxidizers.
62-6003251	SLVH Auto Fog	
62-6003201	LVH-20A Autofog	

Drop Ship Only

CF20 ColdFogger™ (C)

The CF20 Coldfogger Low Volume Sprayer can treat up to 70,000 sq. ft. in 70 minutes of spray time.

The CF20 uses a 3,000 PSI pump to create a much finer spray than standard hydraulic sprayers. This 40µ spray cloud covers more surface area while the high pressure propels the spray deep into the canopy, ensuring even coverage on all surfaces.

The CF20 comes standard with 150 feet of high-pressure hose on our convex reel. Both shorter and longer lengths are available. A separate agitation pump helps prime the spray pump and keeps even stubborn powders in solution.

50 gal/300' hose available.

Specs

- **Tank size:** 20 gallons / 72 liters
- **Hose length:** 150' w/quick connect
- **Motor:** 110 v 60 HZ 10 amp
- **Maximum Pressure:** 3,000 psi
- **Pump Type:** High pressure, diaphragm
- Treat 1,000 sq. ft. in 1 minute
- 40µ VMD sized droplets cover all surfaces
- 3,000 PSI propels the fine droplets deep into the canopy
- Extremely even coverage

Item: 41-1488

Drop Ship Only

DRAMM



A



B



C

CD-120 ChemDose™ (A)

- Apply exact doses directly to root zone
- Apply all formulations of chemicals
- Variable precision output: 10ml-90ml
- Variable interval between dosing
- Dosing cycle counter
- 3 wand lengths: 16", 30", and 38" for bench, ground or hanging baskets

Specs

- **Tank Volume:** 20 gallons
- **Accuracy:** +/-1ml per cycle
- **Power Supply:** 12V DC; rechargeable
- **Hose Length:** 25 ft.
- **Dimensions:** 20½" wide
- **Shipping Weight:** 102 lb.

Drop Ship Only

Item: 41-1195

Chemdose™ 2 (B)

The Damm CD2 Chemdose is the next generation in precision dosing technology. Designed for use with a hydraulic sprayer or a chemical injector, the CD2 precisely measures each dose from any source below 100 PSI and applies it directly to the pot. Eliminating the limitations of power and hose-length constraints, the CD2 is powered by a rechargeable battery. It can either be worn or mounted on a small cart, making the unit extremely portable. Perfect for the application of systemic insecticides or plant growth regulators.

Drop Ship Only

Contact Griffin for more information.

Turbo ULV – Hybrid Sprayer/Fogger (C)

The Turbo ULV – Hybrid Sprayer/Fogger is an electrically powered, pneumatic cold-fogger. Its high-performance turbine creates a powerful, warm flow of air that atomizes and propels the fog up to 75 feet, depending on the nozzle and particle size. The output and droplet size of the Turbo Hybrid may be altered by changing the nozzle for a variety of applications and results.

The Turbo Hybrid is perfect for the directed application of pesticides, fungicides and disinfectants, including corrosive chemicals. Because the unit is a cold fogger, the Turbo ULV is ideal for the application of bio-rational products. For best operation, the Turbo Hybrid requires the use of a carrier solution to help with particle atomization.

The Turbo ULV is a directed, low volume sprayer with a forceful spray with fine droplets that will penetrate the canopy but won't damage plant material.

Drop Ship Only

Contact Griffin for more information.

2024

DRAMM



2024

BP-4Li Rechargeable Backpack Sprayer (A)

Rechargeable, battery-powered sprayer that fits comfortably on your back. Operating at a maximum pressure of 150 psi, the BP-4 offers an adjustable pressure knob for flexibility in spraying. Using the high-pressure setting, the BP-4 atomizes spray solutions better than other backpack sprayers, ensuring excellent coverage. The battery-operated pump ensures even flow rates, perfect for even application of plant growth regulators, insecticides, fungicides, herbicides and other greenhouse chemicals. The BP-4 can run for up to 1 hour on a full charge and recharges in 4 hours. The 4 gallon tank capacity is just the right size. Perfect for spot treatments or concentrated applications, but small enough to still be comfortable to wear.

Specs

- **Tank Capacity:** 4 gallons
- **Power Supply:** Battery - 6V 3.0 Ah
- **Continuous spray time:** 1 hr
- **Weight empty:** 11 lbs.

Drop Ship Only

Item: 62-70056

WaterCart (B)

The WC-20 and WC-50 Watercart are rechargeable, battery operated, portable watering systems for interior or exterior use. The battery operated pump has a flow rate of 5 gallons per minute for fast watering of containers with little spillage. A total of 300 gallons can be applied before the battery needs to be recharged with the included charger. Dramm Bigfoot option available for use on varied terrain.

Drop Ship Only

Contact Griffin for more information.

FertiCart Portable Injector Cart (C)

The Dramm FC20 FertiCart is designed for portable fertilizer injection. Utilizing our durable MS20 cart, the FertiCart fits down most greenhouse aisles while the low center of gravity, low hose draw point and well balanced cart prevents tipping. Locking casters and rubberized wheels prevent slipping on wet surfaces.

The FC20 comes as a complete kit including a filter to protect the injector and a check valve to prevent back flow of chemicals in the tank. All of the plumbing is mounted on a PVC board for durability and includes unions for easy installation of the injector.

Specs

- 20 Gallon Capacity Drain valve for easy clean out
- Kits to fit most injectors available
Hose hook on rear of unit
- Rubberized wheels and casters
Vinyl coated steel frame
- Dimensions- L: 38" W: 21" H: 48

Drop Ship Only

Item	Description
41-1235	Dramm FertiCart+ 20gl tank-for your Dosatron Injector FC20-DT
41-1236	Dramm FertiCart+ 20gl tank-for your Dosmatic Injector FC20-DM



A



B



C



D



Mist'r Drench (A)

High or low pressure to mist chemicals, drench, or shade.

- 800 PSI max pressure
- 3 GPM max flow
- 100' 3/8" wire braid hose (standard)
- 60 gallon tank with sump
- Constant agitation
- Towing tongue
- 2 guns, quick coupled with 12" and 18" wands
- Gas or electric options
- Also available in 100 and 200 gallon

Item	Description
41-2025	Electric Mister Drench with hose reel
41-38100	100' - 3/8" Replacement Sprayhose

Drop Ship Only

Siebring Sprayers Available, Special Order w/Gas Engines

Fox Sprayer (B)

- 800 PSI max pressure
- 3 GPM max flow
- 100' 3/8" wire braid hose (standard)
- 35 gallon tank with sump
- Constant agitation
- Solid rubber tires
- Highly maneuverable – narrow front steering mechanism for tight turns
- Towing tongue
- 2 guns, quick coupled with 12" and 18" wands
- Gas or electric options

Item	Description
41-2120	Siebring Fox 120V Sprayer with STD Reel/35 gal. Tank/100' Hose
41-38100	100' - 3/8" Replacement Sprayhose

Drop Ship Only

Coyote Sprayer (C)

- 800 PSI max pressure
- 3 GPM max flow
- 100' 3/8" wire braid hose (standard)
- 55 gallon tank with sump
- Constant agitation
- Solid rubber tires
- Towing tongue
- 2 guns, quick coupled with 12" and 18" wands
- Gas or electric options

Item	Description
COYOTESS	Coyote 800 120V stainless 100'hose, reel, 1.5HP

Drop Ship Only

Kruser Sprayer (D)

- 750 PSI max pressure
- 1.5 GPM max flow
- 100' 1/4" wire braid hose (standard)
- 25 gallon tank with sump
- Constant agitation
- Solid rubber tires
- Gun and wand, quick coupled
- Gas or electric options

Item	Description
542SF30ES1	750 120v W/100' Spray Hose, 25G Tank, 1.5 gpm, Electric Motor
542SF30GS1H	750 W/100' Spray Hose, Honda Gas Engine

Drop Ship Only



2024 **Multi-Purpose Sprayer (A)**

Chapin's 10031 2-liter multi-purpose sprayer is perfect for spraying pesticides and herbicides in your garden and potted plants. Homeowners and professionals can keep it for outdoor and indoor use and it's a great tool for general cleaning. The translucent tank is chemical and rust resistant and adjustable spray nozzle lets you spray a stream or shower as needed. Made in the USA with global materials.

Item #	Description	CS/UOS
82210027	2L/67oz	6/6

Lawn & Garden Sprayer (B)

Chapin's 16100 1-gallon home and garden poly tank sprayer is a value option for homeowners. It's made for quick and simple jobs inside and outside your home. The seals and gaskets are compatible with common herbicides, pesticides and fertilizers. Its ergonomic pump handle, 12-inch poly wand, poly trigger shut-off with lock-on, adjustable cone nozzle, and an in-tank filter is standard on this home and garden sprayer. Made in the USA and backed by Chapin's 1-year limited warranty.

Item #	Description	CS/UOS
82210029	1gal/3.8L	1/1

Lawn & Garden Sprayer (C)

Chapin's 16200 home and garden sprayer is the value option for homeowners. For quick and simple jobs around the house, inside and out. It's compatible with common herbicides, pesticides, fertilizers and general cleaners. The 2-gallon poly tank comes with an ergonomic pump handle, poly wand with comfortable trigger shut-off, adjustable cone nozzle, and an in-tank filter for continuous spraying. Made in the USA with global materials.

Item #	Description	CS/UOS
82210030	2gal/7.6L	1/1

Poly Knapsack Sprayer (D)

Chapin's 61900 4-gallon ProSeries professional backpack sprayer with positional pump handle allows you to comfortably control this unit whether you're left or right handed. It comes with chemical-resistant seals for harsher weed control, pest control or fertilizers. Multiple nozzles are included. Its chemical-resistant poly tank is rust resistant and translucent. The backpack comes with Chapin's standard 3-stage filtration system. Made in the USA with global materials.

Item #	Description	CS/UOS
82210059	4gal/15.1L	1/1

Wet or Dry Spray Hose End (E)

Fertilizing your plants, spraying to rid your yard of pesky weeds, or stopping insects from infiltrating your property? Chapin's G6015 wet/dry hose-end sprayer is one of the easiest hose-end sprayers Chapin's designed. Use both liquid or water-soluble lawn and garden chemicals in this sprayer. Attach to the end of a standard garden hose, set the dial and it automatically mixes the right amount of chemical with water. Made in the USA with global materials.

Item #	Description	CS/UOS
82210128	32 oz capacity	4/4

Spray Power Mister (F)

Chapin's 1055 trigger sprayer is compatible with common fertilizers, weed killers and pesticides. It's great for everyday tasks around the home, garden, cleaning or in the garage. This 32-ounce sprayer has a translucent plastic bottle so you easily see how full it is.

Item #	Description	CS/UOS
82210005	32oz/1L	12/12

Sprayer Hose End (G)

Chapin's G390 20-gallon hose-end lawn sprayer fits onto any hose end and offers up to 20 gallons of finished spray, a built-in anti-siphon feature to prevent backflow, fingertip on/off control, durable, chemical-resistant and rustproof polyethylene construction. It automatically mixes liquid concentrate with water. Made in the USA with global materials.

Item #	Description	CS/UOS
82210124	20gal/75.7L	6/6

Terms and Conditions

UPS / FED EX

We generally recommend UPS / Fed Ex deliveries as the best method for shipping, providing these requirements can be met: all UPS / Fed Ex shipments require a street address and a zip code. Please do not ask us to ship UPS / Fed Ex unless these requirements are met.

Hazardous materials can not be shipped UPS / FEDEX / USPS

There is a \$26.00 charge per package for all C.O.D deliveries by UPS / Fed Ex. We suggest paying by credit card to alleviate this. UPS / Fed Ex has a fuel surcharge into their freight rates that will fluctuate monthly based on current fuel cost. All orders will have a \$15.00 charge for packaging and handling. There is an additional handling fee of \$25.00 for all packages not in a box or 48 inches along it's longest side, and 30 inches along its second longest side, or has an actual weight of 70 pounds or greater. **Any refused C.O.D deliveries will incur a 25% restocking charge.**

UPS / FED Ex- Damaged Shipments

If you see that a shipment is damaged upon receipt from UPS / Fed Ex, refuse shipment. UPS / Fed Ex will return the shipment to us, and we will file the claim and send a new shipment to you. If after opening the package you find concealed damage, call us at once. We will instruct UPS / Fed Ex to pick up the package and return it to us for a claim. We will reshipe your order.

C.O.D. Shipment

Will be made to all accounts with a balance over 60 days.

Payments

We accept Cash, Check, or the following major Credit Cards: American Express, Visa, MasterCard, and Discover. No additional discounts allowed on credit card payments. Credit cards taken after the initial purchase will require a signed form stating that purchaser agrees to a 2% processing fee, charged by Griffin Greenhouse Supplies, Inc. and will be charged with the balance being paid.

Offerings

Listed are made subject to being available. We will not be held responsible for delays in shipment caused by conditions beyond our control. Applicable substitutes will be made when necessary.

Terms

Are net 30 days unless otherwise stated. A 1½% per month service charge is added on all overdue accounts. This is an 18% annual charge. Terms are COD where credit has not been established. Returned checks will be assessed a \$20.00 fee. Delayed Payment Plan (dating) will only be extended to accounts with a satisfactory payment record.

Direct Shipment Deposits

All material that is shipped Direct from the manufacturer to the customer will require a 30% deposit before the order can be placed with the manufacturer. Depending on the size or complexity of the order you will be required to sign off on a bill of lading to ensure the accuracy and condition of the order.

Returns

No merchandise may be returned without authorization from our office. Merchandise must be returned within 60 days of purchase. Invoice number and date of purchase is required for any/all returns. A restocking charge of 20% is charged on all returns unless merchandise is defective. **ITEMS THAT ARE SPECIAL ORDERED, MADE TO CUSTOMER SPECIFICATIONS, NON-INVENTORY OR NON-STOCK ITEMS, CANNOT BE RETURNED FOR ANY CREDIT DUE TO THEIR SPECIAL NATURE.**

Chemical Shipping

No chemicals will be left without a customer signature. All restricted use products must be accepted and signed for by the license holder only, which is enforced by state law.

Sales Tax

Appropriate state tax will be charged based on location of delivery. All items will be charged sales tax unless we have your tax exempt number on file. In compliance with the law, we must charge the tax on all items, which the state designates as taxable even though you have provided us with your sales tax number. If any items purchased are for company use please notify us so the appropriate tax can be charged.

Recommendations

Made by us are compiled from recognized horticultural sources. We are not responsible for damage or failure due to recommendations given by Griffin Greenhouse Supplies, Inc.

Notice to Purchaser

The following is made in lieu of all warranties expressed or implied. Seller's and manufacturer's only obligation shall be to replace such quantity of the product proved to be defective. Neither seller nor manufacturer shall be liable for any injury, loss or damage, direct or consequential, arising out of the use or the inability to use the product. Before using, user shall determine the suitability of the product for his intended use, and user assumes all risk and liability whatsoever in connection therewith. The foregoing may not be changed except by an agreement signed by officers of seller and manufacturer. All terms and conditions listed are subject to change.

Motor Freight Shipments

In order to provide you with the best service possible all deliveries made must be signed for, which will ensure the right product and quantities are received. All pallets are wrapped with black wrap and taped to ensure your order arrives complete. If your pallet is tampered with, please sign the bill of lading **"1 pallet received, tape and wrap has been broken."** Any shortages or missed shipments must be noted upon receipt of your delivery, so please try to be available on delivery date.

All orders for delivery must be placed 24 hours, or 2 working days, prior to your delivery day.

The original Bill of Lading attached to our invoice indicates that material shipped has now become your property and is an acknowledgment by the transportation company of the receipt of the property in good condition. Safe delivery of this shipment is now the responsibility of the carrier. Please examine your shipment carefully before signing the freight bill. We will be glad to assist in tracing or recovery of lost merchandise.

Motor Freight - Damage or Shortage

If any damage is noted, or if the number of pieces received does not agree with the number on the bill of lading, **DO NOT** accept the shipment without shortage or damage notated on your freight bill and signed by the carrier's agent (driver). Failure to do so may jeopardize your recovery. If any concealed damage or shortage is discovered when unpacking, leave the material and the packing as is and notify the carrier for a concealed damage or shortage inspection. Consult the carrier for the necessary claim papers and disposition of damaged articles. When checking shipments, compare what was received with packing list or invoice. If there is a shortage or damage, **YOU MUST CONTACT US WITHIN 24 to 48 HOURS** and provide us with full details and pictures.

Claims with motor freight companies must be made promptly. The freight company will not consider a claim unless it is presented within nine months from the date of shipment. The carriers agent will assist you in making that claim. Claims for loss or damaged material and transportation charges **MUST NOT** be deducted from the invoice and the payment of invoices **MUST NOT** be withheld awaiting adjustment of such claims, since it is the function of the carrier to guarantee safe delivery.

PRICES AND TERMS ARE SUBJECT TO CHANGE WITHOUT NOTICE.

Prices at time of shipment will prevail. For current quotations, please call us. Prices quoted are FOB Denver, CO; Cheshire, CT; Ball Ground, GA; Tewksbury, MA; Gray, ME; Bridgeton, NJ; Auburn, NY; Brookhaven, NY; Schenectady, NY; Salem, OR; Morgantown, PA; Richmond, VA; and Woodridge, IL. or FOB the factory unless otherwise stated.

A

- A-Rest340
 Abamectin350, 356, 359
 Accessories - Greenhouses49
 Acephate349
 Acequinocyl359
 Acetamiprid360
 Acme Ventilation 56-57, 59
 Agriform Planting Tablets279
 AgroFabric 197
 Air Inflation- Fan Replacement44
 Air Purifying Helmets378
 Aluminum Doors53
 Aluminum Wall Shutter 56-57, 60
 American Coolair Fans 60-61
 Ametoctradin334
 Ammonium nonanoate344
 Ancymidol340
 Anderson Injectors 314-315
 Angle Arrow Drippers297
 Anti-Transpirants369
 Arcadia 174
 Aqua-Gro372
 Aquatrols369, 372
 Automation 94-99
 Avid350
 Azadirachtin350, 351, 356
 Azatin O350, 351

B

- BASF268, 329,331,334,335,338, 339,345,347,350,351,358,360,362,366, 367,374
 Bacillus amyloliquefaciens330, 338, 339
 Bacillus subtilis279
 Bacillus thuringiensis israelensis354
 Bacillus thuringiensis kurstaki353
 Ball Valve288, 289, 300, 302
 Bamboo Products 143, 201, 202
 Banrot329
 BCAs 363-367
 Beauveria351, 352, 356, 357, 361
 Bee Safety327

- Beer Boxes212
 Belden153
 Belt Tightener57
 Benching 83-92
 Beneficial Insectary 364-368
 Benzyladenine 341-342
 Berry 35-37, 39-41
 Bifenazate353, 354, 359
 Bifenthrin350, 360
 Biobee 364-368
 Bioline Agrosociences 364-367
 Biological Control Agents 363-367
 BioSafe 266-267, 270, 332, 335, 339, 340, 344, 350, 351, 352, 370, 371
 BioWorks269, 281,330, 333, 336, 337, 359, 366, 367, 374
 Blackout Systems77
 Bluelab 283-284
 Bowl Planters137
 169-171
 BroadStar344
 Buprofezin360
 Burlap - Bulk Treated Squares201

C

- Calibration Solutions284, 318
 Cane Stakes202
 Carrying Trays 137-142,145-152, 158-259
 Carts - transportation 102-103
 Chemical Measuring Kit373
 Chlorfenapyr358
 Chloromequat340, 341
 Chlorothalonil331
 Chromobacterium subtsugae354
 Clamp288, 302
 Classic Home and Garden 160-173
 Clethodim345
 Clopyralid 345-346
 Co-Ex Pots & Trays 132-134
 Coco Nest Baskets 174
 Coir Potting Media242, 218, 228, 230, 234

- Commercial Rubber/Vinyl Hose ... 286-287
 Concept Greenhouse 176-180
 Conley's Greenhouses 21-23
 Containers 121-193
 Controllers - Environmental72
 Controllers - Irrigation 312-313
 Conveyors 94-96, 99
 Copper Hydroxide329, 331, 333, 344
 Copper sulfate pentahydrate336, 369
 Corrugated Plant Trays212
 Corrugated Poly Greenhouse Panels48, 52
 Coveralls379
 Cow Pots 192
 CRF- Nutricote273
 CRF-Osmocote 275-279
 Crop Cover 197-198
 Crop Protection 322-376
 Crystalite Standard Flat Fiberglass50
 Cuprous Oxide334
 Custom Pots 120, 144, 147, 156
 Cutter for Polyethylene & PVC Pipe302
 Cyantraniliprole355
 Cyazofamid337
 Cyflumetofen360
 Cyfluthrin353
 Cyprodinil335
 Cyromazine352

D

- Daminozide 340-341
 Dec-Grow Pots- Nursery Supplies 156
 Decree 50 WDG331
 Dichlobenil344
 Didecyldimethylammonium chloride
333, 371, 373
 Diflubenzuron344, 349
 Dilution Solutions 316-318
 Dimethenamid-P345
 Dimethomorph334, 338
 Dinotefuran358
 Diphacinone373
 Diquat348

- Disc Filters311
 Disinfectants..... 370-371
 Display Benches..... 86-90
 Displays - Custom 120
 Doors53
 Dosatron 316-318
 Dramm 58, 64, 29-291,366,382-386
 Drip Irrigation..... 392-302
 Dust Masks378
- E**
- Ebb & Flow Benches84
 EC Meters282, 283, 318
 Emitters..... 296-297
 Endeavor.....353
 Environmental Controllers72
 Equipment..... 93-104
 Eskay-Lite Vinyl Covering.....50
 Ethephon.....341
 Ethoxylated nonylphenol.....369
 Etoxazole.....351, 360
 Etridiazole.....329, 338, 339
 Evo Film32
 Exhaust Fans.....56
- F**
- Fans 56-61
 Fascination341
 Fenamidone332
 Fenhexamid.....331
 Fenpyroximate.....350
 Fertilizer 247-284
 Fertilizer Dispenser277
 Fertilizer Injectors..... 314-317
 Fertilizer- Control Release..... 277-280
 Fertilizer- Retail 117
 Fertilizer- WSF 248-264
 FiberDust.....242
 Fiberglass.....50
 FiberGrow Products 183-185
 Film - Greenhouse 30-40
 Film - Nursery 30-40
- Filters318, 310
 Flagship.....354
 Flats 137, 139, 141, 150, 159
 Flat Fillers 96-97, 99
 Floating Crop Covers- AgroFabric..... 197
 Flonicamid.....350, 357
 Florikan.....289
 Florist Box212
 Fludioxonil333, 335, 337
 Flumioxazin344, 346, 348, 349
 Flurprimidol.....342
 Fluxapyroxad334
 Foil Wrap207
 Foggers..... 384-385
 Four Year Film..... 32-37
 Fox Farm 116
 Frost Protection 198
 Fungicides 328-340
- G**
- Garden Center Cart & Wagons 102-103
 Geranium Pots 132, 134
 Germination Mixes.....229
 Gibberellic acid GA3342
 Gloves380
 Glufosinate355
 Glyphosate345, 347, 348
 Gowan331, 332,348, 352, 355, 358
 Greenhouse Film 30-42
 Greenhouse Structures..... 11-28
 Greenhouse Thermometers213, 282
 Greenhouse- Conley..... 21-23
 Greenhouse- Gutter Connected ..16, 24
 Greenhouse- Windjammer 24-25
 Greenhouse- High Tunnel19, 25
 Greenhouse- Gothic14, 19, 20
 Greenhouse- Quonset19
 Greenhouse- Free Standing20
 Grodan..... 241-242
 Ground Cover..... 195-198
 Growing Bags.....145
 Grow Bags242
- Growing Mix- Jolly Gardner235
 Growing Mix- Lambert..... 226-232
 Growing Mix- Premier..... 216-225
 Growth Regulators 340-344
- H**
- HAF Fans 58-59
 Halosulfuron-methyl.....347
 Hanging Basket Accessories 185
 Hanging Basket Sleeves.....204
 Hanging Baskets- Belden 153
 Hanging Baskets- HC... 123-126, 129-131
 Hanging Sprinkler Assembly293
 Hanna Instruments282
 Hard Cover Acc. for Greenhouses49
 Hardwood Stakes (Hyacinth)201
 Harnois..... 15-18, 28
 HC Companies 122-144, 182-185
 HE Anderson..... 314-315
 Heater- Gas-Fired..... 62-63, 66
 Heating System- Modine 62-63
 Heating System- Siebring66
 Herbicides 344-349
 Heterorhabditis bacteriophora367
 Hexythiazox.....355
 Horizontal Air Flow System 58-59
 Hormodin Powder343
 Horticultures.....245
 Hose 286-287
 Hose Accessories..... 288-291
 Hose Shut-off 288-289
 Hydrogen dioxide339, 340, 371
 Hydrogen peroxide.....335, 340, 371

- I**
- ICL Crop Protection 329, 339, 346, 347, 351, 372
- ICL Fertilizer..... 259-263, 268, 274-279
- Identification Cards.....203
- Imidacloprid.....351, 352, 353, 356
- Indaziflam346
- Infrared Greenhouse Film.....33
- Injection Flats & Trays- HC..... 139-140
- Injectors314, 316
- Innovative Growers Equipment 84-85
- Insect Screen64
- Insecticides 349-361
- Inserts 138
- Iprodione330
- Iron sulfate.....268
- Irrigation 285-321
- Irrigation Controllers..... 322-323
- Irrigation Time Clocks 312-313
- Isoxaben.....345, 346, 348
- J**
- Jack's Classic 246-251
- Janor/Summit Pots..... 146-147, 144
- Jiffy Products..... 191, 239
- JR Peters 246-253, 266-268
- K**
- Kinoprene.....353
- Klerk's.....38
- KOOL-RAY Classic Liquid Shading.....81
- L**
- Label Machine.....200
- Labeling- Pots 120, 144, 147, 156
- Labels 120, 208, 211
- Labels - Wooden/Plastic..... 120, 208, 211
- Lambert Soils 226-232
- Laminator209
- Laminator Film Pouches209
- Landmark..... 158-159
- LED Fixtures 74-75
- Lighting 74-75, 77
- Light Deprivation Systems77
- Link467, 313
- Liquid Shading81
- Luminance Film35
- Lumite Ground Cover 196
- M**
- Mancozeb336
- Mandipropamid333
- Marathon.....356
- Master Plant Prod..... 254-258, 266-268
- Matra Plast.....50
- Mefenoxam338
- Metaldehyde.....352
- Meters (PH/EC) 282-284
- Metolachlor347
- Micronutrients.....268
- Mist' R Drench AG Sprayer.....387
- Modine 62-63
- Monitor Card374
- Motorola Radios214
- Mulch Film.....40
- Multi-Formes 175, 203
- Mycorrhizal Applications271
- N**
- Napthaleneacetic acid343
- Natures Source264
- Needle Seeder.....93
- Netafim Drip Irrigation..... 392-300, 306-307, 310-311
- Netting208
- Novaluron.....357
- Nozzle- Comfort Grip.....289
- Nozzle- Fogg-It.....291
- NU Pots and Trays..... 146
- Nursery Containers - NSI..... 154-157
- Nursery Film 30-41
- Nursery Supplies 154-157
- Nufarm328,330,335,336,337, 341,342,344,345,347,348,349,353,354, 356,357,358,360
- Nutricote (Sojitz of America).....273
- Nutrients.....248-263, 273-280
- Nutritional Supplements..... 271-272
- O**
- Oasis Grower Solutions 243-246
- Octanoate329, 332
- OHP.....328,330,332,333,334,337, 338,339,340,342,343,344,345,346,347, 349,350,352,353,354,355,356, 357,359,360
- Oldcastle235
- Osmocote Contr Release Fert 275-279
- Osmocote Plus Tablets.....279
- Overhead Irrigation System.....309
- Overwintering & 1 Year Film.....39
- Overwintering Nursery Sheeting... 197-198
- Oxathiapiprolin.....337
- Oxyfluorfen344
- P**
- Pace 49.....333, 370,371,373
- Pack Mfg..... 96-99
- Packaging - Custom..... 120
- Paclobutrazol340,342
- ParSource75
- Peat Pellets- Jiffy-7239
- Pelargonic acid.....348
- Pendimethalin.....345,347
- Peracetic acid.....339,340,371
- Perlite- Whitemore.....237
- Peroxyacetic acid340
- Pesticide Permit Policy326
- Peters - WSF..... 259-263
- pH/EC/TDS Meter 281-284, 318
- PL Light Systems74
- Plant Foil Wrap207
- Plant Signage 203, 210-211,120
- Plant Sleeves.....204, 206
- Plant Support 143
- Plantex Fertilizers..... 254-258, 266-268
- Plastic Carriers & Pen Paks 145
- Plastic Labels208, 211
- Plastic Sheeting & Film41
- Plexiglass Doors53

Plug Trays..... 141,149
 Poison Control Centers.....326
 Poly Attachment Systems.....43
 Poly Inflation Units44
 Poly Tape.....46
 Poly Tex..... 26-27, 91
 Poly-1-p-menthene372
 Poly-Paks- Jiffy.....191
 Polycarbonate Greenhouse Panels .. 48-50
 Polydimethylsiloxane.....373
 Polyether modified polysiloxane372
 Polyethylene Film..... 30-42
 Polyethylene Film- Berry 35-37,39-41
 Polyethylene Film- Construction Grade ..41
 Polyethylene Fittings.....301
 Polyethylene Pipe (flexible).....301
 Polyethylene Sheeting- Black.....41
 Pot Labels - Wooden/Plastic 120, 208, 211
 Pot Sleeves204,206
 Pot-in-Pot Systems 157
 Potassium bicarbonate.....267,333
 Potassium hydroxide284,369
 Potassium salts of fatty acids..... 355-356
 Pots-Vacuum..... 141
 Predatory Mite..... 364-365
 Premier Professional Soil 216-225
 Pressure Regulator310
 Pride Garden Products 186-187
 Pro-Mix 216-225
 Prodiamine344,346
 Propagation Dome 145
 Propagation Sheets 148, 148
 Protective Equipment 378-380
 Protective Eyewear.....380
 Purlin Pipe47
 Pymetrozine353
 Pyraclostrobin.....331,334,335
 Pyrethrins351,358
 Pyridalyl.....357
 Pyrifluquinazon358
 Pyriproxyfen.....353

R

Respiratory Protection378
 Retail 105-119
 Reynoutria sachalinensis.....336
 Rockwool241
 Rollup Doors53
 Rootcubes.....244
 Rooting Hormones343
 Rubber Bands201

S

Sanitation 369-370
 Schaefer HAF Fans.....58
 Screws49
 Secondary Nutrients.....266
 Seeder99
 Seedling Flat..... 141
 Self-Locking Plant Trays212
 Sensaphone70
 Sensor Monitor Card374
 Sepro..... 329,331,340,342,344,350,
 355,358,360,369
 Shade Cloth 80-81
 Shading Liquid 81-82
 Shipping Boxes212
 Shopping Cart..... 103
 Shutters.....57, 60
 Siebring.....66
 Sign Holder203, 210
 Signage - Custom 106
 Slabs - Growing Media241,242
 Sleeves.....204, 206
 Slitted Row Tunnels 199
 Soil Moist373
 Soiless Mix - Lambert..... 226-232
 Soiless Mix - Oldcastle235
 Soiless Mix- Premier 216-225
 Soiless Mixes and Media..... 215-246
 Solatenol334
 Sphagnum Moss 192, 237
 Spinosad352, 354
 Spiromesifen259
 Spirotetramat.....355

Sprayers-
 (Hydraulic, Fogging, Backpack) ... 380-388
 Sprinkler Heads 304-305
 Sprinkler Supply Pipe301
 Sprinkler System- Netafim 392-300,
 306-307, 310-311
 Sprint268
 Square Pots 136,146,151,153,159
 Stakes- Cane202
 Stakes- Hardwood202
 Standard 1020 Inserts & Flats..... 150
 Star Steel Structures..... 19-20
 Steinernema feltiae366
 Steinernema kraussei367
 Sticky Cards374
 Streptomyces lydicus328
 Streptomycin sulfate328
 Stretch Wrap212
 Summit Plastics/Janor..... 146-147, 144
 SunMaster Film 31-34, 39
 Super4 Film35
 Supplements258, 268, 270, 271
 Surfactants.....372
 Sustane.....265
 Syngenta 329, 331, 332, 333-338,
 340,342,344,346-350,352-355

T

T.O. Plastics 148-152
 Tape- All Purpose P/E Repair Tape46
 Tape- Batten.....39, 46
 Temp Alert Thermometer70
 Tenax.....208
 Testing Equipment..... 281-284, 318
 Thermal Film.....32
 Thermax Film.....35
 Thermalarm III Thermometer.....70
 Thermo Pots & Trays 132-134, 158-159
 Thermometers.....213
 Thermostats64
 Thiamethoxam.....354
 Thinwall Pots- HC..... 134-136
 Thiophanate-methyl.....329,330,334
 Tolfenpyrad.....355

Tomato Cages 143
 Trace Elements 278
 Transport & Merchandising Carts 102-103
 Trellis Netting 208
 Trichoderma harzianum rifai 336-337
 Trichoderma virens 336-337
 Trifloxystrobin 329-330
 Triflumizole 338
 Trifluralin 348,349
 Triticonazole 339
 Trunk Liner 205
 Tube Hanger Set 61
 Tube Support Wire Package 61
 Tubing- Ventilation 61
 Twine (Polypropylene) 201
 Twist-ems 201
 Tyne 208

U

Uni-Mix 11-5-11 279
 Uniconazole 341,342
 Utility Bags (Polyethylene) 205

V

V-Belts 57
 Vacuum Inserts & Flats- HC 137-140
 Vacuum Trays & Pots- HC 137
 Vent Controls 69
 Ventilation Tubing- Ultra Violet 61
 Vermiculite- Whittemore 237
 Vertical Air Flow Fans 59
 Vinyl Sheeting 50

W

Wadsworth Vent Control 68-69
 Wagons 102-103
 Warning Signs- EPA Approved 374
 Washers 289

Water Soluble Fertilizers 248-264
 Water Breakers 290
 Watering Tools 290,291
 Watering Wands 291, 301
 Wedges - Growing Media 243-246
 Western Pulp 188-189
 Wadsworth Vent Control 68-69
 Wetting Agents 372-373
 Wire Extension Hangers 175
 Wire Hanging Baskets 174-175
 Wire-Lock Poly Attachment 43
 Wooden Baskets 193
 Wooden Pot Labels 208

Y

Yucca schidigera 372

Z

ZeroTol 2.0 339

Credit Application

INTERESTED IN APPLYING FOR CREDIT?

Credit applications can be completed online.

Email creditapplication@griffinmail.com to receive an email with a link to our secure online portal.

If you are unable to access the online form you can call us at 800.888.0054 and ask for the Credit Dept.



GROWING CALENDAR

Starshine Blue from Syngenta Flowers

☉ Full Moon Days
■ Holidays

2023

2024

JULY							
WEEK	S	M	T	W	T	F	S
26							1
27	2	3	4	5	6	7	8
28	9	10	11	12	13	14	15
29	16	17	18	19	20	21	22
30	23 30	24 31	25	26	27	28	29

AUGUST							
WEEK	S	M	T	W	T	F	S
31			1	2	3	4	5
32	6	7	8	9	10	11	12
33	13	14	15	16	17	18	19
34	20	21	22	23	24	25	26
35	27	28	29	30	31		

SEPTEMBER							
WEEK	S	M	T	W	T	F	S
35						1	2
36	3	4	5	6	7	8	9
37	10	11	12	13	14	15	16
38	17	18	19	20	21	22	23
39	24	25	26	27	28	29	30

OCTOBER							
WEEK	S	M	T	W	T	F	S
40	1	2	3	4	5	6	7
41	8	9	10	11	12	13	14
42	15	16	17	18	19	20	21
43	22	23	24	25	26	27	28
44	29	30	31				

NOVEMBER							
WEEK	S	M	T	W	T	F	S
44				1	2	3	4
45	5	6	7	8	9	10	11
46	12	13	14	15	16	17	18
47	19	20	21	22	23	24	25
48	26	27	28	29	30		

DECEMBER							
WEEK	S	M	T	W	T	F	S
48						1	2
49	3	4	5	6	7	8	9
50	10	11	12	13	14	15	16
51	17	18	19	20	21	22	23
52	24 31	25	26	27	28	29	30

JANUARY							
WEEK	S	M	T	W	T	F	S
1		1	2	3	4	5	6
2	7	8	9	10	11	12	13
3	14	15	16	17	18	19	20
4	21	22	23	24	25	26	27
5	28	29	30	31			

FEBRUARY							
WEEK	S	M	T	W	T	F	S
5					1	2	3
6	4	5	6	7	8	9	10
7	11	12	13	14	15	16	17
8	18	19	20	21	22	23	24
9	25	26	27	28	29		

MARCH							
WEEK	S	M	T	W	T	F	S
9						1	2
10	3	4	5	6	7	8	9
11	10	11	12	13	14	15	16
12	17	18	19	20	21	22	23
13	24 31	25	26	27	28	29	30

APRIL							
WEEK	S	M	T	W	T	F	S
14		1	2	3	4	5	6
15	7	8	9	10	11	12	13
16	14	15	16	17	18	19	20
17	21	22	23	24	25	26	27
18	28	29	30				

MAY							
WEEK	S	M	T	W	T	F	S
18				1	2	3	4
19	5	6	7	8	9	10	11
20	12	13	14	15	16	17	18
21	19	20	21	22	23	24	25
22	26	27	28	29	30	31	

JUNE							
WEEK	S	M	T	W	T	F	S
22							1
23	2	3	4	5	6	7	8
24	9	10	11	12	13	14	15
25	16	17	18	19	20	21	22
26	23 30	24	25	26	27	28	29

JULY							
WEEK	S	M	T	W	T	F	S
27		1	2	3	4	5	6
28	7	8	9	10	11	12	13
29	14	15	16	17	18	19	20
30	21	22	23	24	25	26	27
31	28	29	30	31			

AUGUST							
WEEK	S	M	T	W	T	F	S
31					1	2	3
32	4	5	6	7	8	9	10
33	11	12	13	14	15	16	17
34	18	19	20	21	22	23	24
35	25	26	27	28	29	30	31

SEPTEMBER							
WEEK	S	M	T	W	T	F	S
36	1	2	3	4	5	6	7
37	8	9	10	11	12	13	14
38	15	16	17	18	19	20	21
39	22	23	24	25	26	27	28
40	29	30					

OCTOBER							
WEEK	S	M	T	W	T	F	S
40			1	2	3	4	5
41	6	7	8	9	10	11	12
42	13	14	15	16	17	18	19
43	20	21	22	23	24	25	26
44	27	28	29	30	31		

NOVEMBER							
WEEK	S	M	T	W	T	F	S
44						1	2
45	3	4	5	6	7	8	9
46	10	11	12	13	14	15	16
47	17	18	19	20	21	22	23
48	24	25	26	27	28	29	30

DECEMBER							
WEEK	S	M	T	W	T	F	S
49	1	2	3	4	5	6	7
50	8	9	10	11	12	13	14
51	15	16	17	18	19	20	21
52	22	23	24	25	26	27	28
1	29	30	31				

CONTACT GRIFFIN

Phone: 800.888.0054

Grower/Retail Fax: 877.636.3623

Green Goods Fax: 610.913.3091

Email: orders@griffinmail.com

Online Ordering: www.griffins.com