

**GSH XPERT SOLUTIONS**  
YOUR NEEDS, OUR PRIORITY

**PARRROT**  
**PRODUCTS**  
A Zero Defect Supplier

# General Catalogue



# A zero defect supplier

## Why we exist

Our purpose is to secure ourselves as a contributor to your business success.  
Our dealer base includes major retailers and our customers Blue Chip organisations

We are solution providers with active support structures in place, assisting in the sales process through to the final satisfied purchase.

## We invite you to experience our commitment to you, discuss the following opportunities with your local sales team:

- National free delivery to all major cities with our in-house extensive delivery fleet - ensuring on time delivery of undamaged goods
- Training Centres & showrooms in major city centres throughout SA – for use by you and your customers
- Make use of our state of the art showrooms and invite your sales team and/or your key clients for in-depth knowledge on our extensive range
- Marketing support
- Personalised catalogues of our full range
- We invest in our dealer base by providing consignment stock models that are managed, administered, merchandised & consistently reviewed - with you - by Parrot staff. Increased returns on investment with no capital requirements.
- Proof of Concepts – to assist your customer in making the right decision
- Demonstrations
- Joint sales calls – supporting you with on-site advice and assisting the sales process
- Our in-house IT department facilitates integration of the Parrot ERP with your in-house program, ensuring lower admin costs and speed of transacting
- Professional installation services of any of our product range, in Gauteng, Bloemfontein, Nelspruit, Durban, Cape Town, Port Elizabeth & Namibia. Providing free quotations, turnkey solutions of Pre-sales, In-sales and After-sales from friendly and efficient teams.
- Through our Parrot online experience view national stock levels, PODs, Invoices, Credit Notes & Statements. Quotations can be processed online and converted to order, providing ease and convenience for online ordering.



## Who are we ?

Parrot Products was created in 1992, driven by its founders for a desire to service the presentation and education industries with locally manufactured quality products, on a national basis at unprecedented speed. **OUR RANGE NEXT DAY.**

We consider ourselves market leaders in the ranges of products we supply. Customised solutions are available throughout our range.

Our four clearly defined product categories are, **Office Equipment, Interactive, Display and Janitorial.**



## An inside look

We are an ISO certified company, evidence of the fact that we believe a quality organisation produces quality people and product. Our manufacturing and warehousing plant is situated in Cleveland, Johannesburg and operates from a site spanning 12000 square metres.

With fully stocked branches in Johannesburg, Cape Town, Durban, Bloemfontein, Nelspruit, Port Elizabeth, Namibia, Gaborone and Lusaka, our team is motivated and continually excited to ensure our Dealers and their customers receive excellent products from a high quality brand. A centralised national call centre is on standby to administer product support information and processing of orders & quotes.

Throughout its history and into the present day, Parrot Products continues to innovate and diversify in an effort to offer a wider range of products, contributing to our Dealers success.

With over 60% of product manufactured locally and with a staff compliment of over 300 staff members, Parrot Products are a proudly South African concern.



# Contents

## Boards

Slimline Whiteboards - Magnetic & Non-magnetic	1 - 2
Whiteboards - Magnetic & Non-magnetic	3 - 4
Alufine Magnetic Whiteboard	5
Floating Glass Whiteboard	5
Glass Whiteboards Printed - Magnetic & Non-magnetic	6 - 8
Chalk Boards - Magnetic & Non-Magnetic	9
Educational Boards	10-12
Installations	13
Writing Slates & Clipboards	14-16
Whiteboard Mini Tiles - Magnetic, Flexi Magnetic	17
Pin Boards, Self Adhesive, No Frame	18
Info Boards, Felt - Alufine Frame & Aluminium Frame	19-20
Bulletin Boards, New Ribbed Carpet	21
Combi Boards, Non-magnetic	22
Display Cases	23
Flipcharts - Standard Models & Glass	24-26
Flipcharts - Standard Carry Bag	27
Flipcharts - Paper Carrier & Paper	27
Board Support, T-legs, Easel & Desk Partition Clamp	28
Mobile / Revolving Boards & Glass	29-30
A-frame Boards, Poster Frame	31
Easy Rail System	32
Lap Trays	33
Customized Products	34-35
Cast Acrylic Planners	36
Perpetual Year Planners - Magnetic & Glass	37-38
In/Out Slides & Boards	39-40
Wooden Frames	41
Stationery	42

## Interactive

Interactive Touch LED Panels	78
Interactive Whiteboard System - IR Board	79
Non-reflective Whiteboard	80
Interactive Stands for LED Panels & IWB	81
Data Projectors	82
Ceiling Mounting Brackets & Projector Cage	83
Data Projector Trolley	84
Data Projector Screens & Keystone Adjusters	85-88
Laser Pointers	88
Monitor Clamp Bracket	89
Tripod - Mini, Econo, Deluxe	90
Brackets - Tablet, TV & Security Cable	91
Graphics Tablet Wired	92
Air-mouse, Wireless Keyboard & Mouse	93
Speaker Sound Bars	93-94
Audio Devices	95-96
Acoustic Panel	97
Lectern & Wireless Mic	98
Video Conference Camera, Webcam & Microphone	99-100
Wireless Presentation	101
Visualizers	101
External Storage	102
Cables & Adaptors	103
LED Modular Display	104-105

## Accessories

Vinyl Lettering / Vinyl Lining Tape & Magnetic Sheeting	4
Magnetic Ruler ACP	4
Flexible Magnetic Accessories	4
Magnetic Photo Paper & Tape	4
Moulded Magnets, Extra Strong	4
Magnetic Map Pins & Magnetic Label Carriers	4
Drawing Pins & Push Pins	4
Dusters, Erasers & Aqua Wipe	4
Pen and Eraser Holder Magnetic	4
Office Equipment & Whiteboard Cleaner	4
Whiteboard Starter Packs	4
Chalk & Chalk Holder	4
Whiteboard Markers - Bullet Tip	4
- Slimline Tip	4
Permanent Markers - Bullet Tip	5
- Chisel Tip	5
- Ultra Finesline	5
Whiteboard Marker Magnetic / Eraser	5
Glass Board Markers	5
Highlighter Markers - Chisel Tip, Slimline & Liquid Ink	5

## Displays

Poster Frames & Security Frame	106-107
Media Cover, DBL Sided Window Frame	108
Poster Frame Support	109
Poster Frame Stands - Double-sided, Single-sided	110-111
Poster Frame - Hanging Systems	112
Flush Wall Signs	113-114
Double Sided Standing Signs	115
Double-Sided Wall Signs	116
Landscape & Portrait Desk Signs	116
Safety Signs	117
Hospital Glass Board	118
Splashbacks - Kitchen, Glass Wall Art & Bathroom	119-120
Acrylic Certificate Holders	121
Acrylic Display Holders	122-123
Designer Mounting Systems - Ceiling & Floor Systems	124
- Modular Mounting System	125-126
- Glass Cube Display Stand	127
Retractable Q-Barrier System	128

## Office Equipment

Shredders - S100, S1006S, S200, S1008CC, S1012CC	54 - 55
Shredders - S516, S1024CC, S1008MC	56
Shredders - S605, S801 & Shredder oil	57
Shredder Comparisons	58
Comb Binding Machines	59-60
Craft Knives & Rotary Blades	61
Guillotines - Plastic, Steel Base & Medium Duty	62-63
Rotary Trimmers	64-65
Laminators	66
Laminator Consumables	67
Staplers, Staples & Staple Remover	68-73
Punches	74-75
Carpet Protectors	76
Megaphone	77

## Janitorial

Janitorial Foot Dispensers	129
Sanitizers	130
Chemical Range	131
Refillable Bottles, Refuse bags, Touchless bin	132
Dispensers	133
Janitorial Accessories	134-135
Microfibre Cloths & Bubble Wrap	136

**Due to continuous improvement products may be subject to change without notice.**



# Slimline Whiteboards

Magnetic & Non Magnetic

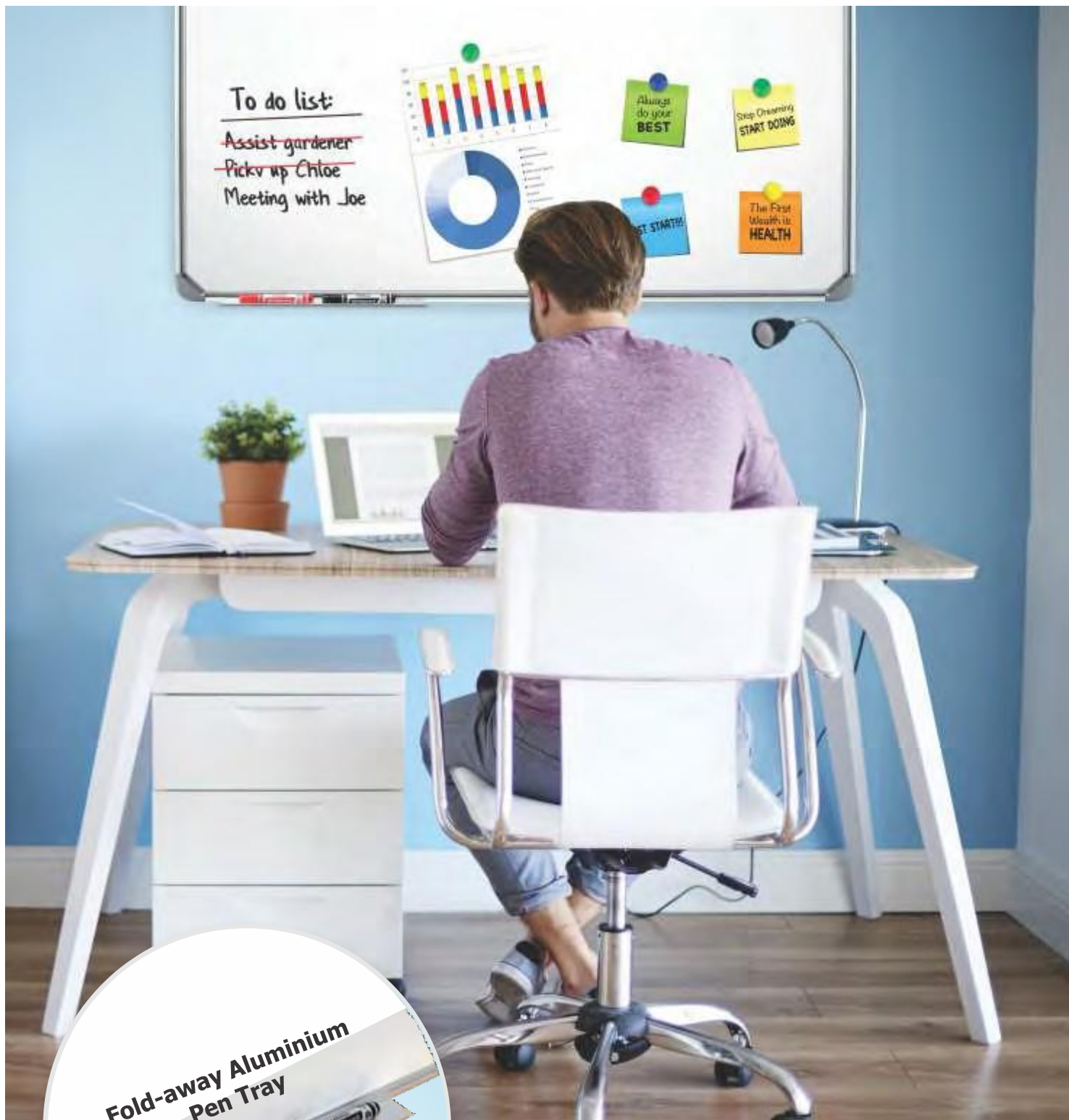

**Fold-away Aluminium  
Pen Tray**





## Slimline Whiteboard Retail Pack - Non-Magnetic

Code	Size
BD1520A*	600 x 450mm
BD1525A	900 x 600mm

- **BD1520A includes:**
  - 1 Whiteboard Marker
  - 1 Whiteboard Non-Magnetic Eraser
- **BD1525A includes:**
  - 28ml Office Equipment & Whiteboard Cleaner
  - 2 Whiteboard Markers
  - 1 Whiteboard Non-Magnetic Eraser

\* Plastic moulded frame on 600 x 450mm Slimline Retail Whiteboards 2 sides

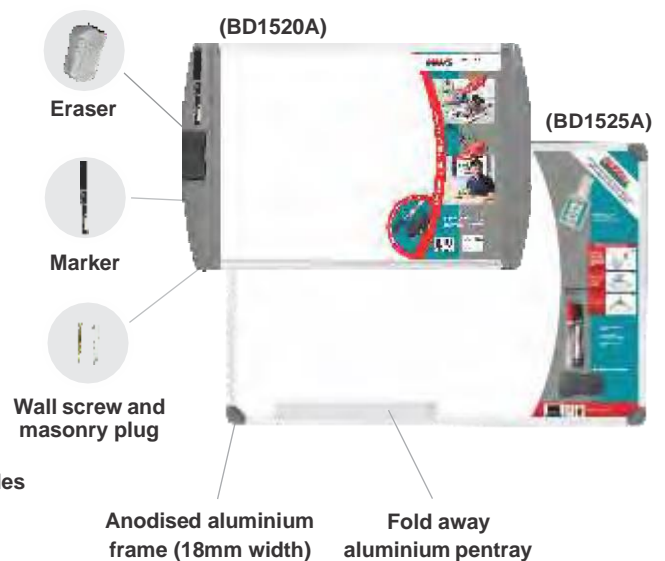

## Slimline Whiteboard Retail Pack - Magnetic

Code	Size
BD1120A*	600 x 450mm
BD1125A	900 x 600mm
BD1141A	1200 x 900mm

- **BD1120A Magnetic includes:**
  - 4 Moulded Magnets (20mm)
  - 1 Whiteboard Marker
  - 1 Whiteboard Non-Magnetic Eraser
- **BD1125A & BD1141A includes:**
  - 4 Moulded Magnets (20mm)
  - 28ml Office Equipment & Whiteboard Cleaner
  - 2 Whiteboard Markers
  - 1 Whiteboard Non-Magnetic Eraser

\* Plastic moulded frame on 600 x 450mm Slimline Retail Whiteboards 2 sides

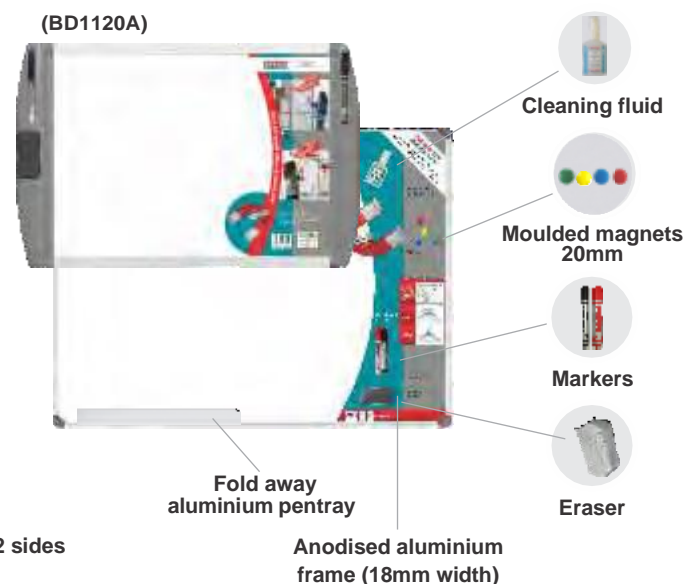

## Whiteboard Slimline - Magnetic & Non-Magnetic

Code	Description	Size
BD1115*	Magnetic	300 x 450mm
BD1120	Magnetic	600 x 450mm
BD1125	Magnetic	900 x 600mm
BD1128	Magnetic	900 x 900mm
BD1141	Magnetic	1200 x 900mm
BD1515*	Non-Magnetic	300 x 450mm
BD1520	Non-Magnetic	600 x 450mm
BD1525	Non-Magnetic	900 x 600mm
BD1528	Non-Magnetic	900 x 900mm
BD1541	Non-Magnetic	1200 x 900mm

- Includes mounting instructions.
- Concealed mounting (wall screws and masonry plugs supplied, 6mm).
- 18mm frame width

\* Supplied with double-sided tape.

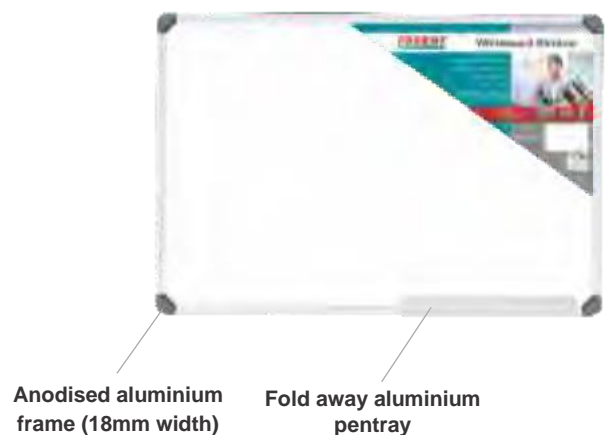

# Whiteboards

Non-Magnetic



## Code

## Size

BD1220	600 x 450mm
BD1225	900 x 600mm
BD1228	900 x 900mm
BD1241	1200 x 900mm
BD1244	1000 x 1000mm
BD1248	1200 x 1000mm
BD1252	1200 x 1200mm
BD1260	1500 x 1200mm
BD1261	1500 x 900mm
BD1268	1800 x 1200mm
BD1269	1800 x 900mm
BD1270	2000 x 1200mm
BD1276	2400 x 1200mm



- Can be mounted horizontally or vertically
- Includes Mounting instructions
- Supplied with pentray and concealed mounting (wall screws and masonry plugs, 6mm)
- Can be used with the Easy Rail System (see page 32)
- Can be mounted on T-legs



Boards larger than 1500 x 1200mm are supplied with two 450 x 35mm pentrays.

Pricing for full length pentrays available on request

Note: 3000 x 1200mm Whiteboard available in Magnetic only



# Whiteboards

Magnetic



Code	Size
BD0920	600 x 450mm
BD0925	900 x 600mm
BD0928	900 x 900mm
BD0941	1200 x 900mm
BD0944	1000 x 1000mm
BD0948	1200 x 1000mm
BD0952	1200 x 1200mm
BD0960	1500 x 1200mm
BD0961	1500 x 900mm
BD0968	1800 x 1200mm
BD0969	1800 x 900mm
BD0970	2000 x 1200mm
BD0976	2400 x 1200mm
BD0984	3000 x 1200mm



- Can be mounted horizontally or vertically
- Includes Mounting instructions
- Supplied with pentray and concealed mounting (wall screws and masonry plugs, 6mm)
- Can be used with the Easy Rail System
- Can be mounted on T-legs



Boards larger than 1500 x 1200mm are supplied with two 450 x 35mm pentrays.

Pricing for full length pentrays available on request

Please enquire about boards made to your specifications

# Alufine Magnetic Whiteboard

Includes PW0101M

## Code Size

BD1020	600 x 450mm
BD1025	900 x 600mm
BD1041	1200 x 900mm

- Magnetic receptive steel surface
- Sleek and modern anodised 5mm aluminium frame
- No visible frame joins
- Light weight
- Includes mounting tabs
- Can be mounted landscape or portrait
- For home and office use
- Includes PW0101M (Whiteboard Marker with magnetic integrated eraser cap)

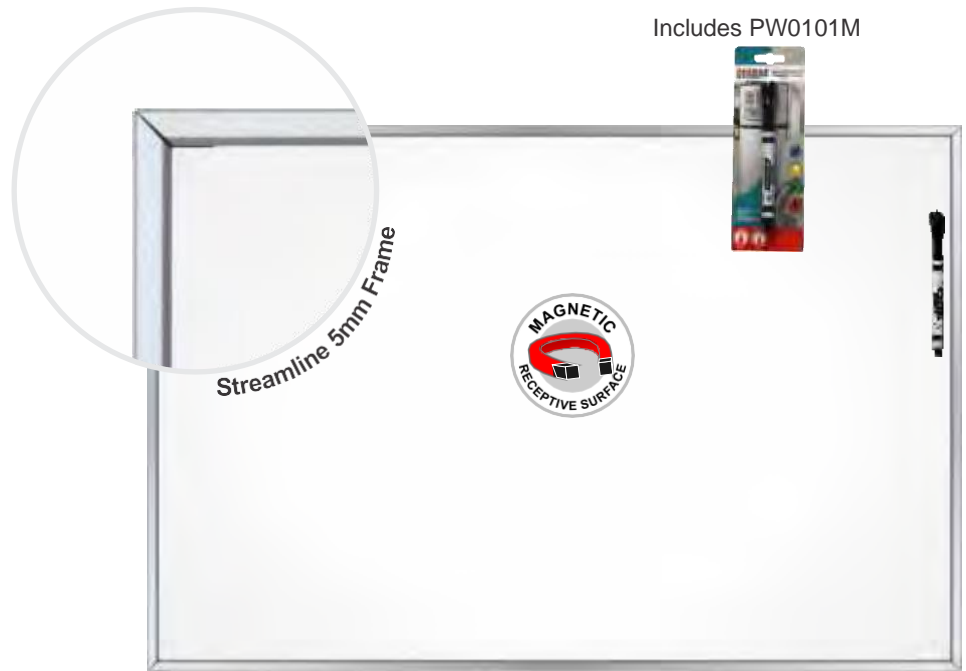

# Floating Glass Whiteboard

## Magnetic

## Code Size

BD2025	900 x 600mm x 4mm
BD2028	900 x 900mm x 4mm
BD2041	1200 x 900mm x 4mm
BD2052	1200 x 1200mm x 4mm
BD2061	1500 x 1200mm x 4mm
BD2068	1800 x 1200mm x 4mm
BD2076	2400 x 1200mm x 4mm

- 2 x aluminium mounting strips
- Magnetic receptive steel surface
- Includes mounting screws & wall plugs
- Tempered glass pentray & stainless steel pentray mounts
- 2 Markers, 1 Eraser & 4 Magnets
- Concealed mounting
- No stand offs
- Sleek frameless design
- Multiple boards can be used to create a glass whiteboard wall
- Perfect for private office and conference rooms



**While stocks last**



# Glass Whiteboards



Includes:  
4 Extra Strong  
Magnets



Mounting  
Brackets



Glass Pen tray

2 Markers  
and 1 Eraser

## Magnetic

### Code Size

BD1725	900 x 600mm x 4mm
BD1728	900 x 900mm x 4mm
BD1741	1200 x 900mm x 4mm
BD1752	1200 x 1200mm x 4mm
BD1761	1500 x 1200mm x 4mm
BD1768	1800 x 1200mm x 4mm
BD1776	2400 x 1200mm x 4mm

#### Magnetic includes:

- Stainless steel mounting brackets, set of 4
- Tempered glass pen tray & stainless steel pen tray mounts
- 2 Markers, 1 Eraser & 4 Extra Strong Magnets

## Non-Magnetic

### Code Size

BD1941	1200 x 900mm x 4mm
BD1952	1200 x 1200mm x 4mm
BD1961	1500 x 1200mm x 4mm
BD1968	1800 x 1200mm x 4mm
BD1976	2400 x 1200mm x 4mm

#### Non-magnetic includes:

- Stainless steel mounting brackets, set of 4
- Tempered glass pen tray & stainless steel pen tray mounts
- 2 Markers, 1 Eraser

#### Accessories Re-order Code:

- DM8101A (Mounting edge grips)
- AL3023 (Pen tray) & AL3024 (Pen tray Mounts)



*\*Only extra strength magnets can be used*

- Superior writing surface
- Cleans perfectly after every use
- Print any graphic, pattern or image
- Aesthetically pleasing alternative to traditional printed whiteboards
- Panels can be mounted landscape or portrait

# Printed Glass Whiteboards

Magnetic & Non-magnetic

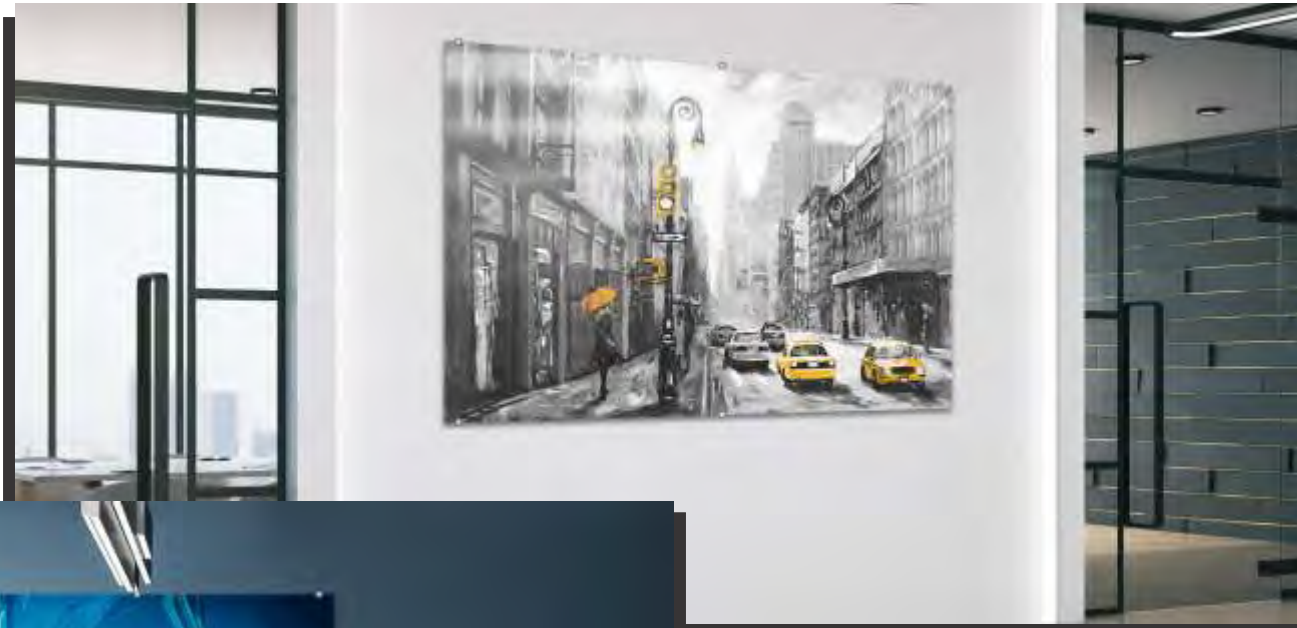



# Printed Glass Whiteboards

Magnetic & Non-magnetic

Code	Description	Size
BD1725A	Magnetic Printed	900 x 600mm x 4mm
BD1728A	Magnetic Printed	900 x 900mm x 4mm
BD1741A	Magnetic Printed	1200 x 900mm x 4mm
BD1752A	Magnetic Printed	1200 x 1200mm x 4mm
BD1761A	Magnetic Printed	1500 x 1200mm x 4mm
BD1768A	Magnetic Printed	1800 x 1200mm x 4mm
BD1776A	Magnetic Printed	2400 x 1200mm x 4mm
BD1941A	Non-Magnetic Printed	1200 x 900mm x 4mm
BD1952A	Non-Magnetic Printed	1200 x 1200mm x 4mm
BD1961A	Non-Magnetic Printed	1500 x 1200mm x 4mm
BD1968A	Non-Magnetic Printed	1800 x 1200mm x 4mm
BD1976A*	Non-Magnetic Printed	2400 x 1200mm x 4mm

## Magnetic includes:

- Stainless steel mounting brackets, set of 4
- Tempered glass pen tray & stainless steel pen tray mounts
- 2 Markers, 1 Eraser & 4 Extra Strong Magnets

## Non-magnetic includes:

- Stainless steel mounting brackets, set of 4
- Tempered glass pen tray & stainless steel pen tray mounts
- 2 Markers & 1 Eraser

- Superior writing surface
- Cleans perfectly after every use
- Print any graphic, pattern or image
- Aesthetically pleasing alternative to traditional printed whiteboards
- Panels can be mounted landscape or portrait
- Customised graphics glass boards are made to order  
Subject to glass availability or stock size
- Design fee will apply if artwork is not supplied in vector format, for example: \*.ai, \*.pdf, \*.eps or \*.cdr



Solid colours with or without branding

\* 2400 x 1200mm is supplied with 8 mounting brackets

## Standard Colour Range

*Metallic Colours will incur an additional cost \*\**

**Solid Colour Magnetic Glass Boards include:** Stainless steel mountings and a tempered glass pen tray.

Colour : Telegrey 4 Code : PT149	Colour : Purple Red Code : PT150	Colour : Signal Grey Code : PT151	Colour : Mouse Grey Code : PT152	Colour : Papyrus White Code : PT153	Colour : Grey Blue Code : PT154	Colour : Pastel Blue Code : PT155	Colour : Pigeon Blue Code : PT156	Colour : Charcoal   Gun Metal Code : PT157	Colour : Ocean Blue Code : PT158
Colour : Reseda Green Code : PT159	Colour : Pastel Green Code : PT160	Colour : Pastel Turquoise Code : PT161	Colour : White Code : PT162	Colour : Beige Code : PT163	Colour : Metallic Champagne Code : PT164	Colour : Metallic Silver Code : PT165	Colour : Rose Gold Code : PT166	Colour : Metallic Gun Metal Code : PT167	Colour : Metallic Black Code : PT168

Colours can vary when printed on glass due to their refractory properties as well as the pureness of the clear glass.

# Chalk Boards

Non Magnetic & Magnetic



**Non-Magnetic**  
Specially-coated MDF board and is the best value for money



**Magnetic**  
Specially-coated steel, high quality surface which is the most popular option for schools and offices



## Non-Magnetic

Code	Size
BD2820	600 x 450mm
BD2825	900 x 600mm
BD2828	900 x 900mm
BD2841	1200 x 900mm
BD2844	1000 x 1000mm
BD2848	1200 x 1000mm
BD2852	1200 x 1200mm
BD2860	1500 x 1200mm
BD2861	1500 x 900mm
BD2868	1800 x 1200mm
BD2869	1800 x 900mm
BD2870	2000 x 1200mm
BD2876	2400 x 1200mm

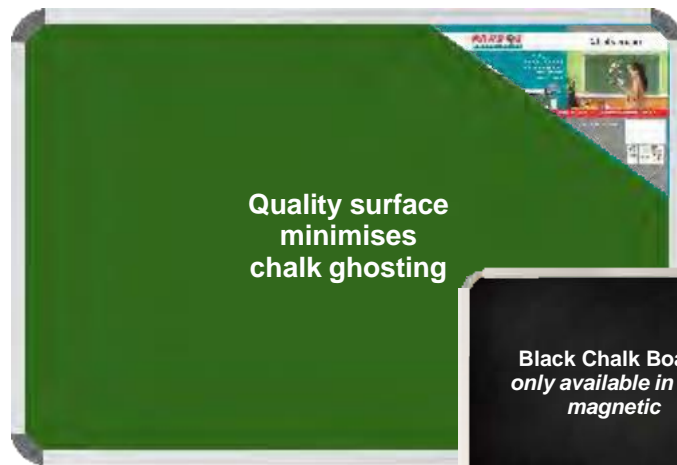

**Black Chalk Board  
only available in non  
magnetic**



## Magnetic

Code	Size
BD2720	600 x 450mm
BD2725	900 x 600mm
BD2728	900 x 900mm
BD2741	1200 x 900mm
BD2744	1000 x 1000mm
BD2748	1200 x 1000mm
BD2752	1200 x 1200mm
BD2760	1500 x 1200mm
BD2761	1500 x 900mm
BD2768	1800 x 1200mm
BD2769	1800 x 900mm
BD2770	2000 x 1200mm
BD2776	2400 x 1200mm
BD2784	3000 x 1200mm

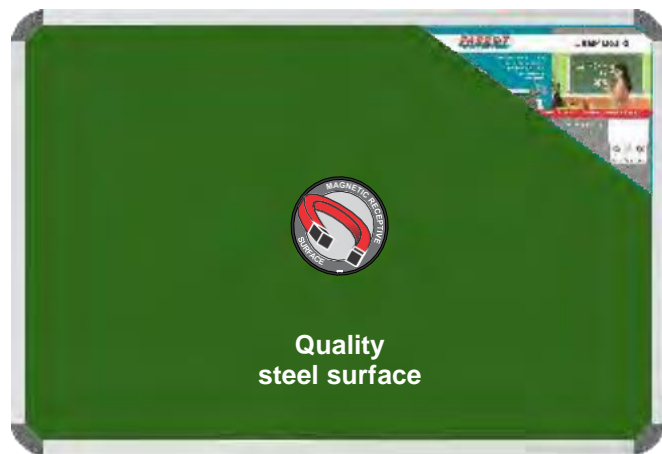

**\* 3000mm  
Supplied in  
magnetic only**

## Product Features

- Concealed mounting (wall screws and masonry plugs supplied, 6mm)
- Slide-in aluminium Chalk Rail (450 x 35mm)
- Additional mounting brackets for boards larger than 1500mm
- Can be used with the Easy Rail System
- Can be used with T-leg stand

See page 48 for Chalk & Chalk Holders



# Educational Boards

## Embedded Grid Surface Print



Each board is ordered separately to create a complete solution.

**Sections to be ordered separately:** A) Side Panels, B) Swing Leafs, C) Centre Panel

### **A** Educational Board Side Panel 1220 x 920mm

#### Code Description

ED1268A Whiteboard Magnetic Grey Squares  
ED3268A Chalk Board Magnetic Grey Squares

### **B** Educational Board Swing Leaf 1220 x 910mm

#### Code Description

ED4168A Whiteboard Magnetic Grey Squares one side  
ED6268A Chalk Board Magnetic Grey Squares one side

### **C** Educational Board Centre Panel 1820 x 1220mm

#### Code Description

ED7068 Whiteboard Magnetic  
ED8068 Chalk Board Magnetic  
ED9068 Chalk Board Non-Magnetic  
AL0320 Hinge Plastic Grey & Aluminium Mounting (each)  
AL0330 Steel Hinge (each)

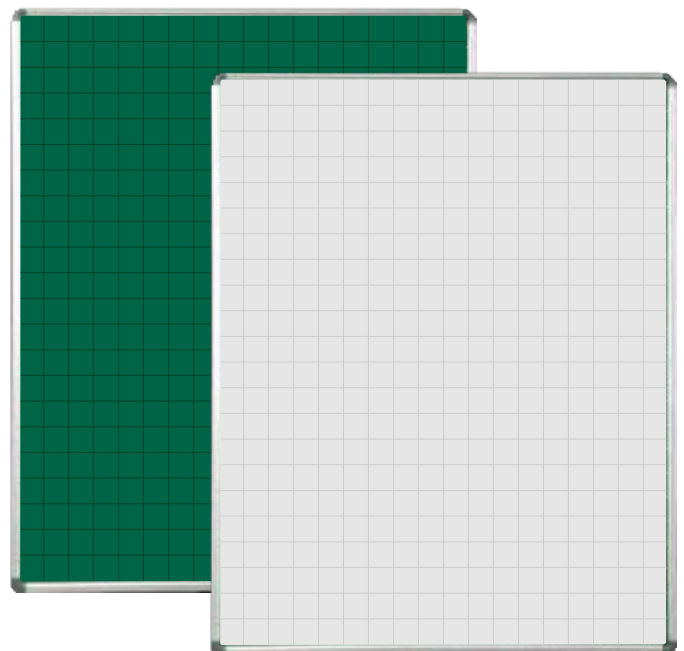

- A modern alternative to the existing Parrot Edu Board Range
- Cost effective, high quality educational board
- Magnetic receptive steel surface
- Light grey embedded grid print on either White or Green surface
- Feint grid is unobtrusive and allows for presentation with or without use of grid
- Grid serves dual purpose of lines and/or grid
- Supplied with pentray, mounting screws and plugs
- Grid size: 50 x 50mm

#### Benefits of new surface:

Shorter lead time on larger quantities

Made to order in centre panels and double sided swing leaves



Deluxe Frame



AL0320 Heavy Duty Hinges



Corner Buffers



AL0330 Steel Hinge Available on request

# Educational Boards

CKS 36: 2004 Compliant

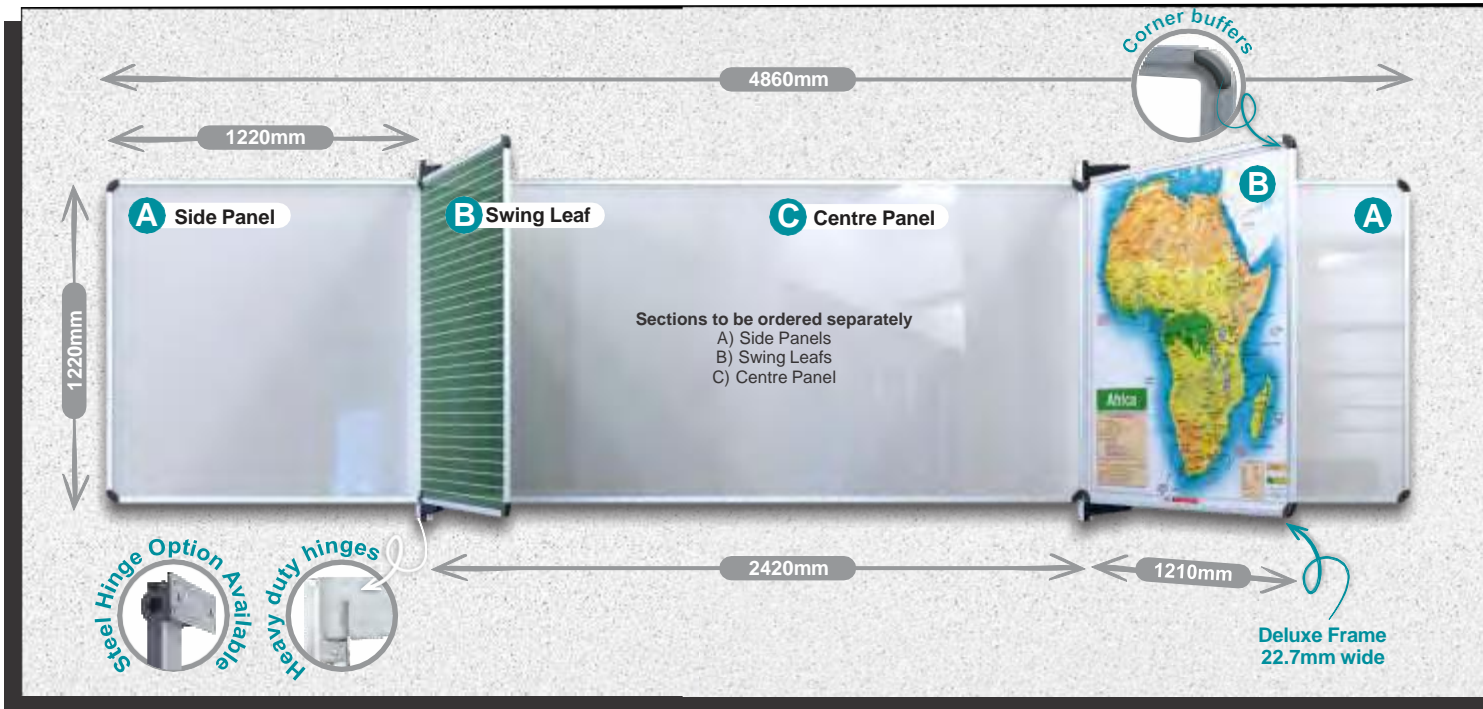

## **A** Educational Board Side Panel 1220 x 1220mm

### Code Description

ED1052	Whiteboard Magnetic
ED1152	Whiteboard Magnetic <i>Lines 50mm</i>
ED1252	Whiteboard Magnetic <i>Squares 50 x 50mm</i>
ED2052	Chalk Board Magnetic
ED3052	Chalk Board Non-Magnetic
ED3152	Chalk Board Non-Magnetic, <i>Lines 50mm</i>
ED3252	Chalk Board Non-Magnetic, <i>Squares 50 x 50mm</i>
GB1052	Whiteboard Magnetic Music Lines
GB2052	Whiteboard Magnetic South Africa Map
GB3052	Whiteboard Magnetic Africa Map

### Code Description

ED6052	Chalk Board Non-Magnetic
ED6152	Chalk Board Non-Magnetic <i>Lines 50mm one side</i>
ED6252	Chalk Board Non-Magnetic <i>Squares 50 x 50mm one side</i>
ED6352	Chalk Board Non-Magnetic <i>Lines 50mm / Squares 50 x 50mm</i>

## **B** Educational Board Swing Leaf 1220 x 1210mm

### Code Description

ED4052	Whiteboard Magnetic
ED4152	Whiteboard Magnetic <i>Lines 50mm one side</i>
ED4252	Whiteboard Magnetic <i>Squares 50 x 50mm one side</i>
ED4352	Whiteboard Magnetic <i>Lines 50mm / Squares 50 x 50mm</i>
ED5052	Chalk Board Magnetic

## **C** Educational Board Centre Panel 2420 x 1220mm

### Code Description

ED7076	Whiteboard Magnetic
ED8076	Chalk Board Magnetic
ED9076	Chalk Board Non-Magnetic
ED9176	Chalk Board Non-Magnetic <i>Lines</i>
AL0320	Hinge Plastic Grey & Aluminium Mounting (each)
AL0330	Steel Hinge (each)

- Heavy-duty plastic hinges, Steel hinge option available • Aluminium frame.
- Centre panel fitted with an aluminium Chalk Rail / Pen tray.
- Double-sided swing-leaf panels. • Deluxe frame 22.7mm wide • Includes mounting instructions.
- **Available in 7 writing surfaces:**
  - Magnetic & Non-Magnetic Whiteboard.
  - Magnetic & Non-Magnetic Chalkboard.
  - Lines & Grids (on Magnetic Whiteboard and Non-Magnetic Chalk Board surfaces only).
  - Maps & Music Lines (on Magnetic Whiteboard surface only).



- All boards comply to Standards South Africa in terms of CKS 36:2004 Edition 4. As approved by the Department of Trade and Industry in April 2004.

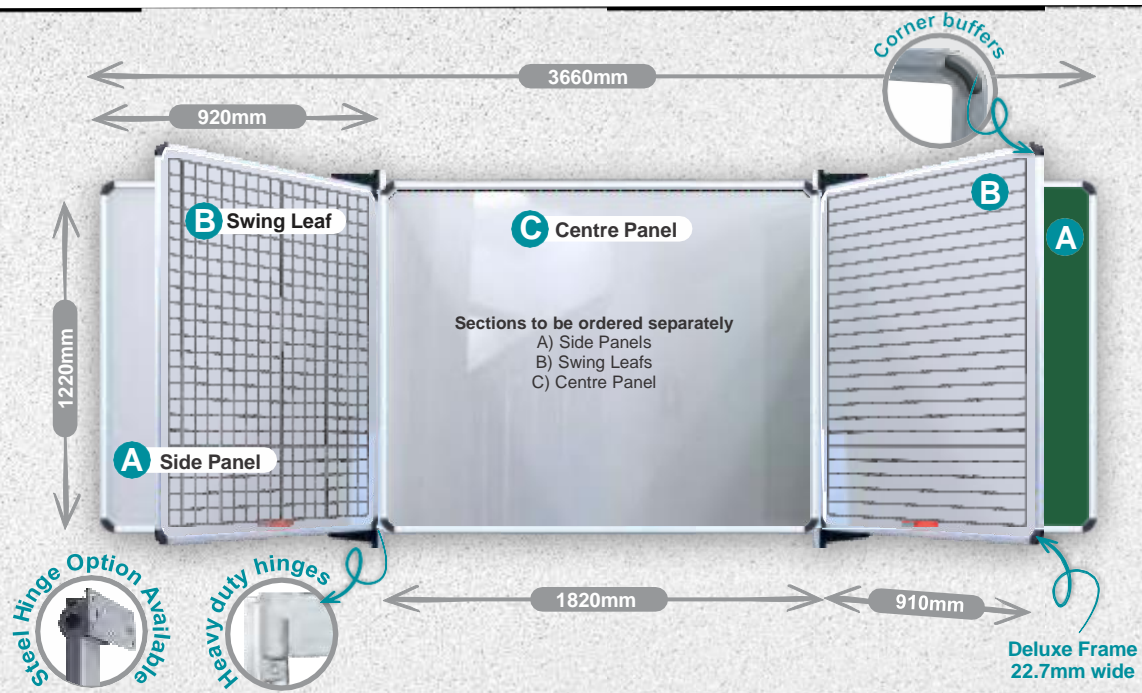

### A Educational Board Side Panel 1220 x 920mm

#### Code Description

ED1068	Whiteboard Magnetic
ED1168	Whiteboard Magnetic Lines 50mm
ED1268	Whiteboard Magnetic Squares 50 x 50mm
ED2068	Chalk Board Magnetic
ED3068	Chalk Board Non-Magnetic
ED3168	Chalk Board Non-Magnetic, Lines 50mm
ED3268	Chalk Board Non-Magnetic, Squares 50 x 50mm
GB3068	Whiteboard Magnetic Africa Map

### B Educational Board Swing Leaf 1220 x 910mm

#### Code Description

ED4068	Whiteboard Magnetic
ED4168	Whiteboard Magnetic Lines 50mm one side
ED4268	Whiteboard Magnetic Squares 50 x 50mm one side
ED4368	Whiteboard Magnetic Lines 50mm / Squares 50 x 50mm
ED5068	Chalk Board Magnetic
ED6068	Chalk Board Non-Magnetic

#### Code Description

ED6168	Chalk Board Non-Magnetic Lines 50mm one side
ED6268	Chalk Board Non-Magnetic Squares 50 x 50mm one side
ED6368	Chalk Board Non-Magnetic Lines 50mm / Squares 50 x 50mm

### C Educational Board Centre Panel 1820 x 1220mm

#### Code Description

ED7068	Whiteboard Magnetic
ED8068	Chalk Board Magnetic
ED9068	Chalk Board Non-Magnetic
AL0320	Hinge Plastic Grey & Aluminium Mounting (each)
AL0330	Steel Hinge (each)



Music Lines  
30mm apart inside blocks



Map Africa



Educational Lines  
50mm apart



50 x 50mm Squares

See page 48 for Chalk & Chalk Holder





**We**  
***install***  
**just about**  
***anywhere***

- A friendly & efficient team
- Affordable rates • Installation of any of our product range

☎ 0722593444    ✉ [george@gshxpertsolutions.co.za](mailto:george@gshxpertsolutions.co.za)

Installation in Gauteng, Bloemfontein, Durban, Cape Town, Port Elizabeth, Nelspruit & Namibia

# Writing Slates

## Chalk board, Markerboard & Plastic



### Code

### Description

### Size

BD2802	Writing Slate Chalk Board Single Sided Carded	297 x 210 x 3mm
BD2802A	Writing Slate Chalk Board Single Sided Uncarded Pack of 10	297 x 210 x 3mm
BD2805	Writing Slate Markerboard Chalkboard Double Sided Carded	297 x 210 x 4mm
BD2805A	Writing Slate Markerboard Chalkboard Double Sided Uncarded Pack 10	297 x 210 x 4mm
BD1002	Writing Slate Markerboard Single Sided Carded	297 x 210 x 3mm
BD1002A	Writing Slate Markerboard Single Sided Uncarded Pack 10	297 x 210 x 3mm
BD1003	Writing Slate Markerboard Single Sided (A3)	420 x 297 x 3mm
BD1003A	Writing Slate Markerboard Single Sided (A3) Uncarded Pack 10	420 x 297 x 3mm
BD1004B	Writing Slate Plastic Writing Lines	297 x 210 x 0.75mm
BD1004C	Writing Slate Plastic Lines <i>**While stocks last</i>	297 x 210 x 0.75mm
BD1004D	Writing Slate Plastic Music Lines	297 x 210 x 0.75mm
BD1004R	Writing Slate Plastic Retail	297 x 210 x 0.75mm

#### Board Writing Slate Product Features

- Writing Slates are available in double and single-sided, single-carded packs or uncarded packs of ten.

#### Plastic Writing Slate Product Features

- Permanently printed teaching lines and grids. • Use with Parrot Whiteboard Markers for write and wipe surface.

# Writing Slates

Chalk board, Markerboard & Plastic



BD2802



BD1002



BD1003A



BD2805



BD1004B



BD1004C



BD1004D



BD1004R

# Clipboards

Whiteboard, Masonite & Brushed Aluminium

Code	Description	Size
CB3000	Clipboard Whiteboard	355 x 230 x 3mm
CB3005	Clipboard Masonite	355 x 230 x 3mm
CB3010	Clipboard Masonite (A5)	210 x 147 x 3mm
CB3015	Clipboard - Brushed Aluminium	355 x 230 x 3mm

- Clipboard Whiteboard has a Write 'n Wipe surface.
- All Clipboards have a Bulldog clip.

- Customized printing or logo print on whiteboard is available



CB3000

CB3005

CB3015



# Writing Slate/Tablet LCD



Reminders & Notes

Practice & Learning

Teaching & Demonstrating

## Code Screen Size

BD2810 10inch

- 10" LCD Writing Tablet
- Easy to write
- Easy to erase with the one touch erase button
- Light weight & portable
- Ideal for home and office use
- No electricity required
- Stylus Pen included
- CR2025 battery included



LCD Writing



Erase Button



Child Friendly



Long Lasting Battery

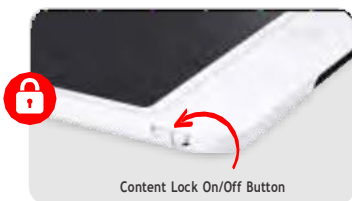

Content Lock On/Off Button



Erase Button

# Whiteboard Mini Tiles

Magnetic 355 x 355mm

## Code

BD1817B  
BD1817G  
BD1817P  
BD1817W  
BD1817S

- Write & Wipe surface
- Ideal for Home & Office use
- 1 Dry Erase Marker
- 1 Wet Erase Marker (BD1817B only)
- 4x Corner Mounting Tape



BD1817B

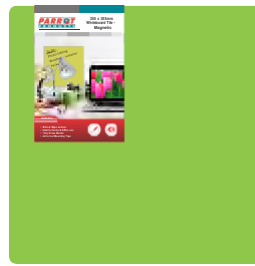

BD1817G



BD1817P



BD1817W



BD1817S



**Available colours - ex stock:**  
Colour codes: Black(B), Green(G),  
Pink(P), White(W), Silver (S)



## Flexi Magnetic 240 x 170mm

### Code Description

BD1001 Flexi - Magnetic A5

- Whiteboard Marker with magnetic cap & integrated eraser included.
- Perfect to use on fridges or any steel surface.



# Pin Board

Self Adhesive Backing, No Frame



**Code**    **Size**

BD0315	450 x 300mm
BD0320	600 x 450mm
BD0325	900 x 600mm

**Features:**

- Full adhesive backing requires no mounting devices
- Superior pinning surface
- Lightweight
- Frameless
- For home and office use

**Includes:**

- Adhesive Backing
- 3 x Drawing Pins



Include colour code when ordering

Available felt colours - ex stock:

Colour codes: Black(B), Grey(L), Royal Blue(D), Red(R), Lime(C)





# Info Boards

Alufine Frame, Felt

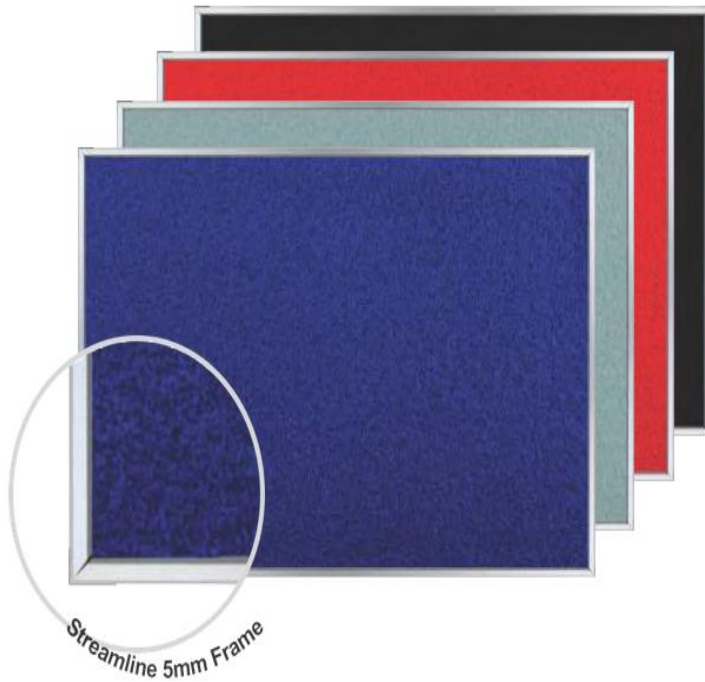

Code	Size
BD0820	600 x 450mm
BD0825	900 x 600mm
BD0841	1200 x 900mm

- Felt pinning surface
- Low density pinning surface
- Sleek and modern anodised 5mm aluminium frame
- No visible frame joins
- Light weight
- Includes mounting tabs
- Can be mounted horizontally or vertically
- For home and office use

- Felt dye lots may vary (Lead times apply)

#### Include colour code when ordering

##### Available felt colours - ex stock:

Colour codes: Black(B), Grey(L), Royal Blue(D), Red(R)



#### Include colour code when ordering

##### Felt colours - made to order (lead times apply)

Colour codes: Lime(C), Purple(A), Orange(O), Sky(S), Beige(F), Pink(P), Yellow(Y), Green(G), Cork (K).



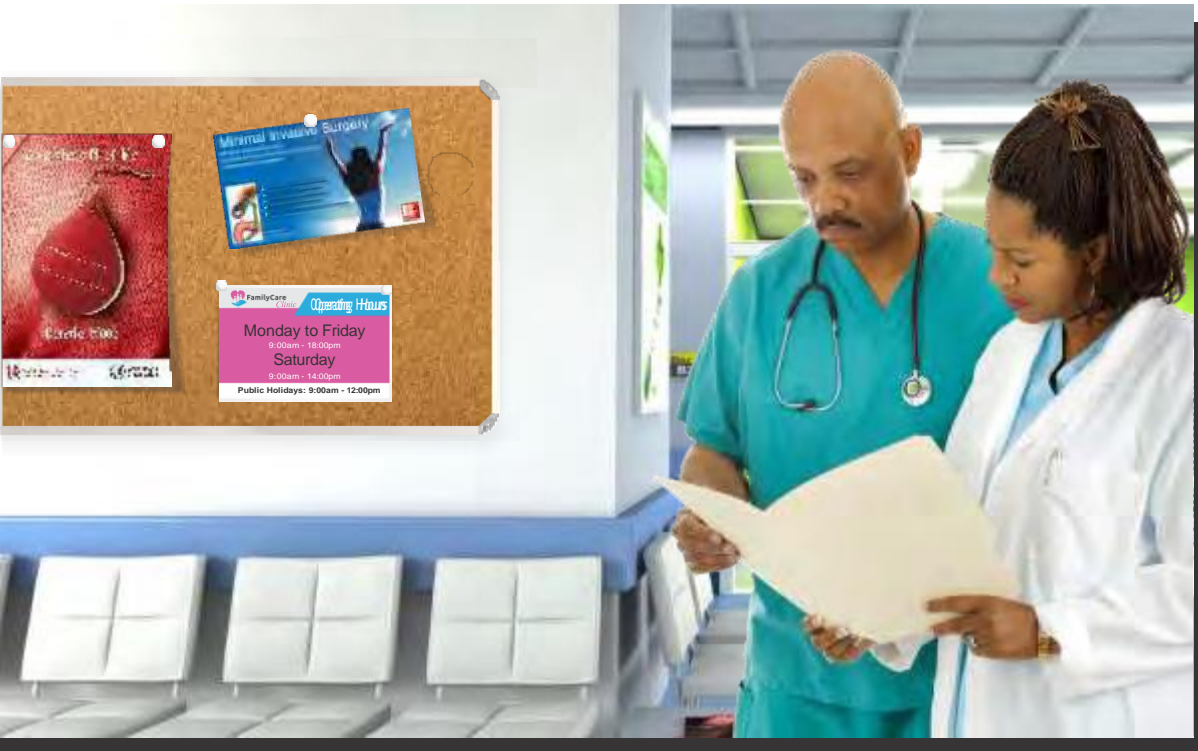

Code	Size
BD0720	600 x 450mm
BD0725	900 x 600mm
BD0728	900 x 900mm
BD0741	1200 x 900mm
BD0744	1000 x 1000mm
BD0748	1200 x 1000mm
BD0752	1200 x 1200mm
BD0760	1500 x 1200mm
BD0761	1500 x 900mm
BD0768	1800 x 1200mm
BD0769	1800 x 900mm
BD0770	2000 x 1200mm
BD0776	2400 x 1200mm
BD0784	3000 x 1200mm



- Anodised aluminium frame.
- Available in felt or cork pinning surfaces.
- Can be mounted on T-legs

- Felt dye lots may vary  
 - Cork surface(K) made to order (aluminium frames only)  
 (Lead times apply)

**Available felt colours - ex stock:**

Colour codes: Black(B), Grey(L), Royal Blue(D), Burgandy(U), Green(G).



**Felt colours - made to order (lead times apply)**

Colour codes: Lime(C), Purple(A), Orange(O), Sky(S), Beige(F), Pink(P), Yellow(Y), Red(R), Cork (K).



# Bulletin Boards

Aluminium Frame, Ribbed Carpet



Code	Size
BD0620	600 x 450mm
BD0625	900 x 600mm
BD0628	900 x 900mm
BD0641	1200 x 900mm
BD0644	1000 x 1000mm
BD0648	1200 x 1000mm
BD0652	1200 x 1200mm
BD0660	1500 x 1200mm
BD0661	1500 x 900mm
BD0668	1800 x 1200mm
BD0669	1800 x 900mm
BD0670	2000 x 1200mm
BD0676	2400 x 1200mm
BD0684	3000 x 1200mm

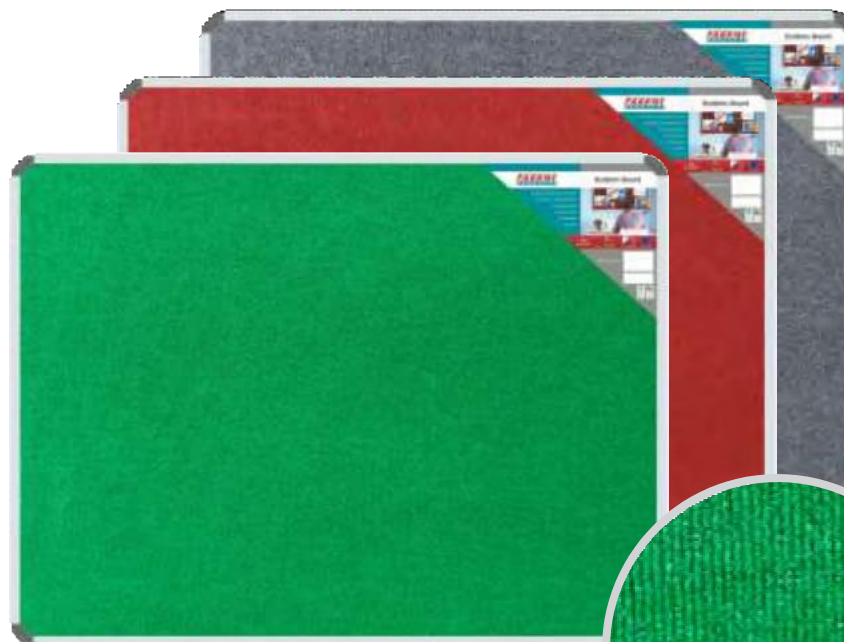

- Anodised aluminium frame.
- Velcro friendly.
- Can be mounted on T-legs

Include colour code when ordering

New ribbed surfaces available colours - ex stock:

Denim(Blue - C), Spice(Beige - Q), Tropical(Maroon - T), Laurel(Grey - X), Palm(Green - Z). - Dye lots may vary





# Combi Boards

Non-Magnetic



Code	Size
BD3325	900 x 600mm
BD3041	1200 x 900mm
BD3070	2000 x 1200mm

- Half Whiteboard & half Pin Board
- Slide-in aluminium pen tray (450 x 35mm).
- Anodised aluminium frame.
- Aluminium H-Bar divider 10mm wide.
- Can be mounted vertically or horizontally.

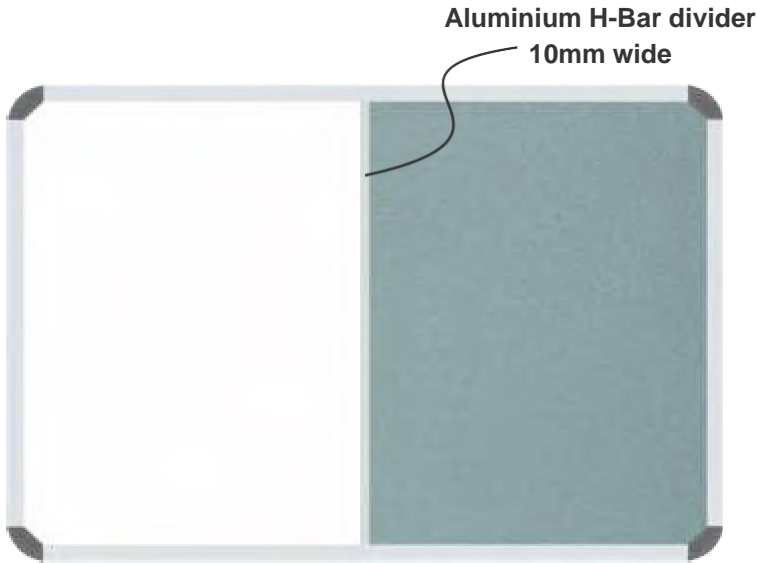

**Include colour code when ordering**  
**Available felt colours - ex stock:**  
 Colour codes: Black(B), Grey(L), Royal Blue(D), Burgandy(U), Green(G).



**Include colour code when ordering**  
**Felt colours - made to order (lead times apply)**  
 Colour codes: Lime(C), Purple(A), Orange(O), Sky(S), Beige(F), Pink(P), Yellow(Y), Red(R).



# Display Cases

## Pinning Board



Mounting brackets (wall screws & masonry plugs supplied, 6mm) | Toughened glass - 4mm.  
Aluminium frame with reinforced plastic corners | Inside usable depth - 25mm. Outside depth - 60mm.

## Hinged Doors

**Code**    **Size**

BD3825    900 x 600mm x 60mm

- Security lock with 2 keys built into doorframe.
- Lockable hinged door. • Packed for retail.
- Can be mounted on T-Legs (T-legs made to order)

## Sliding Doors

**Code**    **Size**

BD3841    1200 x 900mm x 60mm

BD3860    1500 x 1200mm x 60mm

- Security lock with 2 keys built into frame.
- Sliding doors.
- 1200 x 900mm display case can be mounted on T-legs. (T-legs made to order)

Sliding glass doors

Hinged doors

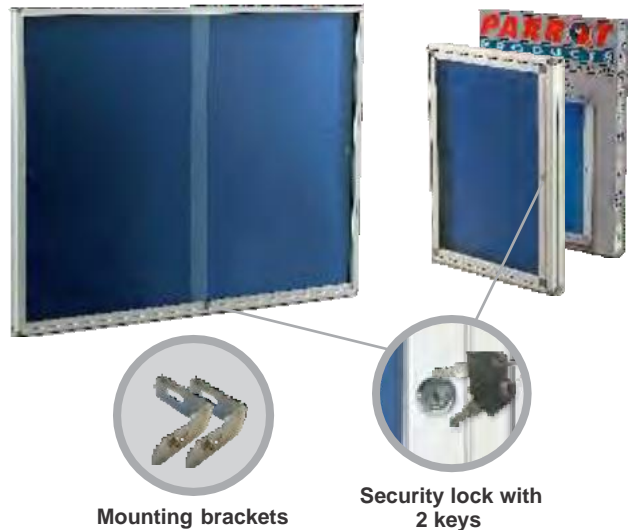

Mounting brackets

Security lock with 2 keys

**Include colour code when ordering**

**Available felt colours - ex stock:**

Colour codes: Black(B), Grey(L), Royal Blue(D)



**Include colour code when ordering**

**Felt colours - made to order (lead times apply)**

Colour codes: Pink(P), Purple(A), Lime(C), Orange(O), Sky(S)

Red(R), Green(G), Beige(F), Burgandy(U)



# Flipcharts

## Standard Model Non-Magnetic & Magnetic



Code	Description	Size
BD9131	Non-Magnetic	1000 x 640mm
BD9132	Magnetic	1000 x 640mm

- Self-adjusting hinge for centre leg
- Max. overall height 1840mm
- In locked position, middle leg can be used as carry handle



Paper clamp

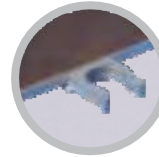

Locking clip at back



Integrated pentray



Self-adjusting hinge



Height adjustable legs



End caps

## Standard Model Retail Pack

Code	Size
BD9131A	1000 x 640mm

- Self-adjusting hinge for centre leg
- Max. overall height 1840mm
- In locked position, middle leg can be used as carry handle
- Flipchart Non-Magnetic Retail Pack includes: Whiteboard Markers Bullet Tip 10 assorted colours & Flipchart Paper



Paper clamp



Locking clip at back



Integrated pentray



W/board Markers  
Bullet Tip 10 Assorted



Self-adjusting hinge



Height adjustable legs



Flipchart Paper





# Flipchart Deluxe Castors



## Code Size

BD9145 1000 x 680mm

- Magnetically receptive steel whiteboard surface
- Dry erase surface
- Removable Ruler
- Spring loaded paper gripper
- Integrated folding pentray
- Height adjustable up to 1960mm
- Lockable castors



Height adjustable



Spring-loaded Paper Gripper



Clear Ruler Guide



Eraser & Pentray Holder



Lockable castors



# Flipchart Glassboards



Code	Description	Size
BD9144	Flipchart Glass Magnetic	900 x 1200mm
BD9144A	Flipchart Glass Stand Legs	

- Mobile Flipchart Glassboard for writing with Parrot Markers
- Height Adjustable to 1820mm (overall size)
- Includes Paper Hooks and Pen Tray
- Angle Adjustable
- Frameless Design
- Glass Board size: 900 x 1200mm
- Custom graphics, colour, pattern or image to suit any interior
- Powder coated mild steel stand with lockable castor wheels



Angle adjustable



Paper gripper



Lockable castors



\* Refer to page 8 for glass colours

# Flipchart Standard Carry Bag

**Code**      **Size**

BA2120      1100 x 680 x 90mm

- Made of durable polyester.
- Holds Standard Flipchart only.



# Flipchart Paper Carrier

**Code**      **Size**

BD9341      600mm

- Slides into all standard frame boards.
- Adjustable paper hooks fit all Flipchart Pads.
- For use with Aluminium Frame Boards only (Standard & Deluxe).
- Holds up to 50 sheets.

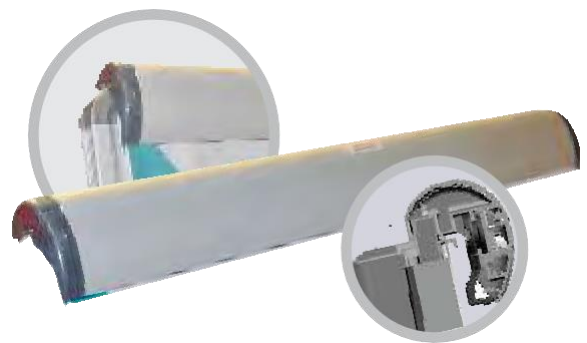

# Flipchart Paper

**Code**      **Description**

**Size**

BA2101*	Flipchart Paper Newsprint 50 sheets	860 x 610mm
BA2104*	Flipchart Paper Newsprint 20 sheets	860 x 610mm
BA2102	Flipchart Paper Bond 50 sheets	860 x 610mm
BA2105	Flipchart Paper Bond 20 sheets	860 x 610mm
BA2106*	Flipchart Paper Graph 20 sheets	860 x 610mm
BA2107*	Flipchart Paper Rainbow 20 sheets	860 x 610mm

**\* While stocks last**

- **Newsprint Pads (45gsm)**
    - 50 Sheets
    - 20 Sheets
  - **Bond Pads (60gsm)**
    - 50 Sheets
    - 20 Sheets
  - **Graph Pads (54gsm)**
    - 20 Sheets
    - 10 x 10mm squares
  - **Rainbow Pads (54gsm)**
    - 20 sheets
    - 5 colours
- Slotted holes to fit most Flipchart stands.  
• Perforated sheets.

**Newsprint  
20 sheets**



**Bond  
20 sheets**



**Graph  
20 sheets**



**Newsprint  
50 sheets**



**Bond  
50 sheets**



**Rainbow  
20 sheets**





# Board Supports

## T-Legs

### Code Description

BD9010	T-Leg Set (for Boards up to 1500mm)
BD9015	T-Leg Set (for Boards 1600mm to 2400mm)

- Lockable and non-lockable castors.
- Horizontal support allows for height adjustment.
- Can be fitted to Standard Frame boards up to 2400mm.

#### T-legs Set for Boards up to 1500mm

Size: 1400 x 600mm.

Not recommended for boards larger than 1500 x 1200mm.

Board sold separately. No crossbar required.

#### T-legs Set - Adjustable for Boards 1600mm to 2400mm

Size: 1400 x 600mm.

Not for boards smaller than 1600 x 1200mm.

Board sold separately. Width adjustable crossbar.

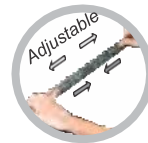

Adjustable width



Horizontal support



Lockable castors

## Steel Easel

### Code Description

BD9000	Easel Steel Telescopic
--------	------------------------

- Height-adjustable board supports.
- Telescopic legs.

Folded size: 1060 x 700mm.

Fully extended size: 1000 x 1900mm.

Not recommended for boards larger than 1200 x 1200mm.



Self-adjusting hinge for stability



Board supports



Board supports

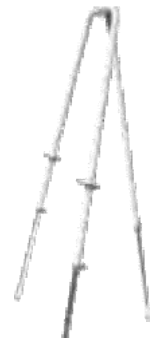

## Aluminium Easel

### Code Description

BD9135	Easel Aluminium Adjustable
--------	----------------------------

- Extends up to 1530mm (H).
- Holds up to 800mm Boards.
- High quality aluminium tube.
- Ideal for studio work.

## Desk Partition Clamp

### Code Description

DC0001	Desk Partition Clamp
DC0002	Desk Partition Clamp Under Counter Single Sided
DC0003	Desk Partition Clamp Under Counter Double Sided

- Silver Aluminium Alloy • Desk mounted
- Suitable for panels 3mm up to 16mm (can be used with standard frame whiteboard)
- Spacing: 700mm centre to centre



DC0001



DC0002  
Spacing of  
25mm



DC0003  
Spacing of  
25mm

# Mobile / Revolving Boards

Magnetic

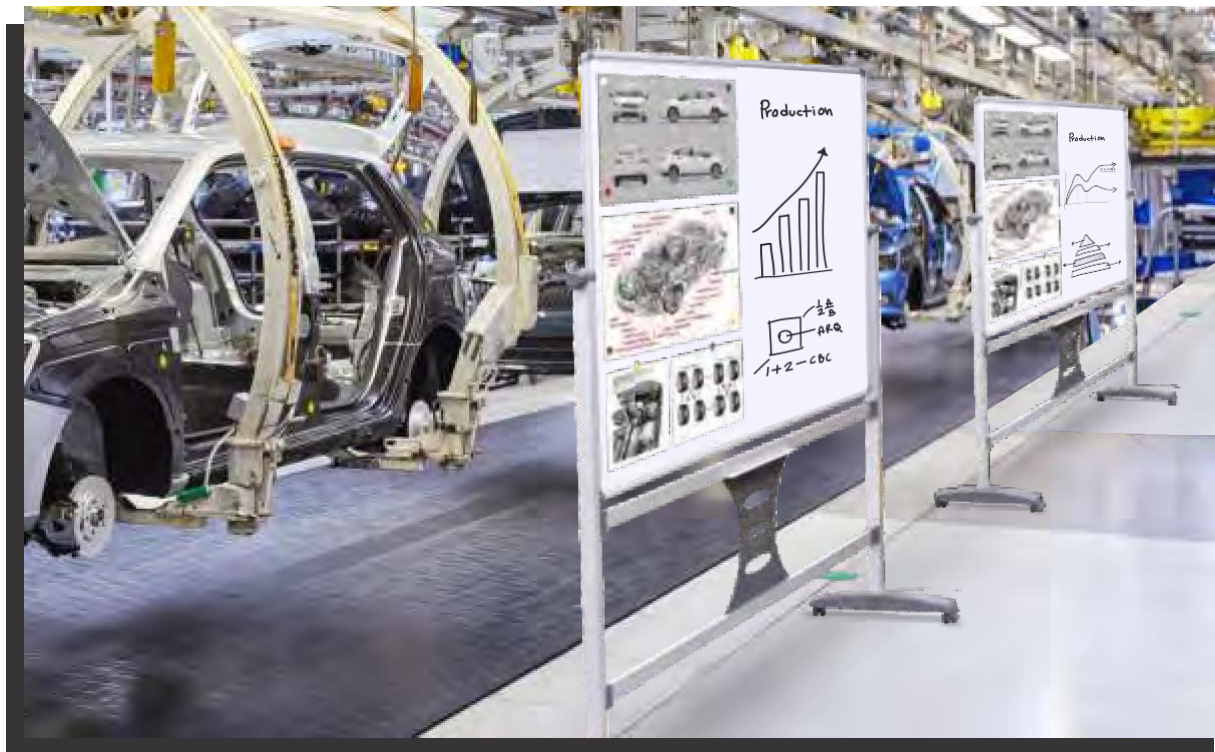

## Code Size

BD4241	1200 x 900mm
BD4260	1500 x 1200mm
BD4261	1500 x 900mm
BD4268	1800 x 1200mm
BD4269	1800 x 900mm

- Anodised aluminium frame.
- Double-sided Whiteboard Magnetic.
- Assembles easily without tools.
- Durable and stylish plastic cross bar stabilizer.
- 360° Degrees rotation.



Tightening mechanism to allow rotation



Double-sided pen tray (450mm)

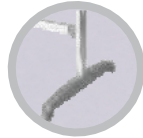

Lockable and non-lockable castors

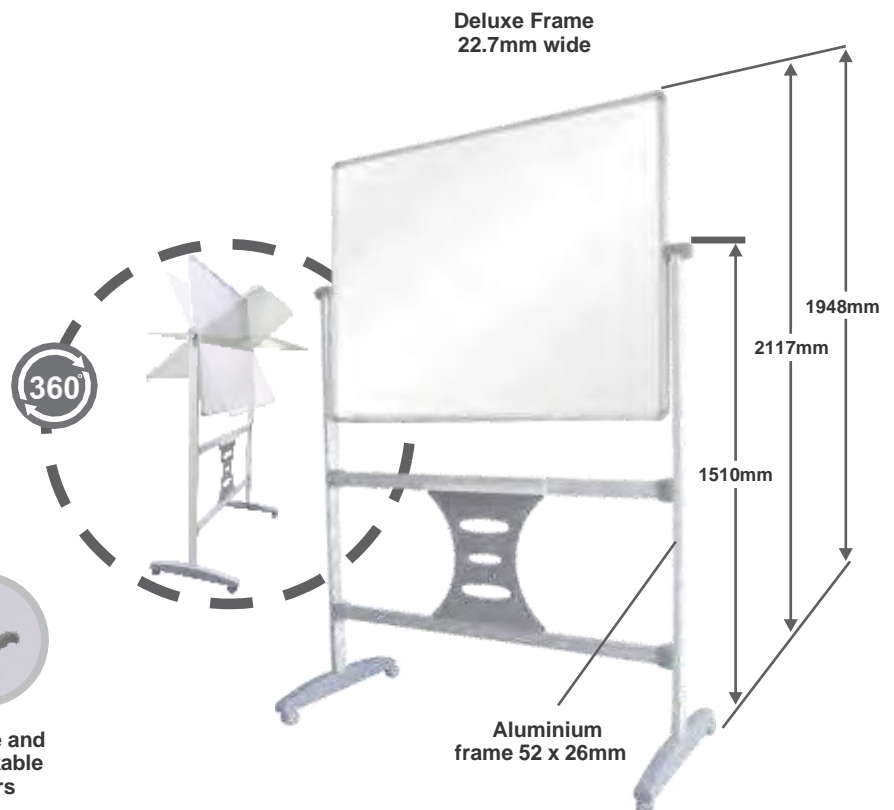

# Mobile/Revolving Glass Board

Magnetic Glass - Leg Set



**Code**    **Size**

BD4270    1200 x 900mm

- Magnetic Surface
- Double-sided pentray (450mm)
- Double-sided Glass Whiteboard
- Double cross bars ensure stability
- Assembles easily without tools
- Durable and stylish plastic crossbar stabilizer
- Will go through a standard door (2100mm diagonally) without disassembling

**Can be personalised to any of our solid colour range**

- Refer to page 8 for colour range



**Tightening mechanism to allow rotation**

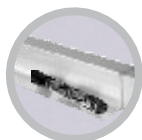

**Double-sided Pentray (450mm)**

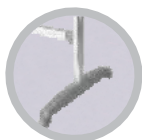

**Lockable and Non-lockable Castors**



*Double layered glass board with pre-drilled holes for assembly of leg set*



# A-frames

## Non-magnetic

Code	Description	Size
SN0624	A-Frame Whiteboard Aluminium Frame	900 x 600mm
SN0724	A-Frame Chalk Board Non-Magnetic	900 x 600mm
SN0824	A-Frame Whiteboard Non-Magnetic	900 x 600mm

### SN0624 Features:

- Board locks in stable position.
- Lightweight.
- Standing height of 850mm when open.
- Aluminium framework (25mm).
- Weather resistant.
- Supplied with Whiteboard Marker (Black).

### SN0724 & SN0824 Features:

- Board locks in stable position.
- Standing height of 960mm when open.
- Frame 35mm wide.
- Weather resistant.



SN0724



Powder-coated steel frame 35mm wide

SN0824

Customized print available

Aluminium framework (25mm)



SN0624

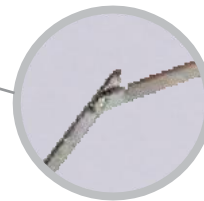

Board locks

## Poster A-Frame

Code	Description	Size
BG8100	A-Frame Poster Frame (A0)	1250 x 900mm
BG8101	A-Frame Poster Frame (A1)	900 x 655mm
BG8102	A-Frame Poster Frame (A2)	655 x 480mm

- Board locks in stable position.
- Mitred corner.
- Aluminium, spring action frame, 39mm wide.
- Quick and easy display change.
- Non-reflective media cover supplied
- see page 108 for clear media cover options.

Frame 39mm wide



Spring action aluminium frame

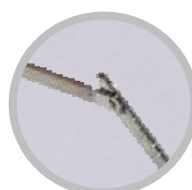

Board locks



## Code Description

ER0001	Easy Rail 1 meter
ER0002	Easy Rail 2 meter
ER0003	Easy Rail 3 meter
ER0004	Easy Rail 4 meter
ER0005	Easy Rail 5 meter
ER0010	Easy Rail Mounting Bracket Set Short
ER0011	Easy Rail Mounting Bracket Set Long
ER0015	Easy Rail Connector (for flush mounting of two Easy Rail sections)

- Double rail system.
- Top brackets with sliders, bottom brackets with wheels.
- Mounting bracket sets supplied with silicone for smooth sliding.
- Double rail system with end stoppers and built-in paper gripper.
- Allows boards to pass in front or behind of one another.
- Largest recommended board size is 1800 x 1200mm.
- Paper Gripper not recommended for laminated paper.
- Fix-screws for mounting are supplied, along with a plastic strip for concealed mounting.

\*Boards sold separately

Top brackets with sliders



Size of Brackets

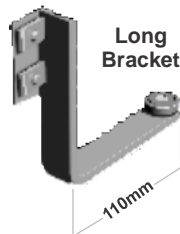

Bottom brackets with wheels

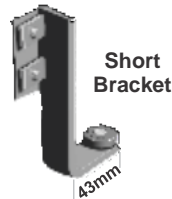
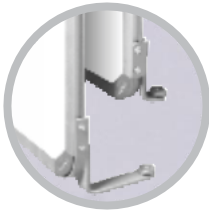

Built-in paper gripper



## Multi-Purpose Paper Gripper

Code	Description	Size
BD9342	Paper Gripper Retail	360mm
BD9342A	Paper Gripper	1000mm
BD9342B	Paper Gripper	2000mm

- Hanging display for paper products
- Ideal for restaurants, offices and classrooms.
- Supplied with masonry screws and double-sided tape.
- Can be installed next to each other for a larger surface area for custom lengths or packed for retail (BD9342).

**While stocks last**

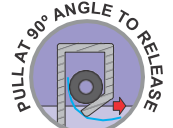
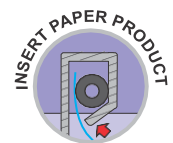

# Lap Trays



Code	Description	Size
MI0002	Lap Tray Tablet - White	450 x 325mm
MI0002A	Lap Tray Tablet - Grey	450 x 325mm

- Perfect as a stable surface for writing, reading and surfing the internet in the home or on the go.
- Soft-touch wrist pads provide a layer of comfort
- Also suitable to be used with laptops or cellphones

Available colours:



*\* Laptop not included*



*Products tailored to the specific needs of our customers*

Carry your corporate identity through your building with custom made products

### Powder Coated Poster Frames



Only applicable to Mitred Corner and Deluxe frames. Colours are available on request, and customization size is max A0.

### Signage - Aluminium Sign Frames

Single or double sided including custom print



Add your company logo or design on any of our sign frames.

- Make your statement and stand out from the crowd
- Digital Printing is permanent and will not crack or fade
- Custom made to any size and design

### Graphics Boards

Custom Design & Print

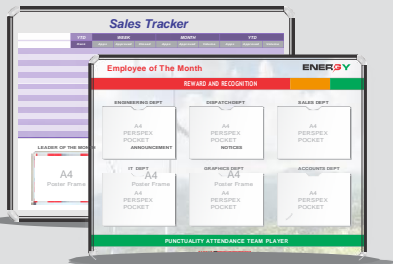

Our graphics boards are made-to-order. We will require you to provide us with your image, design, or our in-house design team can design the artwork at a cost.

### Glass Boards

Designed as artistic display or whiteboard



Print any graphic of your choice from the Shutterstock image library or select from our standard 25 solid colour range.

### Glass Flipcharts

Full colour or custom print with logo



Select from our standard 25 solid colour range. Provide us with your image or a custom design. Available in magnetic glass board.

### Printed Pin Boards

Customized print available

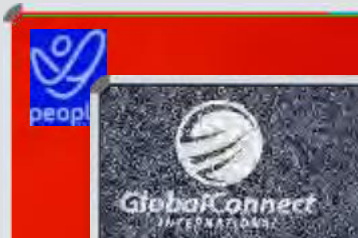

Select from our standard range of felt and carpet stock colours. Customize with your company logo or graphic or provide your design.

### Custom Hospital Theatre Glass Boards



Custom print on both Magnetic & Non-magnetic Glass boards. Ideal for hospitals, clinics and medical institutions.

### Custom Hospital Glass Boards

Ward - Nurse Station



Available in Magnetic or non-magnetic Custom prints & sizes available on request

\*Please note that pricing on customized boards, poster frames and signage is available on request.

# Custom Printed Boards



- From shipping movements to menus, hospital plans to information maps, factory and machine schedules. We can produce a unique board incorporating your own design.
- Permanent prints, full colour, with any image, logo or background.
- Includes Starter pack: 2x W/board Markers, Eraser (95 x 55mm), Cleaning Fluid 28ml.

**How to order**

## OPTION 1



You already have print ready artwork

- The artwork must be in vector format, for example: \*.ai, \*.pdf, \*.eps or \*.cdr - No design fee will apply
- Forward all relevant artwork information to sales@parrotproducts.biz - No design fee will apply
- Quotation will follow.

## OPTION 2



You have a rough idea or sketch of what you'd like

- Contact one of our Key Account Managers or call our National Call Centre on 010 140 4900
- Payment or a company order number for the design fee is required before design process can commence.
- Artwork can be designed in our Graphics Studio. A proof will be sent to you for your approval
- Design fee will apply

## OPTION 3



You are unsure of what you need or you have no existing artwork

- Contact one of our Key Account Managers or call our National Call Centre on 010 140 4900
- Payment or a company order number for the design fee is required before design process can commence.
- Artwork can be designed in our Graphics Studio. A proof will be sent to you for your approval
- Design fee will apply

# Cast Acrylic Planners

Monthly, Weekly & Yearly Planners 600 x 450mm



**Code**    **Description**

- BD7125    Cast Acrylic Weekly Planner
- BD7126    Cast Acrylic Monthly Planner
- BD7127    Cast Acrylic Yearly Planner

- Slimline Design (3mm thickness)
- Mounted with Double-side tape
- Use with Whiteboard Markers
- Frameless
- Light Weight



Monthly Planner



Weekly Planner

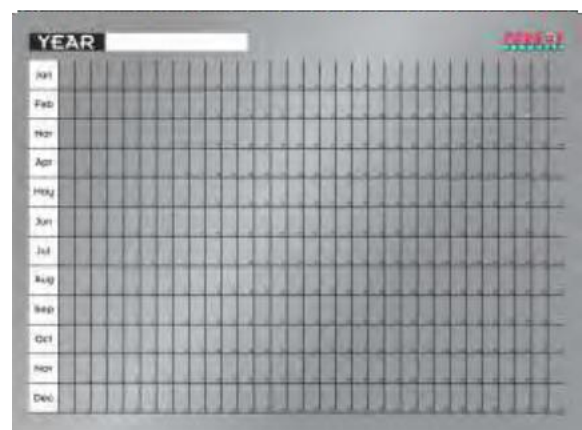

Yearly Planner



# Year Planners

## Perpetual Year Planner Magnetic



Code	Description	Size
BD5140	Year Planner Magnetic	1200 x 900mm
BD5160	Year Planner Magnetic	1500 x 1200mm
BD5176	Year Planner Magnetic	2400 x 1200mm
AL3040	Date Strips Replacement Kits for 900mm high boards	
AL3041	Date Strips Replacement Kits for 1200mm high boards	

- Concealed mounting (wall screws and masonry plugs supplied, 6mm).
- Additional mounting brackets for boards larger than 1500mm.
- Slide-in aluminium pentray (450 x 35mm).
- Includes mounting instructions.
- Boards larger than 1500 x 1200mm supplied with 2 pentrays.
- Also supplied with:  
Markers, Magnetic Date Strips, Public Holiday Indicators, Planning Shapes & 2 Label Carriers.

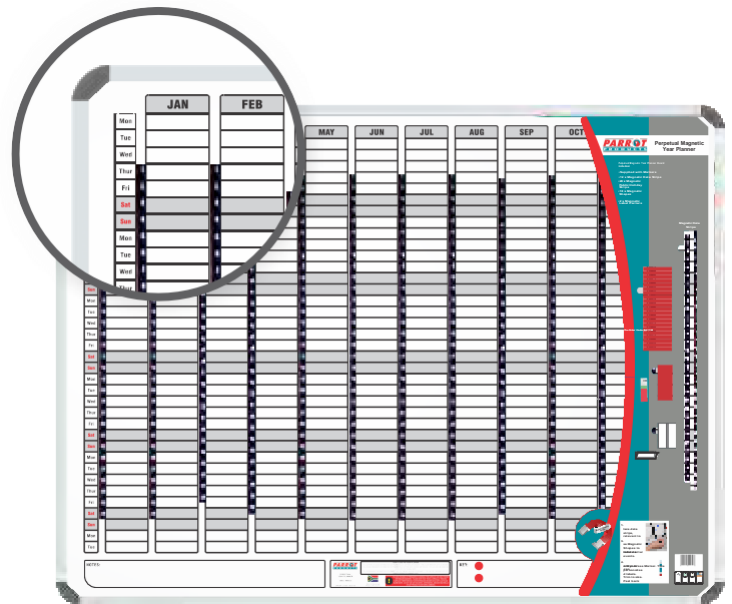

### Actual sizes of blocks for each planner

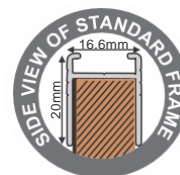
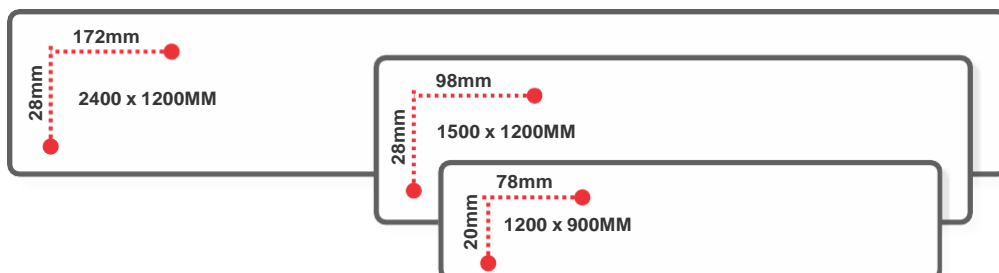

# Year Planner

## Glass Board Non Magnetic

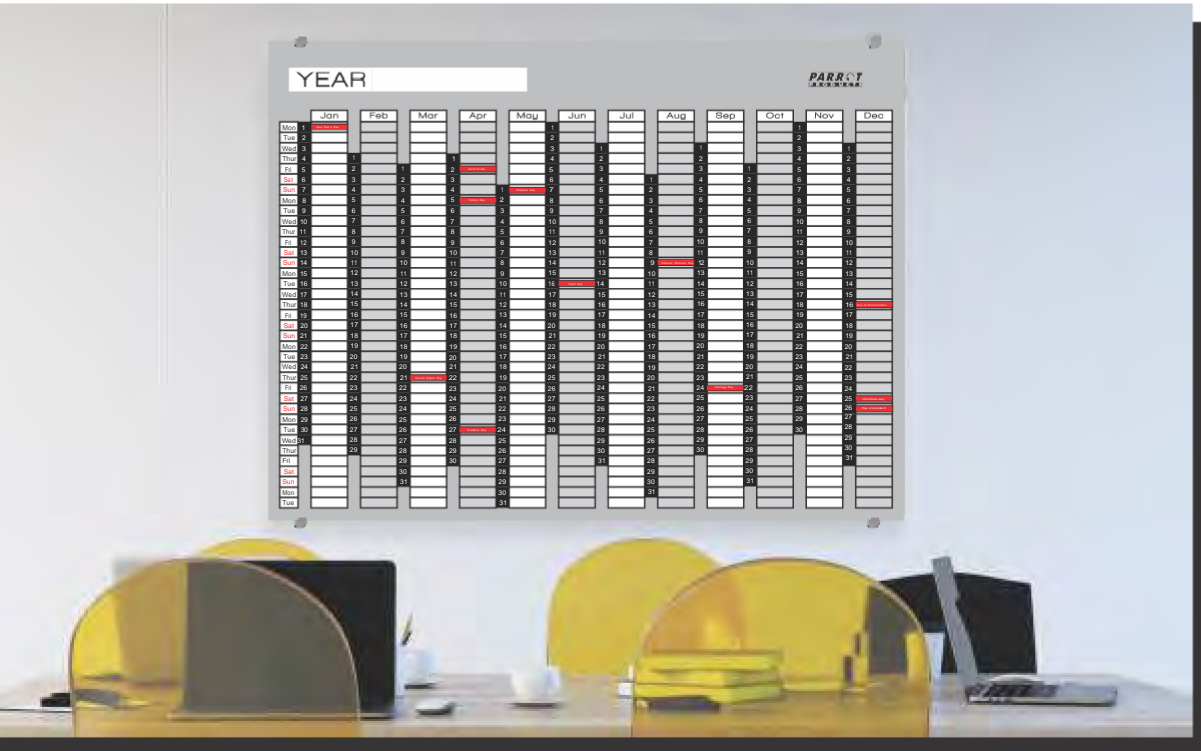

### Code Size

BD5140G 1200 x 900mm

- Non Magnetic Glass
- Stainless steel mounting brackets (Set of 4 - Re-Order Code: AL3022A)
- For Tempered Glass pentray (Re-Order Code: AL3023)
- Stainless Steel pentray mounts (Re-Order Code: AL3024)

### Includes:

- Non Magnetic Glass Whiteboard
- Markers (Red & Black)
- Eraser
- Nano Tape Date strips
- Public Holiday Indicators
- Tempered glass pentray

YEAR												
	Jan	Feb	Mar	Apr	May	Jun	Jul	Aug	Sep	Oct	Nov	Dec
Mon	1					1					1	
Tue	2					2				2		2
Wed	3					3				3		3
Thur	4	1		1		4				4		4
Fri	5	2	1	2		5				5		5
Sat	6	3	2	3		6				6		6
Sun	7	4	3	4		7				7		7
Mon	8	5	4	5		8				8		8
Tue	9	6	5	6		9				9		9
Wed	10	7	6	7		10				10		10
Thur	11	8	7	8		11				11		11
Fri	12	9	8	9		12				12		12
Sat	13	10	9	10		13				13		13
Sun	14	11	10	11		14				14		14
Mon	15	12	11	12		15				15		15
Tue	16	13	12	13		16				16		16
Wed	17	14	13	14		17				17		17
Thur	18	15	14	15		18				18		18
Fri	19	16	15	16		19				19		19
Sat	20	17	16	17		20				20		20
Sun	21	18	17	18		21				21		21
Mon	22	19	18	19		22				22		22
Tue	23	20	19	20		23				23		23
Wed	24	21	20	21		24				24		24
Thur	25	22	21	22		25				25		25
Fri	26	23	22	23		26				26		26
Sat	27	24	23	24		27				27		27
Sun	28	25	24	25		28				28		28
Mon	29	26	25	26		29				29		29
Tue	30	27	26	27		30				30		30
Wed	31	28	27	28		31				31		31
Thur		29	28	29								
Fri		30	29	30								
Sat		31										
Sun												
Mon												
Tue												

# In/Out Slides

## Surface Mounted In/Out Slides



Code	Description	Size
BD4110	In / Out Slide Box of 10	400 x 50mm
SN1003A	Sign Frame In/Out Slide Printable Sticker	38 x 99mm

- The printable stickers can be used for the Parrot In / Out Slide Sign frame.
- Print the name on Self-adhesive Labels provided.  
(To be used with laser printers only)
- 2 sheets of Self-adhesive Labels
- 14 stickers per sheet
- White colour stickers
- Each label size is 38 x 99mm

Packed for Retail

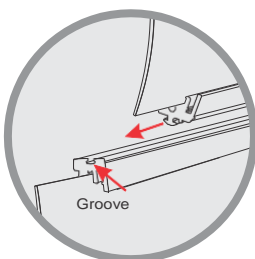

For Personalised Surface Mounted In / Out Slides contact our Call Centre



NAME	IN/OUT	RETURNING	MESSAGES
Mark V	IN		
Thabo M	IN	4pm	Presentation / MVP
Robin	IN		
Mr Errol	IN	12pm	Client Meeting
Cassidy	IN	11:30	Client Meeting
Benjamin	IN	3pm	Trade Show
Jake	IN		
Cyril	IN		
Whitney	IN		
Siphokasi	IN		

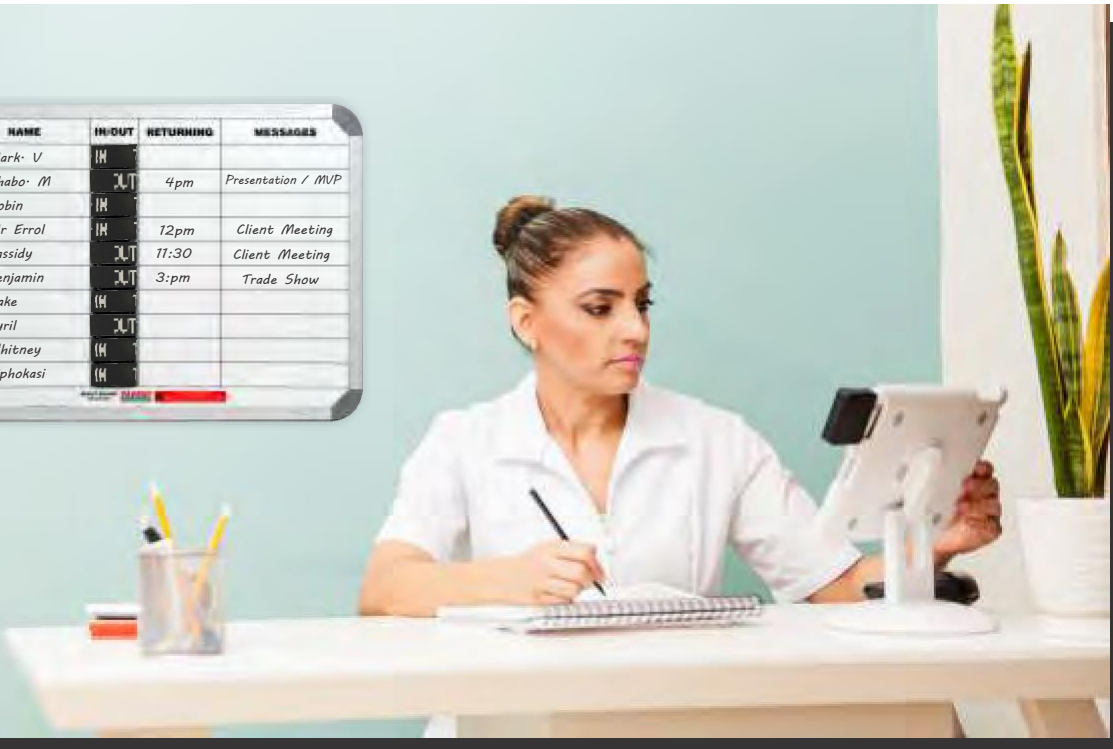

Code	Description	Size
BD4010	In / Out Board Magnetic 10 Name	600 x 450mm
BD4020	In / Out Board Magnetic 20 Name	900 x 600mm

- Concealed mounting (wall screws and masonry plugs supplied, 6mm).
- Slide-in aluminium pentray (450 x 35mm).
- Pentray packed in back of board to ensure no damages while being transported.
- Can be used with the Easy Rail System
- In / Out slides included.
- Names can be personalised to suit your requirements.
- Column sizes:  
Name - 200 x 35mm.  
In / Out - 68 x 35mm.  
Returning - 112 x 35mm.  
Messages - 190 x 35mm.



Concealed mounting

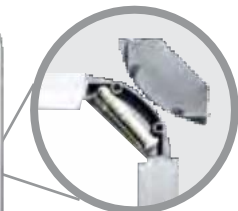

Standard Frame  
20mm wide

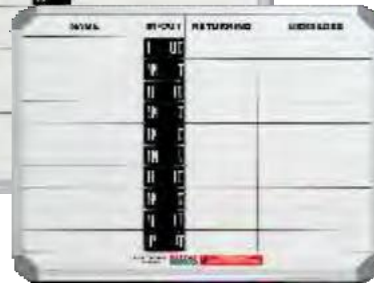

Concealed mounting

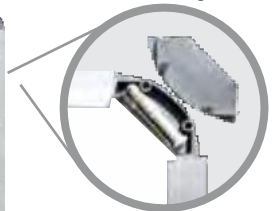

Standard Frame  
20mm wide



For Personalised In/Out Boards contact our Call Centre

# Synthetic Wooden Frames



## Product Features

- Synthetic wood moulding. Can be used with most surfaces in our range.
- Frame 39mm wide.
- Frame depth 23mm.
- Up to 3000mm in length.
- Match accent colours of interior decor

Available in the following simulated wood finishes:

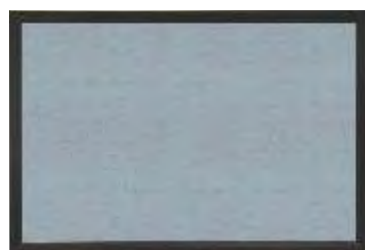

Frame  
39mm wide

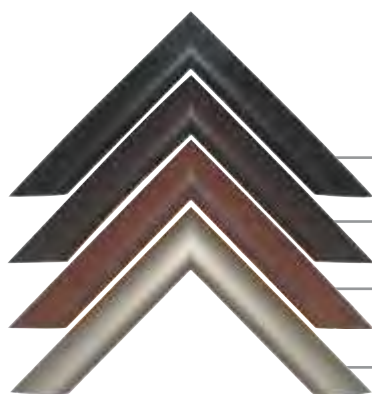

Black (WF001)

Imbuia (WF1002)

Cherry (WF1003)

Matte Silver (WF1005)

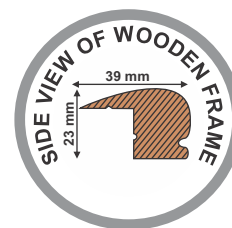

## Abacus

Code	Description	Size
AB1010	Abacus 100 Beads	230 x 153mm
AB1010-Z	Abacus 100 Beads Box of 40	



- Calculation tool used to demonstrate maths concepts
- Abacus allows children to visually and tangibly move beads as they count, add, subtract, multiply, identify place value and more
- 10 rows
- **Colours:** blue, yellow, orange, green & red

## Desktop Calculator

Code	Description
AB0012	Calculator Desktop 12 Digit

**Dual power supply**  
Solar and battery operated

- 12 Digits
- Auto/Manual power off
- Memory function
- Large LCD display
- Batteries not included (1 x AG10)

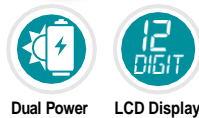

## Flexible Ruler

Code	Description
SA0030	Flexible Ruler 30cm

- 30cm shatterproof flexible ruler
- Measures in CM and MM



Include colour code when ordering  
Available colours - ex stock:  
Colour codes: Pink(P), Blue(D), Clear(T)



## Scissors

Code	Description
SA1014	Scissors 14cm - Lime
SA1018	Scissors 18cm - Grey

- |  |  |
|--|--|
| <ul style="list-style-type: none"> <li>• For school &amp; home use</li> <li>• Blade length: 14cm</li> <li>• Blade thickness: 1.5mm</li> <li>• Rounded Safety tips</li> <li>• Comfort grip handles</li> </ul> | <ul style="list-style-type: none"> <li>• For office &amp; home use</li> <li>• Blade length: 18cm</li> <li>• Blade thickness: 1.8mm</li> <li>• Rounded Safety tips</li> <li>• Comfort grip handles</li> </ul> |
|--|--|



SA1014



SA1018

## Arts & Crafts Glue

Code	Description
SA2250	Arts And Craft Glue 250ml
SA2005	Arts And Craft Glue - 5L

- High quality adhesive
- Suitable for DIY, hobby, craft and school projects
- Fast drying
- Applications: Paper, cardboard, cork, most types of woods and wooden materials
- Characteristics:
  - Solvent-free
  - Suitable and safe for children
  - Can be applied to one surface only and joined immediately
  - VAE based adhesive



SA2250



SA2005



# Board Accessories

## Vinyl Lining Tape

Code	Colour	Size
VT7003	Black	10m x 3mm
VT7004	Red	10m x 3mm
VT7005	Blue	10m x 3mm
VT7006	Black	10m x 6mm
VT7007	Red	10m x 6mm
VT7008	Blue	10m x 6mm

- Recommended for advertising, vehicle and general signage.
- Ideal on Whiteboards.

Available colours:



Easily separates VINYL from BACKING TAPE

## Flexible Magnetic Sheeting

Code	Size
BA1161	1000 x 610 x 0.8mm

- Recommended for use on Magnetic Boards or any steel surface.
- Can be cut with scissors.
- No Write 'n Wipe ability.
- Magnetic Sheeting can have any digital print applied upon request.

Available colours:



**\* While stocks last**

\*Magnetic sheeting with no colour.



## Magnetic Ruler ACP

**Code**    **Size**  
BA0211    1000mm

- 1000mm magnetic Ruler
- Aluminium handle
- Metric measurements
- Perfect for magnetic chalk boards and whiteboards



## Flexible Magnetic Strips

**Code**    **Size**  
BA1110    1000mm(2 x 500mm) x 10mm x 0.8mm  
BA1115    1000mm(2 x 500mm) x 15mm x 0.8mm  
BA1120    1000mm(2 x 500mm) x 20mm x 0.8mm

- Recommended for use on Magnetic Boards or any steel surface.
- Writeable surface, ideal for labels or planning boards, can be cut with scissors.

Available colours:



Include colour code when ordering

Available colours - ex stock:

Colour codes: Yellow(Y), Blue(S), Red(R), Black(B), Orange(O), White(W), Green(G)

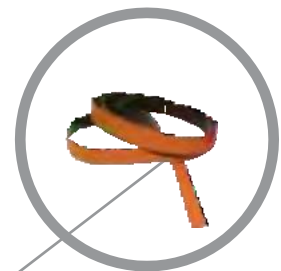

Flexible Magnetic Strips

\* Supplied in two strips of 500mm

## Flexible Magnetic Shapes

**Code**    **Size**  
BA1195    15mm

- Two of each shape in each colour: red, blue, orange, green & black.
- No Write 'n Wipe ability.
- **5 Shapes in each pack:** circles, squares, triangles, stars & arrows.
- **Bulk of single shapes or colours can be made to order (lead times apply).**

Available colours: (for bulk orders)

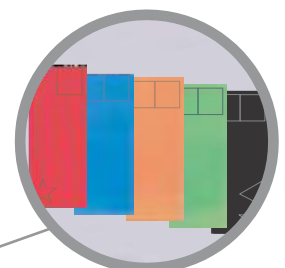

Flexible Magnetic Shapes

# Board Accessories

## Magnetic Photo Paper & Magnetic Tape

Code	Description	Size
BA1196	Magnetic Flexible Tape S/Adhesive	3m x 19mm x 0.3mm
BA1197	Magnetic Flexible Photo Paper A4 (3 sheets)	210 x 297mm

- **Magnetic Self-Adhesive Tape** - Use to mount menu's, to do lists, family notes, pictures & children's artwork. To use on magnetic-receptive surfaces.
- **Magnetic Photo Quality Paper** - Print photo's, educational aids, fridge magnets, gifts, souvenirs & business cards. Not weatherproof or bendable. Material - Semi - Anisotropic. 1.5mm thick. Magnetic strength 130 Gauss.



BA1197



BA1196

## Moulded Magnets



Actual Size



Holds up to 8 A4 80gsm pages | Holds up to 4 A3 80gsm pages



Actual Size

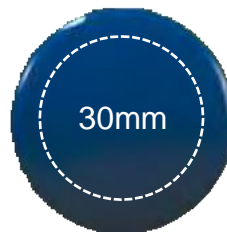

Holds up to 6 A4 80gsm pages | Holds up to 3 A3 80gsm pages



Actual Size



Holds up to 4 A4 80gsm pages | Holds up to 2 A3 80gsm pages

Code	Description	Size
BA0605	Magnets Circle (6 per card)	20mm
BA0608	Magnets Circle (5 per card - excludes white)	30mm
BA0612	Magnets Circle (4 per card - excludes white & black)	40mm

- Moulded plastic magnets. • Available in packs of assorted colours only.

\* Not Suitable for use on magnetic glassboards

### Available colours



## Moulded Magnets - Extra Strength

Code	Description	Size
BA0609	Magnetic Circle Extra-Strength (5 per card)	30mm

- Available in white only.
- Recommended for Glass/Whiteboards (See pages 6 - 10 for Glass Whiteboards)



Holds up to 6 A4 80gsm pages

Holds up to 4 A3 80gsm pages

Holds 1 laminated A4 80gsm pages

Cannot hold laminated A3 80gsm pages



## Magnetic Map Pins

Code	Description	Size
BA0915	6 per card - black, white, red, blue, green & yellow	16mm
BA0915B	Box 25 - Black	16mm
BA0915W	Box 25 - White	16mm
BA0915Y	Box 25 - Yellow	16mm
BA0915R	Box 25 - Red	16mm
BA0915G	Box 25 - Green	16mm
BA0914	4 per card - excl black & white*	30mm
BA0922	2 per card - red & yellow only	36mm

- Carded packs available in assorted colours only.
- Magnetic Map Pins pictured actual size.



Available colours



## Magnetic Label Carriers - Pack of 10

Code	Size
BA1130	20 x 60mm
BA1131	20 x 80mm
BA1132	20 x 100mm

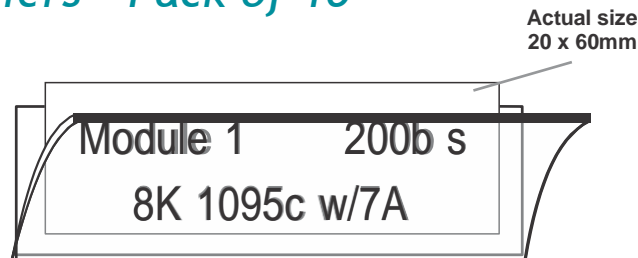

- Magnet-backed plastic holders for mounting of paper labels. • Paper labels not included.

## Drawing Pins & Push Pins

Code	Description
BA3001	Push Pins Boxed 30 Assorted
BA3001B	Push Pins Boxed 30 Black
BA3001D	Push Pins Boxed 30 Blue
BA3001G	Push Pins Boxed 30 Green
BA3001R	Push Pins Boxed 30 Red
BA3001Y	Push Pins Boxed 30 Yellow
BA3002	Drawing Pins Boxed 100
BA3003	Giant Push Pins Boxed 15
BA3004	Hexagonal Pins Boxed 30
BA3005	Map Pins Boxed 100
BA3007	Drawing Pins Brass Pack 100



- Map Pins - coloured heads for coding.
- All pins in assorted colours only, except BA3001 - Thumb Tacks Boxed 25.
- Push Pins - long heads, can be used as hooks.
- Drawing Pins - flat plastic heads.
- Giant Push Pins - easy grip.
- Hexagonal Pins - paper labels on heads for coding.

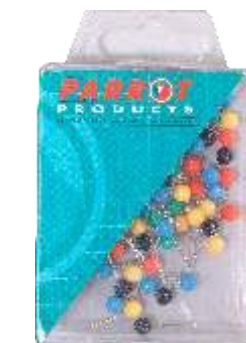

• All pins supplied in a storeable plastic box.

# Board Accessories

## Dusters - Wood Chalk Board

Code	Description	Size
BA0115	Duster - Carded Grey	95 x 35mm
BA0115B*	Duster - Uncarded Grey (Pack of 10)	95 x 35mm
BA0116A	Duster - Boxed 100 Green	150 x 35mm
BA0116B	Duster - Uncarded Green(Pack of 10)	150 x 35mm
BA0117A*	Duster - Boxed 100 Grey	150 x 35mm
BA0118	Mini Duster - Uncarded Green (Pack of 10)	50 x 35mm

- For use on Chalk Boards and Chalk Writing Slates.
- Chalk Dusters supplied with wooden handles.
- High-quality green or grey felt.



(New Mini Duster)

**\* While stocks last**

## Erasers & Aqua Wipes

Code	Description	Size
BA0101	Eraser Whiteboard - 12 peel-off layers	95 x 50mm
BA0102	Eraser Whiteboard - 12 peel-off layers	145 x 50mm
BA0105	Eraser Magnetic Whiteboard	145 x 55mm
BA0106	Eraser Magnetic Refill (12 per pack)	145 x 55mm
BA0110	Eraser Aqua Wipe	400 x 300mm

- Non-Magnetic Erasers have 12 peel off layers.
- Magnetic Eraser refill pads are available.
- Aqua Wipe - highly absorbent, removes smudging, staining and ghosting on Whiteboard surfaces.



Aqua Wipe

145 x 50mm

145 x 50mm

95 x 50mm

Do Not Wash With Detergents

## Pen and Eraser Holder Magnetic

Code	Size
BA0210*	210 x 210mm

- Holds up to 10 Whiteboard Markers and a Whiteboard Eraser.
- Perfect for office and home use.
- Efficiently stores and organizes accessories.
- Visibility of accessories for easy reach.

**\* Accessories not included**

**\* While stocks last**



## Whiteboard Cleaning Fluid

**Code**      **Description**

- BA0201      250ml Bottle Carded
- BA0201Z    250ml Box of 6 Uncarded



BA0201

BA0203

## Office Equipment Cleaning Fluid

**Code**      **Description**

- BA0203      Fluid 250ml Bottle Carded
- BA0203Z    Fluid 250ml Box of 6 Uncarded

## Aerosol Whiteboard Cleaner

**Code**      **Description**

- BA0205      Cleaning Fluid Whiteboard Aerosol 400ml Single
- BA0205Z    Cleaning Fluid Whiteboard Aerosol 400ml Box of 12

- Removes stains, marks & Permanent Marker ink from Whiteboard surfaces.
- Ideal as an office equipment cleaning solution.
- Ideal for all Whiteboard & Glassboard surfaces
- Antibacterial, Antiviral & Antifungal Sanitizing Solution



BA0205

**While stocks last**

## Whiteboard Starter Pack

**Code**      **Description**

- BA0200      Starter Pack Whiteboard

**• Starter Pack contains:**

- 2 Whiteboard Markers
- 1 Cloth
- 1 Eraser (95 x 55mm)
- 1 Cleaning Fluid (250ml)

**Code**      **Description**

- BA0202      Starter Pack Whiteboard Magnetic

**• Magnetic Starter Pack contains:**

- 2 Whiteboard Markers
- 1 Cloth
- 1 Magnetic Eraser (145 x 55mm)
- 1 Cleaning Fluid (250ml)
- 4 Moulded Magnets (20mm)



BA0200



BA0202

## Chalk & Chalk Holder

**Code**      **Description**

- CH0012A\*    Chalk Dustless Box 12 Assorted Colours
- CH0012W\*    Chalk Dustless Box 12 White
- CH0001Y      Chalk Holder Plastic Single



**\* While stocks last**



# Whiteboard Markers

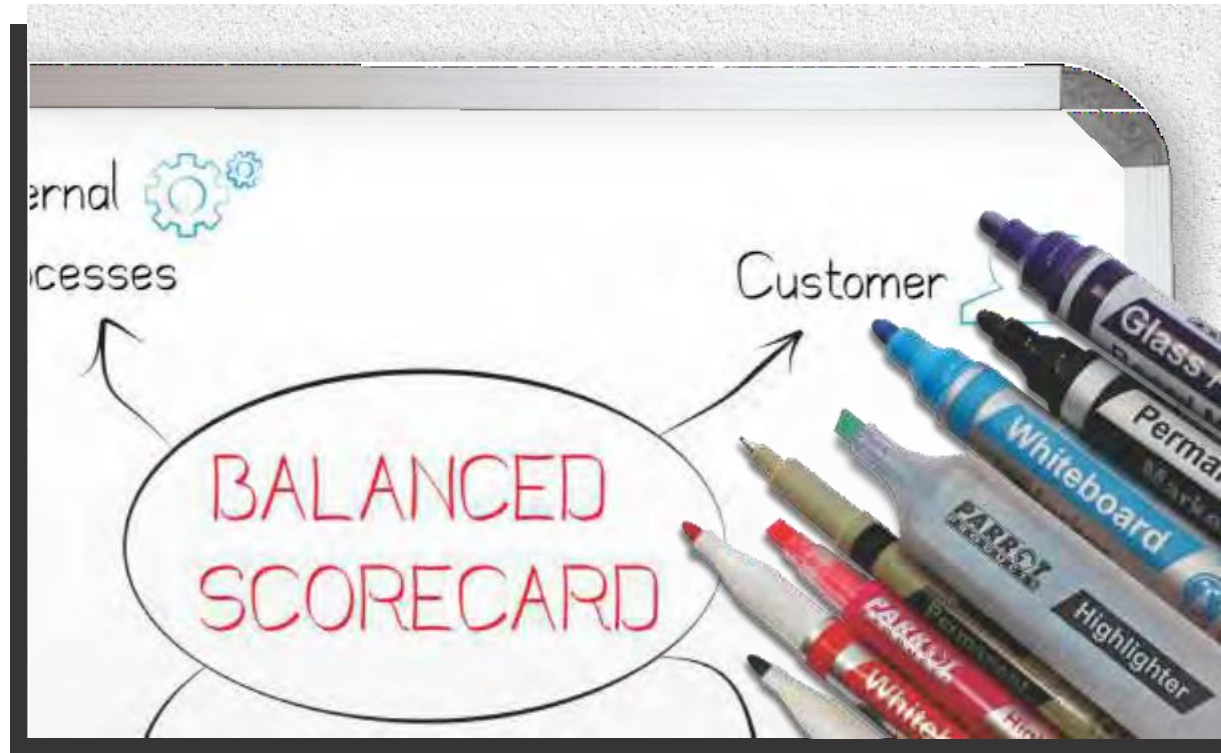

## Single Carded Bullet Tip

Code	Description
PW0101B	Marker Whiteboard Bullet Carded Black
PW0101D	Marker Whiteboard Bullet Carded Blue
PW0101R	Marker Whiteboard Bullet Carded Red
PW0101G	Marker Whiteboard Bullet Carded Green



PW0101

BULLET TIP  
Nib Size: 3mm



## Assorted 4, 6 & 10 Slimline & Bullet Tip

Code	Description
PW0401A*	Marker Whiteboard Bullet Pouch 4
PW0601A*	Marker Whiteboard Bullet Pouch 6
PW0401B*	Marker Whiteboard Slimline Pouch 4
PW0601B*	Marker Whiteboard Slimline Pouch 6
PW1001A*	Marker Whiteboard Bullet Pouch 10
PW1001B	Marker Whiteboard Bullet Box 10 Black
PW1001D	Marker Whiteboard Bullet Box 10 Blue
PW1001R	Marker Whiteboard Bullet Box 10 Red
PW1001G	Marker Whiteboard Bullet Box 10 Green
PW2001B	Marker Whiteboard Slimline Box 10 Black
PW2001D	Marker Whiteboard Slimline Box 10 Blue
PW2001R	Marker Whiteboard Slimline Box 10 Red
PW2001G	Marker Whiteboard Slimline Box 10 Green



Available colours:



Slimline  
Box of 10



Slimline  
Pouch 4



Bullet  
Pouch 6

SLIMLINE TIP  
Nib Size: 2mm



BULLET TIP  
Nib Size: 3mm



\* Reusable pouch included



## Bullet Tip

Code	Description
PP0101B	Single Carded Black
PP1001B	Box 10 Black

- Permanent Marker ink on Whiteboards can be removed with Whiteboard Cleaner.

\* Available in black only

BULLET TIP  
Nib Size: 3mm



## Chisel Tip

Code	Description
PP0301B	Single Carded Black
PP3001B	Box of 10 Black

- Low odour
- Quick drying
- Fibre nib for smooth writing
- High intensity permanent ink

\* Available in black only

CHISEL TIP  
Nib Size: 5mm



# Permanent Markers

## Ultra Finesline

### Code Description

PP0201B	Permanent Marker Ultra Finesline	Single Carded
PP2001B	Permanent Marker Ultra Finesline	Box of 12

- Low odour
- Quick drying
- Fibre nib for smooth writing
- High intensity permanent ink

\* Available in black only

ULTRA FINELINE  
Nib Size: 0.5mm



Box of 12



Single Carded

## Marker Magnetic/Eraser

### Code

PW0101M

- Ideal for refrigerator doors.
- Magnetic cap.
- Integrated eraser.
- Xylene and Toluene free.

BULLET TIP  
Nib Size: 2mm



Magnetic Cap  
with Eraser





# Glass/Chalk Board Markers

To do this week:

- Take pet to vet
- Parent meeting 6:30pm tuesday
- Groceries friday



## Code Description

PC1001A	Marker Glass / Chalk Board White	Box of 10
PC0602A*	Marker Glass / Chalk Board Bullet	Pouch 4 Assorted
PC0602B	Marker Glass / Chalk Board Bullet	Pouch 4 Assorted

**\* While stocks last**

- Low odour
- Pump action marker
- Fibre nib for smooth writing
- Writes on dark / light board surfaces
- Not for use on chalk board paint surfaces
- Suitable for Black Boards, Whiteboards, Chalk Boards and Glass Boards.
- Wet-Erase Marker, can be erased with a wet cloth.



PC0602A

\*Available colours:



BULLET TIP  
Nib Size: 4mm



PC1001A



PC0602B

# Highlighters



## Assorted Pouch 4, Box of 10 - Chisel Tip

Highlighter design / model may vary

### Code Description

PH0401B Pouch 4 Assorted  
PH1001 Box of 10

- Non-fading Highlighter.
- Copier, fax and scanner friendly.



Pouch 4 available colours:



Box of 10 available colours:



Include colour code when ordering

Available colours - ex stock:

Colour codes: Yellow(Y), Pink(P), Orange(O), Blue(S), Green(G), Violet(V)

## Assorted Pouch 4, Box of 10 - Slimline

### Code Description

PH2001P Marker Highlighter Slimline Box 12 Pink  
PH2001S Marker Highlighter Slimline Box 12 Blue  
PH2001O Marker Highlighter Slimline Box 12 Orange  
PH2001Y Marker Highlighter Slimline Box 12 Yellow  
PH0401C Marker Highlighter Slimline Pouch 4 Assorted

- Low odour
- Quick drying
- Fibre nib for smooth writing
- Fluorescent ink

\*Available colours:





## S100

Code	Description	Size
S100	Shredder Paper 5 sheets (strip cut 6.8mm)	300*150*280mm

- 2min continuous use (cool off period 45min)
- Overheat protection • Auto on / off
- Manual reverse • Staple friendly
- Extendable Arm: Extends 68mm to accommodate shredding over larger waste bins
- 10 Litre waste bin



\* While stocks last



## S1006S

Code	Description	Size
S1006S	Shredder Paper 6 sheets (strip cut 6mm)	330*155*375mm

- 2 min continuous use (cool off period 15min)
- Overheat protection • Manual reverse
- Staple friendly
- Extendable Arm: Extends to 68mm to accommodate shredding over larger waste bins
- 10 Litre waste bin

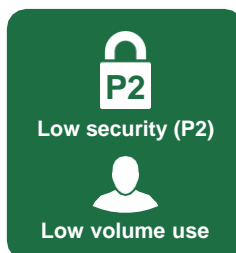
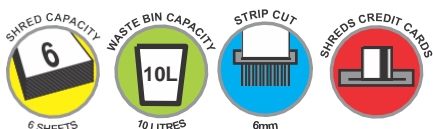



# Shredders

## S200

Code	Description	Size
S200	Shredder Paper 8 sheets (cross cut 5*38mm)	320*190*366mm

- 2min continuous use (cool off period 30min)
- Auto on / off • Auto reverse
- Staple friendly
- Shreds paper & credit cards
- Shred capacity: 8 sheets
- 16 Litre waste bin

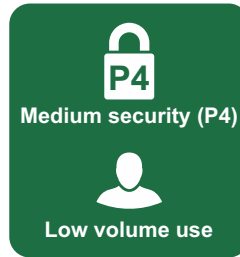
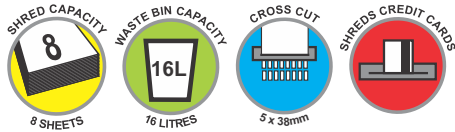

\* While stocks last



## S1008CC

Code	Description	Size
S1008CC	Shredder Paper 8 sheets (cross cut 5*47mm)	306*170*425mm

- 2-3min continuous use (cool off period 30min)
- Overheat protection
- Auto on / off • Auto reverse
- Staple friendly
- Shreds paper & credit cards
- 13 Litre waste bin

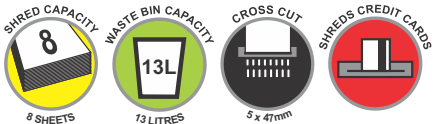

## S1012CC

Code	Description	Size
S1012CC	Shredder Paper 12 sheets (cross cut 5*40mm)	329*226*495mm

- 7min continuous use (cool off period 45min)
- Overheat protection
- Auto on / off
- Auto & Manual forward / reverse
- 15 Litre waste bin

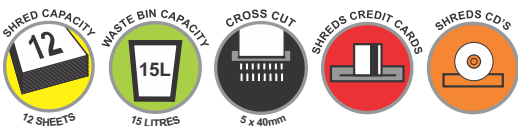

## S516

Code	Description	Size
S516	Shredder Paper 16 sheets (cross cut 3.9*44mm)	373*277*645mm

- 7min continuous use (cool off period 45min)
- Overheat protection
- Auto on / off
- Manual forward / reverse
- Auto stop when waste bin is full
- 28 Litre waste bin

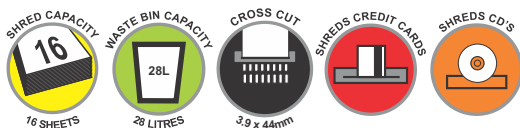

\* While stocks last



## S1024CC

Code	Description	Size
S1024CC	Shredder Paper 24 sheets (cross cut 4*38mm)	385*280*669mm

- 40min continuous use (cool off period 45min)
- Overheat protection
- Auto on / off
- Auto & Manual forward / reverse
- 26.5 Litre waste bin

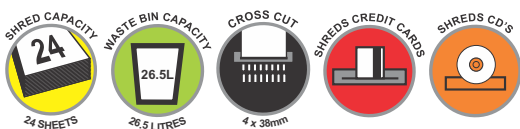

## S1008MC

Code	Description	Size
S1008MC	Shredder Paper 8 sheets (Mini cross cut 4*12mm)	329*226*495mm

- 5min continuous use (cool off period 30min)
- Overheat protection
- Auto on / off
- Auto forward / reverse
- 15 Litre waste bin

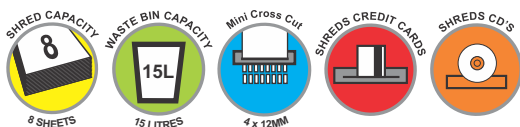

# Shredders

## S605

Code	Description	Size
S605	Shredder Paper 75 sheets Auto Feed (Micro cut 3*9mm)	370*265*492mm

- 15min continuous use (cool off period 30min)
- Auto shred 75 sheets
- Shred capacity: 6 sheets
- Auto on / off / reverse • Manual forward / reverse.
- Overload protection
- Staple friendly
- 23 Litre waste bin

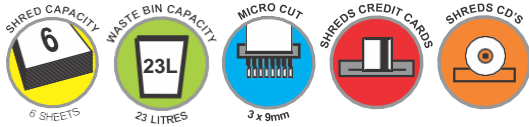

## S801

Code	Description	Size
S801	Shredder Paper 60 sheets Auto Feed (cross cut 4*30mm)	345*269*555mm

- 5min continuous use (cool off period 40min)
- Auto Feed function 60 sheets.
- Auto on / off • Manual forward / reverse
- Shred capacity: 8 sheets
- Auto stop when waste bin is full
- 22 Litre waste bin.

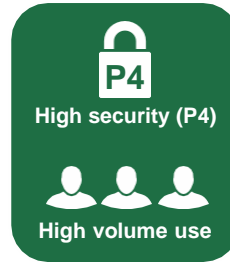
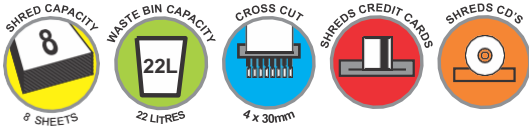

## BA0252

### Code Description

BA0252 Shredder Oil 250ml

- Eliminates build-up of paper dust • Prevents jamming
- Conditions blades to extend shredder lifespan

#### Why oil your shredder?

- It is very important to keep oiling the cutting cylinders on your shredder
- It will prolong the life of your shredder and will prevent annoying squeaks that may occur











#### Shredding machines that are not oiled will:

- Take longer to shred
- Be more prone to jamming
- Start to shred fewer sheets of paper per pass per minute





# Shredders Comparison

	S100	S1006S	S200	S1008CC	S1012CC	S516	S1024CC	S1008MC	S605	S801
Noise level	72Db	70Db	72Db	70Db	65Db	60Db	65Db	65Db	60Db	55Db
Security level	P2	P2	P4	P3	P3	P4	P4	P4	P4	P4
Cut Size	6.8mm	6mm	5x38mm	5x47mm	5x40mm	3.9x44mm	4x38mm	4x12mm	3x9mm	4x30mm
Strip Cut	✓	✓								
Cross Cut			✓	✓	✓	✓	✓	✓		✓
Micro Cut									✓	
Entry Width	220mm	220mm	223mm	220mm	220mm	225mm	220mm	220mm	220mm	225mm
Shred Capacity (80g A4)	5pg	6pg	8pg	8pg	12pg	16pg	24pg	8pg	6pg	8pg
Waste Basket Capacity Litres	10Ltr	10Ltr	16Ltr	13Ltr	15Ltr	28Ltr	26.5Ltr	15Ltr	23Ltr	22Ltr
Speed (Meters per min)	3m/min	2.9m/min	2m/min	2.5m/min	2m/min	2m/min	1.8m/min	2m/min	2m/min	2.4m/min
Motor	100w	220V	220w	220V	220V	270w	220V	220V	210w	145w
Dimensions	300x150x280mm	330x155x375mm	320x190x366mm	306x170x420mm	329x226x495mm	645x373x277mm	385x280x669mm	329x226x495mm	492x265x370mm	555x269x345mm
Carton Dimensions	282x152x268mm	372x331x306mm	376x330x205mm	380x340x400mm	543x383x472mm	688x418x308mm	477x375x687mm	543x383x472mm	552x315x420mm	648x345x425mm
Nett Weight	1.1kg	2.05kg	3.5kg	3.79kg	7.7kg	9.6kg	14.3kg	7.8kg	9.5kg	10kg
Auto On / Off	✓	✓	✓	✓	✓	✓	✓	✓	✓	✓
Forward / Reverse	Manual	Manual	Auto Reverse	Auto	Auto / Manual	Manual	Auto / Manual	Auto	Manual	Manual
Auto Reverse Overload Function		✓		✓	✓	✓	✓	✓	✓	
Shred CD's and Credit Cards		Credit Card	✓	Credit Card	✓	✓	✓	✓	✓	✓
Staple Friendly	✓	✓	✓	✓	✓	✓	✓	✓	✓	✓
Castors	No	No	No	No	Yes	Plastic	Yes	Yes	Yes	Plastic
Retail Packaging	Yes	Yes	Yes	Yes	Yes	Yes	Yes	Yes	Yes	Yes
Use	Home/Office	Home/Office	Home/Office	Home/Office	Home/Office	Small Office	Home/Office	Small Office	Home/Office	Home/Office
	Low Use Low Jam Risk	Low Use Low Jam Risk	Low Use Low Jam Risk	Medium Use Low Jam Risk	Medium Use Low Jam Risk	Medium Use Low Jam Risk	High Use Low Jam Risk	High Use Low Jam Risk	High Use Low Jam Risk	High Use Low Jam Risk
Duty Cycle	2 Minutes On	2-3 Minutes On	2 Minutes On	2 Minutes On	7 Minutes On	7 Minutes On	40 Minutes On	5 Minutes On	24hrs a day Integrated Cooling System Inside Machine	5 Minutes On
Cool Off Period	45 Minutes Off	15 Minutes Off	30 Minutes Off	30 Minutes Off	45 Minutes Off	45 Minutes Off	45 Minutes Off	30 Minutes Off		40 Minutes Off
Shred Paper Size Actual Size										
	6.8mm	6mm	5x38mm	5x47mm	5x40mm	3.9x44mm	4x38mm	4x12mm	3x9mm	4x30mm

Specifications may change due to product improvements

# Comb Binding Machines



## B2988-4

Code	Description	Size
B2988-4	Comb Binding Machine	388 x 260 x 160mm

- For office and home use.
- Punch up to 12 sheets of paper.
- Bind up to 450 sheets of paper.
- Punch 21 holes for comb binding.
- Punch 4 holes for ring binding.
- Bind with combs 6 to 51mm.

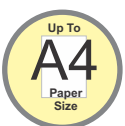

# Comb Binding Machine

## B2950

Code	Description	Size
B2950	Comb Binding Machine	390 x 231 x 100mm

- For office and home use.
- Punch up to 8 sheets of paper.
- Bind up to 150 sheets of paper.
- Punch 21 holes for comb binding.
- Bind with combs 6 to 20mm.

**\* While stocks last**

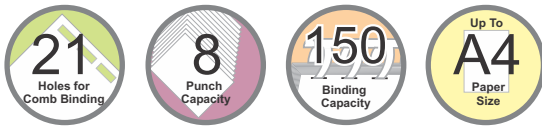

## B2937 Heavy Duty

Code	Description	Size
B2937	Comb Binding Machine	388 x 260 x 160mm

- For office and home use.
- Punch up to 15 sheets of paper.
- Bind up to 450 sheets of paper.
- 7 Pin adjuster for punching selection.
- Punch 21 holes for comb binding.
- Bind with combs 6 to 51mm.

**\* While stocks last**

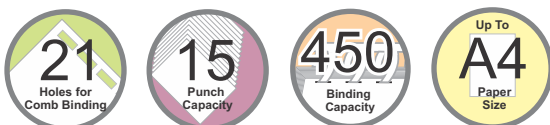



# Blades

## Craft Knife

Code	Description
CK1010R	Craft Knife Metal Red
CK1011	Craft Knife Blades Refill Pack

- Strong steel casing.
- 8 snap-off 9mm 30° blades.
- Refill pack contains 10 blades.
- Useful tool for safely snapping off blades included on end of knife.



## Craft Knife - Rotary Blade

Code	Description	Size
CK1110R	Craft Knife Rotary Plastic Red	
CK1111	Craft Knife Rotary Straight Blades Refill Pack	28mm
CK1112	Craft Knife Rotary Perforating Blades Refill Pack	28mm
Ck1113	Craft Knife Rotary Pinking Blades Refill Pack	28mm

- Safety blade retraction system for when not in use.
- 28mm interchangeable blades.
- Refill pack contains 3 blades.



### Pinking Blade



### Perforating Blade



### Straight Blade



# Guillotines

## Guillotines - Plastic Base



Code	Description	Size
GU2010	Guillotine A4 - 10 Sheets	437 x 337mm
GU2020*	Guillotine A4 - 20 Sheets	437 x 337mm

- Durable sharp blade capable of making over 1000 cuts.
- Page guide for straight cuts.
- Blade safety lock to ensure safety when the guillotine is not being used.
- Press clamp to hold pages to be cut in place.
- ABS safety shield.
- Max Cutting Length: 343.0mm.
- Cuts A6 - A4 Pages.

**\* While stocks last**



GU2010



GU2020



# Guillotines

## Guillotines - Steel Base

Code	Description	Size	Cutting Capacity (80gsm)
GU4010	Guillotine Steel Base	350 x 255mm	A4 - 20 Sheets
GU4020	Guillotine Steel Base	480 x 331mm	A3 - 20 Sheets
GU5010	Guillotine Medium Duty	445 x 226mm	A4 - 40 Sheets

GU4010



- Integrated paper clamp system
- Page guide for straight cuts
- Blade safety lock to ensure safety when the guillotine is not being used
- Press clamp to hold pages to be cut in place
- ABS safety shield

GU5010



- High Carbon Steel Blade  
(GU5010 Spare Blade Re-Order Code: AL3084)  
(GU5010 Blade Sharpening Re-Order Code: AL3089)

GU4020





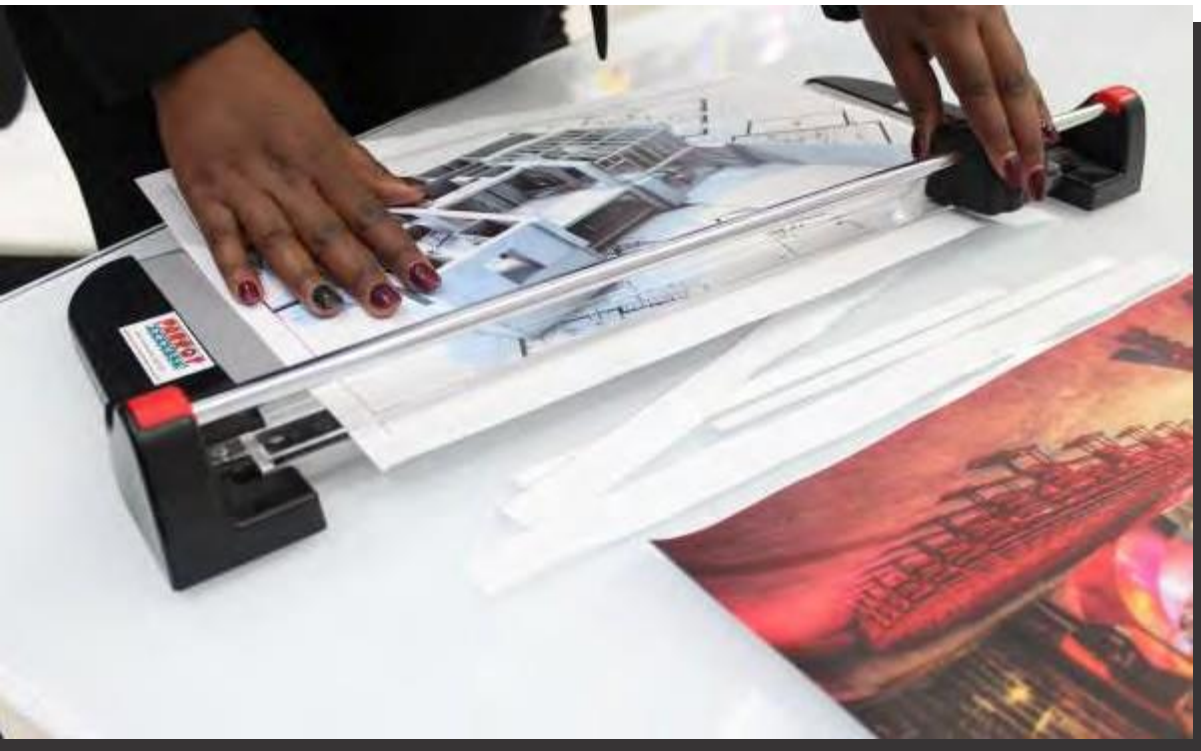

Code	Description	Size
RT4020	7 Sheets - Steel Base	A0

- Integrated clamp system.
- Measuring scale in Millimetres and Inches.
- Perfect for Home and Office use.
- Includes stand.
- Paper waste catchment tray, conveniently collects paper waste underneath the working table

- **Replacement Blades**  
- Re-Order Code: AL3075

**\* While stocks last**



# Rotary Trimmers

## Plastic & Steel Base

Code	Description	Size
RT1010	10 Sheets - Plastic Base	A4
RT2020	7 Sheets - Steel Base	A3
RT3010*	15 Sheets - Steel Base	A4
RT3020	15 Sheets - Steel Base	A3
RT3030	12 Sheets - Steel Base	A2

\* While stocks last

- Automatic clamp system.
- Measuring scale in Millimetres and Inches.
- Perfect for Home and Office use.

### • Replacement Blades

- RT1010 (Re-Order Code: AI3074)
- RT2020 (Re-Order Code: AL3076)
- RT3010, RT3020 & RT3030 (Re-Order Code: AL3075)

10 Sheets - Plastic Base    A4



RT1010

7 Sheets - Steel Base    A3



RT2020

15 Sheets - Steel Base    A4



RT3010

15 Sheets - Steel Base    A3



RT3020

12 Sheets - Steel Base    A2



RT3030



Code	Description	Size	Speed
LF9040R	A4 - 2 Roller	346 x 150 x 85mm	400mm/min

### LF9040R Retail Pack:

- For office and home use
- Ultra slim design
- Hot lamination
- Laminate up to 250 mic pouch
- 90 second warm up time
- High Speed: 400mm/min
- Overheating protection (power off)
- Auto power off 30min
- 10 X Free A4 Pouches



## Laminators

Code	Description	Size	Speed
LF9040	A4 - 2 Roller	370 x 80 x 45mm	400mm/min
LF9041	A3 - 2 Roller	470 x 95 x 60mm	400mm/min

- For office and home use
- Ultra slim design
- Hot lamination (A4)
- Hot and cold lamination (A3)
- Jam release function (A3)
- Laminate up to 250 mic pouch
- 90 second warm up time
- High Speed: 400mm/min
- Overheating protection (power off)
- Auto power off 30min



• Ultra Slim Laminator - up to A4



LF9040

• Ultra Slim Laminator - up to A3



LF9041





# Laminator Consumables

## Laminating Pouches

Code	Description	Size	Micron	
LFA480	Laminating Pouch A4	220 x 310mm	160** (80+80)*	Box of 100
LFA380	Laminating Pouch A3	320 x 426mm	160** (80+80)*	Box of 100
LFA480/10	Laminating Pouch A4	220 x 310mm	160** (80+80)*	Pack 10
LFA480/25	Laminating Pouch A4	220 x 310mm	160** (80+80)*	Pack 25
LA1050	Laminating Self Adhesive ID Tags & clips	74 x 104mm	160** (80+80)*	Pack 6

\* Thickness per side of pouch

\*\* Total thickness both sides

	Size	Usage
A3	 305 x 426mm	To fit 297 x 420mm (11.69" x 16.53") A3 size paper
A4	 220 x 310mm	To fit 210 x 297mm (8.26" x 11.69") A4 size paper

LA1050



## Heavy Duty Stapler 200 pages

**Code**    **Description**                      **Size**

ST2076B    Heavy Duty Stapler 200 pages    343 x 87 x 182mm

- Loads 100 standard staple (Half strip)
- Staples 30-200 pages

Staple Order Chart			
Order Code	Pages	Leg Length	Staple
SS023/8	50	8mm	23/8
SS023/10	50	23mm	23/10
SS023/13	100	13mm	23/13
SS023/23	200	23mm	23/23



Available colours:



## Heavy Duty Stapler 100 pages

**Code**    **Description**                      **Size**

ST2066B    Heavy Duty Stapler 100 pages    282 x 68 x 136mm

- Loads 100 standard staple (Half Strip)
- Staples 30-200 pages

Staple Order Chart			
Order Code	Pages	Leg Length	Staple
SS023/8	50	8mm	23/8
SS023/10	50	23mm	23/10
SS023/13	100	13mm	23/13



Available colours:



# Staplers

## Long-Reach Stapler 20 pages

**Code**    **Description**                      **Size**  
 ST2055B    Long-Reach Stapler 20 pages    405 x 52 x 55mm

- Loads 210 Standard staples. (Full Strip)
- Staples 20 pages.



Staple Order Chart			
Order Code	Pages	Leg Length	Staple
SS024/6	20	6mm	24/6
SS026/6	30	6mm	26/6

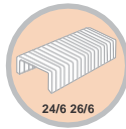

Available colours: ●

## Plier Stapler Metallic 50 pages

**Code**    **Description**                      **Size**  
 ST2079M    Plier Stapler Metallic 50 pages    195 x 27 x 64mm

- Loads 105 standard staples. (Half Strip)
- Staples 50 pages.



Staple Order Chart			
Order Code	Pages	Leg Length	Staple
SS024/6	20	6mm	24/6
SS026/6	30	6mm	26/6
SS023/8	50	8mm	23/8



Available colours: ●

## Plier Stapler 20 pages

**Code**    **Description**                      **Size**  
 ST2078B    Plier Stapler 20 pages    172 x 30 x 63mm

- Loads 105 standard staples. (Half Strip)
- Staples 20 pages.
- Can also be used for tacking.



Available colours: ●

Staple Order Chart			
Order Code	Pages	Leg Length	Staple
SS024/6	15	6mm	24/6
SS026/6	20	6mm	26/6

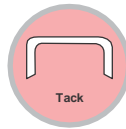
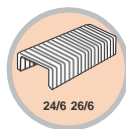



## Plier Stapler 20 pages

### Code Description

ST2080M Plier Stapler 20 pages 174 x 90 x 25

- Loads up 210 staples (Full Strip).
- Extra long throat design for easy stapling.
- Staple from any angle.
- Contoured grip to reduce hand fatigue.

Staple Order Chart			
Order Code	Pages	Leg Length	Staple
SS024/6	20	6mm	24/6

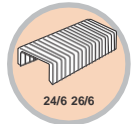

Available colours: ●

## Front-Load Stapler 50 pages

### Code Description

### Size

ST3032B Front-Load Stapler 50 pages 182 x 49 x 74mm

- Loads 100 standard staple strip.
- Staples 50 pages.
- Can also be used for tacking.

Staple Order Chart			
Order Code	Pages	Leg Length	Staple
SS024/6	20	6mm	24/6
SS026/6	30	6mm	26/6
SS023/8	50	8mm	23/8

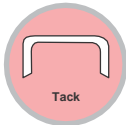

Available colours: ●

## Desktop Stapler Steel Large 20 pages

### Code Description

### Size

ST2035M Large Metallic 20 pages 170 x 36 x 50mm  
 ST2035B Large Black 20 pages 170 x 36 x 50mm

- Loads 210 standard staple (Full strip)
- Staples 20 pages.
- Can also be used for tacking.

Staple Order Chart			
Order Code	Pages	Leg Length	Staple
SS024/6	20	6mm	24/6
SS026/6	30	6mm	26/6

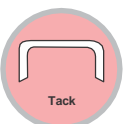
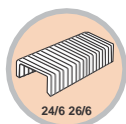

Available colours: ● ●

# Staplers

## Desktop Stapler Steel Medium 20 pages

**Code**    **Description**                      **Size**  
 ST2023M    Medium Metallic 20 pages    137 x 37 x 55mm

- Loads 105 standard staples. (Half Strip)
- Staples 20 pages.



Staple Order Chart			
Order Code	Pages	Leg Length	Staple
SS024/6	20	6mm	24/6
SS026/6	30	6mm	26/6



Available colours: ●

## Desktop Stapler Vertical 20 pages

**Code**    **Description**                      **Size**  
 ST2045L    Desktop Stapler Vertical 20 pages    128 x 35 x 57mm

- Loads 105 standard staples. (Half Strip)
- Staples 20 pages.

Stands vertically or horizontally

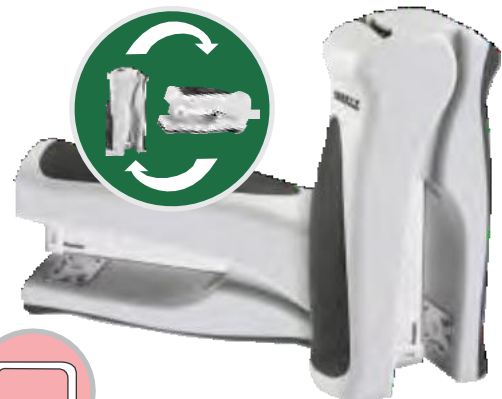

Staple Order Chart			
Order Code	Pages	Leg Length	Staple
SS024/6	20	6mm	24/6
SS026/6	30	6mm	26/6

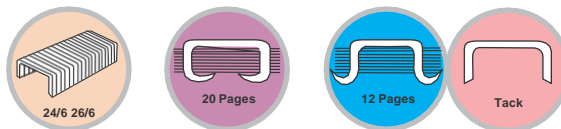

Available colours: ●

## Desktop Stapler Large 20 pages

**Code**    **Description**                      **Size**  
 ST3048B    Desktop Stapler Large 20 pages    163 x 37 x 60mm

- Loads 210 standard staples. (Full Strip)
- Staples 20 pages.



Staple Order Chart			
Order Code	Pages	Leg Length	Staple
SS024/6	20	6mm	24/6
SS026/6	20	6mm	26/6



Available colours: ●

## Desktop Stapler Medium 20 pages

Code	Description	Size
ST3047	Desktop Stapler Medium 20 pages	134 x 35 x 54mm

- Loads 105 standard staples. (Half Strip)
- Staples 20 pages.



Staple Order Chart			
Order Code	Pages	Leg Length	Staple
SS024/6	20	6mm	24/6
SS026/6	30	6mm	26/6



Available colours:

## Stapler Light-Touch

Code	Description	Size
ST3060B	Light-Touch Stapler Plastic	135 x 65 x 45mm

- Loads 50 standard staple strips
- Staples 20 pages



Staple Order Chart			
Order Code	Pages	Leg Length	Staple
SS024/6	20	6mm	24/6
SS026/6	30	6mm	26/6

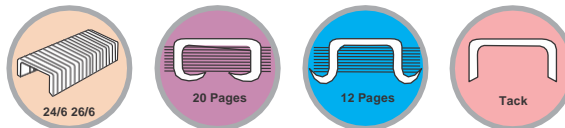

Available colours:

## Stapler Mini 20 pages

Code	Description
ST3050	Stapler Mini 20 pages + Staples
ST3051A	Stapler Mini 20 pages - 40 Assorted
ST3051	Stapler Mini 20 pages - Single

- Loads 50 standard staples.
- Staples 20 pages.
- For office and home use
- Durable and high quality
- Built-in staple remover
- Single units available to replenish stock



Built-in staple remover



Singles

Supplied with 1000 Staples 26/6 (No.56)

Re-Order Code: SS026/6-1

**ST3050**

**Include colour code when ordering**

**Available felt colours - ex stock:**

Colour codes: Black(B), Blue(D), Green(G), Pink(P)



**ST3051**

**Include colour code when ordering**

**Available felt colours - ex stock:**

Colour codes: Black(B), Blue(D), Green(G), Pink(P)





# Staple Remover

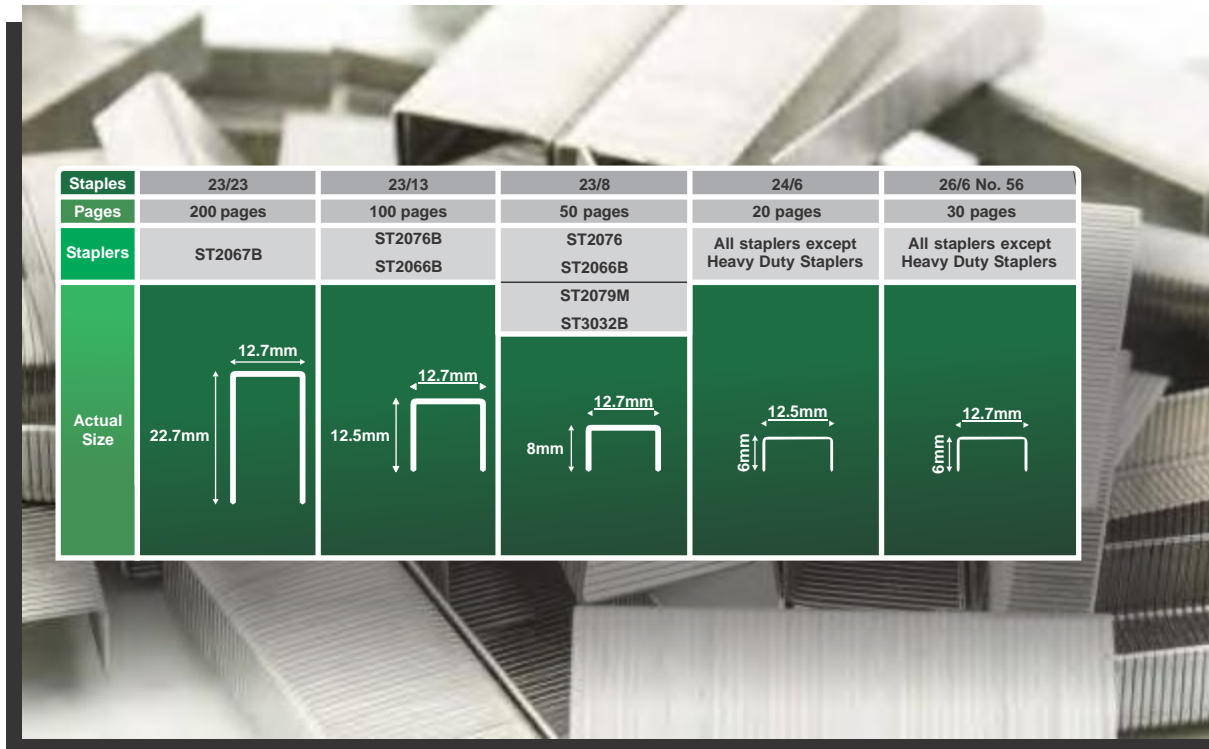

**Code**    **Description**    **Size**  
 SR2018B    Staple Remover    54 x 35 x 42mm

- For office and home use.
- Locks closed.
- Durable and high quality.



Available colours: 

## Staples

Code	Description	Units
SS026/6-1	Staples (No.56)	26/6 1000
SS026/6-5	Staples (No.56)	26/6 5000
SS024/6	Staples	24/6 1000
SS023/8	Staples	23/8 1000
SS023/10	Staples	23/10 1000
SS023/13	Staples	23/13 1000
SS023/23	Staples	23/23 1000



See page 68 - 72 for Staplers

# Punches

## 40 & 65 Sheet Punch



Code	Description	Size
PU3084B	40 Sheet Punch	147 x 119 x 60mm
PU4065B	65 Sheet Punch	216 x 104 x 230mm

- For office and home use.
- Punch up to 40/65 sheets.
- Centering arm adjustable to A4.
- Durable and high quality.



Available colours: ●



PU4065B



PU3084B

# Punches

## 30 Sheet Punch

**Code**   **Description**   **Size**

PU3083   30 Sheet Punch   133 x 114 x 93mm

- For office and home use.
- Punch up to 30 sheets.



Available colours: ● ●

## 20 Sheet Punch

**Code**   **Description**   **Size**

PU2082   20 Sheet Punch   105 x 80 x 40mm

- For office and home use.
- Punch up to 20 sheets.

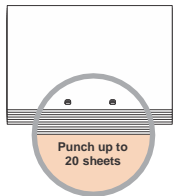

Available colours: ● ● ● ●

## 10 Sheet Punch

**Code**   **Description**   **Size**

PU2065   10 Sheet Punch   107 x 67 x 39mm

- For office and home use.
- Punch up to 10 sheets.



Available colours: ● ●



# Carpet & Tile Protectors

Non Slip Tapered & Non-Slip Rectangle Shape



Code	Description	Size
CP1042	Carpet Protector Non-slip Grey Tapered	1200 x 900 x 2.7mm
CP1043	Carpet Protector Non-slip Silver Tapered	1200 x 900 x 2.7mm
CP1044C	Floor Protector Ribbed Non-slip - Denim	1200 x 850 x 5.5mm
CP1044Q	Floor Protector Ribbed Non-slip - Spice	1200 x 850 x 5.5mm
CP1044T	Floor Protector Ribbed Non-slip - Tropical	1200 x 850 x 5.5mm
CP1044X	Floor Protector Ribbed Non-slip - Laurel	1200 x 850 x 5.5mm
CP1044Z	Floor Protector Ribbed Non-slip - Palm	1200 x 850 x 5.5mm

## Carpet Protector

- Protects either carpet, wood or tiled surface
- Polycarbonate material
- Not impacted by use of heels on protected surface
- Easy to clean

## Floor Protector

- Protects either carpet, wood or tiled surface
- Slip resistant rubberized backing
- Non-static

## Available colours:

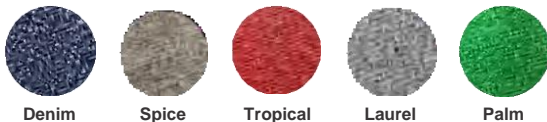

Denim

Spice

Tropical

Laurel

Palm



## Floor Protector



# Megaphone 25 Watt



## Code Description

IS1001 Megaphone 25 Watt

- Long range - 700m
- Compact & powerful
- Clear sound
- ABS Body
- Dry Cell operation
- Built-in Siren & Microphone
- Operates with C batteries (not included with product)

### How to operate:

- Open the back cover by pressing the latch.
- Insert 8 x C batteries.
- To activate the megaphone, switch the button to TALK, and press the button on the handle.
- Adjust the volume control to the desired volume whilst avoiding feedback.
- Switch the button to SIREN to activate the emergency siren.

\* Enquire for availability



Volume Control



Built-in Microphone



Built-in Siren

# Interactive Touch LED Panels



Code	Description	Size
TWB - 6519A	Interactive Touch LED Panel	65"
TWB - 7519A	Interactive Touch LED Panel	75"
TWB - 8619A	Interactive Touch LED Panel	86"

- Resolution: 1920 x 1080P / 3840 x 2160P
- Display Colours: 10bit
- Aspect Ratio: 16:9
- Outputs: AV x1/ Speaker x1/ SPDIF x1/ VGA x1
- Output: HDMI/VGA/USB
- Anti-Reflection Glass
- Touch Sensor: IR
- 6-Point Writing / 10-Point Touch
- Scan Speed: 8ms / 12ms.

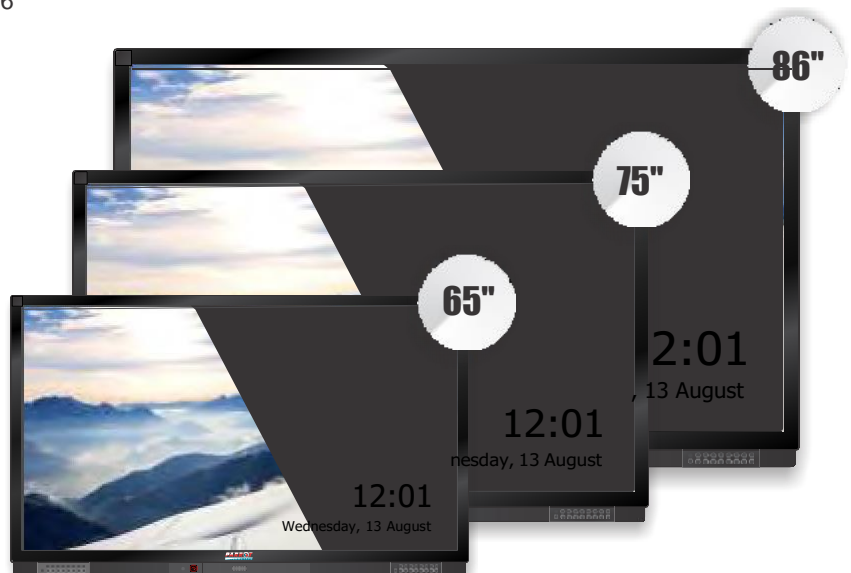



# Interactive Whiteboards



Code	Description	Size
HV-1683	Multi-Touch Interactive Whiteboard	78" 1,571 x 1,178mm
HV-16103	Multi-Touch Interactive Whiteboard	98" 2,176 x 1,326mm

- Technology: IR (infra-red).
- Aspect Ratio: 4:3 / 16:10
- Multi-Touch Point: 10 Points.
- Input: Finger or Pen.
- Touch Accuracy: 1mm.
- Connection Type: USB Cable.
- USB Type: A (Client) -B (IWB).
- USB Length in standard package: 5m.
- Driver Support OS: Win 7 / 8 / 10.
- MAC and Linux: Drivers available on request.

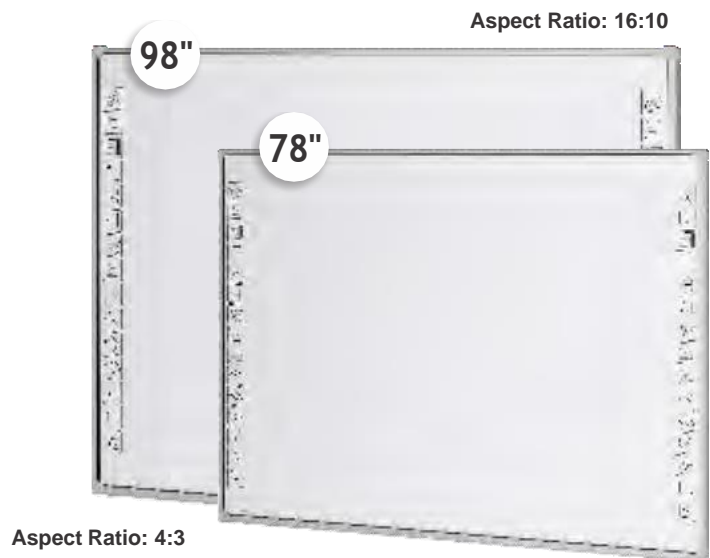

**Only Suitable for use with Parrot Whiteboard Markers**  
**Wet erase recommended**



BA0201



PW0601A



BA0110

Product Includes:



# Non-reflective Whiteboard



Code	Description	Size
IW1063	Non-Reflective Whiteboard For Interactive System	1620 x 1220mm

- Can be used with the Parrot IWB system (IW1000)

Custom non - reflective available *limit size* of 3000mm x 1200mm

Provides a low glare surface and quality visuals, when used with short or long throw projectors

Seamless transition between projection and writing



**Only Suitable for use with Parrot Whiteboard Markers**  
Wet erase only



BA0201



PW0601A



BA0110

# Stands

## Interactive Touch LED Stand

### Code Description

IW7101	Interactive Touch Led Stand
IW7102	Interactive Touch Panel Mobile Stand Grey
IW7103	Interactive Touch Panel Mobile Stand White

\* Excludes Interactive Touch LED Panel



## Coming Soon

IW7102



- Mobile Castor Stand
- Powder Coated
- Max Load Capacity 57.6kg
- Easy assembly
- Built in Cable management
- Perfect for TV's and Touch Screens

IW7103



- Mobile Steel Castor Stand
- Adjustable screen/board sizes 42"-98"
- Max Load Capacity 160kg
- Easy assembly
- Perfect for TV's, Touch Screen and Interactive Whiteboards

## Interactive Whiteboard Stand on Castors

### Code Description

IW2051	Interactive Whiteboard Stand on Castors
--------	---

- Compatible with all Parrot interactive whiteboards
- Fits through a standard door frame
- Maximum weight: 60kg
- Frame Width:
  - Minimum Width: 32mm
  - Maximum Width: 42mm
- Light weight
- Stylish aluminium design
- Lockable castors

\* Excludes Interactive Whiteboard

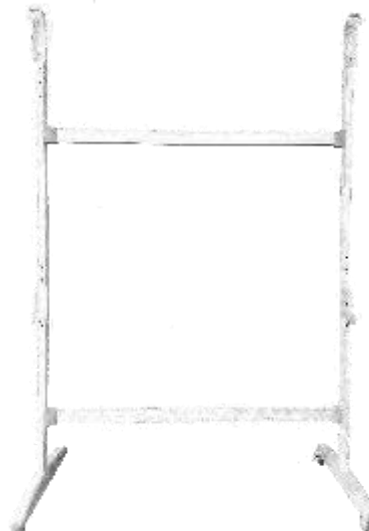



## Long Throw



## Short Throw



Enquire about our range of latest short throw  
or long throw data projectors

*\* Models may vary*

# DLP/LCD Ceiling Mounting Bracket / Projector Security Cage

Code	Description	Size
OP0300	Ceiling Mount Bracket Projector	400 - 650mm
OP0301	Ceiling Mount Projector Security Cage	450 x 220 x 340mm
OP0302	Ceiling Mount Bracket Projector	52mm
OP0310*	Ceiling Mount Bracket Projector Lockable	430 - 650mm
OP0312*	Ceiling Mount Bracket Projector Lockable	62mm
OP0330	Ceiling Mount Bracket Extension	1800mm
OP0331	Ceiling Mount Bracket Extension	900mm
OP0343	Wall Mount Bracket Projector Adjustable	820 - 1200mm

- Projector not included
- Universal projector mounts
- Adjustable tilt and height on OP0300 & OP0310

- \* Cable management system
- \* Security System

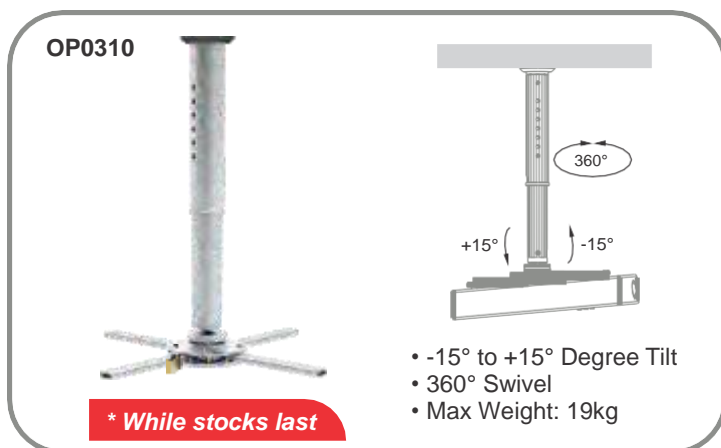
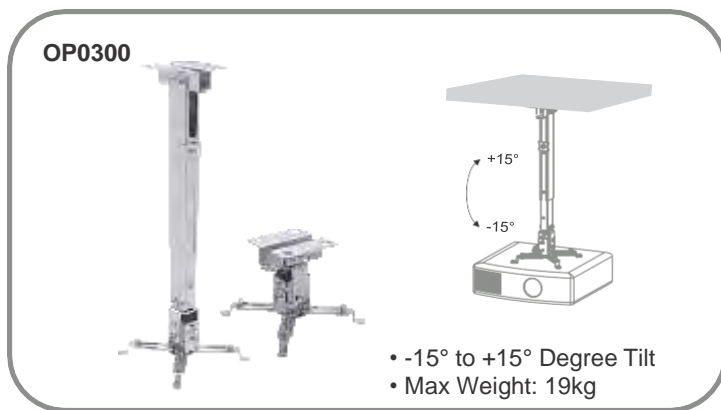
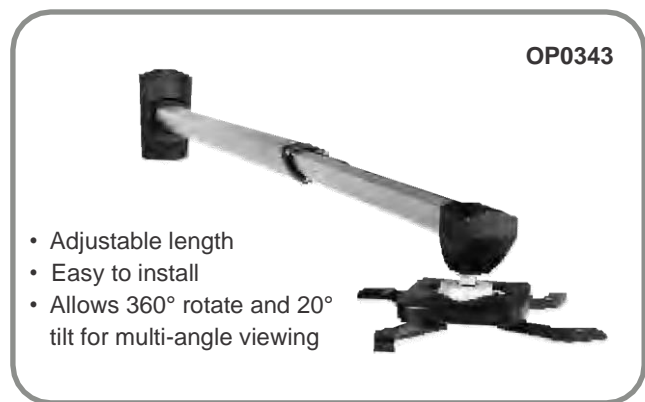
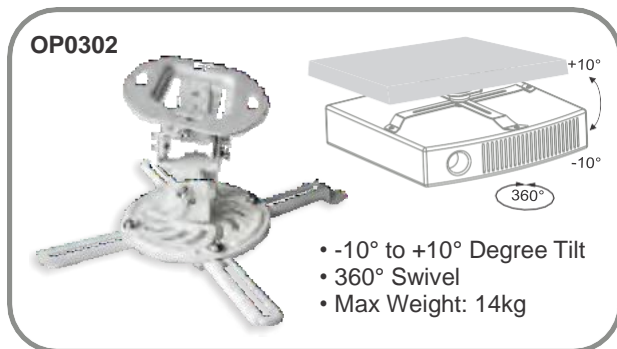

# Data Projector Trolleys

Code	Description	Size
OP1052	Data Projector & Laptop Trolley	1000 x 880 x 620mm

## Product Features

- Angle-adjustable top
- Lockable castors



## Screen Ratios

### Which ratio screen suits you?

1:1 Ratio screens are ideal for square projections such as Overhead Projectors.

4:3 Ratio screens are sized for a computer monitor and work ideally with DLP/LCD Projectors.

16:9 Ratio screens are formatted for modern video in cinematic format.





# Projector Screens

## Pulldown



### 1:1 Ratio

Code	Description	Size	Viewing Area
SC0252	Screen Pulldown PVC	1270 x 1270mm	1220 x 1220mm
SC0265	Screen Pulldown PVC	1520 x 1520mm	1470 x 1470mm
SC0269	Screen Pulldown PVC	1830 x 1830mm	1780 x 1780mm
SC0271	Screen Pulldown PVC	2130 x 2130mm	2030 x 2030mm
SC0278	Screen Pulldown PVC	2440 x 2440mm	2340 x 2340mm
SC0287	Screen Pulldown PVC	3050 x 3050mm	2950 x 2950mm

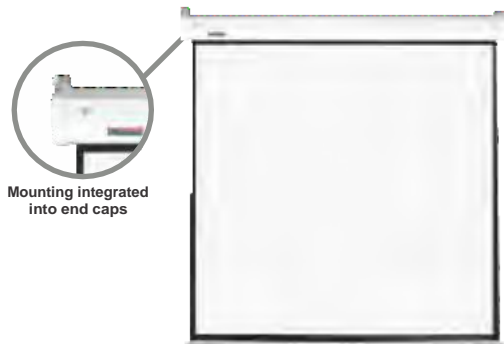

### 4:3 Ratio

Code	Description	Size	Viewing Area
SC0273	Screen Pulldown PVC	1760 x 1330mm	1710 x 1280mm
SC0274	Screen Pulldown PVC	2110 x 1600mm	2030 x 1520mm
SC0275	Screen Pulldown PVC	2440 x 1850mm	2340 x 1750mm
SC0285	Screen Pulldown PVC	3050 x 2310mm	2950 x 2210mm

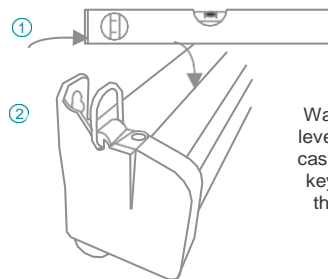

Wall screens must be mounted level ① and with the back of the case parallel to the wall. Use the keyhole slot ② at the back of the hanging bracket for flush wall mounting.

### 16:9 Ratio

Code	Description	Size	Viewing Area
SC0068	Screen Pulldown PVC	1870 x 1050mm	1770 x 950mm
SC0074	Screen Pulldown PVC	2450 x 1420mm	2350 x 1320mm
SC0080	Screen Pulldown PVC	3040 x 1760mm	2940 x 1660mm

- Self-locking system is easy to use.
- Screen stays wrinkle-free, is flame retardant and mildew resistant.
- Black framed, black backed screen.



### 1:1 Ratio

Code	Description	Size	Viewing Area
SC0152	Screen Tripod	1270 x 1270mm	1220 x 1220mm
SC0165	Screen Tripod	1520 x 1520mm	1470 x 1470mm
SC0169	Screen Tripod	1830 x 1830mm	1780 x 1780mm
SC0171	Screen Tripod	2130 x 2130mm	2030 x 2030mm

### 4:3 Ratio

Code	Description	Size	Viewing Area
SC0173	Screen Tripod	1760 x 1330mm	1710 x 1280mm
SC0174	Screen Tripod	2110 x 1600mm	2030 x 1520mm
SC0175	Screen Tripod	2440 x 1850mm	2340 x 1750mm

### 16:9 Ratio

Code	Description	Size	Viewing Area
SC0474	Screen Tripod	2450 x 1420mm	2350 x 1320mm



Keystone bracket



Bottom casing roll up



Tripod feet

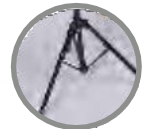

- The adjustable stand allows various heights suitable for every need.
- The screen hook has different angle positions for keystone adjustment.
- Black-framed, black-backed screen.

# Projector Screens

## Electric

### 1:1 Ratio

Code	Description	Size	Viewing Area
SC0369	Screen Electric	1830 x 1830mm	1780 x 1780mm
SC0378	Screen Electric	2440 x 2440mm	2340 x 2340mm
SC0387	Screen Electric	3050 x 3050mm	2950 x 2950mm

### 4:3 Ratio

Code	Description	Size	Viewing Area
SC0374	Screen Electric	2110 x 1600mm	2030 x 1520mm
SC0375	Screen Electric	2440 x 1830mm	2340 x 1750mm
SC0385	Screen Electric	3050 x 2310mm	2950 x 2210mm

### 16:9 Ratio

Code	Description	Size	Viewing Area
SC0568*	Screen Electric	1870 x 1110mm	1770 x 1000mm
SC0574	Screen Electric	2440 x 1420mm	2340 x 1320mm
SC0579	Screen Electric	2730 x 1580mm	2630 x 1430mm



Remote control

- Remote and wall-mounted controls included.
- The motor is quiet, secure and precise.
- The screen stays wrinkle-free, is flame-retardant and mildew-resistant.
- Black-framed, black-backed screen.

**\* While stocks last**



## Keystone Adjusters

Code	Description	Size
SC0400	Keystone Brackets Adjustable Set of 2	300mm

- Recommended when using Overhead Projectors.
- Ideal for Pulldown Screens.



See page 82 For Projectors



## Ceiling Box

### Code Description

### Width of Screen

### Space Required for Ceiling Box

SC0652	Ceiling Box Recessed to fit screens	A: 1270mm width of screen	B: 1670mm
SC0665	Ceiling Box Recessed to fit screens	A: 1520mm width of screen	B: 1920mm
SC0669	Ceiling Box Recessed to fit screens	A: 1830mm width of screen	B: 2230mm
SC0675	Ceiling Box Recessed to fit screens	A: 2130mm width of screen	B: 2530mm
SC0678	Ceiling Box Recessed to fit screens	A: 2440mm width of screen	B: 2840mm
SC0679	Ceiling Box Recessed to fit screens	A: 3050mm width of screen	B: 3520mm
SC0683	Ceiling Box Recessed to fit screens	A: 3620mm width of screen	B: 4120mm

- Conceals screen within the ceiling.
- Recommended for Electric Screens.
- Aluminium extruded box with plastic end caps.

**\* While stocks last**

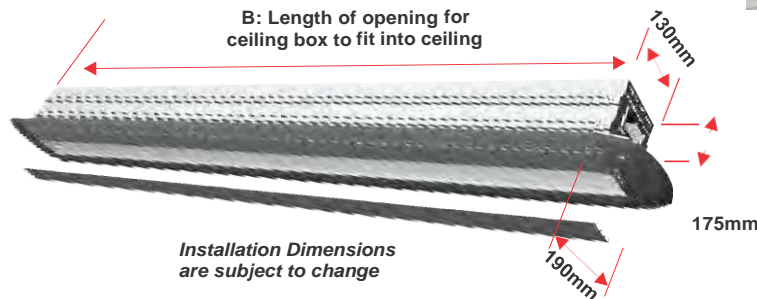

## Laser Pointers

### Laser Pointer Presenter USB2.0, Pen & Batteries

#### Code Description

EL1002	Laser Pointer Stylus
EL1005	Laser Pointer Presenter USB 2.0 Red Laser

#### EL1002 Laser Pointer Stylus

- Ideal for presentations
- Integrated mini flashlight and stylus nib
- Black ball point pen
- Red laser light
- Requires 3 x AG3 batteries (not included)



EL1002

#### EL1005 Laser Pointer Presenter USB2.0

- Laser Pointer Presenter USB 2.0 Red Laser - red laser pointer, page up page down buttons, USB 2.0 connection, plug & play.
- 1 x AAA battery for up to 10 hours use (Included)
- Working distance 10m

Laser Pointer Presenter USB 2.0 Red Laser



EL1005

# Monitor Clamp Brackets



## Code Description

AL6001 Bracket Monitor Clamp Single Arm With Gas Spring

## Code Description

AL6002 Bracket Monitor Clamp Dual Arm With Gas Spring

## Code Description

AL6003 Bracket Monitor Clamp Triple Arm With Gas Spring



### Features:

- Single monitor clamp
- Fits most 17" - 32" flat & curved monitors
- Built-in spring tension gauge & gas spring
- 75 x 75 or 100 x 100 VESA compatible
- 40 degree tilt / 360 degree rotation
- Cable management
- Weight capacity: 1 - 9kg (per arm)

### Features:

- Dual monitor clamp
- Fits most 17" - 32" flat & curved monitors
- Built-in spring tension gauge & gas spring
- 75 x 75 or 100 x 100 VESA compatible
- 40 degree tilt / 360 degree rotation
- Cable Management
- Weight capacity: 1 - 9kg (per arm)

### Features:

- Triple monitor clamp
- Fits most 17" - 32" flat & curved monitors
- Built-in spring tension gauge & gas spring
- 75 x 75 or 100 x 100 VESA compatible
- 40 degree tilt / 360 degree rotation
- Cable management
- Weight capacity: 1 - 7kg (per arm)



## Mini, Econo & Deluxe Tripods

**Code**    **Description**  
AL6100    Tripod - Desktop Mini 130mm



- Features:**
- Lightweight & portable
  - Easy to use
  - Compact mounting solution
  - Suitable for digital cameras, webcams & mobile phones (Not included)

**Code**    **Description**  
AL6110    Tripod - Econo 1350mm



- Features:**
- Multi-purpose head with quick release
  - Secure mounting plate
  - 3-way pan head
  - 3-section telescopic legs
  - Built-in bubble level
  - Flip lock legs

**Code**    **Description**  
AL6120    Tripod Deluxe 1570mm



- Features:**
- Ideal for professional use
  - Built-in ball head
  - Secure mounting plate
  - 4-section telescopic legs
  - Tripod legs with twist lock
  - Easily converts to a monopod



# Brackets

Code	Description	Size
AL4001	Tablet Secured Stand Universal	10.1"
AL0131	Motion TV Wall Mount Economy Full	
AL0132	Motion TV Wall 60" - 100" Full	
AL0133	Flat Mount 60" - 100"	
AL0134	Flat Mount 37" - 80"	



AL4001

- Height-adjustable aluminium tube
- Retractable leg
- Multiple display angles, rotates 360°



AL0133

- Slim design, distance to the wall is 32mm
- Supports TV's between 60" – 100"

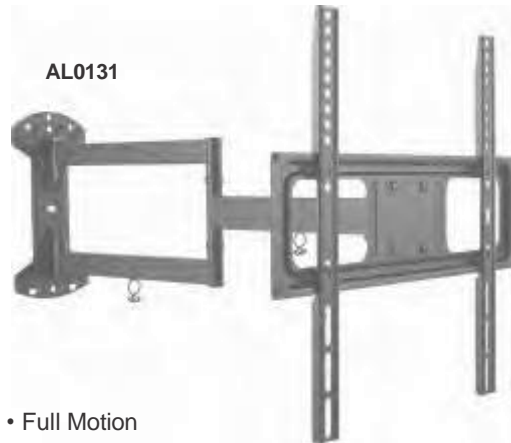

AL0131

- Full Motion
- Fits most TV's: 32" - 55"
- Side to side swivelling



AL0132

- Swiveling arm offers maximum viewing
- Cable management system
- Supports TV's between 60" – 100"

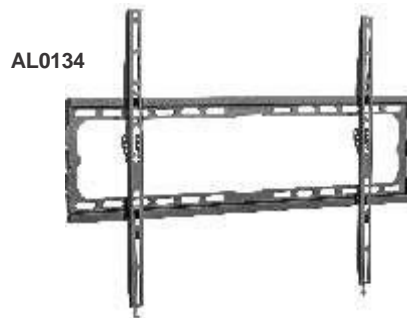

AL0134

- Slim design, distance to the wall is 20mm
- Supports TV's between 37" – 80"

# Security Cable

Code	Description
AL6200	Remote Control Security Cable

- Ideal for use in conference, meeting or education rooms and retail stores.
- Protective anti-theft solution for remote controls / Prevents lost, stolen or misplaced remote controls
- Includes adhesive backing - easy to install
- 950mm retractable steel cord



AL6200

# Graphics Tablet Wired



## Code Description

GT1060P Graphics Tablet Wired 10 x 6"

- Unleashing digital creativity
- Enhance work flow and photo editing accuracy
- Battery-Free pressure pen
- Sample rate: 233 PPS USB interface
- Resolution: 5080 LPI
- Active height: 15mm
- Built-in driver
- Multiple drawing program support
- Pressure sensitivity: 8192 levels
- Active drawing area: 10 x 6.25 inches



### Included in package:

- 1 x Pressure pen
- User Manual
- 8 x Spare Nibs
- 1 x Nib Clip



Plug & Play

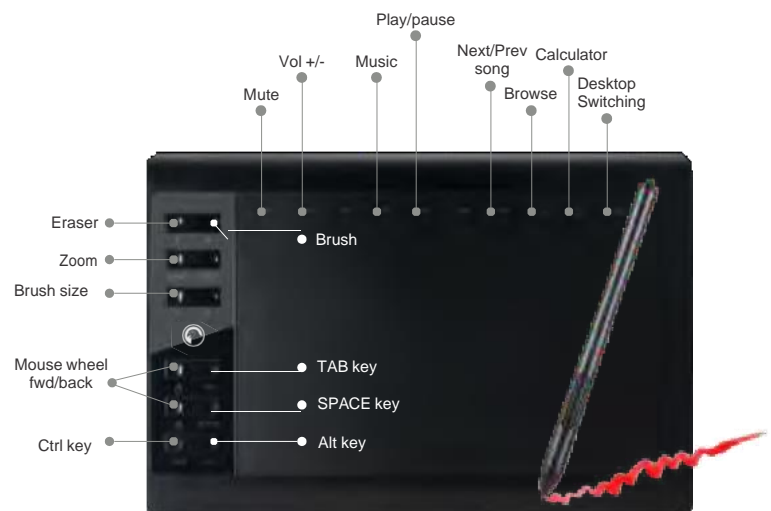

# Air Mouse

## Code Description

IWC3001 Air Mouse Wireless Keyboard

- High precision 6-axis Gyroscope
- Perfect for Home and Office use
- Air Mouse with Wireless QWERTY Keyboard
- Supports: Android, Windows, Mac OS and Linux
- Supports motion-sensing gaming
- Connects with most devices via 2.4GHz wireless
- Up to 10m distance range
- Compatible with: Smart TV's, Computers  
Game Consoles and Tablets



Due to continuous technological improvements, models may be upgraded prior to Catalogue reprint.



# Wireless Keyboard & Mouse

## Code Description

IC0003 Wireless Keyboard & Mouse

- High quality design
  - Plug and Play, no driver needed
  - 2.4GHz wireless ultra-thin keyboard mouse combo
  - Low-profile keys
  - Portable mouse with unifying receiver
  - 10m wireless transmission distance
  - Resolution: 1000DPI Batteries:
    - Mouse: 1xAA\*\*\*
    - Keyboard: 1xAA\*\*\*
- \*\*\*Batteries not included



# Speaker Sound Bar

## Code Description

CT3006 Speaker Sound Bar

**CT3006**

- LED display and remote control
- Bluetooth 3.0
- 2.1 Channel Sound Bar
- RMS: 35W = 2 x 10w + 15w (80db)
- Wall mountable (brackets and screws not included)
- The perfect entry level Sound Bar







# Speaker Sound Bar

## Code Description

CT3017 Speaker Sound Bar Econo

- Sleek & elegant design
- High-end audio experience
- 2.0 Surround sound
- Built-In subwoofer
- Enhanced dual bass ports
- 3 Equalizer modes

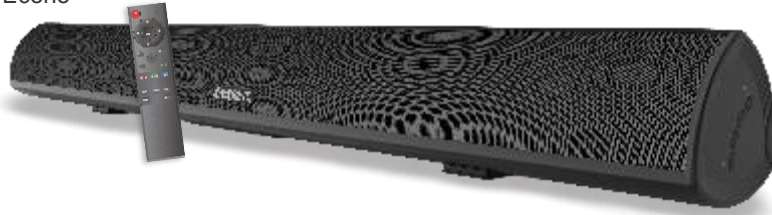

## Code Description

CT3018 Parrot Speaker Sound Bar + 5,25 Inch Wireless Sub

- Sleek & elegant design
- High-end audio experience
- 2.1 Surround sound
- Wireless subwoofer
- Enhanced dual bass ports
- 3 Equalizer modes



# Audio Devices

## Bluetooth Earphone

### Code Description

CT3010 Wireless Bluetooth Earphones

- Built-in Microphone
- iOS battery display
- Supports HD Voice
- Bluetooth: V4.1 + EDR
- Operating Range: 10m
- Standby Time: 1.5hrs
- Talk/Playing Time: 7hrs
- Charging Port: Micro USB



Soft Ear Hooks



HD Sound & Bass



Hands-Free



Battery Time: +5hrs

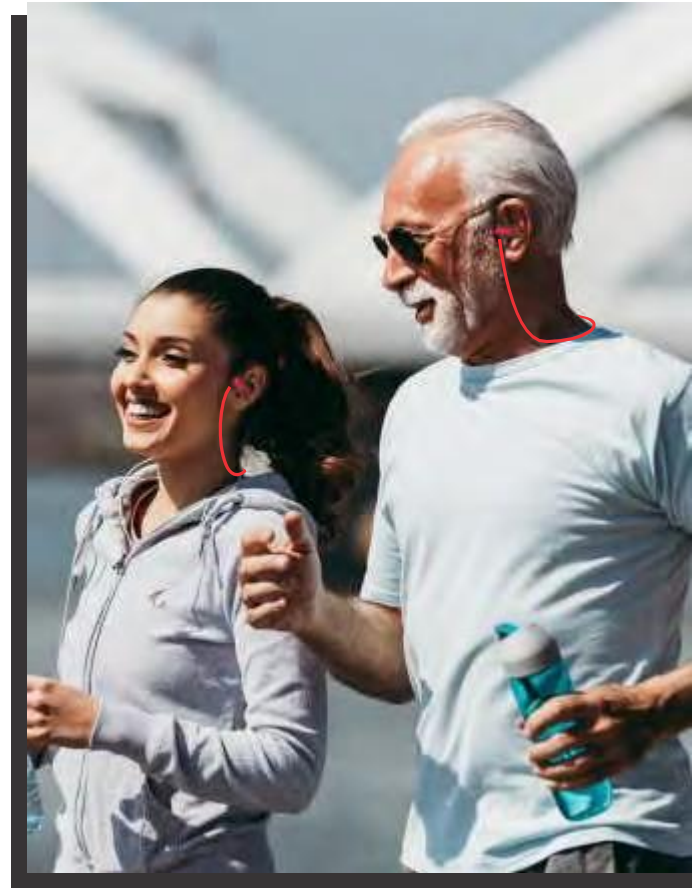

## Wired Earphones

### Code Description

CT3014 Audio - Wired Earphones

- Perfect for sports use
- Ergonomic 45° Design
- Multi-function three button control
- Compatible with most devices



Built-in Mic



3.5mm Audio Jack



HD Sound Quality



## Mobile Bluetooth Speaker

### Code Description

CT3011 Mobile Bluetooth Speaker

- Noise Ratio:  $\geq 80$ DB
- Distortion: THD=1%
- Music Format: MP3 WAV
- Bluetooth: V4.1 + EDR
- Operating Range: 10m
- Battery Operating Time: 6-12hrs
- Charging Port: Micro USB
- Built-In Powerbank - 4500 mAh



Hands-Free Call



Max Output: 16W



## Call Centre Wired Headset

### Code Description

CT4001 Call Centre Wired Headset

- Plug & Play
- Noise cancellation mic
- Binaural for immersive, high quality sound
- Flexible boom arm
- Soft protein ear pads
- Dual connection options: USB or 3.5mm Audio
- 90° Rotating ear cups



## Call Centre Wireless Mono

**Coming Soon**

### Code Description

CT4002 Call Centre Headset Wireless Mono

- Wireless bluetooth headset
- Noise cancelling
- 30 Hours talk time battery life
- 10 meter operation range
- 2 Hour charge time
- Rotatable microphone turns to be used either on the left or right-hand side
- Bluetooth V5.0
- Nett weight: 79g



## Wired Headphones

### Code Description

CT3012 Wired Headphones  
CT3013 Wired Headphones Pro

- HD sound quality
- 6.3mm & 3.5mm Audio Jack inputs
- 90° rotating ear cups
- 2m - 3m stretch coiled cable
- Adjustable head band
- Noise isolation earcup



CT3012



CT3013

## Bluetooth Headphones

### Code Description

CT3016 Bluetooth Headphones

- HD sound quality
- 6.3mm & 3.5mm Audio Jack inputs
- 2m - 3m stretch coiled cable
- Adjustable head band
- 12m wireless range
- Up to 20hrs talk time
- Bluetooth 5.0
- Premium tuned sound quality





# Acoustic Panel



## Coming Soon

### Code Description

AP3030B	Acoustic Panel 300 x 300mm Pyramid - Black
AP3030L	Acoustic Panel 300 x 300mm Pyramid - Dark Grey
AP3030LG	Acoustic Panel 300 x 300mm Pyramid - Light Grey

- Excellent solution for reducing unwanted reverberation and echo in a room
- Ideal for home theatres, offices, board rooms, restaurants, classrooms and recording studios
- 12 panels (1.08sqm)  
Individual Panel size: 300 x 300mm
- Fire Resistant Polyurethane foam
- Available in Black, light grey and dark grey
- Easy to install  
Self-adhesive backing
- Stylish pyramid design
- 25Kgs/M3 High Density
- Prevent echoes inside a room
- Noise reduction



# Lectern & Wireless Mic



## Code Description

LE1001 Lectern with Microphone

- One gooseneck mic and one lamp
- Built-in 60W amplifier
- One line input, two microphone inputs
- One line output, one record output
- Signal transmission distance max 100 meters
- Dimensions (L x W x H): 580 x 420 x 1100mm

*\*Compatible with the Wireless Lapel Mic*



Back

Front

## Wireless Lapel Mic

### Code Description

IS1002 Wireless Lapel Mic  
(Dual-channel UHF wireless Technology)

- Professional recording quality
- Professional-level LOW-CUT & mixing function
- Real-time fold back interface for monitoring recording effects
- The volume of monitoring and recording output can be adjusted independently and has memory function
- High-performance audio compression expander provides wider audio dynamic response
- Dual-channel UHF wireless receiving technology, for simultaneous use of 2 transmitters



# Video Conference Camera



## Code Description

VC1080C Video Conference Camera - FHD 1080P  
 VC1080CM Conferencing Camera Mounting Bracket

- 355° Horizontal Pan
- Unique 60° Tilt Range
- 1/2.8" Progressive CMOS
- IR Remote Controller Included
- Installation methods:  
 Wall mountable, Freestanding  
 Ceiling mountable
- Integrated & delicate design



VC1080C



VC1080CM

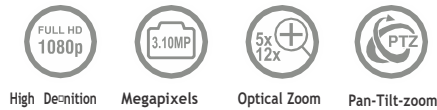

## Video Conference Speaker Microphone

### Code Description

VC1080M Wired Speaker Microphone  
 VC1080W Wireless Speaker Microphone

- Firm and compact structural design
- Remarkable voice quality
- Dynamic noise reduction
- Duplex audio technology
- USB 2.0
- Cardioid microphone



VC1080M



VC1080W



- Wireless connectivity 2.4 Ghz
- Wireless range of 10 - 15 meters



# Video Conference Webcam

## Code Description

VC0001 Video Conference Webcam Full HD

- Resolution: 1920 x 1080p
- Video mode: 24bit true colour
- Interface: USB port
- Manual focus
- Automatic light enhancement
- Built-in noise reduction microphone
- Optical glass lens
- Multi-purpose base

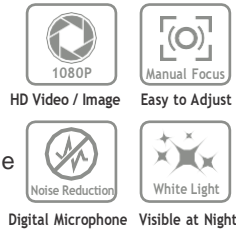

## Code Description

VC0003 Video Conference Wide Angle 100 Degree Webcam 4k

- 1/2.8 inch high quality 4K CMOS sensor
- 8.28MP 16:9
- 2x Built - in mic pickup
- 3x Digital zoom
- Manual focus
- White balance auto / manual
- Exposure auto / manual



## Desktop USB Microphone

### Code Description

IS1003 Desktop USB Microphone

- High quality sound
- Ideal for recording and live streaming
- Reduces background noise
- Unidirectional microphone
- Includes table top stand



See page 78 - 80 for Interactive Whiteboards and LED Panels

# Wireless Presentation

## Code Description

MTC-4500	Wireless Presentation Unit
MTC-4500BH	Wireless Presentation Unit + Dongle
MTC-4500H	Wireless Presentation Dongle

### MTC-4500H

- HDMI Dongle for effortless plug & play connectivity to MTC-4500

### MTC-4500

- Wireless presentation tool for collaboration and file sharing
- Allows 16 users to connect PC's or tablet devices with 4 devices to mirror as main screens
- offers annotation and whiteboard tool to enhance collaboration



MTC-4500H

# Visualizers

## Code Description

VZ0001	Visualizer Presenter Econo
VZ0002	Visualizer Presenter Deluxe

### VZ0001

- Auto Focus
- 5 x Digital zoom
- 8 Megapixel
- 30fps focus
- USB or DC Power Connection
- USB Output
- Built-in LED Light
- Built-in Mic

### VZ0002

- Auto Focus
- 100 x Digital zoom
- 8 Megapixel
- Full HDMI
- 30fps focus
- VGA, HDMI & USB Outputs
- SD Card reader for storing video
- Built-in LED Light
- Built-in Mic

Supports:



VZ0001

VZ0002

# External Storage



## Code

## Description

XT0032	External Storage USB 3 Type A + USB C 32GB Flash Drive
XT0064	External Storage USB 3 Type A + USB C 64GB Flash Drive
XT00128	External Storage USB 3 Type A + USB C 128GB Flash Drive

- High Speed USB 3
- Dual USB Type A and USB type C
- Allows you to easily transfer files from smart phones, tablets and PCs
- 25Mbps write speed
- 80Mbps Read speed
- Transfer speed of up to 150Mbps



## Code

## Description

XT2256	External Storage M.2 Sata Portable Type C 256GB
XT2500	External Storage M.2 Sata Portable Type C 500GB

- M.2 SATA portable type C
- Read/Write speed: 256Mbps / 500Mbps
- Storage capacity: 256GB / 500GB
- Metal casing
- Dimensions: 12.3\*3.3\*0.6cm
- Net Weight: 40.1g





# Cables

## Code Description

CL1002	HDMI 2m
CL1002A	HDMI 180 Degree Rotatable 1.8m
CL1002B	HDMI Male to Micro HDMI 2m
CL1005	HDMI 5m
CL1010	HDMI 10m
CL1020	HDMI 20m
CL2002	USB 2.0 A Male To A Male 1.8m
CL2002B	USB 3.0 CM to AM 2m
CL2003B	USB 3.0 CM to AM 3m
CL2010A	USB 2.0 Extension 10m
CL2010B	USB 2.0 Active Extension 10m
CL2020A	USB 2.0 AM to BM 20m
CL3002	CAT6 Network - 2m
CL3005	CAT6 Network - 5m
CL3010	CAT6 Network - 10m
CL3020	CAT6 Network - 20m
CL4002	3.5MM Jack - Jack 1.8m
CL4002A	3.5MM Jack - Two Male RCA 1.8m
CL4010	3.5MM Jack - Jack 10m
CL4010A	3.5MM Jack - Two Male RCA 10m
CL4020	3.5MM Jack - Jack 20m
CL4020A	3.5MM Jack - Two Male RCA 20m
AC1001	Plug - 6 x 16A SA & 5 x Euro and 1 X Schucko Extender
AC1008	Plug - 3 x 16A SA & 3 x Euro Extender
AC1009	Plug - RSA Twin Euro Adaptor
AC1010	Plug - 1 x 16A SA & 2 X Euro and 1 x Schucko Socket Adaptor
CL1030	Cable - HDMI 8k Fibre 2,1 Cable 30 Meter
CL1050	Cable - HDMI 8k Fibre 2,1 Cable 50 Meter
CON0001	Conduit Aluminium 22 x 11 x 2900mm

### HDMI Fibre Cables



### HDMI Cables



### HDMI 180 Degree Rotatable



### USB Cables



### Audio Cables



### Network Cables



### Power Plugs & Cables

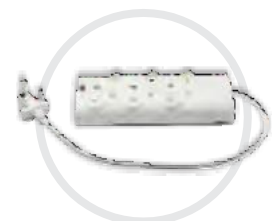

### Conduit Aluminium



Include colour code when ordering

Available colours - ex stock:  
Colour codes: Mill(M), Grey(G),  
White(W), Special(S)

# Adaptors

## Code Description

AD1001	90 Degrees 3.5mm Jack
AD1002	3.5mm Stereo Male to 2x Stereo Female
AD2003	Male for 15 Pin Female to Female VGA
AD2004	Lindy HDMI Female to Mini HDMI Male
AD2005	HDMI Switch 3 to 1
AD2006	HDMI Switch 5 to 1
AD2008	HDMI to VGA with Audio
AD2010	1 To 2 HDMI Splitter
AD2011	1 To 4 HDMI Splitter
AD2012	1 To 8 HDMI Splitter
AD2013	HDMI Extender by CAT5/6 up to 30m
AD2015	Display Port to HDMI
AD2016	Display Port Male to VGA Female
AD2017	HDMI Female to HDMI Female
AD2018	Adaptor - USB C Male to USB B Female
AD2019	Adaptor - USB C to HDMI Converter
AD2020	Adaptor - USB C Male to 3,5mm Female Audio Jack
AD2021	Adaptor - 3.5mm Male to 3,5mm Female Audio Jack
AD3001	USB Extender over CAT5/6
AD3002	4 Port USB2.0 Hub
AD3003	4 Port USB3.0 Hub
AD3004	Adaptor - USB C Hub 7 in 1

### HDMI Extender



### Display Adaptor



### 15 Pin Female to Female VGA adaptor



### USB C Male to 3.5mm Female jack



### Female to Male HDMI



### HDMI to VGA With Audio

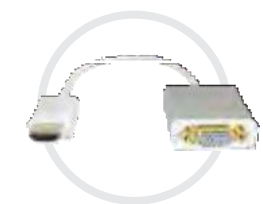

### Rj45 Over CAT5E .CAT6E USB Extender



### 4 Port USB Hub





Digital displays with advertising feature benefits such as web connectivity & high-definition displays which combine vivid colours that attract attention. Easily updatable with the ability to provide audiences with engaging information that ensures dynamic and visible content.

## Outdoor Cabinets

Code	Description	Size
DSP5-640	Digital Sign – Parrot P5	640 x 640mm
DSP8-960	Digital Sign – Parrot P8	960 x 960mm

## Indoor Cabinets

Code	Description	Size
DSP4-512	Digital Sign – Parrot P3.9	500 x 500mm
DSP2-480	Digital Sign – Parrot P1.875	540 x 480mm

High definition displays for indoor & outdoor use

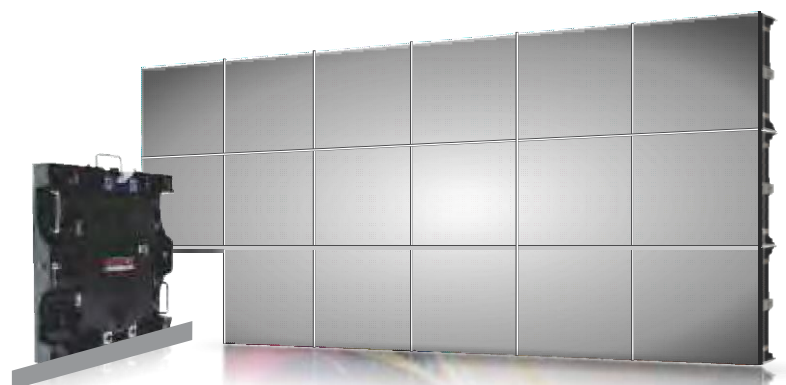

\* Pictures shown are for illustration purpose only. Actual product may vary.



# LED Modular Display



## Mitred Econo Frame

Code	Description	Poster Size	Size
BG3200	A0 Single Mitred Econo	1189 x 841mm	1230 x 870mm
BG3201	A1 Single Mitred Econo	841 x 594mm	870 x 625mm
BG3202	A2 Single Mitred Econo	594 x 420mm	625 x 450mm
BG3203	A3 Single Mitred Econo	420 x 297mm	450 x 330mm
BG3204	A4 Single Mitred Econo	297 x 210mm	330 x 240mm

- Mitred corner.
- Aluminium frame 23mm wide.
- Spring action frame.
- Quick and easy poster display change.
- Mounting screws and wall plugs included.
- Non-reflective media cover supplied - see page 108 clear media cover options.



## Mitred Corner

Code	Description	Poster Size	Size
BG1000	A0 Single Sided	1189 x 841mm	1250 x 900mm
BG1001	A1 Single Sided	841 x 594mm	900 x 655mm
BG1002	A2 Single Sided	594 x 420mm	655 x 480mm
BG1003	A3 Single Sided	420 x 297mm	480 x 360mm
BG1004	A4 Single Sided	297 x 210mm	335 x 230mm
BG2000*	A0 Double Sided	1189 x 841mm	1250 x 900mm
BG2001*	A1 Double Sided	841 x 594mm	900 x 655mm
BG2002*	A2 Double Sided	594 x 420mm	655 x 480mm
BG2003*	A3 Double Sided	420 x 297mm	480 x 360mm
BG2004*	A4 Double Sided	297 x 210mm	360 x 270mm

- Mitred corner.
- 32mm Frame
- UV resistant media cover
- Weather resistant
- High Quality Frame
- Spring action frame
- Mounting screws and wall plugs included for single sided Poster Frames only.



Spring action Aluminium

Available double & single sided

\* Poster frame can be made to order

**\* While stocks last**

## Plastic Corner

Code	Description	Poster Size	Size
BG3101	A1 Plastic Corner	841 x 594mm	900 x 655mm
BG3102	A2 Plastic Corner	594 x 420mm	655 x 480mm
BG3103	A3 Plastic Corner	420 x 297mm	480 x 360mm
BG3104	A4 Plastic Corner	297 x 210mm	360 x 270mm

- Grey matte plastic corner
- Aluminium frame 25mm wide
- Quick and easy Poster display change
- Mounting screws and wall plugs included
- UV resistant media cover
- Weather resistant
- High Quality Frame
- Spring action frame



Spring action frame \* Poster frame can be made to order

**While stocks last**



# Poster Frames

## Chrome Corner

Code	Description	Poster Size	Size
BG3000	A0 Chrome Corner	1250 x 900mm	1189 x 841mm
BG3001	A1 Chrome Corner	900 x 655mm	841 x 594mm
BG3002	A2 Chrome Corner	655 x 480mm	594 x 420mm
BG3003	A3 Chrome Corner	480 x 360mm	420 x 297mm
BG3004	A4 Chrome Corner	360 x 270mm	297 x 210mm

- Chrome plated plastic corner
- Aluminium frame 33mm wide
- Spring action frame
- Quick and easy Poster display change
- Mounting screws and wall plugs included
- Non-reflective media cover supplied
  - see additional 108 clear media cover options
- UV resistant media cover
- Weather resistant
- High Quality Frame



Spring action Frame



\* Poster frame can be made to order

## Security Frames

Code	Description	Poster Size	Size
BG1103	A3 Single Sided	420 x 297mm	450 x 327mm
BG1104	A4 Single Sided	297 x 210mm	327 x 240mm

- Mitred corner
- Aluminium frame 25mm wide
- Secure profile
- Weather resistant
- Quick and easy poster display change
- Includes screws and wall plugs
- Supplied with unlocking tool
- Non-reflective media cover supplied
  - see page 108 clear media cover options



## Double Sided Window Poster Frames

Code	Description	Poster Size	Size
BG1203	A3 Double Sided	450 x 327mm	420 x 297mm
BG1204	A4 Double Sided	327 x 240mm	297 x 210mm

- Mitred corner
- Aluminium frame 25mm wide
- Spring action frame
- Quick and easy poster display change
- Double sided tape included for mounting
- Non-reflective media cover supplied

**While stocks last**



## Double Sided, Self-adhesive Magnetic Poster Frame - Flexi

Code	Description	Size
BG4103	Poster Frame, Magnetic Self Adhesive	A3
BG4104	Poster Frame, Magnetic Self Adhesive	A4

- Ideal for use on windows or clear surfaces
- Scratch-resistant
- Portrait or landscape
- Simple and stylish
- Clear self-adhesive mounting
- Double-sided poster display



## Poster Frame Clear Media Cover

Code	Description	Size
BG0000	Media Cover A0 (Clear)	1189 x 841 x 1.2mm
BG0001	Media Cover A1 (Clear)	841 x 594 x 1.2mm
BG0002	Media Cover A2 (Clear)	594 x 420 x 1.2mm
BG0003	Media Cover A3 (Clear)	297 x 420 x 1.2mm
BG0004	Media Cover A4 (Clear)	297 x 210 x 1.2mm

- Durable.
- Plexiglass thickness 1.2mm.
- Poster Frames not included.
- Clear reflective surface.
- UV resistant.

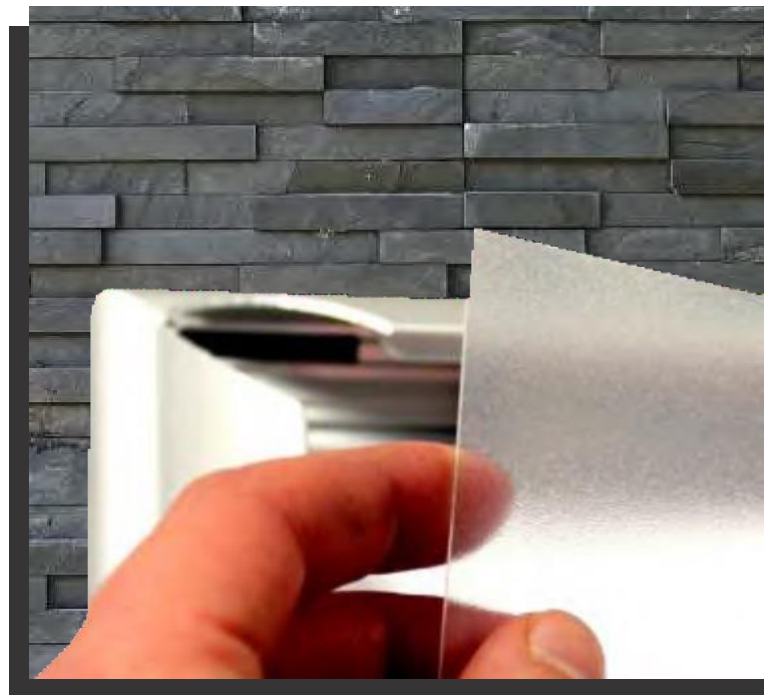

# Poster Frames Supports

## Poster Frame Stand - Double Sided

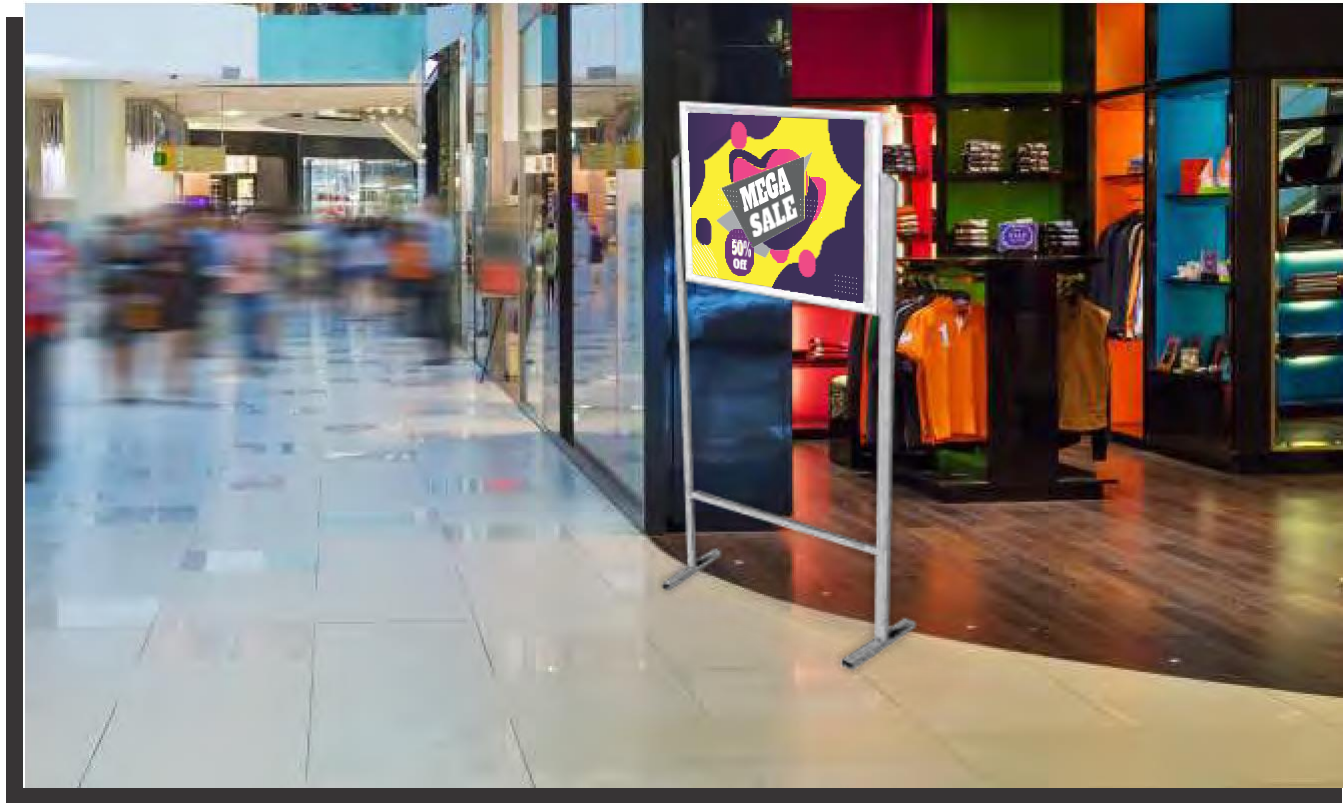

### Code Description

Code	Description	Portrait Max. Height	Landscape Max. Height
BG9400	Poster Frame Stand Double Sided A0	2135mm	1960mm
BG9401	Poster Frame Stand Double Sided A1	1960mm	1858mm
BG9402	Poster Frame Stand Steel Double Sided A2	1858mm	1750mm
BG9402L	Poster Frame Stand Steel Double Sided A2 Landscape	1858mm	1750mm
BG9403	Poster Frame Stand Steel Double Sided A3	1750mm	1642mm
BG9403L	Poster Frame Stand Steel Double Sided A3 Landscape	1750mm	1642mm

- Lockable castors (BG9400 & BG9401).
- Width adjustable for landscape or portrait display (BG9400 & BG9401).
- Can only be used with Poster Frames.
- Includes Double-Sided Poster Frame.

#### Lockable castors



#### Adjustable crossbar

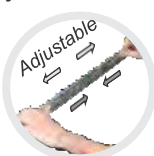

**BG9400 & BG9401**  
Poster Frame Stand  
Double-Sided for A0 & A1



**BG9402(L) & BG9403(L)**  
Poster Frame Stand  
Steel Double-Sided for A2 & A3



# Poster Frames

## Poster Frame Stand



Code	Description	Base Size
BG9002	Poster Frame Stand A2 Portrait	318 x 245mm
BG9002L	Poster Frame Stand A2 Landscape	318 x 245mm
BG9003	Poster Frame Stand A3 Portrait	318 x 245mm
BG9003L	Poster Frame Stand A3 Landscape	318 x 245mm
BG9004	Poster Frame Stand A4 Portrait	318 x 245mm

- Includes Poster Frame
- Suitable for A2, A3 & A4
- Angle adjustment on single sided frames
- Adjustable screw-in feet on single pole stands
- Base plate with single pole
- Assembles easily without tools
- Can only be used with Poster Frames

**While stocks last**



# Poster Frames Supports

## Poster Frame Stand - Double Upright



Code	Description	Base Size	Height
BG9000	Poster Frame Stand A0 Portrait	660 x 620mm	1300mm
BG9000L	Poster Frame Stand A0 Landscape	660 x 620mm	1300mm
BG9001	Poster Frame Stand A1 Portrait	660 x 620mm	1300mm
BG9001L	Poster Frame Stand A1 Landscape	660 x 620mm	1300mm

- Includes Poster Frame.
- Suitable for A0 & A1.
- Angle adjustable on single sided frames
- Lockable castors on double pole stands.
- Base plate with double pole for A0 & A1 Poster Frames.
- Assembles easily without tools.
- Can only be used with Poster Frames.

**While stocks last**

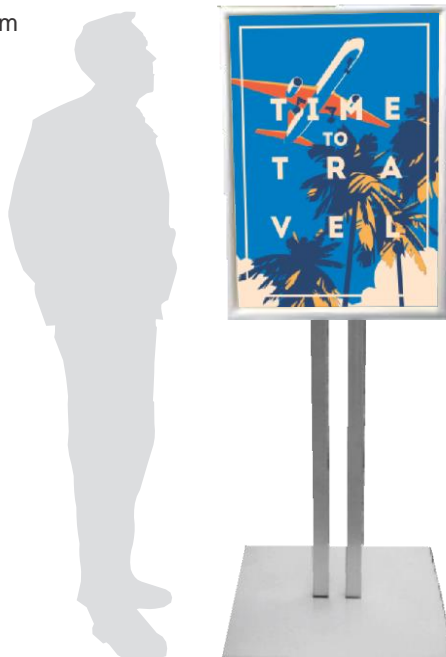



# Poster Frames

## Hanging System



Code	Description	Size
BG9201*	Hanging Set Battens A1	600mm
BG9202*	Hanging Set Battens A2	430mm
BG9203*	Hanging Set Battens A3	310mm
BG9204*	Hanging Set Battens A4	220mm
BG9301	Poster Frame Hanging System 1 meter	1000mm
BG9302	Poster Frame Hanging System 2 meter	2000mm

\* Supplied with Rope - 1 metre

#### Hanging Battens

- Available for A1, A2, A3, & A4 posters

#### Hanging System

- Hanging hooks and screws included for hanging Poster Frames

#### Customizable sizes

Up to 3000mm in width (Left to Right)



Hanging Battens



# Sign Frames

## 80 - 1200mm Wall Signs - Flush

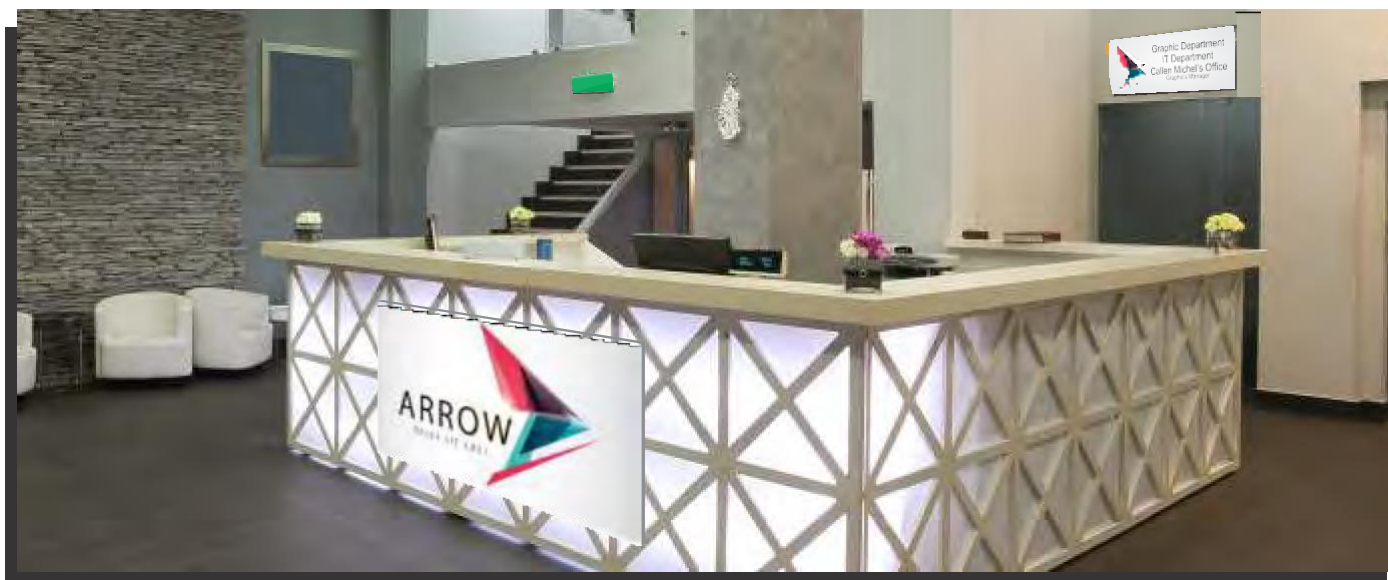

Code	Description	Size	Code	Description	Size
SF0820	Sign Frame	80 x 200mm	SF4106	Sign Frame	420 x 250mm
SF0830	Sign Frame	80 x 300mm	SF4110	Sign Frame (A3)	420 x 300mm
SF0840	Sign Frame	80 x 400mm	SF4112	Sign Frame	420 x 500mm
SF0850	Sign Frame	80 x 500mm	SF4114	Sign Frame	420 x 600mm
SF1030	Sign Frame	100 x 300mm	SF4116	Sign Frame	420 x 700mm
SF1040	Sign Frame	100 x 400mm	SF4118	Sign Frame	420 x 800mm
SF1050	Sign Frame	100 x 500mm	SF4202	Sign Frame	500 x 150mm
SF1060	Sign Frame	100 x 600mm	SF4204	Sign Frame	500 x 200mm
SF1230	Sign Frame	120 x 300mm	SF4206	Sign Frame	500 x 250mm
SF1530	Sign Frame	150 x 300mm	SF4208	Sign Frame	500 x 300mm
SF1540	Sign Frame	150 x 400mm	SF4210	Sign Frame	500 x 400mm
SF1550	Sign Frame	150 x 500mm	SF4212	Sign Frame	500 x 500mm
SF1560	Sign Frame	150 x 600mm	SF4214	Sign Frame	500 x 600mm
SF1570	Sign Frame	150 x 700mm	SF4216	Sign Frame	500 x 700mm
SF2020	Sign Frame	200 x 200mm	SF4218	Sign Frame	500 x 800mm
SF2040	Sign Frame	200 x 400mm	SF4302	Sign Frame	600 x 150mm
SF2129	Sign Frame (A4)	210 x 297mm	SF4304	Sign Frame	600 x 200mm
SF2140	Sign Frame	210 x 400mm	SF4306	Sign Frame	600 x 250mm
SF2145	Sign Frame	210 x 450mm	SF4308	Sign Frame	600 x 300mm
SF2150	Sign Frame	210 x 500mm	SF4310	Sign Frame	600 x 400mm
SF2160	Sign Frame	210 x 600mm	SF4312	Sign Frame	600 x 500mm
SF2170	Sign Frame	210 x 700mm	SF4314	Sign Frame	600 x 600mm
SF4002	Sign Frame	300 x 150mm	SF4316	Sign Frame	600 x 700mm
SF4004	Sign Frame	300 x 200mm	SF4318	Sign Frame	600 x 800mm
SF4006	Sign Frame	300 x 250mm	SF4320	Sign Frame	600 x 900mm
SF4008	Sign Frame	300 x 300mm	SF4422	Sign Frame	700 x 1000mm
SF4010	Sign Frame (A3)	300 x 420mm	SF4524	Sign Frame	800 x 1100mm
SF4012	Sign Frame	300 x 500mm	SF4520V	Sign Frame (A0) Portrait	820 x 1189mm
SF4014	Sign Frame	300 x 600mm	SF4626	Sign Frame	900 x 1200mm
SF4016	Sign Frame	300 x 700mm	SF4726	Sign Frame	1000 x 1200mm
SF4018	Sign Frame	300 x 800mm	SF4828	Sign Frame	1100 x 1400mm
SF4102	Sign Frame	420 x 150mm	SF4929	Sign Frame	1200 x 1500mm
SF4104	Sign Frame	420 x 200mm	SF4976	Sign Frame	1200 x 2400mm



Code	Description	Size
SF0510	Sign Frame	50 x 100mm
SF0515	Sign Frame	50 x 150mm
SF0520	Sign Frame	50 x 200mm
SF0521	Sign Frame	50 x 210mm
SF0525	Sign Frame	50 x 250mm
SF0529	Sign Frame	50 x 297mm
SF0530	Sign Frame	50 x 300mm
SF0535	Sign Frame	50 x 350mm
SF0540	Sign Frame	50 x 400mm
SF0540S	Sign Frame with slide	50 x 400mm
SF0545	Sign Frame	50 x 450mm
SF0550	Sign Frame	50 x 500mm
SF0560S	Sign Frame In/Out Slide & Message Strip	50 x 600mm
BD4101	Sign Frame In/Out Single Carded Retail	50 x 400mm
BD4110	Sign Frame In/Out Ten Boxed Retail	50 x 400mm
SN1000	Sign Frame Retail Pack	50 x 280mm



- Includes media cover, print not included
- Plastic end caps, masonry screws and plugs
- Aluminium Extrusion
- For indoor or outdoor use, depending on media used
- Includes message strip



# Sign Frames

## Double Sided - Standing



Code	Description	Size
SF4040	Sign Frame DBL Sided Standing	300 x 1800mm
SF4140	Sign Frame DBL Sided Standing	420 x 1800mm
SF4240	Sign Frame DBL Sided Standing	500 x 1800mm
SF4340	Sign Frame DBL Sided Standing	600 x 1800mm
SF4440	Sign Frame DBL Sided Standing	700 x 1800mm
SF4540	Sign Frame DBL Sided Standing	800 x 1800mm
SF4640	Sign Frame DBL Sided Standing	900 x 1800mm
SF4743	Sign Frame DBL Sided Standing	1000 x 2100mm
SF4844	Sign Frame DBL Sided Standing	1100 x 2200mm
SF4946	Sign Frame DBL Sided Standing	1200 x 2400mm

- Easy to change sign
- Custom sign graphic design and printing available but not included
- Powder Coated base and top
- Can be made to custom sizes
- For indoor and outdoor use, depending on media used





# Sign Frames

## Double Sided Wall mounted



Reception Desk

### Wall Signs - Double Sided

Code	Description	Size	
SF1030D	Sign Frame DBL Sided Wall Mounted (M)	100 x 300mm	<ul style="list-style-type: none"> <li>• (M) Includes media cover</li> <li>• Custom sign graphic design and printing available but not included</li> <li>• Powder coated end caps</li> <li>• Masonry screws and plugs</li> <li>• For indoor or outdoor use, depending on media used</li> </ul>
SF2123D	Sign Frame DBL Sided Wall Mounted (M)	210 x 230mm	
SF2129D	Sign Frame DBL Sided Wall Mounted (M)	210 x 297mm	
SF2140D	Sign Frame DBL Sided Wall Mounted (M)	210 x 400mm	
SF4030	Sign Frame DBL Sided Wall Mounted (A3)	300 x 420mm	
SF4130	Sign Frame DBL Sided Wall Mounted (A3)	420 x 300mm	

### Desktop Signs

Code	Description	Size	
SF2115H	Sign Frame Desk Top Landscape (A5) (M)	210 x 148mm	<ul style="list-style-type: none"> <li>• (M) Includes media cover</li> <li>• Powder coated end caps</li> <li>• Free standing</li> <li>• Custom sign graphic design and printing available but not included</li> <li>• SN1300 &amp; SN1305 Plastic End Cap</li> </ul>
SF2115V	Sign Frame Desk Top Portrait (A5) (M)	148 x 210mm	
SF2129H	Sign Frame Desk Top Landscape (A4) (M)	210 x 297mm	
SF2129V	Sign Frame Desk Top Portrait (A4) (M)	210 x 297mm	
SN1300	Sign Frame Desk Name Plate	50 x 280mm	
SN1305	Sign Frame Desk Name Plate Double Side	50 x 280mm	

# Safety Signs



Red Print on White ACP



SN4101



SN4102



SN4103

Black Print on Brushed Aluminium ACP



SN4104



SN4105



SN4106

White Print on Black ACP



SN4107



SN4108



SN4109

Red and Black Print on White ACP



NO PARKING  
SN4110



NO SMOKING  
SN4111



NO ENTRY  
SN4112

Green Print on White ACP



SN4113



FIRST AID  
SN4114



SN4115

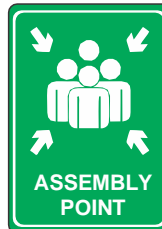

ASSEMBLY  
POINT  
SN4116



EXIT  
SN4117

- 150 x 150 mm • Printed with UV print
- Double sided tape included
- Special signs made to order
- Assembly point sign A4 210 x 297mm
- Exit sign 150 x 300mm

# Hospital Bed Boards



Code	Description	Size
BD1703	A3 Glass Hospital Bed Board	297 x 420mm
BD1704	A4 Glass Hospital Bed Board	210 x 297mm
BD1705	Glass Hospital Bed Board	250 x 450mm
BD1710	Glass Hospital Bed Board	300 x 350mm

## Product Features

- 6mm Toughened Glass
- Includes 4x stainless steel wall mounts
- Customised prints and sizing available
- Easy to clean
- Non-porous and hygienic
- Scratch resistant
- Artwork to be supplied in high resolution tiff, jpeg, pdf or vector format



- Printing included (standard sized boards only)



# Glass Splashbacks

## Hobs Splashback



Select from our new standard range of 20 colours: *Metallic Colours will incur an additional cost \*\**

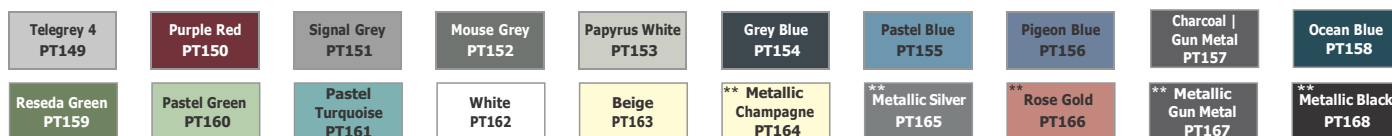

Select from our previous standard range of 25 colours: *\*While Stocks Last*

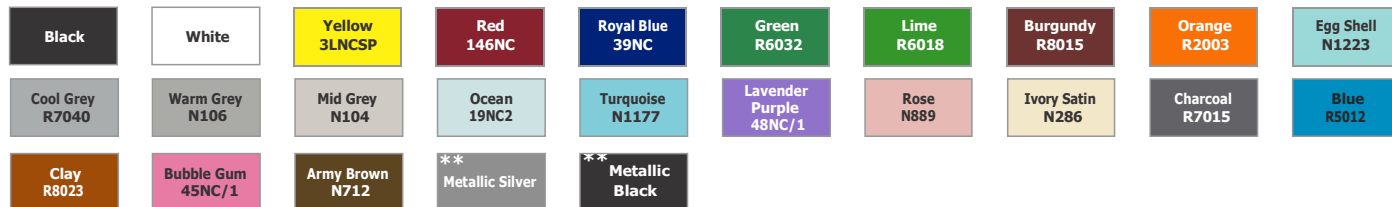

Colours can vary when printed on glass due to their refractory properties as well as the pureness of the clear glass.

### Our new standard range of printed hobs



### Code Description Size

GR017S	Glass Splashback	
SB6065*	Splashback Hob	598 x 650 x 6mm
SB9070	Splashback Hob	898 x 700 x 6mm

- SABS approved glass
- 6mm floated tempered/toughened glass
- Low maintenance and easy to clean
- Steam resistant
- Printing will not crack or fade
- Image is printed directly on the glass surface
- Mold and oil stain resistant

- No charge for standard electric and plumbing cutouts
- Can print up to 1500 x 3000mm
- Thicker glass is available on request
- Artwork to be supplied in high resolution tiff, jpeg, pdf or vector format
- Mounted with solvent free silicone

\* **SB6065 Portrait Glass**

# Customised Glass Splashback & Wall Art



## Code Description

GR017S Glass Splashback

## Product Features

- SABS approved glass
- 6mm opti-clear (low Iron) tempered/toughened glass
- Low maintenance and easy to clean
- Printing will not crack or fade
- Image is printed directly on the glass surface
- Mold and oil stain resistant
- No charge for standard electric and plumbing cutouts
- Thicker glass is available on request
- Artwork to be supplied in high resolution tiff, jpeg, pdf or vector format
- Mounted with solvent free silicone
- Measured using state of the art equipment for tailor fit finish

# Acrylic Certificate Holder

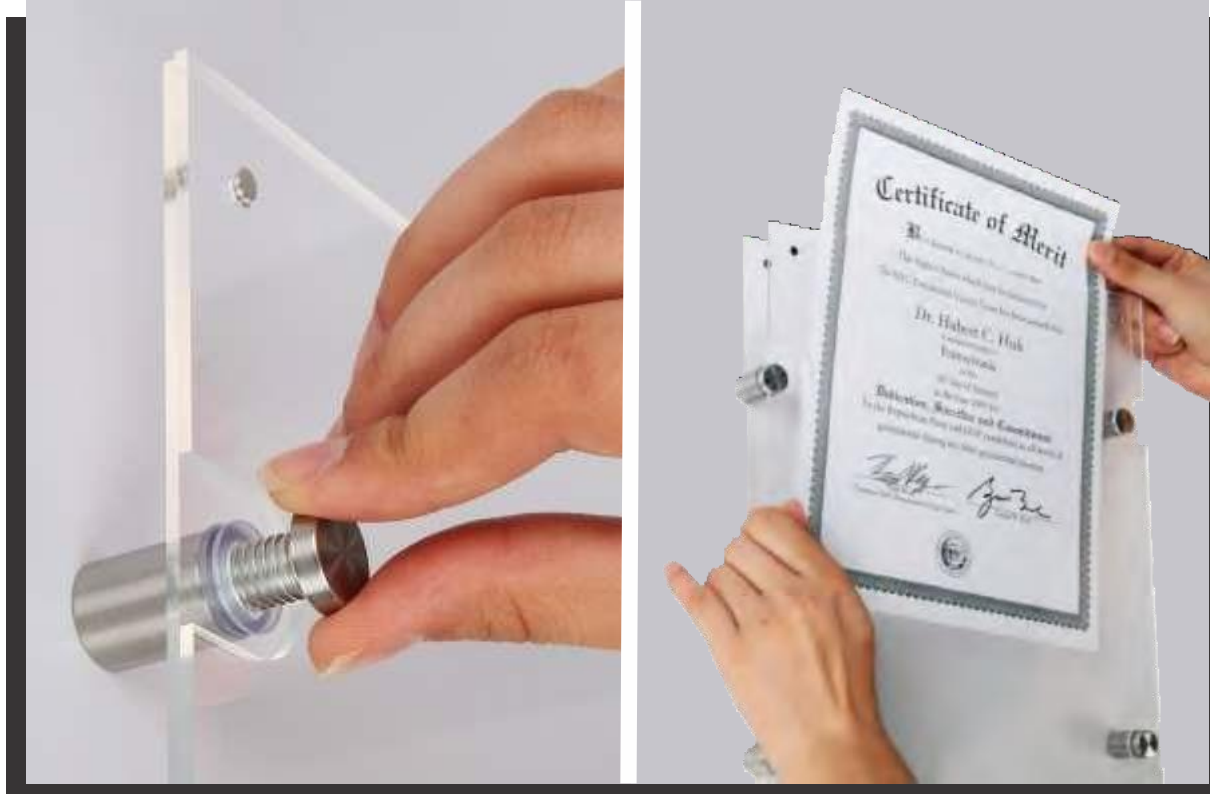

Code	Description	Size
DP2004	Acrylic Certificate Holder	A4
DP2003	Acrylic Certificate Holder	A3

- Frameless display system
- Crystal clear acrylic finish - 2mm thick
- Suitable for office and reception areas
- Ideal for certificates and other general information
- Includes 4x stainless steel stand offs and mounting screws
- Easy to remove and update display
- Features a magnetic clip that holds display closed





# Acrylic Display Holders



## Code Description

DP0404 Flat Packable Laptop Stand

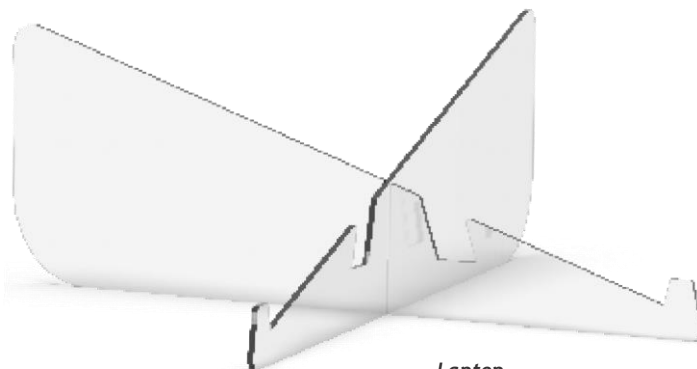

*Laptop  
not included*

- Flat packable for easy storage
- Easy to set up
- Portable and light weight – fits in laptop bag
- Ergonomic
- Can be used as tablet stand for video conferencing
- Manufactured from durable 3mm clear acrylic

## Code Description

DP0405 Tablet/ Cellphone Stand Acrylic Flat Pack



*Tablet/Cellphone  
not included*

- 4mm Clear Perspex construction
- Portable and light weight
- Elevated design allows for heat dissipation and increased airflow beneath the cellphone or tablet, preventing overheating

# Acrylic Display Holders

## Single Sided Menu Holder

Code	Description
DP0106L-Z	A6 Acrylic Menu Holder - Landscape - Box of 5
DP0106P-Z	A6 Acrylic Menu Holder - Portrait - Box of 5
DP0105L-Z	A5 Acrylic Menu Holder - Landscape - Box of 5
DP0105P-Z	A5 Acrylic Menu Holder - Portrait - Box of 5
DP0104L-Z	A4 Acrylic Menu Holder - Landscape - Box of 5
DP0104P-Z	A4 Acrylic Menu Holder - Portrait - Box of 5

- A6, A5 & A4 made with 2mm thick Acrylic
- Ideal for restaurants, reception desks and business
- Single sided design with shaped foot
- Available in portrait and landscape

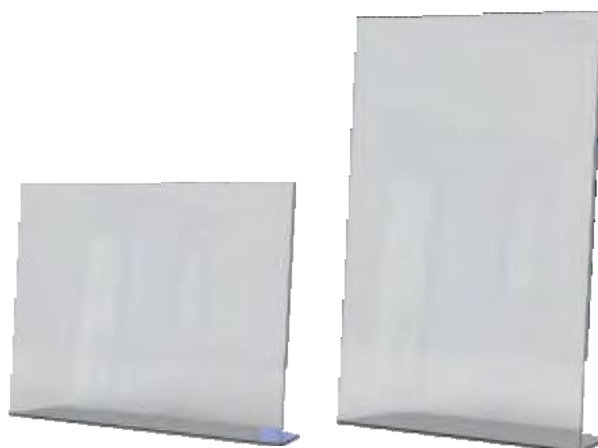

## Double Sided Menu Holder

Code	Description
DP0134-Z	1/3 (DL) A4 Single Sided Acrylic Menu Holder - Box of 5
DP0206L-Z	A6 Acrylic Menu Holder - Landscape - Box of 5
DP0206P-Z	A6 Acrylic Menu Holder - Portrait - Box of 5
DP0205L-Z	A5 Acrylic Menu Holder - Landscape - Box of 5
DP0205P-Z	A5 Acrylic Menu Holder - Portrait - Box of 5
DP0204L-Z	A4 Acrylic Menu Holder - Landscape - Box of 5
DP0204P-Z	A4 Acrylic Menu Holder - Portrait - Box of 5
DP0234-Z	1/3 (DL) A4 Double Sided Acrylic Menu Holder - Box of 5

- A6, A5 & A4 made with 2mm thick Acrylic
- Ideal for restaurants, reception desks and business
- Double sided T design
- Available in portrait and landscape



## Acrylic Table Talker & Table Brochure Holder

Code	Description
DP0305	A5 Three Sided Acrylic Table Talker
DP0506-Z	A6 Standard Acrylic Table Brochure Holder - Box of 5
DP0505-Z	A5 Standard Acrylic Table Brochure Holder - Box of 5
DP0504-Z	A4 Standard Acrylic Table Brochure Holder - Box of 5

### DP0305:

- 2mm Acrylic construction
- Three side viewing

### DP0506, DP0505 & DP0504:

- A6, A5 & A4 made with 2mm thick Acrylic
- Ideal for restaurants, reception desks and business
- 30mm in depth



# Designer Mounting Systems

Ceiling Hanging Systems, Floor to Ceiling Systems



Code	Description	Size
DM5020	Single-sided clamp	3000mm
DM5030	Double-sided clamp	21mm x 15mm
DM5110	Ceiling Hanging Grip and Cable	39mm x 15mm
DM5200	Cable floor to ceiling	1000mm

- Aluminium with a satin finish
- Accommodates panels 3-8mm
- Can be used with glass, aluminium composite panel, acrylic, etc
- Masonry screws, wall plugs and allen key are included
- Sign material excluded
- Custom graphic design and printing available but not included

**While stocks last**



DM5020



DM5030



DM5110



DM5200

*\* Images are not to scale*



# Designer Mounting Systems



## Code Description

DM3000	Aluminium Wall Clamp 80mm
DM3001	Aluminium Wall Clamp 120mm
DM3002	Aluminium Wall Clamp 180mm
DM4100	Aluminium Standoff 4 Way
DM8000	Aluminium Side Wall Clamp
DM8100	Stainless Steel Standoff Single
DM8101	Chrome Standoff Edge Grip

**While stocks last**

DM3000



DM3001



DM3002



DM4100



DM8000



DM8101



DM8100



*\* Images are not to scale*

# Designer Mounting Systems



## Code Description

DM5000	Aluminium Free Standing Frame Kit
DM5010	Aluminium Cable Wall Fixture Set
DM5020	Aluminium Cable Material Clamp Single Sided
DM5030	Aluminium Cable Material Clamp Double Sided
DM5100	Aluminium Floor to Ceiling Channel
DM5300	Aluminium Cable System Floor to Ceiling Channel Set

**While stocks last**

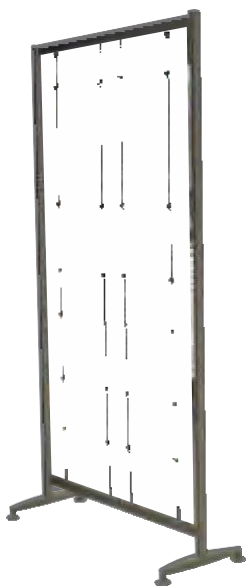

DM5000



DM5010



DM5020



DM5030



DM5100



DM5300

*\* Images are not to scale*

# Glass Cube Display Stand

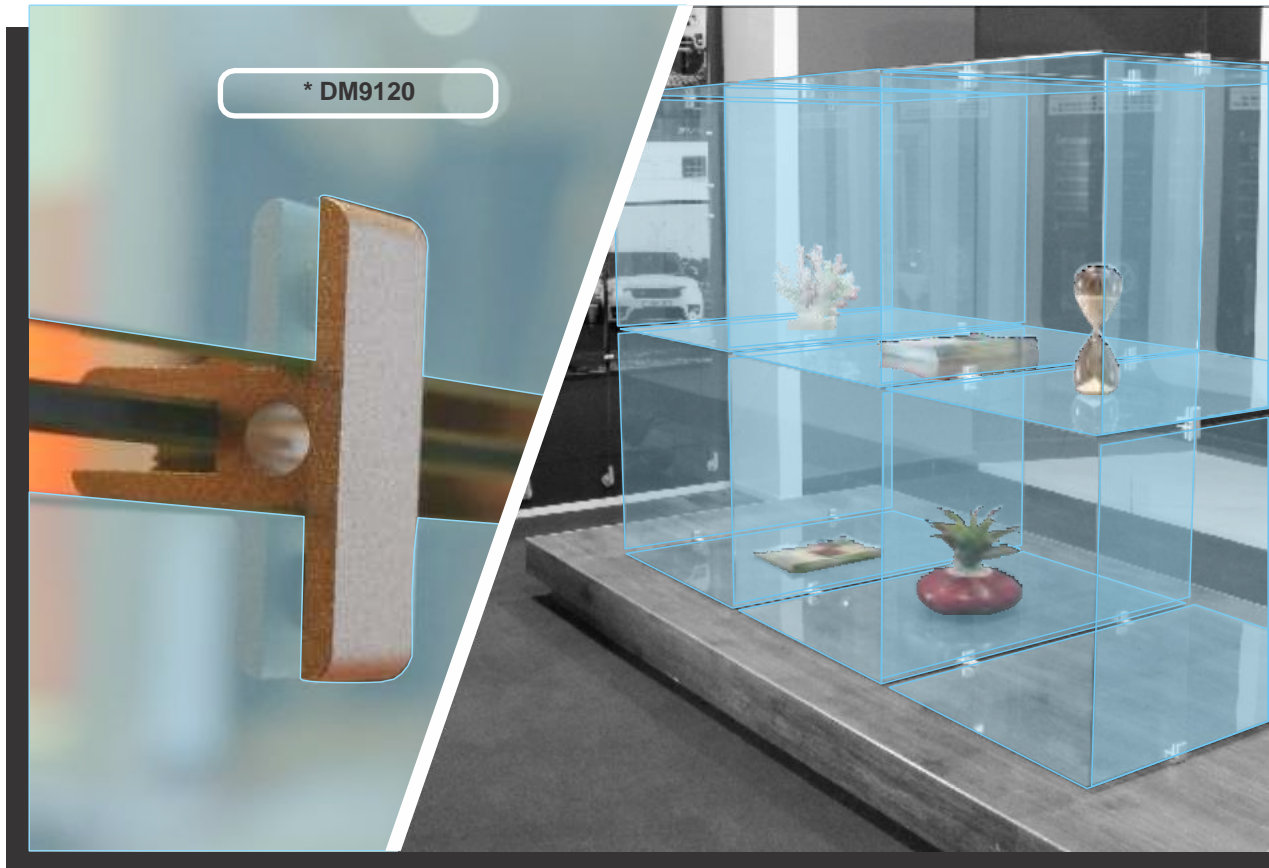

Code	Description	Size
DM9110	Two way grip	38 x 38 x 38mm
DM9120	Three way grip	58 x 38 x 38mm
DM9130	Four way grip	58 x 38 x 58mm

- Aluminium with a satin finish
- Accommodates panels 6-8mm
- Can be used with glass, aluminium composite panel, acrylic, etc.
- Material excluded
- Multiple design layouts
- Phillips screwdriver is required
- Custom graphic design and printing available but not included

**While stocks last**



DM9110

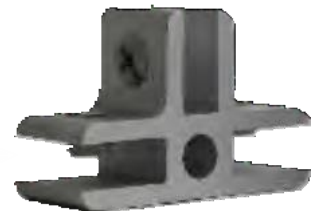

DM9120



DM9130



# Retractable Q-Barrier system



Code	Description	Dimensions
DP9132	Retractable Queue Barrier Chrome with Black Belt	320 x 320 x 910mm
DP9132R	Retractable Queue Barrier Chrome with Black Belt - Box of 2	320 x 320 x 910mm

- Dimensions 320 x 320 x 910mm
- Barrier feature a heavy weighted 7.5kg base with rubberized floor protector
- System comes with a retractable 2 meter black belt
- 4-Way Connection: for convenient control management setups
- The system has a high polished chrome finish
- Endless Uses: perfect for crowd control at retail stores, sporting arenas, airports, banks, registrations, hotels, concert venues, trade shows etc



# Janitorial Dispenser Stand



## Code

JA0502SS

## Description

Dispenser Stand - Stainless Steel

### JA0502SS features:

- Floor standing soap or sanitizer dispenser stand
- Stainless Steel Construction
- Highly durable design
- Drip tray
- To be used in conjunction with:  
JA0502AS or JA0502AG
- Height : 1440mm



*\* Dispenser not included*

## Hand Soap

JA0401HS

Code	Description
JA0401HS	Janitorial Hand Soap - 5Litre

- Scented
- Gentle on skin
- Reduces germs
- Protects hands



## Hand Sanitizer

Code	Description
MEDHS03	Hand Sanitizer - 5Litre
MEDHS02Z	Hand Sanitizer - 250ml (Box of 6)
MEDHS01Z	Hand Sanitizer - 28ml (Box of 20)

### Sanitizer Features:

- Antibacterial • Antiviral
- Antifungal Sanitizing solution
- 90% Iso Propyl Alcohol



## Surface & Hand Sanitizer

Code	Description
MEDHS04	Surface & Hand Sanitizer - 400ml Aerosol Single
MEDHS04Z	Surface & Hand Sanitizer - 400ml Aerosol Box of 12

- A fast and effective Sanitizing Solution to help reduce bacteria & viruses on skin & surfaces.
- Ideal for hands and surfaces
- Citrus Scented,
- Antibacterial, Antiviral & Antifungal Sanitizing Solution

**While stocks last**





# Janitorial Chemical Range



## Code Description

JA0401DC Janitorial Toilet Cleaner

- Features:**
- Dilute 35ml with water

## Code Description

JA0401WC Janitorial Window Cleaner

- Features:**
- Dilute 1:10 with water

## Code Description

JA0401TC Janitorial Tile Cleaner



**Note:** Maximum temperature for storage is +/- 30 degrees°C • Store in a cool, dark place out of direct sunlight

## Code Description

JA0401B Janitorial Bleach 3%

## Code Description

JA0401D Janitorial Dishwashing Liquid

## Code Description

JA0401H Janitorial Handy Klean



**Note:** Maximum temperature for storage is +/- 30 degrees°C • Store in a cool, dark place out of direct sunlight

# Janitorial Re $\square$ llable Bottles

Code	Description	QTY	Size
JA0401S	Bottle 250ml and Spray Cap Single	1	250ml
JA0401SP	Bottle 250ml	Box of 250	250ml
JA0401C	Cap 250ml Bottle	Box of 250	
JA0401HB	Refillable Bottle for Handy Kleen	Box of 12	750ml
JA0401BB	Refillable Bottle for Bleach	Box of 12	750ml
JA0401WB	Refillable Bottle for Window Cleaner	Box of 12	750ml
JA0401SB	Refillable Bottle for Dishwashing Liquid	Box of 12	750ml
JA0401DB	Refillable Bottle for Toilet Cleaner	Box of 12	750ml
JA0401AB	Refillable Bottle for Assorted	Box of 5	750ml
JA0401JSE	Bottle 5L Jerry 120g and Cap Single	1	5L
JA0401JE	Bottle 5L Jerry 120g	Box of 24	5L
JA0401JSM	Bottle 5L Jerry 160g and Cap Single	1	5L
JA0401JM	Bottle 5L Jerry 160g	Box of 24	5L
JA0401JSP	Bottle 5L Jerry 200g and Cap Single	1	5L
JA0401JP	Bottle 5L Jerry 200g	Box of 24	5L
JA0401JC	Cap Sandard 5L Jerry	Box of 24	
JA0401JCS	Cap Sandard 5L Jerry	Box of 150	

\* All bottles are empty and should be used in conjunction with Parrots Janitorial Cleaning Chemicals

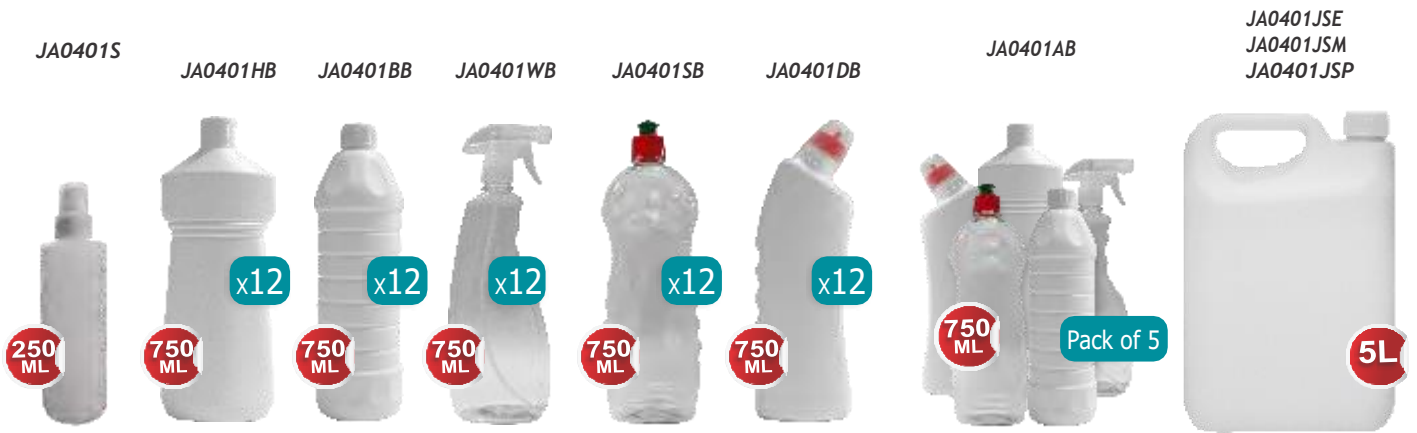

## Refuse Disposal

### Touchless Bin

Code	Description
JA0801	Janitorial Bin Touchless

#### Product Features

- 50L bin capacity
- Stainless steel casing
- Infrared motion sensor with automatic opening & closing
- 6 x AA battery operated (not included)
- Low battery power consumption
- Ideal for use in homes, kitchens & offices
- Firm fit lid helps reduce odours
- Touch free operation helps reduce contamination of germs
- Bin size: 42\*31.5\*61cm

**50L**  
CAPACITY



### Refuse Bags

Code	Description	Size
JA0402R	Janitorial Refuse Bags 28 Micron	750 x 950mm

#### Product Features

- Interleaved
- 28 Micron
- Made from 60% recycled material
- 100% Recyclable
- Size: 750 x 950mm
- Fits most household bins
- Available in black only

**80L**  
CAPACITY

**20**  
BAGS



# Janitorial Dispensers

## Desktop Dispenser

### Code Description

JA0502DS Desktop Sanitizer Dispenser - Auto  
 JA0502DG Desktop Soap Dispenser - Auto

- Automatic desktop dispenser
- Infrared sensor - touch free
- Ideal for home and office use
- No installation required
- Refillable 500ml bottle
- Ideal for gel soaps and lotions / liquid sanitizers
- Requires 4 x AA Batteries - not included



JA0502DG



JA0502DS

## Dispenser Plastic

### Code Description

JA0502AS Sanitizer Dispenser - Auto  
 JA0502AG Soap Dispenser - Auto

- Automatic gel or spray dispenser
- Infrared sensor touch free
- Refillable 1000ml bottle
- Easily converts to gel or spray dispenser
- Lockable
- Requires 6 x AA Batteries (Not included)
- Spare nozzles available:  
 JA0502G – Gel / JA0502S – Spray
- Spare bottle available: JA0502BA



### Code Description

JA0502MS Sanitizer Dispenser - Manual  
 JA0502MG Soap Dispenser - Manual

- Manual gel or spray dispenser
- Refillable 1000ml bottle
- Easily converts to gel or spray dispenser
- Lockable
- Includes spray nozzle
- Spare nozzles available:  
 JA0502G – Gel / JA0502S – Spray
- Spare bottle available: JA0502BM



## Dispenser Stainless Steel

### Code Description

JA0503AG Dispenser Automatic - Gel Pump  
 JA0503AS Dispenser Automatic - Spray Pump

- Automatic dispenser
- Mirror finish 304 stainless steel
- Infrared sensor, touch free
- Refillable 1000ml bottle
- Easily converts to gel or spray dispenser
- Lockable with keys
- Requires 6 x AA Batteries (Not included)
- Includes mounting screws & wall plugs



### Code Description

JA0503MG Dispenser Manual - Gel Pump  
 JA0503MS Dispenser Manual - Spray Pump

- Manual dispenser
- Mirror finish 304 stainless steel
- Easy push mechanism
- Refillable 1000ml bottle
- Easily converts to gel or spray dispenser
- Lockable with keys
- Includes mounting screws & wall plugs





## Janitorial Dustpan & Brush

**Code**    **Description**

JA0102    Janitorial Dustpan and Brush Set

- Light weight
- Ideal for soft and hard surfaces
- Quality fibre for effective sweeping
- Ergonomic handle for comfort while in use
- Rubber lip assists with the collection of dirt by ensuring contact between the dustpan & floor

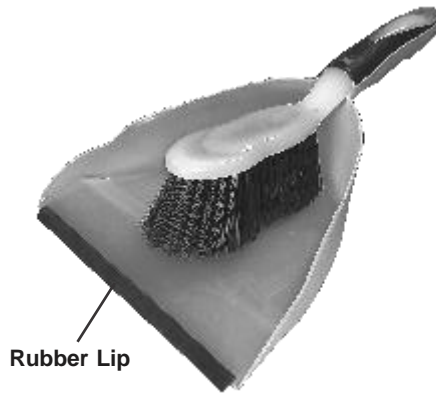

## Janitorial Bucket 14L

**Code**    **Description**

JA0702    Janitorial Bucket 14L

- Ergonomic carry handle
- Pour spout
- Strong durable design
- Rectangular shape, fits most standard mops and rollers
- **Ideal for use with:** JA0301 (Janitorial Mop PVA Double Roller)



Comfortable Carry Handle

**Code**    **Description**

JA0104    Janitorial Rubber Broom

**Features:**

- Ideal to sweep up dust, pet hair or liquids & around the pool side
- Durable 500G rubber head
- 300mm wide
- 1400mm handle



**Code**    **Description**

JA0101    Janitorial Soft Broom

**Features:**

- Light Weight
- 300mm Soft Head
- 1200mm Powder Coated Handle
- Quality fibre for effective sweeping



**Coming Soon**

# Janitorial Accessories

## Code Description

JA0103 Janitorial Yard Broom Hard Bristle - 450mm

### Features:

- 450mm plastic molded hard bristle broom
- Cushioned grip handle for additional comfort.
- 1200mm powder coated handle
- Light weight
- Weather & impact resistance
- Quality fibre for effective sweeping

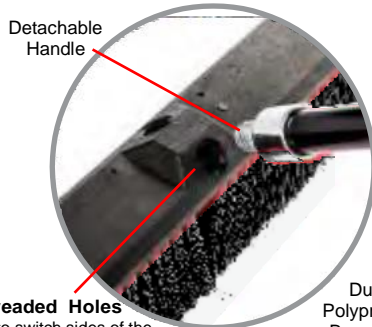

Durable Polypropylene Broom Head



## Code Description

JA0202 Janitorial Fan Mop - 400g

### Features:

- 400g Mop Head
- 100% Cotton
- 1200mm Aluminium Handle
- High Quality
- Super Absorbent

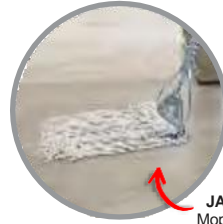

## Code Description

JA0301 Janitorial Mop PVA Double Roller

### Features:

- Double Roller Mechanism
- Super absorbent PVA sponge
- Retractable handle for ease of use
- Soft-grip handle

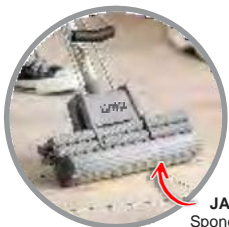

## Code Description

JA0204 Microfibre Floor Sweeper Mop

### Features:

- Lightweight high strength aluminium design
- Refillable on-board 600ml reservoir – add water and floor chemical of your choice.
- Fan shaped spray to easily wet and clean floors
- Swivel head for difficult to reach corners
- 2 x microfibre wash pads are included in JA0204
- Microfibre wash pads can be easily removed and are machine washable.





## Micro Fibre Cloth

### Code Description

JA0901 Janitorial Micro Fibre Cloth 280GSM (pack 5)

- Highly absorbent, machine washable cloth
- Removes grease and grime
- Safe on all surfaces
- 280GSM
- 300 X 300mm

**Coming Soon**



## Bubble Wrap

### Code Description

PM0100 Bubble Wrap

- Bubble wrap roll, perfect for protecting all sensitive and fragile items from breaking and scratching.
- 1250mm width
- 100 meter length





# Index

Abacus 100 Beads	42	Headphones - Wireless & Wired	96
Adaptors	103	Highlighters - Slimline	53
Acrylic Display holders	122-123	Highlighters - Chisel Tip	53
Aerosol Whiteboard Cleaner	48	Hospital Glass Board	118
Air-mouse Keyboard	93	In/Out Boards	40
A-Frame Boards - Aluminum Frame	31	Info Boards – Alufine Frame & Aluminium Frame	19-20
A-Frame Boards - Steel Frame	31	Installation	13
A-Frame Boards - Poster Frame	31	Interactive Touch LED Panels	78
Alufine Magnetic boards	5	Interactive Whiteboard System - IR Board	79
Board Supports - Easels & T-legs	28	Keystone Adjusters	87
Bulletin Boards - Aluminium Frame, Carpet	21	Laminator Consumables	67
Cables	103	Laminators	66
Cast Acrylic Planners	36	Laser Pointers	88
Ceiling Box	88	Lectern & Wireless Mic	98
Ceiling Mounting Bracket, Projectors Cage	83	LED Modular Display	104-105
Certificate Holder	121	Magnetic Label Carriers	46
Chalk & Chalk Holder	48	Magnetic Map Pins	46
Chalk Boards - Magnetic	9	Magnetic Photo Paper & Tape	45
Chalk Boards - Non Magnetic	9	Magnetic Ruler ACP	44
Clipboards	15	Media Cover	108
Comb Binding Machines	59-60	Megaphone	77
Combi Boards	22	Microphone USB	100
Craft Knives, Blades, Rotary	61	Mobile Bluetooth Speaker	95
Custom Products	34-35	Mobile / Revolving Boards	29
Data Projectors	82	Mops & Brooms	134-135
Dispensers - Auto & Manual	133	Moulded Magnets	45
Display Cases - Hinged Doors	23	Moulded Magnets - Extra Strength	45
Display Cases - Sliding Doors	23	Monitor Clamp Bracket	89
Drawing Pins & Push Pins	46	Office Equipment & Whiteboard Cleaner	48
Dusters	47	Paper Gripper, Multi Purpose	32
Dustpan & Brush	134	Pen and Eraser Holder Magnetic	47
Easy Rail System	32	Permanent Markers - Bullet Tip	50
Earphones - Wireless & Wired	95	Permanent Markers - Chisel Tip & Ultra Finline	50-51
Educational Boards - CKS Compliant	10-12	Perpetual Year Planners - Magnetic & Glass	37-38
Erasers & Aqua Wipe	47	Pin Boards, No Frame, Felt	18
Flexible Magnetic Strips & Shapes	44	Poster Frame Stand - Double Sided	109
Flexible Magnetic Sheeting	43	Poster Frames - Double-sided Upright	111
Flipchart Accessories - Flipchart Paper	27	Poster Frames - Mitred Econo, Mitred Corner, Plastic	106
Flipchart Paper Carrier	27	Poster Frames - Chrome Corner, Security Frame	107
Flipchart Carry Bag	27	Poster Frames - Window Frame & Magnetic Self Adhesive	107-108
Flipchart - Standard Models	24	Poster Frames - Hanging System	112
Flipchart Castors	25	Power Plugs	103
Floating Glass Whiteboard	5	Projectors	82
Glass Boards - Magnetic & Non Magnetic, Printed	6-8	Projector Screens - Screen Ratio	84
Glass/Chalkboard Markers	52	- Pulldown	85
Guillotines	63	- Tripod	86
Graphic Tablet Wired	92	- Electric	87

# Our Added Value to you

Projector Trolleys	84
Punches	74-75
Push Pins & Drawing Pins	46
Refillable Bottles	132
Retractable Q-Barrier System	128
Rotary Trimmers	64-65
Safety Signs	117
Sanitizers	130
Shredder Comparisons	58
Shredders	54-57
Splashbacks - Kitchen, Bathroom, Glass Wall Art	119-120
Signage - Flush Wall Signs	113-114
Signage - Double Sided Wall Signs	116
Signage - Landscape & Portrait Desk Signs	116
Signage - Double Sided Standing Signs	115
Signage - Ceiling Mounts	124
Signage - Modular Mounting System	125-126
Signage - Glass Cube Display Stand	127
Slimline Whiteboards - Non Magnetic and Magnetic	1-2
Speaker Sound Bar	93-94
Staple Remover	73
Staplers	68-72
Staples	73
Surface Mounted In/Out Slides	39
T-Legs	28
Tripods - Mini, Econo & Deluxe	90
Video Conference Camera	99
Visualizers	101
Vinyl Lettering / Vinyl Lining Tape	43
Webcam	100
Whiteboard Magnetic Eraser	47
Whiteboard Cleaner	48
Whiteboard Markers - Bullet Tip	49
Whiteboard Markers - Slimline Tip	49
Whiteboard Starter Packs	48
Whiteboards - Magnetic	4
Whiteboards - Non-Magnetic	3
Whiteboards - Mini Tiles Magnetic	17
Wireless Presentation Unit	101
Wooden Frames	41
Write 'n Wipe, Flexi-Mag	17
Writing Slates - Chalk Board, Whiteboard, Plastic & LCD	14-16



## PRE-SALES

- Free consultations
- Free demo & training sessions
- Free site inspections

01



## IN-SALES

- Distribution
- Installation
- Commissioning

02



## AFTER-SALES

- Training
- Remote and on-site support & ongoing consultations

03

