

# PRO-MED



Magen, Darm, Rectum  
Leber, Galle, Niere  
Urologie  
Gynäkologie, Geburtshilfe

Stomach, Intestines, Rectum  
Liver, Gall, Kidney  
Urology  
Gynecology, Obstetrics

Estomac, Intestines, Rectum  
Foie, Bile, Reins  
Urologie  
Gynécologie, Accouchement

Estómago, Intestinos, Recto  
Hígado, Bilis, Riñón  
Urología  
Ginecología, Obstetricia

Stomaco, Intestini, Retto  
Fegato, Bile, Reni  
Urologia  
Ginecologia, Ostetricia

# PRO-MED

Dieser Katalog bleibt unser ausschließliches Eigentum.  
Unsere „Allgemeinen Lieferungs- und Zahlungsbedingungen“ finden Sie auf unserer Internetseite  
[www.pro-med-tut.com](http://www.pro-med-tut.com)  
Nachdruck, auch auszugsweise, ist ohne unser schriftliches Einverständnis verboten.

This catalogue remains our exclusive property.  
Our “General Terms of Sale and Payment” may be found on our homepage  
[www.pro-med-tut.com](http://www.pro-med-tut.com)  
Reprinting, even partially, is prohibited without our written consent.

Ce catalogue est exclusivement notre propriété.  
Nos “Conditions générales du vente et de paiement” sont mentionnées sur l’Internet à  
[www.pro-med-tut.com](http://www.pro-med-tut.com)  
Toute representation ou reproduction intégrale ou partielle – faite sans l’autorisation écrite de la Société **PRO-MED** est interdite.

Este catálogo es exclusivamente de nuestra propiedad.  
Nuestros condiciones generales de venta y de pago se encuentran en nuestra página Internet  
[www.pro-med-tut.com](http://www.pro-med-tut.com)  
Reimpresión, aunque sea parcialmente, queda terminantemente prohibida.

Il presente catalogo rimane di nostra proprietà.  
Le nostre condizioni di vendita e di pagamento le trovo sul nostro sito Internet  
[www.pro-med-tut.com](http://www.pro-med-tut.com)  
La riproduzione del catalogo è proibita.

Modelländerungen vorbehalten  
Patterns are subject to change.  
Tous droits réservés des changements de modèle.  
Salvo modificaciones.  
Ci riserviamo la facoltà di cambiamenti nei modelli





**PRO-MED**

INSTRUMENTE GMBH

## **INT / URO / GYN / OB**

**Garantierte Qualitätsinstrumente**

**Guaranteed Quality Instruments**

**Instrumente de Chirurgie de qualité garantie**

**Instrumentos de Calidad con garantia**

**Strumenti di chirurgia con qualità garantita**

**PRO-MED**

Instrumente GmbH  
Gänsäcker 9  
D-78532 TUTTLINGEN  
Germany

Telephone +49(0) 74 62 / 20 42 40  
Telefax +49(0) 74 62 / 20 42 49 0  
E-Mail [pro-med-tut@t-online.de](mailto:pro-med-tut@t-online.de)  
Internet [www.pro-med-tut.com](http://www.pro-med-tut.com)

# PRO-MED

Qualität ist eine Frage des  
Anspruchs ...

Quality is a question of demand ...

La qualité est une question  
d'exigence ...

Calidad es la pregunta de  
pretension ...

Qualità è una domanda di pretesa...

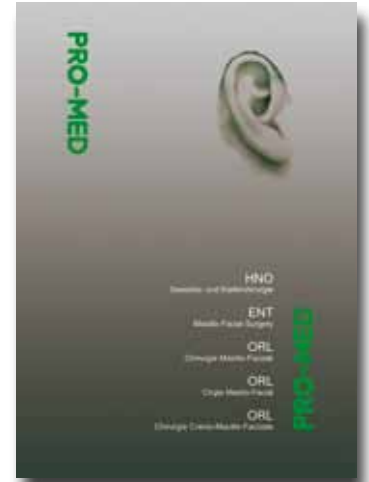
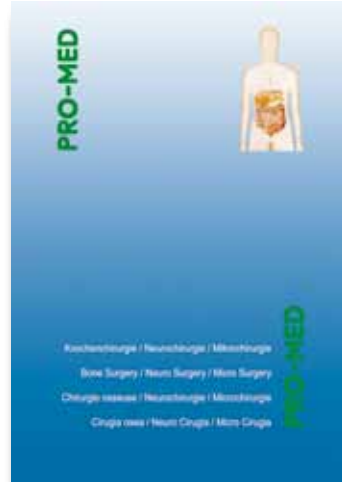
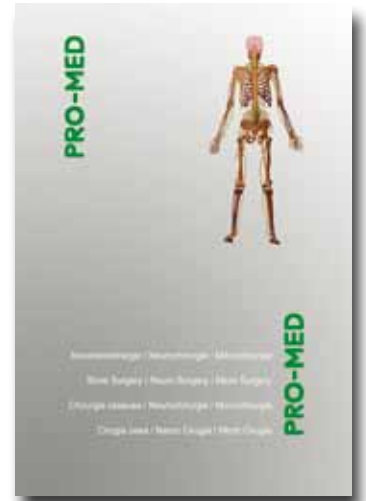
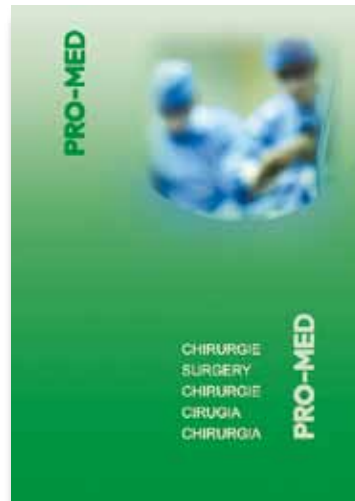

Unsere Kataloge  
Our Catalogs  
Nos catalogues  
Nuestros catálogos  
I nostri cataloghi

Chirurgie / Surgery / Chirurgie / Cirugia / Chirurgia  
Ortho / Neuro / Micro  
Thorax / Cardiovascular  
INT / URO / GYN / OB  
HNO / ENT / ORL





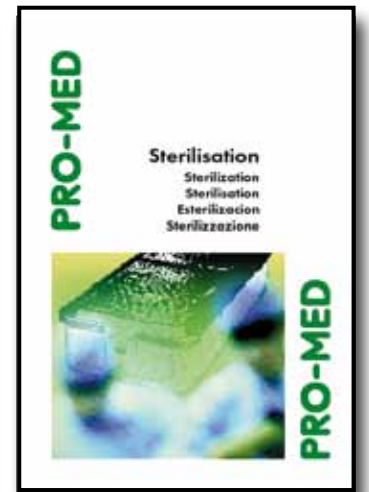





Bariatrische Chirurgie / Bariatric Surgery / Chirurgie bariatrique /  
Cirugia Bariátrica / Chirurgia Bariátrica

Sterilisation / Sterilization / Stérilisation / Esterilización / Sterilizzazione







**ÜBERSICHTSTAFEL  
SECTION INDEX  
SOMMAIRE  
CONTENU  
INDICE DI CATALOGO**

**SEITE  
PAGE  
PAGE  
PAGINA  
PAGINA**

<p>DIAGNOSTIK DIAGNOSTICS DIAGNOSTIC DOAGNOSTICO DIAGNOSTICA</p>		7-15,195-198
<p>VERGLEICH SINSTRUMENTE COMPARING INSTRUMENTS INSTRUMENTS A COMPARISON INSTRUMENTOS PARA COMPARICION STRUMENTI DI PARAGONE</p>		17-20
<p>VORBEREITUNG, DERMATOLOGIE, HYGIENE PREPARATION, DERMATOLOGY, HYGIENE PREPARATION, DERMATOLOGIE, HYGIENE PREPARACION, DERMATOLOGIA, HIGIENE PREPARAZIONE, DERMATOLOGIA, IGIENE</p>		21-24
<p>MAGEN, DARM, MASTDARM STOMACH, INTESTINES, RECTUM ESTOMAC, INTESTINS, RECTUM ESTOMAGO, INTESTINOS, RECTO STOMACO, INTESTINI, RETTO</p>		25-71
<p>GALLE, LEBER, NIERE GALL, LIVER, KIDNEY BILE, FOIE, REIN BILIS, HIGADO, RINON BILE, REGATO, RENE</p>		73-92
<p>UROLOGIE UROLOGY UROLOGIE ROLOGIA UROLOGIA</p>		93-104
<p>GYNÄKOLOGIE GYNECOLOGY GYNECOLOGIE GINECOLOGIA GINECOLOGIA</p>		105-173
<p>GEBURTSHILFE OBSTETRICS OBSTETRIQUE OBSTETRICIA OSTETRICIA</p>		175-191
<p>ALLGEMEINE INSTRUMENTE GENERAL INSTRUMENTS INSTRUMENTS GENERAUC INSTRUMENTOS GENERALES STRUMENTI GENERALI</p>		193-371
<p>SKALPELLGRIFFE, KLINGEN SCALPEL BLADES, HANDLES LAMES DE BISTOURIS, MANCHES HOJAS DE BISTURIS, MANGOS LAME PER BISTURI, MANICI</p>		199-205
<p>SCHEREN SCISSORS CISEAUX TIJERAS FORBICI</p>		207-232

**ÜBERSICHTSTAFEL  
SECTION INDEX  
SOMMAIRE  
CONTENU  
INDICE DI CATALOGO**

**SEITE  
PAGE  
PAGE  
PAGINA  
PAGINA**

PINZETTEN FORCEPS PINCES PINZAS PINZETTEN		233-266
ARTERIENKLEMMEN HEMOSTATIC FORCEPS PINCES HEMOSTATIQUES PINZAS HEMOSTATICAS PINZE EMOSTATICHE		267-293
TUCHKLEMMEN, SCHLAUCHKLEMMEN, TUPERZANGEN TOWEL- AND TUBING CLAMPS, DRESSING- AND SPONGE FORCEPS PINCES A CHAMPS, PRESSE-TUBES, ET TAMPONS PINZAS DE CAMPO, PARA TUBOS Y TAMPONES PINZE FISSATELLI, PINZE SERRATUBI, PINZE PER TAMPONI		295-304
WUNDHAKEN RETRACTORS ECARTEURS SEPARADORES DIVARICATORI		305-317
WUNDSPREIZER SELF-RETAINING RETRACTORS ECARTEURS AUTOSTATIQUES SEPARADORES AUTOSTATICOS DIVARICATORI AUTOSTATICI		319-341
NAHT SUTURE SUTURE SUTURA SUTURA		343-361
SONDEN, SAUGROHRE, TROKARE PROBES, ASPIRATION, TROCARS STYLETS, ASPIRATION, TROCARTS ESTILETES, ASPIRACION, TROCARES SPECILLI, ASPIRAZIONE, TREQUARTI		363-371
STERILISATION, VERSCHIEDENES STERILIZATION, MISCELLANEOUS STERILISATION, ARTICLES DIVERS ESTERILIZACION, DIVERSOS ARTICULOS STERILIZZAZIONE, DIVERSOS ARTICOLI		373-395
ALPHABEBISCHER INDEX ALPHABETICAL INDEX INDEX ALPHABETIQUE INDICE ALFABETICO INDICE ALFABETICO		397-435
NUMERISCHER INDEX NUMERICAL INDEX INDEX NUMERIQUE IINDICE NUMERICO INDICE NUMERICO		437-448

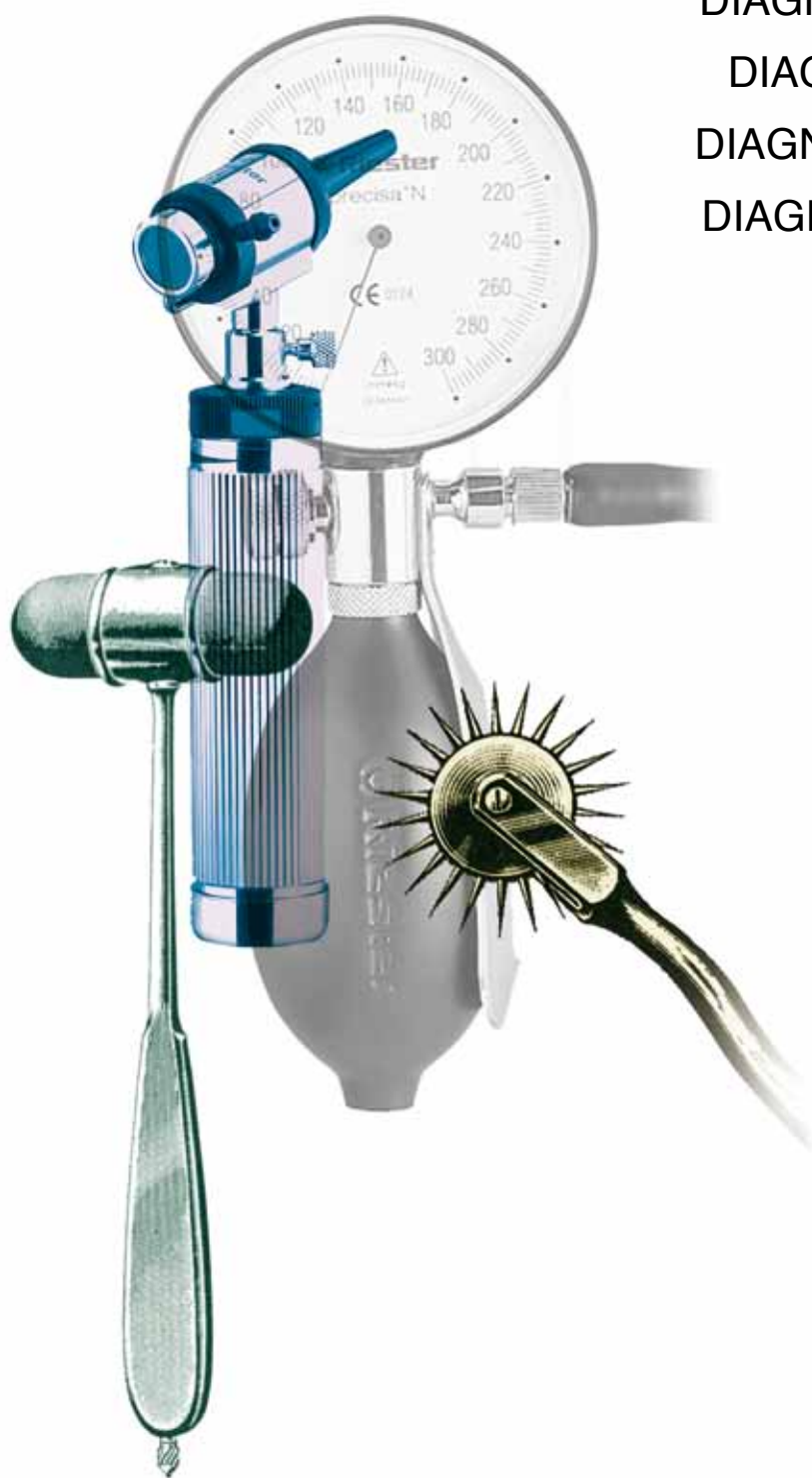

DIAGNOSTIK  
DIAGNOSTICS  
DIAGNOSTIC  
DIAGNÓSTICO  
DIAGNOSTICA





Blutdruckmesser  
Blood Pressure Manometers  
Tensiomètres  
Sfigmanometros  
Sfigmanometri



## 10.0010 NOVA-PRESAMETER

Quecksilbergerät in Metalletui. Skala bis 300 mm Hg. Fehlertoleranz: +/- 3 mm Hg. Kalibrierte Velcromanschette mit Latexpolster 2-Schlauch.

Mercurial sphygmomanometer in metal case. Graduated scale; maximum reading 300 mm Hg. Maximum error throughout range +/- 3 mm Hg. Calibrated nylon velcro cuff with 2-tube latex bladder.

Appareil à colonne de mercure en boîtier métallique. Echelle anodisée jusqu'à 300 mm Hg. Tolérance maximale +/- 3 mm Hg. Avec brassard nylon-velcro, calibré, et vessie latex à 2 tubes.

Tensiómetro de mercurio en estuche metálico. Escala anodizada hasta 300 mm Hg. Tolerancia max +/- 3 mm Hg. Brazaletes velcro de nilon, calibrado, con bolsa latex de 2 tubos

Sfigmanometro in astuccio metallo, Scala 0 - 300 mmHg. Tolleranza +/- 3 mmHg. Bracciale calibrato velcro-nylon di camera d'aria di latex a 2-tubi.



## 10.0020 PRECISA N

Manometer-Blutdruckmessgerät; ergonomischer Löffelgriff; Lineare Skale 0 - 300 mm Hg; maximale Fehlertoleranz +/- 3 mmHg

Blood Pressure Manometer; Ergonomic spoon-shaped grip; linear, tilted aluminum scale from 0 to 300 mm Hg; max. error tolerance +/- 3 mmHg

Tensiomètre à cadran; poignée-cuiller ergonomique; graduation linéaire inclinée, de 0 à 300 mm Hg; tolérance max. d'erreur +/- 3 mmHg

Tensiómetro aneroides; Mango de cuchara ergonómico; Escala de aluminio lineal, inclinada, 0 - 300 mmHg; Máxima tolerancia de error de +/- 3 mmHg

Sfigmanometro moderno e economico. Scala 0 - 300 mmHg, 53 mm Ø. Valore massimo 300 mmHg. Tolleranza +/- 3 mmHg. Bracciale calibrato velcro-nylon di camera d'aria di latex a 1 tubo

Blutdruckmesser  
Blood Pressure Manometers  
Tensiomètres  
Sfigmanómetros  
Sfigmanometri



#### 10.0030 MINIMUS II

Einhandmodell in Vinyltasche mit Reißverschluss. Keine Nullpunktfixierung. Gut ablesbare Aluminiumskala Ø 49 mm bis 300 mm Hg. Maximale Fehlertoleranz +/- 3 mm Hg. Mit kalibrierter Nylon-Velcromanschette komplett mit Latexpolster 1-Schlauch.

Palm-style sphygmomanometer in vinyl zipper case. Graduated aluminum scale Ø 49 mm. Maximum reading 300 mm Hg. Maximum error +/- 3 mm Hg. With calibrated nylon-velcro cuff and 1-tube latex bladder.

Manopoire en étui vinyl avec fermeture éclair. Echelle Ø 49 mm jusqu'à 300 mm Hg. Tolérance maximale +/- 3 mm Hg. Avec brassard nylon-velcro calibré, et vessie latex à 1 tube.

Modelo de mano. Lectura de la escala Ø 49 mm hasta 300 mm Hg. Tolerancia max. +/- 3 mm Hg. Brazaletes velcro de nilón, calibrado; cámara d'aria de latex ad 1 tubo.

Sfigmanometro ad aneroide in borsa vinilpelle con cerniera lampo. Senza fissaggio a zero. Scala graduata in alluminio 49 mm Ø, 0 - 300 mmHg. Tolleranza +/- 3 mmHg. Bracciale calibrato velcro-nylon di camera d'aria di latex a 1 tubo



#### 10.0040 EXACTA

Hochleistungs-Blutdruckmessgerät in 2-Schlauch-Ausführung. Lineare Skala Ø 40 mm, von 0 - 300 mm Hg; max. Fehlertoleranz +/- 3 mmHg

High quality Sphygmomanometer in a 2-tube version; Linear scale Ø 49 mm, 0 - 300 mmHg; Max. error tolerance +/- 3 mmHg

Tensiomètre à cadran de haute qualité à 2 tubes; Graduation linéaire, Ø 49 mm de 0 à 300 mmHg; tolérance max. d'erreur de +/- 3 mmHg

Tensiómetro de precisión de alta calidad, con 2 tubos; Escala lineal Ø 49 mm, 0 - 300 mmHg; Máxima tolerancia de error de +/- 3 mmHg

Sfigmanometro di alta prestazione. Scasla lineare 0 - 300 mmHg, 49 mm Ø. Tolleranza +/- 3 mmHg. Bracciale calibrato velcro-nylon di camera d'aria di latex a 2 tubi



kalibrierte Nylon-Velcromanschetten, 2-Schlauch  
Calibrated nylon-velcro cuffs 2-tube  
Brassards nylon-velcro calibré avec 2-tubes  
Brazeletes velcro de nilón con 2 tubos  
Bracciali velcro solo a 2 tubi

**10.0080**

für Erwachsene / for adults / pour adultes / para adultos / per adulti

**10.0081**

für Erwachsene (dünne Arme) / for adults (thin arms) / pour adultes (bras minces) / para adultos (brazos delgados) per adulti (braccie fine)

**10.0082**

für Oberschenkel /for femur / pour fémur / para muslo / per coscie

**10.0083**

für Neugeborene / for newborn / p. nouveaux-nés / p. racien nacidas / per neonato

**10.0084**

für Säuglinge / for Infants / pour bébés / p. lactantes / per lattante

**10.0085**

für Kinder / for children / pour enfants / para niños / per bambini

kalibrierte Nylon-Velcromanschetten, 1-Schlauch  
Calibrated nylon-velcro cuffs 1-tube  
Brassards nylon-velcro calibré avec 1-tube  
Brazeletes velcro de nilón con 1 tubo  
Bracciali velcro solo a 1 tubo

**10.0090**

für Erwachsene / for adults / pour adultes / para adultos / per adulti

**10.0091**

für Erwachsene (dünne Arme) / for adults (thin arms) / pour adultes (bras minces) / para adultos (brazos delgados) per adulti (braccie fine)

**10.0092**

für Oberschenkel /for femur / pour fémur / para muslo / per coscie

**10.0094**

für Neugeborene / for newborn / p. nouveaux-nés / p. racien nacidas / per neonato

**10.0095**

für Kinder / for children / pour enfants / para niños / per bambini

Stethoskope  
Stethoscopes  
Stéthoscopes  
Estetoscopios  
Stetoscopi



aus Aluminium  
of aluminium  
de aluminium  
de aluminio  
in alluminio

**PINARD**  
**10.0400**  
15 cm

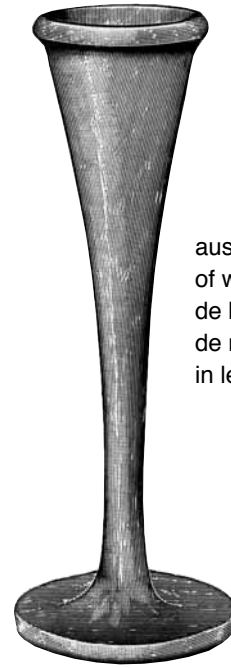

aus Holz  
of wood  
de bois  
de madera  
in legno

**PINARD**  
**10.0410**  
18 cm



**DUPLEX**  
**10.0460**



**DUPLEX DE LUXE**  
**10.0462**

<b>OCULUS Binokulare Kopflupe</b> <b>OCULUS Binocular Magnifying Loupe</b> <b>OCULUS Loupe binoculaire frontale</b> <b>OCULUS Lupa frontal binocular</b> <b>OCULUS Lente binoccolare frontale</b>	Vergrößerung magnification grossissement aumento Ingrandimento	Arbeitsabstand working distance distance de travail distancia de trabajo distanza di osservazione	Arbeitsfeld working field champ visuel campo de visión campo visivo
 <p><b>28.7050 OCULUS</b> Lupenbrille mit Gestell / binocular loupe with frame loupe binoculaire avec monture / lupa binocular con montura/ Occhiali a lenti binoculari</p>	1,8X	370 mm	90 mm
 <p><b>28.7055 OCULUS</b> Lupe allein / magnifying loupe only loupe seule / lente de aumento suelta / Lente sola</p>	1,8X	370 mm	90 mm
<p><b>28.7057 OCULUS</b> Vorsatzobjektive 2,0X zur Montage an 1,8X slip-on objectives to increase 1,8X to 2,0X loupes additionnelles de 1,8X à 2,0X lentes adicionales de 1,8X a 2,0X 2 lenti addizionali, ingrandimento 2,0 x</p> 	2,0X	220 mm	50 mm
<p><b>28.7058 OCULUS</b> Vorsatzobjektive 2,5X zur Montage an 1,8X slip-on objectives to increase 1,8X to 2,5X loupes additionnelles de 1,8X à 2,5X lentes adicionales de 1,8X a 2,5X 2 lenti addizionali, ingrandimento 2,5 x</p> 	2,5X	180 mm	45 mm
<p><b>28.7059 OCULUS</b> Etui alleine / case only / etui seule / estuche suelto / Astucchio solo</p>			

Stirnspiegel und -lampen  
 Head Mirrors and Lights  
 Mirrors frontaux  
 Espejos frontales  
 Specchi frontali



**ZIEGLER**  
**10.0700**  
 compl.



**ZIEGLER**  
**10.0709**



**10.0707**

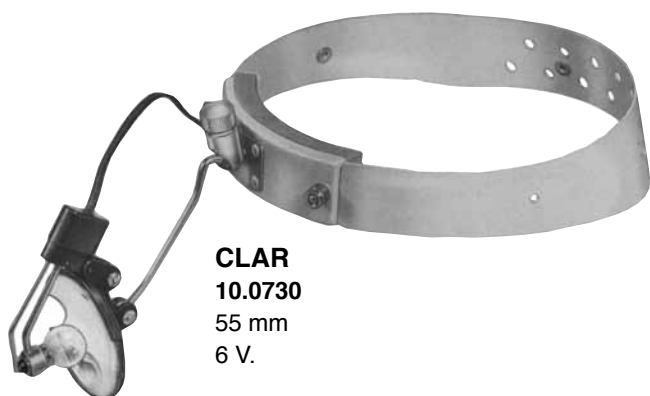

**CLAR**  
**10.0730**  
 55 mm  
 6 V.

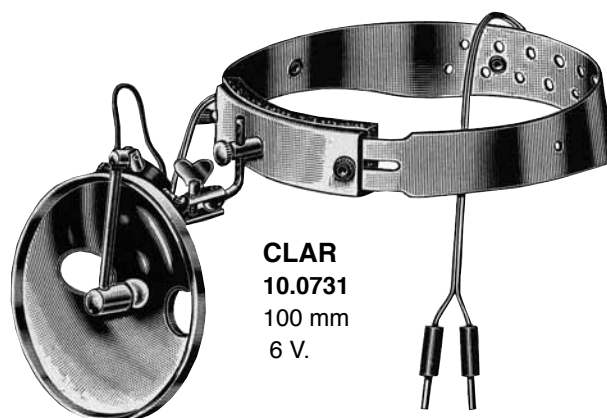

**CLAR**  
**10.0731**  
 100 mm  
 6 V.

Klein-Transformator 220 Volt, stufenlos regulierbar von 0-10 Volt  
 Mini-Transformer 220 Volts, infinitely variable from 0-10 Volts  
 Transformateur, petit modèle, de 220 Volts, réglable sans paliers de 0 à 10 Volts  
 Transformador pequeño 220 voltios, con regulación continua de 0 a 10 voltios  
 Trasformatore piccolo, 220 Volt, regolazione continua da 0 a 10 Volt



**CLAR**  
**10.0737**



**CLAR**  
**10.0739** 6 V.



**10.0750**



**10.0760**  
FOCUS Halogen-Stirnlampe 220 V.  
Halogen-Headlight 230 V.  
Lampe frontale halogène 230 V.  
Lámpara frontal halógeno 230 V.  
lampada frontale alogena, 230 V.



**10.0762**  
FOCUS Lampenkopf mit Sockel und Halogenlampe  
Lamp head with quick lock and halogen light  
Tête de lampe avec socle et lampe halogène  
Cabeza de lámpara con zócalo y lámpara de halógeno  
Testa de lampada con base e lampada alogena

**10.0761**  
FOCUS Stirnband mit Kabel  
Headband with cable  
Bandeau frontal avec cordon d'alimentation  
Cinta de frente con cable  
Fascia frontale con cavo

**10.0763**  
FOCUS Trafo m.Kabel u.Stufenschalter 230 V  
Plug-in charger with cable and switch 230 V  
Transformateur avec cordon d'alimentation et commutateur  
pas-en-pàs 230 V.  
Transformador con cable y conmutador de dos posiciones 230 V.  
Transformatore con cavo e interruttore di 2 regolazioni 230 V.

**10.0769**  
FOCUS Halogen Ersatzlampe 8 V. für Stirnlampe  
Halogen Spare bulb 8 V. for headlight  
Lampe de rechange halogène 8 V. pour lampe frontal  
Lámpara de repuesto halógeno 8 V. para lampara frontal  
Lampadina di ricambio 8 V. per lampada frontale

**10.0790**  
CLAR Stirnspiegel Ø 33 mm KALTLICHT mitverstellbarem  
Kopfband , 220 cm Lichtkabel, Anschlüsse for Wolf & Storz  
CLAR Headmirror Ø 33 mm FIBER OPTIC with adjustable  
headband, 220 cm Fibre Optic cable and Wolf & Storz  
connectors  
CLAR Miroir frontal Ø 33 mm à lumière froide avec bandeau  
frontal, 220cm câble à lumière froide, connecteurs Wolf &  
Storz,  
CLAR Espejo frontal Ø 33 mm luz fria con cinta ajustable, 220  
cm cable luz fria, connexion Wolf & Storz  
CLAR Specchio frontale Ø 33mm LUCE FREDO con fascia  
regolabile, 220 cm cavo conduttore, arracco Wolf & Storz



**10.2000**  
Kaltlichtquelle Halogen HL 150W, 230 V, B 175 x H 82,5 x T 202mm.  
Schutzklasse BF  
Halogen Cold Light Projector HL 150, 230V, Size 175 x 82,5 x 202mm,  
Protective Class BF  
Dispositif à lumière froide Halogène, HL 150W, 230 V, 175 x 82,5 x 202mm;  
Classe de protection BF  
Proyector halógeno de luz fria HL 150W 230 V, 175 x 82,5 x 202mm,  
Clase de protección BF  
Proiettore Luce Fredda Alogeno HL 150W 230 V.; 175 x 82,5 202 mm;  
classificazione di protezione BF







VERGLEICHSTRUMENTE  
COMPARING INSTRUMENTS  
INSTRUMENTS A COMPARISON  
INSTRUMENTOS PARA COMPARACION  
STRUMENTI DI PARAGONE





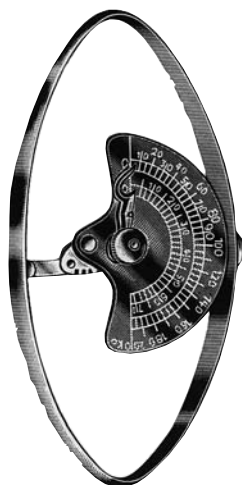

**COLLIN**  
**10.0300**

Dynamometer  
Dynamometer  
Dynamomètre  
Dinamómetro  
Dinamometro



**10.0331**   **10.0322**   **10.0333**   **10.0334**   **10.0335**  
10 cm / 4"   15 cm / 6"   20 cm / 8"   30 cm / 12"   50 cm / 20"

Metal-Maßstäbe / Metal Rulers /  
Règles, en métal / Reglas de metal /  
Reguli di acciaio



Maßband, Leinen  
Tape measure, Linen  
Ruban métrique en toile  
Cinta métrica de tela  
Nastro metrico di tela  
**10.0350**  
1,5 m

Maßband, Stahl  
Tape measure, steel  
Ruban métrique en acier  
Cinta métrica de acero  
Nastro metrico metallico  
**10.0352**  
2 m

Beckenzirkel  
Pevimeters  
Pelvimètres  
Pelvimetros  
Pelvimetri



**MARTIN**  
**56.0010**

30 cm  
cm/Zoll-Skala / cm/inch scale /  
échelle en cm/pouces / escala en  
cm/pulg. / scala in cm/pollici



**COLLIER**  
**56.0020**

30 cm  
cm/Zoll-Skala / cm/inch scale /  
échelle en cm / pouces / escala  
en cm/pulg. / scala in cm/pollici

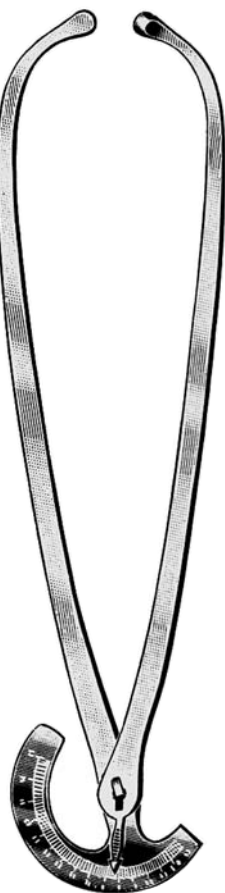

**COLLIN**  
**56.0030**

35 cm  
cm Skala / cm scale / échelle en  
cm / escala en cm / scala in cm

VORBEREITUNG, DERMATOLOGIE  
PREPARATION, DERMATOLOGY  
PREPARATION, DERMATOLOGIE  
PREPARACION, DERMATOLOGIA  
PREPARAZIONE, DERMATOLOGIA





Maniküre, Pedicure / Manicure, Pedicure / Manicure, Pédicure / Manicura, Pedicura / Manicure, Pedicure

Nagelzangen / Nail Nippers / Pinces à ongles / Pinzas corta-uñas / Tonchesine per unghie 14 cm



**58.0501**  
14 cm



**TURNBULL**  
**58.0520** 11,5 cm  
**58.0522** 13,5 cm



**58.0530**  
14 cm

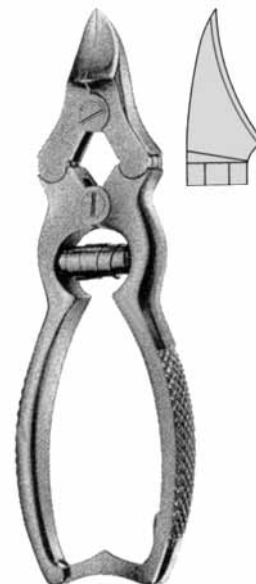

**58.0540**  
15 cm



**58.0550**  
13 cm



**LITTAUER**  
**58.0551** 11 cm  
**58.0553** 13 cm  
**58.0555** 15 cm

Nagelhaut- und Nagelscheren / Cuticle- and Nail Scissors /  
 Ciseaux à envies et à ongles / Tijeras cuticulares y para uñas /  
 Forbici per la cuticula e unghie

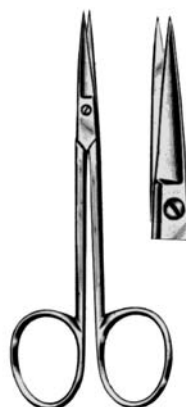

**58.0600**  
10 cm



**58.0601**  
10 cm

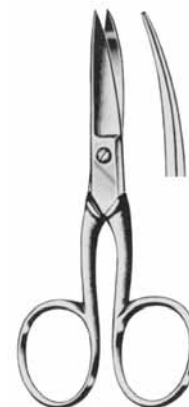

**58.0621**  
10 cm



Schwesterngarnitur / Nurses' Set /  
Etui pour infirmières / Surtido para enfermeras /  
Necessario per infermiera

Nagelfeilen / Nail-files / Limes à ongles / Limas de uñas / Lime per le unghie



58.0700



58.0710  
10 cm



58.0712  
12 cm



58.0715  
15 cm

Bürstenspender für 20 Bürsten / Dispensers for 20 brushes /  
Distributeurs pour 20 brosses / Dispensadores para 20 cepillos  
/ Dispenser per 20 spazzole

Handwaschbürste / Nail Brush / Brosse à main /  
Cepillo a mano / Spazzola a mano



- 58.1000 SILBER / SILVER / ARGENTE / PLATEADO / ARGENTEO
- 58.1001 BLAU / BLUE / BLEU / AZUL / AZZURO
- 58.1002 ROT / RED / ROUGE / ROJO / ROSSO
- 58.1003 GRÜN / GREEN / VERT / VERDE / VERDE
- 58.1004 GOLD / GOLD / DORE / DORADO / D'ORO



58.1040

MAGEN, DARM, MASTDARM  
STOMACH, INTESTINES, RECTUM  
ESTOMAC, INTESTINS, RECTUM  
ESTÓMAGO, INTESTINOS, RECTO  
STOMACO, INTESTINI, RETTO



Empfohlene Operationsbestecke für den Bereich "MAGEN, DARM, MASTDARM"  
(Details erhalten Sie über Ihren Fachhändler)

Suggested Instrument Sets for „STOMACH, INTESTINES, RECTUM“  
(Please ask your dealer for details)

Suggestions de boîtes opératoires pour le secteur „ESTOMAC, INTESTINS, RECTUM“.  
(Pour plus de détails veuillez contacter votre distributeur.)

Cajas quirurgicas para "ESTOMAGO, INTESTINOS, RECTO" (para detalles póngase en contacto con su distribuidor)

Strumentari raccomandati per "LO STOMACO, L'INTESTINALE, L'INTESTINO RETTO"  
(Per ulteriori informazioni, vi preghiamo di contattare il Vostro rivenditore)

**SET 48.0100** Gastrointestinal Operating Set

**SET 48.0200** Gastrectomy Set

**SET 48.0300** Intestinal Operating Set

**SET 48.0400** Colostomy Set

**SET 48.0500** Perineal Resection Set

**SET 48.0600** Vagotomy Set

**SET 48.1000** Major Rectal Instrument Set

**SET 48.1200** Anal Set

**SET 48.2000** Proctology Set

**SET 48.2100** Haemorrhoidectomy Set

**SET 48.2200** Rubber Band Ligation Set

**SET 48.2300** Anal Fistulectomy Set

**SET 48.2400** Pilonidal Cyst Excision Set

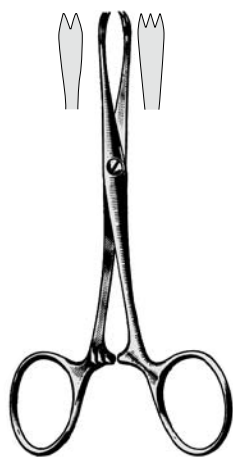

**CHAPUT**  
 15.1200 12 cm



**TUFFIER**  
 15.1204 13 cm



**15.1270**  
 15,5 cm



**15.1272**  
 20 cm



**PENNINGTON**  
 15.1300 15 cm  
 15.1302 20 cm



**ALLIS-BABY**  
 48.0004 13 cm, 4 x 5  
 48.0006 14 cm, 4 x 5

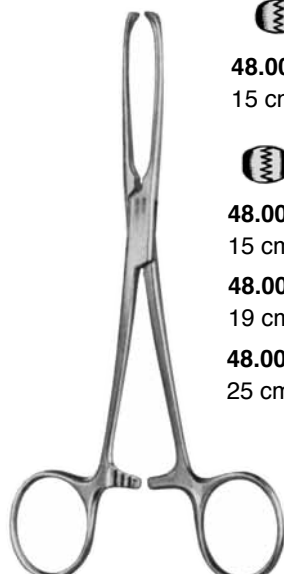

**ALLIS**

  
**48.0010**  
 15 cm, 4 x 5

  
**48.0011**  
 15 cm, 5 x 6

**48.0014**  
 19 cm, 5 x 6

**48.0016**  
 25 cm, 5 x 6

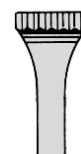

**ALLIS**  
 48.0019 36 cm, 5 x 6

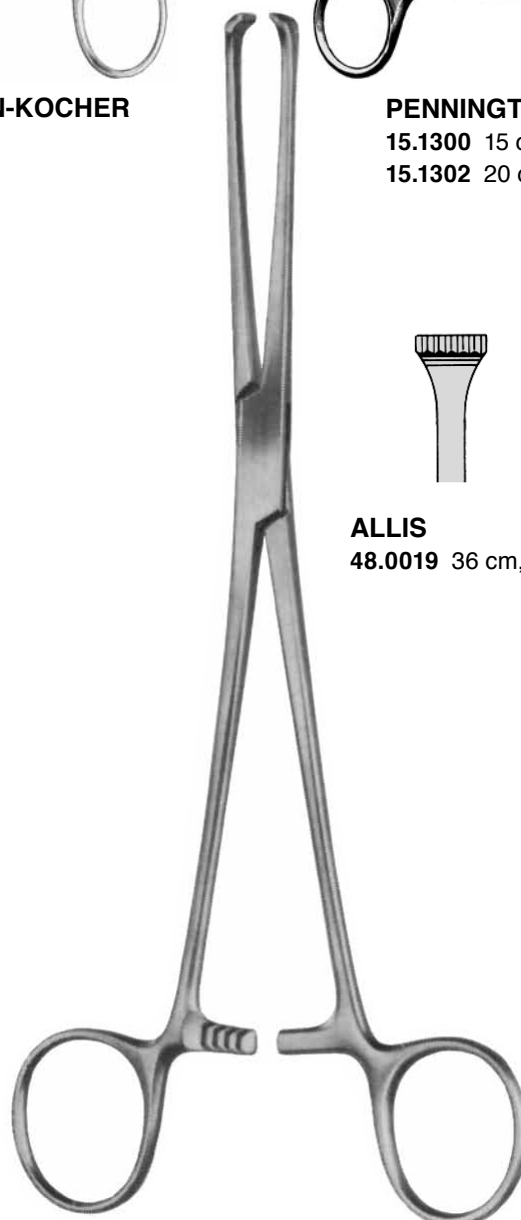

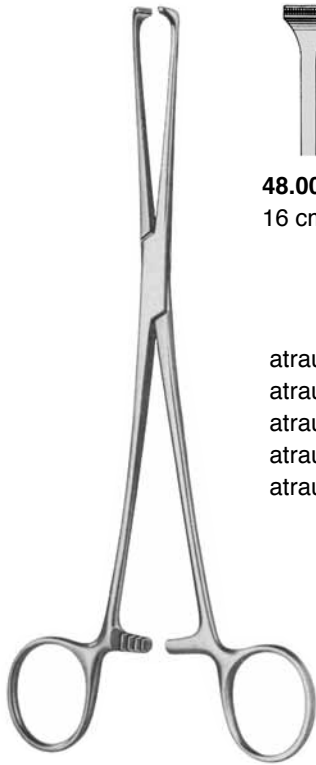

**ALLIS**



**48.0020**  
16 cm



**48.0024**  
20 cm



**48.0028**  
25 cm



**48.0029**  
30 cm

atraumatisch  
 atraumatic  
 atraumatique  
 atraumática  
 atraumatiche



**ALLIS-ADAIR**  
48.0030 15,5 cm



**JUDD-ALLIS**  
48.0032 15 cm  
48.0034 19 cm  
3 x 4

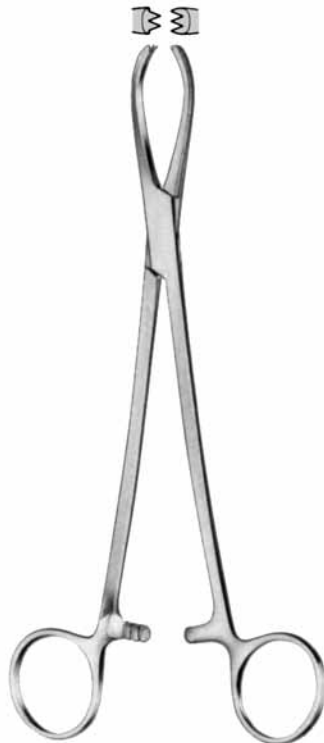

**LITTLEWOOD**  
48.0035 19 cm  
2 x 3



**BOYS-ALLIS**  
48.0036 15 cm



**THOMS-ALLIS**  
48.0038 20 cm  
6 x 7



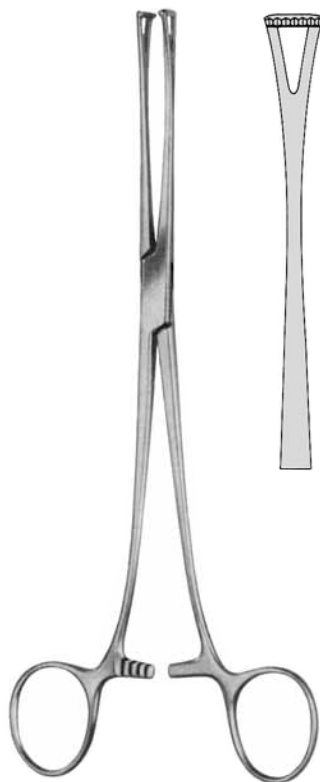

**LOCKWOOD**  
 48.0040 19,5 cm

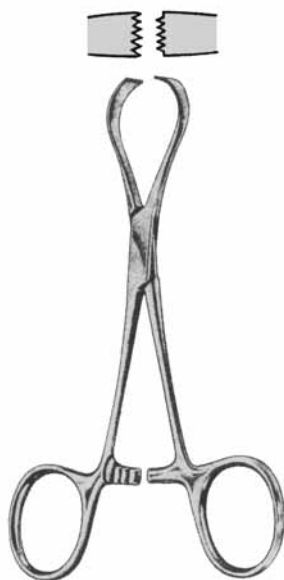

**OMBREDANNE**  
 48.0050 13,5 cm



**WILLIAMS**  
 48.0045 16,5 cm



**BABCOCK**  
 48.0062 16 cm



**48.0064**  
 18 cm



**48.0066**  
 20 cm

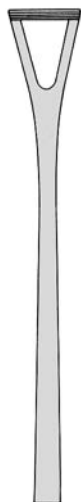

**48.0068**  
 24 cm

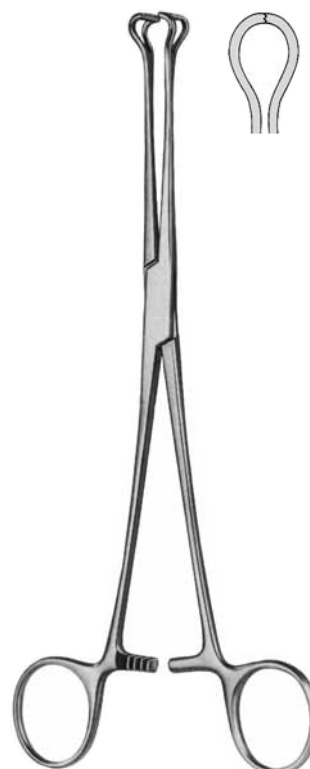

**BABCOCK-DEBAKEY**  
 48.0069 36 cm

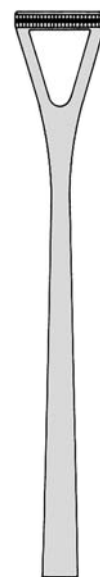



**BABCOCK**



**48.0072**  
16 cm

**48.0074**  
18 cm



**48.0076**  
20 cm

**48.0078**  
24 cm

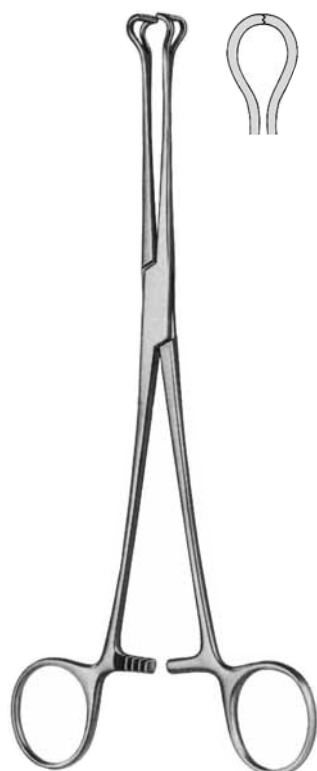

**BABCOCK-DEBAKEY**



**48.0082**  
16 cm



**48.0086**  
20 cm

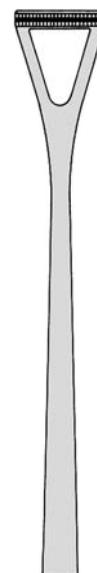

**48.0088**  
23 cm



**COLLIN**  
**48.0089**  
 14 cm



**DUVAL**



**48.0090**  
 18 cm / 14 mm  
**48.0092**  
 20 cm / 14 mm

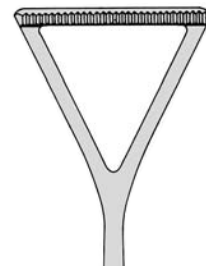

**48.0094**  
 20 cm / 25 mm  
**48.0098**  
 23 cm / 25 mm

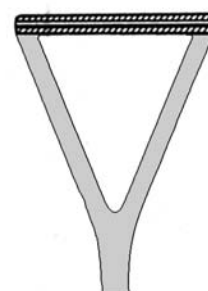

**48.0094AT**  
 20 cm / 20 mm  
**48.0098AT**  
 23 cm / 25 mm  
 atraumatisch  
 atraumatic  
 atraumatique  
 atraumática  
 atraumatiche



**DUVAL**

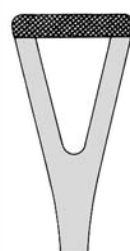

**48.0099**  
 20 cm / 15 mm







**15.1580**  
25 cm



**15.1582**  
27 cm



**DEBAKEY**

atraumatisch  
atraumatic  
atraumatique  
atraumática  
atraumatiche

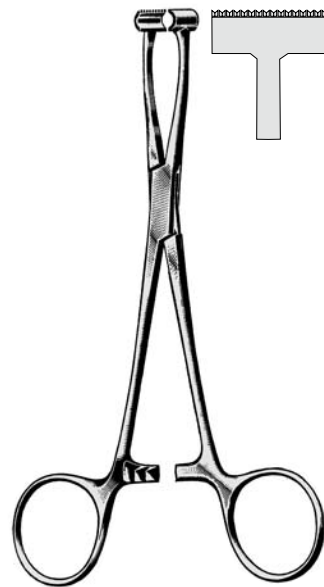

**PRATT**  
**15.1350** 15 cm



**KOCHER-BABY**  
 13 cm



48.0100



48.0101

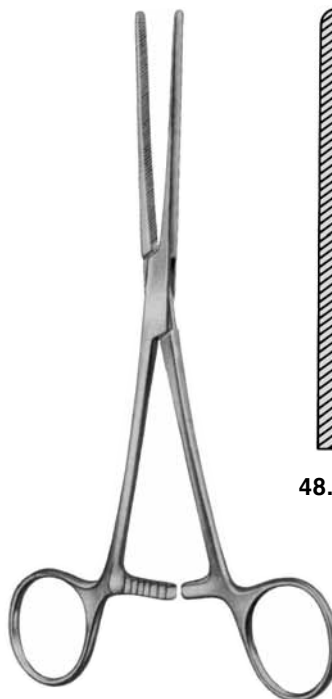

**DOYEN**  
 18 cm



48.0102



48.0103



**DOYEN**



48.0104 21 cm

48.0106 23 cm

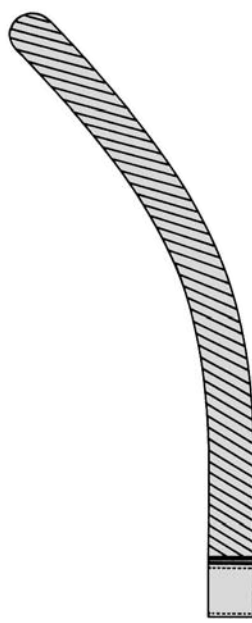

48.0105 21 cm

48.0107 23 cm



**LANG-STEVENSON**  
 48.0210 20 cm

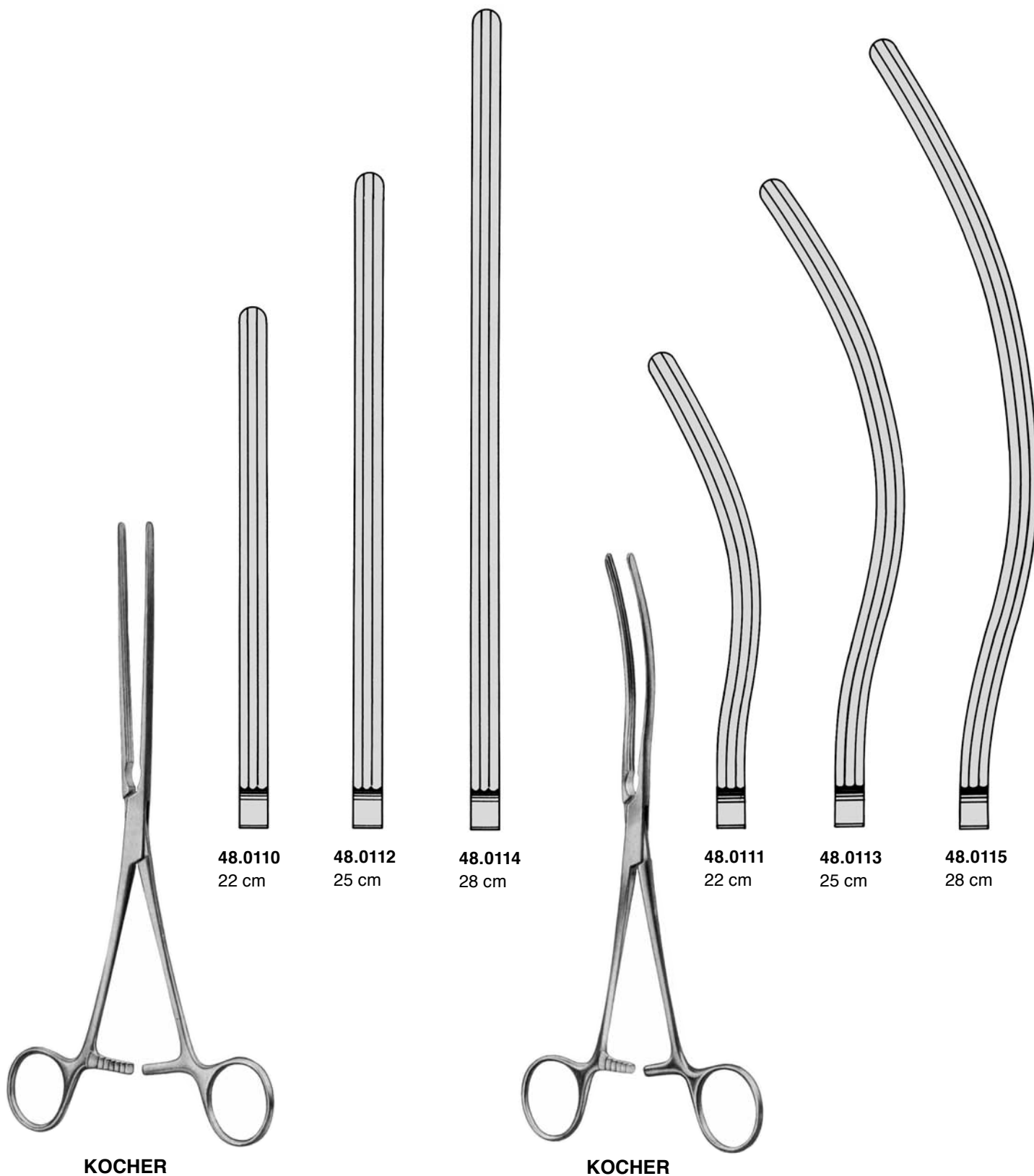

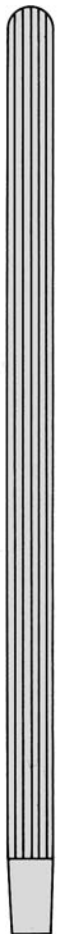

48.0118  
25 cm

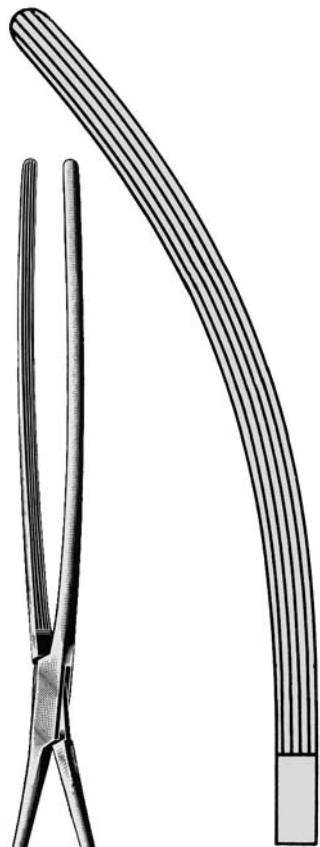

48.0119  
25 cm

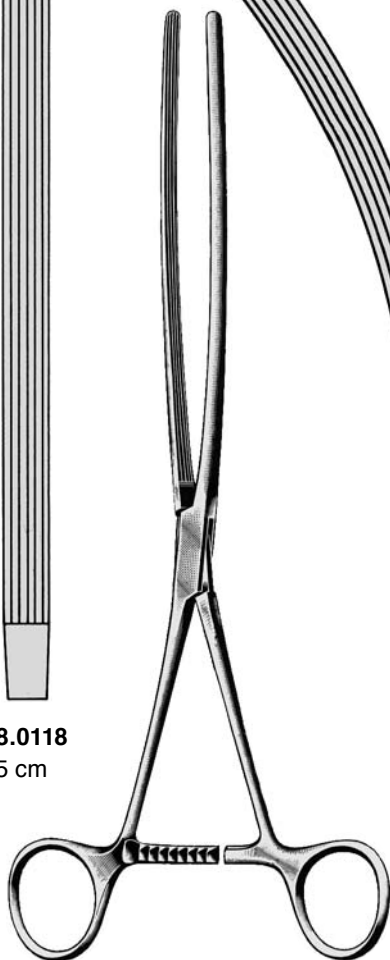

MAYO-ROBSON



48.0120  
33 cm

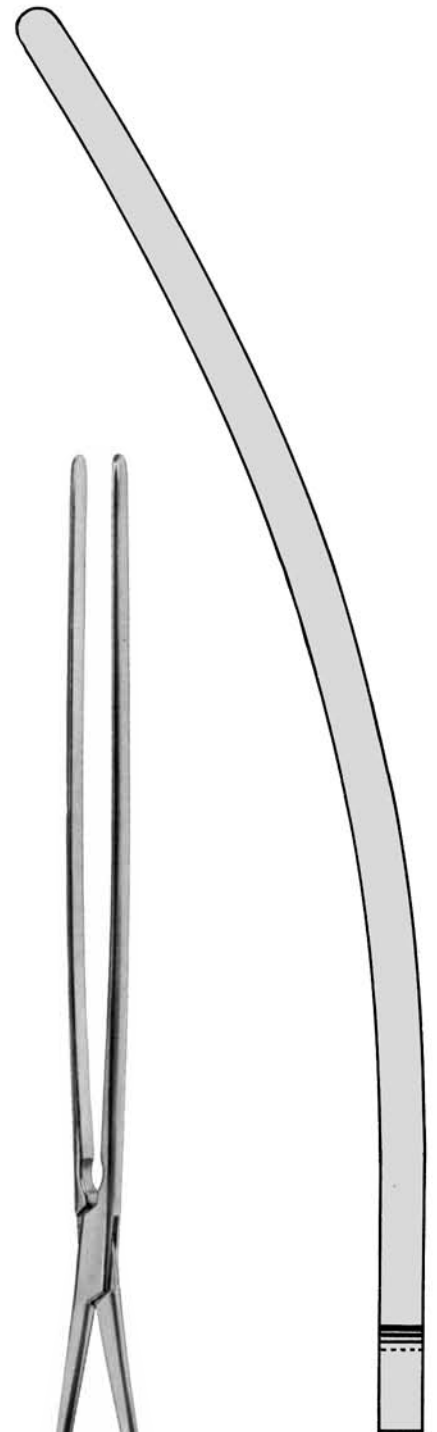

48.0121  
33 cm

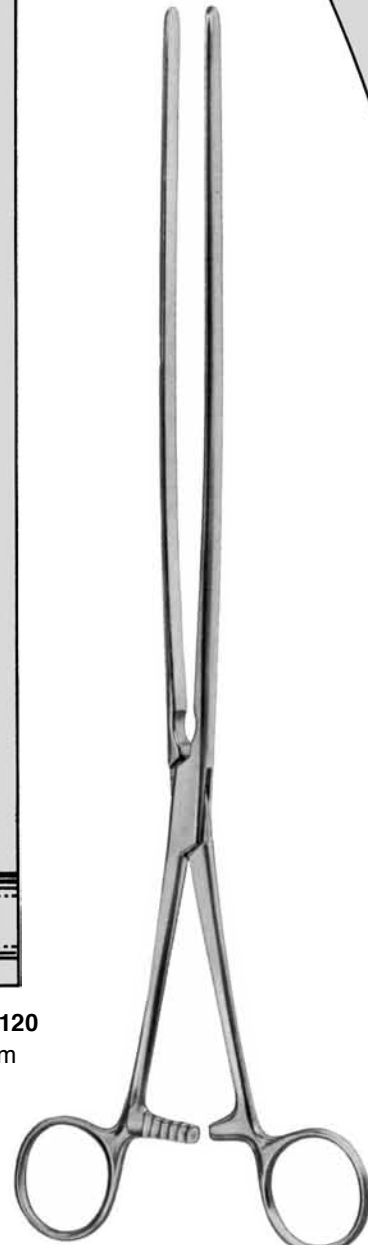

SCUDDER

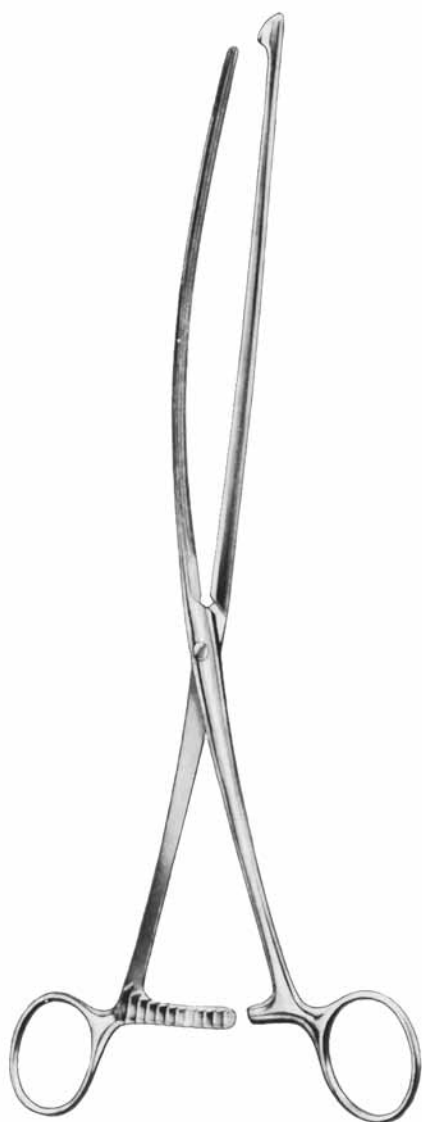

**NUSSBAUM**  
25 cm

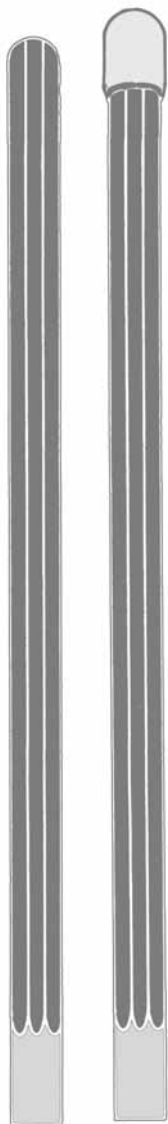

**48.0122**

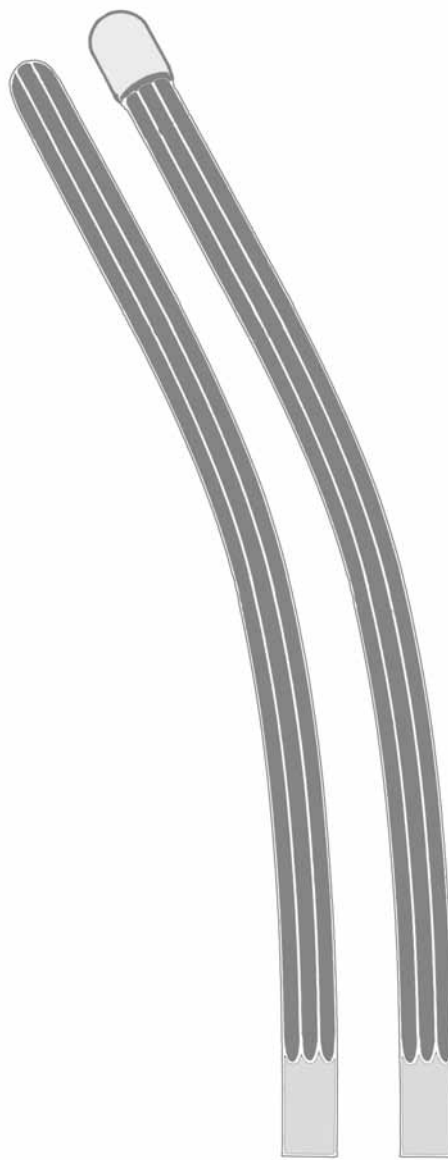

**48.0123**

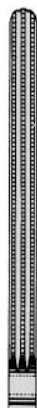

48.0150 13 cm  
 48.0152 16 cm

DOYEN-DEBAKEY



48.0151 13 cm  
 48.0153 16 cm

DOYEN-DEBAKEY

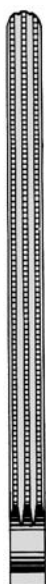

48.0154 18 cm  
 48.0156 21 cm  
 48.0158 23 cm

DOYEN-DEBAKEY

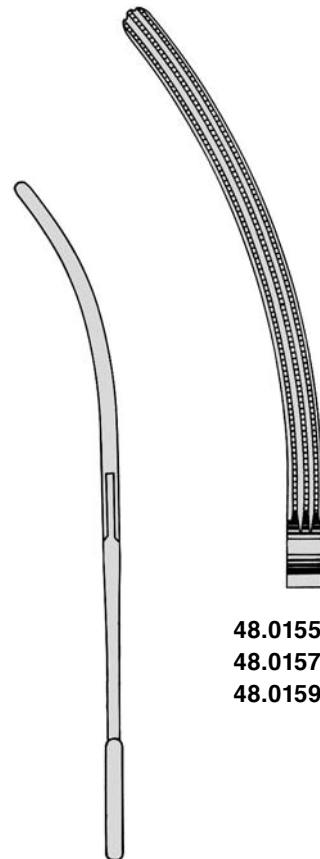

48.0155 18 cm  
 48.0157 21 cm  
 48.0159 23 cm

DOYEN-DEBAKEY

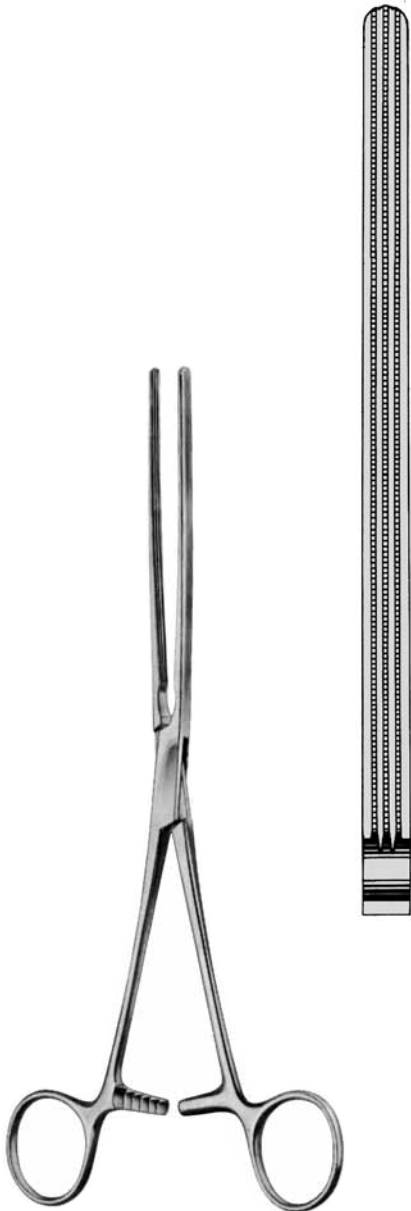

**KOCHER-DEBAKEY**

48.0160 22 cm

48.0162 25 cm

48.0164 28 cm



**KOCHER-DEBAKEY**

48.0161 22 cm

48.0163 25 cm

48.0165 28 cm



**HAYES-DEBAKEY**



**48.0170**  
26 cm / 55 mm

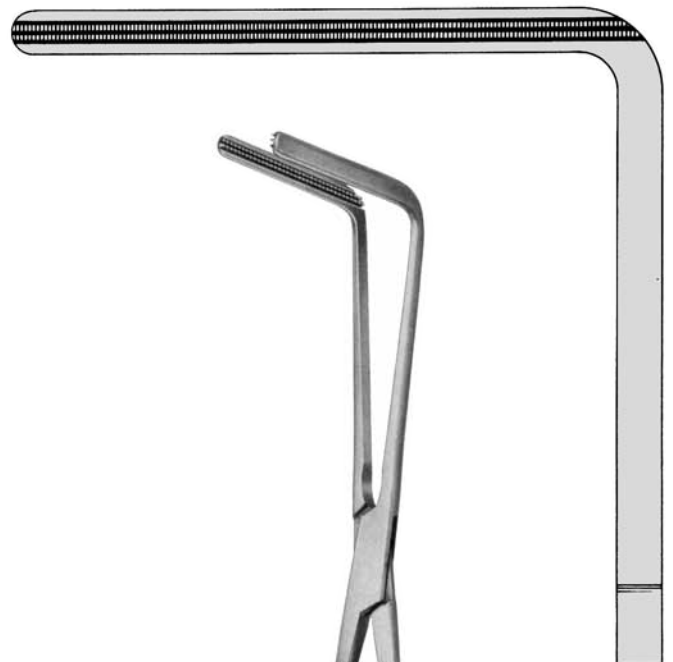

**48.0172**  
28 cm / 85 mm



**FEHLANT-DEBAKEY**  
48.0180 24 cm



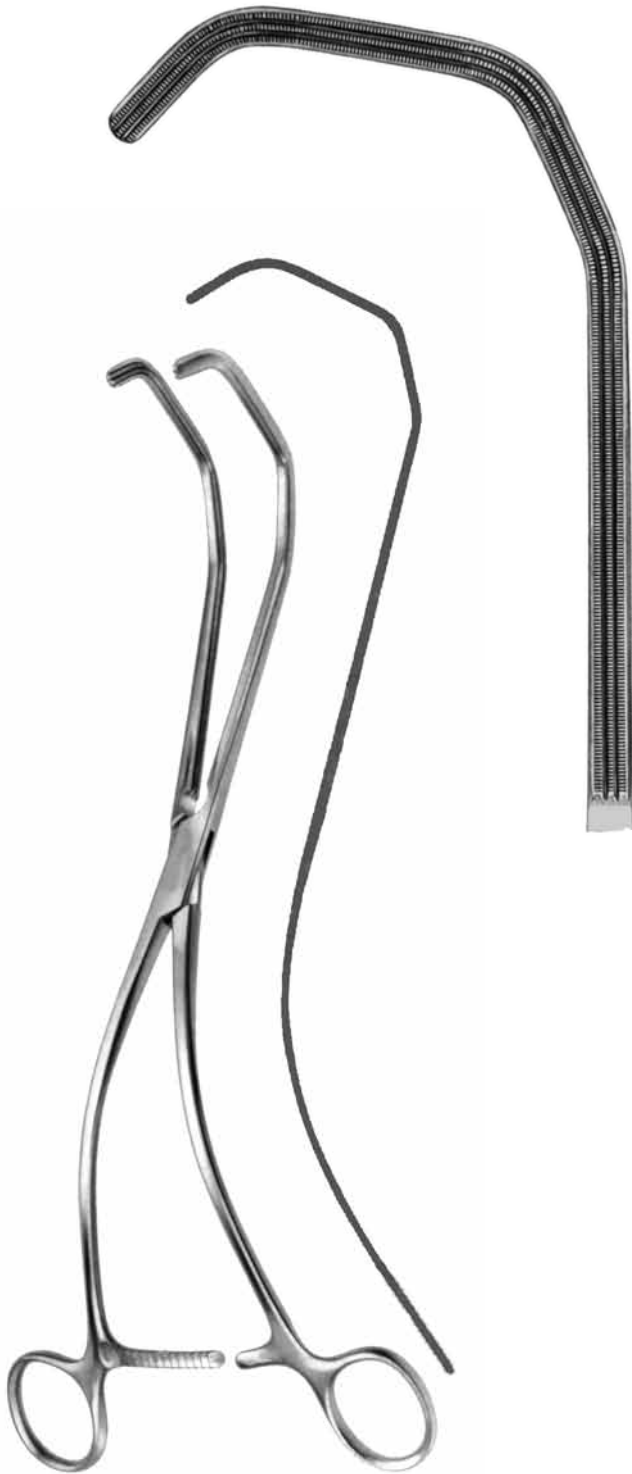

**KERSTING**  
48.0184  
31 cm

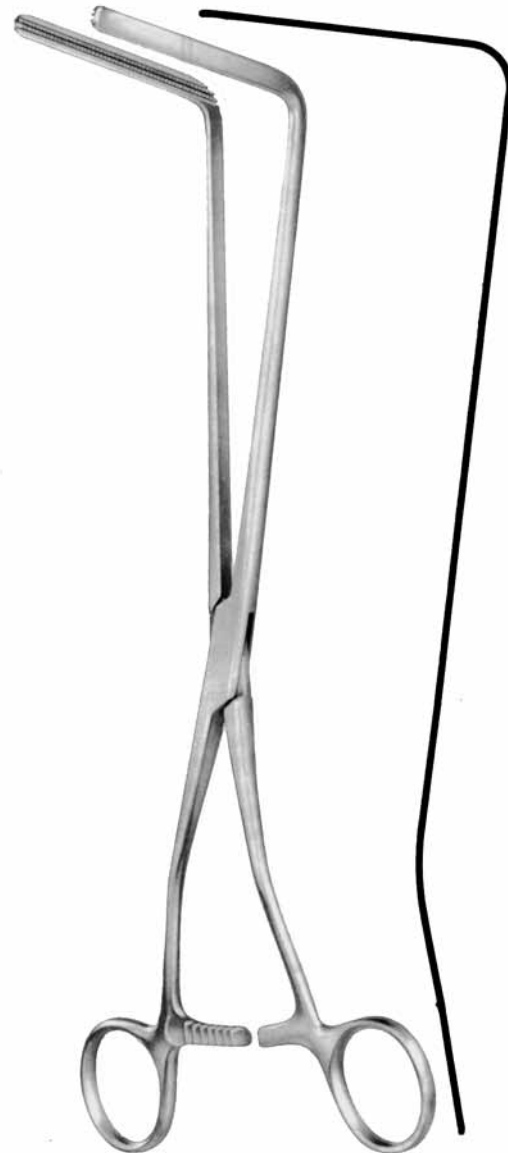

**RESANO**  
48.0186  
30 cm



**SCUDDER-DEBAKEY**  
48.0190  
33 cm

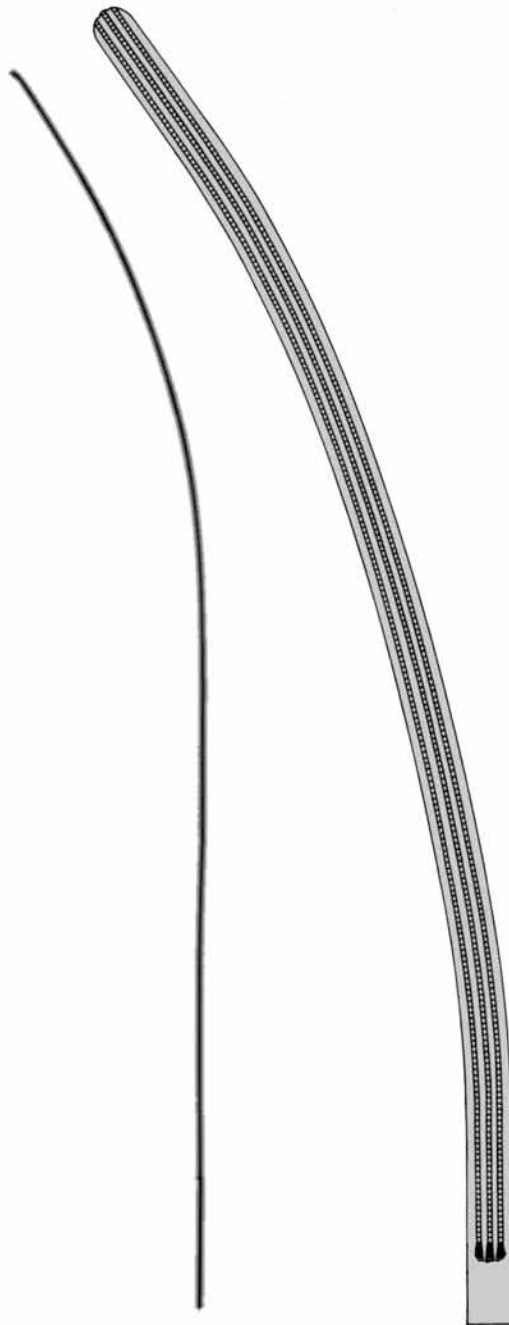

**SCUDDER-DEBAKEY**  
48.0191  
33 cm

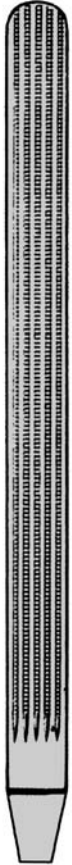

**48.0200**  
25 cm 0°

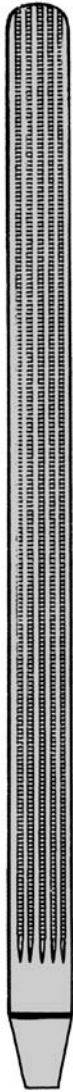

**48.0204**  
28 cm 0°

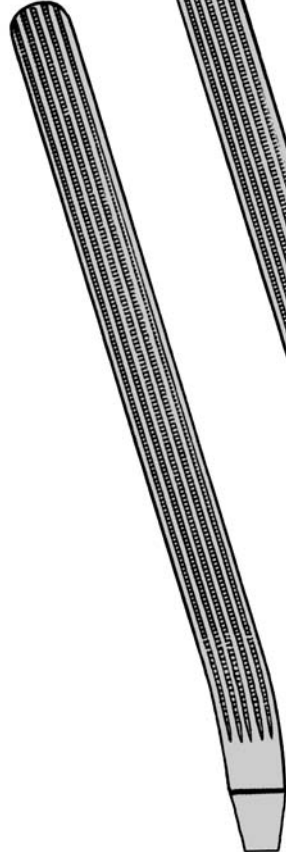

**48.0201**  
25 cm 15°



**48.0205**  
28 cm 15°

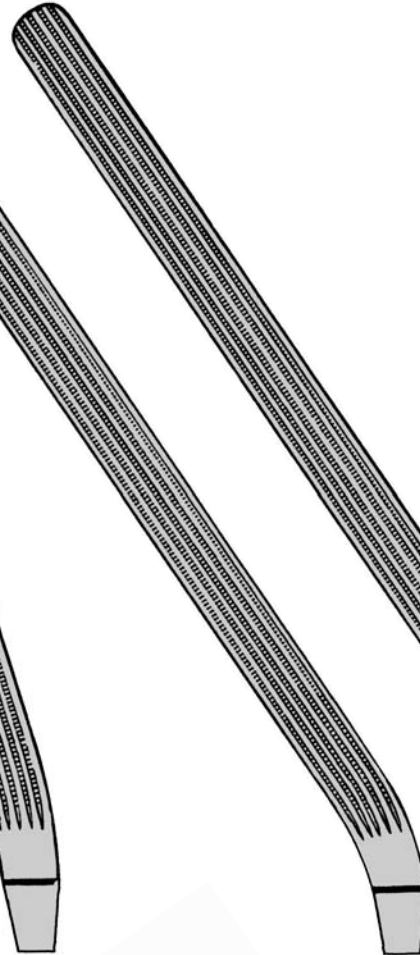

**48.0203**  
25 cm 30°



**48.0207**  
28 cm 30°

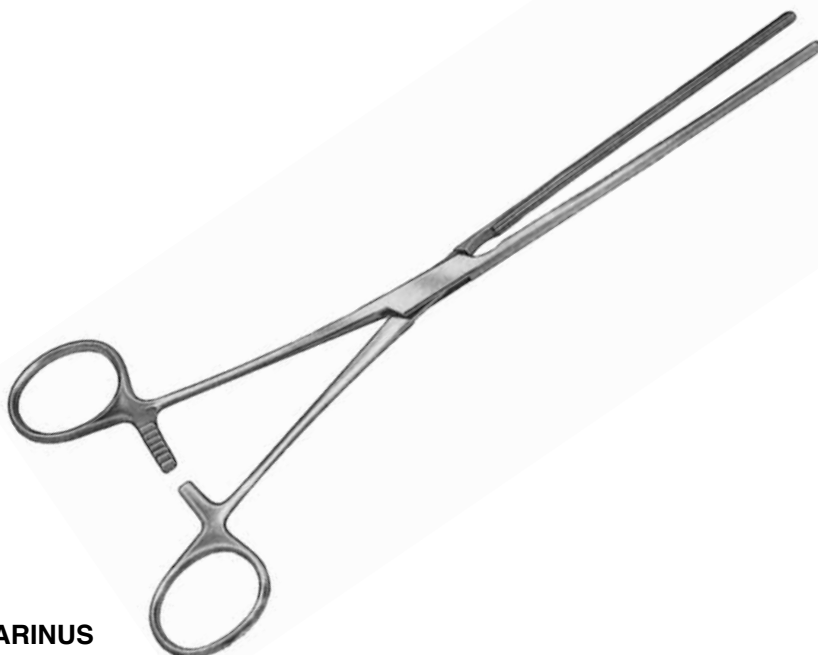

**MARINUS**

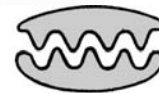



**BUIE**  
 48.0300 21 cm



**LLOYD-DAVIES**  
 48.0350 31,5 cm

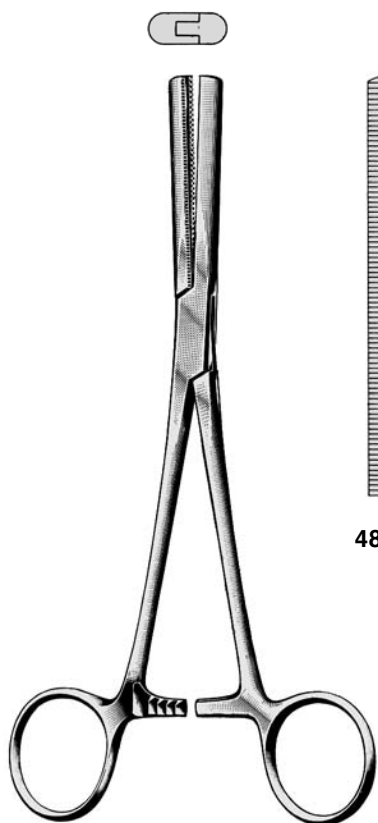

**FERGUSSON**

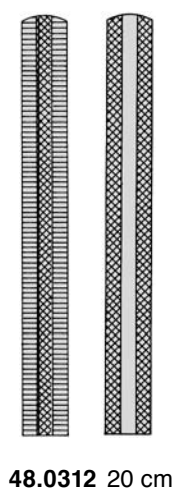

**48.0312** 20 cm

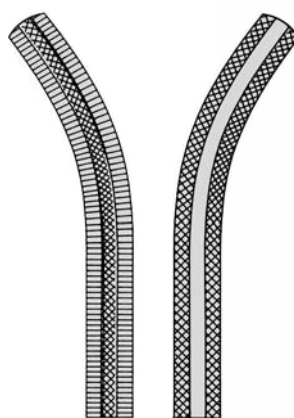

**48.0313** 20 cm



**48.0510** 18 cm  
mit stift  
with pin  
avec broche  
con espiga  
con perno



**PAYR-BABY**



**PAYR**



**48.0511** 20 cm  
mit stift  
with pin  
avec broche  
con espiga  
con perno

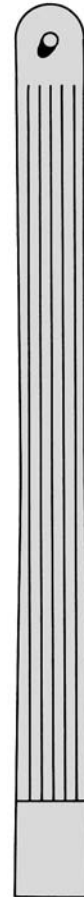

**48.0512** 28 cm  
mit stift  
with pin  
avec broche  
con espiga  
con perno

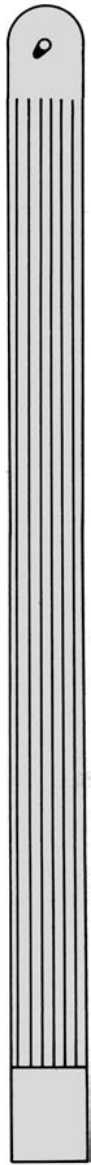

**48.0513** 35 cm  
mit stift  
with pin  
avec broche  
con espiga  
con perno



**BENSON**  
**48.0700**  
15 cm

Pylorusspreizer  
Pylorus Spreader  
Ecarteur du pylore  
Separador para piloro  
Divaricatore per piloro

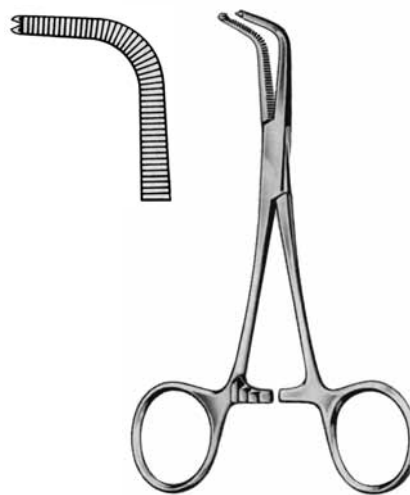

**KLEINSCHMIDT**  
**48.0710**  
12,5 cm

Appendektomieklemme  
Appendectomy Clamp  
Clamp à appendectomie  
Pinza para apendectomia  
Clamp per appendectomia



48.0530 5 cm



48.0532 7,5 cm



48.0534 10 cm



Satz zu 3 Klemmen  
 Set of 3 clamps  
 Jeu de 3 clamps  
 Juego de 3 clamps  
 Set 3 pezzi

**DEMARTEL-WOLFSON**

Klemmschließzange  
 Closing Forceps  
 Pince pour fermer les clamps  
 Pinza para cerrar los clamps  
 Serrapinze

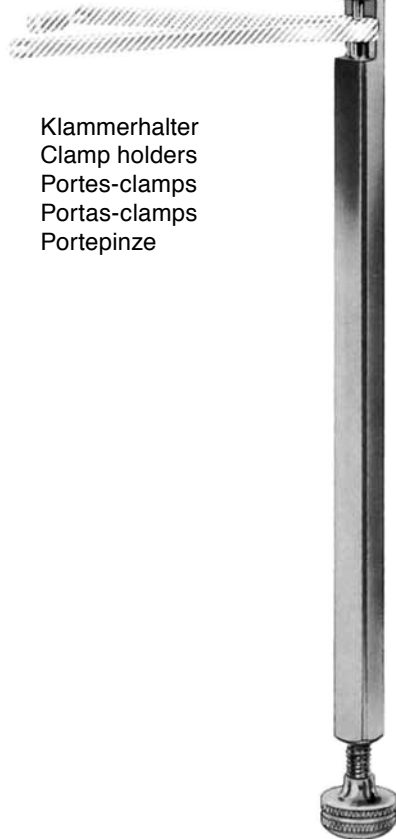

Klammerhalter  
 Clamp holders  
 Portes-clamps  
 Portas-clamps  
 Portepinze



**DEMARTEL-  
 WOLFSON**  
 48.0536 8,5 cm

**DEMARTEL-  
 WOLFSON**  
 48.0537 23 cm

**DEMARTEL-  
 WOLFSON**  
 48.0538 26 cm



**HILL-FERGUSON**  
**48.0900**  
21,5cm 60x25mm  
**48.0902**  
21,5cm 70x29mm  
**48.0904**  
24,0cm 75x40mm



**CZERNY**  
**48.1055**  
22 cm 105x22mm





**SIMS**  
48.1000  
16 cm

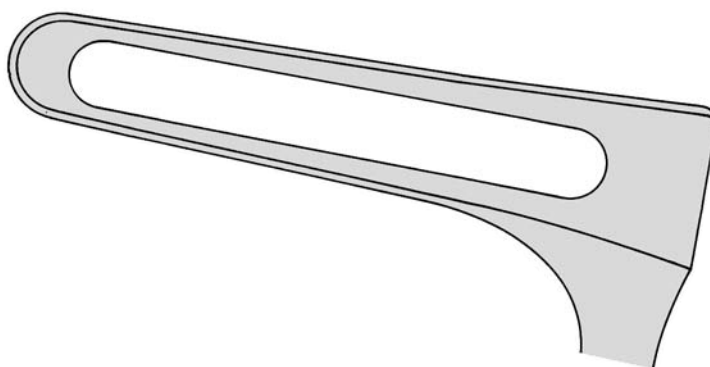

**SCHULZE-BERGMANN**  
22 cm

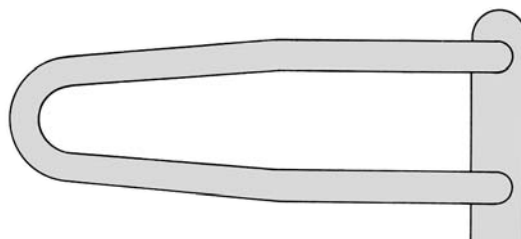

**48.1005** 65 mm

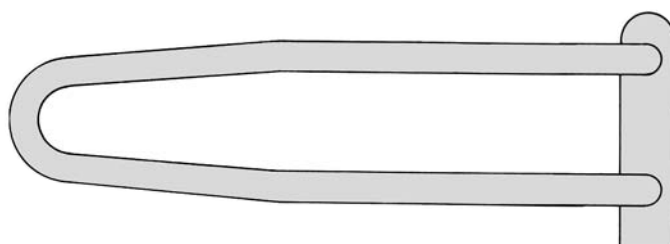

**48.1006** 85 mm

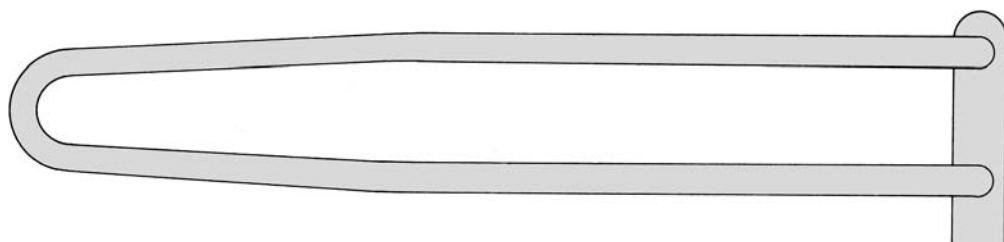

**48.1007** 125 cm

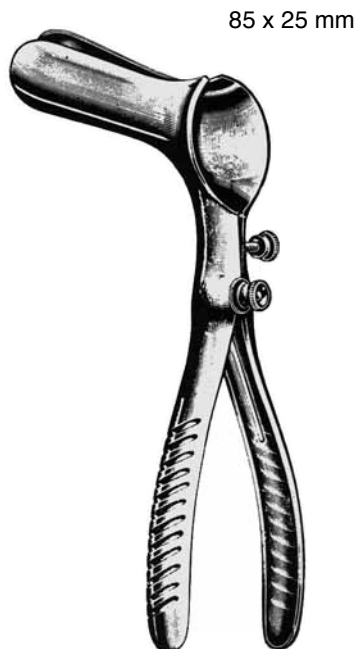

**PRATT**  
**48.1020**  
21,5 cm 85x25mm



**MATHIEU**  
**48.1030**  
19,5 cm 90x15mm



**BODENHAMMER**  
**48.1040**  
15,5 cm

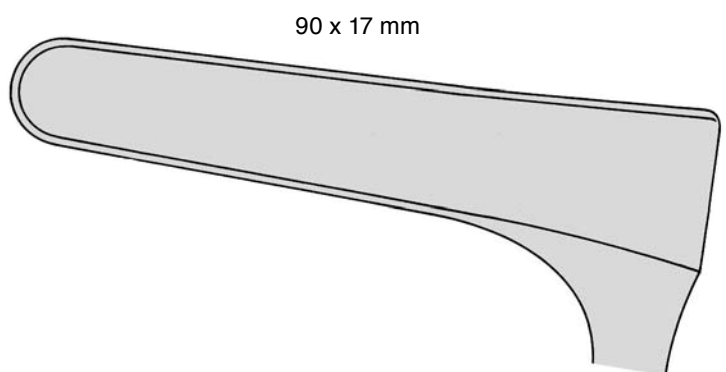

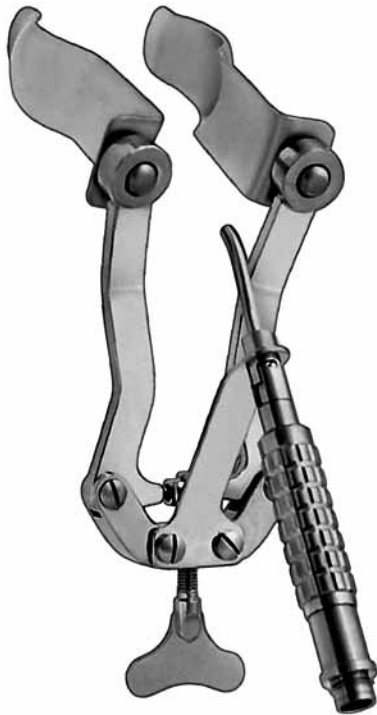

**PARKS**  
**49.1046**

verwendbar mit Kaltlichtstab 48.1249  
useable with Fibre optic handle No. 48.1249  
pour embout lumière froide 48.1249  
para adaptador luz fria 48.1249  
per inserto a fibra ottica 48.1249

bestehend aus: 1 x 48.1047 Rahmen / Frame / Cadre / Bastidor / Telaio  
consisting of: 1 x 48.1052 (Paar / Pair / Paire / Par / Paio)  
comprendant: 1 x 48.1053 (Paar / Pair / Paire / Par / Paio)  
compuesto de:  
composta da:



**48.1249**

Lichtstab für Analspreizer, Proktoskope mit  
Adapter für Lichtkabel ACMI, STORZ, WOLF

Fibre Optic Light attachment for Recto-  
scopes and -spreaders with connectors for  
ACMI, STORZ, WOLF

Embout lumière froide p. Proctoscopes,  
Ecarteurs rectaux lumière froide avec  
adaptateur ACMI, STORZ, WOLF

Adaptador luz fria para Proctoscopios,  
Separadores rectales con adaptador ACMI,  
STORZ, WOLF

Inserto per Proctoscopi, Divaricatori rettali  
a fibra ottica con adattatore ACMI, STORZ,  
WOLF



**ALAN-PARKS**  
**48.1052**

75x22 mm  
Paar / Pair / Paire / Par / Paio



**ALAN-PARKS**  
**48.1053**

95x24 mm PAAR  
Paar / Pair / Paire / Par / Paio

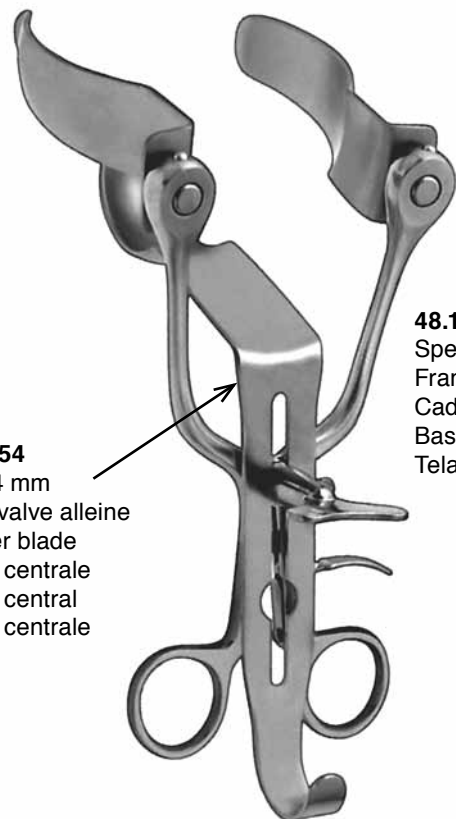

**48.1054**  
95x24 mm  
Mittelvalve alleine  
Center blade  
Valve centrale  
Valve central  
Valva centrale

**48.1051**  
Sperrer alleine  
Frame only  
Cadre seul  
Bastidor solo  
Telaio solo

**ALAN-PARKS**  
**48.1050**

bestehend aus: 1 x 48.1051 (Sperrer / Frame / Cadre /  
Bastidor / Telaio)  
consisting of:  
comprendant: 1 x 48.1052 (Paar/ Pair/ Paire / Par / Paio)  
compuesto de: 1 x 48.1053 (Paar/ Pair/ Paire / Par / Paio)  
composta da: 1 x 48.1054 (Mittelvalve / Center blade /  
Valve centrale / Valva central / Valva centrale



**BARR**  
48.1070

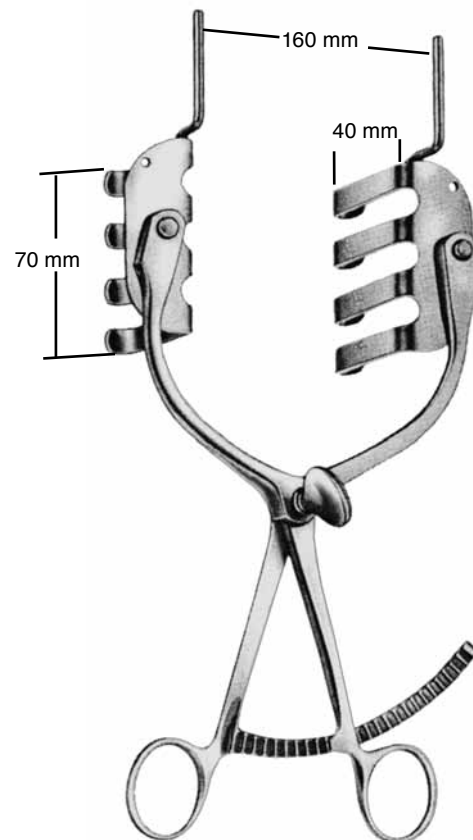

**ST.MARKS**  
48.1080  
22 cm  
Perinealspreizer  
Perineal Retractor  
Ecarteur à perinée  
Separador para perinea  
Divaricatore pelviano



**KELLY**

**48.1200** 50 x 21 mm

**48.1202** 50 x 25 mm

konisch / conical / conique / cónico / conico



**KELLY**

**48.1210** 50 x 22 mm

**48.1212** 100 x 22 mm

**48.1214** 140 x 22 mm

**48.1216** 200 x 22 mm



**ST.MARKS**

**48.1220**

65X10mm

verwendbar mit Kaltlichtstab 48.1249 (Seite 53)

useable with Fibre optic handle No. 48.1249 (page 53)

pour embout lumière froide 48.1249 (page 53)

para adaptador luz fria 48.1249 (página 53)

per inserto a fibra ottica 48.1249 (pagina 53)



**HIRSCHMANN**

**48.1230** 65 x 16 mm

**48.1232** 65 x 19 mm

**48.1234** 65 x 22 mm

**48.1236** 65 x 25 mm



## MORGAN

48.1240 65 x 17 mm

48.1242 65 x 20 mm

48.1244 65 x 24 mm

48.1246 80 x 24 mm

verwendbar mit Kaltlichtstab 48.1249

useable with Fibre optic handle No. 48.1249

pour embout lumière froide 48.1249

para adaptador luz fria 48.1249

per inserto a fibra ottica 48.1249



## 48.1249

Kaltlicht Beleuchtungsstab für Proktoskope, Analspreizer mit ACMI, STORZ, WOLF Anschluß

Fibre Optic Light attachment for Rectoscopes and -spreaders with connectors for ACMI, STORZ, WOLF

Embout lumière froide pour Proctoscopes, Ecarteurs rectaux, lumière froide avec adaptateur ACMI, STORZ, WOLF

Adaptador luz fria para Proctoscopios, Separadores rectales con adaptadores ACMI, STORZ, WOLF

Inserto per Proctoscopi, Divaricatori rettali a fibra ottica con adattatore ACMI, STORZ, WOLF



## BENSAUDE

48.1250 70 x 19 mm

48.1252 70 x 22 mm



## FANSLER-IVES

48.1255 80 x 22 mm



**FANSLER-IVES**

**48.1256** 22 mm

mit Kaltlicht-Anschluss (ACMI,WOLF,STORZ)  
with Cold-light attachment (ACMI,WOLF,STORZ)  
avec lumière froide (ACMI,WOLF,STORZ)  
con alumbrado frio (ACMI,WOLF,STORZ)  
con fibra ottica (ACMI,WOLF,STORZ)



**55.3600**

KALTLICHT-Klammer für Proktoskope & Amnioskope,  
Vaginal Spekula mit Kombistecker für alle Systeme

COLDLIGHT-Clip for proctoscopes & amnioscopes  
vaginal specula with combi-plug for all systems

CLIP - lumière froide pour proctoscopes, amnioscopes,  
spéculum vaginaux avec fiche utilisable pour tous  
systèmes

CLIP - luz fria para proctoscopios, amnioscopios,  
espéculos vaginales con clavija para todos sistemas

CLIP - illuminazione alogena per proctoscopios, specoli  
vaginali e amnioscopios per tutti sistemi



**48.1136**

Kaltlichtgriff für Anuskope/Proktoskope, WOLF-Anschluß & Kopfstück 48.1140

Fiber optic light handle for anoscopies, proctoscopes with WOLF connector & headpiece 48.1140

Manche à lumière froide pour anoscopies, proctoscopes avec connexion WOLF & tête 48.1140

Mango luz fria para anoscopios, proctoscopios, con conexión WOLF & cabeza 48.1140

Manico a luce fredda per anoscopi, manico a luce fredda per anoscopi, testa 48.1140



**48.1137**

Adapter für Kaltlichtgriff 48.1136 zum Anschluß an AESCULAP/OLYMPUS/STORZ Kabel

Adapter for fiber optic light handle 48.1136 for connection to AESCULAP/OLYMPUS/STORZ cables

Adaptateur pour manche 48.1136 pour connexion avec câbles AESCULAP / OLYMPUS / STORZ

Adaptore para mango luz fria 48.1136 para conexión con cintas AESCULAP/OLYMPUS/STORZ

Adattore per Manico a luce fredda 48.1136 per connessione con cavi AESCULAP / OLYMPUS / STORZ



**48.1140**

Kopfstück für Anuskope/Proktoskope 48.1138, 48.1139

Headpiece only for anoscopies, proctoscopes 48.1138, 48.1139

Tête seule pour anoscopies, proctoscopes 48.1138, 48.1139

Cabeza sola para anoscopios, proctoscopios 48.1138, 48.1139

Testa sola per anoscopi, proctoscopi 48.1138, 48.1139

**48.1139**

Batteriegriff für Anuskope/Proktoskope allein  
Battery handle for anoscopies, proctoscopes only  
Manche à piles pour anoscopies, proctoscopes seul  
Mango de pilas para anoscopios, proctoscopios solo  
Manico a batterie per anoscopi, proctoscopi solo

**48.1138**

Batteriegriff für Anuskope/Proktoskope mit Kopfstück 48.1140 und Glühlampe 2,5V 48.1159

Battery handle for anoscopies, proctoscopes with headpiece 48.1140 & spare lamp 2,5 V 48.1159

Manche à piles pour anoscopies, proctoscopes avec tête 48.1140 et lampe de rechange 48.1159

Mango de pilas para anoscopios, proctoscopios con cabeza 48.1140 y bombilla de repuesto 2,5 V 49.1159

Manico a batterie per anoscopi, proctoscopi con testa 48.1140 e lampadina di ricambio 2,5 V 48.1159



**48.1159**

Ersatzbirne kurz 2,5 V für Anoskop / Proktoskop-Griff 48.1139

Spare lamp 2,5V for Anoscopes, Proctoscop handle 48.1139

Lampe de rechange 2,5 V pour Anoscopes, Proctoscopes manche 48.1139

Bombilla de repuesto para anoscopios, proctoscopios 2,5 V para mango 48.1139

Lampadina di ricambio 2,5 V per Anoscopi Proctoscopi manico 48.1139





**48.1141**

**BLOND** Proktoskop-Tubus 75mm Ø 18-24 mm konisch mit seitlichem Ausblick, oval  
**BLOND** Proctoscope-tube 75mm Ø 18-24 mm, conical, lateral oval view  
**BLOND** Tube conique de proctoscope 75mm Ø 18-24 mm vue ovale, latérale  
**BLOND** Tubo cónico proctoscopico 75mm Ø 18-24 mm, vista laterale, oval  
**BLOND** Tubo protoscopico, vista laterale ovale, 75mm Ø 18-24 mm



**48.1142**

**BLOND** Proktoskop-Tubus 75mm Ø 18-24 mm konisch mit seitlichem Ausblick, rund  
**BLOND** Proctoscope-tube 75mm Ø 18-24 mm conical, lateral round view  
**BLOND** Tube conique de proctoscope 75mm Ø 18-24 mm vue ronde, latérale  
**BLOND** Tubo cónico proctoscopico 75mm Ø 18-24 mm, vista laterale, rondo  
**BLOND** Tubo protoscopico, vista laterale tondo, 75mm Ø 18-24 mm



**48.1143**

**BLOND** Proktoskop-Tube 75mm Ø 15-23 mm konisch mit seitlichem Ausblick, oval  
**BLOND** Proctoscope-tube 75mm Ø 15-23 mm conical, lateral oval view  
**BLOND** Tube conique de proctoscope 75mm Ø 15-23 mm vue ovale, latérale  
**BLOND** Tubo cónico proctoscopico 75mm Ø 15-23 mm, vista laterale, oval  
**BLOND** Tubo protoscopico, vista laterale ovale, 75mm Ø 15-23 mm



**48.1144**

**BLOND** Proktoskop-Tubus 105mm Ø 18-25 mm konisch m. seitr. Ausblick, oval  
**BLOND** Proctoscope-tube 105mm Ø 18-25 mm conical, lateral oval view  
**BLOND** Tube conique de proctoscope 105mm 18-25 mm vue oval, latérale  
**BLOND** Tubo cónico proctoscopico 105mm 18-25 mm, vista laterale, oval  
**BLOND** Tubo protoscopico, vista laterale ovale, 105mm 18-25 mm



**48.1145**

**BLOND** Anoskop mit Mandrin 80mm x Ø 21 mm  
**BLOND** Anoscope with obturator 80 x Ø 21 mm  
**BLOND** Anoscope avec obturateur 80 x Ø 21mm  
**BLOND** Anoscopio con obturador 80 x Ø 21 mm  
**BLOND** Anoscopio con otturatore 80 x Ø 21 mm



**48.1146**

**BLOND** Anoskop mit Mandrin 60 x Ø 26 mm  
**BLOND** Anoscope with obturator 60 x Ø 26 mm  
**BLOND** Anoscope avec obturateur 60 x Ø 26 mm  
**BLOND** Anoscopio con obturador 60 x Ø 26 mm  
**BLOND** Anoscopio con otturatore 60 x Ø 26 mm



**48.1147**

**BLOND** Anoskop mit Mandrin 80 x Ø 24 mm  
**BLOND** Anoscope with obturator 80 x Ø 24 mm  
**BLOND** Anoscope avec obturateur 80 x Ø 24 mm  
**BLOND** Anoscopio con obturador 80 x Ø 24 mm  
**BLOND** Anoscopio con otturatore 80 x Ø 24 mm



**48.1148**

**BLOND** Anoskop mit Mandrin 120 x Ø 21 mm zylindrisch, gerader Ausblick geschlitzt  
**BLOND** Anoscope with obturator 120 x Ø 21 mm cylindrical, straight view, with slot  
**BLOND** Anoscope avec obturateur 120 x Ø 21 mm cylindrique, vue droite, à fente  
**BLOND** Anoscopio con obturador 120 x Ø 21 mm cilíndrico, vista recta, ranurado  
**BLOND** Anoscopio con otturatore 120 x Ø 21 mm cilindrico, vista diritta, spaccato

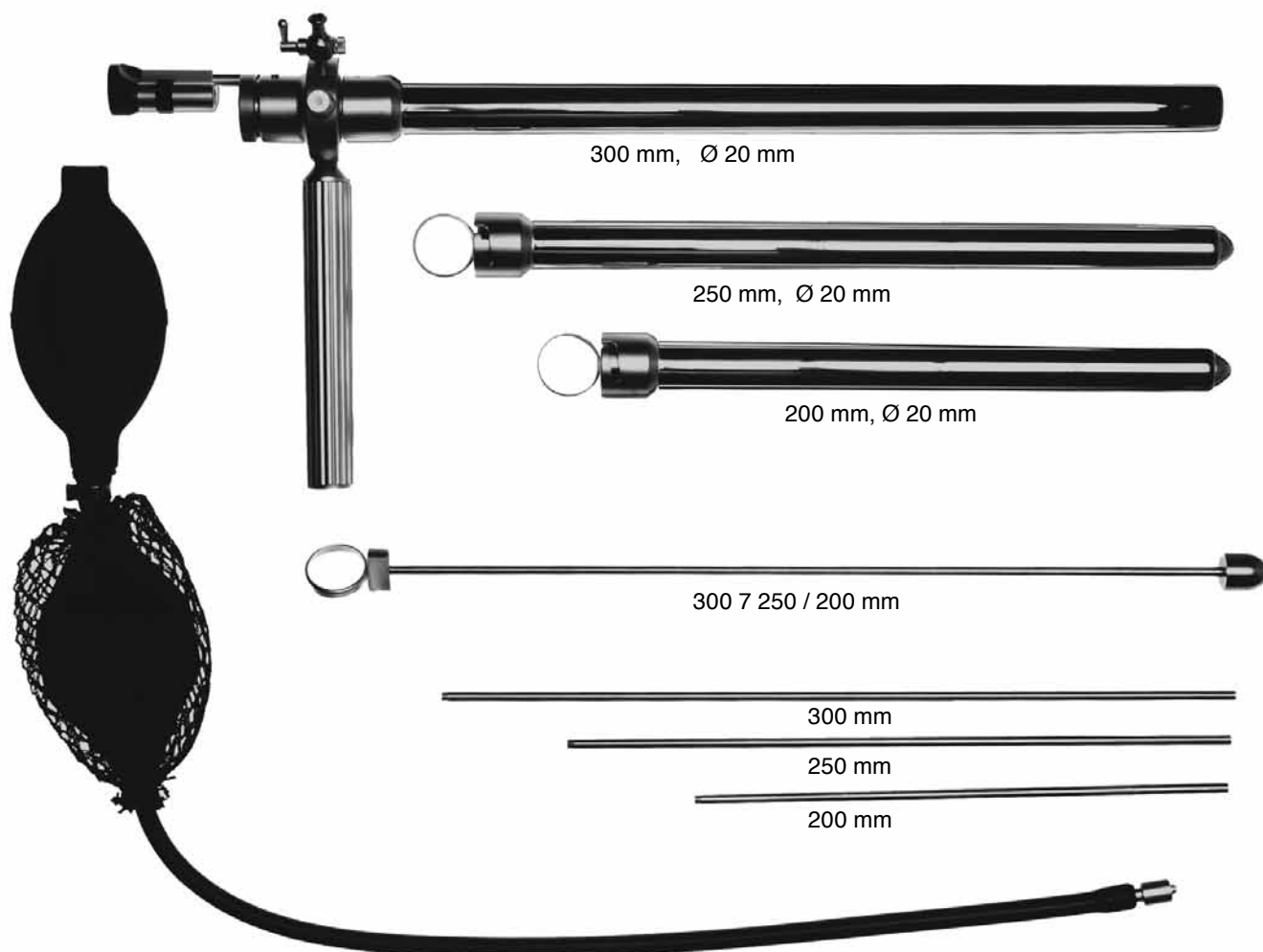

## STRAUSS 48.1270

Rektoskop mit Kaltlicht-Beleuchtung komplett  
Rectoscope with Fibre Light illumination complete  
Rectoscope avec illumination à lumière froide, complet  
Rectoscopio, iluminación para luz fría, completo  
Rettoscopio con illuminazione luce fredda, completo

### 10.2000

Kaltlichtquelle Halogen HL 150W, 230 V, B 175 x H 82,5 x T 202mm.  
Schutzklasse BF  
Halogen Cold Light Projector HL 150, 230V, Size 175 x 82,5 x 202mm,  
Protective Class BF  
Dispositif à lumière froide Halogène, HL 150W, 230 V, 175 x 82,5 x 202mm;  
Classe de protection BF  
Proyector halógeno de luz fría HL 150W 230 V, 175 x 82,5 x 202mm,  
Clase de protección BF  
Proiettore Luce Fredda Alogeno HL 150W 230 V.; 175 x 82,5 202 mm;  
classificazione di protezione BF



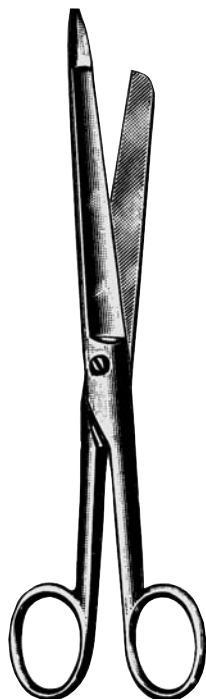

**ENTEROTOMY**  
13.2170 21 cm

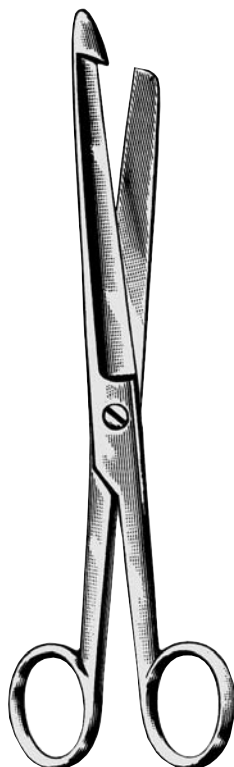

**ENTEROTOMY**  
13.2172 21 cm

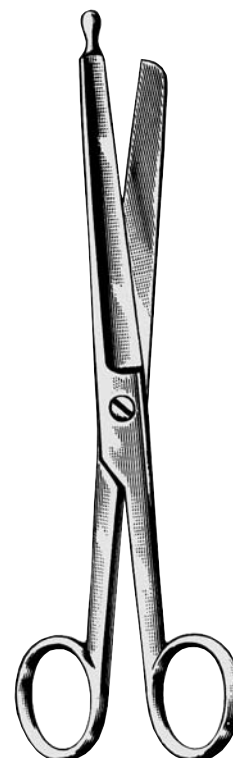

**ENTEROTOMY**  
13.2174 21 cm



**MILLER**  
13.2181 17 cm

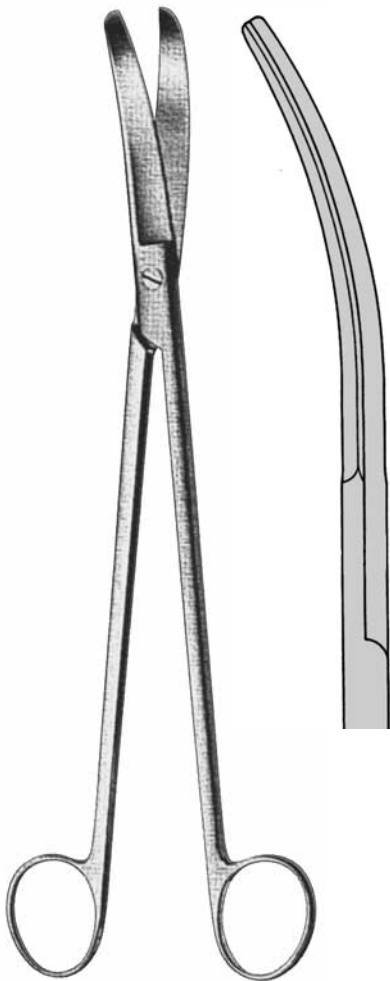

**LLOYD-DAVIS**  
13.2183 27 cm

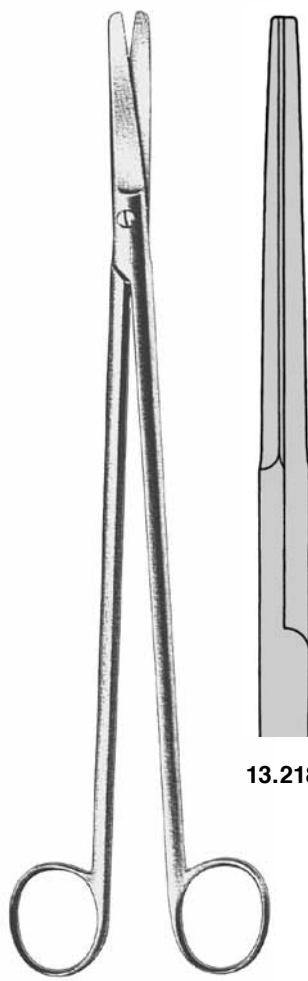

**STELZNER**  
27 cm

13.2186



13.2187

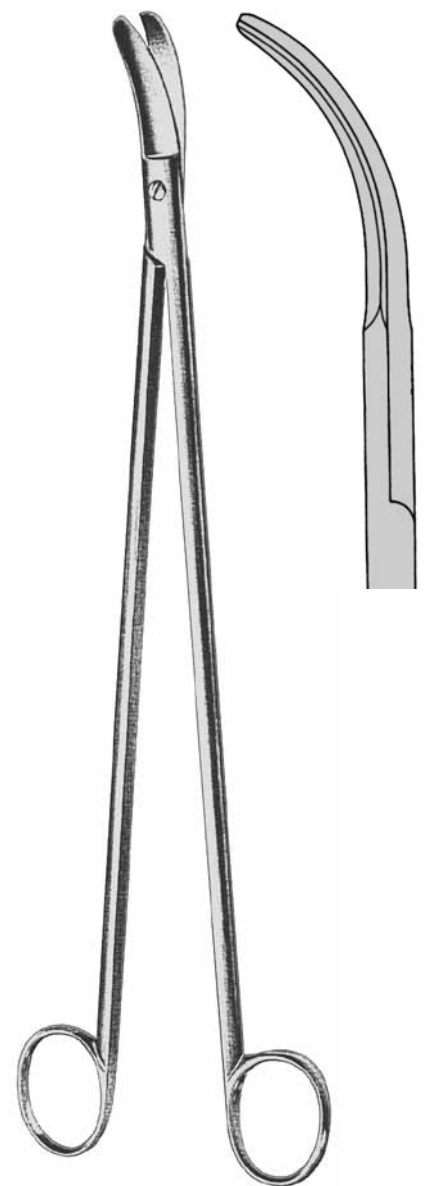

**13.2189** 32 cm

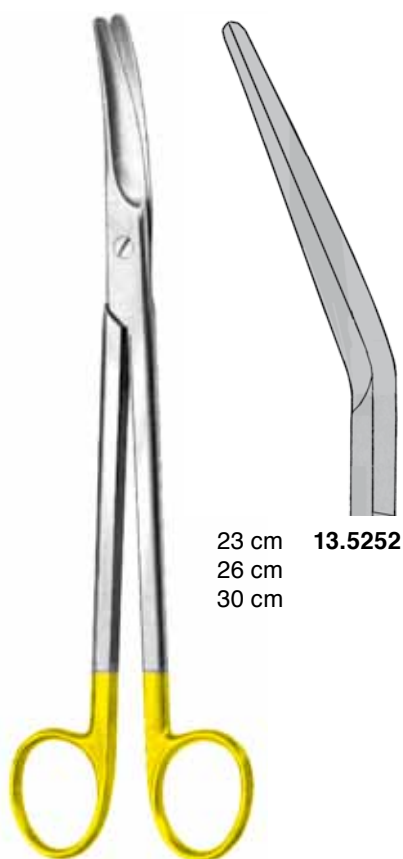

23 cm **13.5252**  
26 cm  
30 cm

**PARAMETRIUM**



**13.5255**  
**13.5265**  
**13.5275**



**13.5257**  
**13.5267**  
**13.5277**

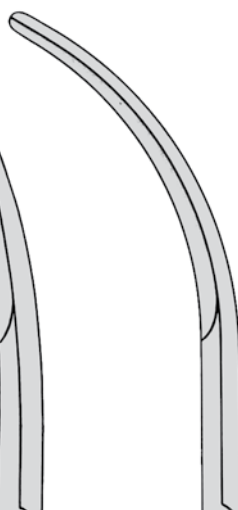

**13.5259**  
**13.5269**  
**13.5279**



**BLESSING**  
**13.5281**  
30 cm

Schere für Rektumchirurgie  
Scissors for rectal surgery  
Ciseaux pour chirurgie rectale  
Tijera para la cirugía del recto  
Forbici per la chirurgia rettale

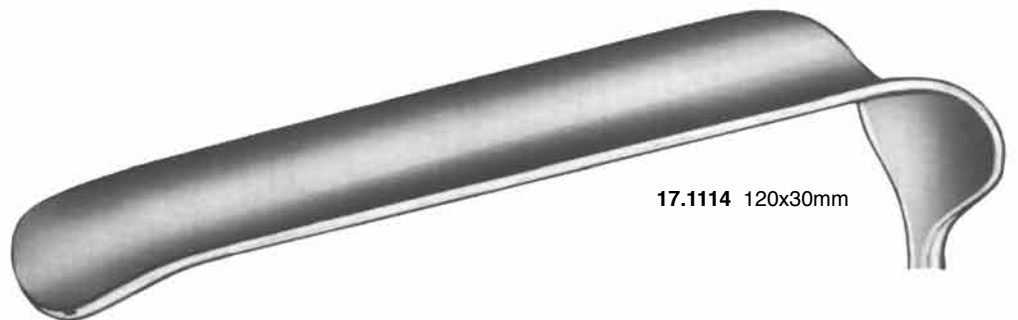
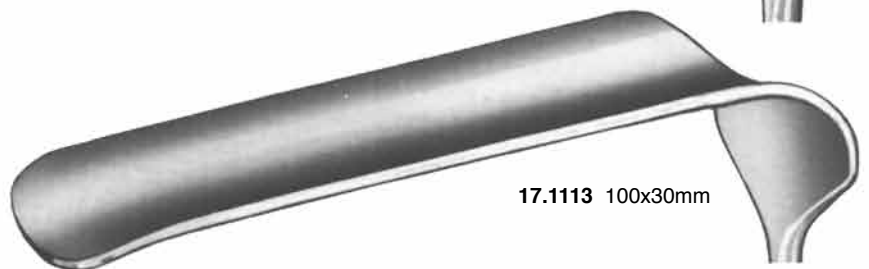

17.1117 220x40mm  
ohne Abb. / without illustration / sans illustration / sin ilustración / senza illustrazione

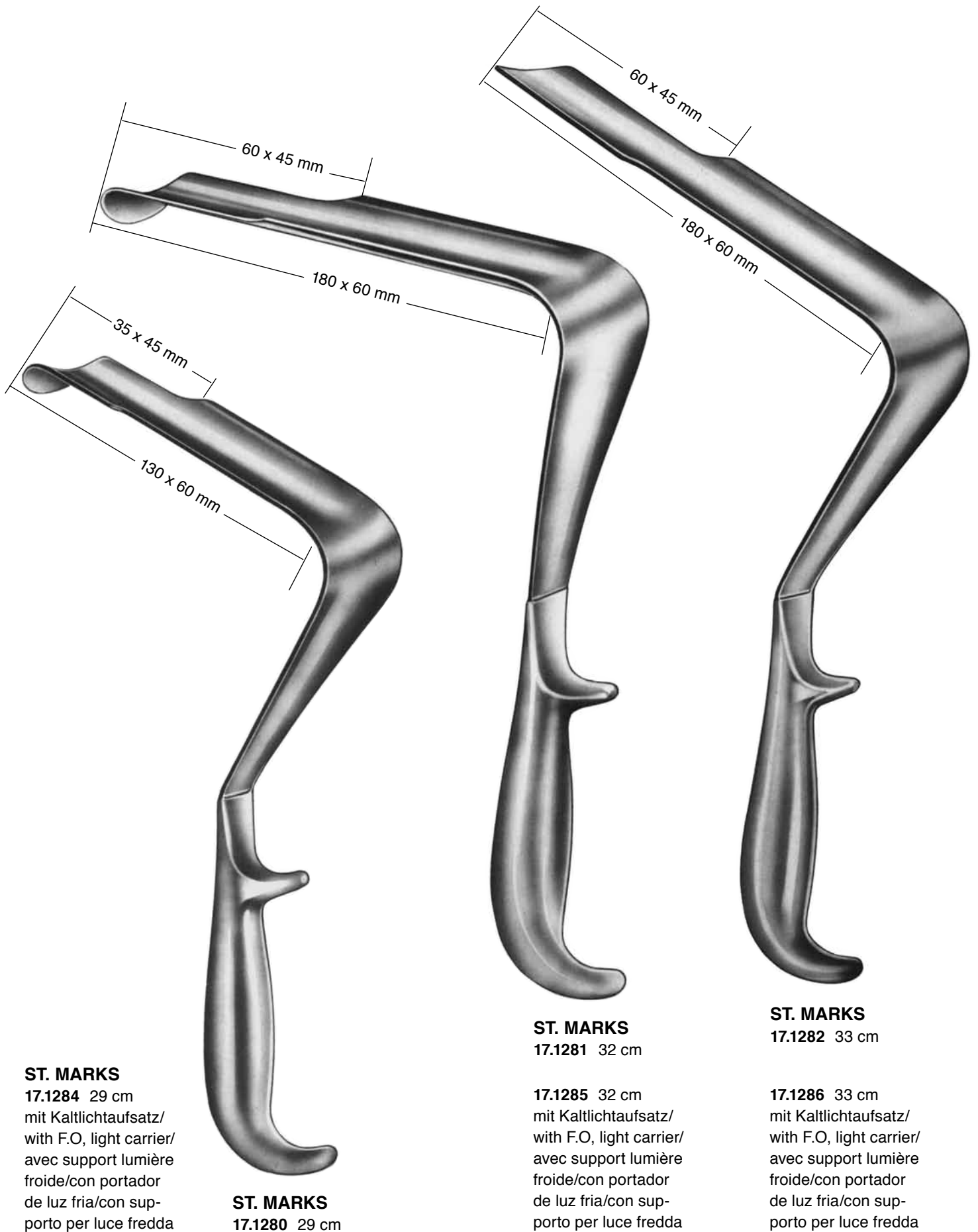

**ST. MARKS**

**17.1284** 29 cm  
 mit Kaltlichtaufsatz/  
 with F.O, light carrier/  
 avec support lumière  
 froide/con portador  
 de luz fria/con sup-  
 porto per luce fredda

**ST. MARKS**  
**17.1280** 29 cm

**ST. MARKS**  
**17.1281** 32 cm

**17.1285** 32 cm  
 mit Kaltlichtaufsatz/  
 with F.O, light carrier/  
 avec support lumière  
 froide/con portador  
 de luz fria/con sup-  
 porto per luce fredda

**ST. MARKS**  
**17.1282** 33 cm

**17.1286** 33 cm  
 mit Kaltlichtaufsatz/  
 with F.O, light carrier/  
 avec support lumière  
 froide/con portador  
 de luz fria/con sup-  
 porto per luce fredda

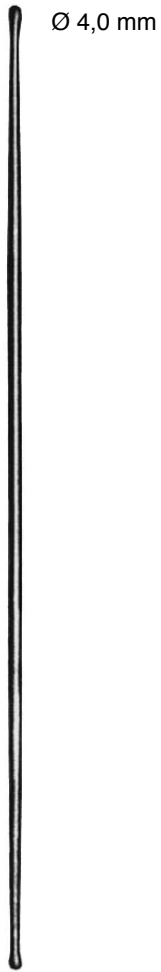

Ø 4,0 mm

**19.0128**  
40 cm

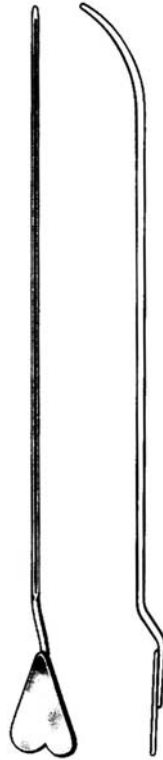

**LOCKHART-MUMMERY**  
16,5 cm



**19.0371**  
# 1



**19.0372**  
# 2



**19.0373**  
# 3



**19.0374**  
# 4



**PRATT**  
21,5 cm



**48.1301**  
#1



**48.1302**  
#2



**48.1303**  
#3

Cystikus-Häkchen  
 Crypt hooks  
 Crochets à fistules  
 Ganchos para fistulas  
 Ganci a cripta



**BUIE**  
**48.1310**  
16 cm

Fistelsonde  
 Fistula probe  
 Sonde pour fistules  
 Sonda para fistulas  
 Sonda per fistole





**BUIE**  
48.1420 40 cm

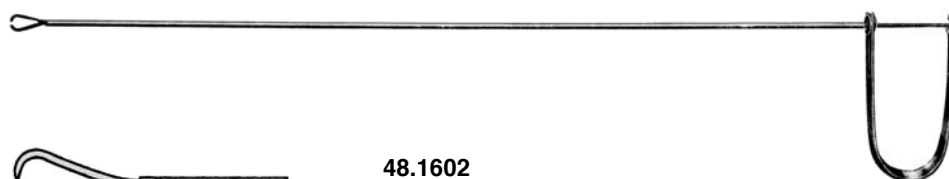

**48.1602**  
38 cm

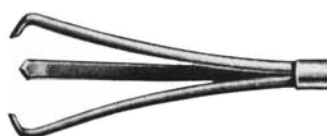

**48.1601**  
28 cm

**48.1603**  
35 cm

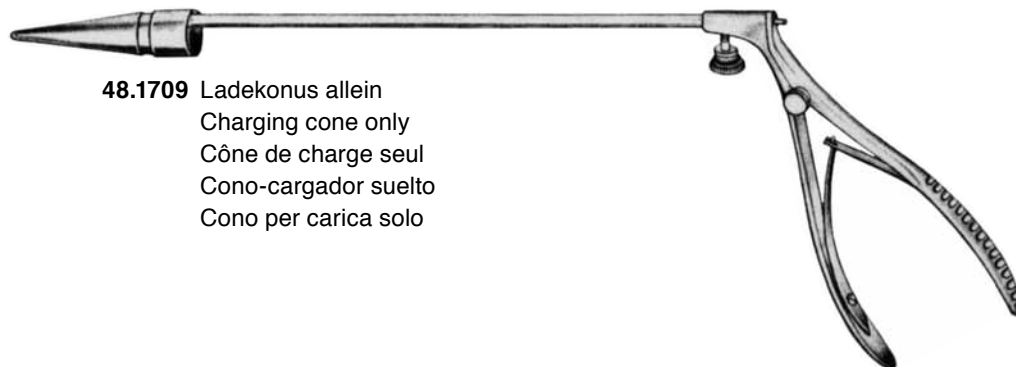

**48.1709** Ladekonus allein  
Charging cone only  
Cône de charge seul  
Cono-cargador suelto  
Cono per carica solo

**MCGIVNEY**  
**48.1700**

Haemorrhoidal Ligator komplett Ø 12 mm mit Ladeaufsatz 48.1709 und 100 Gummiringen 48.1715

Haemorrhoidal Ligator Ø 12 mm complete with loading attachment 48.1709 and 100 rubber rings 48.1715

Ligateur pour hémorroïdes Ø 12 mm avec embout conique 48.1709 et 100 anneaux de caoutchouc 48.1715

Ligador hemorroïdal completo Ø 12 mm con aditamento de carga 48.1709 y 100 anillos de goma 48.1715

Legatore emorroidale Ø 12 mm completo con cono per carica 48.1709 e 100 anelli per legatura de gomma 48.1715

**48.1719**

Ladekonus für Ø 12 mm Ligator 48.1710  
Charging cone Ø 12 mm only for ligator 48.1710  
Cône de charge Ø 12 mm pour ligateur 48.1710  
Cono-cargador Ø 12 mm para ligador 48.1710  
Cono per carica Ø 12 mm solo per ligatore 48.1710



**RUDD**  
**48.1710**

Haemorrhoidal Ligator komplett Ø 12 mm mit Ladeaufsatz 48.1719 und 100 Gummiringen 48.1715

Haemorrhoidal Ligator Ø 12 mm complete with loading attachment 48.1719 and 100 rubber rings 48.1715

Ligateur pour hémorroïdes Ø 12 mm avec embout conique 48.1719 et 100 anneaux de caoutchouc 48.1715

Ligador hemorroïdal completo Ø 12 mm con aditamiento de carga 48.1719 y 100 anillos de goma 48.1715

Legatore emorroidale completo Ø 12 mm con cono per carica 48.1719 e 100 anelli per legatura de gomma 48.1715

**RUDD**  
**48.1715**

Ligatur-Gummiringe, 100 St.  
Ligature rubber rings, 100 pcs.  
Anneaux en caoutchouc pour ligatures, 100 pièces  
Anillos de goma para ligaduras, 100 piezas  
Anelli per legatura de gomma, 100 pezzi



**48.1709**

Ladekonus allein  
Charging cone only  
Cône de charge seul  
Cono-cargador suelto  
Cono per carica solo

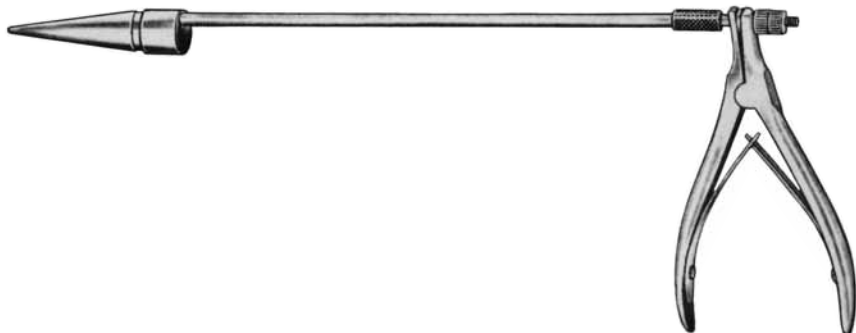

**FORD-DIXON**  
48.1730

Haemorrhoidal Ligator komplett Ø 12 mm mit Ladeaufsatz 48.1709 und 100 Gummiringen 48.1715

Haemorrhoidal Ligator Ø 12 mm complete with loading attachment 48.1709 and 100 rubber rings 48.1715

Ligateur pour hémorroïdes Ø 12 mm avec embout conique 48.1709 et 100 anneaux de caoutchouc 48.1715

Ligador hemorroïdal completo Ø 12 mm con aditamiento de carga 48.1709 y 100 anillos de goma 48.1715

Legatore Ø 12 mm completo con cono per carica 48.1709 e 100 anelli per legatura de gomma 48.1715

**48.1748** Ø 8 mm  
**48.1749** Ø 10 mm

Ladekonus allein  
Charging cone only  
Cône de charge seul  
Cono-cargador suelto  
Cono per carica solo

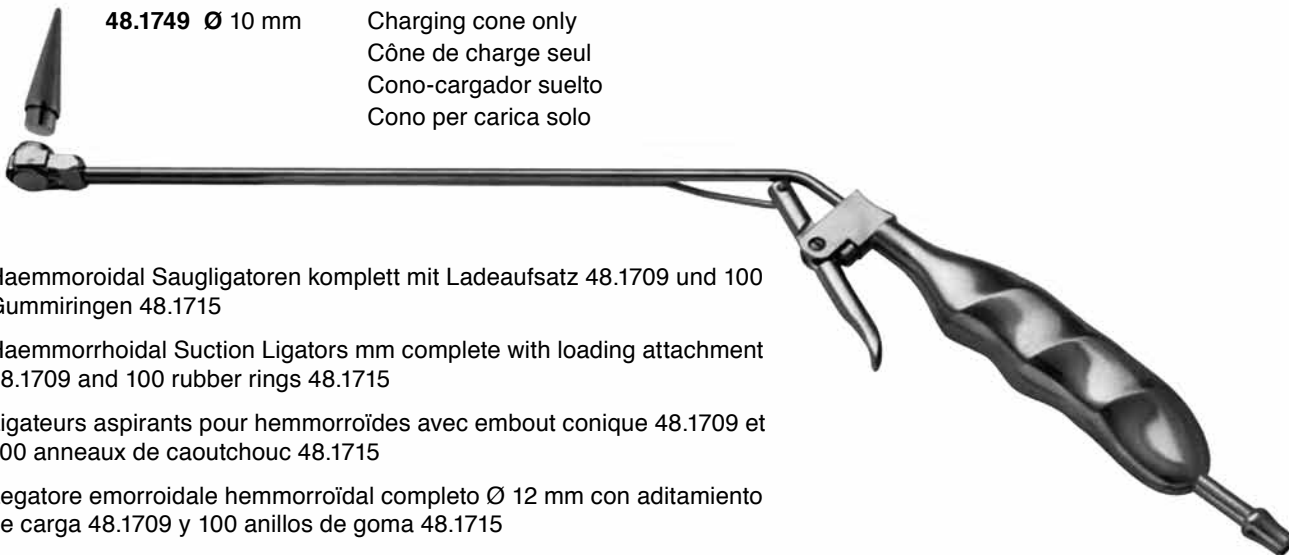

Haemorrhoidal Saugligatoren komplett mit Ladeaufsatz 48.1709 und 100 Gummiringen 48.1715

Haemorrhoidal Suction Ligators mm complete with loading attachment 48.1709 and 100 rubber rings 48.1715

Ligateurs aspirants pour hémorroïdes avec embout conique 48.1709 et 100 anneaux de caoutchouc 48.1715

Legatore emorroidale hemorroïdal completo Ø 12 mm con aditamiento de carga 48.1709 y 100 anillos de goma 48.1715

Legatore completo con cono per carica 48.1749 e 100 anelli per legatura de gomma 48.1715

**48.1740** Ø 8 mm  
**48.1742** Ø 10 mm

90° aufwärts gewinkelt  
90° angled up  
90° coudé vers le haut  
90° acodada hacia arriba  
90° angolato in alto

**48.1749** Ø 10 mm Ladekonus allein  
 Charging cone only  
 Cône de charge seul  
 Cono-cargador suelto  
 Cono per carica solo

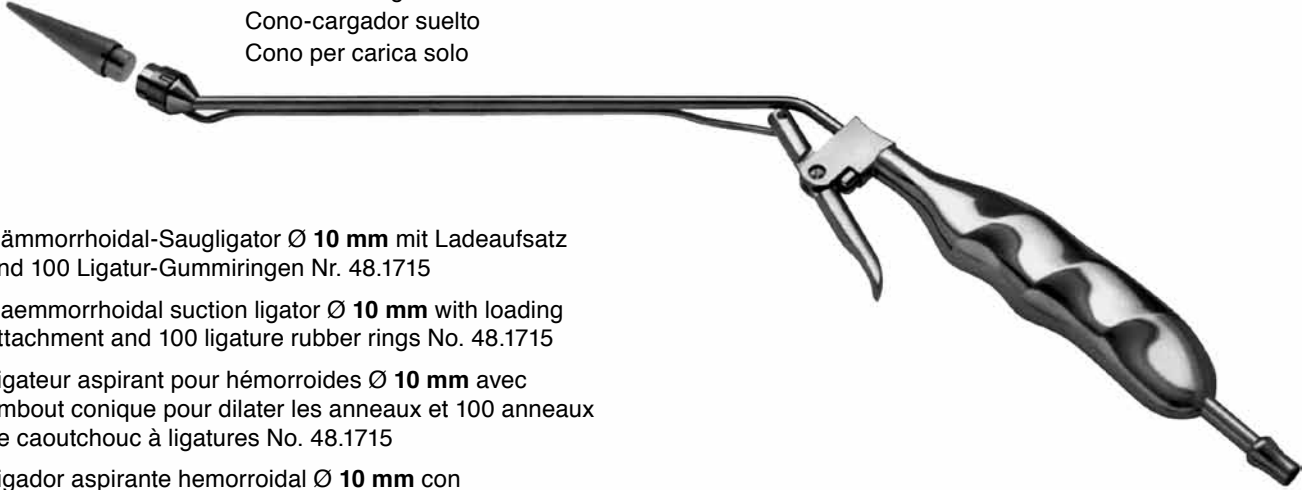

Hämorrhoidal-Saugligator Ø 10 mm mit Ladeaufsatz und 100 Ligatur-Gummiringen Nr. 48.1715

Haemorrhoidal suction ligator Ø 10 mm with loading attachment and 100 ligature rubber rings No. 48.1715

Ligateur aspirant pour hémorroïdes Ø 10 mm avec embout conique pour dilater les anneaux et 100 anneaux de caoutchouc à ligatures No. 48.1715

Ligador aspirante hemorroidal Ø 10 mm con aditamiento de carga y 100 anillos de goma para ligaduras No. 48.1715

Legatore completo con cono per carica 48.1715 e 100 anelli per legatura de gomma 48.1715

**48.1750** Ø 10 mm

30° aufwärts gewinkelt  
 30° angled up  
 30° coudé vers le haut  
 30° acodada hacia arriba  
 30° angolato in alto

**48.1749** Ø 10 mm Ladekonus allein  
 Charging cone only  
 Cône de charge seul  
 Cono-cargador suelto  
 Cono per carica solo



Hämorrhoidal-Saugligator Ø 10 mm mit Ladeaufsatz und 100 Ligatur-Gummiringen Nr. 48.1715

Haemorrhoidal suction ligator Ø 10 mm with loading attachment and 100 ligature rubber rings No. 48.1715

Ligateur aspirant pour hémorroïdes Ø 10 mm avec embout conique pour dilater les anneaux et 100 anneaux de caoutchouc à ligatures No. 48.1715

Ligador aspirante hemorroidal Ø 10 mm con aditamiento de carga y 100 anillos de goma para ligaduras No. 48.1715

Legatore completo con cono per carica 48.1715 e 100 anelli per legatura de gomma 48.1715

**48.1755** Ø 10 mm

30° abwärts gewinkelt  
 30° angled down  
 30° coudé ver le bas  
 30° acodada hacia abajo  
 30° angolato in basso

**48.1749** Ø 10 mm Ladekonus allein  
Charging cone only  
Cône de charge seul  
Cono-cargador suelto  
Cono per carica solo



Hämorrhoidal-Saugligator Ø 10 mm mit Ladeaufsatz  
und 100 Ligatur-Gummiringen Nr. 48.1715

Haemorrhoidal suction ligator Ø 10 mm with loading  
attachment and 100 ligature rubber rings No. 48.1715

Ligateur aspirant pour hémorroïdes Ø 10 mm avec  
embout conique pour dilater les anneaux et 100 anneaux  
de caoutchouc à ligatures No. 48.1715

Ligador aspirante hemorroidal Ø 10 mm con  
aditamiento de carga y 100 anillos de goma para  
ligaduras No. 48.1715

Legatore completo con cono per carica 48.1715 e 100  
anelli per legatura de gomma 48.1715

**48.1756** Ø 10 mm

gerade  
straight  
droite  
recto  
retto

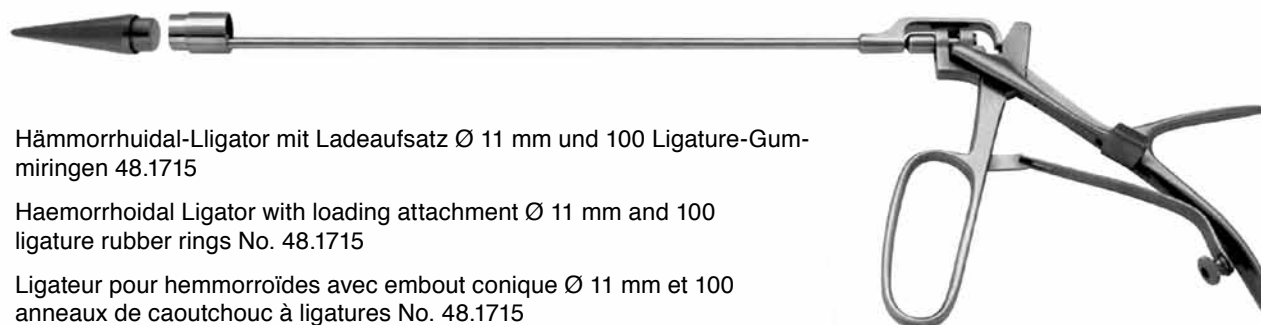

Hämorrhoidal-Lligator mit Ladeaufsatz Ø 11 mm und 100 Ligature-Gum-  
miringen 48.1715

Haemorrhoidal Ligator with loading attachment Ø 11 mm and 100  
ligature rubber rings No. 48.1715

Ligateur pour hémorroïdes avec embout conique Ø 11 mm et 100  
anneaux de caoutchouc à ligatures No. 48.1715

Ligador hemorroidal con aditamiento de carga Ø 11 mm y 100 anillos de  
goma para ligaduras No. 48.1715

Legatore completo con cono per carica Ø 11 mm e 100 anelli per  
legatura de gomma No. 48.1715

**BARRON**  
**48.1760** Ø 11 mm



**48.1787**  
Ø 10 mm x 11 mm

**48.1788**  
Ø 10 mm x 16 mm

Saugkopf allein  
Suction head only  
Tête aspiratrice seule  
Pieza aspiradora sola  
Testa aspiratrice sola



**48.1789**  
Ladekonus allein  
Loading cone only  
Cône de charge seul  
Cono de carga solo  
Cono per carica solo



**48.1781** Ligaturinstrument allein  
Ligatur only  
Ligateur aspirant seul  
Ligador aspirante suelto  
Legatore solo

**McGIVNEY**  
**48.1780**

Haemorrhoidal Saug-Ligator mit je 1 Saugkopf Nr. 48.1787 und 48.1788, Ladekonus Nr. 48.1789 und 100 Ligatur-Gummiringe 48.1715

Haemorrhoidal Suction Ligator with 1 ea. Suction head No. 48.1787 and 48.1788, loading cone No. 48.1789, and 100 ligature rubber rings No. 48.1715

Ligateur aspirant pour hémorroïdes avec une de chaque tête aspiratrice No. 48.1787 et 48.1788, cône de charge No. 48.1789, 100 anneaux de caoutchouc à ligatures No. 48.1715

Ligador aspirante hemorroïdal con cada uno pieza aspiradora No. 48.1787 y 48.1788, cono de carga No. 48.1788, 100 anillos para ligaduras No. 47.1715

Legatore con aspiratore completo con ciascuno testa aspiratrice 48.1787, 48.1788, cono per carica 48.1789, 100 anelli per legatura No. 48.1715



**McGIVNEY**  
48.1702 19 cm



**McGIVNEY**  
48.1704 19 cm

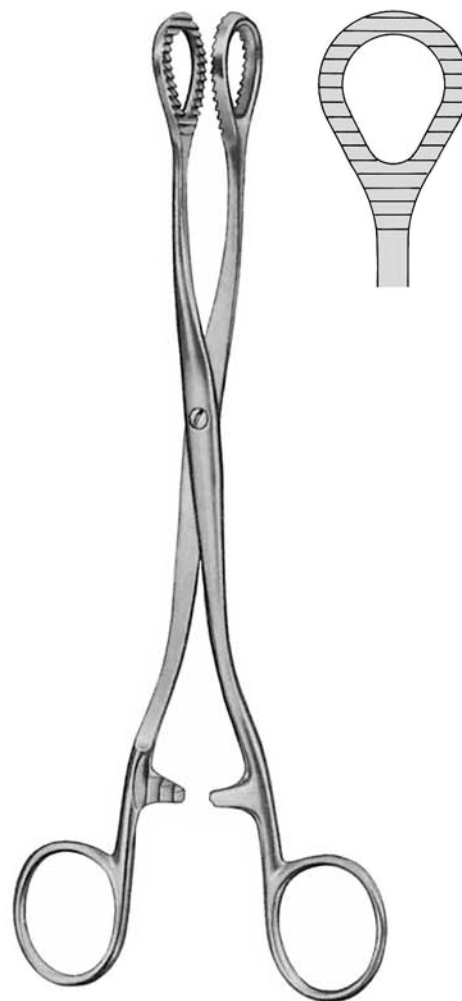

**HEYWOOD-SMITH**  
48.2200 20 cm



**BARRON**  
48.1900 25 cm

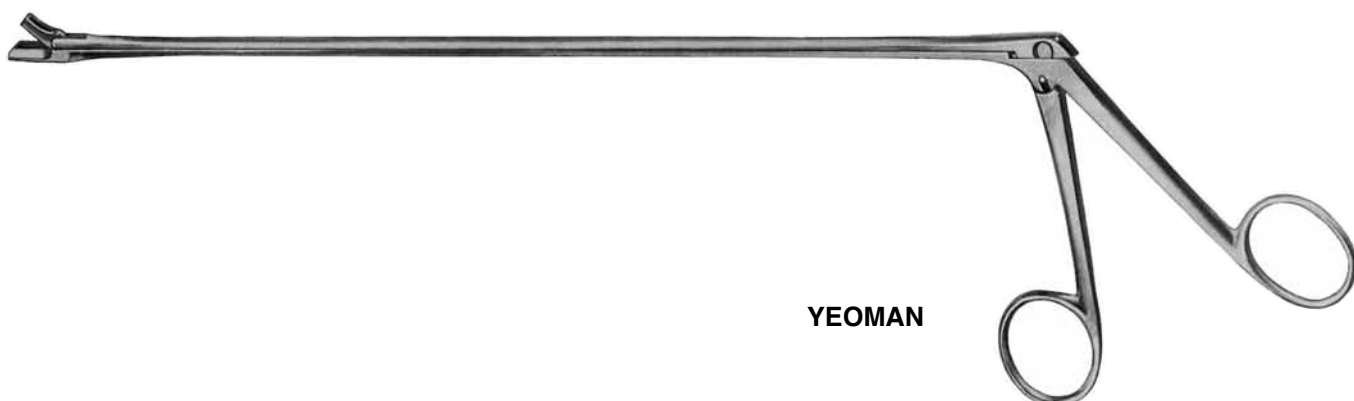

YEOMAN

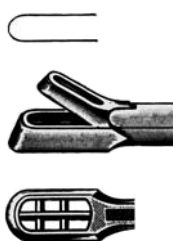

#1

48.2001 28 cm  
48.2011 35 cm  
48.2015 42 cm

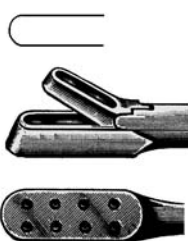

#2

48.2002 28 cm  
48.2012 35 cm  
48.2016 42 cm

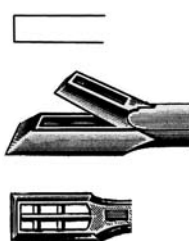

#3

48.2003 28 cm  
48.2013 35 cm  
48.2017 42 cm

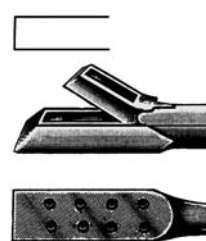

#4

48.2004 28 cm  
48.2014 35 cm  
48.2018 42 cm

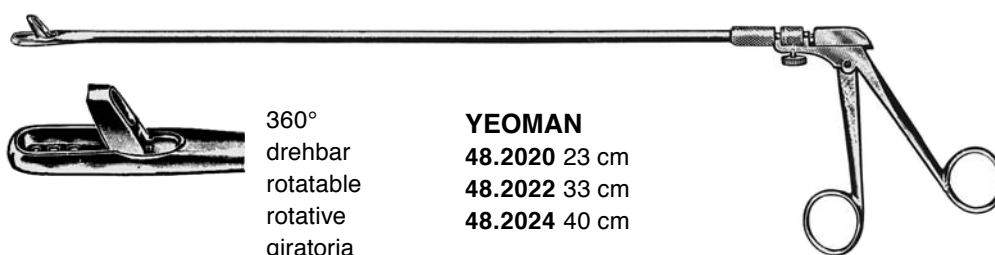

360°  
drehbar  
rotatable  
rotative  
giratoria  
rotante

YEOMAN

48.2020 23 cm  
48.2022 33 cm  
48.2024 40 cm

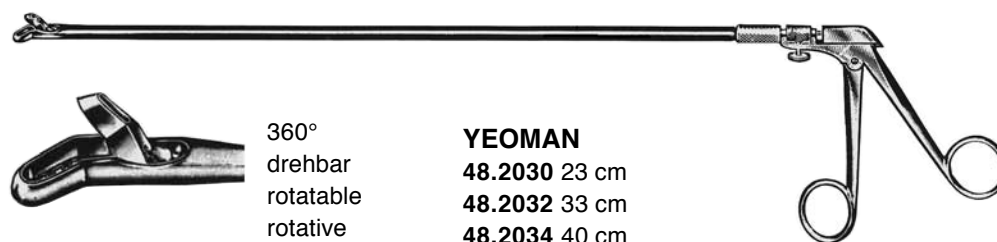

360°  
drehbar  
rotatable  
rotative  
giratoria  
rotante

YEOMAN

48.2030 23 cm  
48.2032 33 cm  
48.2034 40 cm





GALLE, LEBER, NIERE

GALL, LIVER, KIDNEY

BILE, FOIE, REIN

BILIS, HIGADO, RINON

BILE, FEGATO, RENE



Empfohlene Operationsbestecke für den Bereich "LEBER, GALLE, NIERE"  
(Details erhalten Sie über Ihren Fachhändler)

Suggested Instrument Sets for „LIVER, GALL, KIDNEY“  
(Please ask your dealer for details)

Suggestions de boîtes opératoires pour le secteur "BILE, FOIE, REIN".  
(Pour plus de détails veuillez contacter votre distributeur.)

Cajas quirurgicas para "BILIS, HIGADO, RINON" (para detalles póngase en  
contacto con su distribuidor)

Strumentari raccomandati per "BILE, FEGATO, RENE"  
(Per ulteriori informazioni, vi preghiamo di contattare il Vostro rivenditore)

- SET 50.0100** Liver Transplant Set (Donor)
- SET 50.0200** Liver Transplant Set (Recipient)
- SET 50.1000** Kidney Set (Adult)
- SET 50.1100** Kidney Neonatal Set
- SET 50.1200** Kidney Donor Preparation Extras
- SET 50.1350** Kidney Paediatric Transplant Set
- SET 50.1500** Renal Perfusion Set
- SET 50.2000** Cholecystectomy Set
- SET 50.4600** Urethral Dilatation Set



**MOYNIHAN**  
50.0140  
34 cm  
biegsam  
malleable  
malléable  
maleable  
malleabile

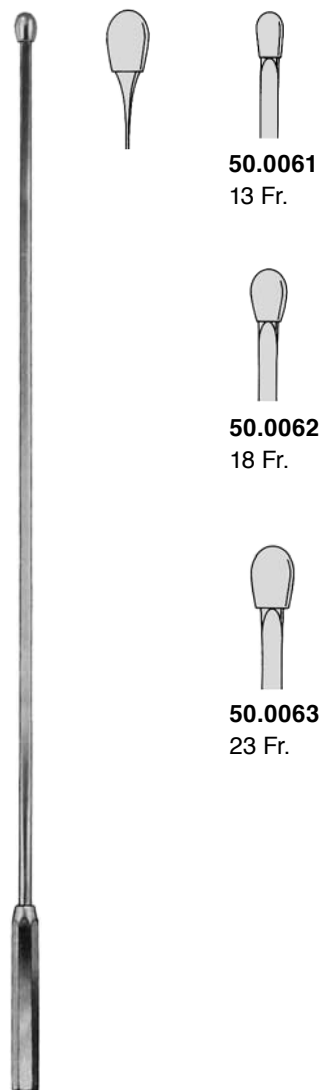

**DESJARDINS**  
30 cm  
federnd  
elastic  
élastique  
elásticos  
elastico

50.0061  
13 Fr.

50.0062  
18 Fr.

50.0063  
23 Fr.

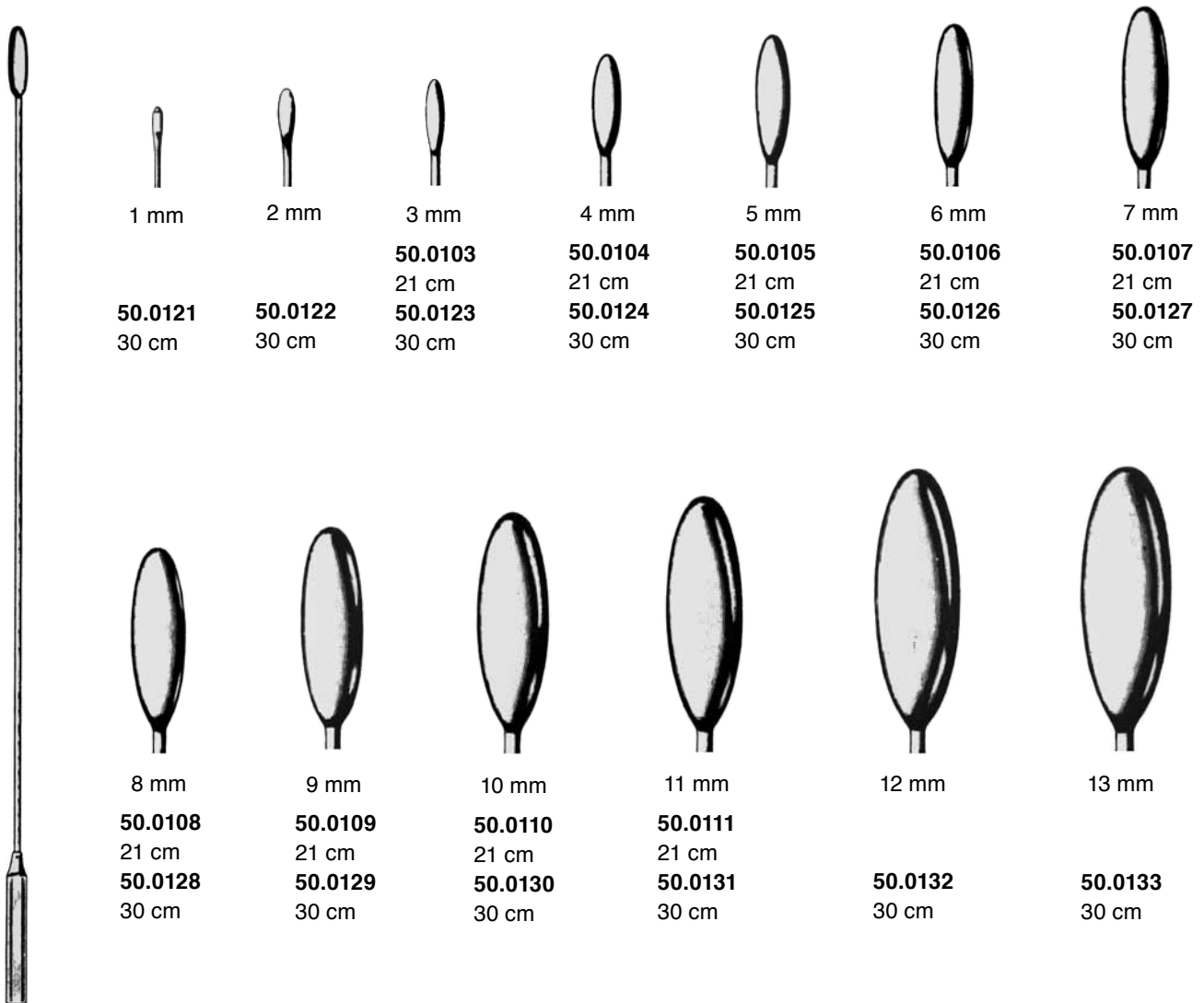

1 mm

2 mm

3 mm

4 mm

5 mm

6 mm

7 mm

**50.0103**

**50.0104**

**50.0105**

**50.0106**

**50.0107**

**50.0122**

**50.0123**

**50.0124**

**50.0125**

**50.0126**

**50.0127**

**50.0121**  
30 cm

30 cm

30 cm

30 cm

30 cm

30 cm

30 cm

8 mm

9 mm

10 mm

11 mm

12 mm

13 mm

**50.0108**

**50.0109**

**50.0110**

**50.0111**

**50.0132**

**50.0133**

21 cm

21 cm

21 cm

21 cm

30 cm

30 cm

**50.0128**

**50.0129**

**50.0130**

**50.0131**

30 cm

30 cm

30 cm

30 cm

30 cm

30 cm

**BAKES**

Schaft biegsam  
 malleable shaft  
 tige malléable  
 vástago maleable  
 gambo flessibile

**50.0100**

Satz / set / jeu / juego / set  
 21 cm 3 - 11 mm

**50.0120**

Satz / set / jeu / juego / set  
 30 cm 1 - 13 mm



**MAYO**  
**50.0200**  
28 cm d/e



**MAYO**  
27 cm

biegsam  
malleable  
malléable  
maleable  
malleabile



**50.0204**  
4 mm



**50.0205**  
5 mm



**50.0206**  
7 mm



**MAYO**  
**50.0210**  
27 cm

biegsam  
malleable  
malléable  
maleable  
malleabile



**MOORE**  
**50.0240**  
28 cm

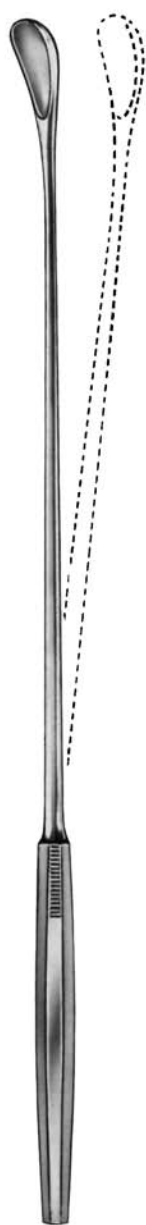

**50.0270**  
2,5 mm

**50.0271**  
3,2 mm

**50.0272**  
4,2 mm

**50.0273**  
5,5 mm

**50.0274**  
6,7 mm

**50.0275**  
8,0 mm

**50.0276**  
11,0 mm

**50.0277**  
15,0 mm

**LUER-KOERTE**

32 cm

Gallenblasenlöffel, biegsam  
Gall Bladder Scoops, malleable  
Curettes pour calculs biliaires, malléables  
Cucharillas para los cálculos biliares, maleable  
Cucchiai per calcoli biliari, maleablili

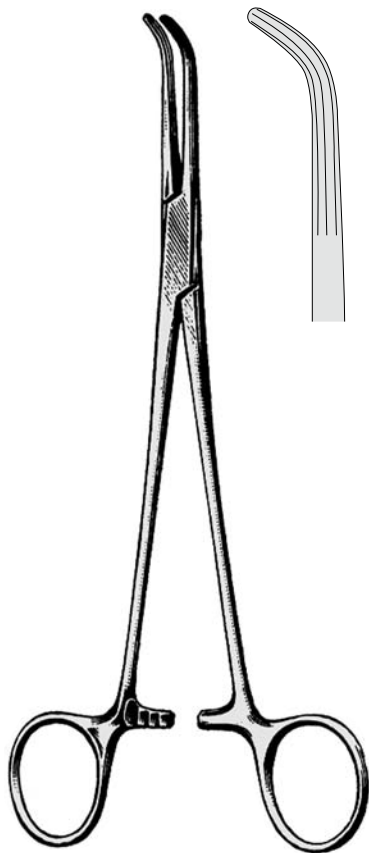

**LAHEY**  
15.0841 19 cm  
15.0843 23 cm



**MOYNIHAN**  
15.0901 23 cm  
15.0903 24 cm

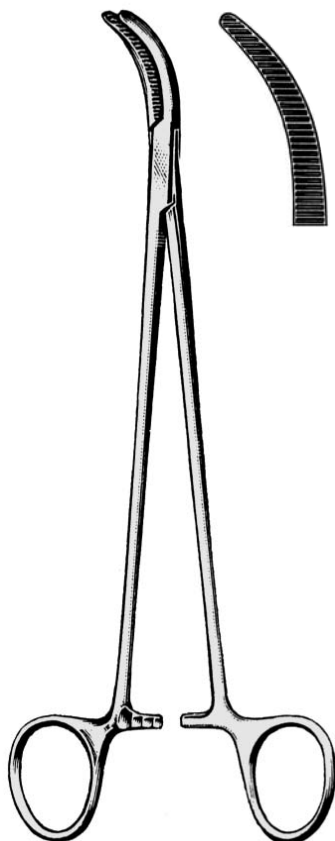

**DESJARDIN**  
15.0911 21 cm

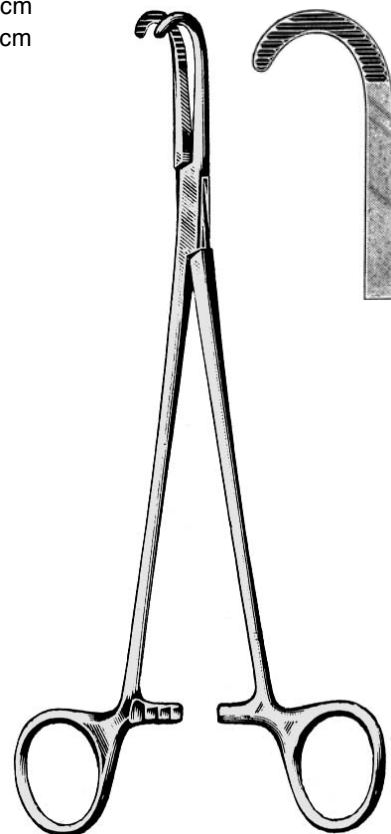

**DESJARDIN**  
15.0913 21 cm



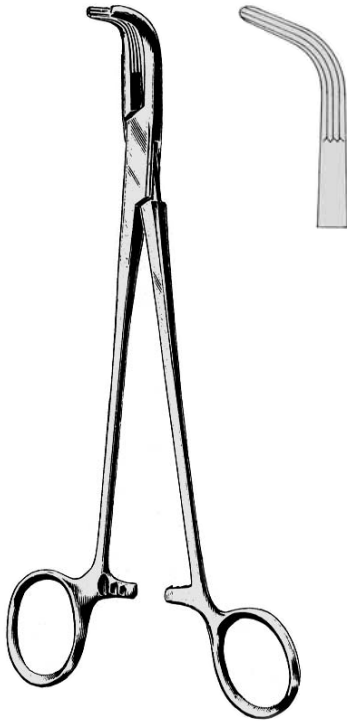

**LOWER**  
15.0931 18 cm



**JOHNS-HOPKINS**  
15.0941 20 cm



**MIXTER**  
15.1015 22 cm



**GRAY**  
15.1031 22 cm #1

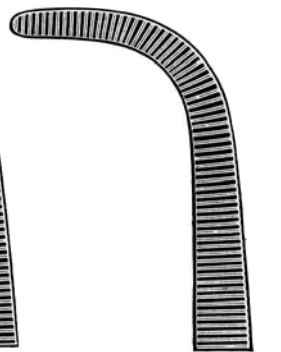

15.1033  
23 cm #2

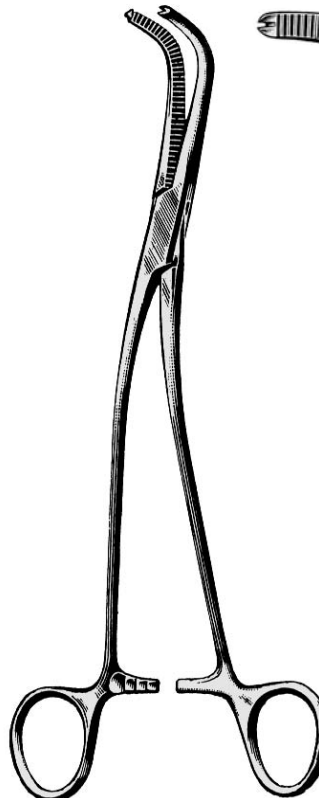

**GRAY**  
15.1035 22 cm #1

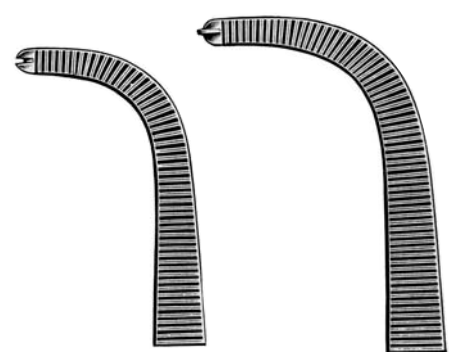

15.1037  
23 cm #2



**BLAKE**  
20 cm



50.0300

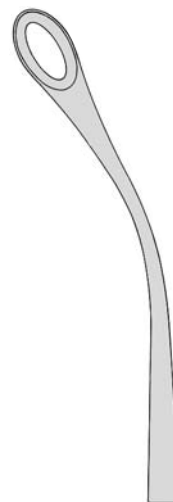

50.0301

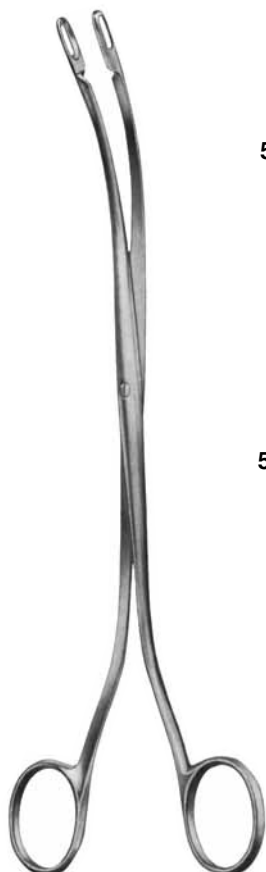

**DESJARDINS**  
23 cm



50.0311  
#1



50.0313  
#2



**DESJARDINS**

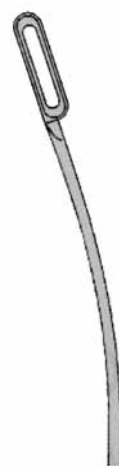

50.0315  
24 cm



50.0317  
22,5 cm



**MAYO-BLAKE**  
50.0320  
20 cm



**MAYO-BLAKE**  
50.0321  
20 cm



**MIXTER**  
50.0325  
22 cm

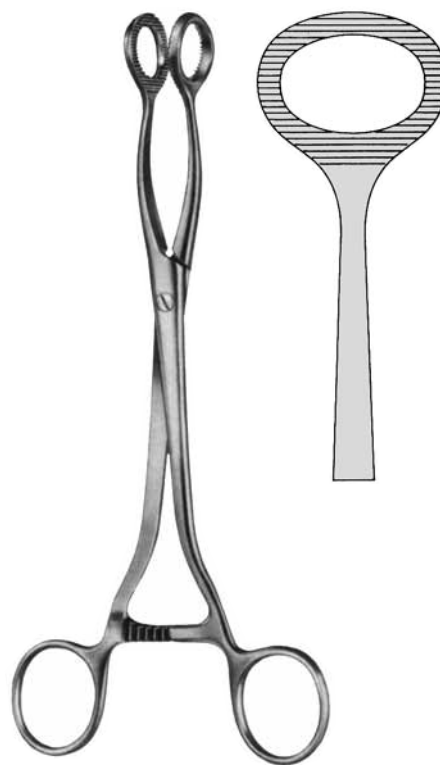

**DOYEN**  
50.0330  
20 cm



**BALLENGER**

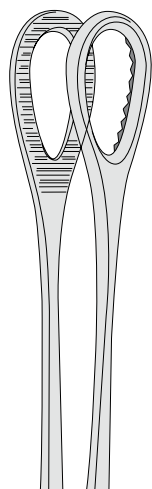

**16.0416** 25 cm

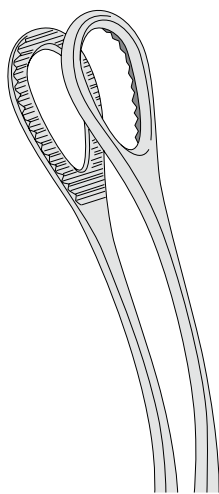

**16.0417** 25 cm



**DEBAKEY**



**15.1580**  
25 cm



**15.1582**  
27 cm

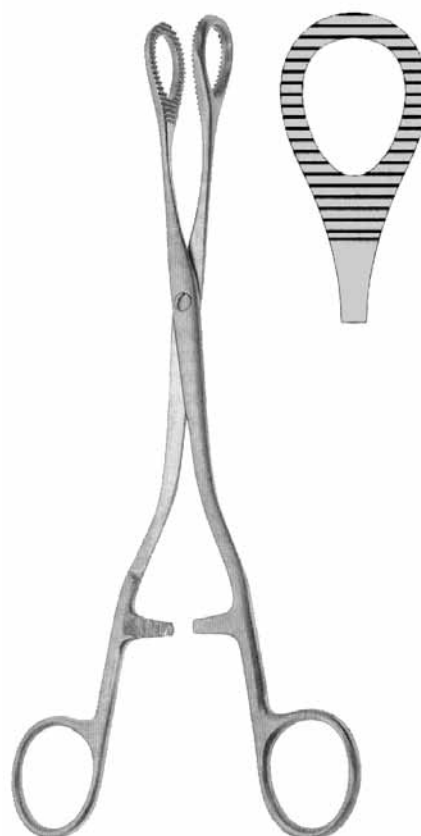

**HEYWOOD-SMITH**

**56.0880** 21 cm

**56.0882** 25 cm



**POTTS-DE-MARTEL**

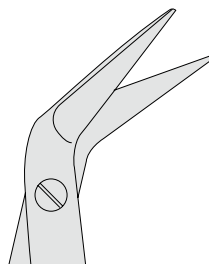

**13.1180** 21 cm /60°  
**13.1182** 24 cm /60°

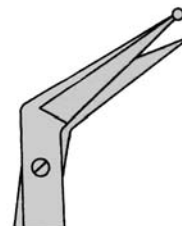

**MILLS**

**13.1190** 18 cm /60°  
**13.1192** 22 cm /60°  
1 Blatt geknöpft  
1 probe-pointed blade  
1 lame boutonée  
1 hoja botonada  
1 lama bottonuta



**POTTS-SMITH**

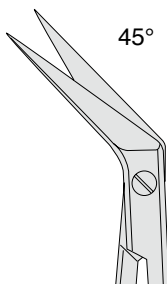

**POTTS-SMITH**  
**13.5601** 19 cm



**DEBAKEY**

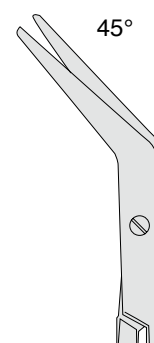

**DEBAKEY**  
**13.5621** 23 cm



**KELLY**

26 cm

**17.1118** 160 x 38 mm

**17.1119** 160 x 57 mm

**17.1093** 190 x 38 mm

**17.1094** 190 x 57 mm



**MIKULICZ**

24 cm

**17.1166** 95 x 35 mm



**MIKULICZ**

26 cm

**17.1167** 120 x 50 mm

**17.1168** 155 x 50 mm

**17.1169** 180 x 50 mm



**PITTSBURG**

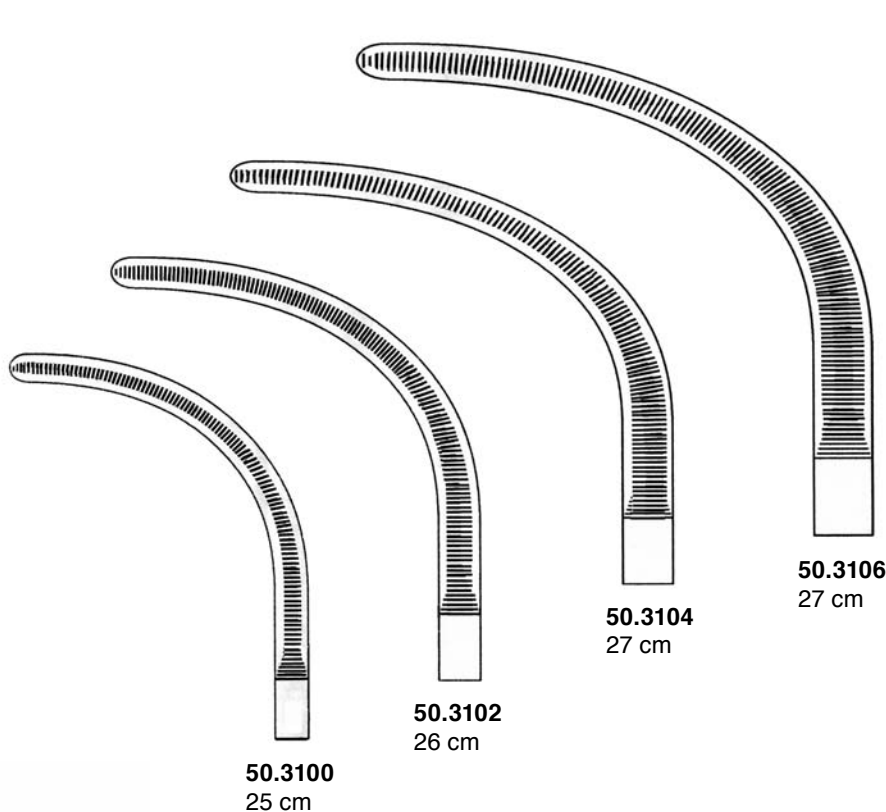



für Leberblindpunktion, mit Stoppsonde  
for liver blind puncture, with stopping probe  
pour ponction aveugle du foie, avec clou d'arrêt  
para punción ciega del hígado, con aguja limitadora  
per puntatura con ago limitatore

## MENGHINI

- 19.3000** 1,00 x 35 mm
- 19.3001** 1,00 x 70 mm
- 19.3010** 1,20 x 70 mm
- 19.3011** 1,20 x 100 mm
- 19.3020** 1,40 x 70 mm
- 19.3021** 1,40 x 100 mm
- 19.3030** 1,60 x 70 mm
- 19.3040** 1,80 x 80 mm
- 19.3041** 1,80 x 100 mm



für gezielte Leberpunktion  
for controlled liver pucture  
pour ponction contrôlée du foie  
para punción controlada del hígado  
per puntatura controllata del fegato

## MENGHINI

- 19.3043** 1,40 x 168 mm
- 19.3044** 1,80 x 168 mm



## FRANKLIN-SILVERMAN

- 19.3051** 2,0 x 100 mm
- 19.3053** 2,5 x 145 mm



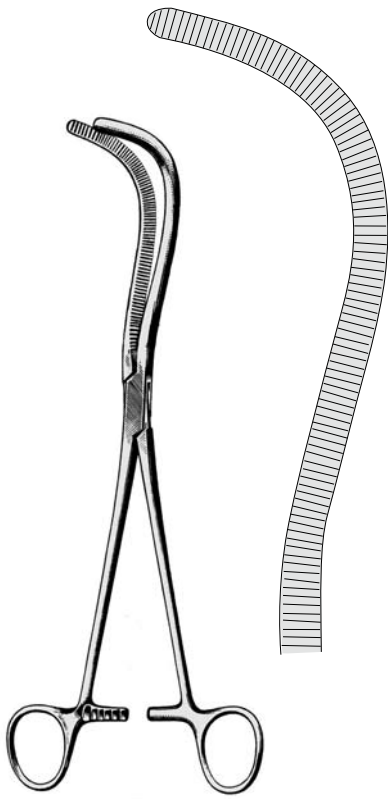

**MAYO-GUYON**  
15.1930 23 cm

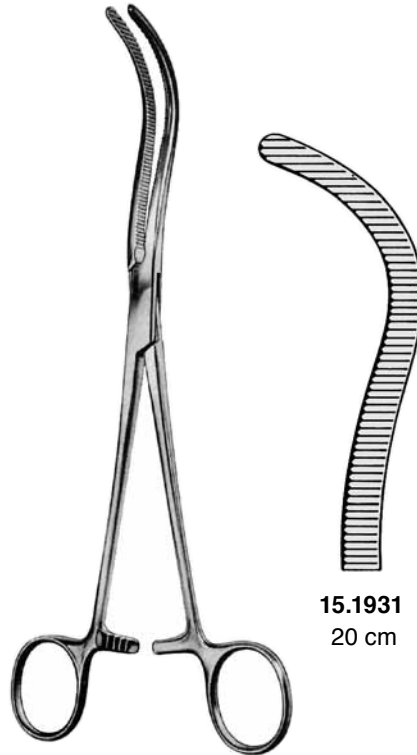

**GUYON**

**15.1931**  
20 cm

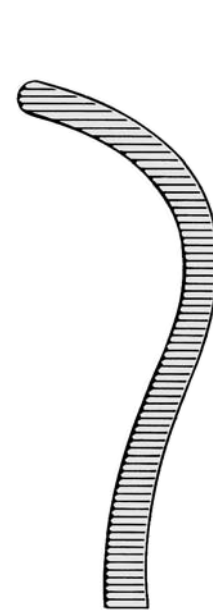

**15.1933**  
22 cm

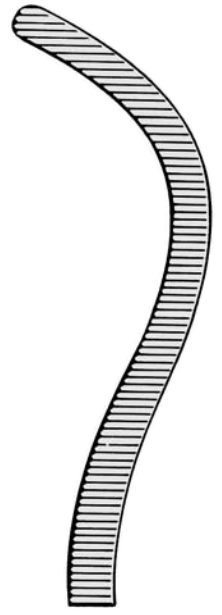

**15.1935**  
24 cm



**GUYON**  
15.1937 23 cm

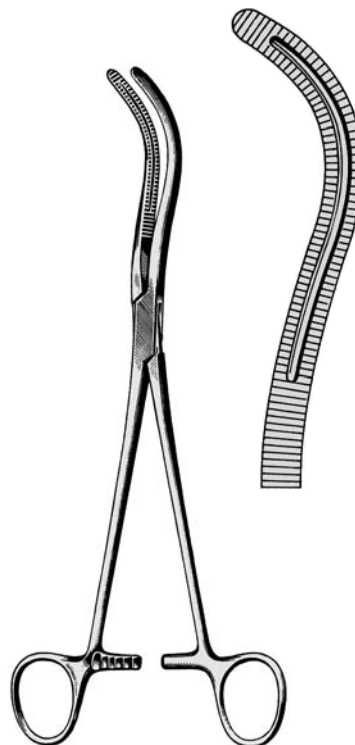

**STILLE**  
15.1940 23 cm

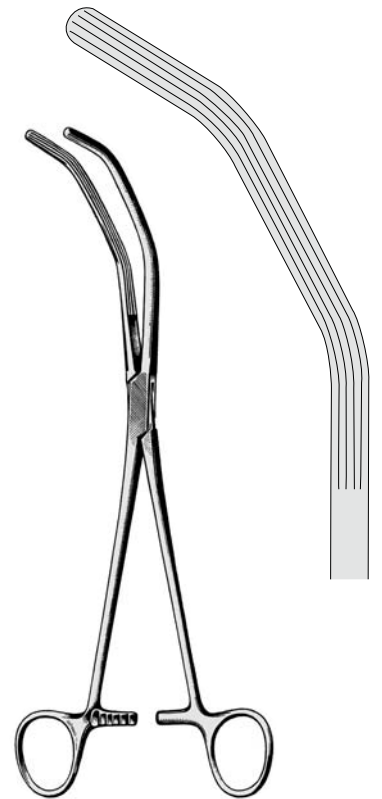

**HERRICK**  
15.1960 23 cm

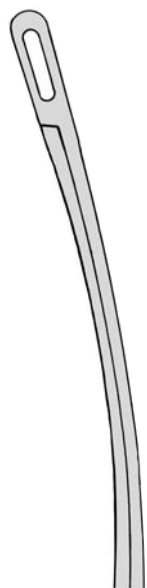

**50.0340**  
 23 cm #1

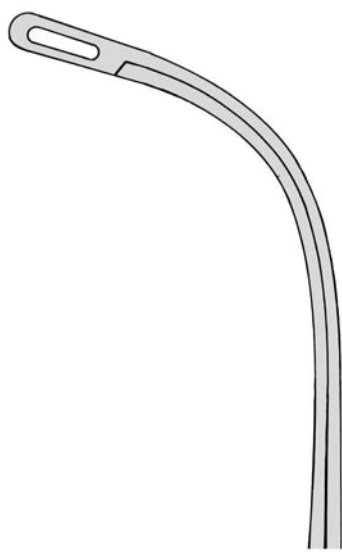

**50.0342**  
 21 cm #2

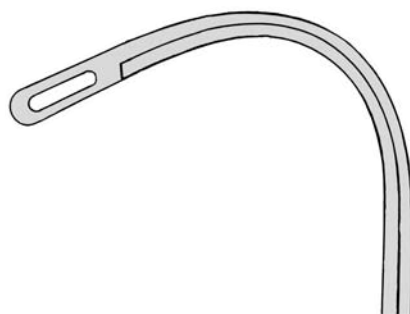

**50.0344**  
 19 cm #3

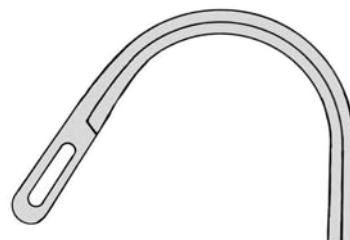

**50.0346**  
 18 cm #4



1



2

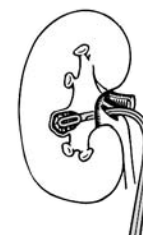

3



4

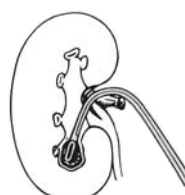

5 / 6

## RANDALL

**50.0347**

Satz #1-4 / Set #1-4 /

Jeu #1-4 / Juego #1-4 / Serie di #1-4



**RANDALL**

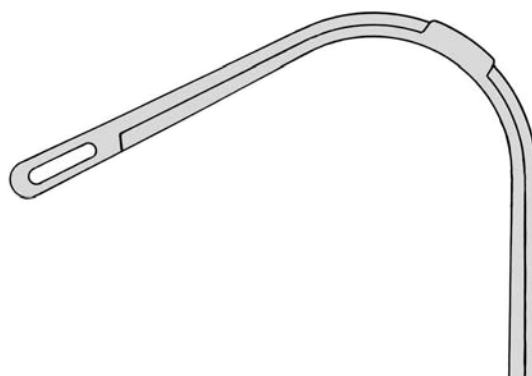

**50.0348**  
 19 cm #5

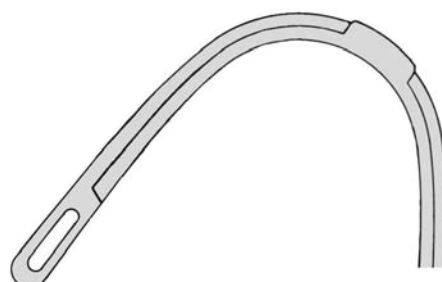

**50.0350**  
 19 cm #6

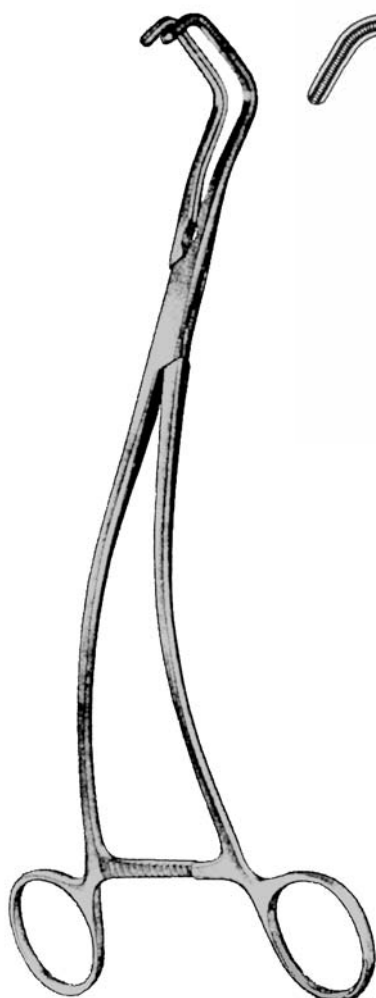

**URO**  
24 cm

Ureterzangen  
Ureter Forceps  
Pincés pour urètère  
Pinzas para uréter  
Pinze per uretere



**50.0401**  
# 1

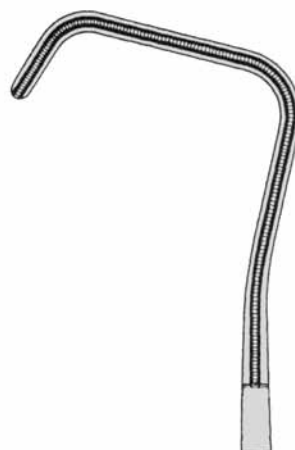

**50.0402**  
# 2



**DARTIGUES**  
55.1520  
27 cm

Nierenfaßzange  
Kidney elevating forceps  
Hystérolabe  
Pinza para sostener el riñón  
Pinze per afferare il rene



**MARBERGER**  
20 cm



**17.0671** 8 mm



**17.0672** 11 mm



**17.0673** 15 mm



**17.0674** 17 mm



**17.0675** 20 mm



**17.0676** 23 mm

biegsam  
 malleable  
 malléable  
 maleable  
 malleabili



**GIL-VERNET**  
24 cm



**17.0680** 9 mm



**17.0681** 11 mm



**17.0682** 13 mm



**17.0683** 15 mm



**17.0684** 18 mm

biegsam  
 malleable  
 malléable  
 maleable  
 malleabili

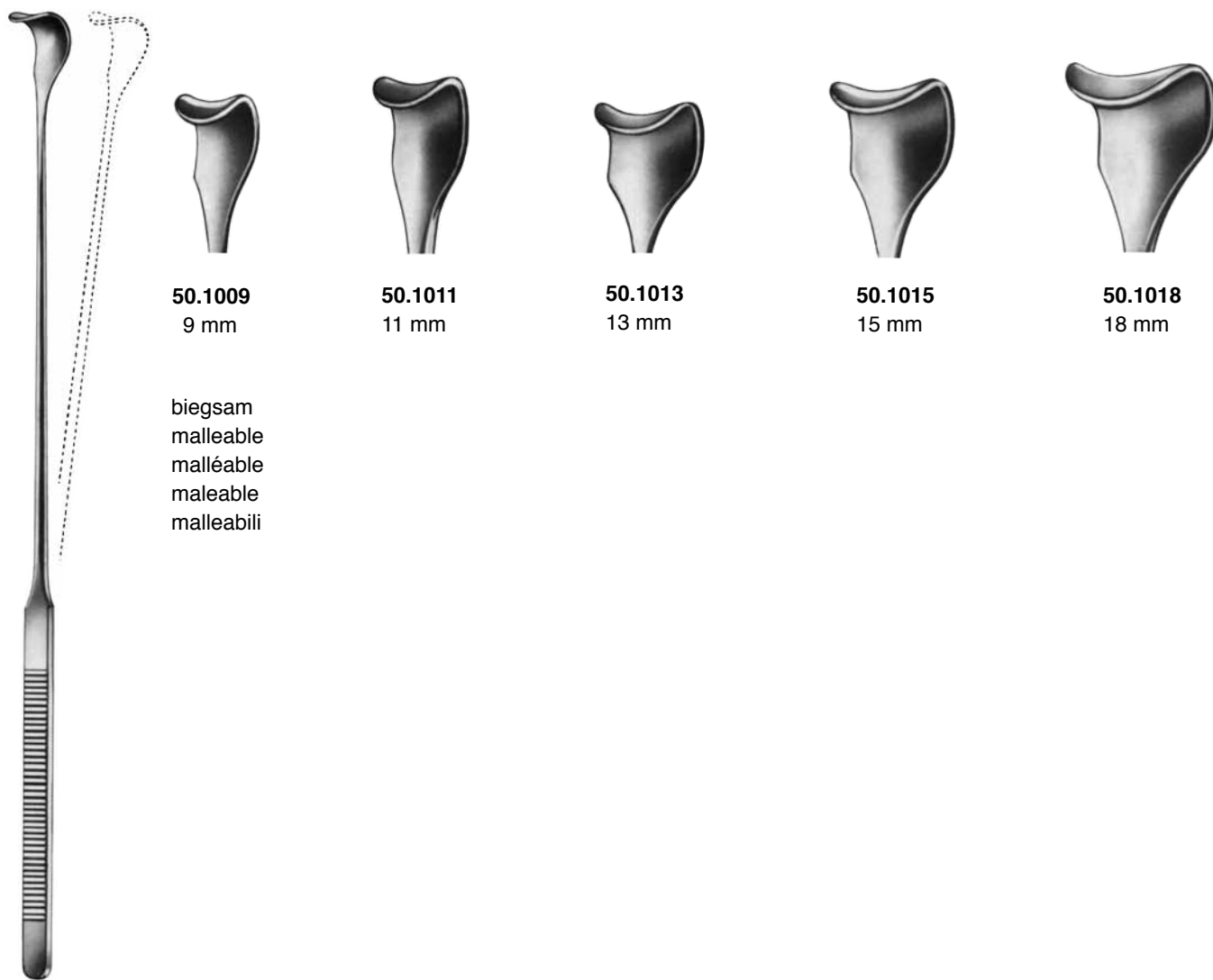

**50.1009**  
9 mm

**50.1011**  
11 mm

**50.1013**  
13 mm

**50.1015**  
15 mm

**50.1018**  
18 mm

biegsam  
malleable  
malléable  
maleable  
malleabili

**GIL-VERNET**  
28 cm

UROLOGIE  
UROLOGY  
UROLOGIE  
UROLOGIA  
UROLOGIA



Empfohlene Operationsbestecke für den Bereich "UROLOGIE"  
(Details erhalten Sie über Ihren Fachhändler)

Suggested Instrument Sets for „UROLOGY“  
(Please ask your dealer for details)

Suggestions de boîtes opératoires pour le secteur "UROLOGIE".  
(Pour plus de détails veuillez contacter votre distributeur.)

Cajas quirurgicas para "UROLOGIA" (para detalles póngase en contacto  
con su distribuidor)

Strumentari raccomandati per "UROLOGIA"  
(Per ulteriori informazioni, vi preghiamo di contattare il Vostro rivenditore)

- SET 51.0100** Urology Basic Instrument Set
- SET 51.0200** Urology Paediatric Basic Instrument Set
- SET 51.0300** Bladder Operating Set (Basic)
- SET 51.1000** Urology – Stones Set
- SET 51.1500** Prostatectomy Set
- SET 51.1550** Perineal Prostatectomy Set
- SET 51.1600** Supra-Retropubic Prostatectomy Set
- SET 51.2000** Urethral Dilation Inter Urethrotomy Set
- SET 51.2100** Meatotomy Set
- SET 51.2200** Orchiectomy Set
- SET 51.2300** Cystoscopy Basic Set
- SET 51.2500** Epispadias Repair Set
- SET 51.3000** Vasectomy Set
- SET 51.3100** Vasectomy Set "Non-Scalpel"
- SET 51.5000** Circumcision Set - Adult
- SET 51.5100** Circumcision Set - Newborn

Prostata-Fasszange  
 Prostatic grasping forceps  
 Pince à saisir la prostate  
 Pinza para coger prostata  
 Pinza per afferare la prostata

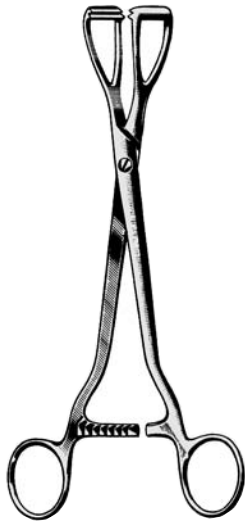

**YOUNG**  
 51.0004  
 20 cm

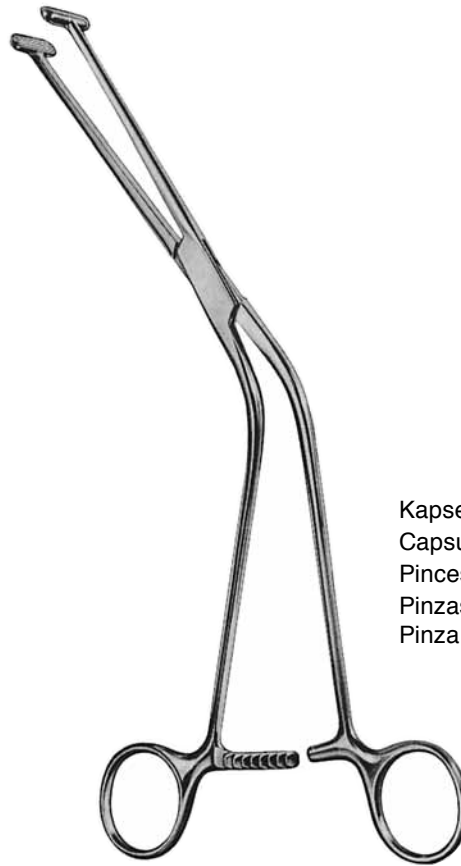

**MILLIN**  
 23 cm

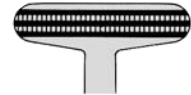

51.0009

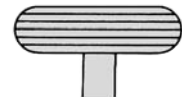

51.0010

Kapselasszangen  
 Capsule forceps  
 Pincés pour saisir les capsules  
 Pinzas para coger capsulas  
 Pinza per afferare la prostata

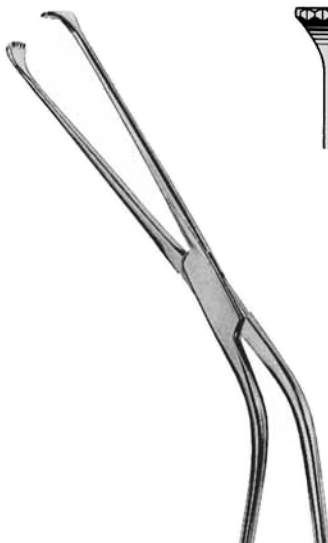

**MILLIN**  
 51.0011  
 23 cm



für die vorderen Lappen  
 for anterior lobes  
 pour lobe antérieur  
 para lobo anterior  
 per lobuli anteriori



**MILLIN**  
 51.0015  
 23 cm

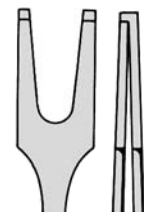

Fadenführungs-  
 zange  
 Ligatur carrier  
 Porte-ligature  
 Porta-ligaduras  
 Pinza porta filo



Blasenhalsspreizer  
Bladder neck spreader  
Ecarteur pour col vésical  
Dilatador para el cuello vesical  
Divaricatore per collo vescicale



**MILLIN**  
51.0020  
24 cm

Samenstrang-Fixierklemme  
Spermatic cord fixation clamp  
Pince pour fixer le canal déférent  
Pinza-fixajion canal espermatica  
Pinza per fissare cordone spermatico



**SPERMATIC**  
51.0040  
14,5 cm

Ureterklemmen  
Ureter clamps  
Pinces à urètere  
Pinzas clamps para ureter  
Pinze per uretere

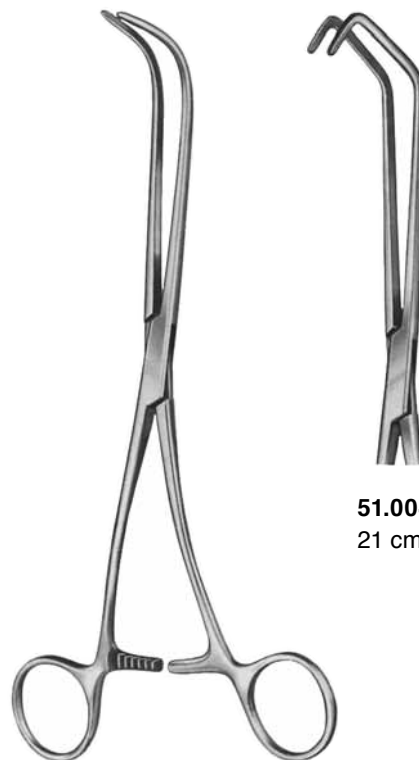

**51.0042**  
21 cm #2

**LURZ**  
51.0041  
21 cm #1

Prostatahaken  
Prostatic Retractors  
Ecarteurs à prostate  
Sparadores para prostata  
Reptrattori prostatici



35 mm

**LEGUEU**  
51.0050  
27 cm / 35 mm



67 mm

**KOCHER**  
51.0053  
26 cm / 67 mm

Prostatahaken  
Prostatic Retractors  
Ecarteurs à prostate  
Sparadores para prostata  
Re trattori prostatici

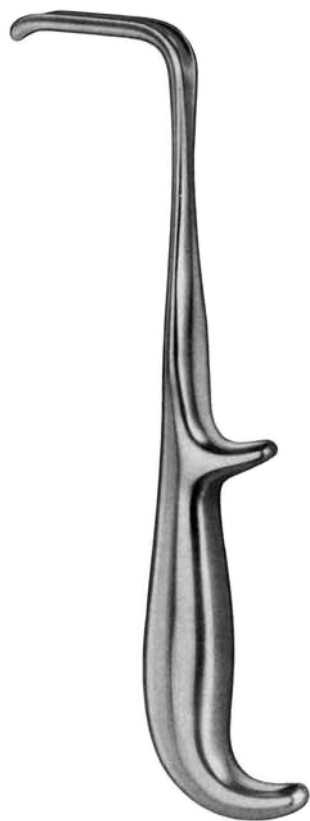

**YOUNG**  
**51.0055**  
21 cm

lateral  
lateral  
latéral  
lateral  
laterale



**YOUNG**  
**51.0056**  
22 cm

anterior  
anterior  
antérieur  
anterior  
anteriore



**YOUNG**  
**51.0057**  
21 cm

Bulbus-Haken  
Bulbus hook  
Crochet à bulbus  
Gancho para el bulbus  
Uncino per bulbo



**YOUNG**  
**51.0058**  
22 cm

gegabelt  
forked  
en fourhce  
horquilla  
a forchetta

Vasektomieklemmen / Vasectomy Clamps / Pincés pour Vasectomie / Pinzas para vasectomia / Pinze per Vasectomia



**51.0043**  
14 cm Ø 3,0 mm



**51.0044**  
14 cm Ø 4,7 mm



**51.0045**  
12,5 cm  
gebogen, spitz  
curved, sharp  
courbe, pointu  
curva, agudo  
curvo, acuto

Samenstranghaken / Spermatic cord hooks / Crochets pour cordon spermatique /  
Ganchos para cordón espermático / Uncini per cordone spermatico



**SPERMATIC**  
**51.0060**  
16 cm

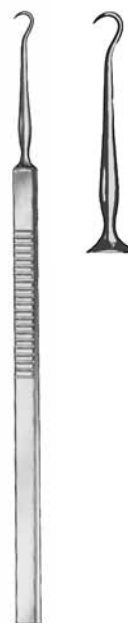

**17.0001**  
16 cm



**MILLIN**  
**51.0020**  
28 cm

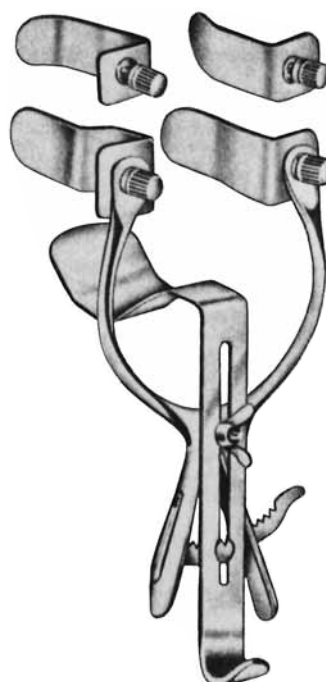

**MILLIN**  
**51.0080**

komplett, mit 2 Seitenvlaven 57x25 mm und 80x25 mm, 1 Mittelvale 120x45 mm  
complete, with 2 lateral valves 57x25 mm and 80x25 mm, 1 center blade 120x45 mm  
complet, avec 2 valves latérales 57x25 mm et 80x25 mm, 1 valve centrale 120x45 mm  
completo, con 2 valvas laterales 57x25 mm y 80x25 mm, 1 valva central 120x45 mm  
completo, con 2 valve laterali 57x25 mm e 80x25 mm, 1 valva centrale 120x45 mm



**JUDD-MASSON**  
**51.0070**  
Spreizweite 100 mm  
spread 100 mm  
ouverture 100 mm  
apertura 100 mm  
apertura 100 mm



## JUDD-MASSON

**51.0072**

komplett, mit 2 Seitenvalven 70x25 mm und 1 Mittelvale 84x24 mm  
complete, with 2 lateral valves 70x25 mm and 1 center blade 84x24 mm  
complet, avec 2 valves latérales 70x25 mm et 1 valve centrale 84x24 mm  
completo, con 2 valvas laterales 70x25 mm y 1 valva central 84x24 mm  
completo, con 2 valve laterali 70x25 mm e 1 valva centrale 84x24 mm

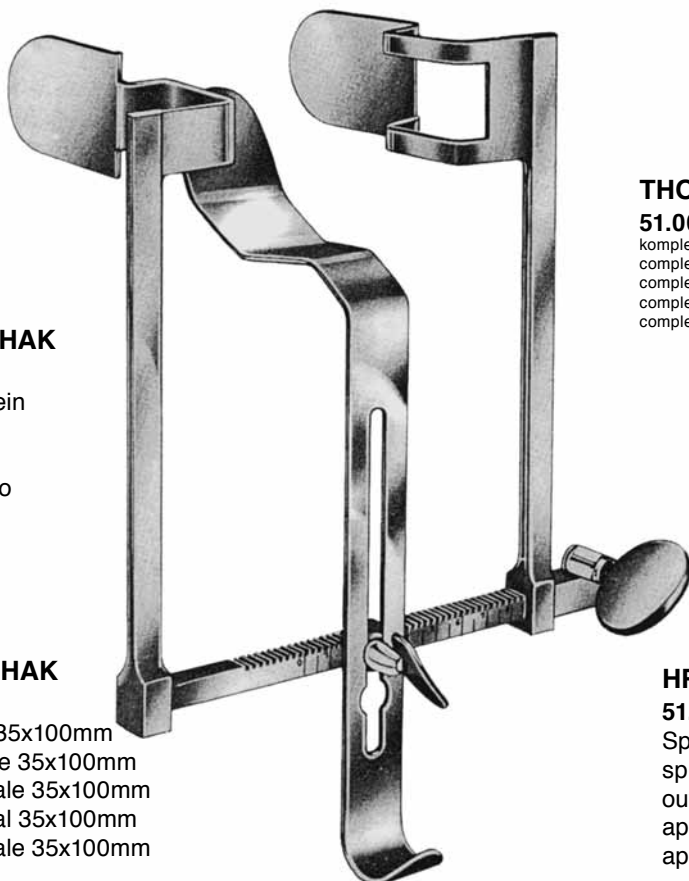

## HRYNTSCHAK

**51.0098**

Rahmen allein  
Frame only  
Cadre seul  
Bastidor solo  
Telaio solo

## HRYNTSCHAK

**51.0099**

Mittelvalve 35x100mm  
Center blade 35x100mm  
Valve centrale 35x100mm  
Valva central 35x100mm  
Valva centrale 35x100mm

## THOMSON-WALKER

**51.0090**

komplett, mit 2 Seitenvalven 70x25 mm und 75x25 mm, 1 Mittelvale 90x25 mm  
complete, with 2 lateral valves 70x25 mm and 75x25 mm, 1 center blade 90x25 mm  
complet, avec 2 valves latérales 70x25 mm et 75x25 mm, 1 valve centrale 90x25 mm  
completo, con 2 valvas laterales 70x25 mm y 75x25 mm, 1 valva central 90x25 mm  
completo, con 2 valve laterali 70x25 mm e 75x25 mm, 1 valva centrale 90x25 mm

## HRYNTSCHAK

**51.0097**

Spreizweite 110 mm  
spread 110 mm  
ouverture 110 mm  
apertura 110 mm  
apertura 110 mm

für Männer  
 for men  
 pour hommes  
 para hombres-  
 per uomini

fur Frauen  
 for women  
 pour femmes  
 para mujeres  
 per donne



- 51.0106 6 Fr.
- 51.0107 7 Fr.
- 51.0108 8 Fr.
- 51.0109 9 Fr.
- 51.0110 10 Fr.
- 51.0112 12 Fr.
- 51.0114 14 Fr.
- 51.0116 16 Fr.
- 51.0118 18 Fr.
- 51.0120 20 Fr.
- 51.0122 22 Fr.
- 51.0124 24 Fr.



- 51.0136 6 Fr.
- 51.0137 7 Fr.
- 51.0138 8 Fr.
- 51.0139 9 Fr.
- 51.0140 10 Fr.
- 51.0141 11 Fr.
- 51.0142 12 Fr.
- 51.0143 13 Fr.
- 51.0144 14 Fr.
- 51.0145 15 Fr.
- 51.0146 16 Fr.
- 51.0148 18 Fr.
- 51.0150 20 Fr.
- 51.0152 22 Fr.
- 51.0154 24 Fr.

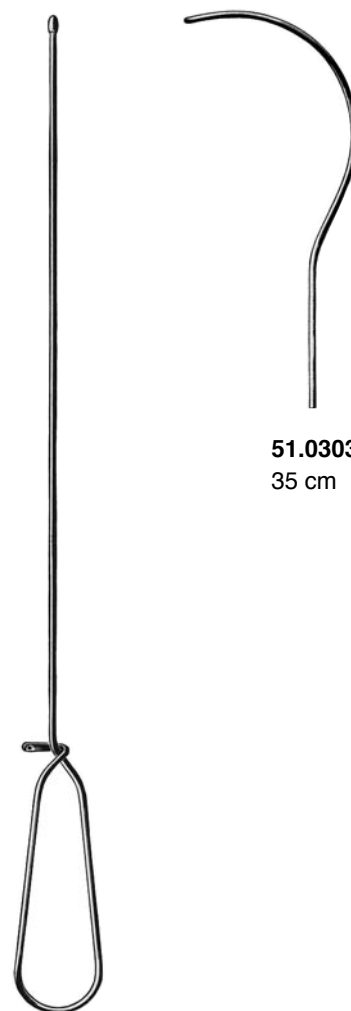

**51.0303**  
 35 cm

**GUYON**  
**51.0302**  
 39 cm



**GUTTMAN**  
 51.0350  
 26 cm



Sekretlöffel biegsam  
 Secretion curette, malleable  
 Cuillère pour sécrétions, malleable  
 Cucharilla para secreción, maleable  
 Curetta per secrezioni, malleabile



**STOCKMANN**  
 51.0600

Penisklemmen  
 Penis Clamps  
 Pincés pour pénis  
 Pinzas para pene  
 Pinze serrapene



**STRAUSS**  
 51.0610

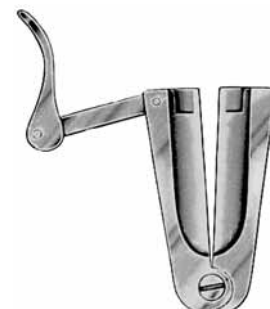

**MOGEN**  
 51.0720  
 7,5 cm

Beschneidungsinstrument  
 Circumcision instrument  
 Instrument de circoncision  
 Instrumento para circoncisión  
 Strumento per circoncisione

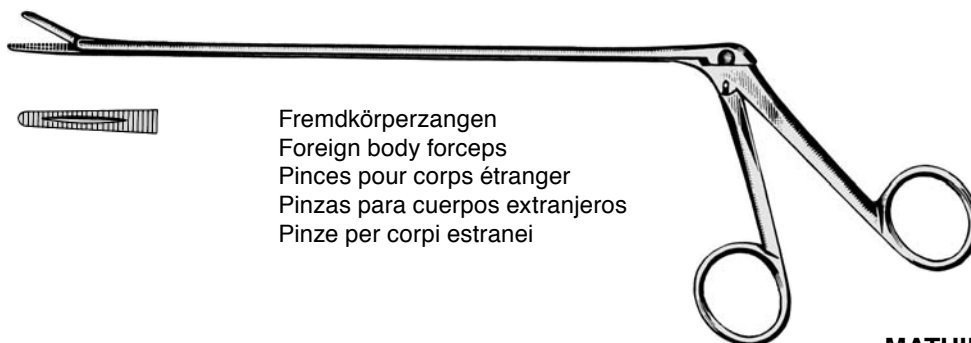

Fremdkörperzangen  
 Foreign body forceps  
 Pincés pour corps étranger  
 Pinzas para cuerpos extranjeros  
 Pinze per corpi estranei

**MATHIEU**  
 51.0800 20 cm  
 51.0802 28 cm



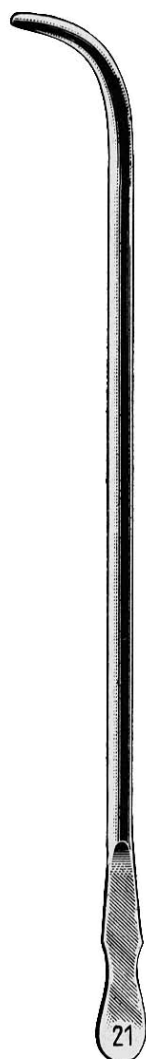

**VAN BUREN**

28 cm

- 51.1008** 8 Fr.
- 51.1010** 10 Fr.
- 51.1012** 12 Fr.
- 51.1014** 14 Fr.
- 51.1016** 16 Fr.
- 51.1018** 18 Fr.
- 51.1020** 20 Fr.
- 51.1022** 22 Fr.
- 51.1024** 24 Fr.
- 51.1026** 26 Fr.
- 51.1028** 28 Fr.
- 51.1030** 30 Fr.
- 51.1032** 32 Fr.
- 51.1034** 34 Fr.
- 51.1036** 36 Fr.

**51.1040** 8 - 36 Fr.

Satz / set / jeu / juego / serie

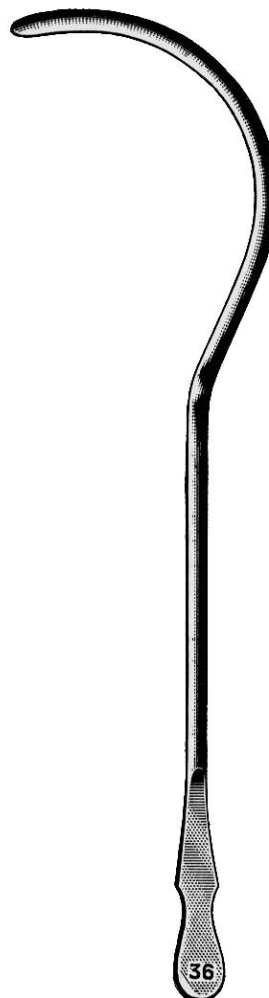

**GUYON**

26 cm

- 51.1107** 7Fr.
- 51.1108** 8Fr.
- 51.1109** 9Fr.
- 51.1110** 10 Fr.
- 51.1111** 11 Fr.
- 51.1112** 12 Fr.
- 51.1113** 13 Fr.
- 51.1114** 14 Fr.
- 51.1115** 15 Fr.
- 51.1116** 16 Fr.
- 51.1117** 17 Fr.
- 51.1118** 18 Fr.
- 51.1119** 19 Fr.
- 51.1120** 20 Fr.
- 51.1121** 21 Fr.
- 51.1122** 22 Fr.
- 51.1123** 23 Fr.
- 51.1124** 24 Fr.
- 51.1125** 25 Fr.
- 51.1126** 26 Fr.
- 51.1127** 27 Fr.
- 51.1128** 28 Fr.
- 51.1129** 29 Fr.
- 51.1130** 30 Fr.

**51.1140** 10 - 30 Fr.

Satz / set / jeu / juego / serie

GYNÄKOLOGIE  
GYNECOLOGY  
GYNECOLOGIE  
GINECOLOGIA  
GINECOLOGIA

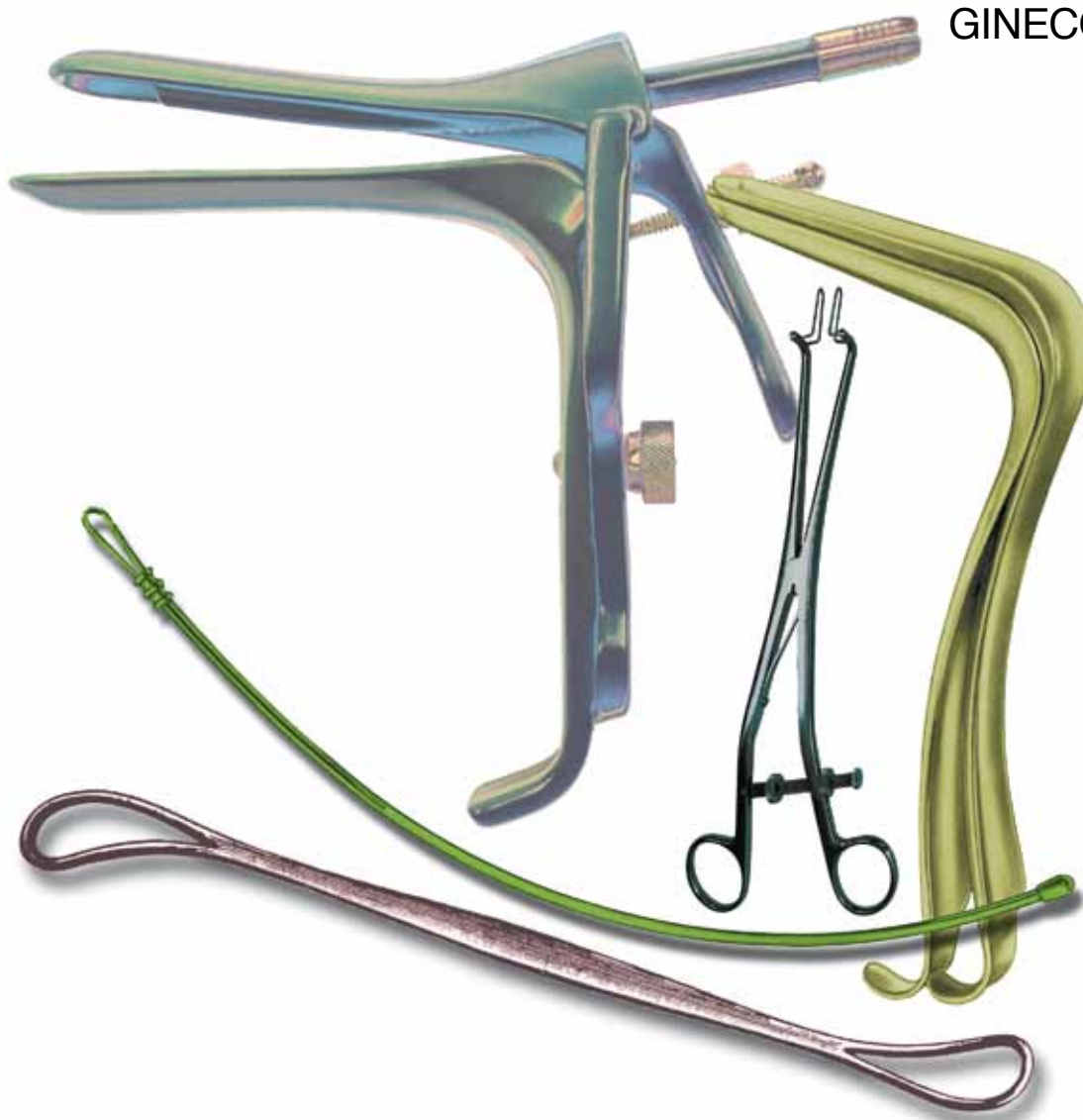

Empfohlene Operationsbestecke für den Bereich "GYNÄKOLOGIE"  
(Details erhalten Sie über Ihren Fachhändler)

Suggested Instrument Sets for „GYNECOLOGY“  
(Please ask your dealer for details)

Suggestions de boîtes opératoires pour le secteur "GYNECOLOGIE".  
(Pour plus de détails veuillez contacter votre distributeur.)

Cajas quirurgicas para "GINECOLOGIA" (para detalles póngase en contacto con su distribuidor)

Strumentari raccomandati per "GINECOLOGIA"  
(Per ulteriori informazioni, vi preghiamo di contattare il Vostro rivenditore)

- SET 55.0010** Gynaecological Ward Treatment Set
- SET 55.0020** Gynaecological Examination Set
- SET 55.0100** Colposcopy Set
- SET 55.0200** Dilation & Curetage Set
- SET 55.0220** Hysteroscopy Set Basic
- SET 55.0300** Gynaecologic Set
- SET 55.0400** Abdominal Gynaecological Set
- SET 55.1000** Abdominal Hysterectomy Set
- SET 55.1100** Vaginal Hysterectomy Set
- SET 55.1200** Cone Biopsy Set
- SET 55.1300** Gynaecology Laparotomy Set
- SET 55.1400** Basic Vaginal Instrument Set
- SET 55.1450** Vaginal Repair Set
- SET 55.1500** Vaginal Closure Set
- SET 55.1600** Tubal Plasty Set
- SET 55.1650** Open Tubal Surgery Set
- SET 55.1700** Salpingostomy Set
- SET 55.1800** Perineal Plastic Set
- SET 55.1900** Radical Vulvectomy Set
- SET 55.1950** Colpotomy Set
- SET 55.2000** Cervical Biopsy Set
- SET 55.2100** Uterine Biopsy Set
- SET 55.2200** Bartholin Cyst Excision Set
- SET 55.2300** Vaginal Repair Set
- SET 55.2350** Vesicovaginal Fistula Repair Set
- SET 55.2400** Anterior / Posterior Colporrhaphy Set
- SET 55.2500** Parametrial Fixation Set
- SET 55.3000** IUD Insertion & Extraction Set



**CUSCO**  
55.0010 75 x 17 mm  
für Jungfrauen  
for virgins  
pour vierges  
para virgenes  
per vergini



**COLLIN**  
55.0025 55 x 10 mm  
für Kinder  
child size  
pour enfants  
para niños  
per bambine



**PEDERSON**  
55.0040 75 x 13 mm

konische Blätter, für Jungfrauen  
tapered blades, for virgins  
valves coniques, pour vierges  
hojas cónicas, para vírgenes  
valve coniche, per vergini



**KRISTELLER**

21 cm

**55.0230** 110 x 18 mm # 00

**55.0231** 110 x 21 mm # 0



**KRISTELLER**

21 cm

**55.0233** 115 x 14 mm # 00

**55.0234** 115 x 17 mm # 0



**KRISTELLER**

Satz / set / jeu / juego

**55.0236** 110 x 18 mm # 00

**55.0237** 110 x 21 mm # 0



### 55.3530

VAGINOSKOP 65 x Ø 10 mm mit Kaltlicht-Anschluss  
ACMI,WOLF,STORZ

VAGINOSCOPE 65 x Ø 10 mm with Cold-light attachment  
(ACMI,WOLF,STORZ)

VAGINOSCOPE 65 x Ø 10 mm avec lumière froide  
(ACMI,WOLF,STORZ)

VAGINOSCOPIO 65 x Ø 10 mm con alumbrado frio  
(ACMI,WOLF,STORZ)

VAGINOSCOPIO 65 x Ø 10 mm fibra ottica (ACMI,WOLF,  
STORZ)

### 48.1249

Kaltlicht Beleuchtungsstab für Proktoskope, Analspreizer mit  
ACMI, STORZ, WOLF Anschluß

Fibre Optic Light attachment for Rectoscopes and -spreaders  
with connectors for ACMI, STORZ, WOLF

Embout lumière froide pour Proctoscopes, Ecarteurs rectaux,  
lumière froide avec adaptateur ACMI, STORZ, WOLF

Adaptador luz fria para Proctoscopios, Separadores rectales  
con adaptadores ACMI, STORZ, WOLF

Inserto per Proctoscopi, Divaricatori rettali a fibra ottica con  
adattatore ACMI, STORZ, WOLF



**CUSCO**

<b>55.0014</b>	90 x 23 mm	Schweizer Modell
<b>55.0015</b>	100 x 25 mm	Swiss pattern
<b>55.0016</b>	110 x 27 mm	Modèle suisse
		Modelo suizo
		Modello svizzero



**CUSCO**

<b>55.0017</b>	75 x 32 mm	Mittelschraube
<b>55.0018</b>	85 x 35 mm	Center screw
<b>55.0019</b>	100 x 37 mm	Vis centrale
		Tornillo central
		Vite centrale



## CUSCO

55.0011 75 x 32 mm

55.0012 85 x 35 mm

55.0013 100 x 37 mm



## CUSCO

55.0011B 75x32 mm

55.0012B 85x35 mm

55.0013B 100x37 mm

blendfrei - für LASER Chirurgie, mit Rauchabsaugung  
antiglare - for LASER Surgery - with smoke evacuation  
antiréfléchissant - pour chirurgie LASER, avec aspiration de la fumée  
antideslumbrante - para cirugía LASER, con aspiración de humo  
antiabbagliante - per chirurgia LASER, con aspirazione di fumo



## CUSCO

55.0011HF 75x32 mm

55.0012HF 85x35 mm

55.0013HF 100x37 mm

isoliert - für HF-Chirurgie, mit Rauchabsaugung  
insulated - for HF Surgery, with smoke evacuation  
isolés - pour chirurgie HF, avec aspiration de la fumée  
aislados - para cirugía HF, con aspiración de humo  
asolari - per chirurgia HF, con aspirazione di fumo



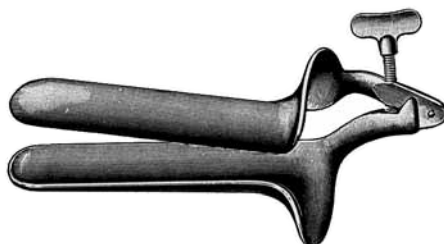

**COLLIN**

**55.0020** 85 x 30 mm

**55.0021** 100 x 35 mm

**55.0022** 110 x 40 mm



**COLLIN**

**55.0020B** 85x30 mm

**55.0021B** 100x35 mm

**55.0022B** 110x40 mm

blendfrei - für LASER Chirurgie, mit Rauchabsaugung  
antiglare - for LASER Surgery - with smoke evacuation  
antiréfléchissant - pour chirurgie LASER, avec aspiration de la fumée  
antideslumbrante - para cirugía LASER, con aspiración de humo  
antiabbagliante - per chirurgia LASER, con aspirazione di fumo



**COLLIN**

**55.0020HF** 85x30 mm

**55.0021HF** 100x35 mm

**55.0022HF** 110x40 mm

isoliert - für HF-Chirurgie, mit Rauchabsaugung  
insulated - for HF Surgery, with smoke evacuation  
isolés - pour chirurgie HF, avec aspiration de la fumée  
aislados - para cirugía HF, con aspiración de humo  
asolari - per chirurgia HF, con aspirazione di fumo



### GRAVE

55.0030 75 x 20 mm

55.0031 95 x 30 mm

55.0032 115 x 35 mm



### GRAVE

55.0030B 75x20 mm

55.0031B 95x30 mm

55.0032B 115x35 mm

blendfrei - für LASER Chirurgie, mit Rauchabsaugung  
antiglare - for LASER Surgery - with smoke evacuation  
antiréfléchissant - pour chirurgie LASER, avec aspiration de la fumée  
antideslumbrante - para cirugía LASER, con aspiración de humo  
antiabbagliante - per chirurgia LASER, con aspirazione di fumo



### GRAVE

55.0030HF 75x20 mm

55.0031HF 95x30 mm

55.0032HF 115x35 mm

isoliert - für HF-Chirurgie, mit Rauchabsaugung  
insulated - for HF Surgery, with smoke evacuation  
isolés - pour chirurgie HF, avec aspiration de la fumée  
aislados - para cirugía HF, con aspiración de humo  
asolari - per chirurgia HF, con aspirazione di fumo



**PEDERSON**

**55.0040** 75 x 13 mm

**55.0041** 100 x 22 mm

**55.0042** 120 x 25 mm

**55.0045** 100 x 16 mm



**PEDERSON**

**55.0040B** 75x13 mm

**55.0041B** 100x22 mm

**55.0042B** 120x25 mm

blendfrei - für LASER Chirurgie, mit Rauchabsaugung  
antiglare - for LASER Surgery - with smoke evacuation  
antiréfléchissant - pour chirurgie LASER, avec aspiration de la fumée  
antideslumbrante - para cirugía LASER, con aspiración de humo  
antiabbagliante - per chirurgia LASER, con aspirazione di fumo



**PEDERSON**

**55.0040HF** 75x13 mm

**55.0041HF** 100x22 mm

**55.0042HF** 120x25 mm

isoliert - für HF-Chirurgie, mit Rauchabsaugung  
insulated - for HF Surgery, with smoke evacuation  
isolés - pour chirurgie HF, avec aspiration de la fumée  
aislados - para cirugía HF, con aspiración de humo  
asolari - per chirurgia HF, con aspirazione di fumo

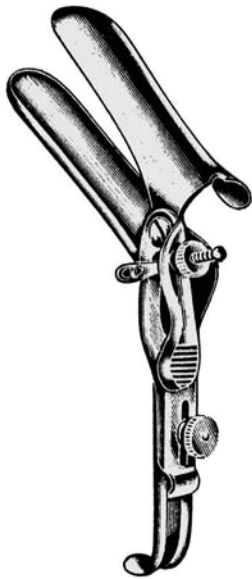

### GRAVE

**55.0036** 45° 100x35 mm  
rechte Seite offen  
right side open  
ouvert à droit  
abierto a la derecha  
aperto sulla destra

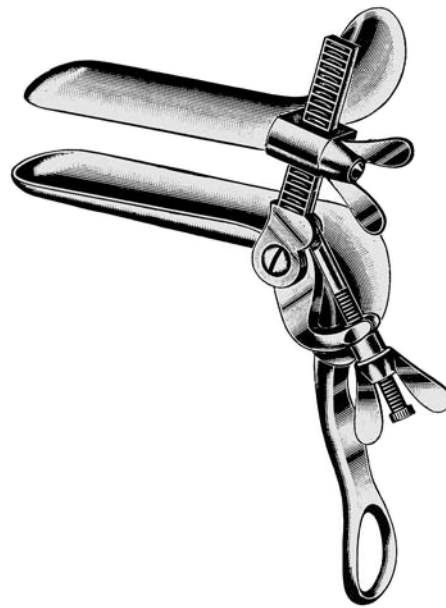

### TRELAT

**55.0050** 85 x 33 mm  
**55.0051** 95 x 35 mm  
**55.0052** 115 x 43 mm



### SEYFFERT

**55.0060** 100 x 17 mm  
**55.0062** 110 x 33 mm



### SEMM

**55.0066** 90 x 40/18 mm  
**55.0067** 100 x 17/20 mm  
**55.0068** 110 x 25/30 mm



**AUVARD**

**55.0100**

**55.0101**

abnehmbares Gewicht  
detachable weight  
poids démontable  
peso desmontable  
peso smontabile

80 x 38 mm

100 x 38 mm

140 x 32 mm

**AUVARD**

**55.0102**

**55.0103**

**55.0105**

festes Gewicht  
fixed weight  
poids fixe  
pesa fija  
peso fisso



**SCHERBAK**  
55.0112



**SCHERBAK**  
55.0116 # 1, 80 x 30 mm  
55.0117 # 2, 85 x 35 mm  
55.0118 # 3, 90 x 40 mm



**SCHERBAK**  
55.0119 # 4, 40/60 x 55 mm  
55.0120 # 5, 45/70 x 70 mm

### SCHERBAK

#### 55.0110

Scheidenspekulum, Satz komplett, bestehend aus:

- 55.0112 Griff
- 55.0113 Gewicht 400 g.
- 55.0116 Valve # 1, 80 x 30 mm
- 55.0117 Valve # 2, 85 x 35 mm
- 55.0118 Valve # 3, 90 x 40 mm
- 55.0119 Valve # 4, 40/60 x 55 mm

Vaginal Speculum, complete Set consisting of:

- 55.0112 Handle
- 55.0113 Weight 400 gr.
- 55.0116 Valve # 1, 80 x 30 mm
- 55.0117 Valve # 2, 85 x 35 mm
- 55.0118 Valve # 3, 90 x 40 mm
- 55.0119 Valve # 4, 40/60 x 55 mm

Spéculum vaginal, jeu complet, comprenant:

- 55.0112 Manche
- 51.0113 Poids 400 g.
- 55.0116 Valve # 1, 80 x 30 mm
- 55.0117 Valve # 2, 85 x 35 mm
- 55.0118 Valve # 3, 90 x 40 mm
- 55.0119 Valve # 4, 40/60 x 55 mm

Espéculo vaginal, juego completo, compuesto de:

- 55.0112 Mango
- 55.0113 Peso 400 gr.
- 55.0116 Valva # 1, 80 x 30 mm
- 55.0117 Valva # 2, 85 x 35 mm
- 55.0118 Valva # 3, 90 x 40 mm
- 55.0119 Valva # 4, 40/60 x 55 mm

Specolo vaginale, serie completa, composta da:

- 55.0112 Manico
- 55.0113 Peso 400 gr.
- 55.0116 Valva # 1, 80 x 30 mm
- 55.0117 Valva # 2, 85 x 35 mm
- 55.0118 Valva # 3, 90 x 40 mm
- 55.0119 Valva # 4, 40/60 x 55 mm

### SCHERBAK

#### 55.0111

Scheidenspekulum, Satz komplett, bestehend aus:

- 55.0112 Griff
- 55.0113 Gewicht 400 g.
- 55.0116 Valve # 1, 80 x 30 mm
- 55.0117 Valve # 2, 85 x 35 mm
- 55.0118 Valve # 3, 90 x 40 mm
- 55.0119 Valve # 4, 40/60 x 55 mm
- 55.0120 Valve # 5, 45/70 x 70 mm

Vaginal Speculum, complete Set consisting of:

- 55.0112 Handle
- 55.0113 Weight 400 gr.
- 55.0116 Valve # 1, 80 x 30 mm
- 55.0117 Valve # 2, 85 x 35 mm
- 55.0118 Valve # 3, 90 x 40 mm
- 55.0119 Valve # 4, 40/60 x 55 mm
- 55.0120 Valve # 5, 45/70 x 70 mm

Spéculum vaginal, jeu complet, comprenant:

- 55.0112 Manche
- 51.0113 Poids 400 g.
- 55.0116 Valve # 1, 80 x 30 mm
- 55.0117 Valve # 2, 85 x 35 mm
- 55.0118 Valve # 3, 90 x 40 mm
- 55.0119 Valve # 4, 40/60 x 55 mm
- 55.0120 Valve # 5, 45/70 x 70 mm

Espéculo vaginal, juego completo, compuesto de:

- 55.0112 Mango
- 55.0113 Peso 400 gr.
- 55.0116 Valva # 1, 80 x 30 mm
- 55.0117 Valva # 2, 85 x 35 mm
- 55.0118 Valva # 3, 90 x 40 mm
- 55.0119 Valva # 4, 40/60 x 55 mm
- 55.0120 Valva # 5, 45/70 x 70 mm

Specolo vaginale, serie completa, composta da:

- 55.0112 Manico
- 55.0113 Peso 400 gr.
- 55.0116 Valva # 1, 80 x 30 mm
- 55.0117 Valva # 2, 85 x 35 mm
- 55.0118 Valva # 3, 90 x 40 mm
- 55.0119 Valva # 4, 40/60 x 55 mm
- 55.0120 Valva # 5, 45/70 x 70 mm



**SCHERBAK**  
55.0113 400 gr.  
55.0114 600 gr.  
55.0115 800 gr.



**WEISSBARTH**  
55.0130 80 x 42 mm  
20 cm



**KRISTELLER**

19 cm

- ★ 55.0190 70 x 15 mm
- 55.0200 70 x 27 mm
- 55.0201 75 x 30 mm
- 55.0202 90 x 36 mm

★ für Kinder  
for children  
pour enfants  
para niños  
per bambine



**KRISTELLER**

18 cm

- ★ 55.0193 70 x 15 mm
- 55.0203 75 x 23 mm
- 55.0204 80 x 26 mm
- 55.0205 95 x 32 mm



**KRISTELLER**

Satz / set / jeu / juego / Set

- ★ 55.0196 70 x 15 mm
- 55.0206 70 x 27 mm
- 55.0207 75 x 30 mm
- 55.0208 90 x 36 mm



flache Spekula  
flat hollow specula  
spéculums plats  
especulos profundos  
Specoli piatti



## KRISTELLER

22 cm

**55.0210** 105 x 26 mm

**55.0211** 105 x 28 mm

**55.0212** 105 x 33 mm



## KRISTELLER

22 cm

**55.0213** 115 x 22 mm

**55.0214** 115 x 24 mm

**55.0215** 115 x 29 mm



## KRISTELLER

Satz / set / jeu / juego / Set

**55.0216** 105 x 26 mm

**55.0217** 105 x 28 mm

**55.0218** 105 x 33 mm



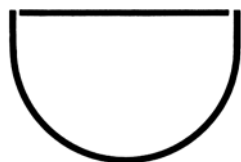

tiefe Spekula  
deep hollow specula  
spéculums profonds  
espéculos profundos  
Specoli profondi



**KRISTELLER**

22 cm

**55.0220** 110 x 27 mm

**55.0221** 110 x 30 mm

**55.0222** 110 x 36 mm



**KRISTELLER**

22 cm

**55.0223** 115 x 23 mm

**55.0224** 115 x 26 mm

**55.0225** 115 x 32 mm



**KRISTELLER**

Satz / set / jeu / juego / Set

**55.0226** 110 x 27 mm

**55.0227** 110 x 30 mm

**55.0228** 110 x 36 mm

extra groß  
extra large  
extra grand  
extra grande  
extra grande



**KRISTELLER**  
21 cm  
55.0240 135 x 36 mm

**KRISTELLER**  
21 cm  
55.0243 140 x 30 mm

**KRISTELLER**  
Satz / set / jeu / juego / Set  
55.0246 135 x 36 mm



**KALLMORGEN**

**55.0248**

70 x 40 mm

Satz / set / Jeu / Juego / Set

**KALLMORGEN**

**55.0250**

70 x 40 mm

Spekula / Specula / Spéculum /  
Espéculos / Specoli

**55.0252**

70 x 33 mm

Scheidenhalter / Vaginal Retractors / Valves  
vaginales / Valvas vaginales / Valve vaginali



**KALLMORGEN**

**55.0249**

90 x 40 mm

Satz / set / Jeu / Juego / Set

**KALLMORGEN**

**55.0251**

90 x 40 mm

Spekula / Specula / Spéculum /  
Espéculos / Specoli

**55.0253**

90 x 33 mm

Scheidenhalter / Vaginal Retractors / Valves  
vaginales / Valvas vaginales / Valve vaginali

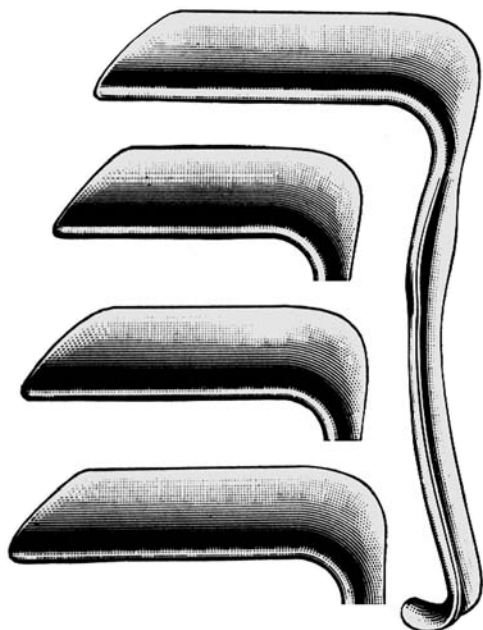

## JACKSON

18 cm

**55.0270** 75 x 30 mm

**55.0271** 90 x 38 mm

**55.0272** 100 x 38 mm



## EASTMAN

18 cm

**55.0275** 76 x 38 mm

**55.0276** 89 x 38 mm

**55.0277** 101 x 38 mm



## SIMS

18 cm

**55.0260** 60 x 25 + 30 mm

**55.0261** 70 x 30 + 35 mm

**55.0262** 80 x 35 + 40 mm

**55.0265** Satz / set / jeu / juego / Set



**BREISKY**

30 cm

- 55.0280 100 x 20 mm
- 55.0281 100 x 25 mm
- 55.0282 100 x 30 mm
- 55.0283 100 x 35 mm
- 55.0284 100 x 40 mm
- 55.0285 130 x 20 mm
- 55.0286 130 x 25 mm
- 55.0287 130 x 30 mm
- 55.0288 130 x 35 mm
- 55.0289 130 x 40 mm
- 55.0294 160 x 40 mm
- 55.0299 180 x 40 mm



**LANDAU**

30 cm

- 55.0310 100 x 28 mm
- 55.0311 110 x 38 mm



## DOYEN

24 cm

- 55.0320** 55 x 35 mm
- 55.0321** 85 x 35 mm
- 55.0322** 115 x 35 mm
- 55.0323** 55 x 45 mm
- 55.0324** 85 x 45 mm
- 55.0325** 115 x 45 mm
- 55.0326** 55 x 60 mm
- 55.0327** 85 x 60 mm
- 55.0328** 115 x 60 mm
- 55.0329** 160 x 60 mm



## SIMON

28 cm

- 55.0340** 115 x 22 mm
- 55.0342** 115 x 27 mm

Wiener Model  
Vienna pattern  
Modèle viennois  
Modelo vienés  
modello viennese



**KRISTELLER**

20 cm

**55.0350** 110 x 20 mm

**55.0351** 110 x 30 mm

**55.0352** 110 x 36 mm

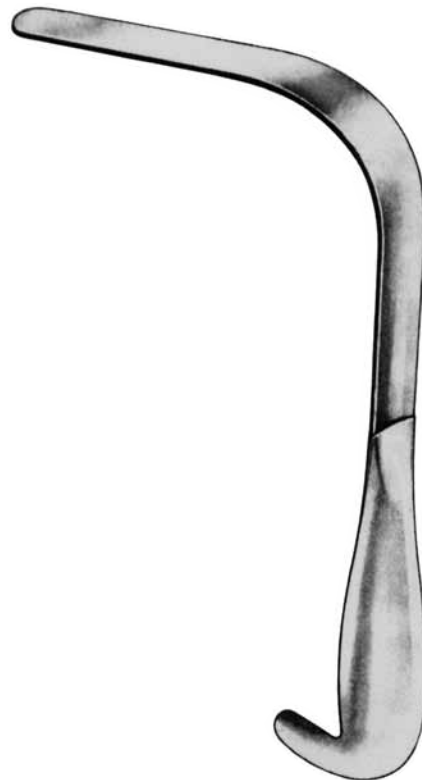

**KRISTELLER**

21 cm

**55.0353** 115 x 18 mm

**55.0354** 115 x 26 mm

**55.0355** 115 x 32 mm

Satz / set / jeu / juego / Set

**55.0357** 110 x 20 mm

**55.0358** 110 x 30 mm

**55.0359** 110 x 36 mm



**FRIEDMANN**

**55.0500** 10 cm



**KOGAN**  
55.0530 24 cm



**KOGAN**  
55.0532 24 cm

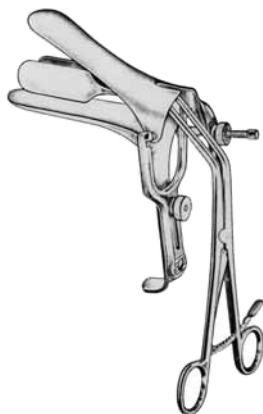

**LATERAL**  
55.0550  
22 cm





**HEGAR**

**55.0735** Satz / set / jeu / juego / Serie 4 -17 mm

in auskochbarer Stoffrolltasche  
 in boilable canvas roll  
 en toile roulable, lavable à l'eau bouillant  
 en bolsa de tela esterilizable para embullición  
 in busta di tela sterilizzabile

**HEGAR**

Ø mm		Ø mm	
1	55.0701	1,5	55.0791
2	55.0702	2,5	55.0792
3	55.0703	3,5	55.0793
4	55.0704	4,5	55.0794
5	55.0705	5,5	55.0795
6	55.0706	6,5	55.0796
7	55.0707	7,5	55.0797
8	55.0708	8,5	55.0798
9	55.0709	9,5	55.0799
10	55.0710	10,5	55.0800
11	55.0711	11,5	55.0801
12	55.0712	12,5	55.0802
13	55.0713	13,5	55.0803
14	55.0714	14,5	55.0804
15	55.0715	15,5	55.0805
16	55.0716	16,5	55.0806
17	55.0717	17,5	55.0807
18	55.0718	18,5	55.0808
19	55.0719	19,5	55.0809
20	55.0720		
21	55.0721		
22	55.0722		
23	55.0723		
24	55.0724		
25	55.0725		
26	55.0726		
27	55.0727		
28	55.0728		
29	55.0729		
30	55.0730		
32	55.0731		

**55.0732** Satz / set / jeu / juego / Serie 4 - 17 mm

**55.0733** Satz / set / jeu / juego / Serie 1 - 26 mm



**HEGAR**

**55.0736** Satz / set / jeu / juego / Serie 4 - 17 mm

**55.0737** Satz / set / jeu / juego / Serie 1 - 26 mm

in Metalletui Nr. 55.0851  
 in Metal case No. 55.0851  
 en boîte métal No. 55.0851  
 en caja metálica No. 55.0851  
 in scatola metallica 55.0851

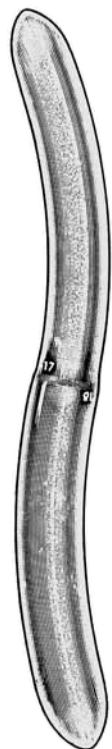

## HEGAR

Ø mm	
1 / 2	55.0741
3 / 4	55.0743
5 / 6	55.0745
7 / 8	55.0747
9 / 10	55.0749
11 / 12	55.0751
13 / 14	55.0753
15 / 16	55.0755
17 / 18	55.0757
19 / 20	55.0759
21 / 22	55.0761
23 / 24	55.0763
25 / 26	55.0765

55.0772 Satz / set / jeu / juego / Serie 3 / 4 - 17 / 18 mm

55.0773 Satz / set / jeu / juego / Serie 1 / 2 - 25 / 26 mm



## HEGAR

55.0775 Satz / set / jeu / juego / Serie 3 / 4 - 17 / 18 mm

in auskochbarer Stoffrolltasche  
in boilable canvas roll  
en toile roulable, lavable à l'eau bouillant  
en bolsa de tela esterilizable para embullición  
in busta di tela sterilizzabile



## HEGAR

55.0776 Satz / set / jeu / juego / Serie 3 / 4 - 17 / 18 mm

55.0777 Satz / set / jeu / juego / Serie 1 / 2 - 25 / 26 mm

in Metalletui  
in Metal case  
en boîte métal  
en caja metálica  
in scatola metallica



## GOODELL

55.0902 34 cm



**SIMS**

**55.1001** 32 cm

mit Zentimetereinteilung, biegsam, versilbert  
graduated in cm, malleable, silver-plated  
gradu  en cm, mall able, argent   
graduado in centimetros, maleable, plateado  
graduato in cm, malleabile, argentato

**55.1004** 32 cm

mit Zentimetereinteilung, starr, versilbert  
graduated in cm, rigid, silver-plated  
gradu  en cm, rigide, argent   
graduado in centimetros, r gido, plateado  
graduato in cm, rigido, argentato

**SIMS**

**55.1001S** 32 cm

mit Zentimetereinteilung, biegsam, 18/8 Stahl  
graduated in cm, malleable, 18/8 steel  
gradu  en cm, mall able, acier 18/8  
graduado in centimetros, maleable, acero 18/8  
graduato in cm, malleabile, acciaio 18/8

**55.1004S** 32 cm

mit Zentimetereinteilung, starr, 18/8 Stahl  
graduated in cm, rigid, 18/8 steel  
gradu  en cm, rigide, acier 18/8  
graduado in centimetros, r gido, acero 18/8  
graduato in cm, rigido, acciaio 18/8

**MARTIN**

**55.1021** 32 cm

biegsam/malleable  
mall abl/maleable/malleabile

**55.1024** 32 cm

starr/rigid  
rigide/rigida/rigido

**VALLEIX**

**55.1030**

27 cm



**BRAUN**  
55.1100  
28 cm

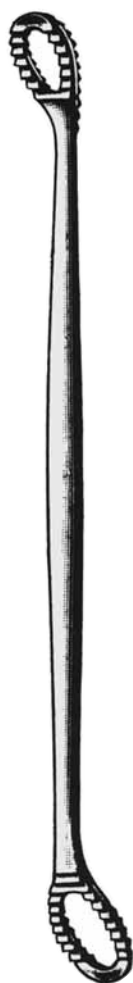

**SIMS**  
55.1110  
26 cm

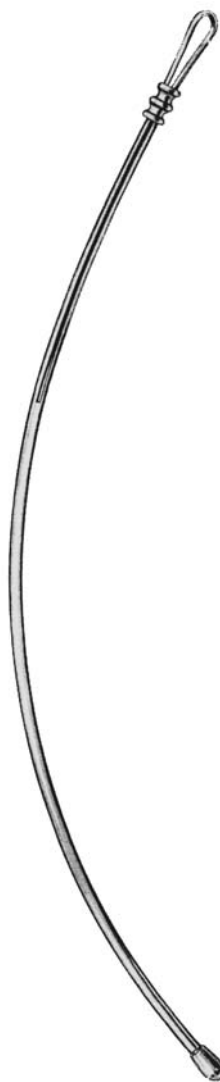

**AMANN**  
55.1120  
32 cm  
Tamponadeführer  
Uterine gauze packer  
Conducteur porte-tampon  
Conductor de tampónes  
Porta garza uterino



**BEACHAM**  
55.1200  
26 cm  
Amniotom  
Amniotome  
Amniotome  
Amniotómo  
Amniotomo

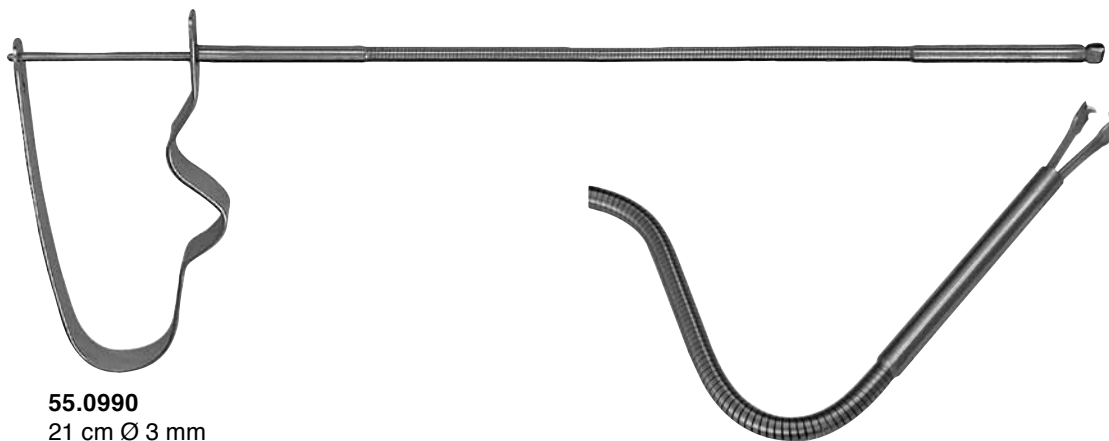

**55.0990**

21 cm Ø 3 mm

starr / rigid / rigide / rigido / rigido

**55.0991**

21 cm Ø 3 mm

biegsam / malleable / malléable / maleable / malleabile



**IUP**

**55.1565**

26 cm

IUP Haken zur Entfernung, biegsam

IUD Extractor hook, malleable

DIU Crochet pour extraction, malléable

DIU Gancho para extracción, maleable

IUD Uncino per estrazione, malleabile

**RAMATHIBODI**

**55.1525**

27,5 cm

Uterusmanipulator

Uterine Manipulator

Manipulateur utérin

Manipulador uterino

Manipulatore uterino

**RAMATHIBODI**

**55.1526**

25,5 cm

Tubus-Haken

Tubular Hook

Crochet tubulaire

Gancho tubular

Uncino tubular



**BARRETT**  
55.0930  
18 cm

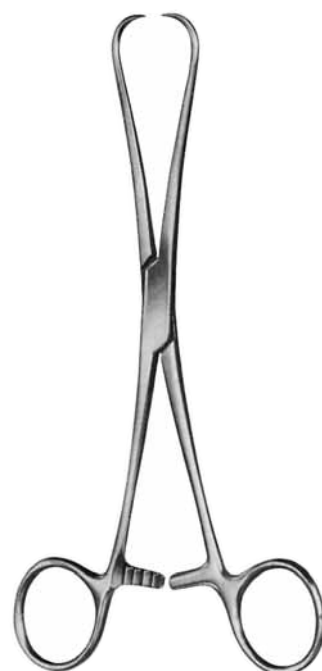

**STAUDE-MOORE**  
55.0932  
17 cm



**BRAUN**  
55.0934  
25 cm

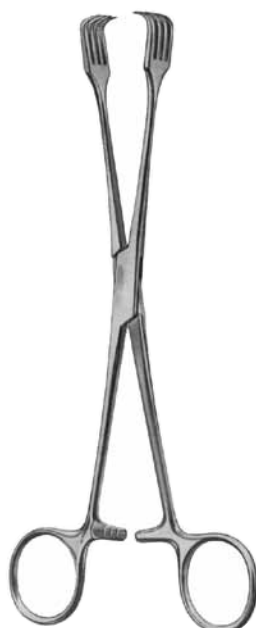

**BRAUN**  
55.0933  
16 cm



**CZERNY**  
55.0936  
21 cm



**ADAIR**  
55.0937 16 cm  
55.0938 19 cm



**SCHROEDER**  
55.0940 25 cm

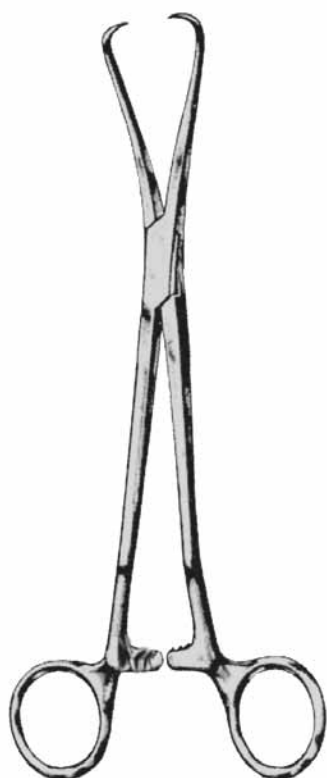

**JARCHO**  
55.0945 20 cm



**POZZI**  
55.0942 25cm  
stumpf / blunt / mousse / roma / smussa  
55.0944 25cm  
spitz / sharp / pointu / agudo / acuto



**DUPLAY**  
55.0947  
28 cm



**HULKA**  
55.0948  
29 cm

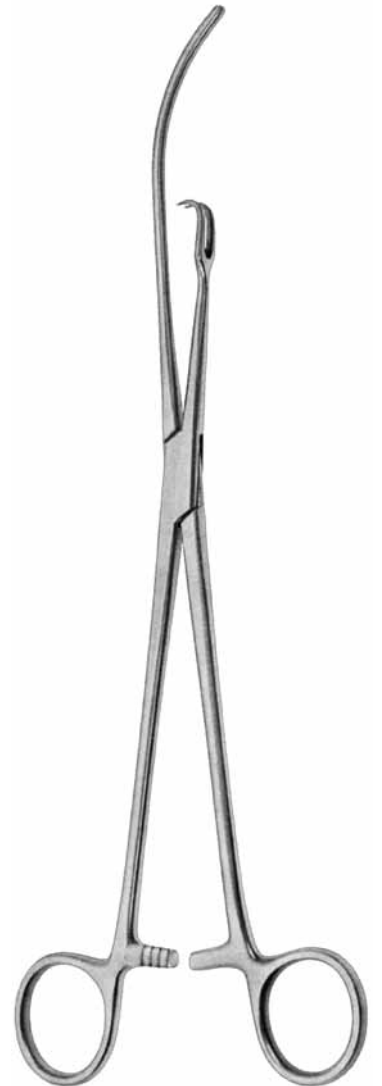

**HULKA-KENWICK**  
55.0949  
29 cm





**SKENE**  
55.0951  
24 cm

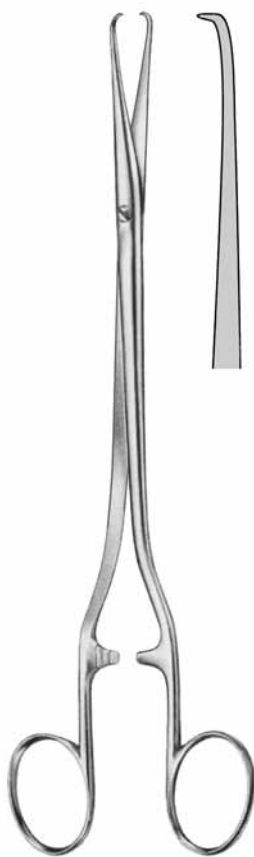

**TIEMANN**  
55.0956  
22 cm

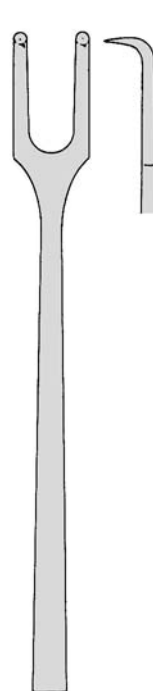

**55.0962**  
2 x 2

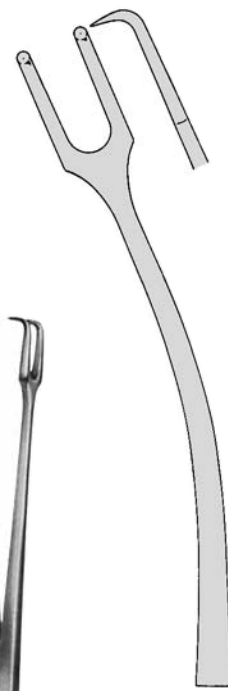

**55.0963**  
2 x 2



**SCHROEDER**  
24 cm

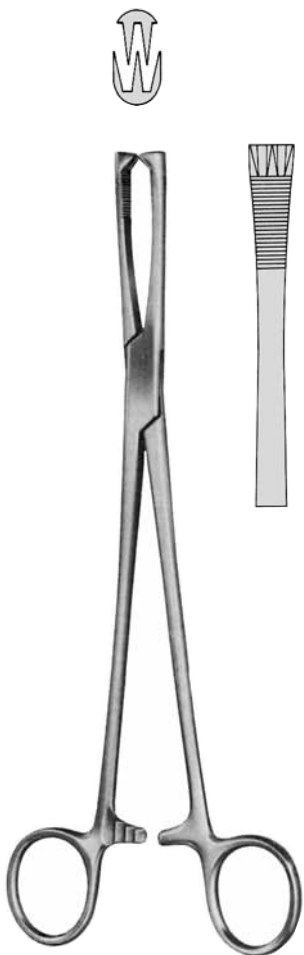

**HENROTIN**  
55.0965  
21 cm 2 x 3



**PRATT (Billroth)**  
55.0966  
26,5 cm

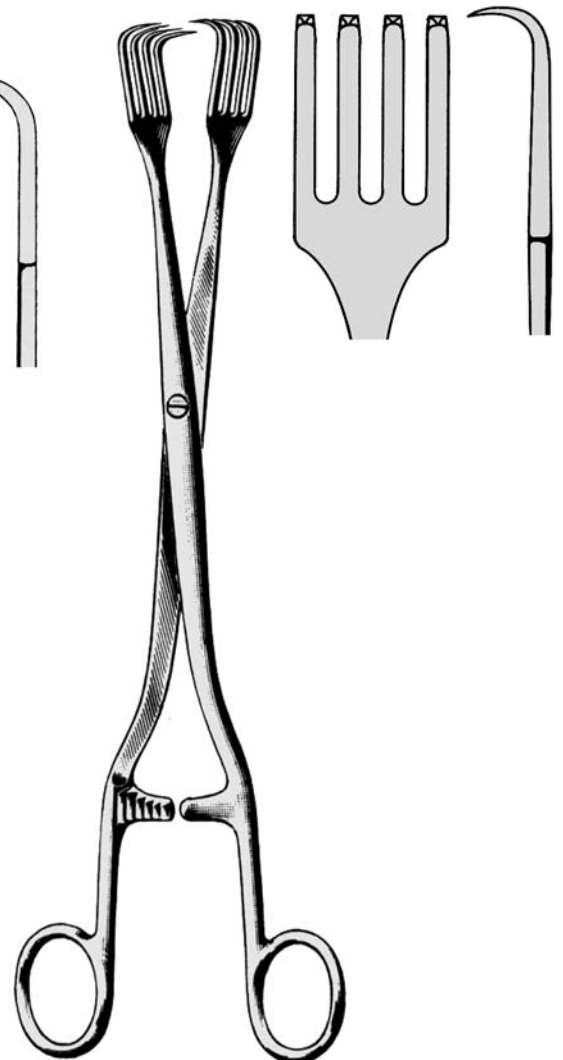

**PRATT**  
55.0968  
28 cm



**JACOBS**  
55.0970 21 cm



**TEALE**  
55.0973 18 cm 3 x 4  
55.0975 23 cm 3 x 4



**KÜSTNER**  
55.0977 25 cm 2 x 3

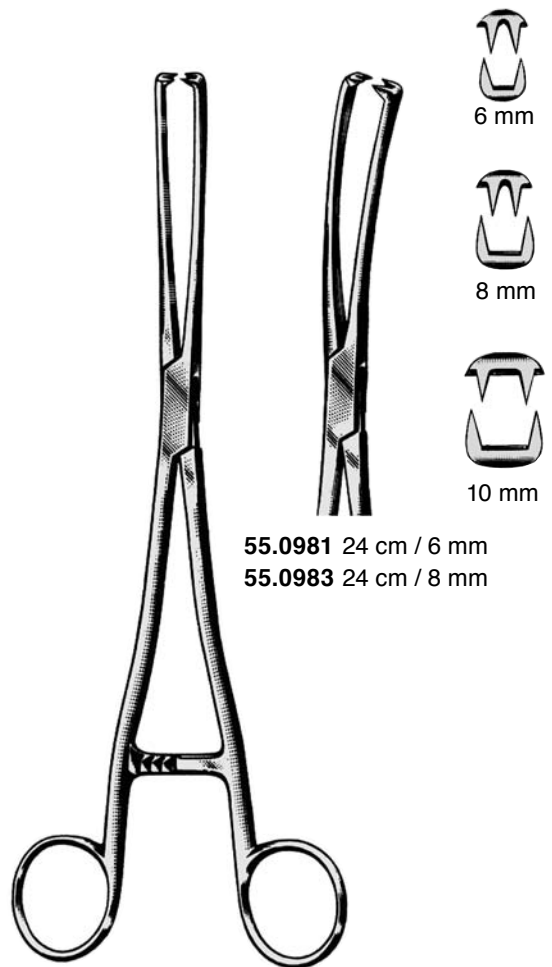

55.0981 24 cm / 6 mm  
55.0983 24 cm / 8 mm

**MUSEUX**  
55.0980 24 cm / 6 mm  
55.0982 24 cm / 8 mm  
55.0984 24 cm / 10 mm



**SOMER**  
**55.1500**  
23 cm



**COLLIN**  
**55.1510**  
25 cm



**COLLIN**  
55.1511  
25 cm



**DARTIGUES**  
55.1520  
27 cm



**HEYWOOD-SMITH**

**56.0880** 21 cm

**56.0882** 25 cm

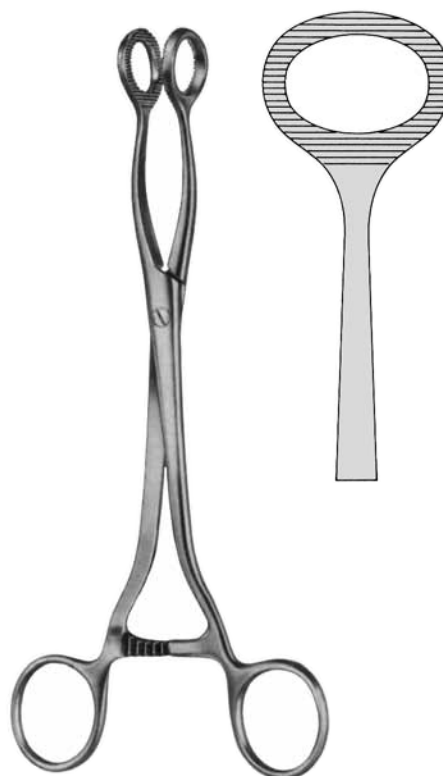

**DOYEN**

**56.0890** 20 cm



**NOTO**  
56.0896 27 cm



**BUMM**  
56.0898 28 cm





**EMMET**  
22 cm



**55.1551**  
# 1



**55.1552**  
# 2



**55.1553**  
# 3



**55.1554**  
# 4



**55.1555**  
# 5

Fistelhaken  
Fistula hooks  
Crochets pour fistules  
Ganchitos para fistulas  
Uncini per fistole



**SIMON**  
**55.1561**  
22 cm



**SIMON**  
**55.1562**  
22 cm



**DOYEN**  
55.1600  
17 cm Ø 26 mm

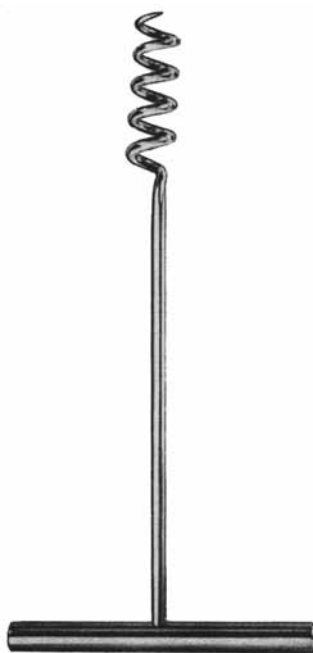

**DOYEN**  
55.1602  
17 cm Ø 20 mm

Myomheber  
Myoma Screws  
Tracteurs pour fibromes  
Tirabuzones para fibroma  
Tiramiomi

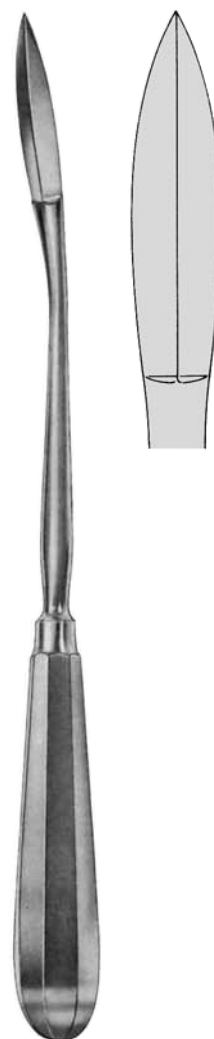

**SEGOND**  
55.1610  
27 cm

Myommesser  
Myoma Knife  
Couteau pour fibromes  
Cuchillo para fibroma  
Bisturi per fibromi



**WERTHEIM**  
 15.2125  
 24 cm 1x2

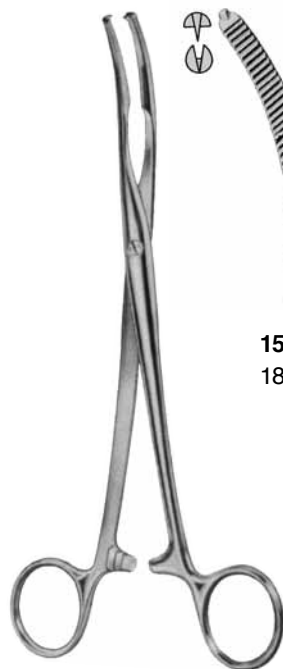

**15.2200**  
 18 cm

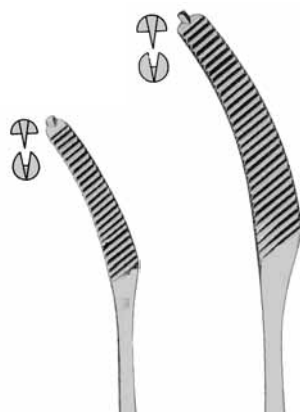

**15.2202**  
 20 cm

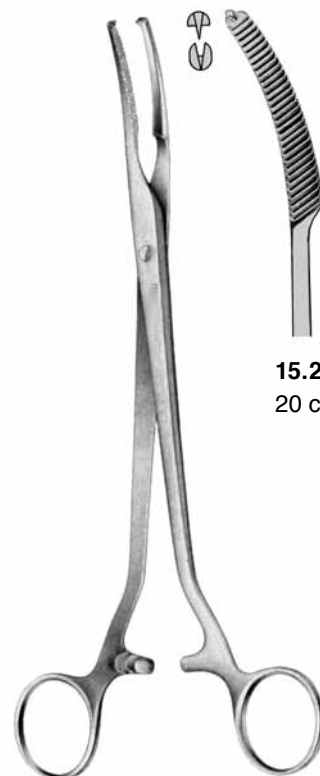

**15.2209**  
 20 cm



**15.2211**  
 20 cm

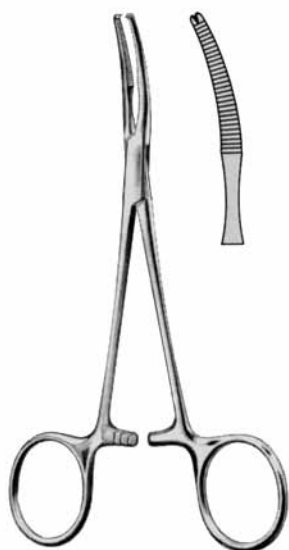

**MIKULICZ-BABY**  
 15.2215 14 cm

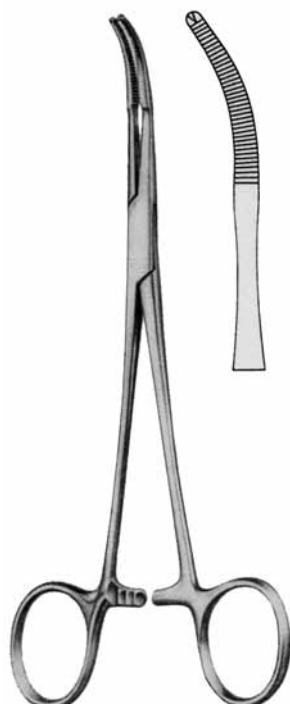

**MIKULICZ**  
 15.2216 18 cm

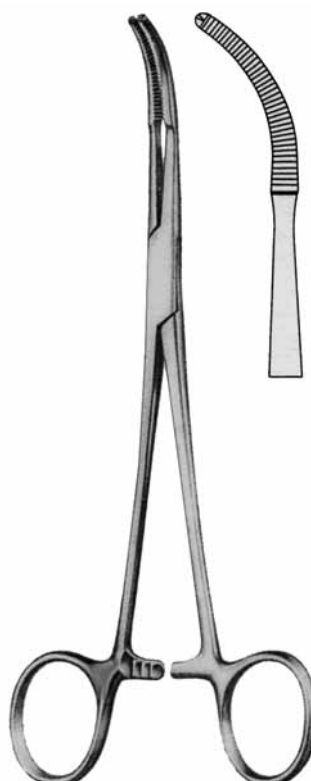

**MIKULICZ**  
 15.2217 20 cm

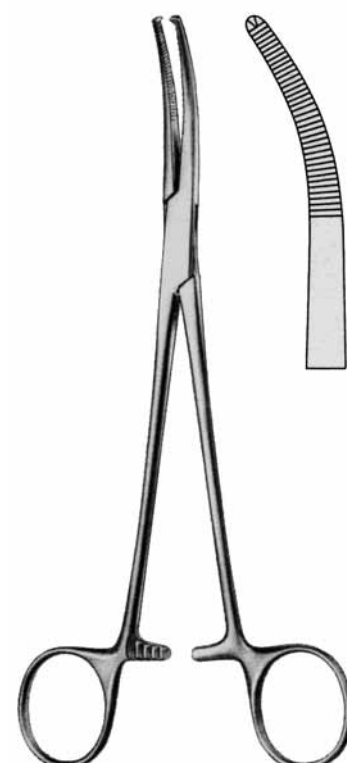

**MIKULICZ**  
 15.2218 21 cm



**FAURE**  
20 cm



15.2221



15.2223



**FAURE**  
15.2225 25 cm

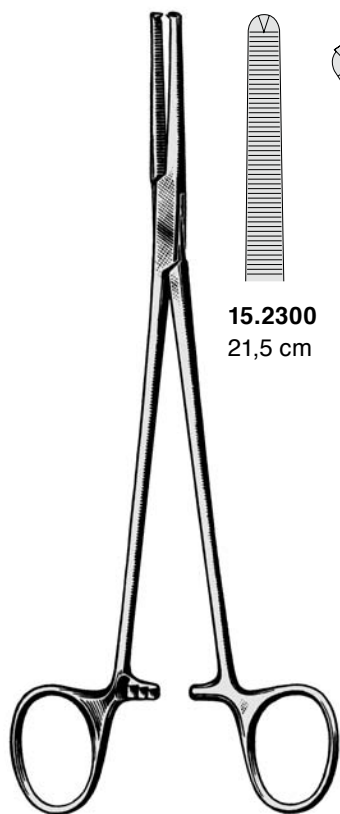

15.2300  
21,5 cm

15.2301  
21,5 cm

PHANEUF

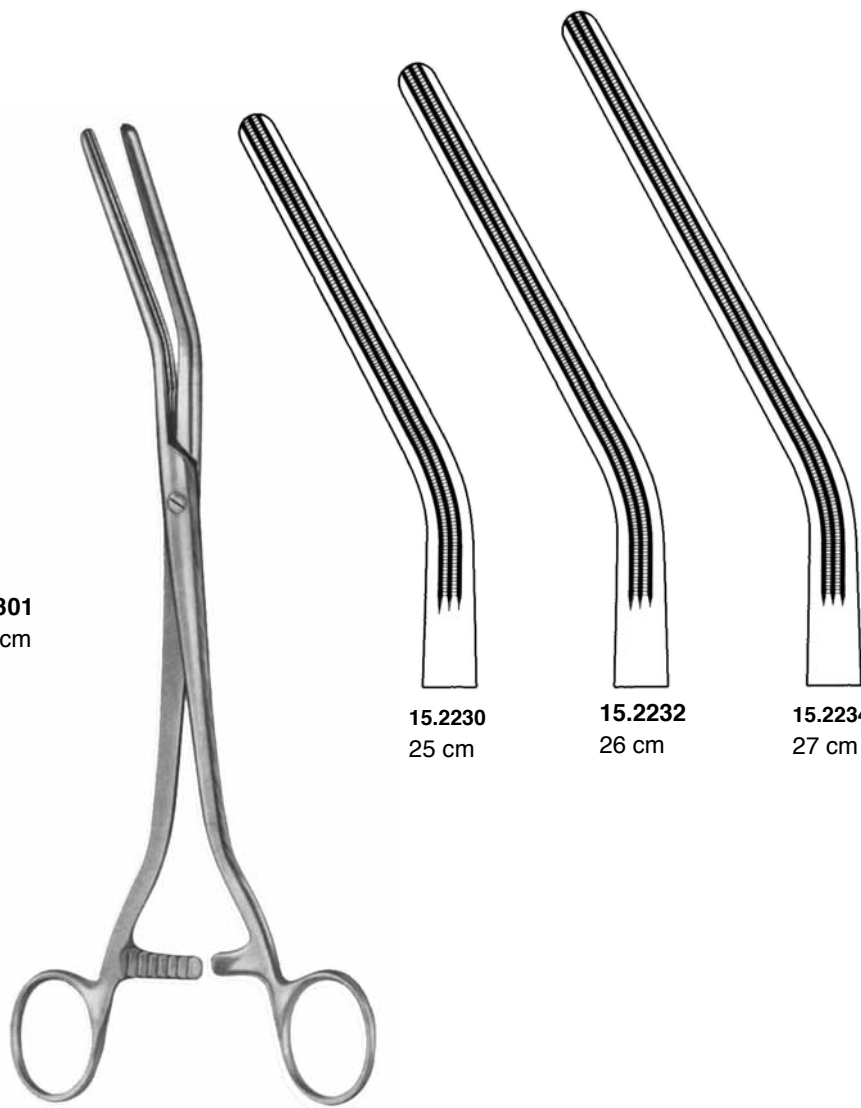

15.2230  
25 cm

15.2232  
26 cm

15.2234  
27 cm

DICK

Druckklemmen  
Pressure Clamps  
Pincés à pression  
Pinzas de presión  
Pinze de pressione

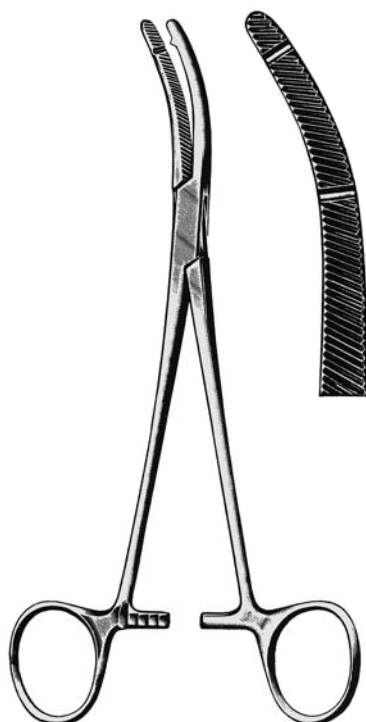

**HEANEY-KANTOR**

15.2311 20 cm

15.2313 23 cm



**HEANEY-REZEK**

15.2314 23 cm

15.2316 21 cm



**HEANEY**

15.2315 20 cm

15.2317 23 cm

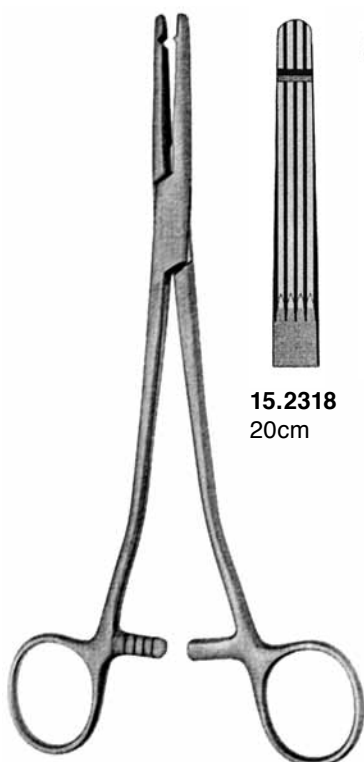

**HEANEY-BALLENTINE**

15.2318  
20cm



15.2319  
20cm

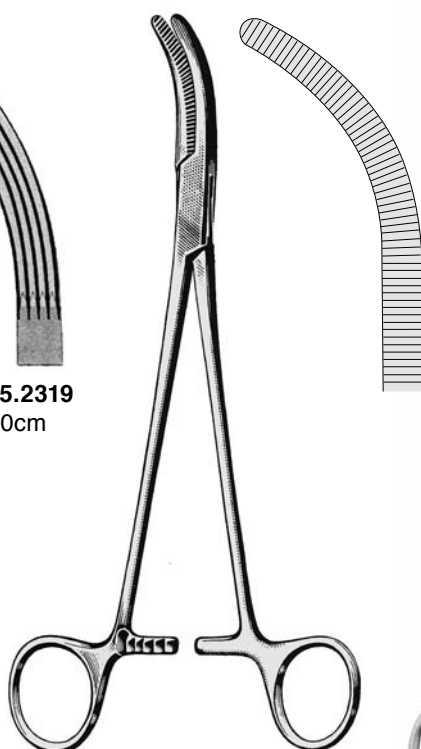

**WERTHEIM**

15.2321 25 cm

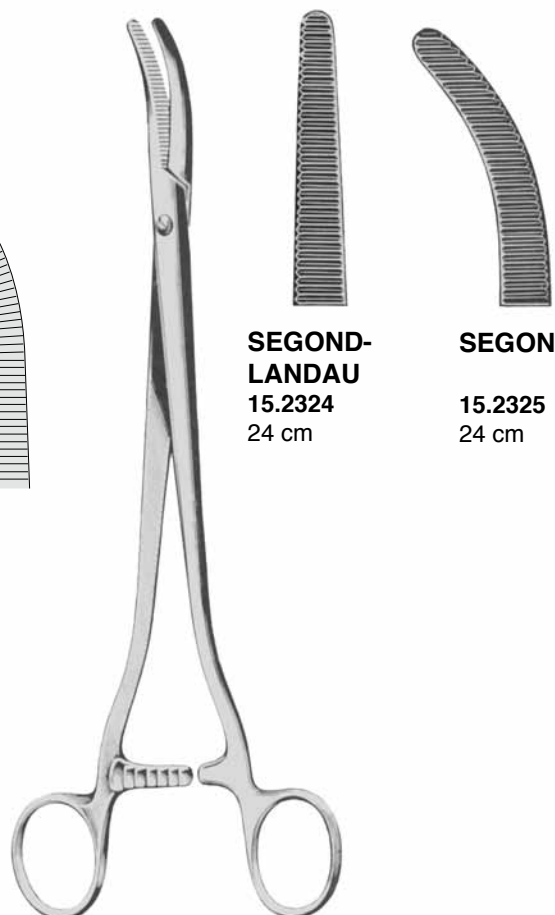

**SECOND-  
LANDAU**

15.2324  
24 cm

**SECOND**

15.2325  
24 cm

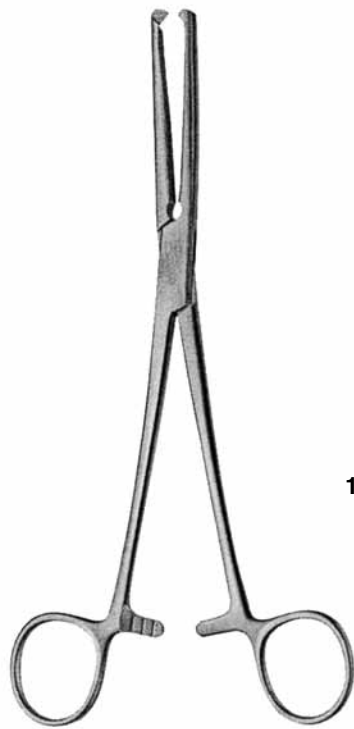

**GWILLIAM**  
20 cm

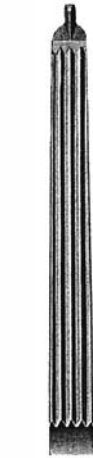

15.2330



15.2331



**BERKELEY-BONNEY**  
15.2337  
20 cm

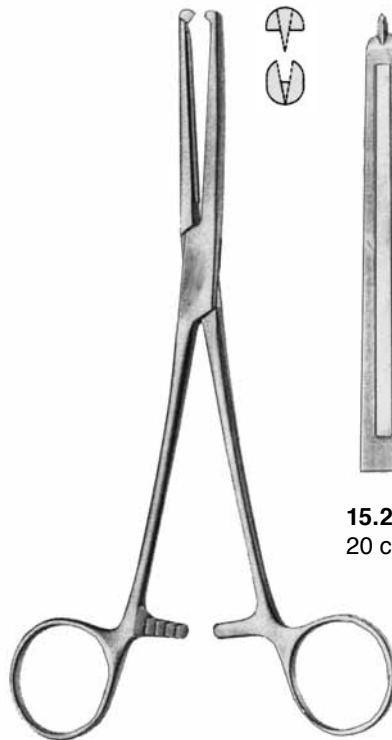

**MAINGOT**



15.2332  
20 cm 1x2



15.2333  
20 cm 1x2



15.2335  
25 cm 1x2



**WERTHEIM-CULLEN**  
15.2340 21,5 cm

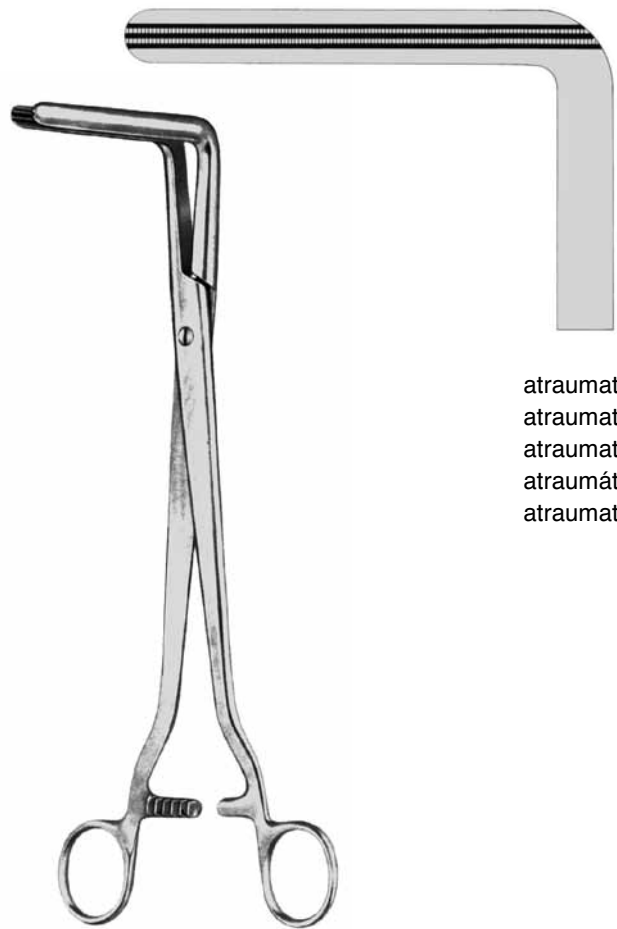

**WERTHEIM-ATRAUMA**  
15.2344 21 cm

atraumatisch  
atraumatic  
atraumatique  
atraumática  
atraumatiche





**15.2345**  
22 cm  
1x2

**WERTHEIM**



**15.2347**  
22 cm  
1x2

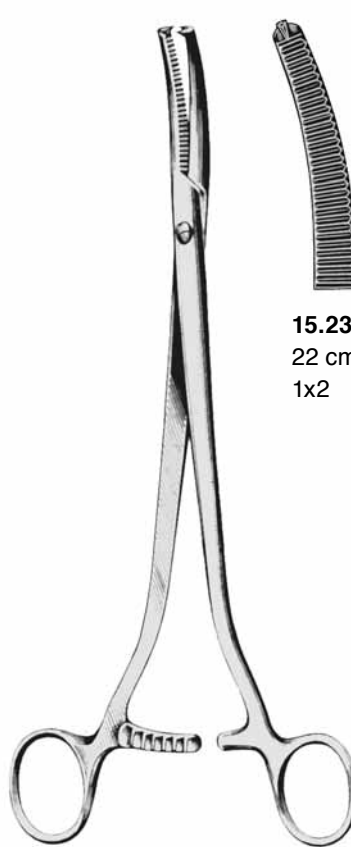

**15.2348**  
22 cm  
1x2

**WERTHEIM**



**15.2349**  
22 cm  
1x2

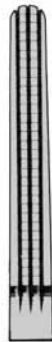

**15.2360**  
22 cm



**15.2361**  
22 cm



**15.2362**  
21 cm



**15.2363**  
20 cm



**WERTHEIM-DEBAKEY**

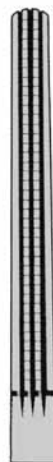

**15.2365**  
25 cm



**15.2366**  
25 cm



**15.2367**  
25 cm

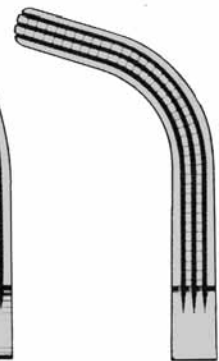

**15.2368**  
24 cm



**Z-HYSTEREKTOMY**



- 15.2380 21 cm
- 15.2384 24 cm
- 15.2388 30 cm
- 15.2392 35 cm



- 15.2381 21 cm
- 15.2385 24 cm
- 15.2389 30 cm
- 15.2393 35 cm



- 15.2382 21 cm
- 15.2386 24 cm
- 15.2390 30 cm
- 15.2394 35 cm



- 15.2383 21 cm
- 15.2387 24 cm
- 15.2391 30 cm
- 15.2395 35 cm



**THOMS-GAYLOR**  
55.1802 24 cm

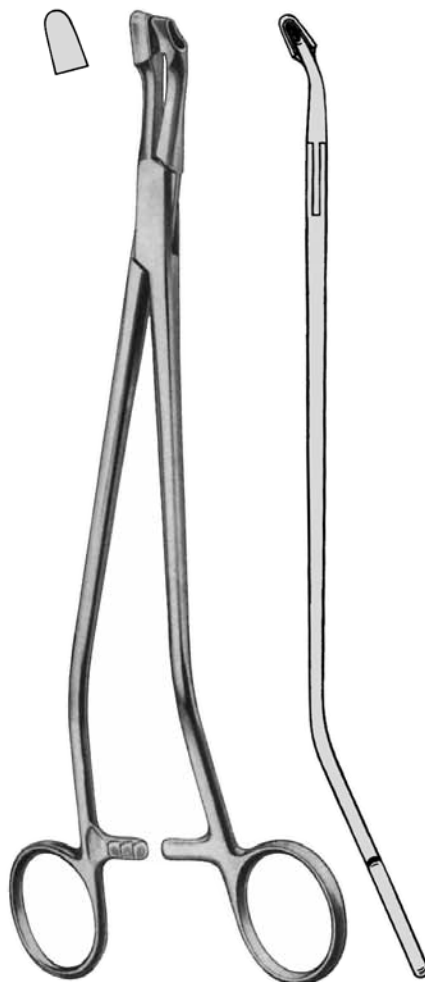

**VAN DOREN**  
55.1803 25 cm



**SCHUMACHER-VAN DOREN**  
55.1805 24 cm



4x8 mm



**SCHUBERT**  
55.1820 21 cm  
55.1822 28 cm



4x8 mm



**SCHUBERT**  
55.1825 26 cm



5x9,5 mm

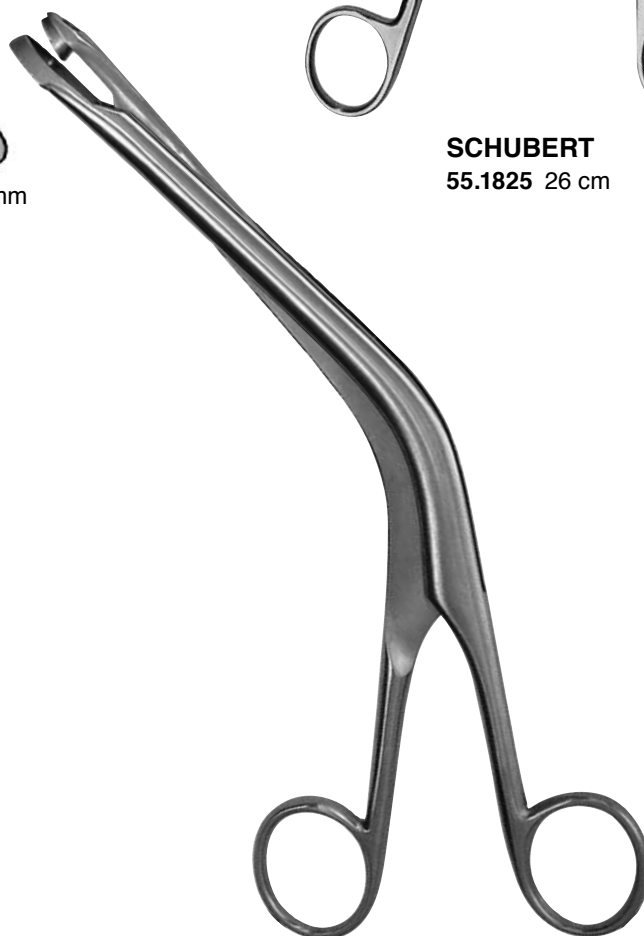

**FAURE**  
55.1835 21 cm

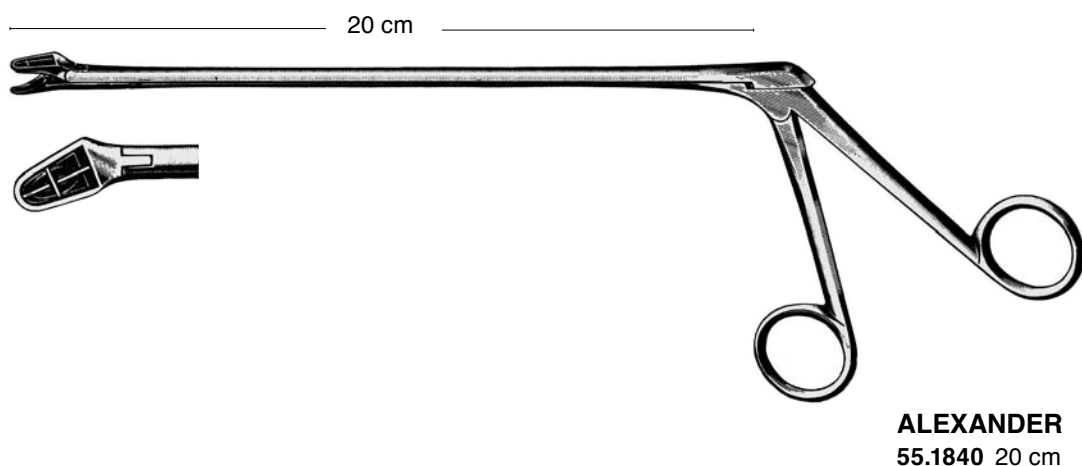
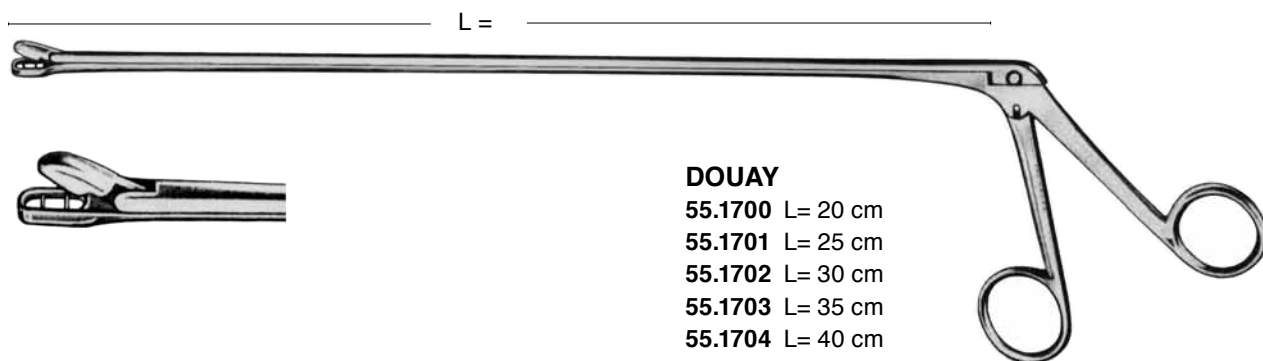

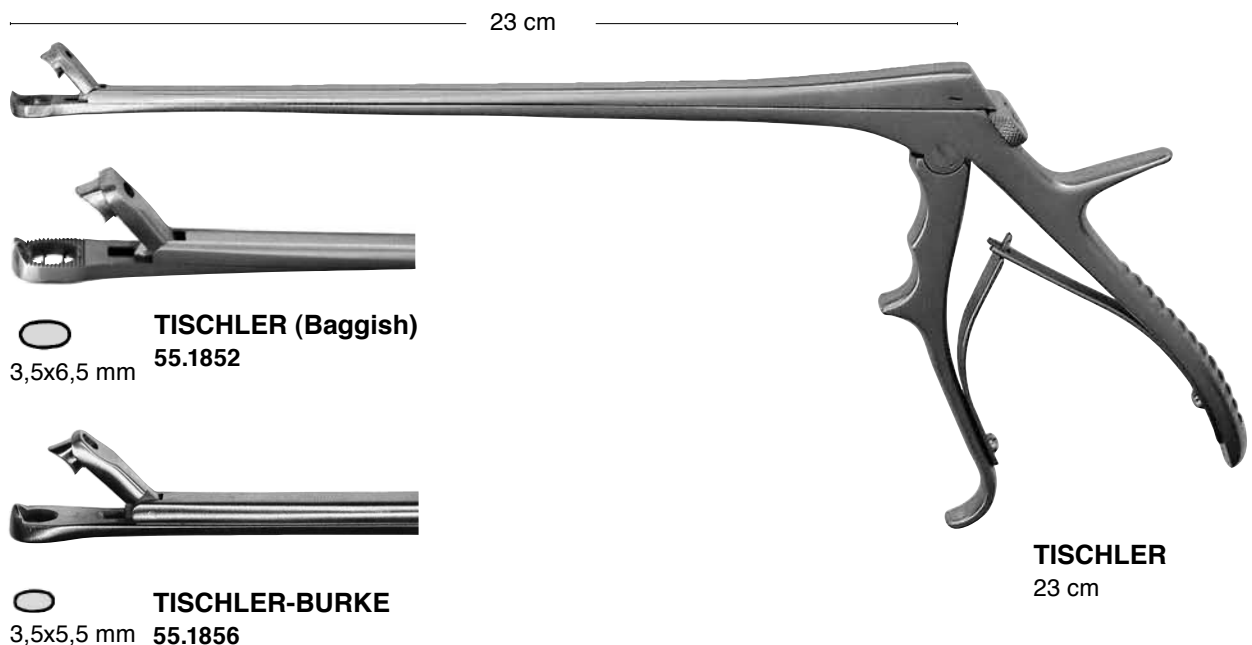
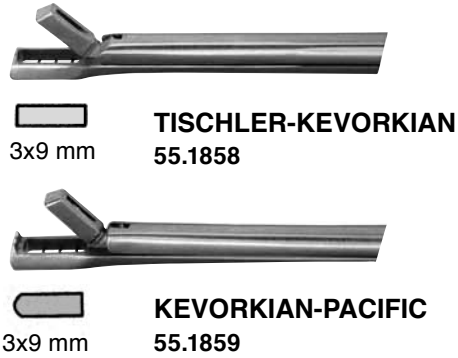
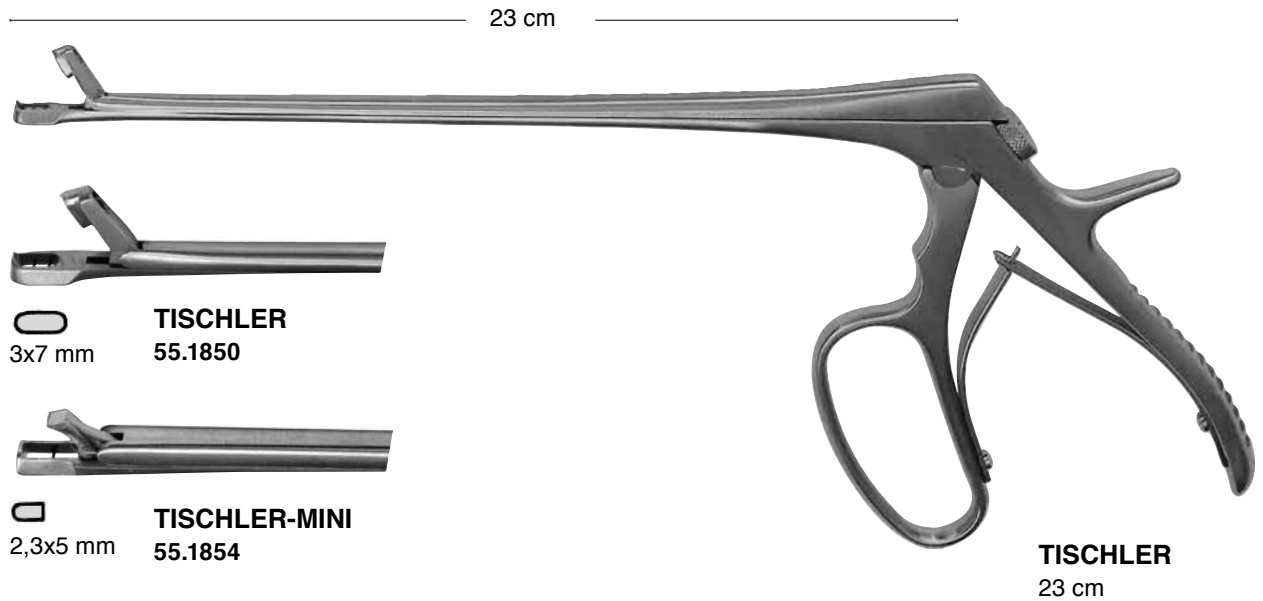

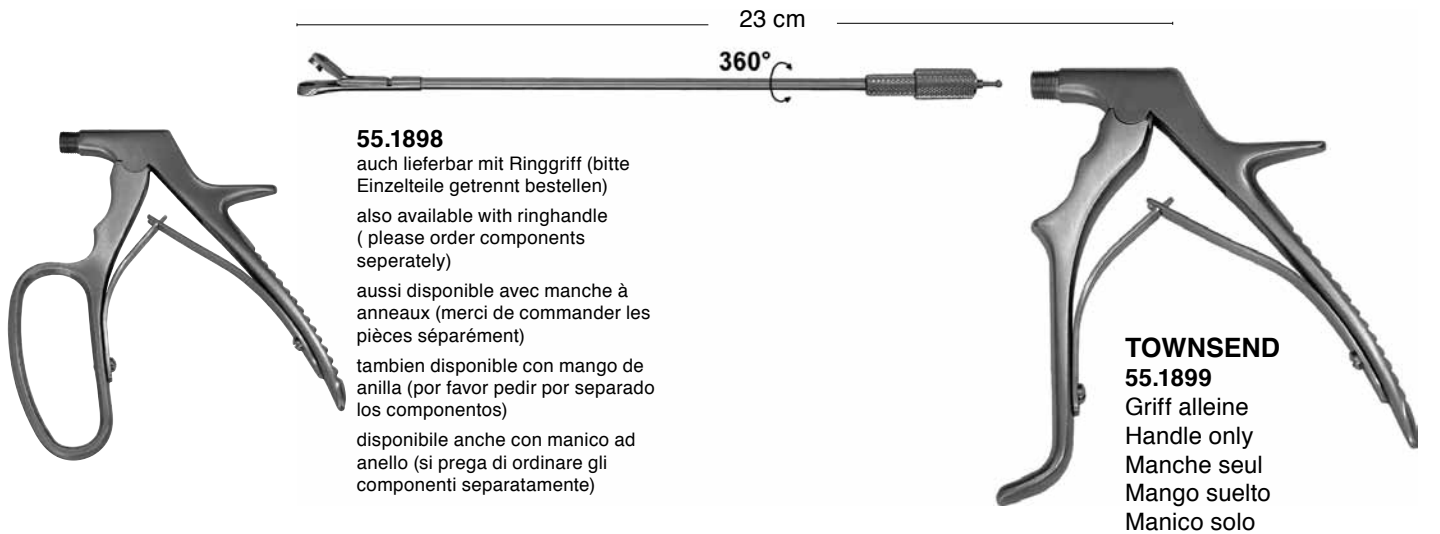

**55.1898**  
 auch lieferbar mit Ringgriff (bitte Einzelteile getrennt bestellen)  
 also available with ringhandle ( please order components seperately)  
 aussi disponible avec manche à anneaux (merci de commander les pièces séparément)  
 tambien disponible con mango de anilla (por favor pedir por separado los componentes)  
 disponibile anche con manico ad anello (si prega di ordinare gli componenti separatamente)

**TOWNSEND 55.1899**  
 Griff alleine  
 Handle only  
 Manche seul  
 Mango suelto  
 Manico solo

gerade / straight  
 droits / derecha / retto

aufgebogen / curved up / courbe vers le haut / curva arriba / curvo in alto

abwärts gebogen / curved down / courbe vers le bas / curva abajo / curva in basso

3x7 mm

**TOWNSEND-TISCHLER 55.1860 360°**  
 komplett / complete  
 complet / completo / completo

**55.1880**  
 Aufsatz alleine / tip only  
 embout seul / punta suelto / Punta sola

3x7 mm

**TOWNSEND-TISCHLER 55.1861 360°**  
 komplett / complete  
 complet / completo / completo

**55.1881**  
 Aufsatz alleine / tip only  
 embout seul / punta suelto / Punta sola

3x7 mm

**TOWNSEND-TISCHLER 55.1863 360°**  
 komplett / complete  
 complet / completo / completo

**55.1883**  
 Aufsatz alleine / tip only  
 embout seul / punta suelto / Punta sola

2,3x5 mm

**TOWNSEND-MINI 55.1866 360°**  
 komplett / complete  
 complet / completo / completo

**55.1886**  
 Aufsatz alleine / tip only  
 embout seul / punta suelto / Punta sola

2,3x5 mm

**TOWNSEND-MINI 55.1867 360°**  
 komplett / complete  
 complet / completo / completo

**55.1887**  
 Aufsatz alleine / tip only  
 embout seul / punta suelto / Punta sola

2,3x5 mm

**TOWNSEND-MINI 55.1869 360°**  
 komplett / complete  
 complet / completo / completo

**55.1889**  
 Aufsatz alleine / tip only  
 embout seul / punta suelto / Punta sola

3x5,5 mm

**TOWNSEND-BURKE 55.1870 360°**  
 komplett / complete  
 complet / completo / completo

**55.1890**  
 Aufsatz alleine / tip only  
 embout seul / punta suelto / Punta sola

3x9 mm

**TOWNSEND-KEVORKIAN 55.1872 360°**  
 komplett / complete  
 complet / completo / completo

**55.1892**  
 Aufsatz alleine / tip only  
 embout seul / punta suelto / Punta sola

3x5,5 mm

**TOWNSEND-KRAUSE 55.1874 360°**  
 komplett / complete  
 complet / completo / completo

**55.1894**  
 Aufsatz alleine / tip only  
 embout seul / punta suelto / Punta sola



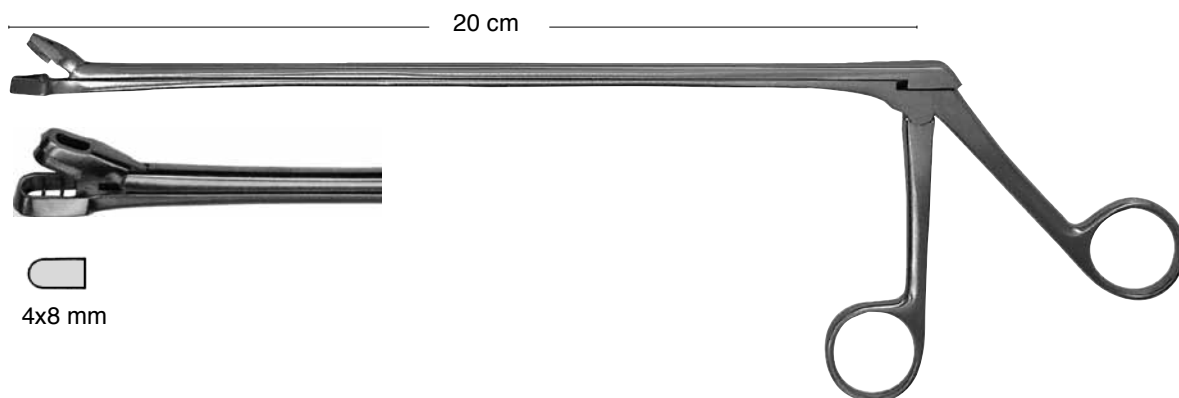

**EPPENDORF**  
 55.1900 20 cm

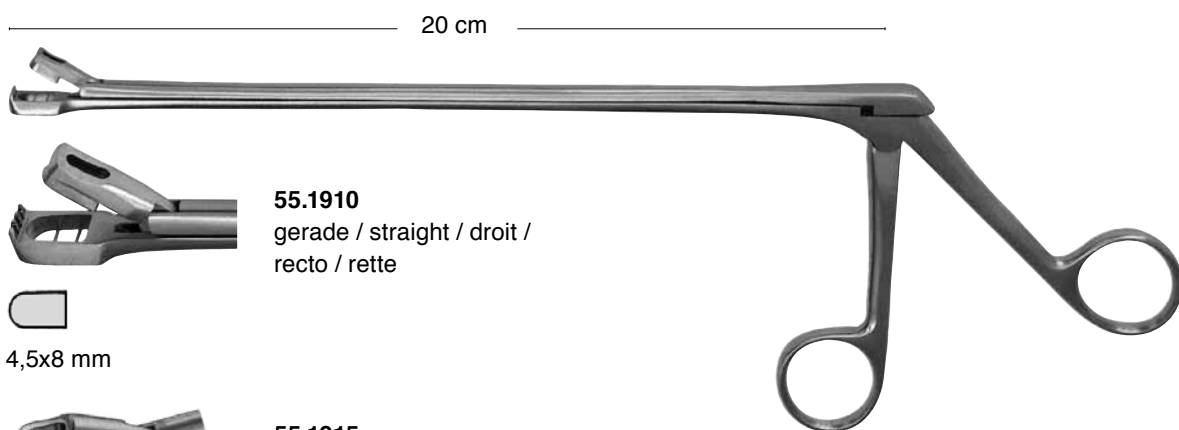

**55.1910**  
 gerade / straight / droit /  
 recto / rette

4,5x8 mm

**55.1915**  
 gebogen / curved /  
 courbe / curvo / curve

4,5x8 mm

**WITNER**  
 20 cm

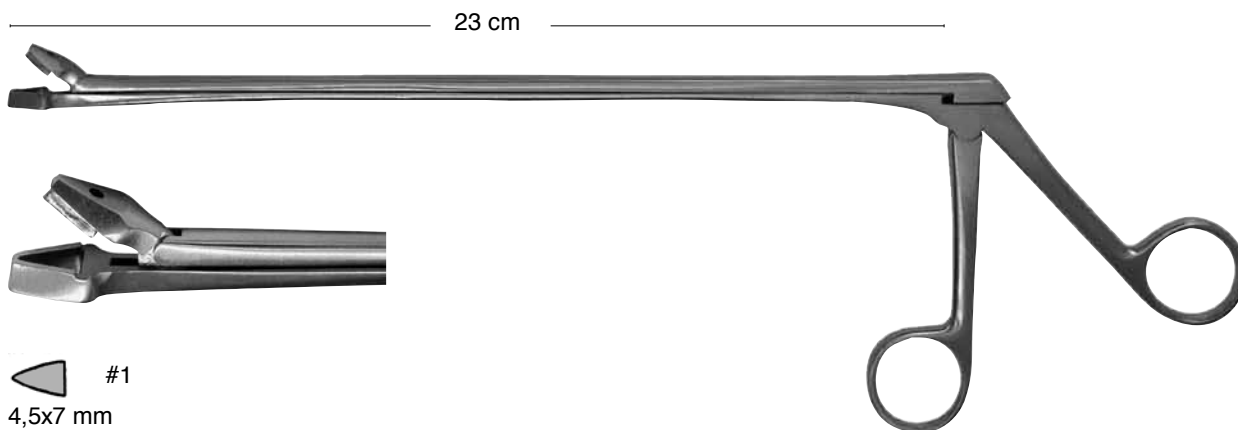

#1  
 4,5x7 mm

#2  
 6x9 mm

**SCHUMACHER**  
 55.1920 23 cm #1  
 55.1922 23 cm #2

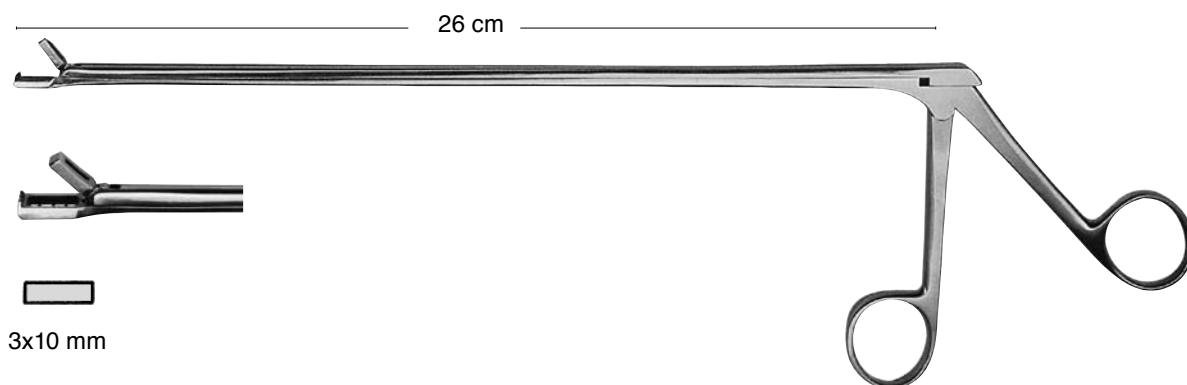

**KEVORKIAN**  
55.1962 26 cm

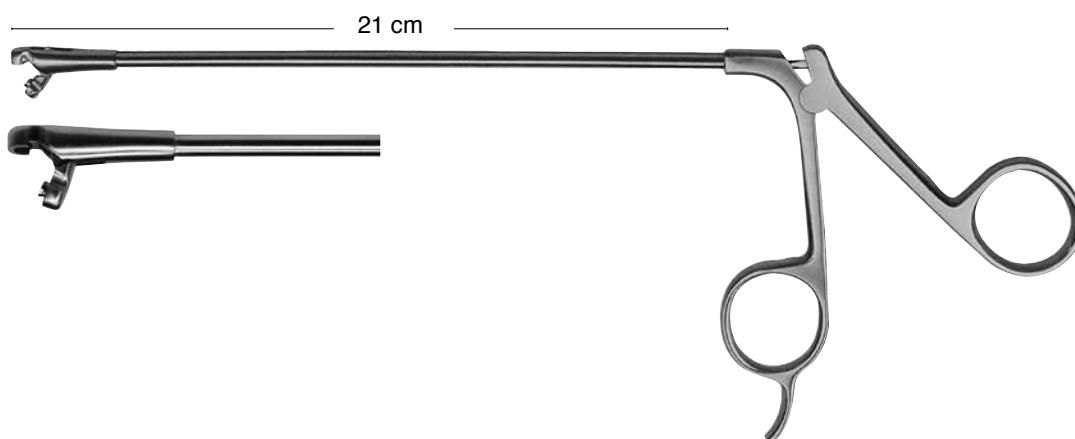

**BERGER**  
55.1973

○ 21 cm / Ø 3 mm

55.1975

○ 21 cm / Ø 5 mm

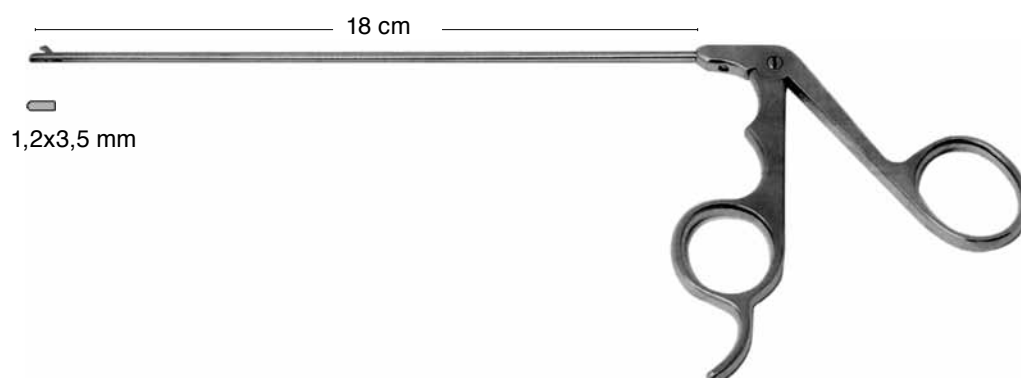

**MICRO**  
55.1980 18 cm



55.2240



55.2242



55.2244

**KEVORKIAN**  
30 cm



**TOWNSEND**  
55.2246  
30 cm



**ROTOCURETTE**  
55.2250  
30 cm



55.2254  
Ø 4 mm



55.2255  
Ø 5 mm







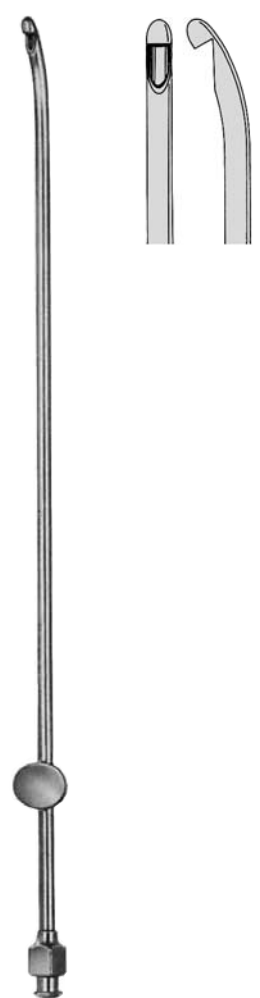





**MUENCHEN**  
27 cm



**NOVAK**  
23 cm  
55.2201 Ø 1 mm  
55.2202 Ø 2 mm  
55.2203 Ø 3 mm  
55.2204 Ø 4 mm

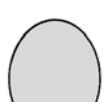

**RANDALL**  
23 cm  
55.2210 Ø 4 mm

	 <b>55.2001</b> # 1-7 mm		 <b>55.2181</b> #1 10x7 mm
	 <b>55.2002</b> # 2-8 mm		 <b>55.2182</b> #2 12x8 mm
	 <b>55.2003</b> # 3-10 mm		 <b>55.2183</b> #3 13x10 mm
	 <b>55.2004</b> # 4-11 mm		 <b>55.2184</b> #4 16x11 mm
	 <b>55.2005</b> # 5-12 mm		 <b>55.2185</b> #5 16x13 mm
	 <b>55.2006</b> # 6-15 mm		 <b>55.2186</b> #6 20x14 mm
<b>SCHROEDER</b> 30 cm	<b>BLAKE</b> <b>55.2010</b> 27 cm	<b>SIMON</b> 24 cm	

stumpf  
 blunt  
 mousse  
 romo  
 smusso

scharf  
 sharp  
 tranchante  
 cortante  
 tagliente



**55.2190**  
6 mm



**55.2191**  
8 mm



**GOURDET**  
28 cm



**55.2192**  
10 mm



**55.2193**  
12 mm



**55.2194**  
14 mm



**THOMAS**  
28 cm



**55.2221**  
#1 Ø 10 mm



**55.2224**  
#4 Ø 13 mm



**55.2222**  
#2 Ø 11 mm



**55.2225**  
#5 Ø 14 mm



**55.2223**  
#3 Ø 12 mm



**55.2226**  
#6 Ø 15 mm

biegsam, stumpf  
 malleable, blunt  
 malléable, mousse  
 maleable, romo  
 malleabile, smusso

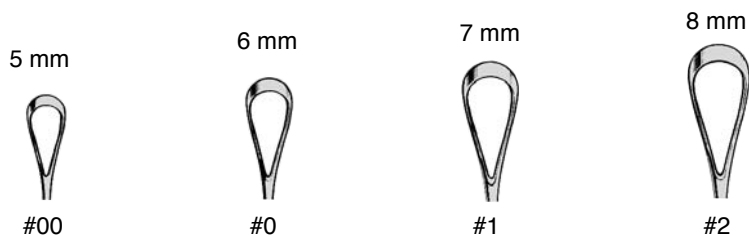

fest, scharf / rigid, sharp / rigide, tranchante / rigida, cortante / rigido, tagliente	<b>55.2019</b>	<b>55.2020</b>	<b>55.2021</b>	<b>55.2022</b>
fest, stumpf / rigid, blunt / rigide, mousse / rigida, roma / rigido, smusso	<b>55.2039</b>	<b>55.2040</b>	<b>55.2041</b>	<b>55.2042</b>
biegsam, scharf / malleable, sharp / malléable, tranchante / maleable, cortante / malleabile, tagliente	<b>55.2059</b>	<b>55.2060</b>	<b>55.2061</b>	<b>55.2062</b>
biegsam, stumpf / malleable, blunt / malléable, mousse / maleable, roma / malleabile, smusso	<b>55.2079</b>	<b>55.2080</b>	<b>55.2081</b>	<b>55.2082</b>

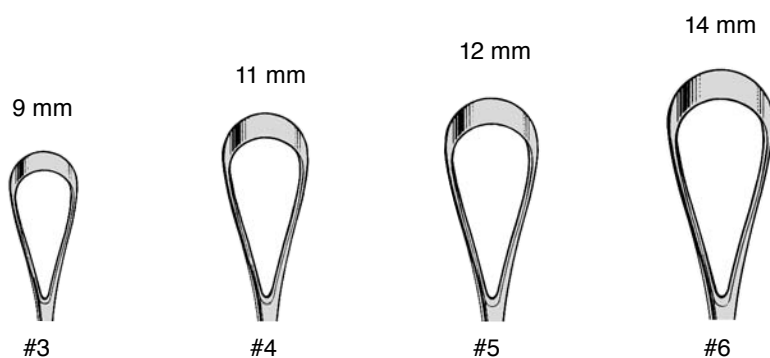

fest, scharf / rigid, sharp / rigide, tranchante / rigida, cortante / rigido, tagliente	<b>55.2023</b>	<b>55.2024</b>	<b>55.2025</b>	<b>55.2026</b>
fest, stumpf / rigid, blunt / rigide, mousse / rigida, roma / rigido, smusso	<b>55.2043</b>	<b>55.2044</b>	<b>55.2045</b>	<b>55.2046</b>
biegsam, scharf / malleable, sharp / malléable, tranchante / maleable, cortante / malleabile, tagliente	<b>55.2063</b>	<b>55.2064</b>	<b>55.2065</b>	<b>55.2066</b>
biegsam, stumpf / malleable, blunt / malléable, mousse / maleable, roma / malleabile, smusso	<b>55.2083</b>	<b>55.2084</b>	<b>55.2085</b>	<b>55.2086</b>

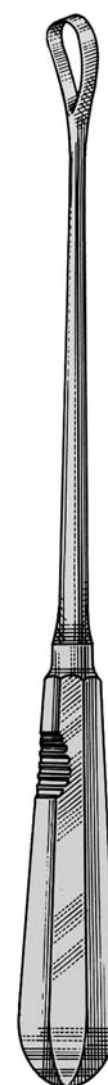

**SIMS**  
29 cm

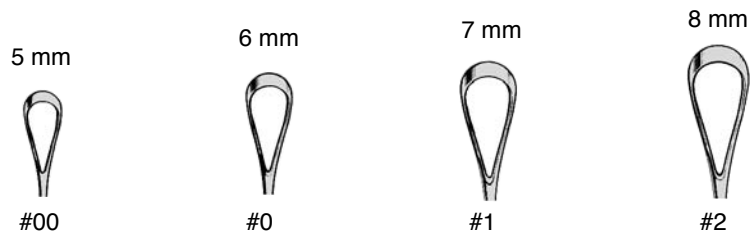

fest, scharf / rigid, sharp rigide, tranchante / rigida, cortante / rigido, tagliente	<b>55.2109</b>	<b>55.2110</b>	<b>55.2111</b>	<b>55.2112</b>
fest, stumpf / rigid, blunt rigide, mousse / rigida, roma / rigido, smusso	<b>55.2129</b>	<b>55.2130</b>	<b>55.2131</b>	<b>55.2132</b>
biegsam, scharf / malleable, sharp / malléable, tranchante / maleable, cortante / malleabile, tagliente	<b>55.2139</b>	<b>55.2140</b>	<b>55.2141</b>	<b>55.2142</b>
biegsam, stumpf / malleable, blunt / malléable, mousse / maleable, roma / malleabile, smusso	<b>55.2149</b>	<b>55.2150</b>	<b>55.2151</b>	<b>55.2152</b>

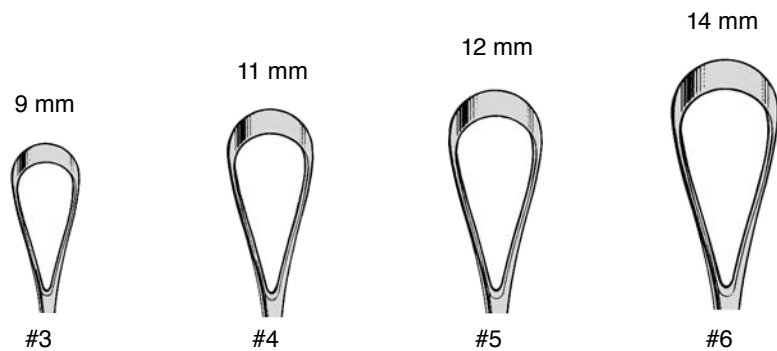

fest, scharf / rigid, sharp rigide, tranchante / rigida, cortante / rigido, tagliente	<b>55.2113</b>	<b>55.2114</b>	<b>55.2115</b>	<b>55.2116</b>
fest, stumpf / rigid, blunt rigide, mousse / rigida, roma / rigido, smusso	<b>55.2133</b>	<b>55.2134</b>	<b>55.2135</b>	<b>55.2136</b>
biegsam, scharf / malleable, sharp / malléable, tranchante / maleable, cortante / malleabile, tagliente	<b>55.2143</b>	<b>55.2144</b>	<b>55.2145</b>	<b>55.2146</b>
biegsam, stumpf / malleable, blunt / malléable, mousse / maleable, roma / malleabile, smusso	<b>55.2153</b>	<b>55.2154</b>	<b>55.2155</b>	<b>55.2156</b>

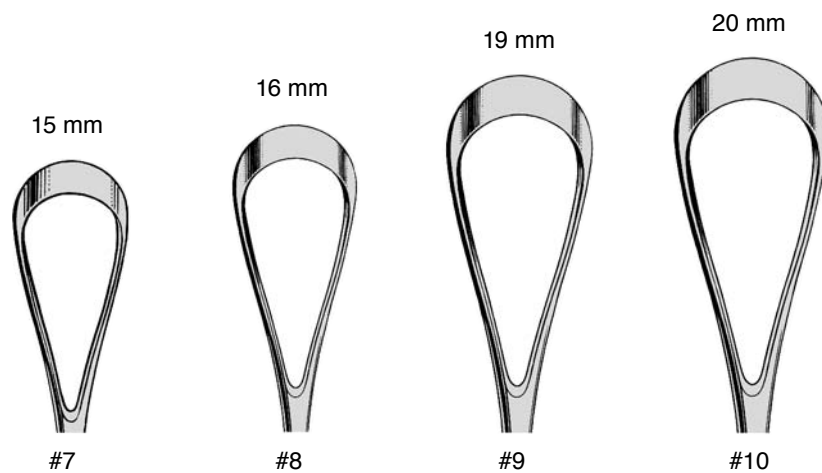

fest, scharf / rigid, sharp rigide, tranchante / rigida, cortante / rigido, tagliente	<b>55.2117</b>	<b>55.2118</b>	<b>55.2119</b>	<b>55.2120</b>
fest, stumpf / rigid, blunt rigide, mousse / rigida, roma / rigido, smusso	<b>55.2137</b>	<b>55.2138</b>	<b>55.2127</b>	<b>55.2128</b>
biegsam, scharf / malleable, sharp / malléable, tranchante / maleable, cortante / malleabile, tagliente	<b>55.2147</b>	<b>55.2148</b>		
biegsam, stumpf / malleable, blunt / malléable, mousse / maleable, roma / malleabile, smusso	<b>55.2157</b>	<b>55.2158</b>	<b>55.2159</b>	<b>55.2160</b>



**RECAMIER**  
31 cm



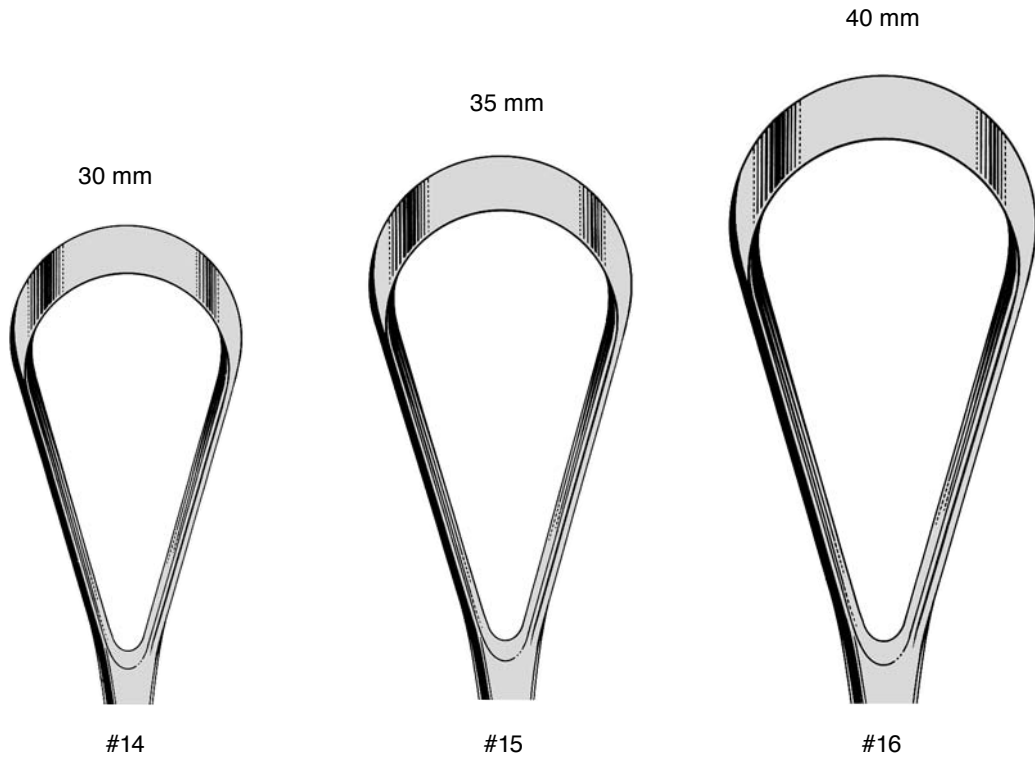

biegsam, scharf  
 malleable, sharp  
 malléable, tranchante  
 maleable, cortante  
 malleabile, tagliente

**55.2171**

**55.2172**

**55.2173**

biegsam, stumpf  
 malleable, blunt  
 malléable, mousse  
 maleable, roma  
 malleabile, smusso

**55.2174**

**55.2175**

**55.2176**



**BUMM**  
 31 cm



35 mm



40 mm

fest, stumpf  
rigid, blunt  
rigide, mousse  
rigida, roma  
rigido, smusso

**55.2178**

**55.2179**

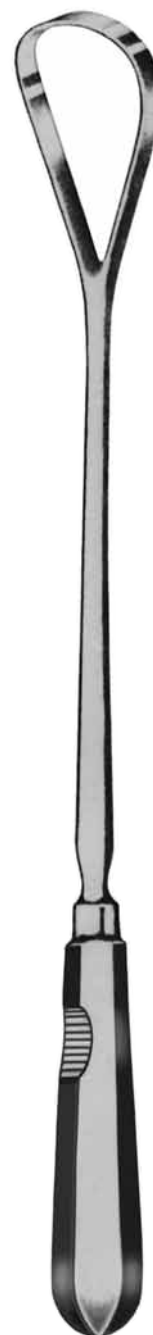

**BUMM**  
36 cm



**55.2260**  
28 cm / Ø 4 mm



**55.2261**  
28 cm / Ø 6 mm



**55.2262**  
28 cm / Ø 8 mm



**55.2263**  
28 cm / Ø 10 mm



**55.2264**  
28 cm / Ø 12 mm



**55.2265**  
28 cm / Ø 14 mm



**55.2269**  
Schlauch-Verbindungsstück  
Hose connector  
Raccord coudé  
Conector inoxidable  
Racordo per tubi d'aspirazione

Salpingograph zur Sterilitätsdiagnose  
Salpingograph for hystero-salpingography  
Salpingographe pour hystero-salpingographie  
Salpingógrafo para histero-salpingografía  
Salpingografo per la diagnosi della sterilita

## SCHULTZE

### 55.2290

Salpingograph komplett in Holzetui bestehend aus:

- 55.2291 Druck-Manometer mit Leuchtskala
- 55.2292 Zwischenstück
- 55.2293 Tubenkatheter m. Hahn
- 55.2294 Uterusverschlußkegel, klein
- 55.2295 Uterusverschlußkegel, mittel
- 55.2296 Uterusverschlußkegel, gross
- 55.2297 Rekordspritze 10 ml LL

### 55.2290

Salpingograph complete in wooden case consisting of:

- 55.2291 Manometer with luminescent scale
- 55.2292 Connecting piece
- 55.2293 Tubal Catheter
- 55.2294 Uterine occlusion cone, small
- 55.2295 Uterine occlusion cone, meduim
- 55.2296 Uterine occlusion cone, large
- 55.2297 Record Syringe 10 ccm, LL

### 55.2290

Salpingographe, complet en boîte bois, comprenant:

- 55.2291 Manomètre à cadran lumineux
- 55.2292 Pièce intermédiaire
- 55.2293 Sonde pour trombes
- 55.2294 Cône-obturateur utérin, petit
- 55.2295 Cône-obturateur utérin, moyen
- 55.2296 Cône-obturateur utérin, grand
- 55.2297 Seringue Record 10 ccm, LL

### 55.2290

Salpingógrafo completo en estuche de madera, compuesto de:

- 55.2291 Manómetro con escala luminosa
- 55.2292 Pieza intermedia
- 55.2293 Sonda para trompas con llave
- 55.2294 Cono uterino, pequeno
- 55.2295 Cono uterino, mediano
- 55.2296 Cono uterino grande
- 55.2297 Jeringa Record 10 cc LL

### 55.2290

Salpingografo completo in astuccio di legno, composta da:

- 55.2291 Manometro con scala luminosa
- 55.2292 Raccordo
- 55.2293 Catetere tubarico
- 55.2294 Cono-otturatore dell'utero piccolo
- 55.2295 Cono-otturatore dell'utero medio
- 55.2296 Cono-otturatore dell'utero grande
- 55.2297 Siringa Record 10 cc LL

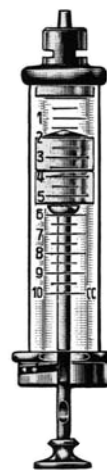

55.2297



55.2294



55.2295



55.2296

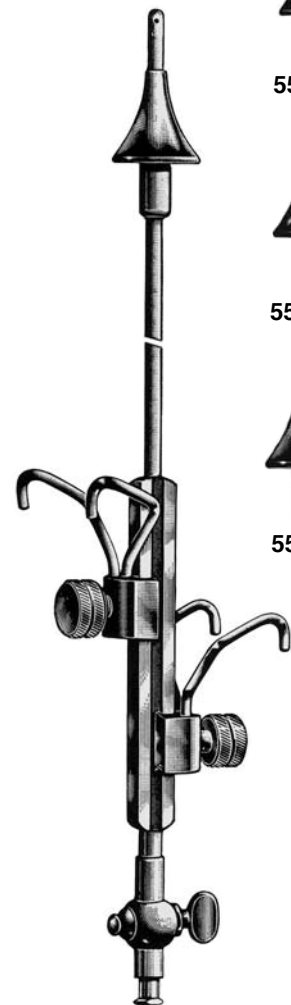

55.2291



55.2293

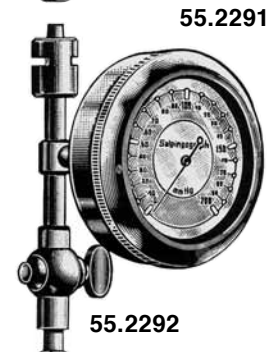

55.2292

## SCHULTZE

55.2290 compl.

Amnioskop Tubus mit Mandrin  
Amnioscope tube with obturator  
Amniscosope avec obturateur  
Amniscoscopio con mandril  
Amniscoscopio conico con otturatore



55.3500 Ø 12:24 mm / 20 cm



55.3502 Ø 16:24 mm / 20 cm



55.3504 Ø 20:24 mm / 20 cm

Amnioskop Tubus mit Mandrin zur Mikro-Blutentnahme  
Amnioscope tube with obturator for micro blood extraction  
Amniscosope avec obturateur pour micro-extraction du sang  
Amniscoscopio con mandril para micro-extraccion del sangre  
Amniscoscopi per salasso, conico, con otturatore

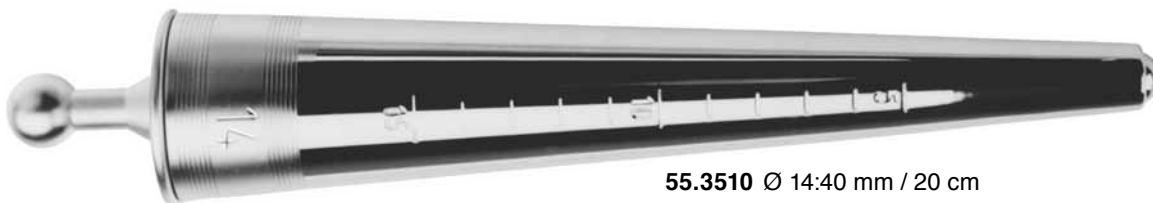

55.3510 Ø 14:40 mm / 20 cm

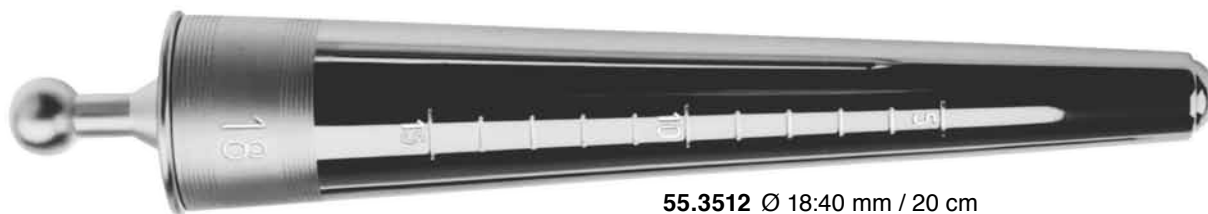

55.3512 Ø 18:40 mm / 20 cm



55.3514 Ø32:40 mm / 14 cm



**55.3530**

VAGINOSKOP 65 x Ø 10 mm mit Kaltlicht-Anschluss  
ACMI,WOLF,STORZ

VAGINOSCOPE 65 x Ø 10 mm with Cold-light attachment  
(ACMI,WOLF,STORZ)

VAGINOSCOPE 65 x Ø 10 mm avec lumière froide  
(ACMI,WOLF,STORZ)

VAGINOSCOPIO 65 x Ø 10 mm con alumbrado frio  
(ACMI,WOLF,STORZ)

VAGINOSCOPIO 65 x Ø 10 mm fibra ottica (ACMI,WOLF,  
STORZ)



**55.3600**

KALTLICHT-Klammer für Proktoskope & Amnioskope,  
Vaginal Spekula mit Kombistecker für alle Systeme

COLDLIGHT-Clip for proctoscopes & amnioscopes  
vaginal specula with combi-plug for all systems

CLIP - lumière froide pour proctoscopes, amnioscopes,  
spéculum vaginaux avec fiche utilisable pour tous  
systèmes

CLIP - luz fria para proctoscopios, amnioscopios,  
espéculos vaginales con clavija para todos sistemas

CLIP - illuminazione alogena per proctoscopios, specoli  
vaginali e amnioscopios per tutti sistemi



GEBURTSHILFE  
OBSTETRICS  
OBSTETRIQUE  
OBSTETRICIA  
OSTETRICIA





Empfohlene Operationsbestecke für den Bereich "GEBURTSHILFE"  
(Details erhalten Sie über Ihren Fachhändler)

Suggested Instrument Sets for "OBSTETRICS"  
(Please ask your dealer for details)

Suggestions de boîtes opératoires pour le secteur "ACCOUCHEMENT".  
(Pour plus de détails veuillez contacter votre distributeur.)

Cajas quirurgicas para "OBSTETRICA" (para detalles póngase en contacto con su distribuidor)

Strumentari raccomandati per "OSTETRICA"  
(Per ulteriori informazioni, vi preghiamo di contattare il Vostro rivenditore)

**SET 56.0100** GYNECOLOGY / OBSTETRIC SET

**SET 56.0200** PELVIC SET

**SET 56.1000** OBSTETRICAL INSTRUMENT SET

**SET 56.2000** DELIVERY SET

**SET 56.2100** CAESAREAN SECTION TRAY

**SET 56.3000** EPISIOTOMY / LACERATION REPAIR SET

**SET 56.3100** UTERINE EVACUATION

**SET 56.3200** EMBRYOTOMY SET

**SET 56.5000** DECAPITATION SET



**MARTIN**  
56.0010  
34 cm



**COLLYER**  
56.0020  
30 cm

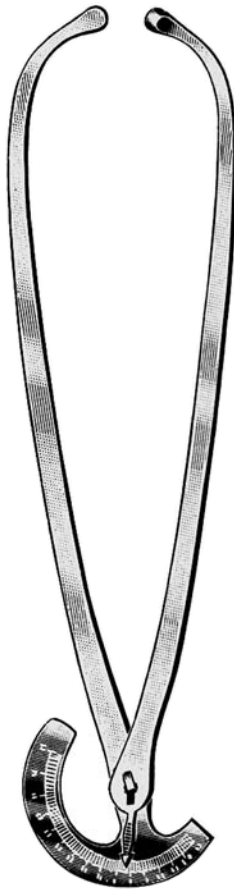

**COLLIN**  
56.0030  
35 cm

für Innenmessung  
for internal measuring  
pour mesurer à l'intérieur  
para medir en la interior  
paer misurare all' interiore



**DE LEE**  
56.0050  
20 cm

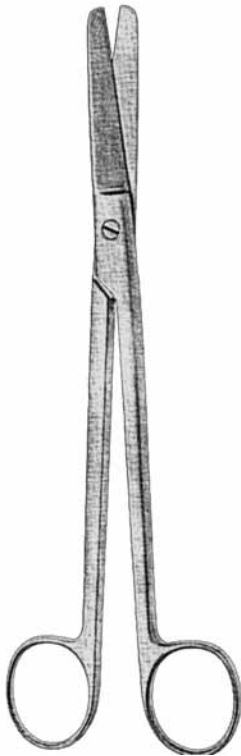

13.2101 20 cm **13.2101SC**  
 13.2103 23 cm **13.2103SC**



**SIMS**

13.2100 20 cm **13.2100SC**  
 13.2102 23 cm **13.2102SC**

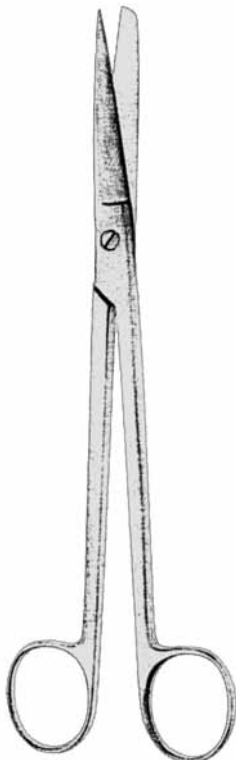

13.2111 20 cm  
 13.2113 23 cm



**SIMS**

13.2110 20 cm  
 13.2112 23 cm

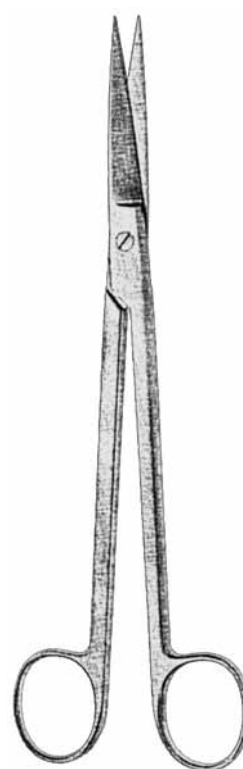

13.2121 20 cm  
 13.2123 23 cm



**SIMS**

13.2120 20 cm  
 13.2122 23 cm

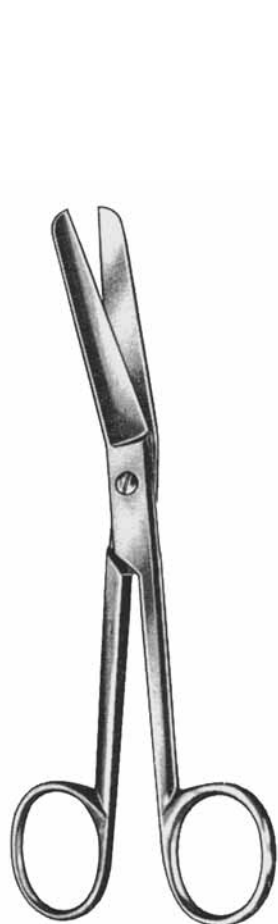

**FERGUSON**  
 13.2134 18 cm

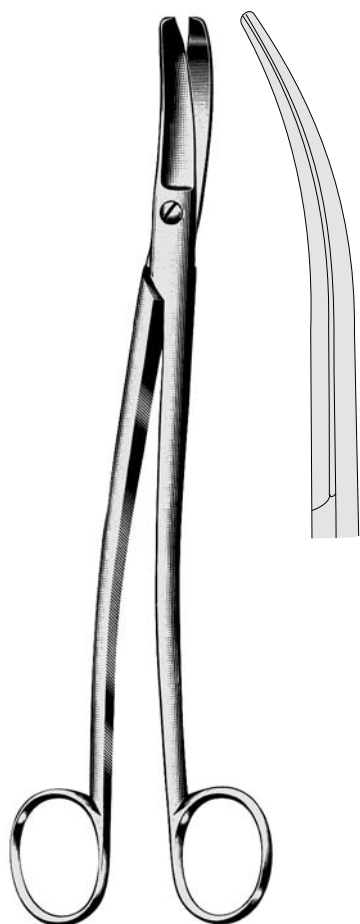

**SIEBOLD**  
 13.2150 24 cm

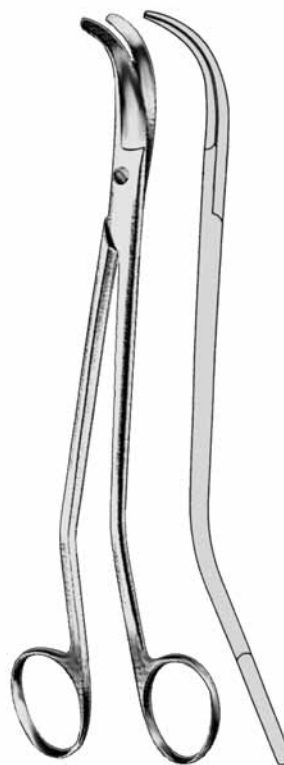

**BOZEMANN**  
 13.2155 21 cm

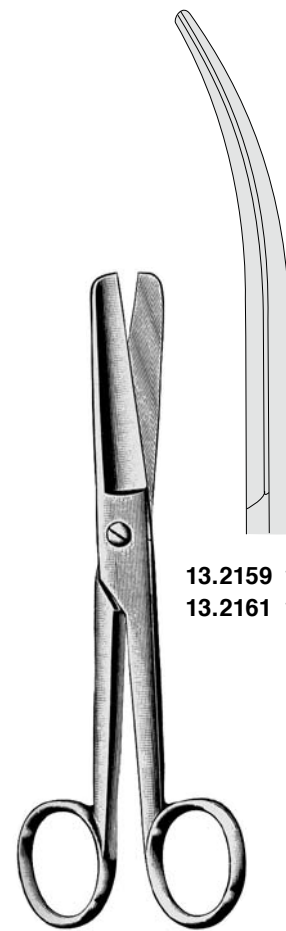

13.2159 16 cm  
 13.2161 18 cm

**DOYEN**  
 13.2158 16 cm  
 13.2160 18 cm

Nabelschnurscheren  
 Umbilical scissors  
 Ciseaux pour section de cordon  
 Tijeras umbilicales  
 Forbici ombelicali



**SCHUMACHER**  
 13.2210 15 cm



**UMBILICAL-USA**  
 13.2220 10 cm

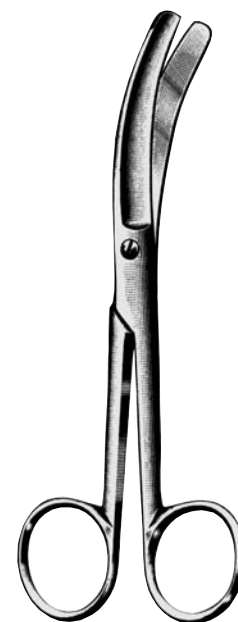

**BUSCH**  
 13.2232 16 cm



Kephalatomiescheren  
Decapitating scissors  
Ciseaux à détroncation  
Tijeras para decapitación  
Forbici per decapitazione

Damm- (Episiotomie) Scheren  
Perineum (Episiotomy) Scissors  
Ciseaux à périnée (à ,épisiotomie)  
Tijeras para perineo (Episiotomia)  
Forbici per perineo (episiotomia)



**BRAUN-STADLER**  
13.2200 14 cm  
13.2202 22 cm  
Episiotomy

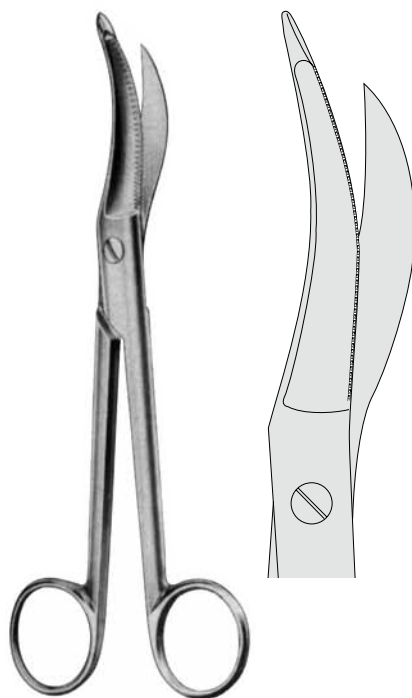

**WALDMAN**  
13.2240 18 cm **13.2240SC**  
13.2244 20 cm  
13.2246 24 cm  
Episiotomy

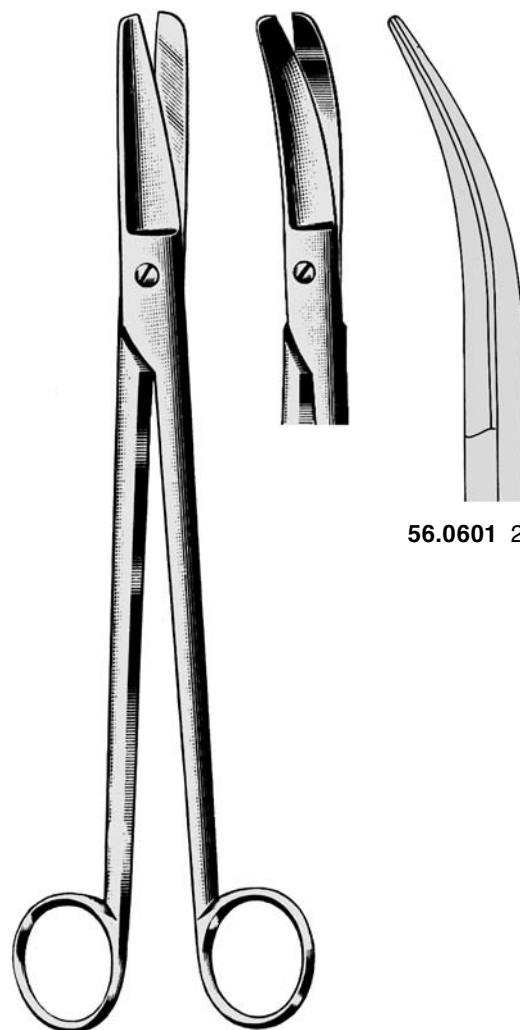

**DUBOIS**  
56.0600 27 cm

56.0601 27 cm

Geburtszangen für section caesares (Schnittentbindung)  
 Forceps for caesarean section  
 Forceps pour césarienne  
 Fórceps para operación cesárea  
 Forcipi per tagli cesarei

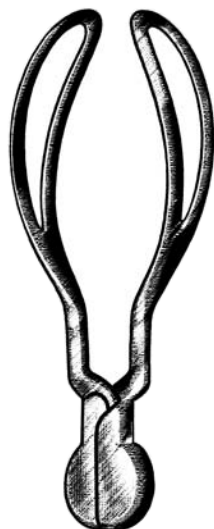

**SIMPSON**  
 56.0224  
 23 cm

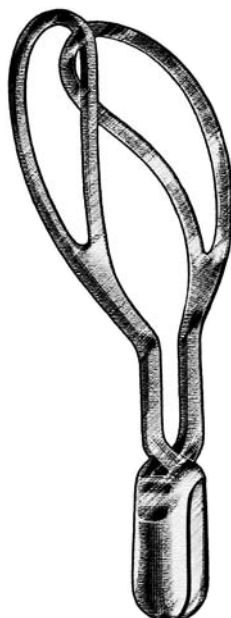

**WRIGLEY**  
 56.0226  
 25 cm

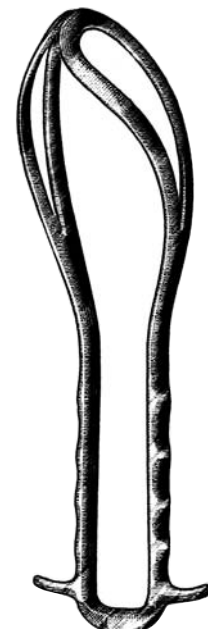

**BOERMA**  
 56.0240  
 28 cm

Kopfhebel für unteres Segment bei Kaiserschnitt  
 Head extractor for lower segment in caesarean section  
 Levier à tête utilisé en cas de césarienne  
 Elevador para cabeza usándose en le segmento inferior  
 del utero en casos de operaciones dcesáreas  
 Elevatore per testa in interventi con taglio cesareo



**MURLESS**  
 56.0400 26 cm

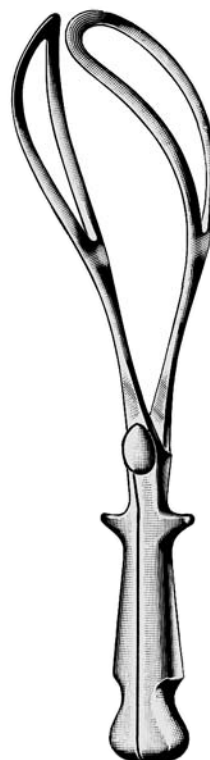
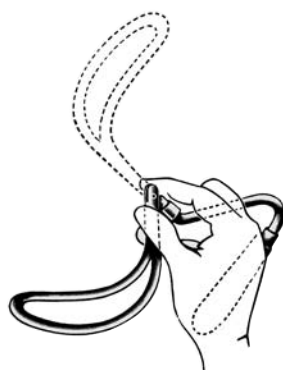

**NAEGELE (DeLEE)**  
 56.0200 36 cm  
 56.0202 40 cm

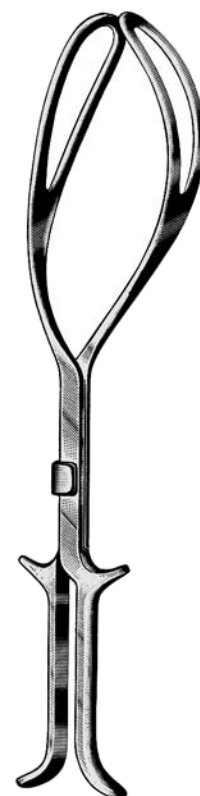

**KIELLAND**  
 56.0210  
 41 cm

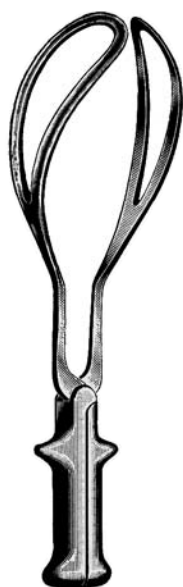

**DeLEE**  
56.0220  
30 cm

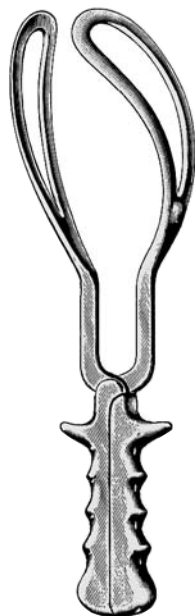

**SIMPSON-BRAUN**  
56.0222  
36 cm

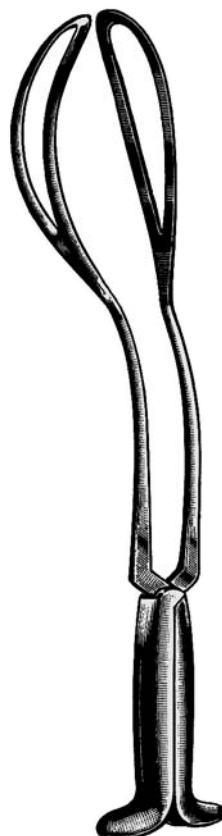

**PIPER**  
56.0230  
44 cm

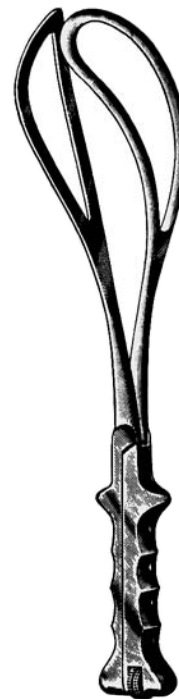

**ELLIOT**  
56.0250 32 cm  
56.0252 38 cm

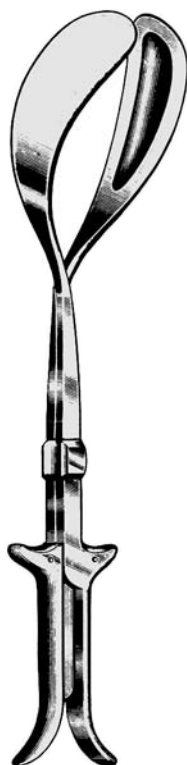

**LUIKART**  
56.0260 40 cm



**KIELLAND-LUIKART**  
56.0262 40 cm

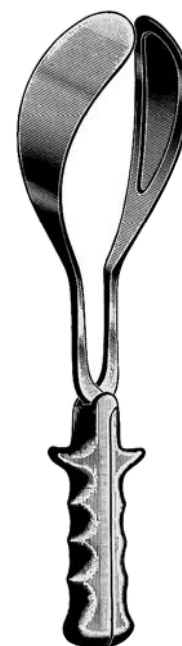

**SIMPSON-LUIKART**  
56.0265 36 cm



**McLEAN-LUIKART**  
 56.0270 39 cm



**McLEAN-TUCKER**  
 56.0272 39 cm



**McLEAN**  
 56.0274 36 cm

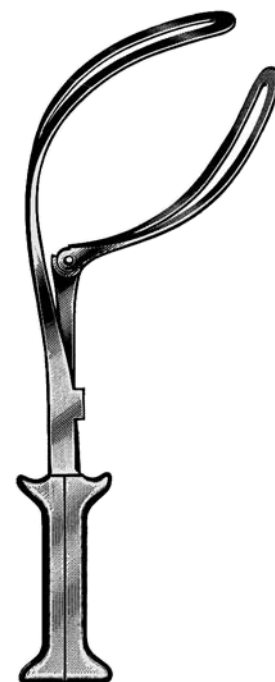

**BARTON**  
 56.0280 36 cm

Zughebel  
 Traction handle  
 Tracteur  
 Tractor  
 Trattore

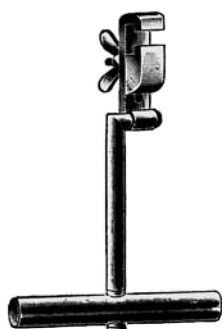

**BARTON**  
 56.0289

mit Zughebel  
 with traction handle  
 avec tracteur  
 con tractor  
 con trattore



**DEWEY**  
 56.0290 37 cm

mit Zughebel  
 with traction handle  
 avec tracteur  
 con tractor  
 con trattore

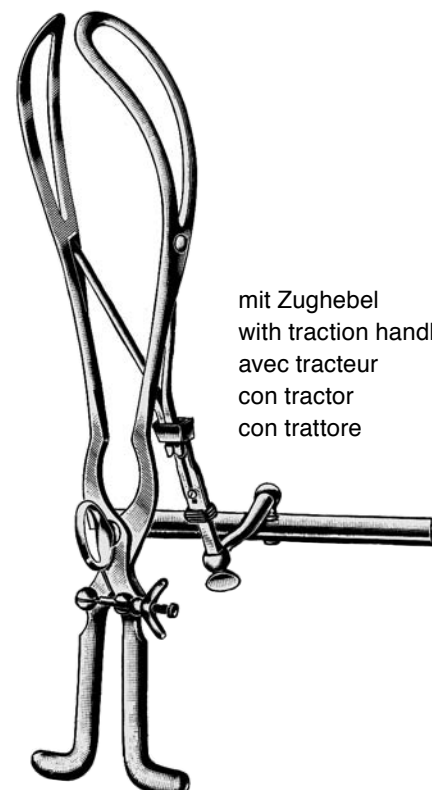

**TARNIER**  
 56.0300 40 cm





**PIPER**  
 56.0310 40 cm  
 mit Zughebel  
 with traction handle  
 avec tracteur  
 con tractor  
 con trattore

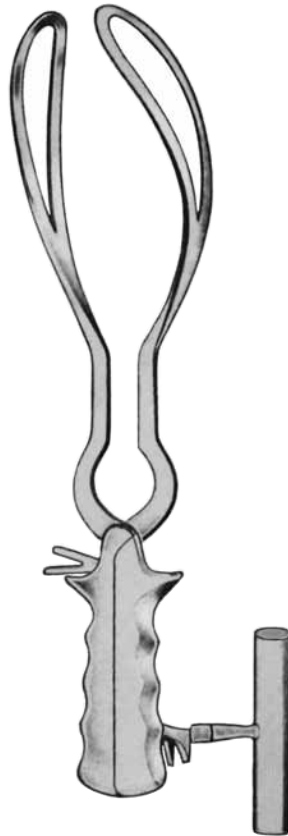

**BARNES-NEVILLE**  
 56.0320 41 cm  
 mit Zughebel  
 with traction handle  
 avec tracteur  
 con tractor  
 con trattore

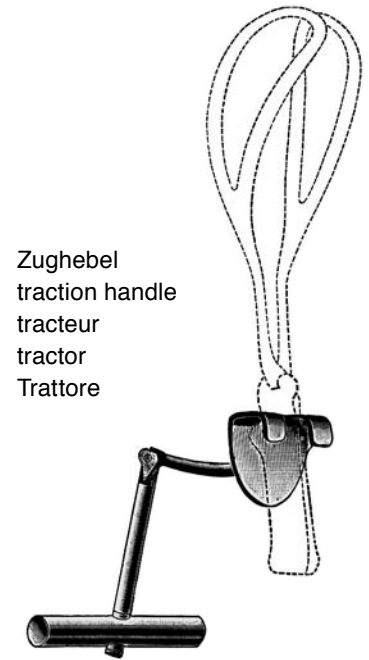

Zughebel  
 traction handle  
 tracteur  
 tractor  
 Trattore

**BILL**  
 56.0350

Zughebel, passend für alle Geburtszangen  
 mit gehörntem Standard-Griff

Tractor handles fitting all forceps with  
 standard type handle

Tracteurs pour tous les forceps avec man-  
 ches ordinaires

Tractors adecuados para todas las fórceps  
 con mango standard

Trattore adatto a tutte le forcipi con manico  
 standard

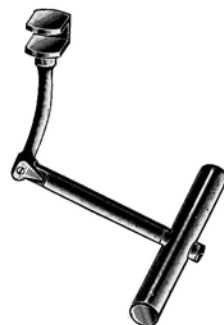

**LUIKART-BILL**  
 56.0360

Geburtslöffel  
 Obstetrical Lever  
 Levier obstétrique  
 Elevador obstetrico  
 Leva ostetrica



**SELLHEIM**  
 56.0410 28 cm

Geburtshaken  
Obstetrical hook  
Crochet à obstétrique  
Gancho para partos  
Uncino ostetrico



**SMELLIE**  
56.0515 33 cm

Nabelschnurklemmen  
Umbilical Cord Clamps  
Clamps pour cordon umbilical  
Clamps para cordon umbilical  
Clamps ombelicali

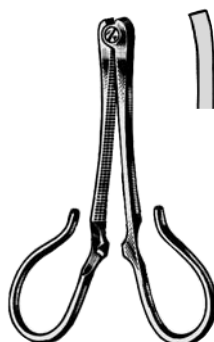

**KANE**  
56.0700  
8,5 cm



**COLLIN**  
56.0702  
9 cm

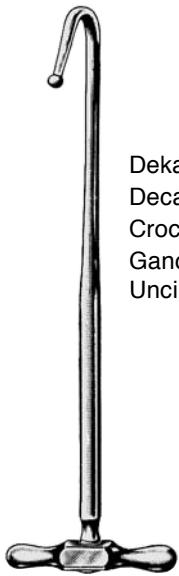

Dekapitationshaken  
 Decapitating hook  
 Crochet pour détroncation  
 Gancho para decapitación  
 Uncino di decapitazione

**BRAUN**  
**56.0505**  
 33 cm



**NAEGELE**  
**56.0506**  
 25 cm

Perforatorien  
 Perforators  
 Perces-crâne  
 Perforadores-cranei  
 Spezzecrani

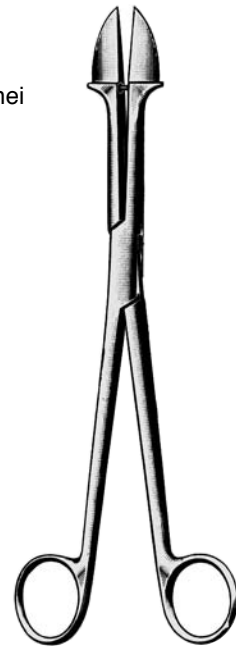

**SMELLIE**  
**56.0510**  
 25 cm

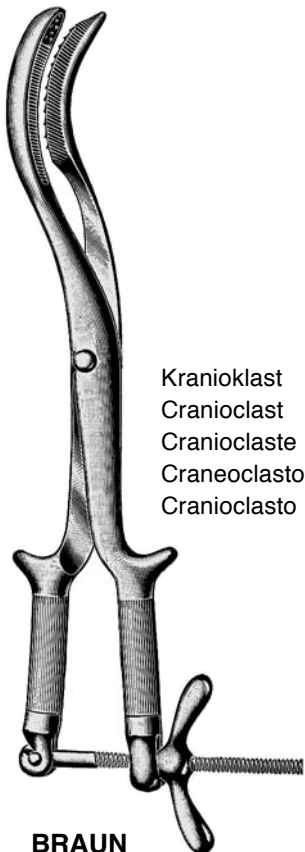

Kranioklast  
 Cranioclast  
 Cranioclaste  
 Craneoclasto  
 Cranioclasto

**BRAUN**  
**56.0500**  
 42 cm

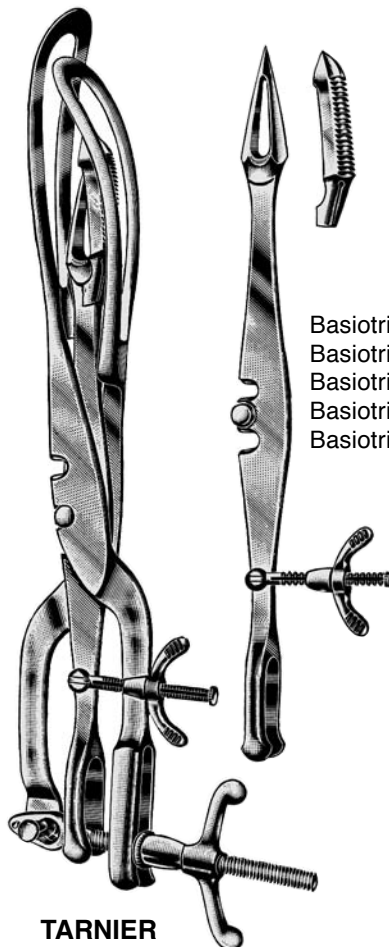

Basiotrib  
 Basiotribe  
 Basiotribe  
 Basiotribo  
 Basiotribo

**TARNIER**  
**56.0520**  
 46 cm

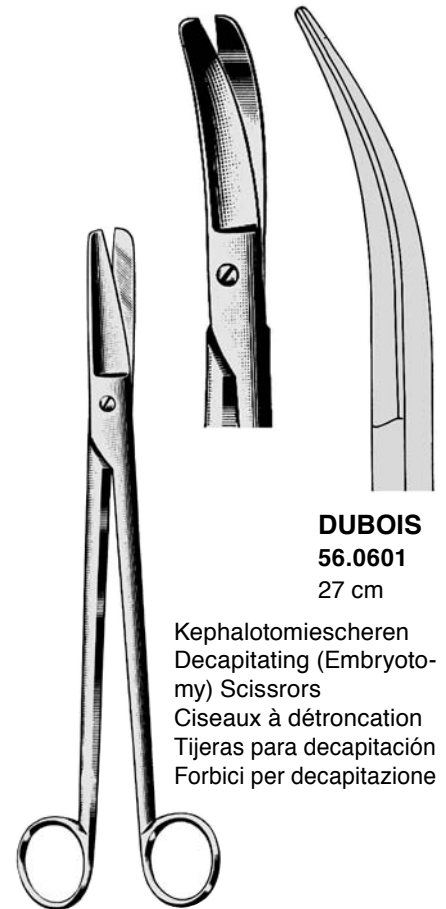

**DUBOIS**  
**56.0601**  
 27 cm

Kephalotomiescheren  
 Decapitating (Embryotomy) Scissors  
 Ciseaux à détroncation  
 Tijeras para decapitación  
 Forbici per decapitazione

**DUBOIS**  
**56.0600**  
 27 cm

Klemmzange / Uterine Hemostatic Forceps /  
Pince-Clamp utérine / Pinza-Clamp uterina / Pinza-Clamp uterina

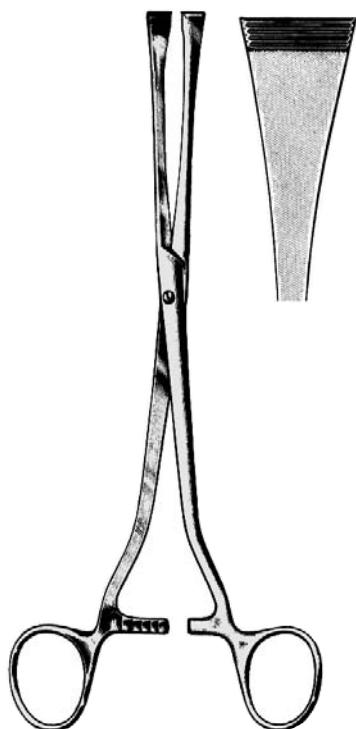

**GREEN-ARMYTAGE**  
56.0800 22 cm

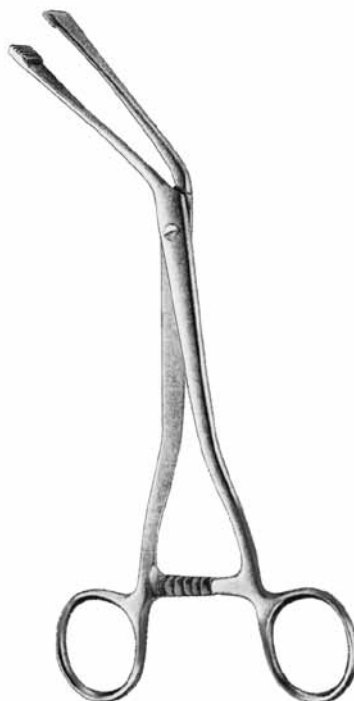

**GREEN-ARMYTAGE**  
56.0801 20 cm

Kopfschwartenzangen / Scalp flap forceps / Pincés pour le  
cuir chevelu / Pinzas para pericráneo / Pinze per pericráneo

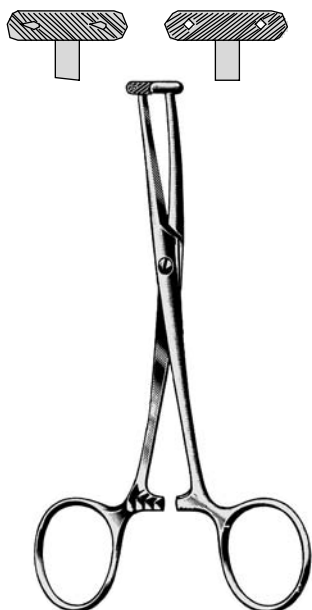

**MARTEL**  
15.1340 14 cm



**WILLET**  
15.1342 19 cm



**GAUSS**  
56.0805 26 cm

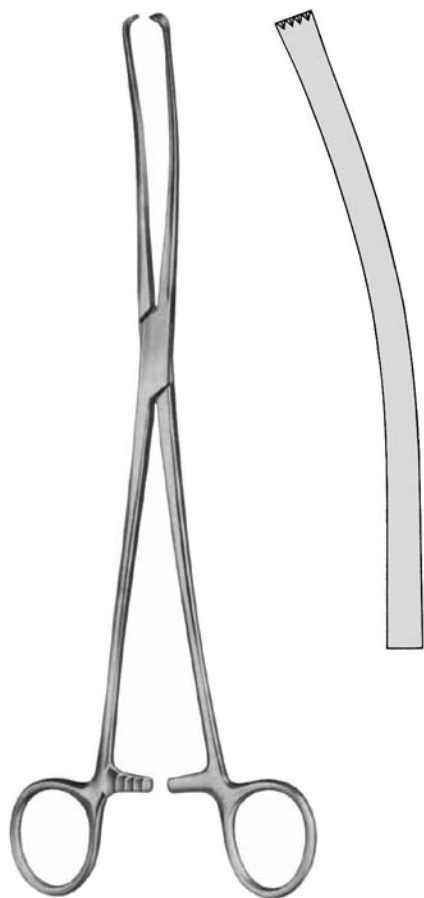

Blasensprenger  
Membrane puncturing forceps  
Pince perce-membrane  
Pinza rompe membrana  
Pinza rompere membrana

**IOWA**  
**56.0820** 26 cm

Instrument zur transvaginalen Anaesthetie  
Transvaginal anaesthesia instrument  
Instrument pour l'anesthetie des organes g nitaux externes  
Instrumento para la anestesia transvaginal  
Strumento per anestesia paracervicale



**IOWA**  
**56.0740** 15 cm

**56.0748** 14 cm  
Nadelf hrung alleine  
Needle Guide only  
Guide-aiguilles seul  
Gu a-agujas suelto  
Guida per aghi

**56.0749**  
Kan le, allein 1,5 x 150 mm  
Needle only, 1,5 x 150 mm  
Aiguille seul, 1,5 x 150 mm  
Aguja suelta, 1,5 x 150 mm  
Ago solo 1,5 x 150 mm

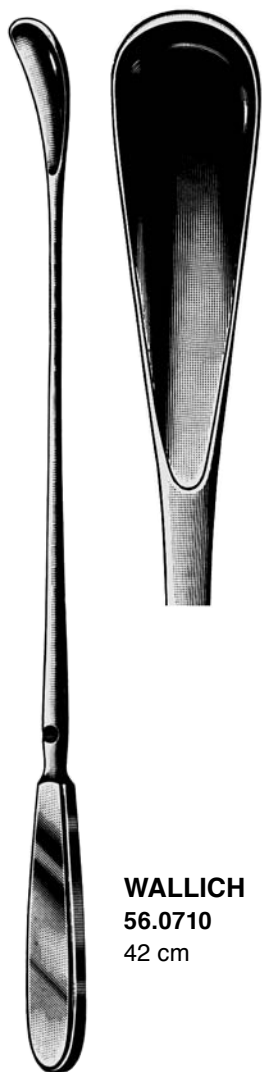

**WALLICH**  
56.0710  
42 cm

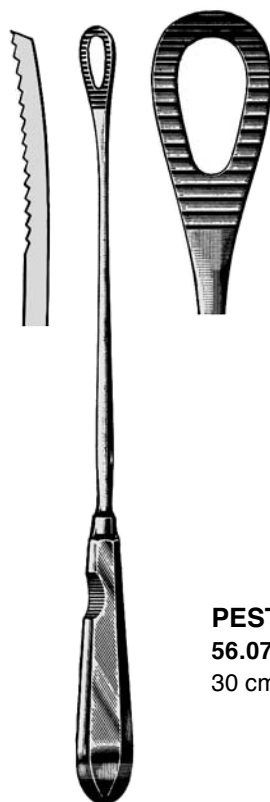

**PESTALOZZA**  
56.0720  
30 cm



**CUZZI**

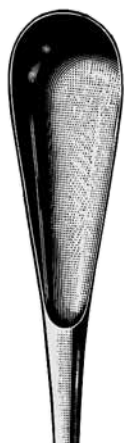

56.0721  
30 cm / 14 mm

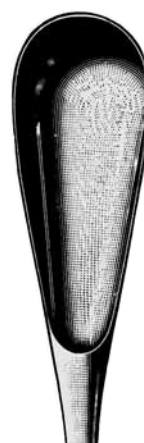

56.0722  
30 cm / 18 mm

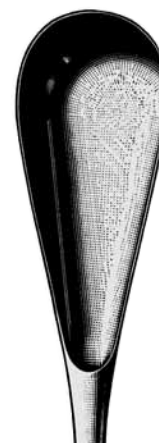

56.0723  
30 cm / 21 mm

Uterus-Polypenzangen / Uterine Polypus Forceps /  
Pincès à polypes utérines / Pinzas para pólipos uterinos /  
Pinze per polipi uterini



**HEYWOOD-SMITH**

56.0880 21 cm

56.0882 25 cm

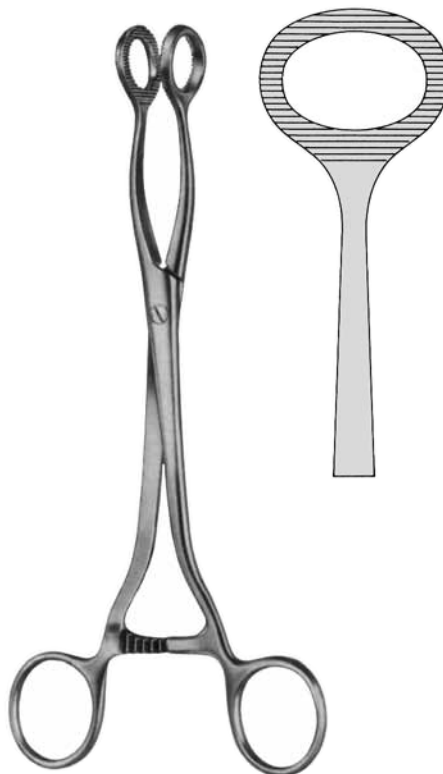

**DOYEN**

56.0890 20 cm



**NOTO**

56.0896 27 cm



**BUMM**

56.0898 28 cm

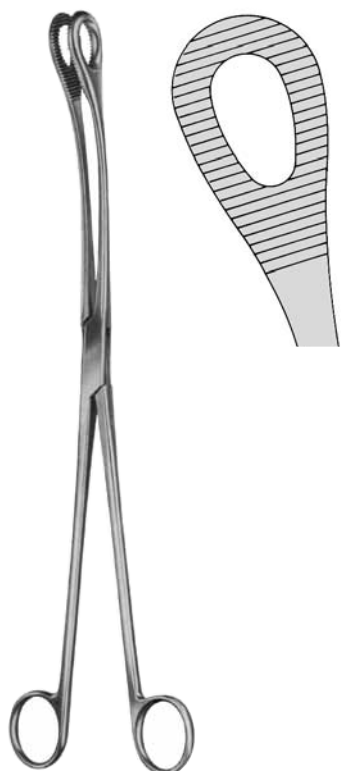

**KELLY**  
 56.0900 32 cm

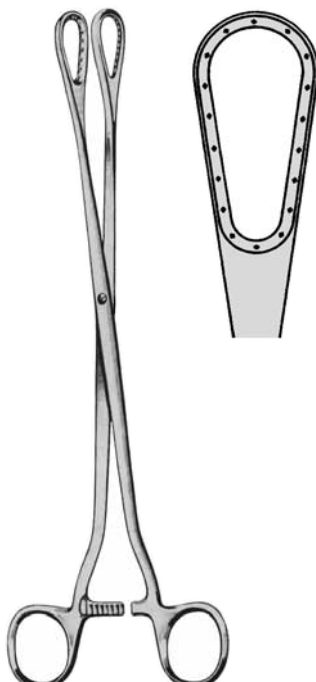

**SAENGER**  
 56.0910 27 cm

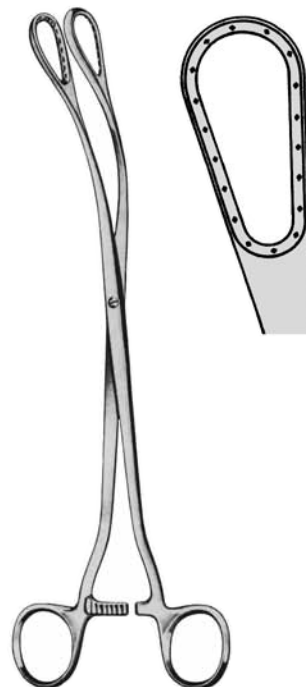

**SAENGER**  
 56.0911 27 cm

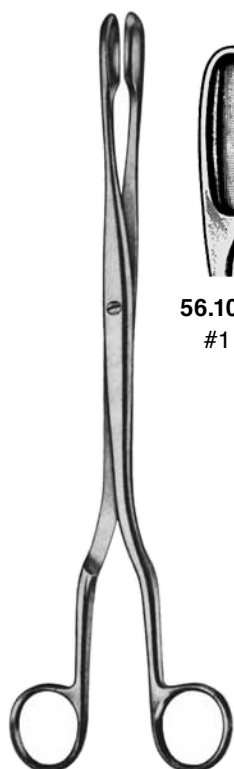

**WINTER**  
 29 cm

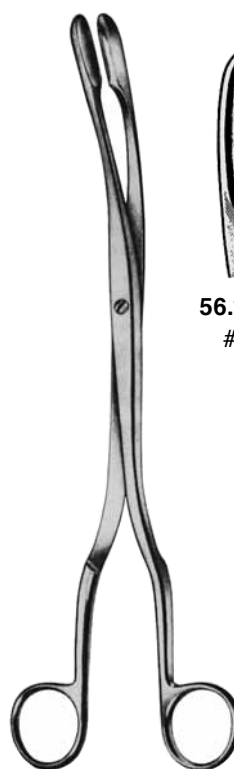
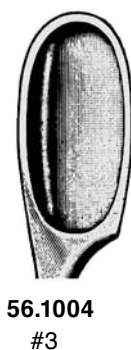
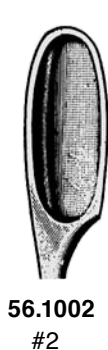

**WINTER**  
 29 cm

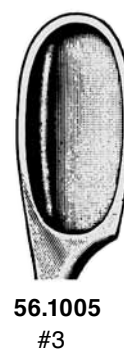





ALLGEMEINE INSTRUMENTE  
GENERAL INSTRUMENTS  
INSTRUMENTS GENERAUX  
INSTRUMENTOS GENERALES  
STRUMENTI GENERALI

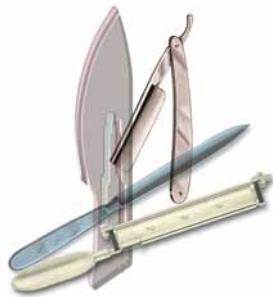



Blutdruckmesser  
Blood Pressure Manometers  
Tensiomètres  
Sfigmanómetros  
Sfigmanometri



### 10.0010 NOVA-PRESAMETER

Quecksilbergerät in Metalltui. Skala bis 300 mm Hg. Fehlertoleranz: +/- 3 mm Hg. Kalibrierte Velcromanschette mit Latexpolster 2-Schlauch.

Mercurial sphygmomanometer in metal case. Graduated scale; maximum reading 300 mm Hg. Maximum error throughout range +/- 3 mm Hg. Calibrated nylon velcro cuff with 2-tube latex bladder.

Appareil à colonne de mercure en boîtier métallique. Echelle anodisée jusqu'à 300 mm Hg. Tolérance maximale +/- 3 mm Hg. Avec brassard nylon-velcro, calibré, et vessie latex à 2 tubes.

Tensiómetro de mercurio en estuche metálico. Escala anodizada hasta 300 mm Hg. Tolerancia max +/- 3 mm Hg. Brazaletes velcro de nylon, calibrado, con bolsa latex de 2 tubos

Sfigmanometro in astuccio metallo, Scala 0 - 300 mmHg. Tolleranza +/- 3 mmHg. Bracciale calibrato velcro-nylon di camera d'aria di latex a 2-tubi.



### 10.0020 PRECISA N

Manometer-Blutdruckmessgerät; ergonomischer Löffelgriff; Lineare Skale 0 - 300 mm Hg; maximale Fehlertoleranz +/- 3 mmHg

Blood Pressure Manometer; Ergonomic spoon-shaped grip; linear, tilted aluminum scale from 0 to 300 mm Hg; max. error tolerance +/- 3 mmHg

Tensiomètre à cadran; poignée-cuillère ergonomique; graduation linéaire inclinée, de 0 à 300 mm Hg; tolérance max. d'erreur +/- 3 mmHg

Tensiómetro aneroides; Mango de cuchara ergonómico; Escala de aluminio lineal, inclinada, 0 - 300 mmHg; Máxima tolerancia de error de +/- 3 mmHg

Sfigmanometro moderno e economico. Scala 0 - 300 mmHg, 53 mm Ø. Valore massimo 300 mmHg. Tolleranza +/- 3 mmHg. Bracciale calibrato velcro-nylon di camera d'aria di latex a 1 tubo

Blutdruckmesser  
Blood Pressure Manometers  
Tensiomètres  
Sfigmanómetros  
Sfigmanometri



#### 10.0030 MINIMUS II

Einhandmodell in Vinyltasche mit Reißverschluss. Keine Nullpunktfixierung. Gut ablesbare Aluminiumskala Ø 49 mm bis 300 mm Hg. Maximale Fehlertoleranz +/- 3 mm Hg. Mit kalibrierter Nylon-Velcromanschette komplett mit Latexpolster 1-Schlauch.

Palm-style sphygmanometer in vinyl zipper case. Graduated aluminum scale Ø 49 mm. Maximum reading 300 mm Hg. Maximum error +/- 3 mm Hg. With calibrated nylon-velcro cuff and 1-tube latex bladder.

Manopire en étui vinyl avec fermeture éclair. Echelle Ø 49 mm jusqu'à 300 mm Hg. Tolérance maximale +/- 3 mm Hg. Avec brassard nylon-velcro calibré, et vessie latex à 1 tube.

Modelo de mano. Lectura de la escala Ø 49 mm hasta 300 mm Hg. Tolerancia max. +/- 3 mm Hg. Brazaletes velcro de nilón, calibrado; cámara d'aria de latex ad 1 tubo.

Sfigmanometro ad aneroide in borsa vinilpelle con cerniera lampo. Senza fissaggio a zero. Scala graduata in alluminio 49 mm Ø, 0 - 300 mmHg. Tolleranza +/- 3 mmHg. Bracciale calibrato velcro-nylon di camera d'aria di latex a 1 tubo



#### 10.0040 EXACTA

Hochleistungs-Blutdruckmessgerät in 2-Schlauch-Ausführung. Lineare Skala Ø 40 mm, von 0 - 300 mm Hg; max. Fehlertoleranz +/- 3 mmHg

High quality Sphygmanometer in a 2-tube version; Linear scale Ø 49 mm, 0 - 300 mmHg; Max. error tolerance +/- 3 mmHg

Tensiomètre à cadran de haute qualité à 2 tubes; Graduation linéaire, Ø 49 mm de 0 à 300 mmHg; tolérance max. d'erreur de +/- 3 mmHg

Tensiómetro de precisión de alta calidad, con 2 tubos; Escala lineal Ø 49 mm, 0 - 300 mmHg; Máxima tolerancia de error de +/- 3 mmHg

Sfigmanometro di alta prestazione. Scasla lineare 0 - 300 mmHg, 49 mm Ø. Tolleranza +/- 3 mmHg. Bracciale calibrato velcro-nylon di camera d'aria di latex a 2 tubi



kalibrierte Nylon-Velcromanschetten, 2-Schlauch  
Calibrated nylon-velcro cuffs 2-tube  
Brassards nylon-velcro calibré avec 2-tubes  
Brazeletes velcro de nilón con 2 tubos  
Bracciali velcro solo a 2 tubi

**10.0080**

für Erwachsene / for adults / pour adultes / para adultos / per adulti

**10.0081**

für Erwachsene (dünne Arme) / for adults (thin arms) / pour adultes (bras minces) / para adultos (brazos delgados) per adulti (braccie fine)

**10.0082**

für Oberschenkel /for femur / pour fémur / para muslo / per coscìe

**10.0083**

für Neugeborene / for newborn / p. nouveaux-nés / p. racien nacidas / per neonato

**10.0084**

für Säuglinge / for Infants / pour bébés / p. lactantes / per lattante

**10.0085**

für Kinder / for children / pour enfants / para niños / per bambini

kalibrierte Nylon-Velcromanschetten, 1-Schlauch  
Calibrated nylon-velcro cuffs 1-tube  
Brassards nylon-velcro calibré avec 1-tube  
Brazeletes velcro de nilón con 1 tubo  
Bracciali velcro solo a 1 tubo

**10.0090**

für Erwachsene / for adults / pour adultes / para adultos / per adulti

**10.0091**

für Erwachsene (dünne Arme) / for adults (thin arms) / pour adultes (bras minces) / para adultos (brazos delgados) per adulti (braccie fine)

**10.0092**

für Oberschenkel /for femur / pour fémur / para muslo / per coscìe

**10.0094**

für Neugeborene / for newborn / p. nouveaux-nés / p. racien nacidas / per neonato

**10.0095**

für Kinder / for children / pour enfants / para niños / per bambini

Stethoskope  
Stethoscopes  
Stéthoscopes  
Estetoscopios  
Stetoscopi



aus Aluminium  
of aluminium  
de aluminium  
de aluminio  
in alluminio

**PINARD**  
**10.0400**  
15 cm



aus Holz  
of wood  
de bois  
de madera  
in legno

**PINARD**  
**10.0410**  
18 cm



**DUPLEX**  
**10.0460**



**DUPLEX DE LUXE**  
**10.0462**

Mikro-Skalpellklingen und -griffe  
 Micro Scalpel Blades and Handles  
 Micro lames de bistouris et manches  
 Micro hojas de bisturi y mangos  
 Micro lame per bisturi e manici

in Packungen à 10 St.  
 in packages of 10 ea.  
 en boîtes de 10 pièces  
 en cajas de 10 c/u  
 en scatole di 10 pezzi



**12.0061** #61      **12.0062** #62      **12.0062S** #62S      **12.0065** #65      **12.0067** #67      **12.0069** #69

Griffe für Klingen  
 handles for blades  
 manches pour lames  
 mangos para hojas  
 manici per bisturi

12.0061 - 12.0069



**12.0180** 100 mm  
**12.0182** 125 mm  
**12.0184** 155 mm  
**12.0186** 180 mm  
**12.0188** 200 mm



**LANDOLD**  
**12.0153**  
 21 cm bajonett



**LANDOLD**  
**12.0157**  
 25 cm bajonett



steril, in Packungen à 100  
sterile, in packages of 100  
stériles, en boîtes de 100  
estériles, en cajas de 100  
sterili, confezione da 100



**12.0010**  
# 10



**12.0011**  
# 11



**12.0012**  
# 12

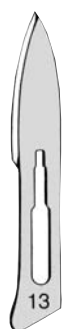

**12.0013**  
# 13



**12.0014**  
# 14



**12.0015**  
# 15



**12.0016**  
# 16



**12.0017**  
# 17

Der „**PRO-MED SEKUR**™“ Klingenhalter ermöglicht das Einsetzen und Entfernen der Klingle, ohne den vorderen - kontaminierten - Teil der Klinge zu berühren

This „**PRO-MED SEKUR**™“ Blade handle allows inserting and removing of blades without touching the - contaminated - tip of blades.

Le porte-lames „**PRO-MED SEKUR**™“ permet la mise en place et l'enlèvement des lames sans toucher la partie coupante et contaminée de celles-ci..

El mango „**PRO-MED SEKUR**™“ permite aplicar y quitar la hoja sin tener que tocar su parte delantera contaminada.

Il portalama „**PRO-MED SEKUR**™“ permette l'applicazione delle lame senza entrare in contatto con la parte anteriore contaminata.



**PRO-MED SEKUR**™  
12.0193  
12,5 cm #3

für Klingle:  
for blades:  
pour lames:  
para bisturis:  
per bisturi:

Fig. 10, 11, 12, 13,  
14, 15, 16, 17

**PRO-MED SEKUR**™  
12.0194  
13,5 cm #4

für Klingle:  
for blades:  
pour lames:  
para bisturis:  
per bisturi:

Fig. 18, 19, 20, 21,  
22, 23, 24, 25  
34, 36, 44, 46

Klinge im breiten Teil über oberen Stift des Klingenhalters setzen.

Insert lower end of blade into upper pin of blade handle

Tenir la lame en bas et introduire le pivot supérieur dans la partie élargie de la fente de la lame.

Introdur la hoja en la parte ancha de la clavija en el soporte de la hoja superior.

Innestare la lama con la parte più larga della sua apertura al perno terminale del portalama

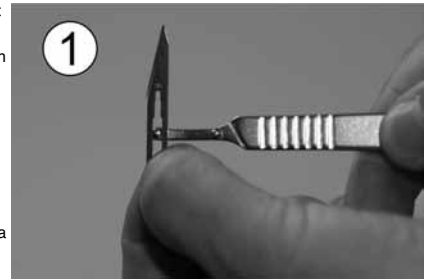

Klinge bis zum Anschlag nach unten ziehen

Pull blade all the way down

Tirer la lame jusqu'à la butée.

Tirar la hoja hacia abajo hasta el fondo.

Tirare la lama verso il basso fino al suo arresto

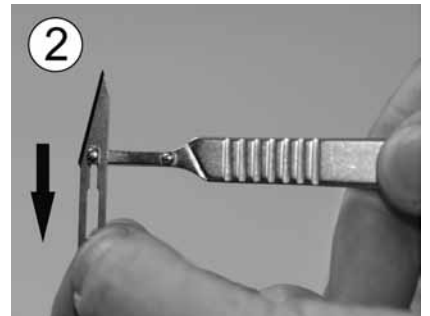

In Anschlagposition um 90° Grad drehen

Turn blade 90° until it touches lower pin of blade handle.

En position butoire tourner la lame à 90°.

En posicion del fondo girar la hoja ha 90°.

Ruotare di 90° verso l'alto fino a raggiungere il secondo perno prossimo all'impugnatura

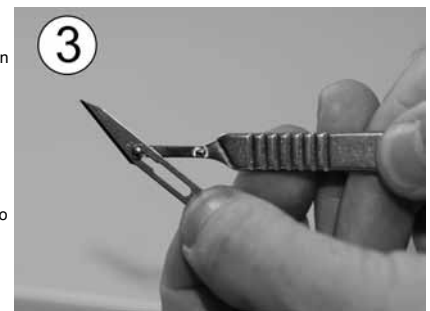

Klingenende wird über den unteren Stift des Klingenhalters gehoben

Lift end of blade over lower pin of blade handle

Passer la lame par dessus la tige inférieure du manche

Coger la hoja por el extremo inferior, levantada hacia la clavija

Innestare la parte posteriore della lama al perno prossimo all'impugnatura del portalama

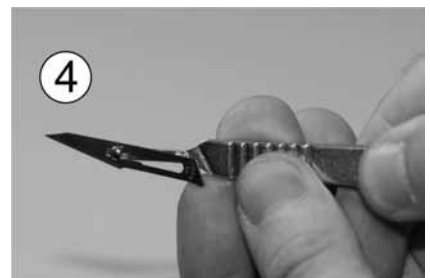

Klinge rastet ein und ist fixiert und gebrauchsfertig - Entfernen der Klinge in umgekehrter Reihenfolge

Lock blade into place which is now ready for use. - Remove blade in reverse order

La lame s'encliquète, est fixée et prête à l'emploi. - Oter la lame par ordre inverse.

La hoja se involucra se fija y listo para usar. - Retire la hoja en orden inverso.

La lama è pronta all'uso - Per rimuovere la lama operate in senso inverso

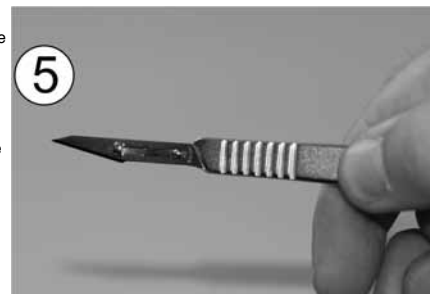

Griffe für Klagen  
 Handles for Blades  
 Manches pour lames  
 Mangos para bisturis  
 Manici per bisturi Fig.

Fig. 10,11,12,12d,13,14,15,15c,16,17,

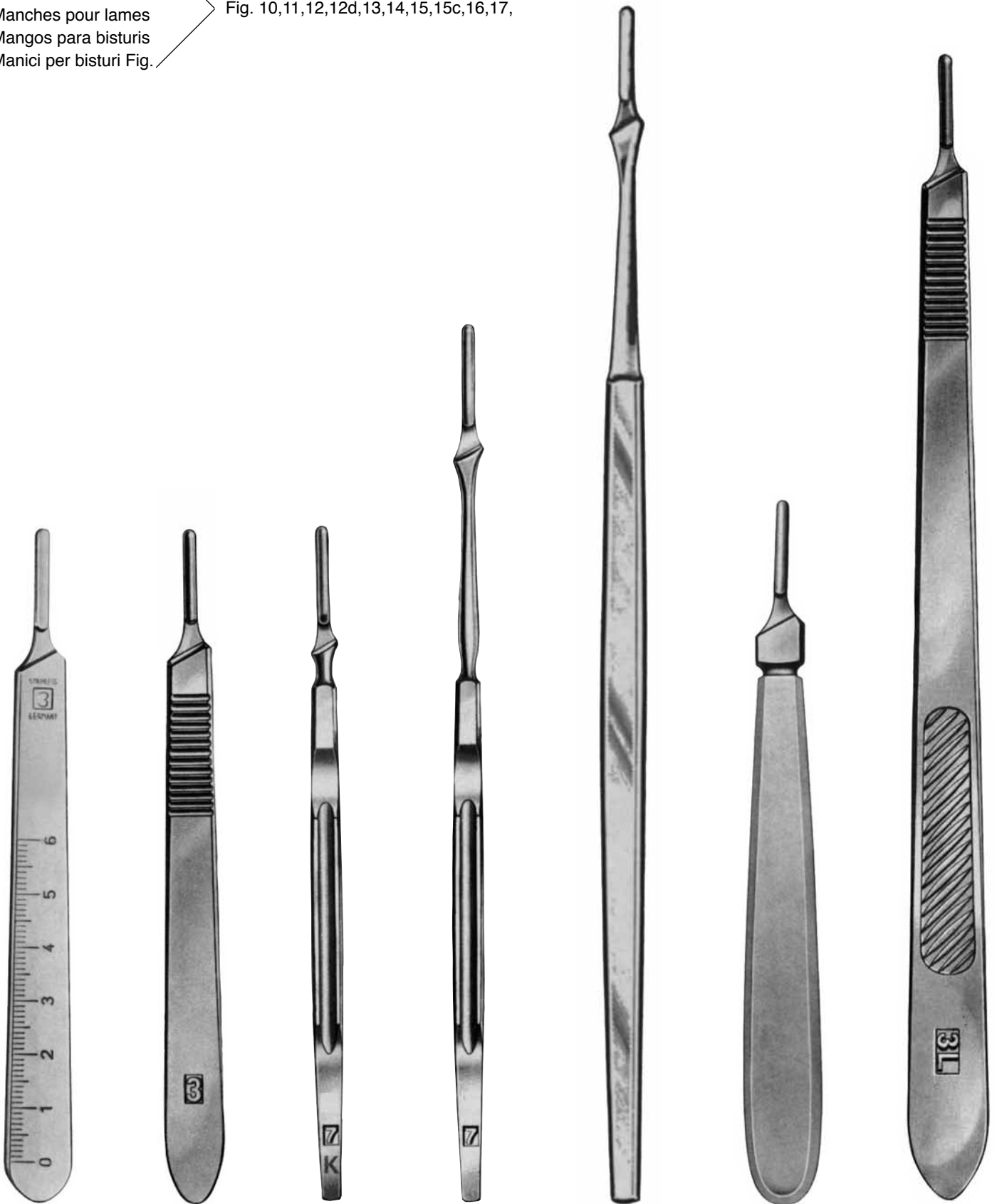

**12.0101**  
 Technical #3

**12.0103**  
 #3 12 cm

**12.0106**  
 #7 K 12,5 cm

**12.0107**  
 #7 16 cm

**12.0127**  
 #7 L 22,5 cm

**COLLIN**  
**12.0108**  
 #8 13 cm

**12.0113**  
 #3 L 21 cm

Griffe für Klengen  
 Handles for Blades  
 Manches pour lames  
 Mangos para bisturis  
 Manici per bisturi

Fig. 10,11,12,12d,13,14,15,15c,16,17,



**12.0115**  
 #3 L 20 cm



**12.0123**  
 #5, 16 cm



**12.0125**  
 #5, 16 cm



**12.0133**  
 #3, 21cm



**BARRON**  
**12.0163**  
 #3 13 cm



**12.0173**  
 12,5 cm

Kunststoffgriff  
 plastic handle  
 manche en plastique  
 mango plástico  
 manico plastica

steril, in Packungen à 100  
 sterile, in packages of 100  
 stériles, en boîtes de 100  
 estériles, en cajas de 100  
 sterili, confezione da 100

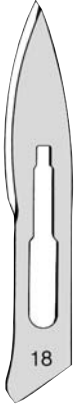

**12.0018**  
# 18



**12.0019**  
# 19



**12.0020**  
# 20



**12.0021**  
# 21



**12.0022**  
# 22



**12.0023**  
# 23



**12.0024**  
# 24



**12.0025**  
# 25



**12.0034**  
# 34



**12.0036**  
# 36

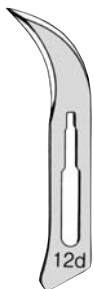

**12.0042**  
# 12 d



**12.0044**  
# 24 d



**12.0045**  
# 15 c



**12.0046**  
# 36 d

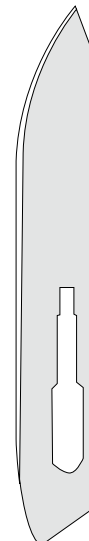

**POST-MORTEM**  
**12.0060**  
# 60

nicht steril  
 not sterile  
 pas stériles  
 no estériles  
 non sterile

Griffe für Klengen  
 Handles for Blades  
 Manches pour lames  
 Mangos para bisturis  
 Manici per bisturi

Fig. 18,19,20,21,22,23,24,25,34,36,44,46

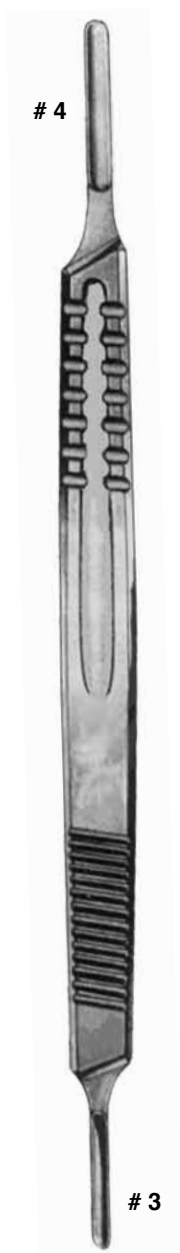

**12.0105**  
 # 3/4 16 cm



**12.0102**  
 Technical #4



**12.0104**  
 #4 12 cm



**COLLIN**  
**12.0109**  
 #9 14 cm

Griffe für Klagen  
 Handles for Blades  
 Manches pour lames  
 Mangos para bisturis  
 Manici per bisturi

Fig. 18,19,20,21,22,23,24,25,34,36,44,46

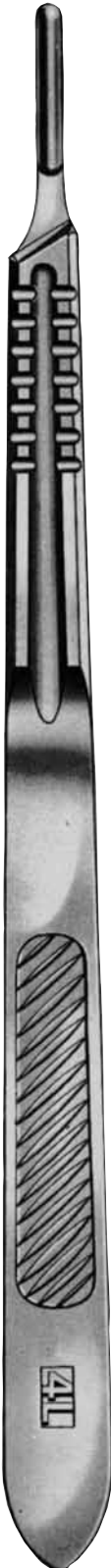

**12.0114**  
 #4 L 21 cm



**12.0117**  
 #4 L 20 cm



**KLING-EX**  
**12.0070**  
 Skalpelklagen-Abnehmer  
 Scalpel-blade remover  
 Oteur-bistouris  
 Quita hojas  
 togliere-lame



Kunststoffgriff  
 plastic handle  
 manche en plastique  
 mango plástico  
 manico plastica

**12.0174**  
 13,5 cm

SCHEREN  
SCISSORS  
CISEAUX  
TIJERAS  
FORBICI







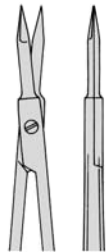

**28.2112**  
18,5 cm



**28.2113**  
18,5 cm

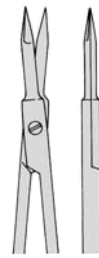

**28.2114**  
23 cm

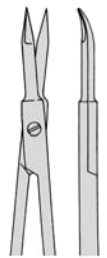

**28.2115**  
23 cm



**VANNAS-MIKRO**

**VANNAS-MIKRO**



**28.2102**  
15 cm  
Ø 8 mm  
**28.2104**  
18cm



**28.2103**  
15 cm  
Ø 8 mm  
**28.2105**  
18 cm



**28.2124**  
18 cm / Ø 8 mm  
gerade / straight  
droit / recto / retto



**28.2150 (GYN)**  
18 cm / Ø 8 mm  
gerade / straight  
droit / recto / retto



**28.2125**  
18 cm / Ø 8 mm  
gebogen / curved  
courbe / curvo /  
curvo

**28.2151 (GYN)**  
18 cm / Ø 8 mm  
gebogen / curved  
courbe / curvo /  
curvo

**VANNAS-MIKRO**

**TITANIUM**



18 cm



28.2460  
**28.2460T**  
 25°



28.2470  
**28.2470T**  
 25°



28.2461  
**28.2461T**  
 45°



28.2471  
**28.2471T**  
 45°



28.2462  
**28.2462T**  
 60°



28.2472  
**28.2472T**  
 60°



28.2463  
**28.2463T**  
 90°



28.2473  
**28.2473T**  
 90°



28.2464  
**28.2464T**  
 125°



28.2474  
**28.2474T**  
 125°



18 cm

mit 1 geknöpfen Blatt  
 1 probe-pointed blade  
 1 lame boutonée  
 1 punta botonada  
 1 lame abbottona



**28.2600** 16,5 cm  
**28.2602** 20,0 cm



**28.2601** 16,5 cm  
**28.2603** 20,0 cm



**28.2605** 20,0 cm



**28.2608** 20,0 cm



**28.2609** 20,0 cm



**28.2620** 22,5 cm



**28.2623** 22,5 cm  
**28.2625** 24,5 cm



**28.2624** 22,5 cm

**28.2622** 22,5 cm  
 gezahnt  
 serrated  
 dentelées  
 dentada  
 dentate



**28.2628** 22,5 cm



**28.2629** 22,5 cm



**28.2640** 22,5 cm



**28.2641** 22,5 cm

**VANNAS**



**NAGEL**

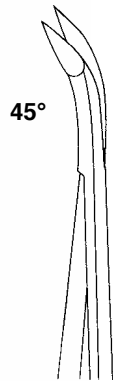

45°

**28.2656** 20,0 cm

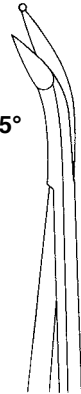

45°

**28.2657** 20,0 cm

geknöpft  
button-end  
boutonée  
abotonada  
con 1 lama abbottona



125°

**28.2659** 20,0 cm

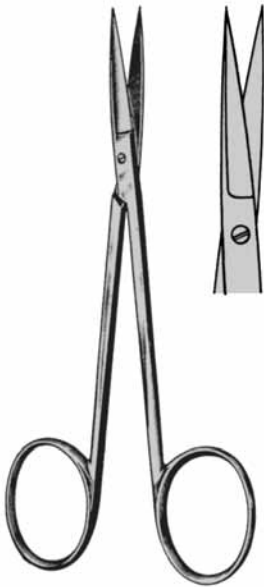

**IRIS**

- 13.0010 9,0 cm
- 13.0010SC** 9,0 cm
- 13.0012 10,5 cm
- 13.0012SC** 10,5 cm
- 13.0014 11,5 cm
- 13.0014SC** 11,5 cm

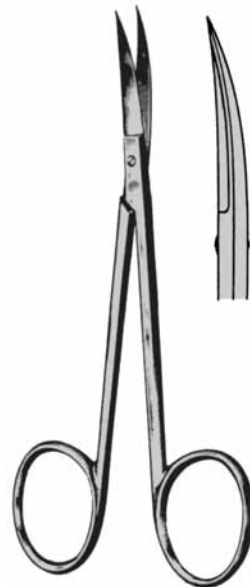

**IRIS**

- 13.0011 9,0 cm
- 13.0011SC** 9,0 cm
- 13.0013 10,5 cm
- 13.0013SC** 10,5 cm
- 13.0015 11,5 cm
- 13.0015SC** 11,5 cm



**IRIS**

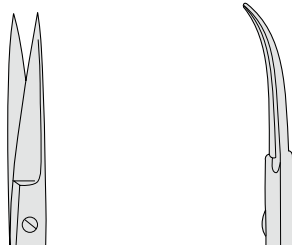

- 13.0012L 10,5 cm
- 13.0012LSC** 10,5 cm
- 13.0013L 10,5 cm
- 13.0013LSC** 10,5 cm

linkshändig / left handed /  
 pour gaucher / para zurdo / per mano sinistra

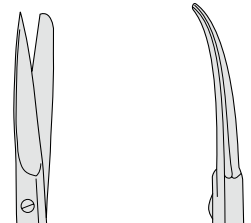

- 13.0022 10 cm
- 13.0023 10 cm

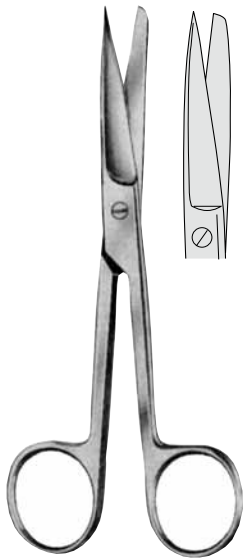

- 13.0300 11,5 cm
- 13.0302 13,0 cm
- 13.0302SC** 13,0 cm
- 13.0304 14,5 cm
- 13.0304SC** 14,5 cm
- 13.0306 15,5 cm
- 13.0308 16,5 cm
- 13.0308SC** 16,5 cm
- 13.0310 18,5 cm
- 13.0312 20,0 cm



- 13.0304L** 14,5 cm
- linkshändig
- left-handed
- pour gaucher
- para zurdo
- per mano sinistra



- 13.0394** 14,5 cm
- gezahnt
- serrated
- dentées
- dentadas
- dentata

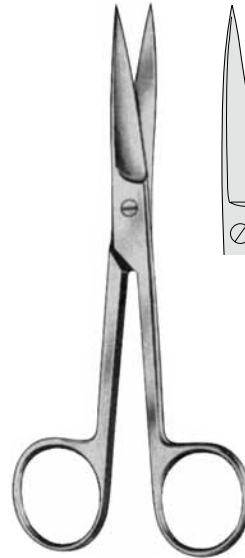

- 13.0330 11,5 cm
- 13.0330SC** 11,5 cm
- 13.0332 13,0 cm
- 13.0334 14,5 cm
- 13.0334SC** 14,5 cm
- 13.0336 15,5 cm
- 13.0338 16,5 cm
- 13.0340 18,5 cm
- 13.0342 20,0 cm

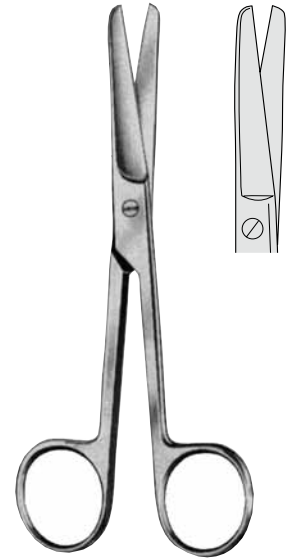

- 13.0350 11,5 cm
- 13.0352 13,0 cm
- 13.0352SC** 13,0 cm
- 13.0354 14,5 cm
- 13.0354SC** 14,5 cm
- 13.0356 15,5 cm
- 13.0358 16,5 cm
- 13.0358SC** 16,5 cm
- 13.0360 18,5 cm
- 13.0360SC** 18,5 cm
- 13.0362 20,0 cm

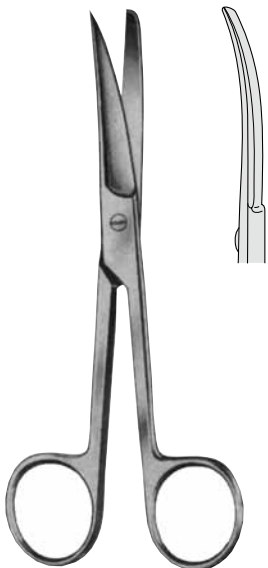

- 13.0301 11,5 cm
- 13.0303 13,0 cm
- 13.0305 14,5 cm
- 13.0307 15,5 cm
- 13.0309 16,5 cm
- 13.0311 18,5 cm
- 13.0313 20,0 cm

- 13.0301SC**
- 13.0303SC**
- 13.0305SC**
- 13.0309SC**

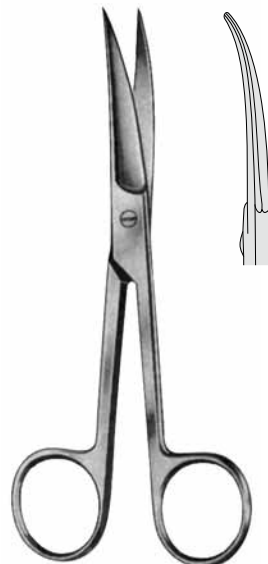

- 13.0331 11,5 cm
- 13.0333 13,0 cm
- 13.0335 14,5 cm
- 13.0337 15,5 cm
- 13.0339 16,5 cm
- 13.0341 18,5 cm
- 13.0343 20,0 cm

- 13.0333SC**
- 13.0335SC**

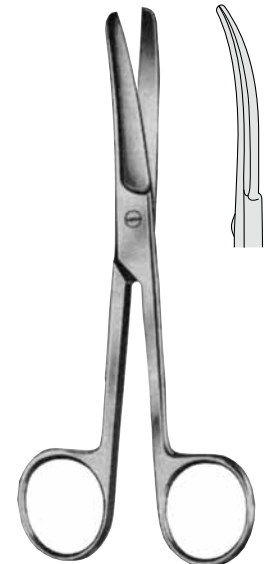

- 13.0351 11,5 cm
- 13.0353 13,0 cm
- 13.0355 14,5 cm
- 13.0357 15,5 cm
- 13.0359 16,5 cm
- 13.0361 18,5 cm
- 13.0363 20,0 cm

- 13.0355SC**
- 13.0363SC**





**MAYO**

- 13.0400 14,5 cm
- 13.0400SC** 14,5 cm
- 13.0402 15,5 cm
- 13.0402SC** 15,5 cm
- 13.0404 17,0 cm
- 13.0404SC** 17,0 cm
- 13.0406 20,0 cm
- 13.0406SC** 20,0 cm
- 13.0408 23,0 cm
- 13.0408SC** 23,0 cm

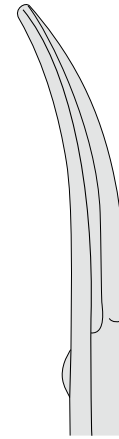

- 13.0401 14,5 cm
- 13.0401SC** 14,5 cm
- 13.0403 15,5 cm
- 13.0403SC** 15,5 cm
- 13.0405 17,0 cm
- 13.0405SC** 17,0 cm
- 13.0407 20,0 cm
- 13.0407SC** 20,0 cm
- 13.0409 23,0 cm
- 13.0409SC** 23,0 cm

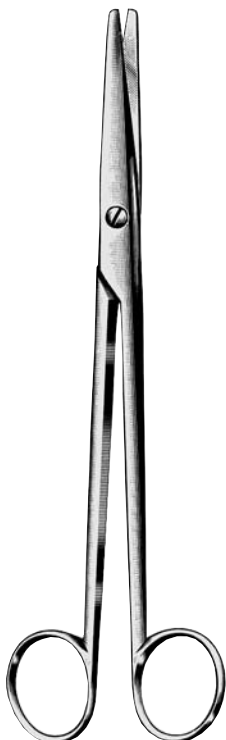

**MAYO-STILLE**

- 13.0432 15,0 cm
- 13.0432SC** 15,0 cm
- 13.0434 17,0 cm
- 13.0434SC** 17,0 cm
- 13.0436 19,5 cm
- 13.0438 21,0 cm



- 13.0433 15,0 cm
- 13.0433SC** 15,0 cm
- 13.0435 17,0 cm
- 13.0435SC** 17,0 cm
- 13.0437 19,5 cm
- 13.0439 21,0 cm



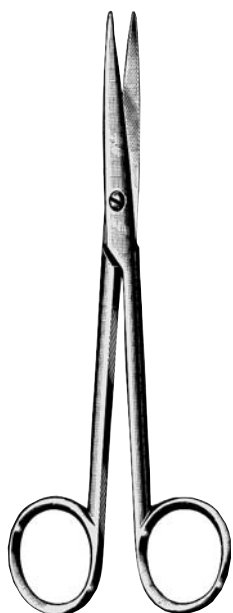

**MAYO-LEXER**  
13.0440 16,5 cm  
**13.0440SC** 16,5 cm

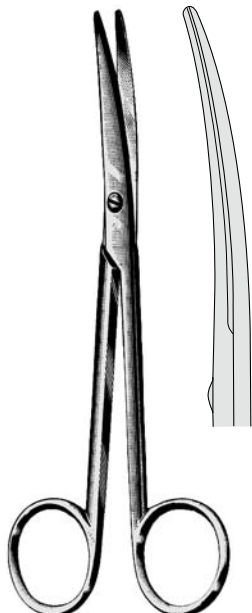

**MAYO-LEXER**  
13.0441 16,5 cm  
**13.0441SC** 16,5 cm

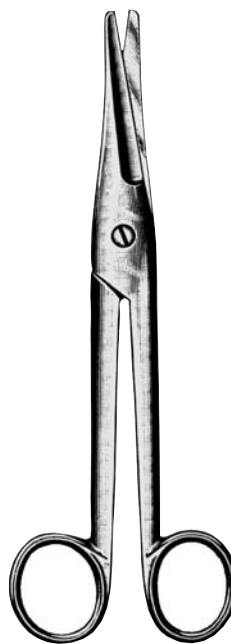

**MAYO-NOBLE**

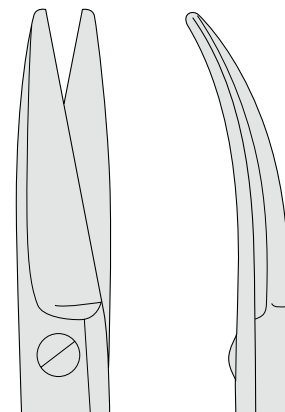

13.0462 17 cm 13.0463 17 cm

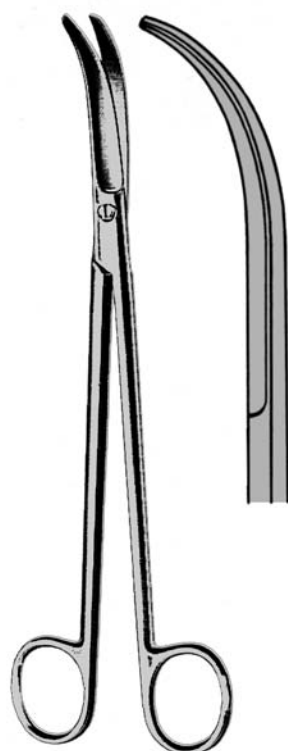

**JÖRGENSON**  
13.0541 23 cm

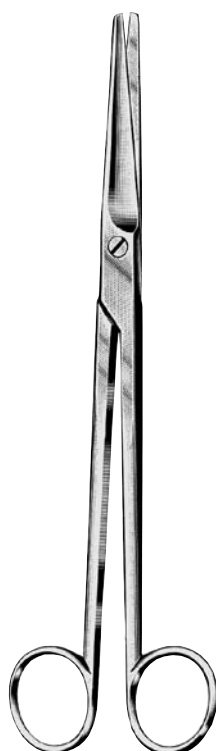

**MAYO-HARRINGTON**



13.0550 23 cm  
13.0554 28 cm  
**13.0554SC** 28 cm



13.0551 23 cm  
13.0555 28 cm  
**13.0555SC** 28 cm

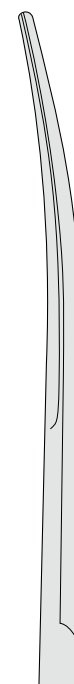

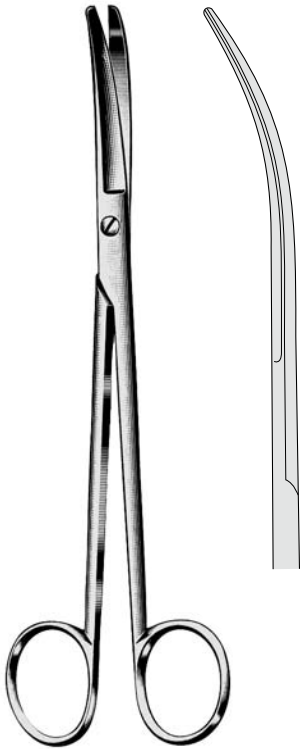

**WERTHEIM**

- 13.0561 14,5 cm
- 13.0562 19,5 cm
- 13.0563 22,5 cm



**THOREK**

- 13.0565 19 cm
- 13.0567 23 cm



**LEXER-BABY**

- 13.0700  
10 cm

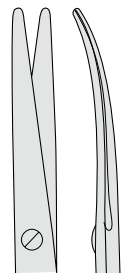

- 10.0701  
10 cm

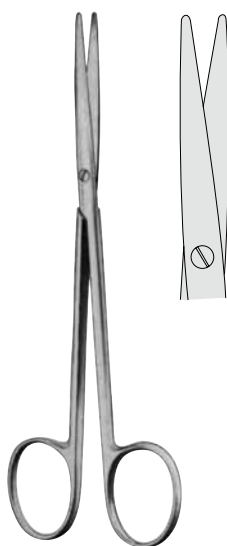

**METZENBAUM-BABY**

- 13.0594 11,5 cm
- 13.0594SC 11,5 cm
- 13.0596 13,0 cm
- 13.0598 14,5 cm
- 13.0598SC 14,5 cm



**METZENBAUM-BABY**

- 13.0595 11,5 cm
- 13.0595SC 11,5 cm
- 13.0597 13,0 cm
- 13.0599 14,5 cm
- 13.0599SC 14,5 cm



stumpf - stumpf  
blunt - blunt  
mousses - mousses  
romo - romo  
smusso - smusso



spitz - stumpf  
sharp - blunt  
pointu - mousses  
agudo - romo  
appuntato - smusso



### METZENBAUM

13.0602	18,0 cm	13.0602SC
13.0604	20,0 cm	13.0604SC
13.0606	23,0 cm	13.0606SC
13.0608	25,0 cm	13.0608SC
13.0610	28,0 cm	13.0610SC
13.0612	30,0 cm	13.0612SC

### METZENBAUM

13.0603	18,0 cm	13.0603SC
13.0605	20,0 cm	13.0605SC
13.0607	23,0 cm	13.0607SC
13.0609	25,0 cm	13.0609SC
13.0611	28,0 cm	13.0611SC
13.0613	30,0 cm	13.0613SC

### METZENBAUM

13.0622	18,0 cm
13.0624	20,0 cm
13.0626	23,0 cm
13.0628	25,0 cm
13.0630	28,0 cm

### METZENBAUM

13.0623	18,0 cm
13.0625	20,0 cm
13.0627	23,0 cm
13.0629	25,0 cm
13.0631	28,0 cm



spitz - spitz  
sharp - sharp  
pointu - pointu  
agudo - agudo  
appuntato - appuntato

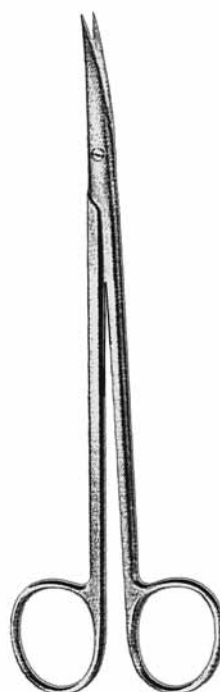

### METZENBAUM

13.0642	18,0 cm	
13.0644	20,0 cm	13.0644SC
13.0646	23,0 cm	
13.0648	25,0 cm	
13.0650	28,0 cm	13.0650SC

### METZENBAUM

13.0643	18,0 cm	
13.0645	20,0 cm	13.0645SC
13.0647	23,0 cm	
13.0649	25,0 cm	
13.0651	28,0 cm	13.0651SC

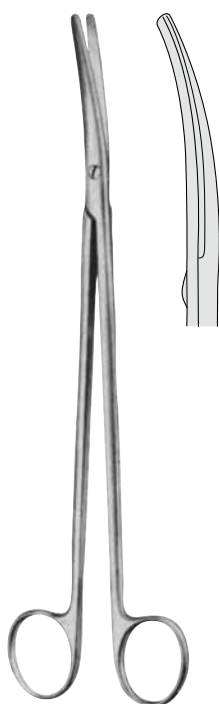
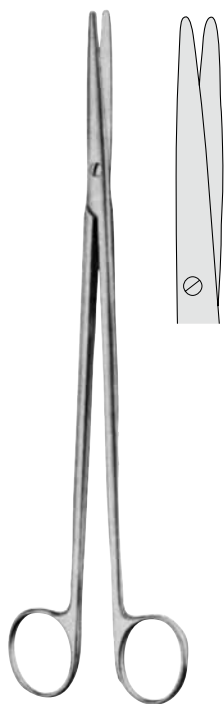

**METZENBAUM-FINO**

- 13.0660 14,5 cm **13.0660SC**
- 13.0662 18,0 cm **13.0662SC**
- 13.0664 20,0 cm **13.0664SC**
- 13.0666 23,0 cm **13.0666SC**

**METZENBAUM-FINO**

- 13.0661 14,5 cm **13.0661SC**
- 13.0663 18,0 cm **13.0663SC**
- 13.0665 20,0 cm **13.0665SC**
- 13.0667 23,0 cm **13.0667SC**

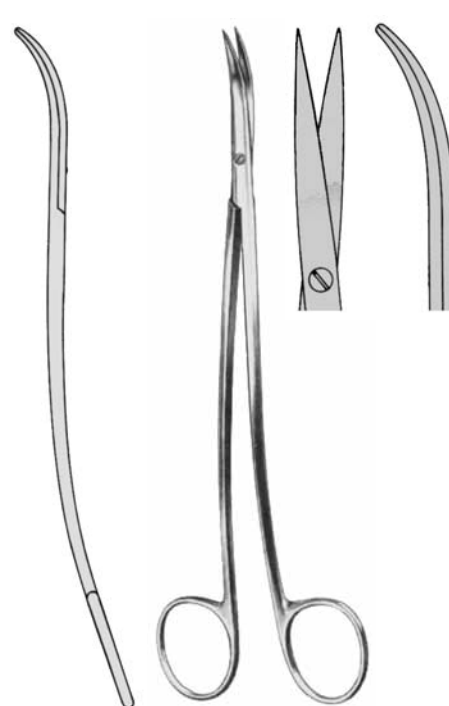
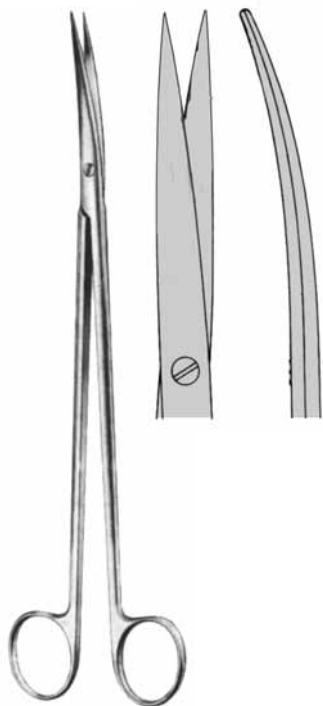
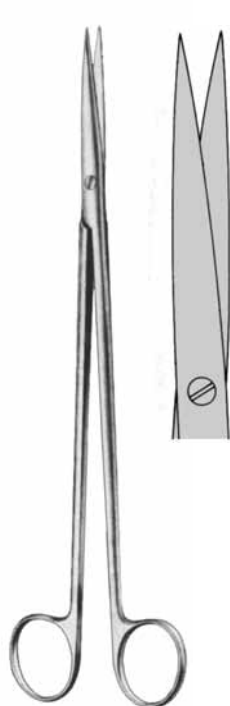

**METZENBAUM-FINO**

- 13.0670 14,5 cm
- 13.0672 18,0 cm
- 13.0674 20,0 cm
- 13.0676 23,0 cm

**METZENBAUM-FINO**

- 13.0671 14,5 cm
- 13.0673 18,0 cm
- 13.0675 20,0 cm
- 13.0677 23,0 cm

**METZENBAUM-FINO**

- 13.0683 18,0 cm
- 13.0685 20,0 cm
- 13.0687 23,0 cm

**METZENBAUM-FINO**

- 13.0693 18,0 cm
- 13.0695 20,0 cm
- 13.0697 23,0 cm



**METZENBAUM**  
**13.0614**  
36 cm



**METZENBAUM**  
**13.0615**  
36 cm

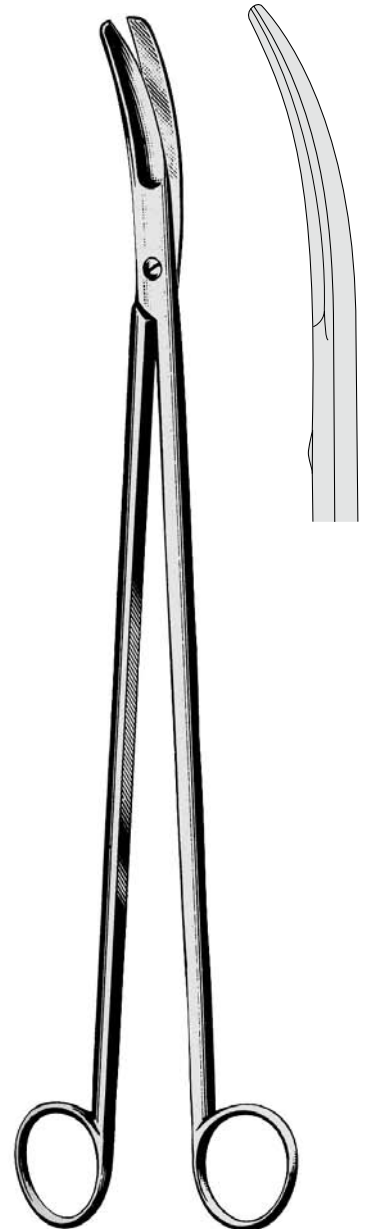

**CRAFOORD**  
**13.1083**  
31,5 cm



**MAYO**  
13.5208  
36 cm

**MAYO**  
13.5209  
36 cm

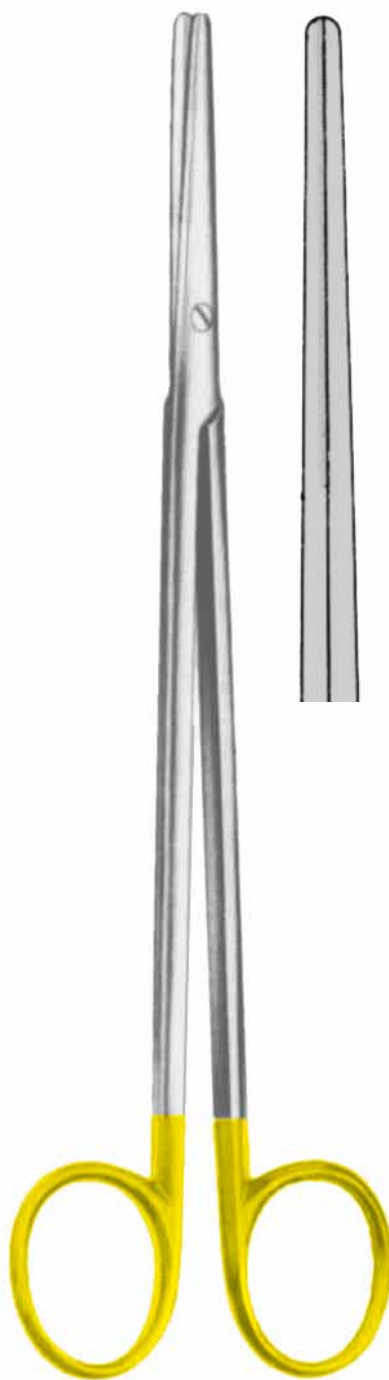

**METZENBAUM**  
13.5382  
36 cm

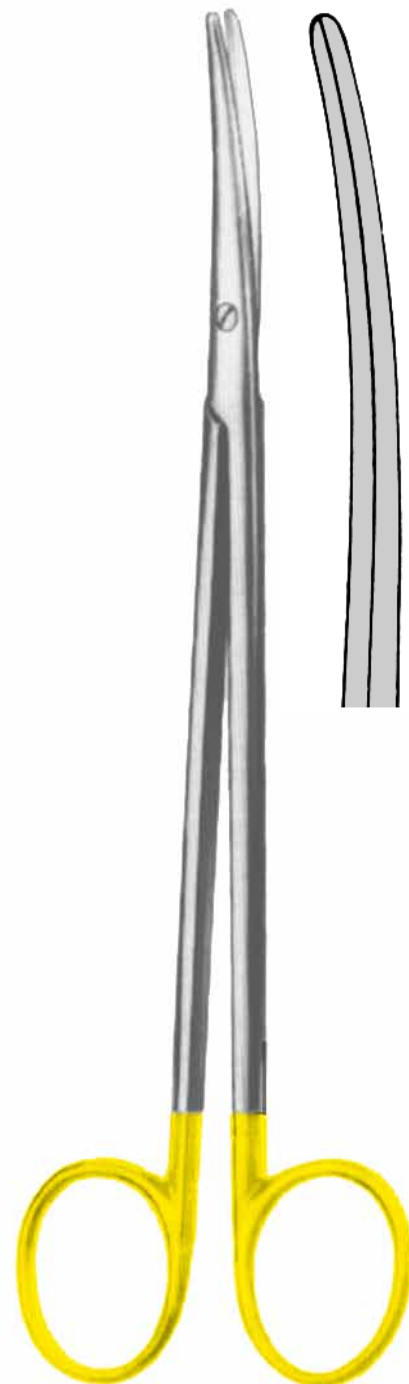

**METZENBAUM**  
13.5383  
36 cm

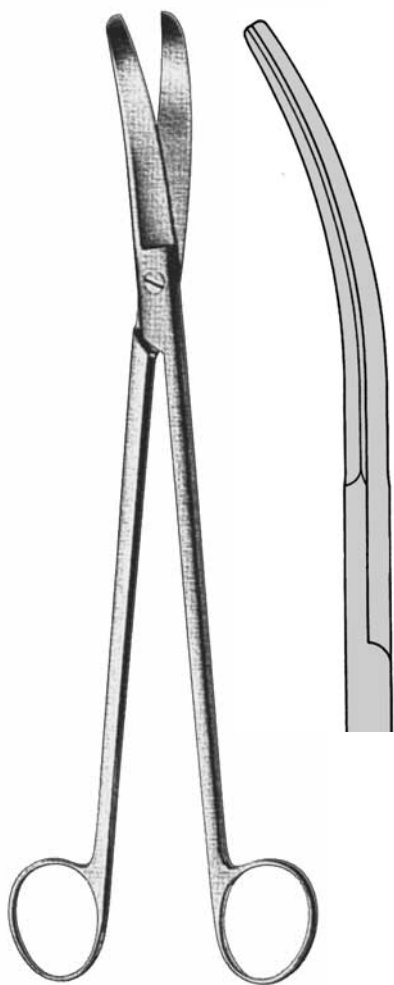

**LLOYD-DAVIS**  
13.2183 27 cm

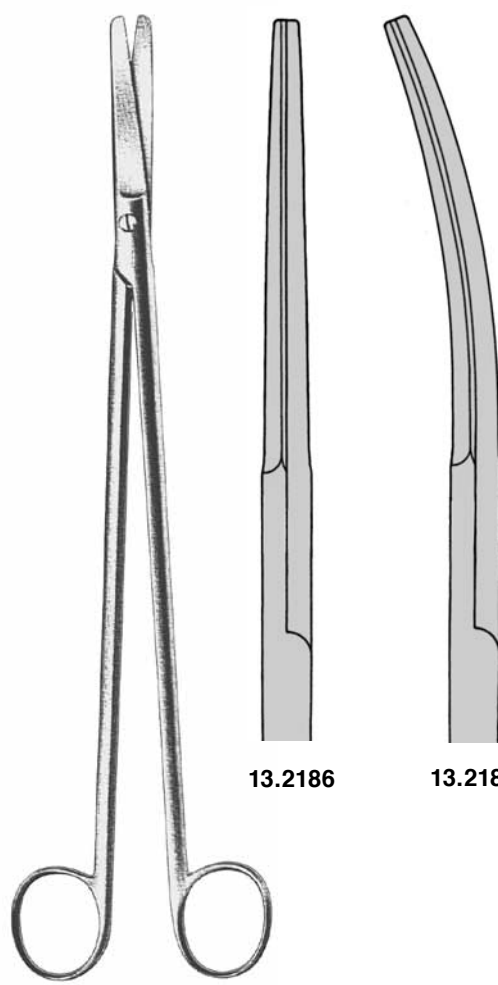

**STELZNER**  
27 cm

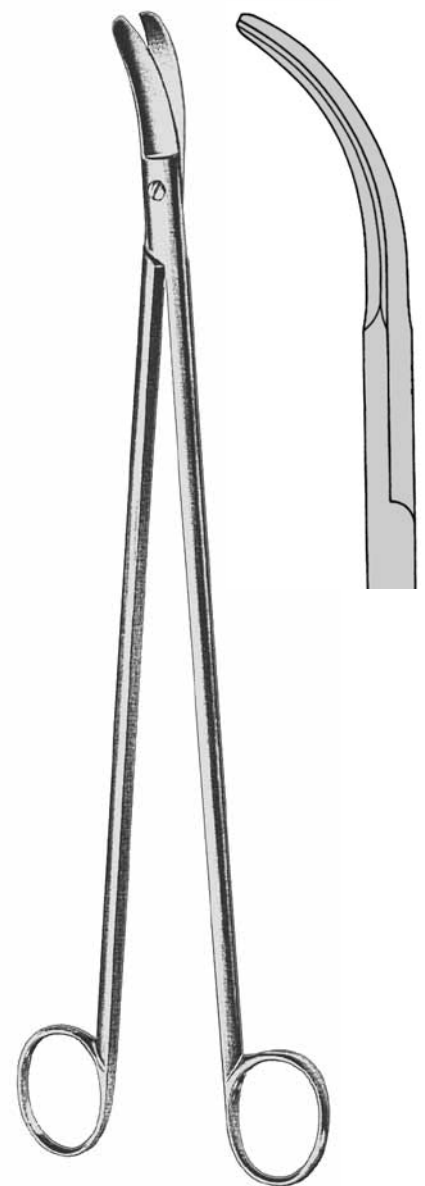

13.2189 32 cm



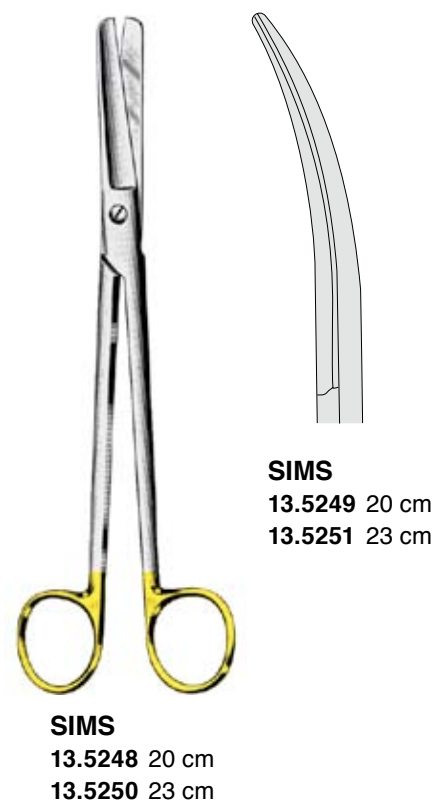
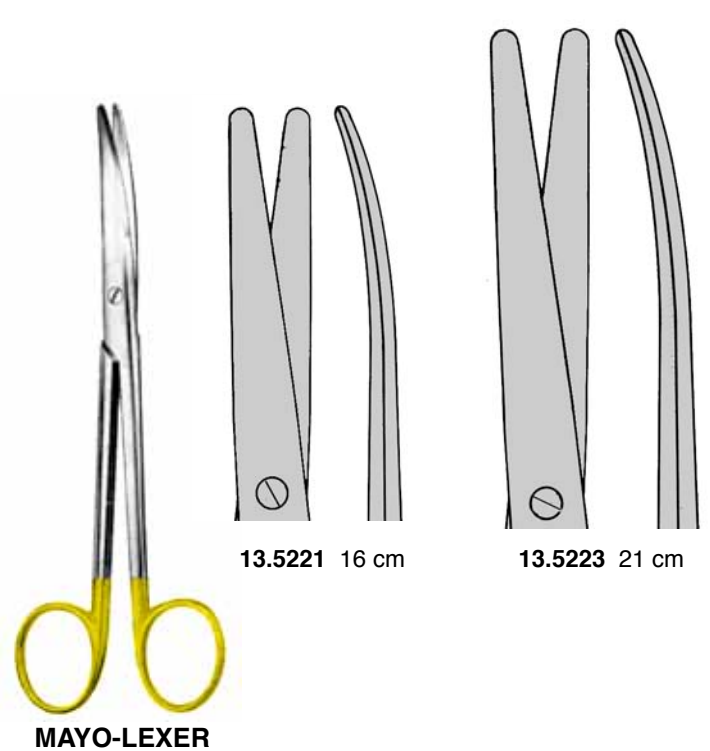
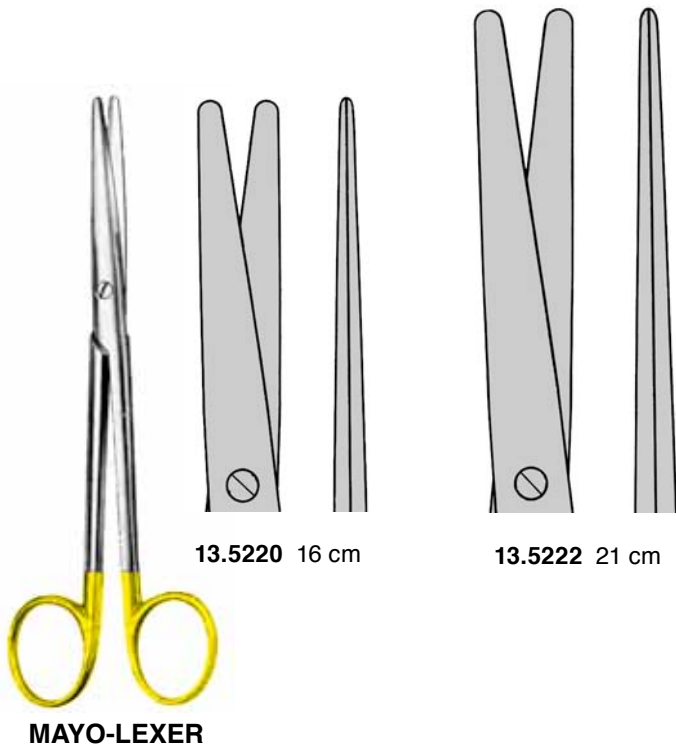



**PARAMETRIUM**

23 cm **13.5252**  
 26 cm  
 30 cm

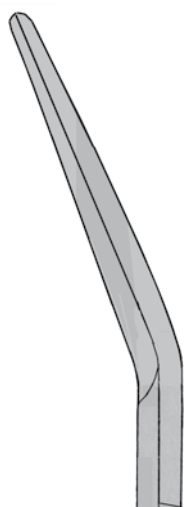

**13.5255**  
**13.5265**  
**13.5275**



**13.5257**  
**13.5267**  
**13.5277**

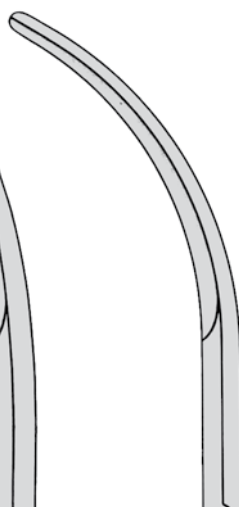

**13.5259**  
**13.5269**  
**13.5279**



**BLESSING**

**13.5281**  
 30 cm



Schere für Rektumchirurgie  
 Scissors for rectal surgery  
 Ciseaux pour chirurgie rectale  
 Tijera para la cirugía del recto  
 Forbici per la chirurgia rettale



**METZENBAUM**

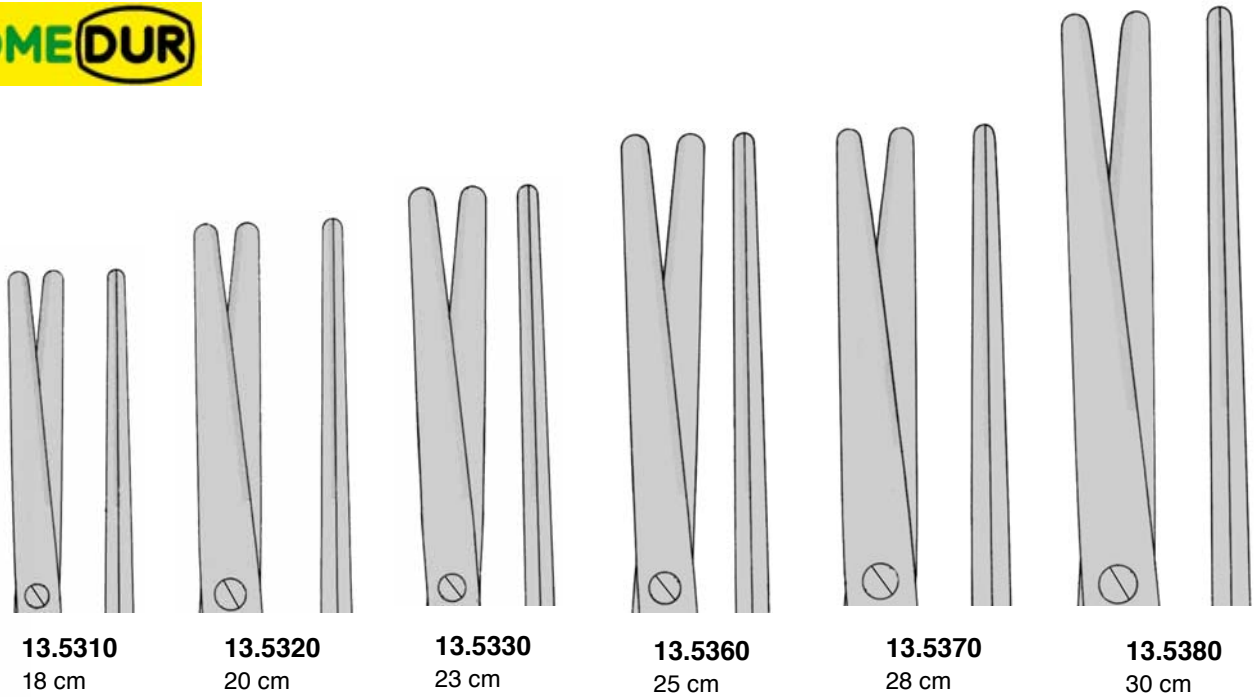

**13.5310**  
18 cm

**13.5320**  
20 cm

**13.5330**  
23 cm

**13.5360**  
25 cm

**13.5370**  
28 cm

**13.5380**  
30 cm



**METZENBAUM**

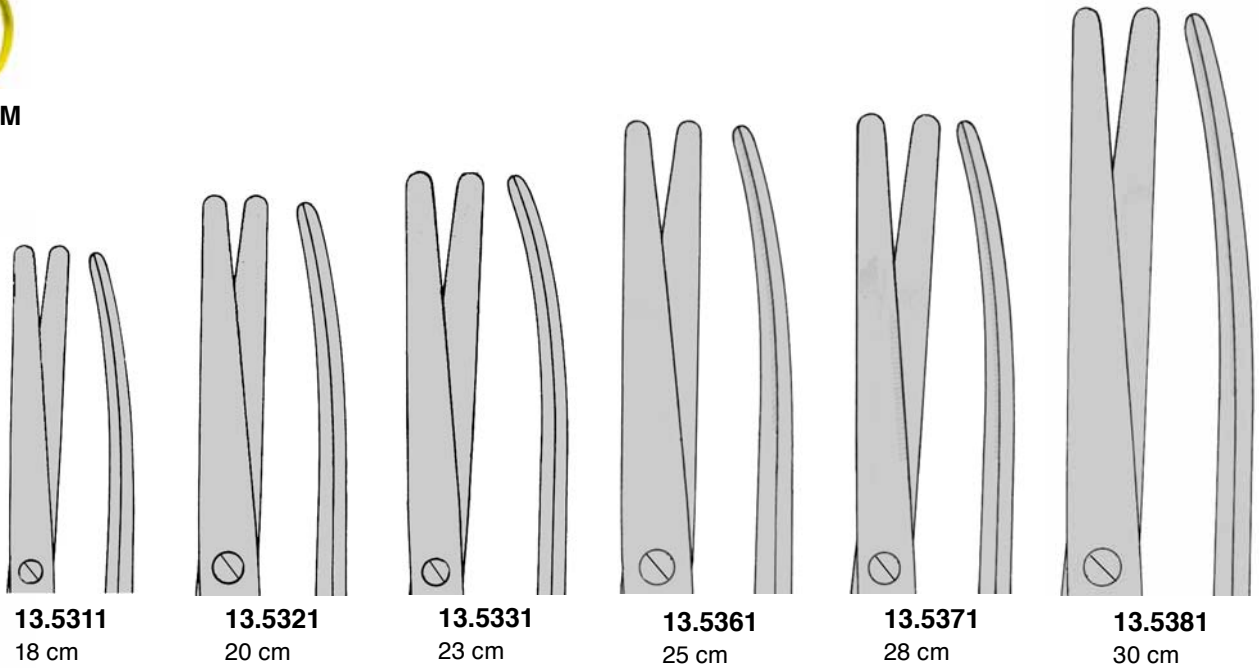

**13.5311**  
18 cm

**13.5321**  
20 cm

**13.5331**  
23 cm

**13.5361**  
25 cm

**13.5371**  
28 cm

**13.5381**  
30 cm

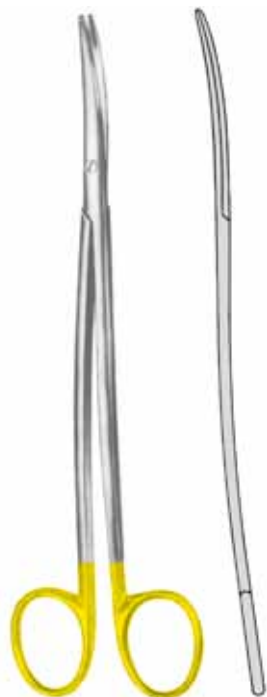

**METZENBAUM-FINO**

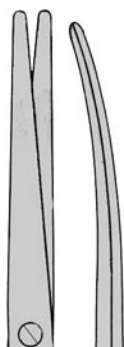

**13.5313**  
18 cm

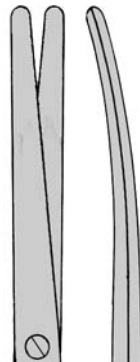

**13.5323**  
20 cm

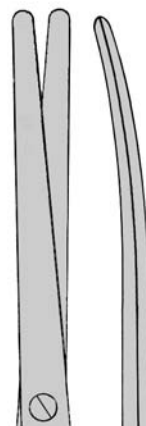

**13.5333**  
23 cm



**METZENBAUM-FINO**

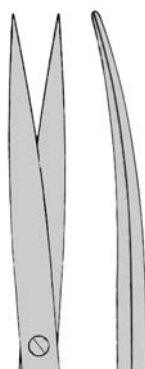

**13.5317**  
18 cm

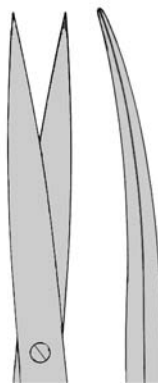

**13.5327**  
20 cm



**13.5337**  
23 cm

„BiTech“ Bipolare Scheren  
„BiTech“ Bipolar Scissors  
„BiTech“ Ciseaux bipolaires  
„BiTech“ Tijeras bipolares  
„BiTech“ Forbici bipolari

**MICRO**



**13.8003**  
13 cm

**13.8005**  
14 cm

**13.8007**  
18 cm

„BiTech“ Bipolare Scheren  
„BiTech“ Bipolar Scissors  
„BiTech“ Ciseaux bipolaires  
„BiTech“ Tijeras bipolares  
„BiTech“ Forbici bipolari

## STANDARD



**13.8023**  
18 cm

**13.8025**  
21 cm

**13.8027**  
23 cm

**13.8029**  
28 cm

„BiTech“ Bipolare Scheren  
„BiTech“ Bipolar Scissors  
„BiTech“ Ciseaux bipolaires  
„BiTech“ Tijeras bipolares  
„BiTech“ Forbici bipolari

**DELICATE**



**13.8043**  
18 cm

**13.8045**  
21 cm

**13.8047**  
23 cm

**13.8049**  
28 cm

bipolare Scheren-Klemmen  
Bipolar Clamp-Scissors  
Clamp-Ciseaux bipolaires  
Pinzas-Tijeras bipolares  
Forbici-Pinze bipolarari



**13.8304**  
14 cm

**13.8305**  
14 cm

**13.8310**  
19 cm

**13.8311**  
19 cm



Kabel für "BiTech" Bipolare Scheren  
Cables for "BiTech" Bipolar Scissors  
Câbles pour "BiTech" Ciseaux bipolaires  
Cables para Tijeras bipolares  
Cavi per "BiTech" Forbici bipolari  
**13.8003 - 13.8049**



Kabel für bipolare Scheren-Klemmen  
Cables for Bipolar Clamp-Scissors  
Câbles pour Clamp-Ciseaux bipolaires  
Cables para Pinzas-Tijeras bipolares  
Cavi per Forbici-Pinze bipolari  
**13.8304 - 13.8311**



Stecker Generatorseitig  
Plug, Generator side:  
Connecteur, côté générateur  
Clavia, lado del generador  
Spina, lato generatore

"2-Banana"



3 m

**13.8100**

**13.8400**

ERBE



3 m

**13.8110**

**13.8410**

MARTIN,  
BERCHTOLD;  
AESCULAP GK 55  
GK 60



3 m

**13.8120**

**13.8420**

VALLEYLAB, EMC,  
LAMIDEY



3 m

**13.8130**

**13.8430**

PINZETTEN  
FORCEPS  
PINCES  
PINZAS  
PINZE

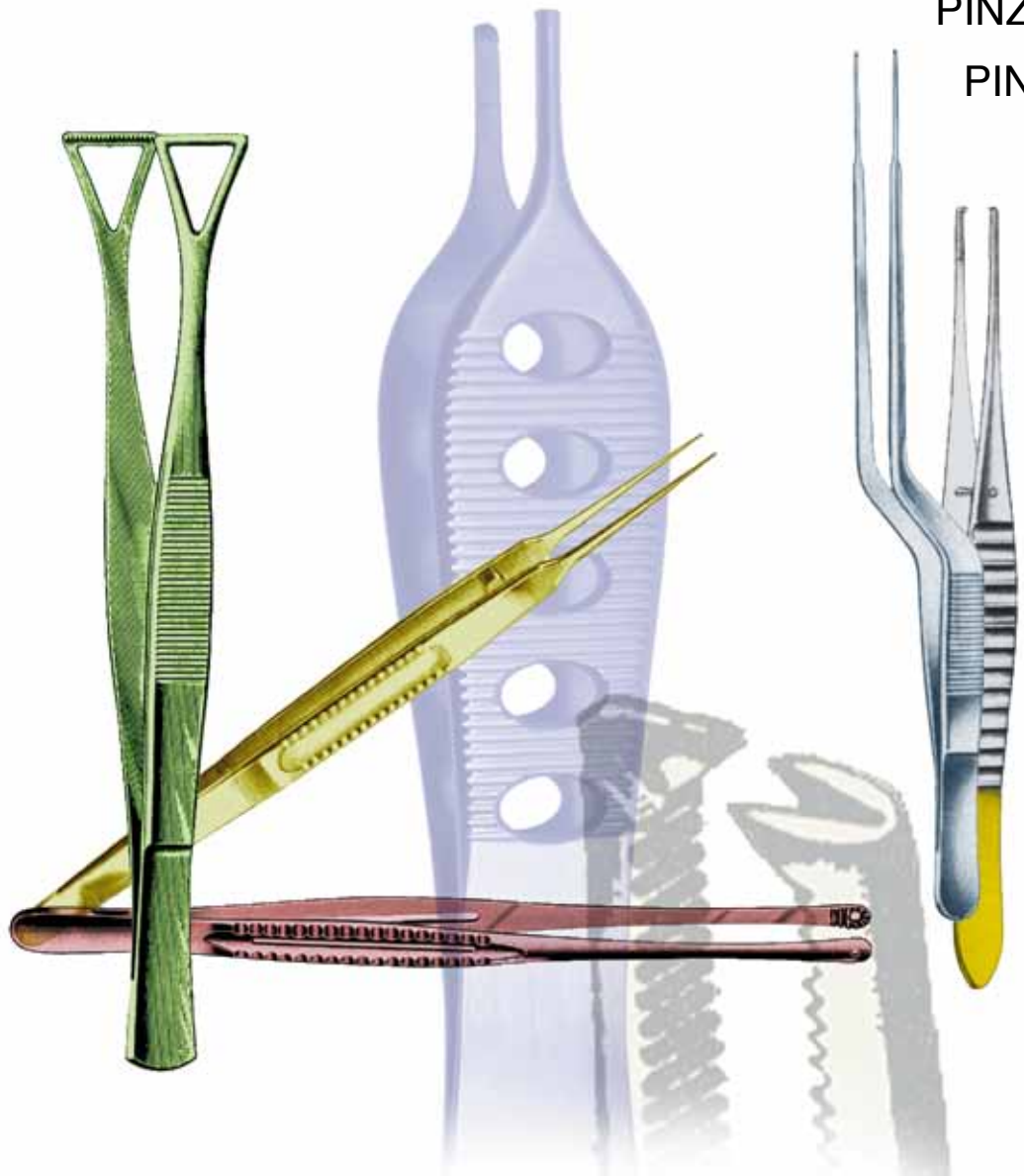





**ADSON**  
 14.0026 12 cm



**ADSON-MICRO**  
 14.0028 12 cm



**ADSON-MICRO**  
 14.0030 12 cm  
 14.0032 15 cm

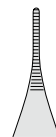

**ADSON**  
 14.0040 12 cm  
 14.0042 15 cm

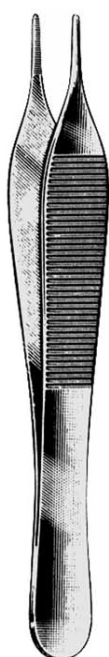

12 cm

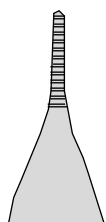

**EWALD**  
 14.0049

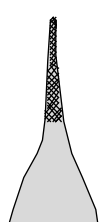

**ADSON**  
 "Criss-Cross"  
 14.0050



**ADSON-DEBAKEY**  
 14.0546 12,5 cm  
 14.0547 15,0 cm

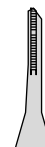



**ADSON**  
 14.0044 18 cm



**JEFFERSON**  
 14.0056 18 cm



**SEMKEN**



**14.0060** 12 cm  
**14.0062** 15 cm



**14.0061**  
**14.0063**



**McINDOE**



**14.0070** 15 cm



### DRESSING-FINO

14.0100	10,5 cm
14.0101	11,5 cm
14.0102	13,0 cm
14.0103	14,5 cm
14.0104	15,0 cm
14.0105	16,0 cm
14.0107	18,0 cm
14.0108	20,0 cm
14.0109	25,0 cm



### DRESSING-FINO

14.0110	10,5 cm
14.0111	11,5 cm
14.0112	13,0 cm
14.0113	14,5 cm
14.0114	15,0 cm
14.0115	16,0 cm
14.0116	18,0 cm
14.0117	20,0 cm
14.0118	25,0 cm
14.0119	30,0 cm



### DRESSING

14.0120	10,5 cm
14.0121	11,5 cm
14.0122	13,0 cm
14.0123	14,5 cm
14.0124	15,0 cm
14.0125	16,0 cm
14.0127	18,0 cm
14.0128	20,0 cm
14.0129	25,0 cm
14.0130	30,0 cm



### DRESSING

14.0151	11,5 cm
14.0152	13,0 cm
14.0153	14,5 cm
14.0154	15,0 cm
14.0155	16,0 cm
14.0157	18,0 cm
14.0158	20,0 cm



### DRESSING-USA

14.0181	11,5 cm
14.0182	13,0 cm
14.0183	14,5 cm
14.0184	15,5 cm
14.0187	18,0 cm
14.0188	20,0 cm
14.0189	25,0 cm



### STILLE

14.0202	13 cm
14.0204	15 cm
14.0207	17 cm
14.0220	20 cm

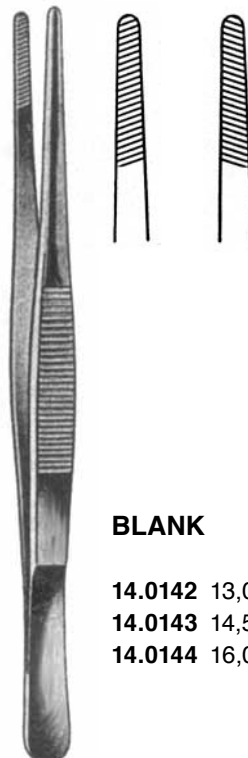

### BLANK

14.0142	13,0 cm
14.0143	14,5 cm
14.0144	16,0 cm



### BROPHY 14.0300 20 cm



### BROPHY 14.0301 20 cm



**DUEHRSSSEN**  
14.0330 20 cm

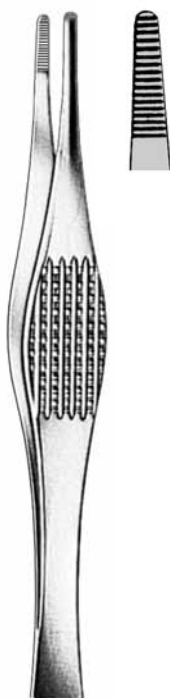

**RAMSEY**  
14.0340 18 cm



**BONNEY**  
14.0390 18 cm



**POTTS-SMITH**  
14.0350 18 cm  
14.0352 21 cm  
14.0354 25 cm

Pinzetten / Dressing- and Tissue Forceps / Pincés à dissection / Pinzas de disección / Pinze per dissezione



**DRESSING**  
14.0132  
36 cm

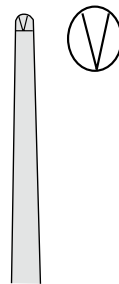
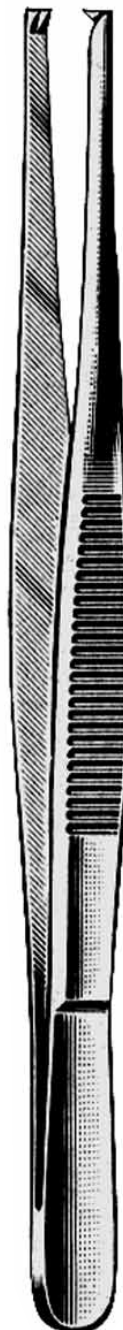

**TISSUE**  
14.0632  
36 cm  
1x2

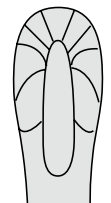
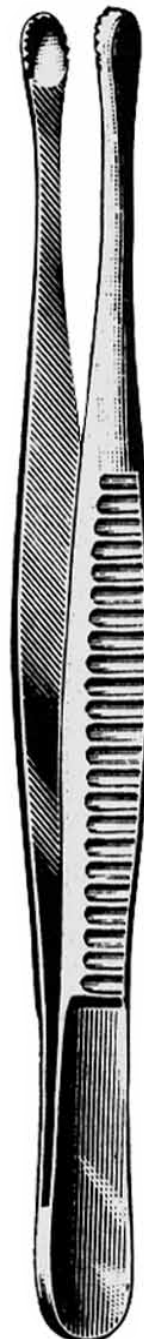

**RUSSIAN**  
14.0938  
36 cm



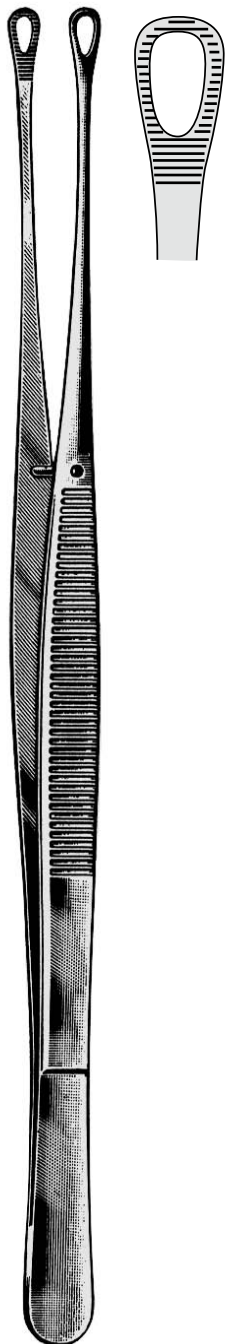

**SINGLEY**  
14.0958  
36 cm



**DEBAKEY**  
14.1018  
36 cm/2 mm



**ADSON**  
**14.0526**  
 12 cm 1x2



**ADSON-SELECT-MICRO**  
**14.0527**  
 12 cm 1x2



**ADSON-MICRO**  
**14.0528**  
 12 cm 1x2



**ADSON-MICRO**  
**14.0530** 12 cm  
**14.0532** 15 cm

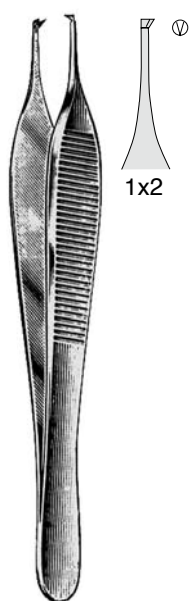

**ADSON**  
**14.0540** 12 cm  
**14.0542** 15 cm

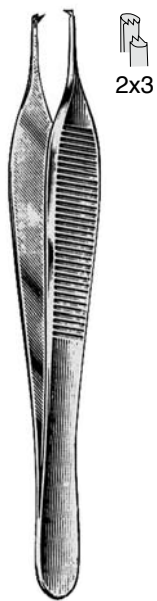

**ADSON**  
**14.0541** 12 cm 2x3

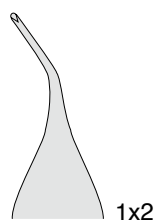

**ADSON**  
**14.0543** 12 cm 45° 1x2  
**14.0545** 15 cm 45° 1x2

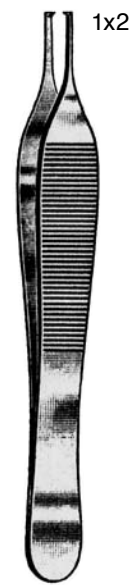

**EWALD**  
**14.0549** 12 cm



**ADSON-GRAEFE**  
 14.0548 12 cm

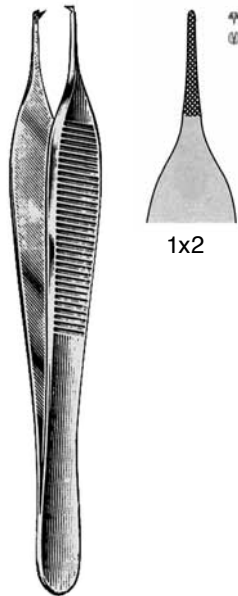

**ADSON**  
 "Criss-Cross"  
 14.0550 12 cm



**ADSON**  
 14.0554 18 cm

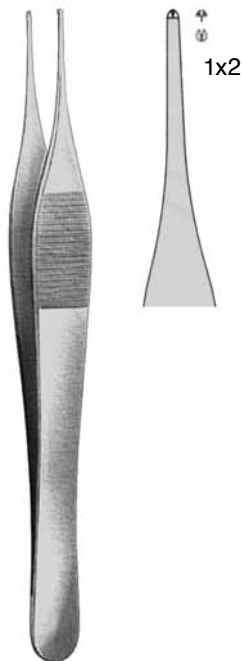

**JEFFERSON**  
 14.0556 18 cm



**SEMKEN**  
 14.0560 12 cm  
 14.0562 15 cm

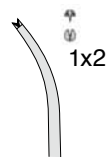

**SEMKEN**  
 14.0561 12 cm  
 14.0563 15 cm

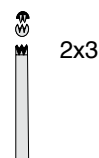

**SEMKEN**  
 14.0566 12 cm



**GILLIES**  
 14.0570 15 cm



### TISSUE-FINO

14.0600	10,5 cm	1x2
14.0601	11,5 cm	1x2
14.0602	13,0 cm	1x2
14.0603	14,5 cm	1x2
14.0604	15,0 cm	1x2
14.0605	16,0 cm	1x2
14.0607	18,0 cm	1x2
14.0608	20,0 cm	1x2
14.0609	25,0 cm	1x2



### TISSUE

14.0620	10,5 cm	1x2
14.0621	11,5 cm	1x2
14.0622	13,0 cm	1x2
14.0623	14,5 cm	1x2
14.0624	15,0 cm	1x2
14.0625	16,0 cm	1x2
14.0627	18,0 cm	1x2
14.0628	20,0 cm	1x2
14.0629	25,0 cm	1x2
14.0630	30,0 cm	1x2



### TISSUE

14.0653	14,0 cm	1x2
14.0657	18,0 cm	1x2



### TISSUE-USA

14.0681	12,0 cm	1x2
14.0682	13,0 cm	1x2
14.0683	14,5 cm	1x2
14.0684	15,5 cm	1x2
14.0687	18,0 cm	1x2
14.0688	21,0 cm	1x2
14.0689	25,0 cm	1x2



### TISSUE

14.0701	11,5 cm	2x3
14.0702	13,0 cm	2x3
14.0703	14,5 cm	2x3
14.0704	15,0 cm	2x3
14.0705	16,0 cm	2x3
14.0707	18,0 cm	2x3
14.0708	20,0 cm	2x3
14.0709	25,0 cm	2x3

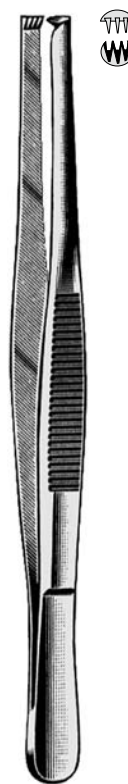

### TISSUE

14.0722	13,0 cm	3x4
14.0723	14,5 cm	3x4
14.0724	15,0 cm	3x4
14.0725	16,0 cm	3x4
14.0727	18,0 cm	3x4
14.0728	20,0 cm	3x4

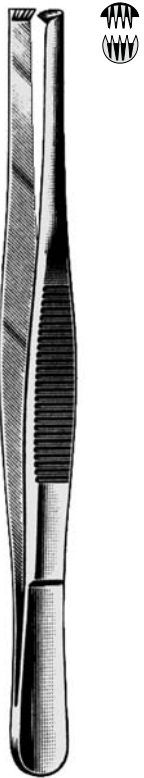

**TISSUE**  
 14.0732 13,0 cm 4x5  
 14.0733 14,5 cm 4x5  
 14.0734 15,0 cm 4x5  
 14.0735 16,0 cm 4x5

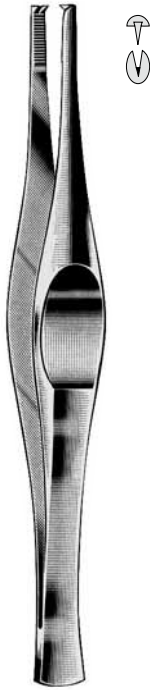

**FERRIS-SMITH**  
 14.0790 18 cm 1x2

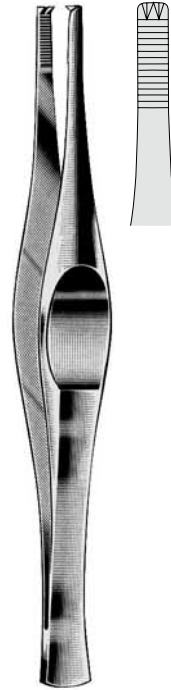

**FERRIS-SMITH**  
 14.0792 18 cm 2x3

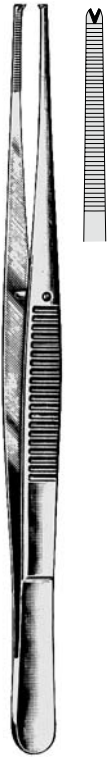

**BROPHY**  
 14.0800 20 cm 1x2



**BROPHY**  
 14.0801 20 cm 1x2



**GERALD**  
 14.0820 18 cm 1x2



**GERALD**  
 14.0821 18 cm 1x2



**GERALD**  
 14.0825 18 cm 1x2



**DUEHRSEN**  
14.0830 20 cm 1x2

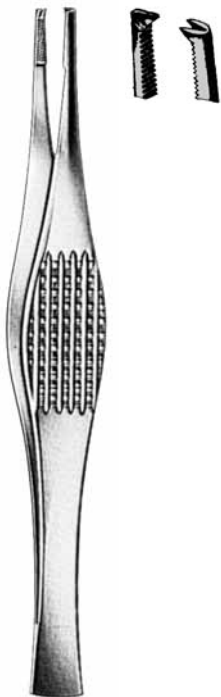

**RAMSEY**  
14.0840 18 cm 1x2

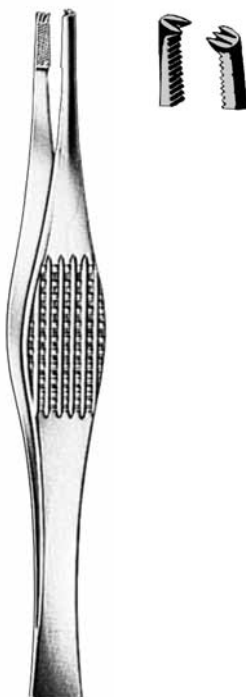

**RAMSEY**  
14.0842 18 cm 2x3



**POTTS-SMITH**  
14.0850 18 cm 1x2  
14.0852 21 cm 1x2  
14.0854 25 cm 1x2



**POTTS-SMITH**  
14.0851 18 cm 1x2  
14.0853 21 cm 1x2  
14.0855 25 cm 1x2

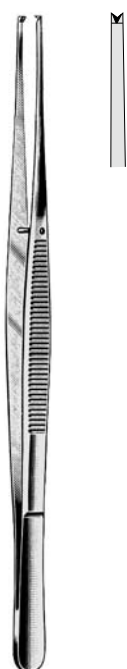

**TAYLOR**  
14.0860 18 cm



**TAYLOR**  
14.0861 18 cm

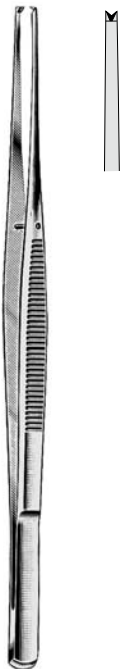

**TAYLOR-CUSHING**  
14.0862 18 cm



**TAYLOR-CUSHING**  
14.0865 18 cm



**ALDERKREUZ**  
 14.0866 15 cm 2x3  
 14.0867 20 cm 2x3

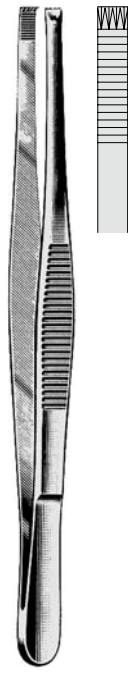

**ALDERKREUZ**  
 14.0868 15 cm 4x5  
 14.0869 20 cm 4x5

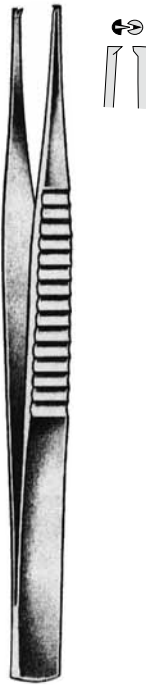

**TREVES**  
 14.0870 13 cm 1x2  
 14.0872 15 cm 1x2

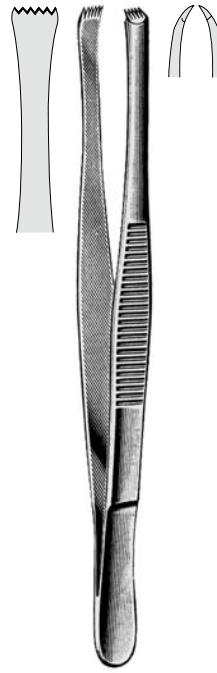

**LERCHE**  
 14.0880 15 cm 5x6

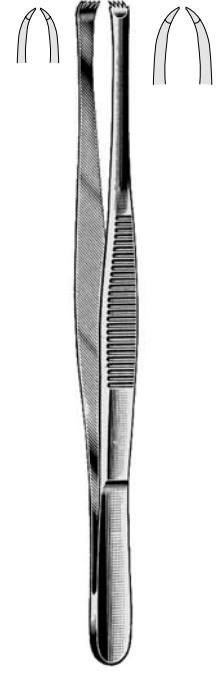

**STONE**  
 14.0885 15 cm 4x5

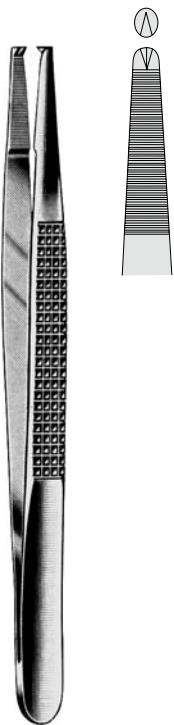

**BONNEY**  
 14.0890  
 18 cm 1x2



**BONNEY**  
 14.0892  
 18 cm 2x3



**NELSON**  
 14.0895 15 cm  
 14.0896 20 cm  
 14.0897 23 cm



**ADSON-BROWN**  
 14.0900 12 cm 9x9

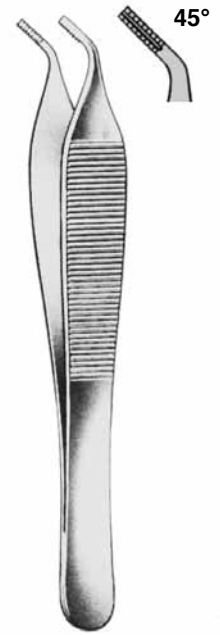

**ADSON-BROWN**  
 14.0904 12 cm 9x9



**BROWN**  
14.0910 15 cm  
14.0912 20 cm  
14.0914 25 cm



**LANE**  
14.0920 14,5 cm 1x2  
14.0922 20,0 cm 1x2



**LANE**  
14.0925 14,5 cm 2x3  
14.0927 20,0 cm 2x3



**RUSSIAN**  
14.0930 15 cm  
14.0932 20 cm  
14.0934 25 cm

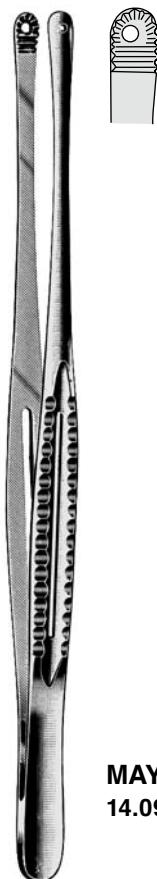

**MAYO-RUSSIAN**  
14.0940 23 cm



**WANGENSTEEN**  
14.0948 23 cm



**SINGLEY (TUTTLE)**  
14.0950 15 cm  
14.0952 18 cm  
14.0954 23 cm



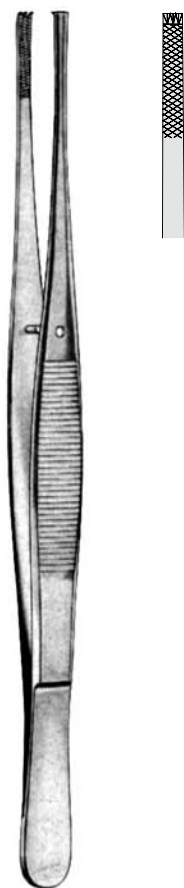

**STILLE-BARRAYA**

14.0960 18 cm  
14.0962 20 cm  
14.0964 25 cm

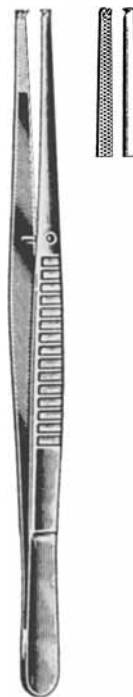

**WAUGH**

14.0968 15 cm  
14.0970 20 cm



**DURANTE**



14.0980  
14,5 cm



14.0982  
16 cm



14.0984  
20 cm

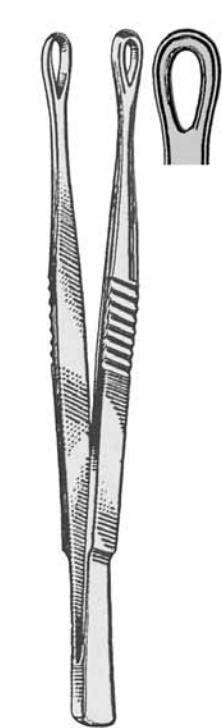

**DENIS-BROWN**  
14.0988 18 cm

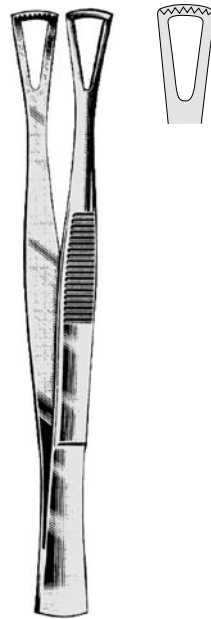

**DUVAL**  
14.0990 14,5 cm

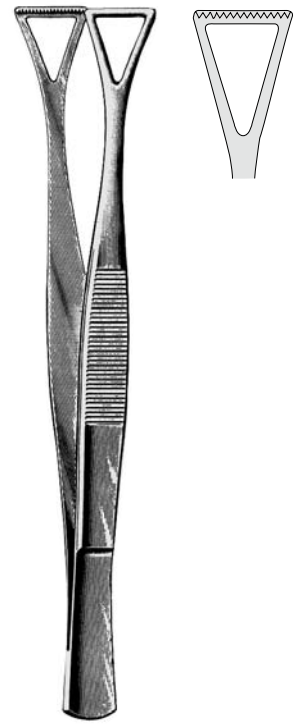

**COLLIN-DUVAL**  
14.0994 20 cm, 14 mm  
14.0996 20 cm, 18 mm  
14.0998 20 cm, 27 mm

**TITANIUM**



**DEBAKEY**

- 14.1000** 15 cm / 1,5 mm
- 14.1002** 20 cm / 1,5 mm
- 14.1004** 24 cm / 1,5 mm
- 14.1006** 30 cm / 1,5 mm



**DEBAKEY**

- 14.1007T** 16 cm / 1,5 mm
- 14.1008T** 20 cm / 1,5 mm
- 14.1009T** 24 cm / 1,5 mm



**DEBAKEY**

- 14.1010** 15 cm/2 mm
- 14.1010T** 15 cm/2 mm
- 14.1012** 20 cm/2 mm
- 14.1012T** 20 cm/2 mm
- 14.1014** 24 cm/2 mm
- 14.1014T** 24 cm/2 mm
- 14.1016** 30 cm/2 mm
- 14.1016T** 30 cm/2 mm



**DEBAKEY**

- 14.1017T** 16 cm/1,8 mm
- 14.1018T** 20 cm/1,8 mm
- 14.1019T** 24 cm/1,8 mm



**DEBAKEY**

- 14.1021** 16 cm/2 mm
- 14.1021T** 16 cm/2 mm
- 14.1023** 20 cm/2 mm
- 14.1023T** 20 cm/2 mm
- 14.1025** 24 cm/2 mm
- 14.1025T** 24 cm/2 mm
- 14.1027** 30 cm/2 mm
- 14.1027T** 30 cm/2 mm



**DEBAKEY**

- 14.1030** 16 cm/2,7 mm
- 14.1030T** 16 cm/2,7 mm
- 14.1032** 20 cm/2,7 mm
- 14.1032T** 20 cm/2,7 mm
- 14.1034** 24 cm/2,7 mm
- 14.1034T** 24 cm/2,7 mm
- 14.1036** 30 cm/2,7 mm
- 14.1036T** 30 cm/2,7 mm

## TITANIUM



### DEBAKEY

- 14.1040 15 cm/3,5 mm
- 14.1040T 15 cm/3,5 mm
- 14.1042 20 cm/3,5 mm
- 14.1042T 20 cm/3,5 mm
- 14.1044 24 cm/3,5 mm
- 14.1044T 24 cm/3,5 mm
- 14.1046 30 cm/3,5 mm
- 14.1046T 30 cm/3,5 mm



### COOLEY

- 14.1050 15 cm/2 mm
- 14.1050T 15 cm/2 mm
- 14.1052 20 cm/2 mm
- 14.1052T 20 cm/2 mm
- 14.1054 24 cm/2 mm
- 14.1054T 24 cm/2 mm

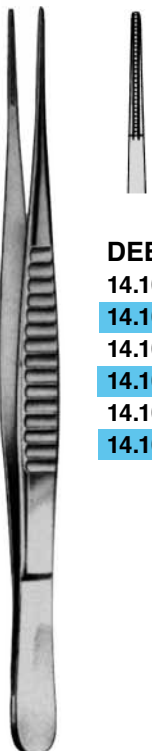

### DEBAKEY

- 14.1060 15 cm /1 mm
- 14.1060T 15 cm /1 mm
- 14.1062 20 cm/1 mm
- 14.1062T 20 cm/1 mm
- 14.1064 24 cm/1 mm
- 14.1064T 24 cm/1 mm

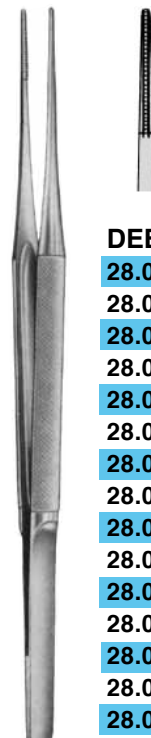

### DEBAKEY

- 28.0320T 15 cm /1,2 mm
- 28.0320S 15 cm /1,2 mm
- 28.0322T 18 cm /1,2 mm
- 28.0322S 18 cm /1,2 mm
- 28.0324T 21 cm /1,2 mm
- 28.0324S 21 cm /1,2 mm
- 28.0326T 23 cm /1,2 mm
- 28.0326S 23 cm /1,2 mm
- 28.0330T 15 cm /2,0 mm
- 28.0330S 15 cm /2,0 mm
- 28.0332T 18 cm /2,0 mm
- 28.0332S 18 cm /2,0 mm
- 28.0334T 21 cm /2,0 mm
- 28.0334S 21 cm /2,0 mm
- 28.0336T 23 cm /2,0 mm
- 28.0336S 23 cm /2,0 mm



**GLASSMANN**



**14.1070**  
15 cm 4 mm



**14.1072**  
24 cm 8 mm



**14.2001** 12 cm  
 glatt / smooth  
 lisse / lisa / liscio



**ADSON**  
 14.2000 12 cm  
 14.2002 15 cm

**ADSON**  
 14.2005 12 cm 1x2  
 14.2007 15 cm 1x2

**SEMKEN**  
 14.2010 15 cm

**CUSHING**  
 14.2020 18 cm

**CUSHING**  
 14.2021 18 cm



1.8 mm

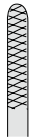

2.7 mm

**CUSHING**  
 14.2023 19 cm

**POTTS-SMITH**  
 14.2049 15 cm  
 14.2050 18 cm  
 14.2052 21 cm  
 14.2054 25 cm

**WANGENSTEEN**  
 14.2070 15 cm  
 14.2072 23 cm  
 14.2074 25 cm

**DRESSING**  
 14.2103 14,5 cm  
 14.2105 16,0 cm  
 14.2107 18,0 cm  
 14.2108 20,0 cm  
 14.2109 25,0 cm  
 14.2110 30,0 cm

**DRESSING**  
 14.2122 13,0 cm  
 14.2123 14,5 cm  
 14.2125 16,0 cm  
 14.2127 18,0 cm  
 14.2128 20,0 cm  
 14.2129 25,0 cm  
 14.2130 30,0 cm



**MC INDOE**  
14.2170 15 cm



**DEBAKEY**  
14.2200  
15 cm / 1,5 mm  
14.2202  
19 cm / 1,5 mm  
14.2204  
24 cm / 1,5 mm



**DEBAKEY**  
14.2210  
15 cm / 2 mm  
14.2212  
19 cm / 2 mm  
14.2214  
24 cm / 2 mm

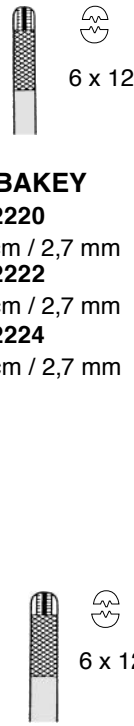

**DEBAKEY**  
14.2230  
15 cm / 3,5 mm  
14.2232  
19 cm / 3,5 mm  
14.2234  
24 cm / 3,5 mm



**DEBAKEY**  
14.2240  
15 cm / 2 mm  
14.2242  
19 cm / 2 mm  
14.2244  
24 cm / 2 mm



**GERALD**  
14.2320 18 cm



**BONNEY**  
14.2390 18 cm



**GERALD**  
14.2820 18 cm 1x2



**GILLIES**  
14.2570 15 cm 1x2



### OEHLER

- 14.2623 14 cm
- 14.2625 16 cm
- 14.2627 18 cm
- 14.2628 20 cm
- 14.2629 25 cm
- 14.2630 30 cm



### BONNEY

- 14.2890 18 cm 1x2



### ADSON-BROWN

- 14.2900 12 cm 9x9



Kein Ankleben von koagulierte[m] Gewebe

„Bei der Koagulation des Gewebes kann es zum Verkleben des koagulierten Gewebes mit der Pinzettenspitze kommen. Dieser unerwünschte Effekt kann durch den Einsatz von NONSTICK Bipolar-Pinzetten praktisch vollständig verhindert werden. Zeitraubendes Reinigen dieser Pinzetten während der OP entfällt, was Unterbrechungen beim Arbeiten erheblich reduziert. Pinzettenspitzen aus Material mit besonders guten thermischen Eigenschaften ermöglichen diese Verbesserung. Der “NONSTICK“ Effekt bleibt dauerhaft erhalten und wird auch durch häufiges Sterilisieren nicht gemindert.“

No adhesion of tissue during coagulation

During coagulation tissue may stick to the forceps-tip. This adverse effect can be avoided almost completely by using NONSTICK Bipolar Forceps. Forceps-tips of material with excellent thermal properties prevent tissue from sticking to the instrument. Cleaning of the instrument during operation is no longer required thus reducing the interruptions during the procedure. The NONSTICK-effect is permanent, even if subject to frequent sterilization.

Aucune adhésion du tissu coagulé

Pendant la coagulation du tissu il se peut que le tissu coagulé adhère à la pointe de la pince. L'utilisation des pinces NONSTICK permet de supprimer cet effet indésirable quasi complètement. Le nettoyage difficile et pénible des pinces pendant l'opération n'est plus nécessaire, ce qui réduit considérablement les interruptions de travail. Tout cela est possible, car les pointes des pinces sont faites d'une manière présentant des caractéristiques thermiques excellentes. L'effet NONSTICK (non-adhésif) est assuré en permanence et n'est pas ou plus réduit par une stérilisation fréquente.

Sin adhesión del tejido coagulado

Al coagular un tejido puede que el tejido coagulado quede adherido a la punta de las pinzas. Este efecto no deseado puede evitarse prácticamente por completo usando las pinzas bipolares NONSTICK. La limpieza molesta de las pinzas durante la operación que además exige mucho tiempo queda suprimida lo que reduce considerablemente las interrupciones en el trabajo. Esto se consigue aplicando un material con propiedades térmicas especialmente buenas a las puntas de las pinzas. El efecto NONSTICK (antiadhesivo) es duradero y no se verá mermado por esterilizaciones frecuentes.

Nessuna adesione des tessuto coagulato

Con la coagulazione des tessuto può darsi che il tessuto coagulato si attacchi alla punta della pinza. L'uso delle pinze bipolari NONSTICK permette di impedire questo effetto indesiderato quasi completamente. La pulizia faticosa delle pinze che richiede molto tempo non è più necessaria durante l'operazione, il che riduce notevolmente le interruzioni di lavoro. C'è è possibile utilizzando un materiale con caratteristiche termiche eccellenti per le punte delle pinze. L'effetto NONSTICK (non adesivo) si mantiene permanentemente e non viene neanche ridotto da una sterilizzazione frequente.



Flachstecker / flat plug / fiche plat / enchufe plano / spina piatta



2-Pin-Stecker / 2-pin-plug / fiche 2-pin / clavija 2-pin / spina 2-pin

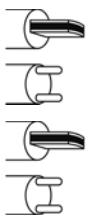

**14.3500** 11 cm/0,25 mm

**14.3503** 11 cm,/0,25 mm

**14.3500.2** 11 cm/0,25 mm

**14.3503.2** 11 cm/0,25 mm

**14.3502** 11 cm/0,60 mm

**14.3505** 11 cm/0,60 mm

**14.3502.2** 11 cm/0,60 mm

**14.3505.2** 11 cm/0,60 mm



Flachstecker / flat plug / fiche plat / enchufe plano / spina piatta

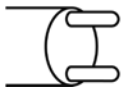

2-Pin-Stecker / 2-pin-plug / fiche 2-pin / clavija 2-pin / spina 2-pin



**14.3600** 15 cm/0,3 mm

**14.3602** 18 cm/0,3 mm

**14.3604** 20 cm/0,3 mm

**14.3606** 22 cm/0,3 mm



**14.3600.2** 15 cm/0,3 mm

**14.3602.2** 18 cm/0,3 mm

**14.3604.2** 20 cm/0,3 mm

**14.3606.2** 22 cm/0,3 mm



**14.3610** 15 cm/1,0 mm

**14.3612** 18 cm/1,0 mm

**14.3614** 20 cm/1,0 mm

**14.3616** 22 cm/1,0 mm



**14.3610.2** 15 cm/1,0 mm

**14.3612.2** 18 cm/1,0 mm

**14.3614.2** 20 cm/1,0 mm

**14.3616.2** 22 cm/1,0 mm



**14.3620** 15 cm/2,0 mm

**14.3622** 18 cm/2,0 mm

**14.3624** 20 cm/2,0 mm

**14.3626** 22 cm/2,0 mm



**14.3620.2** 15 cm/2,0 mm

**14.3622.2** 18 cm/2,0 mm

**14.3624.2** 20 cm/2,0 mm

**14.3626.2** 22 cm/2,0 mm

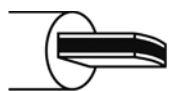

Flachstecker / flat plug / fiche plat / enchufe plano / spina piatta



2-Pin-Stecker / 2-pin-plug / fiche 2-pin / clavija 2-pin / spina 2-pin



**14.3641** 15 cm/0,3 mm



**14.3641.2** 15 cm/0,3 mm



**14.3651** 15 cm/1,0 mm



**14.3651.2** 15 cm/1,0 mm



**14.3661** 15 cm/2,0 mm



**14.3661.2** 15 cm/2,0 mm

**14.3643** 18 cm/0,3 mm

**14.3643.2** 18 cm/0,3 mm

**14.3653** 18 cm/1,0 mm

**14.3653.2** 18 cm/1,0 mm

**14.3663** 18 cm/2,0 mm

**14.3663.2** 18 cm/2,0 mm

"NONSTICK" BIPOLARE PINZETTEN  
 "NONSTICK" BIPOLAR FORCEPS  
 "NONSTICK" PINCES BIPOLAIRES  
 "NONSTICK" PINZAS BIPOLARES  
 "NONSTICK" PINZE BIPOLARI

**PRO-MED**

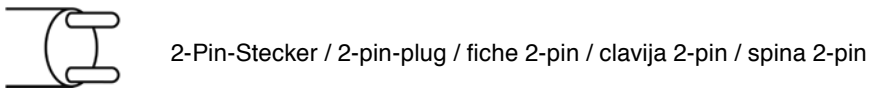
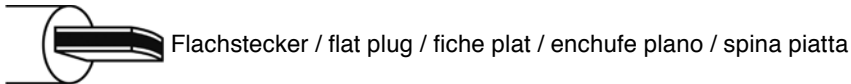

	<b>14.3702</b>	18 cm/0,3 mm	<b>14.3704</b>	20 cm/0,3 mm	<b>14.3706</b>	22 cm/0,3 mm	<b>14.3708</b>	24 cm/0,3 mm
	<b>14.3702.2</b>	18 cm/0,3 mm	<b>14.3704.2</b>	20 cm/0,3 mm	<b>14.3706.2</b>	22 cm/0,3 mm	<b>14.3708.2</b>	24 cm/0,3 mm
	<b>14.3712</b>	18 cm/1,0 mm	<b>14.3714</b>	20 cm/1,0 mm	<b>14.3716</b>	22 cm/1,0 mm	<b>14.3718</b>	24 cm/1,0 mm
	<b>14.3712.2</b>	18 cm/1,0 mm	<b>14.3714.2</b>	20 cm/1,0 mm	<b>14.3716.2</b>	22 cm/1,0 mm	<b>14.3718.2</b>	24 cm/1,0 mm
	<b>14.3722</b>	18 cm/2,0 mm	<b>14.3724</b>	20 cm/2,0 mm	<b>14.3726</b>	22 cm/2,0 mm	<b>14.3728</b>	24 cm/2,0 mm
	<b>14.3722.2</b>	18 cm/2,0 mm	<b>14.3724.2</b>	20 cm/2,0 mm	<b>14.3726.2</b>	22 cm/2,0 mm	<b>14.3728.2</b>	24 cm/2,0 mm

Unsere bipolaren Pinzetten sind mit Flackstecker oder 2-Pin-Stecker lieferbar und dadurch kompatibel mit allen gängigen HF-Generatoren.

Our bipolar Forceps are available with flat plug or 2-pin plug and thus compatible with all common high-frequency generators.

compatibles avec tous les générateurs H.F. courants. Tous nos pinces bipolaires sont disponibles avec connecteur plat ou connecteur à 2 pins, et, donc

Toadas las pinzas bipolares son disponibles con enchufes planos o enchufes a 2 pins por lo que son compatibles con todos los generadores AF corrientes.

Tutte le pinze bipolari sono disponibili con spina piatta o spina a 2 pin e, quindi, compatibili con tutti i generatori correnti ad alta frequenza.

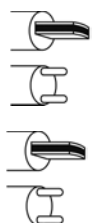
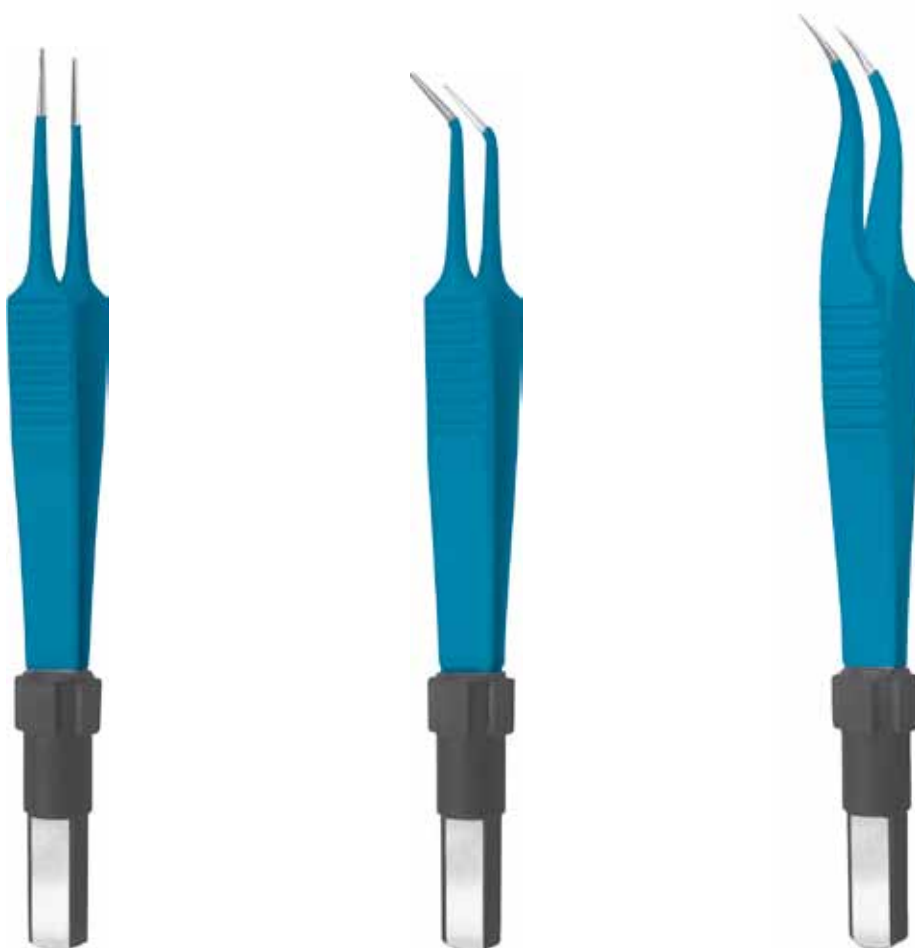

**14.3000** 11 cm/0,25 mm

**14.3000.2** 11 cm/0,25 mm

**14.3002** 11 cm/0,60 mm

**14.3002.2** 11 cm/0,60 mm

**14.3003** 11 cm/0,25 mm

**14.3003.2** 11 cm/0,25 mm

**14.3005** 11 cm/0,60 mm

**14.3005.2** 11 cm/0,60 mm

**14.3007** 11 cm/0,25 mm

**14.3007.2** 11 cm/0,25 mm

**14.3009** 11 cm/0,60 mm

**14.3009.2** 11 cm/0,60 mm

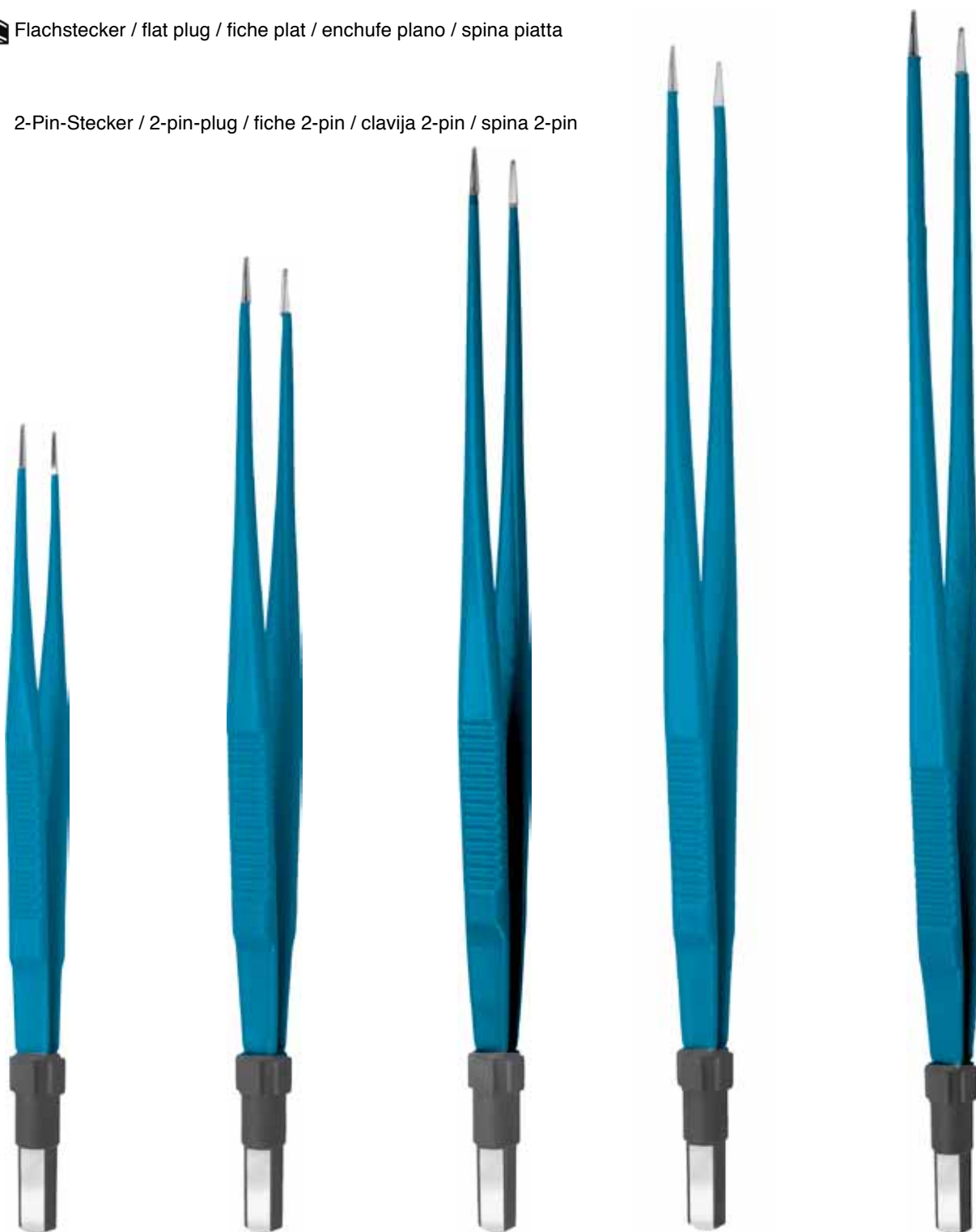
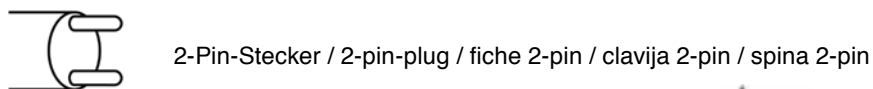
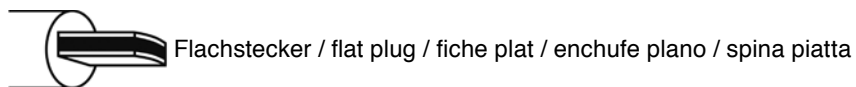

	<b>14.3100</b> 1 5 cm/0,3 mm	<b>14.3102</b> 18 cm/0,3 mm	<b>14.3104</b> 20 cm/0,3 mm	<b>14.3106</b> 22 cm/0,3 mm	<b>14.3108</b> 24 cm/0,3 mm
	<b>14.3100.2</b> 15 cm/0,3 mm	<b>14.3102.2</b> 18 cm/0,3 mm	<b>14.3104.2</b> 20 cm/0,3 mm	<b>14.3106.2</b> 22 cm/0,3 mm	<b>14.3108.2</b> 24 cm/0,3 mm
	<b>14.3110</b> 15 cm/1,0 mm	<b>14.3112</b> 18 cm/1,0 mm	<b>14.3114</b> 20 cm/1,0 mm	<b>14.3116</b> 22 cm/1,0 mm	<b>14.3118</b> 24 cm/1,0 mm
	<b>14.3110.2</b> 15 cm/1,0 mm	<b>14.3112.2</b> 18 cm/1,0 mm	<b>14.3114.2</b> 20 cm/1,0 mm	<b>14.3116.2</b> 22 cm/1,0 mm	<b>14.3118.2</b> 24 cm/1,0 mm
	<b>14.3120</b> 15 cm/2,0 mm	<b>14.3122</b> 18 cm/2,0 mm	<b>14.3124</b> 18 cm/2,0 mm	<b>14.3126</b> 22 cm/2,0 mm	<b>14.3128</b> 24 cm/2,0 mm
	<b>14.3120.2</b> 15 cm/2,0 mm	<b>14.3122.2</b> 18 cm/2,0 mm	<b>14.3124.2</b> 18 cm/2,0 mm	<b>14.3126.2</b> 22 cm/2,0 mm	<b>14.3128.2</b> 24 cm/2,0 mm



Flachstecker / flat plug / fiche plat / enchufe plano / spina piatta

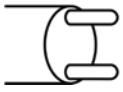

2-Pin-Stecker / 2-pin-plug / fiche 2-pin / clavija 2-pin / spina 2-pin



**14.3141** 15 cm/0,3 mm    **14.3143** 18 cm/0,3 mm    **14.3145** 20 cm/0,3 mm    **14.3147** 22 cm/0,3 mm    **14.3149** 24 cm/0,3 mm



**14.3141.2** 15 cm/0,3 mm    **14.3143.2** 18 cm/0,3 mm    **14.3145.2** 20 cm/0,3 mm    **14.3147.2** 22 cm/0,3 mm    **14.3149.2** 24 cm/0,3 mm



**14.3151** 15 cm/1,0 mm    **14.3153** 18 cm/1,0 mm    **14.3155** 20 cm/1,0 mm    **14.3157** 22 cm/1,0 mm    **14.3159** 24 cm/1,0 mm



**14.3151.2** 15 cm/1,0 mm    **14.3153.2** 18 cm/1,0 mm    **14.3155.2** 20 cm/1,0 mm    **14.3157.2** 22 cm/1,0 mm    **14.3159.2** 24 cm/1,0 mm



**14.3161** 15 cm/2,0 mm    **14.3163** 18 cm/2,0 mm    **14.3165** 20 cm/2,0 mm    **14.3167** 22 cm/2,0 mm    **14.3169** 24 cm/2,0 mm



**14.3161.2** 15 cm/2,0 mm    **14.3163.2** 18 cm/2,0 mm    **14.3165.2** 20 cm/2,0 mm    **14.3167.2** 22 cm/2,0 mm    **14.3169.2** 24 cm/2,0 mm



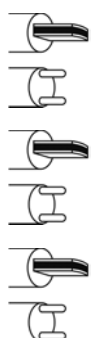
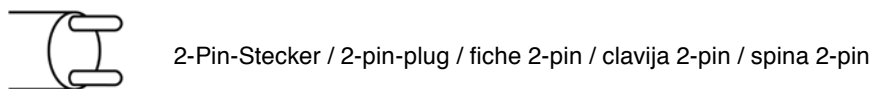
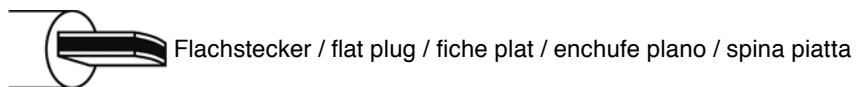

**14.3061** 17 cm/0,3 mm  
**14.3061.2** 17 cm/0,3 mm  
**14.3071** 17 cm/1,0 mm  
**14.3071.2** 17 cm/1,0 mm  
**14.3081** 17 cm/2,0 mm  
**14.3081.2** 17 cm/2,0 mm

**14.3202** 18 cm/0,3 mm  
**14.3202.2** 18 cm/0,3 mm  
**14.3212** 18 cm/1,0 mm  
**14.3212.2** 18 cm/1,0 mm  
**14.3222** 18 cm/2,0 mm  
**14.3222.2** 18 cm/2,0 mm

**14.3204** 20 cm/0,3 mm  
**14.3204.2** 20 cm/0,3 mm  
**14.3214** 20 cm/1,0 mm  
**14.3214.2** 20 cm/1,0 mm  
**14.3224** 20 cm/2,0 mm  
**14.3224.2** 20 cm/2,0 mm



Flachstecker / flat plug / fiche plat / enchufe plano / spina piatta



2-Pin-Stecker / 2-pin-plug / fiche 2-pin / clavija 2-pin / spina 2-pin



**14.3206** 22 cm/0,3 mm



**14.3206.2** 22 cm/0,3 mm



**14.3216** 22 cm/1,0 mm



**14.3216.2** 22 cm/1,0 mm



**14.3226** 22 cm/2,0 mm



**14.3226.2** 22 cm/2,0 mm

**14.3208** 24 cm/0,3 mm

**14.3208.2** 24 cm/0,3 mm

**14.3218** 24 cm/1,0 mm

**14.3218.2** 24 cm/1,0 mm

**14.3228** 24 cm/2,0 mm

**14.3228.2** 24 cm/2,0 mm

**BIPOLAR-Kabel 3 m, f. Bipolpinzetten** mit Flachstecker

**Cables 3 mtr.** for Forceps with flat plug

**Cordons 3 mtr.** pour pinces avec fiches plats

**Cables 3 mtr.** para pinzas con clavijas plano

**Cavi 3 mtr.** per pinze con spine piatto



**14.3900**

2-Bananenstecker

2-banana-plug

fiche 2-bananas

clavija 2-bananas

spina "2 banani"



**BIPOLAR-Kabel 3 m, f. Bipolpinzetten** mit "2-Pin"-Stecker

**Cables 3 mtr.** for Forceps with "2-pin"-plug

**Cordons 3 mtr.** pour pinces avec fiches <<2-pin>>

**Cables 3 mtr.** para pinzas con 2-pin clavija

**Cavi 3 mtr.** per pinze con spina a due pin



**14.3905**

2-Bananenstecker

2-banana-plug

fiche 2-bananas

clavija 2-bananas

spina "2 banani"

**14.3910**

Model Erbe

Model Erbe

Modèle Erbe

Modelo Erbe

Modello Erbe



**14.3915**

Model Erbe

Model Erbe

Modèle Erbe

Modelo Erbe

Modello Erbe

**14.3920**

Model Martin

Model Martin

Modèle Martin

Modelo Martin

Modello Martin



**14.3925**

Model Martin

Model Martin

Modèle Martin

Modelo Martin

Modello Martin

**14.3930**

Model Valleylab

Model Valleylab

Modèle Valleylab

Modelo Valleylab

Modello Valleylab



**14.3935**

Model Valleylab

Model Valleylab

Modèle Valleylab

Modelo Valleylab

Modello Valleylab

**14.3940**

Model Aesculap GK50

Model Aesculap GK50

Modèle Aesculap GK50

Modelo Aesculap GK50

Modello Aesculap GK50



**14.3945**

Model Aesculap GK50

Model Aesculap GK50

Modèle Aesculap GK50

Modelo Aesculap GK50

Modello Aesculap GK50

**14.3950**

Model Codman CMC II

Model Codman CMC II

Modèle Codman CMC II

Modelo Codman CMC II

Modello Codman CMC II



**14.3955**

Model Codman CMC II

Model Codman CMC II

Modèle Codman CMC II

Modelo Codman CMC II

Modello Codman CMC II

ARTERIENKLEMMEN, PRÄPARIERKLEMMEN  
HEMOSTATIC- AND DISSECTING FORCEPS  
PINCES HEMOSTATIQUES ET A PREPARATION  
PINZAS HEMOSTATICAS Y PARA PREPARACIONES  
PINZE EMOSTATICHE E PER PREPARAZIONE

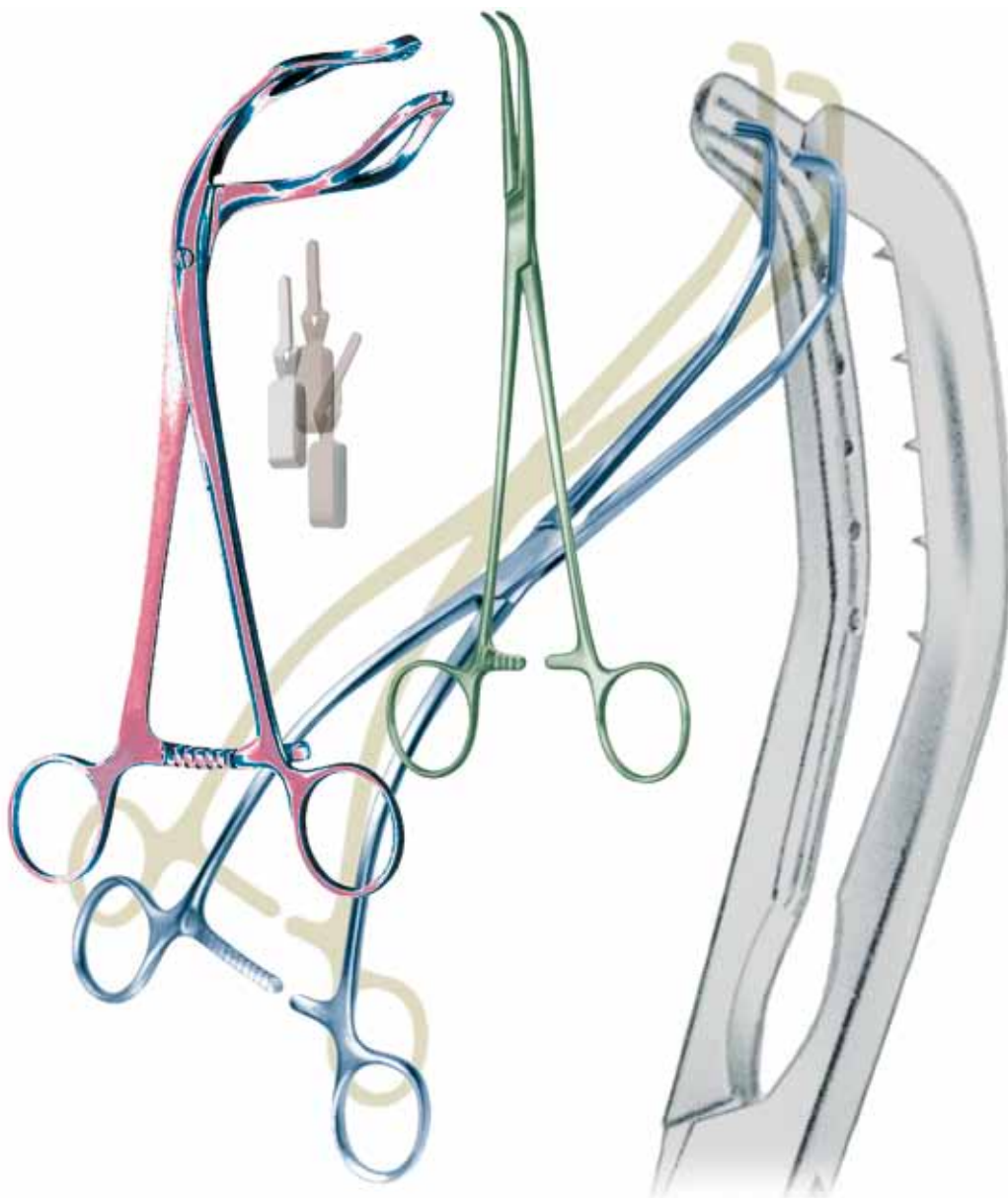





**GLOVER**

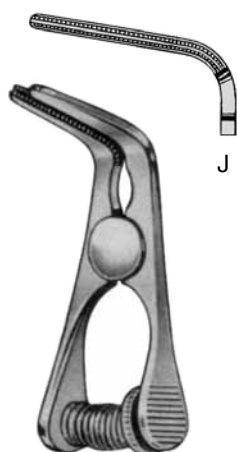

**GLOVER**

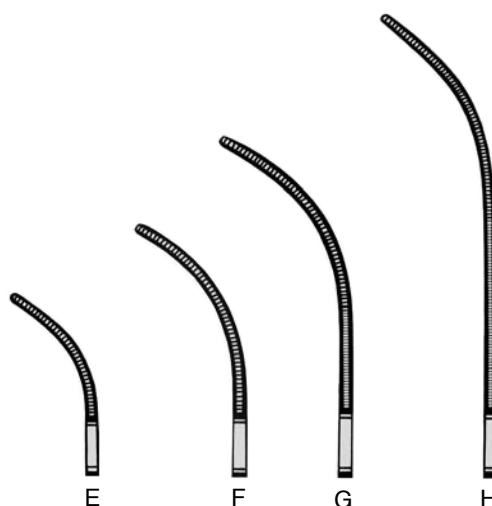

Artikel Item	Fig.	Gesamtlänge Overall length Longeur complet largo total Lunghezza total	Maullänge Jaw length longeur de mors largo de boca Lunghezza del morso	Gewicht Weight Poids Peso Peso
41.0000	A	60 mm	20 mm	5 g
41.0001	E	55 mm	20 mm	5 g
41.0005	B	70 mm	30 mm	9 g
41.0006	F	65 mm	30 mm	9 g
41.0010	C	90 mm	43 mm	12 g
41.0011	G	85 mm	43 mm	12 g
41.0015	D	105 mm	56 mm	14 g
41.0016	H	100 mm	56 mm	14 g
41.0019	J	55 mm	25 mm	7 g



**GREGORY**

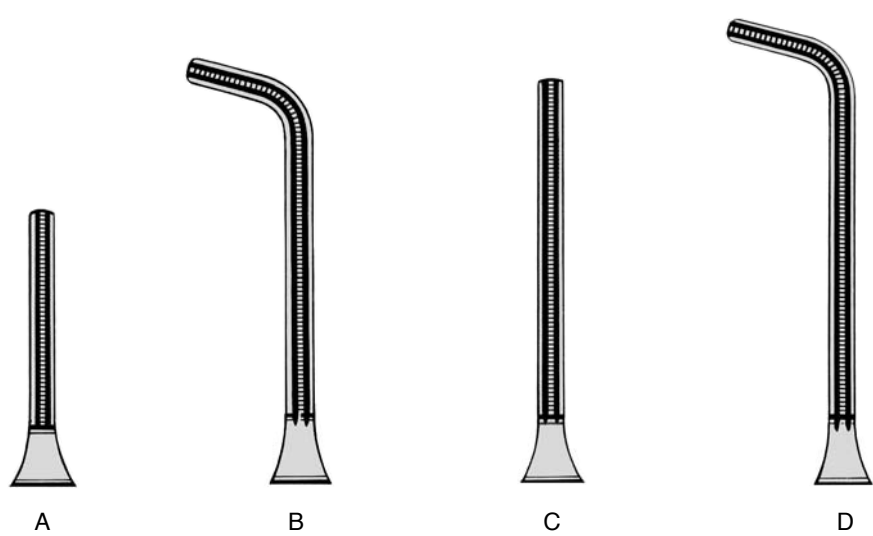

Artikel Item	Fig.	Gesamtlänge Overall length Longeur complet largo total Lunghezza total	Maullänge Jaw length longeur de mors largo de boca Lunghezza del morso	Gewicht Weight Poids Peso Peso
41.0020	A	90 mm	27 mm	11 g
41.0021	B	100 mm	44 mm	12 g
41.0022	C	110 mm	55 mm	12 g
41.0023	D	110 mm	60 mm	12 g



**GREGORY**

nach links gebogen  
 curved to left  
 courbe à gauche  
 curva a la izquierda  
 curvo a sinistra



nach rechts gebogen  
 curved to right  
 courbe à droit  
 curva a la derecha  
 curvo a destra



Artikel Item	Fig.	Gesamtlänge Overall length Longeur complet largo total Lunghezza total	Maullänge Jaw length longeur de mors largo de boca Lunghezza del morso	Gewicht Weight Poids Peso Peso
41.0024	A	110 mm	60 mm	12 g
41.0025	B	110 mm	60 mm	12 g

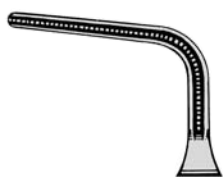

30 mm Maullänge  
 Jaw length  
 longueur de mors  
 largo de boca  
 Lunghezza del morso

**SANTULLI**  
**41.0028**  
 70 mm



**DIETRICH**



A

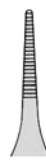

B

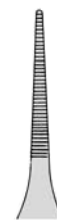

C



D

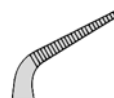

E

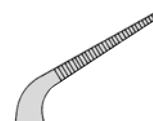

F

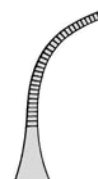

G

Artikel Item	Fig.	Gesamtlänge Overall length Longeur complet largo total Lunghezza total	Maullänge Jaw length longueur de mors largo de boca Lunghezza del morso	Gewicht Weight Poids Peso Peso	Schliesdruck Closing pressure Pression d'Occlusion Presión de cierre Pressione di chiusura
41.0030	A	50 mm	8 mm	3 g	80
41.0031	D	43 mm	8 mm	3 g	80
41.0032	B	53 mm	12 mm	3 g	80
41.0033	E	45 mm	12 mm	3 g	80
41.0034	C	60 mm	20 mm	3 g	80
41.0035	F	50 mm	20 mm	3 g	80
41.0037	G	54 mm	20 mm	3 g	80





**DEBAKEY-MICRO**

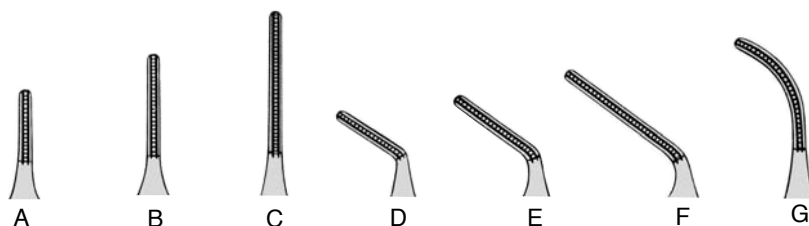

Artikel Item	Fig.	Gesamtlänge Overall length Longeur complet largo total Lunghezza total	Maullänge Jaw length longeur de mors largo de boca Lunghezza del morso	Gewicht Weight Poids Peso	Schliessdruck Closing pressure Pression d'Occlusion Presión de cierre Pressione di chiusura
41.0090	A	47 mm	10 mm	3 g	180
41.0091	D	44 mm	10 mm	3 g	180
41.0092	B	51 mm	14 mm	3 g	180
41.0093	E	46 mm	14 mm	3 g	180
41.0094	C	57 mm	20 mm	3 g	180
41.0095	F	49 mm	20 mm	3 g	180
41.0099	G	54 mm	20 mm	3 g	180



**DEBAKEY**

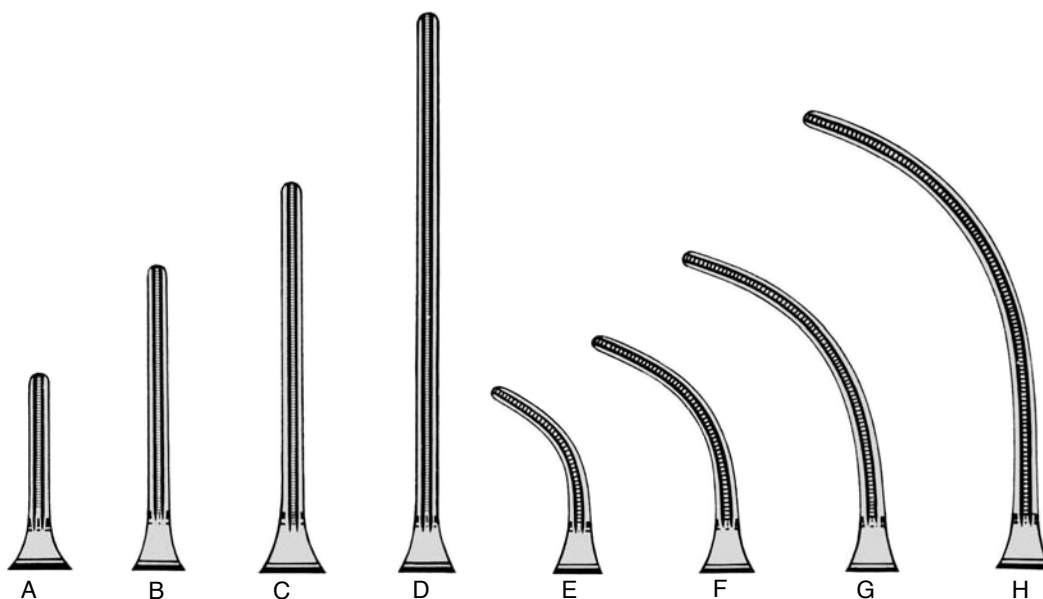

Artikel Item	Fig.	Gesamtlänge Overall length Longeur complet largo total Lunghezza total	Maullänge Jaw length longeur de mors largo de boca Lunghezza del morso	Gewicht Weight Poids Peso
41.0100	A	80 mm	20 mm	10 g
41.0101	E	75 mm	20 mm	10 g
41.0110	B	90 mm	30 mm	11 g
41.0111	F	85 mm	30 mm	11 g
41.0115	C	105 mm	45 mm	12 g
41.0116	G	95 mm	45 mm	12 g
41.0120	D	125 mm	68 mm	12 g
41.0121	H	115 mm	68 mm	12 g



**CARREL**  
15.0098 8,5 cm



15.0100

**HARTMANN**  
10 cm



**15.0108**  
glattes Maul  
smooth jaws  
lisses  
lisas  
liscio



**HARTMANN**  
15.0101 10 cm

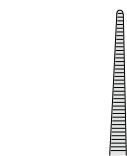

**HARTMANN-MICRO**  
15.0102 10 cm



**HARTMANN-MICRO**  
15.0103 10 cm



**HARTMANN**  
15.0104 10 cm 1x2



**HARTMANN**  
15.0105 10 cm 1x2

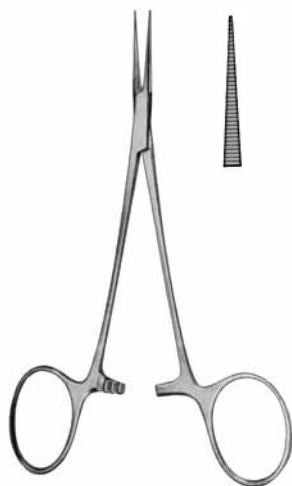

15.0117

**JACOBSON-MICRO**  
 15.0116 12,5 cm

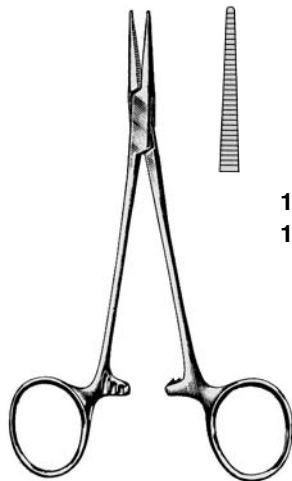

15.0121 12,5 cm  
 15.0125 14 cm

**MOSQUITO**  
 15.0120 12,5 cm  
 15.0120L 12,5 cm  
 linkshändig / left-handed  
 pour gaucher / para zurdo / per mano sinistra  
 15.0124 14 cm



15.0121L  
 linkshändig  
 left-handed  
 pour gaucher  
 para zurdo  
 per mano sinistra



15.0123

**MICRO-MOSQUITO**  
 15.0122 12,5 cm



15.0129 1x2

**MICRO-MOSQUITO**  
 15.0128 12 cm 1x2



15.0127 12,5 cm 1x2  
 15.0137 14 cm 1x2

**MOSQUITO**  
 15.0126 12,5 cm 1x2  
 15.0136 14 cm 1x2



**MICRO-MOSQUITO**  
 15.0139 12,5 cm  
 kreuzgerieft / cross-serrated  
 rainures croisées  
 estriada en forma de cruz  
 striatura cruciforme

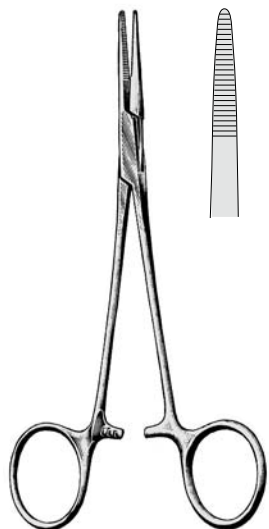

15.0131

**PROVIDENCE-HOSPITAL**  
15.0130 14,5 cm

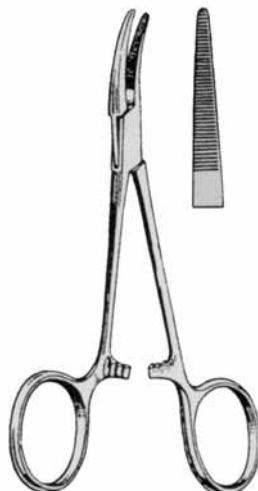

15.0181

**DUNHILL**  
15.0180 12,5 cm

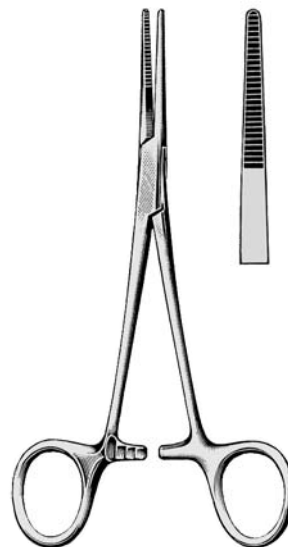

15.0201

**KELLY**  
15.0200 14 cm



**CRILE**  
15.0210 14 cm



15.0211

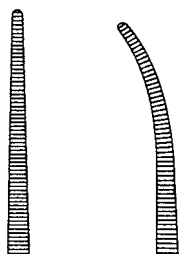

**CRILE-BABY**  
15.0212 15.0213

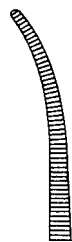

15.0214 1x2



15.0215 1x2



15.0240

15.0241

**RANKIN-KELLY**  
16 cm



15.0251

**RANKIN-CRILE**  
15.0250 16 cm



15.0253  
1x2

**RANKIN-CRILE**  
15.0252 16 cm 1x2



15.0260  
14 cm

15.0262  
16 cm

15.0261  
14 cm

15.0263  
16 cm

**COLLER-CRILE**

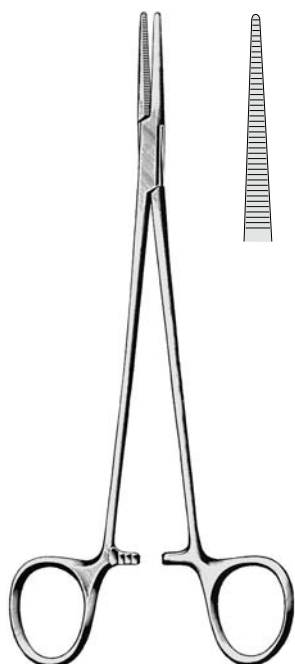

**HALSTED**  
 15.0300 18 cm  
 15.0302 21 cm

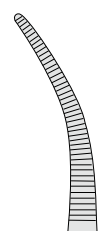

**15.0301** 18 cm  
**15.0303** 21 cm



**15.0306** 18 cm 1x2  
**15.0308** 21 cm 1x2

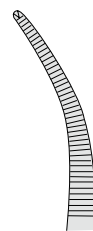

**15.0307** 18 cm 1x2  
**15.0309** 21 cm 1x2



**ADSON-BABY**  
 15.0313 14 cm



**15.0315**  
 18 cm

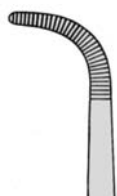

**15.0311**



**ADSON**  
 15.0310 18,5 cm

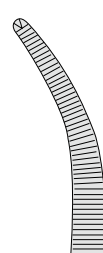

**15.0317** 1x2

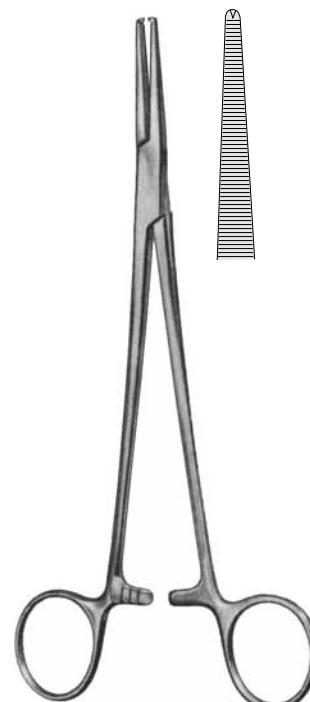

**ADSON**  
 15.0316 18,5 cm 1x2



**HEISS**  
 15.0320 20 cm

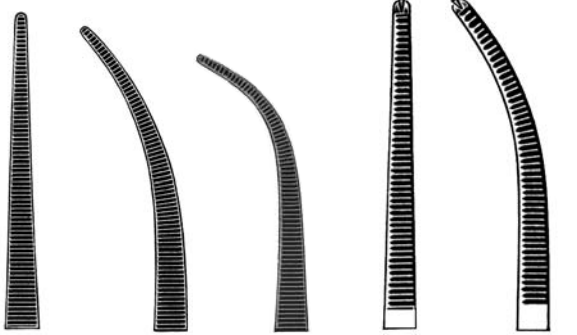

15.0321 15.0323 15.0324 15.0325  
 1x2 1x2



**FUCHSIG**  
 15.0331 18,5 cm

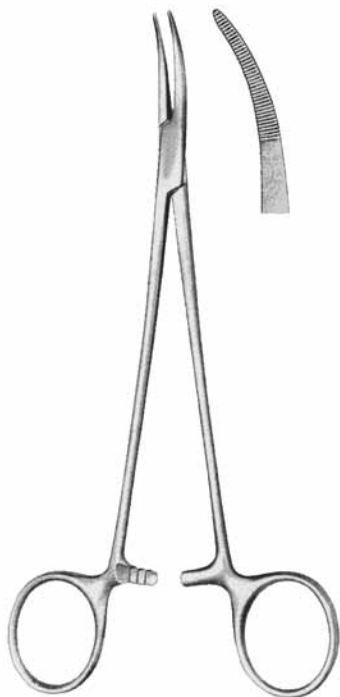

**NISSEN**  
 15.0335 19 cm

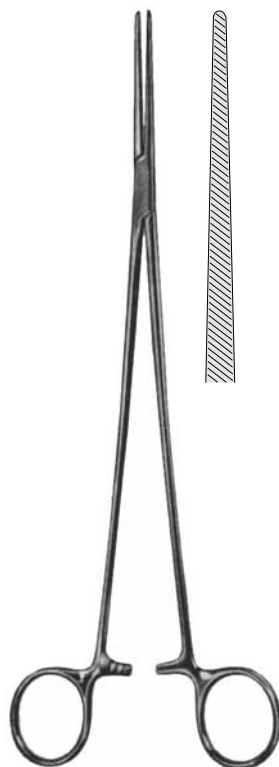

**BENGOLEA**  
 15.0360 20 cm  
 15.0362 26 cm

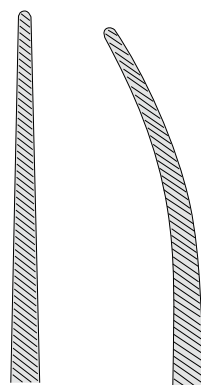

15.0361 20 cm  
 15.0363 26 cm

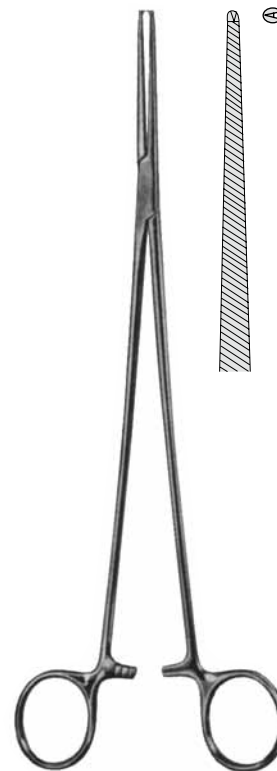

**BENGOLEA**  
 15.0364 20 cm 1x2  
 15.0366 26 cm 1x2

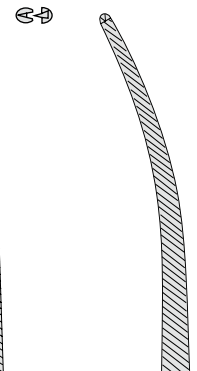

15.0365 20 cm 1x2  
 15.0367 26 cm 1x2



**BRIDGE**  
15.0392 28 cm

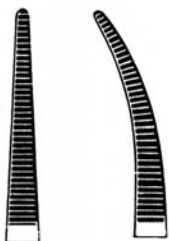

**15.0393**  
28 cm

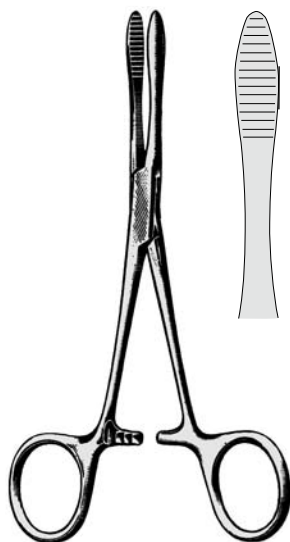

**PEAN**  
15.0404 12,5 cm  
15.0406 14,5 cm  
15.0408 16 cm

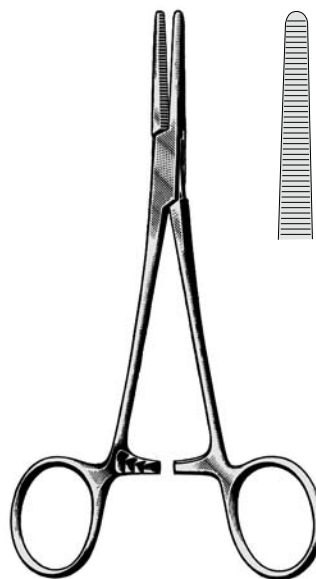

**SPENCER-WELLS**  
15.0410 13 cm  
15.0412 14 cm  
15.0414 15 cm  
15.0416 18 cm  
15.0418 20 cm

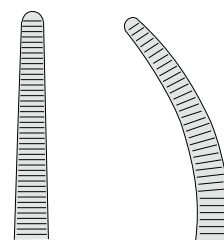

**SPENCER-WELLS**  
15.0411 13 cm  
15.0413 14 cm  
15.0415 15 cm  
15.0417 18 cm  
15.0419 20 cm



**ROCH-CARMALT**  
15.0430 16 cm  
15.0432 20 cm

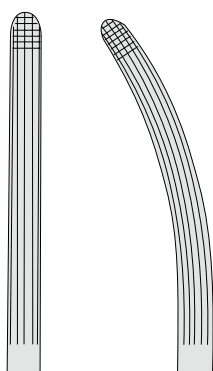

15.0431 16 cm  
15.0433 20 cm

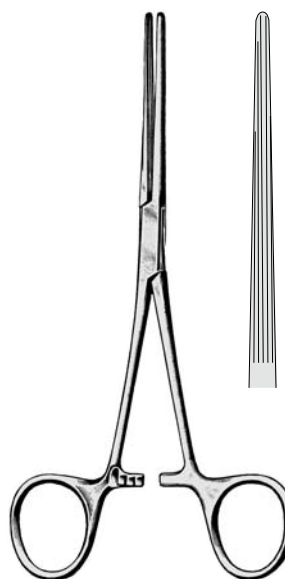

**BAINBRIDGE**  
15.1320 15,5 cm  
15.1322 18,0 cm



15.1321 15,5 cm  
15.1323 18,0 cm



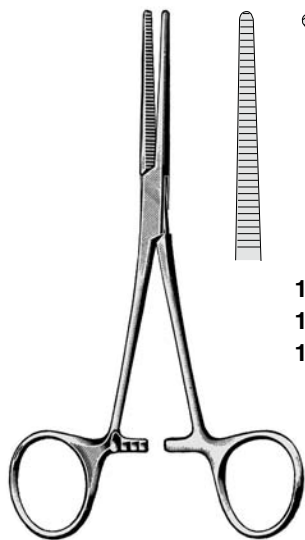

- 15.0451 13 cm
- 15.0453 14 cm
- 15.0455 16 cm

**PEAN-FINO**

- 15.0450 13 cm
- 15.0452 14 cm
- 15.0454 16 cm

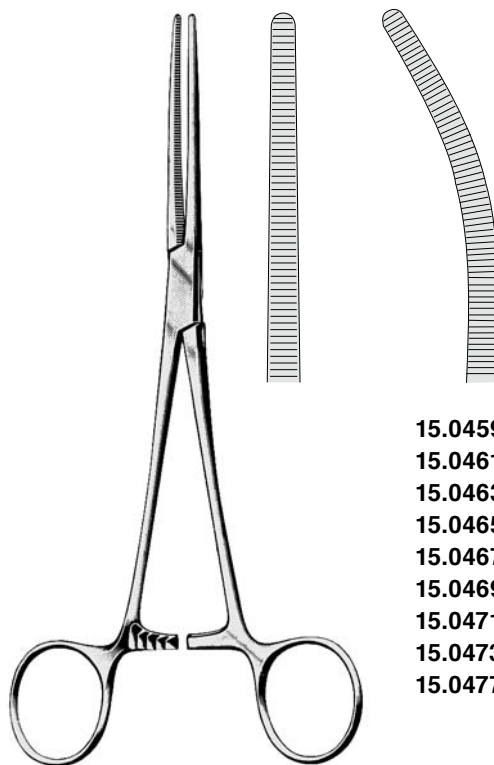

- 15.0459 13 cm
- 15.0461 14 cm
- 15.0463 16 cm
- 15.0465 18 cm
- 15.0467 20 cm
- 15.0469 22 cm
- 15.0471 24 cm
- 15.0473 26 cm
- 15.0477 30 cm

**ROCHESTER-PEAN**

- 15.0458 13 cm
- 15.0460 14 cm
- 15.0462 16 cm
- 15.0464 18 cm
- 15.0466 20 cm
- 15.0468 22 cm
- 15.0470 24 cm
- 15.0472 26 cm
- 15.0476 30 cm



15.0481

**ROBERTS**

- 15.0480 22 cm

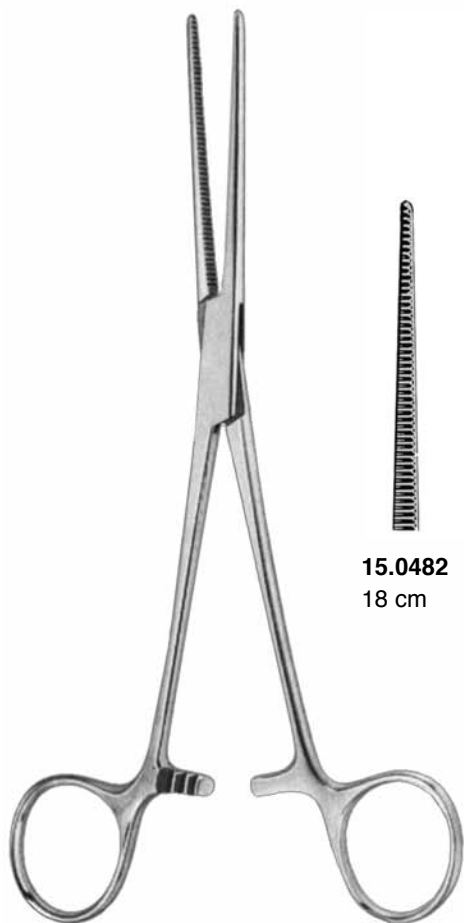

**OLIVECRONA**

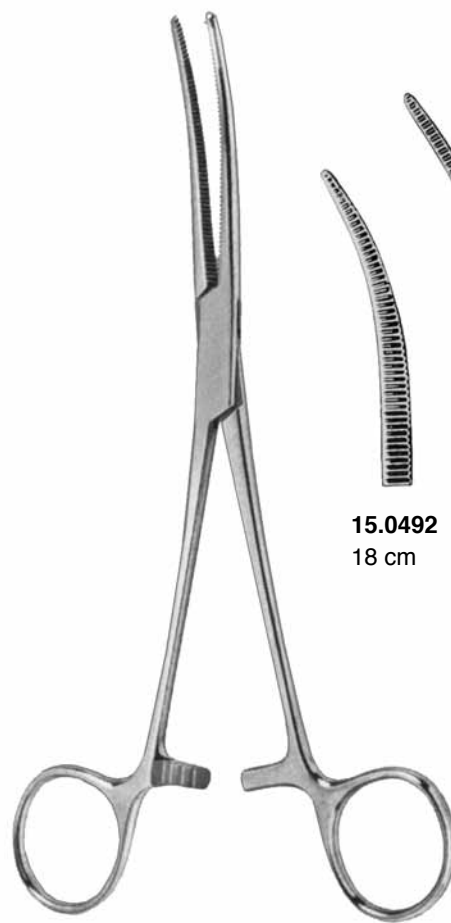
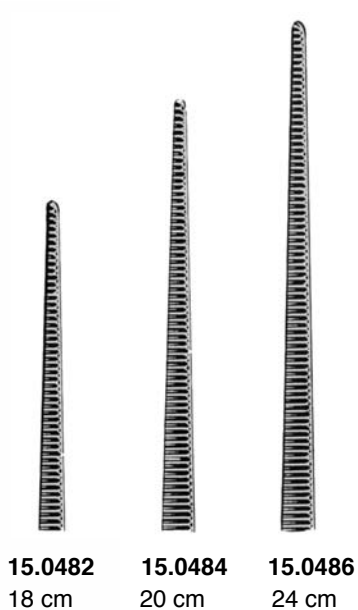

**CRAFOORD**

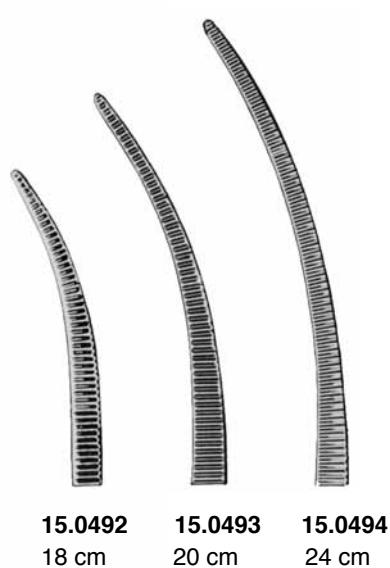

**CRAFOORD-SELLORS**  
24 cm

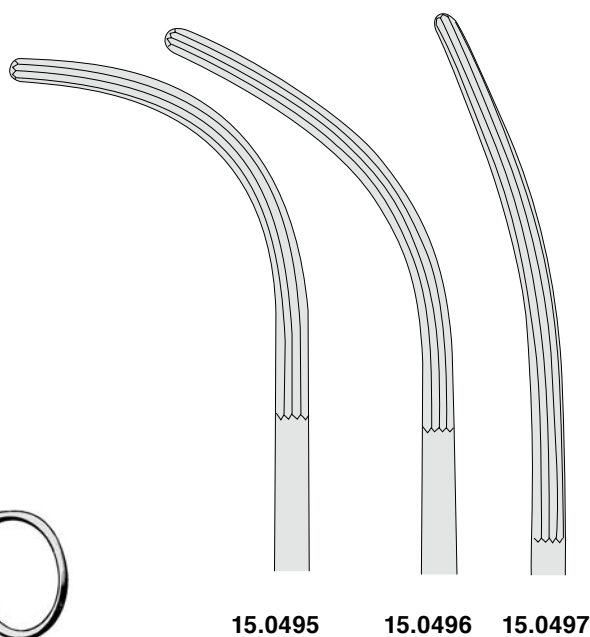



**ROCHESTER-OCHSNER**

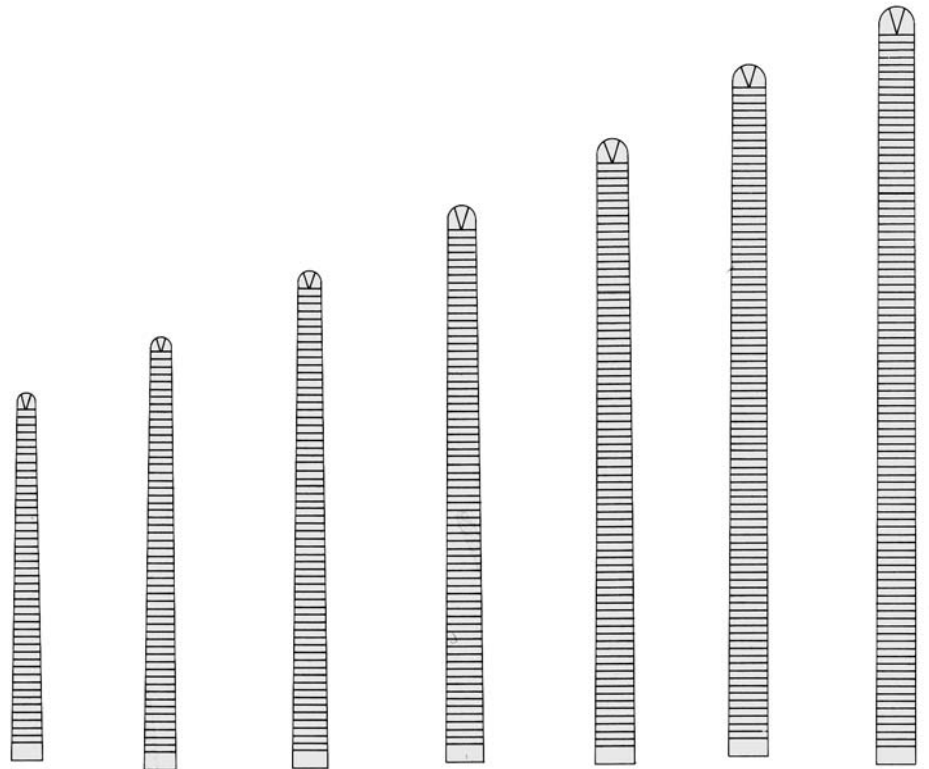

<b>15.0620</b>	<b>15.0622</b>	<b>15.0624</b>	<b>15.0626</b>	<b>15.0628</b>	<b>15.0630</b>	<b>15.0632</b>
16 cm	18 cm	20 cm	22 cm	24 cm	26 cm	30 cm
1x2	1x2	1x2	1x2	1x2	1x2	1x2

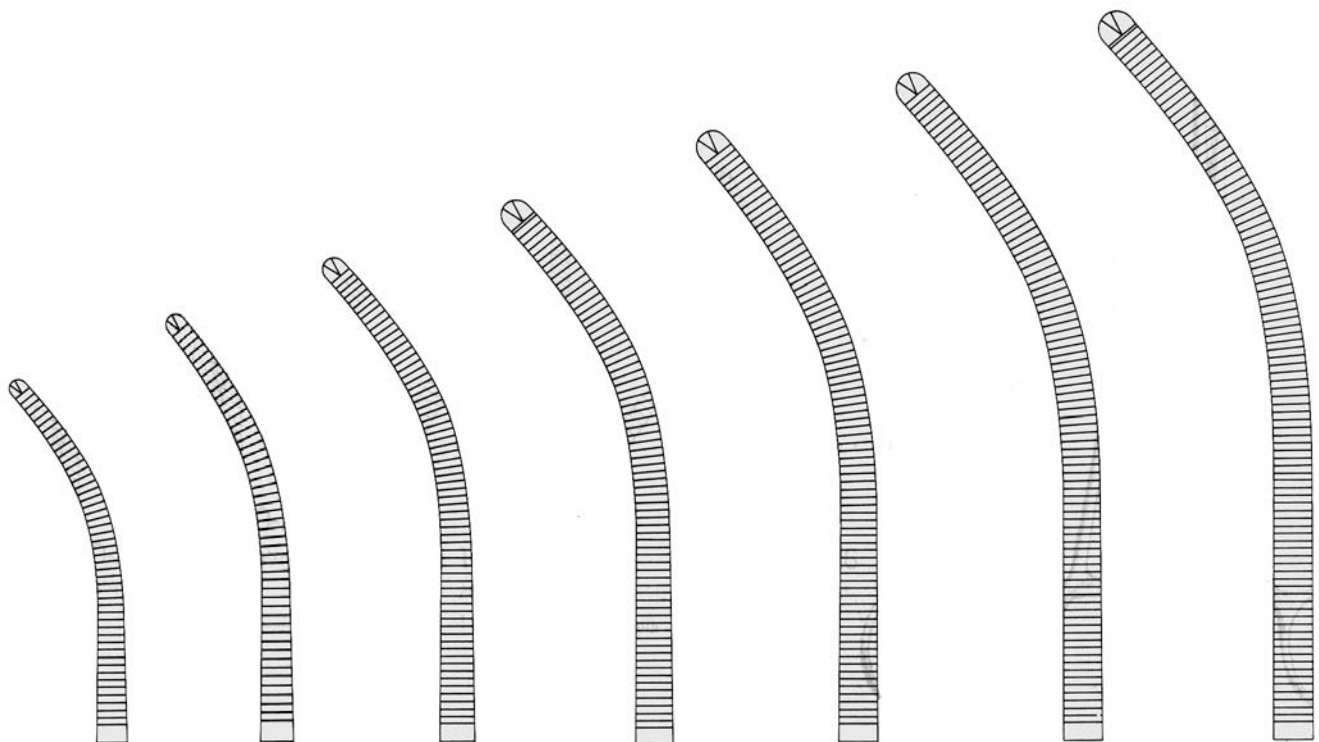

<b>15.0621</b>	<b>15.0623</b>	<b>15.0625</b>	<b>15.0627</b>	<b>15.0629</b>	<b>15.0631</b>	<b>15.0633</b>
16 cm	18 cm	20 cm	22 cm	24 cm	26 cm	30 cm
1x2	1x2	1x2	1x2	1x2	1x2	1x2

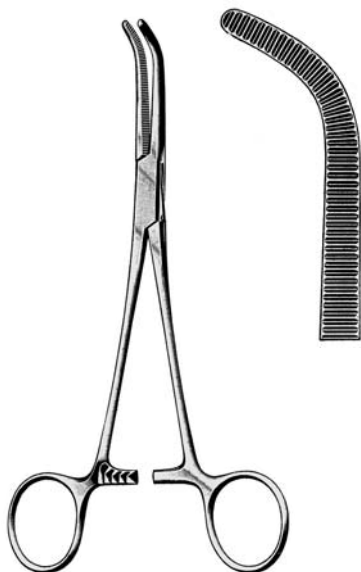

**MIXTER-O'SHAUGHNESSY**

15.0701 15 cm

15.0703 19 cm



**OVERHOLT-BABY**

15.0720 14 cm

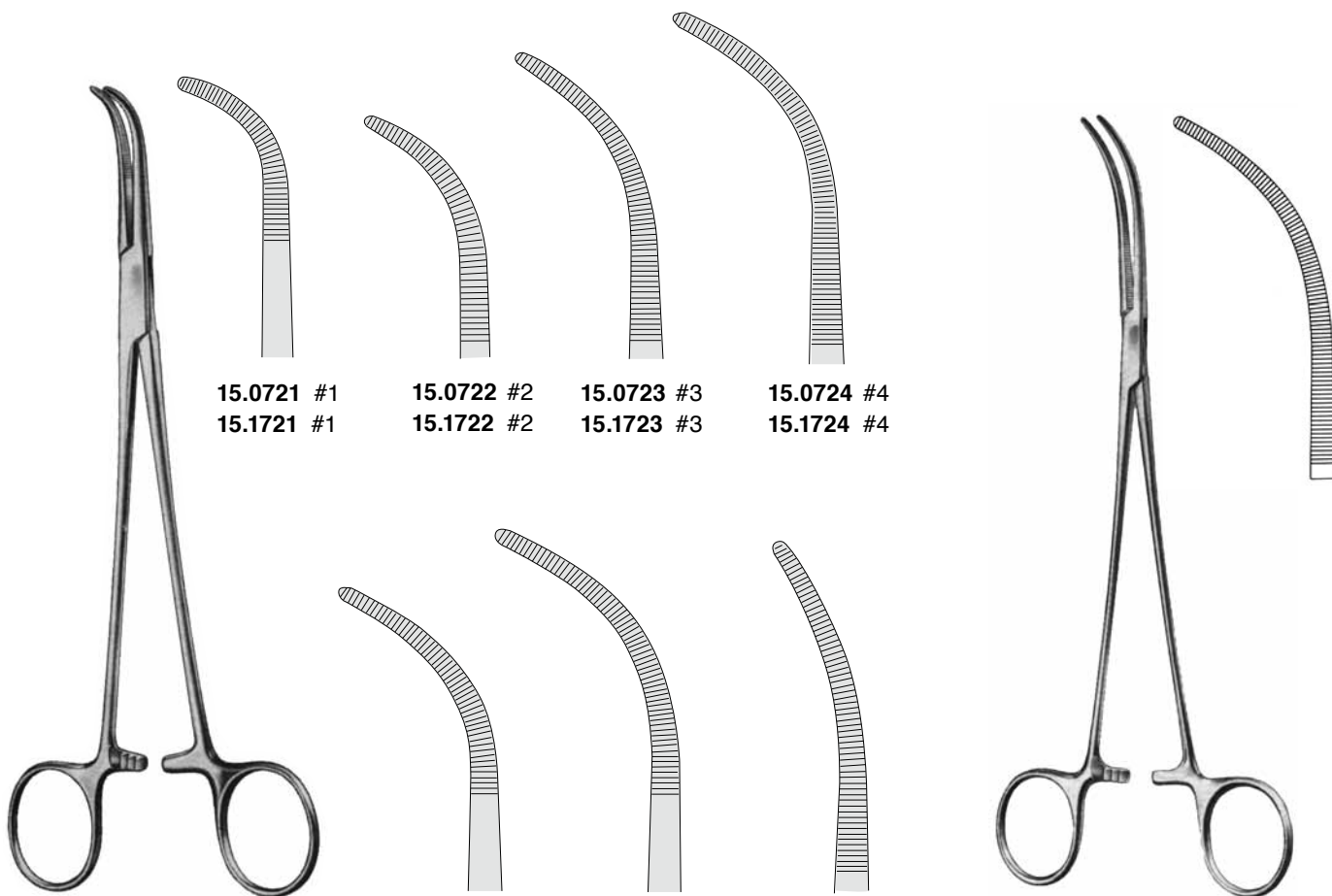

15.0721 #1

15.1721 #1

15.0722 #2

15.1722 #2

15.0723 #3

15.1723 #3

15.0724 #4

15.1724 #4

15.0725 #5

15.1725 #5

15.0726 #6

15.1726 #6

15.0727 #7

15.1727 #7

**OVERHOLT-GEISSENDOERFER**

15.0721-15.0727 21 cm

15.1721-15.1727 27 cm

**OVERHOLT-MIXTER**

15.0729 21 cm

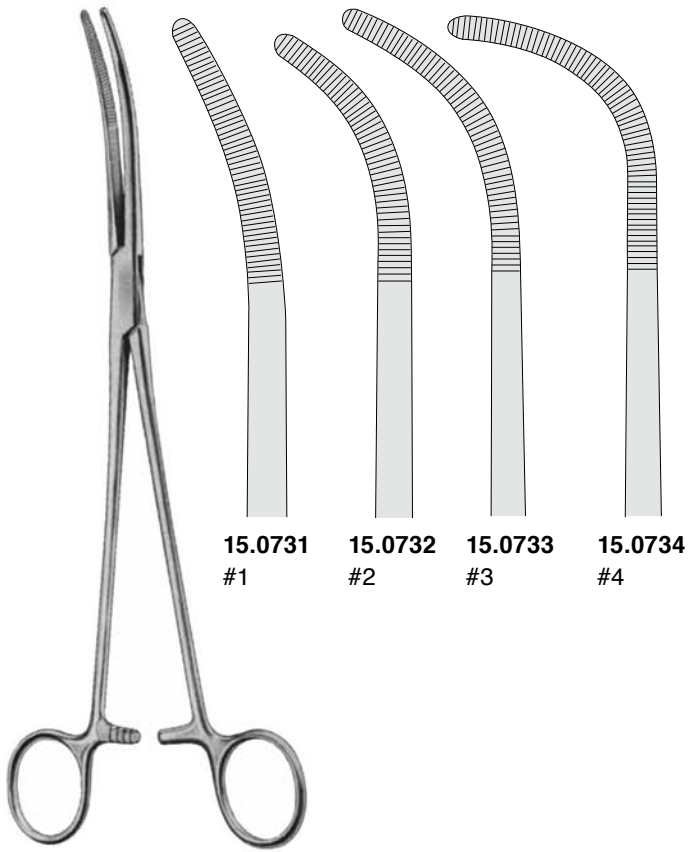

**RUMEL**  
23 cm

15.0731 #1  
 15.0732 #2  
 15.0733 #3  
 15.0734 #4



**KANTROWITZ**

15.0741 20 cm  
 15.0743 24 cm  
 15.0745 28 cm

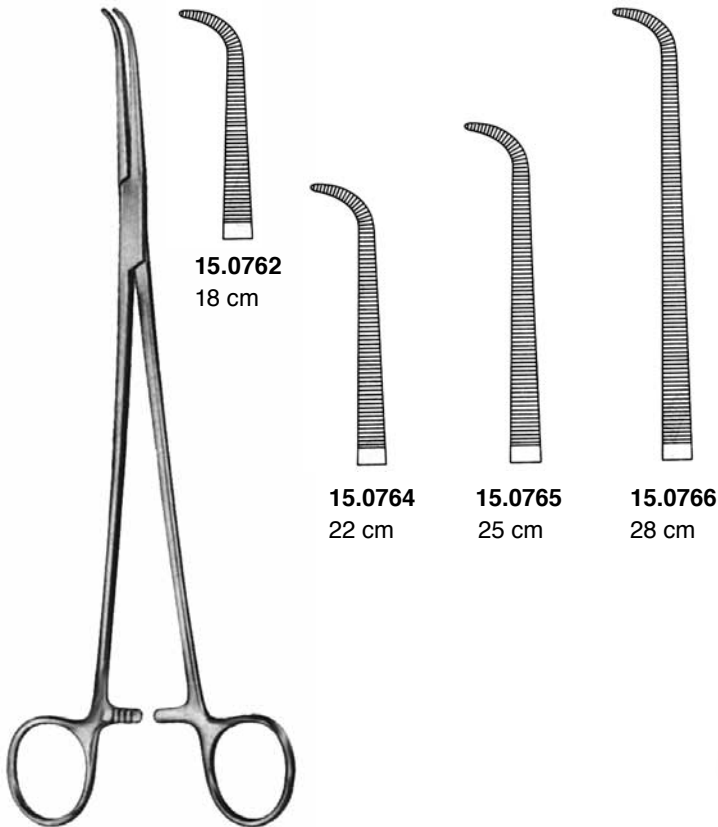

**GEMINI-MINI**

15.0762 18 cm  
 15.0764 22 cm  
 15.0765 25 cm  
 15.0766 28 cm

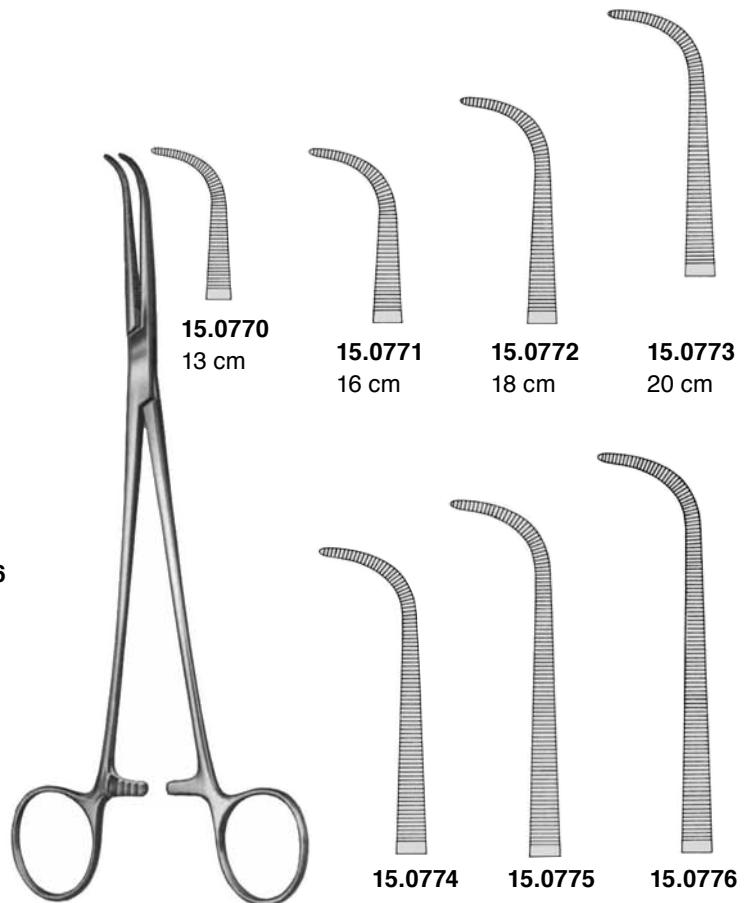

**GEMINI**

15.0770 13 cm  
 15.0771 16 cm  
 15.0772 18 cm  
 15.0773 20 cm  
 15.0774 23 cm  
 15.0775 25 cm  
 15.0776 28 cm

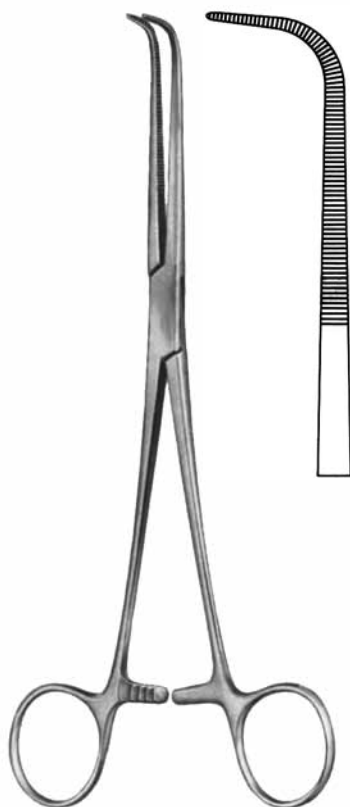

**WIKSTROEM**  
 15.0780 21 cm  
 15.0782 24 cm



**LAWRENCE**  
 15.0784 28 cm



**MEEKER**  
 15.0786 28 cm

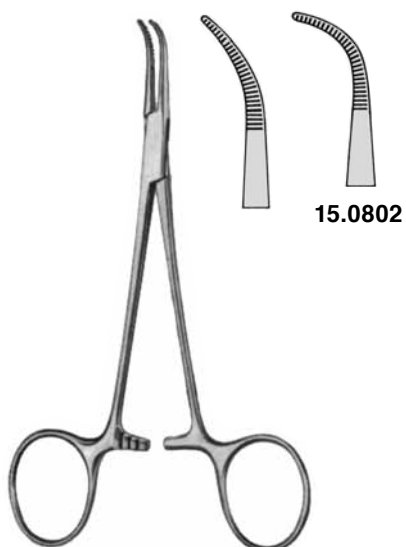

**MIXTER-BABY**  
 15.0801 14,5 cm



**MIXTER-BABY**  
 15.0803 18 cm

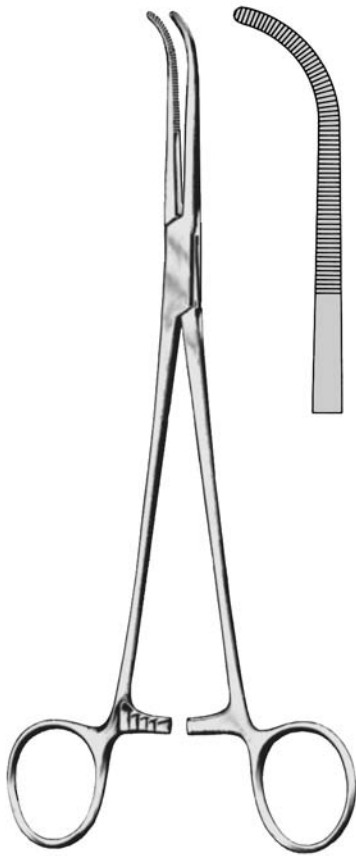

**MIXTER**  
 15.0807 22 cm



**MIXTER**  
 15.0809 23 cm



**MIXTER**

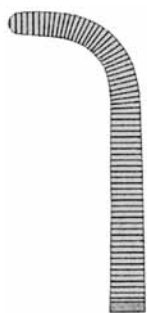

**15.0811**  
 16 cm

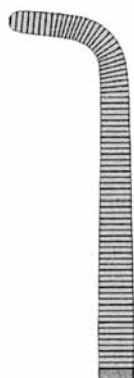

**15.0813**  
 19 cm



**15.0817**  
 23 cm



**MIXTER**

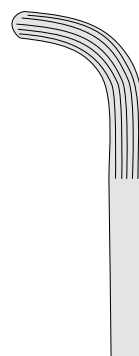

**15.0831**  
 22 cm

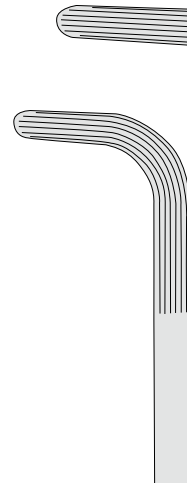

**15.0833**  
 25 cm

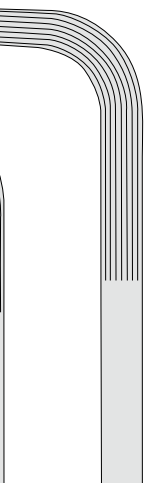

**15.0835**  
 28 cm

Arterien- und Präparierklemmen  
Hemostatic- and Dissecting Forceps  
Pincès hémostatiques et à disséquer  
Pinzas hemostáticas y para preparación  
Pinze emostatiche e per preparazione



**DEBAKEY-COLLIER**  
15.0269  
36 cm



Arterien- und Präparierklemmen / Hemostatic- and Dissecting Forceps /  
Pincas hémostatiques et à disséquer / Pinzas hemostáticas y para preparación /  
Pinze emostatiche e per preparazione



**ROCHESTER-PEAN**  
15.0478  
36 cm



**ROCHESTER-PEAN**  
15.0479  
36 cm

Arterien- und Präparierklemmen / Hemostatic- and Dissecting Forceps /  
Pincés hémostatiques et à disséquer / Pinzas hemostáticas y para preparación /  
Pinze emostatiche e per preparazione



**CRAFOORD-SELLORS**  
15.0499  
36 cm



**SAROT**  
15.0503  
36 cm

Arterien- und Präparierklemmen / Hemostatic- and Dissecting Forceps /  
Pincas hémostatiques et à disséquer / Pinzas hemostáticas y para preparación /  
Pinze emostatiche e per preparazione



**ROCH.-OCHSNER**  
15.0634  
36 cm



**ROCH.-OCHSNER**  
15.0635  
36 cm

Arterien- und Präparierklemmen / Hemostatic- and Dissecting Forceps /  
Pincas hémostatiques et à disséquer / Pinzas hemostáticas y para preparación /  
Pinze emostatiche e per preparazione



**GEMINI**  
15.0778  
36 cm



**GUYON**  
15.1936  
36 cm

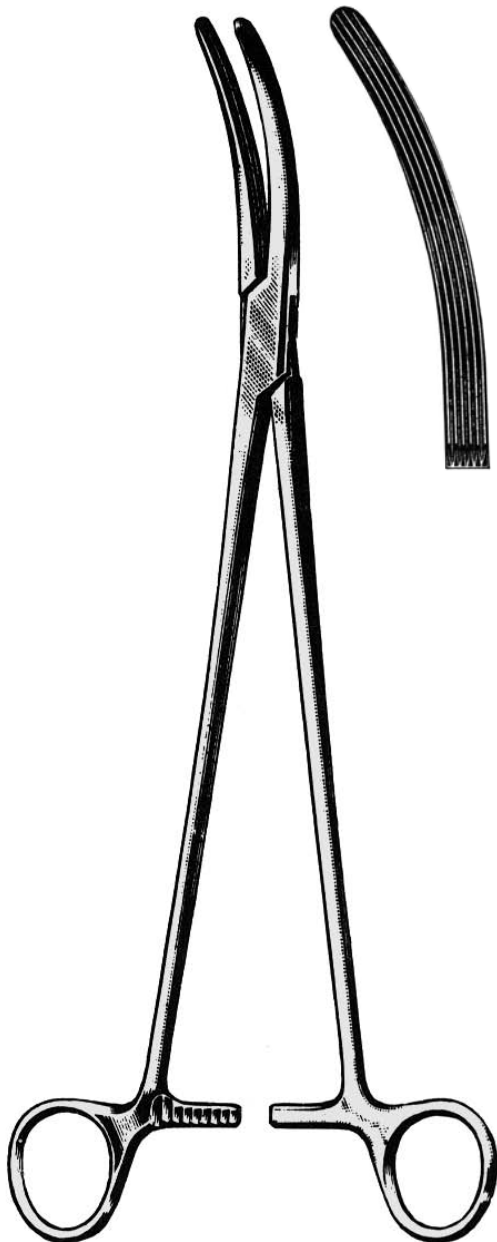

**HARRINGTON**  
40.0705  
36 cm



**ALLIS**  
48.0019  
36 cm  
5 x 6

Arterien- und Präparierklemmen / Hemostatic- and Dissecting Forceps /  
Pinces hémostatiques et à disséquer / Pinzas hemostáticas y para preparación /  
Pinze emostatiche e per preparazione

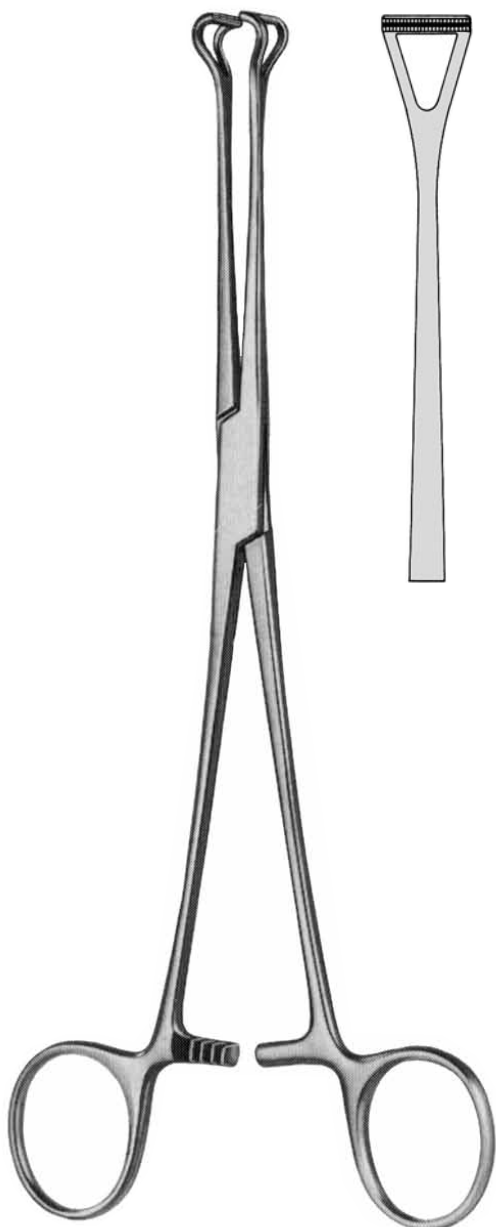

**BABCOCK**  
48.0069  
36 cm

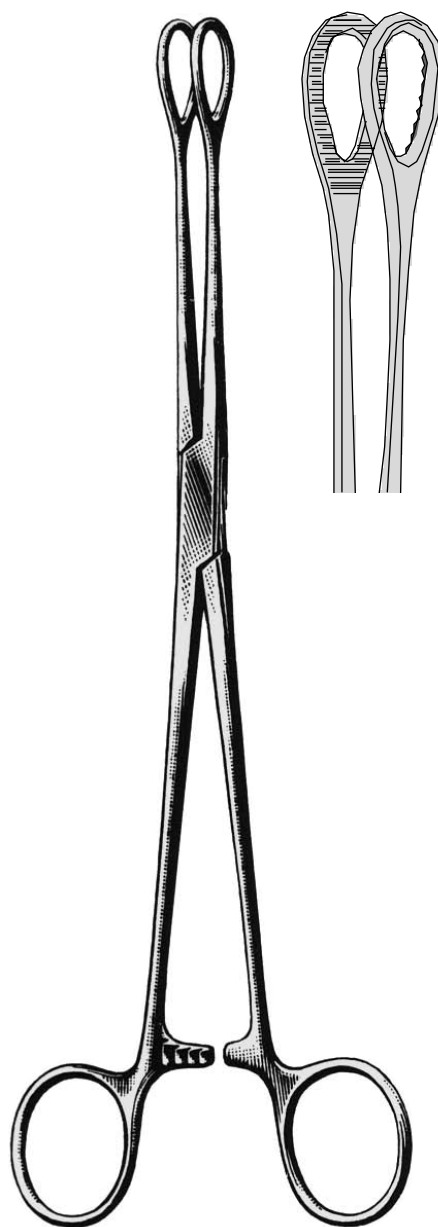

**FOERSTER**  
16.0436  
36 cm  
gerieft  
serrated  
strié  
estriada  
con striatura



TUCH- UND SCHLAUCHKLEMMEN,  
TUPFERZANGEN

TOWEL- AND TUBING CLAMPS,  
DRESSING- AND SPONGE FORCEPS

PINCES A CHAMPS ET A TAMPONS,  
PINCES PRESSE-TUBES

PINZAS DE CAMPO, PARA TUBOS  
Y PARA TAMPONES

PINZE FISSATELI, PINZE SERRATUBI  
PINZE PER TAMPONI









**JONES**  
16.0010 5 cm  
16.0012 9 cm



**SCHAEDEL**  
16.0031 9 cm



**OMBREDANNE (Jackson)**  
16.0150 13,5 cm

mit Schlauchhalter  
with tubeholder  
avec clamp porte-tube  
con porta-tubo  
con porta-tubo

für Papiertücher  
for paper drapes  
pour champs en papier  
para paños de papel  
per fazzoletti di carta



**BACKHAUS**  
16.0100 9 cm  
16.0102 11cm  
16.0105 13 cm  
16.0106 15 cm



**BACKHAUS**  
16.0107 11 cm  
16.0108 13 cm

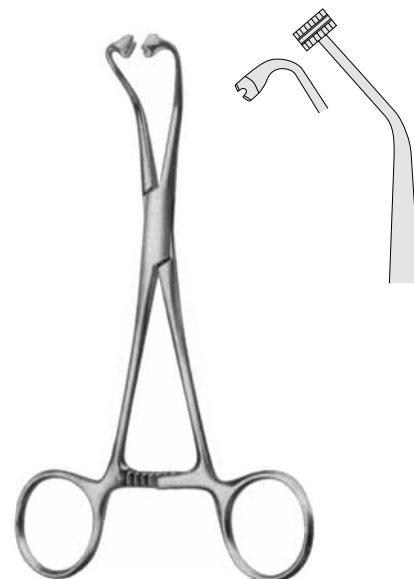

**PEERS**  
16.0112 14,5 cm

für Papierabdeckung / for paper drapes / pour couverture en papier / para paños de papel / per copertura di carta



**ROEDER**

16.0115 13 cm  
16.0116 15 cm

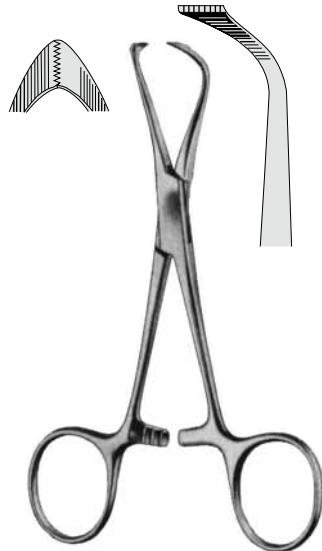

**LORNA**

16.0120 10 cm  
16.0125 13 cm



**BALL&SOCKET**

16.0132 11 cm  
16.0135 13 cm



**TOHOKU**

16.0140 10 cm  
16.0145 13 cm

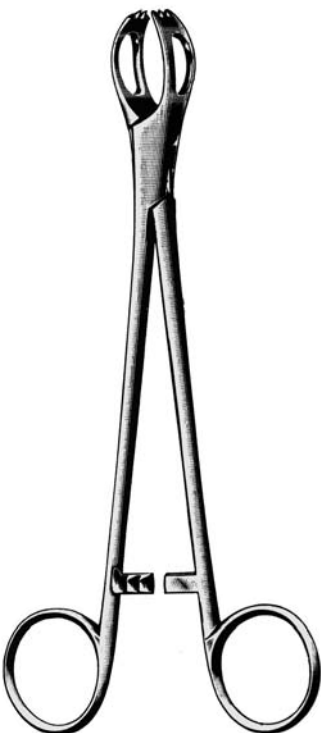

**LANE**

16.0160 15 cm  
16.0164 20 cm



**BERNHARD**

16.0170 16,5 cm

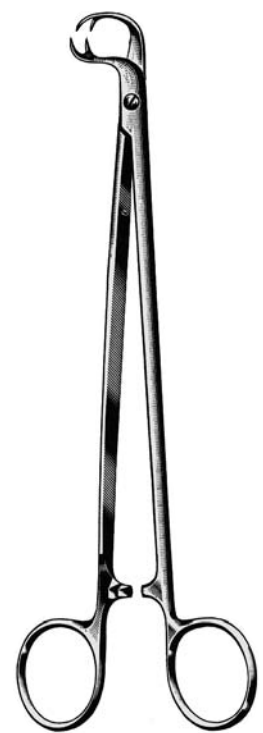

**MOYNIHAN**

16.0180 19 cm

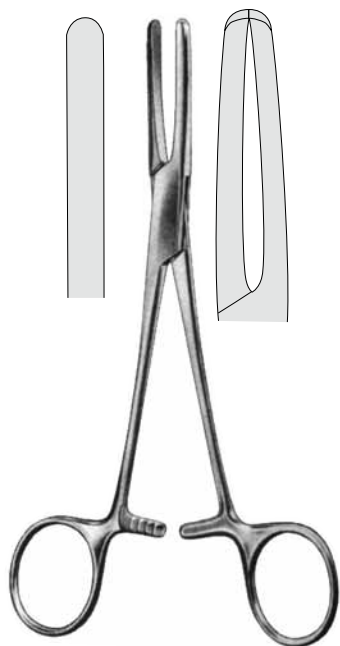

**PRESBYTERIAN**  
16.0200 16 cm  
16.0202 18 cm



**KLINIK-BERLIN**  
16.0210 14,5 cm

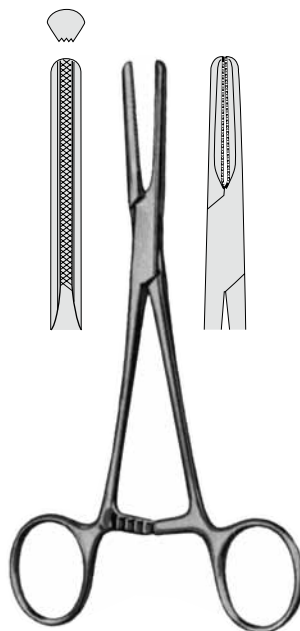

**USA-MODEL**  
16.0220 16 cm  
16.0222 18 cm  
16.0224 20 cm

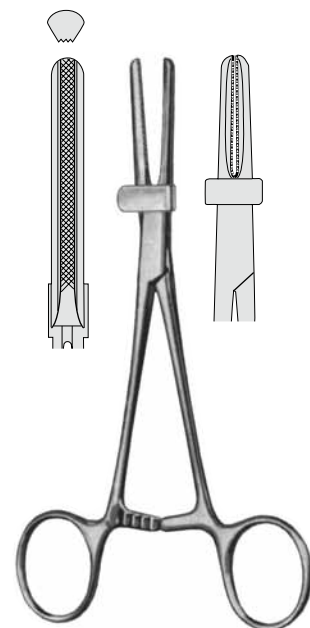

**TUBING**  
16.0230 16 cm  
16.0232 18 cm  
16.0234 20 cm

Schlauchroller  
Tube milking clamps  
Pinces à traire les drains  
Rodillos para tubos  
Pinze pressa tubi con rulli



**BROMPTON**  
16.0280 15,5 cm

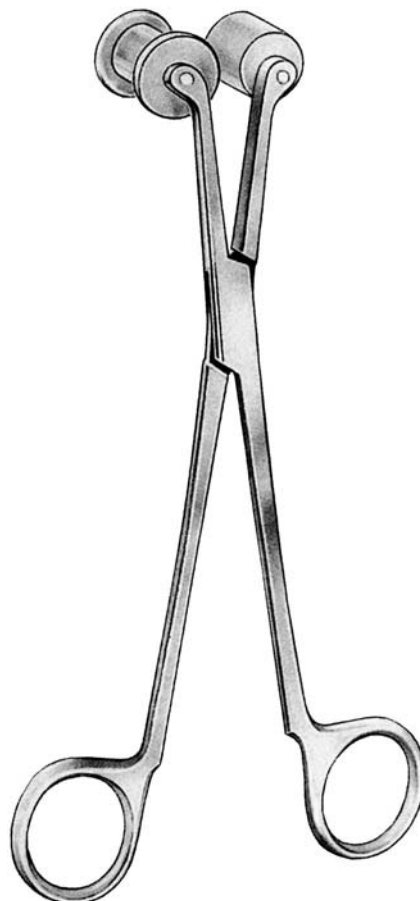

**GUNNAR-HEY**  
16.0290 19 cm

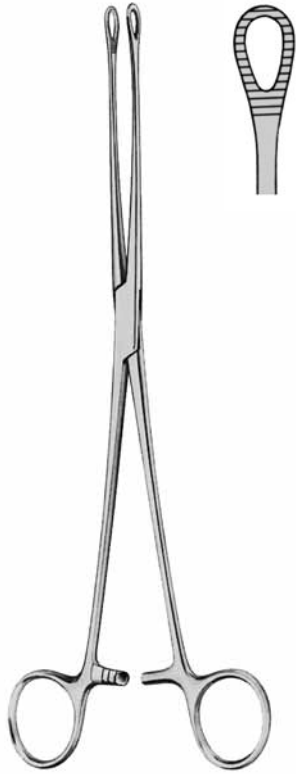

**BERGMANN-FOERSTER**  
 16.0390 24 cm



**BERGMANN-FOERSTER**  
 16.0391 24 cm

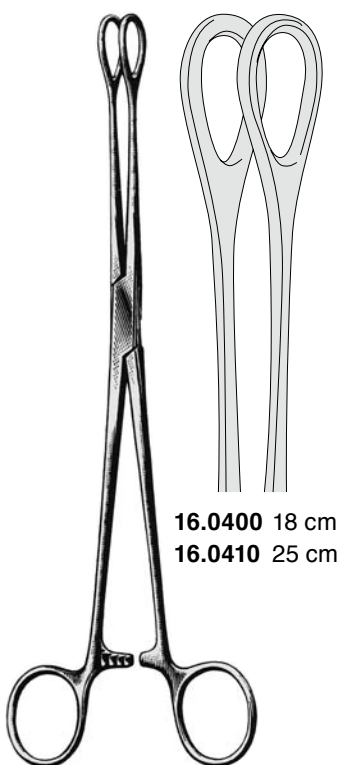

**16.0400** 18 cm  
**16.0410** 25 cm

**FOERSTER**

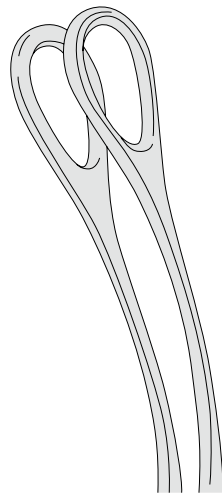

**16.0401** 18 cm  
**16.0411** 25 cm

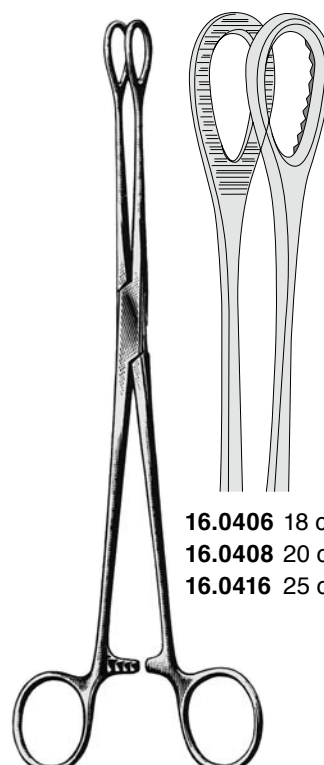

**16.0406** 18 cm  
**16.0408** 20 cm  
**16.0416** 25 cm

**BALLENGER**

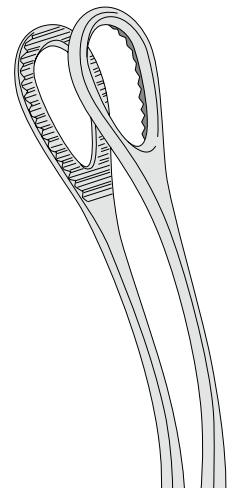

**16.0407** 18 cm  
**16.0409** 20 cm  
**16.0417** 25 cm



**FOERSTER-DELIKAT**  
 25 cm

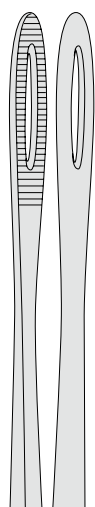

**16.0418**

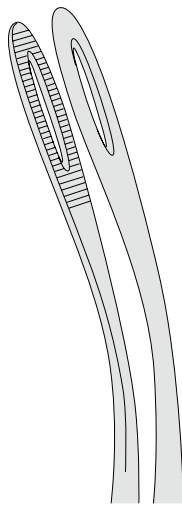

**16.0419**



**RAMPLEY**  
 16.0420 25 cm

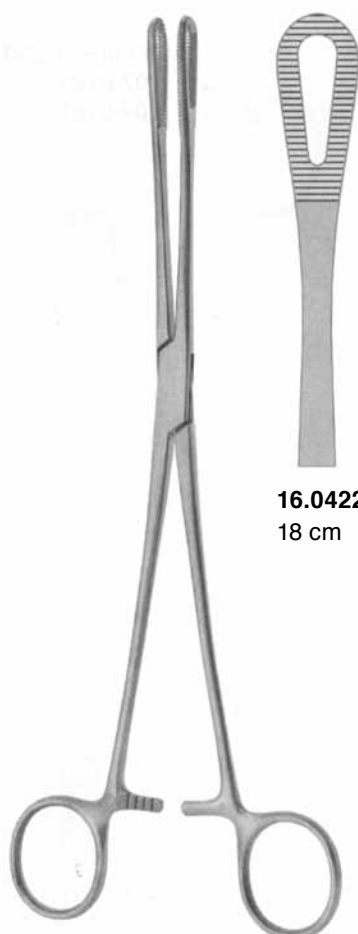

**16.0422**  
 18 cm

**RAMPLEY**



**16.0423**  
 25 cm



**FLETCHER (Javerts)**  
 16.0424 24 cm



**FLETCHER (Javerts)**  
 16.0425 24 cm

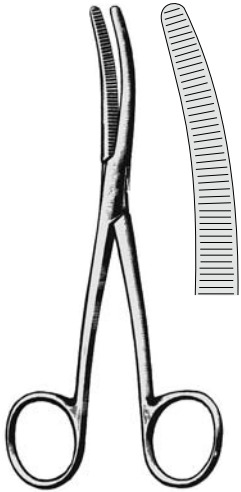

**BRYANT**  
16.0300 13 cm



**LISTER-SINUS**  
16.0360 13 cm  
16.0362 16 cm  
16.0364 18 cm

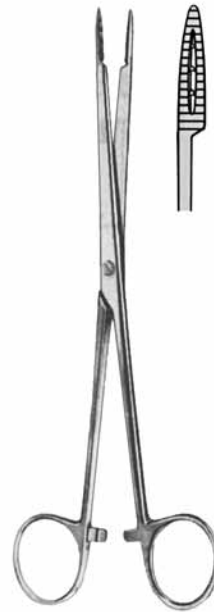

**WALTON**  
16.0370 17 cm



**WALTON**  
16.0371 17 cm

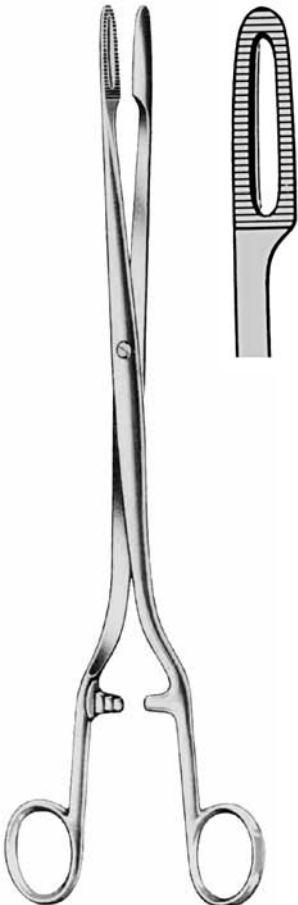

**SIMS-MAIER**  
16.0426 28 cm



**SIMS-MAIER**  
16.0427 28 cm



**PELKMANN**  
16.0430 25 cm



**PELKMANN**  
16.0431 25 cm



**DUPLAY**  
 16.0440 20 cm

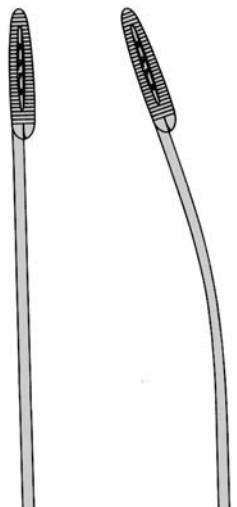

16.0441



**GROSS**  
 16.0450 20 cm  
 16.0452 22 cm  
 16.0454 26 cm

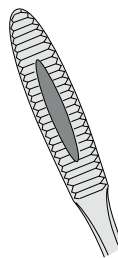

16.0451 20 cm  
 16.0453 22 cm  
 16.0455 26 cm

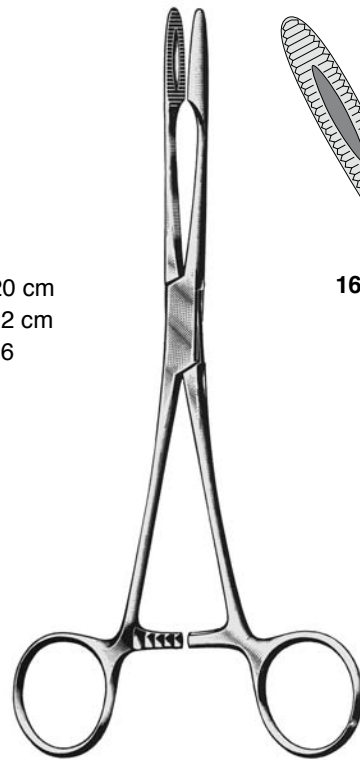

**MAIER**  
 16.0460 25 cm

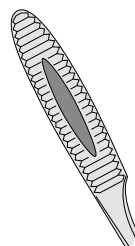

16.0461

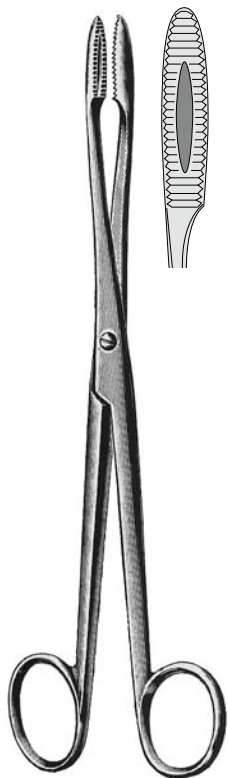

**MAIER**  
 16.0462 25 cm

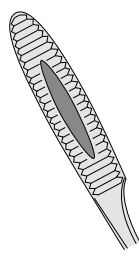

16.0463



**EMMET**  
 16.0466 21 cm

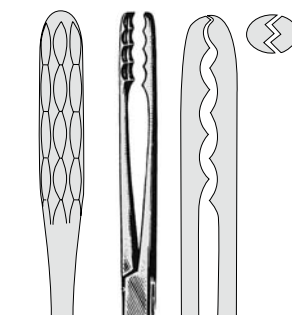

**ULRICH**  
 16.0470 22 cm  
 16.0472 25 cm

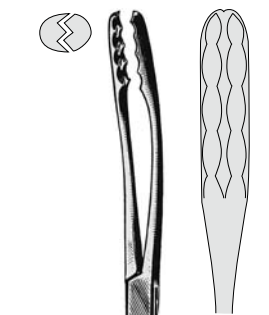

**ULRICH**  
 16.0471 22 cm  
 16.0473 25 cm



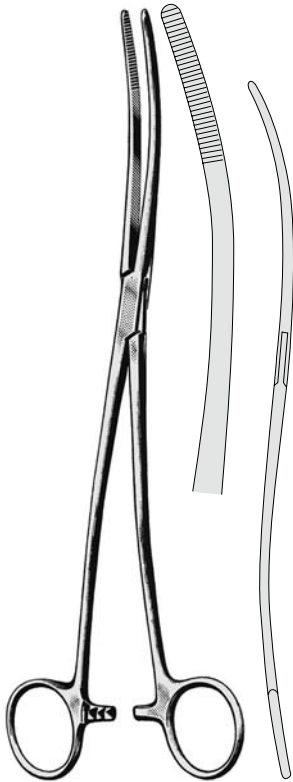

**BOZEMANN**

**16.0500** 26 cm

gerade /straight /droit /recto /retto

**16.0501** 26 cm

gebogen /curved / courbe /curvo /  
curvo

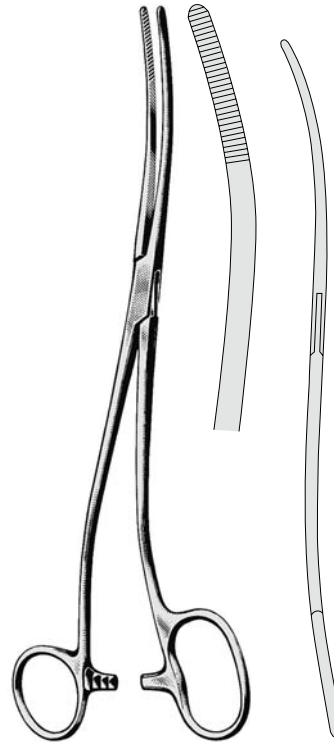

**BOZEMAN-DOUGLAS**

**16.0505** 25 cm



**CHERON**

**16.0510** 25 cm

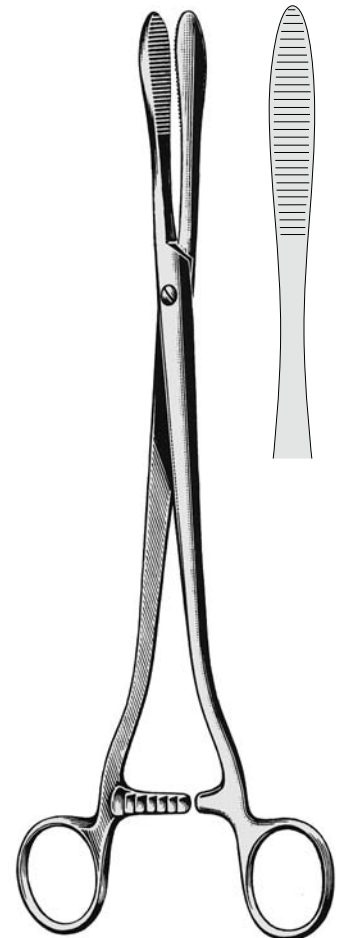

**COLLIN**

**16.0520** 25 cm

WUNDHAKEN  
RETRACTORS  
ECARTEURS  
SEPARADORES  
DIVARICATORI





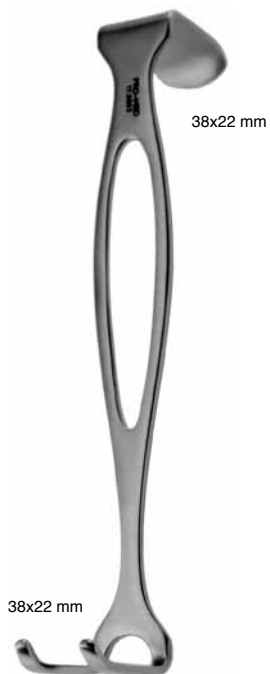

**CZERNY**  
17.0662 18 cm



**MORRIS**  
24cm  
17.0665 32x51/38x51 mm  
17.0666 44x51/51x51 mm  
17.0667 64x51/38x51 mm



**GOELET**  
17.0670 19 cm

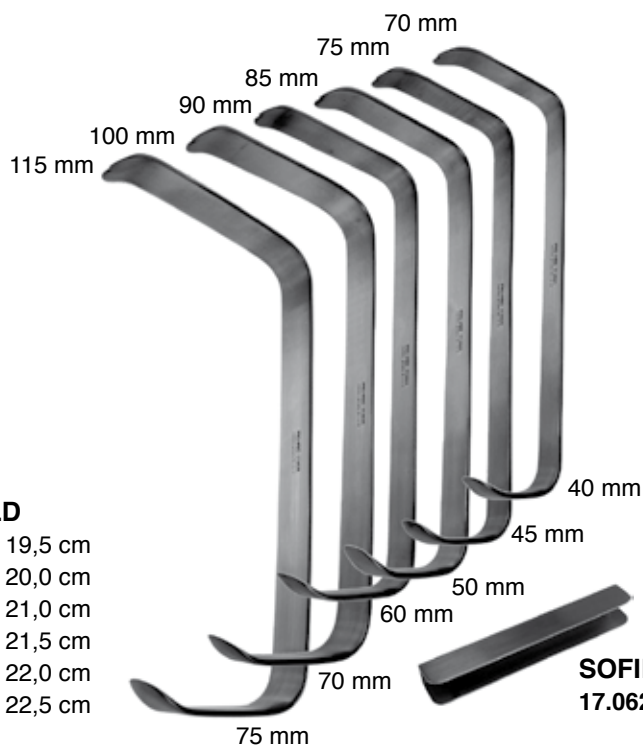

**SOFIELD**  
17.0621 19,5 cm  
17.0622 20,0 cm  
17.0623 21,0 cm  
17.0624 21,5 cm  
17.0625 22,0 cm  
17.0626 22,5 cm

**SOFIELD**  
17.0629



**SOFIELD**  
17.0620



**WASSMUND**  
 17.0900 20 cm  
 33 x 20 mm



**OLLIER**  
 17.0912 22,5 cm  
 36 x 60 mm

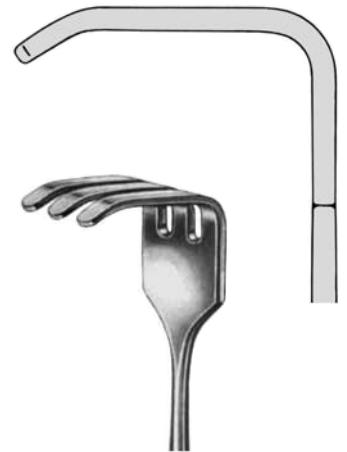

**17.0910**  
 36 x 30 mm



**KOERTE**  
 17.0922 24 cm  
 stumpf  
 blunt  
 mousse  
 romo  
 smusso

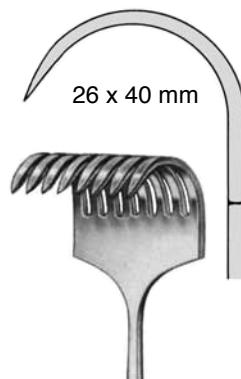

**17.0920**  
 scharf  
 sharp  
 pointu  
 agudo  
 acuto



**KOERTE**  
 17.0925  
 23 cm  
 stumpf  
 blunt  
 mousse  
 romo  
 smusso



**ISRAEL**  
25 cm



**17.0930**  
40 x 40 mm



**17.0931**  
45 x 50 mm



**17.0932**  
50 x 60 mm



**17.0934**  
70 x 70 mm

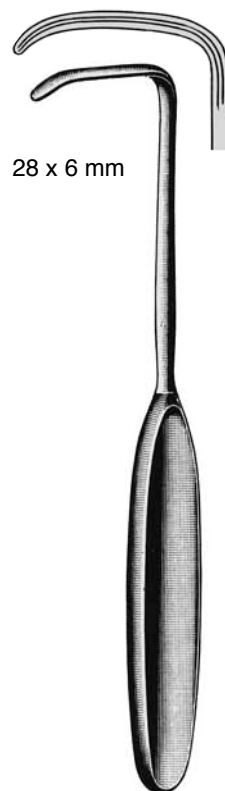

28 x 6 mm

**LAHEY**  
17.1000 19 cm

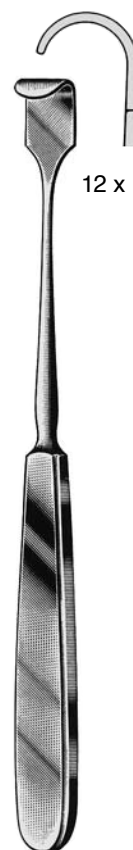

12 x 14 mm

**LITTLE**  
17.1010 20 cm



**MIDDELDORPF**

23 cm

**17.1086** 20 x 22 mm

**17.1087** 26 x 30 mm



**GREEN**

22 cm

**17.1088** 12 x 25 mm

Schilddrüsenhaken

Thyroid gland retractor

Ecarteur pour la thyroïde

Separador par la glándula tiroidea

Divaricatore per la tiroide



**RICHARDSON**

24 cm

**17.1090** 28 x 20 mm

**17.1091** 36 x 28 mm

**17.1092** 44 x 38 mm



49 x 38 mm

28 x 20 mm

36 x 28 mm

71 x 43 mm

**RICHARDSON-EASTMANN**

**17.1097** Satz/Set/Jeu/Juego/Serie

**17.1098** Klein/small/petit/chico/piccolo

**17.1099** Groß/large/grand/grande/grande



**KELLY**

26 cm

**17.1095** 65 x 50 mm

**17.1096** 70 x 63 mm



**KELLY**

23,5 cm

**17.1101** 38 x 51 mm

**17.1102** 51 x 64 mm

25,5 cm

**17.1103** 64 x 76 mm

**17.1104** 76 x 89 mm



**KELLY**

26 cm

**17.1118** 160 x 38 mm

**17.1119** 160 x 57 mm

**17.1093** 190 x 38 mm

**17.1094** 190 x 57 mm



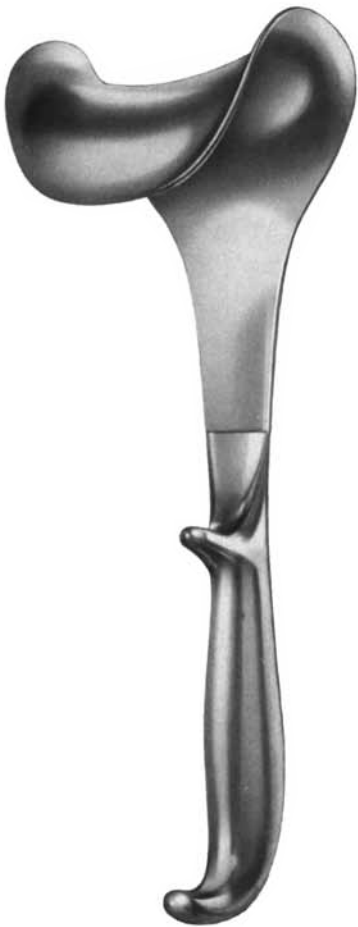

**DOYEN**  
25 cm  
**17.1100** 85 x 50 mm



**DOYEN-STILLE**  
20 cm  
**17.1105** 90 x 28 mm  
**17.1106** 105 x 30 mm  
**17.1107** 120 x 52 mm



**MORRIS**  
21 cm  
**17.1108** 38 x 51 mm  
**17.1109** 51 x 51 mm  
**17.1110** 64 x 51 mm



## FRITSCH

24 cm

- 17.1120 35 x 40 mm
- 17.1121 45 x 40 mm
- 17.1122 45 x 50 mm
- 17.1123 45 x 60 mm
- 17.1124 55 x 75 mm
- 17.1125 65 x 80 mm



## KOCHER-WAGNER

28 cm

- 17.1130 22 x 15 mm
- 17.1131 38 x 20 mm
- 17.1132 67 x 25 mm
- 17.1133 100 x 35 mm



## TUEBINGEN

- 17.1154 28 cm  
95 x 20 mm



**DEAVER**  
17.1273C-17.1279C

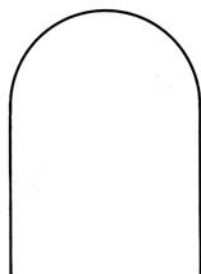

**17.1273C**  
300 x 25 mm

**17.1274C**  
330 x 25 mm

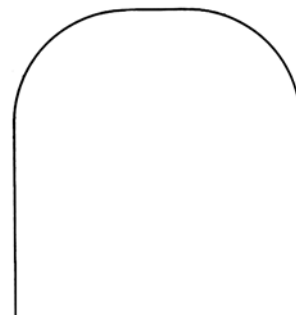

**17.1276C**  
330 x 38 mm

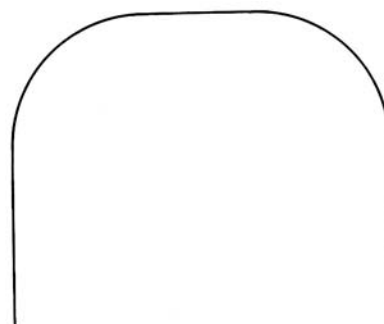

**17.1277C**  
330 x 50 mm

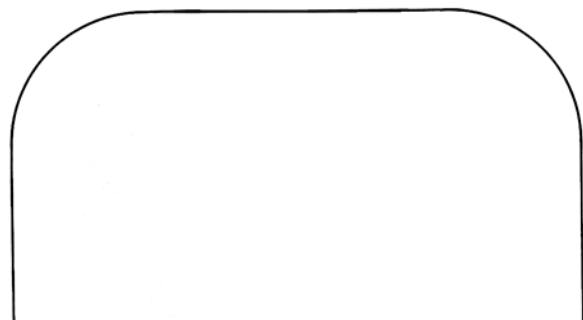

**17.1278C**  
330 x 75 mm

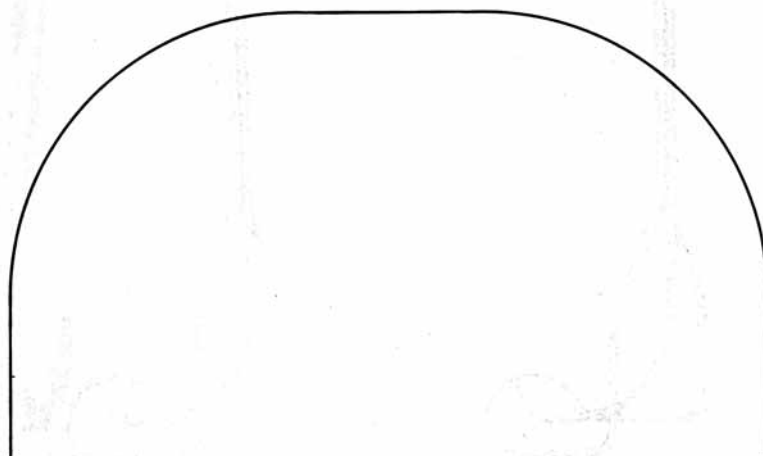

**17.1279C**  
330 x 100 mm



**DEAVER**  
17.1270  
180 x 19 cm

**DEAVER**  
17.1271  
215 x 22 mm

**DEAVER**  
17.1272  
230 x 25 mm

**DEAVER**  
17.1273  
300 x 25 mm

**DEAVER**  
17.1274  
330 x 25 mm

**DEAVER**  
17.1275  
360 x 25 mm



**DEAVER**  
17.1276 300 x 38 mm



**DEAVER**  
17.1277 300 x 50 mm



**DEAVER**  
17.1278 300 x 75 mm  
17.1279 330 x 100 mm



**CUSHING**  
17.0576  
36 cm  
11x12 mm



**DEAVER**  
17.1275  
36cm / 25 mm



**DEAVER**  
17.1275.36  
36 cm / 65 mm



WUNDSPEIZER  
RETRACTORS, SELF-RETAINING  
ECARTEURS AUTOSTATIQUES  
SEPARADORES AUTOSTATICOS  
DIVARICATORI AUTOSTATICI

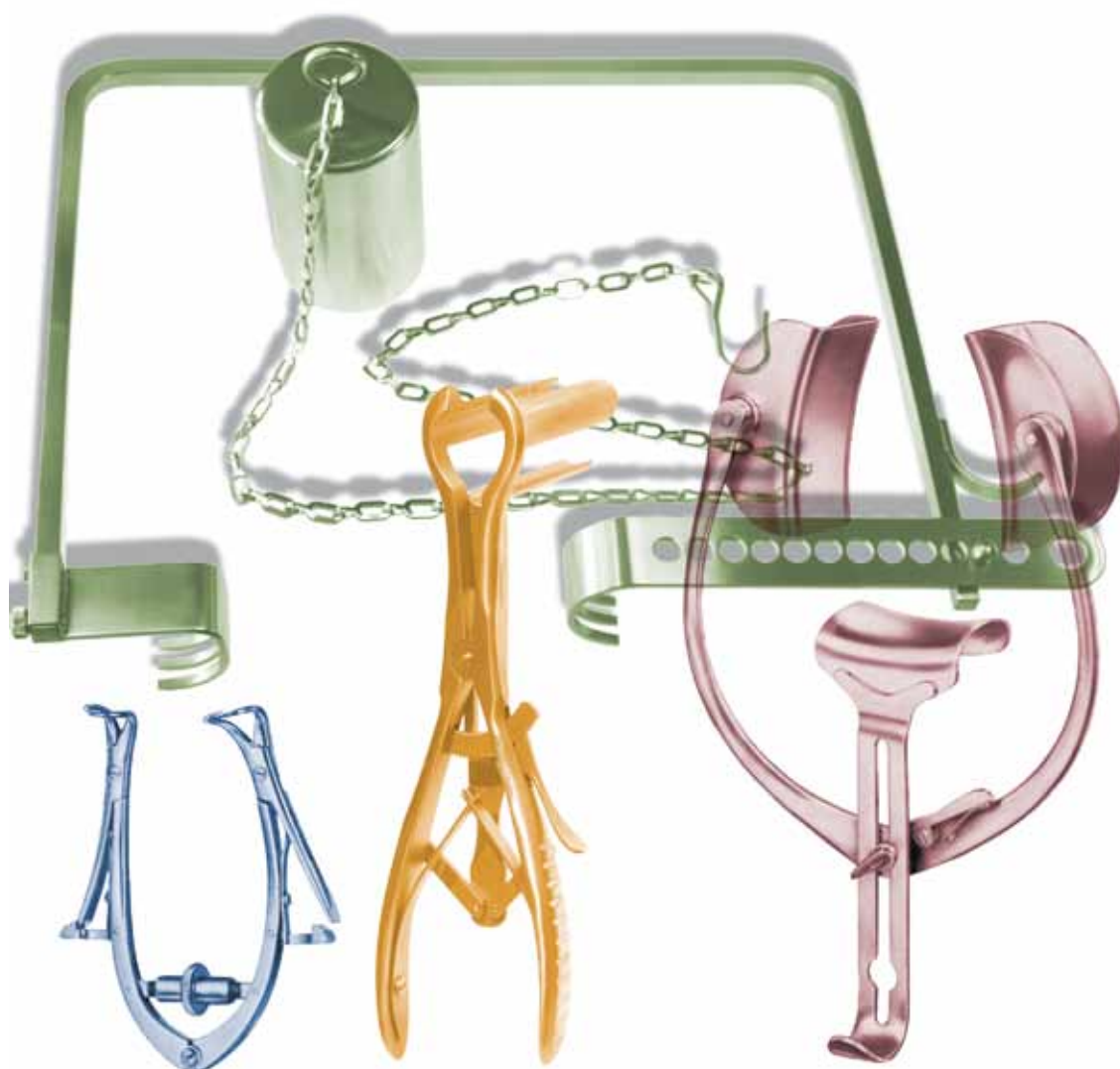





76x40 64x25 mm



**DARLING**  
17.5670 18 cm

64x25 76x40 mm



**DARLING**  
17.5672 18 cm



**DEBAKEY-FEMUR**  
17.5890  
10 cm

Kinder  
children  
enfants  
niños  
bambini



**DEBAKEY-FEMUR**  
17.5892  
14,5 cm



**JOLL (FRIEDMANN)**  
55.0500  
10 cm

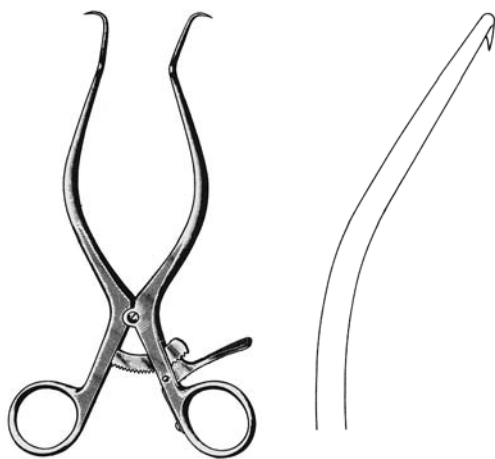

**GELPI-MINI**  
17.5899 10 cm



**GELPI-BABY**  
17.5900 14 cm



**GELPI**  
18 cm  
17.5901 spitz / sharp / pointu / agudo / acuto  
17.5902 stumpf / blunt / mousse / romo / smusso

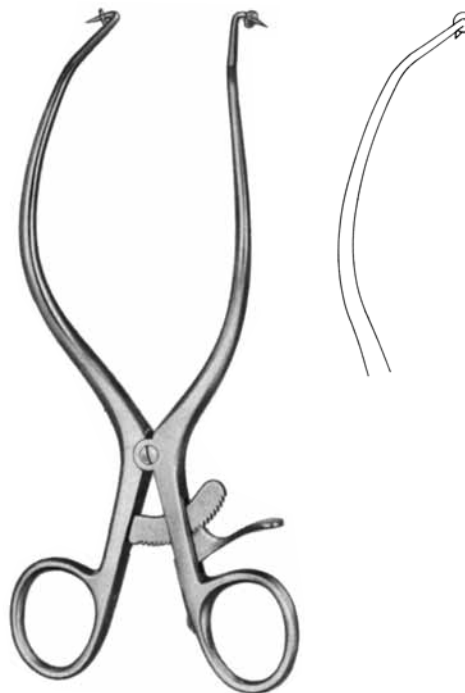

**GELPI**  
17.5905 18 cm



**GELPI-SELETZ**  
17.5907 15 cm

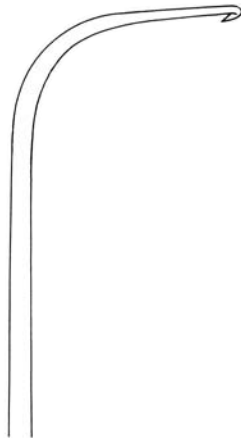

**JACKSON-BURROWS**  
17.5908 18,5 cm

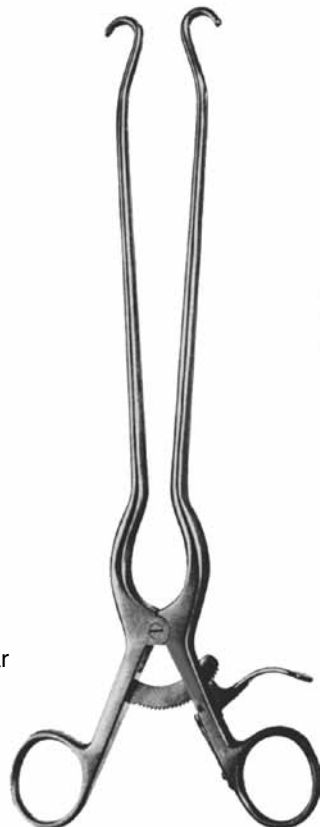

**MORRIS-MITRAL**  
40.3400  
16 cm



**GELPI-ORTHO**  
17.5906  
30 cm

Gefäßwundspreizer  
Vascular Retractor  
Ecarteur vasculaire  
Separador vascular  
Divaricatore vascolar

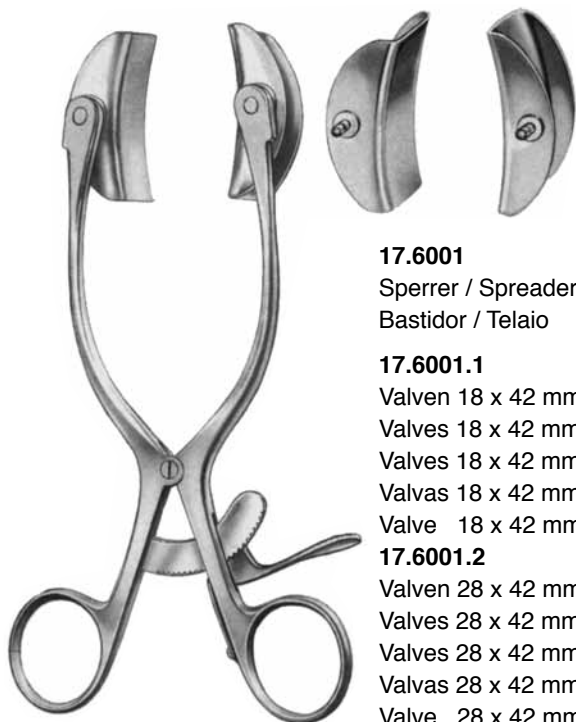

**17.6001**  
 Sperrer / Spreader / Cadre /  
 Bastidor / Telaio

**17.6001.1**  
 Valven 18 x 42 mm (Paar)  
 Valves 18 x 42 mm (Pair)  
 Valves 18 x 42 mm (Paire)  
 Valvas 18 x 42 mm (Par)  
 Valve 18 x 42 mm (Paio)

**17.6001.2**  
 Valven 28 x 42 mm (Paar)  
 Valves 28 x 42 mm (Pair)  
 Valves 28 x 42 mm (Paire)  
 Valvas 28 x 42 mm (Par)  
 Valve 28 x 42 mm (Paio)

**COLLIN-BABY**

**17.6000** 18 cm

bestehend aus:

- 17.6001 Rahmen
- 17.6001.1 1 Paar Valven 18x42 mm
- 17.6001.2 1 Paar Valven 28x42 mm

consisting of:

- 17.6001 Frame
- 17.6001.1 Blades 18x42 mm (Pair)
- 17.6001.2 Blades 28x42 mm (Pair)

comprenant:

- 17.6001 cadre seul
- 17.6001.1 valves 18x42 mm (paire)
- 17.6001.2 valves 28x42 mm (paire)

compuetso de:

- 17.6001 bastidor suelto
- 17.6001.1 valvas 18x42 mm (par)
- 17.6001.1 valvas 28x42 mm)

composto da:

- 17.6001 Telaio solo
- 17.6001.1 valve 18x42mm (par)
- 17.6001.2 valve 28x42 mm (par)



**COLLIN**

**17.6002** 22 cm  
 38 x 60 mm

Valven / Lateral blades / valves latérales  
 / valvas laterales / valve laterali 38 x  
 60 mm



**COLLIN**

22 cm

**17.6003**

Seitenvalven / Lateral blades / valves  
 latérales / valvas laterales / valve  
 laterali 38 x 60 mm

Mittelvalve / center blade / valve  
 central / valva centrale / valva  
 centrale 38 x 55 mm

**17.6004**

Seitenvalven / Lateral blades / valves  
 latérales / valvas laterales / valve  
 laterali 38 x 80 mm

Mittelvalve / center blade / valve  
 central / valva centrale / valva  
 centrale 50 x 75 mm



### COLLIN-LOCKTITE

17.6007 26 cm

60 x 80 mm

Seitenvalven / Lateral blades /  
valves latérales / valvas laterales /  
valve laterali 60 x 80 mm

Mittelvalve / center blade /  
valve central / valva centrale /  
valva centrale 60 x 75 mm

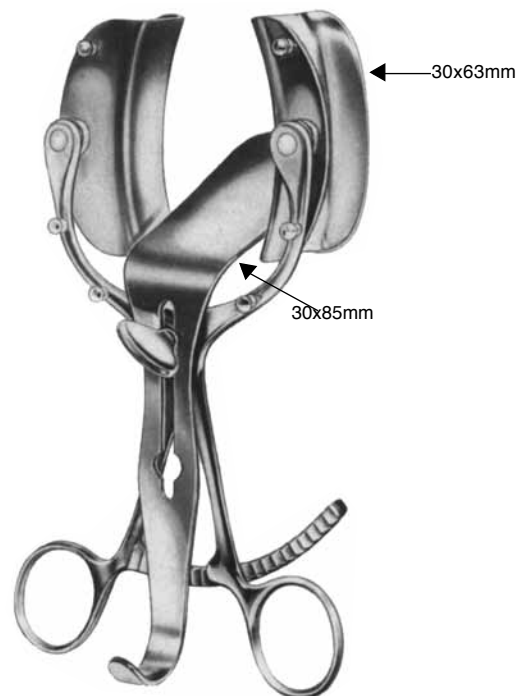

### LEGUEU

17.6010 18 cm



### MAYO-ADAMS

17.6015 17 cm



**HOLZBACH**  
**17.6020**



**RICARD**

**17.6030** 28 cm

Mittelvalve 55x70mm, Seitenvalven 50x58mm  
Centervalue 55x70, lateral blades 50x58 mm  
valve centrale 55x70, valves latérales 50x58mm  
valva central 55x70, valvas laterales 50x58mm  
valva centrale 55x70, valve laterali 50x58mm

**17.6035** 30 cm

Mittelvalve 80x90mm, Seitenvalven 60x80mm  
Centervalue 80x90, lat. blades 60x80 mm  
valve centrale 80x90, valves latérales 60x80mm  
valva central 80x90, valvas laterales 60x80mm  
valva centrale 80x90, valve laterali 60x80mm



## ROBIN-MASSE

17.6040 21cm

Mittelvalve 40x64mm, Seitenvlaven 38x62mm  
 Centervlaven 40x64, lat. blades 38x62 mm  
 valve centrale 40x64, valves latérales 38x62mm  
 valva central 40x64, valvas laterales 38x62mm  
 valva centrale 40x64, valve laterali 38x62mm

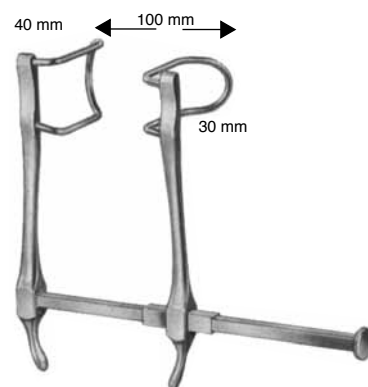

## GOSSET

17.6100 100 mm

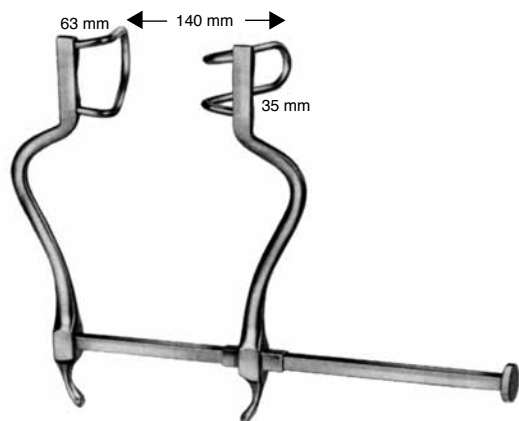

## GOSSET

17.6101 140mm

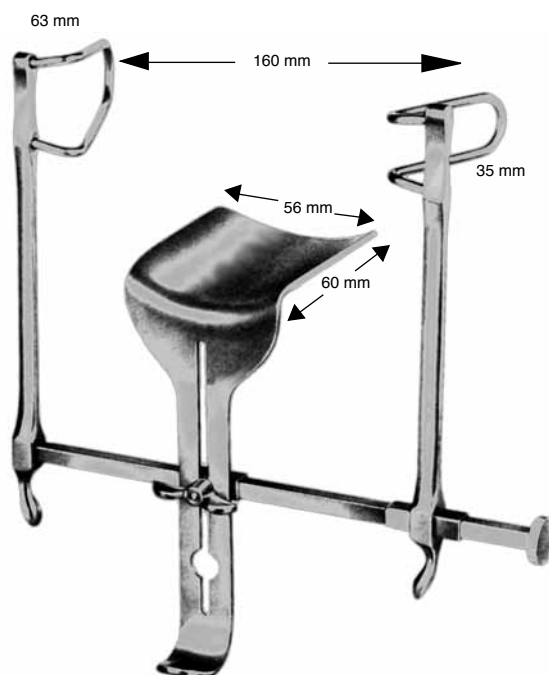

## GOSSET

17.6102 160mm



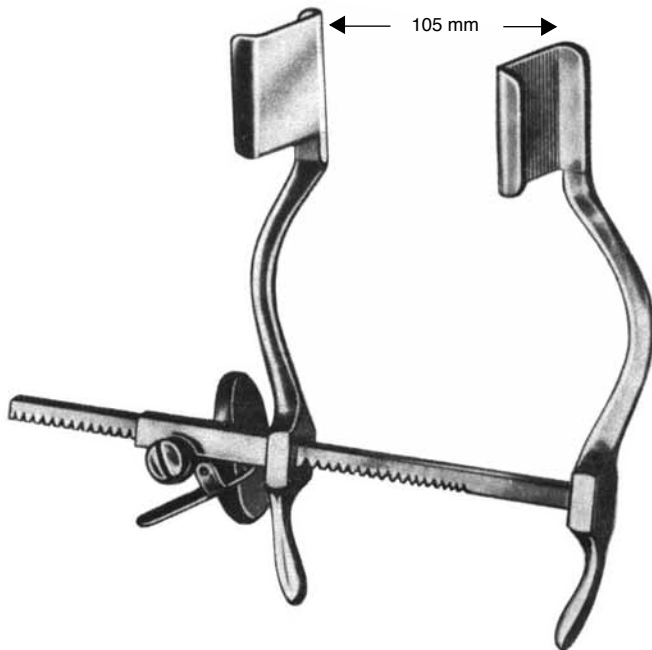

**HERTZLER**  
 17.6110

Spreizweite / spread / écartement / abertura / apertura 105 mm  
 Tiefe, Breite / Depth, Width / profondeur, largeur /  
 profundidad, ancho / profondità, larghezza : 25 x 25 mm



**BALFOUR-BABY**  
 17.6150 90 mm

Spreizweite / spread / écartement / abertura / apertura 90 mm

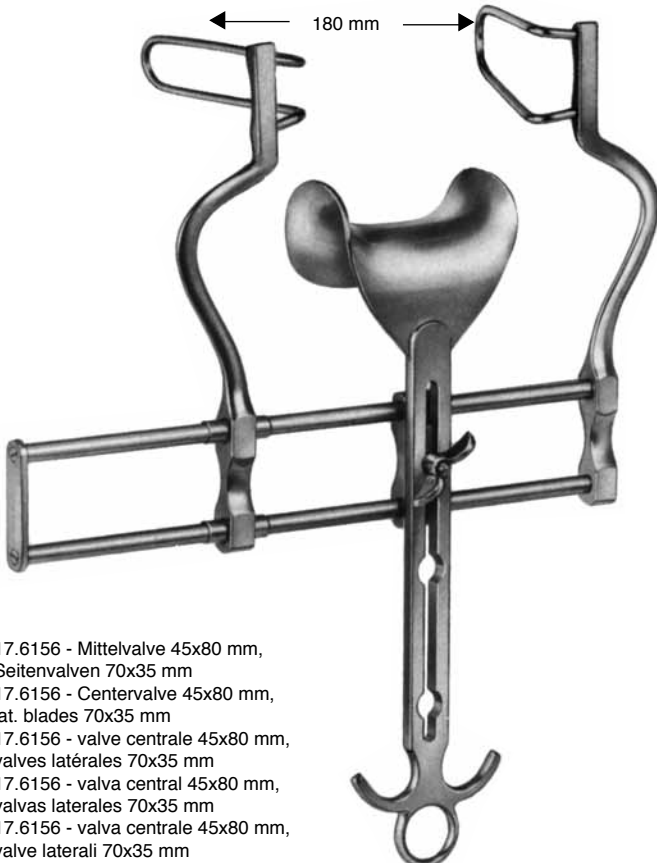

17.6156 - Mittelvalve 45x80 mm,  
 Seitenvlaven 70x35 mm  
 17.6156 - Centervlaven 45x80 mm,  
 lat. blades 70x35 mm  
 17.6156 - valve centrale 45x80 mm,  
 valves latérales 70x35 mm  
 17.6156 - valva central 45x80 mm,  
 valvas laterales 70x35 mm  
 17.6156 - valva centrale 45x80 mm,  
 valve laterali 70x35 mm

**BALFOUR**  
 17.6152 180 mm

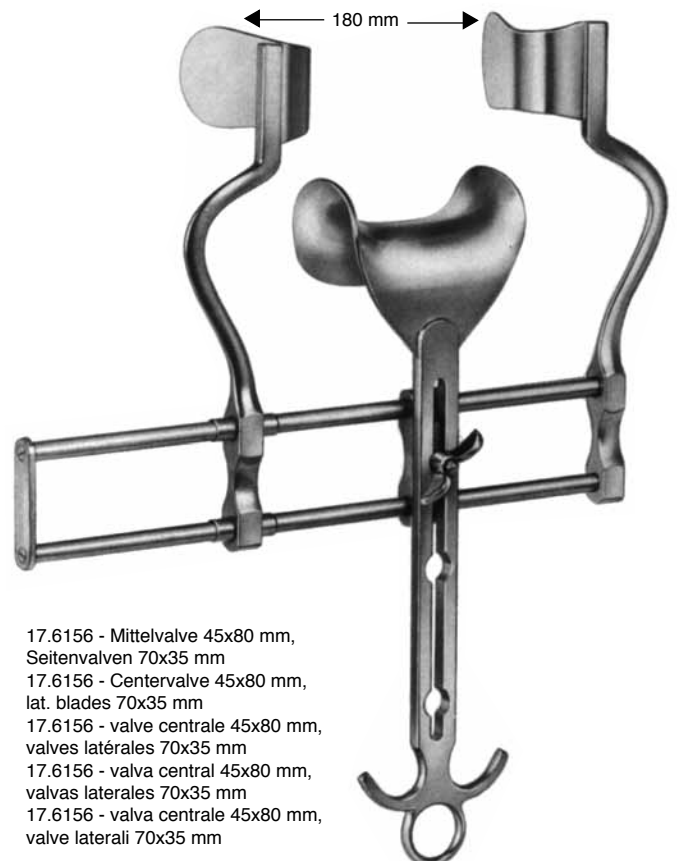

17.6156 - Mittelvalve 45x80 mm,  
 Seitenvlaven 70x35 mm  
 17.6156 - Centervlaven 45x80 mm,  
 lat. blades 70x35 mm  
 17.6156 - valve centrale 45x80 mm,  
 valves latérales 70x35 mm  
 17.6156 - valva central 45x80 mm,  
 valvas laterales 70x35 mm  
 17.6156 - valva centrale 45x80 mm,  
 valve laterali 70x35 mm

**BALFOUR**  
 17.6153 180 mm

17.6158 - Mittelvalve 70x85, Seitenvalven 100x35 mm  
 17.6158 - Centervalue 70x85, lateral blades 100x35 mm  
 17.6158 - valve centrale 70x85, valves latérales 100x35 mm  
 17.6158 - valva central 70x85, valvas laterales 100x35 mm  
 17.6158 - valva centrale 70x85, valve laterali 100x35 mm

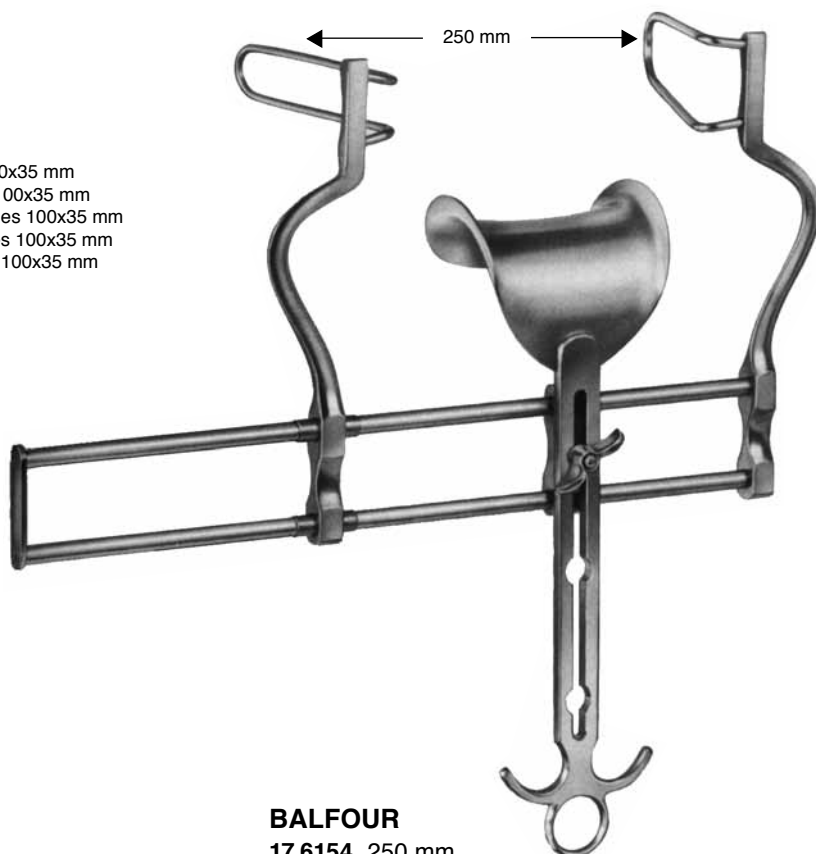

**BALFOUR**  
 17.6154 250 mm

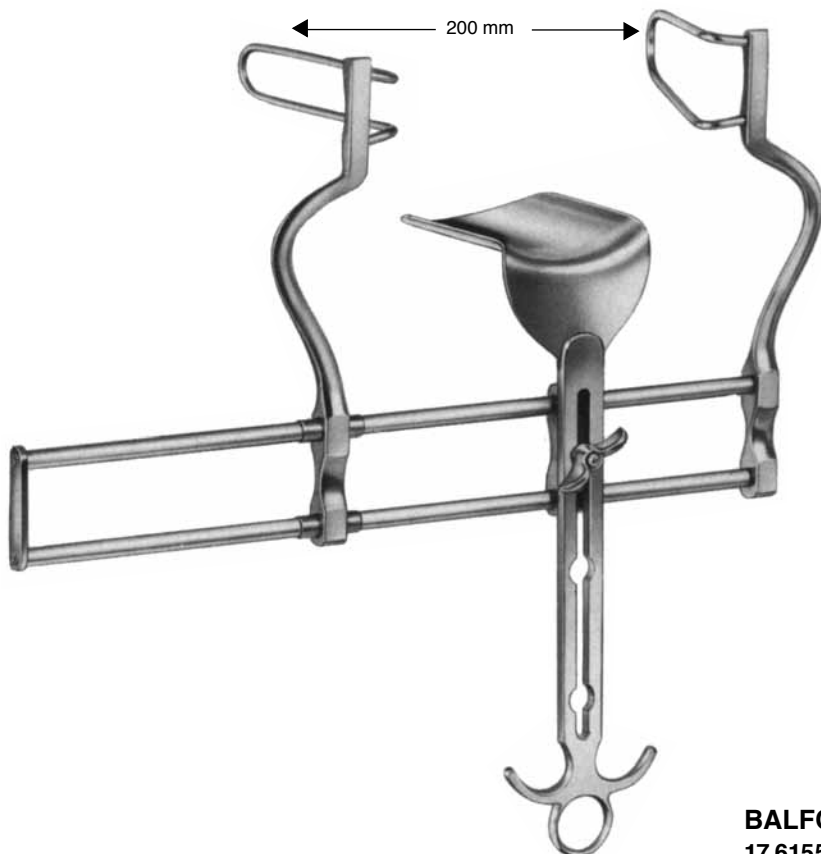

17.6157 - Mittelvalve 100x70mm,Seitenvalven 100x35 mm  
 17.6157 - Centervalue 100x70, lateral blades 100x35 mm  
 17.6157 - valve centrale 100x70, valves latérales 100x35 mm  
 17.6157 - valva central 100x70, valvas laterales 100x35 mm  
 17.6157 - valva centrale 100x70, valve laterali 100x35 mm

**BALFOUR**  
 17.6155 200 mm



**17.6174**  
 Paar/Pair  
 Pair/Par  
 Paio 89x45mm

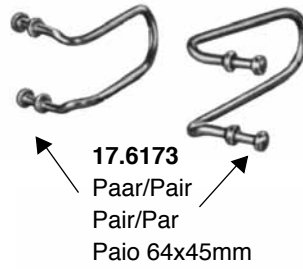

**17.6173**  
 Paar/Pair  
 Pair/Par  
 Paio 64x45mm

**17.6178L**  
 Seitenarm links  
 4th blade attachment left  
 Bras latéral à gauche  
 Brazo lateral izquierdo  
 Braccio lateral sinistra

**17.6178R**  
 Seitenarm rechts  
 4th blade attachment right  
 Bras latéral à droite  
 Brazo lateral derecho  
 Braccio lateral destra

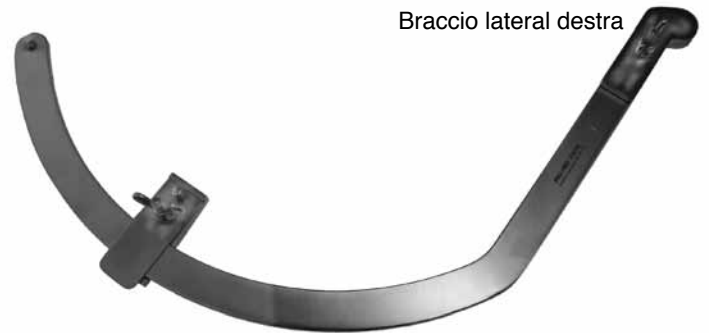

**BALFOUR-Modif.**  
**17.6170** 200 mm  
**17.6172** 265 mm  
 komplett/complete/  
 complet/completo/completo

**BALFOUR**  
**17.6178L**  
**17.6178R**

Mittelvalven für Bauchdeckenhalter  
 Center blades  
 Valves centrales  
 Valvas centrales  
 Valve centrali



**BALFOUR**  
**17.6156** 45 x 80 mm  
**17.6158** 70 x 85 mm  
**17.6159** 80 x 90 mm

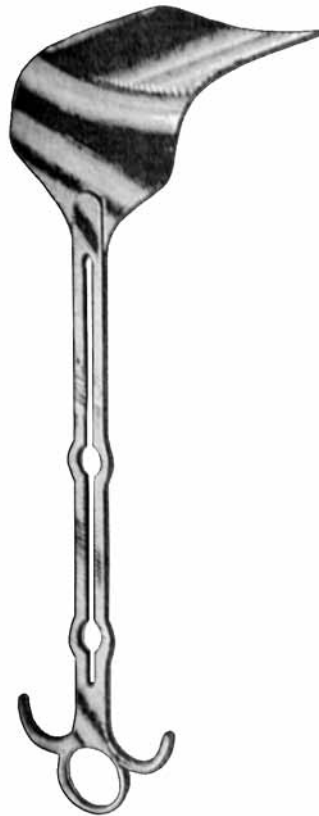

**BALFOUR**  
**17.6157** 100 x 70 mm



**HORGAN**  
**17.6176** 51 x 198 mm



**HORGAN**  
**17.6177** 51 x 127 mm

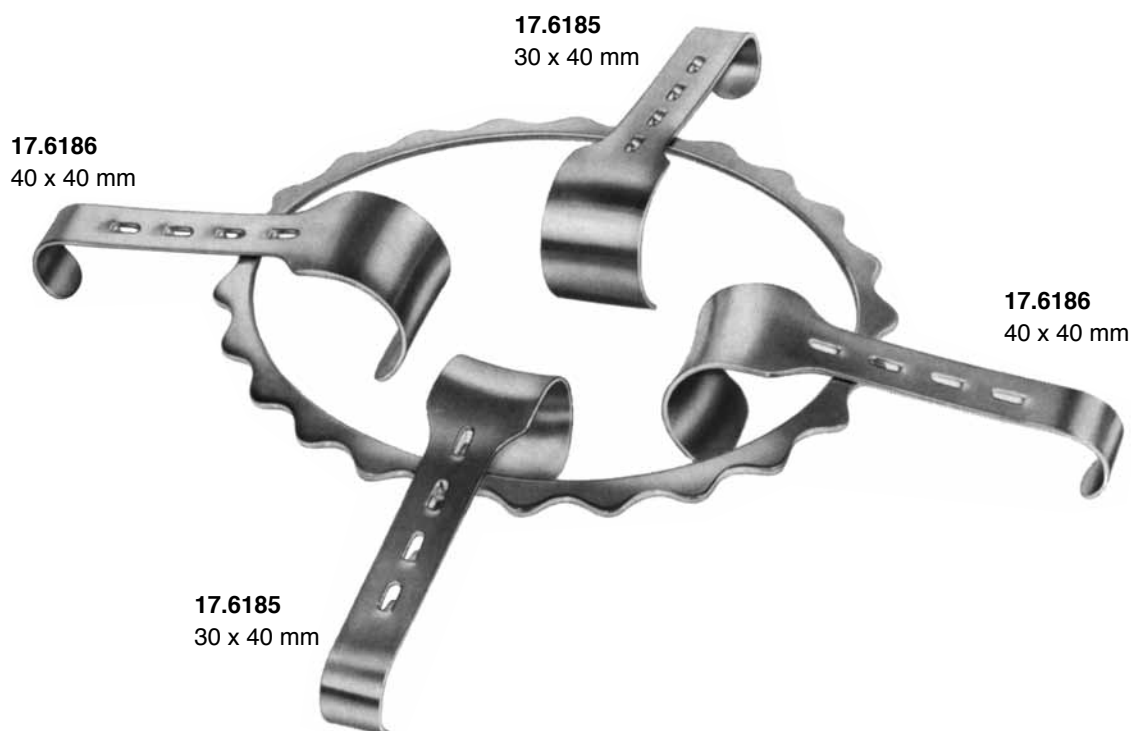

## DENIS-BROWN

**17.6180** für Kinder, bestehend aus:  
 17.6181 Rahmen 180x150 mm  
 17.6185 2 Valven 30x40 mm  
 17.6186 2 Valven 40x40 mm

for children, consisting of:  
 17.6181 Frame 180x150 mm  
 17.6185 2 valves 30x40 mm  
 17.6186 2 valves 40x40 mm

pour enfants, comprenant:  
 17.6181 cadre 180x150 mm  
 17.6185 2 valves 30x40 mm  
 17.6186 2 valves 40x40 mm

para niños, compuesto de:  
 17.6181 cuadro 180x150 mm  
 17.6185 2 valvas 30x40 mm  
 17.6186 2 valvas 40x40 mm

per bambini, composto da:  
 17.6181 telaio 180x150 mm  
 17.6185 2 valve 30x40 mm  
 17.6186 2 valve 40x40 mm

## DENIS-BROWN

**17.6182** für Erwachsene, bestehend aus:  
 17.6183 Rahmen 255x180 mm  
 17.6185 2 Valven 30x40 mm  
 17.6186 2 Valven 40x40 mm

for adults, consisting of:  
 17.6183 Frame 255x180 mm  
 17.6185 2 valves 30x40 mm  
 17.6186 2 valves 40x40 mm

pour adultes, comprenant:  
 17.6183 cadre 255x180 mm  
 17.6185 2 valves 30x40 mm  
 17.6186 2 valves 40x40 mm

para adultos, compuesto de:  
 17.6183 cuadro 255x180 mm  
 17.6185 2 valvas 30x40 mm  
 17.6186 2 valvas 40x40 mm

per adulti, composto da:  
 17.6183 telaio 255x180 mm  
 17.6185 2 valve 30x40 mm  
 17.6186 2 valve 40x40 mm

## DENIS-BROWN

**17.6181** Rahmen / frame / cadre / cuadro / telaio 180 x150 mm

**17.6183** Rahmen / frame / cadre / cuadro / telaio 255 x180 mm

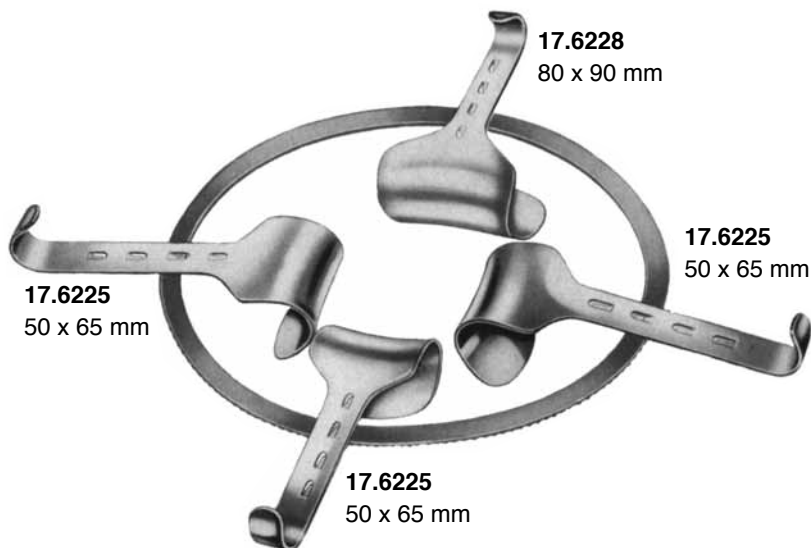

**KIRSCHNER**

17.6211 300x240 mm  
 Rahmen allein / Frame only / Cadre, seul / Cuadro, solo / Telaio, solo

**KIRSCHNER**

17.6210 bestehend aus  
 17.6211 ovaler Rahmen 300x240 mm  
 17.6225 3 Valven 50x65 mm  
 17.6228 1 Valve 80x90 mm  
 17.6229 1 Valve 98x50 mm  
 17.6230 1 Valve 105x35 mm  
 consisting of:  
 17.6211 oval Frame 300x240 mm  
 17.6225 3 valves 50x65 mm  
 17.6228 1 valve 80x90 mm  
 17.6229 1 valve 98x50 mm  
 17.6230 1 valve 105x35 mm  
 comprenant:  
 17.6211 cadre oval 300x240 mm  
 17.6225 3 Valves 50x65 mm  
 17.6228 1 Valve 80x90 mm  
 17.6229 1 Valve 98x50 mm  
 17.6230 1 Valve 105x35 mm  
 compuesto de:  
 17.6211 cuadro oval 300x240 mm  
 17.6225 3 valvas 50x65 mm  
 17.6228 1 valva 80x90 mm  
 17.6229 1 valva 98x50 mm  
 17.6230 1 valva 105x35 mm  
 composto da:  
 17.6211 telaio oval 300x240 mm  
 17.6225 3 valve 50x65 mm  
 17.6228 1 valva 80x90 mm  
 17.6229 1 valva 98x50 mm  
 17.6230 1 valva 105x35 mm

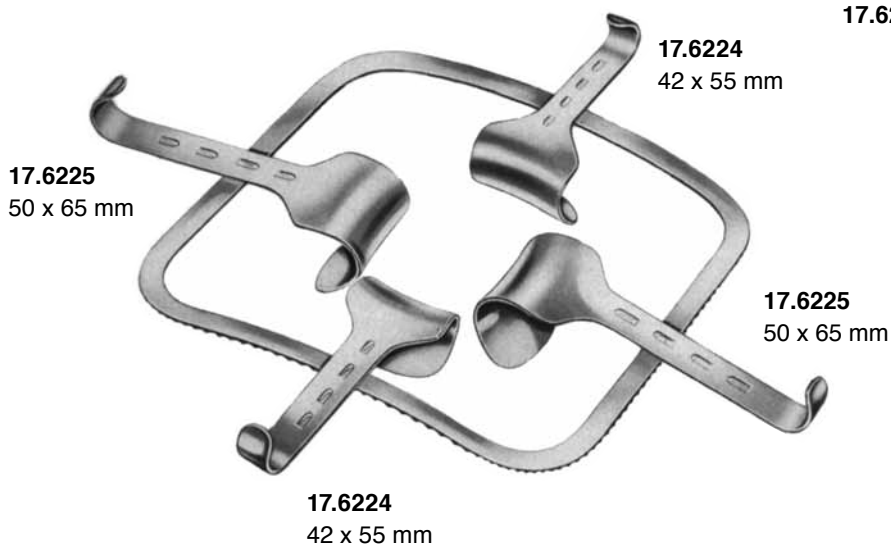

**KIRSCHNER**

17.6222 Rahmen allein / Frame only / Cadre, seul / Cuadro, solo / Telaio, solo

**KIRSCHNER**

17.6220 bestehend aus:  
 17.6222 starrer Rahmen 250x250 mm  
 17.6224 2 Valven 42 x 55 mm  
 17.6225 2 Valven 50 x 65 mm  
 consisting of:  
 17.6222 rigid frame 250x250 mm  
 17.6224 2 valves 42 x 55 mm  
 17.6225 2 valves 50 x 65 mm  
 comprenant:  
 17.6222 cadre fixe 250 x 250 mm  
 17.6224 2 valves 42 x 55 mm  
 17.6225 2 valves 50 x 65 mm  
 compuesto de:  
 17.6222 cuadro fijo 250 x 250 mm  
 17.6224 2 valvas 42 x 55 mm  
 17.6225 2 valvas 50 x 65 mm  
 composto da:  
 17.6222 telaio fisso 250 x 250 mm  
 17.6224 2 valve 42 x 55 mm  
 17.6225 2 valce 50 x 65 mm

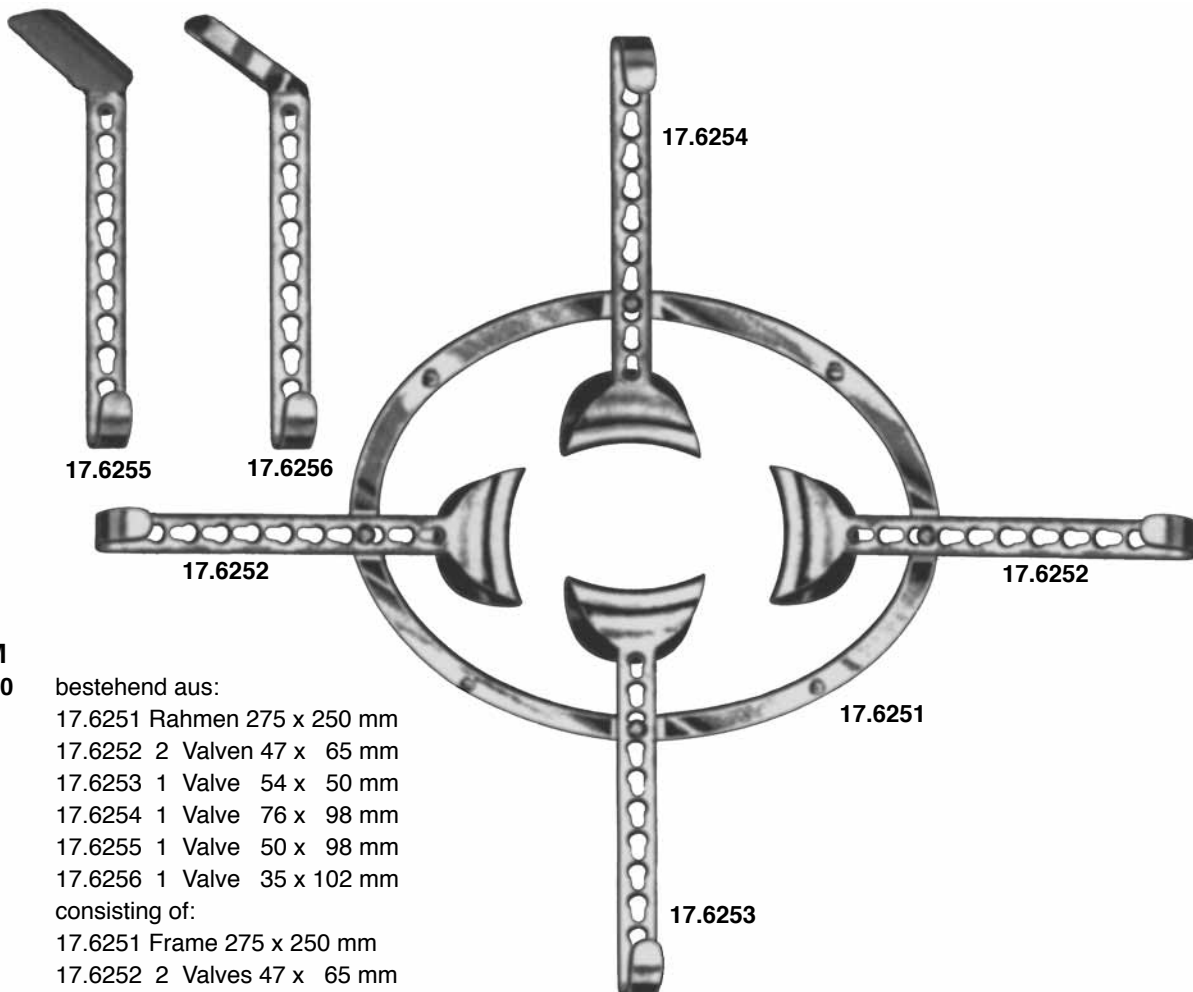

**SEMM  
 17.6250**

bestehend aus:

- 17.6251 Rahmen 275 x 250 mm
- 17.6252 2 Valven 47 x 65 mm
- 17.6253 1 Valve 54 x 50 mm
- 17.6254 1 Valve 76 x 98 mm
- 17.6255 1 Valve 50 x 98 mm
- 17.6256 1 Valve 35 x 102 mm

consisting of:

- 17.6251 Frame 275 x 250 mm
- 17.6252 2 Valves 47 x 65 mm
- 17.6253 1 Valve 54 x 50 mm
- 17.6254 1 Valve 76 x 98 mm
- 17.6255 1 Valve 50 x 98 mm
- 17.6256 1 Valve 35 x 102 mm

comprenant:

- 17.6251 Cadre 275 x 250 mm
- 17.6252 2 Valves 47 x 65 mm
- 17.6253 1 Valve 54 x 50 mm
- 17.6254 1 Valve 76 x 98 mm
- 17.6255 1 Valve 50 x 98 mm
- 17.6256 1 Valve 35 x 102 mm

compuesto de:

- 17.6251 Cuadro 275 x 250 mm
- 17.6252 2 Valvas 47 x 65 mm
- 17.6253 1 Valva 54 x 50 mm
- 17.6254 1 Valva 76 x 98 mm
- 17.6255 1 Valva 50 x 98 mm
- 17.6256 1 Valva 35 x 102 mm

composto da:

- 17.6251 Telaio 275 x 250 mm
- 17.6252 2 Valve 47 x 65 mm
- 17.6253 1 Valva 54 x 50 mm
- 17.6254 1 Valva 76 x 98 mm
- 17.6255 1 Valva 50 x 98 mm
- 17.6256 1 Valva 35 x 102 mm

**SEMM**

**17.6251** 275 x 250 mm

Rahmen allein / Frame only / Cadre, seul /  
 Cuadro, solo / Telaio, solo

**17.6252** 47 x 65 mm

**17.6253** 54 x 50 mm

**17.6254** 76 x 98 mm

**17.6255** 50 x 98 mm

**17.6256** 35 x 135 mm

Valve / Blades / Lames / Valvas / Valve

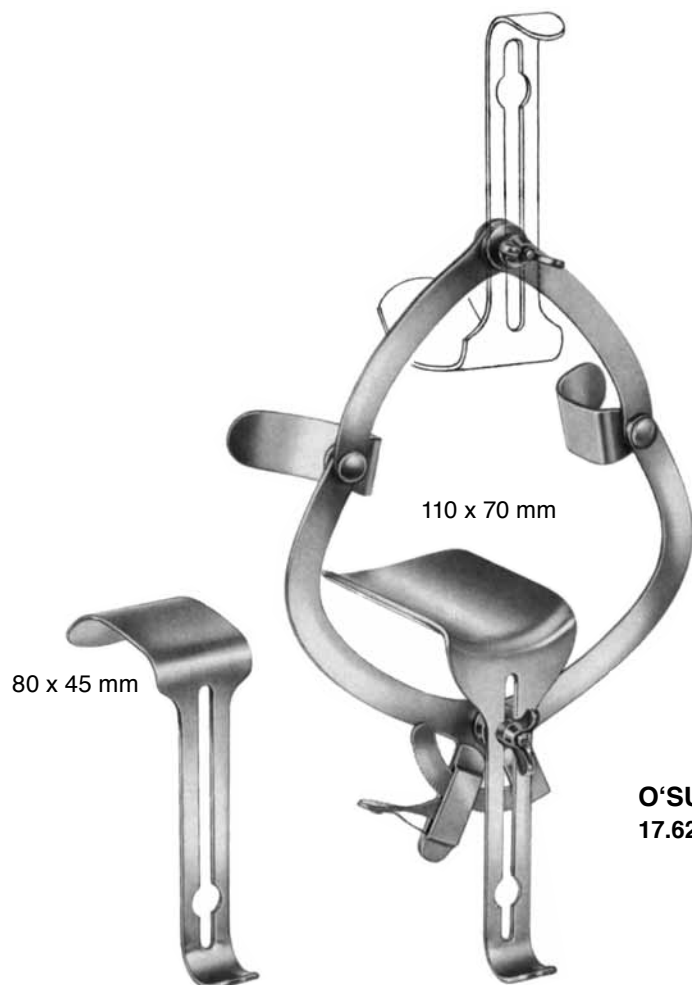

#### O'SULLIVAN-O'CONNOR

**17.6260**

bestehend aus:

17.6261 Rahmen mit 2 Seitenvalven 62 x 25 mm

17.6262 2 Valven 85 x 45 mm

17.6263 1 Valve 105 x 70 mm

consisting of:

17.6261 Frame with 2 lateral valves 62 x 25 mm

17.6262 2 Valves 85 x 45 mm

17.6263 1 Valve 105 x 70 mm

comprenant:

17.6261 Cadre avec 2 valves latérales 62 x 25 mm

17.6262 2 Valves 85 x 45 mm

17.6263 1 Valve 105 x 70 mm

compuesto de:

17.6261 Cuadro con 2 valvas laterales 62 x 25 mm

17.6262 2 Valves 85 x 45 mm

17.6263 1 Valva 105 x 70 mm

composta da:

17.6261 Telaio con 2 valve laterali 62 x 25 mm

17.6262 2 Valve 85 x 45 mm

17.6263 1 Valva 105 x 70 mm

**17.6261**

Rahmen allein / Frame only / Cadre, seul /  
Cuadro, solo / Telaio, solo

**17.6262**

45 x 85 mm

**17.6263**

70 x 105 mm

Valve / Blades / Lames / Valvas / Valve

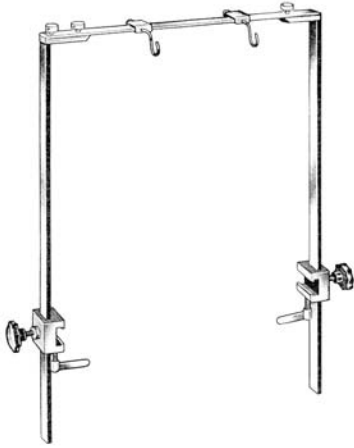

**ROCHARD**  
**17.6277**  
 Rahmen, doppelt  
 Frame, double  
 Cadre, double  
 Quadro doble  
 Telaio doppio

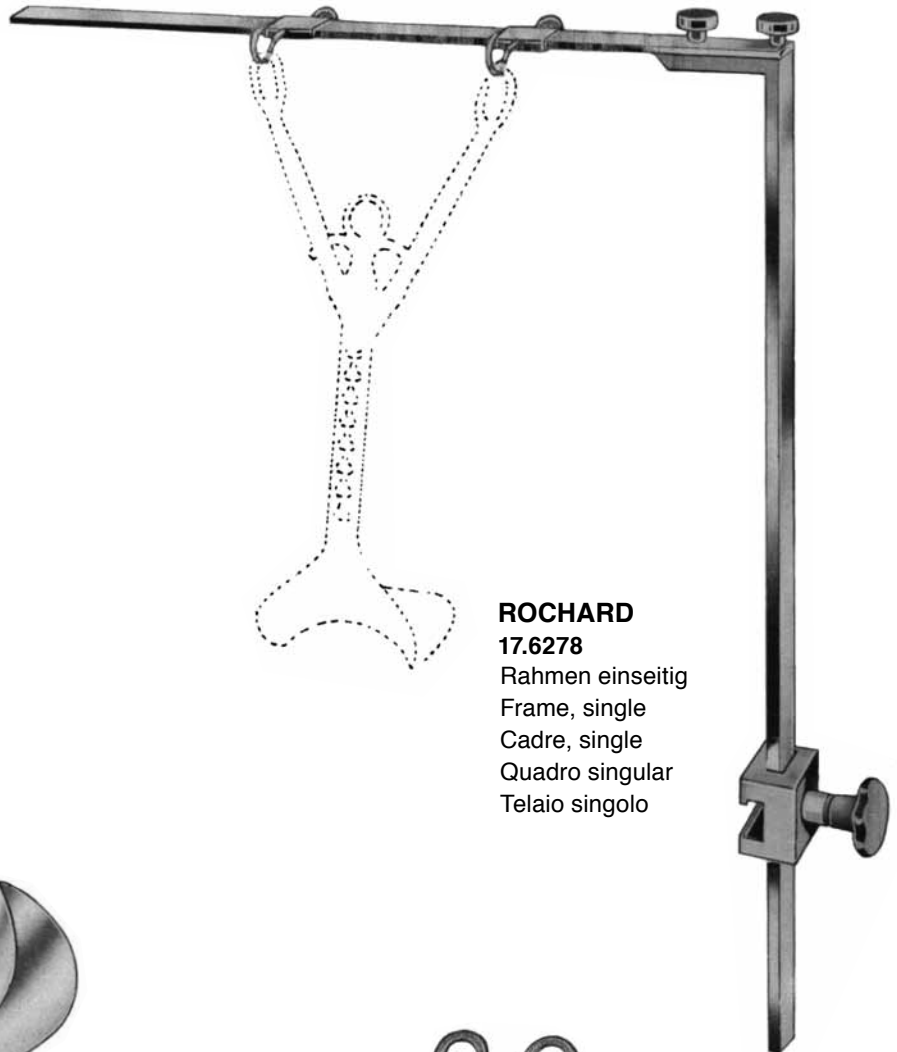

**ROCHARD**  
**17.6278**  
 Rahmen einseitig  
 Frame, single  
 Cadre, single  
 Quadro singular  
 Telaio singolo



**ROCHARD**  
**17.6270** 95 mm  
**17.6271** 105 mm  
**17.6272** 120 mm  
**17.6273** 135 mm  
**17.6274** 155 mm



**ROCHARD**  
**17.6279**  
 Fixiervorrichtung  
 Fixation device  
 Compas articulé  
 Dispositivo de fijación  
 Dispositivo di fissaggio





**DOYEN**

17.6350 55 x 95 mm  
17.6353 55 x 105 mm  
17.6354 55 x 115 mm  
17.6355 55 x 125 mm

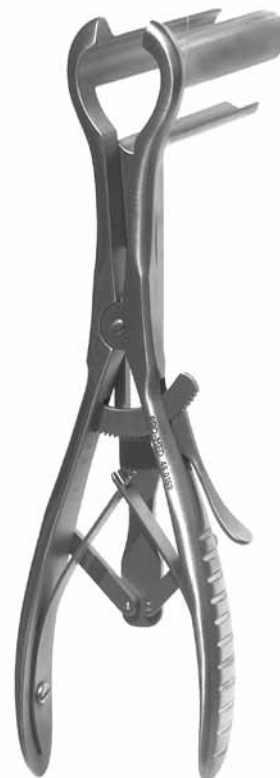

**ABDOMINAL**

46.0169 20,5 cm  
Spekulum 70 mm / 90°  
Abdominal Specula 70 mm / 90°  
Spéculum abdominal 70 mm / 90°  
espéculeo abdominale 70 mm / 90°  
Specola abdominale 70 mm / 90°



**17.6309** 8 mm  $\varnothing$

20 Ersatzknöpfe

20 Spare buttons

20 Boutons de rechange

20 Botones de repuesto

20 Bottone de ricambio

## FOERSTER

**17.6300**  $\varnothing$  255 mm

Kunststoff, schwarz, röntgenfähig, komplett mit 4 Valven Nr. 17.6303

plastic, black, transparent to X-Ray, complete with 4 valves 17.6303

plastique, noir, transparent aux rayons X, complet avec 4 valves 17.6303

plástico, negro, transparente a los rayos-X, completo con 4 valvas 17.6303

plastica, nero, radiotrasparente, completo con 4 valve 17.6303

## 17.6301

Rahmen / frame / Cadre / Cuadro / Telaio  $\varnothing$  255 mm



**17.6303** 50 x 65 mm



**17.6304** 65 x 75 mm

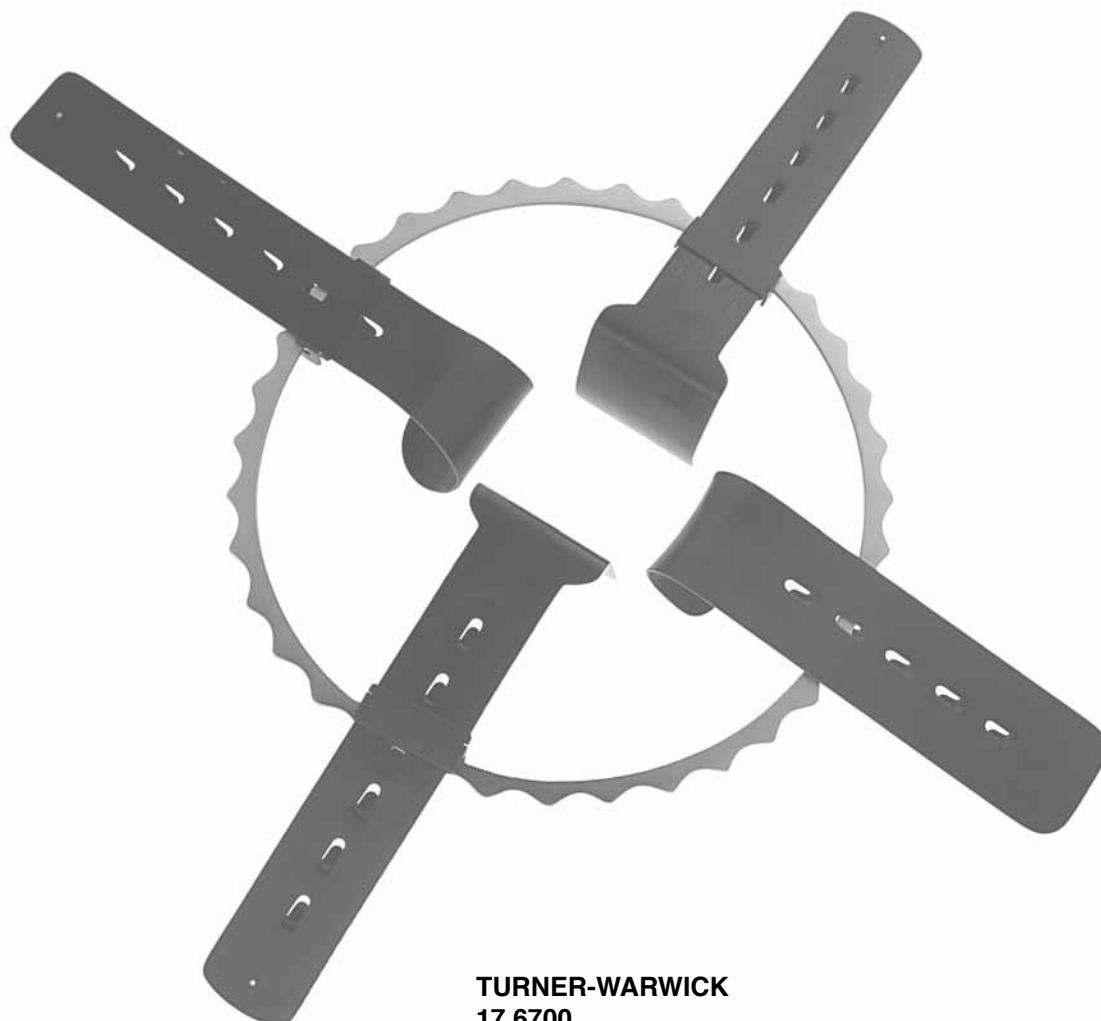

**TURNER-WARWICK**

**17.6700**

bestehend aus

consisting of:

comprendant:

compuesto de:

composta da:

17.6701 1

17.6702 1

17.6703 1

17.6710 2

17.6711 2

17.6712 2

17.6713 2

17.6714 2

17.6715 2

17.6716 2

17.6717 2

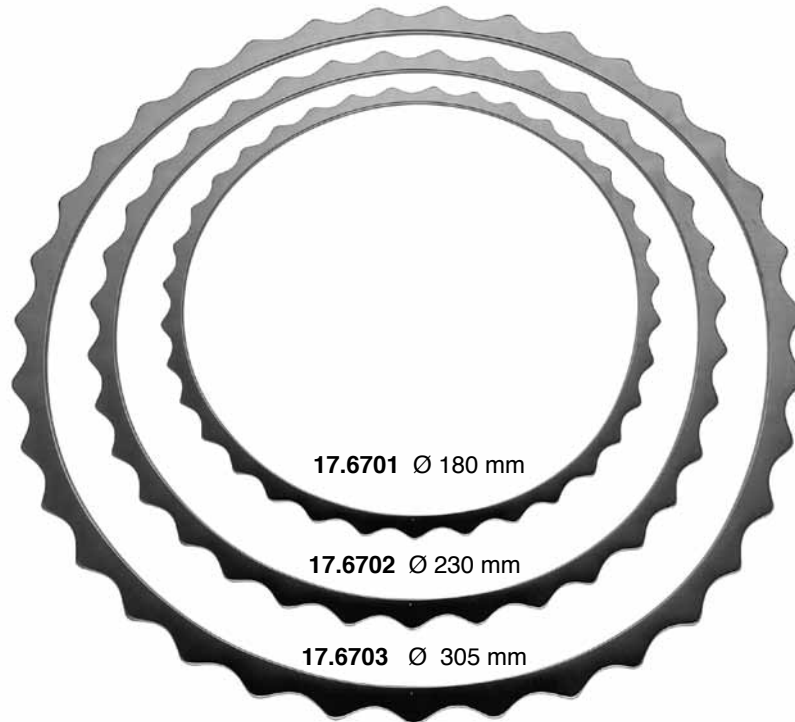

17.6701 Ø 180 mm

17.6702 Ø 230 mm

17.6703 Ø 305 mm

**TURNER-WARWICK**

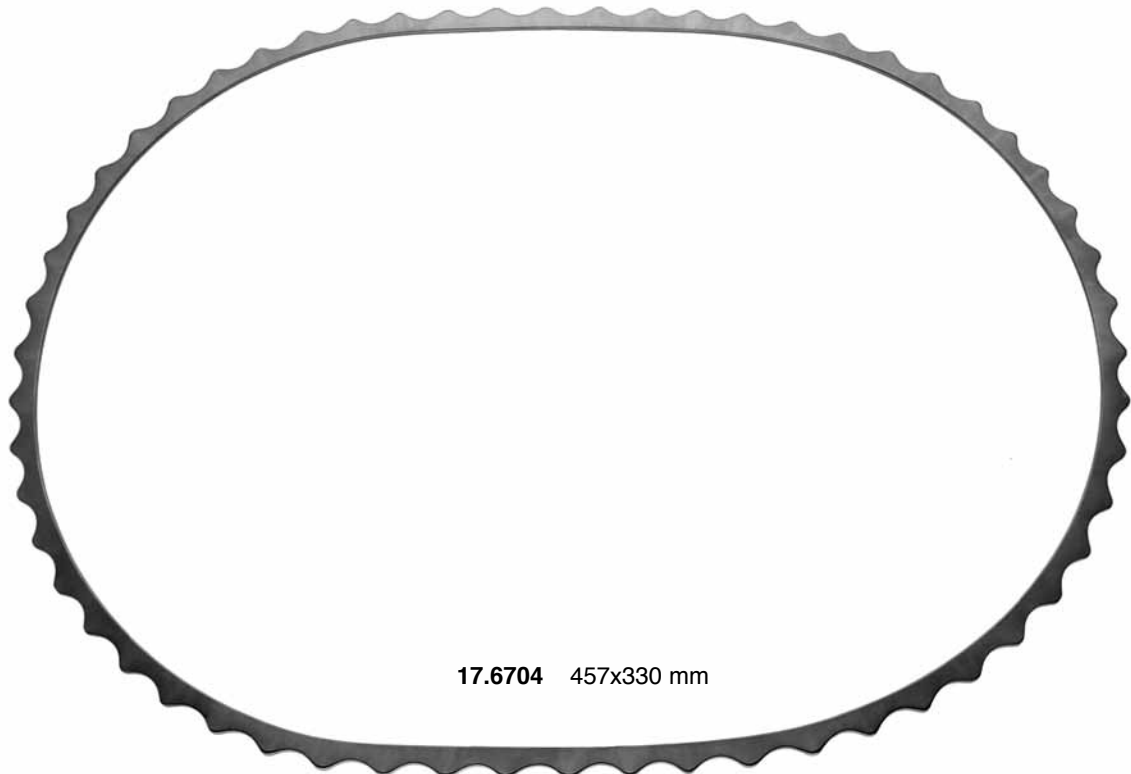

17.6704 457x330 mm

**TURNER-WARWICK**



**TURNER-WARWICK**  
17.6710 76 x 19 mm

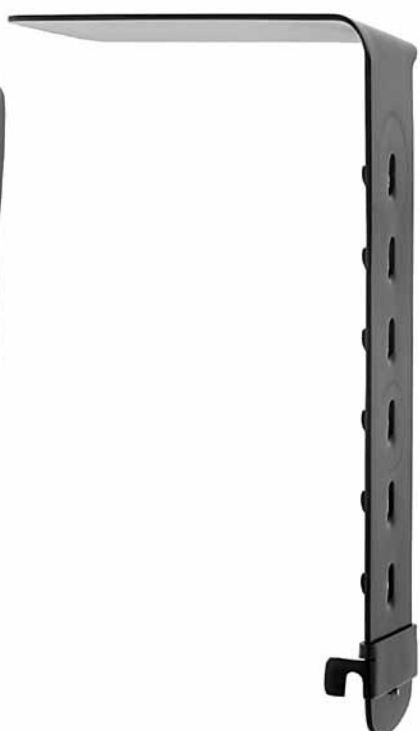

**TURNER-WARWICK**  
17.6711 102 x 38 mm



**TURNER-WARWICK**  
17.6712 89 x 57 mm



**TURNER-WARWICK**  
17.6713 114 x 57 mm



**TURNER-WARWICK**  
17.6714 51 x 38 mm

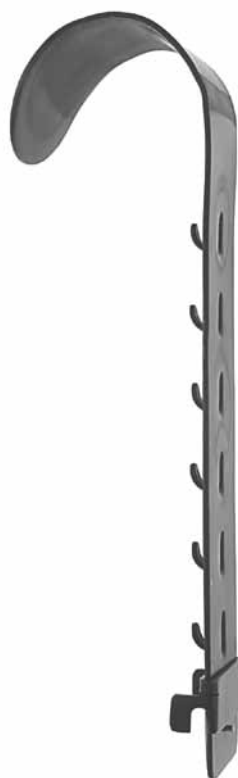

**TURNER-WARWICK**  
17.6715 76 x 60 mm

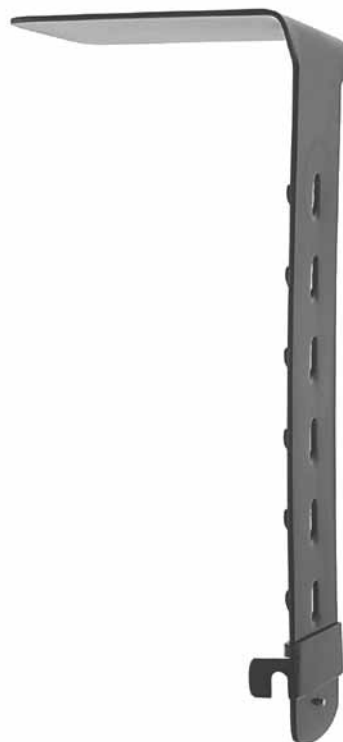

**TURNER-WARWICK**  
17.6716 89 x 60 mm  
17.6717 114 x 60 mm



**TURNER-WARWICK**  
17.6718 13 mm

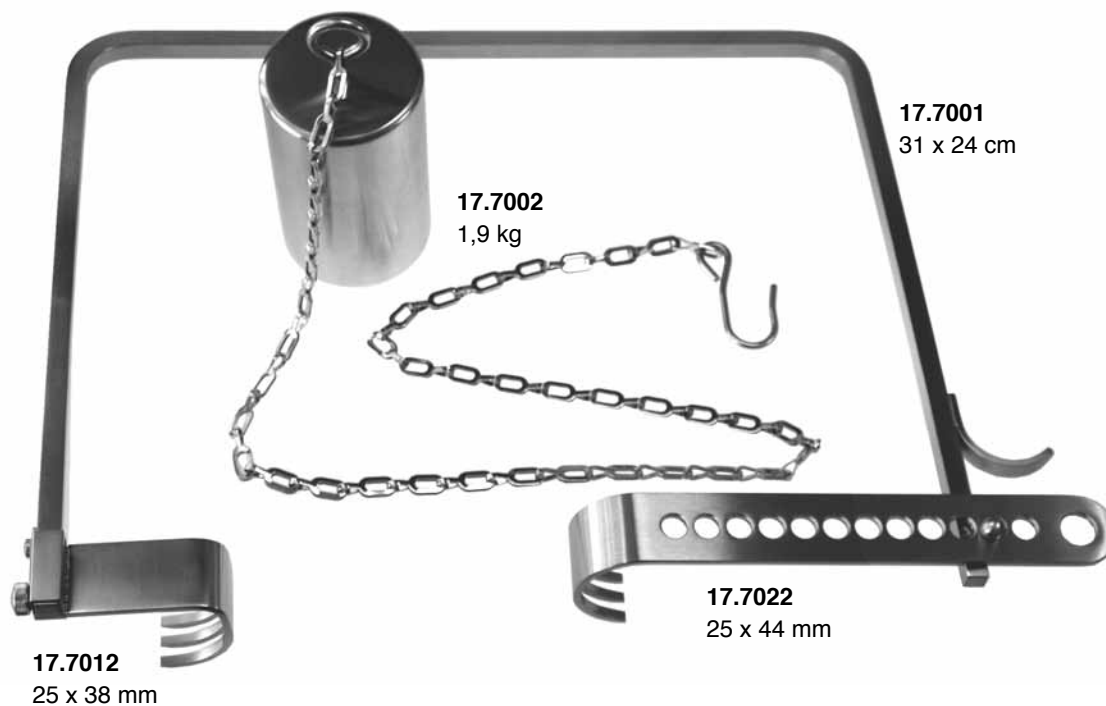

**CHARNLEY compl.**  
**17.7000**

bestehend aus:

consisting of:

comprendand:

compuesto de:

composta da:

17.7001 Rahmen / Frame / Cadre / Cuadro / Telaio 31 x 24 cm

17.7002 Gewicht mit Kette / Weight with chain / poids avec chaîne /  
peso con cadena / peso con catena

17.7012 Valve / Valve / Valva / Valve 25 x 38 mm

17.7022 Valve / Valve / Valva / Valve 25 x 44 mm



NAHT  
SUTURE  
SUTURE  
SUTURA  
SUTURA









**CASTROVIEJO**



**18.0800** 14 cm  
**18.0802** 18 cm  
**18.0804** 22 cm

**18.1800** 14 cm  
**18.1802** 18 cm  
**18.1804** 22 cm



**18.0810**  
**18.0812**  
**18.0814**

**18.1810**  
**18.1812**  
**18.1814**



**18.0801** 14 cm  
**18.0803** 18 cm  
**18.0805** 22 cm

**18.1801** 14 cm  
**18.1803** 18 cm  
**18.1805** 22 cm



**18.0811**  
**18.0813**  
**18.0815**

**18.1811**  
**18.1813**  
**18.1815**



**CASTROVIEJO**

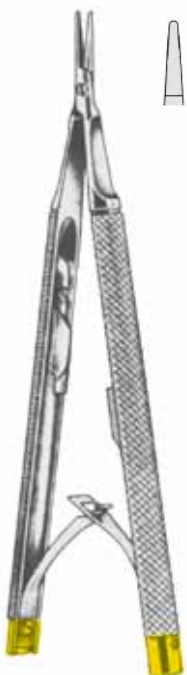

**CASTROVIEJO**  
**18.0840** 13 cm

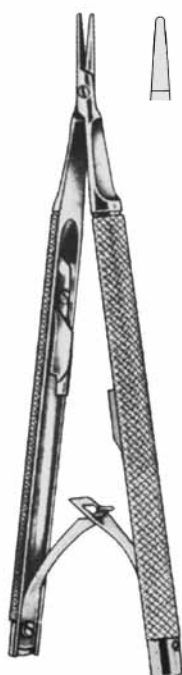

**CASTROVIEJO**  
**18.1840** 13 cm



**BOYNTON**  
**18.1850** 12 cm



21 cm

mit Sperre  
with lock  
avec arrêt  
con cierre  
con caramagliera

**28.3154**  
gerade  
straight  
droit  
recto  
retto

**28.3155**  
gebogen  
curved  
courbe  
curvo  
curvo



23 cm

mit Sperre  
with lock  
avec arrêt  
con cierre  
con caramagliera

**28.3156**  
gerade  
straight  
droit  
recto  
retto

**28.3157**  
gebogen  
curved  
courbe  
curvo  
curvo



15 cm

**28.3242**  
gerade  
straight  
droit  
recto  
retto

**28.3243**  
gebogen  
curved  
courbe  
curvo  
curvo



18 cm

**28.3252**  
gerade  
straight  
droit  
recto  
retto

**28.3253**  
gebogen  
curved  
courbe  
curvo  
curvo



21 cm

**28.3254**

gerade  
straight  
droit  
recto  
retto

**28.3255**

gebogen  
curved  
courbe  
curvo  
curvo



23 cm

**28.3256**

gerade  
straight  
droit  
recto  
retto

**28.3257**

gebogen  
curved  
courbe  
curvo  
curvo



Diamantbeschichtete Spitzen  
Diamond coated tips  
Avec bouts de diamant  
Puntas con cascós de diamante  
Morsi con rivestimento di diamante



Maul 2 mm breit gerieft  
Jaws 2 mm wide serrated  
mors 2 mm, dentelées  
boca 2 mm, dentadas  
morso 2 mm, dentate

**28.3662**

18 cm / 10 mm

**28.3664**

21 cm / 10 mm

**GREGORY**



**28.3662D**

18 cm / 10 mm

**28.3664D**

21 cm / 10 mm





**GREGORY**





**TITANIUM**











Diamantbeschichtete Spitzen  
 Diamond coated tips  
 Avec bouts de diamant  
 Puntas con cascos de diamante  
 Morsi con rivestimento di diamante

mit Sperre  
 with lock  
 avec arrêt  
 con cierre  
 con arresto

				
0,4mm				
15 cm		<b>28.3630</b>	28.3630SD	28.3630S
18 cm		<b>28.3632</b>	28.3632SD	28.3632S
21 cm		<b>28.3634</b>	28.3634SD	28.3634S
23 cm		<b>28.3636</b>	28.3636SD	28.3636S

				
0,4mm				
15 cm		<b>28.3631</b>	28.3631SD	28.3631S
18 cm		<b>28.3633</b>	28.3633SD	28.3633S
21 cm		<b>28.3635</b>	28.3635SD	28.3635S
23 cm		<b>28.3637</b>	28.3637SD	28.3637S

				
0,8mm				
15 cm		<b>28.3640</b>	28.3640SD	28.3640S
18 cm		<b>28.3642</b>	28.3642SD	28.3642S
21 cm		<b>28.3644</b>	28.3644SD	28.3644S
23 cm		<b>28.3646</b>	28.3646SD	28.3646S

				
0,8mm				
15 cm		<b>28.3641</b>	28.3641SD	28.3641S
18 cm		<b>28.3643</b>	28.3643SD	28.3643S
21 cm		<b>28.3645</b>	28.3645SD	28.3645S
23 cm		<b>28.3647</b>	28.3647SD	28.3647S

**TITANIUM**

**TITANIUM**

## TITANIUM



Diamantbeschichtete Spitzen  
 Diamond coated tips  
 Avec bouts de diamant  
 Puntas con cascós de diamante  
 Morsi con rivestimento di diamante

ohne Sperre  
 without lock  
 sans arrêt  
 sin cierre  
 senza caramagliera



1 mm  
 21 cm



**28.3700**



28.3700SD



28.3700S

1 mm  
 21 cm



**28.3701**



28.3701SD



28.3701S

1 mm  
 23 cm



**28.3702**



28.3702SD



28.3702S

1 mm  
 23 cm



**28.3703**



28.3703SD



28.3703S

TITANIUM

TITANIUM



MIKRO-NADELHALTER MIT PROFILGRIFF  
MICRO-NEEDLEHOLDERS WITH PROFILE HANDLE  
MICRO-PORTE-AIGUILLES AVEC MANCHE PROFIL  
MICRO-PORTA-AGUJAS CON MANGO "PERFIL"  
MICRO-PORTHAGI CON MANICO "PROFILO"

**PRO-MED**



**28.3504** 20,0 cm  
**28.3506** 22,0 cm



**28.3501** 16,0 cm  
**28.3505** 20,0 cm  
**28.3507** 22,0 cm  
**28.3509** 24,0 cm



<p><b>NEIVERT</b> 18.0050 12 cm</p>	<p><b>BABY-CRILE-WOOD</b> 18.0069 15 cm</p>	<p><b>CRILE-WOOD</b></p>	<p><b>18.0070</b> 15 cm</p>	<p><b>18.0071</b> 15 cm</p>	
			<p><b>18.0070L</b> 15 cm für Linkshänder for left-handers pour gauchers para zurdos per mono sinistra</p>		
			<p><b>18.0072</b> 18 cm</p>	<p><b>18.0074</b> 20 cm</p>	<p><b>18.0076</b> 23 cm</p>
			<p><b>18.0072L</b> 18 cm</p>	<p><b>18.0074L</b> 20 cm</p>	<p><b>18.0076L</b> 23 cm</p>
			<p>für Linkshänder / for left-handers / pour gauchers para zurdos / per mono sinistra</p>		

## TITANIUM

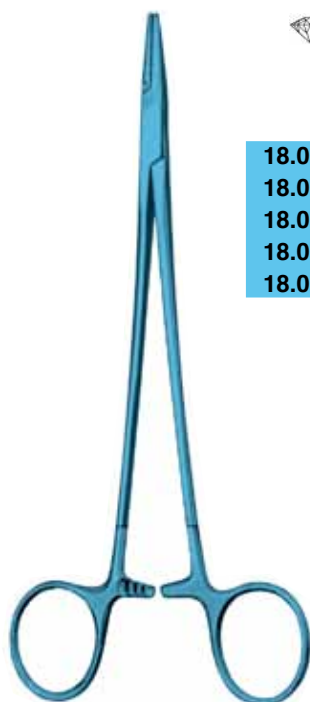

**MICRO-VASCULAR**







- 18.0016TD** 12,5 cm
- 18.0070TD** 14,5 cm
- 18.0100TD** 17,5 cm
- 18.0102TD** 19,5 cm
- 18.0104TD** 22,5 cm

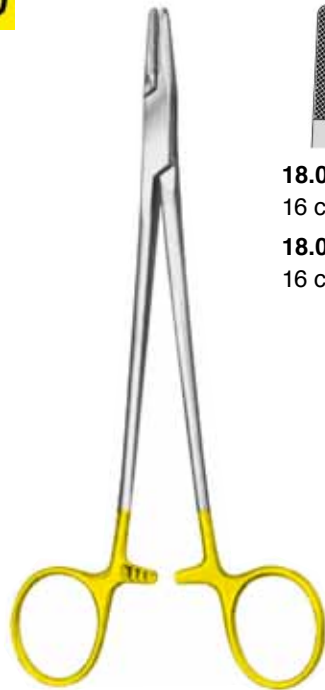





Diamantbeschichtete Spitzen  
 Diamond coated tips  
 Avec bouts de diamant  
 Puntas con cascós de diamante  
 Morsi con rivestimento di diamante



**MAYO-HEGAR**

				
<b>18.0080</b> 16 cm	<b>18.0082</b> 18 cm	<b>18.0084</b> 20 cm	<b>18.0086</b> 24 cm	<b>18.0088</b> 26 cm
<b>18.0080L</b> 16 cm	<b>18.0082L</b> 18 cm	<b>18.0084L</b> 20 cm	<b>18.0086L</b> 24 cm	<b>18.0088L</b> 26 cm

für Linkshänder / for left-handers / pour gauchers / para zurdos / per mono sinistra

			
<b>18.0090</b> 30 cm	<b>18.0092</b> 35 cm	<b>18.0094</b> 37 cm	<b>18.0096</b> 40 cm

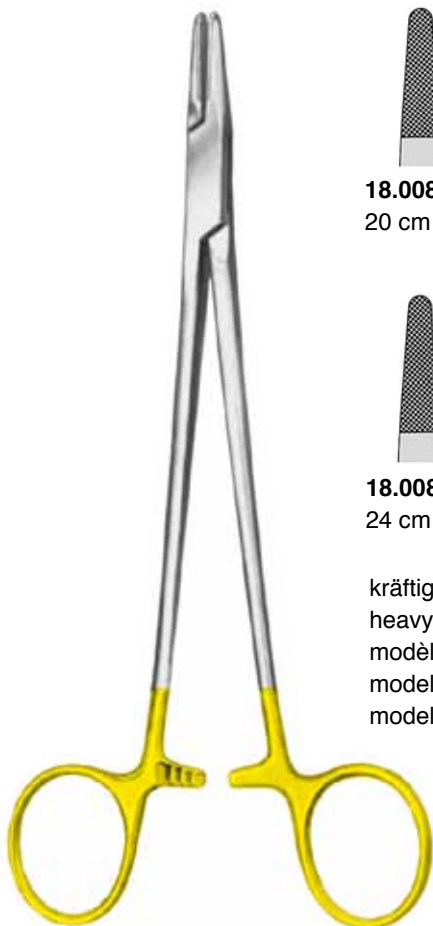

**MAYO-HEGAR**







  
**18.0084HP**  
 20 cm

  
**18.0086HP**  
 24 cm

kräftige Modelle  
 heavy patterns  
 modèles forts  
 modelos robustos  
 modelli robusti



**DEBAKEY**

		
<b>18.0100</b> 18 cm	<b>18.0102</b> 20 cm	<b>18.0104</b> 23 cm
		
<b>18.0106</b> 26 cm	<b>18.0108</b> 30 cm	<b>18.0110</b> 37 cm



**LANGENBECK**

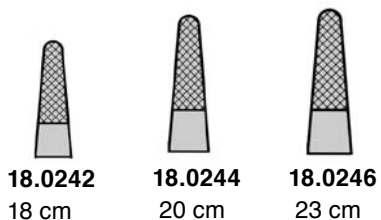

**18.0242**  
18 cm

**18.0244**  
20 cm

**18.0246**  
23 cm

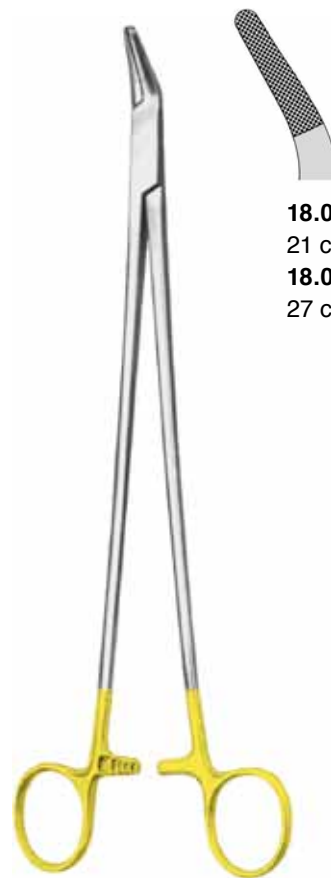

**FINOCHIETTO**

**18.0150**  
21 cm  
**18.0152**  
27 cm

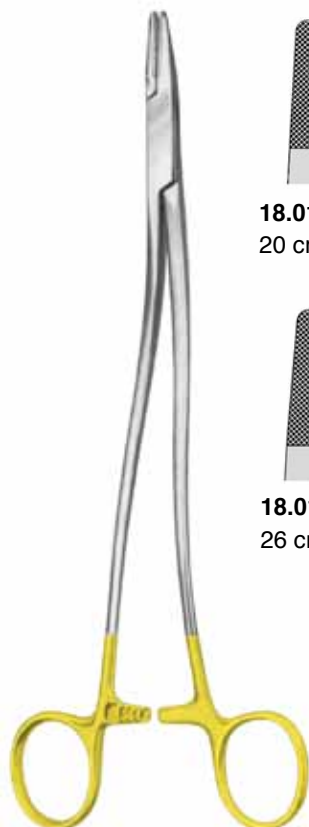

**BOZEMANN**

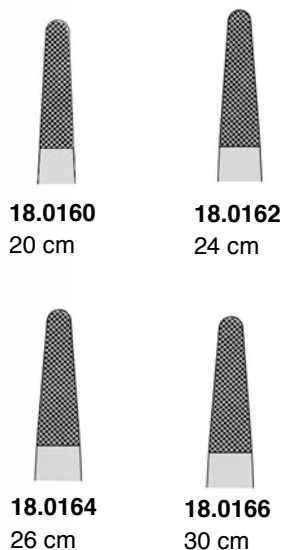

**18.0160**  
20 cm

**18.0162**  
24 cm

**18.0164**  
26 cm

**18.0166**  
30 cm



**MASSON**  
18.0170 27 cm



**WANGENSTEEN**  
18.0180 28 cm

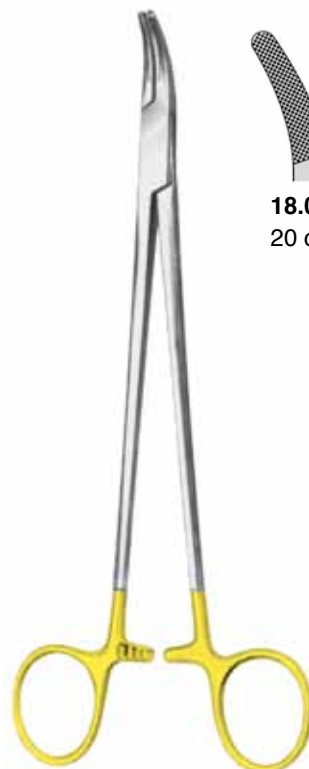

**HEANEY**



18.0190  
20 cm

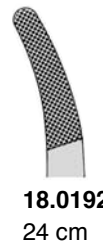

18.0192  
24 cm



18.0194  
26 cm



**STRATTE**

**18.0202**  
21 cm

**18.0204**  
23 cm

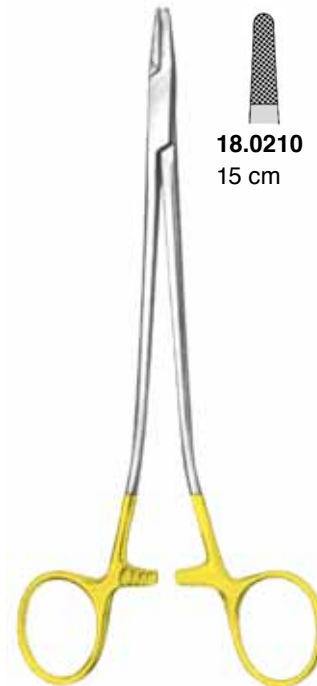

**SAROT**

**18.0210**  
15 cm

**18.0212**  
18 cm

**18.0214**  
27 cm



**NAUNTON-MORGAN**

**18.0220**  
26 cm



**MATHIEU**

**18.0250**  
14 cm

**18.0252**  
17 cm

**18.0254**  
20 cm

**18.0256**  
24 cm



**MATHIEU**

**18.0260**  
14 cm

**18.0262**  
17 cm

**18.0264**  
20 cm

**18.0266**  
23 cm

mit Innensperre  
 with inside ratchet  
 avec crémaillère interne  
 con cremallera interior  
 con cremagliera interna



**MATHIEU-KOCHER**

**18.0270**  
14 cm

**18.0272**  
17 cm

**18.0274**  
20 cm



**LICHTENBERG**

**18.0280**  
20 cm

Maul glatt mit Spezialkehle  
Smooth jaws, with special groove  
Mâchoires lisses, avec cannelure spécial  
Bocas lisas, con acanaladura especial  
morso liscio con scannellatura speciale



**NEIVERT**  
18.1050 12 cm



**CRILE**  
18.1060 15 cm



**CRILE-MURRAY**  
18.1065 15 cm



**CRILE-WOOD**  
18.1070 15 cm

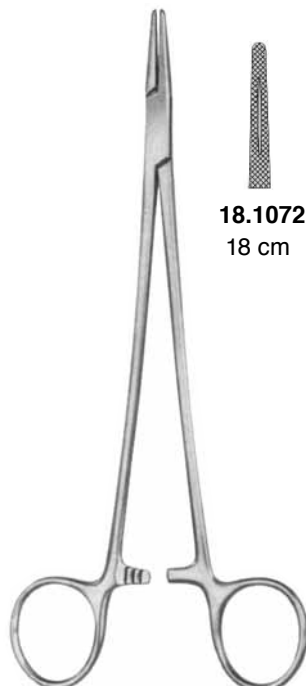

**CRILE-WOOD**

**18.1072**  
18 cm

**18.1074**  
20 cm

**18.1076**  
23 cm

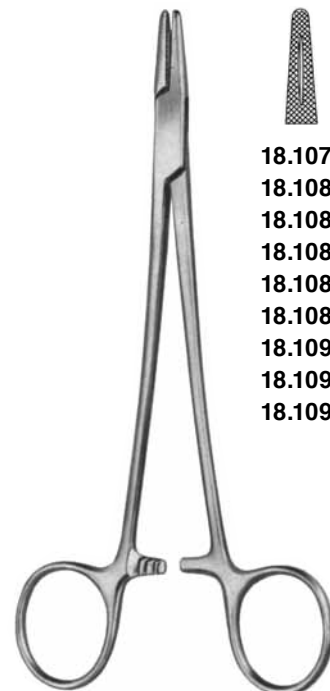

**MAYO-HEGAR**

- 18.1078** 14 cm
- 18.1080** 16 cm
- 18.1082** 18 cm
- 18.1084** 20 cm
- 18.1086** 24 cm
- 18.1088** 26 cm
- 18.1090** 30 cm
- 18.1092** 35 cm
- 18.1094** 40 cm





**METZENBAUM**  
18.1100 18 cm



**ADSON**  
18.1110 18 cm



**FINOCHIETTO**  
18.1152 21 cm  
18.1154 27 cm



**JOHNSON**  
18.1160 27 cm



**BOZEMANN**  
18.1161 20 cm  
18.1162 24 cm  
18.1164 26 cm

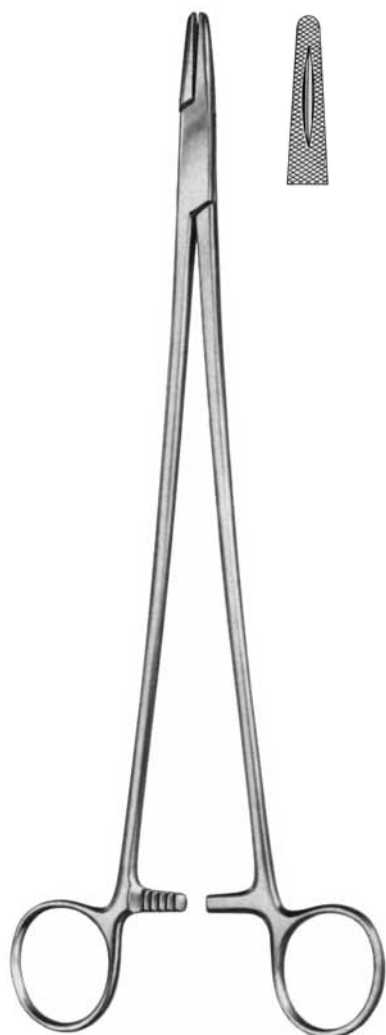

**MASSON**  
18.1170 27 cm

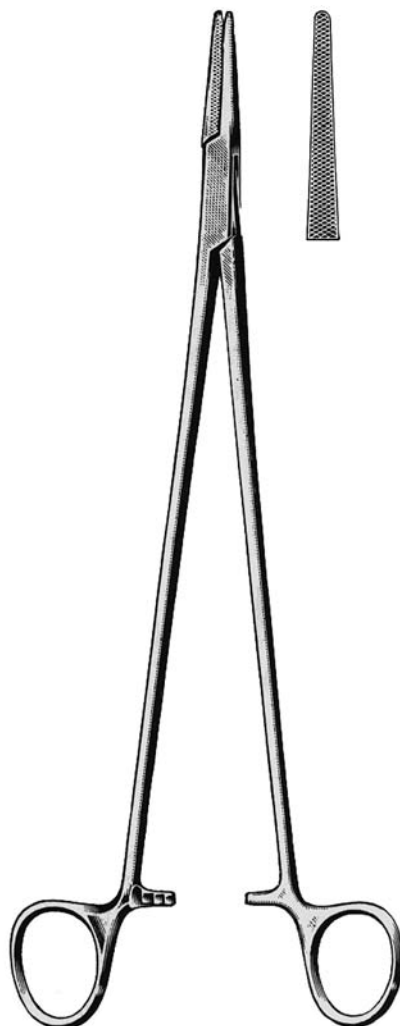

**WANGENSTEEN**  
18.1180 27 cm



**HEANEY (HEGAR)**  
18.1190 20 cm

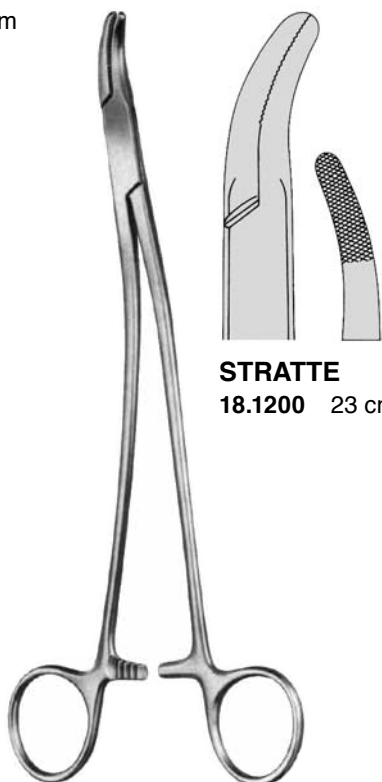

**STRATTE**  
18.1200 23 cm



**SAROT**  
18.1212 18 cm  
18.1214 26 cm



SONDEN, SAUGROHRE, TROKARE  
PROBES, ASPIRATION, TROCARS  
STYLETS, ASPIRATION, TROCARTS  
ESTILETES, ASPIRACION ,TROCARES  
SPECILLI, ASPIRAZIONE, TREQUARTI

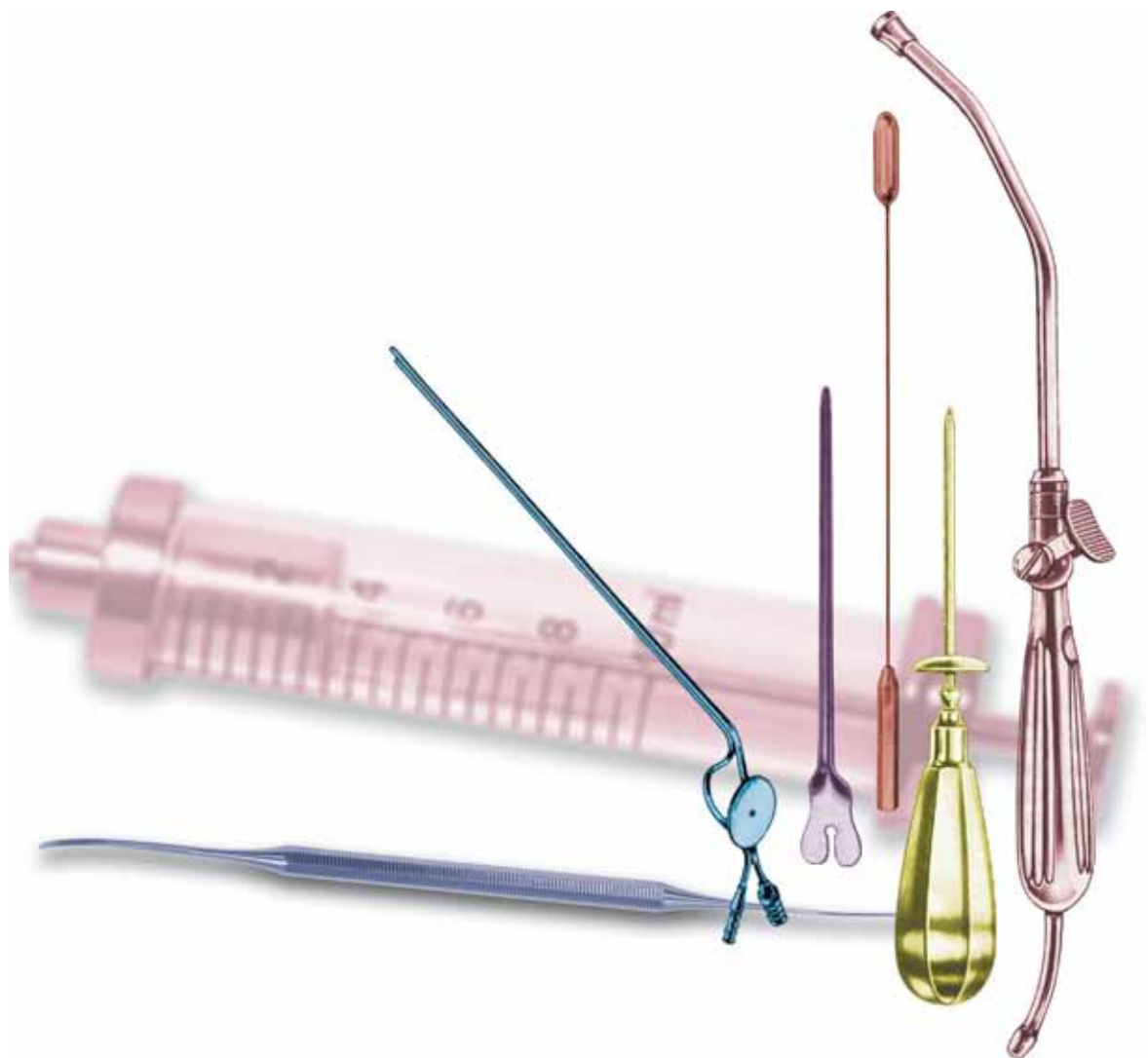





**19.0101**  
13,0 cm /Ø 1,0 mm  
**19.0102**  
14,5 cm /Ø 1,0 mm  
**19.0103**  
16,0 cm /Ø 1,0 mm  
**19.0104**  
18,0 cm /Ø 1,0 mm  
**19.0105**  
20,0 cm /Ø 1,0 mm  
**19.0106**  
25,0 cm /Ø 1,0 mm



**19.0109**  
10,5 cm /Ø 1,5 mm  
**19.0110**  
11,5 cm /Ø 1,5 mm  
**19.0111**  
13,0 cm /Ø 1,5 mm  
**19.0112**  
14,5 cm /Ø 1,5 mm  
**19.0113**  
16,0 cm /Ø 1,5 mm  
**19.0114**  
18,0 cm /Ø 1,5 mm  
**19.0115**  
20,0 cm /Ø 1,5 mm  
**19.0116**  
25,0 cm /Ø 1,5 mm  
**19.0117**  
30,0 cm /Ø 1,5 mm



**19.0119**  
10,5 cm /Ø 2,0 mm  
**19.0120**  
11,5 cm /Ø 2,0 mm  
**19.0121**  
13,0 cm /Ø 2,0 mm  
**19.0122**  
14,5 cm /Ø 2,0 mm  
**19.0123**  
16,0 cm /Ø 2,0 mm  
**19.0124**  
18,0 cm /Ø 2,0 mm  
**19.0125**  
20,0 cm /Ø 2,0 mm  
**19.0126**  
25,0 cm /Ø 2,0 mm  
**19.0127**  
30,0 cm /Ø 2,0 mm



Ø 4,0 mm

**19.0128**  
40 cm



**19.0200**  
11,5 cm /Ø 2,0 mm  
**19.0201**  
13,0 cm /Ø 2,0 mm  
**19.0202**  
14,5 cm /Ø 2,0 mm  
**19.0203**  
16,0 cm /Ø 2,0 mm  
**19.0204**  
18,0 cm /Ø 2,0 mm  
**19.0205**  
20,0 cm /Ø 2,0 mm  
**19.0206**  
25,0 cm /Ø 2,0 mm  
**19.0207**  
30,0 cm /Ø 2,0 mm



Silber  
Silver  
Argent  
Plata  
Argento

**19.0210**  
11,5 cm /Ø 2,0 mm  
**19.0211**  
13,0 cm /Ø 2,0 mm  
**19.0212**  
14,5 cm /Ø 2,0 mm  
**19.0213**  
16,0 cm /Ø 2,0 mm  
**19.0214**  
18,0 cm /Ø 2,0 mm  
**19.0215**  
20,0 cm /Ø 2,0 mm  
**19.0216**  
25,0 cm /Ø 2,0 mm

mit Ohr / with eye / avec oeillet / con ojo / con occhiello



**19.0302**  
 14,5 cm  
**19.0303**  
 16 cm

**MYRTLE**



**19.0320**  
 11,5 cm  
**19.0321**  
 13 cm  
**19.0322**  
 14,5 cm  
**19.0323**  
 16 cm  
**19.0324**  
 18 cm  
**19.0325**  
 20 cm

**DOYEN**



**19.0332**  
 14.5 cm



**19.0351**  
 11,5 cm  
**19.0352**  
 13 cm  
**19.0353**  
 14,5 cm  
**19.0354**  
 16 cm  
**19.0355**  
 18 cm  
**19.0356**  
 20 cm



**NELATON**  
**19.0363** 16 cm

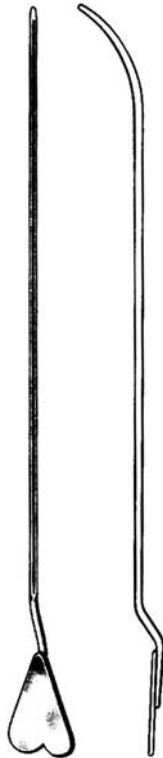

**LOCKHART-MUMMERY**  
 16,5 cm



**19.0371**  
 # 1



**19.0372**  
 # 2



**19.0373**  
 # 3



**19.0374**  
 # 4



**ANDREW-PYNCHON**

19.0700 24 cm

Ø 6 mm



**COUPLAND**

33.1160 26 cm

mit 2 Ansätzen  
with 2 tips  
avec 2 embouts  
con 2 puntas  
con 2 punte  
1,5 / 2,0 mm Ø

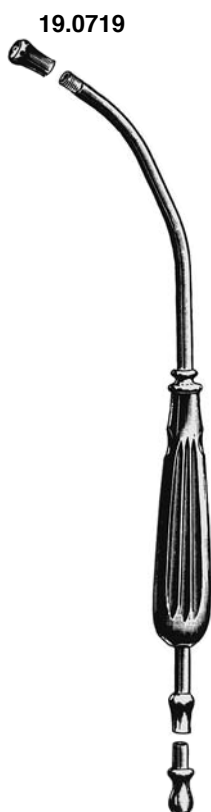

**YANKAUER**

19.0710 27 cm

19.0711 36 cm

19.0712 40 cm

19.0713 46 cm

Ø 10 mm

komplett

complete

complet

completo

19.0718



**YANKAUER**

19.0715 33 cm

Ø 10 mm

mit Absperrventil u. abschraubbarem Rohr  
with stopcock and removeable tube  
avec robinet et canule demontable  
con llave y tubo desmontable  
con interruttore e tubo svitabile





**POOLE**  
**19.0726**  
 20 cm, Ø 5,5 mm



**POOLE**  
**19.0727**  
 20 cm, Ø 5,5 mm



**POOLE**  
**19.0720**  
 23 cm / 30 Fr.



**POOLE**  
**19.0721** 20 cm, Ø 8 mm  
**19.0722** 30 cm, Ø 10 mm  
**19.0723** 36 cm, Ø 10 mm  
**19.0724** 46 cm, Ø 10 mm

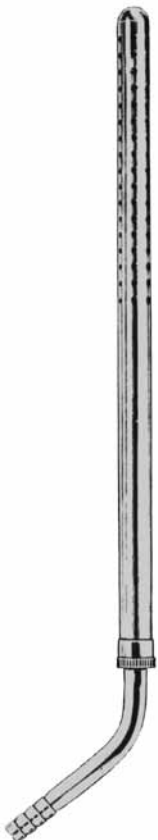

**WIJNEN**  
**19.0738**  
 33 cm Ø 12 mm



**DEBAKEY**  
**19.0746**  
 31 cm Ø 9 mm

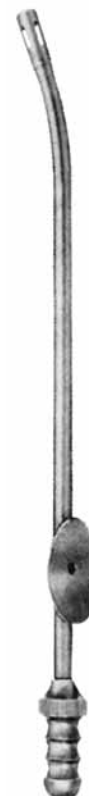

**DEBAKEY**  
**19.0747**  
 16 cm Ø 5 mm  
**19.0748**  
 27 cm Ø 5 mm

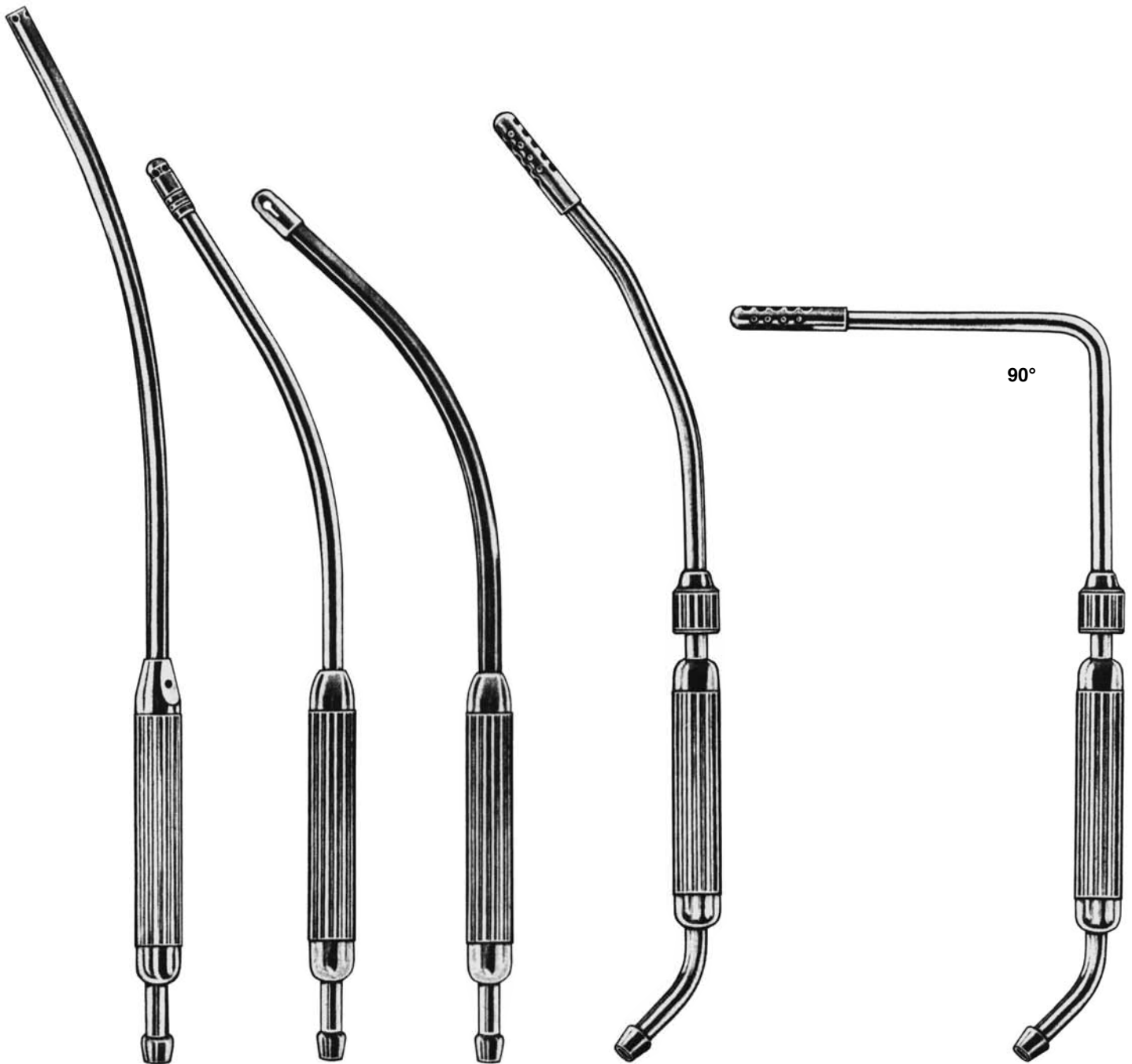

**COOLEY**  
**19.0750**  
36 cm  
Ø 8 mm #1

**COOLEY**  
**19.0751**  
31 cm  
Ø 7 mm #2

**COOLEY**  
**19.0752**  
31 cm  
Ø 10 mm #3

**COOLEY**  
**19.0753**  
35 cm  
Ø 8 mm #4

**COOLEY**  
**19.0754**  
25 cm  
Ø 9 mm #5

Probes, Suction Tubes / Sondes, Tubes d'aspiration / Sondas, Tubos de aspiración / Sonde, Tubi d'aspirazione



**POOLE**

**19.0722** 30 cm, Ø 10 mm

**19.0723** 35 cm, Ø 10 mm

**19.0724** 46 cm, Ø 10 mm



**COOLEY**

**19.0750**

36 cm, Ø 8 mm



**WIJNEN**

**19.0738**

33 cm, Ø 12 mm

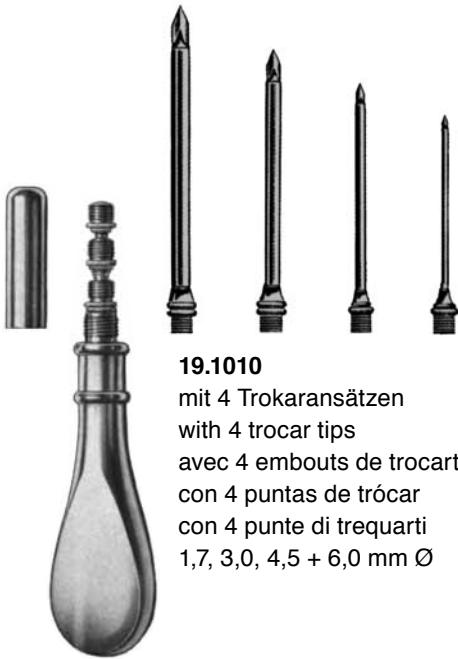

**19.1010**  
mit 4 Trokaransätzen  
with 4 trocar tips  
avec 4 embouts de trocars  
con 4 puntas de trócar  
con 4 punte di trequarti  
1,7, 3,0, 4,5 + 6,0 mm Ø

**UNIVERSAL**  
14 cm



Ø  
**19.1020** 3,0 mm  
**19.1021** 3,5 mm  
**19.1022** 4,0 mm  
**19.1023** 4,5 mm  
**19.1024** 5,0 mm  
**19.1025** 5,5 mm  
**19.1026** 6,0 mm

**UNIVERSAL**



Ø  
**19.1030** 3,0 mm  
**19.1031** 3,5 mm  
**19.1032** 4,0 mm  
**19.1033** 4,5 mm  
**19.1034** 5,0 mm  
**19.1035** 5,5 mm  
**19.1036** 6,0 mm

mit Absperrventil  
with stopcock  
avec robinet  
con interruptor  
con interruttore

**UNIVERSAL**



**LICHTWITZ**  
**19.1050**  
19 cm Ø1,75 mm



Ø  
**19.1199** 9 Fr. / 3,0 mm  
**19.1200** 10 Fr. / 3,5 mm  
**19.1201** 12 Fr. / 4,0 mm  
**19.1202** 14 Fr. / 4,5 mm  
**19.1204** 16 Fr. / 5,5 mm  
**19.1205** 18 Fr. / 6,0 mm  
**19.1206** 20 Fr. / 6,5 mm

**OCHSNER**  
15 cm



Ø  
**19.1210** 25 Fr./ 8 mm  
**19.1211** 30 Fr./10 mm  
**19.1212** 33 Fr./11 mm  
**19.1213** 35 Fr./12 mm

**NELSON**  
21 cm



STERILISATION  
STERILIZATION  
STERILISATION  
ESTERILIZACION  
STERILIZZAZIONE

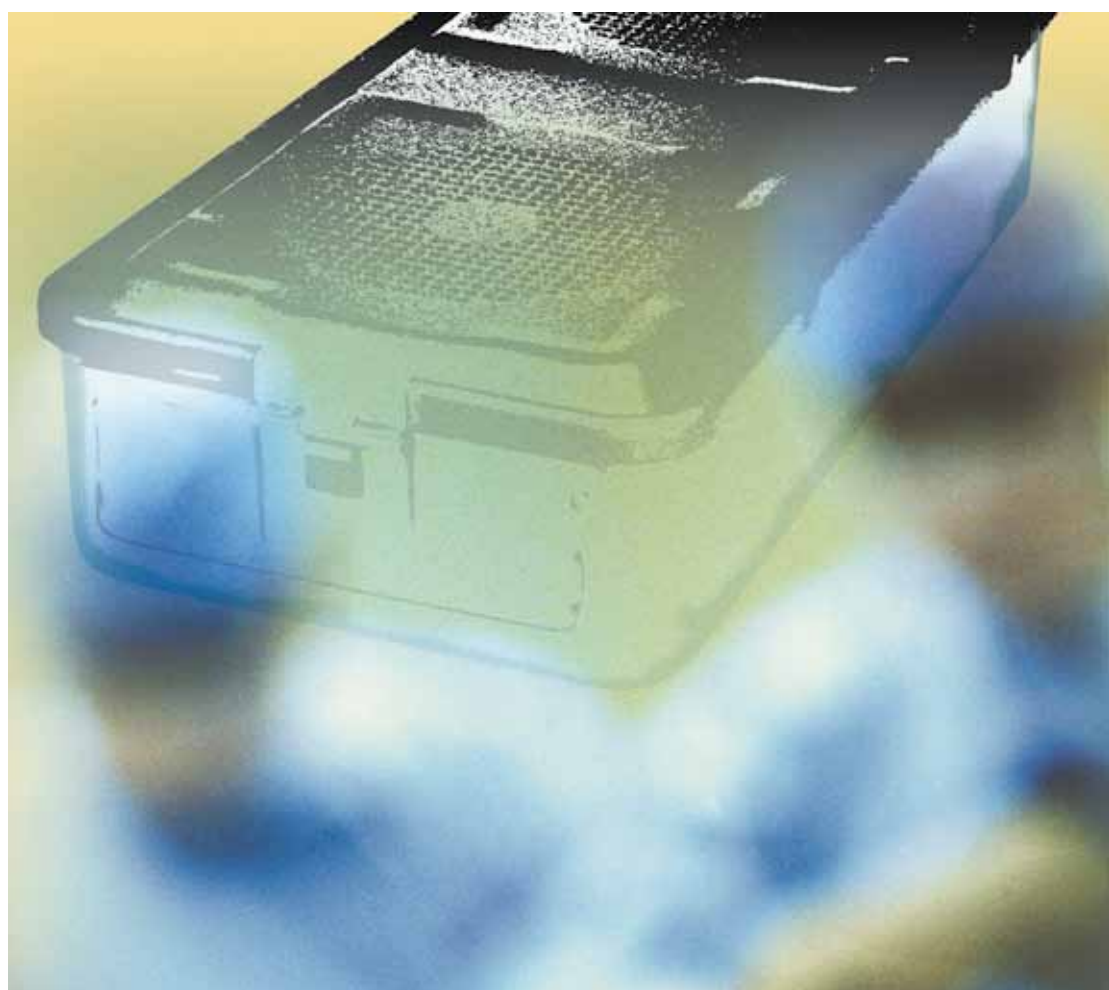



**DAVIS**  
16.1000 16 cm  
16.1002 20 cm  
16.1004 25 cm



**CHEATTLE**  
16.1010 27 cm



**ROGGE**  
16.1020 23 cm



**STERILIZING**  
16.1030 20 cm  
16.1032 30 cm



**STERILIZING**  
16.1040 20 cm  
16.1042 28 cm

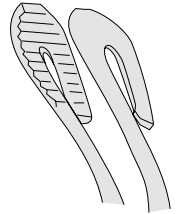

16.1041 20 cm  
16.1043 28 cm

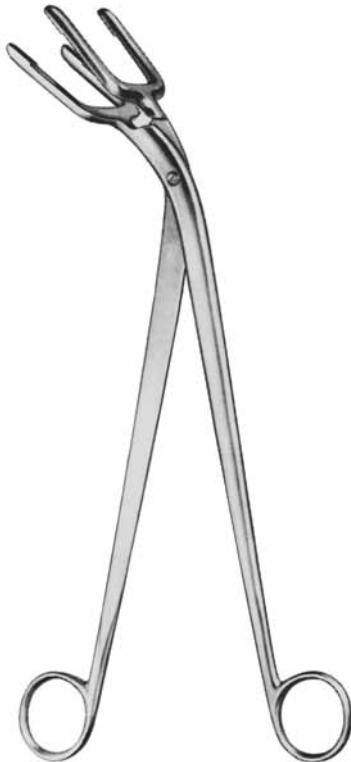

**HARRISON**  
16.1050 25 cm  
16.1052 30 cm



**MARTIN**  
16.1060 58 cm



**SAUERBRUCH**  
16.1070 55 cm



**BUNT**  
 16.1100  
 12 cm



**MAYO**  
 16.1110  
 14 cm



**MAYO**  
 16.1115  
 14 cm



**STRINGER**

- 16.1150 10 x 7 cm
- 16.1152 15 x 7 cm
- 16.1153 20 x 7 cm
- 16.1154 25 x 7 cm
- 16.1155 30 x 7 cm
- 16.1156 35 x 7 cm
- 16.1157 40 x 7 cm
- 16.1158 45 x 9 cm
- 16.1159 50 x 9 cm



**16.1500**

Infusionsflaschen-Öffnungszange  
 Infusion-bottle Opening Forceps  
 Pince pour ouvrir les bouteilles d'infusion  
 Pinza para abrir botellas de infusión  
 Pinza apri flebo



# 1/2 Container, ALU

Deckel gelocht und farbig  
 Lid perforated and colored  
 Couvercle perforé et coloré  
 Tapas perforadas y coloreados  
 Coperchio perforato e colorato



**L x B x H mm**

285x280x100	80.6001	80.6002	80.6003	80.6004	80.6005	80.6006
285x280x135	80.6011	80.6012	80.6013	80.6014	80.6015	80.6016
285x280x150	80.6021	80.6022	80.6023	80.6024	80.6025	80.6026
285x280x200	80.6031	80.6032	80.6033	80.6034	80.6035	80.6036
285x280x260	80.6041	80.6042	80.6043	80.6044	80.6045	80.6046

Sicherheitsdeckel / Safety lid / Couvercle de sécurité / Tapa di seguridad / Coperchio di sicurezza



285x280	80.6001SL	80.6002SL	80.6003SL	80.6004SL	80.6005SL	80.6006SL
---------	-----------	-----------	-----------	-----------	-----------	-----------

## Zubehör · Accessories · Accessoires · Accesorios · Accessori

für  
1/2 Container

for  
1/2 Containers

pour  
1/2 Containers

para  
1/2 Contenedores

per  
1/2 Contenitori



**Siebkörbe**  
**Wire baskets**  
**Plateaux inox**  
**Bandejas inoxidable**  
**Cestelli in acciaio fino**

80.6203 255x245x 30 mm  
80.6205 255x245x 50 mm  
80.6207 255x245x 70 mm  
80.6210 255x245x100 mm

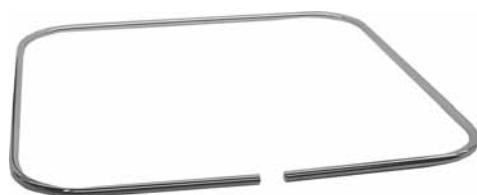

**Spannrahmen**  
**Cloth fixing frames**  
**Cadres fixe-toile**  
**Cuadros para fijar panos**  
**Telai fissateli**

80.6231 255x255 mm



80.6232 255x255x30 mm



**Teiler**  
**Deviders**  
**Cloisons**  
**Tabiques**  
**Divisori**

80.6240 255x245x130 mm

# 3/4 Container, ALU

Deckel gelocht und farbig  
 Lid perforated and colored  
 Couvercle perforé et coloré  
 Tapas perforadas y coloreados  
 Coperchio perforato e colorato

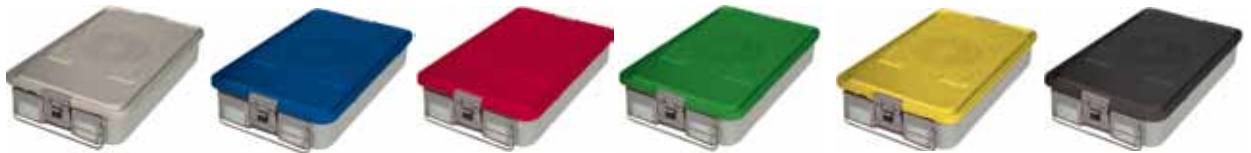

**L x B x H mm**

465x280x100	80.6301	80.6302	80.6303	80.6304	80.6305	80.6306
465x280x135	80.6311	80.6312	80.6313	80.6314	80.6315	80.6316
465x280x150	80.6321	80.6322	80.6323	80.6324	80.6325	80.6326

Sicherheitsdeckel / Safety lid / Couvercle de securité / Tapa di seguridad / Coperchio di sicurezza

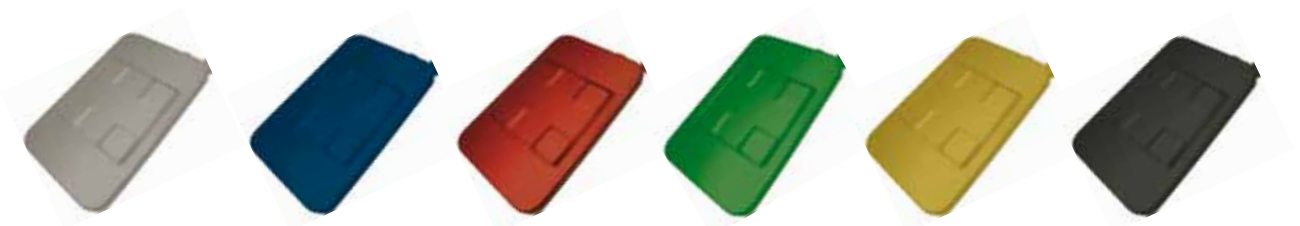

465x280	80.6301SL	80.6302SL	80.6303SL	80.6304SL	80.6305SL	80.6306SL
---------	-----------	-----------	-----------	-----------	-----------	-----------

## Zubehör · Accessories · Accessoires · Accesorios · Accessori

für  
3/4 Container

for  
3/4 Containers

pour  
3/4 Containers

para  
3/4 Contenedores

per  
3/4 Contenitori

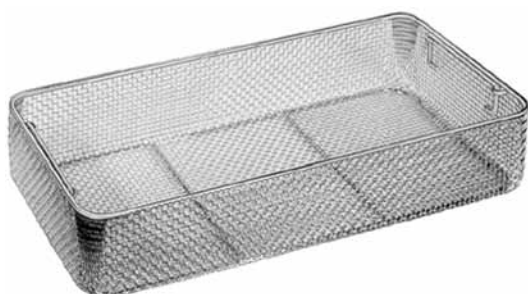

**Siebkörbe**  
**Wire baskets**  
**Plateaux inox**  
**Bandejas inoxidable**  
**Cestelli in acciaio fino**

80.6503	405x245x 30 mm
80.6505	405x245x 50 mm
80.6507	405x245x 70 mm
80.6510	405x245x100 mm



**Spannrahmen**  
**Cloth fixing frames**  
**Cadres fixe-toile**  
**Cuadros para fijar panos**  
**Telai fissateli**

80.6531	405x255 mm
---------	------------



80.6532	405x255x30 mm
---------	---------------

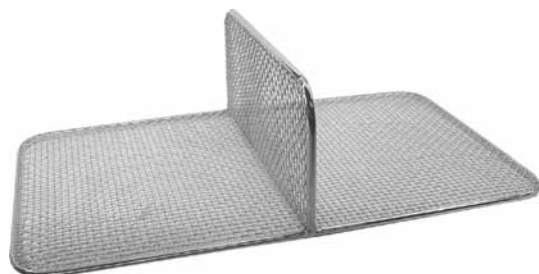

**Teiler**  
**Deviders**  
**Cloisons**  
**Tabiques**  
**Divisori**

80.6540	405x250x130 mm
---------	----------------



80.6541	405x250x130 mm
---------	----------------

# 1/1 Container, ALU

Deckel gelocht und farbig  
 Lid perforated and colored  
 Couvercle perforé et coloré  
 Tapas perforadas y coloreadas  
 Coperchio perforato e colorato

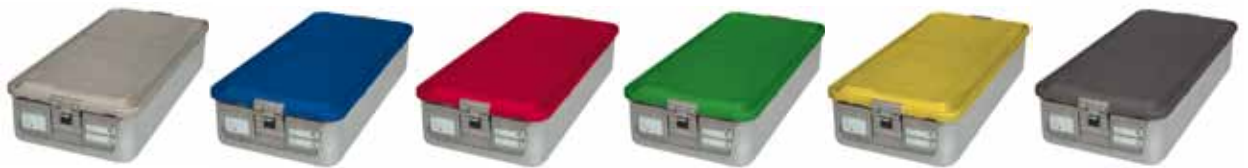

**L x B x H mm**

580x280x100	80.6601	80.6602	80.6603	80.6604	80.6605	80.6606
580x280x135	80.6611	80.6612	80.6613	80.6614	80.6615	80.6616
580x280x150	80.6621	80.6622	80.6623	80.6624	80.6625	80.6626
580x280x200	80.6631	80.6632	80.6633	80.6634	80.6635	80.6636
580x280x260	80.6641	80.6642	80.6643	80.6644	80.6645	80.6646

Sicherheitsdeckel / Safety lid / Couvercle de sécurité / Tapa di seguridad / Coperchio di sicurezza



580x280

80.6601SL	80.6602SL	80.6603SL	80.6604SL	80.6605SL	80.6606SL
-----------	-----------	-----------	-----------	-----------	-----------

## Zubehör · Accessories · Accessoires · Accesorios · Accessori

für  
1/1 Container

for  
1/1 Containers

pour  
1/1 Containers

para  
1/1 Contenedores

per  
1/1 Contenitori

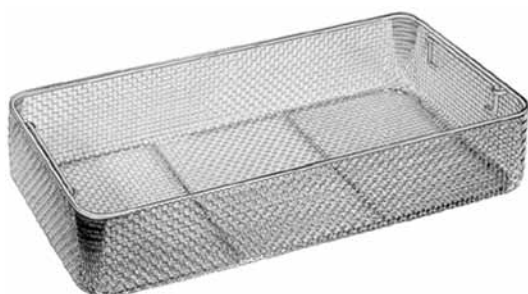

**Siebkörbe**  
**Wire baskets**  
**Plateaux inox**  
**Bandejas inoxidable**  
**Cestelli in acciaio fino**

80.6803	485x285x 30 mm
80.6805	485x285x 50 mm
80.6807	485x285x 70 mm
80.6810	485x285x100 mm
80.6813	540x285x 30 mm
80.6815	540x285x 50 mm
80.6817	540x285x 70 mm
80.6820	540x285x100 mm



**Spannrahmen**  
**Cloth fixing frames**  
**Cadres fixe-toile**  
**Cuadros para fijar panos**  
**Telai fissateli**

80.6841	545x245 mm
---------	------------



80.6842 5	45x245x30 mm
-----------	--------------



**Teiler**  
**Deviders**  
**Cloisons**  
**Tabiques**  
**Divisori**

80.6850	510x250x130 mm
---------	----------------



80.6851	510x250x130 mm
---------	----------------

# Flach- und Mini-Container, ALU eloxiert

Flat- and Mini-Containers, ALU

Containers plates et mini en aluminium

Contenedores planos y mini de aluminio

Contentori piatti e mini in alluminio



Deckel gelocht und farbig  
 Lid perforated and colored  
 Couvercle perforé et coloré  
 Tapas perforadas y coloreados  
 Coperchio perforato e colorato



Flach – Flat – Plat – Plano – Platto



L x B x H mm

285x280x55	80.7001	80.7002	80.7003	80.7004	80.7005	80.7006
285x280x85	80.7011	80.7012	80.7013	80.7014	80.7015	80.7016



Mini

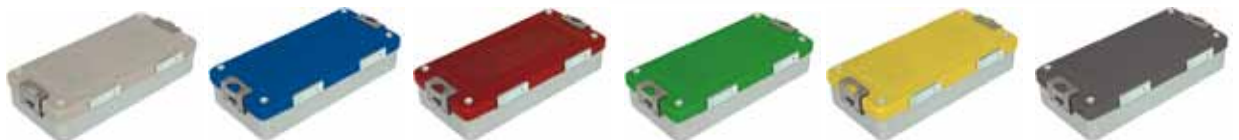

L x B x H mm

300x140x40	80.7301	80.7302	80.7303	80.7304	80.7305	80.7306
300x140x70	80.7311	80.7312	80.7313	80.7314	80.7315	80.7316
300x140x100	80.7321	80.7322	80.7323	80.7324	80.7325	80.7326

## Zubehör · Accessories · Accessoires · Accesorios · Accessori

für FLACH- und  
MINI-Container

for FLAT- and MI-  
NI-Containers

pour Containers  
PLARTS et MINI

para Contenedores  
PLANOS y MINI

per Contenitori  
PIATTI e MINI



**Siebkorb mit Deckel**  
**Wire basket with lid**  
**Panier avec couvercle**  
**Cestillo con cobertera**  
**Cestello con coperchio**

80.7410 267x125x50 mm



**Siebeinlage f. MINI-Container**  
**Separate base for MINI-Container**  
**Fond du crible pour MINI-Container**  
**Base para MINI-Container**  
**Base per MINI-Container**

80.7420 270x125 mm



**Spannrahmen für Mini-Container**  
**Cloth fixing frames for MINI-Container**  
**Cadres fixe-toile pour MINI-Container**  
**Cuadros para fijar panos para MINI-Container**  
**Telai fissateli per MINI-Container**

80.7431 270x125 mm



# Endoskopie-Container, ALU eloxiert

Endoscopy-Containers, ALU

Containers para endoscopia en aluminium

Contenedores para endoscopia de aluminio

Contenitori per endoscopia in alluminio

Deckel gelocht und farbig

Lid perforated and colored

Couvercle perforé et coloré

Tapas perforadas y coloreados

Coperchio perforato e colorato



L x B x H mm

250x60x50

80.7501

80.7503

80.7504

450x70x70

80.7511

80.7513

80.7514

## Zubehör · Accessories · Accessoires · Accesorios · Accessori

Siebköbe Endoskopie

Wire baskets Endoscopy

Paniers Endoscopie

Cestillos Endoscopia

Cestilli Endoscopia

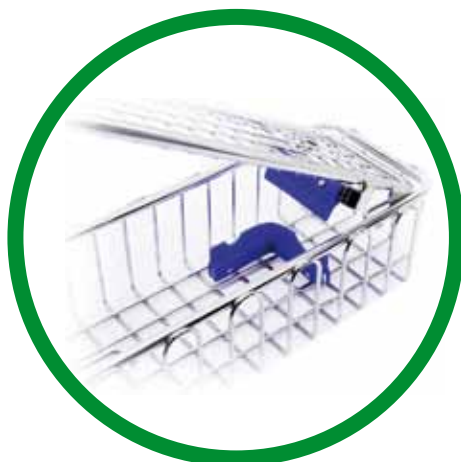

80.7551 290x 80x50 mm

80.7552 460x 80x50 mm

80.7553 640x150x77 mm

## Zubehör · Accessories · Accessoires · Accesorios · Accessori

Kennzeichnungsschilder, Aluminium ohne Text  
Identification labels, aluminium, neutral  
Plaquettes d'identificationen aluminium, neutres  
Placas de identificación, aluminio, neutral  
Targhette di identificazione d'alluminio, neutre



80.7901 80.7902 80.7903 80.7904 80.7905 80.7906

Kennzeichnungsschilder, Aluminium graviert  
Identification labels, aluminium, engraved  
Plaquettes d'identificationen aluminium, gravées  
Placas de identificación, aluminio, grabadas  
Targhette di identificazione d'alluminio, incise



80.7911 80.7912 80.7913 80.7914 80.7915 80.7916

Sortiermagazin für Kennzeichnungsschilder  
Rack for identification labels  
Magasin à plaquettes d'identification  
Cajita para seleccionar placas  
Cassetta da selezione targhette

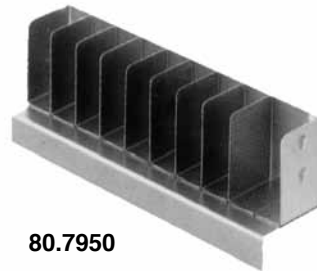

80.7950

Indikator-Schilder, Papier, 100 St.  
Indicating labels, paper, 100 pcs.  
Etiquettes d'identification en papier, les 100  
Etiquetas indicadoras, papel 100 c/u  
Targhette con indicatore, papel, 100 pezzi



80.7960

klein / small / petite / pequenas / piccolo

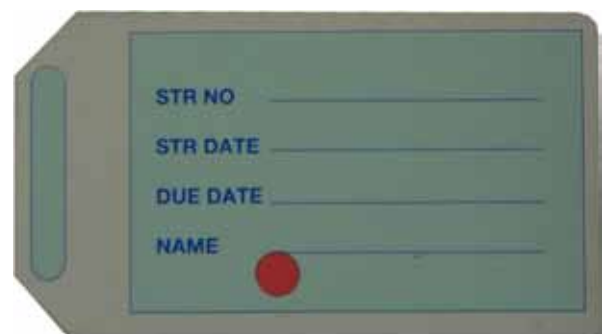

80.7962

groß / large / grande / grande / grande

Sicherungsplomben, Plastik, 100 St.  
Safety Seals, plastic, 100 pcs.  
Scellés de sécurité, plastique, les 100  
Precintos de seguridad,plastico 100 c/u  
Sigilli di sicurezza, plastica, 100 pezzi



80.7980

**Zubehör · Accessories · Accessoires · Accesorios · Accessori**

**Filterspender für 1/2, 3/4, 1/1 Container-Filter**  
**Filter Dispenser for 1/2, 3/4, 1/1 Container-Filters**  
**Présentoir de filtres pour les 1/2, 3/4, 1/1 Containers**  
**Distribuidor de filtros para los 1/2, 3/4, 1/1 Containers**  
**Distributore di filtri per 1/2, 3/4, 1/1 Container**



80.8000

**Filterhalter für 1/2, 3/4, 1/1 Container**  
**Filter Holder for 1/2, 3/4, 1/1 Containers**  
**Fixe-filtres pour 1/2, 3/4, 1/1 Containers**  
**Sujetafiltros para los 1/2, 3/4, 1/1 Containers**  
**Fermafiltro per 1/2, 3/4, 1/1 Container**



80.8010

**Filter, Einmalgebrauch, Papier 1000 St.**  
**Single use filters, paper 1000 pcs.**  
**Filtres en papier à usage unique, les 1000**  
**Filtros, monouso, papel, 1000 c/u**  
**Filtri, monouso, carta, 1000 pezzi**

**FILTER, Papier für 1/2, 3/4, 1/1 Container**  
**for 1/2, 3/4, 1/1 Containers**  
**pour 1/2, 3/4, 1/1 Containers**  
**para los 1/2, 3/4, 1/1 Containers**  
**per 1/2, 3/4, 1/1 Container**



80.8050

**FILTER, Papier für MINI-Container**  
**for MINI-Containers**  
**pour MINI-Containers**  
**para MINI-Containers**  
**per MINI-Containers**

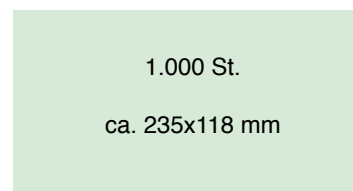

80.8052

**FILTER, Papier für DENTAL Container**  
**for DENTAL-Containers**  
**pour DENTAL-Containers**  
**para DENTAL-Containers**  
**per DENTAL-Containers**

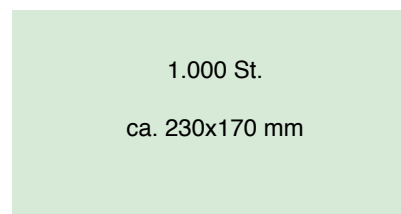

80.8054

## Zubehör · Accessories · Accessoires · Accesorios · Accessori

**Langzeit-Textilfilter, 1 St.**  
**Long-term textile filters, 1 pc.**  
**Filtres en textile, la pièce**  
**Filtros de textil, 1 c/u**  
**Filtri tessili, il pezzo**

FILTER, Textil für 1/2, 3/4, 1/1 Container  
for 1/2, 3/4, 1/1 Containers  
pour 1/2, 3/4, 1/1 Containers  
para los 1/2, 3/4, 1/1 Containers  
per 1/2, 3/4, 1/1 Container

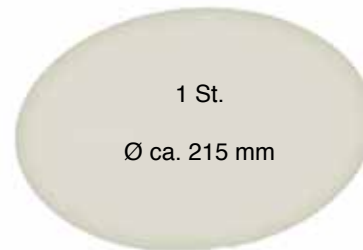

80.8060

FILTER, Textil für MINI-Container  
for MINI-Containers  
pour MINI-Containers  
para MINI-Containers  
per MINI-Containers

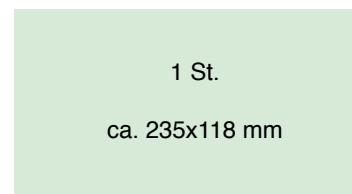

80.8062

FILTER, Textil für DENTAL Container  
for DENTAL-Containers  
pour DENTAL-Containers  
para DENTAL-Containers  
per DENTAL-Containers

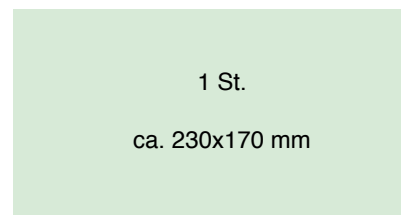

80.8064

**Sterilisier-Tücher, Baumwolle**  
**Sterilizing Drapes, cotton**  
**Champs à stérilisation, coton**  
**Paños de esterilización de algodón**  
**Pannos di sterilizzazione, cotone**

**80.8100** 40 x 60 cm  
**80.8105** 85 x 85 cm  
**80.8110** 100 x 140 cm  
**80.8115** 275 x 125 cm  
**80.8120** 245 x 245 cm



80.8100-  
80.8120

**Noppenmatten, Silikon**  
**Silicone Pads**  
**Tapis port-instruments, silicone**  
**Tapices porta instrumentos de silicona**  
**Tapetti porta-strumenti in silicone**

**80.8131** 275 x 125 mm  
**80.8132** 225 x 225 mm  
**80.8133** 300 x 300 mm



80.8131-  
80.8133

**Zubehör · Accessories · Accessoires · Accesorios · Accessori**

**Fixierklammern für Tücher**  
**Fixation Clamps for Drapes**  
**Pinces fixe-toiles**  
**Grapas para fijar paños**  
**Pinze di fillaggio per teli**



**80.8150**

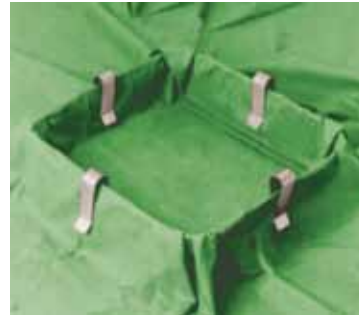

**80.8160** Ø 7 - 12 mm  
**80.8161** Ø 12 - 16 mm  
**80.8162** Ø 16 - 26 mm  
**80.8163** Ø 26 - 36 mm  
**80.8164** Ø 36 - 45 mm



**80.8160-  
70.8164**

**Fixierfedern**  
**Spiral Supports**  
**Ressorts spiraux**  
**Apoyos con resorte spiral**  
**Supporte a molle**

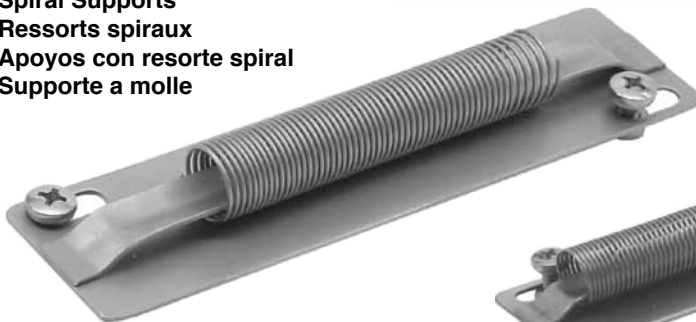

**80.8191** 115 x 30 mm



**80.8192** 230 x 30 mm

**80.8140 SILIKON Fixierstreifen Set**

bestehend aus:

80.8141 1 Silikon Streifen 246 x 13 mm

80.8142 2 Silikon Halteknöpfe

**SILICONE Storage Strip Set**

consisting of:

80.8141 1 Silicone Storage Strip 246x13 mm

80.8142 2 Silicone Fastening Knobs

**SILICONE bande porte instrum.** 243 x 13 mm

Jeu comprenant:

80.8141 1 Silicone bande à sécurité 243 x 13 mm

80.8142 2 Silicone boutons à fixation

**SILICONE tira de protección** 243 x 13 mm

Juego compuesto de:

80.8141 1 Silicone tira de protección 243 x 13 mm

80.8142 2 Silicone botones de fijar

**SILICONE strisce per assicurare** 243x13 mm

Set composto da:

80.8141 1 Silicone strisce per assicurare 243x13 mm

80.8142 2 Silicone botoni di fissare



**80.8141** 246x13 mm



**80.8142** 2 Stück / 2 pieces / 2 pièces / 2 piezas / 2 pezzi

## Zubehör · Accessories · Accessoires · Accesorios · Accessori

**Haltestifte, Trennbleche**  
**Fixing bolts, Dividers**  
**Attaches de fixation, Séparateurs**  
**Piñons para fijar, Separadores**  
**Perne di fissaggio, Divisori**

Haltestift für Instrumente  
for instruments  
pour instruments  
para instrumentos  
per strumenti



80.8201



Haltestift für Trennbleche  
for Dividers  
pour Séparateurs  
para Separadores  
per Divisori



80.8202

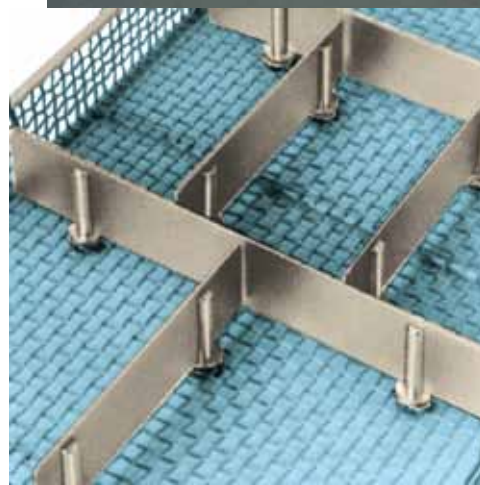

**Trennbleche**  
**Dividers**  
**Séparateurs**  
**Separadores**  
**Divisori**

80.8211 50x20 mm  
80.8212 130x20 mm  
80.8213 225x20 mm  
80.8214 460x20 mm



**Winkelbleche**  
**Angled Dividers**  
**Séparateurs angulés**  
**Separadores angulados**  
**Divisori angulate**

80.8221 110 mm  
80.8222 170 mm  
80.8223 230 mm  
80.8223 470 mm

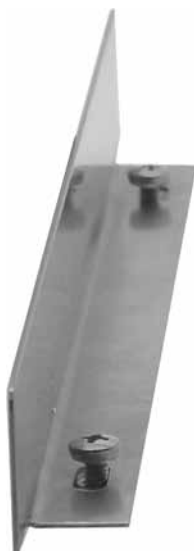

**Sterilisierahmen für 8 Mikro-Instrumente**  
**Sterilizing Rack for 8 Micro-Instruments**  
**Chevalet à Sterilisation pour 8 Micro-Instruments**  
**Porta-instrumentos para 8 Micro Instrumentos**  
**Telaio per sterilizzazione per 8 micro-strumenti**

80.3190 190 x 36 x 35 mm

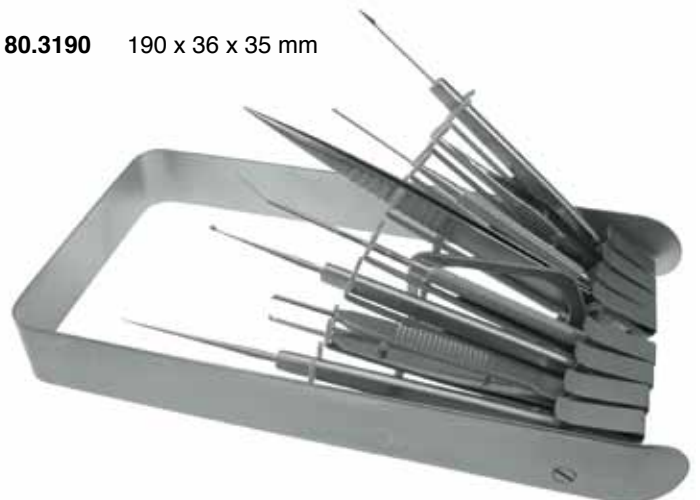

**Sterilisation · Sterilization · Sterilisation · Esterilizacion · Sterilizzazione**

Container für mikrochirurgische Instrumente  
 Containers for microsurgical instruments  
 Containers pour instruments de microchirurgie  
 Contenedores para instrumental microcirugia  
 Contenitori per strumenti per microchirurgia



**80.3112** 300x220x55 mm  
**80.3114** 285x280x55 mm  
**80.3116** 400x290x55 mm



**80.3162** 300x220x75 mm  
**80.3164** 285x280x75 mm  
**80.3166** 400x290x75 mm

Sterilisiertrommeln  
 Sterilizing drums  
 Boites rondes à sterilisation  
 Tambores de esterilizacion  
 Cestelli rotondi per sterilizzazione

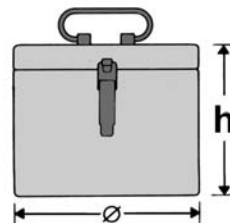

**SCHIMMELBUSCH**

<b>80.4002</b>	120x120 mm	<b>80.4016</b>	240x240 mm
<b>80.4004</b>	140x140 mm	<b>80.4018</b>	290x160 mm
<b>80.4006</b>	160x120 mm	<b>80.4020</b>	290x240 mm
<b>80.4008</b>	160x150 mm	<b>80.4022</b>	340x160 mm
<b>80.4010</b>	190x150 mm	<b>80.4024</b>	340x240 mm
<b>80.4012</b>	190x190 mm	<b>80.4026</b>	390x190 mm
<b>80.4014</b>	240x160 mm	<b>80.4028</b>	390x290 mm



**80.4002-  
80.4028**

**KONRICH**

<b>80.4040</b>	96 x 99 mm	<b>80.4054</b>	285 x 240 mm
<b>80.4042</b>	156 x 146 mm	<b>80.4056</b>	334 x 158 mm
<b>80.4044</b>	188 x 140 mm	<b>80.4058</b>	334 x 238 mm
<b>80.4046</b>	188 x 185 mm	<b>80.4060</b>	384 x 138 mm
<b>80.4048</b>	239 x 160 mm	<b>80.4062</b>	384 x 188 mm
<b>80.4050</b>	239 x 240 mm	<b>80.4064</b>	384 x 288mm
<b>80.4052</b>	285 x 160 mm		



**80.4040-  
80.4064**

## Zubehör · Accessories · Accessoires · Accesorios · Accessori

Pflegeöl für chirurgische Instrumente  
Lubricating Oil for Surgical Instruments  
Huile pour lubrifier les instruments chirurgicaux  
Lubrificante para las instrumentos quirúrgicos  
Olio per lubrificazione di strumenti chirurgici

80.0010 50 cc.  
80.0012 250 cc.  
80.0014 1000 cc.



80.0010

Wattespender  
Cotton dispensers  
Distributeurs de coton  
Dispensores de algodón  
Distributore del cotone

80.1000 75 x 50 Ø  
80.1002 115 x 75 Ø



80.1000-  
80.1002

Watteabfallbehälter  
Cotton Waste Collector  
Poubelle pour coton  
Recipiente para algodón  
Recipiente per cotone usato

80.1010 75 x 50 Ø  
80.1012 100 x 75 Ø



80.1010-  
80.1012

Nadeldosen  
Needle Cases  
Boîtes à aiguilles  
Estuches para agujas  
Astucci per aghi

80.2000 65x17 mm  
komplett - complete - complet - completo - completo



80.2000

80.2009 Innendose allein für 80.2000  
insert only for 80.2000  
boîte int Érieure seulement pour 80.2000  
Caja interior suelta para 80.2000  
Scatola interna sola per 80.2000

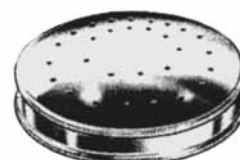

80.2009



**Zubehör · Accessories · Accessoires · Accesorios · Accessori**

**80.2020** 150x95x13 mm



**80.2020**

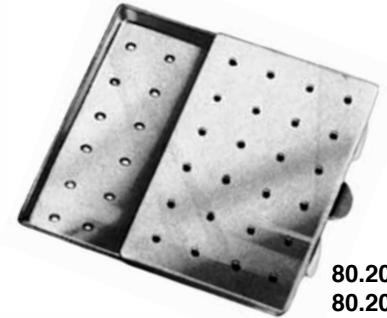

**80.2030-  
80.2032**

**80.2030** 50x25x4,5 mm

**80.2031** 65x42x8,0 mm

**80.2032** 75x25x4,5 mm

**SAUERBRUCH  
80.2060**



**80.2060**

**Meßbecher  
Measuring jugs  
Gobelets gradués  
Copas graduadas  
Misurini**

**80.2070** 0,25 l.

**80.2072** 0,5 l.

**80.2074** 1,0 l.

**80.2076** 1,5 l.

**80.2078** 2,0 l.



**80.2070 -80.2078**

**Petrischale  
Petri Dish  
Boîte de Petri  
Cubeta de Petri  
Scodella di Petri**

**80.2090** 100 X 20 mm



**80.2090**

## Zubehör · Accessories · Accessoires · Accesorios · Accessori

**Nierenschalen**  
**Kidney bowls**  
**Bassins réniformes**  
**Riñoneras**  
**Padelle reniformi**

80.2100	170 x 37 mm
80.2101	205 x 45 mm
80.2102	250 x 39 mm
80.2104	275 x 45 mm



80.2100 -  
80.2104

**Runde Schalen**  
**Round Bowls**  
**Cuvettes rondes**  
**Cubetas redondas**  
**Scodelle rotonde**

80.2200	40 x 19 mm	0,05 l
80.2202	60 x 30 mm	0,07 l
80.2204	80 x 40 mm	0,14 l
80.2206	100 x 50 mm	0,20 l
80.2208	120 x 55 mm	0,35 l
80.2210	150 x 65 mm	0,70 l



80.2200 -  
80.2210

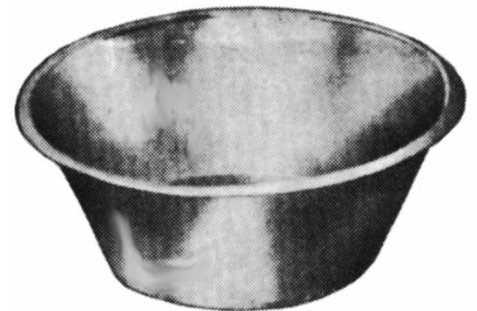

80.2240 -  
80.2262

80.2240	150 x 74 mm	0,75 l
80.2242	160 x 65 mm	1,00 l
80.2244	220 x 70 mm	2,00 l
80.2246	225 x 90 mm	2,50 l
80.2248	240 x 95 mm	3,00 l
80.2250	255 x 115 mm	4,00 l
80.2252	260 x 130 mm	4,50 l
80.2254	300 x 105 mm	6,00 l
80.2256	310 x 120 mm	6,00 l
80.2258	320 x 140 mm	8,00 l
80.2260	380 x 125 mm	11,00 l
80.2262	400 x 150 mm	14,00 l

**Kappenzangen mit Behälter und Deckel**  
**Sterilizing Forceps with jar and lid**  
**Pincas à stérilisation avec éprouvette et couvercle**  
**Pinzas para esterilización con recipiente y tapa**  
**Pinze per sterilizzazione con recipiente e coperchio**

80.2270	25 cm
80.2272	32 cm



80.2270 -  
80.2272

**Zubehör · Accessories · Accessoires · Accesorios · Accessori**

**Standgefäße**

Jars

Récipients cylindriques

Tarros

Recipienti cilindrici

80.2280	30 x 90 mm
80.2282	50 x 100 mm
80.2284	50 x 135 mm
80.2286	50 x 180 mm
80.2288	80 x 130 mm
80.2290	80 x 180 mm
80.2292	100 x 200 mm



80.2280 -  
80.2292

**Medizinbecher und -löffel**

Medicine Cups and Spoons

Gobelets et cuillère à médicaments

Vasos y cuchara para medicamentos

Bicchieri e cucchiaio per medicinali

80.2300	30 cc
80.2302	50 cc



80.2300



80.2302

80.2310	6,8 x 1,8 cm
---------	--------------



80.2310

80.2315	11 x 2 cm
---------	-----------



80.2315

## Zubehör · Accessories · Accessoires · Accesorios · Accessori

Instrumenttenablegeplatten  
Instrument depositing trays  
Plateaux pour déposer les instruments  
Bandejas para instrumentos  
Vassoi per strumenti

80.2400	210 x 160 x 10 mm
80.2401	240 x 180 x 10 mm
80.2402	310 x 150 x 10 mm
80.2406	310 x 210 x 10 mm
80.2407	400 x 270 x 20 mm
80.2408	420 x 280 x 10 mm

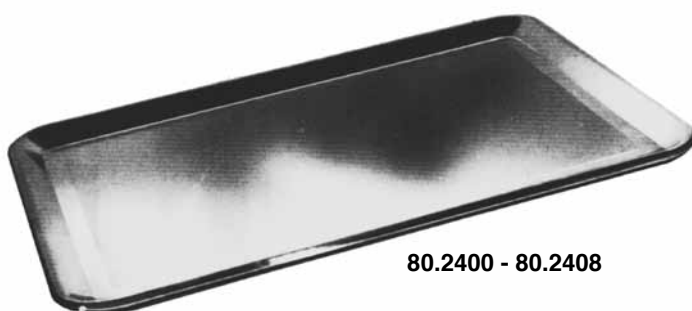

80.2400 - 80.2408

80.2430	230 x 155 x 30 mm
80.2432	300 x 175 x 30 mm
80.2434	300 x 175 x 40 mm
80.2436	350 x 240 x 36 mm
80.2438	400 x 300 x 50 mm



80.2400 - 80.2408

Instrumentenkästen  
Instrument Boxes  
Boîtes à Instruments  
Cajas para instrumentos  
Cestelli per strumenti

80.4100	16x10x 3 cm
80.4101	20x10x 5 cm
80.4102	22x15x 5 cm
80.4103	26x15x 5 cm
80.4104	30x20x 5 cm



80.4100 - 80.4104



# INHALTSVERZEICHNIS

## A

ABDOMINAL Spekulum	336
Abortuskürette	189
Abortuslöffel	189
Abortuszangen	187,191
Absaugküretten	170
ADAIR Hakenzangen	134
Adapter für Kaltlichtgriff	55
ADLERKREUTZ chirurgische Pinzetten	246
ADSON anatomische Pinzetten	235,236
ADSON anatomische Pinzetten PROMEDUR	253
ADSON Arterienklemmen	277
ADSON chirurgische Pinzetten	241,242
ADSON chirurgische Pinzetten PROMEDUR	253
ADSON Nadelhalter	360
ADSON Pinzetten mit LOCHGRIFF	235
ADSON-BABY Arterienklemmen	277
ADSON-BROWN chirurgische Pinzetten	246
ADSON-BROWN chirurgische Pinzetten PROMED	255
ADSON-DEBAKEY atraumatische Pinzetten	235
ADSON-GRAEFE chirurgische Pinzette	242
ADSON-MIKRO anatomische Pinzetten	235
ADSON-MIKRO chirurgische Pinzetten	241
ADSON-SELECT chirurgische Pinzetten	241
ALAN-PARKS Rektalspreizer	50
ALEXANDER Biopsiezange	157
ALLEN Kinderdarmklemme	27
Allgemeine Instrumente	193-372
ALLIS atraumatische Klemmen	28
ALLIS Gewebefaßklemmen	27-31
ALLIS-ADAIR Gewebefaßklemme	28
ALLIS-BABY Gewebefaßklemmen	27
AMANN Tamponadeführer	131
Amnioskope	172
Amniotom	131
Anaesthesie-Kanüle	188
Analpreizer	50,51
Anastomosenklemmen	46
anatomische Pinzetten	235-240
anatomische Pinzetten für bariatrische Chirurgie	239
anatomische Pinzetten PROMEDUR	253
ANDREW-PYNCHON Saugkanüle	367
Anschlußkabel für bipolare Pinzetten	266
Anschlußkabel für bipolare Scheren	232
Anuskope, Rektuskope, Proktoskope	54-57
Appendektomieklammer	45
Arterienklemmen, Präparierklemmen	237-293
AUVARD Vaginalsepekula	116

## B

BABCOCK Gewebefaßklemmen	29,30,293
BABCOCK Gewebefaßklemmen PROMEDUR	30
BABCOCK-DEBAKEY Klemmen	30
BABY-ADSON Arterienklemmen	277
BABY-ALLIS Gewebefaßklemmen	27
BABY-BALFOUR Bauchdeckenhalter	328
BABY-COLLIN Bauchdeckenhalter	324
BABY-CRILE Arterienklemmen	275
BABY-CRILE-WOOD Nadelhalter PROMEDUR	353
BABY-GELPI Wundsperrer	322
BABY-KOCHER Darmklemmen	33
BABY-LEXER Präparierscheren	218
BABY-METZENBAUM Präparierscheren	218
BABY-MIKULICZ Peritoneumklemme	146
BABY-MIXTER Arterienklemmen	285
BABY-OVERHOLT Arterienklemmen	283
BABY-PAYR Darmquetschklemme	44
BACKHAUS Tuchklemmen	297
BAINBRIDGE Arterienklemmen	279
BAKES Gallengangsonden	76
BALFOUR Bauchdeckenhalter	328-330
BALFOUR Mittelblätter	330

Seite

BALFOUR Seitenarme	330
BALFOUR-BABY Bauchdeckenhalter	328
BALFOUR-Modif. Bauchdeckenhalter	330
BALL & SOCKET Tuchklemmen	298
BALLENGER Schwammzangen	300
BARNES-NEVILLE Geburtszange	184
BARR Analspreizer	51
BARRET Hakenzange	133
BARRON Hämorrhoidal Ligator	68
BARRON Hämorrhoiden Faßzange	70
BARRON Skalpellgriff	203
BARTON Geburtszange	183
BARTON Zughebel	183
Batteriegriffe für Anuskope/Proktoskope	55
Bauchdeckenhalter	324-341
Bauchdeckenspekulum	336
BEACHAM Amniotom	131
Beckenzirkel	20,177
BENGOLEA Arterienklemmen	278
BENSAUDE Anuskope	53
BENSON Pyloruspreizer	45
BERGER Biopsiezangen	161
BERGMANN-FOERSTER Schwammzangen	300
BERKELEY-BONNEY Hysterektomieklammer	150
BERNHARD Tuchklemme	298
Beschneidungsgerät	103
BILL Zughebel	184
Biopsieküretten	162-163
Biopsiezangen für Rektum	71
BIPOLAR Pinzetten	257-265
BIPOLAR Scheren	228-230
BIPOLAR Scheren-Klemmen	231
BIPOL-Kabel für "BiTech" Scheren	232
BIPOL-Kabel für Bipolpinzetten	266
BiTech Bipol-Scheren	228-230
BLAKE Gallensteinzangen	81
BLAKE Uteruskürette doppelendig	164
BLANK atraumatische Pinzetten	237
Blasenhalsspreizer	96,100
Blasensprenger	188
Blasenwundspreizer	100,101
BLESSING Rektumschere	60,225
BLOND Anuskope	56
BLOND Proktoskop-Tubus	56
Blutdruckmesser	11,196,197
Blutdruckmesser, Manschetten	11,197
BODENHAMMER-SIMS Mastdarmspekulum	49
BOERMA Geburtszange	181
BONNEY anatomische Pinzette	238
BONNEY anatomische Pinzetten PROMEDUR	254
BONNEY chirurgische Pinzetten	246
BONNEY chirurgische Pinzetten PROMEDUR	255
BOYNTON Nadelhalter	345
BOYS-ALLIS Gewebefaßklemme	28
BOZEMANN Nadelhalter	360
BOZEMANN Nadelhalter PROMEDUR	355
BOZEMANN Schwammzangen	304
BOZEMANN Uterusschere	179
BOZEMANN-DOUGLAS Schwammzange	304
BRAUN Dekapitationshaken	186
BRAUN Hakenzangen	133
BRAUN Kranioklast	186
BRAUN Uterusdepressor	131
BRAUN-STADLER Episiotomie-Scheren	180
BREISKY Scheidenhalter	124
BRIDGE Arterienklemmen	279
BROMPTON Schlauchroller	299
BROPHY anatomische Pinzetten	237
BROPHY chirurgische Pinzetten	244
BROWN chirurgische Pinzetten	247
BRYANT Tupferzange	302
BUIE Druckklemme	43
BUIE Fistelsonde	63
BUIE Rektal-Absaugrohr	64
Bulldogklemmen	269-272

Seite

	Seite		Seite
BUMM Uterusküretten	167,168	DEAVER Wundhaken	314-316,317
BUMM Uterus-Polypenzange	143,190	DEBAKEY atraumatische Pinzetten	250-252
BUNT Sterilisierklammer	375	DEBAKEY Bulldogklemmen	272
Bürstenspender	23	DEBAKEY Gallengangschere	84
BUSCH Nabelschnurschere	179	DEBAKEY Gewebe- und Organfaßzangen	32,83
<b>C</b>		DEBAKEY Nadelhalter PROMEDUR	354
CARREL Arterienklemme	273	DEBAKEY Pinzette für bariatrische Chirurgie	240
CASTROVIEJO Nadelhalter	345	DEBAKEY Pinzetten PROMEDUR	254
CASTROVIEJO Nadelhalter PROMEDUR	345	DEBAKEY Saugkanülen	368
CHAPUT Arterienklemme	27	DEBAKEY Wundsperrer	321
CHARNLEY Wundspreizer	341	DEBAKEY-BABCOCK Klemmen	30
CHEATLE Sterilisierzange	374	DEBAKEY-DOYEN Darmklemmen	37
CHERON Schwammzange	304	DEBAKEY-FEHLAND Darmklemme	39
Chirurgische Pinzetten	243-249	DEBAKEY-HAYES Darmklemmen	39
Chirurgische Pinzetten für bariatrische Chirurgie	239	DEBAKEY-KOCHER Darmklemmen	38
Chirurgische Scheren	215	DEBAKEY-MIKRO atraumatische Pinzetten	251
Chirurgische Scheren für Linkshänder	215	DEBAKEY-MIKRO Bulldogklemmen	272
CLAR Stirnspiegel	14,15	DEBAKEY-SCUDDER Darmklemmen	41
COLLER-CRILE Arterienklemmen	276,287	DEMARTEL Gallengangschere	84
COLLIN Bauchdeckenhalter	324	DEMARTEL-WOLFSON Anastomosenklemmen	46
COLLIN Beckenzirkel	20,177	DENIS-BROWN Bauchdeckenhalter	331
COLLIN Dynamometer	19	DENIS-BROWN Bauchdeckenhalter für Kinder	331
COLLIN Gewebefaßfazzange	31	DENIS-BROWN Darmfasspinzette	249
COLLIN Kornzange	304	DESJARDINS Gallenkanalklemmen	79
COLLIN Nabelschnurklemme	185	DESJARDINS Gallensteinsonden	75
COLLIN Skalpellgriffe	202,204	DESJARDINS Gallensteinzangen	81
COLLIN Uterusfazzange	141	DEWEY Geburtszange	183
COLLIN Vaginalsepekula	112	Diagnostik	7-15, 195-198
COLLIN Vaginalsepekula, blendfrei für Laserchirurgie	112	DICK Klemmzangen	148
COLLIN Vaginalsepekula, isoliert für HF-Chirurgie	112	DIETRICH Bulldogklemmen	271
COLLIN Vaginalsepekulum für Kinder	107	Dilatations-Bougies	104
COLLIN-BABY Bauchdeckenhalter	324	DOUAY Biopsiezangen	157
COLLIN-DUVAL Fasspinzetten	249	DOYEN Bauchdeckenhalter	336
COLLIN-LOCKTITE Bauchdeckenhalter	325	DOYEN Darmklemmen	33
COLLYER Beckenzirkel	20,177	DOYEN gynäkologische Scheren	179
COOLEY atraumatische Pinzetten	251	DOYEN Hohlsonde	366
COOLEY Saugkanülen	369	DOYEN Myomheber	145
Coronarscheren	210	DOYEN Polypenzangen	82
COUPLAND Saugkanüle	367	DOYEN Scheidenspekula	125
CRAFOORD Arterienklemmen	281	DOYEN Uterus-Polypenzange	142,190
CRAFOORD Operationsschere	221	DOYEN Wundhaken	312
CRAFOORD-SELLORS Arterienklemmen	281,289	DOYEN-DEBAKEY Darmklemmen	37
CRILE Arterienklemmen	275	DOYEN-STILLE Wundhaken	312
CRILE Nadelhalter	359	Druckklemmen	43
CRILE-BABY Arterienklemmen	275	DUBOIS Kephalotomiescheren	180,186
CRILE-COLLER Arterienklemmen	276	DUEHRSEN anatomische Pinzetten	238
CRILE-MURRAY Nadelhalter	359	DUEHRSEN chirurgische Pinzette	245
CRILE-RANKIN Arterienklemmen	276	DUNHILL Arterienklemmen	275
CRILE-WOOD Nadelhalter	359	DUPLAY Hakenzange	135
CRILE-WOOD Nadelhalter PROMEDUR	353	DUPLAY Kornzangen	303
CRILE-WOOD-BABY Nadelhalter PROMEDUR	353	DUPLEX Stethoskope	12,198
CUSCO Vaginalsepekula	110,111	DURANTE chirurgische Pinzetten	248
CUSCO Vaginalsepekula, blendfrei für Laserchirurgie	111	DUVAL atraumatische Darmklemmen	31
CUSCO Vaginalsepekula, isoliert für HF-Chirurgie	110	DUVAL Darmfasspinzette	249
CUSCO Vaginalsepekula, schweizer Model	110	DUVAL Gewebefaßklemmen	31
CUSCO Vaginalsepekulum für Kinder	107	DUVAL Gewebefaßklemmen PROMEDUR	31
CUSHING anatomische Pinzetten PROMEDUR	253	Dynamometer	19
CUSHING Venenhaken	317	<b>E</b>	
CUZZI Abortuslöffel	189	EASTMAN Scheidenspekula	123
Cystikus-Haken	63	EDNA (Lorna) Tuchklemmen	298
CZERNY Hakenzange	133	ELLIOT Geburtszangen	182
CZERNY Mastdarm-Valve	47	EMMET Fistelhaken	144
CZERNY Wundhaken	307	EMMET Korn- u. Tupferzange	303
<b>D</b>		Empfohlene Operationsbestecke für GEBURTSHILFE	176
DARLING Wundspreizer	321	Empfohlene Operationsbestecke für GYNÄKOLIGIE	106
Darmklemmen	33-46	Empfohlene Operationsbestecke für LEBER, GALLE, NIERE	74
Darmquetschklemmen	44	Empfohlene Operationsbestecke für MAGEN, DARM, MASTDARM	26
Darmscheren	58,59,223	Empfohlene Operationsbestecke für UROLOGIE	94
DARTIGUES Uterusfazzange	90,141	Endoskopie-Sterilisiercontainer	384
DAVIS Sterilisierpinzetten	374	Endozervikalspreizer	127
DE LEE Beckenzirkel	177	Episiotomiescheren	180
DE LEE Geburtszange	182	EPPENDORF Biopsiezange	160
		ER.DE Manipulator	175

	Seite		Seite
EWALD anatomische Pinzette	235	GRAVE Vaginalsepekula, isoliert für HF-Chirurgie	113
EWALD chirurgische Pinzette	241	GRAY Gallenkanalklemmen	80
EXACTA Blutdruckmesser	10,196	GREEN Wundhaken	310
<b>F</b>		GREEN-ARMYTAGE Abortuszangen	187
Fadenzange	95	GREGORY Bulldogklemmen	270
FANSLER-IVES Anoskop mit Kaltlichtanschluss	54	GREGORY Mikronadelhalter	349
FANSLER-IVES Anuskope	53,54	GREGORY Mikronadelhalter DIAMANT	351
FAURE Biopsiezange	156	GREGORY Mikronadelhalter PROMEDUR	351
FAURE Peritoneumklemmen	147	GROSS Kornzangen	303
FEHLAND-DEBAKEY Darmklemme	39	GUNNAR-HEY Schlauchroller	299
feine Scheren	214	GUTTMAN Sekretlöffel	103
feine Scheren für Linkshänder	214	GUYON Dilatationsbougies	104
FERGUSSON Druckklemmen	43	GUYON Katheterspanner	102
FERGUSSON gynäkologische Schere	179	GUYON Nierenstielklemmen	88,291
FERRIS-SMITH chirurgische Pinzetten	244	GWILLIAM Hysterektomieklappen	150
Filter, Papier für Container	386	Gynäkologie	105-180
Filter, Textil für Container	387	Gynäkologische Scheren	178-180
Filterhalter für Container	386	<b>H</b>	
Filterspender für Container	386	Haemorrhoidal Fasszangen	70
FINOCHIETTO Nadelhalter	360	Hakenzangen	133-139
FINOCHIETTO Nadelhalter PROMEDUR	355	Halogen Stirnlampen	15
Fistel- und Myominstrumente	144,145	HALSTED Arterienklemmen	277
Fistelhaken	144	HALSTED-MOSQUITO Arterienklemmen	274
Fistelsonen	63,366	Haltestifte für Instrumente	389
Fixierfedern für Instrumente	388	Handwaschbürste	23
Fixierklammern für Tücher	388	HARRINGTON Bronchusklemme f. bariat. Chirurgie	292
Fixierklemme, Samenstrang	96	HARRISON Sterilisierzangen	374
Flach-Container	382	HARTMANN Arterienklemmen	273
FLETCHER (Javerts) Schwammzange	301	HARTMANN-MIKRO Arterienklemmen	273
FLETCHER Schwammzange	301	HAYES-DEBAKEY Darmklemmen	39
FOCUS Halogen-Stirnlampe	15	HEANEY (Hegar) Nadelhalter	361
FOERSTER Bauchdeckenhalter, röntgenfähig	337	HEANEY Hysterektomieklappen	149
FOERSTER Gallenblasenzangen	83,300	HEANEY Nadelhalter PROMEDUR	356
FOERSTER Schwammzangen	293,300,301	HEANEY-BALLENTINE Hysterektomieklappen	149
FORD-DIXON Hämorrhoidal Ligator	66	HEANEY-KANTER Hysterektomieklappen	149
FRANKLIN-SILVERMAN Leberpunktionskanülen	87	HEANEY-REZEK Hysterektomieklappen	149
Fremdkörperzangen	103	HEGAR Uterusdilatoren	128,129
FRIEDMANN (Joll) Wundspreizer	126,321	HEISS Arterienklemmen	278
FRITSCH Wundhaken	313	HENROTIN Hakenzange	137
FUCHSIG Arterienklemme	278	HERRICK Nierenstielklemme	88
<b>G</b>		HERTZLER Bauchdeckenhalter	328
Galle, Leger, Niere	73 - 92	HEYWOOD-SMITH Gallenblasenzangen	83
Gallenblasenzangen	83,300	HEYWOOD-SMITH Hämorrhoidalzange	70
Gallengangscheren	83	HEYWOOD-SMITH Uterus-Polypenzange	83,142,190
Gallengangsonden	76	HF-Chirurgie - Vaginalsepekula	111-114
Gallenkanalklemmen	79	HILL-FERGUSON Mastdarm-Valven	47
Gallensteinlöffel	77,78	HILL-FERGUSON Rektalspekula	47
Gallensteinsonden	75	HIRSCHMANN Anuskope	52
Gallensteinzangen	80-82	Hohlsonden	366
GAUSS Kopfschwartenzange	187	HOLZBACH Bauchdeckenhalter	326
Geburtshilfe	176-191	HORGAN Mittelvalven	330
Geburtzangen	181-184	HÖSEL Wundhaken	61
GELPI Wundsperrer	322,323	HRYNTSCHAK Blasenwundspreizer	101
GELPI-BABY Wundsperrer	322	HULKA Hakenzange	135
GELPI-MINI Wundsperrer	322	HULKA-KENWICK Hakenzange	135
GELPI-SELETZ Wundspreizer	323	Hysterektomieklappen	149-154
GEMINI Arterienklemmen	284,291,294	Hystero-Salpingograph	171
GEMINI-MINI Arterienklemmen	284	<b>I</b>	
GERALD chirurgische Pinzetten	244	Instrumenten-Pflegeöl	391
GERALD chirurgische Pinzetten PROMED	254	Instrumentenkästen	395
Gewebe- und Organfaßzangen	27-32	Indikatorschilder für Sterilisation	385
GILLIES chirurgische Pinzette	242	Infusionsflaschen-Öffnungszange	375
GILLIES chirurgische Pinzetten PROMED	254	Instrumentenbügel	375
GIL-VERNET Sinus Renalis Haken	91,92	Instrumentenschalen	395
GLASSMANN atraumatische Pinzetten	252	IOWA Blasensprenger	188
GLOVER Bulldogklemmen	269	IOWA Pudendus-Anaesthesiekanüle	188
GOELET Wundhaken	307	ISRAEL Wundhaken	309
GOODELL Uterus Dilator	129	IUP Haken zur Entfernung	132
GOSSET Bauchdeckenhalter	327	IUP-Fasszangen & Tupferträger	132
GOURDET Uteruslöffel	165		
GRAVE Vaginalsepekula	113,115		
GRAVE Vaginalsepekula, blendfrei für Laserchirurgie	113		



	Seite		Seite
<b>J</b>			
JACKSON Scheidenspekula	123	LAWRENCE Arterienklemme	285
JACKSON-BURROWS Wundreizer	323	Leberhaken	85
JACOBS Hakenzangen	138	Leberpunktionskanülen	87
JACOBSON-MIKRO Arterienklemmen	274	Lebertransplantationsklemmen	86
JARCHO Hakenzange	134	LEGUEU Blasenspatel	97
JEFFERSON anatomische Pinzette	236	LEGUEU Blasen-Wundspreizer	325
JEFFERSON chirurgische Pinzette	242	LERCHE chirurgische Pinzette	246
JOHN-HOPKINS Gallenkanalklemme	80	LEXER-BABY Präparierscheren	218
JOHNSON Nadelhalter	360	LICHTENBERG Nadelhalter PROMEDUR	358
JOLL (Friedmann) Wundspreizer	126,321	Lichtstab für Proktoskope, Anuskope, Spekula	50,53,109
JONES Tuchklemmen	297	LICHTWITZ Trokar	371
JUDD-ALLIS Gewebefaßklemmen	28	Linkshänder feine Arterienklemmen	274
JUDD-MASON Blasenwundspreizer	100,101	Linkshänder Nadelhalter	353,354
<b>K</b>			
Kabel für "BiTech" Scheren	232	Linkshänder Scheren	214,215
Kabel für bipolare Pinzetten	266	LISTER-SINUS Zängchen	302
KALLMORGEN Scheidenspekula und -halter	122	LITTAUER Nageleckenzangen	22
Kaltlichtgriff für Anuskope, Proktoskope	55	LITTLE Wundhaken	309
Kaltlicht-Klammer für Proktoskope	54,173	LITTLEWOOD Gewebefaßklemme	28
Kaltlichtquelle für Stirnlampen	15,57	LLOYD-DAVIS Rektum-Anastomosenklemme	43
Kaltlichtstab für Proktoskope, Anuskope, Spekula	50,53,109	LLOYD-DAVIS Rektumschere	59,223
KANE Nabelschnurklemme	185	LOCKHART-MUMMERY Fistelsonden	63,366
KANTROWITZ Arterienklemmen	284	LOCKWOOD Gewebefaßklemme	29
Kappenzangen	393	LORNA (Edna) Tuchklemmen	298
Kapselassenzangen	95	LOWER Gallenkanalklemme	80
Katheter für Frauen, Männer	102	LUER-KOERTE Gallensteinlöffel	78
Katheterspanner	102	LUIKART Geburtszange	182
KELLY Abortuszange	191	LUIKART-BILL Zughebel	184
KELLY Arterienklemmen	275	Lupenbrille	13
KELLY Leberhaken	85,311	LURZ Hämorrhoidal Saug-Ligatoren	66
KELLY Proktoskope	52	LURZ Ureterklemmen	96
KELLY Sphinkteroskope	52	<b>M</b>	
KELLY Wundhaken	85,311	Magen, Darm, Mastdarm	27-71
KELLY-RANKIN Arterienklemmen	276	MAIER Kornzangen	303
Kennzeichnungsschilder / Sterilisation	385	MAINGOT Hysterektomieklappen	150
Kephalotomiescheren	180,186	Manschetten für Blutdruckmesser	11,197
KERSTING atraumatische Darmklemme	40	MARBERGER Sinus Renalis Haken	91
KEVORKIAN Biopsieküretten	162	MARINUS Darmklemmen	42
KEVORKIAN Biopsiezangen	161	MARTEL Kopfschwartenzange	187
KEVORKIAN-PACIFIC Biopsiezange	158	MARTIN Abfallzange	374
KIELLAND Geburtszange	181	MARTIN Beckenzirkel	20,177
KIELLAND-LUIKART Geburtszange	182	MARTIN Uterussonden	130
KIRSCHNER Bauchdeckenhalter	332	Maßbänder	19
KLEINSCHMIDT Appendektomieklammer	45	MASSON Nadelhalter	361
Klemmzangen atraumatisch	148	MASSON Nadelhalter PROMEDUR	356
KLING-EX Klingentferner	205	Maßstäbe	19
KLINIKUM-BERLIN Schlauchklemme	299	Mastdarm-Spekula	47-51
Knopfsonden	365,366	Mastdarm-Valven	47
Koagulationspinzetten, bipolar	257-265	MATHIEU Fremdkörperzange	103
KOCHER Darmklemmen	34	MATHIEU Nadelhalter PROMEDUR	358
KOCHER Prostatahaken	97	MATHIEU Rektalspekulum	49
KOCHER-BABY Darmklemmen	33	MATHIEU-KOCHER Nadelhalter PROMEDUR	358
KOCHER-DEBAKEY Darmklemmen	38	MAYO Gallensteinlöffel	77
KOCHER-WAGNER Wundhaken	313	MAYO Operations- und Präparierscheren	216,222
KOERTE Wundhaken	308	MAYO Sterilisierklammern	375
KOGAN Endospekula	127	MAYO-ADAMS Bauchdeckenhalter	325
KONRICH Sterilisiertrömmeln	390	MAYO-BLAKE Gallensteinzangen	82
KRISTELLER Scheidenhalter für Kinder	108	MAYO-GUYON Nierenklemme	88
KRISTELLER Scheidenspekula und -halter	118,119,120,121,126	MAYO-HARRINGTON Operations- und Präparierscheren	217,224
KÜSTNER Hakenzange	139	MAYO-HEGAR Nadelhalter	359
<b>L</b>			
LAHEY Gallenkanalklemmen	79	MAYO-HEGAR Nadelhalter für Linkshänder	354
LAHEY Wundhaken	309	MAYO-HEGAR Nadelhalter PROMEDUR	354
LANDAU Scheidenhalter	124	MAYO-LEXER Operations- und Präparierscheren	217,224
LANDOLD Skalpellgriffe für Mikroklingen	199	MAYO-NOBLE Operations- und Präparierscheren	217
LANE chirurgische Pinzetten	247	MAYO-ROBSON Darmklemmen	35
LANE Tuchklemmen	298	MAYO-RUSSIAN chirurgische Pinzette	247
LANGENBECK Nadelhalter PROMEDUR	355	MAYO-STILLE Operations- und Präparierscheren	216
LANG-STEVENSON Darmklemme	33	McGIVNEY Haemorrhoidal Ligatoren	65,69
Laserchirurgie - Vaginalspekula	111,112,113,114	McGIVNEY Haemorrhoidal Faszange	70
LATERAL-Retraktor	127	McINDOE anatomische Pinzette	236
		McINDOE chirurgische Pinzetten PROMED	254
		McLEAN Geburtszange	183
		McLEAN-LUIKART Geburtszange	183
		McLEAN-TUCKER Geburtszange	183

	Seite		Seite
Medizinbecher	394	NAUNTON-MORGAN Nadelhalter PROMEDUR	357
Medizinlöffel	394	NEIVERT Nadelhalter	359
Medizinschale	394	NEIVERT Nadelhalter PROMEDUR	353
MEEKER Arterienklemme	285	NELATON Hohlsonde	366
MENGHINI Leberpunktionskanülen	87	NELSON chirurgische Pinzetten	246
Messbecher	392	NELSON Trokare	371
Metalletui für Hegar Uterus Dilatatoren	128	Nierenfasszange	90
Metallkatheter für Frauen und Männer	102	Nierenklemmen	88
Metall-Maßstäbe	19	Nierenschalen	393
METZENBAUM Nadelhalter	360	Nierensteinzangen	89
METZENBAUM Operations- und Präparierscheren	219,219,221,222,226	NISSEN Arterienklemme	278
METZENBAUM-BABY Präparierscheren	218	NONSTICK-BIPOLAR Pinzetten	257
METZENBAUM-FINO Operations- und Präparierscheren	220,227	Noppenmatten, Silikon	387
MICRO-DEBAKEY Bulldogklemmen	272	NOTO Uterus-Polypenzange	143,190
MICRO-MOSQUITO Arterienklemmen	274	NOVAK Biopsieküretten	163
MICRO-VASCULAR Nadelhalter, Titanium	353	NOVA-PRESAMETER Blutdruckmesser	9,195
MIDDELDORF Wundhaken	310	NUSSBAUM Darmklemmen	36
MIKRO-ADSON anatomische Pinzetten	235		
MIKRO-ADSON chirurgische Pinzetten	241	<b>O</b>	
Mikro-Biopsiestanze für Gynäkologie	161	OCHSNER Trokare	371
MIKRO-DEBAKEY atraumatische Pinzetten	251	OCULUS Lupenbrille	13
MIKRO-HARTMANN Arterienklemmen	273	OEHLER chirurgische Pinzetten PROMEDUR	255
MIKRO-JACOBSON Arterienklemmen	274	Öffnungszange für Infusionsflaschen	375
Mikro-Nadelhalter	346-353	Öhrronden	365
Mikroscheren für Gynäkologie	209-213	OLLIER Wundhaken	308
Mikro-Skalpellklingen	199	OLVECRONA Arterienklemmen	281
MIKULICZ Leberhaken	85	OMBREDANNE Darmfassklemmen	29
MIKULICZ Peritoneumklemmen	146	OMBREDANNE Tuchklemme	297
MIKULICZ-BABY Peritoneumklemme	146	Operations- und Präparierscheren	216-221
MILLER Rektumschere	58	Operations- und Präparierscheren PROMEDUR	222,225-227
MILLIN Blasenhalsspreizer	96,100	Operationsbestecke für GEBURTSHILFE	176
MILLIN Blasen spreizer	100	Operationsbestecke für GYNÄKOLOGIE	106
MILLIN Fadenzange	95	Operationsbestecke für LEBER, GALLE, NIERE	74
MILLIN Fasszange	95	Operationsbestecke für MAGEN, DARM, MASTDARM	26
MILLIN Kapsel fasszangen	95	Operationsbestecke für UROLOGIE	94
MILLS Gallengangs chere	84	O'SULLIVAN-O'CONNOR Bauchdeckenhalter	334
Mini-Container	382	OVERHOLT-BABY Arterienklemme	283
MINI-GELPI Wundsperrerr	322	OVERHOLT-GEISSENDÖRFER Arterienklemmen	283
MINI-GEMINI Arterienklemme	284	OVERHOLT-MIXTER Arterienklemme	283
MINIMUS Blutdruckmesser	10,196		
Mischschalen	393	<b>P</b>	
MIXTER Arterienklemmen	286	Papierfilter für Container	386
MIXTER Gallensteinzange	82	Parametriumscheren	60,225
MIXTER-BABY Arterienklemmen	285	PARKS Analspreizer verwendbar mit Kaltlicht	50
MOD. MÜNCHEN Biopsieküretten	163	PAYR Darmquetschklemmen	44
MOGEN Beschneidungsgerät	103	PAYR-BABY Darmquetschklemme	44
MOORE Gallensteinlöffel	77	PEAN Arterienklemmen	279
MORGAN Proktoskope	53	PEAN-FINO Arterienklemmen	280
MORRIS Wundhaken	307,312	PEDERSON Vaginalsepekula	114
MORRIS-MITRAL Gefäßswundspreizer	323	PEDERSON Vaginalsepekula, blendfrei für Laserchirurgie	114
MOSQUITO Arterienklemmen für Linkshänder	274	PEDERSON Vaginalsepekula, isoliert für HF-Chirurgie	114
MOSQUITO-MICRO Arterienklemme	274	PEDERSON Vaginalsepekulum für Kinder	107,114
MOYNIHAN Gallenkanalklemme	79	PEERS Tuchklemme für Papiertücher	297
MOYNIHAN Gallensteinsonde	75	PELKMANN Kornzangen	302
MOYNIHAN Tuchklemme	298	Pelvishaken	62
MÜNCHENER Model Biopsieküretten	163	Penisklemmen	103
MURLESS Kopfhebel	181	PENNINGTON Arterienklemmen	27
MUSEUX Hakenzangen	139	Perinealspreizer	52
Myomheber	145	Peritoneumklemmen	146-148
Myommesser	145	PESTALOZZA Abortuskürette	189
Myrtenblattsonden	366	Petrischale	392
		Pflegeöl für Instrumente	391
<b>N</b>		PHANEUF Peritoneumklemmen	148
Nabelschnurklemmen	185	PINARD Stethoskope	12,198
Nabelschnurscheren	179	Pinzetten	235-266
Nadeldosen	391,392	PIPER Geburtszangen	182,184
NAEGELE (DeLee) Geburtszange	181	PITTSBURG Lebertransplantationsklemmen	86
NAEGELE Geburtszange	181	POOLE Saugkanülen	368,370
NAEGELE Perforator	186	POST-MORTEM-Skalpellklinge	203
NAGEL Mikroscheren mit Profilgriff	213	POTTS-DE-MARTEL Gallengangscheren	84
Nagelfeilen	23	POTTS-SMITH chirurgische Pinzetten	245
Nagelhautscheren	22	POTTS-SMITH chirurgische Pinzetten PROMED	253
Nagelzangen	22	POTTS-SMITH Gallengangs chere PROMEDUR	84
Naht	343-361	POZZI Hakenzangen	134

	Seite		Seite
Präparier- und Arterienklemmen	273-293	Schlauchklemmen	299
Präparierscheren mit Profilgrif	211,216-222	Schlauchklemmen mit Schutzbügel	299
PRATT (Billroth)Hakenzange	137	Schlauchroller	299
PRATT Cystikus-Haken	63	SCHROEDER Hakenzange	134,136
PRATT Hakenzange	137	SCHROEDER Uteruslöffel	164
PRATT Mastdarmspekulum	49	SCHUBERT Biopsiezangen	156
PRATT-"T" Arterienklemme	32	SCHULTZE Salpingograph	171
PRECISA Blutdruckmesser	9,195	SCHULZE-BERGMANN Mastdarm-Spekula	48
PRESBYTERIAN Schlauchklemmen	299	SCHUMACHER Biopsiezangen	160
Proktoskope, Anuskope, Rektuskope	54-57	SCHUMACHER Nabelschnurschere	179
PRO-MEDSEKUR™ Skalpellgriffe	201	SCHUMACHER-VAN DOREN Biopsiezange	155
PROMEDUR Nadelhalter	353-358	Schwammzangen	300-304
PROMEDUR Scheren	222,224-227	Schwesterngarnitur	23
Prostatahaken	98	SCUDDER Darmklemmen	35
Prostataklemme	95	SCUDDER-DEBAKEY Darmklemmen	41
PROVIDENCE-HOSPITAL Arterienklemmen	275	SEGOND Hysterektomieklammer	149
Pylorusspreizer	45	SEGOND Myommesser	145
		SEGOND-LANDAU Hysterektomieklammer	149
<b>R</b>		Sekretlöffel, Urologie	103
RAMATHIBODI Tubushaken	132	SELLHEIM Geburtsloeffel	184
RAMATHIBODI Uterusmanipulator	132	SEMKEN anatomische Pinzetten	236
RAMPLEY Schwammzangen	301	SEMKEN anatomische Pinzetten PROMEDUR	253
RAMSEY anatomische Pinzette	238	SEMKEN chirurgische Pinzetten	242
RAMSEY chirurgische Pinzetten	245	SEMM Bauchdeckenhalter	333
RANDALL Biopsiekürette	163	SEMM Vaginalspekula	115
RANDALL Nierensteinzangen	89	SEYFFERT Vaginalspekula	115
RANKIN-CRILE Arterienklemmen	276	Sicherheitsdeckel für Sterilisiercontainer	376,378,380
RANKIN-KELLY Arterienklemmen	276	Sicherungsplomben, Plastik	385
RECAMIER (BUMM) Uterusküretten	168,169	Siebkörbe	377,379,381,383
RECAMIER Uterusküretten	167	Siebkörbe für Endoskopie-Instrumente	384
Rektalspreizer	50,51	SIEBOLD gynäkologische Schere	179
Rektum-Biopsiezangen	71	Silikon Fixierstreifen	388
Rektumscheren	58,59,60,223,225	Silikon Noppenmatten	387
Rektuskope, Anuskope, Proktoskope	54-57	SIMON Fistelhaken	144
RESANO atraumatische Darmklemme	40	SIMON Scheidenhalter	125
RICARD Bauchdeckenhalter	326	SIMON Uteruslöffeln	164
RICHARDSON Wundhaken	310	SIMPSON Geburtszange	181
RICHARDSON-EASTMAN Wundhaken	310	SIMPSON-BRAUN Geburtszange	182
Ringgriffe für Biopsie-Aufsätze	159	SIMPSON-LUIKART Geburtszange	182
ROBERTS Arterienklemmen	280	SIMS gynäkologische Scheren	178
ROBIN-MASSE Bauchdeckenhalter	327	SIMS Mastdarmspekulum	48
ROCHARD Bauchdeckenhaken	335	SIMS Operations- und Präparierscheren	224
ROCHARD Bauchdeckenhalter	335	SIMS Scheidenspekula	123
ROCHESTER-CARMALT Arterienklemmen	279	SIMS Uterusdepressoren	131
ROCHESTER-OCHSNER Arterienklemmen	282,290	SIMS Uterusküretten	166
ROCHESTER-PEAN Arterienklemmen	280,288	SIMS Uterussonden	130
ROEDER Tuchklemmen	298	SIMS-MAIER Polypenzangen	302
ROGGE Sterilisierzange	374	SINGLEY (TUTTLE) Fasspinzetten	240,247
Rotoklette	162	Sinus Renalis Haken	91,92
RUDD Haemmoridalligator	65	Skalpellgriffe	201-203,204-205
RUDD Ligatur-Gummiringe	65	Skalpellgriffe für Mikroklingen	199
RUMEL Arterienklemmen	284	Skalpellschlingen	199,200,203
RUSSIAN chirurgische Pinzetten	247	SKENE Hakenzange	136
RUSSIAN Fasspinzette	239	SMELLIE Geburtshaken	185
		SMELLIE Perforator	186
<b>S</b>		SOFIELD Wundhaken	307
SAENGER Abortuszangen	191	SOMER Uterusfasszange	140
SAMENSTRANG-Fixierklemme	96	Sonden, Sasugrohre, Trokare	363-371
Samenstranghäkchen	99	Sortiermagazin für Kennzeichnungsschilder	385
SANTULLI Bulldogklemme	271	Spannrahmen für Sterilisiercontainer	377,379,381
SAROT Arterienklemme f. bariatrische Chirurgie	289	SPENCER-WELLS Arterienklemmen	279
SAROT Nadelhalter	361	Sphinkteroskope	52
SAROT Nadelhalter PROMEDUR	357	Spülschalen	393
SAUERBRUCH Abfallzange	374	St.MARKS Pelvishaken	62
SAUERBRUCH Nadeldose	392	St.MARKS Perinealspreizer	51
Saugrohre	367-370	St.MARKS Proktoskop	52
SCHAEDEL Tuchklemme	297	STAUDE-MOORE Hakenzange	133
Scheidenhalter	108-125	STEINER-AUVARD Vaginalspekulum	116
Scheidenhalter für Kinder	108,118	STELZNER Rektumscheren	59,223
SCHERBAK Vaginalspekula	117	Sterilisation	373-395
Scheren	207-232	Sterilisierbehälter	376,378,380,382,384,390
Scheren für Gynäkologie, Geburtshilfe	178-180	Sterilisierbehälter - Zubehör	377,379,381,383
Scheren-Klemmen, bipolar	231	Sterilisiercontainer für Endoskopie	384
SCHIMMELBUSCH Sterilisiertrommeln	390	Sterilisiercontainer für Mikroinstrumente	390
		Sterilisierklammern	375

	Seite		Seite
Sterilisierpinzetten	374	Uterusküretten	164-170
Sterisierrahmen für Mikro-Instrumente	389	Uteruslöffel	164-170
Sterilisiertrommeln	390	Uterusmanipulator	132
Sterilisiertücher	387	Uteruspolypenzange	83,142-144,190
Sterilisierzangen	374	Uterussonden	130
STILLE anatomische Pinzetten	237		
STILLE Nierenstiekllemme	88	<b>V</b>	
STILLE-BARRAYA chirurgische Pinzetten	248	Vaginalsepekula	107-127
Stirnlampen	14, 15	Vaginalsepekula für Kinder	107-109,118
Stirnlampen mit Halogen-Beleuchtung	15	Vaginalsepekula, blendfrei für Laserchirurgie	111,112,113,114
Stirnspiegel	14	Vaginalsepekula, isoliert für HF-Chirurgie	111,112,113,114
STOCKMANN Penisklemme	103	Vaginoskop mit Kaltlichtanschluss für Kinder	109,173
STONE chirurgische Pinzette	246	VALLEIX Uterussonde	130
STRATTE Nadelhalter	361	VAN BUREN Dilatationsbougies	104
STRATTE Nadelhalter PROMEDUR	357	VAN DOREN Biopsiezange	155
STRAUSS Kaltlicht-Rektoskop	57	VANNAS Mikroscheren für Gynäkologie	209,212
STRAUSS Penisklemme	103	Vasektomie-Instrumente	99
STRINGER Instrumentenbügel	375	Vasektomie-Klemmen	99
		Vergleichsinstrumente	17-20
		Vorbereitung	21-24
<b>T</b>			
Tamponadenführer	131	<b>W</b>	
TARNIER Basiotrib	186	WALDMANN Episiotomiescheren	180
TARNIER Geburtszange	183	WALLICH Abortuslöffel	189
TAYLOR chirurgische Pinzetten	245	WALTON Schwammzangen	302
TAYLOR-CUSHING chirurgische Pinzetten	245	WANGENSTEEN Fasspinzette	247
TEALE Hakenzangen	138	WANGENSTEEN Fasspinzette PROMEDUR	253
Teiler für Container	377,379,381	WANGENSTEEN Nadelhalter	361
Textilfilter für Container	387	WANGENSTEEN Nadelhalter PROMEDUR	356
Textilfilter für Container	387	WASSMUND Wundhaken	308
THOMAS Uterusküretten	165	Watteabfallbehälter	391
THOMS-ALLIS Gewebefaßklemme	28	Wattespender	391
THOMS-GAYLOR Biopsiezange	155	Watteträger für Rektoskop	64
THOMSON-WALKER Blasenhalsspreizer	101	WAUGH chirurgische Pinzetten	248
THOREK Präperierscheren	218	WEISSBARTH Scheidenspekulum	118
TIEMANN Kugelzange	136	WERTHEIM chirurgische Scheren	218
TISCHLER (Baggish)Biopsiezange	158	WERTHEIM Hysterektomieklappen	149,152
TISCHLER Biopsiezange	158	WERTHEIM Peritoneumklemme	146
TISCHLER-BURKE Biopsiezange	158	WERTHEIM-ATRAUMA Hysterektomieklappe	151
TISCHLER-KEVORKIAN Biopsiezange	158	WERTHEIM-CULLEN Hysterektomieklappe	151
TISCHLER-MINI Biopsiezange	158	WERTHEIM-DEBAKEY Hysterektomieklappen	153
TITANIUM Microvascular Nadelhalter	353	WIJNEN Saugkanüle	368,370
TOHOKU Tuchklemmen	298	WIKSTROEM Arterienklemmen	285
TOWNSEND Biopsiekürette	162	WILLET Kopfschwanzzange	187
TOWNSEND Griff für Biopsie-Aufsätze	159	WILLIAMS Gewebefaßklemmen	29
TOWNSEND-BURKE Biopsiezange	159	Winkelbleche für Sterilisiercontainer	389
TOWNSEND-KERVORKIAN Biopsiezange	159	WINTER Abortuszangen	191
TOWNSEND-KRAUSE Biopsiezange	159	WITTNER Biopsiezangen	160
TOWNSEND-MINI Biopsiezangen	159	WRIGLEY Geburtszange	181
TOWNSEND-TISCHLER Biopsiezangen	159	Wundhaken	61,62,305-317
Transformator für Stirnlampen	14	Wundspreizer	319-323
TRELAT Vaginalsepekula	115		
Trennbleche für Sterilisiercontainer	389	<b>Y</b>	
TREVES chirurgische Pinzetten	246	YANKAUER Saugkanülen	367
Trokare	371	YEOMAN Biopsiezangen	71
Tuben für Amnioskopie	172	YOUNG Prostatahaken	98
Tubus-Haken	132	YOUNG Prostataklammer	95
Tuch- und Schlauchklemmen, Tupferzangen	295-299		
TUEBINGEN Wundhaken (Scheidenhalter)	313	<b>Z</b>	
TUFFIER Arterienklemme	27	Zangenbehälter	394
Tupferzangen	300-304	Z-HYSTEREKTOMIE atraumatische Klemmen	154
TURNBULL Nagelzangen	22	ZIEGLER Stirnspiegel	14
TURNER-WARWICK Bauchdeckenhalter	338-340		
<b>U</b>			
ULRICH Tupferzangen	303		
UNIVERSAL Trokare	371		
Ureterklemmen	96		
Ureterzangen	90		
Urologie	93-104		
USA-MODEL Schlauchklemmen	299		
Uterusbiopsiezangen	156-161		
Uterusdepressoren	131		
Uterusdilatoren	128,129		
Uterusfasszangen	140,141		



# ALPHABETICAL INDEX

## A

Abdominal Retractors	324-341
Abdominal Speculum	336
Abortion Scoops	189
ADAIR Tenaculum Forceps	134
Adapter for Fiber optic light handle	55
ADLERKREUTZ Tissue Forceps	246
ADSON Dressing Forceps	235,236
ADSON Dressing Forceps PROMEDUR	253
ADSON Hemostatic Forceps	277
ADSON Needleholder	360
ADSON Tissue Forceps	241,242
ADSON Tissue Forceps PROMEDUR	253
ADSON-BABY Hemostatic Forceps	277
ADSON-BROWN Tissue Forceps	246
ADSON-BROWN Tissue Forceps PROMEDUR	255
ADSON-DEBAKEY Tissue Forceps	235
ADSON-GRAEFE Tissue Forceps	242
ADSON-MICRO Dressing Forceps	235
ADSON-MICRO Tissue Forceps	241
ADSON-SELECT Tissue Forceps	241
ALAN-PARKS Rectal Spreader	50
ALEXANDER Uterine Biopsy Forceps	157
ALLEN Intestinal Forceps	27
ALLIS atraumatic Tissue Forceps	28
ALLIS Tissue Forceps	27
ALLIS Tissue Forceps for Bariatric Surgery	27,292
ALLIS-ADAIR Tissue Forceps	28
ALLIS-BABY Tissue Forceps	27
AMANN Uterine Gauze Packer	131
Amnioscopes for micro blood extraction	172
Anaesthesia Needle & Guide	188
Anal Retractor	51
Anastomosis Clamps	46
ANDREW-PYNCHON Suction Tube	367
Angiotribes	43
Anuscopes	52,53
Aspirating Curettes, uterine	170
AUVARD Vaginal Specula	116

## B

BABCOCK Tissue Forceps	29,293
BABCOCK Tissue Forceps PROMEDUR	30
BABCOCK-DEBAKEY atraumatic Tissue Forceps	30
BABY-ADSON Hemostatic Forceps	277
BABY-ALLIS Tissue Forceps	27
BABY-BALFOUR Abdominal Retractor	328
BABY-COLLIN Abdominal Retractor	324
BABY-CRILE Hemostatic Forceps	275
BABY-CRILE-WOOD Needleholder PROMEDUR	353
BABY-GELPI Retractor	322
BABY-KOCHER Intestinal Forceps	33
BABY-LEXER Dissecting Scissors	218
BABY-METZENBAUM Dissecting Scissors	218
BABY-MIKULICZ Peritoneum Clamp	146
BABY-MIXTER Hemostatic Forceps	285
BABY-OVERHOLT Hemostatic Forceps	283
BABY-PAYR Crushing Clamps	44
BACKHAUS Towel Forceps	297
BAINBRIDGE Hemostatic Forceps	279
BAKES Gall Duct Probes	76
BALFOUR Abdominal Retractors	328-330
BALFOUR-BABY Abdominal Retractor	328
BALFOUR-Modif. Abdominal Retractors	330
BALL and SOCKET Towel Forceps	298
BALLENGER Sponge Forceps	300
BARNES-NEVILLE Obstetrical Forceps	184
BARR Anal Retractor	51
BARRET Tenaculum Forceps	133
BARRON Scalpel Handle	203
BARRON Haemorrhoidal Seizing Forceps	70
BARRON Haemorrhoidal Suction Ligator	68

BARTON Obstetrical Forceps	183
BARTON Traction Handle	183
Basiotribe	186
Battery handle for Anuscopes	55
BEACHAM Amniotome	131
BENGOLEA Hemostatic Forceps	278
BENSAUDE Anuscopes	53
BENSON Pylorus Spreader	45
BERGER Uterine Biopsy Forceps	161
BERGMANN-FOERSTER Sponge Forceps	300
BERKELEY-BONNEY Hysterectomy Forceps	150
BERNHARD Towel Forceps	298
BILL Traction Handle	184
Binocular Loupe	13
Biopsy Curettes	162
Biopsy Forceps, rectal	71
Biopsy Forceps, uterine	156-161
Biopsy Needles	87
Bipolar "NONSTICK" Forceps	257-260
Bipolar Clamp-Scissors	231
Bipolar Coagulating Forceps	261-265
Bipolar Scissors	228-230
BIPOL-Cables for "BiTech" Scissors	232
BIPOL-Cables for Bipol-Forceps	266
BiTech Bipolar Scissors	228-230
Bladder Neck Instruments	97
Bladder Retractors	100-101
Blades, Scalpel	199,200,203
BLAKE Gall Stone Forceps	81
BLAKE Uterine Curette	164
BLANK atraumatic Dressing Forceps	237
BLESSING Rectal Scissors PROMEDUR	60,225
BLOND Anuscopes	56
BLOND Proctoscope-tubes	56
BODENHAMMER Rectal Speculum	49
BOERMA Obstetrical Forceps	181
BONNEY Dressing Forceps	238
BONNEY Dressing Forceps PROMEDUR	254
BONNEY Tissue Forceps	246
BONNEY Tissue Forceps PROMEDUR	255
Bowls, round	393
Bowls, solution	393
BOYNTON Needleholder	345
BOYS-ALLIS Tissue Forceps	28
BOZEMANN Needleholders	360
BOZEMANN Needleholders PROMEDUR	355
BOZEMANN Sponge- and Dressing Forceps	304
BOZEMANN Uterine Scissors	179
BOZEMANN-DOUGLAS Dressing Forceps	304
BRAUN Cranioclast	186
BRAUN Obstetrical Hook	186
BRAUN Tenaculum Forceps	133
BRAUN Uterine Depressor	131
BRAUN-STADLER Episiotomy Scissors	180
BREISKY Vaginal Retractors	124
BRIDGE Hemostatic Forceps	279
BROMPTON Drainage Clamp	299
BROPHY Dressing Forceps	237
BROPHY Tissue Forceps	244
BROWN Tissue Forceps	247
Brush Dispensers	23
Brushes, Nail	23
BRYANT Sponge- and Dressing Forceps	302
BUIE Angiotribe	43
BUIE Fistula Probe	63
BUIE Rectal Suction Tube	64
Bulldog Clamps	269-272
BUMM Uterine Curettes	168-169
BUMM Uterine Polypus and Ovum Forceps	143,190
BUNT Sterilizing Clips	375
BUSCH Umbilical Scissors	179

## C

Cables for "BiTech" bipolar Scissors	232
Cables for Bipol-Forceps	266

	Page		Page
Caesarean Section Hemostatic Forceps	187	CUSCO Vaginal Specula	111
CARREL Hemostatic Forceps	273	CUSCO Vaginal Specula BLACK, for LASER Surgery	111
CASTROVIEJO Needleholders	345	CUSCO Vaginal Specula INSULATED, for HF-Surgery	111
CASTROVIEJO Needleholders PROMEDUR	345	CUSCO Vaginal Specula with centerscrew	110
Catheter Guides	102	CUSCO Vaginal Speculum for virgins	107
CHAPUT Intestinal Forceps	27	CUSHING Dressing Forceps PROMEDUR	253
CHARNLEY Abdominal Retractor	341	CUSHING Retractor	317
CHEATLE Sterilizing Forceps	374	Cuticle Scissors	22
CHERON Sponge- and Dressing Forceps	304	CUZZI Abortion Scoops	189
Circumcision Instrument	103	CZERNY Rectal Valve	47
Clampholders	46	CZERNY Retractor	307
Clamps, Bulldog	269-272	CZERNY Tumor Forceps	133
Clamps, Fixation for Drapes	388		
Clamps, Liver Transplant	86	<b>D</b>	
Clamps, Peritoneum	146-148	DARLING Retractors	321
Clamps, Pressure	148	DARTIGUES Uterine Elevating Forceps	90,141
Clamps, Tube-Drainage	299	DAVIS Sterilizing Forceps	374
Clamps, Tubing	299	DE LEE Obstetrical Forceps	182
Clamps, Ureter	96	DE LEE Pelvimeter	177
Clamps, Vasectomy	99	DEAVER Retractors	314-316,317
Clamp-Scissors, bipolar	231	DEBAKEY Bulldog Clamps	272
CLAR Head Mirror	14	DEBAKEY Gall Duct Scissors PROMEDUR	84
CLAR Headmirror FIBER OPTIC	15	DEBAKEY Needleholders PROMEDUR	354
Cloth Fixing Frames	377,379,381,383	DEBAKEY non-traumatic Dressing Forceps	250-252
Coagulating Forceps, bipolar	257-265	DEBAKEY non-traumatic Dressing Forceps, TITANIUM	250-252
Cold Light Projector	15,57	DEBAKEY Retractors	321
Cold Light Vaginoscope	109,173	DEBAKEY Suction Tubes	368
Coldlight-Clip for Proctoscopes, Vaginoscopes	54,173	DEBAKEY Tissue & Organ Grasping Forceps	32,83
COLLER-CRILE Hemostatic Forceps	276,286	DEBAKEY Vascular Forceps	240,250-252
COLLIN Abdominal Retractors	324	DEBAKEY Vascular Forceps PROMEDUR	254
COLLIN Dynamometer	19	DEBAKEY-ADSON Tissue Forceps	235
COLLIN Intestinal Forceps	31	DEBAKEY-BABCOCK atraum. Tissue Forceps	30
COLLIN Pelvimeter	20,177	DEBAKEY-DOYEN Intestinal Clamps	37
COLLIN Polypus Forceps	304	DEBAKEY-FEHLAND Intestinal Clamp	39
COLLIN Scalpel Handles	202,204	DEBAKEY-HAYES Intestinal Clamps	39
COLLIN Umbilical Cord Clamp	185	DEBAKEY-KOCHER Intestinal Clamps	38
COLLIN Uterine Elevating Forceps	140	DEBAKEY-MICRO Bulldog Clamps	272
COLLIN Vaginal Specula	112	DEBAKEY-MICRO Dressing Forceps	251
COLLIN Vaginal Specula BLACK, for LASER Surgery	112	DEBAKEY-SCUDDER Intestinal Clamps	41
COLLIN Vaginal Specula INSULATED, for HF-Surgery	112	DEMARTELL Scissors	84
COLLIN Vaginal Speculum for children	107	DEMARTEL-WOLFSON Anastomosis Clamps	46
COLLIN-BABY Abdominal Retractor	324	DEMARTEL-WOLFSON Applying Forceps	46
COLLIN-DUVAL Grasping Forceps	249	DEMARTEL-WOLFSON Clampholders	46
COLLIN-LOCKTITE Abdominal Retractor	325	DENIS-BROWN Abdominal Retractor for Adults	331
COLLYER Pelvimeter	20,177	DENIS-BROWN Abdominal Retractor for Children	331
Connecting Cables for "BiTech" bipolar Scissors	232	DENIS-BROWN Grasping Forceps	249
Connecting Cables for Bipol-Forceps	266	DESJARDINS Gall Duct Forceps	79
Containers, sterilizing	376,378,380,382,384,390	DESJARDINS Gall Stone Forceps	81
COOLEY non-traumatic Dressing Forceps	251	DESJARDINS Gall Stone Sounds	75
COOLEY non-traumatic Dressing Forceps TITANIUM	251	Deviders for Containers	377,379,381
COOLEY Suction Tubes	369,370	DEWEY Axis Traction Forceps	183
CORONARY Micro-Scissors	210	Diagnostics	7-15, 195-198
Cotton Carrier for Rectoscopes	64	DICK Atrauma Pressure Clamps	148
Cotton Dispensers	391	DIETRICH Bulldog Clamps	271
Cotton Waste Collectors	391	Dilators, uterine	128,129
COUPLAND Suction Tube	367	Dispenser for Identification Labels	385
CRAFOORD Dissecting- and Ligature Forceps	281	Dispensers, Cotton	391
CRAFOORD Dissecting Scissors	221	Dissecting- and Ligature Forceps	277-286
CRAFOORD-SELLORS Dissecting- and Ligature Forceps	281,289	Dissecting Scissors	216-222,226-227
Cranioclast	186	Dividers for containers	389
CRILE Hemostatic Forceps	275	DQUAY Uterine Biopsy Forceps	157
CRILE Needleholder	359	DOYEN Abdominal Retractors	336
CRILE-BABY Hemostatic Forceps	275	DOYEN Director	366
CRILE-COLLER Hemostatic Forceps	276	DOYEN Gynecological Scissors	179
CRILE-MURRAY Needleholder	359	DOYEN Intestinal Forceps	33
CRILE-RANKIN Hemostatic Forceps	276	DOYEN Myoma Screw	145
CRILE-WOOD Needleholders	359	DOYEN Polypus Forceps	82
CRILE-WOOD Needleholders for LEFT HANDER	353	DOYEN Retractor	312
CRILE-WOOD Needleholders PROMEDUR	353	DOYEN Uterine Polypus Forceps	142
CRILE-WOOD-BABY Needleholder PROMEDUR	353	DOYEN Vaginal Retractors	125
Crushing Clamps	44	DOYEN-DEBAKEY Intestinal Clamps	37
Crypt Hooks	63	DOYEN-STILLE Retractors	312
Curettes, Biopsy	162	Drapes Fixation Clamps	388
Curettes, uterine	165-169	Drapes, sterilizing	387
Curettes, uterine aspirating	170	Dressing Forceps	235-237,239,250-255

	Page		Page
Dressing Forceps PROMEDUR	253	Forceps, NONSTICK bipolar	257-260
Dressing Forceps USA-MODEL	237	Forceps, Obstetrical	181-184
Drums, sterilizing	390	Forceps, Ovum	191
DUBOIS Kephlotomy Scissors	180,186	Forceps, Polypus	303,304
DUEHRSEN Dressing Forceps	238	Forceps, Prostatic	95
DUEHRSEN Tissue Forceps	245	Forceps, Scalp flap	187
DUNHILL Hemostatic Forceps	275	Forceps, Sponge	300-304
DUPLAY Polypus Forceps	303	Forceps, sterilizing	374
DUPLAY Tenaculum Forceps	135	Forceps, Tenaculum	133-139
DUPLEX Stethoscopes	12,198	Forceps, Tissue	239-248
DURANTE Tissue Forceps	248	Forceps, Towel	297-298
DUVAL atraumatic Intestinal Forceps	31	Forceps, Tumor	137
DUVAL Grasping Forceps	249	Forceps, Ureter	90
DUVAL Intestinal Forceps	31	Forceps, Uterine Biopsy	156-161
		Forceps, Uterine Elevating	140,141
<b>E</b>		Forceps, Uterine Polypus	142,143
EASTMAN Vaginal Retractors	123	Forceps, Vulsellum	137,138,139
ELLIOT Obstetrical Forceps	182	Forceps, Waste	374
EMMET Fistula Hooks	144	FORD-DIXON Haemorrhoidal Ligator	66
EMMET Sponge- and Dressing Forceps	303	Foreign Body Forceps, G.U.	103
Endospecula	127	FRANKLIN-SILVERMAN Biopsy Needles	87
Enterotomy Scissors	58	FRITSCH Retractors	313
Episiotomy Scissors	180	FUCHSIG Hemostatic Forceps	278
EPPENDORF Uterine Biopsy Forceps	160		
EWALD Dressing Forceps	235	<b>G</b>	
EWALD Tissue Forceps	241	Gall Bladder Forceps	83,300
EXACTA Sphygmometer	10,196	Gall Duct Forceps	79-80
		Gall Duct Probes	76
<b>F</b>		Gall Duct Scissors	84
FANSLER-IVES Anoscope	53	Gall Stone Forceps	80,81-82
FANSLER-IVES Anoscope w. Cold-light attachment	54	Gall Stone Probes and -sounds	75,76
FAURE Peritoneum Clamps	147	Gall Stone Scoops	77,78
FAURE Uterine Biopsy Forceps	156	Gall, Liver, Kidney	73-92
FEHLAND-DEBAKEY Intestinal Clamp	39	GAUSS Scalp Flap Forceps	187
FERGUSON Gynecological Scissors	179	GELPI Retractors	322,323
FERGUSON Angiotribe	43	GELPI-BABY Retractor	322
FERRIS-SMITH Tissue Forceps	244	GELPI-MINI Retractor	322
Fiber Optic light handle for Anoscopes	55	GELPI-ORTHO Retractor	323
Fibre Optic Light attachment for Specula	50,53,109	GELPI-SELETZ Retractor	323
Fibre Optic Rectal Spreader	50	GEMINI Dissecting- and Ligature Forceps	284
FILTER Dispenser	386	GEMINI Hemostats	293,291
FILTER Holder	386	GEMINI-MINI Dissecting- and Ligature Forceps	284
FILTERS, paper	386	General Instruments	193-372
FILTERS, textile	387	Genito-Urinary Instruments	102,103
Fine Scissors	214	GERALD Dressing Forceps PROMEDUR	254
Fine Scissors for LEFT HAND	214	GERALD Tissue Forceps	244
FINOCHIETTO Needleholders	360	GILLIES Tissue Forceps	242
FINOCHIETTO Needleholders PROMEDUR	355	GILLIES Tissue Forceps PROMEDUR	254
Fistula Hooks	144	GIL-VERNET Vein- and Hilar Retractors	91,92
Fistula Probe	63	GLASSMANN non-traumatic Forceps	252
Fistula Sounds	63,366	GLOVER Bulldog Clamps	269
Fixation Clamps for Drapes	388	GOELET Retractor	307
Fixing bolts for Dividers	389	GOODELL Uterine Dilator	129
Fixing bolts for instruments	389	GOSSET Abdominal Retractors	327
FLETCHER (Javerts) Sponge Forceps	301	GOURDET Uterine Scoops	165
FLETCHER Sponge Forceps	301	Grasping Forceps	249
FOCUS Halogen-Headlight	15	GRAVE Vaginal Specula	113,115
FOERSTER Abdominal Retractor X-ray transparent	337	GRAVE Vaginal Specula BLACK, for LASER Surgery	113
FOERSTER Gall Bladder Forceps	83,300	GRAVE Vaginal Specula INSULATED, for HF-Surgery	113
FOERSTER Sponge Forceps	293,300	GRAY Gall Duct Forceps	80
FOERSTER-BERGMANN Sponge Forceps	300	GREEN Retractor	310
FOERSTER-Delicate Sponge Forceps	301	GREEN-ARMYTAGE Caesarean Section Forceps	187
Forceps	233-266	GREGORY Bulldog Clamps	270
Forceps Holders	375	GREGORY Needleholders	349,351
Forceps, bipolar	261-265	Grooved Directors	366
Forceps, bottle-opening	375	GROSS Polypus Forceps	303
Forceps, Caesarean Section hemostatic	187	GROSS Sponge- and Dressing Forceps	303
Forceps, Dissecting- and Ligature	277-286	GUNNAR-HEY Tube-Drainage Clamp	299
Forceps, Dressing	235-237,239,250-255	GUTTMAN Secretion Scoop	103
Forceps, Gall Duct	79-80	GUYON Catheter Guides	102
Forceps, Gall Stone	80,81-82	GUYON Kidney Pedicle Forceps	88,291,293
Forceps, Hysterectomy	150-154	GUYON Urethral Bougies, Sounds	104
Forceps, Kidney	88-90	GWILLIAM Hysterectomy Forceps	150
Forceps, Membrane puncture	188	Gynecological Scissors	178-180



	Page		Page
Gynecology	105-174	JACOBSON-MICRO Hemostatic Forceps	274
		JARCHO Tenaculum Forceps	134
<b>H</b>		Jars	394
Haemorrhoidal Ligators	65-69	JEFFERSON Dressing Forceps	236
Haemorrhoidal Seizing Forceps	70	JEFFERSON Tissue Forceps	242
Haemorrhoidal Suction Ligators	66-68	JOERGENSEN Dissecting Scissors	217
Halogen Cold Light Projector	15,57	JOHN-HOPKINS Gall Duct Forceps	80
Halogen-Headlights	15	JOHNSON Needleholder	360
HALSTED Hemostatic Forceps	277	JOLL (Friedmann) Vaginal Retractor	126,321
HALSTED-MOSQUITO Hemostatic Forceps	274	JONES Towel Forceps	297
Handles for anoscopes	55	JUDD-ALLIS Tissue Forceps	28
Handles for Uterine Biopsy Forceps	159	JUDD-MASON Bladder Retractors	100,101
Handles, Scalpel	199,201-205	<b>K</b>	
HARRINGTON Bronchus Forceps	292	KALLMORGEN Specula, Retractors	122
HARRISON Sterilizing Forceps	374	KANE Umbilical Cord Clamp	185
HARTMANN Hemostatic Forceps	273	KANTROWITZ Dissecting- and Ligature Forceps	284
HARTMANN Ligature-Forceps	273	KELLY Hemostatic Forceps	275
HARTMANN-MICRO Hemostatic Forceps	273	KELLY Ovum Forceps	191
HAYES-DEBAKEY Intestinal Clamps	39	KELLY Proctoscopes	52
Head Mirrors	14	KELLY Retractors	85,311
Headlights (halogen)	15	KELLY Sphincteroscope	52
HEANEY (Hegar) Needleholder	361	KELLY-RANKIN Hemostatic Forceps	276
HEANEY Hysterectomy Forceps	149	Kephalotomy Scissors	180,186
HEANEY Needleholders PROMEDUR	356	KERSTING Intestinal Clamp	40
HEANEY-BALLENTINE Hysterectomy Forceps	149	KEVORKIAN Biopsy Curettes	162
HEANEY-KANTER Hysterectomy Forceps	149	KEVORKIAN Uterine Biopsy Forceps	161
HEANEY-REZEK Hysterectomy Forceps	149	KEVORKIAN-PACIFIC Uterine Biopsy Forceps	158
HEGAR Uterine Dilators	128	Kidney Bowls	393
HEISS Hemostatic Forceps	278	Kidney Forceps	88-90
Hemostatic- and Dissecting Forceps	267-293	Kidney Stone Forceps	89
HENROTIN Vulsellum Forceps	137	KIELLAND Obstetrical Forceps	181
HERRICK Kidney Pedicle Forceps	88	KIELLAND-LUIKART Obstetrical Forceps	182
HERTZLER Abdominal Retractor	328	KIRSCHNER Abdominal Retractor	332
HEYWOOD-SMITH Haemorrhoidal Forceps	70	KLEINSCHMIDT Appendectomy Clamp	45
HEYWOOD-SMITH Uterine Polypus Forceps	83,142,190	KLING-EX Blade Remover	205
HILL-FERGUSON Rectal Valves	47	KLINIK.BERLIN Tubing Clamp	299
HIRSCHMANN Anoscopes	52	KOCHER Intestinal Forceps	34
HOESEL Retractors	61	KOCHER Prostatic Retractor	97
HOLZBACH Abdominal Retractor	326	KOCHER-BABY Intestinal Forceps	33
Hooklets, Fistula	144	KOCHER-DEBAKEY Intestinal Clamps	38
Hooklets, Spermatic Cord	99	KOCHER-WAGNER Retractors	313
HORGAN Center valve	330	KOERTE Retractors	308
HRYNTSCHAK Bladder Retractor	101	KOGAN Endospecula	127
HULKA Tenaculum Forceps	135	KONRICH Sterilizing Drums	390
HULKA-KENWICK Tenaculum Forceps	135	KRISTELLER Vaginal Retractors for virgins	108
Hysterectomy Forceps	150-154	KRISTELLER Vaginal Specula for virgins	108
<b>I</b>		KRISTELLER Vaginal Specula, Retractors	118-121,126
Identification Labels for Containerns	385	KRISTELLER Vaginal Specula, Retractors for children	118
Infusion-Bottle Opening Forceps	375	KÜSTNER Vulsellum Forceps	139
Instrument depositing Trays	394	<b>L</b>	
Instrument Lubricant	391	LAHEY Gall Duct Forceps	79
Instrument Pads	387	LAHEY Retractor	309
Instrument Sets for GALL, LIVER, KIDNEY	74	LANDAU Vaginal Retractors	124
Instrument Sets FOR GYNECOLOGY	106	LANDOLD Scalpel Handles	199
Instrument Sets for OBSTETRICS	176	LANE Tissue Forceps	247
Instrument Sets for STOMACH, INTESTINES, RECTUM	26	LANE Towel Forceps	298
Instrument Sets for UROLOGY	94	LANGENBECK Needleholders PROMEDUR	355
Instrument Trays	395	LANG-STEVENSON Intestinal Clamp	33
Insufflation-bottle opening Forceps	375	LATERAL Vaginal Retractor	127
Intestinal Forceps	27	LAWRENCE Dissecting- and Ligature Forceps	285
IOWA Mambrane Puncture Forceps	188	LEFT-HANDER Needleholders	353,354
IOWA Pudendus Anesthesia Needle & guide	188	LEFT-HANDER Scissors	215,216
IOWA Trumpet Needle Guide	188	LEGUEU Bladder Retractor	325
ISRAEL Retractors	309	LEGUEU Bladder Spatula	97
IUD Extractor hook	132	LERCHE Tissue Forceps	246
IUD Manipulator & Sponge Forceps	132	LEXER-BABY Dissecting Scissors	218
<b>J</b>		LICHTENBERG Needleholder PROMEDUR	358
JACKSON Vaginal Retractors	123	LICHTWITZ Trocar	371
JACKSON-BURROWS Retractor	323	LISTER-SINUS Dressing Forceps	302
JACOBS Vulsellum Forceps	138	LITTAUER Nail Splitting Forceps	22
		LITTLE Retractor	309
		LITTLEWOOD Tissue Forceps	28

	Page		Page
Liver Biopsy Needles	87	Micro Scalpel Blades	199
Liver Retractors	85	Micro Scissors for Gynecology	209-213
Liver-Transplant Clamp	86	Micro Uterine Biopsy Punch	161
LLOYD-DAVIS Rectal Scissors	59,223	MICRO-ADSON Dressing Forceps	235
LLOYD-DAVIS Sigmoid Anastomosis Forceps	43	MICRO-ADSON Tissue Forceps	241
LOCKHART-MUMMERY Fistula Sounds	63,366	MICRO-DEBAKEY Bulldog Clamps	272
LOCKWOOD Tissue Forceps	29	MICRO-DEBAKEY Dressing Forceps	251
LORNA (Edna) Towel Forceps	298	MICRO-DEBAKEY Dressing Forceps TITANIUM	251
Loupe, operating	13	Micro-Dissecting Scissors	212
LOWER Gall Duct Forceps	80	MICRO-HARTMANN Hemostatic Forceps	273
LUER-KOERTE Gall Stone Scoops	78	MICRO-JACOBSON Hemostatic Forceps	274
LUIKART Obstetrical Forceps	182	MICRO-MOSQUITO Hemostatic Forceps	274
LUIKART-BILL Traction Handle	184	Micro-Needleholders	345-353
LURZ Haemorrhoidal Suction Ligators	66	MICRO-VASCULAR Needleholders TITANIUM	353
LURZ Ureter Clamps	96	MIDDELDORF Retractors	310
		MIKULICZ Peritoneum Clamps	146
		MIKULICZ Retractors	85
<b>M</b>		MIKULICZ-BABY Peritoneum Clamp	146
MAIER Polypus Forceps	303	MILLER Rectal Scissors	58
MAIER Sponge- and Dressing Forceps	303	MILLIN Bladder Neck Spreader	96,100
MAINGOT Hysterectomy Forceps	150	MILLIN Bladder Retractor	100
Manipulator & Sponge Forceps, IUD	132	MILLIN Prostatic Forceps	95
Manometers, bloodpressure	11,197	MILLS Gall Duct Scissors	84
MARBERGER Vein- and Hilar Retractors	91	MINIMUS Sphygmomanometer	10,196
MARINUS Intestinal Clamps	42	Mirros- head	14
MARTEL Scalp Flap Forceps	187	MIXTER Dissecting- and Ligature Forceps	286
MARTIN Pelvimeter	20,177	MIXTER Gall Stone Forceps	80,82
MARTIN Uterine Sounds	130	MIXTER-BABY Hemostatic Forceps	285
MARTIN Waste Forceps	374	MIXTER-O'SHAUGHNESSY Hemostatic Forceps	283
MASSON Needleholder	361	MOGEN Circumcision Instrument	103
MASSON Needleholder PROMEDUR	356	MOORE Gall Stone Scoop	77
MATHIEU Foreign Body Forceps	103	MORGAN Proctoscopes	53
MATHIEU Needleholders PROMEDUR	358	MORRIS Retractors	307,312
MATHIEU Rectal Speculum	49	MORRIS-MITRAL Retractor	323
MATHIEU-KOCHER Needleholders PROMEDUR	358	MOSQUITO Hemostatic Forceps	274
MAYO Dissecting Scissors	216	MOSQUITO-MICRO Hemostatic Forceps	274
MAYO Dissecting Scissors PROMEDUR	222	MOYNIHAN Clamp-Forceps	79
MAYO Gall Stone Scoops	77	MOYNIHAN Gall Stone Probe	75
MAYO Safety Pins	375	MOYNIHAN Towel Forceps	298
MAYO Scissors for LEFT-HANDERS	216	MUENCHEN Endometrial Biopsy Curettes	163
MAYO Sterilizing Clips	375	MURLESS Head Extractor	181
MAYO-ADAMS Abdominal Retractor	325	MUSEUX Vulsellum Forceps	139
MAYO-BLAKE Gall Stone Forceps	82	Myoma Instruments	145
MAYO-GUYON Kidney Forceps	88	MYRTLE LEAF Probes	366
MAYO-HARRINGTON Dissecting Scissors	217		
MAYO-HARRINGTON Dissecting Scissors PROMEDUR	224	<b>N</b>	
MAYO-HEGAR Needleholders	359	NAEGELE (DELEE) Obstetrical Forceps	181
MAYO-HEGAR Needleholders for LEFT-HANDERS	354	NAEGELE Perforator	186
MAYO-HEGAR Needleholders PROMEDUR	354	NAGEL Micro-Scissors	213
MAYO-LEXER Dissecting Scissors	217	Nail files	23
MAYO-LEXER Dissecting Scissors PROMEDUR	224	Nail Nippers	22
MAYO-NOBLE Dissecting Scissors	217	Nail Scissors	22,23
MAYO-ROBSON Intestinal Forceps	35	Nail Splitting Forceps	22
MAYO-RUSSIAN Tissue Forceps	247	Nailbrush autoclavable	23
MAYO-STILLE Dissecting Scissors	216	NAUNTON-MORGAN Needleholder PROMEDUR	357
McGIVNEY Haemorrhoidal Ligator	65	Needle Cases	391,392
McGIVNEY Haemorrhoidal Seizing Forceps	70	Needle Guide	188
McGIVNEY Haemorrhoidal Suction Ligator	69	Needleholders for LEFT-HANDERS	353,354
McINDOE Dressing Forceps	236	Needleholders, Micro	345-353
McINDOE Dressing Forceps PROMEDUR	254	Needleholders, Micro, PROMEDUR	345,347-349,353-358
McLEAN-LUIKART Obstetrical Forceps	183	Needleholders, Micro, TITANIUM	350,351,352,353
McLEAN-TUCKER Obstetrical Forceps	183	Needles, Liver Biopsy	87
Measures, graduated	392	NEIVERT Needleholder	359
Meatus Clamps	103	NEIVERT Needleholder PROMEDUR	353
Medicine Cups	394	NELATON Probe-Director	366
Medicine Spoon	394	NELSON Abdominal Trocars	371
MEEKER Dissecting- and Ligature Forceps	285	NELSON Tissue Forceps	246
MENGHINI Liver Biopsy Needles	87	NISSEN Hemostatic Forceps	278
Metal Catheters, male, female	102	NONSTICK Bipolar Forceps	257-260
METZENBAUM Dissecting Scissors	219,221	NOTO Uterine Polypus Forceps	143,190
METZENBAUM Dissecting Scissors PROMEDUR	222,226,227	NOVAK Endometrial Biopsy Curettes	163
METZENBAUM Needleholder	360	NOVA-PRESAMETER Manometer	9,195
METZENBAUM-BABY Dissecting Scissors	218	NUSSBAUM Intestinal Forceps	36
METZENBAUM-FINO Dissecting Scissors	220		
METZENBAUM-FINO Dissecting Scissors PROMEDUR	227		

	Page		Page
<b>O</b>			
Obstetrical Forceps	181-184	PRO-MED SEKUR™ Scalpel Handles	201
Obstetrical Hook	184,185	Prostatic Retractors	97,98
Obstetrical Lever	184	PROVIDENCE-HOSPITAL Hemostatic Forceps	275
Obstetrics	175-191	Pylorus Spreader	45
OCHSNER Trocars	371	<b>R</b>	
OCULUS Binocular Loupe	13	RAMATHIBODI Tubular Hook	132
OEHLER Tissue Forceps PROMEDUR	255	RAMATHIBODI Uterine Manipulator	132
OLLIER Retractors	308	RAMPLEY Sponge Forceps	301
OLVECRONA Dissecting- and Ligature Forceps	281	RAMSAY Dressing Forceps	238
OMBREDANNE Tissue Forceps	29	RAMSAY Tissue Forceps	245
OMBREDANNE Towel Forceps	297	RANDALL Endometrial Biopsy Curette	163
Operating Loupe	13	RANDALL Kidney Stone Forceps	89
Operating Scissors	215	RANKIN-CRILE Hemostatic Forceps	276
Operating Sets for GALL, LIVER, KIDNEY	74	RANKIN-KELLY Hemostatic Forceps	276
Operating Sets FOR GYNECOLOGY	106	RECAMIER Uterine Curettes	167
Operating Sets for OBSTETRICS	176	Rectal Biopsy Forceps	71
Operating Sets for STOMACH, INTESTINES, RECTUM	26	Rectal Retractors	61,62
Operating Sets for UROLOGY	94	Rectal Scissors	58-60,223
O'SULLIVAN-O'CONNOR Abdominal Retractor	334	Rectal Specula	48,49
OVERHOLT-BABY Hemostatic Forceps	283	Rectal Spreaders	50,51
OVERHOLT-GEISSENDOERFER Hemostatic Forceps	283	Rectal Suction Tube	64
OVERHOLT-MIXTER Hemostatic Forceps	283	Rectal Valves	47
Ovum Forceps	191	Remover for Scalpel blades	205
<b>P</b>			
PARAMETRIUM Scissors	60,225	RESANO Intestinal Clamp	40
PARKS Rectal Spreader with fibre optic	50	Retractors, abdominal	324-341
PAYR Crushing Clamps	44	Retractors, Bladder	100-101
PAYR-BABY Crushing Clamps	44	Retractors, double-ended	307,310
PEAN Hemostatic Forceps	279	Retractors, Hand	305-317
PEAN-FINO Hemostatic Forceps	280	Retractors, Liver	85
PEDERSON Speculum für virgins	107,114	Retractors, Pelvis	62
PEDERSON Vaginal Specula	114	Retractors, prostatic	97,98
PEDERSON Vaginal Specula BLACK, for LASER Surgery	114	Retractors, Rectum	61,62
PEDERSON Vaginal Specula INSULATED, for HF-Surgery	114	Retractors, self-retaining	321-323
PEERS Towel Forceps	297	Retractors, vaginal	108,118-126
PELKMANN Sponge- and Dressing Forceps	302	Retractors, Vein and Hilar	91
Pelvimeters	20,177	RICARD Abdominal Retractors	326
Pelvis Retractors	62	RICHARDSON Retractors	310
PENNINGTON Hemostatic Forceps	27	RICHARDSON-EASTMAN Retractors	310
Perforator, obstetrical	186	ROBERTS Hemostatic Forceps	280
Perineal Retractor	51	ROBIN-MASSE Abdominal Retractor	327
Peritoneum Clamps	146-148	ROCHARD Abdominal Retractors	335
PESTALOZZA Abortion Scoop	189	ROCHARD Fixation Device	335
PETRI Dish	392	ROCHARD Mounting Frames	335
PHANEUF Peritoneum Clamps	148	ROCHESTER-OCHSNER Hemostatic Forceps	279,282,290
PINARD Stethoscopes	12,198	ROCHESTER-PEAN Hemostatic Forceps	280,288
PIPER Axis Traction Forceps	184	ROEDER Towel Forceps	298
PIPER Obstetrical Forceps	182	ROGGE Sterilizing Forceps	374
PITTSBURG Liver Transplant Clamps	86	ROTOCLETTE Uterine Biopsy Curette	162
Polypus Forceps	303,304	Round Bowls	393
POOLE Suction Tubes	368,370	RUDD Haemorrhoidal Ligator	65
POTTS-DE-MARTEL Gall Duct Scissors	84	RUDD Ligature Rubber Rings	65
POTTS-SMITH Dressing Forceps	238	Rulers, metal	19
POTTS-SMITH Dressing Forceps PROMEDUR	253	RUMEL Hemostatic Forceps	284
POTTS-SMITH Gall Duct Scissors PROMEDUR	84	RUSSIAN Tissue Forceps	239,247
POTTS-SMITH Tissue Forceps	245	<b>S</b>	
POZZI Tenaculum Forceps	134	SAENGER Ovum Forceps	191
PRATT (Billroth) Tumor Forceps	137	Safety Lids for Sterilizing Containers	376,378,380
PRATT Crypt Hooks	63	Safety Pins for instruments	375
PRATT Rectal Speculum	49	Safety Seals, plastic	385
PRATT Tumor Forceps	137	Salpingograph, SCHULTZE	171
PRATT-"T" Hemostatic Forceps	32	SANTULLI Bulldog Clamp	271
PRECISA Sphygmomanometer	9,195	SAROT Dissecting- and Ligature Forceps	289
PRESBYTERIAN Tubing Clamp	299	SAROT Needleholders	361
Pressure Clamps	148	SAROT Needleholders PROMEDUR	357
Probes	365	SAUERBRUCH Needle Case	392
Probes with eye	365	SAUERBRUCH Waste Forceps	374
Probes, double ended	365	Scalp Flap Forceps	187
Probes, exploring	365	Scalpel Blade Remover	205
Probes, grooved	366	Scalpel Blades	199,200,204
Proctoscopes	52	Scalpel Blades, Micro	199
Proctoscope-tubes	56	Scalpel Handles	199,201-205
		Scalpel Handles for Micro Blades	199

	Page		Page
Scalpel Handles PRO-MED SEKUR™	201	SPENCER-WELLS Hemostatic Forceps	279
Scalpel Handles, calibrated	202,204	Spermatic Cord Fixation Clamp	96
SCHAEDEL Towel Clip	297	Spermatic Cord Hooklets	99
SCHERBAK Vaginal Specula	117	Sphygmometers, bloodpressure	11,197
SCHIMMELBUSCH Sterilizing Drums	390	Spiral Supports Micro Instruments	388
SCHROEDER Tenaculum Forceps	134	Sponge Forceps	300-304
SCHROEDER Uterine Scoops	164	St.MARKS Pelvis Retractors	62
SCHROEDER Vulsellum Forceps	136	St.MARKS Perineal Retractor	51
SCHUBERT Uterine Biopsy Forceps	156	ST.MARKS Proctoscope	52
SCHULTZE Salpingograph	171	STAUDE-MOORE Tenaculum Forceps	133
SCHULZE-BERGMANN Rectal Specula	48	STEINER-AUVARD Vaginal Speculum	116
SCHUMACHER Umbilical Scissors	179	STELZNER Rectal Scissors	59,223
SCHUMACHER Uterine Biopsy Forceps	160	Sterilization	373-395
SCHUMACHER-VAN DOREN Biopsy Forceps	155	Sterilizing Containers	376,378,380,382,384,390
Scissors	207-232	Sterilizing Containers for Endoscopy Instruments	384
Scissors, bipolar	228-230	Sterilizing Containers, FLAT	382
Scissors, Cuticle	22	Sterilizing Containers, MINI	382
Scissors, delicate	214	Sterilizing Drapes	387
Scissors, dissecting	216	Sterilizing Drums	390
Scissors, Enterotomy	58	Sterilizing Forceps	374
Scissors, Episiotomy	180	Sterilizing Forceps with jar	393
Scissors, Gall Duct	84	Sterilizing Rack for Micro-Instruments	389
Scissors, Gynecology	178-180	Stethoscope	12,198
Scissors, Kephilotomy	180,186	STILLE Dressing Forceps	237
Scissors, Micro	209-213	STILLE Kidney Pedicle Forceps	88
Scissors, Nail	22	STILLE-BARRAYA Tissue Forceps	248
Scissors, Operating	215	STINGER Forceps Holders	375
Scissors, Parametrium	60,225	STOCKMANN Meatus Clamp	103
Scissors, Rectal	58-60,223	Stomach, Intestines, Rectum	25-71
Scissors, Umbilical	179	STONE Tissue Forceps	246
Scissors, unterming	179	Storage Strips, Silicone	388
Scissors-Clamp, bipolar	231	STRATTE Needleholder	361
Scoops, Uterine	164,165	STRATTE Needleholders PROMEDUR	357
SCUDDER Intestinal Forceps	35	STRAUSS Fiber optic Rectoscope	57
SCUDDER-DEBAKEY Intestinal Clamps	41	STRAUSS Meatus Clamp	103
Secretion Scoop	103	STRINGER Forceps Holders	375
SEGOND Hysterectomy Hysterectomy Forceps	149	Suction Tubes	367-390
SEGOND Myoma Knife	145	Suggested Instrument Sets for GALL, LIVER, KIDNEY	74
SEGOND-LANDAU Hysterectomy Forceps	149	Suggested Instrument Sets for GYNECOLOGY	106
Self-retaining Retractors	321-323	Suggested Instrument Sets for OBSTETRICS	176
SELLHEIM Obstetrical Lever	184	Suggested Instrument Sets for STOMACH, INTESTINES, RECTUM	26
SEMKEN Dressing Forceps	236	Suggested Instrument Sets for UROLOGY	94
SEMKEN Dressing Forceps PROMEDUR	253	Supports for Micro Instruments	388
SEMKEN Tissue Forceps	242	Suture	343-361
SEMM Abdominal Retractor	333		
SEMM Vaginal Specula	115	<b>T</b>	
SEYFFERT Vaginal Specula	115	Tablet Dishes	394
SIEBOLD Gynecological Scissors	179	Tape Measures	19
Silicone Instrument Pads	387	TARNIER Basiotribe	186
Silicone Storage Strips	388	TARNIER Obstetrical Forceps	183
SIMON Fistula Hooks	144	TAYLOR Tissue Forceps	245
SIMON Uterine Scoops	164	TAYLOR-CUSHING Tissue Forceps	245
SIMON Vaginal Retractors	125	TEALE Vulsellum Forceps	138
SIMPSON Obstetrical Forceps	181	Teneculum Forceps	133-139
SIMPSON-BRAUN Obstetrical Forceps	182	THOMAS Uterine Curettes	165
SIMPSON-LUIKART Obstetrical Forceps	182	THOMS-ALLIS Tissue Forceps	28
SIMS Gynecological Scissors	178	THOMS-GAYLOR Biopsy Forceps	155
SIMS Gynecological Scissors PROMEDUR	224	THOMSON-WALKER Bladder Retractor	101
SIMS Rectal Speculum	48	THOREK Dissecting Scissors	218
SIMS Uterine Curettes	166	TIEMANN Bullet Forceps	136
SIMS Uterine Depressor	131	TISCHLER (Baggish) Uterine Biopsy Forceps	158
SIMS Uterine Sounds	130	TISCHLER Uterine Biopsy Forceps	158
SIMS Vaginal Specula	123	TISCHLER-BURKE Uterine Biopsy Forceps	158
SIMS-MAIER Sponge- and Dressing Forceps	302	TISCHLER-KEVORKIAN Uterine Biopsy Forceps	158
SINGLEY (TUTTLE) Tissue Forceps	240,247	TISCHLER-MINI Uterine Biopsy Forceps	158
SKENE Tenaculum Forceps	136	Tissue- and Organ holding Forceps	27-32
SMELLIE Obstetrical Hook	185	Tissue Forceps	239-248
SMELLIE Perforator	186	Tissue Forceps USA Model	243
SOFIELD Retractors	307	TITANIUM-COOLEY non-traumatic Dressing Forceps	251
Solution Bowls	393	TITANIUM-DEBAKEY non-traumatic Dressing Forceps	250-252
SOMER Uterine Elevating Forceps	140	TOHOKU Towel Forceps	298
Sounds, Fistula	63,366	Towel Forceps	297-298
Sounds, uterine	130	TOWNSEND Handle for Uterine Biopsy Forceps	159
Specula, vaginal	107-127	TOWNSEND Uterine Biopsy Curette	162
Speculum, abdominal	337	TOWNSEND-BURKE Uterine Biopsy Forceps	159

	Page		Page
TOWNSEND-KERVORKIAN Uterine Biopsy Forceps	159	WERTHEIM-CULLEN Hysterectomy Forceps	151
TOWNSEND-KRAUSE Uterine Biopsy Forceps	159	WERTHEIM-DEBAKEY Hysterectomy Forceps	153
TOWNSEND-MINI Uterine Biopsy Forceps	159	WIJNEN Suction Tube	368,370
TOWNSEND-TISCHLER Uterine Biopsy Forceps	159	WIKSTROEM Dissecting- and Ligature Forceps	285
Traction Handles, obstetrical	183,184	WILLET Scalp Flap Forceps	187
Transformer for Head Mirror	14	WILLIAMS Tissue Forceps	29
Trays, Instrument	395	WINTER Ovum Forceps	191
Trays, kidney-shaped	393	Wire baskets	377,379,381,383,384
TRELAT Vaginal Specula	115	Wire baskets for Endoscopy Instruments	384
TREVES Tissue Forceps	246	WITTNER Uterine Biopsy Forceps	160
Trocars, abdominal	371	WRIGLEY Obstetrical Forceps	181
Tube-Drainage Clamps	299		
Tubes, Suction	367-390	<b>Y</b>	
Tubing Clamps	299	YANKAUER Suction Tubes	367
Tubing Clamps with safeguard	299	YEOMAN Rectal Biopsy Forceps	71
TUEBINGEN Retractor	313	YOUNG Prostatic Grasping Forceps	95
TUFFIER Intestinal Forceps	27	YOUNG Prostatic Retractors	98
Tumor Forceps	137		
TURNBULL Nail Nippers	22	<b>Z</b>	
TURNER-WARWICK Abdominal Retractor	338-340	Z-HYSTEREKTOMY Forceps	154
		ZIEGLER Head Mirror	14
<b>U</b>			
ULRICH Sponge- and Dressing Forceps	303		
Umbilical Cord Clamp	185		
Umbilical Scissors	179		
UNIVERSAL Abdominal Trocars	371		
Utermine Scissors	179		
Ureter Clamp	96		
Ureter Forceps	90		
Urethral Bougies, Sounds	104		
URO Ureter Forceps	90		
Urology	93-104		
USA-MODEL Tubing Clamps	299		
Uterine aspirating Curettes	170		
Uterine Biopsy Curettes	162		
Uterine Biopsy Forceps	156-161		
Uterine Curettes	165-169		
Uterine Depressors	131		
Uterine Dilators	128,129		
Uterine Elevating Forceps	140,141		
Uterine Manipulator	132		
Uterine Polypus Forceps	142,143		
Uterine Scoops	164,165		
Uterine Sounds	130		
<b>V</b>			
Vaginal Retractors	108,118-126		
Vaginal Specula	107-127		
Vaginoscope, Cold light	109,173		
VALLEIX Uterine Sound	130		
VAN BUREN Urethral Bougies, Sounds	104		
VAN DOREN Biopsy Forceps	155		
VANNAS-MICRO Scissors	209,212		
Vasectomy Instruments	99		
Vein- and Hilar Retractors	91,92		
Velcro-cuffs for manometers, sphygmometers	11,197		
Vulsellum Forceps	137,138,139		
<b>W</b>			
WALDMANN Episiotomy Scissors	180		
WALLICH Abortion Scoop	189		
WALTON Sponge- and Dressing Forceps	302		
WANGENSTEEN Dressing Forceps PROMEDUR	253		
WANGENSTEEN Needleholder	361		
WANGENSTEEN Needleholder PROMEDUR	356		
WANGENSTEEN Tissue Forceps	247		
WASSMUND Retractor	308		
Waste Collectors, Cotton	391		
Waste Forceps	374		
WAUGH Tissue Forceps	248		
WEISSBARTH Vaginal Speculum	118		
WERTHEIM Dissecting Scissors	218		
WERTHEIM Hysterectomy Forceps	146,149,152		
WERTHEIM-ATRAUMA Hysterectomy Forceps	151		

**INDEX ALPHABETIQUE****A**

Abdominal Spéculum	336
Accouchement	175-191
ADAIR Pince utérine	133-138
ADLERKREUTZ Pincés à griffes	246
ADSON Pincés à disséquer	235,236
ADSON Pincés à disséquer et à ligatures	277
ADSON Pincés à disséquer PROMEDUR	253
ADSON Pincés à griffes	241,242
ADSON Pincés à griffes PROMEDUR	253
ADSON Porte-aiguilles	360
ADSON-BABY Pincés à disséquer et à ligatures	277
ADSON-BROWN Pince à disséquer PROMEDUR	255
ADSON-BROWN Pincés à griffes	246
ADSON-DEBAKEY Pince à griffes	235
ADSON-DEBAKEY Pince atraumatique	235
ADSON-GRAEFE Pince à griffes	242
ADSON-MICRO Pince à griffes	241
ADSON-MICRO Pincés à disséquer	235
ADSON-SELECT MICRO Pince à sutures	241
ADSON-SELECT Pince à griffes	241
Aiguilles pour biopsie du foie	87
Aiguilles pour ponction du foie	87
ALAN-PARKS Ecarteurs rectaux	50
ALEXANDER Pince à biopsie utérine	157
ALLEN-KOCHER Pincés intestinales	27
ALLIS Pincés intestinales	27
ALLIS Pincés intestinales atraumatique	28
ALLIS-ADAIR Pince intestinale	28
ALLIS-BABY Pince intestinale	27
AMANN Porte-coton	131
Amnioscopie, instruments	172
Amniotome	131
ANDREW-PYNCHON Tube d'aspiration	367
Anneaux en caoutchouc pour ligateurs	65
Anusscopes	52,53,54,56
Appendectomie, Clamps	45
Aspiration	367-370
Attache de fixation pour les instruments	389
Attache de fixation pour séparateurs	389
AUVARD Spéculum vaginaux	116

**B**

BABCOCK Pincés intestinales	29
BABCOCK Pincés intestinales PROMEDUR	30
BABCOCK-DEBAKEY Pincés intestinales atraumatique	30
BABY-ADSON Pincés à disséquer et à ligatures	277
BABY-ALLIS Pince intestinale	27
BABY-BALFOUR Ecarteur abdominal	328
BABY-COLLIN Ecarteur abdominal	324
BABY-CRILE Pincés hémostatiques	275
BABY-CRILE-WOOD s PROMEDUR	353
BABY-GELPI Ecarteur	322
BABY-KOCHER Pincés intestinales	33
BABY-LEXER Ciseaux à préparation	218
BABY-METZENBAUM Ciseaux à préparation	218
BABY-MIKULICZ Pince à péritoine	146
BABY-MIXTER Pincés hémostatiques	285
BABY-OVERHOLT Pincés à préparation	283
BABY-PAYR Ecraseur	44
BACKHAUS Pincés à champs	297
BAINBRIDGE Pincés hémostatiques	279
BAKES Sondes pour le canal cholédoque	76
BALFOUR Bras latérales	330
BALFOUR Ecarteurs abdominaux	328-330
BALFOUR-BABY Ecarteur abdominal	328
BALFOUR-Modif. Ecarteurs abdominaux	330
BALL et SOCKET Pincés à champs	298
BALLENGER Pincés à pansements	300
Bande porte instruments	388
BARNES-NEVILLE Pince obstétricale	184
BARR Ecarteur rectal	51

BARRET Pince utérine	133
BARRON Ligateur pour Hémorroïdes	68
BARRON Manche pour bisturis	203
BARRON Pince à saisir	70
BARTON Pince obstétricale	183
BARTON Tacteur pour Pince obstétricale	183
Basiotribe	186
Bassins reniform	393
BEACHAM Amniotome	131
BENGOLEA Pincés à disséquer et à ligatures	278
BENSAUDE Anusscopes	53
BENSON Ecarteur du pylore	45
BERGER Pincés à biopsie utérine	161
BERGMANN-FOERSTER Pincés à pansements	300
BERKELEY-BONNEY Pincés à hystérectomie	150
BERNHARD Pince à champs	298
Bile, Foie, Rein	73-92
BILL Tacteur pour Pince obstétricale	184
Bipolaire Ciseaux	228-230
Bipolaire Clamps-Ciseaux	231
BIPOL-Cables pour Ciseaux "BiTech"	232
Bistouri à fibromes	145
BiTech Ciseaux bipolaires	228-230
BLAKE Curette utérine	164
BLAKE Pincés pour calculs biliaires	81
BLANK Pincés à disséquer atraumatique	237
BLESSING Ciseaux pour chirurgie rectale	60,225
BLOND Anusscopes	56
BLOND Tubes conique de proctoscope	56
BODENHAMMER Spéculum rectal	49
BOERMA Pince obstétricale	181
Boîtes à aiguilles	391,392
Boîtes à instruments avec couvercle	395
Boîtes à stérilisation	376,378,380,382,384,390
Boîtes à stérilisation plats	382
Boîtes opératoires proposées pour ACCOUCHEMENT	176
Boîtes opératoires proposées pour BILE, FOIE, REIN	74
Boîtes opératoires proposées pour ESTOMAC, INTESTINS, RECTUM	26
Boîtes opératoires proposées pour GYNECOLOGIE	106
Boîtes opératoires proposées pour UROLOGIE	94
BONNEY Pince à disséquer	238
BONNEY Pince à disséquer PROMEDUR	255
BONNEY Pincés à griffes	246
BONNEY Pincés à griffes PROMEDUR	254
Bougies dilatatrices pour l'urètre	104
BOYNTON s	345
BOYS-ALLIS Pince intestinale	28
BOZEMANN Ciseaux pour Gynécologie	179
BOZEMANN Pincés porte-éponges	304
BOZEMANN Porte-aiguilles PROMEDUR	355
BOZEMANN s	360
BOZEMANN-DOUGLAS Pincés porte-éponges	304
Bras latérales pour Ecarteurs Balfour	330
Brassards pour Tensiomètres	11,197
BRAUN Crochet à décapitation	186
BRAUN Depresseur utérin	131
BRAUN Perce-crâne	186
BRAUN Pince utérine	133
BRAUN-STADLER Ciseaux à épisiotomie	180
BREISKY Ecarteurs vaginaux	124
BRIDGE Pincés à disséquer et à ligatures	279
BROMPTON Pince à draire les tubes	299
BROPHY Pincés à disséquer atraumatique	237
BROPHY Pincés à griffes	244
Brosse à main autoclavable	23
Brosses, distributeurs	23
BRYANT Pince-tampons	302
BUIE Pince à pression	43
BUIE Sonde à fistules	63
BUIE Tube à aspiration rectal	64
Bulldog Clamps	269-272
BUMM Curettes malleables tranchante	168,169
BUMM Pince à polypes utérins	143,190
BUNT Epingle à instruments	375
BUSCH Ciseaux pour cordon umbilical	179

	Page		Page
<b>C</b>			
Cables d'alimentation pour ciseaux "BiTech"	232	CORONAIRE Ciseaux	210
Cables d'alimentation pour pinces bipolaires	266	Coupe à comprimés	394
Cadre fixe-toiles pour MINI-Container	383	Coupes	393
Cadres fixe-toiles pour Containers	377,379,381,383	COUPLAND Tube d'aspiration	367
Canal cholédoque, sondes	76	Couvercles de sécurité pour boîtes	378,378,380
Canule pour anesthésie transvaginal	188	CRAFOORD Ciseaux chirurgicaux	221
CARREL Pince hémostatique	273	CRAFOORD-SELLORS Pince hémostatique	289
Cassettes à stérilisation pour instruments délicats	390	CRAFOORD-SELLORS Pinces à dissequer et à ligatures	281
CASTROVIEJO	345	CRILE	359
CASTROVIEJO PROMEDUR	345	CRILE Pinces hémostatiques	275
Cathéters métalliques pour femmes et hommes	102	CRILE-BABY Pinces hémostatiques	275
CHAPUT Pince Intestinal	27	CRILE-MURRAY	359
CHARNLEY Ecarteur abdominal	341	CRILE-WOOD	359
CHEATLE Pinces à stérilisation	374	CRILE-WOOD PROMEDUR	353
CHERON Pince porte-éponges	304	CRILE-WOOD-BABY PROMEDUR	353
Chevalet à stérilisation pour Micro-instruments	389	Crochets à fistules	144
Chirurgie Générale	193-372	Crochets à fistules rectales	63
Circoncision, instrument	103	Crochets pour le canal spermatique	99
Ciseaux	209-232	Cuillère à médecine	394
Ciseaux & Lime à ongles & chain	23	Cuillère pour calculs biliaires	77
Ciseaux à détroncation	180,186	Curettes à aspiration	170
Ciseaux à envies	22	Curettes à biopsie utérine	162,163
Ciseaux à épisiotomie	180	Curettes à faux germes	189
Ciseaux à ongles	22	Curettes pour calculs biliaires	77,78
Ciseaux à parametrium PROMEDUR	60,225	Curettes utérines	164-169
Ciseaux à préparation	216-227	CUSCO Spéculum vaginaux	110
Ciseaux bipolaire "BiTech"	228-230	CUSCO Spéculum vaginaux antiréfléchissant p.Chir. LASER	111
Ciseaux chirurgicaux	215	CUSCO Spéculum vaginaux isolé p. Chirurgie HF	111
Ciseaux chirurgicaux SUPERCUT	215	CUSCO Spéculum vaginaux Modèle suisse	110
Ciseaux coronaires	210,213	CUSHING Ecarteurs pour Chirurgie bariatrique	317
Ciseaux coronaires, Titanium	210	CUSHING Pinces à dissection PROMEDUR	253
Ciseaux délicats	214	Cuvettes rondes	393
Ciseaux délicats pour GAUCHERS	214	CUZZI Curettes à faux germes	189
Ciseaux délicats SUPERCUT	214	CZERNY Ecarteur double	307
Ciseaux pour Accouchement	178-180	CZERNY Pince utérine	133
Ciseaux pour chirurgie rectale	60,225	CZERNY Valve rectal	47
Ciseaux pour cordon umbilical	179		
Ciseaux pour entérotomie	58	<b>D</b>	
Ciseaux pour GAUCHERS	215	D.I.U. Crochet pour extraction	132
Ciseaux pour gynécologie PROMEDUR	224	D.I.U. Pinces à préhension	132
Ciseaux pour le canal cholédoque	84	DARLING Ecarteurs	321
Ciseaux pour rectum	59,223	DARTIGUES Pince Hystérolabe	90,141
Ciseaux-Clamps bipolaires	231	DAVIS Pinces à stérilisation	374
Clamp à Appendectomie	45	DE LEE Pelvimètre	177
Clamps à compression	148	DE LEE Pince obstétricale	182
Clamps Bulldog	269-272	DEAVER Ecarteurs	313-316,317
Clamps pour cordon umbilical	185	DEBAKEY Ciseaux PROMEDUR	84
Clamps-Ciseaux bipolaires	231	DEBAKEY Clamps Bulldog	272
CLAR Miroirs frontaux	14,15	DEBAKEY Ecarteurs autostatiques	321
CLIP - lumière froide pour Proctoscopes	54,173	DEBAKEY Pince à griffes PROMEDUR	254
Coagulation bipolaire, pinces	256-260	DEBAKEY Pince ovulaire	32,83
COLLER-CRILE Pinces hémostatiques	276	DEBAKEY Pinces vasculaires atraumatiques	240,250-252
COLLIN Clamp pour cordon umbilical	185	DEBAKEY Porte-aiguilles PROMEDUR	354
COLLIN Compas pelvimètre	20,177	DEBAKEY Tubes d'aspiration	368
COLLIN Dynamomètre	19	DEBAKEY-BABCOCK Pinces intestinales atraumatique	30
COLLIN Ecarteur abdominal	324	DEBAKEY-COLLIER Pinces hémostatique	287
COLLIN Manches pour bistouris	202,204	DEBAKEY-DOYEN Pinces intestinales	37
COLLIN Pince à polypes	304	DEBAKEY-FEHLAND Pince intestinale	
COLLIN Pince Hystérolabe	140,141	DEBAKEY-HAYES Pinces intestinales	39
COLLIN Pince intestinale	31	DEBAKEY-KOCHER Pinces intestinales	38
COLLIN Spéculum vaginaux	112	DEBAKEY-MICRO Clamps Bulldog	272
COLLIN Spéculum vaginaux antiréfléchissant p.Chir. LASER	112	DEBAKEY-MICRO Pincettes vasculaires	251
COLLIN Spéculum vaginaux isolé p. Chirurgie HF	112	DEBAKEY-MICRO Pincettes vasculaires TITANIUM	251
COLLIN Spéculum vaginaux pour enfants	107-109,118	DEBAKEY-SCUDDER Pinces intestinales	41
COLLIN-BABY Ecarteur abdominal	324	DEBAKEY-WERTHEIM Pinces à hystérectomie	153
COLLIN-DUVAL Pinces à intestins	249	DEMARTELL Ciseaux	84
COLLIN-LOCKTITE Ecarteur abdominal	325	DEMARTEL-WOLFSON Pinces pour anastomoses intestinales	46
COLLYER Compas pelvimètre	20,177	DENIS-BROWN Ecarteurs abdominaux	331
Containers pour instruments d'Endoscopie	384	DENIS-BROWN Pince à intestins	249
COOLEY Pince vasculaires atraumatiques	251	Depresseurs utérins	131
COOLEY Pince vasculaires atraumatiques TITANIUM	251	DESJARDINS Explorateur pour calculs biliaires	75
COOLEY Tubes d'aspiration	369,370	DESJARDINS Pinces pour calculs biliaires	81
Cordons pour ciseaux bipolaires	232	DESJARDINS Pinces pour le canal cholédoque	79
Cordons pour pinces bipolaires	266	DEWEY Pince obstétricale	183
		Diagnostique	195-198

	Page		Page
DICK Clamps à compression	148	FAURE Pincés à péritoine	147
DIETRICH Clamps Bulldog	271	FEHLAND-DEBAKEY Pince intestinale	39
Dilatateurs pour le canal cholédoque	76	FERGUSON Ciseaux pour Gynécologie	179
Dilatateurs utérins	128,129	FERGUSSON Pincés à pression	43
Dispositif à lumière froide Halogène	15,57	FERRIS-SMITH Pincés à griffes	244
Distributeur à filtres	386	Filtres, papier	386
Distributeurs de coton	391	Filtres, textile	387
Distributeurs pour brosses	23	FINOCHIETTO	360
DOUAY Pince à biopsie utérine	157	FINOCHIETTO Porte-aiguilles PROMEDUR	355
DOYEN Ciseaux pour Gynécologie	179	Fixe-filtres	386
DOYEN Ecarteurs abdominaux	312,336	FLETCHER (Javerts) Pince-tampons	301
DOYEN Ecarteurs vaginaux	125	FLETCHER Pincés-tampons	301
DOYEN Pince à polypes	82	FOCUS Halogène-Eclaireur frontal	15
DOYEN Pincés intestinales	33	FOERSTER Ecarteur abdominal, transparent aux rayons X	337
DOYEN Sonde cannelée	366	FOERSTER Pince à éponges	293
DOYEN Tracteur pour fibromes	145	FOERSTER Pincés à pansements	300,301
DOYEN-DEBAKEY Pincés intestinales	37	FOERSTER Pincés pour la vésicule biliaire	83,300
DOYEN-STILLE Ecarteurs abdominaux	312	Fond du crible pour containers	383
Draps de stérilisation	387	FORD-DIXON Ligateur pour Hémorroïdes	66
DUBOIS Ciseaux à détroncation	180,186	FRANKLIN-SILVERMAN Aiguilles à biopsie	87
DUEHRSSSEN Pince à dissequer	238	FRIEDMANN (Joll) Ecarteur autostatique	126,321
DUEHRSSSEN Pince à griffes	245	FRITSCH Ecarteurs abdominaux	313
DUNHILL Pincés hémostatiques	275	FUCHSIG Pince à dissequer et à ligatures	278
DUPLAY Pince utérine	135		
DUPLAY Pincés à polypes	303	<b>G</b>	
DUPLEX Stéthoscopes	12,198	GAUCHERS, Ciseaux	214,215
DURANTE Pincés à dissequer	248	GAUCHERS, Poerte-Aiguilles	353,354
DUVAL Pince à intestins	249	GAUSS Pince pour le cuir chevelu	187
DUVAL Pince intestinale atraumatique PROMEDUR	31	GELPI Ecarteurs autostatiques	322,323
DUVAL Pincés intestinales	31	GELPI-BABY Ecarteur	322
Dynamomètre	19	GELPI-MINI Ecarteur	322
		GELPI-SELETZ Ecarteur	323
<b>E</b>		GEMINI Pincés à préparation	284
EASTMAN Spéculum vaginaux	123	GEMINI Pincés hémostatiques	293,291
Ecarteur à perinée	51	GEMINI-MINI Pincés à préparation	284
Ecarteur abdominal, transparent aux rayons X	337	GERALD Pincés à griffes	244
Ecarteur du pylore	45	GERALD Pincés à griffes PROMEDUR	254
Ecarteur pour le col vésical	96	GILLIES Pince à griffes	242
Ecarteur vesicale	325	GILLIES Pince à griffes PROMEDUR	254
Ecarteurs	305-317	GIL-VERNET Ecarteurs à hile renal	91,92
Ecarteurs à hile renal	91,92	GLASSMANN Pincés atraumatiques	252
Ecarteurs à prostate	97,98	GLOVER Clamps Bulldog	269
Ecarteurs abdominaux	311-313,324-341	Gobelets à médecine	394
Ecarteurs autostatiques	319-341	Gobelets gradués	392
Ecarteurs doubles	307,310,	GOELET Ecarteur double	307
Ecarteurs endo-cervicaux	127	GOODELL Dilatateur utérin	129
Ecarteurs pour Chirurgie bariatrique	321	GOSSET Ecarteurs abdominaux	327
Ecarteurs pour foie	85	GOURDET Curettes utérines	165
Ecarteurs rectaux	50-51,61,62	GRAVE Spéculum vaginaux	113,114
Ecarteurs vaginaux	124-126	GRAVE Spéculum vaginaux antiréfléchissant p.Chir. LASER	113
Ecarteurs vesicaux	101	GRAVE Spéculum vaginaux isolé p. Chirurgie HF	113
Eclaireur frontal, halogène	15	GRAY Pincés pour le canal cholédoque	80
Ecraseurs pour l'intestin	44	GREEN Ecarteur	310
ELLIOT Pincés obstétricales	182	GREEN-ARMYTAGE Pincés utérines	187
Embout lumière froide pour Proctoscopes	50,53,109	GREGORY Clamps Bulldog	270
Embouts, Pincés à biopsie utérine	159	GREGORY MICRO Porte-aiguilles PROMEDUR	349
EMMET Crochets à fistules	144	GROSS Pincés à polypes	303
EMMET Pince porte-tampons	303	GUNNAR-HEY Pince draire-tubes	299
Epingles à instruments	375	GUTTMAN Cuiller à secretion	103
EPPENDORF Pince à biopsie utérine	160	GUYON Bougies dilatatrices pour l'urètre	104
Estomac, Intestins, Rectum	25-71	GUYON Mandrils pour introduire cathéters	102
Etiquettes d'identification en papier	385	GUYON Pincés rénales	88,291
Etriers pour instruments	375	GUYON Trousse à dilatation	104
EWALD Pince à dissequer	235	GWILLIAM Pincés à hystérectomie	150
EXACTA Tensiomètre	10,196	Gynécologie	105-173
Explorateurs pour calculs biliaires	75		
Extracteur-lames	205	<b>H</b>	
		HARRINGTON Pince hémostatique	292
<b>F</b>		HARRISON Pincés à stérilisation	374
FANSLER-IVES Anuscope	53	HARTMANN Pincés hémostatiques	273
FANSLER-IVES Anuscope avec lumière froide	54	HARTMANN-MICRO Pincés hémostatiques	273
FAURE Pince à biopsie utérine	156	HARTMANN-MOSQUITO Pincés hémostatiques	274
		HAYES-DEBAKEY Pincés intestinales	39
		HEANEY (Hegar)	361



	Page		Page
HEANEY Pincés à hystérectomie	149	KOERTE Ecarteurs	308
HEANEY Porte-aiguilles PROMEDUR	356	KOGAN Ecarteurs endocervicaux	127
HEANEY-BALLENTINE Pincés à hystérectomie	149	KONRICH tambours de stérilisation	390
HEANEY-KANTER Pincés à hystérectomie	149	KRISTELLER Spéculems vaginaux	108,118,119-122
HEANEY-REZEK Pincés à hystérectomie	149	KÜSTNER Pince utérine	139
HEGAR Dilatateurs urines	128,129		
HEISS Pincés à dissequer et à ligatures	278	<b>L</b>	
HENROTIN Pince utérine	137	LAHEY Ecarteur	309
HERRICK Pince rénale	88	LAHEY Pincés pour le canal cholédoque	79
HERTZLER Ecarteur abdominal	328	Lames de bistouris	199,200,203
HEYWOOD-SMITH Pince à polypes	83,142,190	Lames de bistouris, Micro	199
HEYWOOD-SMITH Pince pour hémorroïdes	70	LANDAU Ecarteurs vaginaux	124
HILL-FERGUSON Valves rectales	47	LANDOLD Manches pour bisturis	199
HIRSCHMANN Anusscopes	52	LANE Pincés à champs	298
HOESEL Ecarteurs rectaux	61	LANE Pincés à griffes	247
HOLZBACH Ecarteur abdominal	326	LANGENBECK Porte-aiguilles PROMEDUR	355
HORGAN Valves pour Ecarteurs	330	LANG-STEVENSON Pince intestinal	33
HRYNTSCHAK Ecarteur vesical	101	Lateral Ecarteur vaginal	127
Huile d'entretien des instruments	391	LAWRENCE Pince à préparation	285
HULKA Pince utérine	135	LEGUEU Ecarteur à prostate	97
HULKA-KENWICK Pince utérine	135	LEGUEU Ecarteur vesicale	325
Hystéromètres	130	LERCHE Pince à griffes	246
Hystéro-Salpingographie	171	LEXER Ciseaux à préparation	217
		LEXER Ciseaux à préparation PROMEDUR	224
<b>I</b>		LEXER-BABY Ciseaux à préparation	218
Instrument à circoncision	103	LICHTENBERG Porte-aiguilles PROMEDUR	358
Instrumentation pour Amnioscopie et micro-prise de sang	172	LICHTWITZ Trocart	371
Instruments à comparaison	18-19	Ligateurs aspiratrices pour Hémorroïdes	66-68
IOWA Canule pour anesthésia transvaginal	188	Ligateurs pour Hémorroïdes	65-69
IOWA Pince prise membranes	188	Limes à ongles	23
IOWA trompette guide-aiguilles	188	LISTER-SINUS Pincés à tampons	302
ISRAEL Ecarteurs	309	LITTAUER Pincés à ongles	22
		LITTLE Ecarteur	309
<b>J</b>		LITTLEWOOD Pince intestinale	28
JACKSON Spéculems vaginaux	123	LLOYD-DAVIS Ciseaux pour rectum	59,223
JACKSON-BURROWS Ecarteur	323	LLOYD-DAVIS Pince à anastomose	43
JACOBS Pincés utérines	138	LOCKHART-MUMMERY Sondes à fistules	63,366
JACOBSON-MICRO Pincés hémostatiques	274	LOCKWOOD Pince intestinale	29
JARCHO Pince utérine	134	LORNA Pincés à champs	298
JEFFERSON Pince à dissequer	236	Loupes binoculaires	13
JEFFERSON Pince à griffes	242	LOWER Pince pour le canal cholédoque	80
JOERGENSEN Ciseaux à préparation	217	LUER-KOERTE Curettes pour calculs biliaires	78
JOHN-HOPKINS Pince pour le canal cholédoque	80	LUIKART Pince obstétricale	182
JOHNSON	360	LUIKART-BILL Tracteur pour Pince obstétricale	184
JONES Pincés à champs	297	LURZ Cône de charge	66,67,68
JUDD-ALLIS Pincés intestinales	28	LURZ Pincés à urètre	96
JUDD-MASON Ecarteurs vesicaux	100,101		
		<b>M</b>	
<b>K</b>		Magasin à étiquettes d'identification	385
KALLMORGEN Spéculems vaginaux	122	MAIER Pincés à polypes	303
KANE Clamp à cordon umbilical	185	MAINGOT Pincés à hystérectomie	150
KANTROWITZ Pincés à préparation	284	Manche à lumière froide pour Anusscopes	55
KELLY Ecarteurs	311	Manches à piles pour anusscopes	55
KELLY Ecarteurs pour foie	85,311	Manches pour bistouris PRO-MEDSEKUR™	201
KELLY Pince à faux germe	191	Manches pour bisturis	199,201-203,204-205
KELLY Pince à polypes utérins	142,190	Manches pour Microbistouris	199
KELLY Pincés hémostatiques	275	Manches pour Pincés à biopsie utérine	159
KELLY Proctoscopes	52	Mandrils pour introduire cathéters	102
KELLY Sphincteroscopes	52	MARBERGER Ecarteurs à hile rénal	91
KERSTING Clamp Intestinal	40	MARINUS Pincés intestinales	42
KEVORKIAN Curettes à biopsie utérine	162	MARTEL Pince pour le cuir chevelu	187
KEVORKIAN Pince à biopsie utérine	161	MARTIN Compas pelvimètre	20,177
KEVORKIAN-PACIFIC Pince à biopsie	158	MARTIN Hystéromètres	130
KIELLAND Pince obstétricale	181	MARTIN Pince à déchets	374
KIELLAND-LUIKART Pince obstétricale	182	MASSON	361
KIRSCHNER Ecarteurs abdominaux	332	MASSON Porte-aiguilles PROMEDUR	356
KLEINSCHMIDT Clamp pour Appendectomie	45	MATHIEU Pince à corps étrangers	103
KLING-EX Extracteur-Lames	205	MATHIEU Porte-aiguilles PROMEDUR	358
KLINIK.BERLIN Pince presse-tube	299	MATHIEU Spéculem rectal	49
KOCHER Ecarteur à prostate	97	MATHIEU-KOCHER Porte-aiguilles PROMEDUR	358
KOCHER Pincés intestinales	34	MAYO Ciseaux à préparation	216
KOCHER-BABY Pincés intestinales	33	MAYO Ciseaux à préparation PROMEDUR	222
KOCHER-DEBAKEY Pincés intestinales	38	MAYO Curettes pour calculs biliaires	77
KOCHER-WAGNER Ecarteurs abdominaux	313	MAYO Epingles à instruments	375

	Page		Page
MAYO-ADAMS Ecarteur abdominal	325	MURLESS Elevateur à tête	181
MAYO-BLAKE Pincés pour calculs biliaires	82	MUSEUX Pincés utérines	139
MAYO-GUYON Pince rénale	88	<b>N</b>	
MAYO-HARRINGTON Ciseaux à préparation	217	NAEGELE Perce-crâne	186
MAYO-HARRINGTON Ciseaux pour gynécologie	224	NAEGELE Pincés obstétricales	181
MAYO-HEGAR Porte-aiguilles	359	NAGEL Micro-Ciseaux	213
MAYO-HEGAR Porte-aiguilles pour Gauchers PROMEDUR	354	NAUNTON-MORGAN Porte-aiguilles PROMEDUR	357
MAYO-HEGAR Porte-aiguilles PROMEDUR	354	NEIVERT Porte-aiguilles	359
MAYO-LEXER Ciseaux à préparation	217	NEIVERT Porte-aiguilles PROMEDUR	353
MAYO-LEXER Ciseaux à préparation PROMEDUR	224	NELATON Sonde boutonée/cannalée	366
MAYO-NOBLE Ciseaux à préparation	217	NELSON Pince pour saisir	246
MAYO-ROBSON Pincés intestinales	35	NELSON Trocarts	371
MAYO-RUSSIAN Pince à griffes	247	NISSEN Pince à dissequer et à ligatures	278
MAYO-STILLE Ciseaux à préparation	216	NONSTICK Pincés bipolaires	256-260
MAYO-STILLE Ciseaux à préparation SUPERCUT	216	NOTO Pince à polypes utérins	143,190
McGIVNEY Ligateurs pour Hémorroïdes	65,69	NOVAK Curettes à biopsie utérine	163
McGIVNEY Pincés à saisir Hémorroïdes	70	NOVA-PRESAMETER Tensiomètre	9,195
McINDOE Pince à dissequer	236	NUSSBAUM Pincés intestinales	36
McINDOE Pince à dissequer PROMEDUR	254	<b>O</b>	
McLEAN Pince obstétricale	183	Obstétrique	175-191
McLEAN-LUIKART Pince obstétricale	183	OCHSNER Trocarts	371
McLEAN-TUCKER Pince obstétricale	183	OCULUS Loupes binoculaires	13
MEEKER Pince à préparation	285	OEHLER Pincés à griffes PROMEDUR	255
MENGHINI Aiguilles pour biopsie du foie	87	OLLIER Ecarteurs	308
METZENBAUM	360	OLVECRONA Pincés à dissequer et à ligatures	281
METZENBAUM Ciseaux à préparation	219,221	OMBREDANNE Pince à champs	297
METZENBAUM Ciseaux à préparation PROMEDUR	222,226	OMBREDANNE Pince intestinale	29
METZENBAUM-BABY Ciseaux	218	Ongles, instruments	23
METZENBAUM-BABY Ciseaux à préparation	218	O'SULLIVAN-O'CONNOR Ecarteur abdominal	334
METZENBAUM-FINO Ciseaux à préparation	220	Ouvre-bouteilles d'infusion	375
METZENBAUM-FINO Ciseaux à préparation PROMEDUR	227	OVERHOLT-BABY Pincés à préparation	283
MICRO Porte-aiguilles	345-352,353	OVERHOLT-GEISSENDOERFER Pincés hémostatiques	283
MICRO Porte-aiguilles PROMEDUR	347-349	OVERHOLT-MIXTER Pince à préparation	283
MICRO Porte-aiguilles TITANIUM	350,351,353	<b>P</b>	
MICRO-ADSON Pince à griffes	241	Panier à stérilisation avec couvercle	383
MICRO-ADSON Pincés à dissequer	235	Paniers grillagés	377,379,381,383,384
Micro-Ciseaux	205-213	Paniers pour Endoscopie	384
MICRO-DEBAKEY Clamps Bulldog	272	Parametrium Ciseaux	60,225
MICRO-HARTMANN Pincés hémostatiques	273	PARKS Ecarteur rectal pour embout lumière froide	50
MICRO-JACOBSON Pincés hémostatiques	274	PAYR Ecraseurs	44
MICRO-Lames de bistouris	199	PAYR-BABY Ecraseur	44
MICRO-MOSQUITO Pincés hémostatiques	274	PEAN Pincés hémostatiques	279
MICRO-VASCULAR Porte-aiguilles	353	PEAN-FINO Pincés hémostatiques	280
MIDDELDORF Ecarteurs	310	PEDERSON Spéculums vaginaux	107,114
MIKULICZ Ecarteurs pour foie	85	PEDERSON Spéculums vaginaux antiréfléchissant p.Chir. LASER	114
MIKULICZ Pincés à péritoine	146	PEDERSON Spéculums vaginaux isolé p. Chirurgie HF	114
MIKULICZ-BABY Pince à péritoine	146	PEERS Pince à champs	297
MILLER Ciseaux pour enterotomie	58	PELKMANN Pincés à pansements	302
MILLIN Ecarteur à prostatectomie	100	Pelvimètres	20,177
MILLIN Ecarteur pour le col vésical	96,100	PENNINGTON Pincés intestinales	27
MILLIN Pince à fils	95	Perces-crâne	186
MILLIN Pincés pour saisir capsule	95	PESTALOZZA Curette à faux germes	189
MILLS Ciseaux	84	PETRI Boîte ronde	392
MINI Boîtes à stérilisation	382	PHANEUF Pincés à péritoine	148
MINI-GEMINI Pincés à préparation	284	PINARD Stéthoscopes	12,198
MINIMUS II Tensiomètre	10,196	Pince à corps étrangers	103
Miroirs frontaux	14,15	PINCE à griffes USA Model	243
MIXTER Pince pour calculs biliaires	80,81	Pince fixe-toiles	388
MIXTER Pincés hémostatiques	286	Pince Hystérolabe	90,141
MIXTER-BABY Pincés hémostatiques	285	Pince pour fixer canal déférent	96
MIXTER-O'SHAUGHNESSY Pincés à préparation	283	Pince pour Microbiopsie du col	161
MOGEN Instrument à circoncision	103	Pince pour ouvrir bouteilles d'infusion	375
MOORE Cuiller pour calculs biliaires	77	Pince pour pénis	103
MORGAN Proctoscopes	53	Pince pour saisir	247,249
MORRIS Ecarteurs abdominaux	312	Pince pour saisir la prostate	95
MORRIS Ecarteurs doubles	307	Pincés	235-266
MORRIS-MITRAL Ecarteur autostatique	323	Pincés à biopsie rectale	71
MOSQUITO Pincés hémostatiques MAIN GAUCHE	274	Pincés à biopsie utérine	155-161
MOSQUITO-MICRO Pincés hémostatiques	274	Pincés à champs	297-298
MOYNIHAN Explorateur malleable	75	Pincés à déchets	374
MOYNIHAN Pince à champs	298	Pincés à dissequer	235-239
MOYNIHAN Pincés pour le canal cholédoque	79		
MUENCHEN Curettes à biopsie utérine	163		

	Page		Page
Pinces à dissequer et à ligatures	277-286	RAMATHIBODI Manipulateur uterin	132
Pinces à dissequer PROMEDUR	253-255	RAMPLEY Pince à pansements	301
Pinces à dissequer USA-MODEL	237	RAMSAY Pince à dissequer atraumatique	238
Pinces à draire les drains	300	RAMSAY Pinces à griffes	245
Pinces à faux germe	191	RANDALL Curettes à biopsie utérine	163
Pinces à griffes	239,241-248,253-255	RANDALL Pinces pour calculs rénales	89
Pinces à hystérectomie	146-154	RANKIN-CRILE Pinces hémostatiques	276
Pinces à intestins	249	RANKIN-KELLY Pinces hémostatiques	276
Pinces à ongles	22	RECAMIER Curettes utérines	167
Pinces à pansements	300-304	Rectoscope	57
Pinces à péritoine	146-148	Règles	19
Pinces à polypes	302,303	RESANO Clamp Intestinal	40
Pinces à polypes utérins	142,190	Ressorts spiraux pour Micro-instruments	388
Pinces à préhension D.I.U.	132	RICARD Ecarteurs abdominaux	326
Pinces à pression	43	RICHARDSON Ecarteurs	310
Pinces à saisir Hémorroïdes	70	RICHARDSON-EASTMAN Ecarteurs doubles	310
Pinces à stérilisation	374	ROBERTS Pinces hémostatiques	280
Pinces à tampons avec couvercle	393	ROBIN-MASSE Ecarteur abdominal	327
Pinces à urètre	96	ROCHARD Compas articule	335
Pinces atraumatiques	250-252	ROCHARD Dispositifs	335
Pinces atraumatiques TITANIUM	250,251	ROCHARD Ecarteurs abdominaux	335
Pinces bipolaires "NONSTICK"	256-260	ROCHESTER-CARMALT Pinces hémostatiques	279
Pinces bipolaires à coagulation	261-265	ROCHESTER-OCHSNER Pinces hémostatiques	282,29
Pinces hémostatiques	273-276	ROCHESTER-PEAN Pinces hémostatiques	280,288
Pinces hémostatiques et à préparation	269-293	ROEDER Pinces à champs	298
Pinces hystérolabe	141	ROGGE Pince à stérilisation	374
Pinces intestinales	27-44	ROTOCLETTE Curettes à biopsie utérine	162
Pinces intestinales atraumatique	28,29-32,37-41	Rubans métrique	19
Pinces obstétricales	181-184	RUDD Ligateur pour Hémorroïdes	65
Pinces ovales	32,83	RUMEL Pinces à préparation	284
Pinces pour anastomoses intestinales	46	RUSSIAN Pinces à griffes	239,247
Pinces pour calculs biliaires	80,81-82		
Pinces pour calculs rénales	89	<b>S</b>	
Pinces pour la vesicule biliaire	83,300	SAENGER Pinces à faux germe	191
Pinces pour le canal cholédoque	79-80	Salpingographe	171
Pinces pour le col de l'utérus	133	SANTULLI Clamp Bulldog	271
Pinces pour le cuir chevelu	187	SAROT Pince hémostatique	289
Pinces pour saisir capsule	95	SAROT Porte-aiguilles	361
Pinces pour urètre	90	SAROT Porte-aiguilles PROMEDUR	357
Pinces presse-tube	299	SAUERBRUCH Boîte a aiguilles	392
Pinces presse-tube avec protecteur	299	SAUERBRUCH Pince à déchets	374
Pinces rénales	88	Scellés de sécurité plastique	385
Pinces utérines	133-143,187	SCHAEDEL Pince à champs	297
Pinces vasculaires atraumatiques	250-252	SCHERBAK Spéculums vaginaux	117
Pincess pour transplantation du foie	86	SCHIMMELBUSCH tambours de stérilisation	390
Pinces-tampons	302	SCHROEDER Curettes utérines	164
PIPER Pince obstétricale	182,184	SCHROEDER Pinces utérines	134,136
PITTSBURG Clamps pour transplantation fu foie	86	SCHUBERT Pince à biopsie utérine	156
Plaquettes d'identification	385	SCHULTZE Salpingographe	171
Plateaux à instruments	395	SCHULZE-BERGMANN Spéculums rectaux	48
POOLE Tubes d'aspiration	368,37	SCHUMACHER Ciseaux pour cordon umbilical	179
Port-cotons	131	SCHUMACHER Pince à biopsie utérine	160
Porte-aiguilles	345-361	SCHUMACHER-VAN DOREN Pince à biopsie utérine	155
Porte-aiguilles pour Gauchers PROMEDUR	353,354	SCUDDER Pinces intestinales	35
Portes-coton pour rectoscopes	64	SCUDDER-DEBAKEY Pinces intestinales	41
POST-MORTEM Lames de bisturies	203	SEGOND Bistouri à fibromes	145
POTTS-DE-MARTEL Ciseaux	84	SEGOND Pinces à hystérectomie	149
POTTS-SMITH Ciseaux PROMEDUR	84	SEGOND-LANDAU Pinces à hystérectomie	149
POTTS-SMITH Pince à dissequer	238	SELLHEIM Cuiller obstétricale	184
POTTS-SMITH Pince à dissequer PROMEDUR	253	SEMKEN Pince à griffes PROMEDUR	253
POTTS-SMITH Pince à griffes	245	SEMKEN Pinces à dissequer	236
Poubelles pour coton	391	SEMKEN Pinces à griffes	242,253
POZZI Pinces utérines	134	SEMM Ecarteurs abdominaux	333
PRATT Crochets fistules rectales	63	SEMM Spéculums vaginaux	115
PRATT Pinces utérines	137	Séparateurs pour boîtes à stérilisation	377,379,381,389
PRATT Spéculum rectal	49	SEYFFERT Spéculums vaginaux	115
PRATT-"T" Pince hémostatique	32	SIEBOLD Ciseaux pour Gynécologie	179
PRECISA Tensiomètre	9,195	Silicone bande porte-instruments	388
PRESBYTERIAN Pinces presse-tube	299	SIMON Crochets à fistules	144
Proctoscopes	52,56	SIMON Curettes utérines	164
PRO-MEDSEKUR™ Manches à bistouris	201	SIMON Ecarteus vaginaux	125
PROVIDENCE-HOSPITAL Pinces hémostatiques	275	SIMPSON Pince obstétricale	181
		SIMPSON-BRAUN Pince obstétricale	182
		SIMPSON-LUIKART Pince obstétricale	182
		SIMS Ciseaux SUPERCUT	178
<b>R</b>			
RAMATHIBODI Crochet tubulair	132		

	Page		Page
SIMS Ciseaux pour Accouchement	178	TOWNSEND Manche seul	159
SIMS Ciseaux pour gynécologie PROMEDUR	224	TOWNSEND-KERVORKIAN Pince à biopsie utérine	159
SIMS Curettes utérines	166	TOWNSEND-KRAUSE Pince à biopsie utérine	159
SIMS Depresseur utérin	131	TOWNSEND-MINI Pincés à biopsie utérine	159
SIMS Hystéromètres	130	TOWNSEND-TISCHLER Pincés à biopsie utérine	159
SIMS Spéculum rectal	48	Tracteurs pour fibromes	145
SIMS Spéculum vaginaux	123	Tracteurs pour Pince obstétricales	183,184
SIMS-MAIER Pincés à polypes	302	Transformateur à lumière froide Halogène	15
SINGLEY (TUTTLE) Pince à saisir	240,247	Transformateur pour Miroirs frontaux	14
SINGLEY Pincés à saisir	247	TRELAT Spéculum vaginaux	115
SKENE Pince utérine	136	TREVES Pincés à griffes	246
SMELLIE Crochet à obstétrique	185	Trocarts	371
SMELLIE Perce-crâne	186	Tube à aspiration rectal	64
SOFIELD Ecarteurs	307	Tubes conique de proctoscope	56
SOMER Pince hystérolabe	140	Tubes d'aspiration	367-370
Sonde métalliques p.femmes et hommes	102	Tubes d'aspiration pour Chirurgie bariatrique	367-370
Sondes à fistules	63,366	TUEBINGEN Ecarteur	316
Sondes cannelées	366	TUFFIER Pince Intestinal	27
Sondes cannelées/boutonnées	366	TURNBULL Pincés à ongles	22
Sondes pour le canal cholédoque	76	TURNER-WARWICK Ecarteur abdominal	338-340
Sondes, feuille myrte	366		
Spéculum abdominal	336	<b>U</b>	
Spéculum rectaux	47-49	UNIVERSAL Trocarts	371
Spéculum vaginaux	107-127	USA-MODELE Pince presse-tube	299
Spéculum vaginaux antiréfléchissant p.Chir. LASER	111-114		
Spéculum vaginaux isolé p. Chirurgie HF	111-114	<b>V</b>	
SPENCER-WELLS Pincés hémostatiques	279	Vaginoscope	109,173
Sphincteroscopes	52	VALLEIX Hystéromètre	130
St.MARKS Ecarteur à perinée	51	Valves rectales	47
St.MARKS Ecarteurs rectaux	62	VAN BUREN Bougies dilatatrices pour l'urètre	104
ST.MARKS Proctoscope	52,53	VAN DOREN Pince à biopsie utérine	155
STAUDE-MOORE Pince utérine	133	VANNAS-MICRO Ciseaux	209,212
STEINER-AUVARD Spéculum vaginal	116	VANNAS-MICRO Ciseaux, manche "Profil"	212
STELZNER Ciseaux pour rectum	59,223	Vasectomie, instruments	99
Stérilisation	373-395		
Stéthoscopes	12,198	<b>W</b>	
STILLE Pince rénale	88	WALDMANN Ciseaux à épisiotomie	180
STILLE Pincés à dissequer	237	WALLICH Curette à faux germes	189
STILLE-BARRAYA Pincés à griffes	248	WALTON Pincés-tampons	302
STOCKMANN Pince pour pénis	103	WANGENSTEEN Pince à saisir	247
STONE Pince à griffes	246	WANGENSTEEN Pincés à dissection PROMEDUR	253
STRATTE Porte-aiguilles	361	WANGENSTEEN Porte-aiguilles	361
STRATTE Porte-aiguilles PROMEDUR	357	WANGENSTEEN Porte-aiguilles PROMEDUR	356
STRAUSS Pince pour pénis	103	WASSMUND Ecarteur	308
STRAUSS Rectoscope	57	WAUGH Pincés à griffes	248
STRINGER Etriers pour instruments	375	WEISSBARTH Spéculum vaginal	118
Stylets	365	WERTHEIM Ciseaux chirurgicaux	218
Stylets boutonnés	365	WERTHEIM Pincés à hystérectomie	146,149,152
Stylets, Aspiration, Trocarts	365-371	WERTHEIM-ATRAUMA Pincés à hystérectomie	151
Stylets-aiguille	365	WERTHEIM-CULLEN Pincés à hystérectomie	151
Suture	345-361	WERTHEIM-DEBAKEY Pincés à hystérectomie	153
		WIJNEN Tube d'aspiration	368,370
<b>T</b>		WIKSTROEM Pincés à préparation	285
Tambours de stérilisation	390	WILLET Pince pour le cuir chevelu	187
Tapis port-instruments silicone	387	WILLIAMS Pince intestinale	29
TARNIER Basiotribe	186	WINTER Pincés à faux germe	191
TARNIER Pince obstétricale	183	WITTNER Pincés à biopsie utérine	160
TAYLOR Pincés à griffes	245	WRIGLEY Pince obstétricale	181
TAYLOR-CUSHING Pincés à griffes	245		
TEALE Pincés utérines	138	<b>Y</b>	
Tensiomètres	9,10,11,196,197	YANKAUER Tubes d'aspiration	367
THOMAS Curettes utérines	165	YEOMAN Pincés à biopsie rectale	71
THOMS-ALLIS Pince intestinale	28	YOUNG Ecarteurs à prostate	98
THOMS-GAYLOR Pince à biopsie utérine	155	YOUNG Pince à prostatectomie	95
THOMSON-WALKER Ecarteur vesical	101		
THOREK Ciseaux à préparation	218	<b>Z</b>	
TIEMANN Pince tire-balle	136	Z-HYSTEREKTOMIE Clamps	154
TISCHLER (Baggish) Pince à biopsie utérine	158	ZIEGLER Miroir frontal	14
TISCHLER Pince à biopsie utérine	158		
TISCHLER-BURKE Pince à biopsie utérine	158,159		
TISCHLER-KEVORKIAN Pince à biopsie utérine	158		
TISCHLER-MINI Pince à biopsie utérine	158		
TOHOKU Pincés à champs	298		
TOWNSEND Curette à biopsie utérine	162		



# INDICE ALFABETICO

## A

ADAIR Pinze per collo dell'utero	134
ADLERKREUTZ Pinze chirurgiche	246
ADSON Pinze anatomiche	235,236
ADSON Pinze anatomiche PROMEDUR	253
ADSON Pinze chirurgiche	241,242
ADSON Pinze chirurgiche PROMEDUR	253
ADSON Pinze per preparazione e legature	277
ADSON Portaghi	360
ADSON-BABY Pinze emostatiche	277
ADSON-BROWN Pinze chirurgiche	246
ADSON-BROWN Pinze chirurgiche PROMEDUR	254,255
ADSON-DEBAKEY Pinze anatomiche	235
ADSON-GRAEFE Pinze chirurgiche	242
ADSON-MICRO Pinze anatomiche	235
ADSON-MICRO Pinze chirurgiche	241
ADSON-SELECT MICRO Pinze chirurgiche	241
ALAN-PARKS Divaricatore rettale	50
ALEXANDER Pinza per biopsia uterina	157
ALLEN-KOCHER Pinze emostatiche	27
ALLIS Pinza per tessuti e organi	27,292
ALLIS Pinze atraumatiche per tessuti e organi	28
ALLIS-ADAIR Pinza per tessuti e organi	28
ALLIS-BABY Pinza per tessuti e organi	27
AMANN porta garza uterino	131
Amnioscopi	172
Amniotomo	131
ANDREW-PYNCHON Tubo aspirazione	367
Anoscopi	52,53
AUVARD Specoli vaginali	116

## B

BABCOCK Pinze per tessuti e organi	29,293
BABCOCK Pinze per tessuti e organi PROMEDUR	30
BABCOCK-DEBAKEY Pinze per tessuti e organi	30
BABY-ADSON Pinze emostatiche	277
BABY-ALLIS Pinza per tessuti e organi	27
BABY-BALFOUR Divaricatore addominale	329
BABY-COLLIN Divaricatore addominale	324
BABY-CRILE Pinze emostatiche	275
BABY-CRILE-WOOD Portaghi PROMEDUR	353
BABY-GELPI Divaricatore autostatico	322
BABY-KOCHER Pinze intestinali	33
BABY-LEXER Forbici per dissezione	218
BABY-METZENBAUM Forbici per preparazione	218
BABY-MIKULICZ Pinza per peritoneo	146
BABY-MIXTER Pinza per preparazione e legatore	285
BABY-OVERHOLT Pinza emostatica	283
BABY-PAYR Schiacciatore intestinale	44
Bacinelle per compresse	394
Bacinelle universali	395
BACKHAUS Pinze fissateli	297
BACKHAUS Pinze fissateli con porta-tubi	297
BAINBRIDGE Pinze emostatiche	279
BAKES Dilatatori per condotti biliare	76
BAKES Sonda per calcoli biliare	76
BALFOUR Divaricatori addominali	328-330
BALFOUR-BABY Divaricatore addominale	328
BALL e SOCKET Pinze fissateli	298
BALLENGER Pinze per tamponamento	300-304
BARNES-NEVILLE Forcipo obstetrico	184
BARR Divaricatore rettale	51
BARRET Pinza per il collo dell'utero	133
BARRON Legatore emorroidale aspiratrice	68
BARRON Manico per bisturi	203
BARRON Pinza per afferare	70
BARTON Forcipo obstetrico	183
BARTON Manico a trazione	183
Base per MINI-Container	383
Basiotribo	186
BEACHAM Amniotomo	131
BENGOLEA Pinze emostatiche	278

Página

BENSAUDE Anoscopi	53
BENSON Divaricatore per piloro	45
BERGER Pinze per biopsia uterina	161
BERGMANN-FOERSTER Pinze-tamponi	300
BERKELEY-BONNEY Pinza per isterectomia	150
BERNHARD Pinza fissateli	298
Bicchieri graduati	392
Bicchieri per medicina	394
Bile, Fegato, Rene	74-92
BILL Manico a trazione	184
Bipolar cavi per pinze	266
BIPOLAR Pinze NONSTICK	257-259
BIPOLAR Pinze per coagulazione	261-265
Bisturi per fibromi	145
BiTech Micro Forbici bibolari	228
BLAKE Curetta uterina	164
BLAKE Pinze per calcoli biliari	81
BLANK Pinze atraumatiche	237
BLESSING Forbici per chirurgia	60,225
BLOND Anoscopi	56
BLOND Tubi protoscopico	56
BODENMAMMER Specolo rettale	49
BOERMA Forcipo obstetrico	181
BONNEY Pinza anatomiche	238
BONNEY Pinza per dissezione	255
BONNEY Pinze chirurgiche	246
BONNEY Pinze chirurgiche PROMEDUR	254
BOYNTON Porthagi PROMEDUR	345
BOYS-ALLIS Pinza per tessuti e organi	28
BOZEMANN Forbici per Ginecologia/Ostetricia	179
BOZEMANN Pinze per tamponi e spugne	304
BOZEMANN Portaghi	360
BOZEMANN Portaghi PROMEDUR	355
BOZEMANN-DOUGLAS Pinza-tamponi	304
Bracciali per manometri	11,197
BRAUN Cranioclasto	186
BRAUN Depressore uterino	131
BRAUN Pinza per collo dell'utero	133
BRAUN Uncino di decapitazione	186
BRAUN-STADLER Forbici per perineo (Episiotomia)	180
BREISKY Divaricatori vaginali	124
BRIDGE Pinze per preparazione e legature	279
BROMPTON Pinza per drenaggio	299
BROPHY Pinze anatomiche	237
BROPHY Pinze chirurgiche	244
BROWN Pinze chirurgiche	247
BRYANT Pinza-tamponi e spugne	302
BUIE Cannula rettale	64
BUIE Pinza a pressione	43
BUIE Sonda per fistole	63
BULLDOG Pinze atraumatiche	269-272
BUMM Curette uterine	168-169
BUMM Pinza per polipi uterini	143,190
BUSCH Forbici ombelicale	179

Página

## C

Candelette dilatatrici uretrali	104
Cannula per l'anestesia transvaginale del necvo pudico	188
Cannula rettale	64
Cannule per biopsia del fegato	87
Canule per aspirazione	367-370
CARREL Pinze emostatiche	273
Cassetta de selezione tharghette	385
Cassette per strumenti per microcirurgia	390
CASTROVIEJO Portaghi	345
CASTROVIEJO Portaghi PROMEDUR	345
Cateteri metallici donne e uomini	102
Cavi bipolari per forbici "BiTech"	232
Cavi bipolari per pinze	266
Cestelli per strumenti endoscopica	384
Cestelli, griglia in metallo	377,379,381,383,385
CHAPUT Pinza per afferare tessuti	27
CHARNLEY Divaricatore addominale	341
CHEATLE Pinza per la sterilizzazione	374
CHERON Pinze per tamponi e spugne	304

	Página		Página
Circoncisione, strumento	103	DEAVER Divaricatori	314-317
Clamp per appendicectomia	45	DEAVER Divaricatori con manico "Comfort"	314
Clamps ombilicali	185	DEBAKEY Canule per aspirazione	368
CLAR lampada frontale	15	DEBAKEY Divaricatori autostatici	321
CLAR Riflettore frontale	14	DEBAKEY Pinze atraumatiche	240,250-252
CLAR Specchio frontale LUCE FREDO	15	DEBAKEY Pinze Bulldog atraumatiche	272
Clip - illuminazione luce fredda per anoscopi	54,173	DEBAKEY Pinze chirurgiche PROMEDUR	254
COLLER-CRILE Pinze emostatiche	276,287	DEBAKEY Pinze per cistifellea PROMEDUR	84
COLLIN Clamp ombelicale	185	DEBAKEY Pinze per tessuti e organi	32,83
COLLIN Dinamometro	19	DEBAKEY Pinze vascolari	250-252
COLLIN Divaricatori addominali	324	DEBAKEY Pinze vascolari TITANIO	250-252
COLLIN Manici per bisturi	202,204	DEBAKEY Portaghi ROMEDUR	354
COLLIN Pelvimetro	20,177	DEBAKEY-ADSON Pinze anatomiche	235
COLLIN Pinza per tessuti e organi	31	DEBAKEY-MICRO Pinze Bulldog atraumatiche	272
COLLIN Pinze per afferrare l'utero	140,141	DEBAKEY-MICRO Pinze vascolari	251
COLLIN Pinze per tamponi e spugne	304	DEBAKEY-MICRO Pinze vascolari TITANIO	251
COLLIN Specoli vaginali	112	DEBAKEY-WERTHEIM Pinze per isterectomia	153
COLLIN Specoli vaginali antiabbagliante per chirurgia LASER	112	DEMARTELL Forbici per il condotto biliare	84
COLLIN Specoli vaginali isolari per chirurgia HF	112	DEMARTEL-WOLFSON Pinze per anastomosi intestinali	46
COLLIN Speculo vaginale per bambini	108	DENIS-BROWN Divaricatori addominali	331
COLLIN-BABY Divaricatore addominale	324	Depressori uterini	131
COLLIN-DUVAL Pinze intestinali	249	DESJARDINS Pinze per calcoli biliari	81
COLLIN-LOCKTITE Divaricatore addomeneale	325	DESJARDINS Pinze per condotto biliare	79
COLLYER Pelvimetro	20,177	DESJARDINS Sonda per calcoli biliare	75
Container per Endoscopia	384	DEWEY Forcipo obstetrico	183
Container per sterilizzazione	376,378,380,382,384,390	Diagnostica	7-15,195-198
Container piatto per sterilizzazione	382	DICK Pinze de pressione	148
COOLEY Canule per aspirazione	369,370	DIETRICH Pinze Bulldog atraumatiche	271
COOLEY Pinze vascolari	251	Dilatatore per collo vescicale	96,100
COOLEY Pinze vascolari TITANIO	251	Dilatatori per condotti biliare	75,76
Coperchi di sicurezza per container	378,378,380	Dilatatori uterini	128,129
CORONAR Forbici	210	Dinamometro	19
COUPLAND Canula per aspirazione	367	Distributore per spazzole	23
CRAFOORD Forbici per lobectomia	221	Distributori de cotone	391
CRAFOORD Pinze emostatiche	281	Distributori di filtri	386
CRAFOORD-SELLORS Pinza emostatataca	289	DIU Pinze per mettere pessari	132
CRAFOORD-SELLORS Pinze per preparazione e legature	281	DIU Uncino per estrazione	132
Cranioclasto	186	Divaricatore per piloro	45
CRILE Pinze emostatiche	275	Divaricatore rettale per inserto a fibra ottica	50
CRILE Portaghi	359	Divaricatori	305-318
CRILE-BABY Pinze emostatiche	275	Divaricatori addominali	324-341
CRILE-COLLER Pinze emostatiche	276	Divaricatori autostatici	319-341
CRILE-MURRAY Portaghi	359	Divaricatori doppi	307,310
CRILE-RANKIN Pinze emostatiche	276	Divaricatori per fegato	85
CRILE-WOOD Portaghi	359	Divaricatori per seno renali	91,92
CRILE-WOOD Portaghi per mano SINISTRTRA	353	Divaricatori rettali	50-51,60,61
CRILE-WOOD Portaghi PROMEDUR	353	Divaricatori vaginali	124-126
CRILE-WOOD-BABY Portaghi PROMEDUR	353	Divaricatori vescicali	96,100-101,325,
Cucchiai per calcoli biliare	77,78	Divisore per container per sterilizzazione	377,379,381,389
Cucchiai per placenta ed aborto	189	DOUAY Pinze per biopsia uterina	157
Cucchiai uterini	164-166	DOYEN Divaricatore	312
Cucchiaino ostetrico	184	DOYEN Divaricatori addominali	336
Cucchiaino per medicina	394	DOYEN Forbici per Ginecologia/Ostetricia	179
Cucchiaino per secrezione	103	DOYEN Pinza per polipi	82
Curette per aspirazione	170	DOYEN Pinza per polipi uterini	142,190
Curette per biopsia	162-164	DOYEN Pinze intestinali	33
Curette uterine	164-169	DOYEN Sonda scanalate	366
CUSCO Specoli vaginali	110,111	DOYEN Specoli vaginali	125
CUSCO Specoli vaginali antiabbagliante per chirurgia LASER	111	DOYEN Tiramiomi	145
CUSCO Specoli vaginali isolari per chirurgia HF	111	DOYEN-DEBAKEY Pinze intestinali	37
CUSCO Specoli vaginali per bambini e vergini	107-109,118	DOYEN-STILLE Divaricatori	312
CUSHING Divaricatore	317	DUBOIS Forbici per decapitazione	180,186
CUSHING Pinze anatomiche PROMEDUR	253	DUEHRSEN Pinze anatomiche	238
CUZZI Cucchiaino per placenta ee aborto	189	DUEHRSEN Pinze chirurgiche	245
CZERNY Divaricatore doppio	307	DUNHILL Pinze emostatiche	275
CZERNY Pinza per collo dell'utero	133	DUPLAY Pinza per collo dell'utero	135
CZERNY Specolo rettale	47	DUPLAY Pinze per medicatura	303
		DUPLEX Stetoscopi	12,198
<b>D</b>		DURANTE Pinza per intestini	249
DARLING Divaricatori autostatici	321	DURANTE Pinze chirurgiche	248
DARTIGUES Pinza afferrare il rene e utero	90,141	DUVAL Pinza per intestini	249
DAVIS Pinze per la sterilizzazione	374	DUVAL Pinze per tessuti e organi	31
DE LEE Forcipo obstetrico	182	DUVAL Pinze per tessuti e organi PROMEDUR	31
DE LEE Pelvimetro	177		

	Página		Página
<b>E</b>			
EASTMAN Specoli vaginali	123	GILLIES Pinza chirurgiche	242
Elevatore per testa	181	GILLIES Pinza chirurgiche PROMEDUR	254
ELLIOT Forcipi obstetrici	182	GIL-VERNET Divaricatori per seno renali	91
EMMET Pinza per tamponi e spugne	303	Ginecologia	106-173
EMMET Uncini per fistole	144	GLASSMANN Pinze atraumatiche	252
Endospecoli	127	GLOVER Pinze Bulldog atraumatiche	269
EPPENDORF Pinza per biopsia uterina	160	GOELET Divaricatore doppio	307
EWALD Pinza chirurgiche	241	GOODELL Dilatatore uterino	129
EWALD Pinze anatomiche	235	GOSSET Divaricatori addominali	327
EXACTA Sfigmometri	10,196	GOURDET Cucchiari uterini	165
<b>F</b>			
FANSLER-IVES Anoscopi	53,54	GRAVE Specali vaginali	113,115
FANSLER-IVES Anoscopio con luce fredda	54	GRAVE Specoli vaginali antiabbagliante per chirurgia LASER	113
FAURE Pinza per biopsia	156	GRAVE Specoli vaginali isolari per chirurgia HF	113
FAURE Pinza per peritoneo	147	GRAY Pinze per il condotto biliare	80
FEHLAND-DEBAKEY Pinza per amastomosi rettali	39	GREEN Divaricatore	310
FERGUSON Forbici per Ginecologia	179	GREEN-ARMYTAGE Pinza serra utero	187
FERGUSON Pinze a pressione	43	GREGORY Portaghi DIAMANTATE	351
Fermafiltro per Container	386	GREGORY Portaghi PROMEDUR	351
FERRIS-SMITH Pinze chirurgiche	244	GROSS Pinze per medicatura	303
Filtri, carta per Container	386	GUNNAR-HEY Pinza per drenaggio	299
Filtri, tessile per Container	387	GUTTMAN Cucchiario per secrezione	103
FINOCHIETTO Portaghi	360	GUYON Candelette dilatatrici uretrali	104
FINOCHIETTO Portaghi PROMEDUR	355	GUYON Pinza renali	88,293,291
FLETCHER (JAVERTS) Pinza-tamponi	301	GUYON Strumenti per introdurre catetere	102
FLETCHER Pinze-tamponi	301	GWILLIAM Pinze per isterectomia	150
FOCUS Lampada frontale ALOGENO	15	<b>H</b>	
FOERSTER Divaricatore addominale, plastica, radiotrasparente	337	HALSTED Pinze emostatiche	277
FOERSTER Pinza-tamponi	293	HARRINGTON Pinza emostatica	292
FOERSTER Pinze per cistifellea	83,300	HARTMANN-MICRO Pinze emostatiche	273
FOERSTER Pinze-tamponi	300,301	HARTMANN-MOSQUITO Pinze emostatiche	274
Forbici	207-232	HASSISON Pinza per la sterilizzazione	374
Forbici bibolari	228-230	HAYES-DEBAKEY Pinze per anastomosi rettali	39
Forbici chirurgiche	215	HEANEY (Hegar) Portaghi	361
Forbici con taglio in carburo di tungsteno	222,224-227	HEANEY Pinze per isterectomia	149
Forbici delicate	214	HEANEY Portaghi PROMEDUR	356
Forbici delicate per MANO SINISTRA	214	HEANEY-BALLENTINE Pinze per isterectomia	149
Forbici e pinza bipolari	231	HEANEY-KANTER Pinze per isterectomia	149
Forbici ombelicale	179	HEANEY-REZEK Pinza per isterectomia	149
Forbici per decapitazione	180,186	HEGAR Dilatatori uterini	128,129
Forbici per dissezione	216-222	HEISS Pinze emostatiche	278
Forbici per dissezione PROMEDUR	222,225-227	HENROTIN Pinza per collo dell'utero	137
Forbici per Enterotomia	58	HERRICK Pinza renali	88
Forbici per episiotomia (perineo)	180	HERTZLER Divaricatore addominale	328
Forbici per Ginecologia/Ostetricia	179-181	HEYWOOD-SMITH Pinza per polipi	70
Forbici per il condotto biliare	84	HEYWOOD-SMITH Pinze per polipi uterini	83,142,190
Forbici per il retto	58,59,223	HILL-FERGUSON Valve rettale	47
Forbici per la cuticola	22	HIRSCHMANN Anoscopi	52
Forbici per lobectomia	221	HOESEL Divaricatori rettali	61
Forbici per MANO SINISTRA	214,215	HOLZBACH Divaricatore addominale	326
Forbici per operazione	224	HORGAN valve per divaricatori	330
Forbici per parametrio	60,217,225	HRYNYSCHAK Divaricatore vescicale	101
Forbici per perineo (episiotomia)	180	HULKA Pinza per collo dell'utero	135
Forbici per preparazione	219,221,222	HULKA-KENWICK Pinza per collo dell'utero	135
Forbici per unghie	22	<b>I</b>	
Forcipi obstetrici	181-184	Inserto per Proctoscopi fibra ottica	50,53,109
FORD-DIXON Legatore emorroidale	66	IOWA Guida per aghi cannule (tromba)	188
FRANKLIN-SILVERMAN Cannule per biopsia del fegato	87	IOWA Pinza rompimembrana	188
FRITSCH Divaricatori	313	ISRAEL Divaricatori	309
FUCHSIG Pinza emostatiche	278	Isterometri	130
<b>G</b>			
Ganci a cripta	63	Isterosalpionografia	171
GAUSS Pinza per pericraneone	187	<b>J</b>	
GELPI Divaricatori autostatici	322,323	JACKSON Specoli vaginali	123
GELPI-BABY Divaricatore autostatico	322	JACKSON-BURROWS Divaricatore autostatico	323
GELPI-MINI Divaricatore autostatico	322	JACOBS Pinze per collo dell'utero	138
GELPI-SELETZ Divaricatore autostatico	323	JACOBSON-MICRO Pinze emostatiche	274
GEMINI Pinze emostatiche	284,293	JARCHO Pinza per collo dell'utero	134
GEMINI-MINI Pinze emostatiche	284	JEFFERSON Pinza chirurgiche	242
GERALD Pinze chirurgiche	244	JEFFERSON Pinze anatomiche	236
GERALD Pinze chirurgiche PROMEDUR	254	JOHN-HOPKINS Pinza per condotto biliare	80
		JOHNSON Portaghi	360
		JOLL (Friedmann) Divaricatore vaginale autosatico	126,321



	Página		Página
JONES Pinze fissateli	297	Manici a batterie per Anoscopi	55
JUDD-ALLIS Pinze per tessuti e organi	28	Manici a luzce fredda per Anoscopi	55
JUDD-MASON Divaricatori vescicali	100,101	Manici a trazione per Forcipi obstetrici	183,184
<b>K</b>		Manici per bisturi	199,201,202-2035
KALLMORGEN Specoli vaginali	122	Manici per bisturi "PRO-MEDSEKUR™"	201
KANE Clamp ombelicale	185	Manici per micro bisturi	199
KANTROWITZ Pinze emostatiche	284	Manici per pinze per biopsia uterina	159
KELLY Divaricatori	85,311	MANO SINISTRA forbici	214,215
KELLY Pinza per aborto e placenta	191	MANO SINISTRA Portaghi	353,354
KELLY Pinze emostatiche	275	Manometri	9,10,195,196
KELLY Sfinteroscopi	52	MARBERGER Divaricatori per seno renali	91
KELLY-RANKIN Pinze emostatiche	276	MARINUS Pinze intestinali atraumatichi	42
KERSTING Pinza per anastomosi retтали	40	MARTEL Pinza per pericraneo	187
KEVORKIAN Curette per biopsia	162	MARTIN Isterometri	130
KEVORKIAN Pinza per biopsia uterina	161	MARTIN Pelvimetro	20,177
KEVORKIAN-PACIFIC Pinza per biopsia uterina	158	MARTIN Pinza per bendaggi usati	374
KIELLAND Forcipo obstetrico	181	MASSON Portaghi	361
KIELLAND-LUIKART Forcipo obstetrico	182	MASSON Portaghi PROMEDUR	356
KIRSCHNER Divaricatori addominali	332	MATHIEU Pinze per corpi estranei	103
KLEINSCHMIDT clamp per appendicectomia	45	MATHIEU Portaghi PROMEDUR	358
KLING-EX Levare-lame	205	MATHIEU Specolo rettale	49
KLINIKUM BERLIN Pinza serratubi	299	MATHIEU-KOCHER PROMEDUR	358
KOCHER Pinze intestinali	34	MAYO Cuchia per calcoli biliare	77
KOCHER-BABY Pinze intestinali	33	MAYO Forbici per dissezione	216
KOCHER-DEBAKEY Pinze intestinali	38	MAYO Forbici per dissezione PROMEDUR	222
KOCHER-WAGNER Divaricatori	313	MAYO-ADAMS Divaricatore addominale	325
KOERTE Divaricatori	308	MAYO-BLAKE Pinze per calcoli biliari	82
KOGAN Endospecoli	127	MAYO-GUYON Pinza renali	88
KONRICH scatole per sterilizzazione	390	MAYO-HARRINGTON Forbici per dissezione	217
KRISTELLER Divaricatori vaginali	126	MAYO-HARRINGTON Forbici per operazione PROMEDUR	224
KRISTELLER Specoli vaginali	108,118-121	MAYO-HEGAR Portaghi	359
KRISTELLER Specoli vaginali per vergini	108	MAYO-HEGAR Portaghi per mano SINISTRA	354
KÜSTNER Pinza per collo dell'utero	139	MAYO-HEGAR Portaghi PROMEDUR	354
		MAYO-LEXER Forbici PROMEDUR	224
		MAYO-NOBLE Forbici per dissezione	217
<b>L</b>		MAYO-ROBSON Pinze intestinali	35
LAHEY Divaricatori	309	MAYO-RUSSIAN Pinza chirurgiche	247
LAHEY Pinza per il condotto biliare	79	MAYO-STILLE Forbici per dissezione	216
Lame per bisturi	199,200,203	McGIVNEY Legatgore emorroidale	65,69
LANDAU Divaricatori vaginali	124	McGIVNEY Pinze per emorroidi	70
LANDOLD Manici per micro bisturi	199	McINDOE Pinza anatomiche	236
LANE Pinze chirurgiche	247	McINDOE Pinza chirurgiche PROMEDUR	254
LANE Pinze fissateli	298	McLEAN Forcipo obstetrico	183
LANGENBECK Portaghi PROMEDUR	355	McLEAN-LUIKART Forcipi obstetrici	183
LANG-STEVENSIN Pinza intestinali	33	MEEKER Pinza per preparazione e legatore	285
LATERAL Divaricatore vaginale autosatico	127	MENGHINI Cannule per biopsia del fegato	87
LAWRENCE Pinza per preparazione e legatore	285	METZENBAUM Forbici per preparazione	219,221,222
Legatori emorroidali	65-69	METZENBAUM Forbici PROMEDUR	226
LEGUEU Divaricatore vescicale	325	METZENBAUM Portaghi	360
LEGUEU Spatola vescicali	97	METZENBAUM-BABY Forbici per preparazione	218
LERCHE Pinza chirurgiche	246	METZENBAUM-FINO Forbici per preparazione	220
Levare-lame	205	METZENBAUM-FINO Forbici PROMEDUR	227
LEXER-BABY Forbici per dissezione	218	Micro Forbici	209-213
LICHTENBERG Portaghi PROMEDUR	358	Micro Forbici bicolari	228
LICHTWITZ Trequarto	371	Micro lame per bisturi	199
Lime per unghie	23	Micro Portaghi	345-352
LISTER-SINUS Pinze-tamponi	302	Micro Portaghi DIAMAMTATE	349-351,353
LITTAUER Tronchesine per unghie	22	Micro Portaghi PROMEDUR	347-349
LITTLEWOOD Pinza per tessuti e organi	28	Micro Portaghi TITANIO	350-351,353
LLOYD-DAVIS Forbici per il retto	59,223	MICRO-DEBAKEY Pinze Bulldog atraumatiche	272
LLOYD-DAVIS Pinza per anastomosi rettale	43	MICRO-HARTMANN Pinze emostatiche	273
LOCKHART-MUMMERY Sonde per fistole	63,366	MICRO-JACOBSON Pinze emostatiche	274
LOCKWOOD Pinza per tessuti e organi	29	MICRO-MOSQUITO Pinze emostatiche	274
LORNA Pinze fissateli	298	MICRO-VASCULAR Portaghi PROMEDUR DIAMANTATE	353
LOWER Pinza per condotto biliare	80	MIDDELDORF Divaricatori	310
LUER-KOERTE Cuchia per calcoli biliare	78	MIKULICZ Divaricatori per fegato	85
LUIKART Forcipo obstetrico	182	MIKULICZ Pinze per peritoneo	146
LUIKART-BILL Manico a trazione	184	MIKULICZ-BABY Pinza per peritoneo	146
LURZ Legatore emorroidale aspiratrice	66	MILLER Forbici per il retto	58
LURZ Pinze per uretere	96	MILLIN Divaricatore per prostatectomia	100
		MILLIN Dilatatore per collo vescicale	96,100
		MILLIN Pinza per afferare lobuli anteriori	95
<b>M</b>		MILLIN Pinza portafilo	95
MAIER Pinze per medicatura	303	MILLIN Pinze per afferare la prostata	95
MAINGOT Pinze per isterectomia	150	MILLS Forbici per il condotto biliare	84

	Página		Página
MINI Container piatto per sterilizzazione	382	PELKMANN Pinze-tamponi	302
MINIMUS II Sfigmometro	10,196	Pelvimetri	20,177
Misurini graduati	392	PENNINGTON Pinze per tessuti e organi	27
MIXTER Pinza per calcoli biliari	82	Perne di fissaggio per divisori e strumenti	389
MIXTER Pinza per condotto biliare	80	PESTALOZZA Cucchiaino per placenta ed aborto	189
MIXTER Pinze emostatiche	286	PETRI Scodella	392
MIXTER-BABY Pinze per preparazione e legatore	285	PHANEUF Pinze per peritoneo	148
MIXTER-O'SHAUGHNESSY Pinze per preparazione	283	PINARD Stetoscopi fetali	12,198
MOGEN Strumento per circoncisione	103	Pinza afferare il rene e utero	90,141
MOORE Cucchiaino per calcoli biliare	77	Pinza apri flebo	375
MORGAN Proctoscopi	53	Pinza per fissare il tronco spermatico	96
MORRIS Divaricatore autostatico	323	Pinza per microbiopsia uterina	161
MORRIS Divaricatori	312	Pinza per pericraneo	187
MORRIS Divaricatori doppi	307	Pinza rompimembrana	188
MOSQUITO Pinze emostatiche	274	Pinze	233-266
MOSQUITO-MICRO Pinze emostatiche	274	Pinze a pressione	43
MOYNIHAN Exploradore per calcoli biliare	75	Pinze anatomiche FINO	237
MOYNIHAN Pinza fissateli	298	Pinze anatomiche Modello "USA"	237
MOYNIHAN Pinze per condotto biliare	79	Pinze atraumatiche	240,250-252
MÜNCHEN Curette per biopsia	163	Pinze atraumatiche PROMEDUR	250-253
MURLESS Elevatore per testa	181	Pinze atraumatiche TITANIO	250,251
MUSEUX Pinze per collo dell'utero	139	Pinze bipolari	261-265
		Pinze bipolari NONSTICK	257-259
<b>N</b>		Pinze bipolari per coagulazione	256-265
NAEGELE Forcipo obstetrico	181	Pinze Bulldog atraumatiche	269-272
NAEGELE Spezzacrano	186	Pinze calcoli renali	89
NAGEL Micro-Forbici	213	Pinze chirurgiche	241-248
Nastri medico	19	Pinze chirurgiche FINO	243
NAUNTON-MORGAN Portaghi PROMEDUR	357	Pinze chirurgiche Modello USA	243
Necessario per infermeria	23	Pinze de pressione	148
NEIVERT Portaghi	359	Pinze di fillaggio per teli	388
NEIVERT Portaghi PROMEDUR	353	Pinze emostatiche	273-276,280
NELATON Sonda bottonuta scanalata	366	Pinze emostatiche e per preparazione	237-293
NELSON Pinze chirurgiche	246	Pinze emostatiche per chirurgia bariatrica	287-293
NELSON Tre quarti	371	Pinze fissateli, serratubi, tamponi	295-304
NISSEN Pinza emostatica	278	Pinze intestinali	33-46
NONSTICK Pinze bipolari	257-259	Pinze per aborto e placenta	191
NOTO Pinza per polipi uterini	143,190	Pinze per afferare	240,247,249
NOVAK Curette per biopsia	163	Pinze per afferare la prostata	95
NOVA-PRESAMETER Sfigmometro	9,195	Pinze per afferrare l'utero	141-141
NUSSBAUM Pinze intestinali	36	Pinze per anastomosi intestinali	46
		Pinze per anastomosi rettali	38-40
<b>O</b>		Pinze per bendaggi con recipiente	393
Occhiali a lenti binoculari	13	Pinze per bendaggi usati	374
OCHSNER Tre quarti	371	Pinze per biopsia rettale	71
OCULUS Occhiali a lenti binoculari	13	Pinze per biopsia uterina	156-161
OEHLER Pinze chirurgiche PROMEDUR	255	Pinze per calcoli biliari	81,82
Olio per la pulizia degli strumenti	391	Pinze per cistifellea	83,300
OLLIER Divaricatori	308	Pinze per dissezione	235-239
OLVECRONA Pinze emostatiche	281	Pinze per drenaggio tubi con rulli	299
OMBREDANNE Pinza fissateli	297	Pinze per il collo dell'utero	133-139
OMBREDANNE Pinza per intestino	29	Pinze per il condotto biliare	79,80
Ostetricia	176-191	Pinze per isterectomia	149-154
Ostetricia	176-191	Pinze per la sterilizzazione	374,375
O'SULLIVAN-O'CONNOR Divaricatori addominali	334	Pinze per medicaturas	300-304
OVERHOLT-BABY Pinza emostatica	283	Pinze per pericraneo	187
OVERHOLT-GEISSENDOERFER Pinze emostatiche	283	Pinze per peritoneo	146-148
OVERHOLT-MIXTER Pinza emostatica	283	Pinze per polipi uterini	83,142,143,190
		Pinze per preparazione e legature	277-279,281-286
<b>P</b>		Pinze per rifiuti	374
Padelle reniforme	393	Pinze per tamponamento	300-304
Panni di sterilizzazione	387	Pinze per tessuti e organi	27-32
PARAMETRIUM Forbici	60,225	Pinze per trapiantare del fegato	86
PARKS Divaricatore rettale per inserto a fibra ottica	50	Pinze per uretere	90,96
PAYR Schiacciatore intestinale	44	Pinze per vasectomia	99
PAYR-BABY Schiacciatore intestinale 18 c	44	Pinze PROMEDUR	253-255
PEAN Pinze emostatiche	279	Pinze renali	88
PEAN-FINO Pinze emostatiche	280	Pinze serra utero	187
PEDERSON Specoli vaginali	114	Pinze serrapene	103
PEDERSON Specoli vaginali antiabbagliante per chirurgia LASER	114	Pinze serratubi	299
PEDERSON Specoli vaginali isolari per chirurgia HF	114	PIPER Forcipi obstetrici	182,184
PEDERSON Speculo vaginale per vergini	107,114	PITTSBURG Pinze per trapiantare del fegato	86
PEERS Pinza fissateli per fazzoletti di carta	297	POOLE Canule per aspirazione	368,370
		Porta garza uterino	131
		Portacotone e tamponi	64

	Página		Página
POTTS-DE-MARTEL Forbici per il condotto biliare PROMEDUR	84	SCHUMACHER-VAN DOREN Pinza per biopsia uterina	155
POTTS-SMITH Forbici per il condotto biliare	84	Scodelle in acciaio inossidabile	391-395
POTTS-SMITH Pinze anatomiche	238	Scodelle rotonde	393
POTTS-SMITH Pinze anatomiche PROMEDUR	253	SCUDDER Pinze intestinali	35
POTTS-SMITH Pinze chirurgiche	245	SCUDDER-DEBAKEY Pinze intestinali	41
POZZI Pinza per collo dell'utero	134	SEGOND Bisturi per fibromi	145
PRATT Ganci a cripta	63	SEGOND Pinza per isterectomia	149
PRATT Pinze per collo dell'utero	137	SEGOND-LANDAU Pinza per isterectomia	149
PRATT Specolo rettale	49	SELLHEIM Cucchiaino ostetrico	184
PRATT-"T" Pinza emostatiche	32	SEMKEN Pinze anatomiche	236
PRECISA Sfigmometro	9,195	SEMKEN Pinze chirurgiche	242
Preparazione, Dermatologia	21-24	SEMKEN Pinze chirurgiche PROMEDUR	253
PRESBYTERIAN Pinze serratubi	299	SEMM Divaricatore addominale	333
Proctoscopi	52,53,56	SEMM Specoli vaginali	115
Proiettore Luce Fredda Alogeno	15,57	SEYFFERT Specoli vaginali	115
PRO-MEDSEKUR™ Manici per bisturi	201	Sfigmometri	9,10,195,196
PROVIDENCE-HOSPITAL Pinze emostatiche	275	Sfinteroscopi	52
<b>R</b>		SIEBOLD Forbici per Ginecologia	179
RAMATHIBODI Manipolatore uterino	132	Sigilli di sicurezza per sterilizzazione	385
RAMATHIBODI unchino tubular	132	SIMON Cucchiaini uterini	164
RAMPLEY Pinze-tamponi	301	SIMON Divaricatori vaginali	125
RAMSAY Pinza anatomiche	238	SIMON Divaricatori per fistole	144
RAMSEY Pinze chirurgiche	245	SIMPSON Forcipo obstetrico	181
RANDALL Curetta per biopsia	163	SIMPSON-BRAUN Forcipo obstetrico	182
RANDALL Pinze per calcoli renali	89	SIMPSON-LUIKART Forcipo obstetrico	182
RANKIN-CRILE Pinze emostatiche	276	SIMS Curette uterine	166
RANKIN-KELLY Pinze emostatiche	276	SIMS Depressore uterino	131
RECAMIER Curette uterine	167	SIMS Forbici per Ginecologia/Obstetrica	178
Recipiente per cotone usato	391	SIMS Forbici PROMEDUR	224
Recipienti cilindrici	394	SIMS Isterometri	130
RESANO Pinza per anastomosi rettali	40	SIMS Specoli vaginali	123
RICARD Divaricatore addominale	326	SIMS Specolo rettale	48
RICHARDSON Divaricatori	310	SIMS-MAIER Pinze per medicatura	302
RICHARDSON-EASTMAN Divaricatori doppi	310	SINGLEY(TUTTLE) Pinza per afferrare	240
Riflettore frontale	14	SINGLEY(TUTTLE) Pinze chirurgiche	247
Righe	19	SKENE Pinza per collo dell'utero	136
ROBERTS Pinze emostatiche	280	SMELLIE Spezzacrano	186
ROBIN-MASSE Divaricatore addominale	327	SMELLIE Uncino ostetrico	185
ROCH.-OCHSNER Pinze emostatiche	282	SOFIELD Divaricatori doppi	307
ROCHARD Divaricatori addominali	335	SOMER Pinza per afferrare l'utero	140
ROCHESTER-CARMALT Pinze emostatiche	279	SONDA bottonute scanalate	366
ROCHESTER-OCHSNER Pinze emostatiche	292,290	Sonde "mirto"	366
ROCHESTER-PEAN Pinze emostatiche	280,288	Sonde bottonute	365
ROEDER Pinze fissateli	298	Sonde bottonute scanalate	366
ROGGE Pinza per la sterilizzazione	374	Sonde con occhiello	365
ROTOCLETTE Curette per biopsia	162	Sonde per calcoli biliari	75
RUDD Legatgore emorroidale	65	Sonde per fistole	63,366
RUMEL Pinze emostatiche	284	Sonde scanalate	366
RUSSIAN Pinze chirurgiche	239,247	SPAZZOLE per mano	24
<b>S</b>		Specilli, Aspirazione, Trequarti	363-371
SAENGER Pinza aborto e placenta	191	Specilli bottonuti	365,366
SALING Amnioscopi	172	Specoli rettali	48-51
SANTULLI Pinza Bulldog atraumatiche	271	Specoli vaginali	107-127
SAROT Pinza emostatataca	289	Specoli vaginali per bambine e vergini	108
SAROT Portaghi	361	Specolo addominale	336
SAROT Portaghi PROMEDUR	357	SPENCER-WELLS Pinze emostatiche	279
SAUERBRUCH Pinza per bendaggi usati	374	Spezzacrani	186
SAUERBRUCH Scatola per aghi	392	St.MARKS Divaricatore pelviano	51
Scatole per aghi	391,392	St.MARKS Divaricatori rettali	62
Scatole per sterilizzazione	390	ST.MARKS Proctoscopio	52
Scatole per strumenti	395	STAUDE-MOORE Pinza per collo dell'utero	133
SCHAEDEL Pinza fissateli	297	STELZNER Forbici per il retto	59,223
SCHERBAK Specoli vaginali	117	Sterilizzazione	373-395
Schiacciatori intestinali	44	Stetoscopi	12,198
SCHIMMELBUSCH scatole per sterilizzazione	390	STILLE Pinza renali	88
SCHROEDER Curette uterine	164	STILLE Pinze anatomiche	237
SCHROEDER Pinze per collo dell'utero	134,136	STILLE-BARRAYA Pinze chirurgiche	248
SCHUBERT Pinza per biopsia uterina	156	STOCKMANN Pinza serrapene	103
SCHULTZE Isterosalpionografo	171	Stomaco, Intestini, Retto	25-71
SCHULZE-BERGMANN Specoli rettali	48	STONE Pinza chirurgiche	246
SCHUMACHER Forbici ombelicale	179	STRATTE Portaghi	361
SCHUMACHER Pinze per biopsia uterina	160	STRATTE Portaghi PROMEDUR	357
		STRAUSS Pinza serrapene	103
		STRAUSS Rettoscopio fibra ottica	57
		Strisce per fissaggio strumenti	388

	Página
Strumenari raccomandati per BILE, FEGATO, RENE	74
Strumenari raccomandati per GINECOLOGIA	106
Strumenari raccomandati per OSTETRICIA	176
Strumenari raccomandati per UROLOGIA	94
Strumentari raccomandati per STOMAGO, INTESTINALE, RETTO	26
Strumenti di paragone	17-20
Strumenti generali	195-371
Strumenti per introdurre catetere	102
Strumento per circoncisione	103
Supporti a molle	388
Sutura	343-361

## T

Tapetti porta-strumenti in silicone	387
Targhette con indicatore chimico	385
Targhette di identificazione	385
TARNIER Basiotribo	186
TARNIER Forcipo obstetrico	183
TAYLOR Pinze chirurgiche	245
TAYLOR-CUSHING Pinze chirurgiche	245
TEALE Pinze per collo dell'utero	138
Telai fissateli per container per sterilizzazione	377,379,381,383
THOMAS Curette uterine	165
THOMS-ALLIS Pinza per tessuti e organi	28
THOMS-GAYLOR Pinza p. biopsia	155
THOREK (HALLE) Forbici per dissezione	218
THOREK Forbici per dissezione	218
TIEMANN Pinza per collo dell'utero	136
Tiramiomi	145
TISCHLER (Baggish) per biopsia uterina	158
TISCHLER Pinza per biopsia uterina	158
TISCHLER-BURKE Pinza per biopsia uterina	158
TISCHLER-KEVORKIAN per biopsia uterina	158
TISCHLER-MINI Pinza per biopsia uterina	158
TOHOKU Pinze fissateli	298
Tonchesine per unghie	22
TOWNSEND Curetta per biopsia	162
TOWNSEND-BURKE Pinza per biopsia uterina	159
TOWNSEND-KERVORKIAN Pinza per biopsia uterina	159
TOWNSEND-KRAUSE Pinza per biopsia uterina	159
TOWNSEND-MINI Pinze per biopsia uterina	159
TOWNSEND-TISCHLER Pinze per biopsia uterina	159
Trasformatore per riflettore	14
TRELAT Specoli vaginali	115
Trequarti	371
TREVES Pinze chirurgiche	246
Tubi d'aspirazione	367-370
Tubi protoscopico	56
TUEBINGEN Divaricatore	313
TUFFIER Pinza per tessuti e organi	27
TURNBULL Tronchesine per unghie	22

## U

ULRICH Pinze per tamponi e spugne	303
Uncini per cordone spermatico	99
Uncini per fistole	144
Uncino di decapitazione	186
Uncino ostetrico	185
UNIVERSAL Trequarti	371
Urologia	94-104
USA-MODELO Pinza serratubi	299

## V

Vaginoscopio, fibra ottica per vergini	109,173
VALLEIX Isterometro	130
Valve rettale	47
VAN BUREN Candelette dilatatrici uretrali	104
VAN DOREN Pinza p. biopsia	155
VANNAS-Micro Forbici	209

## W

WALDMANN Forbici per episiotomia	180
WALLICH Cucchiaino per placenta ed aborto	189
WALTON Pinze-tamponi	302
WANGENSTEEN Pinza per afferare	247
WANGENSTEEN Pinze per afferare PROMEDUR	253
WANGENSTEEN Portaghi	361
WANGENSTEEN Portaghi PROMEDUR	356
WASSMUND Divaricate	308
WAUGH Pinze chirurgiche	248
WERTHEIM Forbici chirurgiche	218
WERTHEIM Pinza per peritoneo	146
WERTHEIM Pinze per isterectomia	149,152
WERTHEIM-ATRAUMA Pinza per isterectomia	151
WERTHEIM-CULLEN Pinza per isterectomia	151
WERTHEIM-DEBAKEY Pinze per isterectomia	153
WIJNEN Canula per aspirazione	368,370
WIKSTROEM Pinze emostatiche	285
WILLET Pinza per pericraneio	187
WILLIAMS Pinza per tessuti e organi	29
WINTER Pinze per aborto e placenta	191
WITTNER Pinze per biopsia uterina	160
WRIGLEY Forcipo obstetrico	181

## Y

YANKAUER Canule per aspirazione	367
YEOMAN Pinze per biopsia rettale	71
YOUNG Pinza per afferare la prostata	95

## Z

ZIEGLER Riflettore frontale	14
Z-ISTEREKTOMIA Pinze per isterectomia	154



# INDICE ALFABÉTICO

## A

Abdominal Especulo autoestatico	336
Abre-botellas de infusión	375
ADAIR Pinzas para cuello uterino	134
Adaptador luz fria para Proctoscopios,	50,53,109
ADLERKREUTZ Pinzas quirúrgicas	246
ADSON Pinzas anatómicas	235,236
ADSON Pinzas de disección PROMEDUR	253
ADSON Pinzas hemostáticas	277
ADSON Pinzas quirúrgicas	241,242
ADSON Porta-agujas	360
ADSON-BABY Pinzas hemostáticas	277
ADSON-BROWN Pinza de disección PROMEDUR	255
ADSON-BROWN Pinzas quirúrgicas	246
ADSON-DEBAKEY Pinzas anatómicas	235
ADSON-GRAEFE Pinzas quirúrgicas	242
ADSON-MICRO Pinzas anatómicas	235
ADSON-MICRO Pinzas quirúrgicas	241
ADSON-MICRO Pinzas quirúrgicas	241
ADSON-SELECT Pinzas quirúrgicas	241
ALAN-PARKS Espéculo rectal	50
ALEXANDER Pinza para biopsia uterina	157
ALLEN-KOCHER Pinzas para tejidos y organos	27
ALLIS Pinza intestinal atraumatica	28
ALLIS Pinza intestinale atraumatica	28
ALLIS Pinzas para tejidos y organos	27
ALLIS Pinzas para tejidos y organos	27,292
ALLIS-ADAIR Pinza para tejidos y organos	28
ALLIS-BABY Pinza para tejidos y organos	27
AMANN Guida-tampónes	131
Amnioscopios	172
Amniotómo	131
ANDREW-PYNCHON Cánula de aspiración	367
Anoscopios	52,53,55
Apoyos con resorte spiral singular	388
Arandelas de goma para ligadores	65
AUVARD Espéculos vaginales	116

## B

BABCOCK Pinzas intestinales	29
BABCOCK Pinzas intestinales PROMEDUR	30
BABCOCK-DEBAKEY Pinzas intestinales	30
BABY-ADSON Pinzas hemostáticas	277
BABY-ALLIS Pinzas para tejidos y organos	27
BABY-BALFOUR Separador abdominal	328
BABY-COLLIN Separador abdominal	324
BABY-CRILE Pinzas hemostáticas	275
BABY-CRILE-WOOD Porta-agujas PROMEDUR	353
BABY-KOCHER Pinzas intestinales	33
BABY-LEXER Tijeras para preparaciones	218
BABY-METZENBAUM Tijeras para preparaciones	218
BABY-MIKULICZ Pinza para peritoneo	146
BABY-MIXTER Pinzas de disección y ligaduras	285
BABY-PAYR Pinza intestinale para píloro	44
BACKHAUS Pinzas de campo	297
BAINBRIDGE Pinzas intestinales	279
BAKES sondas para conducto biliares	76
BALFOUR brazos para separadores	330
BALFOUR Separadores abdominales	328-330
BALFOUR-BABY Separador abdominal	328
BALFOUR-Modif. Separadores abdominales	330
BALL e SOCKET Pinzas de campo	298
BALLENGER Pinzas para curaciones	300
BALLENGER Pinzas para curaciones	300
Bandejas para esterilización	377,379,381,373,384
Bandejas para instrumentos	395
Bandejita para tabletas	394
BARNES-NEVILLE Forceps obstétrico	184
BARR Espéculo rectal	51
BARRET Pinza uterina	133
BARRON Mango de bisturi	203
BARRON Ligador para hemorroïdes	68

Pagina

BARRON Pinza para coger hemorroïdes	70
BARTON Forceps obstétrico	183
BARTON Tractor	183
BEACHAM Amniotómo	131
BENGOLEA Pinzas hemostáticas	278
BENSAUDE Anoscopios	53
BENSON Separador para píloro	45
BERGER Pinzas para biopsia uterina	161
BERGMANN-FOERSTER Pinzas para curaciones	300
BERKELEY-BONNEY Pinza para histerectomia	150
BERNHARD Pinza de campo	298
Billis, Higado, Riñón,	75-92
BILL Tractor	184
BIPOLAR Pinzas para coagulación	257
Bipolar Tijeras para coagulación	228-230
BIPOL-Cables para Pinzas-Tijeras bipolares	232
BIPOL-Cables para Tijeras "BiTech"	232
BiTech Tijeras bipolares	228
BLAKE Cureta uterina	164
BLAKE Pinzas para cálculos biliares	81
BLANK Pinzas de disección atraumáticas	237
BLESSING Tijeras para recto	60,225
BLOND Anoscopios con obturador	56
BLOND Tubos cónicos para proctoscopios	56
BODENHAMMER Espéculo rectal	49
BOERMA Forceps obstétrico	181
BONNEY Pinza anatómica PROMEDUR	254
BONNEY Pinza de disección promedur	255
BONNEY Pinzas anatómicas	238
BONNEY Pinzas quirúrgicas	246
BOYNTON Porta-agujas	345
BOYS-ALLIS Pinza para tejidos y organos	28
BOZEMANN Pinzas para curaciones	304
BOZEMANN Porta-agujas	360
BOZEMANN Porta-agujas PROMEDUR	355
BOZEMANN Tijeras para ginecologia	179
BOZEMANN-DOUGLAS Pinzas para curaciones	304
BRAUN Craneoclasto	186
BRAUN Depresor uterino	131
BRAUN Gancho para decapitación	186
BRAUN Pinzas para cuello uterino	133
BRAUN-STADLER Tijeras para episiotomia	180
Brazaletes para Tensiómetros	11,197
BREISKY Separdores vaginales	124
BRIDGE Pinzas hemostáticas	279
BROMPTON Pinza para drenaje	299
BROPHY Pinzas de disección	237
BROPHY Pinzas quirúrgicas	244
BROWN Pinzas quirúrgicas	247
BRYANT Pinzas para tampones	302
BUIE Cánulas de aspiración	64
BUIE Pinza de presión	43
BUIE Sonda para fistulas	63
Bujias dilatadoras uretrales	104
BUMM Curetas uterinas	168-169
BUMM Pinza p. polipos uterinos	143,190
BUNT Clavijas de esterilización	375
BUSCH Tijerasumbilicales	179

## C

Cables de conecion para pinzas bipolares	266
Cables para Pinzas-Tijeras bipolares	232
Cables para Tijeras "BiTech"	232
Cajas para instrumentos	395
Cajas para instrumentos con tapa	395
Cajas quirurgicas para BILIS, HIGADO, RINON	74
Cajas quirurgicas para ESTOMAGO, INTESTINO, RECTO	26
Cajas quirurgicas para GINECOLOGIA	106
Cajas quirurgicas para OBSTETRICA	176
Cajas quirurgicas para UROLOGIA	94
Cánula para anestesia transvaginal	188
Cánulas de aspiración	367-370
Cánulas de aspiración	64,367-370
Cánulas para biopsia	87
CARREL Pinza hemostática	273

Pagina

	Pagina		Pagina
CASTROVIEJO Porta-agujas	345	CZERNY Pinza para cuello uterino	133
CASTROVIEJO PROMEDUR Porta-agujas	345	CZERNY Separador doble	307
Catéteres metálicas	102		
Cepillos a mano autoclavables	23	<b>D</b>	
Cestillos, acero para esterilización	377,379,381,383,385	DARLING Separador	321
CHAPUT Pinza para tejidos y órganos	27	DARTIGUES Histérolabe	90,141
CHARNLEY Separador abdominal	341	DARTIGUES Pinzas coger para el útero	90,141
CHEATLE Pinza para esterilización	374	DAVIS Pinzas para esterilización	374
CHERON Pinza para curaciones	304	De LEE Forceps obstétrico	182
Clamps Bulldog atraumáticas	269-272	DE LEE Pelvímetro	177
Clamps intestinales	39-42	DEAVER Separadores	314-316,317
Clamps para cordón umbilical	185	DEBAKEY Cánulas de aspiración	368
CLAR Espejo frontal Ø 33 mm LUZ FRÍA	15	DEBAKEY Clamps Bulldog atraumáticas	272
CLAR Espejos frontales	14	DEBAKEY Pinza vascular	240
Clavijas de esterilización	375	DEBAKEY Pinzas de disección PROMEDUR	254
CLIP - luz fría para proctoscopios	54,173	DEBAKEY Pinzas para tejidos y órganos	32,83
COLLER-CRILE Pinzas hemostáticas	276	DEBAKEY Pinzas vasculares	250
COLLIN Clamp umbilical	185	DEBAKEY Pinzas vasculares TITANIO	250-251
COLLIN Dinamómetro	19	DEBAKEY Porta-agujas PROMEDUR	354
COLLIN Espéculos vaginales para niños y vírgenes	107	DEBAKEY Separadores autoestáticos	321
COLLIN Espéculos vaginales, aislados para cirugía HF	112	DEBAKEY Tijeras para conducto biliar PROMEDUR	84
COLLIN Espéculos vaginales, aislados para cirugía HF	112	DEBAKEY-COLLIER Pinza hemostática	287
COLLIN Espéculos vaginales, antideslumbrante para cirugía LASER	112	DEBAKEY-DOYEN Pinzas intestinales	37
COLLIN Mangos de bisturí	202,205	DEBAKEY-HAYES Pinzas intestinales	39
COLLIN Pelvímetro	20,177	DEBAKEY-KOCHER Pinzas intestinales	38
COLLIN Pinza para curaciones	304	DEBAKEY-MICRO Clamps Bulldog atraumáticas	272
COLLIN Pinza para tejidos y órganos	31	DEBAKEY-MICRO Pinzas vasculares	251
COLLIN Pinzas coger para el útero	140,141	DEBAKEY-SCUDDER Clamps intestinales	41
COLLIN Separadores abdominales	324	DEBAKEY-WERTHEIM Pinza para histerectomía	153
COLLIN-BABY Separador abdominal	324	Decapitación, instrumentos	186
COLLIN-DUVAL Pinzas intestinales	249	DEMARTELL Tijeras para conducto biliar	84
COLLIN-LOCKTITE Separador abdominal	325	DEMARTEL-WOLFSON Pinzas para anastomosis intestinales	46
COLLYER Pelvímetro	20,177	DENIS- BROWNE Pinzas intestinales	249
Contenedores para esterilización	376,378,380,382,384,390	DENIS-BROWN Separadores abdominales	331
Contenedores para esterilización Mini	382	Depresor uterino	131
Contenedores para esterilización para endoscopia	384	DESJARDINS Cucharillas para cálculos biliares	79
Contenedores para esterilización para instrumental microcirugía	390	DESJARDINS Exploradores para cálculos biliares	75
Contenedores para esterilización planos	382	DESJARDINS Pinzas para cálculos biliares	81
COOLEY Cánulas de aspiración	369,370	DEWEY Forceps obstétrico	183
COOLEY Pinzas vasculares	251	Diagnóstico	42186
COOLEY Pinzas vasculares TITANIO	251	Diagnóstico	195-198
Copas graduadas	392	DICK Pinzas de presión	148
COUPLAND Cánula de aspiración	367	DIETRICH Clamps Bulldog atraumáticas	271
CRAFOORD Pinzas hemostáticas	281	Dilatadores uterinos	128,129
CRAFOORD Tijeras quirúrgicas	221	Dinamómetro	19
CRAFOORD-SELLORS Pinzas hemostáticas	281	Dispensores de algodón	391
CRAFOORD-SELLORS Pinzas hemostáticas	289	Distribuidor de filtros	386
Craneoclastos	186	Distribuidores para cepillos	23
CRILE Pinzas hemostáticas	275	DIU instrumentos	132
CRILE Porta-agujas	359	DIU Pinzas para poner y para extracción	132
CRILE-BABY Pinzas hemostáticas	275	DOUAY Pinzas para biopsia uterina	157
CRILE-COLLIER Pinzas hemostáticas	276	DOYEN Pinza para cálculos biliares	82
CRILE-MURRAY Porta-agujas	359	DOYEN Pinzas intestinales	33
CRILE-RANKIN Pinzas hemostáticas	276	DOYEN Separador	312
CRILE-WOOD Porta-agujas	359	DOYEN Separadores abdominales	336
CRILE-WOOD Porta-agujas PROMEDUR	353	DOYEN Separadores vaginales	125
CRILE-WOOD-BABY Porta-agujas PROMEDUR	353	DOYEN Sonda acanalada	366
Cuadros para fijar	377,379,381,383	DOYEN Tijeras para ginecología	179
Cubetas	393	DOYEN Tira miasmas	145
Cuchara para medicamentos	394	DOYEN-DEBAKEY Pinzas intestinales	37
Cucharillas para aborto	189	DOYEN-STILLE Separadores	312
Cucharillas para cálculos biliares	77,78,79	DUBOIS Tijeras para decapitación	180,186
Cucharillas uterinas	164,165	DUEHRSEN Pinza quirúrgica	245
Cuchillo para miasmas	145	DUEHRSEN Pinzas de disección	238
Curetillas aspiradoras uterinas	170	DUNHILL Pinzas hemostáticas	275
Curetillas para biopsia uterina	162,163	DUPLAY Pinzas para cuello uterino	135
Curetillas uterinas	164-169	DUPLAY Pinzas porta-tampones	303
CUSCO Espéculos vaginales	111	DUPLEX DE LUXE Estetoscopio	12,198
CUSCO Espéculos vaginales Modelo suizo	110	DUPLEX Estetoscopio	12,198
CUSCO Espéculos vaginales, aislados para cirugía HF	111	DURANTE Pinzas quirúrgicas	248
CUSCO Espéculos vaginales, antideslumbrante para cirugía LASER	111	DUVAL Pinza para tejidos y órganos PROMEDUR	31
CUSHING Pinzas de disección PROMEDUR	253	DUVAL Pinzas intestinales atraumáticas	31
CUSHING Separador	317	DUVAL Pinzas para tejidos y órganos	31
CUZZI Cucharillas para aborto	189	DUVAL Pinzas per afferare tessuti	249
CZERNY Espéculo rectal	47		

	Pagina		Pagina
<b>E</b>			
EASTMAN Espéculos vaginales	123	Ginecología	105-173
Elevador para cabeza	181	GLASSMANN Pinzas atraumaticas	252
ELLIOT Forceps obstétricos	182	GLOVER Clamps Bulldog atraumáticas	269
EMMET Ganchos para fistulas	144	GOELET Separador doble	307
EMMET Pinza para curaciones	303	GOODELL Dilatador uterino	129
EPPENDORF Pinza para biopsia uterina	160	GOSSET Separadores abdominales	327
Esfinteroscopia	52	GOURDET Cucharillas uterinas	165
Especulo abdominal autoestático	336	Grapas para fijar paños	388
Espéculos rectales	47-49	GRAVES Espéculos vaginales	113,114
Espéculos vaginales	107-127	GRAVES Espéculos vaginales, aislados para cirugía HF	113
Espéculos vaginales para niños y vírgenes	107-109,,118	GRAVES Espéculos vaginales, antideslumbrante para cirugía LASER	113
Esterilización	373-395	GRAY Pinzas para cálculos biliares	80
Estetoscopios	12,198	GREEN Separador	310
Estiletes con ojo	365	GREEN-ARMYTAGE Pinzas uterinas	187
Estiletes dobles abotonados	365	GREGORY Clamps Bulldog atraumáticas	270
Estiletes mirtoform	366	GREGORY Porta-agujas DIAMANTE	349
Estiletes, Sondas	365	GREGORY Porta-agujas PROMEDUR	349
Estómago, Intestinos, Recto	25-71	GROSS Pinzas para curaciones	303
Estrijos para instrumentos	375	GROSS Pinzas para polipos	303
Estuchos para agujas	391,392	Guida-tampónes	131
Etiquetas indicadoras (esterilización)	385	GUNNAR-HEY Pinza para drenaje	299
EWALD Pinzas anatómicas	235	GUTTMAN Cucharilla para secreción	103
EWALD Pinzas quirúrgicas	241	GUYON Bujías dilatadoras uretrales	104
EXACTA Tensiómetro	10,196	GUYON Mandril para sondas	102
Exploradores para cálculos biliares	75	GUYON Pinzas renales	88,291,293
Extractor-hojas de bisturi	205	GWILLIAM Pinzas para histerectomia	150
<b>F</b>			
FANSLER-IVES Anoscopio	53	<b>H</b>	
FANSLER-IVES Anoscopio con alumbrado frio	54	HALSTED Pinzas hemostáticas	277
FAURE Pinza para biopsia uterina	156	HALSTED-MOSQUITO Pinzas hemostáticas	274
FAURE Pinzas para peritoneo	147	HARRINGTON Pinza de disección y ligaduras	292
FEHLAND-DEBAKEY Clamp intestinal	39	HARRISON Pinzas para esterilización	374
FERGUSON Tijeras para ginecología	179	HARTMANN Pinzas hemostáticas	273
FERGUSON Pinza de presión	43	HARTMANN-MICRO Pinzas hemostáticas	273
FERRIS-SMITH Pinzas quirúrgicas	244	HAYES-DEBAKEY Pinzas intestinales	39
FILTROS textil	387	HEANEY (Hegar) Porta-agujas	361
FILTROS, papel	386	HEANEY Pinzas para histerectomia	149
FINOCHIETTO Porta-agujas	360	HEANEY Porta-agujas PROMEDUR	356
FINOCHIETTO Porta-agujas PROMEDUR	355	HEANEY-BALLENTINE Pinza para histerectomia	149
FLETCHER Pinzas para curaciones	301	HEANEY-KANTER Pinza para histerectomia	149
FOCUS Halogen-Lampara frontal 230 V.	15	HEANEY-REZEK Pinzas para histerectomia	149
FOERSTER P/esponj. 25 cm cur.est	83,300	HEGAR Dilatadores uterinos	128,129
FOERSTER Pinza para esponjas	293	HEISS Pinzas hemostáticas	278
FOERSTER Pinzas para curaciones	300,301	HENROTIN Pinza para cuello uterino	137
FOERSTER Pinzas para vesícula biliar	83,300	HERRICK Pinza rénale	88
FOERSTER Separador abdominal plástico, transparente a los rayos-X	337	HERTZLER Separador abdominal	328
Fórceps obstétricos	181-184	HEYWOOD-SMITH Pinza hemorroïdal	70
FORD-DIXON Ligador para hemorroïdes	66	HEYWOOD-SMITH Pinzas para polipos	83,142,190
FRANKLIN-SILVERMAN Cánulas para biopsia	87	HILL-FERGUSON Espéculos rectales	47
FRITSCH Separadores	313	HIRSCHMANN Anoscopios	52
FUCHSIG Pinza hemostática	278	Histerómetros	130
<b>G</b>			
Gancho para decapitación	186	Histero-Salpingografía	171
Gancho para extracción DIU	132	HOESEL Separadores rectales	61
Ganchos para cordón espermático	99	Hojas de bisturi	200,203
Ganchos para fistulas	144	Hojas de Microbisturi	199
GAUSS Pinza para pericráneo	187	HOLZBACH Separador abdominal	326
GELPI Separadores autoestáticos	322,323	HORGAN valva central para separadores	330
GELPI-BABY Separador autoestático	322	HRYNTSCHAK Separador vesical	101
GELPI-MINI Separador autoestático	322	HULKA Pinza para cuello uterino	135
GELPI-SELETZ Separador autoestático	323	HULKA-KENWICK Pinza para cuello uterino	135
GEMINI Pinzas de disección y ligaduras	284	<b>I</b>	
GEMINI Pinzas hemostáticas	293,291	Instrumento para circuncisión	103
GEMINI-MINI Pinzas de disección y ligaduras	284	Instrumentos de aspiración	367-370
GERALD Pinzas de disección PROMEDUR	254	Instrumentos Generales	195-371
GERALD Pinzas quirúrgicas	244	Instrumentos para amnioscopia	172
GILLIES Pinza de disección	242	Instrumentos para introducir catéteres	102
GILLIES Pinza de disección PROMEDUR	254	IOWA Cánula para anestesia transvaginal	188
GIL-VERNET Separadores para venas y hilares	91	IOWA Guía-agujas	188
		IOWA Pinza rompe-membrana	188
		ISRAEL Separadores	309



	Pagina		Pagina
<b>J</b>			
JACKSON Espéculos vaginales	123	LITTLEWOOD Pinza para tejidos y organos	28
JACKSON-BURROWS Separador autoestático	323	Llmparas frontales	15
JACOBS Pinzas para cuello uterino	138	LLOYD-DAVIS Pinzas para anastomosis rectales	43
JACOBSON-MICRO Pinzas hemostáticas	274	LLOYD-DAVIS Tijera para recto	59,223
JARCHO Pinza para cuello uterino	134	LOCKHART-MUMMERY Sondas para fistulas	63,366
JEFFERSON Pinza de disección	242	LOCKWOOD Pinza intestinal	29
JEFFERSON Pinzas anatómicas	236	LORNA Pinzas de campo	298
JOERGENSON Tijeras para preparaciones	217	LOWER Pinza para conducto pililar	80
JOHN-HOPKINS Pinza para conducto biliar	80	LUER-KOERTE Cucharillas para cálculos biliares	78
JOHNSON Porta-agujas	360	LUIKART Forceps obstétrico	182
JOLL (Friedmann) Separador para retención	126,321	LUIKART-BILL Tractor	184
JONES Pinzas de campo	297	Lupas frontales binoculares	13
JUDD-ALLIS Pinzas para tejidos y organos	28	LURZ Pinzas para uretère	96
JUDD-MASON Separador vesical	100	Luz fria, proyector hanógeno	57
JUDD-MASON Separador vesical	101		
Juego de manicura para enfermeras	23		
<b>K</b>			
KALLMORGEN Espéculos vaginales	122	MAIER Pinzas para curaciones	303
KANE Clamp para cordon ombilical	185	MAINGOT Pinzas para histerectomia	150
KANTROWITZ Pinzas de disección y ligaduras	284	Mangos de bisturi	201-203,206-206
KELLY Esfinteroscopia	52	Mangos de bisturi PRO-MEDSEKUR™	202
KELLY Pinza para aborto	191	Mangos de Microbisturi	199
KELLY Pinza para polipos	142,190	Mangos para anoscopios, proctoscopios	55
KELLY Pinzas hemostáticas	275	Mangos para Pinzas para biopsia uterina	159
KELLY Proctoscopios	52	Mano izquierda, Tijeras	214,215
KELLY Separadores	311	MARBERGER Separadores para venas y hilares	91
KELLY Separadores para el higado	85,311	MARINUS Clamps intestinales	42
KELLY-RANKIN Pinzas hemostáticas	276	MARTEL Pinza para pericráneo	187
KERSTING Clamp intestinal	40	MARTIN Histerómetro malleable	130
KEVORKIAN Curetas para biopsia	162	MARTIN Pelvimetro	20,177
KEVORKIAN Pinza para biopsia uterina	161	MARTIN Pinza para desechos	374
KEVORKIAN-PACIFIC Pinza para biopsia uterina	158	MASSON Porta-agujas	361
KIELLAND Forceps obstétrico	181	MASSON Porta-agujas PROMEDUR	356
KIELLAND-LUIKART Forceps obstétrico	182	MATHIEU Espéculo rectal	49
KIRSCHNER Separadores abdominales	332	MATHIEU Pinzas para cuerpos extraños	103
KLEINSCHMIDT Pinza para apendectomia	45	MATHIEU Porta-agujas PROMEDUR	358
KLING-EX Extractor-hojas	205	MATHIEU-KOCHER Porta-agujas PROMEDUR	358
KLINIK.BERLIN Pinza cierra-tubos	299	MAYO Clavijas de esterilización	375
KOCHER Pinzas intestinales	34	MAYO Cucharillas para cálculos biliares	77
KOCHER Separador prostático	97	MAYO Tijeras para preparaciones	216
KOCHER-BABY Pinzas intestinales	33	MAYO Tijeras para preparaciones PROMEDUR	222
KOCHER-DEBAKEY Pinzas intestinales	38	MAYO Tijeras para preparaciones SUPERCUT	216
KOCHER-WAGNER Separadores	313	MAYO-ADAMS Separador autoestático	325
KOERTE Separadores	308	MAYO-BLAKE Pinzas para cálculos biliares	82
KOGAN Endospéculos	127	MAYO-GUYON Pinza rênale	88
KONRICH Tambores de esterilización	390	MAYO-HARRINGTON Tijeras para preparaciones	217
KRISTELLER Espéculos vaginales	118-121	MAYO-HARRINGTON Tijeras para preparaciones PROMEDUR	224
KRISTELLER Espéculos vaginales para niños y vírgenes	108	MAYO-HEGAR Porta-agujas	359
KÜSTNER Pinza uterina	139	MAYO-HEGAR Porta-agujas PROMEDUR	354
		MAYO-LEXER Tijeras para preparaciones	217
		MAYO-LEXER Tijeras para preparaciones PROMEDUR	224
		MAYO-LEXER Tijeras para preparaciones SUPERCUT	217
		MAYO-NOBLE Tijeras para preparaciones	217
		MAYO-ROBSON Pinzas intestinales	35
		MAYO-RUSSIAN Pinza de diseccion	247
		MAYO-STILLE Tijeras para preparaciones	216
		MAYO-STILLE Tijeras para preparaciones SUPERCUT	216
		McGIVNEY Ligadores para hemmorroides	65,69
		McGIVNEY Pinzas para aggarar hemmorroides	70
		McINDOE Pinza anatómica PROMEDUR	254
		McLEAN Forceps obstétrico	183
		McLEAN-TUCKER Forceps obstétrique	183
		MEEKER Pinzas de disección y ligaduras	285
		MENGHINI Cánulas para biopsia del higado	87
		METZENBAUM Porta-agujas	360
		METZENBAUM Tijeras para preparaciones	219,220,221
		METZENBAUM Tijeras para preparaciones PROMEDUR	222,226-227
		METZENBAUM Tijeras para preparaciones SUPERCUT	219
		METZENBAUM-BABY Tijeras para preparaciones	218
		METZENBAUM-FINO Tijeras para preparaciones	220
		METZENBAUM-FINO Tijeras para preparaciones PROMEDUR	227
		MICRO-ADSON Pinzas anatómicas	235
		MICRO-ADSON Pinzas quirúrgicas	241
		MICRO-DEBAKEY Clamps Bulldog atraumáticas	272
		MICRO-DEBAKEY Pinzas vasculares	251
		MICRO-JACOBSON Pinzas hemostáticas	274
<b>L</b>			
LAHEY Pinzas para conducto biliar	79		
LAHEY Separador	309		
LANDAU Separdores vaginales	124		
LANDOLD Mangos de Microbisturi	199		
LANE Pinzas de campo	298		
LANE Pinzas quirúrgicas	247		
LANGENBECK Porta-agujas PROMEDUR	355		
LANG-STEVENSON Pinza intestinales	33		
LATERAL Separador vaginal	127		
LAWRENCE Pinza de disección y ligaduras	285		
LEGUEU Separador vesical	97		
LEGUEU Separador vesical autostatico	325		
LERCHE Pinzas quirúrgicas	246		
LEXER-BABY Tijeras para preparaciones	218		
LICHTENBERG Porta-agujas PROMEDUR	358		
LICHTWITZ Trocar	371		
Ligadores para hemmorroides	65-69		
Limas de uñas	23		
LISTER-SINUS Pinzas para senus	302		
LITTAUER Pinzas corta-uñas	22		
LITTLE Separador	309		

	Pagina		Pagina
MICRO-MOSQUITO Pinzas hemostáticas	274	PEDERSON Espéculos vaginales, antideslumbrante para cirugía LASER114	
Micro-Tijeras	209-213	PEERS Pinza de campo para paños de papel	297
Micro-Tijeras coronarias	210	PELKMANN Pinzas para curaciones	302
Micro-Tijeras para Ginecología	211	Pelvímetros	20,177
MICRO-VASCULAR Porta-agujas PROMEDUR	353	PENNINGTON Pinza para tejidos y órganos	27
MIDDELDORF Separadores	310	Perforadores-cráneo	186
MIKULICZ Pinzas para peritoneo	146	PESTALOZZA Cucharilla para aborto	189
MIKULICZ Separadores para el hígado	85	PETRI cubeta	392
MIKULICZ-BABY Pinza para peritoneo	146	PHANEUF Pinzas para peritoneo	148
MILLER Tijera para recto	58	PINARD Estetoscopios	12,198
MILLIN Pinzas para prostatectomía	95	Piñons para fijar instrumentos	389
MILLIN Separador para prostatectomía	100	Piñons para fijar separadores	389
MILLIN Separadore para cuello vesical	96,100	Pinza para abrir botellas de infusión	375
MILLS Tijeras para aconducto biliar	84	Pinza para apendectomía	45
MINIMUS II Tensiómetro	10,196	Pinza para cordón espermático	96
MIXTER Pinza para cálculos biliares	80,82	Pinza para Microbiopsia uterina	161
MIXTER Pinzas de disección y ligaduras	286	Pinza para pene	103
MIXTER-BABY Pinzas de disección y ligaduras	285	Pinza para útero	90,141
MIXTER-O'SHAUGHNESSY Pinzas hemostáticas	283	Pinza rompe-membrana	188
MOGEN Instrumento para circuncisión	103	Pinza-abrir botellas de infusión	375
MOORE Cucharilla para cálculos biliares	77	Pinzas anatómicas, quirúrgicas, etc.	234-266
MORGAN Proctoscopio	53	Pinzas atraumáticas	250-252
MORRIS Separadores	312	Pinzas bipolares	257-265
MORRIS Separadores dobles	307	Pinzas cierra-tubos	299
MORRIS-MITRAL Separador autoestático	323	Pinzas cierra-tubos con estribo de protección	299
MOSQUITO Pinzas hemostáticas	274	Pinzas corta-uñas	22
MOYNIHAN Cucharillas para cálculos biliares	79	Pinzas de campo	297-298
MOYNIHAN Explorador para cálculos biliares	75	Pinzas de disección	237
MOYNIHAN Pinza de campo	298	Pinzas de disección FINO	237
MÜNCHEN Curetas para biopsia uterina	163	Pinzas de disección PROMEDUR	253-256
MURLESS Elevador para cabeza	181	Pinzas de disección USA-MODEL	237
MUSEUX Pinzas para cuello uterino	139	Pinzas de disección y ligaduras	277-286
		Pinzas de presión	43,148
<b>N</b>		Pinzas hemostáticas	273-281
NAEGELE Forceps obstétrico	181	Pinzas hemostáticas y para preparaciones	269-293
NAEGELE Perforador-cráneo	186	Pinzas intestinales	33-46,279
NAGEL Micro-Tijeras	213	Pinzas intestinales para píloro	44
NAUNTON-MORGAN Porta-agujas PROMEDUR	357	Pinzas para aborto	190,191
NEIVERT Porta-agujas	359	Pinzas para agarrar hemorroides	70
NEIVERT Porta-agujas PROMEDUR	353	Pinzas para anastomosis intestinales	46
NELATON Sonda acanalada	366	Pinzas para anastomosis rectales	44
NELSON Pinzas per afferare tessuti	246	Pinzas para biopsia rectal	71
NELSON Trocares	371	Pinzas para biopsia uterina	155-161
NISSEN Pinza hemostática	278	Pinzas para cálculos biliares	81-82
NONSTICK Pinzas bipolares	257-260	Pinzas para cálculos renales	89
NOTO Pinza para polipos uterinos	143,190	Pinzas para coger el útero	141
NOVAK Curetas para biopsia uterina	163	Pinzas para conducto biliar	79-80
NOVA-PRESAMETER Tensiómetro	9,195	Pinzas para cuello uterino	133-138
NUSSBAUM Pinzas intestinales	36	Pinzas para cuerpos extraños	103
		Pinzas para curaciones	300-304
<b>O</b>		Pinzas para desechos	374
Obstetrica	175-191	Pinzas para drenaje	299
OCHSNER Trocares	371	Pinzas para esterilización	374
OCULUS Lupas frontales	13	Pinzas para histerectomía	149-154
OEHLER Pinza de disección PROMEDUR	255	Pinzas para pericráneo	187
Olío para el mantenimiento de instrumentos	391	Pinzas para peritoneo	146-148
OLLIER Separadores	308	Pinzas para polipos	303
OLVECRONA Pinzas hemostáticas	281	Pinzas para polipos uterinos	142,143
OMBREDANNE Pinza de campo	297	Pinzas para prostatectomía	95
OMBREDANNE Pinza intestinale	29	Pinzas para senus	302
O'SULLIVAN-O'CONNOR Separador abdominal	334	Pinzas para tejidos y órganos	27-32
OVERHOLT-BABY Pinza hemostatática	283	Pinzas para uréter	90,96
OVERHOLT-GEISSENDOERFER Pinzas hemostáticas	283	Pinzas para vasectomía	99
OVERHOLT-MIXTER Pinzas hemostáticas	283	Pinzas para vendajes con tapa	393
		Pinzas per afferare tessuti	240,246,247,249
<b>P</b>		Pinzas porta-tampones	300-304
Paños de esterilización	387	Pinzas quirúrgicas	239-243
PARAMETRIUM Tijeras PROMEDUR	60,225	Pinzas quirúrgicas USA Model	243
PARKS Espéculo rectal para adaptador luz fría	50	Pinzas renales	88
PAYR-BABY Pinza intestinale para píloro	44	Pinzas vasculares	250-252
PEAN Pinzas hemostáticas	279	Pinzas-Clamps para transplantar del hígado	86
PEAN-FINO Pinzas hemostáticas	280	Pinzas-Tijeras bipolares	231
PEDERSON Espéculos vaginales	107,114	PIPER Forceps obstétrico	182,184
PEDERSON Espéculos vaginales, aislados para cirugía HF	114	PITTSBURG Clamps para transplantar del hígado	86
		Placas de identificación (esterilización)	385
		POOLE Cánulas de aspiración	368,37

	Pagina		Pagina
Porta-agujas	345-361	SCHULZE-BERGMANN Espéculo rectal	48
Porta-agujas micro	345-352,353	SCHUMACHER Pinzas para biopsia uterina	160
Porta-agujas micro von mango "PERFIL"	352	SCHUMACHER Tijera umbilicales	179
Porta-agujas PROMEDUR	345,347-349,353-358	SCHUMACHER-VAN DOREN Pinza para biopsia	155
Porta-agujas TITANIO	350,351,352	SCUDDER Pinzas intestinales	35
Porta-aldodones para rectoscopios	64	SCUDDER-DEBAKEY Clamps intestinales	41
Porta-Micro-instrumentos	389	SEGOND Bisturi para fibromas	145
POTTS-DE-MARTEL Tijeras para aconducto biliar	84	SEGOND Pinza para histerectomia	149
POTTS-SMITH Pinzas de disección	238	SEGOND-LANDAU Pinza para histerectomia	149
POTTS-SMITH Pinzas de disección PROMEDUR	253	SELLHEIM Elevador obstetrico	184
POTTS-SMITH Pinzas quirúrgicas	245	SEMKEN Pinzas anatómicas	236
POTTS-SMITH Tijeras para aconducto biliar PROMEDUR	84	SEMKEN Pinzas quirúrgicas	242
POZZI Pinzas para cuello uterino	134	SEMM Espéculos vaginales	115
PRATT Espéculo rectal	49	SEMM Separadores abdominales	333
PRATT Pinzas para cuello uterino	137	Separador abdominal plástico, transparente a los rayos-X	337
PRATT-"T" Pinza para tejidos y organos	32	Separador para perinea	51
Precintos de seguridad	385	Separador para píloro	44
PRECISA I Tensiómetro	9,195	Separador vesical	325
PRESBYTERIAN Pinzas cierra-tubos	299	Separadore para cuello vesical	96
Proctoscopios	52	Separadores	307-341
PRO-MEDSEKUR™ Mangos de bisturi	201	Separadores abdominales	324-341
PROVIDENCE-HOSPITAL Pinzas hemostáticas	275	Separadores autoestáticos	321-341
Proyector halógeno de luz fria	15,57	Separadores dobles	307,310
		Separadores endocervicales	127
		Separadores para contenedores	389
		Separadores para el higado	85
		Separadores para pelvis	63
		Separadores para venas y hilares	91,92
		Separadores prostáticos	98
		Separadores rectales	61,62
		Separadores vesicales	100-101
		Separadores vaginales	124,125
		SEYFFERT Espéculos vaginales	115
		SIEBOLD Tijeras para ginecologia	179
		SIMON Cucharillas uterinas	164
		SIMON Ganchos para fistulas	144
		SIMON Separdores vaginales	125
		SIMPSON Forceps obstétrico	181
		SIMPSON-BRAUN Forceps obstétrico	182
		SIMPSON-LUIKART Forceps obstétrico	182
		SIMS Curetas uterinas	166
		SIMS Depresor uterino	131
		SIMS Espéculo rectal	48
		SIMS Espéculos vaginales	123
		SIMS Histerómetros	130
		SIMS Tijeras para ginecologia	178
		SIMS Tijeras quirúrgicas PROMEDUR	224
		SIMS-MAIER Pinzas para curaciones	302
		SINGLEY (TUTTLE) Pinzas per afferare tessuti	240,247
		SKENE Pinza para cuello uterino	136
		SMELLIE Gancho obstétrico	185
		SMELLIE Perforador-cráneo	186
		SOFIELD Separadores	307
		SOMER Pinza para el útero	140
		Sondas acanaladas	366
		Sondas acanaladas abotonadas	366
		Sondas metalicas p.hombres y mujeres	102
		Sondas para conducto biliares	76
		Sondas para fistulas	63,366
		Sondas, Estiletos	365
		SPENCER-WELLS Pinzas hemostáticas	279
		ST.MARKS Proctoscopio	52
		St.MARKS Separador para perinea	51
		St.MARKS Separadores para pelvis	62
		STAUDE-MOORE Pinza para cuello uterino	133
		STELZNER Tijeras para recto	59,223
		STILLE Pinza rénale	88
		STILLE Pinzas de disección	237
		STILLE-BARRAYA Pinzas quirúrgicas	248
		STINGER Estribos para instrumentos	375
		STOCKMANN Pinza para pene	103
		STONE Pinza quirúrgica	246
		STRATTE Porta-agujas	361
		STRATTE Porta-agujas PROMEDUR	357
		STRAUSS F/O Rectoscopio completo	57
		STRAUSS Pinza para pene	103

## R

RAMATHIBODI Gancho tubular	132
RAMATHIBODI Manipulador uterino	132
RAMPLEY Pinzas para curaciones	301
RAMSAY Pinzas anatómicas	238
RAMSAY Pinzas quirúrgicas	245
RANDALL Cureta para biopsia uterina	163
RANDALL Pinzas para cálculos renales	89
RANKIN-CRILE Pinzas hemostáticas	276
RANKIN-KELLY Pinzas hemostáticas	276
RECAMIER Curetas uterinas	167
Recipientes de algodón	391
Reglas	19
RESANO Clamp intestinal	40
RICARD Separador abdominal	326
RICHARDSON Separadores	310
RICHARDSON-EASTMAN Separadores dobles	310
Riñoneras	393
ROBERTS Pinzas hemostáticas	280
ROBIN-MASSE Separador abdominal	327
ROCHARD Dispositivos	335
ROCHARD Separadores abdominales	335
ROCHESTER-CARMALT Pinzas hemostáticas	279
ROCHESTER-OCHSNER Pinzas hemostáticas	282,290
ROCHESTER-PEAN Pinzas hemostáticas	280,288
ROEDER Pinzas de campo	298
ROGGE Pinzas para esterilización	374
ROTOCRETA Cureta para biopsia uterina	162
RUDD Ligador hemmoroidal	65
RUMEL Pinzas de disección y ligaduras	284
RUSSIAN Pinzas de disección	247
RUSSIAN Pinze per afferare tessuti	239

## S

SAENGER Pinzas para aborto	191
SALING amnioscopios	172
Salpingografía	171
SANTULLI Clamp Bulldog atraumática	271
SAROT Pinza hemostatática	289
SAROT Porta-agujas	361
SAROT Porta-agujas PROMEDUR	357
SAUERBRUCH Estucho para agujas	392
SAUERBRUCH pinza para desechos	374
SCHAEDEL Pinza de campo	297
SCHERBAK Espéculos vaginales	117
SCHIMMELBUSCH Tambores de esterilización	390
SCHROEDER Cucharillas uterinas	164
SCHROEDER Pinzas para cuello uterino	134,136
SCHUBERT Pinzas para biopsia uterina	156
SCHULTZE Salpingógrafo	171

	Página
STRINGER estribos para instrumentos	375
Sujetafiltros	386
Sutura	345-361

## T

Tabiques	377,379,381
Tambores de esterilización	390
Tapas de seguridad para contenedores	376,378,380
Tapices portas instrumentos de silicona	387
TARNIER Basiotribo	186
TARNIER Forceps obstétrico	183
Tarros	394
TAYLOR Pinzas quirúrgicas	245
TAYLOR-CUSHING Pinzas quirúrgicas	245
TEALE Pinzas para cuello uterino	138
Tensiómetros	9-11,195-197
THOMAS Curetas uterinas	165
THOMS-ALLIS Pinza para tejidos y organos	28
THOMS-GAYLOR Pinza p. biopsia 24cm	155
THOMSON-WALKER Separador vesical	101
THOREK Tijeras para vesícula biliar	218
TIEMANN Pinza para cuello uterino	136
TIJERA corta-uñas	22
Tijeras	209-231
Tijeras bipolares	228-230
Tijeras finas	214
Tijeras finas para ZURDOS	214
Tijeras finas SUPERCUT	214
Tijeras para conducto biliar	84
Tijeras para decapitación	180,186
Tijeras para enterotomía	58
Tijeras para episiotomía	180
Tijeras para ginecología	178-180
Tijeras para perineo	180
Tijeras para preparaciones	216-222
Tijeras para recto	59,223
Tijeras para vesícula biliar	218
Tijeras quirúrgicas	215
Tijeras quirúrgicas para ZURDOS	214,215
Tijeras umbilicales	179
Tijeras.cuticulares	22
Tijeras-Pinzas bipolares	231
Tira miomas	145
Tiras de protección	388
TISCHLER (Baggish) Pinza para biopsia uterina	158
TISCHLER Pinza para biopsia uterina	158
TISCHLER-BURKE Pinza para biopsia uterina	158,159
TISCHLER-KEVORKIAN Pinza para biopsia uterina	158
TISCHLER-MINI Pinza para biopsia uterina	158
TOHOKU Pinzas de campo	298
TOWNSEND Curetas para biopsia uterina	162
TOWNSEND Mango suelto	159
TOWNSEND-KERVORKIAN Pinza para biopsia uterina	159
TOWNSEND-KRAUSE Pinza para biopsia uterina	159
TOWNSEND-MINI Pinzas para biopsia uterina	159
TOWNSEND-TISCHLER Pinzas para biopsia uterina	159
Transformador 220 V, 1 A	14
TRELAT Espéculos vaginales	115
TREVES Pinzas quirúrgicas	246
Trocares	371
TUEBINGEN Separador	313
TUFFIER Pinza para tejidos y organos	27
TURNBULL Pinzas corta-uñas	22
TURNER-WARWICK Separador abdominal	338-340

## U

ULRICH Pinzas porta-tampones	303
UNIVERSAL Trocares	371
URO Pinzas para uréter	90
Urología	93-104
USA-MODELO Pinzas cierra-tubos	299

## V

Vaginoscopio con iluminación	173
Vaginoscopio para niños y vírgenes	109,173
VALLEIX Histerómetro	130
VAN BUREN Bujías dilatadoras uretrales	104
VAN DOREN Pinza p. biopsia 25 cm	155
VANNAS Micro-Tijeras	209,212
Vasectomía	99
Vasos para medicamentos	394

## W

WALDMANN Tijeras para episiotomía	180
WALLICH Cucharilla para aborto	189
WALTON Pinzas para curaciones	302
WANGENSTEEN Pinzas de disección PROMEDUR	253
WANGENSTEEN Pinzas per afferare tessuti	247
WANGENSTEEN Porta-agujas	361
WANGENSTEEN Porta-agujas PROMEDUR	356
WASSMUND Separador	308
WAUGH Pinzas quirúrgicas	248
WEISSBARTH Espéculo vaginal	118
WERTHEIM Pinza para peritoneo	146
WERTHEIM Pinzas para histerectomía	149,152
WERTHEIM Tijeras quirúrgicas	218
WERTHEIM-ATRAUMA Pinza para histerectomía	151
WERTHEIM-CULLEN Pinza para histerectomía	151
WERTHEIM-DEBAKEY Pinzas para histerectomía	153
WIJNEN Tubo de aspiración	368,370
WIKSTROEM Pinza de disección y ligaduras	285
WILLET Pinza para pericráneo	187
WILLIAMS Pinza para tejidos y organos	29
WINTER Pinzas para aborto	191
WITTNER Pinzas para biopsia uterina	160
WRIGLEY Forceps obstétrico	181

## Y

YANKAUER Cánulas de aspiración	367
YEOMAN Pinzas para biopsia rectal	71
YOUNG Pinza para prostatectomía	95
YOUNG Separadores prostáticos	98

## Z

Z-HISTEREKTOMIA Pinzas para histerectomía	154
ZIEGLER Espejo frontal	14
ZURDOS, Tijeras	214,215



NUMMERNVERZEICHNIS · NUMMERICAL INDEX · INDEX DES NUMEROS · INDICE NUMERIO · INDICE NUMERIO

Kat.Nr. Cat.No. No. Réf. No. Ref. No. Cat.	Seite Page Page Página Pagina	Kat.Nr. Cat.No. No. Réf. No. Ref. No. Cat.	Seite Page Page Página Pagina	Kat.Nr. Cat.No. No. Réf. No. Ref. No. Cat.	Seite Page Page Página Pagina	Kat.Nr. Cat.No. No. Réf. No. Ref. No. Cat.	Seite Page Page Página Pagina
<b>10...</b>		12.0062S .....	199	13.0309SC .....	215	13.0434 .....	216
10.0010 .....	9,195	12.0065 .....	199	13.0310 .....	215	13.0434SC .....	216
10.0020 .....	9,195	12.0067 .....	199	13.0311 .....	215	13.0435 .....	216
10.0030 .....	10,196	12.0069 .....	199	13.0312 .....	215	13.0435SC .....	216
10.0040 .....	10,196	12.0070 .....	205	13.0313 .....	215	13.0436 .....	216
10.0080 .....	11,197	12.0101 .....	202	13.0330 .....	215	13.0437 .....	216
10.0081 .....	11,197	12.0102 .....	204	13.0330SC .....	215	13.0438 .....	216
10.0082 .....	11,197	12.0103 .....	202	13.0331 .....	215	13.0439 .....	216
10.0083 .....	11,197	12.0104 .....	204	13.0332 .....	215	13.0440 .....	217
10.0084 .....	11,197	12.0105 .....	204	13.0333 .....	215	13.0440SC .....	217
10.0085 .....	11,197	12.0106 .....	202	13.0333SC .....	215	13.0441 .....	217
10.0090 .....	11,197	12.0107 .....	202	13.0334 .....	215	13.0441SC .....	217
10.0091 .....	11,197	12.0108 .....	202	13.0334SC .....	215	13.0462 .....	217
10.0092 .....	11,197	12.0109 .....	204	13.0335 .....	215	13.0463 .....	217
10.0094 .....	11,197	12.0113 .....	202	13.0335SC .....	215	13.0551 .....	217
10.0095 .....	11,197	12.0114 .....	205	13.0336 .....	215	13.0554 .....	217
10.0300 .....	19	12.0115 .....	203	13.0337 .....	215	13.0554SC .....	217
10.0331 .....	19	12.0117 .....	205	13.0338 .....	215	13.0555 .....	217
10.0332 .....	19	12.0123 .....	203	13.0339 .....	215	13.0555SC .....	217
10.0333 .....	19	12.0125 .....	202	13.0340 .....	215	13.0561 .....	218
10.0334 .....	19	12.0127 .....	202	13.0341 .....	215	13.0562 .....	218
10.0335 .....	19	12.0133 .....	203	13.0342 .....	215	13.0563 .....	218
10.0350 .....	19	12.0153 .....	199	13.0343 .....	215	13.0565 .....	218
10.0352 .....	19	12.0157 .....	199	13.0350 .....	215	13.0567 .....	218
10.0400 .....	12,198	12.0163 .....	203	13.0351 .....	215	13.0594 .....	218
10.0410 .....	12,198	12.0173 .....	203	13.0352 .....	215	13.0594SC .....	218
10.0460 .....	12,198	12.0174 .....	205	13.0352SC .....	215	13.0595 .....	218
10.0462 .....	12,198	12.0180 .....	199	13.0353 .....	215	13.0595SC .....	218
10.0700 .....	14	12.0182 .....	199	13.0353SC .....	215	13.0596 .....	218
10.0707 .....	14	12.0184 .....	199	13.0354 .....	215	13.0597 .....	218
10.0709 .....	14	12.0186 .....	199	13.0354SC .....	215	13.0598 .....	218
10.0730 .....	14	12.0188 .....	199	13.0355 .....	215	13.0598SC .....	218
10.0731 .....	14	12.0193 .....	201	13.0355SC .....	215	13.0599 .....	218
10.0737 .....	14	12.0194 .....	201	13.0356 .....	215	13.0599SC .....	218
10.0739 .....	14			13.0357 .....	215	13.0602 .....	219
10.0750 .....	14	<b>13...</b>		13.0358 .....	215	13.0602SC .....	219
10.0760 .....	15	13.0010 .....	214	13.0358SC .....	215	13.0603 .....	219
10.0761 .....	15	13.0010SC .....	214	13.0359 .....	215	13.0603SC .....	219
10.0762 .....	15	13.0011 .....	214	13.0360 .....	215	13.0604 .....	219
10.0763 .....	15	13.0011SC .....	214	13.0360SC .....	215	13.0604SC .....	219
10.0769 .....	15	13.0012 .....	214	13.0361 .....	215	13.0605 .....	219
10.0790 .....	15	13.0012L .....	214	13.0362 .....	215	13.0605SC .....	219
10.2000 .....	15,57	13.0012LSC .....	214	13.0363 .....	215	13.0606 .....	219
		13.0012SC .....	214	13.0363SC .....	215	13.0606SC .....	219
		13.0013 .....	214	13.0394 .....	215	13.0607 .....	219
<b>12...</b>		13.0013L .....	214	13.0400 .....	216	13.0607SC .....	219
12.0010 .....	200	13.0013LSC .....	214	13.0400SC .....	216	13.0608 .....	219
12.0011 .....	200	13.0013SC .....	214	13.0401 .....	216	13.0608SC .....	219
12.0012 .....	200	13.0014 .....	214	13.0401SC .....	216	13.0609 .....	219
12.0013 .....	200	13.0014SC .....	214	13.0402 .....	216	13.0609SC .....	219
12.0014 .....	200	13.0015 .....	214	13.0402SC .....	216	13.0610 .....	219
12.0015 .....	200	13.0015SC .....	214	13.0403 .....	216	13.0610SC .....	219
12.0016 .....	200	13.0022 .....	214	13.0403L .....	216	13.0611 .....	219
12.0017 .....	200	13.0023 .....	214	13.0403SC .....	216	13.0611SC .....	219
12.0018 .....	203	13.0300 .....	215	13.0404 .....	216	13.0612 .....	219
12.0019 .....	203	13.0301 .....	215	13.0404L .....	216	13.0612SC .....	219
12.0020 .....	203	13.0301SC .....	215	13.0404SC .....	216	13.0613 .....	219
12.0021 .....	203	13.0302 .....	215	13.0405 .....	216	13.0613SC .....	219
12.0022 .....	203	13.0302SC .....	215	13.0405SC .....	216	13.0614 .....	221
12.0023 .....	203	13.0303 .....	215	13.0406 .....	216	13.0615 .....	221
12.0024 .....	203	13.0303SC .....	215	13.0406SC .....	216	13.0622 .....	219
12.0025 .....	203	13.0304 .....	215	13.0407 .....	216	13.0623 .....	219
12.0034 .....	203	13.0304L .....	215	13.0407SC .....	216	13.0624 .....	219
12.0036 .....	203	13.0304SC .....	215	13.0408 .....	216	13.0625 .....	219
12.0042 .....	203	13.0305 .....	215	13.0408SC .....	216	13.0626 .....	219
12.0044 .....	203	13.0305SC .....	215	13.0409 .....	216	13.0627 .....	219
12.0045 .....	203	13.0306 .....	215	13.0409SC .....	216	13.0628 .....	219
12.0046 .....	203	13.0307 .....	215	13.0432 .....	216	13.0629 .....	219
12.0060 .....	203	13.0308 .....	215	13.0432SC .....	216	13.0630 .....	219
12.0061 .....	199	13.0308SC .....	215	13.0433 .....	216	13.0631 .....	219
12.0062 .....	199	13.0309 .....	215	13.0433SC .....	216	13.0642 .....	219

Kat.Nr. Cat.No. No. Réf. No. Ref. No. Cat.	Seite Page Page Página Pagina	Kat.Nr. Cat.No. No. Réf. No. Ref. No. Cat.	Seite Page Page Página Pagina	Kat.Nr. Cat.No. No. Réf. No. Ref. No. Cat.	Seite Page Page Página Pagina	Kat.Nr. Cat.No. No. Réf. No. Ref. No. Cat.	Seite Page Page Página Pagina
13.0643.....	219	13.2160.....	179	13.8120.....	232	14.0187.....	237
13.0644.....	219	13.2161.....	179	13.8130.....	232	14.0188.....	237
13.0644SC.....	219	13.2170.....	58	13.8304.....	231	14.0189.....	237
13.0645.....	219	13.2172.....	58	13.8305.....	231	14.0202.....	237
13.0645SC.....	219	13.2174.....	58	13.8310.....	231	14.0204.....	237
13.0646.....	219	13.2181.....	58	13.8311.....	231	14.0207.....	237
13.0647.....	219	13.2183.....	59,223	13.8400.....	232	14.0220.....	237
13.0648.....	219	13.2186.....	59,223	13.8410.....	232	14.0300.....	237
13.0649.....	219	13.2187.....	59,223	13.8420.....	232	14.0301.....	237
13.0650.....	219	13.2189.....	59,223	13.8430.....	232	14.0330.....	238
13.0650SC.....	219	13.2200.....	180			14.0340.....	238
13.0651.....	219	13.2202.....	180	<b>14...</b>		14.0350.....	238
13.0651SC.....	219	13.2210.....	179	14.0026.....	235	14.0352.....	238
13.0660.....	220	13.2220.....	179	14.0028.....	235	14.0354.....	238
13.0660SC.....	220	13.2232.....	179	14.0030.....	235	14.0390.....	238
13.0661.....	220	13.2240.....	180	14.0032.....	235	14.0526.....	241
13.0661SC.....	220	13.2240SC.....	180	14.0040.....	235	14.0527.....	241
13.0662.....	220	13.2244.....	180	14.0042.....	235	14.0528.....	241
13.0662SC.....	220	13.2246.....	180	14.0044.....	236	14.0530.....	241
13.0663.....	220	13.5208.....	222	14.0049.....	235	14.0532.....	241
13.0663SC.....	220	13.5209.....	222	14.0050.....	235	14.0540.....	241
13.0664.....	220	13.5220.....	224	14.0056.....	236	14.0541.....	241
13.0664SC.....	220	13.5221.....	224	14.0060.....	236	14.0542.....	241
13.0665.....	220	13.5222.....	224	14.0061.....	236	14.0543.....	241
13.0665SC.....	220	13.5223.....	224	14.0062.....	236	14.0545.....	241
13.0666.....	220	13.5240.....	224	14.0063.....	236	14.0546.....	235
13.0666SC.....	220	13.5241.....	224	14.0070.....	236	14.0547.....	235
13.0667.....	220	13.5242.....	224	14.0100.....	237	14.0548.....	242
13.0667SC.....	220	13.5243.....	224	14.0101.....	237	14.0549.....	241
13.0670.....	220	13.5248.....	224	14.0102.....	237	14.0550.....	242
13.0671.....	220	13.5249.....	224	14.0103.....	237	14.0554.....	242
13.0672.....	220	13.5250.....	224	14.0104.....	237	14.0556.....	242
13.0673.....	220	13.5251.....	224	14.0105.....	237	14.0560.....	242
13.0674.....	220	13.5255.....	60,225	14.0107.....	237	14.0561.....	242
13.0675.....	220	13.5259.....	60,225	14.0108.....	237	14.0562.....	242
13.0676.....	220	13.5281.....	60,225	14.0109.....	237	14.0563.....	242
13.0677.....	220	13.5310.....	226	14.0110.....	237	14.0566.....	242
13.0683.....	220	13.5311.....	226	14.0111.....	237	14.0570.....	242
13.0685.....	220	13.5313.....	227	14.0112.....	237	14.0600.....	243
13.0687.....	220	13.5317.....	227	14.0113.....	237	14.0601.....	243
13.0693.....	220	13.5320.....	226	14.0114.....	237	14.0602.....	243
13.0695.....	220	13.5321.....	226	14.0115.....	237	14.0603.....	243
13.0697.....	220	13.5323.....	227	14.0116.....	237	14.0604.....	243
13.0700.....	218	13.5327.....	227	14.0117.....	237	14.0605.....	243
13.0701.....	218	13.5330.....	226	14.0118.....	237	14.0607.....	243
13.1083.....	221	13.5331.....	226	14.0119.....	237	14.0608.....	243
13.1180.....	84	13.5333.....	227	14.0120.....	237	14.0609.....	243
13.1182.....	84	13.5337.....	227	14.0121.....	237	14.0620.....	243
13.1190.....	84	13.5360.....	226	14.0122.....	237	14.0621.....	243
13.1192.....	84	13.5361.....	226	14.0123.....	237	14.0622.....	243
13.2100.....	178	13.5370.....	226	14.0124.....	237	14.0623.....	243
13.2100SC.....	178	13.5371.....	226	14.0125.....	237	14.0624.....	243
13.2101.....	178	13.5380.....	226	14.0127.....	237	14.0625.....	243
13.2101SC.....	178	13.5381.....	226	14.0128.....	237	14.0627.....	243
13.2102.....	178	13.5382.....	222	14.0129.....	237	14.0628.....	243
13.2102SC.....	178	13.5383.....	222	14.0130.....	237	14.0629.....	243
13.2103.....	178	13.5601.....	84	14.0132.....	239	14.0630.....	243
13.2103SC.....	178	13.5621.....	84	14.0142.....	237	14.0632.....	239
13.2110.....	178	13.8003.....	228	14.0143.....	237	14.0633.....	243
13.2111.....	178	13.8005.....	228	14.0144.....	237	14.0657.....	243
13.2112.....	178	13.8007.....	228	14.0151.....	237	14.0681.....	243
13.2113.....	178	13.8023.....	229	14.0152.....	237	14.0682.....	243
13.2120.....	178	13.8025.....	229	14.0153.....	237	14.0683.....	243
13.2121.....	178	13.8027.....	229	14.0154.....	237	14.0684.....	243
13.2122.....	178	13.8029.....	229	14.0155.....	237	14.0687.....	243
13.2123.....	178	13.8043.....	230	14.0157.....	237	14.0688.....	243
13.2134.....	179	13.8045.....	230	14.0158.....	237	14.0689.....	243
13.2150.....	179	13.8047.....	230	14.0181.....	237	14.0701.....	243
13.2155.....	179	13.8049.....	230	14.0182.....	237	14.0702.....	243
13.2158.....	179	13.8100.....	232	14.0183.....	237	14.0703.....	243
13.2159.....	179	13.8110.....	232	14.0184.....	237	14.0704.....	243

Kat.Nr. Cat.No. No. Réf. No. Ref. No. Cat.	Seite Page Page Página Pagina	Kat.Nr. Cat.No. No. Réf. No. Ref. No. Cat.	Seite Page Page Página Pagina	Kat.Nr. Cat.No. No. Réf. No. Ref. No. Cat.	Seite Page Page Página Pagina	Kat.Nr. Cat.No. No. Réf. No. Ref. No. Cat.	Seite Page Page Página Pagina
14.0705.....	243	14.0980.....	248	14.2020.....	253	14.3102.....	262
14.0707.....	243	14.0982.....	248	14.2021.....	253	14.3102.2.....	262
14.0708.....	243	14.0984.....	248	14.2023.....	253	14.3104.....	262
14.0709.....	243	14.0988.....	249	14.2049.....	253	14.3104.2.....	262
14.0722.....	243	14.0990.....	249	14.2050.....	253	14.3106.....	262
14.0723.....	243	14.0994.....	249	14.2052.....	253	14.3106.2.....	262
14.0724.....	243	14.0996.....	249	14.2054.....	253	14.3108.....	262
14.0725.....	243	14.0998.....	249	14.2070.....	253	14.3108.2.....	262
14.0727.....	243	14.1000.....	250	14.2072.....	253	14.3110.....	262
14.0728.....	243	14.1002.....	250	14.2074.....	253	14.3110.2.....	262
14.0732.....	244	14.1004.....	250	14.2103.....	253	14.3112.....	262
14.0733.....	244	14.1006.....	250	14.2105.....	253	14.3112.2.....	262
14.0734.....	244	14.1007T.....	250	14.2107.....	253	14.3114.....	262
14.0735.....	244	14.1008T.....	250	14.2108.....	253	14.3114.2.....	262
14.0790.....	244	14.1009T.....	250	14.2109.....	253	14.3116.....	262
14.0792.....	244	14.1010.....	250	14.2110.....	253	14.3116.2.....	262
14.0800.....	244	14.1010T.....	250	14.2122.....	253	14.3118.....	262
14.0801.....	244	14.1012.....	250	14.2123.....	253	14.3118.2.....	262
14.0820.....	244	14.1012T.....	250	14.2125.....	253	14.3120.....	262
14.0821.....	244	14.1014.....	250	14.2127.....	253	14.3120.2.....	262
14.0825.....	244	14.1014T.....	250	14.2128.....	253	14.3122.....	262
14.0830.....	245	14.1016.....	250	14.2129.....	253	14.3122.2.....	262
14.0840.....	245	14.1016T.....	250	14.2130.....	253	14.3124.....	262
14.0842.....	245	14.1017T.....	250	14.2170.....	254	14.3124.2.....	262
14.0850.....	245	14.1018.....	240	14.2200.....	254	14.3126.....	262
14.0851.....	245	14.1018T.....	250	14.2202.....	254	14.3126.2.....	262
14.0852.....	245	14.1019T.....	250	14.2204.....	254	14.3128.....	262
14.0853.....	245	14.1021.....	250	14.2210.....	254	14.3128.2.....	262
14.0854.....	245	14.1021T.....	250	14.2212.....	254	14.3141.....	263
14.0855.....	245	14.1023.....	250	14.2214.....	254	14.3141.2.....	263
14.0860.....	245	14.1023T.....	250	14.2220.....	254	14.3143.....	263
14.0861.....	245	14.1025.....	250	14.2222.....	254	14.3143.2.....	263
14.0862.....	245	14.1025T.....	250	14.2224.....	254	14.3145.....	263
14.0865.....	245	14.1027.....	250	14.2230.....	254	14.3145.2.....	263
14.0866.....	246	14.1027T.....	250	14.2232.....	254	14.3147.....	263
14.0867.....	246	14.1030.....	250	14.2234.....	254	14.3147.2.....	263
14.0868.....	246	14.1030T.....	250	14.2240.....	254	14.3149.....	263
14.0869.....	246	14.1032.....	250	14.2242.....	254	14.3149.2.....	263
14.0870.....	246	14.1032T.....	250	14.2244.....	254	14.3151.....	263
14.0872.....	246	14.1034.....	250	14.2320.....	254	14.3151.2.....	263
14.0880.....	246	14.1034T.....	250	14.2390.....	254	14.3153.....	263
14.0885.....	246	14.1036.....	250	14.2570.....	254	14.3153.2.....	263
14.0890.....	246	14.1036T.....	250	14.2623.....	255	14.3155.....	263
14.0892.....	246	14.1040.....	251	14.2625.....	255	14.3155.2.....	263
14.0895.....	246	14.1040T.....	251	14.2627.....	255	14.3157.....	263
14.0896.....	246	14.1042.....	251	14.2628.....	255	14.3157.2.....	263
14.0897.....	246	14.1042T.....	251	14.2629.....	255	14.3159.....	263
14.0900.....	246	14.1044.....	251	14.2630.....	255	14.3159.2.....	263
14.0904.....	246	14.1044T.....	251	14.2820.....	254	14.3161.....	263
14.0910.....	247	14.1046.....	251	14.2890.....	255	14.3161.2.....	263
14.0912.....	247	14.1046T.....	251	14.2900.....	255	14.3163.....	263
14.0914.....	247	14.1050.....	251	14.3000.....	261	14.3163.2.....	263
14.0920.....	247	14.1050T.....	251	14.3000.2.....	261	14.3165.....	263
14.0922.....	247	14.1052.....	251	14.3002.....	261	14.3165.2.....	263
14.0925.....	247	14.1052T.....	251	14.3002.2.....	261	14.3167.....	263
14.0927.....	247	14.1054.....	251	14.3003.....	261	14.3167.2.....	263
14.0930.....	247	14.1054T.....	251	14.3003.2.....	261	14.3169.....	263
14.0932.....	247	14.1060.....	251	14.3005.....	261	14.3169.2.....	263
14.0934.....	247	14.1060T.....	251	14.3005.2.....	261	14.3202.....	264
14.0938.....	239	14.1062.....	251	14.3007.....	261	14.3202.2.....	264
14.0940.....	247	14.1062T.....	251	14.3007.2.....	261	14.3204.....	264
14.0948.....	247	14.1064.....	251	14.3009.....	261	14.3204.2.....	264
14.0950.....	247	14.1064T.....	251	14.3009.2.....	261	14.3206.....	265
14.0952.....	247	14.1070.....	252	14.3061.....	264	14.3206.2.....	265
14.0954.....	247	14.1072.....	252	14.3061.2.....	264	14.3208.....	265
14.0958.....	240	14.2000.....	253	14.3071.....	264	14.3208.2.....	265
14.0960.....	248	14.2001.....	253	14.3071.2.....	264	14.3212.....	264
14.0962.....	248	14.2002.....	253	14.3081.....	264	14.3212.2.....	264
14.0964.....	248	14.2005.....	253	14.3081.2.....	264	14.3214.....	264
14.0968.....	248	14.2007.....	253	14.3100.....	262	14.3214.2.....	264
14.0970.....	248	14.2010.....	253	14.3100.2.....	262	14.3216.....	265



Kat.Nr. Cat.No. No. Réf. No. Ref. No. Cat.	Seite Page Page Página Pagina	Kat.Nr. Cat.No. No. Réf. No. Ref. No. Cat.	Seite Page Page Página Pagina	Kat.Nr. Cat.No. No. Réf. No. Ref. No. Cat.	Seite Page Page Página Pagina	Kat.Nr. Cat.No. No. Réf. No. Ref. No. Cat.	Seite Page Page Página Pagina
14.3216.2	265	14.3722	260	15.0301	277	15.0478	288
14.3218	265	14.3722.2	260	15.0302	277	15.0479	288
14.3218.2	265	14.3724	260	15.0303	277	15.0480	280
14.3222	265	14.3724.2	260	15.0306	277	15.0481	280
14.3222.2	265	14.3726	260	15.0307	277	15.0482	281
14.3224	264	14.3726.2	260	15.0308	277	15.0484	281
14.3224.2	264	14.3728	260	15.0309	277	15.0486	281
14.3226	265	14.3728.2	260	15.0310	277	15.0492	281
14.3226.2	265	14.3900	266	15.0311	277	15.0493	281
14.3228	265	14.3905	266	15.0313	277	15.0494	281
14.3228.2	265	14.3910	266	15.0315	277	15.0495	281
14.3500	257	14.3915	266	15.0316	277	15.0496	281
14.3500.2	257	14.3920	266	15.0317	277	15.0497	281
14.3502	257	14.3925	266	15.0320	278	15.0499	289
14.3502.2	257	14.3930	266	15.0321	278	15.0503	289
14.3503	257	14.3935	266	15.0323	278	15.0620	282
14.3503.02	257	14.3940	266	15.0324	278	15.0621	282
14.3505	257	14.3945	266	15.0325	278	15.0622	282
14.3505.2	257	14.3950	266	15.0331	278	15.0623	282
14.3600	258	14.3955	266	15.0335	278	15.0624	282
14.3600.2	258			15.0360	278	15.0625	282
14.3602	258	<b>15...</b>		15.0361	278	15.0626	282
14.3602.2	258	15.0098	273	15.0362	278	15.0627	282
14.3604	258	15.0100	273	15.0363	278	15.0628	282
14.3604.2	258	15.0101	273	15.0364	278	15.0629	282
14.3606	258	15.0102	273	15.0365	278	15.0630	282
14.3606.2	258	15.0103	273	15.0366	278	15.0631	282
14.3610	258	15.0104	273	15.0367	278	15.0632	282
14.3610.2	258	15.0105	273	15.0392	279	15.0633	282
14.3612	258	15.0108	273	15.0393	279	15.0634	292,290
14.3612.2	258	15.0116	274	15.0404	279	15.0635	292,290
14.3614	258	15.0117	274	15.0406	279	15.0701	283
14.3614.2	258	15.0120	274	15.0408	279	15.0703	283
14.3616	258	15.0120L	274	15.0410	279	15.0720	283
14.3616.2	258	15.0121	274	15.0411	279	15.0721	283
14.3620	258	15.0121L	274	15.0412	279	15.0722	283
14.3620.2	258	15.0122	274	15.0413	279	15.0723	283
14.3622	258	15.0123	274	15.0414	279	15.0724	283
14.3622.2	258	15.0124	274	15.0415	279	15.0725	283
14.3624	258	15.0125	274	15.0416	279	15.0726	283
14.3624.2	258	15.0126	274	15.0417	279	15.0727	283
14.3626	258	15.0127	274	15.0418	279	15.0729	283
14.3626.2	258	15.0128	274	15.0419	279	15.0731	284
14.3641	259	15.0129	274	15.0430	279	15.0732	284
14.3641.2	259	15.0130	275	15.0431	279	15.0733	284
14.3643	259	15.0131	275	15.0432	279	15.0734	284
14.3643.2	259	15.0136	274	15.0433	279	15.0741	284
14.3651	259	15.0137	274	15.0450	280	15.0743	284
14.3651.2	259	15.0139	274	15.0451	280	15.0745	284
14.3653	259	15.0180	275	15.0452	280	15.0762	284
14.3653.2	259	15.0181	275	15.0453	280	15.0764	284
14.3661	259	15.0200	275	15.0454	280	15.0765	284
14.3661.2	259	15.0201	275	15.0455	280	15.0766	284
14.3663	259	15.0210	275	15.0458	280	15.0770	284
14.3663.2	259	15.0211	275	15.0459	280	15.0771	284
14.3702	260	15.0212	275	15.0460	280	15.0772	284
14.3702.2	260	15.0213	275	15.0461	280	15.0773	284
14.3704	260	15.0214	275	15.0462	280	15.0774	284
14.3704.2	260	15.0215	275	15.0463	280	15.0775	284
14.3706	260	15.0240	276	15.0464	280	15.0776	284
14.3706.2	260	15.0241	276	15.0465	280	15.0778	293,291
14.3708	260	15.0250	276	15.0466	280	15.0780	285
14.3708.2	260	15.0251	276	15.0467	280	15.0782	285
14.3712	260	15.0252	276	15.0468	280	15.0784	285
14.3712.2	260	15.0253	276	15.0469	280	15.0785	285
14.3714	260	15.0260	276	15.0470	280	15.0801	285
14.3714.2	260	15.0261	276	15.0471	280	15.0802	285
14.3716	260	15.0262	276	15.0472	280	15.0803	285
14.3716.2	260	15.0263	276	15.0473	280	15.0807	286
14.3718	260	15.0269	287	15.0476	280	15.0809	286
14.3718.2	260	15.0300	277	15.0477	280	15.0811	286

Kat.Nr. Cat.No. No. Réf. No. Ref. No. Cat.	Seite Page Page Página Pagina	Kat.Nr. Cat.No. No. Réf. No. Ref. No. Cat.	Seite Page Page Página Pagina	Kat.Nr. Cat.No. No. Réf. No. Ref. No. Cat.	Seite Page Page Página Pagina	Kat.Nr. Cat.No. No. Réf. No. Ref. No. Cat.	Seite Page Page Página Pagina
15.0813.....	286	15.2318.....	149	16.0224.....	299	16.1115.....	375
15.0817.....	286	15.2319.....	149	16.0230.....	299	16.1150.....	375
15.0831.....	286	15.2321.....	149	16.0232.....	299	16.1152.....	375
15.0833.....	286	15.2324.....	149	16.0234.....	299	16.1153.....	375
15.0835.....	286	15.2325.....	149	16.0280.....	299	16.1154.....	375
15.0841.....	79	15.2330.....	150	16.0290.....	299	16.1155.....	375
15.0843.....	79	15.2331.....	150	16.0300.....	302	16.1156.....	375
15.0901.....	79	15.2332.....	150	16.0360.....	302	16.1157.....	375
15.0903.....	79	15.2333.....	150	16.0362.....	302	16.1158.....	375
15.0911.....	79	15.2335.....	150	16.0364.....	302	16.1159.....	375
15.0913.....	79	15.2337.....	150	16.0370.....	302	16.1500.....	375
15.0931.....	80	15.2340.....	151	16.0371.....	302		
15.0941.....	80	15.2344.....	151	16.0390.....	300	<b>17...</b>	
15.1015.....	80	15.2345.....	152	16.0391.....	300	17.0001.....	99
15.1031.....	80	15.2347.....	152	16.0400.....	300	17.0576.....	317
15.1033.....	80	15.2348.....	152	16.0401.....	300	17.0620.....	307
15.1035.....	80	15.2349.....	152	16.0406.....	300	17.0621.....	307
15.1037.....	80	15.2360.....	153	16.0407.....	300	17.0622.....	307
15.1200.....	27	15.2361.....	153	16.0408.....	300	17.0623.....	307
15.1204.....	27	15.2362.....	153	16.0409.....	300	17.0624.....	307
15.1270.....	27	15.2363.....	153	16.0410.....	300	17.0625.....	307
15.1272.....	27	15.2365.....	153	16.0411.....	300	17.0626.....	307
15.1300.....	27	15.2366.....	153	16.0416.....	83,300	17.0629.....	307
15.1302.....	27	15.2367.....	153	16.0417.....	83,300	17.0662.....	307
15.1320.....	279	15.2368.....	153	16.0418.....	301	17.0665.....	307
15.1321.....	279	15.2380.....	154	16.0419.....	301	17.0666.....	307
15.1322.....	279	15.2381.....	154	16.0420.....	301	17.0667.....	307
15.1323.....	279	15.2382.....	154	16.0422.....	301	17.0670.....	307
15.1340.....	187	15.2383.....	154	16.0423.....	301	17.0671.....	91
15.1342.....	187	15.2384.....	154	16.0424.....	301	17.0672.....	91
15.1350.....	32	15.2385.....	154	16.0425.....	301	17.0673.....	91
15.1580.....	32,83	15.2386.....	154	16.0426.....	302	17.0674.....	91
15.1582.....	32,83	15.2387.....	154	16.0427.....	302	17.0675.....	91
15.1721.....	283	15.2388.....	154	16.0430.....	302	17.0676.....	91
15.1722.....	283	15.2389.....	154	16.0431.....	302	17.0680.....	91
15.1723.....	283	15.2390.....	154	16.0436.....	293	17.0681.....	91
15.1724.....	283	15.2391.....	154	16.0440.....	303	17.0682.....	91
15.1725.....	283	15.2392.....	154	16.0441.....	303	17.0683.....	91
15.1726.....	283	15.2393.....	154	16.0450.....	303	17.0684.....	91
15.1727.....	283	15.2394.....	154	16.0451.....	303	17.0900.....	308
15.1930.....	88	15.2395.....	154	16.0452.....	303	17.0910.....	308
15.1931.....	88			16.0453.....	303	17.0912.....	308
15.1933.....	88	<b>16...</b>		16.0454.....	303	17.0920.....	308
15.1935.....	88	16.0010.....	297	16.0455.....	303	17.0922.....	308
15.1936.....	293,291	16.0012.....	297	16.0460.....	303	17.0925.....	308
15.1937.....	88	16.0031.....	297	16.0461.....	303	17.0930.....	309
15.1940.....	88	16.0100.....	297	16.0462.....	303	17.0931.....	309
15.1960.....	88	16.0102.....	297	16.0463.....	303	17.0932.....	309
15.2125.....	146	16.0105.....	297	16.0466.....	303	17.0934.....	309
15.2200.....	146	16.0106.....	297	16.0470.....	303	17.1000.....	309
15.2202.....	146	16.0107.....	297	16.0471.....	303	17.1010.....	309
15.2209.....	146	16.0108.....	297	16.0472.....	303	17.1086.....	310
15.2211.....	146	16.0112.....	297	16.0473.....	303	17.1087.....	310
15.2215.....	146	16.0115.....	298	16.0500.....	304	17.1088.....	310
15.2216.....	146	16.0116.....	298	16.0501.....	304	17.1090.....	310
15.2217.....	146	16.0120.....	298	16.0505.....	304	17.1091.....	310
15.2218.....	146	16.0125.....	298	16.0510.....	304	17.1092.....	310
15.2221.....	147	16.0132.....	298	16.0520.....	304	17.1093.....	85,311
15.2223.....	147	16.0135.....	298	16.1000.....	374	17.1094.....	85,311
15.2225.....	147	16.0140.....	298	16.1002.....	374	17.1095.....	311
15.2230.....	148	16.0145.....	298	16.1004.....	375	17.1096.....	311
15.2232.....	148	16.0150.....	297	16.1010.....	374	17.1097.....	310
15.2234.....	148	16.0160.....	298	16.1020.....	374	17.1098.....	310
15.2300.....	148	16.0164.....	298	16.1030.....	374	17.1099.....	310
15.2301.....	148	16.0170.....	298	16.1032.....	374	17.1100.....	312
15.2311.....	149	16.0180.....	298	16.1050.....	374	17.1101.....	311
15.2313.....	149	16.0200.....	299	16.1052.....	374	17.1102.....	311
15.2314.....	149	16.0202.....	299	16.1060.....	374	17.1103.....	311
15.2315.....	149	16.0210.....	299	16.1070.....	374	17.1104.....	311
15.2316.....	149	16.0220.....	299	16.1100.....	375	17.1105.....	312
15.2317.....	149	16.0222.....	299	16.1110.....	375	17.1106.....	312

Kat.Nr. Cat.No. No. Réf. No. Ref. No. Cat.	Seite Page Page Página Pagina	Kat.Nr. Cat.No. No. Réf. No. Ref. No. Cat.	Seite Page Page Página Pagina	Kat.Nr. Cat.No. No. Réf. No. Ref. No. Cat.	Seite Page Page Página Pagina	Kat.Nr. Cat.No. No. Réf. No. Ref. No. Cat.	Seite Page Page Página Pagina
17.1107	312	17.6010	325	17.6702	339	18.0212	357
17.1108	312	17.6015	325	17.6703	339	18.0214	357
17.1109	312	17.6020	326	17.6704	339	18.0220	357
17.1110	312	17.6030	326	17.6710	340	18.0242	355
17.1111	61	17.6035	326	17.6711	340	18.0244	355
17.1112	61	17.6040	327	17.6712	340	18.0246	355
17.1113	61	17.6100	327	17.6713	340	18.0250	358
17.1114	61	17.6101	327	17.6714	340	18.0252	358
17.1115	61	17.6102	327	17.6715	340	18.0254	358
17.1116	61	17.6110	328	17.6716	340	18.0256	358
17.1117	61	17.6150	328	17.6717	340	18.0260	358
17.1118	85,311	17.6152	328	17.6718	340	18.0262	358
17.1119	85,311	17.6153	328	17.7000	341	18.0264	358
17.1120	313	17.6154	329	17.7001	341	18.0266	358
17.1121	313	17.6155	329	17.7002	341	18.0270	358
17.1122	313	17.6156	330	17.7012	341	18.0272	358
17.1123	313	17.6157	330	17.7022	341	18.0274	358
17.1124	313	17.6158	330			18.0280	358
17.1125	313	17.6159	330	<b>18...</b>		18.0800	345
17.1130	313	17.6170	330	18.0016TD	353	18.0801	345
17.1131	313	17.6172	330	18.0050	353	18.0802	345
17.1132	313	17.6173	330	18.0069	353	18.0803	345
17.1133	313	17.6174	330	18.0070	353	18.0804	345
17.1154	313	17.6176	330	18.0070L	353	18.0805	345
17.1166	85	17.6177	330	18.0070TD	353	18.0810	345
17.1167	85	17.6178L	330	18.0071	353	18.0811	345
17.1168	85	17.6178R	330	18.0072	353	18.0812	345
17.1169	85	17.6180	331	18.0072L	353	18.0813	345
17.1270	315	17.6181	331	18.0074	353	18.0814	345
17.1271	315	17.6182	331	18.0074L	353	18.0815	345
17.1272	315	17.6183	331	18.0076	353	18.0840	345
17.1273	315	17.6185	331	18.0076L	353	18.1050	359
17.1273C	314	17.6186	331	18.0080	354	18.1060	359
17.1274	315	17.6210	332	18.0080L	354	18.1065	359
17.1274C	314	17.6211	332	18.0082	354	18.1070	359
17.1275	315,317	17.6222	332	18.0082L	354	18.1072	359
17.1275.36	317	17.6224	332	18.0084	354	18.1074	359
17.1276	316	17.6225	332	18.0084HP	354	18.1076	359
17.1276C	314	17.6228	332	18.0084L	354	18.1078	359
17.1277	316	17.6229	332	18.0086	354	18.1080	359
17.1277C	314	17.6230	332	18.0086HP	354	18.1082	359
17.1278	316	17.6250	333	18.0086L	354	18.1084	359
17.1278C	314	17.6251	333	18.0088	354	18.1086	359
17.1279	316	17.6252	333	18.0088L	354	18.1088	359
17.1279C	314	17.6253	333	18.0090	354	18.1090	359
17.1280	62	17.6254	333	18.0092	354	18.1092	359
17.1281	62	17.6255	333	18.0094	354	18.1094	359
17.1282	62	17.6256	333	18.0096	354	18.1100	360
17.1284	62	17.6260	334	18.0100	354	18.1110	360
17.1285	62	17.6261	334	18.0100TD	353	18.1152	360
17.1286	62	17.6262	334	18.0102	354	18.1154	360
17.5670	321	17.6263	334	18.0102TD	353	18.1160	360
17.5672	321	17.6270	335	18.0104	354	18.1161	360
17.5890	321	17.6271	335	18.0104TD	353	18.1162	360
17.5892	321	17.6272	335	18.0106	354	18.1164	360
17.5899	322	17.6273	335	18.0108	354	18.1170	361
17.5900	322	17.6274	335	18.0110	354	18.1180	361
17.5901	322	17.6277	335	18.0150	355	18.1190	361
17.5902	322	17.6278	335	18.0152	355	18.1200	361
17.5905	322	17.6279	335	18.0160	355	18.1212	361
17.5906	323	17.6300	337	18.0162	355	18.1214	361
17.5907	323	17.6301	337	18.0164	355	18.1800	345
17.5908	323	17.6303	337	18.0166	355	18.1801	345
17.6000	324	17.6304	337	18.0170	356	18.1802	345
17.6001	324	17.6309	337	18.0180	356	18.1803	345
17.6001.1	324	17.6350	336	18.0190	356	18.1804	345
17.6001.2	324	17.6353	336	18.0192	356	18.1805	345
17.6002	324	17.6354	336	18.0194	356	18.1810	345
17.6003	324	17.6355	336	18.0202	357	18.1811	345
17.6004	324	17.6700	338	18.0204	357	18.1812	345
17.6007	325	17.6701	339	18.0210	357	18.1813	345

Kat.Nr. Cat.No. No. Réf. No. Ref. No. Cat.	Seite Page Page Página Pagina	Kat.Nr. Cat.No. No. Réf. No. Ref. No. Cat.	Seite Page Page Página Pagina	Kat.Nr. Cat.No. No. Réf. No. Ref. No. Cat.	Seite Page Page Página Pagina	Kat.Nr. Cat.No. No. Réf. No. Ref. No. Cat.	Seite Page Page Página Pagina
18.1814	345	19.0715	367	28.0334S	251	28.3507	352
18.1815	345	19.0718	367	28.0334T	251	28.3509	352
18.1840	345	19.0720	368	28.0336S	251	28.3630	350
18.1850	345	19.0721	368	28.0336T	251	28.3630S	350
<b>19...</b>		19.0722	368,370	28.2102	209	28.3630SD	350
19.0101	365	19.0723	368,370	28.2103	209	28.3631	350
19.0102	365	19.0724	368,370	28.2104	209	28.3631S	350
19.0103	365	19.0726	368	28.2105	209	28.3631SD	350
19.0104	365	19.0727	368	28.2112	209	28.3632	350
19.0105	365	19.0738	368,370	28.2113	209	28.3632S	350
19.0106	365	19.0746	368	28.2114	209	28.3632SD	350
19.0109	365	19.0747	368	28.2115	209	28.3633	350
19.0110	365	19.0748	368	28.2124	209	28.3633S	350
19.0111	365	19.0750	369,370	28.2125	209	28.3633SD	350
19.0112	365	19.0751	369	28.2150	209	28.3634	350
19.0113	365	19.0752	369	28.2151	209	28.3634S	350
19.0114	365	19.0753	369	28.2460	210	28.3634SD	350
19.0115	365	19.0754	369	28.2460T	210	28.3635	350
19.0116	365	19.1010	371	28.2461	210	28.3635S	350
19.0117	365	19.1020	371	28.2461T	210	28.3635SD	350
19.0119	365	19.1021	371	28.2462	210	28.3636	350
19.0120	365	19.1022	371	28.2462T	210	28.3636S	350
19.0121	365	19.1023	371	28.2463	210	28.3636SD	350
19.0122	365	19.1024	371	28.2463T	210	28.3637	350
19.0123	365	19.1025	371	28.2464	210	28.3637S	350
19.0124	365	19.1026	371	28.2464T	210	28.3637SD	350
19.0125	365	19.1030	371	28.2470	210	28.3640	350
19.0126	365	19.1031	371	28.2470T	210	28.3640S	350
19.0127	365	19.1032	371	28.2471	210	28.3640SD	350
19.0128	365	19.1033	371	28.2471T	210	28.3641	350
19.0200	365	19.1034	371	28.2472	210	28.3641S	350
19.0201	365	19.1035	371	28.2472T	210	28.3641SD	350
19.0202	365	19.1036	371	28.2473	210	28.3642	350
19.0203	365	19.1050	371	28.2473T	210	28.3642S	350
19.0204	365	19.1199	371	28.2474	210	28.3642SD	350
19.0205	365	19.1200	371	28.2474T	210	28.3643	350
19.0206	365	19.1201	371	28.2600	211	28.3643S	350
19.0207	365	19.1202	371	28.2601	211	28.3643SD	350
19.0210	365	19.1204	371	28.2602	211	28.3644	350
19.0211	365	19.1205	371	28.2603	211	28.3644S	350
19.0212	365	19.1206	371	28.2605	211	28.3644SD	350
19.0213	365	19.1210	371	28.2608	211	28.3645	350
19.0214	365	19.1211	371	28.2609	211	28.3645S	350
19.0215	365	19.1212	371	28.2620	212	28.3645SD	350
19.0216	365	19.1213	371	28.2622	212	28.3646	350
19.0302	366	19.3000	87	28.2623	212	28.3646S	350
19.0303	366	19.3001	87	28.2624	212	28.3646SD	350
19.0320	366	19.3010	87	28.2625	212	28.3647	350
19.0321	366	19.3011	87	28.2628	212	28.3647S	350
19.0322	366	19.3020	87	28.2629	212	28.3647SD	350
19.0323	366	19.3021	87	28.2640	212	28.3662	349
19.0324	366	19.3030	87	28.2641	212	28.3662D	349
19.0325	366	19.3040	87	28.2656	213	28.3664	351
19.0332	366	19.3041	87	28.2657	213	28.3664D	351
19.0351	366	19.3043	87	28.2659	213	28.3700	351
19.0352	366	19.3044	87	28.3154	346	28.3700S	351
19.0353	366	19.3051	87	28.3155	346	28.3700SD	351
19.0354	366	19.3053	87	28.3156	346	28.3701	351
19.0355	366	<b>28...</b>		28.3157	346	28.3701S	351
19.0356	366	28.0320T	251	28.3242	347	28.3701SD	351
19.0363	366	28.0322S	251	28.3243	347	28.3702	351
19.0371	63,366	28.0322T	251	28.3252	347	28.3702S	351
19.0372	63,366	28.0324S	251	28.3253	347	28.3702SD	351
19.0373	63,366	28.0324T	251	28.3254	348	28.3703	351
19.0374	63,366	28.0326S	251	28.3255	348	28.3703S	351
19.0700	367	28.0326T	251	28.3256	348	28.3703SD	351
19.0710	367	28.0330S	251	28.3257	348	28.7050	13
19.0711	367	28.0330T	251	28.3501	352	28.7055	13
19.0712	367	28.0332S	251	28.3504	352	28.7057	13
19.0713	367	28.0332T	251	28.3505	352	28.7058	13
				28.3506	352	28.7059	13

Kat.Nr. Cat.No. No. Réf. No. Ref. No. Cat.	Seite Page Page Página Pagina	Kat.Nr. Cat.No. No. Réf. No. Ref. No. Cat.	Seite Page Page Página Pagina	Kat.Nr. Cat.No. No. Réf. No. Ref. No. Cat.	Seite Page Page Página Pagina	Kat.Nr. Cat.No. No. Réf. No. Ref. No. Cat.	Seite Page Page Página Pagina
<b>33...</b>		48.0062.....	29	48.0312.....	43	48.1302.....	63
33.1160.....	367	48.0064.....	29	48.0313.....	43	48.1303.....	63
		48.0066.....	29	48.0350.....	43	48.1310.....	63
<b>40...</b>		48.0068.....	29	48.0510.....	44	48.1420.....	64
40.0705.....	292	48.0069.....	29,293	48.0511.....	44	48.1601.....	64
40.3400.....	323	48.0072.....	30	48.0512.....	44	48.1602.....	64
		48.0074.....	30	48.0513.....	44	48.1603.....	64
<b>41...</b>		48.0076.....	30	48.0530.....	46	48.1700.....	65
41.0000.....	269	48.0078.....	30	48.0532.....	46	48.1702.....	70
41.0001.....	269	48.0082.....	30	48.0534.....	46	48.1704.....	70
41.0005.....	269	48.0086.....	30	48.0536.....	46	48.1709.....	65,66
41.0006.....	269	48.0088.....	30	48.0537.....	46	48.1710.....	65
41.0010.....	269	48.0089.....	31	48.0538.....	46	48.1715.....	65
41.0011.....	269	48.0090.....	31	48.0700.....	45	48.1719.....	65
41.0015.....	269	48.0092.....	31	48.0710.....	45	48.1730.....	66
41.0016.....	269	48.0094.....	31	48.0900.....	47	48.1740.....	66
41.0019.....	269	48.0094AT.....	31	48.0902.....	47	48.1742.....	66
41.0020.....	270	48.0098.....	31	48.0904.....	47	48.1748.....	66
41.0021.....	270	48.0098AT.....	31	48.1000.....	48	48.1749.....	66,67,68
41.0022.....	270	48.0099.....	31	48.1005.....	48	48.1750.....	67
41.0023.....	270	48.0100.....	33	48.1006.....	48	48.1755.....	67
41.0024.....	270	48.0101.....	33	48.1007.....	48	48.1756.....	68
41.0025.....	270	48.0102.....	33	48.1020.....	49	48.1760.....	68
41.0028.....	271	48.0103.....	33	48.1030.....	49	48.1780.....	69
41.0030.....	271	48.0104.....	33	48.1040.....	49	48.1781.....	69
41.0031.....	271	48.0105.....	33	48.1046.....	50	48.1787.....	69
41.0032.....	271	48.0106.....	33	48.1047.....	50	48.1788.....	69
41.0033.....	271	48.0107.....	33	48.1050.....	50	48.1789.....	69
41.0034.....	271	48.0110.....	34	48.1051.....	50	48.1900.....	70
41.0035.....	271	48.0111.....	34	48.1052.....	50	48.2001.....	71
41.0037.....	271	48.0112.....	34	48.1053.....	50	48.2002.....	71
41.0090.....	272	48.0113.....	34	48.1054.....	50	48.2003.....	71
41.0091.....	272	48.0114.....	34	48.1055.....	47	48.2004.....	71
41.0092.....	272	48.0115.....	34	48.1070.....	51	48.2011.....	71
41.0093.....	272	48.0118.....	35	48.1080.....	51	48.2012.....	71
41.0094.....	272	48.0119.....	35	48.1136.....	55	48.2013.....	71
41.0095.....	272	48.0120.....	35	48.1137.....	55	48.2014.....	71
41.0099.....	272	48.0121.....	35	48.1138.....	55	48.2015.....	71
41.0100.....	272	48.0122.....	36	48.1139.....	55	48.2016.....	71
41.0101.....	272	48.0123.....	36	48.1140.....	55	48.2017.....	71
41.0110.....	272	48.0150.....	37	48.1141.....	56	48.2018.....	71
41.0111.....	272	48.0151.....	37	48.1142.....	56	48.2020.....	71
41.0115.....	272	48.0152.....	37	48.1143.....	56	48.2022.....	71
41.0116.....	272	48.0153.....	37	48.1144.....	56	48.2024.....	71
41.0120.....	272	48.0154.....	37	48.1145.....	56	48.2030.....	71
41.0121.....	272	48.0155.....	37	48.1146.....	56	48.2032.....	71
		48.0156.....	37	48.1147.....	56	48.2034.....	71
		48.0157.....	37	48.1148.....	56	48.2200.....	70
<b>46...</b>		48.0158.....	37	48.1159.....	55		
46.0169.....	336	48.0159.....	37	48.1200.....	52	<b>50...</b>	
		48.0160.....	38	48.1202.....	52	50.0061.....	75
<b>48...</b>		48.0161.....	38	48.1210.....	52	50.0062.....	75
48.0004.....	27	48.0162.....	38	48.1212.....	52	50.0063.....	75
48.0006.....	27	48.0163.....	38	48.1214.....	52	50.0100.....	76
48.0010.....	27	48.0164.....	38	48.1216.....	52	50.0103.....	76
48.0011.....	27	48.0165.....	38	48.1220.....	52	50.0104.....	76
48.0014.....	27	48.0170.....	39	48.1230.....	52	50.0105.....	76
48.0016.....	27	48.0172.....	39	48.1232.....	52	50.0106.....	76
48.0019.....	27,292	48.0180.....	39	48.1234.....	52	50.0107.....	76
48.0024.....	28	48.0184.....	40	48.1236.....	52	50.0108.....	76
48.0028.....	28	48.0186.....	40	48.1240.....	53	50.0109.....	76
48.0029.....	28	48.0190.....	41	48.1242.....	53	50.0110.....	76
48.0030.....	28	48.0191.....	41	48.1244.....	53	50.0111.....	76
48.0032.....	28	48.0200.....	42	48.1246.....	53	50.0120.....	76
48.0034.....	28	48.0201.....	42	48.1249.....	50,53,109	50.0121.....	76
48.0035.....	28	48.0203.....	42	48.1250.....	53	50.0122.....	76
48.0036.....	28	48.0204.....	42	48.1252.....	53	50.0123.....	76
48.0038.....	28	48.0205.....	42	48.1255.....	53	50.0124.....	76
48.0040.....	29	48.0207.....	42	48.1256.....	54	50.0125.....	76
48.0045.....	29	48.0210.....	33	48.1270.....	57	50.0126.....	76
48.0050.....	29	48.0300.....	43	48.1301.....	63	50.0127.....	76

Kat.Nr. Cat.No. No. Réf. No. Ref. No. Cat.	Seite Page Page Página Pagina	Kat.Nr. Cat.No. No. Réf. No. Ref. No. Cat.	Seite Page Page Página Pagina	Kat.Nr. Cat.No. No. Réf. No. Ref. No. Cat.	Seite Page Page Página Pagina	Kat.Nr. Cat.No. No. Réf. No. Ref. No. Cat.	Seite Page Page Página Pagina
50.0128	76	51.0072	101	51.1121	104	55.0105	116
50.0129	76	51.0080	100	51.1122	104	55.0110	117
50.0130	76	51.0090	101	51.1123	104	55.0111	117
50.0131	76	51.0097	101	51.1124	104	55.0112	117
50.0132	76	51.0098	101	51.1125	104	55.0113	117
50.0133	76	51.0099	101	51.1126	104	55.0114	117
50.0140	75	51.0106	102	51.1127	104	55.0115	117
50.0200	77	51.0107	102	51.1128	104	55.0116	117
50.0204	77	51.0108	102	51.1129	104	55.0117	117
50.0205	77	51.0109	102	51.1130	104	55.0118	117
50.0206	77	51.0110	102	51.1140	104	55.0119	117
50.0210	77	51.0112	102			55.0120	117
50.0240	77	51.0114	102	<b>55...</b>		55.0130	118
50.0270	78	51.0116	102	55.0010	107	55.0190	118
50.0271	78	51.0118	102	55.0011	111	55.0193	118
50.0272	78	51.0120	102	55.0011B	111	55.0196	118
50.0273	78	51.0122	102	55.0011HF	111	55.0200	118
50.0274	78	51.0124	102	55.0012	111	55.0201	118
50.0275	78	51.0136	102	55.0012B	111	55.0202	118
50.0276	78	51.0137	102	55.0012HF	111	55.0203	118
50.0277	78	51.0138	102	55.0013	111	55.0204	118
50.0300	81	51.0139	102	55.0013B	111	55.0205	118
50.0301	81	51.0140	102	55.0013HF	111	55.0206	118
50.0311	81	51.0141	102	55.0014	110	55.0207	118
50.0313	81	51.0142	102	55.0015	110	55.0208	118
50.0315	81	51.0143	102	55.0016	110	55.0210	119
50.0317	81	51.0144	102	55.0017	110	55.0211	119
50.0320	82	51.0145	102	55.0018	110	55.0212	119
50.0321	82	51.0146	102	55.0019	110	55.0213	119
50.0325	82	51.0148	102	55.0020	112	55.0214	119
50.0330	82	51.0150	102	55.0020B	112	55.0215	119
50.0340	89	51.0152	102	55.0020HF	112	55.0216	119
50.0342	89	51.0154	102	55.0021	112	55.0217	119
50.0344	89	51.0302	102	55.0021B	112	55.0218	119
50.0346	89	51.0303	102	55.0021HF	112	55.0220	120
50.0347	89	51.0350	103	55.0022	112	55.0221	120
50.0348	89	51.0600	103	55.0022B	112	55.0222	120
50.0350	89	51.0610	103	55.0022HF	112	55.0223	120
50.0401	90	51.0720	103	55.0025	107	55.0224	120
50.0402	90	51.0800	103	55.0030	113	55.0225	120
50.1009	92	51.0802	103	55.0030B	113	55.0226	120
50.1011	92	51.1008	104	55.0030HF	113	55.0227	120
50.1013	92	51.1010	104	55.0031	113	55.0228	120
50.1015	92	51.1012	104	55.0031B	113	55.0230	108
50.1018	92	51.1014	104	55.0031HF	113	55.0231	108
50.3100	86	51.1016	104	55.0032	113	55.0233	108
50.3102	86	51.1018	104	55.0032B	113	55.0234	108
50.3104	86	51.1020	104	55.0032HF	113	55.0236	108
50.3106	86	51.1022	104	55.0036	115	55.0237	108
<b>51...</b>		51.1024	104	55.0040	107,114	55.0240	121
51.0004	95	51.1026	104	55.0040B	114	55.0243	121
51.0009	95	51.1028	104	55.0040HF	114	55.0246	121
51.0010	95	51.1030	104	55.0041	114	55.0248	122
51.0011	95	51.1032	104	55.0041B	114	55.0249	122
51.0015	95	51.1034	104	55.0041HF	114	55.0250	122
51.0020	96,100	51.1036	104	55.0042	114	55.0251	122
51.0040	96	51.1040	104	55.0042B	114	55.0252	122
51.0041	96	51.1107	104	55.0042HF	114	55.0253	122
51.0042	96	51.1108	104	55.0045	114	55.0260	123
51.0043	99	51.1109	104	55.0050	115	55.0261	123
51.0044	99	51.1110	104	55.0051	115	55.0262	123
51.0045	99	51.1111	104	55.0052	115	55.0265	123
51.0050	97	51.1112	104	55.0060	115	55.0270	123
51.0053	97	51.1113	104	55.0062	115	55.0271	123
51.0055	98	51.1114	104	55.0066	115	55.0272	123
51.0056	98	51.1115	104	55.0067	115	55.0275	123
51.0057	98	51.1116	104	55.0068	115	55.0276	123
51.0058	98	51.1117	104	55.0100	116	55.0277	123
51.0060	99	51.1118	104	55.0101	116	55.0280	124
51.0070	100	51.1119	104	55.0102	116	55.0281	124
		51.1120	104	55.0103	116	55.0282	124

Kat.Nr. Cat.No. No. Réf. No. Ref. No. Cat.	Seite Page Page Página Pagina	Kat.Nr. Cat.No. No. Réf. No. Ref. No. Cat.	Seite Page Page Página Pagina	Kat.Nr. Cat.No. No. Réf. No. Ref. No. Cat.	Seite Page Page Página Pagina	Kat.Nr. Cat.No. No. Réf. No. Ref. No. Cat.	Seite Page Page Página Pagina
55.0283	124	55.0736	128	55.0984	139	55.1910	160
55.0284	124	55.0737	128	55.0990	132	55.1915	160
55.0285	124	55.0741	129	55.0991	132	55.1920	160
55.0286	124	55.0743	129	55.1001	130	55.1922	160
55.0287	124	55.0745	129	55.1001S	130	55.1962	161
55.0288	124	55.0747	129	55.1004	130	55.1973	161
55.0289	124	55.0749	129	55.1004S	130	55.1975	161
55.0294	124	55.0751	129	55.1021	130	55.1980	161
55.0299	124	55.0753	129	55.1024	130	55.2001	164
55.0310	124	55.0755	129	55.1030	130	55.2002	164
55.0311	124	55.0757	129	55.1100	131	55.2003	164
55.0320	125	55.0759	129	55.1110	131	55.2004	164
55.0321	125	55.0761	129	55.1120	131	55.2005	164
55.0322	125	55.0763	129	55.1200	131	55.2006	164
55.0323	125	55.0765	129	55.1500	140	55.2010	164
55.0324	125	55.0772	129	55.1510	140	55.2019	166
55.0325	125	55.0773	129	55.1511	141	55.2020	166
55.0326	125	55.0775	129	55.1520	90,141	55.2021	166
55.0327	125	55.0776	129	55.1525	132	55.2022	166
55.0328	125	55.0777	129	55.1526	132	55.2023	166
55.0329	125	55.0791	128	55.1551	144	55.2024	166
55.0335	125	55.0792	128	55.1552	144	55.2025	166
55.0340	125	55.0793	128	55.1553	144	55.2026	166
55.0342	125	55.0794	128	55.1554	144	55.2039	166
55.0350	126	55.0795	128	55.1555	144	55.2040	166
55.0351	126	55.0796	128	55.1561	144	55.2041	166
55.0352	126	55.0797	128	55.1562	144	55.2042	166
55.0353	126	55.0798	128	55.1565	132	55.2043	166
55.0354	126	55.0799	128	55.1600	145	55.2044	166
55.0355	126	55.0800	128	55.1602	145	55.2045	166
55.0357	126	55.0801	128	55.1610	145	55.2046	166
55.0358	126	55.0802	128	55.1700	157	55.2059	166
55.0359	126	55.0803	128	55.1701	157	55.2060	166
55.0500	126,321	55.0804	128	55.1702	157	55.2061	166
55.0530	127	55.0805	128	55.1703	157	55.2062	166
55.0532	127	55.0806	128	55.1704	157	55.2063	166
55.0550	127	55.0807	128	55.1802	155	55.2064	166
55.0701	128	55.0808	128	55.1803	155	55.2065	166
55.0702	128	55.0809	128	55.1805	155	55.2066	166
55.0703	128	55.0851	128	55.1820	156	55.2079	166
55.0704	128	55.0902	129	55.1822	156	55.2080	166
55.0705	128	55.0930	133	55.1825	156	55.2081	166
55.0706	128	55.0932	133	55.1835	156	55.2082	166
55.0707	128	55.0933	133	55.1840	157	55.2083	166
55.0708	128	55.0934	133	55.1850	158	55.2084	166
55.0709	128	55.0936	133	55.1852	158	55.2085	166
55.0710	128	55.0937	134	55.1854	158	55.2086	166
55.0711	128	55.0938	134	55.1856	158	55.2109	167
55.0712	128	55.0940	134	55.1858	158	55.2110	167
55.0713	128	55.0942	134	55.1859	158	55.2111	167
55.0714	128	55.0944	134	55.1860	159	55.2112	167
55.0715	128	55.0945	134	55.1861	159	55.2113	167
55.0716	128	55.0947	135	55.1863	159	55.2114	167
55.0717	128	55.0948	135	55.1866	159	55.2115	167
55.0718	128	55.0949	135	55.1867	159	55.2116	167
55.0719	128	55.0951	136	55.1869	159	55.2117	167
55.0720	128	55.0956	136	55.1870	159	55.2118	167
55.0721	128	55.0962	136	55.1872	159	55.2119	167
55.0722	128	55.0963	136	55.1874	159	55.2120	167
55.0723	128	55.0965	137	55.1880	159	55.2127	167
55.0724	128	55.0966	137	55.1881	159	55.2128	167
55.0725	128	55.0968	137	55.1883	159	55.2129	167
55.0726	128	55.0970	138	55.1886	159	55.2130	167
55.0727	128	55.0971	138	55.1887	159	55.2131	167
55.0728	128	55.0973	138	55.1889	159	55.2132	167
55.0729	128	55.0975	138	55.1890	159	55.2133	167
55.0730	128	55.0977	139	55.1892	159	55.2134	167
55.0731	128	55.0980	139	55.1894	159	55.2135	167
55.0732	128	55.0981	139	55.1898	159	55.2136	167
55.0733	128	55.0982	139	55.1899	159	55.2137	167
55.0735	128	55.0983	139	55.1900	160	55.2138	167

Kat.Nr. Cat.No. No. Réf. No. Ref. No. Cat.	Seite Page Page Página Pagina
55.2139	167
55.2140	167
55.2141	167
55.2142	167
55.2143	167
55.2144	167
55.2145	167
55.2146	167
55.2147	167
55.2148	167
55.2149	167
55.2150	167
55.2151	167
55.2152	167
55.2153	167
55.2154	167
55.2155	167
55.2156	167
55.2157	167
55.2158	167
55.2159	167
55.2160	167
55.2171	168
55.2172	168
55.2173	168
55.2174	168
55.2175	168
55.2176	168
55.2178	169
55.2179	169
55.2181	164
55.2182	164
55.2183	164
55.2184	164
55.2185	164
55.2186	164
55.2190	165
55.2191	165
55.2192	165
55.2193	165
55.2194	165
55.2201	163
55.2202	163
55.2203	163
55.2204	163
55.2210	163
55.2221	165
55.2222	165
55.2223	165
55.2224	165
55.2225	165
55.2226	165
55.2240	162
55.2242	162
55.2244	162
55.2246	162
55.2250	162
55.2254	163
55.2255	163
55.2260	170
55.2261	170
55.2262	170
55.2263	170
55.2264	170
55.2265	170
55.2269	170
55.2290	171
55.2291	171
55.2292	171
55.2293	171
55.2294	171

Kat.Nr. Cat.No. No. Réf. No. Ref. No. Cat.	Seite Page Page Página Pagina
55.2295	171
55.2296	171
55.2297	171
55.3500	172
55.3502	172
55.3504	172
55.3510	172
55.3512	172
55.3514	172
55.3530	109,173
55.3600	54,173
<b>56...</b>	
56.0010	20,177
56.0020	20,177
56.0030	20,177
56.0050	177
56.0200	181
56.0202	181
56.0210	181
56.0220	182
56.0222	182
56.0224	181
56.0226	181
56.0230	182
56.0240	181
56.0250	182
56.0252	182
56.0260	182
56.0262	182
56.0265	182
56.0270	183
56.0272	183
56.0274	183
56.0280	183
56.0289	183
56.0290	183
56.0300	183
56.0310	184
56.0320	184
56.0350	184
56.0360	184
56.0400	181
56.0410	184
56.0500	186
56.0505	186
56.0506	186
56.0510	186
56.0515	185
56.0520	186
56.0600	180,186
56.0601	180,186
56.0700	185
56.0702	185
56.0710	189
56.0720	189
56.0721	189
56.0722	189
56.0723	189
56.0740	188
56.0748	188
56.0749	188
56.0800	187
56.0801	187
56.0805	187
56.0820	188
56.0880	83,142,190
56.0882	83,142,190
56.0890	142,190
56.0896	143,190
56.0898	143,190

Kat.Nr. Cat.No. No. Réf. No. Ref. No. Cat.	Seite Page Page Página Pagina
56.0900	191
56.0910	191
56.0911	191
56.1000	191
56.1001	191
56.1002	191
56.1003	191
56.1004	191
56.1005	191
<b>58...</b>	
58.0501	22
58.0520	22
58.0522	22
58.0530	22
58.0540	22
58.0550	22
58.0551	22
58.0553	22
58.0555	22
58.0600	22
58.0601	22
58.0621	22
58.0700	23
58.0710	23
58.0712	23
58.0715	23
58.1000	23
58.1001	23
58.1002	23
58.1003	23
58.1004	23
58.1040	23
<b>80...</b>	
80.0010	391
80.0012	391
80.0014	391
80.1000	391
80.1002	391
80.1010	391
80.1012	391
80.2000	391
80.2009	391
80.2020	392
80.2030	392
80.2031	392
80.2032	392
80.2060	392
80.2070	392
80.2072	392
80.2074	392
80.2076	392
80.2078	392
80.2090	392
80.2100	393
80.2101	393
80.2102	393
80.2104	393
80.2200	393
80.2202	393
80.2204	393
80.2206	393
80.2208	393
80.2210	393
80.2240	393
80.2242	393
80.2244	393
80.2246	393
80.2248	393
80.2250	393

Kat.Nr. Cat.No. No. Réf. No. Ref. No. Cat.	Seite Page Page Página Pagina
80.2252	393
80.2254	393
80.2256	393
80.2258	393
80.2260	393
80.2262	393
80.2270	393
80.2272	393
80.2280	394
80.2282	394
80.2284	394
80.2286	394
80.2288	394
80.2290	394
80.2292	394
80.2300	394
80.2302	394
80.2310	394
80.2315	394
80.2400	395
80.2401	395
80.2402	395
80.2406	395
80.2407	395
80.2408	395
80.2430	395
80.2432	395
80.2434	395
80.2436	395
80.2438	395
80.3112	390
80.3114	390
80.3116	390
80.3162	390
80.3164	390
80.3166	390
80.3190	389
80.4002	390
80.4004	390
80.4006	390
80.4008	390
80.4010	390
80.4012	390
80.4014	390
80.4016	390
80.4018	390
80.4020	390
80.4022	390
80.4024	390
80.4026	390
80.4028	390
80.4040	390
80.4042	390
80.4044	390
80.4046	390
80.4048	390
80.4050	390
80.4052	390
80.4054	390
80.4056	390
80.4058	390
80.4060	390
80.4062	390
80.4064	390
80.4100	395
80.4101	395
80.4102	395
80.4103	395
80.4104	395
80.6001	376
80.6001SL	376



Kat.Nr. Cat.No. No. Réf. No. Ref. No. Cat.	Seite Page Page Página Pagina	Kat.Nr. Cat.No. No. Réf. No. Ref. No. Cat.	Seite Page Page Página Pagina	Kat.Nr. Cat.No. No. Réf. No. Ref. No. Cat.	Seite Page Page Página Pagina	Kat.Nr. Cat.No. No. Réf. No. Ref. No. Cat.	Seite Page Page Página Pagina
80.6002.....	376	80.6540.....	379	80.7314.....	382	80.8222.....	389
80.6002SL.....	376	80.6541.....	379	80.7315.....	382	80.8223.....	389
80.6003.....	376	80.6601.....	380	80.7316.....	382	80.8224.....	389
80.6003SL.....	376	80.6601SL.....	380	80.7321.....	382		
80.6004.....	376	80.6602.....	380	80.7322.....	382		
80.6004SL.....	376	80.6602SL.....	380	80.7323.....	382		
80.6005.....	376	80.6603.....	380	80.7324.....	382		
80.6005SL.....	376	80.6603SL.....	380	80.7325.....	382		
80.6006.....	376	80.6604.....	380	80.7326.....	382		
80.6006SL.....	376	80.6604SL.....	380	80.7410.....	383		
80.6011.....	376	80.6605.....	380	80.7420.....	383		
80.6012.....	376	80.6605SL.....	380	80.7431.....	383		
80.6013.....	376	80.6606.....	380	80.7501.....	384		
80.6014.....	376	80.6606SL.....	380	80.7503.....	384		
80.6015.....	376	80.6611.....	380	80.7504.....	384		
80.6016.....	376	80.6612.....	380	80.7511.....	384		
80.6021.....	376	80.6613.....	380	80.7513.....	384		
80.6022.....	376	80.6614.....	380	80.7514.....	384		
80.6023.....	376	80.6615.....	380	80.7551.....	384		
80.6024.....	376	80.6616.....	380	80.7552.....	384		
80.6025.....	376	80.6621.....	380	80.7553.....	384		
80.6026.....	376	80.6622.....	380	80.7901.....	385		
80.6031.....	376	80.6623.....	380	80.7902.....	385		
80.6032.....	376	80.6624.....	380	80.7903.....	385		
80.6033.....	376	80.6625.....	380	80.7904.....	385		
80.6034.....	376	80.6626.....	380	80.7905.....	385		
80.6035.....	376	80.6631.....	380	80.7906.....	385		
80.6036.....	376	80.6632.....	380	80.7911.....	385		
80.6041.....	376	80.6633.....	380	80.7912.....	385		
80.6042.....	376	80.6634.....	380	80.7913.....	385		
80.6043.....	376	80.6635.....	380	80.7914.....	385		
80.6044.....	376	80.6636.....	380	80.7915.....	385		
80.6045.....	376	80.6641.....	380	80.7916.....	385		
80.6046.....	376	80.6642.....	380	80.7950.....	385		
80.6203.....	377	80.6643.....	380	80.7960.....	385		
80.6205.....	377	80.6644.....	380	80.7962.....	385		
80.6207.....	377	80.6645.....	380	80.7980.....	385		
80.6210.....	377	80.6646.....	380	80.8000.....	386		
80.6231.....	377	80.6803.....	381	80.8010.....	386		
80.6232.....	377	80.6805.....	381	80.8050.....	386		
80.6240.....	377	80.6807.....	381	80.8052.....	386		
80.6301.....	378	80.6810.....	381	80.8054.....	386		
80.6301SL.....	378	80.6813.....	381	80.8060.....	387		
80.6302.....	378	80.6815.....	381	80.8062.....	387		
80.6302SL.....	378	80.6817.....	381	80.8064.....	387		
80.6303.....	378	80.6820.....	381	80.8100.....	387		
80.6303SL.....	378	80.6841.....	381	80.8105.....	387		
80.6304.....	378	80.6842.....	381	80.8110.....	387		
80.6304SL.....	378	80.6850.....	381	80.8115.....	387		
80.6305.....	378	80.6851.....	381	80.8120.....	387		
80.6305SL.....	378	80.7001.....	382	80.8131.....	387		
80.6306.....	378	80.7002.....	382	80.8132.....	387		
80.6306SL.....	378	80.7003.....	382	80.8133.....	387		
80.6311.....	378	80.7004.....	382	80.8140.....	388		
80.6312.....	378	80.7005.....	382	80.8141.....	388		
80.6313.....	378	80.7006.....	382	80.8142.....	388		
80.6314.....	378	80.7011.....	382	80.8150.....	388		
80.6315.....	378	80.7012.....	382	80.8160.....	388		
80.6316.....	378	80.7013.....	382	80.8161.....	388		
80.6321.....	378	80.7014.....	382	80.8162.....	388		
80.6322.....	378	80.7015.....	382	80.8163.....	388		
80.6323.....	378	80.7016.....	382	80.8164.....	388		
80.6324.....	378	80.7301.....	382	80.8191.....	388		
80.6325.....	378	80.7302.....	382	80.8192.....	388		
80.6326.....	378	80.7303.....	382	80.8201.....	389		
80.6503.....	379	80.7304.....	382	80.8202.....	389		
80.6505.....	379	80.7305.....	382	80.8211.....	389		
80.6507.....	379	80.7306.....	382	80.8212.....	389		
80.6510.....	379	80.7311.....	382	80.8213.....	389		
80.6531.....	379	80.7312.....	382	80.8214.....	389		
80.6532.....	379	80.7313.....	382	80.8221.....	389		







