

# **DVB-T TILEVISION® 26**

*the bathroom television*

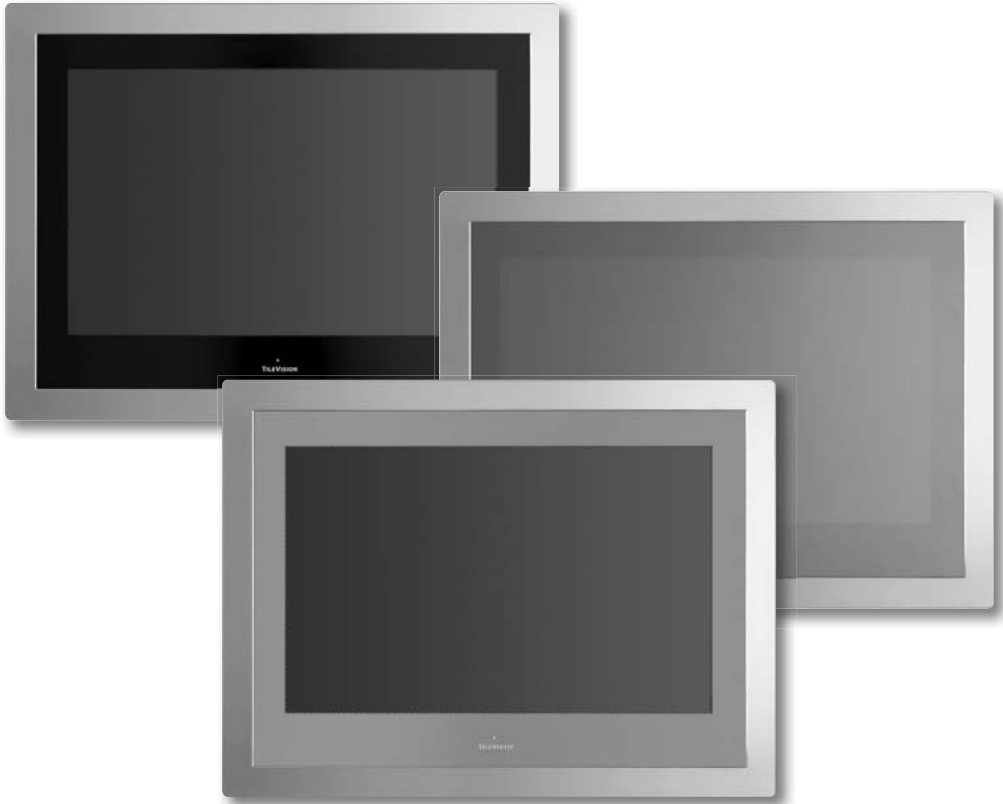



**DVB**  
Digital Video  
Broadcasting

**HDMI**<sup>™</sup>  
HIGH-DEFINITION MULTIMEDIA INTERFACE

# DVB-T TILEVISION® 26

## the bathroom television

	<b>CAUTION</b> RISK OF ELECTRIC SHOCK DO NOT OPEN	
<p><b>WARNING:</b> TO PREVENT INJURY, THIS APPARATUS MUST BE SECURELY ATTACHED TO THE WALL IN ACCORDANCE WITH THE INSTALLATION INSTRUCTIONS.</p> <p><b>CAUTION:</b> DO NOT REMOVE COVER. NO USER-SERVICEABLE PARTS INSIDE. REFER SERVICING TO QUALIFIED SERVICE PERSONNEL. BEWARE OF STATIC SENSITIVE PARTS.</p>		



This symbol is intended to alert the user to the presence of important operating and maintenance (servicing) instructions in the literature accompanying the appliance.



### Waste Electrical and Electronic Equipment (WEEE) Directive

In the European Union, this symbol indicates that this product should not be disposed of with household waste. It should be deposited at an appropriate facility to enable recovery and recycling.



This product contains Electrical/Electronic Parts which are produced using components in compliance with the requirements of: European Union Directive **2002/195/EC** for the Restriction of the use of certain Hazardous Substances in Electrical and Electronics Equipment (RoHS).

## Safety Instructions and Warnings

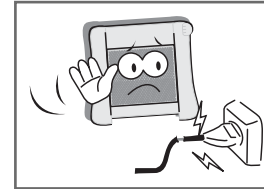

Do not use a damaged socket and do not let the power cord touch a heat source.  
– This may cause an electric shock or fire.

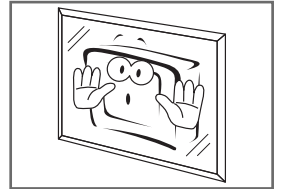

Do not add an additional screen or cover the TileVision's glass.  
– The heated screen prevents condensation forming in steamy rooms and covering the screen may cause the unit to overheat.

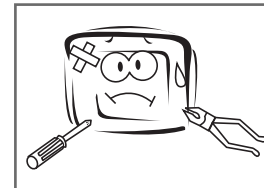

Do not attempt to service the unit.  
Contact an authorised dealer or repair service.  
– Servicing the unit yourself may cause an electric shock or fire.

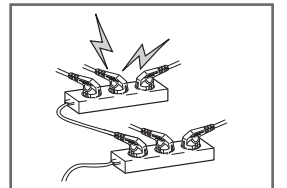

Do not connect too many extension cords or plugs to an outlet.  
– This may cause a fire.

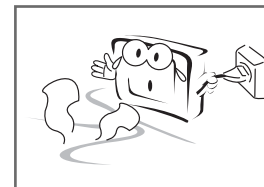

If there are any unusual sounds or smells coming from the unit, turn it off immediately with the isolation switch and contact an authorised dealer or repair service.  
– This may cause an electric shock or fire.

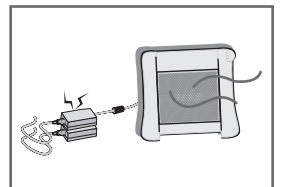

Keep the power adaptor away from any heat source.  
– This may cause a fire.

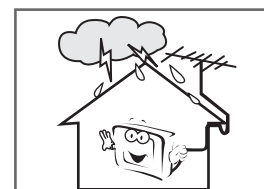

If an outside antenna is connected to the unit, ensure the external to internal cable entry is fully sealed  
– This may cause an electric shock or fire.

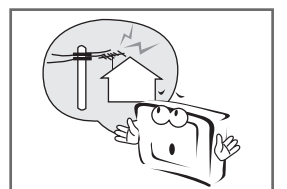

Ensure the antenna is located away from overhead cables.  
– This may cause an electric shock.

To prevent injury, the TileVision® must be securely attached to the wall in accordance with the installation instructions.

The power supply must be connected to a mains socket outlet with a protective earth connection.

The mains isolation switch must remain readily operable.

Failure to observe the above safety warnings may invalidate the warranty.

All electrical installation should be carried out by a fully qualified electrician.

## Tools Required

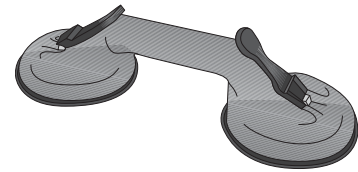

Suction Lifter

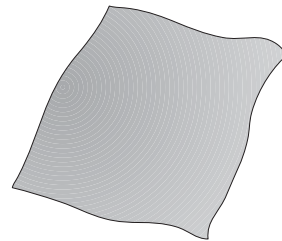

Soft Cloth

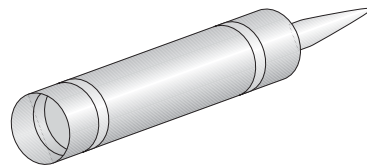

Clear Silicone Sealant



Isopropyl Alcohol

- Silicone Sealant produces acetic acid during cure. Use only in well ventilated areas. Irritating to eyes. Wash hands after use and before meals. Wash splashes from skin, clothing and other surfaces. Use a clean cloth. In case of contact with eyes wash immediately with plenty of water.**

Please observe safety precautions on the container. Keep out of reach of children and animals.



- Isopropyl alcohol is available from most pharmacies and larger electronics wholesalers. It is an effective degreasing agent.**

Please observe safety precautions on the container. Keep out of reach of children and animals. Do not drink.



## Table of Contents

Safety Instructions and Warnings .....	1
Tools Required .....	2
First Fix Kit – Unpacking and Initial Assembly .....	4
First Fix Kit – Installing the Back Box .....	5
First Fix Kit – Cabling .....	6
First Fix Kit – Speaker and Aerial Feed .....	7
Unpacking the TileVision® .....	8
The Waterproof Remote Control .....	8
Checking the Back Box .....	9
The Common Interface (CI) Port .....	9
Sky™ Remote Control Link Setup .....	10
Installing the TileVision® – Initial Connections .....	11
TileVision® Connectors .....	12
Connecting an Antenna or Cable .....	12
The Component and Composite Video Connectors .....	13
The HDMI and S-VIDEO Connectors .....	14
The SCART Connector .....	15
The IR Link, RJ12 and RS-232 Connectors .....	16
Installing the TileVision® – Setup and Tuning .....	17
Installing the TileVision® – Sealing .....	19
The Waterproof Remote Control .....	20
The Standard Remote Control .....	21
Switching the TileVision® On/Off .....	22
Selecting the On-screen Language .....	22
Selecting a Source .....	23
On-screen Menu Summary .....	24
Auto Tuning .....	25
DTV Manual Tuning .....	26
ATV Manual Tuning .....	27
Programme Edit .....	28
CI Information .....	29
Changing Channels .....	30
Programme Information – Basic and Detailed Programme Information .....	31
The Electronic Programme Guide (EPG) .....	32
EPG Date and Programme Reminders .....	33
Setting Programme Reminders .....	34
Picture Settings – Setting the Picture Mode and Personal Picture Mode .....	36
Picture Settings – Setting the Colour Temperature and Personal Colour Temperature .....	37
Picture Settings – Setting the Aspect Ratio .....	38
Picture Settings – Noise Reduction and Subtitles .....	39
Sound Settings – Setting the Sound Mode, Personal Sound Mode and Sound Mute .....	40
Sound Settings – Adjusting the Balance, Auto Volume and Surround Sound .....	41
Sound Settings – Audio Language and Channel Assignment .....	42
Time Functions – Setting On and Off Times .....	43
Time Functions – Setting the Sleep Timer and Time Zone .....	44
The Setup Menu – On-screen Language and Audio Language .....	45
The Setup Menu – Subtitle Language and Hearing Impaired .....	46
The Lock Menu – Lock System and Change Password .....	47
The Lock Menu – Block Programme .....	48
The Lock Menu – Parental Guidance and Restore Setting .....	49
DTV Text .....	50
ATV Teletext .....	51
Troubleshooting .....	52
Specifications .....	53

## First Fix Kit – Unpacking and Initial Assembly

Please note – **A technically competent person should carry out the installation of your TileVision® unit.**

☛ **If any items are missing, contact the dealer that supplied the TileVision®.**

The first fix kit consists of:

- 1 stainless steel back box with 2 fixing brackets and 10 screws
- 1 single stereo speaker and 4.5 metres of 4-core speaker cable
- 1 AC/DC adaptor with integral 4 metre lead and 2 AC leads
- 1 polystyrene aperture protective cover
- 1 TileVision® instruction manual.

### Unpacking your TileVision®

Within the back box there are two right-angled brackets and ten fixing screws. Screw the brackets to the outside of the back box but be aware these will need to be loosened to allow adjustment of the back box when fitted into the wall.

As shown below, the brackets allow 53mm of forwards/backwards adjustment so that the front of the back box can fit flush with the tiled surface. Any additional adjustment needed to ensure the front of the back box is flush with the tiles should be considered before fitting the back box.

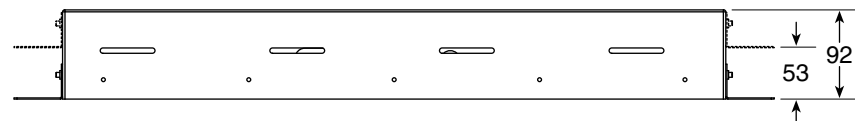

The range of adjustment available with the back box brackets

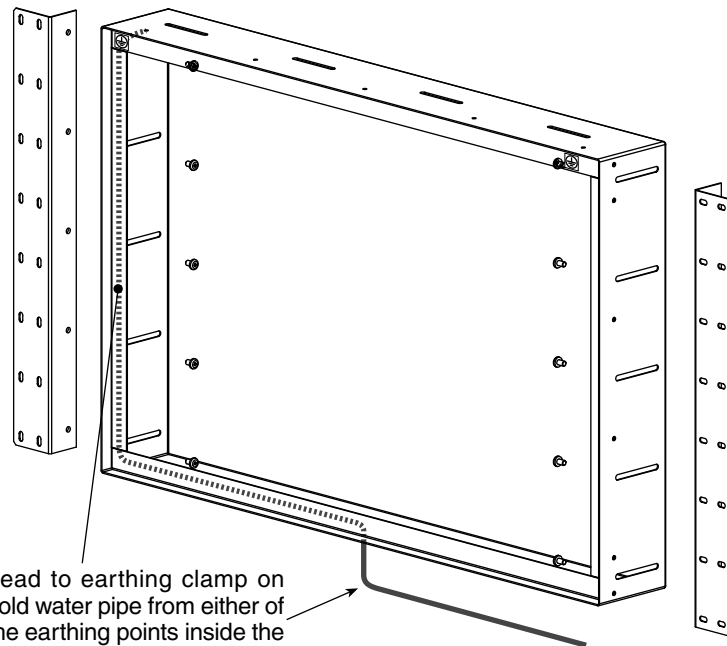

Lead to earthing clamp on cold water pipe from either of the earthing points inside the back box (lead not supplied)

The qualified electrical installer must use one of the earthing screws as an earth point to earth the unit to ground.

The lead used must be terminated with a ring terminal, which, together with the earthing cable's ring terminal, is fastened using the supplied locking washer and screw.

## First Fix Kit – Installing the Back Box

### Installation and positioning

If this has not already been cut, the 26" unit requires a recess of 702 mm x 455 mm and 92 mm depth from the front face of the tiles.

Fit the back box into the wall ensuring that the cable inlets are facing downwards.

To adjust the position of the back box loosen the ten screws, which attach the left and right hand brackets to the back box, these screws are located each side within the back box. Ensure that you do not fully unscrew the fasteners to avoid detaching the brackets from the back box.

Adjust the alignment of back box making sure the front edge of the back box sits flush with the front face of the tiles.

Secure all ten screws to lock the back box into position.

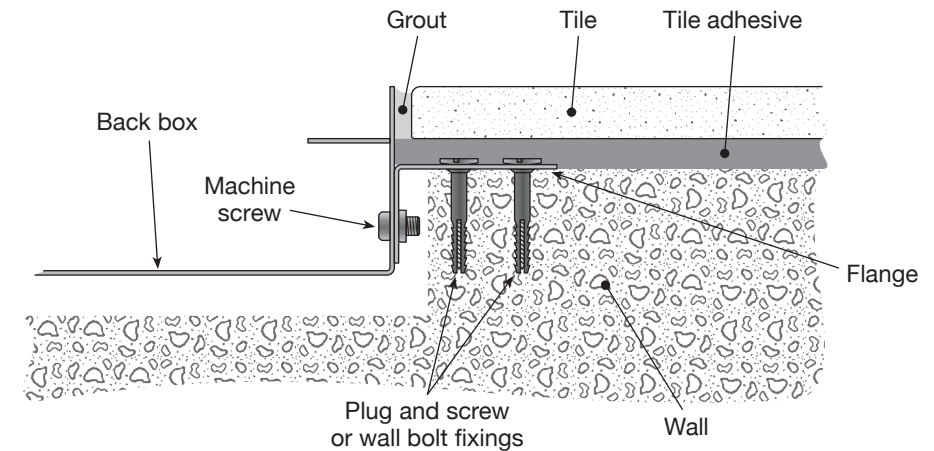

Example of a back box installed in a 'solid' wall

☛ **Note: Removal of the front glass requires a force of 200 kg when using a glass suction lifter. The box must be secured to the wall so that it is able to withstand the pulling force.**

## First Fix Kit – Cabling

Please note – **All electrical installation should be carried out by a fully qualified electrician and all fire & safety regulations must be obeyed.**

### Power Requirement (Mains)

TileVision® requires a 13 amp socket outlet connected to a 240V mains supply via a readily accessible isolation switch. This electrical installation must include an all-pole switch with a contact separation of at least 3mm in each pole. Both the socket and the isolation switch must conform to the latest safety specification and be protected via an RCCD device or similar. This socket must be fitted in a dry area, away from any moisture (usually in the ceiling). The mains plug must be fitted with a 5 amp fuse..

### TileVision® Power Supply (24V)

The 24V power supply unit is not waterproof and so must be positioned in a dry, well-ventilated area away from any water or moisture. It is fitted with an integral 4 metre lead to feed the TileVision®. This lead must not be cut, shortened or lengthened – this could potentially damage the power supply unit and the TileVision® and have implications regarding safety.

Ensure the remote isolation switch is off and connect the power supply mains lead to the 24V power supply unit. Connect the mains plug in to the mains socket.

After piercing one of the grommets in the back box feed the cable from the power supply unit in to the back box. Make sure there is approximately 400mm of slack at this end of the cable.

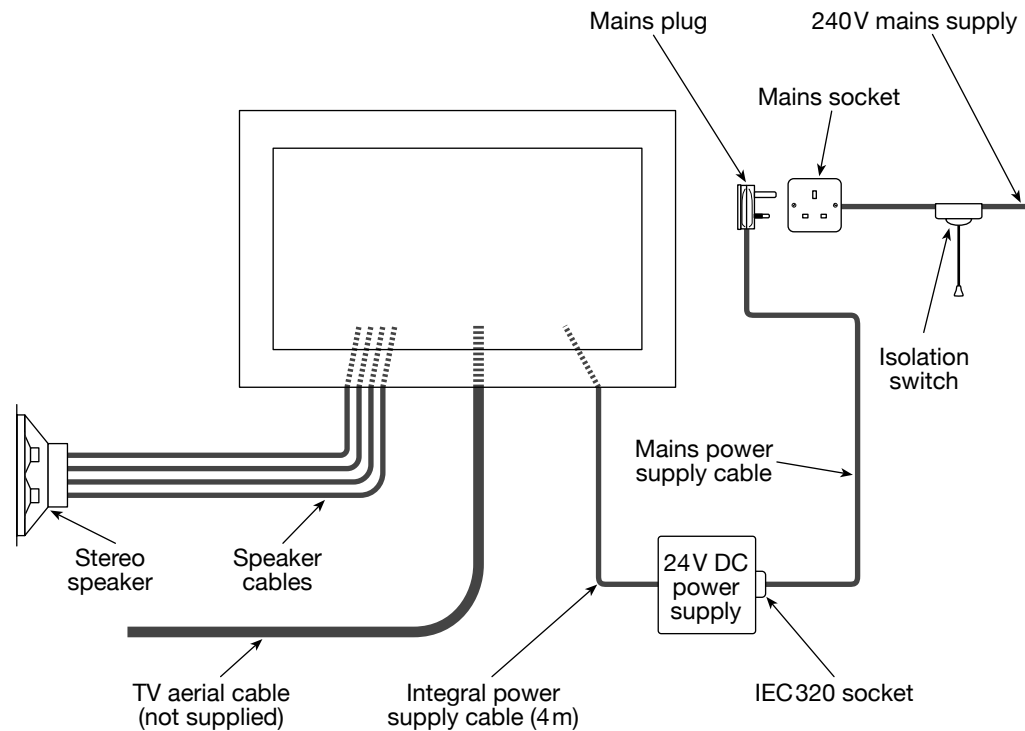

## First Fix Kit – Cabling

Please note – **All required cabling for HDMI, PC RGB, SCART, S-Video, Component and Composite Video must be installed during the installation of the back box.**

### TV Aerial Feed

Pass the aerial lead through the black grommet on the left hand side in to the back box and terminate the aerial lead with a standard 75Ω coax termination.

A TV Distribution Amplifier may be required if you are in an area of weak signal or if other televisions are already being fed from the aerial. If in doubt, consult a qualified aerial technician.

If the TileVision® is to be used with a Sky™ digital receiver which has two RF outputs, the channel can be changed on the Sky™ receiver using the Sky™ remote control via the TileVision®. To use this facility install a good quality coaxial cable that runs directly from the RF2 outlet of the Sky receiver, or from the outlet of a Remote-Link amp, in a continuous uninterrupted run.

The TileVision® will accept additional inputs from many sources and can be integrated with home automation and interactive hotel TV systems. See pages 13 to 16 for specific information.

### Installing the supplied single stereo speaker

To fit the speaker cut a single 208mm diameter hole in the ceiling using the template supplied. Position the template a minimum of 16mm from any joists. Do not cut through any joists, cables or pipes, etc.

A four and a half metre length of four core speaker cable is supplied with the speaker. At the back box, pierce the black grommet on the left hand side and feed one end of the speaker cable through the grommet leaving 400mm of cable protruding in to the back box. The cable should then be run from the TileVision® back box to the position of the speaker leaving any surplus cable in the ceiling space.

The speaker terminals on the TileVision® and on the stereo speaker are colour coded to match the colours of the supplied four core speaker cable. To ensure that the stereo speaker is connected correctly the individual leads must be connected to their matching colours on both the TileVision® and the stereo speaker.

To connect the speaker cable to the ceiling speaker lift one of the lugs to open a terminal and insert the appropriately coloured conductor. After releasing the lug give the lead a slight pull to make sure that the lead is gripped correctly. Connect all of the leads in the same manner.

Loosen all four screws by turning them counter clockwise until the clamps can move freely. Do not remove the screws. Install the speaker in to the precut hole and orientate the speaker so left audio will be heard on the left and right audio heard on the right. Turn the clamp screws clockwise until they are tightened and the speaker is held firmly. Insert the speaker grille by gently pressing it into place. The grille will fit tightly without causing any vibration.

### Back box aperture protective cover

The back box is now correctly installed, please push the aperture cover provided into the front of the back box (printed side outward) to protect the sealing flanges from damage whilst awaiting the installation of the TileVision®.

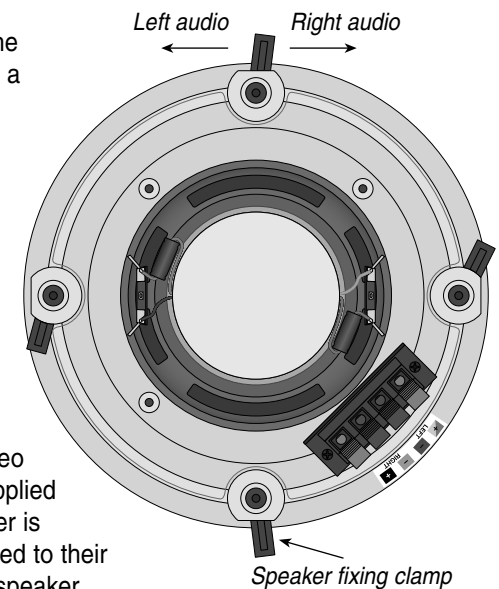

## Unpacking the TileVision®

☛ **If any items are missing, contact the dealer that supplied the TileVision®.**

The second fix kit consists of:

- 1 TileVision® with Velcro fixing strips
- 1 waterproof remote control
- 1 remote control holder
- 1 standard remote control
- 1 mirrored acrylic surround
- 1 TileVision® instruction manual.

Remove the TileVision® from its packaging and place the mirrored acrylic surround to one side for safe keeping.

## The Waterproof Remote Control

Before the waterproof remote control can be used the insulating plastic film must be removed from beneath the battery.

Place the remote control face down on a horizontal flat surface and use the opener to release the battery compartment cover by rotating it in an anti-clockwise direction. Set the battery cover and opener to one side.

Rest one finger lightly on the battery and pull the printed tag to ease the insulating film from underneath the battery. Try to avoid touching the black O-ring as it is coated in light grease.

Replace the battery cover and lock it back in place using the opener.

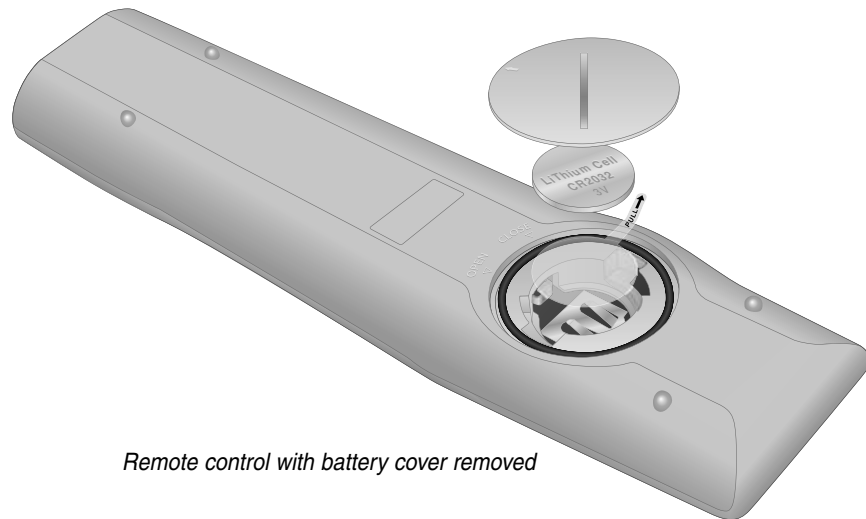

Remote control with battery cover removed

## Checking the Back Box

### Checking the back box prior to installation

Before commencing installation of the TileVision® the polystyrene blanking panel must be removed from the back box. Make sure that all of the required input cables are present within the back box.

It is important to ensure that the flange inside the back box is thoroughly cleaned using isopropyl alcohol and allowed to dry.

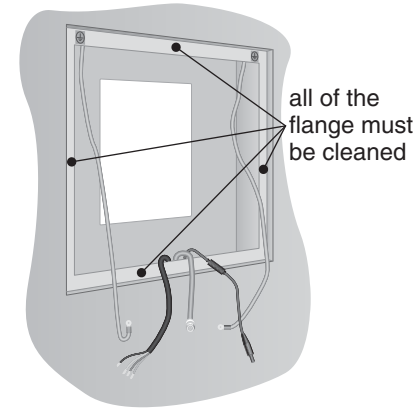

## The Common Interface (CI) Port

If a Conditional Access Module (CAM) is being used to add channels to the TileVision® the CAM should be inserted into the CI Port of TileVision® **with the power disconnected.**

Take a note of the Smart Card's serial number and follow the CAM/Smart Card manufacturer's instructions to insert the Smart Card into the CAM and access the service.

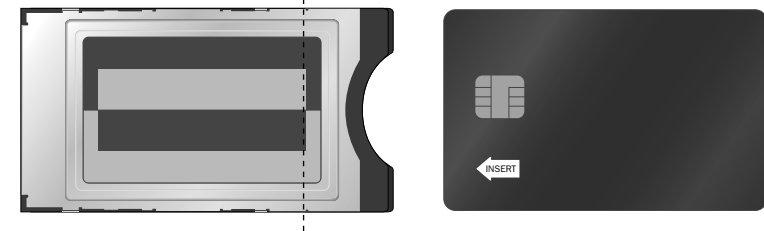

The dotted line indicates the edge of the metalwork when a CAM is correctly inserted.

The Smart Card must be activated in accordance with its service provider's instructions before installation is completed and the TileVision® is sealed (see page 19).

See page 29 for additional CI/Smart Card information.

## Sky™ Remote Control Link Setup

If the TileVision® is used with a Sky™ receiver, the channel can be changed on the Sky™ receiver using the Sky™ remote control via the remote sensor on the TileVision®.

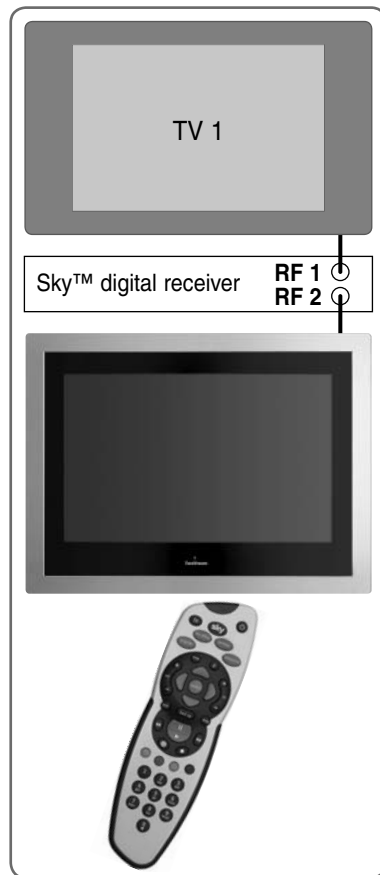

Preparation to use this facility should have been completed during the installation of the first fix assembly (see page 7).

It is advisable to setup the Sky™ receiver so that it can be controlled via the TileVision® before the TileVision® is installed. The red LED on the TV Link (that is fixed to the TileVision®) will light when correctly connected to and powered by the Sky™ receiver. This is checked when connecting the aerial lead to the TileVision®.

The connection to the Antenna/RF connectors on the TileVision® and the Sky™ receiver must be made with both the TileVision® and the Sky™ receiver disconnected from the mains supply. Use good quality coax cable either directly from the RF2 outlet of the receiver or the outlet of a Remote-Link amp in an uninterrupted run.

Once the connections have been made, the Sky™ receiver must be setup to supply power to the RF2 socket as detailed below.

**To set-up the Sky™ receiver to work with the TileVision® the Sky™ remote control must be used via the main TV (TV 1).**

- 1 On the Sky™ remote control press **SERVICES** to show the SERVICES menu.
- 2 Press the **4** button for the SYSTEM SETUP menu.
- 3 Press the **0** button, then the **1** button, then the **select** button, in sequence, to display the INSTALLER SETUP menu.
- 4 Press the **4** button to select RF OUTLETS.
- 5 Press the **down** arrow to select RF Outlet Power Supply and press the **left** or **right** arrows to change the setting to ON.
- 6 Press the **down** arrow to select Save New Settings and press **select** to save the settings.
- 7 Press the **sky** button to return to the previously viewed channel.



Red LED indicator will light when power is received from the Sky™ RF2 outlet

## Installing the TileVision® – Initial Connections

Note: A glass carrier/suction lifter is required when installing a TileVision®.  
All connections should be made with the remote isolation switch for the TileVision® set to OFF.

### Earthing Points

Introduce the lower front edge of the unit into the back box and fit the earth cables to the two earthing screws as indicated by the green labels on the rear of the TileVision®.

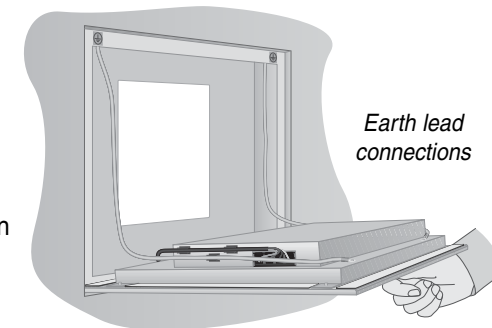

The earth cables are electrical connections and **must not** be used to support the weight of the TileVision®.

### Power Socket

The Power connector is located at the extreme right of the connection array.

### Speaker Connections

The supplied stereo speaker should be connected after the earthing straps are connected to the rear of the TileVision® as detailed above.

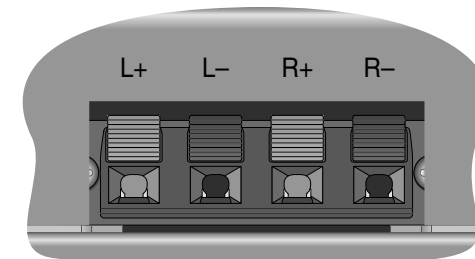

The speaker terminals on the TileVision® and on the stereo speaker are marked with coloured dots which match the colours of the supplied four-core speaker cable. To ensure that the stereo speaker is connected correctly the individual leads should be connected to their matching colours on both the TileVision® and the stereo speaker.

The speaker connection block is found on the left of the rear of the TileVision®. Lift one of the lugs, push one conductor of the speaker lead into the connector, release the lug and give the lead a slight pull to make sure that it is gripped correctly. The other wires should be connected in the same way.

If two separate speakers and alternative speaker cables are being used, the conductor with the stripe should be connected to the negative terminal (L- or R-) and the plain conductor should be connected to the corresponding positive terminal (L+ or R+). The connections to the speakers terminals should be made in the same way – striped conductor to the negative terminal and plain conductor to the positive terminal.

Use the cable clips provided to secure the earth and speaker cables to prevent them obstructing the TileVision® as it is fitted into the back box.

## TileVision® Connectors

All connections must be made before sealing the TileVision® into the back box.

### TV 26 Main Connector Array

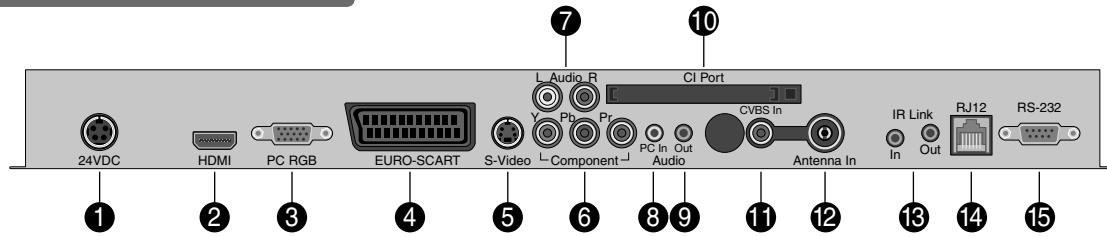

- |   |  |
|---|--|
| 1 DC24V Power In  | 8 PC Audio In                                  |
| 2 HDMI (High Definition Multimedia Interface)                         | 9 Audio Out (Headphones)                       |
| 3 PC/Analog RGB Input (D-SUB)   | 10 CI Port for Conditional Access Module (CAM) |
| 4 EURO-SCART – (RGB, FB, AV In, AV Out)                               | 11 Composite Video Input (CVBS)                |
| 5 S-VIDEO In  | 12 Antenna Input 75Ω                           |
| 6 Component Video Inputs: Green = Y,<br>Blue = Pb (Cb), Red = Pr (Cr) | 13 Infrared Link – In and Out                  |
| 7 Component/S-VIDEO Audio In:<br>White = Left, Red = Right            | 14 RJ12 – for Hotel TV System Integration      |
|   | 15 RS-232 – for Home Automation Systems        |

## Connecting an Antenna or Cable

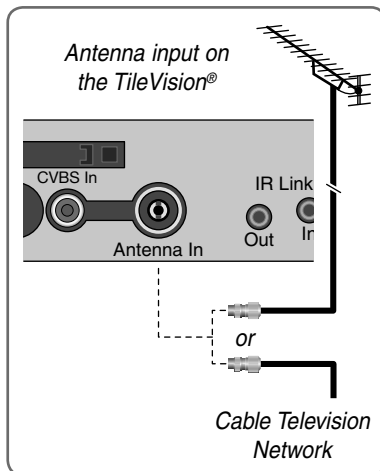

To view television channels correctly, a signal must be received by the TileVision® from one of the following sources:

- an outdoor antenna
- a cable television system
- a satellite receiver.

### Antenna Feed

Connect the antenna or input cable to the 75Ω coaxial connector on the rear of the TileVision®.

Picture quality is determined by the signal level, it is recommended that a qualified aerial technician is consulted.

## The Component and Composite Video Connectors

All connections must be made before sealing the TileVision® into the back box.

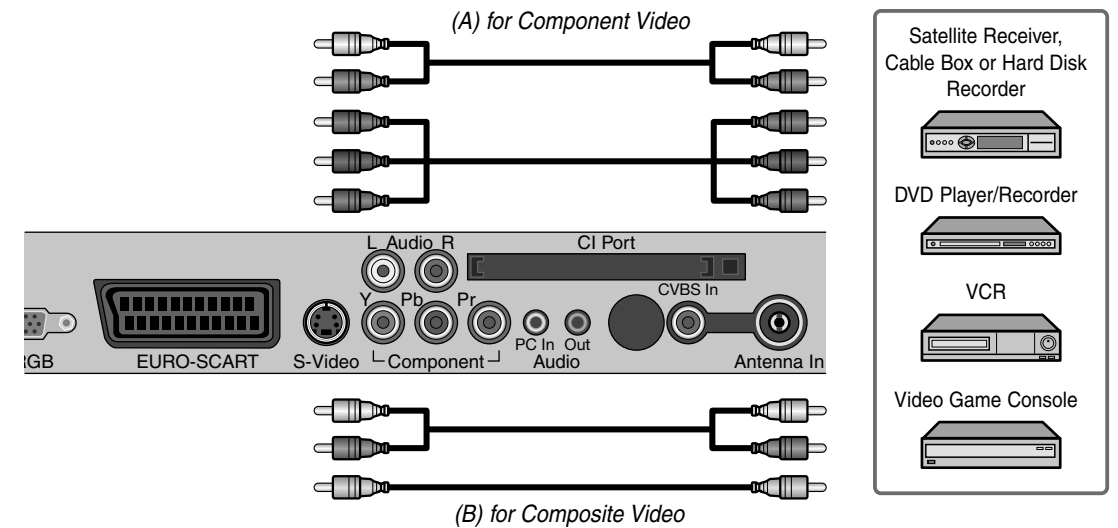

### (A) For Component Video

- 1 Connect the audio cable to the Left and Right Audio connectors (white and red) and the video cable to the Component Y, Pb and Pr Inputs (green, blue and red) on the TileVision® and the corresponding connectors on the external equipment such as a satellite receiver or DVD player.
- 2 If the external equipment only has a mono audio connector, it should be connected to the left (white) connector of the Audio Input.

### (B) For Composite Video

- 1 Connect the audio cable to the Left and Right Audio connectors (white and red) and the video cable to the CVBS Composite connector (yellow) on the TileVision® and the corresponding connectors on the external equipment such as a satellite receiver or DVD player.
- 2 If the external equipment only has a mono audio output, it should be connected to the left (white) connector of the Audio Input.



## The HDMI and S-VIDEO Connectors

All connections must be made before sealing the TileVision® into the back box.

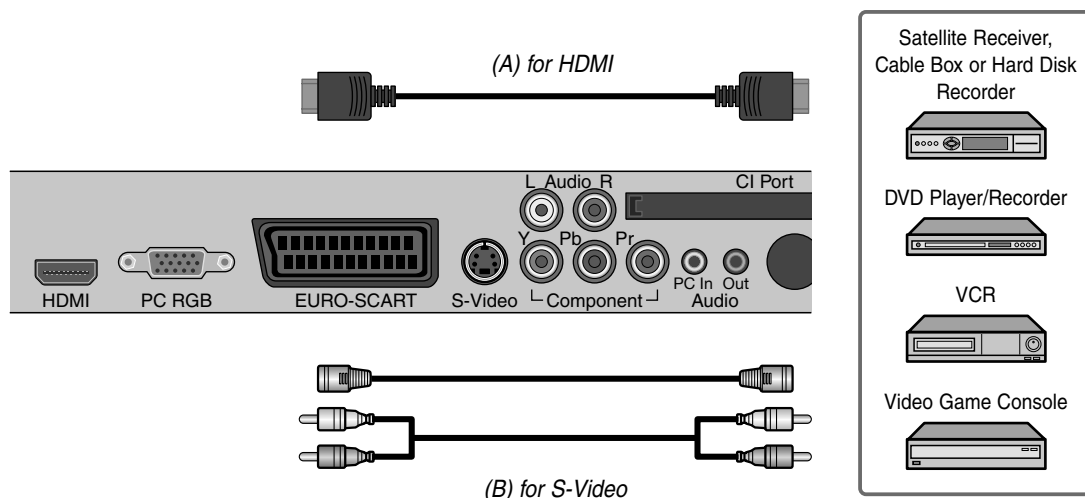

### (A) For HDMI

- 1 Connect the HDMI cable to the HDMI connection on the TileVision® and the HDMI connection on the external equipment such as a satellite receiver or DVD/Blue-ray player.

### (B) For S-VIDEO

- 1 Connect the S-VIDEO cable to the S-VIDEO connector and the audio cable to the Left and Right Audio connectors (white and red) on the TileVision® and the S-VIDEO and Audio Outputs on the external equipment such as a VCR, DVD player/recorder and some video game devices.

- 2 If the external equipment only has a mono audio output, it should be connected to the left (white) Audio connector.

### PC Connections

To use HDMI, connect the HDMI connector of the TileVision® to the HDMI connector on the PC using a HDMI cable.

To use PC RGB, connect the PC RGB connector of the TileVision® to the PC's RGB connector and connect the PC Audio In connector on the TileVision® to the PC's audio out connector.

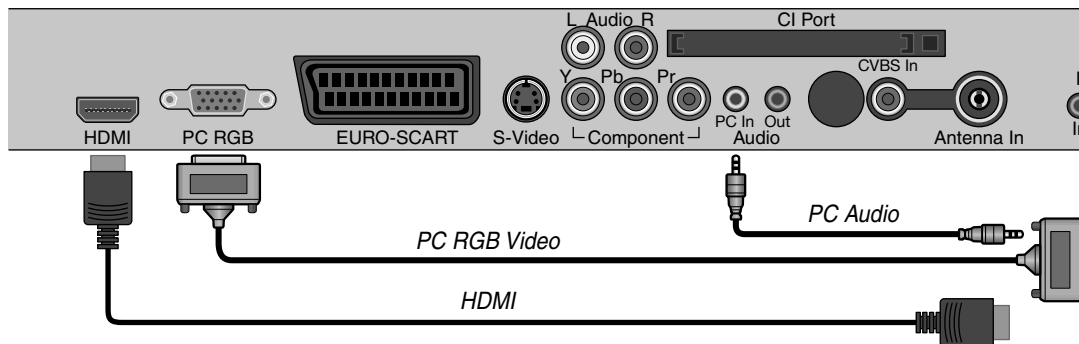

## The SCART Connector

All connections must be made before sealing the TileVision® into the back box.

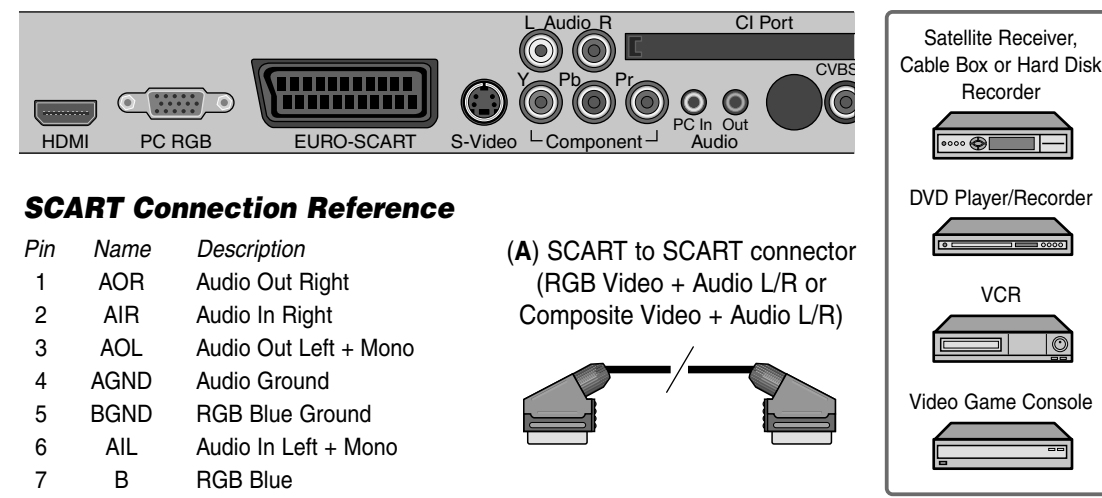

### SCART Connection Reference

Pin	Name	Description
1	AOR	Audio Out Right
2	AIR	Audio In Right
3	AOL	Audio Out Left + Mono
4	AGND	Audio Ground
5	BGND	RGB Blue Ground
6	AIL	Audio In Left + Mono
7	B	RGB Blue
8	SWTCH	Audio, RGB switch, 16:9
9	GGND	RGB Green Ground
10	CLKOUT	Clock Out
11	G	RGB Green
12	DATA	Data Out
13	RGND	RGB Red Ground
14	DATAGND	Data Ground
15	R	RGB Red
16	BLNK	Blanking Signal
17	VGND	Composite Video Ground
18	BLNKGND	Blanking Signal Ground
19	VOUT	Composite Video Out
20	VIN	Composite Video In
21	SHIELD	Chassis Ground, Cable Shield

(A) SCART to SCART connector (RGB Video + Audio L/R or Composite Video + Audio L/R)

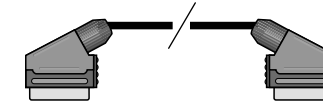

(B) SCART to RCA connectors (Composite Video + Audio L/R)



SCART Pinouts (solder side view)

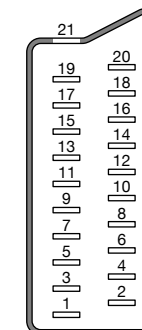

The EURO-SCART connector can be used with equipment which has RGB or composite video inputs and outputs. A VCR, satellite or cable receiver, DVD player, or video game console should be connected using the EURO-SCART connection.

- ◆ The EURO-SCART socket is fully wired as shown above.
- ◆ The audio output from the EURO-SCART can be connected to a separate amplifier to allow integration with a multi-room audio video system. This should be carried out by a qualified engineer.

## The IR Link, RJ12 and RS-232 Connectors

**All connections must be made before sealing the TileVision® into the back box.**

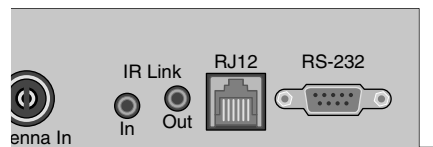

### IR Link In

The IR Link In socket enables the TileVision® to receive the IR code from external equipment or an IR receiver.



The plug for the IR In is a 'stereo' 3.5mm jack plug.

### IR Link Out

The IR Link Out socket enables the TileVision® to pass the IR code to external equipment or an IR emitter, via the IR receiver inside the TileVision®.



The plug for the IR Out is a 'mono' 3.5mm jack plug.

### The RJ12 Connector

The RJ12 connector enables the TileVision® to integrate with Interactive Hotel TV systems.

### The RS-232 Port

The RS-232 control port enables the TileVision® to be controlled from a home automation control system.

For detailed information on the IR Link, RJ12 and RS-232 connections and the relevant control signals see the **TileVision Interface Connections pdf** on the **TileVision®** web site ([www.tilevision.tv](http://www.tilevision.tv) – support – user support).

## Installing the TileVision® – Setup and Tuning

**Ensure that the TileVision® does not get wet until it is fully sealed.**

When the connections have been made as shown on pages 9 to 15 it is time to install the TileVision® into the back box.

Remove the soft adhesive protector from the top length of Velcro, and press the TileVision® into the back box. It may be found necessary to adjust the position of the cables in order to achieve a good fit.

The installation must comply with all relevant electrical safety regulations before the mains supply is turned on using the remote isolation switch. The TileVision® should now show a red indicator light showing that it is in standby mode. Ensure that the TileVision® does not get wet until it is fully sealed.

### Initial Tuning

Press the **POWER** (⏻) button on the remote control to switch the TileVision® on from standby. After a few seconds the **NEW INSTALLATION** menu will be displayed.

The on-screen menus can be in any of the following nine languages: English, Español, Français, Italiano, Nederlands, Polski, Português, Русский, and Deutsch.



- 1 Press the ◀▶ buttons to select the required menu language.
- 2 Press the ▼ button once to select **Auto Tuning** and display the Country selection window as shown on page 18.

If a Sky™ box is being used as a source it should be switched on before tuning the TileVision®. This will allow the TileVision® to tune to the Sky™ box correctly.

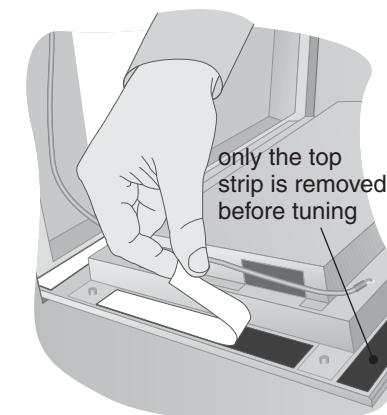

only the top strip is removed before tuning

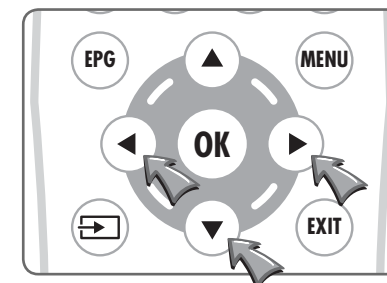

## Installing the TileVision® – Setup and Tuning

**Do not use a lever to remove the TileVision® as this will cause damage to the metalwork and invalidate the guarantee.**

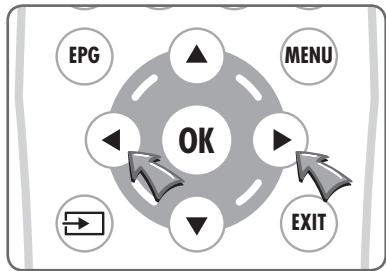

- 3** Select the required country with the ◀▶ buttons. Choose from: Australia, Austria, Belgium, Bulgaria, Croatia, Czech, Denmark, Finland, France, Germany, Greece, Hungary, Italy, Luxembourg, Netherlands, Norway, Poland, Portugal, Romania, Russia, Serbia, Slovenia, Spain, Sweden, Switzerland, UK.



- 4** Press the ▼ button to select **Start**.

- 5** Press the **OK** (OK) button to start the auto tuning.

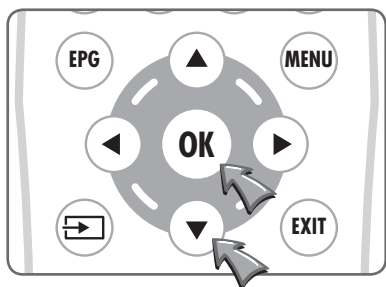

The Channel Tuning dialogue will be displayed to show the progress of the tuning.

When tuning is complete the Channel Tuning dialogue will be cleared and the first available channel will be selected.

If additional sources are being used with the TileVision® their operation should now be checked (see input selection on page 23).

If a CAM is installed make sure it is activated and fully functional as per its service provider's instructions.

Once the unit is tuned and external inputs are working correctly, press the **POWER** (⏻) button on the remote control to put the unit into standby and isolate the unit using the remote isolation switch.

Gently remove the TileVision® using a suction lifter. Next, remove the self-adhesive protectors from the side and bottom Velcro strips and press the TileVision® into the back box with reasonable force. Take care to apply force to all four sides of the TileVision®. Restore mains power using the remote isolation switch and press the **POWER** (⏻) button on the remote control to turn the unit on again and check that it is still working correctly.

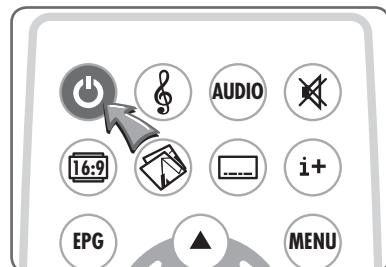

## Installing the TileVision® – Sealing

**Note: It is the installer's responsibility to ensure that the TileVision® is installed and sealed correctly, failure to do so will invalidate the guarantee.**

### Sealing the TileVision®

When correct function has been confirmed, switch the TileVision® to standby and set the isolation switch to off. Apply clear silicone sealant to the joint between the sides of the back box and the sides of the TileVision®. Ensure that the sealant is worked into the space evenly and is applied without any gaps, bubbles or voids. Wipe any excess sealant away and check for any imperfections. Rectify any errors as necessary.

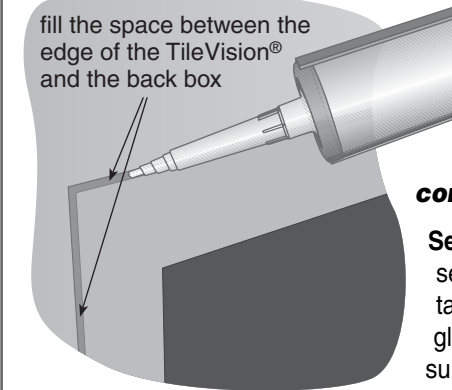

**This seal is essential for the reliable and safe operation of the TileVision® and must be completely waterproof.**

**Sealing Tip:** To achieve a neat seal apply lengths of masking tape around the TileVision® glass screen and the surrounding tiles. Leave sufficient gap to apply the sealant

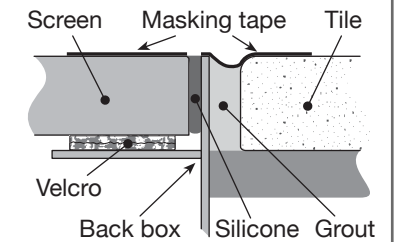

around the joint between the sides of the back box and TileVision®. Once the sealant has set and the masking tape removed the acrylic surround can be fitted as shown below.

### Fitting the mirrored acrylic surround

The mirrored acrylic surround is a cosmetic addition and has no bearing on the integrity of the waterproof seal of the TileVision®.

If the surround is being fitted to the TileVision®, the same silicone sealant used to seal the screen into the back box can be used to fasten the surround to the wall.

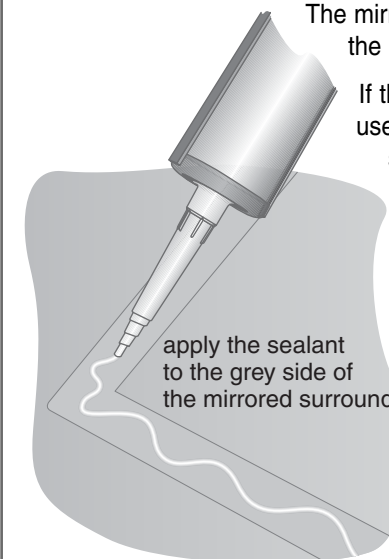

Lay the surround on a flat surface and apply the sealant to the matt grey surface as shown. Once the sealant has been applied, align the surround with the TileVision® using a spirit level as a guide and press the surround firmly to the wall.

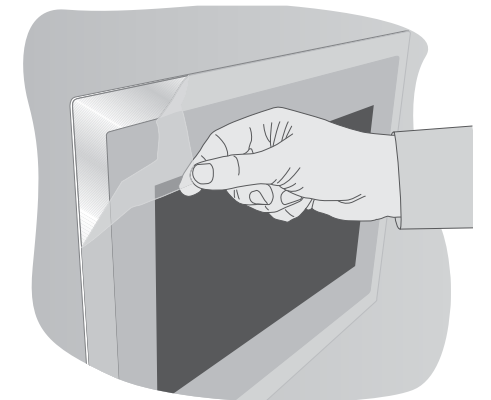

After the sealant has set the protective film can be removed from the front of the surround.

### Cleaning Instructions

**To clean the glass and surround, use only a soft damp cloth. Under no circumstances are abrasive cleaners to be used, failure to observe this warning will invalidate the guarantee.**

## The Waterproof Remote Control

Where buttons have different functions in DTV mode than they have in ATV mode, (D) denotes DTV mode functions and (A) denotes ATV functions.

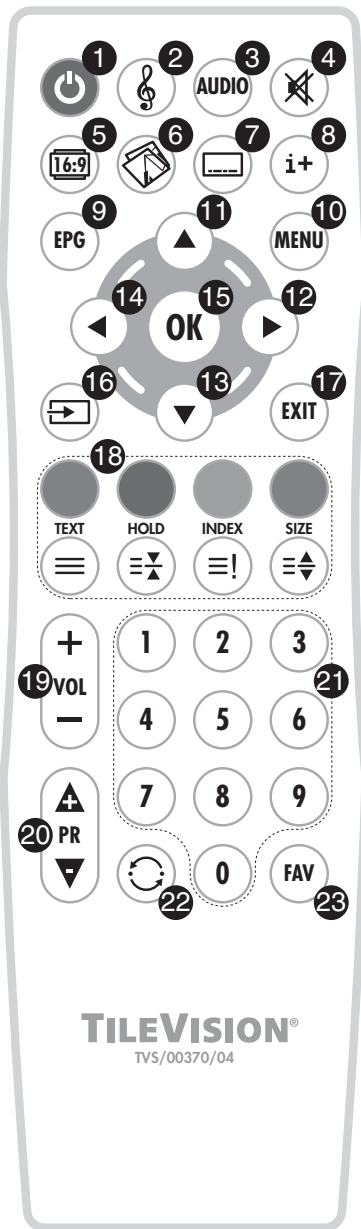

Make sure there are no objects between the remote control and the TileVision®.

Do not place the remote control near a heater.

A strong blow to the remote control may cause it not to operate.

- 1 **Power On/Off button** – Turns the TileVision® on from, or off to, standby – *page 22*
- 2 **Sound Mode button** – Switches between sound modes: Standard, Personal, Sports, Movie, Music – *page 40*
- 3 **AUDIO button** – (D) Selects language for dual language broadcasts – *page 42*
- 4 **Sound Mute button** – Turns the sound on or off – *page 34*
- 5 **Aspect Ratio button** – Switches between picture formats: Auto, 16:9, 4:3, Zoom1, Zoom2 – *page 38*
- 6 **Picture Mode button** – Switches between picture modes: Standard, Movie, Dynamic, Personal, Soft – *page 36*
- 7 **Subtitles button** – Switches subtitles on or off – *page 39*
- 8 **Information button** – (D) Displays channel and programme information – (A) Displays channel information only – *page 31*
- 9 **EPG button** (D) – Displays the Electronic Programme Guide – *page 32*
- 10 **MENU button** – Displays or closes the menus
- 11 **Up button** – Menu and EPG navigation
- 12 **Right button** – Menu and EPG navigation
- 13 **Down button** – Menu and EPG navigation
- 14 **Left button** – Menu and EPG navigation
- 15 **OK button** – Accepts menu selections or displays the programme list – *page 30*
- 16 **Input Source button** – Displays the Input Source menu and allows source selection: DTV, ATV, SCART, COMPONENT, PC-RGB, HDMI, COMPOSITE, S-Video – *page 23*
- 17 **EXIT button** – Closes all on-screen menus and lists
- 18 **Colour and Teletext buttons** – (D) DTV Text and text menu options – (A) Teletext and FastText functions – *see page 51 for Teletext functions*
- 19 **VOL (Volume up/down) buttons** – Adjust the volume
- 20 **PR (Programme up/down) buttons** – Selects next or previous programme
- 21 **Number buttons** – Input programme numbers – (D) DTVText menu options – (A) Teletext page number input
- 22 **Back button** – switches between last and current programmes
- 23 **FAV button** – Displays or closes the favourite programme list.

## The Standard Remote Control

Where buttons have different functions in DTV mode than they have in ATV mode, (D) denotes DTV mode functions and (A) denotes ATV functions.

- 1 **POWER On/Off button** – Turns the TileVision® on from, or off to, standby – *page 22*
- 2 **MUTE button** – Turns the sound on or off – *page 40*
- 3 **Number buttons** – Input programme numbers – (D) DTVText menu options – (A) Teletext page number input
- 4 **NICAM button** – (A) Stereo/Mono
- 5 **TV/RADIO button** – (D) switches between DTV and Radio
- 6 **MENU button** – Displays or closes the menus
- 7 **INPUT button** – Displays the Input Source menu and allows source selection: DTV, ATV, SCART, etc. – *page 23*
- 8 **Up button** – Menu and EPG navigation
- 9 **Right button** – Menu and EPG navigation
- 10 **Down button** – Menu and EPG navigation
- 11 **Left button** – Menu and EPG navigation
- 12 **ENTER button** – Accepts menu selections or displays the programme list – *page 30*
- 13 **RETURN button** – switches between last and current programmes
- 14 **EXIT button** – Closes all on-screen menus and lists
- 15 **VOL (Volume up/down) buttons** – Adjust the volume
- 16 **CH (Channel up/down) buttons** – Selects next or previous channel
- 17 **Sound Mode button** – Switches between sound modes: Standard, Personal, Sports, Movie, Music – *page 40*
- 18 **PC button** – Switches between picture modes: Standard, Dynamic, Personal, Movie – *page 36*
- 19 **SLEEP button** – Displays/sets the sleep timer
- 20 **ASPECT button** – Switches between picture formats: Auto, 16:9, 4:3, Zoom1, Zoom2 – *page 38*
- 21 **AUTO button** – No function on TileVision® TV26
- 22 **SRS button** – No function on TileVision® TV26
- 23 **TEXT button** – switches DTV Text or Teletext on or off
- 24 **INFO button** – (D) Displays channel and programme information – (A) Displays channel information only – *page 31*
- 25 **FAV button** – Displays or closes the favourite programme list
- 26 **EPG button** – (D) Displays the Electronic Programme Guide – *page 32*
- 27 **Colour and Teletext buttons** – (D) DTV Text and text menu options – (A) Teletext and FastText functions – *see page 51 for Teletext functions*
- 28 **AUDIO button** – (D) Selects language for dual language broadcasts – *page 49*
- 29 **SUBTITLE button** – Switches subtitles on or off – *page 39*.



The standard remote control is not waterproof and should not be splashed or immersed in water.

## Switching the TileVision® On/Off

Please allow a minimum of five seconds after switching the TileVision® off before switching it on again.

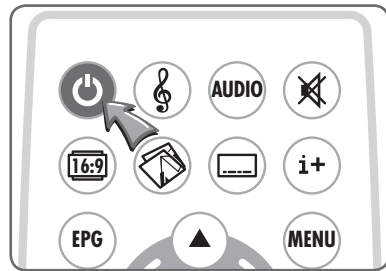

- 1 To switch the TileVision® on, press the **POWER** (⏻) button.  
The LED indicator will show green and TileVision® will display a picture within ten seconds.
- 2 To switch the TileVision® to standby, press the **POWER** (⏻) button again. The LED indicator will show red to indicate that the TileVision® is in standby mode

## Selecting the On-screen Language

English is the preset language for the TileVision®. The language for on-screen menus can be selected during initial set-up or at any time in the future.

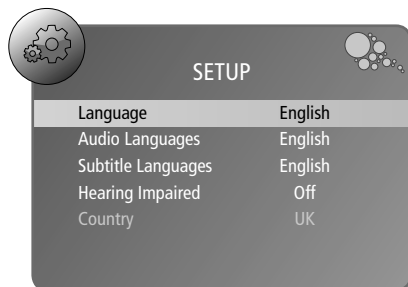
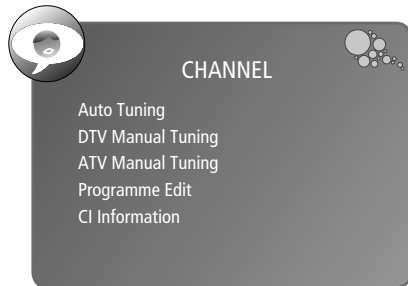
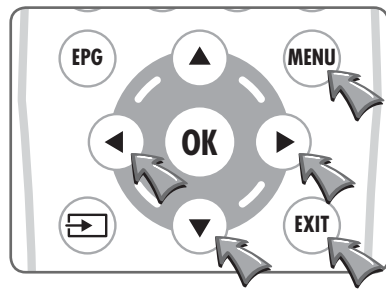

The on-screen menus can be in any of the following nine languages: English, Español, Françes, Italiano, Nederlands, Polski, Portugês, Русский, and Deutsch.

To change the language used follow the sequence below:

- 1 Press the **MENU** (MENU) button to display the **Channel** menu.
- 2 Press the ◀ button twice to display the **SETUP** menu.
- 3 Press the ▼ button once to select **Language**.
- 4 Press the ◀▶ buttons to select the required language.
- 5 Press the **EXIT** (EXIT) button once or the **MENU** (MENU) button twice to save the language choice and close the **SETUP** menu.

All the on-screen displays will now be in the chosen language.

**The selected language applies to both DTV and ATV modes**

## Selecting a Source

If external sources have been connected to the TileVision® they may be viewed by selecting the appropriate input.

The Input Source list allows selection of the following: DTV (Digital Television), ATV (Analogue Television), SCART, COMPONENT (Y, Pb, Pr), PC-RGB, HDMI, COMPOSITE, and S-Video.

- 1 Press the **POWER** (⏻) button to switch the TileVision® on.
- 2 Press the **Input** (Input icon) button to display the **Input Source** list.
- 3 Press the **Input** (Input icon) button or the ▲▼ buttons until the required source is selected.

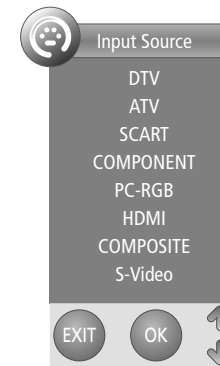

- 4 Press the **OK** (OK) button to confirm selection of the chosen input and to clear the Input Source list from the screen.

Press the **EXIT** (EXIT) button to close the Input Source list without selecting an alternative source.

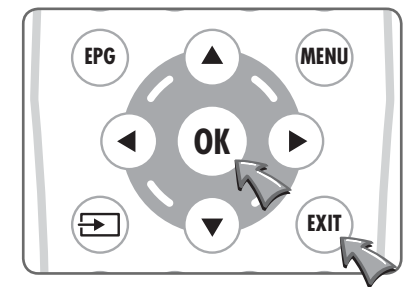
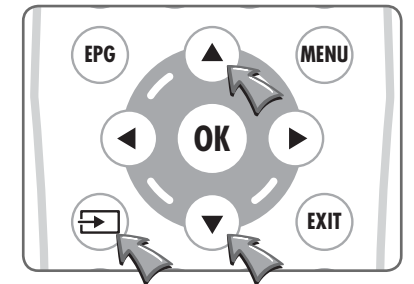
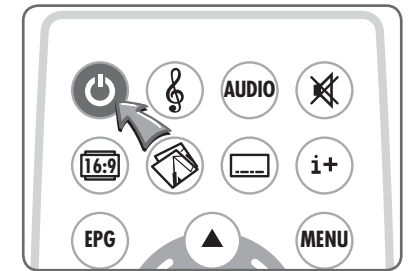

## On-screen Menu Summary

The CHANNEL menu is the default menu if the menu button is pressed whilst watching DTV or ATV – the PICTURE menu is the default menu at all other times.

**CHANNEL**

- Auto Tuning
- DTV Manual Tuning
- ATV Manual Tuning
- Program Edit
- CI Information

**PICTURE**

Picture Mode Standard

Contrast 80

Brightness 50

Colour 50

Sharpness 65

Tint 0

**PICTURE**

Color Temperature Medium

Red 43

Green 50

Blue 60

Aspect Ratio Auto

Noise Reduction Auto

**SOUND**

Sound Mode Standard

Treble 50

Bass 50

Balance 0

Auto Volume Off

Surround Sound Off

**TIME**

Clock -- -- --

Off Time Off

On Time Off

Sleep Timer Off

Auto Sleep Off

Time Zone London GMT

**OPTION**

Language English

Audio Languages English

Subtitle Languages English

Hearing Impaired Off

Country UK

**LOCK**

Lock System Off

Set Password

Block Programme

Parental Guidance Off

Restore Factory Default

**1** Press the **MENU** (MENU) button to display the Channel menu.

**2** Press the **◀▶** buttons to select alternative menus.

**3** Press **▲▼** buttons to select menu items.

**4** Press **◀▶** buttons to alter a select menu item.

**5** Press **EXIT** (EXIT) to save settings and exit the menus.

To move between the two Picture menus press the **▲▼** buttons until the required menu is displayed.

The **EXIT**, **MENU**, **OK** and **Arrow** prompts are common to all seven menus and have not been included on the following pages.

## Auto Tuning

**Note:** It is recommended that Auto Tuning is used when installing the TileVision® as all available digital and analogue programmes will be stored.

### Auto Tuning

- 1 Press the **MENU** (MENU) button to display the **CHANNEL** menu.
- 2 Press the **▼** button to select the **Auto Tuning** and then press the **▶** or **OK** (OK) button.

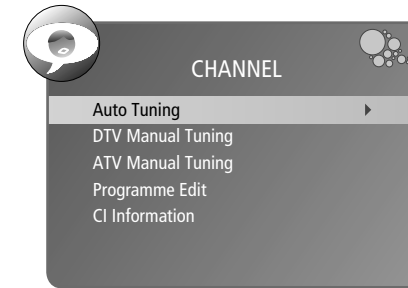

- 3 Select the required country with the **◀▶** buttons. Choose from: Australia, Austria, Belgium, Bulgaria, Croatia, Czech, Denmark, Finland, France, Germany, Greece, Hungary, Italy, Luxembourg, Netherlands, Norway, Poland, Portugal, Romania, Russia, Serbia, Slovenia, Spain, Sweden, Switzerland, UK.

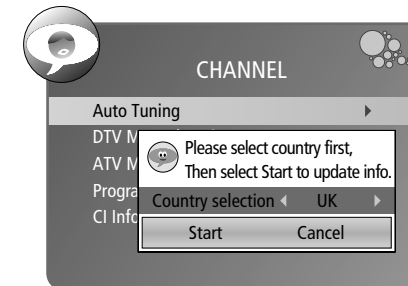

- 4 Press the **▼** button to select **Start**.
- 5 Press the **OK** (OK) button to start the auto tuning.



The Channel Tuning dialogue will be displayed to show the progress of the tuning.

When tuning is complete the Channel Tuning dialogue will be cleared and, the first available, TV channel will be selected.

To delete, skip, move or name the stored programmes see **Programme Edit**, on page 28.

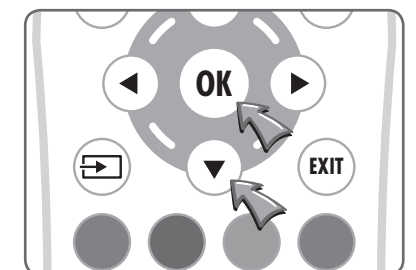
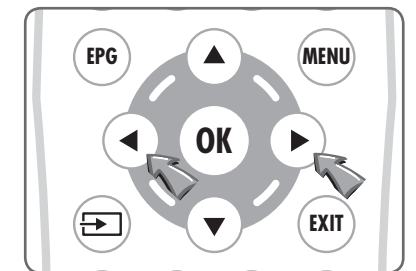
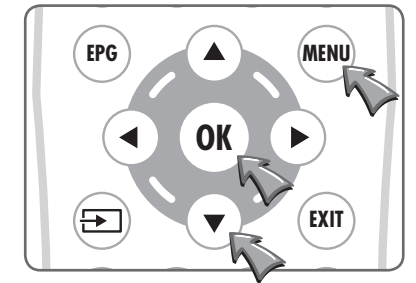

## DTV Manual Tuning

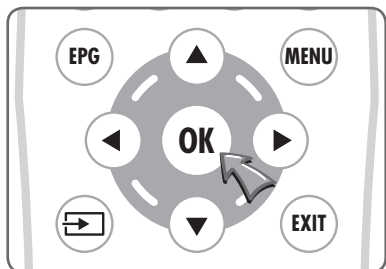
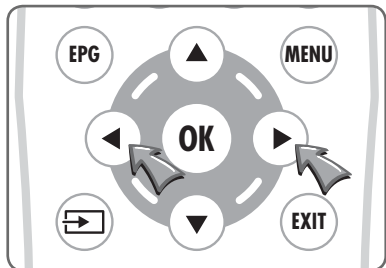
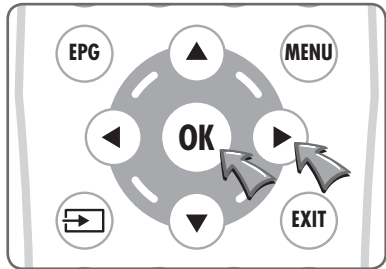
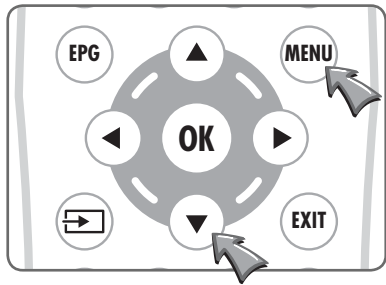

### Digital Television Manual Tuning

**1** Press the **MENU** (MENU) button to display the **CHANNEL** menu and press the **▼** button twice to select the **DTV Manual Tuning**.

**2** Press the **▶** or **OK** (OK) button.

**3** Select the required channel (UHF 21–69) with the **◀▶** buttons.

The DTV Manual Tuning menu will show if a signal is being received on the selected channel.

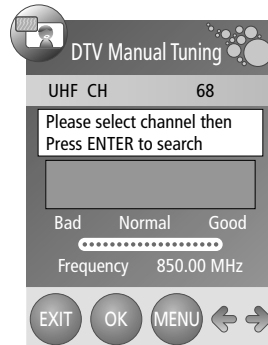

*Good Signal on the selected channel – OK to tune.*



*No Signal on the selected channel – Do not tune.*

**4** If there is a signal on the required channel press the **OK** (OK) button to start tuning the stations on the selected channel.

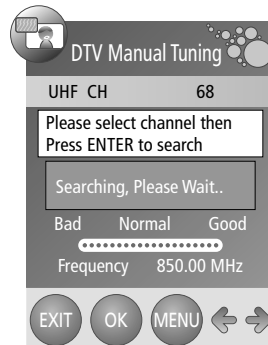

The TileVision® will confirm that it is searching for channels.

After a short time the dialogue will show the number of DTV and Radio programmes that have been tuned.

When the dialogue clears, the newly tuned station with the lowest number will be shown.

To tune additional programmes repeat steps 1 to 4.

## ATV Manual Tuning

### Analogue Television Manual Tuning

**1** Press the **MENU** (MENU) button to display the **CHANNEL** menu.

**2** Press the **▼** button three times to select the **ATV Manual Tuning** and then press the **▶** or **OK** (OK) button.

**3** Use the **◀▶** buttons to select which programme to tune.

**4** Press the **▼** button to select **System**.

**5** Select a **System** with the **◀▶** buttons:

**BG:** Western Europe/Asia/Middle East/Africa/Australia

**I:** UK/Hong Kong/South Africa

**DK:** Russia/China/Eastern Europe

**L:** France.



*The ATV Manual Tuning dialogue.*



*Search in progress.*

**6** Press the **▼** button twice to select **Search** and then press the **◀** or **▶** button to choose the search direction.

The search will stop when the next available station has been tuned. To tune an alternative station press the **◀** or **▶** button to continue searching.

If necessary select **Fine-Tune** and adjust the tuning with the **◀▶** buttons to improve the picture or sound.

**7** Press the **Red** button to save the settings and press the **EXIT** (EXIT) button to close the Manual Tuning window.

**☛ If Skip is selected for a programme it is skipped past with the PR+ (▲) or RP- (▼) buttons. A skipped programme is included in the Channel List and can be selected in the normal way or by entering the channel number directly.**

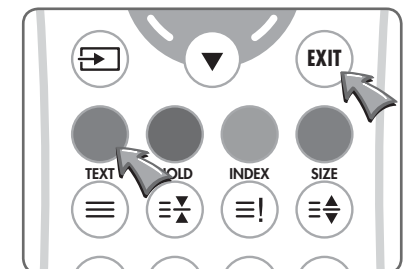
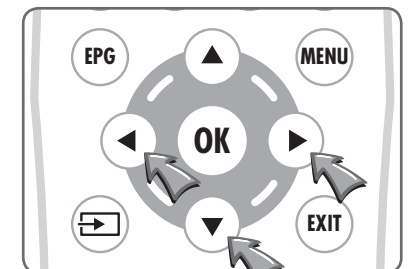
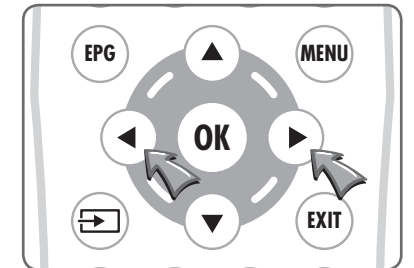
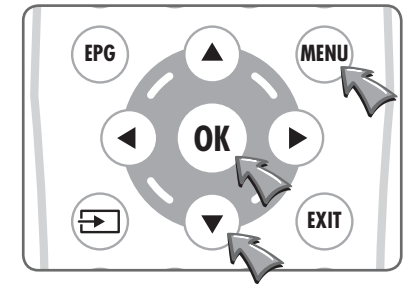

## Programme Edit

**Deleted programme can only be restored by retuning the TileVision® using Auto or Manual Tuning. Setting SKIP for unwanted programmes is usually a better option.**

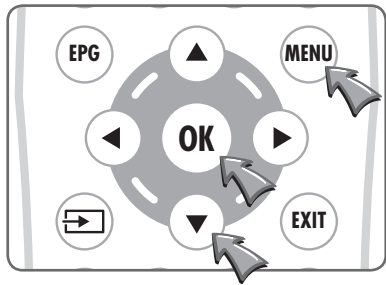

The DTV Programme Edit list.

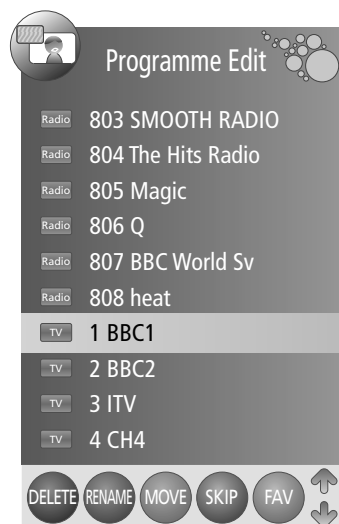

The ATV Programme Edit list.

Programme Edit allows programmes to be deleted, skipped or selected as favourites.

Deleted programmes are removed completely and are not available at all until the TileVision® is retuned using Auto or Manual Tuning.

Skipped programmes are not available by pressing the **PR+** (▲) or the **PR-** (▼) buttons but they can be selected from the EPG, the channel list or by entering a channel number directly.

Favourite programmes are included in the Favourite List which can be displayed by pressing the **FAV** (FAV) button.

### Programme Edit in DTV Mode

- 1 Press the **MENU** (MENU) button to display the **CHANNEL** menu.
- 2 Press the ▼ button four times to select **Programme Edit** and then press the ► or **OK** (OK) button.
- 3 Select a programme with the ▲▼ buttons and press the **Red** button to delete the programme completely and make it unavailable until the TileVision® is retuned.

Press the **Blue** button to select to skip past the programme when using the **PR+** (▲) or **PR-** (▼) buttons to change channel.

Press the **FAV** (FAV) button to include the programme in the favourites list or to remove a programme from the favourites list.

- 4 Press the **EXIT** (EXIT) button to close the Programme Edit dialogue and save settings.

### Programme Edit in ATV Mode

- 1 Press the **MENU** (MENU) button to display the **CHANNEL** menu.
- 2 Press the ▼ button four times to select **Programme Edit** and then press the ► or **OK** (OK) button.
- 3 Select a programme with the ▲▼ buttons and press the **Red** button to delete the programme completely and make it unavailable until the TileVision® is retuned.

Press the **Blue** button to select to skip past the programme when changing channel with the **PR+** (▲) or **PR-** (▼) buttons.

Press the **Green** button to edit a programme's name using the ◀▶ buttons to select the character to edit and the ▲▼ buttons to change the character displayed.

Press the **Yellow** button to allow a programme to be moved to a different position in the channel list by using the ▲▼ buttons.

- 4 Press the **EXIT** (EXIT) button to close the Programme Edit dialogue and save settings.

## CI Information

If a Conditional Access Module (CAM) is installed CI information is available via the CHANNEL menu as follows:

- 1 Press the **MENU** (MENU) button to display the **CHANNEL** menu.
- 2 Press the ▼ button five times to select **CI Information** and then press the ► or **OK** (OK) button.

If no CAM is installed in the TileVision®, the message 'Please insert CI Module' will be displayed.

With a CAM installed the message 'Loading CI MMI...' will be displayed whilst the TileVision® accesses the information from the CAM and viewing card.

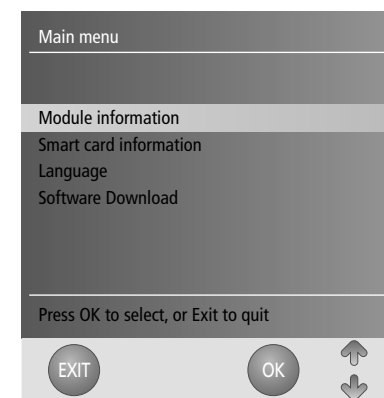

When the Main menu is displayed, press the ▲▼ buttons to select a menu option and press the **OK** (OK) button to view the available information.

Press the **EXIT** (EXIT) or **OK** (OK) button to close the menu.

**Module information** typically includes: Serial number (the 14 digit number on the rear of the CAM), SAP number, Manufacturer, SW version, FW version, Mediaguard version and Download ID.

**Smart card information** typically includes: Serial number, Account date and Admin date.

The **Language** option allows a language to be chosen from those available for the purchased subscription services.

**Software Download** allows update of the software and/or firmware in the CAM.

After using any of the above options press the **EXIT** (EXIT) or **MENU** (MENU) button to return to the Main menu (shown above) and press the **EXIT** (EXIT) or **MENU** (MENU) button to close the Main menu.

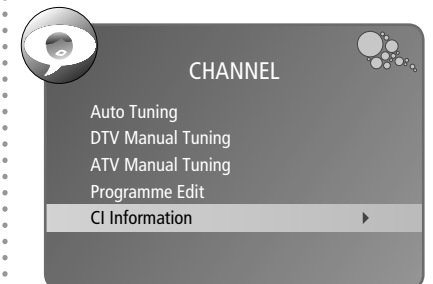
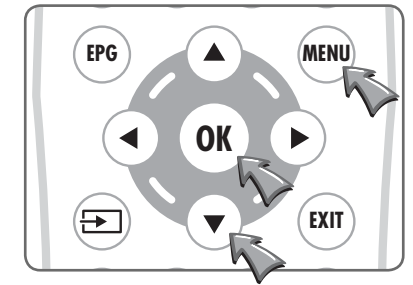



## Changing Channels

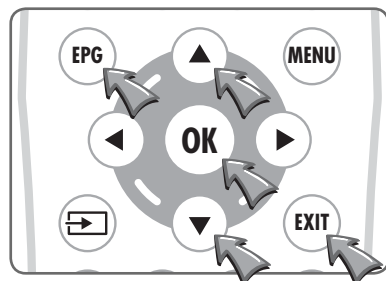
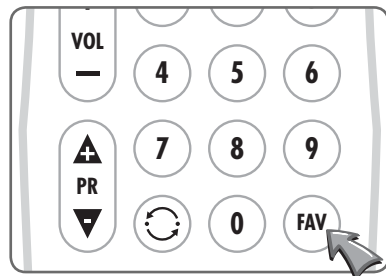
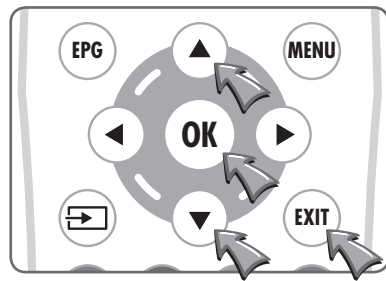
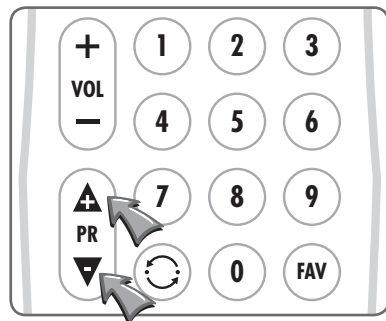

Press the **BACK** (⏪) button to switch between the current and last programme that was viewed.

There are five ways to change to a new channel on the TileVision®:

1. Enter the programme number directly by pressing the number keys. When choosing a programme from 1–9 there is no need to press the 0 key first.
2. Press the **PR +** (▲) or **PR -** (▼) buttons to switch from programme to programme in sequence.

3. Press the **OK** (OK) button to display the Channel List. When the list is displayed use the ▲▼ buttons to select a programme and press the **OK** (OK) button to switch to the selected programme.

The **PR +** (▲) or **PR -** (▼) buttons can be used to move up or down one page at a time.

The Channel List will continue to be displayed for a few seconds or until the **EXIT** (EXIT) button is pressed.

4. Press the **FAV** (FAV) button to display the Favourite List. When the list is displayed use the ▲▼ buttons to select a programme and press the **OK** (OK) button to switch to the selected programme. To edit the Favourite Programme list see page 28.

The Favourite List will continue to be displayed for a few seconds or until the **EXIT** (EXIT) button is pressed.

5. When watching DTV press the **EPG** (EPG) button to display the Electronic Programme Guide.

PROGRAMME GUIDE		DTV 2 BBC TWO	
21 Aug 2008 10:33		10:00 - 11:00 Cash in the Attic	
21 Aug			
DTV	10:30	11:30	
1 BBC ONE	Olympics 2008	BBC News	North ...
2 BBC TWO	Cash in the Attic	Olympics 2008	Diagnosis Murder
3 ITV1	This Morning		60 Minute Makeover
4 Channel 4	T4: Bea..	T4: Vo..	News at Noon
5 Five	Michaela's Zoo Babies		Five Ne... House
6 ITV2	Airline	Coronation Street	Emmerdale
			Airline USA

When the Programme Guide is displayed use the ▲▼ buttons to select a programme and press the **OK** (OK) button to select the chosen programme. Press the **Red** button for page down and the **Green** button for page up.

Press the **EPG** (EPG) or **EXIT** (EXIT) button to close the EPG.

## Programme Information

### Basic DTV Programme Information

The channel number, channel name and signal information are always displayed on screen for a few seconds whenever switching from one channel to another.

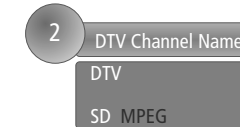

### Basic ATV Programme Information

The channel number, channel name and signal information are always displayed on screen for a few seconds whenever switching from one channel to another.



Because detailed information is not broadcast on analogue television, pressing the **INFO** (i+) button will display the same information as is shown when changing channel.

### Detailed DTV Programme Information

More detailed information about the current programme can be seen at any time by pressing the **INFO** (i+) button.

Press the **INFO** (i+) button again to clear the information banner from the screen.

Programme Title	11:34
Thr, Aug 21 2008	09:30 10:00
Next	Next
Subtitle	English MHEG5 576i
Programme Classification	
The broadcaster's information on the selected programme . . .	

The information contained in the banner is as follows:

- Line 1 the programme title and the current time.
- Line 2 the date and the start and end times of the programme.
- Line 3 the availability of subtitles, the audio language, the availability of MHEG digital text, and the video mode (576i denotes standard resolution).

To view the information on the next programme press the ► button.

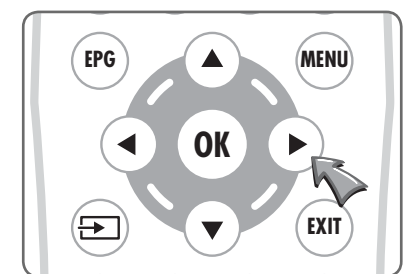
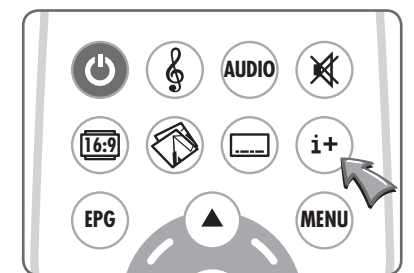
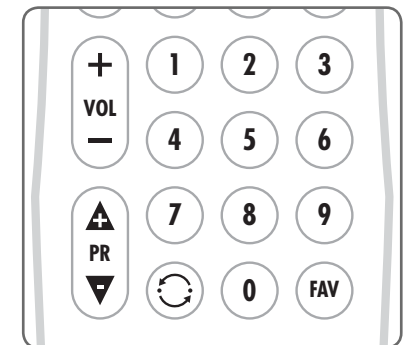

## The Electronic Programme Guide (EPG)

### Viewing the EPG

The EPG information is provided by the broadcasters.

Programme entries may appear blank or out of date as a result of the information broadcast on a given channel. The display will dynamically update as soon as new information becomes available.

EPG information can be viewed at any time when watching digital programmes.

- 1 Press the **EPG** (EPG) button to display the Electronic Programme Guide.

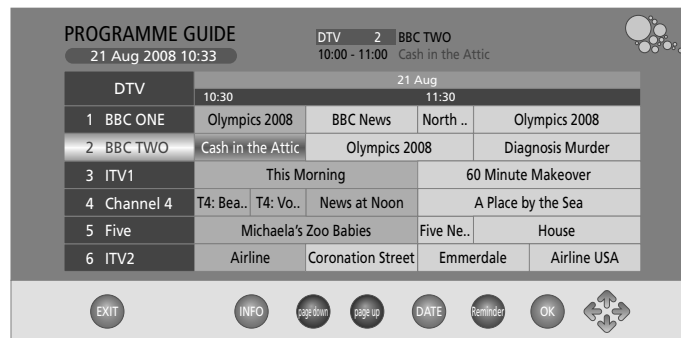

- 2 Use the ▲▼◀▶ buttons to move the highlight around the EPG and use the Red and Green buttons to move down or up one page at a time.
- 3 Press the **OK** (OK) button to select the currently highlighted channel.
- 4 Press the **EPG** (EPG) or **EXIT** (EXIT) button to close the EPG.

Detailed programme information is available without closing the EPG by pressing the **INFO** (i+) button.

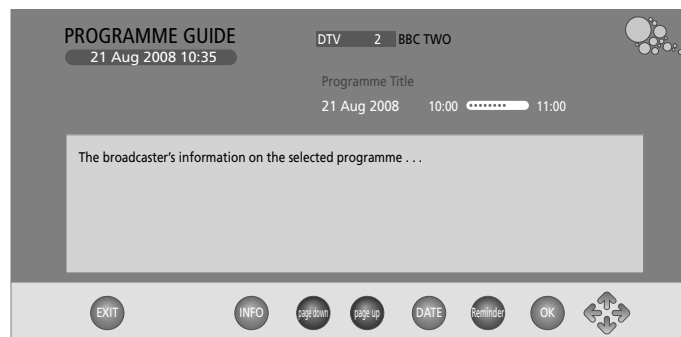

To return to the EPG press the **INFO** (i+) button again.

## EPG Date and Programme Reminders

The EPG can show programmes up to seven days ahead and reminders can be saved to make the TileVision® switch channel so that a chosen programme can be viewed.

Date, Reminder and Schedule options are available by pressing the Yellow, Blue and Green coloured buttons.

- 1 Press the **Yellow** button to select and highlight the Date cell on the EPG.
- 2 Press the ◀▶ buttons to choose a date up to seven days ahead.

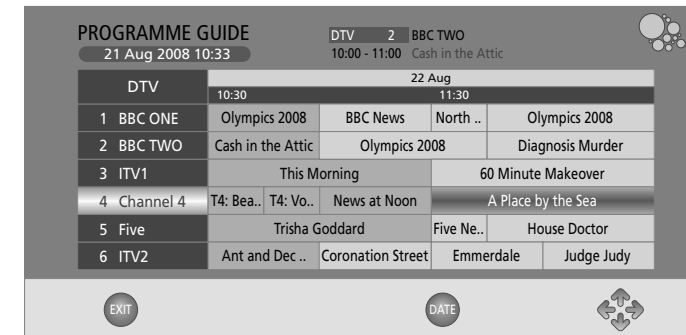

- 3 Once the required date is displayed press the **Yellow** or ▼ button to exit the Date cell.



The EPG now shows two dates, today's date and time is shown above the channel list, with the date of the listed programmes shown in the Date cell.

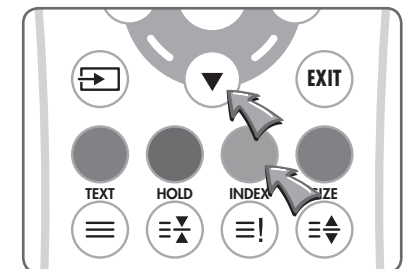
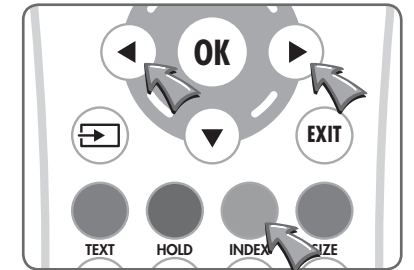

## Setting Programme Reminders

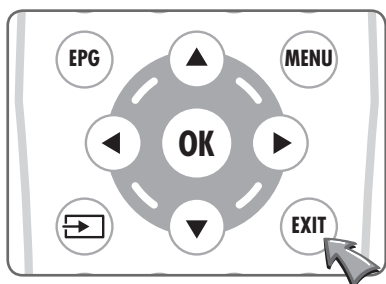
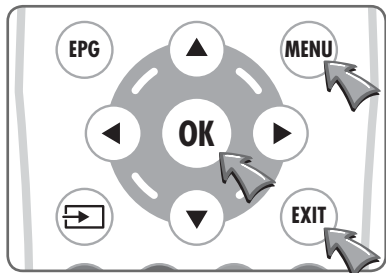
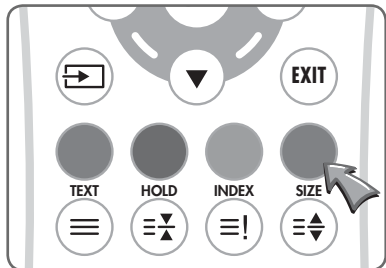
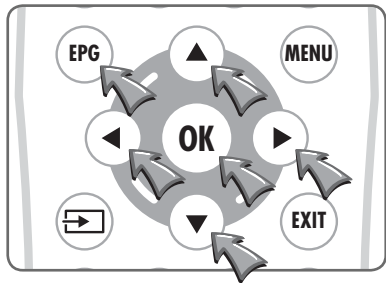

Programme reminders make the TileVision® switch to a chosen channel at a preset time. Reminders can be saved for any programme which has not started. They can be set to work once, repeat every day, or repeat every week.

To set a reminder:

- 1 Open the EPG and highlight a programme of interest which has not started.

- 2 Press the **Blue** button to open the **Reminder** dialogue.



- 3 To cancel setting the reminder and return to the EPG press the **MENU** (MENU) button, or to cancel setting the reminder and return to the television programme press the **EXIT** (EXIT) button.

If the reminder is to repeat, either daily or weekly proceed to step 5 on the next page.

If the reminder is to be set for a single event press the **OK** (OK) button and the Schedule List will be displayed with the new reminder added to the list.



- 4 Press the **EXIT** (EXIT) button to close the Schedule List and return to the television programme.

## Setting Programme Reminders

- 5 To change the mode and make the reminder repeat, press the **▲▼** buttons until **Mode** is selected and press the **◀▶** buttons to select as below.

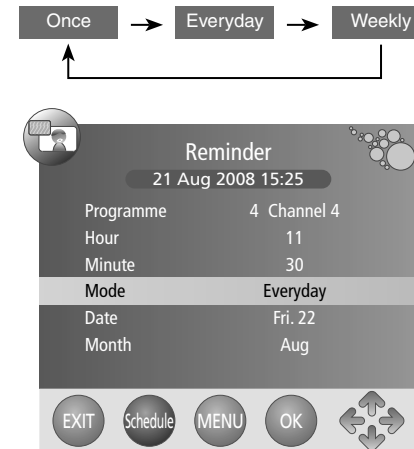

- 6 Press the **OK** (OK) button to save the reminder, press the **MENU** (MENU) button to cancel setting the reminder and return to the EPG, or press the **EXIT** (EXIT) button to cancel setting the reminder and return to the television programme.

To view the Schedule List without saving the current reminder press the **Green** button.

### The Schedule List

The Schedule List can be displayed for checking or editing from the Reminder dialogue by pressing the **Green** button.



To delete a programme from the Schedule List:

- 1 Select the programme with the **▲▼** buttons.
- 2 Press the **Red** button to delete the programme.
- 3 Press the **EXIT** (EXIT) button to close the Schedule List.

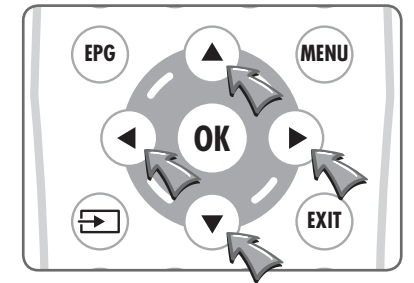

Any data in the reminder can be changed by selecting the appropriate line with the **▲▼** keys and altering the setting with the **◀▶** keys.

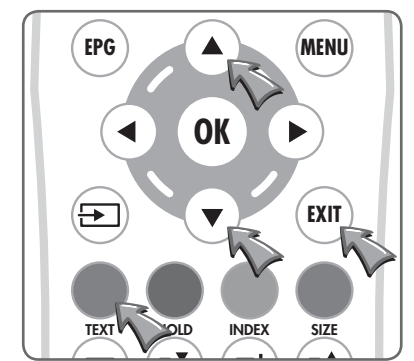
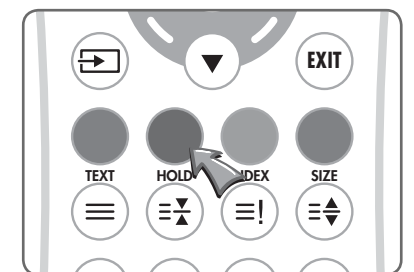
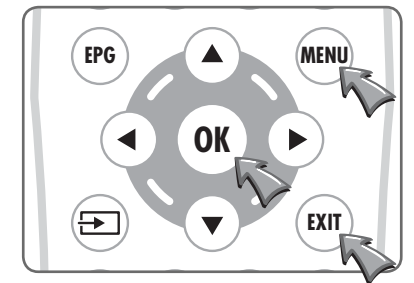

## Picture Settings

The Picture Mode setting is independently adjustable for each input. For example, DTV can be set to Personal and the HDMI input can be set to Movie for DVD playback.

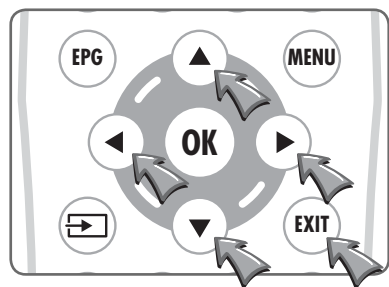
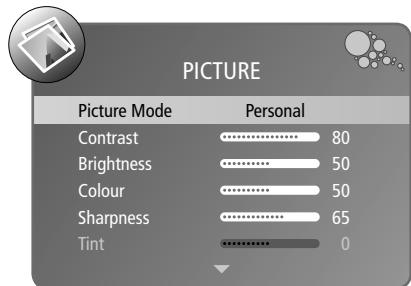
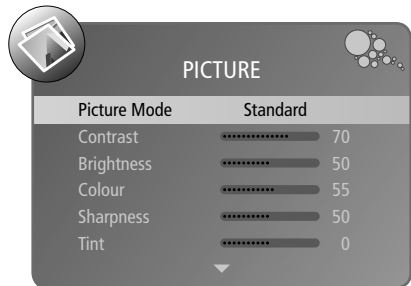
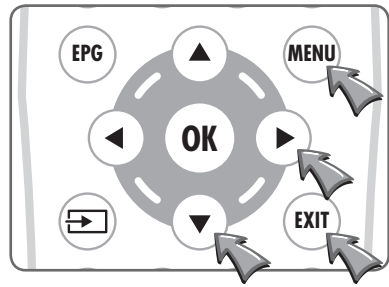

### Setting the Picture Mode

Four preset picture modes can be selected or, using the Personal option, the Contrast, Brightness, Colour Intensity and Sharpness can be set to preferred levels.

- 1 Press the **MENU** (MENU) button.
- 2 Press the **▶** button to select the first **PICTURE** menu and then press the **▼** button once to select **Picture Mode**.
- 3 Press the **◀▶** buttons to select any of the different modes as shown below.

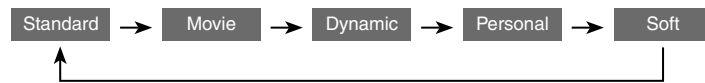

- 4 Press the **EXIT** (EXIT) button once or the **MENU** (MENU) button twice to save the settings and close the PICTURE menu.

### Personal Picture Mode

Contrast, Brightness, Colour and Sharpness can only be adjusted in Personal Picture Mode. Adjustments can be made as follows:

- 1 Press the **MENU** (MENU) button.
- 2 Press the **▶** button to select the first **PICTURE** menu, press the **▼** button once to select **Picture Mode** and press the **◀** or **▶** button until **Personal** is selected.
- 3 Press the **▼▲** buttons to select Contrast, Brightness, Colour or Sharpness and press **◀** or **▶** to adjust the selected item.

Adjustments are made with the PICTURE menu hidden so that most of the picture is visible. Only the item being adjusted is shown on the screen.



- 4 Press **▲▼** to select the item to be adjusted and press the **◀▶** buttons make adjustments.

When all the settings are as required press the **EXIT** (EXIT) button to save the settings and close the adjustment dialogue. Press the **OK** (OK) button to return to the PICTURE menu.

The Tint adjustment does not apply to TileVision®.

**The Picture Mode can be changed whilst watching a programme. Press the Picture (PICTURE) button to sequence through the five modes.**

## Picture Settings

The Colour Temperature can be set independently for each input. For example, DTV can be set to Normal and the HDMI input can be set to Personal for DVD playback.

### Setting the Colour Temperature

Three preset colour temperature settings can be selected or, using the Personal option, the mix of Red, Green and Blue can be set to preferred levels.

- 1 Press the **MENU** (MENU) button.
- 2 Press the **▶** button to select the first **PICTURE** menu and then press the **▼** button until the second **PICTURE** menu is displayed and **Colour Temperature** is selected.
- 3 Press the **◀▶** buttons to select any of the four settings as shown below.

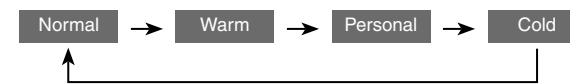

- 4 Press the **EXIT** (EXIT) button once or the **MENU** (MENU) button twice to save the settings and close the PICTURE menu.

### Personal Colour Temperature

The levels of Red, Green and Blue can only be adjusted when using Personal Colour Temperature. Adjustments can be made as follows:

- 1 Press the **MENU** (MENU) button.
- 2 Press the **▶** button to select the first **PICTURE** menu and then press the **▼** button until the second **PICTURE** menu is displayed and **Colour Temperature** is selected.
- 3 Press the **◀** or **▶** button until **Personal** is selected.
- 4 Press the **▼▲** buttons to select Red, Green, or Blue and press **◀** or **▶** to adjust the selected item.

Adjustments are made with the PICTURE menu hidden so that most of the picture is visible. Only the item being adjusted is shown on the screen.



- 5 Press the **▼▲** buttons to select Red, Green, or Blue and press **◀** or **▶** to adjust the selected item.
- 6 Press **▲▼** to select the item to be adjusted and press the **◀▶** buttons make adjustments.

When all the settings are as required press the **EXIT** (EXIT) button to save the settings and close the adjustment dialogue. Press the **OK** (OK) button to return to the second PICTURE menu.

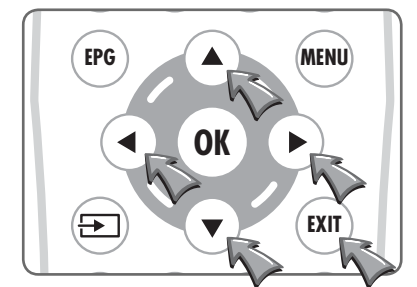
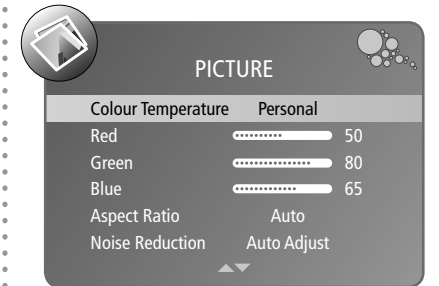
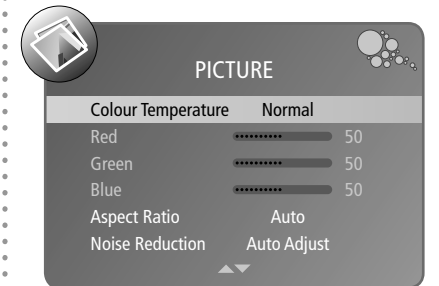
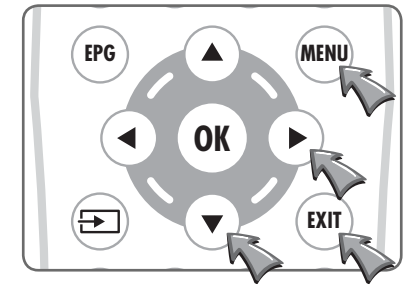

## Picture Settings

The Aspect Ratio can be independently set for each input. For example, DTV can be set to Auto and the HDMI input can be set to Zoom1 for DVD playback.

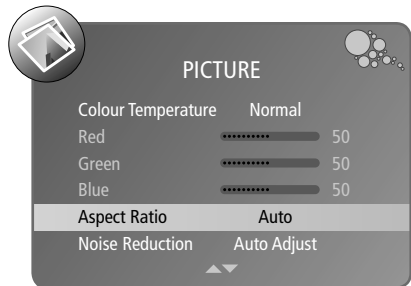
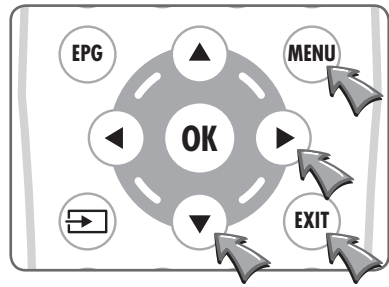

### Setting the Aspect Ratio

If the Aspect Ratio is set to Auto, the TileVision® will alter the picture to best suit the programme being received and there will be little need to change the setting manually.

- 1 Press the **MENU** (MENU) button.
- 2 Press the **▶** button to select the first **PICTURE** menu and then press the **▼** button until the second **PICTURE** menu is displayed and **Aspect Ratio** is selected.
- 3 Press the **◀▶** buttons to select any of the different settings as shown below.

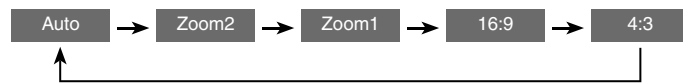

- 4 Press the **EXIT** (EXIT) button once or the **MENU** (MENU) button twice to save the settings and close the PICTURE menu.

### How aspect ratio settings alter the picture

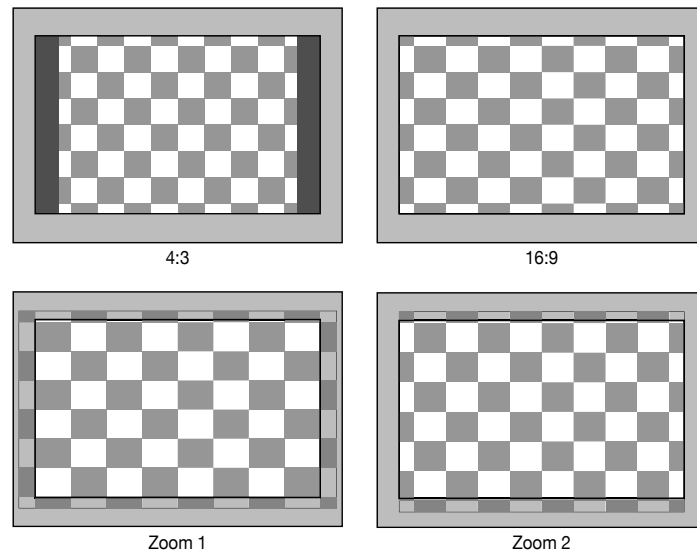

- ☛ The aspect ratio can be changed whilst watching a programme. Press the **Aspect Ratio** (16:9) button to sequence through the five settings.

## Picture Settings

Noise Reduction can be independently set for each input except PC RGB where Noise Reduction setting is not required.

### Noise Reduction

If noise reduction is needed, Auto Adjust is the recommended setting.

Noise reduction can be set as follows:

- 1 Press the **MENU** (MENU) button.
- 2 Press the **▶** button to select the first **PICTURE** menu and then press the **▼** button until the second **PICTURE** menu is displayed and **Noise Reduction** is selected.
- 3 Press the **◀▶** buttons to select any of the different settings as shown below.



- 4 Press the **EXIT** (EXIT) button once or the **MENU** (MENU) button twice to save the settings and close the PICTURE menu.

### Subtitles

Most DTV broadcasts include subtitles in at least one language. To select subtitles or turn subtitles off press the **SUBTITLES** (SUBT) button and the **Subtitle Languages** list will be displayed.



Press the **▲▼** buttons to select a language or turn Subtitles off and press the **EXIT** (EXIT) or **OK** (OK) button to save settings and close the list.

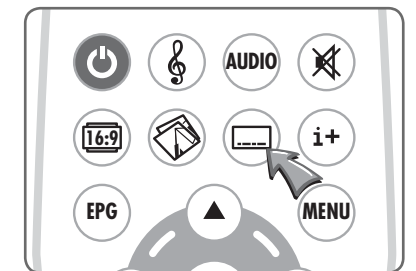
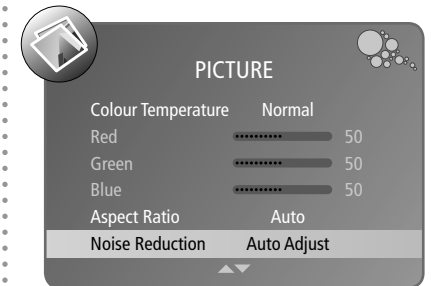
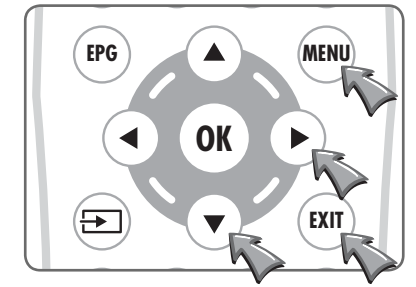

## Sound Settings

Four preset sound modes can be selected or, using the Personal option, Treble and Bass can be set to preferred levels.

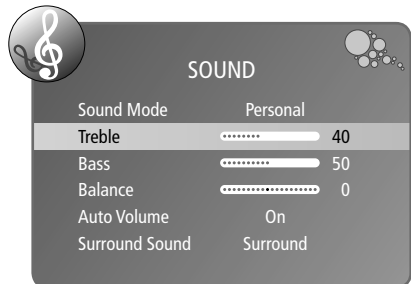
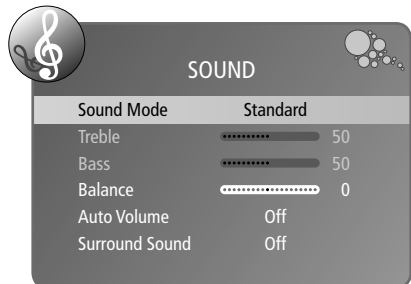
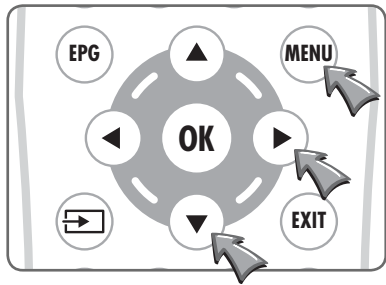

### Setting the Sound Mode

- 1 Press the **MENU** (MENU) button.
- 2 Press the **▶** button twice to select the **SOUND** menu and then press the **▼** button once to select **Sound Mode**.
- 3 Press the **◀▶** buttons to select any of the different modes as shown below.
 

Standard → Music → Movie → Sports → Personal
- 4 Press the **EXIT** (EXIT) button once or the **MENU** (MENU) button twice to save settings and close the SOUND menu.

### Personal Sound Mode

- 1 Press the **MENU** (MENU) button.
- 2 Press the **▶** button twice to select the **SOUND** menu and then press the **▼** button once to select **Sound Mode** and press the **▶** button until **Personal** is selected.
- 3 Press the **▼▲** buttons to select Treble or Bass and press **◀** or **▶** to adjust the selected item.
- 4 Press the **EXIT** (EXIT) button once or the **MENU** (MENU) button twice to save the settings and close the SOUND menu.

**The Sound Mode can be changed without using the menu. Press the Sound (🎵) button to sequence through the five modes.**

### Sound Mute

The sound can be muted by pressing the **MUTE** (MUTE) button.

**MUTE** The mute flag will be displayed on the screen whenever the sound is muted.

To restore the sound to the previous level press the **MUTE** (MUTE) button or press either **VOLUME** button (+) or (-).

## Sound Settings

### Adjusting the Balance

- 1 Press the **MENU** (MENU) button.
- 2 Press the **▶** button twice to select the **SOUND** menu and then press the **▼** button until **Balance** is selected.
- 3 Press the **◀▶** buttons to adjust the Left/Right balance.
- 4 Press the **EXIT** (EXIT) button once or the **MENU** (MENU) button twice to save the setting and close the SOUND menu.

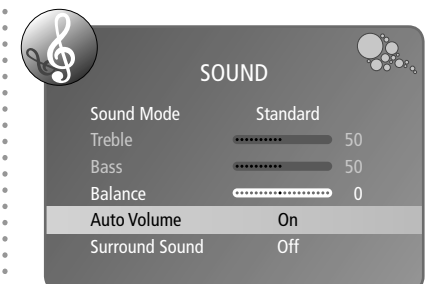
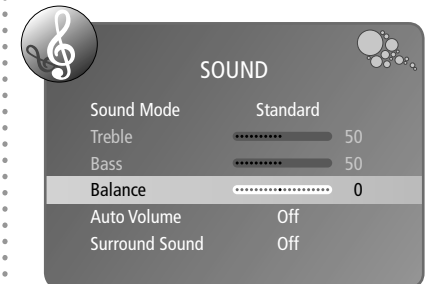
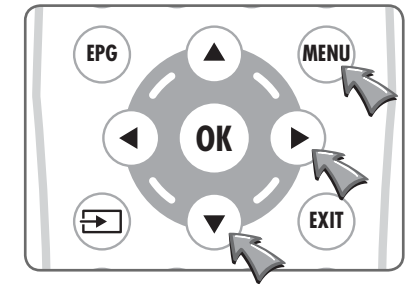

### Auto Volume

If there is a large difference between the volume of one programme and another, setting **Auto Volume** to on will reduce the disparity.

- 1 Press the **MENU** (MENU) button.
- 2 Press the **▶** button twice to select the **SOUND** menu and then press the **▼** button until **Auto Volume** is selected.
- 3 Press the **◀▶** buttons to switch between On and Off.
- 4 Press the **EXIT** (EXIT) button once or the **MENU** (MENU) button twice to save the setting and close the SOUND menu.

### Surround Sound

Surround sound will enhance the audio and provide a more enjoyable and involving presentation.

- 1 Press the **MENU** (MENU) button.
- 2 Press the **▶** button twice to select the **SOUND** menu and then press the **▼** button until **Surround Sound** is selected.
- 3 Press the **◀▶** buttons to switch between TruSurround and Off.
- 4 Press the **EXIT** (EXIT) button once or the **MENU** (MENU) button twice to save the setting and close the SOUND menu.

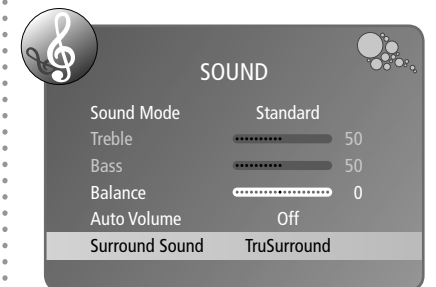

## Sound Settings

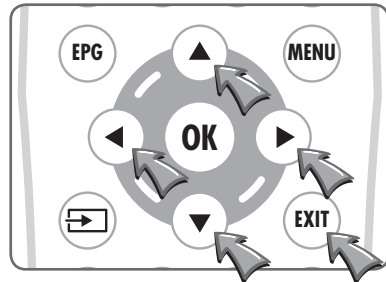
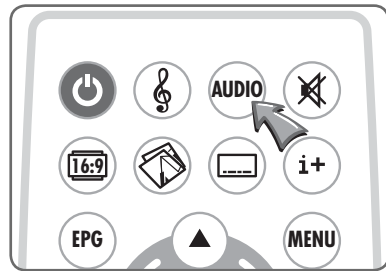

Some DTV broadcasts can include multiple audio languages and/or narrative audio descriptions for the visually impaired (V.I.). The Audio Languages menu allows available languages to be selected and broadcasts with audio descriptions to be chosen if required.

In **DTV** mode the sound output for the left and right speakers can be selected as follows:

- 1 Press the **AUDIO** (AUDIO) button to open the **Audio Languages** list.

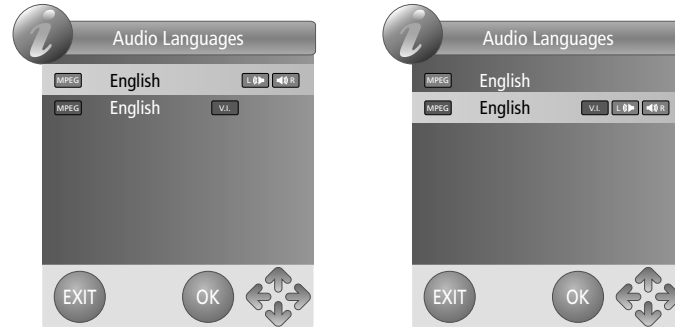

- 2 Press the **▼▲** buttons to select the required broadcast language and V.I. option.
- 3 Press the **◀▶** buttons to sequence through the three options; **L+R**, **L+L**, or **R+R**.
- 4 Press the **EXIT** (EXIT) button or the **OK** (OK) button to save settings and close the list.

## Time Functions

### Setting On and Off Times

The time menu allows the TileVision® to be programmed to switch on or off at preset times and to switch off after a channel closes down.

Both off and on times have the following repeat options available:

Off, Once, Everyday, Mon~Fri, Mon~Sat, Sat~Sun, Sun.

An off time can be set as follows:

- 1 Press the **MENU** (MENU) button.
- 2 Press the **◀** or **▶** button three times to display the **TIME** menu.
- 3 Press the **▼** button to select **Off Time** and press the **▶** button to open the settings window.
- 4 Press the **◀** or **▶** button to select the required Repeat setting.
- 5 When the **Repeat** has been set press the **▼** button to move down one line and press the **◀▶** buttons to set the Hour. The **◀** or **▶** button can be held down to help set the hour more quickly.
- 6 When the **Hour** has been set press the **▼** button to move down one line and press/hold the **◀▶** buttons to set the Minutes.
- 7 When the off time has been set press the **▼** button to move down to **Close** and press the **OK** (OK) button.
- 8 Press the **EXIT** (EXIT) button once or the **MENU** (MENU) button twice to save settings and close the TIME menu.

Setting an on time is the same as setting an off time, except that settings are included for Volume and Mode. The range for the initial volume is 0–100 and the options for Mode are: DTV, ATV and Radio.

**The on time and off time functions are not available on all TileVision® models.**

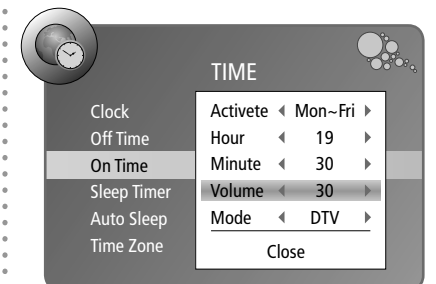
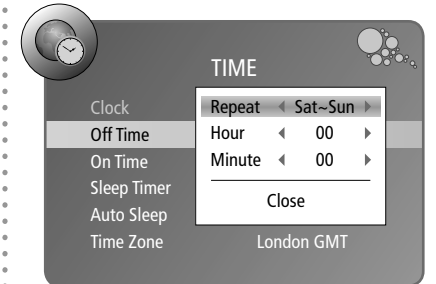
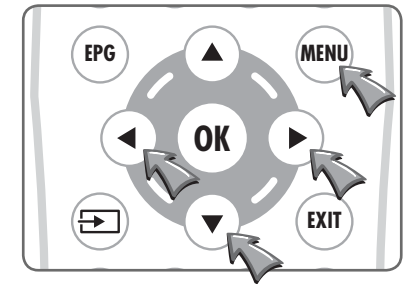

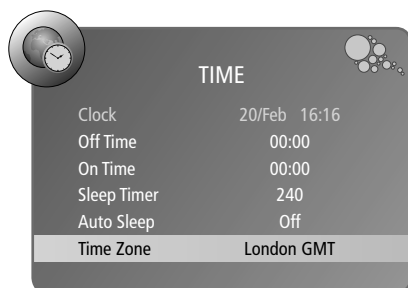
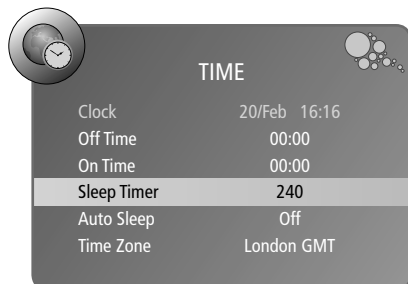
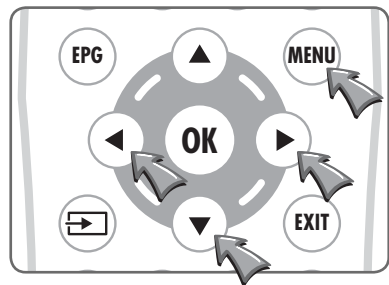

## The Sleep Timer

The TileVision® incorporates a sleep timer which can be set to turn the unit of after a preset time. The available delay times are:

10, 20, 30, 60, 90, 120, 180, and 240 minutes.

The sleep time can be set as follows:

- 1 Press the **MENU** (MENU) button.
- 2 Press the ◀ or ▶ button three times to display the **TIME** menu.
- 3 Press the ▼ button until **Sleep Timer** is selected and press the ◀▶ buttons to select the required delay.
- 4 Press the **EXIT** (EXIT) button once or the **MENU** (MENU) button twice to save settings and close the TIME menu.

An on-screen countdown will be displayed from 30 seconds before the TileVision® switches off.

## Auto Sleep

- 1 Press the **MENU** (MENU) button.
- 2 Press the ◀ or ▶ button three times to display the **TIME** menu.
- 3 Press the ▼ button until **Auto Sleep** is selected and press the ◀▶ buttons to select Off or On.
- 4 Press the **EXIT** (EXIT) button once or the **MENU** (MENU) button twice to save settings and close the TIME menu.

If auto sleep is set to on, the TileVision® will automatically switch off after two minutes with no signal from the chosen source.

## Setting the Time Zone

There is a choice of 32 cities in various time zones.

- 1 Press the **MENU** (MENU) button.
- 2 Press the ◀ or ▶ button three times to display the **TIME** menu.
- 3 Press the ▼ button until **Time Zone** is selected and press the ◀▶ buttons to select choose the appropriate setting.
- 4 Press the **EXIT** (EXIT) button once or the **MENU** (MENU) button twice to save settings and close the TIME menu.

## On Screen Language

The on-screen menus and lists can be in any of the following nine languages: English, Español, Français, Italiano, Nederlands, Polski, Português, Русский, and Deutsch.

To change the language used follow the sequence below:

- 1 Press the **MENU** (MENU) button to display the **Channel** menu.
- 2 Press the ◀ button twice to display the **SETUP** menu.
- 3 Press the ▼ button once to select **Language**.
- 4 Press the ◀▶ buttons to select the required language.
- 5 Press the **EXIT** (EXIT) button once or the **MENU** (MENU) button twice to close the **SETUP** menu and save the desired language.

All the on-screen displays will now be in the chosen language.

**The selected language applies to both DTV and ATV modes**

## Audio Language

The primary or secondary language are used as appropriate if they are available when a multiple language source is broadcast.

Set the preferred audio languages as follows:

- 1 Press the **MENU** (MENU) button.
- 2 Press the ◀ button twice to display the **SETUP** menu.
- 3 Press the ▼ button until **Audio Language** is selected and press the ▶ or the **OK** (OK) button to open the settings window.
- 4 Press the ▼▲ buttons to select Primary or Secondary.
- 5 Press the ◀▶ buttons to choose the required language.
- 6 When finished, press the ▼▲ buttons to select Close and press the **OK** (OK) button to close the settings window
- 7 Press the **EXIT** (EXIT) button once or the **MENU** (MENU) button twice to save settings and close the SETUP menu.

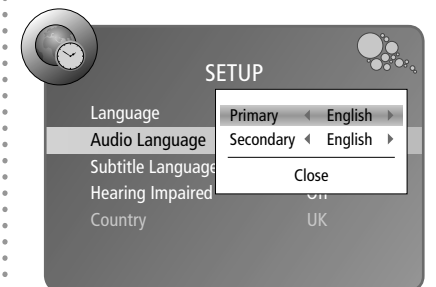
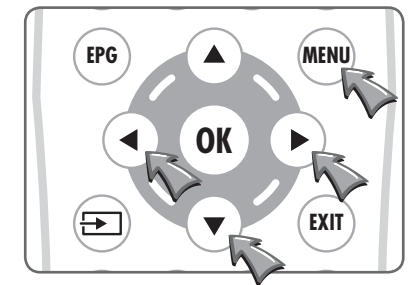



## The Setup Menu

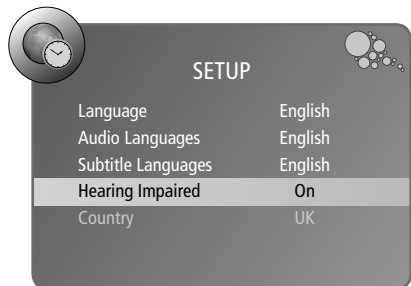
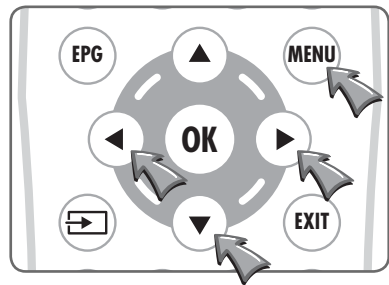
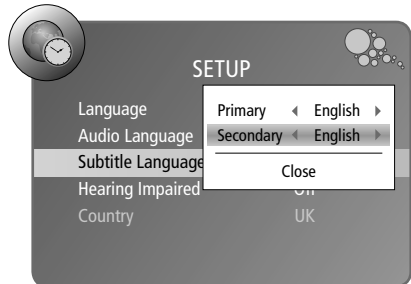
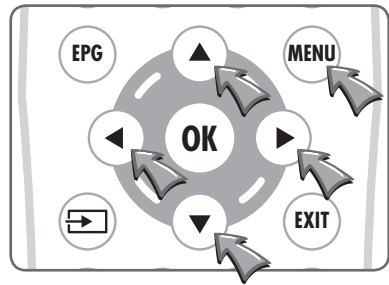

### Subtitle Language

The primary or secondary language are used as appropriate if they are available when multiple subtitle languages are broadcast.

Set the preferred subtitle languages as follows:

- 1 Press the **MENU** (MENU) button.
- 2 Press the **◀** button twice to display the **SETUP** menu.
- 3 Press the **▼** button until **Subtitle Language** is selected and press the **▶** or the **OK** (OK) button to open the settings window.
- 4 Press the **▼▲** buttons to select Primary or Secondary.
- 5 Press the **◀▶** buttons to choose the required language.
- 6 When finished, press the **▼▲** buttons to select Close and press the **OK** (OK) button to close the settings window
- 7 Press the **EXIT** (EXIT) button once or the **MENU** (MENU) button twice to save settings and close the SETUP menu.

### Hearing Impaired

If a broadcast includes alternative audio for the hard of hearing it will be selected when Hearing Impaired is set to on.

The setting can be changed as follows:

- 1 Press the **MENU** (MENU) button.
- 2 Press the **◀** button twice to display the **SETUP** menu.
- 3 Press the **▼** button until **Hearing Impaired** is selected and press the **◀** or **▶** button to choose On or Off.
- 4 Press the **EXIT** (EXIT) button once or the **MENU** (MENU) button twice to save settings and close the SETUP menu.

## The Lock Menu

The lock menu allows a password to be entered so that a number of key settings can be locked, selected programmes can be blocked and parental controls can be imposed.

### Lock System

When lock system is on, Auto Tuning, DTV Manual Tuning, ATV Manual Tuning and Programme Edit can not be accessed from the CHANNEL menu without entering the password. All other menu options are not affected.

The TileVision® default four digit password is 0000.

To turn the lock system on or off:

- 1 Press the **MENU** (MENU) button.
- 2 Press the **◀** button to display the **LOCK** menu.
- 3 Press the **▼** button and enter the password to access the **LOCK** menu.
- 4 Press the **◀▶** buttons to select on or off.
- 5 Press the **EXIT** (EXIT) button once or the **MENU** (MENU) button twice to save settings and close the LOCK menu.

### Change Password

The password can be changed as follows:

- 1 Press the **MENU** (MENU) button.
- 2 Press the **◀** button to display the **LOCK** menu.
- 3 Press the **▼** button and enter the password to access the **LOCK** menu.
- 4 Press the **▼** button to select **Change Password**.
- 5 Press the **▶** button or press the **OK** (OK) button to open the password window.
- 6 Enter and then confirm the new password.
- 7 Press the **EXIT** (EXIT) button once or the **MENU** (MENU) button twice to save the new password and close the LOCK menu.

**👉 If the default password of 0000 is replaced by a user password and the password is forgotten there is no way to access any item on the LOCK menu. Please make sure that any password chosen is memorable.**

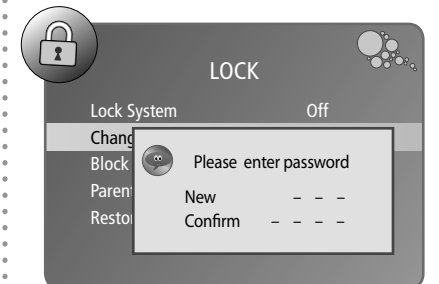
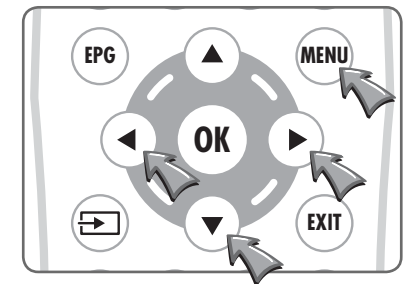
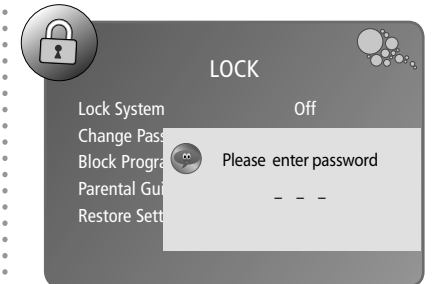
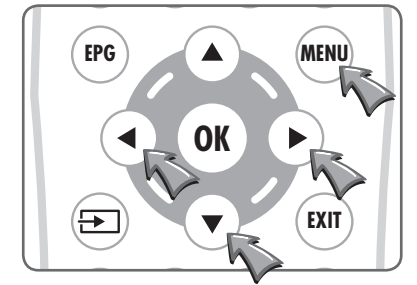

## The Lock Menu

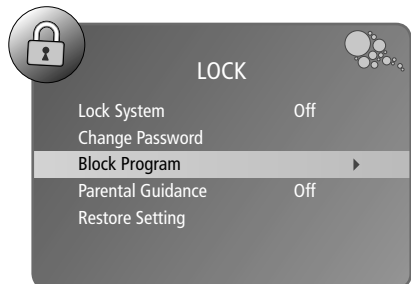
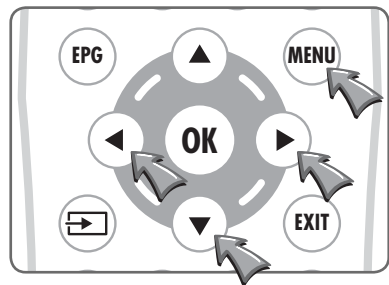

### Block Programme

Blocked programmes can only be viewed by entering the password. The programmes are selected in the normal way but it is necessary to enter the password before the programme is shown.

Programmes are blocked as follows:

- 1 Press the **MENU** (MENU) button.
- 2 Press the **◀** button to display the **LOCK** menu.
- 3 Press the **▼** button and enter the password to access the **LOCK** menu.
- 4 Press the **▼** button twice to select **Block Programme**.
- 5 Press the **▶** button or press the **OK** (OK) button to open the Block Programme list.



Press **▲▼** to select the channel to block and press the **Green** button to toggle the lock setting for the chosen channel.

- 6 Press the **EXIT** (EXIT) button to close the list or press the **MENU** (MENU) button to close the list and return to the LOCK menu.

**The OK (OK) button will make the TileVision® switch to the selected channel so it can be viewed when the list is closed.**

**If the selected channel is locked when the list is closed the password must be entered so that the programme can be viewed.**

## The Lock Menu

### Parental Guidance

The parental guidance option allows any age from 4 to 18 to be select for all programmes. Parental guidance is set as follows:

- 1 Press the **MENU** (MENU) button.
- 2 Press the **◀** button to display the **LOCK** menu.
- 3 Press the **▼** button and enter the password to access the **LOCK** menu.
- 4 Press the **▼** button three times to select **Parental Guidance**.
- 5 Press the **◀▶** buttons to select an age from 4 to 18 or turn parental guidance off.
- 6 Press the **EXIT** (EXIT) button once or the **MENU** (MENU) button twice to confirm the settings and close the LOCK menu.

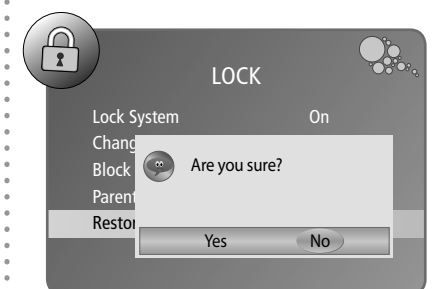
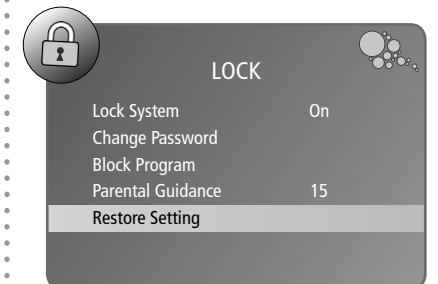
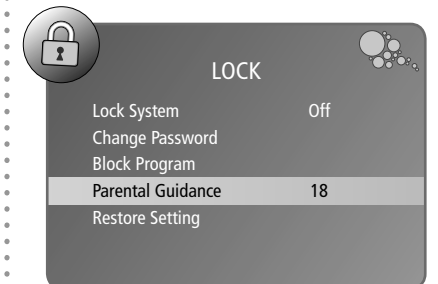
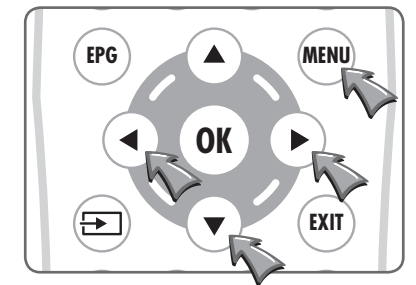

### Restore Settings

There is normally no need to restore factory settings. It can however, be useful to restore factory settings as an easy way of clearing all restrictions, a forgotten password, blocked and skipped channels, personal settings, etc.

Restore settings should also be used in the unlikely event that the TileVision® freezes.

The default factory settings can be restored as follows:

- 1 Press the **MENU** (MENU) button.
- 2 Press the **◀** button to display the **LOCK** menu.
- 3 Press the **▼** button and enter the password to access the **LOCK** menu.
- 4 Press the **▼** button until **Restore Settings** is selected.
- 5 Press the **◀** button to select Yes and press the **OK** (OK) button to restore factory settings.

**After the factory settings have been restored the TileVision® must be retuned (see page 23) and, if used, the preferred user password should be reentered (see page 45) as the password will have been reset to 0000.**

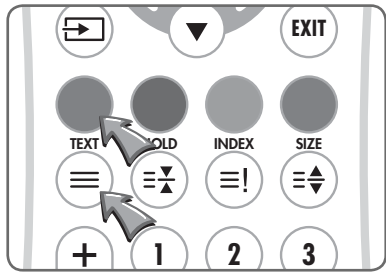

To access DTV Text press the **TEXT** (≡) or **Red** button depending on the programme's broadcaster. A small banner 'loading...' will be displayed on screen. After a few seconds the broadcaster's menu will appear, either overlaying part of the current programme:



Typical overlay example

or with the current programme in a smaller window next to the text menus and instructions:

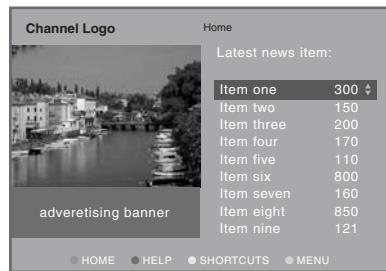

Typical inset example

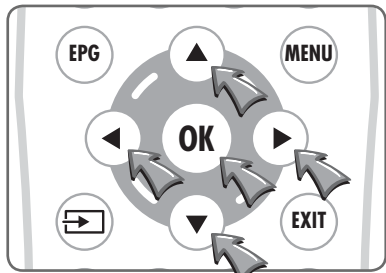

Use the **▲▼** buttons (or in some cases the **◀▶** buttons) to navigate the menus and the **OK** (OK) button to select items. Use the **Red, Green, Yellow** and **Blue** buttons to access shortcuts, help and additional menus etc., as shown on screen.

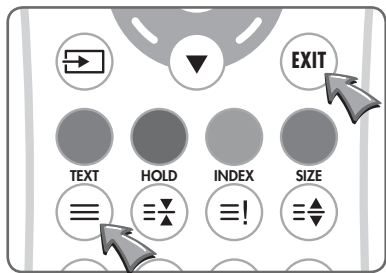

To exit DTV Text press the **TEXT** (≡), the **EXIT** (EXIT) button or change channel.

All DTV Text navigation uses the **▲▼◀▶**, **OK**, **Colour** and **0-9** number buttons, all functions are available with the TileVision® waterproof remote control.

**Some broadcasters show a red on-screen prompt when DTV Text is available.**

**To remove the prompt from the screen press the Green button.**

**DTV Text is not available immediately after changing channel as it takes a few seconds for the TileVision® to receive the data from the broadcaster.**

## Functions of Teletext

- |             |  |
|-------------|--|
| <i>Part</i> | <i>Display Contents</i>                          |
| A           | Selected page number.                            |
| B           | Broadcast Station identity.                      |
| C           | Current page number or searching status.         |
| D           | Date and time.                                   |
| E           | Text information.                                |
| F           | FasText information.<br>Red, Green, Yellow, Blue |

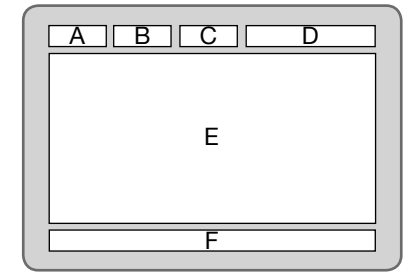

## Switching Teletext On

- 1 Press the **TEXT** (≡) button once to view the Teletext pages.
- 2 Use the **0-9** number buttons and the **Red, Green, Yellow** and **Blue** FastText buttons to navigate the text pages.
- 3 Press the **TEXT** (≡) button again to switch to mix mode with the text overlaying the TV picture. Press the **TEXT** (≡) button again to switch Teletext off and return to normal viewing.

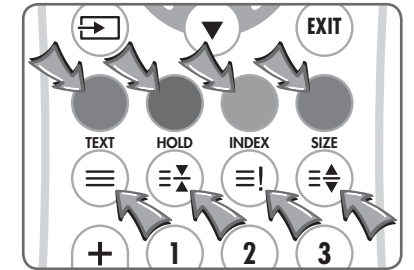

The waterproof remote control includes the Teletext functions as show below:

Icon	Name	Functions
≡	TEXT	Press the button to turn Teletext on, enter Mix Mode and turn Teletext off.
≡	HOLD	Stops the automatic page change, which occurs if a Teletext page consists of two or more sub pages. The stop symbol is displayed in the top left hand corner of the screen. Press the button again to resume.
≡!	INDEX	Press to return to the index page.
≡	SIZE	Press button to enlarge top half of the page. Press again to enlarge the bottom half of the page. Press again to return to normal size text.

## Troubleshooting

### The red/green LED is not lit

- Check for power failure.
- Make sure remote isolation switch is set to on.
- Make sure the mains socket or fused spur is set to on and has power to it.
- Make sure the AC power lead is connected to the power adaptor.
- If the mains supply is via a 13A outlet check the fuse in the mains plug.

### No picture and no sound or poor picture and poor sound

- Press the **POWER** (⏻) button to set the TileVision® to on – the LED indicator will show green.
- Change channel to check another broadcast.
- Check that the **MUTE** (⊗) button has not been pressed.
- Press the button to increase the volume.
- Select a different input (DTV to ATV or ATV to DTV).
- Check the aerial amplifier is switched on.
- Check the aerial lead.
- Check the brightness level.
- Check external equipment is switched on.
- Check external equipment connections.

### Remote control not working

- Replace battery.

👉 **If the LED on a remote control is viewed through a digital camera, the LED will be seen to light when any button on the remote control is pressed. If the LED does not light, either the battery/batteries should be replaced, or the remote control is faulty.**

## Specifications

Model	TV/26/FR1	
External Dimensions (W x H x D)	685 mm x 450 mm x 92 mm	
Total Weight complete with back box	18 Kg	
Power	AC/DC Power Adaptor	Input 100–240 VAC 50/60 Hz Output 24 VDC/5.42 A
	Consumption	72 W max, standby below 3 W
System	Analog	PAL-BG, I, DK/SECAM-BG, DK, L
	Digital	DVB-T (MHEG-5) MPEG-2 decoding
TV	Programme	VHF:2–13 UHF 21–69 Cable S1–S41 FVS 100 programme (Analog)
	Size Diagonal	26" (660 mm) Widescreen (16:9)
LCD	Resolution/Pixel no.	WXGA (1366 x 768)
	Type	a-si TFT active matrix
	Brightness	450 cd/m <sup>2</sup>
	Contrast Ratio	4,000:1
	Viewing Angle	L/R/U/D 89°/89°/89°/89°
	Colour Depth	16.77 M colours (8bit)
	Response Time	8 ms
External Antenna Impedance	VHF/UHF at 75 Ohm	
Audio Output	3W + 3W rms	
	Nicam, A2 Stereo	
	Graphic Equaliser	
OSD	Programme list/edit	
	Menu – multi-language	
Connection Ports	24 VDC/5.42 A	
	HDMI	
	PC-RGB	
	EURO-SCART (Full)	
	S-VIDEO	
	COMPONENT (Y, Pb, Pr)	
	AUDIO IN (L+R)	
	PC AUDIO IN	
	AUDIO OUT (Headphone)	
	ANTENNA/TUNER (Co-axial)	
	COMPOSITE VIDEO (CVBS)	
	Speakers (clip terminals)	
	Control	RS-232 (Home Automation etc.)
3.5 mm IR In		
3.5 mm IR Out		
RJ12 IR Pass Through (Interactive Hotel TV)		
Sky IR Remote Link		
Supplied Loudspeaker	External Single Stereo, 8 Ω	
Functions	Auto Programme	
	Manual Programme	
	Picture Mode	
	Sound Mode	
	Auto Volume Adjustment	
	ARC (Aspect Ratio Control)	
	Teletext – TOP/FLOF/MHEG-5	

👉 **Design and specifications are subject to change without notice.**



PORTER LANCASTRIAN LIMITED  
[WWW.TILEVISION.TV](http://WWW.TILEVISION.TV)