

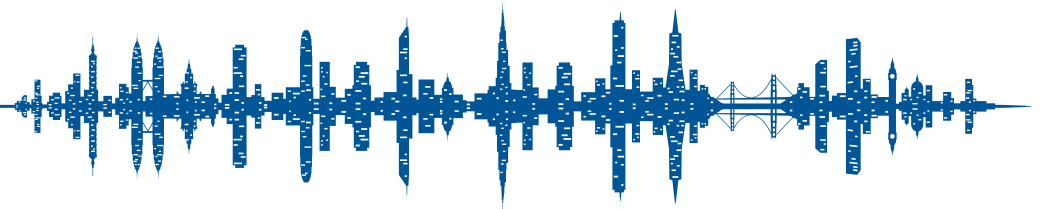

plantronics®

# Electronic Hook Switch Guide



SAVI® 700 SERIES | CS500™/CS500 XD SERIES | MDA200™ | VOYAGER LEGEND® CS

# Electronic Hook Switch Guide Contents

Electronic Hook Switch Cables (EHS) provide remote desk phone call control (answer/end) with your Plantronics wireless headset system (or the MDA200™ headset hub). We offer cables that are compatible with many of the most popular office desk phones.

We also have a handset lifter accessory that can be used with most desk phones that are not compatible with one of our EHS cables.

Visit [Plantronics.com](http://Plantronics.com) for more information.



1  
Aastra Phone Models



7  
Polycom Phone Models



2  
Alcatel-Lucent Phone Models



8  
ShoreTel Phone Models



3  
Avaya Phone Models



9  
Siemens Phone Models



4 - 5  
Cisco Phone Models



10  
Tenovis Phone Models









6  
NEC Phone Models



11  
Toshiba Phone Models

# Electronic Hook Switch for Aastra®

<p><b>Aastra</b></p>  <p><b>Desk Phone Models</b></p> <p>1120E 1140E 1150E 1165E</p> <p>5370 5380 5370 IP 5380 IP 6739i 6753i 6755i</p> <p>6757i 6757i CT 6771 6773 6773 IP 6775 6775 IP</p>	<p><b>EHS Cable</b></p> <p>APS-11* PN: 37818-11</p>  <p>* APS-11 replaces APS-10</p>	<p><b>Plantronics Audio Solutions</b></p> <div style="display: flex; justify-content: space-around;"> <div data-bbox="1218 341 1354 487">  <p><b>Savi® 700 Series</b> Wireless headset system manages PC, mobile and desk phone calls</p> </div> <div data-bbox="1407 341 1543 487">  <p><b>CS500™/CS500 XD™ Series</b> Wireless headsets manage desk phone calls</p> </div> <div data-bbox="1596 389 1743 487">  <p><b>MDA200™</b> Enables USB connectivity to the desk phone to manage both PC and desk phone calls</p> </div> <div data-bbox="1816 324 1963 487">  <p><b>Voyager Legend® CS</b> Wireless Bluetooth headset system manages desk phone and mobile calls</p> </div> </div>
---	--	--

**EHS Setup** Use the EHS setup below to automatically answer a desk phone call by pressing a button on your Savi 700 Series, CS500/CS500 XD Series or Voyager Legend CS headset or MDA200.

**Aastra models:** 1120E, 1140E, 1150E, 1165E, 5370, 5380, 5370 IP, 5380 IP, 6739i, 6753i, 6755i, 6757i, 6757i CT, 6771, 6773 IP, 6775, 6775 IP

**Setup**

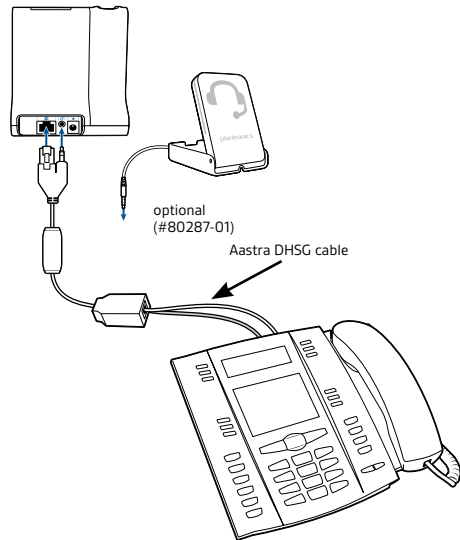



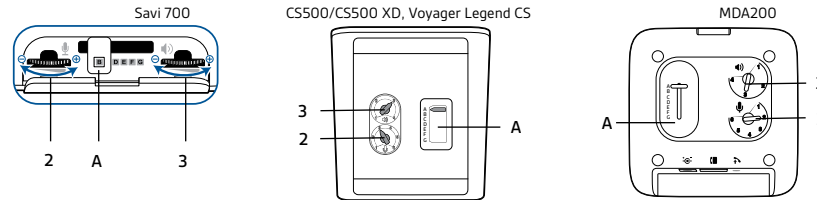



**Configuration**



 Only the Aastra DHSG cable should be connected directly to your phone. No 3rd party DHSG cables should be connected directly to the Aastra IP phone.

# Electronic Hook Switch for Alcatel-Lucent

<p><b>Alcatel-Lucent</b></p>  <p><b>Desk Phone Models</b> IP Touch 4028, IP Touch 4038, IP Touch 4068, Touch 4029, Touch 4039, My IC 8082</p>	<p><b>EHS Cable</b></p>  <p><b>APA-23*</b> PN: 38908-11</p> <p><small>*APA-23 replaces APA-20 and APA-22</small></p>	<p><b>Plantronics Audio Solutions</b></p> <div style="display: flex; justify-content: space-around;"> <div data-bbox="955 332 1144 519">  <p><b>Savi 700 Series</b> Wireless headset system manages PC, mobile and desk phone calls</p> </div> <div data-bbox="1249 332 1417 519">  <p><b>CS500/CS500 XD Series</b> Wireless headsets manage desk phone calls</p> </div> <div data-bbox="1480 357 1690 519">  <p><b>MDA200</b> Enables USB connectivity to the desk phone to manage both PC and desk phone calls</p> </div> <div data-bbox="1774 316 1942 519">  <p><b>Voyager Legend CS</b> Wireless Bluetooth headset system manages desk phone and mobile calls</p> </div> </div>
--	---	---

**EHS Setup** Use the EHS setup below to automatically answer a desk phone call by pressing a button on your Savi 700 Series, CS500/CS500 XD Series or Voyager Legend CS headset or MDA200.

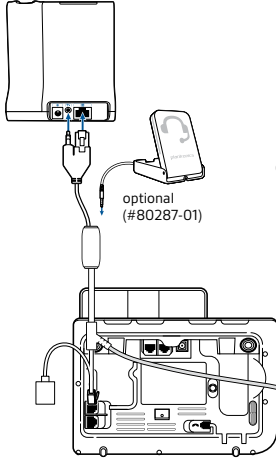
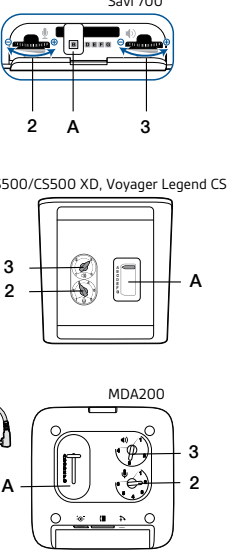
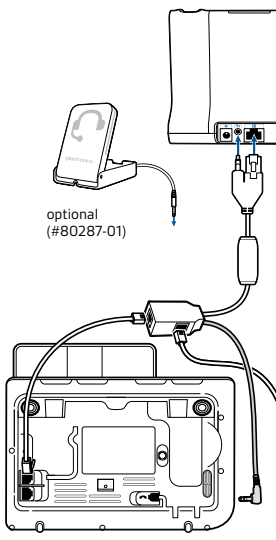
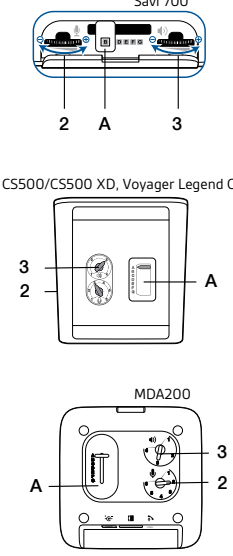
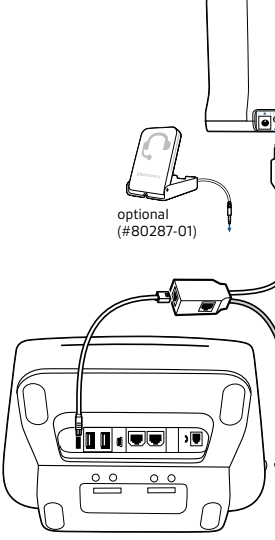
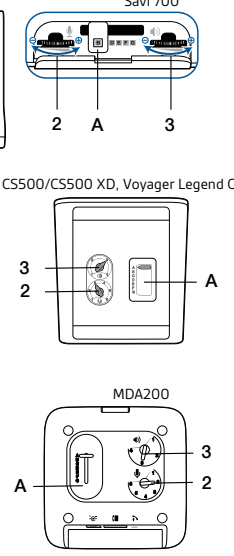
Alcatel-Lucent models: IP Touch 4028, 4038, 4068	Alcatel-Lucent models: Touch 4029, 4039	Alcatel-Lucent models: My IC 8082
<p><b>Setup</b></p>  <p><b>Configuration</b></p>  <p>Savi 700: 2, A, 3</p> <p>CS500/CS500 XD, Voyager Legend CS: 3, 2, A</p> <p>MDA200: 3, 2, A</p>	<p><b>Setup</b></p>  <p><b>Configuration</b></p>  <p>Savi 700: 2, A, 3</p> <p>CS500/CS500 XD, Voyager Legend CS: 3, 2, A</p> <p>MDA200: 3, 2, A</p>	<p><b>Setup</b></p>  <p><b>Configuration</b></p>  <p>Savi 700: 2, A, 3</p> <p>CS500/CS500 XD, Voyager Legend CS: 3, 2, A</p> <p>MDA200: 3, 2, A</p>

# Electronic Hook Switch for Avaya®

**Avaya**



**APV-63 Cable**

1408	9608	9670
1416	9611	9620L
1608	9620	2410
1616	9621	4630
9404	9630	6416D+M
9406	9640	6424D+M
9504	9641G	
9508	9650	

**APV-66 Cable**

2420	4621SW	5420
4610	4622SW	5610
4610SW	4625SW	5620
4620	4630SW	5621
4620SW		

**EHS Cable**

**APV-63\***  
PN: 38734-11



**APV-66\***  
PN: 38633-11



\* APV-63 replaces APV-62; APV-66 replaces APV-65

**Plantronics Audio Solutions**



**Savi 700 Series**  
Wireless headset system manages PC, mobile and desk phone calls



**CS500/CS500 XD Series**  
Wireless headsets manage desk phone calls



**MDA200**  
Enables USB connectivity to the desk phone to manage both PC and desk phone calls



**Voyager Legend CS**  
Wireless Bluetooth headset system manages desk phone and mobile calls

## EHS Setup Use the EHS setup below to automatically answer a desk phone call by pressing a button on your Savi 700 Series, CS500/CS500 XD Series or Voyager Legend CS headset or MDA200.

**Avaya models:** 1408, 1416, 1608, 1616, 9404, 9406, 9504, 9508, 9608, 9611, 9620, 9621, 9630, 9640, 9641G, 9650, 9670, 9620L

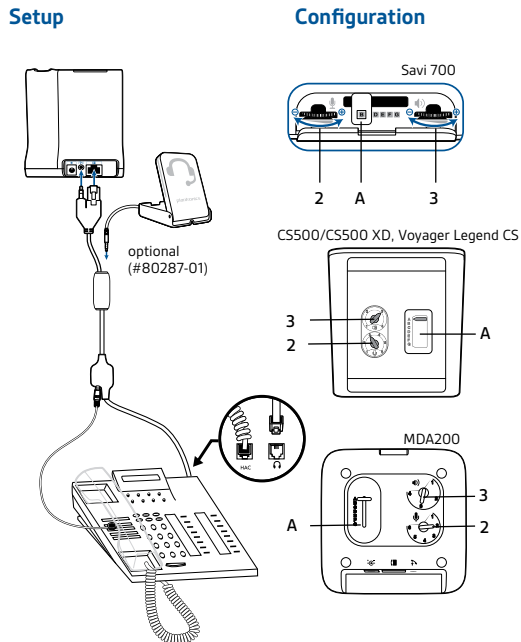

**Avaya models:** 2410, 4630, 6416D+M, 6424D+M

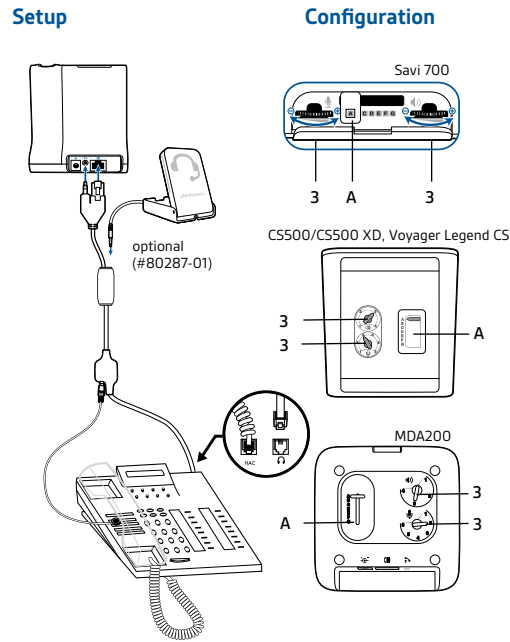

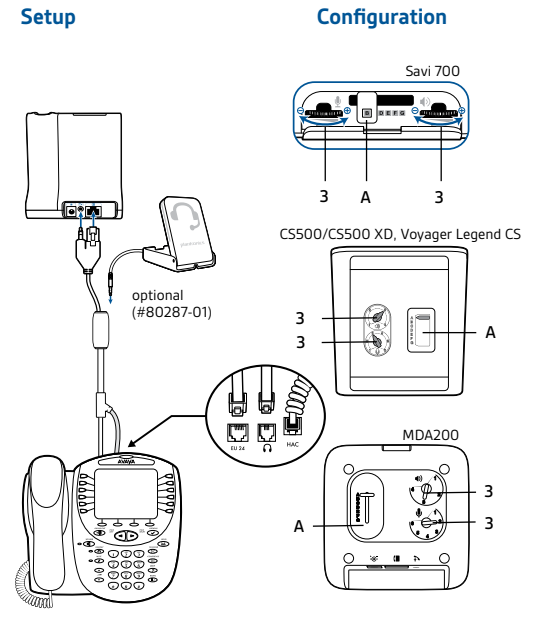

**Avaya models:** 2420, 4610, 4610SW, 4620, 4620SW, 4621SW, 4622SW, 4625SW, 4630SW, 5420, 5610, 5620, 5621





# Electronic Hook Switch for Cisco®

<p><b>Cisco</b></p>  <p><b>APC-41 Cable</b> 7942G 7945G 7962G 7965G 7975G</p> <p><b>APU-71 Cable</b> 8961 9951 9971</p>	+	<p><b>EHS Cable</b></p> <p><b>APC-41*</b> PN: 38350-11</p> <p><b>APU-71*</b> PN: 83018-11</p> <p><small>* APC-41 replaces APC-40; APU-71 has replaced APU-70</small></p> 	+	<p><b>Plantronics Audio Solutions</b></p> <div style="display: flex; justify-content: space-around;"> <div data-bbox="1228 341 1354 487"> <p><b>Savi 700 Series</b> Wireless headset system manages PC, mobile and desk phone calls</p> </div> <div data-bbox="1417 332 1543 487"> <p><b>CS500/CS500 XD Series</b> Wireless headsets manage desk phone calls</p> </div> <div data-bbox="1606 381 1753 495"> <p><b>MDA200</b> Enables USB connectivity to the desk phone to manage both PC and desk phone calls</p> </div> <div data-bbox="1837 324 1963 487"> <p><b>Voyager Legend CS</b> Wireless Bluetooth headset system manages desk phone and mobile calls</p> </div> </div>
--	---	---	---	---

## EHS Setup Use the EHS setup below to automatically answer a desk phone call by pressing a button on your Savi 700 Series, CS500/CS500 XD Series or Voyager Legend CS headset or MDA200.

Cisco models: 7942G, 7945G, 7962G, 7965G, 7975G

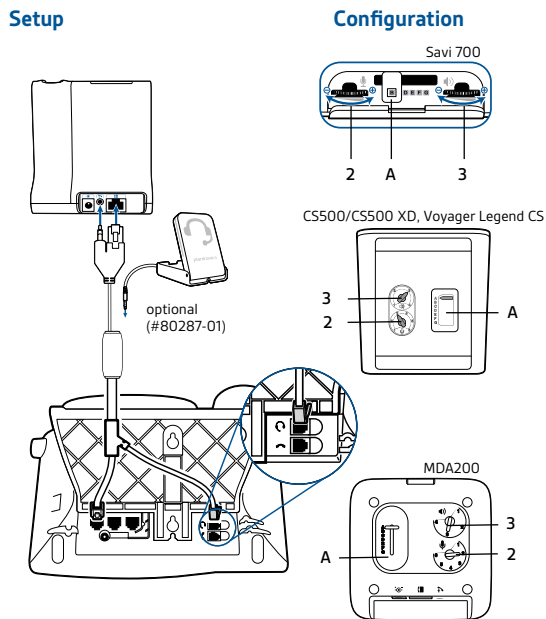

Cisco models: 7942G, 7945G, 7962G, 7965G, 7975G  
Installation with sidcar

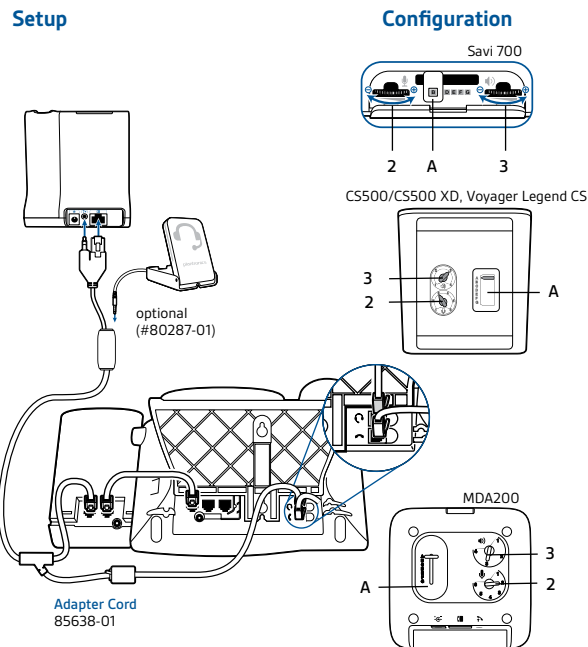

Cisco models: 8961, 9951, 9971

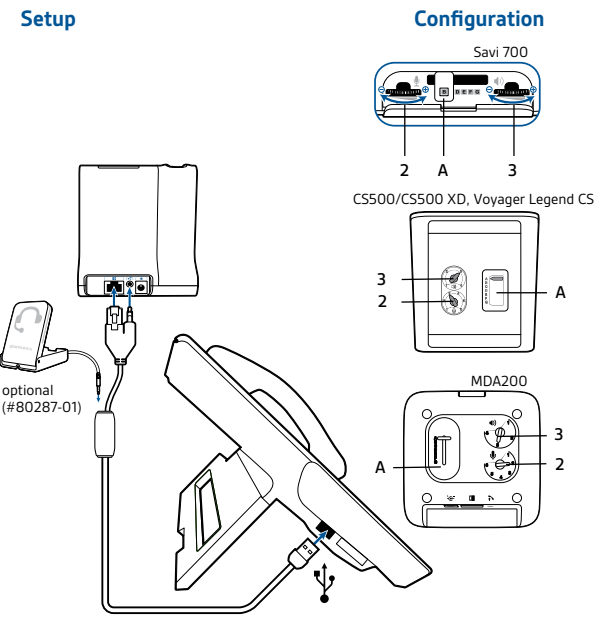

# Electronic Hook Switch for Cisco®

**Cisco**



APC-45 Cable  
SPA512  
SPA514  
SPA525G2

+

**EHS Cable**

APC-45  
P/N: 87317-01



+

**Plantronics Audio Solutions**



**Savi 700 Series**  
Wireless headset system manages PC, mobile and desk phone calls



**CS500/CS500 XD Series**  
Wireless headsets manage desk phone calls



**MDA200**  
Enables USB connectivity to the desk phone to manage both PC and desk phone calls



**Voyager Legend CS**  
Wireless Bluetooth headset system manages desk phone and mobile calls

**EHS Setup** Use the EHS setup below to automatically answer a desk phone call by pressing a button on your Savi 700 Series, CS500/CS500 XD Series or Voyager Legend CS headset or MDA200.

Cisco models: SPA512, SPA514, SPA525G2

**Setup**

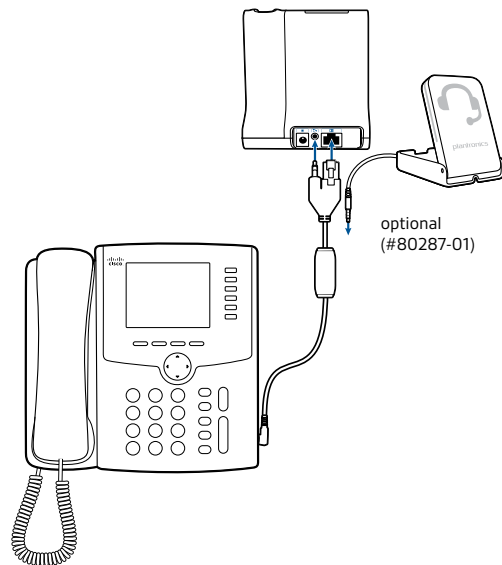

**Configuration**

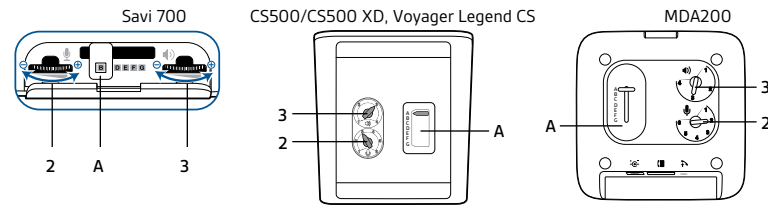

# Electronic Hook Switch for NEC®

<p><b>NEC</b></p>  <p><b>Desk Phone Models</b> DT 330 DT 730 DT 750</p>	<p><b>EHS Cable</b></p>  <p><b>APN-91</b> PN: 89280-11</p>	<p><b>Plantronics Audio Solutions</b></p> <table border="0"> <tr> <td data-bbox="955 324 1144 519">  <p><b>Savi 700 Series</b> Wireless headset system manages PC, mobile and desk phone calls</p> </td> <td data-bbox="1249 324 1417 519">  <p><b>CS500/CS500 XD Series</b> Wireless headsets manage desk phone calls</p> </td> <td data-bbox="1480 324 1690 519">  <p><b>MDA200</b> Enables USB connectivity to the desk phone to manage both PC and desk phone calls</p> </td> <td data-bbox="1774 324 1942 519">  <p><b>Voyager Legend CS</b> Wireless Bluetooth headset system manages desk phone and mobile calls</p> </td> </tr> </table>				 <p><b>Savi 700 Series</b> Wireless headset system manages PC, mobile and desk phone calls</p>	 <p><b>CS500/CS500 XD Series</b> Wireless headsets manage desk phone calls</p>	 <p><b>MDA200</b> Enables USB connectivity to the desk phone to manage both PC and desk phone calls</p>	 <p><b>Voyager Legend CS</b> Wireless Bluetooth headset system manages desk phone and mobile calls</p>
 <p><b>Savi 700 Series</b> Wireless headset system manages PC, mobile and desk phone calls</p>	 <p><b>CS500/CS500 XD Series</b> Wireless headsets manage desk phone calls</p>	 <p><b>MDA200</b> Enables USB connectivity to the desk phone to manage both PC and desk phone calls</p>	 <p><b>Voyager Legend CS</b> Wireless Bluetooth headset system manages desk phone and mobile calls</p>						

## EHS Setup Use the EHS setup below to automatically answer a desk phone call by pressing a button on your Savi 700 Series, CS500/CS500 XD Series or Voyager Legend CS headset or MDA200.

NEC models: DT 330, DT 730, DT 750

### Setup

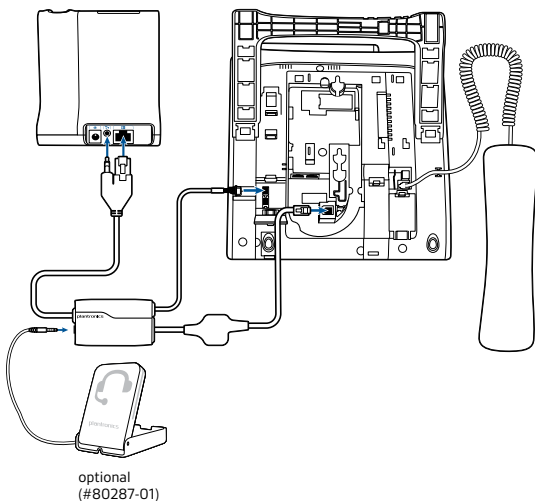

### Configuration

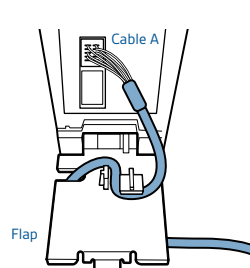
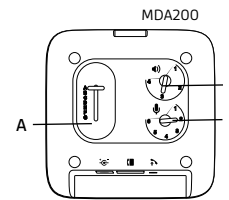
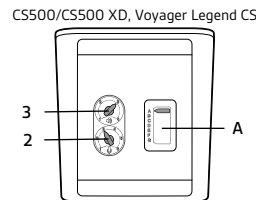
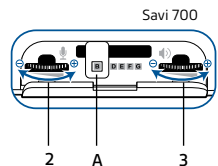

Install the ringer detect device on the phone over the speaker, under the handset. This is then plugged into the socket mounted midway along the audio cable. Supports only DT700/300 Series. Please contact NEC for more information.

**⚠ Note:** Disconnect the phone from the network cable prior to installing the EHS cable. Insert cable "A" per diagram, and install the plastic flap included with the APN-91 cable, per the diagram prior to reconnecting the network connection. Please wait 20-30 seconds after all connections are made before pressing the headset button to make a call. Please contact NEC for more information.

*\*The NEC DT Series phones come in 2 versions, the std SIP (used with NEC product SIP@NET and 3C) and the i-SIP/N-SIP versions which are used with the SV8100, SV8300 and SV8500. The APN-91 only works with the i-SIP/N-SIP versions of the DT700 terminals.*

For phone set-up, please refer to your specific phone manufacturers instructions.



# Electronic Hook Switch for Polycom®

## Polycom



### Desk Phone Models

- SoundPoint® IP 320
- SoundPoint IP 321
- SoundPoint IP 330
- SoundPoint IP 331
- SoundPoint IP 335
- SoundPoint IP 430
- SoundPoint IP 450
- SoundPoint IP 550
- SoundPoint IP 560
- SoundPoint IP 650
- SoundPoint IP 670
- VVX300 VVX600
- VVX400 VVX1500
- VVX500

## EHS Cable



**APP-51\***  
PN: 38439-11

*\* APP-51 replaces APP-50*

## Plantronics Audio Solutions



**Savi 700 Series**  
Wireless headset system manages PC, mobile and desk phone calls



**CS500/CS500 XD Series**  
Wireless headsets manage desk phone calls



**MDA200**  
Enables USB connectivity to the desk phone to manage both PC and desk phone calls



**Voyager Legend CS**  
Wireless Bluetooth headset system manages desk phone and mobile calls

**EHS Setup** Use the EHS setup below to automatically answer a desk phone call by pressing a button on your Savi 700 Series, CS500/CS500 XD Series or Voyager Legend CS headset or MDA200.

**Polycom models:** SoundPoint IP 320, 321, 330, 331, 335, 430, 450, 550, 560, 650, 670, VVX300, VVX400, VVX500, VVX600, VVX1500

### Setup

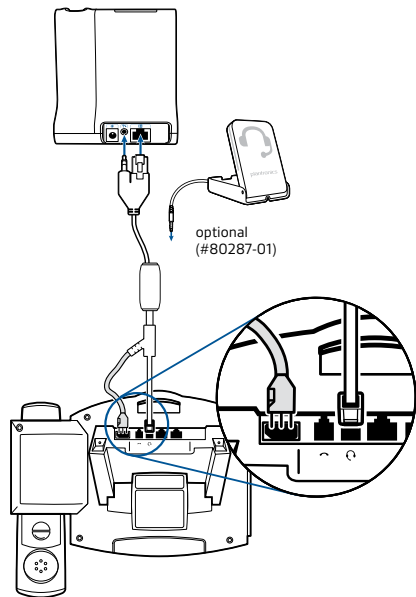

### Configuration

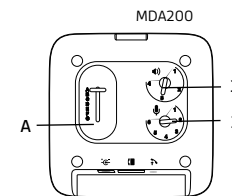
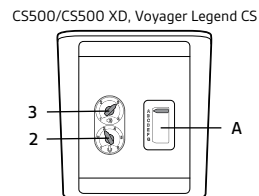
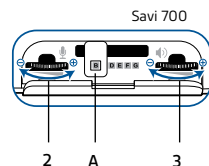

# Electronic Hook Switch for ShoreTel®

<p><b>ShoreTel</b></p>  <p><b>Desk Phone Models</b>          IP212K IP265 IP560 (g)          IP230 IP560 IP655 (g)          IP655*</p>	<p><b>EHS Cable</b></p>  <p><b>RD-1</b>          PN: 78887-01</p> <p><i>* IP 655 uses APD-80 with ShoreTel software version 14 and above</i></p>	<p><b>Plantronics Audio Solutions</b></p> <div style="display: flex; justify-content: space-around;"> <div data-bbox="955 332 1144 625">  <p><b>Savi 700 Series</b>              Wireless headset system manages PC, mobile and desk phone calls</p> </div> <div data-bbox="1207 332 1417 625">  <p><b>CS500/CS500 XD Series</b>              Wireless headsets manage desk phone calls</p> </div> <div data-bbox="1480 349 1690 641">  <p><b>MDA200</b>              Enables USB connectivity to the desk phone to manage both PC and desk phone calls</p> </div> <div data-bbox="1774 316 1963 625">  <p><b>Voyager Legend CS</b>              Wireless Bluetooth headset system manages desk phone and mobile calls</p> </div> </div>			
---	---	---	--	--	--

## EHS Setup Use the EHS setup below to automatically answer a desk phone call by pressing a button on your Savi 700 Series, CS500/CS500 XD Series or Voyager Legend CS headset or MDA200.

ShoreTel models: IP 212K, 230, 265, 560, 560G, 655

### Setup

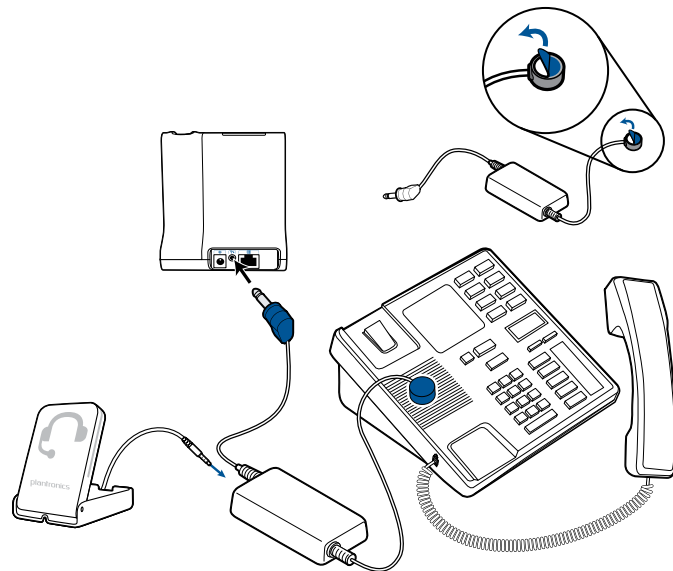

### Configuration

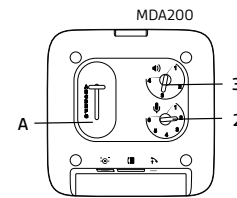
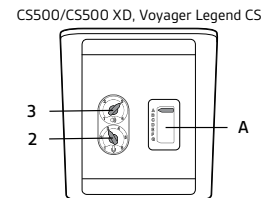
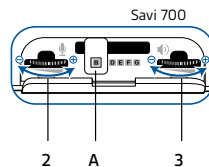

# Electronic Hook Switch for Siemens®

<p><b>Siemens</b></p>  <p><b>Desk Phone Models</b></p> <table border="0"> <tr> <td>Optipoint 410</td> <td>OpenStage 40</td> </tr> <tr> <td>Optipoint 420</td> <td>OpenStage 60</td> </tr> <tr> <td>Optipoint 500</td> <td>OpenStage 80</td> </tr> <tr> <td>Optipoint 600</td> <td></td> </tr> </table>	Optipoint 410	OpenStage 40	Optipoint 420	OpenStage 60	Optipoint 500	OpenStage 80	Optipoint 600		<p><b>EHS Cable</b></p>  <p><b>APS-11*</b> PN: 37818-11</p> <p><small>* APS-11 replaces APS-10</small></p>	<p><b>Plantronics Audio Solutions</b></p> <table border="0"> <tr> <td data-bbox="955 332 1144 519">  <p><b>Savi 700 Series</b> Wireless headset system manages PC, mobile and desk phone calls</p> </td> <td data-bbox="1249 332 1417 519">  <p><b>CS500/CS500 XD Series</b> Wireless headsets manage desk phone calls</p> </td> <td data-bbox="1480 357 1690 519">  <p><b>MDA200</b> Enables USB connectivity to the desk phone to manage both PC and desk phone calls</p> </td> <td data-bbox="1774 316 1942 519">  <p><b>Voyager Legend CS</b> Wireless Bluetooth headset system manages desk phone and mobile calls</p> </td> </tr> </table>	 <p><b>Savi 700 Series</b> Wireless headset system manages PC, mobile and desk phone calls</p>	 <p><b>CS500/CS500 XD Series</b> Wireless headsets manage desk phone calls</p>	 <p><b>MDA200</b> Enables USB connectivity to the desk phone to manage both PC and desk phone calls</p>	 <p><b>Voyager Legend CS</b> Wireless Bluetooth headset system manages desk phone and mobile calls</p>
Optipoint 410	OpenStage 40													
Optipoint 420	OpenStage 60													
Optipoint 500	OpenStage 80													
Optipoint 600														
 <p><b>Savi 700 Series</b> Wireless headset system manages PC, mobile and desk phone calls</p>	 <p><b>CS500/CS500 XD Series</b> Wireless headsets manage desk phone calls</p>	 <p><b>MDA200</b> Enables USB connectivity to the desk phone to manage both PC and desk phone calls</p>	 <p><b>Voyager Legend CS</b> Wireless Bluetooth headset system manages desk phone and mobile calls</p>											

**EHS Setup** Use the EHS setup below to automatically answer a desk phone call by pressing a button on your Savi 700 Series, CS500/CS500 XD Series or Voyager Legend CS headset or MDA200.

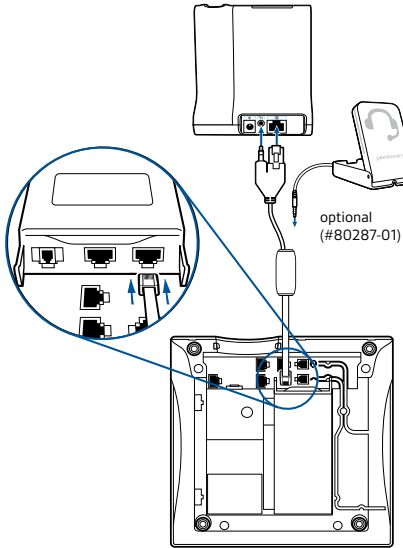
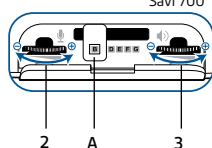
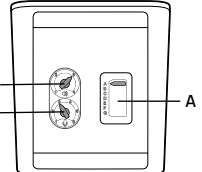
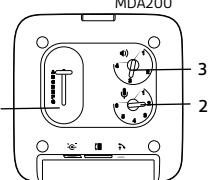
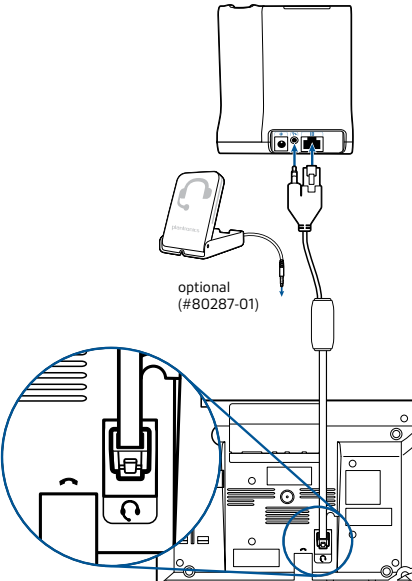
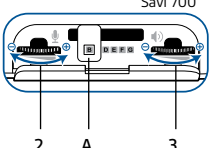
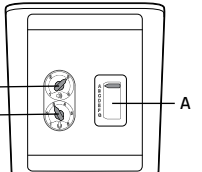
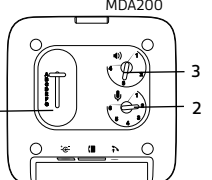
<p><b>Siemens models: Optipoint 410, 420, 500, 600</b></p> <p><b>Setup</b></p> 	<p><b>Configuration</b></p> <p><b>Savi 700</b></p>  <p><b>CS500/CS500 XD, Voyager Legend CS</b></p>  <p><b>MDA200</b></p> 	<p><b>Siemens models: OpenStage 40, 60, 80</b></p> <p><b>Setup</b></p>  <p><b>Configuration</b></p> <p><b>Savi 700</b></p>  <p><b>CS500/CS500 XD, Voyager Legend CS</b></p>  <p><b>MDA200</b></p> 
---	--	--

# Electronic Hook Switch for Tenovis

## Tenovis



- Desk Phone Models**
- T3 Classic with Interface Adapter
  - T3 IP Classic
  - T3 IP II Classic
  - T3 IP Classic with Interface Adapter
  - TH13
  - TM13
  - TS13
  - T3 Compact
  - T3 IP Comfort
  - T3 IP II Comfort
  - OS 13
  - OS33

## EHS Cable



**APT-31\***  
PN: 37820-11

\* APT-31 replaces APT-30

## Plantronics Audio Solutions



**Savi 700 Series**  
Wireless headset system manages PC, mobile and desk phone calls



**CS500/CS500 XD Series**  
Wireless headsets manage desk phone calls



**MDA200**  
Enables USB connectivity to the desk phone to manage both PC and desk phone calls



**Voyager Legend CS**  
Wireless Bluetooth headset system manages desk phone and mobile calls

**EHS Setup** Use the EHS setup below to automatically answer a desk phone call by pressing a button on your Savi 700 Series, CS500/CS500 XD Series or Voyager Legend CS headset or MDA200.

**Tenovis models:** T3 Classic with Interface Adapter, T3 IP Classic, T3 IP II Classic T3 Classic with Interface Adapter, TH13, TM13, TS13, T3 Compact, T3 IP Comfort, T3 IP II Comfort, OS 13, OS33

### Setup

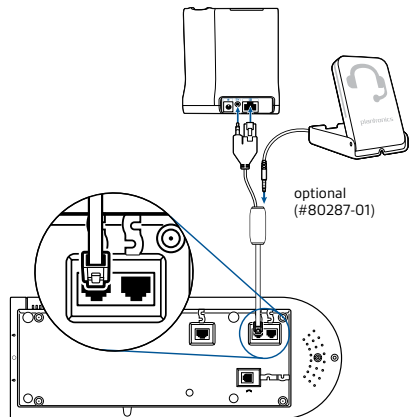

### Configuration

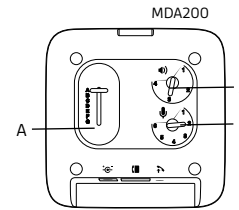
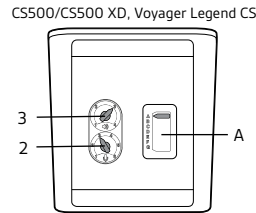
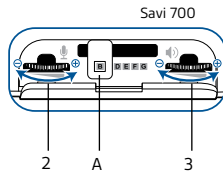

# Electronic Hook Switch for Toshiba®

<p><b>Toshiba</b></p>  <p><b>Desk Phone Models</b>          DP 5118-DP    IPT 2008-SDL          DP 5130-SDL   IPT 2010-SD          DP 5X22-SD    IPT 2020-SD          DP 5X32-SD</p>	<p><b>EHS Cable</b></p>  <p><b>RD-1</b>          PN: 78887-01</p>	<p><b>Plantronics Audio Solutions</b></p> <table border="0"> <tr> <td data-bbox="961 331 1129 516">  <p><b>Savi 700 Series</b>              Wireless headset system manages PC, mobile and desk phone calls</p> </td> <td data-bbox="1251 331 1398 516">  <p><b>CS500/CS500 XD Series</b>              Wireless headsets manage desk phone calls</p> </td> <td data-bbox="1486 354 1692 516">  <p><b>MDA200</b>              Enables USB connectivity to the desk phone to manage both PC and desk phone calls</p> </td> <td data-bbox="1780 315 1940 516">  <p><b>Voyager Legend CS</b>              Wireless Bluetooth headset system manages desk phone and mobile calls</p> </td> </tr> </table>				 <p><b>Savi 700 Series</b>              Wireless headset system manages PC, mobile and desk phone calls</p>	 <p><b>CS500/CS500 XD Series</b>              Wireless headsets manage desk phone calls</p>	 <p><b>MDA200</b>              Enables USB connectivity to the desk phone to manage both PC and desk phone calls</p>	 <p><b>Voyager Legend CS</b>              Wireless Bluetooth headset system manages desk phone and mobile calls</p>
 <p><b>Savi 700 Series</b>              Wireless headset system manages PC, mobile and desk phone calls</p>	 <p><b>CS500/CS500 XD Series</b>              Wireless headsets manage desk phone calls</p>	 <p><b>MDA200</b>              Enables USB connectivity to the desk phone to manage both PC and desk phone calls</p>	 <p><b>Voyager Legend CS</b>              Wireless Bluetooth headset system manages desk phone and mobile calls</p>						

## EHS Setup Use the EHS setup below to automatically answer a desk phone call by pressing a button on your Savi 700 Series, CS500/CS500 XD Series or Voyager Legend CS headset or MDA200.

**Toshiba models:** DP 051180-DP, DP 5130-SDL, DP 5X22-SD, DP-5X32, IPT 2008-SDL, IPT 2010-SDL, IPT 2020-SD

### Setup

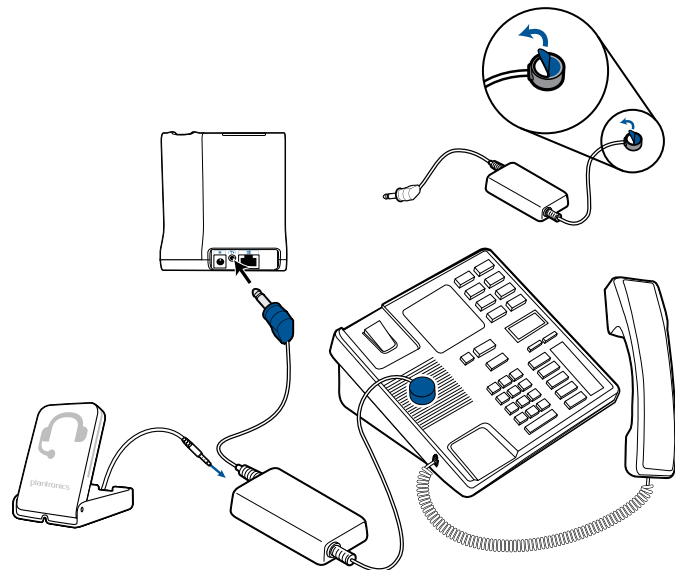

### Configuration

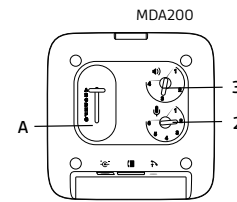
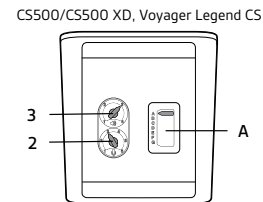
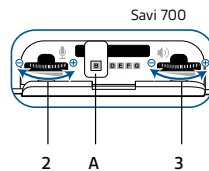



**plantronics®**

Plantronics  
345 Encinal Street  
Santa Cruz, CA 95060

**[plantronics.com](http://plantronics.com)**