

Borrowed from  
Yards & Docks

~~B-6-20~~  
~~B-4-50~~  
P3417

**U. S. NAVY ADVANCE BASE  
EQUIPMENT CATALOG**

OK  
Ed 44 Change No. 1  
Ed 45 Change No. 2

**RESTRICTED**

Editor's Copy

**Bureau of Yards and Docks  
Navy Department  
Washington, D. C.**

NAVY DEPARTMENT,  
Bureau of Yards and Docks  
Washington, D. C.

January 1, 1944

## PREFACE

to the first edition, U. S. Navy Advance Base Equipment Catalog

1. This catalog is issued in order to provide to all activities handling Advance Base equipment, a description of the characteristics and functions of the most essential types of equipment currently being procured by the Bureau of Yards and Docks for use at the U.S. Navy Advance Bases.

2. While it is recognized that this first edition covers only a portion of the overall list of Functional Component items, an attempt has been made to include those items most critical in the establishment of Advance Bases. And while there are occasional omissions of such information as weights and cubes which were not accurately available, the loose-leaf format will allow the future issuance of additional sheets covering additions, omissions and corrections.

3. The catalog is further intended to serve as a supplementary document to the "Stock List of Advance Base Materials, Equipment and Supplies", as issued by the Advance Base Division of the Bureau of Yards and Docks, amplifying and illustrating the data contained therein.

4. The items have been grouped under the same seven sections used in the "Stock List", each section being arbitrarily divided into subsections, with the items in alphabetical order therein.

*B. Maell*

Chief of Bureau

*Revised  
Oct 44  
Oct 45*

## CONTENTS

(Items listed in alphabetical order within subsections)

### Section 1 - Buildings

- Huts, Arch Rib, 20 ft x 36 ft
- Huts, Arch Rib, 20 ft x 48 ft
- Buildings, Arch Rib, 40 ft x 100 ft
- Magazines
- Tents, Large Wall, 14 ft x 14 ft
- Tents, Pyramidal, 16 ft x 16 ft
- Tents, Storage, 17 ft x 20 ft
- Tents, Hospital Ward, 16 ft x 50 ft
- Miscellaneous

### Section 2 - Mechanical Equipment

- Bakery, Galley, Scullery and Refrigeration
- Plumbing, Heating and Laundry
- Fire Fighting
- Water Supply
- Gasoline and Oil Handling
- Miscellaneous

### Section 3 - Electrical Systems and Equipment

- Power and Lighting
- Radio
- Talk-Back Public Address
- Telephone
- Inter-Office Communication
- Miscellaneous

### Section 4 - General Equipment

- Surveying
- Office
- Weapons
- Gas Protection
- Photographic
- Miscellaneous

### Section 5 - Water Front Structures

- Pontoon Gear
- Navigation Aids
- Moorings
- Miscellaneous

### Section 6 - Transportation Equipment

- Trucks
- Tractors
- Trailers
- Maintenance and Repair
- Miscellaneous

### Section 7 - Construction Equipment

- Road and Airfield
- Excavating and Lifting
- Compressed Air
- Pumps
- Woodworking
- Maintenance and Repair
- Miscellaneous

Section 1 - Buildings

**CONTENTS**

Huts, Arch Rib, 20 ft x 36 ft

Huts, Arch Rib, 20 ft x 48 ft

Buildings, Arch Rib, 40 ft x 100 ft

Magazines

Tents, Large Wall, 14 ft x 14 ft

Tents, Pyramidal, 16 ft x 16 ft

Tents, Storage, 17 ft x 20 ft

Tents; Hospital Ward, 16 ft x 50 ft

Miscellaneous

## HUT, ARCH RIB, STANDARD BASIC UNIT

20 FT X 36 FT (HOSPITAL GROUP) ASSEMBLY NO.; NORTHERN, 1178: TROPICAL, 1179



EXTERIOR VIEW

**APPLICATION:** Supplied for hospital usage to house wards, and all other facilities except scullery, laundry, 25 and 100 man galleys and patients mess.

**CAPACITY:** Assigned to various units, partitioned and equipped as required, the capacity varies with the function. Hut contains 720 sq ft of floor area, and 5,654.88 cu ft of space.

**DESCRIPTION:** This hut is built of cold rolled steel ribs, four feet on center with an outer covering of corrugated galvanized iron, painted. One inch of insulation is packed between the steel roof and an interior lining of fibre board. Floors are of plywood, laid in steel joists. The bulkheads, with one door and two flanking windows, are made of plywood. Four flush type windows are shipped with each hut. Ventilators and smoke jacks are included.

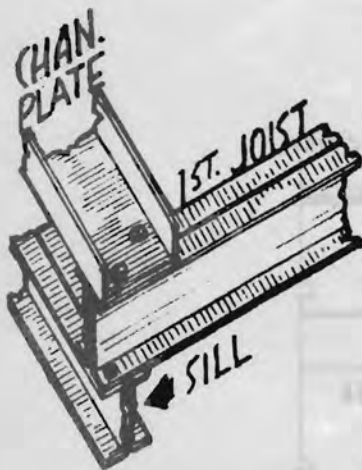

SILL AND JOIST

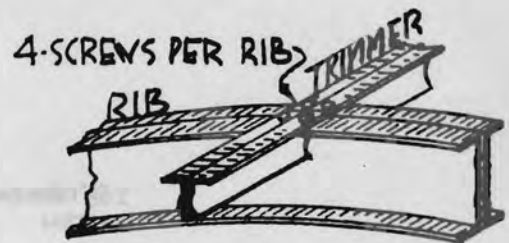

RIB AND TRIMMER

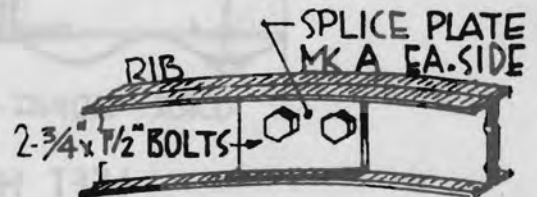

RIB CONNECTION

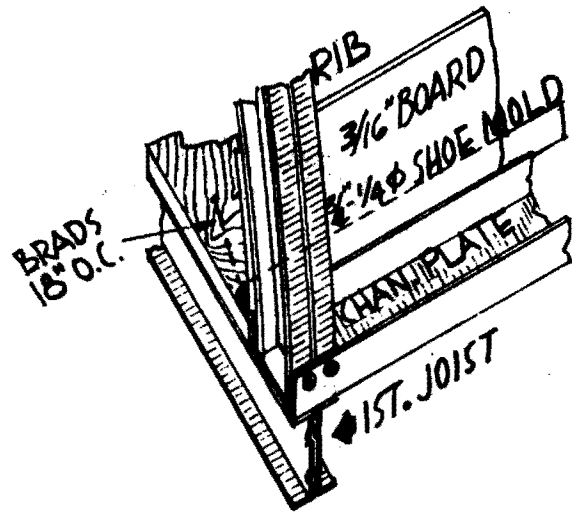

CORNER DETAIL

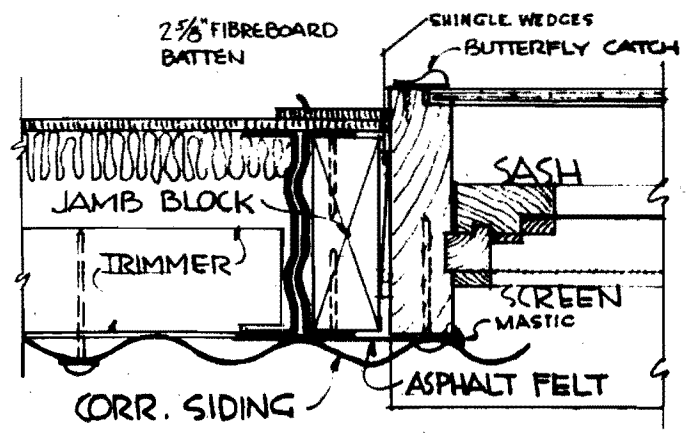

LEFT HAND JAMB

SIDE WALL WINDOW JAMB

## SECTION I - BUILDINGS

## List of Effective Pages

A1 - A2	July 1945	43 - 44	November 1943	99 - 100	November 1943
1 - 2	November 1943	45 - 46	" "	101 - 102	" "
3 - 4	" "	47 - 48	" "	103 - 104	" "
5 - 6	" "	49 - 50	" "	105 - 106	" "
7 - 8	" "	51 - 52	" "	107 - 108	" "
11 - 12	" "	53 - 54	" "	109 - 110	" "
13 - 14	" "	55 - 56	" "	111 - 112	" "
15 - 16	" "	57 - 58	" "	113 - 114	" "
17 - 18	" "	59 - 60	" "	115 - 116	" "
19 - 20	" "	61 - 62	" "	117 - 118	November 1945
21 - 22	" "	63 - 64	" "	119 - 120	" "
23 - 24	" "	65 - 66	" "	121 - 122	" "
25 - 26	" "	67 - 68	" "	127 - 128	" "
27 - 28	" "	69 - 70	" "	129 - 130	" "
29 - 30	" "	83 - 84	" "	131 - 132	" "
31 - 32	" "	85 - 86	" "	133 - 134	" "
33 - 34	" "	87 - 88	" "	135 - 136	" "
37 - 38	" "	89 - 90	" "	143 - 144	" "
39 - 40	" "	95 - 96	" "	145 - 146	" "
41 - 42	" "	97 - 98	" "	147 - 148	" "

## SECTION I - BUILDINGS

## INDEX TO CONTENTS

	<u>Pages</u>		<u>Pages</u>
<u>Huts, 20 Ft x 36 Ft, Arch-Rib</u>		<u>Huts, 20 Ft x 48 Ft, Arch-Rib (Cont'd)</u>	
Eye, Ear, Nose, Throat, and Urology	5 - 6	Refrigerator Storage, Tropical	85 - 86
Laboratory, Hospital	7 - 8	Scullery, Hospital, Northern	87 - 88
Pharmacy-Dental	11 - 12	Scullery, Hospital, Tropical	89 - 90
Standard Basic Unit	1 - 4	Standard Basic Unit, Northern, Continuous Hinged Steel Windows	27 - 30
Stores	13 - 14	Standard Basic Unit, Tropical, Continuous Screened Windows	31 - 34
Surgery	15 - 16		
Utility, Hospital	17 - 18	<u>Buildings</u>	
Ward, Receiving	19 - 20	Lean-to For Boiler Room, Steel, 10 Ft x 24 Ft	99 - 100
Ward With Quiet Room	21 - 22	Parachute Loft and Shop, 40 Ft x 100 Ft	101 - 102
Ward Without Quiet Room	23 - 24	Magazine, Standard Basic Unit, Steel, 10 Ft x 10 Ft	103 - 104
X-Ray, Hospital	25 - 26	Magazine, Standard Basic Unit, Steel, 20 Ft x 20 Ft	105 - 106
		Magazine, Gas-Decontaminating, 20 Ft x 50 Ft	107 - 108
		Magazine, Torpedo-Storage, Standard Basic Unit, Steel 25 Ft x 50 Ft	109 - 110
		Standard Basic Unit, 40 Ft x 100 Ft	95 - 97
<u>Huts, 20 Ft x 48 Ft, Arch-Rib</u>		<u>Tents</u>	
Bakery, 1,000-Men, Northern	37 - 38	Canvas, Wall, 14 Ft x 14 Ft	111 - 112
Bakery, 1,000-Men, Tropical	39 - 40	Administration, 14 Ft x 14 Ft, with Floor	113 - 114
Barracks, Enlisted Men, Northern	41 - 42	Barracks, Officers', 14 Ft x 14 Ft, with Floor	115 - 116
Barracks, Enlisted Men, Tropical	43 - 44	Latrine Pit, with Dirt Floor and Wood Frame, 14 Ft x 14 Ft	117 - 118
Barracks, Officers, Northern	45 - 46	Shower, Officers' 14 Ft x 14 Ft, with Frame and Floor	119 - 120
Barracks, Officers, Tropical	47 - 48	Pyramidal, 16 Ft x 16 Ft	121 - 122
Bombsight Workshop, Northern	49 - 50	Barracks, Enlisted Men's, 16 Ft x 16 Ft, with Floor	127 - 128
Galley and Dry Storage, Northern	51 - 52		
Galley and Dry Storage, Tropical	53 - 54		
Galley, Mess and Dry Storage, Northern	55 - 56		
Galley, Mess and Dry Storage, Tropical	57 - 58		
Galley With Scullery and Preparation, Northern	59 - 61		
Galley With Scullery and Preparation, Tropical	63 - 64		
Laundry, Hospital, Northern	65 - 66		
Laundry, Northern	67 - 68		
Laundry, Tropical	69 - 70		
Refrigerator Storage, Northern	83 - 84		

(Change No. 2 Oct, 1945) A1

CONTENTS - (continued)

**INDEX TO CONTENTS (continued)**

<u>Tents (Cont'd)</u>	<u>Pages</u>	<u>Miscellaneous</u>	<u>Pages</u>
Storage, 17 Ft x 20 Ft	129 - 130	Photographic Laboratory, Hut,	
Administration, 17 Ft x		Northern, 20 Ft x 60 Ft	143 - 144
20 Ft, with Floor	131 - 132	Photographic Laboratory Hut,	
Shower, Enlisted Men's 17		Tropical, 20 Ft x 60 Ft	145 - 146
Ft x 20 Ft, with Frame		Scrub Deck, Tarpaulin,	
and Floor	133 - 134	15 Ft x 20 Ft	147 - 148
Hospital Ward, 16 Ft x 50 Ft	135 - 136		



## SECTION II - MECHANICAL EQUIPMENT

## List of Effective Pages

149 - 150	July 1945	197 - 198	July 1945	263 - 264	November 1943
150A - 150B	" "	199 - 200	November 1943	265 - 266	" "
151 - 152	November 1943	200A - 200B	July 1945	267 - 268	" "
152A - 152B	October 1944	201 - 202	October 1944	268C - 268D	October 1944
153 - 154	November 1943	203 - 204	" "	269 - 270	November 1943
154A - 154B	July 1945	205 - 206	" "	270A - 270B	July 1945
155 - 156	October 1944	206A - 206B	" "	271 - 272	November 1943
157 - 158	" "	207 - 208	November 1943	273 - 274	" "
159 - 160	" "	209 - 210	" "	275 - 276	" "
161 - 162	July 1945	211 - 212	July 1945	276A - 276B	July 1945
163 - 164	" "	217 - 218	November 1943	277 - 278	November 1943
167 - 168	" "	219 - 220	" "	279 - 280	" "
168A - 168B	October 1944	225 - 226	" "	281 - 282	" "
168C - 168D	" "	227 - 228	" "	283 - 284	" "
169 - 170	November 1943	229 - 230	" "	285 - 286	" "
171 - 172	July 1945	231 - 232	July 1945	287 - 288	" "
173 - 174	November 1943	233 - 234	November 1943	289 - 290	" "
175 - 176	" "	235 - 236	" "	291 - 292	" "
179 - 180	October 1944	237 - 238	" "	293 - 294	" "
181 - 182	" "	239 - 240	" "	294A - 294B	July 1945
183 - 184	" "	241 - 242	" "	295 - 296	November 1943
185 - 186	" "	243 - 244	" "	297 - 298	" "
187 - 188	" "	245 - 246	" "	299 - 300	" "
188A - 188B	" "	247 - 248	" "	301 - 302	" "
189 - 190	July 1945	251 - 252	" "	303 - 304	" "
191 - 192	November 1943	253 - 254	" "	305 - 306	" "
195 - 196	" "	261 - 262	" "	307 - 308	" "
				311 - 312	July 1945

## SECTION II - MECHANICAL EQUIPMENT

## INDEX TO CONTENTS

<u>Bakery, Galley, Scullery, and Refrigeration</u>	<u>Pages</u>	<u>Plumbing, Heating, and Laundry</u>	<u>Pages</u>
Boiler, Steam-Generating, 180,000- and 595,000-BTU	150A-150B	Air Drying Tumbler	206A-206B
Cooker, Steam, 3-Compartment	154A-154B	Delousing Chamber	203-204
Dough Trough	151-152	Heater, Space, 50,000-BTU	189-190
Freezer, Ice Cream	152A-152B	Heater, Unit	191-192
Hot Plate, Double Unit	153-154	Heater, Water, Pot-Type, Oil-Burning	195-196
Ice Machine, Flakice	155-156	Heater, Water, Tankless-Type	197-198
Ice Machine, Pakicer	157-158	Irons, Electric, Hand-Pressing	199-200
Mixer, Food	159-160	Ironer, Flat Work, 48-In., Gasoline-Fired	200A-200B
Oven, Bake	161-162	Lavatory, Single Compartment	211-212
Proof Box	163-164	Laundry Unit, Portable	201-202
Range, Galley, with Burner Assembly	167-168	Pump, Sewage-Ejector, 50-GPM	231-232
Range, Galley, Double-Oven-Type	168A-168B	Sink, Galley, 62-In. x 27-In.	207-208
Refrigerator, Elect., 8-Cu Ft	168C-168D	Sink, Double-Compartment, 108-In. Galv., 2 Drainboards	209-210
Refrigerator, Elec., 32-Cu Ft	169 - 170	Sink, Wash, 96-In. x 36-In.	217-218
Refrigerator, 150-Cu Ft, Elect. or Gas-Driven, Portable, Walk-In-Type	171-172	Shower	219-220
Refrigerator, Walk-In, 675-Cu Ft	173-174	Toilet, Chemical, 1-, 2- & 3-Bowl	225-226
Refrigerator, Walk-In, 6,800-Cu Ft	175-176	Tray, Laundry	227-228
Slicer, Bread, Elect.-Driven	179-180	Urinal, Wall-Hanging, 5-Ft	229-230
Slicer, Meat, Elect.-Driven	181-182	Washer, Clothes, 25-Lb Capacity	205-206
Slicer, Meat & Bread, Hand-Operated	183-184		
Torch, Freon Test, for Refrigerators	185-186	<u>Fire-Fighting</u>	
Urn, Coffee	187-188	Extinguisher, Fire, Carbon Tetrachloride, Hand-Type	233-234
Urn, Coffee	188A-188B	Extinguisher, Fire, CO <sub>2</sub>	235-236
		Extinguisher, Fire, Foam, Hand-Type, 2 1/2-Gal	237-238
		Extinguisher, Fire, Foam, Mobile, 40-Gal	239-240

INDEX TO CONTENTS (Continued)

<u>Fire-Fighting (Cont'd)</u>	<u>Pages</u>	<u>Gasoline and Oil Handling (Cont'd)</u>	<u>Pages</u>
Extinguisher, Fire, Hand-Pump-Type, 5-Gal Tank	241-242	Coupling, Grooved-Type, with Bolts, Nuts, and Gaskets	283-284
Extinguisher, Fire, Water, Hand-Pump-Type, 5-Gal, Knapsack Tank	243-244	Hose, Cargo or Submarine Pipe, Spiral-Weld, Grooved for Victualic Coupling	285-286
Play Pipe, Foam, with Pick-Up Tube and Hip Pack	245-246	Pump, Centrifugal, 200-GPM, 50-Lb per Sq In.	287-288
Pump, Fire, Trailer, 500-GPM	247-248	Pump, Centrifugal, 350-GPM, 125-Lb per Sq In.	289-290
Recharging Unit, CO <sub>2</sub> , Electric-Driven	251-252	Pump, Hand	291-292
Scales, Counter, Platform, and Balance Arm	253-254	Pump, Hand, Refueling, 10-GPM	293-294
		Pump, Rotary, 20-GPM, 50-Lb per Sq In.	294A-294B
<u>Water Supply</u>		Pump, Rotary, 100-GPM	295-296
Hypochlorination Unit	261-262	Pump, Rotary, 350-GPM, 160-Lb per Sq In.	297-298
Pump, Centrifugal, 15-GPM @ 50-Ft Head	263-264	Tank, Fuel Oil, Welded-Steel	299-300
Pump, Centrifugal, 55-GPM @ 50-Ft Head	265-266	Tank, Nested, Steel, 5,000-Gal., Underground	301-302
Pump, Centrifugal, Self-Priming, 124-GPM @ 231-Ft Head	267-268	Tank, Steel, Bolted	303-304
Pump, Hi-lift, 30-GPM @ 250-Ft Head	268C-268D	Tees and Elbows, "Grooved"-Type	305-306
Purification Unit	269-270		307-308
Tank, Canvas, 3,000-Gal	271-272	<u>Miscellaneous</u>	
Tank, Mareng Cell, 3,000-Gal	273-274	Shoe Machine, Stitching and Finishing Combination	311-312
Tank, Test	275-276		
Tank, Water, Bolted, 100-, 250-, and 500-Gal Capacity	276A-276B		
Tank, Water, Wood	277-278		
<u>Gasoline and Oil Handling</u>			
Assembly, Loading	279-280		
Clarifier, Filter Unit, Diesel Oil	281-282		

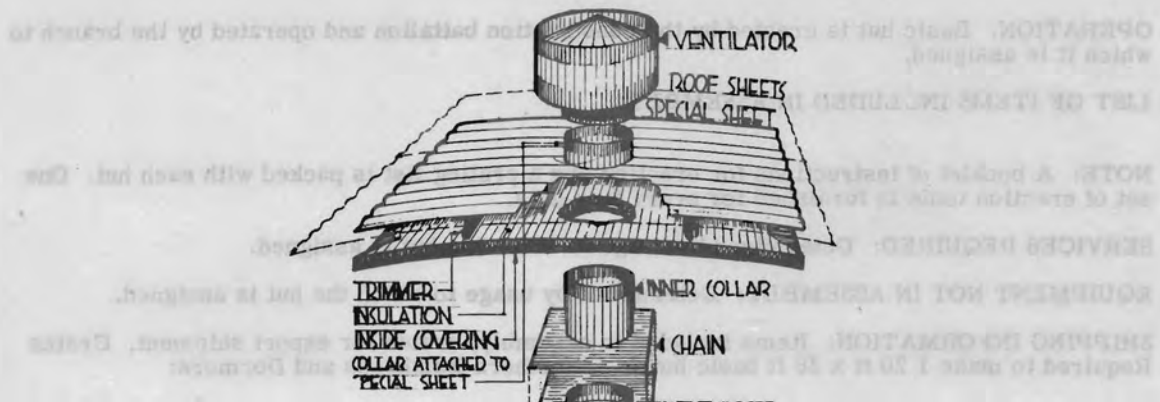

**VENTILATOR CONSTRUCTION**

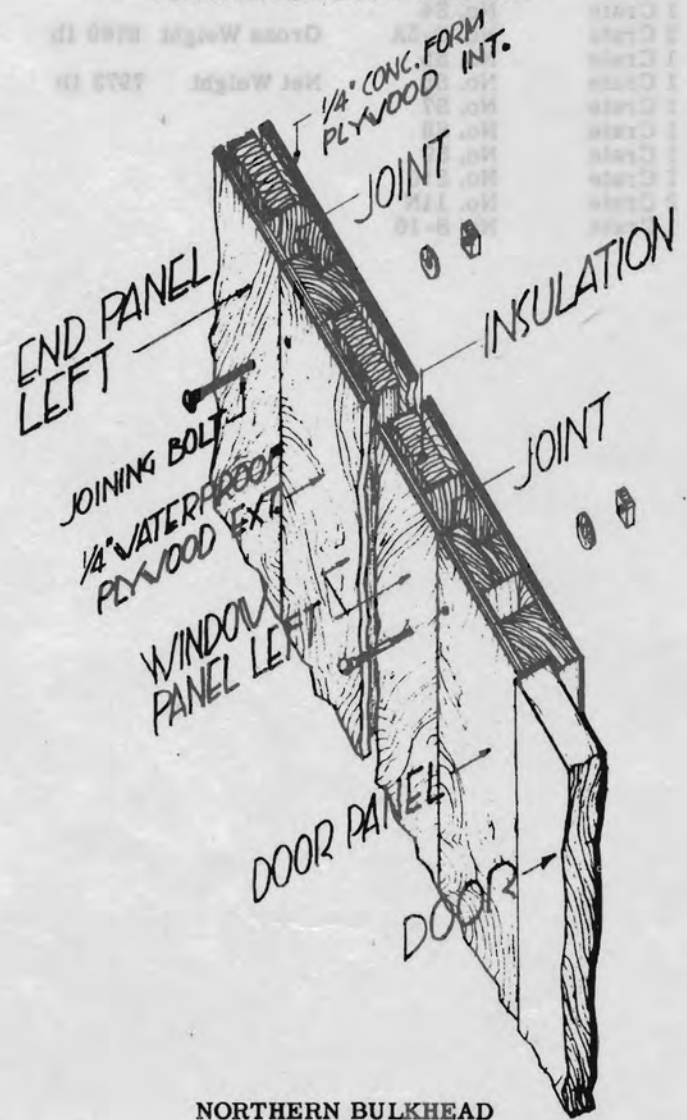

**NORTHERN BULKHEAD**

**OPERATION:** Basic hut is erected by the construction battalion and operated by the branch to which it is assigned.

**LIST OF ITEMS INCLUDED IN ASSEMBLY:**

**NOTE:** A booklet of instructions for erecting and a crating list is packed with each hut. One set of erection tools is furnished for every four huts.

**SERVICES REQUIRED:** Determined by usage to which the hut is assigned.

**EQUIPMENT NOT IN ASSEMBLY:** Determined by usage to which the hut is assigned.

**SHIPPING INFORMATION:** Items included in assembly, crated for export shipment. Crates Required to make 1 20 ft x 36 ft basic hut with Northern Bulkheads and Dormers:

1 Crate	No. S1	
1 Crate	No. S2	
1 Crate	No. S3	Total Cu Ft 273.14
1 Crate	No. S4	
2 Crate	No. S-5A	Gross Weight 8769 lb
1 Crate	No. S5	
1 Crate	No. S6	Net Weight 7973 lb
1 Crate	No. S7	
1 Crate	No. S8	
1 Crate	No. S9	
1 Crate	No. S10	
2 Crate	No. 11N	
1 Crate	No. S-16	

## EYE, EAR, NOSE, THROAT AND UROLOGY

HUT, NORTHERN, 20 FT X 36 FT, ASSEMBLY NO.; NORTHERN, 1034: TROPICAL, 1035

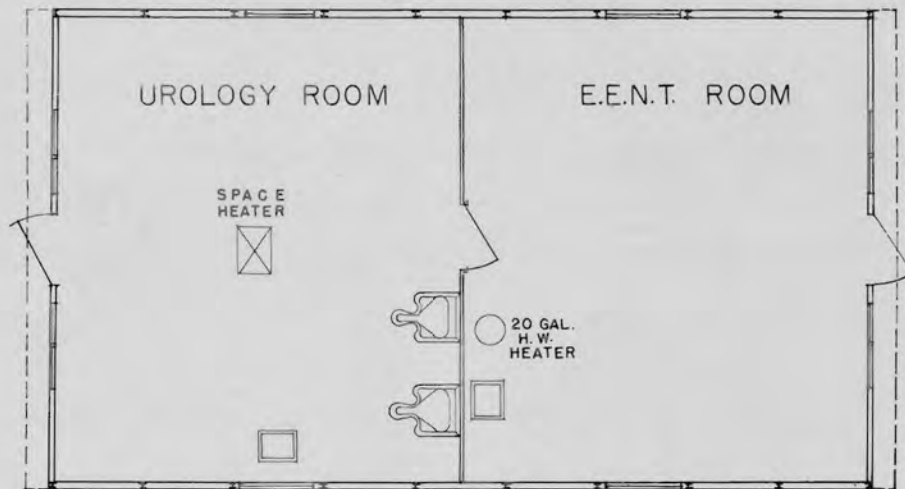

PLAN

**APPLICATION:** This hut consists of two rooms, one of which is used for eye, ear, nose and throat examination and treatment and the other for urology examinations where treatments are made of diseases of the bladder, kidneys, genito-urinary tracts and social diseases.

**CAPACITY:** Hut supplied to following hospital components:

Fundamental Component	No. of Huts
G1 - 600 Bed hospital w/dispensaries	3
G2 - " " without dispensaries	1
G3 - 200 " " w/dispensaries	2
G4 - " " without dispensaries	1
G5 - 100 " Dispensary	1
G7 - 50 " "	1

**DESCRIPTION:** This is a standard hut with addition of partitions and fixtures.

**OPERATION:** By medical unit.

**LIST OF ITEMS INCLUDED IN ASSEMBLY:**

Stock No.	Description	Quantity
1A1-5	Hut, arch rib, standard basic unit, 20 ft x 36 ft w/four flush type windows.	(1)
1A2-1	Bulkhead (Northern)	2
	Partitions, interior.	
2Q15-	Lavatory.	(2)
2Q15-	Stand, straddle.	(2)
2Q18-	Heater, 20 gal, water.	(1)
2H71-10	Tank, oil, 75 gal.	(1)
*2Q11-	Heater, space. w/accessories	(2)
	Electrical equipment. (Additional to standard list)	1 crate
	Plumbing accessories.	

**SERVICES REQUIRED:** Electricity, fuel, oil and water.

**EQUIPMENT NOT SUPPLIED IN ASSEMBLY:** Medical equipment and supplies.

**SHIPPING INFORMATION:** Items included in assembly, crated for export:

Shipping weight 11,640 lb                      Shipping volume 406 cu ft

\* Omit when shipped to tropical climates.

Shipping weight 220 lb                      Shipping volume 20 cu ft

## LABORATORY, HOSPITAL

HUT, 20 FT X 36 FT, ASSEMBLY NO.; NORTHERN, 1074: TROPICAL, 1075

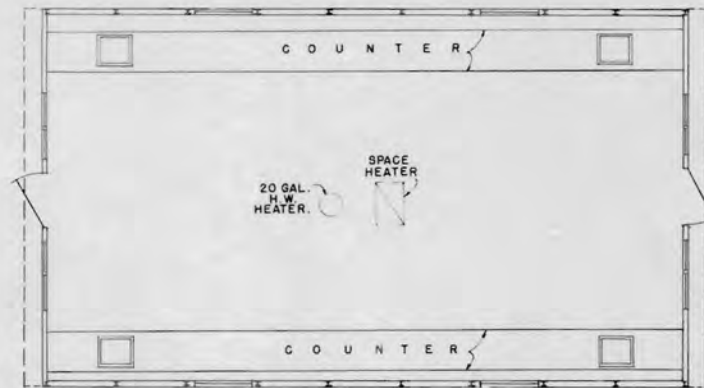

PLAN

**APPLICATION:** This hut is used for the preparation of serums and tests of urine and blood. Routine examinations and laboratory work are performed. Storage space is provided for material used in the above work.

**CAPACITY:** The number of corpsmen required depends on the field activity. Following are the numbers of laboratory huts supplied to various size units.

Functional Component	No. of Huts
G1 - 600 Bed Hospital with dispensaries	3
G2 - 600 " " without "	1
G3 - 200 " " with "	2
G4 - 200 " " without "	1
G5 - 100 " Dispensary	1
G7 - 50 " "	1

**DESCRIPTION:** This is a one room hut with a full length counter, containing two (2) sinks, on each side of the hut. A hot water heater supplies the hot water to the sinks and a space heater keeps the hut warm.

**OPERATION:** Operation of this hut is under control of the medical officer.

**LIST OF ITEMS INCLUDED IN ASSEMBLY:**

Stock No.	Description	Quantity
1A1-5	Hut, arch rib steel, standard basic unit, 20 ft x 36 ft w/4 flush type windows.	(1)
1A2-1	Bulkhead (Northern)	2
4S13	Counters	2
2Q15	Sink, flat rim, 24 in. x 20 in.	4
	Pipe and fittings	1 crate
2Q18	Heater, water, 20 gallon	1
2H71-10	Tank, fuel, 75 gallon	1
	Smoke pipe	1 crate
	Electrical material	1 crate
*2Q11	Heater, space, w/accessories	(2)

**SERVICES REQUIRED:** Fuel oil, water, electricity.

**EQUIPMENT NOT SUPPLIED IN ASSEMBLY:** Medical supplies.

**SHIPPING INFORMATION:** Items included in assembly, crated for export. Shipping weight 11,415 lb Shipping volume 396 cu ft

\* Omit when shipped to tropical climates.  
Shipping weight 220 lb Shipping volume 20 cu ft

## PHARMACY - DENTAL

HUT, (HOSPITAL GROUP), 20 FT X 36 FT, ASSEMBLY NO.; NORTHERN, 1123: TROPICAL, 1124

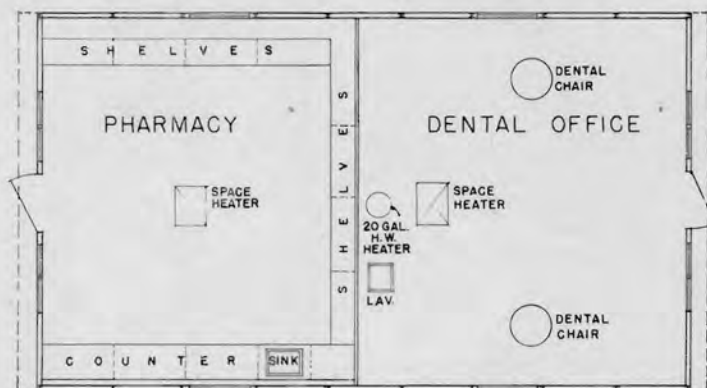

PLAN

**APPLICATION:** The pharmacy dental hut provides housing for compounding prescriptions and dispensing medical supplies as well as dental offices.

**CAPACITY:** Two dentists and two medical men with pharmacy office.

Functional Component	No. of Huts
G1-600 bed hospital w/dispensary	4
G2-600 " " without disp.	1
G3-200 " " w/disp.	3
G4-200 " " without disp.	1
G5-100 " " w/disp.	1
G7- 50 " dispensary	1

**DESCRIPTION:** The pharmacy room in this hut is equipped with shelves, counters, sink and hot water heater. The dental office is equipped with two dental chairs and sink. A partition separates the pharmacy from the dental office.

**OPERATION:** By medical unit.

**LIST OF ITEMS INCLUDED IN ASSEMBLY:**

Stock No.	Description
1A1-5	- Hut, arch rib, steel. Standard basic unit, 20 ft x 36 ft w/4 flush type windows. (1)
1A2-1	- Bulkhead (Northern) 2
	- Partition.
	- Pipe and fittings. 1 crate
4S13	- Counter. (1)
4S8.7	- Shelves. 1 ft 4 in x 4 ft x 4 ft (8)
2Q15	- Sink, (Lavatory) (1)
2Q18	- Heater, water, 20 gal (1)
2H71-10	- Tank, fuel oil, 75 gal (1)
	- Smoke pipe (1)
2Q15	- Sink (1)
*2Q11	- Heater, space w/ acces. (2)
	- Electrical material. 1 crate

**SERVICES REQUIRED:** Electricity, water, fuel oil.

**EQUIPMENT NOT SUPPLIED IN ASSEMBLY:** Medical equipment and supplies. Dental chairs and supplies.

**SHIPPING INFORMATION:** Items included in assembly, crated for export:

Shipping weight	lb	Shipping volume	cu ft
-----------------	----	-----------------	-------

\* Omit for tropical climates and deduct 220 lb and 20 cu ft from shipping weights and cubes.

## STORES

HUT, (HOSPITAL GROUP), 20 FT X 36 FT, ASSEMBLY NO.; NORTHERN, 1163; TROPICAL, 1164

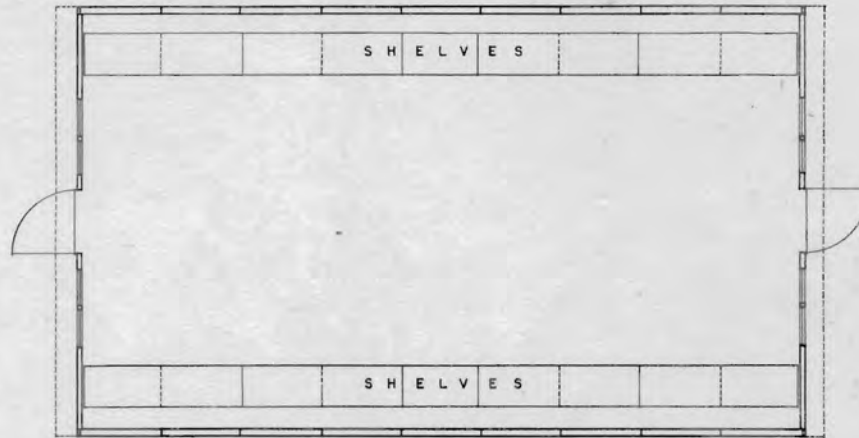

PLAN

**APPLICATION:** Used for storage of general and medical supplies and also storage of sea bags and personal effects belonging to medical unit.

**CAPACITY:**

Functional Component	No. of Huts
G1 600 bed hospital (w/dispensaries)	10
G2 600 " " (without dispensaries)	6
G3 200 " " (w/dispensaries)	5
G4 200 " " (without dispensaries)	4
G5 100 bed dispensary	4
G7 50 " "	1
G8 25 " "	1

**DESCRIPTION:** Standard hut with shelves on both sides and full length of hut.

**OPERATION:** By medical unit.

**LIST OF ITEMS INCLUDED IN ASSEMBLY:**

Stock No.	Description
1A1-5	- Hut, arch rib, steel. Standard basic unit, 20 ft x 36 ft w/4 flush type windows. (1)
1A2-1	- Bulkhead (Northern) (2)
4S8-4	- Shelves, 2 ft x 4 ft x 8 ft (4)
4S8-5	- " 2 ft x 4 ft x 8 ft (4)
4S8-6	- " 2 ft x 4 ft x 3 ft 9 in (2)
*2Q11	- Heater, space w/accessories (1)
	- Electrical material. 1 crate

**SERVICES REQUIRED:** Electricity

**EQUIPMENT NOT SUPPLIED WITH ASSEMBLY:** Medical supplies.

**SHIPPING INFORMATION:** Items included in assembly, crated for export:  
Shipping weight 9,184 lb      Shipping volume 264 cu ft

\*Omit for tropical climates  
Deduct 220 lb 20 cu ft



## SURGERY

HUT, (HOSPITAL GROUP), 20 FT X 36 FT, (W/LEAN-TO), ASSEMBLY NO.;  
NORTHERN, 1171: TROPICAL, 1172

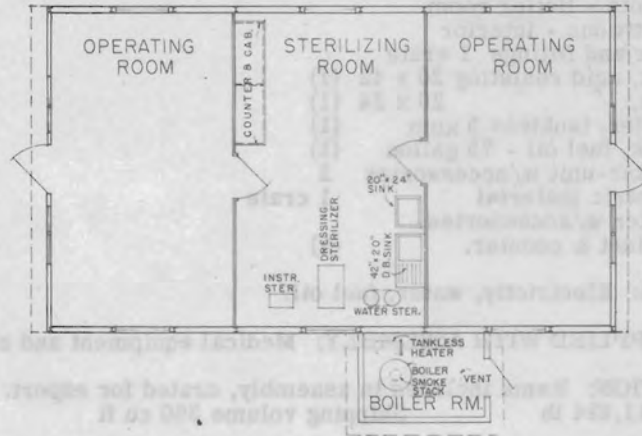

PLAN

**APPLICATION:** For surgical, operative and fracture work; preparation of surgical materials and solutions used in surgical operations.

**CAPACITY:** Varies with local conditions

Functional Component

G1-600 bed hospital	(w/dispensaries)	No. of Huts
G2- " " "	(without " )	
G3-200 bed	" (w/dispensaries)	
G4-200 bed	" (without " )	
G5-100 bed	" dispensary	
G7- 50 bed	" " )	
	" " )	

No. of Huts

3  
2  
2  
1  
1  
1  
1

**DESCRIPTION:** Consists of one sterilizing room, flanked by two operating rooms and one leanto boiler room.

**OPERATION:** By medical unit.



LEAN-TO ON SURGERY HUT

## UTILITY, HOSPITAL

HUT, (HOSPITAL), 20 FT X 36 FT, ASSEMBLY NO.; NORTHERN, 1178: TROPICAL, 1179



PLAN

**APPLICATION:** This hut may be used as an office or for personnel requirements.

**CAPACITY:** Varies with application.

**DESCRIPTION:** Standard hut.

**OPERATION:** Under control of medical unit.

**LIST OF ITEMS INCLUDED IN ASSEMBLY:**

Stock No.	
1A1-5	- Hut, arch rib steel. Standard basic unit, w/4 flush type windows. (1)
1A2-1	- Bulkhead (Northern) (2)
*2Q11	- Heater, space, w/accessories (2)

**SERVICES REQUIRED:** Electrical material, electricity.

**EQUIPMENT NOT SUPPLIED WITH ASSEMBLY:** Varies with application.

**SHIPPING INFORMATION:** Items included in assembly, crated for export:  
Shipping weight 9,184 lb                      Shipping volume 264 cu ft

\* Omit for Tropical climate.  
Deduct 220 lb 20 cu ft

## WARD, RECEIVING

HUT, (HOSPITAL GROUP), 20 FT X 36 FT, ASSEMBLY NO.; NORTHERN, 1135: TROPICAL, 1136

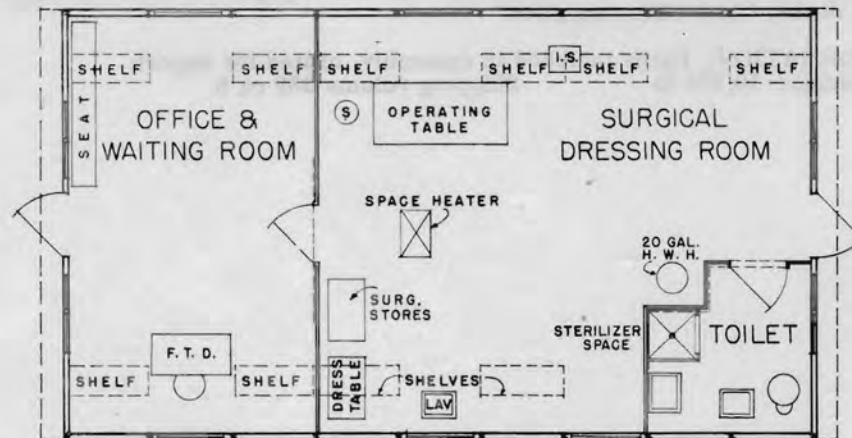

PLAN

**APPLICATION:** Used for the reception of incoming accident and casualty patients and for the treatment of minor ailments and injuries.

**CAPACITY:** Varies with local activities and health conditions. Supplied as follows:

Functional Component	No. of Huts.
G1 - 600 Bed Hospital with Dispensaries	21
G2 - 600 " " without "	2
G3 - 200 " " with "	12
G4 - 200 " " without "	2
G5 - 100 " Dispensary	1
G7 - 50 " "	11
G8 - 25 " "	1
G9 - 10 " "	1

**DESCRIPTION:** The hut contains an office-waiting room, a surgical dressing room and a toilet room.

**OPERATION:** By medical section.

**LIST OF ITEMS INCLUDED IN ASSEMBLY:**

Stock No.	Description	Quantity
1A1-5	- Hut, arch rib, steel. Standard basic unit w/4 flush type windows.	(1)
1A2-1	- Bulkhead (Northern)	2
	- Partitions, interior.	
	- Shelves,	10
	- Pipe and fittings	1 crate
2Q12-1	- Toilet, chemical, one bowl	1
2Q15	- Sink, wash	1
2Q17-1	- Shower and receptor	1
2Q15	- Service sink	1
2Q18	- Heater, water, 20 gal w/accessories	1
2H71-10	- Tank, oil, 75 gal	1
	- Electrical material	
*2Q11	- Heater, space, w/accessories	(2)

**SERVICES REQUIRED:** Water, fuel oil, electricity.

\* Omit for tropical climate  
Deduct 220 lb 20 cu ft

**EQUIPMENT NOT SUPPLIED WITH ASSEMBLY:** Medical equipment, instruments, supplies, toilet supplies, desks, files, office supplies.

**SHIPPING INFORMATION:** Items included in assembly, crated for export:

Shipping weight 10,976 lb

Shipping volume 389 cu ft

## WARD WITH QUIET ROOM

HUT, (HOSPITAL GROUP), 20 FT X 36 FT, ASSEMBLY No.; NORTHERN, 1180: TROPICAL, 1181

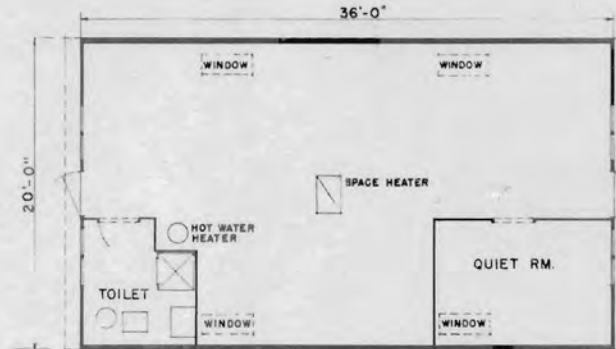

PLAN

APPLICATION: Used for care of personnel who need medical and surgical treatment.

CAPACITY: Eight men per hut.

Functional Component	No. of Huts
G1 - 600 bed hospital (w/dispensaries)	36
G2 - 600 " " (without dispensaries)	36
G3 - 200 " " (w/dispensaries)	12
G4 - 200 " " (without dispensaries)	11
G5 - 100 bed dispensary	5
G7 - 50 " "	2
G8 - 25 " "	1
G9 - 10 " "	1

DESCRIPTION: Hut contains a ward, quiet room and toilet room.

OPERATION: By medical unit.

### LIST OF ITEMS INCLUDED IN ASSEMBLY:

Stock No.	Description	Quantity
1A1-5	Hut, arch rib, steel. Standard basic unit, 20 ft x 36 ft w/4 flush type windows	(1)
1A2-1	Bulkhead (Northern)	(2)
	Partitions, interior	
	Pipe and fittings.	1 crate
2Q12-1	Toilet, chemical, one bowl	(1)
2Q15	Sink, wash	(1)
2Q17-1	Shower and receptor	(1)
2Q15	Sink, service	(1)
2Q18	Heater, water, 20 gallons	(1)
2H71-10	Tank, fuel oil - 75 gallon	(1)
*2Q11	Heater, space w/accessories	(2)
	Electrical material.	1 crate

SERVICES REQUIRED: Electricity, water, fuel oil

EQUIPMENT NOT SUPPLIED IN ASSEMBLY: Beds, medical supplies, toilet supplies.

SHIPPING INFORMATION: Items included in assembly, crated for export:

Shipping weight	lb	Shipping volume	cu ft
-----------------	----	-----------------	-------

\* Omit for tropical climates  
Deduct 220 lb 20 cu ft

## WARD WITHOUT QUIET ROOM

HUT, (HOSPITAL GROUP), 20 FT X 36 FT, ASSEMBLY NO.; NORTHERN, 1182; TROPICAL, 1183

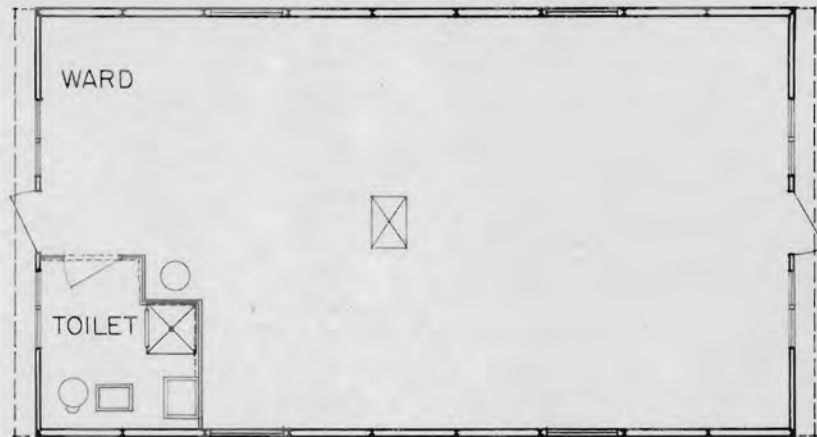

PLAN

**APPLICATION:** Used for the care of personnel who need medical and surgical treatment.

**CAPACITY:** Eight men per hut.

Functional Component	No. of Huts
G1 600 bed hospital (w/dispensaries)	32
G2 600 " " (without dispensaries)	30
G3 200 " " (w/dispensaries)	11
G4 200 " " (without dispensaries)	11
G5 100 " dispensary	5
G7 50 " "	3
G8 25 " "	2

**DESCRIPTION:** Hut contains open space for beds and a toilet room is partitioned off in one corner.

**OPERATION:** By medical unit.

**LIST OF ITEMS INCLUDED IN ASSEMBLY:**

Stock No.	Description
1A1-5	Hut, arch rib, steel. Standard basic unit, 20 ft x 36 ft w/4 flush type windows (1)
1A2-1	Bulkhead (Northern) (2) Partitions, interior Pipe and fittings. 1 crate
2Q12-1	Toilet, chemical, one bowl (1)
2Q15	Sink, wash (1)
2Q17-1	Shower and receptor (1)
2Q15	Sink, service (1)
2Q18	Heater, water, 20 gallon tank (1)
2H71-10	Tank, fuel oil - 75 gallon (1)
*2Q11	Heaters, space w/accessories (2) Electrical material. 1 crate

**SERVICES REQUIRED:** Electricity, water, fuel oil.

**EQUIPMENT NOT SUPPLIED WITH ASSEMBLY:** Beds, medical supplies, toilet supplies.

**SHIPPING INFORMATION:** Items included in assembly, crated for export:  
Shipping weight      lb      Shipping volume      cu ft

\* Omit for tropical climates  
Deduct 220 lb 20 cu ft

## X-RAY, HOSPITAL

HUT, 20 FT X 36 FT, ASSEMBLY NO.; NORTHERN, 1189; TROPICAL, 1190

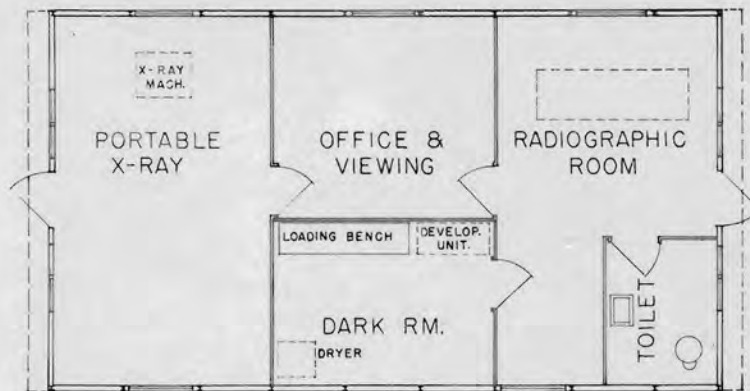

PLAN

**APPLICATION:** For X-ray examination of the patient, radiographic photographing of the injury, dark room for developing prints and office-viewing room for records and examination of X-ray photographs.

**CAPACITY:** Varies with local conditions.

Functional Component	No. of Huts
G1 600 bed hospital (w/dispensaries)	3
G2 " " (without dispensaries)	1
G3 200 " " (w/dispensaries)	2
G4 200 " " (without dispensaries)	1
G5 100 bed dispensary	1

**DESCRIPTION:** Hut is divided into five rooms consisting of an X-ray room, an office-viewing room, a dark room, radiographic room and a toilet. Plywood partitions are used.

**OPERATION:** By medical unit

**LIST OF ITEMS INCLUDED IN ASSEMBLY:**

Stock No.	Description
1A1-5	- Hut, arch rib steel. Standard basic unit, 20 ft x 36 ft w/4 flush type windows.(1)
1A2-1	- Bulkhead (Northern) (2)
	- Partitions, interior.
	- Pipe and fittings. 1 crate
4S5-12	- Bench, loading. (1)
2Q12-1	- Toilet, chemical, one bowl w/accessories. (1)
2Q15-3	- Sink, wash, 20 x 16.. (1)
*2Q11-	- Heater, space w/accessories. (2)
	- Electrical Material. 1 crate

**SERVICES REQUIRED:** Electricity, water, fuel oil.

**EQUIPMENT NOT SUPPLIED WITH ASSEMBLY:** Medical equipment, developing equipment, toilet supplies.

**SHIPPING INFORMATION:** Items included in assembly, crated for export:

Shipping weight 12,101 lb      Shipping volume 473 cu ft

\* Omit for tropical climates.  
Deduct 220 lb 20 cu ft

## HUT, ARCH RIB, STANDARD BASIC UNIT

NORTHERN, 20 FT X 48 FT W/6 FLUSH TYPE WINDOWS, ASSEMBLY NO. 1356  
STOCK NO. 1A1-6(1)  
STOCK NO. 1A2-1(2)

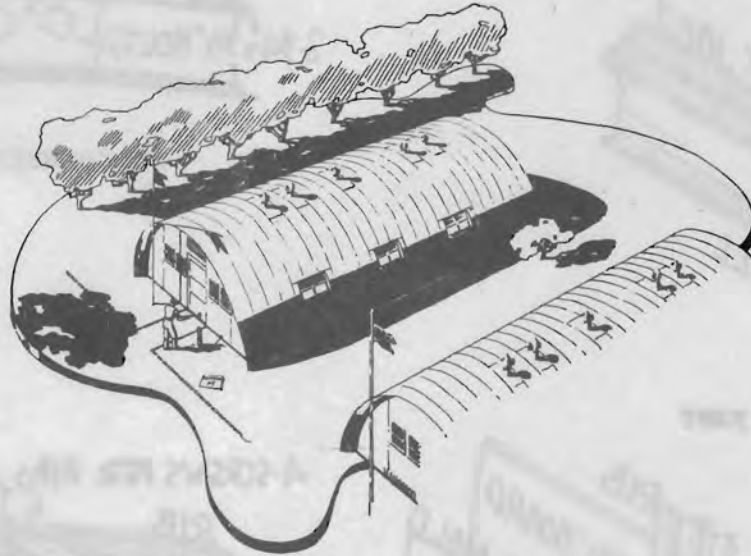

EXTERIOR VIEW

**APPLICATION:** For housing facilities at advanced bases in cold climates. Used as the main structure with interior variations for Administration, Barracks, Galleys, Mess Halls, Recreation, Shower and Latrine, Laundrys, small Workshops, Bakery's, Refrigerator Storage and all similar purposes except hospital facilities. (Note: some hospital facilities are housed in this hut.)

**CAPACITY:** Varies with usage. Contains 960 square feet of floor area and 7540 cu. ft of space.

**DESCRIPTION:** This hut is built of cold rolled steel ribs four feet on center with an outer covering of corrugated galvanized iron, painted. One inch of insulation is packed between the steel roof and an interior lining of fibre board. Floors are of plywood laid on steel joists. The bulkheads, with one door and two flanking windows, are made of plywood. Six flush type windows are shipped with each hut. Ventilators and smoke jacks are included.

**OPERATION:** Basic hut is erected by the construction battalions and operated by the branch to which it is assigned.

**LIST OF ITEMS SUPPLIED WITH ASSEMBLY:**

**NOTE:** A booklet of instructions for erecting and a crating list is packed with each hut. One set of erection tools is furnished for every four huts.

**SERVICES REQUIRED:** Determined by usage to which the hut is assigned.

**EQUIPMENT NOT IN ASSEMBLY:** Determined by usage to which the hut is assigned.

**SHIPPING INFORMATION:** Items included in assembly, crated for export shipment. Crates required to make 1-20 ft x 48 ft Basic Hut with Six Flush Type Windows and Northern Bulkheads, -



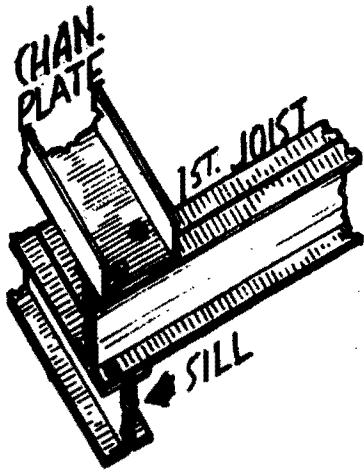

SILL AND JOIST

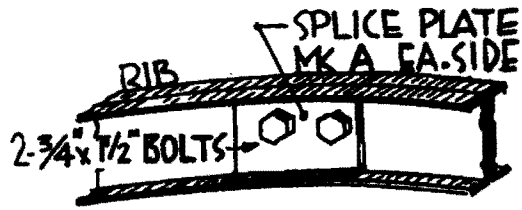

RIB CONNECTION

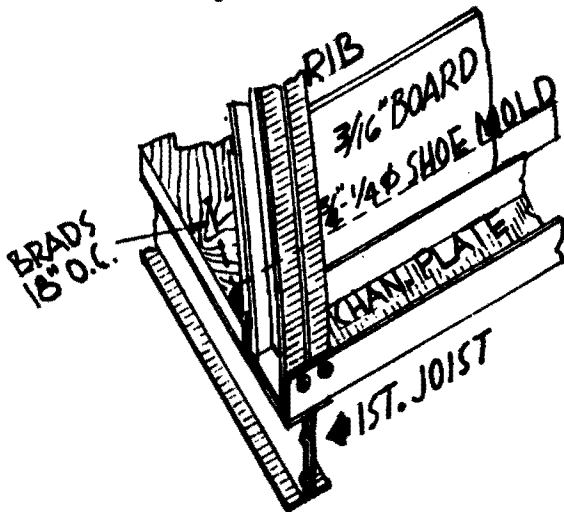

CORNER DETAIL

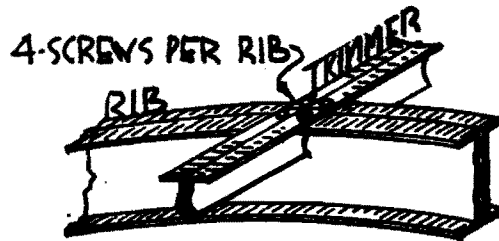

RIB AND TRIMMER

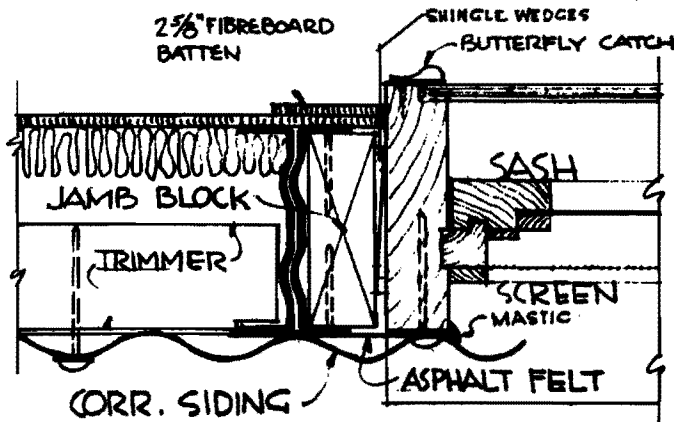

SIDE WALL WINDOW JAMB

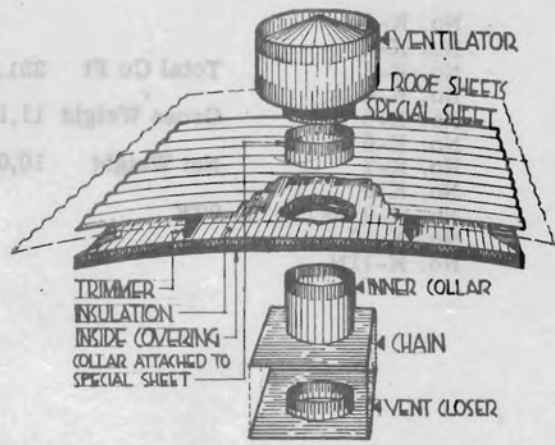

VENTILATOR CONSTRUCTION

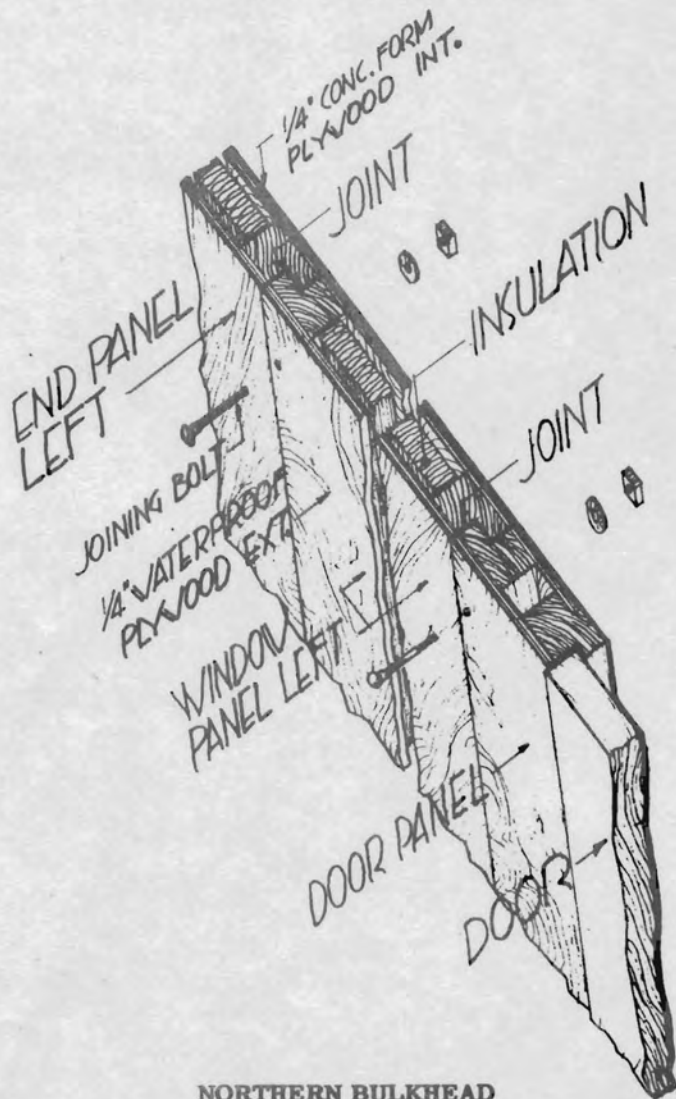

NORTHERN BULKHEAD

1	Crate	No. K-1		
1	Crate	No. K-2		
1	Crate	No. K-3	Total Cu Ft	331.27
1	Crate	No. K-4		
3	Crate	No. K-5	Gross Weight	11,147 lb
1	Crate	No. K-6		
1	Crate	No. K-7	Net Weight	10,003 lb
1	Crate	No. K-8		
1	Crate	No. K-9 or No. K-9TK		
1	Crate	No. K-10		
2	Crate	No. K-11N		

## HUT, ARCH RIB, STANDARD BASIC UNIT

TROPICAL, 20 FT X 48 FT W/6 FLUSH TYPE WINDOWS, ASSEMBLY NO. 1357  
STOCK NO. 1A1-6(1)  
STOCK NO. 1A2-3(2)



VIEW OF TROPICAL EXTENSION AND BULKHEAD

**APPLICATION:** For housing facilities at advanced bases in warm climates. Used as the main structure with interior variations for Administration, Barracks, Galleys, Mess Halls, Recreation, Shower and Latrine, Laundrys, small Workshops, Bakery's, Refrigerator Storage and all similar purposes except hospital facilities. (Note: Some hospital facilities are housed in this hut.)

**CAPACITY:** Varies with usage. Contains 960 sq ft of floor area and 7540 cu ft of space.

**DESCRIPTION:** This hut is built of cold rolled steel ribs four feet on center with an outer covering of corrugated galvanized iron, painted. One inch of insulation is packed between the steel roof and an interior lining of fibre board. Floors are of plywood laid on steel joists. The bulkheads, with one door and two flanking windows, are made of plywood. Six flush type windows are shipped with each hut. Ventilators and smoke jacks are included.

**OPERATION:** Basic hut is erected by the construction battalions and operated by the branch to which it is assigned.

**LIST OF ITEMS SUPPLIED WITH ASSEMBLY:**

**NOTE:** A booklet of instructions for erecting and a crating list is packed with each hut. One set of erection tools is furnished for every four huts.

**SERVICES REQUIRED:** Determined by usage to which the hut is assigned.

**EQUIPMENT NOT IN ASSEMBLY:** Determined by usage to which the hut is assigned.

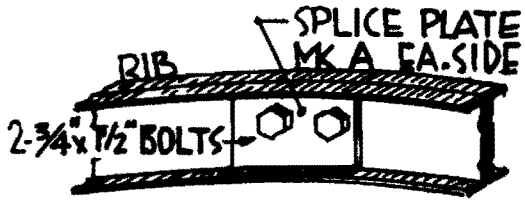

RIB CONNECTION

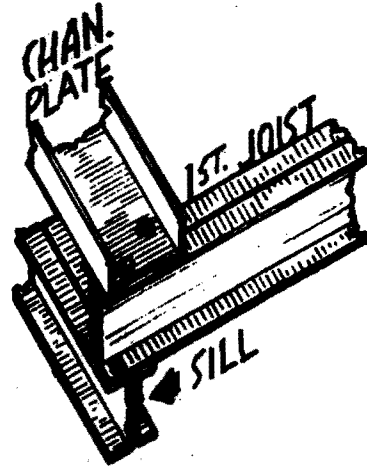

SILL & JOIST

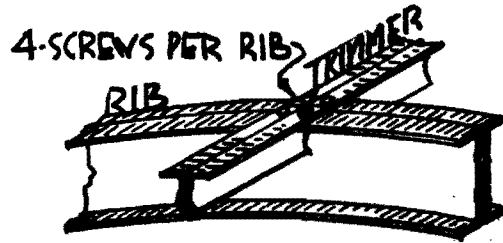
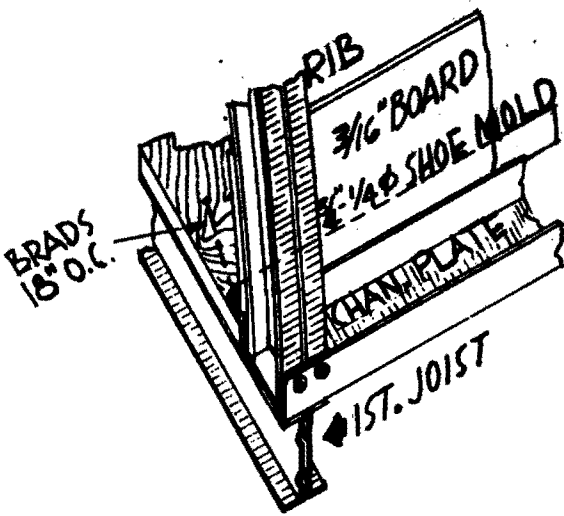

RIB AND TRIMMER

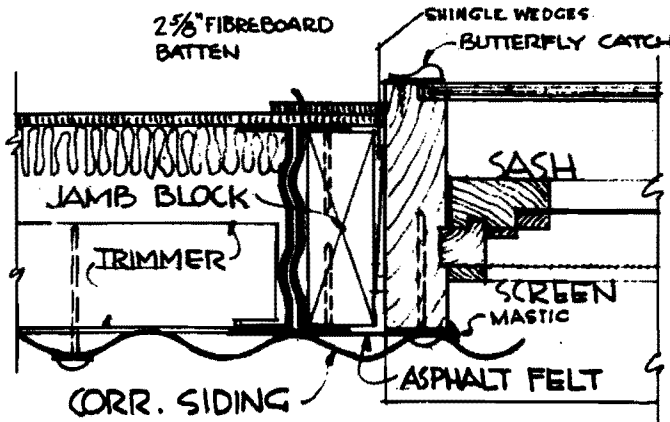

SIDEWALL WINDOW JAMB

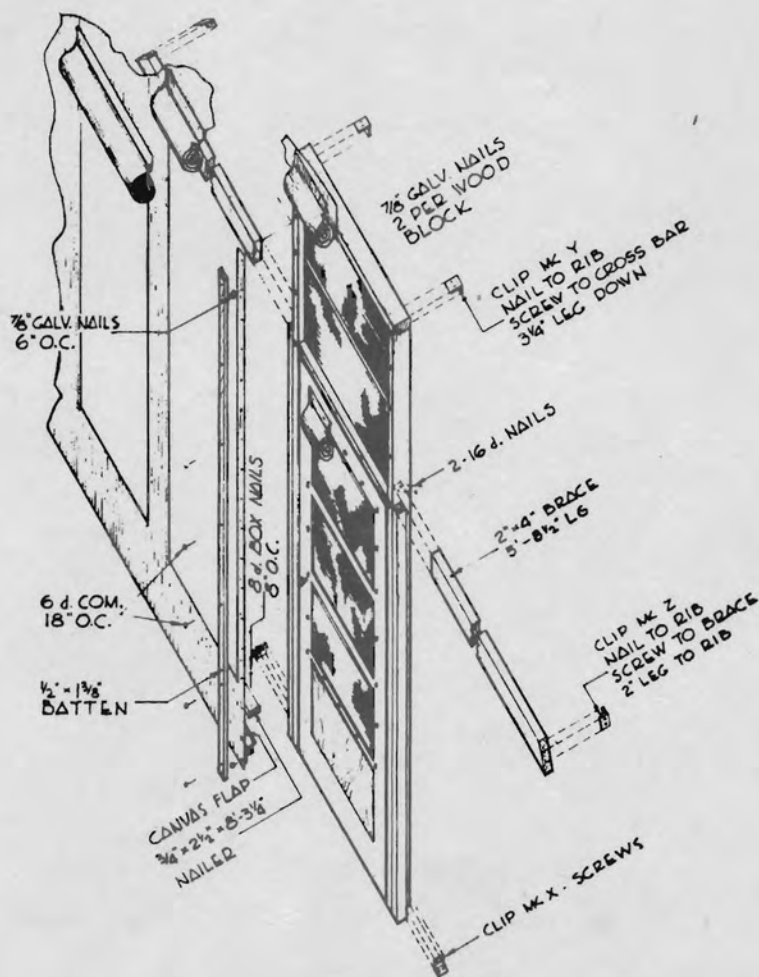
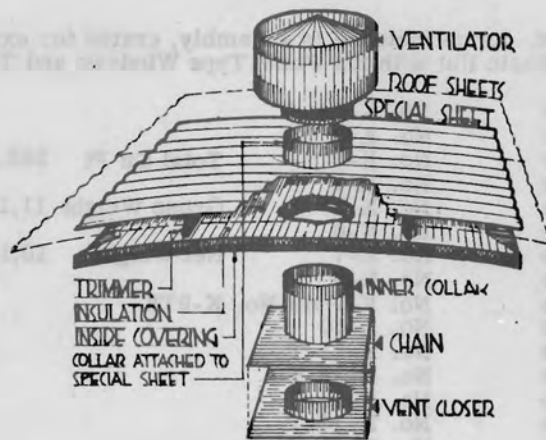

**SHIPPING INFORMATION: Items included in assembly, crated for export. Crates Required to make 1 - 20 ft x 48 ft Basic Hut with Six Flush Type Windows and Tropical Extension, -**

1	Crate	No. K-1		
1	Crate	No. K-2		
1	Crate	No. K-3	Total Cu Ft	282.78
1	Crate	No. K-4		
3	Crate	No. K-5	Gross Weight	11,182 lb
1	Crate	No. K-6		
1	Crate	No. K-7	Net Weight	10,131 lb
1	Crate	No. K-8		
1	Crate	No. K-9 or No. K-9TK		
1	Crate	No. K-10		
1	Crate	No. K-11-T		
1	Crate	No. K-12-T		
1	Crate	No. K-13-T		
1	Crate	No. K-14-T		
1	Crate	No. K-15-T		

## BAKERY, 1,000 MEN

HUT, NORTHERN, 20 FT X 48 FT ASSEMBLY NO. 1191

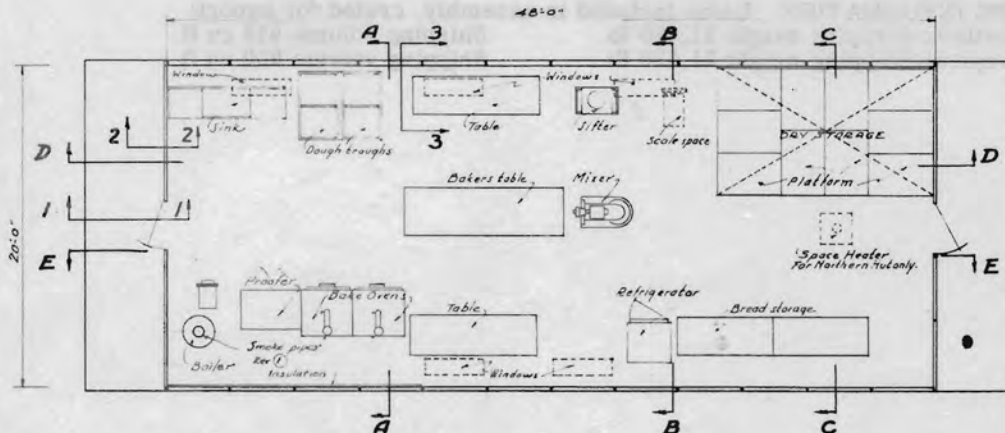

PLAN

APPLICATION: For making of bread for 1,000 men.

CAPACITY: 625 pounds of bread per 8 hour working day.

DESCRIPTION: Standard hut without partitions, but platforms used for dry storage.

OPERATION: Baker and crew.

LIST OF ITEMS INCLUDED IN ASSEMBLY:

Stock or Assembly No.	
1356	- Hut, arch rib, steel. Standard basic unit, 20 ft x 48 ft w/6 flush type windows. (1)
	- Platform, wood, 4 ft x 2 ft 8 in x 7 in (10)
4S9-30	- Table, bakers, 3 ft x 10 ft (1)
4S9-24	- Table, 2 ft 6 in x 8 ft (2)
4S9-29	- Racks, bread, 2 ft 6 in x 6 ft (2)
2Q25.1	- Dough trough (metal) (2) or Dough trough (wood) (4)
	- Sifter stand (1)
	- Mess const. materials
	- Pipe and fittings
2Q21-	- Sifter, flour (1)
2Q15-	- Sink, w/drainboards (1)
2Q22-	- Mixer, dough (1)
2Q24-	- Proof box (1)
2Q27-	- Oven, bake (2)
2Q64-	- Refrigerator, 8 cu ft (1)
2Q18-	- Boiler, w/accessories (1)
2H71-11	- Tank, fuel oil, 275 gal. (1)
* 2Q11-	- Heater, space (1)
	- Smoke pipe 1 crate

SERVICES REQUIRED: Electricity, water, fuel oil.

\* For northern huts only



**EQUIPMENT NOT SUPPLIED IN ASSEMBLY:** Concrete floor, cooking utensils, cleaning equipment and supplies.

**SHIPPING INFORMATION:** Items included in assembly, crated for export:  
Northern: Shipping weight 21,640 lb      Shipping volume 912 cu ft  
Tropical: Shipping weight 21,520 lb      Shipping volume 900 cu ft

## BAKERY, 1,000 MEN

HUT, TROPICAL, 20 FT X 48 FT, ASSEMBLY NO. 1192

PLAN: See Bakery (1,000 men) Hut, Northern.

APPLICATION: For making of bread for 1,000 men.

CAPACITY: 625 pounds of bread per 8 hour working day.

DESCRIPTION: Standard hut without partitions, but platforms used for dry storage.

OPERATION: Baker and crew.

### LIST OF ITEMS INCLUDED IN ASSEMBLY:

Stock or Assembly No.

- Hut, arch rib, steel, standard basic unit, 20 ft x 48 ft w/6 flush type windows, tropical extensions and bulkheads.
- Platform, wood, 4 ft x 2 ft 8 in x 7 in. (10)
- Table, bakers, 3 ft x 10 ft (1)
- Table, 2 ft 6 in x 8 ft (2)
- Racks, bread, 2 ft 6 in x 6 ft (2)
- Dough trough (metal) (2) or  
Dough trough (wood) (4)
- Sifter stand (1)
- Mess const. materials
- Pipe and fittings
- 2Q21- - Sifter, flour (1)
- 2Q15- - Sink, w/drainboards (1)
- 2Q22- - Mixer, dough (1)
- 2Q24- - Proof Box (1)
- 2Q27- - Oven, bake (2)
- 2Q64- - Refrigerator, 8 cu ft (1)
- 2Q18- - Boiler, w/accessories (1)
- 2H71-11 - Tank, fuel oil, 275 gallon (1)
- 2Q11- - Heater, space (1)
- Smoke pipe 1 crate

SERVICES REQUIRED: Electricity, water, fuel oil.

EQUIPMENT NOT SUPPLIED IN ASSEMBLY: Concrete floor, cooking utensils, cleaning equipment and supplies.

SHIPPING INFORMATION: Items included in assembly crated for export

Shipping Weight            lb            Shipping Volume            cu ft

## BARRACKS, ENLISTED MEN

HUT, NORTHERN, 20 FT X 48 FT, ASSEMBLY NO. 1012

PLAN: No partitions are used in this building. It is a standard hut with no variations.

APPLICATION: Provides sleeping quarters for enlisted men.

CAPACITY: Twenty enlisted men.

DESCRIPTION: Standard hut.

OPERATION: Cleaning of hut by enlisted men.

### LIST OF ITEMS INCLUDED IN ASSEMBLY:

Stock No.

1A1-6	Hut, arch rib, steel, standard basic unit, 20 ft x 48 ft w/six flush type windows. (1)
2Q11-	Heater, space. (2)
1A2-1	Bulkhead (Northern) (2)

EQUIPMENT NOT SUPPLIED IN ASSEMBLY: Ten double deck bunks.

SHIPPING INFORMATION: Items included in assembly, crated for export.  
Shipping weight 11,147 lb Shipping volume 331.27 cu ft

## BARRACKS, ENLISTED MEN

HUT, TROPICAL, 20 FT X 48 FT, ASSEMBLY NO. 1013

**PLAN:** No partitions are used in this building. It is a standard hut with no variations.

**APPLICATION:** Provides sleeping quarters for enlisted men.

**CAPACITY:** Twenty enlisted men.

**DESCRIPTION:** Standard hut.

**OPERATION:** Cleaning of hut by enlisted men.

**LIST OF ITEMS INCLUDED IN ASSEMBLY:**

Stock No.

1A1-6 Hut, arch rib, steel, standard basic unit, 20 ft x 48 ft w/six flush type windows. (1)

1A2-3 Tropical extension and bulkhead. (2)

**EQUIPMENT NOT SUPPLIED IN ASSEMBLY:** Ten double deck bunks.

**SHIPPING INFORMATION:** Items included in assembly, crated for export.

Shipping weight 11,182 lb Shipping volume 282.78 cu ft

## BARRACKS, OFFICERS

HUT, NORTHERN, 20 FT X 48 FT, ASSEMBLY NO. 1016

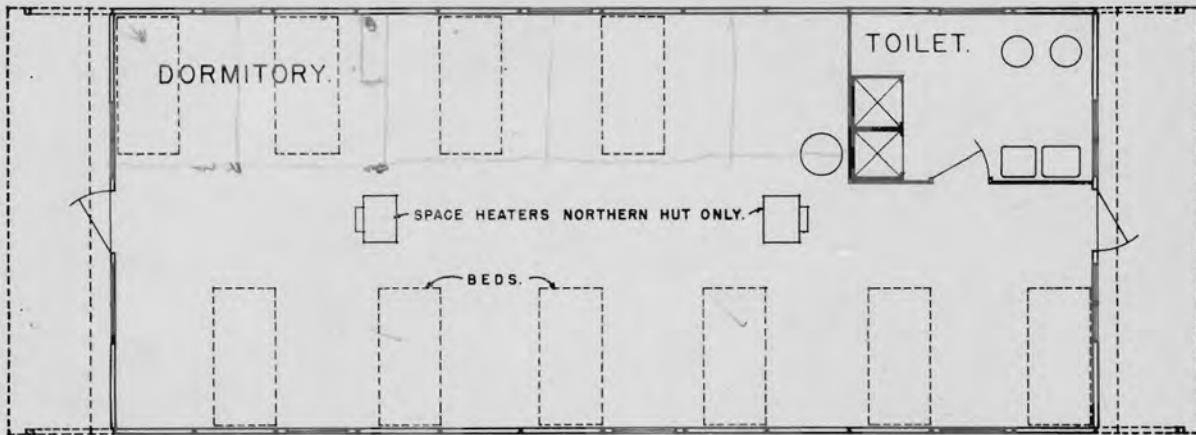

PLAN

**APPLICATION:** Provides sleeping, bathing and toilet facilities for officers.

**CAPACITY:** Ten officers.

**DESCRIPTION:** Standard hut with a partition at toilet and shower room.

**OPERATION:** Enlisted men detailed for cleaning and for care of hut.

**LIST OF ITEMS INCLUDED IN ASSEMBLY:**

Stock No.

- 1A1-6 Hut, arch rib, steel, standard basic unit, 20 ft x 48 ft w/six flush type windows. (1)
- 1A2-1 Bulkhead (Northern) (2)  
Partitions at toilet.  
Pipe and fittings - 1 crate
- 2Q17-1 Shower stalls and receptors. (2)
- 2Q18- Heater, hot water. (1)
- 2Q15- Lavatories. (2)
- 2H71-10 Tank, 75 gal. (1)  
Smoke pipe - 1 crate
- 2Q12-2 Toilet, chemical, 2 bowl. (1)  
Electrical material in addition to material furnished with basic hut.  
- 1 crate.
- 2Q11- Heater, space. (2)

**SERVICES REQUIRED:** Water, electricity and fuel oil.

**EQUIPMENT NOT SUPPLIED IN ASSEMBLY:** Ten bunks.

**SHIPPING INFORMATION:** Items included in assembly, crated for export.

Shipping weight 15,921 lb Shipping volume 603 cu ft

## BARRACKS, OFFICERS

HUT, TROPICAL, 20 FT X 48 FT, ASSEMBLY NO. 1017

PLAN: See Barracks, Officers, Hut, Northern.

APPLICATION: Provides sleeping, bathing and toilet facilities for officers.

CAPACITY: Ten officers.

DESCRIPTION: Standard hut with a partition at toilet and shower room.

OPERATION: Enlisted men detailed for cleaning and for care of hut.

### LIST OF ITEMS INCLUDED IN ASSEMBLY:

Stock No.	
1A1-6	Hut, arch rib, steel, standard basic unit, 20 ft x 48 ft w/six flush type windows.
1A2-3	Tropical extensions and bulkheads. (2) Partitions at toilet. Pipe and fittings - 1 crate
2Q17-1	Shower stalls and receptors. (2)
2Q18-	Heater, hot water. (1)
2Q15-	Lavatories. (2)
2H71-10	Tank, 75 gal. (1) Smoke pipe - 1 crate
2Q12-2	Toilet, chemical, 2 bowl. (1) Electrical material in addition to material furnished with basic hut - 1 crate.

SERVICES REQUIRED: Water, electricity and fuel oil.

EQUIPMENT NOT SUPPLIED IN ASSEMBLY: Ten bunks.

SHIPPING INFORMATION: Items included in assembly, crated for export.  
Shipping weight 15,256 lb                      Shipping volume 505 cu ft

**BOMBSIGHT WORKSHOP**  
HUT, NORTHERN 20 FT X 48 FT ASSEMBLY NO. 1024

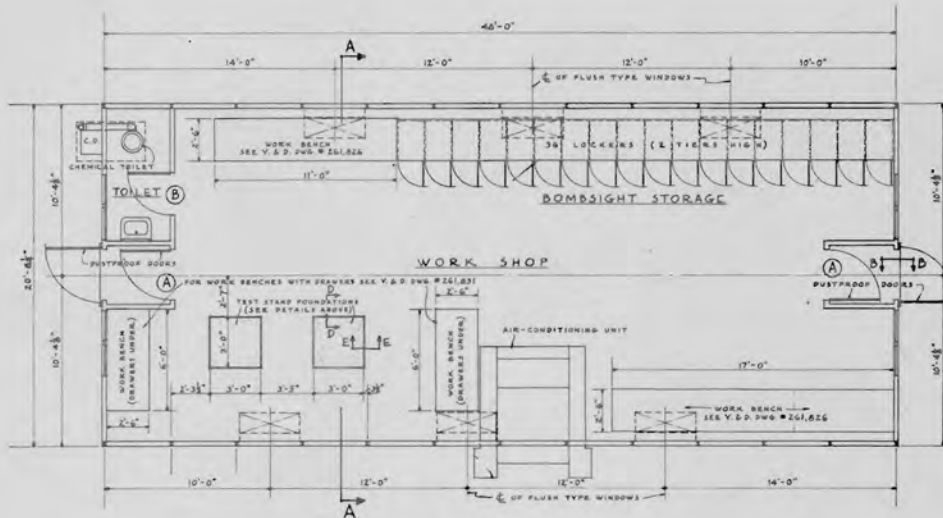

**PLAN**

**APPLICATION:** This air conditioned hut is equipped for repairing bombsights. Cabinet space is provided for storage, air locks for proper air conditioning, a toilet room, and a concrete foundation for testing. For details see Y&D Dwg's No. 264100, 264101 and 264102.

**CAPACITY:** Storage space for 36 bombsights. One supplied to a J-14D component. Work space for repairing same.

**DESCRIPTION:** Because of the delicate nature of the instruments, and their vulnerability to rust, an air conditioning unit is installed in this hut. Air locks at the doors and sealed windows accelerate the efficiency of the air conditioning.

**OPERATION:** By men in the Ordnance unit of J-14D.

**LIST OF ITEMS INCLUDED IN ASSEMBLY:**

Stock No.	
1A1-6	Hut, arch rib, steel, Standard basic unit, 20 ft x 48 ft w/six flush type windows. (1)
1A2-1	Bulkhead (Northern) (2) Partitions, interior.
4C41	Lockers, wood. (36)
4S5-3	Bench, 2 ft 6 in x 6 ft 0 in w/drawers (2)
4S5-4	Bench, 2 ft 6 in x 6 ft 0 in (1)
4S5-5	Bench, 2 ft 6 in x 11 ft 0 in (1)
2Q12-2	Toilet, Chemical, 2 bowl. (1)
2Q15-	Lavatory, (1)
	Air conditioning Unit w/accessories. (1)
	Electrical equipment. (in addition to standard equipment)
	Linoleum - for floor.

**SERVICES REQUIRED:** Electricity, fuel oil and water

**EQUIPMENT NOT SUPPLIED IN ASSEMBLY:** Tools. Toilet supplies.

**SHIPPING INFORMATION:** Items included in assembly crated for export.  
Shipping weight 19,182 lb      Shipping volume 469 cu ft

## GALLEY AND DRY STORAGE

HUT, NORTHERN, 20 FT X 48 FT (100 MEN UNIT) ASSEMBLY NO. 1200

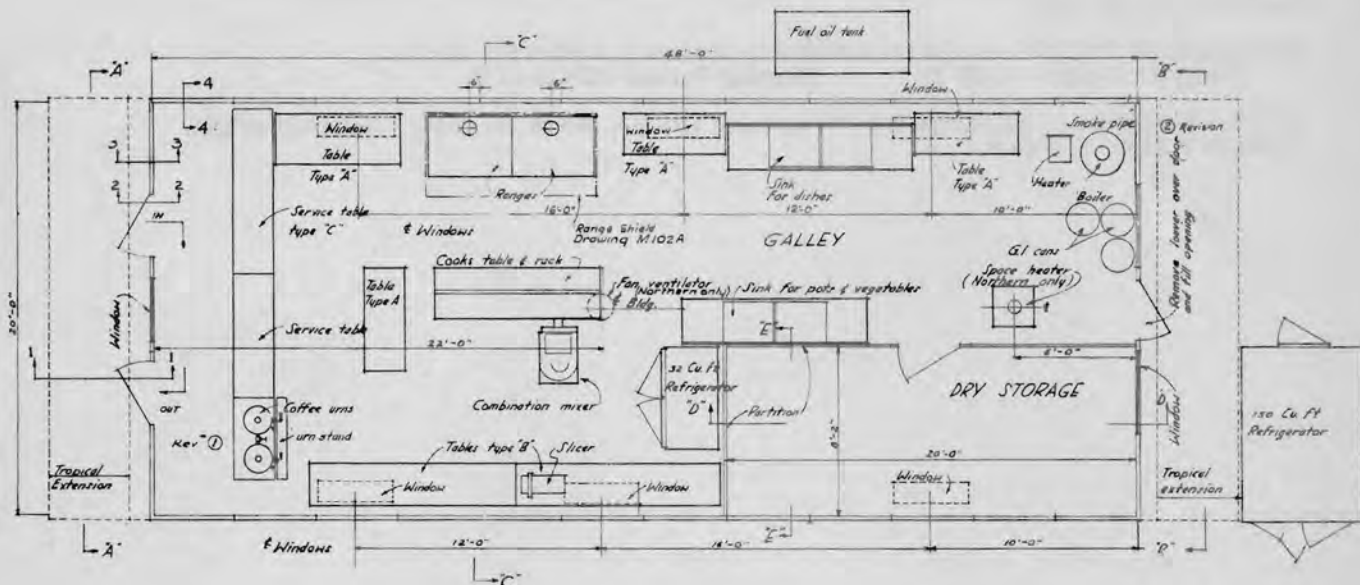

PLAN

APPLICATION: Preparation, cooking and serving of food and storage of food supplies.

CAPACITY: 100 men.

DESCRIPTION: Tables, ranges, sinks, refrigerators and all other equipment needed to prepare meals are located in this hut. Interior partitions separate the dry storage room.

OPERATION: By cook's crew.

### LIST OF ITEMS INCLUDED IN ASSEMBLY:

Stock No.	
1A1-6	- Hut, arch rib, steel. Standard basic unit, 20 ft x 48 ft. w/6 flush type windows. (1)
1A2-1	- Bulkhead (Northern) (2)
	- Partitions, interior (2)
4S9-26	- Table, type "A", 2 ft x 5 ft (3)
4S9-23	- Table, type "A", 2 ft 6 in x 6 ft (1)
	- Table, type "B", 2 ft x 10 ft (2)
4S9-28	- Table, type "C", 2 ft x 8 ft (1)
4S9-27	- Table, service, 2 ft x 6 ft (1)
4S9-24	- Table, cook, 2 ft 6 in x 8 ft (1)
2Q15-	- Sink (2)
2Q28-	- Range, w/accessories (2)
2Q22-	- Mixer, w/accessories (1)
2Q31-	- Slicer, bread and meat (1)
2Q34-	- Urn, set, 10 gal. coffee and 20 gal. water (1)
2Q64-	- Refrigerator, 150 cu ft (1)
2Q64-	- Refrigerator, 32 cu ft (1)
4B16-5	- Cans, galvanized iron, 32 gallon (4)
2Q18-	- Heater, water (1)
2H71-11	- Tank, fuel oil, 550 gallon (1)
2Q11-	- Heater, space, w/accessories (1)
	- Fan, ventilator (1)
	- Pipes and fittings 1 crate
	- Electrical equipment 1 crate



**SERVICES REQUIRED:** Electricity, water, fuel oil.

**EQUIPMENT NOT SUPPLIED WITH ASSEMBLY:** Concrete floor, cooking utensils, cleaning material, dry storage.

**SHIPPING INSTRUCTIONS:** Items included in assembly, crated for export.  
Shipping Weight 18,260 lb      Shipping Volume 1264.6 cu ft

**NOTE:** For Hospital unit usage use ice machine and bin. Stock No. 2Q37 - Shipping weight, 1,740 lb Volume 87.4 cu ft

## GALLEY AND DRY STORAGE

HUT, TROPICAL, 20 FT X 48 FT, (100 MEN UNIT), ASSEMBLY NO. 1201

PLAN: See Galley and Dry Storage, Northern.

APPLICATION: Preparation, cooking, and serving of food and storage of food supplies.

CAPACITY: 100 men.

DESCRIPTION: Tables, ranges, sinks, refrigerators and all other equipment needed to prepare meals are located in this hut. Interior partitions separate the dry storage room.

OPERATION: By cook's crew.

### LIST OF ITEMS INCLUDED IN ASSEMBLY:

Stock No.		
1A1-6	- Hut, arch rib, steel. Standard basic unit, 20 ft x 48 ft w/6 flush type windows (1)	
1A2-3	- Tropical extension and bulkhead (2)	
	- Partitions, interior	2
4S9-26	- Table, type "A", 2 ft x 5 ft	3
4S9-23	- Table, type "A", 2 ft 6 in x 6 ft	1
	- Table, type "B", 2 ft x 10 ft	2
4S9-28	- Table, type "C", 2 ft x 8 ft	1
4S9-27	- Table, service, 2 ft x 6 ft	1
4S9-24	- Table, cook, 2 ft 6 in x 8 ft	1
2Q15-	- Sink	2
2Q28-	- Range, w/accessories	2
2Q22-	- Mixer, w/accessories	1
2Q31-	- Slicer, bread and meat	1
2Q34-	- Urn, set, 10 gal coffee and 20 gal water	1
2Q64-	- Refrigerator, 150 cu ft	1
2Q64-	- Refrigerator, 32 cu ft	1
4B16-5	- Cans, galvanized iron, 32 gallon	4
2Q18-	- Heater, water	1
2H71-11	- Tank, fuel oil, 550 gallon	1
	- Fan, ventilator	1
	- Pipes and fittings	1 crate
	- Electrical equipment	1 crate

SERVICES REQUIRED: Electricity, water, fuel oil.

EQUIPMENT NOT SUPPLIED WITH ASSEMBLY: Concrete floor, cooking utensils, cleaning material, dry storage.

SHIPPING INSTRUCTIONS: Items included in assembly, crated for export.  
Shipping Weight 18,260 lb      Shipping volume 1264.6 cu ft

NOTE: For Hospital unit usage use ice machine and bin.  
Stock No. 2Q37 - Shipping weight, 1,740 lb  
Shipping volume 87.4 cu ft

## GALLEY, MESS AND DRY STORAGE

HUT, NORTHERN 20 FT X 48 FT, (25 MEN UNIT), ASSEMBLY NO. 1196

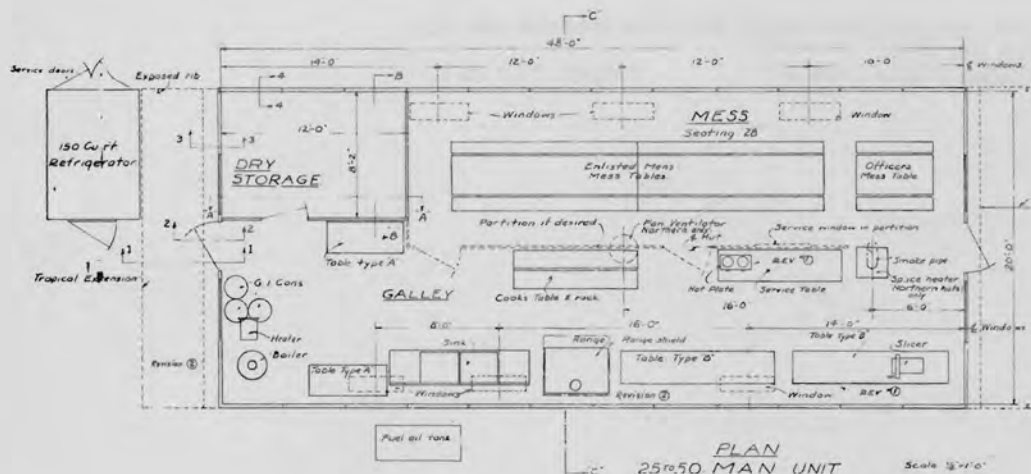

### PLAN

**APPLICATION:** Preparation, cooking and serving of food to men and officers in one building.

**CAPACITY:** 24 men and 4 officers.

**DESCRIPTION:** Equipment is supplied for the storage, preparation and cooking of food and serving the same to mess tables within the building. Interior partitions separate the dry storage room.

**OPERATION:** Cooks crew.

#### LIST OF ITEMS INCLUDED IN THIS ASSEMBLY:

Stock No.		
1A1-6	- Hut, arch rib, steel. Standard basic unit, 20 ft x 48 ft w/6 flush type windows (1)	
1A2-1	- Bulkhead (Northern) (2)	
	- Partitions, interior	
4S9-24	- Table, cooks, 2 ft 6 in x 8 ft	(1)
4S9-27	- Table, service, 2 ft x 8 ft	(1)
	- Table, Type "A", 2 ft x 10 ft	(2)
4S9-26	- Table, Type "B", 2 ft x 5 ft	(2)
4S9-17	- Mess table, 5 ft long	(1)
4S9-16	- " " 12 ft " "	(2)
2Q15-	- Sink	(1)
2Q28-	- Range	(1)
2Q20-	- Hot Plate	(1)
2Q31-	- Slicer, bread and meat	(1)
2Q64-	- Refrigerator, 150 cu ft	(1)
4B16-5	- Cans, galvanized iron, 32 gallon	(3)
2Q18-	- Heater, water	(1)
2H71-11	- Tank, fuel oil, 275 gallon	(1)
2Q11-	- Heater, space w/accessories	(1)
2Q3	- Fan, ventilator 16 in	(1)
	- Pipe and fittings	1 crate
	- Electrical materials	1 crate

**SERVICES REQUIRED:** Electricity, fuel oil, water.

**EQUIPMENT NOT INCLUDED IN ASSEMBLY:** Concrete floor, cooking utensils, cleaning supplies, food storage.

**SHIPPING INFORMATION:** Items included in assembly, crated for export.  
Shipping weight 20,000 lb                      Shipping volume 1350 cu ft

**NOTE:** For hospital unit usage, use 1 ice machine and bin.  
Stock No. 2Q37  
Shipping weight 1740 lb                      Volume 87.4 cu ft

## GALLEY, MESS AND DRY STORAGE

HUT, TROPICAL, 20 FT X 48 FT, (25 MEN UNIT), ASSEMBLY NO. 1197

PLAN: See Galley, Mess and Dry Storage, Northern.

APPLICATION: Preparation, cooking, and serving of food to men and officers in one building.

CAPACITY: 24 men and 4 officers.

DESCRIPTION: Equipment is supplied for the storage preparation and cooking of food and serving the same to mess tables within the building. Interior partitions separate the dry storage room.

OPERATION: Cook's crew.

### LIST OF ITEMS INCLUDED IN ASSEMBLY:

Stock No.		
1A1-6	- Hut, arch rib, steel. Standard basic unit, 20 ft x 48 ft w/6 flush type windows	(1)
1A2-3	- Tropical extension and bulkhead	(2)
	- Partitions, interior	
4S9-29	- Table, cooks, 2 ft 6 in x 8 ft	(1)
4S9-27	- Table, service, 2 ft x 8 ft	(1)
	- Table, type "A", 2 ft x 10 ft	(2)
4S9-26	- Table, type "B", 2 ft x 5 ft	(2)
4S9-17	- Mess table, 5 ft long	(1)
4S9-16	- " " 12 ft long	(2)
2Q15-	- Sink	(1)
2Q28-	- Range	(1)
2Q20-	- Hot plate	(1)
2Q31-	- Slicer, bread and meat	(1)
2Q64-	- Refrigerator, 150 cu ft	(1)
4B16-5	- Cans, galvanized iron, 32 gallon	(3)
2Q18	- Heaters, water	(1)
2H71-11	- Tank, fuel oil, 275 gallon	(1)
2Q3	- Fan, ventilator, 16 in	(1)
	- Pipe and fittings	1 crate
	- Electrical materials	1 crate

SERVICES REQUIRED: Electricity, fuel oil, water.

EQUIPMENT NOT INCLUDED IN ASSEMBLY: Concrete floor, cooking utensils, cleaning supplies, food storage.

SHIPPING INFORMATION: Items included in assembly, crated for export.

Shipping weight 20,000 lb                      Shipping volume 1350 cu ft

NOTE: For hospital unit usage, use one ice machine and bin.

Stock No. 2Q37  
Shipping weight 1740 lb                      Shipping volume 87.4 cu ft

## GALLEY WITH SCULLERY AND PREPARATION

HUT, NORTHERN, 20 FT X 48 FT, (250 MEN UNIT), ASSEMBLY NO. 1043

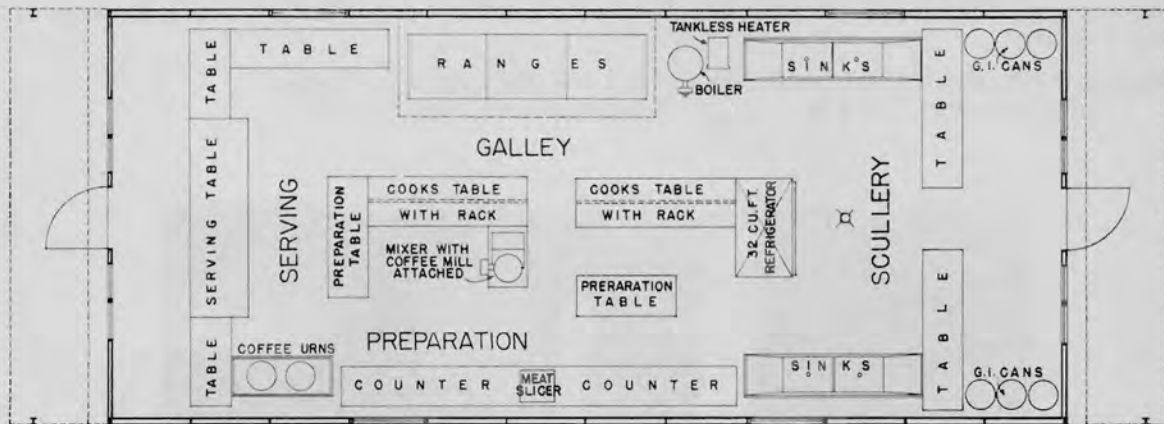

PLAN

**APPLICATION:** Food is prepared, cooked and served in this hut and accommodations are provided for cleaning of mess kits, dishes and trays, etc.

**CAPACITY:** Supplies a 250 men unit.

**DESCRIPTION:** This is a standard arch rib steel hut containing special equipment necessary for its intended use. A concrete floor should be constructed at the site.

**OPERATION:** By two cook's crews serving meals in two shifts.

### LIST OF ITEMS INCLUDED IN THE ASSEMBLY:

Stock No.			
1A1-6	- Hut, arch rib, steel, standard basic unit, 20 ft x 48 ft, w/six flush type windows	(1)	
1A2-1	- Bulkhead (Northern)	(2)	
2Q28-	- Ranges	(2)	
2Q15-	- Sink w/drainboards	(2)	
2Q18-	- Boiler w/accessories	(1)	
2H71-11	- Tank, oil, 275 gal	(1)	
2Q22-	- Mixer, galley	(1)	
2Q31-	- Slicer, meat	(1)	
2Q34-	- Urn, 20 gal, hot water	(1)	
2Q34-	- Urn, 10 gal, coffee	(1)	
2Q64-	- Refrigerator, 32 cu ft	(1)	
4S9-29	- Table, cooks w/rack	(2)	
4B16-5	- Cans G.I., 32 gal	(6)	
	- Pipe and fittings	1 crate	
	- Heads and vents	1 crate	
4S9-25	- Table, type "A"	4 ft 6 in (2)	
4S9-26	- " " "	5 ft 0 in (1)	
4S9-27	- " " "	6 ft 0 in (1)	
4S9-28	- " " "	8 ft 0 in (3)	
4S9-30	- " " "C"	10 ft 0 in (1)	
4S9-31	- Counter	20 ft 0 in (1)	
	- Electric material. (in addition to stock list for standard hut)	1 crate	

**SERVICES REQUIRED:** Electricity, water, and fuel oil.

**AUXILIARY EQUIPMENT NEEDED BUT NOT SUPPLIED:** A concrete floor; galley and scullery supplies.

**SHIPPING INFORMATION:** Items included in assembly, crated for export.  
Shipping weight 23,471 lb                      Shipping volume 1051.27 cu ft

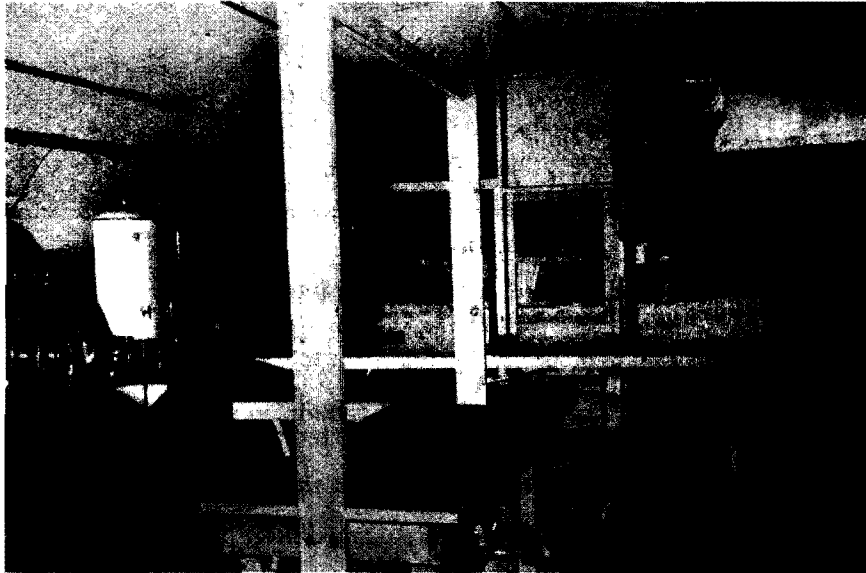

**INTERIOR VIEWS**

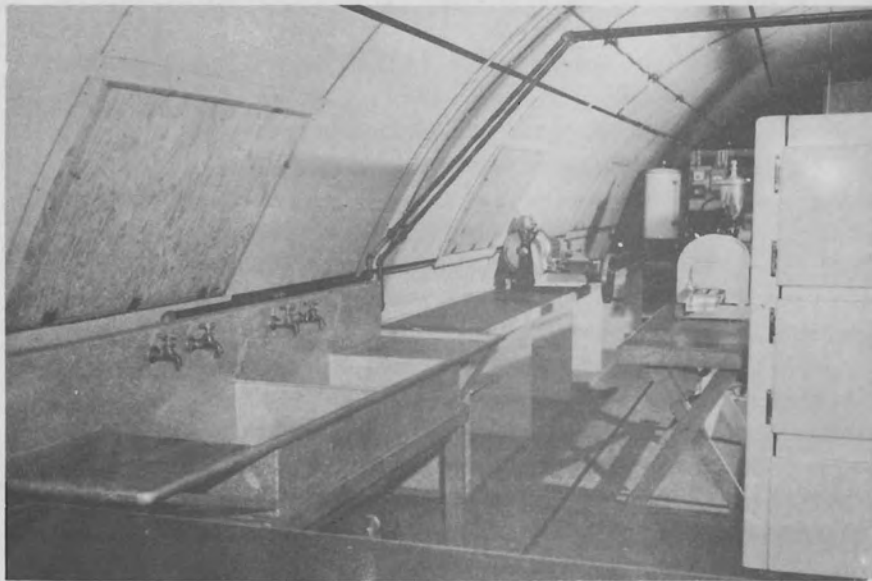
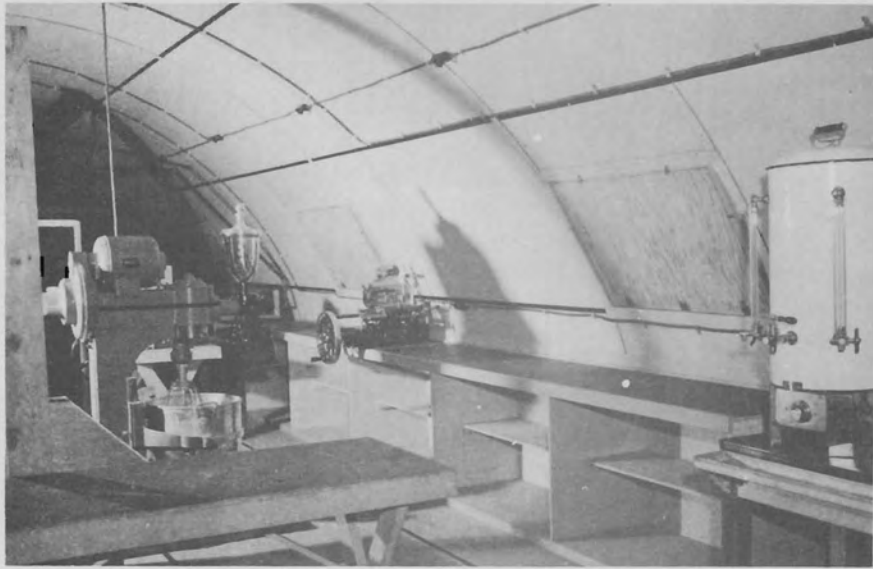

INTERIOR VIEWS



## GALLEY WITH SCULLERY AND PREPARATION

HUT, TROPICAL, 20 FT X 48 FT (250 MEN UNIT), ASSEMBLY NO. 1044

PLAN: See GALLEY W/SCULLERY AND PREPARATION HUT, NORTHERN 20 FT X 48 FT

APPLICATION: Food is prepared, cooked and served in this hut and accommodations are provided for cleaning of mess kits, dishes and trays, etc.

CAPACITY: Supplies a 250 men unit.

DESCRIPTION: This is a standard arch rib steel hut containing special equipment necessary for its intended use. A concrete floor should be constructed at the site.

OPERATION: By two cook's crews serving meals in two shifts.

### LIST OF ITEMS INCLUDED IN THE ASSEMBLY:

Stock No.

1A1-6	- Hut, arch rib, steel, standard basic unit, 20 ft x 48 ft, w/six flush type windows (1)
1A2-3	- Tropical extension and bulkhead (2)
2Q28-	- Ranges (2)
2Q15-	- Sink w/drainboards (2)
2Q18-	- Boiler w/accessories (1)
2H71-11	- Tank, oil, 275 gal (1)
2Q22-	- Mixer, galley (1)
2Q31-	- Slicer, meat (1)
2Q34-	- Urn, 20 gal, hot water (1)
2Q34-	- Urn, 10 gal, coffee (1)
2Q64-	- Refrigerator, 32 cu ft (1)
4S9-29	- Table, cooks w/rack (2)
4B16-5	- Cans, G.I., 32 gal (6)
	- Pipe and fittings 1 crate
	- Hoods and vents 1 crate
4S9-25	- Table, type "A" 4 ft 6 in (2)
4S9-26	- " " " 5 ft 0 in (1)
4S9-27	- " " " 6 ft 0 in (1)
4S9-28	- " " " 8 ft 0 in (3)
4S9-30	- " " "C" 10 ft 0 in (1)
4S9-31	- Counter 20 ft 0 in (1)
	- Electric material. (in addition to stock list for standard hut) 1 crate
2Q37-	- Flake ice machine (1)

SERVICES REQUIRED: Electricity, water and fuel oil.

EQUIPMENT NOT SUPPLIED IN ASSEMBLY: A concrete floor

SHIPPING INFORMATION: Items included in assembly crated for export  
Shipping weight 24,235 lb      Shipping volume 1097 cu ft

LAUNDRY, HOSPITAL  
HUT, NORTHERN 20FT X 48FT ASSEMBLY NO. 1080

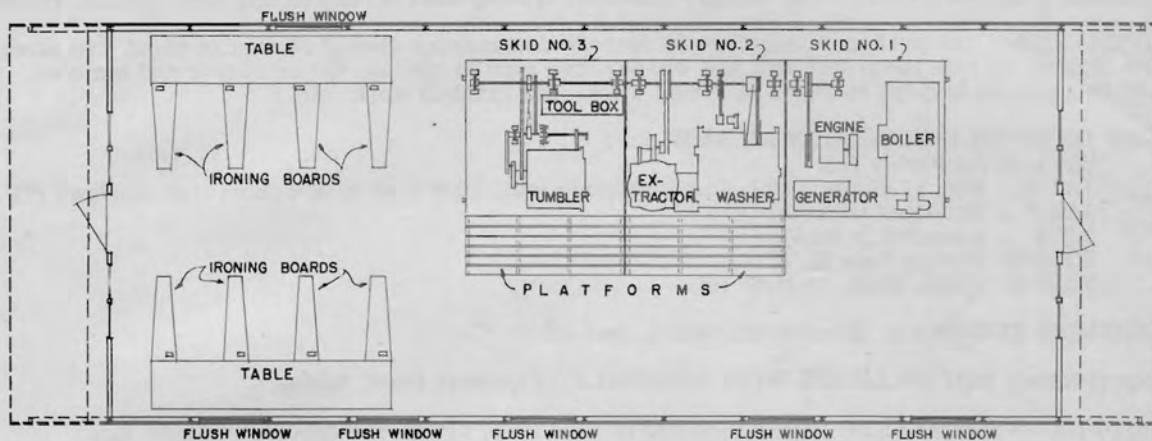

PLAN

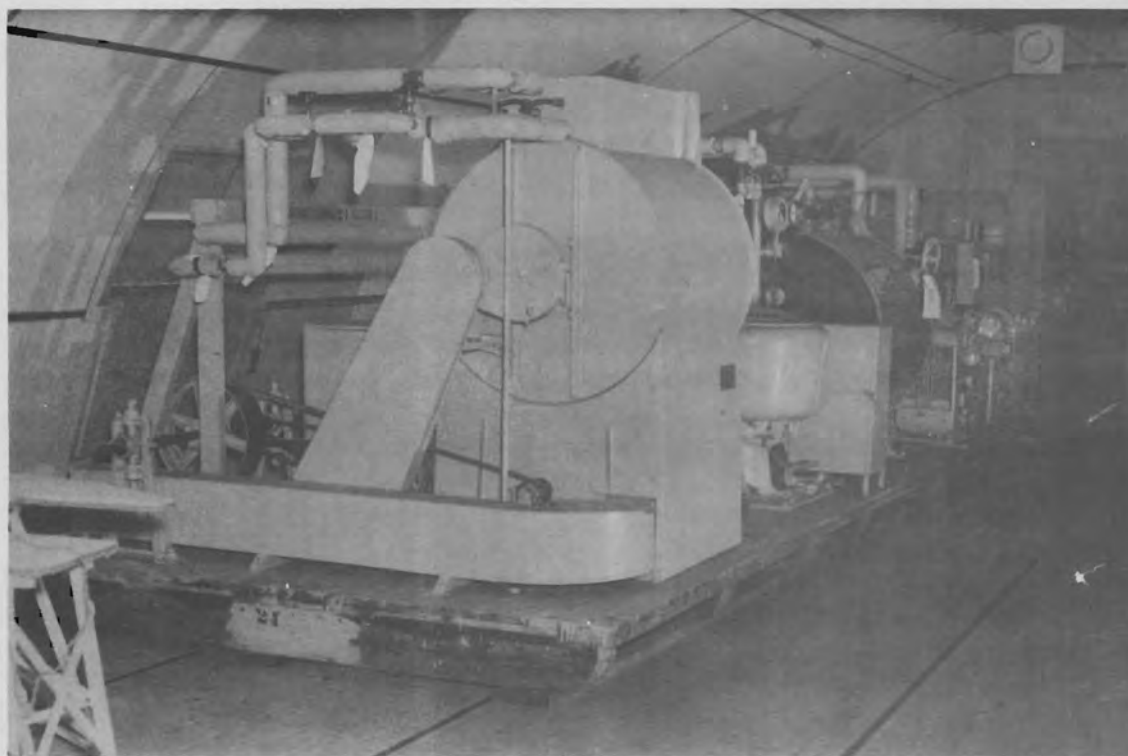

INTERIOR VIEW

**APPLICATION:** For rough dry cleaning of hospital laundry and a certain amount of ironing as required.

**CAPACITY:** Laundry facilities for one 200 bed hospital. Seventy-five pounds dry weight per hour.

**DESCRIPTION:** All purpose laundry, designed to finish clothing, sheets etc rough dried. Hut equipment includes a three unit laundry machine, ironing boards, tables and hand electric irons.

**OPERATION:** The personnel required to operate this laundry should consist of about five men; one man to operate the power unit and washer, two men to operate the extractor and tumbler, and two men as helpers to check in soiled work, fold finished work, etc.

**LIST OF ITEMS INCLUDED IN ASSEMBLY:**

Stock or Assembly No.

1A1-6 - Hut, arch rib, steel, standard basic unit, 20 ft x 48 ft w/6 flush type windows (1)

1A2-1 - Bulkhead (Northern)(2)

2Q54 - Laundry, portable (1)

2Q55-2- Ironing boards (8)

2Q55-3- Irons, hand, electric (8)

**SERVICES REQUIRED:** Electricity, water, fuel oil

**EQUIPMENT NOT INCLUDED WITH ASSEMBLY:** Concrete floor, tables.

**SHIPPING INFORMATION:** Items included in assembly, crated for export.

Shipping weight 29,569 lb

Shipping volume 1,456 cu ft

## LAUNDRY

HUT, NORTHERN, 20 FT X 48 FT, ASSEMBLY NO. 1078

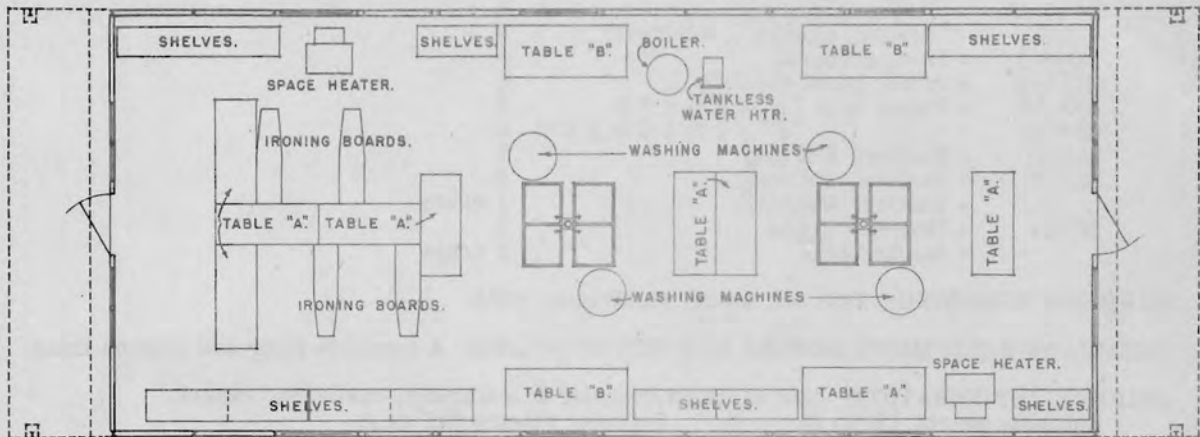

PLAN

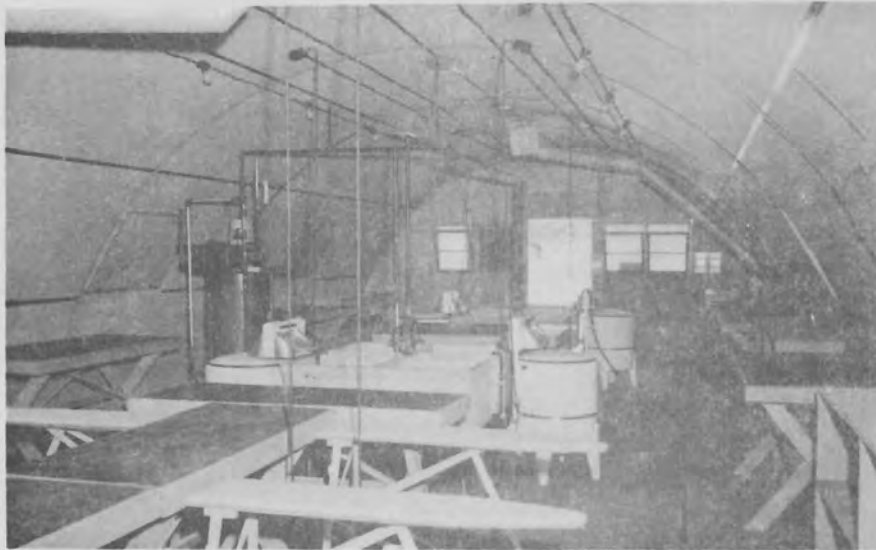

INTERIOR VIEW

**APPLICATION:** Laundry facilities for enlisted men.

**CAPACITY:** One laundry hut is supplied to a 250 men unit

**DESCRIPTION:** A standard hut is supplied for laundry usage. It is equipped with washing machines and electric irons for the convenience of the enlisted men. A concrete floor (not in this assembly) is constructed at the site.

**OPERATION:** By the enlisted men, who do their own laundry.

**LIST OF ITEMS INCLUDED IN ASSEMBLY:**

Stock No.

- |       |  |         |
|-------|--|---------|
| 1A1-6 | - Hut, arch rib, steel, Standard basic unit, 20 ft x 18 ft w/6 flush type windows(1) |         |
| 1A2-1 | - Bulkhead (Northern)  | (2)     |
|       | - Pipe and fittings  | 1 crate |

2Q18-	- Boiler w/accessories	1
2H71-11	- Tank, fuel, 275 gallons	1
2Q15-12	- Trays, laundry	4
2Q56-	- Washer, clothes (electric)	4
2Q55-2	- Ironing boards	4
2Q55-3	- Irons, hand, electric	8
4S9-26	- Table, type "A" - 2 ft x 5 ft	8
4S9-27	- " " "B" - 2 ft x 6 in x 6 ft	4
4S8-3	- Shelves, 8 ft long	5
4S8-2	- Shelves, 4 ft long	2
	- Electric Material	1 crate
2Q11-	- Heater - space	2
	- Smoke jacks	1 crate

**SUPPLIES REQUIRED:** Fuel oil, water, electricity, soap.

**AUXILIARY EQUIPMENT NEEDED BUT NOT SUPPLIED:** A concrete floor and clothes lines.

**SHIPPING INFORMATION:** List of items included in assembly, crated for export.  
 Shipping weight 19846 lb                      Shipping volume 917 cu ft

## LAUNDRY

HUT, TROPICAL, 20 FT X 48 FT, ASSEMBLY NO. 1079

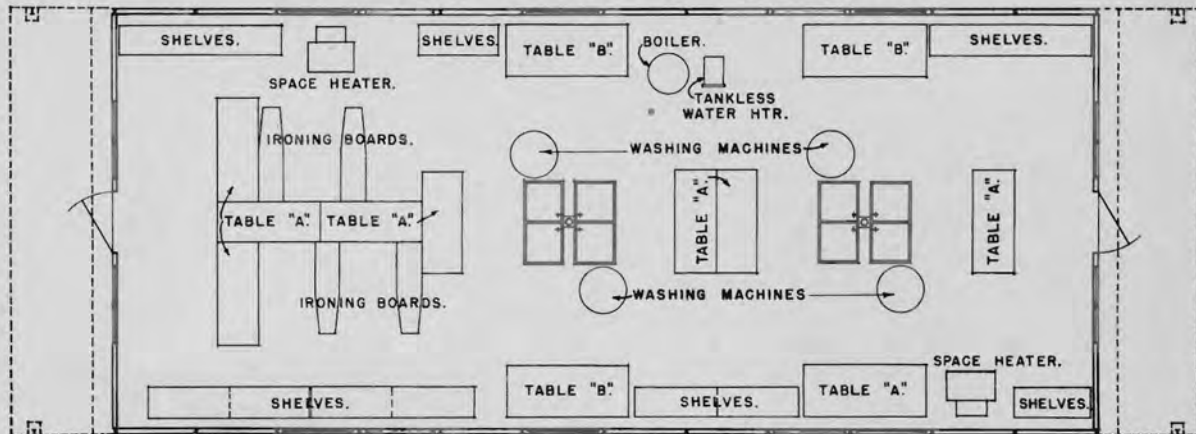

**APPLICATION:** Laundry facilities for enlisted men.

**CAPACITY:** One laundry hut is supplied to a 250 men unit.

**DESCRIPTION:** A standard hut is supplied for laundry usage. It is equipped with washing machines and electric irons for the convenience of the enlisted men. A concrete floor (not in this assembly) is constructed at the site.

**OPERATION:** By the enlisted men who do their own laundry.

**LIST OF ITEMS INCLUDED IN ASSEMBLY:**

Stock No.		
1A1-6	- Hut, arch rib, steel, standard basic unit, 20 ft x 48 ft w/6 flush type windows (1)	
1A2-3	- Tropical extension and bulkhead (2)	
	- Pipe and fittings	1 crate
2Q18-	- Boiler w/accessories	1
2H71-11	- Tank, fuel, 275 gallons	1
2Q15-12	- Trays, laundry	4
2Q56-	- Washing Machines, electric	4
2Q55-2	- Ironing boards	4
2Q55-3	- Irons, hand, electric	8
4S9-26	- Table, Type "A"- 2 ft x 5 ft	8
4S9-27	- Table, Type "B"- 2 ft 6 in. x 6 ft	4
4S8-3	- Shelves, 8 ft long	5
4S8-2	- Shelves, 4 ft long	4
	- Electric material	1 crate

**SERVICES REQUIRED:** Fuel oil, water, and electricity

**EQUIPMENT NOT SUPPLIED IN ASSEMBLY:** Concrete floor, Clothes lines.

**SHIPPING INFORMATION:** Items included in assembly, crated for export.

Shipping weight 19216 lb

Shipping volume 728 cu ft

## REFRIGERATOR STORAGE

HUT, NORTHERN, 20 FT X 48 FT, ASSEMBLY NO. 1142

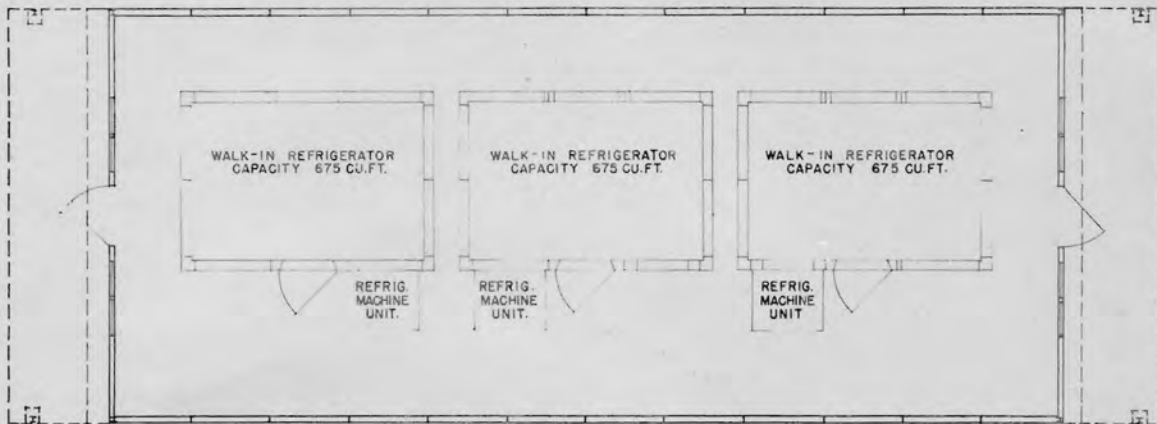

PLAN

**APPLICATION:** A hut to house three 675 Cu Ft Refrigerators.

**CAPACITY:** Three 675 Cu Ft Refrigerators.

**DESCRIPTION:** Standard hut to hold 3-675 Cu Ft Refrigerators.

**OPERATION:** By enlisted men, care of refrigeration machinery.

**LIST OF ITEMS INCLUDED IN ASSEMBLY.**

Stock No.

- |       |   |         |
|-------|---|---------|
| 1A1-6 | - Hut, arch rib, steel. Standard basic unit, 20 ft x 48 ft w/6 flush type windows (1) |         |
| 1A2-1 | - Bulkhead (Northern)   | 2       |
| 2Q64  | - Refrigerator- 675 cu ft   | (3)     |
|       | - Electric material   | 1 crate |
|       | - Structural material for refrigerator support.                                       |         |

**SERVICES REQUIRED:** Electricity.

**EQUIPMENT NOT INCLUDED IN ASSEMBLY:** Concrete floor.

**SHIPPING INFORMATION:** Items included in assembly, crated for export.

Shipping weight 20156 lb

Shipping volume 849.97 cu ft

**NOTE:** This hut supplied on special request.

## REFRIGERATOR STORAGE

HUT, TROPICAL, 20 FT X 48 FT, ASSEMBLY NO. 1143

PLAN: See Refrigerator Storage, Hut, Northern.

APPLICATION: A hut to house three 675 cu ft refrigerators.

CAPACITY: Three 675 cu ft refrigerators

DESCRIPTION: Standard hut to hold 3-675 cu ft refrigerators.

OPERATION: By enlisted men, care of refrigeration machinery.

### LIST OF ITEMS INCLUDED IN ASSEMBLY:

Stock No.

- |       |  |         |
|-------|--|---------|
| 1A1-6 | - Hut, arch rib, steel, standard, basic unit, 20 ft x 48 ft w/6 flush type windows (1) |         |
| 1A2-3 | Tropical extension and bulkhead  | (2)     |
| 2Q64- | - Refrigerator, 675 cu ft  | (3)     |
|       | - Electric material  | 1 crate |
|       | - Structural material for refrigerator support.  |         |

SERVICES REQUIRED: Electricity.

EQUIPMENT NOT INCLUDED IN ASSEMBLY: Concrete floor.

SHIPPING INFORMATION: Items included in assembly, crated for export.  
Shipping weight      lb                      Shipping volume      cu ft

NOTE: This hut supplied on special request.



## SCULLERY, HOSPITAL

HUT, NORTHERN, 20 FT X 48 FT, ASSEMBLY NO. 1147

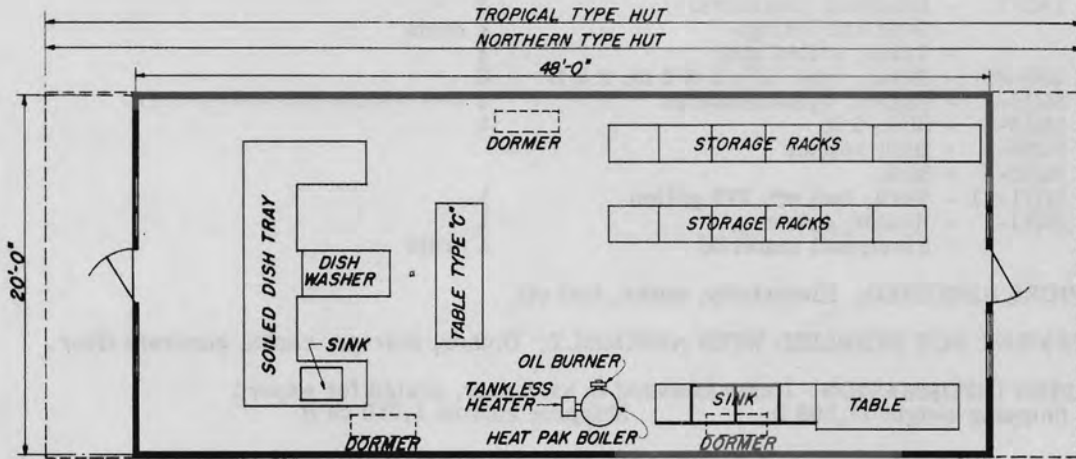

PLAN

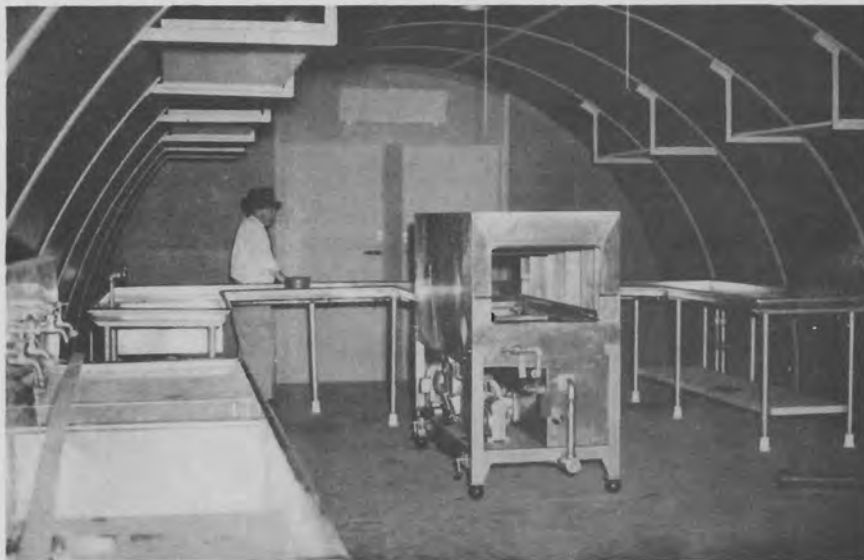

INTERIOR VIEW

**APPLICATION:** Dish cleaning hut for hospital usage.

**CAPACITY:** Functional Component.

G1 - 600 bed hospital (w/dispensaries)	3
G2 - 600 " " (without dispensaries)	3
G3 - 200 " " (w/dispensaries)	1
G4 - 200 " " (without dispensaries)	1
G5 - 100 " Dispensaries	1

No. of Huts

**DESCRIPTION:** Standard hut with dishwasher, tables, sinks and dish racks.

**OPERATION:** By hospital unit.

**LIST OF ITEMS INCLUDED IN ASSEMBLY:**

Stock No.

1A1-6	- Hut, arch rib, steel, standard basic unit, 20 ft x 48 ft w/6 flush type windows. (1)	
1A2-1	- Bulkhead (Northern)	2
	- Pipe and fittings	1 crate
	- Table, soiled dish	1
4S9-28	- Table, type "C", 2 ft 6 in. x 8 ft	2
2Q18-	- Boiler, w/accessories	1
2Q15-	- Sink, 9 ft	1
2Q56-	- Dish washer	
2Q15-	- Sink	
2H71-11	- Tank, fuel oil, 275 gallon	1
2Q11-	- Heater, space	1
	- Electrical material	1 crate

**SERVICES REQUIRED:** Electricity, water, fuel oil.

**EQUIPMENT NOT SUPPLIED WITH ASSEMBLY:** Dishes, storage racks, concrete floor.

**SHIPPING INFORMATION:** Items included in assembly, crated for export.

Shipping weight 17,502 lb      Shipping volume 1,050 cu ft

## SCULLERY, HOSPITAL

HUT, TROPICAL, 20 FT X 48 FT, ASSEMBLY NO. 1148

PLAN: See Scullery, Hut, (hospital group) Northern;

APPLICATION: Dish cleaning hut for hospital usage.

CAPACITY: Functional Component.	No. of Huts
G1 - 600 bed hospital (w/dispensaries)	3
G2 - 600 " " (without dispensaries)	3
G3 - 200 " " (w/dispensaries)	1
G4 - 200 " " (without dispensaries)	1
G5 - 100 " Dispensaries	1

DESCRIPTION: Standard hut with dishwasher, tables, sinks and dish racks.

OPERATION: By hospital unit.

### LIST OF ITEMS INCLUDED IN ASSEMBLY:

Stock No.		
1A1-6	- Hut, arch rib, steel, standard basic unit, 20 ft x 48 ft w/6 flush type windows. (1)	
1A2-3	- Tropical extension and bulkhead	(2)
	- Pipe and fittings	1 crate
	- Table, soiled dish	1
4S9-28	- Table, type "C", 2 ft 6 in. x 8 ft	2
2Q18-	- Boiler, w/accessories	1
2Q15-	- Sink, 9 ft	1
2Q56-	- Dish washer	
2Q15-	- Sink	
2H71-11	- Tank, fuel oil, 275 gallon	1
	- Electrical material	1 crate

SERVICES REQUIRED: Electricity, water, fuel oil.

EQUIPMENT NOT SUPPLIED WITH ASSEMBLY: Dishes, storage racks, concrete floor.

SHIPPING INFORMATION: Items included in assembly, crated for export.

Shipping weight 17502 lb

Shipping volume 1050 cu ft

**BUILDING, STANDARD BASIC UNIT**  
40 FT X 100 FT, ARCH RIB SHOP, STOCK NO. 1C-32-1



**EXTERIOR VIEW**



**INTERIOR VIEW**

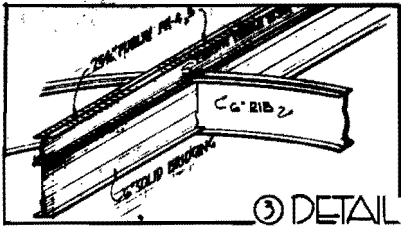

③ DETAIL

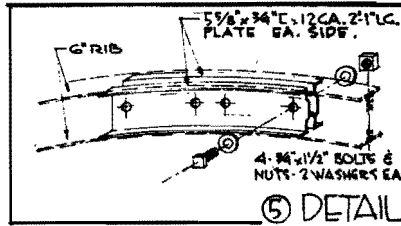

⑤ DETAIL

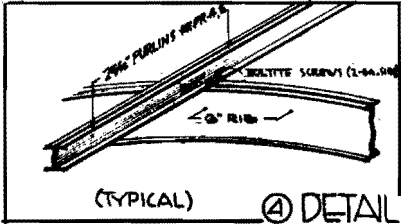

(TYPICAL) ④ DETAIL

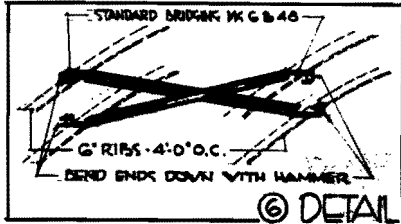

⑥ DETAIL

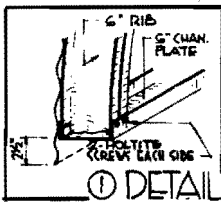

① DETAIL

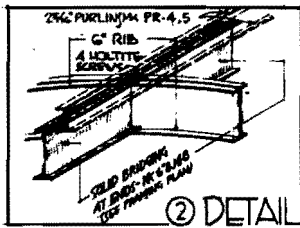

② DETAIL

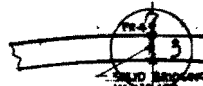

SECTION AT ENDS (SEE PLAN)

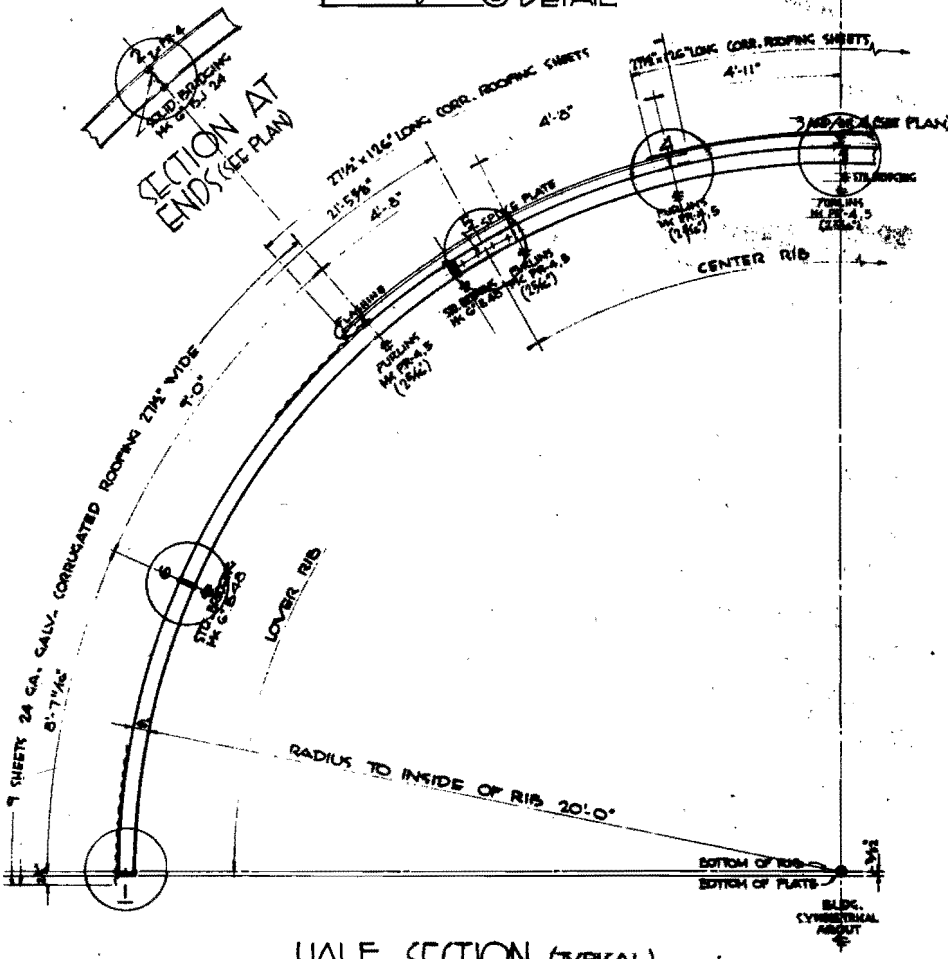

HALF SECTION (TYPICAL)

BUILDING, STANDARD BASIC UNIT  
40 FT X 100 FT, ARCH RIB SHOP, STOCK NO. 1C-32-1 (CONT'D)

APPLICATION: For housing of shops and storage.

CAPACITY: Contains 4,000 sq ft of floor area and 62,832 cubical content.

DESCRIPTION: Consists of cold rolled arched steel ribs, 4 ft on center with an outer covering of galvanized iron. Metal bulkheads with windows and a 12 ft x 12 ft double sliding door. No floor framing is supplied.

OPERATION: By the unit to which the building is assigned.

LIST OF ITEMS INCLUDED IN ASSEMBLY: (Note: A booklet of instructions for erecting and a crating list is packed with each hut. One set of erection tools is furnished for every four huts.)

SERVICES REQUIRED: Depends on the function of shop building.

EQUIPMENT NOT INCLUDED IN ASSEMBLY: Concrete floors. Heating system and lean-tos where required.

SHIPPING INFORMATION: Items included in assembly, crated for export shipment.  
Shipping weight 25812 lb                      Shipping volume - 369 cu ft

## LEAN-TO FOR BOILER ROOM

10 FT X 24 FT, FOR USE WITH 40 FT X 100 FT BUILDINGS, ASSEMBLY NO.



**APPLICATION:** For housing the boiler when steam heating systems are installed in Northern Climates.

**CAPACITY:** One boiler.

**DESCRIPTION:** This lean-to may be erected at any desired location on the buildings. It is built of metal studs, corrugated galvanized iron sides and roof.

**OPERATION:** By the unit occupying the building.

**LIST OF ITEMS INCLUDED IN ASSEMBLY:**  
See Y&D Dwg. 264,099

**EQUIPMENT NOT SUPPLIED IN ASSEMBLY:** Concrete floor and steam heating system.

**SHIPPING INFORMATION:** Items included in assembly, crated for export.  
Shipping weight 4014 lb                      Shipping volume 87 cu ft

PARACHUTE LOFT AND SHOP

40 FT X 100 FT BUILDING W/LOFT ADDITION, ASSEMBLY NO. 1297



PLAN

APPLICATION: Drying, repairing, folding, and storing of parachutes.

CAPACITY: For drying 68 parachutes at one time.

DESCRIPTION: Standard arch rib building w/air-conditioning for Tropics, and Heating for Northern. 40 ft x 20 ft loft addition.

OPERATION: By aviation repair unit.

LIST OF ITEMS INCLUDED IN ASSEMBLY: (See Y&D Dwgs. No. 262,151 - 262,152 - 262,154-262,653 - 264,168 - 256,363 - 256,364 - 256,365.

SERVICES REQUIRED: Electricity, water, fuel oil.

EQUIPMENT NOT SUPPLIED IN ASSEMBLY: Benches etc., described as being furnished by Bureau of Aeronautics - concrete floor.

SHIPPING INFORMATION: Items included in assembly, crated for export.

	Shipping Weight	Shipping volume
Northern Bldg. w/steam heating system and lean-to.	lb	cu ft
Northern Bldg. w/Hot air heating system-	lb	cu ft
Tropical Bldg. w/Air conditioning-	lb	cu ft
For additional bldg, 40 x 100 add.-	lb	cu ft



**MAGAZINE, STANDARD BASIC UNIT, STEEL**  
10FT X 10FT, READY, STOCK NO. 1D1-1

**APPLICATION:** For ammunition that is in readiness to be used.



**EXTERIOR FRONT VIEW**

**DESCRIPTION:** Corrugated metal sheets curved to a 5 ft radius and bolted together, sheet metal rear bulkhead. Front bulkhead of sheet metal doors. To be covered at least two feet over the crown with earth.

**OPERATION:** By ordnance unit.

**LIST OF ITEMS INCLUDED IN ASSEMBLY:**  
Stock No. 1D1-1 (See crating list furnished with each magazine).

**EQUIPMENT NOT INCLUDED IN ASSEMBLY:**  
Concrete floor (when used).



**EXTERIOR REAR VIEW**

**SHIPPING INFORMATION:** Items included in assembly, crated for export.  
Shipping weight 2564 lb      Shipping volume 141 cu ft

MAGAZINE, STANDARD BASIC UNIT, STEEL  
20FT X 20FT STOCK NO. 1D1-4

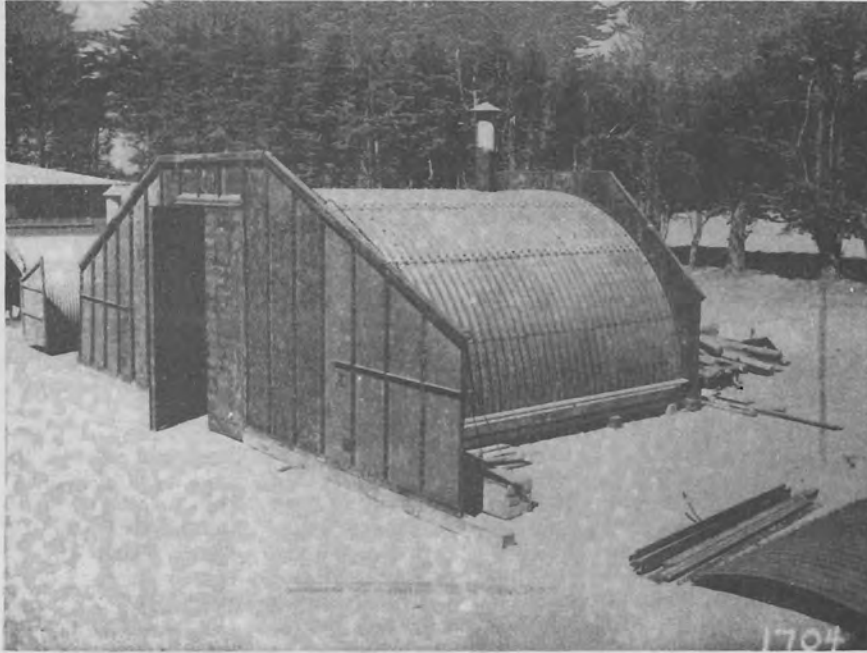

EXTERIOR VIEW (NOT COVERED)

**APPLICATION:** Ammunition storage.

**CAPACITY:** Floor area 400 sq ft, cubical content 3,140 cu ft

**DESCRIPTION:** Roof of corrugated metal, bolted together. Bulkheads of sheet metal with wings at entrance for retaining the earth work. Covered with earth a minimum depth of 2 ft.

**OPERATION:** By Ordnance unit.

**LIST OF ITEMS INCLUDED IN ASSEMBLY:**

Stock No.  
1D1-4 (See crating list included with each magazine)

**SERVICES REQUIRED:** None

**EQUIPMENT NOT INCLUDED IN ASSEMBLY:** Concrete floor (when used)

**SHIPPING INFORMATION:** Items included in assembly, crated for export  
Shipping weight 12350 lb                      Shipping volume 217.5 cu ft

## MAGAZINE, GAS DECONTAMINATING

20FT X 50FT ASSEMBLY NO. 1049

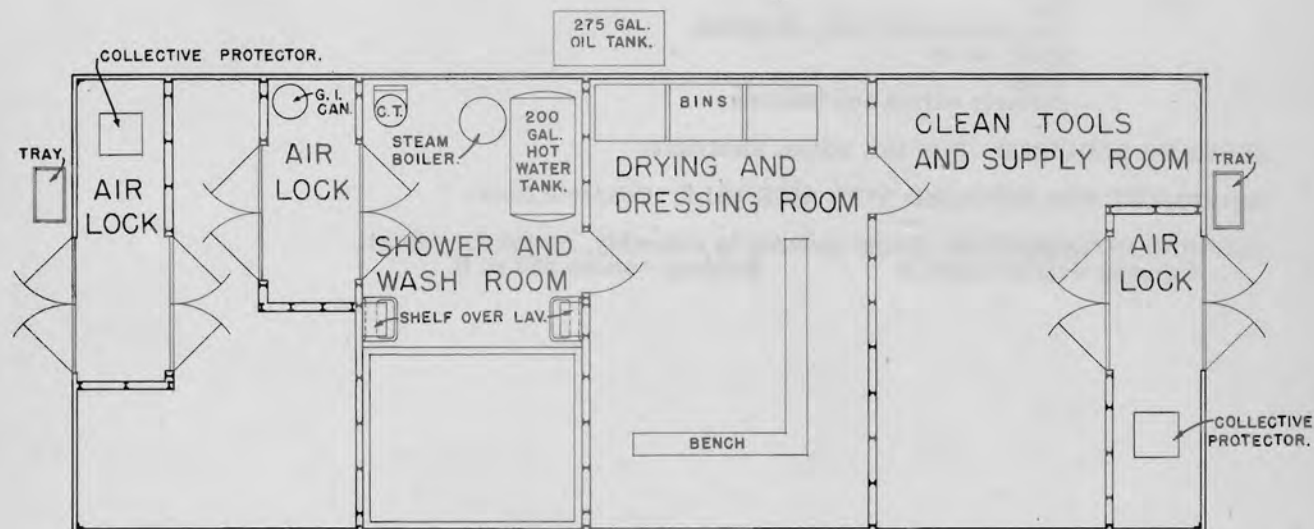

PLAN

**APPLICATION:** For removing of contaminated clothing safely and bathing to remove any contamination which may have come through the clothing. There are also provisions for first aid to minor casualties. It may be used for a base of operation for decontamination squads and stowing protective clothing, tools and other equipment.

**CAPACITY:** Continuous operation consisting of removal and disposal of clothing, bathing of eyes, complete shower and issue of clean clothing.

**DESCRIPTION:** This unit is composed mainly of 8 guage multiplate arched roof as used in a standard magazine but the wing walls are omitted and a special bulkhead is used at each end. Special partitions are used in the interior of the building. Plans and details are supplied with each bldg.

**OPERATION:** Operation of this station is under the control of the medical officer.

**LIST OF ITEMS INCLUDED IN ASSEMBLY:**

Stock No.		Quantity
	- Decontaminating Magazine w/partitions	1
	- Pipe and fittings	1 crate
2Q15-	- Sink, 16 x 20	2
2Q12-1	- Toilet, chemical, one bowl	1
401-2	- Collective Protectors	2
2Q18-	- Boiler w/accessories.	1

- Tank, 200 gallon, water
- 2H71-11 - Tank, 275 gallon, fuel
- Bench
- 407-1 - Bin
- Can, galvanized iron, 36 gallon
- Shelf, wood
- Tray
- Electric wiring and fixtures

**SERVICES REQUIRED:** Fuel Oil, water, electricity

**EQUIPMENT NOT SUPPLIED WITH ASSEMBLY:** Concrete floor.

**SHIPPING INFORMATION:** Items included in assembly, crated for export.

Shipping weight 26,201 lb

Shipping volume 528 cu ft

MAGAZINE, TORPEDO STORAGE,  
STANDARD BASIC UNIT, STEEL

25FT X 50FT, STOCK NO. 1D1-6



PLAN

APPLICATION: Torpedo storage magazine.

CAPACITY:

DESCRIPTION: Corrugated metal roof bolted together, concrete or dirt floor, sheet metal bulkheads with a wing at one end to retain dirt from entrance when covered with earth.

OPERATION: By ordnance unit.

LIST OF ITEMS INCLUDED IN ASSEMBLY:

Stock or Assembly No. 1D1-6 (See crating list supplied with each magazine.)

EQUIPMENT NOT INCLUDED IN ASSEMBLY: Concrete floor.

SHIPPING INFORMATION: Items included in assembly, crated for export.

Shipping weight 33,200 lb

Shipping volume 430 cu ft

## TENT, CANVAS

WALL, 14FT X 14FT, (FSC NO. 24-T-209), STOCK NO. 1Z1-2

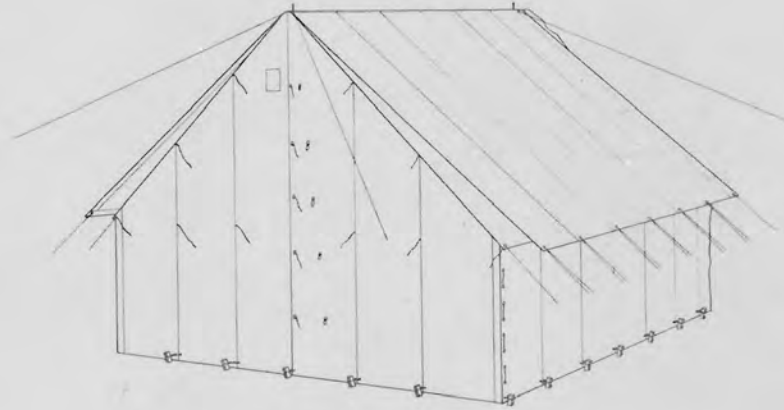

PLAN

**APPLICATION:** Temporary housing.

**CAPACITY:** Varies with usage.

**DESCRIPTION:** Tent, complete with pins, poles and fly. Tent is made of 29-1/2 in. wide cotton duck, of a minimum weight of 12.29 ounces per square yard. It is olive drab, fire, water and weather resistant. Each tent is folded, tied and placed in a tent bag.

**OPERATION:** Erected by construction battalion.

**LIST OF ITEMS INCLUDED IN ASSEMBLY:**

Stock No. 1Z1-2 - Tent, w/pins, poles and fly.

**SERVICES REQUIRED:** Electricity, (depends on usage).

**EQUIPMENT NOT INCLUDED IN ASSEMBLY:** Torch Lighting Except in special cases electricity is used.

**SHIPPING INFORMATION:** Items included in assembly, crated for export.

Shipping weight 213 lb Shipping volume 10.8 cu ft

## ADMINISTRATION TENT

14FT X 14FT WITH FLOOR, ASSEMBLY NO. 1001

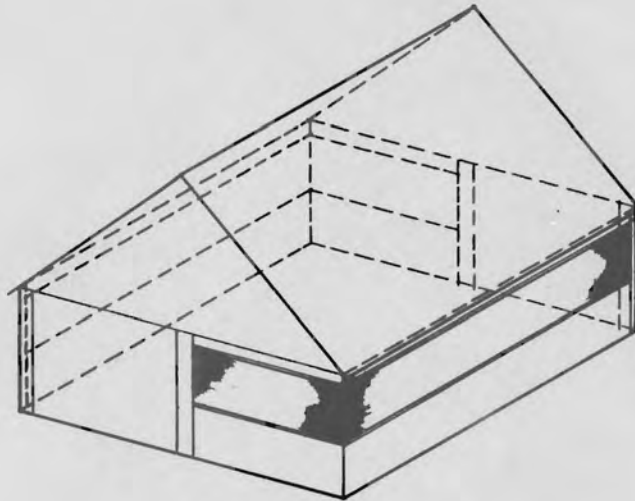

TENT WALL-LARGE  
14FT X 14FT

**APPLICATION:** To supply housing accommodations for personnel and equipment for office work required of a battalion.

**CAPACITY:** Two officers, one yeoman, desks and files.

**DESCRIPTION:** This assembly includes a standard tent with plywood floor and a wall screen.

**LIST OF ITEMS INCLUDED IN ASSEMBLY:**

Stock No.	
1Z1-2	Tent, large wall, canvas, complete w/poles, pins and flies, 14ft x 14ft (FSC No. 24-T-819).
	Floor, plywood with sleepers (Y&D Dwg No. 264241).
	Screen, wall (Y&D Dwg No. 264240)

**EQUIPMENT NOT SUPPLIED IN ASSEMBLY:** Desks, chairs, filing cases and other office equipment depending on the nature of the work performed.

Tent stove w/accessories in N1-A camp component sent to northern climates.

**SHIPPING INFORMATION:** Items included in assembly, crated for export.  
Shipping weight 898 lb                      Shipping volume 26.26 cu ft

BARRACKS TENT, OFFICERS  
14FT X 14FT WITH FLOOR, ASSEMBLY NO. 1014

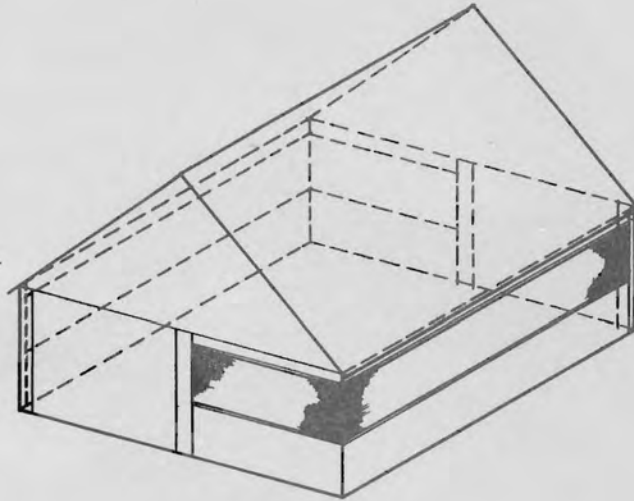

TENT WALL-LARGE  
14FT X 14FT

APPLICATION: Provides sleeping quarters for officers.

CAPACITY: Two officers.

DESCRIPTION: A standard tent is supplied with wood floor and wall screen.

LIST OF ITEMS INCLUDED IN ASSEMBLY:

Stock No.

- 1Z1-2 Tent, large, wall canvas, complete w/poles, pins and flies, 14ft x 14ft (FSC No. 24-T-819)  
Floor, plywood w/sleepers. (Y&D Dwg No. 264241)  
Screen, wall. (Y&D Dwg No. 264240)

EQUIPMENT NOT SUPPLIED IN ASSEMBLY: Two canvas cots, torch lights.

Stove w/accessories in N1-A camp component for northern climates.

SHIPPING INFORMATION: Items included in assembly, crated for export.

Shipping weight 898 lb

Shipping volume 26.26 cu ft



## LATRINE PIT TENT

WITH DIRT FLOOR AND WOOD FRAME, 14FT X 14FT, ASSEMBLY NO. 1077

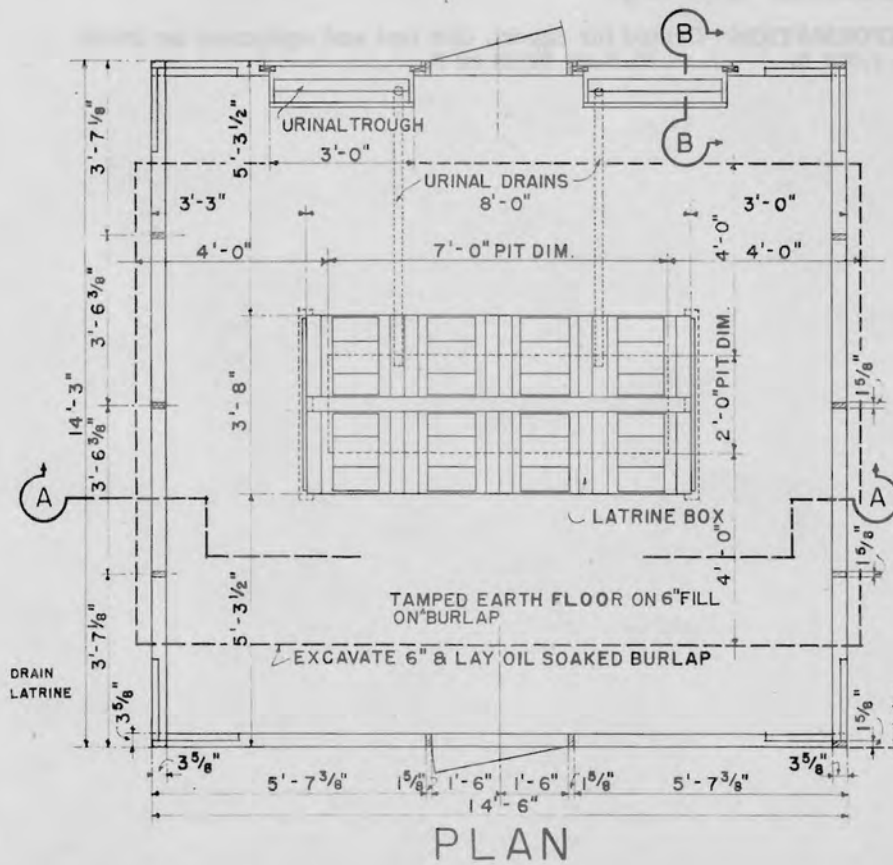
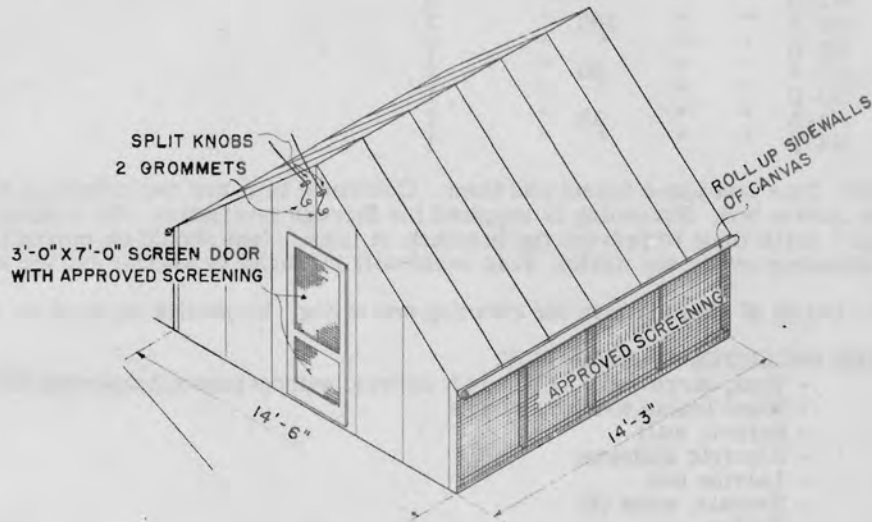

APPLICATION: This tent is equipped with an eight hole latrine box and two urinals.

CAPACITY:		Functional Component	No. of Tents
N1-A	Camp Unit - 250 men		4
N1-B	" " " "		3
N2-A	" " 100 "		2
N2-B	" " " "		1
N3-A	" " 50 "		2
N3-B	" " " "		1
N4-A	" " 25 "		2
N4-B	" " " "		1

**DESCRIPTION:** This tent has a frame and floor. Contained in it are two urinals 3 ft long and one eight hole latrine box. Screening is supplied for through ventilation. Oil soaked burlap is laid in a tamped earth floor to prevent the breeding of flies. Tent should be moved to a newly dug pit approximately every six weeks. It is eventually replaced by shower latrine hut.

**OPERATION:** Detail of enlisted men for cleaning and oiling. Inspection by medical officer.

**LIST OF ITEMS INCLUDED IN ASSEMBLY:**

- Tent, large wall, 14 ft x 14 ft canvas, without pins and poles but with fly.
- Wood frame w/door, screen
- Screen, wall
- Electric material
- Latrine box
- Urinals, wood (2)
- Burlap

**SERVICES REQUIRED:** Electricity.

**SHIPPING INFORMATION:** Crated for export, this tent and equipment as listed  
 Weighs 1,521 lb                      Volume 52.85 cu ft

## SHOWER, OFFICERS' TENT

14FT X 14FT WITH FRAME AND FLOOR ASSEMBLY NO.  
Y & D DRAWING NO. 261692

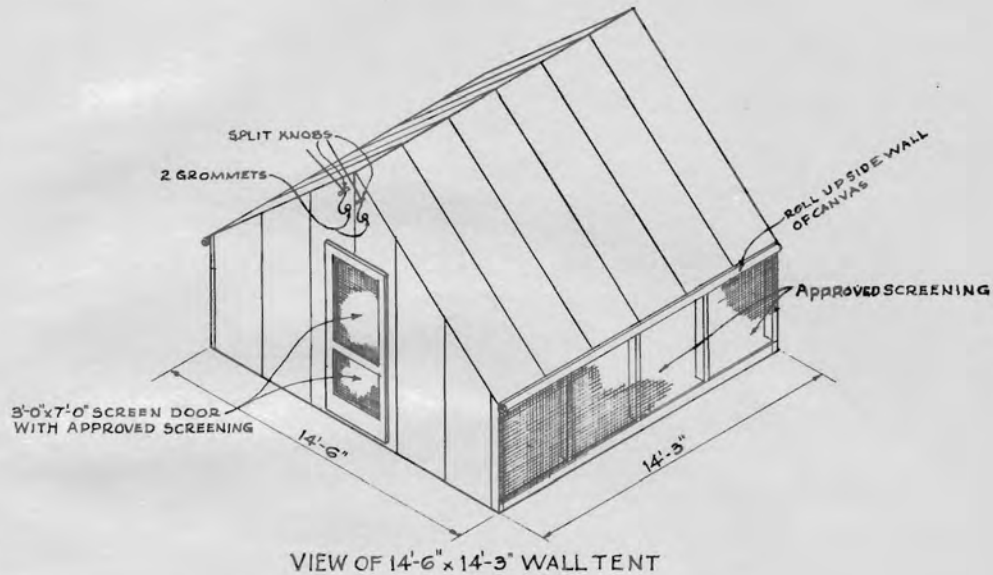

**APPLICATION:** Showers (4 head) for officers.

**CAPACITY:** Dressing room and showers for a maximum of 4 officers at one time. One tent for 25 officers.

**DESCRIPTION:** Tent, 14 ft x 14 ft with frame and removable floor. Drainage to a rock filled ventilated pit. Screened.

**OPERATION:** Cleaning by enlisted men.

**LIST OF ITEMS INCLUDED IN ASSEMBLY:**  
Stock or Assembly No.

Tent and fly, screens, lumber for framing and floors, plumbing equipment, electrical supplies.

**SERVICES REQUIRED:** Electricity, water.

**EQUIPMENT NOT INCLUDED IN ASSEMBLY:** Concrete drainage ramp. Pit ventilators.

**SHIPPING INFORMATION:** Items included in assembly, crated for export.  
Shipping weight 3169 lb                      Shipping volume 83.6 cu ft

## TENT, PYRAMIDAL

16FT X 16FT (FSC NO. 24-T-219), STOCK NO. 1Z1-3

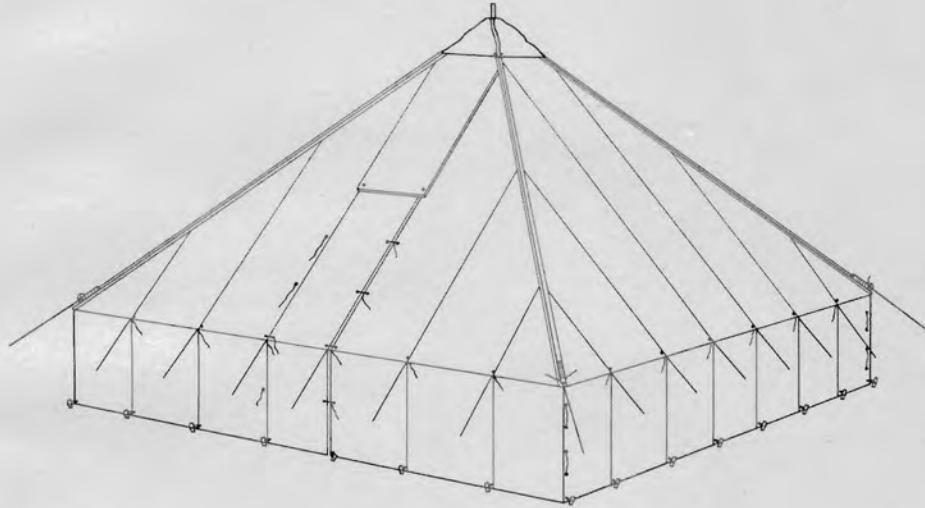

PLAN

**APPLICATION:** Temporary housing.

**CAPACITY:** Varies with usage.

**DESCRIPTION:** Tent, complete with pins, poles and fly. Tent is made of 29-1/2 in. wide cotton duck, of a minimum weight of 12.29 ounces per square yard. It is olive drab, fire, water and weather resistant. Each tent is folded, tied and placed in a tent bag.

**OPERATION:** Erected by construction battalion.

**LIST OF ITEMS INCLUDED IN ASSEMBLY:** - Tent, w/pins, poles and fly.  
Stock No. 1Z1-3

**SERVICES REQUIRED:** ELECTRICITY

**EQUIPMENT NOT INCLUDED IN ASSEMBLY:** Torch lighting. Except in special cases electricity is used.

**SHIPPING INFORMATION:** Items included in assembly, crated for export.  
Shipping weight 183 lb                      Shipping volume 10.8 cu ft

BARRACKS TENT, ENLISTED MEN'S  
16FT X 16FT WITH FLOOR, ASSEMBLY NO. 1011

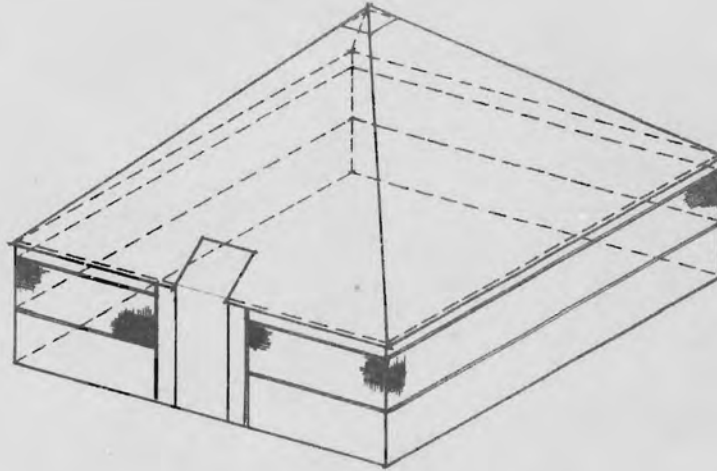

TENT-PYRAMIDAL  
16FT X 16FT

APPLICATION: Sleeping quarters for enlisted men.

CAPACITY: Five men per tent.

DESCRIPTION: A standard tent is supplied with wood floor and walls screen.

OPERATION:

LIST OF ITEMS INCLUDED IN ASSEMBLY:

Stock No.	
1Z1-3	Canvas pyramidal tent, complete w/poles, pins, (no fly) 16ft x 16ft (FSC No 24-T219)
	Floor, plywood w/sleepers. (Y&D Dwg No. 264241)
	Screen, wall. (Y&D Dwg No. 264240)

EQUIPMENT NOT SUPPLIED IN ASSEMBLY: Five canvas cots, bedding and torch lights.

Tent stove w/accessories in N1-A component sent to northern climate.

SHIPPING INFORMATION: Items included in assembly, crated for export.

Shipping weight 1056 lb	Shipping volume 30.5 cu ft
-------------------------	----------------------------

## TENT

STORAGE 17FT X 20FT STOCK NO. 1Z1-5

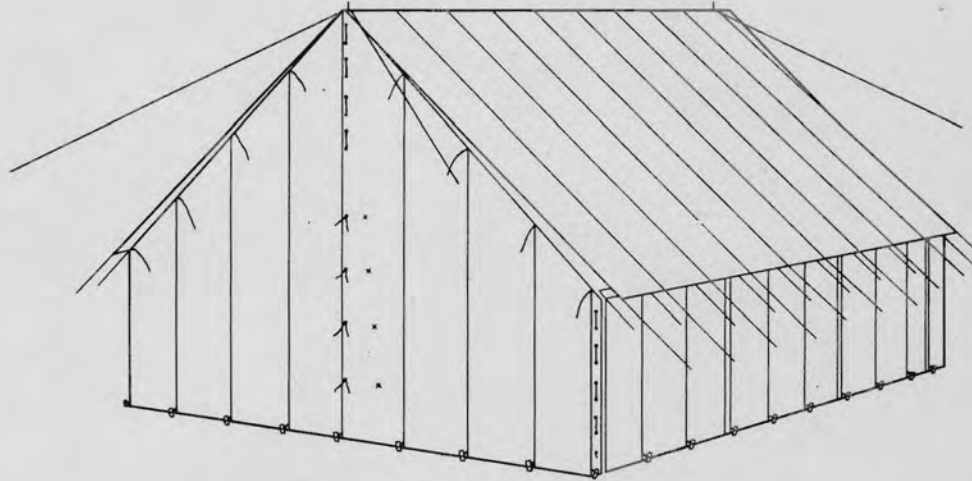

PLAN

**APPLICATION:** Temporary housing.

**CAPACITY:** Varies with usage.

**DESCRIPTION:** Tent, complete with pins, poles and fly. Tent is made of 29-1/2 in. wide cotton duck, of a minimum weight of 12.29 ounces, per square yard. It is olive drab, fire, water, and weather resistant. Each tent is folded, tied and placed in a tent bag.

**OPERATION:** Erected by construction battalion.

**LIST OF ITEMS INCLUDED IN ASSEMBLY:** - Tent, w/pins, poles and fly.  
Stock No. 1Z1-5

**SERVICES REQUIRED:** Electricity, (depends on usage).

**EQUIPMENT NOT INCLUDED IN ASSEMBLY:** Torch lighting. Except in special cases electricity is used.

**SHIPPING INFORMATION:** Items included in assembly, crated for export.  
Shipping weight 499 lb                      Shipping volume 20.8 cu ft

ADMINISTRATION TENT  
17 FT X 20 FT WITH FLOOR, ASSEMBLY NO. 1002

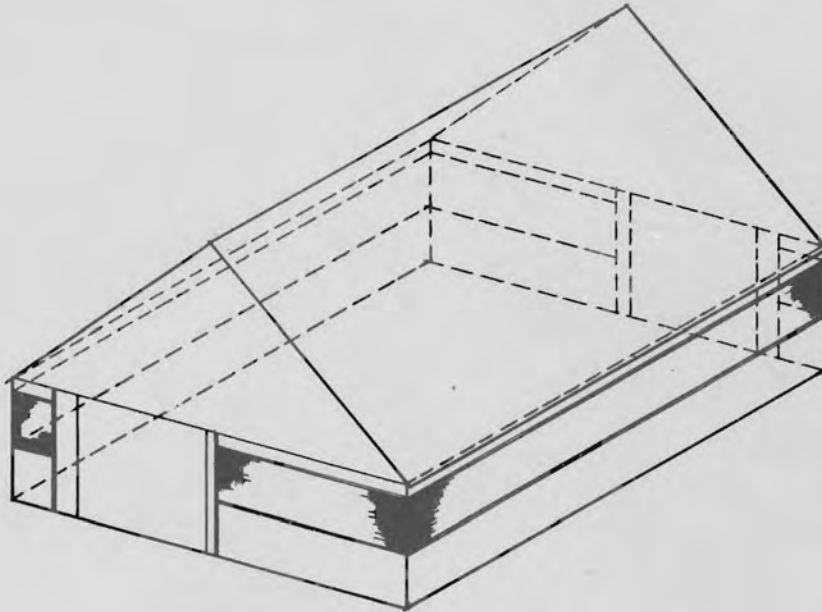

TENT-STORAGE 17 FT X 20 FT

**APPLICATION:** To supply housing accommodations for battalion office needs.

**CAPACITY:** Four officers, two yeomen, desks and files.

**DESCRIPTION:** This assembly includes a standard tent with plywood floor and wall screen.

**LIST OF ITEMS INCLUDED IN ASSEMBLY:**

Stock No.	
1Z1-5	Canvas Storage Tent, complete w/poles, pins and flies, 17 ft x 20 ft. (FSC No. 24-T-224)
	Floor, plywood w/sleepers. (Y&D Dwg No. 264241)
	Screen, wall. (Y&D Dwg No. 264240)

**EQUIPMENT NOT SUPPLIED:** Desks, chairs, filing cases and other office equipment depending on the nature of the work performed.

Tent stove w/accessories in N1-A camp component sent to northern climates.

**SHIPPING INFORMATION:** Items included in assembly crated for export:  
Shipping weight 1,747 lb                      Shipping volume 48.9 cu ft

## SHOWER, ENLISTED MEN'S TENT

17 FT X 20 FT WITH FRAME AND FLOOR, Y&D DRAWING NO. 261693, ASSEMBLY NO.

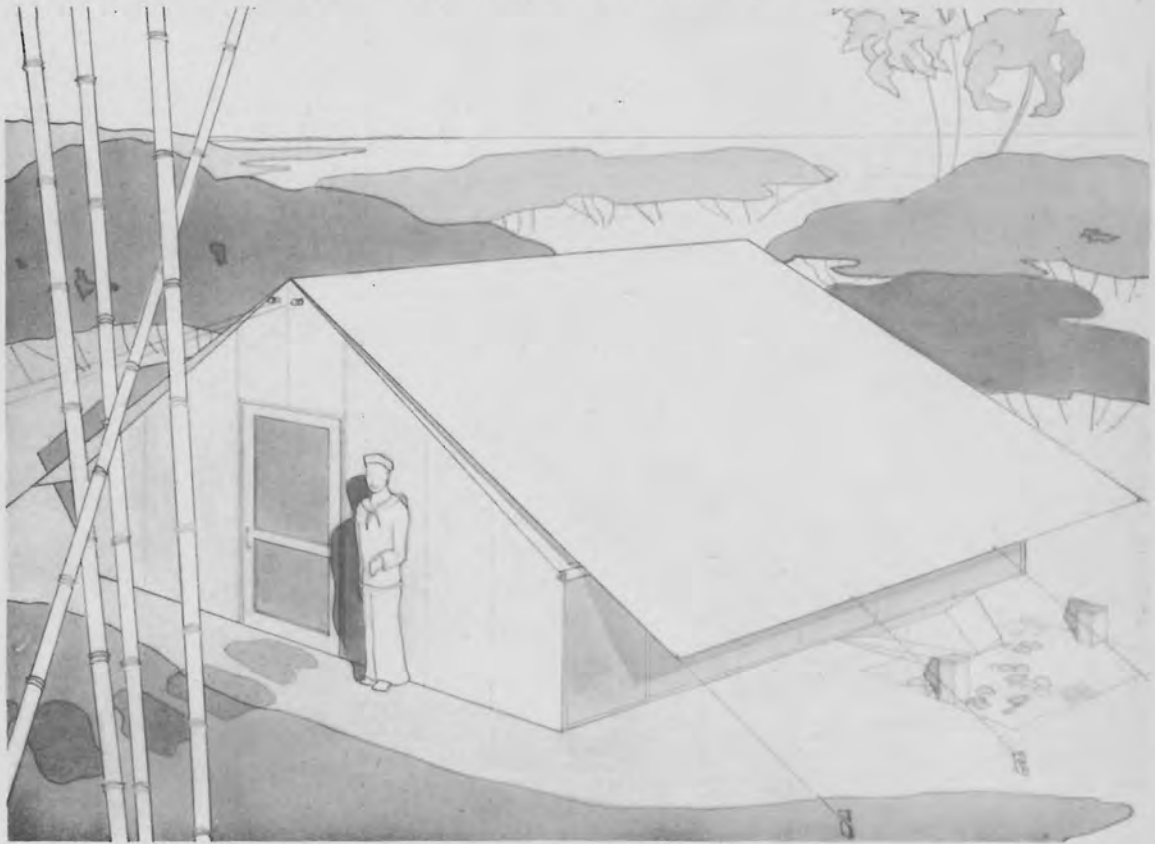

**APPLICATION:** Showers (12 head) for enlisted men.

**CAPACITY:** Dressing room and showers for maximum of 12 men at one time.

**DESCRIPTION:** Tent, 17 ft x 20 ft, with frame and removable floor. Drainage to a rock filled ventilated pit. Screened.

**OPERATION:** By enlisted men.

**LIST OF ITEMS INCLUDED IN ASSEMBLY:** Tent and fly, screens, lumber for framing and floor, plumbing equipment and electrical supplies.

**SERVICES REQUIRED:** Electricity, water.

**EQUIPMENT NOT INCLUDED IN ASSEMBLY:** Concrete drainage ramp. Pit ventilators.

**SHIPPING INFORMATION:** Items included in assembly crated for export:  
Shipping weight 4,952 lb                      Shipping volume 176.7 cu ft



## TENT, HOSPITAL WARD

TENT, (NO FLY) 16 FT X 50 FT (FSC NO. 24-T-199), STOCK NO. 1Z1-4

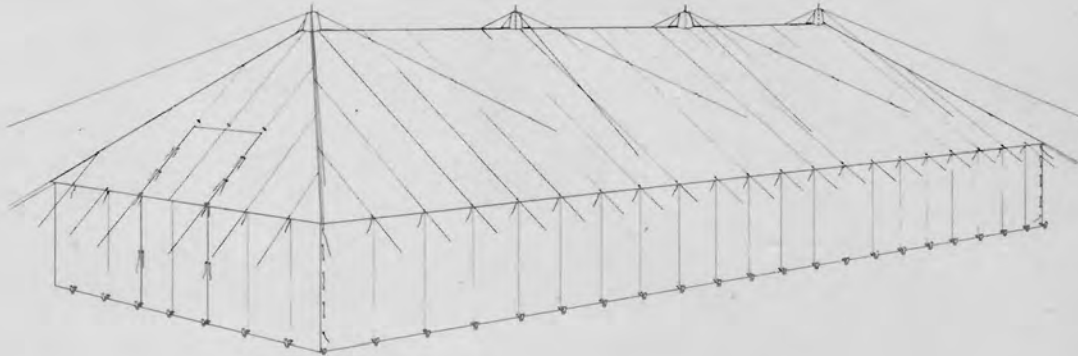

**APPLICATION:** Temporary housing.

**CAPACITY:** Varies with usage.

**DESCRIPTION:** Tent, complete with pins and poles. Tent is made of 29 1/2 inch wide cotton duck, of a minimum weight of 12.29 ounces per square yard. It is olive drab, fire, water and weather resistant. Each tent to be folded, tied and placed in a tent bag.

**OPERATION:** Erected by construction battalion.

**LIST OF ITEMS INCLUDED IN ASSEMBLY:**

Stock No.  
1Z1-4 Tent w/pins, poles and no fly.

**SERVICES REQUIRED:** Electricity (depends on usage).

**EQUIPMENT NOT INCLUDED IN ASSEMBLY:** Torch lighting. Except in special cases electricity is used.

**SHIPPING INFORMATION:** Items included in assembly, crated for export:  
Shipping weight 554 lb                      Shipping volume 26.3 cu ft

# PHOTOGRAPHIC LABORATORY

HUT, NORTHERN 20 FT X 60 FT ASSEMBLY NO. 1126

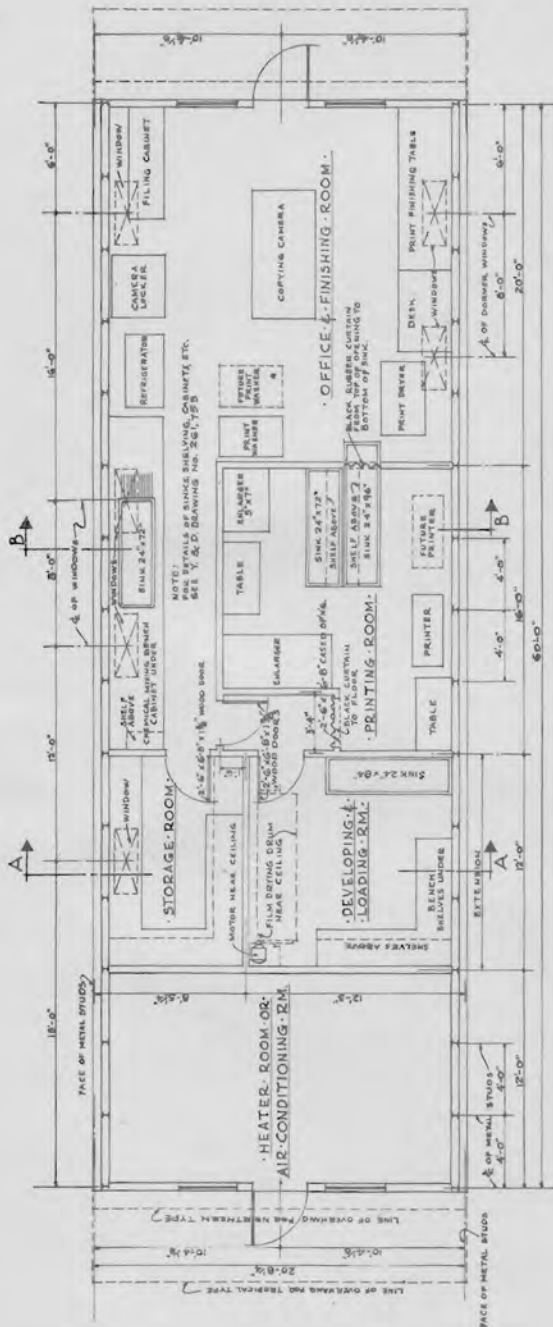

PLAN

**APPLICATION:** For photographic developing and printing.

**CAPACITY:** Varies with local conditions.

**DESCRIPTION:** Provides space for installation of necessary items of photographic equipment required at advance bases. Supplied to Functional component, H17-E.

**OPERATION:** By crew of six to fourteen photographers, depending on work required.

**LIST OF ITEMS INCLUDED IN ASSEMBLY:**

- Stock or Assembly No.
- 1A1-6 Hut, arch rib, steel, 20 ft x 48 ft, w/6 flush type windows. (1)
- 1A3-1 Addition extending basic hut (1)
- 1A2-1 Bulkhead (Northern) 2
  - Construction materials. (Y&D Dwg. No. 261,752).
  - Furnishings. (Y&D Dwg. No. 261,753).
  - Heating equipment (Y&D Dwg. No. 261,754).
  - Electrical material (Y&D Dwg. No. 261,756).

**SERVICES REQUIRED:** Electricity, water, fuel oil.

**EQUIPMENT NOT SUPPLIED IN ASSEMBLY:** Concrete floor, photographic supplies and equipment.

**SHIPPING INFORMATION:** Items included in assembly, crated for export.  
Shipping weight 24,344 lb  
Shipping volume 714 Cu Ft

## SCRUB DECK

TARPAULIN, 15 FT X 20 FT ASSEMBLY NO. 1306



**APPLICATION:** For cleaning of enlisted mens' and officers' clothes.

**CAPACITY:** Eight men at one time.

**DESCRIPTION:** A tarpaulin with pins and poles and a wooden scrub deck with drainboard. Water pipe and faucets. Y&D Dwg. No. 250,562, one for approximately 135 men.

**OPERATION:** By enlisted men.

**LIST OF ITEMS INCLUDED IN ASSEMBLY:**

Stock or Assembly No. 4G2-4

- Tarpaulin, 15 ft. x 20 ft.
- Scrub deck, wood, with pipes,
- poles, pins, and ropes.

**SERVICES REQUIRED:** Water.

**SHIPPING INFORMATION:** Items included in assembly, crated for export.  
Shipping weight 1,002 lb                      Shipping volume 25.41 cu ft

## PHOTOGRAPHIC LABORATORY

HUT, TROPICAL, 20 FT X 60 FT ASSEMBLY NO. 1127

**PLAN.** See photographic Laboratory, Northern.

**APPLICATION:** For photographic developing and printing.

**CAPACITY:** Varies with local conditions.

**DESCRIPTION:** Provides space for installation of necessary items of photographic equipment required at Advance Bases. Supplied to Functional component, H17-E.

**OPERATION:** By crew of six to fourteen photographers, depending on work required.

**LIST OF ITEMS INCLUDED IN ASSEMBLY:**

Stock or Assembly No.

- 1A1-6 - Hut, arch rib, steel, 20 ft x 48 ft w/6-flush type windows (1)
- 1A3-1 - Addition, extending basic hut (1)
- 1A2-3 - Bulkhead & Tropical extension (2)
  - Construction material (Y&D Dwg. No. 261,752).
  - Furnishings (Y&D Dwg. No. 261,753).
  - Air conditioning equipment (Y&D Dwg. No. 261,755).
  - Electrical material (Y&D Dwg. No. 261,756).

**SERVICES REQUIRED:** Electricity, water, fuel, oil.

**EQUIPMENT NOT SUPPLIED IN ASSEMBLY:** Concrete floor, photographic supplies and equipment.

**SHIPPING INFORMATION:** Items included in assembly, crated for export  
Shipping Weight 24344 lb                      Shipping volume 714 Cu Ft

## BOILER, STEAM-GENERATING

STOCK LIST NO. 2Q1-1 (LARGE) AND 2Q1-22 (SMALL)

**APPLICATION:** The primary function of these boilers is to supply steam to the tankless water heaters in the various huts and to the proofer in the bakery. They were selected for use with the heaters so as to provide a closed system which would eliminate large quantities of make-up water and consequent scaling of the heaters and boilers. Boilers are furnished in two sizes for low-pressure steam generation. The small-sized boiler is used to supply steam to the 25- and 50-man, 100-man, and 250-man galley, the 250-man laundry, as well as the 1000- to 3000-man bakery. The large-sized boiler is used for steam supply to the 250-man shower, latrine, and hospital service.

**CAPACITY:** Output of Steam Capacity

Small-Sized Boiler: 130,000 BTU at 1.4-gph average oil-firing rate  
180,000 BTU at 1.75-gph maximum oil-firing rate

Large-Sized Boiler: 420,000 BTU at 4.5-gph average oil-firing rate  
595,000 BTU at 6.0-gph maximum oil-firing rate

Output of Oil Burners

Burner for Small Boiler: 0.80-gph minimum oil-firing rate  
1.75-gph maximum oil-firing rate

*66% efficiency*



*1 gallon = 99,000 BTU  
PER HOUR*

Burner for Large Boiler: 3.0-gph minimum oil-firing rate  
6.0-gph maximum oil-firing rate

**DESCRIPTION:** The boiler units of each is a direct-fired, vertical, fire-tube type, with a pressure-atomizing forced-draft-type oil burner having automatic ignition and control. Both boilers are equipped with instruments and safety appliances for proper operation and automatic firing control, including a fusible safety switch, pressuretrol low-water cut-off, and stack-type protectorelay. Flue pipes and appurtenances are also furnished with each boiler.

**OPERATION:** Operation of boiler is automatic. Periodic cleaning and adjustment are required.

**SUPPLIES REQUIRED:** The following quantity of fuel is estimated to be required for operating the equipment 1,000 hours under severe conditions at the atmospheric temperature range shown:

	32°F to 70°F
Fuel, Diesel oil (Small boiler), gal	1750
(Large boiler), gal	6000

**AUXILIARY EQUIPMENT SUPPLIED:** Spare parts, flue pipe and appurtenances, and operating manual.

**AUXILIARY EQUIPMENT NEEDED BUT NOT SUPPLIED:** Pipe and fittings, fuel, and 110-volt, 60-cycle, single-phase, a-c current.

**SHIPPING INFORMATION:**

Small Boiler (Stock List No. 2Q1-22)	Weight: 1240 lb
	Cube: 47 cu ft
Large Boiler (Stock List No. 2Q1-1)	Weight: 2719 lb
	Cube: 105 cu ft

## DOUGH TROUGH

STOCK NO. 2Q25-1

**APPLICATION:** Used to handle dough from the mixer to the proof box and to the forming table in the bakery.

**CAPACITY:** 14 cubic feet of dough.

**DESCRIPTION:** Heavy sheet steel construction, lacquer finished outside, mounted on 4 single wheel roll-bearing casters with ball-bearing swivel.

Overall length 52 in.  
Overall width 30 in.  
Overall height 26 1/8 in.

**OPERATION:** Lubricate caster and swivel bearings.

**SUPPLIES REQUIRED:** 9110 (SAE 10)

**AUXILIARY EQUIPMENT SUPPLIED:** Spare parts.

**SHIPPING INFORMATION:**

Total weight of box 360 lb  
Total cube 34 cu ft  
Dimensions 52 in. x 30 in. x 26 1/8 in.

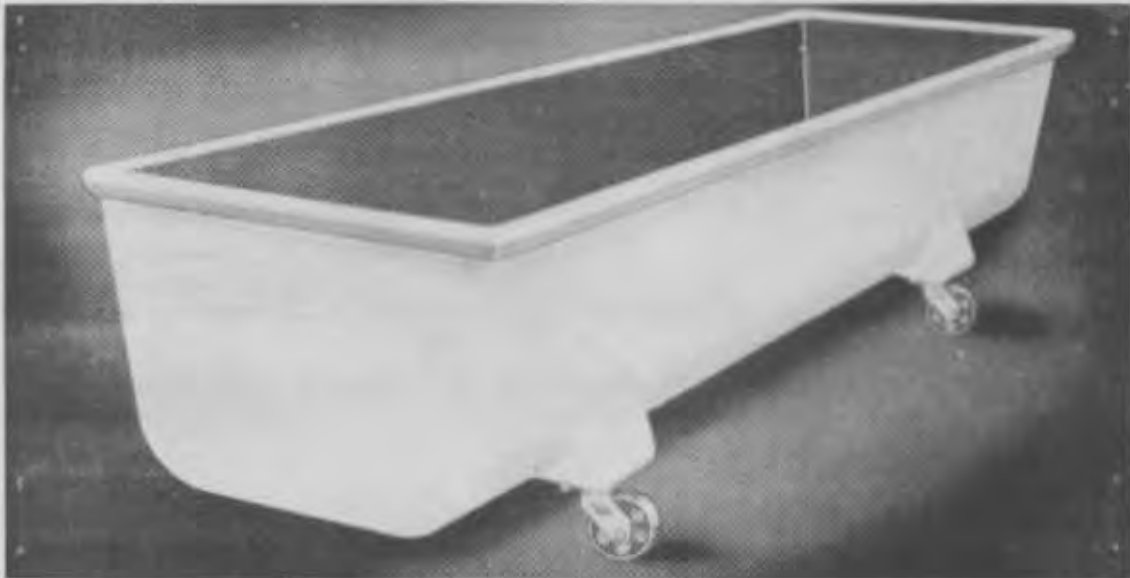

DOUGH TROUGH (2Q25)

## FREEZER, ICE CREAM

STOCK LIST NO. 2Q39-1

**APPLICATION:** Used for making and dispensing ice cream; also for dispensing frosted malteds and other products direct from the freezer.

**CAPACITY:** Freeze and whip in 6-qt batches 15 to 20 gal per day.  
20 gal, hardening,  
20 gal, dispensing, and  
9 gal, unfrozen

**DESCRIPTION:** The unit consists of an insulated steel cabinet on a channel base, a cylindrical ice cream freezer mounted on top of cabinet and a self-contained air-cooled refrigeration unit. Sides of cabinet are baked enamel and top of cabinet and ice cream freezing unit are stainless steel. Over-all dimensions are 51 1/2 in. height, 55 in. length and 35 in. depth. Freezer agitator is driven by 1/4-hp motor and refrigeration unit by 1/2-hp motor. Ice cream freezer is equipped with access door and draw-off valve. Control equipment includes:

1. Regulator for temperature control within freezer cylinder after freezing is completed.
2. Motor control switch for use when beater is operated without refrigeration.
3. Automatic freezing time control with range 0 - 12 minutes.

**OPERATION:** One man is required to operate the machine. Periodic cleaning is essential to proper operation. Gear case on freezer unit and compressor motor should be lubricated every 3 months.

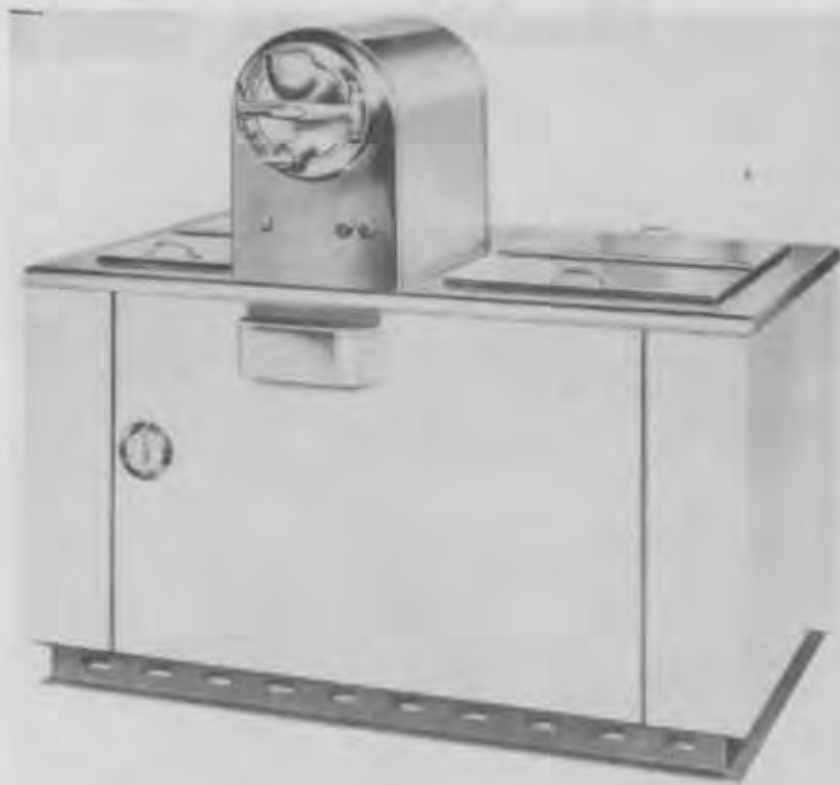

ICE CREAM FREEZER (2Q39-1)



**SUPPLIES REQUIRED:** The following quantities of fuel and lubricants are estimated to be required for operating the equipment 1,000 hr under severe conditions at the atmospheric temperature ranges shown:

	32°F and lower	32°F to 70°F	70°F and higher
--	-------------------	-----------------	--------------------

Electric current, 110-V, single-phase,  
60-cycle, a-c

**Oils -**

Gear, 14L4-80 (SAE 80) (Hypoid) qt	1	1	1
Gear, 14L4-90 (SAE 90) (Hypoid) qt			1
Motor 9110 (SAE 10) qt	1		
Motor 9250 (SAE 30) qt		1	1

**AUXILIARY EQUIPMENT SUPPLIED:** One mix can and eight 2 1/2-gal ice cream cans with lids and spare parts, including a can of gear lubricant and a qt of motor oil 9250 for the compressor, is furnished with each unit. Instructions with each shipment for operation and maintenance are included.

**SHIPPING INFORMATION:** Shipped in one crate.  
Weight: 1,050 lb  
Cube: 81 cu ft  
Dimensions: 60 in. x 41 in. x 57 in.

## HOT PLATE

DOUBLE UNIT, ELECTRIC, STOCK NO. 2Q20-1

**APPLICATION:** Used for making icings, etc., for pastry in bakeries. One hot plate is furnished to each 20-ft x 48-ft bakery and storage hut. Also used in 25-50-man galley for light cooking and coffee making.

**CAPACITY:** 2.4 kw and 4 kw.

**DESCRIPTION:** The frame is iron with a white porcelain finish. It is equipped with standard range units for 3-heat operation. The switch is protected from spill-overs.

Overall length: 21 in.  
Overall width: 13 in.  
Overall height: 5 in.

**OPERATION:** The plate is put into operation by turning on one or both switches. To avoid frequent replacement of the unit burners they should be kept clean.

**SUPPLIES REQUIRED:** 120-volt, 60-cycle, a-c electric power,

**AUXILIARY EQUIPMENT SUPPLIED:** Spare parts are included.

**AUXILIARY EQUIPMENT NOT SUPPLIED:** Pots and pans supplied with regular bakery equipment in smaller sizes may be used. Electric power supply system.

**SHIPPING INFORMATION:** Shipped in one (1) crate.

Shipping weight: 65 lb  
Shipping volume: 2.3 cu ft  
Dimensions: 27 in. x 18 1/2 in. x 8 in.



HOT PLATE (2Q20)

## COOKER, STEAM, 3-COMPARTMENT

STOCK LIST NO. 2Q22-10

**APPLICATION:** Cooker is for steaming of all kinds of vegetables, meats, poultry, sea food, and cereals; used in 1000-man galleys.

**CAPACITY:** Cooker is the 3-compartment type; each having a capacity of two bushels.

**DESCRIPTION:** The cooker is of the direct-steam-connected 3-compartment type, made of seamless, welded 3/16-in. steel plate and mounted on a heavy structural-steel base. Each compartment has dimensions of 24 in. x 24 in. x 14 in. high. The cooker is equipped with a steam gage, safety valve, and a synchronized thermostatic control for operation at 5-psi gauge pressure in the cooking compartments. Each compartment is supplied with steam gage thru a quick-opening safety throttle valve.

Cooker is furnished with six 24-gal galvanized perforated baskets about 11 in. x 23 in. x 12 in.

**OPERATION:** One-man operation.

**AUXILIARY EQUIPMENT SUPPLIED:** Operating manual and spare parts.

**AUXILIARY EQUIPMENT NEEDED BUT NOT SUPPLIED:** Supply of steam.

**SHIPPING INFORMATION:**

Weight: 1266 lbs  
Cube: 57 cu ft

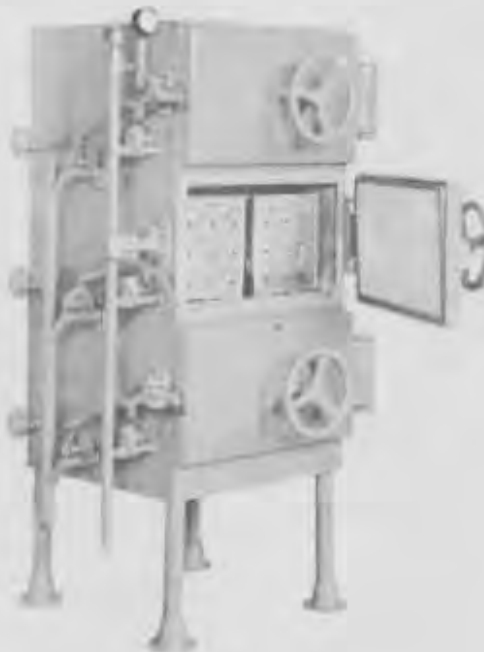

## ICE MACHINE, FLAKICE

STOCK LIST NO. 2Q37-3

**APPLICATION:** This machine is for producing ice crystals to preserve food and to cool beverages.

**CAPACITY:** 2,000 lbs of ice per 24 hr at 40°F cooling water or 1600 lbs at 85°F cooling water, with a compressor discharge pressure of not to exceed 120 psi and a suction pressure of 18-19 psi.

**DESCRIPTION:** This machine is a direct expansion unit which produces ice in a broken ribbon form with average thickness of 0.07 in. The unit consists of a two-cylinder gas compressor driven by a 2hp electric 3-ph a-c motor, a vertical shell and coil-type water cooled condenser, a rotating cell-type evaporator mounted in a water tank, and driven thru a shaft and pinion by 1/6-1/8 single-phase gearmotor and an ice cutter mounted in two self-aligning bearings at the top of the water tank. Controls are provided to insure positive operation and include thermostat, expansion valve, water float valve, condenser water regulating valve, low and high pressure cutout, motor starter and start-stop switch for the compressor and gear motors. The compressor, motor and condenser units are spring mounted. The complete unit is housed in a steel cabinet furnished in baked enamel, complete with chute and canvas connections, and ready for operation when connected to water, drain and electric lines. Refrigerant used in this unit is Freon 12.

**OPERATION:** Unit is automatic in operation after being started by one man. Periodic inspection and lubrication are required.

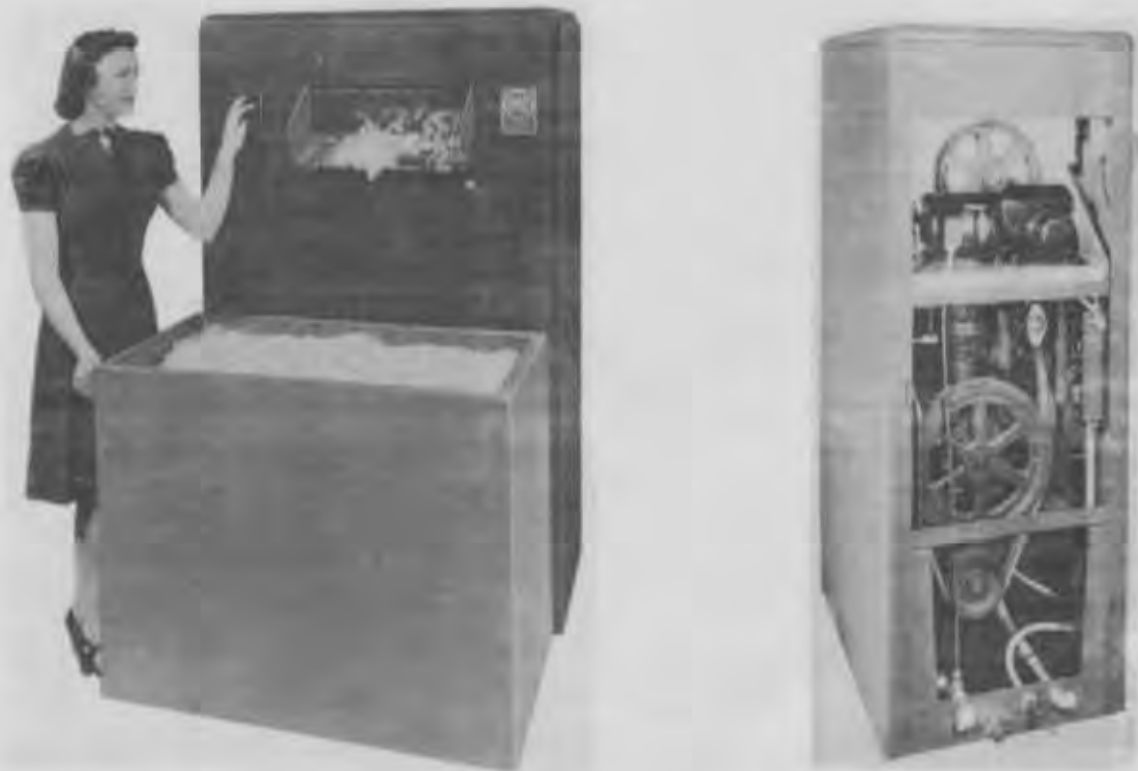

FLAKICE ICE MACHINE (2Q37-3)

**SUPPLIES REQUIRED:** The following quantities of fuel and lubricants are estimated to be required for operating the equipment 1,000 hr under severe conditions at the atmospheric temperature ranges shown:

	32°F and lower	32°F to 70°F	70°F and higher
<b>Greases -</b>			
General purpose 14L10 No. 2 (wheel bearing) lb	1	1	1
<b>Oils -</b>			
Gear, 14L4-80 (SAE 80) (Hypoid) gal	1	1	1
Motor 9110 (SAE 10) gal	1	1	1
Refrigerator 3050	1	1	1

**AUXILIARY EQUIPMENT SUPPLIED:** Spare parts, operating manual and parts list.

**AUXILIARY EQUIPMENT NEEDED BUT NOT SUPPLIED:** Electric power supply system, 220-V, 3-phase, 60-cycle a-c. Water supply.

**SHIPPING INFORMATION:**

	<u>Ice Machine</u>	<u>Bin</u>
Weight:	1810 lb	780 lb
Cube:	83 cu ft	59.2 cu ft

## ICE MACHINE, PACKICER

STOCK LIST NO. 2Q37-5

**APPLICATION:** This machine can be used for producing ice crystals to preserve food and to cool beverages.

**CAPACITY:** One ton (2,000 lb) of ice crystals per 24 hr from 70°F water.

**DESCRIPTION:** The unit consists of a stationary circular freezer coil evaporator with three rotating steel cutters attached to the freezer rotor which is accurately mounted to insure proper clearance for scraping ice from the evaporator surface. Water spray-nozzles attached to the rotor produce a uniform water film on the evaporator surface for maintaining an ice film. This rotor and spider with attached cutters is driven by a 1/2-hp 3-phase, 60-cycle, 220-volt motor through a "v" belt drive and gear reduction unit at 38 rpm. A water supply pump is mounted on the extended drive shaft of the reduction unit. This part of the apparatus (freeze coil assembly) is enclosed and mounted on top of a half-ton capacity wood storage bin with a water reservoir in the bottom. Float-operated water makeup valve maintains the water level in the reservoir. The water supply pump secures water from this reservoir for the icing process. A 3-cylinder, water-cooled, self-contained compressor unit driven by a 3-hp, 3-phase, 60-cycle, 220-volt motor is mounted on a base adjacent to storage bin. This unit is complete with thermal expansion valve, condenser-receiver, high and low pressure cut-out and automatic regulating syphon bellows-type valve for the condenser water-flow control. Storage bin is of one-half ton capacity, constructed of wood with reinforcing cleats and cadmium plated steel tie rods and hardware. Refrigerant is Freon 12.

**OPERATION:** Unit is automatic in operation after being started by one man. Periodic inspection and lubrication are required.



PACKICER ICE MACHINE (2Q37-5)

**SUPPLIES REQUIRED:** The following quantities of fuel and lubricants are estimated to be required for operating the equipment 1,000 hr under severe conditions at the atmospheric temperature ranges shown:

	32°F and lower	32°F to 70°F	70°F and higher
<b>Greases -</b>			
General purpose 14L10 No. 2 (wheel bearing) lb	1	1	1
<b>Oils -</b>			
Gear, 14L4-80 (SAE 80) (Hypoid) gal	1	1	1
Motor 9110 (SAE 10) gal	2	2	2
Refrigerator 3050	1	1	1

**AUXILIARY EQUIPMENT SUPPLIED:** Spare parts, parts list and operating manual.

**AUXILIARY EQUIPMENT NEEDED BUT NOT SUPPLIED:** 220-V, 3-phase, 60-cycle - a-c current. Water supply.

**SHIPPING INFORMATION:** Shipped in one box  
 Weight: 2,530 lb  
 Cube: 177 cu ft

## MIXER, FOOD, WITH ATTACHMENTS

STOCK LIST NO. 2Q22-14

**APPLICATION:** One used in bakery for mixing dough of all kinds, whipping eggs, making pie fillings and frostings; and one in galleys for mashing potatoes, mixing various foods, making mayonnaise, grinding coffee and meat, slicing vegetables and sharpening tools.

**CAPACITY:** 80 qt, 135 lb of dough or 60 lb of potatoes.

**DESCRIPTION:** Unit is constructed with cast iron frame and base with top-mounted electric motor and reduction gears which drive attachments through a clutch at variable speeds. All moving parts, except attachments, are totally enclosed. Dimensions vary with different manufacturers but are approximately 27 in. wide, 37 in. long and 71 in. high.

**OPERATION:** Requires periodic cleaning, oiling, greasing and adjustment.

**SUPPLIES REQUIRED:** The following quantities of fuel and lubricants are estimated to be required for operating the equipment 1,000 hr under severe conditions at the atmospheric temperature ranges shown:

	32°F and lower	32°F to 70°F	70°F and higher
<b>Greases -</b>			
General purpose 14L10 No. 2 (wheel bearing) lb	1	1	1
<b>Oils -</b>			
Gear, 14L4-90 (SAE 90) (Hypoid) gal	1	1	1
Motor 9110 (SAE 10) gal	1	1	1



FOOD MIXER (2Q22-14)



**AUXILIARY EQUIPMENT SUPPLIED:**

One 30,60 and 80 qt mixing bowl  
One 30,60 and 80 qt batter beater  
One 30,60 and 80 qt. wire whip  
One 30,60 and 80 qt dough hook  
One coffee grinder  
One batter beater  
One meat grinder  
One tool sharpener  
One vegetable slicer  
Spare parts  
(Note: Mixer of same size but without attachment drive and coffee-grinder also being purchased)

**AUXILIARY EQUIPMENT NEEDED BUT NOT SUPPLIED:** Electric power supply 220-V.  
3-ph, 60-cycle a-c.

**SHIPPING INFORMATION:**

	MINIMUM	MAXIMUM
Weight:	1,470 lb	1,700 lb
Cube:	72 cu ft	95.4 cu ft
Dimensions:	50 1/2 in. x 34 1/2 in x 71 1/2 in.	60 in. x 38 in. x 72 in.

(Note: Weight and cube varies with the different manufacturers)

## OVEN, BAKE, GRAVITY OIL-FIRED

STOCK LIST NO. 2Q27-2

**APPLICATION:** This oven is for use in the 250-man galley and 1000- to 3000-man bakery.

**CAPACITY:** Forty-eight 1 1/2-lb loaves of bread.  
Twenty-four 10-in. pies.

**DESCRIPTION:** This oven is an all-welded type suitable for oil or gasoline firing, and is 39 in. wide x 36 in. deep x 75 in. high. It is provided with four refractory lined shelves, each 34 in. wide x 29 in. deep x 7 in. high. The oven is equipped with an electric-motor-driven forced-draft blower and two 10-in. pot-type gravity-feed vaporizing burners. Fuel control valves are of the combined metering, constant-level type. Oven is equipped with flue pipe and flashing.

**OPERATION:** Periodic cleaning and adjusting of burner is necessary. The oven must be kept clean to prevent rust.

**SUPPLIES REQUIRED:** The following quantities of fuel are estimated to be required for operating the equipment 1,000 hours under severe conditions at the atmospheric temperature range shown:

<b>Fuel</b>		32°F to 70°F
Unleaded gasoline, 65-octane, gal		1000
Diesel oil, 50-cetane, gal		1000



**AUXILIARY EQUIPMENT SUPPLIED:** This unit is complete for operation when connected to fuel oil line, electricity, and smoke pipe. Spare parts and operating manual are included.

**AUXILIARY EQUIPMENT NEEDED BUT NOT SUPPLIED:** 110-Volt, single-phase, 60-cycle, a-c power.

**SHIPPING INFORMATION:**

Weight: 1635 lb  
Cube: 95 cu ft



**PROOF BOX**  
STOCK LIST NO. 2Q24-5

**APPLICATION:** Proof box is used in the 1000- to 3000-man bakery for raising and storing bread.

**CAPACITY:** Proof box is 32 in. wide by 44 in. long, by 71 in. high, and is equipped with nine shelves approximately 28 in. wide x 38 in. deep.

**DESCRIPTION:** This proof box is of the shelf type, constructed of 22-gage galvanized sheet iron on a galvanized iron frame. The unit has full-length double doors and is mounted on four 4-in., swivel, ball-bearing, wheel casters. Proof box is provided with nine removable galvanized wire shelves spaced about 5 5/8 in. apart. Each proofer is equipped with 3/4-in. perforated steam pipes.

**OPERATION:** Steam is admitted to the proof box thru the perforated pipe. No maintenance is required except lubricating casters.

**SUPPLIES REQUIRED:** Motor Oil 9110 (SAE 10)

**AUXILIARY EQUIPMENT SUPPLIED:** Instructions for assembly.

**SHIPPING INFORMATION:**

Weight: 545 lb  
Cube: 26 cu ft



## RANGE, GALLEY, WITH BURNER ASSEMBLY

STOCK LIST NO. 2Q28-3

**APPLICATION:** Used in 20-ft x 48-ft galley huts for cooking food. Two units are installed side by side in each 100-man and 250-man galley. One unit installed in each 25- 50-man galley.

**CAPACITY:** The two units satisfy the requirements of 250-man galleys. Two oil burners in each unit generate enough heat for cooking top and the oven.

**DESCRIPTION:** This range unit is an all-welded steel-constructed cooking range, single oven, suitable for oil or gasoline firing complete with necessary control equipment. The range size is 48 in. wide, 38 in. deep, and 33 in. high to cooking top and 39 in. high to top of back splasher. The unit is provided with a 27 in. x 24 in. x 16 in. high oven, insulated door and grease trough.

Each range is equipped with two 10-in. forced draft, pot-type, gravity-feed vaporizing burners, appropriate fuel lines and clean-out rods. The burners are suitable for burning either gasoline or Diesel oil per BuShips specifications 7-0-2 (INT). The combustion chamber is lined with moulded refractory. The control of the fuel to the burners is affected by the fuel control valves of the combined metering, constant-level type and is protected by suitable guards. The necessary air for atomization and sustaining the combustion of the liquid fuel is afforded by an electrically driven centrifugal blower mounted in front of the burner assembly. The blower motor is a constant-speed-type wound for 110-Volt, 60-cycle, single-phase current. A motor starting switch is provided and all internal wiring installed on each unit for immediate operation of the range. Access openings are provided for natural draft, maintenance, and care of the unit, and insulation placed where needed. A canopy is provided with each range, constructed of two 48-in. x 38-in., No. 24 gage sheets, one sheet provided with a grease trough and the other cut in the proper places for flue pipes and holes provided for fastening to range.



GALLEY RANGE (2Q28-3)

**OPERATION:** Periodic adjustment and cleaning of burners is necessary. Keep inside of oven clean and dry to avoid rust.

**SUPPLIES REQUIRED:** The following quantities of fuel and lubricants are estimated to be required for operating the equipment 1,000 hr under severe conditions at the atmospheric temperature ranges shown:

	32°F to 70°F
<b>Fuel -</b>	
Unleaded gasoline, 65-octane, gal	1,000
Diesel oil, gal                    either	1,000
Kerosene, gal	1,000

**AUXILIARY EQUIPMENT SUPPLIED:** Each range is provided with six 8-in-diam, 24-in. lengths of 26-gage black iron flue pipe, one 8-in. barometric draft regulator, one 8-in. Artis-type cap and roof flashing with 8-in. collar to fit corrugated roof of huts.

**AUXILIARY EQUIPMENT NEEDED BUT NOT SUPPLIED:** Connections are required for oil lines and 110-Volt, single-phase, 60-cycle, a-c power.

**SHIPPING INFORMATION:** Shipped in one crate.  
Weight: 1300 lb  
Cube: 75 cu ft

## RANGE, GALLEY DOUBLE-OVEN-TYPE WITH BURNER ASSEMBLY

STOCK LIST NO. 2Q28-8

**APPLICATION:** The double unit is to be used in 1,000-man galleys for cooking food.

**CAPACITY:** Three of these units will satisfy the requirement of 1,000-man galleys.

**DESCRIPTION:** Body of range is made of welded 14-gage steel with cast iron top, 72 in. by 38 in., ground to a smooth finish. Height of range is 33 in. Both ovens are 28 in. deep, 22 in. wide by 16 in. high and are insulated and equipped with dampers. Combustion chamber is located between the ovens and is lined with refractory tile. Access and clean-out openings are provided. Oil burner is center front mounted and is of the horizontal, rotary atomizing type, gravity fed and suitable for burning diesel oil per BuShips specifications 7-0-2. Burner is designed to burn from 3/8 gph to 1 1/2 gph at a minimum draft of .03 in. wp with an oil pressure of 3 to 4 ft. The burner assembly includes safety-oil solenoid-valve oil-strainer, fan, air filters and throttle valve. It is driven by a direct connected 110-volt, single-phase, 60-cycle, tropical insulated, enclosed motor equipped with switch and thermal overload protection and is completely wired, mounted and ready for service connections.

**OPERATION:** Periodic adjustment and cleaning of burners is necessary. Oven must be kept clean and dry to avoid rust.

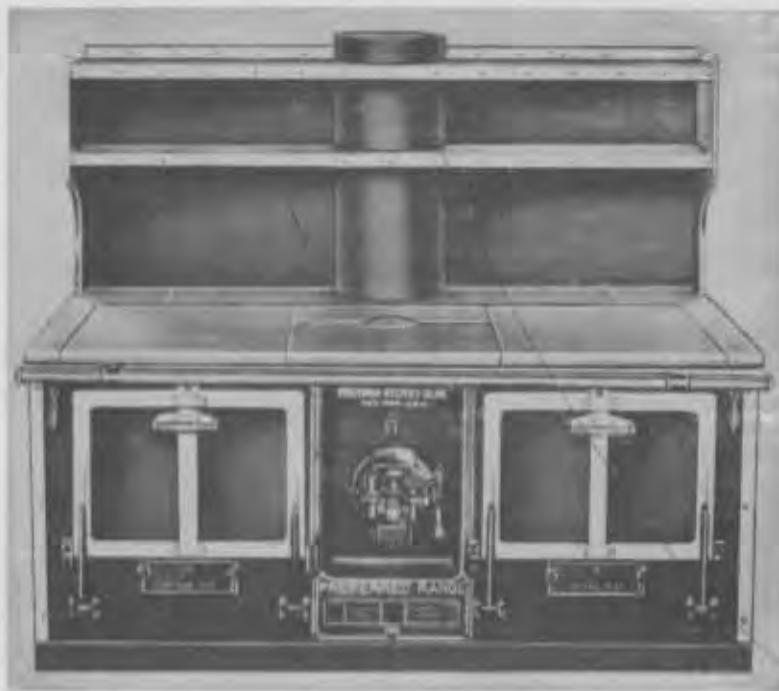

GALLEY RANGE (2Q28-8)

**SUPPLIES REQUIRED:** The following quantities of fuel and lubricants are estimated to be required for operating the equipment 1,000 hr under severe conditions at the atmospheric temperature ranges shown:

	32°F and lower	32°F to 70°F	70°F and higher
Fuel - Diesel oil, 50-centane	3,000	3,000	3,000

**AUXILIARY EQUIPMENT SUPPLIED:** Spare parts, flue pipe assemblies and operation manuals are included with each shipment.

**AUXILIARY EQUIPMENT NEEDED BUT NOT SUPPLIED:** Oil tank, pipe connections and 110-Volt, single-phase, 60-cycle, a-c power are required.

**SHIPPING INFORMATION:** Shipped in one crate.  
Weight: 1,900 lb  
Cube: 67.5 cu ft

**ORDERING INSTRUCTIONS:**



## REFRIGERATOR

8 CU FT STOCK LIST NO. 2Q64

**APPLICATION:** One used in 20-ft x 56-ft hut bakery for perishable food storage.

**CAPACITY:** 8 cu ft

**DESCRIPTION:** Refrigerator is a self-contained domestic reach-in type with an all-steel insulated cabinet. Unit is provided with a one-piece enamel cold storage compartment liner with rust proof, acid-resisting shelves, trays and grids.

Stock List No. 2Q64-19 is equipped with absorption-type refrigeration unit, using an aqueous solution of ammonia and hydrogen for the refrigerant. Unit is self-contained, consisting of a generator, absorber, gas heat exchanger, condenser, rectifier and evaporator. Burner fuel is kerosene. Tank has capacity of 4 1/2 gal and is equipped with gage.

Stock List No. 2Q64-20 is of the electric-driven compressor-type with air-cooled condenser equipped with cold control, automatic unloader, thermal overload and a 110-volt, single-phase, 60-cycle motor. Refrigerant is Freon 12.

**OPERATION:** Requires periodic cleaning only.

**SUPPLIES REQUIRED:** Stock List 2Q64-20 requires 110-volt, a-c single-phase, 60-cycle power, 1 gal 9110 (SAE 10) oil, and 1 gal of refrigerator oil 3050. Stock List 2Q64-19 requires kerosene.

**AUXILIARY EQUIPMENT SUPPLIED:** Instruction Manual.

**AUXILIARY EQUIPMENT NEEDED BUT NOT SUPPLIED:** Electric power and lubricants.

**SHIPPING INFORMATION:** Shipped one in a crate.

Electric Refrigerator	Kerosene Refrigerator
Weight: 478 lb	640 lb
Cube: 45.48 cu ft	56.6 cu ft



## REFRIGERATOR

ELECTRIC, 32 CU FT, STOCK NO. 2Q64-7

**APPLICATION:** One used in 20-ft x 48-ft galley for perishable food storage.

**CAPACITY:** 32 cu ft

**DESCRIPTION:** Metal construction on wood frame, approximately 54 in. wide, 33 in. deep and 74 in. high, insulated throughout, white baked-finish interior and exterior, four gasketed doors, rust-proof wire shelving, complete with blower type, forced-draft cooling coil, expansion valve, 1/3hp air cooled condensing unit, compressor, receiver and controls. (Refrigerant Freon 12.)

**OPERATION:** Requires cleaning only.

**SUPPLIES REQUIRED:** 110-v., 60-cycle, single-phase a-c, 9110 (SAE-10) oil, and 1 gal of refrigerator oil 3050.

**AUXILIARY EQUIPMENT SUPPLIED:** Spare parts.

**AUXILIARY EQUIPMENT NOT SUPPLIED:** Electric power.

**SHIPPING INFORMATION:** Shipped one in a crate.

Gross weight: 1450 lb  
Cube: 101.9 cu ft  
Dimensions: 80 in. x 55 in. x 40 in.

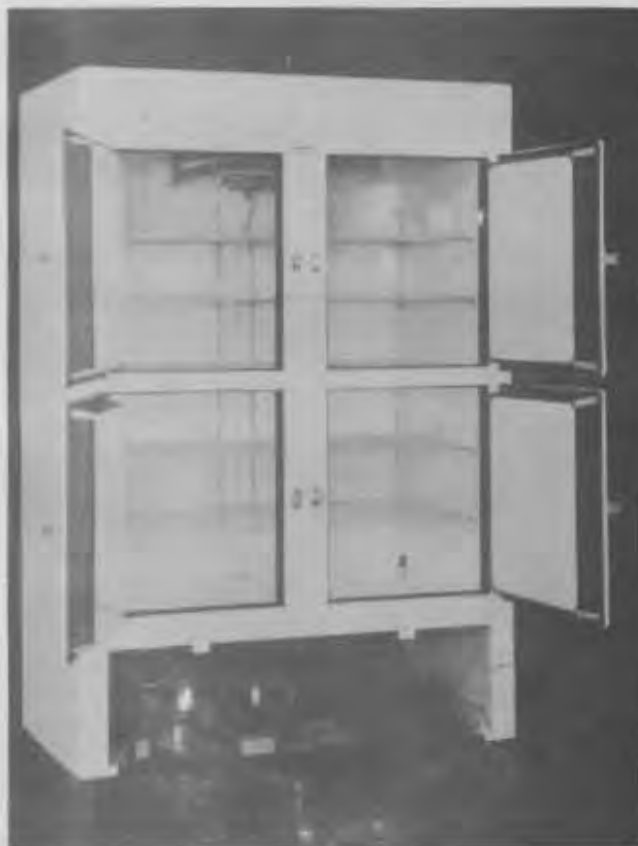

ELECTRIC REFRIGERATOR (2Q64)

## REFRIGERATOR, 150-CU FT, PORTABLE

STOCK LIST NO. 2Q84-16

**APPLICATION:** Provides storage for perishable foods in connection with 250-man galleys.

**CAPACITY:** 150 cu ft.

**DESCRIPTION:** The refrigerator consists of an insulated box and a refrigeration unit. The overall dimensions are: 8 ft 6 in. in length, 6 ft 0 in. in width, and 6 ft 6 in. in height. Entrance door clear opening is 2 ft 6 in. x 5 ft 0 in. The refrigeration unit is driven with either an electric or gasoline motor and includes compressor with condenser, liquid receiver, heat exchanger, liquid line dehydrator, suction and discharge lines and control valves. The refrigerator cabinet is metal-clad, finished in enamel. Unit is mounted on permanently attached skids. Towing eyes on the bottom and lifting lugs on top afford means for towing or lifting. The door latch hardware is packed in the unit with the tools, spare parts, etc. Refrigeration system is charged with Freon 12 refrigerant.

**OPERATION:** One man is required to operate refrigerator. All vents should be open when unit is in operation. Vent on upper left side of box need not be open when refrigerating unit is motor-driven.



**SUPPLIES REQUIRED:** 110-volt, single-phase, 60-cycle power. The following quantities of fuel and lubricants are estimated to be required for operating the equipment 1,000 hours under severe conditions at the atmospheric temperature ranges shown:

	32°F and lower	32°F to 70°F	70°F and higher
<b>Fuel -</b>			
Leaded gasoline, 80-octane, gal	2,200	2,200	2,200
<b>Greases -</b>			
General purpose 14L10 No. 2 (wheel bearing), lb	1	1	1
Water pump 1411, lb	1	1	1
<b>Oils -</b>			
Motor 9110 (SAE 10), gal	26	1	1
Motor 9250 (SAE 30), gal		25	25
Refrigerator oil 3050, qt	1	1	1

**AUXILIARY EQUIPMENT SUPPLIED:** Spare parts, supplies, operation instructions and a spare parts list are included with shipment.

**AUXILIARY EQUIPMENT NEEDED BUT NOT SUPPLIED:** Electric power.

**SHIPPING INFORMATION:**

Weight: 5340 lb  
 Cube: 405 cu ft



## REFRIGERATOR, WALK-IN

875 CU FT, STOCK NO. 2Q64-11

**APPLICATION:** Three boxes are required for each 20-ft x 48-ft refrigerator storage hut for storage of perishable foods.

**CAPACITY:** The refrigerated supplies in three 875-cu ft boxes will take care of 250 men for 90 days.

**DESCRIPTION:** Overall length: 12 ft 10 in.; overall width: 9 ft 0 in.; overall height: 7 ft 6 in. This refrigerator is large enough to permit a man to walk inside; the cabinet is a knock-down type. The complete outfit consists of an insulated box and a refrigeration unit which is comprised of a compressor, electric motor, condenser, receiver, dryer and strainer, interchange, evaporator, with fittings and accessories. A fan circulates air over the cooling coil into the storage space.

**OPERATION:** One man is required to service and operate this machine. The refrigeration unit is completely assembled at the factory and needs only to be installed in the box and connected to the source of power.

**SUPPLIES REQUIRED:** The following quantities of fuel and lubricants are estimated to be required for operating the equipment 1,000 hours under severe conditions at the atmospheric temperature ranges shown:

	32° F and lower	32° F to 70° F	70° F and higher
<b>Fuel -</b> Electric current, 220v, 3 ph, 60 cy, AC			
<b>Greases -</b> General purpose 14L9 No. 1 (chassis) lb	1.	1.	1.
<b>Oils -</b> Motor 9110 (SAE 10) Refrigerator oil 3050	1. 1.	1. 1.	1. 1.

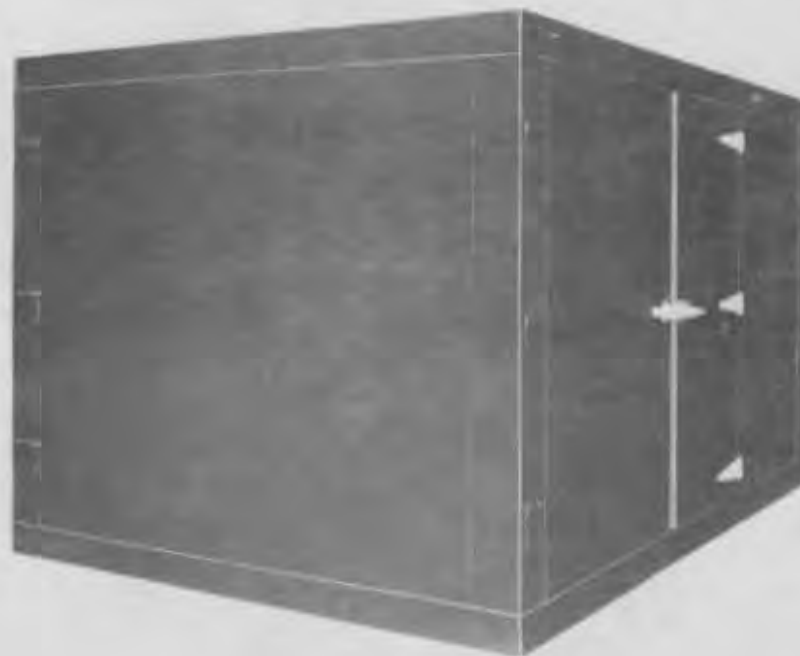

REFRIGERATOR (2Q64 875 CU FT)

**AUXILIARY EQUIPMENT SUPPLIED:** Spare parts, complete instructions for operating and servicing this machine, and a spare parts list are included with each machine.

**AUXILIARY EQUIPMENT NOT SUPPLIED:** Lubricants, electric power.

**SHIPPING INFORMATION:** Shipped in twelve crates.

Total weight: 7,420 lb

Cube: 476.1 cu ft

Weight of heaviest crate: 1,920 lb

Dimensions of largest crate: 162 in. x 14 1/2 in. x 36 1/2 in.

## REFRIGERATOR, WALK-IN

6800 CU FT, STOCK NO. 2Q64-13

**APPLICATION:** Used for central storage of perishable foods and to be installed in 40-ft by 100-ft buildings, two in each building.

**CAPACITY:** 6,800 cu ft.

**DESCRIPTION:** Overall dimensions: 12 ft 10 in. by 93 ft 4 in. by 7 ft 6 in. The refrigerator is a knocked-down type to be erected in the field and made up of six separate cold-storage rooms with insulated metal walls, ceilings, floors, and partitions. Six electric-powered refrigeration units, one for each cold-storage room, are mounted in compartments attached to the outside of the box with blower coil and fan extending into the cold-storage room. These units are identical with those used in the 675 cu ft box. An electric light with switch and padlocks for all doors are furnished.

**OPERATION:** A 3-man crew is required for the operation of this equipment which involves maintaining the refrigeration units; keeping the refrigerators, machinery and surroundings clean; and checking and adjusting for correct humidity and temperature, depending on the kind of food stored.

**SUPPLIES REQUIRED:** The following quantities of fuel and lubricants are estimated to be required for operating the equipment 1,000 hours under severe conditions at the atmospheric temperature ranges shown:

	32°F and lower	32°F to 70°F	70°F and higher
<b>Fuel -</b>			
Electric current, 220v, 3 ph, 60 cy, AC			
<b>Greases -</b>			
General purpose 14L9 No. 1 (chassis) lb	1.	1.	1.
<b>Oils -</b>			
Motor 9110 (SAE 10)	1.	1.	1.
Refrigerator oil 3050	6	6	6

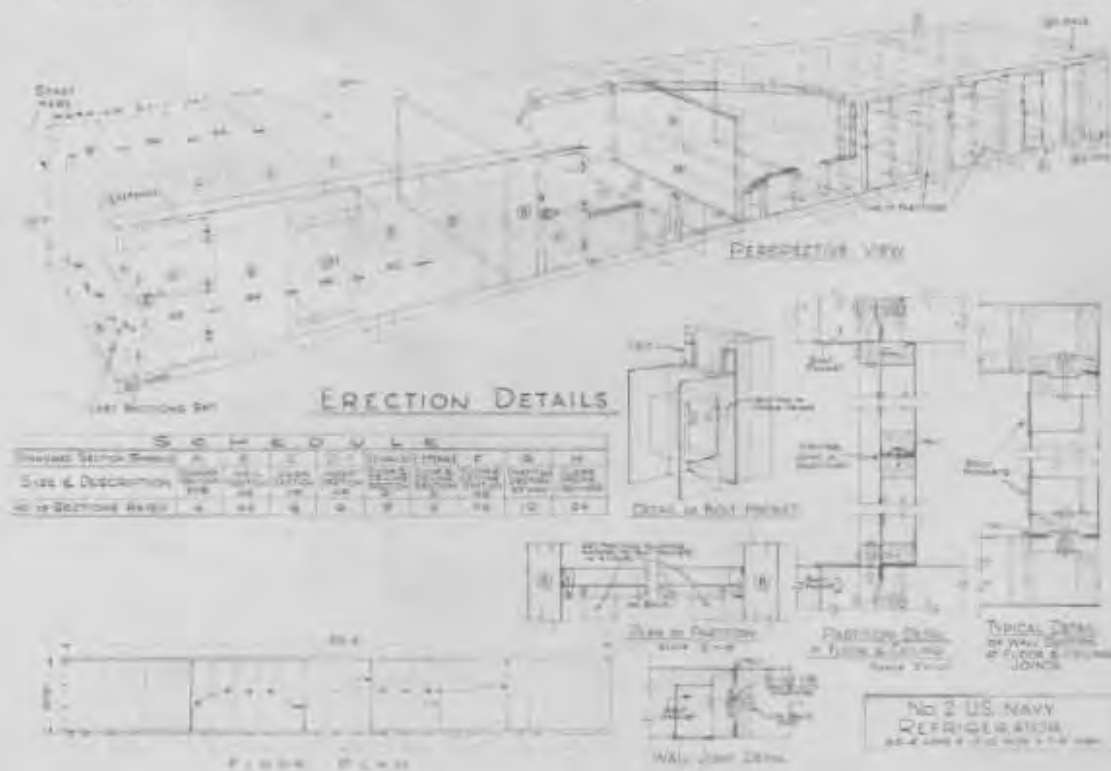

**AUXILIARY EQUIPMENT SUPPLIED:** Spare parts, spare parts list, and instructions for operation and erection are included with the shipment. Six refrigerating units are supplied.

**AUXILIARY EQUIPMENT NOT SUPPLIED:** A 40-ft by 100-ft building and electric power.

**SHIPPING INFORMATION:** Shipped in 63 or 81 crates depending on make.

Gross weight: 6,255 lb

Cube: 641 cu ft

Heaviest crate: 1,720 lb

Largest crate: 13 ft 4 in by 4 ft 4 in by 1 ft 5 in

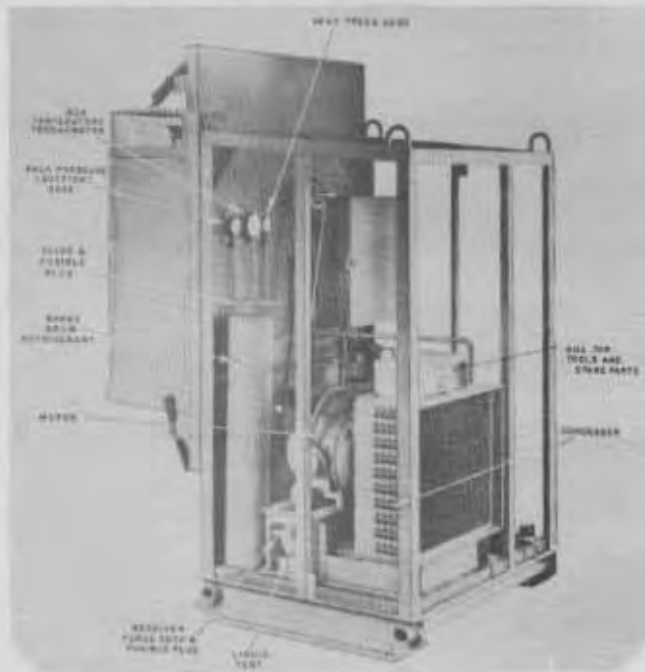



## SLICER, BREAD, ELECTRIC-DRIVEN

STOCK LIST NO. 2Q31-8

**APPLICATION:** This power-operated slicer is suitable for slicing bread in various thicknesses. Used in 1000-man galley and 1000-man bakery

**CAPACITY:** The machine can slice bread up to a maximum loaf size of 7 in. sq by 26 in. long and at the rate of 175 to 200 slices per minute.

**DESCRIPTION:** Slicer is of all metal construction with all parts coming in contact with the bread heavily tinned and highly polished. The bread is automatically carried to the knife, cut to the desired thickness and stacked. The knife and feed screw is driven by a 1/6-hp motor thru a V-belt drive. The knife and motor belt is well guarded with suitable bake enamel guards and a safety lock is provided which prevents the knife from turning when the machine is idle. The thickness of a slice is adjustable from 1/8 in. to 7/8 in. A removable pan 28 in. long is included.

**OPERATION:** One man is required to operate the machine. The slicer should be oiled at least twice a week and all parts wiped off at least once a week to insure proper working order.

**SUPPLIES REQUIRED:** 9110 (SAE 10) oil

**AUXILIARY EQUIPMENT SUPPLIED:** Each unit includes one (1) motor start switch or capacitor and one (1) V-drive belt as spare parts.

**AUXILIARY EQUIPMENT NEEDED BUT NOT SUPPLIED:** Electric current, 110-volt, single-phase, 60-cycle a-c.

**SHIPPING INFORMATION:** Shipped in one box  
Weight: 131 lb  
Cube: 16.5 cu ft

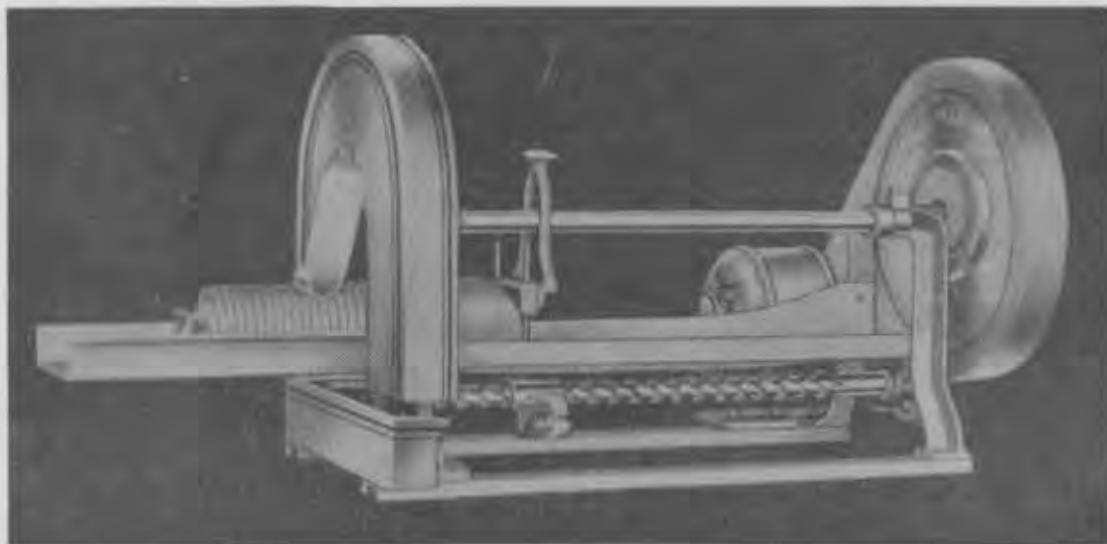

BREAD SLICER (2Q31-8)

## SLICER, MEAT, ELECTRIC-DRIVEN

STOCK LIST NO. 2Q31-4

**APPLICATION:** This power-operated rotary slicer is suitable for slicing all kinds of meat, fruit, cheese and vegetables. Used in 1000-man galley.

**CAPACITY:** Machine can handle meat of any length up to 9 in. in width and 6 1/2 in. in height.

**DESCRIPTION:** Slicer is of all-metal construction about 18 in. wide, 20 in. long and 13 in. high with a cutting blade about 9 in. in diameter of corrosion resisting metal driven by a 1/6-hp electric motor thru a V-belt drive. The cutting blade spindle runs in roller bearings and a removable guard is provided. The machine is equipped with a hand operated sliding platform which has a stroke of 11 in. moving past the spinning blade. Feed pressure is obtained thru a spring loaded adjustable pressure plate. A slice regulator and indicator and a removable receiving tray is included with the machine.

**OPERATION:** One man is required to operate the machine. Periodic cleaning, adjusting and oiling are required.

**SUPPLIES REQUIRED:** 9110 (SAE 10) oil

**AUXILIARY EQUIPMENT SUPPLIED:** Each unit includes one (1) slicer belt as spare parts.

**AUXILIARY EQUIPMENT SUPPLIED:** <sup>NEEDED BUT NOT</sup> Electric current. 110-volt, single-phase, 60-cycle a-c.

**SHIPPING INFORMATION:** Shipped in one box.  
Weight: 111 lb  
Cube: 2.87 cu ft

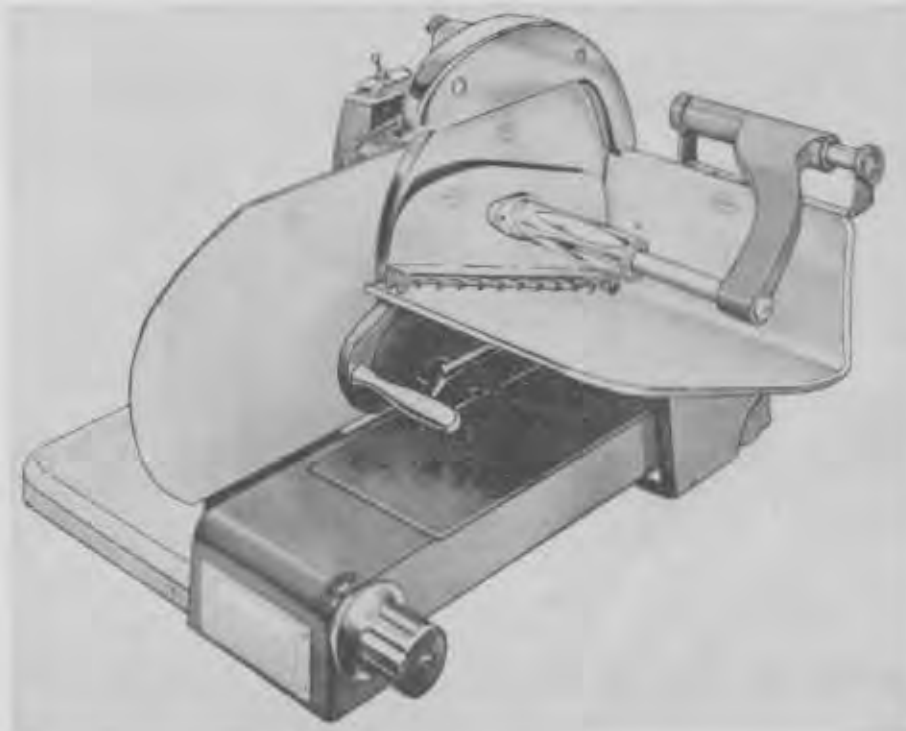

MEAT SLICER (2Q31-4)

## SLICER, BREAD AND MEAT, HAND OPERATED

STOCK LIST NO. 2Q31-5

**APPLICATION:** Used for slicing bread and meat in 250-man galleys.

**CAPACITY:** Maximum cross section of slices 6 1/2 in. high and 11 in. wide, any length.

**DESCRIPTION:** Slicer is of all metal construction, 15 in. wide, 11 1/4 in. high and 17 1/2 in. long with 9 in. diam stainless steel knife, blade guard and sharpener. Sliding platform is supported by extra heavy bearings and is equipped with food clamp. Unit has slice regulator and gage, removable tray and table clamp and weighs 32 lb.

**OPERATION:** One man to operate. Periodic cleaning, adjusting and oiling are required.

**SUPPLIES REQUIRED:** 9110 (SAE 10) oil.

**AUXILIARY EQUIPMENT SUPPLIED:** Spare parts, instructions for operation and maintenance and a spare parts list are included with each shipment.

**SHIPPING INFORMATION:** Shipped in one crate.  
Weight: 60 lb  
Cube: 3.8 cu ft.

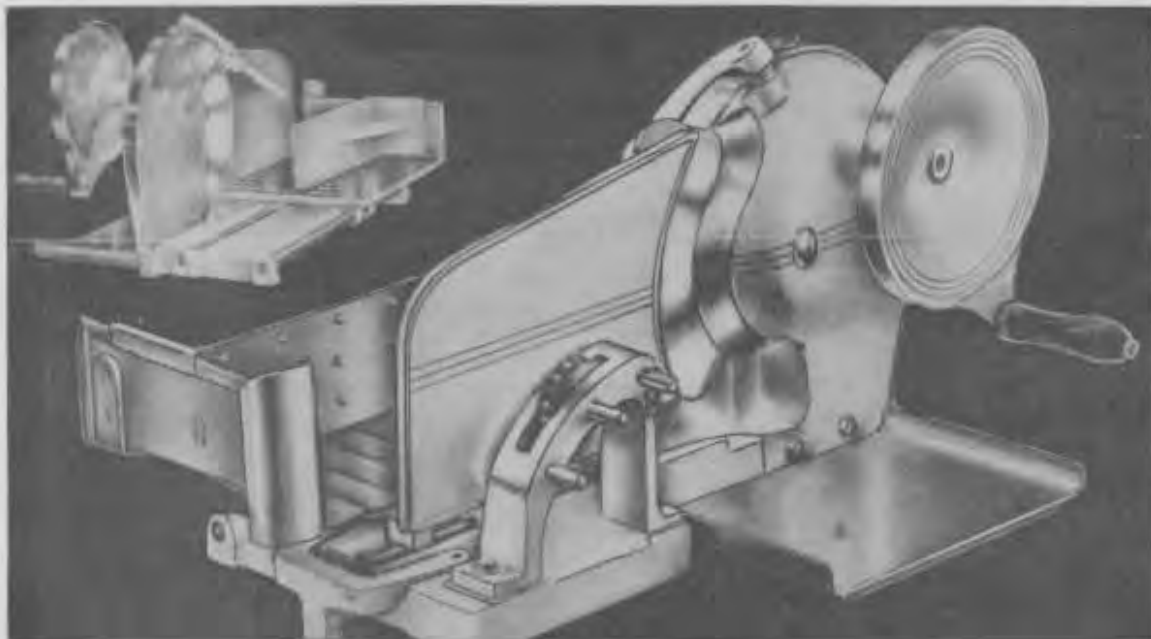

HAND OPERATED BREAD AND MEAT SLICER (2Q31-5)

## TORCH, FREON TEST ,FOR REFRIGERATORS

STOCK LIST NO. 2Q64-17

**APPLICATION:** Used for testing leaks in refrigeration equipment using freon.

**CAPACITY:** The torch will burn for about 45 to 60 min on a full charge of alcohol in tank.

**DESCRIPTION:** Torch is of all-metal construction consisting of an alcohol tank on which is mounted a burner with an adjustable needle-type shut-off valve. The leak detector is similar to a blow torch with a specially designed burner housing to which is attached a sampling tube. When the open end of the sampling tube is held near a joint to be tested, any gas that has leaked out is drawn in with the air to the burner and the color of the flame changes from pale blue to green. If there is a large amount of Freon present it will cause flame to turn a deep violet. Weight of torch is 3 lb.

**OPERATION:** One man.

**SUPPLIES REQUIRED:** Alcohol, 1 gal

**SHIPPING INFORMATION:**

Weight: 4 lb  
Cube: 0.75 cu ft



FREON TEST TORCH (2Q64-17)

## URN, COFFEE

STOCK LIST NO. 2Q34-9

**APPLICATION:** Two coffee urns and one water urn are furnished to be used in each 1,000-man galley hut to make coffee.

**CAPACITY:** Water boiler: 30 gal  
Coffee urn: 15 gal ( each )

**DESCRIPTION:** This consists of two 15-gal coffee urns connected to one pressure-type 30-gal water boiler urn. Water is siphoned from boiler to coffee urns by means of steam pressure. Water urn is equipped with two combination vacuum and pressure relief valves, non-drip draw-off faucet, gage glass, water make-up connection with valve and clean-out plate. The bodies, covers, coffee liners and all spinnings are made of 18-gage metal and are finished in acid-proof porcelain enamel inside and out. Each coffee urn has a one piece coffee liner with a hot water jacket and a steam coil and is provided with two no-drip faucets with separately protected gage glass, one for water and one for coffee. The coffee urns are each connected to the water boiler by double side connections with valves, one for water jacket and one for coffee spray head. Water boiler urn is heated by means of a heavy, seamless steam coil of sufficient capacity to boil 60°F water in one hour with steam at 20 psi pressure.

**OPERATION:** One man is required to operate and maintain.

**AUXILIARY EQUIPMENT SUPPLIED:** 3 coffee bags for each coffee urn.

**AUXILIARY EQUIPMENT NEEDED BUT NOT SUPPLIED:** Piping system and steam supply.

**SHIPPING INFORMATION:** Shipped in two crates  
Weight: 260 lb each  
Cube: 17.3 cu ft and 23.4 cu ft



COFFEE URN (2Q34-9)

## URN, COFFEE

STOCK LIST NO. 2Q34-7

**APPLICATION:** Combination coffee and water urn is for 250-man and smaller galley service.

**CAPACITY:** This urn has an 8-gal coffee and 12-gal water boiler capacity.

**DESCRIPTION:** This coffee urn is known as a "siphon" urn, as the steam pressure developed in the water compartment is employed to force boiling water through a spray and over the coffee. It consists of a pressure-tight water compartment and a coffee container inserted in a well within this water compartment. Hot water in the water jacket keeps the coffee hot without boiling it.

An immersion-type electric heater supplies the heat necessary to boil the water, and the water remaining in the urn after maximum draw-off provides adequate protection for the heating unit.

This urn is a two-faucet type, the right-hand faucet connecting to the coffee liner, and the left-hand faucet connecting to the water compartment. The coffee liner has a capacity of 8 gal and the water compartment has a usable water capacity of 8 gal.

A combination pressure relief valve and vacuum breaking valve insures safety in operation.

**OPERATION:** One man operation.

**AUXILIARY EQUIPMENT SUPPLIED:** Coffee bag ring, three coffee bags and spare parts.

**AUXILIARY EQUIPMENT NEEDED BUT NOT SUPPLIED:** Plumbing system and electric power supply, 220-volt, single-phase, a-c

**SHIPPING INFORMATION:** Shipped in one crate  
Weight: 141 lb  
Cube: 13.9 cu. ft



COFFEE URN (2Q34-7)

## HEATER, SPACE, 50,000-BTU

STOCK LIST NO. 2Q11-9

**APPLICATION:** Used for heating 20 ft x 48 ft Northern huts.

**CAPACITY:** 50,000 btu per hour.

**DESCRIPTION:** The unit consists of a sheet-metal combustion drum containing a knock-down pot-type burner housed in a steel metal-grilled cabinet and an automatic constant-level oil control valve. Burner will operate on Diesel oil or kerosene. Gasoline is recommended only as an emergency fuel. A 5-gal fuel tank is mounted in the back of the cabinet with fuel connections to the control valve and the pot burner. Clean-out rod, tank shut-off, and barometric draft control are furnished with the unit. The cabinet is supplied with 6-in. x 24-in. flue pipe, 6-in. x 90° elbows and four adjustable leg levelers.

**OPERATION:** Automatic in operation after being supplied with fuel and the burner is ignited.

**SUPPLIES REQUIRED:** The following quantities of fuel and lubricants are estimated to be required for operating the equipment 1,000 hr under severe conditions at the atmospheric temperature ranges shown:

	32° F to 70° F
Fuel -	
Kerosene, gal	500
Diesel oil, gal	500

**AUXILIARY EQUIPMENT SUPPLIED:** Four lengths of pipe and one elbow are shipped with each unit. Instructions for assembly and operation are included.

**SHIPPING INFORMATION:** Shipped two in one crate.

Weight: 110 lb  
Cube: 10.4 cu ft



## HEATER, UNIT

STOCK NO. 2Q7

**APPLICATION:** Two units each used for heating in the 20 ft x 36 ft surgery and 20 ft x 48 ft shower and latrine huts in northern climates.

**CAPACITY:** 38,700 btu per hr with 2 lb steam pressure and 60° entering air. The entering air volume is 840 cu ft of air per minute at 60° and 905 cu ft of air at a final temperature of 101°.

**DESCRIPTION:** The complete set includes two unit heaters with fans and motors and one thermostat. Each unit is driven by a 1/2 hp 1725 rpm, single-phase motor. The unit has a metal-finned tube heating element in a pressed-metal frame.

Overall width: 16 in. approx. Overall depth: 13 in. approx.  
Overall height: 16 in. approx. Net Weight: 65 lb

**OPERATION:** Lubricate motor bearings and clean dust from between steam coils periodically.

**SUPPLIES REQUIRED:** Steam and electric connections are required. S110(SAE-10) oil is necessary for motor bearings.

**AUXILIARY EQUIPMENT SUPPLIED:** Spare parts are furnished.

**AUXILIARY EQUIPMENT NOT SUPPLIED:** Steam supply and electric current.

**SHIPPING INFORMATION:** Shipped two heaters to a box.

Total weight: 170 lb  
Total cube: 8.75 cu ft  
Dimensions: 38 in x 22 in x 18 in



UNIT HEATER (2Q7)



## HEATER, WATER, TANKLESS-TYPE

STOCK LIST NOS. 2Q18-35 and - 41

**APPLICATION:** These heaters are to be used in connection with a low-pressure steam boiler to furnish hot water for galley, bakery, laundry, and shower supply. The small (5-gpm) size is to be used in the 250-man galley, 1,000-man bakery, 25- to 50-man galley, 100-man galley, 250-man laundry, and the photographic laboratory. The larger (15-gpm) size is for use in the hospital scullery hut, the 1,000- to 1,500-man galley and the 250-man shower and latrine.

**CAPACITY:** Heaters are furnished in two sizes: 5 and 15 gpm of hot water heated to 154°F with steam at 5 lb psi gage. The pressure drop on the water side is approximately 1 lb psi gage @ 5 gpm for the 5-gpm heater, and 1 lb psi gage @ 11.6 gpm for the 15-gpm heater.

**DESCRIPTION:** Heaters are the external, tankless, indirect type with a straight-tube floating-head and through-bolt design on water-box cover plates and shell flanges, which makes removal of scale accumulation very simple. Water passes through the tubes and the steam is on the shell side. The heaters are suitable for a maximum steam working pressure of 75-lb psi gage and 125-lb psi gage water pressure. Heater sizes and Stock List Nos. are as follows:

5-gpm Heater, Water, Tankless Type: Stock List No. 2Q18-41  
15-gpm Heater, Water, Tankless Type: Stock List No. 2Q18-35

**OPERATION:** Automatic in operation. Heaters must be drained if heating equipment is shut down during freezing weather.

**AUXILIARY EQUIPMENT SUPPLIED:** This equipment is ready for operation when connected to heating system. Instruction manual, tube cleaner, and gaskets are furnished.

**AUXILIARY EQUIPMENT NEEDED BUT NOT SUPPLIED:** Low-pressure steam boiler. 11.5 boiler horse power (385,000 btu's) is required to develop full capacity of the 5-gpm unit and 35 bhp (1,170,800 btu's) for the 15-gpm unit.

**SHIPPING INFORMATION:**

	5-gpm Heater	15-gpm Heater
Weight:	390 lb	450 lb
Cube:	7.2 cu ft	8 cu ft



## IRONS, ELECTRIC

HAND PRESSING, STOCK NO. 2Q55-3

**APPLICATION:** Used for pressing clothes in laundries and tailor shops.

**CAPACITY:** Comes in two sizes of 675 watts and 1000 watts heating capacity.

**DESCRIPTION:** Irons are of metal construction, chromium finished, with wood handles and weigh 5 1/2 lb each. The 675 watt iron does not have heat control but is equipped with a detachable 6 1/2 ft electric cord with plugs and a separate horizontal stand. The 1000 watt iron has built-in heat control which is adjustable thru "low" "intermediate" and "high" heats as well as "off" position, by a lever on top of iron. A 7-ft electric cord with plugs is attached to the iron as is also a heel stand. Bottoms of irons are 7 1/4 in. x 4 5/16 in.

**OPERATION:** One man.

**SUPPLIES REQUIRED:** 110 volt electric current. The 675 watt iron will operate on either alternating or direct current, but the 1000 watt iron is for alternating current only.

**AUXILIARY EQUIPMENT SUPPLIED:** Spare parts are furnished.

**AUXILIARY EQUIPMENT NOT SUPPLIED:** Ironing boards.

**SHIPPING INFORMATION:** Six irons are packed in one box.

	675 watt iron	1000 watt iron
Weight	52 lb	60 lb
Cube	123 cu ft	86 cu ft

**ORDERING INSTRUCTIONS:** State which size is desired.



HAND PRESSING ELECTRIC IRON (2Q55)

## IRONER, FLAT WORK

48-INCH, GASOLINE-FIRED  
STOCK LIST NO. 2Q55-6

**APPLICATION:** Ironer is used for ironing wearing apparel and flat work, such as sheets, slips, etc.

**CAPACITY:** Machine will handle 15-20 sheets per hour from an extractor, or 50-60 sheets from a drying tumbler. Ironing speed is approximately 9 ft per minute.

**DESCRIPTION:** The ironer is 48 inches wide, single roll heated, chest-type mounted on a cast iron frame and designed for handling flat work and plain garments. Ironer is equipped with a gasoline burner, a built-in 3-gallon gasoline tank and blower. A thermostat mounted on top of the chest, set for 350°F, controls the variable speed blower motor for the control of the temperature. The padded roll is driven by a 1/3-hp motor thru a V-belt drive at a speed of 4 1/2 rpm.

**OPERATION:** One-man operation. Ironer should be heated for 15 minutes before being placed in operation.

**SUPPLIES REQUIRED:** The following quantities of fuel are estimated to be required for operating the equipment 1,000 hours under severe conditions at the atmospheric temperature ranges shown:

	32° F to 70° F
Fuel - Unleaded gasoline, 65-octane, gal	500
<b>AUXILIARY EQUIPMENT SUPPLIED:</b> 8 ft of 3-in. stock, two elbows and an adaptor for 1 1/2-in. flue pipe connection.	



ENGINE TABLE

AUXILIARY EQUIPMENT NEEDED BUT NOT SUPPLIED: 110-volt, 60-cycle, single-phase, a-c power.

SHIPPING INFORMATION:

Weight: 1000 lb  
Cube: 63 cu ft



## LAUNDRY UNIT

PORTABLE, 75-LB CAPACITY  
STOCK LIST NO. 2Q54-6

BURNER	1/2	
WATER HEATER	1/2	
WATER PUMP	3/4	5/8
WASHER	1/2	
EXTRACTOR	3/4	USE 1 HP

**APPLICATION:** This all-purpose laundry unit is designed to wash and rough-dry clothing, sheets, garments, etc.

**CAPACITY:** Test capacity of the laundry unit is 100 lb (dry weight) per hour.

**DESCRIPTION:** This portable laundry is made up in two sections and includes washer, extractor, tumbler drier and auxiliary equipment. Section 1 includes the washer, water heater and pump, and a wet clothes storage pan. Section 2 includes the extractor, tumbler drier, and a tool box. Equipment is mounted on termite proof wooden skids which serve as the bottom of the crates and as a permanent foundation. The washer is 30 in. in diameter and 36 in. long and has a galvanized cylinder. It is electric-motor driven through a chain drive and is equipped with 2-in. lever-operated outlet valve, 1-in. hot and cold water supply valves, float gage, thermometer and 0- to 60-minute timer. The tumbler drier is of the air heated, reversing, cylinder-type with end access door and 0- to 60-minute timer. Burner is of the oil-fired induced-air type powered by a 1/2-hp electric motor. Air is heated by a heat exchanger and is thermostatically controlled. Vents are provided for spent gases and moist air. Safety switch is provided in stack for protection in the event that oil fails to ignite. Extractor is of the centrifugal type with galvanized basket and is electric-motor driven through a V-belt drive. Water heater is a three-pass type, with motor-driven draft-type oil burner controlled by aquastat. Motor is 1/2 hp. Flue is provided of adequate length to extend 18 in. above roof. Water pump has a capacity of 20 gpm against a head of 20 psi and is driven by a 1-hp electric motor. Interconnecting pipe and valves are furnished.

**OPERATION:** It requires about four men to operate laundry unit: one man on washer and heater, two men to operate the extractor and tumbler and one helper for soil work.

**SUPPLIES REQUIRED:** The following quantities of fuel and lubricants are estimated to be required for operating the equipment 1,000 hours under severe conditions at the atmospheric temperature ranges shown:

	32°F and lower	32°F to 70°F	70°F and higher
Fuel -			
Diesel oil. 50 centane	5000	5000	5000
Greases -			
Ball and roller-bearing 14L3b grade No. 11. lb	80	60	60

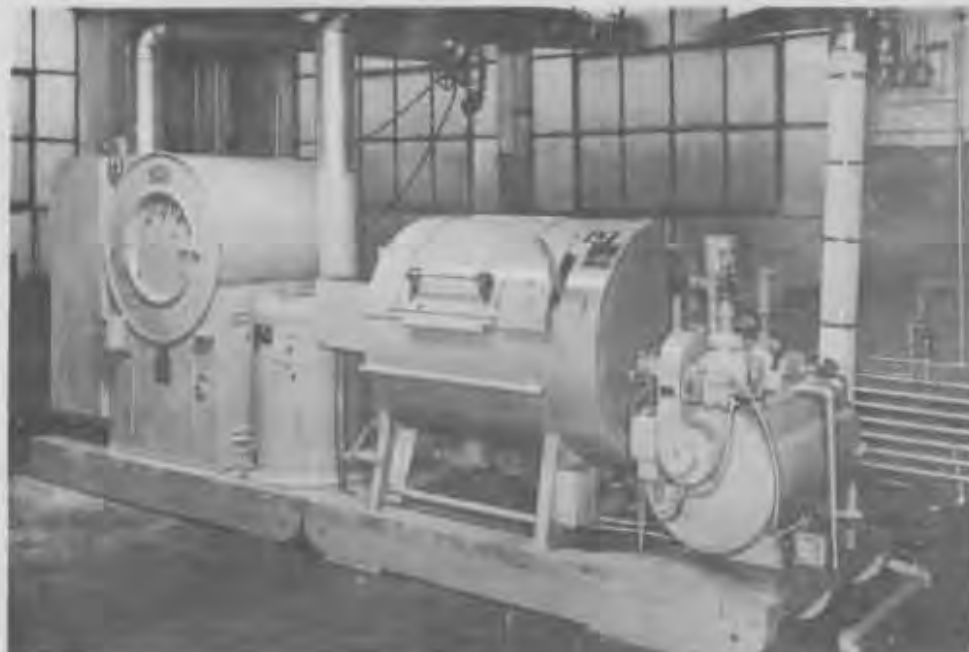

32°F and  
lower

32°F to  
70°F

70°F and  
higher

Oils -

Motor 9110 (SAE 10), gal  
Motor 9250 (SAE 30), gal

12

12

12

AUXILIARY EQUIPMENT SUPPLIED: Operating manuals, spare parts, and tools.

AUXILIARY EQUIPMENT NEEDED BUT NOT SUPPLIED: 220-volt, 60-cycle, single-phase current. Building.

SHIPPING INFORMATION: Shipped in two crates

	1st Section	2nd Section
Weight:	6,607 lb	6,607 lb
Cube:	172 cu ft	207 cu ft

## DELOUSING CHAMBER

STOCK LIST NO. 2Q50-2

**APPLICATION:** The delousing chamber is used to fumigate barracks, bags, clothing, blankets or other material in the field.

**CAPACITY:** The dimensions of chamber are: 6 ft wide and 8 ft 11 in. long and 6 ft 1 in. high. 100 barracks bags can be deloused at one time.

**DESCRIPTION:** The delousing chamber consists of plywood and metal-covered plywood sections constructed to form a portable, gas-tight chamber for fumigation purposes. The fumigation is accomplished by the circulation of methyl bromide gas inside the chamber. The chamber is equipped with a methyl bromide injector with a water heater, a recirculating and exhaust fan with ducts and stack, portable racks in two sizes, two 4 ft and four 6 ft long, and a halide leak detector.

**OPERATION:** Delousing chamber can be operated by one man. Caution should be exercised in the operation of delouser as methyl bromide is toxic.

**AUXILIARY EQUIPMENT SUPPLIED:** One box of tools and operating manual.

**AUXILIARY EQUIPMENT NEEDED BUT NOT SUPPLIED:** 110-volt, 60-cycle, single-phase current.

**SHIPPING INFORMATION:**

Weight: 4,500 lb  
Cube: 1,160 cu ft



DELOUSING CHAMBER (2Q20-2)

## WASHER, CLOTHES

25-LB CAPACITY  
STOCK LIST NO. 2Q56-14

**APPLICATION:** This washer is designed to wash and wring sheets, garments and wearing apparel.

**CAPACITY:** Washer has a capacity of 25 lb (dry weight) per hr.

**DESCRIPTION:** Washer is a 24-in. x 24-in. end loading, one door, open end type made of galvanized steel. Unit is motor driven through a cross belt which affords reversing action. Washer is equipped with a wringer with rolls 2-1/4 in. in diameter and 12 in. in length. The wringer is driven by the main drive motor through gearing or a V-belt and is arranged to operate simultaneously or independently of the washer cylinder.

**OPERATION:** Requires two men for operation at capacity.

**SUPPLIES REQUIRED:** The following quantities of fuel and lubricants are estimated to be required for operating the equipment 1,000 hours under severe conditions at the atmospheric temperature ranges shown:

	32°F and lower	32°F to 70°F	70°F and higher
Greases -			
Ball and roller-bearing 14L3b grade			
No. 11, lb	20	20	20





	32°F and lower	32°F to 70°F	70°F and higher
Oils -			
Motor 9110 (SAE 10), gal	3	3	
Motor 9250 (SAE 30), gal			3

AUXILIARY EQUIPMENT SUPPLIED: Operating manual and spare parts.

AUXILIARY EQUIPMENT NEEDED BUT NOT SUPPLIED: 110-volt, 60-cycle, three-phase, a-c power, and plumbing system.

SHIPPING INFORMATION:

Weight: 920 lb approx.  
 Cube: 32 cu ft

## AIR DRYING TUMBLER

PART OF STOCK LIST NO. 2Q54-7

**APPLICATION:** The drying tumbler is used for drying sheets, garments and wearing apparel in conjunction with a 25-lb washer with wringer.

**CAPACITY:** The tumbler will remove 1.14 lb water per minute. It has an hourly load capacity of 40 pounds (dry weight) when used with wringer.

**DESCRIPTION:** The air drying tumbler is a 36 in. x 30 in. mechanical reversing header-type driven by 3/4-hp motor. The air heater is insulated with magnesia block and is oil fired. The oil burner is of the induced-draft-type with thermostatically controlled electric ignition and is driven by a 1/6-hp electric motor. A thermostatically operated safety switch is mounted in the stack. Heater and tumbler exhausts are furnished with necessary stack lengths and weather caps for carrying moist air and exhaust gases to point above the roof of arch-rib huts.

**OPERATION:** One man operation.

**SUPPLIES REQUIRED:** The following quantities of fuel and lubricants are estimated to be required for operating the equipment 1,000 hours under severe conditions at the atmospheric temperature ranges shown.

	32°F and lower	32°F to 70°F	70°F and higher
<b>Fuel -</b>			
Diesel oil, 50 centane	1000	1000	1000
<b>Greases -</b>			
Ball and roller-bearing 14L3b grade No. 11, lb	25	25	25
<b>Oils -</b>			
Motor 9110 (SAE 10), gal	6	6	
Motor 9250 (SAE 30), gal			6



AUXILIARY EQUIPMENT SUPPLIED: Operating manual and spare parts.

AUXILIARY EQUIPMENT NEEDED BUT NOT SUPPLIED: 220-volt, three-phase, 60-cycle a-c power.

SHIPPING INFORMATION:

Weight: 1975 lb  
Cube: 112.5 cu ft

## SINK, GALLEY

62 IN. X 27 IN, GALVANIZED STEEL, STOCK NO. 2Q15

**APPLICATION:** One used in the 20-ft x 48-ft bakery and one in the 20-ft x 36-ft morgue.

**DESCRIPTION:** A galvanized-steel single-compartment sink with integral drain-board and back and angle-iron legs, approx. 62 in. x 27 in. x 12 in. deep, complete with faucets, drain plug with stopper and chain, tail piece and "P" trap.

**OPERATION:** Cleaning and faucet washer replacements.

**SUPPLIES REQUIRED:** Faucet washers.

**AUXILIARY EQUIPMENT NOT SUPPLIED:** Plumbing system.

**SHIPPING INFORMATION:** Shipped one in a crate.

Total weight: 275 lb  
Cube: 28.4 cu ft  
Dimensions: 65 1/2 in. x 25 in. x 30 in.



**DRAIN PLUG  
WITH STOPPER**



**"P" TRAP**

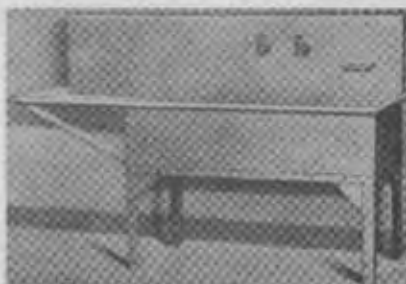

**GALVANIZED STEEL GALLEY SINK(2Q15)**

## SINK, DOUBLE-COMPARTMENT

108 IN. GALVANIZED, 2 DRAINBOARDS, STOCK NO. 2Q15

**APPLICATION:** Two used in each 100-man and 250-man galley huts, and one in each 25-50-man galley and scullery hut.

**DESCRIPTION:** This sink is 9 ft 0 in. long, galvanized, double-compartment with double integral drainboards on four angle-iron legs, with four 3/4 in. compression faucets with either integral or adjustable flanges, two plain and two with hose ends, two sink plugs with stopper and chain, and two 2 in. x 1 1/2 in. "P" traps with cleanout and slip nut inlet.

**OPERATION:** Periodic cleansing of traps and replacement of faucet washers is necessary.

**SUPPLIES REQUIRED:** Faucet washers.

**AUXILIARY EQUIPMENT NOT SUPPLIED:** Plumbing system.

**SHIPPING INFORMATION:** Shipped in one (1) crate.

Gross weight: 447 lb

Cube: 58.7 cu ft

Dimensions 111 in. x 30 in. x 30 in.



DOUBLE COMPARTMENT GALVANIZED SINK (2Q15)

## LAVATORY, SINGLE COMPARTMENT

STOCK LIST NO. 2Q15-33

**APPLICATION:** This type of sink is to be used in 20-ft x 56-ft dental pharmacy, ward with quiet room, and ward, receiving.

**DESCRIPTION:** This lavatory is a single-compartment type, of galvanized welded steel having overall dimensions of 20 in. x 16 in. x 6 in. deep. Unit is supported by angle iron supports, constructed in sections. Lavatory is complete with two compression faucets, 1 1/2-in. waste opening with stopper and chain, 1 1/2-in. x 4-in. tail-piece, and 1 1/2-in. x 1 1/2-in. black iron "P" trap with slip-joint inlet.

**OPERATION:** Requires cleaning and faucet-washer replacements.

**AUXILIARY EQUIPMENT NEEDED BUT NOT SUPPLIED:** Plumbing system.

**SHIPPING INFORMATION:**

Weight: 47.4 lb  
Cube: 1.7 cu ft



## SINK, WASH

96 IN BY 36 IN, STOCK NO. 2Q15 - " / "

**APPLICATION:** Two used in each 125 man shower and latrine hut.

**DESCRIPTION:** Galvanized steel 96 in. by 36 in. wash sinks, complete with wood frame supports for sinks, shelves and mirrors. Eight combination faucets, strainer with removable grid, tail piece and "P" trap.

**OPERATION:** Cleaning and faucet washers.

**SUPPLIES REQUIRED:** Water

**AUXILIARY EQUIPMENT NOT SUPPLIED:** Plumbing system.

**SHIPPING INFORMATION:** Shipped two in one crate.

Total weight: 610 lb

Cube: 33.4 cu ft

Dimensions: 103 in. x 40 in. x 14 in.

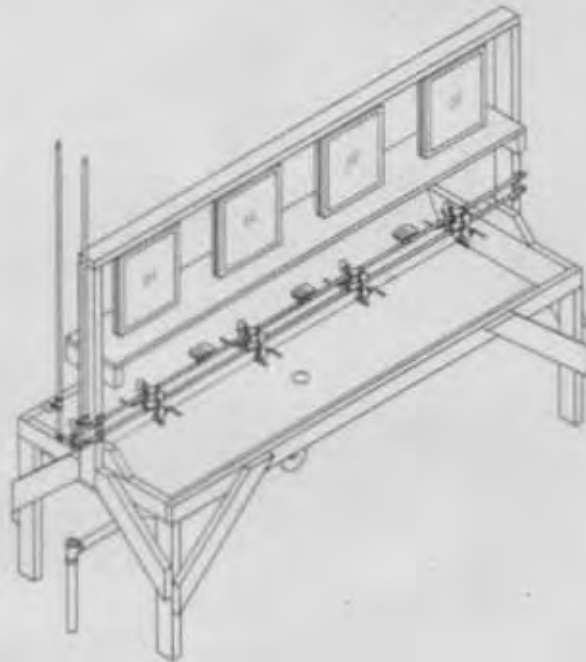

WASH SINK (2Q15)

## SHOWER

STOCK NO. 2Q17-1

**APPLICATION:** Two used in 20-ft x 48-ft officers' quarters huts and one each in the following huts: ward without quiet room; ward with quiet room; receiving ward.

**DESCRIPTION:** This is a shower bath compartment 30 in. x 30 in. x 75 in., with a precast concrete receptor and drain cast integrally. Walls are of hard-pressed oil-treated fiber board, furnished with one coat of prime and one finished coat of gray baked-on-enamel. The cabinet is equipped with a white duck curtain, and with necessary plumbing fittings for connection with hot and cold water supply and sewer lines, ready for use.

**OPERATION:** No maintenance is required except cleaning of stall and drain.

**AUXILIARY EQUIPMENT SUPPLIED:** Instructions for assembly are included in each crate.

**AUXILIARY EQUIPMENT NOT SUPPLIED:** Plumbing system.

**SHIPPING INFORMATION:**

Stall shipped in one crate.

Gross weight: 200 lb

Cube: 16.6 cu ft

Dimensions: 77 in. x 37 in. x 10 in.

Stall and receptor shipped in one crate.

Gross weight: 375 lb

Cube: 16 cu ft

Dimensions: 72 in. x 35 in. x 11 in.

Receptor shipped in one crate.

210 lb

7.85 cu ft

38 1/2 in. x 36 in. x 10 in.





## TOILET, CHEMICAL

1-BOWL, 2-BOWL, and 3-BOWL, STOCK NO. 2Q12

**APPLICATION:** Used in the following huts where no running water is available: four sets of the 3-bowl system in each shower and latrine; one 2-bowl system in each officers' quarters; one 1-bowl system in each surgical without quiet room, surgical with quiet room, and X-ray.

**CAPACITY:** One for approximately ten men.

**DESCRIPTION:** Each single-bowl system consists of an asphalt-coated septic tank, a drop tube, a metal bowl with wood seat, a vent pipe, a bowl connector, two adjustable elbows, a wall stay, a ceiling collar, a putty and roof cement, a toilet paper cabinet and paper. Multiple systems include multiple-bowl system except that the capacity of the tank is increased 200 gallons for each additional bowl.

System	Tank Size	Stock No.
1-bowl	38 in. diam 48 in. long	2Q12-1
2-bowl	38 in. diam 96 in. long	2Q12-2
3-bowl	38 in. diam 144 in. long	2Q12-3

**OPERATION:** None required except cleaning.

**SUPPLIES REQUIRED:** 25 lb of chemical per bowl is to be added to the tank to liquify and purify the sewage. The tank is discharged by pumping out with sewage-disposal tank-truck-pump.

**AUXILIARY EQUIPMENT SUPPLIED:** Instructions for installation are included with each system shipped.

**AUXILIARY EQUIPMENT NOT SUPPLIED:** Sewage tank-truck with pump.

SHIPPING INFORMATION:	1-bowl system	2-bowl system	3-bowl system
Shipping wt in lb:	262	420	570
Cube in cu ft:	21.4	42	42

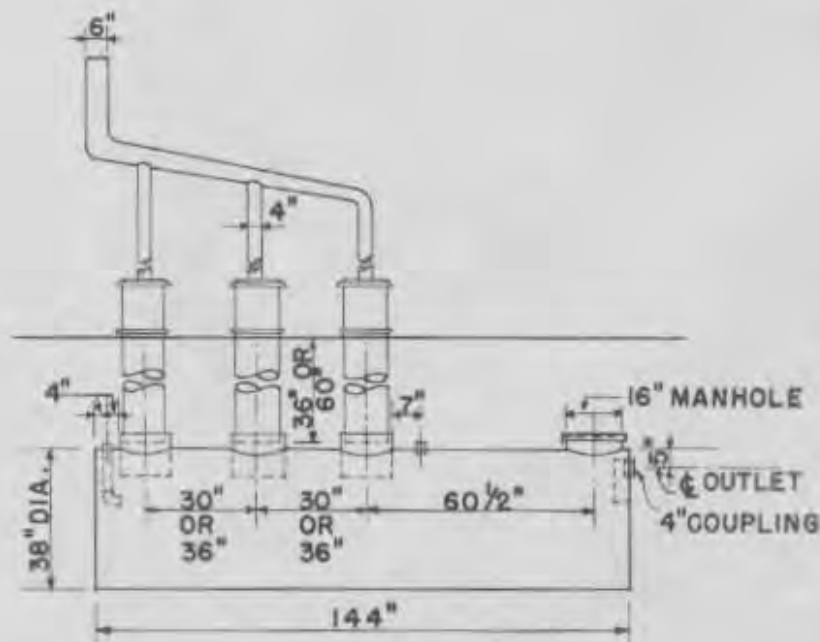

## TRAY, LAUNDRY

STOCK NO.2Q15-21

**APPLICATION:** Four used in the 20-ft x 48-ft Laundry Hut for soaking, washing and rinsing clothes.

**DESCRIPTION:** This tray is made of No. 20 gage galvanized steel and is 47 1/2 in. x 21 1/2 in. x 13 in. It is divided into two parts by a center partition of No. 18 gage steel. It is of welded construction and is provided with angle brackets on the bottom for connecting it to a wooden frame support. Faucets, drains and wooden frame supports are also furnished.

**OPERATION:** Cleaning and faucet washer replacements.

**SUPPLIES REQUIRED:** Faucet washers.

**AUXILIARY EQUIPMENT NOT SUPPLIED:** Plumbing system.

**SHIPPING INFORMATION:** Shipped in one crate

Total weight: 125 lb  
Total cube: 14 cu ft  
Dimensions: 48 in. x 24 in. x 21 in.



LAUNDRY TRAY (2Q15)

## URINAL

5FT WALL-HANGING, STOCK NO. 2Q13-1

**APPLICATION:** Used in shower and latrine huts, two urinals per hut.

**CAPACITY:** Provides facilities for 125 men.

**DESCRIPTION:**

Overall length: 5 ft 0 in

Overall depth: 12 in.

Overall height: 10 in.

This is a sheet-metal wall-hanging urinal with center drain, flush assemble, and rough brass beehive strainer and trap.

**OPERATION:** Fitted for connecting to water and sewer lines. Daily cleaning is necessary.

**AUXILIARY EQUIPMENT SUPPLIED:** Instructions for installation are attached with shipment.

**AUXILIARY EQUIPMENT NOT SUPPLIED:** Plumbing system.

**SHIPPING INFORMATION:** Shipped two in one (1) crate.

Gross weight: 166 lb

Cube: 13.8 cu ft

Dimensions: 65 in. x 23 in. x 16 in.



URINAL (2Q13)

## PUMP, SEWAGE, EJECTOR, 50-GPM

STOCK LIST NO. 2H93-81

**APPLICATION:** This type of ejector pump is used for removal of sewage from 250-man shower and latrine huts and officers' quarters.

**CAPACITY:** The sewage ejector-type pump has a capacity of 50 gpm against a total dynamic head of 15 ft. Pump is designed to pass a 2-in. sphere without clogging.

**DESCRIPTION:** This pump is a vertical centrifugal unit with a non-clogging-type impeller. The outlet tapping is 4 in. Pump is suspended from a 20-in. steel plate and is direct-connected to a 1/2-hp totally enclosed tropical-insulated motor. Controls include a magnetic starter with overload and under-voltage protection, float, float-switch and push-button station, wired for ON-OFF-AUTOMATIC operation. The distance from the bottom of the support bars to the bottom of the suction bell is 6 ft.

**OPERATION:** Pump is automatic in operation.

**SUPPLIES REQUIRED:** The following quantities of fuel and lubricants are estimated to be required for operating the equipment 1,000 hours under severe conditions at the atmospheric temperature ranges shown:

	32°F and lower	32°F to 70°F	70°F and higher
<b>Greases:</b>			
Ball-and roller-bearing 14L3 grade No. II, lb	1	1	1
Water pump 14L11, lb	1	1	1
<b>Oils</b>			
Motor 9110 (SAE 10), gal	5	5	5
Motor 9250 (SAE 30), gal			



**AUXILIARY EQUIPMENT SUPPLIED:** Spare parts and operation manual.

**AUXILIARY EQUIPMENT NEEDED BUT NOT SUPPLIED:** 220-volt, 3-phase, 60-cycle, a-c power.

**SHIPPING INFORMATION:**

Weight: 672 lb  
Cube: 47 cu ft

Qty	Part No.	Description
1	1	...
1	2	...
1	3	...



## EXTINGUISHER, FIRE, CARBON TETROCHLORIDE

HAND TYPE, STOCK NO.2K22

**APPLICATION:** Furnished to all Advanced Bases for extinguishing all classes of small fires of various materials including gasoline, oil, alcohol, paints, greases, fires in and around electrical apparatus, gasoline or diesel oil engines, boats, trucks, etc.

**CAPACITY:** Furnished in 1-qt and 1 1/2-qt sizes.

**DESCRIPTION:** Body of brass, with built-in double action pump, capable of discharging vaporizing liquid (carbon tetrochlorides) approximately 25 ft from any position. Weight about 10 lb with wall bracket.

**OPERATION:** One man - Pumping action - Requires recharging only after use and will not freeze at minus 48°F.

**SUPPLIES REQUIRED:** Vaporizing liquid for refill furnished in 1 qt and 1 gal containers.

**SHIPPING INFORMATION:** Twelve 1-qt refills shipped in one box, weighing 300 lb - cube 7 1/2 cu ft. Ten 1 1/2 qt extinguishers shipped in one box weighing 112 lb, cube 3.12 cu ft. Ten 1-gal refills shipped in one box weighing 160 lb, cube 2.32 cu ft.



FIRE EXTINGUISHER (2K22)

## EXTINGUISHERS, FIRE, CO<sub>2</sub>

STOCK NO. 2K22

**APPLICATION:** Used for combating fires in flammable liquids, electrical apparatus, boat or truck engines and fuel tanks.

**CAPACITY:** Extinguishers of 2, 4, 7 1/2, 10, 15 and 20 lb net compressed gas capacity may be procured. Each pound of compressed gas expands, upon release, to approximately 9 cu ft of effective carbon dioxide.

**DESCRIPTION:** Metal cylinders contain the compressed carbon dioxide gas which is released by means of a hand-wheel valve of either the seat or frangible disk type through a hose terminating in a non-metallic flaring horn shaped nozzle. An extinguisher having the disk type valve must be completely discharged once it is put into use, since this valve, if shut off, will not be gas-tight. Extinguishers with the seat-type valve may be turned on and off intermittently. After use, extinguishers of either type must be recharged with a carbon dioxide recharger.

Extinguisher size	2 lb	4 lb	7 1/2 lb	10 lb	15 lb	20 lb
Height, inches	15 1/4	20	30	22 1/2	30	31
Diameter, inches	3 1/2	4 1/2	4 1/2	6 3/16	6 3/16	7
Weight, lbs	11	21	33	34	42	55

**OPERATION:** One man can operate any of the extinguishers shown.

**SUPPLIES REQUIRED:** Carbon dioxide cylinders for recharging, and frangible discs for replacement.

**AUXILIARY EQUIPMENT NOT SUPPLIED:** Carbon dioxide recharger.



CO<sub>2</sub> GAS-FILLED FIRE EXTINGUISHER (2K22)

## EXTINGUISHER, FIRE, FOAM

HAND TYPE, 2 1/2 GAL - STOCK NO. 2K22-16

**APPLICATION:** Furnished to all Advanced Bases for extinguishing flammable liquids, greases, paints, varnishes, and similar fires. **DO NOT USE** on fires involving electrical apparatus as the stream discharged from the extinguisher is a conductor of electricity.

**CAPACITY:** Rated at 2 1/2 gallons of liquid which produces about 20 or 22 gallons of foam in operation.

**DESCRIPTION:** Body of steel, with hose and nozzle, inner cylinder separating the two types of liquids which when merged form the foam. Approx. 7 in. diam x 27 in. high weighing about 22 lb. Throws a stream of foam about 35 ft.

**OPERATION:** One Man - Chemical action is started by inverting the extinguisher which mixes the two liquids. Extinguisher should be protected from freezing and should be recharged yearly if not used.

**SUPPLIES REQUIRED:** Dry chemical powders "A" and "B" which should be mixed in water and placed in the separate extinguisher compartments.

**SHIPPING INFORMATION:** Shipped 4 extinguishers per box 127 lb total weight, Cube 4.37 cu ft.



HAND-TYPE FOAM FIRE EXTINGUISHER (2K22)



## EXTINGUISHER, FIRE, FOAM

MOBILE, 40 GAL, STOCK NO. 2K22-16

**APPLICATION:** Used for combatting oil or other liquid fires and all miscellaneous fires except of electrical apparatus which are too large for hand extinguishers.

**CAPACITY:** 40 gal of foam-generating liquids, from which 300 gal of foam is produced.

**DESCRIPTION:** The extinguisher consists of a welded steel cylindrical outer tank enclosing an inner copper cylinder of smaller diameter. The copper cylinder contains one of the foam-producing liquids and the other occupies the space between the inner and outer tanks. The tank unit is mounted on two steel-tired wheels and there is also provided a reel and 50 ft of drag rope, a crossbar pull handle, 50 ft of 1 1/4 in. chemical hose with nozzle, control valve and hose rack or basket. The wheels are furnished in either 2 1/2 in. or 8 in. tire widths. Extinguishers on the small tired wheels weigh 540 lb empty and 890 lb charged, and measure 50 in. x 46 in. x 85 in. The 8 in. tired size weighs 66 lb empty, 1016 lb charged, and measures 50 in. x 47 1/2 in. x 85 in. A refill unit in which two packages, one containing the first chemical and the other the second, are enclosed together in a sealed outer package, weighs approximately 65 lb and measures 12 in. x 13 in. x 18 in.

**OPERATION:** Several men are required to move the extinguisher but only one is needed to operate the control valve and play the foam stream on the fire. Recharging is necessary after the extinguisher has been used.

**SUPPLIES REQUIRED:** The two kinds of foam-producing chemicals furnished as refills, and 14L10 No- 2 grease for the wheel and reel bearings.

**AUXILIARY EQUIPMENT SUPPLIED:** Refill units ( in the quantity ordered).

**SHIPPING INFORMATION:**

One extinguisher	Shipping weight: 1,069 lb	Cube: 251 cu ft
6 refill units (boxed together)	405 lb	7 cu ft

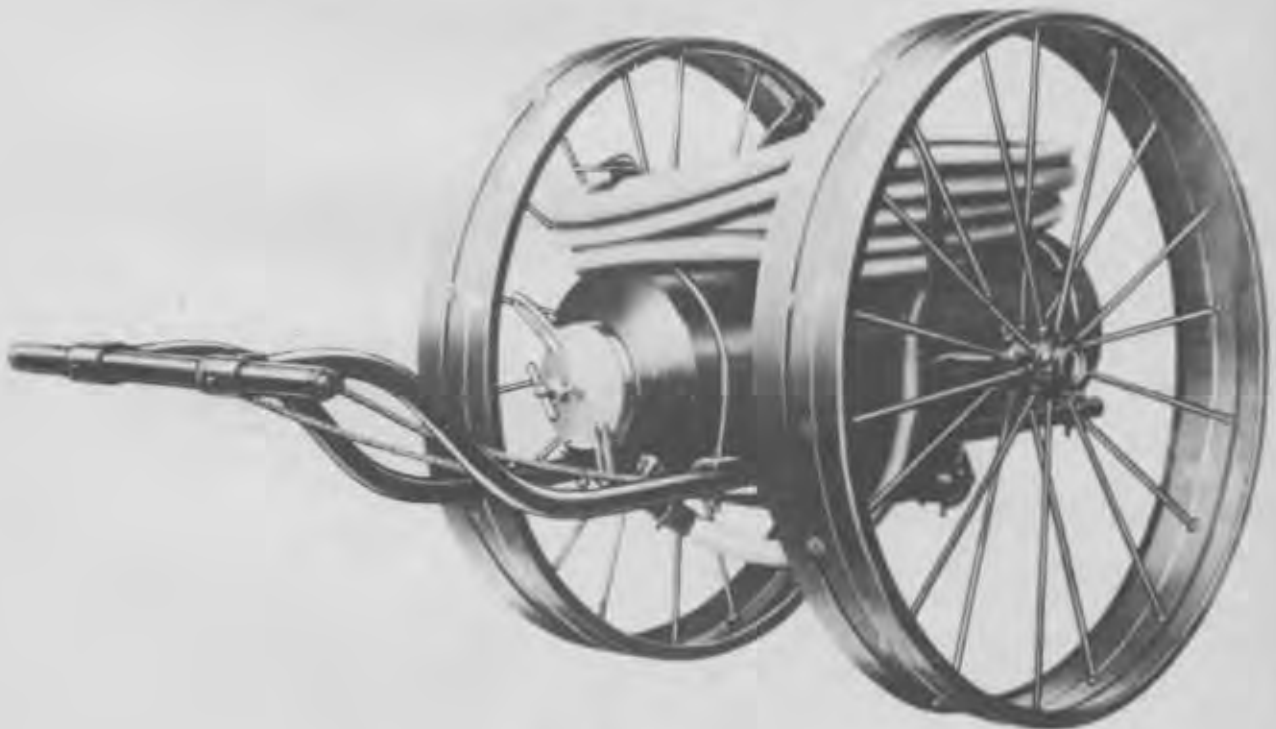

PORTABLE, FOAM FIRE EXTINGUISHER (2K22)

## EXTINGUISHER, FIRE, HAND PUMP TYPE

5 GAL TANK STOCK NO. 2K22 - 7

**APPLICATION:** Used to combat ordinary fires in materials not involving oils, greases, etc.

**CAPACITY:** Five gallons of liquid, either plain water or where subject to freezing temperatures an anti-freezing solution.

**DESCRIPTION:** The hand pump tank is of metal construction with corrosion resistant coating about 9 1/2 in. x 16 1/2 in. with built-in single suction, double discharge hand pump equipped with strainer, air chamber and 26 in. long hose with nozzle. Unit is 9 1/2 in. diam x 24 in high and weighs 13 lb empty. Will throw a stream about 40 ft.

**OPERATION:** One man.

**SUPPLIES REQUIRED:** Water or anti-freeze solution.

**SHIPPING INFORMATION:** Shipped 4 per box.

Total weight: 70 lb  
Total cube: 8.27 cu ft  
Dimensions: 27 1/2 in. x 21 in. x 21 in.



HAND PUMP FIRE EXTINGUISHER (2K22)

WATER HANDPUMP TYPE, 5 GAL KNAPSACK  
"EXTINGUISHER, [REDACTED] TYPE."  
STOCK NO. 2K22-36."

**APPLICATION:** Particularly adapted to combating brush and other spreading fires where considerable area must be covered with a light application of water.

**CAPACITY:** 5 gallons of water.

**DESCRIPTION:** The pump is contained in a tubular handle at the discharge end of the hose and the tank is provided with a special harness to facilitate operation while it is carried on the back of the operator.

**OPERATION:** One man is required to operate. Pump leathers should be checked periodically and renewed if necessary.

**SHIPPING INFORMATION:**

Weight: 13 lb  
Cube: 1.2 cu ft  
Dimensions: 18 1/2 in. x 15 in. x 7 1/2 in.



KNAPSACK-TYPE FIRE EXTINGUISHER (2K22)

## PLAY PIPE, FOAM

WITH PICK UP TUBE AND HIP PACK, STOCK NO. 2H92-16

**APPLICATION:** Used to combat fires in flammable liquids, grease, paint, etc., which are beyond the scope of hand fire extinguishers.

**CAPACITY:** The hip pack holds two gallons of foam-producing solution. One gallon of the solution will produce 350 gallons of foam in one minute.

**DESCRIPTION:** This extinguisher consists essentially of a chromium-plated brass play pipe which has a threaded connection for receiving adapters for connecting to 1 1/2 in. and 2 1/2 in. water hose; a pickup tube; and a hip pack for containing foam-producing solution. The pickup tube is connected with the play pipe at one end and terminates in the hip pack at the other. The play pipe is 26 1/4 in. long and 4 in. in diam, and it weighs 8 3/4 lb. The hip pack is a chromium-plated copper cylinder 15 3/4 in. high and 7 in. in diam. It has an adjustable leather shoulder strap and weighs 7 1/2 lb empty and 24 1/2 lb when filled with 2 gal of foam-producing solution.

**OPERATION:** One man can operate this extinguisher but two men will operate it more efficiently. One man will keep the hip pack filled with solution while the other plays the stream upon the fire. Through the 1 1/2 in. hose or 2 1/2 in. hose connected to the play pipe a stream of water is played upon the fire. This water and air draws the foam-producing solution up through the pickup tube and converts it into foam as it leaves the play pipe nozzle. Removing the pickup tube from the hip sack results in a plain water stream being played upon the fire.

**AUXILIARY EQUIPMENT SUPPLIED:** Two sizes of hose adapters, 1 1/2 in. and 2 1/2 in.

**AUXILIARY EQUIPMENT NOT SUPPLIED:** Water connection through a fire hose.

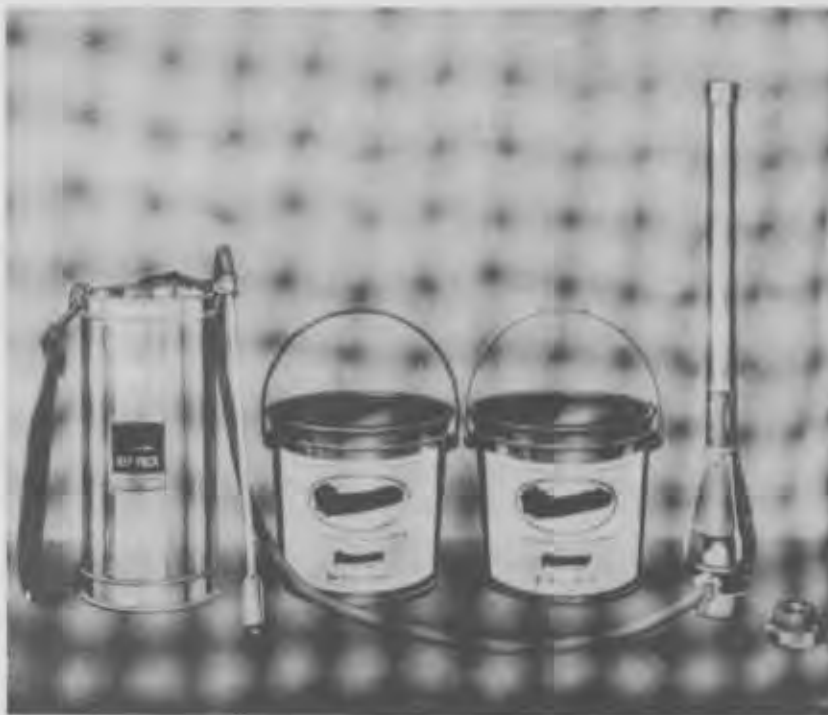

HIP PACK-FOAM FIRE EXTINGUISHER (2H92)

## PUMP, FIRE TRAILER

500 GPM, STOCK NO. 2H93-25

**APPLICATION:** Used at advanced bases to combat all general fires except those burning inflammable liquids, paints and greases, and fires in electrical apparatus. This unit can handle water from hydrants, tanks, streams, ponds or other bodies of water.

**CAPACITY:** 500 gpm at 120 lb per sq in., with a 10 ft suction lift.

**DESCRIPTION:** This unit comprises a centrifugal pump directly connected to a water-cooled gasoline engine with which it is mounted on a steel trailer which rolls on two pneumatic-tired wheels. The engine set-up includes an electric starter, a governor, a 17 gal gasoline tank and radiator. The pump is provided with an exhaust-ejector primer, quick opening discharge valves and caps, and a safety relief valve. Two 15 ft sections of 4 in. suction hose with couplings are looped around the trailer and 500 ft of 2 1/2 in. discharge hose coupled in 50 ft lengths is furnished on reels. Wrenches, spanners, adapters, sundry other tools, nozzles, and a 1 qt vaporizing liquid fire extinguisher are also provided. The trailer is fitted with a ball-and socket hitch, adjustable jacks and extension rod handles for manual handling. The unit, exclusive of discharge hose and fittings, weighs 2,700 lb. Its length is 110 in., width 75 in. and height 65 in.

**OPERATION:** One man is required to operate the pump and several others are needed for making hose connections and playing streams on fires. Periodic inspection and adjustments are also required.



TRAILER FIRE PUMP (2H93)

SUPPLIES REQUIRED: The following quantities of fuel and lubricants are estimated to be required for operating the equipment 1,000 hours under severe conditions at the atmospheric temperature ranges shown:

	32°F and lower	32°F to 70°F	70°F and higher
Fuel - <span style="margin-left: 100px;">30</span> leaded gasoline, 85 octane, gals	3000	3000	3000
Greases -			
General purpose 14L9 No. 1 (chassis) lb	1	1	1
General purpose 14L10 No. 2 (wheel bearing) lb	10	10	10
Water Pump 14L11 lb			
Oils -			
Motor 9110 (SAE 10) gal	29	1	1
" 9250 ( " 30) gal		25	50
" 9500 ( " 50) gal		3	3
Hydraulic Brake Fluid -			
USA2 - 111 HB, gal	1	1	1

SHIPPING INFORMATION: Shipped one in a box.

Weight: 3,380 lb  
 Cube: 360 cu ft  
 Dimensions: 117 in. x 78 in. x 68 in.

## RECHARGING UNIT, CO<sub>2</sub>

ELECTRIC DRIVEN - STOCK NO. 2K22

**APPLICATION:** This unit is used for charging carbon dioxide fire extinguishers and for transferring carbon dioxide from one container or cylinder to another.

**CAPACITY:** The unit is capable of pumping 80% of the carbon dioxide from a fully charged 50 lb supply cylinder.

**DESCRIPTION:** This unit consists of a single-cylinder single-acting reciprocating pump, "V" belt driven by an electric motor, integrally mounted on a solid base. The unit is provided with a rack for inverting the extinguisher or cylinder to be charged, a tilting rack for inverting the supplying cylinder, 6 ft of inlet hose with adapter and strainer, and 6 ft of outlet hose with adapter and control valve.

**OPERATION:** One man operated. Periodic lubricating is required.

**SUPPLIES REQUIRED:** 110-volt, 60 cycles, a-c electricity, and the following quantities of fuel and lubricants are estimated to be required for operating the equipment 1,000 hours under severe conditions at the atmospheric temperature ranges shown:

	32°F and lower	32°F to 70°F	70°F and higher
Greases -			
General purpose 14L9 No. 1 (chassis) lb	1	1	1
Oils -			
Motor 9250 (SAE 30) gal	1	1	1

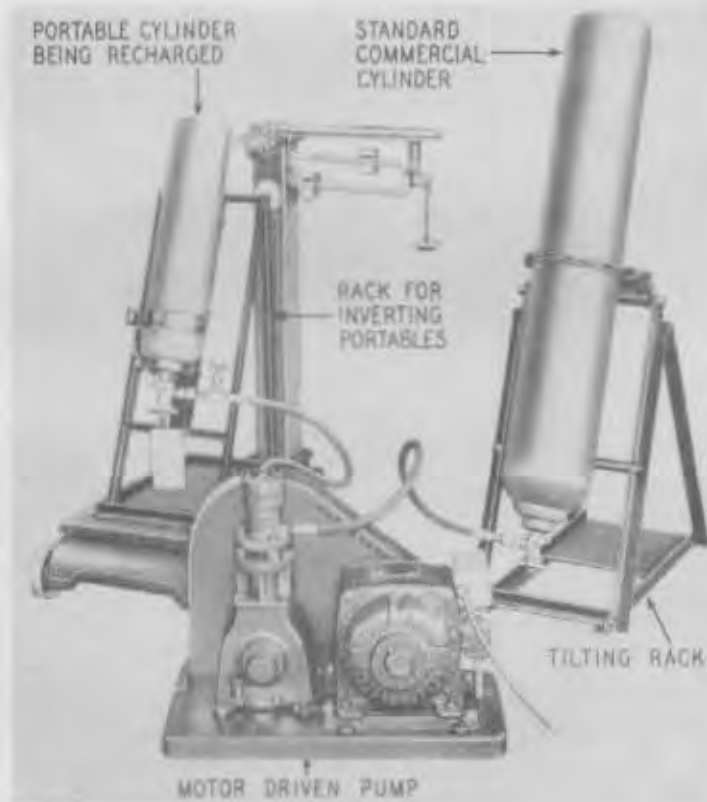

FIRE EXTINGUISHER (CO<sub>2</sub> GAS) RECHARGING UNIT (2K22)

AUXILIARY EQUIPMENT SUPPLIED: Spare parts.

AUXILIARY EQUIPMENT NOT SUPPLIED: A scale for weighing the amount of carbon dioxide transferred.

SHIPPING INFORMATION: Shipped in two boxes.

Boxed Pump and Motor

Weight: 280 lb

Cube: 7.5 cu ft

Dimensions: 24 in. x 18 in. x 30 in.

Boxed Racks

168 lb

10.3 cu ft

31 1/2 in. x 18 in. x 31 1/2 in.



## SCALES, COUNTER

### PLATFORM AND BALANCE ARM

**APPLICATION:** For weighing anything that can be put on the scale platform, but specifically intended for weighing the carbon dioxide of fire extinguishers in connection with the use of re-charging units.

**CAPACITY:** Will weigh quantities ranging from 1/4 lb to 300 lb.

**DESCRIPTION:** This unit comprises essentially a cast iron base, a steel weighing platform measuring 10 in. x 13 1/2 in., connecting links, a brass balance arm and weighing rider or slide, and a set of cast iron weights. The overall dimensions are 21 in. x 23 in. x 9 1/2 in. and the net weight is 37 lb.

**OPERATION:** One man is required to adjust balance slide and weights and record weights.

**SHIPPING INFORMATION:** Shipped in one box.

Weight: 55 lb  
Cube: 2.3 cu ft



PLATFORM SCALES

## HYPOCHLORINATION UNIT

STOCK NO. 2E32 - 3.

**APPLICATION:** Used to chlorinate water but should not be used in the tropics or any region where amoebic dysentery may be endemic. It is connected between a pumping unit and storage tanks as shown on Y&D Dwg No. 208,160.

**CAPACITY:** Two to 100 gallons per minute.

**DESCRIPTION:** The unit is mounted on a pipe frame with skids. Its main parts are: automatic hypochlorinator; hypochlorite reservoir; meter; tool box; pressure regulating valve; range adjusting valve, sight glass; and hose, pipe, fittings, etc., necessary to make the unit complete. A removable canvas cover is provided for protection in bad weather.

Overall length	25 in.
" width	28 1/2 in.
" height	25 1/2 in.

**OPERATION:** One man can operate this unit. Operation consists of making up the hypochlorite solution, testing for residual chlorine and adjusting the valves. If the unit is removed from service or exposed to freezing temperature during shut-downs the water must be drained out.

**SUPPLIES REQUIRED:** Hypochlorite powder packed in small containers.

**AUXILIARY EQUIPMENT SUPPLIED:** Tools, spare parts, spare parts list and instructions for operation and maintenance are included with each unit when shipped.

**SHIPPING INFORMATION:** Shipped in one crate.

Gross Weight	1,645 lb
Cube	41 cu ft

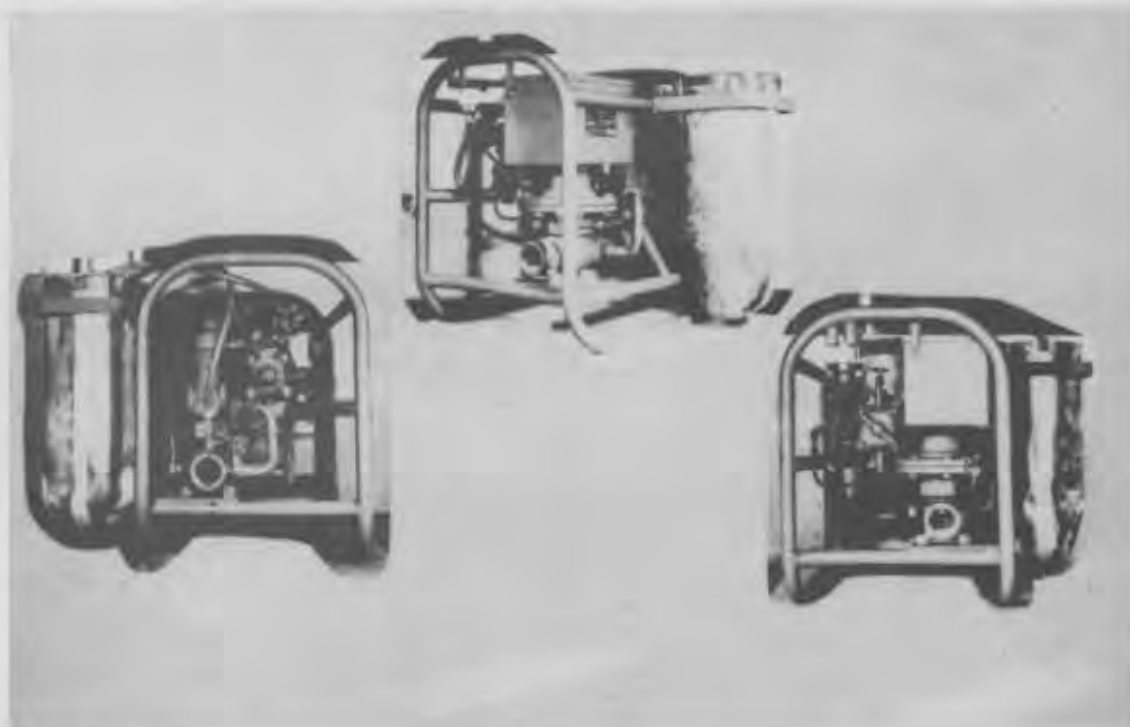

HYPOCHLORINATION UNIT (2E32)

## PUMP, CENTRIFUGAL, 15 GPM @ 50 FT HEAD

STOCK NO. 2H93-20 *obsolete.*

**APPLICATION:** Used for pumping water in a 30 gph temporary distillation system (Y&D Dwg No. 240,004) where a booster pump is needed between the source of supply and the distillation unit, between the 2-in. pump and storage tanks, or between the source of supply and settling tanks. This pump is furnished as an accessory with the distillation unit.

**CAPACITY:** 15 gpm @ 50 ft total head including 15 ft suction lift.

**DESCRIPTION:** This is a self-priming pump with 1 1/2-in. suction and 1 1/2-in. discharge, aluminum alloy shell and open-type bronze impeller resistant to salt water action. It is directly connected to a 3/4 hp, 4-cycle, single-cylinder air-cooled gasoline engine with magneto ignition, gasoline filter, oil-immersed air cleaner, and gasoline tank. The complete unit is mounted on skids. The overall length of the pump is 18 in., the width 9 1/2 in., height 19 in. and net weight 72 lb.

**OPERATION:** One man can start the pump. It then requires no attention except to refill the fuel tank when required and check the lubricating oil.



15 GPM CENTRIFUGAL PUMP (2H93)

*15  
20  
900*

**SUPPLIES REQUIRED:** The following quantities of fuel and lubricants are estimated to be required for operating the equipment 1,000 hours under severe conditions at the atmospheric temperature ranges shown:

	32°F and lower	32°F to 70°F	70°F and higher
Fuel - <span style="margin-left: 100px;">80</span> Unleaded gasoline, 85 octane, gals	100	100	100
Oils -			
Gear, VV-L-761 (SAE 90) (Hypoid)		3.	3.
Motor 9110 (SAE 10)	4.		
" 9250 ( " 30)	4.	4.	4.

**AUXILIARY EQUIPMENT SUPPLIED:** Two 25-ft lengths of 1 1/2 in. suction hose with couplings, foot valve, and strainer. Spare parts, spare parts list, and instructions for operation and maintenance are supplied with each unit.

**SHIPPING INFORMATION:** Shipped in one crate.

Gross weight      225 lb  
 Cube                17 cu ft  
 Dimensions      36 in. x 29 in. x 28 in.

## PUMP, CENTRIFUGAL, 55 GPM @ 50 FT HEAD

STOCK NO. 2H93-53 10

APPLICATION: Used for pumping water in the following supply systems:

30-gph Distillation	Y&D Dwg No.	246,604
15-gpm Purification	"	246,605
100-gpm Distillation	"	246,606
Typical layout	"	246,607
Typical layout	Shallow Well	"
	Mobile Repair Base	"
15-gpm Purification	"	257,174
250-gph Distillation	"	257,175

CAPACITY: 55 gpm at 50 ft total head including 15 ft suction lift. The maximum total head against which the pump will operate at all is 90 ft.

DESCRIPTION: This pump has a 2-in. suction and discharge bushed to 1 1/2 in. It is self-priming and has a bronze priming valve, bronze impeller, stainless steel shaft and rubber-face iron check valve. The impeller is designed to protect the steel shaft from contact with salt water. The pump is directly connected with a 3.8-hp air-cooled single cylinder gasoline engine with oil bath air cleaner and 2-gal fuel tank, all mounted on a steel base. A handle is provided so that it can be easily carried.

Overall length	24 in.
" width	16 1/4 in.
" height	23 1/4 in.
Net weight	135 lb

OPERATION: One man can start the pump which then requires little attention except to refill the gasoline tank and check the crankcase oil level. The pump must be primed when first started. Drain, if shut down in freezing weather. Drain and refill crankcase after every 50 hr of operation.



55 GPM CENTRIFUGAL PUMP

SUPPLIES REQUIRED: The following quantities of fuel and lubricants are estimated to be required for operating the equipment 1,000 hours under severe conditions at the atmospheric temperature ranges shown:

	32°F and lower	32°F to 70°F	70°F and higher
Fuel - <sup>30</sup> Unleaded gasoline, 85 octane, gals	300.	300.	300.
Oils -			
Gear, VV-L-761 (SAE 90) (Hypoid)		3.	3.
Motor 9110 (SAE 10)	4.		
" 9250 ( " 30)	4.	4.	4.

AUXILIARY EQUIPMENT SUPPLIED: Spare parts, spare parts list, and instructions for operation and maintenance are included with each unit when shipped.

SHIPPING INFORMATION: Shipped in one crate.

Gross Weight      245 lb  
 Cube                8 1/2 cu ft  
 Dimensions        30 in. x 18 in. x 26 in.

2H93-14

## PUMP, CENTRIFUGAL, 125 GPM @ 231 FT HEAD

STOCK NO. 2H93-~~14~~-73

**APPLICATION:** Used for pumping water in a 4-in. Main Distribution System, a typical layout of which is shown on Y&D Dwg No. 257,176

**CAPACITY:** The pump will deliver 125 gpm at 231-ft head (100 lb per sq in.) and will pump water one mile through a 4-in. pipe, or 220 ft vertically. It will supply 75,000 gal in 10 hr for 12-250-man camps, or 25 gal per man per day.

**DESCRIPTION:** This is a 4-in. single stage, horizontal, close-coupled, self-priming centrifugal pump. Each unit weighs 756 lb and is mounted on a structural steel base with a 4-cylinder, 4-cycle, 22-hp, air-cooled gasoline engine. The engine is complete with engine house, a 6-gal fuel tank, oil-bath air cleaner, magneto with impulse coupling, carburetor, flyball governor, spark plugs and wires, and crank.

**OPERATION:** One man can operate this unit and his full time would not be required. The pump must be primed just before putting it into operation for the first time or after it has been idle for a long period. Warm water should be used for priming during freezing weather and the pump should be drained when shut down during the winter. Crankcase oil should be drained and replaced by fresh oil after every 50 hrs of operation.

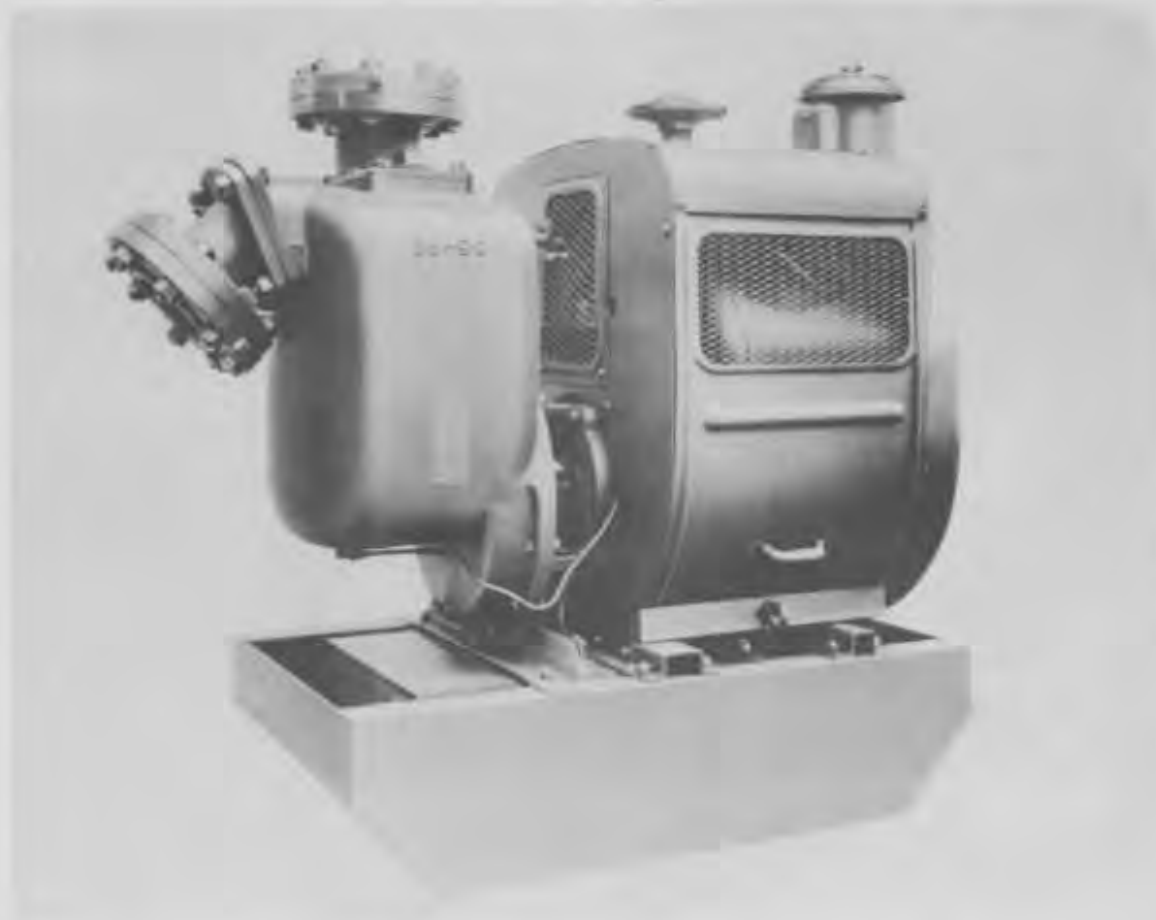

125 GPM CENTRIFUGAL PUMP (2H93)

SUPPLIES REQUIRED: The following quantities of fuel and lubricants are estimated to be required for operating the equipment 1,000 hours under severe conditions at the atmospheric temperature ranges shown:

	32°F and lower	32°F to 70°F	70°F and higher
Fuel - <sup>30</sup> leaded gasoline, <sup>80</sup> octane, gals	2200.	2200.	2200.
Greases - Water Pump 14L11 lb	10.	10.	10.
Oils - Gear, VV-L-761 (SAE 90) (Hypoid) gal Motor 9250 (SAE 30)	20.	20.	20.

AUXILIARY EQUIPMENT SUPPLIED: Companion flanges; bolts and gaskets; spare parts; spare parts list and instructions for operation and maintenance are included with each unit when shipped.

SHIPPING INFORMATION: Shipped in one crate.

Gross Weight 930 lb  
 Cube 38.3 cu ft  
 Dimensions 26 in. x 47 in. x 54 in.



*Hi-LIFT*  
PUMP, , 30GPM @ 250FT HEAD

STOCK LIST NO. 2H93-78 *OK*

**APPLICATION:** Used for pumping water from well to reservoir or distribution system.

**CAPACITY:** The design capacity of the pump is 30 gpm against a total dynamic head of 250 ft with a well setting of 200 ft. Maximum total head is 525 ft, the discharge at this head being 28 gpm. Maximum well setting is 400 ft.

**DESCRIPTION:** Pump is of the deep well type having a water lubricated rotor and stator pumping element submerged in the well. Shaft connecting element with gear head at surface is located within and guided by discharge casing by means of spiders and cutless rubber bearings placed on 10 ft centers. Weight of shafting is carried by roller thrust bearings mounted in gear head. Column pipe is of 2 1/2 in. standard black pipe assembled in 10-ft lengths by means of screw couplings. Intake is fitted with foot valve and strainer and the pump is driven by a one cylinder air-cooled gasoline engine through a right-angled gear drive assembly (gear ratio 1:1). Connection between engine take-off shaft and horizontal gear head shaft is of the flexible type.

Two 3-groove pulleys and belts are furnished for use with other power units. Accessories which are furnished are 2-in. gate valve, 1/4-in. relief valve, 200-lb pressure gage and requisite fittings.

**OPERATION:** One man can operate and perform running maintenance on this equipment. The pump itself needs no lubrication. The pump gear head and power unit required periodic lubrication and greasing. Lubricate pump with water before starting.

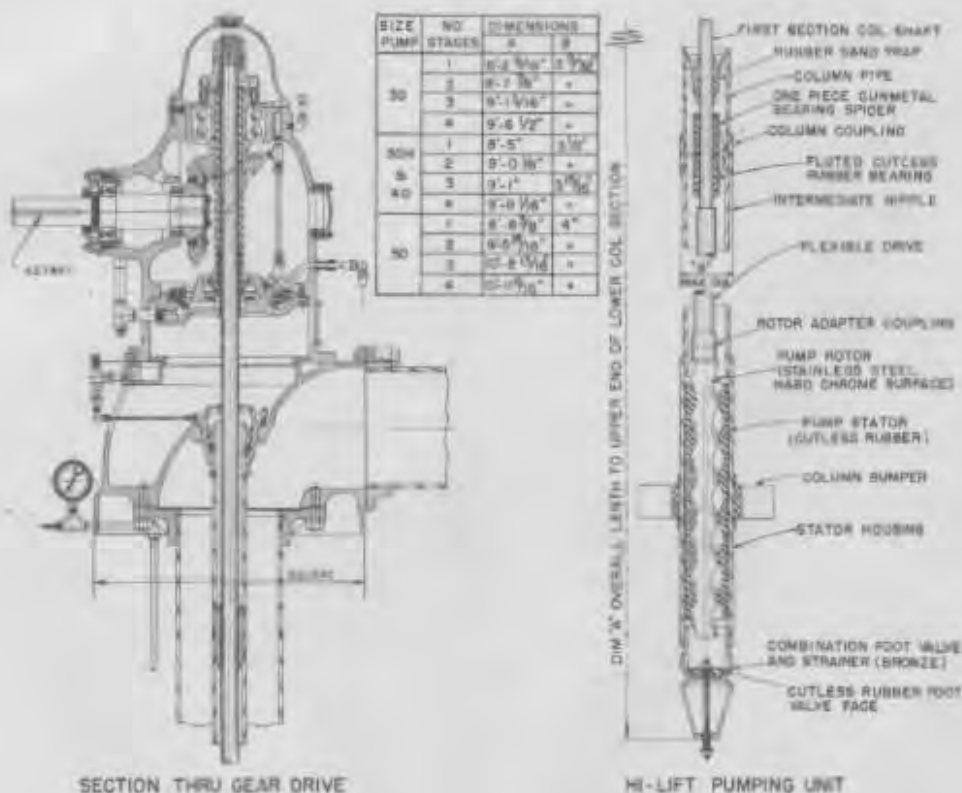

ROTARY PUMP (2H93-78)

**SUPPLIES REQUIRED:** The following quantities of fuel and lubricants are estimated to be required for operating the equipment 1,000 hr under severe conditions at the atmospheric temperature ranges shown:

	32°F and lower	32°F to 70°F	70°F and higher
<b>Fuel-</b>			
Leaded gasoline, 80 octane, gal	600	600	600
<b>Oils-</b>			
Gear, 14L4-90 gal ✓	6	6	6
Motor 9110 (SAE 10) gal	8	8	8

**AUXILIARY EQUIPMENT SUPPLIED:** Spare parts and instructions for operation and maintenance are included in the shipment.

**AUXILIARY EQUIPMENT NEEDED BUT NOT SUPPLIED:** Gasoline tanks, pipe, fittings and timber or concrete for foundation.

**SHIPPING INFORMATION:**

Weight: 3,160 lb  
 Cube: 117.1 cu ft

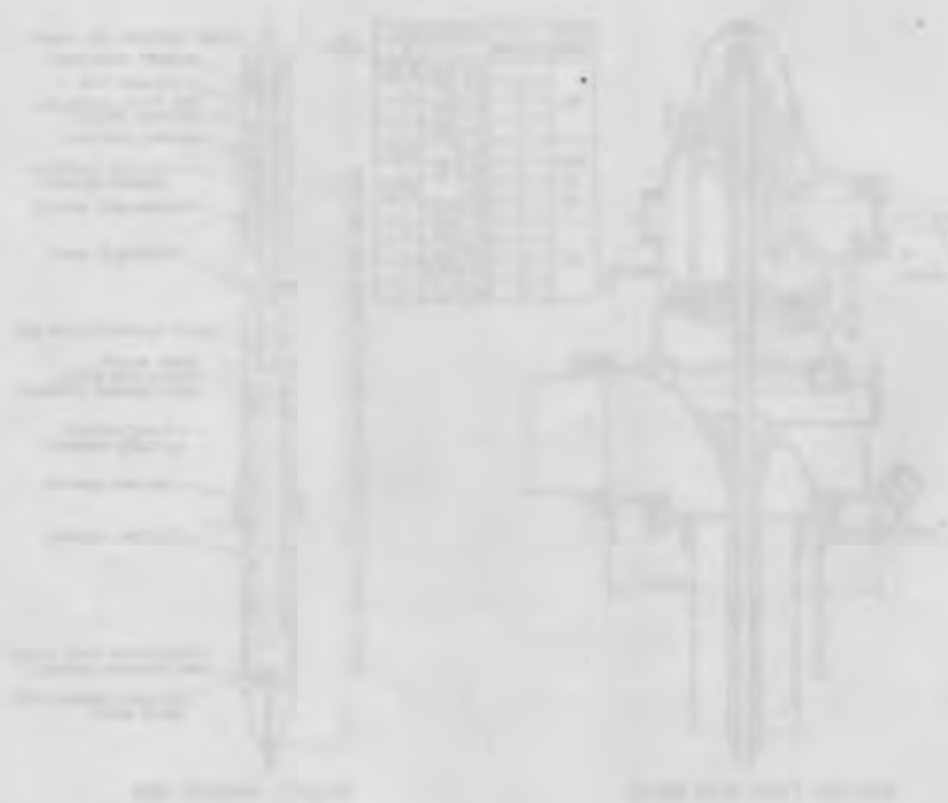

## PURIFICATION UNIT

STOCK NO. 2E21-6

*Use for 2E21-20*

**APPLICATION:** Used to filter and purify water from shallow wells, lakes, reservoirs and streams in temporary or semipermanent systems. It is connected between the source of supply and a water storage tank (Y&D Dwg No. 246,605 and 257,174) or between a 2-in. booster pump and storage tanks as shown on Y&D Dwg No. 246,606 and 246,610.

**CAPACITY:** The rate of flow through this unit depends largely on the turbidity of the raw water and will vary between 7 1/2 gpm and 10 gpm. The unit is estimated to produce 10,000 gal of purified water in 24 hr., based on a 7 1/2-gpm rate. If the filter is not being used and chlorination only is being effected, the pumping rate may range up to 45 gpm, depending upon the total static head.

**DESCRIPTION:** The frame of the pumping and treating unit is made of 1-in. steel pipe with skids and 4 retractible handles. The main parts are comprised of two chemical pot-feed devices, a venturi tube, a hypo-chlorinator, a hypochlorite solution reservoir, a 1 1/2-in. pump with gasoline engine, and a tool box. The filter unit is an 18-in. diam metal tank with under-drain system. It contains pure quartz, sand and gravel. A canvas cover is provided for the pumping and treating unit.

Overall length 31 in.  
" width 25 in.  
" height 37 1/2 in.

**OPERATION:** One man can operate the unit. Water should not be used for drinking in less than 1/2 hr after chlorination.



PURIFICATION UNIT (2E21)

**SUPPLIES REQUIRED:** The following quantities of fuel and lubricants are estimated to be required for operating the equipment 1,000 hours under severe conditions at the atmospheric temperature ranges shown:

	32°F and lower	32°F to 70°F	70°F and higher
Fuel - Unleaded gasoline, 65 octane, gals	100.	100.	100.
Oils - Gear, VV-L-761 (SAE 90) (Hypoid) gal		3.	3.
Motor 9110 (SAE 10)	4.		
" 9250 ( " 30)	4.	4.	4.

**AUXILIARY EQUIPMENT SUPPLIED:** A 6-mo supply of chemicals needed in the purification process, spare parts, tools, spare parts list, and instructions for operation and maintenance are shipped with each unit.

**SHIPPING INFORMATION:** Shipped in 2 crates.

Gross Weight	1,776 lb	Heaviest crate	1,296 lb
Cube	87 cu ft	Cube of "	69 cu ft

## PURIFICATION UNIT, KIT-TYPE

STOCK LIST NO. 2E21-19

**APPLICATION:** This manually operated, self-priming, filtering pump, is used for filtering small quantities of water. Intake is placed in a stream and filtrate discharges into canteen or similar container. Sterilization chemicals are included.

**CAPACITY:** One-half gpm

**DESCRIPTION:** Unit consists of a hand-operated, positive-displacement pump with a diaphragm and spring-loaded suction and discharge valves; a filter unit; suction, discharge, and connecting hose; strainer and float; filter pads; "Filteraid"; and vials of C.D.C. (chlor and de-chlor) units; all packed in a carrying knapsack. Unit operates at a rate of 80 to 90 strokes per min, and produces good, filtered water. C.D.C. units are for sterilizing the filtrate in canteens.

**OPERATION:** One-man operation.

**AUXILIARY EQUIPMENT SUPPLIED:** 6 sets of filter pads, 6 pkgs of powdered "Filteraid", 16 pkgs (160 vials) of sterilizing tablets.

**SHIPPING INFORMATION:**

Weight: 18 lb  
Cube: 0,8 cu ft



## TANK, CANVAS, 3000 GAL

STOCK NO. 2H71-1

**APPLICATION:** Used for the initial temporary storage only of pure water, or for water that is to receive subsequent treatment. If the water to be treated is extremely dirty two of these tanks may be used alternately for settling out excessive turbidity.

**CAPACITY:** Three thousand gallons.

**DESCRIPTION:** This tank consists essentially of No. 1 cotton duck side walls, bottom and cover; 20 wood staves; 4 3/4-in. diam manila stay lines, each 39 ft long; 20 1/2-in. diam support ropes, each 18 in. long; 16 1/2-in. diam tie lines, each 36 in. long for securing the top; and 3 2-in. outlet flanges without reducing bushings and 1 1/2-in. plugs spaced 120° apart near the bottom. The inside diam of the tank is 11 ft 3 in. and the height to the top of staves is 5 ft 0 in.

**OPERATION:** When used as a settling tank, periodic flushing is required. One man can take care of this operation.

**AUXILIARY EQUIPMENT SUPPLIED:** A timber-trestle platform and the required pipe, hose, fittings, valves, etc are furnished.

**SHIPPING INFORMATION:**

Gross weight	400 lb
Cube	17.4 cu ft



3000-GALLON CANVAS TANK (2H71)

## TANK, MARENG CELL

3,000 GAL., STOCK NO. 2H71-35

**APPLICATION:** This unit may be used for storing distilled water, gasoline, aromatic fuel or similar liquids above ground. Two of these cells are used in each submarine shop for storing battery water. See Y&D Dwg. No. 264,201.

**CAPACITY:** 3,000 gallons.

**DESCRIPTION:** When assembled, this unit provides a water-tight storage cell or tank 15 ft 5 in. in diam and 4 ft 4 in. high. It comprises an inner cell made of a fabric coated with a synthetic substance called Thiokol, set up in an enclosing housing plywood. The essentials of the unit are the inner cell, top cell supporting tabs, metal interlockers, plywood housing panels, metal supporting bands, turnbuckles, access door and access door vent, access door rope, bottom cell supporting tabs and ground cloth. There is a 1 1/2-in. inlet fitting in the access door and a 1 1/2-in. outlet fitting in the side near the bottom for a flange or pipe connection. A top canvas cover, cover braces and brace fittings are also included.

**OPERATION:** Four men can erect this cell in 24 minutes. Care must be taken to avoid damaging the inner cell of synthetic coated fabric, especially during erection.

**AUXILIARY EQUIPMENT SUPPLIED:** A repair kit, useful in repairing leaks, and printed instructions covering the erection of the unit, are included with each cell when shipped.

**AUXILIARY EQUIPMENT NOT SUPPLIED:** A timber platform.

**SHIPPING INFORMATION:** Shipped in one crate.

Gross Weight 945 lb  
Cube 50.2 cu ft  
Dimensions 62 1/4 in. x 35 1/4 in. x 32 1/4 in.



STORAGE CELL (2H137)

## TANK, TEST

STOCK NO. 2H71-13

**APPLICATION:** Used in pairs to test water from 30 gph and 100 gph units as shown on Bu Y&D Dwg No. 246,604, 246,606, and 264,201.

**CAPACITY:** Fifty gallons.

**DESCRIPTION:** This tank is made of No. 18 gage galvanized sheet steel and flares from 2 ft square at the bottom to 2 ft 6 in. square at the top. The top edges of the sides are rolled around a 1/4-in. diam steel rod, forming a rim. The tank is 18 in. high and its net weight is 44 lb. The seams are soldered and lap-riveted with 5/32-in diam rivets on 2-in. centers. Tanks intended for holding battery water are provided with cotton duck linings.

**OPERATION:** When one tank has been filled, intake and discharge hoses are transferred to the other; after samples have been taken for testing, the contents of the tank is pumped to storage.

**SHIPPING INFORMATION:** Two tanks are nested in a crate.

Gross Weight	164 lb
Cube	14 cu ft
Dimensions	35 in. x 33 in. x 21 in.

**ORDERING INSTRUCTIONS:** State if canvas lining is desired.

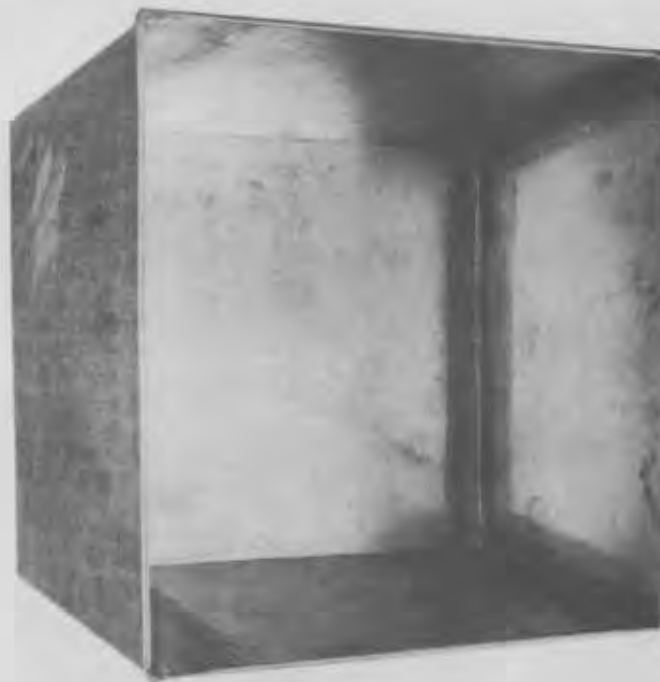

TEST TANK (2H71)



## TANKS, WATER, BOLTED-STEEL, 100-, 250-, AND 500-BBL CAPACITY

STOCK LIST NO. 2H71-59, 2H71-57, 2H71-60

**APPLICATION:** These tanks are used for the storage of water or fuel oil. Tanks are water-tight and fuel-oil-tight.

**CAPACITY:**

2H71-59: 100 bbl or 4,200 gal  
2H71-57: 250 bbl or 10,500 gal  
2H71-60: 500 bbl or 21,000 gal

**DESCRIPTION:** Bolted steel-plate tanks, having flat circular bottoms 1/4 in. thick, designed to rest on level ground, and have #12 gage steel-plate cylindrical sides and circular, pitched deck. All joints are single-lap joints sealed with strip gaskets and held by 1/2-in. bolts, 2 in. on centers. Roof has a manhole hatch and cover with handle. Center supporting post runs from bottom to deck on inside and there are inside and outside ladders. A cleanout opening and flanges for inlet, outlet, and drain connections are in the side near the bottom. The deck is structurally reinforced underneath to support a live load of 30 lb psf. Tank is also provided with a bronze-screened free vent for letting out air, and a liquid level indicator. The outside is painted green 2A and the interior is given 2 coats of Bitumastic solution after erection.

**CAPACITY:**

	Dimensions (inside)		
	Diameter		Height
100-bbl	9 ft 2 3/4 in.	}	8 ft 0 1/2 in.
250-bbl	15 ft 4 5/8 in.		
500-bbl	21 ft 6 1/2 in.		

**AUXILIARY EQUIPMENT SUPPLIED:**

100-bbl tank: 3 gal Bitumastic paint  
250-bbl tank: 6 gal Bitumastic paint  
500-bbl tank: 9 gal Bitumastic paint

**SHIPPING INFORMATION:**

CAPACITY	WEIGHT	CUBE
100-bbl	3900 lb	136 cu ft
250-bbl	6100 lb	171 cu ft
500-bbl	8711 lb	215 cu ft

## TANK, WATER, WOOD

STOCK NO. 2H71

### CAPACITY:

#### In Gallons

#### Use

500	Used to provide storage to backwash the filter of a 15-gpm purification and filtering unit (Y&D Dwg No. 257,174) or for sampling batches from a 250-gph distillation unit (Y&D Dwg No. 257, 175). Stock No: 2H71-25
3,000	Connected with a 4-in. main distribution system, a 15-gpm purification unit, or a 250-gph distillation unit for storage supply to bldgs. (Y&D Dwg No. 257,177). Stock No: 2H71-26
5,000	Used for fresh water for a 15-gpm purification unit layout (Y&D Dwg No. 257,174) or for salt water and for fresh water storage for a 250-gph distillation unit layout. (Y&D Dwg No. 257,175). Stock No: 2H71-27
15,000	For water storage for 400-men systems. (Y&D Dwg No. 257,174). Stock No. 2H71-28
126,000	Connected between a 100-gpm hypochlorination unit and a 4-in. pipe distribution system for storage. (Y&D Dwg No. 208,160). Stock No. 2H71-29

**DESCRIPTION:** Furnished with chine-joists, wood cover, automatic indicator, a weather tight hatch, and overflow pipe. Hoops are wrought iron or mild steel rods, with a button head on one end and thread and nut at the other, connected with malleable iron lugs. Lumber for staves and bottom may be white cedar, cyprus, white pine, redwood, or Douglas fir, air-dried. Lumber for roofs may be No. 1 common



WOOD WATER TANKS (2H71)

yellow pine or Douglas fir, treated with creosote. Roof is supported on joists resting on and anchored to the staves.

**CAPACITY:**

In Gallons	Fittings	Diameter
500	2 2 1/2-in.	5 ft 0 in. to 5 ft 6 in.
3,000	1 2-in.	8 ft 0 in. to 10 ft 0 in.
5,000	2 2 1/2-in.	10 ft 0 in. to 11 ft 9 in.
15,000	2 2 1/2-in.	14 ft 0 in.
126,000	2 4-in.	34 ft 0 in.

**OPERATION:** Keep all metal parts painted. Do not expose to weather before setting up but fill tank as soon as erected.

**SUPPLIES REQUIRED:** Paint for metal parts.

**AUXILIARY EQUIPMENT SUPPLIED:** Instructions for erection are included with each shipment.

**SHIPPING INFORMATION:** Shipped knocked down.

Capacity: Gallons	Gross Weight: lbs	Cube: cu ft
500	580	43
3,000	4,464	124
5,000	4,720	196
15,000	7,832	354
126,000	57,985	2,003

## ASSEMBLY, LOADING

### TANK TRUCK AND CAN FILLING, ASSEMBLY NO. 2012

**APPLICATION:** Used for filling tank trucks and gasoline drums, the rack is connected to a 4-in. lateral tapped off a gasoline header. (See Y&D Dwg Nos. 204,050 and 264,138)

**CAPACITY:** Facilities for loading two tank trucks and three nozzles for can filling.

**DESCRIPTION:** The frame has an overall length of 16 ft and an overall width of 6 ft. The two 3-in. tank truck filling spouts are 12 ft 4 in. above the road, are counter-balanced, have an adjustable length and a 360° horizontal swing. A 3-in. gate valve controls the discharge. The pressure fuel nozzle for can filling are connected to a 1 1/2-in. hose 15 ft long and discharge is controlled by a 1 1/2-in. hose valve.

**OPERATION:** Operation can be taken care of by truck crews. No maintenance is required. If sufficient pressure cannot be obtained by gravity a 350 gpm, centrifugal, gasoline engine driven pump can be used for this purpose.

**SHIPPING INFORMATION:** Shipped knocked down.

Gross Weight:

Cube:

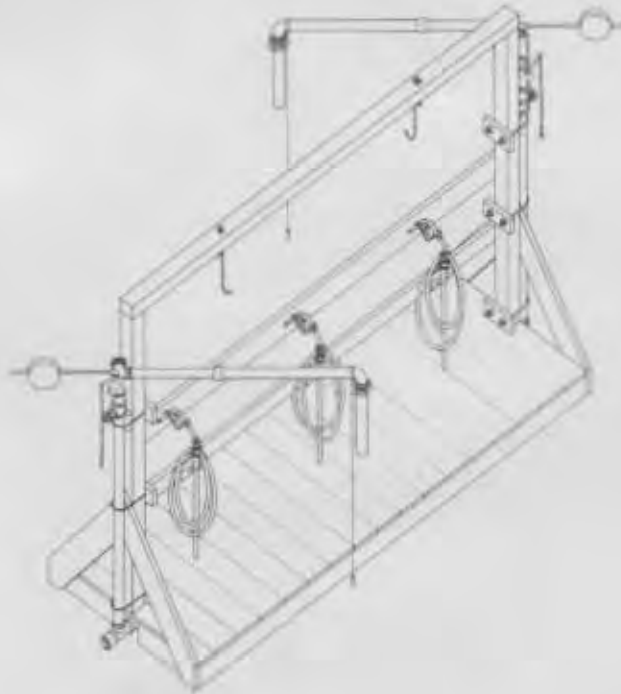

## CLARIFIER, FILTER UNIT

DIESEL OIL, STOCK NO. 2H112-1

**APPLICATION:** Used to remove contamination, both solids and solubles, from diesel fuel oil, which contamination enters the oil through transportation, handling, and storage conditions. One clarifier and one strainer make up a unit. It is connected between the main 8-in oil header to storage tanks and sea line. (See Y&D Dwg No. 204051) Filters are to be used only when filling ships from tanks. Use by-pass when filling tanks from sea. Filter is to be located as close to shore as possible.

**CAPACITY:** Rated flow capacity per unit: 160 gpm  
Maximum flow capacity per unit: 170 gpm

**DESCRIPTION:** The strainers are metal-edge scraper type for removing solid contaminants above .003 in. in diameter. Strainer will handle the full flow capacity of the clarifier. The clarifier uses absorbent type Fuller's earth refills in the second stage. All contamination above .003 in diameter and harmful acids and gums are removed.

			weight dry	weight wet
Strainer	16 1/4 in O.D.	38 11/16 in high	260 lb	447 lb
Clarifier	28 3/8 in O.D.	60 1/2 in high	542 lb	1000 lb

**OPERATION:** One man can operate and maintain this unit but will not be needed full time. Maintenance consists of draining off sediment periodically from both units through sump drains. The clarifier will need servicing, and refills will require replacing in the clarifier.

**AUXILIARY EQUIPMENT SUPPLIED:** Eighty refills, spare parts, a spare parts list, and instructions for operation and servicing are included with each unit when shipped.

**AUXILIARY EQUIPMENT NOT SUPPLIED:** Pipe valves, fitting, etc.

**SHIPPING INFORMATION:** Shipped in three (3) crates.

Gross Weight: 2,200 lb  
Heaviest crate: 975 lb  
Cube: 967 cu ft  
Largest Crate: 3 ft 7 in by 2 ft 5 in x 5 ft x 7 in



OIL CLARIFIER, FILTER UNIT (2H112)

## COUPLING, GROOVED TYPE

WITH BOLTS, NUTS AND GASKETS, STOCK NO. 2H80

**APPLICATION:** Used to make connections on grooved pipe, either standard or spiral weld, carrying oil or gasoline.

**CAPACITY:** Couplings come in 4 in, 6 in, 8 in and 12 in pipe sizes.

**DESCRIPTION:** Couplings consist of metal half-housings, two bolts and nuts, and synthetic rubber sealing gasket.

**OPERATION:** Two men to make connections

**AUXILIARY EQUIPMENT NOT SUPPLIED:** Wrenches

**SHIPPING INFORMATION:**

Shipping weights, 4 in 9 lb each, 6 in 16 lb each, 8 in 28 lb each and 12 in 50 lb each.

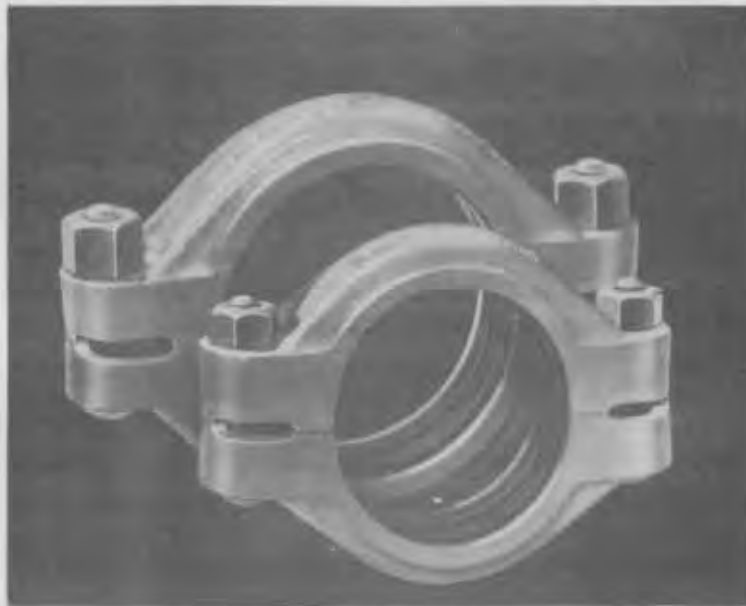

GROOVED TYPE COUPLING 2H80

## HOSE, CARGO OR SUBMARINE

STOCK NO. 2H111

**APPLICATION:** Used on the end of submerged sea lines for connection between tankers and tank farms, both gasoline and oil. (See Y&D Dwg. 204,054)

**DESCRIPTION:** Hose is smooth bore consisting of a helix of round wire and multi-ply of heavy cotton duck imbedded in synthetic rubber and built-in steel nipples with flanges, bolts, nuts and gaskets. Hose 6 in diam is used for Diesel oil and gasoline and 8 in diam. hose is used for fuel oil. Both sizes are 25 ft long with flanges at both ends.

**OPERATION:** Two men to make flanged connections

**AUXILIARY EQUIPMENT NOT SUPPLIED:** Marker Buoy

**SHIPPING INFORMATION:** Shipped one 25 ft length per box. 6 in diam. 8 in diam.

Weight: 584 lb    600 lb  
Cube:    46 cu ft    60 cu ft

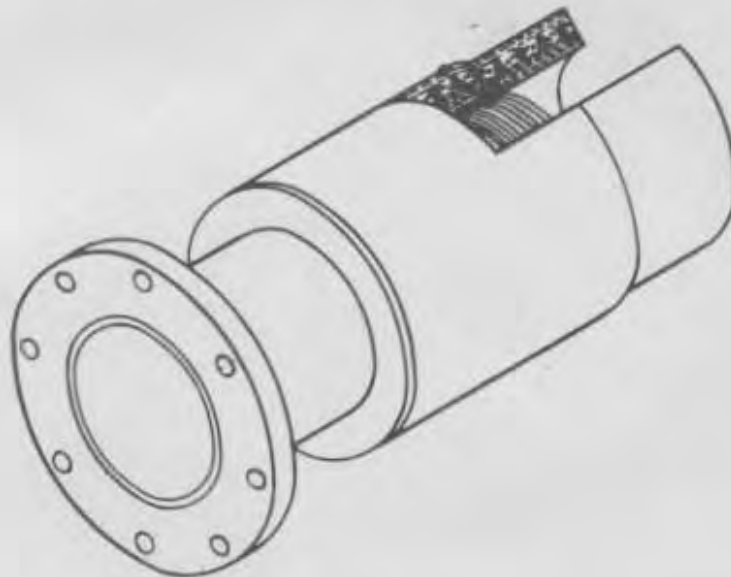

CARGO OR SUBMARINE HOSE (2H111)

## PIPE, SPIRAL WELD

GROOVED FOR VICTAULIC COUPLING, STOCK NO. 2H72

**APPLICATION:** This pipe is used for water, oil and gasoline lines in all tank farms.

**DESCRIPTION:** Pipe is fabricated from sheet metal strips spirally wound and welded, to which short sections of standard pipe with grooves are welded on each end. Pipe comes in 30 ft lengths in the following sizes with approximate weight per ft 4 in 3.33 lb., 6 in 6.88 lb, 8 in dia. 9.22 lb and 12 in dia. 17.81 lb.

**OPERATION:** Two men to make connections.

**AUXILIARY EQUIPMENT NOT SUPPLIED:** Victaulic couplings and fittings for connections.

**SHIPPING INFORMATION:** Shipped loose in 30 ft lengths

	4 in	6 in	8 in	12 in
Weight: (approx.)	100 lb	207 lb	277 lb	535 lb
Cube:	2.6 cu ft	5.3 cu ft	10.6 cu ft	23.56 cu ft

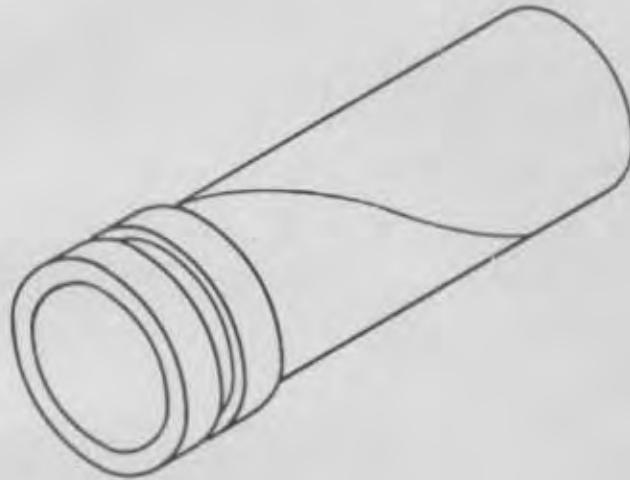

SPIRAL WELD PIPE



PUMP, CENTRIFUGAL, 200 GPM, 50 LB PER SQ IN.

STOCK NO. 2H93-46. Y11-P-733-220

APPLICATION: This pump is used for pumping gasoline from underground storage tanks, (See Y&D Dwg Nos. 204,055 and 264,138). It may also be used to pump diesel or fuel oil at temperatures above 80°F.

CAPACITY: 200 gpm at 50 lb per sq in and 1760 rpm

DESCRIPTION: This is a six-stage, centrifugal deep-well type gasoline pump with a 4-in flanged discharge connection driven by a 17-hp, 4-cylinder, 4-cycle, V-type air-cooled gasoline engine.

Overall length of pump:	11 ft 4 5/8 in
Diameter of deck plate:	20 ft
Overall height above deck plate:	4 ft 5 5/8 in
Overall length of power unit:	25 3/8 in
" height " " " "	28 7/8 in
" width " " " "	22 1/2 in
Net weight " " " "	245 lb

OPERATION: One man can operate and maintain this equipment. The pump itself needs no lubrication. The pump gear head and power unit requires periodic lubrication and greasing.

SUPPLIES REQUIRED: The following quantities of fuel and lubricants are estimated to be required for operating the equipment 1,000 hours under severe conditions at the atmospheric temperature ranges shown:

	32°F and lower	32°F to 70°F	70°F and higher
Fuel - <del>80</del> 80 leaded gasoline, 80 octane, gals	1700.	1700.	1700.
Greases - General purpose 14L9 No. 1 (chassis) lb	1	1	1
Oils - Gear, VV-L-761 (SAE 90) (Hypoid) gal	1	1	1
Motor 9110 (SAE 10) gal	21.		
" 9250 ( " 30) gal		21.	21.

AUXILIARY EQUIPMENT SUPPLIED: Spare parts and instruction for operation and maintenance are included in the shipment.

AUXILIARY EQUIPMENT NOT SUPPLIED: Gasoline tanks, pipe and fittings.

SHIPPING INFORMATION: Shipped in two crates

Gross weight: 1482 lb  
Cube: 63 cu ft

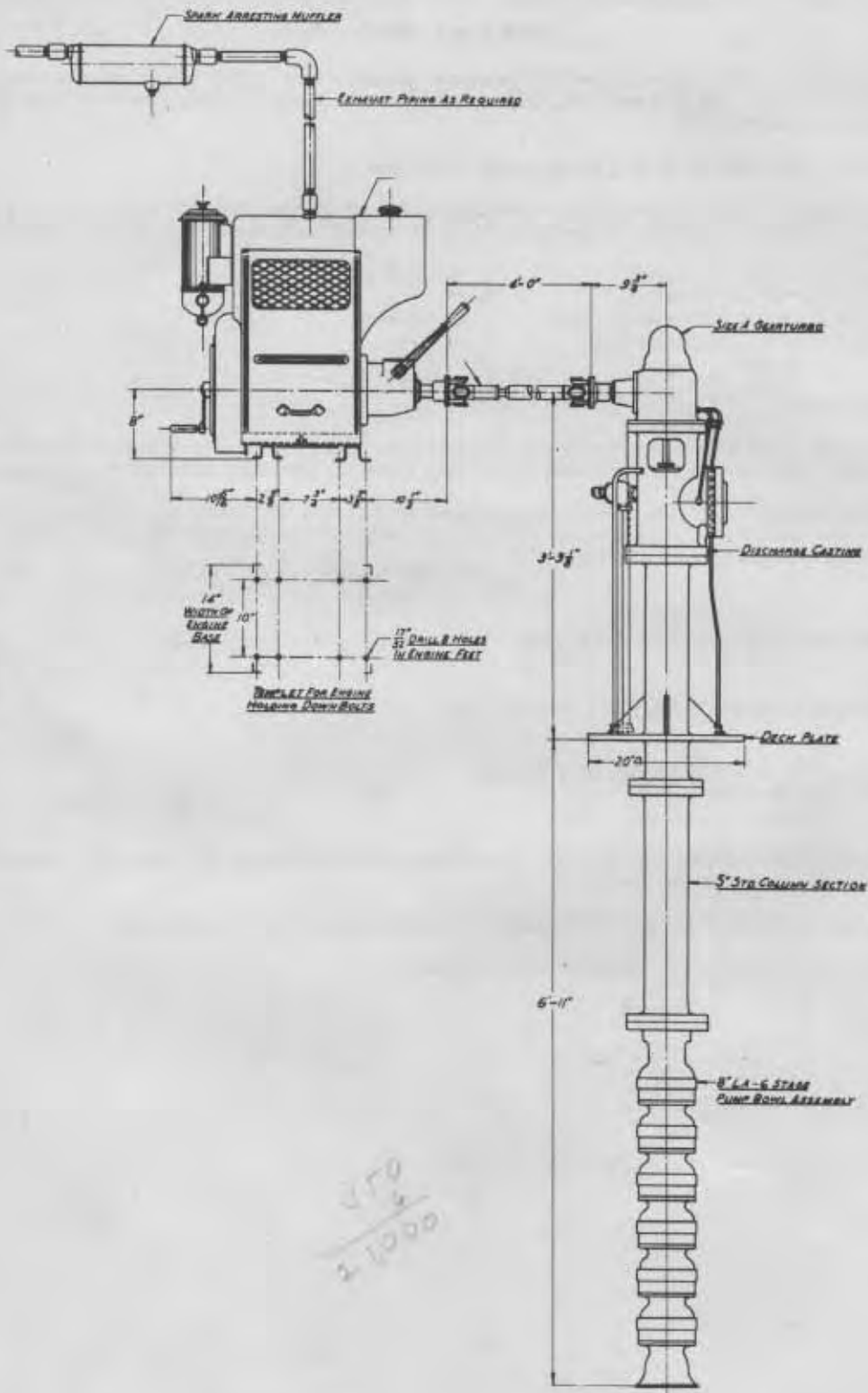

PUMP, CENTRIFUGAL, 350 GPM, 125 LB PER SQ IN. *2H93*

STOCK NO. 2H93

APPLICATION: Used to pump diesel oil, gasoline, and also fuel oil where temperatures are such that the viscosity is below 1300 SSU. (See BuY&D Dwgs. Nos. 204,049; 219,783; 219,784, and 219,790). It is also used to pump salt water for fire protection. (BuY&D Dwg. No. 204,052)

CAPACITY: Three hundred and fifty gal per min at 125 lb per sq in discharge pressure.

DESCRIPTION: This is a single stage centrifugal gasoline engine driven pump. It has a 6-in flanged end suction and a 4-in flanged end discharge. The engine has 6 cylinders, is water cooled and develops 86 hp at 2,800 rpm. It is equipped with a 16-gal gasoline tank, an air cleaner, oil filter, mechanical type governor, storage battery, generator, electric starter, flame arrestor type muffler, and instrument panel. The complete unit is mounted on a heavy steel box type welded frame with beveled ends. Net weight 1,465 lb.

OPERATION: One man can operate this unit:

SUPPLIES REQUIRED: All gasoline up to 100 octane, and lubricants. The proper lubricants to be used are specified on the name plate. The following quantities of fuel and lubricants are estimated to be required for operating the equipment 1,000 hours under severe conditions at the atmospheric temperature ranges shown:

	32°F and lower	32°F to 70°F	70°F and higher
Fuel - <del>un</del> leaded gasoline, <sup>80</sup> octane, gals	10,000.	10,000.	10,000.
Greases -			
General purpose 14L10 No. 2 (wheel bearing) lb	10	10	10
Ball and roller bearing 14L3b grade No. 11 lb	10	10	10
Water Pump 14L11 lb	10	10	10
Oils -			
Motor 9110 (SAE 10) gal	40	40	
" 9250 ( " 30) gal			40



350 GPM CENTRIFUGAL PUMP (2H93)

AUXILIARY EQUIPMENT SUPPLIED: Tools, spare parts, spare parts list, and instructions for operation and maintenance are included with each unit when shipped.

SHIPPING INFORMATION: One crate mounted on a 4 in x 6 in wood skids.

Gross weight: 1,840 lb

Cube: 88 cu ft

Dimensions: 79 in x 54 in x 36 in

## PUMP, HAND

STOCK NO. 2H93-38

**APPLICATION:** This pump is used for pumping sludge and water from the bottom of 5,000 gallon gasoline storage tanks.

**CAPACITY:** 3/4-in discharge, 1-in suction. Stroke is 5-1/2 in, drawing 1/2 pint per stroke.

**DESCRIPTION:** The pump is constructed of bronze with an iron handle. The discharge spout is threaded at the outlet with male hose thread and at the inlet with a 3/4 in female iron pipe thread.

Net weight: 6 1/4 lb

**OPERATION:** One man can operate this pump. Plunger leathers will need replacing occasionally.

**AUXILIARY EQUIPMENT SUPPLIED:** Spare parts.

**AUXILIARY EQUIPMENT NOT SUPPLIED:** Hose for discharge.

**SHIPPING INFORMATION:**

Gross weight: 8 lb

Cube: 0.12 cu ft



HAND PUMP (2H93)

## PUMP, HAND, REFUELING, 10-GPM

STOCK LIST NO. 2H93-79

**APPLICATION:** This pump, an all-purpose, rotary, barrel-pump unit, is generally used for servicing planes, trucks, cars, tractors, or similar equipment with fuel or lubricating oil.

**CAPACITY:** The capacity of the pump depends upon the cranking speed, varying between 7 and 20 gpm.

**DESCRIPTION:** This hand-operated pumping unit consists of a barrel pump with bucket-type rotors which require no adjustment for normal wear, housed in a vertical, split-type housing with suction and discharge tapped outlets. Each unit has a crank with a hardwood handle, and a 42-in. suction pipe with 1 1/2- to 2-in. bung attachment. Also furnished are 8 ft of 3/4-in. gasoline hose with bronze nozzle, and combination hose holder and vacuum breaker.

**OPERATION:** One-man operation.

**AUXILIARY EQUIPMENT SUPPLIED:** An instruction and maintenance manual is supplied with each unit.

**SHIPPING INFORMATION:** Complete unit packed in one box.

Weight: 62.5 lb  
Cube: 2 cu ft



PUMP, ROTARY, 20 GPM, 50 LB PER SQ IN.

STOCK NO. 2H93-26 *OK Y11-P-702-4*

APPLICATION: This pump is used to pump gasoline from main storage to distant airfields. It may be used to pump all types of thin liquids which do not contain dirt or grit.

CAPACITY: Twenty gallons per minute at 50 lb per sq in.

DESCRIPTION: The pump is comprised of casing, head, rotor and idler, and is directly connected to a single-cylinder, 4-cycle, air-cooled, 1.7 - 3.0 hp gasoline engine with 1-gal gasoline tank, screen-type air cleaner, flyball governor, and magneto. The unit is mounted on a cast iron base. Suction and discharge openings are 1 inch in diam.

OPERATION: One man can operate this pump and full time will not be required. Operation will consist of starting and stopping the engine when required, refilling gasoline tank and replacing oil in engine crankcase after every 50 hrs of operation, and periodic greasing.

SUPPLIES REQUIRED: The following quantities of fuel and lubricants are estimated to be required for operating the equipment 1,000 hours under severe conditions at the atmospheric temperature ranges shown:

	32°F and lower	32°F to 70°F	70°F and higher
Fuel - <del>un</del> leaded gasoline, <sup>80</sup> octane, gals	300.	300.	300.
Greases -			
Ball and roller bearing 14L3b grade No. 11 lb	1	1	1
Water Pump 14L11 lb	1	1	1
Oils -			
Motor 9110 (SAE 10) gal	5		
" 9250 ( " 30) gal		5	5



**AUXILIARY EQUIPMENT SUPPLIED:** Tools, spare parts, spare parts list and instructions for operation and maintenance are included with each unit when shipped.

**AUXILIARY EQUIPMENT NOT SUPPLIED:** Protection of engine against bad weather should be provided.

**SHIPPING INFORMATION:**

	Weight: lb	Cube: cu ft
Pump and engine units	200	12.0
" " spare parts	25	0.9
Service Kit spares	14	0.7



## PUMP, ROTARY, 100 GPM

STOCK NO. 2H93 "28"

**APPLICATION:** Used as an alternate for the 200 gpm centrifugal deep well pump for pumping gasoline from underground gasoline storage tanks. It is also used for pumping gasoline from drums to storage tanks. (See Y&D Dwg Nos. 137,548,204,055 and 264,138)

**CAPACITY:** 100 gpm at free flow

**DESCRIPTION:** The unit is mounted on a supporting frame with skids and is either gasoline or ~~electric~~ driven. It consists of a 3-inch variable control rotary pump driven by a gasoline engine or an electric motor. The gasoline is deaerated by an air release chamber and water removed by a segregator. Direction of the flow is controlled by two plug valves and controlling lever. A canvas cover is provided.

**OPERATION:** One man can operate and maintain this unit. By changing a single lever, which operates two plug valves, gasoline may be pumped from drums to storage tanks or from storage tanks to tender pits.

**SUPPLIES REQUIRED:** Gasoline fuel in gasoline engine is used, electric power if electric motor is used. The following quantities of fuel and lubricants are estimated to be required for operating the equipment 1,000 hours under severe conditions at the atmospheric temperature ranges shown:

	32°F and lower	32°F to 70°F	70°F and higher
Fuel -			
<del>Un</del> leaded gasoline, <sup>80</sup> 80 octane, gals	900	900	900
Greases -			
Ball and roller bearing 14L3b grade No. 11 lb	1	1	1
Water Pump 14L11 lb	1	1	1
Oils -			
Motor 9110 (SAE 10) gal	5		
Motor 9250 ( " 30) gal		5	5

**AUXILIARY EQUIPMENT SUPPLIED:** 5-connection manifold with a 5 20-ft hose sections, 5 plug valves and 5 brass tubes for gasoline drums. Tools, spare parts and an "Operating and Maintenance Manual with Parts List" is included with the shipment.

**SHIPPING INFORMATION:** Shipped in one crate.

Gross weight: 1,670 lb

Cube: 102 cu ft

**ORDERING INSTRUCTIONS:** State whether the gasoline engine or electric motor equipped unit is desired.

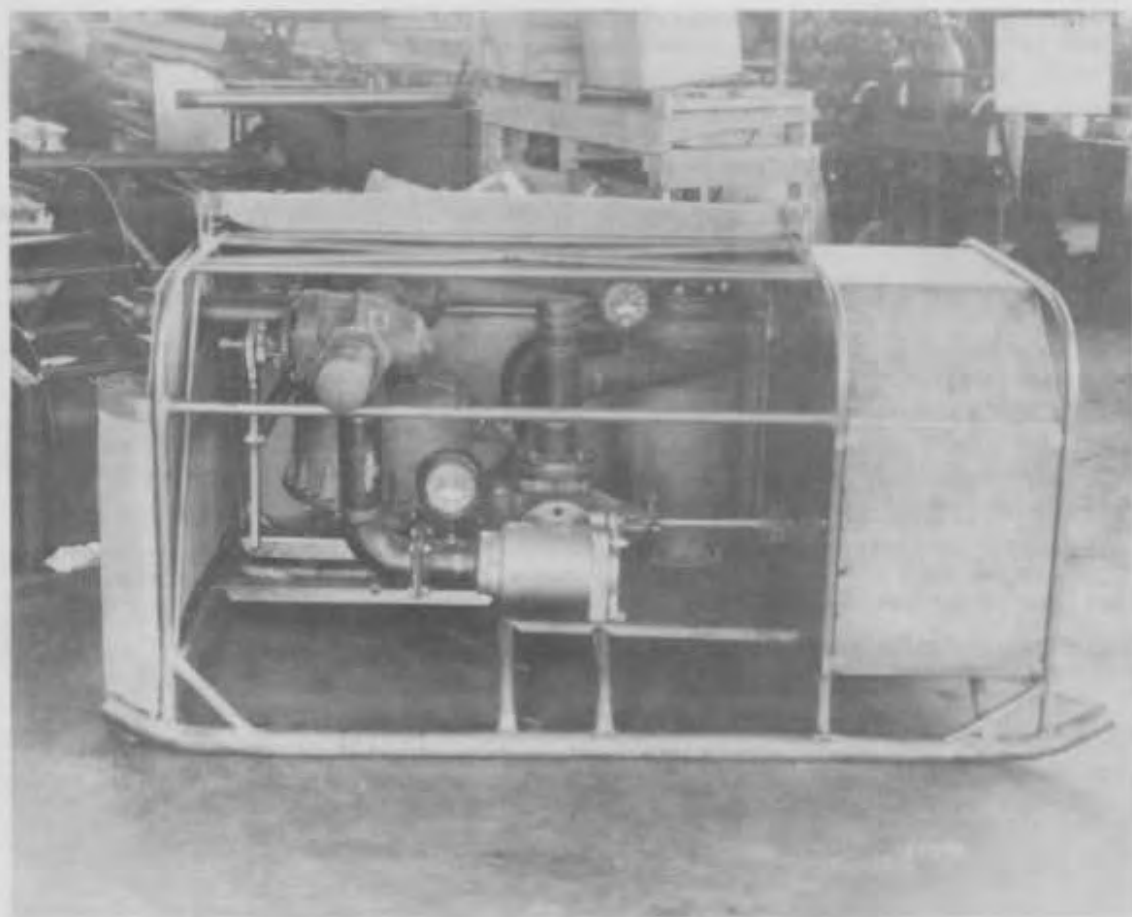

PUMP, ROTARY, 350 GPM, 160 LB PER SQ IN.

STOCK NO. 2H93 - *3/4" flange*

**APPLICATION:** This pump is used in place of centrifugal pumps for pumping fuel oil at locations where low temperatures cause a viscosity above 1300 ssu (not much below 65°F for Navy Special fuel oil)

**CAPACITY:** Three hundred and fifty gpm against 160 lb discharge pressure when operating at 210 rpm, handling Bunker "A" fuel at 45°F and 4,000 ssu viscosity.

**DESCRIPTION:** Several makes are available. The unit includes a 6- or 8-cyl water-cooled gasoline engine, a rotary pump, and double gear reduction all mounted on a structural steel base with skids. The suction and discharge varies from 4 to 6 in depending on make. Flanged and furnished with companion flanges. (See Y&D Dwg. Nos. 204,049; 258,308; and 258,309.)

**OPERATION:** One man is needed to operate the unit. Lubricate and grease according to instructions.

**SUPPLIES REQUIRED:** The following quantities of fuel and lubricants are estimated to be required for operating the equipment 1,000 hours under severe conditions at the atmospheric temperature ranges shown:

	32°F and lower	32°F to 70°F	70°F and higher
Fuel -			
■ leaded gasoline, <i>80</i> octane, gals	9500	9500	9500

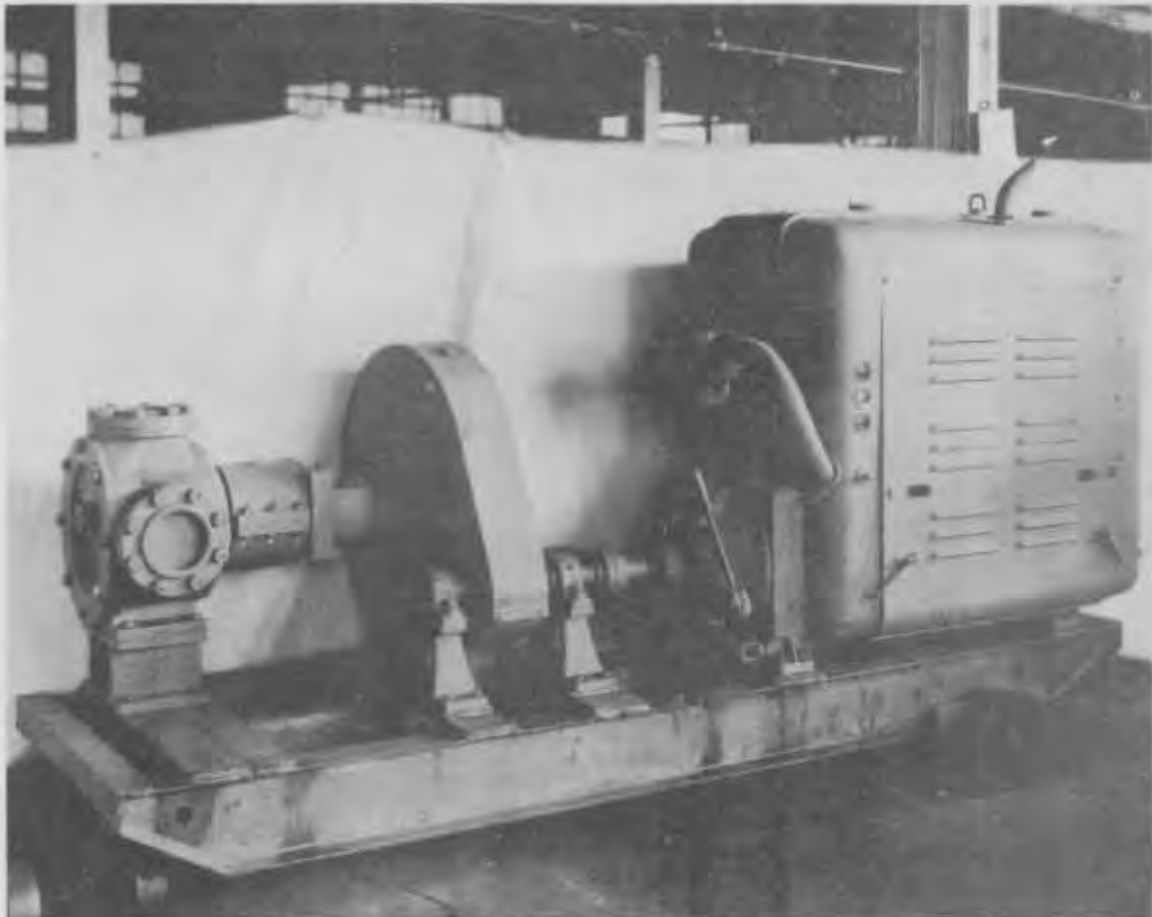

350 GPM ROTARY PUMP (2H93)

	32°F and lower	32°F to 70°F	70°F and higher
<b>Greases -</b>			
Ball and roller bearing 14L3b grade No. 11 lb	5	5	5
Water Pump 14L11 lb	5	5	5
<b>Oils -</b>			
Gear, VV-L-761 (SAE 90) (Hypoid) gal	20	20	20
Motor 9110 (SAE 10) gal	80		
" 9250 ( " 30) gal		80	80

**AUXILIARY EQUIPMENT SUPPLIED:** Spare parts, spare parts list, tools and instructions for operation and maintenance are included with each unit when shipped.

**SHIPPING INFORMATION:** Shipped in 1 crate

Total weight: 4,750 lb (approx)  
 cube: 250 cu ft  
 Dimensions: 10 ft 6 in x 4 ft 4 in x 5 ft 3 in

## TANKS, FUEL OIL

WELDED STEEL, STOCK NO. 2H71

**APPLICATION:** One 75-gal tank is furnished for fuel oil storage for water heaters with each of the following huts: Officers' Quarters; Ward without Quiet Room; Ward with Quiet Room; Receiving Ward; Pharmacy-Dental; Eye, Ear, Nose and Throat and Urology; Laboratory; and Morgue. A 75-gal tank is also furnished for oil storage for the oven in the Bakery Hut, and one 275-gal tank is furnished for fuel oil storage for the boilers with each of the following huts: Bakery; Scullery; Laundry; Surgery; and Galley. The tank for the Galley also supplies the ranges. A 550-gal tank is furnished for fuel oil storage for the boiler in the Shower and Latrine Hut.

**CAPACITY:** 75 gallons, 275 gallons and 550 gallons.

**DESCRIPTION:** These tanks are made of sheet steel with welded seams and heads and openings for filling, vent and emptying, all provided with plugs. The 75-gal and the 550-gal tanks are cylindrical in shape while the 275-gal tank is a cylindroid, that is, its cross-section is elliptical. The dimensions of the latter are width, 44 in, height 27 in and length 62 in. The 550-gal tank is 48 in. in diam and 70 in long.

**OPERATION:** Periodic painting only.

**AUXILIARY EQUIPMENT NOT SUPPLIED:** Supports where tanks are located above ground, and piping connections for filling vent and fuel outlet.

**SHIPPING INFORMATION:** Uncrated, with openings plugged.

	75-gal tank	275-gal tank	550-gal tank
Weight	79 lb	260 lb	650 lb
Cube	14.1 cu ft	42.6 cu ft	93.3 cu ft
Dimensions approx.	31 in x 28 in x 28 in	62 in x 44 in x 27 in	70 in x 48 in x 48 in
Stock Nos	2H71-10	2H71-11	2H71-12



WELDED FUEL OIL TANKS (2H71)

## TANK, NESTED, STEEL

5,000 GAL, UNDERGROUND, STOCK NO. 2H71-40

**APPLICATION:** Used for local ready gasoline storage at airfields and seaplane facilities. Usually four or more of these tanks are installed as shown on Bureau of Yards and Docks Dwg No. 264,138.

**CAPACITY:** The tanks come in six sizes, varying from 7 ft 3 in diam. x 18 ft 1/2 in long to 6 ft 7 1/2 in diam. 18 ft 1/2 in long and 5434 gal to 4520 gal.

**DESCRIPTION:** Tanks are of steel plate, 5/16 in shells with 3/8 in dished heads, fabricated in halves which nest inside each other. Halves are welded together in the field and a 2 in backing strip for this girth seam is provided. Tanks have one 3 in threaded coupling in one head and opposite head has a 4 in threaded coupling. Holes for 3/4 in cleanout pipe, 4 in fill pipe, manhead for pump and 2 in tapped plates are provided and these items are welded to the tank in the field.

**OPERATION:** After installation tank requires only periodic cleaning with hand sludge pump.

**AUXILIARY EQUIPMENT NOT SUPPLIED:** Piping, hand sludge pump, fill and vent caps and gasoline engine driven centrifugal pump.

**SHIPPING INFORMATION:** Shipped in nested halves or singly in halves.

	One tank:	Four tanks in nest:	Six tanks in nest:
Weight (approx.)	6844 lb	26456 lb	38858 lb
Cube	710 cu ft	748 cu ft	768 cu ft

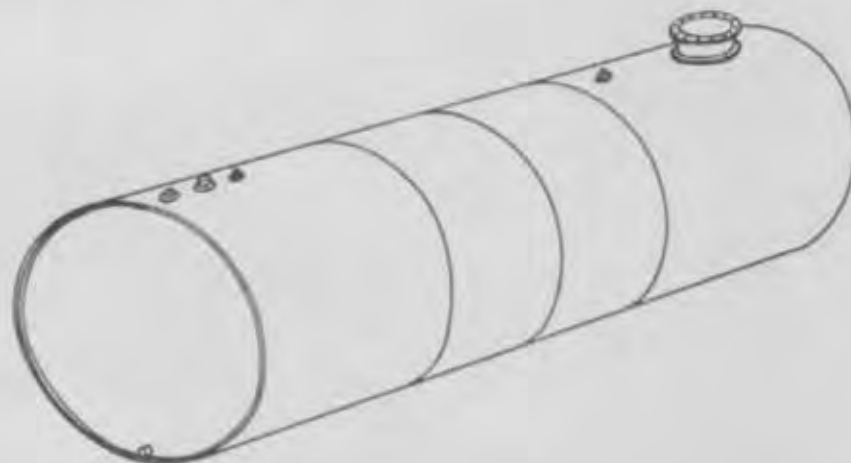

WELDED GASOLINE TANK (2H71)

## TANKS, STEEL, BOLTED

STOCK NO. 2H71

**APPLICATION:** The 1,000 bbl tanks are either high or low type and are used for storage of high octane gasoline, either straight 100<sup>o</sup> octane or aromatic. The 10,000-bbl tank is used for fuel or diesel oil storage. The low type 1,000-bbl tank is not used for pontoon barge installation.

**CAPACITY:** 1,000 and 10,000 barrels.

**DESCRIPTION:**

Nominal Capacity Barrels	Dimensions Inside Diam	Height	Net Wt lb (approx)
H-1000	21 ft 6 1/2 in	16 ft 1 in	10,000
L-1000	29 ft 8 5/8 in	8 ft 0 1/2 in	13,000
10,000	54 ft 11 3/4 in	24 ft 2 in	70,000
Shell openings, 1 each	H-1,000 and L-1,000 bbl.		10,000 bbl.
Tank nozzle	4 in		12 in
Foam chamber	none needed		8 in
Water draw-off	2 in		3 in
Clean out			
Roof openings, 1 each			
Gage hatch	8 in		6 in
Vent	none needed		8 in
Manhole	20 in		20 in
Indicator gage cable	sealed type		non-sealed type
<b>Note:</b> Blind flanges for all openings except manhole.			
<b>Fittings and accessories, 1 each</b>			
Gage hatch	8 in (with air relief and vacuum breaker)		6 in
Free vent gooseneck	none needed		8 in
Manhole dome	20 in		20 in
Water draw-off	2 in		3 in
Tank nozzle	4 in		12 in
Indicator, shell reading, gage board	sealed type		non-sealed type
Inside ladder			
Outside ladder			

The 1,000 bbl tanks are built to withstand a 16 oz pressure and are furnished with special packing, gaskets, and sealant. The 10,000 bbl tanks are furnished with standard gaskets.

**OPERATION:** Estimated time for erection of the H-1000, L-1000 and 10,000 bbl tanks are 10, 6 and 80 eight-hour man days respectively.

**AUXILIARY EQUIPMENT SUPPLIED:** Special tools and instructions for erection are provided.

**AUXILIARY EQUIPMENT NOT SUPPLIED:** Stabilized soil bricks for splinterproofing; nets, garnish and paint for camouflaging as required; also bitumastic pipe coating for underside of tank bottom.

**SHIPPING INFORMATION:** Shipped knocked down in bundles and crates, no one of which weighs more than a ton. Approx gross wt of H-1000, L-1000, and 10,000 bbl tanks are 10,500, 15,500, and 80,000 lb respectively.

**ORDERING INSTRUCTIONS:** Specify if wooden foundation is needed with H-1000 bbl tank for tank barge installation.



H-1,000 BARREL

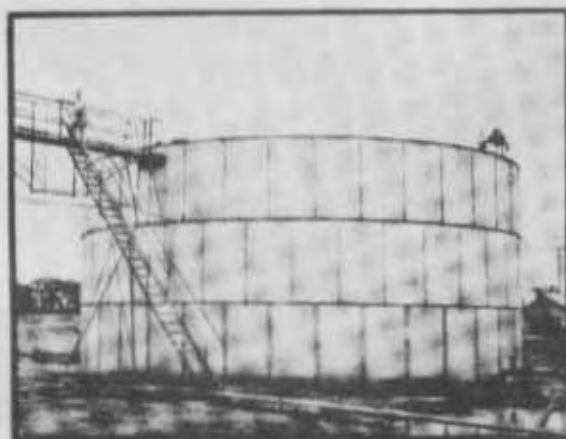

10,000 BARREL



## TEES AND ELBOWS, "GROOVED" TYPE

STOCK NOS. TEES 2H75 AND ELBOWS 2H77

**APPLICATION:** Used to change direction of, or make branch connections to grooved pipe, either standard or spiral weld, carrying oil or gasoline.

**CAPACITY:** Tees come in straight sizes only, elbows come in 90° and 45° for 4 in, 6 in, 8 in and 12 in pipe sizes.

**DESCRIPTION:** Fittings are of malleable iron with upset machined ends to match grooved pipe ends.

**OPERATION:** Two men to make connections.

**AUXILIARY EQUIPMENT NOT SUPPLIED:** Pipe and couplings.

**SHIPPING INFORMATION:**

Shipping weights		Elbows	
Tees		45°	90°
4 in x 4 in x 4 in	13 lb	4 in 6 lb	4 in 8 lb
6 in x 6 in x 6 in	30 lb	6 in 20 lb	6 in 20 lb
8 in x 8 in x 8 in	50 lb	8 in 50 lb	8 in 49 lb
12 in x 12 in x 12 in	140 lb	12 in 135 lb	12 in 110 lb

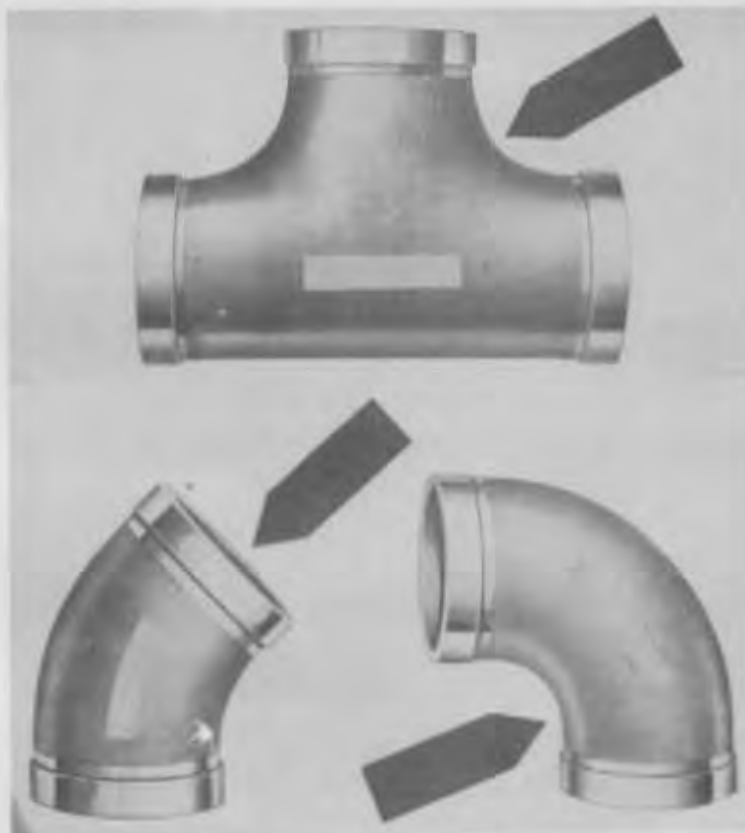

PIPE FITTINGS (2H75, 2H77)

## SHOE MACHINE: STITCHING & FINISHING COMBINATION, ELECTRIC

STOCK LIST NO. 2Q75-10

**APPLICATION:** Shoe-repair machine for stitching leather and composition shoes, patching and general seam work; and for scouring and finishing soles and other parts of shoes.

**CAPACITY:** Machine has a capacity of approximately 30 pairs of shoes per hour.

**DESCRIPTION:** Machine is a compact, portable, motor-driven unit completely equipped for stitching and finishing shoes. A dust collector is a standard part of the machine. Driving power is provided by belt drive from a 1-hp single-phase motor. Net weight of machine is approximately 950 lb.

**OPERATION:** One-man operation.

**SUPPLIES REQUIRED:** Motor oil 9110 (SAE 10)

**AUXILIARY EQUIPMENT SUPPLIED:** Operating manual and spare parts.

**AUXILIARY EQUIPMENT NEEDED BUT NOT SUPPLIED:** 110-Volt, 60-cycle, single-phase, a-c power.

**SHIPPING INFORMATION:**

Weight: 1155 lb  
Cube: 86 cu ft

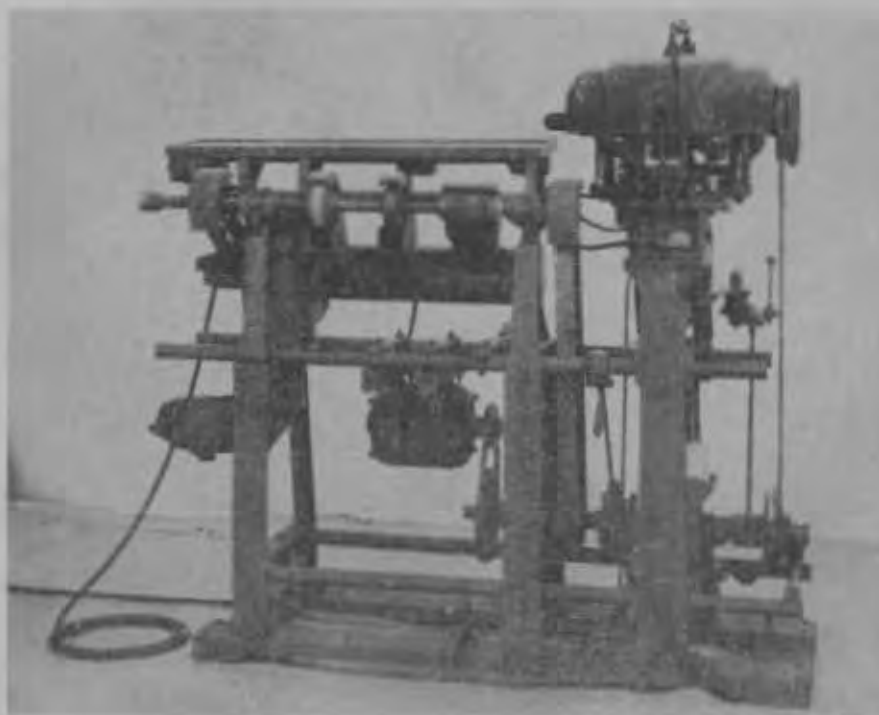

**SECTION III - ELECTRICAL SYSTEMS AND EQUIPMENT**

**List of Effective Pages**

A313 - A314	July 1945	327 - 328	November 1943	343 - 344	November 1943
313 - 314	November 1943	329 - 330	" "	345 - 346	" "
315 - 316	" "	331 - 332	" "	347 - 348	" "
317 - 318	" "	333 - 334	" "	349 - 350	" "
319 - 320	" "	335 - 336	" "	351 - 352	" "
321 - 322	" "	337 - 338	" "	353 - 354	" "
323 - 324	" "	339 - 340	" "	355 - 356	" "
325 - 326	" "	341 - 342	" "		

**SECTION III - ELECTRICAL SYSTEMS AND EQUIPMENT**

**INDEX TO CONTENTS**

<u>Power and Lighting</u>	<u>Pages</u>	<u>Talk-Back Public Address</u>	<u>Pages</u>
Floodlight Trailer	313-316	Control Panel, Talk-Back, Public Address System	343-344
Generator Set, 1/4-KW, D-C, Electric, Gas-Engine-Driven	317-318	Loud Speaker Station	345-346
Generator Set, 2-KW, D-C, Gas-Engine-Driven	319-320	Microphone Oscillator Unit Public Address System, Talk-Back	347-348 341-342
Generator Set, 5-KW, A-C, Gas-Engine-Driven	321-322	<u>Telephone</u>	
Generator Set, 15-KW, A-C, Gas-Driven	323-324	Telephone Switchboard, 50- Circuit, Sectional-Unit-Type	351-352
Generator Sets, 50-KW and 75-KW, Diesel-Engine- Driven	325-326	Telephone Systems, 50- Circuit	349-350
Transformers, Distribution, Air-Cooled, Single-Phase	327-328	<u>Inter-Office Communication</u>	
<u>Radio</u>		Communication System, Inter- Office	353-354
Antenna, Radio, Fixed and Mobile	331-332	<u>Miscellaneous</u>	
Battery, Storage, Radio	333-334	Siren, Vertical-Type	355-356
Mast, Radio, Ninety-Ft Length	335-336		
Radio, Two-Way System, Frequency-Modulated	329-330		
Radio Station, Fixed	337-338		
Radio Station, Mobile	339-340		

## FLOODLIGHT TRAILER

STOCK NO. 3E34-4

**APPLICATION:** Floodlight trailers are procured for the purpose of fulfilling the requirements of allowance lists that include similar apparatus. Their completeness and mobility make them most convenient as a source of quick illumination for work areas on docks, beaches or other operations remote from the main electric power service of the base.

**CAPACITY:** 6 - 500 Watt floodlights and a reserve capacity for the operation of 120 v single phase electrical tools such as electric drills, grinders, small blowers, soldering irons and other similar equipment.

**DESCRIPTION:** The "Floodlight Trailer" is composed of a gasoline engine driven electric generator and a "Cab" mounted on a trailer chassis. It may be attached to any vehicle and towed to the desired location. The cab is arranged for housing the six floodlights and has compartments that contain the eight - 100 ft cords, spare parts, tools and spare electric bulbs.

**OPERATION:** The trailer is a complete power unit, ready for immediate operation. The engine should be checked for cooling water, lubrication and gasoline. The floodlights should be placed where they will illuminate the area.

An extension cord is then plugged into the receptacle on the flood light and the other end plugged into the receptacle on the generator panel. Start engine and by means of the rheostat that controls the generator field current, bring the voltage up to 115 or 120 volts to match the voltage of the light bulbs that are furnished with the flood lights. Watch the voltage and adjust as necessary until the generator is operating at a constant temperature.

**SUPPLIES REQUIRED:** The following quantities of fuel and lubricants are estimated to be required for operating the equipment 1,000 hours under severe conditions at the atmospheric temperature ranges shown:

	32° F and lower	32° F to 70° F	70° F and higher
<b>Fuel -</b>			
Unleaded gasoline, 65 octane, gals	2000.	2000.	2000.
<b>Greases -</b>			
General purpose 14L9 No. 1 (chassis) lb	1.	1.	1.
Ball and roller bearing 14L3b grade No. 11 lb	1.	1.	1.
<b>Oils -</b>			
Motor 9110 (SAE 10)	20.		
"    9250 ( " 30)		20.	20.

**AUXILIARY EQUIPMENT SUPPLIED:** A set of spare parts, fuses and spare floodlight bulbs are furnished with the trailer.

**AUXILIARY EQUIPMENT NOT SUPPLIED:** Replacements of spare parts as used and floodlight bulbs as required.

**SHIPPING INFORMATION:** The entire outfit weighs 1950 pounds when packed for export shipment.

**NOTE:-** All cords for floodlights to be 2 cond. #14 type "S" 100 feet long, each equipped with a male connector on one end and a female connector on the other.

Each floodlight to be equipped with male connector.

Floodlights to be held in place by clamping device to prevent movement during transit.

All housing around floodlights to be made of wood.

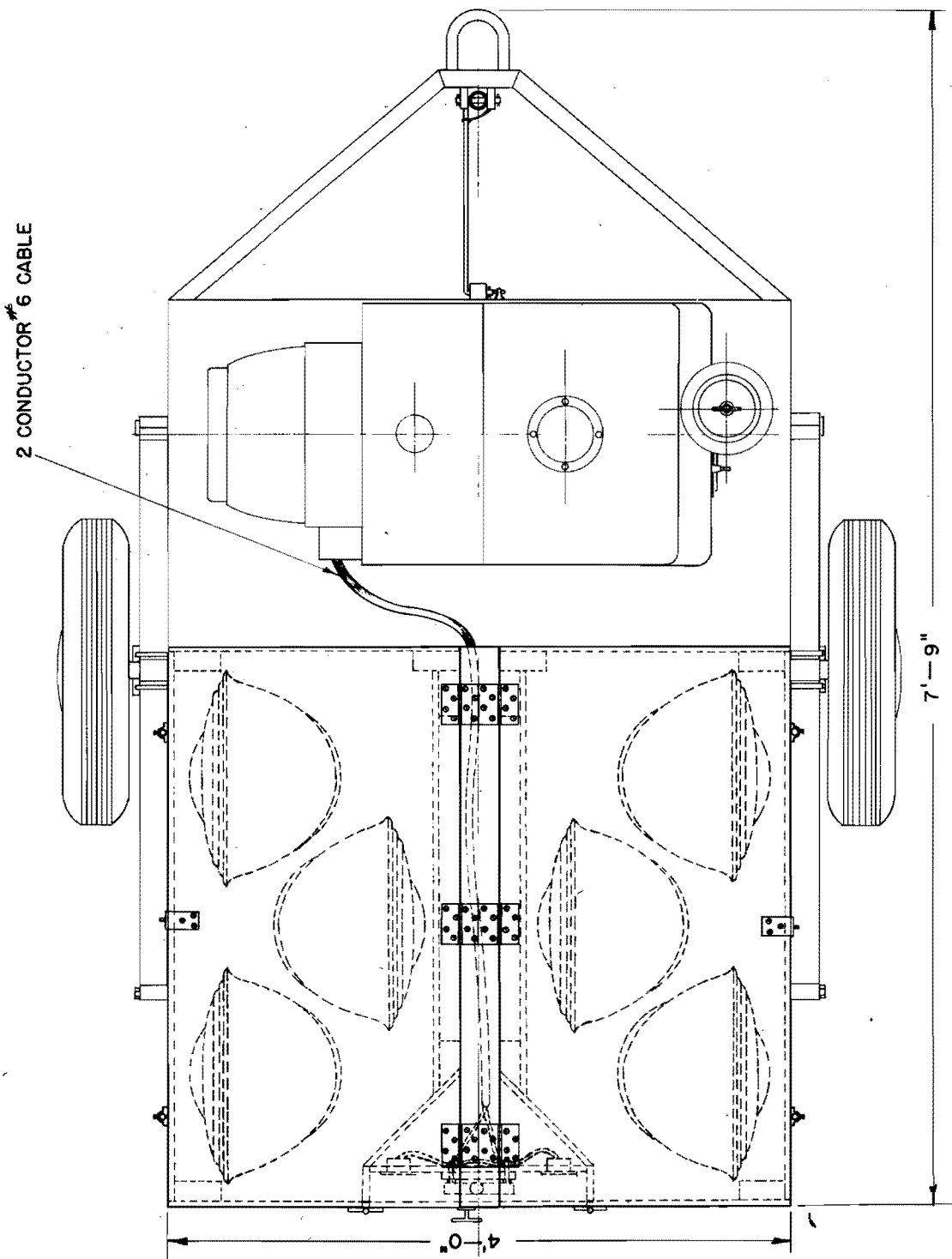

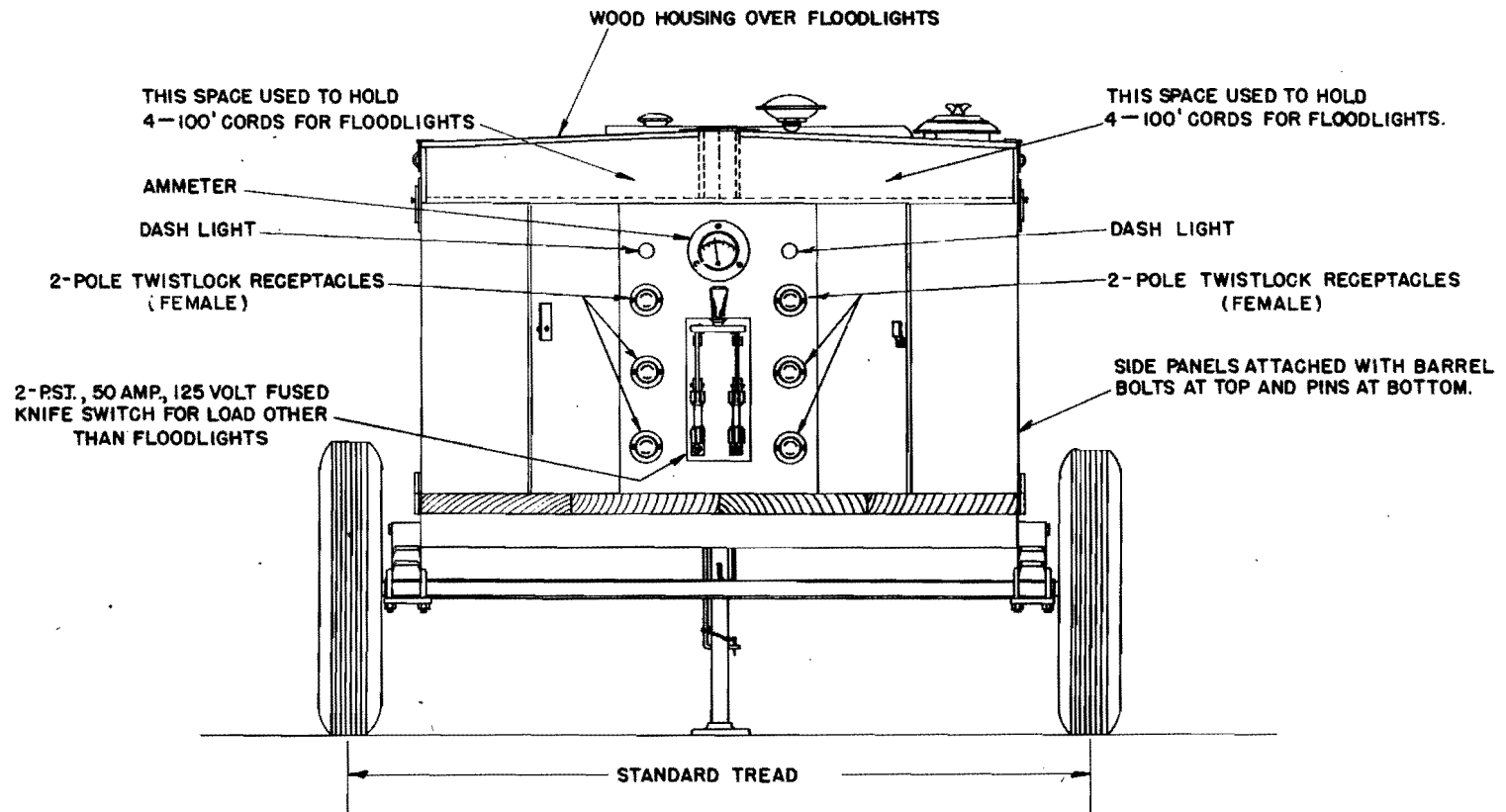

REAR VIEW SHOWING  
ELECTRIC PANEL DOOR  
OPEN

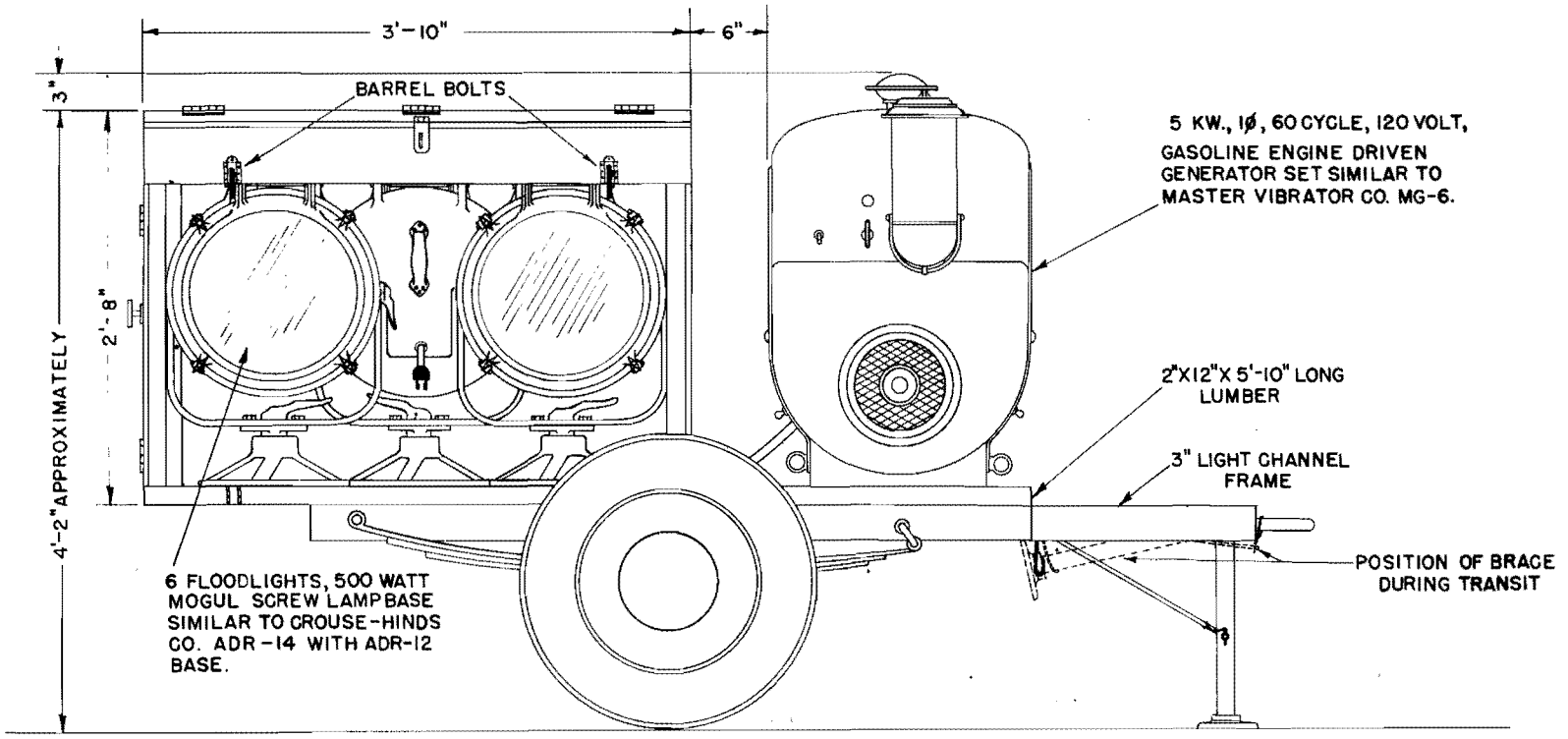

SIDE VIEW - PANEL REMOVED

(November 1943) 316

## GENERATOR SET, 1/4 KW, D-C

ELECTRIC, GAS-ENGINE DRIVEN, FOR MOBILE RADIO STATION, STOCK NO. 3E9

**APPLICATION:** The engine-generator set is a low voltage direct-current electric power plant furnished with the mobile radio station, to supply charging current for the storage battery.

**CAPACITY:** The capacity of the generator is 1/4 kw. It will generate direct-current electricity at 6-volts potential.

**DESCRIPTION:** The generator is driven by a small gas engine properly sized to drive it at maximum capacity.

**OPERATION:** Proper lubrication is very important. The oil should be clean and maintained at the right level. Instructions are supplied with each set.

**SUPPLIES REQUIRED:** The following quantities of fuel and lubricants are estimated to be required for operating the equipment 1,000 hours under severe conditions at the atmospheric temperature ranges shown:

	32°F and lower	32°F to 70°F	70°F and higher
Fuel - Unleaded gasoline, 65 octane, gals	200.	200.	200.
Greases - Ball and roller bearing 14L3b grade No. 11 lb	1.	1.	1.
Oils - Motor 9110 (SAE 10) " 9250 ( " 30)	10.	10.	10.

**AUXILIARY EQUIPMENT SUPPLIED:** Instructions for operation and maintenance and all auxiliary equipment including spare parts for one year's operation are supplied with the sets.

**SHIPPING INFORMATION:** When crated for export the engine generator set weighs 100 lb. The crate measures 1 ft 9 in. x 1 ft 3 1/2 in. x 1 ft 7 in.

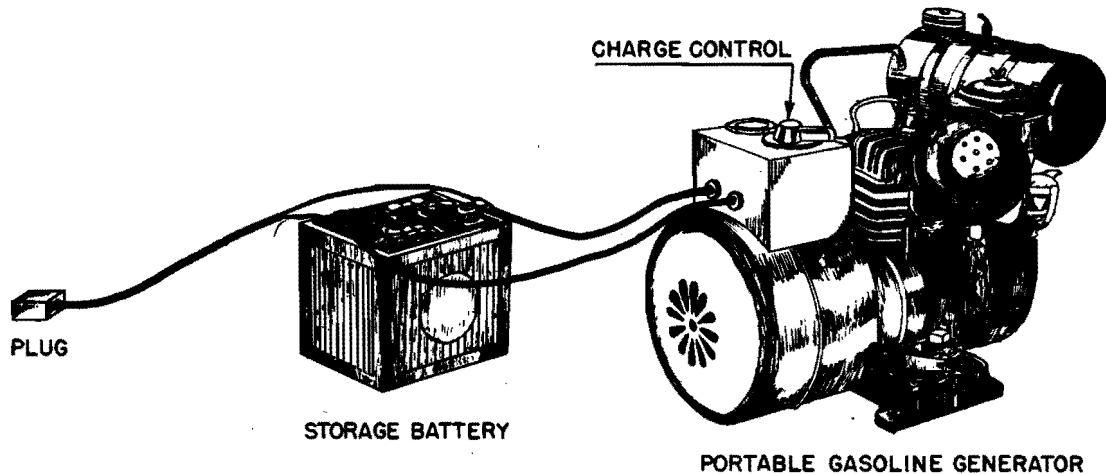

**PORTABLE POWER SUPPLY FOR MOBILE EQUIPMENT**



## GENERATOR SET, 2 KW, D-C

GAS ENGINE DRIVEN, STOCK NO. 3E9-6

**APPLICATION:** Used for small lighting requirements at locations remote from the main electrical distribution system such as floodlighting or to feed a line of lights around a work area. They are more easily portable than the larger units and can be taken to the job on a light truck.

**CAPACITY:** Two kilowatts at 110 volts d-c.

**DESCRIPTION:** This set comprises a generator and the gasoline engine which drives it, mounted as a unit on skids. A metal housing is included for protection when operating the set outdoors in inclement weather. The engine has 4 cylinders and is rated a 4 1/2 hp when turning over a 1350 rpm.

**OPERATION:** The 2 kw electric generator sets are designed for manual starting and stopping.

**SUPPLIES REQUIRED:** The following quantities of fuel and lubricants are estimated to be required for operating the equipment 1,000 hours under severe conditions at the atmospheric temperature ranges shown:

	32°F and lower	32°F to 70°F	70°F and higher
<b>Fuel -</b> Unleaded gasoline, 65 octane, gals	1500	1500	1500
<b>Greases -</b> General purpose 14L9 No. 1 (chassis) lb	1.	1.	1.
Ball and roller bearing 14L3b grade No. 11 lb	1.	1.	1.
<b>Oils -</b> Motor 9110 (SAE 10) gal	10.	10.	
" 9.50 ( " 30) gal			10.



**AUXILIARY EQUIPMENT SUPPLIED:** Spare parts, a standard tool kit and operating instructions are furnished with each set.

**AUXILIARY EQUIPMENT NOT SUPPLIED:** Equipment necessary to handle, erect or house the set may be acquired from other sections of the allowance list.

**SHIPPING INFORMATION:**

Weight	Cube
875 lb	18 cu ft

## GENERATOR SET, 5 KW, A-C

GAS ENGINE DRIVEN, STOCK NO. 3E9-10

**APPLICATION:** These sets are furnished to supply electric current for light and power where the demand for current is within their capacity. They could be used for floodlighting, or for servicing a group of buildings remote from the main electric system.

**CAPACITY:** The capacity is 5000 watts at 120 or 240 volts @ .80 power factor, or 6300 watts @ 1.00 power factor.

**DESCRIPTION:** The engine and generator are mounted on skids with a metal housing for operation out in the weather. The engine has four cylinders. At 1200 rpm it will develop 13 hp. The electrical characteristics are 120-v or 240-v, 60-cycle, single-phase, a-c.

**OPERATION:** This set is started and stopped by hand but it does not require the services of an operator while it is running. Fueling, lubricating, cleaning and maintenance attention are the only other operational requirements.

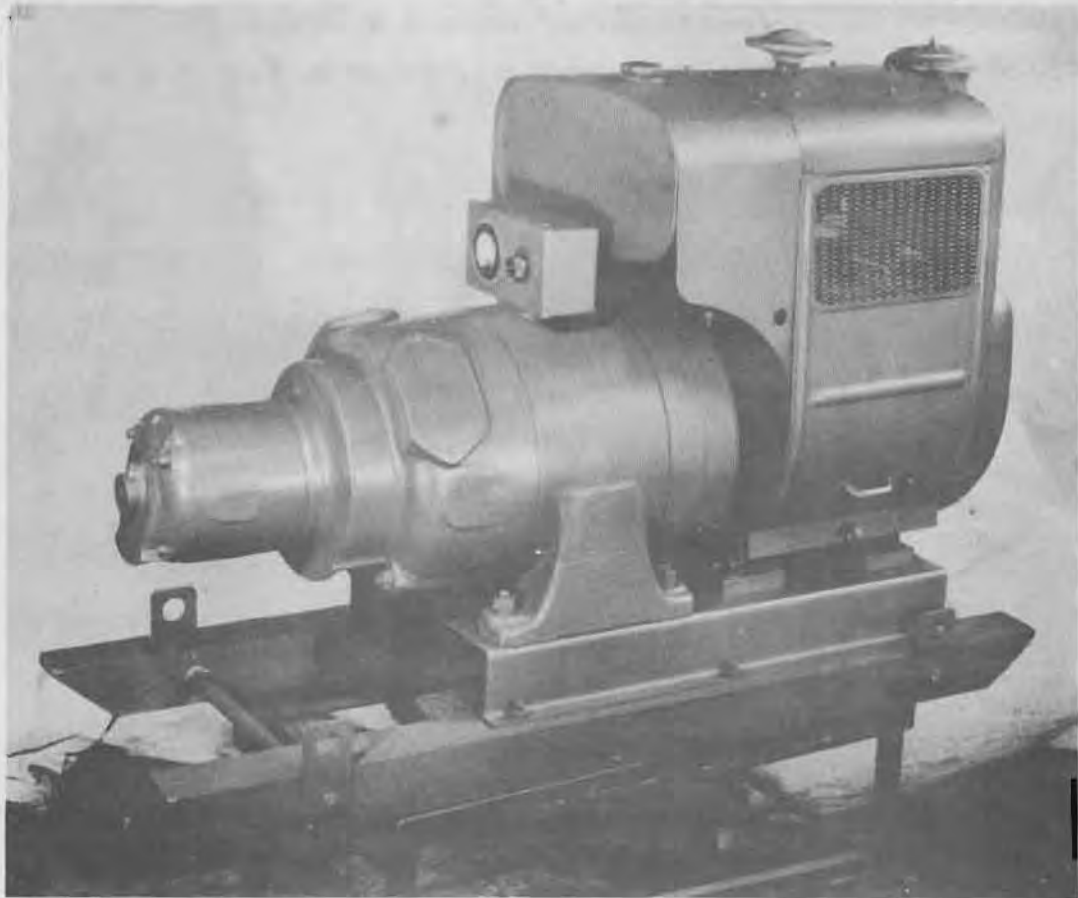

**SUPPLIES REQUIRED:** The following quantities of fuel and lubricants are estimated to be required for operating the equipment 1,000 hours under severe conditions at the atmospheric temperature ranges shown:

	32° F and lower	32° F to 70° F	70° F and higher
<b>Fuel -</b>			
Unleaded gasoline, 65 octane, gals	2000.	2000.	2000.
<b>Greases -</b>			
General purpose 14L9 No. 1 (chassis) lb	1.	1.	1.
Water Pump 14L11 lb	1.	1.	1.
<b>Oils -</b>			
Motor 9110 (SAE 10)	20.	20.	
" 9250 ( " 30)			20.

**AUXILIARY EQUIPMENT SUPPLIED:** Spare parts, tool kit and operating instructions are furnished with each set.

**AUXILIARY EQUIPMENT NOT SUPPLIED:** Equipment necessary to handle, erect or house the generator set, may be acquired from other sections of the allowance list.

**SHIPPING INFORMATION:** The shipping weight is 1,600 lb and the space 100 cu ft.

## GENERATOR SET, 15 KW, A-C

GAS DRIVEN, STOCK NO. 3E9-24

**APPLICATION:** These plants are procured for advance bases. They are used for generating three phase power and can also be used for furnishing electric service for lighting systems as well.

**CAPACITY:** They have a capacity of 15 kw and can be used to supply electric current to loads within that amount.

The generators are rated @.80 power factor when used for lights only (1.0 power factor) they will supply electric service for a load of 18.7 kw or kva.

**DESCRIPTION:** The gasoline engine and the electric generator are mounted on skids and have a weather proof metal housing. They are designed for operation out of doors.

**OPERATION:** The plants are designed for non-automatic, manual, operation and require regular attention and maintenance.

**SUPPLIES REQUIRED:** The following quantities of fuel and lubricants are estimated to be required for operating the equipment 1,000 hours under severe conditions at the atmospheric temperature ranges shown:

	32° F and lower	32° F to 70° F	70° F and higher
Fuel -			
Unleaded gasoline, 65 octane, gals	4000.	4000.	4000.
Greases -			
Ball and roller bearing 14L3b grade No. 11 lb	1.	1.	1.
Oils -			
Motor 9110 (SAE 10) gal	35.		
"    9250 ( " 30) gal		35.	35.

**AUXILIARY EQUIPMENT SUPPLIED:** Spare parts, a tool kit and operating instruction are furnished with each set.

**AUXILIARY EQUIPMENT NOT SUPPLIED:** Equipment necessary to handle, erect or house, will have to be acquired from other sections of the allowance list.

**SHIPPING INFORMATION:** The shipping weight is - 2150 pounds  
The cube is - 65 cu ft  
Spare parts weight - 65 pounds  
" " cube - 5 cu ft

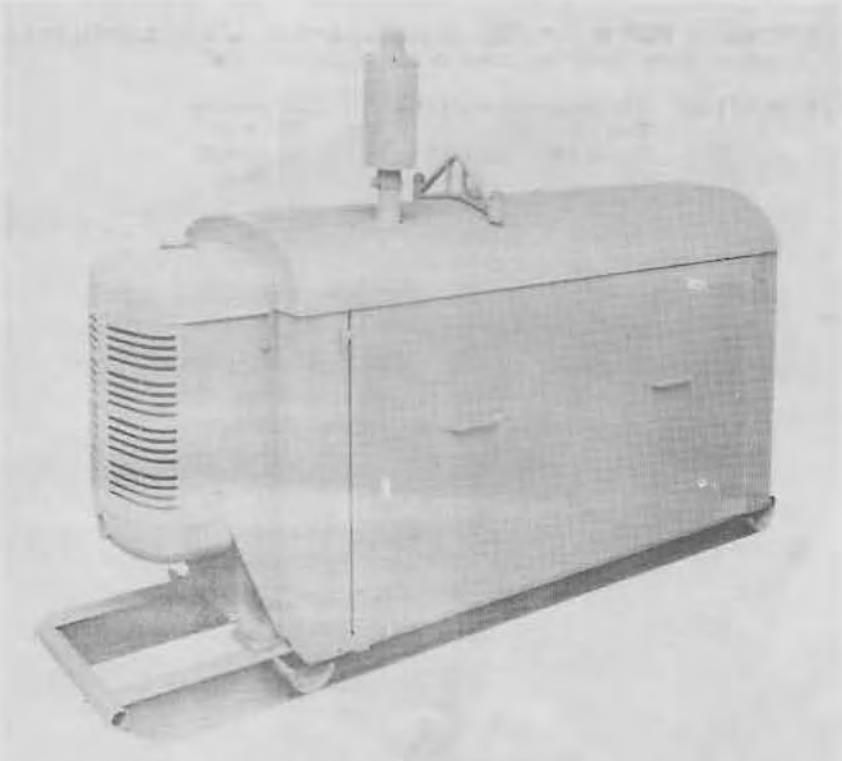
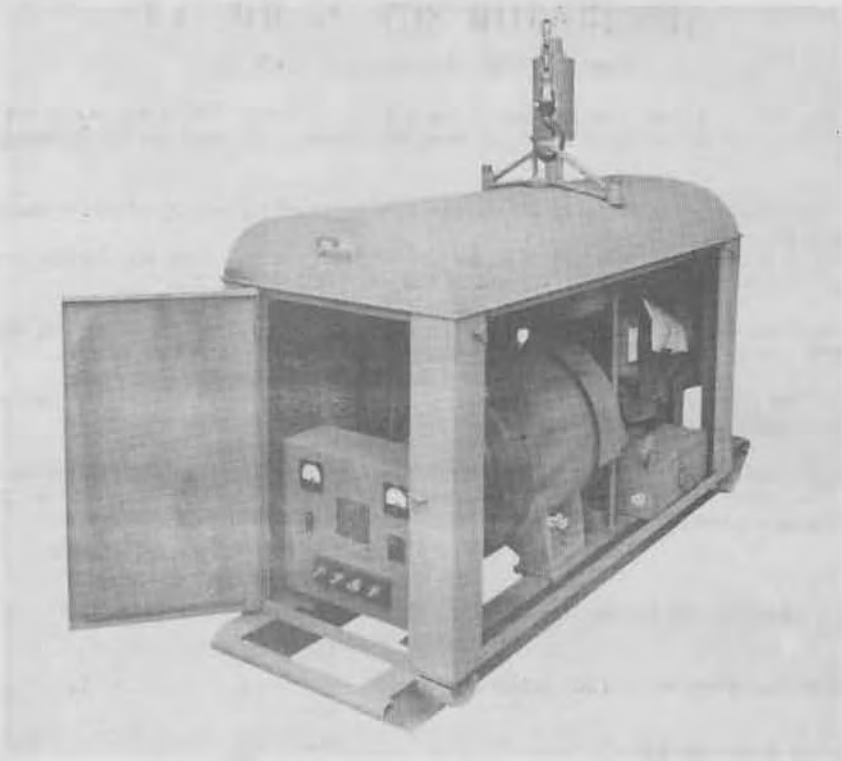

## GENERATOR SETS, 50 KW AND 75 KW

DIESEL ENGINE DRIVEN, STOCK NOS. 50 KW - 3E9-25, 75 KW - 3E9-26

**APPLICATION:** Either the 50 kw or the 75 kw Electric Generator, driven by a Diesel engine is used as the principle source of electric power for advance base light and power requirements.

**CAPACITY:** 62.5 kva or 50 kw @ .8 power factor.  
93.5 kva or 75 kw @ .8 power factor.

**DESCRIPTION:** The 50 kw and 75 kw generators have similar electrical characteristics and may be operated in parallel with each other, each adjusted to take its proportionate share of the load. The principle differences between them are the capacities of the generators and engines. The engine of the 50 kw set has four cylinders while the 75 kw set engine has six cylinders. The bore and stroke are the same for both. The electrical characteristics are 220-v or 440-v, 60-cycle, 3-phase a-c, connected in star for feeding a 4-wire distribution system. The running speed is 900 rpm.

**OPERATION:** The diesel electric generators are sturdy, self-regulating, reliable and dependable machines. The care and maintenance should be approximately the same as for any other Diesel electric power plant. Operating instructions and a maintenance manual are furnished with each machine. Each station should be operated by a qualified engineman. Sufficient assistance should be available so that during light loads, machines may be taken off the line for regular servicing and cleaning, and so that necessary repairs and adjustments can be made to maintain the machines in top condition.

**SUPPLIES REQUIRED:** The following quantities of fuel and lubricants are estimated to be required for operating the equipment 1,000 hours under severe conditions at the atmospheric temperature ranges shown:

	20° F and lower	32° F to 70° F	70° F and higher
<b>Fuel -</b>			
Unleaded gasoline, 65 octane, gals (50 kw)	35	35	35
(75 kw)	35	35	35
Diesel oil, 50 centane (50 kw)	5000.	5000.	5000.
(75 kw)	7000.	7000.	7000.
<b>Greases -</b>			
General purpose 14L9 No. 1 (chassis) lb	1.	1.	1.
Water Pump 14L11 lb	1.	1.	1.
<b>Oils -</b>			
Motor 9110 (SAE 10) (50 kw)	45. ✓	45.	45.
(75 kw)	65. ✓	65.	65.
" 9250 ( " 30) (50 kw)	45. ✓	45.	45.
(75 kw)	65. ✓	65.	65.

**AUXILIARY EQUIPMENT SUPPLIED:** A Kit of tools and a standard set of spare parts are supplied with each generator set.

**AUXILIARY EQUIPMENT NOT SUPPLIED:** Equipment necessary to handle, erect or house these sets, may be acquired from other sections of the allowance list.

	Weight: lbs.	Cube: cu. ft.
<b>SHIPPING INFORMATION:</b> 50 kw set -	11,557	330
5 para parts -	500	53.5
75 kw set	13,150	368
spare parts	500	53.5





## TRANSFORMERS, DISTRIBUTION

AIR COOLED, SINGLE PHASE, STOCK NO. 3E11

**APPLICATION:** Transformers are procured and stocked at Advance Base Depots for use at advance bases in shop buildings that have 440-volt electric power. This voltage is too high for lighting, running power tools and appliances and the transformers reduce the incoming voltage to the value desired.

**CAPACITY:** The transformers stocked and procurable range in capacity from 1/2-kva to 25-kva, all 60-cycle, single-phase. Specifically, the following sizes are carried: 1/2-kva; 3/4-kva; 1-kva; 1 1/2-kva; 3-kva; 5-kva; 7 1/2-kva; 10-kva; 15-kva; and 25-kva. Two or three transformers can be connected in banks on a three-phase system. Connected thus, three 25-kva transformers are capable of serving a three-phase load of 75-kva. Two 25-kva transformers, connected in open delta to a three-phase feeder, will have a capacity to serve a three-phase load of 43.4 kva, approximately 13% less than the sum of their single-phase ratings. Transformers are rated according to their ability to dissipate the heat generated by them while operating. The permissible heat for any particular transformer is determined by the "hot-spot" temperature, which is the highest temperature to which the insulation on the core windings may be subjected. The allowable full-load hot-spot temperature is usually 95°C (203°F) when the transformer is operating continuously in a surrounding temperature of 30°C (86°F). The rating may be increased 1% for each 1°C (1.8°F) that the surrounding air temperature falls below 30°C and decreased 2% for each 1°C (1.8°F) rise above this governing temperature. Transformers operated on intermittent or short time services may be loaded in excess of their rating. For example, for 2 hours' service a hot-spot temperature of 110°C (230°F) may be permitted a transformer, which, if on duty continuously for eight hours, would be restricted to a hot-spot temperature of 105°C (221°F). The operation of transformers above their normal ratings is largely dependent upon the regulation of the system, the nature of the load, thermal characteristics of the transformer, temperature of the surrounding air and means for cooling.



DESCRIPTION: These transformers are of the dry type and do not require insulating liquids to help keep them cool but dissipate the heat from their outer surfaces by radiation and convection to the surrounding air. They have two windings, the primary winding being connected to the incoming high voltage service conductors. The secondary winding, thoroughly insulated from the primary, has fewer turns of proportionately larger wire and supplies the lower voltage required by the load. Some of the transformers have taps brought out from the windings for adjusting the secondary voltage. All unused taps must be thoroughly insulated the same as the one being used. Most of the transformers are provided with connection boxes and are adapted for mounting either on wall or floor.

SHIPPING INFORMATION:

	Weight: lb	Cube: cu ft	Stock No:
1/2 kva transformer	25	.15	3E11-1
3/4 " "	42	.33	3E11-2
1 " "	56	.63	3E11-3
1 1/2 " "	65	.64	3E11-7
3 " "	108	1.40	3E11-12
5 " "	175	1.70	3E11-18
7 1/2 " "	261	2.45	3E11-23
10 " "	335	3.00	3E11-28
15 " "	554	5.17	3E11-32
25 " "	662	13.25	3E11-34

## RADIO, TWO WAY SYSTEM

### FREQUENCY MODULATED

**APPLICATION:** The Two-way radio systems are included in the procurement lists for advanced bases in order that communication may be established between the main base and points beyond the range of the local telephone systems, such as a ship anchored offshore or a nearby island.

**CAPACITY:** The system is designed for communicating between distances of from fifteen to twenty miles. Under normal atmospheric conditions, the operating range should be between twenty-five and thirty miles. When the weather is ideal, the operating range may increase to sixty-five miles or more.

**DESCRIPTION:** The system consists of a fixed station, a mobile transmitter-receiver unit, a ninety-foot mast, testing meters, a 6-volt storage battery, a portable engine-generator set and antenna material.

**SUPPLIES REQUIRED:** The following quantities of fuel and lubricants are estimated to be required for operating the equipment 1,000 hours under severe conditions at the atmospheric temperature ranges shown:

	32° F and lower	32° F to 70° F	70° F and higher
<b>Fuel -</b> Unleaded gasoline, 65 octane, gals	200.	200.	200.
<b>Greases -</b> Ball and roller bearing 14L3b grade No. 11 lb	1.	1.	1.
<b>Oils -</b> Motor 9110 (SAE 10) " 9250 ( " 30)	10.	10.	10.

**OPERATION:** The fixed station and mobile unit each require one man. The fixed station may be operated from any convenient 105-125 volt 60-cycle a-c source of electric power. The mobile unit is operated by power from a 6-volt radio storage battery. A 6-volt gasoline-engine generator set is furnished to keep the battery charged.

**AUXILIARY EQUIPMENT SUPPLIED:** Spare parts for one year's operation and instructions for operation and maintenance of each unit are included with each shipment.

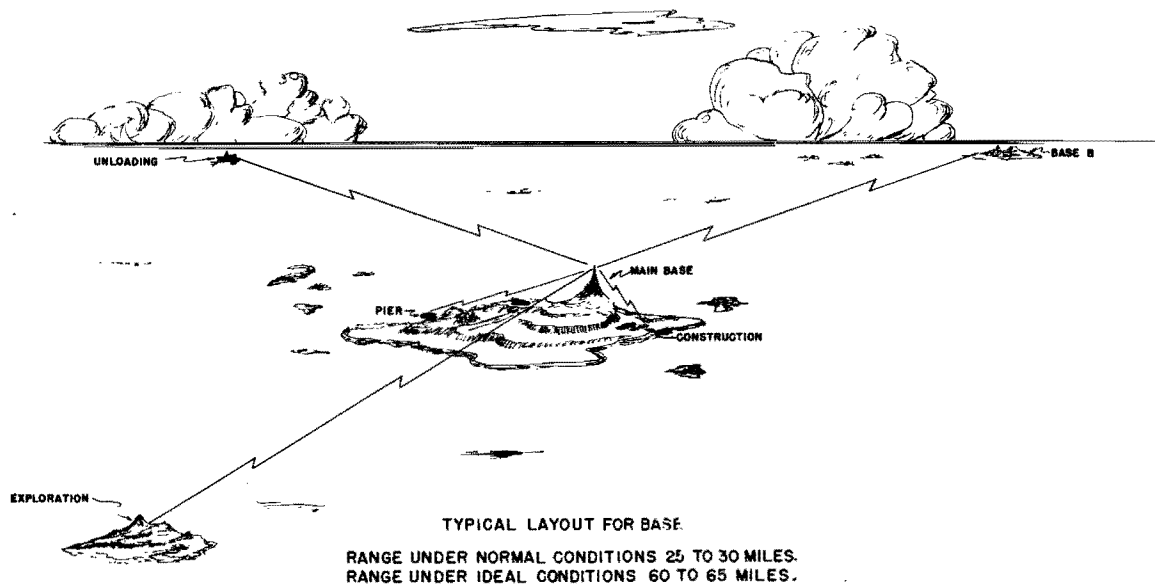

**AUXILIARY EQUIPMENT NOT SUPPLIED:** A supply of 60A21/TS-120 volt lamps for replacement of the mast obstruction of lights. A 105-125 volt, 60-cycle a-c source of electrical power.

**SHIPPING INFORMATION:** The system is prepared for export shipment in seven boxes, one bundle, and an unboxed casting. The latter is marked directly on its surfaces. The total cube is 93.55 cubic feet and weight 2,370 pounds. The bundle is 22 ft long, 1 ft high, 1 1/2 ft wide, weighs 850 lb and occupies 33.1 cu ft. The largest box is 5 ft long, 2 ft 8 in. wide and 2 ft 1 1/2 in. deep. It occupies 28.9 cu ft. Its gross weight is 700 lb.

## ANTENNA, RADIO

FIXED AND MOBILE, STOCK NO. 3F13

**APPLICATION:** These antennas are for use with two-way frequency-modulation radio systems.

**DESCRIPTION:** Sets consist of one antenna for the fixed station of a system and one antenna for the mobile station. The former is mounted on a mast and the latter suspended by a line from any high object. Both are of the 1/4-wave vertical type, designed for the frequency of the transmitters.

**OPERATION:** The mobile-station antenna is mounted in the field by throwing a line over the limb of a tree or other high object and raising the antenna as high as possible.

**AUXILIARY EQUIPMENT NOT SUPPLIED:** A 90-foot radio mast to support the fixed-station antenna. A line for elevating the mobile antenna. A transmission line to connect the antenna with the transmitter.

**SHIPPING INFORMATION:** The fixed and mobile antennas are packed for export shipment in one crate that weighs 70 lb, and is 12 ft 1 in. long x 6 1/2 ft wide x 5 in. deep.

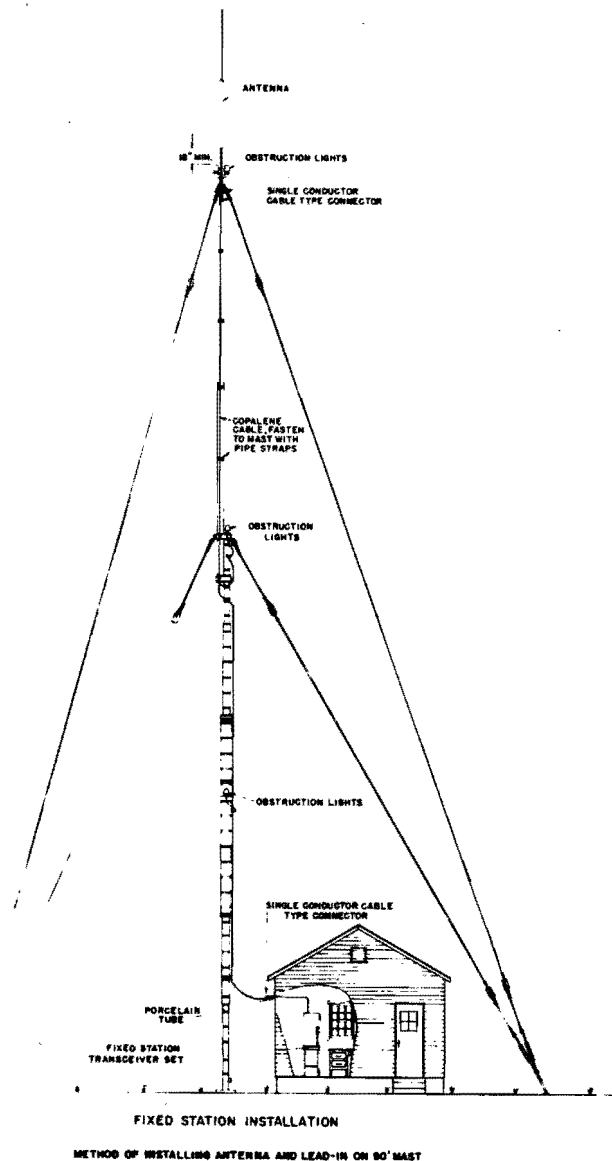
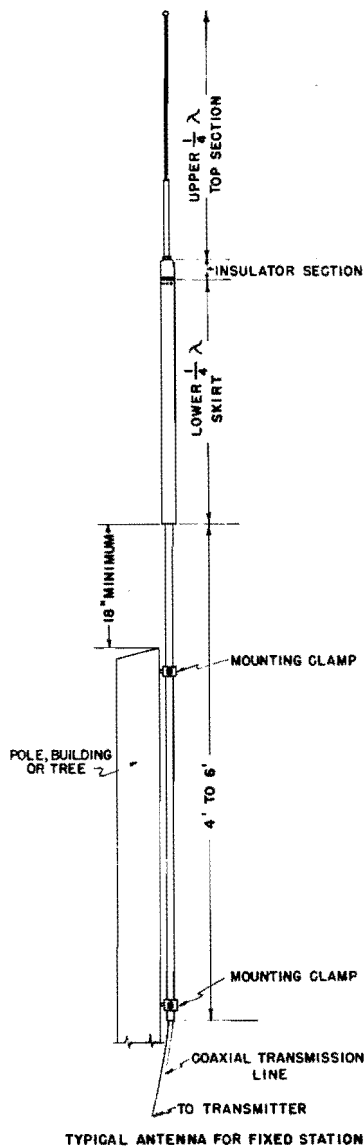

## BATTERY, STORAGE, RADIO

STOCK NO. 3K16-4

**APPLICATION:** The storage battery is required to furnish the electric power necessary to operate the mobile radio station.

**CAPACITY:** The batteries furnished at present have thirteen plates. They are rated to discharge 88.8 ampere hours to a final voltage of 1.75 volts in 8 hours. Higher discharge rates may be taken from the battery. However, in doing so there would be some sacrifice of ampere-hour capacity.

**DESCRIPTION:** The batteries are of the six-volt automobile type. They have a three-cell hard rubber case and hard rubber cell-covers with vented fill caps. The plates are dry charged and the acid electrolyte (sp.g-1.270) is packed and shipped in a separate crate.

**SUPPLIES REQUIRED:** Distilled water.

**SHIPPING INFORMATION:** The packing box is 11 in. long x 8 in. wide x 10 in. high and weighs 55 lb when packed for export.



## MAST, RADIO

NINETY-FOOT LENGTH, STOCK NO. 3F10-1

**APPLICATION:** The 90-ft tubular radio mast is furnished with the radio system for the purpose of supporting the fixed station antenna.

**DESCRIPTION:** The tubular mast is shipped in five sections. The mast has a 2 ft x 2 ft base plate; aviation obstruction lights and guy wires, and is complete with thimbles, turnbuckles, strain insulators and clips, pole steps, and hoisting equipment. Anchors for the guy wires are not included.

**OPERATION:** After the mast has been properly erected, the principal maintenance items are occasional adjustment of the guy wires. The obstruction lights must be inspected daily and any lamp bulbs that are burned out replaced.

**SHIPPING INFORMATION:** Shipped complete with all necessary fittings - a bundle of mast sections, a base plate, and two boxes of equipment and parts. The largest box is 5 ft x 2 ft 8 in. x 2 ft 1 1/2 in. and weighs 700 lb. It occupies 28.9 cubic feet of space. When bundled for shipment, the mast is only 22 ft long and weighs 850 lb. The gross weight is 1,700 lb and the gross cube is 63.8 cu ft.

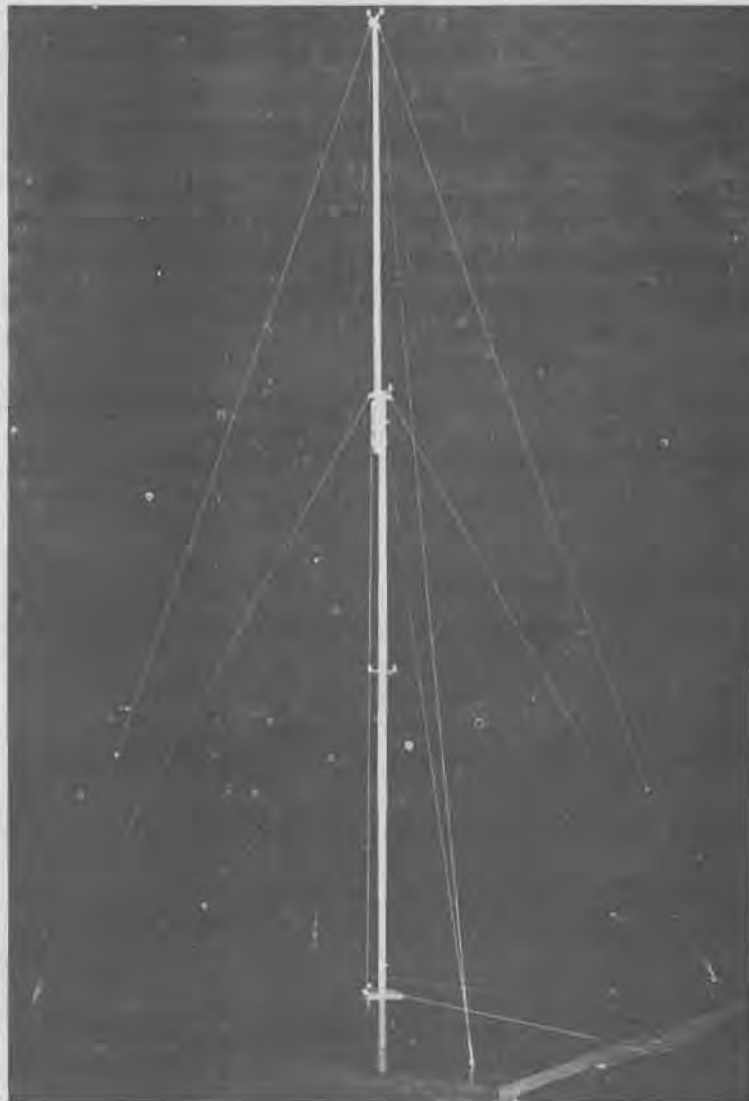

## RADIO STATION, FIXED

STOCK NO. 3F11

**APPLICATION:** Radio apparatus makes possible communication between an advanced base and points beyond the limits of the telephone system, such as nearby islands or ships offshore.

**CAPACITY:** The transmitter is designed to radiate 50 watts of radio energy to the antenna system. The set is designed to give dependable service over distances of between 15 and 20 miles. Since the range or distance that the set will cover will vary according to the prevailing atmospheric condition and the terrain over which the communication is being worked, greater distances may be attained when conditions are favorable for radio communication.

**DESCRIPTION:** The apparatus is tuned to a very high frequency wave-cycle. This makes it possible to take advantage of desirable characteristics of frequency modulation instead of using the usual method of amplitude modulation. Both the transmitter and receiver are set for a single frequency band. Crystal oscillators are employed to stabilize the tuning and hold it constantly at the right frequency. The receiver is of the superheterodyne type; by the use of two crystal-controlled intermediate amplifiers and power rectifiers suitable for receiving frequency modulated signals, the reception is made clear and free from noise.

**OPERATION:** Special operators are not required. One man can operate the set.

**SUPPLIES REQUIRED:** Spare parts estimated to meet the needs for operating the sets for one year and instructions for operation and maintenance are included.

**AUXILIARY EQUIPMENT NOT SUPPLIED:** A separate circuit of 60-cycle 105-125 volt, single-phase alternating electric current is required to operate the set.

**SHIPPING INFORMATION:** Spare parts are packed for export in the same crate as the radio station. The crate is 3 ft 1 in. long x 2 ft 2 1/2 in. wide x 1 ft 6 in. deep. It weighs 220 lb and occupies 10 1/2 cu ft of shipping space.





## RADIO STATION, MOBILE

STOCK NO. 3F11

**APPLICATION:** The mobile radio transmitting and receiving sets are supplied for the purpose of maintaining communication between the main and exploration or reconnaissance parties or points beyond the limit of the local telephone system.

**CAPACITY:** The mobile radio station has a transmitting capacity of about 25 watts. The receiver has approximately the same range and characteristics as the fixed-station receiver.

**DESCRIPTION:** With the exception of the power output and of the fact that the power input is supplied by a six-volt portable engine generator, the characteristics of the mobile station are similar to those of the fixed station.

**OPERATION:** Personnel instructed in the functioning of the controls can operate the stations.

**SUPPLIES REQUIRED:** Six-volt d-c electricity and the following quantities of fuel and lubricants are estimated to be required for operating the equipment 1,000 hours under severe conditions at the atmospheric temperature ranges shown:

	32° F and lower	32° F to 70° F	70° F and higher
<b>Fuel -</b> Unleaded gasoline, 65 octane, gals	200.	200.	200.
<b>Greases -</b> Ball and roller bearing 14L3b grade No. 11 lb	1.	1.	1.
<b>Oils -</b> Motor 9110 (SAE 10) " 9250 ( " 30)	10.	10.	10.

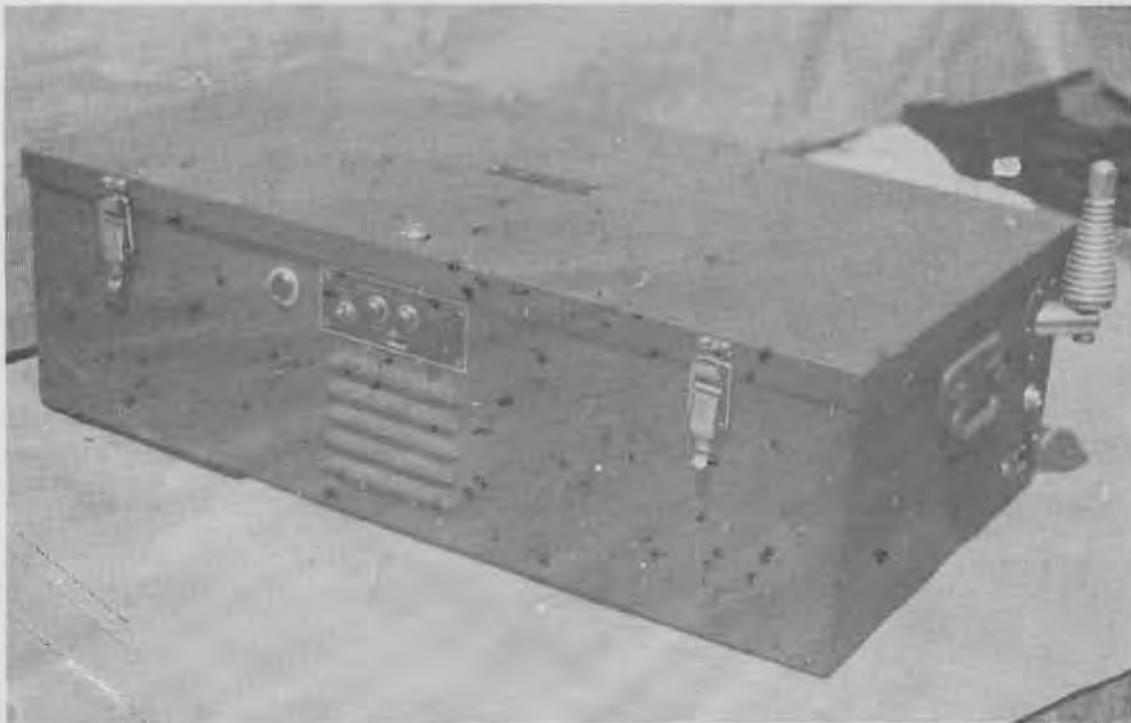

**AUXILIARY EQUIPMENT SUPPLIED:** One year's supply of spare parts is furnished with the system. Instructions for operation and maintenance are included.

**AUXILIARY EQUIPMENT NOT SUPPLIED:** A six-volt storage battery and a six-volt engine generator set. The radio systems include the mobile antenna equipment. If additional mobile stations are ordered, the antenna equipment will have to be included.

**SHIPPING INFORMATION:** With the exception of the six-volt storage battery and the six-volt engine generator set, the mobile station is crated for export shipment in a box 4 ft 5 in. long x 1 ft 11 in. wide x 1 ft 5 in. high. It weighs 240 lb and occupies 12 cu ft of shipping space. The box includes a radio test meter and fifty feet of antenna transmission line.

## **SYSTEM, PUBLIC ADDRESS, TALK BACK**

**ASSEMBLY NO. 3006**

**APPLICATION:** This system is used for communications between two persons or with eight persons dispersed over rather wide areas. The system consists of a control station and eight speaker-microphones. The operator at the control station can announce by loud speaker or code signal to any of the remote stations, which must be located within 2000 feet of the control station. He may also connect additional stations or all of the stations to listen in on the communication. Any person who is within approximately 30 feet of a speaker-microphone station set up for communication may answer back to the operator and be heard by all of the other remote stations that are in on the set-up.

**CAPACITY:** Only one conversation or "talk-back" may be conducted over this system between the control station and any remote station or between any two remote stations at a time, but the other stations on the line may listen in. Or, a communication may be delivered from one station to the other eight simultaneously.

**OPERATION:** One man at the control station can operate the system.

**SUPPLIES REQUIRED:** A 15-ampere, 105-to 125-volt, 50-60 cycle, single-phase electric circuit will be required to supply power to operate the system.

**AUXILIARY EQUIPMENT SUPPLIED:** Along with each system is shipped a supply of spare tubes and parts, estimated to be sufficient for one year of operation.

**AUXILIARY EQUIPMENT NOT SUPPLIED:** The necessary hand tools that will be required for making repairs are not furnished with the systems but will be available at the base from other sources.

**SHIPPING INFORMATION:** The system is packed for export in ten containers numbered from one to ten. The total weight is 4814 lb and volume 228 1/2 cu ft. The largest container is 73 1/2 in. x 35 1/2 in. All the material that is necessary for a complete system, including the wire, is supplied.

**ORDERING INSTRUCTIONS:** Additional systems to meet special needs will have to be ordered by the commanding officer through regular channels.

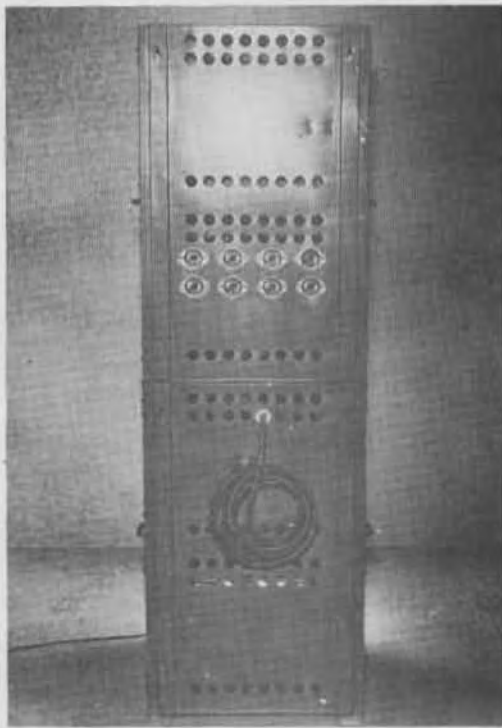

## CONTROL PANEL

### TALK BACK, PUBLIC ADDRESS SYSTEM

**APPLICATION:** The purpose of the "Control Panel" is to furnish the necessary audio power amplification to operate loud speakers. By means of the various switches on the panel, the operator can select and communicate with the desired remote stations.

**CAPACITY:** Sufficient to operate eight loud speaker stations simultaneously.

**DESCRIPTION:** The "Control Panel" is a dual rack assembly consisting of an upper section cabinet complete with a voltage amplifier, monitor speaker, high-pass filter, master switch, speaker switches, talk-listen switch, volume control, pilot light assembly, microphone control, master gain control, matching transformers, microphone receptacle, panels and connection cord. The lower section cabinet is complete with two power amplifiers, plugs and panels.

**OPERATION:** The operator need not have special technical training. Follow simple instructions and use as you would a telephone.

**SUPPLIES REQUIRED:** A source of 105 to 125 volt 60 cycle alternating current is required to operate the apparatus. A supply of spare parts, tubes, 1 - ampere fuse for the voltage amplifier and 3 ampere fuses for the power amplifier should be available for ready replacement.

**AUXILIARY EQUIPMENT SUPPLIED:** A book of instructions is packed with the control panel.

**AUXILIARY EQUIPMENT NOT SUPPLIED:** A microphone oscillator input unit, loud speaker and matching transformer assemblies, 8 - 2000 ft reels of line wire, a supply of spare parts, spare tubes and spare fuses.

**SHIPPING INFORMATION:** When packed for export, the crate measures 67 in. long x 26 in. wide x 19-1/2 in. deep. The volume is 20 cu ft and weighs 270 lb.



# COMMUNICATIONS

THE COMMUNICATIONS SECTION OF THE ARMY SIGNAL CORPS

The communications section of the Army Signal Corps is responsible for the maintenance and operation of all communication equipment used by the Army. This includes the installation, operation, and maintenance of all types of communication equipment, including radio, telephone, and teletype systems. The section also provides technical assistance to other units in the Army and is responsible for the development of new communication equipment and systems.

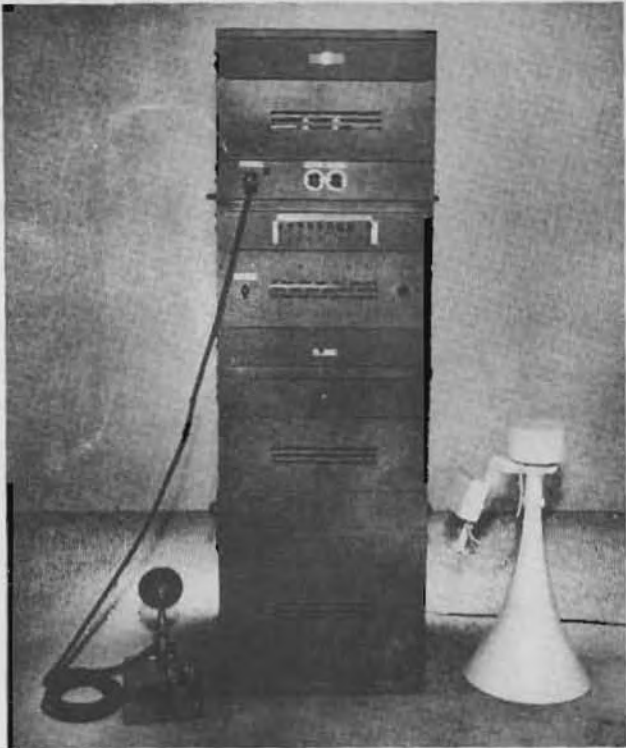

## LOUD SPEAKER STATION

TALK-BACK PUBLIC ADDRESS SYSTEM, STOCK NO. 3L1

**APPLICATION:** The loudspeakers are installed at the remote stations so that an announcement coming over the system from the control station can be heard at a considerable distance from the station. The speaker may also be used as reply microphones or input units, so that an attendant within a radius of 30 feet of a speaker may answer back and be heard over the rest of the system.

**CAPACITY:** Each speaker will take a normal input of 10 to 20 watts continuously. They will handle a peak input of 20 watts each.

**DESCRIPTION:** The loudspeaker station should be set up in a location suitable for commanding the desired area. The station consists essentially of the speaker mechanism, a narrow beam baffle, a matching transformer enclosed in a 4 in. x 4 in. steel box, and the mounting bracket. The speaker mechanism is of the permanent magnet, moving-voice-coil, dynamic type. The permanent magnet renders a flux density of 12,000 gages and the voice coil has a resistance of 15 ohms. The latter weighs 10 3/4 lb and is 4 1/2 in. high and 5 1/2 in. in diam. The narrow beam baffle is constructed of non-vibratory material in order to obviate rim-rattle. It responds to frequencies of between 300 and 7000 cycles, is 22 in. long and has a bell diam. of 12 1/2 in. The net weight of the narrow beam baffle is 6 1/2 lb. The matching transformer, furnished to match the line impedance to the 15-ohm voice coil of the speaker mechanism, is rated at 10-watts audio power. It is connected at the factory to the proper primary taps and no further adjustments are necessary. The net weight of the matching transformer is 6 oz. The entire assembly is mounted on an upright bracket provided with a mounting base.

**OPERATION:** The speaker is operated by the audio-frequency electric current that is generated by the control panel. The current is fed to the speaker by a 2-conductor, 14-gage copper wire. For best results, the length of the 2-conductor line to any station should not exceed 2,000 feet.

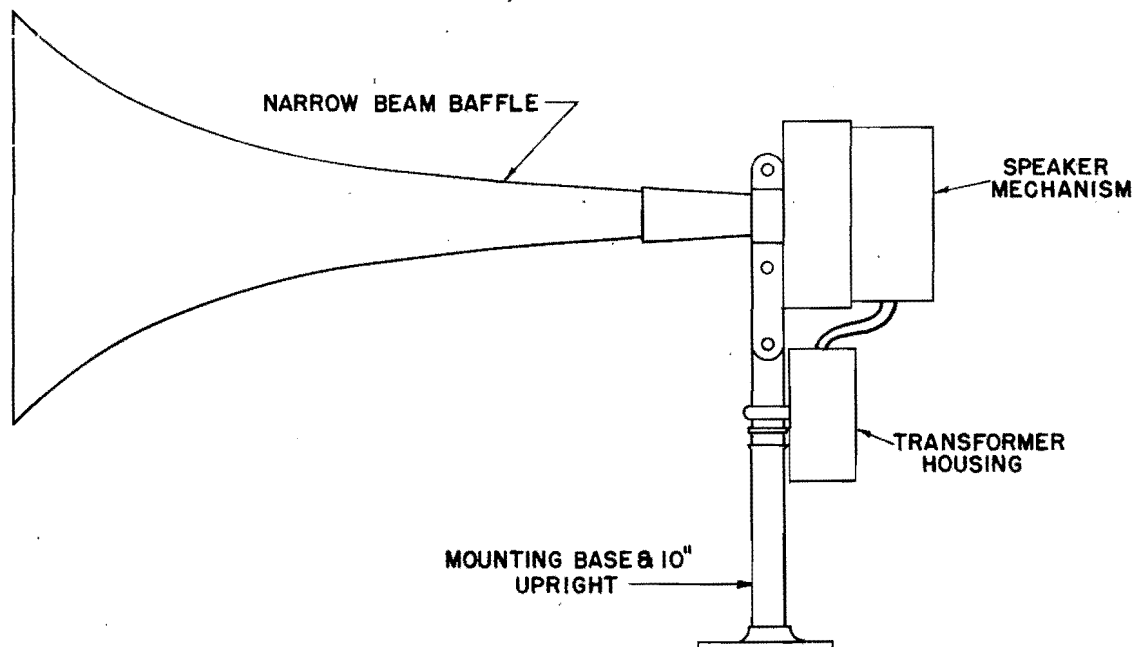

DETAIL "C" LOUDSPEAKER

**AUXILIARY EQUIPMENT SUPPLIED:** 1 additional speaker mechanism, 1 extra baffle and 1 matching transformer as spare parts.

**SHIPPING INFORMATION:** The loudspeaker assemblies are packed and shipped along with the microphone oscillator unit and the allotted spare parts. The crate measures 73 in. x 44 1/2 in. x 35 1/2 in. and weighs 680 lb.



## MICROPHONE OSCILLATOR UNIT

TALK-BACK PUBLIC ADDRESS SYSTEM, STOCK NO. 3L1

**APPLICATION:** The microphone picks up sound waves and converts them into electrical impulses of the same frequency as that of the sound that is picked up. It generates the electrical vibrations that are fed into and amplified by the voltage amplifier. The oscillator, which is operated by a telegraph key, generates electrical oscillations of 300 cycles or 600 cycles. The oscillator enables the operator to send code messages out over the system, with a tone that can be heard through the other sounds in the vicinity of the remote speakers, and to test system at regular intervals.

**CAPACITY:** The microphone is an "all-purpose" low impedance (250 ohms) instrument. The frequency response is 60-cycles to 10,000-cycles. The output level is 51 decibels 10 bar, open circuit, to a reference level of 1 milliwatt (.001 watt).

**DESCRIPTION:** The microphone oscillator input unit is composed of a microphone, a push mike adapter, telegraph key, switch, volume control and metal housing, complete with a 15-foot shielded connecting cable and microphone plug.

**OPERATION:** The unit is so designed that the operator may use it from a position on a table or as a hand set. The 15-foot cable permits a fair radius of operation.

**SUPPLIES REQUIRED:** The electric power for operating the unit is supplied from the control panel.

**AUXILIARY EQUIPMENT SUPPLIED:** A spare microphone oscillator unit complete with tubes, and two extra sets of tubes are furnished with the system. All necessary auxiliary equipment is furnished for an estimated one year's operation.

**SHIPPING INFORMATION:** The microphone oscillator is shipped packed in the same box with the loudspeakers and the spare parts furnished with the system.

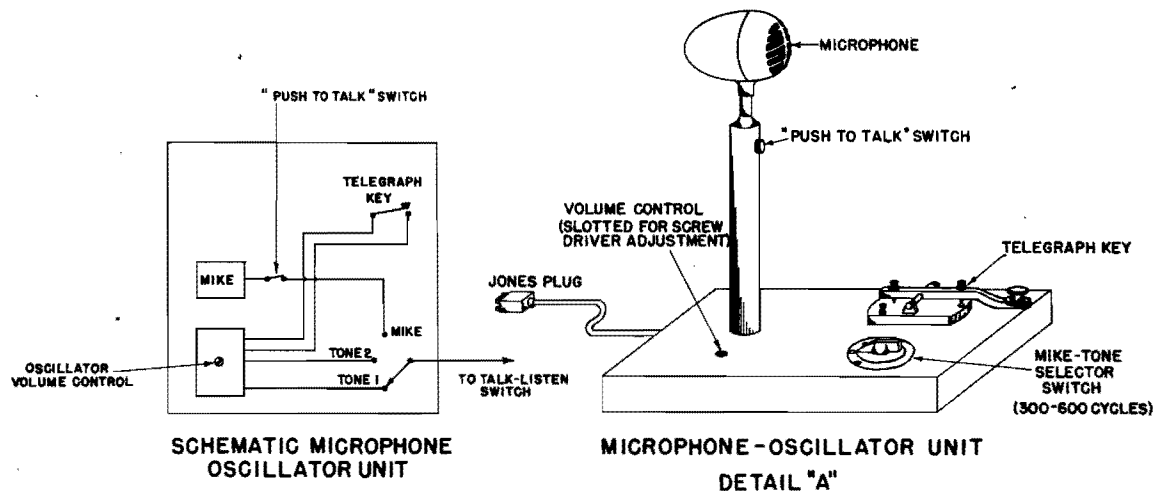

## SYSTEMS, TELEPHONE

50 CIRCUIT, ASSEMBLY NO. 3007

**APPLICATION:** The telephone systems are provided for general communication throughout the base and between posts.

**CAPACITY:** The telephone systems included in the allowance lists for advanced bases are made up from a number of 50-line systems, as required. For bases that would need a lesser number of lines, systems of ten, twenty, thirty or forty lines may be procured.

**DESCRIPTION:** Each station is comprised of a desk set, a magneto set for calling the switchboard, and a local battery to energize the talking circuit. Where lines are run overhead, each station is supplied with a 98A-lightning protector to protect the instrument from damage. Reasonable quantities of line wire and splicing equipment are supplied as a part of the system.

**OPERATION:** The system switchboard is furnished with a convenient hand set for answering calls and supervising the connections. When traffic is light the operator may attend to other duties that will not take him out of hearing distance from the switchboard signal.

**SUPPLIES REQUIRED:** The principle supplies are furnished along with the system and consist of standard kits of spare parts, batteries, and line wire.

### TELEPHONE SYSTEMS

BILL OF MATERIAL			
ITEM	DESCRIPTION OF ITEM	QUANTITY	UNIT OF MEASURE
1.	WESTERN ELECTRIC *1800 SECTIONAL UNIT TYPE, MAGNETO NON-MULTIPLE SWITCHBOARD CONSISTING OF THE FOLLOWING:		
	AA-1 TOP UNIT	1	EACH
	BA-12 LINE UNITS	5	EACH
	CB-6 CORD UNIT	1	EACH
	D-3 SUPPORTING UNIT	1	EACH
	D-4 SUPPORTING UNIT	1	EACH
	NIGHT ALARM CIRCUIT	1	EACH
	T-1600 AIR-CELLS (1.5 VOLTS EA)	8	EACH
2.	WESTERN ELECTRIC 1420B DISTRIBUTING FRAME CONSISTING OF THE FOLLOWING:		
	*1420B DISTRIBUTING FRAME	1	EACH
	*1431A 20 LINE MAIN FRAME UNITS CONSISTING OF THE FOLLOWING:		
	1435W INSIDE PROTECTIVE GROUP	3	EACH
3.	WESTERN ELECTRIC *E841 CABLE TERMINAL CONSISTING OF THE FOLLOWING:		
	E-51 CABLE TERMINAL BOX	1	EACH
	E-51 BINDING POST CHAMBER	1	EACH
	87-A PROTECTOR MOUNTINGS	2	EACH
4.	*211AW HAND TELEPHONE SETS	1	EACH
5.	*1407C TESTING CABINET	1	EACH
6.	*250 AW-3 TELEPHONE SET	50	EACH
7.	*300N DESK SET WITH *48 TYPE GENERATOR	50	EACH
8.	T-1600 AIR-CELLS (1.5 VOLTS EA.)	150	EACH
9.	2 CONDUCTOR TELEX CABLE *17 AWG	90-2500 FT LENGTHS	FEET
10.	CABLE, LEAD COVERED BPA-51	50	FEET
11.	CABLE, SWITCHBOARD 1804GL	25	FEET
12.	PROTECTORS *98A	60	EACH
13.	FUSES *11C	100	EACH
14.	PROTECTOR BLOCKS *26	100	EACH
15.	PROTECTOR BLOCKS *27	100	EACH
16.	*10 R.H. BRASS WOOD SCREWS, 1/4" LONG	1	GROSS
17.	GROUND CLAMPS, *1 RELIABLE	75	EACH
18.	3/8" LB. ROLL FRICTION TAPE, "MANSON"	25	EACH
19.	3/8" LB. ROLL RUBBER TAPE, "ONONITE"	15	EACH
20.	*14 TELEX GROUND WIRE	3000	FEET
21.	SPLICING SLEEVES, "NICOPRESS", S-0458	250	EACH
22.	"NICOPRESS" SPLICING SLEEVE TOOL *17	3	SETS
23.	*801 PAINE ROMAX STRAPS (ONE HOLE)	8	LBS.

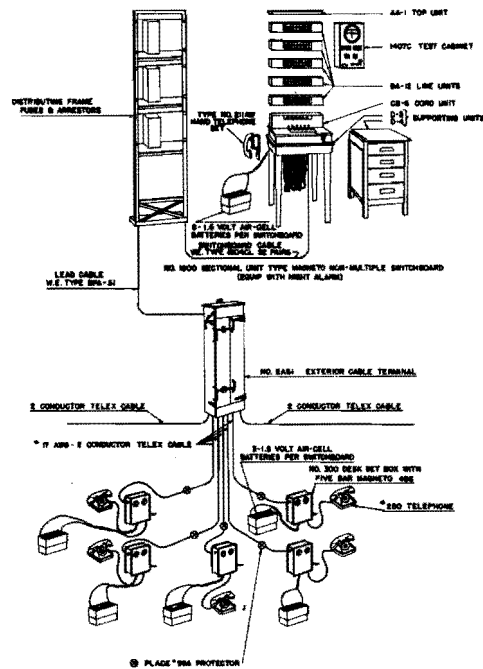

**AUXILIARY EQUIPMENT SUPPLIED:** The necessary auxiliary equipment, such as the "Testing Cabinet", is furnished with the 50-line system.

**AUXILIARY EQUIPMENT NEEDED BUT NOT SUPPLIED:** Additional auxiliary equipment will be required only when it is necessary to extend the number of stations beyond the number included by installing additional instruments and arranging to call them by a coded ring signal. In which case additional wire and instruments would have to be ordered for shipment to the base.

**SHIPPING INFORMATION:** A 50-station system complete is shipped in 30 crates and 90 reels of wire. The heaviest crate weighs 379 lb and the largest crate is 30.2 cu ft. The entire shipment weighs 16,663 lb and measures 652.1 cubic feet. These figures do not include the standard allotment of spare parts.

## TELEPHONE SWITCHBOARD

50 CIRCUIT, SECTIONAL UNIT TYPE, STOCK NO. 3K10-2

**APPLICATION:** The No. 1800 telephone switchboards are designed primarily for use in small telephone central offices. They serve a dependable purpose for making communication connections between the various telephone stations of the system.

**CAPACITY:** The switchboard has a capacity of fifty private lines. The cord unit furnished with the board will permit a traffic load of twelve stations, or six conversations at the same time. The switchboard is very flexible in its arrangement, and if required, the system can be extended to seventy private lines, provided that the permissible six conversations satisfy the traffic requirements. Two or more of these switchboards may be used to serve systems of greater capacity.

**DESCRIPTION:** The switchboard together with the main distributing frame occupies a floor space of approximately thirty square feet and the frame height is 6 ft 9 5/8 in. The weight of the switchboard is insufficient to require any special foundation preparations. It may be located and placed as other office furniture.

**OPERATION:** The switchboards are furnished with convenient hand-set telephones so that when traffic is light, the operator may attend other duties about the office.

**SUPPLIES REQUIRED:** The supplies required to maintain the switchboard in operation are the necessary list of replacement parts, batteries, fuses and heater coils.

**AUXILIARY EQUIPMENT NOT SUPPLIED:** Additional supplies such as spare parts, batteries, fuses, heater coils, wire, and telephone sets should be ordered when the inventory of these supplies reaches a pre-determined low amount.

**SHIPPING INFORMATION:** Shipped in 4 crates.

Gross weight: 797 lb

Cube: 62.2 cu ft.

Dimensions of the largest crate are 52 1/2 in. x 32 in. x 31 in. The heaviest crate weighs 326 lb.

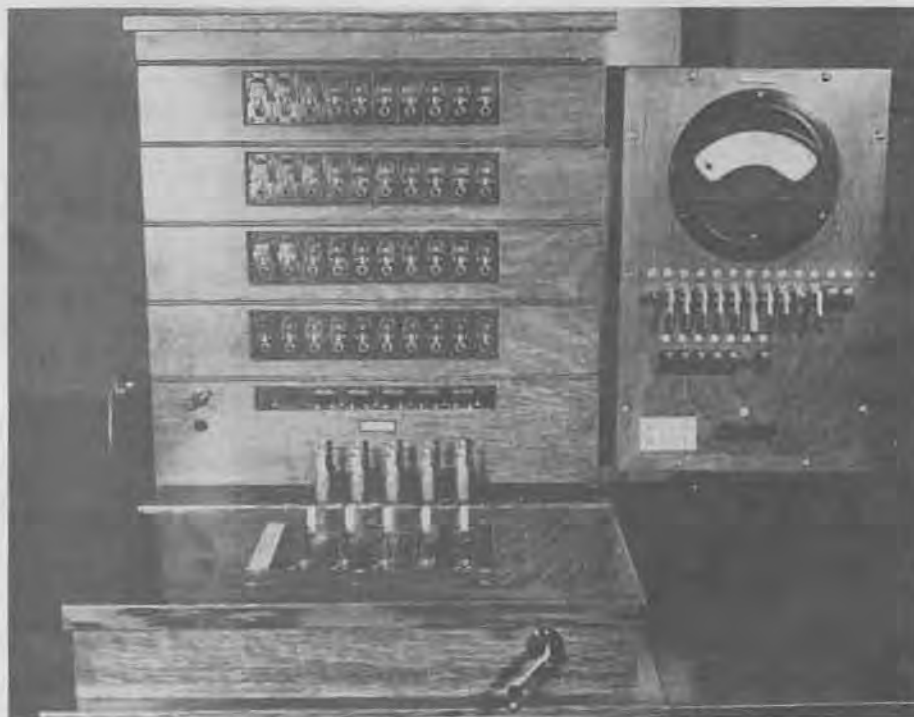

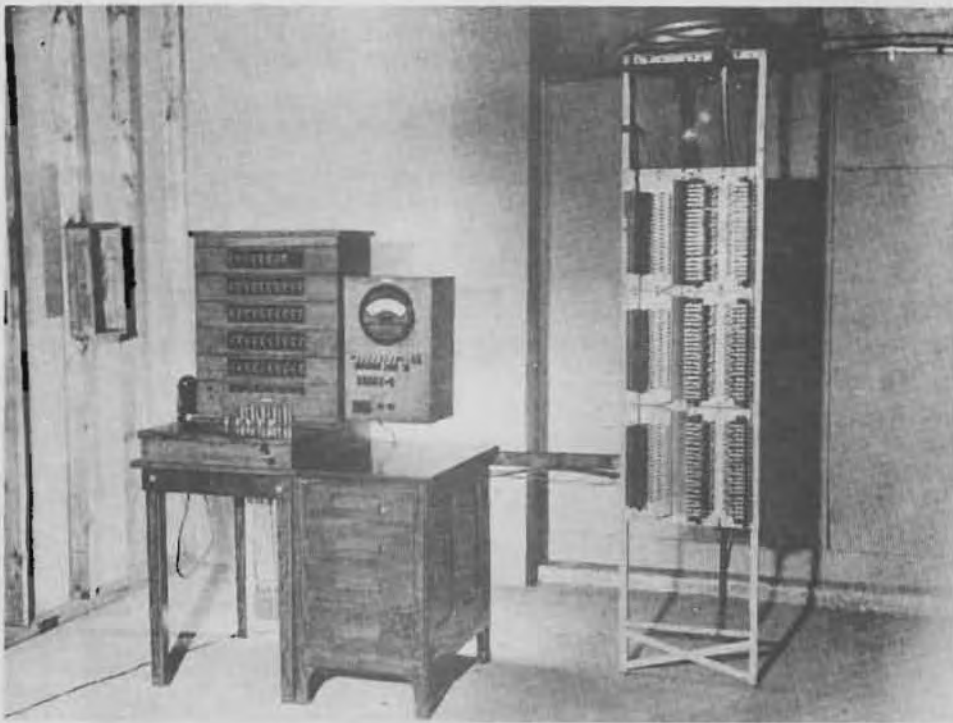

## COMMUNICATION SYSTEM, INTER-OFFICE

ASSEMBLY NO. 3005

**CAPACITY:** The system consists of one control station and six remote units. The control station may communicate with from one to six remote stations.

**DESCRIPTION:** The control station may communicate with any remote unit by merely pushing a button to establish instant connection. The control station may communicate with more than one station at a time, by pushing the desired station push-buttons in at the same time. The control station and remote units are contained in compact desk or table cabinets.

**OPERATION:** The inter-office communication system is quite simple to put into operation. Full instructions and wiring diagrams are furnished with each system. A three conductor cable is run from the control station and is connected to the remote station instrument. The length of the cable may be as long as 1,000 ft. The instruments will operate on either a.c. or d.c. current. The voltage may range from 105 to 125. Electric power is required at the control station instrument only.

**AUXILIARY EQUIPMENT SUPPLIED:** An ample supply of three-conductor line wire and spare parts are furnished with the system.

**AUXILIARY EQUIPMENT NOT SUPPLIED:** A source of electric power.

SHIPPING INFORMATION:	Weight: lb	Cube: cu ft
System:	140	2.24
6 - 1,000-ft reels of wire	230 ea.	32 in. x 32 in. x 23 in.

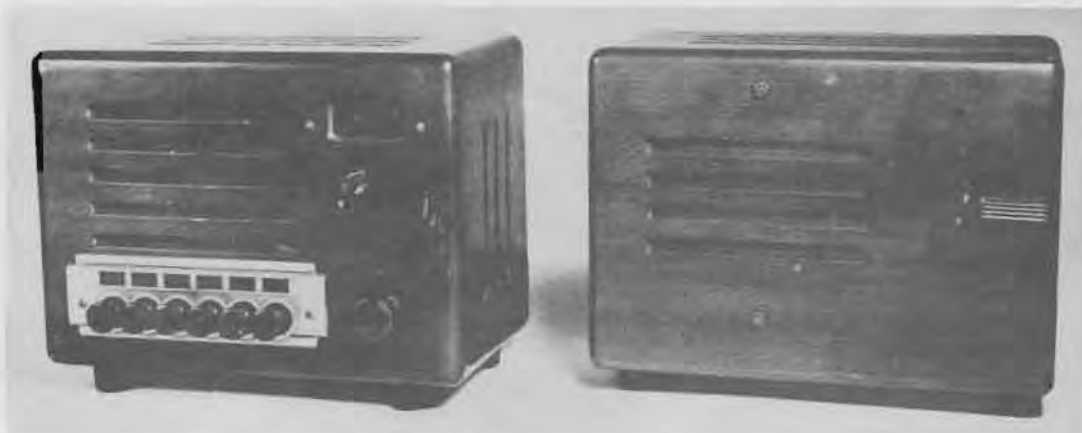

## SIREN

VERTICAL TYPE, STOCK NO. 3Q4-1

**APPLICATION:** Power driven sirens are designed to make audible signals that can be heard over wide areas for fire alarms, air raid alarms - gas attacks, work program signals and to meet other requirements for audible signals.

**CAPACITY:** A 2-horse power motor drives the siren to a sound level that can be heard in still air a distance of about 1 1/2 miles and against a 22 knot wind for about .8 mile. The contour of the terrain and the proximity of trees and other growth will need to be taken into consideration as local surroundings may affect materially the sound range. For best performance the siren should be mounted as high above the surroundings as possible.

**DESCRIPTION:** The vertical type siren is a well designed weather proof apparatus. It has a dynamically balanced rotor. The motor has ball bearings and will carry an overload of 100%. Net weight is 65 lb.

**OPERATION:** The motor is wound to operate on a 110/220 volt single phase 60 cycle electric circuit. It can be operated manually by closing the control switch or from code units that operate the motor by means of a power relay.

**SUPPLIES REQUIRED:** 9110 (SAE-10) lubricating oil for bearings and 110 volt electric current.

**AUXILIARY EQUIPMENT NOT SUPPLIED:** The auxiliary equipment will have to be procured for the requirements of each installation. It will be necessary to procure a supply of electric wire, a disconnect switch, a motor starter, remote control units (as required) and materials to mount the siren as high as possible above ground.

**SHIPPING INFORMATION:** The dimensions are 18 3/4 in. high by 31 in. in diameter.

Shipping weight 120 lb

The shipping space required is approx. 14 cu ft.



**VERTICAL SIREN**

SECTION IV - GENERAL EQUIPMENT

List of Effective Pages

	July 1945		November 1943		November 1943
A357 - A358	July 1945		381 - 382	November 1943	403 - 404
357 - 358	November 1943		383 - 384	" "	405 - 406
359 - 360	" "		385 - 386	" "	407 - 408
361 - 362	" "		387 - 388	" "	409 - 410
363 - 364	" "		389 - 390	" "	411 - 412
365 - 366	" "		391 - 392	" "	413 - 414
367 - 368	" "		393 - 394	" "	415 - 416
369 - 370	" "		395 - 396	" "	417 - 418
373 - 374	" "		397 - 398	" "	419 - 420
375 - 376	" "		399 - 400	" "	421 - 422
377 - 378	" "		401 - 402	" "	425 - 426

SECTION IV - GENERAL EQUIPMENT

INDEX TO CONTENTS

	<u>Pages</u>		<u>Pages</u>
<u>Surveying</u>		<u>Gas Protection (Cont'd)</u>	
Compass	357-358	Apparatus, (Sprayer), Decontaminating, 1 1/2-Qt	401-402
Level, Engineer's	359-360	Apparatus, (Sprayer), Decontaminating, 3-Gal	403-404
Level, Hand-Type	361-362	Apparatus, (Sprayer), Decontaminating, Power-Driven, M4 (400-Gal)	405-406
Matchete	363-364	Clothing, Protective, Suit, Gloves & Socks	407-408
Pole, Range	365-366	Protector, Collective, Navy, Design No. 1	417-418
Rod, Leveling	367-368	Pump, Stirrup	419-420
Tape, 100-Ft, Steel, in Case	369-370	<u>Photographic</u>	
Transit, Engineer's	373-374	Photographic Projector, Movie and Slide, with Case and Automatic Takeup	421-422
<u>Office</u>		<u>Miscellaneous</u>	
Calculating Machine, Hand or Electric	375-376	Insecticide, (Non-refillable), Self-Spraying	425-426
Duplicator, Machine	377-378		
<u>Weapons</u>			
Carbine, .30-Cal, M1	381-382		
Grenade, Hand, Fragmentary, Mark II	383-384		
Machine Gun, .30-Cal, Browning, (1919A4)	385-386		
Mortar, 60-MM, M2	387-388		
Pistol, .45-Calibre, Complete with Holster and Belt	389-390		
Rifle, Browning Automatic	391-392		
Rifle, .30-Cal, Complete with Sling	393-394		
Submachine Gun, .45-Cal, Thompson, M/1928A1	395-396		
Very Pistol, 10-Gage, Mark II	397-398		
<u>Gas Protection</u>			
Alarm, Gas	399-400		



## COMPASS

STOCK NOS. 4F7-3 AND 4F7-4

**APPLICATION:** Used on reconnaissance or other rough surveys to obtain magnetic bearings of lines.

**DESCRIPTION:** No. 4F7-3 has a 2 in. needle with jewel center and automatic stop. Graduated on raised silvered ring to degrees, numbered 0 to 360°, made of aluminum with black hardened surface with sighting line on lid. No. 4F7-4 is similar to No. 4F7-3 but numbered in quadrants.

**OPERATION:** To make an observation the operator lays the cover back, holds the compass in a horizontal position and releases the needle so it is free to rotate. A sight is taken along the line on the cover; the needle is clamped in position by depressing the pin and the bearing is read.

**AUXILIARY EQUIPMENT NOT SUPPLIED:** Range poles, chaining pins and steel tape may be required.

**SHIPPING INFORMATION:** State which type of compass is desired.  
Gross weight: 0.75 lb if shipped separately



COMPASS (4F7-3, 4F7-4)

## LEVEL, ENGINEER'S

STOCK NO. 4F7-11

**APPLICATION:** Used for establishing bench marks, profile leveling, cross sectioning, making field measurements for determination of earthwork volumes, setting grades, establishing elevations for structures under construction, and locating contours in topographic surveying.

**CAPACITY:** Magnifying power 32x

**DESCRIPTION:** The level consists of a telescope with level tube attached, mounted on a level bar rigidly fastened to a spindle which fits into a cone-shaped bearing in the leveling head. The bubble is leveled by means of leveling screws bearing on the leveling head. Vertical and horizontal cross-hairs in the telescope appear in the image viewed through the telescope. The telescope is focused by means of a focusing screw and is screwed to a wooden tripod for use.

**OPERATION:** To set up the instrument, screw it to the wooden tripod, adjusting the legs so the instrument is approximately level and clamp each leg after pushing tripod shoes firmly into the deck. Loosen the lock nut permitting the instrument to rotate and locate the spirit level over two diagonally opposite leveling screws. Grasp one leveling screw in the left hand and one in the right hand and level the bubble approximately by turning both leveling screws outward simultaneously or inward simultaneously. Rotate the spirit level over the two remaining diagonally opposite leveling screws and repeat the procedure. Continue this procedure until the instrument is level in all positions.

**AUXILIARY EQUIPMENT SUPPLIED:** The instrument is complete with sunshade, adjusting pins, screw driver, wrench, and waterproof cover. Packed in mahogany case, with carrying strap, lock and key and with tripod.

**SHIPPING INFORMATION:** Gross weight packed for export: 27 lb

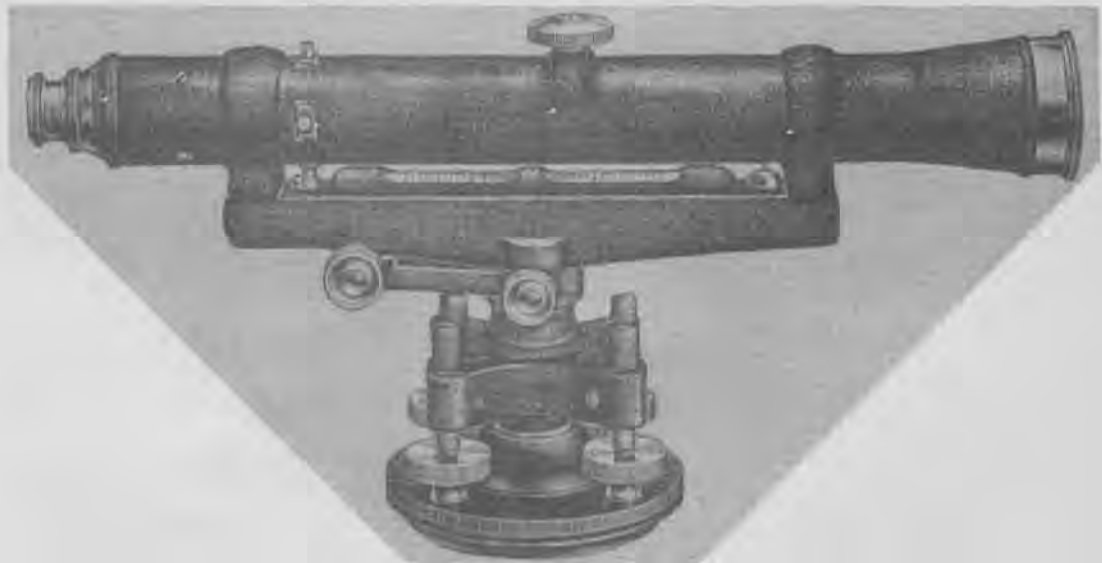

ENGINEER'S LEVEL (4F7-11)

## LEVEL, HAND-TYPE

STOCK NOS. 4F7-9 AND 4F7-10

**APPLICATION:** For obtaining approximate levels of lines, for rough contour surveying, and cross sectioning.

**DESCRIPTION:** No. 4F7-9 is plain and No. 4F7-10 contains stadia hairs. The hand level is a metal tube 5 in. long. A spirit level is mounted on top and the image of the bubble is reflected by a prism to the eye end of the level. An adjustable cross-hair is located just below the bubble vial. The eyepiece consists of a peep-hole mounted in the end. Both the object and the eye ends are closed by plain glass to keep dust out, supplied in a sewed leather pouch, with belt loop.

**OPERATION:** The instrument is held at the eye and tipped up or down until the bubble is centered on the cross hair indicating that the line of sight is horizontal.

**AUXILIARY EQUIPMENT NOT SUPPLIED:** Leveling rod, Field book, and steel tape.

**SHIPPING INFORMATION:** Gross weight if shipped separately. 0.5 lb

**ORDERING INSTRUCTIONS:** State if No. 4F7-9 plain, or No. 4F7-10 stadia type is desired.



HAND-TYPE LEVEL (4F7-9, 4F7-10)

## MATCHET

STOCK NO. 4F7-12

**APPLICATION:** Used for clearing brush, vines and tree branches in surveying work.

**DESCRIPTION:** Approximate weight is 1 1/4 lb. The blade is 22 in. and the handle 5 in. long; supplied with sewed 22 in. leather sheath, with belt loop.

**OPERATION:** Keep sharp, clean and oiled to prevent rust.

**SHIPPING INFORMATION:** Gross weight: 9lb if shipped separately. Cube: 20 cu ft



MATCHET (4F7-12)

## POLE, RANGE

STOCK NO. 4F7-17

APPLICATION: Used in surveying to indicate the position of points or the direction of lines.

DESCRIPTION: Eight feet long, constructed of either steel or wood, octagonal or circular cross-section and pointed at the lower end. The wood poles are shod with steel points. Painted with alternate red and white bands 1 ft long.

SHIPPING INFORMATION: Gross weight: 4 lb if shipped separately, Cube: 5 cu ft



RANGE POLE (4F7-17)

## ROD, LEVELING

STOCK NOS. 4F7-19, 4F7-20, and 4F7-21

**APPLICATION:** Used to measure difference in elevation and graduated into feet and decimals of a foot.

**DESCRIPTION:** The Philadelphia rod (No. 4F7-19) is designed as a self reading rod but may also be used with the target supplied. The rod consists of two sliding sections and on a white enameled  $1\frac{1}{8}$  in. face, is graduated, to feet, 10ths, and 100ths of a foot, with vernier reading to 1,000ths of a foot. Rod is 6.5 ft extending to 12 ft. The Chicago rod (No. 4F7-20) is a self reading rod graduated on one side only on a white enameled  $1\frac{1}{2}$ -in. face, to feet, 10ths and 100ths of a foot. When disjoined, each section is 4.5 ft. long and when assembled has a 12.5-ft working length. The sections are fitted together by brass telescopic rigid joints. The target supplied has a screw clamp to hold it at fixed points. Furnished with partitioned canvas case. The flexible rod (No. 4F7-21) is  $3\frac{1}{8}$  in. wide and is divided into feet, 10ths and 100ths of a foot and also is a self reading rod used by fastening to a straight board by means of thumb tacks. When not in use it may be rolled up and carried in the pocket.

**OPERATION:** The rod is held vertically, and the reading as indicated by the horizontal cross-hair of the level is a measure of the vertical distance between the point on which the rod is held and the line of sight.

**AUXILIARY EQUIPMENT NOT SUPPLIED:**  
Transit, alidade or level.

**SHIPPING INFORMATION:** Packed for export if shipped separately.

	Weight	Cube
No. 4F7-19	- 8 lb	1.40 cu ft
" 4F7-20	- 6 lb	1.40 " "
" 4F7-21	- 1 lb	.005 " "



4F7-19



4F7-20



4F7-21

## TAPE, 100-FT, STEEL, IN CASE

STOCK NO. 4F7-25

**APPLICATION:** Used in surveying to obtain the horizontal distance between two points.

**CAPACITY:** Total length 100 feet. Graduated in 1/10ths of a foot.

**DESCRIPTION:** Graduated under a tension of 10 lbs. When supported their entire length, they are accurate according to U.S. Standard at 68°F. The coefficient of expansion of steel tapes as determined by the United States Bureau is 0.00000645 per degree Fahrenheit. This tape is furnished with a leather case convenient to use and carry.

**OPERATION:** A head chainman and rear chainman manipulate the tape when making direct linear measurements of survey lines. Steel tapes rust easily and must be wiped dry after using. Tapes will break if kinked and subjected to a strong pull.

**SUPPLIES REQUIRED:** Rust preventive oil compound grade III, 52-C-18.

**AUXILIARY EQUIPMENT NOT SUPPLIED**  
Chaining pins and plumb bob.

**SHIPPING INFORMATION:** Shipping weight: 1.5 lb

Cube: .07 cu ft



100-FOOT STEEL TAPE (4F7-25)

## TRANSIT, ENGINEER'S

STOCK NO. 4F7-28

**APPLICATION:** In addition to being applicable for all uses for which the engineer's level may be employed, the transit will measure vertical and horizontal angles, and magnetic bearings. It may be used: to lay out engineering structures, in location surveys for roads, airplane runways, pipe lines and the like, and for topographic and hydrographic surveys. The telescope is equipped with stadia hairs for measuring distances without chaining, a method extensively used in topographic and hydrographic surveying to secure data for plotting maps. The transit may also be used to take observations on the sun or stars for latitude and longitude.

**CAPACITY:** Magnifying power is approximately 20. The vertical circle is numbered in quadrants and the horizontal circle is numbered 0-360° and 360°-0. Both the vertical and horizontal circles are graduated in 1/2° and with vernier may be read to the nearest minute of arc.

**DESCRIPTION:** The transit consists of: a telescope containing cross hairs and stadia hairs, a vertical graduated circle with vernier measuring vertical rotation of telescope, spirit level attached to and below the telescope, lower plate with graduated circle measuring horizontal rotation, upper plate to which is attached 2 verniers for horizontal circle, telescope, standards, magnetic compass, and 2 spirit levels at right angles mounted horizontally, and attached to plate proper, 4 leveling screws threaded into leveling head and bearing against foot plate; and chain with hook for plumb bob. The instrument may be shifted with respect to the foot plate to center over tack, it is mounted on a tripod by screwing the foot plate onto the tripod head. The telescope is focused by means of a focusing screw. Vertical rotation of the telescope and horizontal rotations of the upper and lower plates may be locked by means of clamp screws and small rotations are adjusted by means of tangent screws.

**OPERATION:** To set up, adjust the legs so the instrument is approximately level, clamp tripod legs, set the transit over the tack and push tripod shoes firmly into the deck. Loosen the leveling screws, shift leveling head on foot plate until plumb bob is directly over the tack, tighten leveling screws (not too tight) for firm contact. Rotate horizontal spirit levels in lines parallel to diagonally opposite leveling screws. Grasp one leveling screw in left hand and one in right hand and level the bubble approximately by turning both leveling screws outward simultaneously or inward simultaneously. Rotate the instrument 90° and repeat the procedure. Continue this operation until the instrument is level in all positions.

**AUXILIARY EQUIPMENT SUPPLIED:** Sunshade, plumb bob, adjusting pins, magnifying glass, screwdriver, center wrench, oil can, brush, and waterproof cover. Packed in hardwood case with carrying strap, lock and key. Supplied with tripod.

**SHIPPING INFORMATION:** Shipping weight 27 lb





ENGINEER'S TRANSIT (4F7-28)

## CALCULATING MACHINE. HAND OR ELECTRIC

STOCK NO. 4D41

**APPLICATION:** This machine may be used for calculations involving multiplication, division, square root, cube root, addition and subtraction.

**CAPACITY:** Ten keyboard columns, eleven lower dial places and twenty one upper dial places.

**DESCRIPTION:** The machine is composed of its internal mechanism, housing, keyboard, upper and lower carriage dials, carriage shift lever, crank, keyboard clearing key, carriage clearing levers and positive or negative quotient key.

Net weight 27 lb

**OPERATION:** One man operation. Instructions for operation may be found in the operating manual. Keep covered when not in use.

**SUPPLIES REQUIRED:** A source of 110 volt electric current if electric machine is furnished.

**AUXILIARY EQUIPMENT SUPPLIED:** Cover and operating manual. No spare parts are furnished, if the machine breaks down send back to Adv. Base Depot for repair.

**SHIPPING INFORMATION:** Shipped in one box.  
Shipping weight 54 lb (approx.)

**ORDERING INSTRUCTIONS:** State whether hand or electric machine is desired.

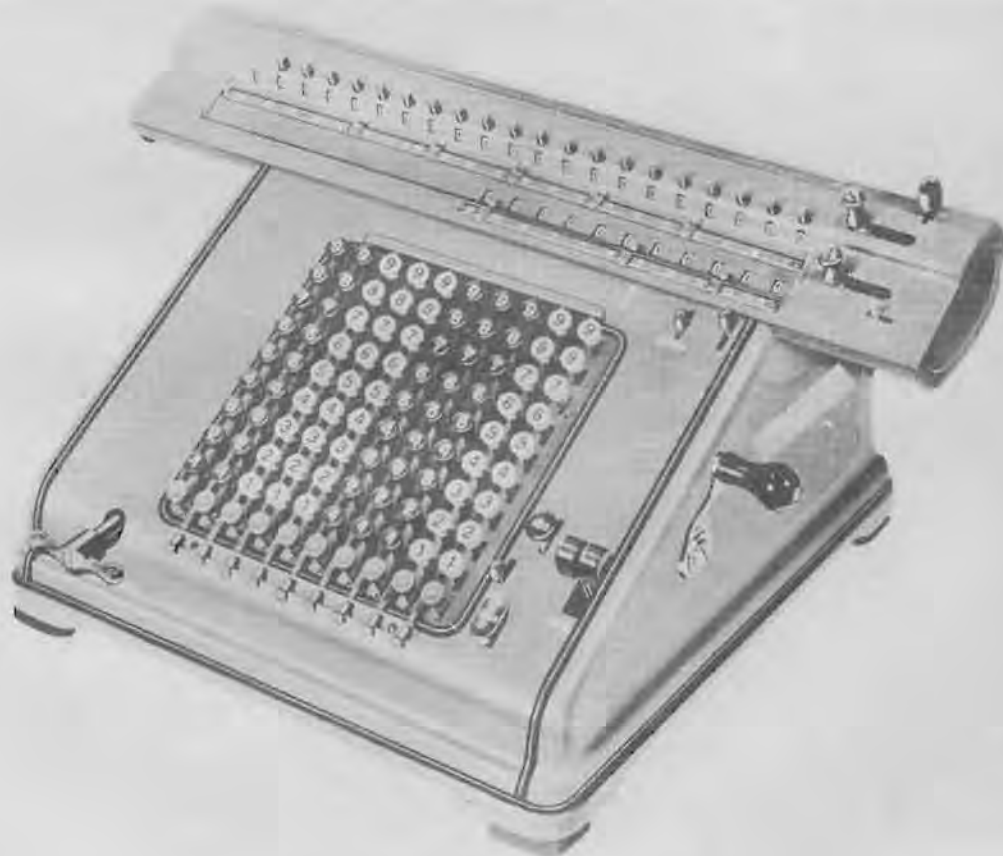

CALCULATING MACHINE (4041)

## DUPLICATOR, MACHINE

STOCK NO. 4D44-1

**APPLICATION:** Used for reproduction of reports, orders, maps, charts, communications, etc.

**CAPACITY:** Prints from 50 to 150 copies per minute and up to 4 colors in one operation. Maximum size of sheets 9 in. x 14 in.

**DESCRIPTION:** This machine is of steel frame construction inclosed in sheet metal housing and mounted on rubber feet, finished in black crackle finish. Prints several hundred copies from each master - which may be typed, drawn, printed or hand written.

**OPERATION:** One man can operate the machine. One turn of the handle is required for each copy. Feeding, printing, counting, and stacking is automatic.

**SUPPLIES REQUIRED:** Sheets of purple, blue, green and red spirit carbon. Sheets of master paper, copy, fluid and pouring spout, correction pencils, drawing pencils 4-H and 3-H, and cleansing cream.

**AUXILIARY EQUIPMENT SUPPLIED:** Replacement parts: 2 each - starting wheels with wrench, paper pusher rubber rollers, rubber paper grippers, fluid bottle gaskets. Assembly and operating instructions.

**SHIPPING INFORMATION:** Gross weight, in waterproof export case: 100 lb

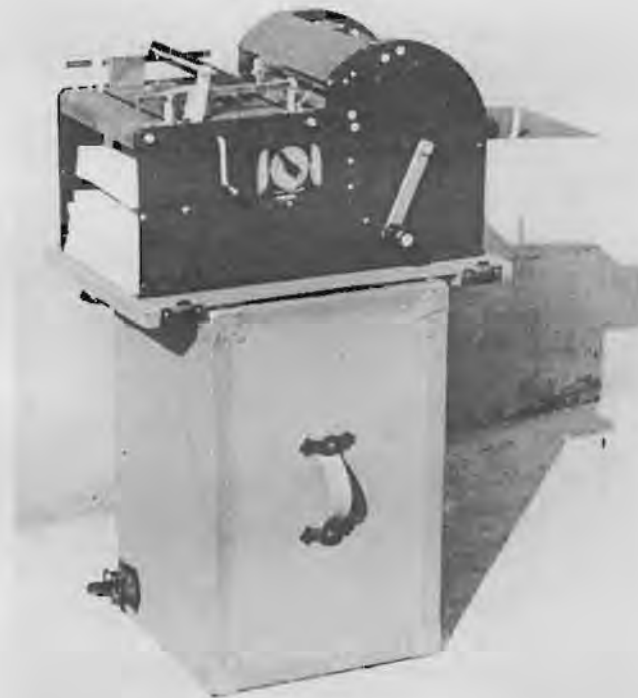

DUPLICATING MACHINE (4D44)

## CARBINE 30 CAL. M1

STOCK NO. 4X7-25

**APPLICATION:** This carbine is the basic arm of the construction battalions in both offensive and defensive operations.

**CAPACITY:**

Practical rate of aimed fire	40 spm
Magazine Capacity	15 rounds
Maximum effective range	300 yards

**DESCRIPTION:**

Calibre	0.30 in.
Over-all length	35.5 in.
Weight with sling	5.23 lb

**OPERATION:** Semiautomatic, gas operated, magazine fed, air cooled and individually operated. Care and maintenance instructions are covered by War Department Basic Field Manual, U. S. Carbine, Caliber .30, M1 (FM23-7) O.P. 859.

**SUPPLIES REQUIRED:** Cartridge, Carbine, calibre .30 M1, and light mineral oil.

Lubricants for 30 days	Below 0°	Above 0°
Oil, preservative lubricating, light (L-1165M) (Army Special OS1362)	3 oz.	3 oz.
Cleaner, Rifle Bore (R1X205)	3 oz.	3 oz.
Kerosene		
Rust Preventive Compound (52-C-18 grade III)		

**AUXILIARY EQUIPMENT SUPPLIED:** Tools, spare parts and cleaning equipment.

**SHIPPING INFORMATION:**

Shipping weight	lb
volume	cu ft

**ORDERING INSTRUCTIONS:** Supplied to BuY&D through Bu Ord, construction battalion officers should order through regular channels.



CARBINE, CAL. 30, M1 - RIGHT SIDE VIEW (4X7-25)

## GRENADE, HAND, FRAGMENTARY MK II

STOCK NO. 4X7-26

**APPLICATION:** Used against enemy machine guns or small groups.

**CAPACITY:** Fragments may fly over 200 yd, but the most effective radius is 30 yd.

**DESCRIPTION:** The body of the grenade is made of cast iron and is about the size of a lemon. The outside surface is serrated horizontally and vertically to cause uniform fragmentation. The bursting charge is 0.74 ounce of EC blank fire powder and the fuze is the M10 igniting fuze. Complete description and instructions are given in War Department Basic Field Manual, Grenades (FM23-30)

**OPERATION:** The average throw is 35 yards and the grenade should never be thrown unless adequate protection is at hand for the thrower and friendly troops who may be close by.

**AUXILIARY EQUIPMENT NOT SUPPLIED:** A canvas carrying bag.

**SHIPPING INFORMATION:**

Shipping weight	lb
volume	cu ft

**ORDERING INSTRUCTIONS:** Supplied to Bureau of Yards & Docks through Bureau of Ordnance Construction battalion officers should order from Bureau of Yards & Docks through regular procedure.

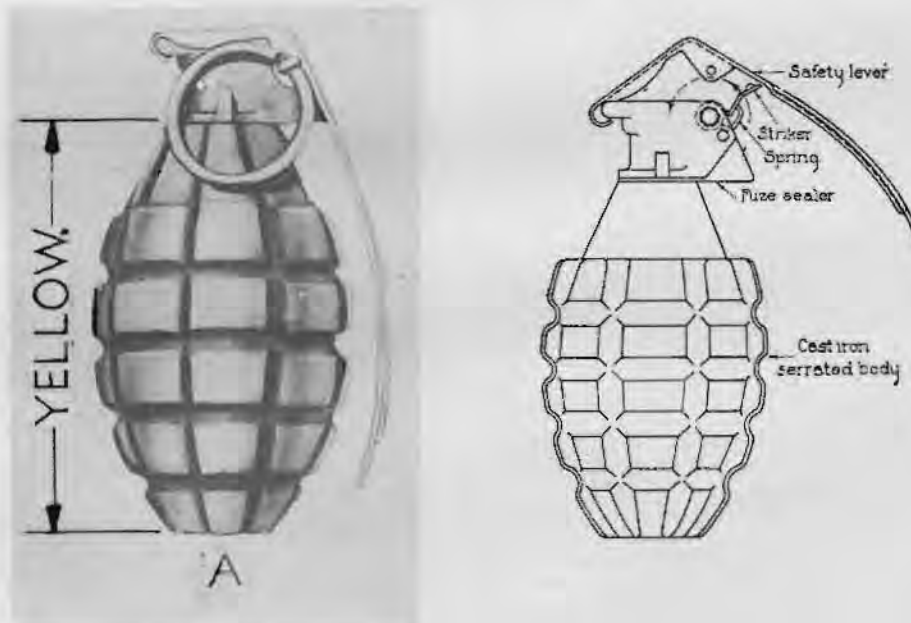

FRAGMENTARY HAND GRENADE MK11 (4X7-26)

## MACHINE GUN, .30 CAL, BROWNING (1919A4)

STOCK NO. 4X7-18

**APPLICATION:** Used in both the attack and the defense where a large volume of fire is required.

**CAPACITY:** Practical rate of aimed fire 125 spm  
Maximum effective range 1,800 yd

**DESCRIPTION:**

Calibre	0.30 inches
Weight - gun without water	30 lb
" - gun with water	36.76 lb
" - tripod	48 lb

**OPERATION:** Automatic, recoil-operated, belt fed and water cooled. Manned by two men, one to aim and fire and one to supply ammunition in cartridge belt to the gun. Care and maintenance instructions are covered by the following references, copies of which are supplied to construction battalions:

- (1) War Department Basic Field Manual Browning Machine Gun, Calibre .30, M1917 (FM23-55) O.P. 113.
- (2) War Department Technical Manual, Ordnance Maintenance, Browning Machine Gun, Calibre .30, all types (TM9-1205) O.P. 930.

**SUPPLIES REQUIRED:** Lubricating oil and ammunition.

	Below 0°	Above 0°
Lubricants for 30 days		
Oil, preservative lubricating, light (L-1165M) (Army Special OS1362)	4 oz.	4 oz.
Cleaner, Rifle Bore (R1X205)	4 oz.	4 oz.
Kerosene		
Rust Preventive Compound (52-C-18 grade III)		

**AUXILIARY EQUIPMENT SUPPLIED:** Tools and spare parts and cleaning equipment.

**SHIPPING INFORMATION:**

Shipping weight	lb
volume	cu ft

**ORDERING INSTRUCTIONS:** Supplied to Bureau of Yards & Docks through Bureau of Ordnance Construction Battalion officers should order from Bureau of Yards & Docks through regular procedure.

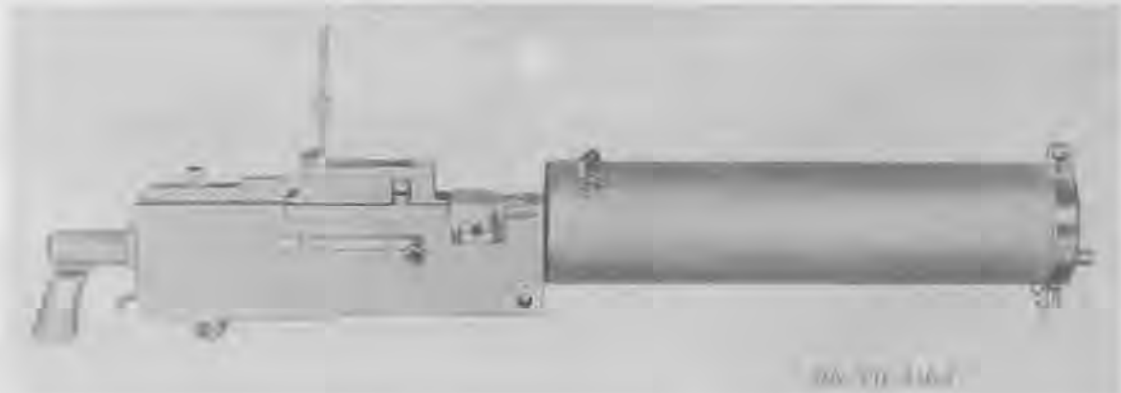

## MORTAR, 60 MM M2

STOCK NO. 4X7 - 19

**APPLICATION:** Used to throw projectiles with a high angle trajectory and a low muzzle velocity against personnel and light material targets and for illumination of objects not within range of other ground flares.

**CAPACITY:**

Rate of fire:  
 Maximum rounds \_\_\_\_\_ 30 to 35 per minute  
 Normal " \_\_\_\_\_ 18 " "  
 Range, approximate:  
 Shell, HE, M49A2 )  
 Shell, practice, M50A2 ) 100 to 1,985 yards

**DESCRIPTION:**

Weight of complete mortar \_\_\_\_\_ 42 pounds  
 Over-all length \_\_\_\_\_ 28.6 inches  
 Elevations, approximate \_\_\_\_\_ 40 to 85 degrees  
 Traverse, right or left, approximate \_\_\_\_\_ 125 mils

**OPERATION:** The mortar squad is composed of a squad leader and 4 men: gunner, assistant gunner, and two to carry and supply ammunition to the assistant gunner as directed by him. The squad leader determines the location for firing, directs the fire of his squad and acts as the observer. Operation, care, and maintenance instructions are covered by the following reference supplied to construction battalions: War Department Basic Field Manual, 60-mm 1 mortar M2(FM23-85).

**SUPPLIES REQUIRED:** Lubricants, cleaning agents, and rust preventatives. The following ammunition may be used: Shell, HE, M49A2, with PDF M52, 60-mm mortar, Shell, practice, M50A2, with PDF M52, 60mm mortar.

Projectile, training, M69, 60-mm mortar.

Shell, illuminating, M83, 60-mm mortar.

Lubricants for 30 days

Below 0°

Above 0°

Oil, preservative lubricating, light (L-1165M)  
 " " " (Army Special OS1362)

4 oz.

4 oz.

Cleaner, Rifle Bore (R1X205)

4 oz.

4 oz.

Kerosene

Rust Preventive Compound (52-C-18 grade III)



**AUXILIARY EQUIPMENT SUPPLIED:** Spare parts, tools and equipment required for disassembling and assembling, and for the cleaning and preservation of the equipment, also chests necessary for storage and protection of the equipment. Accessories include: ammunition bags; muzzle cover, with carrying strap; shoulder pads; cleaning staff; cleaning instruments; and a sight extension.

**AUXILIARY EQUIPMENT NOT SUPPLIED:** Aiming stakes, improvised as required and a binocular field glass with horizontal mil scale for observation.

**SHIPPING INFORMATION:**

Shipping weight \_\_\_\_\_  
Cube \_\_\_\_\_

**ORDERING INSTRUCTIONS:** Supplied to BuY&D through BuOrd. construction battalion officers should order from BuY&D through regular procedure.



## PISTOL, .45 CALIBRE

COMPLETE WITH HOLSTER AND BELT, STOCK NO. 4X7-8

**APPLICATION:** Standard side arm for commanding officer of the battalion, only one issued to a construction battalion.

**CAPACITY:**

Magazine capacity	7 rounds
Practical rate of aimed fire	10 spm
Maximum effective range	50 yards

**DESCRIPTION:** Care and maintenance instructions are covered by the following references, copies of which are supplied to the construction battalions:

- (1) War Department Basic Field Manual Automatic Pistol, Calibre .45, M1911 and M1911A1 (FM23-35) O.P.68
- (2) War department technical manual, Ordnance Maintenance, Pistols and Revolvers (TM9-1295) O.P. 218.

The M1911A1 pistol is the same as the M1911 with slight modifications.

Calibre	0.45 inches
Over-all length	8.6 inches
Weight with magazine	2.4 pounds

**OPERATION:** Recoil, semiautomatic and individually operated.

**SUPPLIES REQUIRED:** Lubricating oil and ammunition.

Lubricants for 30 days	Below 0°	Above 0°
Oil, preservative lubricating, light (L-1165M) " " " " (Army Special OS1362)	2 oz.	2 oz.
Cleaner, Rifle Bore (R1X205)	2 oz.	2 oz.
Kerosene		
Rust Preventive Compound (52-C-18 grade III)		

**AUXILIARY EQUIPMENT SUPPLIED:** Spare parts and cleaning equipment

**SHIPPING INFORMATION:**

Shipping weight	lb
" volume	cu ft

**ORDERING INSTRUCTIONS:** Supplied to Bureau of Yards & Docks through Bureau of Ordnance. Construction battalion officers should order from Bureau of Yards and Docks through regular procedure.



AUTOMATIC PISTOL, CAL. 45, M1911A1, ASSEMBLED (4X7-8)

## RIFLE, BROWNING AUTOMATIC

STOCK NO. 4X7-158

**APPLICATION:** Used in both the attack and in the defense where a large volume of accurate fire is required. It may be employed effectively against enemy machine guns or small groups and to cover probable avenues of approach. It is also effective against hostile airplanes.

**CAPACITY:**

Magazine capacity.....	20 rounds
Practical rate of aimed fire.....	40 spm
Maximum effective range.....	600 yards

**DESCRIPTION:**

Calibre.....	0.30
Over-all length.....	47 inches
Weight.....	15.87 pounds

**OPERATION:** Gas operated, magazine fed, air cooled, automatic or semiautomatic. Individually operated. Care and maintenance instructions are covered by the following references supplied to each construction battalion:

- (1) War Department Basic Field Manual, Browning Automatic Rifle, Calibre .30, M1918A2 with bipod (FM23-15), O.P.927.
- (2) War Department Basic Field Manual, Browning Automatic Rifle, Calibre .30, M1918A2 without bipod (FM23-20), O.P.773.
- (3) War Department Technical Manual, Ordnance Maintenance, Browning Automatic Rifle, Calibre .30, all types (TM9-1211) O.P.928

**SUPPLIES REQUIRED:** The following ammunition may be used in the Browning Automatic Rifle:

Cartridge, Armor-Piercing, Caliber .30, M2		
Cartridge, Ball, Caliber .30M1		
Cartridge, Tracer, Caliber .30, M1		
Cartridge, Dummy, Caliber .30, M1906		
Lubricants for 30 days		
Oil, preservative lubricating, light (L-1165M)	Below 0°	Above 0°
"          "          "          "          "          " (Army Special OS1362)	4 oz.	4 oz.
Cleaner, Rifle Bore (R1X205)	4 oz.	4 oz.
Kerosene		
Rust Preventive Compound (52-C-18 grade III)		

**AUXILIARY EQUIPMENT SUPPLIED:** Tools for disassembling and assembling and for cleaning and preservation of the rifle and spare parts and spare twenty-round magazines are supplied.

**SHIPPING INFORMATION:**

Shipping weight:  
Shipping cube :

**ORDERING INSTRUCTIONS:** Supplied to BuY&D through BuOrd, construction battalion officers should order from BuY&D through regular procedure.



BROWNING AUTOMATIC RIFLE, CAL. .30, M1918 - RIGHT SIDE VIEW (4X7-158)

## RIFLE, .30 CAL

COMPLETE WITH SLING, STOCK NO. 4X7-12

**APPLICATION:** This is a substitute arm furnished to construction battalions when the .30 cal. carbine is not available.

**CAPACITY:** Magazine capacity 5 rounds  
Practical rate of armed fire, 10 spm  
Maximum effective range 600 yards

**DESCRIPTION:**  
Calibre 0.30 inches  
Overall length 43.46 "  
Weight 8.69 pounds

**OPERATION:** Manual, magazine fed and individually operated. Care and maintenance instructions are covered by the following references, copies of which are supplied to construction battalions:

- (1) War Department Basic Field Manual United States Rifle, Calibre .30, M1903 (FM23-10), O.P. 776.
- (2) War Department technical Manual, Ordnance Maintenance, Rifles, United States Calibre .30, M1903 and M1903A1 (TM9-1270) O. P. 596.

**SUPPLIES REQUIRED:** Lubricating oil and ammunition.

Lubricants for 30 days	Below 0°	Above 0°
Oil, preservative lubricating, light (L-1165M) (Army Special OS1362)	3 oz.	3 oz.
Cleaner, Rifle Bore (R1X205)	3 oz.	3 oz.
Kerosene		
Rust Preventive Compound (52-C-18 grade III)		

**AUXILIARY EQUIPMENT SUPPLIED:** Spare parts and cleaning equipment.

**SHIPPING INFORMATION:**

Shipping weight	15 lb
volume	.65 cu ft

**ORDERING INSTRUCTIONS:** Supplied to Bureau of Yards & Docks through Bureau of Ordnance Construction Battalion officers should order from Bureau of Yards & Docks through regular procedure.



.30 CALIBRE RIFLE (4X7-12)

## SUBMACHINE GUN, .45 CAL, THOMPSON, M/1928A1

**APPLICATION:** The weapon is intended for firing at short ranges where a large volume of fire is required. It may be effectively employed against moving ground targets, both vehicular and personnel but is relatively ineffective against hostile aircraft.

<b>CAPACITY:</b>	Muzzle velocity	802 f.s.
	Bullet weight	234 grains
	Practical rate of aimed fire:	
	automatic	100 spm
	semiautomatic	40 spm
	Maximum effective range, slow fire	200 yards
	automatic	25 yards
	Magazine capacity:	
	drum type	50 rounds
	box type	20 rounds

**DESCRIPTION:** This weapon is air cooled, recoil-operated, and magazine fed. The extension surface of the rear portion of the barrel contains a series of annular flanges for dissipating heat. A wooden fore grip protects the hand of the gunner and a rear grip is also provided. Swivels are attached for a gun sling. A "cuts" recoil compensator is provided to lessen the recoil and the tendency for the muzzle to rise when fired full automatic.

Caliber	0.45 inches
Overall length	33.75 inches
Weight without magazine	10.75 pounds
" with loaded 20 round magazine	12.06 pounds
" " " 50 " "	16.70 pounds

**OPERATION:** Pressure of gases when cartridge is exploded drives bullet through the bore and drives the bolt and actuator together to the rear against the pressure of the recoil spring. During rearward movement, unlocking, extracting, ejecting, and compressing recoil spring takes place, during forward movements, feeding, locking and firing is affected.

**SUPPLIES REQUIRED:** Sperm oil (U.S.A. Spec. 2-45A) or motor oil S.A.E. 20 when sperm oil is not available for cleaning the bore. Aircraft machine gun lubricating oil (U.S.A. Spec. 2-27) or sperm (U.S.A. Spec. 2-45A) is used for lubricating. Patches and rags are needed for cleaning and oiling.

Lubricants for 30 days	Below 0°	Above 0°
Oil, preservative lubricating, light (L-1165M)		4 oz.
" " " " (Army Special OS1362)	4 oz.	
Cleaner, Rifle Bore (R1X205)	4 oz.	4 oz.
Kerosene	4 oz.	
Rust Preventive Compound (52-C-18 grade III)		



AUXILIARY EQUIPMENT SUPPLIED: Spare parts, tools for cleaning, assembling and disassembling, case for spare parts and small accessories, and sling.

SHIPPING INFORMATION:

Shipping weight	lb
cube	cu ft

ORDERING INSTRUCTIONS: Furnished through the Bureau of Ordnance. Construction battalion officers should order through regular channels.

## VERY PISTOL, 10-GAGE, MK 111

STOCK NO. 4 X 7-24

**APPLICATION:** The very pistol is used for firing signals of a pyrotechnic nature from the ground, or from moving vehicles on the ground. It is used by lightly equipped ground troops.

**CAPACITY:** The approximate height of the signal trajectory is 200 feet and the pistol is single loading and single acting.

**DESCRIPTION:** The pistol consists of a bronze frame which houses the firing mechanism and to which are attached the wooden side grips. A smooth bore steel barrel is hinged to the frame and locked by the barrel latch when in firing position. When the barrel latch is depressed the barrel swings upward on the frame and permits loading and unloading.

**OPERATION:** To load the very pistol hold it in the right hand, depress the barrel latch with the left thumb, and press down on the barrel with the left hand. Look through the barrel to make sure there are no obstructions, insert the cartridge and close the breech. The hammer is cocked with the thumb and the "safe" position is at half cock. To fire the pistol the trigger is pulled by a continuous pressure. To unload depress the barrel latch, open the breech and remove the cartridge.

**CAUTION:** Count 30 slowly before unloading if misfires occur.

**SUPPLIES REQUIRED:** Ammunition: (1) light, signal, Very MK 11, red star, (2) light, signal, Very, MK 11, white star, and (3) light, signal, Very, MK 11, green star. Very lights are identified by the marking on the item and on the packings. In addition the closing wad is shaped, as illustrated, for identification by touch in the dark. Cleaning supplies include: cleaner, rifle bore, oil; lubricating, preservative, light; swabs and rags. Clean all metal parts with solvent, dry cleaning before use in temperatures below 0°F.

	Below 0°	Above 0°
Lubricants for 30 days		
Oil, preservative lubricating, light (L-1165M)		2 oz.
Oil, preservative lubricating, light (Army Special OS1362)	2 oz.	
Cleaner, Rifle Bore (R1X205)	2 oz.	2 oz.
Kerosene		
Rust Preventive Compound (52-C-18 grade III)		

**AUXILIARY EQUIPMENT SUPPLIED:** A leather holster and spare parts.



VERY LIGHTS AND PISTOL

AUXILIARY EQUIPMENT NOT SUPPLIED: Cleaning kit.

SHIPPING INFORMATION.

Shipping weight: 4.3 lb  
Shipping cube: 0.25 cu ft

ORDERING INSTRUCTIONS: Supplied to construction battalions through the Bureau of Ordnance. Order in the field through regular channels.

## ALARM, GAS

**APPLICATION:** For local gas alarms to spread the alarm when gas is detected by a gas sentry and to supplement the general gas alarm in case of gas attacks.

**CAPACITY:** The distance from which this alarm can be heard varies with the amount of noise present but under ordinary conditions the effective range is about 200 ft.

**DESCRIPTION:** This alarm is made entirely of wood and consists of a handle with a notched wheel securely fastened to it. A housing containing a thin flexible tongue fastened on one end swings around the handle as a bearing and noise is produced by the action of the free end of the tongue passing over the notched wheel.

Overall dimensions:

Length 15 in  
Width 3 in  
Height 6-3/4 in

**OPERATION:** By a gas sentry. All sentries are charged with spreading the gas alarm in addition to their other duties. Special gas sentries may be used if the need arises.

**SHIPPING INFORMATION:** For export  
to a box

Shipping weight lb  
Shipping volume cu ft



**HAND - OPERATED GAS ALARM**



## APPARATUS, (SPRAYER), DECONTAMINATING, 1 1/2-QT

STOCK NO. 405-4

**APPLICATION:** For emergency use to decontaminate small areas and for use on instruments, tools, machinery and leather or metal surfaces. Carried in vehicles which must function during a gas attack.

**CAPACITY:** One and one half quarts of non-corrosive decontaminating agent only.

**DESCRIPTION:** The apparatus is composed of a metal tube containing a hand pump with a handle at one end of the tube and a spray nozzle at the other end.

**OPERATION:** Operated by one man. Operating instructions are on a metal plate which is attached to the side of the tube of each apparatus. Solution should be renewed every 3 months.

**SUPPLIES REQUIRED:** Non-corrosive decontaminating powder and tetrachlorethane to be mixed in the field in the proportions of one pound of powder to ten pounds of solvent.

**AUXILIARY EQUIPMENT NOT SUPPLIED:** Pump washers will need replacing as required.

**SHIPPING INFORMATION:**

Shipping weight 2.5 lb  
Shipping volume .2 cu ft



1 1/2-QUART DECONTAMINATING SPRAYER (405-4)

## APPARATUS, (SPRAYER), DECONTAMINATING, 3 GAL

STOCK NO. 405-z

**APPLICATION:** Used to decontaminate areas which have been contaminated with a vesicant agent by means of spraying a solution of 50% bleach and 50% water by weight commonly called slurry. It is also used to spray non-corrosive decontaminating agent and to spray oil in mosquito control work.

**CAPACITY:** Three gallons of liquid or slurry.

**DESCRIPTION:** This apparatus is comprised of a metal tank containing a hand pump to build up air pressure, a flexible hose to which a spray nozzle is attached with hand operated valve. A shoulder strap is fastened to the tank. Similar to a garden insecticide sprayer.

**OPERATION:** By one man who carries the apparatus with him to the area being decontaminated. The effective range of the spray is approximately 3 ft. Flush apparatus thoroughly with cold water after each operation. Strain slurry thoroughly through a strainer supplied with the apparatus before putting in tank.

**SUPPLIES REQUIRED:** Bleach (Grade B or C)

**AUXILIARY EQUIPMENT SUPPLIED:** A funnel strainer and wooden paddle.

**AUXILIARY EQUIPMENT NOT SUPPLIED:** Pump washers, which will need replacing as required.

**SHIPPING INFORMATION:**

Shipping weight: 10 lb  
Shipping volume: 3 cu ft



3-GALLON DECONTAMINATING SPRAYER (405-5)

## APPARATUS,(SPRAYER), DECONTAMINATING, POWER DRIVEN, M4 (400 GAL)

STOCK NO. 7S5-1

**APPLICATION:** For decontaminating by spraying a mixture of bleaching powder and water (slurry) where large areas such as roads and buildings have been covered with lewisite or mustard. Can also be used for fire fighting, transporting water, and spraying runways or roads.

**CAPACITY:** Four hundred gallons of slurry.

**DESCRIPTION:** The apparatus is mounted on skids. It is recommended that it be loaded onto a truck for easy mobility when in operation. It is a modified orchard type sprayer with a 400 gal wood tank containing a horizontal shaft with 6 agitators, chain drive connected to a reciprocating pump (capable of 30 to 36 gal per min. at 400-500 lb per sq in pressure) connected through a clutch assembly thus permitting the slurry to be mixed while the pump is not operating. The pump is also used for filling the tank in addition to providing adequate pressure to the two spray nozzles. Power is supplied from a 22 h.p. gasoline engine. The unit is complete with hose, pipe, hose and pipe fittings, valves, gauges, etc.

**OPERATION:** A minimum crew of 3 men wearing protective clothing and gas masks, is required: one truck driver, and one man operating each spray nozzle. One half to one hour is required to load and mix the slurry, which must be well mixed to prevent clogging and resulting damage to the apparatus. Keep the tank full of water when not in use to prevent it from drying and leaking. In freezing weather the pump, piping and engine radiator should be drained according to accompanying instructions.

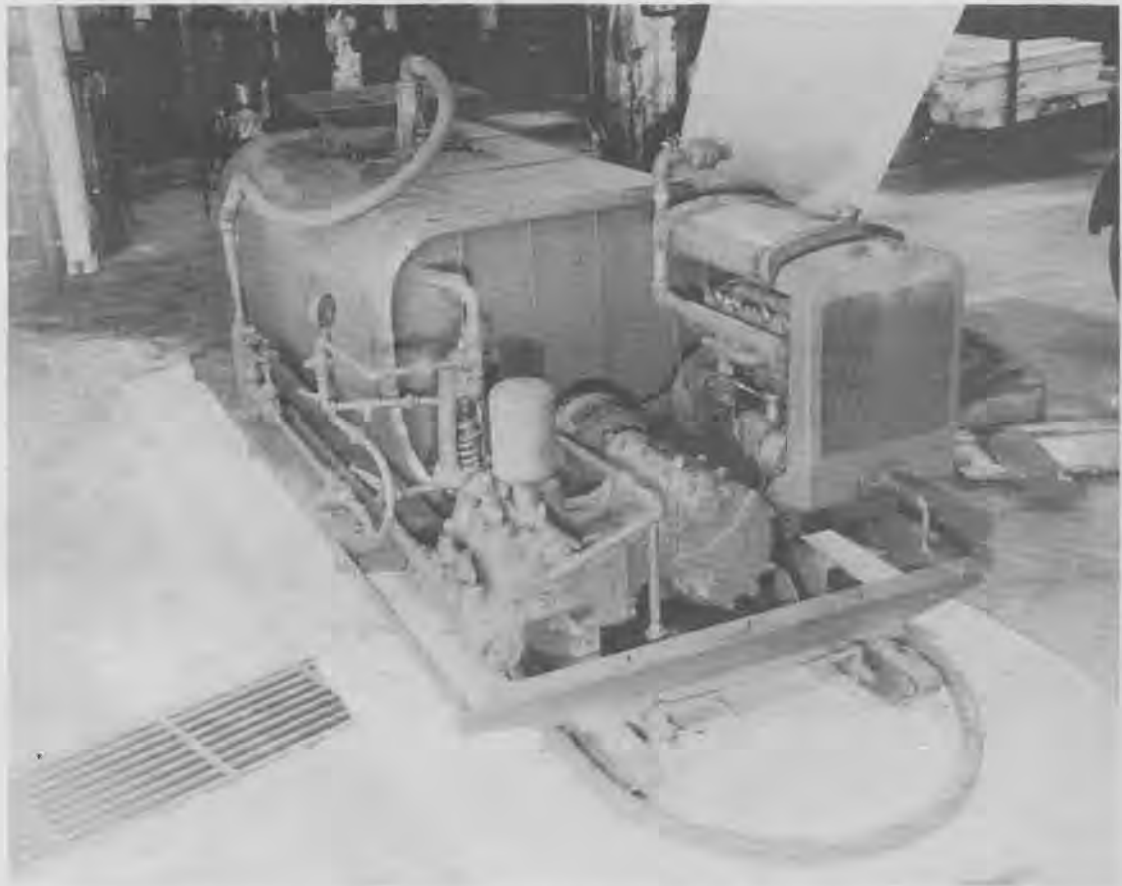

400-GALLON DECONTAMINATING APPARATUS M4(755-1)

SUPPLIES REQUIRED: Gasoline, lubricants, bleaching powder and water. The following quantities of fuel and lubricants are estimated to be required for operating the equipment 1,000 hours under severe conditions:

	32°F and lower	32°F to 70°F	70°F and higher
Fuel - Unleaded gasoline, 65 octane, gals	2200	2200	2200
Greases -			
General purpose 14L9 No. 1 (chassis) lb	1	1	1
Water Pump 14L11 lb	1	1	1
Oils -			
Gear, VV-L-761 (SAE 90) (Hypoid) gal	2	2	2
Motor 9110 (SAE 10)	25		
" 9250 (SAE 30)		25	25

AUXILIARY EQUIPMENT SUPPLIED: Tools, Spare parts and instruction manual.

AUXILIARY EQUIPMENT NOT SUPPLIED: Equipment to load the apparatus on and off the truck. A 2 1/2-ton truck with a flat (stake) body.

SHIPPING INFORMATION:

Shipping weight 3,360 lb  
Shipping volume cu ft

## CLOTHING, PROTECTIVE

SUIT, STOCK NO. 403-b; GLOVES, STOCK NO. 403-1; SOCKS, STOCK NO. 403-4

**APPLICATION:** Gives protection to the body against the blistering action of vesicants in vapor form, and in liquid form in small droplets only.

**DESCRIPTION:** The suit is made of a close woven cotton Arzen cloth and is comprised of pants with suspenders and a jacket with attached hood. Gloves are heavy knit wool, fitting well up over the forearm and socks are of regular government issue. Usually clothing is issued already impregnated with special chemical, but may be issued unimpregnated accompanied with the necessary materials for field impregnation.

**OPERATION:** The complete outfit to be worn by one man consists of suit, gloves, gas mask (ND Mark 111), 2 pairs of socks, and impregnated government issue shoes. Clothing must fit tightly around the wrists, ankles, and head. If issued already impregnated it should be stored in a cool, dark, dry place and inspected periodically to detect any evidence of deterioration. Instructions for reimpregnation are contained in FTP 190, a registered publication issued by VCNO.

**SUPPLIES REQUIRED:** Impregnating paste for shoes.

**AUXILIARY EQUIPMENT NOT (GENERALLY) SUPPLIED:** Gas mask (ND Mark 111), impregnating paste for shoes, and a decontamination magazine where the wearer may safely discard contaminated protective clothing, bathe and change into regular uniform.

**SHIPPING INFORMATION:** Suit including gloves and socks.

Shipping weight	4 1/4 lb
Shipping cube	0.32 cu ft

**ORDERING INSTRUCTIONS:** Supplied by Bureau of Ships but should be ordered through regular channels by construction battalion officers.



## CRAYON, DETECTOR, VESICANT M7

STOCK NO. 407-5

**APPLICATION:** Used to detect liquid vesicant by testing with a piece of paper coated with crayon chalk or by dusting with powder scraped from the crayon or to detect strong vapors by dusting only.

**DESCRIPTION:** The crayon is similar in appearance to blackboard chalk commonly used in school rooms. It is pink in color and will turn blue upon coming in contact with a vesicant.

**OPERATION:** Instructions for use are printed on each box. Inspect every 60 days; if pink or red it is still sensitive but if brown in color it should be discarded and replaced by a new supply

**AUXILIARY EQUIPMENT NEEDED BUT NOT SUPPLIED:** Pieces of white paper to coat with crayon or a knife to scrape powder from the crayon.

**SHIPPING INFORMATION:** Twelve crayons to a box, \_\_\_\_\_ boxes to a carton  
Shipping weight            lb  
Shipping cube              cu ft



CRAYON-TYPE VESICANT GAS DETECTOR

## KIT, H5 VAPOR DETECTOR, M4

**APPLICATION:** A field kit used to identify mustard gas vapor

**CAPACITY:** Thirty six tests can be made with the equipment furnished.

**DESCRIPTION:** The kit as shown in the illustration is an assembly of all necessary equipment needed to make up a complete outfit packed in a small wooden box. Bottle "C" is used only for experimental purposes to make sure that the correct procedure is being followed.

**OPERATION:** Detailed instructions and directions for use are included in each kit.

**SHIPPING INFORMATION:**

Shipping weight	lb
Shipping volume	cu ft



MUSTARD VAPOR DETECTOR KIT M4



## MASK, GAS (ND MARK 111)

STOCK NO. 403-3

**APPLICATION:** Gives full protection against war gases except vesicants; also protects the face, eyes and respiratory tract against vesicants.

**CAPACITY:** Purifies air for breathing requirements of one man.

**DESCRIPTION:** The gas mask is comprised of a facepiece with diaphragm, a canister and two hose tubes and is packed in a carrying bag when not in use.

Net weight of gas mask and carrier 5 lb

**OPERATION:** Air is drawn in through the filtration and adsorption canister where it is purified, then passes through the hose tubes to the facepiece and inhaled into the wearer's lungs. Exhaled air passes through an outlet valve in the facepiece. The diaphragm in the facepiece permits the wearer to talk to another person without removing the mask. Care and instructions for fitting mask are given in detail in "Navy Passive Defense Handbook No. 7, First Edition" furnished to all construction battalions.

**AUXILIARY EQUIPMENT SUPPLIED:** Anti-dim compound in a small can is included in the carrier for each mask and may be applied to the eye lenses to prevent fogging.

**SHIPPING INFORMATION:** Shipped 20 to a box.

Shipping weight 140 lb

Shipping cube 10 cu ft

**ORDERING INSTRUCTIONS:** Made in four different sizes: No. 1 (small); No. 2 (medium); No. 3 (large); and No. 4 (very large), state size desired when ordering.



## PAINT, DETECTOR, VESICANT, M5

STOCK NO. 407-6

**APPLICATION:** Used to detect the presence of vesicant spray. It may be painted on a surface so located that vesicant spray may come in contact or painted on strips of paper to be wiped on objects suspected of being contaminated. The paint will not react to vesicant vapor.

**CAPACITY:** One lb of paint will cover approximately 50 sq ft of surface. One coat is usually sufficient.

**DESCRIPTION:** In liquid form similar to ordinary paint. It has a green or olive drab color changing to red when exposed to vesicant liquid.

**OPERATION:** Brushed onto smooth wood, metal, cardboard or paper. Only pure mineral spirit may be used for thinning. The sensitivity of the paint lasts about one month under ordinary conditions depending upon exposure to sunlight.

**SUPPLIES REQUIRED:** Mineral spirit for thinning if required.

**AUXILIARY EQUIPMENT NOT SUPPLIED:** Pieces of wood, metal, cardboard, or paper and a paint brush.

**SHIPPING INFORMATION:** 24 1/4 lb cans are packed to a carton

Shipping weight 7 lb  
Shipping cube 0.2 cu ft



PAINT-TYPE VESICANT DETECTOR (407-6)

## PROTECTOR, COLLECTIVE, NAVY, DESIGN NO. 1

STOCK NO. 401-1

**APPLICATION:** Supplies purified air to buildings which must be kept operating during a gas attack, such as communication center, command posts, surgeries, splint proof shelters, and decontamination centers. Can also be used to ventilate these buildings when no gas is present - has treadle operated blast for blowing gas from clothes of persons entering building.

**CAPACITY:** 250 cfm against a static head of 1/2 inch of water in the building

**DESCRIPTION:** Electric motor drive, with auxiliary gasoline engine for use in case of power failure.

Electric motor - 3/4 hp, 115 - 230 volt, Single phase 60 cycle - 3500 rpm

Gasoline Engine - 1-1/2 hp - 4 cycle - 2800 rpm.

Weight - 1530 lb (including spare canister)

Approx. Space Requirement

Height - 7 ft 3 in

Length - 4 ft 0 in

Width - 5 ft 0 in

**OPERATION:** Machine is started by throwing motor switch, or starting gasoline engine. No attendance required while operating. Maintenance consists of lubrication of motor, blower, and gasoline engine as per instruction accompanying unit. Instructions are also given for periodic tests for air tightness and effectiveness of filter.

**SUPPLIES REQUIRED:** 220 volt electric current. The following quantities of fuel and lubricants are estimated to be required for operating the equipment 1,000 hours under severe conditions:

	32°F and lower	32°F to 70°F	70°F and higher
<b>Fuel -</b> Unleaded gasoline, 65 octane, gals	150.	150.	150.
<b>Oils -</b> Motor 9110 (SAE 10) " 9250 (SAE 30)	20.	20.	* 20.

**AUXILIARY EQUIPMENT SUPPLIED:** One (1) spare filter adsorptive canisters; two (2) air pressure valves for installation in building; tools & spare parts; operating instructions.

**AUXILIARY EQUIPMENT NOT SUPPLIED:** Air inlet stack and purified air distribution system.

**SHIPPING INFORMATION:**

Shipping weight 2260 lb  
Cube 114 cu ft  
Crate 68 in x 37 in x 78 in

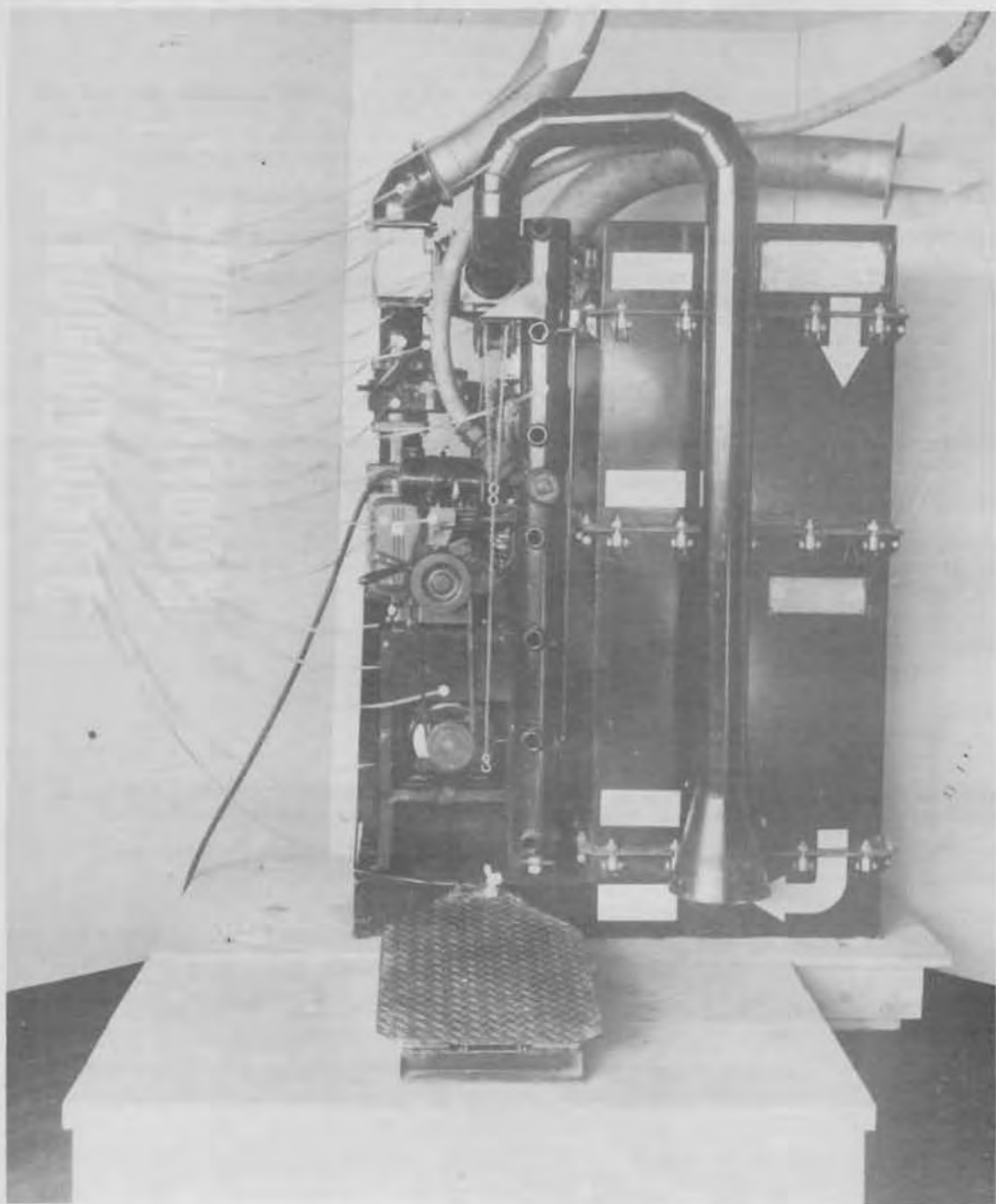

DESIGN NO. 1. NAVY COLLECTIVE PROTECTOR

## PUMP, STIRRUP

STOCK NO. 4G5-1

**APPLICATION:** Used in conjunction with a pail or other suitable container, for fire extinguishment or decontamination of chemical warfare agents. Pump will handle either water or chemical solutions.

**CAPACITY:** At 60 strokes per minute pump discharges 2 gallons. Between 40 and 60 strokes per minute throws a solid stream about 30 ft between 30 and 50 strokes per minute produces a spray stream varying in width from 24 in to 36 in at a distance of 12 ft.

**DESCRIPTION** Pump is double acting with cylinder and piston of steel tubing porcelainized, valves, piston assembly and rings of plastic material, iron handle, pressed steel stirrup and 10 ft of 3/8 in single braid synthetic rubber lined hose and brass nozzle with spray slide. Webbed strap is fastened to pump flange to hold hose in coiled position and pump plunger in telescoped position. Pump with hose weighs about 8 lb.

**OPERATION:** One man.

**AUXILIARY EQUIPMENT NOT SUPPLIED:** Water or chemical solution container

**SHIPPING INFORMATION:** Shipped 20 per box.

Weight	215 lb
Dimensions	28 1/2 in x 21 1/2 in x 35 1/2 in
Cube	12.63 cu ft



STIRRUP PUMP (4G5)

## PHOTOGRAPHIC, PROJECTOR, MOVIE AND SLIDE

WITH CASE AND AUTOMATIC TAKEUP, STOCK NO. 418

**APPLICATION:** To project pictures onto a screen.

**CAPACITY:** 2 in x 2 in slides to 35 mm film strips and from single to double frame pictures.

**DESCRIPTION:** Complete with 150-watt lamp, 5 in anastigmatic lens, semi-automatic vertical slide changer, and leatherette carrying case.

Dimensions: 10 1/4 x 7 1/4 in x 4 in

Weight: approximately 5 1/4 lb

**OPERATION:** One man can operate this machine. Always keep the projector clean and dry, and in its case when not in use.

**SUPPLIES REQUIRED:** The current used is ordinarily 110-120 volt. By changing to the appropriate lamp, the projector can be used directly on 6-volt, 12 volt or 32 volt connections. It can be used on 220 volt current with the aid of a resistor inserted between the main socket and the projector.

**AUXILIARY EQUIPMENT SUPPLIED:** Spare parts and instructions for operating.

**AUXILIARY EQUIPMENT NOT SUPPLIED:** A screen.

**SHIPPING INFORMATION:**

Shipping weight 15 lb

Shipping volume cu ft

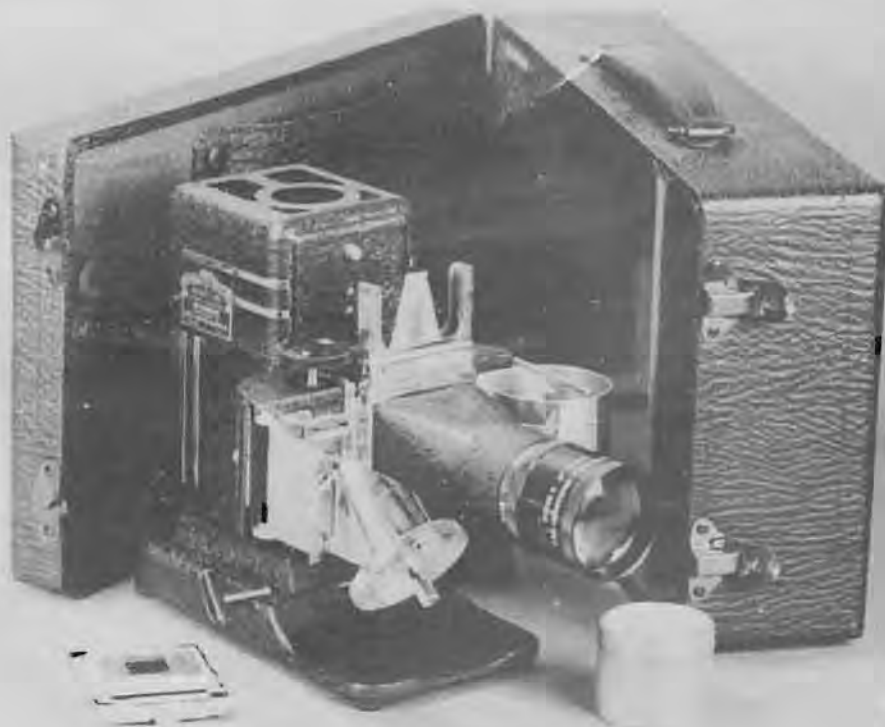

PROJECTION MACHINE, MOVIE AND SLIDE (4118)

## INSECTICIDE, (NON-REFILLABLE), SELF SPRAYING

STOCK NO. 4R4

**APPLICATION:** Used to kill insects within enclosed areas.

**CAPACITY:** Each container has approximately 1 pound of the mixture which is sufficient to effectively cover an area of approximately 150,000 cubic feet.

**DESCRIPTION:** The insecticide dispenser is a container approximately 3 inches in diameter and 6 inches in length, which contains an insecticide mixture composed of Freon, Pyrethrum and Sesame oil.

**OPERATION:** The Freon acts as a propellant discharging the contents through a capillary tube into the open air where the mixture will rapidly expand as it is permitted its freedom thereby sending small particles of the insecticidal mixture to all parts of an enclosed area.

**SUPPLIES REQUIRED:** The dispenser has been designed as a "one-time" device permitting the container itself to be discarded after contents have been discharged.

**SHIPPING INFORMATION:** The dispensers are packed in boxes of 25, with each box made of water-resistant fibreboard with full overlap style. Two of these boxes of 25 are put into a wooden box for shipment. Each export box of 50 has a gross weight of 116 pounds and is 2.76 cubic feet in size.



INSECTICIDE SPRAYER (4R4)

## BARGE, PONTOON

3 x 7, 50-TON, ASSEMBLY NO. 5032

**APPLICATION:** As a barge, this unit is used for freighting and transporting loads up to 50 tons on the waterfront. It is used for loading and unloading cargoes, for transporting equipment, supplies and materials either by towing or by self-propulsion when equipped with propelling units. It is used also to mount a 5-ton crawler crane, for lifting purposes or for dredging with a clamshell bucket.

**CAPACITY:** 50 tons concentrically loaded, it mounts a five-ton crane having a range of 5 1/2 tons at 10 ft radius to 2 tons at 30 ft radius. It makes 4 to 6 knots with one propulsion unit depending upon load carried. It draws 20 inches of water light and 48 inches when fully loaded.

**DESCRIPTION:** 21 ft wide, 43 ft long, and 5 ft deep this barge consists of 15 T6 and 6 T7 pontoons bolted into strings of 7 and pinned and stayed together. Deck closures, fill in the deck area suitably for all ordinary uses, but for loose materials heavy paper or canvas should be laid down to prevent loss through openings. By the addition of one or more propelling units it becomes self-propelling and is very maneuverable, turning completely around in its own length. Propelling units of the outboard type have been found very effective in drawing off a beach after having been run aground.

**OPERATION:** One-man operation when self-propelled.

**AUXILIARY EQUIPMENT SUPPLIED:** All attachments and fastening as well as tools and instructions for assembly are included.

**AUXILIARY EQUIPMENT NOT SUPPLIED:** Stanchions and life line cable as well as 12 in. flash boards are available for around the deck, if required, but should be ordered. Propelling units not included unless ordered.

**SHIPPING INFORMATION:** Shipped knocked down, as individual pontoons, loose assembly angles and boxes of fittings and tools. Weight: 76,875 lb. Cube: 4818 cu ft

**ORDERING INSTRUCTIONS:** Order crawler crane attachments, life line, flash boards and propulsion units separately, if required.







## BARGE, PONTOON

4 x 7, 65-TON, ASSEMBLY NO. 5033

**APPLICATION:** As a barge, this unit is used for transporting loads up to 65 tons on the water-front. Although this size of barge is usable for any of the transporting tasks within its capacity, it is particularly suitable for mounting a 10-ton crane for lifting assignments or for the operation of a clamshell bucket.

**CAPACITY:** 65 tons concentrically loaded, it mounts a 10-ton crane having a range between 9 1/2 tons at 18 ft to 3 tons at 45 ft. Equipped with one propelling unit, it makes 4 to 6 knots depending upon load carried. It draws 20 inches of water light and 48 inches fully loaded.

**DESCRIPTION:** 28 ft wide, 43 ft long and 5 ft deep, this barge consists of 20 T6 pontoons and 8 T7 pontoons bolted into strings of 7, pinned and stayed together. Deck closures fill in the deck area suitably for all ordinary uses, but for supporting loose materials heavy paper or canvas should be laid down to prevent loss through openings. By the addition of one or more propelling units it becomes self-propelling and very maneuverable, being able to turn completely around within its own length. Propelling units of the outboard type have been found to be highly effective in backing off a beach after having grounded on it. Assembly details are given on Y&D Dwg. #143056.

**OPERATION:** One-man operation when self-propelled.

**AUXILIARY EQUIPMENT SUPPLIED:** All attachments and fastenings as well as tools and instructions for assembly are included.

**AUXILIARY EQUIPMENT NEEDED BUT NOT SUPPLIED:** Stanchions and life line cables as well as 12-in. flashboards for the edges of the deck are available but should be ordered if required.

**SHIPPING INFORMATION:** Shipped knocked down as individual pontoons, loose assembly angles and boxes of parts, fittings, and tools. Weight:- 102,200 lb. Cube:- 6430 cu ft

**ORDERING INSTRUCTIONS:** Order crane and mounting, life line, flashboards and propulsion units separately if required.



## BARGE, PONTOON, TENDER

4 x 7, FOR PONTOON DRYDOCK, ASSEMBLY NO. 5080

**APPLICATION:** This barge is specifically assembled as a tender barge for the floating pontoon drydock, and is furnished on PT bases along with the drydock. It is however adaptable to any of the assignments within the capacity of this assembly of equipment, i.e. floating mobile crane, clamshell bucket dredge or pile driver.

**CAPACITY:** The capacity of the assembly as a crane ranges from its maximum of 10 tons at 12-ft radius out to 3 tons at 45 ft. As a clamshell dredge it is capable of operating a 3/4-cu yd clamshell bucket 30 ft below the water level. As a floating pile driver it is capable of supporting 30-ft hanging leads from the 50-ft boom. It is also capable of making 1 to 5 knots with one propulsion unit, depending upon load carried. As a cargo barge it is capable of carrying 37 tons concentrically placed in addition to the crane and propelling unit. It draws 30 in. of water light and 48 in. of water fully loaded.

**DESCRIPTION:** The barge is 28 ft wide, 43 ft long and 5 ft deep and is composed of 20 T6 and 8 T7 pontoons bolted into strings of 7 pinned and stayed together. The crane is installed on a special barge mounting, has a 50-ft boom, is gasoline engine driven, is fully enclosed and rigged for use as a crane or as a clamshell bucket dredge. The crane is also equipped with cab lights, trouble light and cab and boom mounted floodlight, all operated from gas engine driven 1500W 110-120 volt lighting plant installed in the cab. Propelling unit is one of three makes procured and described under propulsion units. Walkway between tender and barge included.

**OPERATION:** One operator is required for propulsion unit or crane.

**SUPPLIES REQUIRED:** The following quantities of fuel and lubricants are estimated to be required for operating the equipment 1,000 hours under severe conditions at the atmospheric temperature ranges shown:

	32°F and lower	32°F to 70°F	70°F and higher
<b>Propulsion Unit</b>			
<b>Fuel -</b>			
Unleaded gasoline, 65 octane, gals	8000	8000	8000
Diesel oil, 50 centane gal	2	2	2
Kerosene gal	1		
<b>Greases -</b>			
General purpose 14L9 No. 1 (chassis) lb	15	15	15
Water Pump 14L11 lb	60	60	60
<b>Oils -</b>			
Gear, VV-L-761 (SAE 90) (Hypoid) gal	20	20	20
Motor 9110 (SAE 10) gal	20		
" 9250 ( " 30) gal		20	20
<b>10T Crane</b>			
<b>Fuel -</b>			
Unleaded gasoline, 65 octane, gals	} either	6000	6000
Diesel oil, 50 centane gals			
<b>Greases -</b>			
Ball and roller bearing 14L3b grade No. 11 lb	250	250	250
Water Pump 14L11 lb	1	1	1
Wire rope chain and open gears VV-L-751 lb	250	250	250
<b>Oils -</b>			
Gear, VV-L-761 (SAE 90) (Hypoid) gal	15	15	15
Motor 9110 (SAE 10) gal	120		
" 9250 ( " 30) gal		132	132
" 9500 ( " 50) gal			8

**AUXILIARY EQUIPMENT SUPPLIED:** All attachments, fittings, tools and instructions for assembly are included as well as spare parts estimated to operate all machinery one year. Manual of instruction for operation and maintenance furnished, together with a spare parts list.

**AUXILIARY EQUIPMENT NEEDED BUT NOT SUPPLIED:** Pontoon floating drydock and machine shop barge mounted.

**SHIPPING INFORMATION:** Shipped knocked down into individual pontoons, loose assembly angles, boxed small parts, boxed machinery, loose boom sections, buckets, etc.

Weight: 152,000 lb      Cube: 8,700 cu ft

**ORDERING INSTRUCTIONS:** Order pontoon drydock and machine shop barge separately.



## BARGE, PONTOON

4 x 12, 100-TON, ASSEMBLY NO. 5034

**APPLICATION:** This barge is used for transporting loads up to 100 tons by water; for mounting a 10-ton crane for lifting, for dredging or for floating pile drivers, and, with special equipment, for handling nets.

**CAPACITY:** 100 tons concentrically loaded, three 28-ton tanks with landing ramp and propulsion units or a 10-ton crane with capacity of 10 tons at 12 ft and 3 tons at 45 ft. Equipped with one propelling unit it will make 4 to 6 knots depending upon load carried.

**DESCRIPTION:** 28 ft wide, 72 ft long and 5 ft deep this barge is composed of 40 T6 and 8 T7 pontoons bolted into strings of 12, pinned and stayed together. It draws 20 inches of water when light and 48 inches when fully loaded. Stanchions supporting life line cable and 12-in flashboards may be added around the deck for safety, and also propelling units if required. Deck closures fill in the deck area suitably for all ordinary uses, but for loose materials heavy paper or canvas should be laid down to prevent loss through openings. By the addition of one or more propelling units it becomes self-propelling and very maneuverable, having the ability to turn completely around within its own length. Propelling units of the outboard type have been found to be very effective in backing off after having been grounded on a beach. Assembly details are given on Y & D Dwg #143056.

**OPERATION:** One-man operated when self-propelled.

**AUXILIARY EQUIPMENT SUPPLIED:** All attachments and fastenings as well as tools and instructions for assembly are included. Hand rail stanchions and life line cable are shipped with each unit.



**AUXILIARY EQUIPMENT NEEDED BUT NOT SUPPLIED:** Flashboards are available, but should be ordered separately. Propelling units not included unless ordered.

**SHIPPING INFORMATION:** Shipped knocked down as individual pontoons, loose assembly angles and boxes small parts and tools. Weight: 177,400 lb      Cube: 10,800 cu ft

**ORDERING INSTRUCTIONS:** Order crane and mounting, flashboards, landing ramp and propelling units separately, if required.

## BARGE, PONTOON

5 x 12, 125-TON, ASSEMBLY NO. 5036

**APPLICATION:** This size barge is used particularly for the mounting of a 20-ton crane although it is suitable for any of the transporting or supporting assignments within its capacity.

**CAPACITY:** 125 tons concentrically loaded, supporting a 20-ton crane mounted about 20 ft from one end it provides a lifting capacity of 20 tons at 12-ft radius which ranges down to 7 tons at 55 ft radius. It draws 20 in. of water light and 48 in. fully loaded. Equipped with 1 to 3 propelling units it is capable of 3 to 6 knots, and is highly maneuverable, being able to turn completely around within its own length. The outboard type propelling units have been found to be very effective in backing off after having been beached.

**DESCRIPTION:** 36 ft wide, 73 ft long and 5 ft deep this barge is composed of 50 T6 and 10 T7 pontoons bolted into strings of 12 and pinned and stayed together. Stanchions and life line cable and 12 in. flashboards may be installed around deck for safety, if desired. Propelling units may be installed for self-propulsion. Deck closures are provided for the deck areas which are adequate for all ordinary uses but for supporting loose materials heavy paper or canvas should first be laid down to prevent loss through openings. Assembly details are given on Y & D drawing number 143051.

**OPERATION:** One-man operated when self-propelled.

**AUXILIARY EQUIPMENT SUPPLIED:** All attachments and fastenings as well as tools and instructions for assembly are included. Hand rail stanchions and life line cable are shipped with each unit.

**AUXILIARY EQUIPMENT NEEDED BUT NOT SUPPLIED:** Flash boards, propelling units, barge crane.

**SHIPPING INFORMATION:** Shipped knocked down as individual pontoons, loose assembly angles and boxed small parts and tools. Weight: 221,000 lb      Cube: 13,100 cu ft

**ORDERING INSTRUCTIONS:** Order stanchions, flash boards, propelling units and barge crane separately, if required.



## BARGE, PONTOON WITH CRANE

6 x 18, 75-TON, ASSEMBLY NO. 5043

**APPLICATION:** This is a special-purpose assembly for lifting PT boats out of the water and raising them high enough above the water level to load onto or unload from the deck of a cargo ship.

**CAPACITY:** PT boats, slings and cradle, weighing up to 75 tons. The working height of the hook is about 66 ft above the deck and 40 ft ahead of the bow of the barge. Equipped with 1 to 3 propulsion units, the barge is capable of making 1 to 6 knots depending upon load carried, and is readily maneuvered, being able to turn completely around within its own length. It draws 26 in. water light and 56 in. fully loaded.

**DESCRIPTION:** The barge is 43 ft wide, 108 ft long and 5 ft deep. The boom is fixed on the barge and has no ability to change position except by moving the barge. Its operation is by 1 in. diam wire rope in 12 parts between lifting blocks and powered by a single-drum gasoline-engine-driven winch mounted on the after part of barge deck by means of hold-down bolts through the mounting skids and with weather-proof removable covering over its engine.

**OPERATION:** An operating crew of engineer, signalman and slingers is required for operation but full barge and boom erection crews should be provided for assembly and erection of unit.

**SUPPLIES REQUIRED:** The following quantities of fuel and lubricants are estimated to be required for operating the equipment 1,000 hours under severe conditions at the atmospheric temperature ranges shown:

	32°F and lower	32°F to 70°	70°F and higher
<b>Fuel -</b>			
Unleaded gasoline, 65 octane, gals	} either { 10000	10000	10000
Diesel oil, 50 centane gals			
<b>Greases -</b>			
General purpose 14L9 No. 1 (chassis) lb	10	10	10
Ball and roller bearing 14L3b grade No. 11 lb	5	5	5
Water Pump 14L11 lb	1.	1.	1.
Wire rope, chain and open gears VV-L-751 lb	10	10	10
<b>Oils -</b>			
Gear, VV-L-761 (SAE 90) (Hypoid) gal.	15	15	15
Motor 9110 (SAE 10) gal.	50		
" 9250 ( " 30)		50	50

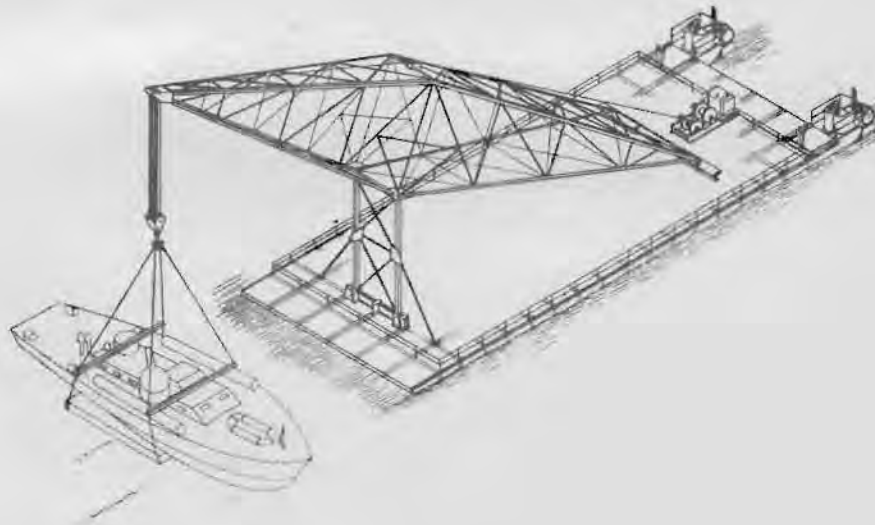



**AUXILIARY EQUIPMENT SUPPLIED:** All attachments, fittings, and tools for the assembly and erection of all items are furnished, including special jacking pole sets with rigging for assembly of boom in confined quarters and without the benefit of additional weight lifting facilities.

**AUXILIARY EQUIPMENT NEEDED BUT NOT SUPPLIED:** Flashboards, and propelling units.

**SHIPPING INFORMATION:** The barge is shipped knocked down into individual pontoons, loose assembly angles, and boxed small parts. Boom is shipped knocked down into bundles of structural steel and boxed attachments. Winch is boxed for export with cable on separate spool or spool of the winch.

	Weight lb	Cube cf
Barge	401,000	23,500
Boom and Blocks	89,000	4,000
Winch and Cable	<u>9,000</u>	<u>400</u>
Total	499,000	27,900

**ORDERING INSTRUCTIONS:** Order flashboards and propelling units separately, if required.

## BARGE, PONTOON

6 x 18, 250-TON, ASSEMBLY NO. 5037

**APPLICATION:** This size barge is used for transporting loads up to 250 tons and for several special tasks such as supporting 3 1,000-bbl tanks and supporting the 75-ton boom. It becomes self-propelling by the addition of propulsion units.

**CAPACITY:** 250 tons concentrically placed; 3 1,000-bbl tanks partly filled with fuel oil, gasoline or water; or one 75-ton boom with load. It draws 20 in. of water light and 48 in. fully loaded. With the addition of 1 to 3 propelling units it is capable of 1 to 6 knots depending upon load carried.

**DESCRIPTION:** 43 ft wide, 108 ft long and 5 ft deep, this barge is composed of 96 T6 and 12 T7 pontoons bolted into strings of 18, pinned and stayed together. Deck closures included close off the deck area for all ordinary uses, but for the support of loose materials heavy paper or canvas should be laid down to prevent loss through the openings. Stanchions with life line cable and 12-in. flashboards may be added for safety. Propelling units may be added for self-propulsion. The barge is highly maneuverable, self-propelled, being capable of turning completely around within its own length. Outboard type of propulsion units have been found to be very effective for backing off after having been grounded on a beach. Assembly details are given on Y & D Dwg number 143,088 and 218,784.

**OPERATION:** One-man operated when self-propelled.

**AUXILIARY EQUIPMENT SUPPLIED:** All attachments, fittings, tools and instructions for assembly are included. Hand rail stanchions and life line cable are shipped with each unit.

**AUXILIARY EQUIPMENT NEEDED BUT NOT SUPPLIED:** Flashboards, propulsion units.



SHIPPING INFORMATION: Shipped knocked down as individual pontoons, loose assembly and angles and boxed small parts. Weight: 401,000 lb Cube: 23,000 cu ft

ORDERING INSTRUCTIONS: Order flashboards and propelling units separately, if required.

## BOAT SUPPORTS AND KEEL BLOCKS

FOR PONTOON DRYDOCK, 4 x 15, ASSEMBLY NO. 5045

**APPLICATION:** Adjustable boat supports and keel blocks for the support of PT boats and similar craft in the pontoon floating drydock.

**CAPACITY:** The boat supports are designed for the PT boat hulls with six crossframes set up in accordance with the six-point supporting plans. The frames may be moved readily to suit the bulkheads of the boat or they may be removed entirely for flat bottomed craft.

**DESCRIPTION:** The equipment consists of 22 wood and 10 steel blocking frames which clamp to the deck assembly angles of the pontoon drydock and form a base for the six adjustable steel boat supports built into cross frames which rest upon them. The cross frames attach to the wooden blocking frames by means of dogbolts. The member which supports the boat chock is hinged at its lower end and supported by a post at its outer end provided with a series of pin holes for adjustment in elevation. The entire cross frame may be moved and fastened at any point on the blocking frames by means of the dogbolts. The chocks, which are wooden members shaped to the cross section of the hull and padded where they touch the hull, rest on and fasten to the boat supports. The chocks are not supplied with the boat supports but are fashioned at the base from dimensions on the docking plans accompanying each of the five hull types which may be docked, unless the chocks on the boat's shipping cradle are suitable.

**AUXILIARY EQUIPMENT NOT SUPPLIED:** Chocks for PT boat hulls.

**SHIPPING INFORMATION:** Shipped bundled as steel and wood frames  
Weight: 24,000 lb                      Cube: 500 cu ft

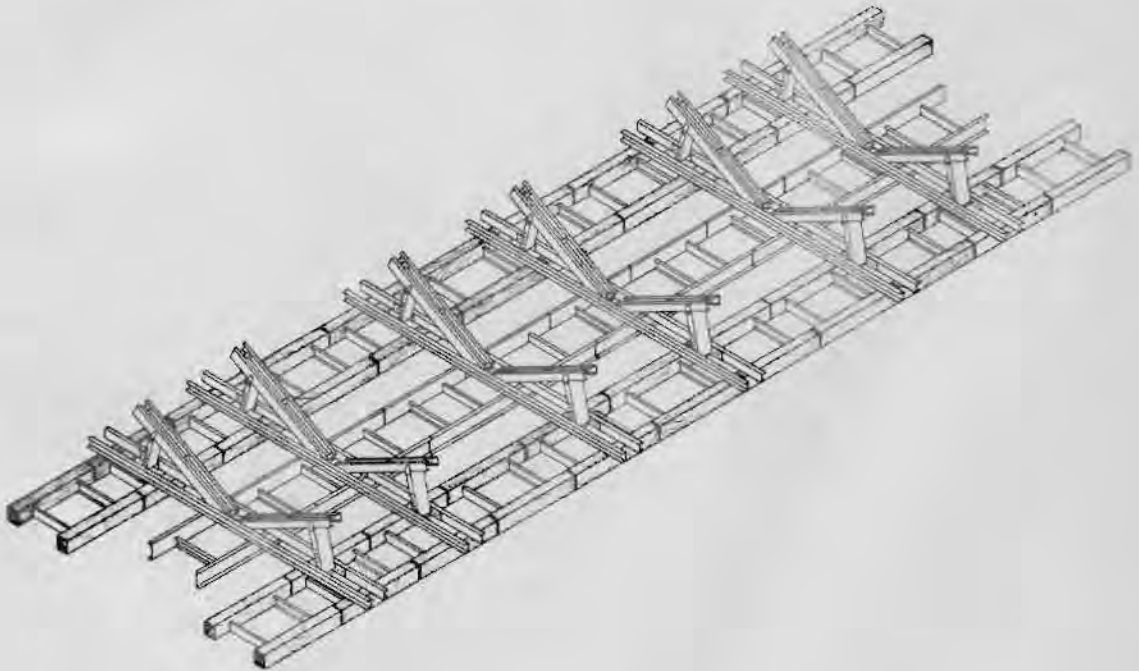

## BARGE, PONTOON, WITH OIL TANKS

6 x 18, 250-TON, FUEL OIL, ASSEMBLY NO. 5042

**APPLICATION:** This is a special assembly for transportation by water, or storage at the waterfront of oils, gasoline or water.

**CAPACITY:** 2,300 bbl of oil, 2,000 bbl of water or 2,300 bbl of gasoline. It draws 24 in water light and 56 in fully loaded. Self-propelled by the addition of 1 to 3 propulsion units, it is capable of 1 to 6 knots depending upon the load carried.

**DESCRIPTION:** The barge, 43 ft wide, 108 ft long and 5 ft deep, is composed of 96 T6 and 12 T7 pontoons bolted into strings of 18 and pinned and stayed together. In addition there are 3 high-type bolted steel 1,000-bbl capacity tanks complete with attachments, cover and ladders, 2 350-gpm gasoline engine driven fuel oil pumps, mounted on skids in weather proof housing, and a sufficient quantity of 8 in and 6 in pipe and fittings to connect the pumps and tanks and to reach to the edge of the barge deck.

**OPERATION:** One pump and engine tender required.

**SUPPLIES REQUIRED:** The following quantities of fuel and lubricants are estimated to be required for operating both pumps 1,000 hours under severe conditions at the atmospheric temperature ranges shown:

	32°F and lower	32°F to 70°F	70°F and higher
<b>Fuel -</b>			
Unleaded gasoline, 65 octane, gals	20000	20000	20000
<b>Greases -</b>			
General purpose 14L10 No. 2 (wheel bearing) lb	20	20	20
Ball and roller bearing 14L3b grade No. 11 lb	20	20	20
Water Pump 14L11 lb	20	20	20
<b>Oils -</b>			
Motor 9110 (SAE 10) gal	80	80	
" 9250 ( " 30) gal			80

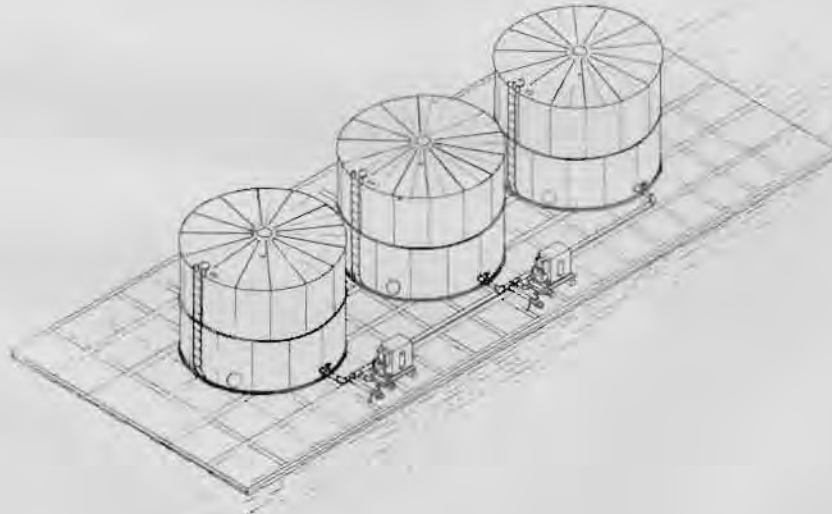

**AUXILIARY EQUIPMENT SUPPLIED:** All attachments, fittings, tools and instructions for assembly of the barge are included. All attachments and fittings for assembly of tanks, pumps and connecting pipe are included. Manual of instruction for operation and maintenance furnished, together with a spare parts list.

**AUXILIARY EQUIPMENT NEEDED BUT NOT SUPPLIED:** Flashboards, and propelling units, if required, and hose connections from pumps outward.

**SHIPPING INFORMATION:** The barge is shipped knocked down into individual pontoons, loose assembly angles and boxed small parts. The tanks are knocked down into individual plates nested and boxed fastenings. The pumps are boxed for export and the pipe and fittings are shipped loose.

Weight: 455,300 lb      Cube: 26,800 cu ft

**ORDERING INSTRUCTIONS:** Order separately, if required, flashboards, propulsion units and hose connections from pumps outward.

## BRIDGE, PONTOON

2 x 12, 50-TON CAPACITY, ASSEMBLY NO. 5046

**APPLICATION:** An assembly used as a connecting link between a pontoon wharf and the shore, and also for connecting end-to-end and forming finger piers out into the water.

**CAPACITY:** This pontoon bridge has a capacity of 50 tons concentrically placed. Properly connected at the ends, it is capable of supporting a moving load up to 40 tons. It draws 20 in. of water when light and 48 in. when fully loaded.

**DESCRIPTION:** 14 ft wide, 70 ft long and 5 ft deep, the pontoon bridge is composed of 24 T6 pontoons bolted into 2 strings of 12, pinned and stayed together. Details of assembly are shown on Y&D Dwg #124,960

**AUXILIARY EQUIPMENT SUPPLIED:** All attachments and fittings, as well as tools and instructions for assembly are included.

**AUXILIARY EQUIPMENT NEEDED BUT NOT SUPPLIED:** Bridge-to-bridge connections and bridge-to-wharf connections.

**SHIPPING INFORMATION:** Shipped knocked down as individual pontoons, loose assembly angles and boxed fittings and small parts.

Weight 83,800 lb

Cube 5,000 cu ft

**ORDERING INSTRUCTIONS:** Order bridge-to-bridge and bridge-to-wharf connections separately when required.

Bridge-to-bridge connection 1,500 lb 39 cu ft

Bridge-to-wharf connection 2,150 lb 33 cu ft



## DRYDOCK, PONTOON

4 x 15, 125-TON, ASSEMBLY NO. 5049

**APPLICATION:** Used for drydocking P.T. boats and other water craft within its capacity.

**CAPACITY:** It is capable of drydocking vessels up to 125 tons displacement. It draws 28 in. of water when light, 52 in. fully loaded, and requires 18 feet of water to submerge its deck 12 feet, its maximum safe submergence. A P.T. boat requires 27 min. for a complete docking cycle, i.e. docking and undocking. The deck is a 4 x 15 pontoon assembly, providing a width between towers of 28 ft - 7 in. and a length of deck of 87 ft.

**DESCRIPTION:** It is composed of 80 T6 pontoons, 60 of which are bolted into strings of 15, pinned and stayed together. Five pairs of pontoons, bolted end to end are attached just off the edge of the deck on each side, to form the positive buoyancy towers. The tower tops on each side are connected by walkways and provide continuous footing for docking personnel as well as cleats for tying up lines while centering the boat. Each deck pontoon is connected by piping from the upper 2-in. opening into four headers. One header groups the piping of each quarter of the deck. Each pipe header connects by means of 2 in. air hose to a manifold equipped with pressure gage, pressure relief valve, four 2-in. hose connections on the inlet and the outlet sides, each connection provided with a two-way lever-operated stop cock. The manifold connects on the inlet side to groups of air compressors consisting of 4 100-cfm or 2 244-cfm low pressure rotary-type or to 2 210-cfm portable construction-type compressors. The portable construction-type compressors, when furnished, are accompanied by pressure reducing valves to hold the delivered air pressure within proper limits.

**OPERATION:** The dock is operated by submerging to a depth sufficient to allow the docking craft to enter and be centered over the blocking, then raising the dock with the boat resting in the blocking. Submergence is managed by opening the air cocks at the air manifold allowing the air to escape from the deck pontoons and the water to enter through the lower 2-in. pipe connections which have previously been opened. When submerged to the proper depth, the four cocks controlling the escape of air are closed thus holding the dock at that level. The crew of the docking boat handles all lines and centers the boat over the supports as directed by the dockmaster. Once centered, the dock is raised by opening the cocks from the compressors so that air is forced into all deck pontoons, expelling the water and raising the dock and boat. Operation of the dock requires one dockmaster, one manifold operator and one compressor operator. The boat crew handles the boat. Undocking is the reverse of the above procedure.

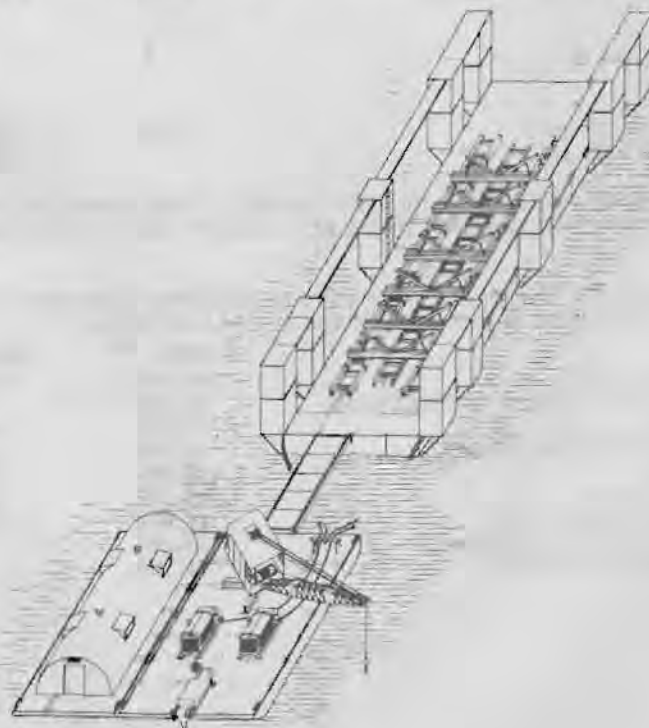



**SUPPLIES REQUIRED:** The following quantities of fuel and lubricants are estimated to be required for operating the equipment 1,000 hours under severe conditions at the atmospheric temperature ranges shown:

	32°F and lower	32°F to 70°F	70°F and higher
<b>10T Crane</b>			
Fuel -			
Unleaded gasoline, 65 octane, gals) either	6000	6000	6000
Diesel oil, 50 centane gals )	4200	4200	4200
<b>Greases -</b>			
Ball and roller bearing 14L3b grade No. 11 lb	250	250	250
Water Pump 14L11 lb	1	1	1
Wire rope chain and open gears VV-L-751 lb	250	250	250
<b>Oils</b>			
Gear, VV-L-761 (SAE 90) (Hypoid) gal.	15	15	15
Motor 9110 (SAE 10) gal.	120		
" 9250 ( " 30) gal.		132	132
" 9500 ( " 50) gal.			8
<b>Propulsion Unit</b>			
Fuel -			
Unleaded gasoline, 65 octane, gals	8000	8000	8000
Diesel oil, 50 centane gal	2	2	2
Kerosene, gal	1		
<b>Greases -</b>			
General purpose 14L9 No. 1 (chassis) lb	15	15	15
Water Pump 14L11 lb	60	60	60
<b>Oils -</b>			
Gear, VV-L-761 (SAE 80) (Hypoid) gal.	20	20	20
Motor 9110 (SAE 10) gal.	20		
" 9250 ( " 30) gal.		20	20
<b>4 Compressors</b>			
Fuel -			
Unleaded gasoline, 65 octane, gals	8000	8000	8000
<b>Greases -</b>			
Water Pump 14L11 lb	4	4	4
<b>Oils -</b>			
Motor 9110 (SAE 10) gal	260	160	160
" 9250 ( " 30) gal		100	100

**AUXILIARY EQUIPMENT SUPPLIED:** All attachments, fittings, tools and instructions required for the assembly of the dock and piping are included together with anchors and chain for anchoring same.

**SHIPPING INFORMATION:** Shipped knocked down as individual pontoons, loose assembly angles and piping, boxed small parts, skidded and crated machinery.

		Weight: lb	Cube: cu ft
4 x 15	Pontoon D.D.	272,000	17,600
	P.T. boat supports & keel blocks	24,000	800
3 x 7	Barge	76,000	4,300
	16 x 36 Machine Shop	10,500	400
4 x 7	Barge	102,000	6,400
	1-10T Crane	36,000	1,700
	1 - Propulsion unit	13,000	1,400
	DD operating equipment	11,000	800
	Connecting walkway	2,500	100

## PIER, PONTOON

2 x 24

**APPLICATION:** The pontoon pier is used as a tying up or servicing pier for small craft, or as a connecting link between a pontoon wharf and the shore wherever rapid construction and portability are required.

**CAPACITY:** 50 tons to each 2 x 12 string concentrically placed, or a 40 ton moving load providing ends are properly connected. The pier draws 20 in. of water when light and 48 in. fully loaded.

**DESCRIPTION:** The pier is made up of two 2 x 12 pontoon bridge sections attached end to end by means of a bridge-to-bridge connection. Each bridge unit consists of 24 T6 pontoons bolted into strings of 12, pinned and stayed together. Anchors and bridge-to-bridge connection are included.

**AUXILIARY EQUIPMENT SUPPLIED:** All attachments, fittings, tools and instructions for assembly are included.

**SHIPPING INFORMATION:** Shipped knocked down as individual pontoons, loose assembly angles and anchors and boxed small parts.

Weight 172,300 lb

Cube 10,000 cu ft

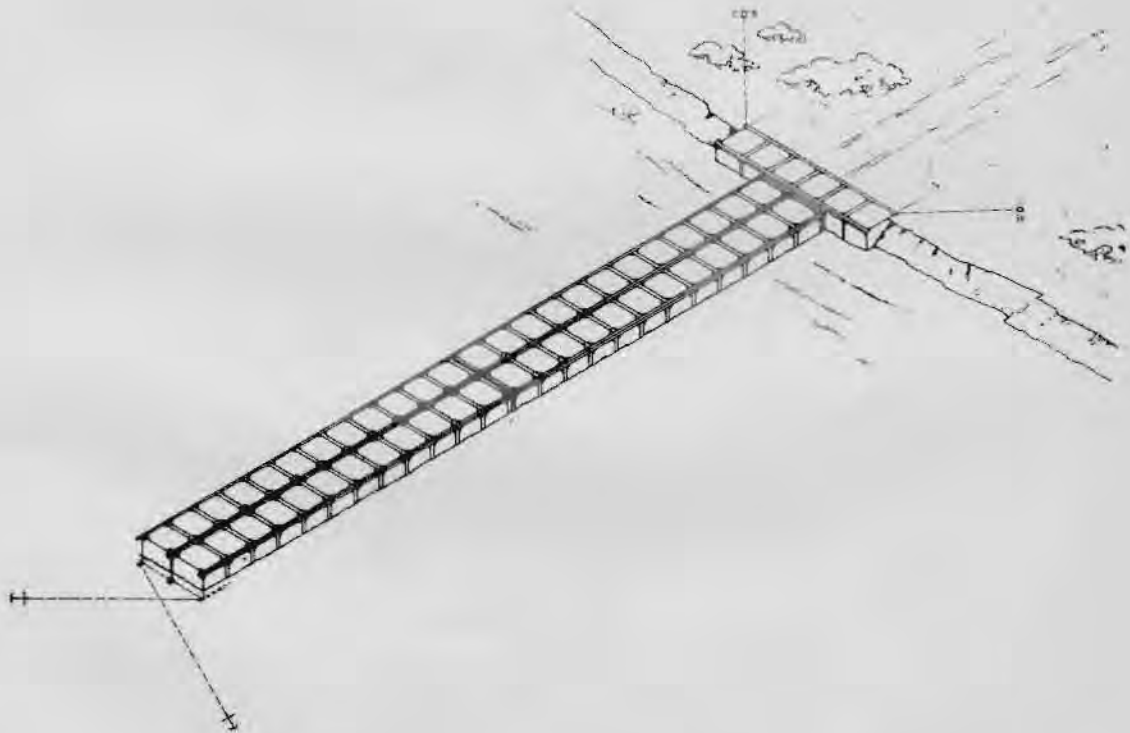

## PROPELLING UNITS

STOCK NO. 5F45

**APPLICATION:** Used for propelling and steering pontoon barges.

**CAPACITY:** These propelling units will move pontoon barges at speeds varying from one to eight knots per hour, depending upon the size of barge, the load carried and the number of units installed. A barge equipped with one or more of these units is highly maneuverable, it being possible to turn it completely around in its own length. Propelling units of the outboard type have proved to be very effective in backing a grounded barge off a beach. A barge may be served by as many units as there are strings of pontoons. For instance, one unit only has been found adequate for 3 x 7 and 4 x 7 barges while two or three units may be desirable on 100, 125 and 250 ton barges that are being used for cargo transportation.

**DESCRIPTION:** Three makes of propelling units are supplied, two outboard and one inboard. Each of the outboard types rest on an end pontoon with its propeller extending vertically into the water over the end of the barge. The inboard type has its engine housed in its own pontoon, which replaces an end pontoon of the barge, and its propeller shaft extends horizontally into the water. All three types are steered manually by wheel, one outboard type by changing the position of the propeller and the other two by means of a movable rudder, the propeller remaining in its fixed position. Each of the three makes is powered by the same model gasoline engine (equipped with starter) and the outboard type engine is protected by a removable panel steel weatherproof housing. The working level of the propeller in the water is generally about two ft below the bottom of the barge but the propellers are adaptable for being raised high enough to clear the bottom of the barge.

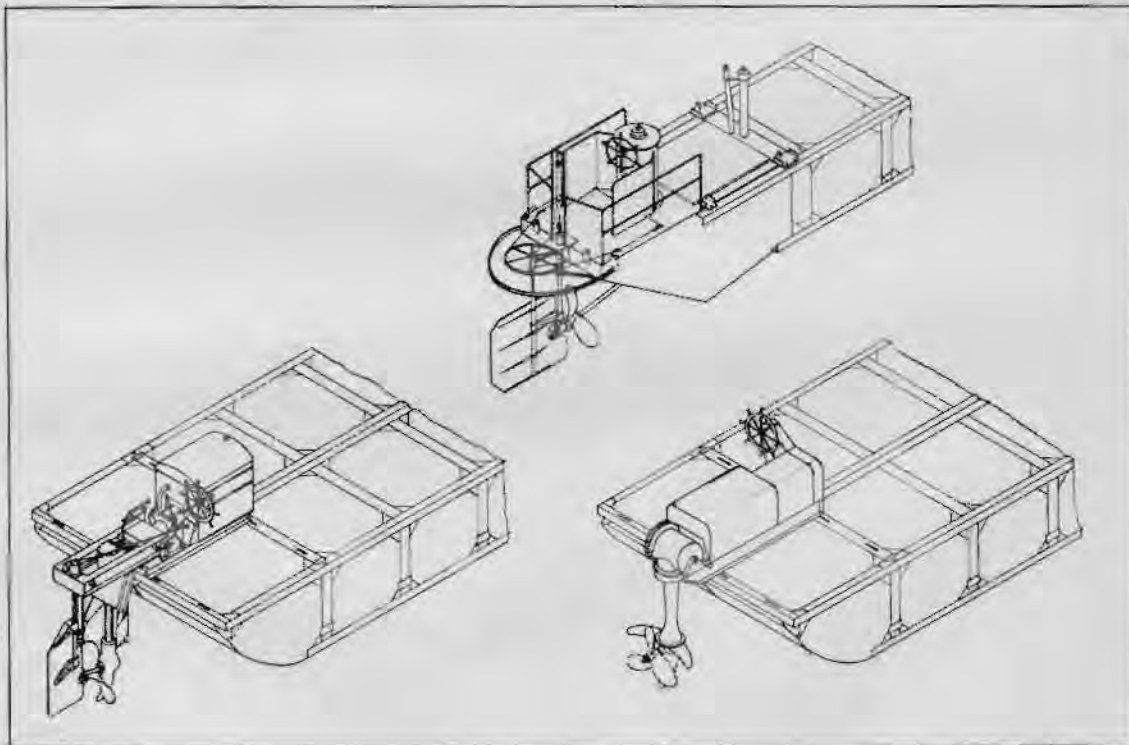

**SUPPLIES REQUIRED:** The following quantities of fuel and lubricants are estimated to be required for operating the equipment 1,000 hours under severe conditions at the atmospheric temperature ranges shown:

	32°F and lower	32°F to 70°F	70°F and higher
<b>Fuel -</b>			
Unleaded gasoline, 65 octane, gals	8000	8000	8000
Diesel oil, 50 centane gal	2	2	2
Kerosene gal	1		
<b>Greases -</b>			
General purpose 14L9 No. 1 (chassis) lb	15	15	15
Water Pump 14L11 lb	60	60	60
<b>Oils -</b>			
Gear, VV-L-761 (SAE 80) (Hypoid) gal	20	20	20
Motor 9110 (SAE 10) gal	20		
" 9250 ( " 30) gal		20	20

**AUXILIARY EQUIPMENT SUPPLIED:** All attachments and tools for attaching are included.

**SHIPPING INFORMATION:** Shipped on skids, crated and boxed for export.

Chrysler Sea Tractor	12600 lb	1460 cu ft
Muncie (outboard with rudder)	8600 lb	600 cu ft
Murray & Tregurtha (outboard)	7500 lb	670 cu ft

## RAMP

LANDING, PONTOON BARGE, 30-TON, ASSEMBLY NO. 5055

**APPLICATION:** Used on pontoon barges as a landing ramp or gangway for unloading or loading heavy, mobile equipment.

**CAPACITY:** 30-ton moving load

**DESCRIPTION:** As given in detail on Y&D Dwgs No 142,832 & 142,833 the ramps consists of 2 load-carrying beams, laterally braced and supporting 3-in. x 10-in. wooden deck members, attached by means of hinges to the end of the barge top assembly angles, and supported at outer ends by means of wire rope cables which connect to light A-frames and hand-operated winches mounted near the hinged ends. The ramp has vertical adjustment of outer end by means of the winches.

**OPERATION:** One-man operation of winches

**AUXILIARY EQUIPMENT SUPPLIED:** All attachments and fittings as well as tool required to install them are supplied.

**AUXILIARY EQUIPMENT NEEDED BUT NOT SUPPLIED:** Pontoon barge

**SHIPPING INFORMATION:** Shipped knocked down as loose structural members, plank and boxed small parts.    Weight: 7200 lb                      Cube: .220 cu ft



## WALKWAY, PONTOON

### FROM DRYDOCK TO TENDING BARGE

**APPLICATION:** This unit is provided as a connecting link and walkway between the pontoon drydock and its tending barge.

**CAPACITY:** The walkway is designed for a uniformly distributed live load of 150 psf or a concentrated load of 1000 lb.

**DESCRIPTION:** This walkway unit after assembly is approximately 20 ft long. It consists of 3-in. plank decking about 8 ft wide with a 4 in. x 4 in. wooden curb running along each side, supported on two channel stringers. Each stringer is made up of a pair of 8-in. channels turned back to back and maintained one inch apart by means of filler plates. The stringers are coped, both flanges at the ends, reinforced with connecting plates and provided with pin holes for attaching to fittings on the ends of barge and drydock assembly angles. The decking is pre-fabricated in 5 panels and is made fast to the stringers by means of bolts which fit between the separated channels and are secured to the bottom flanges with nuts and washers.

**AUXILIARY EQUIPMENT NEEDED BUT NOT SUPPLIED:** Attachment fittings and pins are supplied with barge and pontoon drydock.

**SHIPPING INFORMATION:** Shipped as loose stringers and bundled deck panels, and boxed or bundled bolts.      Weight: 2200 lb      Cube: 110 cu ft

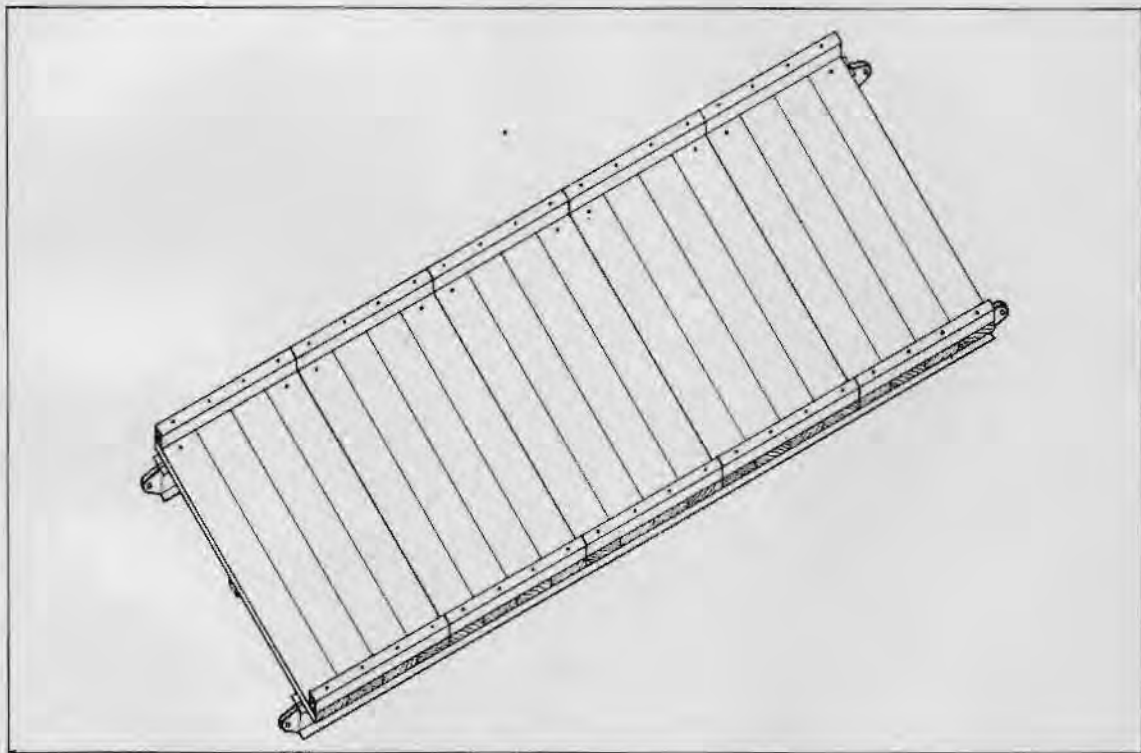

## WHARF, PONTOON

5 x 12, 125-TON, ASSEMBLY NO. 5054

**APPLICATION:** Because of their portability and ready assembly, pontoon wharves are used at advance bases for wharf facilities, both for loading and unloading cargoes and also for servicing and tying up of water craft.

**CAPACITY:** The 5 x 12 pontoon wharf is capable of supporting 125 tons concentrically loaded or a moving load of 40 tons when properly connected to bridges, piers, other pontoon assemblies or to the shore. It draws 20 in. of water when light and 48 in. of water fully loaded.

**DESCRIPTION:** 36 ft wide, 70 ft long and 5 ft deep the pontoon wharf is composed of 60 T6 pontoons bolted into strings of 12, pinned and stayed together. Cleats are provided for the lines of craft tying up, and anchors with chain are provided for each corner of the wharf. For assembly detail see Y&D Dwg 143089.

**AUXILIARY EQUIPMENT SUPPLIED:** 4-200 lb anchors each with 150 ft of 5/8-in. diameter close-link chain and all attachments and fittings as well as all tools and instructions for assembly are included.

**SHIPPING INFORMATION:** Shipped knocked down into individual pontoons, loose assembly angles and boxed small parts, loose anchors and chain.

	Weight: lb	Cube: cu ft
Wharf	220,000	13,000
Anchors and Chain	3,200	20

**ORDERING INSTRUCTIONS:** Order bridge-to-wharf connections if required.



## BUOY, HEAVY SEA, LIGHTED

ASSEMBLY NO. 5024

**APPLICATION:** An emergency navigational aid, based on USCG Dwg No. BU-41-158, to be shipped on special directive only.

**CAPACITY:** For use in water areas exposed to heavy seas.

**DESCRIPTION:** The buoy consists of the following items:

- 1 buoy 9 x 38 WA (9 ft diam x 38 ft long)
- 1 375 mm acetylene lantern
- 2 A 300 acetylene tanks
- 180 ft of 1 1/2-in. chain
- 1 cast iron sinker

**OPERATION:** Requires periodical attention of light tender for cleaning and refueling. Whistle is automatic and is actuated by the movement of the buoy in the seas.

**SUPPLIES REQUIRED:** Refueling.

**SHIPPING INFORMATION:** Lantern boxed for export - other items unboxed.

	Weight:lb	Cube: cu ft
1 Buoy	20,616	1,000.
1 Lantern	617.	6.
2 Tanks	2,600.	80.
180 ft of Chain	4,248.	44.
1 Sinker	<u>6,500.</u>	<u>40.</u>
Total	34,581.	1,170.

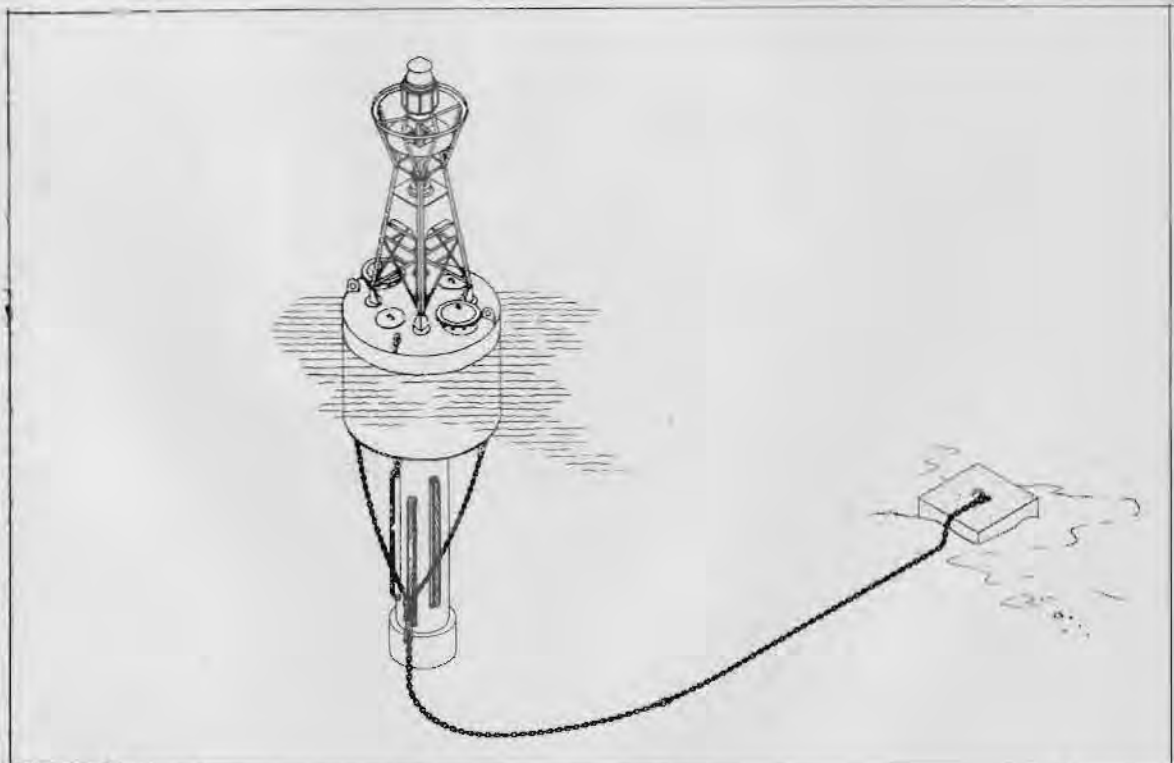



## BUOY, HEAVY SEA, UNLIGHTED

ASSEMBLY NO. 5025

**APPLICATION:** An emergency navigational aid based upon USCG Dwg No. BU-41-158 to be shipped on special directive only, for use as a navigational marker in areas subjected to heavy seas.

**DESCRIPTION:** The buoy equipment consists of the following items:

- 1 First-class standard can buoy, 6 ft diam, 10 ft high.
- 90 ft, 1 1/4-in. chain.
- 1 Ballast ball.
- 1 Sinker.

**SHIPPING INFORMATION:** Shipped separately, unboxed.

	Weight: lb	Cube: cu ft
Can buoy 5B50-5	3,500	270
Chain	1,250	13
Ballast ball	1,250	6
Sinker	<u>5,000</u>	<u>33</u>
Total	11,000	322

**ORDERING INSTRUCTIONS:** Nuns and cans of the same class are interchangeable.

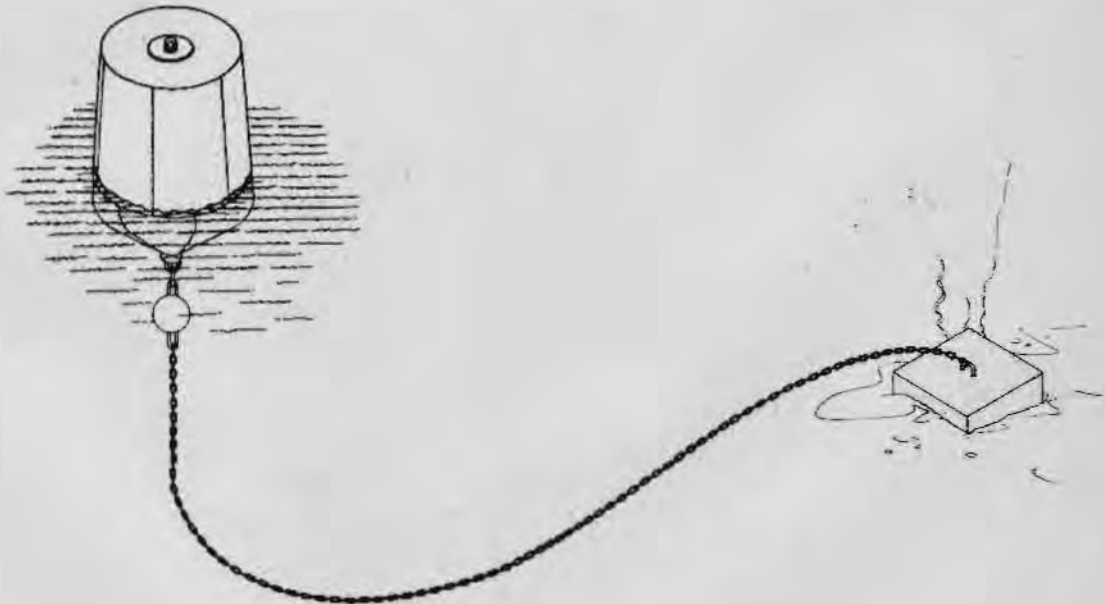

## BEACON, HOUSE AND TOWER, 18 FT

ASSEMBLY NO. 5001

**APPLICATION:** This assembly is used as a navigational beacon located either on land or in shoal water to serve as a range light for ships and planes.

**CAPACITY:** One 200 mm lantern with space for batteries in the house below.

**DESCRIPTION:** The house and tower are of wood construction, prefabricated, furnished knocked down by the U. S. Coast Guard. Both structures are shown in detail on USCG Dwg No. M3T67 or on Y&D Dwg No. 250,550 and are usually placed on concrete foundations or piers. The wiring diagram for the lantern is shown on Y&D Dwg No. The assembly consists of the following:

	Weight, lb	Cube, cu ft
1 - House and Tower	6,700	200
1 - 200 mm lantern	70	2
1 - Set of six 2 volt low discharge wet cell storage batteries for buoy service in cans.	600	6
1 - Lamp changer	10	1
8 - 12 V .77 amp lamps	10	1
1 - 12 V 0.4 to 3.6 sec flasher	10	1
All wiring and connections necessary for the installation.	20	1

**OPERATION:** The lantern flashes at the set interval automatically but requires periodic inspection for cleaning, replacing lamps and renewing battery charges.

**SUPPLIES REQUIRED:** New lamps, fully charged batteries.

**AUXILIARY EQUIPMENT NEEDED BUT NOT SUPPLIED:** Foundation materials, usually concrete, are not included, but will be required by the construction crews setting up the beacon.

**SHIPPING INFORMATION:** Bundled and boxed. Weight, lb - 7420 Cube, cu ft 212  
For individual items see description above.

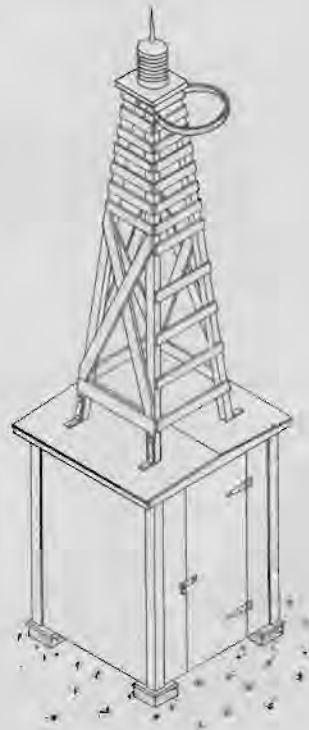

## BEACON, 3 PILE MINOR LIGHT

ASSEMBLY NO. 5002

**APPLICATION:** A navigational beacon installed in shoal or navigable waters to serve as a range light for ships and planes. The three pile structure is for use in locations where winds and tide are moderate and a 3 pile structure is considered rugged enough.

**CAPACITY:** For gas post or battery operated electric lantern, the structure is shown on Y&D Dwg No. 199,921, while the design of the battery box and the wiring diagram are given on Y&D Dwg No.

**DESCRIPTION:** The structure when assembled provides a platform support for the lantern mounted on a battery house or box. It is prefabricated and includes the piles, bracing, platform, handrail and ladder members together with all fastenings. The assembly consists of the following:

	Weight lb	Cube cu ft
1 - 3 pile minor light structure	8,000	230
1 - 200 mm lantern	70	1
1 - set of six 2 V low discharge wet cell storage batteries for buoy service in cans.	600	6
1 - lamp changer	10	1
1 - flasher, 12 V .4 to 3.6	10	1
8 - 12 V .77 amp lamps	10	1
1 - complete set of wiring and connectors for the installation.	20	1

**OPERATION:** The construction of the structure requires a dock building crew equipped to drive piles in water. The light flashes at the set interval automatically but requires periodic inspection and attention of the light tender to clean, replace burned out lamps and recharge the storage batteries.

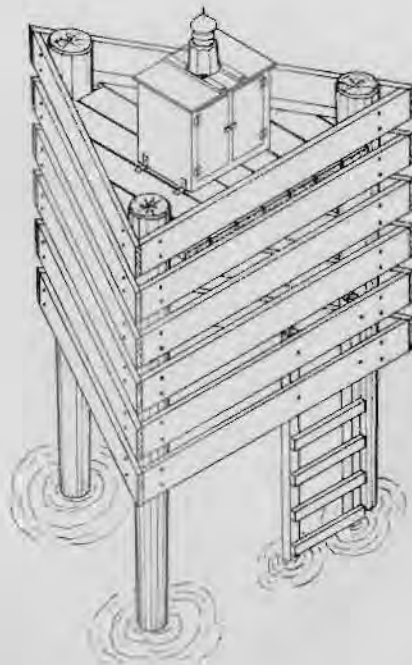

**AUXILIARY EQUIPMENT NEEDED BUT NOT SUPPLIED:** No battery box or house is furnished so it will be necessary to construct a suitable weatherproof box in the field to house the batteries and support the lantern.

**SHIPPING INFORMATION:** Loose, bundled and boxed.

Total            Weight lb 8,720            Cube cu ft 241

For individual items see description on preceding page.



## BEACON, 6 PILE MINOR LIGHT

ASSEMBLY NO. 5003

**APPLICATION:** A navigational beacon installed in shoal or navigable waters to serve as a range light for ships and planes. The six pile structure is for use in locations, where due to depth of water or velocity of wind or water, a more rugged structure is required than the three pile.

**CAPACITY:** For gas post or battery operated electric lantern, the structure is shown on Y&D Dwg No. 199,921 while the design of battery box and the wiring diagram for the lantern are shown on Y&D Dwg No.

**DESCRIPTION:** The structure when assembled provides a platform support for the lantern mounted on a battery house or box. It is prefabricated and includes the piles, bracing, platform, handrail and ladder members together with all fastenings. The assembly consists of the following:

	Weight lb	Cube cu ft
1 - 6 pile minor light structure	15,700	380
1 - 200 mm lantern	70	1
1 - set of six 2 volt low discharge wet cell storage batteries for buoy service in cans.	600	6
1 - lamp changer	10	1
1 - flasher, 12 V .4 to 3.6 sec	10	1
8 - 12 V .77 amp lamps	10	1
1 - complete set of wiring and connectors for the installation	20	1

**OPERATION:** The construction of the structure requires a dock building crew equipped to drive piles in water. The light flashes at the set interval automatically but requires periodic inspection and attention of the light tender to clean, replace burned out lamps and recharge the storage batteries.

**SUPPLIES REQUIRED:**

Lamps and battery recharging.

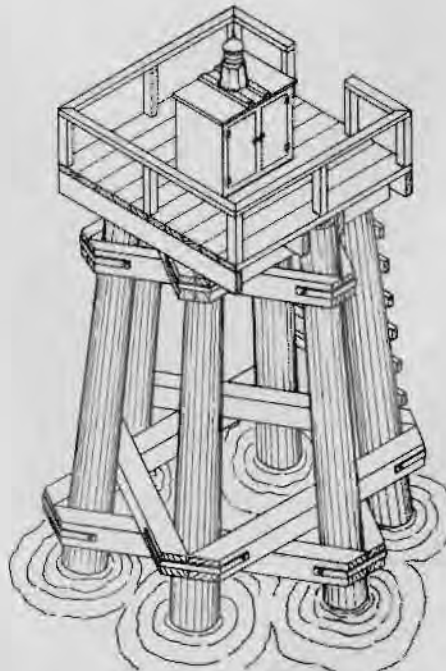

**AUXILIARY EQUIPMENT NEEDED BUT NOT SUPPLIED:** No battery box or house is furnished so it will be necessary to construct a suitable weatherproof box in the field to house the batteries and support the lantern.

**SHIPPING INFORMATION:** Loose, bundled and boxed.

	Weight lb	Cube cu ft
Total	16,420	391

For individual items see description on preceding page.

## BUOY, MODERATE SEA, LIGHTED

ASSEMBLY NO. 5026

**APPLICATION:** An emergency navigational aid, based on USCG Dwg No. BU-41-158, to be shipped on special directive only. For use in waters subject to moderate seas as a range light for ships and planes.

**DESCRIPTION:** The buoy consists of the following items:

- 1 buoy 8 x 26 BE or WE (8ft diam x 26 ft long)
- 1 electric lantern
- 1 set of batteries
- 120 ft of 1 1/2-in. chain
- 1 cast iron sinker

**OPERATION:** Requires the periodic attention of a light keeper for cleaning and servicing light and batteries. The bell (or whistle-- whichever is furnished) is automatic and is actuated by the movement of the buoy in the seas.

**SUPPLIES REQUIRED:** Requires only cleaning and the recharging of batteries.

**SHIPPING INFORMATION:** Lantern and batteries boxed for export; other items unboxed.

Item	Weight: lb	Cube: cu ft
1 8 x 26BE (Bell Elec.) Buoy 5B50-8	12,680	880 or
1 8 x 26WE (Whistle Elec.) Buoy	13,554	880
1 Lantern	95	4
1 Set of batteries	2,510	72
120 ft of chain	2,811	28
1 Sinker	5,000	33
	<u>23,096 or</u>	<u>1,017</u>
	24,970	

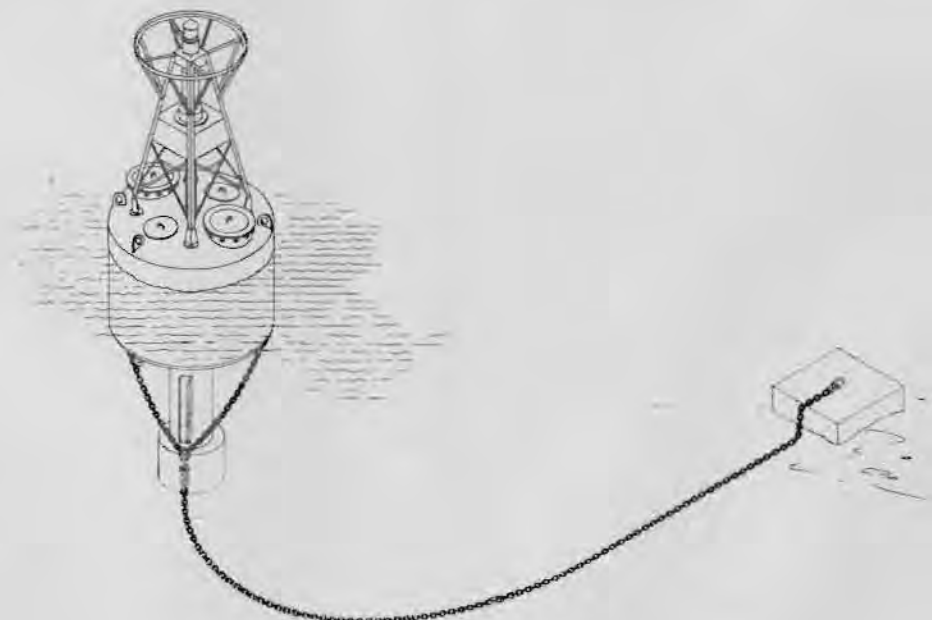

## BUOY, MODERATE SEA, UNLIGHTED

ASSEMBLY NO. 5027

**APPLICATION:** An emergency navigational aid based on USCG Dwg No. BU-41-158, to be shipped on special directive only. For use in waters exposed to moderate seas as navigational aids or markers.

**DESCRIPTION:** The buoy consists of the following items:

- 1 First-class standard nun buoy, 6 ft 4 in. diam, 12 ft high.
- 90 Ft 1 1/4-in. chain.
- 1 Ballast ball.
- 1 Sinker.

**SHIPPING INFORMATION:** Shipped separately unboxed.

	Weight: lb	Cube: cu'ft
Buoy 5B50-16	3,200	336
Chain	1,250	13
Ballast ball	1,250	6
Sinker	<u>3,000</u>	<u>20</u>
Total	<u>8,700</u>	<u>375</u>

**ORDERING INSTRUCTIONS:** Nuns and cans of the same class are interchangeable.

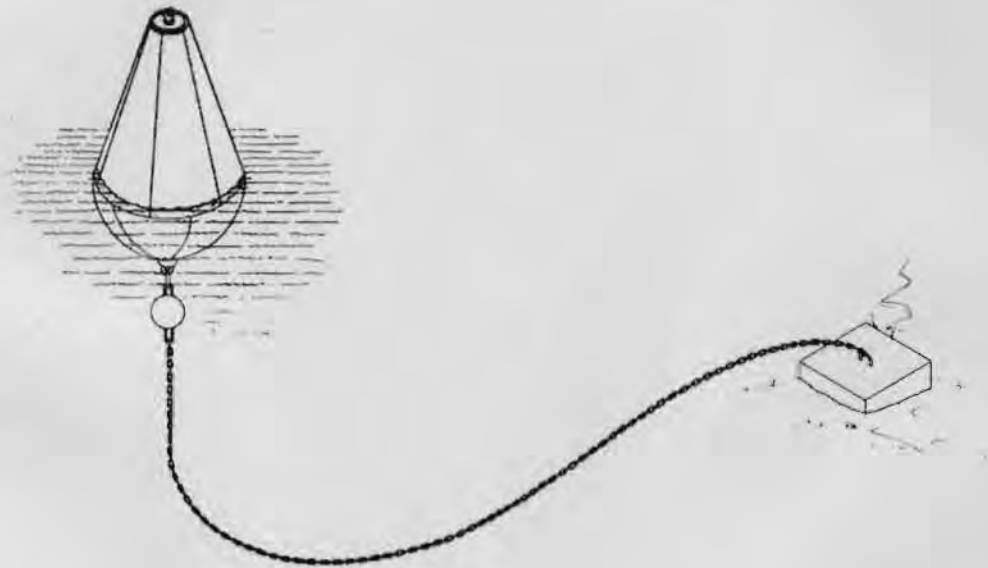



## BUOY, PROTECTED SEA, LIGHTED

ASSEMBLY NO. 5028

**APPLICATION:** An emergency navigational aid, based on USCG Dwg No. BU-41-158, to be shipped on special directive only. For use as navigational aids or markers in protected seas only.

**CAPACITY:** Suitable for use in areas subjected to protected seas.

**DESCRIPTION:** The buoy consists of the following items:

- 1 Buoy 6 x 20 E (6 ft diam x 20 ft long)
- 1 200 mm electric lantern
- 2 Type 23 battery racks
- 90 Ft of 1 1/8-in. chain
- 1 Cast iron sinker

**OPERATION:** Requires the periodical attention of light keeper for cleaning and adjusting, and recharging batteries.

**SUPPLIES REQUIRED:** Cleaning and battery recharging.

**SHIPPING INFORMATION:** Shipped lantern and batteries boxed; other items separately and unboxed.

	Weight: lb	Cube: cu ft
1 Buoy 5B50-7	5,537	463
1 Lantern	95	3
2 Battery racks	1,350	90
90 Ft of chain	1,112	11
1 Sinker	5,000	33
Total	13,094	600

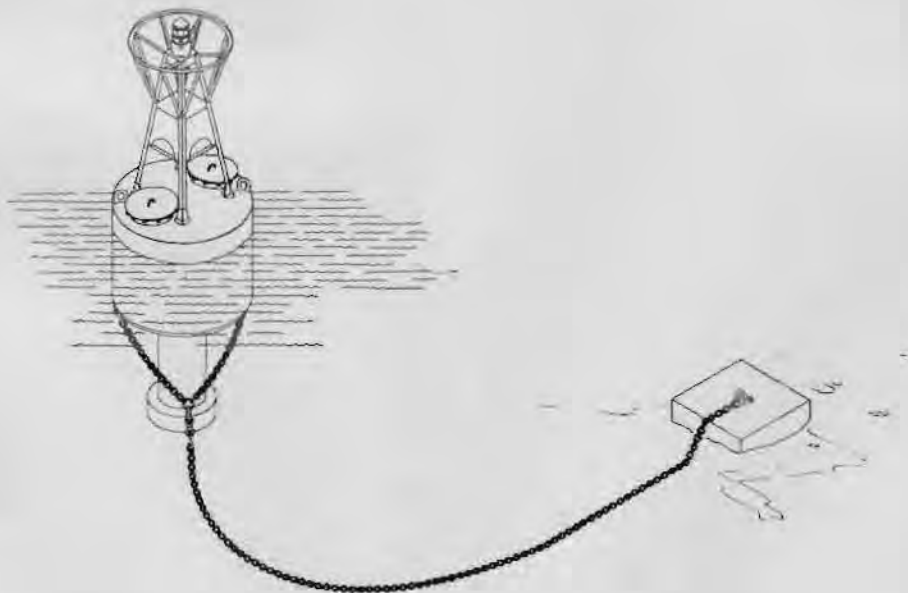

## BUOY, PROTECTED SEA, UNLIGHTED

ASSEMBLY NO. 5029

**APPLICATION:** An emergency navigational aid based on USCG Dwg No. BU-41-158, to be shipped on special directive only. For use as navigational aid and marker in protected sea areas.

**DESCRIPTION:** The buoy consists of the following items:  
 1 First-class standard can buoy, 6 ft diam, 10 ft high  
 90 Ft of 7/8-in. chain.  
 1 Ballast ball  
 1 Sinker, C.I.

**SHIPPING INFORMATION:** Shipped separately, unboxed.

	Weight: lb	Cube: cu ft
Buoy 5B50-5	3,500	280
Chain	632	6
Ballast ball	410	2
Sinker	2,000	14
Total	6,542	302

**ORDERING INSTRUCTIONS:**\* Nuns and cans of the same class are interchangeable.

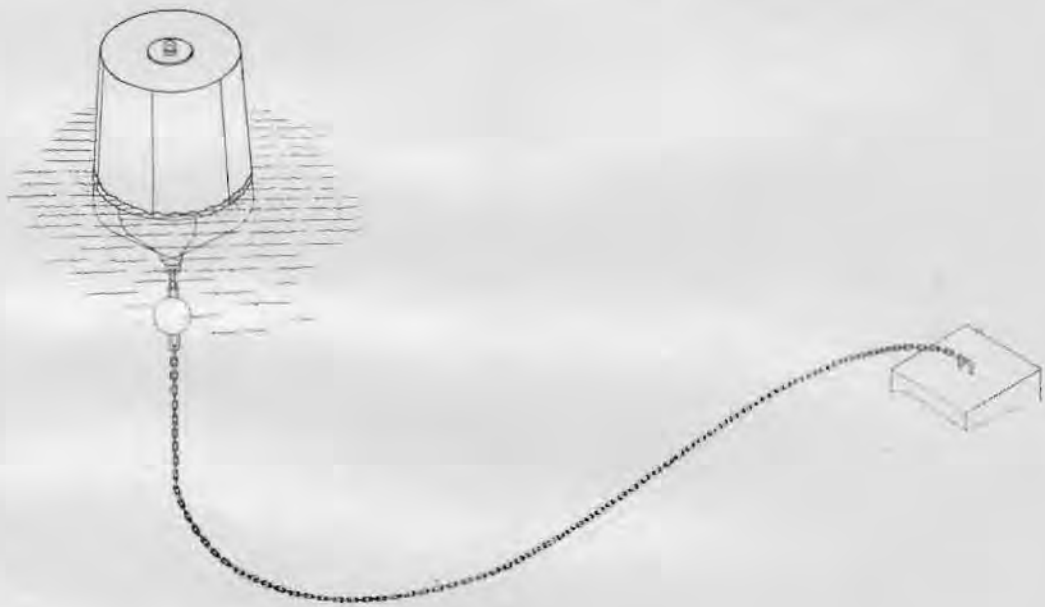

## BUOY, SMOOTH SEA, LIGHTED

ASSEMBLY NO. 5030

**APPLICATION:** An emergency navigational aid, based on USCG Dwg No. BU-41-158, to be shipped on special directive only. For use as navigational aid and marker in water areas subject to smooth seas only.

**CAPACITY:** Suitable for use where exposed to smooth seas.

**DESCRIPTION:** The buoy consists of the following items:

- 1 Buoy 6 x 20 E (6 ft diam x 20 ft long)
- 1 200 mm electric lantern
- 2 Type 23 battery racks
- 90 Ft of 1 1/8-in. chain
- 1 Cast iron sinker

**OPERATION:** Requires the periodic attention of light tender for cleaning lantern and recharging the batteries.

**SUPPLIES REQUIRED:** Cleaning and battery recharging.

**SHIPPING INFORMATION:** Lantern and batteries boxed, other items unboxed.

	Weight: lb	Cube: cu ft
1 - 6 x 20 E Buoy 5B50-7	5,537	463
1 - 200 mm electric lantern	95	3
2 - Battery racks	1,350	90
90 - Ft chain	1,112	11
1 - Sinker	5,000	33
Total	13,094	600

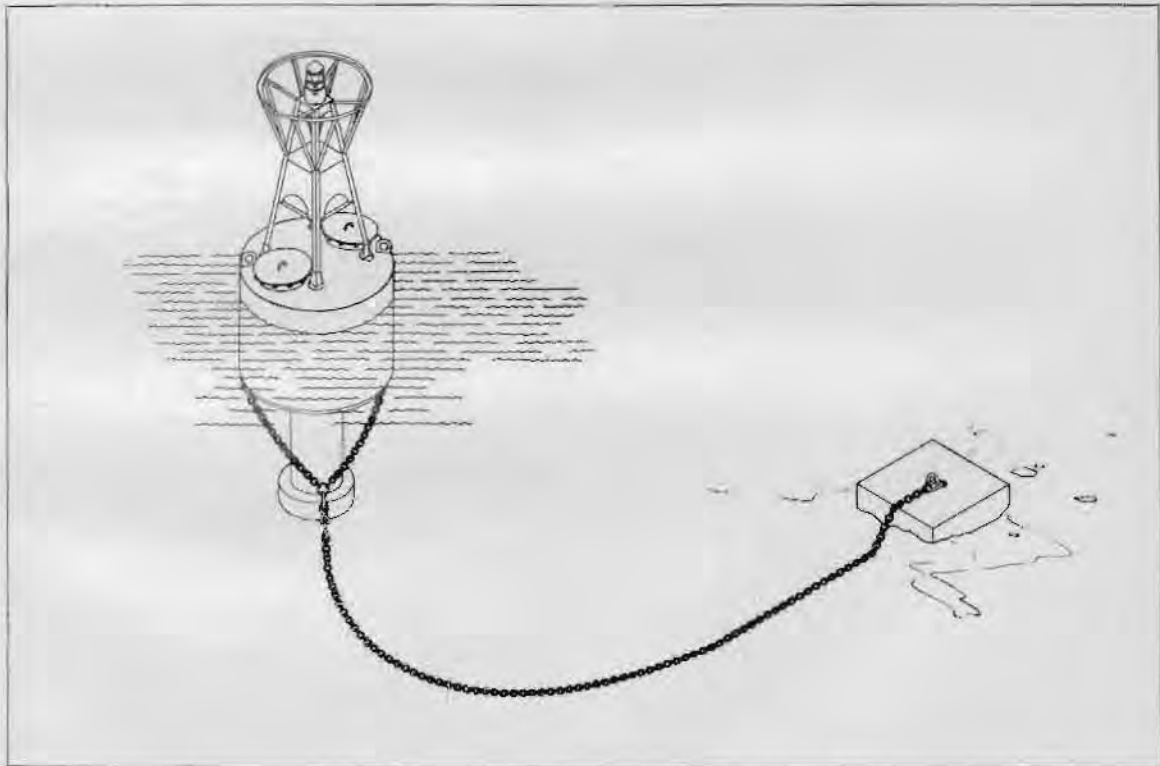

## BUOY, SMOOTH SEA, UNLIGHTED

ASSEMBLY NO. 5031

**APPLICATION:** An emergency navigational aid based on USCG Dwg No. BU-41-158, to be shipped on special directive only. For use in waters exposed to smooth seas only, as aids to navigation or as markers.

**DESCRIPTION:** The buoy equipment consists of the following items:

- 1 Second-class standard nun buoy, 4 ft 6 in. diam, 8 ft high
- 45 Ft of 7/8-in. chain
- 1 Ballast ball
- 1 Sinkers

**SHIPPING INFORMATION:** Shipped separately unboxed:

	Weight: lb	Cube: cu ft
Buoy 5B50-17	1,810	120
Chain	316	3
Ballast ball	410	2
Sinker	2,000	14
Total	<u>4,536</u>	<u>139</u>

**ORDERING INSTRUCTIONS:** Nuns and cans of the same class are interchangeable.

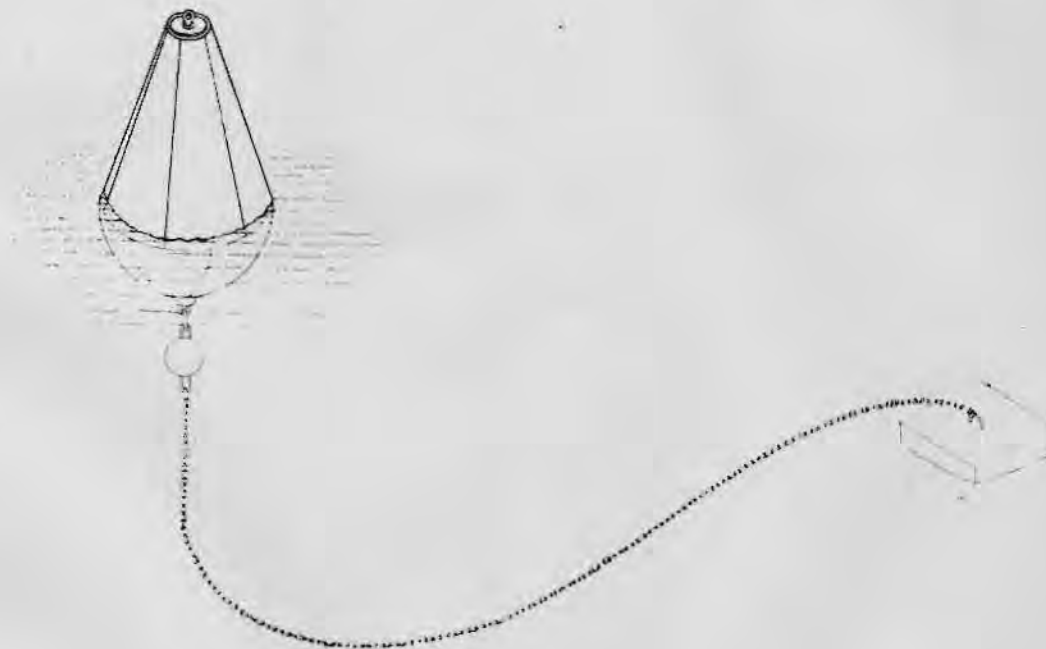

## DOLPHIN, 19-PILE

ASSEMBLY NO. 5011

**APPLICATION:** This is a pile cluster placed at corners of piers and wharves or adjacent to any other waterfront structures for protection against collision with floating craft.

**DESCRIPTION:** It consists of nineteen 70-ft piles with 200 lineal feet of 3/4-in. diam wire rope and staples for driving in a cluster, as shown on Y&D Dwg No. 206,672.

**AUXILIARY EQUIPMENT NEEDED BUT NOT SUPPLIED:** Pile driving rig.

**SHIPPING INFORMATION:** Shipped as 19 piles, coil or wire rope and keg or box of staples.  
Weight: 46,000 lb                      Cube: 1400 cu ft

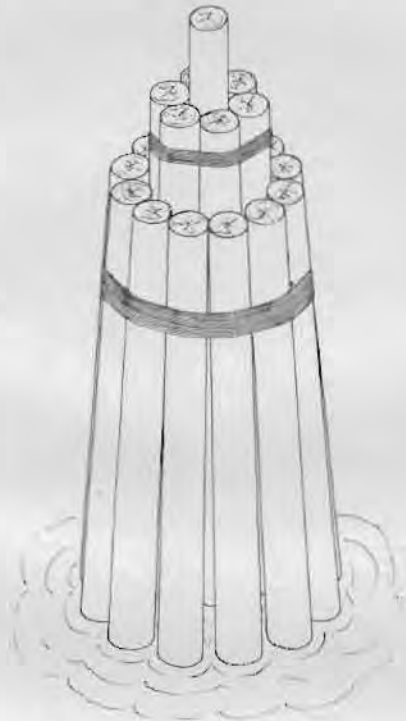

## MOORING, AUXILIARY VESSELS

RISER CHAIN TYPE FOR 50-FT DEPTH OF WATER, ASSEMBLY NO. 5013

**APPLICATION:** A conventional riser chain type of mooring omitting facilities for telephone cable installation.

**CAPACITY:** This mooring, designed for a total horizontal pull of 124,000 lb, the equivalent of 20 lb per sq ft wind pressure on an end presentment of 4,750 sq ft plus 25 percent surge, is adequate for mooring auxiliary vessels of 15,000 to 25,000 tons in localities where the water depth is as shown above, the bottom equal to or better than firm sand, and the wind velocity no greater than 70 mph.

**DESCRIPTION:** The mooring consists of the following items:

- 1 Buoy 9 1/2 ft diam, 5 ft high (Y&D Dwg No. 191,296)
- 3 Anchors ( " 164,615)
- 3 Sinker ( " 198,766)
- 1 Chain set #8 revised, as follows:
  - 1 2 1/2-in. "E" link
  - 1 2 1/2-in. "D" shackle
  - 1 44-ft riser chain consisting of 9 "A" links, "B" link, swivel, "B" link 39 "A" links.
  - 6 90-ft shots 2 1/2-in. stud link chain, each has 109 "A" links.
  - 3 45-ft half shots 2 1/2-in. stud link chain, each has 55 "A" links.
  - 3 "B" link cast together with "E" link.
  - 1 5 1/2-in. by 15-in. inside diam chain ring.
  - 5 5 5/8-in. anchor joining links.
  - 3 2 7/8-in. anchor joining links.
  - 6 2 1/2-in. anchor joining links.
  - 9 2 1/2-in. joining links.
  - 20 13/16-in. x 5 3/8-in. csk iron rivets.
  - 12 11/16-in. x 4 5/8-in. csk iron rivets.
  - 24 5/8-in. x 4 1/8-in. csk iron rivets.
  - 36 5/8-in. x 3 5/8-in. csk iron rivets.

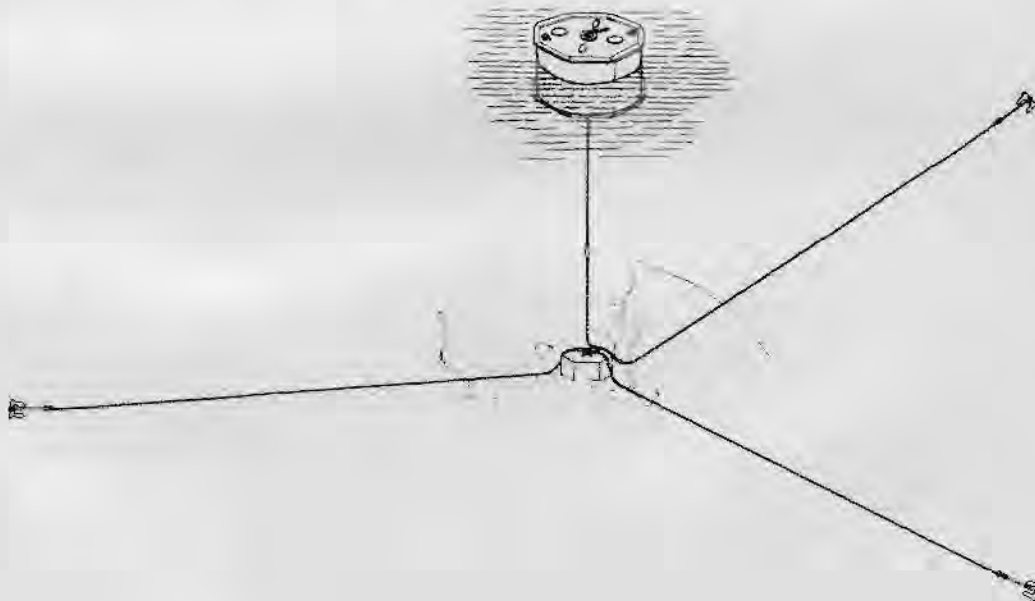

AUXILIARY EQUIPMENT NOT SUPPLIED: When the metal only is furnished for the concrete sinker, the concrete materials, (cement, sand and stone) are to be drawn from depot stocks or secured locally for casting the sinker adjacent to the mooring site.

SHIPPING INFORMATION: Shipped as separate items unboxed.

	Weight: lb	Cube: cu ft
Chain Set	44,000	350
Buoy 5B50-13	8,000	500
Anchors (3)	60,000	400
Sinker	18,000	150
Total	<u>130,000</u>	<u>1,400</u>

Extra 90-ft chain shots with shackle 5,200 lb ea, 45 cu ft.

ORDERING INSTRUCTIONS:

Note: For water depths other than 50 ft, furnish chain shots and joining links for both riser chain and ground legs as indicated by table on Y&D Dwg No. 198,766. Because of the critical nature of chain it is necessary to know before shipment the depth of water, character of bottom, maximum wind velocity and class of service in order to determine the requirement for each mooring.

## MOORING, AUXILIARY VESSELS

TELEPHONE BUOY TYPE FOR 62- FT DEPTH OF WATER, ASSEMBLY NO. 5012

**APPLICATION:** The telephone type mooring is furnished to facilitate ship-to-shore and ship-to-ship communication, where standard mooring might contribute to entanglement if improvised cable installation is used, and where visual or radio communication might aid the enemy.

**CAPACITY:** This mooring, designed for a total horizontal pull of 124,000 lb, the equivalent of 20 lb per sq ft wind pressure on an end presentment of 4,750 sq ft plus 25 percent surge, is adequate for mooring auxiliary vessels of 15,000 to 25,000 tons in localities where the water depth is as shown above, the bottom equal to or better than firm sand and the wind velocity no greater than 70 mph.

**DESCRIPTION:** The mooring consists of the following items:

- 1 Buoy 14 ft diam, 7 ft high (Y&D Dwg No. 188,511)
- 3 Anchors ( " 164,615)
- 3 Sinkers ( " 188,510)
- 1 Chain Set No. 7 as follows:
  - 9 15-fath 2 1/2-in. stud link chain. (Each has 109 "A" links.)
  - 3 7 1/2-fath 2 1/2-in. stud link chain. (Each has 55 "A" links.)
  - 3 4-ft 5-in. lengths 2 1/2-in. stud link chain. (Each has 4 "A" links and one 2 1/2-in. anchor-joining link one end.)
  - 15 2 1/2-in. joining links.
  - 3 2 7/8-in. anchor-joining links.
  - 3 2 1/2-in. anchor-joining links.
  - 6 2-in. anchor-joining links.
  - 3 2-in. "A" links (separate).
  - 3 2 1/4-in. "E" links.
  - 3 2 1/2-in. "F" shackles.
  - 12 11/16-in. x 4 5/8-in. rivets.
  - 12 5/8-in. x 4 1/8-in. rivets.
  - 24 1/2-in. x 3 1/2-in. rivets.
  - 60 5/8-in. x 3 5/8-in. rivets.
  - 2 3 1/2-in. anchor-joining links and 8 13/16 in. x 5 3/8-in. rivets. (For buoy swivel.)

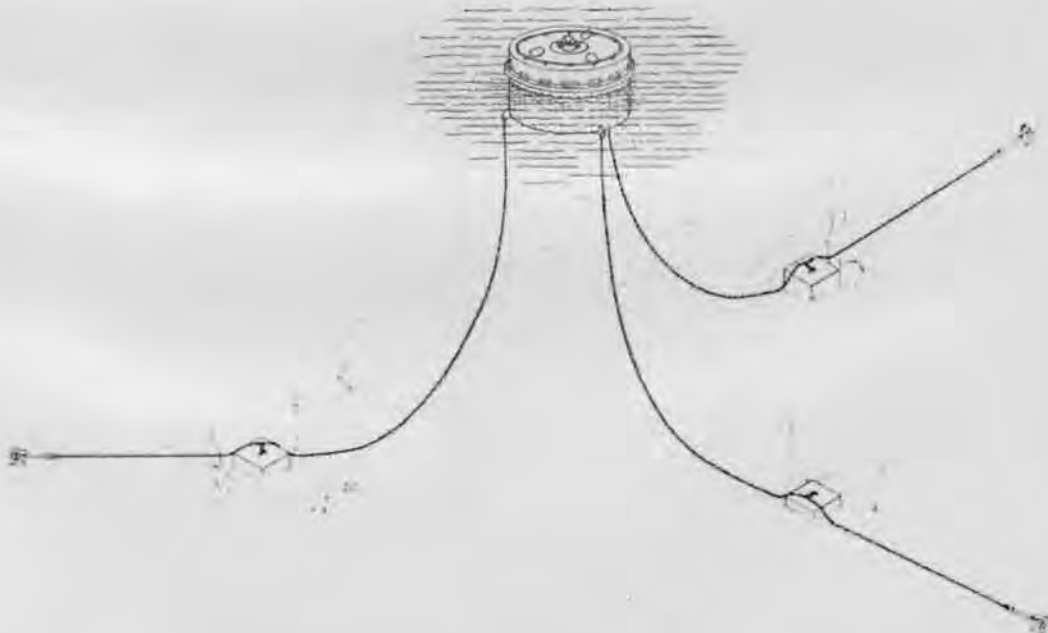



AUXILIARY EQUIPMENT NOT SUPPLIED: Telephone cable installation. When the metal only is furnished for the concrete sinker, the concrete materials (cement, sand and stone) are to be drawn from depot stocks or secured locally for casting the sinker adjacent to the mooring site.

SHIPPING INFORMATION: Shipped as separate items unboxed.

	Weight: lb	Cube: cu ft
Chain set	55,000	450
Buoy 5B50-14	22,000	1,200
Anchors (3)	60,600	400
Sinkers (3)	15,000	100
	<u>Total</u>	<u>2,150</u>
Extra 90-ft chain shot with shackle	5,200	45

ORDERING INSTRUCTIONS: For water depths other than 52 feet, furnish chain shots and shackles as indicated by table on Y&D Dwg No. 188,510. For water depths between 120 feet and 170 feet, furnish a 15-ft diam by 7-ft 6-in. telephone mooring buoy. For water depths greater than 170 feet, furnish a 16-ft diam by 8-ft 6-in. telephone mooring buoy. Because of the critical nature of chain it is necessary to know before shipment the depth of water, character of bottom, maximum wind velocity and class of service in order to determine the requirements for each mooring.

## MOORING, BATTLESHIP AND AIRCRAFT CARRIER

RISER CHAIN TYPE FOR 54-FT DEPTH OF WATER, ASSEMBLY NO. 5015

**APPLICATION:** Riser chain type of mooring for battleships and aircraft carriers with no provision for telephone cable installation.

**CAPACITY:** This mooring, designed for a total horizontal pull of 142,000 lb, the equivalent of 20 lb per sq ft wind pressure on an end presentment of 5,400 sq ft plus 25 percent surge, is adequate for mooring one battleship or one heavy aircraft carrier in localities where the water depth is as shown above, the bottom equal to or better than firm sand and the wind velocity no greater than 70 mph.

**DESCRIPTION:** The mooring consists of the following items:

- 1 12-ft diam by 6-ft mooring buoy (Y&D Dwg No. 128,328)
- 3 Anchors, 25,000-lb cast steel stockless (Y&D Dwg No. 164,615)
- 1 Sinker, 22,800-lb concrete (Y&D Dwg No. 191,297)
- 1 Chain set No. 9A as follows:
  - 1 Riser Chain, 60-ft length, 2 3/4-in. chain and appendages consisting of:
    - 1 "E" Link, 4 "B" Links, 1 "C" Link, 56 "A" Links, swivel, joining link, and rubbing castings.
  - 1 2 3/4-in. "D" shackle.
  - 1 2 3/4-in. "E" Link.
  - 1 Ring, 18-in. inside diam, 6 1/4-in. stock with five (5) special pear shaped links.
  - 6 15-fath shots 2 3/4-in. stud link chain, each consisting of 98 "A" links.
  - 9 2 3/4-in. joining links.
  - 6 "E" & "B" links cast together.
  - 3 3 1/2-in. Anchor joining links.
  - 5 3-in. anchor joining links.

**AUXILIARY EQUIPMENT NOT SUPPLIED:** When the metal only is furnished for the concrete sinker, the concrete materials (cement, sand and stone) are to be drawn from depot stocks or secured locally for casting the sinker adjacent to the mooring site.

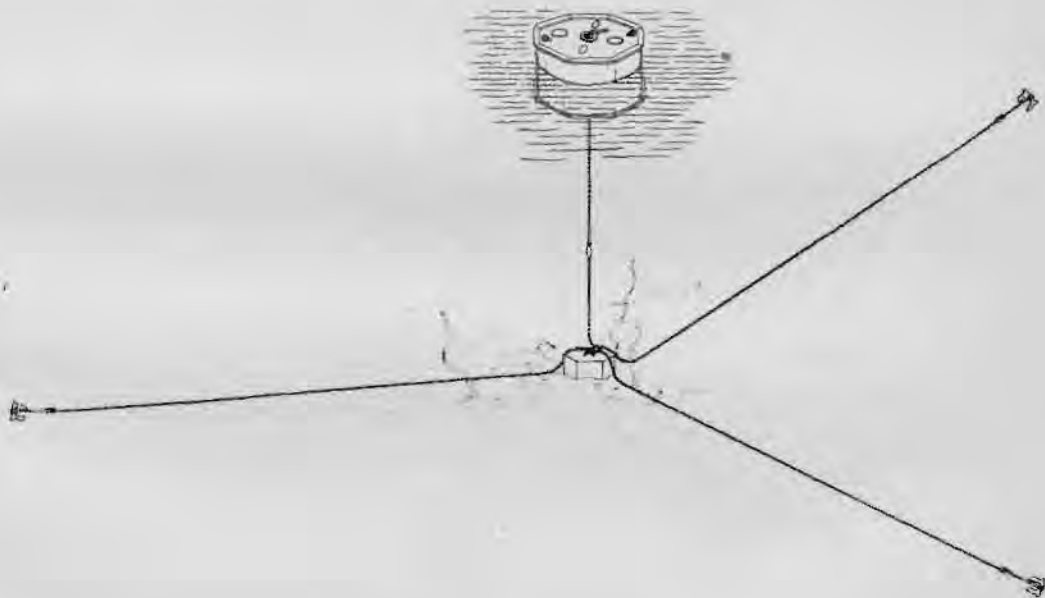

SHIPPING INFORMATION: Shipped as separate items unboxed.

	Weight: lb	Cube: cu ft
Chain set	43,000	350
Buoy 5B50-13	15,000	700
Anchors (3)	75,000	500
Sinker	23,000	150
Total	<u>156,000</u>	<u>1,700</u>
Extra 90-ft shot of chain with joining link.	6,300	50

ORDERING INSTRUCTIONS: For water depths other than 54 ft, furnish chain shots and joining links for both riser and ground chains indicated by table on Y&D Dwg No. 191,297. Because of the critical nature of chain it is necessary to know before shipment the depth of water, character of bottom maximum wind velocity and class of service in order to determine the requirements for each mooring.

## MOORING, BATTLESHIP AND AIRCRAFT CARRIERS,

TELEPHONE TYPE FOR 4-FT DEPTH OF WATER, ASSEMBLY NO. 5014

**APPLICATION:** The telephone type mooring is furnished to facilitate communication from ship-to-shore and from ship-to-ship, where standard type mooring contributes to the entanglement of telephone cable if improvised gear is used and where visual and radio communication might aid the enemy.

**CAPACITY:** This mooring, designed for a total horizontal pull of 142,000 lb, the equivalent of 20 lb per sq ft wind pressure on an end presentment of 5,400 sq ft plus 25 percent surge, is adequate for mooring one battleship or one heavy aircraft carrier in localities where the water depth is as shown above, the bottom equal to or better than firm sand and the wind velocity no greater than 70 mph.

**DESCRIPTION:** The mooring consists of the following items:

- 1 15-ft diam x 7-ft 6-in. telephone type mooring buoy (Y&D Dwg No. 188,311)
- 3 Cast steel stockless anchors, 25,000 lb each.
- 3 Concrete sinkers, 5,000 lb each.
- 1 Chain set No. 1A as follows:
  - 6 15-fath shots 2 3/4-in. stud link chain. (Each has 99 "A" links.)
  - 3 7 1/2-fath shots 2 3/4-in. stud link chain. (Each has 49 "A" links.)
  - 3 3-ft 8-in. lengths 2 3/4-in. stud link chain. (Each has 4 "A" links.)
  - 3 2 3/4-in. "F" shackles.
  - 5 3 1/2-in. anchor joining links (two for connection to buoy swivel).
  - 6 2 3/4-in. anchor joining links.
  - 12 2 3/4-in. joining links.
  - 6 2-in. anchor joining links.
  - 3 2-in. "A" links.
  - 3 2 1/2-in. "E" links.
  - 20 13/16-in. x 5 3/8-in. rivets.
  - 24 11/16-in. x 4 1/2-in. rivets.
  - 48 11/16-in. x 4-in. rivets.
  - 24 1/2-in. x 3 1/2-in. rivets.

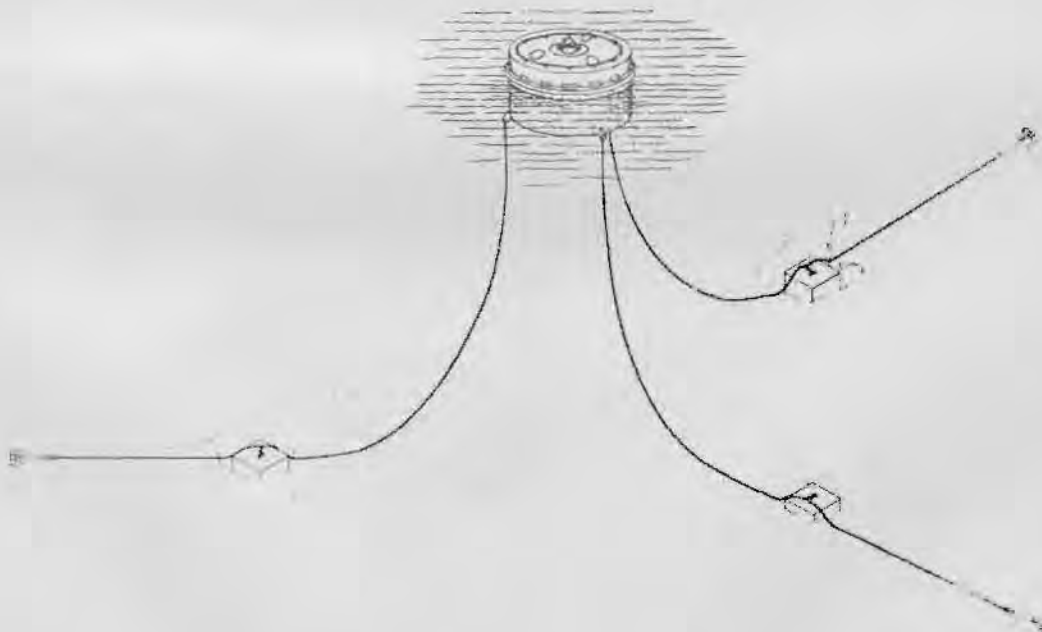

AUXILIARY EQUIPMENT NOT SUPPLIED: Telephone cable installation. When the metal only is furnished for the concrete sinker, the concrete materials (cement, sand and stone) are to be drawn from depot stocks or secured locally for casting the sinker adjacent to the mooring site.

SHIPPING INFORMATION: Shipped as separate items unboxed:

	Weight: lb	Cube: cu ft
Buoy 5B50-15	25,000	1,500
Chain Set	50,000	400
Anchors (3)	75,000	500
Sinkers (3)	15,000	100
Total	<u>165,000</u>	<u>2,500</u>
Extra 15-fath chain shots with shackle.	6,500	50

ORDERING INSTRUCTIONS: For water depth greater than 48 ft, furnish additional chain and joining links as indicated by table on Y&D Dwg No. 188,510. For water depths greater than 130 ft, furnish 16-ft diam x 8-ft 6-in. telephone mooring buoy. Because of the critical nature of chain it is necessary to know before shipment the depth of water, character of bottom, maximum wind velocity and class of service in order to determine the requirements for each mooring.

## MOORING, BATTLESHIP AND AIRCRAFT CARRIER

TELEPHONE TYPE FOR 48-FT DEPTH WATER, ASSEMBLY NO. 5014

**APPLICATION:** The telephone type mooring is to facilitate communication from ship-to-shore and from ship-to-ship where standard type moorings contribute to entanglement of telephone cable if improvised gear is used and where visual and radio communication might aid the enemy.

**CAPACITY:** This mooring, designed for a total horizontal pull of 142,000 lb, the equivalent of 20 lb per sq ft wind pressure on an end presentment of 5,400 sq ft plus 25 percent surge, is adequate for mooring one battleship or one heavy aircraft carrier in localities where the water depth is as shown above, the bottom equal to or better than firm sand and the wind velocity no greater than 70 mph.

**DESCRIPTION:** The mooring consists of the following items:

- 1 15 ft diam x 7 ft 6 in. telephone type mooring buoy (Y&D Dwg No. 188,511)
- 1 Chain Set No. 1 as follows:
  - 6 15-fath shots 2 3/4-in. sq lk mooring chain. (Each has 30 2 3/4-in. "A" lks.)
  - 3 7-fath shots 2 3/4-in. sq lk mooring chain. (Each has 14 2 3/4-in. "A" lks.)
  - 18 2 3/4 -in. forelock type mooring shackles complete with pin washer and forelock.
  - 3 2 3/4-in. special lks.
  - 3 2 3/4-in. mooring chain lks.
  - 6 2-in. anchor-joining Naco lks.
  - 24 1/2 in. x 3 1/2 in. CSK rivets.
  - 3 2-in. common "A" lks.
  - 8 13/16 in. x 5 3/8 in. CSK rivets.
  - 2 3 1/2-in. anchor joining lks.
- 3 25,000 lb cast steel anchors, Y&D Dwg No. 164,615.
- 3 5,000 lb concrete sinkers, Y&D Dwg No. 188,510.

**AUXILIARY EQUIPMENT NEEDED BUT NOT SUPPLIED:** Telephone cable installation. When the metal only is furnished for the concrete sinker, the concrete materials (cement, sand and stone) are to be drawn from depot stocks or secured locally for casting the sinker adjacent to the mooring site.

*(Illustration - same as 493)*

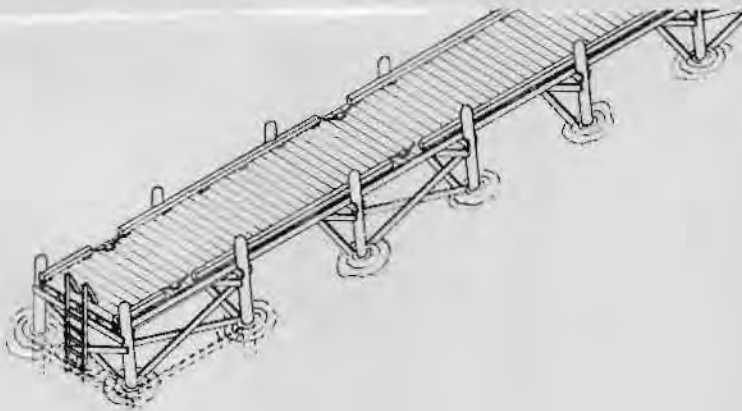

SHIPPING INFORMATION: Shipped as separate items unboxed:

Item	Weight: lb	Cube: cu ft
Chain set	65,000	500
Buoy 5B50-15	25,000	1,500
Anchors (3)	75,000	500
Sinkers (3)	15,000	100
Total	<u>180,000</u>	<u>2,600</u>
Extra 90-ft chain shots with shackle	8,000 ea	55

ORDERING INSTRUCTIONS: For water depths greater than forty-eight (48) ft, furnish additional chain shots and shackles as indicated by table on Y&D Dwg No. 188,510. For water depths greater than 130 feet, furnish a 16 ft diam x 8 ft telephone mooring buoy. Because of the critical nature of chain it is necessary to know before shipment the depth of water, character of bottom, maximum wind velocity and class of service in order to determine the requirements for each mooring.

## MOORING CATWALK

### FOR PT BOATS

**APPLICATION:** For mooring and handling the mooring lines of PT Boats while centering them over the marine railway cradle preparatory to dry docking.

**CAPACITY:** The mooring catwalk is provided with mooring cleats and a walkway wide enough that shore personnel may handle all of the lines while centering the boat on the cradle.

**DESCRIPTION:** This structure has been found useful in readily handling of the mooring lines with the least danger of damage to the hull during the centering operation.

**OPERATION:** All lines handled by shore personnel; one man for each line.

**SHIPPING INFORMATION:** Shipped as loose lumber, piles and boxed or bundled fastenings and hardware.

	Weight, lb	Cube, cu ft
Lumber	46,000	1,100
Pile	30,000	800
Hardware	2,000	20
Total	78,000	1,920

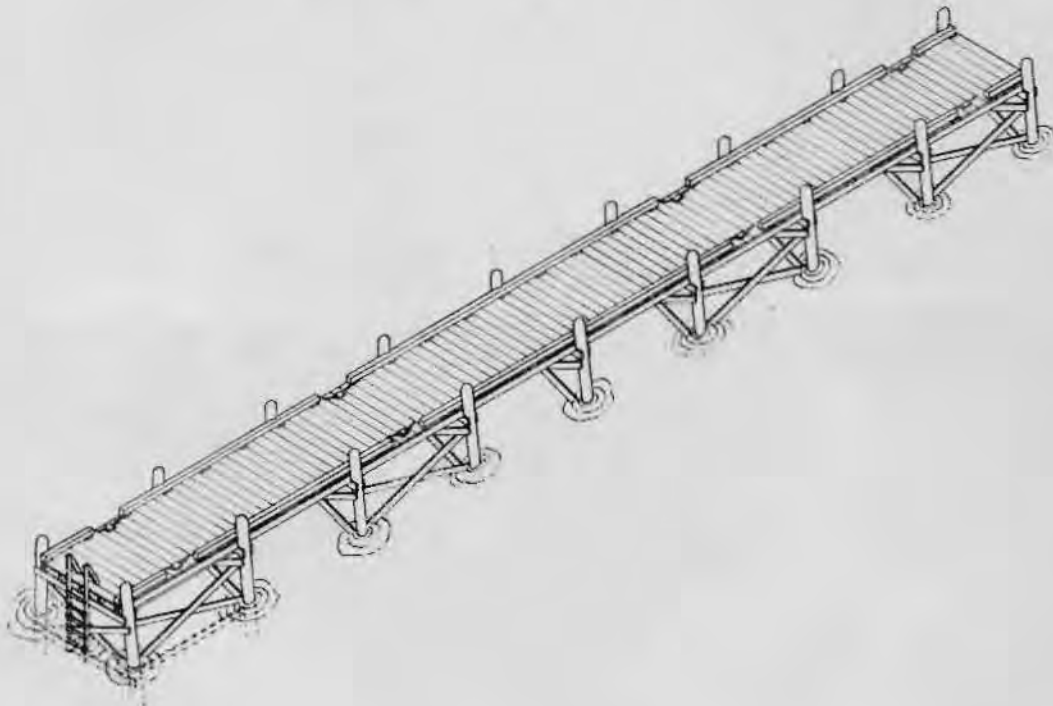



## MOORING, CLASS "E"

RISER CHAIN TYPE FOR 84-FT DEPTH OF WATER, ASSEMBLY NO.

**APPLICATION:** For mooring minor fleet units or any craft within its holding capacity.

**CAPACITY:** This mooring is designed for a total horizontal pull of 60,800 lb in water of the depth shown, where the bottom is equal to or better than firm sand, which is the equivalent of 20 lb per sq ft wind pressure on an end presentment of 2,432 sq ft plus 25% surge, and is roughly adequate for mooring 2 destroyers, 2 LST's or a 5,000 ton cargo vessel, where wind velocities do not exceed 70 mph.

**DESCRIPTION:** The mooring consists of the following:

- 1 9 ft 8 in. x 5 ft mooring buoy, riser chain type (Y&D Dwg No. 191,296)
- 3 Cast steel anchor 9,000 lb (Y&D Dwg No. 164,615)
- 1 Concrete sinker (Y&D Dwg No. 219,998)
- 1 No. 5 Chain Set as follows:
  - 12 15-fath 1 1/2-in. stud link chains with oversize end link each end.
  - 1 15-fath 1 1/2-in. stud link chain equipped with swivel, 2-in. joining shackle at one end and oversize end link at other end.
  - 1 Cast steel ground ring of 3 1/2-in. stock 10 in. inside diam with pear shaped links 1 1/2-in stock.
  - 10 1 1/2-in. joining shackles.
  - 8 2-in. joining shackles.
  - 1 2 1/4-in. open end link.

**AUXILIARY EQUIPMENT NOT SUPPLIED:** When the metal only for the concrete sinker is furnished, the concrete materials (cement, sand and gravel) are to be drawn from depot stocks or secured locally for casting the sinker adjacent to the mooring site.

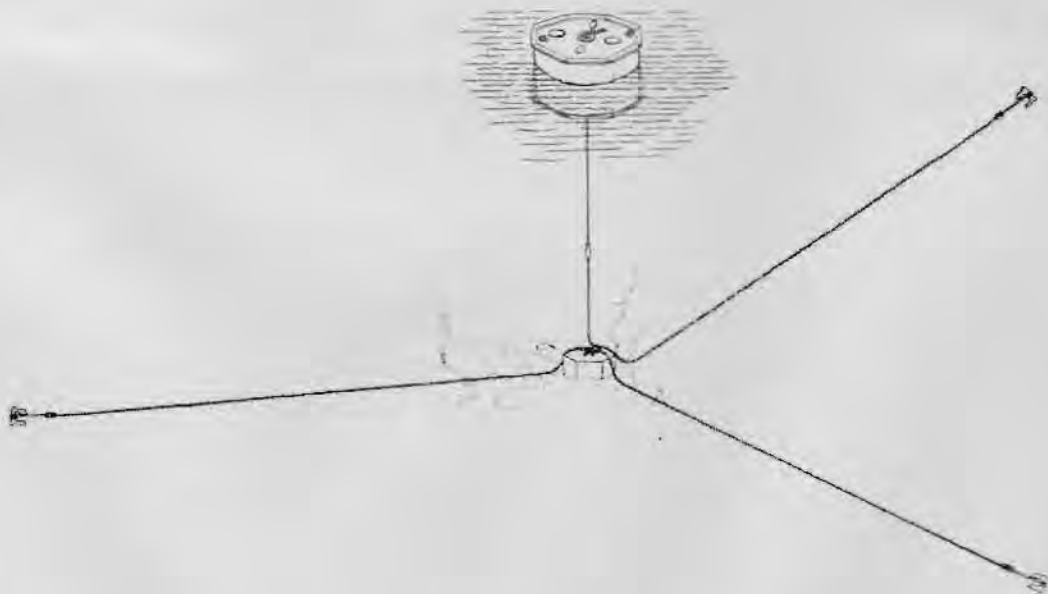

SHIPPING INFORMATION:

	Stock No.	Weight: lb	Cube: cu ft
Buoy		7,800	440
Chain set		27,000	200
Anchors (3)		27,000	200
Sinker (concrete included)		8,200	60
Total		<u>70,000</u>	<u>900</u>

ORDERING INSTRUCTIONS: For water depths other than 84 ft the chain set requires modification as shown on Y&D Dwg No. 219,998. For localities having wind velocities greater than 70 mph or bottom conditions less favorable than firm sand, anchors having greater holding power are required and a special study is indicated. Because of the critical nature of chain it is necessary to know before shipment the depth of water, character of bottom, maximum wind velocity and class of service in order to determine the requirements for each mooring.

## MOORING, CLASS "F"

RISER CHAIN TYPE, FOR 84-FT DEPTH OF WATER, ASSEMBLY NO.

**APPLICATION:** For mooring minor fleet units, or any craft within its holding capacity.

**CAPACITY:** This mooring is designed for a total horizontal pull of 30,500 lb in water of the depth shown, where the bottom is equal to firm sand or better, which is the equivalent of 20 lb per sq ft wind pressure on an end presentment of 1,392 sq ft plus 25% surge, and is roughly adequate for mooring 1 destroyer, 1 LST, 1 3,000 ton cargo vessel, or 4 LCI(L) craft, where wind velocities do not exceed 70 mph.

**DESCRIPTION:** The mooring consists of the following:

- 1 6 ft 6 in x 4 ft mooring buoy, riser chain type (Y&D Dwg No. 22,000)
- 3 cast steel anchors 5,000 lb each (Y&D Dwg No. 164,615)
- 1 concrete sinker, (Y&D Dwg No. 219,999)
- 1 No. 6 Chain Set as follows:

- 9 15-fath 1 1/2-in. stud link chain shots with 1 13/16-in. "C" type open-end link each end.
- 3 7 1/2-fath 1 1/2-in. stud link chain with 1 13/16-in. "C" type open-end link each end.
- 1 15-fath 1 1/2-in. stud link riser chain with swivel and 1 13/16-in. "C" type open-end link each end.
- 1 ground ring, cast steel, 15 in. inside diam of 3 1/2-in. stock with 5 pear shaped links.
- 5 1 5/8-in. type "F" bending shackles.
- 14 1 1/2-in. joining shackles.
- 1 1 13/16-in. "C" type open end link.

**AUXILIARY EQUIPMENT NEEDED BUT NOT SUPPLIED:** When the metal only is furnished for the concrete sinker, the concrete materials (cement, sand and stone) are to be drawn from depot stocks or secured locally for casting the sinker adjacent to the mooring site.

*(illus. same as 499)*

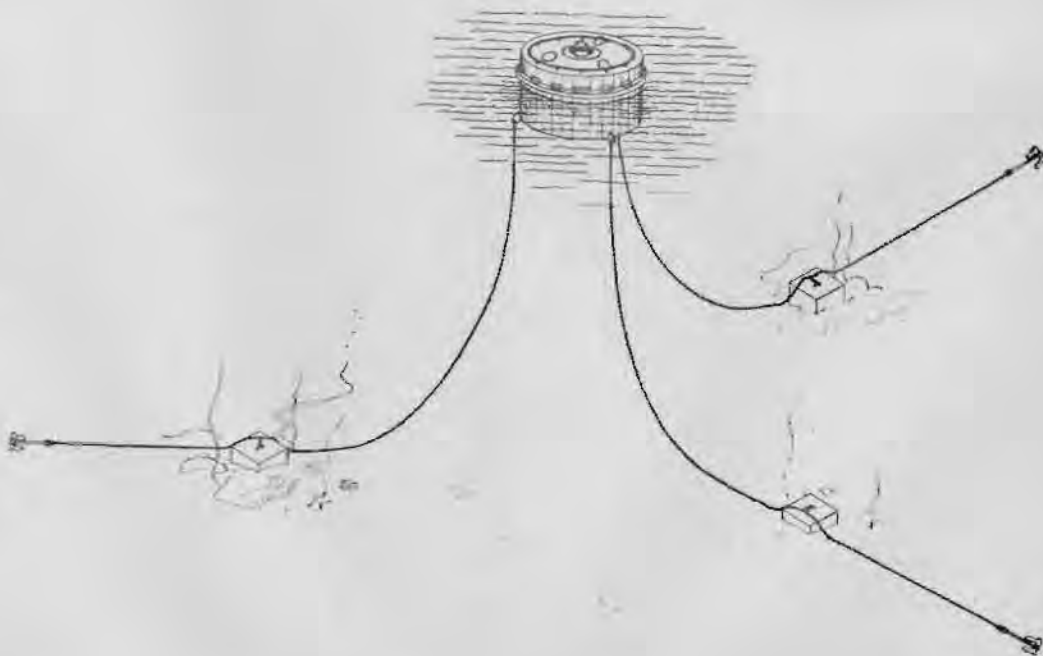

SHIPPING INFORMATION:

Stock No.	Weight: lb	Cube: cu ft
Buoy	2,200	160
Chain Set	23,900	180
Anchors (3)	15,000	120
Sinker (concrete included)	4,900	40
Total	46,000	500

ORDERING INSTRUCTIONS: For water depths other than 84 ft the chain set requires modification as shown on Y&D Dwg No. 219,999. For localities having wind velocities greater than 70 mph, or bottom conditions less favorable than firm sand, anchors having greater holding power are required and a special study is indicated. Because of the critical nature of chain it is necessary to know before shipment the depth of water, character of bottom, maximum wind velocity and class of service in order to determine the requirements for each mooring.

## MOORING, CRUISER

TELEPHONE BUOY TYPE FOR 41-FT DEPTH OF WATER, ASSEMBLY NO. 5016

**APPLICATION:** The telephone type mooring is furnished to facilitate ship-to-shore and ship-to-ship communication where conventional riser chain type might contribute to entanglement of improvised telephone cable installation and where visual or radio communication might aid the enemy.

**CAPACITY:** This mooring, designed for a total horizontal pull of 106,000 lb, the equivalent of 20 lb per sq ft wind pressure on an end presentment of 4,000 sq ft plus 25 percent surge, is adequate for mooring one light or heavy cruiser up to 10,000 tons in localities where the water depth is as shown above, the bottom equal to or better than firm sand and the wind velocity no greater than 70 mph.

**DESCRIPTION:** The mooring consists of the following items:

- 1 14-ft diam x 7-ft telephone type mooring buoy (Y&D Dwg No. 188,511)
- 3 15,000-lb anchors (Y&D Dwg No. 164,615)
- 3 5,000-lb sinkers ( " 188,510)
- 1 Chain set No. 10 as follows:
  - 6 90-ft shots 2 1/4-in. stud link chain. (Each has 119 "A" links.)
  - 3 45-ft half shots 2 1/4-in. stud link chain. (Each has 59 "A" links.)
  - 3 3-ft 10-in. lengths. (Each has 4 "A" links and 2 1/4-in. anchor joining link.)
  - 3 2 1/4-in. "F" shackles.
  - 3 2-in. "E" links.
  - 3 2 7/8-in. anchor joining links.
  - 3 2 1/4-in. anchor joining links.
  - 6 2-in. anchor joining links.
  - 12 2-in. joining links.
  - 3 2-in. "A" links (separate).
  - 12 1 1/16-in. x 4 1/8-in. iron rivets.
  - 12 9/16-in. x 3/8-in. iron rivets.
  - 24 1/2-in. x 3 1/8-in. iron rivets.
  - 2 3 1/2-in. anchor joining links (for buoy connection).
  - 8 13/16-in. x 4 7/8-in. iron rivets.

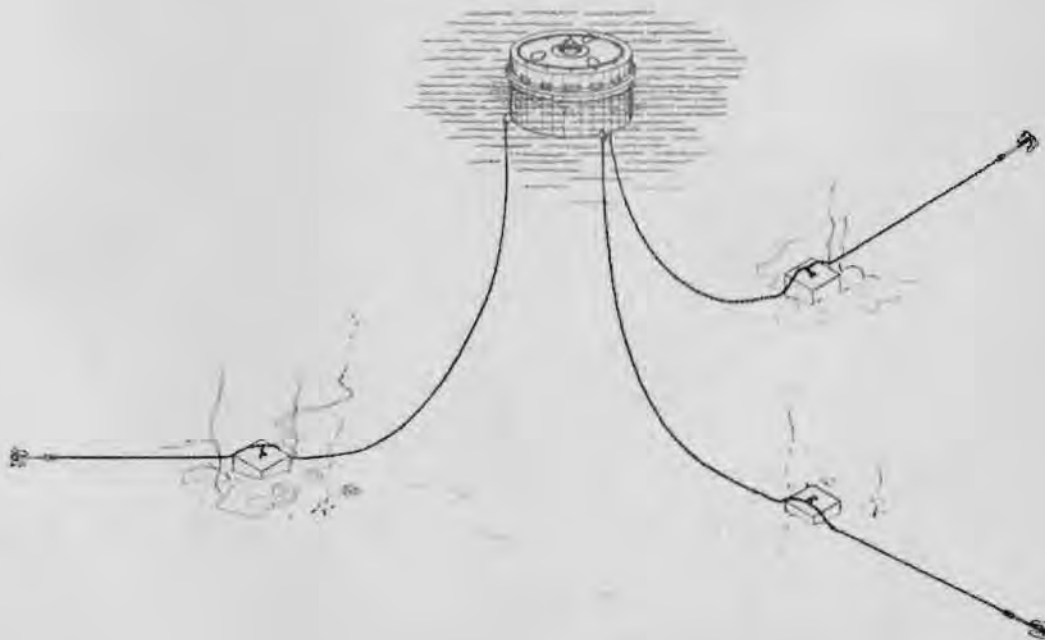

AUXILIARY EQUIPMENT NOT SUPPLIED: Telephone cable installation. When the metal only is furnished for the concrete sinker, the concrete materials (cement, sand and stone) are to be drawn from depot stocks or secured locally for casting the sinker adjacent to the mooring site.

SHIPPING INFORMATION: Shipped as individual items unboxed.

	Weight: lb	Cube: cu ft
Chain set	32,000	300
Buoy 5B50-14	22,000	1,200
Anchors (3)	45,000	350
Sinkers (3)	15,000	100
Total	114,000	1,950
Extra 90-ft chain shots with shackle	4,000	30

ORDERING INSTRUCTIONS: For water depths other than 41 feet, furnish chain shots and joining links as indicated by table on Y&D Dwg No. 138,510. For depths greater than 130 ft, furnish 15-ft diam x 7- ft 6-in. telephone buoy. Because of the critical nature of chain it is necessary to know before shipment the depth of water, character of bottom, maximum wind velocity and class of service in order to determine the requirements for each mooring.

## MOORING, DESTROYER

TELEPHONE BUOY TYPE FOR 43-FT DEPTH OF WATER, ASSEMBLY NO. 5018

**APPLICATION:** The telephone type mooring is used to facilitate communication from ship-to-shore or ship-to-ship where standard type moorings contribute to entanglement of telephone cable if improvised gear is used and where visual and radio communication might aid the enemy.

**CAPACITY:** This mooring, designed for a total horizontal pull of 85,000 lb, the equivalent of 20 lb per sq ft wind pressure on an end presentment of 3,300 sq ft, plus 25 percent surge, is adequate for mooring 4 destroyers or 1 light cruiser up to 7,050 tons in localities where the water depth is as shown above, the bottom equal to or better than firm sand and the wind velocity no greater than 70 mph.

**DESCRIPTION:** The mooring consists of the following items:

- 1 Telephone type buoy 14-ft diam x 7-ft (Y&D Dwg No. 188,511).
- 3 Cast steel anchors 13,000 lb each (Y&D Dwg No. 164,615).
- 3 Concrete sinkers 5,000 lb each.
- 1 Chain set No. 2 as follows:
  - 3 15-fath 2-in. stud mooring chains. (Each has 135 2-in. "A" links, and 1 2-in. anchor-joining Naco link.)
  - 3 15-fath 2-in. stud mooring chains. (Each has 135 2-in. "A" links).
  - 3 7 1/2-fath 2-in. stud mooring chains. (Each has 67 2-in. "A" links).
  - 3 4-link sections, 2-in. chain.
  - 15 2-in. joining links.
  - 6 2-in. anchor joining links.
  - 3 2 1/2-in. anchor joining links.
  - 60 1/2-in. x 3 1/4-in. csk rivets.
  - 24 1/2-in. x 3 1/2-in. csk rivets.
  - 3 2-in. "A" links.
  - 12 5/8-in. x 4 1/4-in. csk rivets.
  - 8 13/16-in. x 5 3/8-in. csk rivets.
  - 2 3 1/2-in. anchor joining links.
  - 3 1 3/4-in. "E" links.
  - 3 2-in. "F" shackles complete with pin.

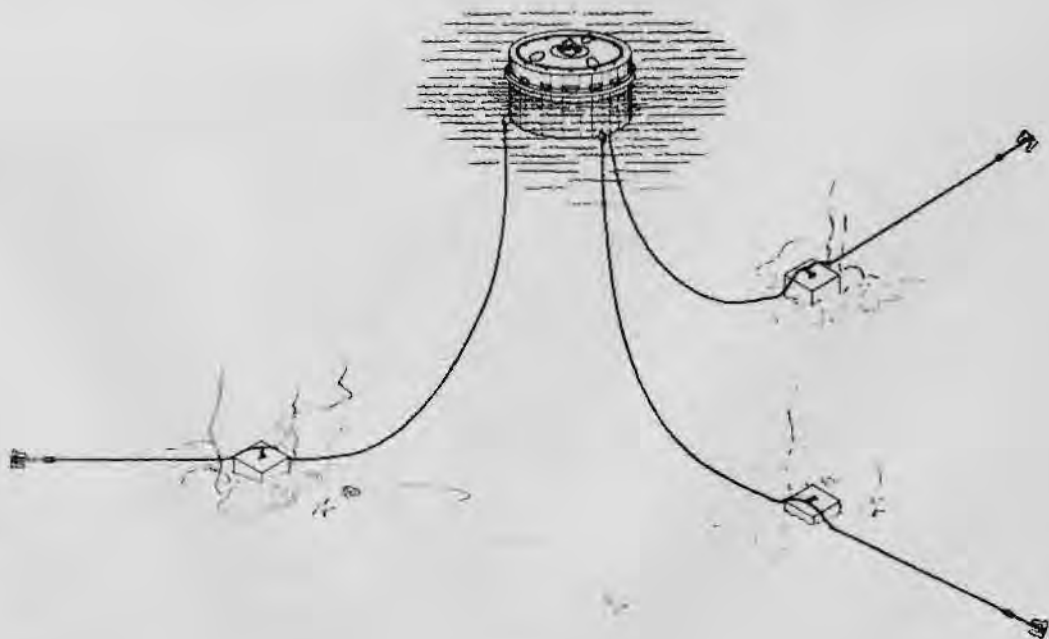

AUXILIARY EQUIPMENT NOT SUPPLIED: Telephone cable installation. When the metal only is furnished for the concrete sinker, the concrete materials (cement, sand and stone) are to be drawn from depot stocks or secured locally for casting the sinker adjacent to the mooring site.

SHIPPING INFORMATION: Shipped as separate items unboxed.

	Weight: lb	Cube: cu ft
Buoy 5B50-14	22,000	1,200
Chain Set	30,000	200
Anchors (3)	39,000	300
Sinkers (3)	15,000	100
Total	106,000	1,800
Extra 90-ft chain shot and connecting link	3,500	20

ORDERING INSTRUCTIONS: For water depths greater than 43 ft, determine chain length as indicated by table on Y&D Dwg No. 133,510. For water depths greater than 200 ft, furnish 15-ft diam x 7-ft telephone buoy. Because of the critical nature of chain it is necessary to know before shipment the depth of water, character of bottom, maximum wind velocity and class of service in order to determine the requirements for each mooring.



## MOORING, FUEL LOADING

FOR 60-FT DEPTH OF WATER, ASSEMBLY NO. 5019

**APPLICATION:** For discharging fuel at shore storage points and for fueling ships in harbors and roadsteads where, due to local conditions, it is not possible or practicable to fuel alongside a pier or tanker.

**CAPACITY:** Each leg of the mooring is designed for a pull of 106,000 lb which is the equivalent of the side presentation of a 10,000-ton cruiser in a 34 mph wind with a 50 percent surge.

**DESCRIPTION:** The mooring consists of the following items for each leg:

- 1 9-ft 6-in. x 5-ft mooring buoy (Y&D Dwg No. 191,296).
- 2 1 3/4-in. hairpin rods for 2 concrete sinkers. (Y&D Dwg No. 236,933).
- 1 15,000-lb cast steel anchor (Y&D Dwg No. 164,615)
- 1 Chain set No. 3A as follows:
  - 1 90-ft shot 2 5/8-in. rod chain with "H" link one end, "J" link and "E" link other end.
  - 2 90-ft shots 2 5/8-in. rod chain.
  - 1 90-ft shot 2 5/8-in. rod chain with "H" link one end.
  - 1 "K" link.

The following must also be included either tack welded in position or in separate packages:

- 2 2 3/4-in. U-bars to complete "H" links.
- 3 2 3/8-in. U connecting shackles
- 2 1 3/4-in. U-bars to complete "K" links.
- 1 1 3/4-in. U-bars to complete "J" links.

**AUXILIARY EQUIPMENT NOT SUPPLIED:** When the metal only is furnished for the concrete sinker, the concrete materials (cement, sand and stone) are to be drawn from depot stocks or secured locally for casting the sinker adjacent to the mooring site.

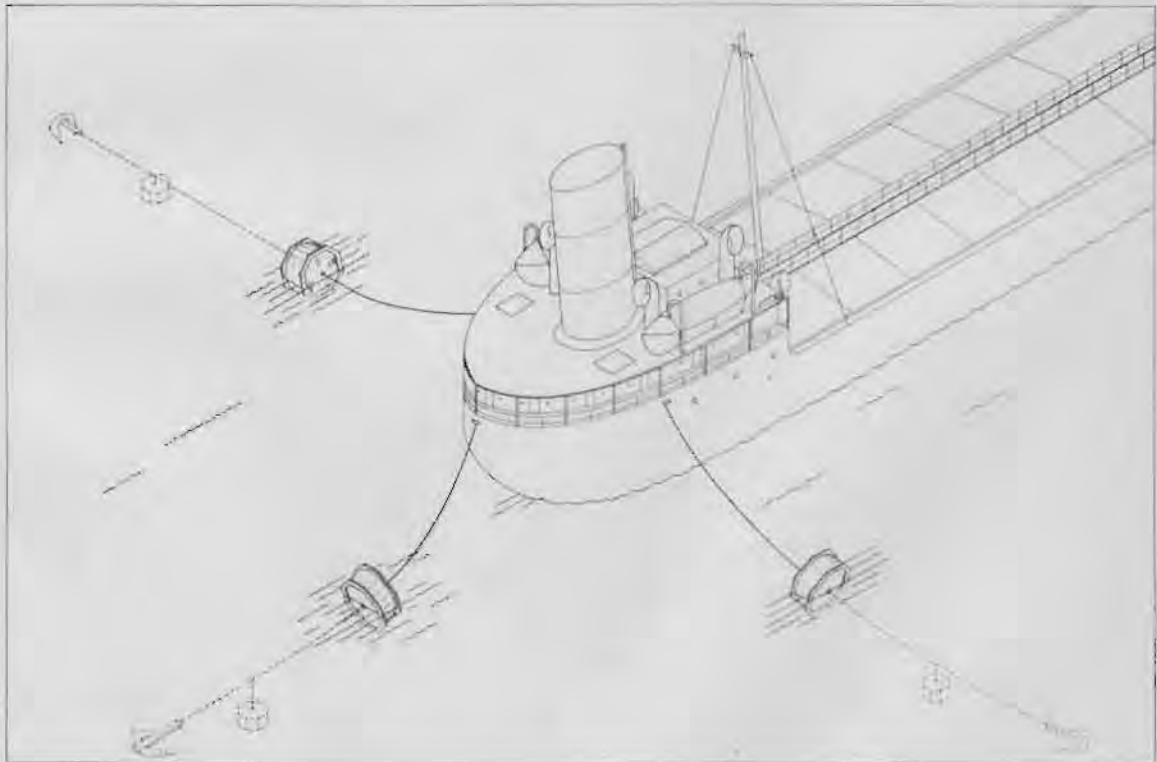

SHIPPING INFORMATION: Shipped separately, unboxed:

	Weight: lb	Cube: cu ft
Chain set, each leg	10,000	80
Buoy, each 5B50-11	8,000	450
Anchor, each	<u>15,000</u>	<u>120</u>
Total	33,000	650
Additional 90-ft chain shot when required:	2,500	20

ORDERING INSTRUCTIONS: For water depths other than 60-ft, furnish chain shots and connecting U's as indicated by table on Y&D Dwg No. 236,933. When buoy specified above is not available, substitute 12-ft x 6-ft mooring buoy in accordance with Y&D Dwg No. 128,328 and BUOY ADAPTER in accordance with Y&D Dwg No. 247,697, Adapter A. ACORN moorings to be furnished with two complete legs as above. All other Tank Farm Installations to have three complete legs unless otherwise stated. Because of the critical nature of chain it is necessary to know before shipment the depth of water, character of bottom, maximum wind velocity and class of service in order to determine the requirements for each mooring.

## MOORING, HEAVY CRUISER

RISER CHAIN TYPE FOR 37-FT DEPTH OF WATER, ASSEMBLY NO. 5017

APPLICATION: A conventional mooring with no provision for telephone cable installation.

CAPACITY: This mooring, designed for a total horizontal pull of 108,000 lb, the equivalent of 20 lb per sq ft wind pressure on an end presentment of 4,000 sq ft plus 25 percent surge, is adequate for mooring one light or heavy cruiser not over 10,000 tons in localities where the water depth is as shown above, the bottom equal to or better than firm sand, and the wind velocity no greater than 70 mph.

DESCRIPTION: The mooring consists of the following items:

- 1 Riser chain type buoy 9 1/2-ft diam x 5-ft (Y&D Dwg No. 191,296)
- 3 15,000-lb cast steel anchors. (Y&D Dwg No. 164,615)
- 1 15,000-lb concrete sinker. (Y&D Dwg No. 191,298)
- 1 Chain set cast steel No. 4B as follows:
  - 1 2 1/4-in. special end link.
  - 1 2 1/4-in. "D" shackle.
  - 1 2 1/4-in. anchor joining link.
  - 1 36-ft riser chain consisting of "E" link, "B" link
  - 3 "A" links, "B" link, swivel, B link, 38 "A" links.
  - 6 90-ft shots 2 1/4-in. stud link chain. (Each has 117 "A" links, "B" link, and "E" link.
  - 5 3 5/8-in. anchor joining links.
  - 3 2 7/8-in. anchor joining links.
  - 5 2 1/2-in. anchor joining links.
  - 3 2 1/4-in. joining links.
  - 1 5 1/2-in. x 15-in. inside diam chain ring.
  - 20 13/16-in. x 5 3/8-in. csk iron rivets.
  - 12 11/16-in. x 4 5/8-in. csk iron rivets.
  - 20 5/8-in. x 4 1/8-in. csk iron rivets.
  - 4 9/16-in. x 3 3/4-in. csk iron rivets.
  - 12 9/16-in. x 3 3/8-in. csk iron rivets.

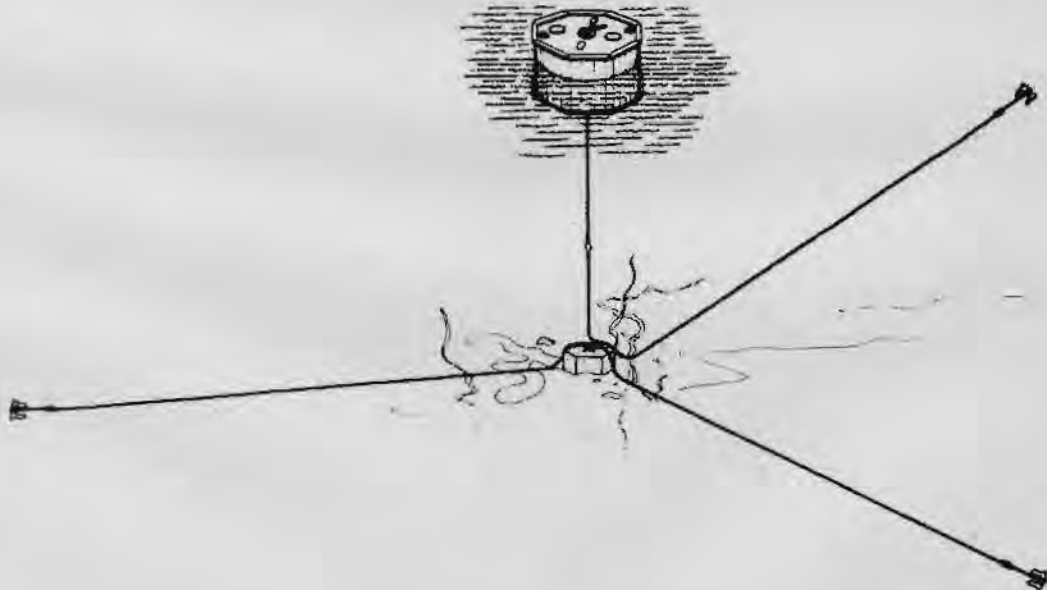

**AUXILIARY EQUIPMENT NOT SUPPLIED:** When the metal only is furnished for the concrete sinker, the concrete materials (cement, sand and stone) are to be drawn from depot stocks or secured locally for casting the sinker adjacent to the mooring site.

**SHIPPING INFORMATION:** Shipped as separate items unboxed.

	Weight: lb	Cube: cu ft
Buoy 5B50-11	8,000	500
Chain set	33,000	250
Anchors (3)	45,000	350
Sinker	15,000	100
Total	<u>101,000</u>	<u>1,200</u>
Extra 90-ft chain shot with joining link and rivets	4,000 est. wt.	25 est. volume

**ORDERING INSTRUCTIONS:** For water depths other than 40 ft, use chain in riser and ground legs as indicated by table Y&D Dwg No. 191,298. Because of the critical nature of chain it is necessary to know before shipment the depth of water, character of bottom, maximum wind velocity and class of service in order to determine the requirements for each mooring.



## MOORING, HEAVY CRUISER

RISER CHAIN TYPE FOR 84-FT DEPTH OF WATER, ASSEMBLY NO.

APPLICATION: A conventional mooring with no provision for telephone cable installation.

CAPACITY: This mooring, designed for a total horizontal pull of 106,000 lb, the equivalent of 20 lb per sq ft wind pressure on an end presentation of 4,000 sq ft plus 25 percent surge, is adequate for mooring one light or heavy cruiser of not over 10,000 tons in localities where the water depth is as shown above, the bottom equal to or better than firm sand and the wind velocity no greater than 70 mph.

DESCRIPTION: The mooring consists of the following items:

- 1 12-ft x 6-ft mooring buoy, riser chain type (Y&D Dwg No. 128,328)
- 3 Cast steel anchors 15,000 lb each (Y&D Dwg No. 164,615).
- 1 Concrete sinker 15,000 lb.
- 1 Chain set No. 4 as follows:
  - 1 67-ft swivel shot 2 1/4-in stud link chain consisting of 2 1/2-in. anchor joining links, "E" link, 3 "B" links, swivel, and 83 "A" links.
  - 1 18-ft rubbing casting shot 2 1/4-in. stud link chain consisting of "C" link, "B" link, rubbing casting, and 22 "A" links.
  - 3 7 1/2-fath 2 1/4-in. stud link chains. (Each has 58 2 1/4-in. "A" links, "B" and "E" links, and 2 1/2-in. anchor joining link.)
  - 6 15-fath 2 1/4-in. stud link chains. (Each has 119 "A" links.)
  - 3 15-fath 2 1/4-in. stud link chains. (Each has 119 "A" links, "B" link and "E" link.)
  - 1 Chain ring 5 1/2-in. diameter.
  - 1 2 1/4-in. special pear-shaped end link.
  - 1 2 1/4-in. "D" shackle and pin.
  - 11 2 1/4-in. joining links.
  - 44 9/16-in. x 3 3/8-in. csk rivets.
  - 4 5/8-in. x 4 1/4-in. csk rivets.
  - 1 2 1/2-in. anchor joining links.
  - 3 2 7/8-in. anchor joining links.
  - 12 11/16-in. x 4 1/2-in. csk rivets.
  - 20 13/16-in. x 5 3/8-in. csk rivets.
  - 5 3 5/8-in. anchor joining links.

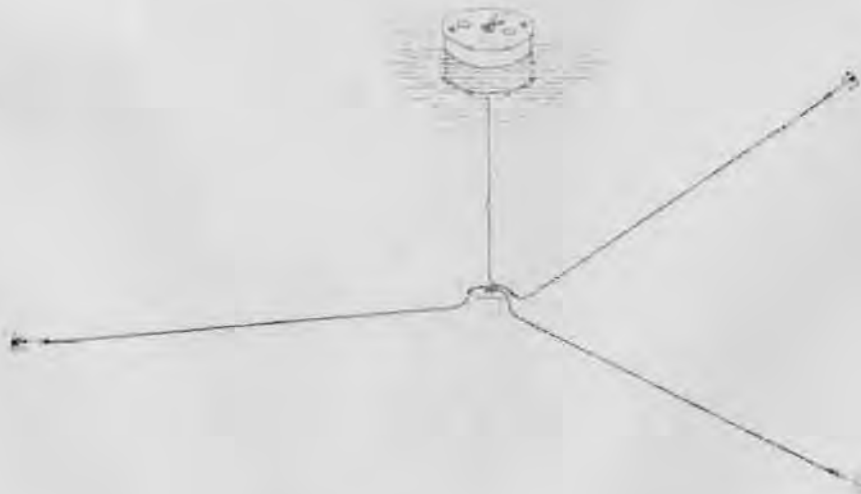

**AUXILIARY EQUIPMENT NOT SUPPLIED:** When the metal only is furnished for the concrete sinker, the concrete materials (cement, sand and stone) are to be drawn from depot stocks or secured locally for casting the sinker adjacent to the mooring site.

**SHIPPING INFORMATION:** Shipped as separate items unboxed.

	Weight: lb	Cube: cu ft
Buoy 5B50-13	15,000	700
Chain set	55,000	170
Anchors (3)	45,000	350
Sinker	15,000	100
Total	130,000	1,320
Extra 90-ft shot with joining link and rivets	4,000	25

**ORDERING INSTRUCTIONS:** For water depths greater than 84 ft, use extra chain in riser and ground legs as indicated by table on Y&D Dwg No. 191,298. Because of the critical nature of chain it is necessary to know before shipment the depth of water, character of bottom, maximum wind velocity and class of service in order to determine the requirements for each mooring.

## MOORING FOR PT BOATS

VARIABLE DEPTH OF WATER, ASSEMBLY NOS. 5020, 5021, 5022

**APPLICATION:** For mooring PT boats.

**CAPACITY:** A mooring for a PT boat or other craft up to 50 tons, shown in detail on Y&D Dwg No. 206,673.

**DESCRIPTION:** The mooring consists of the following items:

- 1 Concrete anchor and either
- 1 30-gal wooden barrel-type buoy with 5020, or
- 1 Spherical-type metal buoy with 5021 or
- 1 Wooden float-type buoy with 5022 and the following with each:
  - 1 Buoy cable
  - 1 Mooring cable
  - 3 Shackles

**AUXILIARY EQUIPMENT NOT SUPPLIED:** When the metal only is furnished for the concrete sinker, the concrete materials (cement, sand and stone) are to be drawn from depot stocks or secured locally for casting the sinker adjacent to the mooring site.

**SHIPPING INFORMATION:** Shipped as individual items, unboxed.

	Weight: lb	Cube: cu ft
1 Concrete anchor	15,000	100
1 30-gal wooden barrel-type buoy, or	69	16
1 Spherical type metal buoy, or	45	8
1 Wooden float-type buoy	420	16
1 Buoy cable	15	1
1 Mooring cable. . . . . (per ft). . .	1	1
3 Shackles	15	1
Total	15,565	143

**ORDERING INSTRUCTIONS:** State length of cable required. Determine proper length from graph on Y&D Dwg No. 206,673 for depth of water where mooring is to be installed. Because of the critical nature of chain it is necessary to know before shipment the depth of water, character of bottom, maximum wind velocity and class of service in order to determine the requirements for each mooring.

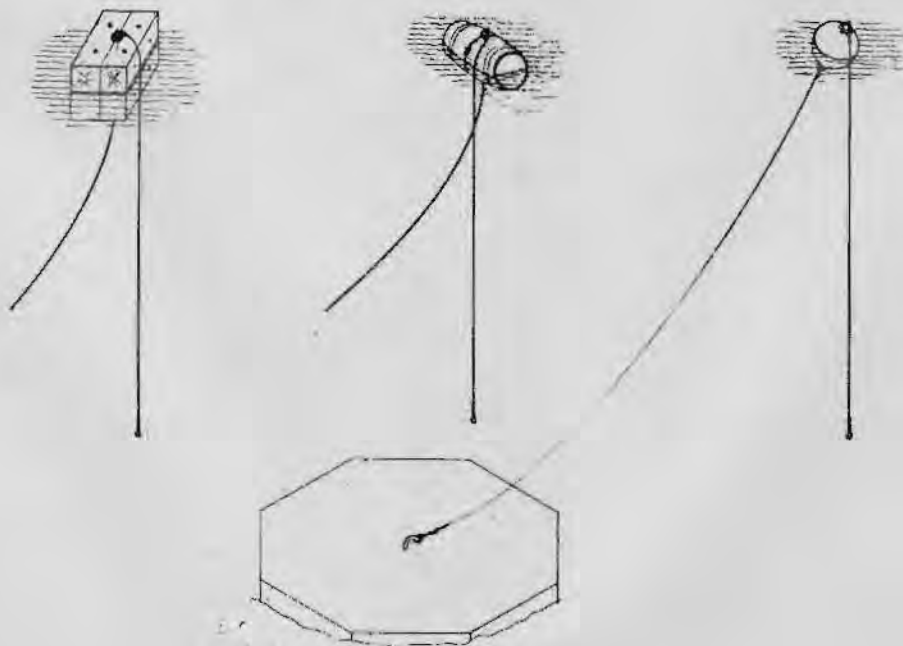

## MOORING, PT BOAT TENDER

RISER CHAIN TYPE FOR VARIABLE DEPTHS OF WATER, ASSEMBLY NO. 5023

APPLICATION: This mooring is for a PT boat tender or any craft of similar size.

CAPACITY: One PT boat tender or similar craft. Shown in detail on Y&D Dwg No. 203,976.

DESCRIPTION: The mooring consists of the following items:

- 1 Concrete anchor
- 1 1 1/2-in. "F" end-shackle.
- 2 1 1/2-in. "C" links
- 2 1 1/2-in. "B" links
- 2 or more 1 1/2-in. "G" detachable links
- "A" links shots, (see table under ordering instructions)
- 1 "D" connecting shackles
- 1 Steel buoy, 6 1/2-ft diam x 4-ft high.

AUXILIARY EQUIPMENT NOT SUPPLIED: When the metal only is furnished for the concrete sinker, the concrete materials (cement, sand and stone) are to be drawn from depot stocks or secured locally for casting the sinker adjacent to the mooring site.

SHIPPING INFORMATION: Shipped separately unboxed

	Weight: lb	Cube: cu ft
1 Concrete anchor	49,000	326
1 1 1/2-in. "F" end shackle	50	1
2 1 1/2-in. "C" links	100	1
2 1 1/2-in. "B" links	30	1
2 (or more) "G" detachable links	30	1
1 1/2-in. "A" links (per shot)	2,033	21
1 1 1/2-in. "D" connecting shackle	30	1
1 Steel buoy, 6 1/2-ft x 4-ft, 5B50-9	2,100	250
Total	53,373	602

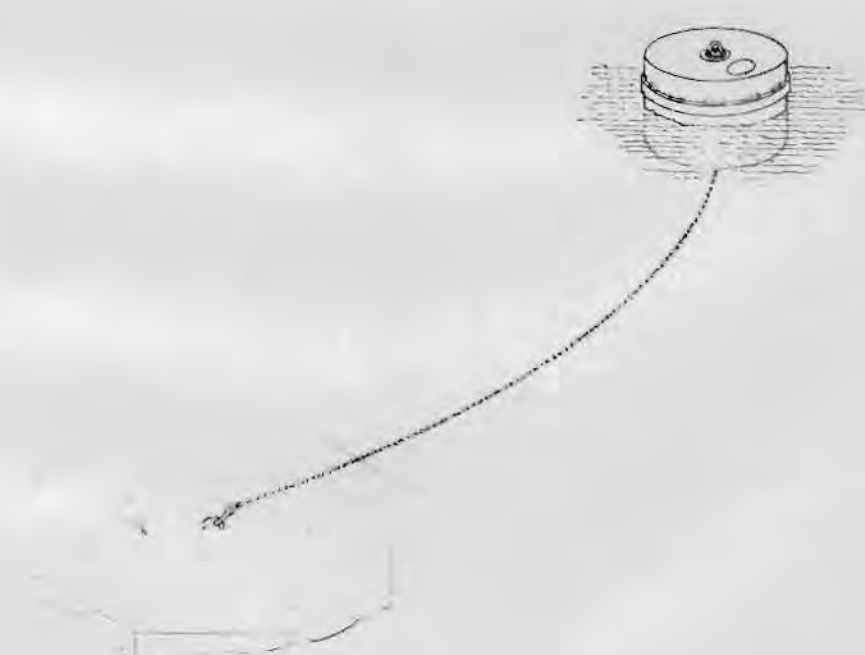



ORDERING INSTRUCTIONS: State depth of water for which mooring is desired. Determine number of "G" and "A" links from table given on Y&D Dwg No. 203,976 and reproduced here for depth of water where mooring is to be installed.

Depth of water in feet	No. of 90-ft shots of "A" links required.
Up to 35 ft	1
35 to 50 ft	1 1/2
50 to 70 ft	2
70 to 90 ft	2 1/2
90 to 110 ft	3
110 to 132 ft	3 1/2

Because of the critical nature of chain it is necessary to know before shipment the depth of water, character of bottom, maximum wind velocity and class of service in order to determine the requirements for each mooring.

## TELEPHONE CABLE INSTALLATION

### FOR TELEPHONE-TYPE MOORINGS

**APPLICATION:** The telephone-type mooring is used to facilitate communication from ship-to-shore and from ship-to-ship, where standard type moorings would contribute to entanglement of telephone cable if improvised gear is used, or where visual and radio communication might aid the enemy.

**CAPACITY:** 2 Telephones per mooring and at shore end.

**DESCRIPTION:** This telephone cable installation consists of 3,000 lin ft of submarine telephone cable, one instrument box at each buoy, splices, two telephones for each mooring at the ship end and two telephones for each mooring at the shore end. See Y&D Dwg No. 208,649.

**OPERATION:** Installation requires the services of telephone men equipped to lay the submerged telephone cable.

**SHIPPING INFORMATION:** Shipped boxed and bundled.

Weight: lb  
2,200

Cube: cu ft  
70

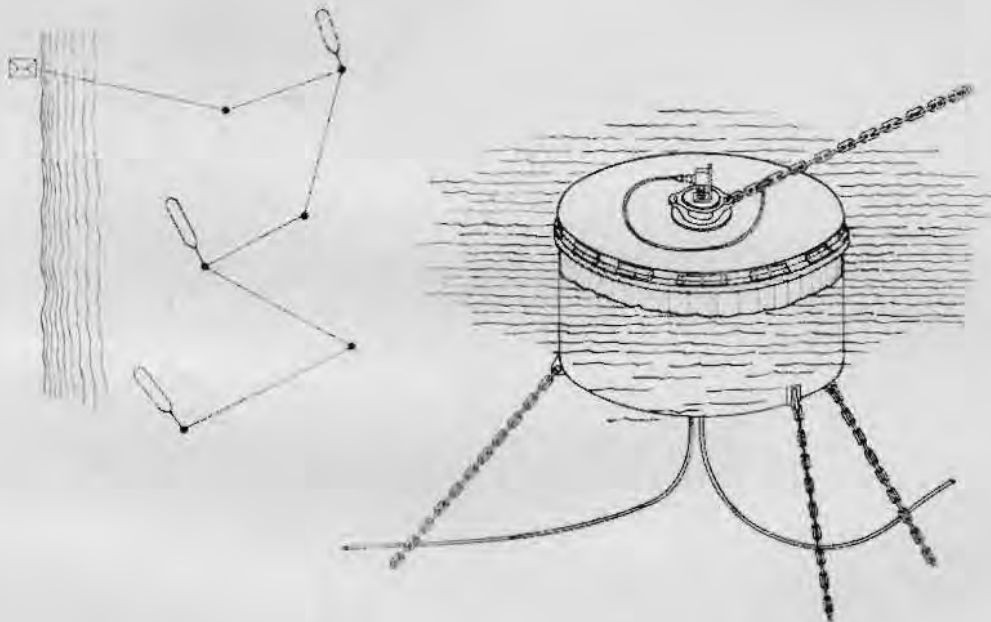

## CRADLE

FOR PT BOAT MARINE RAILWAY, DESIGN #1, STOCK NO. 5B13-1

**APPLICATION:** This cradle is the principal item of the marine railway. The boat being docked rests upon it and is drawn out of the water by means of a winch which pulls the cradle up the inclined track or ramp.

**CAPACITY:** One PT boat or one MT boat.

**DESCRIPTION:** The cradle consists of a welded and bolted structural frame 43 ft long and 23 ft wide supported on four pairs of 8 in. x 38 in. solid rubber-tired fixed-direction wheels and supporting four pairs of movable steel chairs fitted with padded wooden chocks shaped to fit the hull to be docked. The chairs are movable so as to be set directly under the bulkheads of the boat. Guide bars are supplied at the four corners for centering the boat in the cradle. A towing sling is provided for attaching to hauling line from winch. The steering bogie included is a separate welded structural frame 23 ft long and 7 ft wide having two pairs of wheels arranged to steer as automobile wheels. The bogie is bolted in place after raising the front end of the cradle, by means of the jacks, so that front cradle wheels are 2-1/2 in. off the ground, and enables the cradle to be steered like a four wheeled trailer truck.

**OPERATION:** The cradle and bogie combination may be used in any one of four ways, (1) without steering bogie when shelter or repair shop is in direct line with the ramp, (2) without the steering bogie when the cradle is to be lifted with slings by a crane, (3) with the steering bogie when steering of the cradle is necessary, (4) with the steering bogie replacing the fixed front wheel section when no fixed direction movement is required. Assembly (covered in detail in manufacturers instructions accompanying shipment) consists of spacing the lateral wheel sections, weighing approximately 4000 lb each, placing on top of them the two longitudinal sections supporting chains and chocks, weighing approximately 7000 lb each and wheeling the steering bogie into position which weighs approximately 9000 lb.



**SUPPLIES REQUIRED:** The following quantities of fuel and lubricants are estimated to be required for operating the equipment 1,000 hours under severe conditions at the atmospheric temperature ranges shown:

	32°F and lower	32°F to 70°F	70°F and higher
Greases - Water Pump 14L11 lb	20	20	20

**AUXILIARY EQUIPMENT SUPPLIED:** 2 Jacks for use in attaching steering bogies, one towing bridle.

**AUXILIARY EQUIPMENT NEEDED BUT NOT SUPPLIED:** Hoisting winch, cables, blocks and ramp.

**SHIPPING INFORMATION:** Shipped in five pieces, 2 fixed wheel lateral frames, 2 longitudinal frames with chairs, chocks, towing bridle, guide bars, jacks and erection bolts attached, and one steering bogie.

	Wt: lb	Cube: cu ft
Complete unit with one set chocks and without lifting slings and spreaders	31000	2100
Each set of chocks	1000	33
Lifting slings and spreaders	2400	80

**ORDERING INSTRUCTIONS:** State which additional chock sets, if any, are required. State whether lifting slings and spreaders are required.

**Note:** There are six different hulls which may require docking, but in the event no chocks are at hand, they may be shaped locally from the docking plans carried on each boat.

## LIFTING FRAME

### FOR PT BASE HULL REPAIR SHOPS

**APPLICATION:** This frame is designed to facilitate the removal and replacing of engines or fuel tanks in P T Boats which are brought under it on the marine railway cradle.

**CAPACITY:** The frame is adequate for supporting the hand hoist which has a lifting capacity of 4000 lb and a reach sufficient for lifting an engine or tank from ground level and lowering same to the floor of a truck or other means of transportation. The hoist trolley-rail has a reach of 5 ft beyond either end of the frame.

**DESCRIPTION:** This equipment comprises a structural timber frame or gantry designed to straddle the marine railway ramp immediately outside the hull repair shop, a traveling hand hoist or chain block, and a trolley rail fixed to the under part of the bridge section of the frame. The legs of the frame are secured to adequate foundations. The frame may be equipped with an electrically operated hoist where electricity is available. The frame has an inside clear width of 24 ft 6 in. and a vertical clearance of 27 ft 6 in. which dimensions are sufficient for providing clearance for the boat in the cradle and for the lifting and handling operations. Lumber for constructing timber foundations is also furnished for use where concrete footings are not feasible. Details of the frame, together with a bill of materials, appear on Y&D Dwg No. 262,581.

**OPERATION:** When a lift is to be made, the boat in the cradle is positioned under the frame. One man can operate the hoist.

**SUPPLIES REQUIRED:** Electric current, and lubricants for the hoist and the following quantities of fuel and lubricants are estimated to be required for operating the equipment 1,000 hours under severe conditions at the atmospheric temperature ranges shown:

	32° F and lower	32° F to 70° F	70° F and higher
Oils -			
Gear, VV-L-761 (SAE 80) (Hypoid)	1	1	1

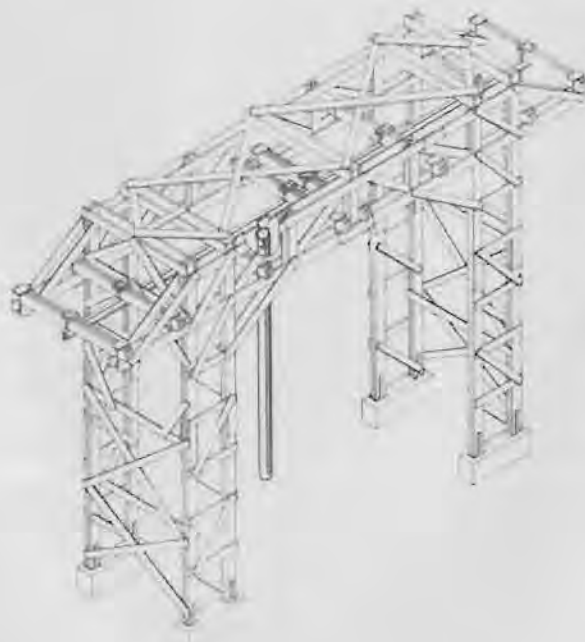

AUXILIARY EQUIPMENT SUPPLIED: Spare parts for the hoist estimated to be required during a year's operation are included, as well as a manual of instruction for its operation and maintenance.

AUXILIARY EQUIPMENT NEEDED BUT NOT SUPPLIED: Special close slings for handling engines. These are supplied with the engines.

SHIPPING INFORMATION: Packed for export as loose lumber and boxed or keged small parts.

	Weight: lb	Cube: cu ft
Lumber for frame	18,000	460
Lumber for timber footing	12,000	310
Trolley beams, hardware & fastenings	2,900	29
Hand operated hoist	400	12
Cement	7,200	80

## TENT, HATCH

FOR 20 FT x 30 FT HATCH, STOCK NO. 5B34

**APPLICATION:** For excluding rain, hail and snow from open hatches of ships during cargo handling operations.

**CAPACITY:** This tent is designed primarily for a hatch 20 ft by 30 ft. It has base dimensions of 30 ft by 40 ft a height of 25 ft and a ridge length of 30 ft.

**DESCRIPTION:** It is a specially designed tent of 6 oz duck, waterproofed, mildew proofed, painted Navy gray, reinforced at edges with rope bindings and fitted with tie ropes for suspending and tying down and with laced openings for bypassing stays and for fitting around deck houses and winches. The hatch tent is designed to suspend from the cargo booms without interfering with the travel of the cargo load line, to provide a maximum of shelter for the open cargo hatch and the winch operators adjacent and to restrict as little as possible the working space and view around the hatch opening.

<b>SHIPPING INFORMATION:</b> Baled for export	Weight lb	Cube of
	960	100



## PIERS, TIMBER

20 FT, 30 FT, 40 FT, AND 50 FT WIDE.

**APPLICATION:** To provide loading, unloading and servicing facilities for ships Y&D Dwg No. 267,768 to 267,772, inclusive, which contain working drawings, details and bills of material for standard timber piers 20, 30, 40, and 50 ft wide, have been developed.

**CAPACITY:** These pier standards have been designed for a uniformly distributed live load of 400 psf, for one truck carrying a five-ton payload or an eleven-ton load on one track of a crawler crane and for a horizontal thrust of 1,000 lb per linear ft. Bent spacings are the same in all widths, and details are common to all so that timbers, piles and hardware items carried in advance base depot stocks are suitable to any of these piers, and variation occurs only in quantities required.

**DESCRIPTION:** For each width pier there is furnished one sheet of drawings containing the working drawings and bill of material for that width pier. An additional sheet shows details and data which are common to all widths.

The hardware only, the metal fastenings and fixtures, including bolts, pins, spikes, cleats and bitts, for a 500 ft length of the 40 ft-pier is included. Additional materials or pier materials require a special directive.

**OPERATION:** The construction of these piers requires the services of a dock building company with complete tools, including pile driving facilities.

**AUXILIARY EQUIPMENT NEEDED BUT NOT SUPPLIED:** Timbers and piling.

**SHIPPING INFORMATION:** Hardware for 500 ft length of 40-ft pier bundled and boxed, small parts, and loose cleats and bitts.

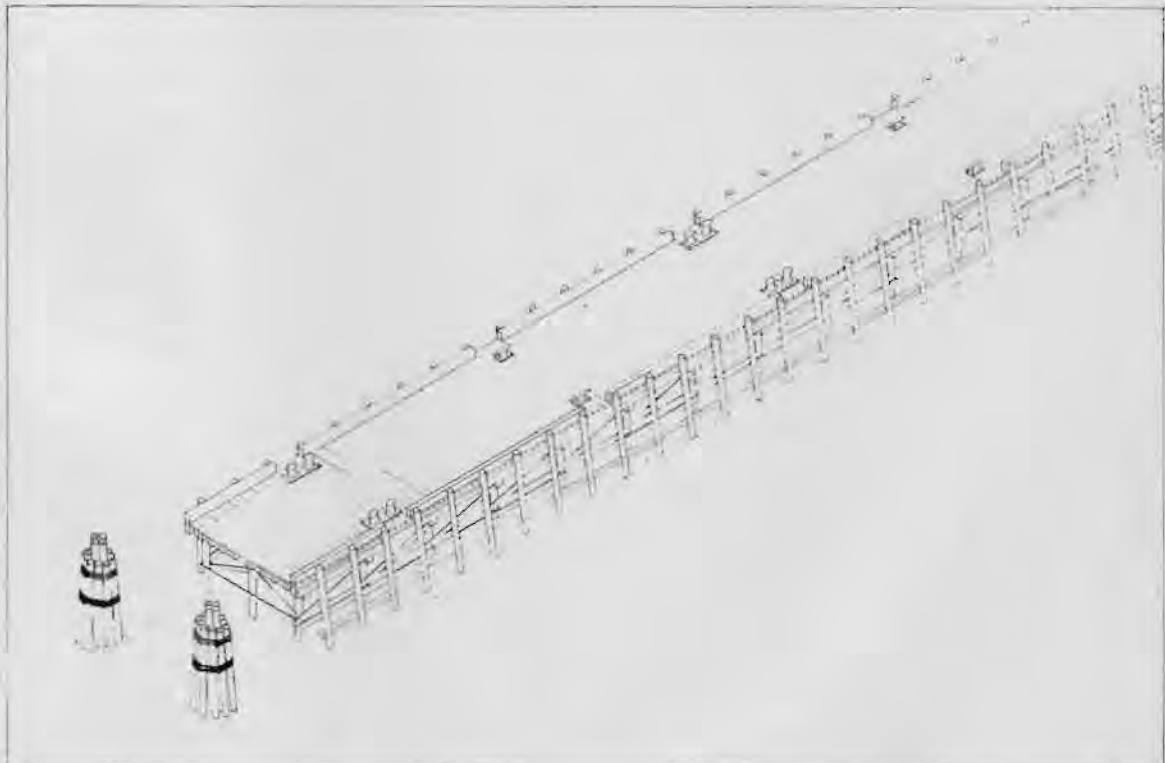



ORDERING INSTRUCTIONS: If known, state length and width of piers required and whether timbers and piling are to be included. Quantities required for a 300-foot pier are as follows:

	Weight: lb	Cube: cu ft
Piling (20 ft wide)	273,400	7,800
Timber	280,400	8,100
Hardware	30,400	300
Piling (30 ft wide)	304,100	8,700
Timber	383,600	10,900
Hardware	47,500	480
Piling (40 ft wide)	367,300	10,500
Timber	468,400	13,400
Hardware	51,400	500
Piling (50 ft wide)	399,000	11,400
Timber	565,900	16,000
Hardware	55,500	550

## MARINE RAILWAY

### FOR PT BOATS.

**APPLICATION:** For drydocking PT boats or other craft of similar size.

**CAPACITY:** The marine railway is located at the hull repair shop for drydocking PT boats. The cradle is drawn into the hull repair shop at the upper end of the railway where hull repairs are made while the boat is on the cradle. The weight lifting frame is located just outside the hull repair shop for pulling engines or tanks or making any other lifts up to 2 tons.

**DESCRIPTION:** This marine railway consists essentially of a ramp of pierced steel plank which extends into the water, a cradle on wheels which is equipped to accommodate the hulls of PT boats or other craft of approximately the same size, and a winch with cable and blocking for pulling the loaded cradle up into the hull repair shop at the onshore end of the ramp. The ramp is 35 ft wide and 300 ft long and has a wood curb along each side to prevent the cradle from slipping off in the event there is side-slippage. The fabricated steel cradle is furnished in 5 readily assembled frames of one of two designs which vary as to length, the number of chairs and the method of steering. Each of these designs may either be steered or have its wheels fixed in line and each will accommodate all PT hulls according to either the four or six point hull supporting plan. The winch is powered by a gasoline engine and it is capable of a 17,000 lb single line pull at 60 fpm on a single drum for a single-ramp installation and on double lines and drums for a two-ramp installation. Tackle blocks and 1-in. wire rope cable are furnished for use on the winch for pulling the cradles. Details of the ramp and winch and their foundations and anchorages are shown on Y&D Dwg No. 264,225; and the hull repair shop is detailed on Y&D Dwgs Nos. 261,703 and 261,705. The engine lifting frame which is pictured in front of the hull repair shop in the accompanying illustration is detailed on Y&D Dwg No. 262,581.

**OPERATION:** To bring a boat into the repair shop by means of this equipment, the cradle is first allowed to roll down the ramp until it is submerged an amount equal to the docking draft of the PT boat. Guide bars at each end of the cradle indicate its position while the

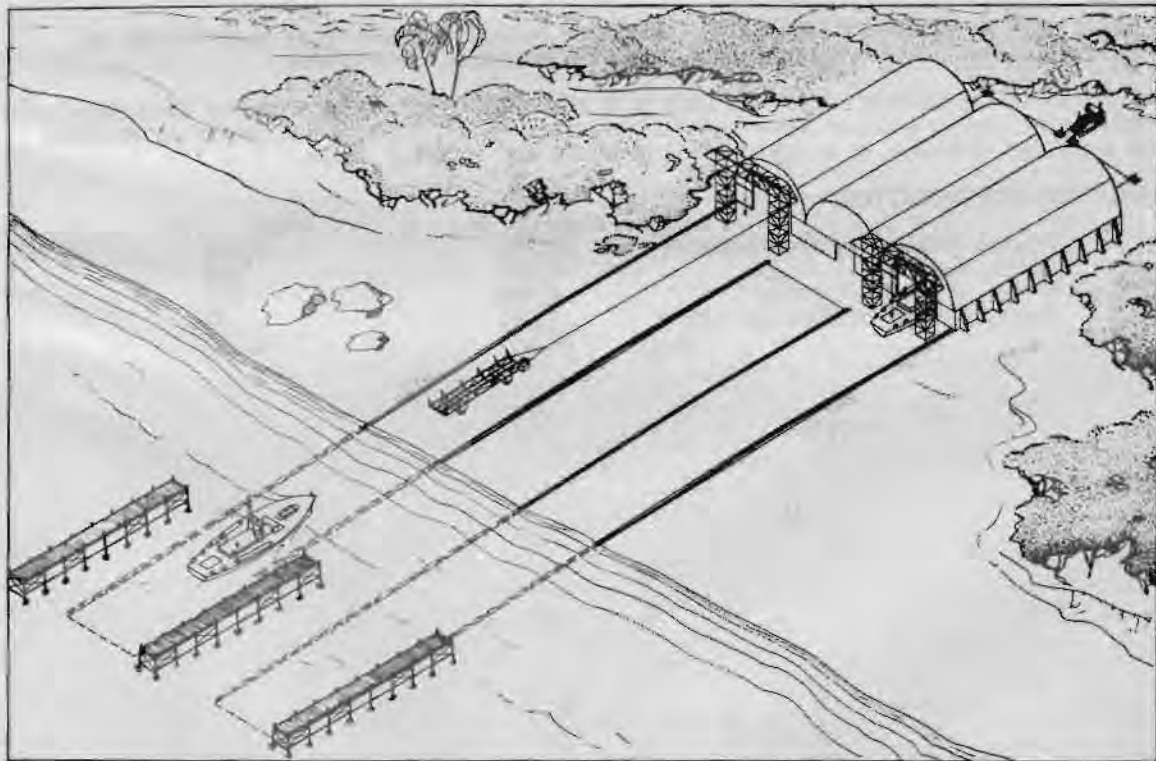

**OPERATION (CONT'D)**

boat is being centered over the chocks. When centered, the bowline of the boat is made fast to the hauling line of the cradle and the cradle is then drawn up slowly until the entire boat settles properly on all the chocks. The cradle and boat are then drawn up into the shop. The reverse operation is by gravity through permitting the cradle cable to unwind from the winch under control. The docking crew consists of a winch operator and sufficient men to secure and watch snubbing lines fore and aft, all under the supervision of a dock master. The crew centers the boat under the direction of the dock master. On some installations there is a tendency for the cradle to slide off to one side. In such cases it is necessary to have snubbing lines controlling the cradle while it is travelling the ramp.

**SUPPLIES REQUIRED:** The following quantities of fuel and lubricants are estimated to be required for operating the equipment 1,000 hours under severe conditions at the atmospheric temperature ranges shown:

	32°F and lower	32°F to 70°F	70°F and higher
Winch			
Fuel -			
Unleaded gasoline, 85 octane, gals) either	( 10000	10000	10000
Diesel oil, 50 centane gals )	( 7000	7000	7000
Greases -			
General purpose 14L9 No. 1 (chassis) lb	10	10	10
Ball and roller bearing 14L3b grade No. 11 lb	5	5	5
Water Pump 14L11 lb	1	1	1
Wire rope chain and open gears VV-L-751 lb	10	10	10
Oils -			
Gear, VV-L-761 (SAE 90) (Hypoid) gal.	15	15	15
Motor 9110 (SAE 10) gal	50		
" 9250 ( " 30) gal		50	50
Cradle			
Greases -			
Water Pump 14L11 lb	20	20	20

**AUXILIARY EQUIPMENT SUPPLIED:** Operating instructions and spare parts for the machinery estimated to be required during a year's operation are included.

**AUXILIARY EQUIPMENT NEEDED BUT NOT SUPPLIED:** Means for securing lines for holding the boat in position while centering over cradle are required and may be in the form of moorings, dolphins, or a slip of piling provided with mooring cleats.

**SHIPPING INFORMATION:**

	Weight: lb	Cube: cu ft
1 Cradle, (fabricated steel frames)	32,000	2,200
1 Ramp, bundled.	54,500	600
1 Winch, skidded for export.	9,000	400
Blocks & cable bundled for export	1,000	50
Total	96,500	3,250

## MAT, AIRPLANE LANDING

PIERCED PLANK, 10 GAGE, STOCK NO. 5D1-2

**APPLICATION:** These planks are laid over sandy or gravelly soils having good bearing power but lacking in cohesion, over soil aggregate courses which become very muddy or dusty and over firm natural soil or native turf which needs relatively light reinforcement to support expected wheel loads. They are used to form airplane landing strips and runways and to form the marine railway ramp for docking P.T. boats.

**CAPACITY:** Used as above they provide a surface which is adequate for the support of military plane landing strips and runways and for the support of cradle wheel loads for P.T. boat Marine Railway.

**DESCRIPTION:** Planks are press formed from 10-gage steel sheets, ribbed for stiffness and lightened by perforations permitting the growth of grass and weeds through them, a necessary feature for camouflage and concealment. Individual planks are 1 ft 4 in. wide, laying up 15 in. center to center and 9 ft 11 3/4 in. long and weigh 71 lb each. Edges interlock and by staggering end joints the entire surface is interlocked in both directions, but individual planks in an area may be removed and relaced when necessary for repair or for repair of the ground below.



**OPERATION:** Planks are laid manually at the average rate of 80 sq ft per man hour.

**SUPPLIES REQUIRED:** Spring clips for locking planks in place are supplied, 6 for each plank.

**AUXILIARY EQUIPMENT SUPPLIED:** Tools consisting of hammers and hand hooks are furnished. Manual of instruction for operation and maintenance furnished, together with a spare parts list.

**SHIPPING INFORMATION:** Shipped nested in bundles in 40 planks per bundle and handled individually by hand or in bundles by special lifting devices when derricks are available.

Weight: 5.2 lb per sq ft      Cube: 0.055 cu ft per sq ft  
Weight of shipping bundles: 2840 lb

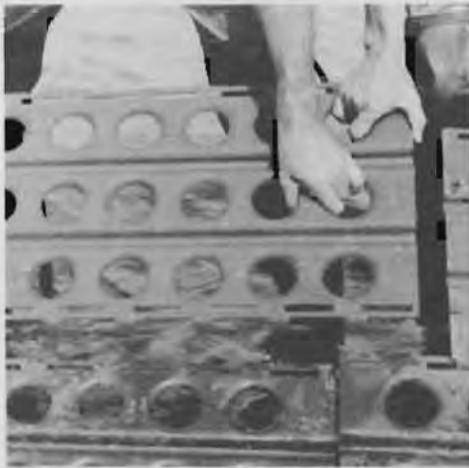

## MAT, AIRPLANE LANDING

WIRE MESH, 2-IN. X 2-IN. NO. 4 WIRES, STOCK NO. 5D1-1

**APPLICATION:** Used to form a supporting surface for roadways over loose or weak soils and for seaplane ramps.

**CAPACITY:** Military truck traffic and seaplane cradles.

**DESCRIPTION:** This mesh in sheets 6 ft wide, 20 ft-long weighing 200 lbs each is laid down and connected either by means of welding the ends of rods together or by clipping the rods together with a two-handed one-man-operated stapling machine with a magazine capacity of 400 staples. Furnished on all bases.

**OPERATION:** Laid down manually at the rate of 180 sq ft per man hour.

**AUXILIARY EQUIPMENT SUPPLIED:** Stapling machines are included at the rate of 1 stapler for each 3000 sq ft of mesh and 1 staple for each sq ft of mesh.

**SHIPPING INFORMATION:** Shipped in flat sheets, stacked, 6 ft x 20 ft @ 200 lb each.  
Weight: 1 2/3 lb per sq ft - Cube: 0.03 cu ft per sq ft

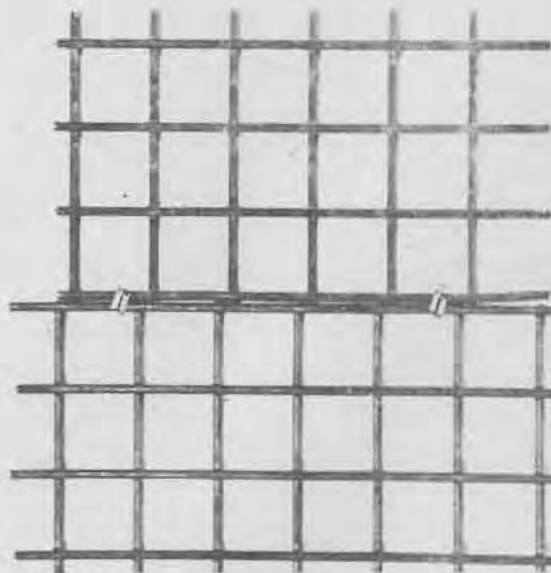

## PALLET, PLATFORM WITH SLINGS

STOCK NO. 5B34-13

**APPLICATION:** For making lifts of numerous packages of cargo by means of crane hook.

**CAPACITY:** The platform is made of 2x6 oak or fir members with a 2 1/2 in. curb all around. Its dimensions inside the curb are 4 ft 6 in by 7 ft while the overall dimensions are 5 ft by 7 ft 6 in. It is supported at each corner by 1/2 in. dia wire rope having a length 8 ft c to c of thimbles connected to the platform by means of 3/4 in x 4 in. rings and together at the top by means of a 1 in. x 6 in. ring.

**DESCRIPTION:** The members making up the platform are nailed and bolted together while the corner irons are continuous across the short ends and are bolted to the platform and the wire rope lengths are attached by means of cable clips forming a rugged and durable platform for handling cargo lifts.

<b>SHIPPING INFORMATION:</b> Packed for export.	Weight lb	Cube cf
	360.	16



## WINCH

ENGINE DRIVEN, STOCK NO. 5L3

**APPLICATION:** This winch is supplied to operate the 75-ton boom, to haul the PT boat cradle for the single ramp installation of the marine railway; and a similar double drum hoist is supplied for hauling the cradles for the double-ramp installation of the marine railway.

**CAPACITY:** The winch is capable of a single line pull of 17,000 pounds at 60 feet per minute.

**DESCRIPTION:** The winch consists of a cable drum designed for spooling 1200 lin ft of 1-in. wire rope, powered by a gasoline engine protected by a removable weatherproof housing. The controls, consisting of throttle, clutch and break levers, are conveniently grouped on one side and a single niggerhead is attached to the end of the drum on the opposite side. The whole is mounted on a steel channel frame, adequately braced and having bolt holes adapted for anchoring.

**OPERATION:** One operating-engineer controls the machine but an additional hand is required when the niggerhead is in use.

**SUPPLIES REQUIRED:** The following quantities of fuel and lubricants are estimated to be required for operating the equipment 1,000 hours under severe conditions at the atmospheric temperature ranges shown:

	32°F and lower	32°F to 70°F	70°F and higher
<b>Fuel -</b>			
Unleaded gasoline, 65 octane, gals)	10000	10000	10000
Diesel oil, 50 centane gals ) either	7000	7000	7000
<b>Greases -</b>			
General purpose 14L9 No. 1 (chassis) lb	10	10	10
Ball and roller bearing 14L3b grade No. 11 lb	5	5	5
Water Pump 14L11 lb	1	1	1
Wire rope chain and open gears VV-L-751 lb	10	10	10
<b>Oils -</b>			
Gear, VV-L-761 (SAE 90) (Hypoid) gal	15	15	15
Motor 9110 (SAE 10) gal	50		
9250 ( 30) gal		50	50





AUXILIARY EQUIPMENT SUPPLIED: Spare parts estimated to keep winch operating one year are included, as well as operating instructions. Cable for each use is included.

SHIPPING INFORMATION:	Weight: lb	Cube: cu ft
Single-Drum winch	9,700.	400.
Double-Drum winch	13,000.	600.

## WINCH

HAND OPERATED, 5 TON, STOCK NO. 5L3

**APPLICATION:** It is used for power in the operation of landing ramp and anchor hoists on pontoon barges but is also adaptable to the entire range of hand hoisting, lowering or pulling within its capacity.

**CAPACITY:** This hoist has a 5-ton capacity for a single line pull and has 2 speed variations through 4:1 and 14:1 gearing. Its drum has cable capacity as follows: 445 ft 3/8-in. cable, 325 ft 7/16-in. cable, 250 ft 1/2-in. cable and 160 ft 5/8-in. cable.

**DESCRIPTION:** The hoist weighs 110 lb, consists of 8 all-steel parts, is compact and is readily mounted by means of four 5/8-in. diam bolts. It is equipped with a positive locable friction brake as well as a holding dog.

**OPERATION:** It is operated by one or two men, depending upon the load to be moved.

**SUPPLIES REQUIRED:** The following quantities of fuel and lubricants are estimated to be required for operating the equipment 1,000 hours under severe conditions at the atmospheric temperature ranges shown:

	32°F and lower	32°F to 70°F	70°F and higher
Greases -			
General purpose 14L10 No. 2 (wheel bearing) lb	1	1	1
Wire rope chain and open gears VV-L-751 lb	1	1	1

**AUXILIARY EQUIPMENT SUPPLIED:** Spare parts estimated to be needed during a year's operation are included.

**AUXILIARY EQUIPMENT NEEDED BUT NOT SUPPLIED:** Cable.

**SHIPPING INFORMATION:** Boxed for export weight is 135 lb; cube, 4 cu ft.

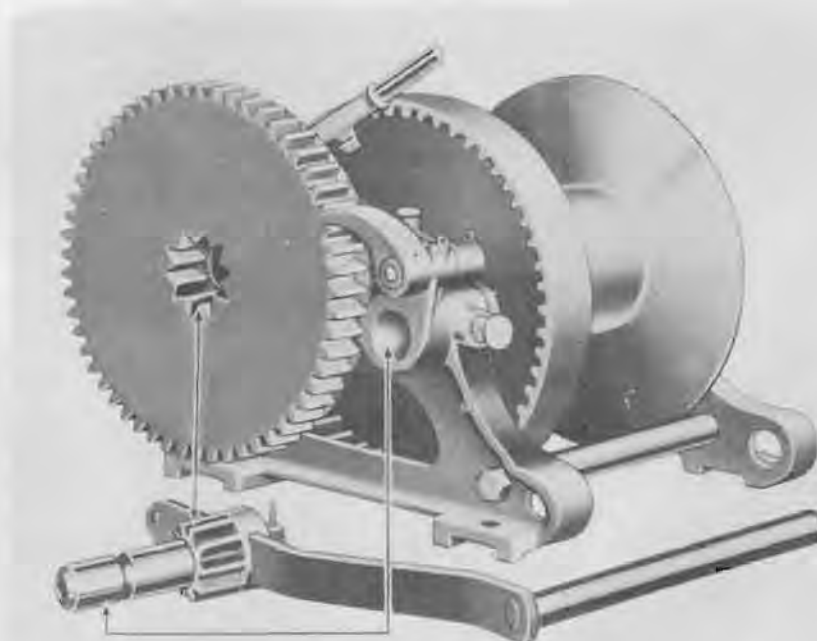

## SECTION VI - TRANSPORTATION EQUIPMENT

## List of Effective Pages

539 - 540	July 1945	557 - 558	November 1943	572A - 572B	July 1945
541 - 542	November 1943	559 - 560	" "	572C - 572D	" "
543 - 544	" "	561 - 562	" "	573 - 574	November 1943
544A - 544B	July 1945	563 - 564	" "	574A - 574B	July 1945
545 - 546	November 1943	565 - 566	" "	575 - 576	November 1943
547 - 548	" "	567 - 568	" "	577 - 578	" "
549 - 550	" "	569 - 570	" "	587 - 588	July 1945
551 - 552	" "	570A - 570B	July 1945	589 - 590	November 1943
553 - 554	" "	570C - 570D	" "	590A - 590B	July 1945
555 - 556	" "	571 - 572	November 1943	590C - 590D	" "

## SECTION VI - TRANSPORTATION EQUIPMENT

## INDEX TO CONTENTS

<u>Trucks</u>	<u>Pages</u>	<u>Trailers (Cont'd)</u>	<u>Pages</u>
Truck, Ambulance, 3/4-Ton, 4 x 4	557-558	Trailer, Dock, 3 x 6, with Steel Wheels	569-570
Truck, Amphibian, 1/4-Ton, 4 x 4	553-554	Trailer, Dock, 10-Ton, Fifth- Wheel-Type	570A-570B
Truck, Cargo, 1 1/2-Ton, 4 x 4	551-552	Trailer, Lowbed, 25-Ton, Platform	571-572
Truck, Cargo, 2 1/2-Ton, 6 x 6	549-550	Trailer, Machine-Shop, Marine Corps Type	567-568
Truck, Command Recon- naissance, 3/4-Ton, 4 x 4	547-548	Trailer, Military-Type, Cargo	570C-570D
Truck, Dump, 2 1/2-Ton, 6 x 6	545-546	Trailer, Tank, Water, 300- Gal, Marine Corps Type	565-566
Truck, Lift, Fork-Type, 3- Ton Load, 8 2/3-Ft Lift	543-544	Trailer, Track-Tread, Full, 6-Ton, Platform	572A-572B
Truck, Lift, Fork-Type, 7 1/2- Ton Load, 17 1/2-Ft Lift	541-542	Trailer, Track-Tread, Full, 15-Ton, Platform	573-574
Truck, Lift, Fork-Type, 8000-lb Load, 14-Ft Lift	544A-544B	<u>Maintenance and Repair</u>	
Truck, Reconnaissance, 1/2- Ton 4 x 4	559-560	Charger, Battery, 12-Volt, Portable	589-590
Truck, Refrigerator	561-562	Compressor, Air, 3.0-Cu Ft per Min	587-588
Truck, Weapon-Carrier, 3/4-Ton, 4 x 4	555-556	Demounter, Tire, Portable	574A-574B
<u>Tractors</u>		Grinder, Valve Refacer, 5/8- In. with Standard Equipment	577-578
Tractor, Truck, (Dock Mule), 4,000-Lb Drawbar Pull	563-564	Lathe, Brake-Drum, 9-In. Drum Face	590C-590D
<u>Trailers</u>		Reliner, Brake	575-576
Trailer, Commercial, Refrig- erator	572C-572D	Shield, Truck-Cab- Protector	590A-590B

## TRUCK, LIFT, FORK TYPE

7 1/2-TON LOAD, 17 1/2-FT LIFT, STOCK NO. 6F30

**APPLICATION:** For transporting, tiering, loading and unloading miscellaneous cargo in unit packages at docks, yards, terminals and warehouses.

**CAPACITY:** The capacity of this truck decreases as the length of forks used increases, from a 7.5-ton load using 42-in forks down to a 6-ton load on 72-in forks. The truck will lift its load up to 17.5 ft above the floor and will tilt 4 deg forward and 12 deg backward. It travels at speeds up to 36 mph, lifts at rates up to 45 fpm and lowers at rates up to 60 fpm. It has a turning radius of 13 ft either to the right or left and a ground clearance of 6.5 in. It is usually furnished with 60-in forks.

**DESCRIPTION:** The truck is mounted on pneumatic tires, is powered by a 84-hp gasoline engine and is equipped with rear-wheel steering. All controls are conveniently grouped within the operator's reach under a heavy protective screen extending over the operator's compartment. The lifting and tilting mechanisms are hydraulically actuated and both may be operating while the truck is traveling. The overall dimensions are 138 in long, including forks, 150 in high with lift telescoped, and 84 in wide. The working weight of the truck is 15,800 lb.

**OPERATION:** One-man operation.

**SUPPLIES REQUIRED:** The following quantities of fuel and lubricants are estimated to be required for operating the equipment 1,000 hours under severe conditions at the atmospheric temperature ranges shown:

	32°F and lower	32°F to 70°F	70°F and higher
Fuel - Unleaded gasoline, 65 octane, gals	8,500	8,500	8,500



	32°F and lower	32°F to 70°F	70°F and higher
<b>Greases -</b>			
General purpose 14L9 No. 1 (chassis) lb	15	15	
General purpose 14L10 No. 2 (wheel bearing) lb	5	5	20
Ball and roller bearing 14L3b grade No. 11 lb	1	1	1
Water Pump 14L11 lb	1	1	1
<b>Oils -</b>			
Gear, VV-L-761 (SAE 90) (Hypoid) gal	10	10	10
Motor 9110 (SAE 10) gal	72	42	42
" 9250 ( " 30) gal		30	
" 9500 ( " 50) gal			30
<b>Hydraulic Brake Fluid -</b>			
USA2 - 111 HB, pt	1	1	1
<b>Shock absorber fluid -</b>			
USA2-112 light, pt	1	1	1
USA2-112 heavy, pt	1	1	1

**AUXILIARY EQUIPMENT SUPPLIED:** Spare parts estimated to be required during a year's operation are included. Manual of instruction for operation and maintenance furnished, together with a spare parts list.

**SHIPPING INFORMATION:** Boxed for export  
 Weight 16,400 lb  
 Cube 520 cu ft

## TRUCK, LIFT, FORK TYPE

3-TON LOAD, 8 2/3-FT LIFT, STOCK NO. 6F30

**APPLICATION:** For transporting, tiering, loading and unloading miscellaneous cargo in unit packages at docks, terminals, warehouses or other places where floors are suitable for the traffic.

**CAPACITY:** The capacity of this truck is 3 tons on the standard forks 24 in long and it will lift its load up to 104 in above the floor. It tilts forward 3 deg and backward 10 deg travels at 7 mph forward and 6 mph backward, lifts and lowers at an average rate of 36 fpm and climbs 9% grades in high gear and 18% grades in low gear. It has an inside turning radius of 6 in and an outside turning radius of 81 in.

**DESCRIPTION:** This truck travels on solid rubber tired wheels, steering wheels being at the rear, is powered by a 50-hp gasoline engine and all its controls are conveniently grouped at the operator's seat. The lifting and tilting mechanisms are hydraulically activated. The truck operates readily in confined spaces and is capable of making sharp turns in narrow aisles. Its overall dimensions are 115 in long (including 25 in forks), 44 in wide, and 83 in high (with lift in low position,) and its service weight is 10,000 lb.

**OPERATION:** One-man operation

**SUPPLIES REQUIRED:** The following quantities of fuel and lubricants are estimated to be required for operating the equipment 1,000 hours under severe conditions at the atmospheric temperature ranges shown:

	32°F and lower	32°F to 70°F	70°F and higher
Fuel - Unleaded gasoline, 65 octane, gals	5,000	5,000	5,000



	32°F and lower	32°F to 70°F	70°F and higher
<b>Greases -</b>			
General purpose 14L9 No. 1 (chassis) lb	15	15	
General purpose 14L10 No. 2 (wheel bearing) lb	5	5	20
Ball and roller bearing 14L3b grade No. 11 lb	1	1	1
Water Pump 14L11 lb	1	1	1
<b>Oils -</b>			
Gear, VV-L-761 (SAE 90) (Hypoid) gal	10	10	10
Motor 9110 (SAE 10) gal	60	30	30
" 9250 ( " 30) gal		30	
" 9500 ( " 50) gal			30
<b>Hydraulic Brake Fluid -</b>			
USA2 - 111 HB, pt	1	1	1
<b>Shock absorber fluid -</b>			
USA2 - 112 light, pt	1	1	1
USA2 - 112 heavy, pt	1	1	1

**AUXILIARY EQUIPMENT SUPPLIED:** Spare parts estimated to be required during a year's operation are included.

**SHIPPING INFORMATION:** Boxed for export

Weight 11,100 lb  
Cube 480 cu ft

**TRUCK, LIFT, FORK-TYPE, GAS-DRIVEN, WAREHOUSE**  
**168-IN. LIFTING HT., 6000 LB. CAPACITY**  
STOCK LIST NO. 6F30-9

**APPLICATION:** For transporting, tiering, loading, and unloading miscellaneous cargo in unit packages at docks, terminals, warehouses, or other places where floors are suitable for traffic.

**CAPACITY:** The truck has a capacity of 3 tons at 25 in. from the heel of the forks with a lifting height of 168 in. above the floor. Machine tilts under hydraulic operation 5 to 6 degrees forward and 10 degrees backward.

**DESCRIPTION:** The truck, mounted on pneumatic tires, is powered by a heavy-duty 4-Cyl Continental gasoline engine with 162-cu in. displacement and is equipped for rear-wheel steering and front-wheel drive. All controls are grouped within reach of the operator's seat which is located to afford clear vision under all operating conditions. The lifting and tilting mechanisms are hydraulically actuated and both may be operated while the truck is in motion. The transmission furnished affords 3 speeds forward and 3 speeds in reverse. The machine is equipped with lifting forks, 48 in. long, adjustable from 18 in. to 52 in. in width. Tire size 7.50 x 15, 12-ply.

**OPERATION:** One-man operation.

**SUPPLIES REQUIRED:** The following quantities of fuel and lubricants are estimated to be required for operating the equipment 1,000 hours under severe conditions at the atmospheric temperature ranges shown:

	32°F and lower	32°F to 70°F	70°F and higher
Fuel			
Leaded gasoline, 80-octane, gal	4000	4000	4000

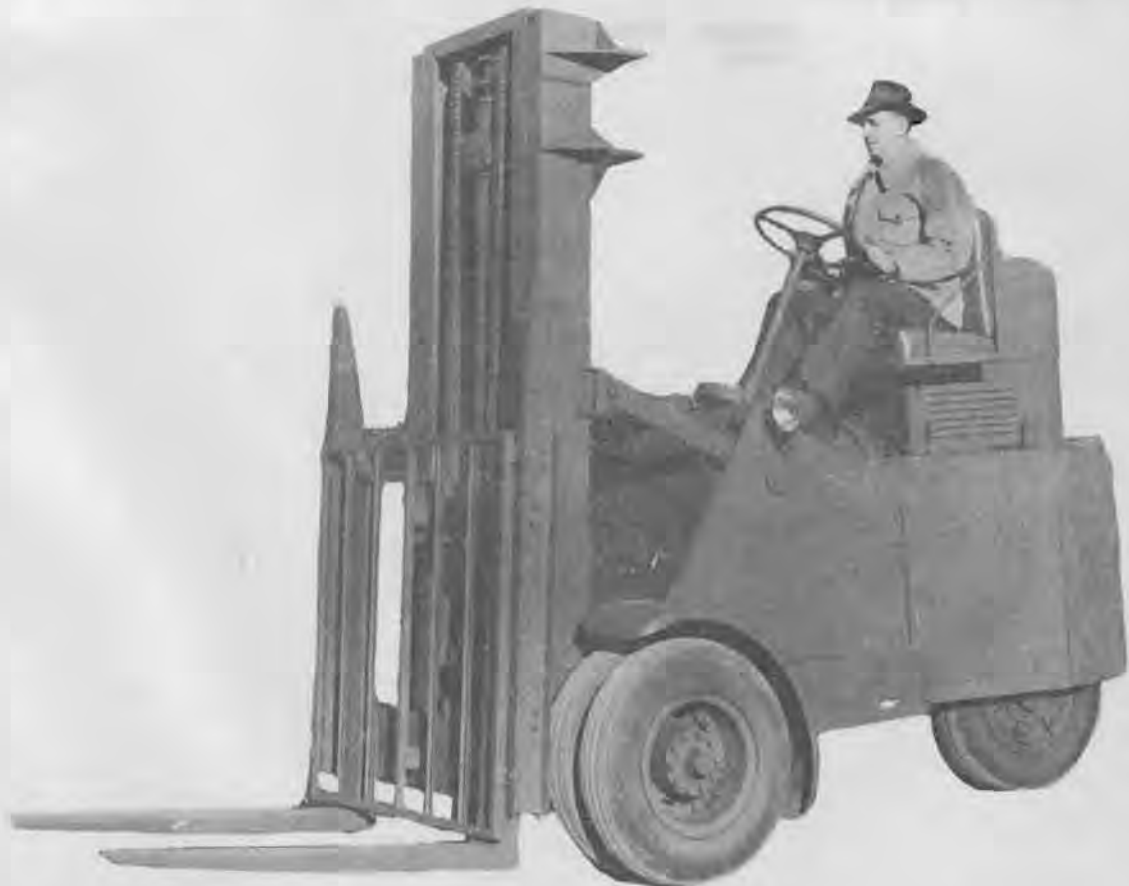



	32°F and lower	32°F to 70°F	70°F and higher
<b>Greases</b>			
General Purpose 14L9 No. 1 (classis), lb	10	10	10
General Purpose 14L10 No. 2 (wheel bearing), lb	5	5	5
Ball and roller-bearing 14L3 grade No. II, lb	1	1	1
Water pump 14L11, lb	1	1	1
<b>Oils</b>			
Gear, USA Spec. 2-105, Grade 90, gal	8	8	8
Motor 9110 (SAE 10), gal	50	25	10
Motor 9250 (SAE 30), gal	50	25	
Motor 9500 (SAE 50), gal			25
<b>Hydraulic Brake Fluid</b>			
USA2 - 111, pt	1	1	1
<b>Shock Absorber Fluid</b>			
USA 2 - 112 light, pt	1	1	1
USA 2 - 112 heavy, pt	1	1	1

**AUXILIARY EQUIPMENT SUPPLIED:** Operating manual and spare parts.

**AUXILIARY EQUIPMENT NEEDED BUT NOT SUPPLIED:** Gasoline fuel.

**SHIPPING INFORMATION:**

Weight: 9000 lb  
Cube: 438 cu ft

## TRUCK, DUMP

2 1/2-TON, 6 X 6, STOCK NO. 6K6-4

**APPLICATION:** For the transportation of personnel and general cargo. This truck is furnished with steel body and with or without a winch.

**CAPACITY:** The truck has a payload capacity of 5,000 lb, can negotiate a maximum grade low gear fully-loaded, of 65%, has a turning radius in either direction of 35 ft, a ground clearance of 10 in, a speed range between 2 and 47 mph, a cruising range of 240 miles, a fuel tank capacity of 40 gal, and a winch-line-pull capacity of 10,000 lb. There is included 300 ft of 1/2-in. diam wire rope on the winch.

**DESCRIPTION:** This is a six-wheel-drive vehicle powered by a gasoline engine and having removable wood-slat siding extending 2 ft above the body on the sides and front, with a cab protecting extension in front. It has an open type cab provided with completely enclosing storm curtains, dual windshield wipers, radiator and headlight brush-guard, rear-view mirror and side and rear reflectors. There is a towing hitch at the rear and towing hooks are at the front. The truck is also provided with a spare tire, tire carrier and tool set. The tail-gate-releasing lever is at the side within the reach of the driver and the controls for the operation of the hydraulic dumping-lift are in the cab.

**OPERATION:** One-man operation

**SUPPLIES REQUIRED:** The following quantities of fuel and lubricants are estimated to be required for operating the equipment 10,000 miles under severe conditions at the atmospheric temperature ranges shown:

	32°F and lower	32°F to 70°F	70°F and higher
Fuel -			
Unleaded gasoline, 65 octane, gals	2000 1000	2000 1000	2000 1000



	32°F and lower	32°F to 70°F	70°F and higher
<b>Greases -</b>			
General purpose 14L9 No. 1 (chassis) lb	30	30	
General purpose 14L10 No. 2 (wheel bearing) lb	10	10	40
Water Pump 14L11 lb	1	1	1
Wire rope chain and open gears VV-L-751 lb	1	1	1
<b>Oils -</b>			
Gear, VV-L-761 (SAE 80) (Hypoid) gal	10		
Gear, VV-L-761 (SAE 90) (Hypoid) gal		10	10
Motor 9110 (SAE 10) gal	30		
" 9250 ( " 30) gal		30	
" 9500 ( " 50) gal			30
<b>Hydraulic Brake Fluid -</b>			
USA2 - 111 HB, pt	1	1	1
<b>Shock absorber fluid -</b>			
USA2 - 112 heavy, qt	1	1	1

**AUXILIARY EQUIPMENT SUPPLIED:** Spare parts estimated to be required during a year's operation are included, as well as manuals of instruction for the operation and maintenance of the machine.

<b>SHIPPING INFORMATION:</b>	Not boxed	weight: lb	cube: cu ft
	With winch	16,000	1,110
	Without winch	15,100	1,050

## TRUCK, COMMAND RECONNAISSANCE

3/4-TON, 4 X 4, STOCK NO. 6K3-1

**APPLICATION:** To provide transportation for command officers in the field.

**CAPACITY:** The 4 x 4 command reconnaissance has a load capacity of 1500 lb, seating capacity for four (including driver) and a small rear trunk with cover which forms a load carrying tailgate when open. It travels at speeds up to 55 mph with governor. It is furnished with and without a front-end-mounted power winch capable of a 5000 lb pull and equipped with 300 ft of 3/8-in diam wire rope. The truck will haul a 1000 lb tow, and has a ground clearance of 10 in, a turning radius of 22 ft in either direction, normally fords 34 in of water and climbs 54% grades.

**DESCRIPTION:** The truck is a four-wheeled four-wheel-drive vehicle equipped with fire extinguisher, rear pintle hook, two front towing hooks, two windshield wipers, radiator brush guard, four single tire chains, rear-view mirror, reflectors on side and rear of body, complete suppression of all electrical interference with radio reception, and map board under the instrument panel. The top is of waterproofed composition material which may be folded down or removed. Storm curtains are provided for the sides, and the windshield may be folded forward into a horizontal position. The overall dimensions are 176 in long, 79 in wide and 82 in high (reducible to 62 in with top down.) The wheelbase is 98 in.

**OPERATION:** One-man operated.

**SUPPLIES REQUIRED:** The following quantities of fuel and lubricants are estimated to be required for operating the equipment 10,000 miles under severe conditions at the atmospheric temperature ranges shown:

	32°F and lower	32°F to 70°F	70°F and higher
Fuel - Unleaded gasoline, 85 octane, gals	1000	1000	1000
	1334	1334	1334

833 Hours



	32°F and lower	32°F to 70°F	70°F and higher
<b>Greases -</b>			
General purpose 14L9 No. 1 (chassis) lb	15	15	
General purpose 14L10 No. 2 (wheel bearing) lb	5	5	20
Water Pump 14L11 lb	1	1	1
<b>Oils -</b>			
Gear, VV-L-761 (SAE 80) (Hypoid) gal	5		
Gear, VV-L-761 (SAE 90) (Hypoid) gal		5	5
Motor 9110 (SAE 10) gal	15		
" 9250 ( " 30) gal		15	
" 9500 ( " 50) gal			15
<b>Hydraulic Brake Fluid -</b>			
USA2 - 111 HB, pt	1	1	1
<b>Shock absorber fluid -</b>			
USA2 - 112 light, pt	1	1	1
USA2 - 112 heavy, pt	1	1	1

**AUXILIARY EQUIPMENT SUPPLIED:** Spare parts estimated to be required during a period of a year's operation are included. Manual of instruction for operation and maintenance furnished, together with a spare parts list.

**SHIPPING INFORMATION:** Shipped completely assembled and ready to operate.

	Weight	5700 lb	Cube	653 cu ft top up
Boxed two vehicles in 3 boxes				500 cu ft top down
	Weight	6500 lb each vehicle		337 cu ft each vehicle

## TRUCK, CARGO

2 1/2-TON, 6 X 6, STOCK NO. 6K6

**APPLICATION:** For the transportation of personnel and general cargo. This truck is furnished with either wood or steel body and with or without winch.

**CAPACITY:** The truck has a payload capacity of 5,000 lb, can negotiate a maximum grade in low gear, fully loaded, of 65%, has a turning radius of 35 ft in either direction, a ground clearance of 10 in, a speed range between 2 and 47 mph, a cruising range of 240 miles, a fuel tank capacity of 40 gal, a winch-line-pull capacity of 10,000 lb and 300 ft of 1/2-in diam wire rope on the winch.

**DESCRIPTION:** This is a six-wheel-drive vehicle, with gasoline engine, removable wood-slat siding 2 ft high above body on 2 sides and front, open type cab provided with complete storm curtain enclosures, dual windshield wiper, rear-view mirror, radiator and headlight brush-guard, side and rear reflectors, a towing hitch at rear, tow hooks at the front, spare tire, carrier, and tool set.

**OPERATION:** One-man operation.

**SUPPLIES REQUIRED:** The following quantities of fuel and lubricants are estimated to be required for operating the equipment 10,000 miles under severe conditions at the atmospheric temperature ranges shown:

	32°F and lower	32°F to 70°F	70°F and higher
Fuel - Unleaded gasoline, 65 octane, gals	2000	2000	2000



CGEK-352  
50" Front End  
With Winch

6000 miles

	32°F and lower	32°F to 70°F	70°F and higher
<b>Greases -</b>			
General purpose 14L9 No. 1 (chassis) lb	30 18	30	
General purpose 14L10 No. 2 ( wheel bearing) lb	10 6	10	40 24
Water Pump 14L11 lb	1 1	1	1 1
Wire rope chain and open gears VV-L-751 lb	1 1	1	1 1
<b>Oils -</b>			
Gear, VV-L-761 (SAE 80) (Hypoid) gal	10 6		
Gear, VV-L-761 (SAE 90) (Hypoid) gal		10	10 6
Motor 9110 (SAE 10) gal	30 18		
" 9250 ( " 30) gal		30	
" 9500 ( " 50) gal			30 18
<b>Hydraulic Brake Fluid</b>			
USA2 - 111 HB, pt.	1 1	1	1 1
<b>Shock absorber fluid -</b>			
USA2 - 112 heavy, qt	1 1	1	1 1

**AUXILIARY EQUIPMENT SUPPLIED:** Spare parts estimated to be required during a year's operation, as well as manuals of instruction for the operation and maintenance of the machine, are included.

**SHIPPING INFORMATION:** Not boxed

	Weight: lb	Cube: cu ft
With winch	16,200	1,220
Without winch	15,100	1,170

TRUCK, CARGO

1 1/2-TON, 4 X 4, STOCK NO. 6K5

**APPLICATION:** For transportation of personnel or general cargo. This truck is furnished with or without winch and with either wood or steel body.

**CAPACITY:** The truck has a payload capacity of 3,000 lb, a maximum gradability of 65% in low, fully loaded, a turning radius in either direction of 29 1/2 ft, a ground clearance of 10 in, a top governed-speed of 48 mph, a cruising range of 195 miles, a fuel tank capacity of 40 gal and a winch-line-pull capacity of 10,000 lb 300 ft of 1/2-in diam wire rope included on the winch.

**DESCRIPTION:** This is a four-wheel-drive vehicle, with gasoline engine, removable wood sideboards, removable wood-slat siding 2 ft high above the sideboards with wood hoops over the top of body, canvas tarpaulin body-cover with roll-up panel at rear, enclosed type cab, dual windshield wipers, rear view mirror, radiator and headlight brush-guards, side and rear reflectors, towing hitch at the rear, pull hooks at the front, spare tire, carrier and tool set. Its overall dimensions are length with winch 231 in, without winch 224 in, width 86 in, height top up 105 in, top down 87 in.

**OPERATION:** One-man operation.

**SUPPLIES REQUIRED:** The following quantities of fuel and lubricants are estimated to be required for operating the equipment 1,000 hours under severe conditions at the atmospheric temperature ranges shown:

	32°F and lower	32°F to 70°F	70°F and higher
Fuel -			
Unleaded gasoline, 65 octane, gals	1300	1300	1300
	1667	1667	1667 <i>Teak</i>





2000 miles

	32°F and lower	32°F to 70°F	70°F and higher
<b>Greases -</b>			
General purpose 14L9 No. 1 (chassis) lb	30	30	
General purpose 14L10 No. 2 (wheel bearing) lb	10	10	40
Water Pump 14L11 lb	1	1	1
Wire rope chain and open gears VV-L-751 lb	1	1	1
<b>Oils -</b>			
Gear, VV-L-761 (SAE 80) (Hypoid) gal	10		
Gear, VV-L-761 (SAE 90) (Hypoid) gal		10	10
Motor 9110 (SAE 10) gal	30		
" 9250 ( " 30) gal		30	
" 9500 ( " 50) gal			30
<b>Hydraulic Brake Fluid -</b>			
USA2 - 111 HB, pt	1	1	1
<b>Shock absorber fluid -</b>			
USA2 - 112 heavy, qt	1	1	1

**AUXILIARY EQUIPMENT SUPPLIED:** Spare parts estimated to be required during a year's operation, as well as manuals of instruction for the operation and maintenance of the machine are included.

**SHIPPING INFORMATION:** Not boxed

Weight: 8,200 lbs  
Cube: 1,200 cu ft (with top up)  
" 1,000 cu ft (with top down)

## TRUCK, AMPHIBIAN

1/4-TON, 4 X 4, STOCK NO. 6K1-1

**APPLICATION:** The purposes of this truck are the carrying of personnel, primarily for reconnaissances, the transporting of light cargo and towing a 37 mm anti-tank gun. It will also mount a .50 calibre machine gun.

**CAPACITY:** This truck has seating capacity for five persons and will carry a payload of 800 lb, including the driver and personnel. It travels at road speeds ranging up to 50 mph, and in still water it will make 6.5 mph. Under favorable conditions this vehicle will climb a 43% grade, and it will negotiate a 5% grade from a standing start, fully loaded and towing an additional 1200 lb rolling load. It has a turning radius of 18 ft in either direction and a ground clearance of 8 3/4 in. Afloat, it draws about 36 in. of water when fully loaded.

**DESCRIPTION:** This is the truck familiarly known as the jeep remodeled into an amphibian, with a rudder arranged for operation from the steering wheel and with a propeller and four drive wheels so arranged that they may be operated simultaneously or independently. The windshield is hinged to fold down. A built-up cowling to deflect the bow wave from the engine ventilators while traveling in the water is hinged to fold back behind the headlights and ventilator when the vehicle is traveling on land. The outside dimensions of this truck are length 182 in., width 64 in., height 43 in. with windshield down. Its net service weight is 3400 lb.

**OPERATION:** One-man operation

**SUPPLIES REQUIRED:** The following quantities of fuel and lubricants are estimated to be required for operating the equipment 10,000 miles under severe conditions at the atmospheric temperature ranges shown:

	32°F and lower	32°F to 70°F	70°F and higher
Fuel - Unleaded gasoline, 65 octane, gals	500	500	500



	32°F and lower	32°F to 70°F	70°F and higher
<b>Greases -</b>			
General purpose 14L9 No. 1 (chassis) lb	15	15	
General purpose 14L10 No. 2 (wheel bearing) lb	5	5	20
Water Pump 14L11 lb	40	40	40
Wire rope chain and open gears VV-L-751 lb	1	1	1
<b>Oils -</b>			
Gear, VV-L-761 (SAE 80)(Hypoid) gal	5		
Gear, VV-L-761 (SAE 90)(Hypoid) "		5	5
Motor 9110 (SAE 10) gal	15		
" 9250 ( " 30) "		15	
" 9500 ( " 50) "			15
<b>Hydraulic Brake Fluid -</b>			
USA2 - 111 HB, pt	1	1	1
<b>Shock absorber fluid -</b>			
USA2 - 112 light, pt	1	1	1
USA2 - 112 heavy, pt	1	1	1

**AUXILIARY EQUIPMENT SUPPLIED:** Spare parts estimated to be required during a year's operation, as well as manuals of instruction for operation and maintenance of the machine, are included.

**SHIPPING INFORMATION:** Boxed for export

Weight: 3700 lb  
Cube: 460 cu ft

## TRUCK, WEAPON CARRIER

3/4-TON, 4 X 4, STOCK NO. 6K3-4

**APPLICATION:** To transport weapons, tools and equipment.

**CAPACITY:** The 4 x 4 weapon carrier has a load capacity of 1,500 lb. It is regularly used as a gun carrier for a 37 mm gun mount. It will haul a 1,000 lb tow, has a ground clearance of 10 in. a turning radius of 22 ft in either direction, normally fords 34 in of water, climbs 54% grades and travels at speeds up to 55 mph with governor. It is furnished with and without a front-end-mounted power winch capable of 5,000 lb pull and equipped with 300 ft of 3/8-in diam wire rope.

**DESCRIPTION:** This truck is a four-wheeled, four-wheel-drive vehicle with two bucket seats facing forward, equipped with a fire extinguisher, a rear pintle hook, two front tow hooks, two windshield wipers, radiator brush guard, four single tire chains, a rear-view mirror, reflectors side and rear, complete suppression of electrical interference with radio reception, and map board under instrument panel. It has inside clear body dimensions of 72 in long, 48 in wide and panel height of 18 in. Above this, removable side boards and hoops supporting a removable canvas covering are provided enclosing an additional space 80 in wide and 32 in high for the full length of the body. The windshield folds forward into a horizontal position if desired. Compartments arranged outside of the body box and adjacent to the wheel pockets serve as side seats when carrying personnel. When serving as a mount for the 37 mm gun, two additional seats for the gun personnel are provided facing to the rear directly behind the permanent seats. The overall dimensions are 167 in long, 83 in wide and 82 in high, the height being reducible to 62 in.

**OPERATION:** One-man operated.



**SUPPLIES REQUIRED:** The following quantities of fuel and lubricants are estimated to be required for operating the equipment 10,000 miles under severe conditions at the atmospheric temperature ranges shown:

	32°F and lower	32°F to 70°F	70°F and higher
<b>Fuel -</b>			
Unleaded gasoline, 65 octane, gals	1000	1000	1000
<b>Greases -</b>			
General purpose 14L9 No. 1 (chassis) lb	15	15	
General purpose 14L10 No. 2 (wheel bearing) lb	5	5	20
Water Pump 14L11 lb	1	1	1
Wire rope chain and open gears VV-L-751 lb	1	1	1
<b>Oils -</b>			
Gear, VV-L-761 (SAE 80) (Hypoid) gal	5		
Gear, VV-L-761 (SAE 90) (Hypoid) gal		5	5
Motor 9110 (SAE 10) gal	15		
" 9250 ( " 30) gal		15	
" 9500 ( " 50) gal			15
<b>Hydraulic Brake Fluid -</b>			
USA2 - 111 HB, pt	1	1	1
<b>Shock absorber fluid -</b>			
USA2 - 112 light, pt	1	1	1
USA2 - 112 heavy, pt	1	1	1

**AUXILIARY EQUIPMENT SUPPLIED:** Spare parts estimated to be required during a year's operation are supplied. Manual of instruction for operation and maintenance furnished, together with a spare parts list.

**SHIPPING INFORMATION:** Shipped completely assembled and ready to operate.

Weight: 5,300 lb

Cube: 658 cu ft top up  
" 502 cu ft top down

Boxed 2 units to 3 boxes.

Weight: 6,800 lb each

Cube: 293 cu ft each

## TRUCK, AMBULANCE

3/4-TON, 4 X 4, STOCK NO. 6K3-2

**APPLICATION:** For transporting sick or wounded personnel.

**CAPACITY:** The ambulance has a load capacity of 1,500 lb. It has room for 4 stretcher cases on the racks and 4 walking cases on the floor, in addition to the driver and attendant. Folding seats are provided for use of walking cases when racks are not in use. The ambulance travels at speeds up to 55 mph with governor. It will haul a 1000 lb tow, has a ground clearance of 10 in, a turning radius of 26 ft in either direction, fords 34 in of water and climbs 54% grades.

**DESCRIPTION:** The ambulance is a four-wheeled four-wheel-drive vehicle equipped with fire extinguishers, rear pintle hook, two front tow hooks, two windshield wipers, radiator brush guard, four single tire chains, two rear view mirrors, reflectors on sides and rear of body, complete suppression of all electrical interference with radio reception and map board under instrument panel. It has inside body dimensions of 97 in long, 62 in wide and panel height of 55 in. The overall dimensions are 194 in long, 77 in wide, 90 in high and the wheelbase is 121 in. It has a rear folding step and double doors opening out to provide access to and unrestricted use of full inside dimensions.

**OPERATION:** One-man operation.

**SUPPLIES REQUIRED:** The following quantities of fuel and lubricants are estimated to be required for operating the equipment 10,000 miles under severe conditions at the atmospheric temperature ranges shown:

	32°F and lower	32°F to 70°F	70°F and higher
Fuel - Unleaded gasoline, 65 octane, gals	1000	1000	1000



	32°F and lower	32°F to 70°F	70°F and higher
<b>Greases -</b>			
General purpose 14L9 No. 1 (chassis) lb	15	15	
General purpose 14L10 No. 2 (wheel bearing) lb	5	5	20
Water Pump 14L11 lb	1	1	1
<b>Oils -</b>			
Gear, VV-L-761 (SAE 80) (Hypoid) gal	5		
Gear, VV-L-761 (SAE 90) (Hypoid) gal		5	5
Motor 9110 (SAE 10) gal	15		
" 9250 ( " 30) gal		15	
" 9500 ( " 50) gal			15
<b>Hydraulic Brake Fluid -</b>			
USA2 - 111 HB, pt	1	1	1
<b>Shock absorber fluid -</b>			
USA2 - 112 light, pt	1	1	1
USA2 - 112 heavy, pt	1	1	1

**AUXILIARY EQUIPMENT SUPPLIED:** Spare parts estimated to be required during a year's operation. Manual of instruction for operations and maintenance furnished, together with spare parts list.

**SHIPPING INFORMATION:** Shipped completely assembled and ready to operate.

Weight: 5,900 lb  
Cube: 790 cu ft

## TRUCK, RECONNAISSANCE

1/4-TON, 4 X 4, STOCK NO. 6K1

**APPLICATION:** This truck is used primarily for carrying personnel, chiefly on reconnoissances, transporting light cargo and towing a 37 mm anti-tank gun. It also mounts a .50 calibre machine gun.

**CAPACITY:** This vehicle has seating capacity for five persons, carries a payload of 800 lb, including the driver and personnel, travels at speeds up to 65 mph and fords 18 in of water. It will climb a 59% grade, has a cruising range of 300 miles, and has a turning radius of 17 1/2 ft in either direction. The ground clearance of the truck is 8 3/4 in.

**DESCRIPTION:** This is the truck universally called the jeep. It is ruggedly built, is powerful and fast and highly maneuverable. It has the four wheel drive, is light in weight and low-bodied. It is powered by a gasoline engine and is equipped with radiator and headlight brush-guards, heavy bumpers, a rear towing hitch, folding windshield and top with storm curtains. The outside dimensions of this truck are length 132 in, width 62 in, and height 70 in (reducible to 52 in) Its net service weight is 2,325 lb.

**OPERATION:** One-man operation.

**SUPPLIES REQUIRED:** The following quantities of fuel and lubricants are estimated to be required for operating the equipment 10,000 miles under severe conditions at the atmospheric temperature ranges shown:

	32°F and lower	32°F to 70°F	70°F and higher
Fuel - Unleaded gasoline, 65 octane, gals	500	500	500
	667 <i>Jules</i>	667 <i>Jules</i>	667 <i>Jules</i>



15.0  
mpg  
Jules  
@  
11/4



	32°F and lower	32°F to 70°F	70°F and higher
<b>Greases -</b>			
General purpose 14L9 No. 1 (chassis) lb	15	15	
General purpose 14L10 No. 2 ( wheel bearing) lb	5	5	20
Water Pump 14L11 lb	1	1	1
Wire rope chain and open gear VV-L-751 lb	1	1	1
<b>Oils -</b>			
Gear, VV-L-761 (SAE 80) (Hypoid) gal	5		
Gear, VV-L-761 (SAE 90) (Hypoid) gal		5	5
Motor 9110 (SAE 10) gal	15		
" 9250 ( " 30) gal		15	
" 9500 ( " 50) gal			15
<b>Hydraulic Brake Fluid -</b>			
USA2 - 111 HB, pt	1	1	1
<b>Shock absorber fluid</b>			
USA2 - 112 light, pt	1	1	1
USA2 - 112 heavy, pt	1	1	1

**AUXILIARY EQUIPMENT SUPPLIED:** Spare parts estimated to be required during a year's operation, together with manuals of instruction for the operation and maintenance of the machine, are included.

**SHIPPING INFORMATION:** Boxed for export

Weight: 2,700 lb  
Cube: 250 cu ft

## TRUCK, REFRIGERATOR

STOCK NO. 6F21

**APPLICATION:** For the transportation of perishable commodities

**CAPACITY:** The truck has 70-gal gas tank capacity. The refrigerator, with a cubical content of about 600 cu ft, is approximately 15 ft long, 7 ft wide and 6 ft high inside, has a shelf at either side at mid-height and 6 heavy duty meat hooks at the front. It is accessible through two walk-in doors (at the rear and right side) and is equipped with a refrigerating unit capable of maintaining a 40 degree temperature inside with a 110 degree temperature outside.

**DESCRIPTION:** The unit consists of a refrigerator body mounted on a 4 x 2 cab type truck chassis which is equipped with dual windshield wipers, automotive air brakes, shock absorbers, towing hooks front, and rear-view reflectors at rear and side. The refrigerator body is metal-faced inside and out on a wood frame and insulated with 4 in of cork or fibre glass all around. The refrigerating unit, complete and independent of the truck engine but drawing its fuel from the truck gas tanks, is powered by a 6-hp air-cooled gas engine and is mounted outside the truck frame below the refrigerator floor.

**OPERATION:** Operated by the truck driver

**SUPPLIES REQUIRED:** The following quantities of fuel and lubricants are estimated to be required for operating the equipment 10,000 miles under severe conditions at the atmospheric temperature ranges shown:

	32°F and lower	32°F to 70°F	70°F and higher
Fuel - Unleaded gasoline, 65 octane, gals	2000	2000	2000



	32°F and lower	32°F to 70°F	70°F and higher
<b>Greases -</b>			
General purpose 14L9 No. 1 (chassis) lb	30	30	
General purpose 14L10 No. 2 (wheel bearing) lb	10	10	40
Water Pump 14L11 lb	1	1	1
Wire rope chain and open gears VV-L-751 lb	1	1	1
<b>Oils -</b>			
Gear, VV-L-761 (SAE 80) (Hypoid) gal	10		
Gear, VV-L-761 (SAE 90) (Hypoid) gal		10	10
Motor 9110 (SAE 10) gal	30		
" 9250 ( " 30) gal		30	
" 9500 ( " 50) gal			30
<b>Hydraulic Brake Fluid -</b>			
USA2 - 111 HB, pt	1	1	1
<b>Shock absorber fluid -</b>			
USA2 - 112 heavy, qt.	1	1	1

**AUXILIARY EQUIPMENT SUPPLIED:** Spare parts estimated to be required during a year's operation are included, as well as manuals of instruction for the operation and maintenance of the machines.

**SHIPPING INFORMATION:** The unboxed weight and cube of the complete unit are:  
 Weight 15,000 lbs  
 Cube 2,100 cu ft

## TRACTOR, TRUCK (DOCK MULE)

4,000-LB DRAWBAR PULL, STOCK NO. 6G1

**APPLICATION:** For pulling and pushing tractor assignments at docks, warehouses, terminals and yards or wherever the floor surface is suitable for the traffic.

**CAPACITY:** This truck develops a drawbar pull of 4,000 lb., travels at speeds up to 12 mph, has a towing capacity on the level of 85 tons and has a turning radius in either direction of 116 in.

**DESCRIPTION:** It travels on pneumatic tires arranged for front-wheel-automotive steering, is powered by a 54-hp gasoline engine, and is equipped with coupler at the rear and a large heavy bumper plate at the front, the latter functioning when the mule is used for pushing. It operates readily in confined spaces and makes sharp turns. It has overall dimensions of 100 in. in length, 65 in. in width and 59 in. in height, and its service weight is 5,000 lb.

**OPERATION:** One-man operated.

**SUPPLIES REQUIRED:** The following quantities of fuel and lubricants are estimated to be required for operating the equipment 1,000 hours under severe conditions at the atmospheric temperature ranges shown:

	32°F and lower	32°F to 70°F	70°F and higher
Fuel - Unleaded gasoline, 65 octane, gals	1200	1200	1200

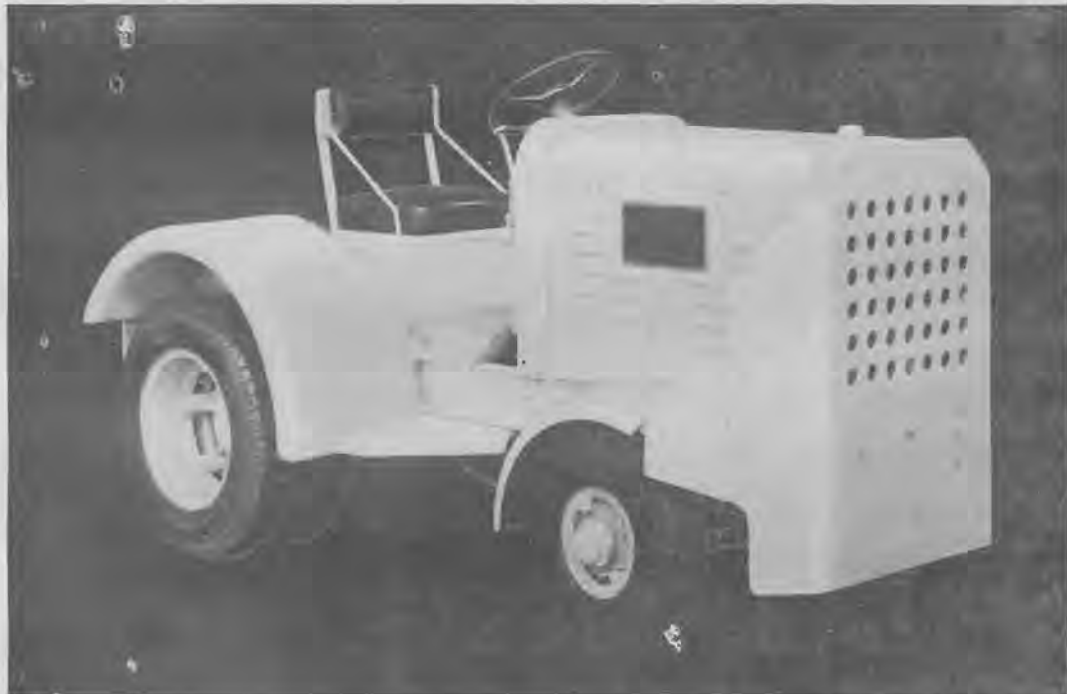

	32°F and lower	32°F to 70°F	70°F and higher
<b>Greases -</b>			
General purpose 14L9 No. 1 (chassis) lb	15	15	
General purpose 14L10 No. 2 (wheel bearing) lb	5	5	20
Water Pump 14L11 lb	1	1	1
Wire rope chain and open gears VV-L-751 lb	1	1	1
<b>Oils -</b>			
Gear, VV-L-761 (SAE 80) (Hypoid) gal	5		
Gear, VV-L-761 (SAE 90) (Hypoid) gal		5	5
Motor 9110 (SAE 10) gal	15		
" 9250 ( " 30) gal		15	
" 9500 ( " 50) gal			15
<b>Hydraulic Brake Fluid -</b>			
USA2 - 111 HB, pt	1	1	1
<b>Shock absorber fluid -</b>			
USA2 - 112 light, pt	1	1	1
USA2 - 112 heavy, pt	1	1	1

**AUXILIARY EQUIPMENT SUPPLIED:** Spare parts estimated to be needed during a year's operation are included.

**SHIPPING INFORMATION:** Boxed for export.

Weight 6,300 lb  
Cube: 270 cu ft

## TRAILER, TANK, WATER

300 GAL., MARINE CORPS TYPE, STOCK NO. 6K9-2

**APPLICATION:** Used in temporary water supply systems to transport water from storage tanks to locations where needed.

**CAPACITY:** Three hundred gallons.

**DESCRIPTION:** This unit consists of a steel tank mounted on a structural steel frame which is secured to an axle supported by two pneumatic-tired wheels, the whole adapted for being towed by a truck or other power-driven vehicle. There is included a spring, a handbrake, shock absorbers, a lifting hook at each of the four corners of the frame, a collapsible tongue support, a hook at the front for a clevis connection, chains for securing to the towing vehicle, and a faucet. The tires are size 7.00 x 20, 8-ply. The tank is filled through an opening in the top. Net weight 1,550 lbs.

**SUPPLIES REQUIRED:** The following quantities of fuel and lubricants are estimated to be required for operating the equipment 1,000 hours under severe conditions at the atmospheric temperature ranges shown:

	32°F and lower	32°F to 70°F	70°F and higher
<b>Greases -</b>			
General purpose 14L9 No. 1 (chassis) lb	15	15	
General purpose 14L10 No. 2 (wheel bearing) lb	5	5	20
Wire rope chain and open gears VV-L-751 lb	1	1	1
<b>Hydraulic Brake Fluid -</b>			
USA2 - 111 HB, pt	1	1	1
<b>Shock absorber fluid -</b>			
USA2 - 112 light, pt	1	1	1
USA2 - 112 heavy, pt	1	1	1



**AUXILIARY EQUIPMENT SUPPLIED:** Spare parts and a faucet wrench are supplied.

**AUXILIARY EQUIPMENT NEEDED BUT NOT SUPPLIED:** Towing vehicles.

**SHIPPING INFORMATION:**

Gross weight 2,400 lb

Cube 192 cu ft

Dimensions 11 ft 4 in x 4 ft 6 in x 3 ft 9 in

## TRAILER, MACHINE SHOP

MARINE CORPS TYPE, STOCK NO. 6K9-3

**APPLICATION:** An automotive repair unit having mobility at truck speeds especially designed for expeditionary requirements but suitable for any use within the capacity of its tools. It is furnished on special request only.

**CAPACITY:** Shop equipment consists of: a 5 kw generator furnishing 2-wire ac 60 cycle 1-phase current powered by a water-cooled battery-started gasoline engine which also powers a 25 cfm compressor for air pressures adjustable up to 100 psi having 2 to 16-gallon receivers; unloader system permitting engine to be started against full tank pressure and to unload automatically at full pressure, all operated from a remote control panel mounted conveniently at the front of the shop and provided with, a battery-charger ammeter, push-button starter-switch, hand-adjustable choke control, key-type ignition switch, oil pressure gage, 110v circuit breaker and cutout switch, 110v rheostat control, generator ammeter and voltmeter and air pressure gage; an 11-in. lathe with headstock motor drive complete with 1/2 hp 115v ac motor, reversing drum switch with 7 1/2 in. self-centering 3-jaw universal chuck mounted, with milling head complete and all completely tooling; a 6-in double wheel 1/4 hp drum driven bench grinder complete with guards and rests; a Barrett 3-35 brake drum lathe completely tooling for passenger car, truck and motorcycle work; a Barrett reliner and grinder with 6 1/2-in. grinder complete with universal motor, carboloy counter-sinks and completely tooling; a 5-ton arbor press with 5 extra arbors and connecting rod aligner completely tooling; a 5/8-in. super service wet grinding refacer complete with 2 collets, universal motor drive, carbon silicate grinding wheel and all tools; a heavy duty bench drill taking 1/2-in. to 7/8-in. drills; a portable heavy-duty electric drill taking #2 Morse taper drills up to 7/8 in. diam. with complete tools; a 4-in. combination pipe and jaw swivel-base vise; a 10-in. oscillating fan and lamp and shade over lathe; 2 trouble lights on 25-ft cords on reels; benches and lockers equipped with drawers in which the small tools are stored, including complete sets of hand tools ordinarily needed in automotive repair work; a complete set of oxyacetylene cutting and welding torches, tools, gages and hose; a 1500-w portable generator for 110-v ac; a paint spray gun, hose and tools; a gasoline-fired water distiller; locker space for oxygen and acetylene tanks for cutting and welding set; and complete sets of taps and dies for 1/4-in. to 1-in. USS and SAE.





**DESCRIPTION:** The trailer is made so that its sides may be folded up and down to form working platforms and canopies. The bench tools are located conveniently on the benches with small tools in the drawers. Canvas tarpaulins are provided to hang from the trailer for additional shade and shelter and all tools and machines are arranged to be readily accessible and for instant use when the trailer is opened up and power plant started.

**OPERATION:** Shop facilities are so arranged that several mechanics may be working at different tasks at one time.

**SUPPLIES REQUIRED:** Fuel and lubricants as well as oxygen and acetylene for the cutting and welding outfit. The following quantities of fuel and lubricants are estimated to be required for operating the equipment 1,000 hours under severe conditions at the atmospheric temperature ranges shown:

	32°F and lower	32°F to 70°F	70°F and higher
<b>Fuel -</b>			
Unleaded gasoline, 65 octane, gals	2000	2000	2000
Kerosene, gal	5	5	5
<b>Greases -</b>			
General purpose 14L9 No. 1 (chassis) lb	20	20	20
General purpose 14L10 No. 2 (wheel bearing) lb	40	40	40
Water Pump 14L11 lb	1	1	1
Wire rope chain and open gear VV-L-751 lb	1	1	1
<b>Oils -</b>			
Gear, VV-L-761 (SAE 80) (Hypoid) gal	5	5	5
Motor 9110 (SAE 10) gal	60		
" 9250 ( " 30) gal		60	20
" 9500 ( " 50) gal			40

**AUXILIARY EQUIPMENT SUPPLIED:** Spare parts estimated to keep the shop and machines in operation one year are included. Manual of instruction for operation and maintenance furnished, together with a spare parts list.

**AUXILIARY EQUIPMENT NEEDED BUT NOT SUPPLIED:** Oxygen and acetylene tanks and contents.

**SHIPPING INFORMATION:** Boxed for export.

Weight: 17,000 lb  
Cube: 1,200 cu ft

## TRAILER, DOCK

3 X 6, WITH STEEL WHEELS, STOCK NO. 6G2-20

**APPLICATION:** A trailer for transporting packaged cargo at docks, warehouses, terminals or other points where floor surfaces are satisfactory for the traffic, either singly by hand or in trains by mechanical mule.

**CAPACITY:** The capacity of each trailer is 4,000 lb on a platform whose dimensions are 3 ft x 6 ft.

**DESCRIPTION:** The trailer consists of a hardwood platform on an all steel frame with four semi-steel wheels, the front two of which are castored for guiding, and with steel-pipe-rail guards at each end to permit of high piling and operating singly by hand. All wheels are equipped with roller bearings, and the castored wheels turn on ball bearings. Each trailer is equipped with automatic couplers for operation in trains behind dock mules.

**OPERATION:** Singly, these trailers may be manually operated by one man. In trains, they track satisfactorily when pulled or pushed by a mechanical mule.

**SUPPLIES REQUIRED:** The following quantities of fuel and lubricants are estimated to be required for operating the equipment 1,000 hours under severe conditions at the atmospheric temperature ranges shown:

	32°F and lower	32°F to 70°F	70°F and higher
Greases -			
Wire rope chain and open gears VV-L-751 lb	1	1	1

**AUXILIARY EQUIPMENT SUPPLIED:** Spare parts estimated to be required during a year's use are supplied.

**SHIPPING INFORMATION:** Shipped boxed 2 to a box.

Weight: 1,200 lb  
Cube: 52 cu ft



**TRAILER. DOCK. FULL. PLATFORM 10-TON,  
FIFTH-WHEEL TYPE, W/UNIVERSAL SAFETY COUPLER**

STOCK LIST NO. 6G2-46

**APPLICATION:** The trailer is for transporting package and crated cargo at docks, warehouses, terminals, or other places where floor surfaces and load ways are satisfactory for traffic; either singly by hand, or in trains by mechanical power.

**CAPACITY:** Deck of trailer is 5 ft by 12 ft; capacity is 20,000 lb.

**DESCRIPTION:** Trailer is of welded steel except platform which is of 2-in. hardwood, 5 ft x 12 ft in plan, and 28 in. above ground. The fifth wheel or steering assembly consists of a lower frame with four roller stabilizers which support a 40-in.-diam. plate welded to body frame. A roller-bearing king bolt takes the pulling strain. Wheels are of malleable iron, with 20-in. x 5-in. dual tires front and rear, and are equipped with Timken bearings in dust-proof housing. Wheel base is 8 ft. Trailer is equipped with a 3-in.-diameter drawbar ring for a pintle hitch and a cast-steel pintle hook with safety lock for coupling another trailer in rear. The trailer is equipped with stake pockets on all sides. Tire size 20 x 5 in., solid.

**OPERATION:** These trailers are for operation singly or in trains pulled or pushed by mechanical power.

**SUPPLIES REQUIRED:** The following quantities of fuel and lubricants are estimated to be required for operating the equipment 1,000 hours under severe conditions at the atmospheric temperature ranges shown:

	32° F and lower	32° F to 70° F	70° F and higher
<b>Greases</b>			
General purpose 14L9 No. 1 (Chassis), lb	10	10	11
General purpose 14L10 No. 2 (wheel), lb	5	5	15

**AUXILIARY EQUIPMENT SUPPLIED:** No spare parts are furnished.

**AUXILIARY EQUIPMENT NEEDED BUT NOT SUPPLIED:** Tractor.

**SHIPPING INFORMATION:**

Weight: 2640 lb  
Cube: 139 cu ft



## TRAILER, MILITARY-TYPE, CARGO

1/4-TON, 2-WHEEL, STOCK LIST NO. 6K9-5

**APPLICATION:** A trailer for transporting package goods, machinery, and miscellaneous materials at truck speeds to locations where needed.

**CAPACITY:** The trailer has a load capacity of 500 lb or 1/4 ton with a loading height of 22 in., and a round clearance of 12 1/4 in. Towing trailer should be a 1/4- or 3/4-ton truck.

**DESCRIPTION:** The body is of all-steel construction and welded into one unit with the frame side rails. The box panels are all of 18-gage steel strengthened with 16-gage, 1-in. O.D. welded tubular frame around the top of the box. All panels have wide welding flanges which strengthen the box and provide large welding and sealing surfaces. They are reinforced with webs for further strength. The box is watertight and will float the vehicle when loaded with a 500-lb load. The water line is 12 in. above the box floor. A manually operated drain valve is provided in the right rear corner of the floor which seals against a seat welded to the body. The fenders are replaceable and bolted to the frame and brackets on the body. The fenders are interchangeable and can be used on either side. The brakes are cable-operated and the hand lever is mounted on the front side of the body at the right. A tarpaulin, provided to cover the box, is held on by a half hitch around the body hooks. When not in use, it is carried folded in the box. Trailer is equipped with two tail and stop lights. Tire size 6.00 x 16.

**OPERATION:** One man is required to move trailer. A second man is required to hook loaded trailer to vehicle.

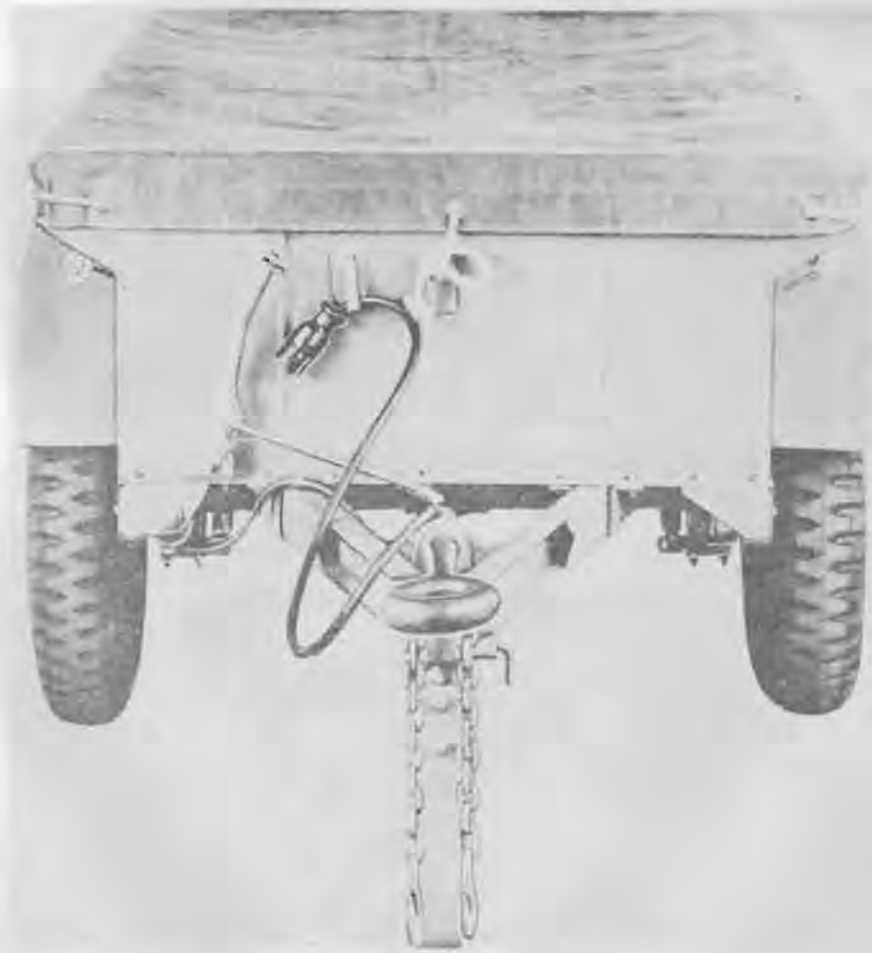

**SUPPLIES REQUIRED:** The following quantities of fuel and lubricants are estimated to be required for operating the equipment 1,000 hours under severe conditions at the atmospheric temperature ranges shown:

	32°F and lower	32°F to 70°F	70°F and higher
<b>Greases</b>			
General purpose 14L9 No. 1 (chassis), lb	15	15	
General purpose 14L10 No. 2 (wheel bearing), lb	5	5	20
Wire rope chain and open gears VV-L-751 lb	1	1	1
<b>Hydraulic Brake Fluid</b>			
USA2 - 111, gal	1	1	1
<b>Shock Absorber Fluid</b>			
USA2 - 112 light, gal	1	1	1
USA2 - 112 heavy, gal	1	1	1

**AUXILIARY EQUIPMENT SUPPLIED:** Spare parts and maintenance manual.

**AUXILIARY EQUIPMENT NEEDED BUT NOT SUPPLIED:** Towing vehicles.

**SHIPPING INFORMATION:**

Gross weight: 430 lb  
 Cube: 156 cu ft  
 Dimensions: 108 1/2 in. x 56 in. x 40 in.

## TRAILER, LOW BED

25-TON, PLATFORM, STOCK NO. 6G2-32

**APPLICATION:** For the transportation of heavy equipment or machinery at truck speeds.

**CAPACITY:** The trailer has a load carrying capacity of 25 tons. The solid portion of the deck is 10 ft. x 16 ft. while the bridge portion over the rear wheel pockets which is elevated 6 in. higher than the solid decking provides an additional 5 ft. length of supporting surface. The solid decking is 29 in. above the roadway, while the roadway clearance is 12 1/2 in. and the overall length exclusive of the draw bar is 28 1/2 ft.

**DESCRIPTION:** The trailer consists of a welded steel frame decked with 2 1/2 in. oak, supported at the rear by a 4 dual tired wheels equipped with equalizing manually operated brakes mounted on rocking axles and at the front by 2 dual tired wheels with semi-elliptical springs. It is equipped with 2 lashing D's on each side, at the rear of trailer and gooseneck and one at the front center of gooseneck, a towing eye at the rear of trailer and a tow bar at the front of trailer. In addition there are 4 oak loading ramps 4 in. x 12 in. x 16 ft. Its working weight is 13,600 lbs.

**SUPPLIES REQUIRED:** The following quantities of fuel and lubricants are estimated to be required for operating the equipment 1,000 hours under severe conditions at the atmospheric temperature ranges shown:

	32°F and lower	32°F to 70°F	70°F and higher
<b>Greases -</b>			
General purpose 14L9 No. 1 (chassis) lb	30	30	
General purpose 14L10 No. 2 (wheel bearing) lb	10	10	40
Wire ropes chain or open gears VV-L-751 lb	5	5	5
<b>Hydraulic Brake Fluid -</b>			
USA2 - 111 HB, pt	1	1	1

**AUXILIARY EQUIPMENT NEEDED BUT NOT SUPPLIED:** Tractor

**SHIPPING INFORMATION:** Packed for export.

Weight 14,600 lb  
Cube 1,290 cu ft

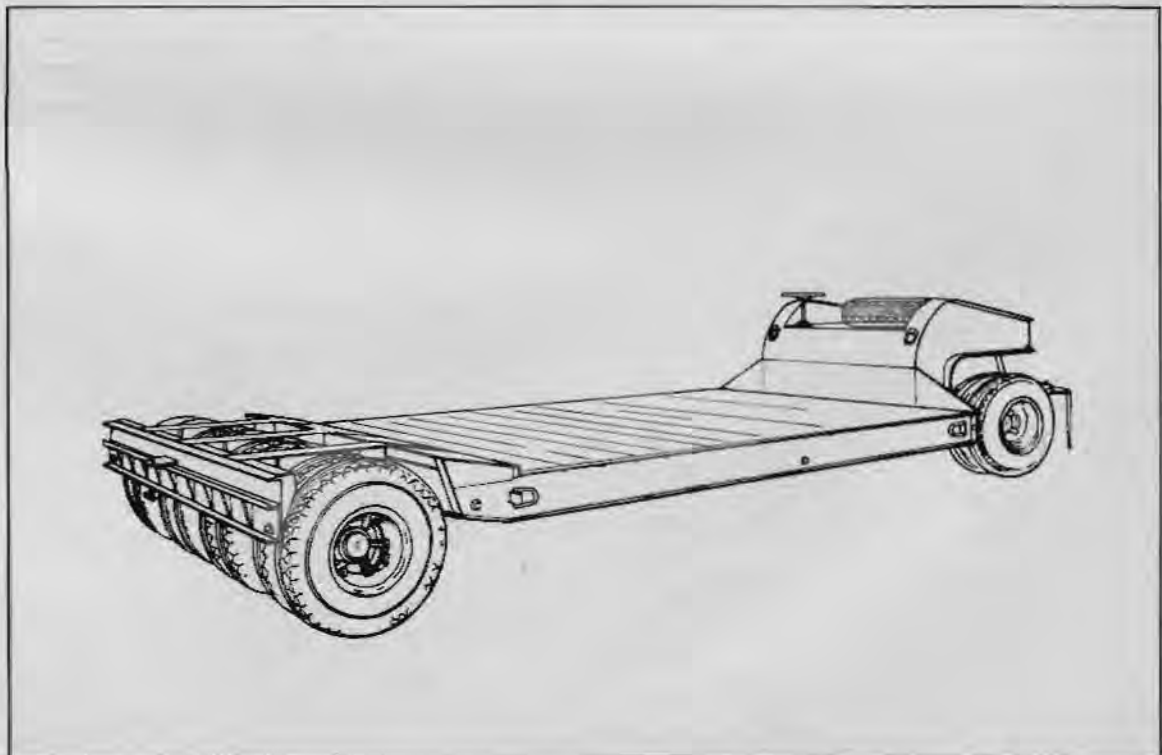

**TRAILER, TRACK-TREAD, FULL, PLATFORM-STAKE, 6-TON**  
STOCK LIST NO. 6G2-42

**APPLICATION:** For the transportation of heavy loads and non-mobile machines and equipment over steep grades and rough or soft terrain or where roads are in poor condition unable to support heavy wheel loads.

**CAPACITY:** The trailer has a 6-ton carrying capacity.

**DESCRIPTION:** Trailer consists of a steel-plate platform 7 ft 6 in. x 15 ft, supported by a steel frame mounted on a crawler track mechanism. Platform is equipped with stakes at sides and ends and lashing hooks for canopy. Unit has a pintle hook at the rear and rigid-type lunette at the front. A screw-type drawbar jack is provided to raise and lower front end and facilitate coupling. A rear frame support is provided for use during loading and unloading.

**SUPPLIES REQUIRED:** The following quantities of fuel and lubricants are estimated to be required for operating the equipment 1,000 hours under severe conditions at the atmospheric temperature ranges shown:

	32°F and lower	32°F to 70°F	70°F and higher
<b>Greases</b>			
General purpose 14L9 No. 1 (chassis), lb	50	50	50
Wire rope chain and open gears VV-L-751, lb	1	1	1
<b>Oils</b>			
Gear 14L4-80 (SAE 80) (Hypoid), gal	10		
Gear 14L4-90 (SAE 90) (Hypoid), gal		10	10

**AUXILIARY EQUIPMENT SUPPLIED:** Operation and spare parts manual.

**AUXILIARY EQUIPMENT NEEDED BUT NOT SUPPLIED:** Towing vehicle.

**SHIPPING INFORMATION:**

Weight: 11,005 lb  
Cube: 920 cu ft



## TRAILER, COMMERCIAL-TYPE, FULL, REFRIGERATOR

STOCK LIST NO. 6G2-49

**APPLICATION:** For the transportation of perishable commodities.

**CAPACITY:** The refrigerator has a capacity of approximately 600 cu ft.

**DESCRIPTION:** The unit consists of a refrigerator body 8 ft wide x 16 ft long, mounted on heavy-duty trailer. The compressor compartment rests on the front end of trailer chassis. The refrigerator body is metal faced inside and outside and has doors at side and rear. The entire interior of the body is lined with 1/4-in., 3-ply, fir, ply-wood fastened to the steel body frame. Interior is equipped with removable shelves, meat rail, and hooks. Body is thoroughly insulated with cork and batt-type fiber-glass insulation. A complete hold-over plate-type refrigeration unit is provided and installed in compressor compartment and is powered by a 6-hp air-cooled gasoline engine. Refrigerator will maintain interior temperatures of 0° to 30°F with external temperature at 120°F. A 6-volt battery and generator with voltage regulator and meters are installed on trailer. Brakes: 17 1/4 x 4, electric, on rear axle only, with hand control for prime mover; manually controlled ratchet; brake for parking. Tires: 8-9.00, x 20, 10-ply.

**OPERATION:** One-man operation.





**SUPPLIES REQUIRED:** The following quantities of fuel and lubricants are estimated to be required for operating the equipment 1,000 hours under severe conditions at the atmospheric temperature ranges shown:

	32°F and lower	32°F to 70°F	70°F and higher
<b>Fuel</b>			
Leaded gasoline, 80-octane, gal	600	600	600
<b>Greases:</b>			
General purpose 14L9 No. 1 (chassis), lb	15	15	
General purpose 14L10 No. 2 (wheel bearing), lb	5	5	20
Water pump 14L11, lb	1	1	1
<b>Oils</b>			
Motor 9110 (SAE 10), gal	1	1	1
<b>Hydraulic Brake Fluid</b>			
USA2 - 111, pt	1	1	1
<b>Shock Absorber fluid</b>			
USA2 - 112 light, pt	1	1	1
USA2 - 112 heavy, pt	1	1	1

**AUXILIARY EQUIPMENT SUPPLIED:** Spare parts and operating manuals.

**SHIPPING INFORMATION:**

Weight: 13630 lb  
 Cube: 1853 cu ft

## TRAILER, TRACK TYPE

15-TON, PLATFORM, STOCK NO. 6G2

**APPLICATION:** For the transportation of heavy loads and non-mobile machines and equipment over terrain where roads are either non-existent or in too poor condition to support heavy wheel loads.

**CAPACITY:** The trailer has a 15 ton carrying capacity on a hardwood platform 8 ft x 15 ft and is supported at the ground on 14 in. wide tracks providing 1,120 sq in. of bearing surface at zero penetration and 2,184 sq in. at 8 in. penetration.

**DESCRIPTION:** It consists of the hardwood platform equipped with stakes at sides and ends and supported by a steel frame mounted on a crawler track running gear mechanism with pintle hook at the rear and swivel lunette at the front equipped with landing jack for connecting to tractor and requiring a drawbar pull of about 1,800 lb fully loaded. The net working weight of the trailer is 9,000 lb and 40,500 fully loaded.

**SUPPLIES REQUIRED:** The following quantities of fuel and lubricants are estimated to be required for operating the equipment 1,000 hours under severe conditions at the atmospheric temperature ranges shown:

	32°F and lower	32°F to 70°F	70°F and higher
<b>Greases -</b>			
General purpose 14L9 No. 1 (chassis) lb	100	100	100
Wire rope chain or open gear VV-L-751 lb	1	1	1
<b>Oils -</b>			
Gear, VV-L-761 (SAE 80) (Hypoid) gal	10		
Gear, VV-L-761 (SAE 90) (Hypoid) gal		10	10

**SHIPPING INFORMATION:** Uncrated with stakes bundled.

Weight 9,000 lb  
Cube 500 cu ft

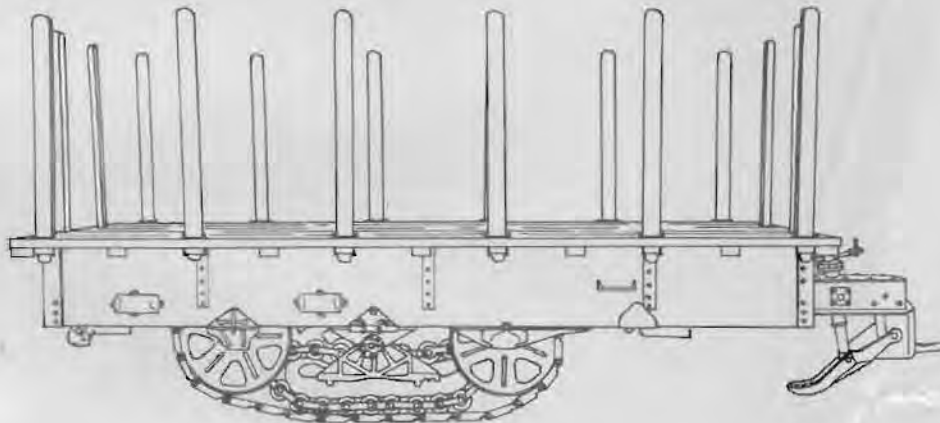

## DEMOUNTER, TIRE, PORTABLE

STOCK LIST NO. 6D1-2

**APPLICATION:** For removing pneumatic tires from wheel rims of automotive equipment.

**CAPACITY:** Tire demounter has a capacity for removing pneumatic tires ranging in size from 7.00 x 15 to 21.00 x 24.

**DESCRIPTION:** The device is a hand-operated, screw-type, tire puller with 9-in. adjustable legs fastened to a welded push spider. A capstan-type nut and screw serves to apply the force necessary to impart the push and pull action for removing the tire from the rim. Net weight 190 lb. Complete with 6 sets of fixtures for tires ranging in size from 7.00 x 15 to 21.00 x 24.

**OPERATION:** One man and helper.

**SHIPPING INFORMATION:**

Weight: 300 lb  
Cube: 9 cu ft



## RELINER, BRAKE

STOCK NO. 6B34

**APPLICATION:** A shop tool for relining the brake shoes of automotive vehicles.

**CAPACITY:** This machine combines all of the features for quickly relining, countersinking, riveting and grinding all types of passenger car, bus or truck brake shoes. It is powered by a 1/4-hp 110-V a-c 60-cycle motor with convenient starting switch.

**DESCRIPTION:** The machine consists of the motor and a motor-operated countersinking drill, grinder and suction-fan mounted on a cast iron and steel floor stand, together with a foot-pedal-operated riveter, dust collection bag, used rivet storage compartment, rivet tray and tool rack and all necessary knurrs, punches, countersinks, drills, wrenches anvils and tool-holders necessary for the operation and adjustment of the machine.

**OPERATION:** One-man operation.

**SUPPLIES REQUIRED:** Electrical current, 9110 (SAE 10) lubricating oil, rivets, and lining material and abrasives for the grinding wheel.

**AUXILIARY EQUIPMENT SUPPLIED:** Spare parts estimated to be required during a year's operation, as well as manuals of instruction for the operation and maintenance of the machine, are included.

**SHIPPING INFORMATION:** Boxed for export.

Weight: 500 lb

Cube: 20 cu ft

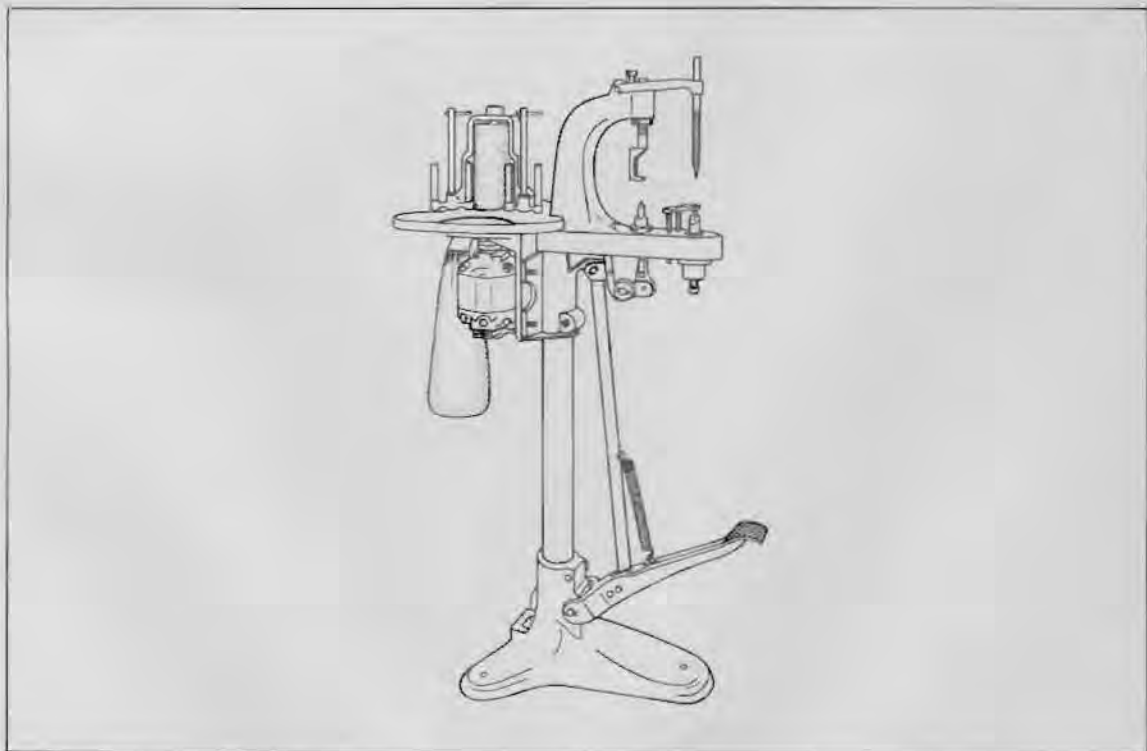

## GRINDER, VALVE REFACER

5/8-IN., WITH STANDARD EQUIPMENT, STOCK NO. 6B60-3

**APPLICATION:** This is a power-driven bench-mounted machine for refacing or "grinding" gasoline engine valves.

**CAPACITY:** The nominal size is given as 5/8-in, but the machine is provided with two collets or work holders, the first of which is adapted for taking valve stems varying in diameter from 9/32 in. to 9/16 in. The other collet will hold valves whose stems range in diam. from 1/2 in. to 11/16 in. The machine will grind valves having disks or faces up to 3 1/2 in. in diam and it has an angular adjustment of from 30 to 90 deg.

**DESCRIPTION:** There are three motors incorporated in this unit, the first of which turns the abrasive wheel, the second turns the work and the third operates a centrifugal pump which forces a stream of cooling fluid over the valve disk as it is being worked. All three motors are of the universal current type, taking 110 volts. The coolant after flowing over the work, returns to the tank where it runs through a filter into another compartment and thence back to the pump.

**OPERATION:** One-man operation.

**SUPPLIES REQUIRED:** Electric current, lubricant 9110 (SAE-10) abrasive wheels, grinding compound and coolant.

**AUXILIARY EQUIPMENT SUPPLIED:** Spare parts estimated to be required during a year's operation, as well as manual covering the operation and maintenance of the machine, are included.

**SHIPPING INFORMATION:** Boxed for export

Weight: 300 lb

Cube: 10 cu ft

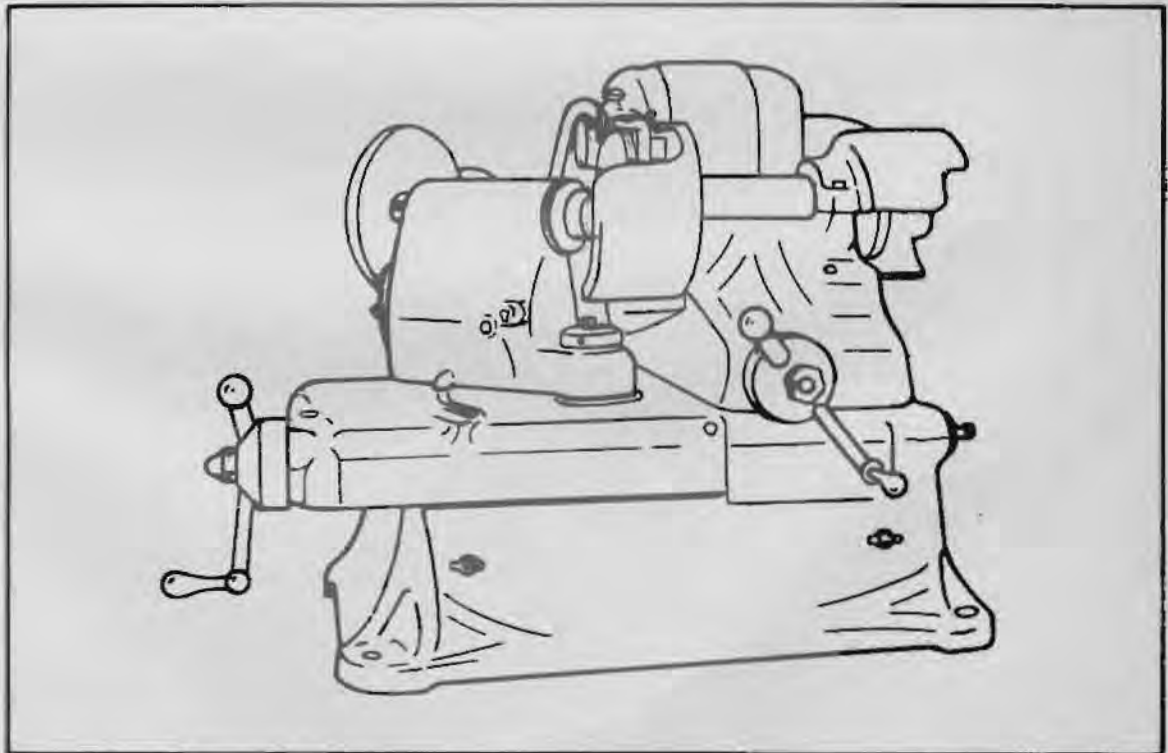

**COMPRESSOR, AIR  
SHOP-TYPE, ELECTRIC-DRIVEN**  
STOCK LIST NO. 6R1-13

**APPLICATION:** For tire inflation and grease gun operation at repair and service stations and maintenance shops, where electric power is available.

**CAPACITY:** The compressor capacity is 7-8 cu ft per min. Receiver capacity of the unit is 8 cu ft.

**DESCRIPTION:** The unit consists of a two-stage air-cooled compressor, driven by a 1 1/2-hp motor through V-belt, all mounted on a common base welded to the top of an 8-cu ft horizontal cylindrical tank. The unit is supported by four steel legs provided with holes for floor or bench mounting. The compressor is equipped with an automatic unloader to release when tank pressure is reached and a hand unloader for starting purposes.

**OPERATION:** Operation is automatic when unit is started.

**SUPPLIES REQUIRED:** The following quantities of fuel and lubricants are estimated to be required for operating the equipment 1,000 hours under severe conditions at the atmospheric temperature ranges shown:

	32°F and lower	32°F to 70°F	70°F and higher
<b>Greases</b>			
Ball- and roller-bearing 14L3b grade No. 11, lb.	1	1	1
<b>Oils</b>			
Motor 9110 (SAE 10) Gal	3	3	3
Motor 9250 (SAE 30) Gal	3	3	3

**AUXILIARY EQUIPMENT SUPPLIED:** Operating manual and spare parts; 50 ft of 1/2-in. air hose.

**AUXILIARY EQUIPMENT NEEDED BUT NOT SUPPLIED:** 110/220-Volt, 3-phase, 60-cycle, a-c power, and electrical control equipment.

**SHIPPING INFORMATION:** Weight: 670 lb  
Cube: 37 cu ft



## CHARGER, BATTERY

12-VOLT, PORTABLE, STOCK NO. 6B18

**APPLICATION:** For charging 12-volt automotive or radio storage batteries.

**CAPACITY:** This charger is rated electrically at 12 volts with a capacity of 300 watts. It will charge up to 4 12-volt batteries at one time and will charge 6-volt batteries provided they are hooked up in series in pairs. This unit may also be used on a 12-volt lighting circuit within its capacity with voltage regulation and proper protection against overload.

**DESCRIPTION:** The unit consists of a heavy duty ball-bearing four pole generator directly connected to a four-cycle single-cylinder air-cooled gasoline engine mounted on a cast iron base and equipped with conveniently located ammeter, battery terminals, throttle for speed control, starting button for starting on the battery being charged if not entirely spent, pulley for rope starting without battery, a carrying handle for portability and a muffler on the exhaust line. The battery being charged is a part of the ignition system for the charger engine. Its service weight is 59 lb.

**OPERATION:** It operates automatically when started but should have an operator's attention to regulate speed and rate of charge.



**SUPPLIES REQUIRED:** The following quantities of fuel and lubricants are estimated to be required for operating the equipment 1,000 hours under severe conditions at the atmospheric temperature ranges shown:

	32°F and lower	32°F to 70°F	70°F and higher
<b>Fuel -</b> Unleaded gasoline, 65 octane, gals	100	100	100
<b>Greases -</b> General purpose 14L9 No. 1 (chassis) lb	1	1	1
<b>Oils -</b> Motor 9110 (SAE 10) gal " 9250 ( " 30)	3 3	3 3	3 3

**AUXILIARY EQUIPMENT SUPPLIED:** Spare parts estimated to be required during a year's operation are included together with operating and service manuals for the care and operation of the equipment.

**SHIPPING INFORMATION:** Boxed for export.  
Weight: 86 lb                      Cube: 2 cu ft



## SHIELD, TRUCK-CAB PROTECTOR

STOCK LIST NO. 686-1

**APPLICATION:** The cab-protector shield is to be used on dump body trucks.

**DESCRIPTION:** The shield for cab protection is made in two sections of No. 8 gage plate rolled in such shape to afford the protection required. The plate is bolted to three 3-in., 4.1-lb channel arch supports with 3/8-in. bolts. The cab-protection shield as a unit is bolted to the head of truck body with nine 3/8-in. bolts. Holes are provided in the center of the shield to afford adequate rear vision.

**AUXILIARY EQUIPMENT NEEDED BUT NOT SUPPLIED:** Necessary bolts.

**SHIPPING INFORMATION:**

Weight: 375 lb  
Cube: 4.5 cu ft

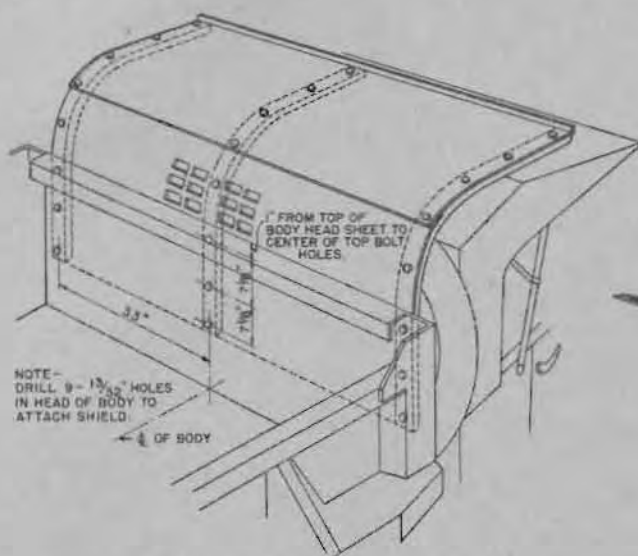

PERSPECTIVE



ASSEMBLED FOR SHIPMENT

## LATHE, BRAKE-DRUM

9-INCH DRUM FACE, STOCK LIST NO. 6L1-1

**APPLICATION:** For machining brake drums on passenger cars and trucks. Machine is also equipped to hone or grind.

**CAPACITY:** Lathe can handle brake drums from 7 1/2-in. to 24-in. diameter up to 9-in. face.

**DESCRIPTION:** The brake-drum lathe is a portable type with a stand for stationary mounting if desired. Lathe is driven by a 110-Volt, a-c, d-c universal motor which is controlled by a rheostat and affords 10 speeds for machining, grinding, and honing. Lathe is equipped with attachments for passenger car, heavy duty truck, and motorcycle work.

**OPERATION:** One-man operation.

**SUPPLIES REQUIRED:** 9110 (SAE 10)

**AUXILIARY EQUIPMENT SUPPLIED:** Extra cutting tool kit and metal box for attachments. Operation manual is supplied.

**AUXILIARY EQUIPMENT NEEDED BUT NOT SUPPLIED:** Either 110-Volt, 60-cycle, a-c single-phase, or d-c power.

**SHIPPING INFORMATION:**

Weight: 550 lb  
Cube: 20 cu ft

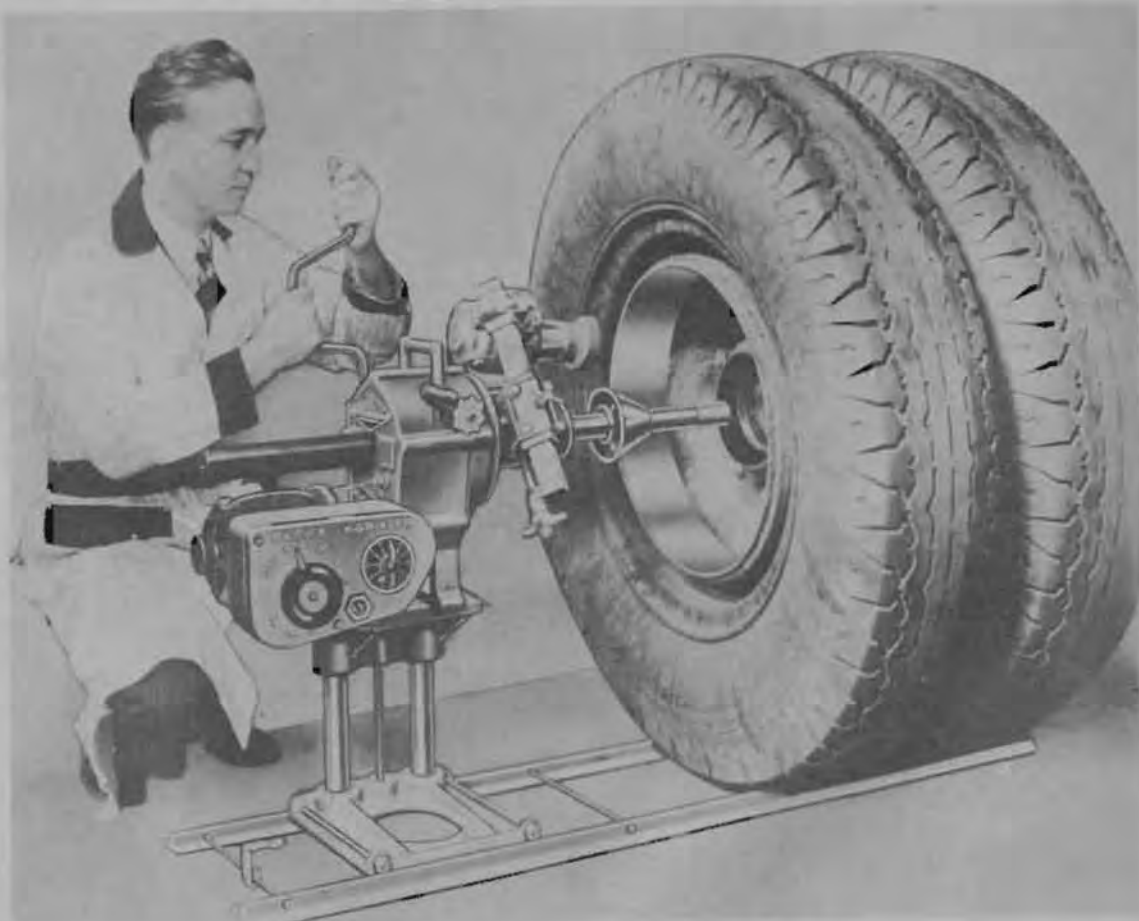

## SECTION VII - CONSTRUCTION EQUIPMENT

## List of Effective Pages

A591 - A592	July 1945	647 - 648	November 1943	705 - 706	November 1943
591 - 592	November 1943	649 - 650	" "	707 - 708	" "
593 - 594	" "	651 - 652	" "	709 - 710	" "
595 - 596	" "	653 - 654	" "	711 - 712	" "
597 - 598	" "	655 - 656	" "	713 - 714	" "
599 - 600	" "	657 - 658	" "	715 - 716	" "
601 - 602	" "	659 - 660	" "	717 - 718	" "
603 - 604	" "	661 - 662	" "	719 - 720	" "
605 - 606	" "	663 - 664	" "	721 - 722	" "
607 - 608	" "	665 - 666	" "	723 - 724	" "
609 - 610	" "	667 - 668	" "	725 - 726	" "
611 - 612	" "	669 - 670	" "	727 - 728	" "
613 - 614	" "	671 - 672	" "	729 - 730	" "
615 - 616	" "	673 - 674	" "	731 - 732	" "
617 - 618	" "	675 - 676	" "	733 - 734	" "
619 - 620	" "	677 - 678	" "	735 - 736	" "
621 - 622	" "	679 - 680	" "	737 - 738	" "
623 - 624	" "	681 - 682	" "	739 - 740	" "
625 - 626	" "	683 - 684	" "	741 - 742	" "
627 - 628	" "	685 - 686	" "	743 - 744	" "
629 - 630	" "	687 - 688	" "	745 - 746	" "
631 - 632	" "	689 - 690	" "	747 - 748	" "
633 - 634	" "	691 - 692	" "	749 - 750	" "
635 - 636	" "	693 - 694	" "	751 - 752	" "
637 - 638	" "	695 - 696	" "	753 - 754	" "
639 - 640	" "	697 - 698	" "	755 - 756	" "
641 - 642	" "	699 - 700	" "	757 - 758	" "
643 - 644	" "	701 - 702	" "	759 - 760	" "
645 - 646	" "	703 - 704	" "		

## SECTION VII - CONSTRUCTION EQUIPMENT

## INDEX TO CONTENTS

<u>Road and Air Field</u>	<u>Pages</u>	<u>Road and Air Field (Cont'd)</u>	<u>Pages</u>
Crushers, Rock, Mobile, 20 to 30 Tons Per Hr	591-592	Rooter, Tractor-Drawn, 5- Tooth, Light Duty	621-622
Crusher, Rock, Semimobile, 50 to 60 Tons per Hr	593-594	Rooter, Tractor-Drawn	623-624
Distributor, Asphalt, 1250- Gal, Trailer-Mounted	595-596	Scraper, Carryall, 5-Cu Yd, Power-Controlled	625-626
Grader, Motor, with Scarifier	597-598	Scraper, Carryall, 8-Cu Yd, Power-Controlled	627-628
Grader, Tractor-Drawn, Leaning Wheel, with Scarifier	599-600	Scraper, Carryall, 12-Cu Yd, Power-Controlled	629-630
Harrow, Disc	601-602	Spreader, Box for Dump Truck Mounting	631-632
Harrow, Spike Tooth, 4- Section	603-604	Tractor, Crawler Type, Class-4, 35- to 49-HP	633-634
Kettle, Asphalt, Mobile, 165-Gal, Hand Spray	605-606	Tractor, Crawler Type, Class-3, 50- to 60-HP	635-636
Mixer, Rotary Tiller, Self- Powered, Trailer-Mounted	607-608	Tractor, Crawler Type, Class-2, 65- to 86-HP	637-638
Mower, Tractor-Drawn	608 A&B	Tractor, Crawler Type, Class-1, 87-HP and over	639-640
Plow, Disc, Five 28-In. Discs	609-610		
Plow, Gang, 4-Bottom, 14-In.	611-612	<u>Excavating and Lifting</u>	
Puller, Tree and Stump, Tractor-Operated	613-614	Crane, Barge Mounting, 10- Ton, with 3/4-Cu Yd Clam- shell Bucket Conversion	641-642
Roller, Road, 5- to 8-Ton, Tandem, Gas-Driven	615-616	Crane, Cargo, 5-Ton, Tractor- Mounted	643-644
Roller, Road, 10-Ton, 3- Wheel	617-618	Crane, Cargo, 5-Ton Whirler, Tractor-Mounted	645-646
Roller, Sheepsfoot Tamping, 3-Drum	619-620		

INDEX TO CONTENTS (Continued)

<u>Excavating and Lifting (Cont'd)</u>	<u>Pages</u>	<u>Woodworking Tools (Cont'd)</u>	<u>Pages</u>
Crane, Cargo, 5-Ton Whirler, Wheel-Mounted	647-648	Saw, Chain, Portable, Gasoline-Engine-Operated	703-704
Crane Cargo, 5-Ton	648A - 648B	Saw, Circular, Electric-Driven, Portable	705-706
Crane, Crawler 5-Ton with 1/2-Cu Yd Dragline Conversion	649-650	<u>Maintenance and Repair</u>	
Crane, Crawler, 5-Ton, with 1/2-Cu Yd Clamshell Conversion	651-652	Grinder, Bench, Electric	707-708
Crane, Crawler, 3/4-Cu Yd or 10-Ton, with Shovel, Clamshell, Dragline, Backhoe, and Pile-Driver Conversion	653-654	Grindstone, Mounted	709-710
Crane, Crawler, 1 1/2-Cu Yd or 25-Ton, with Shovel and Dragline Conversion	655-656	Kit, Welding and Cutting, Oxy-Acetylene	711-713
Crane, Crawler, 2 1/2-Cu Yd, 40-to 50-Ton, with Shovel Conversion	657-658	Lathe, Metal-Working, Back-Geared, Screw-Cutting, Bench Model	715-716
Crane, Tractor-Drawn, 20-Ton	659-660	Press, Hydraulic, 100-Ton, Portable	717-718
Crane, Truck-Mounted, 10-Ton, Tandem Rear Axle	661-662	Press, Drill, Motor-Driven	719-
Ditcher, Crawler, 24-In x 5 1/2-Ft	663-664	Press, Hydraulic Trailer-Mounted, for Tractor Track Pins and Bushings	721-722
Ditcher, Crawler, 24-In x 8-Ft or Less, Gas-Driven	665-666	Saw, Hack, Power	723-724
<u>Compressed Air</u>		Shanking Device, Hand, for Drill Rods	725-726
Borer, Wood	667-668	Sprayer, Paint, Mobile	727-728
Breaker, Paving	669-670	Threading Device, Hand, for Drill-Rod Turning, Facing and Threading	729-730
Compressor, Air, Mobile, 210-CFM, Gasoline-Engine-Driven	671-672	Threading Machine, Pipe and Bolt, 3-HP	731-732
Compressor, Air, Portable, 315-CFM, Gasoline-Engine-Driven	673-674	<u>Miscellaneous</u>	
Drill, Rock, 1-In x 4 1/4-In. Chuck	675-676	Brake, Sheet Metal	761-762
Drill, Wagon, Mounted	677-678	Breaker, Paving, Gas-Driven	733-734
Hoist, Air, Single-Drum	679-680	Conveyor, Gravity Roller	735-736
Pump, Sump	681-682	Conveyor, Elevating, Mobile, Motor-Driven	737-738
Saw, Circular, Portable	683-684	Drilling Rig, Well, Mobile, Gas-Driven	739-740
Tamper, Backfill	685-686	Drilling Rig, Well, Auxiliary Equipment	741-742
Wrench, Impact	687-688	Generator, Acetylene, Portable	743-744
<u>Pumps</u>		Machine, Blasting, 50-Hole Capacity	745-746
Pump, Centrifugal, 20,000-GPH	689-690	Mixer, Concrete, 7S, Mobile	747-748
Pump, Centrifugal, 40,000-GPH	691-692	Mixer, Concrete, 14S, Mobile	749-750
Pump, Centrifugal, 90,000-GPH	693-694	Sawmill	751-752
Pump, Diaphragm, 3-In., 3,000-GPH	695-696	Stapler, for Wire Road Mesh	753-754
Pump, Diaphragm, 4-In., 12,000-GPH	697-698	Truck, 2-Wheel, Hand-Type	755-756
Pump, Rotary, Hand-Operated	698 A&B	Welder, Electric, Gas-Driven 300-Amp, Mobile	757-758
<u>Woodworking Tools</u>		Winch, 2-Drum, Gas-Engine-Driven, 7,500-Lb Line Pull	759-760
Saw, Circular, Electric-Driven, 3/4-HP	699-700		
Saw, Circular, Electric-Driven, 5-HP	701-702		

## CRUSHER, ROCK, MOBILE, 20 TO 30 TONS PER HR

STOCK NO. 781

**APPLICATION:** For crushing rock into sizes suitable for use in the construction, maintenance and repair of roads, streets and airfield runways and as aggregate for concrete, wherever run-of-the-crusher sizes are satisfactory and the need for screened sizes arises only occasionally.

**CAPACITY:** This plant has capacity for 20 to 30 tons per hour of crushed rock at the 2 1/2-in. setting of the crusher. It has no facilities for mechanical screening and is not provided with a storage bin.

**DESCRIPTION:** The plant consists of a jaw-type crusher mounted on one end of a steel chassis equipped with four steel wheels and a steering and towing tongue, a 40-hp gasoline engine centrally mounted and a 20-ft folding type elevating bucket conveyor mounted at the other end. Crushings travel from the crusher to elevator by way of a belt underconveyor, there to be raised, and discharged either directly into trucks or into a stock-pile. In addition 3 pieces each of 6 ft x 6 ft screen wire with 1/4 in., 1 in., and 2 in. clear square openings are furnished for job-site frames for manual screening when any screened sizes are required.

**OPERATION:** It is necessary to construct a suitable ramp and charging platform serving the crusher for most efficient operation. Stone for the crusher is wheeled or trucked up the ramp adjacent to the hopper opening and deposited within reach of a man with a hook-bar who pulls them into the hopper at the proper rate for continuous operation without clogging. Working drawing for a standard truck ramp and charging platform adaptable to this plant are given on Y&D Dwg. 264226, 264,227, and 264228.

**SUPPLIES REQUIRED:** The following quantities of fuel and lubricants are estimated to be required for operating the equipment 1,000 hours under severe conditions at the atmospheric temperature ranges shown:



	32°F and lower	32°F to 70°F	70°F and higher
Fuel -			
Unleaded gasoline, 65 octane, gals	4000	4000	4000
Greases -			
General purpose 14L9 No. 1 (chassis) lb	100	100	100
General purpose 14L10 No. 2 (wheel bearing) lb	50		
Ball and roller bearing 14L3b grade No. 11 lb		50	50
Water Pump 14L11 lb	1	1	1
Wire rope chain and open gears VV-L-751 lb	10	10	10
Oils -			
Gear, VV-L-761 (SAE 90) (Hypoid) gal	2	2	2
Motor 9110 (SAE 10) gal	50		
" 9250 ( " 30) "		50	
" 9500 ( " 50) "			50

AUXILIARY EQUIPMENT SUPPLIED: Spare parts estimated to keep the plant in operation one year are included as well as operating and maintenance instructions.

AUXILIARY EQUIPMENT NOT SUPPLIED: Quarrying tools, explosives, trucks and materials for constructing ramp and charging platform.

SHIPPING INFORMATION: Bundled and boxed for export.  
Crusher plant                      Weight: 18,000 lb                      Cube: 600 cu ft

ORDERING INSTRUCTIONS: State whether materials for ramp and charging platform are required.

## CRUSHER, ROCK, SEMIMOBILE, 50 TO 60 TONS PER HOUR

STOCK NO. 7S1-11

**APPLICATION:** For crushing and screening rock for use in the construction, maintenance and repair of roads, streets and airfield runways, and as aggregate for concrete.

**CAPACITY:** This plant has capacity for crushing, screening and binning crushed stone at the rate of 50 to 60 tons per hour of 2 1/2 in. crusher sizes.

**DESCRIPTION:** This plant consists essentially of a timber charging ramp and platform, two mobile crushers working in tandem and a three-compartment timber storage bin of 35 tons capacity. The primary crusher, of the jaw type, is truck-charged by gravity through an opening in the charging platform. This crusher, its 60-hp gasoline engine power unit and a 30-ft long folding belt conveyor are mounted on a steel chassis supported on four steel wheels and provided with a towing and steering tongue. The secondary crusher, of the roll or intercone type, its 60-hp gasoline engine power unit and a 25-ft long folding bucket elevator are also mounted on a four-wheeled steel chassis similar to that of the primary crusher. The stone crushed by the primary crusher is conveyed by the belt to a bar grizzly or grid which deflects the oversized pieces into the secondary crusher where it is further crushed and then spilled into the bucket elevator which carries it over a 3 ft x 8 ft double-deck pulsating screen into the storage bin. The undersized material passed by the grizzly also falls into the bucket elevator and is carried over the pulsator into the bin. The pulsator separates the crushed stone into three sizes which are deflected into three separate compartments of the bin. Any oversized crushings are diverted from the pulsator to a return conveyor which brings them back to the secondary crusher for another pass. The bin compartments are provided with manually-operated bottom-opening roller-type-gates through which the material is permitted to pass into trucks or other conveyances in the quantity desired. The ramp and platform, storage bins, and general plant layout are shown in detail on Y&D Dwgs No. 264,226, 264,227 and 264,228, together with complete bills of material.

**OPERATION:** The best performance of this plant is attainable with properly built charging facilities and bin for handling the crushings. In addition, it is also important to provide truck capacity for charging and hauling the sized material that is equal to the plant capacity. One

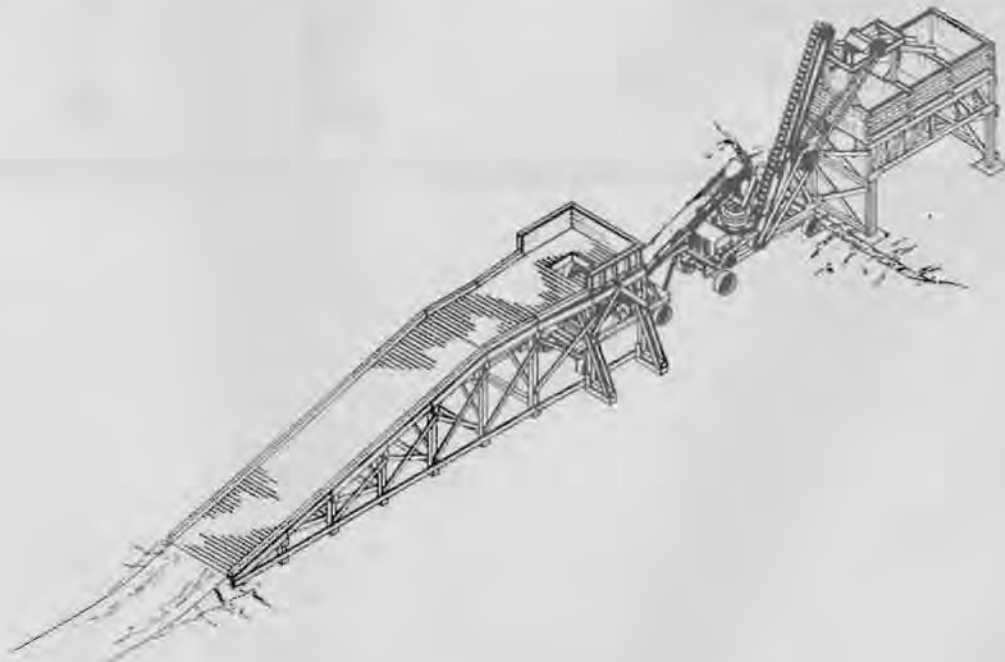

to three men are needed at the hopper of the primary crusher to maintain an even rate of feed without clogging and to remove any rock too large for the crusher, and one man is needed at the bin gates and one man lubricating and servicing the machinery. A foreman should be present to oversee and direct the haulage.

**SUPPLIES REQUIRED:** Drills and explosives for the quarrying operations and the following quantities of fuel and lubricants are estimated to be required for operating the equipment 1,000 hours under severe conditions at the atmospheric temperature ranges shown:

	32°F and lower	32°F to 70°F	70°F and higher
<b>Fuel -</b>			
Unleaded gasoline, 65 octane, gals	12000	12000	12000
<b>Greases -</b>			
General purpose 14L9 No. 1 (chassis) lb	200	200	200
General purpose 14L10 No. 2 (wheel bearing) lb	100		
Ball and roller bearing 14L3b grade No. 11 lb		100	100
Water Pump 14L11 lb	2	2	2
Wire rope chain and open gears VV-L-751 lb	20	20	20
<b>Oils -</b>			
Gear, VV-L-761 (SAE 90) (Hypoid) gal	4	4	4
Motor 9110 (SAE 10) gal	100		
" 9250 ( " 30) "		100	
" 9500 ( " 50) "			100

**AUXILIARY EQUIPMENT SUPPLIED:** Spare parts estimated to be required to keep this plant operating a year are included, as well as operating and maintenance instructions.

**AUXILIARY EQUIPMENT NOT SUPPLIED:** Trucks, drills, explosives, lumber and hardware for ramp, bins and chutes.

<b>SHIPPING INFORMATION:</b> Bundled for export.	Weight: lb	Cube: cu ft
Primary Crusher Assembly	33,000	1640
Secondary " "	22,000	1120
Bin Gates	500	6
24 ft Return Conveyor	2,400	50
3 ft x 8 ft Screen	<u>3,000</u>	<u>200</u>
Total	60,900	3016

**ORDERING INSTRUCTIONS:** State whether materials for ramp and bins are to be furnished



## DISTRIBUTOR, ASPHALT

1250 GAL, TRAILER MOUNTED, STOCK NO. 7A1-1

**APPLICATION:** A distributor for hot or cold asphalt, road oil, tar or emulsions, it is used in the construction, repair and maintenance of road, street and airfield surfaces.

**CAPACITY:** The machine has a capacity for 1250 gallons, heats and distributes by spraying over a path up to 24 ft wide and is equipped with a precision pump which measures the flow from tank to spray bars, regulating the sprayed material between one-tenth to three gallons per sq yd of road surface. It is equipped with pump tachometer which registers from zero up to 375 gpm, the pump's capacity, and with an odometer which registers the fpm travel of the truck on a 5 in. dial located conveniently within operator's view.

**DESCRIPTION:** The machine consists of a storage tank containing flues for the heating gases from built-in oil burner and a material pump serving the distributor bars and powered by a directly connected gasoline engine. The pump is so piped that it can be used for self-loading from tank car or for transferring from one tank to another as well as deliver material to the spray bars. Spray bars are equipped with nozzles for accurate distribution of material. They can be turned in the up-position when not spraying, to prevent dripping and in that position all material in the pipes drains to a low point and is pumped back into the tank. Spray bars fold up within truck width when travelling.

**OPERATION:** One man operates from a rear platform.

**SUPPLIES REQUIRED:** The following quantities of fuel and lubricants are estimated to be required for operating the equipment 1,000 hours under severe conditions at the atmospheric temperature ranges shown:

	32°F and lower	32°F to 70°F	70°F and higher
Fuel -			
Unleaded gasoline, 65 octane, gals	2000	2000	2000
Diesel oil, 50 centane gals	8000	8000	8000



	32°F and lower	32°F to 70°F	70°F and higher
<b>Greases -</b>			
General purpose 14L9 No. 1 (chassis) lb	5	5	5
General purpose 14L10 No. 2 (wheel bearing) lb	30		
Ball and roller bearing 14L3b grade No. 11 lb		30	30
Water Pump 14L11 lb	1	1	1
Wire rope chain and open gears VV-L-751 lb	1	1	1
<b>Oils -</b>			
Motor 9110 (SAE 10) gal	20		
" 9250 ( " 30) "		20	
" 9500 ( " 50) "			20

**AUXILIARY EQUIPMENT SUPPLIED:** Spare parts estimated to keep machine in operation one year are included. Manual of instruction for operation and maintenance furnished, together with a spare parts list.

**AUXILIARY EQUIPMENT NOT SUPPLIED:** Tractor or truck for pulling the distributor.

**SHIPPING INFORMATION:** Shipped bundled for export.  
 Weight: 11,500 lb      Cube: 1,250 cu ft

## GRADER, MOTOR WITH SCARIFIER

STOCK NO. 7M1

**APPLICATION:** (Principal use, other uses, quality of product): For scarifying, leveling and grading roads, streets, airfield landing strips, for cutting shallow ditches and embankments and for mixing finishing materials.

**CAPACITY:** Scarifies a swath 46 in. wide, plows ditches, turns and moves windrows, trims banks, and travels at truck speed. Blade cuts 6 in below surface and raises to clear 12 in. above, shifts to the side a maximum of 45 in., reaches beyond the line of wheels approximately 6 1/2 ft, and lifts for bank trimming to an angle of 90 degrees with the horizontal.

**DESCRIPTION:** This machine is powered by a 70-hp water-cooled diesel engine which drives the wheels and supplies the power for mechanically operating the moldboard controls. All controls are brought to the enclosed cab convenient to the operator. Automotive lighting is provided front and rear.

**OPERATION:** One-man operation

**SUPPLIES REQUIRED:** The following quantities of fuel and lubricants are estimated to be required for operating the equipment 1,000 hours under severe conditions at the atmospheric temperature ranges shown:

	32°F and lower	32°F to 70°F	70°F and higher
<b>Fuel -</b>			
Diesel oil, 50 centane gals	3000	3000	3000
<b>Greases -</b>			
General purpose 14L9 No. 1 (chassis) lb	30	30	
General purpose 14L10 No. 2 (wheelbearing) lb	10	10	40
Water Pump 14L11 lb	1	1	1
Wire rope chain and open gears VV-L-751 lb	2	2	2
<b>Oils -</b>			
Gear, VV-L-761 (SAE 80) (Hypoid) gal	10		
Gear, VV-L-761 (SAE 90) (Hypoid) gal		10	10
Motor 9110 (SAE 10) gal	30		



Oils (Cont'd)

32°F and 32°F to 70°F and  
lower 70°F higher

Motor 9250 (SAE 30) gal		30	
" 9500 (" 50) "			30

Hydraulic Brake Fluid - USA2 - 111 HB, pt	1	1	1
--	---	---	---

**AUXILIARY EQUIPMENT SUPPLIED:** Spare parts estimated to keep machine operating one year are included as well as a tool kit for operating adjustments. Manual of instruction for operation and maintenance furnished, together with a spare parts list.

SHIPPING INFORMATION:	Weight: lb	Cube: cu ft
Boxed for export	25000	900
Knocked down	24000	1400
Assembled	23000	1800

## GRADER, TRACTOR DRAWN

LEANING WHEEL, WITH SCARIFIER; STOCK NO. 7M1

**APPLICATION:** This grader is used for rough and fine grading, heavy and light ditching, scarifying, mixing, terracing and snow-plowing on construction and maintenance work for roads, streets and airfield runways.

**CAPACITY:** It plows, ditches, turns and moves windrows of loose materials, trims banks, and travels at tractor speed. The blade, which may be raised to clear 12 in. above the ground or shifted sideways a maximum of 45 in., will reach out approximately 6 1/2 ft beyond the line of wheels and will rotate to an angle of 90 degrees with the horizontal for trimming banks.

**DESCRIPTION:** This machine is tractor-drawn and all its controls are operated manually from the operator's platform at the rear of the machine.

**OPERATION:** One man operation behind a class-2 tractor.

**SUPPLIES REQUIRED:** The following quantities of fuel and lubricants are estimated to be required for operating the equipment 1,000 hours under severe conditions at the atmospheric temperature ranges shown:

	32°F and lower	32°F to 70°F	70°F and higher
<b>Greases -</b>			
General purpose 14L9 No. 1 (chassis) lb	30	30	
General purpose 14L10 No. 2 (wheel bearing) lb	10	10	40
Wire rope chain and open gears VV-L-751 lb	2	2	2
<b>Oils -</b>			
Gear, VV-L-761 (SAE 80) (Hypoid) gal	5		
Gear, VV-L-761 (SAE 90) (Hypoid) gal		5	5
Motor 9110 (SAE 10) gal	1	1	1

**AUXILIARY EQUIPMENT SUPPLIED:** Spare parts estimated to keep machine in operation one year are included. Manual of instruction for operation and maintenance furnished, together with a spare parts list.

**AUXILIARY EQUIPMENT NOT SUPPLIED:** A class-2 tractor is required for continuous operation.

**SHIPPING INFORMATION:** Bundled for export.  
Weight 10000 lb

Cube 2600 cu ft



## HARROW, DISC

STOCK NO. 7A80-6

**APPLICATION:** An offset sectional disc harrow used for pulverizing, turning, and mixing materials for soil stabilization work for construction, repair, and maintenance of roads, streets and airfield runways.

**CAPACITY:** It cuts, pulverizes, turns and mixes a swath 9 ft wide and operates behind a class-4 tractor.

**DESCRIPTION:** The disc harrow is tractor drawn. The working angle of the gang is controlled by moving the tractor and operating a trip latch by means of a rope to the tractor operator.

**OPERATION:** Operated by tractor operator.

**SUPPLIES REQUIRED:** The following quantities of fuel and lubricants are estimated to be required for operating the equipment 1,000 hours under severe conditions at the atmospheric temperature ranges shown:

	32°F and lower	32°F to 70°F	70°F and higher
Oils -			
Gear, VV-L-761 (SAE 80) (Hypoid) gal		35	
Gear, VV-L-761 (SAE 90) (Hypoid) *			35

**AUXILIARY EQUIPMENT SUPPLIED:** Spare parts estimated to be required during a year's operation are included.



**AUXILIARY EQUIPMENT NEEDED BUT NOT SUPPLIED:** The harrow requires a class-4 tractor for ordinary soil conditions.

**SHIPPING INFORMATION:** Shipped bundled for export  
Weight: 3300 lb                      Cube: 62 cu ft

## HARROW, SPIKE TOOTH

4-SECTION, STOCK NO. 7A80

**APPLICATION:** This harrow is used generally for crumbling and homogenizing turned soil in the construction of roadways, airfields and similar areas, and for mixing sands and clays, oil-impregnated soils and cement or asphalt stabilized soils on soil stabilization projects. It is useful also in maintenance and repair operations on roads, streets and runways.

**CAPACITY:** Harrow works a swath 20 ft wide with 120 teeth.

**DESCRIPTION:** The harrow sections are arranged for connecting together in parallel and when assembled the harrow is provided with a hitch for tractor drawbar.

**OPERATION:** Tractor drawn.

**AUXILIARY EQUIPMENT SUPPLIED:** Spare parts estimated to be required over a year of operation are included. Manual of instruction for operation and maintenance furnished, together with a spare parts list.

**AUXILIARY EQUIPMENT NEEDED BUT NOT SUPPLIED:** A Class-4 tractor or equivalent truck is required for power.

**SHIPPING INFORMATION:** Shipped Bundled for export.  
Weight: 600 lb                      Cube 50 cu ft

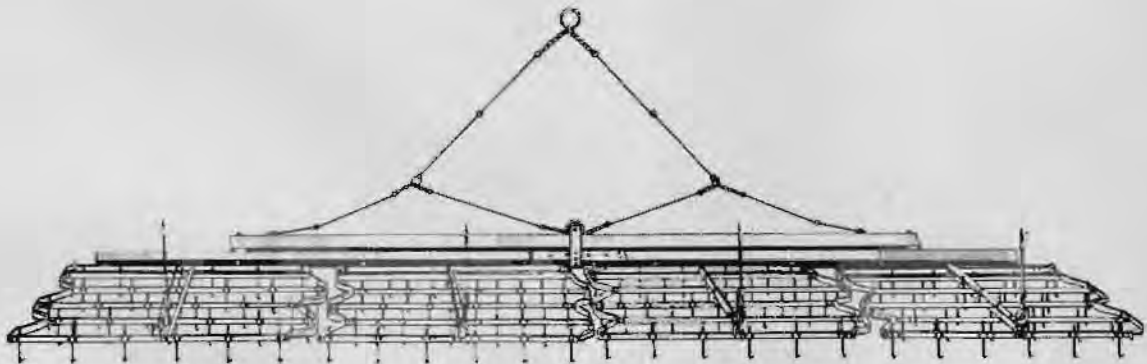



## KETTLE, ASPHALT, MOBILE

165 GAL, HAND SPRAY, STOCK NO. 7A1-2

**APPLICATION:** Used for heating, transporting and spraying bituminous products in small quantities for maintenance and repair of road, street and airfield work.

**CAPACITY:** 165 gallons of material. Pipe connections to discharge tap and pump servicing hand spray are 1-in. Spray is controlled to deliver 10-18 gpm.

**DESCRIPTION:** The equipment consists of a kettle, fired by a vaporizing torch burning gasoline under hand pump pressure and served by a 2 hp gas engine driven rotary type pump, all being mounted for mobility on a 2-wheel steel trailer with towing hitch. The hand spray is finger-tip controlled and is equipped with 15 ft of flexible metal hose for reaching the work areas. The pump is so arranged that it may be reversed by hand to return to the kettle the unused materials in the hose.

**OPERATION:** One-man operation.

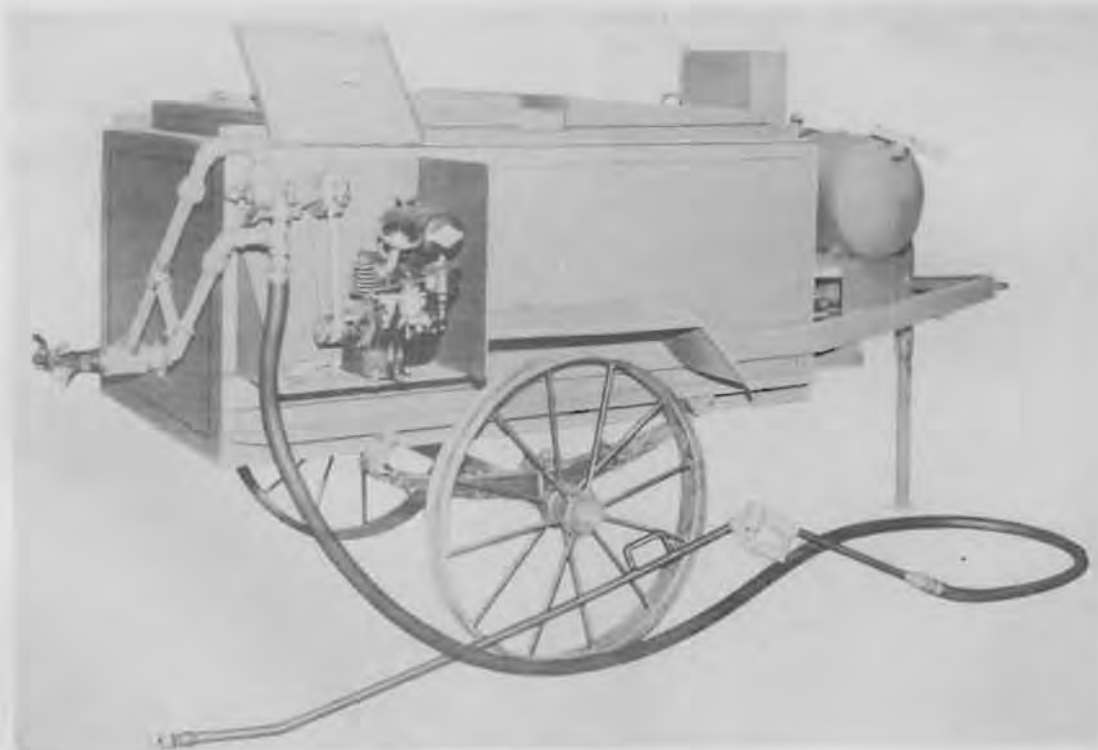

**SUPPLIES REQUIRED:** The following quantities of fuel and lubricants are estimated to be required for operating the equipment 1,000 hours under severe conditions at the atmospheric temperature ranges shown:

	32°F and lower	32° to 70°F	70°F and higher
<b>Fuel -</b>			
Unleaded gasoline, 65 octane, gals	200	200	200
Diesel oil, 50 centane, gals	2000	2000	2000
<b>Greases -</b>			
General purpose 14L9 No. 1 (chassis) lb	1	1	1
General purpose 14L10 No. 2 (wheel bearing) lb	1	1	1
<b>Oils -</b>			
Motor 9110 (SAE 10) gal	13		
" 9250 ( " 30) "		13	13

**AUXILIARY EQUIPMENT SUPPLIED:** Spare parts estimated to be required during a year's operation are included. Manual of instruction for operation and maintenance furnished, together with a spare parts list.

**AUXILIARY EQUIPMENT NEEDED BUT NOT SUPPLIED:** Truck or tractor with trailer hitch is required for mobility.

**SHIPPING INFORMATION:** Boxed for export  
 Weight: 2100 lb      Cube: 160 cu ft

## MIXER, ROTARY TILLER

SELF-POWERED, TRAILER-MOUNTED, STOCK NO. 701-21

**APPLICATION:** This mixer is used for pulverizing and mixing soils and for mixing cement and oils into soils in stabilization work for the construction, repair and maintenance of roads, streets and airfield runways.

**CAPACITY:** The rotor turning at 300 rpm imparts a tine-point velocity of 2,100 fpm while the machine travels at the normal forward rate of 2 mph. It cuts and mixes up to a depth of 12-in. and over a width of 75 in. The cutting-depth adjustment and the lifting of the entire assembly for transport is effected by means of a built-in hydraulic lift.

**DESCRIPTION:** The machine consists of a rotating tiller consisting of 72 spring-type cutting tines, housed in an open-bottomed box, powered by a 70-hp water-cooled gasoline engine equipped with electric starter, all mounted on a 2-wheel pneumatic-tired trailer with towing hitch. The rotating and cutting action of the tines pulverizes and mixes the materials through which they pass. The rotary tiller is self-powered but a tractor providing a minimum of 20 draw-bar horsepower is required for towing.

**OPERATION:** Tractor-drawn and operated by the tractor operator.

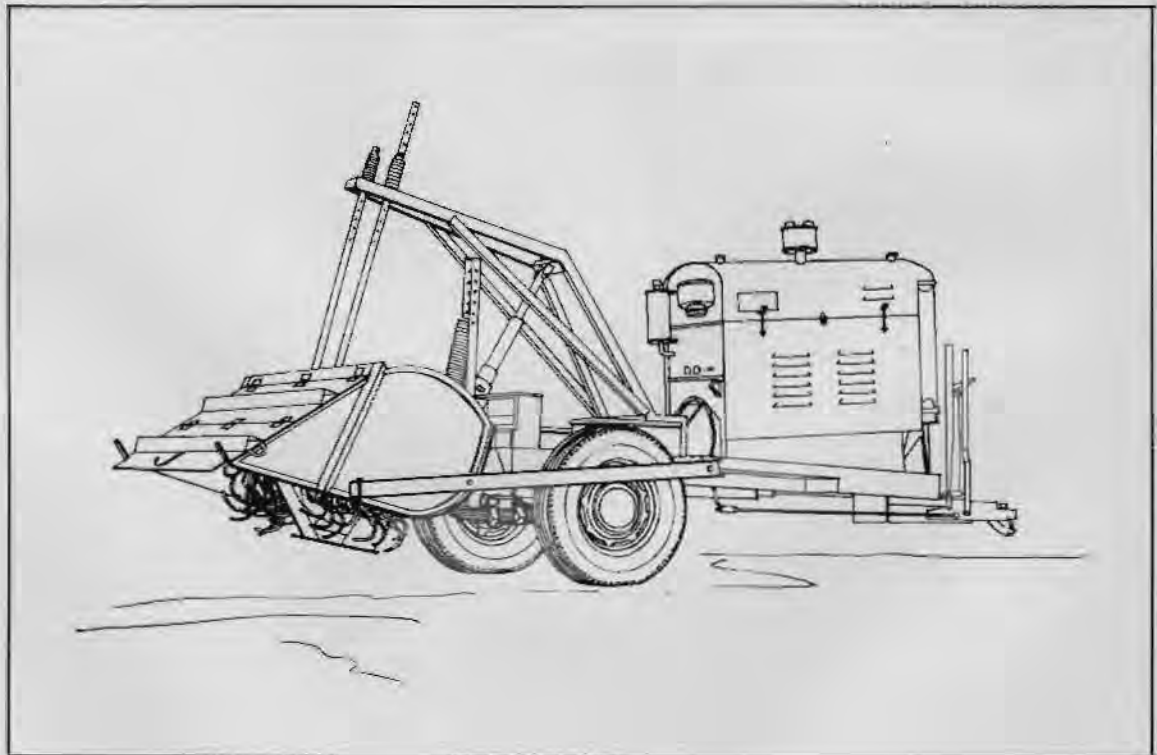

SUPPLIES REQUIRED: The following quantities of fuel and lubricants are estimated to be required for operating the equipment 1,000 hours under severe conditions at the atmospheric temperature ranges shown:

	32°F and lower	32°F to 70°F	70°F and higher
Fuel - Unleaded gasoline, 65 octane, gals	6000	6000	6000
Greases -			
General purpose 14L9 No. 1 (chassis) lb	30	30	
General purpose 14L10 No. 2 (wheel bearing) lb	10	10	40
Water Pump 14L11 lb	1	1	1
Wire rope, chain and open gears VV-L-751 lb			
Oils -			
Gear, VV-L-761 (SAE 80) (Hypoid) gal	10		
Gear, VV-L-761 (SAE 90) (Hypoid) "		10	10
Motor 9110 (SAE 10) gal	30		
" 9250 ( " 30) "		30	
" 9500 ( " 50) "			30

AUXILIARY EQUIPMENT SUPPLIED: Spare parts estimated to be required during a year's operation are included, as well as manuals of instruction for the operation and maintenance of the machine.

AUXILIARY EQUIPMENT NEEDED BUT NOT SUPPLIED: A class-4 tractor.

SHIPPING INFORMATION: Boxed for export.  
Weight: 5,300 lb                      Cube: 530 cu ft

## PLOW, DISC, 5-28 IN. DISCS

STOCK NO. 7A81-3

**APPLICATION:** The plow is used for turning up, pulverizing and mixing soils in stabilization work for the construction, maintenance and repair of roads, streets and airfield runways.

**CAPACITY:** It cuts a swath 50 in. wide to a depth varying between 5 and 17 inches. It requires a class-4 tractor for medium cuts in light mellow soils but a class-3 tractor for deep cuts in heavy tight soils.

**DESCRIPTION:** The plow travels on three steel wheels which are raised or lowered by means of a power lift built into the landside wheel. Depth of cut is regulated manually by crank reached from tractor drivers seat. Levelling cranks are manually operated. The hitch is an automatic releasing spring type safety latch which cuts the plow loose from the tractor when an obstruction is encountered, which would otherwise damage the equipment.

**OPERATION:** It is tractor drawn and operated manually by the tractor driver.

**SUPPLIES REQUIRED:** The following quantities of fuel and lubricants are estimated to be required for operating the equipment 1,000 hours under severe conditions at the atmospheric temperature ranges shown:

	32°F and lower	32°F to 70°F	70°F and higher
Greases -			
General purpose 14L10 No. 2 (wheel bearing) lb	10	10	10

**AUXILIARY EQUIPMENT SUPPLIED:** Spare parts estimated to keep the plow operating one year are included. Manual of instruction for operation and maintenance furnished, together with a spare parts list.

**AUXILIARY EQUIPMENT NEEDED BUT NOT SUPPLIED:** Class 3 or 4 tractor, see capacity above.

**SHIPPING INFORMATION:** Boxed for export.      Weight: 6400 lb      Cube: 100 cu ft



## PLOW, GANG, 4 BOTTOM, 14 IN.

STOCK NO. 7A81-2

**APPLICATION:** The plow is used for turning up, pulverizing and mixing soils in stabilization work for the construction, maintenance and repair of roads, streets and airfield runways.

**CAPACITY:** It cuts a swath 56 in. wide to a depth varying between 3 and 12 inches. It requires a class-4 tractor for medium depth cuts in light mellow soil but a class-3 tractor for deep operation in heavy tight soil.

**DESCRIPTION:** The plow travels on 2 steel wheels which are raised or lowered by means of a power lift built into the landside wheel and operated by a rope from the tractor seat. The leveling and cutting depth adjustments are controlled by means of long levers reached from the tractor driver's seat. The plow is also equipped with a spring-type releasing safety latch which automatically cut the plow loose from the tractor when an obstruction is encountered which might otherwise damage the equipment.

**OPERATION:** It is tractor-drawn and operated manually by the tractor driver from the tractor seat.

**SUPPLIES REQUIRED:** The following quantities of fuel and lubricants are estimated to be required for operating the equipment 1,000 hours under severe conditions at the atmospheric temperature ranges shown:

	32°F and lower	32°F to 70°F	70°F and higher
Greases -			
General purpose 14L10 No. 2 (wheel bearing) lb	10	10	10

**AUXILIARY EQUIPMENT SUPPLIED:** Spare parts estimated to keep the plow operating one year are included. Manual of instruction for operation and maintenance furnished, together with a spare parts list.

**AUXILIARY EQUIPMENT NEEDED BUT NOT SUPPLIED:** Class-3 or 4 tractor, see capacity above.

**SHIPPING INFORMATION:** Bundled for export. Weight: 2500 lb      Cube: 700 cu ft



## PULLER, TREE AND STUMP, TRACTOR OPERATED

STOCK NO. 7C64-38

**APPLICATION:** This rig is supplied for clearing and grubbing operations. It uproots stumps and trees quickly and effectively but may also be used for any other pulls within its capacity.

**CAPACITY:** This machine will develop single line pulls in excess of 80,000 lb and has a range of line speeds from 4 to 230 fpm. The cable drum has capacity for 350 ft of 3/4 in. cable, 200 ft of 7/8 in. and 140 ft of 1 in.

**DESCRIPTION:** The machine consists of the stump-pulling rig mounted on a wheel-type tractor in such a way as to be powered from the power take-off of the tractor, operated from the driver's seat and anchored for pulling operations without putting any strain on the tractor itself. It is mobile at tractor speeds but is frequently required to pull itself in and out of locations impossible to reach by driving. The weight of the stump puller alone is approximately 900 lb, mounted on the tractor 5500 lb. It projects slightly beyond the tractor at one end but not at the sides. The tractor is furnished with either pneumatic or steel cleated wheels.

**OPERATION:** The machine is used by placing it in direct line between its anchorage and the object to be pulled, attaching the cables and pulling. For clearing work, an economical crew has been found to be a machine operator and 3 men attaching cables.



**SUPPLIES REQUIRED:** The following quantities of fuel and lubricants are estimated to be required for operating the equipment 1,000 hours under severe conditions at the atmospheric temperature ranges shown:

	32°F and lower	32°F to 70°F	70°F and higher
<b>Fuel -</b>			
Unleaded gasoline, 65 octane, gals	2000	2000	2000
<b>Greases -</b>			
General purpose 14L9 No. 1 (chassis) lb	30	30	
General purpose 14L10 No. 2 (wheel bearing) lb	10	10	40
Water Pump 14L11 lb	1	1	1
Wire rope chain and open gears VV-L-751 lb	5	5	5
<b>Oils -</b>			
Gear, VV-L-761 (SAE 80) (Hypoid) gal	20		
Gear, VV-L-761 (SAE 90) (Hypoid) "		20	20
Motor 9110 (SAE 10) gal	60		
" 9250 ( " 30) "		60	
" 9500 ( " 50) "			60

**AUXILIARY EQUIPMENT SUPPLIED:** In addition to the stump puller there is included also with each unit a complete assembly of pulling, choker and anchor cables of various sizes and lengths, all with end fittings and including blocks, hooks and root hooks. Spare parts estimated to be required during a year's use are included, as well as manuals of instruction for the operation and maintenance of machines.

**SHIPPING INFORMATION:** Winch shipped mounted on tractor with clearing gear bundled and boxed.

	Weight (lb)	Cube (cu ft)
Tractor with puller mounted	6,000	200
Clearing Gear	3,700	100



## ROLLER, ROAD, 5 TO 8 TON, TANDEM

GAS ENGINE DRIVEN, STOCK NO. 7N1

**APPLICATION:** Used for general, as well as precision, rolling in the preparation of sub-base for and the construction and maintenance of roads, streets and airfield work.

**CAPACITY:** Exerts pressures varying between 130 and 230 psi depending upon whether empty or filled with water ballast. Rolls a swath 5 ft wide. Water tank capacity 102 gallons.

**DESCRIPTION:** The roller is powered by a gasoline engine, is equipped with a sprinkler system, with hydraulic steering, front and rear electric lights for night operation and with lifting lugs for lifting by means of slings.

**OPERATION:** One-man operation.

**SUPPLIES REQUIRED:** The following quantities of fuel and lubricants are estimated to be required for operating the equipment 1,000 hours under severe conditions at the atmospheric temperature ranges shown:

	32°F and lower	32°F to 70°F	70°F and higher
<b>Fuel -</b>			
Unleaded gasoline, 65 octane, gals	4600	4600	4600
<b>Greases -</b>			
General purpose 14L9 No. 1 (chassis) lb	30	30	
General purpose 14L10 No. 2 (wheel bearing) lb	10	10	40
Water Pump 14L11 lb	1	1	1
Wire rope chain and open gear VV-L-751 lb	1	1	1
<b>Oils -</b>			
Gear, VV-L-761 (SAE 80) (Hypoid) gal	10		
Gear, VV-L-761 (SAE 90) (Hypoid) "		10	10
Motor 9110 (SAE 10) gal	40		
" 9250 ( " 30) "		40	
" 9500 ( " 50) "			40

**AUXILIARY EQUIPMENT SUPPLIED:** Spare parts estimated to maintain operation throughout one year are included. Manual of instruction for operation and maintenance furnished, together with a spare parts list.

**SHIPPING INFORMATION:** Shipped as is with spare parts boxed for export.  
Weight: 12,000 lb      Cube: 700 cu ft



## ROLLER, ROAD, 10 TON, 3 WHEEL

GAS ENGINE DRIVEN, STOCK NO. 7N1

**APPLICATION:** Used for consolidating loose materials making up the base or finish sources of road, street or airfield surfaces.

**CAPACITY:** This roller exerts a pressure of approximately 400 psi under the driving rolls and 200 under guiding rolls. It rolls and scarifies over a path 6 ft wide.

**DESCRIPTION:** This is a self-propelled roller powered by a gasoline or diesel engine complete with starter, hydraulic steering apparatus, electric lights front and rear for night operation and service kit. The machine travels at speeds ranging between 1 and 5 mph, has an outside turning radius of 20 ft and has overall dimensions approximately as follows: 6 ft high 6 ft wide and 20 ft long. Scarifier attachment is power operated.

**OPERATION:** One-man operation.

**SUPPLIES REQUIRED:** The following quantities of fuel and lubricants are estimated to be required for operating the equipment 1,000 hours under severe conditions at the atmospheric temperature ranges shown:

	32°F and lower	32°F to 70°F	70°F and higher
<b>Fuel -</b>			
Unleaded gasoline, 65 octane, gals)	5800	5800	5800
Diesel oil, 50 centane gals )either	4100	4100	4100
<b>Greases -</b>			
General purpose 14L9 No. 1 (chassis) lb	30	30	
General purpose 14L10 No. 2 (wheel bearing) lb	10	10	40
Water Pump 14L11 lb	1	1	1
Wire rope chain and open gears VV-L-751 lb	1	1	1
<b>Oils -</b>			
Gear, VV-L-761 (SAE 80) (Hypoid) gal	10		
Gear, VV-L-761 (SAE 90) (Hypoid)		10	10
Motor 9110 (SAE 10) gal	40		
"    9250 (    "    30)		40	
"    9500 (    "    50)			40

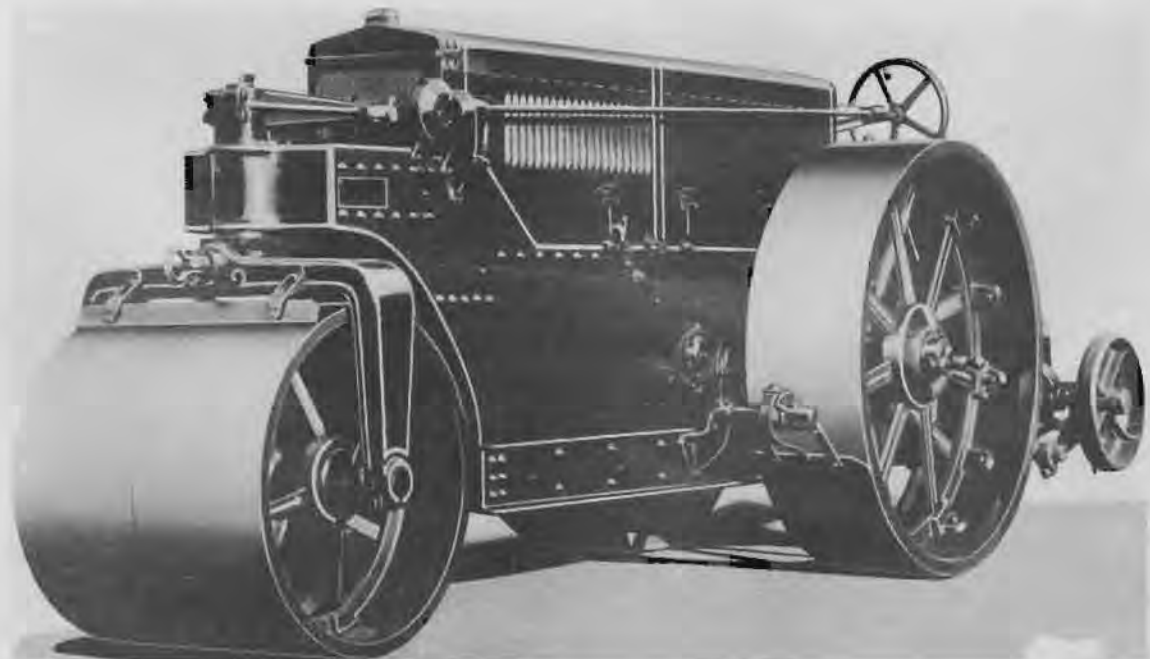

**AUXILIARY EQUIPMENT SUPPLIED:** Spare parts estimated to keep machine in operation one year are included. Manual of instruction for operation and maintenance furnished, together with a spare parts list.

**SHIPPING INFORMATION:** Shipped as is, with lifting hook for lifting.  
Weight: 20,000 lb                      Cube: 700 cu ft

## ROLLER, SHEEPSFOOT TAMPING, 3 DRUM

STOCK NO. 7N1

**APPLICATION:** Used for deep tamping of fills to prevent settlement under road, street and airfield traffic.

**CAPACITY:** Each drum is 4 ft wide and may be used singly, in tandem, three-wide, or in trains and exert ground pressures varying from 150 psi to 400 psi depending upon whether the drums are empty or filled with water or sand or both.

**DESCRIPTION:** The rolls are equipped with hitches for towing and for fastening together in the combinations desired. In tandem they roll a swath 9 ft wide, and used three wide they roll a 14 ft wide swath.

**OPERATION:** Tractor drawn.

**SUPPLIES REQUIRED:** The following quantities of fuel and lubricants are estimated to be required for operating the equipment 1,000 hours under severe conditions at the atmospheric temperature ranges shown:

	32°F and lower	32°F to 70°F	70°F and higher
Greases - General purpose 14L10 No. 2 (wheel bearing) lb	100	100	100

**AUXILIARY EQUIPMENT SUPPLIED:** Spare parts estimated to keep roller operating one year are included. Manual of instruction for operation and maintenance furnished, together with a spare parts list.

**SHIPPING INFORMATION:** Weight: 9500 lb      Cube: 800 cu ft



## ROOTER, TRACTOR DRAWN

5-TOOTH, LIGHT-DUTY, STOCK NO. 7A78

**APPLICATION:** Used for scarifying, loosening rocks and roots, pulverizing, aerating and mixing soils in stabilization and preparatory work for the construction, repair and maintenance of roads, streets, and airfield runways.

**CAPACITY:** The rooter has capacity for digging 15 inches maximum depth over a path 5 feet wide.

**DESCRIPTION:** The rooter is mounted on two steel wheels and equipped with towing hitch for tractor drawbar. The manual depth control for teeth and release for getting clear of obstructions are operated from the tractor.

**OPERATION:** Tractor-drawn and operated by tractor operator, it requires a class-4 tractor for maximum performance.

**SUPPLIES REQUIRED:** The following quantities of fuel and lubricants are estimated to be required for operating the equipment 1,000 hours under severe conditions at the atmospheric temperature ranges shown:

	32°F and lower	32°F to 70°F	70°F and higher
Greases -			
General purpose 14L10 No. 2 (wheel bearing) lb	5	5	5

**AUXILIARY EQUIPMENT SUPPLIED:** Spare parts estimated to be required during a year's operation are included. Manual of instruction for operation and maintenance furnished, together with a spare parts list.

**AUXILIARY EQUIPMENT NEEDED BUT NOT SUPPLIED:** Class-4 tractor.

**SHIPPING INFORMATION:** Shipping Weight: 3000 lb      Shipping Cube: 230 cu ft

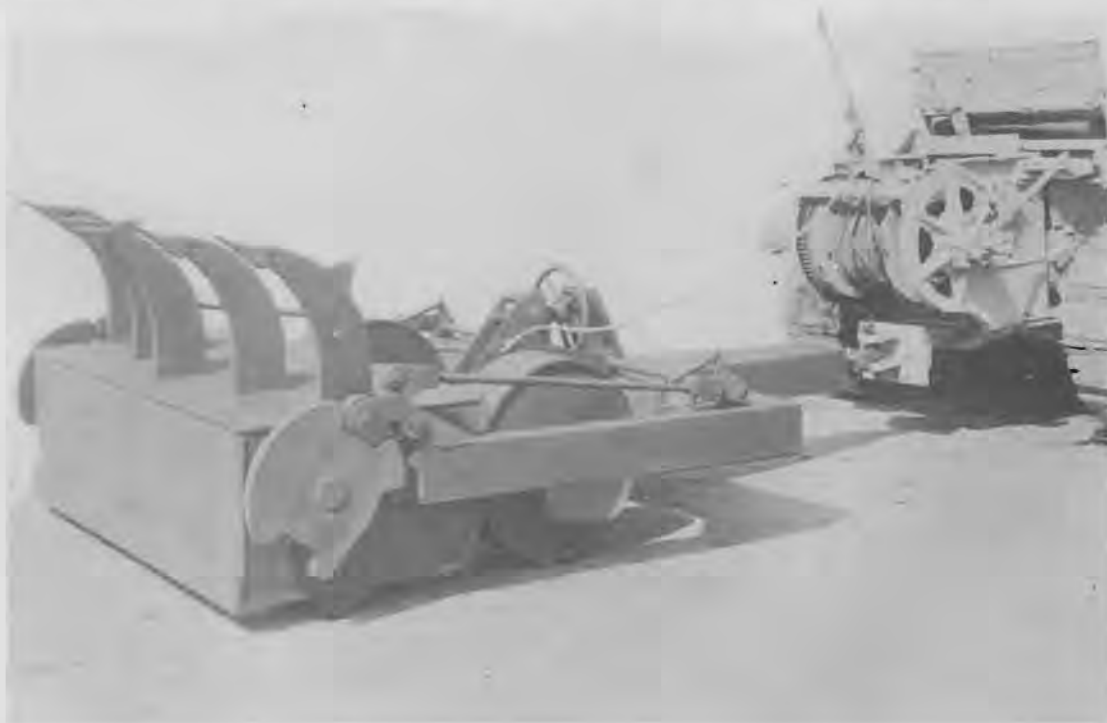

## ROOTER, TRACTOR DRAWN

STOCK NO. 7A78

**APPLICATION:** A tractor-drawn tool for ripping up hard surfaces such as hard-packed earth or bituminous surfaces preparatory to excavating, reworking or regrading used for construction and maintenance of roads, streets and airfields.

**CAPACITY:** These tools are capable of ripping to a depth of 29 in. in a path 7 ft wide. Designed for operation behind a class-1 tractor.

**DESCRIPTION:** This unit has a working weight of approximately 7000 lb and the working depth of teeth is controlled from the tractor seat by means of a single drum cable control provided with 1/2 in. wire rope.

**OPERATION:** Controlled by tractor operator.

**SUPPLIES REQUIRED:** The following quantities of fuel and lubricants are estimated to be required for operating the equipment 1,000 hours under severe conditions at the atmospheric temperature ranges shown:

	32°F and lower	32°F to 70°F	70°F and higher
<b>Greases -</b>			
General purpose 14L10 No. 2 (wheel bearing) lb	5	5	5

**AUXILIARY EQUIPMENT SUPPLIED:** Spare parts estimated to be required during a year's operation are included. Manual of instruction for operation and maintenance furnished, together with a spare parts list.

**AUXILIARY EQUIPMENT NEEDED BUT NOT SUPPLIED:** Class-1 tractor with single drum cable control unit.

**SHIPPING INFORMATION:** Shipped skidded for export.  
Weight: 8500 lb                      Cube: 300 cu ft

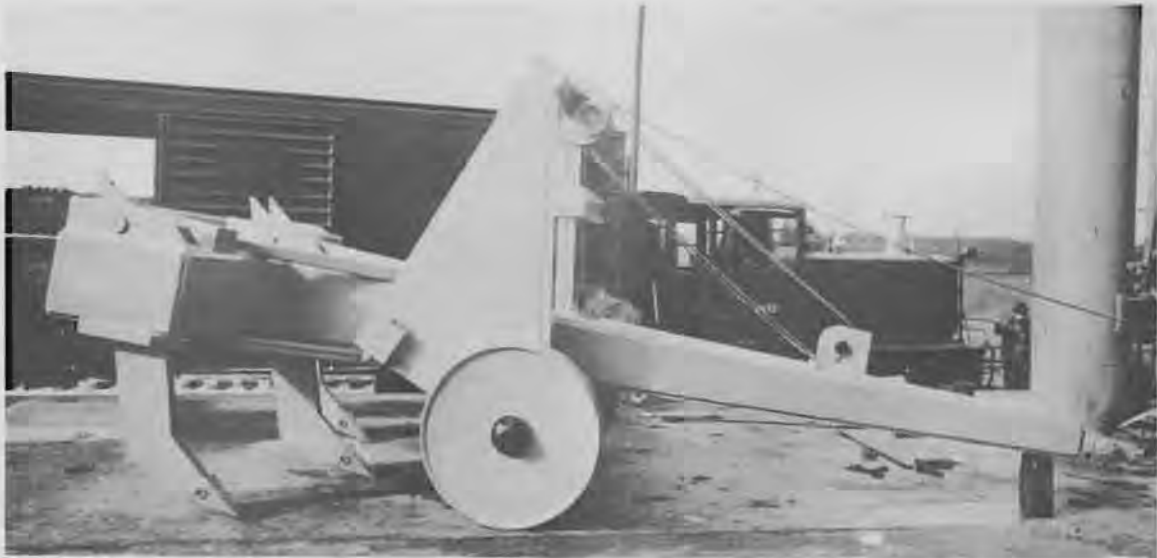

## SCRAPER, CARRYALL, 5 CU YD

POWER CONTROLLED, STOCK NO. 7J4

**APPLICATION:** A carryall scraper for excavating, carrying and spread dumping for the cut and fill operations necessary in the construction of roads, streets and airfields.

**CAPACITY:** 5 cu yd struck measure. It is recommended for use behind a class-3 tractor equipped with a double-drum cable control and has a turning radius of 14 ft.

**DESCRIPTION:** Mounted on pneumatic tired wheels this scraper, provided with a cutting apron 6 ft wide cuts up to a depth of 12 in., spreads up to a depth of 14 in. and travels at tractor speeds. Depth of cut and spread is readily controlled from the tractor driver's seat.

**OPERATION:** Operated by tractor driver.

**SUPPLIES REQUIRED:** The following quantities of fuel and lubricants are estimated to be required for operating the equipment 1,000 hours under severe conditions at the atmospheric temperature ranges shown:

	32°F and lower	32°F to 70°F	70°F and higher
Greases -			
General purpose 14L9 No. 1 (chassis) lb	250	250	250
General purpose 14L10 No. 2 (wheel bearing) lb	12	12	12

**AUXILIARY EQUIPMENT SUPPLIED:** Spare parts estimated to be required during one year's operation are included.

**AUXILIARY EQUIPMENT NEEDED BUT NOT SUPPLIED:** Class-3 or class-4 tractor equipped with double drum cable control unit.

**SHIPPING INFORMATION:** Weight: 9000 lb

Cube: 1000 cu ft



## SCRAPER, CARRYALL, 8 CU YD

POWER CONTROLLED, STOCK NO. 714

**APPLICATION:** A carryall scraper for excavating, carrying and spread dumping for the cut and fill operations necessary in the construction of roads, streets, and airfields.

**CAPACITY:** 8 cu yd struck measure. It is recommended for use behind a class 2 tractor equipped with double drum cable control. Turning radius is 16 ft.

**DESCRIPTION:** Mounted on pneumatic tired wheels this scraper, provided with a 9-ft cutting apron cuts up to a depth of 8 in. spreads up to a depth of 16 in., travels readily at tractor speeds. Depth of cut and spread is readily controlled at tractor operator's seat.

**OPERATION:** Operated by tractor driver.

**SUPPLIES REQUIRED:** The following quantities of fuel and lubricants are estimated to be required for operating the equipment 1,000 hours under severe conditions at the atmospheric temperature ranges shown:

	32°F and lower	32°F to 70°F	70°F and higher
Greases -			
General purpose 14L9 No. 1 (chassis) lb	350	350	350
General purpose 14L10 No. 2 (wheel bearing) lb	15	15	15

**AUXILIARY EQUIPMENT SUPPLIED:** Spare parts estimated to be required during a year's operation are included. Manual of instruction for operation and maintenance furnished, together with a spare parts list.

**AUXILIARY EQUIPMENT NEEDED BUT NOT SUPPLIED:** Class 2 tractor equipped with a double-drum cable control.

**SHIPPING INFORMATION:** Weight: 22,000 lb                      Cube: 1300 cu ft





## SCRAPER, CARRYALL, 12 CU YD

POWER CONTROLLED, STOCK NO. 7j4

**APPLICATION:** A carryall scraper for excavating, carrying, and spread dumping for the cut and fill operations necessary in the construction of roads, streets and airfields.

**CAPACITY:** Capacity 12 cu yd struck measure, recommended for use behind a class-1 tractor equipped with double-drum cable-control unit. Turning radius 20 ft.

**DESCRIPTION:** Mounted on pneumatic tired wheels this scraper, provided with a 10-ft cutting apron cuts up to a depth of 12 in. in filling, travels readily at tractor speeds and spreads in discharging up to 18 in. Depth of cut and spread is readily controlled at tractor seat.

**OPERATION:** Operated by tractor driver.

**SUPPLIES REQUIRED:** The following quantities of fuel and lubricants are estimated to be required for operating the equipment 1,000 hours under severe conditions at the atmospheric temperature ranges shown:

	32°F and lower	32°F to 70°F	70°F and higher
Greases -			
General purpose 14L9 No. 1 (chassis) lb	400	400	400
General purpose 14L10 No. 2 (wheel bearing) lb	18	18	18

**AUXILIARY EQUIPMENT SUPPLIED:** Spare parts estimated to be required during a year's operation are included. Manual of instruction for operation and maintenance furnished, together with a spare parts list.

**AUXILIARY EQUIPMENT NEEDED BUT NOT SUPPLIED:** Class-1 tractor equipped with a double drum cable control unit.

**SHIPPING INFORMATION:** Weight: 24,000 lb                      Cube: 1600 cu ft



## SPREADER, BOX

FOR DUMP TRUCK MOUNTING, STOCK NO. 7C118-1

**APPLICATION:** This device is used for spreading loose materials evenly and accurately, chiefly in the construction, maintenance and repair of roads, streets, and airfield runways.

**CAPACITY:** The capacity of the box is 32 cubic feet and it spreads over a width of 11 ft, handling various sized aggregate and laying a controlled thickness of material.

**DESCRIPTION:** The spreader, which in operation is close-hauled to a towing dump truck which feeds the spreading material to it, comprises a 3/16 in. reinforced steel plate box which rolls on four steel wheels. Besides supporting the box, these wheels drive a cylindrical feed roll which is as long as the feed opening of the box. The box is equipped with flexible couplers that permit the spreader to follow the contour of the road surface; also with five sets of truck hitches, and with dual feed controls which are readily accessible. The traveling truck, pulling the spreader box, spills aggregate into the box where the rotating feed roll forces it out through the gate which has been set to deliver the desired thickness of spread. A reversing transmission permits material to be laid with the spreader moving backward, if required.

**OPERATION:** A dump truck fitted with a truck hitch backs up and couples to the spreader box, then releases its tail gate and elevates body to dump material at a rate to keep the spreader box full, without spilling over. The truck then proceeds forward and the operator starts the feed roll at the point where the spread is to begin. When the truck becomes empty it is stopped and uncoupled, and a fully loaded truck is coupled on to the box and the spread continued. The operator walks alongside when the last bit of a load is being fed out and the spreader box becomes empty as it sometimes becomes necessary to move the material remaining in the box to the ends by hand to continue the even spread. When transporting the box from one location to another, chains should be provided for hanging it on the truck because the spreader box wheels are not designed to travel at speeds in excess of 10 miles per hour.

**SUPPLIES REQUIRED:** The following quantities of fuel and lubricants are estimated to be required for operating the equipment 1,000 hours under severe conditions at the atmospheric

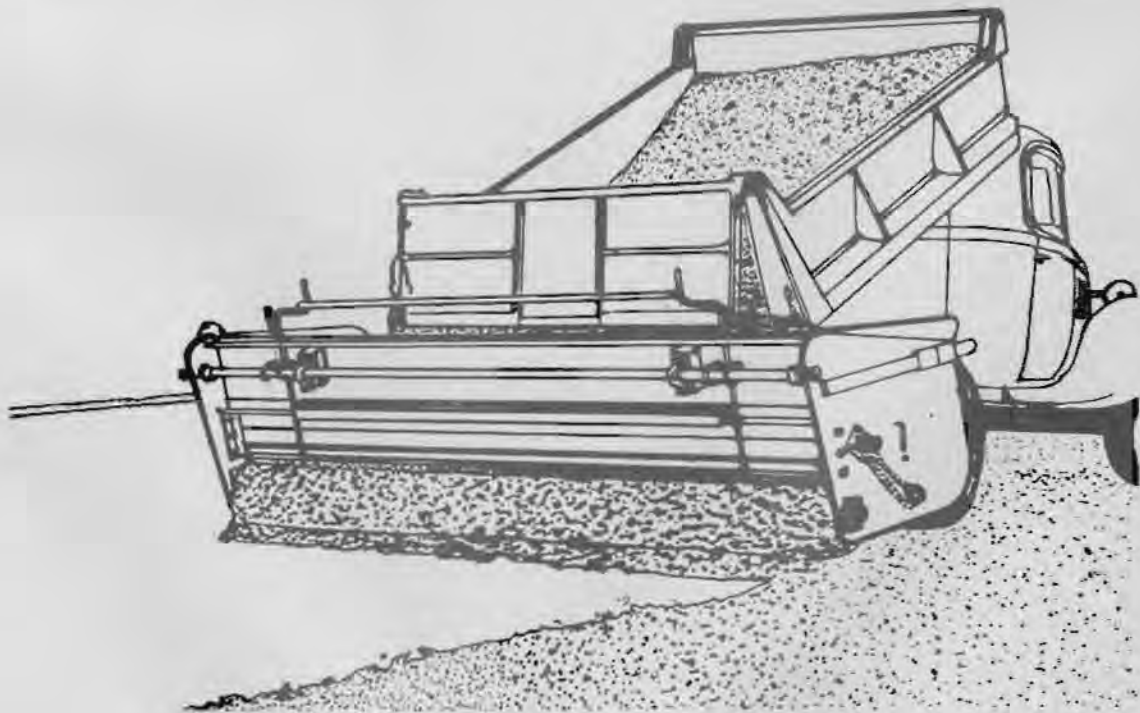

temperature ranges shown:

	32°F and lower	32°F to 70°F	70°F and higher
--	----------------	--------------	-----------------

Greases -

General purpose 14L9 No. 1 (chassis) lb	50	50	50
Wire rope chain and open gear VV-L-751 lb	5	5	5

**AUXILIARY EQUIPMENT SUPPLIED:** Spare parts estimated to be required during a year's operation, as well as manuals of instruction for the operation and maintenance of the machine, are included.

**SHIPPING INFORMATION:** Packed for export

Weight: 2300 lb      Cube: 140 cu ft

TRACTOR, CRAWLER TYPE, CLASS-4

T9 GAS

35 TO 49 HP, STOCK NO. 7A72

**APPLICATION:** This class of tractor is suited to light push-and-pull assignments and is furnished on all bases.

**CAPACITY:** This class of tractor operates 6-ft to 8-ft blade bulldozers; 8-ft to 10-ft blade bullgraders; 3-to 4-cu yd 2-wheel carryall scrapers; 4-to 5-cu yd 4-wheel carryall scrapers; 1-to 2-cu yd rollover scraper; 8-ft to 10-ft blade graders and terracers; 3/4-cu yd front-end shovel; 2-ton tractor-mounted cranes; towing winches capable of a line pull of 12,000 lb at 100 fpm; oil-field winches capable of 25,000 lb at 35 fpm; 8-ft to 9-ft-swath medium-cut snow-plows; pipe booms capable of 5,000 lb at 8-ft overhang; rollers; 4-bottom gang plows; disc and spike-toothed harrows.

**DESCRIPTION:** This machine is diesel-powered with electric starter and front and rear lights. It is mounted on crawler treads, equipped with radiator and crank case guards, front-pull hooks and rear drawbar, muffler, heavy-duty track and roller guards, front idler and sprocket shields, and power take-off. When furnished as an allowance list item a bulldozer is mounted on 1 of every 2 of this class of tractor, a single drum winch on 1 of every 2 and a front end shovel on 1 of every 2.

**OPERATION:** One-man operation.

**SUPPLIES REQUIRED:** The following quantities of fuel and lubricants are estimated to be required for operating the equipment 1,000 hours under severe conditions at the atmospheric temperature ranges shown:

	32°F and lower	32°F to 70°F	70°F and higher
<b>Fuel -</b>			
Diesel oil, 50 centane gals	3100	3100	3100
<b>Greases -</b>			
General purpose 14L9 No. 1 (chassis) lb	100	100	100
Water Pump 14L11 lb	1	1	1
Wire rope chain and open gear VV-L-751 lb	10	10	10
<b>Oils -</b>			
Gear, VV-L-761 (SAE 80) (Hypoid) gal	15		
Gear, VV-L-761 (SAE 90) (Hypoid)	10	25	25

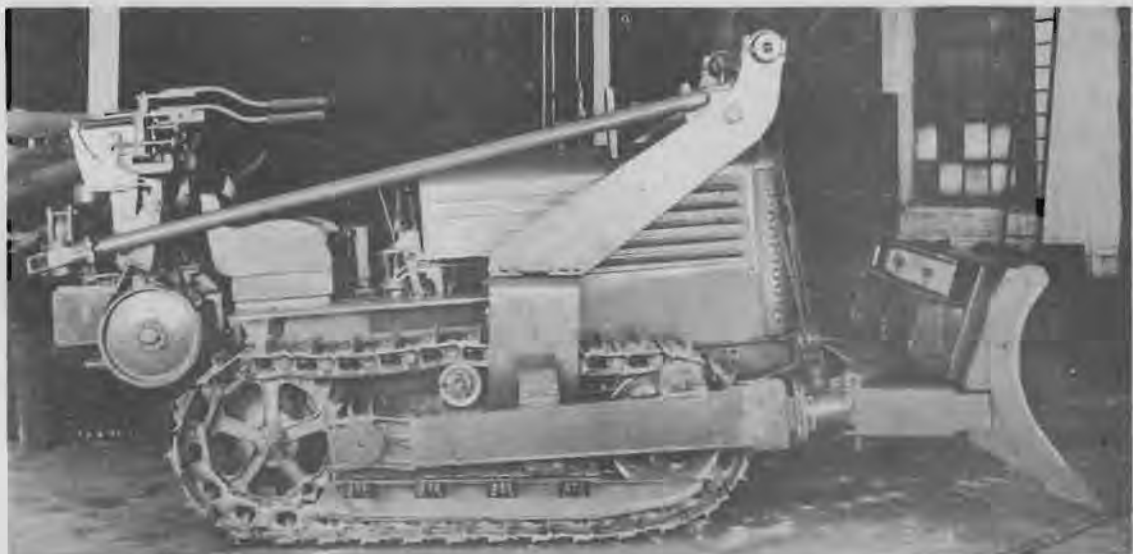

Oils (cont'd)

32°F and 32°F to 70°F and  
lower 70°F higher

Motor 9110 (SAE 10) gal	100		
" 9250 ( " 30) "		100	
" 9500 ( " 50) "			100

AUXILIARY EQUIPMENT SUPPLIED: Spare parts estimated to keep machine in operation one year are included. Manual of instruction for operation and maintenance furnished, together with a spare parts list.

SHIPPING INFORMATION: Shipped bundled for export	Weight: lb	Cube: cu ft
Tractor	10,000	300
Bulldozer	4,000	120
Single drum winch	1,000	35
Front end shovel	4,000	400

ORDERING INSTRUCTION: When ordering this item state what accessory items are required.

## TRACTOR, CRAWLER TYPE, CLASS-3

50 TO 60 HP, STOCK NO. 7A72

**APPLICATION:** This class of tractor is suited to the medium push-and-pull assignments and is furnished on special request only.

**CAPACITY:** This class of tractor operates 8-ft to 10-ft blade bulldozers; 10-ft to 12-ft bull-graders; 4-to 5-cu yd 2-wheel carryall scrapers; 6-to 7-cu yd 4-wheel carryall scrapers; 2-to 3-cu yd rollover scrapers; 10-ft to 12-ft blade graders; 3-tooth medium cut rippers; 4-to 5-ton tractor-mounted cranes; towing winches capable of 17,000 lb pull at 100 fpm; oil-field winches capable of 60,000 lb line pull at 30 fpm; 8-to 9-cu yd dump wagons; 9-ft to 10-ft swath medium-cut snow plows; 10-ft blade terracers; pipe booms, capable of 10,000 lb at 8-ft over-hand; rollers; 4-bottom gang plows; disc and spike toothed harrows.

**DESCRIPTION:** This machine is diesel-powered with electric starter and front and rear lights. It is mounted on crawler treads, equipped with radiator and crankcase guards, front-pull hooks and rear draw bar, muffler, heavy-duty track roller guards, front idlers and sprocket shields, and power take-off. When furnished as an allowance list item a bulldozer is mounted on each of this class tractor with a single drum winch on 1 of every 5 and a double drum cable control on 4 of every 5.

**OPERATION:** One-man operation.

**SUPPLIES REQUIRED:** The following quantities of fuel and lubricants are estimated to be required for operating the equipment 1,000 hours under severe conditions at the atmospheric temperature ranges shown:

	32°F and lower	32°F to 70°F	70°F and higher
<b>Fuel -</b>			
Diesel oil, 50 centane gals	4500	4500	4500
<b>Greases -</b>			
General purpose 14L9 No. 1 (chassis) lb	100	100	100
Water Pump 14L11 lb	1	1	1
Wire rope chain and open gear VV-L-751	10	10	10
<b>Oils</b>			
Gear, VV-L-761 (SAE 80) (Hypoid) gal	15		
Gear, VV-L-761 (SAE 90) (Hypoid) "	10	25	25
Motor 9110 (SAE 10) gal	110		
" 9250 ( " 30) "		110	
" 9500 ( " 50) "			110

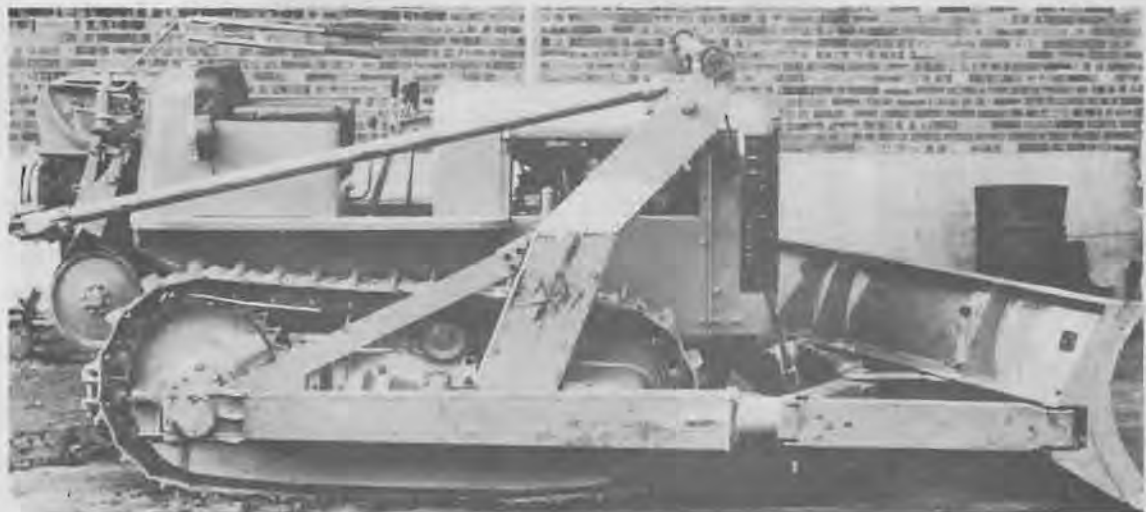

AUXILIARY EQUIPMENT SUPPLIED: Spare parts estimated to keep machine in operation one year are included. Manual of instruction for operation and maintenance furnished, together with a spare parts list.

SHIPPING INFORMATION: Shipped bundled for export.	Weight: lb	Cube: cu ft
Tractor	16,000	500
Bulldozer	5,700	180
Double drum cable control	1,500	40
Single drum winch	1,500	40

ORDERING INSTRUCTIONS: When ordering this item state what accessory items are required.

## TRACTOR, CRAWLER TYPE, CLASS-2

65 TO 86 HP, STOCK NO. 7A72

**APPLICATION:** This class of tractor draws the light heavy push-and-pull assignments and is furnished on all bases.

**CAPACITY:** This class of tractor operates 9-ft to 9-ft blade bulldozers; 11-ft to 12-ft blade bullgraders; 7-to 9-cu yd 2-wheel carryall scrapers; 9-to 10-cu yd 4-wheel carryall scrapers; 3-to 4-cu yd rollover scrapers; 12-to 14-ft blade graders; 3-tooth heavy cut rippers; 42-to 48-in. engine powered elevating graders; 6-to 7-ton tractor-mounted cranes; towing winches capable of 23,000 lb line pull at 23 fpm; 10-to 13-cu yd dump wagons; 10-ft swath heavy-cut snow plows; pipe line booms handling 13,000 lb at 8 ft overhand; 4-bottom gang plows; and disc and spike harrows.

**DESCRIPTION:** This machine is diesel engine powered with electric starter and front and rear lights. It is mounted on crawler treads, equipped with crankcase and radiator guards, front-pull hook and rear draw bar, muffler, heavy duty track roller guards, front idler and sprocket shields, and power take-off. In addition a bulldozer and double drum cable control are mounted on each tractor of this class.

**OPERATION:** One-man operation.

**SUPPLIES REQUIRED:** The following quantities of fuel and lubricants are estimated to be required for operating the equipment 1,000 hours under severe conditions at the atmospheric temperature ranges shown:

	32°F and lower	32°F to 70°F	70°F and higher
<b>Fuel -</b>			
Diesel oil, 50 centane gals	6000	6000	6000
<b>Greases -</b>			
General purpose 14L9 No. 1 (chassis) lb	150	150	150
Water Pump 14L11 lb	1	1	1
Wire rope chain and open gear VV-L-751 lb	15	15	15
<b>Oils -</b>			
Gear, VV-L-761 (SAE 80) (Hypoid) gal	25		

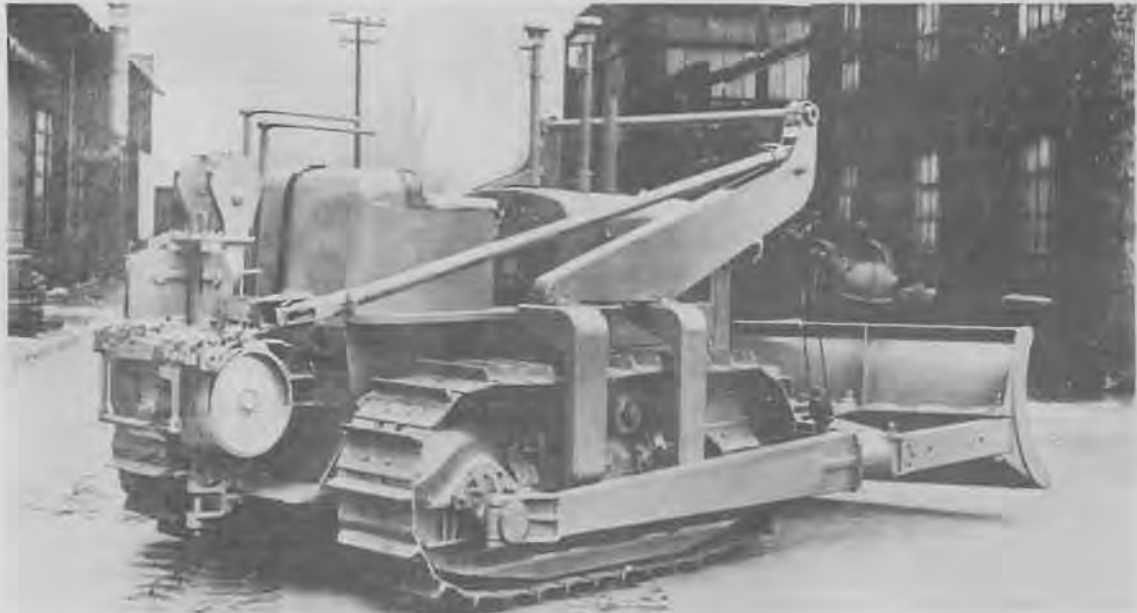



Oils (cont'd)

	32°F and 32°F to 70°F and		
	lower	70°F	higher
Gear, VV-L-761 (SAE 90) (Hypoid) gal	15	40	40
Motor 9110 (SAE 10) gal	165		
" 9250 { " 30 } "		165	
" 9500 { " 50 } "			165

AUXILIARY EQUIPMENT SUPPLIED: Spare parts estimated to keep machine in operation one year are included. Manual of instruction for operation and maintenance furnished together with a spare parts list.

SHIPPING INFORMATION: Shipped bundled for export	Weight: lb	Cube: cu ft
Tractor	24,000	800
Bulldozer	7,000	400
Double drum cable control	2,000	45

## TRACTOR, CRAWLER TYPE, CLASS-1

87 HP AND OVER, STOCK NO. 7A72

**APPLICATION:** This class of tractor is suited to the heavy assignments of push-and-pull tractor work and is furnished on all bases.

**CAPACITY:** This class tractor operates 47-in. x 10-ft blade bulldozers; 36-in. x 13-ft blade bullgraders; 7-to 9-cu yd 2-wheel carryall scrapers; 10-to 15 cu yd 4-wheel carryall scrapers alone and 15-to 33-cu yd carryall scrapers with pusher; 3-to 4-cu yd rollover scrapers; 12-ft to 14-ft heavy cut towed blade graders; 3-and 5-tooth heavy cut (29-in. x 86-in) rippers; 48-in. engine-driven elevating graders; 6-to 10-ton tractor-mounted cranes; 20-ton 2-wheel towed cranes; towing winches developing 43,000 lb line pull at 100 fpm; oil-field winches; 13-to 18 cu yd dump wagons; 11-ft swath heavy-cut snow plows; pipe booms capable of 16,000 lb at 8-ft overhang; 1-1/8-in. cable logging arches; gang plows; and disc and toothed harrows.

**DESCRIPTION:** This machine is diesel engine powered with electric starter and is mounted on crawler treads and is equipped with front and rear lights, crank case and radiator guards, front-pull hooks, muffler, heavy-duty track roller guards, front idler and sprocket shields and rear draw-bar and power take-off. When furnished as an allowance list item each tractor is equipped with a bulldozer, 3 of every 4 are equipped with a double drum cable control and 1 of every 4 is equipped with a single drum winch.

**OPERATION:** One-man operation.

**SUPPLIES REQUIRED:** The following quantities of fuel and lubricants are estimated to be required for operating the equipment 1,000 hours under severe conditions at the atmospheric temperature ranges shown:

	32°F and lower	32°F to 70°F	70°F and higher
Fuel - Diesel oil, 50 centane, gals	6500	6500	6500

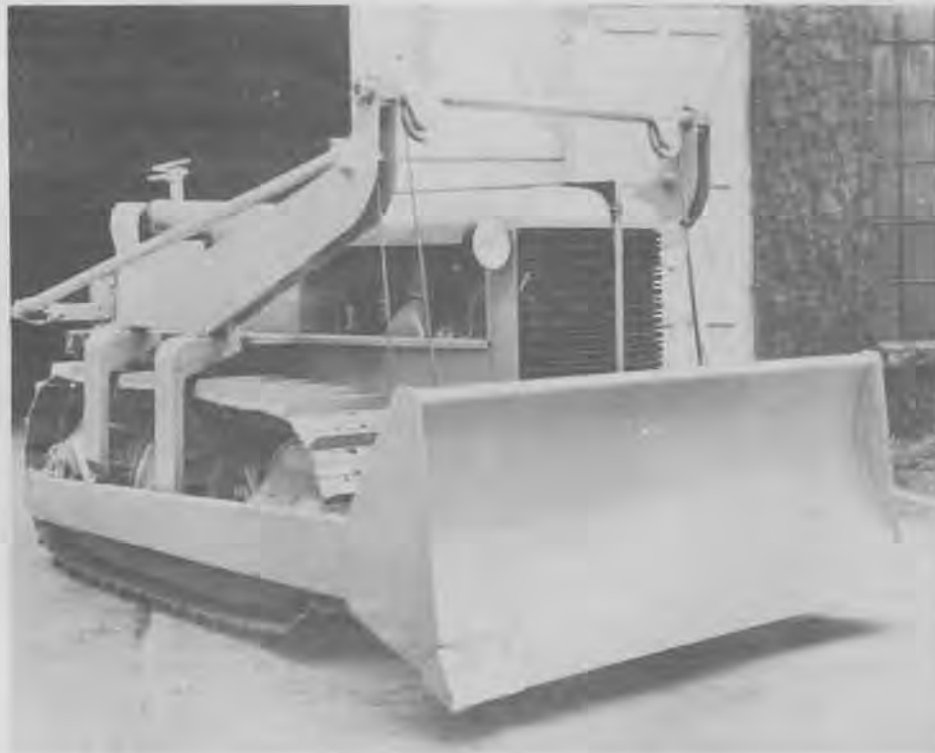

32°F and 32°F to 70°F and  
lower 70°F higher

Greases -

General purpose 14L9 No. 1 (chassis) lb	200	200	200
Water Pump 14L11 lb	1	1	1
Wire rope chain and open gear VV-L-751 lb	20	20	20

Oils -

Gear, VV-L-761 (SAE 80) (Hypoid) gal	30		
Gear, VV-L-761 (SAE 90) (Hypoid) "	20	50	50
Motor 9110 (SAE 10) gal	220		
" 9250 ( " 30) "		220	
" 9500 ( " 50) "			220

AUXILIARY EQUIPMENT SUPPLIED: Spare parts estimated to keep machine in operation one year are included. Manual of instruction for operation and maintenance furnished, together with a spare parts list.

SHIPPING INFORMATION: Shipped bundled for export.

	Weight: lb	Cube: cu ft
Tractor	35,000	1,100
Bulldozer	8,700	340
Double drum cable control	2,200	70
Single drum winch	3,000	60

ORDERING INSTRUCTIONS: When ordering this item state what accessory items are required.

## CRANE, BARGE MOUNTING, 10 TON

WITH 3/4 CU YD CLAMSHELL BUCKET CONVERSION

**APPLICATION:** Regularly mounted on 4 x 7 pontoon barge as a part of the pontoon floating dry-dock assembly, this crane is mountable on any four or six-wide pontoon barge having a length of 7 pontoons or greater. It is used for any lifts along the waterfront, for dredging with a 3/4-cu yd clamshell bucket or mounted on a 4 x 12 pontoon barge and with pile driving leads as a floating pile driving rig.

**CAPACITY:** Varies from 10-ton lifts at 12-ft radius to 3 tons at 45-ft radius.

**DESCRIPTION:** This is a 10-ton crane, with a barge mounting in place of the crawler tracks, equipped with a 3-piece 50-ft boom and 10-ton single sheave hook block and including a 3/4-cu yd steel clamshell bucket and all attachments for its use with cable sufficient to operate the bucket 30 ft below the water level. The unit is powered by a gasoline or diesel engine according to make supplied, with starter and a separate gas engine driven 1500-w light plant all housed in a fully enclosed cab with steel box containing tools and spare parts estimated to maintain the unit during a year's operation. The complete lighting system includes cab lights, trouble light and cab-mounted as well as boom-mounted flood lights for night use. The barge-mounting is shown on Y&D dwg. no. 143,055.

**OPERATION:** One-man operation.

**SUPPLIES REQUIRED:** The following quantities of fuel and lubricants are estimated to be required for operating the equipment 1,000 hours under severe conditions at the atmospheric temperature ranges shown:

		32°F and lower	32°F to 70°F	70°F and higher
Fuel -	Unleaded gasoline, 65 octane, gals	6000	6000	6000
	Diesel oil, 50 centane, gals	4200	4200	4200
		} either		

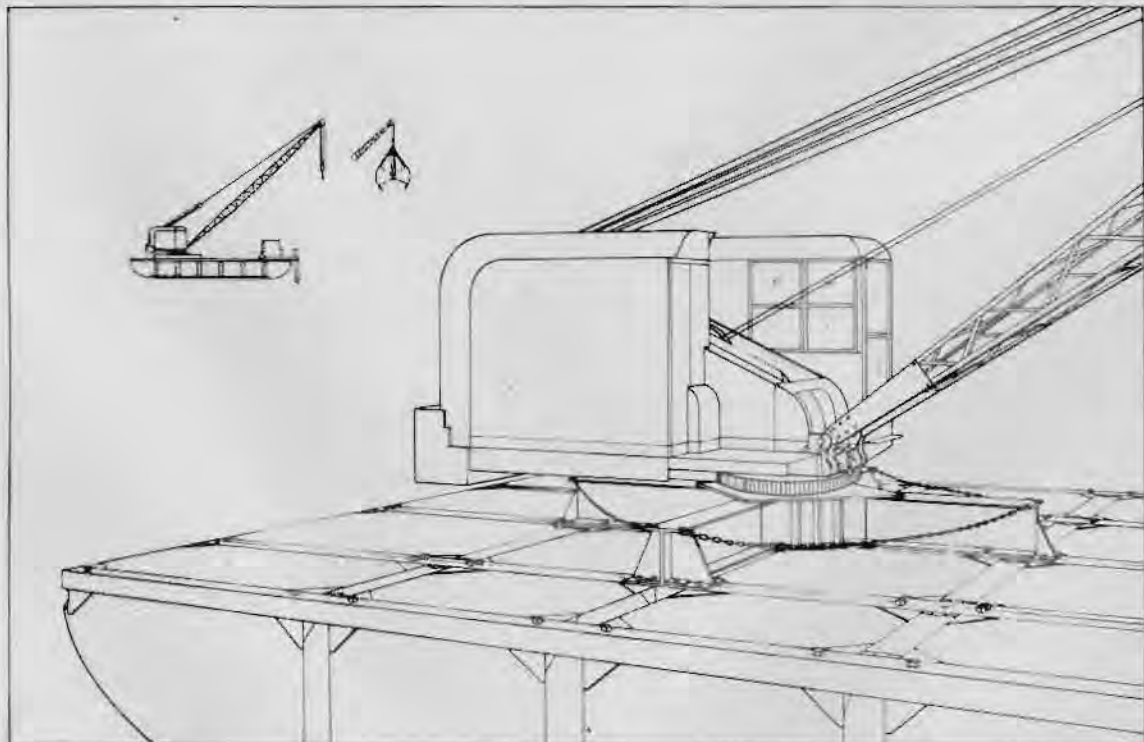

32°F and 32°F to 70°F and  
 lower 70°F higher

**Greases -**

Ball and roller bearing 14L3b grade			
No. 11 lb	200	200	200
Water Pump 14L11 lb	1	1	1
Wire rope chain and open gear VV-L-751 lb	200	200	200

**Oils -**

Gear, VV-L-761 (SAE 90) (Hypoid) gal	15	15	15
Motor 9110 (SAE 10) gal	120		
" 9250 ( " 30) "		132	132
" 9500 ( " 50) "			8

**AUXILIARY EQUIPMENT SUPPLIED:** 3/4-cu yd clamshell bucket and all attachments for its use, extra single sheave block for whip line, barge mounting and all attachments, tools and spare parts. Manual of instruction for operation and maintenance furnished, together with a spare parts list.

**AUXILIARY EQUIPMENT NOT SUPPLIED:** Barge

**SHIPPING INFORMATION:** Skidded for export, boom disassembled and small parts boxed.  
 Weight: 35,000 lb                      Cube: 1,650 cu ft

## CRANE, CARGO, 5-TON

TRACTOR MOUNTED, STOCK NO. 7L55

**APPLICATION:** This is a mobile unit designed for lifting and lugging under its own power. It is procured for use in handling cargoes at docks, yards, terminals and warehouses.

**CAPACITY:** The crane has capacity for a 5 ton lift 3 ft ahead of the bumper and this ranges downward to 1 1/2 tons at a point 9 ft ahead of the bumper. The boom working height is adjustable up to 17 ft and its working reach from 3 to 9 ft ahead of front bumper. The tractor motor develops 40 hp at 1450 rpm, and the tractor has a turning radius of 13 ft in either direction.

**DESCRIPTION:** The unit consists of the lifting crane mounted on a solid-tired-wheel tractor with lifting drum powered from tractor motor, a protective screen over the operator's seat, a manually operated cable drum hoist for adjusting the height of the boom-supporting mast, counterweights at the rear end and a large plate bumper at the front for pushing. Adjustment of height and reach of boom is accomplished in two ways: by changing the position of the heel pin in the eight positions provided for it over a range of 4 ft; and by elevating the telescoping mast, both being done manually before lifting the load. The overall dimensions of the unit with boom lowered and drawn-in are length 17 ft 6 in., width 5 ft 6 in., and height 7 ft, and its service weight is 16,000 lb.

**OPERATION:** One operator handles all controls for the lifting hoist and for the movement and direction of the tractor.

**SUPPLIES REQUIRED:** The following quantities of fuel and lubricants are estimated to be required for operating the equipment 1,000 hours under severe conditions at the atmospheric



temperature ranges shown:

	32°F and lower	32°F to 70°F	70°F and higher
Fuel - Unleaded gasoline, 65 octane, gals	4000	4000	4000
Greases -			
General purpose 14L9 No. 1 (chassis) lb	30	30	
General purpose 14L10 No. 2 (wheel bearing) lb	10	10	40
Water Pump 14L11 lb	1	1	1
Wire rope chain and open gear VV-L-751 lb	5	5	5
Oils -			
Gear, VV-L-761 (SAE 80) (Hypoid) gal	30		
Gear, VV-L-761 (SAE 90) (Hypoid) "		30	30
Motor 9110 (SAE 10) gal	60		
" 9250 ( " 30) "		60	
" 9500 ( " 50) "			60

AUXILIARY EQUIPMENT SUPPLIED: Spare parts estimated to be required during a year's operation are included, as well as manuals covering the operation and maintenance of the machine.

SHIPPING INFORMATION: Boxed for export.  
Weight: 17,600 lb                      Cube: 600 cu ft

## CRANE, CARGO, 5-TON

WHIRLER, TRACTOR MOUNTED, STOCK NO. 7L55

**APPLICATION:** For lifting, loading, unloading and lugging cargo at docks, yards, warehouses and terminals.

**CAPACITY:** The unit has a lifting capacity of 5 tons at 3 feet ahead of the front bumper which ranges downward to 2 tons at 18 ft radius. It swings 4 tons in a full circle at 6 ft radius and 1 ton at 15 ft radius. It travels at tractor speeds 2 to 10 mph, is powered by a 57-hp water-cooled gasoline engine, and has a turning radius of 16 ft.

**DESCRIPTION:** This unit consists of the crane mounted on an industrial tractor which travels on solid-rubber-tired wheels. The crane will revolve 180 deg in either direction on its mounting, all its power being derived from the tractor engine. All controls are conveniently grouped close to the operator's seat and they are so arranged that the load may be lifted and the boom luffed and swung either independently or simultaneously. Loads of 2 tons may be handled with a single line, 4 tons with a two-part line and 5 tons with a three-part line.

**OPERATION:** The tractor operator handles all crane controls.

**SUPPLIES REQUIRED:** The following quantities of fuel and lubricants are estimated to be required for operating the equipment 1,000 hours under severe conditions at the atmospheric





temperature ranges shown:

	32°F and lower	32°F to 70°F	70°F and higher
Fuel - Unleaded gasoline, 65 octane, gals	4000	4000	4000
Greases -			
General purpose 14L9 No. 1 (chassis) lb	30	30	
General purpose 14L10 No. 2 (wheel bearing) lb	10	10	40
Water Pump 14L11 lb	1	1	1
Wire rope, chain and open gear VV-L-751 lb	5	5	5
Oils -			
Gear, VV-L-761 (SAE 80) (Hypoid) gal	30		
Gear, VV-L-761 (SAE 90) (Hypoid) "		30	30
Motor 9110 (SAE 10) gal	60		
" 9250 ( " 30) "		60	
" 9500 ( " 50) "			60

AUXILIARY EQUIPMENT SUPPLIED: Spare parts estimated to be required during a year's operation, together with manuals of instruction for the operation and maintenance of the machine, are included.

SHIPPING INFORMATION: Boxed for export  
 Weight: 20,100 lb    Cube: 1200 cu ft

## CRANE, CARGO, 10-TON

WHIRLER, WHEEL-MOUNTED, STOCK NO. 7L55-422

**APPLICATION:** This is a mobile full revolving crane designed for industrial use and procured for handling cargo at docks, warehouses, yards and terminals.

**CAPACITY:** This crane will lift and swing 10 tons in a complete circle with the boom elevated so that the load is 6 ft in front of the bumpers and 1 ton at 21 feet in front of the bumpers. The length of boom may be varied from a maximum of 20 ft to a minimum of 14 ft. The crane will travel in 4 speeds forward and 1 reverse, while for the lifting, luffing and revolving or swinging operations there are 2 speeds available. It will swing at a rate of from 2 to 4 rpm, hoist at from 17 to 40 fpm hook travel and travel at speeds varying from 1 to 8 mph. The crane is powered by a 49-hp gasoline engine.

**DESCRIPTION (Pertinent dimensions, weight, mounting):** The unit is a modification of the Whirler crane design without cab and is mounted on chain-driven solid rubber tired wheels for mobility. It is not as maneuverable as the tractor-mounted cargo cranes having larger turning radii, but it handles a greater load and may swing, hoist and luff, or travel, hoist and luff under power simultaneously. Its overall dimensions without the boom are length 11 ft, width 7 ft 8 in. and height 9 ft 2 in. It has a tail swing of 4 ft 2 in. and a service weight of 26,500 lb.

**OPERATION:** One-man operated. All controls are conveniently grouped at operator's seat.



**SUPPLIES REQUIRED:** The following quantities of fuel and lubricants are estimated to be required for operating the equipment 1,000 hours under severe conditions at the atmospheric temperature ranges shown:

	32°F and lower	32°F to 70°F	70°F and higher
<b>Fuel -</b>			
Unleaded gasoline, 65 octane, gals	5000	5000	5000
<b>Greases -</b>			
General purpose 14L9 No. 1 (chassis) lb	100	100	100
General purpose 14L10 No. 2 (wheel bearing) lb	100	100	100
Ball and roller bearing 14L3b grade			
No. 11 lb	100	100	100
Water Pump 14L11 lb	1	1	1
Wire rope chain and open gear VV-L-751 lb	100	100	100
<b>Oils -</b>			
Gear, VV-L-761 (SAE 90) (Hypoid) gal	15	15	15
Motor 9110 (SAE 10) gal	120		
" 9250 ( " 30) "		132	132
" 9500 ( " 50) "			8

**AUXILIARY EQUIPMENT SUPPLIED:** Spare parts estimated to be required during a year's operation are included, as well as manuals of instruction for the assembly, operation and maintenance of the machine.

**SHIPPING INFORMATION:** Boxed for export in 3 boxes. Readily assembled by inexperienced men.

Weight: 28100 lb                      Cube: 650 cu ft

## CRANE, CRAWLER. 5-TON

WITH 1/2-CU YD DRAGLINE CONVERSION, STOCK NO. 7L55

**APPLICATION:** This machine is furnished for material handling both in connection with construction and maintenance work as well as cargo handling for loading and unloading and also for dragline excavation with the dragline conversion. A mounting is available for this size crane on a 4 x 7 pontoon barge to convert it into a floating crane.

**CAPACITY:** Equipped with a 30 ft boom the crane is capable of a 5-ton lift at 10-ft operating radius and a 1-ton lift at 30-ft operation radius on firm ground. As a dragline it operates a 1/2 cu yd bucket within an operating radius of 30 ft. Travel speed on crawler treads varies between 1 and 2 mph.

**DESCRIPTION:** The machine is powered by a gasoline or diesel engine of approximately 50 hp, depending upon make furnished, has a starting system, a fuel tank capacity of 40 gallons and a fully enclosed cab with removable panels for access and operation. A separate 1500-watt, 110 - 120 v a-c gasoline engine driven lighting plant supplies current to interior cab and trouble lights and to exterior boom mounted and exterior front and rear cab mounted flood lights. The machine has a working weight of 25,000 lb and exerts a ground pressure through caterpillar treads of 8 psi. Equipment includes a 1/2-cu yd dragline bucket and all attachments for rigging it.

**OPERATION:** One-man operation.

**SUPPLIES REQUIRED:** The following quantities of fuel and lubricants are estimated to be required for operating the equipment 1,000 hours under severe conditions at the atmospheric temperature ranges shown:

Fuel -		32°F and lower			32°F to 70°F			70°F to 70°F and higher		
Unleaded gasoline, 65 octane, gals	} either	(5400	5400	5400	(3800	3800	3800	(5400	5400	5400
Diesel oil, 50 centane gals										



32°F and 32°F to 70°F and  
lower 70°F higher

**Greases -**

General purpose 14L9 No. 1 (chassis) lb	100	100	100
General purpose 14L10 No. 2 (wheel bearing) lb	100	100	100
Ball and roller bearing 14L3b grade			
No. 11 lb	100	100	100
Water Pump 14L11 lb	1	1	1
Wire rope chain and open gear VV-L-751 lb	100	100	100

**Oils -**

Gear, VV-L-761 (SAE 90) (Hypoid) gal	15	15	15
Motor 9110 (SAE 10) gal	120		
" 9250 { " 30 } "		132	132
" 9500 { " 50 } "			8

**AUXILIARY EQUIPMENT SUPPLIED:** Spare parts are included, estimated to keep machine operating one year, as well as hand tools necessary for the ordinary adjustments of operation. Manual of instruction for operation and maintenance furnished, together with a spare parts list.

**SHIPPING INFORMATION:** Shipped bundled for export  
Weight: 28,500 lb                      Cube: 1000 cu ft

## CRANE, CRAWLER, 5-TON

WITH 1/2-CU YD CLAMSHELL CONVERSION, STOCK NO. 7L55

**APPLICATION:** This machine is furnished for material handling both in connection with construction and maintenance work, but also for handling cargo during loading and unloading. A mounting is available for using this size crane on a 4 x 7 pontoon barge as a floating rig for lifts or clamshell bucket work.

**CAPACITY:** Equipped with a 30-ft boom this crane is capable of a 5-ton lift at 10-ft operating radius and a 1-ton lift at 30-ft operating radius on firm ground. As a clamshell it handles a 1/2-cu yd clamshell bucket between a 10-ft and a 30-ft radius and for barge mountings has cable long enough to operate the bucket 30 ft below the surface of the water. Travel speeds range between 1 to 2 mph.

**DESCRIPTION:** The machine is powered by a gasoline or diesel engine of approximately 50 hp depending upon the make supplied, has a starting system, a fuel tank capacity of 40 gallons and a fully enclosed cab with removable panels for access and operation. A separate 1500 w, 110-120 v ac gasoline engine driven lighting plant supplies current to interior fixed and trouble lights and to exterior boom mounted and exterior front and rear cab mounted flood lights. Machine has a working weight of 25,000 lb and exerts a ground pressure through caterpillar treads of 8.0 lb per sq in. Equipment includes a 1/2-cu yd clamshell bucket and all attachments necessary for rigging it.

**OPERATION:** One-man operation but requires periodic lubrication and refueling.

**SUPPLIES REQUIRED:** The following quantities of fuel and lubricants are estimated to be required for operating the equipment 1,000 hours under severe conditions at the atmospheric temperature ranges shown:

Fuel -	32°F and lower			32°F to 70°F			70°F to 70°F and higher		
	Unleaded gasoline, 65 octane, gals	Diesel Oil, 50 centane, gals	either	Unleaded gasoline, 65 octane, gals	Diesel Oil, 50 centane, gals	either	Unleaded gasoline, 65 octane, gals	Diesel Oil, 50 centane, gals	either
	(5400	5400	5400	(3800	3800	3800	(3800	3800	3800



32°F and lower      32°F to 70°F      70°F and higher

	32°F and lower	32°F to 70°F	70°F and higher
<b>Greases -</b>			
General purpose 14L9 No. 1 (chassis) lb	100	100	100
General purpose 14L10 No. 2 (wheel bearing) lb	100	100	100
Ball and roller bearing 14L3b grade			
No. 11 lb	100	100	100
Water Pump 14L11 lb	1	1	1
Wire rope, chain and open gear VV-L-751 lb	100	100	100
<b>Oils -</b>			
Gear, VV-L-761 (SAE 90) (Hypoid) gal	15	15	15
Motor 9110 (SAE 10) gal	120		
"    9250 ( " 30) "		132	132
"    9500 ( " 50) "			8

**AUXILIARY EQUIPMENT SUPPLIED:** Spare parts are included estimated to keep machine operating one year as well as hand tools necessary for the ordinary adjustments of operation. Manual of instruction for operation and maintenance furnished, together with a spare parts list.

**SHIPPING INFORMATION:** Shipped bundled for export  
 Weight: 28,500 lb      Cube: 1000 cu ft

## CRANE, CRAWLER, 3/4 CU YD OR 10 TON

WITH SHOVEL, CLAMSHELL, DRAGLINE, BACKHOE AND PILE DRIVER CONVERSION  
STOCK NO. 7L55

**APPLICATION:** Primarily a 3/4-cu yd power shovel, this machine is also provided with all necessary attachments for ready conversion into a crane operating with hook block, with clamshell or dragline buckets, or as a drop hammer pile driver. It is used for excavation, material handling, lifts and pile-driving work.

**CAPACITY:** It operates 3/4-cu yd shovel, backhoe, clamshell and dragline buckets, with boom 35 ft long. As a crane it has a capacity of 7 to 13 tons at 12-ft radius which ranges down to 1 1/2 tons at 35 ft radius. Provided with 38-ft piledriver leads and drop hammer, it can set and drive piles 36 ft long when driving point is at level of crawler treads. Longer piles may be handled by means of a longer boom or by raising the machine.

**DESCRIPTION:** The machine is readily converted from one tool to the other in the field or equipment yard and all attachments for these conversions are included with it. It is powered by a 70 hp gasoline engine and equipped with removable panel type steel and safety-glass cab. Interior cab lights, trouble lights and exterior cab and boom-mounted floodlights are installed and are powered from an engine mounted generator. Pile driving equipment includes a 2,000-lb drop hammer and 800-lb follower.

**OPERATION:** One-man operated.

**SUPPLIES REQUIRED:** The following quantities of fuel and lubricants are estimated to be required for operating the equipment 1,000 hours under severe conditions at the atmospheric temperature ranges shown:

	32°F and lower	32°F to 70°F	70°F and higher
<b>Fuel -</b> Unleaded gasoline, 65 octane, gals	7000	7000	7000
<b>Greases -</b> Ball and roller bearing 14L3b grade No. 11 lb	250	250	250

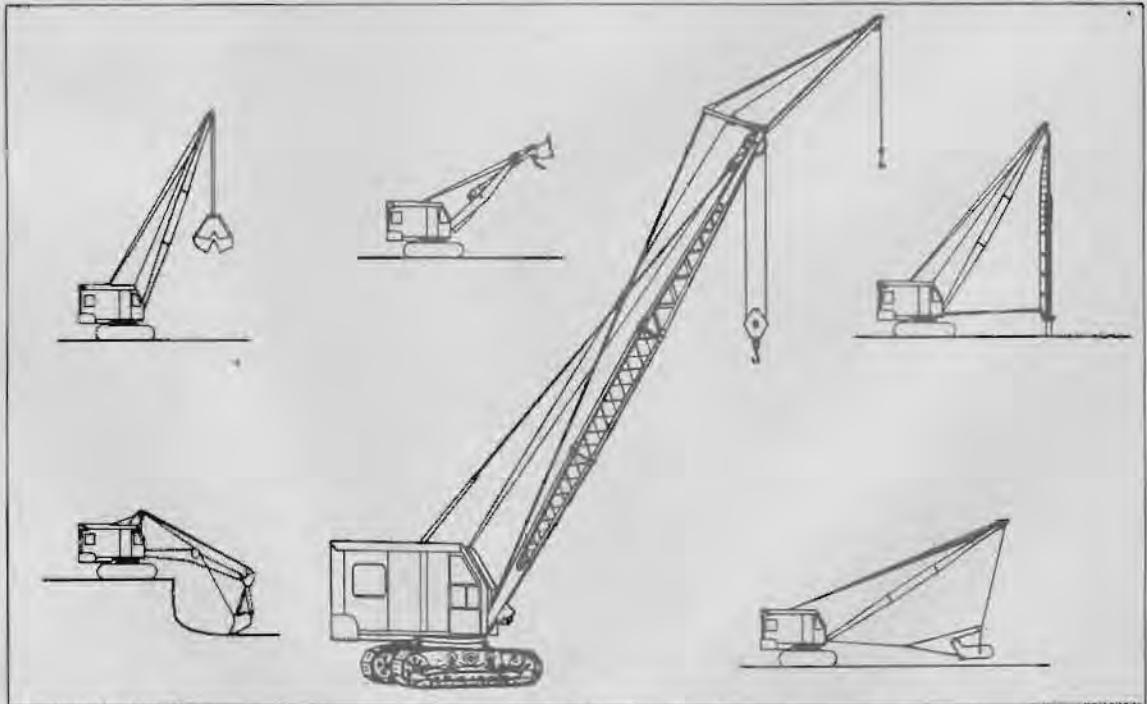



## Greases (cont'd)

32°F and 32°F to 70°F and  
lower 70°F higher

Water Pump 14L11 lb	1	1	1
Wire rope chain and open gears VV-L-751 lb	250	250	250

## Oils -

Gear, VV-L-761 (SAE 90) (Hypoid) gal	15	15	15
Motor 9110 (SAE 10) gal	120		
" 9250 ( " 30) "		132	132
" 9500 ( " 50) "			8

AUXILIARY EQUIPMENT SUPPLIED: Spare parts estimated to maintain operation one year are included. Manual of instruction for operation and maintenance furnished, together with a spare parts list.

## SHIPPING INFORMATION: Shipped bundled and boxed for export.

	Stock No.	Weight: lb	Cube: cu ft
Shovel, cab & chassis	7L55	41,000	1,520
Crane boom and hookblock, 40 ft	7L55	2,300	240
Crane boom jib, 10 ft with stays	7L55	500	10
Clamshell bucket	7L55	3,100	100
Dragline bucket and fairlead	7L55	2,100	70
Pile driving leads	7L55	2,800	170
Pile driving hammer and follower	7L55	3,000	20
Backhoe	7L55	5,500	350

## CRANE, CRAWLER, 1 1/2 CY OR 25 TON

WITH SHOVEL AND DRAGLINE CONVERSION STOCK NO. 7L55

**APPLICATION:** Primarily a 1 1/2-cu yd power shovel, this machine is also provided with all attachments for ready conversion into a crane operating with hook block or dragline bucket and is used for excavating, material handling and miscellaneous lifting.

**CAPACITY:** It operates 1 1/2-cu yd shovel and dragline buckets and has a crane boom 50 ft long. As a crane it has a capacity 23 to 30 tons at 12-ft radius which ranges down to 3 1/2 tons at 50-ft radius.

**DESCRIPTION:** The machine is readily converted from one tool to the other in the field or equipment yard and all attachments for these conversions are included with it. It is powered by a 130-hp gasoline or diesel engine and equipped with removable panel-type steel and safety-glass cab. Interior cab lights, trouble lights and exterior cab and boom-mounted flood lights powered by an engine mounted generator are included.

**OPERATION:** One-man operated.

**SUPPLIES REQUIRED:** The following quantities of fuel and lubricants are estimated to be required for operating the equipment 1,000 hours under severe conditions at the atmospheric temperature ranges shown:

			32°F and lower	32°F to 70°F	70°F and higher
Fuel -	Unleaded gasoline, 65 octane, gals	} either	(13000	13000	13000
	Diesel oil, 50 centane gals		( 9000	9000	9000



32°F and lower    32°F to 70°F    70°F and higher

**Greases -**

General purpose 14L9 No. 1 (chassis) lb	200	200	200
General purpose 14L10 No. 2 (wheel bearing) lb	200	200	200
Ball and roller bearing 14L3b grade			
No. 11 lb	250	250	250
Water Pump 14L11 lb	2	2	2
Wire rope chain or open gear VV-L-751 lb	250	250	250

**Oils -**

Gear, VV-L-761 (SAE 90) (Hypoid) gal	30		
Gear, VV-L-761 (SAE 90) (Hypoid) "		30	30
Motor 9110 (SAE 10) gal	250		
" 9250 ( " 30) "		250	
" 9500 ( " 50) "			250

**AUXILIARY EQUIPMENT SUPPLIED:** Spare parts estimated to keep machine operating one year included. Manual of instruction for operation and maintenance furnished, together with a spare parts list.

**SHIPPING INFORMATION:** Shipped bundled and boxed for export.

	Stock No.	Weight: lb	Cube: cu ft
Shovel, cab & chassis	7L55	104,500	2,520
Crane boom and block, 60 ft	7L55	6,000	600
Crane boom jib, 12 ft with stays	7L55	1,000	10
Dragline bucket and fair-lead	7L55	5,200	180

## CRANE, CRAWLER, 2 1/2 CU YD, 40 TO 50 TON

WITH SHOVEL CONVERSION STOCK NO. 7L55

**APPLICATION:** Primarily a 2-to 2 1/2-cu yd power shovel, this machine is also provided with all attachments for ready conversion into crane operating with hookblock, and is used for excavating, material handling and miscellaneous lifting.

**CAPACITY:** It operates a 2-to 2 1/2-cu yd shovel and is equipped with a 60-ft standard length of boom and has a capacity of 20 to 60 tons at a 15 ft radius ranging down to 4 tons at a 60-ft radius.

**DESCRIPTION:** The machine is readily converted from one tool to the other in the field or equipment yard and all attachments for these conversions are included. It is powered by a 190-hp gasoline engine, has a removable panel-type steel and safety-glass cab and is provided with portable trouble lights, fixed interior cab lights and fixed exterior cab and boom mounted floodlights powered by an engine-mounted generator.

**OPERATION:** One-man operated.

**SUPPLIES REQUIRED:** The following quantities of fuel and lubricants are estimated to be required for operating the equipment 1,000 hours under severe conditions at the atmospheric temperature ranges shown:

	32°F and lower	32°F to 70°F	70°F and higher
Fuel -			
Unleaded gasoline, 65 octane, gals ) either	(20000	20000	20000
Diesel oil, 50 centane gals. )	(14000	14000	14000
Greases -			
General purpose 14L9 No. 1 (chassis) lb	250	250	250
General purpose 14L10 No. 2 (wheel bearing) lb	250	250	250
Ball and roller bearing 14L3b grade No. 11 lb	250	250	250

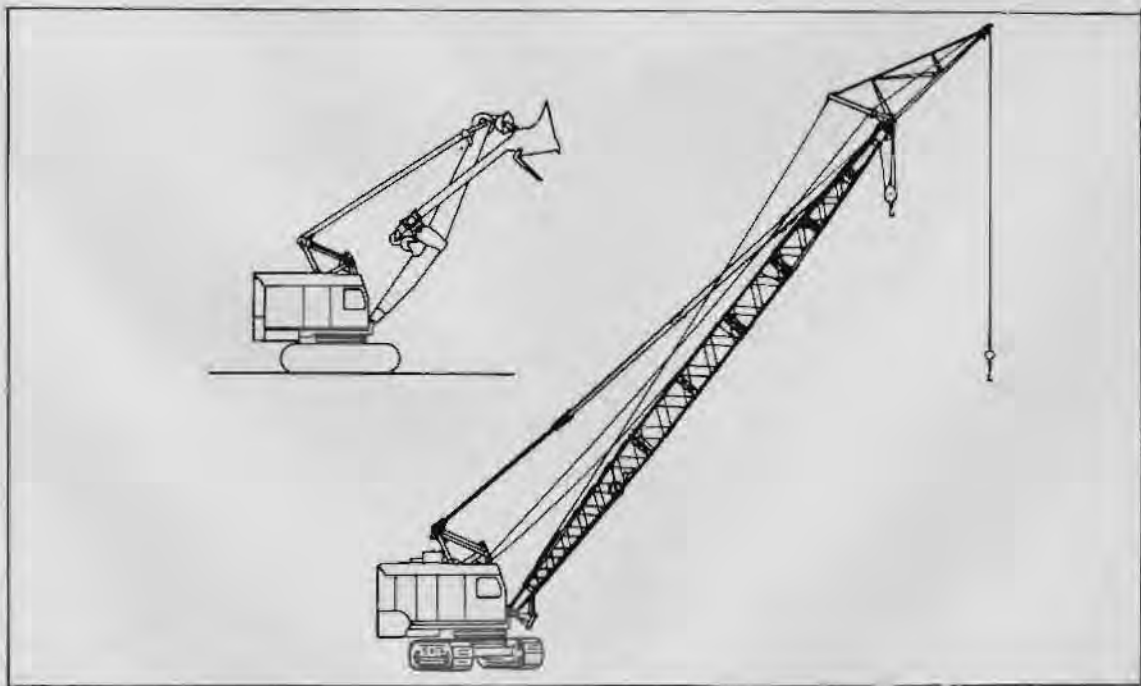

## Greases (cont'd)

32°F and lower      32°F to 70°F      70°F and higher

Water Pump 14L11 lb	2	2	2
Wire rope chain and open gears VV-L-751 lb	250	250	250

## Oils -

Gear, VV-L-761 (SAE 80) (Hypoid) gal	40		
Gear, VV-L-761 (SAE 90) (Hypoid) gal		40	40
Motor 9110 (SAE 10) gal	300		
" 9250 ( " 30) "		300	300
" 9500 ( " 50) "			20

AUXILIARY EQUIPMENT SUPPLIED: Spare parts estimated to keep machine operating one year are included.

## SHIPPING INFORMATION: Shipped bundled and boxed for export.

	Stock No.	Weight lb	Cube ft
Shovel, cab & chassis	7L55	160,500	4,200
Crane boom & hookblock, 80 ft	7L55	9,000	970
Crane boom jib with stays, 15 ft	7L55	1,200	20

## CRANE, TRACTOR DRAWN, 20 TON

STOCK NO. 7L55

**APPLICATION:** A tractor-drawn and operated crane mounted on pneumatic tires for mobility and maneuverability.

**CAPACITY:** Lifting capacity is 20 tons at 5 ft radius but for continuous operation the manufacturer recommends that loads be kept under 6 1/2 tons. The crane will reach out 16 ft with 6 1/2 tons when hooked to a class 1 tractor. This crane is operatable attached to any class track tractor but additional counterweights will be required for class 2, 3 and 4 tractors if loads in excess of 6 1/2 tons are to be handled.

**DESCRIPTION:** The crane has the following overall dimensions: height upright 23 ft, width 12 ft, and length upright 26 ft. It is attached to tractor drawbar and operated by a double-drum power-control unit having drum capacities for 250 ft of 1/2 in. wire rope. It is equipped with roller bearings and with pressure lubrication fittings.

**OPERATION:** Operated by tractor operator from tractor controls.

**SUPPLIES REQUIRED:** The following quantities of fuel and lubricants are estimated to be required for operating the equipment 1,000 hours under severe conditions at the atmospheric temperature ranges shown:

	32°F and lower	32°F to 70°F	70°F and higher
Greases -			
General purpose 14L9 No. 1 (chassis) lb	5	5	5
General purpose 14L10 No. 2 (wheel bearing) lb	10	10	10
Wire rope chain and open gear VV-L-751 lb	5	5	5

**AUXILIARY EQUIPMENT SUPPLIED:** Spare parts estimated to keep crane operating one year are included. Manual of instruction for operation and maintenance furnished, together with a spare parts list.

**AUXILIARY EQUIPMENT NEEDED BUT NOT SUPPLIED:** Tractor with double-drum power control, see capacity and description above.

**SHIPPING INFORMATION:** Bundled and boxed for export.  
Weight: 8000 lb                      Cube: 1050 cu ft



(November 1943) 660

## CRANE, TRUCK MOUNTED, 10 TON

TANDEM REAR AXLE, STOCK NO. 7L55

**APPLICATION:** This crane is furnished for lifts within its capacity when mobility at truck speeds is required.

**CAPACITY:** Essentially the mechanism of a 1/2-cu yd shovel or 5-ton crawler crane, this unit has been mounted on a heavy truck chassis equipped with telescoping outriggers which provide a heavier and broader base, thus adding considerably to the weight lifting capacity of the machine. Around a 10-ft circle it lifts 10 tons with outrigger set and 7 tons without, and this capacity ranges out to 2 tons at 40 ft with outriggers and 1 ton without.

**DESCRIPTION:** This machine is fully enclosed both as to crane and truck cabs. It has the following characteristics: weight, 34,000 lb; overall length, 24 ft without boom; width, 8 ft; height 11 ft-6 in; turning radius, 30 ft; power, gasoline engine 80 hp; electric starter; electric lighting system for truck and crane including crane, cab, and boom mounted floodlights; 10 pneumatic multiple heavy-duty tires; and, hook block and all cables included.

**OPERATION:** One operator may operate truck and crane alternately but two are required for simultaneous operation of both.

**SUPPLIES REQUIRED:** The following quantities of fuel and lubricants are estimated to be required for operating the crane 1,000 hours under severe conditions at the atmospheric temperature ranges shown:

	32°F and lower	32°F to 70°F	70°F and higher
<b>CRANE, TRUCK MTD, 10 T.</b>			
<b>Fuel -</b>			
Unleaded gasoline, 65 octane, gals	8000	8000	8000
<b>Greases -</b>			
General purpose 14L9 No. 1 (chassis) lb	100	100	100
General purpose 14L10 No. 2 (wheel bearing) lb	100	100	100
Ball and roller bearing 14L3b grade No. 11 lb	100	100	100
Water Pump 14L11 lb	1	1	1
Wire rope chain and open gears VV-L-751 lb	100	100	100
<b>Oils -</b>			
Gear, VV-L-761 (SAE 80) (Hypoid) gal	15		
Gear, VV-L-761 (SAE 90) (Hypoid) "		15	15
Motor 9110 (SAE 10) gal	120		
" 9250 ( " 30) "		132	132
" 9500 ( " 50) "			8





## TRUCKS

The following quantities of fuel and lubricants are estimated to be required for operating the truck 10,000 miles under severe conditions at the atmospheric temperature ranges shown:

	32°F and lower	32°F to 70°F	70°F and higher
<b>Fuel -</b>			
Unleaded gasoline, 65 octane, gals	2000	2000	2000
<b>Greases -</b>			
General purpose 14L9 No. 1 (chassis) lb	30	30	
General purpose 14L10 No. 2 (wheel bearing) lb	10	10	40
Water Pump 14L11 lb	1	1	1
Wire rope chain and open gear VV-L-751 lb	1	1	1
<b>Oils -</b>			
Gear, VV-L-761 (SAE 80) (Hypoid) gal	10		
Gear, VV-L-761 (SAE 90) (Hypoid) "		10	10
Motor 9110 (SAE 10) gal	30		
" 9250 ( " 30) "		30	
" 9500 ( " 50) "			30

**AUXILIARY EQUIPMENT SUPPLIED:** Spare parts estimated to anticipate a year's operation are included. Manual of instruction for operation and maintenance furnished, together with a spare parts list.

### SHIPPING INFORMATION:

Weight: 40,500 lb

Cube: 1600 cu ft

## DITCHER, CRAWLER, 24 IN. X 5 1/2 FT

STOCK NO. 6C74

**APPLICATION:** For excavating trenches within its capacity for any purpose but particularly for under ground pipe lines and air field drainage systems.

**CAPACITY:** The ditcher excavates trenches with vertical sides 24 in. wide up to 5 1/2 ft deep either holding to a straight line or following curves. Digging speeds are variable through 25 steps between 19 in. and 420 in. per minute to suit the type of soil being trenched and the depth of cut being made. All operating controls are conveniently grouped at the operators position.

**DESCRIPTION:** The machine consists of a wheel with detachable toothed buckets mounted on a boom which raises or lowers it to the proper cutting depth powered by a 63 hp heavy tractor type gasoline engine and all mounted on a pair of crawler tracks. The buckets on the revolving wheel cut the trench and raise the cuttings to a belt conveyor above which drops them well back from the side of the trench. The clutch is arranged to kick out when an immovable object is encountered by the bucket teeth. The operator's position is equipped with a saddle seat which permits easy access to all controls and a clear view of the trench line and the operating mechanisms.

**OPERATION:** A single operator operates the machine.

**SUPPLIES REQUIRED:** Fuel, Replacements for the bucket teeth as wear occurs, and the following quantities of fuel and lubricants are estimated to be required for operating the equipment 1,000 hours under severe conditions at the atmospheric temperature ranges shown:

	32°F and lower	32°F to 70°F	70°F and higher
Fuel - Unleaded gasoline, 65 octane, gals	6300	6300	6300
Greases - General purpose 14L9 No. 1 (chassis) lb	250		
General purpose 14L10 No. 2 (wheel bearing) lb		250	250

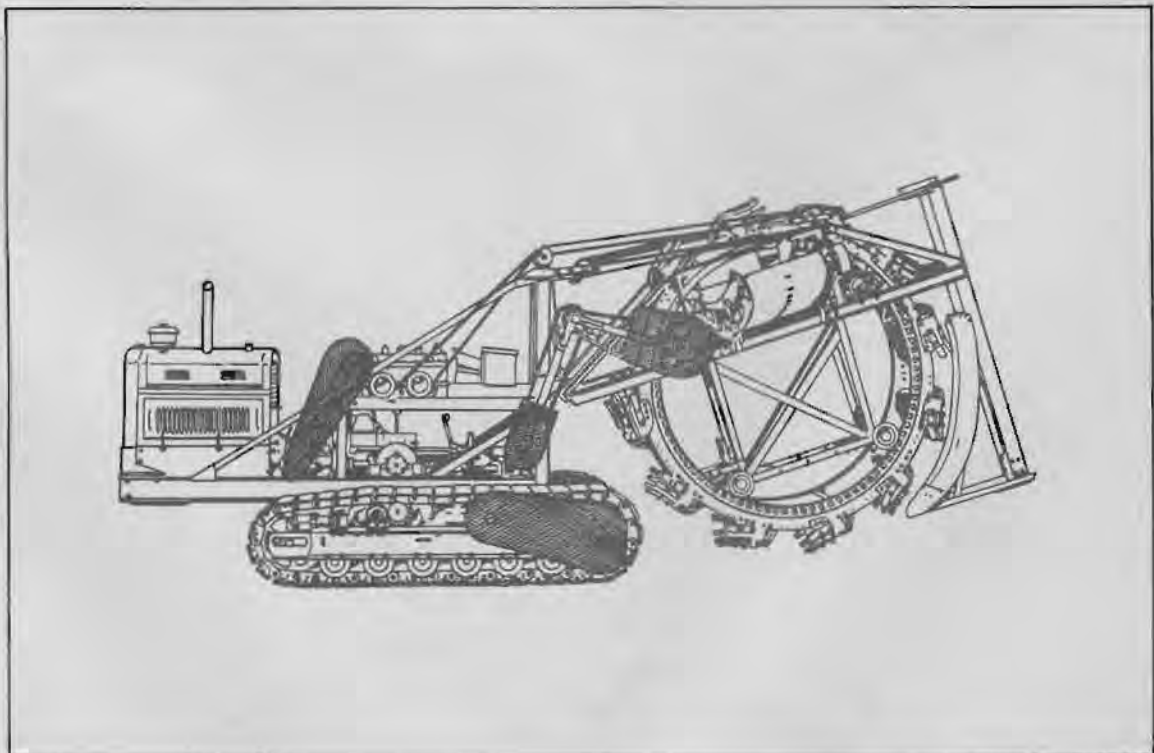

Greases (cont'd)

32°F and lower    32°F to 70°F    70°F and higher

Water Pump 14L11 lb	1	1	1
Wire rope chain and open gear VV-L-751 lb	30	30	30

Oils -

Gear, VV-L-761 (SAE 80) (Hypoid) gal	10		
Gear, VV-L-781 (SAE 90) (Hypoid) "		10	10
Motor 9110 (SAE 10) gal	60		
" 9250 ( " 30) "		60	
" 9500 ( " 50) "			60

**AUXILIARY EQUIPMENT SUPPLIED:** Spare parts estimated to be required during a year's operation are included as well as manuals of instruction for the operation, maintenance and repair of the equipment.

**SHIPPING INFORMATION:** Boxed for shipment  
 Weight lb 28,000                      Cube cu ft 1,400

## DITCHER, CRAWLER, 24 IN X 8 FT

24 IN. X 8 FT OR LESS, GAS DRIVEN, STOCK NO. 7C74

**APPLICATION:** This machine is for the excavation of trenches for pipe lines and drainage tile or for any other purpose within its capacity.

**CAPACITY:** Cuts a 24-in. wide straight sided trench any depth up to 8 ft and cuts a straight or curved trench and has travel speeds up to 2 1/2 mph.

**DESCRIPTION:** A series of buckets equipped with digging teeth mounted on an endless chain digs and elevates the spoil to a short cross-belt conveyor which in turn spills it a variable distance up to 8 ft from the trench. The machine is powered by a built-in gasoline engine which also drives the caterpillar treads on which it is mounted. All controls are carried to the operator's seat on the side away from the spoil conveyor.

**OPERATION:** One-man operation.

**SUPPLIES REQUIRED:** The following quantities of fuel and lubricants are estimated to be required for operating the equipment 1,000 hours under severe conditions at the atmospheric temperature ranges shown:

	32°F and lower	32°F to 70°F	70°F and higher
<b>Fuel -</b> Unleaded gasoline, 65 octane, gals	5000	5000	5000
<b>Greases -</b> General purpose 14L9 No. 1 (chassis) lb	250		
General purpose 14L10 No. 2 (wheel bearing) lb		250	250



32°F and 32°F to 70°F and  
lower 70°F higher

Water Pump 14L11 lb	1	1	1
Wire rope chain and open gear VV-L-751 lb	30	30	30
Oils -			
Gear, VV-L-761 (SAE 80) (Hypoid) gal	10		
Gear, VV-L-761 (SAE 90) (Hypoid) "		10	10
Motor 9110 (SAE 10) gal	60		
" 9250 ( " 30) "		60	
" 9500 ( " 50) "			60

**AUXILIARY EQUIPMENT SUPPLIED:** Spare parts estimated to keep machine in operation one year are included as well as tools necessary for operation and adjustments. Manual of instruction for operation and maintenance furnished, together with a spare parts list.

**SHIPPING INFORMATION:**

Weight: 28000 lb

Cube: 1300 cu ft



## BORER, WOOD

STOCK NO. 7Q51

**APPLICATION:** For boring holes in timbers mechanically, especially where there are a large quantity to be bored or where the timber or hole sizes are large.

**CAPACITY:** Holes 1 to 4 inches in diameter bored one at a time.

**DESCRIPTION:** The wood borer is a hand-held compressed-air-operated portable tool capable of, and equipped with bits for, boring holes 1 in. to 4 in. in diam. It weighs 41 lb, operates at 400 rpm and takes a 1/2-in. hose connection.

**OPERATION:** One man can operate this tool but for accuracy and speed a helper should also be used.

**SUPPLIES REQUIRED:** Compressed air at 90 psi. and 9110 (SAE 10) oil.

**AUXILIARY EQUIPMENT SUPPLIED:** Bits for holes ranging from 1 in. to 4 in. in diameter as well as spare parts estimated to keep tool operating one year. Manual of instruction for operation and maintenance furnished, together with a spare parts list.

**AUXILIARY EQUIPMENT NOT SUPPLIED:** Air compressors, hose, etc.

**SHIPPING INFORMATION:** Packed for export.  
Weight: 50 lb                      Cube: 3 cu ft



## BREAKER, PAVING

STOCK NO. 7Q1-5

**APPLICATION:** This is a standard size of breaker for operatingmoil points, chisels, clay spades, tampers, and sheeting hammers. It is used wherever compressed air at 80 psi is available in the proper capacity.

**CAPACITY:** It has capacity for breaking up hard surfaces such as concrete and asphalt pavements for loosening material for excavation which otherwise would require picking, for tamping backfill and for driving sheeting for excavations. It requires free air at the rate of 50 cfm for continuous operation.

**DESCRIPTION:** The net working weight of the breaker is 80 lb and the items comprising the assembly are as follows:

	Stock No.	Weight: lb	Cube: cu ft
1 - Breaker	7Q1	70	1.60
4 - Narrow chisels	7Q54-5	40	.32
1 - Wide chisel	7Q54-4	13	.14
8 - Moil points	7Q53-2	48	.56
1 - Sheathing driver, 2 in. head			
1 - Clay spade	7Q54-3	15	.86
1 - Tamping head			
4 - Lengths of 3/4 in. diam. air hose in 25 ft lengths with couplings			

**OPERATION:** One-man operation

**SUPPLIES REQUIRED:** Compressed air at 80 psi and lubricating oil 9110(SAE 10)

**AUXILIARY EQUIPMENT SUPPLIED:** Spare parts estimated to provide a year's operation are included. Manual of instruction for operation and maintenance furnished, together with a spare parts list.

**AUXILIARY EQUIPMENT NEEDED BUT NOT SUPPLIED:** Air Compressor.

**SHIPPING INFORMATION:** Boxed for export  
Weight: 500 lb      Cube: 12 cu ft

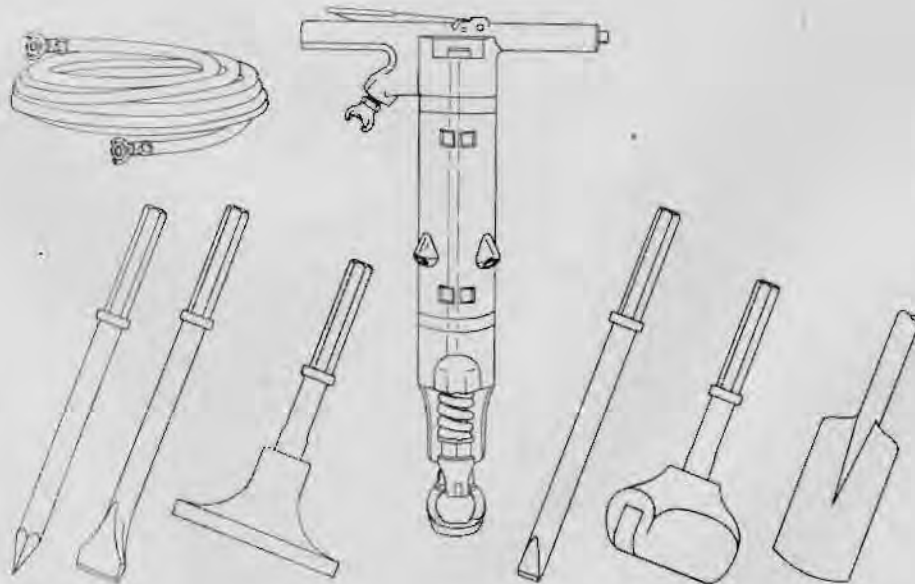

## COMPRESSOR, AIR, MOBILE, 210 CFM

GASOLINE ENGINE DRIVEN, STOCK NO. 7P1 - 33

**APPLICATION:** These machines are used to supply the compressed air for the operation of wood borers, paving breakers, rock drills, tigger hoists, saws, sump pumps, backfill tampers, impact wrenches, sheeting driving and pile driving hammers and other tools. Compressed air is widely used for the operation of construction tools because of the portability of compressors and is particularly adapted for use in and around water where the use of electricity might not be safe.

**CAPACITY:** It delivers 210 cu ft of free air per minute and operates continuously 9 backfill tampers, 3 80-lb paving breakers, 3 sheeting drivers, 2 55-lb rock drills, 1 wagon drill, 1 tigger hoist, 3 sump pumps, 3 12-in. circular saws, or 3 impact wrenches.

**DESCRIPTION:** The air-cooled compressor is operated by a direct-connected water-cooled gasoline engine and together with fuel tank, receiver and 4 way manifold is mounted on a four-steel-wheeled truck with towing tongue and enclosed in weatherproof removable housing. The assembly consists of the following items:

	Stock No.	Weight lb	Cube cu ft
1 210 cfm compressor	7P1	7000	300
1 4 way manifold	}	300	10
12 Bushings, 3/4 in. to 1/2 in. dia			
4 couplings (halves) 3/4 in. male & female			
48 coupling washers, 3/4 in.			
3 couplings, 1/2 in. (pairs)			
3 couplings, 3/4 in. (pairs)			
4 50 ft lengths of 3/4 in. hose with couplings			
1 25 ft length of 1/2 in. hose with couplings			
1 Hose clamp tool, hand tightening			
2 Line oilers (1/2 pint cap)			
12 3/4 in. dia mender inserts			

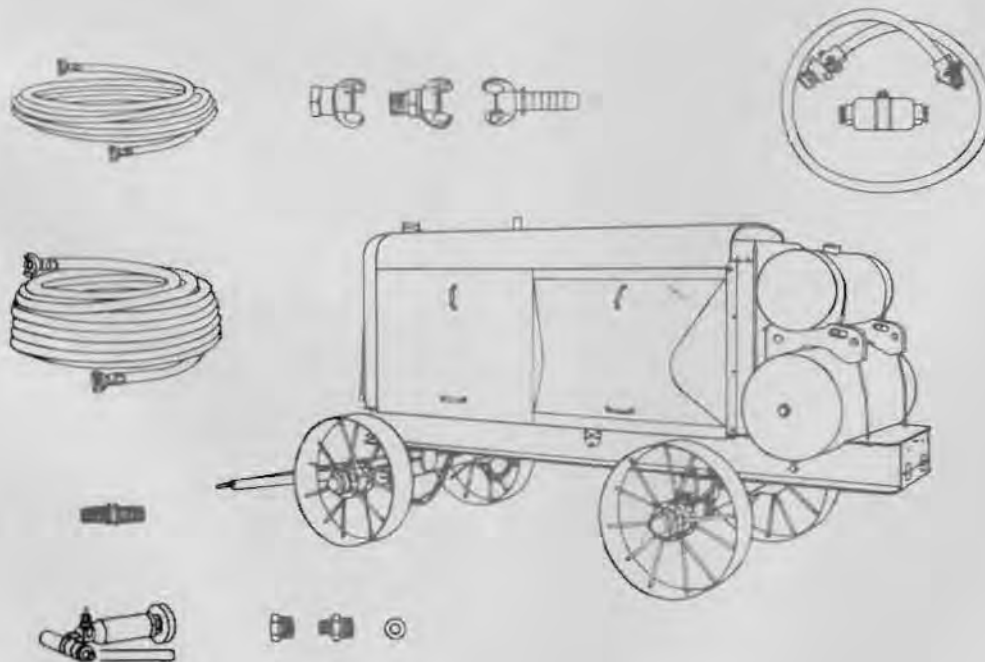



OPERATION: Requires starting, refueling and periodic maintenance, operation is continuous and is automatically controlled by the consumption of air.

SUPPLIES REQUIRED: The following quantities of fuel and lubricants are estimated to be required for operating the equipment 1,000 hours under severe conditions at the atmospheric temperature ranges shown:

	32°F and lower	32°F to 70°F	70°F and higher
Fuel -			
Unleaded gasoline, 65 octane, gals	3000	3000	3000
Greases -			
General purpose 14L9 No. 1 (chassis) lb	15	15	
General purpose 14L10 No. 2 (wheel bearing) lb	5	5	20
Water Pump 14L11 lb	1	1	1
Oils -			
Motor 9110 (SAE 10) gal	125	125	
"    9250 ( " 30) "			125

AUXILIARY EQUIPMENT SUPPLIED: Spare parts estimated to keep machine in operation one year. Manual of instruction for operation and maintenance furnished, together with a spare parts list.

AUXILIARY EQUIPMENT NEEDED BUT NOT SUPPLIED: Tools.

SHIPPING INFORMATION: Boxed for export.           Weight: 7300 lb           Cube: 310 cu ft

## COMPRESSOR, AIR, MOBILE, 315 CFM

GASOLINE ENGINE DRIVEN, STOCK NO. 7P1 -34

**APPLICATION:** These machines are used to supply the compressed air for the operation of wood borers, paving breakers, rock drills, tugger hoists, saws, sump pumps, backfill tampers, impact wrenches, sheeting driving and pile driving hammers and other tools. Compressed air is widely used for the operation of construction tools because of the portability of compressors and is particularly adapted for use in and around water where the use of electricity might not be safe.

**CAPACITY:** It delivers 315 cu ft of free air per minute and operates continuously 16 backfill tampers, 5 80-lb paving breakers, 5 sheeting drivers, 3 55-lb rock drills, 1 wagon drill, 1 tugger hoist, 4 sump pumps, 4 12-in. circular saws or 5 impact wrenches.

**DESCRIPTION:** This air cooled compressor is operated by a direct-connected water-cooled gasoline engine and, together with fuel tank receiver and 4 way manifold is mounted on a four-steel-wheeled truck with towing tongue and enclosed in weatherproof removable housing. The assembly consists of the following items:

	Stock No.	Weight: lb	Cube: cu ft
1 315 cfm compressor on 4 steel wheels	7P1	8300	350
1 4 way manifold	}	500	15
2 50 ft lengths of 1 in. dia hose with couplings			
3 50 ft lengths of 3/4 in. dia hose with couplings			
2 25 ft lengths of 1/2 in. dia hose with couplings			
4 3/4 in. dia coupling halves, male and female			
9 3/4 in. dia mender inserts			
6 1 in. dia mender inserts			
1 Hand tightening hose clamp tool			
24 1 in. dia washers			
48 3/4 in. dia washers			
2 1/2 in. dia couplings (pairs)			
2 3/4 in. dia couplings (pairs)			
2 1 in. dia couplings (pairs)			
12 Bushings 1 in. to 3/4 in. dia			
12 Bushings 3/4 in. to 1/2 in. dia			
3 Line oilers (1/2 pint capacity)			

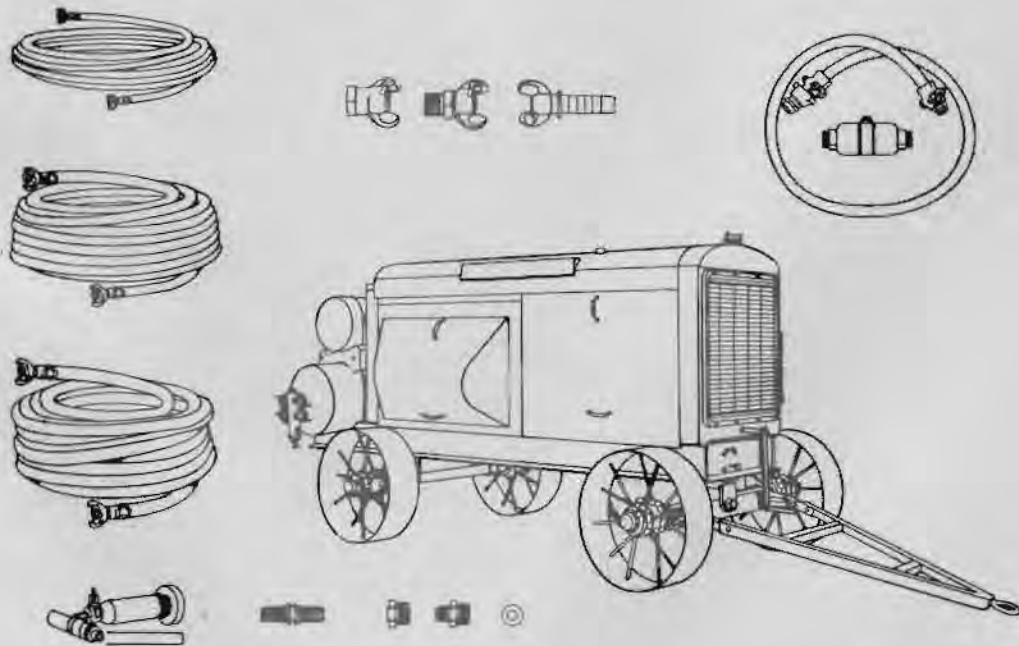

**OPERATION:** Requires starting, refueling and periodic maintenance. Operation is continuous and automatically controlled by the consumption of air.

**SUPPLIES REQUIRED:** The following quantities of fuel and lubricants are estimated to be required for operating the equipment 1,000 hours under severe conditions at the atmospheric temperature ranges shown:

	32°F and lower	32°F to 70°F	70°F and higher
<b>Fuel -</b>			
Unleaded gasoline, 65 octane, gals	7000	7000	7000
<b>Greases -</b>			
General purpose 14L9 No. 1 (chassis) lb	15	15	
General purpose 14L10 No. 2 (wheel bearing) lb	5	5	20
Water Pump 14L11 lb	1	1	1
<b>Oils -</b>			
Motor 9110 (SAE 10) gal	150	150	
"    9250 ( " 30) "			150

**AUXILIARY EQUIPMENT SUPPLIED:** Spare parts estimated to keep machine in operation one year. Manual of instruction for operation and maintenance furnished, together with a spare parts list.

**AUXILIARY EQUIPMENT NEEDED BUT NOT SUPPLIED:** Tools.

**SHIPPING INFORMATION:** Boxed for export.      Weight: 8800 lb      Cube 365 cu ft

## DRILL, ROCK

1 IN. X 4 1/4 IN. CHUCK, STOCK NO. 7Q21

**APPLICATION:** Used for drilling rock and any other hard surfaces, particularly useful where rock is to be blasted either for excavation or quarry use. Useful wherever compressed air is available.

**CAPACITY:** This drill is capable of drilling 20 ft through rock although the longest rods supplied with it are 8 ft. It operates on 80 psi compressed air and requires approximately 84 cfm of free air for continuous operation. It operates with 1-in. diam rods and bit sizes ranging between 1-3/8 in. and 2 in. depending upon the depth of the hole.

**DESCRIPTION:** This is a 55-lb tool, hand held, which constantly rotates the drill steel while operating and is of the dry type, blowing the drillings out of the hole by means of a blast of air through the hollow drill steel. The following items comprise the assembly:

	Stock No.	Weight: lb	Cube: cu ft
1 Drill, 55 lb with 1 x 4 1/4 chuck	7Q21	80.	2
280 Detachable Bits sizes 1 1/2, 1 5/8, 1 3/4, 1 7/8 and 2 in.	7Q12	300.	6
4 25 ft lengths of 3/4 in. dia hose with couplings	7D40	160.	8
4 Drill steels, 2 ft	7Q11-1	200.	8
4 Drill steels, 4 ft	7Q11-3		
4 Drill steels, 6 ft	7Q11-5		
2 Drill steels, 8 ft	7Q11-6		

**OPERATION:** One-man operated.

**SUPPLIES REQUIRED:** Occasional lubrication w/9110(SAE10) and frequent sharpening of bits.

**AUXILIARY EQUIPMENT SUPPLIED:** Spare parts estimated to keep drill in operation one year. Manual of instruction for operation and maintenance furnished, together with a spare parts list.

**AUXILIARY EQUIPMENT NEEDED BUT NOT SUPPLIED:** Compressors and bit sharpening and drill steel shanking and threading tools.

**SHIPPING INFORMATION:** Shipped boxed for export with drill rods bundled.  
Weight: 740 lb                      Cube: 24 cu ft

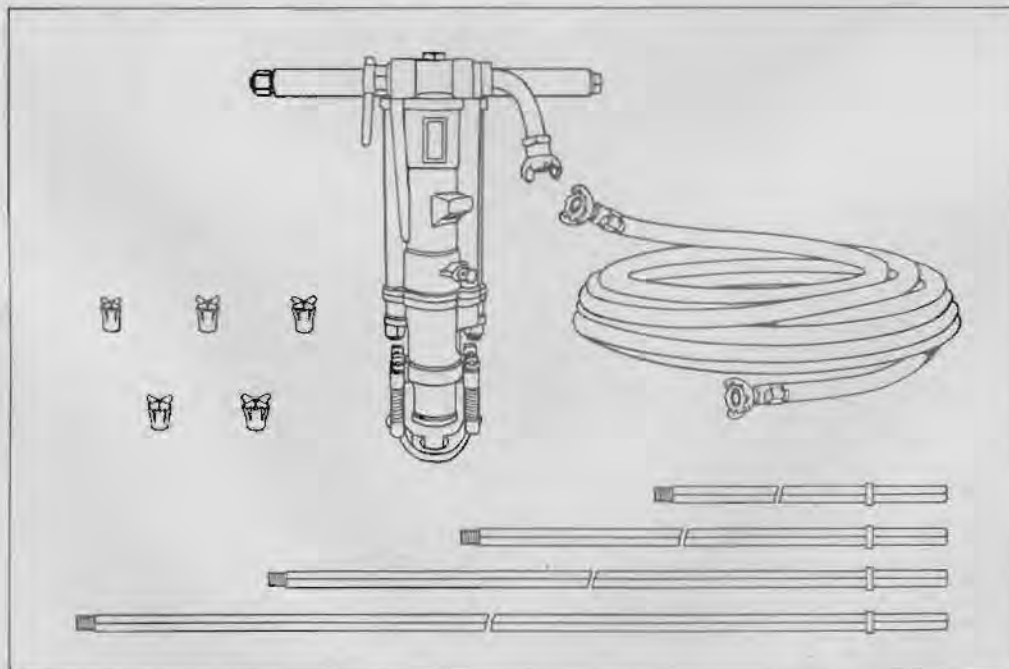

## DRILL, WAGON, MOUNTED

STOCK NO. 7Q20

**APPLICATION:** A mechanically-held and mechanically-fed rock drill for consistent deep rock drilling, especially suited to drilling rock preparatory to blasting.

**CAPACITY:** The wagon drill is capable of drilling holes in rock 1 3/4 in. to 2 1/8 in. in diam up to 24 ft deep, although the longest drill steel furnished is 18 ft. Feed travel is such as to accommodate 6 ft steel changes. This machine operates 1 1/4 in. diam hollow drill rods and requires compressed air at 80 psi at the rate of 185 cfm for maximum continuous operation.

**DESCRIPTION:** For mobility, this machine is mounted on a three-wheeled frame which is fitted with a towing tongue. Late models are equipped with steel wheels. The two rear wheels swivel through 180 deg so that a line of holes close to an obstruction may be drilled without advancing and backing the machine for every hole, or so that the machine may be maneuvered conveniently in confined spaces. The rig can be adjusted to drill full-depth holes in any direction. The machine weighs 1600 lb. The drills included with each wagon drill are as follows:

- 30 Sets of 4-point side hole bits, 1 3/4 in., 1 7/8 in., 2 in. and 2 1/8 in.
- 6 1 1/4-in. diam drill rods 6 ft long
- 6 1 1/4-in. diam drill rods 12 ft long
- 4 1 1/4-in. diam drill rods 18 ft long

**OPERATION:** A driller and helper are the usual operating crew, although the driller frequently operates alone. Periodic lubrication and frequent sharpening of bits are required.



**SUPPLIES REQUIRED:** Compressed air operation and the following quantities of fuel and lubricants are estimated to be required for operating the equipment 1,000 hours under severe conditions at the atmospheric temperature ranges shown:

	32°F and lower	32°F to 70°F	70°F and higher
<b>Greases -</b>			
General purpose 14L10 No. 2 (wheel bearing) lb	1	1	1
Wire rope chain and open gear VV-L-751 lb	5	5	5
<b>Oils -</b>			
Motor 9110 (SAE 10) gal	1	1	1

**AUXILIARY EQUIPMENT SUPPLIED:** Spare parts estimated to operate machine one year are included. Manual of instruction for operation and maintenance furnished, together with a spare parts list.

**AUXILIARY EQUIPMENT NOT SUPPLIED:** The wagon drill requires a 210-cfm compressor with hose, couplings, etc.

**SHIPPING INFORMATION:** Shipped boxed for export with drill rods bundled.  
Weight: 2200 lb                      Cube: 140 cu ft

## HOIST, AIR, SINGLE DRUM

STOCK NO. 7C61-1

**APPLICATION:** For mechanical pulls wherever compressed air is available.

**CAPACITY:** For line pulls not to exceed 1000 lb at the rate of 75 cfm this hoist provides approximately 200 ft of 3/8-in. wire rope and requires compressed air at 80 psi at the rate of 200 cfm for continuous operation and requires 3/4-in hose connections.

**DESCRIPTION:** The tugger hoist weighs approximately 300 lb and is mountable horizontally, vertically, or overhead by means of bolts. Equipped with throttle, clutch, and band type brake, with all controls readily at hand, this machine has piston type motor operation, is fully enclosed against dust infiltration but readily lubricated and is equipped with roller bearings throughout.

**OPERATION:** One-man operation, it requires periodic lubrication and replacement of wearing parts.

**SUPPLIES REQUIRED:** The following quantities of fuel and lubricants are estimated to be required for operating the equipment 1,000 hours under severe conditions at the atmospheric temperature ranges shown:

	32°F and lower	32°F to 70°F	70°F and higher
<b>Greases -</b>			
General purpose 14L9 No. 1 (chassis) lb	1	1	1
Wire rope chain and open gear VV-L-751 lb	5	5	5

**AUXILIARY EQUIPMENT SUPPLIED:** 3/8-in. cable and spare parts estimated to be needed during a year's operation are included. Manual of instruction for operation and maintenance furnished, together with a spare parts list.

**AUXILIARY EQUIPMENT NOT SUPPLIED:** Compressed air and hose connections.

**SHIPPING INFORMATION:** Boxed for export.      Weight: 500 lb      Cube: 15 cu ft



## PUMP, SUMP

STOCK NO. 7K1

**APPLICATION:** A useful pump for handling water within its capacity wherever compressed air is available to operate it.

**CAPACITY:** The capacity of various heads is 205 gpm against a 20-ft head and 175 gpm against a 30-ft head. It requires compressed air at 80 psi at the rate of 70 cfm of free air for continuous operation through a 3/4-in. hose connection, and handles clean or dirty water against heads up to 50 ft.

**DESCRIPTION:** The pump is of the sump type which is suspended in the water. It weighs 50 lb and is equipped with a 20-ft section of discharge hose. Its dimensions are approximately 23 in. high and 11 in. overall width.

**OPERATION:** It requires no priming, simply lower pump into water and turn on the air. It requires periodic lubrication.

**SUPPLIES REQUIRED:** Lubricant with 9250 (SAE 30) oil.

**AUXILIARY EQUIPMENT SUPPLIED:** Included are a 20-ft length of 2 1/2-in. discharge hose and spare parts estimated to anticipate a years operation. Manual of instruction for operation and maintenance furnished, together with a spare parts list.

**AUXILIARY EQUIPMENT NEEDED BUT NOT SUPPLIED:** Compressors and hose.

**SHIPPING INFORMATION:** Shipped boxed for export with hose bundled.  
Weight: 100 lb                      Cube: 10 cu ft





## SAW, CIRCULAR, PORTABLE

STOCK NO. 7C66-3

**APPLICATION:** A useful tool in connection with timber construction and dock building wherever compressed air is available.

**CAPACITY:** Makes a cut up to 4 1/2 in. in depth and requires compressed air at 90 lb per sq in. at the rate of 70 cfm for continuous operation through a 1/2 in. hose connection. It develops 2.7 hp and operates at 1400 rpm.

**DESCRIPTION:** Saw weighs 29 lbs and requires a blade 12 in. in diam in order to make maximum depth cut. It is equipped with blades for ripping and cross cutting and with safety guard and is so arranged that exhaust air blows the sawdust off the cutting line. It is adjustable for cutting bevels up to 45 degrees.

**OPERATION:** One-man held and operated, it requires periodic lubrication and sharpening of saws.

**SUPPLIES REQUIRED:** Lubricant, with 9110 (SAE 10) oil, saw blade vise, saw files, and saw sets.

**AUXILIARY EQUIPMENT SUPPLIED:** Spare parts estimated to operate the saw one year are included. Manual of instruction for operation and maintenance furnished, together with a spare parts list.

**AUXILIARY EQUIPMENT NEEDED BUT NOT SUPPLIED:** Compressors and hose.

**SHIPPING INFORMATION:** Shipped boxed for export.    Weight: 50 lb                    Cube: 3 cu ft

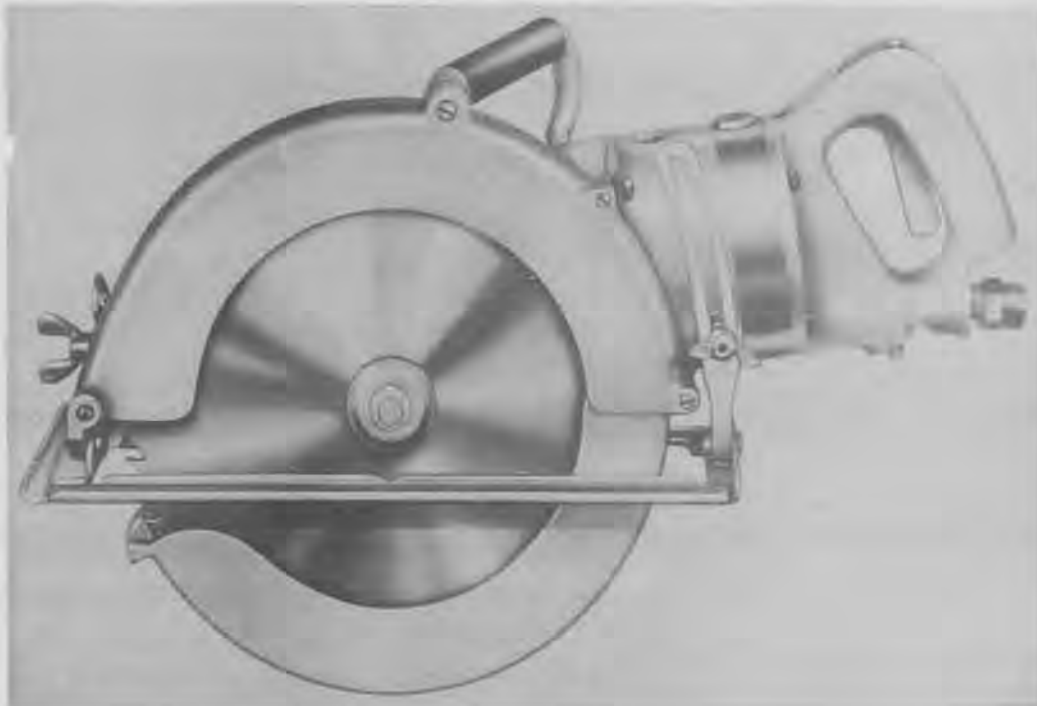

## TAMPER, BACKFILL

STOCK NO. 7W20-2

**APPLICATION:** Used for tamping backfill in trenches or excavation to prevent future settlement.

**CAPACITY:** Strikes 750 blows per minute, requires compressed air at 80 psi at the rate of 32 cfm for continuous operation and takes a 1/2-in. hose connection.

**DESCRIPTION:** The tamper weighs 30 lb and has an overall length of 50 in.

**OPERATION:** One-man operated, requires periodic lubrication.

**SUPPLIES REQUIRED:** Lubricant with 9110 (SAE 10) oil.

**AUXILIARY EQUIPMENT SUPPLIED:** Spare parts estimated to keep tool in operation one year are included. Manual of instruction for operation and maintenance furnished, together with a spare parts list.

**AUXILIARY EQUIPMENT NEEDED BUT NOT SUPPLIED:** Compressors and hose.

**SHIPPING INFORMATION:** Boxed for export.  
Weight: 40 lb                      Cube: 4 cu ft



## WRENCH, IMPACT

STOCK NO. 7W15-156

**APPLICATION:** This tool is for running down and tightening bolts. It is very useful where a large number of bolts are to be tightened, particularly for structural steel, bolted timber, or for bolted tanks.

**CAPACITY:** Capacity is provided for all bolt sizes up to 1 in. diam. It requires compressed air at 80 psi at the rate of 60 cfm for continuous operation through a 1/2-in. hose connection.

**DESCRIPTION:** The wrench weighs 30 lb and is equipped with sockets for all bolt sizes within its capacity.

**OPERATION:** One-man operation.

**SUPPLIES REQUIRED:** Lubricant with 9110 (SAE 10) oil.

**AUXILIARY EQUIPMENT SUPPLIED:** Spare parts estimated to provide operation over a period of one year are included. Manual of instruction for operation and maintenance furnished, together with a spare parts list.

**AUXILIARY EQUIPMENT NEEDED BUT NOT SUPPLIED:** Compressors and hose.

**SHIPPING INFORMATION:** Boxed for export.  
Weight: 40 lb                      Cube: 2 cu ft



## PUMP, CENTRIFUGAL, 20,000 GPH

STOCK NO. 7K1-47

**APPLICATION:** Used for pumping water for construction work; also as shown on Y&D Dwg 208160 in a 100 gpm hypochlorination water supply system.

**CAPACITY:** Varies from 325 gpm against a 25-ft head with 10-ft suction down to 40 gpm against a 80-ft head with 20-ft suction. It is capable of discharging 95 gpm 60 ft vertically or 5,400 ft horizontally through 4-in. pipe.

**DESCRIPTION:** This pump is of the centrifugal type, with 3-in. suction and discharge connections and is powered by an air-cooled gasoline engine direct-connected, the whole mounted on an angle-iron frame supported at the rear by steel legs and at the front by 2 steel wheels. The frame is fitted with a gas-pipe handle for use in tilting and rolling the pump. 20-ft lengths of suction and discharge hose, equipped with connections, and a foot-valve and strainer are furnished with each pump.

**OPERATION:** Runs automatically after starting.

**SUPPLIES REQUIRED:** The following quantities of fuel and lubricants are estimated to be required for operating the equipment 1,000 hours under severe conditions at the atmospheric temperature ranges shown:

	32°F and lower	32°F to 70°F	70°F and higher
<b>Fuel -</b>			
Unleaded gasoline, 65 octane, gals	600	600	600
<b>Greases -</b>			
General purpose 14L9 No. 1 (chassis) lb	2	2	2
Water Pump 14L11 lb	2	2	2
<b>Oils -</b>			
Gear, VV-L-761 (SAE 90) (Hypoid) gal	3	3	3
Motor 9110 (SAE 10) gal	20	20	
" 9250 ( " 30) "			20



**AUXILIARY EQUIPMENT SUPPLIED:** Spare parts estimated to keep pump operating one year are included. Manual of instruction for operation and maintenance furnished, together with a spare parts list.

**SHIPPING INFORMATION:** Boxed for export.  
Weight: 800 lb      Cube: 60 cu ft

## PUMP, CENTRIFUGAL -40,000 GPH

STOCK NO. 7K1

**APPLICATION:** Used for pumping water wherever a portable unit of this capacity is required.

**CAPACITY:** The capacity of this pump varies from 665 gpm against a 25 ft head with a 10 ft suction lift down to 50 gpm against a 110 ft head with a 20 ft suction lift.

**DESCRIPTION:** The pump is of the centrifugal type with 4 in. suction and discharge connections and is powered by a 20-25 hp air-cooled gasoline engine directly connected and mounted on a 2-steel-wheeled truck for mobility. 20 ft sections of suction and discharge hose complete with fittings, footvalve and strainer are included with each pump.

**OPERATION:** Operates automatically after being started.

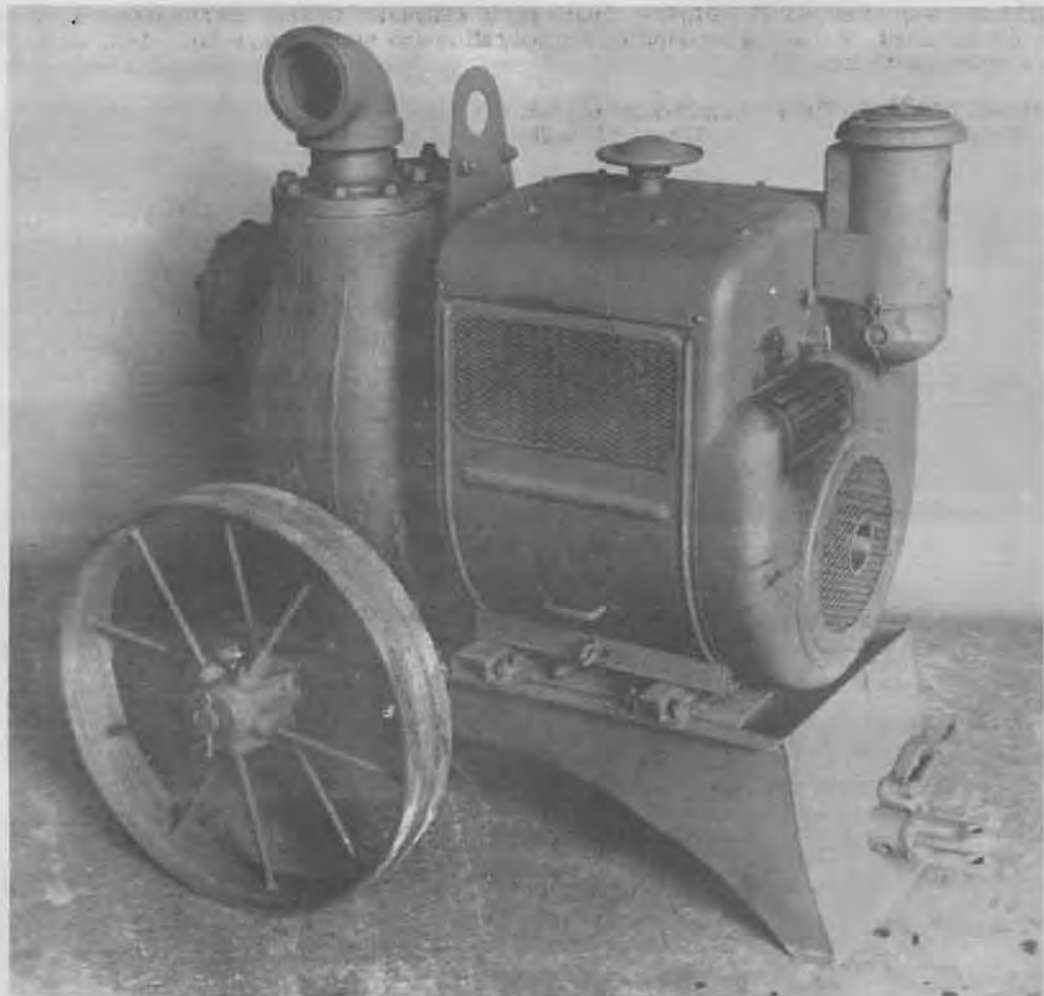

**SUPPLIES REQUIRED:** The following quantities of fuel and lubricants are estimated to be required for operating the equipment 1,000 hours under severe conditions at the atmospheric temperature ranges shown:

	32°F and lower	32°F to 70°F	70°F and higher
<b>Fuel -</b>			
Unleaded gasoline, 65 octane, gals	2500	2500	2500
<b>Greases -</b>			
General purpose 14L9 No. 1 (chassis) lb	2	2	2
Water Pump 14L11 lb	2	2	2
<b>Oils -</b>			
Gear, VV-L-761 (SAE 90) (Hypoid) gal	6	6	6
Motor 9110 (SAE 10) gal	25	25	
" 9250 ( " 30) "			25

**AUXILIARY EQUIPMENT SUPPLIED:** Spare parts estimated to keep machine operating one year are included. Manual of instruction for operation and maintenance furnished, together with a spare parts list.

**SHIPPING INFORMATION:** Bundled for export.  
 Weight: 1000 lb                      Cube: 61 cu ft

## PUMP, CENTRIFUGAL 90,000 GPH

STOCK NO. 7K1

**APPLICATION:** Used for pumping water.

**CAPACITY:** The capacity of this pump varies from 1500 gpm against a 25 ft head and with a 10 ft suction lift down to 100 gpm against a 100 ft head and with a 20 ft suction lift.

**DESCRIPTION:** The pump is of the centrifugal type powered by a 30 hp water-cooled gasoline engine directly connected and all mounted on a steel frame with 2 steel wheels for mobility. A 20 ft length each of suction and discharge hose complete with fittings, foot valve and strainer are included with each pump.

**OPERATION:** Continuous operation when started.

**SUPPLIES REQUIRED:** The following quantities of fuel and lubricants are estimated to be required for operating the equipment 1,000 hours under severe conditions at the atmospheric temperature ranges shown:

	32°F and lower	32°F to 70°F	70°F and higher
<b>Fuel -</b>			
Unleaded gasoline, 65 octane, gals	3500	3500	3500
<b>Greases -</b>			
General purpose 14L9 No. 1 (chassis) lb	3	3	3
Water Pump 14L11 lb	3	3	3
<b>Oils -</b>			
Gear, VV-L-761 (SAE 90) (Hypoid) gal	9	9	9
Motor 9110 (SAE 10) gal	30		
" 9250 ( " 30) "		30	
" 9500 ( " 50) "			30





AUXILIARY EQUIPMENT SUPPLIED: Spare parts estimated for one year's operation are included. Manual of instruction for operation and maintenance furnished, together with a spare parts list.

SHIPPING INFORMATION: Bundled for export.  
Weight: 2800 lb      Cube: 105 cu ft

## PUMP, DIAPHRAGM, 3 IN., 3000 GPH

STOCK NO. 7K1 -45

**APPLICATION:** Used for pumping water, particularly muddy water with high percentage of sediment, which quickly clogs and wears out other types of pumps.

**CAPACITY:** The capacity of this pump ranges from 3000 gph against no discharge head and with a 10 ft suction lift down to 1500 gph against no discharge head and with a 20 ft suction lift. It will pump against a maximum discharge head of 40 ft.

**DESCRIPTION:** This diaphragm pump is powered by a 3 hp air or water cooled gas engine and is mounted on 2 steel wheels for mobility. 3 in. suction and discharge connections, a 20 ft length of suction and discharge hose complete with fittings, foot valve and strainer are included with each pump.

**OPERATION:** Operated continuously when started.

**SUPPLIES REQUIRED:** The following quantities of fuel and lubricants are estimated to be required for operating the equipment 1,000 hours under severe conditions at the atmospheric temperature ranges shown:

	32°F and lower	32°F to 70°F	70°F and higher
<b>Fuel -</b>			
Unleaded gasoline, 65 octane, gals	300	300	300
<b>Greases -</b>			
General purpose 14L9 No. 1 (chassis) lb	2	2	2
Water Pump 14L11 lb	2	2	2
<b>Oils -</b>			
Gear, VV-L-761 (SAE 90) (Hypoid) gal	3	3	3
Motor 9110 (SAE 10) gal	20	20	
" 9250 ( " 30) "			20

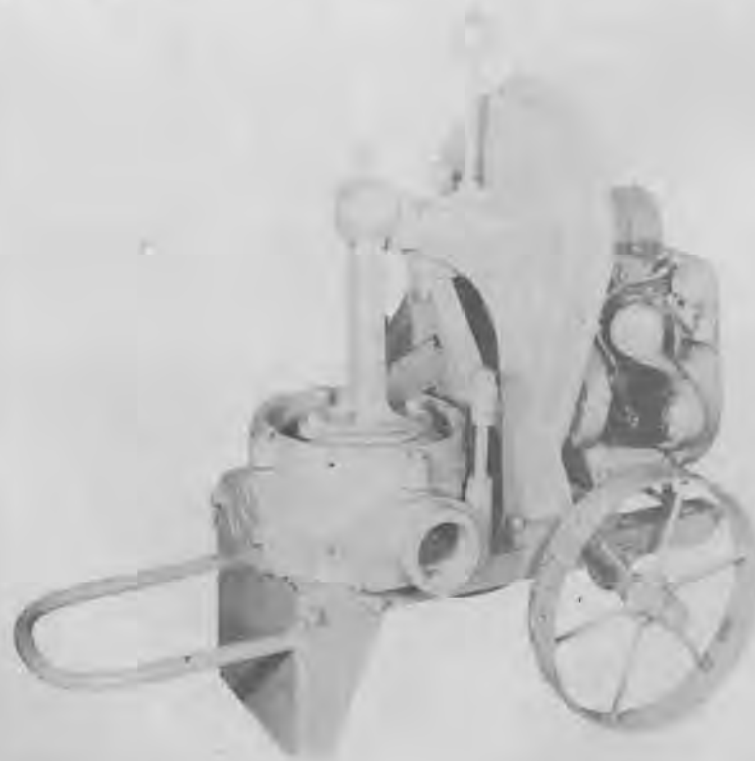

**AUXILIARY EQUIPMENT SUPPLIED:** Spare parts estimated to be needed during one year's operation are included. Manual of instruction for operation and maintenance furnished, together with a spare parts list.

**SHIPPING INFORMATION:** Boxed for export.      Weight: 800 lb      Cube: 24 cu ft

## PUMP, DIAPHRAGM, 4 IN., 12000 GPH

STOCK NO. 7K1

**APPLICATION:** Used for pumping water, particularly muddy water with a high percentage of sediment which rapidly wears out other types of pumps.

**CAPACITY:** The capacity of this pump ranges from 12,000 gph against no discharge head with 10 ft suction lift down to 8,000 gph against no discharge head with 20 ft suction lift. It pumps against a maximum discharge head of 75 ft. This type of pump passes as much as 5 cu yd of sand, mud and stone in an hour's pumping without clogging.

**DESCRIPTION:** The pump is powered by a 12 hp gas engine and mounted on 4 steel wheels for mobility. 4-in. suction and discharge connections and a 20 ft length of suction and discharge hose fitted and with footvalve and strainer are included with each pump.

**OPERATION:** Operates continuously when started.

**SUPPLIES REQUIRED:** The following quantities of fuel and lubricants are estimated to be required for operating the equipment 1,000 hours under severe conditions at the atmospheric temperature ranges shown:

	32°F and lower	32°F to 70°F	70°F and higher
<b>Fuel -</b>			
Unleaded gasoline, 65 octane, gals	400	400	400
<b>Greases -</b>			
General purpose 14L9 No. 1 (chassis) lb	2	2	2
Water Pump 14L11 lb	2	2	2
<b>Oils -</b>			
Gear, VV-L-761 (SAE 90) (Hypoid) gal	6	6	6
Motor 9110 (SAE 10) gal	25	25	
" 9250 ( " 30) "			25

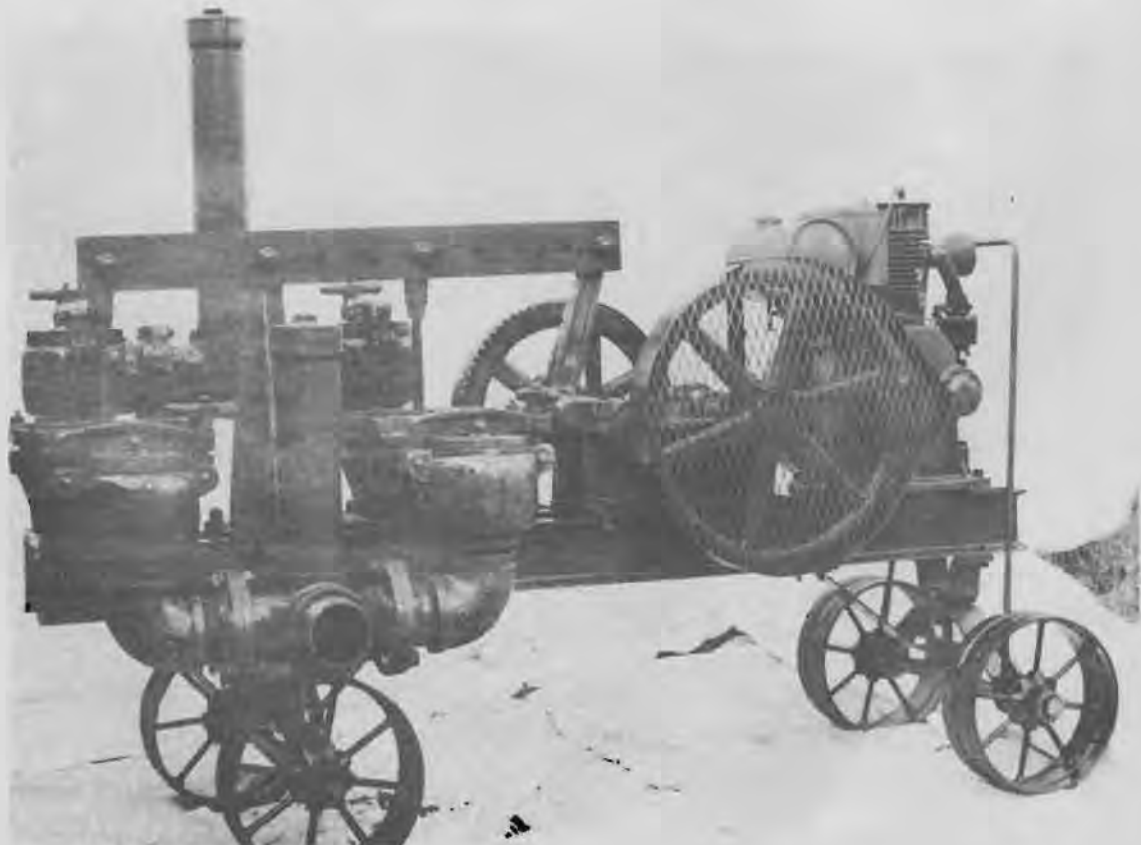

**AUXILIARY EQUIPMENT SUPPLIED:** Spare parts estimated to keep pumps in operation one year are included.

**SHIPPING INFORMATION:** Shipped, bundled for export.  
Weight: 2600 lb      Cube: 137 cu ft

## SAW, CIRCULAR, ELECTRIC DRIVEN, 3/4 HP

STOCK NO. 7C66-8

**APPLICATION:** A portable power saw capable of numerous light cutting operations in wood.

**CAPACITY:** The saw makes a cut 2-1/8 in. deep and will cut through 1x12 and 2x10 rough or dressed board sizes. It will cross cut, rip, miter, bevel cutoff, double miter, dado, plough and rabbet, and is also capable of other operations such as shaping, routing and tool dressing when those tools are available.

**DESCRIPTION:** The shipping unit consists of the saw assembly, carriage, arm, column, table and stand with operating switch, 3 combination 9 in. rip and cross cut blades and 1 6 in. x 13/16 in. dado head. The saw is attached to the shaft of a 3/4 hp 3 ph 220 V 3600 rpm AC 40 deg. continuous duty motor which is supported by means of a trunnion in the inverted U shaped yoke of the ball bearing equipped carriage travelling on tracks inside the arm mounted on the adjustable column which is a part of the cast iron stand. The saw assembly rotates 180 deg. in the carriage yoke. The yoke rotates 360 deg. about the carriage. The arm rotates 360 deg. about the table and the column raises and lowers in the stand. All of these adjustments are held by means of readily operated locking devices with well marked 45 and 90 deg. positions which permit the numerous cuts and operations of which the machine is capable.

**OPERATION:** One-man operation.

**SUPPLIES REQUIRED:** Proper electrical current and the following quantities of fuel and lubricants are estimated to be required for operating the equipment 1,000 hours under severe conditions at the atmospheric temperature ranges shown:

	32°F and lower	32°F to 70°F	70°F and higher
Oils -			
Gear, VV-L-761 (SAE 90) (Hypoid) gal	1	1	1
Motor 9110 (SAE 10) gal	1	1	1

**AUXILIARY EQUIPMENT SUPPLIED:** Spare parts estimated to be required during a years operation as well as manuals of instruction for operation, maintenance and repair of the machine.

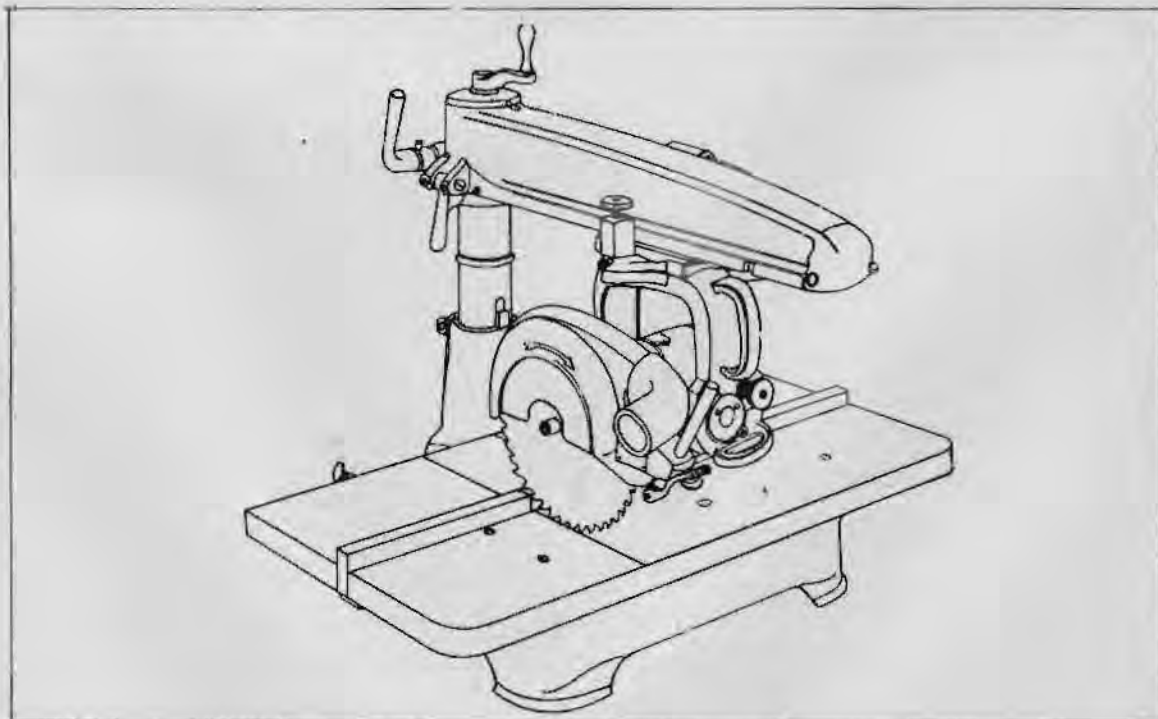

AUXILIARY EQUIPMENT NEEDED BUT NOT SUPPLIED: Saw sharpening tools.

SHIPPING INFORMATION: Boxed for export  
Weight lb            Cube cu ft  
          250.            17.



## SAW, CIRCULAR, ELECTRIC DRIVEN, 5 HP

STOCK NO. 7C68

**APPLICATION:** A power saw capable of numerous heavy duty cutting operations in wood.

**CAPACITY:** The saw is capable of a cut 4-3/8 in. deep with the 16 in. blade and 4-7/8 in. deep with the 20 in. blade and of cross cuts 3 in. x 17 in. and 4 in. x 16 in. respectively with the 16 in. and the 20 in. blades. It will cross cut, rip, miter, bevel cutoff, double miter, dado, plough, rabbet and operate the saw grinding wheel, and is capable of other operations such as shaping and routing when those tools are available.

**DESCRIPTION:** The shipping unit consists of the saw assembly, carriage, arm, column, table and stand with operating switch, 3 - 16 in. combination blades, 2 - 16 in. rip blades, 1 - 10 in. x 3/16 in. dado head, 1 - 14 in. hollow ground miter blade, 2 - 6 in. x 3/8 in. saw grinding wheels, 2 - 20 in. combination blades and an additional guard for the 20 in. blades. The saw is attached to the shaft of a 5 hp 3 ph 60 cy 220V, AC, 55 deg rise continuous duty motor which is supported by means of a trunnion in the inverted U shaped yoke of the carriage travelling on ball bearings within the arm mounted on the adjustable column which is a part of the stand. The saw assembly rotates 180 deg. in the carriage yoke. The yoke rotates 360 deg. about the carriage. The arm rotates 360 deg. about the column and the column raises and lowers in the stand. All of these adjustments are held by readily operated locking devices with well defined 45 deg and 90 deg positions and permit the numerous cuts and operations of which the machine is capable.

**OPERATION:** One-man operation

**SUPPLIES REQUIRED:** Proper electrical current and the following quantities of fuel and lubricants are estimated to be required for operating the equipment 1,000 hours under severe conditions at the atmospheric temperature ranges shown:

Oils -	32°F and lower			32°F to 70°F			70°F and higher		
	gal	gal	gal	gal	gal	gal	gal	gal	gal
Gear, VV-L-761 (SAE 90) (Hypoid)		2	2	2	2	2	2	2	2
Motor 9110 (SAE 10)		2	2	2	2	2	2	2	2

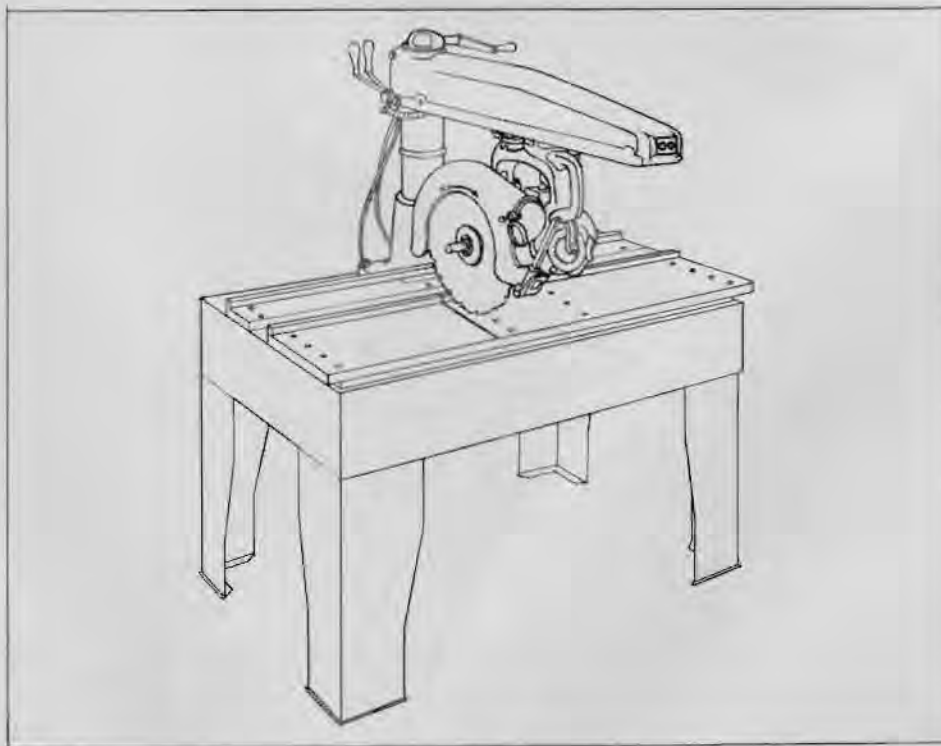



AUXILIARY EQUIPMENT NEEDED BUT NOT SUPPLIED: Saw sharpening tools

SHIPPING INFORMATION: Boxed for export

Weight: lb  
1000

Cube: cu ft  
50

## SAW, CHAIN, PORTABLE, GASOLINE ENGINE OPERATED

STOCK NO. 7C66

**APPLICATION:** Used for heavy crosscut sawing jobs, for timbers, piles, logs, or for felling trees.

**CAPACITY:** The saw has a capacity for a 48-in. log.

**DESCRIPTION:** The net weight of saw is 115 lb. The 5-hp air-cooled gasoline-engine drive is mounted on one end and is connected to chain saw drive by means of a swivel which permits blade to turn for sawing in any direction while the engine remains in the vertical position.

**OPERATION:** Two-man operated.

**SUPPLIES REQUIRED:** The following quantities of fuel and lubricants are estimated to be required for operating the equipment 1,000 hours under severe conditions at the atmospheric temperature ranges shown:

	32°F and lower	32°F to 70°F	70°F and higher
Fuel - Unleaded gasoline, 65 octane, gals	1000	1000	1000
Greases - Wire rope chain and open gear VV-L-751 lb			30
Oils - Gear, VV-L-761 (SAE 80) (Hypoid) gal	2		
Gear, VV-L-761 (SAE 90) (Hypoid) "		2	2
Motor 9110 (SAE 10) gal	100	100	
" 9250 ( " 30) "	20	20	120

**AUXILIARY EQUIPMENT SUPPLIED:** An extra chain saw and service kit including saw sharpening device for rapid sharpening of saw in field as well as spare parts estimated to be required during a years operation are included. Manual of instruction for operation and maintenance furnished, together with a spare parts list.

**SHIPPING INFORMATION:** Boxed for export,  
Weight: 150 lb                      Cube: 5 cu ft



## SAW, CIRCULAR, ELECTRIC DRIVEN, PORTABLE

STOCK NO. 7C66

**APPLICATION:** For sawing lumber and timber where current is available. This saw is furnished in the 6 in., 7 in., 8-in., and 9 in., blade sizes.

**CAPACITY:** Each size has a cutting depth capacity as follows:

6 in. blade	makes a	1 7/8-in.	deep cut
7 " "	" "	2 3/8-in.	" "
8 " "	" "	2 5/8-in.	" "
9 " "	" "	2 7/8-in.	" "

The motor driving this saw is of the universal current type operating on either d-c or a-c current up to 60 cycles at 110V, and having free blade speeds varying between 3,000 and 3,400 rpm.

**DESCRIPTION:** The saw has an operating switch in its handle, a base adjustment for vertical depth of cut and for bevel cuts, high grade ball bearings throughout, a blower which keeps the cutting-line free of sawdust, an automatic telescoping blade guard and a rubber covered cord connection with plug attached. In addition, there is included a combination blade, 3 extra blades, a socket wrench for adjustments, a supply of lubricant for the saw and a permanent steel carrying case. The working weights and overall length are as follows: 6 in. blade 12 lb and 16 in. long; 7 in. blade 15 lb and 17 in. long; 8 in. blade 18 lb and 18 in. long, and 9 in. blade 22 lb and 19 in. long.

**OPERATION:** One-man operated, hand guided.

**SUPPLIES REQUIRED:** Electrical current supply and lubricants, 9110 (SAE-10)

**AUXILIARY EQUIPMENT SUPPLIED:** Spare parts estimated to be required during a year's use, as well as operating and maintenance manuals of instruction.

**SHIPPING INFORMATION:** Boxed for export

	Weight: lb	Cube: cu ft
6 in. blade	60	2
7 " "	105	3
8 " "	120	3
9 " "	150	4

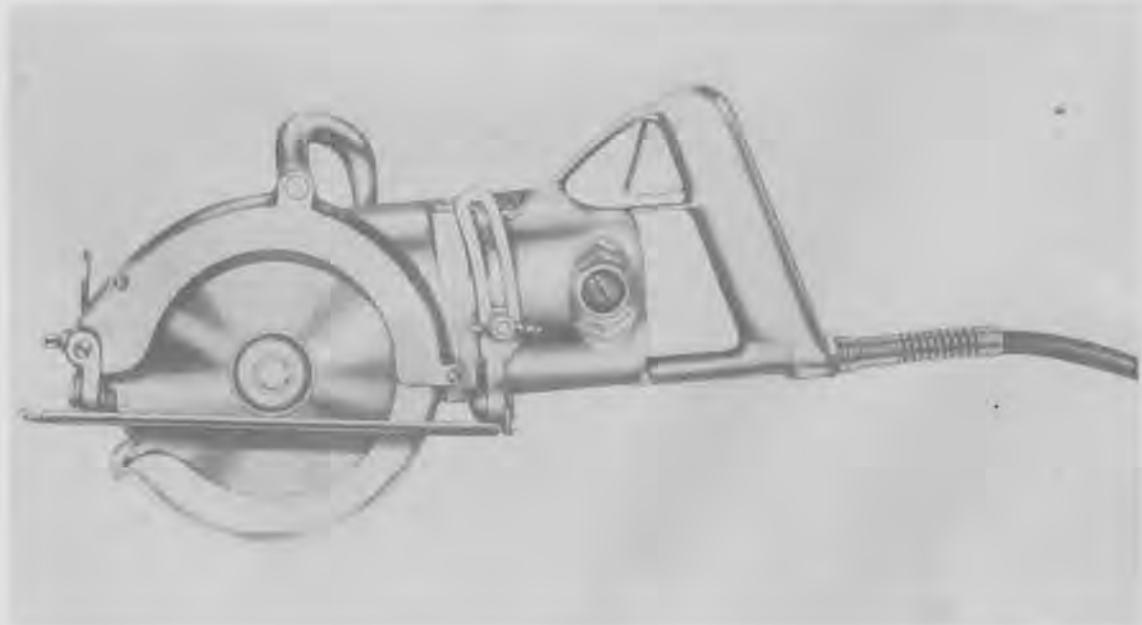

## GRINDER, BENCH, ELECTRIC

STOCK NO. 7W100-1

**APPLICATION:** A shop tool for sharpening tools or for any metal grinding within its capacity

**CAPACITY:** The grinder is powered by a 1/2 hp motor requiring 110 to 120 v, 1 ph, 60 cy, A.C. and equipped with 1 in. x 7 in. x 5/8 in. coarse and fine abrasive wheels.

**DESCRIPTION:** The unit consists of the two abrasive wheels mounted on the driving motor shaft, protected by wheel guard and unbreakable eyeguards and with adjustable tool rests, all mounted in a bench stand with snap switch and plug in cord. Two additional coarse and fine wheels are provided with each grinder.

**SUPPLIES REQUIRED:** Electrical current and 9110 (SAE-10) oil.

**SHIPPING INFORMATION:** Boxed for export  
Weight: 100 lb                      Cube: 3 cu ft

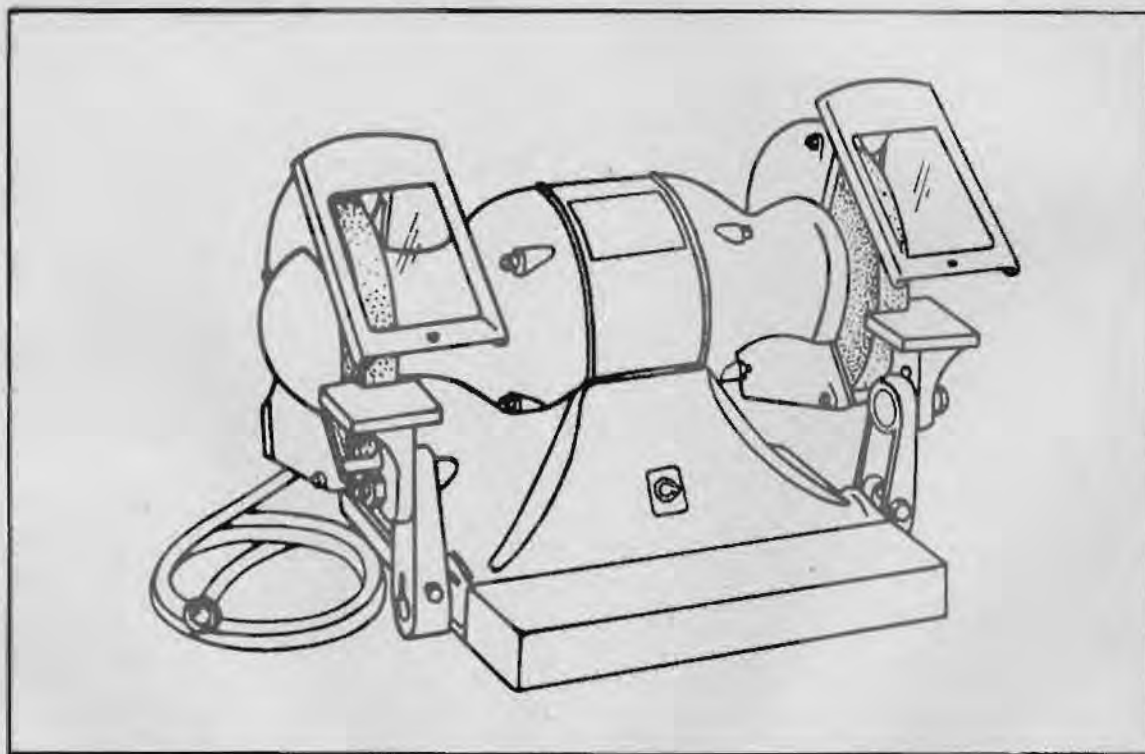

## GRINDSTONE, MOUNTED

STOCK NO. 7W88-4

**APPLICATION:** For off hand axe and tool grinding

**CAPACITY:** This stone sharpens hand tools which are held to the stone by hand by the operator while turning the stone by means of the foot pedals.

**DESCRIPTION:** The assembly consists of the stone, its metal stand with foot pedals, suspended dripping water can and the circular sandstone wheel. It enables one man to operate the stone with his feet while holding the tools with his hands.

**OPERATION:** One-man operated.

**SUPPLIES REQUIRED:** Lubricants 9110 (SAE-10)

**SHIPPING INFORMATION:** Boxed for export.

Weight	lb	Cube	cu ft
	200		24

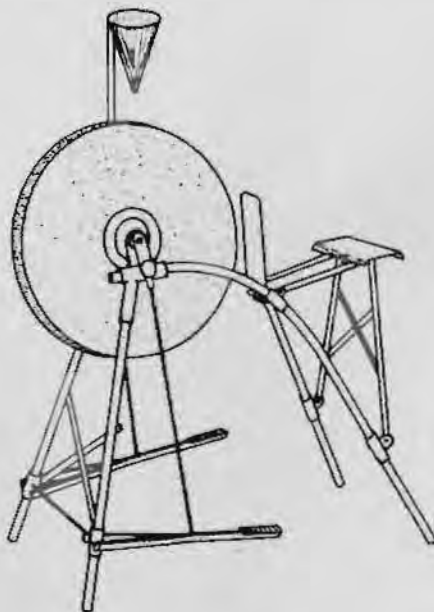

## KIT, WELDING AND CUTTING, OXY-ACETYLENE

STOCK NO. 7013

**APPLICATION:** For welding and cutting operations by means of the oxy-acetylene method.

**CAPACITY:** This assembly is for general purpose welding where welding is the principal operation engaged in but also including a readily attached cutting head for infrequent cutting operations. The welding tips included, No. 1 - 10 inclusive, are suitable for welding metal thicknesses ranging from 1/16 in. to 2 in. and the No. 1, 2, & 3 medium pre heating 4 flame cutting tips are suitable for the same range of thicknesses. All tools necessary for one operators use are included in this kit.

**DESCRIPTION:** The set includes the following:

- |    |  |
|----|--|
| 1  | 2 - Wire Brushes   |
| 2  | 3 pairs Leather Welders' Gloves  |
| 3  | 1 - Combination 5-way Wrench   |
| 4  | 1 - Ball Pein Hammer, 1-1/2 lb.  |
| 5  | 2 - 1 in. Cold Chisels   |
| 6  | 2 - Size 1 Cutting Tips<br>2 - Size 2 Cutting Tips<br>2 - Size 3 Cutting Tips  |
| 7  | 1 - Cutting Attachment, 75 deg head  |
| 8  | 1 - Welding Torch  |
| 9  | 2 - Mixer for Welding Torch  |
| 10 | 1 - Two-stage Oxygen Regulator   |
| 11 | 1 - Two-stage Acetylene Regulator  |
| 12 | 2 - Size 3 Welding Tip<br>2 - Size 4 Welding Tip<br>2 - Size 5 Welding Tip<br>2 - Size 6 Welding Tip<br>2 - Size 7 Welding Tip |
| 13 | 8 - Beveled Glasses for Regulator Gauges   |
| 14 | 3 - Sparklighters  |
| 15 | 6 boxes (6 per box) Renewal Flints for Sparklighter  |
| 16 | 1 - Goggle with No. 5 Shade Lens (50 mm)   |
| 17 | 1 - Goggle (Coverspec) with No. 5 Shade Lens (50 mm)   |
| 18 | 24 pairs Clear Cover Lenses (50 mm)  |
| 19 | 10 pairs No. 5 Shade Lenses (50 mm)  |
| 20 | 6 - Seats (Replacement spares for Regulators)  |
| 21 | 2 - Seats (Replacement spares for Cutting Attachment)  |
| 22 | 2 - Oxygen Hose Couplings (9/16 in. - 18 thread R.H.)  |
| 23 | 2 - Hose Splicers for 1/4 in. or 5/16 in. inside diam Hose   |
| 24 | 2 - Acetylene Hose Couplings (9/16 in. - 18 Thread L.H.)   |
| 25 | 2 - 25 ft lengths 1/4 in. inside diam Twin Hose with connections attached  |
| 26 | 1 - Adapter for connecting Airco Acetylene Regulator to P.Q.L. Cylinder  |
| 27 | 1 - Steel Carrying Case 22 in. long 8 in. wide 9 in. deep with sliding tray  |

**SUPPLIES REQUIRED:** Oxygen and acetylene under pressure

**AUXILIARY EQUIPMENT SUPPLIED:** Spare parts estimated to be required during a year of use are furnished as well as manuals of instruction covering the operation, maintenance and repair of the equipment.

**AUXILIARY EQUIPMENT NEEDED BUT NOT SUPPLIED:** Oxygen and acetylene in convenient portable cylinders.

**SHIPPING INFORMATION:** Shipped boxed for export 2 sets to a case  
Weight: 115 lb                      Cube: 5 cu ft

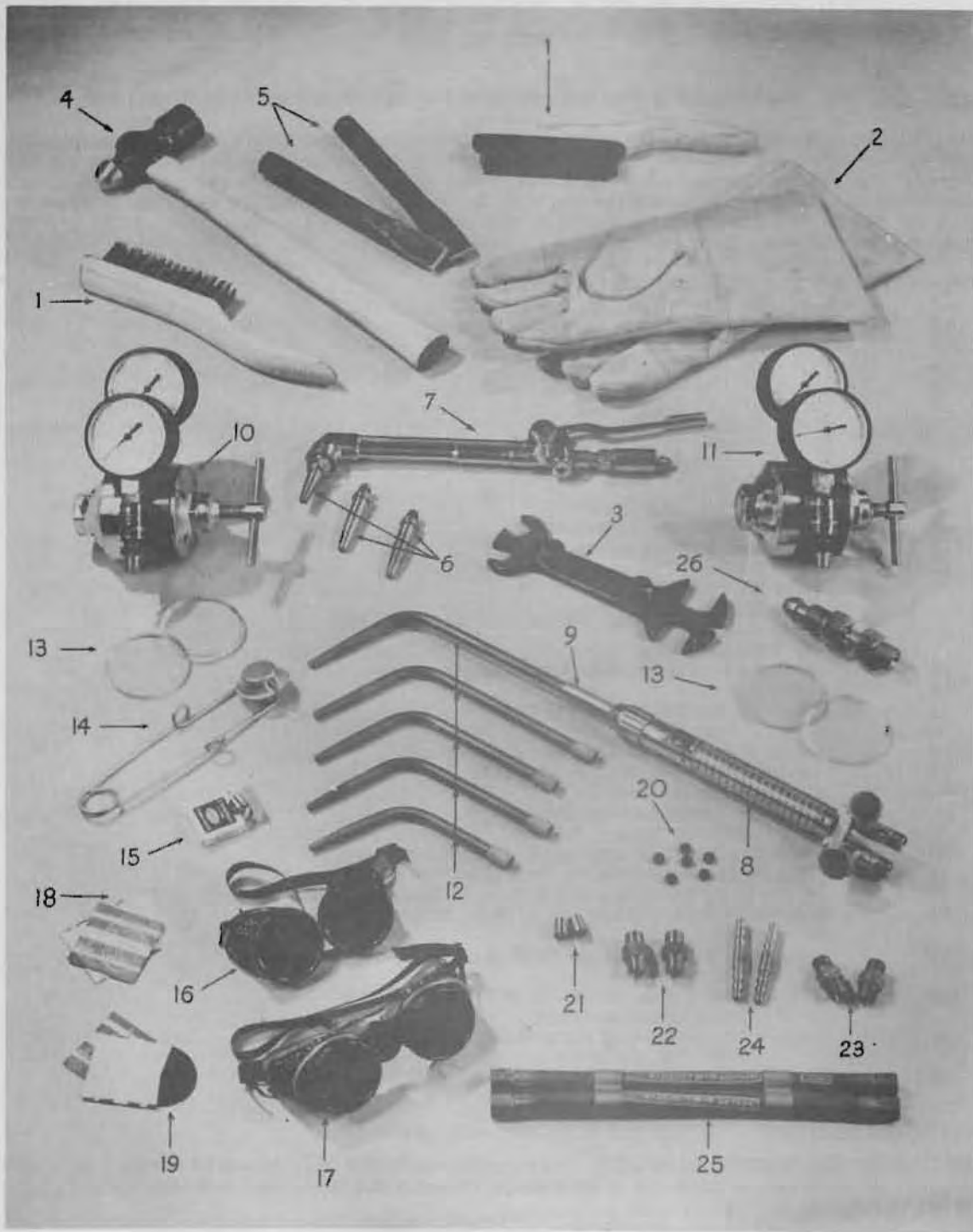

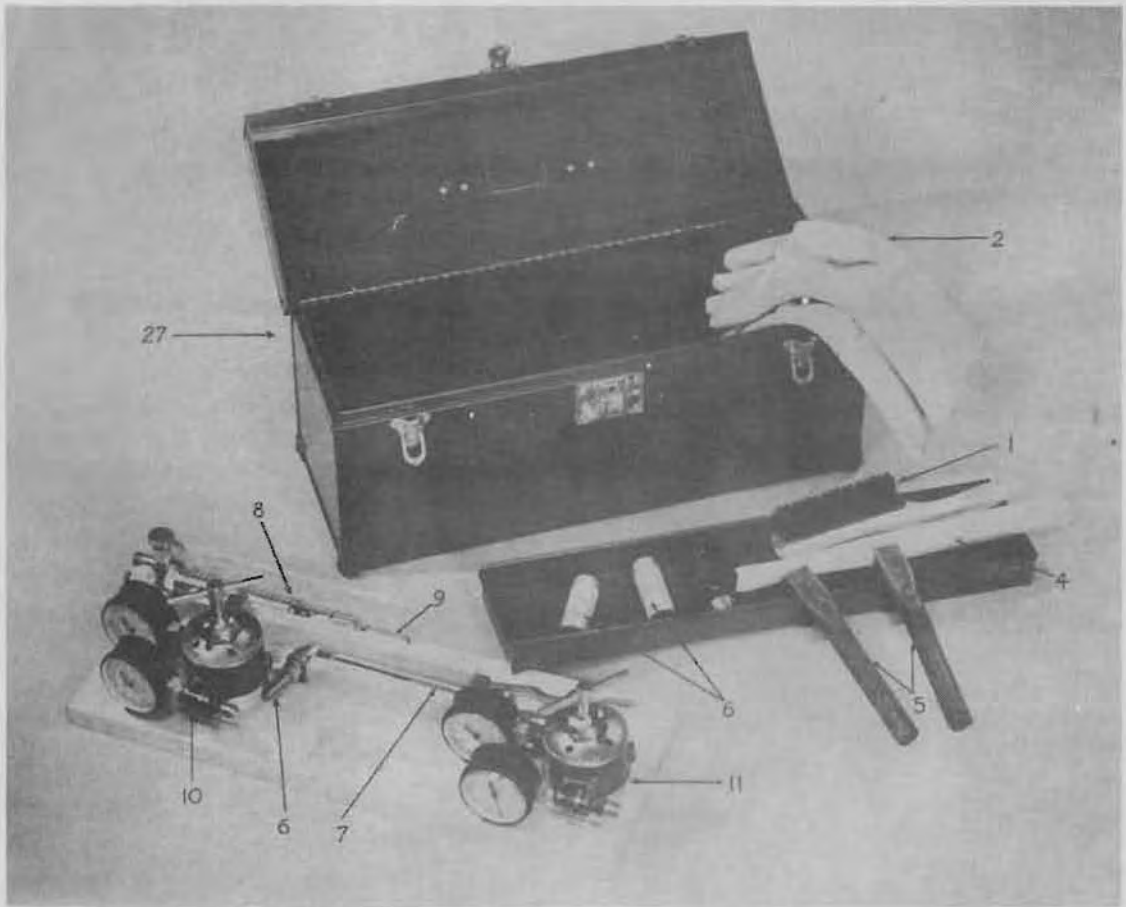



## LATHE, METAL WORKING

BACK GEARED, SCREW CUTTING, BENCH MODEL, STOCK NO. 7C64

**APPLICATION:** A production machine tool for all lathe work within its capacity particularly suited to machine and equipment repair shop use.

**CAPACITY:** The lathe has capacity for a 10 1/2 in. swing over bed and saddle wings, a 6 1/8 in. swing over saddle cross slide and has a distance between centers of 24 in. It is equipped with a 1/2 hp 110-220 V, 1 ph, 1750 rpm electric motor and drum type reversing switch.

**DESCRIPTION:** All gears and belt drive pulleys are fully enclosed but readily accessible for quick change. There is also included the following:

- 1 - 6 in. face plate
- 2 - 60 deg centers
- 17 - Change gears
- 1 - Threading dial
- 1 - Threading chart
- 1 - No. 3 - No. 2 morse taper adaptor
- 1 - Tool Post Holder & wrench
- 1 - Tail stock wrench

**OPERATION:** Single operator.

**SUPPLIES REQUIRED:** Electrical current and the following quantities of fuel and lubricants are estimated to be required for operating the equipment 1,000 hours under severe conditions at the atmospheric temperature ranges shown:

	32°F and lower	32°F to 70°F	70°F and higher
Oils -			
Gear, VV-L-761 (SAE 90) (Hypoid) gal	1	1	1
Motor 9110 (SAE 10) gal	1	1	1

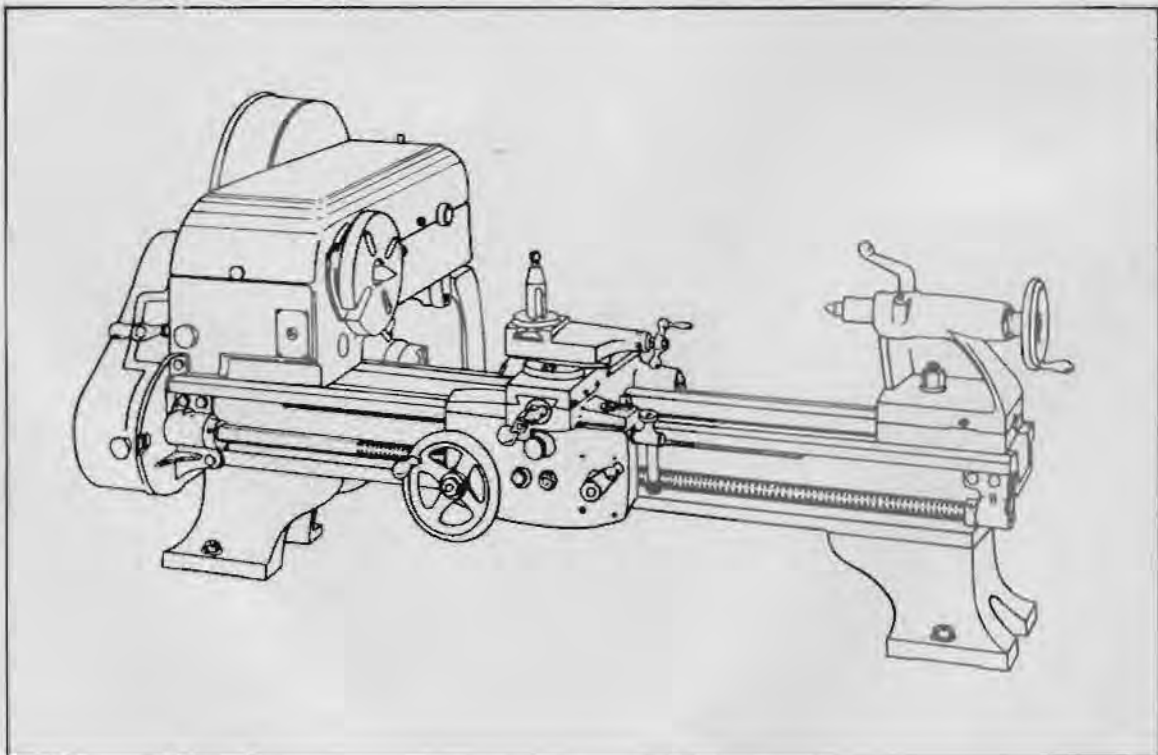

**AUXILIARY EQUIPMENT SUPPLIED:** Spare parts estimated to be required during a year's use are included as well as manuals of instruction for the operation, maintenance and repair of the machine.

**AUXILIARY EQUIPMENT NEEDED BUT NOT SUPPLIED:** Cutting tools and accessories.

**SHIPPING INFORMATION:** Boxed for export.  
Weight: 470 lb                      Cube: 45 cu ft

## PRESS, HYDRAULIC, 100-TON, PORTABLE

STOCK NO. 7C64-160

**APPLICATION:** A versatile and portable tool for bending, straightening, pressing, pulling and jacking jobs, furnished for equipment maintenance and repair shops and particularly for the field servicing of construction equipment with crawler tracks.

**CAPACITY:** The press has a capacity of 100 tons. Rod centers are 30 in. by 11 1/2 in. and the daylight dimension between frames is 24 1/2 in. The press cylinder may be used either without the frame as an ordinary jack, with the frame as a press, or without the frame but with caterpillar-service tool-head for caterpillar track work.

**DESCRIPTION:** The unit consists of the frame, head, base and bolts; a service tool head; a tractor track servicing attachment; a 100-ton universal cylindrical press with ram travel of 6 1/2 in.; a 4-speed hand pump; 10-ft lengths of high-pressure hydraulic hose and return oil hose and all connecting fittings, gages etc. In addition to the parts of the press proper there is also included with each unit a set of tools and adaptors necessary for servicing track pins and bushings and for pulling sprockets and sprocket shafts for caterpillar D4, D6, D7 and D8 tractors, Allis Chalmers M, HD7, HD10, and HD14 tractors, and International Harvester TD9, TD14 and TD18 tractors. The weights of press parts are head 147 lb, base 110 lb, rods 54 lb, press cylinder 75 lb and pump 75 lb.

**OPERATION:** The operation of the press is by one man, but additional hands are required to handle the parts, depending upon their weight.

**SUPPLIES REQUIRED:** The following quantities of fuel and lubricants are estimated to be required for operating the equipment 1,000 hours under severe conditions at the atmospheric temperature ranges shown:

32°F and lower      32°F to 70°F      70°F and higher

Oils -

Motor 9110 (SAE 10) gal

1                      1                      1

**AUXILIARY EQUIPMENT SUPPLIED:** Spare parts estimated to be required over a period of a year's operation are included, as well as manuals of instruction for the operation and maintenance of the machine.

**SHIPPING INFORMATION:** Packed for export.  
Weight: 2000 lb                      Cube: 60 cu ft



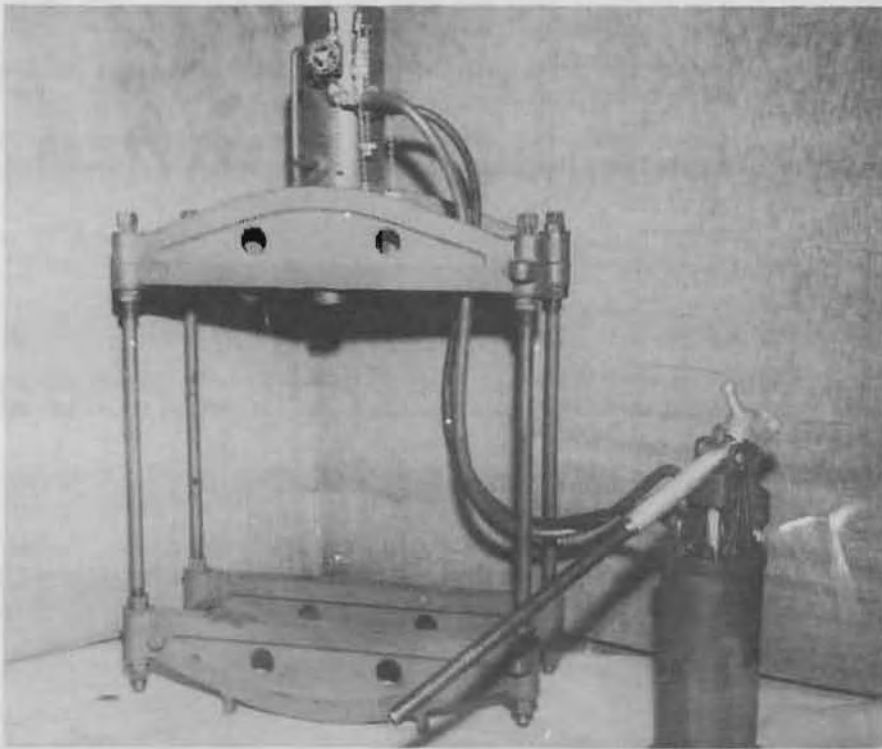

(November 1943) 718

## PRESS, DRILL, MOTOR DRIVEN

STOCK NO. 7C11-2

**APPLICATION:** A motor-driven back-geared upright power-drill for shop installations.

**CAPACITY:** This machine takes the smallest drills up to 1 1/2-in. diam and has a table traverse on the column of 21 in. and a column to center of spindle distance of 10 1/2 in. It is back-geared with 4-step cone pulleys. The spindle traverses 9 in.

**DESCRIPTION:** The drill is made with square base, has eight speeds with three distinct and complete feeds-power feed, hand screw feed and hand lever feed. The spindle is counterbalanced by a weight in the hollow column and has an automatic stop attachment with quick return to the lever giving rapid movement to the spindle. The drill has a quick action screw for raising and lowering the table. The V-belt drive can be adjusted by means of the adjustable motor base. The drill is powered by a 1-hp 3 phase 220-V motor which, together with belts, accompanies each drill.

**OPERATION:** One-man operation

**SUPPLIES REQUIRED:** Current, drills and the following quantities of fuel and lubricants are estimated to be required for operating the equipment 1,000 hours under severe conditions at the atmospheric temperature ranges shown:

32°F and lower      32°F to 70°F and higher  
1                      1                      1

Oils -  
Motor 9110 (SAE 10) gal

1                      1                      1

**AUXILIARY EQUIPMENT SUPPLIED:** Spare parts estimated to be required during a year's operation, as well as manuals of instruction for operation and maintenance of the machine, are included.

**SHIPPING INFORMATION:** Packed for export.  
Weight 1400 lb      Cube: 100 cu ft

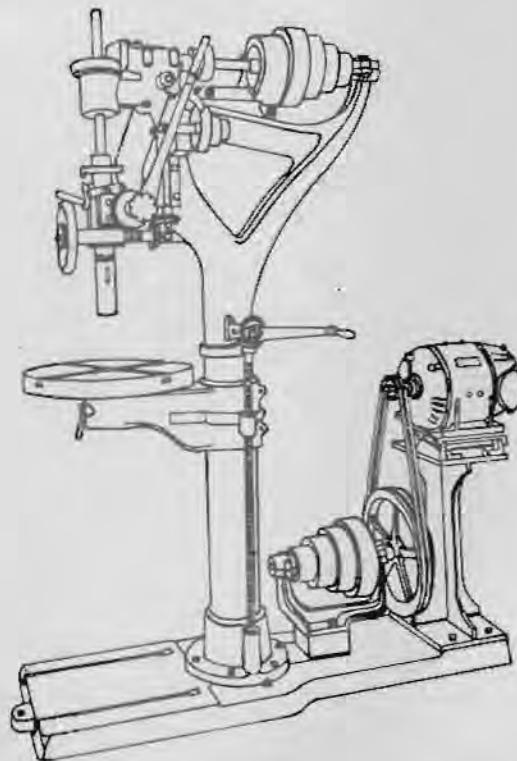

PRESS, HYDRAULIC, TRAILER MOUNTED  
FOR TRACTOR TRACK PINS AND BUSHINGS, STOCK NO. 7C64

**APPLICATION:** This is a hydraulic press, trailer mounted and especially designed and equipped for servicing tractor tracks.

**CAPACITY:** The press has a capacity of 120 tons with a ram travel of 13 1/2 in. in 14 seconds. The machine time required for servicing two large tractor tracks is approximately 3 1/2 hours. Complete tool sets for servicing all Caterpillar, Allis-Chalmers, International Harvester and Cletrac tractor tracks are included.

**DESCRIPTION:** The unit consists a press frame, a press cylinder with ram, a power-operated pump, a power-operated track wrench and a gasoline engine power-unit, all mounted on a 4-wheeled, pneumatic-tired trailer. The trailer is provided with a track work table, tools and a sectional roller conveyor. The work table is adapted for bringing tracks to the proper height for servicing but it may be removed when other operations are desired. The pump is provided with an adjustable pressure control which permits of a selection of the working pressure used. The 10-hp water-cooled gasoline engine powers the pump, generates the current for the lights, powers the mechanical track wrench and is equipped with an electric storage battery automotive type starting system. The power wrench is used for removing track plates before the track pins and bushings are serviced. All controls for both the engine and press are conveniently grouped near the operator's place. The clearance between the rods of the press frame is 38 in. and the length 60 in. The overall dimensions of the machine are length 144 in., width 66 in. and height 56 in.

**OPERATION:** Two men ordinarily can mount small or medium sized track on the machine with the conveyor sections, but pulling and handling heavy and large tracks requires more men or the use of a mechanical lifting device.

**SUPPLIES REQUIRED:** The following quantities of fuel and lubricants are estimated to be required for operating the equipment 1,000 hours under severe conditions at the atmospheric temperature ranges shown:

	32°F and lower	32°F to 70°F	70°F and higher
<b>Fuel -</b>			
Unleaded gasoline, 65 octane, gals	1000	1000	1000
<b>Greases -</b>			
General purpose 14L9 No. 1 (chassis) lb	15	15	
General purpose 14L10 No. 2 (wheel bearing) lb	5	5	20
Water Pump 14L11 lb	1	1	1
<b>Oils -</b>			
Gear, VV-L-761 (SAE 80) (Hypoid) gal	2		
Gear, VV-L-761 (SAE 90) (Hypoid) "		2	2
Motor 9110 (SAE 10) gal	36	36	6
" 9250 ( " 30) "			30

**AUXILIARY EQUIPMENT SUPPLIED:** Spare parts estimated to be required during a year's operation are included, as well as manuals of instruction for the operation and maintenance of the machine.

**SHIPPING INFORMATION:** Boxed for export.  
Weight: lb                      Cube: cu ft  
          6,000                      500

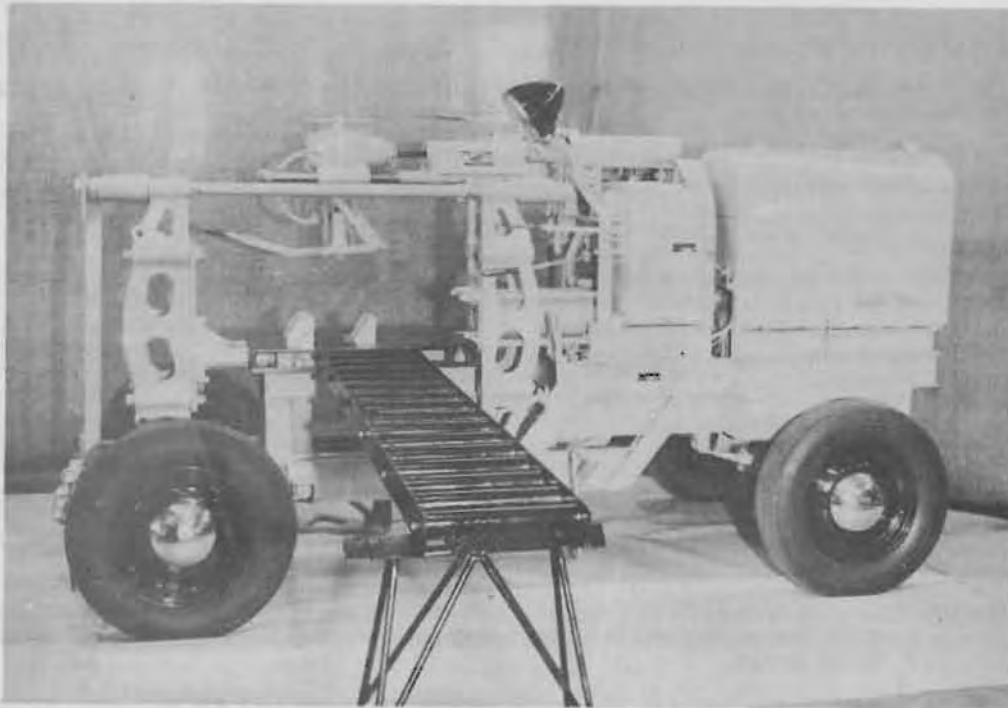

## SAW, HACK, POWER

STOCK NO. 7C66-27

**APPLICATION:** This is a power hacksaw for shop use in sawing steel and iron mechanically.

**CAPACITY:** This machine takes a blade 12 to 14 in. long, has a cutting stroke of 6 in. and has cutting capacity for material up to 6 in. by 6 in.

**DESCRIPTION:** The unit consists of a work holder, a saw frame, reciprocating mechanism and motor drive, all mounted on a cast iron stand. The work holder is a screw vise which swivels up to 45 deg. The reciprocating mechanism imparts power on the cutting stroke and raises the blade on the return stroke. It is also arranged so that weights may be added when the saw blade becomes dulled. The motor, which is belt-connected, is a 1/2-hp 110-V 60-cycle single-phase electric.

**OPERATION:** Operation is continuous and automatic once the work has been placed and machine started.

**SUPPLIES REQUIRED:** Current, blades and the following quantities of fuel and lubricants are estimated to be required for operating the equipment 10,000 hours under severe conditions at the atmospheric temperature ranges shown:

	32°F and lower	32°F to 70°F	70°F and higher
<b>Greases -</b>			
Wire rope chain and open gear VV-L-751 lb	1	1	1
<b>Oils -</b>			
Motor 9110 (SAE 10) gal	1	1	1

**AUXILIARY EQUIPMENT SUPPLIED:** One gross of blades together with spare parts estimated

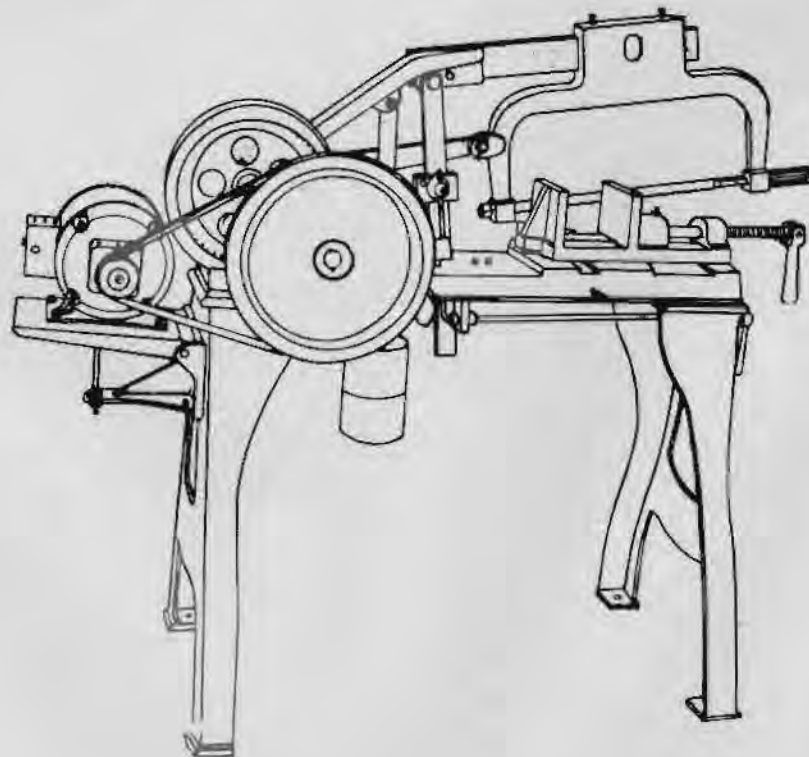



to be required during a year's operation, and manuals of instruction for the operation and maintenance of the machine, are included with each unit.

**SHIPPING INFORMATION:** Boxed for export.  
Weight: 460 lb                      Cube: 28 cu ft



## SHANKING DEVICE, HAND

FOR DRILL RODS, STOCK NO. 7Q79

**APPLICATION:** This hand shanking device is for use in forming shanks on steel drill rods and jackhammer rods where such rods are forged by a blacksmith. It is essentially a shop tool for servicing compressed air operated steel drill and hammer rods.

**CAPACITY:** It is equipped to form 1 in. x 4 1/4 in. and 1 1/4 in. x 4 1/4 in. shanks.

**DESCRIPTION:** This device is used in the blacksmith shop to forge shanks on hot rods. It is simple to use, rugged in construction, and it provides a fast hand method of forming perfectly made collars and shanks of proper length with true, square ends. Shanks turned out on this device are equal in every way to those made on a power sharpener, but the operation is not as rapid. Its service weight is 250 lb and all parts are of steel.

**SUPPLIES REQUIRED:** 9110 (SAE 10) oil

**AUXILIARY EQUIPMENT SUPPLIED:** Spare parts estimated to be required during a year's operation are included as well as all required gages, discs, etc. Manual of instruction for operation and maintenance furnished, together with a spare parts list.

**SHIPPING INFORMATION:** Packed for export.  
Weight: 600 lb                      Cube: 10 cu ft



## SPRAYER, PAINT, MOBILE

STOCK NO. 7C80

**APPLICATION:** For spray painting of any class or kind but particularly for camouflage purposes.

**CAPACITY:** The paint capacity of the tank is 5 gal and the assembly operates two production spray guns. The compressor delivers 17 cfm of free air at a working pressure of 80 psi into a 12 gal receiver and is powered by a 4 hp gas engine.

**DESCRIPTION:** The compressor and engine drive, both air cooled, are mounted, together with the air receiver, on a steel four wheel truck with tongue and handle for pulling by hand. The assembly also includes a 5 gal pressure feed tank with hand and air motor agitator and equipped for double regulation, 2 production type pistol grip spray guns, 2 extension handles 4 ft and 6 ft in length, a 50 ft length of 5/16 in. air hose with connections, a 25 ft length each of 5/16 in. air hose and 3/8 in. fluid hose with connections and a filter type respirator with extra filters.

**OPERATION:** Operation of the compressor and engine after being started is automatic and is usually looked after by the mechanics operating the spray guns.

**SUPPLIES REQUIRED:** The following quantities of fuel and lubricants are estimated to be required for operating the equipment 1,000 hours under severe conditions at the atmospheric temperature ranges shown:

	32°F and lower	32°F to 70°F	70°F and higher
<b>Fuel -</b> Unleaded gasoline, 65 octane, gals	500	500	500
<b>Greases -</b> General purpose 14L9 No. 1 (chassis) lb	2	2	2
<b>Oils -</b> Motor 9110 (SAE 10) gal " 9250 ( " 30) "	6 6	6 6	6 6

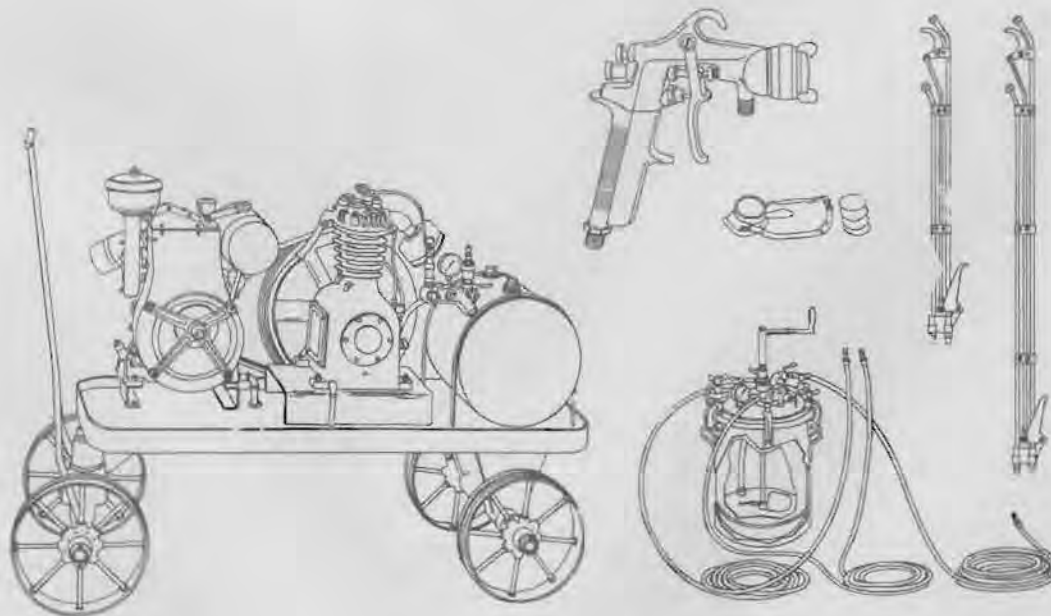

AUXILIARY EQUIPMENT SUPPLIED: Spare parts estimated to be required during a year of operation are included as well as manuals of instruction for the operation, maintenance and repair of the equipment.

SHIPPING INFORMATION: Shipped boxed for export.

Weight: 1600 lb

Cube: 65 cu ft

## THREADING DEVICE, HAND

FOR DRILL ROD TURNING, FACING AND THREADING, STOCK NO. 7Q79

**APPLICATION:** This tool is for turning and facing rock drill rods and for cutting Ingersoll-Rand threads on them for detachable bits.

**CAPACITY:** The tool is equipped with cutters and dies for 1-in hex drill rods and 1 1/4-in round wagon drill rods. It completely machines a rough annealed rod without the additional use of any other tool or machine.

**DESCRIPTION:** This tool consists of a work holder, a turning and facing device, a die head, ratchet handle, cutters and dies. The rod to be worked is first secured by a vise and the work holder then placed on and tightened to the rod where it remains in one position until the work is done. The work holder serves as a support for the turning and facing device and the die head. When the turning and facing device has accomplished its work it is removed and the threads, if required, are cut by means of the die head and ratchet handle.

**OPERATION:** The tool is manually operated by one man and requires only a vise or holder for the drill rod.

**SUPPLIES REQUIRED:** Spare cutters and the following quantities of fuel and lubricants are estimated to be required for operating the equipment 1,000 hours under severe conditions at the atmospheric temperature ranges shown:

Oils -	32°F and lower	32°F to 70°F	70°F and higher
Gear, VV-L-761 (SAE 90) (Hypoid) gal	1	1	1
Motor 9110 (SAE 10) gal	1	1	1

**AUXILIARY EQUIPMENT SUPPLIED:** Spare parts estimated to be required during a year's operation are supplied. Manual of instruction for operation and maintenance furnished, together with a spare parts list.

**SHIPPING INFORMATION:** Boxed for export.

Weight: 40 lb  
Cube: 2 cu ft



## THREADING MACHINE, PIPE AND BOLT, 3 HP

STOCK NO. 7C78-1

**APPLICATION:** For cutting, threading and reaming pipe, for turning fittings on or off and for cutting and threading bolts, a semi portable tool for repair, maintenance and construction shops use.

**CAPACITY:** The machine is equipped with cutters and dies for the complete range of pipe sizes between 1 1/4 in. dia to 6 in. dia bolt dies for 3/4 in. 7/8 in. and 1 in. dia. It is powered by a 3 hp 60 cy 220 V motor with manual control.

**DESCRIPTION:** The unit consists of the turning machine, with motor, controls, all cutters and dies as above listed, wrenches, and an adjustable pipe stand on which the machine is mounted.

**OPERATION:** It is arranged for one man operations.

**SUPPLIES REQUIRED:** Electrical current and the following quantities of fuel and lubricants are estimated to be required for operating the equipment 1,000 hours under severe conditions at the atmospheric temperature ranges shown:

	32°F and lower	32°F to 70°F	70°F and higher
Oils -			
Gear, VV-L-761 (SAE 90) (Hypoid) gal	5	5	5
Motor 9110 (SAE 10) gal	5	5	5

**AUXILIARY EQUIPMENT SUPPLIED:** Spare parts estimated to be required during a year's operation are included as well as manuals of instruction for the operation and maintenance of the machine.

**SHIPPING INFORMATION:** Boxed for export

Weight 3,200 lb  
Cube 80 cu ft

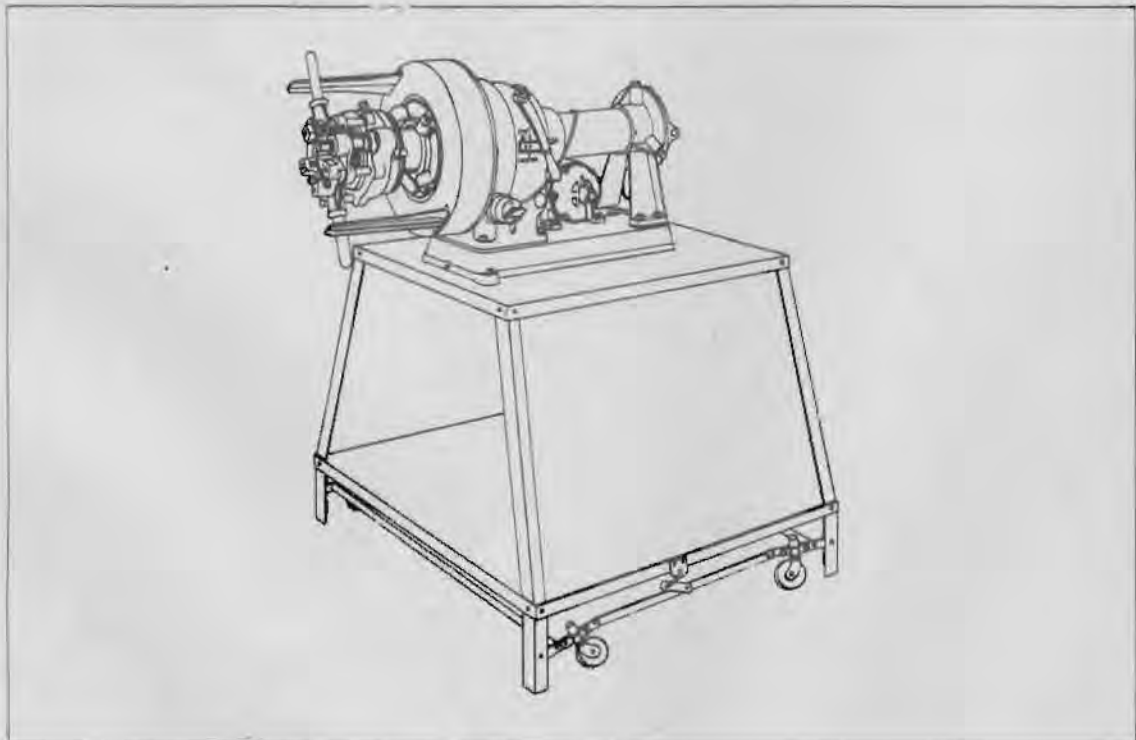

## BREAKER, PAVING, GAS DRIVEN

STOCK NO. 7Q1-6

**APPLICATION:** Used as a paving breaker, rock drill, digging tool or mechanical hammer where compressors are not available.

**CAPACITY:** It operates moil points, chisels, rock drills, clay spades, tampers and sheeting hammers.

**DESCRIPTION:** This machine is powered by a gasoline engine which is an integral part of it, with battery for ignition which is separate but attached by cable. It is portable, weighing 96 lb and requires no additional powering equipment. Each hammer is complete including battery, battery case, all electrical cables, as well as a set of tools including 2 narrow chisels, 2 wide chisels, 10 moil points, 1 sheathing driver and one tamper.

**OPERATION:** One-man operation.

**SUPPLIES REQUIRED:** The following quantities of fuel and lubricants are estimated to be required for operating the equipment 1,000 hours under severe conditions at the atmospheric temperature ranges shown:

	32° F and lower	32° F to 70° F	70° F and higher
Fuel - Unleaded gasoline, 65 octane, gals	60	60	60
Oils - Motor 9110 (SAE 10) gal	4		
"    9250 ( " 30) "		4	
"    9500 ( " 50) "			4

**AUXILIARY EQUIPMENT SUPPLIED:** Spare parts estimated to keep the machine operating one year are included. Manual of instruction for operation and maintenance furnished, together with a spare parts list.

**SHIPPING INFORMATION:** Boxed for export  
Weight: 500 lb  
Cube: 10 cu ft

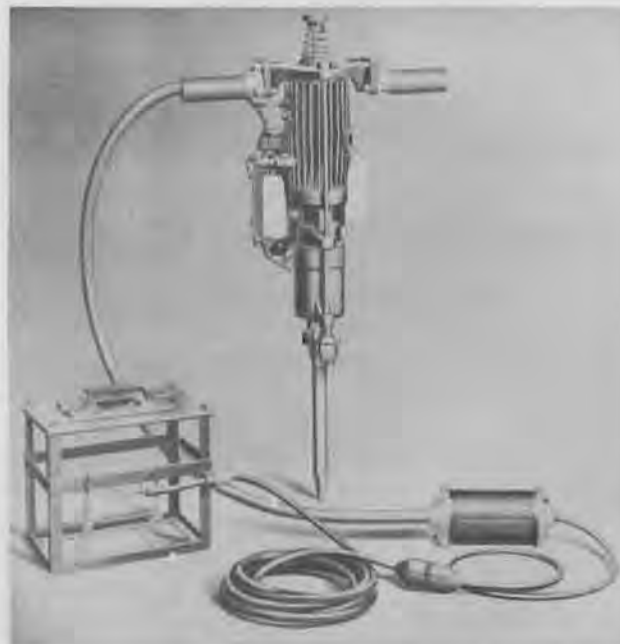

## CONVEYOR, GRAVITY ROLLER

STOCK NO. 7C60

**APPLICATION:** For conveying packaged units by gravity at docks, yards, terminals or warehouses.

**CAPACITY:** The conveyor is 24 in. wide and is supplied in sections 10 ft long. It will support a uniform load of 300 lb per linear ft.

**DESCRIPTION:** It consist of free-running ball-bearing rollers 2 1/2 in. in diam and 24 in long set 4 in cc in a 4-in channel frame which is supported at either end by a pair of legs mounted on ball-bearing steel casters which hold it 26 in. above the floor level. The sections are readily moved about on the casters. They may be arranged on a level line for pushing the units along or one pair of legs may be elevated slightly for conveying by gravity.

**OPERATION:** Operation is automatic by gravity when set up in an inclined position but the packaged units are hand-actuated when the conveyor sections are level.

**SUPPLIES REQUIRED:** Lubricants. VV-L-761(SAE 90) oil

**AUXILIARY EQUIPMENT SUPPLIED:** Spare parts estimated to be required during a year's operation are included.

**SHIPPING INFORMATION:** Shipped 6 sections to a box.

	Weight lb	Cube cu ft
10 ft section each	280	8.2
Supports for each section	36	2.3





## CONVEYOR, ELEVATING, MOBILE, MOTOR DRIVEN

STOCK NO. 7C60

**APPLICATION:** Used for conveying, elevating or lowering packaged units at docks, warehouses, terminals or yards.

**CAPACITY:** The conveyor is 40 ft long and one end may be raised 19 ft above the floor. It is equipped with a 3-ph 60 cy 220-V ball-bearing electric-motor drive with reversing drum-type controller conveniently mounted for operation of the conveyor in either direction.

**DESCRIPTION:** The unit consists of a 24-in endless belt conveyor 40 ft cc of end pulleys powered by motor attached below and mounted at one end on casters and near the other end on a mast-type truck with steel swivel wheels and a manually operated drum-and-cable-type raising and lowering device. It may be moved about for use in different locations and the swivel-type wheels aid its maneuverability. Its service weight is 4,300 lb.

**OPERATION:** It operates automatically after being started.

**SUPPLIES REQUIRED:** Electrical current and the following quantities of fuel and lubricants are estimated to be required for operating the equipment 1,000 hours under severe conditions at the atmospheric temperature ranges shown:

	32°F and lower	32°F to 70°F	70°F and higher
Oils -			
Gear, VV-L-761 (SAE 90) (Hypoid) gal	5	5	5
Motor 9110 (SAE 10) gal	5	5	5

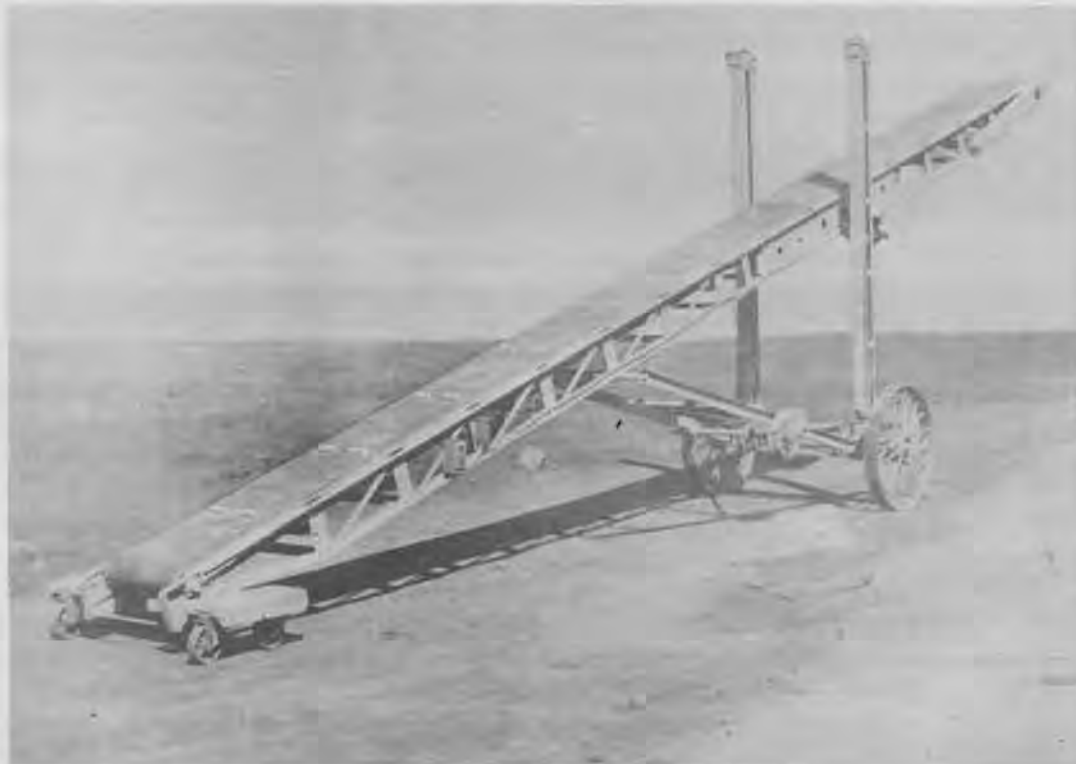

**AUXILIARY EQUIPMENT SUPPLIED:** Spare parts estimated to be required during a year's operation are included. Manual of instruction for operation and maintenance furnished, together with a spare parts list.

**SHIPPING INFORMATION:** Shipped boxed for export.

Weight: 7,300 lb  
Cube: 494 cu ft

## DRILLING RIG, WELL, MOBILE, GAS DRIVEN

STOCK NO. 7C63-1

**APPLICATION:** Used for drilling wells of any kind within its capacity but mainly for water wells and is furnished only on special request.

**CAPACITY:** This rig is suitable and equipped for drilling 4-in minimum diameter holes up to a depth of 700 ft.

**DESCRIPTION:** This rig is complete and consists of the drilling machine arranged for wire line drilling and powered by a 35-hp gasoline water-cooled engine, a 38-ft telescoping and folding mast with pantograph type tool guide and power raising and lowering device, a slack line cable holder and a belt driven blower all mounted on a trailer with 4 steel wheels, towing tongue and hitch. In addition, there is included a complete set of 4-in drilling tools, casing driving tools, dressing tools, and fishing tools together with 800 ft of mild plow steel 5/8-in diam drilling line and 3/8-in diam cast steel baling line.

**OPERATION:** Ordinarily this rig is one-man operated but it is customary to have a helper when dressing and handling the tools.

**SUPPLIES REQUIRED:** Casing and the following quantities of fuel and lubricants are estimated to be required for operating the equipment 1,000 hours under severe conditions at the atmospheric temperature ranges shown:

	32°F and lower	32°F to 70°F	70°F and higher
<b>Fuel -</b>			
Unleaded gasoline, 65 octane, gals	3500	3500	3500
<b>Greases -</b>			
General purpose 14L9 No. 1 (chassis) lb	5	5	5
Water Pump 14L11 lb	1	1	1
Wire rope chain and open gear VV-L-751 lb	10	10	10
<b>Oils -</b>			
Gear, VV-L-761 (SAE 80) (Hypoid) gal	5		
Gear, VV-L-761 (SAE 90) (Hypoid) gal		5	5
Motor 9110 (SAE 10) gal	40		
" 9250 ( " 30) "		40	
" 9500 ( " 50) "			40



**AUXILIARY EQUIPMENT SUPPLIED:** Spare parts estimated to be needed during a year of operation are included. Manual of instruction for operation and maintenance furnished, together with a spare parts list.

**AUXILIARY EQUIPMENT NOT SUPPLIED:** Well casing.

**SHIPPING INFORMATION:** Shipped bundled and boxed for export.

	Weight: lb	Cube: cu ft
Machine	13,000	600
Tools	6,000	100

## DRILLING RIG, WELL, AUXILIARY EQUIPMENT

**APPLICATION:** This is the assembly of auxiliary equipment furnished with each well drilling rig which is necessary for the permanent construction of the well including screening at the water inlet level and air lift pumps for lifting out the water.

**CAPACITY:** The method of determining the submergence necessary for the efficient operation of the airlift pump and the quantity and pressure of compressed air necessary for its operation, once the water stream is reached and the flow and lift are known, is given on Y&D Dwg. No. 264,238

**DESCRIPTION:** The units comprising this assembly are as follows:

- 300 ft 6 in. standard steel drive pipe, threaded and with couplings, 1/2 in. random lengths.
- 600 ft 3 in. standard steel black or galvanized pipe threaded and with couplings
- 600 ft 1 in. standard steel galvanized pipe threaded and with couplings.
- 5 6 in. steel drive shoes for the 6 in. drive pipe
- 1 set of elevators for 6 in. drive pipe
- 1 set of elevators for 3 in. standard pipe
- 5 6 in. wound wire well screen 5-5/8 in. outside dia. of everdur or silicon bronze with 10 ft of #25 non clogging slot, 2 ft of brass blank tubing and a lead packer at the top and a flat bail plug at the bottom together with a setting hook and a swage block and bar threaded for pipe for setting the screen and expanding the packer.
- 5 Air lift pumps consisting of the foot piece assembly, the casing top assembly which passes the 3 in. riser tubing and the 1 in. air line through a tight flanged connection at the top of the well casing and the umbrella separator assembly with plugged opening for air line pressure gage and regulator valve at the air inlet line.

**SUPPLIES REQUIRED:** Compressed air at the proper pressure and in the proper quantity see capacity above.

**AUXILIARY EQUIPMENT SUPPLIED:** Well drilling rig see Drilling Rig, Well

**AUXILIARY EQUIPMENT NOT SUPPLIED:** Collecting tank for the water at the top and its connections.

**SHIPPING INFORMATION:** Boxed and bundled for export.

	Weight lb	Cube cu ft
Pipe	11,570.	122.
Drive shoes	135.	3.
Elevators	168.	8.
Screens	200.	12.
Air lift pumps	1,750.	300.

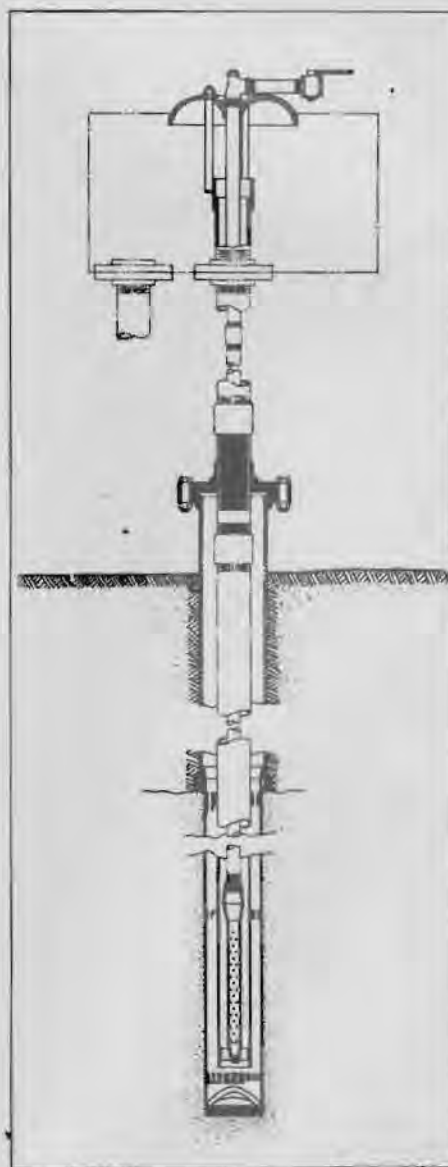

## GENERATOR, ACETYLENE, PORTABLE

STOCK NO. 7R13

**APPLICATION:** This generator is used for generating acetylene gas at the job site for use in oxyacetylene cutting and welding sets and also in carbide flood and flare lights.

**CAPACITY:** The size furnished is rated to deliver 50 cu ft per hour of pure hot gas as required for the smallest or largest tip, at pressures varying from 2 to 15 lb per sq in. When fully charged, it holds 25 lb of carbide and 25 gal of water, each filling providing about half the amount of gas contained in one large cylinder of gas. The floodlight furnishes 10,000 candlepower of non-glare light, throws a broad beam approximately 500 ft and will burn 2 hours on one pound of carbide.

**DESCRIPTION:** Acetylene gas is generated by bringing calcium carbide and water together. This unit consists of a carbide container of heat-proof glass arranged to feed the carbide at a regulated rate to the supply of water in the tank below, where the gas generates and is delivered to the torch or floodlight as required and under complete control. The glass carbide compartment permits observing the amount of charge available at any time. The unit is protected by feed and pressure-regulators, a flashback arrestor and a pressure relief valve. It is equipped with side handles for lugging and is mounted on a 4-steel-wheel cart for mobility about the shop. The use of floodlight and cutting and welding torches may be independent or simultaneous. The generator weighs 120 lb empty and 353 lb fully charged. The cart weighs 110 lb.

**OPERATION:** Floodlight operation is continuous when started. Gas generation for cutting and welding operations is regulated and controlled by the mechanic handling the torches and does not require an independent operator if within his reach.

**SUPPLIES REQUIRED:** Carbide and water.



**AUXILIARY EQUIPMENT SUPPLIED:** Spare parts estimated to be required during a year's operation, as well as instruction manuals for operation and maintenance are included.

**AUXILIARY EQUIPMENT NEEDED BUT NOT SUPPLIED:** Carbide, water, oxygen and cutting and welding equipment.

**SHIPPING INFORMATION:** Boxed for export.

Weight: 300 lb

Cube: 60 cu ft

## MACHINE, BLASTING

50 HOLE CAPACITY, STOCK NO. 7G25-3

**APPLICATION:** The blasting machine generates the electrical current for firing dynamite caps used in blasting operations.

**CAPACITY:** This machine is the largest practical size and is capable of firing from 1 to 50 dynamite caps at one time.

**DESCRIPTION:** This machine is of the push-down type, weighing 23 lb and having overall dimensions approximately 8 in x 8 in x 18 in. It is strongly constructed and is housed in an oak box designed to withstand the rough usage encountered on blasting operations.

**OPERATION:** One-man operated.

**AUXILIARY EQUIPMENT SUPPLIED:** An ohmmeter-galvanometer for indicating the condition of blasting cap circuit and a rheostat for indicating the condition of the blasting machine are included with each machine. Spare parts estimated to be needed during a year's operation are also included. Manual of instruction for operation and maintenance furnished, together with a spare parts list.

**AUXILIARY EQUIPMENT NEEDED BUT NOT SUPPLIED:** Connecting wires, dynamite and caps.

**SHIPPING INFORMATION:** Shipped boxed for export

Weight: 35 lb  
Cube: 2 cu ft

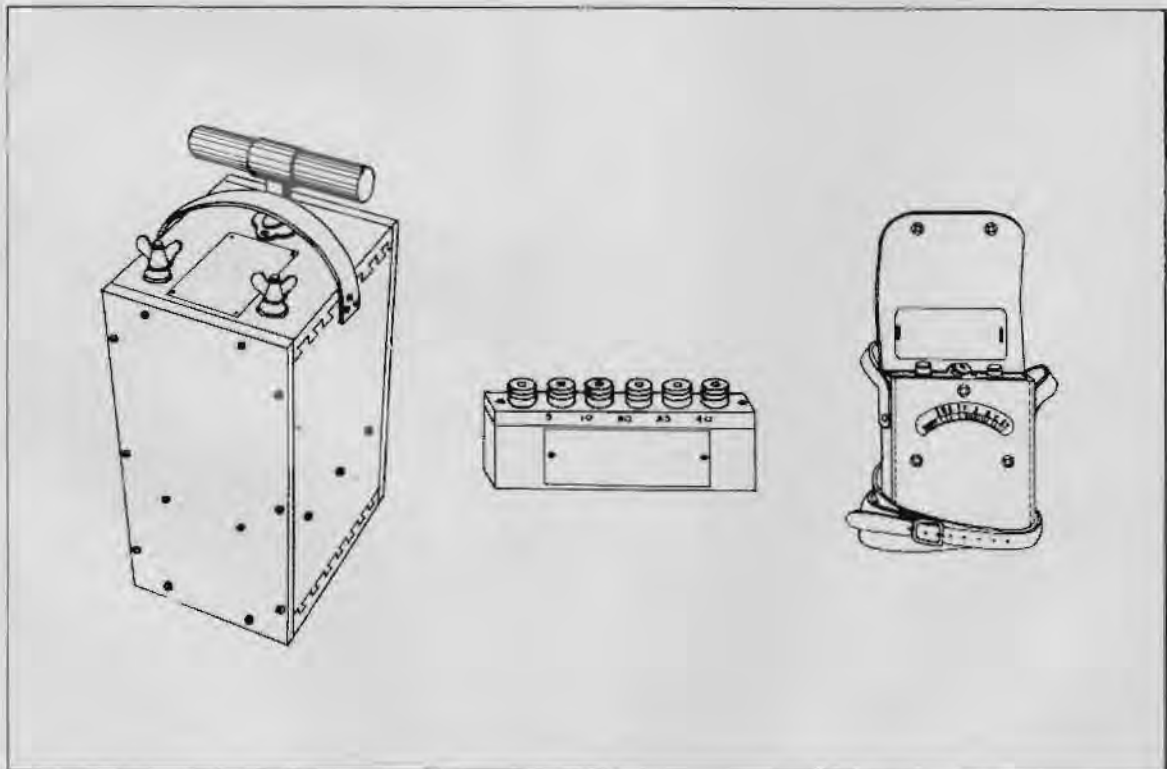



## MIXER, CONCRETE, 7S, MOBILE

STOCK NO. 701

**APPLICATION:** Used for mixing concrete.

**CAPACITY:** Capacity, seven cubic feet of concrete.

**DESCRIPTION:** This mixer is of the non-tilting type, equipped with overhead automatic metering water tank, power operated loading skip and skip shaker, is powered by a 15-hp air-cooled gasoline engine, and is mounted on a steel trailer with four steel wheels, a towing tongue and hitch.

**OPERATION:** One-man operation.

**SUPPLIES REQUIRED:** The following quantities of fuel and lubricants are estimated to be required for operating the equipment 1,000 hours under severe conditions at the atmospheric temperature ranges shown:

	32°F and lower	32°F to 70°F	70°F and higher
<b>Fuel -</b>			
Unleaded gasoline, 65 octane, gals	1500	1500	1500
<b>Greases -</b>			
General purpose 14L9 No. 1 (chassis) lb	5	5	5
Wire rope, chain and open gear VV-L-751 lb	5	5	5



Oils -	32°F and lower	32°F to 70°F	70°F and higher
Gear, VV-L-761 (SAE 80) (Hypoid) gal	2		
Gear, VV-L-761 (SAE 90) (Hypoid) gal		2	2
Motor 9110 (SAE 10) gal	20	20	
" 9250 ( " 30) gal			20

AUXILIARY EQUIPMENT SUPPLIED: Spare parts estimated to keep machine in operation one year are included. Manual of instruction for operation and maintenance furnished, together with a spare parts list.

SHIPPING INFORMATION: Bundled for export.

Weight: 3,700 lb  
Cube: 214 cu ft

## MIXER, CONCRETE- 14S, MOBILE

STOCK NO. 701

**APPLICATION:** Used for mixing concrete.

**CAPACITY:** 14 cu ft of mixed concrete per batch.

**DESCRIPTION:** This mixer is of the nontilting revolving drum type. It is equipped with an overhead automatic metering water tank and power-operated loading skip and skip-shaker; and is powered by a 28-hp air-cooled gasoline engine, all of which is mounted on a steel trailer with four steel wheels, towing tongue and hitch.

**OPERATION:** One-man operation.

**SUPPLIES REQUIRED:** The following quantities of fuel and lubricants are estimated to be required for operating the equipment 1,000 hours under severe conditions at the atmospheric temperature ranges shown:

	32°F and lower	32°F to 70°F	70°F and higher
<b>Fuel -</b>			
Unleaded gasoline, 65 octane, gals	2500	2500	2500
<b>Greases -</b>			
General purpose 14L9 No. 1 (chassis) lb	5	5	5
Wire rope chain and open gear VV-L-751 lb	5	5	5
<b>Oils -</b>			
Gear, VV-L-761 (SAE 80) (Hypoid) gal	5		
Gear, VV-L-761 (SAE 90) (Hypoid) gal		5	5
Motor 9110 (SAE 10) gal	30		
"    9250 ( " 30) gal		30	
"    9500 ( " 50) gal			30



**AUXILIARY EQUIPMENT SUPPLIED:** Spare parts estimated required for one year's operation are included. Manual of instruction for operation and maintenance furnished, together with a spare parts list.

**SHIPPING INFORMATION:** Bundled for export.

Weight: 6,600 lb

Cube: 400 cu ft

## SAWMILL

STOCK NO. 7C119

**APPLICATION:** For sawing logs into boards, planks and timbers.

**CAPACITY:** This mill will handle logs up to 24 in.diam 16 to 18 ft long at its rated capacity of about 8,000 fbm per eight hour day. It is equipped with inserted tooth saws and excess power capacity considered to be adequate for sawing the toughest woods.

**DESCRIPTION:** The mill is completely equipped for sawing, trimming, edging, conveying and saw sharpening. Precut timber supports for the various pieces as well as for the overhead transmission shafts and cross cut saw are included. The principal items of the mill are as follows:

- 1 Sawmill, complete with 14 ft carriage
- 1 48 in. inserted tooth saw
- 1 54 in. inserted tooth saw
- 1 Wood swing cutoff with 36 in saw
- 1 Edger with 2 - 20 in. saws
- 1 Trimmer with 2 - 20 in. saws
- Live and dead conveying rolls
- 2 Sawdust conveyors
- 2 Gasoline engine powers
- 1 Automatic saw sharpener
- All necessary belts, shafts, pulley etc. for power transmission

**OPERATION:** A mill operating crew of not less than six is required for capacity operation.

**SUPPLIES REQUIRED:** The following quantities of fuel and lubricants are estimated to be required for operating the equipment 1,000 hours under severe conditions at the atmospheric temperature ranges shown:

	32°F and lower	32°F to 70°F	70°F and higher
Fuel - Unleaded gasoline, 65 octane, gals	12,000	12,000	12,000

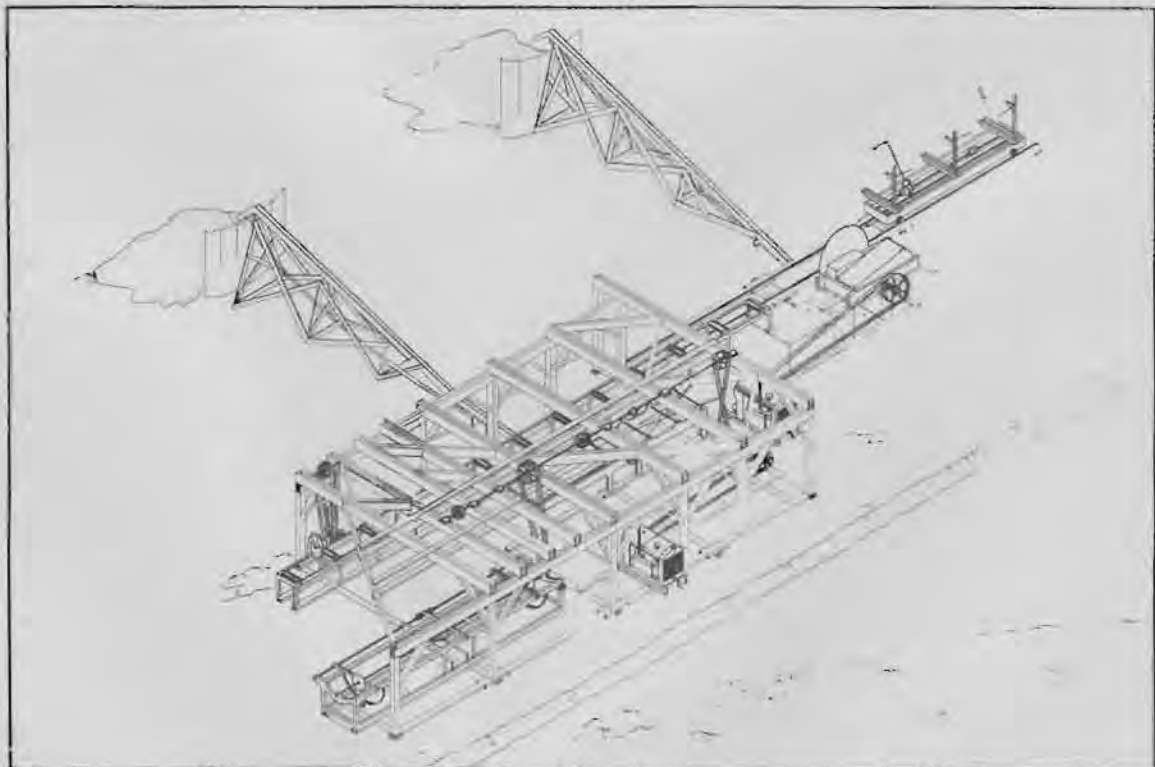

	32°F and lower	32°F to 70°F	70°F and higher
Greases -			
Ball and roller bearing 14L3b grade			
No. 11 lb	15	15	15
Water Pump 14L11 lb	2	2	2
Wire rope chain and open gear VV-L-751 lb	15	15	15
Oils -			
Gear, VV-L-761 (SAE 80) (Hypoid) gal	5		
Gear, VV-L-761 (SAE 90) (Hypoid) gal		5	5
Motor 9110 (SAE 10) gal	60		
" 9250 ( " 30) gal		60	
" 9500 ( " 50) gal			60

AUXILIARY EQUIPMENT SUPPLIED: Spare parts estimated to be required during a year of operation are included as well as instruction manuals for the operation, maintenance and repair of the machines.

SHIPPING INFORMATION: Boxed for export with timber framing bundled.  
 Sawmill complete Weight: 21,300 lb Cube: 1,360 cu ft  
 Timber frames complete Weight: 11,900 lb Cube: 500 cu ft

## STAPLER

FOR WIRE ROAD MESH, STOCK NO. 7W53-2

**APPLICATION:** Used for stapling together the sheets of 2 in x 2 in #4 wire road mesh furnished on all bases.

**DESCRIPTION:** The stapler is a two-handled tool similar to a bolt cutter operated by one man in standing position. It has a magazine for staples which holds 400 staples.

**SUPPLIES REQUIRED:** Lubricate with 9110 (SAE 10) machine oil occasionally.

**AUXILIARY EQUIPMENT SUPPLIED:** Staples are supplied. Spare parts estimated to anticipate a year's operation are included. Manual of instruction for operation and maintenance furnished, together with a spare parts list.

**SHIPPING INFORMATION:** Shipped boxed at the rate of 1 stapler for each 3,000 sq ft of mesh and 1 staple for each sq ft of mesh.

	Weight:	Cube:
Stapler	15 lb	1. cu ft
1,000 staples	20 lb	0.2 cu ft

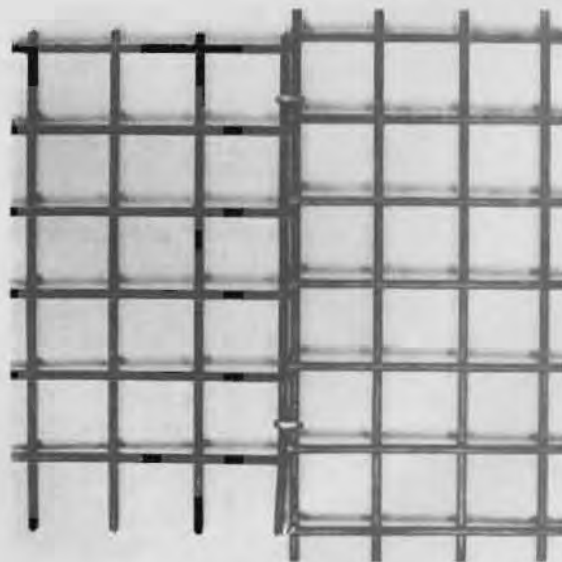

## TRUCK, 2 WHEEL HAND TYPE

STOCK NO. 7C85-1

**APPLICATION:** For handling cargo at warehouses, dock, terminals and yards.

**CAPACITY:** This truck enables one man to move baled, bagged, barrelled, bundled and boxed units of cargo weighing up to 500 lb over floors that are hard surfaced and smooth enough for rolling.

**DESCRIPTION:** It is a rugged all steel hand truck with smooth wood handles, semi-steel roller bearing wheels and with strong tapered nose to slip under heavy items for ready loading onto the truck. It is 56 in. long, not more than 24 in. wide at the handles and weighs 88 lb.

**OPERATION:** One man operated.

**SUPPLIES REQUIRED:** Lubricants 9110 (SAE 10)

**SHIPPING INFORMATION:** Boxed for export.

Weight 110 lb  
Cube 15 cu ft

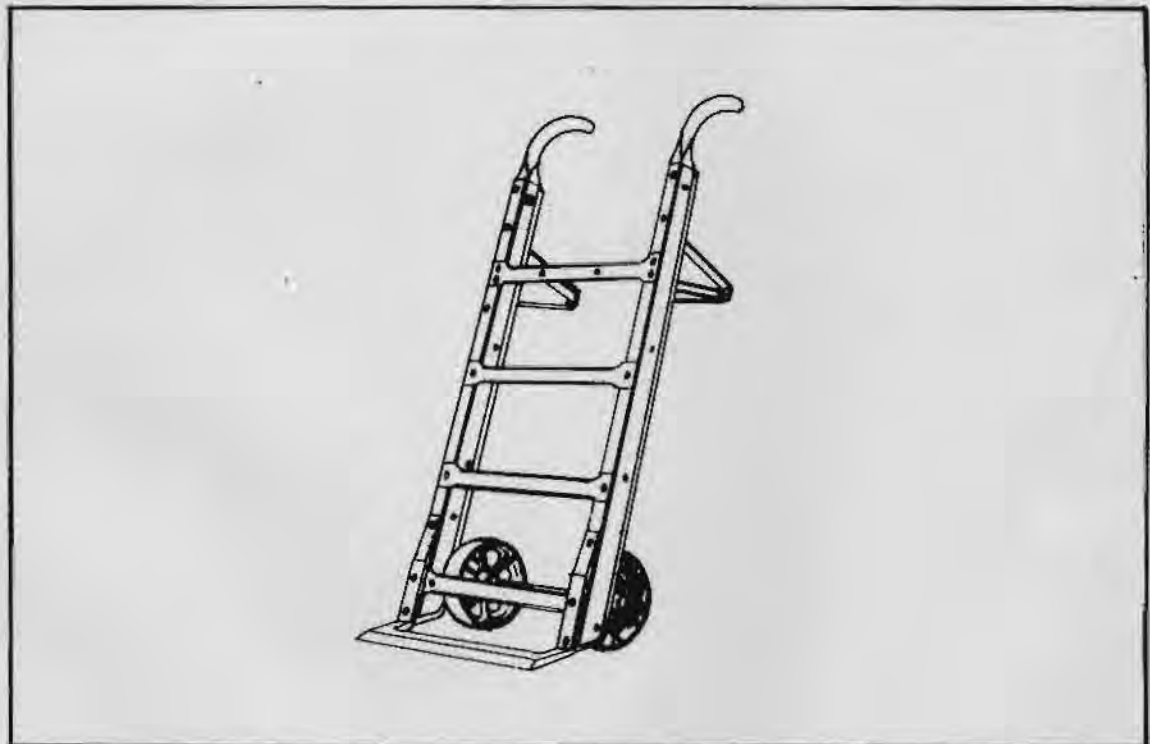



## WELDER, ELECTRIC, GAS DRIVEN

300 AMP, MOBILE, STOCK NO. 7R1-7

**APPLICATION:** Used for arc welding.

**CAPACITY:** This machine has a capacity for 300 amperes at 40v at 1,500 rpm and has a current range of from 50 to 400 amperes regulated by multi-range dual controls having up to 1,000 combinations to obtain the desired arc characteristics.

**DESCRIPTION:** The generator is direct connected to an industrial water-cooled gasoline engine with starter and control panels, all housed in a weatherproof removable panel type steel housing and all mounted on yard-type trailer with towing tongue and four steel wheels. The equipment included with each machine is as follows: 100 ft lengths of ground and lead cables; leather and cotton gloves; welding helmets with extra lenses; and electrode holders.

**OPERATION:** Operates continuously when started and is regulated by welder.

**SUPPLIES REQUIRED:** Welding rods and the following quantities of fuel and lubricants are estimated to be required for operating the equipment 1,000 hours under severe conditions at the atmospheric temperature ranges shown:

	32°F and lower	32°F to 70°F	70°F and higher
<b>Fuel -</b>			
Unleaded gasoline, 65 octane, gals	4,000	4,000	4,000
<b>Greases -</b>			
General purpose 14L10 No. 2 (wheel bearing) lb	1	1	1
Ball and roller bearing 14L3b grade No. 11 lb	1	1	1

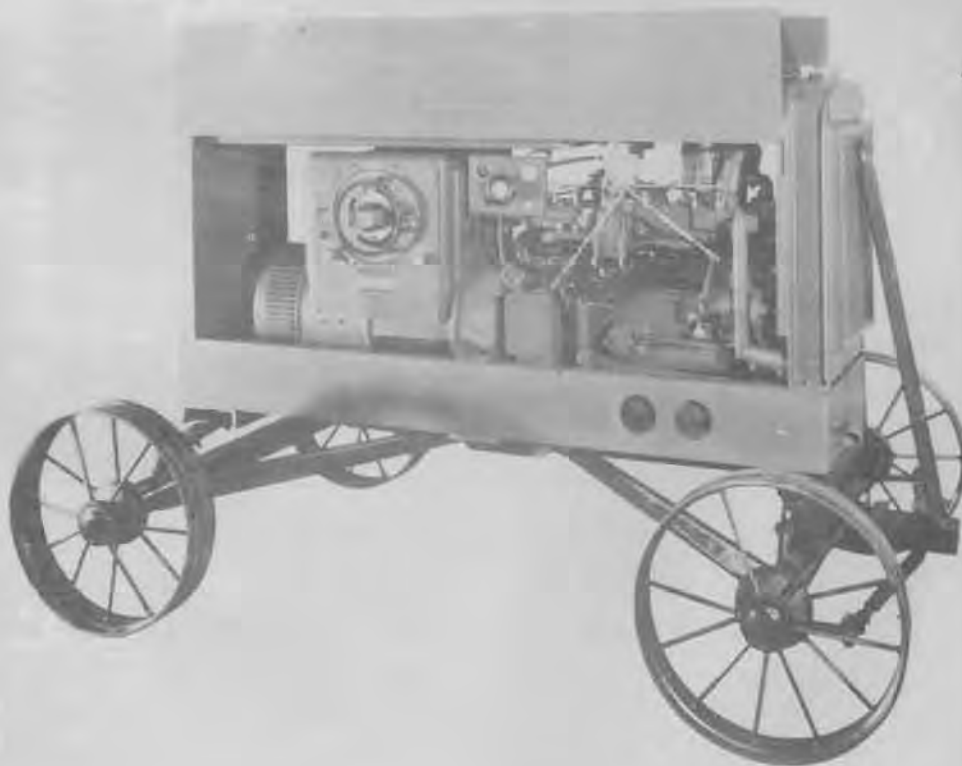

	32°F and lower	32°F to 70°F	70°F and higher
Oils -			
Motor 9110 (SAE 10) gal	35		
" 9250 ( " 30) gal		35	35

AUXILIARY EQUIPMENT SUPPLIED: Spare parts estimated to be required during a years operation. Manual of instruction for operation and maintenance furnished, together with a spare parts list.

SHIPPING INFORMATION: Packed for export.

Weight: 2900 lb  
Cube: 250 cu ft

## WINCH, 2 DRUM, GAS ENGINE DRIVEN

7,500 LB LINE PULL, STOCK NO. 7C61-21

**APPLICATION:** This winch is suitable for general derrick work, pile driving, steel erection and construction hoisting and pulling assignments generally. It is furnished only on special request.

**CAPACITY:** Each drum has capacity for 1,800 ft of 1/2-in diam or 450 ft of 1 in diam wire rope and is capable of a single line pull of 7,500 lb on the second wrapping at 200 fpm.

**DESCRIPTION:** The winch consist of two wire rope drums with a single nigger head on the outside of each, powered by a 70 - 75 hp gasoline water cooled engine all mounted on a frame with steel skids. Each drum is operatable alone, is equipped with brakes and safety locking dogs and all controls are located convenient for one man operation.

**OPERATION:** One engineer operates the drums but an additional operator is required when the niggerheads are in use.

**SUPPLIES REQUIRED:** The following quantities of fuel and lubricants are estimated to be required for operating the equipment 1,000 hours under severe conditions at the atmospheric temperature ranges shown:

	32°F and lower	32°F to 70°F	70°F and higher
<b>Fuel -</b>			
Unleaded gasoline, 65 octane, gals	7500	7500	7500
<b>Greases -</b>			
Ball and roller bearing 14L3b grade No. 11 lb	5	5	5
Water Pump 14L11 lb	1	1	1
Wire rope chain and open gear VV-L-751 lb	5	5	5

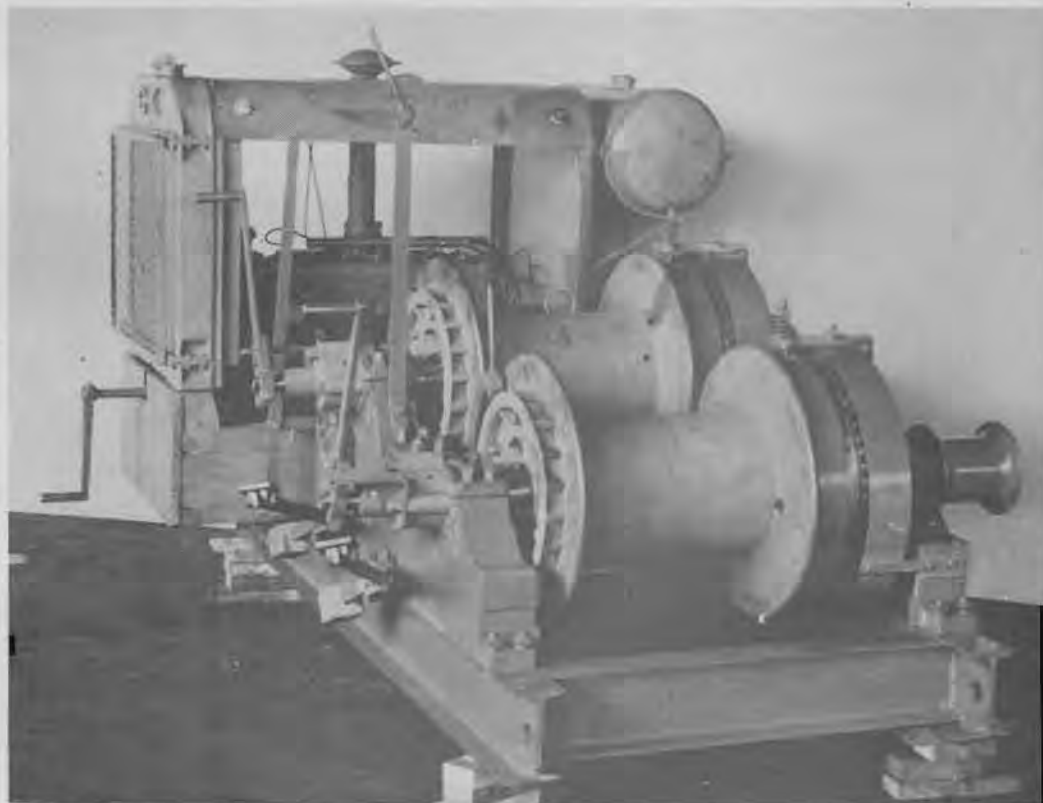

Oils -	32°F and lower	32°F to 70°F	70°F and higher
Gear, VV-L-761 (SAE 80) (Hypoid) gal	2		
Gear, VV-L-761 (SAE 90) (Hypoid) gal		2	2
Motor 9110 (SAE 10) gal	30		
" 9250 ( " 30) gal		30	
" 9500 ( " 50) gal			30

AUXILIARY EQUIPMENT SUPPLIED: Spare parts estimated to keep the machine operating a year are included.

AUXILIARY EQUIPMENT NEEDED BUT NOT SUPPLIED: Cables for the drums.

SHIPPING INFORMATION: Bundled for export:

Weight: 5,700 lb  
Cube: 235 cu ft

ORDERING INSTRUCTIONS: State size and length of cables desired.