

Innovations for the 21st Century
Worldwide Radio Communication Solutions



Maritime radio receiver E80



Branch in Kiel

Neufeldt & Kuhnke, founders of Hagenuk



Former company logo



Advertisement from the 1950's



View of our office in Flintbek, near Kiel, northern Germany



Typical operator console

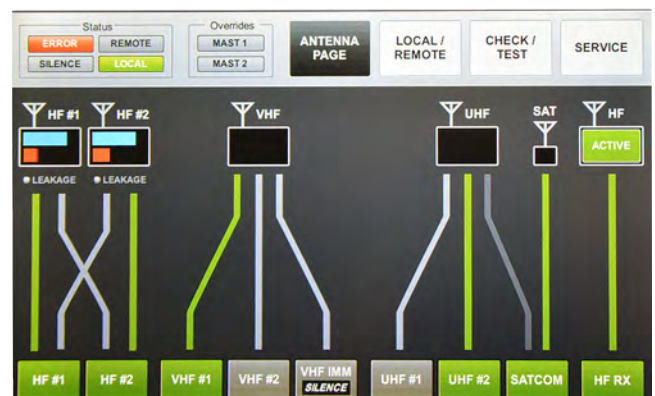

GUI of a coaxial switching unit (CSU) 3008

Origin

The Hagenuk History

Hagenuk Marinekommunikation GmbH (HMK) can look back on a long and successful history. In the late 19th century, Hagenuk co-founders Hans Neufeldt and Karl Kuhnke were not only among the pioneers of telephony but were also fascinated by the physics of wireless telegraphy. As a result, state-of-the-art ship- and shore-based radio systems from HMK have now been providing reliable communication for more than 50 years.

Today, we respect and continue Neufeldt & Kuhnke's tradition of commitment, enthusiasm, research and engineering excellence.

Background

1899	Foundation of Neufeldt & Kuhnke in Kiel, Germany	1998	Merger of Daimler-Benz with Chrysler (USA) and renaming of DASA to DaimlerChrysler Aerospace
1914	Hanseatische Apparatebau Gesellschaft opens a branch at Neufeldt & Kuhnke company grounds	2000	DaimlerChrysler Aerospace (DASA, Germany), Aerospace Matra (France), and CASA (Spain) merge to form the European Aeronautic Defence and Space Company (EADS)
1937	Hanseatische Apparatebau-Gesellschaft and Neufeldt & Kuhnke merge into Hagenuk	2007	Hagenuk Marinekommunikation GmbH is taken over by Atlas Elektronik GmbH (Bremen, Germany), a joint company of thyssenkrupp AG and EADS
1995	Hagenuk Funknachrichtentechnik GmbH is founded from Hagenuk's former radio communication division; relocation to Flintbek, near Kiel	2017	thyssenkrupp AG has taken over the Atlas Elektronik GmbH part from EADS and assigned it to thyssenkrupp Marine Systems GmbH
1996	Daimler-Benz Aerospace (DASA) takes over Hagenuk Funknachrichtentechnik GmbH and renames it to Hagenuk Marinekommunikation GmbH (HMK)		

References



German submarine U 212A



German combat support ship EGV

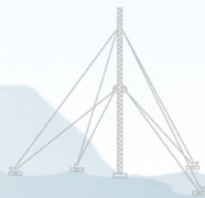

Since 1973, Hagenuk has delivered more than 560 customized ship communication systems to 29 navies worldwide, including sustained high level technical support from Hagenuk staff and our local service partners.

The know-how and expertise that we gained from numerous projects in the last four decades all over the world allows us to look to the future with confidence.

SHIPS EQUIPPED WITH OUR COMMUNICATION SYSTEMS

1	Helicopter carrier
11	Destroyers
71	Frigates (incl. 34 MEKO ships)
32	Corvettes (incl. 11 MEKO ships)
79	Fast patrol boats
13	Off-shore patrol vessels
68	Mine hunters
138	Submarines
172	Auxiliary vessels
5	LPDs

07.2018

Furthermore, we have delivered a significant number of high-performance HF radio systems with up to 10 kW transmitter power for shore-based applications such as naval base, coastal radio, ground-to-air stations, and mobile shelters. Thousands of installed HF radios and hundreds of digital audio/data distribution systems provide reliable and secure communications for our international customers.

System house profile

The extensive technical knowledge and operational experience that we gathered from the early days until today enables HMK to deliver radio communication systems and radio equipment to navies all over the globe. The expertise acquired hereby is condensed in our high-tech products, our customer-oriented engineering approach, and in our production know-how for turnkey integrated tactical communication systems. In combination with our flexibility and unique product range, we provide cost-effective system solutions for all kinds of customer demands.

Our clients can always rely on our rapid and efficient response to individual requirements, as well as our professional project management skills. All our products comply with relevant national and international standards; our quality assurance system is certified according to DIN EN ISO 9001. Our GMDSS equipment is certified acc. to Marine Equipment Directive (MED) 2014/90/EU.

In order to sustain and strengthen our system house competence and to maintain our high technological skills and standards, we will continue our extensive research and development activities.



German frigate F 124



German corvette K 130

German shore station with two 10 kW HF transmitters



The HF Radio Family Series 3000

Versatile product family through modularity



5 kW HF Receiver TX 3500



10 kW HF Receiver TX 310kFH



New Exciter / Receiver ERX 3003

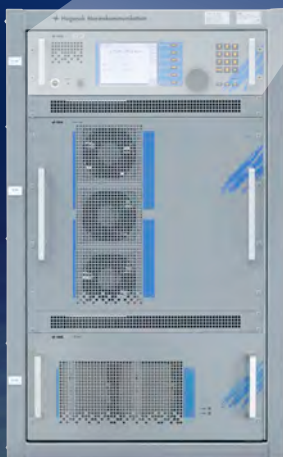

1 kW HF Transceiver TRX 3100



120W HF Transceiver TRX 3015



500 W HF Transceiver TRX 3050

As a leading system house and manufacturer of naval communication systems and HF radio equipment, we focus on integrated communication systems (ICS) for naval vessels and shore-based HF systems.

Product Range HF radio family series 3000

- HF transceivers 120 W / 500 W / 1 kW
- HF transmitters 500 W / 1 kW / 5 kW / 10 kW
- VLF/HF receiver

- Automatic antenna tuning units (ATU) up to 1 kW
- HF broadband systems and components
- HF e-mail system SEICAM® 5066
- Digital audio and data distribution systems for tactical internal and external communications (SEICAM® 3000 / SEICAM® 5000 families)
- Various intercom subsystems
- Integrated message handling and control systems (SEICAM® 2000)
- Modular console and rack systems (MRS 5000)

The **HF Series 3000** is a family of software defined radios that has been developed especially for use aboard naval ships under harsh environmental conditions, where simultaneous and fail-safe operation in a co-located multi-transmitter antenna environment is mandatory.

Transmitter power levels range from 120 W to 10 kW. A wide optional range of MIL / STANAG compatible waveforms can be integrated, including various modems for up to 9.6 kbps / 19.2 kbps coded data rate, a STANAG compatible HF e-mail system, as well as modes for frequency hopping (FH) and LINK 11 / 22 operations.

With the **new ERX 3003 / RX 3003 HF wideband exciter / receiver** the data transmission speed will be boosted up to 120 kbit/s.

Due to the modular design and inherent software flexibility, all radios can be adapted most effectively to meet any customer-specific communication requirement and allow on-site upgrade of waveforms and functions. Furthermore, many waveform options are available as embedded modules, e.g. automatic link establishment (ALE), multifunction data modem (MDM) and pre / interselector (PSI).



Automatic antenna tuning units

The SEICAM® Family Tactical Communication



SEICAM® 2000 integrated message handling and control system



User station UST 5200 for tactical intercom

The SEICAM® product family is designed primarily for tactical communication aboard naval ships.

Based on well-proven legacy technologies in service with numerous navies all over the world, our tactical integrated communication system **SEICAM® 3000** features high-performance multi-channel digital audio and data exchange for internal and external communication. Due to its uncompromising switch modularity and configuration flexibility, all kinds of equipment can be connected, e.g. user stations and data terminals, radio equipment, message handling, and remote control facilities. With respect to legacy systems in service, **SEICAM® 3000** continues to provide robust and reliable TDMA switching technology. In response to new customer requirements and stimulated by the progress and availability of broadband IP network technologies, we have extended the IP interface and the IP-capable intercom to form the **SEICAM® 3000 IP**.

The **SEICAM® 5000** belongs to the next generation of integrated IP-based audio, video, and data distribution systems. The intrinsic generic IP network infrastructure for internal and external communications allows us to implement technologies such as VoIP and fully touch-screen operated user terminals (UST 5200) with optional video and equipment-to-bus interfaces (EBI) for reduced cabling. The system provides distribution of all kinds of concurrent traditional audio and data. It can be configured to support video and multimedia services and seamlessly interfaces with any existing ship communication system.

The **SEICAM® 2000** is an integrated message handling and control system. Featuring a multi-user and multitasking workstation to support comprehensive radio and network control and communication for message handling, radio remote control, network management, communication planning (COMPLAN), and frequency and antenna management (FAM).

The **SEICAM® 5066** provides IP connectivity over HF links and accommodates key services for the participation in national and international network centric warfare. The system is based on the NATO standard STANAG 5066, which describes a "profile for maritime high frequency (HF) radio data communications". It caters to reliable and adaptive data communication over HF radio links and defines interfaces of a node to a range of sub-networks for various IP-based services.

The Modular Rack System **MRS 5000** is the result of our long experience in the field of naval rack design for all types of ships. Our consoles feature a modular, user-configurable, and rugged design based on bolted or welded parts which can easily be adapted to customer-specific requirements. All kinds of naval communication tasks can be implemented such as network management, message handling, specific command and control tasks, and monitoring. The **MRS 5000** features a competitive price-performance ratio, while maintaining a high military performance and application flexibility. Furthermore, HMK provides a wide range of highly compact and customizable consoles.



Hagenuk Marinekommunikation System House

Any Type, all Kinds, one System



Typical operator console

Principle layout of an HF antenna broadband system

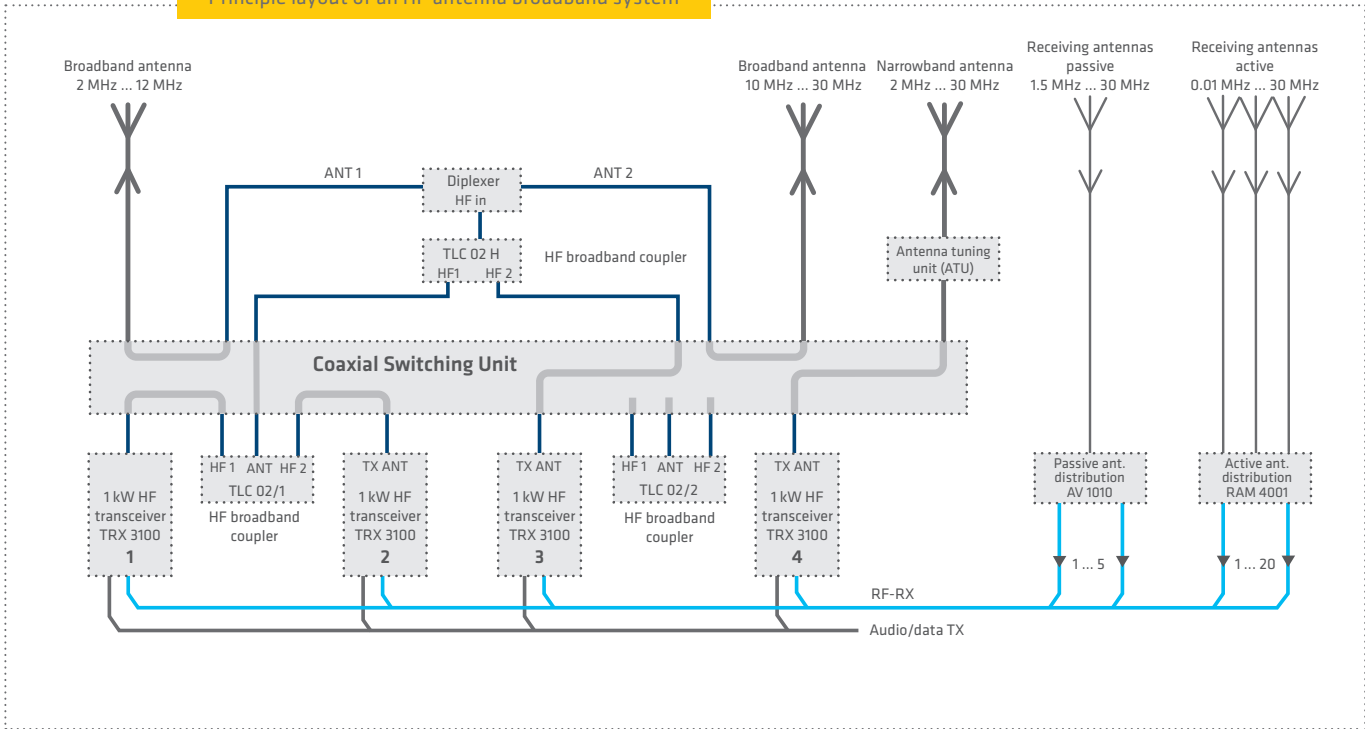

CAD-development



Radio console in testfield



Factory assembly and integration

Based on decades of proven technical and operational expertise, Hagenuk Marinekommunikation enjoys an excellent reputation as a system house and system-of-systems integrator.

One of our major strengths is our capability to integrate any type of system or equipment with all kinds of interfaces into a common system. Integrated communication systems may consist of all kinds of equipment or subsystems with customer-selected components, whether composed in a single radio console, a large communication centre, or in containerized subsystems.

The operation of our broadband antenna systems overcomes the drawbacks of siting antennas (especially HF antennas) in a limited space and meets the demands for expansion of the number of available links (see block diagram above).

Stringent and comprehensive factory and field acceptance tests demonstrate both product and system integrity.

Our dedicated project management monitors and controls the entire project, culminating in final acceptance by the customer.

MAIN SERVICES

- Feasibility and project studies
- System engineering
- Design and development
- Production
- System integration and setting-to-work
- Project and configuration management
- Local partnership
- Integrated logistic support (ILS) throughout product's lifetime

Service

Worldwide – for a Lifetime

OVERVIEW

One of the key elements of HMK's service activities is our comprehensive customer support. It covers a wide range of service options throughout the product's life, e.g.

- Worldwide installation of equipment and systems
- Acceptance testing (factory, harbour, sea)
- Setting-to-work
- Onboard technical instructions / training
- Customer support during / after warranty
- Maintenance and repair services (inhouse / onboard)
- Software updates
- Quick reaction support
- Full logistics support
- Intense briefings
- Spare parts supply
- Technical consulting in case of modifications, upgrades, and innovations.



Production line



Shipping



Customer on-site support



INTEGRATED LOGISTIC SUPPORT

ILS is the coordinated management and application of all logistic elements which are required for successful operational performance and maintenance of a system or equipment.

HMK is reputable for its service and support solutions which guarantee reliability and meet the unique performance requirements of the customer. ILS will assist you significantly in planning the lifetime support logistics for your systems and equipment. HMK offers an extensive range of ILS services which covers core logistic elements including:

Technical Publications

- Equipment / system operation and maintenance documentation
- Illustrated spare parts catalogue
- Interactive electronic technical documentations (IETD) acc. to ASD S1000D and S2000M specification

Logistic Support Analysis (LSA)

- Spare parts calculation, supply and distribution
- Support and test equipment supply and distribution
- Maintenance concept and logistic breakdown structure
- Life cycle cost analysis
- Integrated logistic support and configuration management plan
- Logistic data packages
- Functional / dysfunctional report
- Maintainability, reliability, testability and availability report

Training

- Operator and on-the-job trainings
- Maintainer trainings (operator, on-board and depot level)
- Instructor trainings (train-the-trainer)

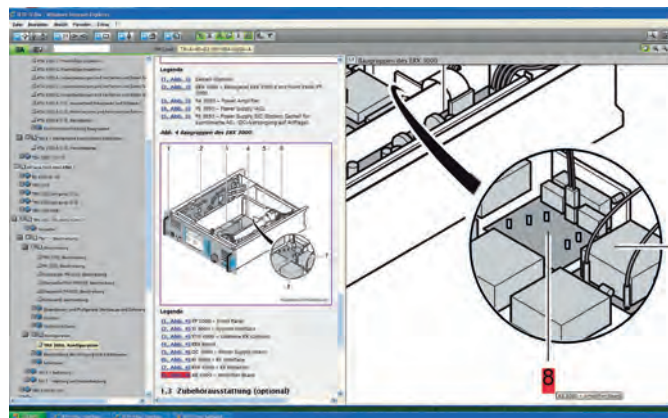

German IETD browser



Inhouse training

Our dedication to uncompromising quality not only encompasses the supply of turnkey systems and the respective service activities. We also try to develop and cultivate a close, direct, and confidential partnership with all our customers.

Innovation and Progress

Study of an operator console



Hagenuk Marinekommunikation continues to align key products and development roadmaps for new and challenging customer demands.

As a prerequisite for network based operations, interoperable and secure multi-service capable radio solutions, as well as an IP communication infrastructure are vital for modern integrated weapon platforms. Thus, HMK focuses on continuous product innovations, characterized by more sophisticated software capability and utmost waveform flexibility in the HF radio domain, as well as on IP-based voice, video, and data exchange in the tactical integrated communications domain.

However, as a system house, our focus is not only on the development and production of our own products. Our systems must and do also interface with heterogeneous communication facilities of third-party suppliers, both military and commercial, as well as all other kinds of radio or command and control subsystems.

To fulfil the demand for greater simultaneous HF radio link capacity in a co-sited antenna environment, new products have been developed to substantially increase HF broadband transmission performance. For example, multiple high-power data links via a single broadband antenna can be established by using high-power antenna couplers such as our HF broadband couplers and/or coaxial switching units.

HMK is proud to have been selected as systems developer, integrator, and supplier for several major current procurement programs, and that both NATO and third-party nations trust in our competence by calling HMK's services for future major programs. This confirms our system integrator leadership and continued commitment in the development and delivery of high quality and advanced integrated communication systems.

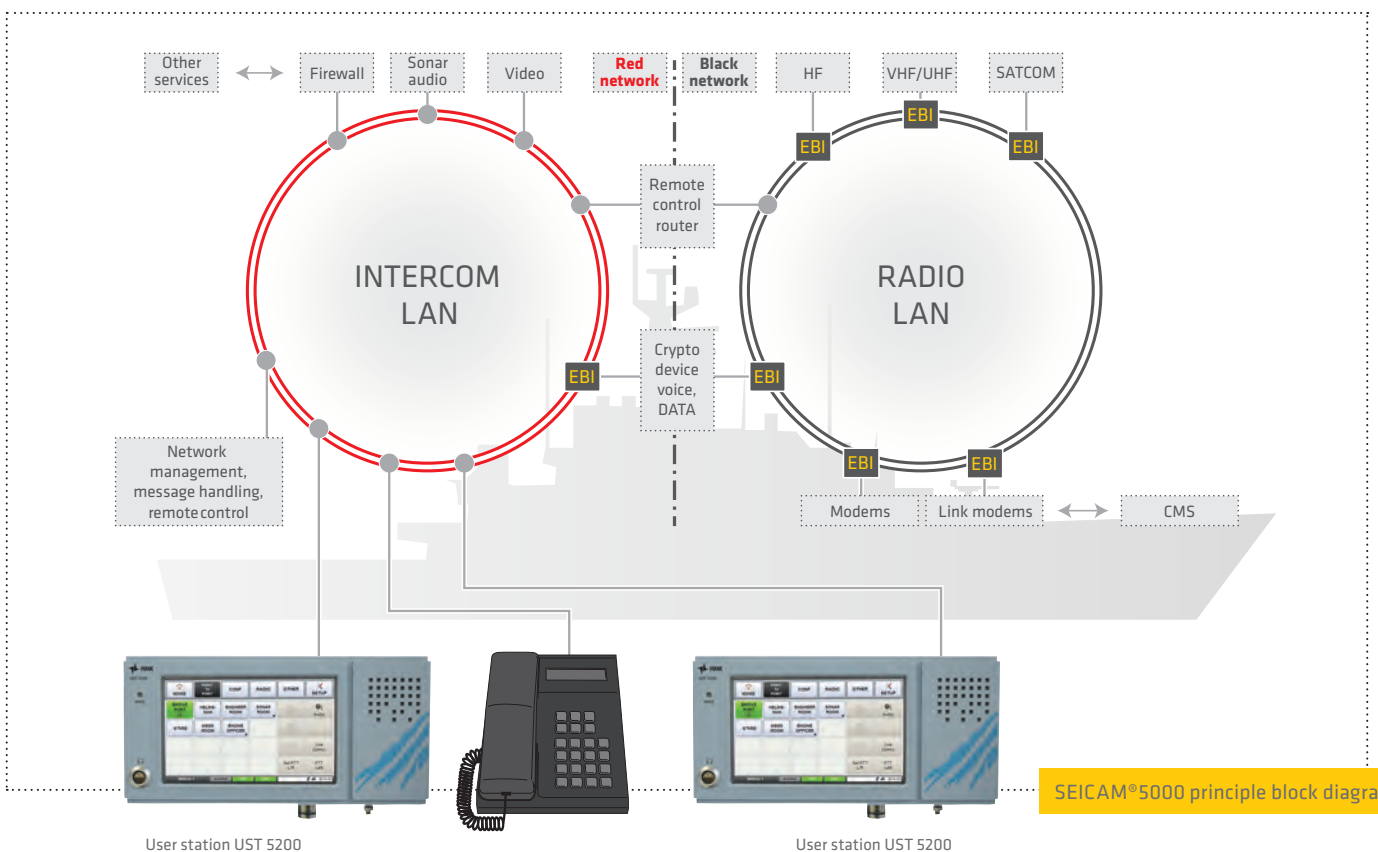

User station UST 5200

User station UST 5200

SEICAM®5000 principle block diagram

SDR-HF radio modules for the German Armed Forces

For the next generation of SDR technologies, we are prepared to integrate our radios with a standardized operating environment, e.g. as defined by the software communications architecture (SCA).

Hagenuk Marinekommunikation has developed the HF components (transceiver module, power amplifier, and antenna tuning units) of the joint radio system SVFuA (Streikräftegemeinsame Verbundfähige Funkgeräteausrüstung) for the German Armed Forces (Bundeswehr). This SDR system will allow the Bundeswehr to participate in future interoperable communication networks of joint and combined military operations.



New SDR radio modules and digital antenna tuning units

New ERX 3003 / RX 3003 – pushing the limits! 24 kHz (prepared for 48 kHz) wideband capability

With its outstanding and new RF direct sampling technology this new radio boosts transceivers / receivers into the new generation of software defined radios (SDR)



Features

- Frequency range: 1.5 MHz - 30 MHz transmit and 10 kHz - 30 MHz receive
- HF@SATCOM speed: Up to 24 kHz bandwidth allows up to 120 kBit/s data transmission speed
- High dynamic conversion technology for outstanding co-site performance
- Fully digital signal processing and software defined channel filtering eliminating any physical mixers and filter devices
- Software defined architecture simply adaptable to upcoming standards by software upgrade
- LAN interfaces for remote control + audio (VoIP)
- Plug & play replacement of the well-known exciter / receiver ERX 3000

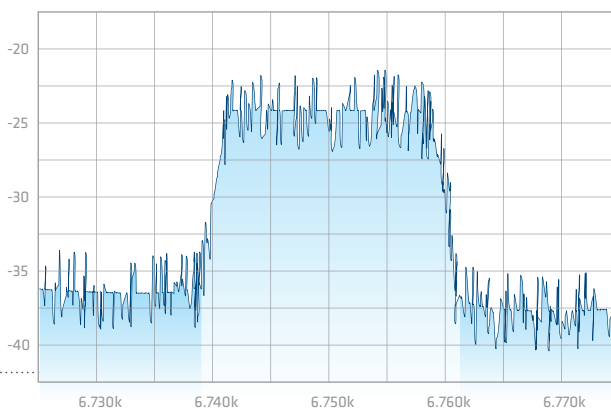

HF wideband spectrum

Contact

Hagenuk Marinekommunikation GmbH

Hamburger Chaussee 25

24220 Flintbek | Germany

Phone: +49 4347 714-101

Fax +49 4347 714-110

info@hmk.atlas-elektronik.com

www.hmk.atlas-elektronik.com

